

AM335x Sitara™ Processors

Technical Reference Manual



Literature Number: SPRUH73L
October 2011–Revised February 2015

Preface	170
1 Introduction	172
1.1 AM335x Family	172
1.1.1 Device Features	172
1.1.2 Device Identification	173
1.1.3 Feature Identification	173
2 Memory Map	177
2.1 ARM Cortex-A8 Memory Map	177
3 ARM MPU Subsystem	186
3.1 ARM Cortex-A8 MPU Subsystem	187
3.1.1 Features	188
3.1.2 MPU Subsystem Integration	188
3.1.3 MPU Subsystem Clock and Reset Distribution	189
3.1.4 ARM Subchip	192
3.1.5 Interrupt Controller	193
3.1.6 Power Management	194
3.1.7 ARM Programming Model	196
4 Programmable Real-Time Unit Subsystem and Industrial Communication Subsystem (PRU-ICSS)	198
4.1 Introduction	199
4.1.1 Features	200
4.2 Integration	201
4.2.1 PRU-ICSS Connectivity Attributes	202
4.2.2 PRU-ICSS Clock and Reset Management	202
4.2.3 PRU-ICSS Pin List	203
4.2.4 PRU-ICSS Internal Pinmux	204
4.3 PRU-ICSS Memory Map Overview	206
4.3.1 Local Memory Map	206
4.3.2 Global Memory Map	207
4.4 Functional Description	208
4.4.1 PRU Cores	208
4.4.2 Interrupt Controller (INTC)	225
4.4.3 Industrial Ethernet Peripheral (IEP)	232
4.4.4 Universal Asynchronous Receiver/Transmitter (UART)	235
4.4.5 ECAP	248
4.5 Registers	249
4.5.1 PRU_ICSS_PRU_CTRL Registers	249
4.5.2 PRU_ICSS_PRU_DEBUG Registers	259
4.5.3 PRU_ICSS_INTC Registers	324
4.5.4 PRU_ICSS_IEP Registers	388
4.5.5 PRU_ICSS_UART Registers	408
4.5.6 PRU_ICSS_ECAP Registers	427
4.5.7 PRU_ICSS_CFG Registers	427
5 Graphics Accelerator (SGX)	444

5.1	Introduction	445
5.1.1	POWERVR SGX Main Features	445
5.1.2	SGX 3D Features	446
5.1.3	Universal Scalable Shader Engine (USSE) – Key Features	447
5.1.4	Unsupported Features	447
5.2	Integration.....	448
5.2.1	SGX530 Connectivity Attributes	448
5.2.2	SGX530 Clock and Reset Management.....	448
5.2.3	SGX530 Pin List	449
5.3	Functional Description.....	450
5.3.1	SGX Block Diagram	450
5.3.2	SGX Elements Description	450
6	Interrupts	452
6.1	Functional Description.....	453
6.1.1	Interrupt Processing	454
6.1.2	Register Protection	455
6.1.3	Module Power Saving	455
6.1.4	Error Handling	455
6.1.5	Interrupt Handling	455
6.2	Basic Programming Model.....	456
6.2.1	Initialization Sequence	456
6.2.2	INTC Processing Sequence	456
6.2.3	INTC Preemptive Processing Sequence	460
6.2.4	Interrupt Preemption.....	464
6.2.5	ARM A8 INTC Spurious Interrupt Handling	464
6.3	ARM Cortex-A8 Interrupts	465
6.4	PWM Events.....	469
6.5	Interrupt Controller Registers.....	470
6.5.1	INTC Registers.....	470
7	Memory Subsystem	516
7.1	GPMC	517
7.1.1	Introduction	517
7.1.2	Integration.....	520
7.1.3	Functional Description.....	522
7.1.4	GPMC High-Level Programming Model Overview	601
7.1.5	Use Cases	612
7.1.6	GPMC Registers	622
7.2	OCMC-RAM	820
7.2.1	Introduction	820
7.2.2	Integration.....	821
7.3	EMIF	822
7.3.1	Introduction	822
7.3.2	Integration.....	824
7.3.3	Functional Description.....	826
7.3.4	Use Cases	844
7.3.5	EMIF4D Registers	844
7.3.6	DDR2/3/mDDR PHY Registers	888
7.4	ELM.....	897
7.4.1	Introduction	897
7.4.2	Integration.....	898
7.4.3	Functional Description.....	899
7.4.4	Basic Programming Model.....	902
7.4.5	ELM Registers.....	907

8	Power, Reset, and Clock Management (PRCM)	1112
8.1	Power, Reset, and Clock Management	1113
8.1.1	Introduction	1113
8.1.2	Device Power-Management Architecture Building Blocks	1113
8.1.3	Clock Management	1113
8.1.4	Power Management	1119
8.1.5	PRCM Module Overview	1130
8.1.6	Clock Generation and Management	1132
8.1.7	Reset Management	1148
8.1.8	Power-Up/Down Sequence	1156
8.1.9	IO State	1157
8.1.10	Voltage and Power Domains	1157
8.1.11	Device Modules and Power Management Attributes List	1158
8.1.12	Clock Module Registers	1161
8.1.13	Power Management Registers	1315
9	Control Module	1355
9.1	Introduction	1356
9.2	Functional Description	1356
9.2.1	Control Module Initialization	1356
9.2.2	Pad Control Registers	1356
9.2.3	EDMA Event Multiplexing	1357
9.2.4	Device Control and Status	1358
9.2.5	DDR PHY	1364
9.3	Registers	1365
9.3.1	CONTROL_MODULE Registers	1365
10	Interconnects	1468
10.1	Introduction	1469
10.1.1	Terminology	1469
10.1.2	L3 Interconnect	1469
10.1.3	L4 Interconnect	1472
11	Enhanced Direct Memory Access (EDMA)	1473
11.1	Introduction	1474
11.1.1	EDMA3 Controller Block Diagram	1474
11.1.2	Third-Party Channel Controller (TPCC) Overview	1475
11.1.3	Third-Party Transfer Controller (TPTC) Overview	1476
11.2	Integration	1477
11.2.1	Third-Party Channel Controller (TPCC) Integration	1477
11.2.2	Third-Party Transfer Controller (TPTC) Integration	1478
11.3	Functional Description	1480
11.3.1	Functional Overview	1480
11.3.2	Types of EDMA3 Transfers	1483
11.3.3	Parameter RAM (PaRAM)	1485
11.3.4	Initiating a DMA Transfer	1497
11.3.5	Completion of a DMA Transfer	1500
11.3.6	Event, Channel, and PaRAM Mapping	1501
11.3.7	EDMA3 Channel Controller Regions	1503
11.3.8	Chaining EDMA3 Channels	1505
11.3.9	EDMA3 Interrupts	1506
11.3.10	Memory Protection	1512
11.3.11	Event Queues	1516
11.3.12	EDMA3 Transfer Controller (EDMA3TC)	1518
11.3.13	Event Dataflow	1521

11.3.14	EDMA3 Prioritization	1521
11.3.15	EDMA3 Operating Frequency (Clock Control)	1522
11.3.16	Reset Considerations	1522
11.3.17	Power Management	1522
11.3.18	Emulation Considerations	1522
11.3.19	EDMA Events	1540
11.4	EDMA3 Registers	1543
11.4.1	EDMA3CC Registers	1543
11.4.2	EDMA3TC Registers	1678
11.5	Appendix A	1731
11.5.1	Debug Checklist	1731
11.5.2	Miscellaneous Programming/Debug Tips	1732
11.5.3	Setting Up a Transfer	1734
12	Touchscreen Controller	1736
12.1	Introduction	1737
12.1.1	TSC_ADC Features	1737
12.1.2	Unsupported TSC_ADC_SS Features	1737
12.2	Integration	1738
12.2.1	TSC_ADC Connectivity Attributes	1738
12.2.2	TSC_ADC Clock and Reset Management	1739
12.2.3	TSC_ADC Pin List	1739
12.3	Functional Description	1740
12.3.1	Hardware-Synchronized or Software-Enabled	1740
12.3.2	Open Delay and Sample Delay	1740
12.3.3	Averaging of Samples (1, 2, 4, 8, and 16)	1740
12.3.4	One-Shot (Single) or Continuous Mode	1740
12.3.5	Interrupts	1740
12.3.6	DMA Requests	1741
12.3.7	Analog Front End (AFE) Functional Block Diagram	1741
12.4	Operational Modes	1743
12.4.1	PenCtrl and PenIRQ	1744
12.5	Touchscreen Controller Registers	1747
12.5.1	TSC_ADC_SS Registers	1747
13	LCD Controller	1829
13.1	Introduction	1830
13.1.1	Purpose of the Peripheral	1830
13.1.2	Features	1831
13.2	Integration	1832
13.2.1	LCD Controller Connectivity Attributes	1832
13.2.2	LCD Controller Clock and Reset Management	1833
13.2.3	LCD Controller Pin List	1833
13.3	Functional Description	1834
13.3.1	Clocking	1834
13.3.2	LCD External I/O Signals	1836
13.3.3	DMA Engine	1837
13.3.4	LIDD Controller	1838
13.3.5	Raster Controller	1840
13.3.6	Interrupt Conditions	1852
13.3.7	DMA	1854
13.3.8	Power Management	1854
13.4	Programming Model	1855
13.4.1	LCD Character Displays	1855
13.4.2	Active Matrix Displays	1858

13.4.3	System Interaction	1858
13.4.4	Palette Lookup.....	1858
13.4.5	Test Logic	1860
13.4.6	Disable and Software Reset Sequence	1860
13.4.7	Precedence Order for Determining Frame Buffer Type	1861
13.5	Registers	1862
13.5.1	LCD Registers	1862
14	Ethernet Subsystem	1899
14.1	Introduction.....	1900
14.1.1	Features	1900
14.1.2	Unsupported Features.....	1901
14.2	Integration	1902
14.2.1	Ethernet Switch Connectivity Attributes	1903
14.2.2	Ethernet Switch Clock and Reset Management	1904
14.2.3	Ethernet Switch Pin List	1905
14.2.4	Ethernet Switch RMII Clocking Details	1905
14.2.5	GMII Interface Signal Connections and Descriptions	1906
14.2.6	RMII Signal Connections and Descriptions	1908
14.2.7	RGMII Signal Connections and Descriptions.....	1910
14.3	Functional Description	1912
14.3.1	CPSW_3G Subsystem	1912
14.3.2	CPSW_3G.....	1917
14.3.3	Ethernet Mac Sliver (CPGMAC_SL)	1960
14.3.4	Command IDLE	1962
14.3.5	RMII Interface.....	1962
14.3.6	RGMII Interface.....	1963
14.3.7	Common Platform Time Sync (CPTS)	1964
14.3.8	MDIO.....	1969
14.4	Software Operation	1972
14.4.1	Transmit Operation.....	1972
14.4.2	Receive Operation	1974
14.4.3	Initializing the MDIO Module.....	1975
14.4.4	Writing Data to a PHY Register	1975
14.4.5	Reading Data from a PHY Register	1976
14.4.6	Initialization and Configuration of CPSW	1976
14.5	Ethernet Subsystem Registers	1977
14.5.1	CPSW_ALE Registers.....	1977
14.5.2	CPSW_CPDMA Registers	1992
14.5.3	CPSW_CPTS Registers.....	2047
14.5.4	CPSW_STATS Registers	2060
14.5.5	CPDMA_STATERAM Registers.....	2060
14.5.6	CPSW_PORT Registers	2094
14.5.7	CPSW_SL Registers.....	2149
14.5.8	CPSW_SS Registers	2163
14.5.9	CPSW_WR Registers	2176
14.5.10	MDIO Registers	2212
15	Pulse-Width Modulation Subsystem (PWMSS).....	2223
15.1	Pulse-Width Modulation Subsystem (PWMSS)	2224
15.1.1	Integration	2226
15.1.2	PWMSS Registers	2228
15.2	Enhanced PWM (ePWM) Module	2233
15.2.1	Introduction.....	2233
15.2.2	Functional Description	2237

15.2.3	Use Cases	2297
15.2.4	EPWM Registers	2321
15.3	Enhanced Capture (eCAP) Module	2357
15.3.1	Introduction.....	2357
15.3.2	Functional Description	2358
15.3.3	Use Cases	2367
15.3.4	Registers	2383
15.4	Enhanced Quadrature Encoder Pulse (eQEP) Module	2399
15.4.1	Introduction.....	2399
15.4.2	Functional Description	2402
15.4.3	EQEP Registers	2420
16	Universal Serial Bus (USB).....	2447
16.1	Introduction.....	2448
16.1.1	Acronyms, Abbreviations, and Definitions	2448
16.1.2	USB Features.....	2449
16.1.3	Unsupported USB OTG and PHY Features	2450
16.2	Integration	2451
16.2.1	USB Connectivity Attributes	2451
16.2.2	USB Clock and Reset Management	2452
16.2.3	USB Pin List	2452
16.2.4	USB GPIO Details.....	2452
16.2.5	USB Unbonded PHY Pads.....	2453
16.3	Functional Description	2454
16.3.1	VBUS Voltage Sourcing Control	2454
16.3.2	Pullup/PullDown Resistors	2454
16.3.3	Role Assuming Method.....	2455
16.3.4	Clock, PLL, and PHY Initialization	2455
16.3.5	Indexed and Non-Indexed Register Spaces	2455
16.3.6	Dynamic FIFO Sizing	2455
16.3.7	USB Controller Host and Peripheral Modes Operation	2456
16.3.8	Protocol Description(s)	2458
16.3.9	Communications Port Programming Interface (CPPI) 4.1 DMA	2491
16.3.10	USB 2.0 Test Modes	2515
16.4	Supported Use Cases	2517
16.5	USB Registers	2518
16.5.1	USBSS Registers	2518
16.5.2	USB0_CTRL Registers	2563
16.5.3	USB1_CTRL Registers	2613
16.5.4	USB2PHY Registers	2661
16.5.5	CPPI_DMA Registers.....	2686
16.5.6	CPPI_DMA_SCHEDULER Registers.....	2842
16.5.7	QUEUE_MGR Registers	2845
17	Interprocessor Communication.....	3996
17.1	Mailbox	3997
17.1.1	Introduction.....	3997
17.1.2	Integration	3998
17.1.3	Functional Description	3999
17.1.4	Programming Guide	4003
17.1.5	MAILBOX Registers	4006
17.2	Spinlock.....	4067
17.2.1	SPINLOCK Registers.....	4067
18	Multimedia Card (MMC).....	4105
18.1	Introduction.....	4106

18.1.1	MMCHS Features	4106
18.1.2	Unsupported MMCHS Features	4106
18.2	Functional Description	4112
18.2.1	MMC/SD/SDIO Functional Modes	4112
18.2.2	Resets	4118
18.2.3	Power Management	4119
18.2.4	Interrupt Requests	4122
18.2.5	DMA Modes	4124
18.2.6	Mode Selection	4127
18.2.7	Buffer Management	4127
18.2.8	Transfer Process	4130
18.2.9	Transfer or Command Status and Error Reporting	4131
18.2.10	Auto Command 12 Timings	4136
18.2.11	Transfer Stop	4138
18.2.12	Output Signals Generation	4139
18.2.13	Card Boot Mode Management	4141
18.2.14	CE-ATA Command Completion Disable Management	4143
18.2.15	Test Registers	4143
18.2.16	MMC/SD/SDIO Hardware Status Features	4144
18.3	Low-Level Programming Models	4145
18.3.1	Surrounding Modules Global Initialization	4145
18.3.2	MMC/SD/SDIO Controller Initialization Flow	4145
18.3.3	Operational Modes Configuration	4148
18.4	Multimedia Card Registers	4150
18.4.1	MULTIMEDIA_CARD Registers	4150
19	Universal Asynchronous Receiver/Transmitter (UART)	4207
19.1	Introduction	4208
19.1.1	UART Mode Features	4208
19.1.2	IrDA Mode Features	4208
19.1.3	CIR Mode Features	4208
19.1.4	Unsupported UART Features	4208
19.2	Integration	4210
19.2.1	UART Connectivity Attributes	4210
19.2.2	UART Clock and Reset Management	4211
19.2.3	UART Pin List	4213
19.3	Functional Description	4214
19.3.1	Block Diagram	4214
19.3.2	Clock Configuration	4215
19.3.3	Software Reset	4215
19.3.4	Power Management	4215
19.3.5	Interrupt Requests	4217
19.3.6	FIFO Management	4220
19.3.7	Mode Selection	4228
19.3.8	Protocol Formatting	4234
19.4	UART/IrDA/CIR Basic Programming Model	4257
19.4.1	UART Programming Model	4257
19.4.2	IrDA Programming Model	4263
19.5	UART Registers	4266
19.5.1	UART Registers	4266
20	Timers	4324
20.1	DMTimer	4325
20.1.1	Introduction	4325
20.1.2	Integration	4327

20.1.3	Functional Description	4331
20.1.4	Use Cases	4340
20.1.5	TIMER Registers	4340
20.2	DMTimer 1ms	4359
20.2.1	Introduction	4359
20.2.2	Integration	4361
20.2.3	Functional Description	4363
20.2.4	DMTIMER_1MS Registers	4371
20.3	RTC_SS	4395
20.3.1	Introduction	4395
20.3.2	Integration	4396
20.3.3	Functional Description	4398
20.3.4	Use Cases	4406
20.3.5	RTC Registers	4406
20.4	WATCHDOG	4444
20.4.1	Introduction	4444
20.4.2	Integration	4445
20.4.3	Functional Description	4447
20.4.4	Watchdog Registers	4454
21	I2C	4472
21.1	Introduction	4473
21.1.1	I2C Features	4473
21.1.2	Unsupported I2C Features	4473
21.2	Integration	4474
21.2.1	I2C Connectivity Attributes	4474
21.2.2	I2C Clock and Reset Management	4475
21.2.3	I2C Pin List	4475
21.3	Functional Description	4476
21.3.1	Functional Block Diagram	4476
21.3.2	I2C Master/Slave Controller Signals	4476
21.3.3	I2C Reset	4477
21.3.4	Data Validity	4478
21.3.5	START & STOP Conditions	4479
21.3.6	I2C Operation	4479
21.3.7	Arbitration	4481
21.3.8	I2C Clock Generation and I2C Clock Synchronization	4481
21.3.9	Prescaler (SCLK/ICLK)	4482
21.3.10	Noise Filter	4482
21.3.11	I2C Interrupts	4482
21.3.12	DMA Events	4483
21.3.13	Interrupt and DMA Events	4483
21.3.14	FIFO Management	4483
21.3.15	How to Program I2C	4488
21.3.16	I2C Behavior During Emulation	4489
21.4	I2C Registers	4490
21.4.1	I2C Registers	4490
22	Multichannel Audio Serial Port (McASP)	4541
22.1	Introduction	4542
22.1.1	Purpose of the Peripheral	4542
22.1.2	Features	4542
22.1.3	Protocols Supported	4543
22.1.4	Unsupported McASP Features	4543
22.2	Integration	4544

22.2.1	McASP Connectivity Attributes	4544
22.2.2	McASP Clock and Reset Management	4545
22.2.3	McASP Pin List	4545
22.3	Functional Description	4546
22.3.1	Overview	4546
22.3.2	Functional Block Diagram	4547
22.3.3	Industry Standard Compliance Statement	4550
22.3.4	Definition of Terms	4554
22.3.5	Clock and Frame Sync Generators	4556
22.3.6	Signal Descriptions.....	4560
22.3.7	Pin Multiplexing	4560
22.3.8	Transfer Modes	4561
22.3.9	General Architecture	4568
22.3.10	Operation	4572
22.3.11	Reset Considerations	4589
22.3.12	Setup and Initialization	4589
22.3.13	Interrupts	4594
22.3.14	EDMA Event Support	4596
22.3.15	Power Management	4598
22.3.16	Emulation Considerations	4598
22.4	Registers	4599
22.4.1	MCASP Registers	4599
23	Controller Area Network (CAN)	4661
23.1	Introduction.....	4662
23.1.1	DCAN Features.....	4662
23.1.2	Unsupported DCAN Features	4662
23.2	Integration	4663
23.2.1	DCAN Connectivity Attributes	4663
23.2.2	DCAN Clock and Reset Management.....	4664
23.2.3	DCAN Pin List	4664
23.3	Functional Description	4665
23.3.1	CAN Core	4665
23.3.2	Message Handler	4666
23.3.3	Message RAM	4666
23.3.4	Message RAM Interface.....	4666
23.3.5	Registers and Message Object Access	4666
23.3.6	Module Interface.....	4666
23.3.7	Dual Clock Source	4666
23.3.8	CAN Operation	4667
23.3.9	Dual Clock Source	4673
23.3.10	Interrupt Functionality	4674
23.3.11	Local Power-Down Mode	4676
23.3.12	Parity Check Mechanism	4678
23.3.13	Debug/Suspend Mode	4679
23.3.14	Configuration of Message Objects	4679
23.3.15	Message Handling.....	4682
23.3.16	CAN Bit Timing.....	4687
23.3.17	Message Interface Register Sets	4695
23.3.18	Message RAM	4697
23.3.19	GIO Support	4702
23.4	Registers	4703
23.4.1	DCAN Registers	4703
24	Multichannel Serial Port Interface (McSPI).....	4774

24.1	Introduction	4775
24.1.1	McSPI Features	4775
24.1.2	Unsupported McSPI Features	4775
24.2	Integration	4776
24.2.1	McSPI Connectivity Attributes	4777
24.2.2	McSPI Clock and Reset Management	4777
24.2.3	McSPI Pin List	4777
24.3	Functional Description	4778
24.3.1	SPI Transmission	4778
24.3.2	Master Mode	4785
24.3.3	Slave Mode	4802
24.3.4	Interrupts	4806
24.3.5	DMA Requests	4807
24.3.6	Emulation Mode	4808
24.3.7	Power Saving Management	4809
24.3.8	System Test Mode	4810
24.3.9	Reset	4810
24.3.10	Access to Data Registers	4811
24.3.11	Programming Aid	4811
24.3.12	Interrupt and DMA Events	4812
24.4	McSPI Registers	4812
24.4.1	SPI Registers	4812
25	General-Purpose Input/Output	4865
25.1	Introduction	4866
25.1.1	Purpose of the Peripheral	4866
25.1.2	GPIO Features	4866
25.1.3	Unsupported GPIO Features	4866
25.2	Integration	4867
25.2.1	GPIO Connectivity Attributes	4867
25.2.2	GPIO Clock and Reset Management	4868
25.2.3	GPIO Pin List	4869
25.3	Functional Description	4870
25.3.1	Operating Modes	4870
25.3.2	Clocking and Reset Strategy	4870
25.3.3	Interrupt Features	4871
25.3.4	General-Purpose Interface Basic Programming Model	4873
25.4	GPIO Registers	4877
25.4.1	GPIO Registers	4877
26	Initialization	4904
26.1	Functional Description	4905
26.1.1	Architecture	4905
26.1.2	Functionality	4905
26.1.3	Memory Map	4906
26.1.4	Start-up and Configuration	4910
26.1.5	Booting	4912
26.1.6	Fast External Booting	4921
26.1.7	Memory Booting	4923
26.1.8	Peripheral Booting	4952
26.1.9	Image Format	4958
26.1.10	Code Execution	4959
26.1.11	Wakeup	4961
26.1.12	Tracing	4962

27	Debug Subsystem	4965
27.1	Functional Description	4966
27.1.1	Debug Resource Manager (DRM)	4966
27.1.2	Debug Ports	4966
27.2	Registers	4969
27.2.1	Debug Resource Manager (DebugSS_DRM) Registers	4969
	Revision History — Version L	4971
A	Revision History	4972

List of Figures

3-1.	Microprocessor Unit (MPU) Subsystem	187
3-2.	Microprocessor Unit (MPU) Subsystem Signal Interface	189
3-3.	MPU Subsystem Clocking Scheme	190
3-4.	Reset Scheme of the MPU Subsystem	191
3-5.	MPU Subsystem Power Domain Overview.....	194
4-1.	PRU-ICSS Block Diagram	199
4-2.	PRU-ICSS Integration	201
4-3.	PRU-ICSS Internal Signal Muxing: pin_mux_sel[0]	204
4-4.	PRU-ICSS Internal Signal Muxing: pin_mux_sel[1]	205
4-5.	PRU Block Diagram	209
4-6.	PRU Module Interface.....	211
4-7.	Event Interface Mapping (R31)	212
4-8.	PRU R31 (GPI) Direct Input Mode Block Diagram	215
4-9.	PRU R31 (GPI) 16-Bit Parallel Capture Mode Block Diagram.....	215
4-10.	PRU R31 (GPI) 28-Bit Shift In Mode	216
4-11.	PRU R30 (GPO) Direct Output Mode Block Diagram	218
4-12.	PRU R30 (GPO) Shift Out Mode Block Diagram	219
4-13.	Integration of the PRU and MPY/MAC.....	220
4-14.	Multiply-Only Mode Functional Diagram	221
4-15.	Multiply and Accumulate Mode Functional Diagram	222
4-16.	Integration of PRU and Scratch Pad	223
4-17.	Interrupt Controller Block Diagram	226
4-18.	Flow of System Events to Host	228
4-19.	IEP DIGIO Data In	233
4-20.	IEP DIGIO Data Out.....	234
4-21.	UART Block Diagram.....	236
4-22.	UART Clock Generation Diagram	237
4-23.	Relationships Between Data Bit, BCLK, and UART Input Clock	238
4-24.	UART Protocol Formats.....	240
4-25.	UART Interface Using Autoflow Diagram.....	243
4-26.	Autoflow Functional Timing Waveforms for UART_nRTS	244
4-27.	Autoflow Functional Timing Waveforms for UART_nCTS	244
4-28.	UART Interrupt Request Enable Paths	246
4-29.	CTRL Register	250
4-30.	STS Register	252
4-31.	WAKEUP_EN Register	253
4-32.	CYCLE Register	254
4-33.	STALL Register	255
4-34.	CTBIR0 Register.....	256
4-35.	CTBIR1 Register.....	257
4-36.	CTPPR0 Register.....	258
4-37.	CTPPR1 Register.....	259
4-38.	GPREG0 Register	261
4-39.	GPREG1 Register	262
4-40.	GPREG2 Register	263
4-41.	GPREG3 Register	264
4-42.	GPREG4 Register	265

4-43.	GPREG5 Register	266
4-44.	GPREG6 Register	267
4-45.	GPREG7 Register	268
4-46.	GPREG8 Register	269
4-47.	GPREG9 Register	270
4-48.	GPREG10 Register	271
4-49.	GPREG11 Register	272
4-50.	GPREG12 Register	273
4-51.	GPREG13 Register	274
4-52.	GPREG14 Register	275
4-53.	GPREG15 Register	276
4-54.	GPREG16 Register	277
4-55.	GPREG17 Register	278
4-56.	GPREG18 Register	279
4-57.	GPREG19 Register	280
4-58.	GPREG20 Register	281
4-59.	GPREG21 Register	282
4-60.	GPREG22 Register	283
4-61.	GPREG23 Register	284
4-62.	GPREG24 Register	285
4-63.	GPREG25 Register	286
4-64.	GPREG26 Register	287
4-65.	GPREG27 Register	288
4-66.	GPREG28 Register	289
4-67.	GPREG29 Register	290
4-68.	GPREG30 Register	291
4-69.	GPREG31 Register	292
4-70.	CT_REG0 Register	293
4-71.	CT_REG1 Register	294
4-72.	CT_REG2 Register	295
4-73.	CT_REG3 Register	296
4-74.	CT_REG4 Register	297
4-75.	CT_REG5 Register	298
4-76.	CT_REG6 Register	299
4-77.	CT_REG7 Register	300
4-78.	CT_REG8 Register	301
4-79.	CT_REG9 Register	302
4-80.	CT_REG10 Register	303
4-81.	CT_REG11 Register	304
4-82.	CT_REG12 Register	305
4-83.	CT_REG13 Register	306
4-84.	CT_REG14 Register	307
4-85.	CT_REG15 Register	308
4-86.	CT_REG16 Register	309
4-87.	CT_REG17 Register	310
4-88.	CT_REG18 Register	311
4-89.	CT_REG19 Register	312
4-90.	CT_REG20 Register	313
4-91.	CT_REG21 Register	314

4-92. CT_REG22 Register	315
4-93. CT_REG23 Register	316
4-94. CT_REG24 Register	317
4-95. CT_REG25 Register	318
4-96. CT_REG26 Register	319
4-97. CT_REG27 Register	320
4-98. CT_REG28 Register	321
4-99. CT_REG29 Register	322
4-100. CT_REG30 Register	323
4-101. CT_REG31 Register	324
4-102. REVID Register	326
4-103. CR Register.....	327
4-104. GER Register.....	328
4-105. GNLR Register	329
4-106. SISR Register	330
4-107. SICR Register	331
4-108. EISR Register	332
4-109. EICR Register	333
4-110. HIEISR Register	334
4-111. HIDISR Register	335
4-112. GPIR Register	336
4-113. SRSR0 Register	337
4-114. SRSR1 Register	338
4-115. SECR0 Register	339
4-116. SECR1 Register	340
4-117. ESR0 Register	341
4-118. ESR1 Register	342
4-119. ECR0 Register	343
4-120. ECR1 Register	344
4-121. CMR0 Register	345
4-122. CMR1 Register	346
4-123. CMR2 Register.....	347
4-124. CMR3 Register.....	348
4-125. CMR4 Register.....	349
4-126. CMR5 Register.....	350
4-127. CMR6 Register.....	351
4-128. CMR7 Register.....	352
4-129. CMR8 Register.....	353
4-130. CMR9 Register.....	354
4-131. CMR10 Register	355
4-132. CMR11 Register	356
4-133. CMR12 Register	357
4-134. CMR13 Register	358
4-135. CMR14 Register	359
4-136. CMR15 Register	360
4-137. HMR0 Register.....	361
4-138. HMR1 Register.....	362
4-139. HMR2 Register.....	363
4-140. HIPIR0 Register.....	364

4-141. HIPIR1 Register	365
4-142. HIPIR2 Register	366
4-143. HIPIR3 Register	367
4-144. HIPIR4 Register	368
4-145. HIPIR5 Register	369
4-146. HIPIR6 Register	370
4-147. HIPIR7 Register	371
4-148. HIPIR8 Register	372
4-149. HIPIR9 Register	373
4-150. SIPR0 Register	374
4-151. SIPR1 Register	375
4-152. SITR0 Register	376
4-153. SITR1 Register	377
4-154. HINLR0 Register	378
4-155. HINLR1 Register	379
4-156. HINLR2 Register	380
4-157. HINLR3 Register	381
4-158. HINLR4 Register	382
4-159. HINLR5 Register	383
4-160. HINLR6 Register	384
4-161. HINLR7 Register	385
4-162. HINLR8 Register	386
4-163. HINLR9 Register	387
4-164. HIER Register	388
4-165. IEP_TMR_GLB_CFG Register	389
4-166. IEP_TMR_GLB_STS Register	390
4-167. IEP_TMR_COMPEN Register	391
4-168. IEP_TMR_CNT Register	392
4-169. IEP_TMR_CMP_CFG Register	393
4-170. IEP_TMR_CMP_STS Register	394
4-171. IEP_TMR_CMP0 Register	395
4-172. IEP_TMR_CMP1 Register	396
4-173. IEP_TMR_CMP2 Register	397
4-174. IEP_TMR_CMP3 Register	398
4-175. IEP_TMR_CMP4 Register	399
4-176. IEP_TMR_CMP5 Register	400
4-177. IEP_TMR_CMP6 Register	401
4-178. IEP_TMR_CMP7 Register	402
4-179. IEP_DIGIO_CTRL Register	403
4-180. IEP_DIGIO_DATA_IN Register	404
4-181. IEP_DIGIO_DATA_IN_RAW Register	405
4-182. IEP_DIGIO_DATA_OUT Register	406
4-183. IEP_DIGIO_DATA_OUT_EN Register	407
4-184. IEP_DIGIO_EXP Register	408
4-185. Receiver Buffer Register (RBR)	410
4-186. Transmitter Holding Register (THR)	411
4-187. Interrupt Enable Register (IER)	412
4-188. Interrupt Identification Register (IIR)	413
4-189. FIFO Control Register (FCR)	415

4-190. Line Control Register (LCR).....	416
4-191. Modem Control Register (MCR)	418
4-192. Line Status Register (LSR)	419
4-193. Modem Status Register (MSR)	422
4-194. Scratch Pad Register (SCR)	423
4-195. Divisor LSB Latch (DLL)	424
4-196. Divisor MSB Latch (DLH)	424
4-197. Revision Identification Register 1 (REVID1)	425
4-198. Revision Identification Register 2 (REVID2)	425
4-199. Power and Emulation Management Register (PWREMU_MGMT)	426
4-200. Mode Definition Register (MDR).....	427
4-201. REVID Register	428
4-202. SYSCFG Register	429
4-203. GPCFG0 Register	430
4-204. GPCFG1 Register	432
4-205. CGR Register	434
4-206. ISRP Register	436
4-207. ISP Register	437
4-208. IESP Register	438
4-209. IECF Register	439
4-210. PMAO Register	440
4-211. IEPCLK Register	441
4-212. SPP Register	442
4-213. PIN_MX Register	443
5-1. SGX530 Integration.....	448
5-2. SGX Block Diagram	450
6-1. Interrupt Controller Block Diagram	453
6-2. IRQ/FIQ Processing Sequence	459
6-3. Nested IRQ/FIQ Processing Sequence	463
6-4. INTC_REVISION Register.....	472
6-5. INTC_SYSCONFIG Register.....	473
6-6. INTC_SYSSTATUS Register.....	474
6-7. INTC_SIR_IRQ Register.....	475
6-8. INTC_SIR_FIQ Register	476
6-9. INTC_CONTROL Register	477
6-10. INTC_PROTECTION Register	478
6-11. INTC_IDLE Register.....	479
6-12. INTC_IRQ_PRIORITY Register.....	480
6-13. INTC_FIQ_PRIORITY Register.....	481
6-14. INTC_THRESHOLD Register	482
6-15. INTC_ITR0 Register.....	483
6-16. INTC_MIR0 Register	484
6-17. INTC_MIR_CLEAR0 Register.....	485
6-18. INTC_MIR_SET0 Register	486
6-19. INTC_ISR_SET0 Register.....	487
6-20. INTC_ISR_CLEAR0 Register	488
6-21. INTC_PENDING_IRQ0 Register.....	489
6-22. INTC_PENDING_FIQ0 Register.....	490
6-23. INTC_ITR1 Register.....	491

6-24.	INTC_MIR1 Register	492
6-25.	INTC_MIR_CLEAR1 Register	493
6-26.	INTC_MIR_SET1 Register	494
6-27.	INTC_ISR_SET1 Register	495
6-28.	INTC_ISR_CLEAR1 Register	496
6-29.	INTC_PENDING_IRQ1 Register.....	497
6-30.	INTC_PENDING_FIQ1 Register	498
6-31.	INTC_ITR2 Register	499
6-32.	INTC_MIR2 Register	500
6-33.	INTC_MIR_CLEAR2 Register	501
6-34.	INTC_MIR_SET2 Register	502
6-35.	INTC_ISR_SET2 Register	503
6-36.	INTC_ISR_CLEAR2 Register	504
6-37.	INTC_PENDING_IRQ2 Register.....	505
6-38.	INTC_PENDING_FIQ2 Register	506
6-39.	INTC_ITR3 Register	507
6-40.	INTC_MIR3 Register	508
6-41.	INTC_MIR_CLEAR3 Register	509
6-42.	INTC_MIR_SET3 Register	510
6-43.	INTC_ISR_SET3 Register	511
6-44.	INTC_ISR_CLEAR3 Register	512
6-45.	INTC_PENDING_IRQ3 Register.....	513
6-46.	INTC_PENDING_FIQ3 Register	514
6-47.	INTC_ILR_0 to INTC_ILR_127 Register.....	515
7-1.	GPMC Block Diagram	519
7-2.	GPMC Integration.....	520
7-3.	GPMC to 16-Bit Address/Data-Multiplexed Memory	524
7-4.	GPMC to 16-Bit Non-multiplexed Memory	525
7-5.	GPMC to 8-Bit NAND Device	525
7-6.	Chip-Select Address Mapping and Decoding Mask.....	530
7-7.	Wait Behavior During an Asynchronous Single Read Access (GPMCFCLKDivider = 1)	533
7-8.	Wait Behavior During a Synchronous Read Burst Access	535
7-9.	Read to Read for an Address-Data Multiplexed Device, On Different CS, Without Bus Turnaround (CS0n Attached to Fast Device).....	537
7-10.	Read to Read / Write for an Address-Data Multiplexed Device, On Different CS, With Bus Turnaround	537
7-11.	Read to Read / Write for a Address-Data or AAD-Multiplexed Device, On Same CS, With Bus Turnaround	538
7-12.	Asynchronous Single Read Operation on an Address/Data Multiplexed Device.....	547
7-13.	Two Asynchronous Single Read Accesses on an Address/Data Multiplexed Device (32-Bit Read Split Into 2 × 16-Bit Read)	548
7-14.	Asynchronous Single Write on an Address/Data-Multiplexed Device	549
7-15.	Asynchronous Single-Read on an AAD-Multiplexed Device	550
7-16.	Asynchronous Single Write on an AAD-Multiplexed Device	552
7-17.	Synchronous Single Read (GPMCFCLKDIVIDER = 0).....	554
7-18.	Synchronous Single Read (GPMCFCLKDIVIDER = 1).....	555
7-19.	Synchronous Multiple (Burst) Read (GPMCFCLKDIVIDER = 0)	557
7-20.	Synchronous Multiple (Burst) Read (GPMCFCLKDIVIDER = 1)	558
7-21.	Synchronous Single Write on an Address/Data-Multiplexed Device	559
7-22.	Synchronous Multiple Write (Burst Write) in Address/Data-Multiplexed Mode	560
7-23.	Synchronous Multiple Write (Burst Write) in Address/Address/Data-Multiplexed Mode.....	561

7-24.	Asynchronous Single Read on an Address/Data-Nonmultiplexed Device	563
7-25.	Asynchronous Single Write on an Address/Data-Nonmultiplexed Device	564
7-26.	Asynchronous Multiple (Page Mode) Read	565
7-27.	NAND Command Latch Cycle	570
7-28.	NAND Address Latch Cycle	571
7-29.	NAND Data Read Cycle	572
7-30.	NAND Data Write Cycle	573
7-31.	Hamming Code Accumulation Algorithm (1 of 2).....	577
7-32.	Hamming Code Accumulation Algorithm (2 of 2).....	578
7-33.	ECC Computation for a 256-Byte Data Stream (Read or Write)	578
7-34.	ECC Computation for a 512-Byte Data Stream (Read or Write)	579
7-35.	128 Word16 ECC Computation	580
7-36.	256 Word16 ECC Computation	580
7-37.	Manual Mode Sequence and Mapping	585
7-38.	NAND Page Mapping and ECC: Per-Sector Schemes	590
7-39.	NAND Page Mapping and ECC: Pooled Spare Schemes.....	591
7-40.	NAND Page Mapping and ECC: Per-Sector Schemes, with Separate ECC	592
7-41.	NAND Read Cycle Optimization Timing Description	599
7-42.	Programming Model Top-Level Diagram	602
7-43.	NOR Interfacing Timing Parameters Diagram	609
7-44.	GPMC Connection to an External NOR Flash Memory	613
7-45.	Synchronous Burst Read Access (Timing Parameters in Clock Cycles).....	615
7-46.	Asynchronous Single Read Access (Timing Parameters in Clock Cycles)	617
7-47.	Asynchronous Single Write Access (Timing Parameters in Clock Cycles)	619
7-48.	GPMC_REVISION Register	627
7-49.	GPMC_SYSCONFIG Register	628
7-50.	GPMC_SYSSTATUS Register	629
7-51.	GPMC_IRQSTATUS Register	630
7-52.	GPMC_IRQENABLE Register	631
7-53.	GPMC_TIMEOUT_CONTROL Register	632
7-54.	GPMC_ERR_ADDRESS Register.....	633
7-55.	GPMC_ERR_TYPE Register.....	634
7-56.	GPMC_CONFIG Register	635
7-57.	GPMC_STATUS Register	636
7-58.	GPMC_CONFIG1_0 Register	637
7-59.	GPMC_CONFIG2_0 Register	640
7-60.	GPMC_CONFIG3_0 Register	641
7-61.	GPMC_CONFIG4_0 Register	643
7-62.	GPMC_CONFIG5_0 Register	645
7-63.	GPMC_CONFIG6_0 Register	646
7-64.	GPMC_CONFIG7_0 Register	647
7-65.	GPMC_NAND_COMMAND_0 Register	648
7-66.	GPMC_NAND_ADDRESS_0 Register.....	649
7-67.	GPMC_NAND_DATA_0 Register	650
7-68.	GPMC_CONFIG1_1 Register	651
7-69.	GPMC_CONFIG2_1 Register	654
7-70.	GPMC_CONFIG3_1 Register	655
7-71.	GPMC_CONFIG4_1 Register	657
7-72.	GPMC_CONFIG5_1 Register	659

7-73.	GPMC_CONFIG6_1 Register	660
7-74.	GPMC_CONFIG7_1 Register	661
7-75.	GPMC_NAND_COMMAND_1 Register	662
7-76.	GPMC_NAND_ADDRESS_1 Register	663
7-77.	GPMC_NAND_DATA_1 Register	664
7-78.	GPMC_CONFIG1_2 Register	665
7-79.	GPMC_CONFIG2_2 Register	668
7-80.	GPMC_CONFIG3_2 Register	669
7-81.	GPMC_CONFIG4_2 Register	671
7-82.	GPMC_CONFIG5_2 Register	673
7-83.	GPMC_CONFIG6_2 Register	674
7-84.	GPMC_CONFIG7_2 Register	675
7-85.	GPMC_NAND_COMMAND_2 Register	676
7-86.	GPMC_NAND_ADDRESS_2 Register	677
7-87.	GPMC_NAND_DATA_2 Register	678
7-88.	GPMC_CONFIG1_3 Register	679
7-89.	GPMC_CONFIG2_3 Register	682
7-90.	GPMC_CONFIG3_3 Register	683
7-91.	GPMC_CONFIG4_3 Register	685
7-92.	GPMC_CONFIG5_3 Register	687
7-93.	GPMC_CONFIG6_3 Register	688
7-94.	GPMC_CONFIG7_3 Register	689
7-95.	GPMC_NAND_COMMAND_3 Register	690
7-96.	GPMC_NAND_ADDRESS_3 Register	691
7-97.	GPMC_NAND_DATA_3 Register	692
7-98.	GPMC_CONFIG1_4 Register	693
7-99.	GPMC_CONFIG2_4 Register	696
7-100.	GPMC_CONFIG3_4 Register	697
7-101.	GPMC_CONFIG4_4 Register	699
7-102.	GPMC_CONFIG5_4 Register	701
7-103.	GPMC_CONFIG6_4 Register	702
7-104.	GPMC_CONFIG7_4 Register	703
7-105.	GPMC_NAND_COMMAND_4 Register	704
7-106.	GPMC_NAND_ADDRESS_4 Register	705
7-107.	GPMC_NAND_DATA_4 Register	706
7-108.	GPMC_CONFIG1_5 Register	707
7-109.	GPMC_CONFIG2_5 Register	710
7-110.	GPMC_CONFIG3_5 Register	711
7-111.	GPMC_CONFIG4_5 Register	713
7-112.	GPMC_CONFIG5_5 Register	715
7-113.	GPMC_CONFIG6_5 Register	716
7-114.	GPMC_CONFIG7_5 Register	717
7-115.	GPMC_NAND_COMMAND_5 Register	718
7-116.	GPMC_NAND_ADDRESS_5 Register	719
7-117.	GPMC_NAND_DATA_5 Register	720
7-118.	GPMC_CONFIG1_6 Register	721
7-119.	GPMC_CONFIG2_6 Register	724
7-120.	GPMC_CONFIG3_6 Register	725
7-121.	GPMC_CONFIG4_6 Register	727

7-122. GPMC_CONFIG5_6 Register	729
7-123. GPMC_CONFIG6_6 Register	730
7-124. GPMC_CONFIG7_6 Register	731
7-125. GPMC_NAND_COMMAND_6 Register	732
7-126. GPMC_NAND_ADDRESS_6 Register	733
7-127. GPMC_NAND_DATA_6 Register	734
7-128. GPMC_PREFETCH_CONFIG1 Register	735
7-129. GPMC_PREFETCH_CONFIG2 Register	737
7-130. GPMC_PREFETCH_CONTROL Register	738
7-131. GPMC_PREFETCH_STATUS Register	739
7-132. GPMC_ECC_CONFIG Register	740
7-133. GPMC_ECC_CONTROL Register	742
7-134. GPMC_ECC_SIZE_CONFIG Register	743
7-135. GPMC_ECC1_RESULT Register	745
7-136. GPMC_ECC2_RESULT Register	747
7-137. GPMC_ECC3_RESULT Register	749
7-138. GPMC_ECC4_RESULT Register	751
7-139. GPMC_ECC5_RESULT Register	753
7-140. GPMC_ECC6_RESULT Register	755
7-141. GPMC_ECC7_RESULT Register	757
7-142. GPMC_ECC8_RESULT Register	759
7-143. GPMC_ECC9_RESULT Register	761
7-144. GPMC_BCH_RESULT0_0 Register	763
7-145. GPMC_BCH_RESULT1_0 Register	764
7-146. GPMC_BCH_RESULT2_0 Register	765
7-147. GPMC_BCH_RESULT3_0 Register	766
7-148. GPMC_BCH_RESULT0_1 Register	767
7-149. GPMC_BCH_RESULT1_1 Register	768
7-150. GPMC_BCH_RESULT2_1 Register	769
7-151. GPMC_BCH_RESULT3_1 Register	770
7-152. GPMC_BCH_RESULT0_2 Register	771
7-153. GPMC_BCH_RESULT1_2 Register	772
7-154. GPMC_BCH_RESULT2_2 Register	773
7-155. GPMC_BCH_RESULT3_2 Register	774
7-156. GPMC_BCH_RESULT0_3 Register	775
7-157. GPMC_BCH_RESULT1_3 Register	776
7-158. GPMC_BCH_RESULT2_3 Register	777
7-159. GPMC_BCH_RESULT3_3 Register	778
7-160. GPMC_BCH_RESULT0_4 Register	779
7-161. GPMC_BCH_RESULT1_4 Register	780
7-162. GPMC_BCH_RESULT2_4 Register	781
7-163. GPMC_BCH_RESULT3_4 Register	782
7-164. GPMC_BCH_RESULT0_5 Register	783
7-165. GPMC_BCH_RESULT1_5 Register	784
7-166. GPMC_BCH_RESULT2_5 Register	785
7-167. GPMC_BCH_RESULT3_5 Register	786
7-168. GPMC_BCH_RESULT0_6 Register	787
7-169. GPMC_BCH_RESULT1_6 Register	788
7-170. GPMC_BCH_RESULT2_6 Register	789

7-171. GPMC_BCH_RESULT3_6 Register	790
7-172. GPMC_BCH_RESULT0_7 Register	791
7-173. GPMC_BCH_RESULT1_7 Register	792
7-174. GPMC_BCH_RESULT2_7 Register	793
7-175. GPMC_BCH_RESULT3_7 Register	794
7-176. GPMC_BCH_SWDATA Register	795
7-177. GPMC_BCH_RESULT4_0 Register	796
7-178. GPMC_BCH_RESULT5_0 Register	797
7-179. GPMC_BCH_RESULT6_0 Register	798
7-180. GPMC_BCH_RESULT4_1 Register	799
7-181. GPMC_BCH_RESULT5_1 Register	800
7-182. GPMC_BCH_RESULT6_1 Register	801
7-183. GPMC_BCH_RESULT4_2 Register	802
7-184. GPMC_BCH_RESULT5_2 Register	803
7-185. GPMC_BCH_RESULT6_2 Register	804
7-186. GPMC_BCH_RESULT4_3 Register	805
7-187. GPMC_BCH_RESULT5_3 Register	806
7-188. GPMC_BCH_RESULT6_3 Register	807
7-189. GPMC_BCH_RESULT4_4 Register	808
7-190. GPMC_BCH_RESULT5_4 Register	809
7-191. GPMC_BCH_RESULT6_4 Register	810
7-192. GPMC_BCH_RESULT4_5 Register	811
7-193. GPMC_BCH_RESULT5_5 Register	812
7-194. GPMC_BCH_RESULT6_5 Register	813
7-195. GPMC_BCH_RESULT4_6 Register	814
7-196. GPMC_BCH_RESULT5_6 Register	815
7-197. GPMC_BCH_RESULT6_6 Register	816
7-198. GPMC_BCH_RESULT4_7 Register	817
7-199. GPMC_BCH_RESULT5_7 Register	818
7-200. GPMC_BCH_RESULT6_7 Register	819
7-201. OCMC RAM Integration.....	821
7-202. DDR2/3/mDDR Memory Controller Signals	826
7-203. DDR2/3/mDDR Subsystem Block Diagram	828
7-204. DDR2/3/mDDR Memory Controller FIFO Block Diagram	829
7-205. EMIF_MOD_ID_REV Register	846
7-206. STATUS Register.....	847
7-207. SDRAM_CONFIG Register.....	848
7-208. SDRAM_CONFIG_2 Register.....	850
7-209. SDRAM_REF_CTRL Register	851
7-210. SDRAM_REF_CTRL_SHDW Register	852
7-211. SDRAM_TIM_1 Register.....	853
7-212. SDRAM_TIM_1_SHDW Register.....	854
7-213. SDRAM_TIM_2 Register.....	855
7-214. SDRAM_TIM_2_SHDW Register.....	856
7-215. SDRAM_TIM_3 Register.....	857
7-216. SDRAM_TIM_3_SHDW Register.....	858
7-217. PWR_MGMT_CTRL Register	859
7-218. PWR_MGMT_CTRL_SHDW Register	861
7-219. Interface Configuration Register	862

7-220. Interface Configuration Value 1 Register	863
7-221. Interface Configuration Value 2 Register	864
7-222. PERF_CNT_1 Register	865
7-223. PERF_CNT_2 Register	866
7-224. PERF_CNT_CFG Register	867
7-225. PERF_CNT_SEL Register.....	868
7-226. PERF_CNT_TIM Register	869
7-227. READ_IDLE_CTRL Register	870
7-228. READ_IDLE_CTRL_SHDW Register	871
7-229. IRQSTATUS_RAW_SYS Register	872
7-230. IRQSTATUS_SYS Register	873
7-231. IRQENABLE_SET_SYS Register	874
7-232. IRQENABLE_CLR_SYS Register	875
7-233. ZQ_CONFIG Register	876
7-234. Read-Write Leveling Ramp Window Register.....	877
7-235. Read-Write Leveling Ramp Control Register	878
7-236. Read-Write Leveling Control Register	879
7-237. DDR_PHY_CTRL_1 Register	880
7-238. DDR_PHY_CTRL_1_SHDW Register	882
7-239. Priority to Class of Service Mapping Register	884
7-240. Connection ID to Class of Service 1 Mapping Register	885
7-241. Connection ID to Class of Service 2 Mapping Register	886
7-242. Read Write Execution Threshold Register	887
7-243. DDR PHY Command 0/1/2 Address/Command Slave Ratio Register (CMD0/1/2_REG_PHY_CTRL_SLAVE_RATIO_0)	890
7-244. DDR PHY Command 0/1/2 Address/Command DLL Lock Difference Register (CMD0/1/2_REG_PHY_DLL_LOCK_DIFF_0)	890
7-245. DDR PHY Command 0/1/2 Invert Clockout Selection Register(CMD0/1/2_REG_PHY_INVERT_CLKOUT_0)	891
7-246. DDR PHY Data Macro 0/1 Read DQS Slave Ratio Register (DATA0/1_REG_PHY_RD_DQS_SLAVE_RATIO_0)).....	891
7-247. DDR PHY Data Macro 0/1 Write Leveling Init Ratio Register (DATA0/1_REG_PHY_WRLVL_INIT_RATIO_0).....	892
7-248. DDR PHY Data Macro 0 Write Leveling Init Mode Ratio Selection Register (DATA0/1_REG_PHY_WRLVL_INIT_MODE_0)	893
7-249. DDR PHY Data Macro 0 DQS Gate Training Init Ratio Register (DATA0_REG_PHY_GATELVL_INIT_RATIO_0)	893
7-250. DDR PHY Data Macro 0/1 DQS Gate Training Init Mode Ratio Selection Register (DATA0/1_REG_PHY_GATELVL_INIT_MODE_0)	894
7-251. DDR PHY Data Macro 0/1 DQS Gate Slave Ratio Register(DATA0/1_REG_PHY_FIFO_WE_SLAVE_RATIO_0).....	894
7-252. DDR PHY Data Macro 0/1 Write Data Slave Ratio Register (DATA0/1_REG_PHY_WR_DATA_SLAVE_RATIO_0)	895
7-253. DDR PHY Data Macro 0/1 Delay Selection Register (DATA0/1_REG_PHY_USE_RANK0_DELAYS).....	896
7-254. DDR PHY Data 0/1 DLL Lock Difference Register (DATA0/1_REG_PHY_DLL_LOCK_DIFF_0)	896
7-255. ELM Integration	898
7-256. ELM_REVISION Register	912
7-257. ELM_SYSCONFIG Register	913
7-258. ELM_SYSSTATUS Register	914
7-259. ELM_IRQSTATUS Register	915
7-260. ELM_IRQENABLE Register	917

7-261. ELM_LOCATION_CONFIG Register.....	918
7-262. ELM_PAGE_CTRL Register	919
7-263. ELM_SYNDROME_FRAGMENT_0_0 Register	920
7-264. ELM_SYNDROME_FRAGMENT_1_0 Register	921
7-265. ELM_SYNDROME_FRAGMENT_2_0 Register	922
7-266. ELM_SYNDROME_FRAGMENT_3_0 Register	923
7-267. ELM_SYNDROME_FRAGMENT_4_0 Register	924
7-268. ELM_SYNDROME_FRAGMENT_5_0 Register	925
7-269. ELM_SYNDROME_FRAGMENT_6_0 Register	926
7-270. ELM_SYNDROME_FRAGMENT_0_1 Register	927
7-271. ELM_SYNDROME_FRAGMENT_1_1 Register	928
7-272. ELM_SYNDROME_FRAGMENT_2_1 Register	929
7-273. ELM_SYNDROME_FRAGMENT_3_1 Register	930
7-274. ELM_SYNDROME_FRAGMENT_4_1 Register	931
7-275. ELM_SYNDROME_FRAGMENT_5_1 Register	932
7-276. ELM_SYNDROME_FRAGMENT_6_1 Register	933
7-277. ELM_SYNDROME_FRAGMENT_0_2 Register	934
7-278. ELM_SYNDROME_FRAGMENT_1_2 Register	935
7-279. ELM_SYNDROME_FRAGMENT_2_2 Register	936
7-280. ELM_SYNDROME_FRAGMENT_3_2 Register	937
7-281. ELM_SYNDROME_FRAGMENT_4_2 Register	938
7-282. ELM_SYNDROME_FRAGMENT_5_2 Register	939
7-283. ELM_SYNDROME_FRAGMENT_6_2 Register	940
7-284. ELM_SYNDROME_FRAGMENT_0_3 Register	941
7-285. ELM_SYNDROME_FRAGMENT_1_3 Register	942
7-286. ELM_SYNDROME_FRAGMENT_2_3 Register	943
7-287. ELM_SYNDROME_FRAGMENT_3_3 Register	944
7-288. ELM_SYNDROME_FRAGMENT_4_3 Register	945
7-289. ELM_SYNDROME_FRAGMENT_5_3 Register	946
7-290. ELM_SYNDROME_FRAGMENT_6_3 Register	947
7-291. ELM_SYNDROME_FRAGMENT_0_4 Register	948
7-292. ELM_SYNDROME_FRAGMENT_1_4 Register	949
7-293. ELM_SYNDROME_FRAGMENT_2_4 Register	950
7-294. ELM_SYNDROME_FRAGMENT_3_4 Register	951
7-295. ELM_SYNDROME_FRAGMENT_4_4 Register	952
7-296. ELM_SYNDROME_FRAGMENT_5_4 Register	953
7-297. ELM_SYNDROME_FRAGMENT_6_4 Register	954
7-298. ELM_SYNDROME_FRAGMENT_0_5 Register	955
7-299. ELM_SYNDROME_FRAGMENT_1_5 Register	956
7-300. ELM_SYNDROME_FRAGMENT_2_5 Register	957
7-301. ELM_SYNDROME_FRAGMENT_3_5 Register	958
7-302. ELM_SYNDROME_FRAGMENT_4_5 Register	959
7-303. ELM_SYNDROME_FRAGMENT_5_5 Register	960
7-304. ELM_SYNDROME_FRAGMENT_6_5 Register	961
7-305. ELM_SYNDROME_FRAGMENT_0_6 Register	962
7-306. ELM_SYNDROME_FRAGMENT_1_6 Register	963
7-307. ELM_SYNDROME_FRAGMENT_2_6 Register	964
7-308. ELM_SYNDROME_FRAGMENT_3_6 Register	965
7-309. ELM_SYNDROME_FRAGMENT_4_6 Register	966

7-310. ELM_SYNDROME_FRAGMENT_5_6 Register	967
7-311. ELM_SYNDROME_FRAGMENT_6_6 Register	968
7-312. ELM_SYNDROME_FRAGMENT_0_7 Register	969
7-313. ELM_SYNDROME_FRAGMENT_1_7 Register	970
7-314. ELM_SYNDROME_FRAGMENT_2_7 Register	971
7-315. ELM_SYNDROME_FRAGMENT_3_7 Register	972
7-316. ELM_SYNDROME_FRAGMENT_4_7 Register	973
7-317. ELM_SYNDROME_FRAGMENT_5_7 Register	974
7-318. ELM_SYNDROME_FRAGMENT_6_7 Register	975
7-319. ELM_LOCATION_STATUS_0 Register	976
7-320. ELM_ERROR_LOCATION_0_0 Register	977
7-321. ELM_ERROR_LOCATION_1_0 Register	978
7-322. ELM_ERROR_LOCATION_2_0 Register	979
7-323. ELM_ERROR_LOCATION_3_0 Register	980
7-324. ELM_ERROR_LOCATION_4_0 Register	981
7-325. ELM_ERROR_LOCATION_5_0 Register	982
7-326. ELM_ERROR_LOCATION_6_0 Register	983
7-327. ELM_ERROR_LOCATION_7_0 Register	984
7-328. ELM_ERROR_LOCATION_8_0 Register	985
7-329. ELM_ERROR_LOCATION_9_0 Register	986
7-330. ELM_ERROR_LOCATION_10_0 Register	987
7-331. ELM_ERROR_LOCATION_11_0 Register	988
7-332. ELM_ERROR_LOCATION_12_0 Register	989
7-333. ELM_ERROR_LOCATION_13_0 Register	990
7-334. ELM_ERROR_LOCATION_14_0 Register	991
7-335. ELM_ERROR_LOCATION_15_0 Register	992
7-336. ELM_LOCATION_STATUS_1 Register	993
7-337. ELM_ERROR_LOCATION_0_1 Register	994
7-338. ELM_ERROR_LOCATION_1_1 Register	995
7-339. ELM_ERROR_LOCATION_2_1 Register	996
7-340. ELM_ERROR_LOCATION_3_1 Register	997
7-341. ELM_ERROR_LOCATION_4_1 Register	998
7-342. ELM_ERROR_LOCATION_5_1 Register	999
7-343. ELM_ERROR_LOCATION_6_1 Register	1000
7-344. ELM_ERROR_LOCATION_7_1 Register	1001
7-345. ELM_ERROR_LOCATION_8_1 Register	1002
7-346. ELM_ERROR_LOCATION_9_1 Register	1003
7-347. ELM_ERROR_LOCATION_10_1 Register	1004
7-348. ELM_ERROR_LOCATION_11_1 Register	1005
7-349. ELM_ERROR_LOCATION_12_1 Register	1006
7-350. ELM_ERROR_LOCATION_13_1 Register	1007
7-351. ELM_ERROR_LOCATION_14_1 Register	1008
7-352. ELM_ERROR_LOCATION_15_1 Register	1009
7-353. ELM_LOCATION_STATUS_2 Register	1010
7-354. ELM_ERROR_LOCATION_0_2 Register	1011
7-355. ELM_ERROR_LOCATION_1_2 Register	1012
7-356. ELM_ERROR_LOCATION_2_2 Register	1013
7-357. ELM_ERROR_LOCATION_3_2 Register	1014
7-358. ELM_ERROR_LOCATION_4_2 Register	1015

7-359. ELM_ERROR_LOCATION_5_2 Register	1016
7-360. ELM_ERROR_LOCATION_6_2 Register	1017
7-361. ELM_ERROR_LOCATION_7_2 Register	1018
7-362. ELM_ERROR_LOCATION_8_2 Register	1019
7-363. ELM_ERROR_LOCATION_9_2 Register	1020
7-364. ELM_ERROR_LOCATION_10_2 Register	1021
7-365. ELM_ERROR_LOCATION_11_2 Register	1022
7-366. ELM_ERROR_LOCATION_12_2 Register	1023
7-367. ELM_ERROR_LOCATION_13_2 Register	1024
7-368. ELM_ERROR_LOCATION_14_2 Register	1025
7-369. ELM_ERROR_LOCATION_15_2 Register	1026
7-370. ELM_ERROR_LOCATION_0_3 Register	1027
7-371. ELM_ERROR_LOCATION_1_3 Register	1028
7-372. ELM_ERROR_LOCATION_2_3 Register	1029
7-373. ELM_ERROR_LOCATION_3_3 Register	1030
7-374. ELM_ERROR_LOCATION_4_3 Register	1031
7-375. ELM_ERROR_LOCATION_5_3 Register	1032
7-376. ELM_ERROR_LOCATION_6_3 Register	1033
7-377. ELM_ERROR_LOCATION_7_3 Register	1034
7-378. ELM_ERROR_LOCATION_8_3 Register	1035
7-379. ELM_ERROR_LOCATION_9_3 Register	1036
7-380. ELM_ERROR_LOCATION_10_3 Register	1037
7-381. ELM_ERROR_LOCATION_11_3 Register	1038
7-382. ELM_ERROR_LOCATION_12_3 Register	1039
7-383. ELM_ERROR_LOCATION_13_3 Register	1040
7-384. ELM_ERROR_LOCATION_14_3 Register	1041
7-385. ELM_ERROR_LOCATION_15_3 Register	1042
7-386. ELM_LOCATION_STATUS_3 Register	1043
7-387. ELM_ERROR_LOCATION_0_4 Register	1044
7-388. ELM_ERROR_LOCATION_1_4 Register	1045
7-389. ELM_ERROR_LOCATION_2_4 Register	1046
7-390. ELM_ERROR_LOCATION_3_4 Register	1047
7-391. ELM_ERROR_LOCATION_4_4 Register	1048
7-392. ELM_ERROR_LOCATION_5_4 Register	1049
7-393. ELM_ERROR_LOCATION_6_4 Register	1050
7-394. ELM_ERROR_LOCATION_7_4 Register	1051
7-395. ELM_ERROR_LOCATION_8_4 Register	1052
7-396. ELM_ERROR_LOCATION_9_4 Register	1053
7-397. ELM_ERROR_LOCATION_10_4 Register	1054
7-398. ELM_ERROR_LOCATION_11_4 Register	1055
7-399. ELM_ERROR_LOCATION_12_4 Register	1056
7-400. ELM_ERROR_LOCATION_13_4 Register	1057
7-401. ELM_ERROR_LOCATION_14_4 Register	1058
7-402. ELM_ERROR_LOCATION_15_4 Register	1059
7-403. ELM_ERROR_LOCATION_0_5 Register	1060
7-404. ELM_ERROR_LOCATION_1_5 Register	1061
7-405. ELM_ERROR_LOCATION_2_5 Register	1062
7-406. ELM_ERROR_LOCATION_3_5 Register	1063
7-407. ELM_ERROR_LOCATION_4_5 Register	1064

7-408. ELM_ERROR_LOCATION_5_5 Register	1065
7-409. ELM_ERROR_LOCATION_6_5 Register	1066
7-410. ELM_ERROR_LOCATION_7_5 Register	1067
7-411. ELM_ERROR_LOCATION_8_5 Register	1068
7-412. ELM_ERROR_LOCATION_9_5 Register	1069
7-413. ELM_ERROR_LOCATION_10_5 Register	1070
7-414. ELM_ERROR_LOCATION_11_5 Register	1071
7-415. ELM_ERROR_LOCATION_12_5 Register	1072
7-416. ELM_ERROR_LOCATION_13_5 Register	1073
7-417. ELM_ERROR_LOCATION_14_5 Register	1074
7-418. ELM_ERROR_LOCATION_15_5 Register	1075
7-419. ELM_LOCATION_STATUS_4 Register	1076
7-420. ELM_ERROR_LOCATION_0_6 Register	1077
7-421. ELM_ERROR_LOCATION_1_6 Register	1078
7-422. ELM_ERROR_LOCATION_2_6 Register	1079
7-423. ELM_ERROR_LOCATION_3_6 Register	1080
7-424. ELM_ERROR_LOCATION_4_6 Register	1081
7-425. ELM_ERROR_LOCATION_5_6 Register	1082
7-426. ELM_ERROR_LOCATION_6_6 Register	1083
7-427. ELM_ERROR_LOCATION_7_6 Register	1084
7-428. ELM_ERROR_LOCATION_8_6 Register	1085
7-429. ELM_ERROR_LOCATION_9_6 Register	1086
7-430. ELM_ERROR_LOCATION_10_6 Register	1087
7-431. ELM_ERROR_LOCATION_11_6 Register	1088
7-432. ELM_ERROR_LOCATION_12_6 Register	1089
7-433. ELM_ERROR_LOCATION_13_6 Register	1090
7-434. ELM_ERROR_LOCATION_14_6 Register	1091
7-435. ELM_ERROR_LOCATION_15_6 Register	1092
7-436. ELM_ERROR_LOCATION_0_7 Register	1093
7-437. ELM_ERROR_LOCATION_1_7 Register	1094
7-438. ELM_ERROR_LOCATION_2_7 Register	1095
7-439. ELM_ERROR_LOCATION_3_7 Register	1096
7-440. ELM_ERROR_LOCATION_4_7 Register	1097
7-441. ELM_ERROR_LOCATION_5_7 Register	1098
7-442. ELM_ERROR_LOCATION_6_7 Register	1099
7-443. ELM_ERROR_LOCATION_7_7 Register	1100
7-444. ELM_ERROR_LOCATION_8_7 Register	1101
7-445. ELM_ERROR_LOCATION_9_7 Register	1102
7-446. ELM_ERROR_LOCATION_10_7 Register	1103
7-447. ELM_ERROR_LOCATION_11_7 Register	1104
7-448. ELM_ERROR_LOCATION_12_7 Register	1105
7-449. ELM_ERROR_LOCATION_13_7 Register	1106
7-450. ELM_ERROR_LOCATION_14_7 Register	1107
7-451. ELM_ERROR_LOCATION_15_7 Register	1108
7-452. ELM_LOCATION_STATUS_5 Register	1109
7-453. ELM_LOCATION_STATUS_6 Register	1110
7-454. ELM_LOCATION_STATUS_7 Register	1111
8-1. Functional and Interface Clocks	1113
8-2. Generic Clock Domain	1118

8-3.	Clock Domain State Transitions	1118
8-4.	Generic Power Domain Architecture.....	1120
8-5.	High Level System View for RTC-only Mode.....	1125
8-6.	System Level View of Power Management of Cortex A8 MPU and Cortex M3	1128
8-7.	IPC Mechanism.....	1129
8-8.	ADPLLS	1133
8-9.	Basic Structure of the ADPLLLJ.....	1135
8-10.	Core PLL	1138
8-11.	Peripheral PLL Structure	1141
8-12.	MPU Subsystem PLL Structure	1143
8-13.	Display PLL Structure.....	1144
8-14.	DDR PLL Structure.....	1145
8-15.	CLKOUT Signals	1146
8-16.	Watchdog Timer Clock Selection	1146
8-17.	Timer Clock Selection	1147
8-18.	RTC, VTP, and Debounce Clock Selection	1148
8-19.	PORz.....	1150
8-20.	External System Reset	1151
8-21.	Warm Reset Sequence (External Warm Reset Source)	1152
8-22.	Warm Reset Sequence (Internal Warm Reset Source).....	1153
8-23.	CM_PER_L4LS_CLKSTCTRL Register.....	1163
8-24.	CM_PER_L3S_CLKSTCTRL Register	1165
8-25.	CM_PER_L3_CLKSTCTRL Register	1166
8-26.	CM_PER_CPGMAC0_CLKCTRL Register	1167
8-27.	CM_PER_LCDC_CLKCTRL Register	1168
8-28.	CM_PER_USB0_CLKCTRL Register	1169
8-29.	CM_PER_TPTC0_CLKCTRL Register.....	1170
8-30.	CM_PER_EMIF_CLKCTRL Register.....	1171
8-31.	CM_PER_OCMCRAM_CLKCTRL Register	1172
8-32.	CM_PER_GPMC_CLKCTRL Register	1173
8-33.	CM_PER_MCASP0_CLKCTRL Register	1174
8-34.	CM_PER_UART5_CLKCTRL Register.....	1175
8-35.	CM_PER_MMC0_CLKCTRL Register	1176
8-36.	CM_PER_ELM_CLKCTRL Register.....	1177
8-37.	CM_PER_I2C2_CLKCTRL Register.....	1178
8-38.	CM_PER_I2C1_CLKCTRL Register.....	1179
8-39.	CM_PER_SPI0_CLKCTRL Register.....	1180
8-40.	CM_PER_SPI1_CLKCTRL Register.....	1181
8-41.	CM_PER_L4LS_CLKCTRL Register	1182
8-42.	CM_PER_MCASP1_CLKCTRL Register	1183
8-43.	CM_PER_UART1_CLKCTRL Register.....	1184
8-44.	CM_PER_UART2_CLKCTRL Register.....	1185
8-45.	CM_PER_UART3_CLKCTRL Register.....	1186
8-46.	CM_PER_UART4_CLKCTRL Register.....	1187
8-47.	CM_PER_TIMER7_CLKCTRL Register	1188
8-48.	CM_PER_TIMER2_CLKCTRL Register	1189
8-49.	CM_PER_TIMER3_CLKCTRL Register	1190
8-50.	CM_PER_TIMER4_CLKCTRL Register	1191
8-51.	CM_PER_GPIO1_CLKCTRL Register	1192

8-52.	CM_PER_GPIO2_CLKCTRL Register	1193
8-53.	CM_PER_GPIO3_CLKCTRL Register	1194
8-54.	CM_PER_TPCC_CLKCTRL Register	1195
8-55.	CM_PER_DCAN0_CLKCTRL Register	1196
8-56.	CM_PER_DCAN1_CLKCTRL Register	1197
8-57.	CM_PER_EPWMSS1_CLKCTRL Register	1198
8-58.	CM_PER_EPWMSS0_CLKCTRL Register	1199
8-59.	CM_PER_EPWMSS2_CLKCTRL Register	1200
8-60.	CM_PER_L3_INSTR_CLKCTRL Register	1201
8-61.	CM_PER_L3_CLKCTRL Register	1202
8-62.	CM_PER_IEEE5000_CLKCTRL Register	1203
8-63.	CM_PER_PRU_ICSS_CLKCTRL Register	1204
8-64.	CM_PER_TIMER5_CLKCTRL Register	1205
8-65.	CM_PER_TIMER6_CLKCTRL Register	1206
8-66.	CM_PER_MMC1_CLKCTRL Register	1207
8-67.	CM_PER_MMC2_CLKCTRL Register	1208
8-68.	CM_PER_TPTC1_CLKCTRL Register	1209
8-69.	CM_PER_TPTC2_CLKCTRL Register	1210
8-70.	CM_PER_SPINLOCK_CLKCTRL Register	1211
8-71.	CM_PER_MAILBOX0_CLKCTRL Register	1212
8-72.	CM_PER_L4HS_CLKSTCTRL Register	1213
8-73.	CM_PER_L4HS_CLKCTRL Register	1214
8-74.	CM_PER_OCPWP_L3_CLKSTCTRL Register	1215
8-75.	CM_PER_OCPWP_CLKCTRL Register	1216
8-76.	CM_PER_PRU_ICSS_CLKSTCTRL Register	1217
8-77.	CM_PER_CPSW_CLKSTCTRL Register	1218
8-78.	CM_PER_LCDC_CLKSTCTRL Register	1219
8-79.	CM_PER_CLKDIV32K_CLKCTRL Register	1220
8-80.	CM_PER_CLK_24MHZ_CLKSTCTRL Register	1221
8-81.	CM_WKUP_CLKSTCTRL Register	1224
8-82.	CM_WKUP_CONTROL_CLKCTRL Register	1226
8-83.	CM_WKUP_GPIO0_CLKCTRL Register	1227
8-84.	CM_WKUP_L4WKUP_CLKCTRL Register	1228
8-85.	CM_WKUP_TIMER0_CLKCTRL Register	1229
8-86.	CM_WKUP_DEBUGSS_CLKCTRL Register	1230
8-87.	CM_L3_AON_CLKSTCTRL Register	1232
8-88.	CM_AUTOIDLE_DPLL_MPU Register	1233
8-89.	CM_IDLEST_DPLL_MPU Register	1234
8-90.	CM_SSC_DELTAMSTEP_DPLL_MPU Register	1235
8-91.	CM_SSC_MODFREQDIV_DPLL_MPU Register	1236
8-92.	CM_CLKSEL_DPLL_MPU Register	1237
8-93.	CM_AUTOIDLE_DPLL_DDR Register	1238
8-94.	CM_IDLEST_DPLL_DDR Register	1239
8-95.	CM_SSC_DELTAMSTEP_DPLL_DDR Register	1240
8-96.	CM_SSC_MODFREQDIV_DPLL_DDR Register	1241
8-97.	CM_CLKSEL_DPLL_DDR Register	1242
8-98.	CM_AUTOIDLE_DPLL_DISP Register	1243
8-99.	CM_IDLEST_DPLL_DISP Register	1244
8-100.	CM_SSC_DELTAMSTEP_DPLL_DISP Register	1245

8-101. CM_SSC_MODFREQDIV_DPLL_DISP Register	1246
8-102. CM_CLKSEL_DPLL_DISP Register	1247
8-103. CM_AUTOIDLE_DPLL_CORE Register	1248
8-104. CM_IDLEST_DPLL_CORE Register	1249
8-105. CM_SSC_DELTAMSTEP_DPLL_CORE Register	1250
8-106. CM_SSC_MODFREQDIV_DPLL_CORE Register	1251
8-107. CM_CLKSEL_DPLL_CORE Register	1252
8-108. CM_AUTOIDLE_DPLL_PER Register	1253
8-109. CM_IDLEST_DPLL_PER Register	1254
8-110. CM_SSC_DELTAMSTEP_DPLL_PER Register	1255
8-111. CM_SSC_MODFREQDIV_DPLL_PER Register	1256
8-112. CM_CLKDCOLDO_DPLL_PER Register	1257
8-113. CM_DIV_M4_DPLL_CORE Register	1258
8-114. CM_DIV_M5_DPLL_CORE Register	1259
8-115. CM_CLKMODE_DPLL_MPU Register	1260
8-116. CM_CLKMODE_DPLL_PER Register	1262
8-117. CM_CLKMODE_DPLL_CORE Register	1263
8-118. CM_CLKMODE_DPLL_DDR Register	1265
8-119. CM_CLKMODE_DPLL_DISP Register	1267
8-120. CM_CLKSEL_DPLL_PERIPH Register	1269
8-121. CM_DIV_M2_DPLL_DDR Register	1270
8-122. CM_DIV_M2_DPLL_DISP Register	1271
8-123. CM_DIV_M2_DPLL_MPU Register	1272
8-124. CM_DIV_M2_DPLL_PER Register	1273
8-125. CM_WKUP_WKUP_M3_CLKCTRL Register	1274
8-126. CM_WKUP_UART0_CLKCTRL Register	1275
8-127. CM_WKUP_I2C0_CLKCTRL Register	1276
8-128. CM_WKUP_ADC_TSC_CLKCTRL Register	1277
8-129. CM_WKUP_SMARTREFLEX0_CLKCTRL Register	1278
8-130. CM_WKUP_TIMER1_CLKCTRL Register	1279
8-131. CM_WKUP_SMARTREFLEX1_CLKCTRL Register	1280
8-132. CM_L4_WKUP_AON_CLKSTCTRL Register	1281
8-133. CM_WKUP_WDT1_CLKCTRL Register	1282
8-134. CM_DIV_M6_DPLL_CORE Register	1283
8-135. CLKSEL_TIMER7_CLK Register	1285
8-136. CLKSEL_TIMER2_CLK Register	1286
8-137. CLKSEL_TIMER3_CLK Register	1287
8-138. CLKSEL_TIMER4_CLK Register	1288
8-139. CM_MAC_CLKSEL Register	1289
8-140. CLKSEL_TIMER5_CLK Register	1290
8-141. CLKSEL_TIMER6_CLK Register	1291
8-142. CM_CPTS_RFT_CLKSEL Register	1292
8-143. CLKSEL_TIMER1MS_CLK Register	1293
8-144. CLKSEL_GFX_FCLK Register	1294
8-145. CLKSEL_PRU_ICSS_OCP_CLK Register	1295
8-146. CLKSEL_LCDC_PIXEL_CLK Register	1296
8-147. CLKSEL_WDT1_CLK Register	1297
8-148. CLKSEL_GPIO0_DBCLK Register	1298
8-149. CM_MPU_CLKSTCTRL Register	1299

8-150. CM_MPU_MPU_CLKCTRL Register	1300
8-151. CM_CLKOUT_CTRL Register	1302
8-152. CM_RTC_RTC_CLKCTRL Register	1304
8-153. CM_RTC_CLKSTCTRL Register	1305
8-154. CM_GFX_L3_CLKSTCTRL Register	1307
8-155. CM_GFX_GFX_CLKCTRL Register	1308
8-156. CM_GFX_L4LS_GFX_CLKSTCTRL Register.....	1309
8-157. CM_GFX_MMUCFG_CLKCTRL Register	1310
8-158. CM_GFX_MMUDATA_CLKCTRL Register.....	1311
8-159. CM_CEFUSE_CLKSTCTRL Register	1313
8-160. CM_CEFUSE_CEFUSE_CLKCTRL Register	1314
8-161. REVISION_PRM Register.....	1316
8-162. PRM_IRQSTATUS_MPU Register	1317
8-163. PRM_IRQENABLE_MPU Register	1318
8-164. PRM_IRQSTATUS_M3 Register	1319
8-165. PRM_IRQENABLE_M3 Register	1320
8-166. RM_PER_RSTCTRL Register	1322
8-167. PM_PER_PWRSTST Register	1323
8-168. PM_PER_PWRSTCTRL Register.....	1324
8-169. RM_WKUP_RSTCTRL Register	1326
8-170. PM_WKUP_PWRSTCTRL Register	1327
8-171. PM_WKUP_PWRSTST Register.....	1328
8-172. RM_WKUP_RSTST Register.....	1329
8-173. PM_MPU_PWRSTCTRL Register	1331
8-174. PM_MPU_PWRSTST Register.....	1333
8-175. RM_MPU_RSTST Register	1334
8-176. PRM_RSTCTRL Register	1336
8-177. PRM_RSTTIME Register.....	1337
8-178. PRM_RSTST Register.....	1338
8-179. PRM_SRAM_COUNT Register.....	1339
8-180. PRM_LDO_SRAM_CORE_SETUP Register.....	1340
8-181. PRM_LDO_SRAM_CORE_CTRL Register.....	1342
8-182. PRM_LDO_SRAM_MPU_SETUP Register.....	1343
8-183. PRM_LDO_SRAM_MPU_CTRL Register.....	1345
8-184. PM_RTC_PWRSTCTRL Register.....	1346
8-185. PM_RTC_PWRSTST Register	1347
8-186. PM_GFX_PWRSTCTRL Register.....	1349
8-187. RM_GFX_RSTCTRL Register.....	1350
8-188. PM_GFX_PWRSTST Register	1351
8-189. RM_GFX_RSTST Register	1352
8-190. PM_CEFUSE_PWRSTCTRL Register	1353
8-191. PM_CEFUSE_PWRSTST Register.....	1354
9-1. USB Charger Detection	1360
9-2. control_revision Register	1370
9-3. control_hwinfo Register.....	1371
9-4. control_sysconfig Register	1372
9-5. control_status Register	1373
9-6. control_emif_sdram_config Register.....	1374
9-7. core_slido_ctrl Register	1376

9-8.	mpu_sldo_ctrl Register	1377
9-9.	clk32kdivratio_ctrl Register	1378
9-10.	bandgap_ctrl Register	1379
9-11.	bandgap_trim Register	1380
9-12.	pll_clkinpulow_ctrl Register	1381
9-13.	mosc_ctrl Register	1382
9-14.	deepsleep_ctrl Register	1383
9-15.	dppll_pwr_sw_status Register	1384
9-16.	device_id Register.....	1385
9-17.	dev_feature Register.....	1386
9-18.	init_priority_0 Register.....	1387
9-19.	init_priority_1 Register.....	1388
9-20.	tptc_cfg Register	1389
9-21.	usb_ctrl0 Register	1390
9-22.	usb_sts0 Register	1392
9-23.	usb_ctrl1 Register	1393
9-24.	usb_sts1 Register	1395
9-25.	mac_id0_lo Register	1396
9-26.	mac_id0_hi Register	1397
9-27.	mac_id1_lo Register	1398
9-28.	mac_id1_hi Register	1399
9-29.	dcan_raminit Register	1400
9-30.	usb_wkup_ctrl Register.....	1401
9-31.	gmii_sel Register	1402
9-32.	pwmss_ctrl Register	1403
9-33.	mreqprio_0 Register	1404
9-34.	mreqprio_1 Register	1405
9-35.	hw_event_sel_grp1 Register.....	1406
9-36.	hw_event_sel_grp2 Register.....	1407
9-37.	hw_event_sel_grp3 Register.....	1408
9-38.	hw_event_sel_grp4 Register.....	1409
9-39.	smrt_ctrl Register.....	1410
9-40.	mpuss_hw_debug_sel Register	1411
9-41.	mpuss_hw_dbg_info Register	1412
9-42.	vdd_mpu_opp_050 Register.....	1413
9-43.	vdd_mpu_opp_100 Register.....	1414
9-44.	vdd_mpu_opp_120 Register.....	1415
9-45.	vdd_mpu_opp_turbo Register	1416
9-46.	vdd_core_opp_050 Register.....	1417
9-47.	vdd_core_opp_100 Register.....	1418
9-48.	bb_scale Register	1419
9-49.	usb_vid_pid Register.....	1420
9-50.	efuse_sma Register.....	1421
9-51.	conf_<module>_<pin> Register	1422
9-52.	cqdetect_status Register	1423
9-53.	ddr_io_ctrl Register	1424
9-54.	vtp_ctrl Register	1425
9-55.	vref_ctrl Register	1426
9-56.	tpcc_evt_mux_0_3 Register	1427

9-57.	tpcc_evt_mux_4_7 Register	1428
9-58.	tpcc_evt_mux_8_11 Register.....	1429
9-59.	tpcc_evt_mux_12_15 Register	1430
9-60.	tpcc_evt_mux_16_19 Register	1431
9-61.	tpcc_evt_mux_20_23 Register	1432
9-62.	tpcc_evt_mux_24_27 Register	1433
9-63.	tpcc_evt_mux_28_31 Register	1434
9-64.	tpcc_evt_mux_32_35 Register	1435
9-65.	tpcc_evt_mux_36_39 Register	1436
9-66.	tpcc_evt_mux_40_43 Register	1437
9-67.	tpcc_evt_mux_44_47 Register	1438
9-68.	tpcc_evt_mux_48_51 Register	1439
9-69.	tpcc_evt_mux_52_55 Register	1440
9-70.	tpcc_evt_mux_56_59 Register	1441
9-71.	tpcc_evt_mux_60_63 Register	1442
9-72.	timer_evt_capt Register	1443
9-73.	ecap_evt_capt Register	1444
9-74.	adc_evt_capt Register.....	1445
9-75.	reset_iso Register	1446
9-76.	dppll_pwr_sw_ctrl Register	1447
9-77.	ddr_cke_ctrl Register	1449
9-78.	sma2 Register	1450
9-79.	m3_txev_eoi Register.....	1451
9-80.	ipc_msg_reg0 Register	1452
9-81.	ipc_msg_reg1 Register	1453
9-82.	ipc_msg_reg2 Register	1454
9-83.	ipc_msg_reg3 Register	1455
9-84.	ipc_msg_reg4 Register	1456
9-85.	ipc_msg_reg5 Register	1457
9-86.	ipc_msg_reg6 Register	1458
9-87.	ipc_msg_reg7 Register	1459
9-88.	ddr_cmd0_ioctrl Register.....	1460
9-89.	ddr_cmd1_ioctrl Register.....	1462
9-90.	ddr_cmd2_ioctrl Register.....	1463
9-91.	ddr_data0_ioctrl Register.....	1464
9-92.	ddr_data1_ioctrl Register.....	1466
10-1.	L3 Topology	1470
10-2.	L4 Topology	1472
11-1.	EDMA3 Controller Block Diagram.....	1474
11-2.	TPCC Integration	1477
11-3.	TPTC Integration	1478
11-4.	EDMA3 Channel Controller (EDMA3CC) Block Diagram	1481
11-5.	EDMA3 Transfer Controller (EDMA3TC) Block Diagram	1482
11-6.	Definition of ACNT, BCNT, and CCNT	1483
11-7.	A-Synchronized Transfers (ACNT = n, BCNT = 4, CCNT = 3).....	1484
11-8.	AB-Synchronized Transfers (ACNT = n, BCNT = 4, CCNT = 3).....	1485
11-9.	PaRAM Set.....	1487
11-10.	Channel Options Parameter (OPT)	1489
11-11.	Linked Transfer	1496

11-12. Link-to-Self Transfer	1497
11-13. DMA Channel and QDMA Channel to PaRAM Mapping.....	1502
11-14. QDMA Channel to PaRAM Mapping	1503
11-15. Shadow Region Registers	1504
11-16. Interrupt Diagram.....	1508
11-17. Error Interrupt Operation	1511
11-18. PaRAM Set Content for Proxy Memory Protection Example	1515
11-19. Channel Options Parameter (OPT) Example.....	1515
11-20. Proxy Memory Protection Example	1516
11-21. EDMA3 Prioritization.....	1523
11-22. Block Move Example	1524
11-23. Block Move Example PaRAM Configuration.....	1524
11-24. Subframe Extraction Example	1525
11-25. Subframe Extraction Example PaRAM Configuration	1525
11-26. Data Sorting Example	1526
11-27. Data Sorting Example PaRAM Configuration	1527
11-28. Servicing Incoming McASP Data Example	1528
11-29. Servicing Incoming McASP Data Example PaRAM Configuration	1528
11-30. Servicing Peripheral Burst Example	1529
11-31. Servicing Peripheral Burst Example PaRAM Configuration	1530
11-32. Servicing Continuous McASP Data Example.....	1531
11-33. Servicing Continuous McASP Data Example PaRAM Configuration.....	1532
11-34. Servicing Continuous McASP Data Example Reload PaRAM Configuration	1532
11-35. Ping-Pong Buffering for McASP Data Example	1535
11-36. Ping-Pong Buffering for McASP Example PaRAM Configuration.....	1535
11-37. Ping-Pong Buffering for McASP Example Pong PaRAM Configuration	1536
11-38. Ping-Pong Buffering for McASP Example Ping PaRAM Configuration	1537
11-39. Intermediate Transfer Completion Chaining Example.....	1538
11-40. Single Large Block Transfer Example	1539
11-41. Smaller Packet Data Transfers Example.....	1539
11-42. PID Register	1546
11-43. CCCFG Register	1547
11-44. SYSCONFIG Register	1549
11-45. DCHMAP_0 to DCHMAP_63 Register	1550
11-46. QCHMAP_0 to QCHMAP_7 Register	1551
11-47. DMAQNUM_0 to DMAQNUM_7 Register.....	1552
11-48. QDMAQNUM Register.....	1557
11-49. QUEPRI Register.....	1560
11-50. EMR Register	1561
11-51. EMRH Register	1562
11-52. EMCR Register	1563
11-53. EMCRH Register	1564
11-54. QEMR Register	1565
11-55. QEMCR Register	1566
11-56. CCERR Register	1567
11-57. CCERRCLR Register	1568
11-58. EEVAL Register	1569
11-59. DRAE0 Register	1570
11-60. DRAEH0 Register	1571

11-61. DRAE1 Register	1572
11-62. DRAEH1 Register	1573
11-63. DRAE2 Register	1574
11-64. DRAEH2 Register	1575
11-65. DRAE3 Register	1576
11-66. DRAEH3 Register	1577
11-67. DRAE4 Register	1578
11-68. DRAEH4 Register	1579
11-69. DRAE5 Register	1580
11-70. DRAEH5 Register	1581
11-71. DRAE6 Register	1582
11-72. DRAEH6 Register	1583
11-73. DRAE7 Register	1584
11-74. DRAEH7 Register	1585
11-75. QRAE_0 to QRAE_7 Register	1586
11-76. Q0E0 Register	1587
11-77. Q0E1 Register	1588
11-78. Q0E2 Register	1589
11-79. Q0E3 Register	1590
11-80. Q0E4 Register	1591
11-81. Q0E5 Register	1592
11-82. Q0E6 Register	1593
11-83. Q0E7 Register	1594
11-84. Q0E8 Register	1595
11-85. Q0E9 Register	1596
11-86. Q0E10 Register.....	1597
11-87. Q0E11 Register.....	1598
11-88. Q0E12 Register.....	1599
11-89. Q0E13 Register.....	1600
11-90. Q0E14 Register.....	1601
11-91. Q0E15 Register.....	1602
11-92. Q1E0 Register	1603
11-93. Q1E1 Register	1604
11-94. Q1E2 Register	1605
11-95. Q1E3 Register	1606
11-96. Q1E4 Register	1607
11-97. Q1E5 Register	1608
11-98. Q1E6 Register	1609
11-99. Q1E7 Register	1610
11-100. Q1E8 Register.....	1611
11-101. Q1E9 Register.....	1612
11-102. Q1E10 Register	1613
11-103. Q1E11 Register	1614
11-104. Q1E12 Register	1615
11-105. Q1E13 Register	1616
11-106. Q1E14 Register	1617
11-107. Q1E15 Register	1618
11-108. Q2E0 Register.....	1619
11-109. Q2E1 Register.....	1620

11-110. Q2E2 Register.....	1621
11-111. Q2E3 Register.....	1622
11-112. Q2E4 Register.....	1623
11-113. Q2E5 Register.....	1624
11-114. Q2E6 Register.....	1625
11-115. Q2E7 Register.....	1626
11-116. Q2E8 Register.....	1627
11-117. Q2E9 Register.....	1628
11-118. Q2E10 Register	1629
11-119. Q2E11 Register	1630
11-120. Q2E12 Register	1631
11-121. Q2E13 Register	1632
11-122. Q2E14 Register	1633
11-123. Q2E15 Register	1634
11-124. QSTAT_0 to QSTAT_2 Register.....	1635
11-125. QWMTHRA Register	1636
11-126. CCSTAT Register.....	1637
11-127. MPFAR Register	1639
11-128. MPFSR Register	1640
11-129. MPFCR Register	1641
11-130. MPPAG Register.....	1642
11-131. MPPA_0 to MPPA_7 Register	1643
11-132. ER Register.....	1644
11-133. ERH Register.....	1645
11-134. ECR Register	1646
11-135. ECRH Register	1647
11-136. ESR Register	1648
11-137. ESRH Register	1649
11-138. CER Register	1650
11-139. CERH Register	1651
11-140. EER Register	1652
11-141. EERH Register	1653
11-142. EECR Register	1654
11-143. EECRH Register	1655
11-144. EESR Register	1656
11-145. EESRH Register	1657
11-146. SER Register	1658
11-147. SERH Register	1659
11-148. SECR Register	1660
11-149. SECRH Register	1661
11-150. IER Register	1662
11-151. IERH Register	1663
11-152. IECR Register	1664
11-153. IECRH Register	1665
11-154. IESR Register	1666
11-155. IESRH Register	1667
11-156. IPR Register	1668
11-157. IPRH Register	1669
11-158. ICR Register.....	1670

11-159. ICRH Register	1671
11-160. IEVAL Register	1672
11-161. QER Register	1673
11-162. QEER Register	1674
11-163. QEECR Register	1675
11-164. QEESR Register	1676
11-165. QSER Register	1677
11-166. QSECR Register	1678
11-167. PID Register	1680
11-168. TCCFG Register	1681
11-169. SYSCONFIG Register.....	1682
11-170. TCSTAT Register	1683
11-171. ERRSTAT Register	1685
11-172. ERREN Register	1686
11-173. ERRCLR Register	1687
11-174. ERRDET Register	1688
11-175. ERRCMD Register.....	1689
11-176. RDRATE Register	1690
11-177. SAOPT Register	1691
11-178. SASRC Register	1693
11-179. SACNT Register	1694
11-180. SADST Register.....	1695
11-181. SABIDX Register.....	1696
11-182. SAMPPRXY Register.....	1697
11-183. SACNTRLD Register	1698
11-184. SASRCBREF Register	1699
11-185. SADSTBREF Register	1700
11-186. DFCNTRLD Register	1701
11-187. DFSRCBREF Register	1702
11-188. DFDSTBREF Register	1703
11-189. DFOPT0 Register	1704
11-190. DFSRC0 Register	1706
11-191. DFCNT0 Register	1707
11-192. DFDST0 Register	1708
11-193. DFBIDX0 Register	1709
11-194. DFMPPRXY0 Register	1710
11-195. DFOPT1 Register	1711
11-196. DFSRC1 Register.....	1713
11-197. DFCNT1 Register	1714
11-198. DFDST1 Register	1715
11-199. DFBIDX1 Register	1716
11-200. DFMPPRXY1 Register	1717
11-201. DFOPT2 Register	1718
11-202. DFSRC2 Register	1720
11-203. DFCNT2 Register	1721
11-204. DFDST2 Register	1722
11-205. DFBIDX2 Register	1723
11-206. DFMPPRXY2 Register	1724
11-207. DFOPT3 Register	1725

11-208. DFSRC3 Register	1727
11-209. DFCNT3 Register	1728
11-210. DFDST3 Register	1729
11-211. DFBIDX3 Register	1730
11-212. DFMPPRXY3 Register	1731
12-1. TSC_ADC Integration.....	1738
12-2. Functional Block Diagram	1742
12-3. Sequencer FSM	1745
12-4. Example Timing Diagram for Sequencer.....	1746
12-5. REVISION Register	1749
12-6. SYSCONFIG Register	1750
12-7. IRQSTATUS_RAW Register.....	1751
12-8. IRQSTATUS Register	1753
12-9. IRQENABLE_SET Register.....	1755
12-10. IRQENABLE_CLR Register.....	1757
12-11. IRQWAKEUP Register	1759
12-12. DMAENABLE_SET Register.....	1760
12-13. DMAENABLE_CLR Register	1761
12-14. CTRL Register	1762
12-15. ADCSTAT Register	1763
12-16. ADCRANGE Register.....	1764
12-17. ADC_CLKDIV Register	1765
12-18. ADC_MISC Register	1766
12-19. STEPENABLE Register	1767
12-20. IDLECONFIG Register	1768
12-21. TS_CHARGE_STEPCONFIG Register	1770
12-22. TS_CHARGE_DELAY Register	1772
12-23. STEPCONFIG1 Register	1773
12-24. STEPDELAY1 Register.....	1775
12-25. STEPCONFIG2 Register	1776
12-26. STEPDELAY2 Register.....	1778
12-27. STEPCONFIG3 Register	1779
12-28. STEPDELAY3 Register.....	1781
12-29. STEPCONFIG4 Register	1782
12-30. STEPDELAY4 Register.....	1784
12-31. STEPCONFIG5 Register	1785
12-32. STEPDELAY5 Register.....	1787
12-33. STEPCONFIG6 Register	1788
12-34. STEPDELAY6 Register.....	1790
12-35. STEPCONFIG7 Register	1791
12-36. STEPDELAY7 Register.....	1793
12-37. STEPCONFIG8 Register	1794
12-38. STEPDELAY8 Register.....	1796
12-39. STEPCONFIG9 Register	1797
12-40. STEPDELAY9 Register.....	1799
12-41. STEPCONFIG10 Register	1800
12-42. STEPDELAY10 Register	1802
12-43. STEPCONFIG11 Register	1803
12-44. STEPDELAY11 Register	1805

12-45. STEPCONFIG12 Register	1806
12-46. STEPDELAY12 Register	1808
12-47. STEPCONFIG13 Register	1809
12-48. STEPDELAY13 Register	1811
12-49. STEPCONFIG14 Register	1812
12-50. STEPDELAY14 Register	1814
12-51. STEPCONFIG15 Register	1815
12-52. STEPDELAY15 Register	1817
12-53. STEPCONFIG16 Register	1818
12-54. STEPDELAY16 Register	1820
12-55. FIFO0COUNT Register.....	1821
12-56. FIFO0THRESHOLD Register.....	1822
12-57. DMA0REQ Register.....	1823
12-58. FIFO1COUNT Register.....	1824
12-59. FIFO1THRESHOLD Register.....	1825
12-60. DMA1REQ Register.....	1826
12-61. FIFO0DATA Register	1827
12-62. FIFO1DATA Register	1828
13-1. LCD Controller	1830
13-2. LCD Controller Integration	1832
13-3. Input and Output Clocks.....	1834
13-4. Logical Data Path for Raster Controller	1841
13-5. Frame Buffer Structure	1842
13-6. 16-Entry Palette/Buffer Format (1, 2, 4, 12, 16 BPP).....	1844
13-7. 256-Entry Palette/Buffer Format (8 BPP)	1845
13-8. 16-BPP Data Memory Organization (TFT Mode Only)—Little Endian	1845
13-9. 12-BPP Data Memory Organization—Little Endian.....	1846
13-10. 8-BPP Data Memory Organization	1846
13-11. 4-BPP Data Memory Organization	1846
13-12. 2-BPP Data Memory Organization	1847
13-13. 1-BPP Data Memory Organization	1847
13-14. Monochrome and Color Output.....	1849
13-15. Example of Subpicture.....	1850
13-16. Subpicture HOLS Bit.....	1850
13-17. Raster Mode Display Format	1851
13-18. Palette Lookup Examples	1859
13-19. PID Register	1863
13-20. CTRL Register.....	1864
13-21. LIDD_CTRL Register	1865
13-22. LIDD_CS0_CONF Register	1867
13-23. LIDD_CS0_ADDR Register	1868
13-24. LIDD_CS0_DATA Register	1869
13-25. LIDD_CS1_CONF Register	1870
13-26. LIDD_CS1_ADDR Register	1871
13-27. LIDD_CS1_DATA Register	1872
13-28. RASTER_CTRL Register	1873
13-29. RASTER_TIMING_0 Register	1876
13-30. RASTER_TIMING_1 Register	1877
13-31. RASTER_TIMING_2 Register	1878

13-32. RASTER_SUBPANEL Register	1880
13-33. RASTER_SUBPANEL2 Register	1881
13-34. LCDDMA_CTRL Register	1882
13-35. LCDDMA_FB0_BASE Register	1884
13-36. LCDDMA_FB0_CEILING Register	1885
13-37. LCDDMA_FB1_BASE Register	1886
13-38. LCDDMA_FB1_CEILING Register	1887
13-39. SYSCONFIG Register	1888
13-40. IRQSTATUS_RAW Register	1889
13-41. IRQSTATUS Register	1891
13-42. IRQENABLE_SET Register	1893
13-43. IRQENABLE_CLEAR Register	1895
13-44. CLKC_ENABLE Register	1897
13-45. CLKC_RESET Register	1898
14-1. Ethernet Switch Integration	1902
14-2. Ethernet Switch RMIIClock Detail	1906
14-3. MII Interface Connections	1907
14-4. RMIIClock Interface Connections	1909
14-5. RGMII Interface Connections	1910
14-6. CPSW_3G Block Diagram	1918
14-7. Tx Buffer Descriptor Format	1923
14-8. Rx Buffer Descriptor Format	1926
14-9. VLAN Header Encapsulation Word	1930
14-10. CPTS Block Diagram	1964
14-11. Event FIFO Misalignment Condition	1966
14-12. HW1/4_TSP_PUSH Connection	1967
14-13. Port TX State RAM Entry	1973
14-14. Port RX DMA State	1974
14-15. IDVER Register	1978
14-16. CONTROL Register	1979
14-17. PRESCALE Register	1981
14-18. UNKNOWN_VLAN Register	1982
14-19. TBLCTL Register	1983
14-20. TBLW2 Register	1984
14-21. TBLW1 Register	1985
14-22. TBLW0 Register	1986
14-23. PORTCTL0 Register	1987
14-24. PORTCTL1 Register	1988
14-25. PORTCTL2 Register	1989
14-26. PORTCTL3 Register	1990
14-27. PORTCTL4 Register	1991
14-28. PORTCTL5 Register	1992
14-29. TX_IDVER Register	1995
14-30. TX_CONTROL Register	1996
14-31. TX_TEARDOWN Register	1997
14-32. RX_IDVER Register	1998
14-33. RX_CONTROL Register	1999
14-34. RX_TEARDOWN Register	2000
14-35. CPDMA_SOFT_RESET Register	2001

14-36. DMACONTROL Register	2002
14-37. DMASSTATUS Register	2004
14-38. RX_BUFFER_OFFSET Register	2006
14-39. EMCONTROL Register	2007
14-40. TX_PRI0_RATE Register	2008
14-41. TX_PRI1_RATE Register	2009
14-42. TX_PRI2_RATE Register	2010
14-43. TX_PRI3_RATE Register	2011
14-44. TX_PRI4_RATE Register	2012
14-45. TX_PRI5_RATE Register	2013
14-46. TX_PRI6_RATE Register	2014
14-47. TX_PRI7_RATE Register	2015
14-48. TX_INTSTAT_RAW Register	2016
14-49. TX_INTSTAT_MASKED Register	2017
14-50. TX_INTMASK_SET Register	2018
14-51. TX_INTMASK_CLEAR Register	2019
14-52. CPDMA_IN_VECTOR Register	2020
14-53. CPDMA_EOI_VECTOR Register	2021
14-54. RX_INTSTAT_RAW Register	2022
14-55. RX_INTSTAT_MASKED Register	2023
14-56. RX_INTMASK_SET Register	2024
14-57. RX_INTMASK_CLEAR Register	2026
14-58. DMA_INTSTAT_RAW Register	2028
14-59. DMA_INTSTAT_MASKED Register	2029
14-60. DMA_INTMASK_SET Register	2030
14-61. DMA_INTMASK_CLEAR Register	2031
14-62. RX0_PENDTHRESH Register	2032
14-63. RX1_PENDTHRESH Register	2033
14-64. RX2_PENDTHRESH Register	2034
14-65. RX3_PENDTHRESH Register	2035
14-66. RX4_PENDTHRESH Register	2036
14-67. RX5_PENDTHRESH Register	2037
14-68. RX6_PENDTHRESH Register	2038
14-69. RX7_PENDTHRESH Register	2039
14-70. RX0_FREEBUFFER Register	2040
14-71. RX1_FREEBUFFER Register	2041
14-72. RX2_FREEBUFFER Register	2042
14-73. RX3_FREEBUFFER Register	2043
14-74. RX4_FREEBUFFER Register	2044
14-75. RX5_FREEBUFFER Register	2045
14-76. RX6_FREEBUFFER Register	2046
14-77. RX7_FREEBUFFER Register	2047
14-78. CPTS_IDVER Register	2049
14-79. CPTS_CONTROL Register	2050
14-80. CPTS_TS_PUSH Register	2051
14-81. CPTS_TS_LOAD_VAL Register	2052
14-82. CPTS_TS_LOAD_EN Register	2053
14-83. CPTS_INTSTAT_RAW Register	2054
14-84. CPTS_INTSTAT_MASKED Register	2055

14-85. CPTS_INT_ENABLE Register	2056
14-86. CPTS_EVENT_POP Register	2057
14-87. CPTS_EVENT_LOW Register	2058
14-88. CPTS_EVENT_HIGH Register	2059
14-89. TX0_HDP Register	2063
14-90. TX1_HDP Register	2064
14-91. TX2_HDP Register	2065
14-92. TX3_HDP Register	2066
14-93. TX4_HDP Register	2067
14-94. TX5_HDP Register	2068
14-95. TX6_HDP Register	2069
14-96. TX7_HDP Register	2070
14-97. RX0_HDP Register	2071
14-98. RX1_HDP Register	2072
14-99. RX2_HDP Register	2073
14-100. RX3_HDP Register	2074
14-101. RX4_HDP Register	2075
14-102. RX5_HDP Register	2076
14-103. RX6_HDP Register	2077
14-104. RX7_HDP Register	2078
14-105. TX0_CP Register	2079
14-106. TX1_CP Register	2080
14-107. TX2_CP Register	2081
14-108. TX3_CP Register	2082
14-109. TX4_CP Register	2083
14-110. TX5_CP Register	2084
14-111. TX6_CP Register	2085
14-112. TX7_CP Register	2086
14-113. RX0_CP Register	2087
14-114. RX1_CP Register	2088
14-115. RX2_CP Register	2089
14-116. RX3_CP Register	2090
14-117. RX4_CP Register	2091
14-118. RX5_CP Register	2092
14-119. RX6_CP Register	2093
14-120. RX7_CP Register	2094
14-121. P0_CONTROL Register	2096
14-122. P0_MAX_BLKs Register	2097
14-123. P0_BLK_CNT Register	2098
14-124. P0_TX_IN_CTL Register	2099
14-125. P0_PORT_VLAN Register	2100
14-126. P0_TX_PRI_MAP Register	2101
14-127. P0_CPDMA_TX_PRI_MAP Register	2102
14-128. P0_CPDMA_RX_CH_MAP Register	2103
14-129. P0_RX_DSCP_PRI_MAP0 Register	2104
14-130. P0_RX_DSCP_PRI_MAP1 Register	2105
14-131. P0_RX_DSCP_PRI_MAP2 Register	2106
14-132. P0_RX_DSCP_PRI_MAP3 Register	2107
14-133. P0_RX_DSCP_PRI_MAP4 Register	2108

14-134. P0_RX_DSCP_PRI_MAP5 Register	2109
14-135. P0_RX_DSCP_PRI_MAP6 Register	2110
14-136. P0_RX_DSCP_PRI_MAP7 Register	2111
14-137. P1_CONTROL Register.....	2112
14-138. P1_MAX_BLKs Register	2114
14-139. P1_BLK_CNT Register.....	2115
14-140. P1_TX_IN_CTL Register	2116
14-141. P1_PORT_VLAN Register.....	2117
14-142. P1_TX_PRI_MAP Register	2118
14-143. P1_TS_SEQ_MTYPE Register	2119
14-144. P1_SA_LO Register	2120
14-145. P1_SA_HI Register	2121
14-146. P1_SEND_PERCENT Register	2122
14-147. P1_RX_DSCP_PRI_MAP0 Register	2123
14-148. P1_RX_DSCP_PRI_MAP1 Register	2124
14-149. P1_RX_DSCP_PRI_MAP2 Register	2125
14-150. P1_RX_DSCP_PRI_MAP3 Register	2126
14-151. P1_RX_DSCP_PRI_MAP4 Register	2127
14-152. P1_RX_DSCP_PRI_MAP5 Register	2128
14-153. P1_RX_DSCP_PRI_MAP6 Register	2129
14-154. P1_RX_DSCP_PRI_MAP7 Register	2130
14-155. P2_CONTROL Register.....	2131
14-156. P2_MAX_BLKs Register	2133
14-157. P2_BLK_CNT Register.....	2134
14-158. P2_TX_IN_CTL Register	2135
14-159. P2_PORT_VLAN Register.....	2136
14-160. P2_TX_PRI_MAP Register	2137
14-161. P2_TS_SEQ_MTYPE Register	2138
14-162. P2_SA_LO Register	2139
14-163. P2_SA_HI Register	2140
14-164. P2_SEND_PERCENT Register	2141
14-165. P2_RX_DSCP_PRI_MAP0 Register	2142
14-166. P2_RX_DSCP_PRI_MAP1 Register	2143
14-167. P2_RX_DSCP_PRI_MAP2 Register	2144
14-168. P2_RX_DSCP_PRI_MAP3 Register	2145
14-169. P2_RX_DSCP_PRI_MAP4 Register	2146
14-170. P2_RX_DSCP_PRI_MAP5 Register	2147
14-171. P2_RX_DSCP_PRI_MAP6 Register	2148
14-172. P2_RX_DSCP_PRI_MAP7 Register	2149
14-173. IDVER Register	2151
14-174. MACCONTROL Register	2152
14-175. MACSTATUS Register	2155
14-176. SOFT_RESET Register	2156
14-177. RX_MAXLEN Register	2157
14-178. BOFFTEST Register	2158
14-179. RX_PAUSE Register	2159
14-180. TX_PAUSE Register	2160
14-181. EMCONTROL Register	2161
14-182. RX_PRI_MAP Register	2162

14-183. TX_GAP Register	2163
14-184. ID_VER Register	2164
14-185. CONTROL Register	2165
14-186. SOFT_RESET Register	2166
14-187. STAT_PORT_EN Register	2167
14-188. PTYPE Register	2168
14-189. SOFT_IDLE Register	2169
14-190. THRU_RATE Register	2170
14-191. GAP_THRESH Register	2171
14-192. TX_START_WDS Register	2172
14-193. FLOW_CONTROL Register	2173
14-194. VLAN_LTYPE Register	2174
14-195. TS_LTYPE Register	2175
14-196. DLR_LTYPE Register	2176
14-197. IDVER Register	2178
14-198. SOFT_RESET Register	2179
14-199. CONTROL Register	2180
14-200. INT_CONTROL Register	2181
14-201. C0_RX_THRESH_EN Register	2182
14-202. C0_RX_EN Register.....	2183
14-203. C0_TX_EN Register	2184
14-204. C0_MISC_EN Register.....	2185
14-205. C1_RX_THRESH_EN Register	2186
14-206. C1_RX_EN Register.....	2187
14-207. C1_TX_EN Register	2188
14-208. C1_MISC_EN Register.....	2189
14-209. C2_RX_THRESH_EN Register	2190
14-210. C2_RX_EN Register.....	2191
14-211. C2_TX_EN Register	2192
14-212. C2_MISC_EN Register.....	2193
14-213. C0_RX_THRESH_STAT Register	2194
14-214. C0_RX_STAT Register	2195
14-215. C0_TX_STAT Register.....	2196
14-216. C0_MISC_STAT Register	2197
14-217. C1_RX_THRESH_STAT Register	2198
14-218. C1_RX_STAT Register	2199
14-219. C1_TX_STAT Register.....	2200
14-220. C1_MISC_STAT Register	2201
14-221. C2_RX_THRESH_STAT Register	2202
14-222. C2_RX_STAT Register	2203
14-223. C2_TX_STAT Register.....	2204
14-224. C2_MISC_STAT Register	2205
14-225. C0_RX_IMAX Register	2206
14-226. C0_TX_IMAX Register	2207
14-227. C1_RX_IMAX Register.....	2208
14-228. C1_TX_IMAX Register	2209
14-229. C2_RX_IMAX Register.....	2210
14-230. C2_TX_IMAX Register	2211
14-231. RGMII_CTL Register	2212

14-232. MDIO Version Register (MDIOVER)	2213
14-233. MDIO Control Register (MDIOCONTROL)	2214
14-234. PHY Acknowledge Status Register (MDIOALIVE)	2215
14-235. PHY Link Status Register (MDIOLINK)	2215
14-236. MDIO Link Status Change Interrupt Register (MDIOLINKINTRAW)	2216
14-237. MDIO Link Status Change Interrupt Register (Masked Value) (MDIOLINKINTMASKED)	2216
14-238. MDIO User Command Complete Interrupt Register (Raw Value) (MDIOUSERINTRAW)	2217
14-239. MDIO User Command Complete Interrupt Register (Masked Value) (MDIOUSERINTMASKED)	2217
14-240. MDIO User Command Complete Interrupt Mask Set Register (MDIOUSERINTMASKSET)	2218
14-241. MDIO User Command Complete Interrupt Mask Clear Register (MDIOUSERINTMASKCLR)	2218
14-242. MDIO User Access Register 0 (MDIOUSERACCESS0)	2219
14-243. MDIO User PHY Select Register 0 (MDIOUSERPHYSEL0)	2220
14-244. MDIO User Access Register 1 (MDIOUSERACCESS1)	2221
14-245. MDIO User PHY Select Register 1 (MDIOUSERPHYSEL1)	2222
15-1. PWMSS Integration	2226
15-2. PWMSS Synchronization	2227
15-3. IDVER Register	2229
15-4. SYSCONFIG Register	2230
15-5. CLKCONFIG Register	2231
15-6. CLKSTATUS Register	2232
15-7. Multiple ePWM Modules	2234
15-8. Submodules and Signal Connections for an ePWM Module	2235
15-9. ePWM Submodules and Critical Internal Signal Interconnects	2236
15-10. Time-Base Submodule Block Diagram	2240
15-11. Time-Base Submodule Signals and Registers	2242
15-12. Time-Base Frequency and Period	2244
15-13. Time-Base Counter Synchronization Scheme 1	2245
15-14. Time-Base Up-Count Mode Waveforms	2247
15-15. Time-Base Down-Count Mode Waveforms	2248
15-16. Time-Base Up-Down-Count Waveforms, TBCTL[PHSDIR = 0] Count Down on Synchronization Event ...	2248
15-17. Time-Base Up-Down Count Waveforms, TBCTL[PHSDIR = 1] Count Up on Synchronization Event	2249
15-18. Counter-Compare Submodule	2250
15-19. Counter-Compare Submodule Signals and Registers	2250
15-20. Counter-Compare Event Waveforms in Up-Count Mode	2253
15-21. Counter-Compare Events in Down-Count Mode	2253
15-22. Counter-Compare Events in Up-Down-Count Mode, TBCTL[PHSDIR = 0] Count Down on Synchronization Event	2254
15-23. Counter-Compare Events in Up-Down-Count Mode, TBCTL[PHSDIR = 1] Count Up on Synchronization Event	2254
15-24. Action-Qualifier Submodule	2255
15-25. Action-Qualifier Submodule Inputs and Outputs	2256
15-26. Possible Action-Qualifier Actions for EPWMxA and EPWMxB Outputs	2257
15-27. Up-Down-Count Mode Symmetrical Waveform	2260
15-28. Up, Single Edge Asymmetric Waveform, With Independent Modulation on EPWMxA and EPWMxB—Active High	2261
15-29. Up, Single Edge Asymmetric Waveform With Independent Modulation on EPWMxA and EPWMxB—Active Low	2263
15-30. Up-Count, Pulse Placement Asymmetric Waveform With Independent Modulation on EPWMxA	2265
15-31. Up-Down-Count, Dual Edge Symmetric Waveform, With Independent Modulation on EPWMxA and EPWMxB — Active Low	2267

15-32. Up-Down-Count, Dual Edge Symmetric Waveform, With Independent Modulation on EPWMxA and EPWMxB — Complementary	2269
15-33. Up-Down-Count, Dual Edge Asymmetric Waveform, With Independent Modulation on EPWMxA—Active Low	2271
15-34. Dead-Band Generator Submodule	2273
15-35. Configuration Options for the Dead-Band Generator Submodule	2274
15-36. Dead-Band Waveforms for Typical Cases (0% < Duty < 100%).....	2276
15-37. PWM-Chopper Submodule	2277
15-38. PWM-Chopper Submodule Signals and Registers	2278
15-39. Simple PWM-Chopper Submodule Waveforms Showing Chopping Action Only	2279
15-40. PWM-Chopper Submodule Waveforms Showing the First Pulse and Subsequent Sustaining Pulses	2279
15-41. PWM-Chopper Submodule Waveforms Showing the Pulse Width (Duty Cycle) Control of Sustaining Pulses.....	2280
15-42. Trip-Zone Submodule.....	2281
15-43. Trip-Zone Submodule Mode Control Logic	2284
15-44. Trip-Zone Submodule Interrupt Logic.....	2284
15-45. Event-Trigger Submodule	2285
15-46. Event-Trigger Submodule Inter-Connectivity to Interrupt Controller.....	2286
15-47. Event-Trigger Submodule Showing Event Inputs and Prescaled Outputs.....	2286
15-48. Event-Trigger Interrupt Generator.....	2288
15-49. HRPWM System Interface	2289
15-50. Resolution Calculations for Conventionally Generated PWM	2290
15-51. Operating Logic Using MEP	2291
15-52. Required PWM Waveform for a Requested Duty = 40.5%	2293
15-53. Low % Duty Cycle Range Limitation Example When PWM Frequency = 1 MHz	2295
15-54. High % Duty Cycle Range Limitation Example when PWM Frequency = 1 MHz	2295
15-55. Simplified ePWM Module.....	2297
15-56. EPWM1 Configured as a Typical Master, EPWM2 Configured as a Slave	2298
15-57. Control of Four Buck Stages. Here $F_{P_{PWM1}} \neq F_{P_{PWM2}} \neq F_{P_{PWM3}} \neq F_{P_{PWM4}}$	2299
15-58. Buck Waveforms for (Note: Only three bucks shown here)	2300
15-59. Control of Four Buck Stages. (Note: $F_{P_{PWM2}} = N \times F_{P_{PWM1}}$)	2302
15-60. Buck Waveforms for (Note: $F_{P_{PWM2}} = F_{P_{PWM1}}$).....	2303
15-61. Control of Two Half-H Bridge Stages ($F_{P_{PWM2}} = N \times F_{P_{PWM1}}$).....	2305
15-62. Half-H Bridge Waveforms for (Note: Here $F_{P_{PWM2}} = F_{P_{PWM1}}$).....	2306
15-63. Control of Dual 3-Phase Inverter Stages as Is Commonly Used in Motor Control	2308
15-64. 3-Phase Inverter Waveforms for (Only One Inverter Shown)	2309
15-65. Configuring Two PWM Modules for Phase Control.....	2312
15-66. Timing Waveforms Associated With Phase Control Between 2 Modules	2313
15-67. Control of a 3-Phase Interleaved DC/DC Converter.....	2314
15-68. 3-Phase Interleaved DC/DC Converter Waveforms for	2315
15-69. Controlling a Full-H Bridge Stage ($F_{P_{PWM2}} = F_{P_{PWM1}}$)	2318
15-70. ZVS Full-H Bridge Waveforms	2319
15-71. TBCTL Register	2322
15-72. TBSTS Register	2324
15-73. TBPHSHR Register	2325
15-74. TBPHS Register	2326
15-75. TBCNT Register	2327
15-76. TBPRD Register.....	2328
15-77. CMPCTL Register	2329
15-78. CMPAHR Register	2331

15-79. CMPA Register	2332
15-80. CMPB Register	2333
15-81. AQCTLA Register	2334
15-82. AQCTLB Register	2336
15-83. AQSFRFC Register	2338
15-84. AQCSFRFC Register	2339
15-85. DBCTL Register	2340
15-86. DBRED Register	2342
15-87. DBFED Register	2343
15-88. TZSEL Register	2344
15-89. TZCTL Register	2345
15-90. TZEINT Register	2346
15-91. TZFLG Register	2347
15-92. TZCLR Register	2348
15-93. TZFRC Register	2349
15-94. ETSEL Register	2350
15-95. ETPS Register	2351
15-96. ETFLG Register	2352
15-97. ETCLR Register	2353
15-98. ETFRC Register	2354
15-99. PCCTL Register	2355
15-100. HRCNFG Register	2356
15-101. Multiple eCAP Modules	2358
15-102. Capture and APWM Modes of Operation	2359
15-103. Capture Function Diagram	2360
15-104. Event Prescale Control	2361
15-105. Prescale Function Waveforms	2361
15-106. Continuous/One-shot Block Diagram	2362
15-107. Counter and Synchronization Block Diagram	2363
15-108. Interrupts in eCAP Module	2365
15-109. PWM Waveform Details Of APWM Mode Operation	2366
15-110. Capture Sequence for Absolute Time-Stamp, Rising Edge Detect	2368
15-111. Capture Sequence for Absolute Time-Stamp, Rising and Falling Edge Detect	2370
15-112. Capture Sequence for Delta Mode Time-Stamp, Rising Edge Detect	2372
15-113. Capture Sequence for Delta Mode Time-Stamp, Rising and Falling Edge Detect	2374
15-114. PWM Waveform Details of APWM Mode Operation	2376
15-115. Multichannel PWM Example Using 4 eCAP Modules	2378
15-116. Multiphase (channel) Interleaved PWM Example Using 3 eCAP Modules	2381
15-117. TSCTR Register	2384
15-118. CTRPHS Register	2385
15-119. CAP1 Register	2386
15-120. CAP2 Register	2387
15-121. CAP3 Register	2388
15-122. CAP4 Register	2389
15-123. ECCTL1 Register	2390
15-124. ECCTL2 Register	2392
15-125. ECEINT Register	2394
15-126. ECFLG Register	2395
15-127. ECCLR Register	2396

15-128. ECFRC Register	2397
15-129. REVID Register	2398
15-130. Optical Encoder Disk	2399
15-131. QEP Encoder Output Signal for Forward/Reverse Movement.....	2400
15-132. Index Pulse Example	2400
15-133. Functional Block Diagram of the eQEP Peripheral	2403
15-134. Functional Block Diagram of Decoder Unit.....	2404
15-135. Quadrature Decoder State Machine	2406
15-136. Quadrature-clock and Direction Decoding	2406
15-137. Position Counter Reset by Index Pulse for 1000 Line Encoder (QPOSMAX = 3999 or F9Fh).....	2408
15-138. Position Counter Underflow/Overflow (QPOSMAX = 4)	2409
15-139. Software Index Marker for 1000-line Encoder (QEPCTL[IEL] = 1).....	2411
15-140. Strobe Event Latch (QEPCTL[SEL] = 1).....	2412
15-141. eQEP Position-compare Unit	2413
15-142. eQEP Position-compare Event Generation Points	2414
15-143. eQEP Position-compare Sync Output Pulse Stretcher.....	2414
15-144. eQEP Edge Capture Unit	2416
15-145. Unit Position Event for Low Speed Measurement (QCAPCTL[UPPS] = 0010).....	2416
15-146. eQEP Edge Capture Unit - Timing Details.....	2417
15-147. eQEP Watchdog Timer.....	2418
15-148. eQEP Unit Time Base	2419
15-149. EQEP Interrupt Generation	2419
15-150. QPOSCNT Register	2421
15-151. QPOSINIT Register.....	2422
15-152. QPOSMAX Register	2423
15-153. QPOSCMP Register.....	2424
15-154. QPOSILAT Register	2425
15-155. QPOSSLAT Register	2426
15-156. QPOSLAT Register.....	2427
15-157. QUTMR Register.....	2428
15-158. QUPRD Register	2429
15-159. QWDTMR Register	2430
15-160. QWDPRD Register	2431
15-161. QDECCTL Register.....	2432
15-162. QEPCTL Register.....	2433
15-163. QCAPCTL Register	2435
15-164. QPOSCTL Register.....	2436
15-165. QEINT Register	2437
15-166. QFLG Register	2438
15-167. QCLR Register	2439
15-168. QFRC Register	2440
15-169. QEPSTS Register.....	2441
15-170. QCTMR Register.....	2442
15-171. QCPRD Register.....	2443
15-172. QCTMRLAT Register.....	2444
15-173. QCPRDLAT Register.....	2445
15-174. REVID Register	2446
16-1. USB Integration.....	2451
16-2. USB GPIO Integration	2453

16-3. CPU Actions at Transfer Phases	2461
16-4. Sequence of Transfer	2462
16-5. Flow Chart of Setup Stage of a Control Transfer in Peripheral Mode	2464
16-6. Flow Chart of Transmit Data Stage of a Control Transfer in Peripheral Mode	2465
16-7. Flow Chart of Receive Data Stage of a Control Transfer in Peripheral Mode	2466
16-8. Flow Chart of Setup Stage of a Control Transfer in Host Mode	2477
16-9. Flow Chart of Data Stage (IN Data Phase) of a Control Transfer in Host Mode	2478
16-10. Flow Chart of Data Stage (OUT Data Phase) of a Control Transfer in Host Mode	2480
16-11. Flow Chart of Status Stage of Zero Data Request or Write Request of a Control Transfer in Host Mode ..	2481
16-12. Chart of Status Stage of a Read Request of a Control Transfer in Host Mode	2483
16-13. Packet Descriptor Layout	2493
16-14. Buffer Descriptor (BD) Layout	2496
16-15. Teardown Descriptor Layout	2498
16-16. Relationship Between Memory Regions and Linking RAM	2503
16-17. High-level Transmit and Receive Data Transfer Example	2508
16-18. Transmit Descriptors and Queue Status Configuration	2510
16-19. Transmit USB Data Flow Example (Initialization)	2511
16-20. Receive Buffer Descriptors and Queue Status Configuration	2513
16-21. Receive USB Data Flow Example (Initialization)	2514
16-22. REVREG Register	2520
16-23. SYSCONFIG Register	2521
16-24. IRQSTATRAW Register	2522
16-25. IRQSTAT Register	2523
16-26. IRQENABLER Register	2524
16-27. IRQCLEARRR Register	2525
16-28. IRQDMATHOLDTX00 Register	2526
16-29. IRQDMATHOLDTX01 Register	2527
16-30. IRQDMATHOLDTX02 Register	2528
16-31. IRQDMATHOLDTX03 Register	2529
16-32. IRQDMATHOLDRX00 Register	2530
16-33. IRQDMATHOLDRX01 Register	2531
16-34. IRQDMATHOLDRX02 Register	2532
16-35. IRQDMATHOLDRX03 Register	2533
16-36. IRQDMATHOLDTX10 Register	2534
16-37. IRQDMATHOLDTX11 Register	2535
16-38. IRQDMATHOLDTX12 Register	2536
16-39. IRQDMATHOLDTX13 Register	2537
16-40. IRQDMATHOLDRX10 Register	2538
16-41. IRQDMATHOLDRX11 Register	2539
16-42. IRQDMATHOLDRX12 Register	2540
16-43. IRQDMATHOLDRX13 Register	2541
16-44. IRQDMAENABLE0 Register	2542
16-45. IRQDMAENABLE1 Register	2544
16-46. IRQFRAMETHOLDTX00 Register	2546
16-47. IRQFRAMETHOLDTX01 Register	2547
16-48. IRQFRAMETHOLDTX02 Register	2548
16-49. IRQFRAMETHOLDTX03 Register	2549
16-50. IRQFRAMETHOLDRX00 Register	2550
16-51. IRQFRAMETHOLDRX01 Register	2551

16-52. IRQFRAMETHOLDRX02 Register	2552
16-53. IRQFRAMETHOLDRX03 Register	2553
16-54. IRQFRAMETHOLDTX10 Register	2554
16-55. IRQFRAMETHOLDTX11 Register	2555
16-56. IRQFRAMETHOLDTX12 Register	2556
16-57. IRQFRAMETHOLDTX13 Register	2557
16-58. IRQFRAMETHOLDRX10 Register	2558
16-59. IRQFRAMETHOLDRX11 Register	2559
16-60. IRQFRAMETHOLDRX12 Register	2560
16-61. IRQFRAMETHOLDRX13 Register	2561
16-62. IRQFRAMEENABLE0 Register.....	2562
16-63. IRQFRAMEENABLE1 Register.....	2563
16-64. USB0REV Register	2565
16-65. USB0CTRL Register	2566
16-66. USB0STAT Register	2568
16-67. USB0IRQMSTAT Register	2569
16-68. USB0IRQSTATRAW0 Register	2570
16-69. USB0IRQSTATRAW1 Register	2572
16-70. USB0IRQSTAT0 Register.....	2574
16-71. USB0IRQSTAT1 Register.....	2576
16-72. USB0IRQENABLESET0 Register.....	2578
16-73. USB0IRQENABLESET1 Register.....	2580
16-74. USB0IRQENABLECLR0 Register.....	2582
16-75. USB0IRQENABLECLR1 Register.....	2584
16-76. USB0TXMODE Register	2586
16-77. USB0RXMODE Register	2588
16-78. USB0GENRNDISEP1 Register.....	2592
16-79. USB0GENRNDISEP2 Register.....	2593
16-80. USB0GENRNDISEP3 Register.....	2594
16-81. USB0GENRNDISEP4 Register.....	2595
16-82. USB0GENRNDISEP5 Register.....	2596
16-83. USB0GENRNDISEP6 Register.....	2597
16-84. USB0GENRNDISEP7 Register.....	2598
16-85. USB0GENRNDISEP8 Register.....	2599
16-86. USB0GENRNDISEP9 Register.....	2600
16-87. USB0GENRNDISEP10 Register	2601
16-88. USB0GENRNDISEP11 Register	2602
16-89. USB0GENRNDISEP12 Register	2603
16-90. USB0GENRNDISEP13 Register	2604
16-91. USB0GENRNDISEP14 Register	2605
16-92. USB0GENRNDISEP15 Register	2606
16-93. USB0AUTOREQ Register.....	2607
16-94. USB0SRPFXITIME Register.....	2609
16-95. USB0_TDOWN Register	2610
16-96. USB0UTMI Register	2611
16-97. USB0MGCUTMILB Register.....	2612
16-98. USB0MODE Register.....	2613
16-99. USB1REV Register	2615
16-100. USB1CTRL Register	2616

16-101. USB1STAT Register.....	2618
16-102. USB1IRQMSTAT Register.....	2619
16-103. USB1IRQSTATRAW0 Register	2620
16-104. USB1IRQSTATRAW1 Register	2622
16-105. USB1IRQSTAT0 Register	2624
16-106. USB1IRQSTAT1 Register	2626
16-107. USB1IRQENABLESET0 Register	2628
16-108. USB1IRQENABLESET1 Register	2630
16-109. USB1IRQENABLECLR0 Register	2632
16-110. USB1IRQENABLECLR1 Register	2634
16-111. USB1TXMODE Register	2636
16-112. USB1RXMODE Register.....	2638
16-113. USB1GENRNDISEP1 Register	2640
16-114. USB1GENRNDISEP2 Register	2641
16-115. USB1GENRNDISEP3 Register	2642
16-116. USB1GENRNDISEP4 Register	2643
16-117. USB1GENRNDISEP5 Register	2644
16-118. USB1GENRNDISEP6 Register	2645
16-119. USB1GENRNDISEP7 Register	2646
16-120. USB1GENRNDISEP8 Register	2647
16-121. USB1GENRNDISEP9 Register	2648
16-122. USB1GENRNDISEP10 Register.....	2649
16-123. USB1GENRNDISEP11 Register.....	2650
16-124. USB1GENRNDISEP12 Register.....	2651
16-125. USB1GENRNDISEP13 Register.....	2652
16-126. USB1GENRNDISEP14 Register.....	2653
16-127. USB1GENRNDISEP15 Register.....	2654
16-128. USB1AUTOREQ Register	2655
16-129. USB1SRPFIXTIME Register	2657
16-130. USB1TDOWN Register	2658
16-131. USB1UTMI Register	2659
16-132. USB1UTMILB Register.....	2660
16-133. USB1MODE Register	2661
16-134. Termination_control Register.....	2663
16-135. RX_CALIB Register	2664
16-136. DLLHS_2 Register.....	2666
16-137. RX_TEST_2 Register	2667
16-138. CHRГ_DET Register.....	2668
16-139. PWR_CNTL Register.....	2670
16-140. UTMI_INTERFACE_CNTL_1 Register.....	2671
16-141. UTMI_INTERFACE_CNTL_2 Register.....	2672
16-142. BIST Register.....	2674
16-143. BIST_CRC Register	2675
16-144. CDR_BIST2 Register.....	2676
16-145. GPIO Register.....	2677
16-146. DLLHS Register	2678
16-147. USB2PHYCM_CONFIG Register.....	2680
16-148. AD_INTERFACE_REG1 Register	2681
16-149. AD_INTERFACE_REG2 Register	2683

16-150. AD_INTERFACE_REG3 Register	2685
16-151. ANA_CONFIG2 Register	2686
16-152. DMAREVID Register	2690
16-153. TDFDQ Register	2691
16-154. DMAEMU Register.....	2692
16-155. TXGCR0 Register.....	2693
16-156. RXGCR0 Register	2694
16-157. RXHPCRA0 Register.....	2696
16-158. RXHPCRB0 Register.....	2697
16-159. TXGCR1 Register.....	2698
16-160. RXGCR1 Register	2699
16-161. RXHPCRA1 Register.....	2701
16-162. RXHPCRB1 Register.....	2702
16-163. TXGCR2 Register.....	2703
16-164. RXGCR2 Register	2704
16-165. RXHPCRA2 Register.....	2706
16-166. RXHPCRB2 Register.....	2707
16-167. TXGCR3 Register.....	2708
16-168. RXGCR3 Register	2709
16-169. RXHPCRA3 Register.....	2711
16-170. RXHPCRB3 Register.....	2712
16-171. TXGCR4 Register.....	2713
16-172. RXGCR4 Register	2714
16-173. RXHPCRA4 Register.....	2716
16-174. RXHPCRB4 Register.....	2717
16-175. TXGCR5 Register.....	2718
16-176. RXGCR5 Register	2719
16-177. RXHPCRA5 Register.....	2721
16-178. RXHPCRB5 Register.....	2722
16-179. TXGCR6 Register.....	2723
16-180. RXGCR6 Register	2724
16-181. RXHPCRA6 Register.....	2726
16-182. RXHPCRB6 Register.....	2727
16-183. TXGCR7 Register.....	2728
16-184. RXGCR7 Register	2729
16-185. RXHPCRA7 Register.....	2731
16-186. RXHPCRB7 Register.....	2732
16-187. TXGCR8 Register.....	2733
16-188. RXGCR8 Register	2734
16-189. RXHPCRA8 Register.....	2736
16-190. RXHPCRB8 Register.....	2737
16-191. TXGCR9 Register.....	2738
16-192. RXGCR9 Register	2739
16-193. RXHPCRA9 Register.....	2741
16-194. RXHPCRB9 Register.....	2742
16-195. TXGCR10 Register	2743
16-196. RXGCR10 Register.....	2744
16-197. RXHPCRA10 Register	2746
16-198. RXHPCRB10 Register	2747

16-199. TXGCR11 Register	2748
16-200. RXGCR11 Register	2749
16-201. RXHPCRA11 Register	2751
16-202. RXHPCRB11 Register	2752
16-203. TXGCR12 Register	2753
16-204. RXGCR12 Register	2754
16-205. RXHPCRA12 Register	2756
16-206. RXHPCRB12 Register	2757
16-207. TXGCR13 Register	2758
16-208. RXGCR13 Register	2759
16-209. RXHPCRA13 Register	2761
16-210. RXHPCRB13 Register	2762
16-211. TXGCR14 Register	2763
16-212. RXGCR14 Register	2764
16-213. RXHPCRA14 Register	2766
16-214. RXHPCRB14 Register	2767
16-215. TXGCR15 Register	2768
16-216. RXGCR15 Register	2769
16-217. RXHPCRA15 Register	2771
16-218. RXHPCRB15 Register	2772
16-219. TXGCR16 Register	2773
16-220. RXGCR16 Register	2774
16-221. RXHPCRA16 Register	2776
16-222. RXHPCRB16 Register	2777
16-223. TXGCR17 Register	2778
16-224. RXGCR17 Register	2779
16-225. RXHPCRA17 Register	2781
16-226. RXHPCRB17 Register	2782
16-227. TXGCR18 Register	2783
16-228. RXGCR18 Register	2784
16-229. RXHPCRA18 Register	2786
16-230. RXHPCRB18 Register	2787
16-231. TXGCR19 Register	2788
16-232. RXGCR19 Register	2789
16-233. RXHPCRA19 Register	2791
16-234. RXHPCRB19 Register	2792
16-235. TXGCR20 Register	2793
16-236. RXGCR20 Register	2794
16-237. RXHPCRA20 Register	2796
16-238. RXHPCRB20 Register	2797
16-239. TXGCR21 Register	2798
16-240. RXGCR21 Register	2799
16-241. RXHPCRA21 Register	2801
16-242. RXHPCRB21 Register	2802
16-243. TXGCR22 Register	2803
16-244. RXGCR22 Register	2804
16-245. RXHPCRA22 Register	2806
16-246. RXHPCRB22 Register	2807
16-247. TXGCR23 Register	2808

16-248. RXGCR23 Register	2809
16-249. RXHPCRA23 Register	2811
16-250. RXHPCRB23 Register	2812
16-251. TXGCR24 Register	2813
16-252. RXGCR24 Register	2814
16-253. RXHPCRA24 Register	2816
16-254. RXHPCRB24 Register	2817
16-255. TXGCR25 Register	2818
16-256. RXGCR25 Register	2819
16-257. RXHPCRA25 Register	2821
16-258. RXHPCRB25 Register	2822
16-259. TXGCR26 Register	2823
16-260. RXGCR26 Register	2824
16-261. RXHPCRA26 Register	2826
16-262. RXHPCRB26 Register	2827
16-263. TXGCR27 Register	2828
16-264. RXGCR27 Register	2829
16-265. RXHPCRA27 Register	2831
16-266. RXHPCRB27 Register	2832
16-267. TXGCR28 Register	2833
16-268. RXGCR28 Register	2834
16-269. RXHPCRA28 Register	2836
16-270. RXHPCRB28 Register	2837
16-271. TXGCR29 Register	2838
16-272. RXGCR29 Register	2839
16-273. RXHPCRA29 Register	2841
16-274. RXHPCRB29 Register	2842
16-275. DMA_SCHED_CTRL Register	2843
16-276. WORD_0 to WORD_63 Register	2844
16-277. QMGRREVID Register	2870
16-278. QMGRRST Register	2871
16-279. FDBSC0 Register	2872
16-280. FDBSC1 Register	2873
16-281. FDBSC2 Register	2874
16-282. FDBSC3 Register	2875
16-283. FDBSC4 Register	2876
16-284. FDBSC5 Register	2877
16-285. FDBSC6 Register	2878
16-286. FDBSC7 Register	2879
16-287. LRAM0BASE Register	2880
16-288. LRAM0SIZE Register	2881
16-289. LRAM1BASE Register	2882
16-290. PEND0 Register	2883
16-291. PEND1 Register	2884
16-292. PEND2 Register	2885
16-293. PEND3 Register	2886
16-294. PEND4 Register	2887
16-295. QMEMRBASE0 Register	2888
16-296. QMEMCTRL0 Register	2889

16-297. QMEMRBASE1 Register	2890
16-298. QMEMCTRL1 Register.....	2891
16-299. QMEMRBASE2 Register	2892
16-300. QMEMCTRL2 Register.....	2893
16-301. QMEMRBASE3 Register	2894
16-302. QMEMCTRL3 Register.....	2895
16-303. QMEMRBASE4 Register	2896
16-304. QMEMCTRL4 Register.....	2897
16-305. QMEMRBASE5 Register	2898
16-306. QMEMCTRL5 Register.....	2899
16-307. QMEMRBASE6 Register	2900
16-308. QMEMCTRL6 Register.....	2901
16-309. QMEMRBASE7 Register	2902
16-310. QMEMCTRL7 Register.....	2903
16-311. QUEUE_0_A Register.....	2904
16-312. QUEUE_0_B Register.....	2905
16-313. QUEUE_0_C Register	2906
16-314. QUEUE_0_D Register	2907
16-315. QUEUE_1_A Register.....	2908
16-316. QUEUE_1_B Register.....	2909
16-317. QUEUE_1_C Register	2910
16-318. QUEUE_1_D Register	2911
16-319. QUEUE_2_A Register.....	2912
16-320. QUEUE_2_B Register.....	2913
16-321. QUEUE_2_C Register	2914
16-322. QUEUE_2_D Register	2915
16-323. QUEUE_3_A Register.....	2916
16-324. QUEUE_3_B Register.....	2917
16-325. QUEUE_3_C Register	2918
16-326. QUEUE_3_D Register	2919
16-327. QUEUE_4_A Register.....	2920
16-328. QUEUE_4_B Register.....	2921
16-329. QUEUE_4_C Register	2922
16-330. QUEUE_4_D Register	2923
16-331. QUEUE_5_A Register.....	2924
16-332. QUEUE_5_B Register.....	2925
16-333. QUEUE_5_C Register	2926
16-334. QUEUE_5_D Register	2927
16-335. QUEUE_6_A Register.....	2928
16-336. QUEUE_6_B Register.....	2929
16-337. QUEUE_6_C Register	2930
16-338. QUEUE_6_D Register	2931
16-339. QUEUE_7_A Register.....	2932
16-340. QUEUE_7_B Register.....	2933
16-341. QUEUE_7_C Register	2934
16-342. QUEUE_7_D Register	2935
16-343. QUEUE_8_A Register.....	2936
16-344. QUEUE_8_B Register.....	2937
16-345. QUEUE_8_C Register	2938

16-346. QUEUE_8_D Register	2939
16-347. QUEUE_9_A Register.....	2940
16-348. QUEUE_9_B Register.....	2941
16-349. QUEUE_9_C Register	2942
16-350. QUEUE_9_D Register	2943
16-351. QUEUE_10_A Register	2944
16-352. QUEUE_10_B Register	2945
16-353. QUEUE_10_C Register	2946
16-354. QUEUE_10_D Register	2947
16-355. QUEUE_11_A Register	2948
16-356. QUEUE_11_B Register	2949
16-357. QUEUE_11_C Register	2950
16-358. QUEUE_11_D Register	2951
16-359. QUEUE_12_A Register	2952
16-360. QUEUE_12_B Register	2953
16-361. QUEUE_12_C Register	2954
16-362. QUEUE_12_D Register	2955
16-363. QUEUE_13_A Register	2956
16-364. QUEUE_13_B Register	2957
16-365. QUEUE_13_C Register	2958
16-366. QUEUE_13_D Register	2959
16-367. QUEUE_14_A Register	2960
16-368. QUEUE_14_B Register	2961
16-369. QUEUE_14_C Register	2962
16-370. QUEUE_14_D Register	2963
16-371. QUEUE_15_A Register	2964
16-372. QUEUE_15_B Register	2965
16-373. QUEUE_15_C Register	2966
16-374. QUEUE_15_D Register	2967
16-375. QUEUE_16_A Register	2968
16-376. QUEUE_16_B Register	2969
16-377. QUEUE_16_C Register	2970
16-378. QUEUE_16_D Register	2971
16-379. QUEUE_17_A Register	2972
16-380. QUEUE_17_B Register	2973
16-381. QUEUE_17_C Register	2974
16-382. QUEUE_17_D Register	2975
16-383. QUEUE_18_A Register	2976
16-384. QUEUE_18_B Register	2977
16-385. QUEUE_18_C Register	2978
16-386. QUEUE_18_D Register	2979
16-387. QUEUE_19_A Register	2980
16-388. QUEUE_19_B Register	2981
16-389. QUEUE_19_C Register	2982
16-390. QUEUE_19_D Register	2983
16-391. QUEUE_20_A Register	2984
16-392. QUEUE_20_B Register	2985
16-393. QUEUE_20_C Register	2986
16-394. QUEUE_20_D Register	2987

16-395. QUEUE_21_A Register	2988
16-396. QUEUE_21_B Register	2989
16-397. QUEUE_21_C Register	2990
16-398. QUEUE_21_D Register	2991
16-399. QUEUE_22_A Register	2992
16-400. QUEUE_22_B Register	2993
16-401. QUEUE_22_C Register	2994
16-402. QUEUE_22_D Register	2995
16-403. QUEUE_23_A Register	2996
16-404. QUEUE_23_B Register	2997
16-405. QUEUE_23_C Register	2998
16-406. QUEUE_23_D Register	2999
16-407. QUEUE_24_A Register	3000
16-408. QUEUE_24_B Register	3001
16-409. QUEUE_24_C Register	3002
16-410. QUEUE_24_D Register	3003
16-411. QUEUE_25_A Register	3004
16-412. QUEUE_25_B Register	3005
16-413. QUEUE_25_C Register	3006
16-414. QUEUE_25_D Register	3007
16-415. QUEUE_26_A Register	3008
16-416. QUEUE_26_B Register	3009
16-417. QUEUE_26_C Register	3010
16-418. QUEUE_26_D Register	3011
16-419. QUEUE_27_A Register	3012
16-420. QUEUE_27_B Register	3013
16-421. QUEUE_27_C Register	3014
16-422. QUEUE_27_D Register	3015
16-423. QUEUE_28_A Register	3016
16-424. QUEUE_28_B Register	3017
16-425. QUEUE_28_C Register	3018
16-426. QUEUE_28_D Register	3019
16-427. QUEUE_29_A Register	3020
16-428. QUEUE_29_B Register	3021
16-429. QUEUE_29_C Register	3022
16-430. QUEUE_29_D Register	3023
16-431. QUEUE_30_A Register	3024
16-432. QUEUE_30_B Register	3025
16-433. QUEUE_30_C Register	3026
16-434. QUEUE_30_D Register	3027
16-435. QUEUE_31_A Register	3028
16-436. QUEUE_31_B Register	3029
16-437. QUEUE_31_C Register	3030
16-438. QUEUE_31_D Register	3031
16-439. QUEUE_32_A Register	3032
16-440. QUEUE_32_B Register	3033
16-441. QUEUE_32_C Register	3034
16-442. QUEUE_32_D Register	3035
16-443. QUEUE_33_A Register	3036

16-444. QUEUE_33_B Register	3037
16-445. QUEUE_33_C Register	3038
16-446. QUEUE_33_D Register	3039
16-447. QUEUE_34_A Register	3040
16-448. QUEUE_34_B Register	3041
16-449. QUEUE_34_C Register	3042
16-450. QUEUE_34_D Register	3043
16-451. QUEUE_35_A Register	3044
16-452. QUEUE_35_B Register	3045
16-453. QUEUE_35_C Register	3046
16-454. QUEUE_35_D Register	3047
16-455. QUEUE_36_A Register	3048
16-456. QUEUE_36_B Register	3049
16-457. QUEUE_36_C Register	3050
16-458. QUEUE_36_D Register	3051
16-459. QUEUE_37_A Register	3052
16-460. QUEUE_37_B Register	3053
16-461. QUEUE_37_C Register	3054
16-462. QUEUE_37_D Register	3055
16-463. QUEUE_38_A Register	3056
16-464. QUEUE_38_B Register	3057
16-465. QUEUE_38_C Register	3058
16-466. QUEUE_38_D Register	3059
16-467. QUEUE_39_A Register	3060
16-468. QUEUE_39_B Register	3061
16-469. QUEUE_39_C Register	3062
16-470. QUEUE_39_D Register	3063
16-471. QUEUE_40_A Register	3064
16-472. QUEUE_40_B Register	3065
16-473. QUEUE_40_C Register	3066
16-474. QUEUE_40_D Register	3067
16-475. QUEUE_41_A Register	3068
16-476. QUEUE_41_B Register	3069
16-477. QUEUE_41_C Register	3070
16-478. QUEUE_41_D Register	3071
16-479. QUEUE_42_A Register	3072
16-480. QUEUE_42_B Register	3073
16-481. QUEUE_42_C Register	3074
16-482. QUEUE_42_D Register	3075
16-483. QUEUE_43_A Register	3076
16-484. QUEUE_43_B Register	3077
16-485. QUEUE_43_C Register	3078
16-486. QUEUE_43_D Register	3079
16-487. QUEUE_44_A Register	3080
16-488. QUEUE_44_B Register	3081
16-489. QUEUE_44_C Register	3082
16-490. QUEUE_44_D Register	3083
16-491. QUEUE_45_A Register	3084
16-492. QUEUE_45_B Register	3085

16-493. QUEUE_45_C Register	3086
16-494. QUEUE_45_D Register	3087
16-495. QUEUE_46_A Register	3088
16-496. QUEUE_46_B Register	3089
16-497. QUEUE_46_C Register	3090
16-498. QUEUE_46_D Register	3091
16-499. QUEUE_47_A Register	3092
16-500. QUEUE_47_B Register	3093
16-501. QUEUE_47_C Register	3094
16-502. QUEUE_47_D Register	3095
16-503. QUEUE_48_A Register	3096
16-504. QUEUE_48_B Register	3097
16-505. QUEUE_48_C Register	3098
16-506. QUEUE_48_D Register	3099
16-507. QUEUE_49_A Register	3100
16-508. QUEUE_49_B Register	3101
16-509. QUEUE_49_C Register	3102
16-510. QUEUE_49_D Register	3103
16-511. QUEUE_50_A Register	3104
16-512. QUEUE_50_B Register	3105
16-513. QUEUE_50_C Register	3106
16-514. QUEUE_50_D Register	3107
16-515. QUEUE_51_A Register	3108
16-516. QUEUE_51_B Register	3109
16-517. QUEUE_51_C Register	3110
16-518. QUEUE_51_D Register	3111
16-519. QUEUE_52_A Register	3112
16-520. QUEUE_52_B Register	3113
16-521. QUEUE_52_C Register	3114
16-522. QUEUE_52_D Register	3115
16-523. QUEUE_53_A Register	3116
16-524. QUEUE_53_B Register	3117
16-525. QUEUE_53_C Register	3118
16-526. QUEUE_53_D Register	3119
16-527. QUEUE_54_A Register	3120
16-528. QUEUE_54_B Register	3121
16-529. QUEUE_54_C Register	3122
16-530. QUEUE_54_D Register	3123
16-531. QUEUE_55_A Register	3124
16-532. QUEUE_55_B Register	3125
16-533. QUEUE_55_C Register	3126
16-534. QUEUE_55_D Register	3127
16-535. QUEUE_56_A Register	3128
16-536. QUEUE_56_B Register	3129
16-537. QUEUE_56_C Register	3130
16-538. QUEUE_56_D Register	3131
16-539. QUEUE_57_A Register	3132
16-540. QUEUE_57_B Register	3133
16-541. QUEUE_57_C Register	3134

16-542. QUEUE_57_D Register	3135
16-543. QUEUE_58_A Register	3136
16-544. QUEUE_58_B Register	3137
16-545. QUEUE_58_C Register	3138
16-546. QUEUE_58_D Register	3139
16-547. QUEUE_59_A Register	3140
16-548. QUEUE_59_B Register	3141
16-549. QUEUE_59_C Register	3142
16-550. QUEUE_59_D Register	3143
16-551. QUEUE_60_A Register	3144
16-552. QUEUE_60_B Register	3145
16-553. QUEUE_60_C Register	3146
16-554. QUEUE_60_D Register	3147
16-555. QUEUE_61_A Register	3148
16-556. QUEUE_61_B Register	3149
16-557. QUEUE_61_C Register	3150
16-558. QUEUE_61_D Register	3151
16-559. QUEUE_62_A Register	3152
16-560. QUEUE_62_B Register	3153
16-561. QUEUE_62_C Register	3154
16-562. QUEUE_62_D Register	3155
16-563. QUEUE_63_A Register	3156
16-564. QUEUE_63_B Register	3157
16-565. QUEUE_63_C Register	3158
16-566. QUEUE_63_D Register	3159
16-567. QUEUE_64_A Register	3160
16-568. QUEUE_64_B Register	3161
16-569. QUEUE_64_C Register	3162
16-570. QUEUE_64_D Register	3163
16-571. QUEUE_65_A Register	3164
16-572. QUEUE_65_B Register	3165
16-573. QUEUE_65_C Register	3166
16-574. QUEUE_65_D Register	3167
16-575. QUEUE_66_A Register	3168
16-576. QUEUE_66_B Register	3169
16-577. QUEUE_66_C Register	3170
16-578. QUEUE_66_D Register	3171
16-579. QUEUE_67_A Register	3172
16-580. QUEUE_67_B Register	3173
16-581. QUEUE_67_C Register	3174
16-582. QUEUE_67_D Register	3175
16-583. QUEUE_68_A Register	3176
16-584. QUEUE_68_B Register	3177
16-585. QUEUE_68_C Register	3178
16-586. QUEUE_68_D Register	3179
16-587. QUEUE_69_A Register	3180
16-588. QUEUE_69_B Register	3181
16-589. QUEUE_69_C Register	3182
16-590. QUEUE_69_D Register	3183

16-591. QUEUE_70_A Register	3184
16-592. QUEUE_70_B Register	3185
16-593. QUEUE_70_C Register	3186
16-594. QUEUE_70_D Register	3187
16-595. QUEUE_71_A Register	3188
16-596. QUEUE_71_B Register	3189
16-597. QUEUE_71_C Register	3190
16-598. QUEUE_71_D Register	3191
16-599. QUEUE_72_A Register	3192
16-600. QUEUE_72_B Register	3193
16-601. QUEUE_72_C Register	3194
16-602. QUEUE_72_D Register	3195
16-603. QUEUE_73_A Register	3196
16-604. QUEUE_73_B Register	3197
16-605. QUEUE_73_C Register	3198
16-606. QUEUE_73_D Register	3199
16-607. QUEUE_74_A Register	3200
16-608. QUEUE_74_B Register	3201
16-609. QUEUE_74_C Register	3202
16-610. QUEUE_74_D Register	3203
16-611. QUEUE_75_A Register	3204
16-612. QUEUE_75_B Register	3205
16-613. QUEUE_75_C Register	3206
16-614. QUEUE_75_D Register	3207
16-615. QUEUE_76_A Register	3208
16-616. QUEUE_76_B Register	3209
16-617. QUEUE_76_C Register	3210
16-618. QUEUE_76_D Register	3211
16-619. QUEUE_77_A Register	3212
16-620. QUEUE_77_B Register	3213
16-621. QUEUE_77_C Register	3214
16-622. QUEUE_77_D Register	3215
16-623. QUEUE_78_A Register	3216
16-624. QUEUE_78_B Register	3217
16-625. QUEUE_78_C Register	3218
16-626. QUEUE_78_D Register	3219
16-627. QUEUE_79_A Register	3220
16-628. QUEUE_79_B Register	3221
16-629. QUEUE_79_C Register	3222
16-630. QUEUE_79_D Register	3223
16-631. QUEUE_80_A Register	3224
16-632. QUEUE_80_B Register	3225
16-633. QUEUE_80_C Register	3226
16-634. QUEUE_80_D Register	3227
16-635. QUEUE_81_A Register	3228
16-636. QUEUE_81_B Register	3229
16-637. QUEUE_81_C Register	3230
16-638. QUEUE_81_D Register	3231
16-639. QUEUE_82_A Register	3232

16-640. QUEUE_82_B Register	3233
16-641. QUEUE_82_C Register	3234
16-642. QUEUE_82_D Register	3235
16-643. QUEUE_83_A Register	3236
16-644. QUEUE_83_B Register	3237
16-645. QUEUE_83_C Register	3238
16-646. QUEUE_83_D Register	3239
16-647. QUEUE_84_A Register	3240
16-648. QUEUE_84_B Register	3241
16-649. QUEUE_84_C Register	3242
16-650. QUEUE_84_D Register	3243
16-651. QUEUE_85_A Register	3244
16-652. QUEUE_85_B Register	3245
16-653. QUEUE_85_C Register	3246
16-654. QUEUE_85_D Register	3247
16-655. QUEUE_86_A Register	3248
16-656. QUEUE_86_B Register	3249
16-657. QUEUE_86_C Register	3250
16-658. QUEUE_86_D Register	3251
16-659. QUEUE_87_A Register	3252
16-660. QUEUE_87_B Register	3253
16-661. QUEUE_87_C Register	3254
16-662. QUEUE_87_D Register	3255
16-663. QUEUE_88_A Register	3256
16-664. QUEUE_88_B Register	3257
16-665. QUEUE_88_C Register	3258
16-666. QUEUE_88_D Register	3259
16-667. QUEUE_89_A Register	3260
16-668. QUEUE_89_B Register	3261
16-669. QUEUE_89_C Register	3262
16-670. QUEUE_89_D Register	3263
16-671. QUEUE_90_A Register	3264
16-672. QUEUE_90_B Register	3265
16-673. QUEUE_90_C Register	3266
16-674. QUEUE_90_D Register	3267
16-675. QUEUE_91_A Register	3268
16-676. QUEUE_91_B Register	3269
16-677. QUEUE_91_C Register	3270
16-678. QUEUE_91_D Register	3271
16-679. QUEUE_92_A Register	3272
16-680. QUEUE_92_B Register	3273
16-681. QUEUE_92_C Register	3274
16-682. QUEUE_92_D Register	3275
16-683. QUEUE_93_A Register	3276
16-684. QUEUE_93_B Register	3277
16-685. QUEUE_93_C Register	3278
16-686. QUEUE_93_D Register	3279
16-687. QUEUE_94_A Register	3280
16-688. QUEUE_94_B Register	3281

16-689. QUEUE_94_C Register	3282
16-690. QUEUE_94_D Register	3283
16-691. QUEUE_95_A Register	3284
16-692. QUEUE_95_B Register	3285
16-693. QUEUE_95_C Register	3286
16-694. QUEUE_95_D Register	3287
16-695. QUEUE_96_A Register	3288
16-696. QUEUE_96_B Register	3289
16-697. QUEUE_96_C Register	3290
16-698. QUEUE_96_D Register	3291
16-699. QUEUE_97_A Register	3292
16-700. QUEUE_97_B Register	3293
16-701. QUEUE_97_C Register	3294
16-702. QUEUE_97_D Register	3295
16-703. QUEUE_98_A Register	3296
16-704. QUEUE_98_B Register	3297
16-705. QUEUE_98_C Register	3298
16-706. QUEUE_98_D Register	3299
16-707. QUEUE_99_A Register	3300
16-708. QUEUE_99_B Register	3301
16-709. QUEUE_99_C Register	3302
16-710. QUEUE_99_D Register	3303
16-711. QUEUE_100_A Register.....	3304
16-712. QUEUE_100_B Register.....	3305
16-713. QUEUE_100_C Register	3306
16-714. QUEUE_100_D Register	3307
16-715. QUEUE_101_A Register.....	3308
16-716. QUEUE_101_B Register.....	3309
16-717. QUEUE_101_C Register	3310
16-718. QUEUE_101_D Register	3311
16-719. QUEUE_102_A Register.....	3312
16-720. QUEUE_102_B Register.....	3313
16-721. QUEUE_102_C Register	3314
16-722. QUEUE_102_D Register	3315
16-723. QUEUE_103_A Register.....	3316
16-724. QUEUE_103_B Register.....	3317
16-725. QUEUE_103_C Register	3318
16-726. QUEUE_103_D Register	3319
16-727. QUEUE_104_A Register.....	3320
16-728. QUEUE_104_B Register.....	3321
16-729. QUEUE_104_C Register	3322
16-730. QUEUE_104_D Register	3323
16-731. QUEUE_105_A Register.....	3324
16-732. QUEUE_105_B Register.....	3325
16-733. QUEUE_105_C Register	3326
16-734. QUEUE_105_D Register	3327
16-735. QUEUE_106_A Register.....	3328
16-736. QUEUE_106_B Register.....	3329
16-737. QUEUE_106_C Register	3330

16-738. QUEUE_106_D Register	3331
16-739. QUEUE_107_A Register.....	3332
16-740. QUEUE_107_B Register.....	3333
16-741. QUEUE_107_C Register	3334
16-742. QUEUE_107_D Register	3335
16-743. QUEUE_108_A Register.....	3336
16-744. QUEUE_108_B Register.....	3337
16-745. QUEUE_108_C Register	3338
16-746. QUEUE_108_D Register	3339
16-747. QUEUE_109_A Register.....	3340
16-748. QUEUE_109_B Register.....	3341
16-749. QUEUE_109_C Register	3342
16-750. QUEUE_109_D Register	3343
16-751. QUEUE_110_A Register.....	3344
16-752. QUEUE_110_B Register.....	3345
16-753. QUEUE_110_C Register	3346
16-754. QUEUE_110_D Register	3347
16-755. QUEUE_111_A Register.....	3348
16-756. QUEUE_111_B Register.....	3349
16-757. QUEUE_111_C Register	3350
16-758. QUEUE_111_D Register	3351
16-759. QUEUE_112_A Register.....	3352
16-760. QUEUE_112_B Register.....	3353
16-761. QUEUE_112_C Register	3354
16-762. QUEUE_112_D Register	3355
16-763. QUEUE_113_A Register.....	3356
16-764. QUEUE_113_B Register.....	3357
16-765. QUEUE_113_C Register	3358
16-766. QUEUE_113_D Register	3359
16-767. QUEUE_114_A Register.....	3360
16-768. QUEUE_114_B Register.....	3361
16-769. QUEUE_114_C Register	3362
16-770. QUEUE_114_D Register	3363
16-771. QUEUE_115_A Register.....	3364
16-772. QUEUE_115_B Register.....	3365
16-773. QUEUE_115_C Register	3366
16-774. QUEUE_115_D Register	3367
16-775. QUEUE_116_A Register.....	3368
16-776. QUEUE_116_B Register.....	3369
16-777. QUEUE_116_C Register	3370
16-778. QUEUE_116_D Register	3371
16-779. QUEUE_117_A Register.....	3372
16-780. QUEUE_117_B Register.....	3373
16-781. QUEUE_117_C Register	3374
16-782. QUEUE_117_D Register	3375
16-783. QUEUE_118_A Register.....	3376
16-784. QUEUE_118_B Register.....	3377
16-785. QUEUE_118_C Register	3378
16-786. QUEUE_118_D Register	3379

16-787. QUEUE_119_A Register.....	3380
16-788. QUEUE_119_B Register.....	3381
16-789. QUEUE_119_C Register	3382
16-790. QUEUE_119_D Register	3383
16-791. QUEUE_120_A Register.....	3384
16-792. QUEUE_120_B Register.....	3385
16-793. QUEUE_120_C Register	3386
16-794. QUEUE_120_D Register	3387
16-795. QUEUE_121_A Register.....	3388
16-796. QUEUE_121_B Register.....	3389
16-797. QUEUE_121_C Register	3390
16-798. QUEUE_121_D Register	3391
16-799. QUEUE_122_A Register.....	3392
16-800. QUEUE_122_B Register.....	3393
16-801. QUEUE_122_C Register	3394
16-802. QUEUE_122_D Register	3395
16-803. QUEUE_123_A Register.....	3396
16-804. QUEUE_123_B Register.....	3397
16-805. QUEUE_123_C Register	3398
16-806. QUEUE_123_D Register	3399
16-807. QUEUE_124_A Register.....	3400
16-808. QUEUE_124_B Register.....	3401
16-809. QUEUE_124_C Register	3402
16-810. QUEUE_124_D Register	3403
16-811. QUEUE_125_A Register.....	3404
16-812. QUEUE_125_B Register.....	3405
16-813. QUEUE_125_C Register	3406
16-814. QUEUE_125_D Register	3407
16-815. QUEUE_126_A Register.....	3408
16-816. QUEUE_126_B Register.....	3409
16-817. QUEUE_126_C Register	3410
16-818. QUEUE_126_D Register	3411
16-819. QUEUE_127_A Register.....	3412
16-820. QUEUE_127_B Register.....	3413
16-821. QUEUE_127_C Register	3414
16-822. QUEUE_127_D Register	3415
16-823. QUEUE_128_A Register.....	3416
16-824. QUEUE_128_B Register.....	3417
16-825. QUEUE_128_C Register	3418
16-826. QUEUE_128_D Register	3419
16-827. QUEUE_129_A Register.....	3420
16-828. QUEUE_129_B Register.....	3421
16-829. QUEUE_129_C Register	3422
16-830. QUEUE_129_D Register	3423
16-831. QUEUE_130_A Register.....	3424
16-832. QUEUE_130_B Register.....	3425
16-833. QUEUE_130_C Register	3426
16-834. QUEUE_130_D Register	3427
16-835. QUEUE_131_A Register.....	3428

16-836. QUEUE_131_B Register.....	3429
16-837. QUEUE_131_C Register	3430
16-838. QUEUE_131_D Register	3431
16-839. QUEUE_132_A Register.....	3432
16-840. QUEUE_132_B Register.....	3433
16-841. QUEUE_132_C Register	3434
16-842. QUEUE_132_D Register	3435
16-843. QUEUE_133_A Register.....	3436
16-844. QUEUE_133_B Register.....	3437
16-845. QUEUE_133_C Register	3438
16-846. QUEUE_133_D Register	3439
16-847. QUEUE_134_A Register.....	3440
16-848. QUEUE_134_B Register.....	3441
16-849. QUEUE_134_C Register	3442
16-850. QUEUE_134_D Register	3443
16-851. QUEUE_135_A Register.....	3444
16-852. QUEUE_135_B Register.....	3445
16-853. QUEUE_135_C Register	3446
16-854. QUEUE_135_D Register	3447
16-855. QUEUE_136_A Register.....	3448
16-856. QUEUE_136_B Register.....	3449
16-857. QUEUE_136_C Register	3450
16-858. QUEUE_136_D Register	3451
16-859. QUEUE_137_A Register.....	3452
16-860. QUEUE_137_B Register.....	3453
16-861. QUEUE_137_C Register	3454
16-862. QUEUE_137_D Register	3455
16-863. QUEUE_138_A Register.....	3456
16-864. QUEUE_138_B Register.....	3457
16-865. QUEUE_138_C Register	3458
16-866. QUEUE_138_D Register	3459
16-867. QUEUE_139_A Register.....	3460
16-868. QUEUE_139_B Register.....	3461
16-869. QUEUE_139_C Register	3462
16-870. QUEUE_139_D Register	3463
16-871. QUEUE_140_A Register.....	3464
16-872. QUEUE_140_B Register.....	3465
16-873. QUEUE_140_C Register	3466
16-874. QUEUE_140_D Register	3467
16-875. QUEUE_141_A Register.....	3468
16-876. QUEUE_141_B Register.....	3469
16-877. QUEUE_141_C Register	3470
16-878. QUEUE_141_D Register	3471
16-879. QUEUE_142_A Register.....	3472
16-880. QUEUE_142_B Register.....	3473
16-881. QUEUE_142_C Register	3474
16-882. QUEUE_142_D Register	3475
16-883. QUEUE_143_A Register.....	3476
16-884. QUEUE_143_B Register.....	3477

16-885. QUEUE_143_C Register	3478
16-886. QUEUE_143_D Register	3479
16-887. QUEUE_144_A Register.....	3480
16-888. QUEUE_144_B Register.....	3481
16-889. QUEUE_144_C Register	3482
16-890. QUEUE_144_D Register	3483
16-891. QUEUE_145_A Register.....	3484
16-892. QUEUE_145_B Register.....	3485
16-893. QUEUE_145_C Register	3486
16-894. QUEUE_145_D Register	3487
16-895. QUEUE_146_A Register.....	3488
16-896. QUEUE_146_B Register.....	3489
16-897. QUEUE_146_C Register	3490
16-898. QUEUE_146_D Register	3491
16-899. QUEUE_147_A Register.....	3492
16-900. QUEUE_147_B Register.....	3493
16-901. QUEUE_147_C Register	3494
16-902. QUEUE_147_D Register	3495
16-903. QUEUE_148_A Register.....	3496
16-904. QUEUE_148_B Register.....	3497
16-905. QUEUE_148_C Register	3498
16-906. QUEUE_148_D Register	3499
16-907. QUEUE_149_A Register.....	3500
16-908. QUEUE_149_B Register.....	3501
16-909. QUEUE_149_C Register	3502
16-910. QUEUE_149_D Register	3503
16-911. QUEUE_150_A Register.....	3504
16-912. QUEUE_150_B Register.....	3505
16-913. QUEUE_150_C Register	3506
16-914. QUEUE_150_D Register	3507
16-915. QUEUE_151_A Register.....	3508
16-916. QUEUE_151_B Register.....	3509
16-917. QUEUE_151_C Register	3510
16-918. QUEUE_151_D Register	3511
16-919. QUEUE_152_A Register.....	3512
16-920. QUEUE_152_B Register.....	3513
16-921. QUEUE_152_C Register	3514
16-922. QUEUE_152_D Register	3515
16-923. QUEUE_153_A Register.....	3516
16-924. QUEUE_153_B Register.....	3517
16-925. QUEUE_153_C Register	3518
16-926. QUEUE_153_D Register	3519
16-927. QUEUE_154_A Register.....	3520
16-928. QUEUE_154_B Register.....	3521
16-929. QUEUE_154_C Register	3522
16-930. QUEUE_154_D Register	3523
16-931. QUEUE_155_A Register.....	3524
16-932. QUEUE_155_B Register.....	3525
16-933. QUEUE_155_C Register	3526

16-934. QUEUE_155_D Register	3527
16-935. QUEUE_0_STATUS_A Register	3528
16-936. QUEUE_0_STATUS_B Register	3529
16-937. QUEUE_0_STATUS_C Register	3530
16-938. QUEUE_1_STATUS_A Register	3531
16-939. QUEUE_1_STATUS_B Register	3532
16-940. QUEUE_1_STATUS_C Register	3533
16-941. QUEUE_2_STATUS_A Register	3534
16-942. QUEUE_2_STATUS_B Register	3535
16-943. QUEUE_2_STATUS_C Register	3536
16-944. QUEUE_3_STATUS_A Register	3537
16-945. QUEUE_3_STATUS_B Register	3538
16-946. QUEUE_3_STATUS_C Register	3539
16-947. QUEUE_4_STATUS_A Register	3540
16-948. QUEUE_4_STATUS_B Register	3541
16-949. QUEUE_4_STATUS_C Register	3542
16-950. QUEUE_5_STATUS_A Register	3543
16-951. QUEUE_5_STATUS_B Register	3544
16-952. QUEUE_5_STATUS_C Register	3545
16-953. QUEUE_6_STATUS_A Register	3546
16-954. QUEUE_6_STATUS_B Register	3547
16-955. QUEUE_6_STATUS_C Register	3548
16-956. QUEUE_7_STATUS_A Register	3549
16-957. QUEUE_7_STATUS_B Register	3550
16-958. QUEUE_7_STATUS_C Register	3551
16-959. QUEUE_8_STATUS_A Register	3552
16-960. QUEUE_8_STATUS_B Register	3553
16-961. QUEUE_8_STATUS_C Register	3554
16-962. QUEUE_9_STATUS_A Register	3555
16-963. QUEUE_9_STATUS_B Register	3556
16-964. QUEUE_9_STATUS_C Register	3557
16-965. QUEUE_10_STATUS_A Register	3558
16-966. QUEUE_10_STATUS_B Register	3559
16-967. QUEUE_10_STATUS_C Register	3560
16-968. QUEUE_11_STATUS_A Register	3561
16-969. QUEUE_11_STATUS_B Register	3562
16-970. QUEUE_11_STATUS_C Register	3563
16-971. QUEUE_12_STATUS_A Register	3564
16-972. QUEUE_12_STATUS_B Register	3565
16-973. QUEUE_12_STATUS_C Register	3566
16-974. QUEUE_13_STATUS_A Register	3567
16-975. QUEUE_13_STATUS_B Register	3568
16-976. QUEUE_13_STATUS_C Register	3569
16-977. QUEUE_14_STATUS_A Register	3570
16-978. QUEUE_14_STATUS_B Register	3571
16-979. QUEUE_14_STATUS_C Register	3572
16-980. QUEUE_15_STATUS_A Register	3573
16-981. QUEUE_15_STATUS_B Register	3574
16-982. QUEUE_15_STATUS_C Register	3575

16-983. QUEUE_16_STATUS_A Register	3576
16-984. QUEUE_16_STATUS_B Register	3577
16-985. QUEUE_16_STATUS_C Register	3578
16-986. QUEUE_17_STATUS_A Register	3579
16-987. QUEUE_17_STATUS_B Register	3580
16-988. QUEUE_17_STATUS_C Register	3581
16-989. QUEUE_18_STATUS_A Register	3582
16-990. QUEUE_18_STATUS_B Register	3583
16-991. QUEUE_18_STATUS_C Register	3584
16-992. QUEUE_19_STATUS_A Register	3585
16-993. QUEUE_19_STATUS_B Register	3586
16-994. QUEUE_19_STATUS_C Register	3587
16-995. QUEUE_20_STATUS_A Register	3588
16-996. QUEUE_20_STATUS_B Register	3589
16-997. QUEUE_20_STATUS_C Register	3590
16-998. QUEUE_21_STATUS_A Register	3591
16-999. QUEUE_21_STATUS_B Register	3592
16-1000. QUEUE_21_STATUS_C Register	3593
16-1001. QUEUE_22_STATUS_A Register	3594
16-1002. QUEUE_22_STATUS_B Register	3595
16-1003. QUEUE_22_STATUS_C Register	3596
16-1004. QUEUE_23_STATUS_A Register	3597
16-1005. QUEUE_23_STATUS_B Register	3598
16-1006. QUEUE_23_STATUS_C Register	3599
16-1007. QUEUE_24_STATUS_A Register	3600
16-1008. QUEUE_24_STATUS_B Register	3601
16-1009. QUEUE_24_STATUS_C Register	3602
16-1010. QUEUE_25_STATUS_A Register	3603
16-1011. QUEUE_25_STATUS_B Register	3604
16-1012. QUEUE_25_STATUS_C Register	3605
16-1013. QUEUE_26_STATUS_A Register	3606
16-1014. QUEUE_26_STATUS_B Register	3607
16-1015. QUEUE_26_STATUS_C Register	3608
16-1016. QUEUE_27_STATUS_A Register	3609
16-1017. QUEUE_27_STATUS_B Register	3610
16-1018. QUEUE_27_STATUS_C Register	3611
16-1019. QUEUE_28_STATUS_A Register	3612
16-1020. QUEUE_28_STATUS_B Register	3613
16-1021. QUEUE_28_STATUS_C Register	3614
16-1022. QUEUE_29_STATUS_A Register	3615
16-1023. QUEUE_29_STATUS_B Register	3616
16-1024. QUEUE_29_STATUS_C Register	3617
16-1025. QUEUE_30_STATUS_A Register	3618
16-1026. QUEUE_30_STATUS_B Register	3619
16-1027. QUEUE_30_STATUS_C Register	3620
16-1028. QUEUE_31_STATUS_A Register	3621
16-1029. QUEUE_31_STATUS_B Register	3622
16-1030. QUEUE_31_STATUS_C Register	3623
16-1031. QUEUE_32_STATUS_A Register	3624

16-1032. QUEUE_32_STATUS_B Register	3625
16-1033. QUEUE_32_STATUS_C Register	3626
16-1034. QUEUE_33_STATUS_A Register	3627
16-1035. QUEUE_33_STATUS_B Register	3628
16-1036. QUEUE_33_STATUS_C Register	3629
16-1037. QUEUE_34_STATUS_A Register	3630
16-1038. QUEUE_34_STATUS_B Register	3631
16-1039. QUEUE_34_STATUS_C Register	3632
16-1040. QUEUE_35_STATUS_A Register	3633
16-1041. QUEUE_35_STATUS_B Register	3634
16-1042. QUEUE_35_STATUS_C Register	3635
16-1043. QUEUE_36_STATUS_A Register	3636
16-1044. QUEUE_36_STATUS_B Register	3637
16-1045. QUEUE_36_STATUS_C Register	3638
16-1046. QUEUE_37_STATUS_A Register	3639
16-1047. QUEUE_37_STATUS_B Register	3640
16-1048. QUEUE_37_STATUS_C Register	3641
16-1049. QUEUE_38_STATUS_A Register	3642
16-1050. QUEUE_38_STATUS_B Register	3643
16-1051. QUEUE_38_STATUS_C Register	3644
16-1052. QUEUE_39_STATUS_A Register	3645
16-1053. QUEUE_39_STATUS_B Register	3646
16-1054. QUEUE_39_STATUS_C Register	3647
16-1055. QUEUE_40_STATUS_A Register	3648
16-1056. QUEUE_40_STATUS_B Register	3649
16-1057. QUEUE_40_STATUS_C Register	3650
16-1058. QUEUE_41_STATUS_A Register	3651
16-1059. QUEUE_41_STATUS_B Register	3652
16-1060. QUEUE_41_STATUS_C Register	3653
16-1061. QUEUE_42_STATUS_A Register	3654
16-1062. QUEUE_42_STATUS_B Register	3655
16-1063. QUEUE_42_STATUS_C Register	3656
16-1064. QUEUE_43_STATUS_A Register	3657
16-1065. QUEUE_43_STATUS_B Register	3658
16-1066. QUEUE_43_STATUS_C Register	3659
16-1067. QUEUE_44_STATUS_A Register	3660
16-1068. QUEUE_44_STATUS_B Register	3661
16-1069. QUEUE_44_STATUS_C Register	3662
16-1070. QUEUE_45_STATUS_A Register	3663
16-1071. QUEUE_45_STATUS_B Register	3664
16-1072. QUEUE_45_STATUS_C Register	3665
16-1073. QUEUE_46_STATUS_A Register	3666
16-1074. QUEUE_46_STATUS_B Register	3667
16-1075. QUEUE_46_STATUS_C Register	3668
16-1076. QUEUE_47_STATUS_A Register	3669
16-1077. QUEUE_47_STATUS_B Register	3670
16-1078. QUEUE_47_STATUS_C Register	3671
16-1079. QUEUE_48_STATUS_A Register	3672
16-1080. QUEUE_48_STATUS_B Register	3673

16-1081. QUEUE_48_STATUS_C Register	3674
16-1082. QUEUE_49_STATUS_A Register	3675
16-1083. QUEUE_49_STATUS_B Register	3676
16-1084. QUEUE_49_STATUS_C Register	3677
16-1085. QUEUE_50_STATUS_A Register	3678
16-1086. QUEUE_50_STATUS_B Register	3679
16-1087. QUEUE_50_STATUS_C Register	3680
16-1088. QUEUE_51_STATUS_A Register	3681
16-1089. QUEUE_51_STATUS_B Register	3682
16-1090. QUEUE_51_STATUS_C Register	3683
16-1091. QUEUE_52_STATUS_A Register	3684
16-1092. QUEUE_52_STATUS_B Register	3685
16-1093. QUEUE_52_STATUS_C Register	3686
16-1094. QUEUE_53_STATUS_A Register	3687
16-1095. QUEUE_53_STATUS_B Register	3688
16-1096. QUEUE_53_STATUS_C Register	3689
16-1097. QUEUE_54_STATUS_A Register	3690
16-1098. QUEUE_54_STATUS_B Register	3691
16-1099. QUEUE_54_STATUS_C Register	3692
16-1100. QUEUE_55_STATUS_A Register	3693
16-1101. QUEUE_55_STATUS_B Register	3694
16-1102. QUEUE_55_STATUS_C Register	3695
16-1103. QUEUE_56_STATUS_A Register	3696
16-1104. QUEUE_56_STATUS_B Register	3697
16-1105. QUEUE_56_STATUS_C Register	3698
16-1106. QUEUE_57_STATUS_A Register	3699
16-1107. QUEUE_57_STATUS_B Register	3700
16-1108. QUEUE_57_STATUS_C Register	3701
16-1109. QUEUE_58_STATUS_A Register	3702
16-1110. QUEUE_58_STATUS_B Register	3703
16-1111. QUEUE_58_STATUS_C Register	3704
16-1112. QUEUE_59_STATUS_A Register	3705
16-1113. QUEUE_59_STATUS_B Register	3706
16-1114. QUEUE_59_STATUS_C Register	3707
16-1115. QUEUE_60_STATUS_A Register	3708
16-1116. QUEUE_60_STATUS_B Register	3709
16-1117. QUEUE_60_STATUS_C Register	3710
16-1118. QUEUE_61_STATUS_A Register	3711
16-1119. QUEUE_61_STATUS_B Register	3712
16-1120. QUEUE_61_STATUS_C Register	3713
16-1121. QUEUE_62_STATUS_A Register	3714
16-1122. QUEUE_62_STATUS_B Register	3715
16-1123. QUEUE_62_STATUS_C Register	3716
16-1124. QUEUE_63_STATUS_A Register	3717
16-1125. QUEUE_63_STATUS_B Register	3718
16-1126. QUEUE_63_STATUS_C Register	3719
16-1127. QUEUE_64_STATUS_A Register	3720
16-1128. QUEUE_64_STATUS_B Register	3721
16-1129. QUEUE_64_STATUS_C Register	3722

16-1130. QUEUE_65_STATUS_A Register	3723
16-1131. QUEUE_65_STATUS_B Register	3724
16-1132. QUEUE_65_STATUS_C Register	3725
16-1133. QUEUE_66_STATUS_A Register	3726
16-1134. QUEUE_66_STATUS_B Register	3727
16-1135. QUEUE_66_STATUS_C Register	3728
16-1136. QUEUE_67_STATUS_A Register	3729
16-1137. QUEUE_67_STATUS_B Register	3730
16-1138. QUEUE_67_STATUS_C Register	3731
16-1139. QUEUE_68_STATUS_A Register	3732
16-1140. QUEUE_68_STATUS_B Register	3733
16-1141. QUEUE_68_STATUS_C Register	3734
16-1142. QUEUE_69_STATUS_A Register	3735
16-1143. QUEUE_69_STATUS_B Register	3736
16-1144. QUEUE_69_STATUS_C Register	3737
16-1145. QUEUE_70_STATUS_A Register	3738
16-1146. QUEUE_70_STATUS_B Register	3739
16-1147. QUEUE_70_STATUS_C Register	3740
16-1148. QUEUE_71_STATUS_A Register	3741
16-1149. QUEUE_71_STATUS_B Register	3742
16-1150. QUEUE_71_STATUS_C Register	3743
16-1151. QUEUE_72_STATUS_A Register	3744
16-1152. QUEUE_72_STATUS_B Register	3745
16-1153. QUEUE_72_STATUS_C Register	3746
16-1154. QUEUE_73_STATUS_A Register	3747
16-1155. QUEUE_73_STATUS_B Register	3748
16-1156. QUEUE_73_STATUS_C Register	3749
16-1157. QUEUE_74_STATUS_A Register	3750
16-1158. QUEUE_74_STATUS_B Register	3751
16-1159. QUEUE_74_STATUS_C Register	3752
16-1160. QUEUE_75_STATUS_A Register	3753
16-1161. QUEUE_75_STATUS_B Register	3754
16-1162. QUEUE_75_STATUS_C Register	3755
16-1163. QUEUE_76_STATUS_A Register	3756
16-1164. QUEUE_76_STATUS_B Register	3757
16-1165. QUEUE_76_STATUS_C Register	3758
16-1166. QUEUE_77_STATUS_A Register	3759
16-1167. QUEUE_77_STATUS_B Register	3760
16-1168. QUEUE_77_STATUS_C Register	3761
16-1169. QUEUE_78_STATUS_A Register	3762
16-1170. QUEUE_78_STATUS_B Register	3763
16-1171. QUEUE_78_STATUS_C Register	3764
16-1172. QUEUE_79_STATUS_A Register	3765
16-1173. QUEUE_79_STATUS_B Register	3766
16-1174. QUEUE_79_STATUS_C Register	3767
16-1175. QUEUE_80_STATUS_A Register	3768
16-1176. QUEUE_80_STATUS_B Register	3769
16-1177. QUEUE_80_STATUS_C Register	3770
16-1178. QUEUE_81_STATUS_A Register	3771

16-1179. QUEUE_81_STATUS_B Register	3772
16-1180. QUEUE_81_STATUS_C Register	3773
16-1181. QUEUE_82_STATUS_A Register	3774
16-1182. QUEUE_82_STATUS_B Register	3775
16-1183. QUEUE_82_STATUS_C Register	3776
16-1184. QUEUE_83_STATUS_A Register	3777
16-1185. QUEUE_83_STATUS_B Register	3778
16-1186. QUEUE_83_STATUS_C Register	3779
16-1187. QUEUE_84_STATUS_A Register	3780
16-1188. QUEUE_84_STATUS_B Register	3781
16-1189. QUEUE_84_STATUS_C Register	3782
16-1190. QUEUE_85_STATUS_A Register	3783
16-1191. QUEUE_85_STATUS_B Register	3784
16-1192. QUEUE_85_STATUS_C Register	3785
16-1193. QUEUE_86_STATUS_A Register	3786
16-1194. QUEUE_86_STATUS_B Register	3787
16-1195. QUEUE_86_STATUS_C Register	3788
16-1196. QUEUE_87_STATUS_A Register	3789
16-1197. QUEUE_87_STATUS_B Register	3790
16-1198. QUEUE_87_STATUS_C Register	3791
16-1199. QUEUE_88_STATUS_A Register	3792
16-1200. QUEUE_88_STATUS_B Register	3793
16-1201. QUEUE_88_STATUS_C Register	3794
16-1202. QUEUE_89_STATUS_A Register	3795
16-1203. QUEUE_89_STATUS_B Register	3796
16-1204. QUEUE_89_STATUS_C Register	3797
16-1205. QUEUE_90_STATUS_A Register	3798
16-1206. QUEUE_90_STATUS_B Register	3799
16-1207. QUEUE_90_STATUS_C Register	3800
16-1208. QUEUE_91_STATUS_A Register	3801
16-1209. QUEUE_91_STATUS_B Register	3802
16-1210. QUEUE_91_STATUS_C Register	3803
16-1211. QUEUE_92_STATUS_A Register	3804
16-1212. QUEUE_92_STATUS_B Register	3805
16-1213. QUEUE_92_STATUS_C Register	3806
16-1214. QUEUE_93_STATUS_A Register	3807
16-1215. QUEUE_93_STATUS_B Register	3808
16-1216. QUEUE_93_STATUS_C Register	3809
16-1217. QUEUE_94_STATUS_A Register	3810
16-1218. QUEUE_94_STATUS_B Register	3811
16-1219. QUEUE_94_STATUS_C Register	3812
16-1220. QUEUE_95_STATUS_A Register	3813
16-1221. QUEUE_95_STATUS_B Register	3814
16-1222. QUEUE_95_STATUS_C Register	3815
16-1223. QUEUE_96_STATUS_A Register	3816
16-1224. QUEUE_96_STATUS_B Register	3817
16-1225. QUEUE_96_STATUS_C Register	3818
16-1226. QUEUE_97_STATUS_A Register	3819
16-1227. QUEUE_97_STATUS_B Register	3820

16-1228. QUEUE_97_STATUS_C Register	3821
16-1229. QUEUE_98_STATUS_A Register	3822
16-1230. QUEUE_98_STATUS_B Register	3823
16-1231. QUEUE_98_STATUS_C Register	3824
16-1232. QUEUE_99_STATUS_A Register	3825
16-1233. QUEUE_99_STATUS_B Register	3826
16-1234. QUEUE_99_STATUS_C Register	3827
16-1235. QUEUE_100_STATUS_A Register	3828
16-1236. QUEUE_100_STATUS_B Register	3829
16-1237. QUEUE_100_STATUS_C Register	3830
16-1238. QUEUE_101_STATUS_A Register	3831
16-1239. QUEUE_101_STATUS_B Register	3832
16-1240. QUEUE_101_STATUS_C Register	3833
16-1241. QUEUE_102_STATUS_A Register	3834
16-1242. QUEUE_102_STATUS_B Register	3835
16-1243. QUEUE_102_STATUS_C Register	3836
16-1244. QUEUE_103_STATUS_A Register	3837
16-1245. QUEUE_103_STATUS_B Register	3838
16-1246. QUEUE_103_STATUS_C Register	3839
16-1247. QUEUE_104_STATUS_A Register	3840
16-1248. QUEUE_104_STATUS_B Register	3841
16-1249. QUEUE_104_STATUS_C Register	3842
16-1250. QUEUE_105_STATUS_A Register	3843
16-1251. QUEUE_105_STATUS_B Register	3844
16-1252. QUEUE_105_STATUS_C Register	3845
16-1253. QUEUE_106_STATUS_A Register	3846
16-1254. QUEUE_106_STATUS_B Register	3847
16-1255. QUEUE_106_STATUS_C Register	3848
16-1256. QUEUE_107_STATUS_A Register	3849
16-1257. QUEUE_107_STATUS_B Register	3850
16-1258. QUEUE_107_STATUS_C Register	3851
16-1259. QUEUE_108_STATUS_A Register	3852
16-1260. QUEUE_108_STATUS_B Register	3853
16-1261. QUEUE_108_STATUS_C Register	3854
16-1262. QUEUE_109_STATUS_A Register	3855
16-1263. QUEUE_109_STATUS_B Register	3856
16-1264. QUEUE_109_STATUS_C Register	3857
16-1265. QUEUE_110_STATUS_A Register	3858
16-1266. QUEUE_110_STATUS_B Register	3859
16-1267. QUEUE_110_STATUS_C Register	3860
16-1268. QUEUE_111_STATUS_A Register	3861
16-1269. QUEUE_111_STATUS_B Register	3862
16-1270. QUEUE_111_STATUS_C Register	3863
16-1271. QUEUE_112_STATUS_A Register	3864
16-1272. QUEUE_112_STATUS_B Register	3865
16-1273. QUEUE_112_STATUS_C Register	3866
16-1274. QUEUE_113_STATUS_A Register	3867
16-1275. QUEUE_113_STATUS_B Register	3868
16-1276. QUEUE_113_STATUS_C Register	3869

16-1277. QUEUE_114_STATUS_A Register	3870
16-1278. QUEUE_114_STATUS_B Register	3871
16-1279. QUEUE_114_STATUS_C Register	3872
16-1280. QUEUE_115_STATUS_A Register	3873
16-1281. QUEUE_115_STATUS_B Register	3874
16-1282. QUEUE_115_STATUS_C Register	3875
16-1283. QUEUE_116_STATUS_A Register	3876
16-1284. QUEUE_116_STATUS_B Register	3877
16-1285. QUEUE_116_STATUS_C Register	3878
16-1286. QUEUE_117_STATUS_A Register	3879
16-1287. QUEUE_117_STATUS_B Register	3880
16-1288. QUEUE_117_STATUS_C Register	3881
16-1289. QUEUE_118_STATUS_A Register	3882
16-1290. QUEUE_118_STATUS_B Register	3883
16-1291. QUEUE_118_STATUS_C Register	3884
16-1292. QUEUE_119_STATUS_A Register	3885
16-1293. QUEUE_119_STATUS_B Register	3886
16-1294. QUEUE_119_STATUS_C Register	3887
16-1295. QUEUE_120_STATUS_A Register	3888
16-1296. QUEUE_120_STATUS_B Register	3889
16-1297. QUEUE_120_STATUS_C Register	3890
16-1298. QUEUE_121_STATUS_A Register	3891
16-1299. QUEUE_121_STATUS_B Register	3892
16-1300. QUEUE_121_STATUS_C Register	3893
16-1301. QUEUE_122_STATUS_A Register	3894
16-1302. QUEUE_122_STATUS_B Register	3895
16-1303. QUEUE_122_STATUS_C Register	3896
16-1304. QUEUE_123_STATUS_A Register	3897
16-1305. QUEUE_123_STATUS_B Register	3898
16-1306. QUEUE_123_STATUS_C Register	3899
16-1307. QUEUE_124_STATUS_A Register	3900
16-1308. QUEUE_124_STATUS_B Register	3901
16-1309. QUEUE_124_STATUS_C Register	3902
16-1310. QUEUE_125_STATUS_A Register	3903
16-1311. QUEUE_125_STATUS_B Register	3904
16-1312. QUEUE_125_STATUS_C Register	3905
16-1313. QUEUE_126_STATUS_A Register	3906
16-1314. QUEUE_126_STATUS_B Register	3907
16-1315. QUEUE_126_STATUS_C Register	3908
16-1316. QUEUE_127_STATUS_A Register	3909
16-1317. QUEUE_127_STATUS_B Register	3910
16-1318. QUEUE_127_STATUS_C Register	3911
16-1319. QUEUE_128_STATUS_A Register	3912
16-1320. QUEUE_128_STATUS_B Register	3913
16-1321. QUEUE_128_STATUS_C Register	3914
16-1322. QUEUE_129_STATUS_A Register	3915
16-1323. QUEUE_129_STATUS_B Register	3916
16-1324. QUEUE_129_STATUS_C Register	3917
16-1325. QUEUE_130_STATUS_A Register	3918

16-1326. QUEUE_130_STATUS_B Register	3919
16-1327. QUEUE_130_STATUS_C Register	3920
16-1328. QUEUE_131_STATUS_A Register	3921
16-1329. QUEUE_131_STATUS_B Register	3922
16-1330. QUEUE_131_STATUS_C Register	3923
16-1331. QUEUE_132_STATUS_A Register	3924
16-1332. QUEUE_132_STATUS_B Register	3925
16-1333. QUEUE_132_STATUS_C Register	3926
16-1334. QUEUE_133_STATUS_A Register	3927
16-1335. QUEUE_133_STATUS_B Register	3928
16-1336. QUEUE_133_STATUS_C Register	3929
16-1337. QUEUE_134_STATUS_A Register	3930
16-1338. QUEUE_134_STATUS_B Register	3931
16-1339. QUEUE_134_STATUS_C Register	3932
16-1340. QUEUE_135_STATUS_A Register	3933
16-1341. QUEUE_135_STATUS_B Register	3934
16-1342. QUEUE_135_STATUS_C Register	3935
16-1343. QUEUE_136_STATUS_A Register	3936
16-1344. QUEUE_136_STATUS_B Register	3937
16-1345. QUEUE_136_STATUS_C Register	3938
16-1346. QUEUE_137_STATUS_A Register	3939
16-1347. QUEUE_137_STATUS_B Register	3940
16-1348. QUEUE_137_STATUS_C Register	3941
16-1349. QUEUE_138_STATUS_A Register	3942
16-1350. QUEUE_138_STATUS_B Register	3943
16-1351. QUEUE_138_STATUS_C Register	3944
16-1352. QUEUE_139_STATUS_A Register	3945
16-1353. QUEUE_139_STATUS_B Register	3946
16-1354. QUEUE_139_STATUS_C Register	3947
16-1355. QUEUE_140_STATUS_A Register	3948
16-1356. QUEUE_140_STATUS_B Register	3949
16-1357. QUEUE_140_STATUS_C Register	3950
16-1358. QUEUE_141_STATUS_A Register	3951
16-1359. QUEUE_141_STATUS_B Register	3952
16-1360. QUEUE_141_STATUS_C Register	3953
16-1361. QUEUE_142_STATUS_A Register	3954
16-1362. QUEUE_142_STATUS_B Register	3955
16-1363. QUEUE_142_STATUS_C Register	3956
16-1364. QUEUE_143_STATUS_A Register	3957
16-1365. QUEUE_143_STATUS_B Register	3958
16-1366. QUEUE_143_STATUS_C Register	3959
16-1367. QUEUE_144_STATUS_A Register	3960
16-1368. QUEUE_144_STATUS_B Register	3961
16-1369. QUEUE_144_STATUS_C Register	3962
16-1370. QUEUE_145_STATUS_A Register	3963
16-1371. QUEUE_145_STATUS_B Register	3964
16-1372. QUEUE_145_STATUS_C Register	3965
16-1373. QUEUE_146_STATUS_A Register	3966
16-1374. QUEUE_146_STATUS_B Register	3967

16-1375. QUEUE_146_STATUS_C Register	3968
16-1376. QUEUE_147_STATUS_A Register	3969
16-1377. QUEUE_147_STATUS_B Register	3970
16-1378. QUEUE_147_STATUS_C Register	3971
16-1379. QUEUE_148_STATUS_A Register	3972
16-1380. QUEUE_148_STATUS_B Register	3973
16-1381. QUEUE_148_STATUS_C Register	3974
16-1382. QUEUE_149_STATUS_A Register	3975
16-1383. QUEUE_149_STATUS_B Register	3976
16-1384. QUEUE_149_STATUS_C Register	3977
16-1385. QUEUE_150_STATUS_A Register	3978
16-1386. QUEUE_150_STATUS_B Register	3979
16-1387. QUEUE_150_STATUS_C Register	3980
16-1388. QUEUE_151_STATUS_A Register	3981
16-1389. QUEUE_151_STATUS_B Register	3982
16-1390. QUEUE_151_STATUS_C Register	3983
16-1391. QUEUE_152_STATUS_A Register	3984
16-1392. QUEUE_152_STATUS_B Register	3985
16-1393. QUEUE_152_STATUS_C Register	3986
16-1394. QUEUE_153_STATUS_A Register	3987
16-1395. QUEUE_153_STATUS_B Register	3988
16-1396. QUEUE_153_STATUS_C Register	3989
16-1397. QUEUE_154_STATUS_A Register	3990
16-1398. QUEUE_154_STATUS_B Register	3991
16-1399. QUEUE_154_STATUS_C Register	3992
16-1400. QUEUE_155_STATUS_A Register	3993
16-1401. QUEUE_155_STATUS_B Register	3994
16-1402. QUEUE_155_STATUS_C Register	3995
17-1. Mailbox Integration	3998
17-2. Mailbox Block Diagram	4000
17-3. REVISION Register	4009
17-4. SYSCONFIG Register	4010
17-5. MESSAGE_0 Register	4011
17-6. MESSAGE_1 Register	4012
17-7. MESSAGE_2 Register	4013
17-8. MESSAGE_3 Register	4014
17-9. MESSAGE_4 Register	4015
17-10. MESSAGE_5 Register	4016
17-11. MESSAGE_6 Register	4017
17-12. MESSAGE_7 Register	4018
17-13. FIFOSTATUS_0 Register	4019
17-14. FIFOSTATUS_1 Register	4020
17-15. FIFOSTATUS_2 Register	4021
17-16. FIFOSTATUS_3 Register	4022
17-17. FIFOSTATUS_4 Register	4023
17-18. FIFOSTATUS_5 Register	4024
17-19. FIFOSTATUS_6 Register	4025
17-20. FIFOSTATUS_7 Register	4026
17-21. MSGSTATUS_0 Register	4027

17-22. MSGSTATUS_1 Register	4028
17-23. MSGSTATUS_2 Register	4029
17-24. MSGSTATUS_3 Register	4030
17-25. MSGSTATUS_4 Register	4031
17-26. MSGSTATUS_5 Register	4032
17-27. MSGSTATUS_6 Register	4033
17-28. MSGSTATUS_7 Register	4034
17-29. IRQSTATUS_RAW_0 Register.....	4035
17-30. IRQSTATUS_CLR_0 Register.....	4037
17-31. IRQENABLE_SET_0 Register.....	4039
17-32. IRQENABLE_CLR_0 Register.....	4041
17-33. IRQSTATUS_RAW_1 Register.....	4043
17-34. IRQSTATUS_CLR_1 Register.....	4045
17-35. IRQENABLE_SET_1 Register.....	4047
17-36. IRQENABLE_CLR_1 Register.....	4049
17-37. IRQSTATUS_RAW_2 Register.....	4051
17-38. IRQSTATUS_CLR_2 Register.....	4053
17-39. IRQENABLE_SET_2 Register.....	4055
17-40. IRQENABLE_CLR_2 Register.....	4057
17-41. IRQSTATUS_RAW_3 Register.....	4059
17-42. IRQSTATUS_CLR_3 Register.....	4061
17-43. IRQENABLE_SET_3 Register.....	4063
17-44. IRQENABLE_CLR_3 Register.....	4065
17-45. REV Register	4070
17-46. SYSCONFIG Register	4071
17-47. SYSTATUS Register.....	4072
17-48. LOCK_REG_0 Register	4073
17-49. LOCK_REG_1 Register	4074
17-50. LOCK_REG_2 Register	4075
17-51. LOCK_REG_3 Register	4076
17-52. LOCK_REG_4 Register	4077
17-53. LOCK_REG_5 Register	4078
17-54. LOCK_REG_6 Register	4079
17-55. LOCK_REG_7 Register	4080
17-56. LOCK_REG_8 Register	4081
17-57. LOCK_REG_9 Register	4082
17-58. LOCK_REG_10 Register.....	4083
17-59. LOCK_REG_11 Register.....	4084
17-60. LOCK_REG_12 Register.....	4085
17-61. LOCK_REG_13 Register.....	4086
17-62. LOCK_REG_14 Register.....	4087
17-63. LOCK_REG_15 Register.....	4088
17-64. LOCK_REG_16 Register.....	4089
17-65. LOCK_REG_17 Register.....	4090
17-66. LOCK_REG_18 Register.....	4091
17-67. LOCK_REG_19 Register.....	4092
17-68. LOCK_REG_20 Register.....	4093
17-69. LOCK_REG_21 Register.....	4094
17-70. LOCK_REG_22 Register.....	4095

17-71. LOCK_REG_23 Register	4096
17-72. LOCK_REG_24 Register	4097
17-73. LOCK_REG_25 Register	4098
17-74. LOCK_REG_26 Register	4099
17-75. LOCK_REG_27 Register	4100
17-76. LOCK_REG_28 Register	4101
17-77. LOCK_REG_29 Register	4102
17-78. LOCK_REG_30 Register	4103
17-79. LOCK_REG_31 Register	4104
18-1. MMC/SD1/2 Connectivity to an MMC/SD Card	4112
18-2. MMC/SD0 Connectivity to an MMC/SD Card.....	4112
18-3. Sequential Read Operation (MMC Cards Only).....	4114
18-4. Sequential Write Operation (MMC Cards Only).....	4114
18-5. Multiple Block Read Operation (MMC Cards Only)	4115
18-6. Multiple Block Write Operation (MMC Cards Only)	4115
18-7. Command Token Format.....	4116
18-8. 48-Bit Response Packet (R1, R3, R4, R5, R6).....	4116
18-9. 136-Bit Response Packet (R2)	4116
18-10. Data Packet for Sequential Transfer (1-Bit)	4117
18-11. Data Packet for Block Transfer (1-Bit)	4117
18-12. Data Packet for Block Transfer (4-Bit).....	4117
18-13. Data Packet for Block Transfer (8-Bit).....	4118
18-14. DMA Receive Mode.....	4125
18-15. DMA Transmit Mode	4126
18-16. Buffer Management for a Write.....	4128
18-17. Buffer Management for a Read	4129
18-18. Busy Timeout for R1b, R5b Responses.....	4132
18-19. Write CRC Status Timeout.....	4133
18-20. Read Data Timeout	4133
18-21. Boot Acknowledge Timeout When Using CMD0.....	4134
18-22. Boot Acknowledge Timeout When CMD Held Low	4134
18-23. Auto CMD12 Timing During Write Transfer.....	4136
18-24. Auto Command 12 Timings During Read Transfer	4137
18-25. Output Driven on Falling Edge	4139
18-26. Output Driven on Rising Edge.....	4140
18-27. Boot Mode With CMD0	4141
18-28. Boot Mode With CMD Line Tied to 0	4142
18-29. MMC/SD/SDIO Controller Software Reset Flow	4146
18-30. MMC/SD/SDIO Controller Bus Configuration Flow	4147
18-31. MMC/SD/SDIO Controller Card Identification and Selection - Part 1	4148
18-32. MMC/SD/SDIO Controller Card Identification and Selection - Part 2	4149
18-33. SD_SYSCONFIG Register	4151
18-34. SD_SYSSTATUS Register.....	4153
18-35. SD_CSRE Register	4154
18-36. SD_SYSTEST Register	4155
18-37. SD_CON Register.....	4159
18-38. SD_PWCNT Register.....	4163
18-39. SD_SDMASA Register	4164
18-40. SD_BLK Register.....	4165

18-41. SD_ARG Register	4166
18-42. SD_CMD Register.....	4167
18-43. SD_RSP10 Register	4172
18-44. SD_RSP32 Register	4173
18-45. SD_RSP54 Register	4174
18-46. SD_RSP76 Register	4175
18-47. SD_DATA Register	4176
18-48. SD_PSTATE Register	4177
18-49. SD_HCTL Register.....	4180
18-50. SD_SYSCCTL Register	4183
18-51. SD_STAT Register.....	4185
18-52. SD_IE Register	4190
18-53. SD_ISE Register	4193
18-54. SD_AC12 Register	4196
18-55. SD_CAPA Register	4198
18-56. SD_CUR_CAPA Register	4200
18-57. SD_FE Register	4201
18-58. SD_ADMAES Register	4203
18-59. SD_ADMASAL Register.....	4204
18-60. SD_ADMASAH Register	4205
18-61. SD_REV Register	4206
19-1. UART/IrDA Module — UART Application	4210
19-2. UART/IrDA Module — IrDA/CIR Application.....	4210
19-3. UART/IrDA/CIR Functional Specification Block Diagram	4215
19-4. FIFO Management Registers	4220
19-5. RX FIFO Interrupt Request Generation	4222
19-6. TX FIFO Interrupt Request Generation	4223
19-7. Receive FIFO DMA Request Generation (32 Characters).....	4224
19-8. Transmit FIFO DMA Request Generation (56 Spaces)	4225
19-9. Transmit FIFO DMA Request Generation (8 Spaces).....	4226
19-10. Transmit FIFO DMA Request Generation (1 Space)	4226
19-11. Transmit FIFO DMA Request Generation Using Direct TX DMA Threshold Programming. (Threshold = 3; Spaces = 8)	4227
19-12. DMA Transmission	4227
19-13. DMA Reception	4228
19-14. UART Data Format.....	4235
19-15. Baud Rate Generation	4235
19-16. IrDA SIR Frame Format	4241
19-17. IrDA Encoding Mechanism	4242
19-18. IrDA Decoding Mechanism.....	4243
19-19. SIR Free Format Mode	4243
19-20. MIR Transmit Frame Format.....	4244
19-21. MIR BAUD Rate Adjustment Mechanism	4245
19-22. SIP Pulse	4245
19-23. FIR Transmit Frame Format	4245
19-24. Baud Rate Generator	4246
19-25. RC-5 Bit Encoding	4250
19-26. SIRC Bit Encoding	4250
19-27. RC-5 Standard Packet Format	4251

19-28. SIRC Packet Format	4251
19-29. SIRC Bit Transmission Example	4251
19-30. CIR Mode Block Components	4252
19-31. CIR Pulse Modulation.....	4254
19-32. CIR Modulation Duty Cycle	4254
19-33. Variable Pulse Duration Definitions	4256
19-34. THR Register	4268
19-35. RHR Register	4269
19-36. DLL Register	4270
19-37. IER_IRDA Register	4271
19-38. IER_CIR Register	4272
19-39. IER_UART Register.....	4273
19-40. DLH Register.....	4274
19-41. EFR Register.....	4275
19-42. IIR_UART Register.....	4277
19-43. IIR_CIR Register	4278
19-44. FCR Register	4279
19-45. IIR_IRDA Register.....	4280
19-46. LCR Register.....	4281
19-47. MCR Register.....	4282
19-48. XON1_ADDR1 Register	4283
19-49. XON2_ADDR2 Register	4284
19-50. LSR_CIR Register.....	4285
19-51. LSR_IRDA Register.....	4286
19-52. LSR_UART Register	4288
19-53. TCR Register	4290
19-54. MSR Register	4291
19-55. XOFF1 Register	4292
19-56. SPR Register	4293
19-57. TLR Register.....	4294
19-58. XOFF2 Register	4295
19-59. MDR1 Register	4296
19-60. MDR2 Register	4297
19-61. TXFLL Register.....	4298
19-62. SFLSR Register	4299
19-63. RESUME Register	4300
19-64. TXFLH Register	4301
19-65. RXFLL Register.....	4302
19-66. SFREGL Register	4303
19-67. SFREGH Register.....	4304
19-68. RXFLH Register	4305
19-69. BLR Register.....	4306
19-70. UASR Register	4307
19-71. ACREG Register	4308
19-72. SCR Register	4309
19-73. SSR Register	4310
19-74. EBLR Register.....	4311
19-75. MVR Register.....	4312
19-76. SYSC Register.....	4313

19-77. SYSS Register	4314
19-78. WER Register	4315
19-79. CFPS Register	4316
19-80. RXFIFO_LVL Register	4317
19-81. TXFIFO_LVL Register	4318
19-82. IER2 Register	4319
19-83. ISR2 Register	4320
19-84. FREQ_SEL Register	4321
19-85. MDR3 Register	4322
19-86. TX_DMA_THRESHOLD Register	4323
20-1. Timer Block Diagram	4326
20-2. Timer0 Integration	4327
20-3. Timer2-7 Integration	4328
20-4. Timing Diagram of Pulse-Width Modulation with SCPWM = 0	4334
20-5. Timing Diagram of Pulse-Width Modulation with SCPWM = 1	4335
20-6. TIDR Register	4341
20-7. TIOCP_CFG Register	4342
20-8. IRQ_EOI Register	4343
20-9. IRQSTATUS_RAW Register	4344
20-10. IRQSTATUS Register	4345
20-11. IRQENABLE_SET Register	4346
20-12. IRQENABLE_CLR Register	4347
20-13. IRQWAKEEN Register	4348
20-14. TCLR Register	4349
20-15. TCRR Register	4351
20-16. TLDR Register	4352
20-17. TTGR Register	4353
20-18. TWPS Register	4354
20-19. TMAR Register	4355
20-20. TCAR1 Register	4356
20-21. TSICR Register	4357
20-22. TCAR2 Register	4358
20-23. Block Diagram	4360
20-24. DMTimer 1 ms Integration	4361
20-25. TCRR Timing Value	4363
20-26. 1ms Module Block Diagram	4364
20-27. Capture Wave Example for CAPT_MODE 0	4366
20-28. Capture Wave Example for CAPT_MODE 1	4366
20-29. Timing Diagram of Pulse-Width Modulation, SCPWM Bit = 0	4368
20-30. Timing Diagram of Pulse-Width Modulation, SCPWM Bit = 1	4368
20-31. Wake-up Request Generation	4370
20-32. TIDR Register	4373
20-33. TIOCP_CFG Register	4374
20-34. TISTAT Register	4375
20-35. TISR Register	4376
20-36. TIER Register	4377
20-37. TWER Register	4378
20-38. TCLR Register	4379
20-39. TCRR Register	4381

20-40. TLDR Register	4382
20-41. TTGR Register	4383
20-42. TWPS Register	4384
20-43. TMAR Register	4386
20-44. TCAR1 Register	4387
20-45. TSICR Register	4388
20-46. TCAR2 Register	4389
20-47. TPIR Register	4390
20-48. TNIR Register	4391
20-49. TCVR Register	4392
20-50. TOCR Register	4393
20-51. TOWR Register	4394
20-52. RTC Integration	4396
20-53. RTC Block Diagram	4398
20-54. RTC Functional Block Diagram	4398
20-55. Kick Register State Machine Diagram	4401
20-56. Flow Control for Updating RTC Registers	4403
20-57. Compensation Illustration	4404
20-58. SECONDS_REG Register	4408
20-59. MINUTES_REG Register	4409
20-60. HOURS_REG Register	4410
20-61. DAYS_REG Register	4411
20-62. MONTHS_REG Register	4412
20-63. YEARS_REG Register	4413
20-64. WEEKS_REG Register	4414
20-65. ALARM_SECONDS_REG Register	4415
20-66. ALARM_MINUTES_REG Register	4416
20-67. ALARM_HOURS_REG Register	4417
20-68. ALARM_DAYS_REG Register	4418
20-69. ALARM_MONTHS_REG Register	4419
20-70. ALARM_YEARS_REG Register	4420
20-71. RTC_CTRL_REG Register	4421
20-72. RTC_STATUS_REG Register	4423
20-73. RTC_INTERRUPTS_REG Register	4424
20-74. RTC_COMP_LSB_REG Register	4425
20-75. RTC_COMP_MSB_REG Register	4426
20-76. RTC_OSC_REG Register	4427
20-77. RTC_SCRATCH0_REG Register	4428
20-78. RTC_SCRATCH1_REG Register	4429
20-79. RTC_SCRATCH2_REG Register	4430
20-80. KICK0R Register	4431
20-81. KICK1R Register	4432
20-82. RTC_REVISION Register	4433
20-83. RTC_SYSCONFIG Register	4434
20-84. RTC_IRQWAKEEN Register	4435
20-85. ALARM2_SECONDS_REG Register	4436
20-86. ALARM2_MINUTES_REG Register	4437
20-87. ALARM2_HOURS_REG Register	4438
20-88. ALARM2_DAYS_REG Register	4439

20-89. ALARM2_MONTHS_REG Register.....	4440
20-90. ALARM2_YEARS_REG Register	4441
20-91. RTC_PMIC Register	4442
20-92. RTC_DEBOUNCE Register.....	4443
20-93. WDTimer Integration	4445
20-94. 32-Bit Watchdog Timer Functional Block Diagram	4447
20-95. Watchdog Timers General Functional View	4448
20-96. WDT_WIDR Register	4456
20-97. WDT_WDSC Register	4457
20-98. WDT_WDST Register	4458
20-99. WDT_WISR Register	4459
20-100. WDT_WIER Register	4460
20-101. WDT_WCLR Register	4461
20-102. WDT_WCRR Register	4462
20-103. WDT_WLDR Register	4463
20-104. WDT_WTGR Register.....	4464
20-105. WDT_WWPS Register	4465
20-106. WDT_WDLY Register	4466
20-107. WDT_WSPR Register.....	4467
20-108. WDT_WIRQSTATRAW Register	4468
20-109. WDT_WIRQSTAT Register.....	4469
20-110. WDT_WIRQENSET Register.....	4470
20-111. WDT_WIRQENCLR Register	4471
21-1. I2C0 Integration and Bus Application.....	4474
21-2. I2C(1–2) Integration and Bus Application	4474
21-3. I2C Functional Block Diagram	4476
21-4. Multiple I2C Modules Connected.....	4477
21-5. Bit Transfer on the I2C Bus	4478
21-6. Start and Stop Condition Events	4479
21-7. I2C Data Transfer	4479
21-8. I2C Data Transfer Formats.....	4480
21-9. Arbitration Procedure Between Two Master Transmitters	4481
21-10. Synchronization of Two I2C Clock Generators.....	4482
21-11. Receive FIFO Interrupt Request Generation	4484
21-12. Transmit FIFO Interrupt Request Generation	4484
21-13. Receive FIFO DMA Request Generation	4485
21-14. Transmit FIFO DMA Request Generation (High Threshold).....	4486
21-15. Transmit FIFO DMA Request Generation (Low Threshold)	4486
21-16. I2C_REVNB_LO Register	4491
21-17. I2C_REVNB_HI Register	4492
21-18. I2C_SYSC Register	4493
21-19. I2C_IRQSTATUS_RAW Register	4495
21-20. I2C_IRQSTATUS Register	4501
21-21. I2C_IRQENABLE_SET Register	4503
21-22. I2C_IRQENABLE_CLR Register	4505
21-23. I2C_WE Register	4507
21-24. I2C_DMARXENABLE_SET Register	4510
21-25. I2C_DMATXENABLE_SET Register	4511
21-26. I2C_DMARXENABLE_CLR Register	4512

21-27. I2C_DMATXENABLE_CLR Register	4513
21-28. I2C_DMARXWAKE_EN Register	4514
21-29. I2C_DMATXWAKE_EN Register	4516
21-30. I2C_SYSS Register	4518
21-31. I2C_BUF Register	4519
21-32. I2C_CNT Register	4521
21-33. I2C_DATA Register	4522
21-34. I2C_CON Register	4523
21-35. I2C_OA Register	4526
21-36. I2C_SA Register	4527
21-37. I2C_PSC Register	4528
21-38. I2C_SCLL Register	4529
21-39. I2C_SCLH Register	4530
21-40. I2C_SYSTEST Register	4531
21-41. I2C_BUFSTAT Register	4534
21-42. I2C_OA1 Register	4535
21-43. I2C_OA2 Register	4536
21-44. I2C_OA3 Register	4537
21-45. I2C_ACTOA Register	4538
21-46. I2C_SBLOCK Register	4539
22-1. McASP0–1 Integration	4544
22-2. McASP Block Diagram	4547
22-3. McASP to Parallel 2-Channel DACs	4548
22-4. McASP to 6-Channel DAC and 2-Channel DAC	4548
22-5. McASP to Digital Amplifier	4549
22-6. McASP as Digital Audio Encoder	4549
22-7. McASP as 16 Channel Digital Processor	4549
22-8. TDM Format–6 Channel TDM Example	4550
22-9. TDM Format Bit Delays from Frame Sync	4551
22-10. Inter-Integrated Sound (I2S) Format	4551
22-11. Biphase-Mark Code (BMC)	4552
22-12. S/PDIF Subframe Format	4553
22-13. S/PDIF Frame Format	4554
22-14. Definition of Bit, Word, and Slot	4555
22-15. Bit Order and Word Alignment Within a Slot Examples	4555
22-16. Definition of Frame and Frame Sync Width	4556
22-17. Transmit Clock Generator Block Diagram	4557
22-18. Receive Clock Generator Block Diagram	4558
22-19. Frame Sync Generator Block Diagram	4559
22-20. Burst Frame Sync Mode	4561
22-21. Transmit DMA Event (AXEVT) Generation in TDM Time Slots	4563
22-22. Individual Serializer and Connections Within McASP	4568
22-23. Receive Format Unit	4569
22-24. Transmit Format Unit	4569
22-25. McASP I/O Pin Control Block Diagram	4571
22-26. Processor Service Time Upon Transmit DMA Event (AXEVT)	4573
22-27. Processor Service Time Upon Receive DMA Event (AREVT)	4574
22-28. McASP Audio FIFO (AFIFO) Block Diagram	4576
22-29. Data Flow Through Transmit Format Unit, Illustrated	4579

22-30. Data Flow Through Receive Format Unit, Illustrated	4581
22-31. Transmit Clock Failure Detection Circuit Block Diagram	4585
22-32. Receive Clock Failure Detection Circuit Block Diagram	4587
22-33. Serializers in Loopback Mode	4588
22-34. Interrupt Multiplexing	4594
22-35. Audio Mute (AMUTE) Block Diagram	4595
22-36. DMA Events in an Audio Example—Two Events (Scenario 1)	4597
22-37. DMA Events in an Audio Example—Four Events (Scenario 2)	4597
22-38. DMA Events in an Audio Example	4598
22-39. REV Register	4601
22-40. PWRIDLESYSCONFIG Register	4602
22-41. PFUNC Register	4603
22-42. PDIR Register	4604
22-43. PDOUT Register	4606
22-44. PDIN Register	4608
22-45. PDCLR Register	4609
22-46. GBLCTL Register	4611
22-47. AMUTE Register	4613
22-48. DLBCTL Register	4615
22-49. DITCTL Register	4616
22-50. RGBLCTL Register	4617
22-51. RMASK Register	4619
22-52. RFMT Register	4620
22-53. AFSRCTL Register	4622
22-54. ACLKRCTL Register	4623
22-55. AHCLKRCTL Register	4624
22-56. RTDM Register	4625
22-57. RINTCTL Register	4626
22-58. RSTAT Register	4628
22-59. RSLOT Register	4630
22-60. RCLKCHK Register	4631
22-61. REVTCTL Register	4632
22-62. XGBLCTL Register	4633
22-63. XMASK Register	4635
22-64. XFMT Register	4636
22-65. AFSXCTL Register	4638
22-66. ACLKXCTL Register	4639
22-67. AHCLKXCTL Register	4640
22-68. XTDM Register	4641
22-69. XINTCTL Register	4642
22-70. XSTAT Register	4644
22-71. XSLOT Register	4646
22-72. XCLKCHK Register	4647
22-73. XEVTCTL Register	4648
22-74. DITCSRA_0 to DITCSRA_5 Register	4649
22-75. DITCSRB_0 to DITCSRB_5 Register	4650
22-76. DITUDRA_0 to DITUDRA_5 Register	4651
22-77. DITUDRB_0 to DITUDRB_5 Register	4652
22-78. SRCTL_0 to SRCTL_5 Register	4653

22-79. XBUF_0 to XBUF_5 Register	4655
22-80. RBUF_0 to RBUF_5 Register	4656
22-81. WFIFOCTL Register	4657
22-82. WFIFOSTS Register	4658
22-83. RFIFOCTL Register	4659
22-84. RFIFOSTS Register.....	4660
23-1. DCAN Integration.....	4663
23-2. DCAN Block Diagram.....	4665
23-3. CAN Module General Initialization Flow.....	4667
23-4. CAN Bit-Timing Configuration	4668
23-5. CAN Core in Silent Mode	4670
23-6. CAN Core in Loopback Mode	4671
23-7. CAN Core in External Loopback Mode.....	4672
23-8. CAN Core in Loop Back Combined With Silent Mode	4673
23-9. CAN Interrupt Topology 1	4675
23-10. CAN Interrupt Topology 2	4675
23-11. Local Power-Down Mode Flow Diagram	4677
23-12. CPU Handling of a FIFO Buffer (Interrupt Driven)	4686
23-13. Bit Timing	4687
23-14. The Propagation Time Segment	4688
23-15. Synchronization on Late and Early Edges	4690
23-16. Filtering of Short Dominant Spikes.....	4691
23-17. Structure of the CAN Core's CAN Protocol Controller	4692
23-18. Data Transfer Between IF1/IF2 Registers and Message RAM	4696
23-19. CTL Register	4705
23-20. ES Register	4708
23-21. ERRRC Register	4710
23-22. BTR Register.....	4711
23-23. INT Register.....	4712
23-24. TEST Register	4713
23-25. PERR Register	4714
23-26. ABOTR Register.....	4715
23-27. TXRQ_X Register	4716
23-28. TXRQ12 Register	4717
23-29. TXRQ34 Register	4718
23-30. TXRQ56 Register	4719
23-31. TXRQ78 Register	4720
23-32. NWDAT_X Register.....	4721
23-33. NWDAT12 Register	4722
23-34. NWDAT34 Register	4723
23-35. NWDAT56 Register	4724
23-36. NWDAT78 Register	4725
23-37. INTPND_X Register.....	4726
23-38. INTPND12 Register	4727
23-39. INTPND34 Register	4728
23-40. INTPND56 Register	4729
23-41. INTPND78 Register.....	4730
23-42. MSGVAL_X Register	4731
23-43. MSGVAL12 Register.....	4732

23-44. MSGVAL34 Register	4733
23-45. MSGVAL56 Register	4734
23-46. MSGVAL78 Register	4735
23-47. INTMUX12 Register	4736
23-48. INTMUX34 Register	4737
23-49. INTMUX56 Register	4738
23-50. INTMUX78 Register	4739
23-51. IF1CMD Register	4740
23-52. IF1MSK Register	4743
23-53. IF1ARB Register	4744
23-54. IF1MCTL Register	4745
23-55. IF1DATA Register	4747
23-56. IF1DATB Register	4748
23-57. IF2CMD Register	4749
23-58. IF2MSK Register	4752
23-59. IF2ARB Register	4753
23-60. IF2MCTL Register	4754
23-61. IF2DATA Register	4756
23-62. IF2DATB Register	4757
23-63. IF3OBS Register	4758
23-64. IF3MSK Register	4760
23-65. IF3ARB Register	4761
23-66. IF3MCTL Register	4762
23-67. IF3DATA Register	4764
23-68. IF3DATB Register	4765
23-69. IF3UPD12 Register	4766
23-70. IF3UPD34 Register	4767
23-71. IF3UPD56 Register	4768
23-72. IF3UPD78 Register	4769
23-73. TIOC Register	4770
23-74. RIOC Register	4772
24-1. SPI Master Application	4776
24-2. SPI Slave Application	4776
24-3. SPI Full-Duplex Transmission	4779
24-4. SPI Half-Duplex Transmission (Receive-only Slave)	4780
24-5. SPI Half-Duplex Transmission (Transmit-Only Slave)	4780
24-6. Phase and Polarity Combinations	4782
24-7. Full Duplex Single Transfer Format with PHA = 0	4783
24-8. Full Duplex Single Transfer Format With PHA = 1	4784
24-9. Continuous Transfers With SPIEN Maintained Active (Single-Data-Pin Interface Mode)	4789
24-10. Continuous Transfers With SPIEN Maintained Active (Dual-Data-Pin Interface Mode)	4789
24-11. Extended SPI Transfer With Start Bit PHA = 1	4791
24-12. Chip-Select SPIEN Timing Controls	4792
24-13. Transmit/Receive Mode With No FIFO Used	4795
24-14. Transmit/Receive Mode With Only Receive FIFO Enabled	4795
24-15. Transmit/Receive Mode With Only Transmit FIFO Used	4796
24-16. Transmit/Receive Mode With Both FIFO Direction Used	4796
24-17. Transmit-Only Mode With FIFO Used	4797
24-18. Receive-Only Mode With FIFO Used	4797

24-19. Buffer Almost Full Level (AFL).....	4798
24-20. Buffer Almost Empty Level (AEL)	4799
24-21. Master Single Channel Initial Delay.....	4800
24-22. 3-Pin Mode System Overview	4801
24-23. Example of SPI Slave with One Master and Multiple Slave Devices on Channel 0.....	4803
24-24. SPI Half-Duplex Transmission (Receive-Only Slave)	4805
24-25. SPI Half-Duplex Transmission (Transmit-Only Slave).....	4806
24-26. MCSPI_REVISION Register	4814
24-27. MCSPI_SYSCONFIG Register	4815
24-28. MCSPI_SYSSTATUS Register	4816
24-29. MCSPI_IRQSTATUS Register	4817
24-30. MCSPI_IRQENABLE Register	4820
24-31. MCSPI_SYST Register	4822
24-32. MCSPI_MODULCTRL Register	4824
24-33. MCSPI_CH0CONF Register	4826
24-34. MCSPI_CH0STAT Register.....	4830
24-35. MCSPI_CH0CTRL Register	4832
24-36. MCSPI_TX0 Register	4833
24-37. MCSPI_RX0 Register.....	4834
24-38. MCSPI_CH1CONF Register	4835
24-39. MCSPI_CH1STAT Register.....	4839
24-40. MCSPI_CH1CTRL Register	4841
24-41. MCSPI_TX1 Register	4842
24-42. MCSPI_RX1 Register.....	4843
24-43. MCSPI_CH2CONF Register	4844
24-44. MCSPI_CH2STAT Register.....	4848
24-45. MCSPI_CH2CTRL Register	4850
24-46. MCSPI_TX2 Register	4851
24-47. MCSPI_RX2 Register.....	4852
24-48. MCSPI_CH3CONF Register	4853
24-49. MCSPI_CH3STAT Register.....	4857
24-50. MCSPI_CH3CTRL Register	4859
24-51. MCSPI_TX3 Register	4860
24-52. MCSPI_RX3 Register.....	4861
24-53. MCSPI_XFERLEVEL Register	4862
24-54. MCSPI_DAFTX Register	4863
24-55. MCSPI_DAFRX Register	4864
25-1. GPIO0 Module Integration	4867
25-2. GPIO[1–3] Module Integration.....	4867
25-3. Interrupt Request Generation.....	4872
25-4. Write @ GPIO_CLEARDATAOUT Register Example.....	4874
25-5. Write @ GPIO_SETIRQENABLEx Register Example.....	4875
25-6. General-Purpose Interface Used as a Keyboard Interface	4876
25-7. GPIO_REVISION Register	4878
25-8. GPIO_SYSCONFIG Register.....	4879
25-9. GPIO_EOI Register	4880
25-10. GPIO_IRQSTATUS_RAW_0 Register	4881
25-11. GPIO_IRQSTATUS_RAW_1 Register	4882
25-12. GPIO_IRQSTATUS_0 Register	4883

25-13. GPIO_IRQSTATUS_1 Register	4884
25-14. GPIO_IRQSTATUS_SET_0 Register	4885
25-15. GPIO_IRQSTATUS_SET_1 Register	4886
25-16. GPIO_IRQSTATUS_CLR_0 Register	4887
25-17. GPIO_IRQSTATUS_CLR_1 Register	4888
25-18. GPIO_IRQWAKEN_0 Register	4889
25-19. GPIO_IRQWAKEN_1 Register	4890
25-20. GPIO_SYSSTATUS Register.....	4891
25-21. GPIO_CTRL Register.....	4892
25-22. GPIO_OE Register	4893
25-23. GPIO_DATAIN Register	4894
25-24. GPIO_DATAOUT Register	4895
25-25. GPIO_LEVELDETECT0 Register	4896
25-26. GPIO_LEVELDETECT1 Register	4897
25-27. GPIO_RISINGDETECT Register.....	4898
25-28. GPIO_FALLINGDETECT Register.....	4899
25-29. GPIO_DEBOUNCENABLE Register.....	4900
25-30. GPIO_DEBOUNCINGTIME Register	4901
25-31. GPIO_CLEARDATAOUT Register.....	4902
25-32. GPIO_SETDATAOUT Register.....	4903
26-1. Public ROM Code Architecture	4905
26-2. Public ROM Code Boot Procedure	4906
26-3. ROM Memory Map	4907
26-4. Public RAM Memory Map	4909
26-5. ROM Code Startup Sequence	4911
26-6. ROM Code Booting Procedure	4912
26-7. Fast External Boot	4922
26-8. Memory Booting	4923
26-9. GPMC XIP Timings	4925
26-10. Image Shadowing on GP Device.....	4928
26-11. GPMC NAND Timings	4929
26-12. NAND Device Detection	4933
26-13. NAND Invalid Blocks Detection.....	4934
26-14. NAND Read Sector Procedure	4935
26-15. ECC Data Mapping for 2 KB Page and 8b BCH Encoding	4936
26-16. ECC Data Mapping for 4 KB Page and 16b BCH Encoding	4937
26-17. MMC/SD Booting	4939
26-18. MMC/SD Detection Procedure	4940
26-19. MMC/SD Booting, Get Booting File.....	4943
26-20. MBR Detection Procedure	4944
26-21. MBR, Get Partition	4945
26-22. FAT Detection Procedure	4948
26-23. Peripheral Booting Procedure	4952
26-24. USB Initialization Procedure	4957
26-25. Image Transfer for USB Boot.....	4958
26-26. Image Formats on GP Devices.....	4959
26-27. Wakeup Booting by ROM	4962
27-1. Suspend Control Registers	4970

List of Tables

1-1.	Device Features.....	172
1-2.	Device_ID (Address 0x44E10600) Bit Field Descriptions	173
1-3.	DEV_FEATURE (Address 0x44E10604) Register Values	174
2-1.	L3 Memory Map.....	177
2-2.	L4_WKUP Peripheral Memory Map	179
2-3.	L4_PER Peripheral Memory Map.....	180
2-4.	L4 Fast Peripheral Memory Map	184
3-1.	MPU Subsystem Clock Frequencies	190
3-2.	Reset Scheme of the MPU Subsystem	191
3-3.	ARM Core Supported Features	193
3-4.	Overview of the MPU Subsystem Power Domain	194
3-5.	MPU Power States	195
3-6.	MPU Subsystem Operation Power Modes	196
4-1.	PRU-ICSS Connectivity Attributes.....	202
4-2.	PRU-ICSS Clock Signals	202
4-3.	PRU-ICSS Pin List.....	203
4-4.	PRU-ICSS Internal Signal Muxing: pin_mux_sel[0]	204
4-5.	PRU-ICSS Internal Signal Muxing: pin_mux_sel[1]	204
4-6.	Local Instruction Memory Map	206
4-7.	Local Data Memory Map.....	206
4-8.	Global Memory Map	207
4-9.	PRU0/1 Constants Table	209
4-10.	Real-Time Status Interface Mapping (R31) Field Descriptions	211
4-11.	Event Interface Mapping (R31) Field Descriptions	212
4-12.	PRU R31 (GPI) Modes.....	213
4-13.	Effective Clock Values	216
4-14.	PRU R30 (GPO) Modes	217
4-15.	PRU GPO Signals and Configurations.....	217
4-16.	Effective Clock Values	218
4-17.	MPY/MAC XFR ID	220
4-18.	MAC_CTRL_STATUS Register (R25) Field Descriptions	221
4-19.	Scratch Pad XFR ID.....	223
4-20.	Scratch Pad XFR Collision & Stall Conditions	223
4-21.	PRU-ICSS System Events.....	227
4-22.	Baud Rate Examples for 192-MHZ UART Input Clock and 16× Over-sampling Mode.....	238
4-23.	Baud Rate Examples for 192-MHZ UART Input Clock and 13× Over-sampling Mode.....	238
4-24.	UART Signal Descriptions	239
4-25.	Character Time for Word Lengths	242
4-26.	UART Interrupt Requests Descriptions	246
4-27.	PRU_ICSS_PRU_CTRL Registers	249
4-28.	CTRL Register Field Descriptions	250
4-29.	STS Register Field Descriptions	252
4-30.	WAKEUP_EN Register Field Descriptions	253
4-31.	CYCLE Register Field Descriptions	254
4-32.	STALL Register Field Descriptions	255
4-33.	CTBIR0 Register Field Descriptions.....	256
4-34.	CTBIR1 Register Field Descriptions.....	257

4-35.	CTPPR0 Register Field Descriptions	258
4-36.	CTPPR1 Register Field Descriptions	259
4-37.	PRU_ICSS_PRU_DEBUG Registers	259
4-38.	GPREG0 Register Field Descriptions	261
4-39.	GPREG1 Register Field Descriptions	262
4-40.	GPREG2 Register Field Descriptions	263
4-41.	GPREG3 Register Field Descriptions	264
4-42.	GPREG4 Register Field Descriptions	265
4-43.	GPREG5 Register Field Descriptions	266
4-44.	GPREG6 Register Field Descriptions	267
4-45.	GPREG7 Register Field Descriptions	268
4-46.	GPREG8 Register Field Descriptions	269
4-47.	GPREG9 Register Field Descriptions	270
4-48.	GPREG10 Register Field Descriptions	271
4-49.	GPREG11 Register Field Descriptions	272
4-50.	GPREG12 Register Field Descriptions	273
4-51.	GPREG13 Register Field Descriptions	274
4-52.	GPREG14 Register Field Descriptions	275
4-53.	GPREG15 Register Field Descriptions	276
4-54.	GPREG16 Register Field Descriptions	277
4-55.	GPREG17 Register Field Descriptions	278
4-56.	GPREG18 Register Field Descriptions	279
4-57.	GPREG19 Register Field Descriptions	280
4-58.	GPREG20 Register Field Descriptions	281
4-59.	GPREG21 Register Field Descriptions	282
4-60.	GPREG22 Register Field Descriptions	283
4-61.	GPREG23 Register Field Descriptions	284
4-62.	GPREG24 Register Field Descriptions	285
4-63.	GPREG25 Register Field Descriptions	286
4-64.	GPREG26 Register Field Descriptions	287
4-65.	GPREG27 Register Field Descriptions	288
4-66.	GPREG28 Register Field Descriptions	289
4-67.	GPREG29 Register Field Descriptions	290
4-68.	GPREG30 Register Field Descriptions	291
4-69.	GPREG31 Register Field Descriptions	292
4-70.	CT_REG0 Register Field Descriptions	293
4-71.	CT_REG1 Register Field Descriptions	294
4-72.	CT_REG2 Register Field Descriptions	295
4-73.	CT_REG3 Register Field Descriptions	296
4-74.	CT_REG4 Register Field Descriptions	297
4-75.	CT_REG5 Register Field Descriptions	298
4-76.	CT_REG6 Register Field Descriptions	299
4-77.	CT_REG7 Register Field Descriptions	300
4-78.	CT_REG8 Register Field Descriptions	301
4-79.	CT_REG9 Register Field Descriptions	302
4-80.	CT_REG10 Register Field Descriptions	303
4-81.	CT_REG11 Register Field Descriptions	304
4-82.	CT_REG12 Register Field Descriptions	305
4-83.	CT_REG13 Register Field Descriptions	306

4-84.	CT_REG14 Register Field Descriptions	307
4-85.	CT_REG15 Register Field Descriptions	308
4-86.	CT_REG16 Register Field Descriptions	309
4-87.	CT_REG17 Register Field Descriptions	310
4-88.	CT_REG18 Register Field Descriptions	311
4-89.	CT_REG19 Register Field Descriptions	312
4-90.	CT_REG20 Register Field Descriptions	313
4-91.	CT_REG21 Register Field Descriptions	314
4-92.	CT_REG22 Register Field Descriptions	315
4-93.	CT_REG23 Register Field Descriptions	316
4-94.	CT_REG24 Register Field Descriptions	317
4-95.	CT_REG25 Register Field Descriptions	318
4-96.	CT_REG26 Register Field Descriptions	319
4-97.	CT_REG27 Register Field Descriptions	320
4-98.	CT_REG28 Register Field Descriptions	321
4-99.	CT_REG29 Register Field Descriptions	322
4-100.	CT_REG30 Register Field Descriptions	323
4-101.	CT_REG31 Register Field Descriptions	324
4-102.	PRU_ICSS_INTC Registers	324
4-103.	REVID Register Field Descriptions	326
4-104.	CR Register Field Descriptions	327
4-105.	GER Register Field Descriptions	328
4-106.	GNLR Register Field Descriptions	329
4-107.	SISR Register Field Descriptions	330
4-108.	SICR Register Field Descriptions	331
4-109.	EISR Register Field Descriptions	332
4-110.	EICR Register Field Descriptions	333
4-111.	HIEISR Register Field Descriptions	334
4-112.	HIDISR Register Field Descriptions	335
4-113.	GPIR Register Field Descriptions	336
4-114.	SRSR0 Register Field Descriptions	337
4-115.	SRSR1 Register Field Descriptions	338
4-116.	SECR0 Register Field Descriptions	339
4-117.	SECR1 Register Field Descriptions	340
4-118.	ESR0 Register Field Descriptions	341
4-119.	ESR1 Register Field Descriptions	342
4-120.	ECR0 Register Field Descriptions	343
4-121.	ECR1 Register Field Descriptions	344
4-122.	CMR0 Register Field Descriptions	345
4-123.	CMR1 Register Field Descriptions	346
4-124.	CMR2 Register Field Descriptions	347
4-125.	CMR3 Register Field Descriptions	348
4-126.	CMR4 Register Field Descriptions	349
4-127.	CMR5 Register Field Descriptions	350
4-128.	CMR6 Register Field Descriptions	351
4-129.	CMR7 Register Field Descriptions	352
4-130.	CMR8 Register Field Descriptions	353
4-131.	CMR9 Register Field Descriptions	354
4-132.	CMR10 Register Field Descriptions	355

4-133. CMR11 Register Field Descriptions	356
4-134. CMR12 Register Field Descriptions	357
4-135. CMR13 Register Field Descriptions	358
4-136. CMR14 Register Field Descriptions	359
4-137. CMR15 Register Field Descriptions	360
4-138. HMR0 Register Field Descriptions	361
4-139. HMR1 Register Field Descriptions	362
4-140. HMR2 Register Field Descriptions	363
4-141. HIPIR0 Register Field Descriptions	364
4-142. HIPIR1 Register Field Descriptions	365
4-143. HIPIR2 Register Field Descriptions	366
4-144. HIPIR3 Register Field Descriptions	367
4-145. HIPIR4 Register Field Descriptions	368
4-146. HIPIR5 Register Field Descriptions	369
4-147. HIPIR6 Register Field Descriptions	370
4-148. HIPIR7 Register Field Descriptions	371
4-149. HIPIR8 Register Field Descriptions	372
4-150. HIPIR9 Register Field Descriptions	373
4-151. SIPR0 Register Field Descriptions	374
4-152. SIPR1 Register Field Descriptions	375
4-153. SITR0 Register Field Descriptions	376
4-154. SITR1 Register Field Descriptions	377
4-155. HINLR0 Register Field Descriptions.....	378
4-156. HINLR1 Register Field Descriptions.....	379
4-157. HINLR2 Register Field Descriptions.....	380
4-158. HINLR3 Register Field Descriptions.....	381
4-159. HINLR4 Register Field Descriptions.....	382
4-160. HINLR5 Register Field Descriptions.....	383
4-161. HINLR6 Register Field Descriptions.....	384
4-162. HINLR7 Register Field Descriptions.....	385
4-163. HINLR8 Register Field Descriptions.....	386
4-164. HINLR9 Register Field Descriptions.....	387
4-165. HIER Register Field Descriptions.....	388
4-166. PRU_ICSS_IEP Registers.....	388
4-167. IEP_TMR_GLB_CFG Register Field Descriptions	389
4-168. IEP_TMR_GLB_STS Register Field Descriptions	390
4-169. IEP_TMR_COMPEN Register Field Descriptions	391
4-170. IEP_TMR_CNT Register Field Descriptions	392
4-171. IEP_TMR_CMP_CFG Register Field Descriptions.....	393
4-172. IEP_TMR_CMP_STS Register Field Descriptions	394
4-173. IEP_TMR_CMP0 Register Field Descriptions	395
4-174. IEP_TMR_CMP1 Register Field Descriptions	396
4-175. IEP_TMR_CMP2 Register Field Descriptions	397
4-176. IEP_TMR_CMP3 Register Field Descriptions	398
4-177. IEP_TMR_CMP4 Register Field Descriptions	399
4-178. IEP_TMR_CMP5 Register Field Descriptions	400
4-179. IEP_TMR_CMP6 Register Field Descriptions	401
4-180. IEP_TMR_CMP7 Register Field Descriptions	402
4-181. IEP_DIGIO_CTRL Register Field Descriptions	403

4-182. IEP_DIGIO_DATA_IN Register Field Descriptions	404
4-183. IEP_DIGIO_DATA_IN_RAW Register Field Descriptions	405
4-184. IEP_DIGIO_DATA_OUT Register Field Descriptions	406
4-185. IEP_DIGIO_DATA_OUT_EN Register Field Descriptions	407
4-186. IEP_DIGIO_EXP Register Field Descriptions	408
4-187. PRU_ICSS_UART Registers	408
4-188. Receiver Buffer Register (RBR) Field Descriptions	410
4-189. Transmitter Holding Register (THR) Field Descriptions	411
4-190. Interrupt Enable Register (IER) Field Descriptions	412
4-191. Interrupt Identification Register (IIR) Field Descriptions	413
4-192. Interrupt Identification and Interrupt Clearing Information	414
4-193. FIFO Control Register (FCR) Field Descriptions	415
4-194. Line Control Register (LCR) Field Descriptions.....	416
4-195. Relationship Between ST, EPS, and PEN Bits in LCR	417
4-196. Number of STOP Bits Generated.....	417
4-197. Modem Control Register (MCR) Field Descriptions	418
4-198. Line Status Register (LSR) Field Descriptions.....	419
4-199. Modem Status Register (MSR) Field Descriptions	422
4-200. Scratch Pad Register (MSR) Field Descriptions	423
4-201. Divisor LSB Latch (DLL) Field Descriptions	424
4-202. Divisor MSB Latch (DLH) Field Descriptions.....	424
4-203. Revision Identification Register 1 (REVID1) Field Descriptions	425
4-204. Revision Identification Register 2 (REVID2) Field Descriptions	425
4-205. Power and Emulation Management Register (PWREMU_MGMT) Field Descriptions	426
4-206. Mode Definition Register (MDR) Field Descriptions.....	427
4-207. PRU_ICSS_CFG Registers	427
4-208. REVID Register Field Descriptions	428
4-209. SYSCFG Register Field Descriptions	429
4-210. GPCFG0 Register Field Descriptions	430
4-211. GPCFG1 Register Field Descriptions	432
4-212. CGR Register Field Descriptions	434
4-213. ISRP Register Field Descriptions.....	436
4-214. ISP Register Field Descriptions.....	437
4-215. IESP Register Field Descriptions	438
4-216. IECF Register Field Descriptions	439
4-217. PMAO Register Field Descriptions	440
4-218. IEPCLK Register Field Descriptions.....	441
4-219. SPP Register Field Descriptions.....	442
4-220. PIN_MX Register Field Descriptions	443
5-1. SGX530 Connectivity Attributes	448
5-2. SGX530 Clock Signals	448
6-1. ARM Cortex-A8 Interrupts	465
6-2. Timer and eCAP Event Capture	469
6-3. INTC Registers.....	470
6-4. INTC_REVISION Register Field Descriptions	472
6-5. INTC_SYSCONFIG Register Field Descriptions	473
6-6. INTC_SYSSTATUS Register Field Descriptions	474
6-7. INTC_SIR_IRQ Register Field Descriptions.....	475
6-8. INTC_SIR_FIQ Register Field Descriptions	476

6-9.	INTC_CONTROL Register Field Descriptions	477
6-10.	INTC_PROTECTION Register Field Descriptions.....	478
6-11.	INTC_IDLE Register Field Descriptions	479
6-12.	INTC_IRQ_PRIORITY Register Field Descriptions	480
6-13.	INTC_FIQ_PRIORITY Register Field Descriptions.....	481
6-14.	INTC_THRESHOLD Register Field Descriptions.....	482
6-15.	INTC_ITR0 Register Field Descriptions	483
6-16.	INTC_MIR0 Register Field Descriptions	484
6-17.	INTC_MIR_CLEAR0 Register Field Descriptions	485
6-18.	INTC_MIR_SET0 Register Field Descriptions	486
6-19.	INTC_ISR_SET0 Register Field Descriptions.....	487
6-20.	INTC_ISR_CLEAR0 Register Field Descriptions	488
6-21.	INTC_PENDING_IRQ0 Register Field Descriptions	489
6-22.	INTC_PENDING_FIQ0 Register Field Descriptions.....	490
6-23.	INTC_ITR1 Register Field Descriptions	491
6-24.	INTC_MIR1 Register Field Descriptions	492
6-25.	INTC_MIR_CLEAR1 Register Field Descriptions	493
6-26.	INTC_MIR_SET1 Register Field Descriptions	494
6-27.	INTC_ISR_SET1 Register Field Descriptions.....	495
6-28.	INTC_ISR_CLEAR1 Register Field Descriptions	496
6-29.	INTC_PENDING_IRQ1 Register Field Descriptions	497
6-30.	INTC_PENDING_FIQ1 Register Field Descriptions.....	498
6-31.	INTC_ITR2 Register Field Descriptions	499
6-32.	INTC_MIR2 Register Field Descriptions	500
6-33.	INTC_MIR_CLEAR2 Register Field Descriptions	501
6-34.	INTC_MIR_SET2 Register Field Descriptions	502
6-35.	INTC_ISR_SET2 Register Field Descriptions.....	503
6-36.	INTC_ISR_CLEAR2 Register Field Descriptions.....	504
6-37.	INTC_PENDING_IRQ2 Register Field Descriptions	505
6-38.	INTC_PENDING_FIQ2 Register Field Descriptions.....	506
6-39.	INTC_ITR3 Register Field Descriptions	507
6-40.	INTC_MIR3 Register Field Descriptions	508
6-41.	INTC_MIR_CLEAR3 Register Field Descriptions	509
6-42.	INTC_MIR_SET3 Register Field Descriptions	510
6-43.	INTC_ISR_SET3 Register Field Descriptions.....	511
6-44.	INTC_ISR_CLEAR3 Register Field Descriptions.....	512
6-45.	INTC_PENDING_IRQ3 Register Field Descriptions	513
6-46.	INTC_PENDING_FIQ3 Register Field Descriptions.....	514
6-47.	INTC_ILR_0 to INTC_ILR_127 Register Field Descriptions	515
7-1.	Unsupported GPMC Features	519
7-2.	GPMC Connectivity Attributes	520
7-3.	GPMC Clock Signals	520
7-4.	GPMC Signal List.....	521
7-5.	GPMC Pin Multiplexing Options	522
7-6.	GPMC Clocks	527
7-7.	GPMC_CONFIG1_i Configuration.....	527
7-8.	GPMC Local Power Management Features	527
7-9.	GPMC Interrupt Events	528
7-10.	Idle Cycle Insertion Configuration	539

7-11.	Chip-Select Configuration for NAND Interfacing.....	568
7-12.	ECC Enable Settings.....	577
7-13.	Flattened BCH Codeword Mapping (512 Bytes + 104 Bits).....	582
7-14.	Aligned Message Byte Mapping in 8-bit NAND.....	582
7-15.	Aligned Message Byte Mapping in 16-bit NAND.....	583
7-16.	Aligned Nibble Mapping of Message in 8-bit NAND.....	583
7-17.	Misaligned Nibble Mapping of Message in 8-bit NAND.....	583
7-18.	Aligned Nibble Mapping of Message in 16-bit NAND.....	583
7-19.	Misaligned Nibble Mapping of Message in 16-bit NAND (1 Unused Nibble).....	584
7-20.	Misaligned Nibble Mapping of Message in 16-bit NAND (2 Unused Nibble).....	584
7-21.	Misaligned Nibble Mapping of Message in 16-bit NAND (3 Unused Nibble).....	584
7-22.	Prefetch Mode Configuration.....	595
7-23.	Write-Posting Mode Configuration.....	597
7-24.	GPMC Configuration in NOR Mode.....	603
7-25.	GPMC Configuration in NAND Mode.....	603
7-26.	Reset GPMC.....	603
7-27.	NOR Memory Type.....	604
7-28.	NOR Chip-Select Configuration.....	604
7-29.	NOR Timings Configuration.....	604
7-30.	WAIT Pin Configuration.....	604
7-31.	Enable Chip-Select.....	605
7-32.	NAND Memory Type.....	605
7-33.	NAND Chip-Select Configuration.....	605
7-34.	Asynchronous Read and Write Operations.....	605
7-35.	ECC Engine.....	605
7-36.	Prefetch and Write-Posting Engine.....	607
7-37.	WAIT Pin Configuration.....	607
7-38.	Enable Chip-Select.....	607
7-39.	Mode Parameters Check List Table.....	608
7-40.	Access Type Parameters Check List Table.....	608
7-41.	Timing Parameters.....	610
7-42.	GPMC Signals.....	612
7-43.	Useful Timing Parameters on the Memory Side.....	614
7-44.	Calculating GPMC Timing Parameters.....	615
7-45.	AC Characteristics for Asynchronous Read Access.....	616
7-46.	GPMC Timing Parameters for Asynchronous Read Access.....	617
7-47.	AC Characteristics for Asynchronous Single Write (Memory Side).....	618
7-48.	GPMC Timing Parameters for Asynchronous Single Write.....	619
7-49.	NAND Interface Bus Operations Summary.....	620
7-50.	NOR Interface Bus Operations Summary.....	620
7-51.	GPMC Registers.....	622
7-52.	GPMC_REVISION Register Field Descriptions.....	627
7-53.	GPMC_SYSCONFIG Register Field Descriptions.....	628
7-54.	GPMC_SYSSTATUS Register Field Descriptions.....	629
7-55.	GPMC_IRQSTATUS Register Field Descriptions.....	630
7-56.	GPMC_IRQENABLE Register Field Descriptions.....	631
7-57.	GPMC_TIMEOUT_CONTROL Register Field Descriptions.....	632
7-58.	GPMC_ERR_ADDRESS Register Field Descriptions.....	633
7-59.	GPMC_ERR_TYPE Register Field Descriptions.....	634

7-60.	GPMC_CONFIG Register Field Descriptions	635
7-61.	GPMC_STATUS Register Field Descriptions	636
7-62.	GPMC_CONFIG1_0 Register Field Descriptions.....	637
7-63.	GPMC_CONFIG2_0 Register Field Descriptions.....	640
7-64.	GPMC_CONFIG3_0 Register Field Descriptions.....	641
7-65.	GPMC_CONFIG4_0 Register Field Descriptions.....	643
7-66.	GPMC_CONFIG5_0 Register Field Descriptions.....	645
7-67.	GPMC_CONFIG6_0 Register Field Descriptions.....	646
7-68.	GPMC_CONFIG7_0 Register Field Descriptions.....	647
7-69.	GPMC_NAND_COMMAND_0 Register Field Descriptions	648
7-70.	GPMC_NAND_ADDRESS_0 Register Field Descriptions	649
7-71.	GPMC_NAND_DATA_0 Register Field Descriptions	650
7-72.	GPMC_CONFIG1_1 Register Field Descriptions.....	651
7-73.	GPMC_CONFIG2_1 Register Field Descriptions.....	654
7-74.	GPMC_CONFIG3_1 Register Field Descriptions.....	655
7-75.	GPMC_CONFIG4_1 Register Field Descriptions.....	657
7-76.	GPMC_CONFIG5_1 Register Field Descriptions.....	659
7-77.	GPMC_CONFIG6_1 Register Field Descriptions.....	660
7-78.	GPMC_CONFIG7_1 Register Field Descriptions.....	661
7-79.	GPMC_NAND_COMMAND_1 Register Field Descriptions	662
7-80.	GPMC_NAND_ADDRESS_1 Register Field Descriptions	663
7-81.	GPMC_NAND_DATA_1 Register Field Descriptions	664
7-82.	GPMC_CONFIG1_2 Register Field Descriptions.....	665
7-83.	GPMC_CONFIG2_2 Register Field Descriptions.....	668
7-84.	GPMC_CONFIG3_2 Register Field Descriptions.....	669
7-85.	GPMC_CONFIG4_2 Register Field Descriptions.....	671
7-86.	GPMC_CONFIG5_2 Register Field Descriptions.....	673
7-87.	GPMC_CONFIG6_2 Register Field Descriptions.....	674
7-88.	GPMC_CONFIG7_2 Register Field Descriptions.....	675
7-89.	GPMC_NAND_COMMAND_2 Register Field Descriptions	676
7-90.	GPMC_NAND_ADDRESS_2 Register Field Descriptions	677
7-91.	GPMC_NAND_DATA_2 Register Field Descriptions	678
7-92.	GPMC_CONFIG1_3 Register Field Descriptions.....	679
7-93.	GPMC_CONFIG2_3 Register Field Descriptions.....	682
7-94.	GPMC_CONFIG3_3 Register Field Descriptions.....	683
7-95.	GPMC_CONFIG4_3 Register Field Descriptions.....	685
7-96.	GPMC_CONFIG5_3 Register Field Descriptions.....	687
7-97.	GPMC_CONFIG6_3 Register Field Descriptions.....	688
7-98.	GPMC_CONFIG7_3 Register Field Descriptions.....	689
7-99.	GPMC_NAND_COMMAND_3 Register Field Descriptions	690
7-100.	GPMC_NAND_ADDRESS_3 Register Field Descriptions	691
7-101.	GPMC_NAND_DATA_3 Register Field Descriptions	692
7-102.	GPMC_CONFIG1_4 Register Field Descriptions.....	693
7-103.	GPMC_CONFIG2_4 Register Field Descriptions.....	696
7-104.	GPMC_CONFIG3_4 Register Field Descriptions.....	697
7-105.	GPMC_CONFIG4_4 Register Field Descriptions.....	699
7-106.	GPMC_CONFIG5_4 Register Field Descriptions.....	701
7-107.	GPMC_CONFIG6_4 Register Field Descriptions.....	702
7-108.	GPMC_CONFIG7_4 Register Field Descriptions.....	703

7-109. GPMC_NAND_COMMAND_4 Register Field Descriptions	704
7-110. GPMC_NAND_ADDRESS_4 Register Field Descriptions	705
7-111. GPMC_NAND_DATA_4 Register Field Descriptions	706
7-112. GPMC_CONFIG1_5 Register Field Descriptions.....	707
7-113. GPMC_CONFIG2_5 Register Field Descriptions.....	710
7-114. GPMC_CONFIG3_5 Register Field Descriptions.....	711
7-115. GPMC_CONFIG4_5 Register Field Descriptions.....	713
7-116. GPMC_CONFIG5_5 Register Field Descriptions.....	715
7-117. GPMC_CONFIG6_5 Register Field Descriptions.....	716
7-118. GPMC_CONFIG7_5 Register Field Descriptions.....	717
7-119. GPMC_NAND_COMMAND_5 Register Field Descriptions	718
7-120. GPMC_NAND_ADDRESS_5 Register Field Descriptions	719
7-121. GPMC_NAND_DATA_5 Register Field Descriptions	720
7-122. GPMC_CONFIG1_6 Register Field Descriptions.....	721
7-123. GPMC_CONFIG2_6 Register Field Descriptions.....	724
7-124. GPMC_CONFIG3_6 Register Field Descriptions.....	725
7-125. GPMC_CONFIG4_6 Register Field Descriptions.....	727
7-126. GPMC_CONFIG5_6 Register Field Descriptions.....	729
7-127. GPMC_CONFIG6_6 Register Field Descriptions.....	730
7-128. GPMC_CONFIG7_6 Register Field Descriptions.....	731
7-129. GPMC_NAND_COMMAND_6 Register Field Descriptions	732
7-130. GPMC_NAND_ADDRESS_6 Register Field Descriptions	733
7-131. GPMC_NAND_DATA_6 Register Field Descriptions	734
7-132. GPMC_PREFETCH_CONFIG1 Register Field Descriptions	735
7-133. GPMC_PREFETCH_CONFIG2 Register Field Descriptions	737
7-134. GPMC_PREFETCH_CONTROL Register Field Descriptions	738
7-135. GPMC_PREFETCH_STATUS Register Field Descriptions	739
7-136. GPMC_ECC_CONFIG Register Field Descriptions	740
7-137. GPMC_ECC_CONTROL Register Field Descriptions	742
7-138. GPMC_ECC_SIZE_CONFIG Register Field Descriptions	743
7-139. GPMC_ECC1_RESULT Register Field Descriptions	745
7-140. GPMC_ECC2_RESULT Register Field Descriptions	747
7-141. GPMC_ECC3_RESULT Register Field Descriptions	749
7-142. GPMC_ECC4_RESULT Register Field Descriptions	751
7-143. GPMC_ECC5_RESULT Register Field Descriptions	753
7-144. GPMC_ECC6_RESULT Register Field Descriptions	755
7-145. GPMC_ECC7_RESULT Register Field Descriptions	757
7-146. GPMC_ECC8_RESULT Register Field Descriptions	759
7-147. GPMC_ECC9_RESULT Register Field Descriptions	761
7-148. GPMC_BCH_RESULT0_0 Register Field Descriptions	763
7-149. GPMC_BCH_RESULT1_0 Register Field Descriptions	764
7-150. GPMC_BCH_RESULT2_0 Register Field Descriptions	765
7-151. GPMC_BCH_RESULT3_0 Register Field Descriptions	766
7-152. GPMC_BCH_RESULT0_1 Register Field Descriptions	767
7-153. GPMC_BCH_RESULT1_1 Register Field Descriptions	768
7-154. GPMC_BCH_RESULT2_1 Register Field Descriptions	769
7-155. GPMC_BCH_RESULT3_1 Register Field Descriptions	770
7-156. GPMC_BCH_RESULT0_2 Register Field Descriptions	771
7-157. GPMC_BCH_RESULT1_2 Register Field Descriptions	772

7-158. GPMC_BCH_RESULT2_2 Register Field Descriptions	773
7-159. GPMC_BCH_RESULT3_2 Register Field Descriptions	774
7-160. GPMC_BCH_RESULT0_3 Register Field Descriptions	775
7-161. GPMC_BCH_RESULT1_3 Register Field Descriptions	776
7-162. GPMC_BCH_RESULT2_3 Register Field Descriptions	777
7-163. GPMC_BCH_RESULT3_3 Register Field Descriptions	778
7-164. GPMC_BCH_RESULT0_4 Register Field Descriptions	779
7-165. GPMC_BCH_RESULT1_4 Register Field Descriptions	780
7-166. GPMC_BCH_RESULT2_4 Register Field Descriptions	781
7-167. GPMC_BCH_RESULT3_4 Register Field Descriptions	782
7-168. GPMC_BCH_RESULT0_5 Register Field Descriptions	783
7-169. GPMC_BCH_RESULT1_5 Register Field Descriptions	784
7-170. GPMC_BCH_RESULT2_5 Register Field Descriptions	785
7-171. GPMC_BCH_RESULT3_5 Register Field Descriptions	786
7-172. GPMC_BCH_RESULT0_6 Register Field Descriptions	787
7-173. GPMC_BCH_RESULT1_6 Register Field Descriptions	788
7-174. GPMC_BCH_RESULT2_6 Register Field Descriptions	789
7-175. GPMC_BCH_RESULT3_6 Register Field Descriptions	790
7-176. GPMC_BCH_RESULT0_7 Register Field Descriptions	791
7-177. GPMC_BCH_RESULT1_7 Register Field Descriptions	792
7-178. GPMC_BCH_RESULT2_7 Register Field Descriptions	793
7-179. GPMC_BCH_RESULT3_7 Register Field Descriptions	794
7-180. GPMC_BCH_SWDATA Register Field Descriptions	795
7-181. GPMC_BCH_RESULT4_0 Register Field Descriptions	796
7-182. GPMC_BCH_RESULT5_0 Register Field Descriptions	797
7-183. GPMC_BCH_RESULT6_0 Register Field Descriptions	798
7-184. GPMC_BCH_RESULT4_1 Register Field Descriptions	799
7-185. GPMC_BCH_RESULT5_1 Register Field Descriptions	800
7-186. GPMC_BCH_RESULT6_1 Register Field Descriptions	801
7-187. GPMC_BCH_RESULT4_2 Register Field Descriptions	802
7-188. GPMC_BCH_RESULT5_2 Register Field Descriptions	803
7-189. GPMC_BCH_RESULT6_2 Register Field Descriptions	804
7-190. GPMC_BCH_RESULT4_3 Register Field Descriptions	805
7-191. GPMC_BCH_RESULT5_3 Register Field Descriptions	806
7-192. GPMC_BCH_RESULT6_3 Register Field Descriptions	807
7-193. GPMC_BCH_RESULT4_4 Register Field Descriptions	808
7-194. GPMC_BCH_RESULT5_4 Register Field Descriptions	809
7-195. GPMC_BCH_RESULT6_4 Register Field Descriptions	810
7-196. GPMC_BCH_RESULT4_5 Register Field Descriptions	811
7-197. GPMC_BCH_RESULT5_5 Register Field Descriptions	812
7-198. GPMC_BCH_RESULT6_5 Register Field Descriptions	813
7-199. GPMC_BCH_RESULT4_6 Register Field Descriptions	814
7-200. GPMC_BCH_RESULT5_6 Register Field Descriptions	815
7-201. GPMC_BCH_RESULT6_6 Register Field Descriptions	816
7-202. GPMC_BCH_RESULT4_7 Register Field Descriptions	817
7-203. GPMC_BCH_RESULT5_7 Register Field Descriptions	818
7-204. GPMC_BCH_RESULT6_7 Register Field Descriptions	819
7-205. OCMC RAM Connectivity Attributes.....	821
7-206. OCMC RAM Clock Signals	821

7-207. Unsupported EMIF Features	823
7-208. DDR2/3/mDDR Memory Controller Signal Descriptions	826
7-209. Digital Filter Configuration	830
7-210. IBANK, RSIZE and PAGESIZE Fields Information	831
7-211. OCP Address to DDR2/3/mDDR Address Mapping for REG_IBANK_POS=0 and REG_EBANK_POS=0 ..	832
7-212. OCP Address to DDR2/3/mDDR Address Mapping for REG_IBANK_POS=1 and REG_EBANK_POS=0 ..	833
7-213. OCP Address to DDR2/3/mDDR Address Mapping for REG_IBANK_POS=2 and REG_EBANK_POS=0 ..	833
7-214. OCP Address to DDR2/3/mDDR Address Mapping for REG_IBANK_POS=3 and REG_EBANK_POS=0 ..	834
7-215. OCP Address to DDR2/3/mDDR Address Mapping for REG_IBANK_POS=0 and REG_EBANK_POS=1 ..	834
7-216. OCP Address to DDR2/3/mDDR Address Mapping for REG_IBANK_POS=1 and REG_EBANK_POS = 1.	834
7-217. OCP Address to DDR2/3/mDDR Address Mapping for REG_IBANK_POS=2 and REG_EBANK_POS = 1.	835
7-218. OCP Address to DDR2/3/mDDR Address Mapping for REG_IBANK_POS=3 and REG_EBANK_POS=1 ..	835
7-219. Refresh Modes	838
7-220. Filter Configurations for Performance Counters	839
7-221. EMIF4D Registers	844
7-222. EMIF_MOD_ID_REV Register Field Descriptions	846
7-223. STATUS Register Field Descriptions	847
7-224. SDRAM_CONFIG Register Field Descriptions	848
7-225. SDRAM_CONFIG_2 Register Field Descriptions	850
7-226. SDRAM_REF_CTRL Register Field Descriptions	851
7-227. SDRAM_REF_CTRL_SHDW Register Field Descriptions	852
7-228. SDRAM_TIM_1 Register Field Descriptions	853
7-229. SDRAM_TIM_1_SHDW Register Field Descriptions	854
7-230. SDRAM_TIM_2 Register Field Descriptions	855
7-231. SDRAM_TIM_2_SHDW Register Field Descriptions	856
7-232. SDRAM_TIM_3 Register Field Descriptions	857
7-233. SDRAM_TIM_3_SHDW Register Field Descriptions	858
7-234. PWR_MGMT_CTRL Register Field Descriptions	859
7-235. PWR_MGMT_CTRL_SHDW Register Field Descriptions	861
7-236. Interface Configuration Register Field Descriptions	862
7-237. Interface Configuration Value 1 Register Field Descriptions	863
7-238. Interface Configuration Value 2 Register Field Descriptions	864
7-239. PERF_CNT_1 Register Field Descriptions	865
7-240. PERF_CNT_2 Register Field Descriptions	866
7-241. PERF_CNT_CFG Register Field Descriptions	867
7-242. PERF_CNT_SEL Register Field Descriptions	868
7-243. PERF_CNT_TIM Register Field Descriptions	869
7-244. READ_IDLE_CTRL Register Field Descriptions	870
7-245. READ_IDLE_CTRL_SHDW Register Field Descriptions	871
7-246. IRQSTATUS_RAW_SYS Register Field Descriptions	872
7-247. IRQSTATUS_SYS Register Field Descriptions	873
7-248. IRQENABLE_SET_SYS Register Field Descriptions	874
7-249. IRQENABLE_CLR_SYS Register Field Descriptions	875
7-250. ZQ_CONFIG Register Field Descriptions	876
7-251. Read-Write Leveling Ramp Window Register Field Descriptions	877
7-252. Read-Write Leveling Ramp Control Register Field Descriptions	878
7-253. Read-Write Leveling Control Register Field Descriptions	879
7-254. DDR_PHY_CTRL_1 Register Field Descriptions	880
7-255. DDR_PHY_CTRL_1_SHDW Register Field Descriptions	882

7-256. Priority to Class of Service Mapping Register Field Descriptions	884
7-257. Connection ID to Class of Service 1 Mapping Register Field Descriptions	885
7-258. Connection ID to Class of Service 2 Mapping Register Field Descriptions	886
7-259. Read Write Execution Threshold Register Field Descriptions	887
7-260. Memory-Mapped Registers for DDR2/3/mDDR PHY	888
7-261. DDR PHY Command 0/1/2 Address/Command Slave Ratio Register (CMD0/1/2_REG_PHY_CTRL_SLAVE_RATIO_0) Field Descriptions	890
7-262. DDR PHY Command 0/1/2 Address/Command DLL Lock Difference Register (CMD0/1/2_REG_PHY_DLL_LOCK_DIFF_0) Field Descriptions	890
7-263. DDR PHY Command 0/1/2 Invert Clockout Selection Register(CMD0/1/2_REG_PHY_INVERT_CLKOUT_0) Field Descriptions.....	891
7-264. DDR PHY Data Macro 0/1 Read DQS Slave Ratio Register (DATA0/1_REG_PHY_RD_DQS_SLAVE_RATIO_0) Field Descriptions	891
7-265. DDR PHY Data Macro 0/1 Write DQS Slave Ratio Register (DATA0/1_REG_PHY_WR_DQS_SLAVE_RATIO_0).....	892
7-266. DDR PHY Data Macro 0/1 Write DQS Slave Ratio Register(DATA0/1_REG_PHY_WR_DQS_SLAVE_RATIO_0) Field Descriptions	892
7-267. DDR PHY Data Macro 0/1 Write Leveling Init Ratio Register (DATA0/1_REG_PHY_WRLVL_INIT_RATIO_0) Field Descriptions.....	892
7-268. DDR PHY Data Macro 0 Write Leveling Init Mode Ratio Selection Register (DATA0/1_REG_PHY_WRLVL_INIT_MODE_0)	893
7-269. DDR PHY Data Macro 0 DQS Gate Training Init Ratio Register (DATA0_REG_PHY_GATELVL_INIT_RATIO_0) Field Descriptions	893
7-270. DDR PHY Data Macro 0/1 DQS Gate Training Init Mode Ratio Selection Register (DATA0/1_REG_PHY_GATELVL_INIT_MODE_0) Field Descriptions	894
7-271. DDR PHY Data Macro 0/1 DQS Gate Slave Ratio Register (DATA0/1_REG_PHY_FIFO_WE_SLAVE_RATIO_0) Field Descriptions	894
7-272. DDR PHY Data Macro 0/1 Write Data Slave Ratio Register (DATA0/1_REG_PHY_WR_DATA_SLAVE_RATIO_0) Field Descriptions	895
7-273. DDR PHY Data Macro 0/1 Delay Selection Register (DATA0/1_REG_PHY_USE_RANK0_DELAYS) Field Descriptions.....	896
7-274. DDR PHY Data 0/1 DLL Lock Difference Register (DATA0/1_REG_PHY_DLL_LOCK_DIFF_0) Field Descriptions	896
7-275. ELM Connectivity Attributes	898
7-276. ELM Clock Signals.....	898
7-277. Local Power Management Features	899
7-278. Events	899
7-279. ELM_LOCATION_STATUS_i Value Decoding Table	901
7-280. ELM Processing Initialization.....	902
7-281. ELM Processing Completion for Continuous Mode	902
7-282. ELM Processing Completion for Page Mode	903
7-283. Use Case: Continuous Mode.....	903
7-284. 16-bit NAND Sector Buffer Address Map.....	905
7-285. Use Case: Page Mode	905
7-286. ELM Registers.....	907
7-287. ELM_REVISION Register Field Descriptions	912
7-288. ELM_SYSCONFIG Register Field Descriptions	913
7-289. ELM_SYSSTATUS Register Field Descriptions	914
7-290. ELM_IRQSTATUS Register Field Descriptions.....	915
7-291. ELM_IRQENABLE Register Field Descriptions.....	917
7-292. ELM_LOCATION_CONFIG Register Field Descriptions	918
7-293. ELM_PAGE_CTRL Register Field Descriptions	919

7-294. ELM_SYNDROME_FRAGMENT_0_0 Register Field Descriptions	920
7-295. ELM_SYNDROME_FRAGMENT_1_0 Register Field Descriptions	921
7-296. ELM_SYNDROME_FRAGMENT_2_0 Register Field Descriptions	922
7-297. ELM_SYNDROME_FRAGMENT_3_0 Register Field Descriptions	923
7-298. ELM_SYNDROME_FRAGMENT_4_0 Register Field Descriptions	924
7-299. ELM_SYNDROME_FRAGMENT_5_0 Register Field Descriptions	925
7-300. ELM_SYNDROME_FRAGMENT_6_0 Register Field Descriptions	926
7-301. ELM_SYNDROME_FRAGMENT_0_1 Register Field Descriptions	927
7-302. ELM_SYNDROME_FRAGMENT_1_1 Register Field Descriptions	928
7-303. ELM_SYNDROME_FRAGMENT_2_1 Register Field Descriptions	929
7-304. ELM_SYNDROME_FRAGMENT_3_1 Register Field Descriptions	930
7-305. ELM_SYNDROME_FRAGMENT_4_1 Register Field Descriptions	931
7-306. ELM_SYNDROME_FRAGMENT_5_1 Register Field Descriptions	932
7-307. ELM_SYNDROME_FRAGMENT_6_1 Register Field Descriptions	933
7-308. ELM_SYNDROME_FRAGMENT_0_2 Register Field Descriptions	934
7-309. ELM_SYNDROME_FRAGMENT_1_2 Register Field Descriptions	935
7-310. ELM_SYNDROME_FRAGMENT_2_2 Register Field Descriptions	936
7-311. ELM_SYNDROME_FRAGMENT_3_2 Register Field Descriptions	937
7-312. ELM_SYNDROME_FRAGMENT_4_2 Register Field Descriptions	938
7-313. ELM_SYNDROME_FRAGMENT_5_2 Register Field Descriptions	939
7-314. ELM_SYNDROME_FRAGMENT_6_2 Register Field Descriptions	940
7-315. ELM_SYNDROME_FRAGMENT_0_3 Register Field Descriptions	941
7-316. ELM_SYNDROME_FRAGMENT_1_3 Register Field Descriptions	942
7-317. ELM_SYNDROME_FRAGMENT_2_3 Register Field Descriptions	943
7-318. ELM_SYNDROME_FRAGMENT_3_3 Register Field Descriptions	944
7-319. ELM_SYNDROME_FRAGMENT_4_3 Register Field Descriptions	945
7-320. ELM_SYNDROME_FRAGMENT_5_3 Register Field Descriptions	946
7-321. ELM_SYNDROME_FRAGMENT_6_3 Register Field Descriptions	947
7-322. ELM_SYNDROME_FRAGMENT_0_4 Register Field Descriptions	948
7-323. ELM_SYNDROME_FRAGMENT_1_4 Register Field Descriptions	949
7-324. ELM_SYNDROME_FRAGMENT_2_4 Register Field Descriptions	950
7-325. ELM_SYNDROME_FRAGMENT_3_4 Register Field Descriptions	951
7-326. ELM_SYNDROME_FRAGMENT_4_4 Register Field Descriptions	952
7-327. ELM_SYNDROME_FRAGMENT_5_4 Register Field Descriptions	953
7-328. ELM_SYNDROME_FRAGMENT_6_4 Register Field Descriptions	954
7-329. ELM_SYNDROME_FRAGMENT_0_5 Register Field Descriptions	955
7-330. ELM_SYNDROME_FRAGMENT_1_5 Register Field Descriptions	956
7-331. ELM_SYNDROME_FRAGMENT_2_5 Register Field Descriptions	957
7-332. ELM_SYNDROME_FRAGMENT_3_5 Register Field Descriptions	958
7-333. ELM_SYNDROME_FRAGMENT_4_5 Register Field Descriptions	959
7-334. ELM_SYNDROME_FRAGMENT_5_5 Register Field Descriptions	960
7-335. ELM_SYNDROME_FRAGMENT_6_5 Register Field Descriptions	961
7-336. ELM_SYNDROME_FRAGMENT_0_6 Register Field Descriptions	962
7-337. ELM_SYNDROME_FRAGMENT_1_6 Register Field Descriptions	963
7-338. ELM_SYNDROME_FRAGMENT_2_6 Register Field Descriptions	964
7-339. ELM_SYNDROME_FRAGMENT_3_6 Register Field Descriptions	965
7-340. ELM_SYNDROME_FRAGMENT_4_6 Register Field Descriptions	966
7-341. ELM_SYNDROME_FRAGMENT_5_6 Register Field Descriptions	967
7-342. ELM_SYNDROME_FRAGMENT_6_6 Register Field Descriptions	968

7-343. ELM_SYNDROME_FRAGMENT_0_7 Register Field Descriptions	969
7-344. ELM_SYNDROME_FRAGMENT_1_7 Register Field Descriptions	970
7-345. ELM_SYNDROME_FRAGMENT_2_7 Register Field Descriptions	971
7-346. ELM_SYNDROME_FRAGMENT_3_7 Register Field Descriptions	972
7-347. ELM_SYNDROME_FRAGMENT_4_7 Register Field Descriptions	973
7-348. ELM_SYNDROME_FRAGMENT_5_7 Register Field Descriptions	974
7-349. ELM_SYNDROME_FRAGMENT_6_7 Register Field Descriptions	975
7-350. ELM_LOCATION_STATUS_0 Register Field Descriptions	976
7-351. ELM_ERROR_LOCATION_0_0 Register Field Descriptions	977
7-352. ELM_ERROR_LOCATION_1_0 Register Field Descriptions	978
7-353. ELM_ERROR_LOCATION_2_0 Register Field Descriptions	979
7-354. ELM_ERROR_LOCATION_3_0 Register Field Descriptions	980
7-355. ELM_ERROR_LOCATION_4_0 Register Field Descriptions	981
7-356. ELM_ERROR_LOCATION_5_0 Register Field Descriptions	982
7-357. ELM_ERROR_LOCATION_6_0 Register Field Descriptions	983
7-358. ELM_ERROR_LOCATION_7_0 Register Field Descriptions	984
7-359. ELM_ERROR_LOCATION_8_0 Register Field Descriptions	985
7-360. ELM_ERROR_LOCATION_9_0 Register Field Descriptions	986
7-361. ELM_ERROR_LOCATION_10_0 Register Field Descriptions.....	987
7-362. ELM_ERROR_LOCATION_11_0 Register Field Descriptions.....	988
7-363. ELM_ERROR_LOCATION_12_0 Register Field Descriptions.....	989
7-364. ELM_ERROR_LOCATION_13_0 Register Field Descriptions.....	990
7-365. ELM_ERROR_LOCATION_14_0 Register Field Descriptions.....	991
7-366. ELM_ERROR_LOCATION_15_0 Register Field Descriptions.....	992
7-367. ELM_LOCATION_STATUS_1 Register Field Descriptions	993
7-368. ELM_ERROR_LOCATION_0_1 Register Field Descriptions	994
7-369. ELM_ERROR_LOCATION_1_1 Register Field Descriptions	995
7-370. ELM_ERROR_LOCATION_2_1 Register Field Descriptions	996
7-371. ELM_ERROR_LOCATION_3_1 Register Field Descriptions	997
7-372. ELM_ERROR_LOCATION_4_1 Register Field Descriptions	998
7-373. ELM_ERROR_LOCATION_5_1 Register Field Descriptions	999
7-374. ELM_ERROR_LOCATION_6_1 Register Field Descriptions.....	1000
7-375. ELM_ERROR_LOCATION_7_1 Register Field Descriptions.....	1001
7-376. ELM_ERROR_LOCATION_8_1 Register Field Descriptions.....	1002
7-377. ELM_ERROR_LOCATION_9_1 Register Field Descriptions.....	1003
7-378. ELM_ERROR_LOCATION_10_1 Register Field Descriptions	1004
7-379. ELM_ERROR_LOCATION_11_1 Register Field Descriptions	1005
7-380. ELM_ERROR_LOCATION_12_1 Register Field Descriptions	1006
7-381. ELM_ERROR_LOCATION_13_1 Register Field Descriptions	1007
7-382. ELM_ERROR_LOCATION_14_1 Register Field Descriptions	1008
7-383. ELM_ERROR_LOCATION_15_1 Register Field Descriptions	1009
7-384. ELM_LOCATION_STATUS_2 Register Field Descriptions.....	1010
7-385. ELM_ERROR_LOCATION_0_2 Register Field Descriptions.....	1011
7-386. ELM_ERROR_LOCATION_1_2 Register Field Descriptions.....	1012
7-387. ELM_ERROR_LOCATION_2_2 Register Field Descriptions.....	1013
7-388. ELM_ERROR_LOCATION_3_2 Register Field Descriptions.....	1014
7-389. ELM_ERROR_LOCATION_4_2 Register Field Descriptions.....	1015
7-390. ELM_ERROR_LOCATION_5_2 Register Field Descriptions.....	1016
7-391. ELM_ERROR_LOCATION_6_2 Register Field Descriptions.....	1017

7-392. ELM_ERROR_LOCATION_7_2 Register Field Descriptions.....	1018
7-393. ELM_ERROR_LOCATION_8_2 Register Field Descriptions.....	1019
7-394. ELM_ERROR_LOCATION_9_2 Register Field Descriptions.....	1020
7-395. ELM_ERROR_LOCATION_10_2 Register Field Descriptions.....	1021
7-396. ELM_ERROR_LOCATION_11_2 Register Field Descriptions.....	1022
7-397. ELM_ERROR_LOCATION_12_2 Register Field Descriptions.....	1023
7-398. ELM_ERROR_LOCATION_13_2 Register Field Descriptions.....	1024
7-399. ELM_ERROR_LOCATION_14_2 Register Field Descriptions.....	1025
7-400. ELM_ERROR_LOCATION_15_2 Register Field Descriptions.....	1026
7-401. ELM_ERROR_LOCATION_0_3 Register Field Descriptions.....	1027
7-402. ELM_ERROR_LOCATION_1_3 Register Field Descriptions.....	1028
7-403. ELM_ERROR_LOCATION_2_3 Register Field Descriptions.....	1029
7-404. ELM_ERROR_LOCATION_3_3 Register Field Descriptions.....	1030
7-405. ELM_ERROR_LOCATION_4_3 Register Field Descriptions.....	1031
7-406. ELM_ERROR_LOCATION_5_3 Register Field Descriptions.....	1032
7-407. ELM_ERROR_LOCATION_6_3 Register Field Descriptions.....	1033
7-408. ELM_ERROR_LOCATION_7_3 Register Field Descriptions.....	1034
7-409. ELM_ERROR_LOCATION_8_3 Register Field Descriptions.....	1035
7-410. ELM_ERROR_LOCATION_9_3 Register Field Descriptions.....	1036
7-411. ELM_ERROR_LOCATION_10_3 Register Field Descriptions.....	1037
7-412. ELM_ERROR_LOCATION_11_3 Register Field Descriptions.....	1038
7-413. ELM_ERROR_LOCATION_12_3 Register Field Descriptions.....	1039
7-414. ELM_ERROR_LOCATION_13_3 Register Field Descriptions.....	1040
7-415. ELM_ERROR_LOCATION_14_3 Register Field Descriptions.....	1041
7-416. ELM_ERROR_LOCATION_15_3 Register Field Descriptions.....	1042
7-417. ELM_LOCATION_STATUS_3 Register Field Descriptions.....	1043
7-418. ELM_ERROR_LOCATION_0_4 Register Field Descriptions.....	1044
7-419. ELM_ERROR_LOCATION_1_4 Register Field Descriptions.....	1045
7-420. ELM_ERROR_LOCATION_2_4 Register Field Descriptions.....	1046
7-421. ELM_ERROR_LOCATION_3_4 Register Field Descriptions.....	1047
7-422. ELM_ERROR_LOCATION_4_4 Register Field Descriptions.....	1048
7-423. ELM_ERROR_LOCATION_5_4 Register Field Descriptions.....	1049
7-424. ELM_ERROR_LOCATION_6_4 Register Field Descriptions.....	1050
7-425. ELM_ERROR_LOCATION_7_4 Register Field Descriptions.....	1051
7-426. ELM_ERROR_LOCATION_8_4 Register Field Descriptions.....	1052
7-427. ELM_ERROR_LOCATION_9_4 Register Field Descriptions.....	1053
7-428. ELM_ERROR_LOCATION_10_4 Register Field Descriptions.....	1054
7-429. ELM_ERROR_LOCATION_11_4 Register Field Descriptions.....	1055
7-430. ELM_ERROR_LOCATION_12_4 Register Field Descriptions.....	1056
7-431. ELM_ERROR_LOCATION_13_4 Register Field Descriptions.....	1057
7-432. ELM_ERROR_LOCATION_14_4 Register Field Descriptions.....	1058
7-433. ELM_ERROR_LOCATION_15_4 Register Field Descriptions.....	1059
7-434. ELM_ERROR_LOCATION_0_5 Register Field Descriptions.....	1060
7-435. ELM_ERROR_LOCATION_1_5 Register Field Descriptions.....	1061
7-436. ELM_ERROR_LOCATION_2_5 Register Field Descriptions.....	1062
7-437. ELM_ERROR_LOCATION_3_5 Register Field Descriptions.....	1063
7-438. ELM_ERROR_LOCATION_4_5 Register Field Descriptions.....	1064
7-439. ELM_ERROR_LOCATION_5_5 Register Field Descriptions.....	1065
7-440. ELM_ERROR_LOCATION_6_5 Register Field Descriptions.....	1066

7-441. ELM_ERROR_LOCATION_7_5 Register Field Descriptions.....	1067
7-442. ELM_ERROR_LOCATION_8_5 Register Field Descriptions.....	1068
7-443. ELM_ERROR_LOCATION_9_5 Register Field Descriptions.....	1069
7-444. ELM_ERROR_LOCATION_10_5 Register Field Descriptions	1070
7-445. ELM_ERROR_LOCATION_11_5 Register Field Descriptions	1071
7-446. ELM_ERROR_LOCATION_12_5 Register Field Descriptions	1072
7-447. ELM_ERROR_LOCATION_13_5 Register Field Descriptions	1073
7-448. ELM_ERROR_LOCATION_14_5 Register Field Descriptions	1074
7-449. ELM_ERROR_LOCATION_15_5 Register Field Descriptions	1075
7-450. ELM_LOCATION_STATUS_4 Register Field Descriptions.....	1076
7-451. ELM_ERROR_LOCATION_0_6 Register Field Descriptions.....	1077
7-452. ELM_ERROR_LOCATION_1_6 Register Field Descriptions.....	1078
7-453. ELM_ERROR_LOCATION_2_6 Register Field Descriptions.....	1079
7-454. ELM_ERROR_LOCATION_3_6 Register Field Descriptions.....	1080
7-455. ELM_ERROR_LOCATION_4_6 Register Field Descriptions.....	1081
7-456. ELM_ERROR_LOCATION_5_6 Register Field Descriptions.....	1082
7-457. ELM_ERROR_LOCATION_6_6 Register Field Descriptions.....	1083
7-458. ELM_ERROR_LOCATION_7_6 Register Field Descriptions.....	1084
7-459. ELM_ERROR_LOCATION_8_6 Register Field Descriptions.....	1085
7-460. ELM_ERROR_LOCATION_9_6 Register Field Descriptions.....	1086
7-461. ELM_ERROR_LOCATION_10_6 Register Field Descriptions	1087
7-462. ELM_ERROR_LOCATION_11_6 Register Field Descriptions	1088
7-463. ELM_ERROR_LOCATION_12_6 Register Field Descriptions	1089
7-464. ELM_ERROR_LOCATION_13_6 Register Field Descriptions	1090
7-465. ELM_ERROR_LOCATION_14_6 Register Field Descriptions	1091
7-466. ELM_ERROR_LOCATION_15_6 Register Field Descriptions	1092
7-467. ELM_ERROR_LOCATION_0_7 Register Field Descriptions.....	1093
7-468. ELM_ERROR_LOCATION_1_7 Register Field Descriptions.....	1094
7-469. ELM_ERROR_LOCATION_2_7 Register Field Descriptions.....	1095
7-470. ELM_ERROR_LOCATION_3_7 Register Field Descriptions.....	1096
7-471. ELM_ERROR_LOCATION_4_7 Register Field Descriptions.....	1097
7-472. ELM_ERROR_LOCATION_5_7 Register Field Descriptions.....	1098
7-473. ELM_ERROR_LOCATION_6_7 Register Field Descriptions.....	1099
7-474. ELM_ERROR_LOCATION_7_7 Register Field Descriptions.....	1100
7-475. ELM_ERROR_LOCATION_8_7 Register Field Descriptions.....	1101
7-476. ELM_ERROR_LOCATION_9_7 Register Field Descriptions.....	1102
7-477. ELM_ERROR_LOCATION_10_7 Register Field Descriptions	1103
7-478. ELM_ERROR_LOCATION_11_7 Register Field Descriptions	1104
7-479. ELM_ERROR_LOCATION_12_7 Register Field Descriptions	1105
7-480. ELM_ERROR_LOCATION_13_7 Register Field Descriptions	1106
7-481. ELM_ERROR_LOCATION_14_7 Register Field Descriptions	1107
7-482. ELM_ERROR_LOCATION_15_7 Register Field Descriptions	1108
7-483. ELM_LOCATION_STATUS_5 Register Field Descriptions.....	1109
7-484. ELM_LOCATION_STATUS_6 Register Field Descriptions.....	1110
7-485. ELM_LOCATION_STATUS_7 Register Field Descriptions.....	1111
8-1. Master Module Standby-Mode Settings	1114
8-2. Master Module Standby Status	1115
8-3. Module Idle Mode Settings.....	1115
8-4. Idle States for a Slave Module	1116

8-5.	Slave Module Mode Settings in PRCM.....	1116
8-6.	Module Clock Enabling Condition	1117
8-7.	Clock Domain Functional Clock States.....	1118
8-8.	Clock Domain States	1119
8-9.	Clock Transition Mode Settings	1119
8-10.	States of a Memory Area in a Power Domain	1120
8-11.	States of a Logic Area in a Power Domain	1120
8-12.	Power Domain Control and Status Registers.....	1121
8-13.	Typical Power Modes	1122
8-14.	USB Wakeup Use Cases Supported in System Sleep States	1126
8-15.	CMD_STAT Field.....	1129
8-16.	CMD_ID Field.....	1129
8-17.	Output Clocks in Locked Condition	1134
8-18.	Output Clocks Before Lock and During Relock Modes	1134
8-19.	Output Clocks in Locked Condition	1136
8-20.	Output Clocks Before Lock and During Relock Modes	1136
8-21.	PLL and Clock Frequencies	1139
8-22.	Core PLL Typical Frequencies (MHz)	1139
8-23.	Bus Interface Clocks	1140
8-24.	Per PLL Typical Frequencies (MHz).....	1141
8-25.	Reset Sources	1155
8-26.	Core Logic Voltage and Power Domains	1157
8-27.	Power Domain State Table	1157
8-28.	Power Domain of Various Modules	1158
8-29.	CM_PER REGISTERS	1161
8-30.	CM_PER_L4LS_CLKSTCTRL Register Field Descriptions	1163
8-31.	CM_PER_L3S_CLKSTCTRL Register Field Descriptions	1165
8-32.	CM_PER_L3_CLKSTCTRL Register Field Descriptions.....	1166
8-33.	CM_PER_CPGMAC0_CLKCTRL Register Field Descriptions.....	1167
8-34.	CM_PER_LCDC_CLKCTRL Register Field Descriptions.....	1168
8-35.	CM_PER_USB0_CLKCTRL Register Field Descriptions	1169
8-36.	CM_PER_TPTC0_CLKCTRL Register Field Descriptions.....	1170
8-37.	CM_PER_EMIF_CLKCTRL Register Field Descriptions.....	1171
8-38.	CM_PER_OCMCRAM_CLKCTRL Register Field Descriptions	1172
8-39.	CM_PER_GPMC_CLKCTRL Register Field Descriptions	1173
8-40.	CM_PER_MCASP0_CLKCTRL Register Field Descriptions	1174
8-41.	CM_PER_UART5_CLKCTRL Register Field Descriptions	1175
8-42.	CM_PER_MMC0_CLKCTRL Register Field Descriptions	1176
8-43.	CM_PER_ELM_CLKCTRL Register Field Descriptions.....	1177
8-44.	CM_PER_I2C2_CLKCTRL Register Field Descriptions	1178
8-45.	CM_PER_I2C1_CLKCTRL Register Field Descriptions	1179
8-46.	CM_PER_SPI0_CLKCTRL Register Field Descriptions	1180
8-47.	CM_PER_SPI1_CLKCTRL Register Field Descriptions	1181
8-48.	CM_PER_L4LS_CLKCTRL Register Field Descriptions	1182
8-49.	CM_PER_MCASP1_CLKCTRL Register Field Descriptions	1183
8-50.	CM_PER_UART1_CLKCTRL Register Field Descriptions	1184
8-51.	CM_PER_UART2_CLKCTRL Register Field Descriptions	1185
8-52.	CM_PER_UART3_CLKCTRL Register Field Descriptions	1186
8-53.	CM_PER_UART4_CLKCTRL Register Field Descriptions	1187

8-54.	CM_PER_TIMER7_CLKCTRL Register Field Descriptions	1188
8-55.	CM_PER_TIMER2_CLKCTRL Register Field Descriptions	1189
8-56.	CM_PER_TIMER3_CLKCTRL Register Field Descriptions	1190
8-57.	CM_PER_TIMER4_CLKCTRL Register Field Descriptions	1191
8-58.	CM_PER_GPIO1_CLKCTRL Register Field Descriptions	1192
8-59.	CM_PER_GPIO2_CLKCTRL Register Field Descriptions	1193
8-60.	CM_PER_GPIO3_CLKCTRL Register Field Descriptions	1194
8-61.	CM_PER_TPCC_CLKCTRL Register Field Descriptions	1195
8-62.	CM_PER_DCAN0_CLKCTRL Register Field Descriptions	1196
8-63.	CM_PER_DCAN1_CLKCTRL Register Field Descriptions	1197
8-64.	CM_PER_EPWMSS1_CLKCTRL Register Field Descriptions	1198
8-65.	CM_PER_EPWMSS0_CLKCTRL Register Field Descriptions	1199
8-66.	CM_PER_EPWMSS2_CLKCTRL Register Field Descriptions	1200
8-67.	CM_PER_L3_INSTR_CLKCTRL Register Field Descriptions	1201
8-68.	CM_PER_L3_CLKCTRL Register Field Descriptions	1202
8-69.	CM_PER_IEEE5000_CLKCTRL Register Field Descriptions	1203
8-70.	CM_PER_PRU_ICSS_CLKCTRL Register Field Descriptions	1204
8-71.	CM_PER_TIMER5_CLKCTRL Register Field Descriptions	1205
8-72.	CM_PER_TIMER6_CLKCTRL Register Field Descriptions	1206
8-73.	CM_PER_MMC1_CLKCTRL Register Field Descriptions	1207
8-74.	CM_PER_MMC2_CLKCTRL Register Field Descriptions	1208
8-75.	CM_PER_TPTC1_CLKCTRL Register Field Descriptions	1209
8-76.	CM_PER_TPTC2_CLKCTRL Register Field Descriptions	1210
8-77.	CM_PER_SPINLOCK_CLKCTRL Register Field Descriptions	1211
8-78.	CM_PER_MAILBOX0_CLKCTRL Register Field Descriptions	1212
8-79.	CM_PER_L4HS_CLKSTCTRL Register Field Descriptions	1213
8-80.	CM_PER_L4HS_CLKCTRL Register Field Descriptions	1214
8-81.	CM_PER_OCPWP_L3_CLKSTCTRL Register Field Descriptions	1215
8-82.	CM_PER_OCPWP_CLKCTRL Register Field Descriptions	1216
8-83.	CM_PER_PRU_ICSS_CLKSTCTRL Register Field Descriptions	1217
8-84.	CM_PER_CPSW_CLKSTCTRL Register Field Descriptions	1218
8-85.	CM_PER_LCDC_CLKSTCTRL Register Field Descriptions	1219
8-86.	CM_PER_CLKDIV32K_CLKCTRL Register Field Descriptions	1220
8-87.	CM_PER_CLK_24MHZ_CLKSTCTRL Register Field Descriptions	1221
8-88.	CM_WKUP Registers	1221
8-89.	CM_WKUP_CLKSTCTRL Register Field Descriptions	1224
8-90.	CM_WKUP_CONTROL_CLKCTRL Register Field Descriptions	1226
8-91.	CM_WKUP_GPIO0_CLKCTRL Register Field Descriptions	1227
8-92.	CM_WKUP_L4WKUP_CLKCTRL Register Field Descriptions	1228
8-93.	CM_WKUP_TIMER0_CLKCTRL Register Field Descriptions	1229
8-94.	CM_WKUP_DEBUGSS_CLKCTRL Register Field Descriptions	1230
8-95.	CM_L3_AON_CLKSTCTRL Register Field Descriptions	1232
8-96.	CM_AUTOIDLE_DPLL_MPU Register Field Descriptions	1233
8-97.	CM_IDLEST_DPLL_MPU Register Field Descriptions	1234
8-98.	CM_SSC_DELTAMSTEP_DPLL_MPU Register Field Descriptions	1235
8-99.	CM_SSC_MODFREQDIV_DPLL_MPU Register Field Descriptions	1236
8-100.	CM_CLKSEL_DPLL_MPU Register Field Descriptions	1237
8-101.	CM_AUTOIDLE_DPLL_DDR Register Field Descriptions	1238
8-102.	CM_IDLEST_DPLL_DDR Register Field Descriptions	1239

8-103. CM_SSC_DELTAMSTEP_DPLL_DDR Register Field Descriptions	1240
8-104. CM_SSC_MODFREQDIV_DPLL_DDR Register Field Descriptions	1241
8-105. CM_CLKSEL_DPLL_DDR Register Field Descriptions	1242
8-106. CM_AUTOIDLE_DPLL_DISP Register Field Descriptions	1243
8-107. CM_IDLEST_DPLL_DISP Register Field Descriptions	1244
8-108. CM_SSC_DELTAMSTEP_DPLL_DISP Register Field Descriptions	1245
8-109. CM_SSC_MODFREQDIV_DPLL_DISP Register Field Descriptions.....	1246
8-110. CM_CLKSEL_DPLL_DISP Register Field Descriptions.....	1247
8-111. CM_AUTOIDLE_DPLL_CORE Register Field Descriptions	1248
8-112. CM_IDLEST_DPLL_CORE Register Field Descriptions	1249
8-113. CM_SSC_DELTAMSTEP_DPLL_CORE Register Field Descriptions	1250
8-114. CM_SSC_MODFREQDIV_DPLL_CORE Register Field Descriptions	1251
8-115. CM_CLKSEL_DPLL_CORE Register Field Descriptions	1252
8-116. CM_AUTOIDLE_DPLL_PER Register Field Descriptions	1253
8-117. CM_IDLEST_DPLL_PER Register Field Descriptions	1254
8-118. CM_SSC_DELTAMSTEP_DPLL_PER Register Field Descriptions.....	1255
8-119. CM_SSC_MODFREQDIV_DPLL_PER Register Field Descriptions	1256
8-120. CM_CLKDCOLDO_DPLL_PER Register Field Descriptions.....	1257
8-121. CM_DIV_M4_DPLL_CORE Register Field Descriptions.....	1258
8-122. CM_DIV_M5_DPLL_CORE Register Field Descriptions.....	1259
8-123. CM_CLKMODE_DPLL_MPU Register Field Descriptions	1260
8-124. CM_CLKMODE_DPLL_PER Register Field Descriptions	1262
8-125. CM_CLKMODE_DPLL_CORE Register Field Descriptions	1263
8-126. CM_CLKMODE_DPLL_DDR Register Field Descriptions	1265
8-127. CM_CLKMODE_DPLL_DISP Register Field Descriptions.....	1267
8-128. CM_CLKSEL_DPLL_PERIPH Register Field Descriptions.....	1269
8-129. CM_DIV_M2_DPLL_DDR Register Field Descriptions.....	1270
8-130. CM_DIV_M2_DPLL_DISP Register Field Descriptions	1271
8-131. CM_DIV_M2_DPLL_MPU Register Field Descriptions	1272
8-132. CM_DIV_M2_DPLL_PER Register Field Descriptions	1273
8-133. CM_WKUP_WKUP_M3_CLKCTRL Register Field Descriptions	1274
8-134. CM_WKUP_UART0_CLKCTRL Register Field Descriptions.....	1275
8-135. CM_WKUP_I2C0_CLKCTRL Register Field Descriptions	1276
8-136. CM_WKUP_ADC_TSC_CLKCTRL Register Field Descriptions	1277
8-137. CM_WKUP_SMARTREFLEX0_CLKCTRL Register Field Descriptions	1278
8-138. CM_WKUP_TIMER1_CLKCTRL Register Field Descriptions.....	1279
8-139. CM_WKUP_SMARTREFLEX1_CLKCTRL Register Field Descriptions	1280
8-140. CM_L4_WKUP_AON_CLKSTCTRL Register Field Descriptions.....	1281
8-141. CM_WKUP_WDT1_CLKCTRL Register Field Descriptions.....	1282
8-142. CM_DIV_M6_DPLL_CORE Register Field Descriptions.....	1283
8-143. CM_DPLL REGISTERS	1284
8-144. CLKSEL_TIMER7_CLK Register Field Descriptions	1285
8-145. CLKSEL_TIMER2_CLK Register Field Descriptions	1286
8-146. CLKSEL_TIMER3_CLK Register Field Descriptions	1287
8-147. CLKSEL_TIMER4_CLK Register Field Descriptions	1288
8-148. CM_MAC_CLKSEL Register Field Descriptions	1289
8-149. CLKSEL_TIMER5_CLK Register Field Descriptions	1290
8-150. CLKSEL_TIMER6_CLK Register Field Descriptions	1291
8-151. CM_CPTS_RFT_CLKSEL Register Field Descriptions	1292

8-152. CLKSEL_TIMER1MS_CLK Register Field Descriptions	1293
8-153. CLKSEL_GFX_FCLK Register Field Descriptions	1294
8-154. CLKSEL_PRU_ICSS_OCP_CLK Register Field Descriptions	1295
8-155. CLKSEL_LCDC_PIXEL_CLK Register Field Descriptions	1296
8-156. CLKSEL_WDT1_CLK Register Field Descriptions	1297
8-157. CLKSEL_GPIO0_DBCLK Register Field Descriptions	1298
8-158. CM_MPU REGISTERS	1298
8-159. CM_MPU_CLKSTCTRL Register Field Descriptions	1299
8-160. CM_MPU_MPU_CLKCTRL Register Field Descriptions	1300
8-161. CM_DEVICE REGISTERS	1300
8-162. CM_CLKOUT_CTRL Register Field Descriptions	1302
8-163. CM_RTC REGISTERS	1303
8-164. CM_RTC_RTC_CLKCTRL Register Field Descriptions	1304
8-165. CM_RTC_CLKSTCTRL Register Field Descriptions	1305
8-166. CM_GFX REGISTERS	1306
8-167. CM_GFX_L3_CLKSTCTRL Register Field Descriptions	1307
8-168. CM_GFX_GFX_CLKCTRL Register Field Descriptions	1308
8-169. CM_GFX_L4LS_GFX_CLKSTCTRL Register Field Descriptions	1309
8-170. CM_GFX_MMUCFG_CLKCTRL Register Field Descriptions	1310
8-171. CM_GFX_MMUDATA_CLKCTRL Register Field Descriptions	1311
8-172. CM_CEFUSE REGISTERS	1311
8-173. CM_CEFUSE_CLKSTCTRL Register Field Descriptions	1313
8-174. CM_CEFUSE_CEFUSE_CLKCTRL Register Field Descriptions	1314
8-175. PRM_IRQ REGISTERS	1315
8-176. REVISION_PRM Register Field Descriptions	1316
8-177. PRM_IRQSTATUS_MPU Register Field Descriptions	1317
8-178. PRM_IRQENABLE_MPU Register Field Descriptions	1318
8-179. PRM_IRQSTATUS_M3 Register Field Descriptions	1319
8-180. PRM_IRQENABLE_M3 Register Field Descriptions	1320
8-181. PRM_PER REGISTERS	1321
8-182. RM_PER_RSTCTRL Register Field Descriptions	1322
8-183. PM_PER_PWRSTST Register Field Descriptions	1323
8-184. PM_PER_PWRSTCTRL Register Field Descriptions	1324
8-185. PRM_WKUP REGISTERS	1325
8-186. RM_WKUP_RSTCTRL Register Field Descriptions	1326
8-187. PM_WKUP_PWRSTCTRL Register Field Descriptions	1327
8-188. PM_WKUP_PWRSTST Register Field Descriptions	1328
8-189. RM_WKUP_RSTST Register Field Descriptions	1329
8-190. PRM_MPU REGISTERS	1329
8-191. PM_MPU_PWRSTCTRL Register Field Descriptions	1331
8-192. PM_MPU_PWRSTST Register Field Descriptions	1333
8-193. RM_MPU_RSTST Register Field Descriptions	1334
8-194. PRM_DEVICE Registers	1334
8-195. PRM_RSTCTRL Register Field Descriptions	1336
8-196. PRM_RSTTIME Register Field Descriptions	1337
8-197. PRM_RSTST Register Field Descriptions	1338
8-198. PRM_SRAM_COUNT Register Field Descriptions	1339
8-199. PRM_LDO_SRAM_CORE_SETUP Register Field Descriptions	1340
8-200. PRM_LDO_SRAM_CORE_CTRL Register Field Descriptions	1342

8-201. PRM_LDO_SRAM_MPU_SETUP Register Field Descriptions	1343
8-202. PRM_LDO_SRAM_MPU_CTRL Register Field Descriptions	1345
8-203. PRM_RTC REGISTERS	1345
8-204. PM_RTC_PWRSTCTRL Register Field Descriptions	1346
8-205. PM_RTC_PWRSTST Register Field Descriptions	1347
8-206. PRM_GFX REGISTERS	1347
8-207. PM_GFX_PWRSTCTRL Register Field Descriptions	1349
8-208. RM_GFX_RSTCTRL Register Field Descriptions	1350
8-209. PM_GFX_PWRSTST Register Field Descriptions	1351
8-210. RM_GFX_RSTST Register Field Descriptions	1352
8-211. PRM_CEFUSE REGISTERS	1352
8-212. PM_CEFUSE_PWRSTCTRL Register Field Descriptions	1353
8-213. PM_CEFUSE_PWRSTST Register Field Descriptions	1354
9-1. Pad Control Register Field Descriptions	1356
9-2. Mode Selection	1357
9-3. Pull Selection	1357
9-4. Interconnect Priority Values.....	1359
9-5. Available Sources for Timer[5–7] and eCAP[0–2] Events	1362
9-6. Selection Mux Values.....	1363
9-7. DDR Slew Rate Control Settings.....	1364
9-8. DDR Impedance Control Settings.....	1364
9-9. DDR PHY to IO Pin Mapping	1364
9-10. CONTROL_MODULE REGISTERS	1365
9-11. control_revision Register Field Descriptions.....	1370
9-12. control_hwinfo Register Field Descriptions	1371
9-13. control_sysconfig Register Field Descriptions.....	1372
9-14. control_status Register Field Descriptions	1373
9-15. control_emif_sdram_config Register Field Descriptions	1374
9-16. core_sldo_ctrl Register Field Descriptions	1376
9-17. mpu_sldo_ctrl Register Field Descriptions	1377
9-18. clk32kdivratio_ctrl Register Field Descriptions	1378
9-19. bandgap_ctrl Register Field Descriptions	1379
9-20. bandgap_trim Register Field Descriptions	1380
9-21. pll_clkinpulow_ctrl Register Field Descriptions	1381
9-22. mosc_ctrl Register Field Descriptions	1382
9-23. deepsleep_ctrl Register Field Descriptions	1383
9-24. dppll_pwr_sw_status Register Field Descriptions	1384
9-25. device_id Register Field Descriptions	1385
9-26. dev_feature Register Field Descriptions	1386
9-27. init_priority_0 Register Field Descriptions.....	1387
9-28. init_priority_1 Register Field Descriptions.....	1388
9-29. tptc_cfg Register Field Descriptions	1389
9-30. usb_ctrl0 Register Field Descriptions.....	1390
9-31. usb_sts0 Register Field Descriptions	1392
9-32. usb_ctrl1 Register Field Descriptions.....	1393
9-33. usb_sts1 Register Field Descriptions	1395
9-34. mac_id0_lo Register Field Descriptions	1396
9-35. mac_id0_hi Register Field Descriptions	1397
9-36. mac_id1_lo Register Field Descriptions	1398

9-37.	mac_id1_hi Register Field Descriptions	1399
9-38.	dcan_raminit Register Field Descriptions	1400
9-39.	usb_wkup_ctrl Register Field Descriptions	1401
9-40.	gmii_sel Register Field Descriptions	1402
9-41.	pwmss_ctrl Register Field Descriptions	1403
9-42.	mreqprio_0 Register Field Descriptions	1404
9-43.	mreqprio_1 Register Field Descriptions	1405
9-44.	hw_event_sel_grp1 Register Field Descriptions	1406
9-45.	hw_event_sel_grp2 Register Field Descriptions	1407
9-46.	hw_event_sel_grp3 Register Field Descriptions	1408
9-47.	hw_event_sel_grp4 Register Field Descriptions	1409
9-48.	smrt_ctrl Register Field Descriptions	1410
9-49.	mpuss_hw_debug_sel Register Field Descriptions	1411
9-50.	mpuss_hw_dbg_info Register Field Descriptions	1412
9-51.	vdd_mpu_opp_050 Register Field Descriptions	1413
9-52.	vdd_mpu_opp_100 Register Field Descriptions	1414
9-53.	vdd_mpu_opp_120 Register Field Descriptions	1415
9-54.	vdd_mpu_opp_turbo Register Field Descriptions	1416
9-55.	vdd_core_opp_050 Register Field Descriptions	1417
9-56.	vdd_core_opp_100 Register Field Descriptions	1418
9-57.	bb_scale Register Field Descriptions	1419
9-58.	usb_vid_pid Register Field Descriptions	1420
9-59.	efuse_sma Register Field Descriptions	1421
9-60.	conf_<module>_<pin> Register Field Descriptions	1422
9-61.	cqdetect_status Register Field Descriptions	1423
9-62.	ddr_io_ctrl Register Field Descriptions	1424
9-63.	vtp_ctrl Register Field Descriptions	1425
9-64.	vref_ctrl Register Field Descriptions	1426
9-65.	tpcc_evt_mux_0_3 Register Field Descriptions	1427
9-66.	tpcc_evt_mux_4_7 Register Field Descriptions	1428
9-67.	tpcc_evt_mux_8_11 Register Field Descriptions	1429
9-68.	tpcc_evt_mux_12_15 Register Field Descriptions	1430
9-69.	tpcc_evt_mux_16_19 Register Field Descriptions	1431
9-70.	tpcc_evt_mux_20_23 Register Field Descriptions	1432
9-71.	tpcc_evt_mux_24_27 Register Field Descriptions	1433
9-72.	tpcc_evt_mux_28_31 Register Field Descriptions	1434
9-73.	tpcc_evt_mux_32_35 Register Field Descriptions	1435
9-74.	tpcc_evt_mux_36_39 Register Field Descriptions	1436
9-75.	tpcc_evt_mux_40_43 Register Field Descriptions	1437
9-76.	tpcc_evt_mux_44_47 Register Field Descriptions	1438
9-77.	tpcc_evt_mux_48_51 Register Field Descriptions	1439
9-78.	tpcc_evt_mux_52_55 Register Field Descriptions	1440
9-79.	tpcc_evt_mux_56_59 Register Field Descriptions	1441
9-80.	tpcc_evt_mux_60_63 Register Field Descriptions	1442
9-81.	timer_evt_capt Register Field Descriptions	1443
9-82.	ecap_evt_capt Register Field Descriptions	1444
9-83.	adc_evt_capt Register Field Descriptions	1445
9-84.	reset_iso Register Field Descriptions	1446
9-85.	dpll_pwr_sw_ctrl Register Field Descriptions	1447

9-86.	ddr_cke_ctrl Register Field Descriptions	1449
9-87.	sma2 Register Field Descriptions	1450
9-88.	m3_txev_eoi Register Field Descriptions	1451
9-89.	ipc_msg_reg0 Register Field Descriptions	1452
9-90.	ipc_msg_reg1 Register Field Descriptions	1453
9-91.	ipc_msg_reg2 Register Field Descriptions	1454
9-92.	ipc_msg_reg3 Register Field Descriptions	1455
9-93.	ipc_msg_reg4 Register Field Descriptions	1456
9-94.	ipc_msg_reg5 Register Field Descriptions	1457
9-95.	ipc_msg_reg6 Register Field Descriptions	1458
9-96.	ipc_msg_reg7 Register Field Descriptions	1459
9-97.	ddr_cmd0_ioctrl Register Field Descriptions	1460
9-98.	ddr_cmd1_ioctrl Register Field Descriptions	1462
9-99.	ddr_cmd2_ioctrl Register Field Descriptions	1463
9-100.	ddr_data0_ioctrl Register Field Descriptions	1464
9-101.	ddr_data1_ioctrl Register Field Descriptions	1466
10-1.	L3 Master — Slave Connectivity	1471
11-1.	TPCC Connectivity Attributes	1477
11-2.	TPCC Clock Signals	1477
11-3.	TPTC Connectivity Attributes	1478
11-4.	TPTC Clock Signals	1478
11-5.	EDMA3 Parameter RAM Contents	1486
11-6.	EDMA3 Channel Parameter Description	1488
11-7.	Channel Options Parameters (OPT) Field Descriptions	1489
11-8.	Dummy and Null Transfer Request	1493
11-9.	Parameter Updates in EDMA3CC (for Non-Null, Non-Dummy PaRAM Set)	1494
11-10.	Expected Number of Transfers for Non-Null Transfer	1500
11-11.	Shadow Region Registers	1504
11-12.	Chain Event Triggers	1506
11-13.	EDMA3 Transfer Completion Interrupts	1506
11-14.	EDMA3 Error Interrupts	1506
11-15.	Transfer Complete Code (TCC) to EDMA3CC Interrupt Mapping	1507
11-16.	Number of Interrupts	1507
11-17.	Allowed Accesses	1512
11-18.	MPPA Registers to Region Assignment	1512
11-19.	Example Access Denied	1513
11-20.	Example Access Allowed	1514
11-21.	Read/Write Command Optimization Rules	1518
11-22.	EDMA3 Transfer Controller Configurations	1520
11-23.	Direct Mapped	1540
11-24.	Crossbar Mapped	1541
11-25.	EDMA3CC Registers	1543
11-26.	PID Register Field Descriptions	1546
11-27.	CCCFG Register Field Descriptions	1547
11-28.	SYSCONFIG Register Field Descriptions	1549
11-29.	DCHMAP_0 to DCHMAP_63 Register Field Descriptions	1550
11-30.	QCHMAP_0 to QCHMAP_7 Register Field Descriptions	1551
11-31.	DMAQNUM_0 to DMAQNUM_7 Register Field Descriptions	1552
11-32.	QDMAQNUM Register Field Descriptions	1557

11-33. QUEPRI Register Field Descriptions	1560
11-34. EMR Register Field Descriptions.....	1561
11-35. EMRH Register Field Descriptions.....	1562
11-36. EMCR Register Field Descriptions.....	1563
11-37. EMCRH Register Field Descriptions.....	1564
11-38. QEMR Register Field Descriptions.....	1565
11-39. QEMCR Register Field Descriptions.....	1566
11-40. CCERR Register Field Descriptions	1567
11-41. CCERRCLR Register Field Descriptions.....	1568
11-42. EEVAL Register Field Descriptions	1569
11-43. DRAE0 Register Field Descriptions.....	1570
11-44. DRAEH0 Register Field Descriptions.....	1571
11-45. DRAE1 Register Field Descriptions.....	1572
11-46. DRAEH1 Register Field Descriptions.....	1573
11-47. DRAE2 Register Field Descriptions.....	1574
11-48. DRAEH2 Register Field Descriptions.....	1575
11-49. DRAE3 Register Field Descriptions.....	1576
11-50. DRAEH3 Register Field Descriptions.....	1577
11-51. DRAE4 Register Field Descriptions.....	1578
11-52. DRAEH4 Register Field Descriptions.....	1579
11-53. DRAE5 Register Field Descriptions.....	1580
11-54. DRAEH5 Register Field Descriptions.....	1581
11-55. DRAE6 Register Field Descriptions.....	1582
11-56. DRAEH6 Register Field Descriptions.....	1583
11-57. DRAE7 Register Field Descriptions.....	1584
11-58. DRAEH7 Register Field Descriptions.....	1585
11-59. QRAE_0 to QRAE_7 Register Field Descriptions	1586
11-60. Q0E0 Register Field Descriptions.....	1587
11-61. Q0E1 Register Field Descriptions.....	1588
11-62. Q0E2 Register Field Descriptions.....	1589
11-63. Q0E3 Register Field Descriptions.....	1590
11-64. Q0E4 Register Field Descriptions.....	1591
11-65. Q0E5 Register Field Descriptions.....	1592
11-66. Q0E6 Register Field Descriptions.....	1593
11-67. Q0E7 Register Field Descriptions.....	1594
11-68. Q0E8 Register Field Descriptions.....	1595
11-69. Q0E9 Register Field Descriptions.....	1596
11-70. Q0E10 Register Field Descriptions	1597
11-71. Q0E11 Register Field Descriptions	1598
11-72. Q0E12 Register Field Descriptions	1599
11-73. Q0E13 Register Field Descriptions	1600
11-74. Q0E14 Register Field Descriptions	1601
11-75. Q0E15 Register Field Descriptions	1602
11-76. Q1E0 Register Field Descriptions.....	1603
11-77. Q1E1 Register Field Descriptions.....	1604
11-78. Q1E2 Register Field Descriptions.....	1605
11-79. Q1E3 Register Field Descriptions.....	1606
11-80. Q1E4 Register Field Descriptions.....	1607
11-81. Q1E5 Register Field Descriptions.....	1608

11-82. Q1E6 Register Field Descriptions	1609
11-83. Q1E7 Register Field Descriptions	1610
11-84. Q1E8 Register Field Descriptions	1611
11-85. Q1E9 Register Field Descriptions	1612
11-86. Q1E10 Register Field Descriptions	1613
11-87. Q1E11 Register Field Descriptions	1614
11-88. Q1E12 Register Field Descriptions	1615
11-89. Q1E13 Register Field Descriptions	1616
11-90. Q1E14 Register Field Descriptions	1617
11-91. Q1E15 Register Field Descriptions	1618
11-92. Q2E0 Register Field Descriptions	1619
11-93. Q2E1 Register Field Descriptions	1620
11-94. Q2E2 Register Field Descriptions	1621
11-95. Q2E3 Register Field Descriptions	1622
11-96. Q2E4 Register Field Descriptions	1623
11-97. Q2E5 Register Field Descriptions	1624
11-98. Q2E6 Register Field Descriptions	1625
11-99. Q2E7 Register Field Descriptions	1626
11-100. Q2E8 Register Field Descriptions	1627
11-101. Q2E9 Register Field Descriptions	1628
11-102. Q2E10 Register Field Descriptions	1629
11-103. Q2E11 Register Field Descriptions	1630
11-104. Q2E12 Register Field Descriptions	1631
11-105. Q2E13 Register Field Descriptions	1632
11-106. Q2E14 Register Field Descriptions	1633
11-107. Q2E15 Register Field Descriptions	1634
11-108. QSTAT_0 to QSTAT_2 Register Field Descriptions	1635
11-109. QWMTHRA Register Field Descriptions	1636
11-110. CCSTAT Register Field Descriptions	1637
11-111. MPFAR Register Field Descriptions	1639
11-112. MPFSR Register Field Descriptions	1640
11-113. MPFCR Register Field Descriptions	1641
11-114. MPPAG Register Field Descriptions	1642
11-115. MPPA_0 to MPPA_7 Register Field Descriptions	1643
11-116. ER Register Field Descriptions	1644
11-117. ERH Register Field Descriptions	1645
11-118. ECR Register Field Descriptions	1646
11-119. ECRH Register Field Descriptions	1647
11-120. ESR Register Field Descriptions	1648
11-121. ESRH Register Field Descriptions	1649
11-122. CER Register Field Descriptions	1650
11-123. CERH Register Field Descriptions	1651
11-124. EER Register Field Descriptions	1652
11-125. EERH Register Field Descriptions	1653
11-126. EECR Register Field Descriptions	1654
11-127. EECRH Register Field Descriptions	1655
11-128. EESR Register Field Descriptions	1656
11-129. EESRH Register Field Descriptions	1657
11-130. SER Register Field Descriptions	1658

11-131. SERH Register Field Descriptions	1659
11-132. SECR Register Field Descriptions	1660
11-133. SECRH Register Field Descriptions	1661
11-134. IER Register Field Descriptions	1662
11-135. IERH Register Field Descriptions	1663
11-136. IECR Register Field Descriptions	1664
11-137. IECRH Register Field Descriptions	1665
11-138. IESR Register Field Descriptions	1666
11-139. IESRH Register Field Descriptions	1667
11-140. IPR Register Field Descriptions	1668
11-141. IPRH Register Field Descriptions	1669
11-142. ICR Register Field Descriptions	1670
11-143. ICRH Register Field Descriptions	1671
11-144. IEVAL Register Field Descriptions	1672
11-145. QER Register Field Descriptions	1673
11-146. QEER Register Field Descriptions	1674
11-147. QEECR Register Field Descriptions	1675
11-148. QEESR Register Field Descriptions	1676
11-149. QSER Register Field Descriptions	1677
11-150. QSECR Register Field Descriptions	1678
11-151. EDMA3TC Registers	1678
11-152. PID Register Field Descriptions	1680
11-153. TCCFG Register Field Descriptions	1681
11-154. SYSCONFIG Register Field Descriptions	1682
11-155. TCSTAT Register Field Descriptions	1683
11-156. ERRSTAT Register Field Descriptions	1685
11-157. ERREN Register Field Descriptions	1686
11-158. ERRCLR Register Field Descriptions	1687
11-159. ERRDET Register Field Descriptions	1688
11-160. ERRCMD Register Field Descriptions	1689
11-161. RDRATE Register Field Descriptions	1690
11-162. SAOPT Register Field Descriptions	1691
11-163. SASRC Register Field Descriptions	1693
11-164. SACNT Register Field Descriptions	1694
11-165. SADST Register Field Descriptions	1695
11-166. SABIDX Register Field Descriptions	1696
11-167. SAMPPRXY Register Field Descriptions	1697
11-168. SACNTRLD Register Field Descriptions	1698
11-169. SASRCBREF Register Field Descriptions	1699
11-170. SADSTBREF Register Field Descriptions	1700
11-171. DFCNTRLD Register Field Descriptions	1701
11-172. DFSRCBREF Register Field Descriptions	1702
11-173. DFDSTBREF Register Field Descriptions	1703
11-174. DFOPT0 Register Field Descriptions	1704
11-175. DFSRC0 Register Field Descriptions	1706
11-176. DFCNT0 Register Field Descriptions	1707
11-177. DFDST0 Register Field Descriptions	1708
11-178. DFBIDX0 Register Field Descriptions	1709
11-179. DFMPPRXY0 Register Field Descriptions	1710

11-180. DFOPT1 Register Field Descriptions.....	1711
11-181. DFSRC1 Register Field Descriptions	1713
11-182. DFCNT1 Register Field Descriptions.....	1714
11-183. DFDST1 Register Field Descriptions.....	1715
11-184. DFBIDX1 Register Field Descriptions.....	1716
11-185. DFMPPRXY1 Register Field Descriptions.....	1717
11-186. DFOPT2 Register Field Descriptions.....	1718
11-187. DFSRC2 Register Field Descriptions	1720
11-188. DFCNT2 Register Field Descriptions.....	1721
11-189. DFDST2 Register Field Descriptions.....	1722
11-190. DFBIDX2 Register Field Descriptions	1723
11-191. DFMPPRXY2 Register Field Descriptions.....	1724
11-192. DFOPT3 Register Field Descriptions.....	1725
11-193. DFSRC3 Register Field Descriptions	1727
11-194. DFCNT3 Register Field Descriptions.....	1728
11-195. DFDST3 Register Field Descriptions.....	1729
11-196. DFBIDX3 Register Field Descriptions	1730
11-197. DFMPPRXY3 Register Field Descriptions.....	1731
11-198. Debug List	1732
12-1. TSC_ADC Connectivity Attributes	1738
12-2. TSC_ADC Clock Signals	1739
12-3. TSC_ADC Pin List	1739
12-4. TSC_ADC_SS Registers	1747
12-5. REVISION Register Field Descriptions.....	1749
12-6. SYSCONFIG Register Field Descriptions.....	1750
12-7. IRQSTATUS_RAW Register Field Descriptions	1751
12-8. IRQSTATUS Register Field Descriptions	1753
12-9. IRQENABLE_SET Register Field Descriptions	1755
12-10. IRQENABLE_CLR Register Field Descriptions	1757
12-11. IRQWAKEUP Register Field Descriptions	1759
12-12. DMAENABLE_SET Register Field Descriptions	1760
12-13. DMAENABLE_CLR Register Field Descriptions	1761
12-14. CTRL Register Field Descriptions.....	1762
12-15. ADCSTAT Register Field Descriptions	1763
12-16. ADCRANGE Register Field Descriptions	1764
12-17. ADC_CLKDIV Register Field Descriptions.....	1765
12-18. ADC_MISC Register Field Descriptions.....	1766
12-19. STEPENABLE Register Field Descriptions	1767
12-20. IDLECONFIG Register Field Descriptions	1768
12-21. TS_CHARGE_STEPCONFIG Register Field Descriptions	1770
12-22. TS_CHARGE_DELAY Register Field Descriptions.....	1772
12-23. STEPCONFIG1 Register Field Descriptions.....	1773
12-24. STEPDELAY1 Register Field Descriptions	1775
12-25. STEPCONFIG2 Register Field Descriptions.....	1776
12-26. STEPDELAY2 Register Field Descriptions	1778
12-27. STEPCONFIG3 Register Field Descriptions.....	1779
12-28. STEPDELAY3 Register Field Descriptions	1781
12-29. STEPCONFIG4 Register Field Descriptions.....	1782
12-30. STEPDELAY4 Register Field Descriptions	1784

12-31. STEPCONFIG5 Register Field Descriptions	1785
12-32. STEPDELAY5 Register Field Descriptions	1787
12-33. STEPCONFIG6 Register Field Descriptions	1788
12-34. STEPDELAY6 Register Field Descriptions	1790
12-35. STEPCONFIG7 Register Field Descriptions	1791
12-36. STEPDELAY7 Register Field Descriptions	1793
12-37. STEPCONFIG8 Register Field Descriptions	1794
12-38. STEPDELAY8 Register Field Descriptions	1796
12-39. STEPCONFIG9 Register Field Descriptions	1797
12-40. STEPDELAY9 Register Field Descriptions	1799
12-41. STEPCONFIG10 Register Field Descriptions	1800
12-42. STEPDELAY10 Register Field Descriptions	1802
12-43. STEPCONFIG11 Register Field Descriptions	1803
12-44. STEPDELAY11 Register Field Descriptions	1805
12-45. STEPCONFIG12 Register Field Descriptions	1806
12-46. STEPDELAY12 Register Field Descriptions	1808
12-47. STEPCONFIG13 Register Field Descriptions	1809
12-48. STEPDELAY13 Register Field Descriptions	1811
12-49. STEPCONFIG14 Register Field Descriptions	1812
12-50. STEPDELAY14 Register Field Descriptions	1814
12-51. STEPCONFIG15 Register Field Descriptions	1815
12-52. STEPDELAY15 Register Field Descriptions	1817
12-53. STEPCONFIG16 Register Field Descriptions	1818
12-54. STEPDELAY16 Register Field Descriptions	1820
12-55. FIFO0COUNT Register Field Descriptions	1821
12-56. FIFO0THRESHOLD Register Field Descriptions	1822
12-57. DMA0REQ Register Field Descriptions	1823
12-58. FIFO1COUNT Register Field Descriptions	1824
12-59. FIFO1THRESHOLD Register Field Descriptions	1825
12-60. DMA1REQ Register Field Descriptions	1826
12-61. FIFO0DATA Register Field Descriptions	1827
12-62. FIFO1DATA Register Field Descriptions	1828
13-1. LCD Controller Connectivity Attributes	1832
13-2. LCD Controller Clock Signals	1833
13-3. LCD Controller Pin List	1833
13-4. LCD External I/O Signals	1836
13-5. Register Configuration for DMA Engine Programming	1837
13-6. LIDD I/O Name Map	1839
13-7. Operation Modes Supported by Raster Controller	1840
13-8. Bits-Per-Pixel Encoding for Palette Entry 0 Buffer	1843
13-9. Frame Buffer Size According to BPP	1843
13-10. Color/Grayscale Intensities and Modulation Rates	1848
13-11. Number of Colors/Shades of Gray Available on Screen	1848
13-12. Highlander 0.8 Interrupt Module Control Registers	1852
13-13. LCD Registers	1862
13-14. PID Register Field Descriptions	1863
13-15. CTRL Register Field Descriptions	1864
13-16. LIDD_CTRL Register Field Descriptions	1865
13-17. LIDD_CS0_CONF Register Field Descriptions	1867

13-18. LIDD_CS0_ADDR Register Field Descriptions.....	1868
13-19. LIDD_CS0_DATA Register Field Descriptions	1869
13-20. LIDD_CS1_CONF Register Field Descriptions.....	1870
13-21. LIDD_CS1_ADDR Register Field Descriptions.....	1871
13-22. LIDD_CS1_DATA Register Field Descriptions	1872
13-23. RASTER_CTRL Register Field Descriptions	1873
13-24. RASTER_TIMING_0 Register Field Descriptions.....	1876
13-25. RASTER_TIMING_1 Register Field Descriptions.....	1877
13-26. RASTER_TIMING_2 Register Field Descriptions.....	1878
13-27. RASTER_SUBPANEL Register Field Descriptions.....	1880
13-28. RASTER_SUBPANEL2 Register Field Descriptions	1881
13-29. LCDDMA_CTRL Register Field Descriptions.....	1882
13-30. LCDDMA_FB0_BASE Register Field Descriptions	1884
13-31. LCDDMA_FB0_CEILING Register Field Descriptions	1885
13-32. LCDDMA_FB1_BASE Register Field Descriptions	1886
13-33. LCDDMA_FB1_CEILING Register Field Descriptions	1887
13-34. SYSCONFIG Register Field Descriptions.....	1888
13-35. IRQSTATUS_RAW Register Field Descriptions	1889
13-36. IRQSTATUS Register Field Descriptions	1891
13-37. IRQENABLE_SET Register Field Descriptions	1893
13-38. IRQENABLE_CLEAR Register Field Descriptions.....	1895
13-39. CLKC_ENABLE Register Field Descriptions	1897
13-40. CLKC_RESET Register Field Descriptions	1898
14-1. Unsupported CPGMAC Features	1901
14-2. Ethernet Switch Connectivity Attributes	1903
14-3. Ethernet Switch Clock Signals.....	1904
14-4. Ethernet Switch Pin List	1905
14-5. GMII Interface Signal Descriptions in MII (100/10Mbps) Mode	1908
14-6. RMII Interface Signal Descriptions	1909
14-7. RGMII Interface Signal Descriptions.....	1910
14-8. VLAN Header Encapsulation Word Field Descriptions.....	1930
14-9. Learned Address Control Bits	1931
14-10. Free (Unused) Address Table Entry Bit Values	1931
14-11. Multicast Address Table Entry Bit Values.....	1932
14-12. VLAN/Multicast Address Table Entry Bit Values	1932
14-13. Unicast Address Table Entry Bit Values	1933
14-14. OUI Unicast Address Table Entry Bit Values.....	1934
14-15. Unicast Address Table Entry Bit Values	1935
14-16. VLAN Table Entry	1936
14-17. Operations of Emulation Control Input and Register Bits	1946
14-18. Rx Statistics Summary.....	1955
14-19. Tx Statistics Summary	1958
14-20. Values of messageType field	1968
14-21. MDIO Read Frame Format.....	1969
14-22. MDIO Write Frame Format.....	1969
14-23. CPSW_ALE REGISTERS.....	1977
14-24. IDVER Register Field Descriptions	1978
14-25. CONTROL Register Field Descriptions	1979
14-26. PRESCALE Register Field Descriptions	1981

14-27. UNKNOWN_VLAN Register Field Descriptions	1982
14-28. TBLCTL Register Field Descriptions.....	1983
14-29. TBLW2 Register Field Descriptions.....	1984
14-30. TBLW1 Register Field Descriptions.....	1985
14-31. TBLW0 Register Field Descriptions.....	1986
14-32. PORTCTL0 Register Field Descriptions.....	1987
14-33. PORTCTL1 Register Field Descriptions.....	1988
14-34. PORTCTL2 Register Field Descriptions.....	1989
14-35. PORTCTL3 Register Field Descriptions.....	1990
14-36. PORTCTL4 Register Field Descriptions.....	1991
14-37. PORTCTL5 Register Field Descriptions.....	1992
14-38. CPSW_CPDMA REGISTERS	1993
14-39. TX_IDVER Register Field Descriptions	1995
14-40. TX_CONTROL Register Field Descriptions	1996
14-41. TX_TEARDOWN Register Field Descriptions	1997
14-42. RX_IDVER Register Field Descriptions	1998
14-43. RX_CONTROL Register Field Descriptions	1999
14-44. RX_TEARDOWN Register Field Descriptions.....	2000
14-45. CPDMA_SOFT_RESET Register Field Descriptions.....	2001
14-46. DMACONTROL Register Field Descriptions	2002
14-47. DMASTATUS Register Field Descriptions	2004
14-48. RX_BUFFER_OFFSET Register Field Descriptions	2006
14-49. EMCONTROL Register Field Descriptions	2007
14-50. TX_PRI0_RATE Register Field Descriptions	2008
14-51. TX_PRI1_RATE Register Field Descriptions	2009
14-52. TX_PRI2_RATE Register Field Descriptions	2010
14-53. TX_PRI3_RATE Register Field Descriptions	2011
14-54. TX_PRI4_RATE Register Field Descriptions	2012
14-55. TX_PRI5_RATE Register Field Descriptions	2013
14-56. TX_PRI6_RATE Register Field Descriptions	2014
14-57. TX_PRI7_RATE Register Field Descriptions	2015
14-58. TX_INTSTAT_RAW Register Field Descriptions.....	2016
14-59. TX_INTSTAT_MASKED Register Field Descriptions.....	2017
14-60. TX_INTMASK_SET Register Field Descriptions	2018
14-61. TX_INTMASK_CLEAR Register Field Descriptions	2019
14-62. CPDMA_IN_VECTOR Register Field Descriptions	2020
14-63. CPDMA_EOI_VECTOR Register Field Descriptions	2021
14-64. RX_INTSTAT_RAW Register Field Descriptions	2022
14-65. RX_INTSTAT_MASKED Register Field Descriptions	2023
14-66. RX_INTMASK_SET Register Field Descriptions.....	2024
14-67. RX_INTMASK_CLEAR Register Field Descriptions	2026
14-68. DMA_INTSTAT_RAW Register Field Descriptions	2028
14-69. DMA_INTSTAT_MASKED Register Field Descriptions	2029
14-70. DMA_INTMASK_SET Register Field Descriptions	2030
14-71. DMA_INTMASK_CLEAR Register Field Descriptions.....	2031
14-72. RX0_PENDTHRESH Register Field Descriptions	2032
14-73. RX1_PENDTHRESH Register Field Descriptions	2033
14-74. RX2_PENDTHRESH Register Field Descriptions	2034
14-75. RX3_PENDTHRESH Register Field Descriptions	2035

14-76. RX4_PENDTHRESH Register Field Descriptions	2036
14-77. RX5_PENDTHRESH Register Field Descriptions	2037
14-78. RX6_PENDTHRESH Register Field Descriptions	2038
14-79. RX7_PENDTHRESH Register Field Descriptions	2039
14-80. RX0_FREEBUFFER Register Field Descriptions	2040
14-81. RX1_FREEBUFFER Register Field Descriptions	2041
14-82. RX2_FREEBUFFER Register Field Descriptions	2042
14-83. RX3_FREEBUFFER Register Field Descriptions	2043
14-84. RX4_FREEBUFFER Register Field Descriptions	2044
14-85. RX5_FREEBUFFER Register Field Descriptions	2045
14-86. RX6_FREEBUFFER Register Field Descriptions	2046
14-87. RX7_FREEBUFFER Register Field Descriptions	2047
14-88. CPSW_CPTS REGISTERS.....	2047
14-89. CPTS_IDVER Register Field Descriptions.....	2049
14-90. CPTS_CONTROL Register Field Descriptions.....	2050
14-91. CPTS_TS_PUSH Register Field Descriptions	2051
14-92. CPTS_TS_LOAD_VAL Register Field Descriptions	2052
14-93. CPTS_TS_LOAD_EN Register Field Descriptions	2053
14-94. CPTS_INTSTAT_RAW Register Field Descriptions.....	2054
14-95. CPTS_INTSTAT_MASKED Register Field Descriptions.....	2055
14-96. CPTS_INT_ENABLE Register Field Descriptions	2056
14-97. CPTS_EVENT_POP Register Field Descriptions.....	2057
14-98. CPTS_EVENT_LOW Register Field Descriptions	2058
14-99. CPTS_EVENT_HIGH Register Field Descriptions.....	2059
14-100. CPSW_STATS REGISTERS.....	2060
14-101. CPDMA_STATERAM REGISTERS	2061
14-102. TX0_HDP Register Field Descriptions	2063
14-103. TX1_HDP Register Field Descriptions	2064
14-104. TX2_HDP Register Field Descriptions	2065
14-105. TX3_HDP Register Field Descriptions	2066
14-106. TX4_HDP Register Field Descriptions	2067
14-107. TX5_HDP Register Field Descriptions	2068
14-108. TX6_HDP Register Field Descriptions	2069
14-109. TX7_HDP Register Field Descriptions	2070
14-110. RX0_HDP Register Field Descriptions.....	2071
14-111. RX1_HDP Register Field Descriptions	2072
14-112. RX2_HDP Register Field Descriptions.....	2073
14-113. RX3_HDP Register Field Descriptions.....	2074
14-114. RX4_HDP Register Field Descriptions.....	2075
14-115. RX5_HDP Register Field Descriptions	2076
14-116. RX6_HDP Register Field Descriptions.....	2077
14-117. RX7_HDP Register Field Descriptions.....	2078
14-118. TX0_CP Register Field Descriptions	2079
14-119. TX1_CP Register Field Descriptions	2080
14-120. TX2_CP Register Field Descriptions	2081
14-121. TX3_CP Register Field Descriptions	2082
14-122. TX4_CP Register Field Descriptions	2083
14-123. TX5_CP Register Field Descriptions	2084
14-124. TX6_CP Register Field Descriptions	2085

14-125. TX7_CP Register Field Descriptions	2086
14-126. RX0_CP Register Field Descriptions	2087
14-127. RX1_CP Register Field Descriptions	2088
14-128. RX2_CP Register Field Descriptions	2089
14-129. RX3_CP Register Field Descriptions	2090
14-130. RX4_CP Register Field Descriptions	2091
14-131. RX5_CP Register Field Descriptions	2092
14-132. RX6_CP Register Field Descriptions	2093
14-133. RX7_CP Register Field Descriptions	2094
14-134. CPSW_PORT Registers	2094
14-135. P0_CONTROL Register Field Descriptions	2096
14-136. P0_MAX_BLKs Register Field Descriptions	2097
14-137. P0_BLK_CNT Register Field Descriptions	2098
14-138. P0_TX_IN_CTL Register Field Descriptions	2099
14-139. P0_PORT_VLAN Register Field Descriptions	2100
14-140. P0_TX_PRI_MAP Register Field Descriptions	2101
14-141. P0_CPDMA_TX_PRI_MAP Register Field Descriptions	2102
14-142. P0_CPDMA_RX_CH_MAP Register Field Descriptions	2103
14-143. P0_RX_DSCP_PRI_MAP0 Register Field Descriptions	2104
14-144. P0_RX_DSCP_PRI_MAP1 Register Field Descriptions	2105
14-145. P0_RX_DSCP_PRI_MAP2 Register Field Descriptions	2106
14-146. P0_RX_DSCP_PRI_MAP3 Register Field Descriptions	2107
14-147. P0_RX_DSCP_PRI_MAP4 Register Field Descriptions	2108
14-148. P0_RX_DSCP_PRI_MAP5 Register Field Descriptions	2109
14-149. P0_RX_DSCP_PRI_MAP6 Register Field Descriptions	2110
14-150. P0_RX_DSCP_PRI_MAP7 Register Field Descriptions	2111
14-151. P1_CONTROL Register Field Descriptions	2112
14-152. P1_MAX_BLKs Register Field Descriptions	2114
14-153. P1_BLK_CNT Register Field Descriptions	2115
14-154. P1_TX_IN_CTL Register Field Descriptions	2116
14-155. P1_PORT_VLAN Register Field Descriptions	2117
14-156. P1_TX_PRI_MAP Register Field Descriptions	2118
14-157. P1_TS_SEQ_MTYPE Register Field Descriptions	2119
14-158. P1_SA_LO Register Field Descriptions	2120
14-159. P1_SA_HI Register Field Descriptions	2121
14-160. P1_SEND_PERCENT Register Field Descriptions	2122
14-161. P1_RX_DSCP_PRI_MAP0 Register Field Descriptions	2123
14-162. P1_RX_DSCP_PRI_MAP1 Register Field Descriptions	2124
14-163. P1_RX_DSCP_PRI_MAP2 Register Field Descriptions	2125
14-164. P1_RX_DSCP_PRI_MAP3 Register Field Descriptions	2126
14-165. P1_RX_DSCP_PRI_MAP4 Register Field Descriptions	2127
14-166. P1_RX_DSCP_PRI_MAP5 Register Field Descriptions	2128
14-167. P1_RX_DSCP_PRI_MAP6 Register Field Descriptions	2129
14-168. P1_RX_DSCP_PRI_MAP7 Register Field Descriptions	2130
14-169. P2_CONTROL Register Field Descriptions	2131
14-170. P2_MAX_BLKs Register Field Descriptions	2133
14-171. P2_BLK_CNT Register Field Descriptions	2134
14-172. P2_TX_IN_CTL Register Field Descriptions	2135
14-173. P2_PORT_VLAN Register Field Descriptions	2136

14-174. P2_TX_PRI_MAP Register Field Descriptions.....	2137
14-175. P2_TS_SEQ_MTYPE Register Field Descriptions.....	2138
14-176. P2_SA_LO Register Field Descriptions.....	2139
14-177. P2_SA_HI Register Field Descriptions.....	2140
14-178. P2_SEND_PERCENT Register Field Descriptions.....	2141
14-179. P2_RX_DSCP_PRI_MAP0 Register Field Descriptions.....	2142
14-180. P2_RX_DSCP_PRI_MAP1 Register Field Descriptions.....	2143
14-181. P2_RX_DSCP_PRI_MAP2 Register Field Descriptions.....	2144
14-182. P2_RX_DSCP_PRI_MAP3 Register Field Descriptions.....	2145
14-183. P2_RX_DSCP_PRI_MAP4 Register Field Descriptions.....	2146
14-184. P2_RX_DSCP_PRI_MAP5 Register Field Descriptions.....	2147
14-185. P2_RX_DSCP_PRI_MAP6 Register Field Descriptions.....	2148
14-186. P2_RX_DSCP_PRI_MAP7 Register Field Descriptions.....	2149
14-187. CPSW_SL Registers.....	2150
14-188. IDVER Register Field Descriptions.....	2151
14-189. MACCONTROL Register Field Descriptions.....	2152
14-190. MACSTATUS Register Field Descriptions.....	2155
14-191. SOFT_RESET Register Field Descriptions.....	2156
14-192. RX_MAXLEN Register Field Descriptions.....	2157
14-193. BOFFTEST Register Field Descriptions.....	2158
14-194. RX_PAUSE Register Field Descriptions.....	2159
14-195. TX_PAUSE Register Field Descriptions.....	2160
14-196. EMCONTROL Register Field Descriptions.....	2161
14-197. RX_PRI_MAP Register Field Descriptions.....	2162
14-198. TX_GAP Register Field Descriptions.....	2163
14-199. CPSW_SS REGISTERS.....	2163
14-200. ID_VER Register Field Descriptions.....	2164
14-201. CONTROL Register Field Descriptions.....	2165
14-202. SOFT_RESET Register Field Descriptions.....	2166
14-203. STAT_PORT_EN Register Field Descriptions.....	2167
14-204. PTYPE Register Field Descriptions.....	2168
14-205. SOFT_IDLE Register Field Descriptions.....	2169
14-206. THRU_RATE Register Field Descriptions.....	2170
14-207. GAP_THRESH Register Field Descriptions.....	2171
14-208. TX_START_WDS Register Field Descriptions.....	2172
14-209. FLOW_CONTROL Register Field Descriptions.....	2173
14-210. VLAN_LTYPE Register Field Descriptions.....	2174
14-211. TS_LTYPE Register Field Descriptions.....	2175
14-212. DLR_LTYPE Register Field Descriptions.....	2176
14-213. CPSW_WR REGISTERS.....	2176
14-214. IDVER Register Field Descriptions.....	2178
14-215. SOFT_RESET Register Field Descriptions.....	2179
14-216. CONTROL Register Field Descriptions.....	2180
14-217. INT_CONTROL Register Field Descriptions.....	2181
14-218. C0_RX_THRESH_EN Register Field Descriptions.....	2182
14-219. C0_RX_EN Register Field Descriptions.....	2183
14-220. C0_TX_EN Register Field Descriptions.....	2184
14-221. C0_MISC_EN Register Field Descriptions.....	2185
14-222. C1_RX_THRESH_EN Register Field Descriptions.....	2186

14-223. C1_RX_EN Register Field Descriptions	2187
14-224. C1_TX_EN Register Field Descriptions.....	2188
14-225. C1_MISC_EN Register Field Descriptions	2189
14-226. C2_RX_THRESH_EN Register Field Descriptions.....	2190
14-227. C2_RX_EN Register Field Descriptions	2191
14-228. C2_TX_EN Register Field Descriptions.....	2192
14-229. C2_MISC_EN Register Field Descriptions	2193
14-230. C0_RX_THRESH_STAT Register Field Descriptions.....	2194
14-231. C0_RX_STAT Register Field Descriptions	2195
14-232. C0_TX_STAT Register Field Descriptions	2196
14-233. C0_MISC_STAT Register Field Descriptions	2197
14-234. C1_RX_THRESH_STAT Register Field Descriptions.....	2198
14-235. C1_RX_STAT Register Field Descriptions	2199
14-236. C1_TX_STAT Register Field Descriptions	2200
14-237. C1_MISC_STAT Register Field Descriptions	2201
14-238. C2_RX_THRESH_STAT Register Field Descriptions.....	2202
14-239. C2_RX_STAT Register Field Descriptions	2203
14-240. C2_TX_STAT Register Field Descriptions	2204
14-241. C2_MISC_STAT Register Field Descriptions	2205
14-242. C0_RX_IMAX Register Field Descriptions	2206
14-243. C0_TX_IMAX Register Field Descriptions.....	2207
14-244. C1_RX_IMAX Register Field Descriptions	2208
14-245. C1_TX_IMAX Register Field Descriptions.....	2209
14-246. C2_RX_IMAX Register Field Descriptions	2210
14-247. C2_TX_IMAX Register Field Descriptions.....	2211
14-248. RGMII_CTL Register Field Descriptions	2212
14-249. MDIO Registers	2213
14-250. MDIOVER Register Field Descriptions.....	2213
14-251. MDIOCONTROL Register Field Descriptions	2214
14-252. MDIOALIVE Register Field Descriptions.....	2215
14-253. MDIOLINK Register Field Descriptions	2215
14-254. MDIOLINKINTRAW Register Field Descriptions.....	2216
14-255. MDIOLINKINTMASKED Register Field Descriptions	2216
14-256. MDIOUSERINTRAW Register Field Descriptions	2217
14-257. MDIOUSERINTMASKED Register Field Descriptions	2217
14-258. MDIOUSERINTMASKSET Register Field Descriptions	2218
14-259. MDIOUSERINTMASKCLR Register Field Descriptions	2218
14-260. MDIOUSERACCESS0 Register Field Descriptions	2219
14-261. MDIOUSERPHYSEL0 Register Field Descriptions.....	2220
14-262. MDIOUSERACCESS1 Register Field Descriptions	2221
14-263. MDIOUSERPHYSEL1 Register Field Descriptions.....	2222
15-1. PWMSS Connectivity Attributes	2227
15-2. PWMSS Clock Signals	2228
15-3. PWMSS Pin List.....	2228
15-4. PWMSS Registers	2228
15-5. IDVER Register Field Descriptions	2229
15-6. SYSCONFIG Register Field Descriptions.....	2230
15-7. CLKCONFIG Register Field Descriptions.....	2231
15-8. CLKSTATUS Register Field Descriptions.....	2232

15-9. Submodule Configuration Parameters.....	2237
15-10. Time-Base Submodule Registers	2242
15-11. Key Time-Base Signals.....	2243
15-12. Counter-Compare Submodule Registers	2251
15-13. Counter-Compare Submodule Key Signals.....	2251
15-14. Action-Qualifier Submodule Registers.....	2255
15-15. Action-Qualifier Submodule Possible Input Events	2256
15-16. Action-Qualifier Event Priority for Up-Down-Count Mode.....	2258
15-17. Action-Qualifier Event Priority for Up-Count Mode.....	2258
15-18. Action-Qualifier Event Priority for Down-Count Mode	2258
15-19. Behavior if CMPA/CMPB is Greater than the Period.....	2259
15-20. EPWMx Initialization for	2262
15-21. EPWMx Run Time Changes for	2262
15-22. EPWMx Initialization for	2264
15-23. EPWMx Run Time Changes for	2264
15-24. EPWMx Initialization for	2266
15-25. EPWMx Run Time Changes for	2266
15-26. EPWMx Initialization for	2268
15-27. EPWMx Run Time Changes for	2268
15-28. EPWMx Initialization for	2270
15-29. EPWMx Run Time Changes for	2270
15-30. EPWMx Initialization for	2272
15-31. EPWMx Run Time Changes for	2272
15-32. Dead-Band Generator Submodule Registers.....	2273
15-33. Classical Dead-Band Operating Modes	2275
15-34. PWM-Chopper Submodule Registers	2277
15-35. Trip-Zone Submodule Registers	2282
15-36. Possible Actions On a Trip Event.....	2283
15-37. Event-Trigger Submodule Registers	2285
15-38. Resolution for PWM and HRPWM	2290
15-39. HRPWM Submodule Registers.....	2291
15-40. Relationship Between MEP Steps, PWM Frequency and Resolution.....	2292
15-41. CMPA vs Duty (left), and [CMPA:CMPAHR] vs Duty (right).....	2293
15-42. EPWM1 Initialization for	2301
15-43. EPWM2 Initialization for	2301
15-44. EPWM3 Initialization for	2301
15-45. EPWM1 Initialization for	2304
15-46. EPWM2 Initialization for	2304
15-47. EPWM1 Initialization for	2307
15-48. EPWM2 Initialization for	2307
15-49. EPWM1 Initialization for	2310
15-50. EPWM2 Initialization for	2310
15-51. EPWM3 Initialization for	2311
15-52. EPWM1 Initialization for	2316
15-53. EPWM2 Initialization for	2316
15-54. EPWM3 Initialization for	2317
15-55. EPWM1 Initialization for	2320
15-56. EPWM2 Initialization for	2320
15-57. EPWM Registers	2321

15-58. TBCTL Register Field Descriptions	2322
15-59. TBSTS Register Field Descriptions	2324
15-60. TBPHSHR Register Field Descriptions	2325
15-61. TBPHS Register Field Descriptions	2326
15-62. TBCNT Register Field Descriptions	2327
15-63. TBPRD Register Field Descriptions	2328
15-64. CMPCTL Register Field Descriptions	2329
15-65. CMPAHR Register Field Descriptions	2331
15-66. CMPA Register Field Descriptions	2332
15-67. CMPB Register Field Descriptions	2333
15-68. AQCTLA Register Field Descriptions	2334
15-69. AQCTLB Register Field Descriptions	2336
15-70. AQSFRD Register Field Descriptions	2338
15-71. AQCSFRD Register Field Descriptions	2339
15-72. DBCTL Register Field Descriptions	2340
15-73. DBRED Register Field Descriptions	2342
15-74. DBFED Register Field Descriptions	2343
15-75. TZSEL Register Field Descriptions	2344
15-76. TZCTL Register Field Descriptions	2345
15-77. TZEINT Register Field Descriptions	2346
15-78. TZFLG Register Field Descriptions	2347
15-79. TZCLR Register Field Descriptions	2348
15-80. TZFRC Register Field Descriptions	2349
15-81. ETSEL Register Field Descriptions	2350
15-82. ETPS Register Field Descriptions	2351
15-83. ETFLG Register Field Descriptions	2352
15-84. ETCLR Register Field Descriptions	2353
15-85. ETFRC Register Field Descriptions	2354
15-86. PCCTL Register Field Descriptions	2355
15-87. HRCNFG Register Field Descriptions	2356
15-88. ECAP Initialization for CAP Mode Absolute Time, Rising Edge Trigger	2369
15-89. ECAP Initialization for CAP Mode Absolute Time, Rising and Falling Edge Trigger	2371
15-90. ECAP Initialization for CAP Mode Delta Time, Rising Edge Trigger	2373
15-91. ECAP Initialization for CAP Mode Delta Time, Rising and Falling Edge Triggers	2375
15-92. ECAP Initialization for APWM Mode	2377
15-93. ECAP1 Initialization for Multichannel PWM Generation with Synchronization	2379
15-94. ECAP2 Initialization for Multichannel PWM Generation with Synchronization	2379
15-95. ECAP3 Initialization for Multichannel PWM Generation with Synchronization	2379
15-96. ECAP4 Initialization for Multichannel PWM Generation with Synchronization	2379
15-97. ECAP1 Initialization for Multichannel PWM Generation with Phase Control	2382
15-98. ECAP2 Initialization for Multichannel PWM Generation with Phase Control	2382
15-99. ECAP3 Initialization for Multichannel PWM Generation with Phase Control	2382
15-100. ECAP Registers	2383
15-101. TSCTR Register Field Descriptions	2384
15-102. CTRPHS Register Field Descriptions	2385
15-103. CAP1 Register Field Descriptions	2386
15-104. CAP2 Register Field Descriptions	2387
15-105. CAP3 Register Field Descriptions	2388
15-106. CAP4 Register Field Descriptions	2389

15-107. ECCTL1 Register Field Descriptions	2390
15-108. ECCTL2 Register Field Descriptions	2392
15-109. ECEINT Register Field Descriptions	2394
15-110. ECFLG Register Field Descriptions	2395
15-111. ECCLR Register Field Descriptions	2396
15-112. ECFRC Register Field Descriptions	2397
15-113. REVID Register Field Descriptions	2398
15-114. Quadrature Decoder Truth Table	2405
15-115. EQEP Registers.....	2420
15-116. QPOSCNT Register Field Descriptions	2421
15-117. QPOSINIT Register Field Descriptions	2422
15-118. QPOSMAX Register Field Descriptions.....	2423
15-119. QPOSCMP Register Field Descriptions	2424
15-120. QPOSILAT Register Field Descriptions.....	2425
15-121. QPOSSLAT Register Field Descriptions.....	2426
15-122. QPOSLAT Register Field Descriptions	2427
15-123. QUTMR Register Field Descriptions	2428
15-124. QUPRD Register Field Descriptions	2429
15-125. QWDTMR Register Field Descriptions.....	2430
15-126. QWDPRD Register Field Descriptions	2431
15-127. QDECCTL Register Field Descriptions	2432
15-128. QEPCTL Register Field Descriptions	2433
15-129. QCAPCTL Register Field Descriptions	2435
15-130. QPOSCTL Register Field Descriptions	2436
15-131. QEINT Register Field Descriptions	2437
15-132. QFLG Register Field Descriptions	2438
15-133. QCLR Register Field Descriptions.....	2439
15-134. QFRC Register Field Descriptions.....	2440
15-135. QEPSTS Register Field Descriptions	2441
15-136. QCTMR Register Field Descriptions	2442
15-137. QCPRD Register Field Descriptions	2443
15-138. QCTMRLAT Register Field Descriptions	2444
15-139. QCPRDLAT Register Field Descriptions.....	2445
15-140. REVID Register Field Descriptions	2446
16-1. USB Connectivity Attributes.....	2451
16-2. USB Clock Signals	2452
16-3. USB Pin List.....	2452
16-4. PERI_TXCSR Register Bit Configuration for Bulk IN Transactions	2468
16-5. PERI_RXCSR Register Bit Configuration for Bulk OUT Transactions	2470
16-6. PERI_TXCSR Register Bit Configuration for Isochronous IN Transactions	2472
16-7. PERI_RXCSR Register Bit Configuration for Isochronous OUT Transactions.....	2473
16-8. Isochronous OUT Error Handling: Peripheral Mode	2474
16-9. Packet Descriptor Word 0 (PD0) Bit Field Descriptions.....	2493
16-10. Packet Descriptor Word 1 (PD1) Bit Field Descriptions.....	2494
16-11. Packet Descriptor Word 2 (PD2) Bit Field Descriptions.....	2494
16-12. Packet Descriptor Word 3 (PD3) Bit Field Descriptions.....	2494
16-13. Packet Descriptor Word 4 (PD4) Bit Field Descriptions.....	2495
16-14. Packet Descriptor Word 5 (PD5) Bit Field Descriptions.....	2495
16-15. Packet Descriptor Word 6 (PD6) Bit Field Descriptions.....	2495

16-16. Packet Descriptor Word 7 (PD7) Bit Field Descriptions	2495
16-17. Buffer Descriptor Word 0 (BD0) Bit Field Descriptions	2496
16-18. Buffer Descriptor Word 1 (BD1) Bit Field Descriptions	2496
16-19. Buffer Descriptor Word 2 (BD2) Bit Field Descriptions	2496
16-20. Buffer Descriptor Word 3 (BD3) Bit Field Descriptions	2496
16-21. Buffer Descriptor Word 4 (BD4) Bit Field Descriptions	2497
16-22. Buffer Descriptor Word 5 (BD5) Bit Field Descriptions	2497
16-23. Buffer Descriptor Word 6 (BD6) Bit Field Descriptions	2497
16-24. Buffer Descriptor Word 7 (BD7) Bit Field Descriptions	2497
16-25. Teardown Descriptor Word 0 Bit Field Descriptions	2498
16-26. Teardown Descriptor Words 1 to 7 Bit Field Descriptions	2498
16-27. Queue-Endpoint Assignments	2499
16-28. 53 Bytes Test Packet Content	2515
16-29. USBSS Registers	2518
16-30. REVREG Register Field Descriptions	2520
16-31. SYSCONFIG Register Field Descriptions	2521
16-32. IRQSTATRAW Register Field Descriptions	2522
16-33. IRQSTAT Register Field Descriptions	2523
16-34. IRQENABLER Register Field Descriptions	2524
16-35. IRQCLEARR Register Field Descriptions	2525
16-36. IRQDMATHOLDTX00 Register Field Descriptions	2526
16-37. IRQDMATHOLDTX01 Register Field Descriptions	2527
16-38. IRQDMATHOLDTX02 Register Field Descriptions	2528
16-39. IRQDMATHOLDTX03 Register Field Descriptions	2529
16-40. IRQDMATHOLDRX00 Register Field Descriptions	2530
16-41. IRQDMATHOLDRX01 Register Field Descriptions	2531
16-42. IRQDMATHOLDRX02 Register Field Descriptions	2532
16-43. IRQDMATHOLDRX03 Register Field Descriptions	2533
16-44. IRQDMATHOLDTX10 Register Field Descriptions	2534
16-45. IRQDMATHOLDTX11 Register Field Descriptions	2535
16-46. IRQDMATHOLDTX12 Register Field Descriptions	2536
16-47. IRQDMATHOLDTX13 Register Field Descriptions	2537
16-48. IRQDMATHOLDRX10 Register Field Descriptions	2538
16-49. IRQDMATHOLDRX11 Register Field Descriptions	2539
16-50. IRQDMATHOLDRX12 Register Field Descriptions	2540
16-51. IRQDMATHOLDRX13 Register Field Descriptions	2541
16-52. IRQDMAENABLE0 Register Field Descriptions	2542
16-53. IRQDMAENABLE1 Register Field Descriptions	2544
16-54. IRQFRAMETHOLDTX00 Register Field Descriptions	2546
16-55. IRQFRAMETHOLDTX01 Register Field Descriptions	2547
16-56. IRQFRAMETHOLDTX02 Register Field Descriptions	2548
16-57. IRQFRAMETHOLDTX03 Register Field Descriptions	2549
16-58. IRQFRAMETHOLDRX00 Register Field Descriptions	2550
16-59. IRQFRAMETHOLDRX01 Register Field Descriptions	2551
16-60. IRQFRAMETHOLDRX02 Register Field Descriptions	2552
16-61. IRQFRAMETHOLDRX03 Register Field Descriptions	2553
16-62. IRQFRAMETHOLDTX10 Register Field Descriptions	2554
16-63. IRQFRAMETHOLDTX11 Register Field Descriptions	2555
16-64. IRQFRAMETHOLDTX12 Register Field Descriptions	2556

16-65. IRQFRAMETHOLDTX13 Register Field Descriptions	2557
16-66. IRQFRAMETHOLDRX10 Register Field Descriptions	2558
16-67. IRQFRAMETHOLDRX11 Register Field Descriptions	2559
16-68. IRQFRAMETHOLDRX12 Register Field Descriptions	2560
16-69. IRQFRAMETHOLDRX13 Register Field Descriptions	2561
16-70. IRQFRAMEENABLE0 Register Field Descriptions	2562
16-71. IRQFRAMEENABLE1 Register Field Descriptions	2563
16-72. USB0_CTRL Registers	2564
16-73. USB0REV Register Field Descriptions	2565
16-74. USB0CTRL Register Field Descriptions.....	2566
16-75. USB0STAT Register Field Descriptions.....	2568
16-76. USB0IRQMSTAT Register Field Descriptions.....	2569
16-77. USB0IRQSTATRAW0 Register Field Descriptions	2570
16-78. USB0IRQSTATRAW1 Register Field Descriptions	2572
16-79. USB0IRQSTAT0 Register Field Descriptions	2574
16-80. USB0IRQSTAT1 Register Field Descriptions	2576
16-81. USB0IRQENABLESET0 Register Field Descriptions	2578
16-82. USB0IRQENABLESET1 Register Field Descriptions	2580
16-83. USB0IRQENABLECLR0 Register Field Descriptions	2582
16-84. USB0IRQENABLECLR1 Register Field Descriptions	2584
16-85. USB0TXMODE Register Field Descriptions	2586
16-86. USB0RXMODE Register Field Descriptions.....	2588
16-87. USB0GENRNDISEP1 Register Field Descriptions	2592
16-88. USB0GENRNDISEP2 Register Field Descriptions	2593
16-89. USB0GENRNDISEP3 Register Field Descriptions	2594
16-90. USB0GENRNDISEP4 Register Field Descriptions	2595
16-91. USB0GENRNDISEP5 Register Field Descriptions	2596
16-92. USB0GENRNDISEP6 Register Field Descriptions	2597
16-93. USB0GENRNDISEP7 Register Field Descriptions	2598
16-94. USB0GENRNDISEP8 Register Field Descriptions	2599
16-95. USB0GENRNDISEP9 Register Field Descriptions	2600
16-96. USB0GENRNDISEP10 Register Field Descriptions.....	2601
16-97. USB0GENRNDISEP11 Register Field Descriptions.....	2602
16-98. USB0GENRNDISEP12 Register Field Descriptions.....	2603
16-99. USB0GENRNDISEP13 Register Field Descriptions.....	2604
16-100. USB0GENRNDISEP14 Register Field Descriptions	2605
16-101. USB0GENRNDISEP15 Register Field Descriptions	2606
16-102. USB0AUTOREQ Register Field Descriptions	2607
16-103. USB0SRPFXITIME Register Field Descriptions	2609
16-104. USB0_TDOWN Register Field Descriptions	2610
16-105. USB0UTMI Register Field Descriptions.....	2611
16-106. USB0MGCUTMILB Register Field Descriptions	2612
16-107. USB0MODE Register Field Descriptions	2613
16-108. USB1_CTRL Registers.....	2613
16-109. USB1REV Register Field Descriptions.....	2615
16-110. USB1CTRL Register Field Descriptions	2616
16-111. USB1STAT Register Field Descriptions	2618
16-112. USB1IRQMSTAT Register Field Descriptions	2619
16-113. USB1IRQSTATRAW0 Register Field Descriptions.....	2620

16-114. USB1IRQSTATRAW1 Register Field Descriptions	2622
16-115. USB1IRQSTAT0 Register Field Descriptions	2624
16-116. USB1IRQSTAT1 Register Field Descriptions	2626
16-117. USB1IRQENABLESET0 Register Field Descriptions	2628
16-118. USB1IRQENABLESET1 Register Field Descriptions	2630
16-119. USB1IRQENABLECLR0 Register Field Descriptions	2632
16-120. USB1IRQENABLECLR1 Register Field Descriptions	2634
16-121. USB1TXMODE Register Field Descriptions.....	2636
16-122. USB1RXMODE Register Field Descriptions	2638
16-123. USB1GENRNDISEP1 Register Field Descriptions	2640
16-124. USB1GENRNDISEP2 Register Field Descriptions	2641
16-125. USB1GENRNDISEP3 Register Field Descriptions	2642
16-126. USB1GENRNDISEP4 Register Field Descriptions	2643
16-127. USB1GENRNDISEP5 Register Field Descriptions	2644
16-128. USB1GENRNDISEP6 Register Field Descriptions	2645
16-129. USB1GENRNDISEP7 Register Field Descriptions	2646
16-130. USB1GENRNDISEP8 Register Field Descriptions	2647
16-131. USB1GENRNDISEP9 Register Field Descriptions	2648
16-132. USB1GENRNDISEP10 Register Field Descriptions	2649
16-133. USB1GENRNDISEP11 Register Field Descriptions	2650
16-134. USB1GENRNDISEP12 Register Field Descriptions	2651
16-135. USB1GENRNDISEP13 Register Field Descriptions	2652
16-136. USB1GENRNDISEP14 Register Field Descriptions	2653
16-137. USB1GENRNDISEP15 Register Field Descriptions	2654
16-138. USB1AUTOREQ Register Field Descriptions	2655
16-139. USB1SRPFIXTIME Register Field Descriptions	2657
16-140. USB1TDOWN Register Field Descriptions	2658
16-141. USB1UTMI Register Field Descriptions.....	2659
16-142. USB1UTMILB Register Field Descriptions	2660
16-143. USB1MODE Register Field Descriptions	2661
16-144. USB2PHY Registers.....	2661
16-145. Termination_control Register Field Descriptions	2663
16-146. RX_CALIB Register Field Descriptions	2664
16-147. DLLHS_2 Register Field Descriptions.....	2666
16-148. RX_TEST_2 Register Field Descriptions	2667
16-149. CHRГ_DET Register Field Descriptions	2668
16-150. PWR_CNTL Register Field Descriptions	2670
16-151. UTMI_INTERFACE_CNTL_1 Register Field Descriptions	2671
16-152. UTMI_INTERFACE_CNTL_2 Register Field Descriptions	2672
16-153. BIST Register Field Descriptions	2674
16-154. BIST_CRC Register Field Descriptions	2675
16-155. CDR_BIST2 Register Field Descriptions	2676
16-156. GPIO Register Field Descriptions	2677
16-157. DLLHS Register Field Descriptions.....	2678
16-158. USB2PHYCM_CONFIG Register Field Descriptions	2680
16-159. AD_INTERFACE_REG1 Register Field Descriptions	2681
16-160. AD_INTERFACE_REG2 Register Field Descriptions	2683
16-161. AD_INTERFACE_REG3 Register Field Descriptions	2685
16-162. ANA_CONFIG2 Register Field Descriptions	2686

16-163. CPPI_DMA REGISTERS	2686
16-164. DMAREVID Register Field Descriptions	2690
16-165. TDFDQ Register Field Descriptions	2691
16-166. DMAEMU Register Field Descriptions	2692
16-167. TXGCR0 Register Field Descriptions	2693
16-168. RXGCR0 Register Field Descriptions	2694
16-169. RXHPCRA0 Register Field Descriptions.....	2696
16-170. RXHPCRB0 Register Field Descriptions.....	2697
16-171. TXGCR1 Register Field Descriptions	2698
16-172. RXGCR1 Register Field Descriptions	2699
16-173. RXHPCRA1 Register Field Descriptions.....	2701
16-174. RXHPCRB1 Register Field Descriptions.....	2702
16-175. TXGCR2 Register Field Descriptions	2703
16-176. RXGCR2 Register Field Descriptions	2704
16-177. RXHPCRA2 Register Field Descriptions.....	2706
16-178. RXHPCRB2 Register Field Descriptions.....	2707
16-179. TXGCR3 Register Field Descriptions	2708
16-180. RXGCR3 Register Field Descriptions	2709
16-181. RXHPCRA3 Register Field Descriptions.....	2711
16-182. RXHPCRB3 Register Field Descriptions.....	2712
16-183. TXGCR4 Register Field Descriptions	2713
16-184. RXGCR4 Register Field Descriptions	2714
16-185. RXHPCRA4 Register Field Descriptions.....	2716
16-186. RXHPCRB4 Register Field Descriptions.....	2717
16-187. TXGCR5 Register Field Descriptions	2718
16-188. RXGCR5 Register Field Descriptions	2719
16-189. RXHPCRA5 Register Field Descriptions.....	2721
16-190. RXHPCRB5 Register Field Descriptions.....	2722
16-191. TXGCR6 Register Field Descriptions	2723
16-192. RXGCR6 Register Field Descriptions	2724
16-193. RXHPCRA6 Register Field Descriptions.....	2726
16-194. RXHPCRB6 Register Field Descriptions.....	2727
16-195. TXGCR7 Register Field Descriptions	2728
16-196. RXGCR7 Register Field Descriptions	2729
16-197. RXHPCRA7 Register Field Descriptions.....	2731
16-198. RXHPCRB7 Register Field Descriptions.....	2732
16-199. TXGCR8 Register Field Descriptions	2733
16-200. RXGCR8 Register Field Descriptions	2734
16-201. RXHPCRA8 Register Field Descriptions.....	2736
16-202. RXHPCRB8 Register Field Descriptions.....	2737
16-203. TXGCR9 Register Field Descriptions	2738
16-204. RXGCR9 Register Field Descriptions	2739
16-205. RXHPCRA9 Register Field Descriptions.....	2741
16-206. RXHPCRB9 Register Field Descriptions.....	2742
16-207. TXGCR10 Register Field Descriptions	2743
16-208. RXGCR10 Register Field Descriptions	2744
16-209. RXHPCRA10 Register Field Descriptions	2746
16-210. RXHPCRB10 Register Field Descriptions	2747
16-211. TXGCR11 Register Field Descriptions	2748

16-212. RXGCR11 Register Field Descriptions	2749
16-213. RXHPCRA11 Register Field Descriptions	2751
16-214. RXHPCRB11 Register Field Descriptions	2752
16-215. TXGCR12 Register Field Descriptions	2753
16-216. RXGCR12 Register Field Descriptions	2754
16-217. RXHPCRA12 Register Field Descriptions	2756
16-218. RXHPCRB12 Register Field Descriptions	2757
16-219. TXGCR13 Register Field Descriptions	2758
16-220. RXGCR13 Register Field Descriptions	2759
16-221. RXHPCRA13 Register Field Descriptions	2761
16-222. RXHPCRB13 Register Field Descriptions	2762
16-223. TXGCR14 Register Field Descriptions	2763
16-224. RXGCR14 Register Field Descriptions	2764
16-225. RXHPCRA14 Register Field Descriptions	2766
16-226. RXHPCRB14 Register Field Descriptions	2767
16-227. TXGCR15 Register Field Descriptions	2768
16-228. RXGCR15 Register Field Descriptions	2769
16-229. RXHPCRA15 Register Field Descriptions	2771
16-230. RXHPCRB15 Register Field Descriptions	2772
16-231. TXGCR16 Register Field Descriptions	2773
16-232. RXGCR16 Register Field Descriptions	2774
16-233. RXHPCRA16 Register Field Descriptions	2776
16-234. RXHPCRB16 Register Field Descriptions	2777
16-235. TXGCR17 Register Field Descriptions	2778
16-236. RXGCR17 Register Field Descriptions	2779
16-237. RXHPCRA17 Register Field Descriptions	2781
16-238. RXHPCRB17 Register Field Descriptions	2782
16-239. TXGCR18 Register Field Descriptions	2783
16-240. RXGCR18 Register Field Descriptions	2784
16-241. RXHPCRA18 Register Field Descriptions	2786
16-242. RXHPCRB18 Register Field Descriptions	2787
16-243. TXGCR19 Register Field Descriptions	2788
16-244. RXGCR19 Register Field Descriptions	2789
16-245. RXHPCRA19 Register Field Descriptions	2791
16-246. RXHPCRB19 Register Field Descriptions	2792
16-247. TXGCR20 Register Field Descriptions	2793
16-248. RXGCR20 Register Field Descriptions	2794
16-249. RXHPCRA20 Register Field Descriptions	2796
16-250. RXHPCRB20 Register Field Descriptions	2797
16-251. TXGCR21 Register Field Descriptions	2798
16-252. RXGCR21 Register Field Descriptions	2799
16-253. RXHPCRA21 Register Field Descriptions	2801
16-254. RXHPCRB21 Register Field Descriptions	2802
16-255. TXGCR22 Register Field Descriptions	2803
16-256. RXGCR22 Register Field Descriptions	2804
16-257. RXHPCRA22 Register Field Descriptions	2806
16-258. RXHPCRB22 Register Field Descriptions	2807
16-259. TXGCR23 Register Field Descriptions	2808
16-260. RXGCR23 Register Field Descriptions	2809

16-261. RXHPCRA23 Register Field Descriptions	2811
16-262. RXHPCRB23 Register Field Descriptions	2812
16-263. TXGCR24 Register Field Descriptions	2813
16-264. RXGCR24 Register Field Descriptions	2814
16-265. RXHPCRA24 Register Field Descriptions	2816
16-266. RXHPCRB24 Register Field Descriptions	2817
16-267. TXGCR25 Register Field Descriptions	2818
16-268. RXGCR25 Register Field Descriptions	2819
16-269. RXHPCRA25 Register Field Descriptions	2821
16-270. RXHPCRB25 Register Field Descriptions	2822
16-271. TXGCR26 Register Field Descriptions	2823
16-272. RXGCR26 Register Field Descriptions	2824
16-273. RXHPCRA26 Register Field Descriptions	2826
16-274. RXHPCRB26 Register Field Descriptions	2827
16-275. TXGCR27 Register Field Descriptions	2828
16-276. RXGCR27 Register Field Descriptions	2829
16-277. RXHPCRA27 Register Field Descriptions	2831
16-278. RXHPCRB27 Register Field Descriptions	2832
16-279. TXGCR28 Register Field Descriptions	2833
16-280. RXGCR28 Register Field Descriptions	2834
16-281. RXHPCRA28 Register Field Descriptions	2836
16-282. RXHPCRB28 Register Field Descriptions	2837
16-283. TXGCR29 Register Field Descriptions	2838
16-284. RXGCR29 Register Field Descriptions	2839
16-285. RXHPCRA29 Register Field Descriptions	2841
16-286. RXHPCRB29 Register Field Descriptions	2842
16-287. CPPI_DMA_SCHEDULER Registers	2842
16-288. DMA_SCHED_CTRL Register Field Descriptions	2843
16-289. WORD_0 to WORD_63 Register Field Descriptions	2844
16-290. QUEUE_MGR REGISTERS	2845
16-291. QMGRREVID Register Field Descriptions	2870
16-292. QMGRRST Register Field Descriptions	2871
16-293. FDBSC0 Register Field Descriptions	2872
16-294. FDBSC1 Register Field Descriptions	2873
16-295. FDBSC2 Register Field Descriptions	2874
16-296. FDBSC3 Register Field Descriptions	2875
16-297. FDBSC4 Register Field Descriptions	2876
16-298. FDBSC5 Register Field Descriptions	2877
16-299. FDBSC6 Register Field Descriptions	2878
16-300. FDBSC7 Register Field Descriptions	2879
16-301. LRAM0BASE Register Field Descriptions	2880
16-302. LRAM0SIZE Register Field Descriptions	2881
16-303. LRAM1BASE Register Field Descriptions	2882
16-304. PEND0 Register Field Descriptions	2883
16-305. PEND1 Register Field Descriptions	2884
16-306. PEND2 Register Field Descriptions	2885
16-307. PEND3 Register Field Descriptions	2886
16-308. PEND4 Register Field Descriptions	2887
16-309. QMEMRBASE0 Register Field Descriptions	2888

16-310. QMEMCTRL0 Register Field Descriptions	2889
16-311. QMEMRBASE1 Register Field Descriptions	2890
16-312. QMEMCTRL1 Register Field Descriptions	2891
16-313. QMEMRBASE2 Register Field Descriptions	2892
16-314. QMEMCTRL2 Register Field Descriptions	2893
16-315. QMEMRBASE3 Register Field Descriptions	2894
16-316. QMEMCTRL3 Register Field Descriptions	2895
16-317. QMEMRBASE4 Register Field Descriptions	2896
16-318. QMEMCTRL4 Register Field Descriptions	2897
16-319. QMEMRBASE5 Register Field Descriptions	2898
16-320. QMEMCTRL5 Register Field Descriptions	2899
16-321. QMEMRBASE6 Register Field Descriptions	2900
16-322. QMEMCTRL6 Register Field Descriptions	2901
16-323. QMEMRBASE7 Register Field Descriptions	2902
16-324. QMEMCTRL7 Register Field Descriptions	2903
16-325. QUEUE_0_A Register Field Descriptions	2904
16-326. QUEUE_0_B Register Field Descriptions	2905
16-327. QUEUE_0_C Register Field Descriptions	2906
16-328. QUEUE_0_D Register Field Descriptions	2907
16-329. QUEUE_1_A Register Field Descriptions	2908
16-330. QUEUE_1_B Register Field Descriptions	2909
16-331. QUEUE_1_C Register Field Descriptions	2910
16-332. QUEUE_1_D Register Field Descriptions	2911
16-333. QUEUE_2_A Register Field Descriptions	2912
16-334. QUEUE_2_B Register Field Descriptions	2913
16-335. QUEUE_2_C Register Field Descriptions	2914
16-336. QUEUE_2_D Register Field Descriptions	2915
16-337. QUEUE_3_A Register Field Descriptions	2916
16-338. QUEUE_3_B Register Field Descriptions	2917
16-339. QUEUE_3_C Register Field Descriptions	2918
16-340. QUEUE_3_D Register Field Descriptions	2919
16-341. QUEUE_4_A Register Field Descriptions	2920
16-342. QUEUE_4_B Register Field Descriptions	2921
16-343. QUEUE_4_C Register Field Descriptions	2922
16-344. QUEUE_4_D Register Field Descriptions	2923
16-345. QUEUE_5_A Register Field Descriptions	2924
16-346. QUEUE_5_B Register Field Descriptions	2925
16-347. QUEUE_5_C Register Field Descriptions	2926
16-348. QUEUE_5_D Register Field Descriptions	2927
16-349. QUEUE_6_A Register Field Descriptions	2928
16-350. QUEUE_6_B Register Field Descriptions	2929
16-351. QUEUE_6_C Register Field Descriptions	2930
16-352. QUEUE_6_D Register Field Descriptions	2931
16-353. QUEUE_7_A Register Field Descriptions	2932
16-354. QUEUE_7_B Register Field Descriptions	2933
16-355. QUEUE_7_C Register Field Descriptions	2934
16-356. QUEUE_7_D Register Field Descriptions	2935
16-357. QUEUE_8_A Register Field Descriptions	2936
16-358. QUEUE_8_B Register Field Descriptions	2937

16-359. QUEUE_8_C Register Field Descriptions	2938
16-360. QUEUE_8_D Register Field Descriptions	2939
16-361. QUEUE_9_A Register Field Descriptions	2940
16-362. QUEUE_9_B Register Field Descriptions	2941
16-363. QUEUE_9_C Register Field Descriptions	2942
16-364. QUEUE_9_D Register Field Descriptions	2943
16-365. QUEUE_10_A Register Field Descriptions	2944
16-366. QUEUE_10_B Register Field Descriptions	2945
16-367. QUEUE_10_C Register Field Descriptions	2946
16-368. QUEUE_10_D Register Field Descriptions	2947
16-369. QUEUE_11_A Register Field Descriptions	2948
16-370. QUEUE_11_B Register Field Descriptions	2949
16-371. QUEUE_11_C Register Field Descriptions	2950
16-372. QUEUE_11_D Register Field Descriptions	2951
16-373. QUEUE_12_A Register Field Descriptions	2952
16-374. QUEUE_12_B Register Field Descriptions	2953
16-375. QUEUE_12_C Register Field Descriptions	2954
16-376. QUEUE_12_D Register Field Descriptions	2955
16-377. QUEUE_13_A Register Field Descriptions	2956
16-378. QUEUE_13_B Register Field Descriptions	2957
16-379. QUEUE_13_C Register Field Descriptions	2958
16-380. QUEUE_13_D Register Field Descriptions	2959
16-381. QUEUE_14_A Register Field Descriptions	2960
16-382. QUEUE_14_B Register Field Descriptions	2961
16-383. QUEUE_14_C Register Field Descriptions	2962
16-384. QUEUE_14_D Register Field Descriptions	2963
16-385. QUEUE_15_A Register Field Descriptions	2964
16-386. QUEUE_15_B Register Field Descriptions	2965
16-387. QUEUE_15_C Register Field Descriptions	2966
16-388. QUEUE_15_D Register Field Descriptions	2967
16-389. QUEUE_16_A Register Field Descriptions	2968
16-390. QUEUE_16_B Register Field Descriptions	2969
16-391. QUEUE_16_C Register Field Descriptions	2970
16-392. QUEUE_16_D Register Field Descriptions	2971
16-393. QUEUE_17_A Register Field Descriptions	2972
16-394. QUEUE_17_B Register Field Descriptions	2973
16-395. QUEUE_17_C Register Field Descriptions	2974
16-396. QUEUE_17_D Register Field Descriptions	2975
16-397. QUEUE_18_A Register Field Descriptions	2976
16-398. QUEUE_18_B Register Field Descriptions	2977
16-399. QUEUE_18_C Register Field Descriptions	2978
16-400. QUEUE_18_D Register Field Descriptions	2979
16-401. QUEUE_19_A Register Field Descriptions	2980
16-402. QUEUE_19_B Register Field Descriptions	2981
16-403. QUEUE_19_C Register Field Descriptions	2982
16-404. QUEUE_19_D Register Field Descriptions	2983
16-405. QUEUE_20_A Register Field Descriptions	2984
16-406. QUEUE_20_B Register Field Descriptions	2985
16-407. QUEUE_20_C Register Field Descriptions	2986

16-408. QUEUE_20_D Register Field Descriptions	2987
16-409. QUEUE_21_A Register Field Descriptions	2988
16-410. QUEUE_21_B Register Field Descriptions	2989
16-411. QUEUE_21_C Register Field Descriptions	2990
16-412. QUEUE_21_D Register Field Descriptions	2991
16-413. QUEUE_22_A Register Field Descriptions	2992
16-414. QUEUE_22_B Register Field Descriptions	2993
16-415. QUEUE_22_C Register Field Descriptions	2994
16-416. QUEUE_22_D Register Field Descriptions	2995
16-417. QUEUE_23_A Register Field Descriptions	2996
16-418. QUEUE_23_B Register Field Descriptions	2997
16-419. QUEUE_23_C Register Field Descriptions	2998
16-420. QUEUE_23_D Register Field Descriptions	2999
16-421. QUEUE_24_A Register Field Descriptions	3000
16-422. QUEUE_24_B Register Field Descriptions	3001
16-423. QUEUE_24_C Register Field Descriptions	3002
16-424. QUEUE_24_D Register Field Descriptions	3003
16-425. QUEUE_25_A Register Field Descriptions	3004
16-426. QUEUE_25_B Register Field Descriptions	3005
16-427. QUEUE_25_C Register Field Descriptions	3006
16-428. QUEUE_25_D Register Field Descriptions	3007
16-429. QUEUE_26_A Register Field Descriptions	3008
16-430. QUEUE_26_B Register Field Descriptions	3009
16-431. QUEUE_26_C Register Field Descriptions	3010
16-432. QUEUE_26_D Register Field Descriptions	3011
16-433. QUEUE_27_A Register Field Descriptions	3012
16-434. QUEUE_27_B Register Field Descriptions	3013
16-435. QUEUE_27_C Register Field Descriptions	3014
16-436. QUEUE_27_D Register Field Descriptions	3015
16-437. QUEUE_28_A Register Field Descriptions	3016
16-438. QUEUE_28_B Register Field Descriptions	3017
16-439. QUEUE_28_C Register Field Descriptions	3018
16-440. QUEUE_28_D Register Field Descriptions	3019
16-441. QUEUE_29_A Register Field Descriptions	3020
16-442. QUEUE_29_B Register Field Descriptions	3021
16-443. QUEUE_29_C Register Field Descriptions	3022
16-444. QUEUE_29_D Register Field Descriptions	3023
16-445. QUEUE_30_A Register Field Descriptions	3024
16-446. QUEUE_30_B Register Field Descriptions	3025
16-447. QUEUE_30_C Register Field Descriptions	3026
16-448. QUEUE_30_D Register Field Descriptions	3027
16-449. QUEUE_31_A Register Field Descriptions	3028
16-450. QUEUE_31_B Register Field Descriptions	3029
16-451. QUEUE_31_C Register Field Descriptions	3030
16-452. QUEUE_31_D Register Field Descriptions	3031
16-453. QUEUE_32_A Register Field Descriptions	3032
16-454. QUEUE_32_B Register Field Descriptions	3033
16-455. QUEUE_32_C Register Field Descriptions	3034
16-456. QUEUE_32_D Register Field Descriptions	3035

16-457. QUEUE_33_A Register Field Descriptions	3036
16-458. QUEUE_33_B Register Field Descriptions	3037
16-459. QUEUE_33_C Register Field Descriptions	3038
16-460. QUEUE_33_D Register Field Descriptions	3039
16-461. QUEUE_34_A Register Field Descriptions	3040
16-462. QUEUE_34_B Register Field Descriptions	3041
16-463. QUEUE_34_C Register Field Descriptions	3042
16-464. QUEUE_34_D Register Field Descriptions	3043
16-465. QUEUE_35_A Register Field Descriptions	3044
16-466. QUEUE_35_B Register Field Descriptions	3045
16-467. QUEUE_35_C Register Field Descriptions	3046
16-468. QUEUE_35_D Register Field Descriptions	3047
16-469. QUEUE_36_A Register Field Descriptions	3048
16-470. QUEUE_36_B Register Field Descriptions	3049
16-471. QUEUE_36_C Register Field Descriptions	3050
16-472. QUEUE_36_D Register Field Descriptions	3051
16-473. QUEUE_37_A Register Field Descriptions	3052
16-474. QUEUE_37_B Register Field Descriptions	3053
16-475. QUEUE_37_C Register Field Descriptions	3054
16-476. QUEUE_37_D Register Field Descriptions	3055
16-477. QUEUE_38_A Register Field Descriptions	3056
16-478. QUEUE_38_B Register Field Descriptions	3057
16-479. QUEUE_38_C Register Field Descriptions	3058
16-480. QUEUE_38_D Register Field Descriptions	3059
16-481. QUEUE_39_A Register Field Descriptions	3060
16-482. QUEUE_39_B Register Field Descriptions	3061
16-483. QUEUE_39_C Register Field Descriptions	3062
16-484. QUEUE_39_D Register Field Descriptions	3063
16-485. QUEUE_40_A Register Field Descriptions	3064
16-486. QUEUE_40_B Register Field Descriptions	3065
16-487. QUEUE_40_C Register Field Descriptions	3066
16-488. QUEUE_40_D Register Field Descriptions	3067
16-489. QUEUE_41_A Register Field Descriptions	3068
16-490. QUEUE_41_B Register Field Descriptions	3069
16-491. QUEUE_41_C Register Field Descriptions	3070
16-492. QUEUE_41_D Register Field Descriptions	3071
16-493. QUEUE_42_A Register Field Descriptions	3072
16-494. QUEUE_42_B Register Field Descriptions	3073
16-495. QUEUE_42_C Register Field Descriptions	3074
16-496. QUEUE_42_D Register Field Descriptions	3075
16-497. QUEUE_43_A Register Field Descriptions	3076
16-498. QUEUE_43_B Register Field Descriptions	3077
16-499. QUEUE_43_C Register Field Descriptions	3078
16-500. QUEUE_43_D Register Field Descriptions	3079
16-501. QUEUE_44_A Register Field Descriptions	3080
16-502. QUEUE_44_B Register Field Descriptions	3081
16-503. QUEUE_44_C Register Field Descriptions	3082
16-504. QUEUE_44_D Register Field Descriptions	3083
16-505. QUEUE_45_A Register Field Descriptions	3084

16-506. QUEUE_45_B Register Field Descriptions	3085
16-507. QUEUE_45_C Register Field Descriptions	3086
16-508. QUEUE_45_D Register Field Descriptions	3087
16-509. QUEUE_46_A Register Field Descriptions	3088
16-510. QUEUE_46_B Register Field Descriptions	3089
16-511. QUEUE_46_C Register Field Descriptions	3090
16-512. QUEUE_46_D Register Field Descriptions	3091
16-513. QUEUE_47_A Register Field Descriptions	3092
16-514. QUEUE_47_B Register Field Descriptions	3093
16-515. QUEUE_47_C Register Field Descriptions	3094
16-516. QUEUE_47_D Register Field Descriptions	3095
16-517. QUEUE_48_A Register Field Descriptions	3096
16-518. QUEUE_48_B Register Field Descriptions	3097
16-519. QUEUE_48_C Register Field Descriptions	3098
16-520. QUEUE_48_D Register Field Descriptions	3099
16-521. QUEUE_49_A Register Field Descriptions	3100
16-522. QUEUE_49_B Register Field Descriptions	3101
16-523. QUEUE_49_C Register Field Descriptions	3102
16-524. QUEUE_49_D Register Field Descriptions	3103
16-525. QUEUE_50_A Register Field Descriptions	3104
16-526. QUEUE_50_B Register Field Descriptions	3105
16-527. QUEUE_50_C Register Field Descriptions	3106
16-528. QUEUE_50_D Register Field Descriptions	3107
16-529. QUEUE_51_A Register Field Descriptions	3108
16-530. QUEUE_51_B Register Field Descriptions	3109
16-531. QUEUE_51_C Register Field Descriptions	3110
16-532. QUEUE_51_D Register Field Descriptions	3111
16-533. QUEUE_52_A Register Field Descriptions	3112
16-534. QUEUE_52_B Register Field Descriptions	3113
16-535. QUEUE_52_C Register Field Descriptions	3114
16-536. QUEUE_52_D Register Field Descriptions	3115
16-537. QUEUE_53_A Register Field Descriptions	3116
16-538. QUEUE_53_B Register Field Descriptions	3117
16-539. QUEUE_53_C Register Field Descriptions	3118
16-540. QUEUE_53_D Register Field Descriptions	3119
16-541. QUEUE_54_A Register Field Descriptions	3120
16-542. QUEUE_54_B Register Field Descriptions	3121
16-543. QUEUE_54_C Register Field Descriptions	3122
16-544. QUEUE_54_D Register Field Descriptions	3123
16-545. QUEUE_55_A Register Field Descriptions	3124
16-546. QUEUE_55_B Register Field Descriptions	3125
16-547. QUEUE_55_C Register Field Descriptions	3126
16-548. QUEUE_55_D Register Field Descriptions	3127
16-549. QUEUE_56_A Register Field Descriptions	3128
16-550. QUEUE_56_B Register Field Descriptions	3129
16-551. QUEUE_56_C Register Field Descriptions	3130
16-552. QUEUE_56_D Register Field Descriptions	3131
16-553. QUEUE_57_A Register Field Descriptions	3132
16-554. QUEUE_57_B Register Field Descriptions	3133

16-555. QUEUE_57_C Register Field Descriptions	3134
16-556. QUEUE_57_D Register Field Descriptions	3135
16-557. QUEUE_58_A Register Field Descriptions	3136
16-558. QUEUE_58_B Register Field Descriptions	3137
16-559. QUEUE_58_C Register Field Descriptions	3138
16-560. QUEUE_58_D Register Field Descriptions	3139
16-561. QUEUE_59_A Register Field Descriptions	3140
16-562. QUEUE_59_B Register Field Descriptions	3141
16-563. QUEUE_59_C Register Field Descriptions	3142
16-564. QUEUE_59_D Register Field Descriptions	3143
16-565. QUEUE_60_A Register Field Descriptions	3144
16-566. QUEUE_60_B Register Field Descriptions	3145
16-567. QUEUE_60_C Register Field Descriptions	3146
16-568. QUEUE_60_D Register Field Descriptions	3147
16-569. QUEUE_61_A Register Field Descriptions	3148
16-570. QUEUE_61_B Register Field Descriptions	3149
16-571. QUEUE_61_C Register Field Descriptions	3150
16-572. QUEUE_61_D Register Field Descriptions	3151
16-573. QUEUE_62_A Register Field Descriptions	3152
16-574. QUEUE_62_B Register Field Descriptions	3153
16-575. QUEUE_62_C Register Field Descriptions	3154
16-576. QUEUE_62_D Register Field Descriptions	3155
16-577. QUEUE_63_A Register Field Descriptions	3156
16-578. QUEUE_63_B Register Field Descriptions	3157
16-579. QUEUE_63_C Register Field Descriptions	3158
16-580. QUEUE_63_D Register Field Descriptions	3159
16-581. QUEUE_64_A Register Field Descriptions	3160
16-582. QUEUE_64_B Register Field Descriptions	3161
16-583. QUEUE_64_C Register Field Descriptions	3162
16-584. QUEUE_64_D Register Field Descriptions	3163
16-585. QUEUE_65_A Register Field Descriptions	3164
16-586. QUEUE_65_B Register Field Descriptions	3165
16-587. QUEUE_65_C Register Field Descriptions	3166
16-588. QUEUE_65_D Register Field Descriptions	3167
16-589. QUEUE_66_A Register Field Descriptions	3168
16-590. QUEUE_66_B Register Field Descriptions	3169
16-591. QUEUE_66_C Register Field Descriptions	3170
16-592. QUEUE_66_D Register Field Descriptions	3171
16-593. QUEUE_67_A Register Field Descriptions	3172
16-594. QUEUE_67_B Register Field Descriptions	3173
16-595. QUEUE_67_C Register Field Descriptions	3174
16-596. QUEUE_67_D Register Field Descriptions	3175
16-597. QUEUE_68_A Register Field Descriptions	3176
16-598. QUEUE_68_B Register Field Descriptions	3177
16-599. QUEUE_68_C Register Field Descriptions	3178
16-600. QUEUE_68_D Register Field Descriptions	3179
16-601. QUEUE_69_A Register Field Descriptions	3180
16-602. QUEUE_69_B Register Field Descriptions	3181
16-603. QUEUE_69_C Register Field Descriptions	3182

16-604. QUEUE_69_D Register Field Descriptions	3183
16-605. QUEUE_70_A Register Field Descriptions	3184
16-606. QUEUE_70_B Register Field Descriptions	3185
16-607. QUEUE_70_C Register Field Descriptions	3186
16-608. QUEUE_70_D Register Field Descriptions	3187
16-609. QUEUE_71_A Register Field Descriptions	3188
16-610. QUEUE_71_B Register Field Descriptions	3189
16-611. QUEUE_71_C Register Field Descriptions	3190
16-612. QUEUE_71_D Register Field Descriptions	3191
16-613. QUEUE_72_A Register Field Descriptions	3192
16-614. QUEUE_72_B Register Field Descriptions	3193
16-615. QUEUE_72_C Register Field Descriptions	3194
16-616. QUEUE_72_D Register Field Descriptions	3195
16-617. QUEUE_73_A Register Field Descriptions	3196
16-618. QUEUE_73_B Register Field Descriptions	3197
16-619. QUEUE_73_C Register Field Descriptions	3198
16-620. QUEUE_73_D Register Field Descriptions	3199
16-621. QUEUE_74_A Register Field Descriptions	3200
16-622. QUEUE_74_B Register Field Descriptions	3201
16-623. QUEUE_74_C Register Field Descriptions	3202
16-624. QUEUE_74_D Register Field Descriptions	3203
16-625. QUEUE_75_A Register Field Descriptions	3204
16-626. QUEUE_75_B Register Field Descriptions	3205
16-627. QUEUE_75_C Register Field Descriptions	3206
16-628. QUEUE_75_D Register Field Descriptions	3207
16-629. QUEUE_76_A Register Field Descriptions	3208
16-630. QUEUE_76_B Register Field Descriptions	3209
16-631. QUEUE_76_C Register Field Descriptions	3210
16-632. QUEUE_76_D Register Field Descriptions	3211
16-633. QUEUE_77_A Register Field Descriptions	3212
16-634. QUEUE_77_B Register Field Descriptions	3213
16-635. QUEUE_77_C Register Field Descriptions	3214
16-636. QUEUE_77_D Register Field Descriptions	3215
16-637. QUEUE_78_A Register Field Descriptions	3216
16-638. QUEUE_78_B Register Field Descriptions	3217
16-639. QUEUE_78_C Register Field Descriptions	3218
16-640. QUEUE_78_D Register Field Descriptions	3219
16-641. QUEUE_79_A Register Field Descriptions	3220
16-642. QUEUE_79_B Register Field Descriptions	3221
16-643. QUEUE_79_C Register Field Descriptions	3222
16-644. QUEUE_79_D Register Field Descriptions	3223
16-645. QUEUE_80_A Register Field Descriptions	3224
16-646. QUEUE_80_B Register Field Descriptions	3225
16-647. QUEUE_80_C Register Field Descriptions	3226
16-648. QUEUE_80_D Register Field Descriptions	3227
16-649. QUEUE_81_A Register Field Descriptions	3228
16-650. QUEUE_81_B Register Field Descriptions	3229
16-651. QUEUE_81_C Register Field Descriptions	3230
16-652. QUEUE_81_D Register Field Descriptions	3231

16-653. QUEUE_82_A Register Field Descriptions	3232
16-654. QUEUE_82_B Register Field Descriptions	3233
16-655. QUEUE_82_C Register Field Descriptions	3234
16-656. QUEUE_82_D Register Field Descriptions	3235
16-657. QUEUE_83_A Register Field Descriptions	3236
16-658. QUEUE_83_B Register Field Descriptions	3237
16-659. QUEUE_83_C Register Field Descriptions	3238
16-660. QUEUE_83_D Register Field Descriptions	3239
16-661. QUEUE_84_A Register Field Descriptions	3240
16-662. QUEUE_84_B Register Field Descriptions	3241
16-663. QUEUE_84_C Register Field Descriptions	3242
16-664. QUEUE_84_D Register Field Descriptions	3243
16-665. QUEUE_85_A Register Field Descriptions	3244
16-666. QUEUE_85_B Register Field Descriptions	3245
16-667. QUEUE_85_C Register Field Descriptions	3246
16-668. QUEUE_85_D Register Field Descriptions	3247
16-669. QUEUE_86_A Register Field Descriptions	3248
16-670. QUEUE_86_B Register Field Descriptions	3249
16-671. QUEUE_86_C Register Field Descriptions	3250
16-672. QUEUE_86_D Register Field Descriptions	3251
16-673. QUEUE_87_A Register Field Descriptions	3252
16-674. QUEUE_87_B Register Field Descriptions	3253
16-675. QUEUE_87_C Register Field Descriptions	3254
16-676. QUEUE_87_D Register Field Descriptions	3255
16-677. QUEUE_88_A Register Field Descriptions	3256
16-678. QUEUE_88_B Register Field Descriptions	3257
16-679. QUEUE_88_C Register Field Descriptions	3258
16-680. QUEUE_88_D Register Field Descriptions	3259
16-681. QUEUE_89_A Register Field Descriptions	3260
16-682. QUEUE_89_B Register Field Descriptions	3261
16-683. QUEUE_89_C Register Field Descriptions	3262
16-684. QUEUE_89_D Register Field Descriptions	3263
16-685. QUEUE_90_A Register Field Descriptions	3264
16-686. QUEUE_90_B Register Field Descriptions	3265
16-687. QUEUE_90_C Register Field Descriptions	3266
16-688. QUEUE_90_D Register Field Descriptions	3267
16-689. QUEUE_91_A Register Field Descriptions	3268
16-690. QUEUE_91_B Register Field Descriptions	3269
16-691. QUEUE_91_C Register Field Descriptions	3270
16-692. QUEUE_91_D Register Field Descriptions	3271
16-693. QUEUE_92_A Register Field Descriptions	3272
16-694. QUEUE_92_B Register Field Descriptions	3273
16-695. QUEUE_92_C Register Field Descriptions	3274
16-696. QUEUE_92_D Register Field Descriptions	3275
16-697. QUEUE_93_A Register Field Descriptions	3276
16-698. QUEUE_93_B Register Field Descriptions	3277
16-699. QUEUE_93_C Register Field Descriptions	3278
16-700. QUEUE_93_D Register Field Descriptions	3279
16-701. QUEUE_94_A Register Field Descriptions	3280

16-702. QUEUE_94_B Register Field Descriptions	3281
16-703. QUEUE_94_C Register Field Descriptions	3282
16-704. QUEUE_94_D Register Field Descriptions	3283
16-705. QUEUE_95_A Register Field Descriptions	3284
16-706. QUEUE_95_B Register Field Descriptions	3285
16-707. QUEUE_95_C Register Field Descriptions	3286
16-708. QUEUE_95_D Register Field Descriptions	3287
16-709. QUEUE_96_A Register Field Descriptions	3288
16-710. QUEUE_96_B Register Field Descriptions	3289
16-711. QUEUE_96_C Register Field Descriptions	3290
16-712. QUEUE_96_D Register Field Descriptions	3291
16-713. QUEUE_97_A Register Field Descriptions	3292
16-714. QUEUE_97_B Register Field Descriptions	3293
16-715. QUEUE_97_C Register Field Descriptions	3294
16-716. QUEUE_97_D Register Field Descriptions	3295
16-717. QUEUE_98_A Register Field Descriptions	3296
16-718. QUEUE_98_B Register Field Descriptions	3297
16-719. QUEUE_98_C Register Field Descriptions	3298
16-720. QUEUE_98_D Register Field Descriptions	3299
16-721. QUEUE_99_A Register Field Descriptions	3300
16-722. QUEUE_99_B Register Field Descriptions	3301
16-723. QUEUE_99_C Register Field Descriptions	3302
16-724. QUEUE_99_D Register Field Descriptions	3303
16-725. QUEUE_100_A Register Field Descriptions	3304
16-726. QUEUE_100_B Register Field Descriptions	3305
16-727. QUEUE_100_C Register Field Descriptions	3306
16-728. QUEUE_100_D Register Field Descriptions	3307
16-729. QUEUE_101_A Register Field Descriptions	3308
16-730. QUEUE_101_B Register Field Descriptions	3309
16-731. QUEUE_101_C Register Field Descriptions	3310
16-732. QUEUE_101_D Register Field Descriptions	3311
16-733. QUEUE_102_A Register Field Descriptions	3312
16-734. QUEUE_102_B Register Field Descriptions	3313
16-735. QUEUE_102_C Register Field Descriptions	3314
16-736. QUEUE_102_D Register Field Descriptions	3315
16-737. QUEUE_103_A Register Field Descriptions	3316
16-738. QUEUE_103_B Register Field Descriptions	3317
16-739. QUEUE_103_C Register Field Descriptions	3318
16-740. QUEUE_103_D Register Field Descriptions	3319
16-741. QUEUE_104_A Register Field Descriptions	3320
16-742. QUEUE_104_B Register Field Descriptions	3321
16-743. QUEUE_104_C Register Field Descriptions	3322
16-744. QUEUE_104_D Register Field Descriptions	3323
16-745. QUEUE_105_A Register Field Descriptions	3324
16-746. QUEUE_105_B Register Field Descriptions	3325
16-747. QUEUE_105_C Register Field Descriptions	3326
16-748. QUEUE_105_D Register Field Descriptions	3327
16-749. QUEUE_106_A Register Field Descriptions	3328
16-750. QUEUE_106_B Register Field Descriptions	3329

16-751. QUEUE_106_C Register Field Descriptions	3330
16-752. QUEUE_106_D Register Field Descriptions	3331
16-753. QUEUE_107_A Register Field Descriptions	3332
16-754. QUEUE_107_B Register Field Descriptions	3333
16-755. QUEUE_107_C Register Field Descriptions	3334
16-756. QUEUE_107_D Register Field Descriptions	3335
16-757. QUEUE_108_A Register Field Descriptions	3336
16-758. QUEUE_108_B Register Field Descriptions	3337
16-759. QUEUE_108_C Register Field Descriptions	3338
16-760. QUEUE_108_D Register Field Descriptions	3339
16-761. QUEUE_109_A Register Field Descriptions	3340
16-762. QUEUE_109_B Register Field Descriptions	3341
16-763. QUEUE_109_C Register Field Descriptions	3342
16-764. QUEUE_109_D Register Field Descriptions	3343
16-765. QUEUE_110_A Register Field Descriptions	3344
16-766. QUEUE_110_B Register Field Descriptions	3345
16-767. QUEUE_110_C Register Field Descriptions	3346
16-768. QUEUE_110_D Register Field Descriptions	3347
16-769. QUEUE_111_A Register Field Descriptions	3348
16-770. QUEUE_111_B Register Field Descriptions	3349
16-771. QUEUE_111_C Register Field Descriptions	3350
16-772. QUEUE_111_D Register Field Descriptions	3351
16-773. QUEUE_112_A Register Field Descriptions	3352
16-774. QUEUE_112_B Register Field Descriptions	3353
16-775. QUEUE_112_C Register Field Descriptions	3354
16-776. QUEUE_112_D Register Field Descriptions	3355
16-777. QUEUE_113_A Register Field Descriptions	3356
16-778. QUEUE_113_B Register Field Descriptions	3357
16-779. QUEUE_113_C Register Field Descriptions	3358
16-780. QUEUE_113_D Register Field Descriptions	3359
16-781. QUEUE_114_A Register Field Descriptions	3360
16-782. QUEUE_114_B Register Field Descriptions	3361
16-783. QUEUE_114_C Register Field Descriptions	3362
16-784. QUEUE_114_D Register Field Descriptions	3363
16-785. QUEUE_115_A Register Field Descriptions	3364
16-786. QUEUE_115_B Register Field Descriptions	3365
16-787. QUEUE_115_C Register Field Descriptions	3366
16-788. QUEUE_115_D Register Field Descriptions	3367
16-789. QUEUE_116_A Register Field Descriptions	3368
16-790. QUEUE_116_B Register Field Descriptions	3369
16-791. QUEUE_116_C Register Field Descriptions	3370
16-792. QUEUE_116_D Register Field Descriptions	3371
16-793. QUEUE_117_A Register Field Descriptions	3372
16-794. QUEUE_117_B Register Field Descriptions	3373
16-795. QUEUE_117_C Register Field Descriptions	3374
16-796. QUEUE_117_D Register Field Descriptions	3375
16-797. QUEUE_118_A Register Field Descriptions	3376
16-798. QUEUE_118_B Register Field Descriptions	3377
16-799. QUEUE_118_C Register Field Descriptions	3378

16-800. QUEUE_118_D Register Field Descriptions	3379
16-801. QUEUE_119_A Register Field Descriptions	3380
16-802. QUEUE_119_B Register Field Descriptions	3381
16-803. QUEUE_119_C Register Field Descriptions	3382
16-804. QUEUE_119_D Register Field Descriptions	3383
16-805. QUEUE_120_A Register Field Descriptions	3384
16-806. QUEUE_120_B Register Field Descriptions	3385
16-807. QUEUE_120_C Register Field Descriptions	3386
16-808. QUEUE_120_D Register Field Descriptions	3387
16-809. QUEUE_121_A Register Field Descriptions	3388
16-810. QUEUE_121_B Register Field Descriptions	3389
16-811. QUEUE_121_C Register Field Descriptions	3390
16-812. QUEUE_121_D Register Field Descriptions	3391
16-813. QUEUE_122_A Register Field Descriptions	3392
16-814. QUEUE_122_B Register Field Descriptions	3393
16-815. QUEUE_122_C Register Field Descriptions	3394
16-816. QUEUE_122_D Register Field Descriptions	3395
16-817. QUEUE_123_A Register Field Descriptions	3396
16-818. QUEUE_123_B Register Field Descriptions	3397
16-819. QUEUE_123_C Register Field Descriptions	3398
16-820. QUEUE_123_D Register Field Descriptions	3399
16-821. QUEUE_124_A Register Field Descriptions	3400
16-822. QUEUE_124_B Register Field Descriptions	3401
16-823. QUEUE_124_C Register Field Descriptions	3402
16-824. QUEUE_124_D Register Field Descriptions	3403
16-825. QUEUE_125_A Register Field Descriptions	3404
16-826. QUEUE_125_B Register Field Descriptions	3405
16-827. QUEUE_125_C Register Field Descriptions	3406
16-828. QUEUE_125_D Register Field Descriptions	3407
16-829. QUEUE_126_A Register Field Descriptions	3408
16-830. QUEUE_126_B Register Field Descriptions	3409
16-831. QUEUE_126_C Register Field Descriptions	3410
16-832. QUEUE_126_D Register Field Descriptions	3411
16-833. QUEUE_127_A Register Field Descriptions	3412
16-834. QUEUE_127_B Register Field Descriptions	3413
16-835. QUEUE_127_C Register Field Descriptions	3414
16-836. QUEUE_127_D Register Field Descriptions	3415
16-837. QUEUE_128_A Register Field Descriptions	3416
16-838. QUEUE_128_B Register Field Descriptions	3417
16-839. QUEUE_128_C Register Field Descriptions	3418
16-840. QUEUE_128_D Register Field Descriptions	3419
16-841. QUEUE_129_A Register Field Descriptions	3420
16-842. QUEUE_129_B Register Field Descriptions	3421
16-843. QUEUE_129_C Register Field Descriptions	3422
16-844. QUEUE_129_D Register Field Descriptions	3423
16-845. QUEUE_130_A Register Field Descriptions	3424
16-846. QUEUE_130_B Register Field Descriptions	3425
16-847. QUEUE_130_C Register Field Descriptions	3426
16-848. QUEUE_130_D Register Field Descriptions	3427

16-849. QUEUE_131_A Register Field Descriptions	3428
16-850. QUEUE_131_B Register Field Descriptions	3429
16-851. QUEUE_131_C Register Field Descriptions	3430
16-852. QUEUE_131_D Register Field Descriptions	3431
16-853. QUEUE_132_A Register Field Descriptions	3432
16-854. QUEUE_132_B Register Field Descriptions	3433
16-855. QUEUE_132_C Register Field Descriptions	3434
16-856. QUEUE_132_D Register Field Descriptions	3435
16-857. QUEUE_133_A Register Field Descriptions	3436
16-858. QUEUE_133_B Register Field Descriptions	3437
16-859. QUEUE_133_C Register Field Descriptions	3438
16-860. QUEUE_133_D Register Field Descriptions	3439
16-861. QUEUE_134_A Register Field Descriptions	3440
16-862. QUEUE_134_B Register Field Descriptions	3441
16-863. QUEUE_134_C Register Field Descriptions	3442
16-864. QUEUE_134_D Register Field Descriptions	3443
16-865. QUEUE_135_A Register Field Descriptions	3444
16-866. QUEUE_135_B Register Field Descriptions	3445
16-867. QUEUE_135_C Register Field Descriptions	3446
16-868. QUEUE_135_D Register Field Descriptions	3447
16-869. QUEUE_136_A Register Field Descriptions	3448
16-870. QUEUE_136_B Register Field Descriptions	3449
16-871. QUEUE_136_C Register Field Descriptions	3450
16-872. QUEUE_136_D Register Field Descriptions	3451
16-873. QUEUE_137_A Register Field Descriptions	3452
16-874. QUEUE_137_B Register Field Descriptions	3453
16-875. QUEUE_137_C Register Field Descriptions	3454
16-876. QUEUE_137_D Register Field Descriptions	3455
16-877. QUEUE_138_A Register Field Descriptions	3456
16-878. QUEUE_138_B Register Field Descriptions	3457
16-879. QUEUE_138_C Register Field Descriptions	3458
16-880. QUEUE_138_D Register Field Descriptions	3459
16-881. QUEUE_139_A Register Field Descriptions	3460
16-882. QUEUE_139_B Register Field Descriptions	3461
16-883. QUEUE_139_C Register Field Descriptions	3462
16-884. QUEUE_139_D Register Field Descriptions	3463
16-885. QUEUE_140_A Register Field Descriptions	3464
16-886. QUEUE_140_B Register Field Descriptions	3465
16-887. QUEUE_140_C Register Field Descriptions	3466
16-888. QUEUE_140_D Register Field Descriptions	3467
16-889. QUEUE_141_A Register Field Descriptions	3468
16-890. QUEUE_141_B Register Field Descriptions	3469
16-891. QUEUE_141_C Register Field Descriptions	3470
16-892. QUEUE_141_D Register Field Descriptions	3471
16-893. QUEUE_142_A Register Field Descriptions	3472
16-894. QUEUE_142_B Register Field Descriptions	3473
16-895. QUEUE_142_C Register Field Descriptions	3474
16-896. QUEUE_142_D Register Field Descriptions	3475
16-897. QUEUE_143_A Register Field Descriptions	3476

16-898. QUEUE_143_B Register Field Descriptions	3477
16-899. QUEUE_143_C Register Field Descriptions	3478
16-900. QUEUE_143_D Register Field Descriptions	3479
16-901. QUEUE_144_A Register Field Descriptions	3480
16-902. QUEUE_144_B Register Field Descriptions	3481
16-903. QUEUE_144_C Register Field Descriptions	3482
16-904. QUEUE_144_D Register Field Descriptions	3483
16-905. QUEUE_145_A Register Field Descriptions	3484
16-906. QUEUE_145_B Register Field Descriptions	3485
16-907. QUEUE_145_C Register Field Descriptions	3486
16-908. QUEUE_145_D Register Field Descriptions	3487
16-909. QUEUE_146_A Register Field Descriptions	3488
16-910. QUEUE_146_B Register Field Descriptions	3489
16-911. QUEUE_146_C Register Field Descriptions	3490
16-912. QUEUE_146_D Register Field Descriptions	3491
16-913. QUEUE_147_A Register Field Descriptions	3492
16-914. QUEUE_147_B Register Field Descriptions	3493
16-915. QUEUE_147_C Register Field Descriptions	3494
16-916. QUEUE_147_D Register Field Descriptions	3495
16-917. QUEUE_148_A Register Field Descriptions	3496
16-918. QUEUE_148_B Register Field Descriptions	3497
16-919. QUEUE_148_C Register Field Descriptions	3498
16-920. QUEUE_148_D Register Field Descriptions	3499
16-921. QUEUE_149_A Register Field Descriptions	3500
16-922. QUEUE_149_B Register Field Descriptions	3501
16-923. QUEUE_149_C Register Field Descriptions	3502
16-924. QUEUE_149_D Register Field Descriptions	3503
16-925. QUEUE_150_A Register Field Descriptions	3504
16-926. QUEUE_150_B Register Field Descriptions	3505
16-927. QUEUE_150_C Register Field Descriptions	3506
16-928. QUEUE_150_D Register Field Descriptions	3507
16-929. QUEUE_151_A Register Field Descriptions	3508
16-930. QUEUE_151_B Register Field Descriptions	3509
16-931. QUEUE_151_C Register Field Descriptions	3510
16-932. QUEUE_151_D Register Field Descriptions	3511
16-933. QUEUE_152_A Register Field Descriptions	3512
16-934. QUEUE_152_B Register Field Descriptions	3513
16-935. QUEUE_152_C Register Field Descriptions	3514
16-936. QUEUE_152_D Register Field Descriptions	3515
16-937. QUEUE_153_A Register Field Descriptions	3516
16-938. QUEUE_153_B Register Field Descriptions	3517
16-939. QUEUE_153_C Register Field Descriptions	3518
16-940. QUEUE_153_D Register Field Descriptions	3519
16-941. QUEUE_154_A Register Field Descriptions	3520
16-942. QUEUE_154_B Register Field Descriptions	3521
16-943. QUEUE_154_C Register Field Descriptions	3522
16-944. QUEUE_154_D Register Field Descriptions	3523
16-945. QUEUE_155_A Register Field Descriptions	3524
16-946. QUEUE_155_B Register Field Descriptions	3525

16-947. QUEUE_155_C Register Field Descriptions	3526
16-948. QUEUE_155_D Register Field Descriptions	3527
16-949. QUEUE_0_STATUS_A Register Field Descriptions	3528
16-950. QUEUE_0_STATUS_B Register Field Descriptions	3529
16-951. QUEUE_0_STATUS_C Register Field Descriptions	3530
16-952. QUEUE_1_STATUS_A Register Field Descriptions	3531
16-953. QUEUE_1_STATUS_B Register Field Descriptions	3532
16-954. QUEUE_1_STATUS_C Register Field Descriptions	3533
16-955. QUEUE_2_STATUS_A Register Field Descriptions	3534
16-956. QUEUE_2_STATUS_B Register Field Descriptions	3535
16-957. QUEUE_2_STATUS_C Register Field Descriptions	3536
16-958. QUEUE_3_STATUS_A Register Field Descriptions	3537
16-959. QUEUE_3_STATUS_B Register Field Descriptions	3538
16-960. QUEUE_3_STATUS_C Register Field Descriptions	3539
16-961. QUEUE_4_STATUS_A Register Field Descriptions	3540
16-962. QUEUE_4_STATUS_B Register Field Descriptions	3541
16-963. QUEUE_4_STATUS_C Register Field Descriptions	3542
16-964. QUEUE_5_STATUS_A Register Field Descriptions	3543
16-965. QUEUE_5_STATUS_B Register Field Descriptions	3544
16-966. QUEUE_5_STATUS_C Register Field Descriptions	3545
16-967. QUEUE_6_STATUS_A Register Field Descriptions	3546
16-968. QUEUE_6_STATUS_B Register Field Descriptions	3547
16-969. QUEUE_6_STATUS_C Register Field Descriptions	3548
16-970. QUEUE_7_STATUS_A Register Field Descriptions	3549
16-971. QUEUE_7_STATUS_B Register Field Descriptions	3550
16-972. QUEUE_7_STATUS_C Register Field Descriptions	3551
16-973. QUEUE_8_STATUS_A Register Field Descriptions	3552
16-974. QUEUE_8_STATUS_B Register Field Descriptions	3553
16-975. QUEUE_8_STATUS_C Register Field Descriptions	3554
16-976. QUEUE_9_STATUS_A Register Field Descriptions	3555
16-977. QUEUE_9_STATUS_B Register Field Descriptions	3556
16-978. QUEUE_9_STATUS_C Register Field Descriptions	3557
16-979. QUEUE_10_STATUS_A Register Field Descriptions	3558
16-980. QUEUE_10_STATUS_B Register Field Descriptions	3559
16-981. QUEUE_10_STATUS_C Register Field Descriptions	3560
16-982. QUEUE_11_STATUS_A Register Field Descriptions	3561
16-983. QUEUE_11_STATUS_B Register Field Descriptions	3562
16-984. QUEUE_11_STATUS_C Register Field Descriptions	3563
16-985. QUEUE_12_STATUS_A Register Field Descriptions	3564
16-986. QUEUE_12_STATUS_B Register Field Descriptions	3565
16-987. QUEUE_12_STATUS_C Register Field Descriptions	3566
16-988. QUEUE_13_STATUS_A Register Field Descriptions	3567
16-989. QUEUE_13_STATUS_B Register Field Descriptions	3568
16-990. QUEUE_13_STATUS_C Register Field Descriptions	3569
16-991. QUEUE_14_STATUS_A Register Field Descriptions	3570
16-992. QUEUE_14_STATUS_B Register Field Descriptions	3571
16-993. QUEUE_14_STATUS_C Register Field Descriptions	3572
16-994. QUEUE_15_STATUS_A Register Field Descriptions	3573
16-995. QUEUE_15_STATUS_B Register Field Descriptions	3574

16-996. QUEUE_15_STATUS_C Register Field Descriptions.....	3575
16-997. QUEUE_16_STATUS_A Register Field Descriptions.....	3576
16-998. QUEUE_16_STATUS_B Register Field Descriptions.....	3577
16-999. QUEUE_16_STATUS_C Register Field Descriptions.....	3578
16-1000. QUEUE_17_STATUS_A Register Field Descriptions.....	3579
16-1001. QUEUE_17_STATUS_B Register Field Descriptions.....	3580
16-1002. QUEUE_17_STATUS_C Register Field Descriptions.....	3581
16-1003. QUEUE_18_STATUS_A Register Field Descriptions.....	3582
16-1004. QUEUE_18_STATUS_B Register Field Descriptions.....	3583
16-1005. QUEUE_18_STATUS_C Register Field Descriptions.....	3584
16-1006. QUEUE_19_STATUS_A Register Field Descriptions.....	3585
16-1007. QUEUE_19_STATUS_B Register Field Descriptions.....	3586
16-1008. QUEUE_19_STATUS_C Register Field Descriptions.....	3587
16-1009. QUEUE_20_STATUS_A Register Field Descriptions.....	3588
16-1010. QUEUE_20_STATUS_B Register Field Descriptions.....	3589
16-1011. QUEUE_20_STATUS_C Register Field Descriptions.....	3590
16-1012. QUEUE_21_STATUS_A Register Field Descriptions.....	3591
16-1013. QUEUE_21_STATUS_B Register Field Descriptions.....	3592
16-1014. QUEUE_21_STATUS_C Register Field Descriptions.....	3593
16-1015. QUEUE_22_STATUS_A Register Field Descriptions.....	3594
16-1016. QUEUE_22_STATUS_B Register Field Descriptions.....	3595
16-1017. QUEUE_22_STATUS_C Register Field Descriptions.....	3596
16-1018. QUEUE_23_STATUS_A Register Field Descriptions.....	3597
16-1019. QUEUE_23_STATUS_B Register Field Descriptions.....	3598
16-1020. QUEUE_23_STATUS_C Register Field Descriptions.....	3599
16-1021. QUEUE_24_STATUS_A Register Field Descriptions.....	3600
16-1022. QUEUE_24_STATUS_B Register Field Descriptions.....	3601
16-1023. QUEUE_24_STATUS_C Register Field Descriptions.....	3602
16-1024. QUEUE_25_STATUS_A Register Field Descriptions.....	3603
16-1025. QUEUE_25_STATUS_B Register Field Descriptions.....	3604
16-1026. QUEUE_25_STATUS_C Register Field Descriptions.....	3605
16-1027. QUEUE_26_STATUS_A Register Field Descriptions.....	3606
16-1028. QUEUE_26_STATUS_B Register Field Descriptions.....	3607
16-1029. QUEUE_26_STATUS_C Register Field Descriptions.....	3608
16-1030. QUEUE_27_STATUS_A Register Field Descriptions.....	3609
16-1031. QUEUE_27_STATUS_B Register Field Descriptions.....	3610
16-1032. QUEUE_27_STATUS_C Register Field Descriptions.....	3611
16-1033. QUEUE_28_STATUS_A Register Field Descriptions.....	3612
16-1034. QUEUE_28_STATUS_B Register Field Descriptions.....	3613
16-1035. QUEUE_28_STATUS_C Register Field Descriptions.....	3614
16-1036. QUEUE_29_STATUS_A Register Field Descriptions.....	3615
16-1037. QUEUE_29_STATUS_B Register Field Descriptions.....	3616
16-1038. QUEUE_29_STATUS_C Register Field Descriptions.....	3617
16-1039. QUEUE_30_STATUS_A Register Field Descriptions.....	3618
16-1040. QUEUE_30_STATUS_B Register Field Descriptions.....	3619
16-1041. QUEUE_30_STATUS_C Register Field Descriptions.....	3620
16-1042. QUEUE_31_STATUS_A Register Field Descriptions.....	3621
16-1043. QUEUE_31_STATUS_B Register Field Descriptions.....	3622
16-1044. QUEUE_31_STATUS_C Register Field Descriptions.....	3623

16-1045. QUEUE_32_STATUS_A Register Field Descriptions	3624
16-1046. QUEUE_32_STATUS_B Register Field Descriptions	3625
16-1047. QUEUE_32_STATUS_C Register Field Descriptions	3626
16-1048. QUEUE_33_STATUS_A Register Field Descriptions	3627
16-1049. QUEUE_33_STATUS_B Register Field Descriptions	3628
16-1050. QUEUE_33_STATUS_C Register Field Descriptions	3629
16-1051. QUEUE_34_STATUS_A Register Field Descriptions	3630
16-1052. QUEUE_34_STATUS_B Register Field Descriptions	3631
16-1053. QUEUE_34_STATUS_C Register Field Descriptions	3632
16-1054. QUEUE_35_STATUS_A Register Field Descriptions	3633
16-1055. QUEUE_35_STATUS_B Register Field Descriptions	3634
16-1056. QUEUE_35_STATUS_C Register Field Descriptions	3635
16-1057. QUEUE_36_STATUS_A Register Field Descriptions	3636
16-1058. QUEUE_36_STATUS_B Register Field Descriptions	3637
16-1059. QUEUE_36_STATUS_C Register Field Descriptions	3638
16-1060. QUEUE_37_STATUS_A Register Field Descriptions	3639
16-1061. QUEUE_37_STATUS_B Register Field Descriptions	3640
16-1062. QUEUE_37_STATUS_C Register Field Descriptions	3641
16-1063. QUEUE_38_STATUS_A Register Field Descriptions	3642
16-1064. QUEUE_38_STATUS_B Register Field Descriptions	3643
16-1065. QUEUE_38_STATUS_C Register Field Descriptions	3644
16-1066. QUEUE_39_STATUS_A Register Field Descriptions	3645
16-1067. QUEUE_39_STATUS_B Register Field Descriptions	3646
16-1068. QUEUE_39_STATUS_C Register Field Descriptions	3647
16-1069. QUEUE_40_STATUS_A Register Field Descriptions	3648
16-1070. QUEUE_40_STATUS_B Register Field Descriptions	3649
16-1071. QUEUE_40_STATUS_C Register Field Descriptions	3650
16-1072. QUEUE_41_STATUS_A Register Field Descriptions	3651
16-1073. QUEUE_41_STATUS_B Register Field Descriptions	3652
16-1074. QUEUE_41_STATUS_C Register Field Descriptions	3653
16-1075. QUEUE_42_STATUS_A Register Field Descriptions	3654
16-1076. QUEUE_42_STATUS_B Register Field Descriptions	3655
16-1077. QUEUE_42_STATUS_C Register Field Descriptions	3656
16-1078. QUEUE_43_STATUS_A Register Field Descriptions	3657
16-1079. QUEUE_43_STATUS_B Register Field Descriptions	3658
16-1080. QUEUE_43_STATUS_C Register Field Descriptions	3659
16-1081. QUEUE_44_STATUS_A Register Field Descriptions	3660
16-1082. QUEUE_44_STATUS_B Register Field Descriptions	3661
16-1083. QUEUE_44_STATUS_C Register Field Descriptions	3662
16-1084. QUEUE_45_STATUS_A Register Field Descriptions	3663
16-1085. QUEUE_45_STATUS_B Register Field Descriptions	3664
16-1086. QUEUE_45_STATUS_C Register Field Descriptions	3665
16-1087. QUEUE_46_STATUS_A Register Field Descriptions	3666
16-1088. QUEUE_46_STATUS_B Register Field Descriptions	3667
16-1089. QUEUE_46_STATUS_C Register Field Descriptions	3668
16-1090. QUEUE_47_STATUS_A Register Field Descriptions	3669
16-1091. QUEUE_47_STATUS_B Register Field Descriptions	3670
16-1092. QUEUE_47_STATUS_C Register Field Descriptions	3671
16-1093. QUEUE_48_STATUS_A Register Field Descriptions	3672

16-1094. QUEUE_48_STATUS_B Register Field Descriptions	3673
16-1095. QUEUE_48_STATUS_C Register Field Descriptions	3674
16-1096. QUEUE_49_STATUS_A Register Field Descriptions	3675
16-1097. QUEUE_49_STATUS_B Register Field Descriptions	3676
16-1098. QUEUE_49_STATUS_C Register Field Descriptions	3677
16-1099. QUEUE_50_STATUS_A Register Field Descriptions	3678
16-1100. QUEUE_50_STATUS_B Register Field Descriptions	3679
16-1101. QUEUE_50_STATUS_C Register Field Descriptions	3680
16-1102. QUEUE_51_STATUS_A Register Field Descriptions	3681
16-1103. QUEUE_51_STATUS_B Register Field Descriptions	3682
16-1104. QUEUE_51_STATUS_C Register Field Descriptions	3683
16-1105. QUEUE_52_STATUS_A Register Field Descriptions	3684
16-1106. QUEUE_52_STATUS_B Register Field Descriptions	3685
16-1107. QUEUE_52_STATUS_C Register Field Descriptions	3686
16-1108. QUEUE_53_STATUS_A Register Field Descriptions	3687
16-1109. QUEUE_53_STATUS_B Register Field Descriptions	3688
16-1110. QUEUE_53_STATUS_C Register Field Descriptions	3689
16-1111. QUEUE_54_STATUS_A Register Field Descriptions	3690
16-1112. QUEUE_54_STATUS_B Register Field Descriptions	3691
16-1113. QUEUE_54_STATUS_C Register Field Descriptions	3692
16-1114. QUEUE_55_STATUS_A Register Field Descriptions	3693
16-1115. QUEUE_55_STATUS_B Register Field Descriptions	3694
16-1116. QUEUE_55_STATUS_C Register Field Descriptions	3695
16-1117. QUEUE_56_STATUS_A Register Field Descriptions	3696
16-1118. QUEUE_56_STATUS_B Register Field Descriptions	3697
16-1119. QUEUE_56_STATUS_C Register Field Descriptions	3698
16-1120. QUEUE_57_STATUS_A Register Field Descriptions	3699
16-1121. QUEUE_57_STATUS_B Register Field Descriptions	3700
16-1122. QUEUE_57_STATUS_C Register Field Descriptions	3701
16-1123. QUEUE_58_STATUS_A Register Field Descriptions	3702
16-1124. QUEUE_58_STATUS_B Register Field Descriptions	3703
16-1125. QUEUE_58_STATUS_C Register Field Descriptions	3704
16-1126. QUEUE_59_STATUS_A Register Field Descriptions	3705
16-1127. QUEUE_59_STATUS_B Register Field Descriptions	3706
16-1128. QUEUE_59_STATUS_C Register Field Descriptions	3707
16-1129. QUEUE_60_STATUS_A Register Field Descriptions	3708
16-1130. QUEUE_60_STATUS_B Register Field Descriptions	3709
16-1131. QUEUE_60_STATUS_C Register Field Descriptions	3710
16-1132. QUEUE_61_STATUS_A Register Field Descriptions	3711
16-1133. QUEUE_61_STATUS_B Register Field Descriptions	3712
16-1134. QUEUE_61_STATUS_C Register Field Descriptions	3713
16-1135. QUEUE_62_STATUS_A Register Field Descriptions	3714
16-1136. QUEUE_62_STATUS_B Register Field Descriptions	3715
16-1137. QUEUE_62_STATUS_C Register Field Descriptions	3716
16-1138. QUEUE_63_STATUS_A Register Field Descriptions	3717
16-1139. QUEUE_63_STATUS_B Register Field Descriptions	3718
16-1140. QUEUE_63_STATUS_C Register Field Descriptions	3719
16-1141. QUEUE_64_STATUS_A Register Field Descriptions	3720
16-1142. QUEUE_64_STATUS_B Register Field Descriptions	3721

16-1143. QUEUE_64_STATUS_C Register Field Descriptions	3722
16-1144. QUEUE_65_STATUS_A Register Field Descriptions	3723
16-1145. QUEUE_65_STATUS_B Register Field Descriptions	3724
16-1146. QUEUE_65_STATUS_C Register Field Descriptions	3725
16-1147. QUEUE_66_STATUS_A Register Field Descriptions	3726
16-1148. QUEUE_66_STATUS_B Register Field Descriptions	3727
16-1149. QUEUE_66_STATUS_C Register Field Descriptions	3728
16-1150. QUEUE_67_STATUS_A Register Field Descriptions	3729
16-1151. QUEUE_67_STATUS_B Register Field Descriptions	3730
16-1152. QUEUE_67_STATUS_C Register Field Descriptions	3731
16-1153. QUEUE_68_STATUS_A Register Field Descriptions	3732
16-1154. QUEUE_68_STATUS_B Register Field Descriptions	3733
16-1155. QUEUE_68_STATUS_C Register Field Descriptions	3734
16-1156. QUEUE_69_STATUS_A Register Field Descriptions	3735
16-1157. QUEUE_69_STATUS_B Register Field Descriptions	3736
16-1158. QUEUE_69_STATUS_C Register Field Descriptions	3737
16-1159. QUEUE_70_STATUS_A Register Field Descriptions	3738
16-1160. QUEUE_70_STATUS_B Register Field Descriptions	3739
16-1161. QUEUE_70_STATUS_C Register Field Descriptions	3740
16-1162. QUEUE_71_STATUS_A Register Field Descriptions	3741
16-1163. QUEUE_71_STATUS_B Register Field Descriptions	3742
16-1164. QUEUE_71_STATUS_C Register Field Descriptions	3743
16-1165. QUEUE_72_STATUS_A Register Field Descriptions	3744
16-1166. QUEUE_72_STATUS_B Register Field Descriptions	3745
16-1167. QUEUE_72_STATUS_C Register Field Descriptions	3746
16-1168. QUEUE_73_STATUS_A Register Field Descriptions	3747
16-1169. QUEUE_73_STATUS_B Register Field Descriptions	3748
16-1170. QUEUE_73_STATUS_C Register Field Descriptions	3749
16-1171. QUEUE_74_STATUS_A Register Field Descriptions	3750
16-1172. QUEUE_74_STATUS_B Register Field Descriptions	3751
16-1173. QUEUE_74_STATUS_C Register Field Descriptions	3752
16-1174. QUEUE_75_STATUS_A Register Field Descriptions	3753
16-1175. QUEUE_75_STATUS_B Register Field Descriptions	3754
16-1176. QUEUE_75_STATUS_C Register Field Descriptions	3755
16-1177. QUEUE_76_STATUS_A Register Field Descriptions	3756
16-1178. QUEUE_76_STATUS_B Register Field Descriptions	3757
16-1179. QUEUE_76_STATUS_C Register Field Descriptions	3758
16-1180. QUEUE_77_STATUS_A Register Field Descriptions	3759
16-1181. QUEUE_77_STATUS_B Register Field Descriptions	3760
16-1182. QUEUE_77_STATUS_C Register Field Descriptions	3761
16-1183. QUEUE_78_STATUS_A Register Field Descriptions	3762
16-1184. QUEUE_78_STATUS_B Register Field Descriptions	3763
16-1185. QUEUE_78_STATUS_C Register Field Descriptions	3764
16-1186. QUEUE_79_STATUS_A Register Field Descriptions	3765
16-1187. QUEUE_79_STATUS_B Register Field Descriptions	3766
16-1188. QUEUE_79_STATUS_C Register Field Descriptions	3767
16-1189. QUEUE_80_STATUS_A Register Field Descriptions	3768
16-1190. QUEUE_80_STATUS_B Register Field Descriptions	3769
16-1191. QUEUE_80_STATUS_C Register Field Descriptions	3770

16-1192. QUEUE_81_STATUS_A Register Field Descriptions	3771
16-1193. QUEUE_81_STATUS_B Register Field Descriptions	3772
16-1194. QUEUE_81_STATUS_C Register Field Descriptions	3773
16-1195. QUEUE_82_STATUS_A Register Field Descriptions	3774
16-1196. QUEUE_82_STATUS_B Register Field Descriptions	3775
16-1197. QUEUE_82_STATUS_C Register Field Descriptions	3776
16-1198. QUEUE_83_STATUS_A Register Field Descriptions	3777
16-1199. QUEUE_83_STATUS_B Register Field Descriptions	3778
16-1200. QUEUE_83_STATUS_C Register Field Descriptions	3779
16-1201. QUEUE_84_STATUS_A Register Field Descriptions	3780
16-1202. QUEUE_84_STATUS_B Register Field Descriptions	3781
16-1203. QUEUE_84_STATUS_C Register Field Descriptions	3782
16-1204. QUEUE_85_STATUS_A Register Field Descriptions	3783
16-1205. QUEUE_85_STATUS_B Register Field Descriptions	3784
16-1206. QUEUE_85_STATUS_C Register Field Descriptions	3785
16-1207. QUEUE_86_STATUS_A Register Field Descriptions	3786
16-1208. QUEUE_86_STATUS_B Register Field Descriptions	3787
16-1209. QUEUE_86_STATUS_C Register Field Descriptions	3788
16-1210. QUEUE_87_STATUS_A Register Field Descriptions	3789
16-1211. QUEUE_87_STATUS_B Register Field Descriptions	3790
16-1212. QUEUE_87_STATUS_C Register Field Descriptions	3791
16-1213. QUEUE_88_STATUS_A Register Field Descriptions	3792
16-1214. QUEUE_88_STATUS_B Register Field Descriptions	3793
16-1215. QUEUE_88_STATUS_C Register Field Descriptions	3794
16-1216. QUEUE_89_STATUS_A Register Field Descriptions	3795
16-1217. QUEUE_89_STATUS_B Register Field Descriptions	3796
16-1218. QUEUE_89_STATUS_C Register Field Descriptions	3797
16-1219. QUEUE_90_STATUS_A Register Field Descriptions	3798
16-1220. QUEUE_90_STATUS_B Register Field Descriptions	3799
16-1221. QUEUE_90_STATUS_C Register Field Descriptions	3800
16-1222. QUEUE_91_STATUS_A Register Field Descriptions	3801
16-1223. QUEUE_91_STATUS_B Register Field Descriptions	3802
16-1224. QUEUE_91_STATUS_C Register Field Descriptions	3803
16-1225. QUEUE_92_STATUS_A Register Field Descriptions	3804
16-1226. QUEUE_92_STATUS_B Register Field Descriptions	3805
16-1227. QUEUE_92_STATUS_C Register Field Descriptions	3806
16-1228. QUEUE_93_STATUS_A Register Field Descriptions	3807
16-1229. QUEUE_93_STATUS_B Register Field Descriptions	3808
16-1230. QUEUE_93_STATUS_C Register Field Descriptions	3809
16-1231. QUEUE_94_STATUS_A Register Field Descriptions	3810
16-1232. QUEUE_94_STATUS_B Register Field Descriptions	3811
16-1233. QUEUE_94_STATUS_C Register Field Descriptions	3812
16-1234. QUEUE_95_STATUS_A Register Field Descriptions	3813
16-1235. QUEUE_95_STATUS_B Register Field Descriptions	3814
16-1236. QUEUE_95_STATUS_C Register Field Descriptions	3815
16-1237. QUEUE_96_STATUS_A Register Field Descriptions	3816
16-1238. QUEUE_96_STATUS_B Register Field Descriptions	3817
16-1239. QUEUE_96_STATUS_C Register Field Descriptions	3818
16-1240. QUEUE_97_STATUS_A Register Field Descriptions	3819

16-1241. QUEUE_97_STATUS_B Register Field Descriptions	3820
16-1242. QUEUE_97_STATUS_C Register Field Descriptions	3821
16-1243. QUEUE_98_STATUS_A Register Field Descriptions	3822
16-1244. QUEUE_98_STATUS_B Register Field Descriptions	3823
16-1245. QUEUE_98_STATUS_C Register Field Descriptions	3824
16-1246. QUEUE_99_STATUS_A Register Field Descriptions	3825
16-1247. QUEUE_99_STATUS_B Register Field Descriptions	3826
16-1248. QUEUE_99_STATUS_C Register Field Descriptions	3827
16-1249. QUEUE_100_STATUS_A Register Field Descriptions.....	3828
16-1250. QUEUE_100_STATUS_B Register Field Descriptions.....	3829
16-1251. QUEUE_100_STATUS_C Register Field Descriptions.....	3830
16-1252. QUEUE_101_STATUS_A Register Field Descriptions.....	3831
16-1253. QUEUE_101_STATUS_B Register Field Descriptions.....	3832
16-1254. QUEUE_101_STATUS_C Register Field Descriptions.....	3833
16-1255. QUEUE_102_STATUS_A Register Field Descriptions.....	3834
16-1256. QUEUE_102_STATUS_B Register Field Descriptions.....	3835
16-1257. QUEUE_102_STATUS_C Register Field Descriptions.....	3836
16-1258. QUEUE_103_STATUS_A Register Field Descriptions.....	3837
16-1259. QUEUE_103_STATUS_B Register Field Descriptions.....	3838
16-1260. QUEUE_103_STATUS_C Register Field Descriptions.....	3839
16-1261. QUEUE_104_STATUS_A Register Field Descriptions.....	3840
16-1262. QUEUE_104_STATUS_B Register Field Descriptions.....	3841
16-1263. QUEUE_104_STATUS_C Register Field Descriptions.....	3842
16-1264. QUEUE_105_STATUS_A Register Field Descriptions.....	3843
16-1265. QUEUE_105_STATUS_B Register Field Descriptions.....	3844
16-1266. QUEUE_105_STATUS_C Register Field Descriptions.....	3845
16-1267. QUEUE_106_STATUS_A Register Field Descriptions.....	3846
16-1268. QUEUE_106_STATUS_B Register Field Descriptions.....	3847
16-1269. QUEUE_106_STATUS_C Register Field Descriptions.....	3848
16-1270. QUEUE_107_STATUS_A Register Field Descriptions.....	3849
16-1271. QUEUE_107_STATUS_B Register Field Descriptions.....	3850
16-1272. QUEUE_107_STATUS_C Register Field Descriptions.....	3851
16-1273. QUEUE_108_STATUS_A Register Field Descriptions.....	3852
16-1274. QUEUE_108_STATUS_B Register Field Descriptions.....	3853
16-1275. QUEUE_108_STATUS_C Register Field Descriptions.....	3854
16-1276. QUEUE_109_STATUS_A Register Field Descriptions.....	3855
16-1277. QUEUE_109_STATUS_B Register Field Descriptions.....	3856
16-1278. QUEUE_109_STATUS_C Register Field Descriptions.....	3857
16-1279. QUEUE_110_STATUS_A Register Field Descriptions.....	3858
16-1280. QUEUE_110_STATUS_B Register Field Descriptions.....	3859
16-1281. QUEUE_110_STATUS_C Register Field Descriptions.....	3860
16-1282. QUEUE_111_STATUS_A Register Field Descriptions.....	3861
16-1283. QUEUE_111_STATUS_B Register Field Descriptions.....	3862
16-1284. QUEUE_111_STATUS_C Register Field Descriptions.....	3863
16-1285. QUEUE_112_STATUS_A Register Field Descriptions.....	3864
16-1286. QUEUE_112_STATUS_B Register Field Descriptions.....	3865
16-1287. QUEUE_112_STATUS_C Register Field Descriptions.....	3866
16-1288. QUEUE_113_STATUS_A Register Field Descriptions.....	3867
16-1289. QUEUE_113_STATUS_B Register Field Descriptions.....	3868

16-1290. QUEUE_113_STATUS_C Register Field Descriptions.....	3869
16-1291. QUEUE_114_STATUS_A Register Field Descriptions.....	3870
16-1292. QUEUE_114_STATUS_B Register Field Descriptions.....	3871
16-1293. QUEUE_114_STATUS_C Register Field Descriptions.....	3872
16-1294. QUEUE_115_STATUS_A Register Field Descriptions.....	3873
16-1295. QUEUE_115_STATUS_B Register Field Descriptions.....	3874
16-1296. QUEUE_115_STATUS_C Register Field Descriptions.....	3875
16-1297. QUEUE_116_STATUS_A Register Field Descriptions.....	3876
16-1298. QUEUE_116_STATUS_B Register Field Descriptions.....	3877
16-1299. QUEUE_116_STATUS_C Register Field Descriptions.....	3878
16-1300. QUEUE_117_STATUS_A Register Field Descriptions.....	3879
16-1301. QUEUE_117_STATUS_B Register Field Descriptions.....	3880
16-1302. QUEUE_117_STATUS_C Register Field Descriptions.....	3881
16-1303. QUEUE_118_STATUS_A Register Field Descriptions.....	3882
16-1304. QUEUE_118_STATUS_B Register Field Descriptions.....	3883
16-1305. QUEUE_118_STATUS_C Register Field Descriptions.....	3884
16-1306. QUEUE_119_STATUS_A Register Field Descriptions.....	3885
16-1307. QUEUE_119_STATUS_B Register Field Descriptions.....	3886
16-1308. QUEUE_119_STATUS_C Register Field Descriptions.....	3887
16-1309. QUEUE_120_STATUS_A Register Field Descriptions.....	3888
16-1310. QUEUE_120_STATUS_B Register Field Descriptions.....	3889
16-1311. QUEUE_120_STATUS_C Register Field Descriptions.....	3890
16-1312. QUEUE_121_STATUS_A Register Field Descriptions.....	3891
16-1313. QUEUE_121_STATUS_B Register Field Descriptions.....	3892
16-1314. QUEUE_121_STATUS_C Register Field Descriptions.....	3893
16-1315. QUEUE_122_STATUS_A Register Field Descriptions.....	3894
16-1316. QUEUE_122_STATUS_B Register Field Descriptions.....	3895
16-1317. QUEUE_122_STATUS_C Register Field Descriptions.....	3896
16-1318. QUEUE_123_STATUS_A Register Field Descriptions.....	3897
16-1319. QUEUE_123_STATUS_B Register Field Descriptions.....	3898
16-1320. QUEUE_123_STATUS_C Register Field Descriptions.....	3899
16-1321. QUEUE_124_STATUS_A Register Field Descriptions.....	3900
16-1322. QUEUE_124_STATUS_B Register Field Descriptions.....	3901
16-1323. QUEUE_124_STATUS_C Register Field Descriptions.....	3902
16-1324. QUEUE_125_STATUS_A Register Field Descriptions.....	3903
16-1325. QUEUE_125_STATUS_B Register Field Descriptions.....	3904
16-1326. QUEUE_125_STATUS_C Register Field Descriptions.....	3905
16-1327. QUEUE_126_STATUS_A Register Field Descriptions.....	3906
16-1328. QUEUE_126_STATUS_B Register Field Descriptions.....	3907
16-1329. QUEUE_126_STATUS_C Register Field Descriptions.....	3908
16-1330. QUEUE_127_STATUS_A Register Field Descriptions.....	3909
16-1331. QUEUE_127_STATUS_B Register Field Descriptions.....	3910
16-1332. QUEUE_127_STATUS_C Register Field Descriptions.....	3911
16-1333. QUEUE_128_STATUS_A Register Field Descriptions.....	3912
16-1334. QUEUE_128_STATUS_B Register Field Descriptions.....	3913
16-1335. QUEUE_128_STATUS_C Register Field Descriptions.....	3914
16-1336. QUEUE_129_STATUS_A Register Field Descriptions.....	3915
16-1337. QUEUE_129_STATUS_B Register Field Descriptions.....	3916
16-1338. QUEUE_129_STATUS_C Register Field Descriptions.....	3917

16-1339. QUEUE_130_STATUS_A Register Field Descriptions.....	3918
16-1340. QUEUE_130_STATUS_B Register Field Descriptions.....	3919
16-1341. QUEUE_130_STATUS_C Register Field Descriptions.....	3920
16-1342. QUEUE_131_STATUS_A Register Field Descriptions.....	3921
16-1343. QUEUE_131_STATUS_B Register Field Descriptions.....	3922
16-1344. QUEUE_131_STATUS_C Register Field Descriptions.....	3923
16-1345. QUEUE_132_STATUS_A Register Field Descriptions.....	3924
16-1346. QUEUE_132_STATUS_B Register Field Descriptions.....	3925
16-1347. QUEUE_132_STATUS_C Register Field Descriptions.....	3926
16-1348. QUEUE_133_STATUS_A Register Field Descriptions.....	3927
16-1349. QUEUE_133_STATUS_B Register Field Descriptions.....	3928
16-1350. QUEUE_133_STATUS_C Register Field Descriptions.....	3929
16-1351. QUEUE_134_STATUS_A Register Field Descriptions.....	3930
16-1352. QUEUE_134_STATUS_B Register Field Descriptions.....	3931
16-1353. QUEUE_134_STATUS_C Register Field Descriptions.....	3932
16-1354. QUEUE_135_STATUS_A Register Field Descriptions.....	3933
16-1355. QUEUE_135_STATUS_B Register Field Descriptions.....	3934
16-1356. QUEUE_135_STATUS_C Register Field Descriptions.....	3935
16-1357. QUEUE_136_STATUS_A Register Field Descriptions.....	3936
16-1358. QUEUE_136_STATUS_B Register Field Descriptions.....	3937
16-1359. QUEUE_136_STATUS_C Register Field Descriptions.....	3938
16-1360. QUEUE_137_STATUS_A Register Field Descriptions.....	3939
16-1361. QUEUE_137_STATUS_B Register Field Descriptions.....	3940
16-1362. QUEUE_137_STATUS_C Register Field Descriptions.....	3941
16-1363. QUEUE_138_STATUS_A Register Field Descriptions.....	3942
16-1364. QUEUE_138_STATUS_B Register Field Descriptions.....	3943
16-1365. QUEUE_138_STATUS_C Register Field Descriptions.....	3944
16-1366. QUEUE_139_STATUS_A Register Field Descriptions.....	3945
16-1367. QUEUE_139_STATUS_B Register Field Descriptions.....	3946
16-1368. QUEUE_139_STATUS_C Register Field Descriptions.....	3947
16-1369. QUEUE_140_STATUS_A Register Field Descriptions.....	3948
16-1370. QUEUE_140_STATUS_B Register Field Descriptions.....	3949
16-1371. QUEUE_140_STATUS_C Register Field Descriptions.....	3950
16-1372. QUEUE_141_STATUS_A Register Field Descriptions.....	3951
16-1373. QUEUE_141_STATUS_B Register Field Descriptions.....	3952
16-1374. QUEUE_141_STATUS_C Register Field Descriptions.....	3953
16-1375. QUEUE_142_STATUS_A Register Field Descriptions.....	3954
16-1376. QUEUE_142_STATUS_B Register Field Descriptions.....	3955
16-1377. QUEUE_142_STATUS_C Register Field Descriptions.....	3956
16-1378. QUEUE_143_STATUS_A Register Field Descriptions.....	3957
16-1379. QUEUE_143_STATUS_B Register Field Descriptions.....	3958
16-1380. QUEUE_143_STATUS_C Register Field Descriptions.....	3959
16-1381. QUEUE_144_STATUS_A Register Field Descriptions.....	3960
16-1382. QUEUE_144_STATUS_B Register Field Descriptions.....	3961
16-1383. QUEUE_144_STATUS_C Register Field Descriptions.....	3962
16-1384. QUEUE_145_STATUS_A Register Field Descriptions.....	3963
16-1385. QUEUE_145_STATUS_B Register Field Descriptions.....	3964
16-1386. QUEUE_145_STATUS_C Register Field Descriptions.....	3965
16-1387. QUEUE_146_STATUS_A Register Field Descriptions.....	3966

16-1388. QUEUE_146_STATUS_B Register Field Descriptions.....	3967
16-1389. QUEUE_146_STATUS_C Register Field Descriptions.....	3968
16-1390. QUEUE_147_STATUS_A Register Field Descriptions.....	3969
16-1391. QUEUE_147_STATUS_B Register Field Descriptions.....	3970
16-1392. QUEUE_147_STATUS_C Register Field Descriptions.....	3971
16-1393. QUEUE_148_STATUS_A Register Field Descriptions.....	3972
16-1394. QUEUE_148_STATUS_B Register Field Descriptions.....	3973
16-1395. QUEUE_148_STATUS_C Register Field Descriptions.....	3974
16-1396. QUEUE_149_STATUS_A Register Field Descriptions.....	3975
16-1397. QUEUE_149_STATUS_B Register Field Descriptions.....	3976
16-1398. QUEUE_149_STATUS_C Register Field Descriptions.....	3977
16-1399. QUEUE_150_STATUS_A Register Field Descriptions.....	3978
16-1400. QUEUE_150_STATUS_B Register Field Descriptions.....	3979
16-1401. QUEUE_150_STATUS_C Register Field Descriptions.....	3980
16-1402. QUEUE_151_STATUS_A Register Field Descriptions.....	3981
16-1403. QUEUE_151_STATUS_B Register Field Descriptions.....	3982
16-1404. QUEUE_151_STATUS_C Register Field Descriptions.....	3983
16-1405. QUEUE_152_STATUS_A Register Field Descriptions.....	3984
16-1406. QUEUE_152_STATUS_B Register Field Descriptions.....	3985
16-1407. QUEUE_152_STATUS_C Register Field Descriptions.....	3986
16-1408. QUEUE_153_STATUS_A Register Field Descriptions.....	3987
16-1409. QUEUE_153_STATUS_B Register Field Descriptions.....	3988
16-1410. QUEUE_153_STATUS_C Register Field Descriptions.....	3989
16-1411. QUEUE_154_STATUS_A Register Field Descriptions.....	3990
16-1412. QUEUE_154_STATUS_B Register Field Descriptions.....	3991
16-1413. QUEUE_154_STATUS_C Register Field Descriptions.....	3992
16-1414. QUEUE_155_STATUS_A Register Field Descriptions.....	3993
16-1415. QUEUE_155_STATUS_B Register Field Descriptions.....	3994
16-1416. QUEUE_155_STATUS_C Register Field Descriptions.....	3995
17-1. Mailbox Connectivity Attributes.....	3998
17-2. Mailbox Clock Signals.....	3999
17-3. Mailbox Implementation.....	3999
17-4. Local Power Management Features.....	4000
17-5. Interrupt Events.....	4001
17-6. Global Initialization of Surrounding Modules for System Mailbox.....	4003
17-7. Mailbox Global Initialization.....	4004
17-8. Sending a Message (Polling Method).....	4004
17-9. Sending a Message (Interrupt Method).....	4004
17-10. Receiving a Message (Polling Method).....	4005
17-11. Receiving a Message (Interrupt Method).....	4005
17-12. Events Servicing in Sending Mode.....	4005
17-13. Events Servicing in Receiving Mode.....	4005
17-14. MAILBOX REGISTERS.....	4006
17-15. REVISION Register Field Descriptions.....	4009
17-16. SYSCONFIG Register Field Descriptions.....	4010
17-17. MESSAGE_0 Register Field Descriptions.....	4011
17-18. MESSAGE_1 Register Field Descriptions.....	4012
17-19. MESSAGE_2 Register Field Descriptions.....	4013
17-20. MESSAGE_3 Register Field Descriptions.....	4014

17-21. MESSAGE_4 Register Field Descriptions	4015
17-22. MESSAGE_5 Register Field Descriptions	4016
17-23. MESSAGE_6 Register Field Descriptions	4017
17-24. MESSAGE_7 Register Field Descriptions	4018
17-25. FIFOSTATUS_0 Register Field Descriptions	4019
17-26. FIFOSTATUS_1 Register Field Descriptions	4020
17-27. FIFOSTATUS_2 Register Field Descriptions	4021
17-28. FIFOSTATUS_3 Register Field Descriptions	4022
17-29. FIFOSTATUS_4 Register Field Descriptions	4023
17-30. FIFOSTATUS_5 Register Field Descriptions	4024
17-31. FIFOSTATUS_6 Register Field Descriptions	4025
17-32. FIFOSTATUS_7 Register Field Descriptions	4026
17-33. MSGSTATUS_0 Register Field Descriptions	4027
17-34. MSGSTATUS_1 Register Field Descriptions	4028
17-35. MSGSTATUS_2 Register Field Descriptions	4029
17-36. MSGSTATUS_3 Register Field Descriptions	4030
17-37. MSGSTATUS_4 Register Field Descriptions	4031
17-38. MSGSTATUS_5 Register Field Descriptions	4032
17-39. MSGSTATUS_6 Register Field Descriptions	4033
17-40. MSGSTATUS_7 Register Field Descriptions	4034
17-41. IRQSTATUS_RAW_0 Register Field Descriptions	4035
17-42. IRQSTATUS_CLR_0 Register Field Descriptions	4037
17-43. IRQENABLE_SET_0 Register Field Descriptions	4039
17-44. IRQENABLE_CLR_0 Register Field Descriptions	4041
17-45. IRQSTATUS_RAW_1 Register Field Descriptions	4043
17-46. IRQSTATUS_CLR_1 Register Field Descriptions	4045
17-47. IRQENABLE_SET_1 Register Field Descriptions	4047
17-48. IRQENABLE_CLR_1 Register Field Descriptions	4049
17-49. IRQSTATUS_RAW_2 Register Field Descriptions	4051
17-50. IRQSTATUS_CLR_2 Register Field Descriptions	4053
17-51. IRQENABLE_SET_2 Register Field Descriptions	4055
17-52. IRQENABLE_CLR_2 Register Field Descriptions	4057
17-53. IRQSTATUS_RAW_3 Register Field Descriptions	4059
17-54. IRQSTATUS_CLR_3 Register Field Descriptions	4061
17-55. IRQENABLE_SET_3 Register Field Descriptions	4063
17-56. IRQENABLE_CLR_3 Register Field Descriptions	4065
17-57. SPINLOCK REGISTERS	4067
17-58. REV Register Field Descriptions	4070
17-59. SYSCONFIG Register Field Descriptions	4071
17-60. SYSTATUS Register Field Descriptions	4072
17-61. LOCK_REG_0 Register Field Descriptions	4073
17-62. LOCK_REG_1 Register Field Descriptions	4074
17-63. LOCK_REG_2 Register Field Descriptions	4075
17-64. LOCK_REG_3 Register Field Descriptions	4076
17-65. LOCK_REG_4 Register Field Descriptions	4077
17-66. LOCK_REG_5 Register Field Descriptions	4078
17-67. LOCK_REG_6 Register Field Descriptions	4079
17-68. LOCK_REG_7 Register Field Descriptions	4080
17-69. LOCK_REG_8 Register Field Descriptions	4081

17-70. LOCK_REG_9 Register Field Descriptions	4082
17-71. LOCK_REG_10 Register Field Descriptions	4083
17-72. LOCK_REG_11 Register Field Descriptions	4084
17-73. LOCK_REG_12 Register Field Descriptions	4085
17-74. LOCK_REG_13 Register Field Descriptions	4086
17-75. LOCK_REG_14 Register Field Descriptions	4087
17-76. LOCK_REG_15 Register Field Descriptions	4088
17-77. LOCK_REG_16 Register Field Descriptions	4089
17-78. LOCK_REG_17 Register Field Descriptions	4090
17-79. LOCK_REG_18 Register Field Descriptions	4091
17-80. LOCK_REG_19 Register Field Descriptions	4092
17-81. LOCK_REG_20 Register Field Descriptions	4093
17-82. LOCK_REG_21 Register Field Descriptions	4094
17-83. LOCK_REG_22 Register Field Descriptions	4095
17-84. LOCK_REG_23 Register Field Descriptions	4096
17-85. LOCK_REG_24 Register Field Descriptions	4097
17-86. LOCK_REG_25 Register Field Descriptions	4098
17-87. LOCK_REG_26 Register Field Descriptions	4099
17-88. LOCK_REG_27 Register Field Descriptions	4100
17-89. LOCK_REG_28 Register Field Descriptions	4101
17-90. LOCK_REG_29 Register Field Descriptions	4102
17-91. LOCK_REG_30 Register Field Descriptions	4103
17-92. LOCK_REG_31 Register Field Descriptions	4104
18-1. Unsupported MMCHS Features	4106
18-2. MMC/SD/SDIO Controller Pins and Descriptions	4113
18-3. Response Type Summary	4116
18-4. Local Power Management Features	4121
18-5. Clock Activity Settings	4121
18-6. Events.....	4122
18-7. Memory Size, BLEN, and Buffer Relationship.....	4129
18-8. MMC, SD, SDIO Responses in the SD_RSPxx Registers.....	4130
18-9. CC and TC Values Upon Error Detected	4131
18-10. MMC/SD/SDIO Controller Transfer Stop Command Summary	4138
18-11. MMC/SD/SDIO Hardware Status Features	4144
18-12. Global Init for Surrounding Modules	4145
18-13. MMC/SD/SDIO Controller Wake-Up Configuration	4146
18-14. MULTIMEDIA_CARD Registers	4150
18-15. SD_SYSCONFIG Register Field Descriptions	4151
18-16. SD_SYSSTATUS Register Field Descriptions	4153
18-17. SD_CSRE Register Field Descriptions	4154
18-18. SD_SYSTEST Register Field Descriptions	4155
18-19. SD_CON Register Field Descriptions	4159
18-20. SD_PWCNT Register Field Descriptions	4163
18-21. SD_SDMASA Register Field Descriptions	4164
18-22. SD_BLK Register Field Descriptions	4165
18-23. SD_ARG Register Field Descriptions.....	4166
18-24. SD_CMD Register Field Descriptions	4168
18-25. SD_RSP10 Register Field Descriptions	4172
18-26. SD_RSP32 Register Field Descriptions	4173

18-27. SD_RSP54 Register Field Descriptions	4174
18-28. SD_RSP76 Register Field Descriptions	4175
18-29. SD_DATA Register Field Descriptions	4176
18-30. SD_PSTATE Register Field Descriptions	4177
18-31. SD_HCTL Register Field Descriptions	4180
18-32. SD_SYSCTL Register Field Descriptions	4183
18-33. SD_STAT Register Field Descriptions	4185
18-34. SD_IE Register Field Descriptions	4190
18-35. SD_ISE Register Field Descriptions	4193
18-36. SD_AC12 Register Field Descriptions	4196
18-37. SD_CAPA Register Field Descriptions	4198
18-38. SD_CUR_CAPA Register Field Descriptions	4200
18-39. SD_FE Register Field Descriptions	4201
18-40. SD_ADMAES Register Field Descriptions	4203
18-41. SD_ADMASAL Register Field Descriptions	4204
18-42. SD_ADMASAH Register Field Descriptions	4205
18-43. SD_REV Register Field Descriptions	4206
19-1. Unsupported UART Features	4209
19-2. UART0 Connectivity Attributes	4210
19-3. UART1–5 Connectivity Attributes	4211
19-4. UART0 Clock Signals	4211
19-5. UART1–5 Clock Signals	4211
19-6. UART Mode Baud and Error Rates	4212
19-7. IrDA Mode Baud and Error Rates	4212
19-8. UART Pin List	4213
19-9. UART Muxing Control	4213
19-10. Local Power-Management Features	4217
19-11. UART Mode Interrupts	4217
19-12. IrDA Mode Interrupts	4218
19-13. CIR Mode Interrupts	4219
19-14. TX FIFO Trigger Level Setting Summary	4221
19-15. RX FIFO Trigger Level Setting Summary	4221
19-16. UART/IrDA/CIR Register Access Mode Programming (Using UART_LCR)	4229
19-17. Subconfiguration Mode A Summary	4229
19-18. Subconfiguration Mode B Summary	4229
19-19. Suboperational Mode Summary	4229
19-20. UART/IrDA/CIR Register Access Mode Overview	4229
19-21. UART Mode Selection	4231
19-22. UART Mode Register Overview	4231
19-23. IrDA Mode Register Overview	4232
19-24. CIR Mode Register Overview	4233
19-25. UART Baud Rate Settings (48-MHz Clock)	4236
19-26. UART Parity Bit Encoding	4236
19-27. UART_EFR[3:0] Software Flow Control Options	4238
19-28. IrDA Baud Rate Settings	4247
19-29. UART Registers	4266
19-30. THR Register Field Descriptions	4268
19-31. RHR Register Field Descriptions	4269
19-32. DLL Register Field Descriptions	4270

19-33. IER_IRDA Register Field Descriptions	4271
19-34. IER_CIR Register Field Descriptions	4272
19-35. IER_UART Register Field Descriptions	4273
19-36. DLH Register Field Descriptions	4274
19-37. EFR Register Field Descriptions	4275
19-38. IIR_UART Register Field Descriptions	4277
19-39. IIR_CIR Register Field Descriptions	4278
19-40. FCR Register Field Descriptions	4279
19-41. IIR_IRDA Register Field Descriptions	4280
19-42. LCR Register Field Descriptions	4281
19-43. MCR Register Field Descriptions	4282
19-44. XON1_ADDR1 Register Field Descriptions.....	4283
19-45. XON2_ADDR2 Register Field Descriptions.....	4284
19-46. LSR_CIR Register Field Descriptions	4285
19-47. LSR_IRDA Register Field Descriptions	4286
19-48. LSR_UART Register Field Descriptions.....	4288
19-49. TCR Register Field Descriptions	4290
19-50. MSR Register Field Descriptions.....	4291
19-51. XOFF1 Register Field Descriptions	4292
19-52. SPR Register Field Descriptions	4293
19-53. TLR Register Field Descriptions.....	4294
19-54. XOFF2 Register Field Descriptions	4295
19-55. MDR1 Register Field Descriptions	4296
19-56. MDR2 Register Field Descriptions	4297
19-57. TXFLL Register Field Descriptions.....	4298
19-58. SFLSR Register Field Descriptions	4299
19-59. RESUME Register Field Descriptions	4300
19-60. TXFLH Register Field Descriptions	4301
19-61. RXFLL Register Field Descriptions	4302
19-62. SFREGL Register Field Descriptions	4303
19-63. SFREGH Register Field Descriptions	4304
19-64. RXFLH Register Field Descriptions.....	4305
19-65. BLR Register Field Descriptions	4306
19-66. UASR Register Field Descriptions	4307
19-67. ACREG Register Field Descriptions	4308
19-68. SCR Register Field Descriptions	4309
19-69. SSR Register Field Descriptions	4310
19-70. EBLR Register Field Descriptions.....	4311
19-71. MVR Register Field Descriptions.....	4312
19-72. SYSC Register Field Descriptions	4313
19-73. SYSS Register Field Descriptions	4314
19-74. WER Register Field Descriptions	4315
19-75. CFPS Register Field Descriptions	4316
19-76. RXFIFO_LVL Register Field Descriptions	4317
19-77. TXFIFO_LVL Register Field Descriptions.....	4318
19-78. IER2 Register Field Descriptions.....	4319
19-79. ISR2 Register Field Descriptions.....	4320
19-80. FREQ_SEL Register Field Descriptions.....	4321
19-81. MDR3 Register Field Descriptions	4322

19-82. TX_DMA_THRESHOLD Register Field Descriptions.....	4323
20-1. Timer Resolution and Maximum Range	4326
20-2. Timer[0] Connectivity Attributes	4328
20-3. Timer[2–7] Connectivity Attributes	4329
20-4. Timer Clock Signals.....	4330
20-5. Timer Pin List	4330
20-6. Prescaler Functionality	4333
20-7. Prescaler Clock Ratios Value.....	4336
20-8. Value and Corresponding Interrupt Period.....	4336
20-9. OCP Error Reporting.....	4337
20-10. TIMER Registers	4340
20-11. TIDR Register Field Descriptions	4341
20-12. TIOCP_CFG Register Field Descriptions	4342
20-13. IRQ_EOI Register Field Descriptions.....	4343
20-14. IRQSTATUS_RAW Register Field Descriptions	4344
20-15. IRQSTATUS Register Field Descriptions	4345
20-16. IRQENABLE_SET Register Field Descriptions	4346
20-17. IRQENABLE_CLR Register Field Descriptions	4347
20-18. IRQWAKEEN Register Field Descriptions	4348
20-19. TCLR Register Field Descriptions.....	4349
20-20. TCRR Register Field Descriptions	4351
20-21. TLDR Register Field Descriptions.....	4352
20-22. TTGR Register Field Descriptions	4353
20-23. TWPS Register Field Descriptions	4354
20-24. TMAR Register Field Descriptions	4355
20-25. TCAR1 Register Field Descriptions.....	4356
20-26. TSICR Register Field Descriptions.....	4357
20-27. TCAR2 Register Field Descriptions.....	4358
20-28. Timer1 Connectivity Attributes.....	4361
20-29. Timer Clock Signals.....	4362
20-30. Value Loaded in TCRR to Generate 1ms Tick	4364
20-31. Prescaler/Timer Reload Values Versus Contexts.....	4367
20-32. SmartIdle - Clock Activity Field Configuration	4369
20-33. Prescaler Clock Ratios Value.....	4370
20-34. Value and Corresponding Interrupt Period.....	4371
20-35. DMTIMER_1MS REGISTERS.....	4371
20-36. TIDR Register Field Descriptions	4373
20-37. TIOCP_CFG Register Field Descriptions	4374
20-38. TISTAT Register Field Descriptions	4375
20-39. TISR Register Field Descriptions	4376
20-40. TIER Register Field Descriptions	4377
20-41. TWER Register Field Descriptions.....	4378
20-42. TCLR Register Field Descriptions.....	4379
20-43. TCRR Register Field Descriptions	4381
20-44. TLDR Register Field Descriptions.....	4382
20-45. TTGR Register Field Descriptions	4383
20-46. TWPS Register Field Descriptions.....	4384
20-47. TMAR Register Field Descriptions	4386
20-48. TCAR1 Register Field Descriptions.....	4387

20-49. TSICR Register Field Descriptions	4388
20-50. TCAR2 Register Field Descriptions	4389
20-51. TPIR Register Field Descriptions	4390
20-52. TNIR Register Field Descriptions	4391
20-53. TCVR Register Field Descriptions	4392
20-54. TOCR Register Field Descriptions	4393
20-55. TOWR Register Field Descriptions	4394
20-56. RTC Module Connectivity Attributes	4396
20-57. RTC Clock Signals	4397
20-58. RTC Pin List.....	4397
20-59. RTC Signals.....	4399
20-60. Interrupt Trigger Events	4399
20-61. RTC Register Names and Values.....	4402
20-62. pmic_power_en Description	4405
20-63. RTC Registers	4406
20-64. SECONDS_REG Register Field Descriptions	4408
20-65. MINUTES_REG Register Field Descriptions	4409
20-66. HOURS_REG Register Field Descriptions.....	4410
20-67. DAYS_REG Register Field Descriptions	4411
20-68. MONTHS_REG Register Field Descriptions.....	4412
20-69. YEARS_REG Register Field Descriptions	4413
20-70. WEEKS_REG Register Field Descriptions.....	4414
20-71. ALARM_SECONDS_REG Register Field Descriptions	4415
20-72. ALARM_MINUTES_REG Register Field Descriptions	4416
20-73. ALARM_HOURS_REG Register Field Descriptions.....	4417
20-74. ALARM_DAYS_REG Register Field Descriptions	4418
20-75. ALARM_MONTHS_REG Register Field Descriptions.....	4419
20-76. ALARM_YEARS_REG Register Field Descriptions	4420
20-77. RTC_CTRL_REG Register Field Descriptions	4421
20-78. RTC_STATUS_REG Register Field Descriptions.....	4423
20-79. RTC_INTERRUPTS_REG Register Field Descriptions	4424
20-80. RTC_COMP_LSB_REG Register Field Descriptions.....	4425
20-81. RTC_COMP_MSB_REG Register Field Descriptions.....	4426
20-82. RTC_OSC_REG Register Field Descriptions	4427
20-83. RTC_SCRATCH0_REG Register Field Descriptions.....	4428
20-84. RTC_SCRATCH1_REG Register Field Descriptions.....	4429
20-85. RTC_SCRATCH2_REG Register Field Descriptions.....	4430
20-86. KICK0R Register Field Descriptions	4431
20-87. KICK1R Register Field Descriptions	4432
20-88. RTC_REVISION Register Field Descriptions.....	4433
20-89. RTC_SYSCONFIG Register Field Descriptions.....	4434
20-90. RTC_IRQWAKEEN Register Field Descriptions	4435
20-91. ALARM2_SECONDS_REG Register Field Descriptions.....	4436
20-92. ALARM2_MINUTES_REG Register Field Descriptions.....	4437
20-93. ALARM2_HOURS_REG Register Field Descriptions	4438
20-94. ALARM2_DAYS_REG Register Field Descriptions.....	4439
20-95. ALARM2_MONTHS_REG Register Field Descriptions	4440
20-96. ALARM2_YEARS_REG Register Field Descriptions.....	4441
20-97. RTC_PMIC Register Field Descriptions	4442

20-98. RTC_DEBOUNCE Register Field Descriptions	4443
20-99. Public WD Timer Module Connectivity Attributes	4445
20-100. Public WD Timer Clock Signals	4446
20-101. Watchdog Timer Events	4447
20-102. Count and Prescaler Default Reset Values	4448
20-103. Prescaler Clock Ratio Values	4449
20-104. Reset Period Examples	4449
20-105. Default Watchdog Timer Reset Periods	4450
20-106. Global Initialization of Surrounding Modules	4453
20-107. Watchdog Timer Module Global Initialization	4453
20-108. Watchdog Timer Basic Configuration	4453
20-109. Disable the Watchdog Timer	4454
20-110. Enable the Watchdog Timer	4454
20-111. WATCHDOG_TIMER Registers	4454
20-112. WDT_WIDR Register Field Descriptions	4456
20-113. WDT_WDSC Register Field Descriptions	4457
20-114. WDT_WDST Register Field Descriptions	4458
20-115. WDT_WISR Register Field Descriptions	4459
20-116. WDT_WIER Register Field Descriptions	4460
20-117. WDT_WCLR Register Field Descriptions	4461
20-118. WDT_WCRR Register Field Descriptions	4462
20-119. WDT_WLDR Register Field Descriptions	4463
20-120. WDT_WTGR Register Field Descriptions	4464
20-121. WDT_WWPS Register Field Descriptions	4465
20-122. WDT_WDLY Register Field Descriptions	4466
20-123. WDT_WSPR Register Field Descriptions	4467
20-124. WDT_WIRQSTATRAW Register Field Descriptions	4468
20-125. WDT_WIRQSTAT Register Field Descriptions	4469
20-126. WDT_WIRQENSET Register Field Descriptions	4470
20-127. WDT_WIRQENCLR Register Field Descriptions	4471
21-1. Unsupported I2C Features	4473
21-2. I2C0 Connectivity Attributes	4474
21-3. I2C(1–2) Connectivity Attributes	4475
21-4. I2C Clock Signals	4475
21-5. I2C Pin List	4475
21-6. Signal Pads	4477
21-7. Reset State of I2C Signals	4477
21-8. I2C Registers	4490
21-9. I2C_REVNB_LO Register Field Descriptions	4491
21-10. I2C_REVNB_HI Register Field Descriptions	4492
21-11. I2C_SYSC Register Field Descriptions	4493
21-12. I2C_IRQSTATUS_RAW Register Field Descriptions	4495
21-13. I2C_IRQSTATUS Register Field Descriptions	4501
21-14. I2C_IRQENABLE_SET Register Field Descriptions	4503
21-15. I2C_IRQENABLE_CLR Register Field Descriptions	4505
21-16. I2C_WE Register Field Descriptions	4507
21-17. I2C_DMARXENABLE_SET Register Field Descriptions	4510
21-18. I2C_DMATXENABLE_SET Register Field Descriptions	4511
21-19. I2C_DMARXENABLE_CLR Register Field Descriptions	4512

21-20. I2C_DMATXENABLE_CLR Register Field Descriptions	4513
21-21. I2C_DMARXWAKE_EN Register Field Descriptions	4514
21-22. I2C_DMATXWAKE_EN Register Field Descriptions	4516
21-23. I2C_SYSS Register Field Descriptions	4518
21-24. I2C_BUF Register Field Descriptions	4519
21-25. I2C_CNT Register Field Descriptions	4521
21-26. I2C_DATA Register Field Descriptions	4522
21-27. I2C_CON Register Field Descriptions	4523
21-28. I2C_OA Register Field Descriptions	4526
21-29. I2C_SA Register Field Descriptions	4527
21-30. I2C_PSC Register Field Descriptions	4528
21-31. I2C_SCLL Register Field Descriptions	4529
21-32. I2C_SCLH Register Field Descriptions	4530
21-33. I2C_SYSTEST Register Field Descriptions	4531
21-34. I2C_BUFSTAT Register Field Descriptions	4534
21-35. I2C_OA1 Register Field Descriptions	4535
21-36. I2C_OA2 Register Field Descriptions	4536
21-37. I2C_OA3 Register Field Descriptions	4537
21-38. I2C_ACTOA Register Field Descriptions	4538
21-39. I2C_SBLOCK Register Field Descriptions	4539
22-1. Unsupported McASP Features	4543
22-2. McASP Connectivity Attributes	4544
22-3. McASP Clock Signals	4545
22-4. McASP Pin List	4545
22-5. Biphase-Mark Encoder	4552
22-6. Preamble Codes	4553
22-7. McASP Interface Signals	4560
22-8. Channel Status and User Data for Each DIT Block	4567
22-9. Transmit Bitstream Data Alignment	4578
22-10. Receive Bitstream Data Alignment	4580
22-11. MCASP Registers	4599
22-12. REV Register Field Descriptions	4601
22-13. PWRIDLESYSCONFIG Register Field Descriptions	4602
22-14. PFUNC Register Field Descriptions	4603
22-15. PDIR Register Field Descriptions	4604
22-16. PDOUT Register Field Descriptions	4606
22-17. PDIN Register Field Descriptions	4608
22-18. PDCLR Register Field Descriptions	4609
22-19. GBLCTL Register Field Descriptions	4611
22-20. AMUTE Register Field Descriptions	4613
22-21. DLBCTL Register Field Descriptions	4615
22-22. DITCTL Register Field Descriptions	4616
22-23. RGBLCTL Register Field Descriptions	4617
22-24. RMASK Register Field Descriptions	4619
22-25. RFMT Register Field Descriptions	4620
22-26. AFSRCTL Register Field Descriptions	4622
22-27. ACLKRCTL Register Field Descriptions	4623
22-28. AHCLKRCTL Register Field Descriptions	4624
22-29. RTDM Register Field Descriptions	4625

22-30. RINTCTL Register Field Descriptions	4626
22-31. RSTAT Register Field Descriptions	4628
22-32. RSLOT Register Field Descriptions.....	4630
22-33. RCLKCHK Register Field Descriptions	4631
22-34. REVTCTL Register Field Descriptions	4632
22-35. XGBLCTL Register Field Descriptions	4633
22-36. XMASK Register Field Descriptions	4635
22-37. XFMT Register Field Descriptions	4636
22-38. AFSXCTL Register Field Descriptions	4638
22-39. ACLKXCTL Register Field Descriptions.....	4639
22-40. AHCLKXCTL Register Field Descriptions.....	4640
22-41. XTDM Register Field Descriptions	4641
22-42. XINTCTL Register Field Descriptions	4642
22-43. XSTAT Register Field Descriptions	4644
22-44. XSLOT Register Field Descriptions.....	4646
22-45. XCLKCHK Register Field Descriptions	4647
22-46. XEVTCTL Register Field Descriptions	4648
22-47. DITCSRA_0 to DITCSRA_5 Register Field Descriptions	4649
22-48. DITCSRB_0 to DITCSRB_5 Register Field Descriptions	4650
22-49. DITUDRA_0 to DITUDRA_5 Register Field Descriptions.....	4651
22-50. DITUDRB_0 to DITUDRB_5 Register Field Descriptions.....	4652
22-51. SRCTL_0 to SRCTL_5 Register Field Descriptions	4653
22-52. XBUF_0 to XBUF_5 Register Field Descriptions	4655
22-53. RBUF_0 to RBUF_5 Register Field Descriptions	4656
22-54. WFIFOCTL Register Field Descriptions	4657
22-55. WFIFOSTS Register Field Descriptions.....	4658
22-56. RFIFOCTL Register Field Descriptions	4659
22-57. RFIFOSTS Register Field Descriptions	4660
23-1. DCAN Connectivity Attributes	4663
23-2. DCAN Clock Signals	4664
23-3. DCAN Pin List	4664
23-4. Initialization of a Transmit Object	4680
23-5. Initialization of a single Receive Object for Data Frames	4680
23-6. Initialization of a Single Receive Object for Remote Frames.....	4681
23-7. Parameters of the CAN Bit Time	4688
23-8. Structure of a Message Object	4698
23-9. Field Descriptions	4698
23-10. Message RAM addressing in Debug/Suspend and RDA Mode.....	4700
23-11. Message RAM Representation in Debug/Suspend Mode	4701
23-12. Message RAM Representation in RAM Direct Access Mode	4701
23-13. DCAN Registers	4703
23-14. CTL Register Field Descriptions.....	4705
23-15. ES Register Field Descriptions	4708
23-16. ERRRC Register Field Descriptions	4710
23-17. BTR Register Field Descriptions	4711
23-18. INT Register Field Descriptions	4712
23-19. TEST Register Field Descriptions.....	4713
23-20. PERR Register Field Descriptions	4714
23-21. ABOTR Register Field Descriptions	4715

23-22. TXRQ_X Register Field Descriptions	4716
23-23. TXRQ12 Register Field Descriptions	4717
23-24. TXRQ34 Register Field Descriptions	4718
23-25. TXRQ56 Register Field Descriptions	4719
23-26. TXRQ78 Register Field Descriptions	4720
23-27. NWDAT_X Register Field Descriptions	4721
23-28. NWDAT12 Register Field Descriptions	4722
23-29. NWDAT34 Register Field Descriptions	4723
23-30. NWDAT56 Register Field Descriptions	4724
23-31. NWDAT78 Register Field Descriptions	4725
23-32. INTPND_X Register Field Descriptions	4726
23-33. INTPND12 Register Field Descriptions	4727
23-34. INTPND34 Register Field Descriptions	4728
23-35. INTPND56 Register Field Descriptions	4729
23-36. INTPND78 Register Field Descriptions	4730
23-37. MSGVAL_X Register Field Descriptions	4731
23-38. MSGVAL12 Register Field Descriptions	4732
23-39. MSGVAL34 Register Field Descriptions	4733
23-40. MSGVAL56 Register Field Descriptions	4734
23-41. MSGVAL78 Register Field Descriptions	4735
23-42. INTMUX12 Register Field Descriptions	4736
23-43. INTMUX34 Register Field Descriptions	4737
23-44. INTMUX56 Register Field Descriptions	4738
23-45. INTMUX78 Register Field Descriptions	4739
23-46. IF1CMD Register Field Descriptions	4740
23-47. IF1MSK Register Field Descriptions	4743
23-48. IF1ARB Register Field Descriptions	4744
23-49. IF1MCTL Register Field Descriptions	4745
23-50. IF1DATA Register Field Descriptions	4747
23-51. IF1DATB Register Field Descriptions	4748
23-52. IF2CMD Register Field Descriptions	4749
23-53. IF2MSK Register Field Descriptions	4752
23-54. IF2ARB Register Field Descriptions	4753
23-55. IF2MCTL Register Field Descriptions	4754
23-56. IF2DATA Register Field Descriptions	4756
23-57. IF2DATB Register Field Descriptions	4757
23-58. IF3OBS Register Field Descriptions	4758
23-59. IF3MSK Register Field Descriptions	4760
23-60. IF3ARB Register Field Descriptions	4761
23-61. IF3MCTL Register Field Descriptions	4762
23-62. IF3DATA Register Field Descriptions	4764
23-63. IF3DATB Register Field Descriptions	4765
23-64. IF3UPD12 Register Field Descriptions	4766
23-65. IF3UPD34 Register Field Descriptions	4767
23-66. IF3UPD56 Register Field Descriptions	4768
23-67. IF3UPD78 Register Field Descriptions	4769
23-68. TIOC Register Field Descriptions	4770
23-69. RIOC Register Field Descriptions	4772
24-1. Unsupported McSPI Features	4775

24-2.	McSPI Connectivity Attributes	4777
24-3.	McSPI Clock Signals.....	4777
24-4.	McSPI Pin List	4777
24-5.	Phase and Polarity Combinations	4782
24-6.	Chip Select ↔ Clock Edge Delay Depending on Configuration	4792
24-7.	CLKSPPIO High/Low Time Computation	4793
24-8.	Clock Granularity Examples	4793
24-9.	FIFO Writes, Word Length Relationship	4794
24-10.	SPI Registers	4812
24-11.	MCSPi_REVISION Register Field Descriptions.....	4814
24-12.	MCSPi_SYSCONFIG Register Field Descriptions.....	4815
24-13.	MCSPi_SYSSTATUS Register Field Descriptions.....	4816
24-14.	MCSPi_IRQSTATUS Register Field Descriptions	4817
24-15.	MCSPi_IRQENABLE Register Field Descriptions	4820
24-16.	MCSPi_SYST Register Field Descriptions.....	4822
24-17.	MCSPi_MODULCTRL Register Field Descriptions	4824
24-18.	MCSPi_CH0CONF Register Field Descriptions.....	4826
24-19.	MCSPi_CH0STAT Register Field Descriptions	4830
24-20.	MCSPi_CH0CTRL Register Field Descriptions	4832
24-21.	MCSPi_TX0 Register Field Descriptions.....	4833
24-22.	MCSPi_RX0 Register Field Descriptions	4834
24-23.	MCSPi_CH1CONF Register Field Descriptions.....	4835
24-24.	MCSPi_CH1STAT Register Field Descriptions	4839
24-25.	MCSPi_CH1CTRL Register Field Descriptions	4841
24-26.	MCSPi_TX1 Register Field Descriptions.....	4842
24-27.	MCSPi_RX1 Register Field Descriptions	4843
24-28.	MCSPi_CH2CONF Register Field Descriptions.....	4844
24-29.	MCSPi_CH2STAT Register Field Descriptions	4848
24-30.	MCSPi_CH2CTRL Register Field Descriptions	4850
24-31.	MCSPi_TX2 Register Field Descriptions.....	4851
24-32.	MCSPi_RX2 Register Field Descriptions	4852
24-33.	MCSPi_CH3CONF Register Field Descriptions.....	4853
24-34.	MCSPi_CH3STAT Register Field Descriptions	4857
24-35.	MCSPi_CH3CTRL Register Field Descriptions	4859
24-36.	MCSPi_TX3 Register Field Descriptions.....	4860
24-37.	MCSPi_RX3 Register Field Descriptions	4861
24-38.	MCSPi_XFERLEVEL Register Field Descriptions	4862
24-39.	MCSPi_DAFTX Register Field Descriptions.....	4863
24-40.	MCSPi_DAFRX Register Field Descriptions	4864
25-1.	GPIO0 Connectivity Attributes	4868
25-2.	GPIO[1:3] Connectivity Attributes	4868
25-3.	GPIO Clock Signals	4868
25-4.	GPIO Pin List	4869
25-5.	GPIO Registers	4877
25-6.	GPIO_REVISION Register Field Descriptions	4878
25-7.	GPIO_SYSCONFIG Register Field Descriptions	4879
25-8.	GPIO_EOI Register Field Descriptions.....	4880
25-9.	GPIO_IRQSTATUS_RAW_0 Register Field Descriptions	4881
25-10.	GPIO_IRQSTATUS_RAW_1 Register Field Descriptions	4882

25-11. GPIO_IRQSTATUS_0 Register Field Descriptions	4883
25-12. GPIO_IRQSTATUS_1 Register Field Descriptions	4884
25-13. GPIO_IRQSTATUS_SET_0 Register Field Descriptions	4885
25-14. GPIO_IRQSTATUS_SET_1 Register Field Descriptions	4886
25-15. GPIO_IRQSTATUS_CLR_0 Register Field Descriptions	4887
25-16. GPIO_IRQSTATUS_CLR_1 Register Field Descriptions	4888
25-17. GPIO_IRQWAKEN_0 Register Field Descriptions	4889
25-18. GPIO_IRQWAKEN_1 Register Field Descriptions	4890
25-19. GPIO_SYSSTATUS Register Field Descriptions	4891
25-20. GPIO_CTRL Register Field Descriptions	4892
25-21. GPIO_OE Register Field Descriptions	4893
25-22. GPIO_DATAIN Register Field Descriptions	4894
25-23. GPIO_DATAOUT Register Field Descriptions	4895
25-24. GPIO_LEVELDETECT0 Register Field Descriptions	4896
25-25. GPIO_LEVELDETECT1 Register Field Descriptions	4897
25-26. GPIO_RISINGDETECT Register Field Descriptions	4898
25-27. GPIO_FALLINGDETECT Register Field Descriptions	4899
25-28. GPIO_DEBOUNCENABLE Register Field Descriptions	4900
25-29. GPIO_DEBOUNCINGTIME Register Field Descriptions	4901
25-30. GPIO_CLEARDATAOUT Register Field Descriptions	4902
25-31. GPIO_SETDATAOUT Register Field Descriptions	4903
26-1. ROM Exception Vectors	4908
26-2. Dead Loops	4908
26-3. RAM Exception Vectors	4909
26-4. Tracing Data	4910
26-5. Crystal Frequencies Supported	4911
26-6. ROM Code Default Clock Settings	4912
26-7. SYSBOOT Configuration Pins ^[4]	4915
26-8. XIP Timings Parameters	4925
26-9. Pins Used for Non-Muxed NOR Boot	4926
26-10. Pins Used for Muxed NOR Boot	4927
26-11. Special SYSBOOT Pins for NOR Boot	4927
26-12. NAND Timings Parameters	4929
26-13. ONFI Parameters Page Description	4930
26-14. Supported NAND Devices	4930
26-15. 4th NAND ID Data Byte	4931
26-16. Pins Used for NANDI2C Boot for I2C EEPROM Access	4932
26-17. NAND Geometry Information on I2C EEPROM	4932
26-18. ECC Configuration for NAND Boot	4932
26-19. Pins Used for NAND Boot	4938
26-20. Configuration Header TOC Item	4941
26-21. Configuration Header Settings	4941
26-22. Master Boot Record Structure	4943
26-23. Partition Entry	4944
26-24. Partition Types	4944
26-25. FAT Boot Sector	4945
26-26. FAT Directory Entry	4949
26-27. FAT Entry Description	4950
26-28. Pins Used for MMC0 Boot	4950

26-29. Pins Used for MMC1 Boot	4950
26-30. Pins Used for SPI Boot	4951
26-31. Blocks and Sectors Searched on Non-XIP Memories	4952
26-32. Pins Used for EMAC Boot in MII Mode	4955
26-33. Pins Used for EMAC Boot in RGMII Mode	4955
26-34. Pins Used for EMAC Boot in RMII Mode.....	4955
26-35. Ethernet PHY Mode Selection.....	4956
26-36. Pins Used for UART Boot	4956
26-37. Customized Descriptor Parameters.....	4957
26-38. Pins Used for USB Boot.....	4958
26-39. GP Device Image Format	4959
26-40. Booting Parameters Structure	4960
26-41. Tracing Vectors	4962
27-1. IEEE1149.1 Signals.....	4967
27-2. ICEPick Boot Modes Upon POR	4968
27-3. Debug Resource Manager (DRM) Registers	4969
27-4. Suspend Control Registers Field Descriptions	4970
A-1. Document Revision History	4972

Read This First

About This Manual

This Technical Reference Manual (TRM) details the integration, the environment, the functional description, and the programming models for each peripheral and subsystem in the device

Related Documentation From Texas Instruments

For a complete listing of related documentation and development-support tools, visit www.ti.com.

Introduction

1.1 AM335x Family

1.1.1 Device Features

This architecture is configured with different sets of features in different devices. This technical reference manual details all of the features available in current and future AM335x devices. Some features may not be available or supported in your particular device. The features supported across different AM335x devices are shown in [Table 1-1](#). For more information on the different packages, refer to your device-specific data manual.

Table 1-1. Device Features

Subsystem/ Co-Processor/ Peripheral	AM3352	AM3354	AM3356	AM3357	AM3358	AM3359
ARM MPU Subsystem	Y	Y	Y	Y	Y	Y
Programmable Real-Time Unit and Industrial Communication Subsystem (PRU-ICSS)	N	N	All features excluding EtherCAT	All features including EtherCAT	All features excluding EtherCAT	All features including EtherCAT
Graphics Accelerator (SGX)	N	Y	N	N	Y	Y
Memory Map	Y	Y	Y	Y	Y	Y
Interrupts	Y	Y	Y	Y	Y	Y
Memory Subsystem	Y	Y	Y	Y	Y	Y
Power and Clock Management (PRCM)	Y	Y	Y	Y	Y	Y
Control Module	Y	Y	Y	Y	Y	Y
Interconnects	Y	Y	Y	Y	Y	Y
Enhanced Direct Memory Access (EDMA)	Y	Y	Y	Y	Y	Y
Touchscreen Controller	Y	Y	Y	Y	Y	Y
LCD Controller	Y	Y	Y	Y	Y	Y
Ethernet Subsystem	ZCE: 1 port ZCZ: 2 ports	ZCE: 1 port ZCZ: 2 ports	No ZCE Available ZCZ: 2 ports	No ZCE Available ZCZ: 2 ports	No ZCE Available ZCZ: 2 ports	No ZCE Available ZCZ: 2 ports
Pulse-Width Modulation Subsystem	Y	Y	Y	Y	Y	Y
Universal Serial Bus (USB)	ZCE: 1 port ZCZ: 2 ports	ZCE: 1 port ZCZ: 2 ports	No ZCE Available ZCZ: 2 ports	No ZCE Available ZCZ: 2 ports	No ZCE Available ZCZ: 2 ports	No ZCE Available ZCZ: 2 ports
Interprocessor Communication	Y	Y	Y	Y	Y	Y
Multimedia Card (MMC)	Y	Y	Y	Y	Y	Y
Universal Asynchronous Receiver/Transmitter (UART)	Y	Y	Y	Y	Y	Y
DMTimer	Y	Y	Y	Y	Y	Y

Table 1-1. Device Features (continued)

Subsystem/ Co-Processor/ Peripheral	AM3352	AM3354	AM3356	AM3357	AM3358	AM3359
DMTimer 1ms	Y	Y	Y	Y	Y	Y
RTCSS	Y	Y	Y	Y	Y	Y
Watchdog	Y	Y	Y	Y	Y	Y
I2C	Y	Y	Y	Y	Y	Y
Multichannel Audio Serial Port (McASP)	Y	Y	Y	Y	Y	Y
Controller Area Network (CAN)	Y	Y	Y	Y	Y	Y
Multichannel Serial Port Interface (McSPI)	Y	Y	Y	Y	Y	Y
General Purpose Input/Output (GPIO)	Y	Y	Y	Y	Y	Y
Initialization	Y	Y	Y	Y	Y	Y

1.1.2 Device Identification

Several registers help identify the type and available features of the device. [Table 1-2](#) summarizes these registers.

Table 1-2. Device_ID (Address 0x44E10600) Bit Field Descriptions

Bit	Field	Value	Description
31-28	DEVREV		Device revision 0000b - Silicon Revision 1.0 0001b - Silicon Revision 2.0 0010b - Silicon Revision 2.1 See device errata for detailed information on functionality in each device revision. Reset value is revision-dependent.
27-12	PARTNUM		Device part number 0xB944
11-1	MFGR		Manufacturer's ID 0x017
0	Reserved		Read always as 0 0x0

1.1.3 Feature Identification

The AM335x has many different feature sets available. The DEV_FEATURE register in the control module identifies which features are available in each device in the AM335x family. See [Table 1-3](#), *dev_feature Register*, in the control module chapter for more information on the bits in the DEV_FEATURE register.

Table 1-3. DEV_FEATURE (Address 0x44E10604) Register Values

Bit	3	3	29	28	27	26	25	24	23	22	21	20	19	18	1	1	15	14	13	12	11	10	9	8	7	6	5	4	3	2	1	0	Register Value	
Bit Definition	Reserved		SGX	Reserved											ICSSFEA		Reserved						Reserved		DCAN	Reserved						CPSSW	ICSS	
AM3352	0	0	0	0	0	0	0	0	1	1	1	1	1	1	0	0	0	0	0	0	0	0	1	1	1	0	0	0	0	0	1	0	0x00FC0382	
AM3354	0	0	1	0	0	0	0	0	1	1	1	1	1	1	0	0	0	0	0	0	0	0	1	1	1	0	0	0	0	0	1	0	0x20FC0382	
AM3356	0	0	0	0	0	0	0	0	1	1	1	1	1	1	0	1	0	0	0	0	0	0	1	1	1	0	0	0	0	0	1	1	0x00FD0383	
AM3357	0	0	0	0	0	0	0	0	1	1	1	1	1	1	1	1	0	0	0	0	0	0	1	1	1	0	0	0	0	0	1	1	0x00FF0383	
AM3358	0	0	1	0	0	0	0	0	1	1	1	1	1	1	0	1	0	0	0	0	0	0	1	1	1	0	0	0	0	0	1	1	0x20FD0383	
AM3359	0	0	1	0	0	0	0	0	1	1	1	1	1	1	1	1	0	0	0	0	0	0	1	1	1	0	0	0	0	0	1	1	0x20FF0383	

Silicon Revision Functional Differences and Enhancements

This section describes the differences in functionality among different silicon revisions of AM335x. Enhancements introduced in silicon revisions are also described. For a description of silicon bugs that were fixed in later revisions of the device, see *AM335x ARM Cortex-A8 Microprocessors (MPUs) Silicon Errata* (literature number [SPRZ360](#)). Errata items that were fixed may or may not show up in this section.

Added RTC Alarm Wakeup for DeepSleep Modes

See [Section 8.1.4.5](#), *Wakeup Sources/Events*.

PG1.0: RTC alarm will not wake up device from DeepSleep0.

PG2.x: RTC alarm was added as a wake-up source from DeepSleep modes.

Changed BOOTP Identifier

See [Section 26.1.8.4.2](#), *BOOTP (RFC 951)* and Errata Advisory 1.0.8.

PG1.0: BOOTP Identifier string is "DM814x ROM v1.0".

PG2.x: BOOTP Identifier string is "AM335x ROM".

Changed Product String in USB Descriptor

See [Section 26.1.8.6.1.2](#), *Enumeration Descriptors*.

PG1.0: Product string in USB descriptor is "Subarctic".

PG2.x: Product string in USB descriptor is "AM335x USB".

Added DPLL Power Switch Control and Status Registers

See [Section 9.3.1.13](#), *dpll_pwr_sw_status Register*, and [Section 9.3.1.74](#), *dpll_pwr_sw_ctrl Register*.

PG1.0: DPLL Power Switch Control and Status registers do not exist.

PG2.x: Added DPLL Power Switch Control and DPLL Power Switch Status registers in the Control Module to facilitate power optimization.

Added Control for CORE SRAM LDO Retention Mode

See newly added SMA2 register, [Section 9.3.1.76](#).

PG1.0: SMA2 register does not exist.

PG2.x: Added SMA2.VSLDO_CORE_AUTO_RAMP_EN.

Added Pin Mux Options for GPMC_A9 to Facilitate RMII Pin Muxing

See newly added SMA2 register, [Section 9.3.1.76](#).

PG1.0: SMA2 register does not exist.

PG2.x: Added SMA2.RMII2_CRS_DV_MODE_SEL.

Changed Polarity of Input Signal nNMI (Pin EXTINTn)

See [Section 6.3](#), *ARM Cortex-A8 Interrupts* and Errata Advisory 1.0.6.

PG1.0: nNMI input signal is active high.

PG2.x: nNMI input signal is active low.

Changed Default Value of ncin and pcin Bits in vtp_ctrl Register

See [Section 9.3.1.52](#), *vtp_ctrl Register*.

PG1.0: VTP_CTRL.NCIN and VTP_CTRL.PCIN reset value is 0.

PG2.x: VTP_CTRL.NCIN and VTP_CTRL.PCIN reset value is 1.

Changed Default Value of RGMII Mode to No Internal Delay

See [Section 9.3.1.29](#), *gmii_sel Register* and Errata Advisory 1.0.10.

PG1.0: RGMII1_IDMODE And RGMII2_IDMODE reset value is 0.

PG2.x: RGMII1_IDMODE And RGMII2_IDMODE reset value is 1.

Changed Default Value of RMII Clock Source

See [Section 9.3.1.29](#), *gmii_sel Register* and Errata Advisory 1.0.18.

PG1.0: RMII1_IO_CLK_EN and RMII2_IO_CLK_EN reset value is 0.

PG2.x: RMII1_IO_CLK_EN and RMII2_IO_CLK_EN reset value is 1.

Changed the Method of Determining Speed of Operation During EMAC Boot

See [Section 26.1.8.4](#), *EMAC Boot Procedure* and Errata Advisory 1.0.7.

PG1.0: Link speed is determined by CONTROL register bit 6 in the external ethernet PHY. Note that some PHYs may not update this bit, as it is not necessary as described in the 802.3 specification.

PG2.x: Link speed is determined by reading the Auto-Negotiation Advertisement and Auto-Negotiation Link Partner Base Page Ability registers in the external ethernet PHY.

Added EFUSE_SMA Register for Help Identifying Different Device Variants

See [Section 9.3.1.48](#), *efuse_sma Register*.

PG1.0: EFUSE_SMA register value is not applicable. Value is always 0.

PG2.x: Added EFUSE_SMA description to distinguish package type and maximum ARM frequency of the device.

Memory Map

This sections describes the memory map for the device.

2.1 ARM Cortex-A8 Memory Map

Table 2-1. L3 Memory Map

Block Name	Start_address (hex)	End_address (hex)	Size	Description
GPMC (External Memory)	0x0000_0000 ⁽¹⁾	0x1FFF_FFFF	512MB	8-/16-bit External Memory (Ex/R/W) ⁽²⁾
Reserved	0x2000_0000	0x3FFF_FFFF	512MB	Reserved
Boot ROM	0x4000_0000	0x4001_FFFF	128KB	
	0x4002_0000	0x4002_BFFF	48KB	32-bit Ex/R/W ⁽²⁾ – Public
Reserved	0x4002_C000	0x400F_FFFF	848KB	Reserved
Reserved	0x4010_0000	0x401F_FFFF	1MB	Reserved
Reserved	0x4020_0000	0x402E_FFFF	960KB	Reserved
Reserved	0x402F_0000	0x402F_03FF	64KB	Reserved
SRAM internal	0x402F_0400	0x402F_FFFF		32-bit Ex/R/W ⁽²⁾
L3 OCMC0	0x4030_0000	0x4030_FFFF	64KB	32-bit Ex/R/W ⁽²⁾ OCMC SRAM
Reserved	0x4031_0000	0x403F_FFFF	960KB	Reserved
Reserved	0x4040_0000	0x4041_FFFF	128KB	Reserved
Reserved	0x4042_0000	0x404F_FFFF	896KB	Reserved
Reserved	0x4050_0000	0x405F_FFFF	1MB	Reserved
Reserved	0x4060_0000	0x407F_FFFF	2MB	Reserved
Reserved	0x4080_0000	0x4083_FFFF	256KB	Reserved
Reserved	0x4084_0000	0x40DF_FFFF	5888KB	Reserved
Reserved	0x40E0_0000	0x40E0_7FFF	32KB	Reserved
Reserved	0x40E0_8000	0x40EF_FFFF	992KB	Reserved
Reserved	0x40F0_0000	0x40F0_7FFF	32KB	Reserved
Reserved	0x40F0_8000	0x40FF_FFFF	992KB	Reserved
Reserved	0x4100_0000	0x41FF_FFFF	16MB	Reserved
Reserved	0x4200_0000	0x43FF_FFFF	32MB	Reserved
L3F CFG Regs	0x4400_0000	0x443F_FFFF	4MB	L3Fast configuration registers
Reserved	0x4440_0000	0x447F_FFFF	4MB	Reserved
L3S CFG Regs	0x4480_0000	0x44BF_FFFF	4MB	L3Slow configuration registers
L4_WKUP	0x44C0_0000	0x44FF_FFFF	4MB	L4_WKUP
Reserved	0x4500_0000	0x45FF_FFFF	16MB	Reserved
McASP0 Data	0x4600_0000	0x463F_FFFF	4MB	McASP0 Data Registers
McASP1 Data	0x4640_0000	0x467F_FFFF	4MB	McASP1 Data Registers
Reserved	0x4680_0000	0x46FF_FFFF	8MB	Reserved
Reserved	0x4700_0000	0x473F_FFFF	4MB	Reserved

⁽¹⁾ The first 1MB of address space 0x0-0xFFFFF is inaccessible externally.

⁽²⁾ Ex/R/W – Execute/Read/Write.

Table 2-1. L3 Memory Map (continued)

Block Name	Start_address (hex)	End_address (hex)	Size	Description
USBSS	0x4740_0000	0x4740_0FFF	32KB	USB Subsystem Registers
USB0	0x4740_1000	0x4740_12FF		USB0 Controller Registers
USB0_PHY	0x4740_1300	0x4740_13FF		USB0 PHY Registers
USB0 Core	0x4740_1400	0x4740_17FF		USB0 Core Registers
USB1	0x4740_1800	0x4740_1AFF		USB1 Controller Registers
USB1_PHY	0x4740_1B00	0x4740_1BFF		USB1 PHY Registers
USB1 Core	0x4740_1C00	0x4740_1FFF		USB1 Core Registers
USB CPPI DMA Controller	0x4740_2000	0x4740_2FFF		USB CPPI DMA Controller Registers
USB CPPI DMA Scheduler	0x4740_3000	0x4740_3FFF		USB CPPI DMA Scheduler Registers
USB Queue Manager	0x4740_4000	0x4740_7FFF		USB Queue Manager Registers
Reserved	0x4740_8000	0x477F_FFFF	4MB-32KB	Reserved
Reserved	0x4780_0000	0x4780_FFFF	64KB	Reserved
MMCHS2	0x4781_0000	0x4781_FFFF	64KB	MMCHS2
Reserved	0x4782_0000	0x47BF_FFFF	4MB-128KB	Reserved
Reserved	0x47C0_0000	0x47FF_FFFF	4MB	Reserved
L4_PER	0x4800_0000	0x48FF_FFFF	16MB	L4 Peripheral (see L4_PER table)
TPCC (EDMA3CC)	0x4900_0000	0x490F_FFFF	1MB	EDMA3 Channel Controller Registers
Reserved	0x4910_0000	0x497F_FFFF	7MB	Reserved
TPTC0 (EDMA3TC0)	0x4980_0000	0x498F_FFFF	1MB	EDMA3 Transfer Controller 0 Registers
TPTC1 (EDMA3TC1)	0x4990_0000	0x499F_FFFF	1MB	EDMA3 Transfer Controller 1 Registers
TPTC2 (EDMA3TC2)	0x49A0_0000	0x49AF_FFFF	1MB	EDMA3 Transfer Controller 2 Registers
Reserved	0x49B0_0000	0x49BF_FFFF	1MB	Reserved
Reserved	0x49C0_0000	0x49FF_FFFF	4MB	Reserved
L4_FAST	0x4A00_0000	0x4AFF_FFFF	16MB	L4_FAST
Reserved	0x4B00_0000	0x4B13_FFFF	1280KB	Reserved
Reserved	0x4B14_0000	0x4B15_FFFF	128KB	Reserved
DebugSS_DRM	0x4B16_0000	0x4B16_0FFF	4KB	Debug Subsystem: Debug Resource Manager
DebugSS_ETB	0x4B16_2000	0x4B16_2FFF	4KB	Debug Subsystem: Embedded Trace Buffer
Reserved	0x4B16_3000	0x4BFF_FFFF	15MB-396KB	Reserved
EMIF0	0x4C00_0000	0x4CFF_FFFF	16MB	EMIF0 Configuration registers
Reserved	0x4D00_0000	0x4DFF_FFFF	16MB	Reserved
Reserved	0x4E00_0000	0x4FFF_FFFF	32MB	Reserved
GPMC	0x5000_0000	0x50FF_FFFF	16MB	GPMC Configuration registers
Reserved	0x5100_0000	0x52FF_FFFF	32MB	Reserved
Reserved	0x5300_0000	0x530F_FFFF	1MB	Reserved
	0x5310_0000	0x531F_FFFF	1MB	Reserved
Reserved	0x5320_0000	0x533F_FFFF	2MB	Reserved
Reserved	0x5340_0000	0x534F_FFFF	1MB	Reserved
	0x5350_0000	0x535F_FFFF	1MB	Reserved
Reserved	0x5360_0000	0x54BF_FFFF	22MB	Reserved
ADC_TSC DMA	0x54C0_0000	0x54FF_FFFF	4MB	ADC_TSC DMA Port
Reserved	0x5500_0000	0x55FF_FFFF	16MB	Reserved

Table 2-1. L3 Memory Map (continued)

Block Name	Start_address (hex)	End_address (hex)	Size	Description
SGX530	0x5600_0000	0x56FF_FFFF	16MB	SGX530 Slave Port
Reserved	0x5700_0000	0x57FF_FFFF	16MB	Reserved
Reserved	0x5800_0000	0x58FF_FFFF	16MB	Reserved
Reserved	0x5900_0000	0x59FF_FFFF	16MB	Reserved
Reserved	0x5A00_0000	0x5AFF_FFFF	16MB	Reserved
Reserved	0x5B00_0000	0x5BFF_FFFF	16MB	Reserved
Reserved	0x5C00_0000	0x5DFF_FFFF	32MB	Reserved
Reserved	0x5E00_0000	0x5FFF_FFFF	32MB	Reserved
Reserved	0x6000_0000	0x7FFF_FFFF	512MB	Reserved
EMIF0 SDRAM	0x8000_0000	0xBFFF_FFFF	1GB	8-/16-bit External Memory (Ex/R/W) ⁽³⁾
Reserved	0xC000_0000	0xFFFF_FFFF	1GB	Reserved

⁽³⁾ Ex/R/W – Execute/Read/Write.

Table 2-2. L4_WKUP Peripheral Memory Map

Region Name	Start Address (hex)	End Address (hex)	Size	Description
L4_WKUP configuration	0x44C0_0000	0x44C0_07FF	2KB	Address/Protection (AP)
	0x44C0_0800	0x44C0_0FFF	2KB	Link Agent (LA)
	0x44C0_1000	0x44C0_13FF	1KB	Initiator Port (IP0)
	0x44C0_1400	0x44C0_17FF	1KB	Initiator Port (IP1)
Reserved	0x44C0_1800	0x44C0_1FFF	2KB	Reserved (IP2 – IP3)
Reserved	0x44C0_2000	0x44CF_FFFF	1MB-8KB	Reserved
Reserved	0x44D0_0000	0x44D0_3FFF	16KB	Reserved
	0x44D0_4000	0x44D0_4FFF	4KB	Reserved
Reserved	0x44D0_5000	0x44D7_FFFF	492KB	Reserved
Reserved	0x44D8_0000	0x44D8_1FFF	8KB	Reserved
	0x44D8_2000	0x44D8_2FFF	4KB	Reserved
Reserved	0x44D8_3000	0x44DF_FFFF	500KB	Reserved
CM_PER	0x44E0_0000	0x44E0_3FFF	1KB	Clock Module Peripheral Registers
CM_WKUP	0x44E0_0400	0x44E0_04FF	256 Bytes	Clock Module Wakeup Registers
CM_DPLL	0x44E0_0500	0x44E0_05FF	256 Bytes	Clock Module PLL Registers
CM_MPU	0x44E0_0600	0x44E0_06FF	256 Bytes	Clock Module MPU Registers
CM_DEVICE	0x44E0_0700	0x44E0_07FF	256 Bytes	Clock Module Device Registers
CM_RTC	0x44E0_0800	0x44E0_08FF	256 Bytes	Clock Module RTC Registers
CM_GFX	0x44E0_0900	0x44E0_09FF	256 Bytes	Clock Module Graphics Controller Registers
CM_CEFUSE	0x44E0_0A00	0x44E0_0AFF	256 Bytes	Clock Module Efuse Registers
PRM_IRQ	0x44E0_0B00	0x44E0_0BFF	256 Bytes	Power Reset Module Interrupt Registers
PRM_PER	0x44E0_0C00	0x44E0_0CFF	256 Bytes	Power Reset Module Peripheral Registers
PRM_WKUP	0x44E0_0D00	0x44E0_0DFF	256 Bytes	Power Reset Module Wakeup Registers
PRM_MPU	0x44E0_0E00	0x44E0_0EFF	256 Bytes	Power Reset Module MPU Registers
PRM_DEV	0x44E0_0F00	0x44E0_0FFF	256 Bytes	Power Reset Module Device Registers
PRM_RTC	0x44E0_1000	0x44E0_10FF	256 Bytes	Power Reset Module RTC Registers

Table 2-2. L4_WKUP Peripheral Memory Map (continued)

Region Name	Start Address (hex)	End Address (hex)	Size	Description
PRM_GFX	0x44E0_1100	0x44E0_11FF	256 Bytes	Power Reset Module Graphics Controller Registers
PRM_CEFUSE	0x44E0_1200	0x44E0_12FF	256 Bytes	Power Reset Module Efuse Registers
Reserved	0x44E0_3000	0x44E0_3FFF	4KB	Reserved
	0x44E0_4000	0x44E0_4FFF	4KB	Reserved
DMTIMER0	0x44E0_5000	0x44E0_5FFF	4KB	DMTimer0 Registers
	0x44E0_6000	0x44E0_6FFF	4KB	Reserved
GPIO0	0x44E0_7000	0x44E0_7FFF	4KB	GPIO Registers
	0x44E0_8000	0x44E0_8FFF	4KB	Reserved
UART0	0x44E0_9000	0x44E0_9FFF	4KB	UART Registers
	0x44E0_A000	0x44E0_AFFF	4KB	Reserved
I2C0	0x44E0_B000	0x44E0_BFFF	4KB	I2C Registers
	0x44E0_C000	0x44E0_CFFF	4KB	Reserved
ADC_TSC	0x44E0_D000	0x44E0_EFFF	8KB	ADC_TSC Registers
	0x44E0_F000	0x44E0_FFFF	4KB	Reserved
Control Module	0x44E1_0000	0x44E1_1FFF	128KB	Control Module Registers
DDR2/3/mDDR PHY	0x44E1_2000	0x44E1_23FF		DDR2/3/mDDR PHY Registers
Reserved	0x44E1_2400	0x44E3_0FFF	4KB	Reserved
DMTIMER1_1MS (Accurate 1ms timer)	0x44E3_1000	0x44E3_1FFF	4KB	DMTimer1 1ms Registers
	0x44E3_2000	0x44E3_2FFF	4KB	Reserved
Reserved	0x44E3_3000	0x44E3_3FFF	4KB	Reserved
	0x44E3_4000	0x44E3_4FFF	4KB	Reserved
WDT1	0x44E3_5000	0x44E3_5FFF	4KB	Watchdog Timer Registers
	0x44E3_6000	0x44E3_6FFF	4KB	Reserved
SmartReflex0	0x44E3_7000	0x44E3_7FFF	4KB	L3 Registers
	0x44E3_8000	0x44E3_8FFF	4KB	Reserved
SmartReflex1	0x44E3_9000	0x44E3_9FFF	4KB	L3 Registers
	0x44E3_A000	0x44E3_AFFF	4KB	Reserved
Reserved	0x44E3_B000	0x44E3_DFFF	12KB	Reserved
RTCSS	0x44E3_E000	0x44E3_EFFF	4KB	RTC Registers
	0x44E3_F000	0x44E3_FFFF	4KB	Reserved
DebugSS Instrumentation HWMaster1 Port	0x44E4_0000	0x44E7_FFFF	256KB	Debug Registers
	0x44E8_0000	0x44E8_0FFF	4KB	Reserved
Reserved	0x44E8_1000	0x44EF_FFFF	508KB	Reserved
Reserved	0x44F0_0000	0x44FF_FFFF	1MB	Reserved

Table 2-3. L4_PER Peripheral Memory Map

Device Name	Start_address (hex)	End_address (hex)	Size	Description
Reserved	0x4800_0000	0x4800_07FF	2KB	Reserved
	0x4800_0800	0x4800_0FFF	2KB	Reserved
	0x4800_1000	0x4800_13FF	1KB	Reserved
	0x4800_1400	0x4800_17FF	1KB	Reserved
	0x4800_1800	0x4800_1BFF	1KB	Reserved
	0x4800_1C00	0x4800_1FFF	1KB	Reserved

Table 2-3. L4_PER Peripheral Memory Map (continued)

Device Name	Start_address (hex)	End_address (hex)	Size	Description
Reserved	0x4800_2000	0x4800_3FFF	8KB	Reserved
Reserved	0x4800_4000	0x4800_7FFF	16KB	Reserved
Reserved	0x4800_8000	0x4800_8FFF	4KB	Reserved
	0x4800_9000	0x4800_9FFF	4KB	Reserved
Reserved	0x4800_A000	0x4800_FFFF	24KB	Reserved
Reserved	0x4801_0000	0x4801_0FFF	4KB	Reserved
	0x4801_1000	0x4801_1FFF	4KB	Reserved
Reserved	0x4801_2000	0x4801_3FFF	8KB	Reserved
Reserved	0x4801_4000	0x4801_FFFF	48KB	Reserved
Reserved	0x4802_0000	0x4802_0FFF	4KB	Reserved
	0x4802_1000	0x4802_1FFF	4KB	Reserved
UART1	0x4802_2000	0x4802_2FFF	4KB	UART1 Registers
	0x4802_3000	0x4802_3FFF	4KB	Reserved
UART2	0x4802_4000	0x4802_4FFF	4KB	UART2 Registers
	0x4802_5000	0x4802_5FFF	4KB	Reserved
Reserved	0x4802_6000	0x4802_7FFF	8KB	Reserved
Reserved	0x4802_8000	0x4802_8FFF	4KB	Reserved
	0x4802_9000	0x4802_9FFF	4KB	Reserved
I2C1	0x4802_A000	0x4802_AFFF	4KB	I2C1 Registers
	0x4802_B000	0x4802_BFFF	4KB	Reserved
Reserved	0x4802_C000	0x4802_CFFF	4KB	Reserved
	0x4802_D000	0x4802_DFFF	4KB	Reserved
Reserved	0x4802_E000	0x4802_EFFF	4KB	Reserved
	0x4802_F000	0x4802_FFFF	4KB	Reserved
McSPI0	0x4803_0000	0x4803_0FFF	4KB	McSPI0 Registers
	0x4803_1000	0x4803_1FFF	4KB	Reserved
Reserved	0x4803_2000	0x4803_2FFF	4KB	Reserved
	0x4803_3000	0x4803_3FFF	4KB	Reserved
Reserved	0x4803_4000	0x4803_4FFF	4KB	Reserved
	0x4803_5000	0x4803_5FFF	4KB	Reserved
Reserved	0x4803_6000	0x4803_6FFF	4KB	Reserved
	0x4803_7000	0x4803_7FFF	4KB	Reserved
McASP0 CFG	0x4803_8000	0x4803_9FFF	8KB	McASP0 CFG Registers
	0x4803_A000	0x4803_AFFF	4KB	Reserved
Reserved	0x4803_B000	0x4803_BFFF	4KB	Reserved
McASP1 CFG	0x4803_C000	0x4803_DFFF	8KB	McASP1 CFG Registers
	0x4803_E000	0x4803_EFFF	4KB	Reserved
Reserved	0x4803_F000	0x4803_FFFF	4KB	Reserved
DMTIMER2	0x4804_0000	0x4804_0FFF	4KB	DMTimer2 Registers
	0x4804_1000	0x4804_1FFF	4KB	Reserved
DMTIMER3	0x4804_2000	0x4804_2FFF	4KB	DMTimer3 Registers
	0x4804_3000	0x4804_3FFF	4KB	Reserved
DMTIMER4	0x4804_4000	0x4804_4FFF	4KB	DMTimer4 Registers
	0x4804_5000	0x4804_5FFF	4KB	Reserved
DMTIMER5	0x4804_6000	0x4804_6FFF	4KB	DMTimer5 Registers
	0x4804_7000	0x4804_7FFF	4KB	Reserved
DMTIMER6	0x4804_8000	0x4804_8FFF	4KB	DMTimer6 Registers

Table 2-3. L4_PER Peripheral Memory Map (continued)

Device Name	Start_address (hex)	End_address (hex)	Size	Description
	0x4804_9000	0x4804_9FFF	4KB	L4 Interconnect
DMTIMER7	0x4804_A000	0x4804_AFFF	4KB	DMTimer7 Registers
	0x4804_B000	0x4804_BFFF	4KB	Reserved
GPIO1	0x4804_C000	0x4804_CFFF	4KB	GPIO1 Registers
	0x4804_D000	0x4804_DFFF	4KB	Reserved
Reserved	0x4804_E000	0x4804_FFFF	8KB	Reserved
Reserved	0x4805_0000	0x4805_FFFF	64KB	Reserved
MMCHS0	0x4806_0000	0x4806_0FFF	4KB	MMCHS0 Registers
	0x4806_1000	0x4806_1FFF	4KB	Reserved
Reserved	0x4806_2000	0x4807_FFFF	120KB	Reserved
ELM	0x4808_0000	0x4808_FFFF	64KB	ELM Registers
	0x4809_0000	0x4809_0FFF	4KB	Reserved
Reserved	0x4809_1000	0x4809_FFFF	60KB	Reserved
Reserved	0x480A_0000	0x480A_FFFF	64KB	Reserved
	0x480B_0000	0x480B_0FFF	4KB	Reserved
Reserved	0x480B_1000	0x480B_FFFF	60KB	Reserved
Reserved	0x480C_0000	0x480C_0FFF	4KB	Reserved
	0x480C_1000	0x480C_1FFF	4KB	Reserved
Reserved	0x480C_2000	0x480C_2FFF	4KB	Reserved
	0x480C_3000	0x480C_3FFF	4KB	Reserved
Reserved	0x480C_4000	0x480C_7FFF	16KB	Reserved
Mailbox 0	0x480C_8000	0x480C_8FFF	4KB	Mailbox Registers
	0x480C_9000	0x480C_9FFF	4KB	Reserved
Spinlock	0x480C_A000	0x480C_AFFF	4KB	Spinlock Registers
	0x480C_B000	0x480C_BFFF	4KB	Reserved
Reserved	0x480C_C000	0x480F_FFFF	208KB	Reserved
Reserved	0x4810_0000	0x4811_FFFF	128KB	Reserved
	0x4812_0000	0x4812_0FFF	4KB	Reserved
Reserved	0x4812_1000	0x4812_1FFF	4KB	Reserved
Reserved	0x4812_2000	0x4812_2FFF	4KB	Reserved
	0x4812_3000	0x4812_3FFF	4KB	Reserved
Reserved	0x4812_4000	0x4813_FFFF	112KB	Reserved
Reserved	0x4814_0000	0x4815_FFFF	128KB	Reserved
	0x4816_0000	0x4816_0FFF	4K	Reserved
Reserved	0x4816_1000	0x4817_FFFF	124KB	Reserved
Reserved	0x4818_0000	0x4818_2FFF	12KB	Reserved
	0x4818_3000	0x4818_3FFF	4KB	Reserved
Reserved	0x4818_4000	0x4818_7FFF	16KB	Reserved
Reserved	0x4818_8000	0x4818_8FFF	4KB	Reserved
	0x4818_9000	0x4818_9FFF	4KB	Reserved
Reserved	0x4818_A000	0x4818_AFFF	4KB	Reserved
	0x4818_B000	0x4818_BFFF	4KB	Reserved
OCP Watchpoint	0x4818_C000	0x4818_CFFF	4KB	OCP Watchpoint Registers
	0x4818_D000	0x4818_DFFF	4KB	Reserved
Reserved	0x4818_E000	0x4818_EFFF	4KB	Reserved
	0x4818_F000	0x4818_FFFF	4KB	Reserved
Reserved	0x4819_0000	0x4819_0FFF	4KB	Reserved

Table 2-3. L4_PER Peripheral Memory Map (continued)

Device Name	Start_address (hex)	End_address (hex)	Size	Description
	0x4819_1000	0x4819_1FFF	4KB	Reserved
Reserved	0x4819_2000	0x4819_2FFF	4KB	Reserved
	0x4819_3000	0x4819_3FFF	4KB	Reserved
Reserved	0x4819_4000	0x4819_BFFF	32KB	Reserved
I2C2	0x4819_C000	0x4819_CFFF	4KB	I2C2 Registers
	0x4819_D000	0x4819_DFFF	4KB	Reserved
Reserved	0x4819_E000	0x4819_EFFF	4KB	Reserved
	0x4819_F000	0x4819_FFFF	4KB	Reserved
McSPI1	0x481A_0000	0x481A_0FFF	4KB	McSPI1 Registers
	0x481A_1000	0x481A_1FFF	4KB	Reserved
Reserved	0x481A_2000	0x481A_5FFF	16KB	Reserved
UART3	0x481A_6000	0x481A_6FFF	4KB	UART3 Registers
	0x481A_7000	0x481A_7FFF	4KB	Reserved
UART4	0x481A_8000	0x481A_8FFF	4KB	UART4 Registers
	0x481A_9000	0x481A_9FFF	4KB	Reserved
UART5	0x481A_A000	0x481A_AFFF	4KB	UART5 Registers
	0x481A_B000	0x481A_BFFF	4KB	Reserved
GPIO2	0x481A_C000	0x481A_CFFF	4KB	GPIO2 Registers
	0x481A_D000	0x481A_DFFF	4KB	Reserved
GPIO3	0x481A_E000	0x481A_EFFF	4KB	GPIO3 Registers
	0x481A_F000	0x481A_FFFF	4KB	Reserved
Reserved	0x481B_0000	0x481B_FFFF	64KB	Reserved
	0x481C_0000	0x481C_0FFF	4KB	Reserved
Reserved	0x481C_1000	0x481C_1FFF	4KB	Reserved
	0x481C_2000	0x481C_2FFF	4KB	Reserved
Reserved	0x481C_3000	0x481C_9FFF	28KB	Reserved
Reserved	0x481C_A000	0x481C_AFFF	4KB	Reserved
	0x481C_B000	0x481C_BFFF	4KB	Reserved
DCAN0	0x481C_C000	0x481C_DFFF	8KB	DCAN0 Registers
	0x481C_E000	0x481C_FFFF	8KB	Reserved
DCAN1	0x481D_0000	0x481D_1FFF	8KB	DCAN1 Registers
	0x481D_2000	0x481D_3FFF	8KB	Reserved
Reserved	0x481D_4000	0x481D_4FFF	4KB	Reserved
	0x481D_5000	0x481D_5FFF	4KB	Reserved
Reserved	0x481D_6000	0x481D_6FFF	4KB	Reserved
	0x481D_7000	0x481D_7FFF	4KB	Reserved
MMC1	0x481D_8000	0x481D_8FFF	4KB	MMC1 Registers
	0x481D_9000	0x481D_9FFF	4KB	Reserved
Reserved	0x481D_A000	0x481F_FFFF	152KB	Reserved
Interrupt controller (INTCPS)	0x4820_0000	0x4820_0FFF	4KB	Interrupt Controller Registers
Reserved	0x4820_1000	0x4823_FFFF	252KB	Reserved
MPUSS config register	0x4824_0000	0x4824_0FFF	4KB	Host ARM non-shared device mapping
Reserved	0x4824_1000	0x4827_FFFF	252KB	Reserved
Reserved	0x4828_0000	0x4828_0FFF	4KB	Reserved
Reserved	0x4828_1000	0x482F_FFFF	508KB	Reserved

Table 2-3. L4_PER Peripheral Memory Map (continued)

Device Name	Start_address (hex)	End_address (hex)	Size	Description
PWM Subsystem 0	0x4830_0000	0x4830_00FF	4KB	PWMSS0 Configuration Registers
eCAP0	0x4830_0100	0x4830_017F		PWMSS eCAP0 Registers
eQEP0	0x4830_0180	0x4830_01FF		PWMSS eQEP0 Registers
ePWM0	0x4830_0200	0x4830_025F		PWMSS ePWM0 Registers
	0x4830_0260	0x4830_1FFF	4KB	Reserved
PWM Subsystem 1	0x4830_2000	0x4830_20FF	4KB	PWMSS1 Configuration Registers
eCAP1	0x4830_2100	0x4830_217F		PWMSS eCAP1 Registers
eQEP1	0x4830_2180	0x4830_21FF		PWMSS eQEP1 Registers
ePWM1	0x4830_2200	0x4830_225F		PWMSS ePWM1 Registers
	0x4830_2260	0x4830_3FFF	4KB	Reserved
PWM Subsystem 2	0x4830_4000	0x4830_40FF	4KB	PWMSS2 Configuration Registers
eCAP2	0x4830_4100	0x4830_417F		PWMSS eCAP2 Registers
eQEP2	0x4830_4180	0x4830_41FF		PWMSS eQEP2 Registers
ePWM2	0x4830_4200	0x4830_425F		PWMSS ePWM2 Registers
	0x4830_4260	0x4830_5FFF	4KB	Reserved
Reserved	0x4830_6000	0x4830_DFFF	32KB	Reserved
LCD Controller	0x4830_E000	0x4830_EFFF	4KB	LCD Registers
	0x4830_F000	0x4830_FFFF	4KB	Reserved
Reserved	0x4831_0000	0x4831_1FFF	8KB	Reserved
	0x4831_2000	0x4831_2FFF	4KB	Reserved
Reserved	0x4831_3000	0x4831_7FFF	20KB	Reserved
Reserved	0x4831_8000	0x4831_BFFF	16KB	Reserved
	0x4831_C000	0x4831_CFFF	4KB	Reserved
Reserved	0x4831_D000	0x4831_FFFF	12KB	Reserved
Reserved	0x4832_0000	0x4832_5FFF	16KB	Reserved
Reserved	0x4832_6000	0x48FF_FFFF	13MB-152KB	Reserved

Table 2-4. L4 Fast Peripheral Memory Map

Device Name	Start_address (hex)	End_address (hex)	Size	Description
L4_Fast configuration	0x4A00_0000	0x4A00_07FF	2KB	Address/Protection (AP)
	0x4A00_0800	0x4A00_0FFF	2KB	Link Agent (LA)
	0x4A00_1000	0x4A00_13FF	1KB	Initiator Port (IP0)
	0x4A00_1400	0x4A00_17FF	1KB	Reserved
	0x4A00_1800	0x4A00_1FFF	2KB	Reserved (IP2 – IP3)
Reserved	0x4A00_2000	0x4A07_FFFF	504KB	Reserved
Reserved	0x4A08_0000	0x4A09_FFFF	128KB	Reserved
	0x4A0A_0000	0x4A0A_0FFF	4KB	Reserved
Reserved	0x4A0A_1000	0x4A0F_FFFF	380KB	Reserved
CPSW_SS	0x4A10_0000	0x4A10_7FFF	32KB	Ethernet Switch Subsystem
CPSW_PORT	0x4A10_0100	0x4A10_07FF		Ethernet Switch Port Control
CPSW_CPDMA	0x4A10_0800	0x4A10_08FF		CPPI DMA Controller Module
CPSW_STATS	0x4A10_0900	0x4A10_09FF		Ethernet Statistics
CPSW_STATERAM	0x4A10_0A00	0x4A10_0BFF		CPPI DMA State RAM
CPSW_CPTS	0x4A10_0C00	0x4A10_0CFF		Ethernet Time Sync Module

Table 2-4. L4 Fast Peripheral Memory Map (continued)

Device Name	Start_address (hex)	End_address (hex)	Size	Description
CPSW_ALE	0x4A10_0D00	0x4A10_0D7F		Ethernet Address Lookup Engine
CPSW_SL1	0x4A10_0D80	0x4A10_0DBF		Ethernet Sliver for Port 1
CPSW_SL2	0x4A10_0DC0	0x4A10_0DFF		Ethernet Sliver for Port 2
Reserved	0x4A10_0E00	0x4A10_0FFF		Reserved
MDIO	0x4A10_1000	0x4A10_10FF		Ethernet MDIO Controller
Reserved	0x4A10_1100	0x4A10_11FF		Reserved
CPSW_WR	0x4A10_1200	0x4A10_1FFF		Ethernet Subsystem Wrapper for RMII/RGMII
CPPI_RAM	0x4A10_2000	0x4A10_3FFF		Communications Port Programming Interface RAM
Reserved	0x4A10_9000	0x4A13_FFFF	220KB	Reserved
Reserved	0x4A14_0000	0x4A14_FFFF	64KB	Reserved
	0x4A15_0000	0x4A15_0FFF	4KB	Reserved
Reserved	0x4A15_1000	0x4A17_FFFF	188KB	Reserved
Reserved	0x4A18_0000	0x4A1A_1FFF	136KB	Reserved
Reserved	0x4A1A_2000	0x4A1A_3FFF	8KB	Reserved
	0x4A1A_4000	0x4A1A_4FFF	4KB	Reserved
Reserved	0x4A1A_5000	0x4A1A_5FFF	4KB	Reserved
	0x4A1A_6000	0x4A1A_6FFF	4KB	Reserved
Reserved	0x4A1A_7000	0x4A1A_7FFF	4KB	Reserved
Reserved	0x4A1A_8000	0x4A1A_9FFF	8KB	Reserved
	0x4A1A_A000	0x4A1A_AFFF	4KB	Reserved
Reserved	0x4A1A_B000	0x4A1A_BFFF	4KB	Reserved
	0x4A1A_C000	0x4A1A_CFFF	4KB	Reserved
Reserved	0x4A1A_D000	0x4A1A_DFFF	4KB	Reserved
Reserved	0x4A1A_E000	0x4A1A_FFFF	8KB	Reserved
	0x4A1B_0000	0x4A1B_0FFF	4KB	Reserved
Reserved	0x4A1B_1000	0x4A1B_1FFF	4KB	Reserved
	0x4A1B_2000	0x4A1B_2FFF	4KB	Reserved
Reserved	0x4A1B_3000	0x4A1B_3FFF	4KB	Reserved
	0x4A1B_4000	0x4A1B_4FFF	4KB	Reserved
Reserved	0x4A1B_5000	0x4A1B_5FFF	4KB	Reserved
	0x4A1B_6000	0x4A1B_6FFF	4KB	Reserved
Reserved	0x4A1B_4000	0x4A1F_FFFF	304KB	Reserved
Reserved	0x4A20_0000	0x4A2F_FFFF	1MB	Reserved
PRU_ICSS	0x4A30_0000	0x4A37_FFFF	512KB	PRU-ICSS Instruction/Data/Control Space
	0x4A38_0000	0x4A38_0FFF	4KB	Reserved
Reserved	0x4A38_1000	0x4A3F_FFFF	508KB	Reserved
Reserved	0x4A40_0000	0x4AFF_FFFF	12MB	Reserved

ARM MPU Subsystem

This chapter describes the MPU Subsystem for the device.

Topic	Page
3.1 ARM Cortex-A8 MPU Subsystem	187

3.1 ARM Cortex-A8 MPU Subsystem

The Microprocessor Unit (MPU) subsystem of the device handles transactions between the ARM core (ARM® Cortex™-A8 Processor), the L3 interconnect, and the interrupt controller (INTC). The MPU subsystem is a hard macro that integrates the ARM® Cortex™-A8 Processor with additional logic for protocol conversion, emulation, interrupt handling, and debug enhancements.

Cortex™-A8 is an ARMv7 compatible, dual-issue, in-order execution engine with integrated L1 and L2 caches with NEON™ SIMD Media Processing Unit.

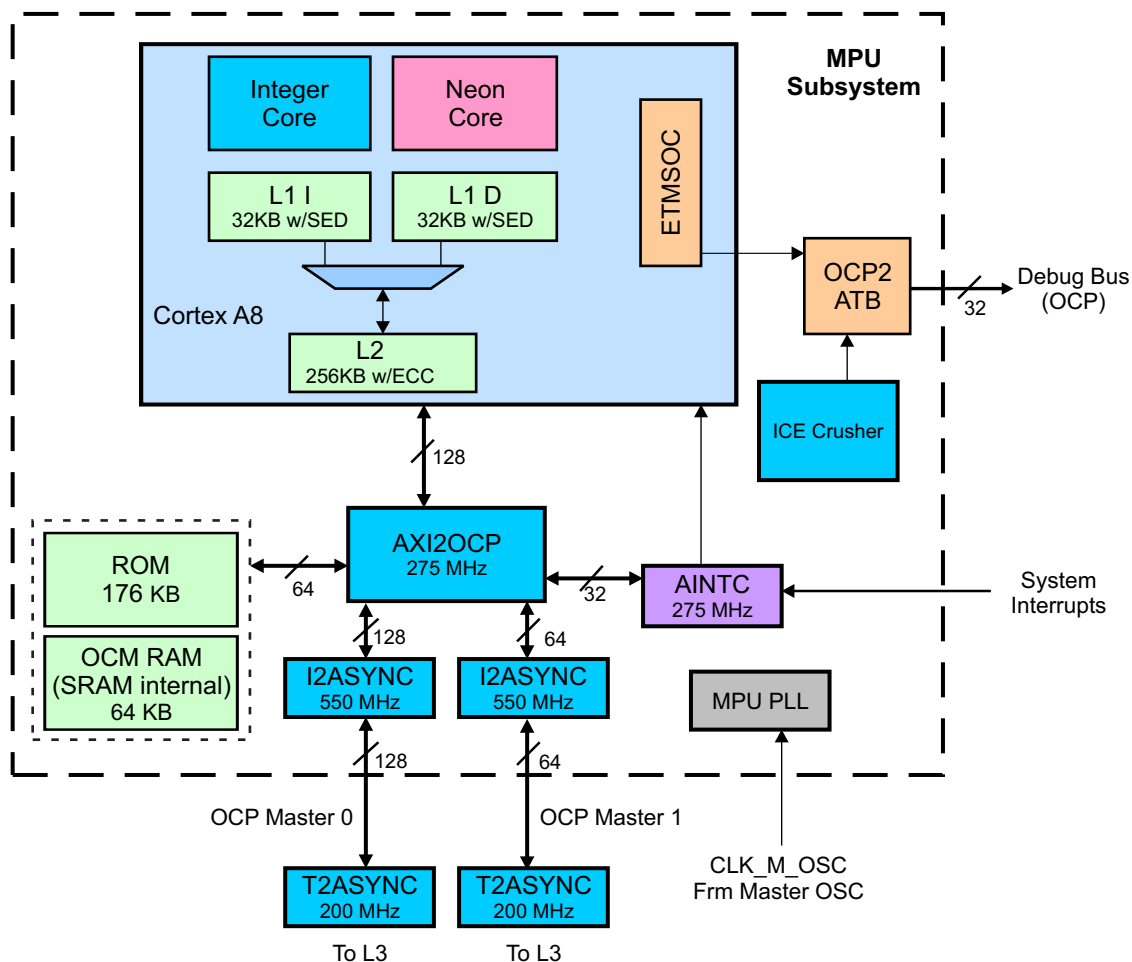
An Interrupt Controller is included in the MPU subsystem to handle host interrupt requests in the system.

The MPU subsystem includes CoreSight compliant logic to allow the Debug Sub-system access to the CortexA8 debug and emulation resources, including the Embedded Trace Macrocell.

The MPU subsystem has three functional clock domains, including a high-frequency clock domain used by the Cortex™-A8. The high-frequency domain is isolated from the rest of the system by asynchronous bridges.

Figure 3-1 shows the high-level block diagram of the MPU subsystem.

Figure 3-1. Microprocessor Unit (MPU) Subsystem



3.1.1 Features

This section outlines the key features of the MPU subsystem:

- ARM Microprocessor
 - Cortex-A8
 - ARM Architecture version 7 ISA.
 - 2-issue, in-order execution pipeline.
 - L1 Instruction and Data Cache of 32KB, 4-way, 16-word line with 128-bit interface.
 - Integrated L2 cache of 256 KB, 8-way, 16 word line, 128 bit interface to L1 along with ECC/Parity supported.
 - Includes the Neon Media coprocessor (NEON™) which implements the Advanced SIMD media processing architecture.
 - Includes the VFP coprocessor which implements the VFPv3 architecture and is fully compliant with IEEE 754 standard.
 - The external interface uses the AXI protocol configured to 128-bit data width.
 - Includes the Embedded Trace Macrocell (ETM) support for non-invasive debugging.
 - Implements the ARMv7 debug with watch-point and breakpoint registers and 32-bit Advanced Peripheral Bus (APB) slave interface to CoreSight debug systems.
- AXI2OCP Bridge
 - Support OCP 2.2.
 - Single Request Multiple Data Protocol on two ports.
 - Multiple targets, including three OCP ports (128-bit, 64-bit and 32-bit).
- Interrupt Controller
 - Support up to 128 interrupt requests
- Emulation/Debug
 - Compatible with CoreSight Architecture.
- Clock Generation
 - Through PRCM

3.1.2 MPU Subsystem Integration

The MPU subsystem integrates the following group of submodules:

ARM® Cortex®-A8 Processor: Provides a high processing capability, including the NEON technology for mobile multimedia acceleration. The ARM communicates through an AXI bus with the AXI2OCP bridge and receives interrupts from the MPU subsystem interrupt controller (MPU INTC).

Interrupt controller: Handles the module interrupts (for details, see [Chapter 6, Interrupts](#)).

AXI2OCP bridge: Allows communication between the ARM (AXI), the INTC (OCP), and the modules (OCP L3).

I2Async bridge: This is an asynchronous bridge interface providing an asynchronous OCP to OCP interface. This interface is between the AXI2OCP bridge within the MPU subsystem and the T2Async bridge external to the MPU subsystem.

Clock Generator: Provides the required divided clocks to the internal modules of the MPU subsystem and has a clock input from MPU_CLK which is fed by the power, reset, and clock management (PRCM) module of the device.

In-Circuit Emulator: It is fully Compatible with CoreSight Architecture and enables debugging capabilities.

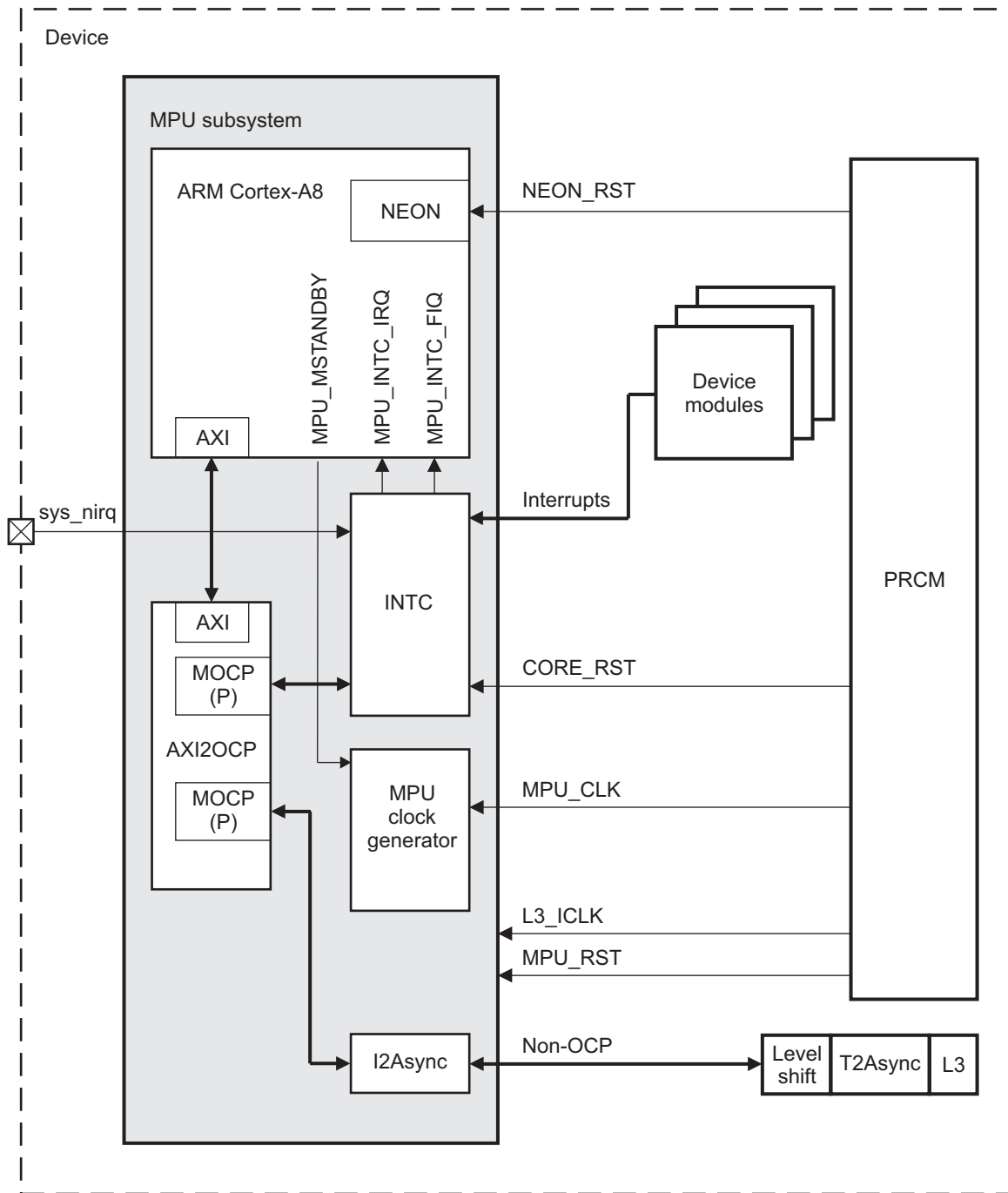


Figure 3-2. Microprocessor Unit (MPU) Subsystem Signal Interface

3.1.3 MPU Subsystem Clock and Reset Distribution

3.1.3.1 Clock Distribution

The MPU subsystem includes an embedded DPLL which sources the clock for the ARM Cortex-A8 processor. A clock divider within the subsystem is used for deriving the clocks for other internal modules.

All major modules inside the MPU subsystem are clocked at half the frequency of the ARM core. The divider of the output clock can be programmed with the `CM_DIV_M2_DPLL_MPU.DPLL_CLKOUT_DIV` register field, the frequency is relative to the ARM core. For details see [Chapter 8, Power, Reset, and Clock Management \(PRCM\)](#).

The clock generator generates the following functional clocks:

ARM (ARM_FCLK): This is the core clock. It is the base fast clock that is routed internally to the ARM logic and internal RAMs, including NEON, L2 cache, the ETM core (emulation), and the ARM core.

AXI2OCP Clock (AXI_FCLK): This clock is half the frequency of the ARM clock (ARM_FCLK). The OCP interface thus performs at one half the frequency of ARM.

Interrupt Controller Functional Clock (MPU_INTC_FCLK): This clock, which is part of the INTC module, is half the frequency of the ARM clock (ARM_FCLK).

ICE-Crusher Functional Clock (ICECRUSHER_FCLK): ICE-Crusher clocking operates on the APB interface, using the ARM core clocking. This clock is half the frequency of the ARM clock (ARM_FCLK).

I2Async Clock (I2ASYNC_FCLK): This clock is half the frequency of the ARM clock (ARM_FCLK). It matches the OCP interface of the AXI2OCP bridge.

NOTE: The second half of the asynchronous bridge (T2ASYNC) is clocked directly by the PRCM with the core clock. T2ASYNC is not part of the MPU subsystem.

Emulation Clocking: Emulation clocks are distributed by the PRCM module and are asynchronous to the ARM core clock (ARM_FCLK) and can run at a maximum of 1/3 the ARM core clock.

[Table 3-1](#) summarizes the clocks generated in the MPU subsystem by the MPU clock generator.

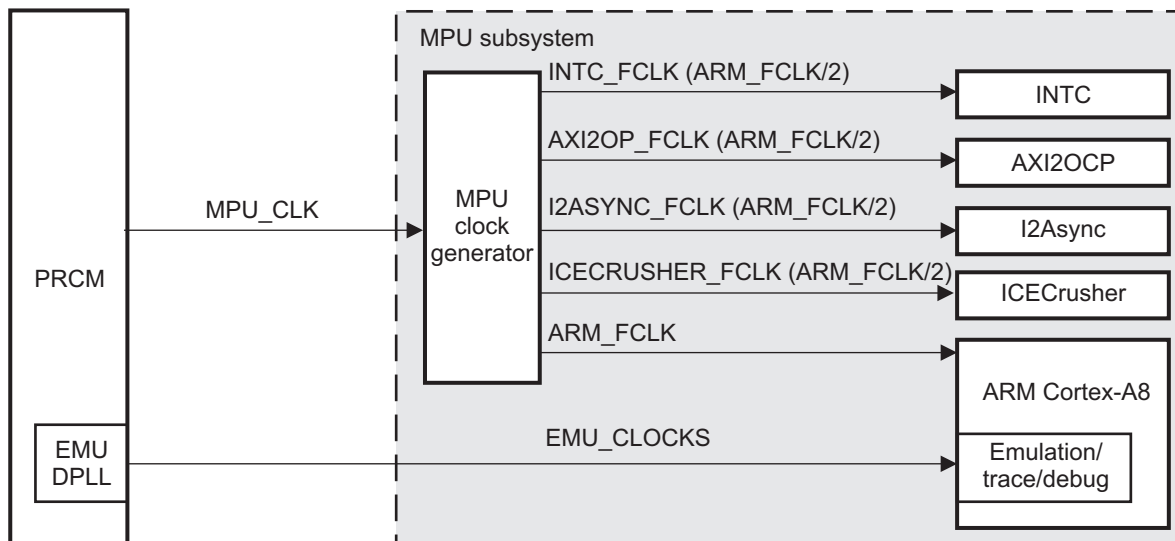


Figure 3-3. MPU Subsystem Clocking Scheme

Table 3-1. MPU Subsystem Clock Frequencies

Clock signal	Frequency
Cortex A8 Core Functional Clock	MPU_CLK
AXI2OCP Bridge Functional Clock	MPU_CLK / 2
Device Clock	MPU_CLK / 2
I2Async Bridge Functional Clock	MPU_CLK / 2

3.1.3.2 Reset Distribution

Resets to the MPU subsystem are provided by the PRCM and controlled by the clock generator module.

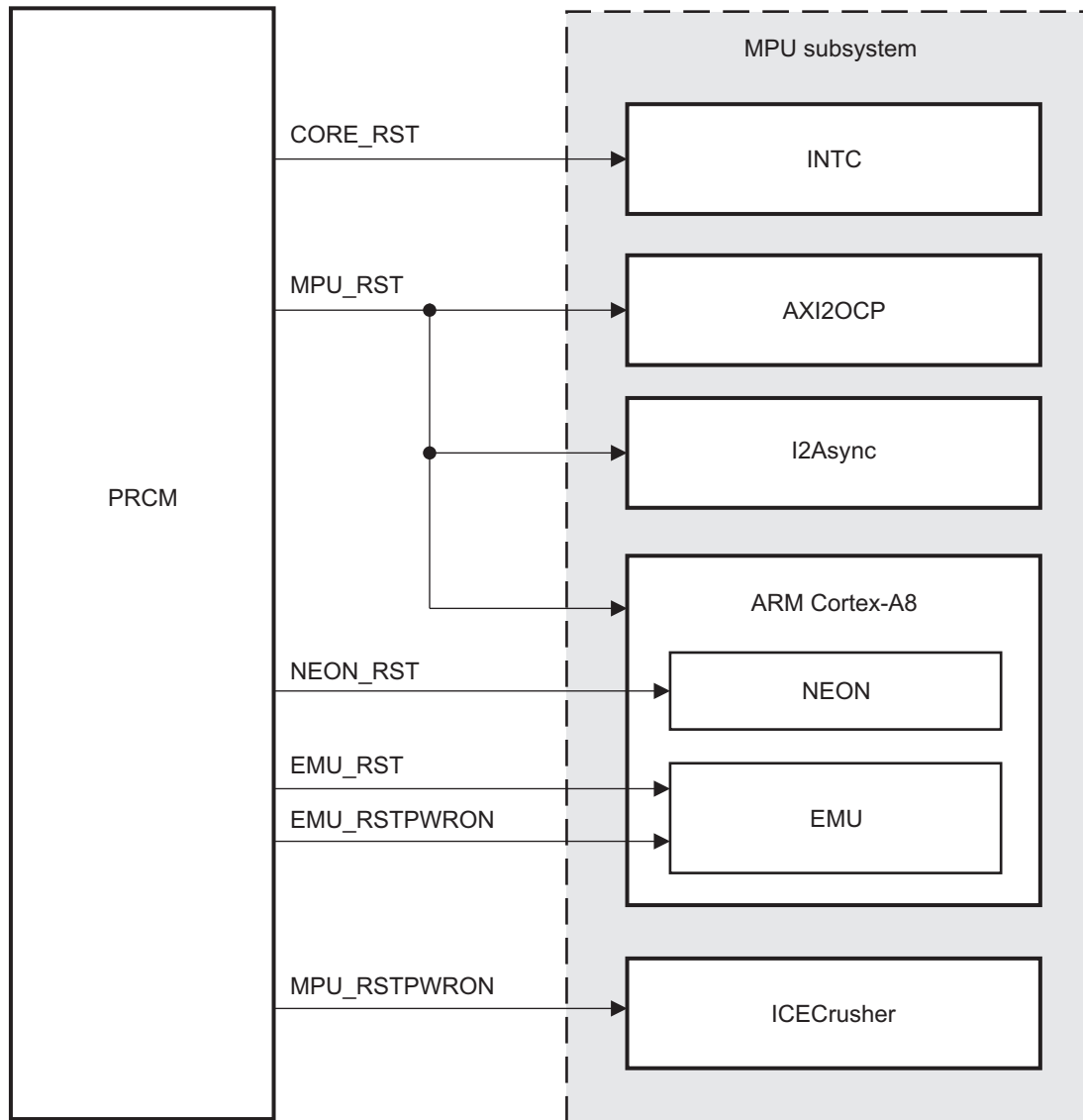


Figure 3-4. Reset Scheme of the MPU Subsystem

Table 3-2. Reset Scheme of the MPU Subsystem

Signal Name	I/O	Interface
MPU_RST	I	PRCM
NEON_RST	I	PRCM
CORE_RST	I	PRCM
MPU_RSTPWRON	I	PRCM
EMU_RST	I	PRCM
EMU_RSTPWRON	I	PRCM

For details about clocks, resets, and power domains, see [Chapter 8, Power, Reset, and Clock Management \(PRCM\)](#).

3.1.4 ARM Subchip

3.1.4.1 ARM Overview

The ARM Cortex-A8 processor incorporates the technologies available in the ARM7™ architecture. These technologies include NEON™ for media and signal processing and Jazelle™ RCT for acceleration of realtime compilers, Thumb®-2 technology for code density and the VFPv3 floating point architecture.

3.1.4.2 ARM Description

3.1.4.2.1 ARM® Cortex™-A8 Instruction, Data, and Private Peripheral Port

The AXI bus interface is the main interface to the ARM system bus. It performs L2 cache fills and non-cacheable accesses for both instructions and data. The AXI interface supports 128bit and 64-bit wide input and output data buses. It supports multiple outstanding requests on the AXI bus and a wide range of bus clock to core clock ratios. The bus clock is synchronous with the core clock.

See the ARM ® Cortex™-A8 Technical Reference Manual for a complete programming model of the transaction rules (ordering, posting, and pipeline synchronization) that are applied depending on the memory region attribute associated with the transaction destination address.

3.1.4.2.2 Secure Monitor Calls to Access CP15 Registers

The device supports special secure monitor functions that allows access to certain ARM core registers in privileged mode. Functions to write to the Auxiliary Control Register, Nonsecure Access Control Register, and the L2 Cache Auxiliary Control Register are provided (see the ARM Technical Reference Manual for a description of these registers).

Service ID (R12)	Description
0x100	Write value in R0 to Auxiliary Control Register
0x101	Write value in R0 to Non Secure Access Control Register
0x102	Write value in R0 to L2 Cache Auxiliary Control Register

In general, the procedure to use these secure monitor call is as follows:

- Write the appropriate service ID to R12 .
- Load R0 with the value to write to the ARM core register.
- Perform barrier operations to ensure proper execution.
- Use SMC #1 (or SMI #1) to make the secure monitor call

Barrier instructions are also necessary to ensure a clean state before entering the secure monitor. Refer to the following example which provides the proper code sequence. This code provides an example of enabling ECC on L2 cache. Note: This function should be executed in an ARM privileged mode.

```

_enableL2ECC:
    STMFD sp!, {r0 - r4}          ; save context of R0-R4, which secure monitor call may use
    MRC p15, #1, r0, c9, c0, #2   ; Read L2 Cache Auxiliary Control Reg into R0
    MOV r1, #0                    ; Clear R1
    MOVT r1, #0x1020              ; enable mask for ECC (set bits 21 and 28 to enable ECC)
    ORR r0, r0, r1                ; OR with original register value
    MOV r12, #0x0102              ; setup service ID in R12
    MCR p15, #0x0, r1, c7, c5, #6 ; invalidate entire branch predictor array
    DSB                           ; data synchronization barrier operation
    ISB                           ; instruction synchronization barrier operation
    DMB                           ; data memory barrier operation
    SMC #1                        ; secure monitor call SMC (previously SMI)
    LDMFD sp!, {r0 - r4}          ; after returning from SMC, restore R0-R4
    MOV pc, lr                    ; return
  
```

3.1.4.2.3 ARM Core Supported Features

Table 3-3 provides a list of main functions of the Cortex™-A8 core supported inside the MPU Subsystem.

Table 3-3. ARM Core Supported Features

Features	Comments
ARM version 7 ISA	Standard ARM instruction set + Thumb2™, JazelleX™ Java accelerator, and Media extensions. Backward compatible with previous ARM ISA versions.
L1 Icache and Dcache	32 KB , 4-way, 16 word line, 128 bit interface.
L2 Cache	256 KB, 8-way, 16 word line, 128 bit interface to L1, ECC/Parity is supported. The L2 cache and cache controller are embedded within the ARM core. L2 valid bits cleared by software loop or by hardware.
TLB	Fully associative and separate ITLB with 32 entries and DTLB with 32 entries.
CoreSight ETM	The CoreSight ETM is embedded with the ARM core. The 32KB buffer (ETB) exists at the Chip Level (DebugSS)
Branch Target Address Cache	512 entries
Enhanced Memory Management Unit	Mapping sizes are 4KB, 64KB, 1MB, and 16MB. (ARM MMU adds extended physical address ranges)
Neon	Gives greatly enhanced throughput for media workloads and VFP-Lite support.
Flat Memories	176 Kbytes of ROM 64 Kbytes of RAM
Buses	128 bit AXI internal bus from CortexA8 routed by an AXI2OCP bridge to the interrupt controller, ROM, RAM, and 3 asynchronous OCP bridges (128 bits, and 64 bits)
Low interrupt latency	Closely coupled INTC to the ARM core with 128 interrupt lines
Vectored Interrupt Controller Port	Present.
JTAG based debug	Supported via DAP
Trace support	Supported via TPIU
External Coprocessor	Not supported

3.1.5 Interrupt Controller

The Host ARM Interrupt Controller (AINTC) is responsible for prioritizing all service requests from the system peripherals and generating either nIRQ or nFIQ to the host. The type of the interrupt (nIRQ or nFIQ) and the priority of the interrupt inputs are programmable. The AINTC interfaces to the ARM processor via the AXI port through an AXI2OCP bridge and runs at half the processor speed. It has the capability to handle up to 128 requests which can be steered/prioritized as A8 nFIQ or nIRQ interrupt requests.

The general features of the AINTC are:

- Up to 128 level sensitive interrupts inputs
- Individual priority for each interrupt input
- Each interrupt can be steered to nFIQ or nIRQ
- Independent priority sorting for nFIQ and nIRQ

3.1.6 Power Management

3.1.6.1 Power Domains

The MPU subsystem is divided into four power domains controlled by the PRCM, as shown in [Figure 3-5](#).

NOTE: The emulation domain and the core domain are not fully embedded in MPU subsystem.

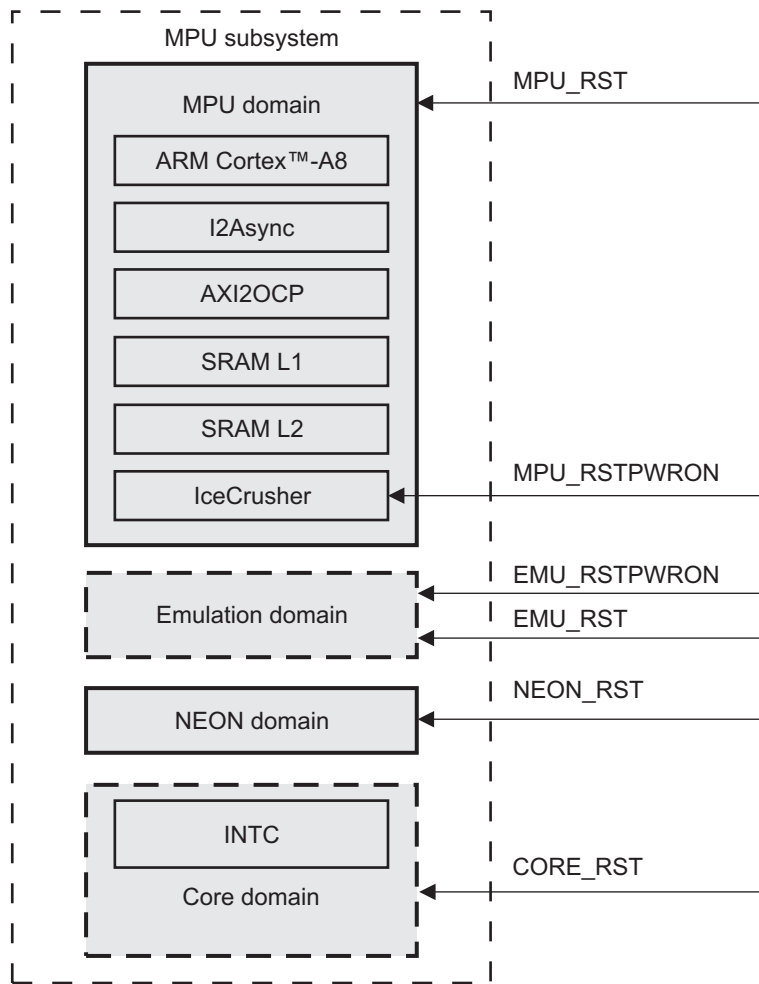


Figure 3-5. MPU Subsystem Power Domain Overview

Power management requirements at the device level govern power domains for the MPU subsystem. The device-level power domains are directly aligned with voltage domains and thus can be represented as a cross reference to the different voltage domains.

[Table 3-4](#) shows the different power domains of the MPU subsystem and the modules inside.

Table 3-4. Overview of the MPU Subsystem Power Domain

Functional Power Domain	Physical Power Domain per System/Module
MPU subsystem domain	ARM, AXI2OCP, I2Asynch Bridge, ARM L1 and L2 periphery logic and array, ICE-Crusher, ETM, APB modules
MPU NEON domain	ARM NEON accelerator
CORE domain	MPU interrupt controller
EMU domain	EMU (ETB,DAP)

NOTE: L1 and L2 array memories have separate control signals into the in MPU Subsystem, thus directly controlled by PRCM. For details on the physical power domains and the voltage domains, see [Chapter 8, Power, Reset, and Clock Management \(PRCM\)](#).

3.1.6.2 Power States

Each power domain can be driven by the PRCM in 3 different states, depending on the functional mode required by the user.

For each power domain the PRCM manages all transitions by controlling domain clocks, domain resets, domain logic power switches and memory power switches.

Table 3-5. MPU Power States

Power State	Logic Power	Memory Power	Clocks
Active	On	On or Off	On (at least one clock)
Inactive	On	On or Off	Off
Off	Off	Off	Off (all clocks)

3.1.6.3 Power Modes

The major part of the MPU subsystem belongs to the MPU power domain. The modules inside this power domain can be off at a time when the ARM processor is in an OFF or standby mode. IDLE/WAKEUP control is managed by the clock generator block but initiated by the PRCM module.

The MPU Standby status can be checked with CM_MPU_MPU_CLKCTRL.STBYST. For the MPU to be on, the core (referred here as the device core) power must be on. Device power management does not allow INTC to go to OFF state when MPU domain is on (active or one of retention modes).

The NEON core has independent power off mode when not in use. Enabling and disabling of NEON can be controlled by software.

CAUTION

The MPU L1 cache memory does not support retention mode, and its array switch is controlled together with the MPU logic. For compliance, the L1 retention control signals exist at the PRCM boundary, but are not used. The ARM L2 can be put into retention independently of the other domains.

[Table 3-6](#) outlines the supported operational power modes. All other combinations are illegal. The ARM L2, NEON, and ETM/Debug can be powered up/down independently. The APB/ATB ETM/Debug column refers to all three features: ARM emulation, trace, and debug.

The MPU subsystem must be in a power mode where the MPU power domain, NEON power domain, debug power domain, and INTC power domain are in standby, or off state.

Table 3-6. MPU Subsystem Operation Power Modes

Mode	MPU and ARM Core Logic	ARM L2 RAM	NEON INTC	Device Core and ETM	APB/ATB Debug
1	Active	Active	Active	Active	Disabled or enabled
2	Active	Active	OFF	Active	Disabled or enabled
3	Active	RET	Active	Active	Disabled or enabled
4	Active	RET	OFF	Active	Disabled or enabled
5	Active	OFF	Active	Active	Disabled or enabled
6	Active	OFF	OFF	Active	Disabled or enabled
7	OFF	RET	OFF	OFF	Disabled or enabled
8	Standby	Active	Standby	Active	Disabled or enabled
9	Standby	Active	OFF	Active	Disabled or enabled
10	Standby	RET	Standby	Active	Disabled or enabled
11	Standby	RET	OFF	Active	Disabled or enabled
12	Standby	OFF	Standby	Active	Disabled or enabled
13	Standby	OFF	OFF	Active	Disabled or enabled
14	OFF	OFF	OFF	OFF	Disabled or enabled

3.1.7 ARM Programming Model

For detailed descriptions of registers used for MPU configuration, see [Chapter 8, Power, Reset, and Clock Management \(PRCM\)](#).

3.1.7.1 Clock Control

For clock configuration settings, see [Chapter 8, Power, Reset, and Clock Management \(PRCM\)](#).

3.1.7.2 MPU Power Mode Transitions

The following subsections describe transitions of different power modes for MPU power domain:

- Basic power on reset
- MPU into standby mode
- MPU out of standby mode
- MPU power on from a powered off state

3.1.7.2.1 Basic Power-On Reset

The power-on reset follows the following sequence of operation and is applicable to initial power-up and wakeup from device off mode:

Reset the INTC (CORE_RST) and the MPU subsystem modules (MPU_RST). The clocks must be active during the MPU reset and CORE reset.

3.1.7.2.2 MPU Into Standby Mode

The MPU into standby mode follows the following sequence of operation and is applicable to initial power-up and wakeup from device Off mode.

1. The ARM core initiates entering into standby via software only (CP15 - WFI).
2. MPU modules requested internally of MPU subsystem to enter idle, after ARM core standby detected.
3. MPU is in standby output asserted for PRCM (all outputs guaranteed to be at reset values).
4. PRCM can now request INTC to enter into idle mode. Acknowledge from INTC goes to PRCM.

NOTE: The INTC SWAKEUP output is a pure hardware signal to PRCM for the status of its IDLE request and IDLE acknowledge handshake.

NOTE: In debug mode, ICE-Crusher could prevent MPU subsystem from entering into IDLE mode.

3.1.7.2.3 MPU Out Of Standby Mode

The MPU out of standby mode follows the following sequence of operation and is applicable to initial power-up and wakeup from device Off mode.

1. PRCM must start clocks through DPLL programming.
2. Detect active clocking via status output of DPLL.
3. Initiate an interrupt through the INTC to wake up the ARM core from STANDBYWFI mode.

3.1.7.2.4 MPU Power On From a Powered-Off State

1. MPU Power On, NEON Power On, Core Power On (INTC) should follow the ordered sequence per power switch daisy chain to minimize the peaking of current during power-up.
-

NOTE: The core domain must be on, and reset, before the MPU can be reset.

2. Follow the reset sequence as described in the Basic Power-On Reset section.

Programmable Real-Time Unit Subsystem and Industrial Communication Subsystem (PRU-ICSS)

This chapter describes the PRU-ICSS for the device.

Topic	Page
4.1 Introduction	199
4.2 Integration	201
4.3 PRU-ICSS Memory Map Overview	206
4.4 Functional Description	208
4.5 Registers	249

4.1 Introduction

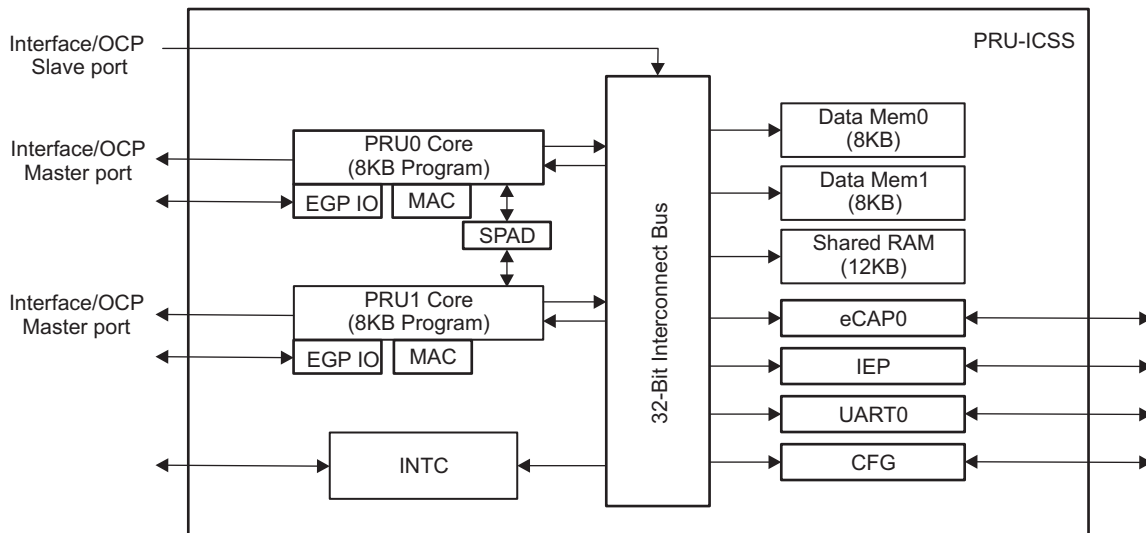
The Programmable Real-Time Unit Subsystem and Industrial Communication Subsystem (PRU-ICSS) consists of dual 32-bit RISC cores (Programmable Real-Time Units, or PRUs), shared, data, and instruction memories, internal peripheral modules, and an interrupt controller (INTC). The programmable nature of the PRU, along with its access to pins, events and all SoC resources, provides flexibility in implementing fast real-time responses, specialized data handling operations, custom peripheral interfaces, and in offloading tasks from the other processor cores of the system-on-chip (SoC).

Figure 4-1 shows the PRU-ICSS details.

The PRUs have access to all resources on the SoC through the Interface/OCP Master port, and the external host processors can access the PRU-ICSS resources through the Interface/OCP Slave port. The 32-bit interconnect bus connects the various internal and external masters to the resources inside the PRU-ICSS. The INTC handles system input events and posts events back to the device-level host CPU.

The PRU cores are programmed with a small, deterministic instruction set. Each PRU can operate independently or in coordination with each other and can also work in coordination with the device-level host CPU. This interaction between processors is determined by the nature of the firmware loaded into the PRU's instruction memories.

Figure 4-1. PRU-ICSS Block Diagram



4.1.1 Features

The PRU-ICSS includes the following main features:

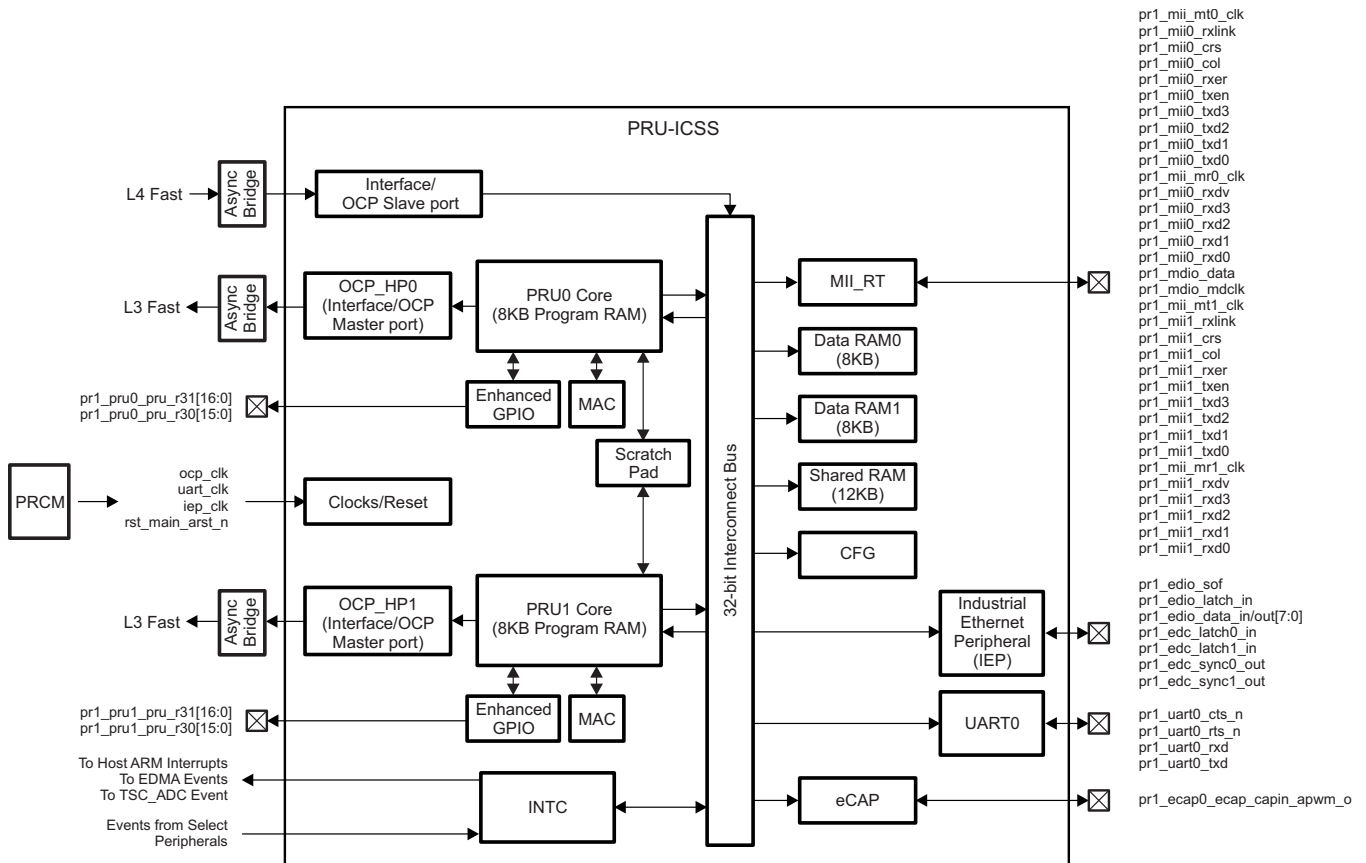
- Two PRUs each with:
 - 8KB program memory
 - 8KB data memory
 - High Performance Interface/OCP Master port for accessing external memories
 - Enhanced GPIO (EGPIO) with async capture and serial support
 - Multiplier with optional accumulation (MPY/MAC)
- One scratch pad (SPAD) memory
 - 3 Banks of 30 32-bit registers
- Broadside direct connect between PRU cores within subsystem
- 12 KB general purpose shared memory
- One Interrupt Controller (INTC)
 - Up to 64 input events supported
 - Interrupt mapping to 10 interrupt channels
 - 10 Host interrupts (2 to PRU0 and PRU1, 8 output to chip level)
 - Each system event can be enabled and disabled
 - Each host event can be enabled and disabled
 - Hardware prioritization of events
- 16 software events generated by 2 PRUs
- One Ethernet MII_RT module with two MII ports and configurable connections to PRUs*
- One MDIO Port*
- One Industrial Ethernet Peripheral (IEP) to manage/generate Industrial Ethernet functions
 - One Industrial Ethernet timer with 10 capture* and eight compare events
 - Two Industrial Ethernet sync signals*
 - Two Industrial Ethernet 16-bit watchdog timers*
 - Industrial Ethernet digital IOs
- One 16550-compatible UART with a dedicated 192-MHz clock
- One Enhanced Capture Module (ECAP)
- Flexible power management support
- Integrated 32-bit interconnect bus for connecting the various internal and external masters to the resources inside the PRU-ICSS
- Interface/OCP Slave port for external masters to access PRU-ICSS memories
- Optional address translation for PRU transaction to External Host
- All memories within the PRU-ICSS support parity

NOTE: * — Module or feature is used by industrial protocols, such as EtherCAT. For availability of EtherCAT, see the device features in [Chapter 1, Introduction](#).

4.2 Integration

The device includes a Programmable Real-Time Unit Subsystem and Industrial Communication Subsystem (PRU-ICSS) consisting of two independent Programmable Real-time Units (PRUs). Each PRU is a 32-bit Load/Store RISC processor with dedicated memories. The PRU-ICSS integration is shown in Figure 4-2.

Figure 4-2. PRU-ICSS Integration



For the availability of all features, see the device features in [Chapter 1, Introduction](#).

4.2.1 PRU-ICSS Connectivity Attributes

The general connectivity attributes for the PRU subsystem are shown in [Table 4-1](#).

Table 4-1. PRU-ICSS Connectivity Attributes

Attributes	Type
Power Domain	Peripheral Domain
Clock Domain	PD_PER_PRU_ICSS_OCP_GCLK (OCP clock) PD_PER_PRU_ICSS_IEP_GCLK (IEP clock) PD_PER_PRU_ICSS_UART_GCLK (UART clock)
Reset Signals	PRU_ICSS_LRST_N
Idle/Wakeup Signals	Standby Idle
Interrupt Requests	8 Interrupts pr1_host_intr[7:1] ⁽¹⁾ to MPU Subsystem pr1_host_intr[0] ⁽¹⁾ to MPU Subsystem and TSC_ADC
DMA Requests	No dedicated DMA events but pr1_host_intr[7:6] ⁽¹⁾ interrupt outputs also connected as DMA events
Physical Address	L4 Fast Slave Port

⁽¹⁾ pr1_host_intr[0:7] corresponds to Host-2 to Host-9 of the PRU-ICSS interrupt controller.

4.2.2 PRU-ICSS Clock and Reset Management

The PRU-ICSS module uses the following functional and OCP interface clocks.

Table 4-2. PRU-ICSS Clock Signals

Clock Signal	Max Freq	Reference / Source	Comments
i3_clk Interface Clock	200 MHz	CORE_CLKOUTM4 or Display PLL CLKOUT	pd_per_pru_icss_ocr_gclk from PRCM Clocks both L3 master and L4F slave
uart_clk Functional Clock	192 MHz	PER_CLKOUTM2	pd_per_pru_icss_uart_gclk from PRCM UART Clock
iep_clk Functional Clock	200 MHz	CORE_CLKOUTM4	pd_per_pru_icss_iep_gclk from PRCM Industrial Ethernet Peripheral Clock

4.2.3 PRU-ICSS Pin List

The PRU-ICSS external interface signals are shown in [Table 4-3](#). PRU GPI/GPO pin function depends on the operation mode. See [Table 4-3](#) for a complete list of pin functions for each mode.

Table 4-3. PRU-ICSS Pin List

Pin	Type	Description
pr1_mii_mr0_clk	I	MII0 Receive Clock
pr1_mii0_rxdv	I	MII0 Receive Data Valid
pr1_mii0_rxd[3:0]	I	MII0 Receive Data
pr1_mii0_rxlink	I	MII0 Receive Link
pr1_mii0_rxer	I	MII0 Receive Data Error
pr1_mii0_crs	I	MII0 Carrier Sense
pr1_mii0_col	I	MII0 Carrier Sense
pr1_mii_mt0_clk	I	MII0 Transmit Clock
pr1_mii0_txen	O	MII0 Transmit Enable
pr1_mii0_txd[3:0]	O	MII0 Transmit Data
pr1_mii_mr1_clk	I	MII1 Receive Clock
pr1_mii1_rxdv	I	MII1 Receive Data Valid
pr1_mii1_rxd[3:0]	I	MII1 Receive Data
pr1_mii1_rxlink	I	MII1 Receive Link
pr1_mii1_rxer	I	MII1 Receive Data Error
pr1_mii1_crs	I	MII1 Carrier Sense
pr1_mii1_col	I	MII1 Carrier Sense
pr1_mii_mt1_clk	I	MII1 Transmit Clock
pr1_mii1_txen	O	MII1 Transmit Enable
pr1_mii1_txd[3:0]	O	MII1 Transmit Data
pr1_mdio_mdclk	O	MDIO Clk
pr1_mdio_data	I/O	MDIO Data
pr1_edio_sof	O	ECAT Digital I/O Start of Frame
pr1_edio_latch_in	I	ECAT Digital I/O Latch In
pr1_edio_data_in[7:0]	I	ECAT Digital I/O Data In
pr1_edio_data_out[7:0]	O	ECAT Digital I/O Data Out
pr1_edc_sync0_out	O	ECAT Distributed Clock Sync Out
pr1_edc_sync1_out	O	ECAT Distributed Clock Sync Out
pr1_edc_latch0_in	I	ECAT Distributed Clock Latch In
pr1_edc_latch1_in	I	ECAT Distributed Clock Latch In
pr1_uart0_cts_n	I	UART Clear to Send
pr1_uart0_rts_n	O	UART Request to Send
pr1_uart0_rxd	I	UART Receive Data
pr1_uart0_txd	O	UART Transmit Data
pr1_ecap0_ecap_capin_apwm_o	I/O	Enhanced capture (ECAP) input or Auxiliary PWM out
pr1_pru0_pru_r30[15:0]	O	PRU0 Register R30 (GPO) Outputs
pr1_pru0_pru_r31[16:0]	I	PRU0 Register R31 (GPI)Inputs
pr1_pru1_pru_r30[15:0]	O	PRU1 Register R30 (GPO) Outputs
pr1_pru1_pru_r31[16:0]	I	PRU1 Register R31 (GPI) Inputs

4.2.4 PRU-ICSS Internal Pinmux

The PRU-ICSS supports an internal pinmux selection option that expands the device-level pinmuxing. The internal pinmuxing is programmable through the PIN_MX register of the PRU-ICSS CFG register space.

The `pin_mux_sel[0]` determines the external signals routed to the internal input signals, `mii0_rxd[3:0]`. The `pin_mux_sel[1]` determines the internal output signals routed to the external signals, `pr1_pru0_pru_r30[13:8]`, and the external signals routed to the internal input signals, `pru0_r30[5:0]`.

Note: `pin_mux_sel[x] = 0` is always the standard pin mapping (default).

Table 4-4. PRU-ICSS Internal Signal Muxing: `pin_mux_sel[0]`

	<code>pin_mux_sel[0] = 1</code>	<code>pin_mux_sel[0] = 0</code>
Internal PRU-ICSS Signal Name	External Chip Level Signal Name	
<code>mii0_rxd[3:0]</code>	<code>pr1_pru1_pru_r31[8:11]</code>	<code>pr1_mii0_rxd[3:0]</code>

Figure 4-3. PRU-ICSS Internal Signal Muxing: `pin_mux_sel[0]`

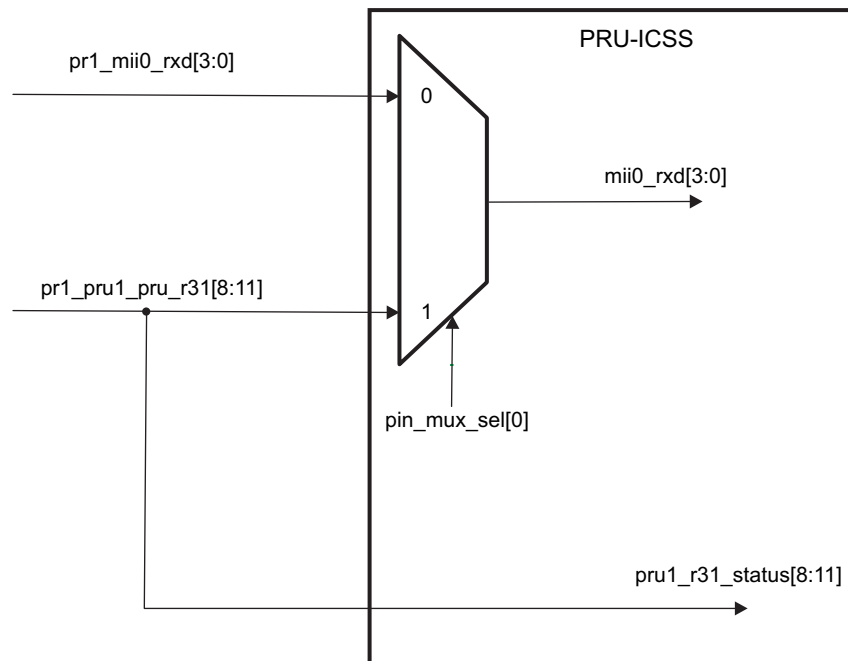
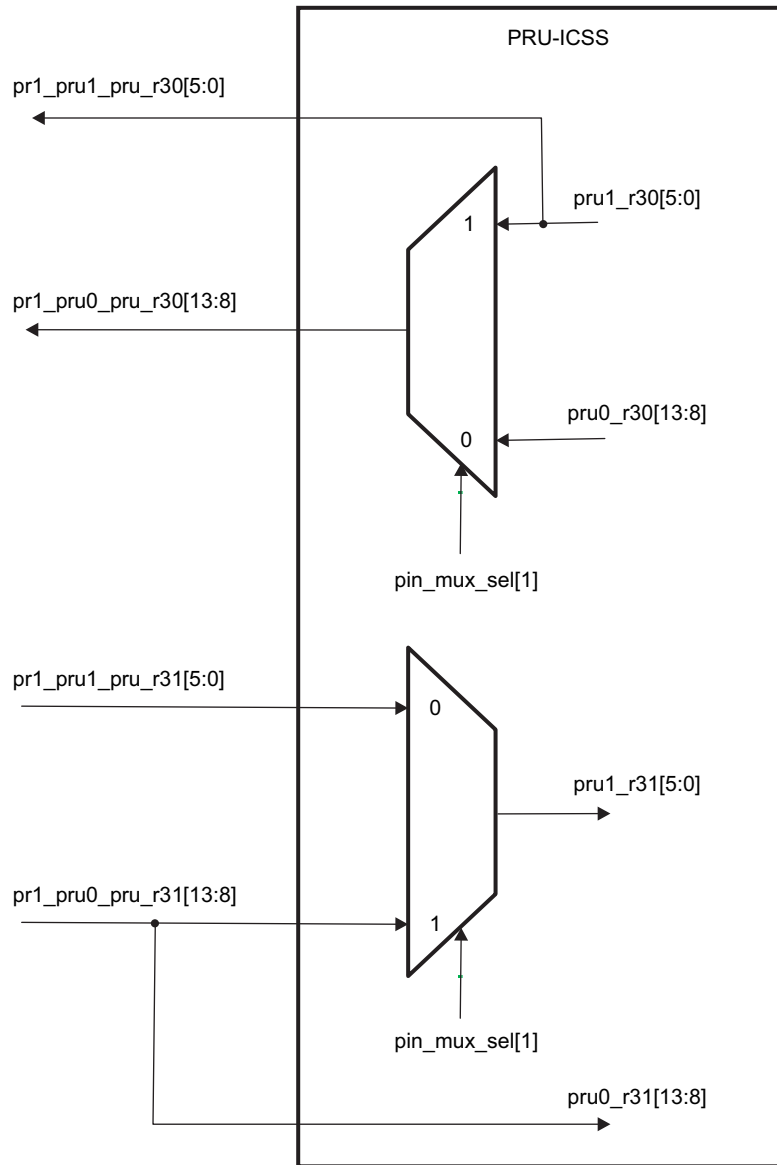


Table 4-5. PRU-ICSS Internal Signal Muxing: `pin_mux_sel[1]`

	<code>pin_mux_sel[1] = 1</code>	<code>pin_mux_sel[1] = 0</code>
External Chip Level Signal Name	Internal PRU-ICSS Signal Name	
<code>pr1_pru0_pru_r30[13:8]</code>	<code>pru1_r30[5:0]</code>	<code>pru0_r30[13:8]</code>
Internal PRU-ICSS Signal Name	External Chip Level Signal Name	
<code>pru1_r31_status[5:0]</code>	<code>pr1_pru0_pru_r31[13:8]</code>	<code>pr1_pru1_pru_r31[5:0]</code>

Figure 4-4. PRU-ICSS Internal Signal Muxing: pin_mux_sel[1]



4.3 PRU-ICSS Memory Map Overview

The PRU-ICSS comprises various distinct addressable regions that are mapped to both a local and global memory map. The local memory maps are maps with respect to the PRU core point of view. The global memory maps are maps with respect to the Host point of view, but can also be accessed by the PRU-ICSS.

4.3.1 Local Memory Map

The PRU-ICSS memory map is documented in [Table 4-6](#) (Instruction Space) and in [Table 4-7](#) (Data Space). Note that these two memory maps are implemented inside the PRU-ICSS and are local to the components of the PRU-ICSS.

4.3.1.1 Local Instruction Memory Map

Each PRU core has a dedicated 8KB of Instruction Memory which needs to be initialized by a Host processor before the PRU executes instructions. This region is only accessible to masters via the interface/ OCP slave port when the PRU is not running.

Table 4-6. Local Instruction Memory Map

Start Address	PRU0	PRU1
0x0000_0000	8KB IRAM	8KB IRAM

4.3.1.2 Local Data Memory Map

The local data memory map in [Table 4-7](#) allows each PRU core to access the PRU-ICSS addressable regions and the external host's memory map.

The PRU accesses the external Host memory map through the Interface/OCP Master port (System OCP_HP0/1) starting at address 0x0008_0000. By default, memory addresses between 0x0000_0000 – 0x0007_FFFF will correspond to the PRU-ICSS local address in [Table 4-7](#). To access an address between 0x0000_0000–0x0007_FFFF of the external Host map, the address offset of –0x0008_0000 feature is enabled through the PMAO register of the PRU-ICSS CFG register space.

Table 4-7. Local Data Memory Map

Start Address	PRU0	PRU1
0x0000_0000	Data 8KB RAM 0 ⁽¹⁾	Data 8KB RAM 1 ⁽¹⁾
0x0000_2000	Data 8KB RAM 1 ⁽¹⁾	Data 8KB RAM 0 ⁽¹⁾
0x0001_0000	Shared Data 12KB RAM 2	Shared Data 12KB RAM 2
0x0002_0000	INTC	INTC
0x0002_2000	PRU0 Control	PRU0 Control
0x0002_2400	Reserved	Reserved
0x0002_4000	PRU1 Control	PRU1 Control
0x0002_4400	Reserved	Reserved
0x0002_6000	CFG	CFG
0x0002_8000	UART 0	UART 0
0x0002_A000	Reserved	Reserved
0x0002_C000	Reserved	Reserved
0x0002_E000	IEP	IEP
0x0003_0000	eCAP 0	eCAP 0
0x0003_2000	Reserved	Reserved
0x0003_2400	Reserved	Reserved
0x0003_4000	Reserved	Reserved

⁽¹⁾ Data RAM0 is intended to be the primary data memory for PRU0, as is Data RAM1 for PRU1. However, both PRU cores can access Data RAM0 and Data RAM1 to pass information between PRUs. Each PRU core accesses their intended Data RAM at address 0x0000_0000 and the other Data RAM at address 0x0000_2000.

Table 4-7. Local Data Memory Map (continued)

Start Address	PRU0	PRU1
0x0003_8000	Reserved	Reserved
0x0004_0000	Reserved	Reserved
0x0008_0000	System OCP_HP0	System OCP_HP1

4.3.2 Global Memory Map

The global view of the PRU-ICSS internal memories and control ports is shown in [Table 4-8](#). The offset addresses of each region are implemented inside the PRU-ICSS but the global device memory mapping places the PRU-ICSS slave port in the address range shown in the external Host top-level memory map.

The global memory map is with respect to the Host point of view, but it can also be accessed by the PRU-ICSS. Note that PRU0 and PRU1 can use either the local or global addresses to access their internal memories, but using the local addresses will provide access time several cycles faster than using the global addresses. This is because when accessing via the global address the access needs to be routed through the switch fabric outside PRU-ICSS and back in through the PRU-ICSS slave port.

Each of the PRUs can access the rest of the device memory (including memory mapped peripheral and configuration registers) using the global memory space addresses. See [Table 4-8](#), *Global Memory Map*, for base addresses of each module in the device.

Table 4-8. Global Memory Map

Offset Address	PRU-ICSS
0x0000_0000	Data 8KB RAM 0
0x0000_2000	Data 8KB RAM 1
0x0001_0000	Shared Data 12KB RAM 2
0x0002_0000	INTC
0x0002_2000	PRU0 Control
0x0002_2400	PRU0 Debug
0x0002_4000	PRU1 Control
0x0002_4400	PRU1 Debug
0x0002_6000	CFG
0x0002_8000	UART 0
0x0002_A000	Reserved
0x0002_C000	Reserved
0x0002_E000	IEP
0x0003_0000	eCAP 0
0x0003_2000	Reserved
0x0003_2400	Reserved
0x0003_4000	PRU0 8KB IRAM
0x0003_8000	PRU1 8KB IRAM
0x0004_0000	Reserved

4.4 Functional Description

4.4.1 PRU Cores

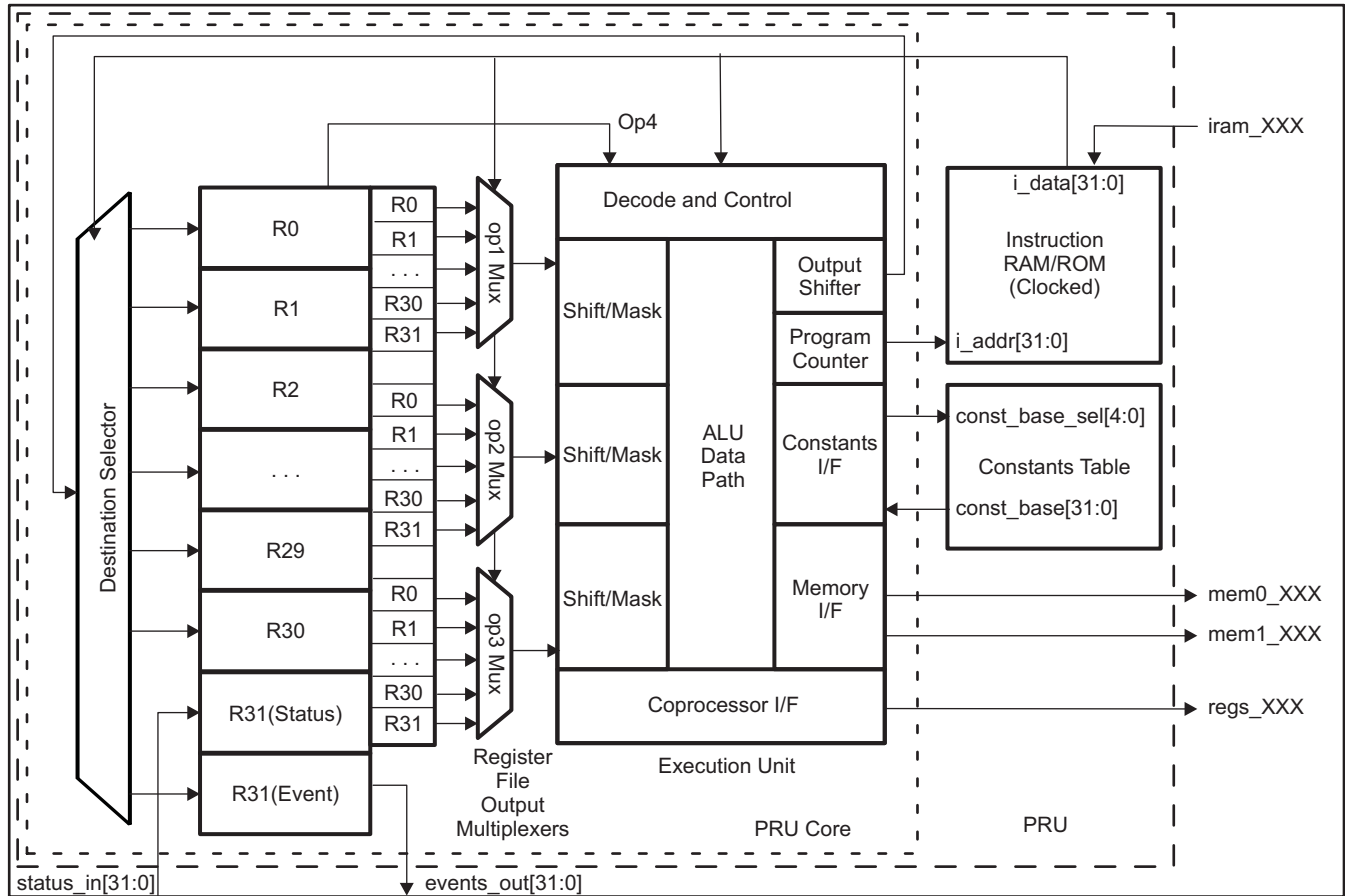
The PRU is a processor optimized for performing embedded tasks that require manipulation of packed memory mapped data structures, handling of system events that have tight real-time constraints and interfacing with systems external to the SoC. The PRU is both very small and very efficient at handling such tasks.

The major attributes of the PRU are as follows.

Attribute	Value
IO Architecture	Load / Store
Data Flow Architecture	Register to Register
Core Level Bus Architecture	
Type	4-Bus Harvard (1 Instruction, 3 Data)
Instruction I/F	32-Bit
Memory I/F 0	32-Bit
Memory I/F 1	32-Bit
Execution Model	
Issue Type	Scalar
Pipelining	None (Purposefully)
Ordering	In Order
ALU Type	Unsigned Integer
Registers	
General Purpose (GP)	30 (R1 – R30)
External Status	1 (R31)
GP / Indexing	1 (R0)
Addressability in Instruction	Bit, Byte (8-bit), Halfword (16-bit), Word (32-bit), Pointer
Addressing Modes	
Load Immediate	16-bit Immediate
Load / Store – Memory	Register Base + Register Offset Register Base + 8-bit Immediate Offset Register Base with auto increment / decrement Constant Table Base + Register Offset Constant Table Base + 8-bit Immediate Offset Constant Table Base with auto increment / decrement
Data Path Width	32-Bits
Instruction Width	32-Bits
Accessibility to Internal PRU Structures	Provides 32-bit slave with three regions: <ul style="list-style-type: none"> • Instruction RAM • Control / Status registers • Debug access to internal registers (R0-R31) and constant table

The processor is based on a four-bus architecture which allows instructions to be fetched and executed concurrently with data transfers. In addition, an input is provided in order to allow external status information to be reflected in the internal processor status register. Figure 4-5 shows a block diagram of the processing element and the associated instruction RAM/ROM that contains the code that is to be executed.

Figure 4-5. PRU Block Diagram



4.4.1.1 Constants Table

The PRU Constants Table is a structure of hard-coded memory addresses for commonly used peripherals and memories. The Constants table exists to more efficiently load/store data to these commonly accessed addresses by:

- Reduce a PRU instruction by not needing to pre-load an address into the internal register file before loading or storing data to a memory address
- Maximize the usage of the PRU register file for embedded processing applications by moving many of the commonly used constants or deterministically calculated base addresses from the internal register file to an external table.

Table 4-9. PRU0/1 Constants Table

Entry No.	Region Pointed To	Value [31:0]
0	PRU-ICSS INTC (local)	0x0002_0000
1	DMTIMER2	0x4804_0000
2	I2C1	0x4802_A000
3	PRU-ICSS eCAP (local)	0x0003_0000
4	PRU-ICSS CFG (local)	0x0002_6000

Table 4-9. PRU0/1 Constants Table (continued)

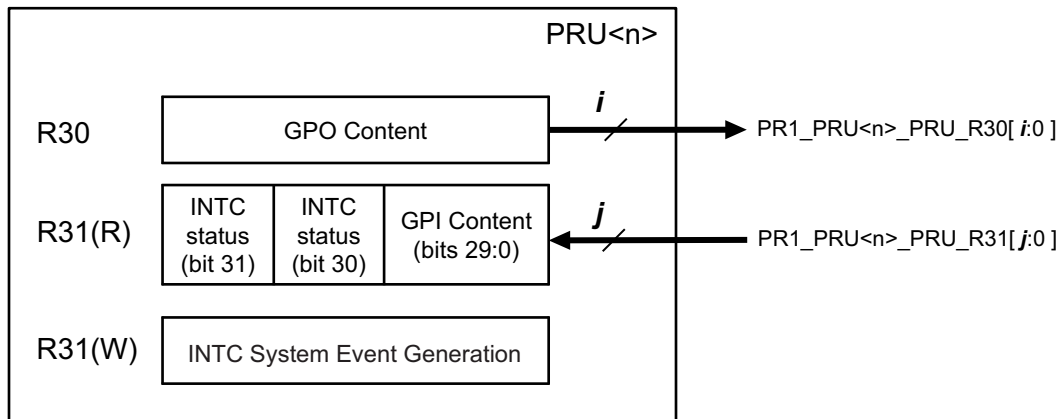
Entry No.	Region Pointed To	Value [31:0]
5	MMCHS 0	0x4806_0000
6	MCSP1 0	0x4803_0000
7	PRU-ICSS UART0 (local)	0x0002_8000
8	McASP0 DMA	0x4600_0000
9	GEMAC	0x4A10_0000
10	Reserved	0x4831_8000
11	UART1	0x4802_2000
12	UART2	0x4802_4000
13	Reserved	0x4831_0000
14	DCAN0	0x481C_C000
15	DCAN1	0x481D_0000
16	MCSP1 1	0x481A_0000
17	I2C2	0x4819_C000
18	eHRPWM1/eCAP1/eQEP1	0x4830_0000
19	eHRPWM2/eCAP2/eQEP2	0x4830_2000
20	eHRPWM3/eCAP3/eQEP3	0x4830_4000
21	Reserved	0x0003_2400
22	Mailbox 0	0x480C_8000
23	Spinlock	0x480C_A000
24	PRU-ICSS PRU0/1 Data RAM (local)	0x0000_0n00, n = c24_blk_index[3:0]
25	PRU-ICSS PRU1/0 Data RAM (local)	0x0000_2n00, n = c25_blk_index[3:0]
26	PRU-ICSS IEP (local)	0x0002_En00, n = c26_blk_index[3:0]
27	Reserved	0x0003_2n00, n = c27_blk_index[3:0]
28	PRU-ICSS Shared RAM (local)	0x00nn_nn00, nnnn = c28_pointer[15:0]
29	TPCC	0x49nn_nn00, nnnn = c29_pointer[15:0]
30	L3 OCMC0	0x40nn_nn00, nnnn = c30_pointer[15:0]
31	EMIF0 DDR Base	0x80nn_nn00, nnnn = c31_pointer[15:0]

NOTE: Addresses in constants entries 24–31 are partially programmable. Their programmable bit field (for example, c24_blk_index[3:0]) is programmable through the PRU CTRL register space. As a general rule, the PRU should configure this field before using the partially programmable constant entries.

4.4.1.2 PRU Module Interface to PRU I/Os and INTC

The PRU module interface consists of the PRU internal registers 30 and 31 (R30 and R31). [Figure 4-6](#) shows the PRU module interface and the functionality of R30 and R31. The register R31 serves as an interface with the dedicated PRU general purpose input (GPI) pins and PRU interrupt controller (INTC). Reading R31 returns status information from the GPI pins and INTC via the PRU Real-Time Status Interface. Writing to R31 generates PRU system events via the PRU Event Interface. The register R30 serves as an interface with the dedicated PRU general purpose output (GPO) pins.

Figure 4-6. PRU Module Interface



4.4.1.2.1 Real-Time Status Interface Mapping (R31): Interrupt Events Input

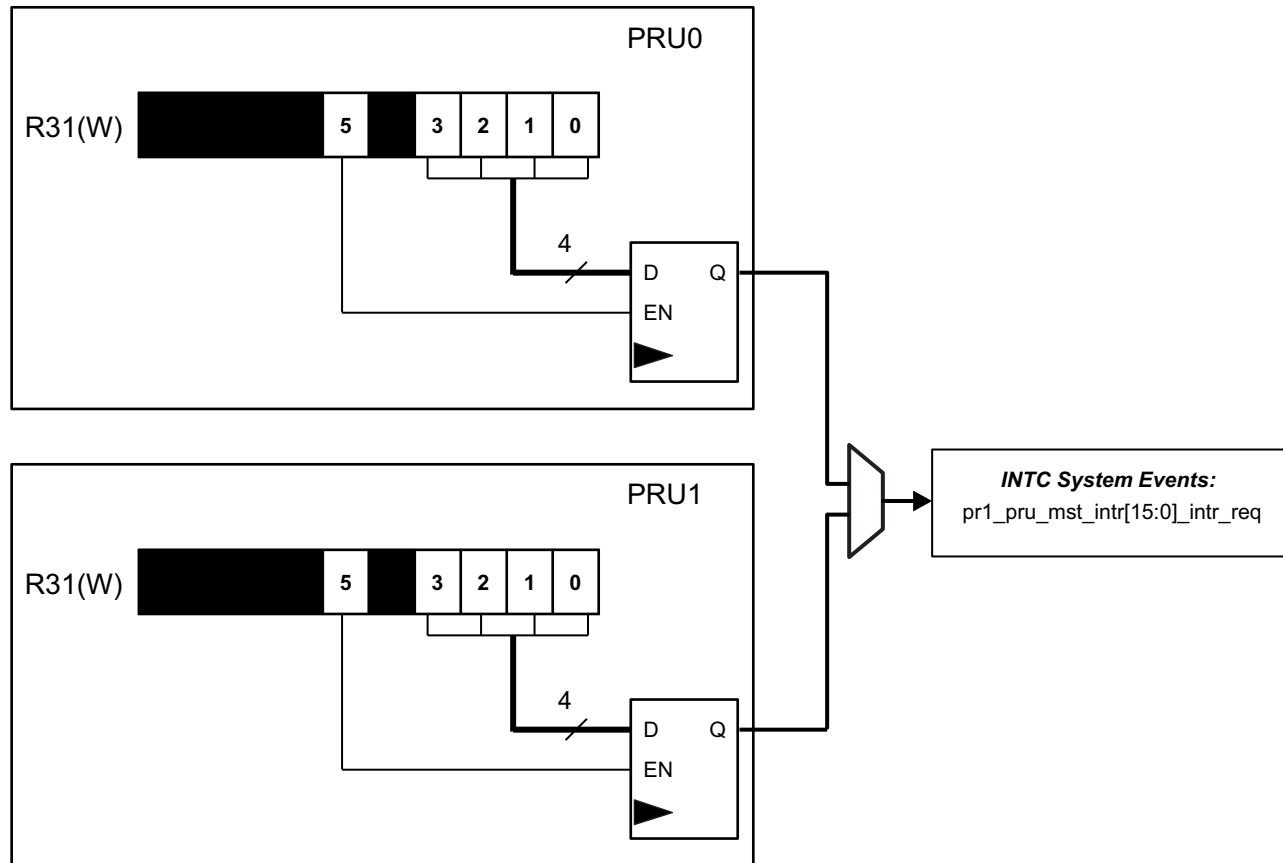
The PRU Real-Time Status Interface directly feeds information into register 31 (R31) of the PRU’s internal register file. The firmware on the PRU uses the status information to make decisions during execution. The status interface is comprised of signals from different modules inside of the PRU-ICSS which require some level of interaction with the PRU. More details on the Host interrupts imported into bit 30 and 31 of register R31 of both the PRUs is provided in Section 4.4.2, Interrupt Controller (INTC).

Table 4-10. Real-Time Status Interface Mapping (R31) Field Descriptions

Bit	Field	Value	Description
31	pru_intr_in[1]		PRU Host Interrupt 1 from local INTC
30	pru_intr_in[0]		PRU Host Interrupt 0 from local INTC
29-0	pru<n>_r31_status[29:0]		Status inputs from primary input via Enhanced GPI port

4.4.1.2.2 Event Interface Mapping (R31): PRU System Events

This PRU Event Interface directly feeds pulsed event information out of the PRU’s internal ALU. These events are exported out of the PRU-ICSS and need to be connected to the system event controller at the SoC level. The event interface can be used by the firmware to create interrupts from the PRU to the Host processor.

Figure 4-7. Event Interface Mapping (R31)

Table 4-11. Event Interface Mapping (R31) Field Descriptions

Bit	Field	Value	Description
31-6	Reserved		
5	pru<n>_r31_vec_valid		Valid strobe for vector output
4	Reserved		
3-0	pru<n>_r31_vec[3:0]		Vector output

Simultaneously writing a '1' to pru<n>_r31_vec_valid (R31 bit 5) and a channel number from 0-16 to pru<n>_r31_vec[3:0] (R31 bits 3:0) creates a pulse on the output of the corresponding pr1_pru_mst_intr[x]_intr_req INTC system event (Table 4-21). For example, writing '100000' will generate a pulse on pr1_pru_mst_intr[0]_intr_req, writing '100001' will generate a pulse on pr1_pru_mst_intr[1]_intr_req, and so on to where writing '101111' will generate a pulse on pr1_pru_mst_intr[15]_intr_req and writing '0xxxxx' will not generate any system event pulses. The output values from both PRU cores in a subsystem are ORed together.

This allows the PRU to assert one of the system events 16-31 by writing to its own R31 register. The system event is used to either post a completion event to one of the host CPUs (ARM) or to signal the other PRU. The host to be signaled is determined by the system event to interrupt channel mapping (programmable). The 16 events are named as pr1_pru_mst_intr<15:0>_intr_req. For more details, see Section 4.4.2, *Interrupt Controller (INTC)*.

4.4.1.2.3 General-Purpose Inputs (R31): Enhanced PRU GP Module

The PRU-ICSS implements an enhanced General-Purpose Input/Output (GPIO) module that supports the following general-purpose input modes: direct input, 16-bit parallel capture, and 28-bit serial shift in. Register R31 serves as an interface with the general purpose inputs.

Table 4-12 describes the input modes in detail. Note each PRU core can only be configured for one GPI mode at a time. Each mode uses the same R31 signals and internal register bits for different purposes. A summary is found in [PRU GPI Signals and Configurations](#).

Table 4-12. PRU R31 (GPI) Modes

Mode	Function	Configuration
Direct input	GPI[0:29] feeds directly to pru<n>_r31_status[0:29]	Default mode
16-bit parallel capture	DATAIN[0:15] is captured by the posedge or negedge of CLOCKIN	<ul style="list-style-type: none"> Enabled by CFG_GPCFGn register CLOCKIN edge selected by CFG_GPCFGn register
28-bit shift in	<ul style="list-style-type: none"> DATAIN is sampled and shifted into a 28-bit shift register mapped to pru<n>_r31_status[0:27] Cnt_16 (Shift Counter) feature is mapped to pru<n>_r31_status[28] SB (Start Bit detection) feature is mapped to pru<n>_r31_status[29] 	<ul style="list-style-type: none"> Enabled by CFG_GPCFGn register Cnt_16 is self clearing and is connected to the PRU INTC Start Bit (SB) is cleared by CFG_GPCFGn register

PRU GPI Signals and Configurations

Pad Names at Device Level	GPI Modes		
	Direct Input	Parallel Capture	28-Bit Shift In
pr1_pru<n>_pru_r31_0	GPI0	DATAIN0	DATAIN
pr1_pru<n>_pru_r31_1	GPI1	DATAIN1	
pr1_pru<n>_pru_r31_2	GPI2	DATAIN2	
pr1_pru<n>_pru_r31_3	GPI3	DATAIN3	
pr1_pru<n>_pru_r31_4	GPI4	DATAIN4	
pr1_pru<n>_pru_r31_5	GPI5	DATAIN5	
pr1_pru<n>_pru_r31_6	GPI6	DATAIN6	
pr1_pru<n>_pru_r31_7	GPI7	DATAIN7	
pr1_pru<n>_pru_r31_8	GPI8	DATAIN8	
pr1_pru<n>_pru_r31_9	GPI9	DATAIN9	
pr1_pru<n>_pru_r31_10	GPI10	DATAIN10	
pr1_pru<n>_pru_r31_11	GPI11	DATAIN11	
pr1_pru<n>_pru_r31_12	GPI12	DATAIN12	
pr1_pru<n>_pru_r31_13	GPI13	DATAIN13	
pr1_pru<n>_pru_r31_14	GPI14	DATAIN14	
pr1_pru<n>_pru_r31_15	GPI15	DATAIN15	
pr1_pru<n>_pru_r31_16	GPI16	CLOCKIN	
pr1_pru<n>_pru_r31_17	GPI17		
pr1_pru<n>_pru_r31_18	GPI18		
pr1_pru<n>_pru_r31_19	GPI19		
pr1_pru<n>_pru_r31_20	GPI20		
pr1_pru<n>_pru_r31_21	GPI21		
pr1_pru<n>_pru_r31_22	GPI22		
pr1_pru<n>_pru_r31_23	GPI23		
pr1_pru<n>_pru_r31_24	GPI24		

PRU GPI Signals and Configurations (continued)

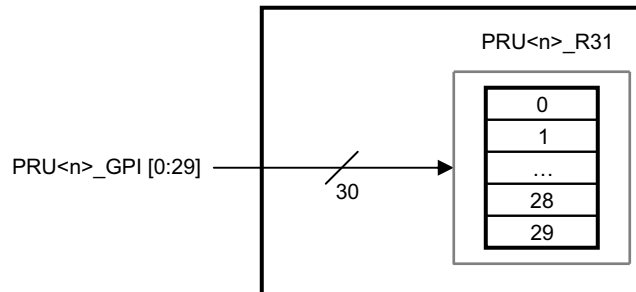
Pad Names at Device Level	GPI Modes		
	Direct Input	Parallel Capture	28-Bit Shift In
pr1_pru<n>_pru_r31_25	GPI25		
pr1_pru<n>_pru_r31_26	GPI26		
pr1_pru<n>_pru_r31_27	GPI27		
pr1_pru<n>_pru_r31_28	GPI28		
pr1_pru<n>_pru_r31_29	GPI29		

NOTE: Some devices may not pin out all 30 bits of R31. For which pins are available on this device, see [Section 4.2.3, PRU-ICSS Pin List](#). See the device's datasheet for device-specific pin mapping.

4.4.1.2.3.1 Direct Input

The pru<n>_r31_status [0:29] (PRU<n>_DATAIN) bits of the internal PRU register file are mapped to device-level general purpose input pins (pru<n>_GPI[0:29]). In GPI Direct Input mode, pru<n>_GPI[0:29] feeds directly to pru<n>_r31_status [0:29]. There are 30 possible general purpose inputs per PRU core; however, some devices may not pin out all of these signals. See the device-specific datasheet for device specific pin mapping.

Figure 4-8. PRU R31 (GPI) Direct Input Mode Block Diagram



4.4.1.2.3.2 16-Bit Parallel Capture

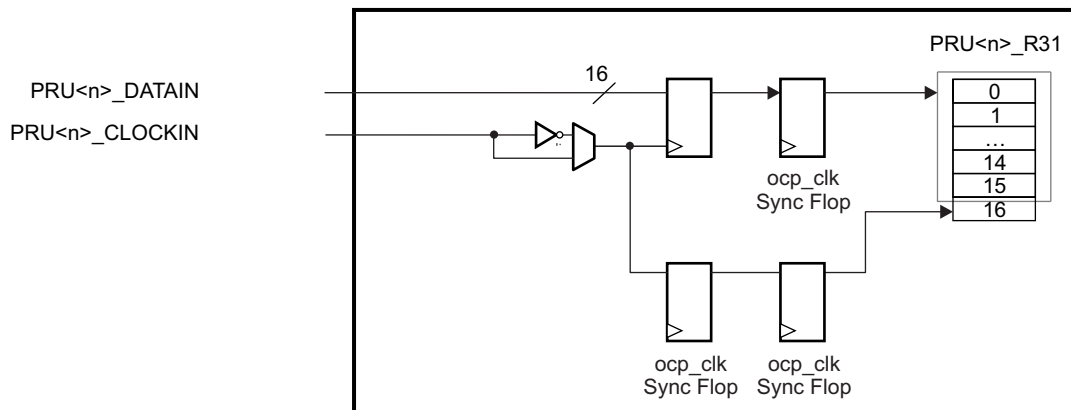
The pru<n>_r31_status [0:16] are mapped out of the PRU-ICSS and are brought out as general-purpose input pins. The pru<n>_r31_status [16] (PRU<n>_CLOCK) is designated for an external strobe clock and is used to capture pru<n>_r31_status [0:15] (PRU<n>_DATAIN). The PRU<n>_DATAIN can be captured either by the positive or the negative edge of PRU<n>_CLOCK, programmable through the PRU-ICSS CFG register space.

If the clocking is configured through the PRU-ICSS CFG register to be positive, then it will equal PRU<n>_CLOCK. However, if the clocking is configured to be negative, then it will equal PRU<n>_CLOCK inverted.

The pru<n>_r31_status [0:15] and pru<n>_r31_status [16] bits of the internal PRU register file are mapped to device-level general purpose input pins (PRU<n>_DATAIN[0:15] and PRU<n>_CLOCKIN, respectively). PRU<n>_CLOCKIN is designated as an external strobe clock and is used to capture PRU<n>_DATAIN[0:15].

The PRU<n>_DATAIN can be captured either on the positive or negative edge of PRU<n>_CLOCK, programmable through the PRU-ICSS CFG register space. If the clocking is configured through the PRU-ICSS CFG register space to be positive, then it will equal PRU<n>_CLOCK. If the clocking is configured to be negative, then it will equal PRU<n>_CLOCK inverted.

Figure 4-9. PRU R31 (GPI) 16-Bit Parallel Capture Mode Block Diagram



4.4.1.2.3.3 28-Bit Shift In

In 28-bit Shift In mode, the device-level general purpose input pin PRU<n>_DATAIN is sampled and shifted into a 28-bit shift register on an internal clock pulse. The register fills in lsb order (from bit 0 to 27) and then overflows into a bit bucket. The 28-bit register is mapped to pru<n>_r31_status [0:27] and can be cleared in software through the PRU-ICSS CFG register space.

Note that the PRU will continually capture and shift the DATAIN input when the GPI mode has been set to 28-bit shift in.

The shift rate is controlled by the effective divisor of two cascaded dividers applied to the ocp_clk. These cascaded dividers can each be configured through the PRU-ICSS CFG register space to a value of {1, 1.5, 2, 16}. [Table 4-13](#) lists sample effective clock values and the divisor values that can be used to generate these clocks.

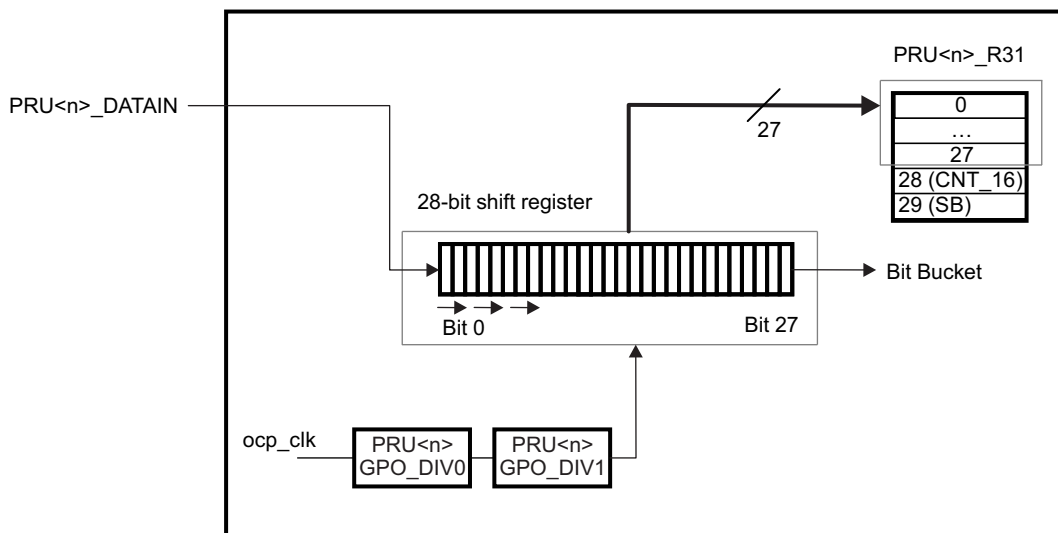
Table 4-13. Effective Clock Values

Generated clock	PRU<n>_GPI_DIV0	PRU<n>_GPI_DIV1
8-MHz	12.5 (0x17)	2 (0x02)
10-MHz	10 (0x10)	2 (0x02)
16-MHz	16 (0x1e)	1 (0x00)
20-MHz	10 (0x10)	1 (0x00)

The 28-bit Shift In mode also supports these features:

- Start Bit detection (SB) is mapped to pru<n>_r31_status [29] and is set when the first 1 is captured on PRU<n>_DATAIN. The SB flag in pru<n>_r31_status [29] is cleared in software through the CFG_GPCFGn register of the PRU-ICSS CFG register space.
- CNT_16 (Shift Counter) is mapped to pru<n>_r31_status [28] and is set on every 16 shift clock sample after the Start Bit has been received. CNT_16 is self clearing and is connected to the PRU-ICSS INTC. For more details, see [Section 4.4.2, Interrupt Controller \(INTC\)](#).

Figure 4-10. PRU R31 (GPI) 28-Bit Shift In Mode



4.4.1.2.4 General-Purpose Outputs (R30): Enhanced PRU GP Module

The PRU-ICSS implements an enhanced General Purpose Input Output (GPIO) module that supports direct output and shift out modes for general purpose outputs.

[Table 4-14](#) describes these modes in detail. Note that each PRU core can only be configured for one GPO mode at a time. Each mode uses the same R30 signals and internal register bits for different purposes. A summary is found in [Table 4-15](#).

Table 4-14. PRU R30 (GPO) Modes

Mode	Function	Configuration
Direct Output	pru<n>_r30[0:31] feeds directly to GPO[0:31]	Default mode
Shift Out	<ul style="list-style-type: none"> pru<n>_r30[0] is shifted out on DATAOUT on every rising edge of pru<n>_r30[1] (CLOCKOUT). LOAD_GPO_SH0 (Load Shadow Register 0) is mapped to pru<n>_r30[29] LOAD_GPO_SH1 (Load Shadow Register 1) is mapped to pru<n>_r30[30] ENABLE_SHIFT is mapped to pru<n>_r30[31] 	Enabled by CFG_GPCFGn register

Table 4-15. PRU GPO Signals and Configurations

Pad Names at Device Level	GPO Modes	
	Direct Output	Shift Out
pr1_pru<n>_pru_r30_0	GPO0	DATAOUT
pr1_pru<n>_pru_r30_1	GPO1	CLOCKOUT
pr1_pru<n>_pru_r30_2	GPO2	
pr1_pru<n>_pru_r30_3	GPO3	
pr1_pru<n>_pru_r30_4	GPO4	
pr1_pru<n>_pru_r30_5	GPO5	
pr1_pru<n>_pru_r30_6	GPO6	
pr1_pru<n>_pru_r30_7	GPO7	
pr1_pru<n>_pru_r30_8	GPO8	
pr1_pru<n>_pru_r30_9	GPO9	
pr1_pru<n>_pru_r30_10	GPO10	
pr1_pru<n>_pru_r30_11	GPO11	
pr1_pru<n>_pru_r30_12	GPO12	
pr1_pru<n>_pru_r30_13	GPO13	
pr1_pru<n>_pru_r30_14	GPO14	
pr1_pru<n>_pru_r30_15	GPO15	
pr1_pru<n>_pru_r30_16	GPO16	
pr1_pru<n>_pru_r30_17	GPO17	
pr1_pru<n>_pru_r30_18	GPO18	
pr1_pru<n>_pru_r30_19	GPO19	
pr1_pru<n>_pru_r30_20	GPO20	
pr1_pru<n>_pru_r30_21	GPO21	
pr1_pru<n>_pru_r30_22	GPO22	
pr1_pru<n>_pru_r30_23	GPO23	
pr1_pru<n>_pru_r30_24	GPO24	
pr1_pru<n>_pru_r30_25	GPO25	
pr1_pru<n>_pru_r30_26	GPO26	
pr1_pru<n>_pru_r30_27	GPO27	
pr1_pru<n>_pru_r30_28	GPO28	
pr1_pru<n>_pru_r30_29	GPO29	
pr1_pru<n>_pru_r30_30	GPO30	
pr1_pru<n>_pru_r30_31	GPO31	

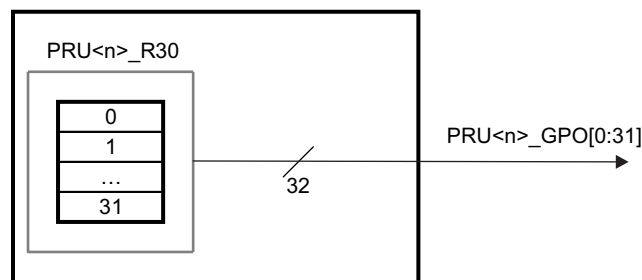
NOTE: Some devices may not pin out all 32 bits of R30. For which pins are available on this device, see [Section 4.2.3, PRU-ICSS Pin List](#). See the device's datasheet for device-specific pin mapping.

4.4.1.2.4.1 Direct Output

The pru<n>_r30 [0:31] bits of the internal PRU register file are mapped to device-level general purpose output pins (PRU<n>_GPO [0:31]). In GPO Direct Output mode, pru<n>_r30 [0:31] feed directly to PRU<n>_GPO [0:31]. There are 32 possible general purpose outputs per PRU core; however, some devices may not pin out all of these signals. See the device-specific datasheet for device specific pin mapping.

NOTE: R30 is not initialized after reset. To avoid unintended output signals, R30 should be initialized before pinmux configuration of PRU signals.

Figure 4-11. PRU R30 (GPO) Direct Output Mode Block Diagram



4.4.1.2.4.2 Shift Out

In shift out mode, data is shifted out of pru<n>_r30[0] on PRU<n>_DATAOUT on every rising edge of pru<n>_r30[1] (PRU<n>_CLOCKOUT). The shift rate is controlled by the effective divisor of two cascaded dividers applied to the op_clk. These cascaded dividers can each be configured through the PRU-ICSS CFG register space to a value of {1, 1.5, , 16}. [Table 4-16](#) shows sample effective clock values and the divisor values that can be used to generate these clocks. Note that PRU<n>_CLOCKOUT is a free-running clock that starts when the PRU GPO mode is set to shift out mode.

Table 4-16. Effective Clock Values

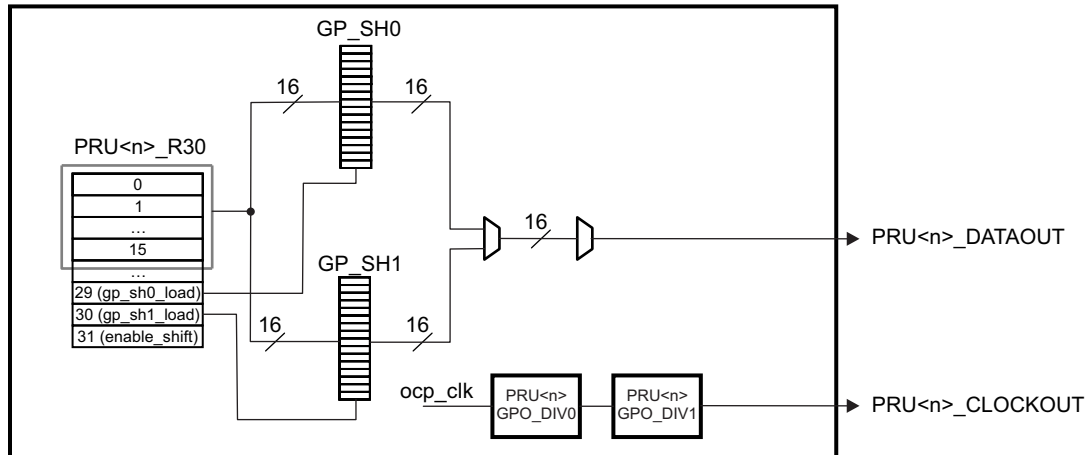
Generated Clock	PRU<n>_GPO_DIV0	PRU<n>_GPO_DIV1
8 MHz	12.5 (0x17)	2 (0x02)
10 MHz	10 (0x10)	2 (0x02)
16 MHz	16 (0x1e)	1 (0x00)
20 MHz	10 (0x10)	1 (0x00)

Shift out mode uses two 16-bit shadow registers (gpo_sh0 and gpo_sh1) to support ping-pong buffers. Each shadow register has independent load controls programmable through pru<n>_r30[29:30] (PRU<n>_LOAD_GPO_SH [0:1]). While PRU<n>_LOAD_GPO_SH [0/1] is set, the contents of pru<n>_r31[0:15] are loaded into gpo_sh0/1.

NOTE: If any device-level pins mapped to pru<n>_r30 [2:15] are configured for the pru<n>_r30 [2:15] pinmux mode, then these pins will reflect the shadow register value written to pru<n>_r30. Any pin configured for a different pinmux setting will not reflect the shadow register value written to pru<n>_r30.

The data shift will start from the lsb of gpo_sh0 when pru<n>_r30[31] (PRU<n>_ENABLE_SHIFT) is set. Note that if no new data is loaded into gpo_shn<n> after shift operation, the shift operation will continue looping and shifting out the pre-loaded data. When PRU<n>_ENABLE_SHIFT is cleared, the shift operation will finish shifting out the current shadow register, stop, and reset.

Figure 4-12. PRU R30 (GPO) Shift Out Mode Block Diagram



Follow these steps to use the GPO shift out mode:

Initialization:

1. Load 16-bits of data into gpo_sh0:
 - (a) Set R30[29] = 1 (PRU<n>_LOAD_GPO_SH0)
 - (b) Load data in R30[15:0]
 - (c) Clear R30[29] to turn off load controller
2. Load 16-bits of data into gpo_sh1:
 - (a) Set R30[30] = 1 (PRU<n>_LOAD_GPO_SH1)
 - (b) Load data in R30[15:0]
 - (c) Clear R30[30] to turn off load controller
3. Start shift operation:
 - (a) Set R30[31] = 1 (PRU<n>_ENABLE_SHIFT)

Shift Loop:

1. Monitor when a shadow register has finished shifting out data and can be loaded with new data:
 - (a) Poll PRU<n>_GPI_SH_SEL bit of the GPCFG<n> register
 - (b) Load new 16-bits of data into gpo_sh0 if PRU<n>_GPI_SH_SEL = 1
 - (c) Load new 16-bits of data into gpo_sh1 if PRU<n>_GPI_SH_SEL = 0
2. If more data to be shifted out, loop to Shift Loop
3. If no more data, exit loop

Exit:

1. End shift operation:
 - (a) Clear R30[31] to turn off shift operation

NOTE: Until the shift operation is disabled, the shift loop will continue looping and shifting out the pre-loaded data if no new data has been loaded into gpo_sh<n>.

4.4.1.3 Multiplier With Optional Accumulation (MPY/MAC)

Each PRU core has a designated multiplier with optional accumulation (MPY/MAC). The MAC has two modes of operation: Multiply Only or Multiply and Accumulate. The MAC is directly connected with the PRU internal registers R25–R29 and uses the broadside load/store PRU interface and XFR instructions to both control the mode of the MAC and import the multiplication results into the PRU.

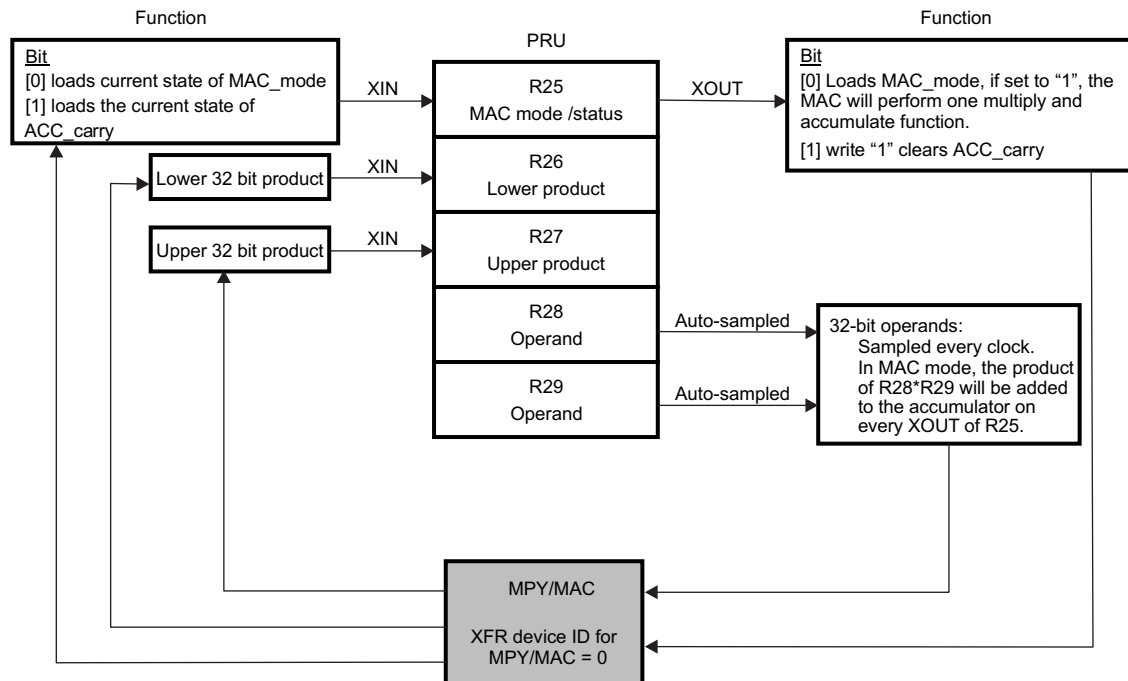
4.4.1.3.1 Features

- Configurable Multiply Only and Multiply and Accumulate functionality via PRU register R25
- 32-bit operands with direct connection to PRU registers R28 and R29
- 64-bit result (with carry flag) with direct connection to PRU registers R26 and R27
- PRU broadside interface and XFR instructions (XIN, XOUT) allow for importing multiplication results and initiating accumulate function

4.4.1.3.2 PRU and MPY/MAC Interface

The MAC directly connects with the PRU internal registers R25–R29 through use of the PRU broadside interface and XFR instructions. Figure 4-13 shows the functionality of each register.

Figure 4-13. Integration of the PRU and MPY/MAC



The XFR instructions (XIN and XOUT) are used to load/store register contents between the PRU core and the MAC. These instructions define the start, size, direction of the operation, and device ID. The device ID number corresponding to the MPY/MAC is shown in Table 4-17.

Table 4-17. MPY/MAC XFR ID

Device ID	Function
0	Selects MPY/MAC

The PRU register R25 is mapped to the MAC_CTRL_STATUS register (Table 4-18). The MAC's current status (MAC_mode and ACC_carry states) is loaded into R25 using the XIN command on R25. The PRU sets the MAC's mode and clears the ACC_carry using the XOUT command on R25.

Table 4-18. MAC_CTRL_STATUS Register (R25) Field Descriptions

Bit	Field	Value	Description
7-2	Reserved		Reserved
1	ACC_carry		Write 1 to clear
		0	64-bit accumulator carry has not occurred
		1	64-bit accumulator carry occurred
0	MAC_mode	0	Accumulation mode disabled and accumulator is cleared
		1	Accumulation mode enabled

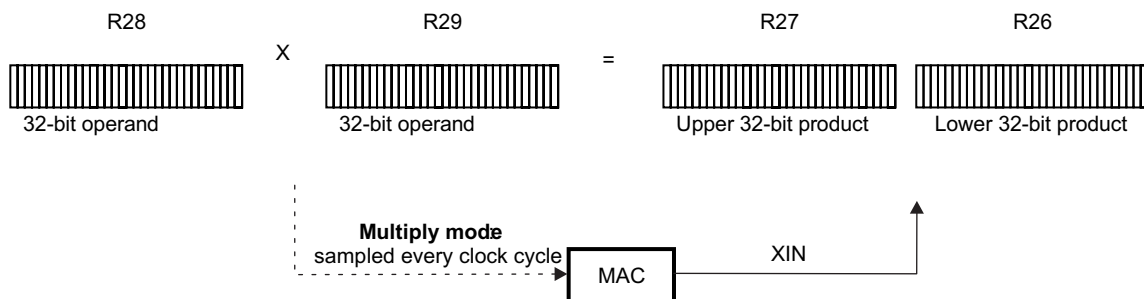
The two 32-bit operands for the multiplication are loaded into R28 and R29. These registers have a direction connection with the MAC. Therefore, XOUT is not required to load the MAC. In multiply mode, the MAC samples these registers every clock cycle. In multiply and accumulate mode, the MAC samples these registers every XOUT R25[7:0] transaction when MAC_mode = 1.

The product from the MAC is linked to R26 (lower 32 bits) and R27 (upper 32 bits). The product is loaded into register R26 and R27 using XIN.

4.4.1.3.2.1 Multiply-Only Mode (Default State), MAC_mode = 0

On every clock cycle, the MAC multiplies the contents of R28 and R29.

Figure 4-14. Multiply-Only Mode Functional Diagram

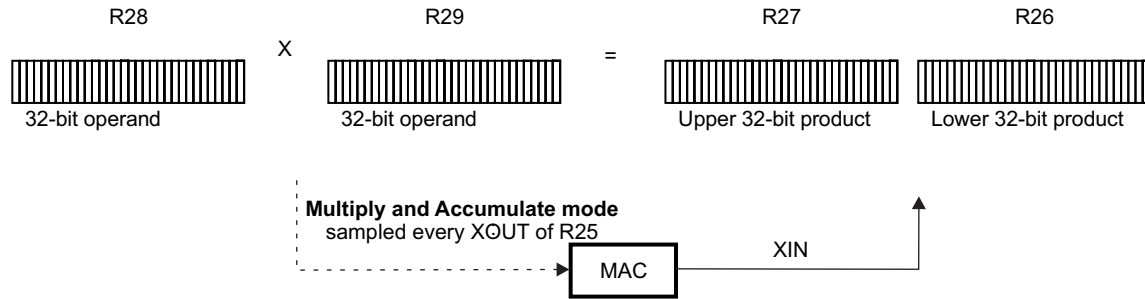


The following steps are performed by the PRU firmware for multiply-only mode:

1. Enable multiply only MAC_mode.
 - (a) Clear R25[0] for multiply only mode.
 - (b) Store MAC_mode to MAC using XOUT instruction with the following parameters:
 - Device ID = 0
 - Base register = R25
 - Size = 1
 2. Load operands into R28 and R29.
 3. Load product into PRU using XIN instruction on R26, R27.
- Repeat steps 2 and 3 for each new operand.

4.4.1.3.2.2 Multiply and Accumulate Mode, MAC_mode = 1

On every XOUT R25_reg[7:0] transaction, the MAC multiplies the contents of R28 and R29, adds the product to its accumulated result, and sets ACC_carry if an accumulation overflow occurs.

Figure 4-15. Multiply and Accumulate Mode Functional Diagram


The following steps are performed by the PRU firmware for multiply and accumulate mode:

1. Enable multiply and accumulate MAC_mode.
 - (a) Set R25[1:0] = 1 for accumulate mode.
 - (b) Store MAC_mode to MAC using XOUT instruction with the following parameters:
 - Device ID = 0
 - Base register = R25
 - Size = 1
2. Clear accumulator and carry flag.
 - (a) Set R25[1:0] = 3 to clear accumulator (R25[1]=1) and preserve accumulate mode (R25[0]=1).
 - (b) Store accumulator to MAC using XOUT instruction on R25.
3. Load operands into R28 and R29.
4. Multiply and accumulate, XOUT R25[1:0] = 1

Repeat step 4 for each multiply and accumulate using same operands.

Repeat step 3 and 4 for each multiply and accumulate for new operands.
5. Load the accumulated product into R26, R27 and the ACC_carry status into R25 using the XIN instruction.

Note: Steps one and two are required to set the accumulator mode and clear the accumulator and carry flag.

4.4.1.4 PRU0/1 Scratch Pad

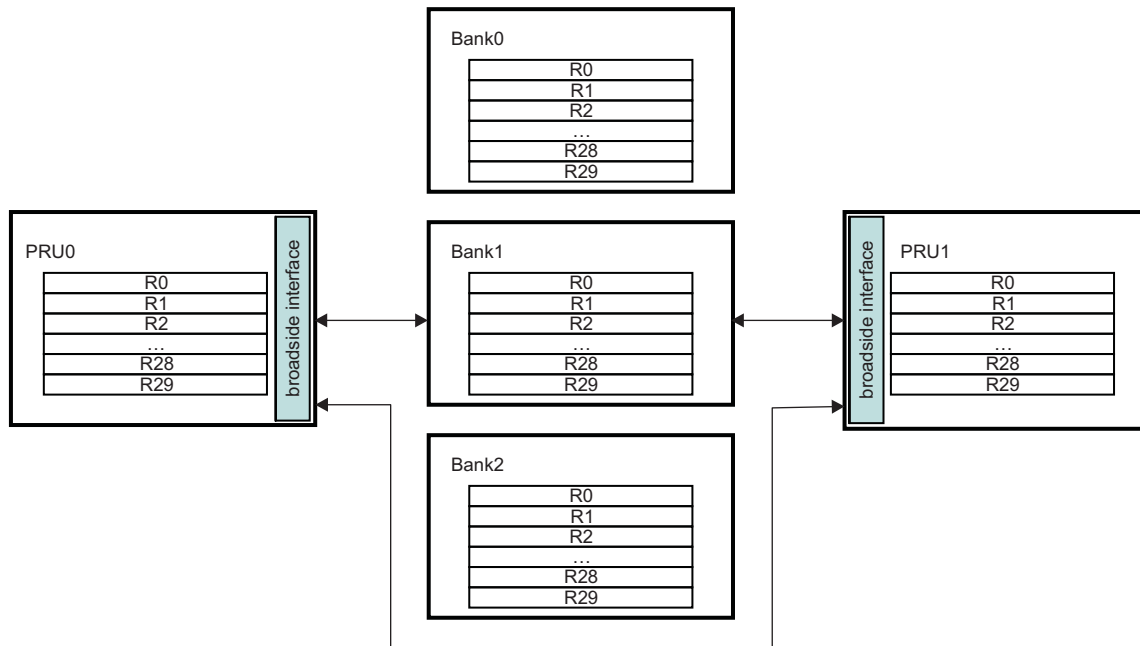
The PRU-ICSS supports a scratch pad with three independent banks accessible by the PRU cores. The PRU cores interact with the scratch pad through broadside load/store PRU interface and XFR instructions. The scratch pad can be used as a temporary place holder for the register contents of the PRU cores. Direct connection between the PRU cores is also supported for transferring register contents directly between the cores.

4.4.1.4.1 Features

The PRU-ICSS scratch pad supports the following features:

- Three scratch pad banks of 30, 32-bit registers (R29:0)
- Flexible load/store options
 - User-defined start byte and length of the transfer
 - Length of transfer ranges from one byte of a register to the entire register content (R29 to R0)
 - Simultaneous transactions supported between PRU0 ↔ Bank<n> and PRU1 ↔ Bank<m>
 - Direct connection of PRU0 → PRU1 or PRU1 → PRU0 for all registers R29–R0
- XFR instructions operate in one clock cycle
- Optional XIN/XOUT shift functionality allows remapping of registers (R<n> → R<m>) during load/store operation

Figure 4-16. Integration of PRU and Scratch Pad



4.4.1.4.2 Implementations and Operations

XFR instructions are used to load/store register contents between the PRU cores and the scratch pad banks. These instructions define the start, size, direction of the operation, and device ID. The device ID corresponds to the external source or destination (either a scratch pad bank or the other PRU core). The device ID numbers are shown in Table 4-19. Note the direct connect mode (device ID 14) can be used to synchronize the PRU cores. This mode requires the transmitting PRU core to execute XOUT and the receiving PRU core to execute XIN.

Table 4-19. Scratch Pad XFR ID

Device ID	Function
10	Selects Bank0
11	Selects Bank1
12	Selects Bank2
13	Reserved
14	Selects other PRU core (Direct connect mode)

A collision occurs when two XOUT commands simultaneously access the same asset or device ID. Table 4-20 shows the priority assigned to each operation when a collision occurs. In direct connect mode (device ID 14), any PRU transaction will be terminated if the stall is greater than 1024 cycles. This will generate the event pr1_xfr_timeout that is connected to INTC.

Table 4-20. Scratch Pad XFR Collision & Stall Conditions

Operation	Collision Handling
PRU<n> XOUT (→) bank[j]	If both PRU cores access the same bank simultaneously, PRU0 is given priority. PRU1 will temporarily stall until the PRU0 operation completes.
PRU<n> XOUT (→) PRU<m>	Direct Connect mode requires the transmitting core (PRU<n>) to execute XOUT and the receiving core (PRU<m>) to execute XIN. If PRU<n> executes XOUT before PRU<m> executes XIN, then PRU<n> will stall until either PRU<m> executes XIN or the stall is greater than 1024 cycles.

Table 4-20. Scratch Pad XFR Collision & Stall Conditions (continued)

PRU<m> XIN (←) PRU<n>	Direct Connect mode requires the transmitting core (PRU<n>) to execute XOUT and the receiving core (PRU<m>) to execute XIN. If PRU<m> executes XIN before PRU<n> executes XOUT, then PRU<m> will stall until either PRU<n> executes XOUT or the stall is greater than 1024 cycles.
-----------------------	--

4.4.1.4.2.1 Optional XIN/XOUT Shift

The optional XIN/XOUT shift functionality allows register contents to be remapped or shifted within the destination's register space. For example, the contents of PRU0 R6-R8 could be remapped to Bank1 R10-12. The XIN/XOUT shift feature is not supported for direct connect mode, only for transfers between a PRU core and scratch pad bank.

The shift feature is enabled or disabled through the SPP register of the PRU-ICSS CFG register space. When enabled, R0[4:0] (internal to the PRU) defines the number of 32-bit registers in which content is shifted in the scratch pad bank. Note that scratch pad banks do not have registers R30 or R31.

4.4.1.4.2.2 Example Scratch Pad Operations

The following PRU firmware examples demonstrate the shift functionality. Note these assume the SHIFT_EN bit of the SPP register of the PRU-ICSS CFG register space has been set.

XOUT Shift By 4 Registers

Store R4:R7 to R8:R11 in bank0:

- Load 4 into R0.b0
- XOUT using the following parameters:
 - Device ID = 10
 - Base register = R4
 - Size = 16

XOUT Shift By 9 Registers, With Wrap Around

Store R25:R29 to R4:R8 in bank1:

- Load 9 into R0.b0
- XOUT using the following parameters:
 - Device ID = 11
 - Base register = R25
 - Size = 20

XIN Shift By 10 Registers

Store R14:R16 from bank2 to R4:R6:

- Load 10 into R0.b0
- XIN using the following parameters:
 - Device ID = 12
 - Base register = R4
 - Size = 12

4.4.2 Interrupt Controller (INTC)

The PRU-ICSS interrupt controller (INTC) is an interface between interrupts coming from different parts of the system (referred to as system events; see [Section 4.4.2.2](#)) and the PRU-ICSS interrupt interface.

The PRU-ICSS INTC has the following features:

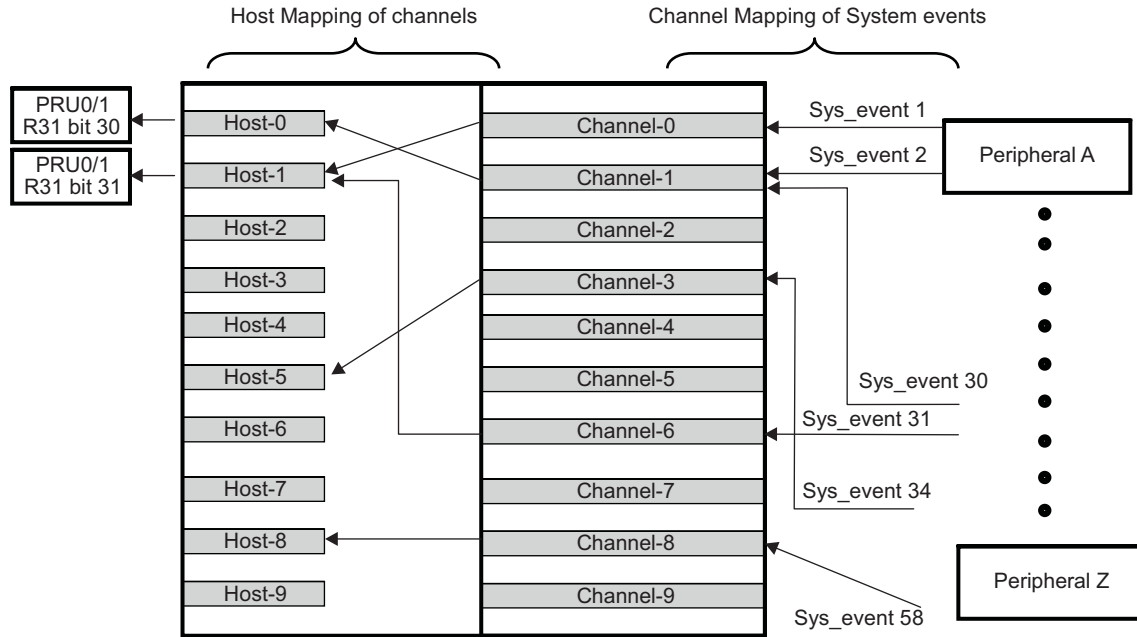
- Capturing up to 64 System Events
- Supports up to 10 interrupt channels.
- Generation of 10 Host Interrupts
 - 2 Host Interrupts for the PRUs.
 - 8 Host Interrupts exported from the PRU-ICSS for signaling the ARM interrupt controllers.
- Each system event can be enabled and disabled.
- Each host event can be enabled and disabled.
- Hardware prioritization of events.

4.4.2.1 INTC Overview

The PRU-ICSS INTC supports up to 64 system events from different peripherals and PRUs to be mapped to 10 channels inside the INTC (see [Figure 4-17](#)). Interrupts from these 10 channels are further mapped to 10 Host Interrupts.

- Any of the 64 system events can be mapped to any of the 10 channels.
- Multiple interrupts can be mapped to a single channel.
- An interrupt should not be mapped to more than one channel.
- Any of the 10 channels can be mapped to any of the 10 host interrupts. It is recommended to map channel “x” to host interrupt “x”, where x is from 0 to 9
- A channel should not be mapped to more than one host interrupt
- For channels mapping to the same host interrupt, lower number channels have higher priority.
- For interrupts on same channel, priority is determined by the hardware interrupt number. The lower the interrupt number, the higher the priority.
- Host Interrupt 0 is connected to bit 30 in register 31 of PRU0 and PRU1.
- Host Interrupt 1 is connected to bit 31 in register 31 for PRU0 and PRU1.
- Host Interrupts 2 through 9 exported from PRU-ICSS for signaling ARM interrupt controllers or other machines like EDMA.

Figure 4-17. Interrupt Controller Block Diagram



4.4.2.2 PRU-ICSS System Events

The PRU-ICSS system events can be found in [Table 4-21](#).

Table 4-21. PRU-ICSS System Events

Int Number	Signal Name (Standard Mode)	Source
63	tpcc_int_pend_po1	TPCC (EDMA)
62	tpcc_errint_pend_po	TPCC (EDMA)
61	tptc_erint_pend_po	TPTC0 (EDMA)
60	initiator_sinterrupt_q_n1	Mbox0 - mail_u1_irq (mailbox interrupt for pru0)
59	initiator_sinterrupt_q_n2	Mbox0 - mail_u2_irq (mailbox interrupt for pru1)
58	Emulation Suspend Signal (software use)	Debugss
57	POINTRPEND1	GPIO0
56	pwm_trip_zone	eHRPWM0/eHRPWM1/eHRPWM2
55	mcasp_x_intr_pend	McASP0 Tx
54	mcasp_r_intr_pend	McASP0 Rx
53	gen_intr_pend	ADC_TSC
52	nirq	UART2
51	nirq	UART0
50	c0_rx_thresh_pend	3PGSW (GEMAC)
49	c0_rx_pend	3PGSW (GEMAC)
48	c0_tx_pend	3PGSW (GEMAC)
47	c0_misc_pend	3PGSW (GEMAC)
46	epwm_intr_intr_pend	eHRPWM1
45	eqep_intr_intr_pend	eQEP0
44	SINTERRUPTN	McSPI0
43	epwm_intr_intr_pend	eHRPWM0
42	ecap_intr_intr_pend	eCAP0
41	POINTRPEND	I2C0
40	dcan_intr	DCAN0
39	dcan_int1	DCAN0
38	dcan_uerr	DCAN0
37	epwm_intr_intr_pend	eHRPWM2
36	ecap_intr_intr_pend	eCAP2
35	ecap_intr_intr_pend	eCAP1
34	mcasp_r_intr_pend	McASP1 Rx
33	mcasp_x_intr_pend	McASP1 Tx
32	nirq	UART1
31	pr1_pru_mst_intr[15]_intr_req	pru0 or pru1
30	pr1_pru_mst_intr[14]_intr_req	pru0 or pru1
29	pr1_pru_mst_intr[13]_intr_req	pru0 or pru1
28	pr1_pru_mst_intr[12]_intr_req	pru0 or pru1
27	pr1_pru_mst_intr[11]_intr_req	pru0 or pru1
26	pr1_pru_mst_intr[10]_intr_req	pru0 or pru1
25	pr1_pru_mst_intr[9]_intr_req	pru0 or pru1
24	pr1_pru_mst_intr[8]_intr_req	pru0 or pru1
23	pr1_pru_mst_intr[7]_intr_req	pru0 or pru1
22	pr1_pru_mst_intr[6]_intr_req	pru0 or pru1
21	pr1_pru_mst_intr[5]_intr_req	pru0 or pru1

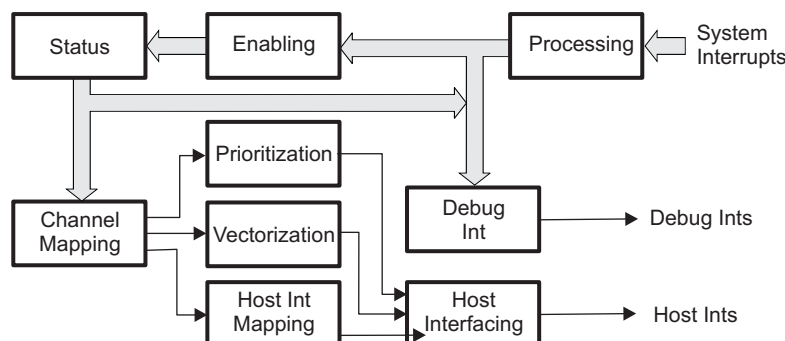
Table 4-21. PRU-ICSS System Events (continued)

Int Number	Signal Name (Standard Mode)	Source
20	pr1_pru_mst_intr[4]_intr_req	pru0 or pru1
19	pr1_pru_mst_intr[3]_intr_req	pru0 or pru1
18	pr1_pru_mst_intr[2]_intr_req	pru0 or pru1
17	pr1_pru_mst_intr[1]_intr_req	pru0 or pru1
16	pr1_pru_mst_intr[0]_intr_req	pru0 or pru1
15	pr1_ecap_intr_req	PRU-ICSS eCAP
14	Reserved	Reserved
13	Reserved	Reserved
12	Reserved	Reserved
11	Reserved	Reserved
10	Reserved	Reserved
9	Reserved	Reserved
8	pr1_digio_event_req	PRU-ICSS IEP
7	pr1_iep_tim_cap_cmp_pend	PRU-ICSS IEP
6	pr1_uart_uint_intr_req	PRU-ICSS UART
5	pr1_uart_utxevt_intr_req	PRU-ICSS UART
4	pr1_uart_urxevt_intr_req	PRU-ICSS UART
3	pr1_xfr_timeout	PRU-ICSS Scratch Pad
2	pr1_pru1_r31_status_cnt16	PRU-ICSS PRU1 (Shift Capture)
1	pr1_pru0_r31_status_cnt16	PRU-ICSS PRU0 (Shift Capture)
0	pr1_parity_err_intr_pend	PRU-ICSS Parity Logic

4.4.2.3 INTC Methodology

The INTC module controls the system event mapping to the host interrupt interface. System events are generated by the device peripherals or PRUs. The INTC receives the system events and maps them to internal channels. The channels are used to group interrupts together and to prioritize them. These channels are then mapped onto the host interrupts. Interrupts from the system side are active high in polarity. They are also pulse type of interrupts.

The INTC encompasses many functions to process the system events and prepare them for the host interface. These functions are: processing, enabling, status, channel mapping, host interrupt mapping, prioritization, and host interfacing. [Figure 4-18](#) illustrates the flow of system events through the functions to the host. The following subsections describe each part of the flow.

Figure 4-18. Flow of System Events to Host


4.4.2.3.1 Interrupt Processing

This block does the following tasks:

- Synchronization of slower and asynchronous interrupts
- Conversion of polarity to active high
- Conversion of interrupt type to pulse interrupts

After the processing block, all interrupts will be active high pulses.

Interrupt Enabling

The next stage of INTC is to enable system events based on programmed settings. The following sequence is to be followed to enable interrupts:

- Enable required system events: System events that are required to get propagated to host are to be enabled individually by writing to IDX field in the system event enable indexed set register (EISR). The event to enable is the index value written. This sets the Enable Register bit of the given index.
- Enable required host interrupts: By writing to the IDX field in the host interrupt enable indexed set register (HIEISR), enable the required host interrupts. The host interrupt to enable is the index value written. This enables the host interrupt output or triggers the output again if that host interrupt is already enabled.
- Enable all host interrupts: By setting the EN bit in the global enable register (GER) to 1, all host interrupts will be enabled. Individual host interrupts are still enabled or disabled from their individual enables and are not overridden by the global enable.

4.4.2.3.2 Interrupt Status Checking

The next stage is to capture which system events are pending. There are two kinds of pending status: raw status and enabled status. Raw status is the pending status of the system event without regards to the enable bit for the system event. Enabled status is the pending status of the system events with the enable bits active. When the enable bit is inactive, the enabled status will always be inactive. The enabled status of system events is captured in system event status enabled/clear registers (SECR1-SECR2).

Status of system event 'N' is indicated by the Nth bit of SECR1-SECR2. Since there are 64 system events, two 32-bit registers are used to capture the enabled status of events. The pending status reflects whether the system event occurred since the last time the status register bit was cleared. Each bit in the status register can be individually cleared.

4.4.2.3.3 Interrupt Channel Mapping

The INTC has 10 internal channels to which enabled system events can be mapped. Channel 0 has highest priority and channel 9 has the lowest priority. Channels are used to group the system events into a smaller number of priorities that can be given to a host interface with a very small number of interrupt inputs.

When multiple system events are mapped to the same channel their interrupts are ORed together so that when one or more is active the output is active. The channel map registers (CMR_m) define the channel for each system event. There is one register per 4 system events; therefore, there are 16 channel map registers for a system of 64 events. The channel for each system event can be set using these registers.

4.4.2.3.3.1 Host Interrupt Mapping

The hosts can be the PRUs or ARM CPU. The 10 channels from the INTC can be mapped to any of the 10 Host events. The Host map registers (HMR_m) define the channel for each system event. There is one register per 4 channels; therefore, there are 3 host map registers for 10 channels. When multiple channels are mapped to the same host interrupt, then prioritization is done to select which interrupt is in the highest-priority channel and which should be sent first to the host.

4.4.2.3.3.2 Interrupt Prioritization

The next stage of the INTC is prioritization. Since multiple events can feed into a single channel and multiple channels can feed into a single host interrupt, it is to read the status of all system events to determine the highest priority event that is pending. The INTC provides hardware to perform this prioritization with a given scheme so that software does not have to do this. There are two levels of prioritizations:

- The first level of prioritization is between the active channels for a host interrupt. Channel 0 has the highest priority and channel 9 has the lowest. So the first level of prioritization picks the lowest numbered active channel.
- The second level of prioritization is between the active system events for the prioritized channel. The system event in position 0 has the highest priority and system event 63 has the lowest priority. So the second level of prioritization picks the lowest position active system event.

This is the final prioritized system event for the host interrupt and is stored in the global prioritized index register (GPIR). The highest priority pending event with respect to each host interrupt can be obtained using the host interrupt prioritized index registers (HIPIRn).

4.4.2.3.4 Interrupt Nesting

The INTC can also perform a nesting function in its prioritization. Nesting is a method of enabling certain interrupts (usually higher-priority interrupts) when an interrupt is taken so that only those desired interrupts can trigger to the host while it is servicing the current interrupt. The typical usage is to nest on the current interrupt and disable all interrupts of the same or lower priority (or channel). Then the host will only be interrupted from a higher priority interrupt.

The nesting is done in one of three methods:

1. Nesting for all host interrupts, based on channel priority: When an interrupt is taken, the nesting level is set to its channel priority. From then, that channel priority and all lower priority channels will be disabled from generating host interrupts and only higher priority channels are allowed. When the interrupt is completely serviced, the nesting level is returned to its original value. When there is no interrupt being serviced, there are no channels disabled due to nesting. The global nesting level register (GNLR) allows the checking and setting of the global nesting level across all host interrupts. The nesting level is the channel (and all of lower priority channels) that are nested out because of a current interrupt.
2. Nesting for individual host interrupts, based on channel priority: Always nest based on channel priority for each host interrupt individually. When an interrupt is taken on a host interrupt, then, the nesting level is set to its channel priority for just that host interrupt, and other host interrupts do not have their nesting affected. Then for that host interrupt, equal or lower priority channels will not interrupt the host but may on other host interrupts if programmed. When the interrupt is completely serviced the nesting level for the host interrupt is returned to its original value. The host interrupt nesting level registers (HINLR1 and HINLR2) display and control the nesting level for each host interrupt. The nesting level controls which channel and lower priority channels are nested. There is one register per host interrupt.
3. Software manually performs the nesting of interrupts. When an interrupt is taken, the software will disable all the host interrupts, manually update the enables for any or all the system events, and then re-enables all the host interrupts. This now allows only the system events that are still enabled to trigger to the host. When the interrupt is completely serviced the software must reverse the changes to re-enable the nested out system events. This method requires the most software interaction but gives the most flexibility if simple channel based nesting mechanisms are not adequate.

4.4.2.3.5 Interrupt Status Clearing

After servicing the event (after execution of the ISR), event status is to be cleared. If a system event status is not cleared, then another host interrupt may not be triggered or another host interrupt may be triggered incorrectly. It is also essential to clear all system events before the PRU is halted as the PRU does not power down unless all the event status are cleared. For clearing the status of an event, whose event number is N, write a 1 to the Nth bit position in the system event status enabled/clear registers (SECR1-SECR2). System event N can also be cleared by writing the value N into the system event status indexed clear register (SICR).

4.4.2.4 Interrupt Disabling

At any time, if any event is not to be propagated to the host, then that event should be disabled. For disabling an event whose event number is N, write a 1 to the Nth bit in the system event enable clear registers (ECR1-ECR2). System event N can also be disabled by writing the value N in the system event enable indexed clear register (EICR).

4.4.2.5 INTC Basic Programming Model

Follow these steps to configure the interrupt controller.

1. Set polarity and type of system event through the System Event Polarity Registers (SIPR1 and SPIR2) and the System Event Type Registers (SITR1 and SITR2). Polarity of all system events is always high. Type of all system events is always pulse.
2. Map system event to INTC channel through CHANMAP registers.
3. Map channel to host interrupt through HOSTMAP registers. Recommend channel “x” be mapped to host interrupt “x”.
4. Clear system event by writing 1s to SECR registers.
5. Enable host interrupt by writing index value to HIER register.
6. Enable interrupt nesting if desired.
7. Globally enable all interrupts through GER register.

4.4.3 Industrial Ethernet Peripheral (IEP)

The industrial ethernet peripheral (IEP) performs hardware work required for industrial ethernet functions. The IEP module features an industrial ethernet timer with 8 compare events and a digital I/O port (DIGIO).

4.4.3.1 IEP Clock Source

The IEP has a selectable module input clock. The clock source is selected by the state of the IEPCLK.OCP_EN bit within the PRU-ICSS CFG register space. Two clock sources are supported for the IEP input clock:

- iep_clk (default): Runs at 200 MHz
- ocp_clk

Switching from iep_clk to ocp_clk is done by writing 1 to the IEPCLK.OCP_EN bit. This is a one time configuration step before enabling the IEP function. Switching back from ocp_clk to iep_clk is only supported through a hardware reset of the PRU-ICSS.

4.4.3.2 Industrial Ethernet Timer

The industrial ethernet timer is a simple 32-bit timer. This timer is intended for use by industrial ethernet functions but can also be leveraged as a generic timer in other applications.

4.4.3.2.1 Features

The industrial ethernet timer supports the following features:

- One master 32-bit count-up counter with an overflow status bit.
 - Runs on iep_clk or ocp_clk
 - Write 1 to clear status
 - Supports a programmable increment value from 1 to 16 (default 5)
 - An optional compensation method allows the increment value to apply a compensation increment value from 1 to 16, counting up to 2^{24} iep_clk/ocp_clk events
- Eight 32-bit compare registers (CMP[7:0], CMP_STAT).
 - Eight status bits, write 1 to clear
 - Eight individual event outputs
 - One global event (any compare event) output for interrupt generation triggered by any compare event
- Sixteen outputs, one high level and one high pulse for each compare hit event
- CMP[0], if enabled, will reset the counter on the next iep_clk or ocp_clk cycle

4.4.3.2.2 Basic Programming Model

Follow these basic steps to configure the IEP Timer.

1. Initialize timer to known state (default values)
 - (a) Disable counter (GLB_CFG.CNT_ENABLE)
 - (b) Reset Count Register (CNT) by writing 0xFFFFFFFF to clear
 - (c) Clear overflow status register (GLB_STS.CNT_OVF)
 - (d) Clear compare status (CMP_STS)
2. Set compare values (CMP0-CMPx)
3. Enable compare event (CMP_CFG.CMP_EN)
4. Set increment value (GLB_CFG.DEFAULT_INC)
5. Set compensation value (COMPEN.COMPEN_CNT)
6. Enable counter (GLB_CFG.CNT_ENABLE)

4.4.3.3 Industrial Ethernet Digital I/O (DIGIO)

The IEP Digital I/O (DIGIO) block provides dedicated I/Os intended for industrial ethernet protocols, but they can also be used as generic I/Os in other applications.

4.4.3.3.1 Features

The industrial ethernet digital I/O supports the following features:

- Digital data output
 - 32 channels (pr1_edio_data_out[31:0])
 - Software controls enable signal driving output data output
- Digital data out enable (optional tri-state control)
- Digital data input
 - 32 channels (pr1_edio_data_in[31:0])
 - DIGIO_DATA_IN_RAW supports direct sampling of pr1_edio_data_in
 - External latch event signal (pr1_edio_latch_in) triggers a pulse on which pr1_edio_data_in is sampled

NOTE: Some devices may not pin out all 32 data signals. For which data pins are available on this device, see [Table 4-3, PRU-ICSS Pin List](#).

4.4.3.3.2 DIGIO Block Diagrams

Figure 4-19 shows the signals and registers for capturing the DIGIO data in. Note that IN_MODE in the DIGIO_CTRL register must be set to 1 for data to be latched on the external pr1_edio_latch_in signal.

Figure 4-19. IEP DIGIO Data In

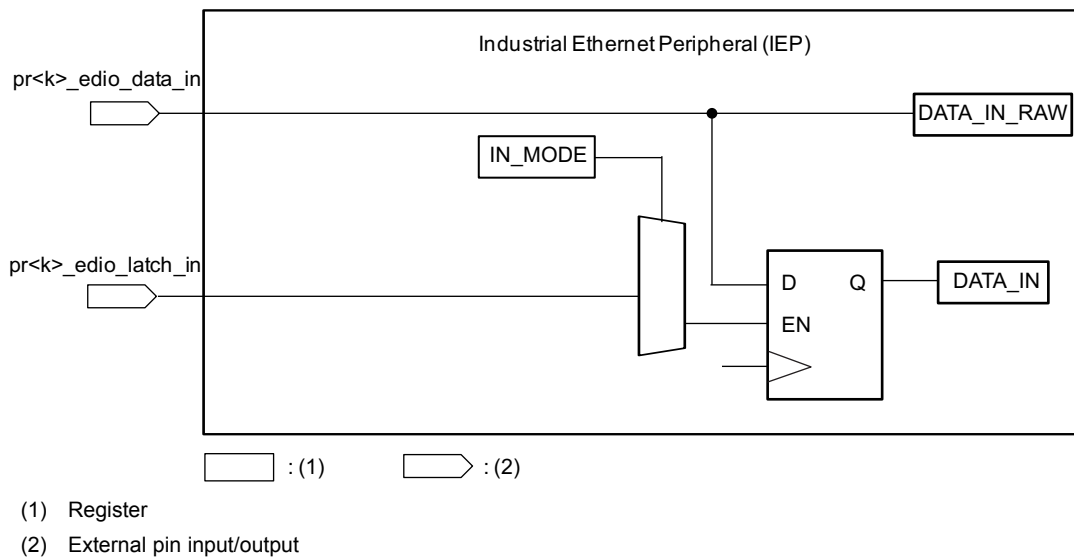
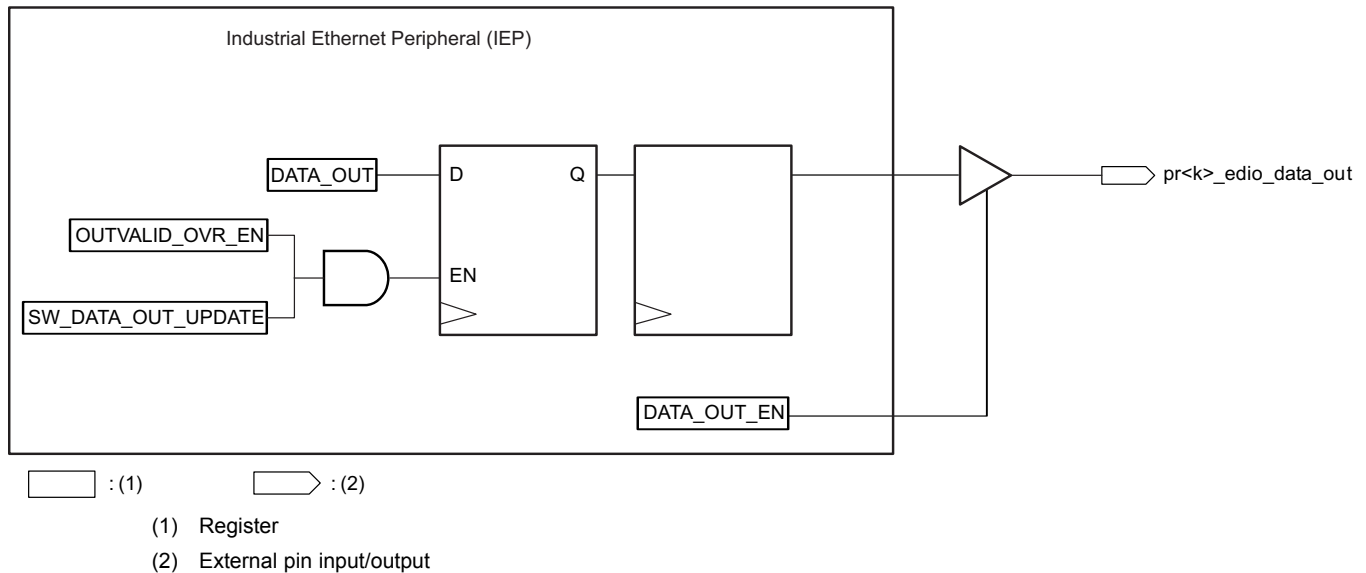


Figure 4-20 shows the signals and registers for driving the DIGIO data out.

Figure 4-20. IEP DIGIO Data Out



4.4.3.3.3 Basic Programming Model

Follow these steps to configure and read the DIGIO Data Input.

1. Read `DIGIO_DATA_IN_RAW` for raw input data

or

1. Enable sampling of `pr1_edio_data_in[31:0]` by setting `DIGIO_CTRL.IN_MODE`
2. Read `DIGIO_DATA_IN` for data sampled by `pr1_edio_latch_in`

Follow these steps to configure and write to the DIGIO Data Output.

1. Pre-configure DIGIO by setting `DIGIO_EXP.OUTVALID_OVR_EN` and `DIGIO_EXP.SW_DATA_OUT_UPDATE`
2. Write to `DIGIO_DATA_OUT` to configure output data
3. To Hi-Z output, set `DIGIO_DATA_OUT_EN` (clear `DIGIO_DATA_OUT_EN` to drive value stored in `DIGIO_DATA_OUT`)

4.4.4 Universal Asynchronous Receiver/Transmitter (UART)

4.4.4.1 Introduction

4.4.4.1.1 Purpose of the Peripheral

The PRU UART peripheral within the PRU-ICSS is based on the industry standard TL16C550 asynchronous communications element, which in turn is a functional upgrade of the TL16C450. Functionally similar to the TL16C450 on power up (single character or TL16C450 mode), the UART can be placed in an alternate FIFO (TL16C550) mode. This relieves the CPU of excessive software overhead by buffering received and transmitted characters. The receiver and transmitter FIFOs store up to 16 bytes including three additional bits of error status per byte for the receiver FIFO.

The UART performs serial-to-parallel conversions on data received from a peripheral device and parallel-to-serial conversion on data received from the CPU. The CPU can read the UART status at any time. The UART includes control capability and a processor interrupt system that can be tailored to minimize software management of the communications link.

The UART includes a programmable baud rate generator capable of dividing the PRU_ICSS_UART_CLK input clock by divisors from 1 to 65535 and producing a 16× reference clock or a 13× reference clock for the internal transmitter and receiver logic. For detailed timing and electrical specifications for the UART, see your device-specific data manual.

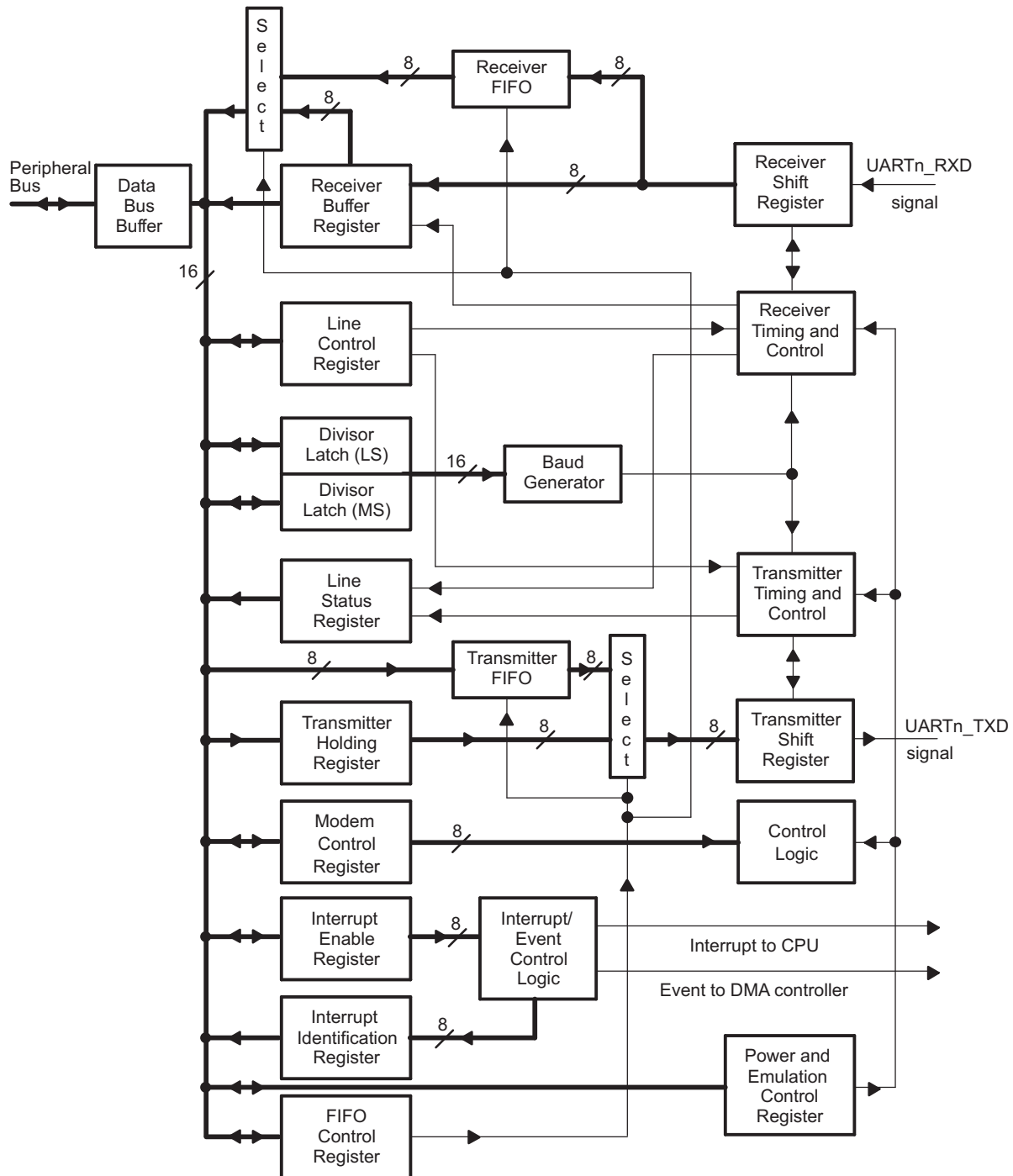
4.4.4.1.2 Functional Block Diagram

A functional block diagram of the UART is shown in [Figure 4-21](#).

4.4.4.1.3 Industry Standard(s) Compliance Statement

The UART peripheral is based on the industry standard TL16C550 asynchronous communications element, which is a functional upgrade of the TL16C450. The information in this chapter assumes you are familiar with these standards.

Figure 4-21. UART Block Diagram



NOTE: The value *n* indicates the applicable UART where there are multiple instances. For the PRU-ICSS, there is only one instance and all UART signals should reflect this (e.g., UART0_TXD instead of UARTn_TXD).

4.4.4.2 Functional Description

4.4.4.2.1 Clock Generation and Control

The UART bit clock is derived from an input clock to the UART. See your device-specific data manual to check the maximum data rate supported by the UART.

Figure 4-22 is a conceptual clock generation diagram for the UART. The PRU_ICSS_UART_CLK is input to the Clock Generator, which uses a programmable divider to produce the UART input clock. The UART contains a programmable baud generator that takes the UART input clock and divides it by a divisor in the range between 1 and $(2^{16} - 1)$ to produce a baud clock (BCLK). The frequency of BCLK is sixteen times (16×) the baud rate (each received or transmitted bit lasts 16 BCLK cycles) or thirteen times (13×) the baud rate (each received or transmitted bit lasts 13 BCLK cycles). When the UART is receiving, the bit is sampled in the 8th BCLK cycle for 16× over sampling mode and on the 6th BCLK cycle for 13× over-sampling mode. The 16× or 13× reference clock is selected by configuring the OSM_SEL bit in the mode definition register (MDR). The formula to calculate the divisor is:

$$\text{Divisor} = \frac{\text{UART input clock frequency}}{\text{Desired baud rate} \times 16} \quad [\text{MDR.OSM_SEL} = 0]$$

$$\text{Divisor} = \frac{\text{UART input clock frequency}}{\text{Desired baud rate} \times 13} \quad [\text{MDR.OSM_SEL} = 1]$$

Two 8-bit register fields (DLH and DLL), called divisor latches, hold this 16-bit divisor. DLH holds the most significant bits of the divisor, and DLL holds the least significant bits of the divisor. For information about these register fields, see the UART register descriptions. These divisor latches must be loaded during initialization of the UART in order to ensure desired operation of the baud generator. Writing to the divisor latches results in two wait states being inserted during the write access while the baud generator is loaded with the new value.

Figure 4-23 summarizes the relationship between the transferred data bit, BCLK, and the UART input clock. Note that the timing relationship depicted in Figure 4-23 shows that each bit lasts for 16 BCLK cycles. This is in case of 16x over-sampling mode. For 13× over-sampling mode each bit lasts for 13 BCLK cycles.

Example baud rates and divisor values relative to a 192-MHz UART input clock and 16× over-sampling mode are shown in Table 4-22.

Figure 4-22. UART Clock Generation Diagram

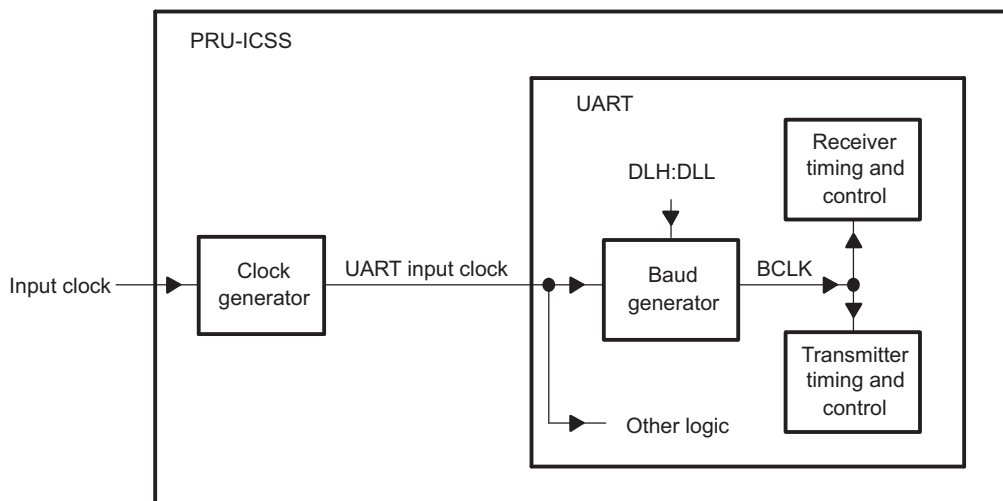
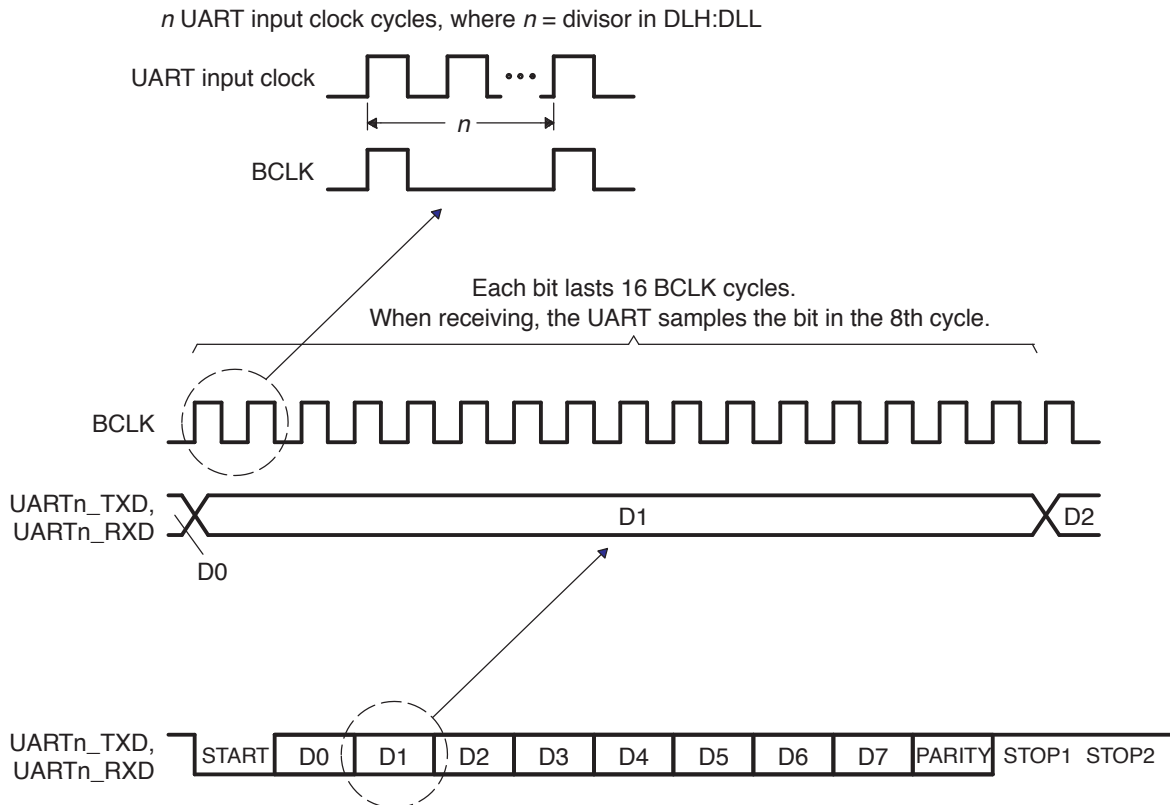


Figure 4-23. Relationships Between Data Bit, BCLK, and UART Input Clock

Table 4-22. Baud Rate Examples for 192-MHZ UART Input Clock and 16× Over-sampling Mode

Baud Rate	Divisor Value	Actual Baud Rate	Error (%)
2400	5000	2400	0.00
4800	2500	4800	0.00
9600	1250	9600	0.00
19200	625	19200	0.00
38400	313	38338.658	-0.16
56000	214	56074.766	0.13
128000	94	127659.574	-0.27
3000000	40	300000	0.00

Table 4-23. Baud Rate Examples for 192-MHZ UART Input Clock and 13× Over-sampling Mode

Baud Rate	Divisor Value	Actual Baud Rate	Error (%)
2400	6154	2399.940	-0.0025
4800	3077	4799.880	-0.0025
9600	1538	9602.881	0.03
19200	769	19205.762	0.03
38400	385	38361.638	-0.10
56000	264	55944.056	-0.10
128000	115	128428.094	0.33
3000000	49	301412.873	0.47

4.4.4.2.2 Signal Descriptions

The UARTs utilize a minimal number of signal connections to interface with external devices. The UART signal descriptions are included in [Table 4-24](#). Note that the number of UARTs and their supported features vary on each device. See your device-specific data manual for more details.

Table 4-24. UART Signal Descriptions

Signal Name ⁽¹⁾	Signal Type	Function
UART _n _TXD	Output	Serial data transmit
UART _n _RXD	Input	Serial data receive
UART _n _CTS ⁽²⁾	Input	Clear-to-Send handshaking signal
UART _n _RTS ⁽²⁾	Output	Request-to-Send handshaking signal

⁽¹⁾ The value *n* indicates the applicable UART; that is, UART0, UART1, etc.

⁽²⁾ This signal is not supported in all UARTs. See your device-specific data manual to check if it is supported.

4.4.4.2.3 Pin Multiplexing

Extensive pin multiplexing is used to accommodate the largest number of peripheral functions in the smallest possible package. Pin multiplexing is controlled using a combination of hardware configuration at device reset and software programmable register settings. See your device-specific data manual to determine how pin multiplexing affects the UART.

4.4.4.2.4 Protocol Description

4.4.4.2.4.1 Transmission

The UART transmitter section includes a transmitter hold register (THR) and a transmitter shift register (TSR). When the UART is in the FIFO mode, THR is a 16-byte FIFO. Transmitter section control is a function of the UART line control register (LCR). Based on the settings chosen in LCR, the UART transmitter sends the following to the receiving device:

- 1 START bit
- 5, 6, 7, or 8 data bits
- 1 PARITY bit (optional)
- 1, 1.5, or 2 STOP bits

4.4.4.2.4.2 Reception

The UART receiver section includes a receiver shift register (RSR) and a receiver buffer register (RBR). When the UART is in the FIFO mode, RBR is a 16-byte FIFO. Receiver section control is a function of the UART line control register (LCR). Based on the settings chosen in LCR, the UART receiver accepts the following from the transmitting device:

- 1 START bit
- 5, 6, 7, or 8 data bits
- 1 PARITY bit (optional)
- 1 STOP bit (any other STOP bits transferred with the above data are not detected)

4.4.4.2.4.3 Data Format

The UART transmits in the following format:

1 START bit + data bits (5, 6, 7, 8) + 1 PARITY bit (optional) + STOP bit (1, 1.5, 2)

It transmits 1 START bit; 5, 6, 7, or 8 data bits, depending on the data width selection; 1 PARITY bit, if parity is selected; and 1, 1.5, or 2 STOP bits, depending on the STOP bit selection.

The UART receives in the following format:

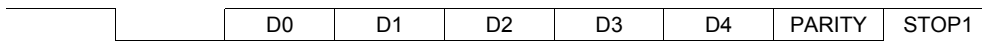
1 START bit + data bits (5, 6, 7, 8) + 1 PARITY bit (optional) + 1 STOP bit

It receives 1 START bit; 5, 6, 7, or 8 data bits, depending on the data width selection; 1 PARITY bit, if parity is selected; and 1 STOP bit.

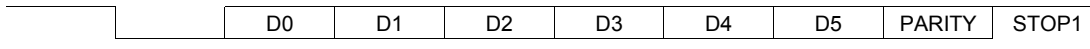
The protocol formats are shown in [Figure 4-24](#).

Figure 4-24. UART Protocol Formats

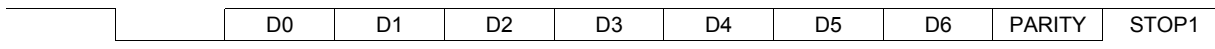
Transmit/Receive for 5-bit data, parity Enable, 1 STOP bit



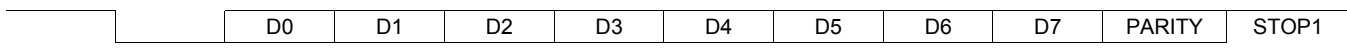
Transmit/Receive for 6-bit data, parity Enable, 1 STOP bit



Transmit/Receive for 7-bit data, parity Enable, 1 STOP bit



Transmit/Receive for 8-bit data, parity Enable, 1 STOP bit



4.4.4.2.5 Operation

4.4.4.2.5.1 Transmission

The UART transmitter section includes a transmitter hold register (THR) and a transmitter shift register (TSR). When the UART is in the FIFO mode, THR is a 16-byte FIFO. Transmitter section control is a function of the UART line control register (LCR). Based on the settings chosen in LCR, the UART transmitter sends the following to the receiving device:

- 1 START bit
- 5, 6, 7, or 8 data bits
- 1 PARITY bit (optional)
- 1, 1.5, or 2 STOP bits

THR receives data from the internal data bus, and when TSR is ready, the UART moves the data from THR to TSR. The UART serializes the data in TSR and transmits the data on the UARTn_TXD pin.

In the non-FIFO mode, if THR is empty and the THR empty (THRE) interrupt is enabled in the interrupt enable register (IER), an interrupt is generated. This interrupt is cleared when a character is loaded into THR or the interrupt identification register (IIR) is read. In the FIFO mode, the interrupt is generated when the transmitter FIFO is empty, and it is cleared when at least one byte is loaded into the FIFO or IIR is read.

4.4.4.2.5.2 Reception

The UART receiver section includes a receiver shift register (RSR) and a receiver buffer register (RBR). When the UART is in the FIFO mode, RBR is a 16-byte FIFO. Timing is supplied by the 16× receiver clock. Receiver section control is a function of the UART line control register (LCR). Based on the settings chosen in LCR, the UART receiver accepts the following from the transmitting device:

- 1 START bit
- 5, 6, 7, or 8 data bits
- 1 PARITY bit (optional)
- 1 STOP bit (any other STOP bits transferred with the above data are not detected)

RSR receives the data bits from the UARTn_RXD pin. Then RSR concatenates the data bits and moves the resulting value into RBR (or the receiver FIFO). The UART also stores three bits of error status information next to each received character, to record a parity error, framing error, or break.

In the non-FIFO mode, when a character is placed in RBR and the receiver data-ready interrupt is enabled in the interrupt enable register (IER), an interrupt is generated. This interrupt is cleared when the character is read from RBR. In the FIFO mode, the interrupt is generated when the FIFO is filled to the trigger level selected in the FIFO control register (FCR), and it is cleared when the FIFO contents drop below the trigger level.

4.4.4.2.5.3 FIFO Modes

The following two modes can be used for servicing the receiver and transmitter FIFOs:

- FIFO interrupt mode. The FIFO is enabled and the associated interrupts are enabled. Interrupts are sent to the CPU to indicate when specific events occur.
- FIFO poll mode. The FIFO is enabled but the associated interrupts are disabled. The CPU polls status bits to detect specific events.

Because the receiver FIFO and the transmitter FIFO are controlled separately, either one or both can be placed into the interrupt mode or the poll mode.

4.4.4.2.5.3.1 FIFO Interrupt Mode

When the receiver FIFO is enabled in the FIFO control register (FCR) and the receiver interrupts are enabled in the interrupt enable register (IER), the interrupt mode is selected for the receiver FIFO. The following are important points about the receiver interrupts:

- The receiver data-ready interrupt is issued to the CPU when the FIFO has reached the trigger level that is programmed in FCR. It is cleared when the CPU or the DMA controller reads enough characters from the FIFO such that the FIFO drops below its programmed trigger level.
- The receiver line status interrupt is generated in response to an overrun error, a parity error, a framing error, or a break. This interrupt has higher priority than the receiver data-ready interrupt. For details, see [Section 4.4.4.2.8](#).
- The data-ready (DR) bit in the line status register (LSR) indicates the presence or absence of characters in the receiver FIFO. The DR bit is set when a character is transferred from the receiver shift register (RSR) to the empty receiver FIFO. The DR bit remains set until the FIFO is empty again.
- A receiver time-out interrupt occurs if all of the following conditions exist:
 - At least one character is in the FIFO,
 - The most recent character was received more than four continuous character times ago. A character time is the time allotted for 1 START bit, n data bits, 1 PARITY bit, and 1 STOP bit, where n depends on the word length selected with the WLS bits in the line control register (LCR). See [Table 4-25](#).
 - The most recent read of the FIFO has occurred more than four continuous character times before.
- Character times are calculated by using the baud rate.
- When a receiver time-out interrupt has occurred, it is cleared and the time-out timer is cleared when the CPU or the EDMA controller reads one character from the receiver FIFO. The interrupt is also cleared if a new character is received in the FIFO or if the URRST bit is cleared in the power and emulation management register (PWREMU_MGMT).
- If a receiver time-out interrupt has not occurred, the time-out timer is cleared after a new character is received or after the CPU or EDMA reads the receiver FIFO.

When the transmitter FIFO is enabled in FCR and the transmitter holding register empty (THRE) interrupt is enabled in IER, the interrupt mode is selected for the transmitter FIFO. The THRE interrupt occurs when the transmitter FIFO is empty. It is cleared when the transmitter hold register (THR) is loaded (1 to 16 characters may be written to the transmitter FIFO while servicing this interrupt) or the interrupt identification register (IIR) is read.

Table 4-25. Character Time for Word Lengths

Word Length (n)	Character Time	Four Character Times
5	Time for 8 bits	Time for 32 bits
6	Time for 9 bits	Time for 36 bits
7	Time for 10 bits	Time for 40 bits
8	Time for 11 bits	Time for 44 bits

4.4.4.2.5.3.2 FIFO Poll Mode

When the receiver FIFO is enabled in the FIFO control register (FCR) and the receiver interrupts are disabled in the interrupt enable register (IER), the poll mode is selected for the receiver FIFO. Similarly, when the transmitter FIFO is enabled and the transmitter interrupts are disabled, the transmitted FIFO is in the poll mode. In the poll mode, the CPU detects events by checking bits in the line status register (LSR):

- The RXFIFOE bit indicates whether there are any errors in the receiver FIFO.
- The TEMT bit indicates that both the transmitter holding register (THR) and the transmitter shift register (TSR) are empty.
- The THRE bit indicates when THR is empty.
- The BI (break), FE (framing error), PE (parity error), and OE (overrun error) bits specify which error or errors have occurred.
- The DR (data-ready) bit is set as long as there is at least one byte in the receiver FIFO.

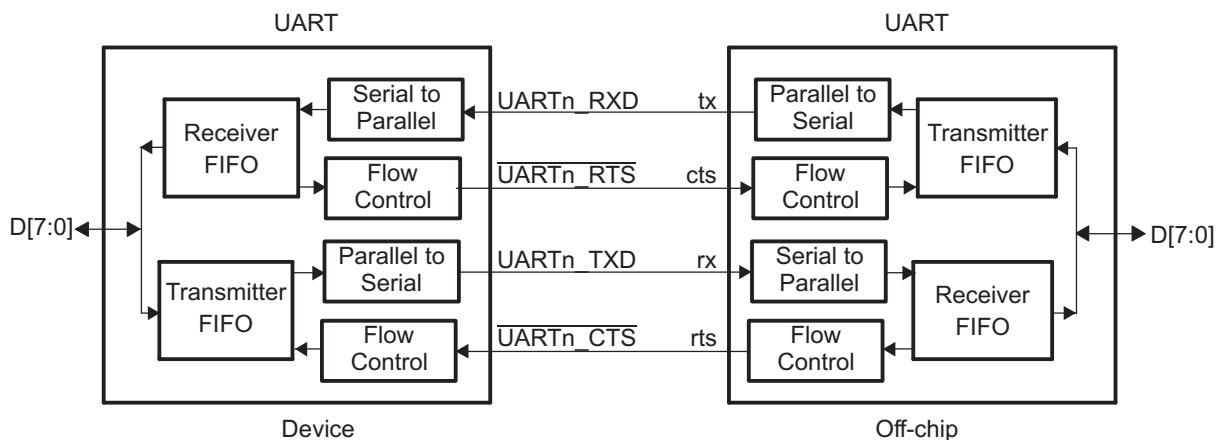
Also, in the FIFO poll mode:

- The interrupt identification register (IIR) is not affected by any events because the interrupts are disabled.
- The UART does not indicate when the receiver FIFO trigger level is reached or when a receiver time-out occurs.

4.4.4.2.5.4 Autoflow Control

The UART can employ autoflow control by connecting the $\overline{\text{UARTn_CTS}}$ and $\overline{\text{UARTn_RTS}}$ signals. Note that all UARTs do not support autoflow control; see your device-specific data manual for supported features. The $\overline{\text{UARTn_CTS}}$ input must be active before the transmitter FIFO can transmit data. The $\overline{\text{UARTn_RTS}}$ output becomes active when the receiver needs more data and notifies the sending device. When $\overline{\text{UARTn_RTS}}$ is connected to $\overline{\text{UARTn_CTS}}$, data transmission does not occur unless the receiver FIFO has space for the data. Therefore, when two UARTs are connected as shown in Figure 4-25 with autoflow enabled, overrun errors are eliminated.

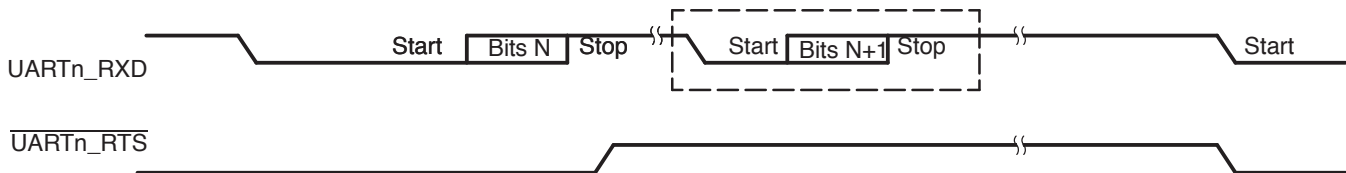
Figure 4-25. UART Interface Using Autoflow Diagram



4.4.4.2.5.4.1 $\overline{\text{UARTn_RTS}}$ Behavior

$\overline{\text{UARTn_RTS}}$ data flow control originates in the receiver block (see Figure 4-21). When the receiver FIFO level reaches a trigger level of 1, 4, 8, or 14 (see Figure 4-26), $\overline{\text{UARTn_RTS}}$ is deasserted. The sending UART may send an additional byte after the trigger level is reached (assuming the sending UART has another byte to send), because it may not recognize the deassertion of $\overline{\text{UARTn_RTS}}$ until after it has begun sending the additional byte. For trigger level 1, 4, and 8, $\overline{\text{UARTn_RTS}}$ is automatically reasserted once the receiver FIFO is emptied. For trigger level 14, $\overline{\text{UARTn_RTS}}$ is automatically reasserted once the receiver FIFO drops below the trigger level.

Figure 4-26. Autoflow Functional Timing Waveforms for $\overline{\text{UARTn_RTS}}$

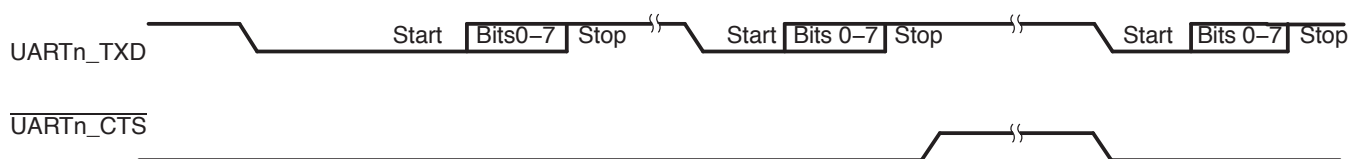


- (1) N = Receiver FIFO trigger level.
- (2) The block in dashed lines covers the case where an additional byte is sent.

4.4.4.2.5.4.2 $\overline{\text{UARTn_CTS}}$ Behavior

The transmitter checks $\overline{\text{UARTn_CTS}}$ before sending the next data byte. If $\overline{\text{UARTn_CTS}}$ is active, the transmitter sends the next byte. To stop the transmitter from sending the following byte, $\overline{\text{UARTn_CTS}}$ must be released before the middle of the last STOP bit that is currently being sent (see Figure 4-27). When flow control is enabled, $\overline{\text{UARTn_CTS}}$ level changes do not trigger interrupts because the device automatically controls its own transmitter. Without autoflow control, the transmitter sends any data present in the transmitter FIFO and a receiver overrun error may result.

Figure 4-27. Autoflow Functional Timing Waveforms for $\overline{\text{UARTn_CTS}}$



- (1) When $\overline{\text{UARTn_CTS}}$ is active (low), the transmitter keeps sending serial data out.
- (2) When $\overline{\text{UARTn_CTS}}$ goes high before the middle of the last STOP bit of the current byte, the transmitter finishes sending the current byte but it does not send the next byte.
- (3) When $\overline{\text{UARTn_CTS}}$ goes from high to low, the transmitter begins sending data again.

4.4.4.2.5.5 Loopback Control

The UART can be placed in the diagnostic mode using the LOOP bit in the modem control register (MCR), which internally connects the UART output back to the UART input. In this mode, the transmit and receive data paths, the transmitter and receiver interrupts, and the modem control interrupts can be verified without connecting to another UART.

4.4.4.2.6 Reset Considerations

4.4.4.2.6.1 Software Reset Considerations

Two bits in the power and emulation management register (PWREMU_MGMT) control resetting the parts of the UART:

- The UTRST bit controls resetting the transmitter only. If UTRST = 1, the transmitter is active; if UTRST = 0, the transmitter is in reset.
- The URRST bit controls resetting the receiver only. If URRST = 1, the receiver is active; if URRST = 0, the receiver is in reset.

In each case, putting the receiver and/or transmitter in reset will reset the state machine of the affected portion but does not affect the UART registers.

4.4.4.2.6.2 Hardware Reset Considerations

When the processor RESET pin is asserted, the entire processor is reset and is held in the reset state until the RESET pin is released. As part of a device reset, the UART state machine is reset and the UART registers are forced to their default states. The default states of the registers are shown in [Section 4.5.5](#).

4.4.4.2.7 Initialization

The following steps are required to initialize the UART:

1. Perform the necessary device pin multiplexing setup (see your device-specific data manual).
2. Set the desired baud rate by writing the appropriate clock divisor values to the divisor latch registers (DLL and DLH).
3. If the FIFOs will be used, select the desired trigger level and enable the FIFOs by writing the appropriate values to the FIFO control register (FCR). The FIFOEN bit in FCR must be set first, before the other bits in FCR are configured.
4. Choose the desired protocol settings by writing the appropriate values to the line control register (LCR).
5. If autoflow control is desired, write appropriate values to the modem control register (MCR). Note that all UARTs do not support autoflow control; see your device-specific data manual for supported features.
6. Choose the desired response to emulation suspend events by configuring the FREE bit, and enable the UART by setting the UTRST and URRST bits in the power and emulation management register (PWREMU_MGMT).

4.4.4.2.8 Interrupt Support

4.4.4.2.8.1 Interrupt Events and Requests

The UART generates the interrupt requests described in [Table 4-26](#). All requests are multiplexed through an arbiter to a single UART interrupt request to the CPU, as shown in [Figure 4-28](#). Each of the interrupt requests has an enable bit in the interrupt enable register (IER) and is recorded in the interrupt identification register (IIR).

If an interrupt occurs and the corresponding enable bit is set to 1, the interrupt request is recorded in IIR and is forwarded to the CPU. If an interrupt occurs and the corresponding enable bit is cleared to 0, the interrupt request is blocked. The interrupt request is neither recorded in IIR nor forwarded to the CPU.

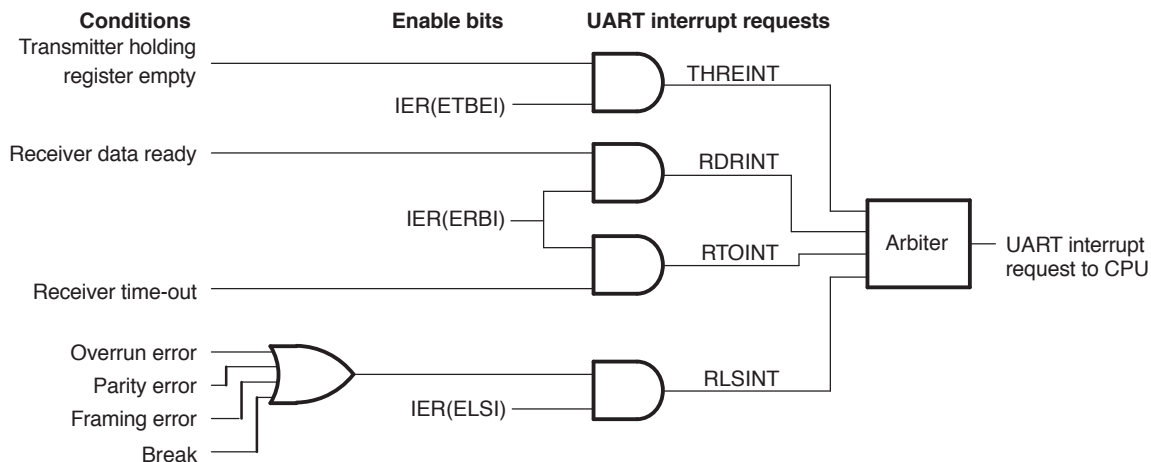
4.4.4.2.8.2 Interrupt Multiplexing

The UARTs have dedicated interrupt signals to the CPU and the interrupts are not multiplexed with any other interrupt source.

Table 4-26. UART Interrupt Requests Descriptions

UART Interrupt Request	Interrupt Source	Comment
THREINT	THR-empty condition: The transmitter holding register (THR) or the transmitter FIFO is empty. All of the data has been copied from THR to the transmitter shift register (TSR).	If THREINT is enabled in IER, by setting the ETBEI bit, it is recorded in IIR. As an alternative to using THREINT, the CPU can poll the THRE bit in the line status register (LSR).
RDAINT	Receive data available in non-FIFO mode or trigger level reached in the FIFO mode.	If RDAINT is enabled in IER, by setting the ERBI bit, it is recorded in IIR. As an alternative to using RDAINT, the CPU can poll the DR bit in the line status register (LSR). In the FIFO mode, this is not a functionally equivalent alternative because the DR bit does not respond to the FIFO trigger level. The DR bit only indicates the presence or absence of unread characters.
RTOINT	Receiver time-out condition (in the FIFO mode only): No characters have been removed from or input to the receiver FIFO during the last four character times (see Table 4-25), and there is at least one character in the receiver FIFO during this time.	The receiver time-out interrupt prevents the UART from waiting indefinitely, in the case when the receiver FIFO level is below the trigger level and thus does not generate a receiver data-ready interrupt. If RTOINT is enabled in IER, by setting the ERBI bit, it is recorded in IIR. There is no status bit to reflect the occurrence of a time-out condition.
RLSINT	Receiver line status condition: An overrun error, parity error, framing error, or break has occurred.	If RLSINT is enabled in IER, by setting the ELSI bit, it is recorded in IIR. As an alternative to using RLSINT, the CPU can poll the following bits in the line status register (LSR): overrun error indicator (OE), parity error indicator (PE), framing error indicator (FE), and break indicator (BI).

Figure 4-28. UART Interrupt Request Enable Paths



4.4.4.2.9 DMA Event Support

In the FIFO mode, the UART generates the following two DMA events:

- **Receive event (URXEVT):** The trigger level for the receiver FIFO (1, 4, 8, or 14 characters) is set with the RXFIFTL bit in the FIFO control register (FCR). Every time the trigger level is reached or a receiver time-out occurs, the UART sends a receive event to the EDMA controller. In response, the EDMA controller reads the data from the receiver FIFO by way of the receiver buffer register (RBR). Note that the receive event is not asserted if the data at the top of the receiver FIFO is erroneous even if the trigger level has been reached.
- **Transmit event (UTXEVT):** When the transmitter FIFO is empty (when the last byte in the transmitter FIFO has been copied to the transmitter shift register), the UART sends a UTXEVT signal to the EDMA controller. In response, the EDMA controller refills the transmitter FIFO by way of the transmitter holding register (THR). The UTXEVT signal is also sent to the DMA controller when the UART is taken out of reset using the UTRST bit in the power and emulation management register (PWREMU_MGMT).

Activity in DMA channels can be synchronized to these events. In the non-FIFO mode, the UART generates no DMA events. Any DMA channel synchronized to either of these events must be enabled at the time the UART event is generated. Otherwise, the DMA channel will miss the event and, unless the UART generates a new event, no data transfer will occur.

4.4.4.2.10 Power Management

The UART peripheral can be placed in reduced-power modes to conserve power during periods of low activity. The power management of the UART peripheral is controlled by the processor Power and Clock Management (PRCM). The PRCM acts as a master controller for power management for all of the peripherals on the device. For detailed information on power management procedures using the PSC, see the chapter *Power, Reset, and Clock Management (PRCM)* in the device reference manual.

4.4.4.2.11 Emulation Considerations

The FREE bit in the power and emulation management register (PWREMU_MGMT) determines how the UART responds to an emulation suspend event such as an emulator halt or breakpoint. If FREE = 0 and a transmission is in progress, the UART halts after completing the one-word transmission; if FREE = 0 and a transmission is not in progress, the UART halts immediately. If FREE = 1, the UART does not halt and continues operating normally.

Note also that most emulator accesses are transparent to UART operation. Emulator read operations do not affect any register contents, status bits, or operating states, with the exception of the interrupt identification register (IIR). Emulator writes, however, may affect register contents and may affect UART operation, depending on which register is accessed and what value is written.

The UART registers can be read from or written to during emulation suspend events, even if the UART activity has stopped.

4.4.4.2.12 Exception Processing

4.4.4.2.12.1 Divisor Latch Not Programmed

Since the processor reset signal has no effect on the divisor latch, the divisor latch will have an unknown value after power up. If the divisor latch is not programmed after power up, the baud clock (BCLK) will not operate and will instead be set to a constant logic 1 state.

The divisor latch values should always be reinitialized following a processor reset.

4.4.4.2.12.2 Changing Operating Mode During Busy Serial Communication

Since the serial link characteristics are based on how the control registers are programmed, the UART will expect the control registers to be static while it is busy engaging in a serial communication. Therefore, changing the control registers while the module is still busy communicating with another serial device will most likely cause an error condition and should be avoided.

4.4.5 ECAP

The PRU ECAP module within the PRU-ICSS is identical to the ECAP module in the AM335x PWMSS. For additional details about the ECAP module, see [Section 15.3, Pulse-Width Modulation Subsystem \(PWMSS\)](#).

4.5 Registers

4.5.1 PRU_ICSS_PRU_CTRL Registers

[Table 4-27](#) lists the memory-mapped registers for the PRU_ICSS_PRU_CTRL. All register offset addresses not listed in [Table 4-27](#) should be considered as reserved locations and the register contents should not be modified.

Table 4-27. PRU_ICSS_PRU_CTRL Registers

Offset	Acronym	Register Name	Section
0h	CTRL		Section 4.5.1.1
4h	STS		Section 4.5.1.2
8h	WAKEUP_EN		Section 4.5.1.3
Ch	CYCLE		Section 4.5.1.4
10h	STALL		Section 4.5.1.5
20h	CTBIR0		Section 4.5.1.6
24h	CTBIR1		Section 4.5.1.7
28h	CTPPR0		Section 4.5.1.8
2Ch	CTPPR1		Section 4.5.1.9

4.5.1.1 CTRL Register (offset = 0h) [reset = 1h]

 CTRL is shown in [Figure 4-29](#) and described in [Table 4-28](#).

CONTROL REGISTER
Figure 4-29. CTRL Register

31	30	29	28	27	26	25	24
PCTR_RST_VAL							
R/W-0h							
23	22	21	20	19	18	17	16
PCTR_RST_VAL							
R/W-0h							
15	14	13	12	11	10	9	8
RUNSTATE	RESERVED	RESERVED				SINGLE_STEP	
R-0h	R-0h	R/W-0h				R/W-0h	
7	6	5	4	3	2	1	0
RESERVED				CTR_EN	SLEEPING	EN	SOFT_RST_N
R/W-0h				R/W-0h	R/W-0h	R/W-0h	R-1h

LEGEND: R/W = Read/Write; R = Read only; W1toCl = Write 1 to clear bit; -n = value after reset

Table 4-28. CTRL Register Field Descriptions

Bit	Field	Type	Reset	Description
31-16	PCTR_RST_VAL	R/W	0h	Program Counter Reset Value: This field controls the address where the PRU will start executing code from after it is taken out of reset.
15	RUNSTATE	R	0h	Run State: This bit indicates whether the PRU is currently executing an instruction or is halted. 0 = PRU is halted and host has access to the instruction RAM and debug registers regions. 1 = PRU is currently running and the host is locked out of the instruction RAM and debug registers regions. This bit is used by an external debug agent to know when the PRU has actually halted when waiting for a HALT instruction to execute, a single step to finish, or any other time when the pru_enable has been cleared.
14	RESERVED	R	0h	Reserved.
13-9	RESERVED	R/W	0h	
8	SINGLE_STEP	R/W	0h	Single Step Enable: This bit controls whether or not the PRU will only execute a single instruction when enabled. 0 = PRU will free run when enabled. 1 = PRU will execute a single instruction and then the pru_enable bit will be cleared. Note that this bit does not actually enable the PRU, it only sets the policy for how much code will be run after the PRU is enabled. The pru_enable bit must be explicitly asserted. It is legal to initialize both the single_step and pru_enable bits simultaneously. (Two independent writes are not required to cause the stated functionality.)
7-4	RESERVED	R/W	0h	
3	CTR_EN	R/W	0h	PRU Cycle Counter Enable: Enables PRU cycle counters. 0 = Counters not enabled 1 = Counters enabled
2	SLEEPING	R/W	0h	PRU Sleep Indicator: This bit indicates whether or not the PRU is currently asleep. 0 = PRU is not asleep 1 = PRU is asleep If this bit is written to a 0, the PRU will be forced to power up from sleep mode.

Table 4-28. CTRL Register Field Descriptions (continued)

Bit	Field	Type	Reset	Description
1	EN	R/W	0h	<p>Processor Enable: This bit controls whether or not the PRU is allowed to fetch new instructions.</p> <p>0 = PRU is disabled. 1 = PRU is enabled.</p> <p>If this bit is de-asserted while the PRU is currently running and has completed the initial cycle of a multi-cycle instruction (LBxO, SBxO, SCAN, etc.), the current instruction will be allowed to complete before the PRU pauses execution. Otherwise, the PRU will halt immediately.</p> <p>Because of the unpredictability/timing sensitivity of the instruction execution loop, this bit is not a reliable indication of whether or not the PRU is currently running.</p> <p>The pru_state bit should be consulted for an absolute indication of the run state of the core.</p> <p>When the PRU is halted, its internal state remains coherent therefore this bit can be reasserted without issuing a software reset and the PRU will resume processing exactly where it left off in the instruction stream.</p>
0	SOFT_RST_N	R	1h	<p>Soft Reset: When this bit is cleared, the PRU will be reset. This bit is set back to 1 on the next cycle after it has been cleared.</p>

4.5.1.2 STS Register (offset = 4h) [reset = 0h]

STS is shown in [Figure 4-30](#) and described in [Table 4-29](#).

STATUS REGISTER

Figure 4-30. STS Register

31	30	29	28	27	26	25	24	23	22	21	20	19	18	17	16	15	14	13	12	11	10	9	8	7	6	5	4	3	2	1	0
RESERVED																PCTR															
R-0h																R-0h															

LEGEND: R/W = Read/Write; R = Read only; W1toCl = Write 1 to clear bit; -n = value after reset

Table 4-29. STS Register Field Descriptions

Bit	Field	Type	Reset	Description
31-16	RESERVED	R	0h	
15-0	PCTR	R	0h	Program Counter: This field is a registered (1 cycle delayed) reflection of the PRU program counter. Note that the PC is an instruction address where each instruction is a 32 bit word. This is not a byte address and to compute the byte address just multiply the PC by 4 (PC of 2 = byte address of 0x8, or PC of 8 = byte address of 0x20).

4.5.1.3 WAKEUP_EN Register (offset = 8h) [reset = 0h]

WAKEUP_EN is shown in [Figure 4-31](#) and described in [Table 4-30](#).

WAKEUP ENABLE REGISTER

Figure 4-31. WAKEUP_EN Register

31	30	29	28	27	26	25	24	23	22	21	20	19	18	17	16	15	14	13	12	11	10	9	8	7	6	5	4	3	2	1	0
BITWISE_ENS																															
R/W-0h																															

LEGEND: R/W = Read/Write; R = Read only; W1toCl = Write 1 to clear bit; -n = value after reset

Table 4-30. WAKEUP_EN Register Field Descriptions

Bit	Field	Type	Reset	Description
31-0	BITWISE_ENS	R/W	0h	<p>Wakeup Enables: This field is ANDed with the incoming R31 status inputs (whose bit positions were specified in the stmap parameter) to produce a vector which is unary ORed to produce the status_wakeup source for the core.</p> <p>Setting any bit in this vector will allow the corresponding status input to wake up the core when it is asserted high.</p> <p>The PRU should set this enable vector prior to executing a SLP (sleep) instruction to ensure that the desired sources can wake up the core.</p>

4.5.1.4 CYCLE Register (offset = Ch) [reset = 0h]

CYCLE is shown in [Figure 4-32](#) and described in [Table 4-31](#).

CYCLE COUNT. This register counts the number of cycles for which the PRU has been enabled.

Figure 4-32. CYCLE Register

31	30	29	28	27	26	25	24	23	22	21	20	19	18	17	16	15	14	13	12	11	10	9	8	7	6	5	4	3	2	1	0
CYCLECOUNT																															
0h																															

LEGEND: R/W = Read/Write; R = Read only; W1toCl = Write 1 to clear bit; -n = value after reset

Table 4-31. CYCLE Register Field Descriptions

Bit	Field	Type	Reset	Description
31-0	CYCLECOUNT		0h	This value is incremented by 1 for every cycle during which the PRU is enabled and the counter is enabled (both bits EN and CTR_EN set in the PRU control register). Counting halts while the PRU is disabled or counter is disabled, and resumes when re-enabled. Counter clears the CTR_EN bit in the PRU control register when the count reaches 0xFFFFFFFF. (Count does not wrap). The register can be read at any time. The register can be cleared when the counter or PRU is disabled. Clearing this register also clears the PRU Stall Count Register.

4.5.1.5 STALL Register (offset = 10h) [reset = 0h]

STALL is shown in [Figure 4-33](#) and described in [Table 4-32](#).

STALL COUNT. This register counts the number of cycles for which the PRU has been enabled, but unable to fetch a new instruction. It is linked to the Cycle Count Register (0x0C) such that this register reflects the stall cycles measured over the same cycles as counted by the cycle count register. Thus the value of this register is always less than or equal to cycle count.

Figure 4-33. STALL Register

31	30	29	28	27	26	25	24	23	22	21	20	19	18	17	16	15	14	13	12	11	10	9	8	7	6	5	4	3	2	1	0
STALLCOUNT																															
0h																															

LEGEND: R/W = Read/Write; R = Read only; W1toCl = Write 1 to clear bit; -n = value after reset

Table 4-32. STALL Register Field Descriptions

Bit	Field	Type	Reset	Description
31-0	STALLCOUNT		0h	This value is incremented by 1 for every cycle during which the PRU is enabled and the counter is enabled (both bits EN and CTR_EN set in the PRU control register), and the PRU was unable to fetch a new instruction for any reason.

4.5.1.6 CTBIR0 Register (offset = 20h) [reset = 0h]

CTBIR0 is shown in [Figure 4-34](#) and described in [Table 4-33](#).

CONSTANT TABLE BLOCK INDEX REGISTER 0. This register is used to set the block indices which are used to modify entries 24 and 25 in the PRU Constant Table. This register can be written by the PRU whenever it needs to change to a new base pointer for a block in the State / Scratchpad RAM. This function is useful since the PRU is often processing multiple processing threads which require it to change contexts. The PRU can use this register to avoid requiring excessive amounts of code for repetitive context switching. The format of this register is as follows:

Figure 4-34. CTBIR0 Register

31	30	29	28	27	26	25	24	23	22	21	20	19	18	17	16
RESERVED								C25_BLK_IDX							
R/W-0h								R/W-0h							
15	14	13	12	11	10	9	8	7	6	5	4	3	2	1	0
RESERVED								C24_BLK_IDX							
R/W-0h								R/W-0h							

LEGEND: R/W = Read/Write; R = Read only; W1toCl = Write 1 to clear bit; -n = value after reset

Table 4-33. CTBIR0 Register Field Descriptions

Bit	Field	Type	Reset	Description
31-24	RESERVED	R/W	0h	
23-16	C25_BLK_IDX	R/W	0h	PRU Constant Entry 25 Block Index: This field sets the value that will appear in bits 11:8 of entry 25 in the PRU Constant Table.
15-8	RESERVED	R/W	0h	
7-0	C24_BLK_IDX	R/W	0h	PRU Constant Entry 24 Block Index: This field sets the value that will appear in bits 11:8 of entry 24 in the PRU Constant Table.

4.5.1.7 CTBIR1 Register (offset = 24h) [reset = 0h]

CTBIR1 is shown in [Figure 4-35](#) and described in [Table 4-34](#).

CONSTANT TABLE BLOCK INDEX REGISTER 1. This register is used to set the block indices which are used to modify entries 24 and 25 in the PRU Constant Table. This register can be written by the PRU whenever it needs to change to a new base pointer for a block in the State / Scratchpad RAM. This function is useful since the PRU is often processing multiple processing threads which require it to change contexts. The PRU can use this register to avoid requiring excessive amounts of code for repetitive context switching. The format of this register is as follows:

Figure 4-35. CTBIR1 Register

31	30	29	28	27	26	25	24	23	22	21	20	19	18	17	16
RESERVED								C27_BLK_IDX							
R/W-0h								R/W-0h							
15	14	13	12	11	10	9	8	7	6	5	4	3	2	1	0
RESERVED								C26_BLK_IDX							
R/W-0h								R/W-0h							

LEGEND: R/W = Read/Write; R = Read only; W1toCl = Write 1 to clear bit; -n = value after reset

Table 4-34. CTBIR1 Register Field Descriptions

Bit	Field	Type	Reset	Description
31-24	RESERVED	R/W	0h	
23-16	C27_BLK_IDX	R/W	0h	PRU Constant Entry 27 Block Index: This field sets the value that will appear in bits 11:8 of entry 27 in the PRU Constant Table.
15-8	RESERVED	R/W	0h	
7-0	C26_BLK_IDX	R/W	0h	PRU Constant Entry 26 Block Index: This field sets the value that will appear in bits 11:8 of entry 26 in the PRU Constant Table.

4.5.1.8 CTPPR0 Register (offset = 28h) [reset = 0h]

CTPPR0 is shown in [Figure 4-36](#) and described in [Table 4-35](#).

CONSTANT TABLE PROGRAMMABLE POINTER REGISTER 0. This register allows the PRU to set up the 256-byte page index for entries 28 and 29 in the PRU Constant Table which serve as general purpose pointers which can be configured to point to any locations inside the session router address map. This register is useful when the PRU needs to frequently access certain structures inside the session router address space whose locations are not hard coded such as tables in scratchpad memory. This register is formatted as follows:

Figure 4-36. CTPPR0 Register

31	30	29	28	27	26	25	24	23	22	21	20	19	18	17	16	15	14	13	12	11	10	9	8	7	6	5	4	3	2	1	0
C29_POINTER																C28_POINTER															
R/W-0h																R/W-0h															

LEGEND: R/W = Read/Write; R = Read only; W1toCl = Write 1 to clear bit; -n = value after reset

Table 4-35. CTPPR0 Register Field Descriptions

Bit	Field	Type	Reset	Description
31-16	C29_POINTER	R/W	0h	PRU Constant Entry 29 Pointer: This field sets the value that will appear in bits 23:8 of entry 29 in the PRU Constant Table.
15-0	C28_POINTER	R/W	0h	PRU Constant Entry 28 Pointer: This field sets the value that will appear in bits 23:8 of entry 28 in the PRU Constant Table.

4.5.1.9 CTPPR1 Register (offset = 2Ch) [reset = 0h]

CTPPR1 is shown in [Figure 4-37](#) and described in [Table 4-36](#).

CONSTANT TABLE PROGRAMMABLE POINTER REGISTER 1. This register functions the same as the PRU Constant Table Programmable Pointer Register 0 but allows the PRU to control entries 30 and 31 in the PRU Constant Table. This register is formatted as follows:

Figure 4-37. CTPPR1 Register

31	30	29	28	27	26	25	24	23	22	21	20	19	18	17	16	15	14	13	12	11	10	9	8	7	6	5	4	3	2	1	0
C31_POINTER																C30_POINTER															
R/W-0h																R/W-0h															

LEGEND: R/W = Read/Write; R = Read only; W1toCl = Write 1 to clear bit; -n = value after reset

Table 4-36. CTPPR1 Register Field Descriptions

Bit	Field	Type	Reset	Description
31-16	C31_POINTER	R/W	0h	PRU Constant Entry 31 Pointer: This field sets the value that will appear in bits 23:8 of entry 31 in the PRU Constant Table.
15-0	C30_POINTER	R/W	0h	PRU Constant Entry 30 Pointer: This field sets the value that will appear in bits 23:8 of entry 30 in the PRU Constant Table.

4.5.2 PRU_ICSS_PRU_DEBUG Registers

[Table 4-37](#) lists the memory-mapped registers for the PRU_ICSS_PRU_DEBUG. All register offset addresses not listed in [Table 4-37](#) should be considered as reserved locations and the register contents should not be modified.

Table 4-37. PRU_ICSS_PRU_DEBUG Registers

Offset	Acronym	Register Name	Section
0h	GPREG0		Section 4.5.2.1
4h	GPREG1		Section 4.5.2.2
8h	GPREG2		Section 4.5.2.3
Ch	GPREG3		Section 4.5.2.4
10h	GPREG4		Section 4.5.2.5
14h	GPREG5		Section 4.5.2.6
18h	GPREG6		Section 4.5.2.7
1Ch	GPREG7		Section 4.5.2.8
20h	GPREG8		Section 4.5.2.9
24h	GPREG9		Section 4.5.2.10
28h	GPREG10		Section 4.5.2.11
2Ch	GPREG11		Section 4.5.2.12
30h	GPREG12		Section 4.5.2.13
34h	GPREG13		Section 4.5.2.14
38h	GPREG14		Section 4.5.2.15
3Ch	GPREG15		Section 4.5.2.16
40h	GPREG16		Section 4.5.2.17
44h	GPREG17		Section 4.5.2.18
48h	GPREG18		Section 4.5.2.19
4Ch	GPREG19		Section 4.5.2.20
50h	GPREG20		Section 4.5.2.21
54h	GPREG21		Section 4.5.2.22
58h	GPREG22		Section 4.5.2.23

Table 4-37. PRU_ICSS_PRU_DEBUG Registers (continued)

Offset	Acronym	Register Name	Section
5Ch	GPREG23		Section 4.5.2.24
60h	GPREG24		Section 4.5.2.25
64h	GPREG25		Section 4.5.2.26
68h	GPREG26		Section 4.5.2.27
6Ch	GPREG27		Section 4.5.2.28
70h	GPREG28		Section 4.5.2.29
74h	GPREG29		Section 4.5.2.30
78h	GPREG30		Section 4.5.2.31
7Ch	GPREG31		Section 4.5.2.32
80h	CT_REG0		Section 4.5.2.33
84h	CT_REG1		Section 4.5.2.34
88h	CT_REG2		Section 4.5.2.35
8Ch	CT_REG3		Section 4.5.2.36
90h	CT_REG4		Section 4.5.2.37
94h	CT_REG5		Section 4.5.2.38
98h	CT_REG6		Section 4.5.2.39
9Ch	CT_REG7		Section 4.5.2.40
A0h	CT_REG8		Section 4.5.2.41
A4h	CT_REG9		Section 4.5.2.42
A8h	CT_REG10		Section 4.5.2.43
ACh	CT_REG11		Section 4.5.2.44
B0h	CT_REG12		Section 4.5.2.45
B4h	CT_REG13		Section 4.5.2.46
B8h	CT_REG14		Section 4.5.2.47
BCh	CT_REG15		Section 4.5.2.48
C0h	CT_REG16		Section 4.5.2.49
C4h	CT_REG17		Section 4.5.2.50
C8h	CT_REG18		Section 4.5.2.51
CCh	CT_REG19		Section 4.5.2.52
D0h	CT_REG20		Section 4.5.2.53
D4h	CT_REG21		Section 4.5.2.54
D8h	CT_REG22		Section 4.5.2.55
DCh	CT_REG23		Section 4.5.2.56
E0h	CT_REG24		Section 4.5.2.57
E4h	CT_REG25		Section 4.5.2.58
E8h	CT_REG26		Section 4.5.2.59
ECh	CT_REG27		Section 4.5.2.60
F0h	CT_REG28		Section 4.5.2.61
F4h	CT_REG29		Section 4.5.2.62
F8h	CT_REG30		Section 4.5.2.63
FCh	CT_REG31		Section 4.5.2.64

4.5.2.1 GPREG0 Register (offset = 0h) [reset = 0h]

GPREG0 is shown in [Figure 4-38](#) and described in [Table 4-38](#).

DEBUG PRU GENERAL PURPOSE REGISTER 0. This register allows an external agent to debug the PRU while it is disabled. Reading or writing to these registers will have the same effect as a read or write to these registers from an internal instruction in the PRU. For R30, this includes generation of the pulse outputs whenever the register is written.

Figure 4-38. GPREG0 Register

31	30	29	28	27	26	25	24	23	22	21	20	19	18	17	16	15	14	13	12	11	10	9	8	7	6	5	4	3	2	1	0
GP_REG0																															
R/W-0h																															

LEGEND: R/W = Read/Write; R = Read only; W1toCl = Write 1 to clear bit; -n = value after reset

Table 4-38. GPREG0 Register Field Descriptions

Bit	Field	Type	Reset	Description
31-0	GP_REG0	R/W	0h	PRU Internal GP Register n: Reading / writing this field directly inspects/modifies the corresponding internal register in the PRU internal regfile.

4.5.2.2 GPREG1 Register (offset = 4h) [reset = 0h]

GPREG1 is shown in [Figure 4-39](#) and described in [Table 4-39](#).

DEBUG PRU GENERAL PURPOSE REGISTER 1. This register allows an external agent to debug the PRU while it is disabled. Reading or writing to these registers will have the same effect as a read or write to these registers from an internal instruction in the PRU. For R30, this includes generation of the pulse outputs whenever the register is written.

Figure 4-39. GPREG1 Register

31	30	29	28	27	26	25	24	23	22	21	20	19	18	17	16	15	14	13	12	11	10	9	8	7	6	5	4	3	2	1	0
GP_REG1																															
R/W-0h																															

LEGEND: R/W = Read/Write; R = Read only; W1toCl = Write 1 to clear bit; -n = value after reset

Table 4-39. GPREG1 Register Field Descriptions

Bit	Field	Type	Reset	Description
31-0	GP_REG1	R/W	0h	PRU Internal GP Register n: Reading / writing this field directly inspects/modifies the corresponding internal register in the PRU internal regfile.

4.5.2.3 GPREG2 Register (offset = 8h) [reset = 0h]

GPREG2 is shown in [Figure 4-40](#) and described in [Table 4-40](#).

DEBUG PRU GENERAL PURPOSE REGISTER 2. This register allows an external agent to debug the PRU while it is disabled. Reading or writing to these registers will have the same effect as a read or write to these registers from an internal instruction in the PRU. For R30, this includes generation of the pulse outputs whenever the register is written.

Figure 4-40. GPREG2 Register

31	30	29	28	27	26	25	24	23	22	21	20	19	18	17	16	15	14	13	12	11	10	9	8	7	6	5	4	3	2	1	0
GP_REG2																															
R/W-0h																															

LEGEND: R/W = Read/Write; R = Read only; W1toCl = Write 1 to clear bit; -n = value after reset

Table 4-40. GPREG2 Register Field Descriptions

Bit	Field	Type	Reset	Description
31-0	GP_REG2	R/W	0h	PRU Internal GP Register n: Reading / writing this field directly inspects/modifies the corresponding internal register in the PRU internal regfile.

4.5.2.4 GPREG3 Register (offset = Ch) [reset = 0h]

GPREG3 is shown in [Figure 4-41](#) and described in [Table 4-41](#).

DEBUG PRU GENERAL PURPOSE REGISTER 3. This register allows an external agent to debug the PRU while it is disabled. Reading or writing to these registers will have the same effect as a read or write to these registers from an internal instruction in the PRU. For R30, this includes generation of the pulse outputs whenever the register is written.

Figure 4-41. GPREG3 Register

31	30	29	28	27	26	25	24	23	22	21	20	19	18	17	16	15	14	13	12	11	10	9	8	7	6	5	4	3	2	1	0
GP_REG3																															
R/W-0h																															

LEGEND: R/W = Read/Write; R = Read only; W1toCl = Write 1 to clear bit; -n = value after reset

Table 4-41. GPREG3 Register Field Descriptions

Bit	Field	Type	Reset	Description
31-0	GP_REG3	R/W	0h	PRU Internal GP Register n: Reading / writing this field directly inspects/modifies the corresponding internal register in the PRU internal regfile.

4.5.2.5 GPREG4 Register (offset = 10h) [reset = 0h]

GPREG4 is shown in [Figure 4-42](#) and described in [Table 4-42](#).

DEBUG PRU GENERAL PURPOSE REGISTER 4. This register allows an external agent to debug the PRU while it is disabled. Reading or writing to these registers will have the same effect as a read or write to these registers from an internal instruction in the PRU. For R30, this includes generation of the pulse outputs whenever the register is written.

Figure 4-42. GPREG4 Register

31	30	29	28	27	26	25	24	23	22	21	20	19	18	17	16	15	14	13	12	11	10	9	8	7	6	5	4	3	2	1	0
GP_REG4																															
R/W-0h																															

LEGEND: R/W = Read/Write; R = Read only; W1toCl = Write 1 to clear bit; -n = value after reset

Table 4-42. GPREG4 Register Field Descriptions

Bit	Field	Type	Reset	Description
31-0	GP_REG4	R/W	0h	PRU Internal GP Register n: Reading / writing this field directly inspects/modifies the corresponding internal register in the PRU internal regfile.

4.5.2.6 GPREG5 Register (offset = 14h) [reset = 0h]

GPREG5 is shown in [Figure 4-43](#) and described in [Table 4-43](#).

DEBUG PRU GENERAL PURPOSE REGISTER 5. This register allows an external agent to debug the PRU while it is disabled. Reading or writing to these registers will have the same effect as a read or write to these registers from an internal instruction in the PRU. For R30, this includes generation of the pulse outputs whenever the register is written.

Figure 4-43. GPREG5 Register

31	30	29	28	27	26	25	24	23	22	21	20	19	18	17	16	15	14	13	12	11	10	9	8	7	6	5	4	3	2	1	0
GP_REG5																															
R/W-0h																															

LEGEND: R/W = Read/Write; R = Read only; W1toCl = Write 1 to clear bit; -n = value after reset

Table 4-43. GPREG5 Register Field Descriptions

Bit	Field	Type	Reset	Description
31-0	GP_REG5	R/W	0h	PRU Internal GP Register n: Reading / writing this field directly inspects/modifies the corresponding internal register in the PRU internal regfile.

4.5.2.7 GPREG6 Register (offset = 18h) [reset = 0h]

GPREG6 is shown in [Figure 4-44](#) and described in [Table 4-44](#).

DEBUG PRU GENERAL PURPOSE REGISTER 6. This register allows an external agent to debug the PRU while it is disabled. Reading or writing to these registers will have the same effect as a read or write to these registers from an internal instruction in the PRU. For R30, this includes generation of the pulse outputs whenever the register is written.

Figure 4-44. GPREG6 Register

31	30	29	28	27	26	25	24	23	22	21	20	19	18	17	16	15	14	13	12	11	10	9	8	7	6	5	4	3	2	1	0
GP_REG6																															
R/W-0h																															

LEGEND: R/W = Read/Write; R = Read only; W1toCl = Write 1 to clear bit; -n = value after reset

Table 4-44. GPREG6 Register Field Descriptions

Bit	Field	Type	Reset	Description
31-0	GP_REG6	R/W	0h	PRU Internal GP Register n: Reading / writing this field directly inspects/modifies the corresponding internal register in the PRU internal regfile.

4.5.2.8 GPREG7 Register (offset = 1Ch) [reset = 0h]

GPREG7 is shown in [Figure 4-45](#) and described in [Table 4-45](#).

DEBUG PRU GENERAL PURPOSE REGISTER 7. This register allows an external agent to debug the PRU while it is disabled. Reading or writing to these registers will have the same effect as a read or write to these registers from an internal instruction in the PRU. For R30, this includes generation of the pulse outputs whenever the register is written.

Figure 4-45. GPREG7 Register

31	30	29	28	27	26	25	24	23	22	21	20	19	18	17	16	15	14	13	12	11	10	9	8	7	6	5	4	3	2	1	0
GP_REG7																															
R/W-0h																															

LEGEND: R/W = Read/Write; R = Read only; W1toCl = Write 1 to clear bit; -n = value after reset

Table 4-45. GPREG7 Register Field Descriptions

Bit	Field	Type	Reset	Description
31-0	GP_REG7	R/W	0h	PRU Internal GP Register n: Reading / writing this field directly inspects/modifies the corresponding internal register in the PRU internal regfile.

4.5.2.9 GPREG8 Register (offset = 20h) [reset = 0h]

GPREG8 is shown in [Figure 4-46](#) and described in [Table 4-46](#).

DEBUG PRU GENERAL PURPOSE REGISTER 8. This register allows an external agent to debug the PRU while it is disabled. Reading or writing to these registers will have the same effect as a read or write to these registers from an internal instruction in the PRU. For R30, this includes generation of the pulse outputs whenever the register is written.

Figure 4-46. GPREG8 Register

31	30	29	28	27	26	25	24	23	22	21	20	19	18	17	16	15	14	13	12	11	10	9	8	7	6	5	4	3	2	1	0
GP_REG8																															
R/W-0h																															

LEGEND: R/W = Read/Write; R = Read only; W1toCl = Write 1 to clear bit; -n = value after reset

Table 4-46. GPREG8 Register Field Descriptions

Bit	Field	Type	Reset	Description
31-0	GP_REG8	R/W	0h	PRU Internal GP Register n: Reading / writing this field directly inspects/modifies the corresponding internal register in the PRU internal regfile.

4.5.2.10 GPREG9 Register (offset = 24h) [reset = 0h]

GPREG9 is shown in [Figure 4-47](#) and described in [Table 4-47](#).

DEBUG PRU GENERAL PURPOSE REGISTER 9. This register allows an external agent to debug the PRU while it is disabled. Reading or writing to these registers will have the same effect as a read or write to these registers from an internal instruction in the PRU. For R30, this includes generation of the pulse outputs whenever the register is written.

Figure 4-47. GPREG9 Register

31	30	29	28	27	26	25	24	23	22	21	20	19	18	17	16	15	14	13	12	11	10	9	8	7	6	5	4	3	2	1	0
GP_REG9																															
R/W-0h																															

LEGEND: R/W = Read/Write; R = Read only; W1toCl = Write 1 to clear bit; -n = value after reset

Table 4-47. GPREG9 Register Field Descriptions

Bit	Field	Type	Reset	Description
31-0	GP_REG9	R/W	0h	PRU Internal GP Register n: Reading / writing this field directly inspects/modifies the corresponding internal register in the PRU internal regfile.

4.5.2.11 GPREG10 Register (offset = 28h) [reset = 0h]

GPREG10 is shown in [Figure 4-48](#) and described in [Table 4-48](#).

DEBUG PRU GENERAL PURPOSE REGISTER 10. This register allows an external agent to debug the PRU while it is disabled. Reading or writing to these registers will have the same effect as a read or write to these registers from an internal instruction in the PRU. For R30, this includes generation of the pulse outputs whenever the register is written.

Figure 4-48. GPREG10 Register

31	30	29	28	27	26	25	24	23	22	21	20	19	18	17	16	15	14	13	12	11	10	9	8	7	6	5	4	3	2	1	0
GP_REG10																															
R/W-0h																															

LEGEND: R/W = Read/Write; R = Read only; W1toCl = Write 1 to clear bit; -n = value after reset

Table 4-48. GPREG10 Register Field Descriptions

Bit	Field	Type	Reset	Description
31-0	GP_REG10	R/W	0h	PRU Internal GP Register n: Reading / writing this field directly inspects/modifies the corresponding internal register in the PRU internal regfile.

4.5.2.12 GPREG11 Register (offset = 2Ch) [reset = 0h]

GPREG11 is shown in [Figure 4-49](#) and described in [Table 4-49](#).

DEBUG PRU GENERAL PURPOSE REGISTER 11. This register allows an external agent to debug the PRU while it is disabled. Reading or writing to these registers will have the same effect as a read or write to these registers from an internal instruction in the PRU. For R30, this includes generation of the pulse outputs whenever the register is written.

Figure 4-49. GPREG11 Register

31	30	29	28	27	26	25	24	23	22	21	20	19	18	17	16	15	14	13	12	11	10	9	8	7	6	5	4	3	2	1	0
GP_REG11																															
R/W-0h																															

LEGEND: R/W = Read/Write; R = Read only; W1toCl = Write 1 to clear bit; -n = value after reset

Table 4-49. GPREG11 Register Field Descriptions

Bit	Field	Type	Reset	Description
31-0	GP_REG11	R/W	0h	PRU Internal GP Register n: Reading / writing this field directly inspects/modifies the corresponding internal register in the PRU internal regfile.

4.5.2.13 GPREG12 Register (offset = 30h) [reset = 0h]

GPREG12 is shown in [Figure 4-50](#) and described in [Table 4-50](#).

DEBUG PRU GENERAL PURPOSE REGISTER 12. This register allows an external agent to debug the PRU while it is disabled. Reading or writing to these registers will have the same effect as a read or write to these registers from an internal instruction in the PRU. For R30, this includes generation of the pulse outputs whenever the register is written.

Figure 4-50. GPREG12 Register

31	30	29	28	27	26	25	24	23	22	21	20	19	18	17	16	15	14	13	12	11	10	9	8	7	6	5	4	3	2	1	0
GP_REG12																															
R/W-0h																															

LEGEND: R/W = Read/Write; R = Read only; W1toCl = Write 1 to clear bit; -n = value after reset

Table 4-50. GPREG12 Register Field Descriptions

Bit	Field	Type	Reset	Description
31-0	GP_REG12	R/W	0h	PRU Internal GP Register n: Reading / writing this field directly inspects/modifies the corresponding internal register in the PRU internal regfile.

4.5.2.14 GPREG13 Register (offset = 34h) [reset = 0h]

GPREG13 is shown in [Figure 4-51](#) and described in [Table 4-51](#).

DEBUG PRU GENERAL PURPOSE REGISTER 13. This register allows an external agent to debug the PRU while it is disabled. Reading or writing to these registers will have the same effect as a read or write to these registers from an internal instruction in the PRU. For R30, this includes generation of the pulse outputs whenever the register is written.

Figure 4-51. GPREG13 Register

31	30	29	28	27	26	25	24	23	22	21	20	19	18	17	16	15	14	13	12	11	10	9	8	7	6	5	4	3	2	1	0
GP_REG13																															
R/W-0h																															

LEGEND: R/W = Read/Write; R = Read only; W1toCl = Write 1 to clear bit; -n = value after reset

Table 4-51. GPREG13 Register Field Descriptions

Bit	Field	Type	Reset	Description
31-0	GP_REG13	R/W	0h	PRU Internal GP Register n: Reading / writing this field directly inspects/modifies the corresponding internal register in the PRU internal regfile.

4.5.2.15 GPREG14 Register (offset = 38h) [reset = 0h]

GPREG14 is shown in [Figure 4-52](#) and described in [Table 4-52](#).

DEBUG PRU GENERAL PURPOSE REGISTER 14. This register allows an external agent to debug the PRU while it is disabled. Reading or writing to these registers will have the same effect as a read or write to these registers from an internal instruction in the PRU. For R30, this includes generation of the pulse outputs whenever the register is written.

Figure 4-52. GPREG14 Register

31	30	29	28	27	26	25	24	23	22	21	20	19	18	17	16	15	14	13	12	11	10	9	8	7	6	5	4	3	2	1	0
GP_REG14																															
R/W-0h																															

LEGEND: R/W = Read/Write; R = Read only; W1toCl = Write 1 to clear bit; -n = value after reset

Table 4-52. GPREG14 Register Field Descriptions

Bit	Field	Type	Reset	Description
31-0	GP_REG14	R/W	0h	PRU Internal GP Register n: Reading / writing this field directly inspects/modifies the corresponding internal register in the PRU internal regfile.

4.5.2.16 GPREG15 Register (offset = 3Ch) [reset = 0h]

GPREG15 is shown in [Figure 4-53](#) and described in [Table 4-53](#).

DEBUG PRU GENERAL PURPOSE REGISTER 15. This register allows an external agent to debug the PRU while it is disabled. Reading or writing to these registers will have the same effect as a read or write to these registers from an internal instruction in the PRU. For R30, this includes generation of the pulse outputs whenever the register is written.

Figure 4-53. GPREG15 Register

31	30	29	28	27	26	25	24	23	22	21	20	19	18	17	16	15	14	13	12	11	10	9	8	7	6	5	4	3	2	1	0
GP_REG15																															
R/W-0h																															

LEGEND: R/W = Read/Write; R = Read only; W1toCl = Write 1 to clear bit; -n = value after reset

Table 4-53. GPREG15 Register Field Descriptions

Bit	Field	Type	Reset	Description
31-0	GP_REG15	R/W	0h	PRU Internal GP Register n: Reading / writing this field directly inspects/modifies the corresponding internal register in the PRU internal regfile.

4.5.2.17 GPREG16 Register (offset = 40h) [reset = 0h]

GPREG16 is shown in [Figure 4-54](#) and described in [Table 4-54](#).

DEBUG PRU GENERAL PURPOSE REGISTER 16. This register allows an external agent to debug the PRU while it is disabled. Reading or writing to these registers will have the same effect as a read or write to these registers from an internal instruction in the PRU. For R30, this includes generation of the pulse outputs whenever the register is written.

Figure 4-54. GPREG16 Register

31	30	29	28	27	26	25	24	23	22	21	20	19	18	17	16	15	14	13	12	11	10	9	8	7	6	5	4	3	2	1	0
GP_REG16																															
R/W-0h																															

LEGEND: R/W = Read/Write; R = Read only; W1toCl = Write 1 to clear bit; -n = value after reset

Table 4-54. GPREG16 Register Field Descriptions

Bit	Field	Type	Reset	Description
31-0	GP_REG16	R/W	0h	PRU Internal GP Register n: Reading / writing this field directly inspects/modifies the corresponding internal register in the PRU internal regfile.

4.5.2.18 GPREG17 Register (offset = 44h) [reset = 0h]

GPREG17 is shown in [Figure 4-55](#) and described in [Table 4-55](#).

DEBUG PRU GENERAL PURPOSE REGISTER 17. This register allows an external agent to debug the PRU while it is disabled. Reading or writing to these registers will have the same effect as a read or write to these registers from an internal instruction in the PRU. For R30, this includes generation of the pulse outputs whenever the register is written.

Figure 4-55. GPREG17 Register

31	30	29	28	27	26	25	24	23	22	21	20	19	18	17	16	15	14	13	12	11	10	9	8	7	6	5	4	3	2	1	0
GP_REG17																															
R/W-0h																															

LEGEND: R/W = Read/Write; R = Read only; W1toCl = Write 1 to clear bit; -n = value after reset

Table 4-55. GPREG17 Register Field Descriptions

Bit	Field	Type	Reset	Description
31-0	GP_REG17	R/W	0h	PRU Internal GP Register n: Reading / writing this field directly inspects/modifies the corresponding internal register in the PRU internal regfile.

4.5.2.19 GPREG18 Register (offset = 48h) [reset = 0h]

GPREG18 is shown in [Figure 4-56](#) and described in [Table 4-56](#).

DEBUG PRU GENERAL PURPOSE REGISTER 18. This register allows an external agent to debug the PRU while it is disabled. Reading or writing to these registers will have the same effect as a read or write to these registers from an internal instruction in the PRU. For R30, this includes generation of the pulse outputs whenever the register is written.

Figure 4-56. GPREG18 Register

31	30	29	28	27	26	25	24	23	22	21	20	19	18	17	16	15	14	13	12	11	10	9	8	7	6	5	4	3	2	1	0
GP_REG18																															
R/W-0h																															

LEGEND: R/W = Read/Write; R = Read only; W1toCl = Write 1 to clear bit; -n = value after reset

Table 4-56. GPREG18 Register Field Descriptions

Bit	Field	Type	Reset	Description
31-0	GP_REG18	R/W	0h	PRU Internal GP Register n: Reading / writing this field directly inspects/modifies the corresponding internal register in the PRU internal regfile.

4.5.2.20 GPREG19 Register (offset = 4Ch) [reset = 0h]

GPREG19 is shown in [Figure 4-57](#) and described in [Table 4-57](#).

DEBUG PRU GENERAL PURPOSE REGISTER 19. This register allows an external agent to debug the PRU while it is disabled. Reading or writing to these registers will have the same effect as a read or write to these registers from an internal instruction in the PRU. For R30, this includes generation of the pulse outputs whenever the register is written.

Figure 4-57. GPREG19 Register

31	30	29	28	27	26	25	24	23	22	21	20	19	18	17	16	15	14	13	12	11	10	9	8	7	6	5	4	3	2	1	0
GP_REG19																															
R/W-0h																															

LEGEND: R/W = Read/Write; R = Read only; W1toCl = Write 1 to clear bit; -n = value after reset

Table 4-57. GPREG19 Register Field Descriptions

Bit	Field	Type	Reset	Description
31-0	GP_REG19	R/W	0h	PRU Internal GP Register n: Reading / writing this field directly inspects/modifies the corresponding internal register in the PRU internal regfile.

4.5.2.21 GPREG20 Register (offset = 50h) [reset = 0h]

GPREG20 is shown in [Figure 4-58](#) and described in [Table 4-58](#).

DEBUG PRU GENERAL PURPOSE REGISTER 20. This register allows an external agent to debug the PRU while it is disabled. Reading or writing to these registers will have the same effect as a read or write to these registers from an internal instruction in the PRU. For R30, this includes generation of the pulse outputs whenever the register is written.

Figure 4-58. GPREG20 Register

31	30	29	28	27	26	25	24	23	22	21	20	19	18	17	16	15	14	13	12	11	10	9	8	7	6	5	4	3	2	1	0
GP_REG20																															
R/W-0h																															

LEGEND: R/W = Read/Write; R = Read only; W1toCl = Write 1 to clear bit; -n = value after reset

Table 4-58. GPREG20 Register Field Descriptions

Bit	Field	Type	Reset	Description
31-0	GP_REG20	R/W	0h	PRU Internal GP Register n: Reading / writing this field directly inspects/modifies the corresponding internal register in the PRU internal regfile.

4.5.2.22 GPREG21 Register (offset = 54h) [reset = 0h]

GPREG21 is shown in [Figure 4-59](#) and described in [Table 4-59](#).

DEBUG PRU GENERAL PURPOSE REGISTER 21. This register allows an external agent to debug the PRU while it is disabled. Reading or writing to these registers will have the same effect as a read or write to these registers from an internal instruction in the PRU. For R30, this includes generation of the pulse outputs whenever the register is written.

Figure 4-59. GPREG21 Register

31	30	29	28	27	26	25	24	23	22	21	20	19	18	17	16	15	14	13	12	11	10	9	8	7	6	5	4	3	2	1	0
GP_REG21																															
R/W-0h																															

LEGEND: R/W = Read/Write; R = Read only; W1toCl = Write 1 to clear bit; -n = value after reset

Table 4-59. GPREG21 Register Field Descriptions

Bit	Field	Type	Reset	Description
31-0	GP_REG21	R/W	0h	PRU Internal GP Register n: Reading / writing this field directly inspects/modifies the corresponding internal register in the PRU internal regfile.

4.5.2.23 GPREG22 Register (offset = 58h) [reset = 0h]

GPREG22 is shown in [Figure 4-60](#) and described in [Table 4-60](#).

DEBUG PRU GENERAL PURPOSE REGISTER 22. This register allows an external agent to debug the PRU while it is disabled. Reading or writing to these registers will have the same effect as a read or write to these registers from an internal instruction in the PRU. For R30, this includes generation of the pulse outputs whenever the register is written.

Figure 4-60. GPREG22 Register

31	30	29	28	27	26	25	24	23	22	21	20	19	18	17	16	15	14	13	12	11	10	9	8	7	6	5	4	3	2	1	0
GP_REG22																															
R/W-0h																															

LEGEND: R/W = Read/Write; R = Read only; W1toCl = Write 1 to clear bit; -n = value after reset

Table 4-60. GPREG22 Register Field Descriptions

Bit	Field	Type	Reset	Description
31-0	GP_REG22	R/W	0h	PRU Internal GP Register n: Reading / writing this field directly inspects/modifies the corresponding internal register in the PRU internal regfile.

4.5.2.24 GPREG23 Register (offset = 5Ch) [reset = 0h]

GPREG23 is shown in [Figure 4-61](#) and described in [Table 4-61](#).

DEBUG PRU GENERAL PURPOSE REGISTER 23. This register allows an external agent to debug the PRU while it is disabled. Reading or writing to these registers will have the same effect as a read or write to these registers from an internal instruction in the PRU. For R30, this includes generation of the pulse outputs whenever the register is written.

Figure 4-61. GPREG23 Register

31	30	29	28	27	26	25	24	23	22	21	20	19	18	17	16	15	14	13	12	11	10	9	8	7	6	5	4	3	2	1	0
GP_REG23																															
R/W-0h																															

LEGEND: R/W = Read/Write; R = Read only; W1toCl = Write 1 to clear bit; -n = value after reset

Table 4-61. GPREG23 Register Field Descriptions

Bit	Field	Type	Reset	Description
31-0	GP_REG23	R/W	0h	PRU Internal GP Register n: Reading / writing this field directly inspects/modifies the corresponding internal register in the PRU internal regfile.

4.5.2.25 GPREG24 Register (offset = 60h) [reset = 0h]

GPREG24 is shown in [Figure 4-62](#) and described in [Table 4-62](#).

DEBUG PRU GENERAL PURPOSE REGISTER 24. This register allows an external agent to debug the PRU while it is disabled. Reading or writing to these registers will have the same effect as a read or write to these registers from an internal instruction in the PRU. For R30, this includes generation of the pulse outputs whenever the register is written.

Figure 4-62. GPREG24 Register

31	30	29	28	27	26	25	24	23	22	21	20	19	18	17	16	15	14	13	12	11	10	9	8	7	6	5	4	3	2	1	0
GP_REG24																															
R/W-0h																															

LEGEND: R/W = Read/Write; R = Read only; W1toCl = Write 1 to clear bit; -n = value after reset

Table 4-62. GPREG24 Register Field Descriptions

Bit	Field	Type	Reset	Description
31-0	GP_REG24	R/W	0h	PRU Internal GP Register n: Reading / writing this field directly inspects/modifies the corresponding internal register in the PRU internal regfile.

4.5.2.26 GPREG25 Register (offset = 64h) [reset = 0h]

GPREG25 is shown in [Figure 4-63](#) and described in [Table 4-63](#).

DEBUG PRU GENERAL PURPOSE REGISTER 25. This register allows an external agent to debug the PRU while it is disabled. Reading or writing to these registers will have the same effect as a read or write to these registers from an internal instruction in the PRU. For R30, this includes generation of the pulse outputs whenever the register is written.

Figure 4-63. GPREG25 Register

31	30	29	28	27	26	25	24	23	22	21	20	19	18	17	16	15	14	13	12	11	10	9	8	7	6	5	4	3	2	1	0
GP_REG25																															
R/W-0h																															

LEGEND: R/W = Read/Write; R = Read only; W1toCl = Write 1 to clear bit; -n = value after reset

Table 4-63. GPREG25 Register Field Descriptions

Bit	Field	Type	Reset	Description
31-0	GP_REG25	R/W	0h	PRU Internal GP Register n: Reading / writing this field directly inspects/modifies the corresponding internal register in the PRU internal regfile.

4.5.2.27 GPREG26 Register (offset = 68h) [reset = 0h]

GPREG26 is shown in [Figure 4-64](#) and described in [Table 4-64](#).

DEBUG PRU GENERAL PURPOSE REGISTER 26. This register allows an external agent to debug the PRU while it is disabled. Reading or writing to these registers will have the same effect as a read or write to these registers from an internal instruction in the PRU. For R30, this includes generation of the pulse outputs whenever the register is written.

Figure 4-64. GPREG26 Register

31	30	29	28	27	26	25	24	23	22	21	20	19	18	17	16	15	14	13	12	11	10	9	8	7	6	5	4	3	2	1	0
GP_REG26																															
R/W-0h																															

LEGEND: R/W = Read/Write; R = Read only; W1toCl = Write 1 to clear bit; -n = value after reset

Table 4-64. GPREG26 Register Field Descriptions

Bit	Field	Type	Reset	Description
31-0	GP_REG26	R/W	0h	PRU Internal GP Register n: Reading / writing this field directly inspects/modifies the corresponding internal register in the PRU internal regfile.

4.5.2.28 GPREG27 Register (offset = 6Ch) [reset = 0h]

GPREG27 is shown in [Figure 4-65](#) and described in [Table 4-65](#).

DEBUG PRU GENERAL PURPOSE REGISTER 27. This register allows an external agent to debug the PRU while it is disabled. Reading or writing to these registers will have the same effect as a read or write to these registers from an internal instruction in the PRU. For R30, this includes generation of the pulse outputs whenever the register is written.

Figure 4-65. GPREG27 Register

31	30	29	28	27	26	25	24	23	22	21	20	19	18	17	16	15	14	13	12	11	10	9	8	7	6	5	4	3	2	1	0
GP_REG27																															
R/W-0h																															

LEGEND: R/W = Read/Write; R = Read only; W1toCl = Write 1 to clear bit; -n = value after reset

Table 4-65. GPREG27 Register Field Descriptions

Bit	Field	Type	Reset	Description
31-0	GP_REG27	R/W	0h	PRU Internal GP Register n: Reading / writing this field directly inspects/modifies the corresponding internal register in the PRU internal regfile.

4.5.2.29 GPREG28 Register (offset = 70h) [reset = 0h]

GPREG28 is shown in [Figure 4-66](#) and described in [Table 4-66](#).

DEBUG PRU GENERAL PURPOSE REGISTER 28. This register allows an external agent to debug the PRU while it is disabled. Reading or writing to these registers will have the same effect as a read or write to these registers from an internal instruction in the PRU. For R30, this includes generation of the pulse outputs whenever the register is written.

Figure 4-66. GPREG28 Register

31	30	29	28	27	26	25	24	23	22	21	20	19	18	17	16	15	14	13	12	11	10	9	8	7	6	5	4	3	2	1	0
GP_REG28																															
R/W-0h																															

LEGEND: R/W = Read/Write; R = Read only; W1toCl = Write 1 to clear bit; -n = value after reset

Table 4-66. GPREG28 Register Field Descriptions

Bit	Field	Type	Reset	Description
31-0	GP_REG28	R/W	0h	PRU Internal GP Register n: Reading / writing this field directly inspects/modifies the corresponding internal register in the PRU internal regfile.

4.5.2.30 GPREG29 Register (offset = 74h) [reset = 0h]

GPREG29 is shown in [Figure 4-67](#) and described in [Table 4-67](#).

DEBUG PRU GENERAL PURPOSE REGISTER 29. This register allows an external agent to debug the PRU while it is disabled. Reading or writing to these registers will have the same effect as a read or write to these registers from an internal instruction in the PRU. For R30, this includes generation of the pulse outputs whenever the register is written.

Figure 4-67. GPREG29 Register

31	30	29	28	27	26	25	24	23	22	21	20	19	18	17	16	15	14	13	12	11	10	9	8	7	6	5	4	3	2	1	0
GP_REG29																															
R/W-0h																															

LEGEND: R/W = Read/Write; R = Read only; W1toCl = Write 1 to clear bit; -n = value after reset

Table 4-67. GPREG29 Register Field Descriptions

Bit	Field	Type	Reset	Description
31-0	GP_REG29	R/W	0h	PRU Internal GP Register n: Reading / writing this field directly inspects/modifies the corresponding internal register in the PRU internal regfile.

4.5.2.31 GPREG30 Register (offset = 78h) [reset = 0h]

GPREG30 is shown in [Figure 4-68](#) and described in [Table 4-68](#).

DEBUG PRU GENERAL PURPOSE REGISTER 30. This register allows an external agent to debug the PRU while it is disabled. Reading or writing to these registers will have the same effect as a read or write to these registers from an internal instruction in the PRU. For R30, this includes generation of the pulse outputs whenever the register is written.

Figure 4-68. GPREG30 Register

31	30	29	28	27	26	25	24	23	22	21	20	19	18	17	16	15	14	13	12	11	10	9	8	7	6	5	4	3	2	1	0
GP_REG30																															
R/W-0h																															

LEGEND: R/W = Read/Write; R = Read only; W1toCl = Write 1 to clear bit; -n = value after reset

Table 4-68. GPREG30 Register Field Descriptions

Bit	Field	Type	Reset	Description
31-0	GP_REG30	R/W	0h	PRU Internal GP Register n: Reading / writing this field directly inspects/modifies the corresponding internal register in the PRU internal regfile.

4.5.2.32 GPREG31 Register (offset = 7Ch) [reset = 0h]

GPREG31 is shown in [Figure 4-69](#) and described in [Table 4-69](#).

Figure 4-69. GPREG31 Register

31	30	29	28	27	26	25	24	23	22	21	20	19	18	17	16	15	14	13	12	11	10	9	8	7	6	5	4	3	2	1	0
GP_REG31																															
R/W-0h																															

LEGEND: R/W = Read/Write; R = Read only; W1toCl = Write 1 to clear bit; -n = value after reset

Table 4-69. GPREG31 Register Field Descriptions

Bit	Field	Type	Reset	Description
31-0	GP_REG31	R/W	0h	

4.5.2.33 CT_REG0 Register (offset = 80h) [reset = 20000h]

CT_REG0 is shown in [Figure 4-70](#) and described in [Table 4-70](#).

DEBUG PRU CONSTANTS TABLE ENTRY 0. This register allows an external agent to debug the PRU while it is disabled. Since some of the constants table entries may actually depend on system inputs / and or the internal state of the PRU, these registers are provided to allow an external agent to easily determine the state of the constants table.

Figure 4-70. CT_REG0 Register

31	30	29	28	27	26	25	24	23	22	21	20	19	18	17	16	15	14	13	12	11	10	9	8	7	6	5	4	3	2	1	0
CT_REG0																															
R-20000h																															

LEGEND: R/W = Read/Write; R = Read only; W1toCl = Write 1 to clear bit; -n = value after reset

Table 4-70. CT_REG0 Register Field Descriptions

Bit	Field	Type	Reset	Description
31-0	CT_REG0	R	20000h	PRU Internal Constants Table Entry n: Reading this field directly inspects the corresponding entry in the PRU internal constants table.

4.5.2.34 CT_REG1 Register (offset = 84h) [reset = 48040000h]

CT_REG1 is shown in [Figure 4-71](#) and described in [Table 4-71](#).

DEBUG PRU CONSTANTS TABLE ENTRY 1. This register allows an external agent to debug the PRU while it is disabled. Since some of the constants table entries may actually depend on system inputs / and or the internal state of the PRU, these registers are provided to allow an external agent to easily determine the state of the constants table.

Figure 4-71. CT_REG1 Register

31	30	29	28	27	26	25	24	23	22	21	20	19	18	17	16	15	14	13	12	11	10	9	8	7	6	5	4	3	2	1	0
CT_REG1																															
R-48040000h																															

LEGEND: R/W = Read/Write; R = Read only; W1toCl = Write 1 to clear bit; -n = value after reset

Table 4-71. CT_REG1 Register Field Descriptions

Bit	Field	Type	Reset	Description
31-0	CT_REG1	R	48040000h	PRU Internal Constants Table Entry n: Reading this field directly inspects the corresponding entry in the PRU internal constants table.

4.5.2.35 CT_REG2 Register (offset = 88h) [reset = 4802A000h]

CT_REG2 is shown in [Figure 4-72](#) and described in [Table 4-72](#).

DEBUG PRU CONSTANTS TABLE ENTRY 2. This register allows an external agent to debug the PRU while it is disabled. Since some of the constants table entries may actually depend on system inputs / and or the internal state of the PRU, these registers are provided to allow an external agent to easily determine the state of the constants table.

Figure 4-72. CT_REG2 Register

31	30	29	28	27	26	25	24	23	22	21	20	19	18	17	16	15	14	13	12	11	10	9	8	7	6	5	4	3	2	1	0
CT_REG2																															
R-4802A000h																															

LEGEND: R/W = Read/Write; R = Read only; W1toCl = Write 1 to clear bit; -n = value after reset

Table 4-72. CT_REG2 Register Field Descriptions

Bit	Field	Type	Reset	Description
31-0	CT_REG2	R	4802A000h	PRU Internal Constants Table Entry n: Reading this field directly inspects the corresponding entry in the PRU internal constants table.

4.5.2.36 CT_REG3 Register (offset = 8Ch) [reset = 30000h]

CT_REG3 is shown in [Figure 4-73](#) and described in [Table 4-73](#).

DEBUG PRU CONSTANTS TABLE ENTRY 3. This register allows an external agent to debug the PRU while it is disabled. Since some of the constants table entries may actually depend on system inputs / and or the internal state of the PRU, these registers are provided to allow an external agent to easily determine the state of the constants table.

Figure 4-73. CT_REG3 Register

31	30	29	28	27	26	25	24	23	22	21	20	19	18	17	16	15	14	13	12	11	10	9	8	7	6	5	4	3	2	1	0
CT_REG3																															
R-30000h																															

LEGEND: R/W = Read/Write; R = Read only; W1toCl = Write 1 to clear bit; -n = value after reset

Table 4-73. CT_REG3 Register Field Descriptions

Bit	Field	Type	Reset	Description
31-0	CT_REG3	R	30000h	PRU Internal Constants Table Entry n: Reading this field directly inspects the corresponding entry in the PRU internal constants table.

4.5.2.37 CT_REG4 Register (offset = 90h) [reset = 26000h]

CT_REG4 is shown in [Figure 4-74](#) and described in [Table 4-74](#).

DEBUG PRU CONSTANTS TABLE ENTRY 4. This register allows an external agent to debug the PRU while it is disabled. Since some of the constants table entries may actually depend on system inputs / and or the internal state of the PRU, these registers are provided to allow an external agent to easily determine the state of the constants table.

Figure 4-74. CT_REG4 Register

31	30	29	28	27	26	25	24	23	22	21	20	19	18	17	16	15	14	13	12	11	10	9	8	7	6	5	4	3	2	1	0
CT_REG4																															
R-26000h																															

LEGEND: R/W = Read/Write; R = Read only; W1toCl = Write 1 to clear bit; -n = value after reset

Table 4-74. CT_REG4 Register Field Descriptions

Bit	Field	Type	Reset	Description
31-0	CT_REG4	R	26000h	PRU Internal Constants Table Entry n: Reading this field directly inspects the corresponding entry in the PRU internal constants table.

4.5.2.38 CT_REG5 Register (offset = 94h) [reset = 48060000h]

CT_REG5 is shown in [Figure 4-75](#) and described in [Table 4-75](#).

DEBUG PRU CONSTANTS TABLE ENTRY 5. This register allows an external agent to debug the PRU while it is disabled. Since some of the constants table entries may actually depend on system inputs / and or the internal state of the PRU, these registers are provided to allow an external agent to easily determine the state of the constants table.

Figure 4-75. CT_REG5 Register

31	30	29	28	27	26	25	24	23	22	21	20	19	18	17	16	15	14	13	12	11	10	9	8	7	6	5	4	3	2	1	0
CT_REG5																															
R-48060000h																															

LEGEND: R/W = Read/Write; R = Read only; W1toCl = Write 1 to clear bit; -n = value after reset

Table 4-75. CT_REG5 Register Field Descriptions

Bit	Field	Type	Reset	Description
31-0	CT_REG5	R	48060000h	PRU Internal Constants Table Entry n: Reading this field directly inspects the corresponding entry in the PRU internal constants table.

4.5.2.39 CT_REG6 Register (offset = 98h) [reset = 48030000h]

CT_REG6 is shown in [Figure 4-76](#) and described in [Table 4-76](#).

DEBUG PRU CONSTANTS TABLE ENTRY 6. This register allows an external agent to debug the PRU while it is disabled. Since some of the constants table entries may actually depend on system inputs / and or the internal state of the PRU, these registers are provided to allow an external agent to easily determine the state of the constants table.

Figure 4-76. CT_REG6 Register

31	30	29	28	27	26	25	24	23	22	21	20	19	18	17	16	15	14	13	12	11	10	9	8	7	6	5	4	3	2	1	0
CT_REG6																															
R-48030000h																															

LEGEND: R/W = Read/Write; R = Read only; W1toCl = Write 1 to clear bit; -n = value after reset

Table 4-76. CT_REG6 Register Field Descriptions

Bit	Field	Type	Reset	Description
31-0	CT_REG6	R	48030000h	PRU Internal Constants Table Entry n: Reading this field directly inspects the corresponding entry in the PRU internal constants table.

4.5.2.40 CT_REG7 Register (offset = 9Ch) [reset = 28000h]

CT_REG7 is shown in [Figure 4-77](#) and described in [Table 4-77](#).

DEBUG PRU CONSTANTS TABLE ENTRY 7. This register allows an external agent to debug the PRU while it is disabled. Since some of the constants table entries may actually depend on system inputs / and or the internal state of the PRU, these registers are provided to allow an external agent to easily determine the state of the constants table.

Figure 4-77. CT_REG7 Register

31	30	29	28	27	26	25	24	23	22	21	20	19	18	17	16	15	14	13	12	11	10	9	8	7	6	5	4	3	2	1	0
CT_REG7																															
R-28000h																															

LEGEND: R/W = Read/Write; R = Read only; W1toCl = Write 1 to clear bit; -n = value after reset

Table 4-77. CT_REG7 Register Field Descriptions

Bit	Field	Type	Reset	Description
31-0	CT_REG7	R	28000h	PRU Internal Constants Table Entry n: Reading this field directly inspects the corresponding entry in the PRU internal constants table.

4.5.2.41 CT_REG8 Register (offset = A0h) [reset = 46000000h]

CT_REG8 is shown in [Figure 4-78](#) and described in [Table 4-78](#).

DEBUG PRU CONSTANTS TABLE ENTRY 8. This register allows an external agent to debug the PRU while it is disabled. Since some of the constants table entries may actually depend on system inputs / and or the internal state of the PRU, these registers are provided to allow an external agent to easily determine the state of the constants table.

Figure 4-78. CT_REG8 Register

31	30	29	28	27	26	25	24	23	22	21	20	19	18	17	16	15	14	13	12	11	10	9	8	7	6	5	4	3	2	1	0
CT_REG8																															
R-46000000h																															

LEGEND: R/W = Read/Write; R = Read only; W1toCl = Write 1 to clear bit; -n = value after reset

Table 4-78. CT_REG8 Register Field Descriptions

Bit	Field	Type	Reset	Description
31-0	CT_REG8	R	46000000h	PRU Internal Constants Table Entry n: Reading this field directly inspects the corresponding entry in the PRU internal constants table.

4.5.2.42 CT_REG9 Register (offset = A4h) [reset = 4A100000h]

CT_REG9 is shown in [Figure 4-79](#) and described in [Table 4-79](#).

DEBUG PRU CONSTANTS TABLE ENTRY 9. This register allows an external agent to debug the PRU while it is disabled. Since some of the constants table entries may actually depend on system inputs / and or the internal state of the PRU, these registers are provided to allow an external agent to easily determine the state of the constants table.

Figure 4-79. CT_REG9 Register

31	30	29	28	27	26	25	24	23	22	21	20	19	18	17	16	15	14	13	12	11	10	9	8	7	6	5	4	3	2	1	0
CT_REG9																															
R-4A100000h																															

LEGEND: R/W = Read/Write; R = Read only; W1toCl = Write 1 to clear bit; -n = value after reset

Table 4-79. CT_REG9 Register Field Descriptions

Bit	Field	Type	Reset	Description
31-0	CT_REG9	R	4A100000h	PRU Internal Constants Table Entry n: Reading this field directly inspects the corresponding entry in the PRU internal constants table.

4.5.2.43 CT_REG10 Register (offset = A8h) [reset = 48318000h]

CT_REG10 is shown in [Figure 4-80](#) and described in [Table 4-80](#).

DEBUG PRU CONSTANTS TABLE ENTRY 10. This register allows an external agent to debug the PRU while it is disabled. Since some of the constants table entries may actually depend on system inputs / and or the internal state of the PRU, these registers are provided to allow an external agent to easily determine the state of the constants table.

Figure 4-80. CT_REG10 Register

31	30	29	28	27	26	25	24	23	22	21	20	19	18	17	16	15	14	13	12	11	10	9	8	7	6	5	4	3	2	1	0
CT_REG10																															
R-48318000h																															

LEGEND: R/W = Read/Write; R = Read only; W1toCl = Write 1 to clear bit; -n = value after reset

Table 4-80. CT_REG10 Register Field Descriptions

Bit	Field	Type	Reset	Description
31-0	CT_REG10	R	48318000h	PRU Internal Constants Table Entry n: Reading this field directly inspects the corresponding entry in the PRU internal constants table.

4.5.2.44 CT_REG11 Register (offset = ACh) [reset = 48022000h]

CT_REG11 is shown in [Figure 4-81](#) and described in [Table 4-81](#).

DEBUG PRU CONSTANTS TABLE ENTRY 11. This register allows an external agent to debug the PRU while it is disabled. Since some of the constants table entries may actually depend on system inputs / and or the internal state of the PRU, these registers are provided to allow an external agent to easily determine the state of the constants table.

Figure 4-81. CT_REG11 Register

31	30	29	28	27	26	25	24	23	22	21	20	19	18	17	16	15	14	13	12	11	10	9	8	7	6	5	4	3	2	1	0
CT_REG11																															
R-48022000h																															

LEGEND: R/W = Read/Write; R = Read only; W1toCl = Write 1 to clear bit; -n = value after reset

Table 4-81. CT_REG11 Register Field Descriptions

Bit	Field	Type	Reset	Description
31-0	CT_REG11	R	48022000h	PRU Internal Constants Table Entry n: Reading this field directly inspects the corresponding entry in the PRU internal constants table.

4.5.2.45 CT_REG12 Register (offset = B0h) [reset = 48024000h]

CT_REG12 is shown in [Figure 4-82](#) and described in [Table 4-82](#).

DEBUG PRU CONSTANTS TABLE ENTRY 12. This register allows an external agent to debug the PRU while it is disabled. Since some of the constants table entries may actually depend on system inputs / and or the internal state of the PRU, these registers are provided to allow an external agent to easily determine the state of the constants table.

Figure 4-82. CT_REG12 Register

31	30	29	28	27	26	25	24	23	22	21	20	19	18	17	16	15	14	13	12	11	10	9	8	7	6	5	4	3	2	1	0
CT_REG12																															
R-48024000h																															

LEGEND: R/W = Read/Write; R = Read only; W1toCl = Write 1 to clear bit; -n = value after reset

Table 4-82. CT_REG12 Register Field Descriptions

Bit	Field	Type	Reset	Description
31-0	CT_REG12	R	48024000h	PRU Internal Constants Table Entry n: Reading this field directly inspects the corresponding entry in the PRU internal constants table.

4.5.2.46 CT_REG13 Register (offset = B4h) [reset = 48310000h]

CT_REG13 is shown in [Figure 4-83](#) and described in [Table 4-83](#).

DEBUG PRU CONSTANTS TABLE ENTRY 13. This register allows an external agent to debug the PRU while it is disabled. Since some of the constants table entries may actually depend on system inputs / and or the internal state of the PRU, these registers are provided to allow an external agent to easily determine the state of the constants table.

Figure 4-83. CT_REG13 Register

31	30	29	28	27	26	25	24	23	22	21	20	19	18	17	16	15	14	13	12	11	10	9	8	7	6	5	4	3	2	1	0
CT_REG13																															
R-48310000h																															

LEGEND: R/W = Read/Write; R = Read only; W1toCl = Write 1 to clear bit; -n = value after reset

Table 4-83. CT_REG13 Register Field Descriptions

Bit	Field	Type	Reset	Description
31-0	CT_REG13	R	48310000h	PRU Internal Constants Table Entry n: Reading this field directly inspects the corresponding entry in the PRU internal constants table.

4.5.2.47 CT_REG14 Register (offset = B8h) [reset = 481CC000h]

CT_REG14 is shown in [Figure 4-84](#) and described in [Table 4-84](#).

DEBUG PRU CONSTANTS TABLE ENTRY 14. This register allows an external agent to debug the PRU while it is disabled. Since some of the constants table entries may actually depend on system inputs / and or the internal state of the PRU, these registers are provided to allow an external agent to easily determine the state of the constants table.

Figure 4-84. CT_REG14 Register

31	30	29	28	27	26	25	24	23	22	21	20	19	18	17	16	15	14	13	12	11	10	9	8	7	6	5	4	3	2	1	0
CT_REG14																															
R-481CC000h																															

LEGEND: R/W = Read/Write; R = Read only; W1toCl = Write 1 to clear bit; -n = value after reset

Table 4-84. CT_REG14 Register Field Descriptions

Bit	Field	Type	Reset	Description
31-0	CT_REG14	R	481CC000h	PRU Internal Constants Table Entry n: Reading this field directly inspects the corresponding entry in the PRU internal constants table.

4.5.2.48 CT_REG15 Register (offset = BCh) [reset = 481D0000h]

CT_REG15 is shown in [Figure 4-85](#) and described in [Table 4-85](#).

DEBUG PRU CONSTANTS TABLE ENTRY 15. This register allows an external agent to debug the PRU while it is disabled. Since some of the constants table entries may actually depend on system inputs / and or the internal state of the PRU, these registers are provided to allow an external agent to easily determine the state of the constants table.

Figure 4-85. CT_REG15 Register

31	30	29	28	27	26	25	24	23	22	21	20	19	18	17	16	15	14	13	12	11	10	9	8	7	6	5	4	3	2	1	0
CT_REG15																															
R-481D0000h																															

LEGEND: R/W = Read/Write; R = Read only; W1toCl = Write 1 to clear bit; -n = value after reset

Table 4-85. CT_REG15 Register Field Descriptions

Bit	Field	Type	Reset	Description
31-0	CT_REG15	R	481D0000h	PRU Internal Constants Table Entry n: Reading this field directly inspects the corresponding entry in the PRU internal constants table.

4.5.2.49 CT_REG16 Register (offset = C0h) [reset = 481A0000h]

CT_REG16 is shown in [Figure 4-86](#) and described in [Table 4-86](#).

DEBUG PRU CONSTANTS TABLE ENTRY 16. This register allows an external agent to debug the PRU while it is disabled. Since some of the constants table entries may actually depend on system inputs / and or the internal state of the PRU, these registers are provided to allow an external agent to easily determine the state of the constants table.

Figure 4-86. CT_REG16 Register

31	30	29	28	27	26	25	24	23	22	21	20	19	18	17	16	15	14	13	12	11	10	9	8	7	6	5	4	3	2	1	0
CT_REG16																															
R-481A0000h																															

LEGEND: R/W = Read/Write; R = Read only; W1toCl = Write 1 to clear bit; -n = value after reset

Table 4-86. CT_REG16 Register Field Descriptions

Bit	Field	Type	Reset	Description
31-0	CT_REG16	R	481A0000h	PRU Internal Constants Table Entry n: Reading this field directly inspects the corresponding entry in the PRU internal constants table.

4.5.2.50 CT_REG17 Register (offset = C4h) [reset = 4819C000h]

CT_REG17 is shown in [Figure 4-87](#) and described in [Table 4-87](#).

DEBUG PRU CONSTANTS TABLE ENTRY 17. This register allows an external agent to debug the PRU while it is disabled. Since some of the constants table entries may actually depend on system inputs / and or the internal state of the PRU, these registers are provided to allow an external agent to easily determine the state of the constants table.

Figure 4-87. CT_REG17 Register

31	30	29	28	27	26	25	24	23	22	21	20	19	18	17	16	15	14	13	12	11	10	9	8	7	6	5	4	3	2	1	0
CT_REG17																															
R-4819C000h																															

LEGEND: R/W = Read/Write; R = Read only; W1toCl = Write 1 to clear bit; -n = value after reset

Table 4-87. CT_REG17 Register Field Descriptions

Bit	Field	Type	Reset	Description
31-0	CT_REG17	R	4819C000h	PRU Internal Constants Table Entry n: Reading this field directly inspects the corresponding entry in the PRU internal constants table.

4.5.2.51 CT_REG18 Register (offset = C8h) [reset = 48300000h]

CT_REG18 is shown in [Figure 4-88](#) and described in [Table 4-88](#).

DEBUG PRU CONSTANTS TABLE ENTRY 18. This register allows an external agent to debug the PRU while it is disabled. Since some of the constants table entries may actually depend on system inputs / and or the internal state of the PRU, these registers are provided to allow an external agent to easily determine the state of the constants table.

Figure 4-88. CT_REG18 Register

31	30	29	28	27	26	25	24	23	22	21	20	19	18	17	16	15	14	13	12	11	10	9	8	7	6	5	4	3	2	1	0
CT_REG18																															
R-48300000h																															

LEGEND: R/W = Read/Write; R = Read only; W1toCl = Write 1 to clear bit; -n = value after reset

Table 4-88. CT_REG18 Register Field Descriptions

Bit	Field	Type	Reset	Description
31-0	CT_REG18	R	48300000h	PRU Internal Constants Table Entry n: Reading this field directly inspects the corresponding entry in the PRU internal constants table.

4.5.2.52 CT_REG19 Register (offset = CCh) [reset = 48302000h]

CT_REG19 is shown in [Figure 4-89](#) and described in [Table 4-89](#).

DEBUG PRU CONSTANTS TABLE ENTRY 19. This register allows an external agent to debug the PRU while it is disabled. Since some of the constants table entries may actually depend on system inputs / and or the internal state of the PRU, these registers are provided to allow an external agent to easily determine the state of the constants table.

Figure 4-89. CT_REG19 Register

31	30	29	28	27	26	25	24	23	22	21	20	19	18	17	16	15	14	13	12	11	10	9	8	7	6	5	4	3	2	1	0
CT_REG19																															
R-48302000h																															

LEGEND: R/W = Read/Write; R = Read only; W1toCl = Write 1 to clear bit; -n = value after reset

Table 4-89. CT_REG19 Register Field Descriptions

Bit	Field	Type	Reset	Description
31-0	CT_REG19	R	48302000h	PRU Internal Constants Table Entry n: Reading this field directly inspects the corresponding entry in the PRU internal constants table.

4.5.2.53 CT_REG20 Register (offset = D0h) [reset = 48304000h]

CT_REG20 is shown in [Figure 4-90](#) and described in [Table 4-90](#).

DEBUG PRU CONSTANTS TABLE ENTRY 20. This register allows an external agent to debug the PRU while it is disabled. Since some of the constants table entries may actually depend on system inputs / and or the internal state of the PRU, these registers are provided to allow an external agent to easily determine the state of the constants table.

Figure 4-90. CT_REG20 Register

31	30	29	28	27	26	25	24	23	22	21	20	19	18	17	16	15	14	13	12	11	10	9	8	7	6	5	4	3	2	1	0
CT_REG20																															
R-48304000h																															

LEGEND: R/W = Read/Write; R = Read only; W1toCl = Write 1 to clear bit; -n = value after reset

Table 4-90. CT_REG20 Register Field Descriptions

Bit	Field	Type	Reset	Description
31-0	CT_REG20	R	48304000h	PRU Internal Constants Table Entry n: Reading this field directly inspects the corresponding entry in the PRU internal constants table.

4.5.2.54 CT_REG21 Register (offset = D4h) [reset = 32400h]

CT_REG21 is shown in [Figure 4-91](#) and described in [Table 4-91](#).

DEBUG PRU CONSTANTS TABLE ENTRY 21. This register allows an external agent to debug the PRU while it is disabled. Since some of the constants table entries may actually depend on system inputs / and or the internal state of the PRU, these registers are provided to allow an external agent to easily determine the state of the constants table.

Figure 4-91. CT_REG21 Register

31	30	29	28	27	26	25	24	23	22	21	20	19	18	17	16	15	14	13	12	11	10	9	8	7	6	5	4	3	2	1	0
CT_REG21																															
R-32400h																															

LEGEND: R/W = Read/Write; R = Read only; W1toCl = Write 1 to clear bit; -n = value after reset

Table 4-91. CT_REG21 Register Field Descriptions

Bit	Field	Type	Reset	Description
31-0	CT_REG21	R	32400h	PRU Internal Constants Table Entry n: Reading this field directly inspects the corresponding entry in the PRU internal constants table.

4.5.2.55 CT_REG22 Register (offset = D8h) [reset = 480C8000h]

CT_REG22 is shown in [Figure 4-92](#) and described in [Table 4-92](#).

DEBUG PRU CONSTANTS TABLE ENTRY 22. This register allows an external agent to debug the PRU while it is disabled. Since some of the constants table entries may actually depend on system inputs / and or the internal state of the PRU, these registers are provided to allow an external agent to easily determine the state of the constants table.

Figure 4-92. CT_REG22 Register

31	30	29	28	27	26	25	24	23	22	21	20	19	18	17	16	15	14	13	12	11	10	9	8	7	6	5	4	3	2	1	0
CT_REG22																															
R-480C8000h																															

LEGEND: R/W = Read/Write; R = Read only; W1toCl = Write 1 to clear bit; -n = value after reset

Table 4-92. CT_REG22 Register Field Descriptions

Bit	Field	Type	Reset	Description
31-0	CT_REG22	R	480C8000h	PRU Internal Constants Table Entry n: Reading this field directly inspects the corresponding entry in the PRU internal constants table.

4.5.2.56 CT_REG23 Register (offset = DCh) [reset = 480CA000h]

CT_REG23 is shown in [Figure 4-93](#) and described in [Table 4-93](#).

DEBUG PRU CONSTANTS TABLE ENTRY 23. This register allows an external agent to debug the PRU while it is disabled. Since some of the constants table entries may actually depend on system inputs / and or the internal state of the PRU, these registers are provided to allow an external agent to easily determine the state of the constants table.

Figure 4-93. CT_REG23 Register

31	30	29	28	27	26	25	24	23	22	21	20	19	18	17	16	15	14	13	12	11	10	9	8	7	6	5	4	3	2	1	0
CT_REG23																															
R-480CA000h																															

LEGEND: R/W = Read/Write; R = Read only; W1toCl = Write 1 to clear bit; -n = value after reset

Table 4-93. CT_REG23 Register Field Descriptions

Bit	Field	Type	Reset	Description
31-0	CT_REG23	R	480CA000h	PRU Internal Constants Table Entry n: Reading this field directly inspects the corresponding entry in the PRU internal constants table.

4.5.2.57 CT_REG24 Register (offset = E0h) [reset = 0h]

CT_REG24 is shown in [Figure 4-94](#) and described in [Table 4-94](#).

DEBUG PRU CONSTANTS TABLE ENTRY 24. This register allows an external agent to debug the PRU while it is disabled. Since some of the constants table entries may actually depend on system inputs / and or the internal state of the PRU, these registers are provided to allow an external agent to easily determine the state of the constants table.

Figure 4-94. CT_REG24 Register

31	30	29	28	27	26	25	24	23	22	21	20	19	18	17	16	15	14	13	12	11	10	9	8	7	6	5	4	3	2	1	0
CT_REG24																															
R-0h																															

LEGEND: R/W = Read/Write; R = Read only; W1toCl = Write 1 to clear bit; -n = value after reset

Table 4-94. CT_REG24 Register Field Descriptions

Bit	Field	Type	Reset	Description
31-0	CT_REG24	R	0h	PRU Internal Constants Table Entry n: Reading this field directly inspects the corresponding entry in the PRU internal constants table. This entry is partially programmable through the C24_BLK_INDEX in the PRU Control register. The reset value for this Constant Table Entry is 0x0000n00, n=C24_BLK_INDEX[3:0].

4.5.2.58 CT_REG25 Register (offset = E4h) [reset = 0h]

CT_REG25 is shown in [Figure 4-95](#) and described in [Table 4-95](#).

DEBUG PRU CONSTANTS TABLE ENTRY 25. This register allows an external agent to debug the PRU while it is disabled. Since some of the constants table entries may actually depend on system inputs / and or the internal state of the PRU, these registers are provided to allow an external agent to easily determine the state of the constants table.

Figure 4-95. CT_REG25 Register

31	30	29	28	27	26	25	24	23	22	21	20	19	18	17	16	15	14	13	12	11	10	9	8	7	6	5	4	3	2	1	0
CT_REG25																															
R-0h																															

LEGEND: R/W = Read/Write; R = Read only; W1toCl = Write 1 to clear bit; -n = value after reset

Table 4-95. CT_REG25 Register Field Descriptions

Bit	Field	Type	Reset	Description
31-0	CT_REG25	R	0h	PRU Internal Constants Table Entry n: Reading this field directly inspects the corresponding entry in the PRU internal constants table. This entry is partially programmable through the C25_BLK_INDEX in the PRU Control register. The reset value for this Constant Table Entry is 0x00002n00, n=C25_BLK_INDEX[3:0].

4.5.2.59 CT_REG26 Register (offset = E8h) [reset = 0h]

CT_REG26 is shown in [Figure 4-96](#) and described in [Table 4-96](#).

DEBUG PRU CONSTANTS TABLE ENTRY 26. This register allows an external agent to debug the PRU while it is disabled. Since some of the constants table entries may actually depend on system inputs / and or the internal state of the PRU, these registers are provided to allow an external agent to easily determine the state of the constants table.

Figure 4-96. CT_REG26 Register

31	30	29	28	27	26	25	24	23	22	21	20	19	18	17	16	15	14	13	12	11	10	9	8	7	6	5	4	3	2	1	0
CT_REG26																															
R-0h																															

LEGEND: R/W = Read/Write; R = Read only; W1toCl = Write 1 to clear bit; -n = value after reset

Table 4-96. CT_REG26 Register Field Descriptions

Bit	Field	Type	Reset	Description
31-0	CT_REG26	R	0h	PRU Internal Constants Table Entry n: Reading this field directly inspects the corresponding entry in the PRU internal constants table. This entry is partially programmable through the C26_BLK_INDEX in the PRU Control register. The reset value for this Constant Table Entry is 0x0002En00, n=C26_BLK_INDEX[3:0].

4.5.2.60 CT_REG27 Register (offset = ECh) [reset = 0h]

CT_REG27 is shown in [Figure 4-97](#) and described in [Table 4-97](#).

DEBUG PRU CONSTANTS TABLE ENTRY 27. This register allows an external agent to debug the PRU while it is disabled. Since some of the constants table entries may actually depend on system inputs / and or the internal state of the PRU, these registers are provided to allow an external agent to easily determine the state of the constants table.

Figure 4-97. CT_REG27 Register

31	30	29	28	27	26	25	24	23	22	21	20	19	18	17	16	15	14	13	12	11	10	9	8	7	6	5	4	3	2	1	0
CT_REG27																															
R-0h																															

LEGEND: R/W = Read/Write; R = Read only; W1toCl = Write 1 to clear bit; -n = value after reset

Table 4-97. CT_REG27 Register Field Descriptions

Bit	Field	Type	Reset	Description
31-0	CT_REG27	R	0h	PRU Internal Constants Table Entry n: Reading this field directly inspects the corresponding entry in the PRU internal constants table. This entry is partially programmable through the C27_BLK_INDEX in the PRU Control register. The reset value for this Constant Table Entry is 0x00032n00, n=C27_BLK_INDEX[3:0].

4.5.2.61 CT_REG28 Register (offset = F0h) [reset = 0h]

CT_REG28 is shown in [Figure 4-98](#) and described in [Table 4-98](#).

DEBUG PRU CONSTANTS TABLE ENTRY 28. This register allows an external agent to debug the PRU while it is disabled. Since some of the constants table entries may actually depend on system inputs / and or the internal state of the PRU, these registers are provided to allow an external agent to easily determine the state of the constants table.

Figure 4-98. CT_REG28 Register

31	30	29	28	27	26	25	24	23	22	21	20	19	18	17	16	15	14	13	12	11	10	9	8	7	6	5	4	3	2	1	0
CT_REG28																															
R-0h																															

LEGEND: R/W = Read/Write; R = Read only; W1toCl = Write 1 to clear bit; -n = value after reset

Table 4-98. CT_REG28 Register Field Descriptions

Bit	Field	Type	Reset	Description
31-0	CT_REG28	R	0h	PRU Internal Constants Table Entry n: Reading this field directly inspects the corresponding entry in the PRU internal constants table. This entry is partially programmable through the C28_POINTER in the PRU Control register. The reset value for this Constant Table Entry is 0x00nnnn00, nnnn=C28_POINTER[15:0].

4.5.2.62 CT_REG29 Register (offset = F4h) [reset = 0h]

CT_REG29 is shown in [Figure 4-99](#) and described in [Table 4-99](#).

DEBUG PRU CONSTANTS TABLE ENTRY 29. This register allows an external agent to debug the PRU while it is disabled. Since some of the constants table entries may actually depend on system inputs / and or the internal state of the PRU, these registers are provided to allow an external agent to easily determine the state of the constants table.

Figure 4-99. CT_REG29 Register

31	30	29	28	27	26	25	24	23	22	21	20	19	18	17	16	15	14	13	12	11	10	9	8	7	6	5	4	3	2	1	0
CT_REG29																															
R-0h																															

LEGEND: R/W = Read/Write; R = Read only; W1toCl = Write 1 to clear bit; -n = value after reset

Table 4-99. CT_REG29 Register Field Descriptions

Bit	Field	Type	Reset	Description
31-0	CT_REG29	R	0h	PRU Internal Constants Table Entry n: Reading this field directly inspects the corresponding entry in the PRU internal constants table. This entry is partially programmable through the C29_POINTER in the PRU Control register. The reset value for this Constant Table Entry is 0x49nnnn00, nnnn=C29_POINTER[15:0].

4.5.2.63 CT_REG30 Register (offset = F8h) [reset = 0h]

CT_REG30 is shown in [Figure 4-100](#) and described in [Table 4-100](#).

DEBUG PRU CONSTANTS TABLE ENTRY 30. This register allows an external agent to debug the PRU while it is disabled. Since some of the constants table entries may actually depend on system inputs / and or the internal state of the PRU, these registers are provided to allow an external agent to easily determine the state of the constants table.

Figure 4-100. CT_REG30 Register

31	30	29	28	27	26	25	24	23	22	21	20	19	18	17	16	15	14	13	12	11	10	9	8	7	6	5	4	3	2	1	0
CT_REG30																															
R-0h																															

LEGEND: R/W = Read/Write; R = Read only; W1toCl = Write 1 to clear bit; -n = value after reset

Table 4-100. CT_REG30 Register Field Descriptions

Bit	Field	Type	Reset	Description
31-0	CT_REG30	R	0h	PRU Internal Constants Table Entry n: Reading this field directly inspects the corresponding entry in the PRU internal constants table. This entry is partially programmable through the C30_POINTER in the PRU Control register. The reset value for this Constant Table Entry is 0x40nnnn00, nnnn=C30_POINTER[15:0].

4.5.2.64 CT_REG31 Register (offset = FCh) [reset = 0h]

CT_REG31 is shown in [Figure 4-101](#) and described in [Table 4-101](#).

DEBUG PRU CONSTANTS TABLE ENTRY 31. This register allows an external agent to debug the PRU while it is disabled. Since some of the constants table entries may actually depend on system inputs / and or the internal state of the PRU, these registers are provided to allow an external agent to easily determine the state of the constants table.

Figure 4-101. CT_REG31 Register

31	30	29	28	27	26	25	24	23	22	21	20	19	18	17	16	15	14	13	12	11	10	9	8	7	6	5	4	3	2	1	0
CT_REG31																															
R-0h																															

LEGEND: R/W = Read/Write; R = Read only; W1toCl = Write 1 to clear bit; -n = value after reset

Table 4-101. CT_REG31 Register Field Descriptions

Bit	Field	Type	Reset	Description
31-0	CT_REG31	R	0h	PRU Internal Constants Table Entry n: Reading this field directly inspects the corresponding entry in the PRU internal constants table. This entry is partially programmable through the C31_POINTER in the PRU Control register. The reset value for this Constant Table Entry is 0x80nnnn00, nnnn=C31_POINTER[15:0].

4.5.3 PRU_ICSS_INTC Registers

[Table 4-102](#) lists the memory-mapped registers for the PRU_ICSS_INTC. All register offset addresses not listed in [Table 4-102](#) should be considered as reserved locations and the register contents should not be modified.

Table 4-102. PRU_ICSS_INTC Registers

Offset	Acronym	Register Name	Section
0h	REVID		Section 4.5.3.1
4h	CR		Section 4.5.3.2
10h	GER		Section 4.5.3.3
1Ch	GNLR		Section 4.5.3.4
20h	SISR		Section 4.5.3.5
24h	SICR		Section 4.5.3.6
28h	EISR		Section 4.5.3.7
2Ch	EICR		Section 4.5.3.8
34h	HIEISR		Section 4.5.3.9
38h	HIDISR		Section 4.5.3.10
80h	GPIR		Section 4.5.3.11
200h	SRSR0		Section 4.5.3.12
204h	SRSR1		Section 4.5.3.13
280h	SECR0		Section 4.5.3.14
284h	SECR1		Section 4.5.3.15
300h	ESR0		Section 4.5.3.16
304h	ESR1		Section 4.5.3.17
380h	ECR0		Section 4.5.3.18
384h	ECR1		Section 4.5.3.19
400h	CMR0		Section 4.5.3.20
404h	CMR1		Section 4.5.3.21
408h	CMR2		Section 4.5.3.22

Table 4-102. PRU_ICSS_INTC Registers (continued)

Offset	Acronym	Register Name	Section
40Ch	CMR3		Section 4.5.3.23
410h	CMR4		Section 4.5.3.24
414h	CMR5		Section 4.5.3.25
418h	CMR6		Section 4.5.3.26
41Ch	CMR7		Section 4.5.3.27
420h	CMR8		Section 4.5.3.28
424h	CMR9		Section 4.5.3.29
428h	CMR10		Section 4.5.3.30
42Ch	CMR11		Section 4.5.3.31
430h	CMR12		Section 4.5.3.32
434h	CMR13		Section 4.5.3.33
438h	CMR14		Section 4.5.3.34
43Ch	CMR15		Section 4.5.3.35
800h	HMR0		Section 4.5.3.36
804h	HMR1		Section 4.5.3.37
808h	HMR2		Section 4.5.3.38
900h	HIPIR0		Section 4.5.3.39
904h	HIPIR1		Section 4.5.3.40
908h	HIPIR2		Section 4.5.3.41
90Ch	HIPIR3		Section 4.5.3.42
910h	HIPIR4		Section 4.5.3.43
914h	HIPIR5		Section 4.5.3.44
918h	HIPIR6		Section 4.5.3.45
91Ch	HIPIR7		Section 4.5.3.46
920h	HIPIR8		Section 4.5.3.47
924h	HIPIR9		Section 4.5.3.48
D00h	SIPR0		Section 4.5.3.49
D04h	SIPR1		Section 4.5.3.50
D80h	SITR0		Section 4.5.3.51
D84h	SITR1		Section 4.5.3.52
1100h	HINLR0		Section 4.5.3.53
1104h	HINLR1		Section 4.5.3.54
1108h	HINLR2		Section 4.5.3.55
110Ch	HINLR3		Section 4.5.3.56
1110h	HINLR4		Section 4.5.3.57
1114h	HINLR5		Section 4.5.3.58
1118h	HINLR6		Section 4.5.3.59
111Ch	HINLR7		Section 4.5.3.60
1120h	HINLR8		Section 4.5.3.61
1124h	HINLR9		Section 4.5.3.62
1500h	HIER		Section 4.5.3.63

4.5.3.1 REVID Register (offset = 0h) [reset = 4E82A900h]

REVID is shown in [Figure 4-102](#) and described in [Table 4-103](#).

Revision ID Register

Figure 4-102. REVID Register

31	30	29	28	27	26	25	24
REV_SCHEME		RESERVED		REV_MODULE			
R-1h		R-0h		R-E82h			
23	22	21	20	19	18	17	16
REV_MODULE							
R-E82h							
15	14	13	12	11	10	9	8
REV_RTL				REV_MAJOR			
R-15h				R-1h			
7	6	5	4	3	2	1	0
REV_CUSTOM		REV_MINOR					
R-0h		R-0h					

LEGEND: R/W = Read/Write; R = Read only; W1toCl = Write 1 to clear bit; -n = value after reset

Table 4-103. REVID Register Field Descriptions

Bit	Field	Type	Reset	Description
31-30	REV_SCHEME	R	1h	SCHEME
29-28	RESERVED	R	0h	
27-16	REV_MODULE	R	E82h	MODULE ID
15-11	REV_RTL	R	15h	RTL REVISIONS
10-8	REV_MAJOR	R	1h	MAJOR REVISION
7-6	REV_CUSTOM	R	0h	CUSTOM REVISION
5-0	REV_MINOR	R	0h	MINOR REVISION

4.5.3.2 CR Register (offset = 4h) [reset = 0h]

CR is shown in [Figure 4-103](#) and described in [Table 4-104](#).

The Control Register holds global control parameters and can force a soft reset on the module.

Figure 4-103. CR Register

31	30	29	28	27	26	25	24
RESERVED							
R/W-0h							
23	22	21	20	19	18	17	16
RESERVED							
R/W-0h							
15	14	13	12	11	10	9	8
RESERVED							
R/W-0h							
7	6	5	4	3	2	1	0
RESERVED			RESERVED	NEST_MODE		RESERVED	RESERVED
R/W-0h			R-0h	R/W-0h		R/W-0h	R/W-0h

LEGEND: R/W = Read/Write; R = Read only; W1toCl = Write 1 to clear bit; -n = value after reset

Table 4-104. CR Register Field Descriptions

Bit	Field	Type	Reset	Description
31-5	RESERVED	R/W	0h	
4	RESERVED	R	0h	Reserved.
3-2	NEST_MODE	R/W	0h	The nesting mode. 0 = no nesting 1 = automatic individual nesting (per host interrupt) 2 = automatic global nesting (over all host interrupts) 3 = manual nesting
1	RESERVED	R/W	0h	Reserved.
0	RESERVED	R/W	0h	

4.5.3.3 GER Register (offset = 10h) [reset = 0h]

GER is shown in [Figure 4-104](#) and described in [Table 4-105](#).

The Global Host Interrupt Enable Register enables all the host interrupts. Individual host interrupts are still enabled or disabled from their individual enables and are not overridden by the global enable.

Figure 4-104. GER Register

31	30	29	28	27	26	25	24
RESERVED							
R/W-0h							
23	22	21	20	19	18	17	16
RESERVED							
R/W-0h							
15	14	13	12	11	10	9	8
RESERVED							
R/W-0h							
7	6	5	4	3	2	1	0
RESERVED							EN_HINT_ANY
R/W-0h							R/W-0h

LEGEND: R/W = Read/Write; R = Read only; W1toCl = Write 1 to clear bit; -n = value after reset

Table 4-105. GER Register Field Descriptions

Bit	Field	Type	Reset	Description
31-1	RESERVED	R/W	0h	
0	EN_HINT_ANY	R/W	0h	The current global enable value when read. Writes set the global enable.

4.5.3.4 GNLR Register (offset = 1Ch) [reset = 100h]

GNLR is shown in [Figure 4-105](#) and described in [Table 4-106](#).

The Global Nesting Level Register allows the checking and setting of the global nesting level across all host interrupts when automatic global nesting mode is set. The nesting level is the channel (and all of lower priority) that are nested out because of a current interrupt. This register is only available when nesting is configured.

Figure 4-105. GNLR Register

31	30	29	28	27	26	25	24
AUTO_OVERR IDE	RESERVED						
W-0h	R/W-0h						
23	22	21	20	19	18	17	16
RESERVED							
R/W-0h							
15	14	13	12	11	10	9	8
RESERVED							GLB_NEST_LE VEL
R/W-0h							R/W-100h
7	6	5	4	3	2	1	0
GLB_NEST_LEVEL							
R/W-100h							

LEGEND: R/W = Read/Write; R = Read only; W1toCl = Write 1 to clear bit; -n = value after reset

Table 4-106. GNLR Register Field Descriptions

Bit	Field	Type	Reset	Description
31	AUTO_OVERRIDE	W	0h	Always read as 0. Writes of 1 override the automatic nesting and set the nesting_level to the written data.
30-9	RESERVED	R/W	0h	
8-0	GLB_NEST_LEVEL	R/W	100h	The current global nesting level (highest channel that is nested). Writes set the nesting level. In auto nesting mode this value is updated internally unless the auto_override bit is set.

4.5.3.5 SISR Register (offset = 20h) [reset = 0h]

SISR is shown in [Figure 4-106](#) and described in [Table 4-107](#).

The System Event Status Indexed Set Register allows setting the status of an event. The event to set is the index value written (0-63). This sets the Raw Status Register bit of the given index.

Figure 4-106. SISR Register

31	30	29	28	27	26	25	24	23	22	21	20	19	18	17	16
RESERVED															
W-0h															
15	14	13	12	11	10	9	8	7	6	5	4	3	2	1	0
RESERVED									STS_SET_IDX						
W-0h									W-0h						

LEGEND: R/W = Read/Write; R = Read only; W1toCl = Write 1 to clear bit; -n = value after reset

Table 4-107. SISR Register Field Descriptions

Bit	Field	Type	Reset	Description
31-10	RESERVED	W	0h	
9-0	STS_SET_IDX	W	0h	Writes set the status of the event given in the index value (0-63). Reads return 0.

4.5.3.6 SICR Register (offset = 24h) [reset = 0h]

SICR is shown in [Figure 4-107](#) and described in [Table 4-108](#).

The System Event Status Indexed Clear Register allows clearing the status of an event. The event to clear is the index value written (0-63). This clears the Raw Status Register bit of the given index.

Figure 4-107. SICR Register

31	30	29	28	27	26	25	24	23	22	21	20	19	18	17	16
RESERVED															
W-0h															
15	14	13	12	11	10	9	8	7	6	5	4	3	2	1	0
RESERVED									STS_CLR_IDX						
W-0h									W-0h						

LEGEND: R/W = Read/Write; R = Read only; W1toCl = Write 1 to clear bit; -n = value after reset

Table 4-108. SICR Register Field Descriptions

Bit	Field	Type	Reset	Description
31-10	RESERVED	W	0h	
9-0	STS_CLR_IDX	W	0h	Writes clear the status of the event given in the index value (0-63). Reads return 0.

4.5.3.7 EISR Register (offset = 28h) [reset = 0h]

EISR is shown in [Figure 4-108](#) and described in [Table 4-109](#).

The System Event Enable Indexed Set Register allows enabling an event. The event to enable is the index value written (0-63). This sets the Enable Register bit of the given index.

Figure 4-108. EISR Register

31	30	29	28	27	26	25	24	23	22	21	20	19	18	17	16	15	14	13	12	11	10	9	8	7	6	5	4	3	2	1	0
RESERVED												EN_SET_IDX																			
W-0h												W-0h																			

LEGEND: R/W = Read/Write; R = Read only; W1toCl = Write 1 to clear bit; -n = value after reset

Table 4-109. EISR Register Field Descriptions

Bit	Field	Type	Reset	Description
31-10	RESERVED	W	0h	
9-0	EN_SET_IDX	W	0h	Writes set the enable of the event given in the index value (0-63). Reads return 0.

4.5.3.8 EICR Register (offset = 2Ch) [reset = 0h]

EICR is shown in [Figure 4-109](#) and described in [Table 4-110](#).

The System Event Enable Indexed Clear Register allows disabling an event. The event to disable is the index value written (0-63). This clears the Enable Register bit of the given index.

Figure 4-109. EICR Register

31	30	29	28	27	26	25	24	23	22	21	20	19	18	17	16	15	14	13	12	11	10	9	8	7	6	5	4	3	2	1	0
RESERVED												EN_CLR_IDX																			
W-0h												W-0h																			

LEGEND: R/W = Read/Write; R = Read only; W1toCl = Write 1 to clear bit; -n = value after reset

Table 4-110. EICR Register Field Descriptions

Bit	Field	Type	Reset	Description
31-10	RESERVED	W	0h	
9-0	EN_CLR_IDX	W	0h	Writes clear the enable of the event given in the index value (0-63). Reads return 0.

4.5.3.9 HIEISR Register (offset = 34h) [reset = 0h]

HIEISR is shown in [Figure 4-110](#) and described in [Table 4-111](#).

The Host Interrupt Enable Indexed Set Register allows enabling a host interrupt output. The host interrupt to enable is the index value written (0-9). This enables the host interrupt output or triggers the output again if already enabled.

Figure 4-110. HIEISR Register

31	30	29	28	27	26	25	24
RESERVED							
R/W-0h							
23	22	21	20	19	18	17	16
RESERVED							
R/W-0h							
15	14	13	12	11	10	9	8
RESERVED							
R/W-0h							
7	6	5	4	3	2	1	0
RESERVED				HINT_EN_SET_IDX			
R/W-0h				R/W-0h			

LEGEND: R/W = Read/Write; R = Read only; W1toCl = Write 1 to clear bit; -n = value after reset

Table 4-111. HIEISR Register Field Descriptions

Bit	Field	Type	Reset	Description
31-4	RESERVED	R/W	0h	
3-0	HINT_EN_SET_IDX	R/W	0h	Writes set the enable of the host interrupt given in the index value (0-9). Reads return 0.

4.5.3.10 HIDISR Register (offset = 38h) [reset = 0h]

HIDISR is shown in [Figure 4-111](#) and described in [Table 4-112](#).

The Host Interrupt Enable Indexed Clear Register allows disabling a host interrupt output. The host interrupt to disable is the index value written (0-9). This disables the host interrupt output.

Figure 4-111. HIDISR Register

31	30	29	28	27	26	25	24
RESERVED							
R/W-0h							
23	22	21	20	19	18	17	16
RESERVED							
R/W-0h							
15	14	13	12	11	10	9	8
RESERVED							
R/W-0h							
7	6	5	4	3	2	1	0
RESERVED				HINT_EN_CLR_IDX			
R/W-0h				R/W-0h			

LEGEND: R/W = Read/Write; R = Read only; W1toCl = Write 1 to clear bit; -n = value after reset

Table 4-112. HIDISR Register Field Descriptions

Bit	Field	Type	Reset	Description
31-4	RESERVED	R/W	0h	
3-0	HINT_EN_CLR_IDX	R/W	0h	Writes clear the enable of the host interrupt given in the index value (0-9). Reads return 0.

4.5.3.11 GPIR Register (offset = 80h) [reset = 80000000h]

GPIR is shown in [Figure 4-112](#) and described in [Table 4-113](#).

The Global Prioritized Index Register shows the event number of the highest priority event pending across all the host interrupts.

Figure 4-112. GPIR Register

31	30	29	28	27	26	25	24
GLB_NONE	RESERVED						
R-1h				R-0h			
23	22	21	20	19	18	17	16
RESERVED							
R-0h							
15	14	13	12	11	10	9	8
RESERVED						GLB_PRI_INTR	
R-0h						R-0h	
7	6	5	4	3	2	1	0
GLB_PRI_INTR							
R-0h							

LEGEND: R/W = Read/Write; R = Read only; W1toCl = Write 1 to clear bit; -n = value after reset

Table 4-113. GPIR Register Field Descriptions

Bit	Field	Type	Reset	Description
31	GLB_NONE	R	1h	No Interrupt is pending. Can be used by host to test for a negative value to see if no interrupts are pending.
30-10	RESERVED	R	0h	
9-0	GLB_PRI_INTR	R	0h	The currently highest priority event index (0-63) pending across all the host interrupts.

4.5.3.12 SRSR0 Register (offset = 200h) [reset = 0h]

SRSR0 is shown in [Figure 4-113](#) and described in [Table 4-114](#).

The System Event Status Raw/Set Register0 show the pending enabled status of the system events 0 to 31. Software can write to the Status Set Registers to set a system event without a hardware trigger. There is one bit per system event

Figure 4-113. SRSR0 Register

31	30	29	28	27	26	25	24	23	22	21	20	19	18	17	16	15	14	13	12	11	10	9	8	7	6	5	4	3	2	1	0
RAW_STS_31_0																															
R/W-0h																															

LEGEND: R/W = Read/Write; R = Read only; W1toCl = Write 1 to clear bit; -n = value after reset

Table 4-114. SRSR0 Register Field Descriptions

Bit	Field	Type	Reset	Description
31-0	RAW_STS_31_0	R/W	0h	System event raw status and setting of the system events 0 to 31. Reads return the raw status. Write a 1 in a bit position to set the status of the system event. Writing a 0 has no effect.

4.5.3.13 SRSR1 Register (offset = 204h) [reset = 0h]

SRSR1 is shown in [Figure 4-114](#) and described in [Table 4-115](#).

The System Event Status Raw/Set Register1 show the pending enabled status of the system events 32 to 63. Software can write to the Status Set Registers to set a system event without a hardware trigger. There is one bit per system event

Figure 4-114. SRSR1 Register

31	30	29	28	27	26	25	24	23	22	21	20	19	18	17	16	15	14	13	12	11	10	9	8	7	6	5	4	3	2	1	0
RAW_STS_63_32																															
R/W-0h																															

LEGEND: R/W = Read/Write; R = Read only; W1toCl = Write 1 to clear bit; -n = value after reset

Table 4-115. SRSR1 Register Field Descriptions

Bit	Field	Type	Reset	Description
31-0	RAW_STS_63_32	R/W	0h	System event raw status and setting of the system events 32 to 63. Reads return the raw status. Write a 1 in a bit position to set the status of the system event. Writing a 0 has no effect.

4.5.3.14 SECR0 Register (offset = 280h) [reset = 0h]

SECR0 is shown in [Figure 4-115](#) and described in [Table 4-116](#).

The System Event Status Enabled/Clear Register0 show the pending enabled status of the system events 0 to 31. Software can write to the Status Clear Registers to clear a system event after it has been serviced. If a system event status is not cleared then another host interrupt may not be triggered or another host interrupt may be triggered incorrectly. There is one bit per system event.

Figure 4-115. SECR0 Register

31	30	29	28	27	26	25	24	23	22	21	20	19	18	17	16	15	14	13	12	11	10	9	8	7	6	5	4	3	2	1	0
ENA_STS_31_0																															
R/W-0h																															

LEGEND: R/W = Read/Write; R = Read only; W1toCl = Write 1 to clear bit; -n = value after reset

Table 4-116. SECR0 Register Field Descriptions

Bit	Field	Type	Reset	Description
31-0	ENA_STS_31_0	R/W	0h	System event enabled status and clearing of the system events 0 to 31. Reads return the enabled status (before enabling with the Enable Registers). Write a 1 in a bit position to clear the status of the system event. Writing a 0 has no effect.

4.5.3.15 SECR1 Register (offset = 284h) [reset = 0h]

SECR1 is shown in [Figure 4-116](#) and described in [Table 4-117](#).

The System Event Status Enabled/Clear Register1 show the pending enabled status of the system events 32 to 63. Software can write to the Status Clear Registers to clear a system event after it has been serviced. If a system event status is not cleared then another host interrupt may not be triggered or another host interrupt may be triggered incorrectly. There is one bit per system event.

Figure 4-116. SECR1 Register

31	30	29	28	27	26	25	24	23	22	21	20	19	18	17	16	15	14	13	12	11	10	9	8	7	6	5	4	3	2	1	0
ENA_STS_63_32																															
R/W-0h																															

LEGEND: R/W = Read/Write; R = Read only; W1toCl = Write 1 to clear bit; -n = value after reset

Table 4-117. SECR1 Register Field Descriptions

Bit	Field	Type	Reset	Description
31-0	ENA_STS_63_32	R/W	0h	System event enabled status and clearing of the system events 32 to 63. Reads return the enabled status (before enabling with the Enable Registers). Write a 1 in a bit position to clear the status of the system event. Writing a 0 has no effect.

4.5.3.16 ESR0 Register (offset = 300h) [reset = 0h]

ESR0 is shown in [Figure 4-117](#) and described in [Table 4-118](#).

The System Event Enable Set Register0 enables system events 0 to 31 to trigger outputs. System events that are not enabled do not interrupt the host. There is a bit per system event.

Figure 4-117. ESR0 Register

31	30	29	28	27	26	25	24	23	22	21	20	19	18	17	16	15	14	13	12	11	10	9	8	7	6	5	4	3	2	1	0
EN_SET_31_0																															
0h																															

LEGEND: R/W = Read/Write; R = Read only; W1toCl = Write 1 to clear bit; -n = value after reset

Table 4-118. ESR0 Register Field Descriptions

Bit	Field	Type	Reset	Description
31-0	EN_SET_31_0		0h	System event enables system events 0 to 31. Read returns the enable value (0 = disabled, 1 = enabled). Write a 1 in a bit position to set that enable. Writing a 0 has no effect.

4.5.3.17 ESR1 Register (offset = 304h) [reset = 0h]

ESR1 is shown in [Figure 4-118](#) and described in [Table 4-119](#).

The System Event Enable Set Register1 enables system events 32 to 63 to trigger outputs. System events that are not enabled do not interrupt the host. There is a bit per system event.

Figure 4-118. ESR1 Register

31	30	29	28	27	26	25	24	23	22	21	20	19	18	17	16	15	14	13	12	11	10	9	8	7	6	5	4	3	2	1	0
EN_SET_63_32																															
0h																															

LEGEND: R/W = Read/Write; R = Read only; W1toCl = Write 1 to clear bit; -n = value after reset

Table 4-119. ESR1 Register Field Descriptions

Bit	Field	Type	Reset	Description
31-0	EN_SET_63_32		0h	System event enables system events 32 to 63. Read returns the enable value (0 = disabled, 1 = enabled). Write a 1 in a bit position to set that enable. Writing a 0 has no effect.

4.5.3.18 ECR0 Register (offset = 380h) [reset = 0h]

ECR0 is shown in [Figure 4-119](#) and described in [Table 4-120](#).

The System Event Enable Clear Register0 disables system events 0 to 31 to map to channels. System events that are not enabled do not interrupt the host. There is a bit per system event.

Figure 4-119. ECR0 Register

31	30	29	28	27	26	25	24	23	22	21	20	19	18	17	16	15	14	13	12	11	10	9	8	7	6	5	4	3	2	1	0
EN_CLR_31_0																															
0h																															

LEGEND: R/W = Read/Write; R = Read only; W1toCl = Write 1 to clear bit; -n = value after reset

Table 4-120. ECR0 Register Field Descriptions

Bit	Field	Type	Reset	Description
31-0	EN_CLR_31_0		0h	System event enables system events 0 to 31. Read returns the enable value (0 = disabled, 1 = enabled). Write a 1 in a bit position to clear that enable. Writing a 0 has no effect.

4.5.3.19 ECR1 Register (offset = 384h) [reset = 0h]

ECR1 is shown in [Figure 4-120](#) and described in [Table 4-121](#).

The System Event Enable Clear Register1 disables system events 32 to 63 to map to channels. System events that are not enabled do not interrupt the host. There is a bit per system event.

Figure 4-120. ECR1 Register

31	30	29	28	27	26	25	24	23	22	21	20	19	18	17	16	15	14	13	12	11	10	9	8	7	6	5	4	3	2	1	0
EN_CLR_63_32																															
0h																															

LEGEND: R/W = Read/Write; R = Read only; W1toCl = Write 1 to clear bit; -n = value after reset

Table 4-121. ECR1 Register Field Descriptions

Bit	Field	Type	Reset	Description
31-0	EN_CLR_63_32		0h	System event enables system events 32 to 63. Read returns the enable value (0 = disabled, 1 = enabled). Write a 1 in a bit position to clear that enable. Writing a 0 has no effect.

4.5.3.20 CMR0 Register (offset = 400h) [reset = 0h]

CMR0 is shown in [Figure 4-121](#) and described in [Table 4-122](#).

The Channel Map Register0 specify the channel for the system events 0 to 3. There is one register per 4 system events. Note each CH_MAP_x bitfield corresponds to a system event. Channel numbers (0-9) should be written to these bitfields.

Figure 4-121. CMR0 Register

31	30	29	28	27	26	25	24	23	22	21	20	19	18	17	16
RESERVED				CH_MAP_3				RESERVED				CH_MAP_2			
R/W-0h				R/W-0h				R/W-0h				R/W-0h			
15	14	13	12	11	10	9	8	7	6	5	4	3	2	1	0
RESERVED				CH_MAP_1				RESERVED				CH_MAP_0			
R/W-0h				R/W-0h				R/W-0h				R/W-0h			

LEGEND: R/W = Read/Write; R = Read only; W1toCl = Write 1 to clear bit; -n = value after reset

Table 4-122. CMR0 Register Field Descriptions

Bit	Field	Type	Reset	Description
31-28	RESERVED	R/W	0h	
27-24	CH_MAP_3	R/W	0h	Sets the channel for the system event 3
23-20	RESERVED	R/W	0h	
19-16	CH_MAP_2	R/W	0h	Sets the channel for the system event 2
15-12	RESERVED	R/W	0h	
11-8	CH_MAP_1	R/W	0h	Sets the channel for the system event 1
7-4	RESERVED	R/W	0h	
3-0	CH_MAP_0	R/W	0h	Sets the channel for the system event 0

4.5.3.21 CMR1 Register (offset = 404h) [reset = 0h]

CMR1 is shown in [Figure 4-122](#) and described in [Table 4-123](#).

The Channel Map Register1 specify the channel for the system events 4 to 7. There is one register per 4 system events.

Figure 4-122. CMR1 Register

31	30	29	28	27	26	25	24	23	22	21	20	19	18	17	16
RESERVED				CH_MAP_7				RESERVED				CH_MAP_6			
R/W-0h				R/W-0h				R/W-0h				R/W-0h			
15	14	13	12	11	10	9	8	7	6	5	4	3	2	1	0
RESERVED				CH_MAP_5				RESERVED				CH_MAP_4			
R/W-0h				R/W-0h				R/W-0h				R/W-0h			

LEGEND: R/W = Read/Write; R = Read only; W1toCl = Write 1 to clear bit; -n = value after reset

Table 4-123. CMR1 Register Field Descriptions

Bit	Field	Type	Reset	Description
31-28	RESERVED	R/W	0h	
27-24	CH_MAP_7	R/W	0h	Sets the channel for the system event 7
23-20	RESERVED	R/W	0h	
19-16	CH_MAP_6	R/W	0h	Sets the channel for the system event 6
15-12	RESERVED	R/W	0h	
11-8	CH_MAP_5	R/W	0h	Sets the channel for the system event 5
7-4	RESERVED	R/W	0h	
3-0	CH_MAP_4	R/W	0h	Sets the channel for the system event 4

4.5.3.22 CMR2 Register (offset = 408h) [reset = 0h]

CMR2 is shown in [Figure 4-123](#) and described in [Table 4-124](#).

The Channel Map Register2 specify the channel for the system events 8 to 11. There is one register per 4 system events.

Figure 4-123. CMR2 Register

31	30	29	28	27	26	25	24	23	22	21	20	19	18	17	16
RESERVED				CH_MAP_11				RESERVED				CH_MAP_10			
R/W-0h				R/W-0h				R/W-0h				R/W-0h			
15	14	13	12	11	10	9	8	7	6	5	4	3	2	1	0
RESERVED				CH_MAP_9				RESERVED				CH_MAP_8			
R/W-0h				R/W-0h				R/W-0h				R/W-0h			

LEGEND: R/W = Read/Write; R = Read only; W1toCl = Write 1 to clear bit; -n = value after reset

Table 4-124. CMR2 Register Field Descriptions

Bit	Field	Type	Reset	Description
31-28	RESERVED	R/W	0h	
27-24	CH_MAP_11	R/W	0h	Sets the channel for the system event 11
23-20	RESERVED	R/W	0h	
19-16	CH_MAP_10	R/W	0h	Sets the channel for the system event 10
15-12	RESERVED	R/W	0h	
11-8	CH_MAP_9	R/W	0h	Sets the channel for the system event 9
7-4	RESERVED	R/W	0h	
3-0	CH_MAP_8	R/W	0h	Sets the channel for the system event 8

4.5.3.23 CMR3 Register (offset = 40Ch) [reset = 0h]

CMR3 is shown in [Figure 4-124](#) and described in [Table 4-125](#).

The Channel Map Register3 specify the channel for the system events 12 to 15. There is one register per 4 system events.

Figure 4-124. CMR3 Register

31	30	29	28	27	26	25	24	23	22	21	20	19	18	17	16
RESERVED				CH_MAP_15				RESERVED				CH_MAP_14			
R/W-0h				R/W-0h				R/W-0h				R/W-0h			
15	14	13	12	11	10	9	8	7	6	5	4	3	2	1	0
RESERVED				CH_MAP_13				RESERVED				CH_MAP_12			
R/W-0h				R/W-0h				R/W-0h				R/W-0h			

LEGEND: R/W = Read/Write; R = Read only; W1toCl = Write 1 to clear bit; -n = value after reset

Table 4-125. CMR3 Register Field Descriptions

Bit	Field	Type	Reset	Description
31-28	RESERVED	R/W	0h	
27-24	CH_MAP_15	R/W	0h	Sets the channel for the system event 15
23-20	RESERVED	R/W	0h	
19-16	CH_MAP_14	R/W	0h	Sets the channel for the system event 14
15-12	RESERVED	R/W	0h	
11-8	CH_MAP_13	R/W	0h	Sets the channel for the system event 13
7-4	RESERVED	R/W	0h	
3-0	CH_MAP_12	R/W	0h	Sets the channel for the system event 12

4.5.3.24 CMR4 Register (offset = 410h) [reset = 0h]

CMR4 is shown in [Figure 4-125](#) and described in [Table 4-126](#).

The Channel Map Register4 specify the channel for the system events 16 to 19. There is one register per 4 system events.

Figure 4-125. CMR4 Register

31	30	29	28	27	26	25	24	23	22	21	20	19	18	17	16
RESERVED				CH_MAP_19				RESERVED				CH_MAP_18			
R/W-0h				R/W-0h				R/W-0h				R/W-0h			
15	14	13	12	11	10	9	8	7	6	5	4	3	2	1	0
RESERVED				CH_MAP_17				RESERVED				CH_MAP_16			
R/W-0h				R/W-0h				R/W-0h				R/W-0h			

LEGEND: R/W = Read/Write; R = Read only; W1toCl = Write 1 to clear bit; -n = value after reset

Table 4-126. CMR4 Register Field Descriptions

Bit	Field	Type	Reset	Description
31-28	RESERVED	R/W	0h	
27-24	CH_MAP_19	R/W	0h	Sets the channel for the system event 19
23-20	RESERVED	R/W	0h	
19-16	CH_MAP_18	R/W	0h	Sets the channel for the system event 18
15-12	RESERVED	R/W	0h	
11-8	CH_MAP_17	R/W	0h	Sets the channel for the system event 17
7-4	RESERVED	R/W	0h	
3-0	CH_MAP_16	R/W	0h	Sets the channel for the system event 16

4.5.3.25 CMR5 Register (offset = 414h) [reset = 0h]

CMR5 is shown in [Figure 4-126](#) and described in [Table 4-127](#).

The Channel Map Register5 specify the channel for the system events 20 to 23. There is one register per 4 system events.

Figure 4-126. CMR5 Register

31	30	29	28	27	26	25	24	23	22	21	20	19	18	17	16
RESERVED				CH_MAP_23				RESERVED				CH_MAP_22			
R/W-0h				R/W-0h				R/W-0h				R/W-0h			
15	14	13	12	11	10	9	8	7	6	5	4	3	2	1	0
RESERVED				CH_MAP_21				RESERVED				CH_MAP_20			
R/W-0h				R/W-0h				R/W-0h				R/W-0h			

LEGEND: R/W = Read/Write; R = Read only; W1toCl = Write 1 to clear bit; -n = value after reset

Table 4-127. CMR5 Register Field Descriptions

Bit	Field	Type	Reset	Description
31-28	RESERVED	R/W	0h	
27-24	CH_MAP_23	R/W	0h	Sets the channel for the system event 23
23-20	RESERVED	R/W	0h	
19-16	CH_MAP_22	R/W	0h	Sets the channel for the system event 22
15-12	RESERVED	R/W	0h	
11-8	CH_MAP_21	R/W	0h	Sets the channel for the system event 21
7-4	RESERVED	R/W	0h	
3-0	CH_MAP_20	R/W	0h	Sets the channel for the system event 20

4.5.3.26 CMR6 Register (offset = 418h) [reset = 0h]

CMR6 is shown in [Figure 4-127](#) and described in [Table 4-128](#).

The Channel Map Register6 specify the channel for the system events 24 to 27. There is one register per 4 system events.

Figure 4-127. CMR6 Register

31	30	29	28	27	26	25	24	23	22	21	20	19	18	17	16
RESERVED				CH_MAP_27				RESERVED				CH_MAP_26			
R/W-0h				R/W-0h				R/W-0h				R/W-0h			
15	14	13	12	11	10	9	8	7	6	5	4	3	2	1	0
RESERVED				CH_MAP_25				RESERVED				CH_MAP_24			
R/W-0h				R/W-0h				R/W-0h				R/W-0h			

LEGEND: R/W = Read/Write; R = Read only; W1toCl = Write 1 to clear bit; -n = value after reset

Table 4-128. CMR6 Register Field Descriptions

Bit	Field	Type	Reset	Description
31-28	RESERVED	R/W	0h	
27-24	CH_MAP_27	R/W	0h	Sets the channel for the system event 27
23-20	RESERVED	R/W	0h	
19-16	CH_MAP_26	R/W	0h	Sets the channel for the system event 26
15-12	RESERVED	R/W	0h	
11-8	CH_MAP_25	R/W	0h	Sets the channel for the system event 25
7-4	RESERVED	R/W	0h	
3-0	CH_MAP_24	R/W	0h	Sets the channel for the system event 24

4.5.3.27 CMR7 Register (offset = 41Ch) [reset = 0h]

CMR7 is shown in [Figure 4-128](#) and described in [Table 4-129](#).

The Channel Map Register7 specify the channel for the system events 28 to 31. There is one register per 4 system events.

Figure 4-128. CMR7 Register

31	30	29	28	27	26	25	24	23	22	21	20	19	18	17	16
RESERVED				CH_MAP_31				RESERVED				CH_MAP_30			
R/W-0h				R/W-0h				R/W-0h				R/W-0h			
15	14	13	12	11	10	9	8	7	6	5	4	3	2	1	0
RESERVED				CH_MAP_29				RESERVED				CH_MAP_28			
R/W-0h				R/W-0h				R/W-0h				R/W-0h			

LEGEND: R/W = Read/Write; R = Read only; W1toCl = Write 1 to clear bit; -n = value after reset

Table 4-129. CMR7 Register Field Descriptions

Bit	Field	Type	Reset	Description
31-28	RESERVED	R/W	0h	
27-24	CH_MAP_31	R/W	0h	Sets the channel for the system event 31
23-20	RESERVED	R/W	0h	
19-16	CH_MAP_30	R/W	0h	Sets the channel for the system event 30
15-12	RESERVED	R/W	0h	
11-8	CH_MAP_29	R/W	0h	Sets the channel for the system event 29
7-4	RESERVED	R/W	0h	
3-0	CH_MAP_28	R/W	0h	Sets the channel for the system event 28

4.5.3.28 CMR8 Register (offset = 420h) [reset = 0h]

CMR8 is shown in [Figure 4-129](#) and described in [Table 4-130](#).

The Channel Map Register8 specify the channel for the system events 32 to 35. There is one register per 4 system events.

Figure 4-129. CMR8 Register

31	30	29	28	27	26	25	24	23	22	21	20	19	18	17	16
RESERVED				CH_MAP_35				RESERVED				CH_MAP_34			
R/W-0h				R/W-0h				R/W-0h				R/W-0h			
15	14	13	12	11	10	9	8	7	6	5	4	3	2	1	0
RESERVED				CH_MAP_33				RESERVED				CH_MAP_32			
R/W-0h				R/W-0h				R/W-0h				R/W-0h			

LEGEND: R/W = Read/Write; R = Read only; W1toCl = Write 1 to clear bit; -n = value after reset

Table 4-130. CMR8 Register Field Descriptions

Bit	Field	Type	Reset	Description
31-28	RESERVED	R/W	0h	
27-24	CH_MAP_35	R/W	0h	Sets the channel for the system event 35
23-20	RESERVED	R/W	0h	
19-16	CH_MAP_34	R/W	0h	Sets the channel for the system event 34
15-12	RESERVED	R/W	0h	
11-8	CH_MAP_33	R/W	0h	Sets the channel for the system event 33
7-4	RESERVED	R/W	0h	
3-0	CH_MAP_32	R/W	0h	Sets the channel for the system event 32

4.5.3.29 CMR9 Register (offset = 424h) [reset = 0h]

CMR9 is shown in [Figure 4-130](#) and described in [Table 4-131](#).

The Channel Map Register9 specify the channel for the system events 36 to 39. There is one register per 4 system events.

Figure 4-130. CMR9 Register

31	30	29	28	27	26	25	24	23	22	21	20	19	18	17	16
RESERVED				CH_MAP_39				RESERVED				CH_MAP_38			
R/W-0h				R/W-0h				R/W-0h				R/W-0h			
15	14	13	12	11	10	9	8	7	6	5	4	3	2	1	0
RESERVED				CH_MAP_37				RESERVED				CH_MAP_36			
R/W-0h				R/W-0h				R/W-0h				R/W-0h			

LEGEND: R/W = Read/Write; R = Read only; W1toCl = Write 1 to clear bit; -n = value after reset

Table 4-131. CMR9 Register Field Descriptions

Bit	Field	Type	Reset	Description
31-28	RESERVED	R/W	0h	
27-24	CH_MAP_39	R/W	0h	Sets the channel for the system event 39
23-20	RESERVED	R/W	0h	
19-16	CH_MAP_38	R/W	0h	Sets the channel for the system event 38
15-12	RESERVED	R/W	0h	
11-8	CH_MAP_37	R/W	0h	Sets the channel for the system event 37
7-4	RESERVED	R/W	0h	
3-0	CH_MAP_36	R/W	0h	Sets the channel for the system event 36

4.5.3.30 CMR10 Register (offset = 428h) [reset = 0h]

CMR10 is shown in [Figure 4-131](#) and described in [Table 4-132](#).

The Channel Map Register10 specify the channel for the system events 40 to 43. There is one register per 4 system events.

Figure 4-131. CMR10 Register

31	30	29	28	27	26	25	24	23	22	21	20	19	18	17	16
RESERVED				CH_MAP_43				RESERVED				CH_MAP_42			
R/W-0h				R/W-0h				R/W-0h				R/W-0h			
15	14	13	12	11	10	9	8	7	6	5	4	3	2	1	0
RESERVED				CH_MAP_41				RESERVED				CH_MAP_40			
R/W-0h				R/W-0h				R/W-0h				R/W-0h			

LEGEND: R/W = Read/Write; R = Read only; W1toCl = Write 1 to clear bit; -n = value after reset

Table 4-132. CMR10 Register Field Descriptions

Bit	Field	Type	Reset	Description
31-28	RESERVED	R/W	0h	
27-24	CH_MAP_43	R/W	0h	Sets the channel for the system event 43
23-20	RESERVED	R/W	0h	
19-16	CH_MAP_42	R/W	0h	Sets the channel for the system event 42
15-12	RESERVED	R/W	0h	
11-8	CH_MAP_41	R/W	0h	Sets the channel for the system event 41
7-4	RESERVED	R/W	0h	
3-0	CH_MAP_40	R/W	0h	Sets the channel for the system event 40

4.5.3.31 CMR11 Register (offset = 42Ch) [reset = 0h]

CMR11 is shown in [Figure 4-132](#) and described in [Table 4-133](#).

The Channel Map Register11 specify the channel for the system events 44 to 47. There is one register per 4 system events.

Figure 4-132. CMR11 Register

31	30	29	28	27	26	25	24	23	22	21	20	19	18	17	16
RESERVED				CH_MAP_47				RESERVED				CH_MAP_46			
R/W-0h				R/W-0h				R/W-0h				R/W-0h			
15	14	13	12	11	10	9	8	7	6	5	4	3	2	1	0
RESERVED				CH_MAP_45				RESERVED				CH_MAP_44			
R/W-0h				R/W-0h				R/W-0h				R/W-0h			

LEGEND: R/W = Read/Write; R = Read only; W1toCl = Write 1 to clear bit; -n = value after reset

Table 4-133. CMR11 Register Field Descriptions

Bit	Field	Type	Reset	Description
31-28	RESERVED	R/W	0h	
27-24	CH_MAP_47	R/W	0h	Sets the channel for the system event 47
23-20	RESERVED	R/W	0h	
19-16	CH_MAP_46	R/W	0h	Sets the channel for the system event 46
15-12	RESERVED	R/W	0h	
11-8	CH_MAP_45	R/W	0h	Sets the channel for the system event 45
7-4	RESERVED	R/W	0h	
3-0	CH_MAP_44	R/W	0h	Sets the channel for the system event 44

4.5.3.32 CMR12 Register (offset = 430h) [reset = 0h]

CMR12 is shown in [Figure 4-133](#) and described in [Table 4-134](#).

The Channel Map Register12 specify the channel for the system events 48 to 51. There is one register per 4 system events.

Figure 4-133. CMR12 Register

31	30	29	28	27	26	25	24	23	22	21	20	19	18	17	16
RESERVED				CH_MAP_51				RESERVED				CH_MAP_50			
R/W-0h				R/W-0h				R/W-0h				R/W-0h			
15	14	13	12	11	10	9	8	7	6	5	4	3	2	1	0
RESERVED				CH_MAP_49				RESERVED				CH_MAP_48			
R/W-0h				R/W-0h				R/W-0h				R/W-0h			

LEGEND: R/W = Read/Write; R = Read only; W1toCl = Write 1 to clear bit; -n = value after reset

Table 4-134. CMR12 Register Field Descriptions

Bit	Field	Type	Reset	Description
31-28	RESERVED	R/W	0h	
27-24	CH_MAP_51	R/W	0h	Sets the channel for the system event 51
23-20	RESERVED	R/W	0h	
19-16	CH_MAP_50	R/W	0h	Sets the channel for the system event 50
15-12	RESERVED	R/W	0h	
11-8	CH_MAP_49	R/W	0h	Sets the channel for the system event 49
7-4	RESERVED	R/W	0h	
3-0	CH_MAP_48	R/W	0h	Sets the channel for the system event 48

4.5.3.33 CMR13 Register (offset = 434h) [reset = 0h]

CMR13 is shown in [Figure 4-134](#) and described in [Table 4-135](#).

The Channel Map Register13 specify the channel for the system events 52 to 55. There is one register per 4 system events.

Figure 4-134. CMR13 Register

31	30	29	28	27	26	25	24	23	22	21	20	19	18	17	16
RESERVED				CH_MAP_55				RESERVED				CH_MAP_54			
R/W-0h				R/W-0h				R/W-0h				R/W-0h			
15	14	13	12	11	10	9	8	7	6	5	4	3	2	1	0
RESERVED				CH_MAP_53				RESERVED				CH_MAP_52			
R/W-0h				R/W-0h				R/W-0h				R/W-0h			

LEGEND: R/W = Read/Write; R = Read only; W1toCl = Write 1 to clear bit; -n = value after reset

Table 4-135. CMR13 Register Field Descriptions

Bit	Field	Type	Reset	Description
31-28	RESERVED	R/W	0h	
27-24	CH_MAP_55	R/W	0h	Sets the channel for the system event 55
23-20	RESERVED	R/W	0h	
19-16	CH_MAP_54	R/W	0h	Sets the channel for the system event 54
15-12	RESERVED	R/W	0h	
11-8	CH_MAP_53	R/W	0h	Sets the channel for the system event 53
7-4	RESERVED	R/W	0h	
3-0	CH_MAP_52	R/W	0h	Sets the channel for the system event 52

4.5.3.34 CMR14 Register (offset = 438h) [reset = 0h]

CMR14 is shown in [Figure 4-135](#) and described in [Table 4-136](#).

The Channel Map Register14 specify the channel for the system events 56 to 59. There is one register per 4 system events.

Figure 4-135. CMR14 Register

31	30	29	28	27	26	25	24	23	22	21	20	19	18	17	16
RESERVED				CH_MAP_59				RESERVED				CH_MAP_58			
R/W-0h				R/W-0h				R/W-0h				R/W-0h			
15	14	13	12	11	10	9	8	7	6	5	4	3	2	1	0
RESERVED				CH_MAP_57				RESERVED				CH_MAP_56			
R/W-0h				R/W-0h				R/W-0h				R/W-0h			

LEGEND: R/W = Read/Write; R = Read only; W1toCl = Write 1 to clear bit; -n = value after reset

Table 4-136. CMR14 Register Field Descriptions

Bit	Field	Type	Reset	Description
31-28	RESERVED	R/W	0h	
27-24	CH_MAP_59	R/W	0h	Sets the channel for the system event 59
23-20	RESERVED	R/W	0h	
19-16	CH_MAP_58	R/W	0h	Sets the channel for the system event 58
15-12	RESERVED	R/W	0h	
11-8	CH_MAP_57	R/W	0h	Sets the channel for the system event 57
7-4	RESERVED	R/W	0h	
3-0	CH_MAP_56	R/W	0h	Sets the channel for the system event 56

4.5.3.35 CMR15 Register (offset = 43Ch) [reset = 0h]

CMR15 is shown in [Figure 4-136](#) and described in [Table 4-137](#).

The Channel Map Register15 specify the channel for the system events 60 to 63. There is one register per 4 system events.

Figure 4-136. CMR15 Register

31	30	29	28	27	26	25	24	23	22	21	20	19	18	17	16
RESERVED				CH_MAP_63				RESERVED				CH_MAP_62			
R/W-0h				R/W-0h				R/W-0h				R/W-0h			
15	14	13	12	11	10	9	8	7	6	5	4	3	2	1	0
RESERVED				CH_MAP_61				RESERVED				CH_MAP_60			
R/W-0h				R/W-0h				R/W-0h				R/W-0h			

LEGEND: R/W = Read/Write; R = Read only; W1toCl = Write 1 to clear bit; -n = value after reset

Table 4-137. CMR15 Register Field Descriptions

Bit	Field	Type	Reset	Description
31-28	RESERVED	R/W	0h	
27-24	CH_MAP_63	R/W	0h	Sets the channel for the system event 63
23-20	RESERVED	R/W	0h	
19-16	CH_MAP_62	R/W	0h	Sets the channel for the system event 62
15-12	RESERVED	R/W	0h	
11-8	CH_MAP_61	R/W	0h	Sets the channel for the system event 61
7-4	RESERVED	R/W	0h	
3-0	CH_MAP_60	R/W	0h	Sets the channel for the system event 60

4.5.3.36 HMR0 Register (offset = 800h) [reset = 0h]

HMR0 is shown in [Figure 4-137](#) and described in [Table 4-138](#).

The Host Interrupt Map Register0 define the host interrupt for channels 0 to 3. There is one register per 4 channels. Channels with forced host interrupt mappings will have their fields read-only.

Figure 4-137. HMR0 Register

31	30	29	28	27	26	25	24	23	22	21	20	19	18	17	16
RESERVED				HINT_MAP_3				RESERVED				HINT_MAP_2			
R/W-0h				R/W-0h				R/W-0h				R/W-0h			
15	14	13	12	11	10	9	8	7	6	5	4	3	2	1	0
RESERVED				HINT_MAP_1				RESERVED				HINT_MAP_0			
R/W-0h				R/W-0h				R/W-0h				R/W-0h			

LEGEND: R/W = Read/Write; R = Read only; W1toCl = Write 1 to clear bit; -n = value after reset

Table 4-138. HMR0 Register Field Descriptions

Bit	Field	Type	Reset	Description
31-28	RESERVED	R/W	0h	
27-24	HINT_MAP_3	R/W	0h	HOST INTERRUPT MAP FOR CHANNEL 3
23-20	RESERVED	R/W	0h	
19-16	HINT_MAP_2	R/W	0h	HOST INTERRUPT MAP FOR CHANNEL 2
15-12	RESERVED	R/W	0h	
11-8	HINT_MAP_1	R/W	0h	HOST INTERRUPT MAP FOR CHANNEL 1
7-4	RESERVED	R/W	0h	
3-0	HINT_MAP_0	R/W	0h	HOST INTERRUPT MAP FOR CHANNEL 0

4.5.3.37 HMR1 Register (offset = 804h) [reset = 0h]

HMR1 is shown in [Figure 4-138](#) and described in [Table 4-139](#).

The Host Interrupt Map Register1 define the host interrupt for channels 4 to 7. There is one register per 4 channels. Channels with forced host interrupt mappings will have their fields read-only.

Figure 4-138. HMR1 Register

31	30	29	28	27	26	25	24	23	22	21	20	19	18	17	16
RESERVED				HINT_MAP_7				RESERVED				HINT_MAP_6			
R/W-0h				R/W-0h				R/W-0h				R/W-0h			
15	14	13	12	11	10	9	8	7	6	5	4	3	2	1	0
RESERVED				HINT_MAP_5				RESERVED				HINT_MAP_4			
R/W-0h				R/W-0h				R/W-0h				R/W-0h			

LEGEND: R/W = Read/Write; R = Read only; W1toCl = Write 1 to clear bit; -n = value after reset

Table 4-139. HMR1 Register Field Descriptions

Bit	Field	Type	Reset	Description
31-28	RESERVED	R/W	0h	
27-24	HINT_MAP_7	R/W	0h	HOST INTERRUPT MAP FOR CHANNEL 7
23-20	RESERVED	R/W	0h	
19-16	HINT_MAP_6	R/W	0h	HOST INTERRUPT MAP FOR CHANNEL 6
15-12	RESERVED	R/W	0h	
11-8	HINT_MAP_5	R/W	0h	HOST INTERRUPT MAP FOR CHANNEL 5
7-4	RESERVED	R/W	0h	
3-0	HINT_MAP_4	R/W	0h	HOST INTERRUPT MAP FOR CHANNEL 4

4.5.3.38 HMR2 Register (offset = 808h) [reset = 0h]

HMR2 is shown in [Figure 4-139](#) and described in [Table 4-140](#).

The Host Interrupt Map Register2 define the host interrupt for channels 8 to 9. There is one register per 4 channels. Channels with forced host interrupt mappings will have their fields read-only.

Figure 4-139. HMR2 Register

31	30	29	28	27	26	25	24	23	22	21	20	19	18	17	16
RESERVED															
R/W-0h															
15	14	13	12	11	10	9	8	7	6	5	4	3	2	1	0
RESERVED				HINT_MAP_9				RESERVED				HINT_MAP_8			
R/W-0h				R/W-0h				R/W-0h				R/W-0h			

LEGEND: R/W = Read/Write; R = Read only; W1toCl = Write 1 to clear bit; -n = value after reset

Table 4-140. HMR2 Register Field Descriptions

Bit	Field	Type	Reset	Description
31-12	RESERVED	R/W	0h	
11-8	HINT_MAP_9	R/W	0h	HOST INTERRUPT MAP FOR CHANNEL 9
7-4	RESERVED	R/W	0h	
3-0	HINT_MAP_8	R/W	0h	HOST INTERRUPT MAP FOR CHANNEL 8

4.5.3.39 HIPIR0 Register (offset = 900h) [reset = 8000000h]

HIPIR0 is shown in [Figure 4-140](#) and described in [Table 4-141](#).

The Host Interrupt Prioritized Index Register0 shows the highest priority current pending interrupt for the host interrupt 0. There is one register per host interrupt.

Figure 4-140. HIPIR0 Register

31	30	29	28	27	26	25	24
NONE_HINT_0		RESERVED					
R-1h		R-0h					
23	22	21	20	19	18	17	16
RESERVED							
R-0h							
15	14	13	12	11	10	9	8
RESERVED						PRI_HINT_0	
R-0h						R-0h	
7	6	5	4	3	2	1	0
PRI_HINT_0							
R-0h							

LEGEND: R/W = Read/Write; R = Read only; W1toCl = Write 1 to clear bit; -n = value after reset

Table 4-141. HIPIR0 Register Field Descriptions

Bit	Field	Type	Reset	Description
31	NONE_HINT_0	R	1h	No pending interrupt.
30-10	RESERVED	R	0h	
9-0	PRI_HINT_0	R	0h	HOST INT 0 PRIORITIZED INTERRUPT. Interrupt number of the highest priority pending interrupt for this host interrupt.

4.5.3.40 HIPIR1 Register (offset = 904h) [reset = 8000000h]

HIPIR1 is shown in [Figure 4-141](#) and described in [Table 4-142](#).

The Host Interrupt Prioritized Index Register1 shows the highest priority current pending interrupt for the host interrupt 1. There is one register per host interrupt.

Figure 4-141. HIPIR1 Register

31	30	29	28	27	26	25	24
NONE_HINT_1	RESERVED						
R-1h	R-0h						
23	22	21	20	19	18	17	16
RESERVED							
R-0h							
15	14	13	12	11	10	9	8
RESERVED						PRI_HINT_1	
R-0h						R-0h	
7	6	5	4	3	2	1	0
PRI_HINT_1							
R-0h							

LEGEND: R/W = Read/Write; R = Read only; W1toCl = Write 1 to clear bit; -n = value after reset

Table 4-142. HIPIR1 Register Field Descriptions

Bit	Field	Type	Reset	Description
31	NONE_HINT_1	R	1h	No pending interrupt.
30-10	RESERVED	R	0h	
9-0	PRI_HINT_1	R	0h	HOST INT 1 PRIORITIZED INTERRUPT. Interrupt number of the highest priority pending interrupt for this host interrupt.

4.5.3.41 HIPIR2 Register (offset = 908h) [reset = 8000000h]

HIPIR2 is shown in [Figure 4-142](#) and described in [Table 4-143](#).

The Host Interrupt Prioritized Index Register2 shows the highest priority current pending interrupt for the host interrupt 2. There is one register per host interrupt.

Figure 4-142. HIPIR2 Register

31	30	29	28	27	26	25	24
NONE_HINT_2		RESERVED					
R-1h		R-0h					
23	22	21	20	19	18	17	16
RESERVED							
R-0h							
15	14	13	12	11	10	9	8
RESERVED						PRI_HINT_2	
R-0h						R-0h	
7	6	5	4	3	2	1	0
PRI_HINT_2							
R-0h							

LEGEND: R/W = Read/Write; R = Read only; W1toCl = Write 1 to clear bit; -n = value after reset

Table 4-143. HIPIR2 Register Field Descriptions

Bit	Field	Type	Reset	Description
31	NONE_HINT_2	R	1h	No pending interrupt.
30-10	RESERVED	R	0h	
9-0	PRI_HINT_2	R	0h	HOST INT 2 PRIORITIZED INTERRUPT. Interrupt number of the highest priority pending interrupt for this host interrupt.

4.5.3.42 HIPIR3 Register (offset = 90Ch) [reset = 8000000h]

HIPIR3 is shown in [Figure 4-143](#) and described in [Table 4-144](#).

The Host Interrupt Prioritized Index Register3 shows the highest priority current pending interrupt for the host interrupt 3. There is one register per host interrupt.

Figure 4-143. HIPIR3 Register

31	30	29	28	27	26	25	24
NONE_HINT_3	RESERVED						
R-1h	R-0h						
23	22	21	20	19	18	17	16
RESERVED							
R-0h							
15	14	13	12	11	10	9	8
RESERVED						PRI_HINT_3	
R-0h						R-0h	
7	6	5	4	3	2	1	0
PRI_HINT_3							
R-0h							

LEGEND: R/W = Read/Write; R = Read only; W1toCl = Write 1 to clear bit; -n = value after reset

Table 4-144. HIPIR3 Register Field Descriptions

Bit	Field	Type	Reset	Description
31	NONE_HINT_3	R	1h	No pending interrupt.
30-10	RESERVED	R	0h	
9-0	PRI_HINT_3	R	0h	HOST INT 3 PRIORITIZED INTERRUPT. Interrupt number of the highest priority pending interrupt for this host interrupt.

4.5.3.43 HIPIR4 Register (offset = 910h) [reset = 8000000h]

HIPIR4 is shown in [Figure 4-144](#) and described in [Table 4-145](#).

The Host Interrupt Prioritized Index Register4 shows the highest priority current pending interrupt for the host interrupt 4. There is one register per host interrupt.

Figure 4-144. HIPIR4 Register

31	30	29	28	27	26	25	24
NONE_HINT_4		RESERVED					
R-1h		R-0h					
23	22	21	20	19	18	17	16
RESERVED							
R-0h							
15	14	13	12	11	10	9	8
RESERVED						PRI_HINT_4	
R-0h						R-0h	
7	6	5	4	3	2	1	0
PRI_HINT_4							
R-0h							

LEGEND: R/W = Read/Write; R = Read only; W1toCl = Write 1 to clear bit; -n = value after reset

Table 4-145. HIPIR4 Register Field Descriptions

Bit	Field	Type	Reset	Description
31	NONE_HINT_4	R	1h	No pending interrupt.
30-10	RESERVED	R	0h	
9-0	PRI_HINT_4	R	0h	HOST INT 4 PRIORITIZED INTERRUPT. Interrupt number of the highest priority pending interrupt for this host interrupt.

4.5.3.44 HIPIR5 Register (offset = 914h) [reset = 8000000h]

HIPIR5 is shown in [Figure 4-145](#) and described in [Table 4-146](#).

The Host Interrupt Prioritized Index Register5 shows the highest priority current pending interrupt for the host interrupt 5. There is one register per host interrupt.

Figure 4-145. HIPIR5 Register

31	30	29	28	27	26	25	24
NONE_HINT_5	RESERVED						
R-1h	R-0h						
23	22	21	20	19	18	17	16
RESERVED							
R-0h							
15	14	13	12	11	10	9	8
RESERVED						PRI_HINT_5	
R-0h						R-0h	
7	6	5	4	3	2	1	0
PRI_HINT_5							
R-0h							

LEGEND: R/W = Read/Write; R = Read only; W1toCl = Write 1 to clear bit; -n = value after reset

Table 4-146. HIPIR5 Register Field Descriptions

Bit	Field	Type	Reset	Description
31	NONE_HINT_5	R	1h	No pending interrupt.
30-10	RESERVED	R	0h	
9-0	PRI_HINT_5	R	0h	HOST INT 5 PRIORITIZED INTERRUPT. Interrupt number of the highest priority pending interrupt for this host interrupt.

4.5.3.45 HIPIR6 Register (offset = 918h) [reset = 8000000h]

HIPIR6 is shown in [Figure 4-146](#) and described in [Table 4-147](#).

The Host Interrupt Prioritized Index Register6 shows the highest priority current pending interrupt for the host interrupt 6. There is one register per host interrupt.

Figure 4-146. HIPIR6 Register

31	30	29	28	27	26	25	24
NONE_HINT_6		RESERVED					
R-1h		R-0h					
23	22	21	20	19	18	17	16
RESERVED							
R-0h							
15	14	13	12	11	10	9	8
RESERVED						PRI_HINT_6	
R-0h						R-0h	
7	6	5	4	3	2	1	0
PRI_HINT_6							
R-0h							

LEGEND: R/W = Read/Write; R = Read only; W1toCl = Write 1 to clear bit; -n = value after reset

Table 4-147. HIPIR6 Register Field Descriptions

Bit	Field	Type	Reset	Description
31	NONE_HINT_6	R	1h	No pending interrupt.
30-10	RESERVED	R	0h	
9-0	PRI_HINT_6	R	0h	HOST INT 6 PRIORITIZED INTERRUPT. Interrupt number of the highest priority pending interrupt for this host interrupt.

4.5.3.46 HIPIR7 Register (offset = 91Ch) [reset = 8000000h]

HIPIR7 is shown in [Figure 4-147](#) and described in [Table 4-148](#).

The Host Interrupt Prioritized Index Register7 shows the highest priority current pending interrupt for the host interrupt 7. There is one register per host interrupt.

Figure 4-147. HIPIR7 Register

31	30	29	28	27	26	25	24
NONE_HINT_7		RESERVED					
R-1h		R-0h					
23	22	21	20	19	18	17	16
RESERVED							
R-0h							
15	14	13	12	11	10	9	8
RESERVED						PRI_HINT_7	
R-0h						R-0h	
7	6	5	4	3	2	1	0
PRI_HINT_7							
R-0h							

LEGEND: R/W = Read/Write; R = Read only; W1toCl = Write 1 to clear bit; -n = value after reset

Table 4-148. HIPIR7 Register Field Descriptions

Bit	Field	Type	Reset	Description
31	NONE_HINT_7	R	1h	No pending interrupt.
30-10	RESERVED	R	0h	
9-0	PRI_HINT_7	R	0h	HOST INT 7 PRIORITIZED INTERRUPT. Interrupt number of the highest priority pending interrupt for this host interrupt.

4.5.3.47 HIPIR8 Register (offset = 920h) [reset = 8000000h]

HIPIR8 is shown in [Figure 4-148](#) and described in [Table 4-149](#).

The Host Interrupt Prioritized Index Register8 shows the highest priority current pending interrupt for the host interrupt 8. There is one register per host interrupt.

Figure 4-148. HIPIR8 Register

31	30	29	28	27	26	25	24
NONE_HINT_8		RESERVED					
R-1h		R-0h					
23	22	21	20	19	18	17	16
RESERVED							
R-0h							
15	14	13	12	11	10	9	8
RESERVED						PRI_HINT_8	
R-0h						R-0h	
7	6	5	4	3	2	1	0
PRI_HINT_8							
R-0h							

LEGEND: R/W = Read/Write; R = Read only; W1toCl = Write 1 to clear bit; -n = value after reset

Table 4-149. HIPIR8 Register Field Descriptions

Bit	Field	Type	Reset	Description
31	NONE_HINT_8	R	1h	No pending interrupt.
30-10	RESERVED	R	0h	
9-0	PRI_HINT_8	R	0h	HOST INT 8 PRIORITIZED INTERRUPT. Interrupt number of the highest priority pending interrupt for this host interrupt.

4.5.3.48 HIPIR9 Register (offset = 924h) [reset = 8000000h]

HIPIR9 is shown in [Figure 4-149](#) and described in [Table 4-150](#).

The Host Interrupt Prioritized Index Register9 shows the highest priority current pending interrupt for the host interrupt 9. There is one register per host interrupt.

Figure 4-149. HIPIR9 Register

31	30	29	28	27	26	25	24
NONE_HINT_9	RESERVED						
R-1h	R-0h						
23	22	21	20	19	18	17	16
RESERVED							
R-0h							
15	14	13	12	11	10	9	8
RESERVED						PRI_HINT_9	
R-0h						R-0h	
7	6	5	4	3	2	1	0
PRI_HINT_9							
R-0h							

LEGEND: R/W = Read/Write; R = Read only; W1toCl = Write 1 to clear bit; -n = value after reset

Table 4-150. HIPIR9 Register Field Descriptions

Bit	Field	Type	Reset	Description
31	NONE_HINT_9	R	1h	No pending interrupt.
30-10	RESERVED	R	0h	
9-0	PRI_HINT_9	R	0h	HOST INT 9 PRIORITIZED INTERRUPT. Interrupt number of the highest priority pending interrupt for this host interrupt.

4.5.3.49 SIPR0 Register (offset = D00h) [reset = 1h]

SIPR0 is shown in [Figure 4-150](#) and described in [Table 4-151](#).

The System Event Polarity Register0 define the polarity of the system events 0 to 31. There is a polarity for each system event. The polarity of all system events is active high; always write 1 to the bits of this register.

Figure 4-150. SIPR0 Register

31	30	29	28	27	26	25	24	23	22	21	20	19	18	17	16	15	14	13	12	11	10	9	8	7	6	5	4	3	2	1	0
POLARITY_31_0																															
R/W-1h																															

LEGEND: R/W = Read/Write; R = Read only; W1toCl = Write 1 to clear bit; -n = value after reset

Table 4-151. SIPR0 Register Field Descriptions

Bit	Field	Type	Reset	Description
31-0	POLARITY_31_0	R/W	1h	Interrupt polarity of the system events 0 to 31. 0 = active low. 1 = active high.

4.5.3.50 SIPR1 Register (offset = D04h) [reset = 1h]

SIPR1 is shown in [Figure 4-151](#) and described in [Table 4-152](#).

The System Event Polarity Register1 define the polarity of the system events 32 to 63. There is a polarity for each system event. The polarity of all system events is active high; always write 1 to the bits of this register.

Figure 4-151. SIPR1 Register

31	30	29	28	27	26	25	24	23	22	21	20	19	18	17	16	15	14	13	12	11	10	9	8	7	6	5	4	3	2	1	0
POLARITY_63_32																															
R/W-1h																															

LEGEND: R/W = Read/Write; R = Read only; W1toCl = Write 1 to clear bit; -n = value after reset

Table 4-152. SIPR1 Register Field Descriptions

Bit	Field	Type	Reset	Description
31-0	POLARITY_63_32	R/W	1h	Interrupt polarity of the system events 32 to 63. 0 = active low. 1 = active high.

4.5.3.51 SITR0 Register (offset = D80h) [reset = 0h]

SITR0 is shown in [Figure 4-152](#) and described in [Table 4-153](#).

The System Event Type Register0 define the type of the system events 0 to 31. There is a type for each system event. The type of all system events is pulse; always write 0 to the bits of this register.

Figure 4-152. SITR0 Register

31	30	29	28	27	26	25	24	23	22	21	20	19	18	17	16	15	14	13	12	11	10	9	8	7	6	5	4	3	2	1	0
TYPE_31_0																															
R/W-0h																															

LEGEND: R/W = Read/Write; R = Read only; W1toCl = Write 1 to clear bit; -n = value after reset

Table 4-153. SITR0 Register Field Descriptions

Bit	Field	Type	Reset	Description
31-0	TYPE_31_0	R/W	0h	Interrupt type of the system events 0 to 31. 0 = level or pulse interrupt. 1 = edge interrupt (required edge detect).

4.5.3.52 SITR1 Register (offset = D84h) [reset = 0h]

SITR1 is shown in [Figure 4-153](#) and described in [Table 4-154](#).

The System Event Type Register1 define the type of the system events 32 to 63. There is a type for each system event. The type of all system events is pulse; always write 0 to the bits of this register.

Figure 4-153. SITR1 Register

31	30	29	28	27	26	25	24	23	22	21	20	19	18	17	16	15	14	13	12	11	10	9	8	7	6	5	4	3	2	1	0
TYPE_63_32																															
R/W-0h																															

LEGEND: R/W = Read/Write; R = Read only; W1toCl = Write 1 to clear bit; -n = value after reset

Table 4-154. SITR1 Register Field Descriptions

Bit	Field	Type	Reset	Description
31-0	TYPE_63_32	R/W	0h	Interrupt type of the system events 32 to 63. 0 = level or pulse interrupt. 1 = edge interrupt (required edge detect).

4.5.3.53 HINLR0 Register (offset = 1100h) [reset = 100h]

HINLR0 is shown in [Figure 4-154](#) and described in [Table 4-155](#).

The Host Interrupt Nesting Level Register0 display and control the nesting level for host interrupt 0. The nesting level controls which channel and lower priority channels are nested. There is one register per host interrupt.

Figure 4-154. HINLR0 Register

31	30	29	28	27	26	25	24
AUTO_OVERR IDE	RESERVED						
W-0h				R/W-0h			
23	22	21	20	19	18	17	16
RESERVED							
R/W-0h							
15	14	13	12	11	10	9	8
RESERVED							NEST_HINT_0
R/W-0h							R/W-100h
7	6	5	4	3	2	1	0
NEST_HINT_0							
R/W-100h							

LEGEND: R/W = Read/Write; R = Read only; W1toCl = Write 1 to clear bit; -n = value after reset

Table 4-155. HINLR0 Register Field Descriptions

Bit	Field	Type	Reset	Description
31	AUTO_OVERRIDE	W	0h	Reads return 0. Writes of a 1 override the auto updating of the nesting_level and use the write data.
30-9	RESERVED	R/W	0h	
8-0	NEST_HINT_0	R/W	100h	Reads return the current nesting level for the host interrupt. Writes set the nesting level for the host interrupt. In auto mode the value is updated internally unless the auto_override is set and then the write data is used.

4.5.3.54 HINLR1 Register (offset = 1104h) [reset = 100h]

HINLR1 is shown in [Figure 4-155](#) and described in [Table 4-156](#).

The Host Interrupt Nesting Level Register1 display and control the nesting level for host interrupt 1. The nesting level controls which channel and lower priority channels are nested. There is one register per host interrupt.

Figure 4-155. HINLR1 Register

31	30	29	28	27	26	25	24
AUTO_OVERR IDE	RESERVED						
W-0h				R/W-0h			
23	22	21	20	19	18	17	16
RESERVED							
R/W-0h							
15	14	13	12	11	10	9	8
RESERVED							NEST_HINT_1
R/W-0h							R/W-100h
7	6	5	4	3	2	1	0
NEST_HINT_1							
R/W-100h							

LEGEND: R/W = Read/Write; R = Read only; W1toCl = Write 1 to clear bit; -n = value after reset

Table 4-156. HINLR1 Register Field Descriptions

Bit	Field	Type	Reset	Description
31	AUTO_OVERRIDE	W	0h	Reads return 0. Writes of a 1 override the auto updating of the nesting_level and use the write data.
30-9	RESERVED	R/W	0h	
8-0	NEST_HINT_1	R/W	100h	Reads return the current nesting level for the host interrupt. Writes set the nesting level for the host interrupt. In auto mode the value is updated internally unless the auto_override is set and then the write data is used.

4.5.3.55 HINLR2 Register (offset = 1108h) [reset = 100h]

HINLR2 is shown in [Figure 4-156](#) and described in [Table 4-157](#).

The Host Interrupt Nesting Level Register2 display and control the nesting level for host interrupt 2. The nesting level controls which channel and lower priority channels are nested. There is one register per host interrupt.

Figure 4-156. HINLR2 Register

31	30	29	28	27	26	25	24
AUTO_OVERR IDE	RESERVED						
W-0h				R/W-0h			
23	22	21	20	19	18	17	16
RESERVED							
R/W-0h							
15	14	13	12	11	10	9	8
RESERVED							NEST_HINT_2
R/W-0h							R/W-100h
7	6	5	4	3	2	1	0
NEST_HINT_2							
R/W-100h							

LEGEND: R/W = Read/Write; R = Read only; W1toCl = Write 1 to clear bit; -n = value after reset

Table 4-157. HINLR2 Register Field Descriptions

Bit	Field	Type	Reset	Description
31	AUTO_OVERRIDE	W	0h	Reads return 0. Writes of a 1 override the auto updating of the nesting_level and use the write data.
30-9	RESERVED	R/W	0h	
8-0	NEST_HINT_2	R/W	100h	Reads return the current nesting level for the host interrupt. Writes set the nesting level for the host interrupt. In auto mode the value is updated internally unless the auto_override is set and then the write data is used.

4.5.3.56 HINLR3 Register (offset = 110Ch) [reset = 100h]

HINLR3 is shown in [Figure 4-157](#) and described in [Table 4-158](#).

The Host Interrupt Nesting Level Register3 display and control the nesting level for host interrupt 3. The nesting level controls which channel and lower priority channels are nested. There is one register per host interrupt.

Figure 4-157. HINLR3 Register

31	30	29	28	27	26	25	24
AUTO_OVERR IDE	RESERVED						
W-0h				R/W-0h			
23	22	21	20	19	18	17	16
RESERVED							
R/W-0h							
15	14	13	12	11	10	9	8
RESERVED							NEST_HINT_3
R/W-0h							R/W-100h
7	6	5	4	3	2	1	0
NEST_HINT_3							
R/W-100h							

LEGEND: R/W = Read/Write; R = Read only; W1toCl = Write 1 to clear bit; -n = value after reset

Table 4-158. HINLR3 Register Field Descriptions

Bit	Field	Type	Reset	Description
31	AUTO_OVERRIDE	W	0h	Reads return 0. Writes of a 1 override the auto updating of the nesting_level and use the write data.
30-9	RESERVED	R/W	0h	
8-0	NEST_HINT_3	R/W	100h	Reads return the current nesting level for the host interrupt. Writes set the nesting level for the host interrupt. In auto mode the value is updated internally unless the auto_override is set and then the write data is used.

4.5.3.57 HINLR4 Register (offset = 1110h) [reset = 100h]

HINLR4 is shown in [Figure 4-158](#) and described in [Table 4-159](#).

The Host Interrupt Nesting Level Register4 display and control the nesting level for host interrupt 4. The nesting level controls which channel and lower priority channels are nested. There is one register per host interrupt.

Figure 4-158. HINLR4 Register

31	30	29	28	27	26	25	24
AUTO_OVERR IDE	RESERVED						
W-0h				R/W-0h			
23	22	21	20	19	18	17	16
RESERVED							
R/W-0h							
15	14	13	12	11	10	9	8
RESERVED							NEST_HINT_4
R/W-0h							R/W-100h
7	6	5	4	3	2	1	0
NEST_HINT_4							
R/W-100h							

LEGEND: R/W = Read/Write; R = Read only; W1toCl = Write 1 to clear bit; -n = value after reset

Table 4-159. HINLR4 Register Field Descriptions

Bit	Field	Type	Reset	Description
31	AUTO_OVERRIDE	W	0h	Reads return 0. Writes of a 1 override the auto updating of the nesting_level and use the write data.
30-9	RESERVED	R/W	0h	
8-0	NEST_HINT_4	R/W	100h	Reads return the current nesting level for the host interrupt. Writes set the nesting level for the host interrupt. In auto mode the value is updated internally unless the auto_override is set and then the write data is used.

4.5.3.58 HINLR5 Register (offset = 1114h) [reset = 100h]

HINLR5 is shown in [Figure 4-159](#) and described in [Table 4-160](#).

The Host Interrupt Nesting Level Register5 display and control the nesting level for host interrupt 5. The nesting level controls which channel and lower priority channels are nested. There is one register per host interrupt.

Figure 4-159. HINLR5 Register

31	30	29	28	27	26	25	24
AUTO_OVERR IDE	RESERVED						
W-0h				R/W-0h			
23	22	21	20	19	18	17	16
RESERVED							
R/W-0h							
15	14	13	12	11	10	9	8
RESERVED							NEST_HINT_5
R/W-0h							R/W-100h
7	6	5	4	3	2	1	0
NEST_HINT_5							
R/W-100h							

LEGEND: R/W = Read/Write; R = Read only; W1toCl = Write 1 to clear bit; -n = value after reset

Table 4-160. HINLR5 Register Field Descriptions

Bit	Field	Type	Reset	Description
31	AUTO_OVERRIDE	W	0h	Reads return 0. Writes of a 1 override the auto updating of the nesting_level and use the write data.
30-9	RESERVED	R/W	0h	
8-0	NEST_HINT_5	R/W	100h	Reads return the current nesting level for the host interrupt. Writes set the nesting level for the host interrupt. In auto mode the value is updated internally unless the auto_override is set and then the write data is used.

4.5.3.59 HINLR6 Register (offset = 1118h) [reset = 100h]

HINLR6 is shown in [Figure 4-160](#) and described in [Table 4-161](#).

The Host Interrupt Nesting Level Register6 display and control the nesting level for host interrupt 6. The nesting level controls which channel and lower priority channels are nested. There is one register per host interrupt.

Figure 4-160. HINLR6 Register

31	30	29	28	27	26	25	24
AUTO_OVERR IDE	RESERVED						
W-0h				R/W-0h			
23	22	21	20	19	18	17	16
RESERVED							
R/W-0h							
15	14	13	12	11	10	9	8
RESERVED							NEST_HINT_6
R/W-0h							R/W-100h
7	6	5	4	3	2	1	0
NEST_HINT_6							
R/W-100h							

LEGEND: R/W = Read/Write; R = Read only; W1toCl = Write 1 to clear bit; -n = value after reset

Table 4-161. HINLR6 Register Field Descriptions

Bit	Field	Type	Reset	Description
31	AUTO_OVERRIDE	W	0h	Reads return 0. Writes of a 1 override the auto updating of the nesting_level and use the write data.
30-9	RESERVED	R/W	0h	
8-0	NEST_HINT_6	R/W	100h	Reads return the current nesting level for the host interrupt. Writes set the nesting level for the host interrupt. In auto mode the value is updated internally unless the auto_override is set and then the write data is used.

4.5.3.60 HINLR7 Register (offset = 111Ch) [reset = 100h]

HINLR7 is shown in [Figure 4-161](#) and described in [Table 4-162](#).

The Host Interrupt Nesting Level Register7 display and control the nesting level for host interrupt 7. The nesting level controls which channel and lower priority channels are nested. There is one register per host interrupt.

Figure 4-161. HINLR7 Register

31	30	29	28	27	26	25	24
AUTO_OVERR IDE	RESERVED						
W-0h				R/W-0h			
23	22	21	20	19	18	17	16
RESERVED							
R/W-0h							
15	14	13	12	11	10	9	8
RESERVED							NEST_HINT_7
R/W-0h							R/W-100h
7	6	5	4	3	2	1	0
NEST_HINT_7							
R/W-100h							

LEGEND: R/W = Read/Write; R = Read only; W1toCl = Write 1 to clear bit; -n = value after reset

Table 4-162. HINLR7 Register Field Descriptions

Bit	Field	Type	Reset	Description
31	AUTO_OVERRIDE	W	0h	Reads return 0. Writes of a 1 override the auto updating of the nesting_level and use the write data.
30-9	RESERVED	R/W	0h	
8-0	NEST_HINT_7	R/W	100h	Reads return the current nesting level for the host interrupt. Writes set the nesting level for the host interrupt. In auto mode the value is updated internally unless the auto_override is set and then the write data is used.

4.5.3.61 HINLR8 Register (offset = 1120h) [reset = 100h]

HINLR8 is shown in [Figure 4-162](#) and described in [Table 4-163](#).

The Host Interrupt Nesting Level Register8 display and control the nesting level for host interrupt 8. The nesting level controls which channel and lower priority channels are nested. There is one register per host interrupt.

Figure 4-162. HINLR8 Register

31	30	29	28	27	26	25	24
AUTO_OVERR IDE		RESERVED					
W-0h		R/W-0h					
23	22	21	20	19	18	17	16
RESERVED							
R/W-0h							
15	14	13	12	11	10	9	8
RESERVED							NEST_HINT_8
R/W-0h							R/W-100h
7	6	5	4	3	2	1	0
NEST_HINT_8							
R/W-100h							

LEGEND: R/W = Read/Write; R = Read only; W1toCl = Write 1 to clear bit; -n = value after reset

Table 4-163. HINLR8 Register Field Descriptions

Bit	Field	Type	Reset	Description
31	AUTO_OVERRIDE	W	0h	Reads return 0. Writes of a 1 override the auto updating of the nesting_level and use the write data.
30-9	RESERVED	R/W	0h	
8-0	NEST_HINT_8	R/W	100h	Reads return the current nesting level for the host interrupt. Writes set the nesting level for the host interrupt. In auto mode the value is updated internally unless the auto_override is set and then the write data is used.

4.5.3.62 HINLR9 Register (offset = 1124h) [reset = 100h]

HINLR9 is shown in [Figure 4-163](#) and described in [Table 4-164](#).

The Host Interrupt Nesting Level Register9 display and control the nesting level for host interrupt 9. The nesting level controls which channel and lower priority channels are nested. There is one register per host interrupt.

Figure 4-163. HINLR9 Register

31	30	29	28	27	26	25	24
AUTO_OVERR IDE	RESERVED						
W-0h				R/W-0h			
23	22	21	20	19	18	17	16
RESERVED							
R/W-0h							
15	14	13	12	11	10	9	8
RESERVED							NEST_HINT_9
R/W-0h							R/W-100h
7	6	5	4	3	2	1	0
NEST_HINT_9							
R/W-100h							

LEGEND: R/W = Read/Write; R = Read only; W1toCl = Write 1 to clear bit; -n = value after reset

Table 4-164. HINLR9 Register Field Descriptions

Bit	Field	Type	Reset	Description
31	AUTO_OVERRIDE	W	0h	Reads return 0. Writes of a 1 override the auto updating of the nesting_level and use the write data.
30-9	RESERVED	R/W	0h	
8-0	NEST_HINT_9	R/W	100h	Reads return the current nesting level for the host interrupt. Writes set the nesting level for the host interrupt. In auto mode the value is updated internally unless the auto_override is set and then the write data is used.

4.5.3.63 HIER Register (offset = 1500h) [reset = 0h]

HIER is shown in [Figure 4-164](#) and described in [Table 4-165](#).

The Host Interrupt Enable Registers enable or disable individual host interrupts. These work separately from the global enables. There is one bit per host interrupt. These bits are updated when writing to the Host Interrupt Enable Index Set and Host Interrupt Enable Index Clear registers.

Figure 4-164. HIER Register

31	30	29	28	27	26	25	24	23	22	21	20	19	18	17	16	15	14	13	12	11	10	9	8	7	6	5	4	3	2	1	0
RESERVED														EN_HINT																	
R/W-0h														R/W-0h																	

LEGEND: R/W = Read/Write; R = Read only; W1toCl = Write 1 to clear bit; -n = value after reset

Table 4-165. HIER Register Field Descriptions

Bit	Field	Type	Reset	Description
31-10	RESERVED	R/W	0h	
9-0	EN_HINT	R/W	0h	The enable of the host interrupts (one per bit). 0 = disabled 1 = enabled

4.5.4 PRU_ICSS_IEP Registers

[Table 4-166](#) lists the memory-mapped registers for the PRU_ICSS_IEP. All register offset addresses not listed in [Table 4-166](#) should be considered as reserved locations and the register contents should not be modified.

Table 4-166. PRU_ICSS_IEP Registers

Offset	Acronym	Register Name	Section
0h	IEP_TMR_GLB_CFG		Section 4.5.4.1
4h	IEP_TMR_GLB_STS		Section 4.5.4.2
8h	IEP_TMR_COMPEN		Section 4.5.4.3
Ch	IEP_TMR_CNT		Section 4.5.4.4
40h	IEP_TMR_CMP_CFG		Section 4.5.4.5
44h	IEP_TMR_CMP_STS		Section 4.5.4.6
48h	IEP_TMR_CMP0		Section 4.5.4.7
4Ch	IEP_TMR_CMP1		Section 4.5.4.8
50h	IEP_TMR_CMP2		Section 4.5.4.9
54h	IEP_TMR_CMP3		Section 4.5.4.10
58h	IEP_TMR_CMP4		Section 4.5.4.11
5Ch	IEP_TMR_CMP5		Section 4.5.4.12
60h	IEP_TMR_CMP6		Section 4.5.4.13
64h	IEP_TMR_CMP7		Section 4.5.4.14
300h	IEP_DIGIO_CTRL		Section 4.5.4.15
308h	IEP_DIGIO_DATA_IN		Section 4.5.4.16
30Ch	IEP_DIGIO_DATA_IN_RAW		Section 4.5.4.17
310h	IEP_DIGIO_DATA_OUT		Section 4.5.4.18
314h	IEP_DIGIO_DATA_OUT_EN		Section 4.5.4.19
318h	IEP_DIGIO_EXP		Section 4.5.4.20

4.5.4.1 IEP_TMR_GLB_CFG Register (offset = 0h) [reset = 550h]

IEP_TMR_GLB_CFG is shown in [Figure 4-165](#) and described in [Table 4-167](#).

GLOBAL CONFIGURE

Figure 4-165. IEP_TMR_GLB_CFG Register

31	30	29	28	27	26	25	24
RESERVED							
R-0h							
23	22	21	20	19	18	17	16
RESERVED				CMP_INC			
R-0h				R/W-5h			
15	14	13	12	11	10	9	8
CMP_INC							
R/W-5h							
7	6	5	4	3	2	1	0
DEFAULT_INC				RESERVED			CNT_ENABLE
R/W-5h				R-0h			R/W-0h

LEGEND: R/W = Read/Write; R = Read only; W1toCl = Write 1 to clear bit; -n = value after reset

Table 4-167. IEP_TMR_GLB_CFG Register Field Descriptions

Bit	Field	Type	Reset	Description
31-20	RESERVED	R	0h	
19-8	CMP_INC	R/W	5h	Defines the increment value when compensation is active
7-4	DEFAULT_INC	R/W	5h	Defines the default increment value
3-1	RESERVED	R	0h	
0	CNT_ENABLE	R/W	0h	Counter enable 0: Disables the counter. The counter maintains the current count. 1: Enables the counter.

4.5.4.2 IEP_TMR_GLB_STS Register (offset = 4h) [reset = 0h]

 IEP_TMR_GLB_STS is shown in [Figure 4-166](#) and described in [Table 4-168](#).

GLOBAL STATUS

Figure 4-166. IEP_TMR_GLB_STS Register

31	30	29	28	27	26	25	24
RESERVED							
R-0h							
23	22	21	20	19	18	17	16
RESERVED							
R-0h							
15	14	13	12	11	10	9	8
RESERVED							
R-0h							
7	6	5	4	3	2	1	0
RESERVED							CNT_OVF
R-0h							R/W1toClr-0h

LEGEND: R/W = Read/Write; R = Read only; W1toCl = Write 1 to clear bit; -n = value after reset

Table 4-168. IEP_TMR_GLB_STS Register Field Descriptions

Bit	Field	Type	Reset	Description
31-1	RESERVED	R	0h	
0	CNT_OVF	R/W1toClr	0h	Counter overflow status. 0: No overflow 1: Overflow occurred

4.5.4.3 IEP_TMR_COMPEN Register (offset = 8h) [reset = 0h]

IEP_TMR_COMPEN is shown in [Figure 4-167](#) and described in [Table 4-169](#).

COMPENSATION

Figure 4-167. IEP_TMR_COMPEN Register

31	30	29	28	27	26	25	24	23	22	21	20	19	18	17	16	15	14	13	12	11	10	9	8	7	6	5	4	3	2	1	0
RESERVED								COMPEN_CNT																							
R-0h								R/W-0h																							

LEGEND: R/W = Read/Write; R = Read only; W1toCl = Write 1 to clear bit; -n = value after reset

Table 4-169. IEP_TMR_COMPEN Register Field Descriptions

Bit	Field	Type	Reset	Description
31-24	RESERVED	R	0h	
23-0	COMPEN_CNT	R/W	0h	Compensation counter. Read returns the current compen_cnt value. 0: Compensation is disabled and counter will increment by DEFAULT_INC. Compensation is enabled until COMPEN_CNT decrements to 0. The COMPEN_CNT value decrements on every iep_clk/ocp_clk cycle. When COMPEN_CNT is greater than 0, then count value increments by CMP_INC.

4.5.4.4 IEP_TMR_CNT Register (offset = Ch) [reset = 0h]

IEP_TMR_CNT is shown in [Figure 4-168](#) and described in [Table 4-170](#).

COUNTER

Figure 4-168. IEP_TMR_CNT Register

31	30	29	28	27	26	25	24	23	22	21	20	19	18	17	16	15	14	13	12	11	10	9	8	7	6	5	4	3	2	1	0
COUNT																															
R/W1toClr-0h																															

LEGEND: R/W = Read/Write; R = Read only; W1toCl = Write 1 to clear bit; -n = value after reset

Table 4-170. IEP_TMR_CNT Register Field Descriptions

Bit	Field	Type	Reset	Description
31-0	COUNT	R/W1toClr	0h	32-bit count value. Increments by (DEFAULT_INC or CMP_INC) on every positive edge of iep_clk (200MHz) or ocp_clk.

4.5.4.5 IEP_TMR_CMP_CFG Register (offset = 40h) [reset = 0h]

IEP_TMR_CMP_CFG is shown in [Figure 4-169](#) and described in [Table 4-171](#).

COMPARE CONFIGURE

Figure 4-169. IEP_TMR_CMP_CFG Register

31	30	29	28	27	26	25	24
RESERVED							
R-0h							
23	22	21	20	19	18	17	16
RESERVED							
R-0h							
15	14	13	12	11	10	9	8
RESERVED							CMP_EN
R-0h							R/W-0h
7	6	5	4	3	2	1	0
CMP_EN						CMP0_RST_CNT_EN	
R/W-0h						R/W-0h	

LEGEND: R/W = Read/Write; R = Read only; W1toCl = Write 1 to clear bit; -n = value after reset

Table 4-171. IEP_TMR_CMP_CFG Register Field Descriptions

Bit	Field	Type	Reset	Description
31-9	RESERVED	R	0h	
8-1	CMP_EN	R/W	0h	Compare registers enable, where CMP_EN[0] maps to CMP[0]. 0: Disables event 1: Enables event
0	CMP0_RST_CNT_EN	R/W	0h	Counter reset enable. 0: Disable 1: Enable the reset of the counter if a CMP0 event occurs

4.5.4.6 IEP_TMR_CMP_STS Register (offset = 44h) [reset = 0h]

 IEP_TMR_CMP_STS is shown in [Figure 4-170](#) and described in [Table 4-172](#).

COMPARE STATUS

Figure 4-170. IEP_TMR_CMP_STS Register

31	30	29	28	27	26	25	24	23	22	21	20	19	18	17	16	15	14	13	12	11	10	9	8	7	6	5	4	3	2	1	0
RESERVED																CMP_HIT															
R-0h																R/W1toClr-0h															

LEGEND: R/W = Read/Write; R = Read only; W1toCl = Write 1 to clear bit; -n = value after reset

Table 4-172. IEP_TMR_CMP_STS Register Field Descriptions

Bit	Field	Type	Reset	Description
31-8	RESERVED	R	0h	
7-0	CMP_HIT	R/W1toClr	0h	Status bit for each of the compare registers, where CMP_HIT[n] maps to CMP[n]. "Match" indicates the current counter is greater than or equal to the compare value. Note it is the firmware's responsibility to handle the IEP overflow. 0: Match has not occurred. 1: Match occurred. The associated hardware event signal will assert and remain high until the status is cleared.

4.5.4.7 IEP_TMR_CMP0 Register (offset = 48h) [reset = 0h]

IEP_TMR_CMP0 is shown in [Figure 4-171](#) and described in [Table 4-173](#).

COMPARE0

Figure 4-171. IEP_TMR_CMP0 Register

31	30	29	28	27	26	25	24	23	22	21	20	19	18	17	16	15	14	13	12	11	10	9	8	7	6	5	4	3	2	1	0
																	CMP0														
																	R/W-0h														

LEGEND: R/W = Read/Write; R = Read only; W1toCl = Write 1 to clear bit; -n = value after reset

Table 4-173. IEP_TMR_CMP0 Register Field Descriptions

Bit	Field	Type	Reset	Description
31-0	CMP0	R/W	0h	Compare 0 value

4.5.4.8 IEP_TMR_CMP1 Register (offset = 4Ch) [reset = 0h]

IEP_TMR_CMP1 is shown in [Figure 4-172](#) and described in [Table 4-174](#).

COMPARE1

Figure 4-172. IEP_TMR_CMP1 Register

31	30	29	28	27	26	25	24	23	22	21	20	19	18	17	16	15	14	13	12	11	10	9	8	7	6	5	4	3	2	1	0
																	CMP1														
																	R/W-0h														

LEGEND: R/W = Read/Write; R = Read only; W1toCl = Write 1 to clear bit; -n = value after reset

Table 4-174. IEP_TMR_CMP1 Register Field Descriptions

Bit	Field	Type	Reset	Description
31-0	CMP1	R/W	0h	Compare 1 value

4.5.4.9 IEP_TMR_CMP2 Register (offset = 50h) [reset = 0h]

IEP_TMR_CMP2 is shown in [Figure 4-173](#) and described in [Table 4-175](#).

COMPARE2

Figure 4-173. IEP_TMR_CMP2 Register

31	30	29	28	27	26	25	24	23	22	21	20	19	18	17	16	15	14	13	12	11	10	9	8	7	6	5	4	3	2	1	0
																CMP2															
																R/W-0h															

LEGEND: R/W = Read/Write; R = Read only; W1toCl = Write 1 to clear bit; -n = value after reset

Table 4-175. IEP_TMR_CMP2 Register Field Descriptions

Bit	Field	Type	Reset	Description
31-0	CMP2	R/W	0h	Compare 2 value

4.5.4.10 IEP_TMR_CMP3 Register (offset = 54h) [reset = 0h]

IEP_TMR_CMP3 is shown in [Figure 4-174](#) and described in [Table 4-176](#).

COMPARE3

Figure 4-174. IEP_TMR_CMP3 Register

31	30	29	28	27	26	25	24	23	22	21	20	19	18	17	16	15	14	13	12	11	10	9	8	7	6	5	4	3	2	1	0
																	CMP3														
																	R/W-0h														

LEGEND: R/W = Read/Write; R = Read only; W1toCl = Write 1 to clear bit; -n = value after reset

Table 4-176. IEP_TMR_CMP3 Register Field Descriptions

Bit	Field	Type	Reset	Description
31-0	CMP3	R/W	0h	Compare 3 value

4.5.4.11 IEP_TMR_CMP4 Register (offset = 58h) [reset = 0h]

IEP_TMR_CMP4 is shown in [Figure 4-175](#) and described in [Table 4-177](#).

COMPARE4

Figure 4-175. IEP_TMR_CMP4 Register

31	30	29	28	27	26	25	24	23	22	21	20	19	18	17	16	15	14	13	12	11	10	9	8	7	6	5	4	3	2	1	0
																	CMP4														
																	R/W-0h														

LEGEND: R/W = Read/Write; R = Read only; W1toCl = Write 1 to clear bit; -n = value after reset

Table 4-177. IEP_TMR_CMP4 Register Field Descriptions

Bit	Field	Type	Reset	Description
31-0	CMP4	R/W	0h	Compare 4 value

4.5.4.12 IEP_TMR_CMP5 Register (offset = 5Ch) [reset = 0h]

IEP_TMR_CMP5 is shown in [Figure 4-176](#) and described in [Table 4-178](#).

COMPARE5

Figure 4-176. IEP_TMR_CMP5 Register

31	30	29	28	27	26	25	24	23	22	21	20	19	18	17	16	15	14	13	12	11	10	9	8	7	6	5	4	3	2	1	0
																	CMP5														
																	R/W-0h														

LEGEND: R/W = Read/Write; R = Read only; W1toCl = Write 1 to clear bit; -n = value after reset

Table 4-178. IEP_TMR_CMP5 Register Field Descriptions

Bit	Field	Type	Reset	Description
31-0	CMP5	R/W	0h	Compare 5 value

4.5.4.13 IEP_TMR_CMP6 Register (offset = 60h) [reset = 0h]

IEP_TMR_CMP6 is shown in [Figure 4-177](#) and described in [Table 4-179](#).

COMPARE6

Figure 4-177. IEP_TMR_CMP6 Register

31	30	29	28	27	26	25	24	23	22	21	20	19	18	17	16	15	14	13	12	11	10	9	8	7	6	5	4	3	2	1	0
																CMP6															
																R/W-0h															

LEGEND: R/W = Read/Write; R = Read only; W1toCl = Write 1 to clear bit; -n = value after reset

Table 4-179. IEP_TMR_CMP6 Register Field Descriptions

Bit	Field	Type	Reset	Description
31-0	CMP6	R/W	0h	Compare 6 value

4.5.4.14 IEP_TMR_CMP7 Register (offset = 64h) [reset = 0h]

IEP_TMR_CMP7 is shown in [Figure 4-178](#) and described in [Table 4-180](#).

COMPARE7

Figure 4-178. IEP_TMR_CMP7 Register

31	30	29	28	27	26	25	24	23	22	21	20	19	18	17	16	15	14	13	12	11	10	9	8	7	6	5	4	3	2	1	0
																CMP7															
																R/W-0h															

LEGEND: R/W = Read/Write; R = Read only; W1toCl = Write 1 to clear bit; -n = value after reset

Table 4-180. IEP_TMR_CMP7 Register Field Descriptions

Bit	Field	Type	Reset	Description
31-0	CMP7	R/W	0h	Compare 7 value

4.5.4.15 IEP_DIGIO_CTRL Register (offset = 300h) [reset = 4h]

 IEP_DIGIO_CTRL is shown in [Figure 4-179](#) and described in [Table 4-181](#).

DIGITAL INPUT OUTPUT CONTROL

Figure 4-179. IEP_DIGIO_CTRL Register

31	30	29	28	27	26	25	24
RESERVED							
R-0h							
23	22	21	20	19	18	17	16
RESERVED							
R-0h							
15	14	13	12	11	10	9	8
RESERVED							
R-0h							
7	6	5	4	3	2	1	0
RESERVED			IN_MODE	RESERVED			
R-0h			R/W-0h	R-4h			

LEGEND: R/W = Read/Write; R = Read only; W1toCl = Write 1 to clear bit; -n = value after reset

Table 4-181. IEP_DIGIO_CTRL Register Field Descriptions

Bit	Field	Type	Reset	Description
31-5	RESERVED	R	0h	
4	IN_MODE	R/W	0h	Enable pr1_edio_data_in [31:0] to be sampled by external pr1_edio_latch_in signal. 0: Disable 1: Enable
3-0	RESERVED	R	4h	

4.5.4.16 IEP_DIGIO_DATA_IN Register (offset = 308h) [reset = 0h]

Register mask: 0h

 IEP_DIGIO_DATA_IN is shown in [Figure 4-180](#) and described in [Table 4-182](#).

DIGITAL DATA INPUT

Figure 4-180. IEP_DIGIO_DATA_IN Register

31	30	29	28	27	26	25	24	23	22	21	20	19	18	17	16	15	14	13	12	11	10	9	8	7	6	5	4	3	2	1	0
DATA_IN																															
R-X																															

LEGEND: R/W = Read/Write; R = Read only; W1toCl = Write 1 to clear bit; -n = value after reset

Table 4-182. IEP_DIGIO_DATA_IN Register Field Descriptions

Bit	Field	Type	Reset	Description
31-0	DATA_IN	R	X	Data input. Sample time of digital inputs is controlled externally by using the pr1_edio_latch_in signal. Must enable by setting DIGIO_CTRL[IN_MODE].

4.5.4.17 IEP_DIGIO_DATA_IN_RAW Register (offset = 30Ch) [reset = 0h]

Register mask: 0h

 IEP_DIGIO_DATA_IN_RAW is shown in [Figure 4-181](#) and described in [Table 4-183](#).

DIGITAL DATA INPUT DIRECT SAMPLE

Figure 4-181. IEP_DIGIO_DATA_IN_RAW Register

31	30	29	28	27	26	25	24	23	22	21	20	19	18	17	16	15	14	13	12	11	10	9	8	7	6	5	4	3	2	1	0
DATA_IN_RAW																															
R-X																															

LEGEND: R/W = Read/Write; R = Read only; W1toCl = Write 1 to clear bit; -n = value after reset

Table 4-183. IEP_DIGIO_DATA_IN_RAW Register Field Descriptions

Bit	Field	Type	Reset	Description
31-0	DATA_IN_RAW	R	X	Raw data input. Direct sample of pr1_edio_data_in[31:0].

4.5.4.18 IEP_DIGIO_DATA_OUT Register (offset = 310h) [reset = 0h]

IEP_DIGIO_DATA_OUT is shown in [Figure 4-182](#) and described in [Table 4-184](#).

DIGITAL DATA OUTPUT

Figure 4-182. IEP_DIGIO_DATA_OUT Register

31	30	29	28	27	26	25	24	23	22	21	20	19	18	17	16	15	14	13	12	11	10	9	8	7	6	5	4	3	2	1	0
DATA_OUT																															
R/W-0h																															

LEGEND: R/W = Read/Write; R = Read only; W1toCl = Write 1 to clear bit; -n = value after reset

Table 4-184. IEP_DIGIO_DATA_OUT Register Field Descriptions

Bit	Field	Type	Reset	Description
31-0	DATA_OUT	R/W	0h	Data output, pr1_edio_data_out[31:0].

4.5.4.19 IEP_DIGIO_DATA_OUT_EN Register (offset = 314h) [reset = 0h]

IEP_DIGIO_DATA_OUT_EN is shown in [Figure 4-183](#) and described in [Table 4-185](#).

DIGITAL DATA OUT ENABLE

Figure 4-183. IEP_DIGIO_DATA_OUT_EN Register

31	30	29	28	27	26	25	24	23	22	21	20	19	18	17	16	15	14	13	12	11	10	9	8	7	6	5	4	3	2	1	0
DATA_OUT_EN																															
R/W-0h																															

LEGEND: R/W = Read/Write; R = Read only; W1toCl = Write 1 to clear bit; -n = value after reset

Table 4-185. IEP_DIGIO_DATA_OUT_EN Register Field Descriptions

Bit	Field	Type	Reset	Description
31-0	DATA_OUT_EN	R/W	0h	Enables tri-state control for pr1_edio_data_out[31:0].

4.5.4.20 IEP_DIGIO_EXP Register (offset = 318h) [reset = 20h]

IEP_DIGIO_EXP is shown in [Figure 4-184](#) and described in [Table 4-186](#).

DIGIO EXPANSION REGISTER

Figure 4-184. IEP_DIGIO_EXP Register

31	30	29	28	27	26	25	24
RESERVED							
R-8h							
23	22	21	20	19	18	17	16
RESERVED							
R-8h							
15	14	13	12	11	10	9	8
RESERVED							
R-8h							
7	6	5	4	3	2	1	0
RESERVED						OUTVALID_OV R_EN	SW_DATA_OU T_UPDATE
R-8h						R/W-0h	R/W-0h

LEGEND: R/W = Read/Write; R = Read only; W1toCl = Write 1 to clear bit; -n = value after reset

Table 4-186. IEP_DIGIO_EXP Register Field Descriptions

Bit	Field	Type	Reset	Description
31-2	RESERVED	R	8h	
1	OUTVALID_OVR_EN	R/W	0h	Enable software to control value of pr1_edio_data_out [31:0]. 0: Disable 1: Enable
0	SW_DATA_OUT_UPDAT E	R/W	0h	Enable DIGIO_DATA_OUT to be driven out on pr1_edio_data_out. Only valid if OUTVALID_OVR_EN = 1. 0: Disable 1: Enable

4.5.5 PRU_ICSS_UART Registers

The system programmer has access to and control over any of the UART registers that are listed in [Table 4-187](#). These registers, which control UART operations, receive data, and transmit data, are available at 32-bit addresses in the device memory map.

- RBR, THR, and DLL share one address. When the DLAB bit in LCR is 0, reading from the address gives the content of RBR, and writing to the address modifies THR. When DLAB = 1, all accesses at the address read or modify DLL. DLL can also be accessed with address offset 20h.
- IER and DLH share one address. When DLAB = 0, all accesses read or modify IER. When DLAB = 1, all accesses read or modify DLH. DLH can also be accessed with address offset 24h.
- IIR and FCR share one address. Regardless of the value of the DLAB bit, reading from the address gives the content of IIR, and writing modifies FCR.

Table 4-187. PRU_ICSS_UART Registers

Offset	Acronym	Register Description	Section
0h	RBR	Receiver Buffer Register (read only)	Section 4.5.5.1
0h	THR	Transmitter Holding Register (write only)	Section 4.5.5.2
4h	IER	Interrupt Enable Register	Section 4.5.5.3
8h	IIR	Interrupt Identification Register (read only)	Section 4.5.5.4
8h	FCR	FIFO Control Register (write only)	Section 4.5.5.5

Table 4-187. PRU_ICSS_UART Registers (continued)

Offset	Acronym	Register Description	Section
Ch	LCR	Line Control Register	Section 4.5.5.6
10h	MCR	Modem Control Register	Section 4.5.5.7
14h	LSR	Line Status Register	Section 4.5.5.8
18h	MSR	Modem Status Register	Section 4.5.5.9
1Ch	SCR	Scratch Pad Register	Section 4.5.5.10
20h	DLL	Divisor LSB Latch	Section 4.5.5.11
24h	DLH	Divisor MSB Latch	Section 4.5.5.11
28h	REVID1	Revision Identification Register 1	Section 4.5.5.12
2Ch	REVID2	Revision Identification Register 2	Section 4.5.5.12
30h	PWREMU_MGMT	Power and Emulation Management Register	Section 4.5.5.13
34h	MDR	Mode Definition Register	Section 4.5.5.14

4.5.5.1 Receiver Buffer Register (RBR)

The receiver buffer register (RBR) is shown in [Figure 4-185](#) and described in [Table 4-188](#).

The UART receiver section consists of a receiver shift register (RSR) and a receiver buffer register (RBR). When the UART is in the FIFO mode, RBR is a 16-byte FIFO. Timing is supplied by the 16x receiver clock or 13x receiver clock by programming OSM_SEL bit field of MDR register. Receiver section control is a function of the line control register (LCR).

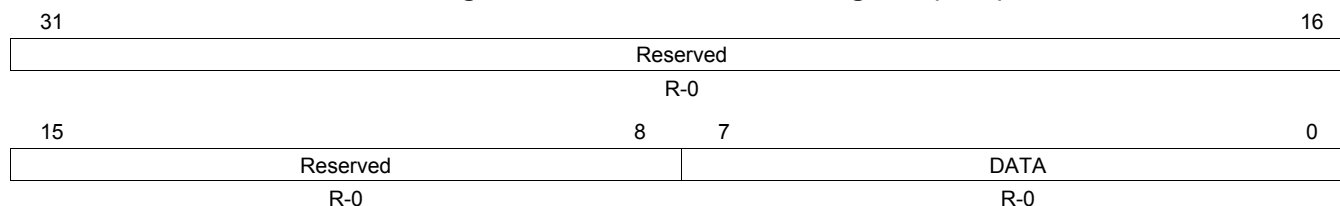
RSR receives serial data from the UARTn_RXD pin. Then RSR concatenates the data and moves it into RBR (or the receiver FIFO). In the non-FIFO mode, when a character is placed in RBR and the receiver data-ready interrupt is enabled (DR = 1 in IER), an interrupt is generated. This interrupt is cleared when the character is read from RBR. In the FIFO mode, the interrupt is generated when the FIFO is filled to the trigger level selected in the FIFO control register (FCR), and it is cleared when the FIFO contents drop below the trigger level.

Access considerations:

RBR, THR, and DLL share one address. To read RBR, write 0 to the DLAB bit in LCR, and read from the shared address. When DLAB = 0, writing to the shared address modifies THR. When DLAB = 1, all accesses at the shared address read or modify DLL.

DLL also has a dedicated address. If you use the dedicated address, you can keep DLAB = 0, so that RBR and THR are always selected at the shared address.

Figure 4-185. Receiver Buffer Register (RBR)



LEGEND: R = Read only; -n = value after reset

Table 4-188. Receiver Buffer Register (RBR) Field Descriptions

Bit	Field	Value	Description
31-8	Reserved	0	Reserved
7-0	DATA	0-FFh	Received data

4.5.5.2 Transmitter Holding Register (THR)

The transmitter holding register (THR) is shown in [Figure 4-186](#) and described in [Table 4-189](#).

The UART transmitter section consists of a transmitter hold register (THR) and a transmitter shift register (TSR). When the UART is in the FIFO mode, THR is a 16-byte FIFO. Transmitter section control is a function of the line control register (LCR).

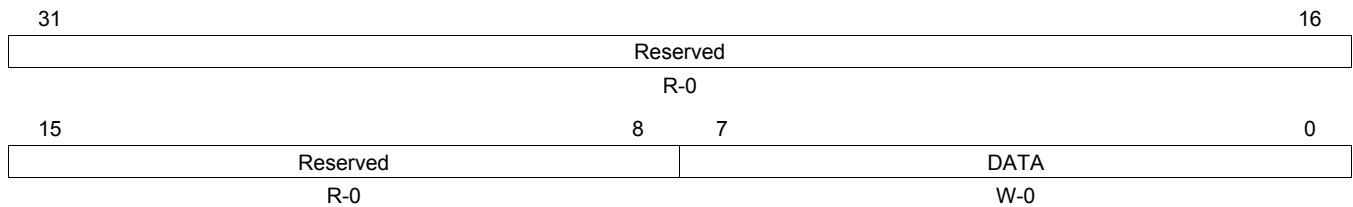
THR receives data from the internal data bus and when TSR is idle, the UART moves the data from THR to TSR. The UART serializes the data in TSR and transmits the data on the TX pin. In the non-FIFO mode, if THR is empty and the THR empty (THRE) interrupt is enabled (ETBEI = 1 in IER), an interrupt is generated. This interrupt is cleared when a character is loaded into THR or the interrupt identification register (IIR) is read. In the FIFO mode, the interrupt is generated when the transmitter FIFO is empty, and it is cleared when at least one byte is loaded into the FIFO or IIR is read.

Access considerations:

RBR, THR, and DLL share one address. To load THR, write 0 to the DLAB bit of LCR, and write to the shared address. When DLAB = 0, reading from the shared address gives the content of RBR. When DLAB = 1, all accesses at the address read or modify DLL.

DLL also has a dedicated address. If you use the dedicated address, you can keep DLAB = 0, so that RBR and THR are always selected at the shared address.

Figure 4-186. Transmitter Holding Register (THR)



LEGEND: R = Read only; W = Write only; -n = value after reset

Table 4-189. Transmitter Holding Register (THR) Field Descriptions

Bit	Field	Value	Description
31-8	Reserved	0	Reserved
7-0	DATA	0-FFh	Data to transmit

4.5.5.3 Interrupt Enable Register (IER)

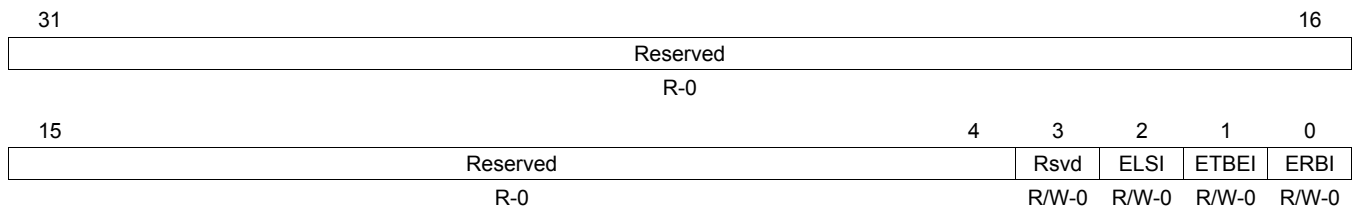
The interrupt enable register (IER) is used to individually enable or disable each type of interrupt request that can be generated by the UART. Each interrupt request that is enabled in IER is forwarded to the CPU. IER is shown in [Figure 4-187](#) and described in [Table 4-190](#).

Access considerations:

IER and DLH share one address. To read or modify IER, write 0 to the DLAB bit in LCR. When DLAB = 1, all accesses at the shared address read or modify DLH.

DLH also has a dedicated address. If you use the dedicated address, you can keep DLAB = 0, so that IER is always selected at the shared address.

Figure 4-187. Interrupt Enable Register (IER)



LEGEND: R/W = Read/Write; R = Read only; -n = value after reset

Table 4-190. Interrupt Enable Register (IER) Field Descriptions

Bit	Field	Value	Description
31-4	Reserved	0	Reserved
3	EDSSI	0	Enable Modem Status Interrupt
2	ELSI	0	Receiver line status interrupt enable. Receiver line status interrupt is disabled.
		1	Receiver line status interrupt is enabled.
1	ETBEI	0	Transmitter holding register empty interrupt enable. Transmitter holding register empty interrupt is disabled.
		1	Transmitter holding register empty interrupt is enabled.
0	ERBI	0	Receiver data available interrupt and character timeout indication interrupt enable. Receiver data available interrupt and character timeout indication interrupt is disabled.
		1	Receiver data available interrupt and character timeout indication interrupt is enabled.

4.5.5.4 Interrupt Identification Register (IIR)

The interrupt identification register (IIR) is a read-only register at the same address as the FIFO control register (FCR), which is a write-only register. When an interrupt is generated and enabled in the interrupt enable register (IER), IIR indicates that an interrupt is pending in the IPEND bit and encodes the type of interrupt in the INTID bits. Reading IIR clears any THR empty (THRE) interrupts that are pending.

IIR is shown in [Figure 4-188](#) and described in [Figure 4-188](#).

The UART has an on-chip interrupt generation and prioritization capability that permits flexible communication with the CPU. The UART provides three priority levels of interrupts:

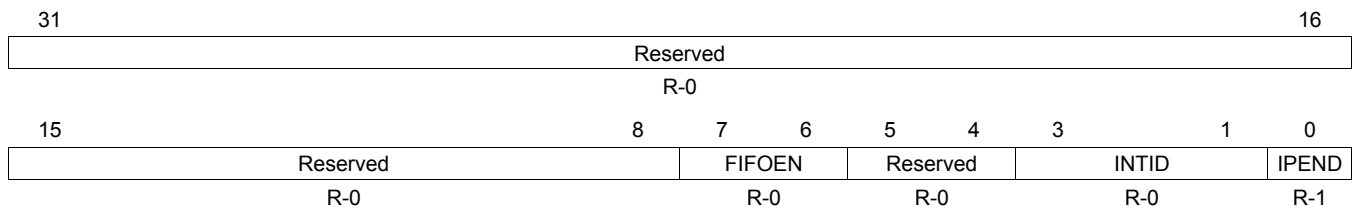
- Priority 1 - Receiver line status (highest priority)
- Priority 2 - Receiver data ready or receiver timeout
- Priority 3 - Transmitter holding register empty

The FIFOEN bit in IIR can be checked to determine whether the UART is in the FIFO mode or the non-FIFO mode.

Access consideration:

IIR and FCR share one address. Regardless of the value of the DLAB bit in LCR, reading from the address gives the content of IIR, and writing to the address modifies FCR.

Figure 4-188. Interrupt Identification Register (IIR)



LEGEND: R = Read only; -n = value after reset

Table 4-191. Interrupt Identification Register (IIR) Field Descriptions

Bit	Field	Value	Description
31-8	Reserved	0	Reserved
7-6	FIFOEN	0-3h 0 1h-2h 3h	FIFOs enabled. Non-FIFO mode Reserved FIFOs are enabled. FIFOEN bit in the FIFO control register (FCR) is set to 1.
5-4	Reserved	0	Reserved
3-1	INTID	0-7h 0 1h 2h 3h 4h-5h 6h 7h	Interrupt type. See Table 4-192 . Reserved Transmitter holding register empty (priority 3) Receiver data available (priority 2) Receiver line status (priority 1, highest) Reserved Character timeout indication (priority 2) Reserved
0	IPEND	0 1	Interrupt pending. When any UART interrupt is generated and is enabled in IER, IPEND is forced to 0. IPEND remains 0 until all pending interrupts are cleared or until a hardware reset occurs. If no interrupts are enabled, IPEND is never forced to 0. Interrupts pending. No interrupts pending.

Table 4-192. Interrupt Identification and Interrupt Clearing Information

Priority Level	IIR Bits				Interrupt Type	Interrupt Source	Event That Clears Interrupt
	3	2	1	0			
None	0	0	0	1	None	None	None
1	0	1	1	0	Receiver line status	Overrun error, parity error, framing error, or break is detected.	For an overrun error, reading the line status register (LSR) clears the interrupt. For a parity error, framing error, or break, the interrupt is cleared only after all the erroneous data have been read.
2	0	1	0	0	Receiver data-ready	Non-FIFO mode: Receiver data is ready. FIFO mode: Trigger level reached. If four character times (see Table 4-25) pass with no access of the FIFO, the interrupt is asserted again.	Non-FIFO mode: The receiver buffer register (RBR) is read. FIFO mode: The FIFO drops below the trigger level. ⁽¹⁾
2	1	1	0	0	Receiver time-out	FIFO mode only: No characters have been removed from or input to the receiver FIFO during the last four character times (see Table 4-25), and there is at least one character in the receiver FIFO during this time.	One of the following events: <ul style="list-style-type: none"> A character is read from the receiver FIFO.⁽¹⁾ A new character arrives in the receiver FIFO. The URRST bit in the power and emulation management register (PWREMU_MGMT) is loaded with 0.
3	0	0	1	0	Transmitter holding register empty	Non-FIFO mode: Transmitter holding register (THR) is empty. FIFO mode: Transmitter FIFO is empty.	A character is written to the transmitter holding register (THR) or the interrupt identification register (IIR) is read.

⁽¹⁾ In the FIFO mode, the receiver data-ready interrupt or receiver time-out interrupt is cleared by the CPU or by the DMA controller, whichever reads from the receiver FIFO first.

4.5.5.5 FIFO Control Register (FCR)

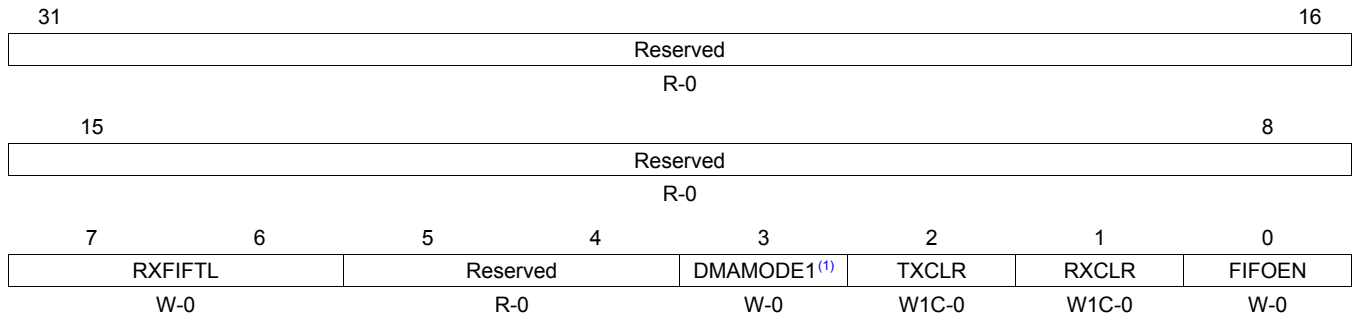
The FIFO control register (FCR) is a write-only register at the same address as the interrupt identification register (IIR), which is a read-only register. Use FCR to enable and clear the FIFOs and to select the receiver FIFO trigger level. FCR is shown in [Figure 4-189](#) and described in [Table 4-193](#). The FIFOEN bit must be set to 1 before other FCR bits are written to or the FCR bits are not programmed.

Access consideration:

IIR and FCR share one address. Regardless of the value of the DLAB bit, reading from the address gives the content of IIR, and writing to the address modifies FCR.

CAUTION

For proper communication between the UART and the EDMA controller, the DMAMODE1 bit must be set to 1. Always write a 1 to the DMAMODE1 bit, and after a hardware reset, change the DMAMODE1 bit from 0 to 1.

Figure 4-189. FIFO Control Register (FCR)

LEGEND: R = Read only; W = Write only; W1C = Write 1 to clear (writing 0 has no effect); -n = value after reset

⁽¹⁾ Always write 1 to the DMAMODE1 bit. After a hardware reset, change the DMAMODE1 bit from 0 to 1. DMAMODE = 1 is required for proper communication between the UART and the DMA controller.

Table 4-193. FIFO Control Register (FCR) Field Descriptions

Bit	Field	Value	Description
31-8	Reserved	0	Reserved
7-6	RXFIFTL	0-3h	Receiver FIFO trigger level. RXFIFTL sets the trigger level for the receiver FIFO. When the trigger level is reached, a receiver data-ready interrupt is generated (if the interrupt request is enabled). Once the FIFO drops below the trigger level, the interrupt is cleared.
		0	1 byte
		1h	4 bytes
		2h	8 bytes
		3h	14 bytes
5-4	Reserved	0	Reserved
3	DMAMODE1	0	DMA MODE1 enable if FIFOs are enabled. Always write 1 to DMAMODE1. After a hardware reset, change DMAMODE1 from 0 to 1. DMAMODE1 = 1 is a requirement for proper communication between the UART and the EDMA controller.
		1	DMA MODE1 is disabled.
		1	DMA MODE1 is enabled.
2	TXCLR	0	Transmitter FIFO clear. Write a 1 to TXCLR to clear the bit.
		1	No effect.
		1	Clears transmitter FIFO and resets the transmitter FIFO counter. The shift register is not cleared.
1	RXCLR	0	Receiver FIFO clear. Write a 1 to RXCLR to clear the bit.
		1	No effect.
		1	Clears receiver FIFO and resets the receiver FIFO counter. The shift register is not cleared.
0	FIFOEN	0	Transmitter and receiver FIFOs mode enable. FIFOEN must be set before other FCR bits are written to or the FCR bits are not programmed. Clearing this bit clears the FIFO counters.
		1	Non-FIFO mode. The transmitter and receiver FIFOs are disabled, and the FIFO pointers are cleared.
		1	FIFO mode. The transmitter and receiver FIFOs are enabled.

4.5.5.6 Line Control Register (LCR)

The line control register (LCR) is shown in [Figure 4-190](#) and described in [Table 4-194](#).

The system programmer controls the format of the asynchronous data communication exchange by using LCR. In addition, the programmer can retrieve, inspect, and modify the content of LCR; this eliminates the need for separate storage of the line characteristics in system memory.

Figure 4-190. Line Control Register (LCR)

31	Reserved								16	
	R-0									
15		8	7	6	5	4	3	2	1	0
	Reserved	DLAB	BC	SP	EPS	PEN	STB	WLS		
	R-0	R/W-0	R/W-0	R/W-0	R/W-0	R/W-0	R/W-0	R/W-0	R/W-0	R/W-0

LEGEND: R/W = Read/Write; R = Read only; -n = value after reset

Table 4-194. Line Control Register (LCR) Field Descriptions

Bit	Field	Value	Description
31-8	Reserved	0	Reserved
7	DLAB	0	Divisor latch access bit. The divisor latch registers (DLL and DLH) can be accessed at dedicated addresses or at addresses shared by RBR, THR, and IER. Using the shared addresses requires toggling DLAB to change which registers are selected. If you use the dedicated addresses, you can keep DLAB = 0.
		1	Allows access to the receiver buffer register (RBR), the transmitter holding register (THR), and the interrupt enable register (IER) selected. At the address shared by RBR, THR, and DLL, the CPU can read from RBR and write to THR. At the address shared by IER and DLH, the CPU can read from and write to IER.
		1	Allows access to the divisor latches of the baud generator during a read or write operation (DLL and DLH). At the address shared by RBR, THR, and DLL, the CPU can read from and write to DLL. At the address shared by IER and DLH, the CPU can read from and write to DLH.
6	BC	0	Break control.
		1	Break condition is transmitted to the receiving UART. A break condition is a condition where the UARTn_TXD signal is forced to the spacing (cleared) state.
5	SP	0	Stick parity. The SP bit works in conjunction with the EPS and PEN bits. The relationship between the SP, EPS, and PEN bits is summarized in Table 4-195 .
		1	Stick parity is enabled. <ul style="list-style-type: none"> • When odd parity is selected (EPS = 0), the PARITY bit is transmitted and checked as set. • When even parity is selected (EPS = 1), the PARITY bit is transmitted and checked as cleared.
4	EPS	0	Even parity select. Selects the parity when parity is enabled (PEN = 1). The EPS bit works in conjunction with the SP and PEN bits. The relationship between the SP, EPS, and PEN bits is summarized in Table 4-195 .
		1	Odd parity is selected (an odd number of logic 1s is transmitted or checked in the data and PARITY bits).
		1	Even parity is selected (an even number of logic 1s is transmitted or checked in the data and PARITY bits).
3	PEN	0	Parity enable. The PEN bit works in conjunction with the SP and EPS bits. The relationship between the SP, EPS, and PEN bits is summarized in Table 4-195 .
		1	No PARITY bit is transmitted or checked.
		1	Parity bit is generated in transmitted data and is checked in received data between the last data word bit and the first STOP bit.

Table 4-194. Line Control Register (LCR) Field Descriptions (continued)

Bit	Field	Value	Description
2	STB	0 1	<p>Number of STOP bits generated. STB specifies 1, 1.5, or 2 STOP bits in each transmitted character. When STB = 1, the WLS bit determines the number of STOP bits. The receiver clocks only the first STOP bit, regardless of the number of STOP bits selected. The number of STOP bits generated is summarized in Table 4-196.</p> <p>1 STOP bit is generated.</p> <p>WLS bit determines the number of STOP bits:</p> <ul style="list-style-type: none"> When WLS = 0, 1.5 STOP bits are generated. When WLS = 1h, 2h, or 3h, 2 STOP bits are generated.
1-0	WLS	0-3h 0 1h 2h 3h	<p>Word length select. Number of bits in each transmitted or received serial character. When STB = 1, the WLS bit determines the number of STOP bits.</p> <p>5 bits</p> <p>6 bits</p> <p>7 bits</p> <p>8 bits</p>

Table 4-195. Relationship Between ST, EPS, and PEN Bits in LCR

ST Bit	EPS Bit	PEN Bit	Parity Option
x	x	0	Parity disabled: No PARITY bit is transmitted or checked
0	0	1	Odd parity selected: Odd number of logic 1s
0	1	1	Even parity selected: Even number of logic 1s
1	0	1	Stick parity selected with PARITY bit transmitted and checked as set
1	1	1	Stick parity selected with PARITY bit transmitted and checked as cleared

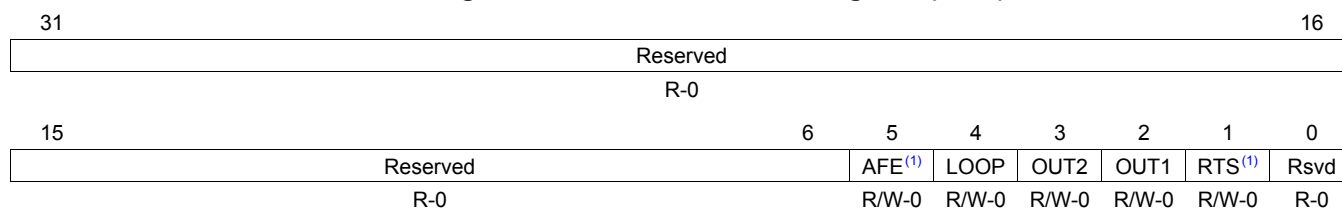
Table 4-196. Number of STOP Bits Generated

STB Bit	WLS Bits	Word Length Selected with WLS Bits	Number of STOP Bits Generated	Baud Clock (BCLK) Cycles
0	x	Any word length	1	16
1	0h	5 bits	1.5	24
1	1h	6 bits	2	32
1	2h	7 bits	2	32
1	3h	8 bits	2	32

4.5.5.7 Modem Control Register (MCR)

The modem control register (MCR) is shown in Figure 4-191 and described in Table 4-197. The modem control register provides the ability to enable/disable the autoflow functions, and enable/disable the loopback function for diagnostic purposes.

Figure 4-191. Modem Control Register (MCR)



LEGEND: R/W = Read/Write; R = Read only; -n = value after reset

⁽¹⁾ All UARTs do not support this feature, see your device-specific data manual for supported features. If this feature is not available, this bit is reserved and should be cleared to 0.

Table 4-197. Modem Control Register (MCR) Field Descriptions

Bit	Field	Value	Description
31-6	Reserved	0	Reserved
5	AFE	0 1	Autoflow control enable. Autoflow control allows the $\overline{\text{UARTn_RTS}}$ and $\overline{\text{UARTn_CTS}}$ signals to provide handshaking between UARTs during data transfer. When AFE = 1, the RTS bit determines the autoflow control enabled. Note that all UARTs do not support this feature, see your device-specific data manual for supported features. If this feature is not available, this bit is reserved and should be cleared to 0. 0 Autoflow control is disabled. 1 Autoflow control is enabled: <ul style="list-style-type: none"> • When RTS = 0, $\overline{\text{UARTn_CTS}}$ is only enabled. • When RTS = 1, $\overline{\text{UARTn_RTS}}$ and $\overline{\text{UARTn_CTS}}$ are enabled.
4	LOOP	0 1	Loop back mode enable. LOOP is used for the diagnostic testing using the loop back feature. 0 Loop back mode is disabled. 1 Loop back mode is enabled. When LOOP is set, the following occur: <ul style="list-style-type: none"> • The $\overline{\text{UARTn_TXD}}$ signal is set high. • The $\overline{\text{UARTn_RXD}}$ pin is disconnected • The output of the transmitter shift register (TSR) is lopped back in to the receiver shift register (RSR) input.
3	OUT2	0	OUT2 Control Bit
2	OUT1	0	OUT1 Control Bit
1	RTS	0 1	RTS control. When AFE = 1, the RTS bit determines the autoflow control enabled. Note that all UARTs do not support this feature, see your device-specific data manual for supported features. If this feature is not available, this bit is reserved and should be cleared to 0. 0 $\overline{\text{UARTn_RTS}}$ is disabled, $\overline{\text{UARTn_CTS}}$ is only enabled. 1 $\overline{\text{UARTn_RTS}}$ and $\overline{\text{UARTn_CTS}}$ are enabled.
0	Reserved	0	Reserved

4.5.5.8 Line Status Register (LSR)

The line status register (LSR) is shown in [Figure 4-192](#) and described in [Table 4-198](#). LSR provides information to the CPU concerning the status of data transfers. LSR is intended for read operations only; do not write to this register. Bits 1 through 4 record the error conditions that produce a receiver line status interrupt.

Figure 4-192. Line Status Register (LSR)

31	Reserved										16
R-0											
15	8	7	6	5	4	3	2	1	0		
Reserved		RXFIFOE	TEMT	THRE	BI	FE	PE	OE	DR		
R-0		R-0	R-1	R-1	R-0	R-0	R-0	R-0	R-0	R-0	

LEGEND: R = Read only; -n = value after reset

Table 4-198. Line Status Register (LSR) Field Descriptions

Bit	Field	Value	Description
31-8	Reserved	0	Reserved
7	RXFIFOE		Receiver FIFO error.
		0	There has been no error, or RXFIFOE was cleared because the CPU read the erroneous character from the receiver buffer register (RBR).
		1	There is a parity error, framing error, or break indicator in the receiver buffer register (RBR).
			In FIFO mode:
		0	There has been no error, or RXFIFOE was cleared because the CPU read the erroneous character from the receiver FIFO and there are no more errors in the receiver FIFO.
		1	At least one parity error, framing error, or break indicator in the receiver FIFO.
6	TEMT		Transmitter empty (TEMT) indicator.
			In non-FIFO mode:
		0	Either the transmitter holding register (THR) or the transmitter shift register (TSR) contains a data character.
		1	Both the transmitter holding register (THR) and the transmitter shift register (TSR) are empty.
			In FIFO mode:
		0	Either the transmitter FIFO or the transmitter shift register (TSR) contains a data character.
		1	Both the transmitter FIFO and the transmitter shift register (TSR) are empty.
5	THRE		Transmitter holding register empty (THRE) indicator. If the THRE bit is set and the corresponding interrupt enable bit is set (ETBEI = 1 in IER), an interrupt request is generated.
			In non-FIFO mode:
		0	Transmitter holding register (THR) is not empty. THR has been loaded by the CPU.
		1	Transmitter holding register (THR) is empty (ready to accept a new character). The content of THR has been transferred to the transmitter shift register (TSR).
			In FIFO mode:
		0	Transmitter FIFO is not empty. At least one character has been written to the transmitter FIFO. You can write to the transmitter FIFO if it is not full.
		1	Transmitter FIFO is empty. The last character in the FIFO has been transferred to the transmitter shift register (TSR).

Table 4-198. Line Status Register (LSR) Field Descriptions (continued)

Bit	Field	Value	Description
4	BI		Break indicator. The BI bit is set whenever the receive data input (UARTn_RXD) was held low for longer than a full-word transmission time. A full-word transmission time is defined as the total time to transmit the START, data, PARITY, and STOP bits. If the BI bit is set and the corresponding interrupt enable bit is set (ELSI = 1 in IER), an interrupt request is generated.
		0	In non-FIFO mode: No break has been detected, or the BI bit was cleared because the CPU read the erroneous character from the receiver buffer register (RBR).
		1	A break has been detected with the character in the receiver buffer register (RBR).
		0	In FIFO mode: No break has been detected, or the BI bit was cleared because the CPU read the erroneous character from the receiver FIFO and the next character to be read from the FIFO has no break indicator.
		1	A break has been detected with the character at the top of the receiver FIFO.
3	FE		Framing error (FE) indicator. A framing error occurs when the received character does not have a valid STOP bit. In response to a framing error, the UART sets the FE bit and waits until the signal on the RX pin goes high. Once the RX signal goes high, the receiver is ready to detect a new START bit and receive new data. If the FE bit is set and the corresponding interrupt enable bit is set (ELSI = 1 in IER), an interrupt request is generated.
		0	In non-FIFO mode: No framing error has been detected, or the FE bit was cleared because the CPU read the erroneous data from the receiver buffer register (RBR).
		1	A framing error has been detected with the character in the receiver buffer register (RBR).
		0	In FIFO mode: No framing error has been detected, or the FE bit was cleared because the CPU read the erroneous data from the receiver FIFO and the next character to be read from the FIFO has no framing error.
		1	A framing error has been detected with the character at the top of the receiver FIFO.
2	PE		Parity error (PE) indicator. A parity error occurs when the parity of the received character does not match the parity selected with the EPS bit in the line control register (LCR). If the PE bit is set and the corresponding interrupt enable bit is set (ELSI = 1 in IER), an interrupt request is generated.
		0	In non-FIFO mode: No parity error has been detected, or the PE bit was cleared because the CPU read the erroneous data from the receiver buffer register (RBR).
		1	A parity error has been detected with the character in the receiver buffer register (RBR).
		0	In FIFO mode: No parity error has been detected, or the PE bit was cleared because the CPU read the erroneous data from the receiver FIFO and the next character to be read from the FIFO has no parity error.
		1	A parity error has been detected with the character at the top of the receiver FIFO.
1	OE		Overrun error (OE) indicator. An overrun error in the non-FIFO mode is different from an overrun error in the FIFO mode. If the OE bit is set and the corresponding interrupt enable bit is set (ELSI = 1 in IER), an interrupt request is generated.
		0	In non-FIFO mode: No overrun error has been detected, or the OE bit was cleared because the CPU read the content of the line status register (LSR).
		1	Overrun error has been detected. Before the character in the receiver buffer register (RBR) could be read, it was overwritten by the next character arriving in RBR.
		0	In FIFO mode: No overrun error has been detected, or the OE bit was cleared because the CPU read the content of the line status register (LSR).
		1	Overrun error has been detected. If data continues to fill the FIFO beyond the trigger level, an overrun error occurs only after the FIFO is full and the next character has been completely received in the shift register. An overrun error is indicated to the CPU as soon as it happens. The new character overwrites the character in the shift register, but it is not transferred to the FIFO.

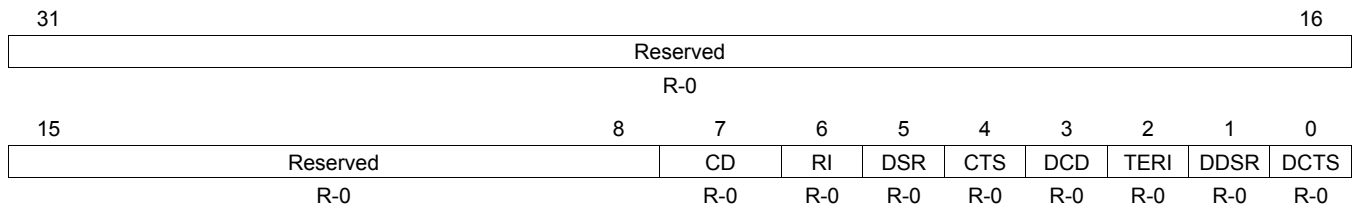
Table 4-198. Line Status Register (LSR) Field Descriptions (continued)

Bit	Field	Value	Description
0	DR		Data-ready (DR) indicator for the receiver. If the DR bit is set and the corresponding interrupt enable bit is set (ERBI = 1 in IER), an interrupt request is generated.
			In non-FIFO mode:
		0	Data is not ready, or the DR bit was cleared because the character was read from the receiver buffer register (RBR).
		1	Data is ready. A complete incoming character has been received and transferred into the receiver buffer register (RBR).
			In FIFO mode:
		0	Data is not ready, or the DR bit was cleared because all of the characters in the receiver FIFO have been read.
		1	Data is ready. There is at least one unread character in the receiver FIFO. If the FIFO is empty, the DR bit is set as soon as a complete incoming character has been received and transferred into the FIFO. The DR bit remains set until the FIFO is empty again.

4.5.5.9 Modem Status Register (MSR)

The Modem status register (MSR) is shown in [Figure 4-193](#) and described in [Table 4-199](#). MSR provides information to the CPU concerning the status of modem control signals. MSR is intended for read operations only; do not write to this register.

Figure 4-193. Modem Status Register (MSR)



LEGEND: R = Read only; -n = value after reset

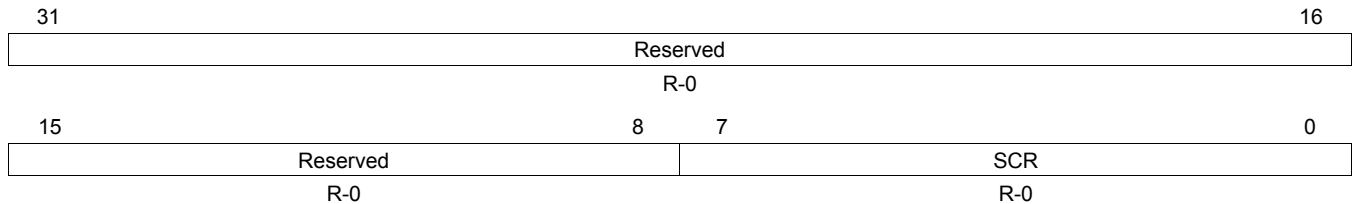
Table 4-199. Modem Status Register (MSR) Field Descriptions

Bit	Field	Value	Description
31-8	Reserved	0	Reserved
7	CD	0	Complement of the Carrier Detect input. When the UART is in the diagnostic test mode (loopback mode MCR[4] = 1), this bit is equal to the MCR bit 3 (OUT2).
6	RI	0	Complement of the Ring Indicator input. When the UART is in the diagnostic test mode (loopback mode MCR[4] = 1), this bit is equal to the MCR bit 2 (OUT1).
5	DSR	0	Complement of the Data Set Ready input. When the UART is in the diagnostic test mode (loopback mode MCR[4] = 1), this bit is equal to the MCR bit 0 (DTR).
4	CTS	0	Complement of the Clear To Send input. When the UART is in the diagnostic test mode (loopback mode MCR[4] = 1), this bit is equal to the MCR bit 1 (RTS).
3	DCD	0	Change in DCD indicator bit. DCD indicates that the DCD input has changed state since the last time it was read by the CPU. When DCD is set and the modem status interrupt is enabled, a modem status interrupt is generated.
2	TERI	0	Trailing edge of RI (TERI) indicator bit. TERI indicates that the RI input has changed from a low to a high. When TERI is set and the modem status interrupt is enabled, a modem status interrupt is generated.
1	DDSR	0	Change in DSR indicator bit. DDSR indicates that the DSR input has changed state since the last time it was read by the CPU. When DDSR is set and the modem status interrupt is enabled, a modem status interrupt is generated.
0	DCTS	0	Change in CTS indicator bit. DCTS indicates that the CTS input has changed state since the last time it was read by the CPU. When DCTS is set (autoflow control is not enabled and the modem status interrupt is enabled), a modem status interrupt is generated. When autoflow control is enabled, no interrupt is generated.

4.5.5.10 Scratch Pad Register (SCR)

The Scratch Pad register (SCR) is shown in [Figure 4-194](#) and described in [Table 4-200](#). SCR is intended for programmer's use as a scratch pad. It temporarily holds the programmer's data without affecting UART operation.

Figure 4-194. Scratch Pad Register (SCR)



LEGEND: R = Read only; -n = value after reset

Table 4-200. Scratch Pad Register (MSR) Field Descriptions

Bit	Field	Value	Description
31-8	Reserved	0	Reserved
7-0	SCR	0	These bits are intended for the programmer's use as a scratch pad in the sense that it temporarily holds the programmer's data without affecting any other UART operation.

4.5.5.11 Divisor Latches (DLL and DLH)

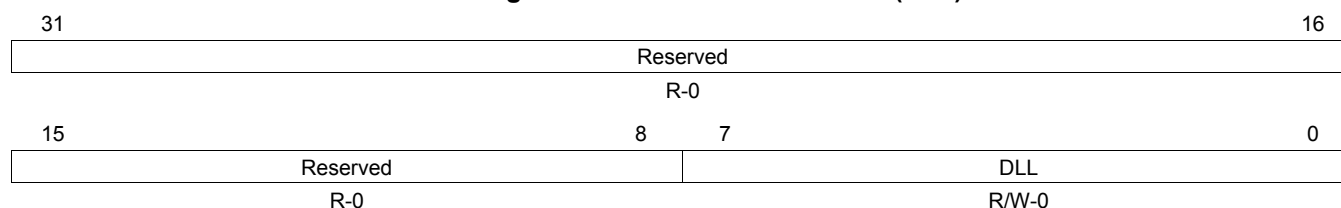
Two 8-bit register fields (DLL and DLH), called divisor latches, store the 16-bit divisor for generation of the baud clock in the baud generator. The latches are in DLH and DLL. DLH holds the most-significant bits of the divisor, and DLL holds the least-significant bits of the divisor. These divisor latches must be loaded during initialization of the UART in order to ensure desired operation of the baud generator. Writing to the divisor latches results in two wait states being inserted during the write access while the baud generator is loaded with the new value.

Access considerations:

- RBR, THR, and DLL share one address. When DLAB = 1 in LCR, all accesses at the shared address are accesses to DLL. When DLAB = 0, reading from the shared address gives the content of RBR, and writing to the shared address modifies THR.
- IER and DLH share one address. When DLAB = 1 in LCR, accesses to the shared address read or modify to DLH. When DLAB = 0, all accesses at the shared address read or modify IER.

DLL and DLH also have dedicated addresses. If you use the dedicated addresses, you can keep the DLAB bit cleared, so that RBR, THR, and IER are always selected at the shared addresses.

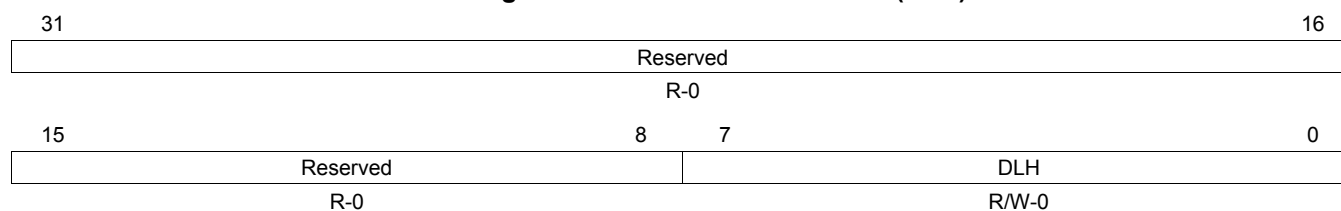
The divisor LSB latch (DLL) is shown in [Figure 4-195](#) and described in [Table 4-201](#). The divisor MSB latch (DLH) is shown in [Figure 4-196](#) and described in [Table 4-202](#).

Figure 4-195. Divisor LSB Latch (DLL)


LEGEND: R/W = Read/Write; R = Read only; -n = value after reset

Table 4-201. Divisor LSB Latch (DLL) Field Descriptions

Bit	Field	Value	Description
31-8	Reserved	0	Reserved
7-0	DLL	0-Fh	The 8 least-significant bits (LSBs) of the 16-bit divisor for generation of the baud clock in the baud rate generator.

Figure 4-196. Divisor MSB Latch (DLH)


LEGEND: R/W = Read/Write; R = Read only; -n = value after reset

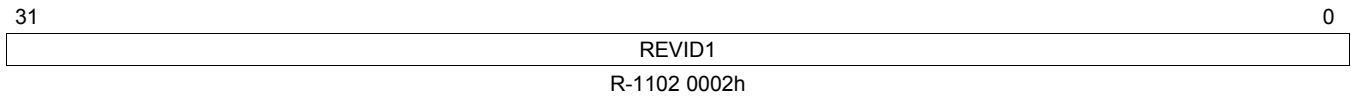
Table 4-202. Divisor MSB Latch (DLH) Field Descriptions

Bit	Field	Value	Description
31-8	Reserved	0	Reserved
7-0	DLH	0-Fh	The 8 most-significant bits (MSBs) of the 16-bit divisor for generation of the baud clock in the baud rate generator.

4.5.5.12 Revision Identification Registers (REVID1 and REVID2)

The revision identification registers (REVID1 and REVID2) contain peripheral identification data for the peripheral. REVID1 is shown in [Figure 4-197](#) and described in [Table 4-203](#). REVID2 is shown in [Figure 4-198](#) and described in [Table 4-204](#).

Figure 4-197. Revision Identification Register 1 (REVID1)

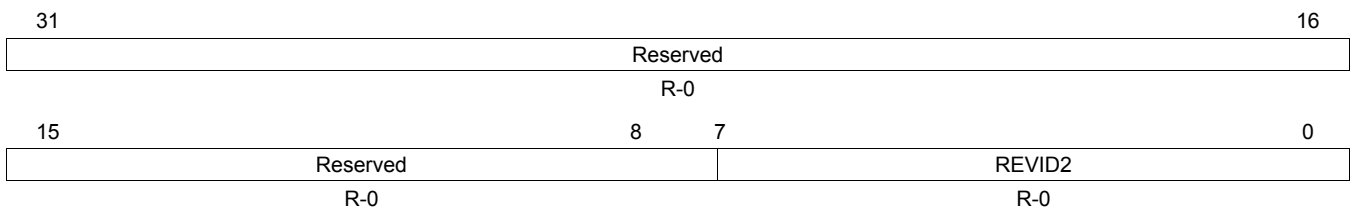


LEGEND: R = Read only; -n = value after reset

Table 4-203. Revision Identification Register 1 (REVID1) Field Descriptions

Bit	Field	Value	Description
31-0	REVID1	1102 0002h	Peripheral Identification Number

Figure 4-198. Revision Identification Register 2 (REVID2)



LEGEND: R = Read only; -n = value after reset

Table 4-204. Revision Identification Register 2 (REVID2) Field Descriptions

Bit	Field	Value	Description
31-8	Reserved	0	Reserved
7-0	REVID2	0	Peripheral Identification Number

4.5.5.13 Power and Emulation Management Register (PWREMU_MGMT)

The power and emulation management register (PWREMU_MGMT) is shown in [Figure 4-199](#) and described in [Table 4-205](#).

Figure 4-199. Power and Emulation Management Register (PWREMU_MGMT)

	Reserved	
	R-0	
31		16
15	14	1
13	12	0
Rsvd	UTRST	FREE
R/W-0	R/W-0	R/W-0
	URRST	R-1
	Reserved	R/W-0

LEGEND: R/W = Read/Write; R = Read only; -n = value after reset

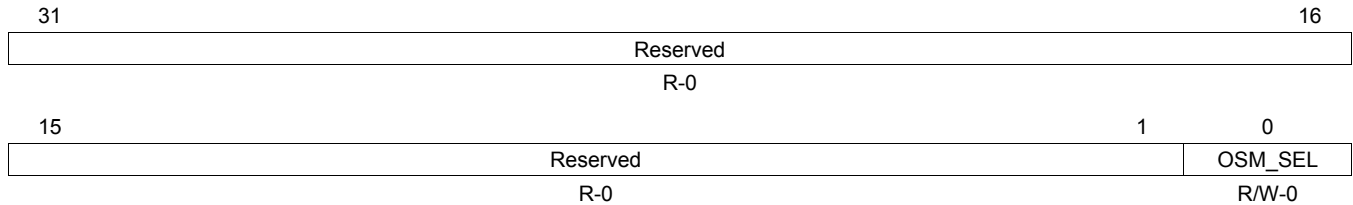
Table 4-205. Power and Emulation Management Register (PWREMU_MGMT) Field Descriptions

Bit	Field	Value	Description
31-16	Reserved	0	Reserved
15	Reserved	0	Reserved. This bit must always be written with a 0.
14	UTRST	0	UART transmitter reset. Resets and enables the transmitter. Transmitter is disabled and in reset state.
		1	Transmitter is enabled.
13	URRST	0	UART receiver reset. Resets and enables the receiver. Receiver is disabled and in reset state.
		1	Receiver is enabled.
12-1	Reserved	1	Reserved
0	FREE		Free-running enable mode bit. This bit determines the emulation mode functionality of the UART. When halted, the UART can handle register read/write requests, but does not generate any transmission/reception, interrupts or events.
		0	If a transmission is not in progress, the UART halts immediately. If a transmission is in progress, the UART halts after completion of the one-word transmission.
		1	Free-running mode is enabled; UART continues to run normally.

4.5.5.14 Mode Definition Register (MDR)

The Mode Definition register (MDR) determines the over-sampling mode for the UART. MDR is shown in [Figure 4-200](#) and described in [Table 4-206](#).

Figure 4-200. Mode Definition Register (MDR)



LEGEND: R/W = Read/Write; R = Read only; -n = value after reset

Table 4-206. Mode Definition Register (MDR) Field Descriptions

Bit	Field	Value	Description
31-1	Reserved	0	Reserved
0	OSM_SEL	0	Over-Sampling Mode Select. 16× over-sampling.
		1	13× over-sampling.

4.5.6 PRU_ICSS_ECAP Registers

The PRU ECAP module within the PRU-ICSS is identical to the ECAP module in the AM335x PWMSS.

For additional details about the ECAP registers, see [Section 15.3](#).

4.5.7 PRU_ICSS_CFG Registers

[Table 4-207](#) lists the memory-mapped registers for the PRU_ICSS_CFG. All register offset addresses not listed in [Table 4-207](#) should be considered as reserved locations and the register contents should not be modified.

Table 4-207. PRU_ICSS_CFG Registers

Offset	Acronym	Register Name	Section
0h	REVID		Section 4.5.7.1
4h	SYSCFG		Section 4.5.7.2
8h	GPCFG0		Section 4.5.7.3
Ch	GPCFG1		Section 4.5.7.4
10h	CGR		Section 4.5.7.5
14h	ISRP		Section 4.5.7.6
18h	ISP		Section 4.5.7.7
1Ch	IESP		Section 4.5.7.8
20h	IECP		Section 4.5.7.9
28h	PMAO		Section 4.5.7.10
30h	IEPCLK		Section 4.5.7.11
34h	SPP		Section 4.5.7.12
40h	PIN_MX		Section 4.5.7.13

4.5.7.1 REVID Register (offset = 0h) [reset = 47000000h]

REVID is shown in [Figure 4-201](#) and described in [Table 4-208](#).

The Revision Register contains the ID and revision information.

Figure 4-201. REVID Register

31	30	29	28	27	26	25	24	23	22	21	20	19	18	17	16	15	14	13	12	11	10	9	8	7	6	5	4	3	2	1	0
REVID																															
R-47000000h																															

LEGEND: R/W = Read/Write; R = Read only; W1toCl = Write 1 to clear bit; -n = value after reset

Table 4-208. REVID Register Field Descriptions

Bit	Field	Type	Reset	Description
31-0	REVID	R	47000000h	Revision ID

4.5.7.2 SYSCFG Register (offset = 4h) [reset = 1Ah]

SYSCFG is shown in [Figure 4-202](#) and described in [Table 4-209](#).

The System Configuration Register defines the power IDLE and STANDBY modes.

Figure 4-202. SYSCFG Register

31	30	29	28	27	26	25	24
RESERVED							
R/W-0h							
23	22	21	20	19	18	17	16
RESERVED							
R/W-0h							
15	14	13	12	11	10	9	8
RESERVED							
R/W-0h							
7	6	5	4	3	2	1	0
RESERVED		SUB_MWAIT	STANDBY_INIT	STANDBY_MODE		IDLE_MODE	
R/W-0h		R-0h	R/W-1h	R/W-2h		R/W-2h	

LEGEND: R/W = Read/Write; R = Read only; W1toCl = Write 1 to clear bit; -n = value after reset

Table 4-209. SYSCFG Register Field Descriptions

Bit	Field	Type	Reset	Description
31-6	RESERVED	R/W	0h	
5	SUB_MWAIT	R	0h	Status bit for wait state. 0 = Ready for Transaction 1 = Wait until 0
4	STANDBY_INIT	R/W	1h	1 = Initiate standby sequence. 0 = Enable OCP master ports.
3-2	STANDBY_MODE	R/W	2h	0h = Force standby mode: Initiator unconditionally in standby (standby = 1). 1h = No standby mode: Initiator unconditionally out of standby (standby = 0). 2h = Smart standby mode: Standby requested by initiator depending on internal conditions. 3h = Reserved.
1-0	IDLE_MODE	R/W	2h	0h = Force-idle mode. 1h = No-idle mode. 2h = Smart-idle mode. 3h = Reserved.

4.5.7.3 GPCFG0 Register (offset = 8h) [reset = 0h]

GPCFG0 is shown in [Figure 4-203](#) and described in [Table 4-210](#).

The General Purpose Configuration 0 Register defines the GPI/O configuration for PRU0.

Figure 4-203. GPCFG0 Register

31	30	29	28	27	26	25	24
RESERVED						PRU0_GPO_SH_SEL	PRU0_GPO_DIV1
R/W-0h						R-0h	R/W-0h
23	22	21	20	19	18	17	16
PRU0_GPO_DIV1				PRU0_GPO_DIV0			
R/W-0h				R/W-0h			
15	14	13	12	11	10	9	8
PRU0_GPO_DIV0	PRU0_GPO_MODE	PRU0_GPI_SB	PRU0_GPI_DIV1				
R/W-0h	R/W-0h	R/W-0h	R/W-0h				
7	6	5	4	3	2	1	0
PRU0_GPI_DIV0					PRU0_GPI_CLK_MODE	PRU0_GPI_MODE	
R/W-0h					R/W-0h	R/W-0h	

LEGEND: R/W = Read/Write; R = Read only; W1toCl = Write 1 to clear bit; -n = value after reset

Table 4-210. GPCFG0 Register Field Descriptions

Bit	Field	Type	Reset	Description
31-26	RESERVED	R/W	0h	
25	PRU0_GPO_SH_SEL	R	0h	Defines which shadow register is currently getting used for GPO shifting. 0 = gpo_sh0 is selected 1 = gpo_sh1 is selected
24-20	PRU0_GPO_DIV1	R/W	0h	Divisor value (divide by PRU0_GPO_DIV1 + 1). 0h = div 1.0. 1h = div 1.5. 2h = div 2.0. .. 1eh = div 16.0. 1fh = reserved.
19-15	PRU0_GPO_DIV0	R/W	0h	Divisor value (divide by PRU0_GPO_DIV0 + 1). 0h = div 1.0. 1h = div 1.5. 2h = div 2.0. .. 1eh = div 16.0. 1fh = reserved.
14	PRU0_GPO_MODE	R/W	0h	0 = Direct output mode 1 = Serial output mode
13	PRU0_GPI_SB	R/W	0h	Start Bit event for 28-bit shift in mode. PRU0_GPI_SB (pru0_r31_status[29]) is set when first capture of a 1 on pru0_r31_status[0]. Read 1: Start Bit event occurred. Read 0: Start Bit event has not occurred. Write 1: Will clear PRU0_GPI_SB and clear the whole shift register. Write 0: No Effect.
12-8	PRU0_GPI_DIV1	R/W	0h	Divisor value (divide by PRU0_GPI_DIV1 + 1). 0h = div 1.0. 1h = div 1.5. 2h = div 2.0. .. 1eh = div 16.0. 1fh = reserved.

Table 4-210. GPCFG0 Register Field Descriptions (continued)

Bit	Field	Type	Reset	Description
7-3	PRU0_GPI_DIV0	R/W	0h	Divisor value (divide by PRU0_GPI_DIV0 + 1). 0h = div 1.0. 1h = div 1.5. 2h = div 2.0. .. 1eh = div 16.0. 1fh = reserved.
2	PRU0_GPI_CLK_MODE	R/W	0h	Parallel 16-bit capture mode clock edge. 0 = Use the positive edge of pru0_r31_status[16] 1 = Use the negative edge of pru0_r31_status[16]
1-0	PRU0_GPI_MODE	R/W	0h	0h = Direct input mode. 1h = 16bit parallel capture mode. 2h = 28bit shift in mode. 3h = Reserved.

4.5.7.4 GPCFG1 Register (offset = Ch) [reset = 0h]

GPCFG1 is shown in [Figure 4-204](#) and described in [Table 4-211](#).

The General Purpose Configuration 1 Register defines the GPI/O configuration for PRU1.

Figure 4-204. GPCFG1 Register

31	30	29	28	27	26	25	24
RESERVED						PRU1_GPO_SH_SEL	PRU1_GPO_DIV1
R/W-0h						R-0h	R/W-0h
23	22	21	20	19	18	17	16
PRU1_GPO_DIV1				PRU1_GPO_DIV0			
R/W-0h				R/W-0h			
15	14	13	12	11	10	9	8
PRU1_GPO_DIV0	PRU1_GPO_MODE	PRU1_GPI_SB	PRU1_GPI_DIV1				
R/W-0h	R/W-0h	R/W-0h	R/W-0h				
7	6	5	4	3	2	1	0
PRU1_GPI_DIV0					PRU1_GPI_CLOCK_MODE	PRU1_GPI_MODE	
R/W-0h					R/W-0h	R/W-0h	

LEGEND: R/W = Read/Write; R = Read only; W1toCl = Write 1 to clear bit; -n = value after reset

Table 4-211. GPCFG1 Register Field Descriptions

Bit	Field	Type	Reset	Description
31-26	RESERVED	R/W	0h	
25	PRU1_GPO_SH_SEL	R	0h	Defines which shadow register is currently getting used for GPO shifting. 0 = gpo_sh0 is selected 1 = gpo_sh1 is selected
24-20	PRU1_GPO_DIV1	R/W	0h	Divisor value (divide by PRU1_GPO_DIV1 + 1). 0h = div 1.0. 1h = div 1.5. 2h = div 2.0. .. 1eh = div 16.0. 1fh = reserved.
19-15	PRU1_GPO_DIV0	R/W	0h	Divisor value (divide by PRU1_GPO_DIV0 + 1). 0h = div 1.0. 1h = div 1.5. 2h = div 2.0. .. 1eh = div 16.0. 1fh = reserved.
14	PRU1_GPO_MODE	R/W	0h	0 = Direct output mode 1 = Serial output mode
13	PRU1_GPI_SB	R/W	0h	28-bit shift in mode Start Bit event. PRU1_GPI_SB (pru1_r31_status[29]) is set when first capture of a 1 on pru1_r31_status[0]. Read 1: Start Bit event occurred. Read 0: Start Bit event has not occurred. Write 1: Will clear PRU1_GPI_SB and clear the whole shift register. Write 0: No Effect.
12-8	PRU1_GPI_DIV1	R/W	0h	Divisor value (divide by PRU1_GPI_DIV1 + 1). 0h = div 1.0. 1h = div 1.5. 2h = div 2.0. .. 1eh = div 16.0. 1fh = reserved.

Table 4-211. GPCFG1 Register Field Descriptions (continued)

Bit	Field	Type	Reset	Description
7-3	PRU1_GPI_DIV0	R/W	0h	Divisor value (divide by PRU1_GPI_DIV0 + 1). 0h = div 1.0. 1h = div 1.5. 2h = div 2.0. .. 1eh = div 16.0. 1fh = reserved.
2	PRU1_GPI_CLK_MODE	R/W	0h	Parallel 16-bit capture mode clock edge. 0 = Use the positive edge of pru1_r31_status[16] 1 = Use the negative edge of pru1_r31_status[16]
1-0	PRU1_GPI_MODE	R/W	0h	0h = Direct input mode. 1h = 16bit parallel capture mode. 2h = 28bit shift in mode. 3h = Reserved.

4.5.7.5 CGR Register (offset = 10h) [reset = 24924h]

CGR is shown in [Figure 4-205](#) and described in [Table 4-212](#).

The Clock Gating Register controls the state of Clock Management of the different modules. Software should not clear {module}_CLK_EN until {module}_CLK_STOP_ACK is 0x1.

Figure 4-205. CGR Register

31	30	29	28	27	26	25	24
RESERVED							
R/W-0h							
23	22	21	20	19	18	17	16
RESERVED						IEP_CLK_EN	IEP_CLK_STOP_ACK
R/W-0h						R/W-1h	R-0h
15	14	13	12	11	10	9	8
IEP_CLK_STOP_REQ	ECAP_CLK_EN	ECAP_CLK_STOP_ACK	ECAP_CLK_STOP_REQ	UART_CLK_EN	UART_CLK_STOP_ACK	UART_CLK_STOP_REQ	INTC_CLK_EN
R/W-0h	R/W-1h	R-0h	R/W-0h	R/W-1h	R-0h	R/W-0h	R/W-1h
7	6	5	4	3	2	1	0
INTC_CLK_STOP_ACK	INTC_CLK_STOP_REQ	PRU1_CLK_EN	PRU1_CLK_STOP_ACK	PRU1_CLK_STOP_REQ	PRU0_CLK_EN	PRU0_CLK_STOP_ACK	PRU0_CLK_STOP_REQ
R-0h	R/W-0h	R/W-1h	R-0h	R/W-0h	R/W-1h	R-0h	R/W-0h

LEGEND: R/W = Read/Write; R = Read only; W1toCl = Write 1 to clear bit; -n = value after reset

Table 4-212. CGR Register Field Descriptions

Bit	Field	Type	Reset	Description
31-18	RESERVED	R/W	0h	
17	IEP_CLK_EN	R/W	1h	IEP clock enable. 0 = Disable Clock 1 = Enable Clock
16	IEP_CLK_STOP_ACK	R	0h	Acknowledgement that IEP clock can be stopped. 0 = Not Ready to Gate Clock 1 = Ready to Gate Clock
15	IEP_CLK_STOP_REQ	R/W	0h	IEP request to stop clock. 0 = do not request to stop Clock 1 = request to stop Clock
14	ECAP_CLK_EN	R/W	1h	ECAP clock enable. 0 = Disable Clock 1 = Enable Clock
13	ECAP_CLK_STOP_ACK	R	0h	Acknowledgement that ECAP clock can be stopped. 0 = Not Ready to Gate Clock 1 = Ready to Gate Clock
12	ECAP_CLK_STOP_REQ	R/W	0h	ECAP request to stop clock. 0 = do not request to stop Clock 1 = request to stop Clock
11	UART_CLK_EN	R/W	1h	UART clock enable. 0 = Disable Clock 1 = Enable Clock
10	UART_CLK_STOP_ACK	R	0h	Acknowledgement that UART clock can be stopped. 0 = Not Ready to Gate Clock 1 = Ready to Gate Clock
9	UART_CLK_STOP_REQ	R/W	0h	UART request to stop clock. 0 = do not request to stop Clock 1 = request to stop Clock
8	INTC_CLK_EN	R/W	1h	INTC clock enable. 0 = Disable Clock 1 = Enable Clock

Table 4-212. CGR Register Field Descriptions (continued)

Bit	Field	Type	Reset	Description
7	INTC_CLK_STOP_ACK	R	0h	Acknowledgement that INTC clock can be stopped. 0 = Not Ready to Gate Clock 1 = Ready to Gate Clock
6	INTC_CLK_STOP_REQ	R/W	0h	INTC request to stop clock. 0 = do not request to stop Clock 1 = request to stop Clock
5	PRU1_CLK_EN	R/W	1h	PRU1 clock enable. 0 = Disable Clock 1 = Enable Clock
4	PRU1_CLK_STOP_ACK	R	0h	Acknowledgement that PRU1 clock can be stopped. 0 = Not Ready to Gate Clock 1 = Ready to Gate Clock
3	PRU1_CLK_STOP_REQ	R/W	0h	PRU1 request to stop clock. 0 = do not request to stop Clock 1 = request to stop Clock
2	PRU0_CLK_EN	R/W	1h	PRU0 clock enable. 0 = Disable Clock 1 = Enable Clock
1	PRU0_CLK_STOP_ACK	R	0h	Acknowledgement that PRU0 clock can be stopped. 0 = Not Ready to Gate Clock 1 = Ready to Gate Clock
0	PRU0_CLK_STOP_REQ	R/W	0h	PRU0 request to stop clock. 0 = do not request to stop Clock 1 = request to stop Clock

4.5.7.6 ISRP Register (offset = 14h) [reset = 0h]

ISRP is shown in [Figure 4-206](#) and described in [Table 4-213](#).

The IRQ Status Raw Parity register is a snapshot of the IRQ raw status for the PRU ICSS memory parity events. The raw status is set even if the event is not enabled.

Figure 4-206. ISRP Register

31	30	29	28	27	26	25	24
RESERVED							
R/W-0h							
23	22	21	20	19	18	17	16
RESERVED				RAM_PE_RAW			
R/W-0h				R/W-0h			
15	14	13	12	11	10	9	8
PRU1_DMEM_PE_RAW				PRU1_IMEM_PE_RAW			
R/W-0h				R/W-0h			
7	6	5	4	3	2	1	0
PRU0_DMEM_PE_RAW				PRU0_IMEM_PE_RAW			
R/W-0h				R/W-0h			

LEGEND: R/W = Read/Write; R = Read only; W1toCl = Write 1 to clear bit; -n = value after reset

Table 4-213. ISRP Register Field Descriptions

Bit	Field	Type	Reset	Description
31-20	RESERVED	R/W	0h	
19-16	RAM_PE_RAW	R/W	0h	RAM Parity Error RAW for Byte3, Byte2, Byte1, Byte0. Note RAM_PE_RAW[0] maps to Byte0. Write 0: No action. Read 0: No event pending. Read 1: Event pending. Write 1: Set event (debug).
15-12	PRU1_DMEM_PE_RAW	R/W	0h	PRU1 DMEM Parity Error RAW for Byte3, Byte2, Byte1, Byte0. Note PRU1_DMEM_PE_RAW[0] maps to Byte0. Write 0: No action. Read 0: No event pending. Read 1: Event pending. Write 1: Set event (debug).
11-8	PRU1_IMEM_PE_RAW	R/W	0h	PRU1 IMEM Parity Error RAW for Byte3, Byte2, Byte1, Byte0. Note PRU1_IMEM_PE_RAW[0] maps to Byte0. Write 0: No action. Read 0: No event pending. Read 1: Event pending. Write 1: Set event (debug).
7-4	PRU0_DMEM_PE_RAW	R/W	0h	PRU0 DMEM Parity Error RAW for Byte3, Byte2, Byte1, Byte0. Note PRU0_DMEM_PE_RAW[0] maps to Byte0. Write 0: No action. Read 0: No event pending. Read 1: Event pending. Write 1: Set event (debug) .
3-0	PRU0_IMEM_PE_RAW	R/W	0h	PRU0 IMEM Parity Error RAW for Byte3, Byte2, Byte1, Byte0. Note PRU0_IRAM_PE_RAW[0] maps to Byte0. Write 0: No action. Read 0: No event pending. Read 1: Event pending. Write 1: Set event (debug) .

4.5.7.7 ISP Register (offset = 18h) [reset = 0h]

ISP is shown in [Figure 4-207](#) and described in [Table 4-214](#).

The IRQ Status Parity Register is a snapshot of the IRQ status for the PRU ICSS memory parity events. The status is set only if the event is enabled. Write 1 to clear the status after the interrupt has been serviced.

Figure 4-207. ISP Register

31	30	29	28	27	26	25	24	23	22	21	20	19	18	17	16
RESERVED												RAM_PE			
R-0h												0h			
15	14	13	12	11	10	9	8	7	6	5	4	3	2	1	0
PRU1_DMEN_PE				PRU1_IMEM_PE				PRU0_DMEN_PE				PRU0_IMEM_PE			
0h				0h				0h				0h			

LEGEND: R/W = Read/Write; R = Read only; W1toCl = Write 1 to clear bit; -n = value after reset

Table 4-214. ISP Register Field Descriptions

Bit	Field	Type	Reset	Description
31-20	RESERVED	R	0h	
19-16	RAM_PE		0h	RAM Parity Error for Byte3, Byte2, Byte1, Byte0. Note RAM_PE[0] maps to Byte0. Write 0: No action. Read 0: No (enabled) event pending. Read 1: Event pending. Write 1: Clear event.
15-12	PRU1_DMEN_PE		0h	PRU1 DMEM Parity Error for Byte3, Byte2, Byte1, Byte0. Note PRU1_DMEN_PE[0] maps to Byte0. Write 0: No action. Read 0: No (enabled) event pending. Read 1: Event pending. Write 1: Clear event.
11-8	PRU1_IMEM_PE		0h	PRU1 IMEM Parity Error for Byte3, Byte2, Byte1, Byte0. Note PRU1_IMEM_PE[0] maps to Byte0. Write 0: No action. Read 0: No (enabled) event pending. Read 1: Event pending. Write 1: Clear event.
7-4	PRU0_DMEN_PE		0h	PRU0 DMEM Parity Error for Byte3, Byte2, Byte1, Byte0. Note PRU0_DMEN_PE[0] maps to Byte0. Write 0: No action. Read 0: No(enabled) event pending. Read 1: Event pending. Write 1: Clear event.
3-0	PRU0_IMEM_PE		0h	PRU0 IMEM Parity Error for Byte3, Byte2, Byte1, Byte0. Note PRU0_IMEM_PE[0] maps to Byte0. Write 0: No action. Read 0: No (enabled) event pending. Read 1: Event pending. Write 1: Clear event.

4.5.7.8 IESP Register (offset = 1Ch) [reset = 0h]

IESP is shown in [Figure 4-208](#) and described in [Table 4-215](#).

The IRQ Enable Set Parity Register enables the IRQ PRU ICSS memory parity events.

Figure 4-208. IESP Register

31	30	29	28	27	26	25	24
RESERVED							
R/W-0h							
23	22	21	20	19	18	17	16
RESERVED				RAM_PE_SET			
R/W-0h				R/W-0h			
15	14	13	12	11	10	9	8
PRU1_DMEN_PE_SET				PRU1_IMEM_PE_SET			
R/W-0h				R/W-0h			
7	6	5	4	3	2	1	0
PRU0_DMEN_PE_SET				PRU0_IMEM_PE_SET			
R/W-0h				R/W-0h			

LEGEND: R/W = Read/Write; R = Read only; W1toCl = Write 1 to clear bit; -n = value after reset

Table 4-215. IESP Register Field Descriptions

Bit	Field	Type	Reset	Description
31-20	RESERVED	R/W	0h	
19-16	RAM_PE_SET	R/W	0h	RAM Parity Error Set Enable for Byte3, Byte2, Byte1, Byte0. Note RAM_PE_SET[0] maps to Byte0. Write 0: No action. Read 0: Interrupt disabled (masked). Read 1: Interrupt enabled. Write 1: Enable interrupt.
15-12	PRU1_DMEN_PE_SET	R/W	0h	PRU1 DMEM Parity Error Set Enable for Byte3, Byte2, Byte1, Byte0. Note PRU1_DMEN_PE_SET[0] maps to Byte0. Write 0: No action. Read 0: Interrupt disabled (masked). Read 1: Interrupt enabled. Write 1: Enable interrupt.
11-8	PRU1_IMEM_PE_SET	R/W	0h	PRU1 IMEM Parity Error Set Enable for Byte3, Byte2, Byte1, Byte0. Note PRU1_IMEM_PE_SET[0] maps to Byte0. Write 0: No action. Read 0: Interrupt disabled (masked). Read 1: Interrupt enabled. Write 1: Enable interrupt.
7-4	PRU0_DMEN_PE_SET	R/W	0h	PRU0 DMEM Parity Error Set Enable for Byte3, Byte2, Byte1, Byte0. Note PRU0_DMEN_PE_SET[0] maps to Byte0. Write 0: No action. Read 0: Interrupt disabled (masked). Read 1: Interrupt enabled. Write 1: Enable interrupt.
3-0	PRU0_IMEM_PE_SET	R/W	0h	PRU0 IMEM Parity Error Set Enable for Byte3, Byte2, Byte1, Byte0. Note PRU0_IMEM_PE_SET[0] maps to Byte0. Write 0: No action. Read 0: Interrupt disabled (masked). Read 1: Interrupt enabled. Write 1: Enable interrupt.

4.5.7.9 IECP Register (offset = 20h) [reset = 0h]

IECP is shown in [Figure 4-209](#) and described in [Table 4-216](#).

The IRQ Enable Clear Parity Register disables the IRQ PRU ICSS memory parity events.

Figure 4-209. IECP Register

31	30	29	28	27	26	25	24
RESERVED							
R/W-0h							
23	22	21	20	19	18	17	16
RESERVED							
R/W-0h							
15	14	13	12	11	10	9	8
PRU1_DMEM_PE_CLR				PRU1_IMEM_PE_CLR			
R/W-0h				R/W-0h			
7	6	5	4	3	2	1	0
PRU0_DMEM_PE_CLR				PRU0_IMEM_PE_CLR			
R/W-0h				R/W-0h			

LEGEND: R/W = Read/Write; R = Read only; W1toCl = Write 1 to clear bit; -n = value after reset

Table 4-216. IECP Register Field Descriptions

Bit	Field	Type	Reset	Description
31-16	RESERVED	R/W	0h	
15-12	PRU1_DMEM_PE_CLR	R/W	0h	PRU1 DMEM Parity Error Clear Enable for Byte3, Byte2, Byte1, Byte0. Note PRU1_DMEM_PE_CLR[0] maps to Byte0. Write 0: No action. Read 0: Interrupt disabled (masked). Read 1: Interrupt enabled. Write 1: Disable interrupt.
11-8	PRU1_IMEM_PE_CLR	R/W	0h	PRU1 IMEM Parity Error Clear Enable for Byte3, Byte2, Byte1, Byte0. Note PRU1_IMEM_PE_CLR[0] maps to Byte0. Write 0: No action. Read 0: Interrupt disabled (masked). Read 1: Interrupt enabled. Write 1: Disable interrupt.
7-4	PRU0_DMEM_PE_CLR	R/W	0h	PRU0 DMEM Parity Error Clear Enable for Byte3, Byte2, Byte1, Byte0. Note PRU0_DMEM_PE_CLR[0] maps to Byte0. Write 0: No action. Read 0: Interrupt disabled (masked). Read 1: Interrupt enabled. Write 1: Disable interrupt.
3-0	PRU0_IMEM_PE_CLR	R/W	0h	PRU0 IMEM Parity Error Clear Enable for Byte3, Byte2, Byte1, Byte0. Note PRU0_IMEM_PE_CLR[0] maps to Byte0. Write 0: No action . Read 0: Interrupt disabled (masked). Read 1: Interrupt enabled. Write 1: Disable interrupt.

4.5.7.10 PMAO Register (offset = 28h) [reset = 0h]

PMAO is shown in [Figure 4-210](#) and described in [Table 4-217](#).

The PRU Master OCP Address Offset Register enables for the PRU OCP Master Port Address to have an offset of minus 0x0008_0000. This enables the PRU to access External Host address space starting at 0x0000_0000.

Figure 4-210. PMAO Register

31	30	29	28	27	26	25	24
RESERVED							
R/W-0h							
23	22	21	20	19	18	17	16
RESERVED							
R/W-0h							
15	14	13	12	11	10	9	8
RESERVED							
R/W-0h							
7	6	5	4	3	2	1	0
RESERVED						PMAO_PRU1	PMAO_PRU0
R/W-0h						R/W-0h	R/W-0h

LEGEND: R/W = Read/Write; R = Read only; W1toCl = Write 1 to clear bit; -n = value after reset

Table 4-217. PMAO Register Field Descriptions

Bit	Field	Type	Reset	Description
31-2	RESERVED	R/W	0h	
1	PMAO_PRU1	R/W	0h	PRU1 OCP Master Port Address Offset Enable. 0 = Disable address offset. 1 = Enable address offset of -0x0008_0000.
0	PMAO_PRU0	R/W	0h	PRU0 OCP Master Port Address Offset Enable. 0 = Disable address offset. 1 = Enable address offset of -0x0008_0000.

4.5.7.11 IEPCLK Register (offset = 30h) [reset = 0h]

IEPCLK is shown in [Figure 4-211](#) and described in [Table 4-218](#).

The IEP Clock Source Register defines the source of the IEP clock.

Figure 4-211. IEPCLK Register

31	30	29	28	27	26	25	24
RESERVED							
R/W-0h							
23	22	21	20	19	18	17	16
RESERVED							
R/W-0h							
15	14	13	12	11	10	9	8
RESERVED							
R/W-0h							
7	6	5	4	3	2	1	0
RESERVED							OCP_EN
R/W-0h							R/W-0h

LEGEND: R/W = Read/Write; R = Read only; W1toCl = Write 1 to clear bit; -n = value after reset

Table 4-218. IEPCLK Register Field Descriptions

Bit	Field	Type	Reset	Description
31-1	RESERVED	R/W	0h	
0	OCP_EN	R/W	0h	0 = iep_clk is the source. 1 = ocp_clk is the source.

4.5.7.12 SPP Register (offset = 34h) [reset = 0h]

SPP is shown in [Figure 4-212](#) and described in [Table 4-219](#).

The Scratch Pad Priority and Configuration Register defines the access priority assigned to the PRU cores and configures the scratch pad XFR shift functionality.

Figure 4-212. SPP Register

31	30	29	28	27	26	25	24
RESERVED							
R/W-0h							
23	22	21	20	19	18	17	16
RESERVED							
R/W-0h							
15	14	13	12	11	10	9	8
RESERVED							
R/W-0h							
7	6	5	4	3	2	1	0
RESERVED						XFR_SHIFT_EN	PRU1_PAD_HP_EN
R/W-0h						R/W-0h	R/W-0h

LEGEND: R/W = Read/Write; R = Read only; W1toCl = Write 1 to clear bit; -n = value after reset

Table 4-219. SPP Register Field Descriptions

Bit	Field	Type	Reset	Description
31-2	RESERVED	R/W	0h	
1	XFR_SHIFT_EN	R/W	0h	Enables XIN/XOUT shift functionality. When enabled, R0 [4:0] (internal to PRU) defines the 32-bit offset for XIN and XOUT operations with the scratch pad. 0 = Disabled. 1 = Enabled.
0	PRU1_PAD_HP_EN	R/W	0h	Defines which PRU wins write cycle arbitration to a common scratch pad bank. The PRU which has higher priority will always perform the write cycle with no wait states. The lower PRU will get stalled/wait states until higher PRU is not performing write cycles. If the lower priority PRU writes to the same byte has the higher priority PRU, then the lower priority PRU will over write the bytes. 0 = PRU0 has highest priority. 1 = PRU1 has highest priority.

4.5.7.13 PIN_MX Register (offset = 40h) [reset = 0h]

PIN_MX is shown in [Figure 4-213](#) and described in [Table 4-220](#).

The Pin Mux Select Register defines the state of the PRU ICSS internal pinmuxing.

Figure 4-213. PIN_MX Register

31	30	29	28	27	26	25	24	23	22	21	20	19	18	17	16
RESERVED															
R/W-0h															
15	14	13	12	11	10	9	8	7	6	5	4	3	2	1	0
RESERVED								PIN_MUX_SEL							
R/W-0h								R/W-0h							

LEGEND: R/W = Read/Write; R = Read only; W1toCl = Write 1 to clear bit; -n = value after reset

Table 4-220. PIN_MX Register Field Descriptions

Bit	Field	Type	Reset	Description
31-8	RESERVED	R/W	0h	
7-0	PIN_MUX_SEL	R/W	0h	Defines the state of PIN_MUX_SEL [1:0] for internal pinmuxing.

Graphics Accelerator (SGX)

This chapter describes the graphics accelerator for the device.

Topic	Page
5.1 Introduction	445
5.2 Integration	448
5.3 Functional Description	450

5.1 Introduction

This chapter describes the 2D/3D graphics accelerator (SGX) for the device.

NOTE: The SGX subsystem is a Texas Instruments instantiation of the POWERVR® SGX530 core from Imagination Technologies Ltd.

This document contains materials that are ©2003-2007 Imagination Technologies Ltd.

POWERVR® and USSE™ are trademarks or registered trademarks of Imagination Technologies Ltd.

The 2D/3D graphics accelerator (SGX) subsystem accelerates 2-dimensional (2D) and 3-dimensional (3D) graphics applications. The SGX subsystem is based on the POWERVR® SGX core from Imagination Technologies. SGX is a new generation of programmable POWERVR graphic cores. The POWERVR SGX530 v1.2.5 architecture is scalable and can target market segments, from portable devices to HMI.

5.1.1 POWERVR SGX Main Features

- 2D and 3D graphics
- Tile-based architecture
- Universal scalable shader engine (USSE™) – multithreaded engine incorporating pixel and vertex shader functionality
- Advanced shader feature set: in excess of OpenGL2.0
- Industry-standard API support: OpenGL ES 1.1 and 2.0, OpenVG v1.0.1
- Fine-grained task switching, load balancing, and power management
- Advanced geometry direct memory access (DMA) driven operation for minimum CPU interaction
- Programmable high-quality image anti-aliasing
- POWERVR SGX core MMU for address translation from the core virtual address to the external physical address (up to 4GB address range)
- Fully virtualized memory addressing for OS operation in a unified memory architecture
- Advanced and standard 2D operations [e.g., vector graphics, BLTs (block level transfers), ROPs (raster operations)]
- 32K stride support

5.1.2 SGX 3D Features

- Deferred pixel shading
- On-chip tile floating point depth buffer
- 8-bit stencil with on-chip tile stencil buffer
- 8 parallel depth/stencil tests per clock
- Scissor test
- Texture support:
 - Cube map
 - Projected textures
 - 2D textures
 - Nonsquare textures
- Texture formats:
 - RGBA 8888, 565, 1555
 - Monochromatic 8, 16, 16f, 32f, 32int
 - Dual channel, 8:8, 16:16, 16f:16f
 - Compressed textures PVR-TC1, PVR-TC2, ETC1
 - Programmable support for YUV 420 and 422 formats for YUV/RGB color conversion
- Resolution support:
 - Frame buffer maximum size = 2048 x 2048
 - Texture maximum size = 2048 x 2048
- Texture filtering:
 - Bilinear, trilinear, anisotropic
 - Independent minimum and maximum control
- Antialiasing:
 - 4x multisampling
 - Up to 16x full scene anti-aliasing
 - Programmable sample positions
- Indexed primitive list support
 - Bus mastered
- Programmable vertex DMA
- Render to texture:
 - Including twiddled formats
 - Auto MipMap generation
- Multiple on-chip render targets (MRT).
Note: Performance is limited when the on-chip memory is not available.

5.1.3 Universal Scalable Shader Engine (USSE) – Key Features

The USSE is the engine core of the POWERVR SGX architecture and supports a broad range of instructions.

- Single programming model:
 - Multithreaded with 16 simultaneous execution threads and up to 64 simultaneous data instances
 - Zero-cost swapping in, and out, of threads
 - Cached program execution model
 - Dedicated pixel processing instructions
 - Dedicated video encode/decode instructions
- SIMD execution unit supporting operations in:
 - 32-bit IEEE float
 - 2-way 16-bit fixed point
 - 4-way 8-bit integer
 - 32-bit bit-wise (logical only)
- Static and dynamic flow control:
 - Subroutine calls
 - Loops
 - Conditional branches
 - Zero-cost instruction predication
- Procedural geometry:
 - Allows generation of primitives
 - Effective geometry compression
 - High-order surface support
- External data access:
 - Permits reads from main memory using cache
 - Permits writes to main memory
 - Data fence facility
 - Dependent texture reads

5.1.4 Unsupported Features

There are no unsupported SGX530 features for this device.

5.2 Integration

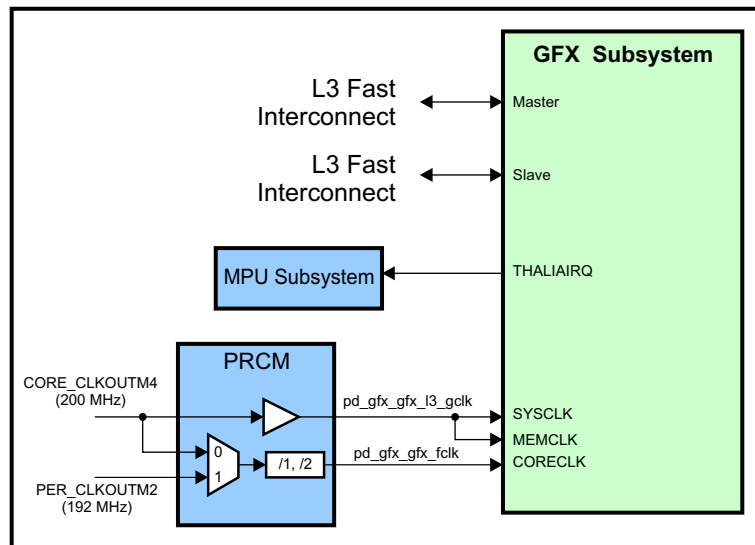


Figure 5-1. SGX530 Integration

5.2.1 SGX530 Connectivity Attributes

The general connectivity attributes of the SGX530 are shown in the following table.

Table 5-1. SGX530 Connectivity Attributes

Attributes	Type
Power domain	GFX Domain
Clock domain	SGX_CLK
Reset signals	SGX_RST
Idle/Wakeup signals	Smart Idle Initiator Standby
Interrupt request	THALIAIRQ (GFXINT) to MPU Subsystem
DMA request	None
Physical address	L3 Fast slave port

5.2.2 SGX530 Clock and Reset Management

The SGX530 uses separate functional and interface clocks. The SYSCLK is the clock for the slave interface and runs at the L3F frequency. The MEMCLK is the clock for the memories and master interface and also runs at the L3F frequency. The CORECLK is the functional clock. It can be sourced from either the L3F clock (CORE_CLKOUTM4) or from the 192 MHz PER_CLKOUTM2 and can optionally be divided by 2.

Table 5-2. SGX530 Clock Signals

Clock signal	Max Freq	Reference / Source	Comments
SYSCLK Interface clock	200 MHz	CORE_CLKOUTM4	pd_gfx_gfx_l3_gclk From PRCM
MEMCLK Memory Clock	200 MHz	CORE_CLKOUTM4	pd_gfx_gfx_l3_gclk From PRCM
CORECLK Functional clock	200 MHz	PER_CLKOUTM2 or CORE_CLKOUTM4	pd_gfx_gfx_fclk From PRCM

5.2.3 SGX530 Pin List

The SGX530 module does not include any external interface pins.

5.3 Functional Description

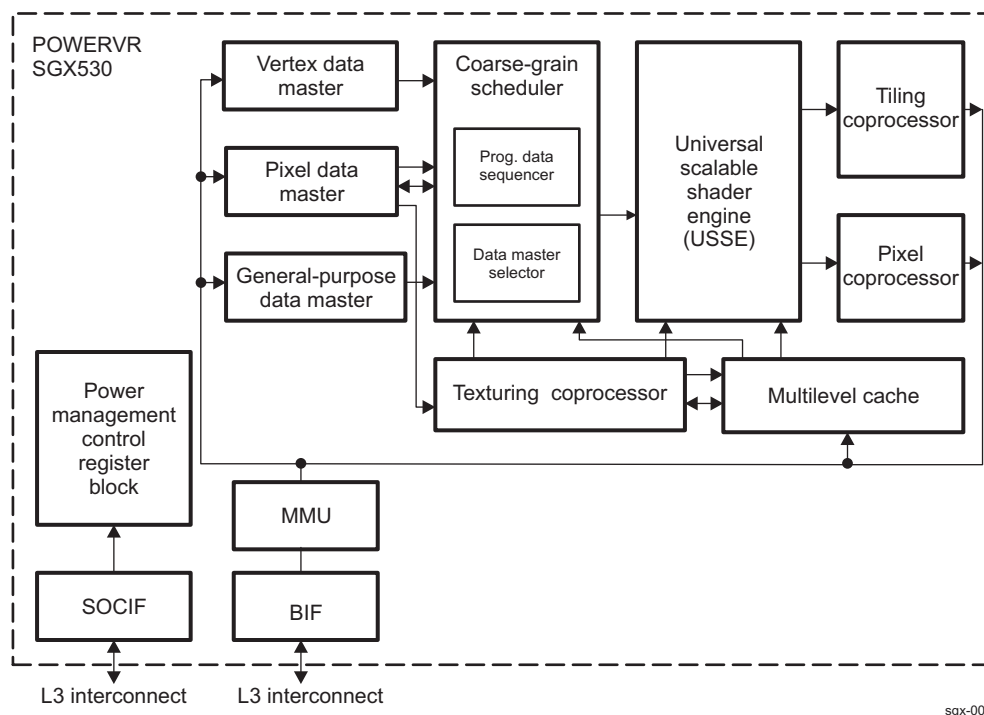
5.3.1 SGX Block Diagram

The SGX subsystem is based on the POWERVR® SGX530 core from Imagination Technologies. The architecture uses programmable and hard coded pipelines to perform various processing tasks required in 2D, 3D, and video processing. The SGX architecture comprises the following elements:

- Coarse grain scheduler
 - Programmable data sequencer (PDS)
 - Data master selector (DMS)
- Vertex data master (VDM)
- Pixel data master (PDM)
- General-purpose data master
- USSE
- Tiling coprocessor
- Pixel coprocessor
- Texturing coprocessor
- Multilevel cache

Figure 5-2 shows a block diagram of the SGX cores.

Figure 5-2. SGX Block Diagram



5.3.2 SGX Elements Description

The coarse grain scheduler (CGS) is the main system controller for the POWERVR SGX architecture. It consists of two stages, the DMS and the PDS. The DMS processes requests from the data masters and determines which tasks can be executed given the resource requirements. The PDS then controls the loading and processing of data on the USSE.

There are three data masters in the SGX core:

- The VDM is the initiator of transform and lighting processing within the system. The VDM reads an

input control stream, which contains triangle index data and state data. The state data indicates the PDS program, size of the vertices, and the amount of USSE output buffer resource available to the VDM. The triangle data is parsed to determine unique indices that must be processed by the USSE. These are grouped together according to the configuration provided by the driver and presented to the DMS.

- The PDM is the initiator of rasterization processing within the system. Each pixel pipeline processes pixels for a different half of a given tile, which allows for optimum efficiency within each pipe due to locality of data. It determines the amount of resource required within the USSE for each task. It merges this with the state address and issues a request to the DMS for execution on the USSE.
- The general-purpose data master responds to events within the system (such as end of a pass of triangles from the ISP, end of a tile from the ISP, end of render, or parameter stream breakpoint event). Each event causes either an interrupt to the host or synchronized execution of a program on the PDS. The program may, or may not cause a subsequent task to be executed on the USSE.

The USSE is a user-programmable processing unit. Although general in nature, its instructions and features are optimized for three types of task: processing vertices (vertex shading), processing pixels (pixel shading), and video/imaging processing.

The multilevel cache is a 2-level cache consisting of two modules: the main cache and the mux/arbitrer/demux/decompression unit (MADD). The MADD is a wrapper around the main cache module designed to manage and format requests to and from the cache, as well as providing Level 0 caching for texture and USSE requests. The MADD can accept requests from the PDS, USSE, and texture address generator modules. Arbitration, as well as any required texture decompression, are performed between the three data streams.

The texturing coprocessor performs texture address generation and formatting of texture data. It receives requests from either the iterators or USSE modules and translates these into requests in the multilevel cache. Data returned from the cache are then formatted according to the texture format selected, and sent to the USSE for pixel-shading operations.

To process pixels in a tiled manner, the screen is divided into tiles and arranged as groups of tiles by the tiling coprocessor. An inherent advantage of tiling architecture is that a large amount of vertex data can be rejected at this stage, thus reducing the memory storage requirements and the amount of pixel processing to be performed.

The pixel coprocessor is the final stage of the pixel-processing pipeline and controls the format of the final pixel data sent to the memory. It supplies the USSE with an address into the output buffer and then USSE returns the relevant pixel data. The address order is determined by the frame buffer mode. The pixel coprocessor contains a dithering and packing function.

Interrupts

This section describes the interrupts for the device.

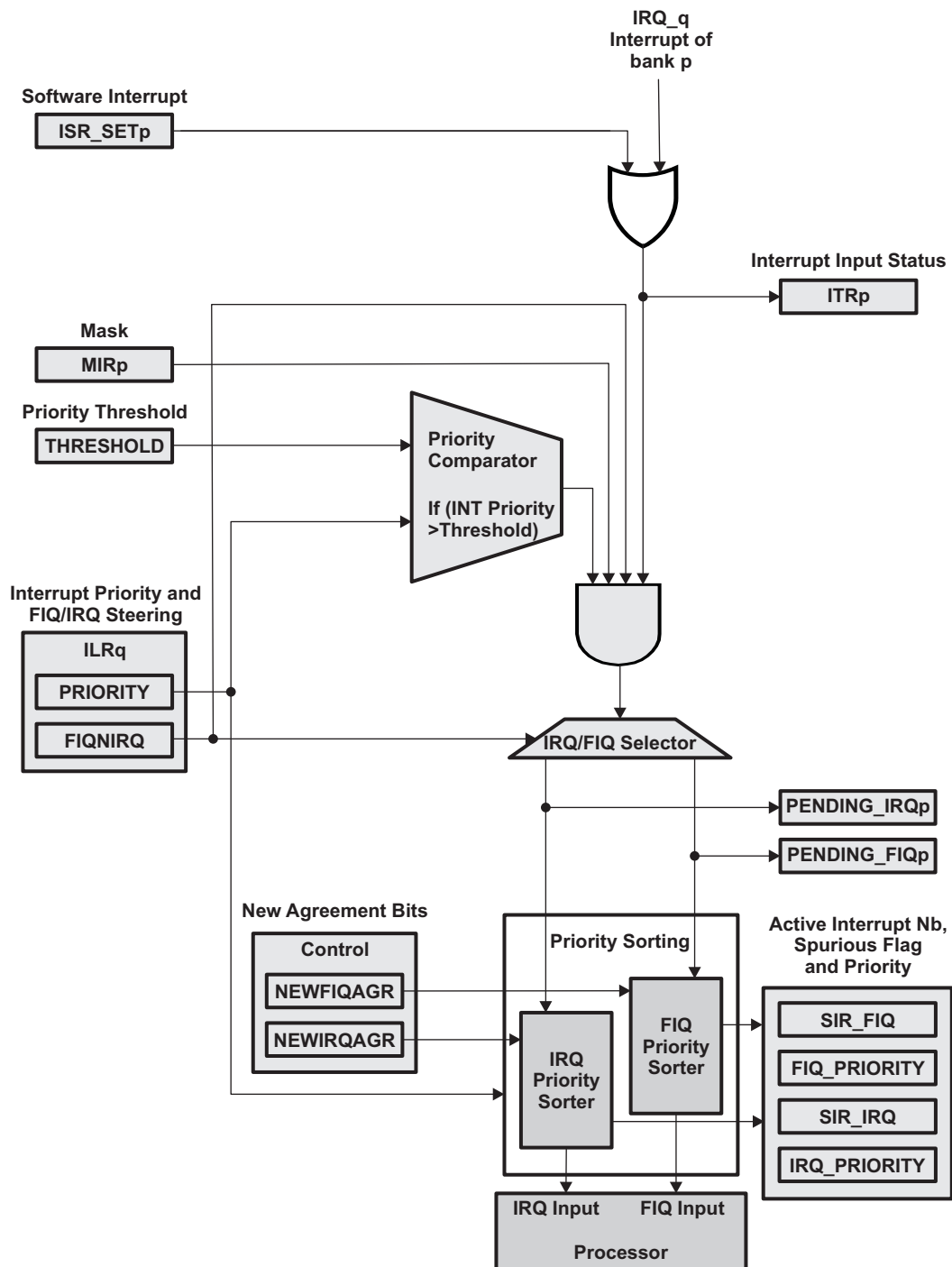
Topic	Page
6.1 Functional Description	453
6.2 Basic Programming Model.....	456
6.3 ARM Cortex-A8 Interrupts.....	465
6.4 PWM Events.....	469
6.5 Interrupt Controller Registers	470

6.1 Functional Description

The interrupt controller processes incoming interrupts by masking and priority sorting to produce the interrupt signals for the processor to which it is attached. Figure 6-1 shows the top-level view of interrupt processing.

NOTE: FIQ is not available on general-purpose (GP) devices.

Figure 6-1. Interrupt Controller Block Diagram



6.1.1 Interrupt Processing

6.1.1.1 Input Selection

The INTC supports only level-sensitive incoming interrupt detection. A peripheral asserting an interrupt maintains it until software has handled the interrupt and instructed the peripheral to deassert the interrupt. A software interrupt is generated if the corresponding bit in the MPU_INTC.INTC_ISR_SETn register is set (register bank number: n = [0,1,2,3] for the MPU subsystem INTC, 128 incoming interrupt lines are supported). The software interrupt clears when the corresponding bit in the MPU_INTC.INTC_ISR_CLEARn register is written. Typical use of this feature is software debugging.

6.1.1.2 Masking

6.1.1.2.1 Individual Masking

Detection of interrupts on each incoming interrupt line can be enabled or disabled independently by the MPU_INTC.INTC_MIRn interrupt mask register. In response to an unmasked incoming interrupt, the INTC can generate one of two types of interrupt requests to the processor:

- IRQ: low-priority interrupt request
- FIQ: fast interrupt request (Not available on General Purpose (GP) devices)

The type of interrupt request is determined by the MPU_INTC.INTC_ILRm[0] FIQNIRQ bit (m= [0,127]). The current incoming interrupt status before masking is readable from the MPU_INTC.INTC_ITRn register. After masking and IRQ/FIQ selection, and before priority sorting is done, the interrupt status is readable from the MPU_INTC.INTC_PENDING_IRQn and MPU_INTC.INTC_PENDING_FIQn registers.

6.1.1.2.2 Priority Masking

To enable faster processing of high-priority interrupts, a programmable priority masking threshold is provided (the MPU_INTC.INTC_THRESHOLD[7:0] PRIORITYTHRESHOLD field). This priority threshold allows preemption by higher priority interrupts; all interrupts of lower or equal priority than the threshold are masked. However, priority 0 can never be masked by this threshold; a priority threshold of 0 is treated the same way as priority 1. PRIORITY and PRIORITYTHRESHOLD fields values can be set between 0x0 and 0x7F; 0x0 is the highest priority and 0x7F is the lowest priority. When priority masking is not necessary, a priority threshold value of 0xFF disables the priority threshold mechanism. This value is also the reset default for backward compatibility with previous versions of the INTC.

6.1.1.3 Priority Sorting

A priority level (0 being the highest) is assigned to each incoming interrupt line. Both the priority level and the interrupt request type are configured by the MPU_INTC.INTC_ILRm register. If more than one incoming interrupt with the same priority level and interrupt request type occur simultaneously, the highest-numbered interrupt is serviced first. When one or more unmasked incoming interrupts are detected, the INTC separates between IRQ and FIQ using the corresponding MPU_INTC.INTC_ILRm[0] FIQNIRQ bit.

The result is placed in INTC_PENDING_IRQn or INTC_PENDING_FIQn. If no other interrupts are currently being processed, INTC asserts IRQ/FIQ and starts the priority computation. Priority sorting for IRQ and FIQ can execute in parallel. Each IRQ/FIQ priority sorter determines the highest priority interrupt number and that number is placed in the corresponding MPU_INTC.INTC_SIR_IRQ[6:0] ACTIVEIRQ field or MPU_INTC.INTC_SIR_FIQ[6:0] ACTIVEFIQ field. The value is preserved until the corresponding MPU_INTC.INTC_CONTROL_NEWIRQAGR or NEWFIQAGR bit is set. Once the interrupting peripheral device has been serviced and the incoming interrupt deasserted, the user must write to the appropriate NEWIRQAGR or NEWFIQAGR bit to indicate to the INTC the interrupt has been handled. If there are any pending unmasked incoming interrupts for this interrupt request type, the INTC restarts the appropriate priority sorter; otherwise, the IRQ or FIQ interrupt line is deasserted.

6.1.2 Register Protection

If the MPU_INTC.INTC_PROTECTION[0] PROTECTION bit is set, access to the INTC registers is restricted to privileged mode. Access to the MPU_INTC.INTC_PROTECTION register is always restricted to privileged mode. For more information, see , *INTC_PROTECTION Register (offset = 4Ch) [reset = 0h]*.

6.1.3 Module Power Saving

The INTC provides an auto-idle function in its three clock domains:

- Interface clock
- Functional clock
- Synchronizer clock

The interface clock auto-idle power-saving mode is enabled if the MPU_INTC.INTC_SYSCONFIG[0] AUTOIDLE bit is set to 1. When this mode is enabled and there is no activity on the bus interface, the interface clock is disabled internally to the module, thus reducing power consumption. When there is new activity on the bus interface, the interface clock restarts without any latency penalty. After reset, this mode is disabled, by default. The functional clock auto-idle power-saving mode is enabled if the MPU_INTC.INTC_IDLE[0] FUNCIDLE bit is set to 0. When this mode is enabled and there is no active interrupt (IRQ or FIQ interrupt being processed or generated) or no pending incoming interrupt, the functional clock is disabled internally to the module, thus reducing power consumption.

When a new unmasked incoming interrupt is detected, the functional clock restarts and the INTC processes the interrupt. If this mode is disabled, the interrupt latency is reduced by one cycle. After reset, this mode is enabled, by default. The synchronizer clock allows external asynchronous interrupts to be resynchronized before they are masked. The synchronizer input clock has an auto-idle power-saving mode enabled if the MPU_INTC.INTC_IDLE[1] TURBO bit is set to 1. If the auto-idle mode is enabled, the standby power is reduced, but the IRQ or FIQ interrupt latency increases from four to six functional clock cycles. This feature can be enabled dynamically according to the requirements of the device. After reset, this mode is disabled, by default.

6.1.4 Error Handling

The following accesses will cause an error:

- Privilege violation (attempt to access PROTECTION register in user mode or any register in user mode if Protection bit is set)
- Unsupported commands

The following accesses will not cause any error response:

- Access to a non-decoded address
- Write to a read-only register

6.1.5 Interrupt Handling

The IRQ/FIQ interrupt generation takes four INTC functional clock cycles (plus or minus one cycle) if the MPU_INTC.INTC_IDLE[1] TURBO bit is set to 0. If the TURBO bit is set to 1, the interrupt generation takes six cycles, but power consumption is reduced while waiting for an interrupt. These latencies can be reduced by one cycle by disabling functional clock auto-idle (MPU_INTC.INTC_IDLE[0] FUNCIDLE bit set to 1), but power consumption is increased, so the benefit is minimal.

To minimize interrupt latency when an unmasked interrupt occurs, the IRQ or FIQ interrupt is generated before priority sorting completion. The priority sorting takes 10 functional clock cycles, which is less than the minimum number of cycles required for the MPU to switch to the interrupt context after reception of the IRQ or FIQ event.

Any read of the MPU_INTC.INTC_SIR_IRQ or MPU_INTC.INTC_SIR_FIQ register during the priority sorting process stalls until priority sorting is complete and the relevant register is updated. However, the delay between the interrupt request being generated and the interrupt service routine being executed is such that priority sorting always completes before the MPU_INTC.INTC_SIR_IRQ or MPU_INTC.INTC_SIR_FIQ register is read.

6.2 Basic Programming Model

6.2.1 Initialization Sequence

1. Program the MPU_INTC.INTC_SYSCONFIG register: If necessary, enable the interface clock autogating by setting the AUTOIDLE bit.
2. Program the MPU_INTC.INTC_IDLE register: If necessary, disable functional clock autogating or enable synchronizer autogating by setting the FUNCIDLE bit or TURBO bit accordingly.
3. Program the MPU_INTC.INTC_ILRm register for each interrupt line: Assign a priority level and set the FIQNIRQ bit for an FIQ interrupt (by default, interrupts are mapped to IRQ and priority is 0x0 [highest]).
4. Program the MPU_INTC.INTC_MIRn register: Enable interrupts (by default, all interrupt lines are masked). NOTE: To program the MPU_INTC.INTC_MIRn register, the MPU_INTC.INTC_MIR_SETn and MPU_INTC.INTC_MIR_CLEARn registers are provided to facilitate the masking, even if it is possible for backward-compatibility to write directly to the MPU_INTC.INTC_MIRn register.

6.2.2 INTC Processing Sequence

After the INTC_MIRn and INTC_ILRm registers are configured to enable and assign priorities to incoming interrupts, the interrupt is processed as explained in the following subsections. IRQ and FIQ processing sequences are quite similar, the differences for the FIQ sequence are shown after a '/' character in the code below.

1. One or more unmasked incoming interrupts (M_IRQ_n signals) are received and IRQ or FIQ outputs (IRQ/FIQ) are not currently asserted.
2. If the INTC_ILRm[0] FIQNIRQ bit is cleared to 0, the MPU_INTC_IRQ output signal is generated. If the FIQNIRQ bit is set to 1, the MPU_INTC_FIQ output signal is generated.
3. The INTC performs the priority sorting and updates the INTC_SIR_IRQ[6:0] ACTIVEIRQ /INTC_SIR_FIQ[6:0] ACTIVEFIQ field with the current interrupt number.
4. During priority sorting, if the IRQ/FIQ is enabled at the host processor side, the host processor automatically saves the current context and executes the ISR as follows.

The ARM host processor automatically performs the following actions in pseudo code:

```

LR = PC + 4                /* return link */
SPSR = CPSR               /* Save CPSR before execution */
CPSR[5] = 0               /* Execute in ARM state */
CPSR[7] = 1               /* Disable IRQ */
CPSR[8] = 1               /* Disable Imprecise Data Aborts */
CPSR[9] = CP15_reg1_EEbit /* Endianness on exception entry */
if interrupt == IRQ then
    CPSR[4:0] = 0b10010    /* Enter IRQ mode */
if high vectors configured then
    PC = 0xFFFF0018
else
    PC = 0x00000018        /* execute interrupt vector */
else if interrupt == FIQ then
    CPSR[4:0] = 0b10001    /* Enter FIQ mode */
    CPSR[6] = 1           /* Disable FIQ */
if high vectors configured then
    PC = 0xFFFF001C
else
    PC = 0x0000001C        /* execute interrupt vector */
endif
    
```

- The ISR saves the remaining context, identifies the interrupt source by reading the ACTIVEIRQ/ACTIVEFIQ field, and jumps to the relevant subroutine handler as follows:

CAUTION

The code in steps 5 and 7 is an assembly code compatible with ARM architecture V6 and V7. This code is developed for the Texas Instruments Code Composer Studio tool set. It is a draft version, only tested on an emulated environment.

```

;INTC_SIR_IRQ/INTC_SIR_FIQ register address
INTC_SIR_IRQ_ADDR/INTC_SIR_FIQ_ADDR .word 0x48200040/0x48200044
; ACTIVEIRQ bit field mask to get only the bit field
ACTIVEIRQ_MASK .equ 0x7F
_IRQ_ISR/_FIQ_ISR:
; Save the critical context
STMFD SP!, {R0-R12, LR} ; Save working registers and the Link register
MRS R11, SPSR ; Save the SPSR into R11
; Get the number of the highest priority active IRQ/FIQ
LDR R10, INTC_SIR_IRQ_ADDR/INTC_SIR_FIQ_ADDR
LDR R10, [R10] ; Get the INTC_SIR_IRQ/INTC_SIR_FIQ register
AND R10, R10, #ACTIVEIRQ_MASK ; Apply the mask to get the active IRQ number
; Jump to relevant subroutine handler
LDR PC, [PC, R10, lsl #2] ; PC base address points this instruction + 8
NOP ; To index the table by the PC
; Table of handler start addresses
.word IRQ0handler ;For IRQ0 of BANK0
.word IRQ1handler
.word IRQ2handler

```

- The subroutine handler executes code specific to the peripheral generating the interrupt by handling the event and deasserting the interrupt condition at the peripheral side.

```

; IRQ0 subroutine
IRQ0handler:
; Save working registers
STMFD SP!, {R0-R1}
; Now read-modify-write the peripheral module status register
; to de-assert the M_IRQ_0 interrupt signal
; De-Assert the peripheral interrupt
MOV R0, #0x7 ; Mask for 3 flags
LDR R1, MODULE0_STATUS_REG_ADDR ; Get the address of the module Status Register
STR R0, [R1] ; Clear the 3 flags
; Restore working registers LDMFD SP!, {R0-R1}
; Jump to the end part of the ISR
B IRQ_ISR_end/FIQ_ISR_end

```

7. After the return of the subroutine, the ISR sets the NEWIRQAGR/NEWFIQAGR bit to enable the processing of subsequent pending IRQs/FIQs and to restore ARM context in the following code. Because the writes are posted on an Interconnect bus, to be sure that the preceding writes are done before enabling IRQs/FIQs, a Data Synchronization Barrier is used. This operation ensure that the IRQ/FIQ line is de-asserted before IRQ/FIQ enabling. After that, the INTC processes any other pending interrupts or deasserts the IRQ/FIQ signal if there is no interrupt.

```

; INTC_CONTROL register address
INTC_CONTROL_ADDR .word 0x48200048;
NEWIRQAGR/NEWFIQAGR bit mask to set only the NEWIRQAGR/NEWFIQAGR bit
NEWIRQAGR_MASK/NEWFIQAGR_MASK .equ 0x01/0x02
IRQ_ISR_end/FIQ_ISR_end:
; Allow new IRQs/FIQs at INTC side
; The INTC_CONTROL register is a write only register so no need to write back others bits
MOV R0, #NEWIRQAGR_MASK/NEWFIQAGR_MASK ; Get the NEWIRQAGR/NEWFIQAGR bit position
LDR R1, INTC_CONTROL_ADDR
STR R0, [R1] ; Write the NEWIRQAGR/NEWFIQAGR bit to allow new IRQs/FIQ
; Data Synchronization Barrier
MOV R0, #0
MCR P15, #0, R0, C7, C10, #4
; restore critical context
MSR SPSR, R11 ; Restore the SPSR from R11
LDMFD SP!, {R0-R12, LR} ; Restore working registers and Link register
; Return after handling the interrupt
SUBS PC, LR, #4

```

8. After the ISR return, the ARM automatically restores its context as follows:

```

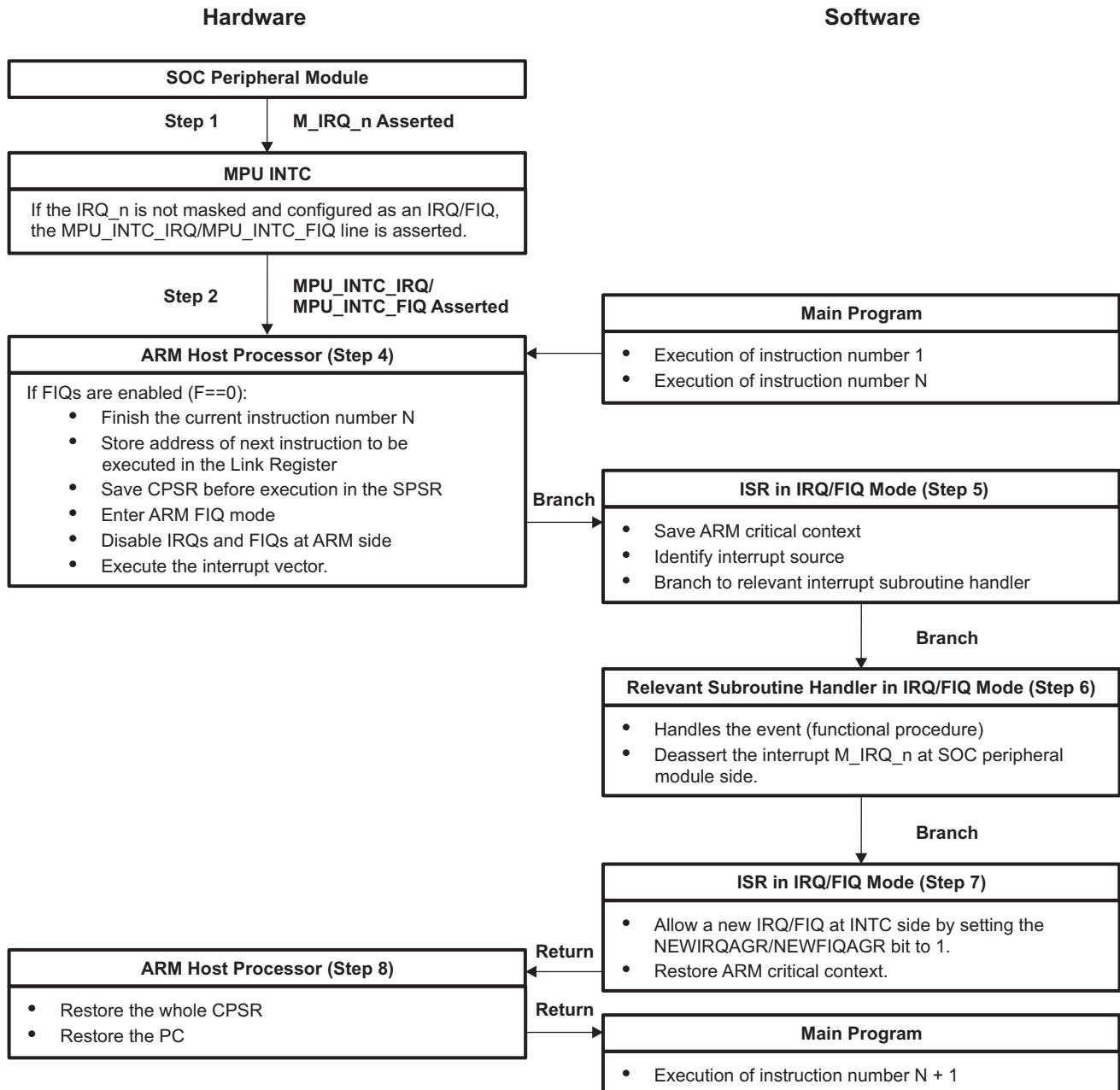
CPSR = SPSR
PC = LR

```

Figure 6-2 shows the IRQ/FIQ processing sequence from the originating device peripheral module to the main program interruption.

The priority sorting mechanism is frozen during an interrupt processing sequence. If an interrupt condition occurs during this time, the interrupt is not lost. It is sorted when the NEWIRQAGR/NEWFIQAGR bit is set (priority sorting is reactivated).

Figure 6-2. IRQ/FIQ Processing Sequence



6.2.3 INTC Preemptive Processing Sequence

Preemptive interrupts, also called nested interrupts, can reduce the latencies for higher priority interrupts. A preemptive ISR can be suspended by a higher priority interrupt. Thus, the higher priority interrupt can be served immediately. Nested interrupts must be used carefully to avoid using corrupted data. Programmers must save corruptible registers and enable IRQ or FIQ at ARM side. IRQ and FIQ processing sequences are quite similar, the differences for the FIQ sequence are shown after a '/' character in the code below.

To enable IRQ/FIQ preemption by higher priority IRQs/FIQs, programmers can follow this procedure to write the ISR.

At the beginning of an IRQ/FIQ ISR:

1. Save the ARM critical context registers.
2. Save the INTC_THRESHOLD PRIORITYTHRESHOLD field before modifying it.
3. Read the active interrupt priority in the INTC_IRQ_PRIORITY IRQPRIORITY/INTC_FIQ_PRIORITY FIQPRIORITY field and write it to the PRIORITYTHRESHOLD(1) field.
4. Read the active interrupt number in the INTC_SIR_IRQ[6:0] ACTIVEIRQ/INTC_SIR_FIQ[6:0] ACTIVEFIQ field to identify the interrupt source.
5. Write 1 to the appropriate INTC_CONTROL NEWIRQAGR and (2) NEWFIQAGR bit while an interrupt is still processing to allow only higher priority interrupts to preempt.
6. Because the writes are posted on an Interconnect bus, to be sure that the preceding writes are done before enabling IRQs/FIQs, a Data Synchronization Barrier is used. This operation ensure that the IRQ line is de-asserted before IRQ/FIQ enabling.
7. Enable IRQ/FIQ at ARM side.
8. Jump to the relevant subroutine handler.

The following sample code shows the previous steps:

CAUTION

The following code is an assembly code compatible with ARM architecture V6 and V7. This code is developed for the Texas Instruments Code Composer Studio tool set. It is a draft version, only tested on an emulated environment.

```

; bit field mask to get only the bit field
ACTIVEPRIO_MASK .equ 0x7F
_IRQ_ISR:
; Step 1 : Save the critical context
STMFD SP!, {R0-R12, LR} ; Save working registers
MRS R11, SPSR ; Save the SPSR into R11
; Step 2 : Save the INTC_THRESHOLD register into R12
LDR R0, INTC_THRESHOLD_ADDR
LDR R12, [R0]
(1) The priority-
threshold mechanism is enabled automatically when writing a priority in the range of 0x00 to
0x3F. Writing a value of 0xFF (reset default) disables the priority-
threshold mechanism. Values between 0x3F and 0xFF must not be used. When the hardware-
priority threshold is in use, the priorities of interrupts selected as FIQ or IRQ become linked
otherwise, they are independent. When they are linked, all FIQ priorities must be set higher than
all IRQ priorities to maintain the relative priority of FIQ over IRQ.
(2) When handling FIQs using the priority-
threshold mechanism, both NEWFIQAGR and NEWIRQAGR bits must be written at the same time to ensure
that the new priority threshold is applied while an IRQ sort is in progress. This IRQ will not
have been seen by the ARM, as it will have been masked on entry to the FIQ ISR. However, the
source of the IRQ remains active and it is finally processed when the priority threshold falls to
a priority sufficiently low to allow it to be processed. The precaution of writing to New FIQ
Agreement is not required during an IRQ ISR, as FIQ sorting is not affected (provided all FIQ
priorities are higher than all IRQ priorities).
; Step 3 : Get the priority of the highest priority active IRQ
LDR R1, INTC_IRQ_PRIORITY_ADDR/INTC_FIQ_PRIORITY_ADDR
LDR R1, [R1] ; Get the INTC_IRQ_PRIORITY/INTC_FIQ_PRIORITY register
AND R1, R1, #ACTIVEPRIO_MASK ; Apply the mask to get the priority of the IRQ
STR R1, [R0] ; Write it to the INTC_THRESHOLD register
; Step 4 : Get the number of the highest priority active IRQ
LDR R10, INTC_SIR_IRQ_ADDR/INTC_SIR_FIQ_ADDR
LDR R10, [R10] ; Get the INTC_SIR_IRQ/INTC_SIR_FIQ register
AND R10, R10, #ACTIVEIRQ_MASK ; Apply the mask to get the active IRQ number
; Step 5 : Allow new IRQs and FIQs at INTC side
MOV R0, #0x1/0x3 ; Get the NEWIRQAGR and NEWFIQAGR bit position
LDR R1, INTC_CONTROL_ADDR
STR R0, [R1] ; Write the NEWIRQAGR and NEWFIQAGR bit
; Step 6 : Data Synchronization Barrier
MOV R0, #0
MCR P15, #0, R0, C7, C10, #4
; Step 7 : Read-modify-write the CPSR to enable IRQs/FIQs at ARM side
MRS R0, CPSR ; Read the status register
BIC R0, R0, #0x80/0x40 ; Clear the I/F bit
MSR CPSR, R0 ; Write it back to enable IRQs
; Step 8 : Jump to relevant subroutine handler
LDR PC, [PC, R10, lsl #2] ; PC base address points this instruction + 8
NOP ; To index the table by the PC
; Table of handler start addresses
.word IRQ0handler ;IRQ0 BANK0
.word IRQ1handler
.word IRQ2handler

```

After the return of the relevant IRQ/FIQ subroutine handle:

1. Disable IRQs/FIQs at ARM side.
2. Restore the INTC_THRESHOLD PRIORITYTHRESHOLD field.
3. Restore the ARM critical context registers.

The following sample code shows the three previous steps:

CAUTION

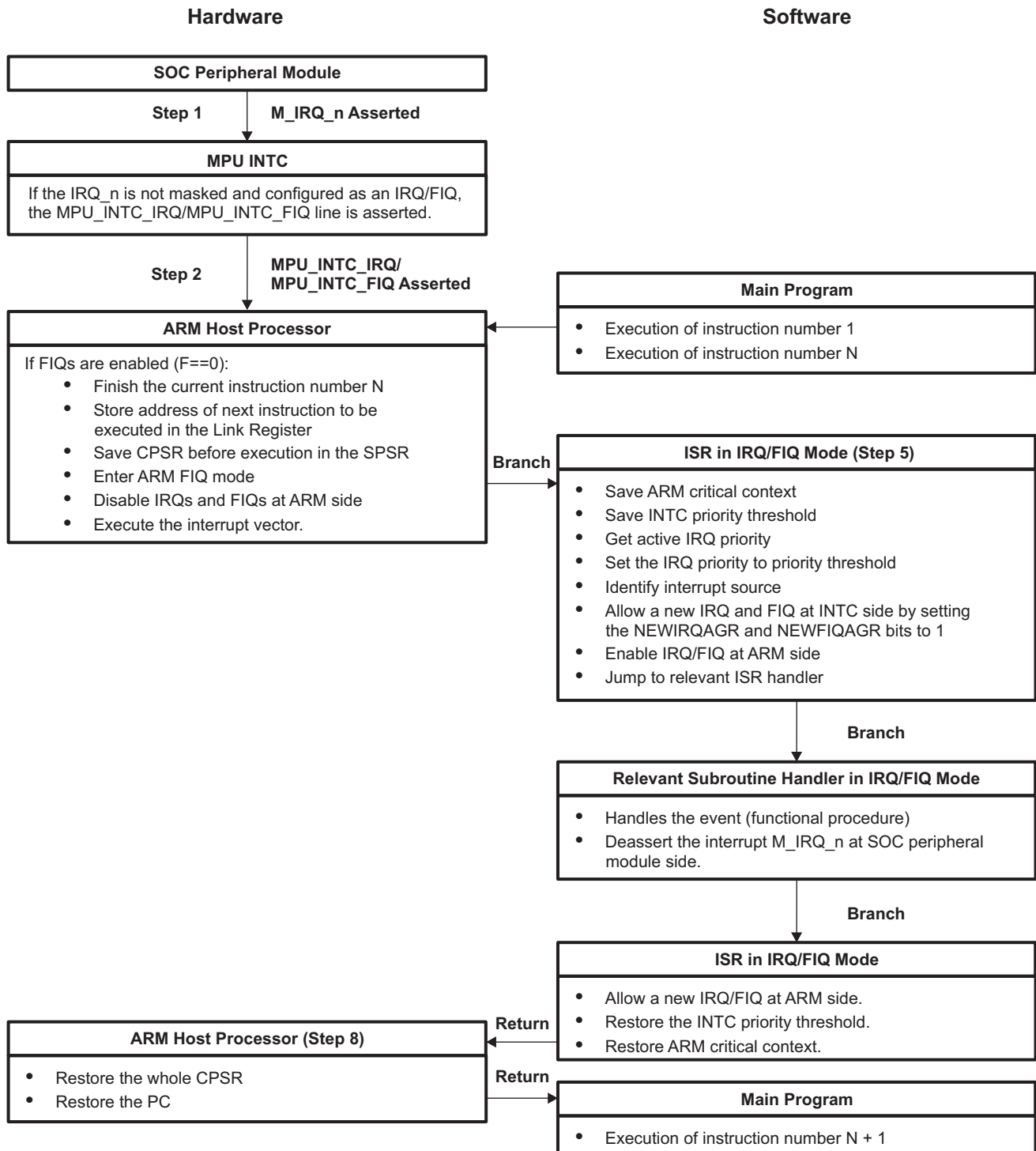
The following code is an assembly code compatible with ARM architecture V6 and V7. This code is developed for the Texas Instruments Code Composer Studio tool set. It is a draft version, only tested on an emulated environment.

```

IRQ_ISR_end:
; Step 1 : Read-modify-write the CPSR to disable IRQs/FIQs at ARM side
MRS R0, CPSR ; Read the CPSR
ORR R0, R0, #0x80/0x40 ; Set the I/F bit
MSR CPSR, R0 ; Write it back to disable IRQs
; Step 2 : Restore the INTC_THRESHOLD register from R12
LDR R0, INTC_THRESHOLD_ADDR
STR R12, [R0]
; Step 3 : Restore critical context
MSR SPSR, R11 ; Restore the SPSR from R11
LDMFD SP!, {R0-R12, LR} ; Restore working registers and Link register
; Return after handling the interrupt
SUBS PC, LR, #4
  
```

[Figure 6-3](#) shows the nested IRQ/FIQ processing sequence from the originating device peripheral module to the main program interruption.

Figure 6-3. Nested IRQ/FIQ Processing Sequence



6.2.4 Interrupt Preemption

If wanting to enable pre-emption by higher priority interrupts, the ISR should read the active interrupt priority and write it to the priority threshold register. Writing a '1' to the appropriate NEW_IRQ_AGR or NEW_FIQ_AGR bits of the CONTROL register while still processing the interrupt will now allow only higher priority interrupts to pre-empt.

For each level of pre-emption, the programmer must save the threshold value before modifying it and restore it at the end of that ISR level.

The priority threshold mechanism is enabled automatically when writing a priority in the range of 0 to 7Fh as will be read from the IRQ_PRIORITY and FIQ_PRIORITY registers. Writing a value of FFh (reset default) disables the priority threshold mechanism.

When the hardware priority threshold is in use the priorities of interrupts selected as FIQ or IRQ become linked, otherwise they are independent. When linked, it is required that all FIQ priorities be set higher than all IRQ priorities to maintain the relative priority of FIQ over IRQ.

When handling FIQs using the priority threshold mechanism, it is required to write both New FIQ Agreement and New IRQ Agreement bits at the same time to cover the case that the new priority threshold is applied while an IRQ sorting is in progress. This IRQ will not have been seen by the ARM as it will have been masked on entry to the FIQ ISR. However, the source of the IRQ will remain active and it will be finally processed when the priority threshold falls to a low enough priority. The precaution of writing to New FIQ Agreement (as well as New IRQ Agreement) is not required during an IRQ ISR as FIQ sorting will not be affected (provided all FIQ priorities are higher than all IRQ priorities).

6.2.5 ARM A8 INTC Spurious Interrupt Handling

The spurious flag indicates whether the result of the sorting (a window of 10 INTC functional clock cycles after the interrupt assertion) is invalid. The sorting is invalid if:

- The interrupt that triggered the sorting is no longer active during the sorting.
- A change in the mask has affected the result during the sorting time.

As a result, the values in the INTC_MIRn, INTC_ILRm, or INTC_MIR_SETn registers must not be changed while the corresponding interrupt is asserted. Only the active interrupt input that triggered the sort can be masked before it turn on the sort. If these registers are changed within the 10-cycle window after the interrupt assertion. The resulting values of the following registers become invalid:

- INTC_SIR_IRQ
- INTC_SIR_FIQ
- INTC_IRQ_PRIORITY
- INTC_FIQ_PRIORITY

This condition is detected for both IRQ and FIQ, and the invalid status is flagged across the SPURIOUSIRQFLAG (see NOTE 1) and SPURIOUSFIQFLAG (see NOTE 2) bit fields in the SIR and PRIORITY registers. A 0 indicates valid and a 1 indicates invalid interrupt number and priority. The invalid indication can be tested in software as a false register value.

NOTE:

1. The INTC_SIR_IRQ[31:7] SPURIOUSIRQFLAG bit field is a copy of the INTC_IRQ_PRIORITY[31:7] SPURIOUSIRQFLAG bit field.
 2. The INTC_SIR_FIQ[31:7] SPURIOUSFIQFLAG bit field is a copy of the INTC_FIQ_PRIORITY[31:7] SPURIOUSFIQFLAG bit field.
-

6.3 ARM Cortex-A8 Interrupts

Table 6-1. ARM Cortex-A8 Interrupts

Int Number	Acronym/name	Source	Signal Name
0	EMUINT	MPU Subsystem Internal	Emulation interrupt (EMUICINTR)
1	COMMTX	MPU Subsystem Internal	CortexA8 COMMTX
2	COMMRX	MPU Subsystem Internal	CortexA8 COMMRX
3	BENCH	MPU Subsystem Internal	CortexA8 NPMUIRQ
4	ELM_IRQ	ELM	Sinterrupt (Error location process completion)
5	Reserved		
6	Reserved		
7	NMI	External Pin (active low) ⁽¹⁾	nmi_int
8	Reserved		
9	L3DEBUG	L3	I3_FlagMux_top_FlagOut1
10	L3APPINT	L3	I3_FlagMux_top_FlagOut0
11	PRCMINT	PRCM	irq_mpu
12	EDMACOMPINT	TPCC (EDMA)	tpcc_int_pend_po0
13	EDMAMPERR	TPCC (EDMA)	tpcc_mpint_pend_po
14	EDMAERRINT	TPCC (EDMA)	tpcc_errint_pend_po
15	Reserved		
16	ADC_TSC_GENINT	ADC_TSC (Touchscreen Controller)	gen_intr_pend
17	USBSSINT	USBSS	usbss_intr_pend
18	USBINT0	USBSS	usb0_intr_pend
19	USBINT1	USBSS	usb1_intr_pend
20	PRU_ICSS_EVTOUT0	pr1_host[0] output/events exported from PRU-ICSS ⁽²⁾	pr1_host_intr0_intr_pend
21	PRU_ICSS_EVTOUT1	pr1_host[1] output/events exported from PRU-ICSS ⁽²⁾	pr1_host_intr1_intr_pend
22	PRU_ICSS_EVTOUT2	pr1_host[2] output/events exported from PRU-ICSS ⁽²⁾	pr1_host_intr2_intr_pend
23	PRU_ICSS_EVTOUT3	pr1_host[3] output/events exported from PRU-ICSS ⁽²⁾	pr1_host_intr3_intr_pend
24	PRU_ICSS_EVTOUT4	pr1_host[4] output/events exported from PRU-ICSS ⁽²⁾	pr1_host_intr4_intr_pend
25	PRU_ICSS_EVTOUT5	pr1_host[5] output/events exported from PRU-ICSS ⁽²⁾	pr1_host_intr5_intr_pend
26	PRU_ICSS_EVTOUT6	pr1_host[6] output/events exported from PRU-ICSS ⁽²⁾	pr1_host_intr6_intr_pend
27	PRU_ICSS_EVTOUT7	pr1_host[7] output/events exported from PRU-ICSS ⁽²⁾	pr1_host_intr7_intr_pend
28	MMCSD1INT	MMCSD1	SINTERRUPTN
29	MMCSD2INT	MMCSD2	SINTERRUPTN
30	I2C2INT	I2C2	POINTRPEND
31	eCAP0INT	eCAP0 event/interrupt	ecap_intr_intr_pend
32	GPIoint2A	GPIO 2	POINTRPEND1
33	GPIoint2B	GPIO 2	POINTRPEND2
34	USBWAKEUP	USBSS	slv0p_Swakeup
35	Reserved		

⁽¹⁾ For differences in operation based on AM335x silicon revisions, see [Silicon Revision Functional Differences and Enhancements, Silicon Revision Functional Differences and Enhancements](#).

⁽²⁾ pr1_host_intr[0:7] corresponds to Host-2 to Host-9 of the PRU-ICSS interrupt controller.

Table 6-1. ARM Cortex-A8 Interrupts (continued)

Int Number	Acronym/name	Source	Signal Name
36	LCDCINT	LCDC	lcd_irq
37	GFXINT	SGX530	THALIAIRQ
38	Reserved		
39	ePWM2INT	eHRPWM2 (PWM Subsystem)	epwm_intr_intr_pend
40	3PGSWRXTHR0 (RX_THRESH_PULSE)	CPSW (Ethernet)	c0_rx_thresh_pend
41	3PGSWRXINT0 (RX_PULSE)	CPSW (Ethernet)	c0_rx_pend
42	3PGSWTXINT0 (TX_PULSE)	CPSW (Ethernet)	c0_tx_pend
43	3PGSWMISC0 (MISC_PULSE)	CPSW (Ethernet)	c0_misc_pend
44	UART3INT	UART3	niq
45	UART4INT	UART4	niq
46	UART5INT	UART5	niq
47	eCAP1INT	eCAP1 (PWM Subsystem)	ecap_intr_intr_pend
48	Reserved		
49	Reserved		
50	Reserved		
51	Reserved		
52	DCAN0_INT0	DCAN0	dcan_intr0_intr_pend
53	DCAN0_INT1	DCAN0	dcan_intr1_intr_pend
54	DCAN0_PARITY	DCAN0	dcan_uerr_intr_pend
55	DCAN1_INT0	DCAN1	dcan_intr0_intr_pend
56	DCAN1_INT1	DCAN1	dcan_intr1_intr_pend
57	DCAN1_PARITY	DCAN1	dcan_uerr_intr_pend
58	ePWM0_TZINT	eHRPWM0 TZ interrupt (PWM Subsystem)	epwm_tz_intr_pend
59	ePWM1_TZINT	eHRPWM1 TZ interrupt (PWM Subsystem)	epwm_tz_intr_pend
60	ePWM2_TZINT	eHRPWM2 TZ interrupt (PWM Subsystem)	epwm_tz_intr_pend
61	eCAP2INT	eCAP2 (PWM Subsystem)	ecap_intr_intr_pend
62	GPIOINT3A	GPIO 3	POINTRPEND1
63	GPIOINT3B	GPIO 3	POINTRPEND2
64	MMCS0INT	MMCS0	SINTERRUPTN
65	McSPI0INT	McSPI0	SINTERRUPTN
66	TINT0	Timer0	POINTR_PEND
67	TINT1_1MS	DMTIMER_1ms	POINTR_PEND
68	TINT2	DMTIMER2	POINTR_PEND
69	TINT3	DMTIMER3	POINTR_PEND
70	I2C0INT	I2C0	POINTRPEND
71	I2C1INT	I2C1	POINTRPEND
72	UART0INT	UART0	niq
73	UART1INT	UART1	niq
74	UART2INT	UART2	niq
75	RTCINT	RTC	timer_intr_pend
76	RTCALARMINT	RTC	alarm_intr_pend
77	MBINT0	Mailbox0 (mail_u0_irq)	initiator_sinterrupt_q_n0
78	M3_TXEV	Wake M3 Subsystem	TXEV
79	eQEP0INT	eQEP0 (PWM Subsystem)	eqep_intr_intr_pend
80	MCATXINT0	McASP0	mcasp_x_intr_pend

Table 6-1. ARM Cortex-A8 Interrupts (continued)

Int Number	Acronym/name	Source	Signal Name
81	MCARXINT0	McASP0	mcasp_r_intr_pend
82	MCATXINT1	McASP1	mcasp_x_intr_pend
83	MCARXINT1	McASP1	mcasp_r_intr_pend
84	Reserved		
85	Reserved		
86	ePWM0INT	eHRPWM0 (PWM Subsystem)	epwm_intr_intr_pend
87	ePWM1INT	eHRPWM1 (PWM Subsystem)	epwm_intr_intr_pend
88	eQEP1INT	eQEP1 (PWM Subsystem)	eqep_intr_intr_pend
89	eQEP2INT	eQEP2 (PWM Subsystem)	eqep_intr_intr_pend
90	DMA_INTR_PIN2	External DMA/Interrupt Pin2 (xdma_event_intr2)	pi_x_dma_event_intr2
91	WDT1INT (Public Watchdog)	WDTIMER1	PO_INT_PEND
92	TINT4	DMTIMER4	POINTR_PEND
93	TINT5	DMTIMER5	POINTR_PEND
94	TINT6	DMTIMER6	POINTR_PEND
95	TINT7	DMTIMER7	POINTR_PEND
96	GPIoint0A	GPIO 0	POINTRPEND1
97	GPIoint0B	GPIO 0	POINTRPEND2
98	GPIoint1A	GPIO 1	POINTRPEND1
99	GPIoint1B	GPIO 1	POINTRPEND2
100	GPMCINT	GPMC	gpmc_sinterrupt
101	DDRERR0	EMIF	sys_err_intr_pend
102	Reserved		
103	Reserved		
104	Reserved		
105	Reserved		
106	Reserved		
107	Reserved		
108	Reserved		
109	Reserved		
110	Reserved		
111	Reserved		
112	TCERRINT0	TPTC0	tptc_erint_pend_po
113	TCERRINT1	TPTC1	tptc_erint_pend_po
114	TCERRINT2	TPTC2	tptc_erint_pend_po
115	ADC_TSC_PENINT	ADC_TSC	pen_intr_pend
116	Reserved		
117	Reserved		
118	Reserved		
119	Reserved		
120	SMRFLX_MPU subsystem	Smart Reflex 0	intrpend
121	SMRFLX_Core	Smart Reflex 1	intrpend
122	Reserved		
123	DMA_INTR_PIN0	External DMA/Interrupt Pin0 (xdma_event_intr0)	pi_x_dma_event_intr0
124	DMA_INTR_PIN1	External DMA/Interrupt Pin1 (xdma_event_intr1)	pi_x_dma_event_intr1
125	McSPI1INT	McSPI1	SINTERRUPTN

Table 6-1. ARM Cortex-A8 Interrupts (continued)

Int Number	Acronym/name	Source	Signal Name
126	Reserved		
127	Reserved		

6.4 PWM Events

Table 6-2. Timer and eCAP Event Capture

Event #	IP	Interrupt Name/Pin
0	For Timer 5 MUX input from IO signal TIMER5	TIMER5 IO pin
	For Timer 6 MUX input from IO signal TIMER6	TIMER6 IO pin
	For Timer 7 MUX input from IO signal TIMER7	TIMER7 IO pin
	For eCAP 0 MUX input from IO signal eCAP0	eCAP0 IO pin
	For eCAP 1 MUX input from IO signal eCAP1	eCAP1 IO pin
	For eCAP 2 MUX input from IO signal eCAP2	eCAP2 IO pin
1	UART0	UART0INT
2	UART1	UART1INT
3	UART2	UART2INT
4	UART3	UART3INT
5	UART4	UART4INT
6	UART5	UART5INT
7	3PGSW	3PGSWRXTHR0
8	3PGSW	3PGSWRXINT0
9	3PGSW	3PGSWTXINT0
10	3PGSW	3PGSWMISC0
11	McASP0	MCATXINT0
12	McASP0	MCARXINT0
13	McASP1	MCATXINT1
14	McASP1	MCARXINT1
15	Reserved	Reserved
16	Reserved	Reserved
17	GPIO 0	GPIOINT0A
18	GPIO 0	GPIOINT0B
19	GPIO 1	GPIOINT1A
20	GPIO 1	GPIOINT1B
21	GPIO 2	GPIOINT2A
22	GPIO 2	GPIOINT2B
23	GPIO 3	GPIOINT3A
24	GPIO 3	GPIOINT3B
25	DCAN0	DCAN0_INT0
26	DCAN0	DCAN0_INT1
27	DCAN0	DCAN0_PARITY
28	DCAN1	DCAN1_INT0
29	DCAN1	DCAN1_INT1
30	DCAN1	DCAN1_PARITY

6.5 Interrupt Controller Registers

NOTE: FIQ is not available on general-purpose (GP) devices.

6.5.1 INTC Registers

Table 6-3 lists the memory-mapped registers for the INTC. All register offset addresses not listed in Table 6-3 should be considered as reserved locations and the register contents should not be modified.

Table 6-3. INTC Registers

Offset	Acronym	Register Name	Section
0h	INTC_REVISION		Section 6.5.1.1
10h	INTC_SYSCONFIG		Section 6.5.1.2
14h	INTC_SYSSTATUS		Section 6.5.1.3
40h	INTC_SIR_IRQ		Section 6.5.1.4
44h	INTC_SIR_FIQ		Section 6.5.1.5
48h	INTC_CONTROL		Section 6.5.1.6
4Ch	INTC_PROTECTION		Section 6.5.1.7
50h	INTC_IDLE		Section 6.5.1.8
60h	INTC_IRQ_PRIORITY		Section 6.5.1.9
64h	INTC_FIQ_PRIORITY		Section 6.5.1.10
68h	INTC_THRESHOLD		Section 6.5.1.11
80h	INTC_ITR0		Section 6.5.1.12
84h	INTC_MIR0		Section 6.5.1.13
88h	INTC_MIR_CLEAR0		Section 6.5.1.14
8Ch	INTC_MIR_SET0		Section 6.5.1.15
90h	INTC_ISR_SET0		Section 6.5.1.16
94h	INTC_ISR_CLEAR0		Section 6.5.1.17
98h	INTC_PENDING_IRQ0		Section 6.5.1.18
9Ch	INTC_PENDING_FIQ0		Section 6.5.1.19
A0h	INTC_ITR1		Section 6.5.1.20
A4h	INTC_MIR1		Section 6.5.1.21
A8h	INTC_MIR_CLEAR1		Section 6.5.1.22
ACh	INTC_MIR_SET1		Section 6.5.1.23
B0h	INTC_ISR_SET1		Section 6.5.1.24
B4h	INTC_ISR_CLEAR1		Section 6.5.1.25
B8h	INTC_PENDING_IRQ1		Section 6.5.1.26
BCh	INTC_PENDING_FIQ1		Section 6.5.1.27
C0h	INTC_ITR2		Section 6.5.1.28
C4h	INTC_MIR2		Section 6.5.1.29
C8h	INTC_MIR_CLEAR2		Section 6.5.1.30
CCh	INTC_MIR_SET2		Section 6.5.1.31
D0h	INTC_ISR_SET2		Section 6.5.1.32
D4h	INTC_ISR_CLEAR2		Section 6.5.1.33
D8h	INTC_PENDING_IRQ2		Section 6.5.1.34
DCh	INTC_PENDING_FIQ2		Section 6.5.1.35
E0h	INTC_ITR3		Section 6.5.1.36
E4h	INTC_MIR3		Section 6.5.1.37
E8h	INTC_MIR_CLEAR3		Section 6.5.1.38
ECh	INTC_MIR_SET3		Section 6.5.1.39

Table 6-3. INTC Registers (continued)

Offset	Acronym	Register Name	Section
F0h	INTC_ISR_SET3		Section 6.5.1.40
F4h	INTC_ISR_CLEAR3		Section 6.5.1.41
F8h	INTC_PENDING_IRQ3		Section 6.5.1.42
FCh	INTC_PENDING_FIQ3		Section 6.5.1.43
100h to 2FCh	INTC_ILR_0 to INTC_ILR_127		Section 6.5.1.44

6.5.1.1 INTC_REVISION Register (offset = 0h) [reset = 50h]

Register mask: FFFFFFFFh

INTC_REVISION is shown in [Figure 6-4](#) and described in [Table 6-4](#).

This register contains the IP revision code

Figure 6-4. INTC_REVISION Register

31	30	29	28	27	26	25	24	23	22	21	20	19	18	17	16	15	14	13	12	11	10	9	8	7	6	5	4	3	2	1	0
RESERVED																								Rev							
R-0h																								R-50h							

LEGEND: R/W = Read/Write; R = Read only; W1toCl = Write 1 to clear bit; -n = value after reset

Table 6-4. INTC_REVISION Register Field Descriptions

Bit	Field	Type	Reset	Description
31-8	RESERVED	R	0h	Reads returns 0
7-0	Rev	R	50h	IP revision [7:4] Major revision [3:0] Minor revision Examples: 0x10 for 1.0, 0x21 for 2.1

6.5.1.2 INTC_SYSCONFIG Register (offset = 10h) [reset = 0h]

Register mask: FFFFFFFFh

INTC_SYSCONFIG is shown in [Figure 6-5](#) and described in [Table 6-5](#).

This register controls the various parameters of the OCP interface

Figure 6-5. INTC_SYSCONFIG Register

31	30	29	28	27	26	25	24
RESERVED							
R/W-0h							
23	22	21	20	19	18	17	16
RESERVED							
R/W-0h							
15	14	13	12	11	10	9	8
RESERVED							
R/W-0h							
7	6	5	4	3	2	1	0
RESERVED			RESERVED		RESERVED	SoftReset	Autoidle
R/W-0h			R-0h		R/W-0h	R/W-0h	R/W-0h

LEGEND: R/W = Read/Write; R = Read only; W1toCl = Write 1 to clear bit; -n = value after reset

Table 6-5. INTC_SYSCONFIG Register Field Descriptions

Bit	Field	Type	Reset	Description
31-5	RESERVED	R/W	0h	
4-3	RESERVED	R	0h	Write 0's for future compatibility. Reads returns 0
2	RESERVED	R/W	0h	
1	SoftReset	R/W	0h	Software reset. Set this bit to trigger a module reset. The bit is automatically reset by the hardware. During reads, it always returns 0. 0h(Read) = always_Always returns 0 1h(Read) = never_never happens
0	Autoidle	R/W	0h	Internal OCP clock gating strategy 0h = clkfree : OCP clock is free running 1h = autoClkGate : Automatic OCP clock gating strategy is applied, bnased on the OCP interface activity

6.5.1.3 INTC_SYSSTATUS Register (offset = 14h) [reset = 0h]

Register mask: FFFFFFFEh

INTC_SYSSTATUS is shown in [Figure 6-6](#) and described in [Table 6-6](#).

This register provides status information about the module

Figure 6-6. INTC_SYSSTATUS Register

31	30	29	28	27	26	25	24
RESERVED							
R-0h							
23	22	21	20	19	18	17	16
RESERVED							
R-0h							
15	14	13	12	11	10	9	8
RESERVED							
R-0h							
7	6	5	4	3	2	1	0
RESERVED							ResetDone
R-0h							R-X

LEGEND: R/W = Read/Write; R = Read only; W1toCl = Write 1 to clear bit; -n = value after reset

Table 6-6. INTC_SYSSTATUS Register Field Descriptions

Bit	Field	Type	Reset	Description
31-8	RESERVED	R	0h	
7-1	RESERVED	R	0h	Reserved for OCP socket status information Read returns 0
0	ResetDone	R	X	Internal reset monitoring 0h = rstOngoing : Internal module reset is on-going 1h = rstComp : Reset completed

6.5.1.4 INTC_SIR_IRQ Register (offset = 40h) [reset = FFFFFFFF80h]

Register mask: FFFFFFFFh

INTC_SIR_IRQ is shown in [Figure 6-7](#) and described in [Table 6-7](#).

This register supplies the currently active IRQ interrupt number.

Figure 6-7. INTC_SIR_IRQ Register

31	30	29	28	27	26	25	24	23	22	21	20	19	18	17	16
SpuriousIRQ															
R/W-1FFFFFFFh															
15	14	13	12	11	10	9	8	7	6	5	4	3	2	1	0
SpuriousIRQ								ActiveIRQ							
R/W-1FFFFFFFh								R/W-0h							

LEGEND: R/W = Read/Write; R = Read only; W1toCl = Write 1 to clear bit; -n = value after reset

Table 6-7. INTC_SIR_IRQ Register Field Descriptions

Bit	Field	Type	Reset	Description
31-7	SpuriousIRQ	R/W	1FFFFFFFh	Spurious IRQ flag
6-0	ActiveIRQ	R/W	0h	Active IRQ number

6.5.1.5 INTC_SIR_FIQ Register (offset = 44h) [reset = FFFFFFFF80h]

Register mask: FFFFFFFFh

INTC_SIR_FIQ is shown in [Figure 6-8](#) and described in [Table 6-8](#).

This register supplies the currently active FIQ interrupt number

Figure 6-8. INTC_SIR_FIQ Register

31	30	29	28	27	26	25	24	23	22	21	20	19	18	17	16
SpuriousFIQ															
R-1FFFFFFFh															
15	14	13	12	11	10	9	8	7	6	5	4	3	2	1	0
SpuriousFIQ								ActiveFIQ							
R-1FFFFFFFh								R-0h							

LEGEND: R/W = Read/Write; R = Read only; W1toCl = Write 1 to clear bit; -n = value after reset

Table 6-8. INTC_SIR_FIQ Register Field Descriptions

Bit	Field	Type	Reset	Description
31-7	SpuriousFIQ	R	1FFFFFFFh	Spurious FIQ flag
6-0	ActiveFIQ	R	0h	Active FIQ number

6.5.1.6 INTC_CONTROL Register (offset = 48h) [reset = 0h]

Register mask: FFFFFFFFh

INTC_CONTROL is shown in [Figure 6-9](#) and described in [Table 6-9](#).

This register contains the new interrupt agreement bits

Figure 6-9. INTC_CONTROL Register

31	30	29	28	27	26	25	24
RESERVED							
R-0h							
23	22	21	20	19	18	17	16
RESERVED							
R-0h							
15	14	13	12	11	10	9	8
RESERVED							
R-0h							
7	6	5	4	3	2	1	0
RESERVED						NewFIQAgr	NewIRQAgr
R-0h						W-0h	W-0h

LEGEND: R/W = Read/Write; R = Read only; W1toCl = Write 1 to clear bit; -n = value after reset

Table 6-9. INTC_CONTROL Register Field Descriptions

Bit	Field	Type	Reset	Description
31-2	RESERVED	R	0h	Write 0's for future compatibility. Reads returns 0
1	NewFIQAgr	W	0h	Reset FIQ output and enable new FIQ generation 0h(Write) = nofun_no function effect 1h(Write) = NewFiq_Reset FIQ output and enable new FIQ generation
0	NewIRQAgr	W	0h	New IRQ generation 0h(Write) = nofun_no function effect 1h(Write) = NewIrq_Reset IRQ output and enable new IRQ generation

6.5.1.7 INTC_PROTECTION Register (offset = 4Ch) [reset = 0h]

Register mask: FFFFFFFFh

 INTC_PROTECTION is shown in [Figure 6-10](#) and described in [Table 6-10](#).

This register controls protection of the other registers. This register can only be accessed in privileged mode, regardless of the current value of the protection bit.

Figure 6-10. INTC_PROTECTION Register

31	30	29	28	27	26	25	24
RESERVED							
R-0h							
23	22	21	20	19	18	17	16
RESERVED							
R-0h							
15	14	13	12	11	10	9	8
RESERVED							
R-0h							
7	6	5	4	3	2	1	0
RESERVED							Protection
R-0h							R/W-0h

LEGEND: R/W = Read/Write; R = Read only; W1toCl = Write 1 to clear bit; -n = value after reset

Table 6-10. INTC_PROTECTION Register Field Descriptions

Bit	Field	Type	Reset	Description
31-1	RESERVED	R	0h	Write 0's for future compatibility. Reads returns 0
0	Protection	R/W	0h	Protection mode 0h = ProtMDis : Protection mode disabled (default) 1h = ProtMEnb : Protection mode enabled. When enabled, only privileged mode can access registers.

6.5.1.8 INTC_IDLE Register (offset = 50h) [reset = 0h]

Register mask: FFFFFFFFh

 INTC_IDLE is shown in [Figure 6-11](#) and described in [Table 6-11](#).

This register controls the clock auto-idle for the functional clock and the input synchronisers

Figure 6-11. INTC_IDLE Register

31	30	29	28	27	26	25	24
RESERVED							
R-0h							
23	22	21	20	19	18	17	16
RESERVED							
R-0h							
15	14	13	12	11	10	9	8
RESERVED							
R-0h							
7	6	5	4	3	2	1	0
RESERVED						Turbo	Funcidle
R-0h						R/W-0h	R/W-0h

LEGEND: R/W = Read/Write; R = Read only; W1toCl = Write 1 to clear bit; -n = value after reset

Table 6-11. INTC_IDLE Register Field Descriptions

Bit	Field	Type	Reset	Description
31-2	RESERVED	R	0h	Write 0's for future compatibility. Reads returns 0
1	Turbo	R/W	0h	Input synchroniser clock auto-gating 0h = SyncFree : Input synchroniser clock is free running (default) 1h = SyncAuto : Input synchroniser clock is auto-gated based on interrupt input activity
0	Funcidle	R/W	0h	Functional clock auto-idle mode 0h = FuncAuto : Functional clock gating strategy is applied (default) 1h = FuncFree : Functional clock is free-running

6.5.1.9 INTC_IRQ_PRIORITY Register (offset = 60h) [reset = FFFFFFFC0h]

Register mask: FFFFFFFFh

INTC_IRQ_PRIORITY is shown in [Figure 6-12](#) and described in [Table 6-12](#).

This register supplies the currently active IRQ priority level

Figure 6-12. INTC_IRQ_PRIORITY Register

31	30	29	28	27	26	25	24	23	22	21	20	19	18	17	16
SpuriousIRQflag															
R-1FFFFFFFh															
15	14	13	12	11	10	9	8	7	6	5	4	3	2	1	0
SpuriousIRQflag									IRQPriority						
R-1FFFFFFFh									R-40h						

LEGEND: R/W = Read/Write; R = Read only; W1toCl = Write 1 to clear bit; -n = value after reset

Table 6-12. INTC_IRQ_PRIORITY Register Field Descriptions

Bit	Field	Type	Reset	Description
31-7	SpuriousIRQflag	R	1FFFFFFFh	Spurious IRQ flag
6-0	IRQPriority	R	40h	Current IRQ priority

6.5.1.10 INTC_FIQ_PRIORITY Register (offset = 64h) [reset = FFFFFFFC0h]

Register mask: FFFFFFFFh

INTC_FIQ_PRIORITY is shown in [Figure 6-13](#) and described in [Table 6-13](#).

This register supplies the currently active FIQ priority level

Figure 6-13. INTC_FIQ_PRIORITY Register

31	30	29	28	27	26	25	24	23	22	21	20	19	18	17	16
SpuriousFIQflag															
R-1FFFFFFFh															
15	14	13	12	11	10	9	8	7	6	5	4	3	2	1	0
SpuriousFIQflag									FIQPriority						
R-1FFFFFFFh									R-40h						

LEGEND: R/W = Read/Write; R = Read only; W1toCl = Write 1 to clear bit; -n = value after reset

Table 6-13. INTC_FIQ_PRIORITY Register Field Descriptions

Bit	Field	Type	Reset	Description
31-7	SpuriousFIQflag	R	1FFFFFFFh	Spurious FIQ flag
6-0	FIQPriority	R	40h	Current FIQ priority

6.5.1.11 INTC_THRESHOLD Register (offset = 68h) [reset = FFh]

Register mask: FFFFFFFFh

INTC_THRESHOLD is shown in [Figure 6-14](#) and described in [Table 6-14](#).

This register sets the priority threshold

Figure 6-14. INTC_THRESHOLD Register

31	30	29	28	27	26	25	24	23	22	21	20	19	18	17	16
RESERVED															
R-0h															
15	14	13	12	11	10	9	8	7	6	5	4	3	2	1	0
RESERVED								PriorityThreshold							
R-0h								R/W-FFh							

LEGEND: R/W = Read/Write; R = Read only; W1toCl = Write 1 to clear bit; -n = value after reset

Table 6-14. INTC_THRESHOLD Register Field Descriptions

Bit	Field	Type	Reset	Description
31-8	RESERVED	R	0h	Reads returns 0
7-0	PriorityThreshold	R/W	FFh	Priority threshold. Values used are 00h to 3Fh. Value FFh disables the threshold.

6.5.1.12 INTC_ITR0 Register (offset = 80h) [reset = 0h]

Register mask: 0h

INTC_ITR0 is shown in [Figure 6-15](#) and described in [Table 6-15](#).

This register shows the raw interrupt input status before masking

Figure 6-15. INTC_ITR0 Register

31	30	29	28	27	26	25	24	23	22	21	20	19	18	17	16	15	14	13	12	11	10	9	8	7	6	5	4	3	2	1	0
																	ltr														
R-X																															

LEGEND: R/W = Read/Write; R = Read only; W1toCl = Write 1 to clear bit; -n = value after reset

Table 6-15. INTC_ITR0 Register Field Descriptions

Bit	Field	Type	Reset	Description
31-0	ltr	R	X	Interrupt status before masking

6.5.1.13 INTC_MIR0 Register (offset = 84h) [reset = FFFFFFFFh]

Register mask: FFFFFFFFh

INTC_MIR0 is shown in [Figure 6-16](#) and described in [Table 6-16](#).

This register contains the interrupt mask

Figure 6-16. INTC_MIR0 Register

31	30	29	28	27	26	25	24	23	22	21	20	19	18	17	16	15	14	13	12	11	10	9	8	7	6	5	4	3	2	1	0
Mir																															
R/W-FFFFFFFh																															

LEGEND: R/W = Read/Write; R = Read only; W1toCl = Write 1 to clear bit; -n = value after reset

Table 6-16. INTC_MIR0 Register Field Descriptions

Bit	Field	Type	Reset	Description
31-0	Mir	R/W	FFFFFFFh	Interrupt mask

6.5.1.14 INTC_MIR_CLEAR0 Register (offset = 88h) [reset = 0h]

Register mask: 0h

INTC_MIR_CLEAR0 is shown in [Figure 6-17](#) and described in [Table 6-17](#).

This register is used to clear the interrupt mask bits.

Figure 6-17. INTC_MIR_CLEAR0 Register

31	30	29	28	27	26	25	24	23	22	21	20	19	18	17	16	15	14	13	12	11	10	9	8	7	6	5	4	3	2	1	0
MirClear																															
W-X																															

LEGEND: R/W = Read/Write; R = Read only; W1toCl = Write 1 to clear bit; -n = value after reset

Table 6-17. INTC_MIR_CLEAR0 Register Field Descriptions

Bit	Field	Type	Reset	Description
31-0	MirClear	W	X	Write 1 clears the mask bit to 0, reads return 0

6.5.1.15 INTC_MIR_SET0 Register (offset = 8Ch) [reset = 0h]

Register mask: 0h

INTC_MIR_SET0 is shown in [Figure 6-18](#) and described in [Table 6-18](#).

This register is used to set the interrupt mask bits.

Figure 6-18. INTC_MIR_SET0 Register

31	30	29	28	27	26	25	24	23	22	21	20	19	18	17	16	15	14	13	12	11	10	9	8	7	6	5	4	3	2	1	0
MirSet																															
W-X																															

LEGEND: R/W = Read/Write; R = Read only; W1toCl = Write 1 to clear bit; -n = value after reset

Table 6-18. INTC_MIR_SET0 Register Field Descriptions

Bit	Field	Type	Reset	Description
31-0	MirSet	W	X	Write 1 sets the mask bit to 1, reads return 0

6.5.1.16 INTC_ISR_SET0 Register (offset = 90h) [reset = 0h]

Register mask: FFFFFFFFh

INTC_ISR_SET0 is shown in [Figure 6-19](#) and described in [Table 6-19](#).

This register is used to set the software interrupt bits. It is also used to read the currently active software interrupts.

Figure 6-19. INTC_ISR_SET0 Register

31	30	29	28	27	26	25	24	23	22	21	20	19	18	17	16	15	14	13	12	11	10	9	8	7	6	5	4	3	2	1	0
IsrSet																															
R/W-0h																															

LEGEND: R/W = Read/Write; R = Read only; W1toCl = Write 1 to clear bit; -n = value after reset

Table 6-19. INTC_ISR_SET0 Register Field Descriptions

Bit	Field	Type	Reset	Description
31-0	IsrSet	R/W	0h	Reads returns the currently active software interrupts, Write 1 sets the software interrupt bits to 1

6.5.1.17 INTC_ISR_CLEAR0 Register (offset = 94h) [reset = 0h]

Register mask: 0h

INTC_ISR_CLEAR0 is shown in [Figure 6-20](#) and described in [Table 6-20](#).

This register is used to clear the software interrupt bits

Figure 6-20. INTC_ISR_CLEAR0 Register

31	30	29	28	27	26	25	24	23	22	21	20	19	18	17	16	15	14	13	12	11	10	9	8	7	6	5	4	3	2	1	0
IsrClear																															
W-X																															

LEGEND: R/W = Read/Write; R = Read only; W1toCl = Write 1 to clear bit; -n = value after reset

Table 6-20. INTC_ISR_CLEAR0 Register Field Descriptions

Bit	Field	Type	Reset	Description
31-0	IsrClear	W	X	Write 1 clears the software interrupt bits to 0, reads return 0

6.5.1.18 INTC_PENDING_IRQ0 Register (offset = 98h) [reset = 0h]

Register mask: FFFFFFFFh

INTC_PENDING_IRQ0 is shown in [Figure 6-21](#) and described in [Table 6-21](#).

This register contains the IRQ status after masking

Figure 6-21. INTC_PENDING_IRQ0 Register

31	30	29	28	27	26	25	24	23	22	21	20	19	18	17	16	15	14	13	12	11	10	9	8	7	6	5	4	3	2	1	0
PendingIRQ																															
R-0h																															

LEGEND: R/W = Read/Write; R = Read only; W1toCl = Write 1 to clear bit; -n = value after reset

Table 6-21. INTC_PENDING_IRQ0 Register Field Descriptions

Bit	Field	Type	Reset	Description
31-0	PendingIRQ	R	0h	IRQ status after masking

6.5.1.19 INTC_PENDING_FIQ0 Register (offset = 9Ch) [reset = 0h]

Register mask: FFFFFFFFh

INTC_PENDING_FIQ0 is shown in [Figure 6-22](#) and described in [Table 6-22](#).

This register contains the FIQ status after masking

Figure 6-22. INTC_PENDING_FIQ0 Register

31	30	29	28	27	26	25	24	23	22	21	20	19	18	17	16	15	14	13	12	11	10	9	8	7	6	5	4	3	2	1	0
PendingFIQ																															
R-0h																															

LEGEND: R/W = Read/Write; R = Read only; W1toCl = Write 1 to clear bit; -n = value after reset

Table 6-22. INTC_PENDING_FIQ0 Register Field Descriptions

Bit	Field	Type	Reset	Description
31-0	PendingFIQ	R	0h	FIQ status after masking

6.5.1.20 INTC_ITR1 Register (offset = A0h) [reset = 0h]

Register mask: 0h

INTC_ITR1 is shown in [Figure 6-23](#) and described in [Table 6-23](#).

This register shows the raw interrupt input status before masking

Figure 6-23. INTC_ITR1 Register

31	30	29	28	27	26	25	24	23	22	21	20	19	18	17	16	15	14	13	12	11	10	9	8	7	6	5	4	3	2	1	0
ltr																															
R-X																															

LEGEND: R/W = Read/Write; R = Read only; W1toCl = Write 1 to clear bit; -n = value after reset

Table 6-23. INTC_ITR1 Register Field Descriptions

Bit	Field	Type	Reset	Description
31-0	ltr	R	X	Interrupt status before masking

6.5.1.21 INTC_MIR1 Register (offset = A4h) [reset = FFFFFFFFh]

Register mask: FFFFFFFFh

INTC_MIR1 is shown in [Figure 6-24](#) and described in [Table 6-24](#).

This register contains the interrupt mask

Figure 6-24. INTC_MIR1 Register

31	30	29	28	27	26	25	24	23	22	21	20	19	18	17	16	15	14	13	12	11	10	9	8	7	6	5	4	3	2	1	0
Mir																															
R/W-FFFFFFFh																															

LEGEND: R/W = Read/Write; R = Read only; W1toCl = Write 1 to clear bit; -n = value after reset

Table 6-24. INTC_MIR1 Register Field Descriptions

Bit	Field	Type	Reset	Description
31-0	Mir	R/W	FFFFFFFh	Interrupt mask

6.5.1.22 INTC_MIR_CLEAR1 Register (offset = A8h) [reset = 0h]

Register mask: 0h

INTC_MIR_CLEAR1 is shown in [Figure 6-25](#) and described in [Table 6-25](#).

This register is used to clear the interrupt mask bits.

Figure 6-25. INTC_MIR_CLEAR1 Register

31	30	29	28	27	26	25	24	23	22	21	20	19	18	17	16	15	14	13	12	11	10	9	8	7	6	5	4	3	2	1	0
MirClear																															
W-X																															

LEGEND: R/W = Read/Write; R = Read only; W1toCl = Write 1 to clear bit; -n = value after reset

Table 6-25. INTC_MIR_CLEAR1 Register Field Descriptions

Bit	Field	Type	Reset	Description
31-0	MirClear	W	X	Write 1 clears the mask bit to 0, reads return 0

6.5.1.23 INTC_MIR_SET1 Register (offset = ACh) [reset = 0h]

Register mask: 0h

INTC_MIR_SET1 is shown in [Figure 6-26](#) and described in [Table 6-26](#).

This register is used to set the interrupt mask bits.

Figure 6-26. INTC_MIR_SET1 Register

31	30	29	28	27	26	25	24	23	22	21	20	19	18	17	16	15	14	13	12	11	10	9	8	7	6	5	4	3	2	1	0
MirSet																															
W-X																															

LEGEND: R/W = Read/Write; R = Read only; W1toCl = Write 1 to clear bit; -n = value after reset

Table 6-26. INTC_MIR_SET1 Register Field Descriptions

Bit	Field	Type	Reset	Description
31-0	MirSet	W	X	Write 1 sets the mask bit to 1, reads return 0

6.5.1.24 INTC_ISR_SET1 Register (offset = B0h) [reset = 0h]

Register mask: FFFFFFFFh

INTC_ISR_SET1 is shown in [Figure 6-27](#) and described in [Table 6-27](#).

This register is used to set the software interrupt bits. It is also used to read the currently active software interrupts.

Figure 6-27. INTC_ISR_SET1 Register

31	30	29	28	27	26	25	24	23	22	21	20	19	18	17	16	15	14	13	12	11	10	9	8	7	6	5	4	3	2	1	0
IsrSet																															
R/W-0h																															

LEGEND: R/W = Read/Write; R = Read only; W1toCl = Write 1 to clear bit; -n = value after reset

Table 6-27. INTC_ISR_SET1 Register Field Descriptions

Bit	Field	Type	Reset	Description
31-0	IsrSet	R/W	0h	Reads returns the currently active software interrupts, Write 1 sets the software interrupt bits to 1

6.5.1.25 INTC_ISR_CLEAR1 Register (offset = B4h) [reset = 0h]

Register mask: 0h

INTC_ISR_CLEAR1 is shown in [Figure 6-28](#) and described in [Table 6-28](#).

This register is used to clear the software interrupt bits

Figure 6-28. INTC_ISR_CLEAR1 Register

31	30	29	28	27	26	25	24	23	22	21	20	19	18	17	16	15	14	13	12	11	10	9	8	7	6	5	4	3	2	1	0
IsrClear																															
W-X																															

LEGEND: R/W = Read/Write; R = Read only; W1toCl = Write 1 to clear bit; -n = value after reset

Table 6-28. INTC_ISR_CLEAR1 Register Field Descriptions

Bit	Field	Type	Reset	Description
31-0	IsrClear	W	X	Write 1 clears the software interrupt bits to 0, reads return 0

6.5.1.26 INTC_PENDING_IRQ1 Register (offset = B8h) [reset = 0h]

Register mask: FFFFFFFFh

INTC_PENDING_IRQ1 is shown in [Figure 6-29](#) and described in [Table 6-29](#).

This register contains the IRQ status after masking

Figure 6-29. INTC_PENDING_IRQ1 Register

31	30	29	28	27	26	25	24	23	22	21	20	19	18	17	16	15	14	13	12	11	10	9	8	7	6	5	4	3	2	1	0
PendingIRQ																															
R-0h																															

LEGEND: R/W = Read/Write; R = Read only; W1toCl = Write 1 to clear bit; -n = value after reset

Table 6-29. INTC_PENDING_IRQ1 Register Field Descriptions

Bit	Field	Type	Reset	Description
31-0	PendingIRQ	R	0h	IRQ status after masking

6.5.1.27 INTC_PENDING_FIQ1 Register (offset = BCh) [reset = 0h]

Register mask: FFFFFFFFh

INTC_PENDING_FIQ1 is shown in [Figure 6-30](#) and described in [Table 6-30](#).

This register contains the FIQ status after masking

Figure 6-30. INTC_PENDING_FIQ1 Register

31	30	29	28	27	26	25	24	23	22	21	20	19	18	17	16	15	14	13	12	11	10	9	8	7	6	5	4	3	2	1	0
PendingFIQ																															
R-0h																															

LEGEND: R/W = Read/Write; R = Read only; W1toCl = Write 1 to clear bit; -n = value after reset

Table 6-30. INTC_PENDING_FIQ1 Register Field Descriptions

Bit	Field	Type	Reset	Description
31-0	PendingFIQ	R	0h	FIQ status after masking

6.5.1.28 INTC_ITR2 Register (offset = C0h) [reset = 0h]

Register mask: 0h

INTC_ITR2 is shown in [Figure 6-31](#) and described in [Table 6-31](#).

This register shows the raw interrupt input status before masking

Figure 6-31. INTC_ITR2 Register

31	30	29	28	27	26	25	24	23	22	21	20	19	18	17	16	15	14	13	12	11	10	9	8	7	6	5	4	3	2	1	0
																	ltr														
R-X																															

LEGEND: R/W = Read/Write; R = Read only; W1toCl = Write 1 to clear bit; -n = value after reset

Table 6-31. INTC_ITR2 Register Field Descriptions

Bit	Field	Type	Reset	Description
31-0	ltr	R	X	Interrupt status before masking

6.5.1.29 INTC_MIR2 Register (offset = C4h) [reset = FFFFFFFFh]

Register mask: FFFFFFFFh

INTC_MIR2 is shown in [Figure 6-32](#) and described in [Table 6-32](#).

This register contains the interrupt mask

Figure 6-32. INTC_MIR2 Register

31	30	29	28	27	26	25	24	23	22	21	20	19	18	17	16	15	14	13	12	11	10	9	8	7	6	5	4	3	2	1	0
Mir																															
R/W-FFFFFFFh																															

LEGEND: R/W = Read/Write; R = Read only; W1toCl = Write 1 to clear bit; -n = value after reset

Table 6-32. INTC_MIR2 Register Field Descriptions

Bit	Field	Type	Reset	Description
31-0	Mir	R/W	FFFFFFFh	Interrupt mask

6.5.1.30 INTC_MIR_CLEAR2 Register (offset = C8h) [reset = 0h]

Register mask: 0h

INTC_MIR_CLEAR2 is shown in [Figure 6-33](#) and described in [Table 6-33](#).

This register is used to clear the interrupt mask bits.

Figure 6-33. INTC_MIR_CLEAR2 Register

31	30	29	28	27	26	25	24	23	22	21	20	19	18	17	16	15	14	13	12	11	10	9	8	7	6	5	4	3	2	1	0
MirClear																															
W-X																															

LEGEND: R/W = Read/Write; R = Read only; W1toCl = Write 1 to clear bit; -n = value after reset

Table 6-33. INTC_MIR_CLEAR2 Register Field Descriptions

Bit	Field	Type	Reset	Description
31-0	MirClear	W	X	Write 1 clears the mask bit to 0, reads return 0

6.5.1.31 INTC_MIR_SET2 Register (offset = CCh) [reset = 0h]

Register mask: 0h

INTC_MIR_SET2 is shown in [Figure 6-34](#) and described in [Table 6-34](#).

This register is used to set the interrupt mask bits.

Figure 6-34. INTC_MIR_SET2 Register

31	30	29	28	27	26	25	24	23	22	21	20	19	18	17	16	15	14	13	12	11	10	9	8	7	6	5	4	3	2	1	0
MirSet																															
W-X																															

LEGEND: R/W = Read/Write; R = Read only; W1toCl = Write 1 to clear bit; -n = value after reset

Table 6-34. INTC_MIR_SET2 Register Field Descriptions

Bit	Field	Type	Reset	Description
31-0	MirSet	W	X	Write 1 sets the mask bit to 1, reads return 0

6.5.1.32 INTC_ISR_SET2 Register (offset = D0h) [reset = 0h]

Register mask: FFFFFFFFh

INTC_ISR_SET2 is shown in [Figure 6-35](#) and described in [Table 6-35](#).

This register is used to set the software interrupt bits. It is also used to read the currently active software interrupts.

Figure 6-35. INTC_ISR_SET2 Register

31	30	29	28	27	26	25	24	23	22	21	20	19	18	17	16	15	14	13	12	11	10	9	8	7	6	5	4	3	2	1	0
IsrSet																															
R/W-0h																															

LEGEND: R/W = Read/Write; R = Read only; W1toCl = Write 1 to clear bit; -n = value after reset

Table 6-35. INTC_ISR_SET2 Register Field Descriptions

Bit	Field	Type	Reset	Description
31-0	IsrSet	R/W	0h	Reads returns the currently active software interrupts, Write 1 sets the software interrupt bits to 1

6.5.1.33 INTC_ISR_CLEAR2 Register (offset = D4h) [reset = 0h]

Register mask: 0h

INTC_ISR_CLEAR2 is shown in [Figure 6-36](#) and described in [Table 6-36](#).

This register is used to clear the software interrupt bits

Figure 6-36. INTC_ISR_CLEAR2 Register

31	30	29	28	27	26	25	24	23	22	21	20	19	18	17	16	15	14	13	12	11	10	9	8	7	6	5	4	3	2	1	0
IsrClear																															
W-X																															

LEGEND: R/W = Read/Write; R = Read only; W1toCl = Write 1 to clear bit; -n = value after reset

Table 6-36. INTC_ISR_CLEAR2 Register Field Descriptions

Bit	Field	Type	Reset	Description
31-0	IsrClear	W	X	Write 1 clears the software interrupt bits to 0, reads return 0

6.5.1.34 INTC_PENDING_IRQ2 Register (offset = D8h) [reset = 0h]

Register mask: FFFFFFFFh

INTC_PENDING_IRQ2 is shown in [Figure 6-37](#) and described in [Table 6-37](#).

This register contains the IRQ status after masking

Figure 6-37. INTC_PENDING_IRQ2 Register

31	30	29	28	27	26	25	24	23	22	21	20	19	18	17	16	15	14	13	12	11	10	9	8	7	6	5	4	3	2	1	0
PendingIRQ																															
R-0h																															

LEGEND: R/W = Read/Write; R = Read only; W1toCl = Write 1 to clear bit; -n = value after reset

Table 6-37. INTC_PENDING_IRQ2 Register Field Descriptions

Bit	Field	Type	Reset	Description
31-0	PendingIRQ	R	0h	IRQ status after masking

6.5.1.35 INTC_PENDING_FIQ2 Register (offset = DCh) [reset = 0h]

Register mask: FFFFFFFFh

INTC_PENDING_FIQ2 is shown in [Figure 6-38](#) and described in [Table 6-38](#).

This register contains the FIQ status after masking

Figure 6-38. INTC_PENDING_FIQ2 Register

31	30	29	28	27	26	25	24	23	22	21	20	19	18	17	16	15	14	13	12	11	10	9	8	7	6	5	4	3	2	1	0
PendingFIQ																															
R-0h																															

LEGEND: R/W = Read/Write; R = Read only; W1toCl = Write 1 to clear bit; -n = value after reset

Table 6-38. INTC_PENDING_FIQ2 Register Field Descriptions

Bit	Field	Type	Reset	Description
31-0	PendingFIQ	R	0h	FIQ status after masking

6.5.1.36 INTC_ITR3 Register (offset = E0h) [reset = 0h]

Register mask: 0h

INTC_ITR3 is shown in [Figure 6-39](#) and described in [Table 6-39](#).

This register shows the raw interrupt input status before masking

Figure 6-39. INTC_ITR3 Register

31	30	29	28	27	26	25	24	23	22	21	20	19	18	17	16	15	14	13	12	11	10	9	8	7	6	5	4	3	2	1	0
ltr																															
R-X																															

LEGEND: R/W = Read/Write; R = Read only; W1toCl = Write 1 to clear bit; -n = value after reset

Table 6-39. INTC_ITR3 Register Field Descriptions

Bit	Field	Type	Reset	Description
31-0	ltr	R	X	Interrupt status before masking

6.5.1.37 INTC_MIR3 Register (offset = E4h) [reset = FFFFFFFFh]

Register mask: FFFFFFFFh

INTC_MIR3 is shown in [Figure 6-40](#) and described in [Table 6-40](#).

This register contains the interrupt mask

Figure 6-40. INTC_MIR3 Register

31	30	29	28	27	26	25	24	23	22	21	20	19	18	17	16	15	14	13	12	11	10	9	8	7	6	5	4	3	2	1	0
Mir																															
R/W-FFFFFFFh																															

LEGEND: R/W = Read/Write; R = Read only; W1toCl = Write 1 to clear bit; -n = value after reset

Table 6-40. INTC_MIR3 Register Field Descriptions

Bit	Field	Type	Reset	Description
31-0	Mir	R/W	FFFFFFFh	Interrupt mask

6.5.1.38 INTC_MIR_CLEAR3 Register (offset = E8h) [reset = 0h]

Register mask: 0h

INTC_MIR_CLEAR3 is shown in [Figure 6-41](#) and described in [Table 6-41](#).

This register is used to clear the interrupt mask bits.

Figure 6-41. INTC_MIR_CLEAR3 Register

31	30	29	28	27	26	25	24	23	22	21	20	19	18	17	16	15	14	13	12	11	10	9	8	7	6	5	4	3	2	1	0
MirClear																															
W-X																															

LEGEND: R/W = Read/Write; R = Read only; W1toCl = Write 1 to clear bit; -n = value after reset

Table 6-41. INTC_MIR_CLEAR3 Register Field Descriptions

Bit	Field	Type	Reset	Description
31-0	MirClear	W	X	Write 1 clears the mask bit to 0, reads return 0

6.5.1.39 INTC_MIR_SET3 Register (offset = ECh) [reset = 0h]

Register mask: 0h

INTC_MIR_SET3 is shown in [Figure 6-42](#) and described in [Table 6-42](#).

This register is used to set the interrupt mask bits.

Figure 6-42. INTC_MIR_SET3 Register

31	30	29	28	27	26	25	24	23	22	21	20	19	18	17	16	15	14	13	12	11	10	9	8	7	6	5	4	3	2	1	0
MirSet																															
W-X																															

LEGEND: R/W = Read/Write; R = Read only; W1toCl = Write 1 to clear bit; -n = value after reset

Table 6-42. INTC_MIR_SET3 Register Field Descriptions

Bit	Field	Type	Reset	Description
31-0	MirSet	W	X	Write 1 sets the mask bit to 1, reads return 0

6.5.1.40 INTC_ISR_SET3 Register (offset = F0h) [reset = 0h]

Register mask: FFFFFFFFh

INTC_ISR_SET3 is shown in [Figure 6-43](#) and described in [Table 6-43](#).

This register is used to set the software interrupt bits. It is also used to read the currently active software interrupts.

Figure 6-43. INTC_ISR_SET3 Register

31	30	29	28	27	26	25	24	23	22	21	20	19	18	17	16	15	14	13	12	11	10	9	8	7	6	5	4	3	2	1	0
IsrSet																															
R/W-0h																															

LEGEND: R/W = Read/Write; R = Read only; W1toCl = Write 1 to clear bit; -n = value after reset

Table 6-43. INTC_ISR_SET3 Register Field Descriptions

Bit	Field	Type	Reset	Description
31-0	IsrSet	R/W	0h	Reads returns the currently active software interrupts, Write 1 sets the software interrupt bits to 1

6.5.1.41 INTC_ISR_CLEAR3 Register (offset = F4h) [reset = 0h]

Register mask: 0h

INTC_ISR_CLEAR3 is shown in [Figure 6-44](#) and described in [Table 6-44](#).

This register is used to clear the software interrupt bits

Figure 6-44. INTC_ISR_CLEAR3 Register

31	30	29	28	27	26	25	24	23	22	21	20	19	18	17	16	15	14	13	12	11	10	9	8	7	6	5	4	3	2	1	0
IsrClear																															
W-X																															

LEGEND: R/W = Read/Write; R = Read only; W1toCl = Write 1 to clear bit; -n = value after reset

Table 6-44. INTC_ISR_CLEAR3 Register Field Descriptions

Bit	Field	Type	Reset	Description
31-0	IsrClear	W	X	Write 1 clears the software interrupt bits to 0, reads return 0

6.5.1.42 INTC_PENDING_IRQ3 Register (offset = F8h) [reset = 0h]

Register mask: FFFFFFFFh

INTC_PENDING_IRQ3 is shown in [Figure 6-45](#) and described in [Table 6-45](#).

This register contains the IRQ status after masking

Figure 6-45. INTC_PENDING_IRQ3 Register

31	30	29	28	27	26	25	24	23	22	21	20	19	18	17	16	15	14	13	12	11	10	9	8	7	6	5	4	3	2	1	0
PendingIRQ																															
R-0h																															

LEGEND: R/W = Read/Write; R = Read only; W1toCl = Write 1 to clear bit; -n = value after reset

Table 6-45. INTC_PENDING_IRQ3 Register Field Descriptions

Bit	Field	Type	Reset	Description
31-0	PendingIRQ	R	0h	IRQ status after masking

6.5.1.43 INTC_PENDING_FIQ3 Register (offset = FCh) [reset = 0h]

Register mask: FFFFFFFFh

INTC_PENDING_FIQ3 is shown in [Figure 6-46](#) and described in [Table 6-46](#).

This register contains the FIQ status after masking

Figure 6-46. INTC_PENDING_FIQ3 Register

31	30	29	28	27	26	25	24	23	22	21	20	19	18	17	16	15	14	13	12	11	10	9	8	7	6	5	4	3	2	1	0
PendingFIQ																															
R-0h																															

LEGEND: R/W = Read/Write; R = Read only; W1toCl = Write 1 to clear bit; -n = value after reset

Table 6-46. INTC_PENDING_FIQ3 Register Field Descriptions

Bit	Field	Type	Reset	Description
31-0	PendingFIQ	R	0h	FIQ status after masking

6.5.1.44 INTC_ILR_0 to INTC_ILR_127 Register (offset = 100h to 2FCh) [reset = 0h]

Register mask: FFFFFFFFh

INTC_ILR_0 to INTC_ILR_127 is shown in [Figure 6-47](#) and described in [Table 6-47](#).

The INTC_ILRx registers contain the priority for the interrupts and the FIQ/IRQ steering.

Figure 6-47. INTC_ILR_0 to INTC_ILR_127 Register

31	30	29	28	27	26	25	24
RESERVED							
R-0h							
23	22	21	20	19	18	17	16
RESERVED							
R-0h							
15	14	13	12	11	10	9	8
RESERVED							
R-0h							
7	6	5	4	3	2	1	0
Priority						RESERVED	FIQnIRQ
R/W-0h						R/W-0h	R/W-0h

LEGEND: R/W = Read/Write; R = Read only; W1toCl = Write 1 to clear bit; -n = value after reset

Table 6-47. INTC_ILR_0 to INTC_ILR_127 Register Field Descriptions

Bit	Field	Type	Reset	Description
31-8	RESERVED	R	0h	Write 0's for future compatibility. Reads returns 0
7-2	Priority	R/W	0h	Interrupt priority
1	RESERVED	R/W	0h	
0	FIQnIRQ	R/W	0h	Interrupt IRQ FIQ mapping 0h = IntIRQ : Interrupt is routed to IRQ. 1h = IntFIQ : Interrupt is routed to FIQ (this selection is reserved on GP devices).

Memory Subsystem

This chapter describes the memory subsystem of the device.

Topic	Page
7.1 GPMC.....	517
7.2 OCMC-RAM.....	820
7.3 EMIF	822
7.4 ELM	897

7.1 GPMC

7.1.1 Introduction

The general-purpose memory controller (GPMC) is an unified memory controller dedicated to interfacing external memory devices:

- Asynchronous SRAM-like memories and application-specific integrated circuit (ASIC) devices
- Asynchronous, synchronous, and page mode (only available in non-multiplexed mode) burst NOR flash devices
- NAND Flash
- Pseudo-SRAM devices

7.1.1.1 GPMC Features

The general features of the GPMC module include:

- Data path to external memory device can be 16- or 8-bit wide
- 32-bit OCPIP 2.0 compliant core, single slave interface. Support non-wrapping and wrapping burst up to 16x32bits.
- Up to 100 MHz external memory clock performance (single device)
- Support for the following memory types:
 - External asynchronous or synchronous 8-bit width memory or device (non burst device)
 - External asynchronous or synchronous 16-bit width memory or device
 - External 16-bit non-multiplexed NOR Flash device
 - External 16-bit address and data multiplexed NOR Flash device
 - External 8-bit and 16-bit NAND flash device
 - External 16-bit pSRAM device
- Up to 16-bit ECC support for NAND flash using BCH code (t=4, 8 or 16) or Hamming code for 8-bit or 16-bit NAND-flash, organized with page size of 512 bytes, 1K bytes, or more.
- Support 512M Bytes maximum addressing capability which can be divided into seven independent chip-select with programmable bank size and base address on 16M Bytes, 32M Bytes, 64M Bytes, or 128M Bytes boundary
- Fully pipelined operation for optimal memory bandwidth usage
- Support external device clock frequency of 1, 2, 3 and 4 divider from L3 clock.
- Support programmable auto-clock gating when there is no access.
- Support Midlreq/SidleAck protocol
- Support the following interface protocols when communicating with external memory or external devices.
 - Asynchronous read/write access
 - Asynchronous read page access (4-8-16 Word16)
 - Synchronous read/write access
 - Synchronous read burst access without wrap capability (4-8-16 Word16)
 - Synchronous read burst access with wrap capability (4-8-16 Word16)
- Address and Data multiplexed access
- Each chip-select as independent and programmable control signal timing parameters for Setup and Hold time. Parameters are set according to the memory device timing parameters, with one L3 clock cycle timing granularity.
- Flexible internal access time control (wait state) and flexible handshake mode using external WAIT pins monitoring (up to two WAIT pins)
- Support bus keeping
- Support bus turn around

- Pre-fetch and write posting engine associated with system DMA to get full performance from NAND device with minimum impact on NOR/SRAM concurrent access.
- On the fly ECC Hamming Code calculation to improve NAND usage reliability with minimum impact on SW

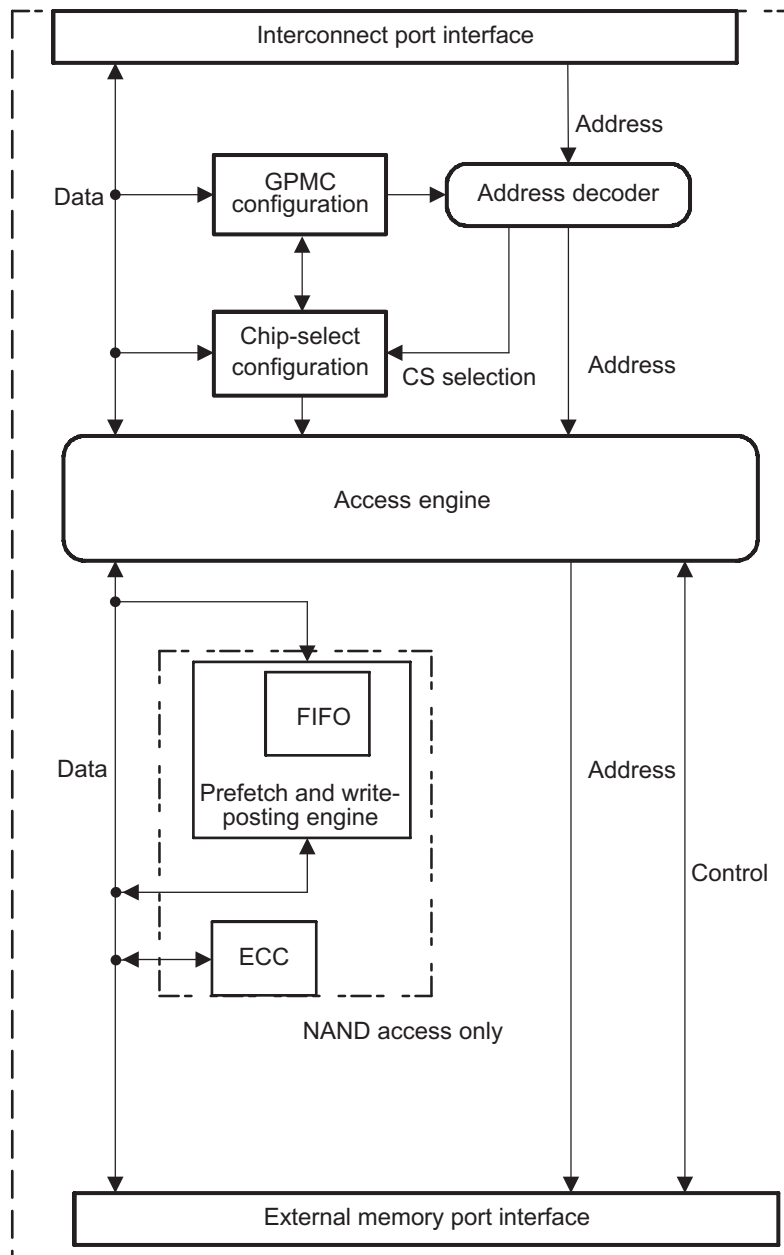
7.1.1.2 Block Diagram

The GPMC can access various external devices through the L3 Slow Interconnect. The flexible programming model allows a wide range of attached device types and access schemes. Based on the programmed configuration bit fields stored in the GPMC registers, the GPMC is able to generate all control signals timing depending on the attached device and access type. Given the chip-select decoding and its associated configuration registers, the GPMC selects the appropriate device type control signals timing.

[Figure 7-1](#) shows the GPMC functional block diagram. The GPMC consists of six blocks:

- Interconnect port interface
- Address decoder, GPMC configuration, and chip-select configuration register file
- Access engine
- Prefetch and write-posting engine
- Error correction code engine (ECC)
- External device/memory port interface

Figure 7-1. GPMC Block Diagram



7.1.1.3 Unsupported GPMC Features

The following module features are not supported in this device.

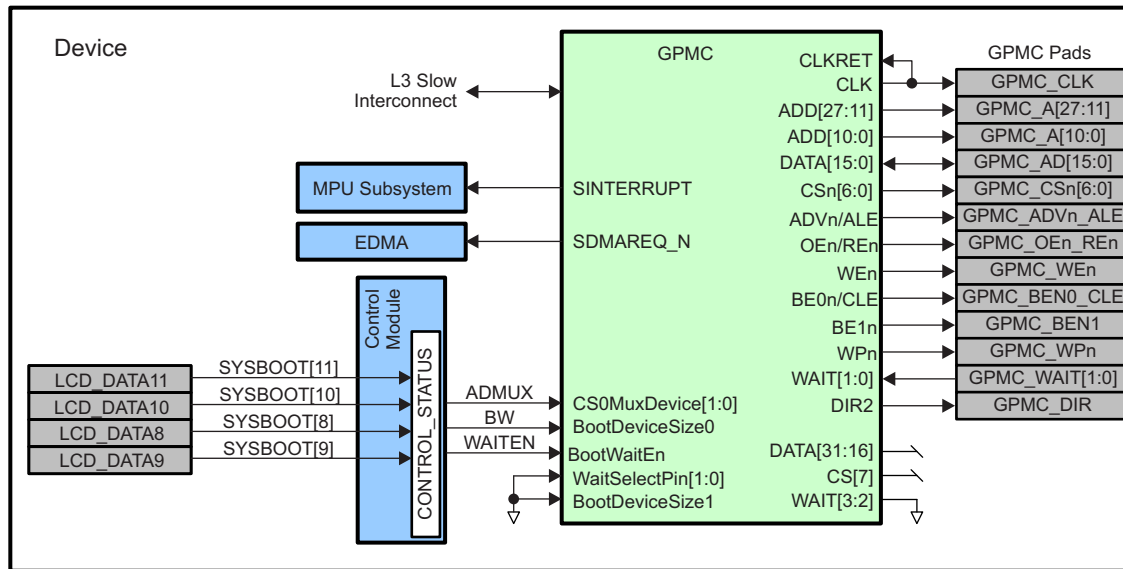
Table 7-1. Unsupported GPMC Features

Feature	Reason
Chip Select 7	Not pinned out
32-bit devices	Only 16 data lines pinned out
WAIT[3:2]	Not pinned out. All CS regions must use WAIT0 or WAIT1

7.1.2 Integration

An instantiation of GPMC provides this device with access to NAND Flash, NOR Flash, and other asynchronous and synchronous interface peripherals. Figure 7-2 shows the integration of the GPMC module in this device.

Figure 7-2. GPMC Integration



7.1.2.1 GPMC Connectivity Attributes

The general connectivity attributes for the GPMC module are shown in Table 7-2.

Table 7-2. GPMC Connectivity Attributes

Attributes	Type
Power Domain	Peripheral Domain
Clock Domain	PD_PER_L3S_GCLK
Reset Signals	PER_DOM_RST_N
Idle/Wakeup Signals	Smart Idle
Interrupt Requests	1 interrupt to MPU Subsystem (GPMCINT)
DMA Requests	1 DMA request to EDMA (GPMCEVT)
Physical Address	L3 Slow Slave Port Memory and control register regions qualified with MAddressSpace bit

7.1.2.2 GPMC Clock and Reset Management

The GPMC is a synchronous design and operates from the same clock as the Slow L3. All timings use this clock as a reference.

Table 7-3. GPMC Clock Signals

Clock Signal	Max Freq	Reference / Source	Comments
prcm_gpmc_clk Interface / Functional clock	100 MHz	CORE_CLKOUTM4 / 2	pd_per_l3s_gclk From PRCM

7.1.2.3 GPMC Signal List

The GPMC external interface signals are shown in Table 7-4.

Table 7-4. GPMC Signal List

Signal	Type	Description
GPMC_A[27:0]	O	Address outputs
GPMC_AD[15:0]	I/O	Data[15:0] in non-muxed mode. A[16:1], D[15:0] in AD-muxed mode. A[27:17], A[16:1], D[15:0] in AAD-muxed mode.
GPMC_CS _n [6:0]	O	Chip selects (active low)
GPMC_CLK	O ⁽¹⁾	Synchronous mode clock
GPMC_ADV _n _ALE	O	Address Valid or Address Latch Enable depending if NOR or NAND protocol memories are selected.
GPMC_OEn_REn	O	Output Enable (active low). Also used as Read Enable (active low) for NAND protocol memories
GPMC_WEn	O	Write Enable (active low)
GPMC_BE0 _n _CLE	O	Lower Byte Enable (active low). Also used as Command Latch Enable for NAND protocol memories
GPMC_BE1 _n	O	Upper Byte Enable (active low)
GPMC_WP _n	O	Write Protect (active low)
GPMC_WAIT[1:0]	I	External wait signal for NOR and NAND protocol memories.
GPMC_DIR	O	GPMC.D[15:0] signal direction control Low during transmit (for write access: data OUT from GPMC to memory) High during receive (for read access: data IN from memory to GPMC)

⁽¹⁾ GPMC_CLK is also used as a re-timing input. The associated CONF_<module>_<pin>_RXACTIVE bit for the output clock must be set to 1 to enable the clock input back to the module. It is also recommended to place a 33-ohm resistor in series (close to the processor) to avoid signal reflections.

7.1.3 Functional Description

7.1.3.1 GPMC Signals

Table 7-5 shows the use of address and data GPMC controller pins based on the type of external device.

Table 7-5. GPMC Pin Multiplexing Options

GPMC Signal	Non Multiplexed Address Data 16-Bit Device ⁽¹⁾	Non Multiplexed Address Data 8-Bit Device	Multiplexed Address Data 16-Bit Device ⁽¹⁾	16-Bit NAND Device	8-Bit NAND Device
GPMC_A[27]	A26	A27	A26	Not Used	Not Used
GPMC_A[26]	A25	A26	Not Used	Not Used	Not Used
GPMC_A[25]	A24	A25	Not Used	Not Used	Not Used
GPMC_A[24]	A23	A24	Not Used	Not Used	Not Used
GPMC_A[23]	A22	A23	Not Used	Not Used	Not Used
GPMC_A[22]	A21	A22	Not Used	Not Used	Not Used
GPMC_A[21]	A20	A21	Not Used	Not Used	Not Used
GPMC_A[20]	A19	A20	Not Used	Not Used	Not Used
GPMC_A[19]	A18	A19	Not Used	Not Used	Not Used
GPMC_A[18]	A17	A18	Not Used	Not Used	Not Used
GPMC_A[17]	A16	A17	Not Used	Not Used	Not Used
GPMC_A[16]	A15	A16	Not Used	Not Used	Not Used
GPMC_A[15]	A14	A15	Not Used	Not Used	Not Used
GPMC_A[14]	A13	A14	Not Used	Not Used	Not Used
GPMC_A[13]	A12	A13	Not Used	Not Used	Not Used
GPMC_A[12]	A11	A12	Not Used	Not Used	Not Used
GPMC_A[11]	A10	A11	Not Used	Not Used	Not Used
GPMC_A[10]	A9	A10	A25	Not Used	Not Used
GPMC_A[9]	A8	A9	A24	Not Used	Not Used
GPMC_A[8]	A7	A8	A23	Not Used	Not Used
GPMC_A[7]	A6	A7	A22	Not Used	Not Used
GPMC_A[6]	A5	A6	A21	Not Used	Not Used
GPMC_A[5]	A4	A5	A20	Not Used	Not Used
GPMC_A[4]	A3	A4	A19	Not Used	Not Used
GPMC_A[3]	A2	A3	A18	Not Used	Not Used
GPMC_A[2]	A1	A2	A17	Not Used	Not Used
GPMC_A[1]	A0	A1	A16	Not Used	Not Used
GPMC_A[0]	Not Used	A0	Not Used	Not Used	Not Used
GPMC_AD[15]	D15	Not Used	A/D[15]	D15	Not Used
GPMC_AD[14]	D14	Not Used	A/D[14]	D14	Not Used
GPMC_AD[13]	D13	Not Used	A/D[13]	D13	Not Used
GPMC_AD[12]	D12	Not Used	A/D[12]	D12	Not Used
GPMC_AD[11]	D11	Not Used	A/D[11]	D11	Not Used
GPMC_AD[10]	D10	Not Used	A/D[10]	D10	Not Used
GPMC_AD[9]	D9	Not Used	A/D[9]	D9	Not Used
GPMC_AD[8]	D8	Not Used	A/D[8]	D8	Not Used
GPMC_AD[7]	D7	D7	A/D[7]	D7	D7
GPMC_AD[6]	D6	D6	A/D[6]	D6	D6

⁽¹⁾ The values in this column represent the signals on the memory. Be aware that some 16-bit memories may label the address lines differently. Some label the LSB as A0, while others use A1 for the LSB. These columns assume the LSB is A0.

Table 7-5. GPMC Pin Multiplexing Options (continued)

GPMC Signal	Non Multiplexed Address Data 16-Bit Device ⁽¹⁾	Non Multiplexed Address Data 8-Bit Device	Multiplexed Address Data 16-Bit Device ⁽¹⁾	16-Bit NAND Device	8-Bit NAND Device
GPMC_AD[5]	D5	D5	A/D[5]	D5	D5
GPMC_AD[4]	D4	D4	A/D[4]	D4	D4
GPMC_AD[3]	D3	D3	A/D[3]	D3	D3
GPMC_AD[2]	D2	D2	A/D[2]	D2	D2
GPMC_AD[1]	D1	D1	A/D[1]	D1	D1
GPMC_AD[0]	D0	D0	A/D[0]	D0	D0
GPMC_CS[0]n	CS0n (Chip Select)	CS0n (Chip Select)	CS0n (Chip Select)	CE0n (Chip Enable)	CE0n (Chip Enable)
GPMC_CS[1]n	CS1n	CS1n	CS1n	CE1n	CE1n
GPMC_CS[2]n	CS2n	CS2n	CS2n	CE2n	CE2n
GPMC_CS[3]n	CS3n	CS3n	CS3n	CE3n	CE3n
GPMC_CS[4]n	CS4n	CS4n	CS4n	CE4n	CE4n
GPMC_CS[5]n	CS5n	CS5n	CS5n	CE5n	CE5n
GPMC_CS[6]n	CS6n	CS6n	CS6n	CE6n	CE6n
GPMC_ADVn_ALE	ADVn (Address Value)	ADVn (Address Value)	ADVn (Address Value)	ALE (address latch enable)	ALE (address latch enable)
GPMC_BE0n_CLE	BE0n (Byte Enable)	BE0n (Byte Enable)	BE0n (Byte Enable)	CLE (command latch enable)	CLE (command latch enable)
GPMC_BE1n	BE1n	BE1n	BE1n		
GPMC_CLK	CLK	CLK	CLK		
GPMC_OE_REn	OEn (Output Enable)	OEn (Output Enable)	OEn (Output Enable)	REn (read enable)	REn (read enable)
GPMC_WAIT0	WAIT0	WAIT0	WAIT0	R/B0n (ready/busy)	R/B0n (ready/busy)
GPMC_WAIT1	WAIT1	WAIT1	WAIT1	R/B1n (ready/busy)	R/B1n (ready/busy)
GPMC_WEn	WEn (Write Enable)	WEn (Write Enable)	WEn (Write Enable)	WEn (write enable)	WEn (write enable)
GPMC_WPn	WPn (Write Protect)	WPn (Write Protect)	WPn (Write Protect)	WPn (write protect)	WPn (write protect)

With all device types, the GPMC does not drive unnecessary address lines. They stay at their reset value of 00.

Address mapping supports address/data-multiplexed 16-bit wide devices:

- The NOR flash memory controller still supports non-multiplexed address and data memory devices.
- Multiplexing mode can be selected through the GPMC_CONFIG1_i[9-8] MUXADDDATA bit field.
- Asynchronous page mode is not supported for multiplexed address and data devices.

7.1.3.2 GPMC Modes

This section shows three GPMC external connections options:

- [Figure 7-3](#) shows a connection between the GPMC and a 16-bit synchronous address/data-multiplexed (or AAD-multiplexed, but this protocol use less address pins) external memory device.
- [Figure 7-4](#) shows a connection between the GPMC and a 16-bit synchronous nonmultiplexed external memory device .
- [Figure 7-5](#) shows a connection between the GPMC and a 8-bit NAND device

Figure 7-3. GPMC to 16-Bit Address/Data-Multiplexed Memory

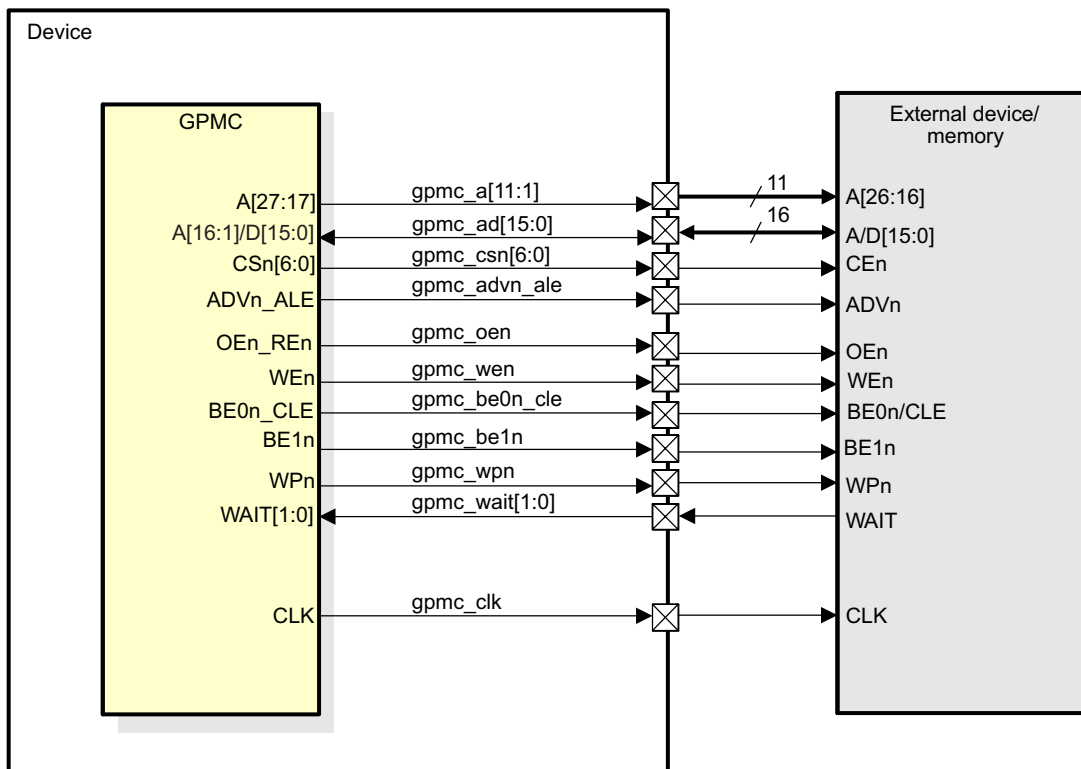


Figure 7-4. GPMC to 16-Bit Non-multiplexed Memory

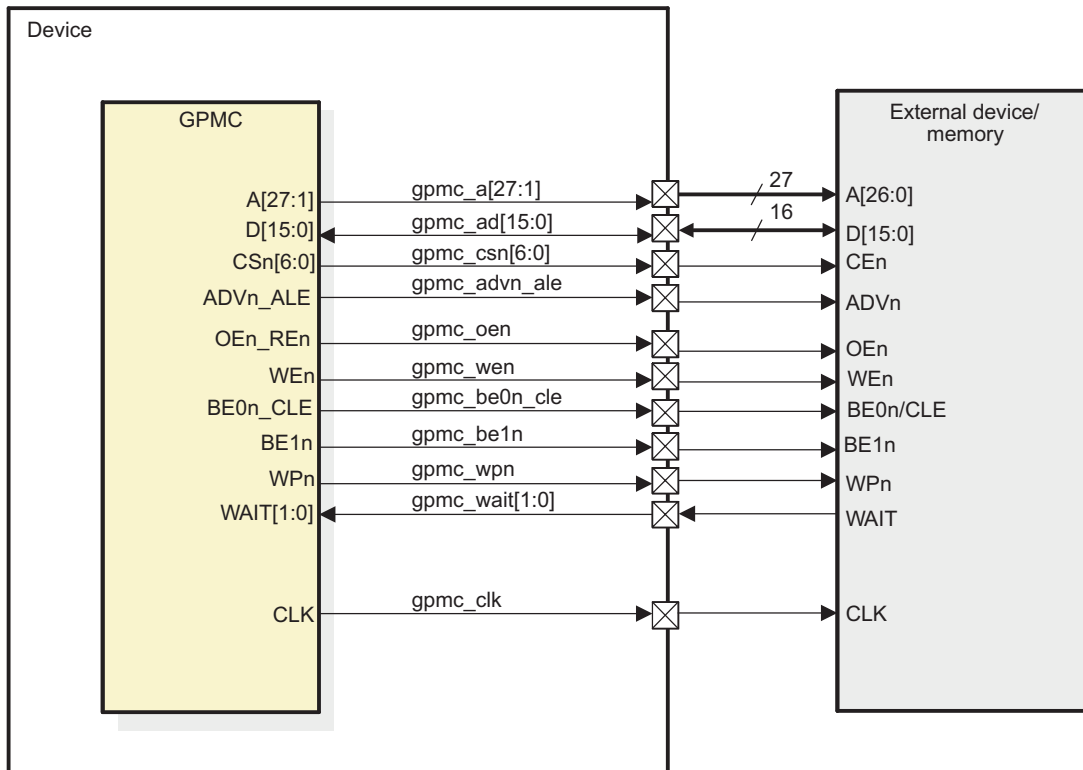
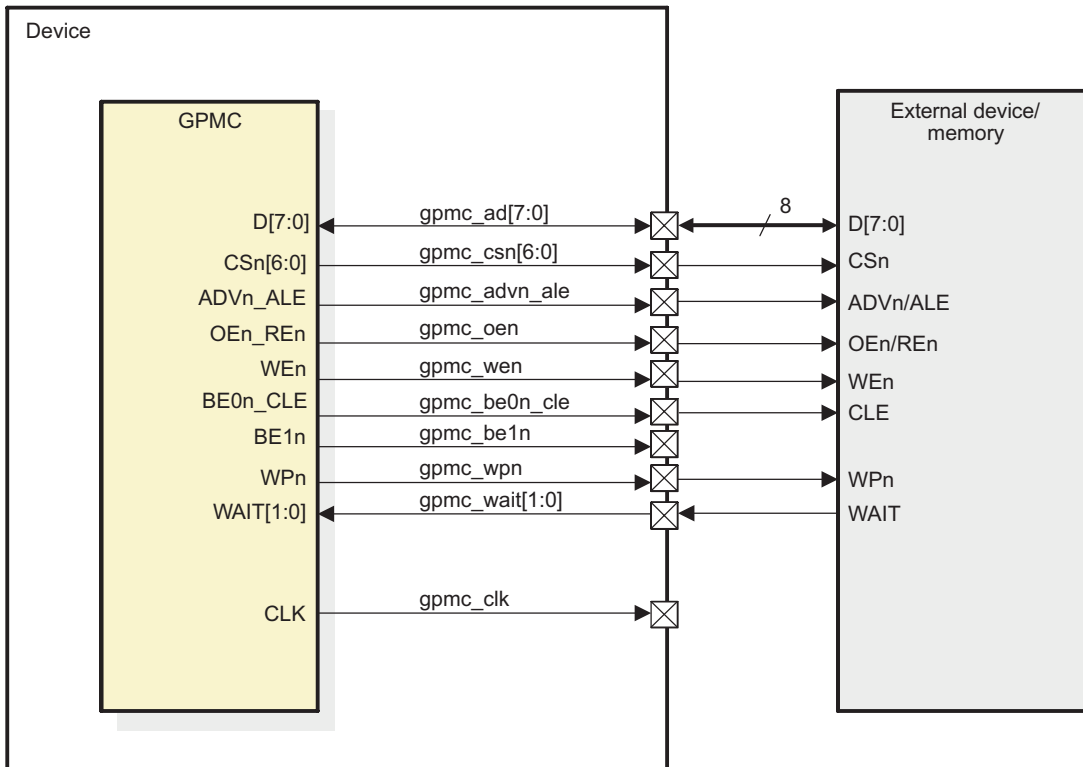


Figure 7-5. GPMC to 8-Bit NAND Device



7.1.3.3 GPMC Functional Description

The GPMC basic programming model offers maximum flexibility to support various access protocols for each of the eight configurable chip-selects. Use optimal chip-select settings, based on the characteristics of the external device:

- Different protocols can be selected to support generic asynchronous or synchronous random-access devices (NOR flash, SRAM) or to support specific NAND devices.
- The address and the data bus can be multiplexed on the same external bus.
- Read and write access can be independently defined as asynchronous or synchronous.
- System requests (byte, 16-bit word, burst) are performed through single or multiple accesses. External access profiles (single, multiple with optimized burst length, native- or emulated-wrap) are based on external device characteristics (supported protocol, bus width, data buffer size, native-wrap support).
- System burst read or write requests are synchronous-burst (multiple-read or multiple-write). When neither burst nor page mode is supported by external memory or ASIC devices, system burst read or write requests are translated to successive single synchronous or asynchronous accesses (single reads or single writes). 8-bit wide devices are supported only in single synchronous or single asynchronous read or write mode.
- To simulate a programmable internal-wait state, an external wait pin can be monitored to dynamically control external access at the beginning (initial access time) of and during a burst access.

Each control signal is controlled independently for each chip-select. The internal functional clock of the GPMC (GPMC_FCLK) is used as a time reference to specify the following:

- Read- and write-access duration
- Most GPMC external interface control-signal assertion and deassertion times
- Data-capture time during read access
- External wait-pin monitoring time
- Duration of idle time between accesses, when required

7.1.3.3.1 GPMC Clock Configuration

Table 7-6 describes the GPMC clocks.

Table 7-6. GPMC Clocks

Signal	I/O	Description
GPMC_FCLK	I	Functional and interface clock
GPMC_CLK	O	External clock provided to synchronous external memory devices.

The GPMC_CLK is generated by the GPMC from the internal GPMC_FCLK clock. The source of the GPMC_FCLK is described in Table 7-3. The GPMC_CLK is configured via the GPMC_CONFIG1_i[1-0] GPMCFCLKDIVIDER field (for i = 0 to 3) as shown in Table 7-7.

Table 7-7. GPMC_CONFIG1_i Configuration

Source Clock	GPMC_CONFIG1_i[1-0] GPMCFCLKDIVIDER	GPMC_CLK Generated Clock Provided to External Memory Device
GPMC_FCLK	00	GPMC_FCLK
	01	GPMC_FCLK/2
	10	GPMC_FCLK/3
	11	GPMC_FCLK/4

7.1.3.3.2 GPMC Software Reset

The GPMC can be reset by software through the GPMC_SYSCONFIG[1] SOFTRESET bit. Setting the bit to 1 enables an active software reset that is functionally equivalent to a hardware reset. Hardware and software resets initialize all GPMC registers and the finite state-machine (FSM) immediately and unconditionally. The GPMC_SYSSTATUS[0] RESETDONE bit indicates that the software reset is complete when its value is 1. The software must ensure that the software reset completes before doing GPMC operations.

7.1.3.3.3 GPMC Power Management

GPMC power is supplied by the CORE power domain, and GPMC power management complies with system power-management guidelines. Table 7-8 describes power-management features available for the GPMC module.

Table 7-8. GPMC Local Power Management Features

Feature	Registers	Description
Clock Auto Gating	GPMC_SYSCONFIG[0] AUTOIDLE] bit	This bit allows a local power optimization inside the module, by gating the GPMC_FCLK clock upon the internal activity.
Slave Idle Modes	GPMC_SYSCONFIG[4-3] SIDLEMODE bit field	Force-idle, No-idle and Smart-idle wakeup modes are available
Clock Activity	N/A	Feature not available
Master Standby Modes	N/A	Feature not available
Global Wake-up Enable	N/A	Feature not available
Wake-up Sources Enable	N/A	Feature not available

7.1.3.3.4 GPMC Interrupt Requests

The GPMC generates one interrupt event as shown in [Figure 7-2](#).

- The interrupt request goes from GPMC (GPMC_IRQ) to the MPU subsystem: A_IRQ_100

[Table 7-9](#) lists the event flags, and their mask, that can cause module interrupts.

Table 7-9. GPMC Interrupt Events

Event Flag	Event Mask	Sensitivity	Map to	Description
GPMC_IRQSTATUS[9] WAIT1EDGEDETECTIO NSTATUS	GPMC_IRQENABLE[9] WAIT1EDGEDETECTIO NENABLE	Edge	A_IRQ_100	Wait1 edge detection interrupt: Triggered if a rising or falling edge is detected on the GPMC_WAIT1 signal. The rising or falling edge detection of Wait1 is selected through GPMC_CONFIG[9] WAIT1PINPOLARITY bit.
GPMC_IRQSTATUS[8] WAIT0EDGEDETECTIO NSTATUS	GPMC_IRQENABLE[8] WAIT0EDGEDETECTIO NENABLE	Edge	A_IRQ_100	Wait0 edge detection interrupt: Triggered if a rising or falling edge is detected on the GPMC_WAIT0 signal. The rising or falling edge detection of Wait0 is selected through GPMC_CONFIG[8] WAIT0PINPOLARITY bit.
GPMC_IRQSTATUS[1] TERMINALCOUNTSTAT US	GPMC_IRQENABLE[1] TERMINALCOUNTENA BLE	Level	A_IRQ_100	Terminal count event: Triggered on prefetch process completion, that is when the number of currently remaining data to be requested reaches 0.
GPMC_IRQSTATUS[0] FIFOEVENTSTATUS	GPMC_IRQENABLE[0] FIFOEVENTENABLE	Level	A_IRQ_100	FIFO event interrupt: Indicates FIFO levels availability for in Write-Posting mode and prefetch mode. GPMC_PREFETCH_CONFIG[2] DMAMODE bit shall be cleared to 0.

7.1.3.3.5 GPMC DMA Requests

The GPMC generates one DMA event, from GPMC (GPMC_DMA_REQ) to the eDMA: e_DMA_53

7.1.3.3.6 L3 Slow Interconnect Interface

The GPMC L3 Slow interconnect interface is a pipelined interface including an 16 × 32-bit word write buffer. Any system host can issue external access requests through the GPMC. The device system can issue the following requests through this interface:

- One 8-bit / 16-bit / 32-bit interconnect access (read/write)
- Two incrementing 32-bit interconnect accesses (read/write)
- Two wrapped 32-bit interconnect accesses (read/write)
- Four incrementing 32-bit interconnect accesses (read/write)
- Four wrapped 32-bit interconnect accesses (read/write)
- Eight incrementing 32-bit interconnect accesses (read/write)
- Eight wrapped 32-bit interconnect accesses (read/write)

Only linear burst transactions are supported; interleaved burst transactions are not supported. Only power-of-two-length precise bursts 2 × 32, 4 × 32, 8 × 32 or 16 × 32 with the burst base address aligned on the total burst size are supported (this limitation applies to incrementing bursts only).

This interface also provides one interrupt and one DMA request line, for specific event control.

It is recommended to program the GPMC_CONFIG1_i ATTACHEDDEVICEPAGELENGTH field ([24-23]) according to the effective attached device page length and to enable the GPMC_CONFIG1_i WRAPBURST bit ([31]) if the attached device supports wrapping burst. However, it is possible to emulate wrapping burst on a non-wrapping memory by providing relevant addresses within the page or splitting transactions. Bursts larger than the memory page length are chopped into multiple bursts transactions. Due to the alignment requirements, a page boundary is never crossed.

7.1.3.3.7 GPMC Address and Data Bus

The current application supports GPMC connection to NAND devices and to address/data-multiplexed memories or devices. Connection to address/data-nonmultiplexed memories Depending on the GPMC configuration of each chip-select, address and data bus lines that are not required for a particular access protocol are not updated (changed from current value) and are not sampled when input (input data bus).

- For address/data-multiplexed and AAD-multiplexed NOR devices, the address is multiplexed on the data bus.
- 8-bit wide NOR devices do not use GPMC I/O: GPMC_AD[15-8] for data (they are used for address if needed).
- 16-bit wide NAND devices do not use GPMC I/O: GPMC_A[27-0].
- 8-bit wide NAND devices do not use GPMC I/O: GPMC_A[27-0] and GPMC I/O: GPMC_AD[15-8].

7.1.3.3.7.1 GPMC I/O Configuration Setting

NOTE: In this section and next sections, the *i* in GPMC_CONFIGx_i stands for the GPMC chip-select *i* where *i* = 0 to 6.

To select a NAND device, program the following register fields:

- GPMC_CONFIG1_i[11-10] DEVICETYPE field = 10b
- GPMC_CONFIG1_i[9-8] MUXADDDATA bit = 00

To select an address/data-multiplexed device, program the following register fields:

- GPMC_CONFIG1_i[11-10] DEVICETYPE field = 00
- GPMC_CONFIG1_i[9-8] MUXADDDATA bit = 10b

To select an address/address/data-multiplexed device, program the following register fields:

- GPMC_CONFIG1_i[11-10] DEVICETYPE field = 00
- GPMC_CONFIG1_i[9-8] MUXADDDATA bit = 01b

To select an address/data-nonmultiplexed device, program the following register fields:

- GPMC_CONFIG1_i[11-10] DEVICETYPE field = 00
- GPMC_CONFIG1_i[9-8] MUXADDDATA bit = 00

7.1.3.3.8 Address Decoder and Chip-Select Configuration

Addresses are decoded accordingly with the address request of the chip-select and the content of the chip-select base address register file, which includes a set of global GPMC configuration registers and eight sets of chip-select configuration registers.

The GPMC configuration register file is memory-mapped and can be read or written with byte, 16-bit word, or 32-bit word accesses. The register file should be configured as a noncacheable, nonbufferable region to prevent any desynchronization between host execution (write request) and the completion of register configuration (write completed with register updated). provides the GPMC register locations. For the map of GPMC memory locations, see [Table 7-51](#).

After the chip-select is configured, the access engine accesses the external device, drives the external interface control signals, and applies the interface protocol based on user-defined timing parameters and settings.

7.1.3.3.8.1 Chip-Select Base Address and Region Size

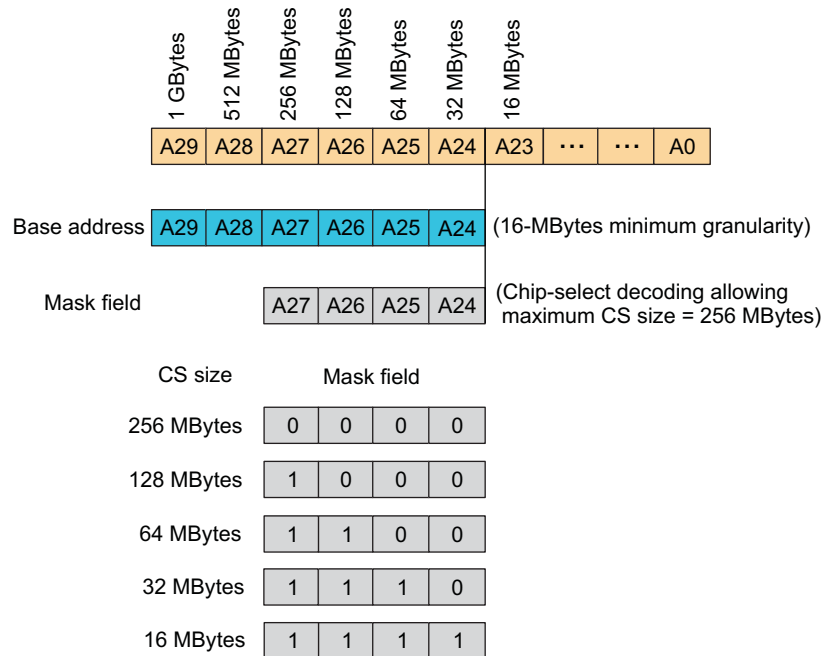
Any external memory or ASIC device attached to the GPMC external interface can be accessed by any device system host within the GPMC 512-Mbyte contiguous address space. For details, see [Table 7-51](#).

The GPMC 512 Mbyte address space can be divided into a maximum of seven chip-select regions with programmable base address and programmable CS size. The CS size is programmable from 16 Mbytes to 256 Mbytes (must be a power-of-2) and is defined by the mask field. Attached memory smaller than the programmed CS region size is accessed through the entire CS region (aliasing).

Each chip-select has a 6-bit base address encoding and a 4-bit decoding mask, which must be programmed according to the following rules:

- The programmed chip-select region base address must be aligned on the chip-select region size address boundary and is limited to a power-of-2 address value. During access decoding, the register base address value is used for address comparison with the address-bit line mapping as described in [Figure 7-6](#) (with A0 as the device system byte-address line). Base address is programmed through the GPMC_CONFIG7_i[5-0] BASEADDRESS bit field.
- The register mask is used to exclude some address lines from the decoding. A register mask bit field cleared to 0 suppresses the associated address line from the address comparison (incoming address bit line is don't care). The register mask value must be limited to the subsequent value, based on the desired chip-select region size. Any other value has an undefined result. When multiple chip-select regions with overlapping addresses are enabled concurrently, access to these chip-select regions is cancelled and a GPMC access error is posted. The mask field is programmed through the GPMC_CONFIG7_i[11-8] MASKADDRESS bit field.

Figure 7-6. Chip-Select Address Mapping and Decoding Mask



A mask value of 0010 or 1001 must be avoided because it will create holes in the chip-select address space.

Chip-select configuration (base and mask address or any protocol and timing settings) must be performed while the associated chip-select is disabled through the GPMC_CONFIG7_i[6] CSVALID bit. In addition, a chip-select configuration can only be disabled if there is no ongoing access to that chip-select. This requires activity monitoring of the prefetch or write-posting engine if the engine is active on the chip-select. Also, the write buffer state must be monitored to wait for any posted write completion to the chip-select.

Any access attempted to a nonvalid GPMC address region (CSVVALID disabled or address decoding outside a valid chip-select region) is not propagated to the external interface and a GPMC access error is posted. In case of chip-selects overlapping, an error is generated and no access will occur on either chip-select. Chip-select 0 is the only chip-select region enabled after either a power-up or a GPMC reset.

Although the GPMC interface can drive up to seven chip-selects, the frequency specified for this interface is for a specific load. If this load is exceeded, the maximum frequency cannot be reached. One solution is to implement a board with buffers, to allow the slowest device to maintain the total load on the lines.

7.1.3.3.8.2 Access Protocol

7.1.3.3.8.2.1 Supported Devices

The access protocol of each chip-select can be independently specified through the GPMC_CONFIG1_i[[11-10] DEVICETYPE parameter for:

- Random-access synchronous or asynchronous memory like NOR flash, SRAM
- NAND flash asynchronous devices

For more information about the NAND flash GPMC basic programming model and NAND support, see [Section 7.1.3.3.12](#) and [Section 7.1.3.3.12.1](#).

7.1.3.3.8.2.2 Access Size Adaptation and Device Width

Each chip-select can be independently configured through the GPMC_CONFIG1_i[[13-12] DEVICESIZE field to interface with a 16-bit wide device or an 8-bit wide device. System requests with data width greater than the external device data bus width are split into successive accesses according to both the external device data-bus width and little-endian data organization.

An 8-bit wide device must be interfaced to the D0-D7 external interface bus lane. GPMC data accesses only use this bus lane when the associated chip-select is attached to an 8-bit wide device.

The 8-bit wide device can be interfaced in asynchronous or synchronous mode in single data phase (no 8-bit wide device burst mode). If the 8-bit wide device is set in the chip-select configuration register, ReadMultiple and WriteMultiple bit fields are considered “don’t care” and only single accesses are performed.

A 16-bit wide device can be interfaced in asynchronous or synchronous mode, with single or multiple data phases for an access, and with native or emulated wrap mode support.

7.1.3.3.8.2.3 Address/Data-Multiplexing Interface

For random synchronous or asynchronous memory interfacing (DEVICETYPE = 0b00), an address- and data-multiplexing protocol can be selected through the GPMC_CONFIG1_i[[9-8] MUXADDDATA bit field. The ADVn signal must be used as the external device address latch control signal. For the associated chip-select configuration, ADVn assertion and deassertion time and OEn assertion time must be set to the appropriate value to meet the address latch setup/hold time requirements of the external device (see [Section 7.1.2](#)).

This address/data-multiplexing interface is not applicable to NAND device interfacing. NAND devices require a specific address, command, and data multiplexing protocol (see [Section 7.1.3.3.12](#)).

7.1.3.3.8.3 External Signals

7.1.3.3.8.3.1 WAIT Pin Monitoring Control

GPMC access time can be dynamically controlled using an external gpmc_wait pin when the external device access time is not deterministic and cannot be defined and controlled only using the GPMC internal RDACCESSTIME, WRACCESSTIME and PAGEBURSTACCESSTIME wait state generator.

The GPMC features two input wait pin:gpmc_wait1, and gpmc_wait0. This pin allow control of external devices with different wait-pin polarity. They also allow the overlap of wait-pin assertion from different devices without affecting access to devices for which the wait pin is not asserted.

- The GPMC_CONFIG1_i[17-16] WAITPINSELECT bit field (where i = 0 to 6) selects which input gpmc_wait pin is used for the device attached to the corresponding chip-select.
- The polarity of the wait pin is defined through the WAITxPINPOLARITY bit of the GPMC_CONFIG register. A wait pin configured to be active low means that low level on the WAIT signal indicates that the data is not ready and that the data bus is invalid. When WAIT is inactive, data is valid.

The GPMC access engine can be configured per CS to monitor the wait pin of the external memory device or not, based on the access type: read or write.

- The GPMC_CONFIG1_i[22] WAITREADMONITORING bit defines whether the wait pin should be monitored during read accesses or not.
- The GPMC_CONFIG1_i[21] WAITWRITEMONITORING bit defines whether the wait pin should be monitored during write accesses or not.

The GPMC access engine can be configured to monitor the wait pin of the external memory device asynchronously or synchronously with the GPMC_CLK clock, depending on the access type: synchronous or asynchronous (the GPMC_CONFIG1_i[29] READTYPE and GPMC_CONFIG1_i[27] WRITETYPE bits).

7.1.3.3.8.3.2 Wait Monitoring During an Asynchronous Read Access

When wait-pin monitoring is enabled for read accesses (WAITREADMONITORING), the effective access time is a logical AND combination of the RDACCESSTIME timing completion and the wait-deasserted state.

During asynchronous read accesses with wait-pin monitoring enabled, the wait pin must be at a valid level (asserted or deasserted) for at least two GPMC clock cycles before RDACCESSTIME completes, to ensure correct dynamic access-time control through wait-pin monitoring. The advance pipelining of the two GPMC clock cycles is the result of the internal synchronization requirements for the WAIT signal.

In this context, RDACCESSTIME is used as a WAIT invalid timing window and is set to such a value that the wait pin is at a valid state two GPMC clock cycles before RDACCESSTIME completes.

Similarly, during a multiple-access cycle (for example, asynchronous read page mode), the effective access time is a logical AND combination of PAGEBURSTACCESSTIME timing completion and the wait-deasserted state. Wait-monitoring pipelining is also applicable to multiple accesses (access within a page).

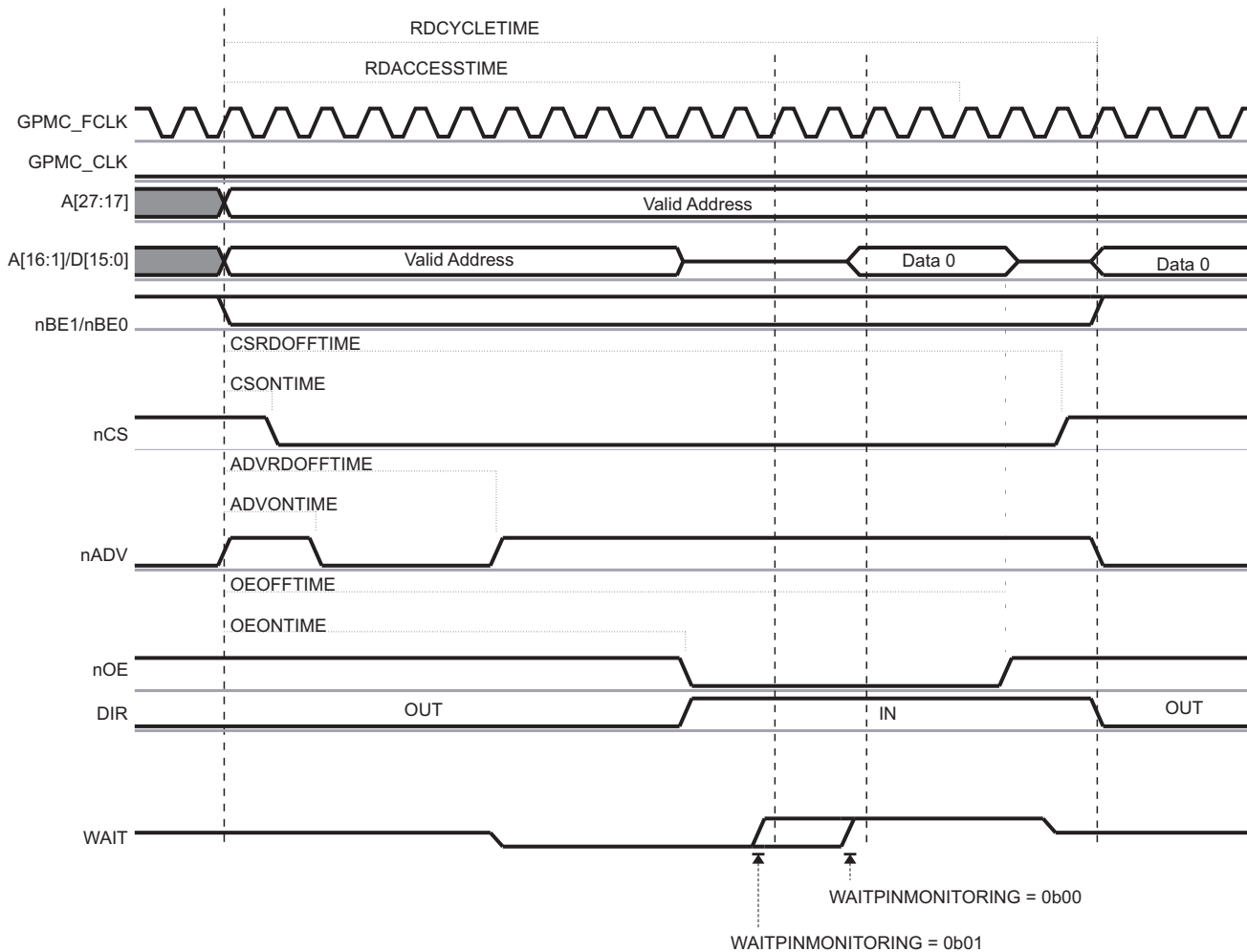
- WAIT monitored as active freezes the CYCLETIME counter. For an access within a page, when the CYCLETIME counter is by definition in a lock state, WAIT monitored as asserted extends the current access time in the page. Control signals are kept in their current state. The data bus is considered invalid, and no data are captured during this clock cycle.
- WAIT monitored as inactive unfreezes the CYCLETIME counter. For an access within a page, when the CYCLETIME counter is by definition in a lock state, WAIT monitored as inactive completes the current access time and starts the next access phase in the page. The data bus is considered valid, and data are captured during this clock cycle. In case of a single access or if this was the last access in a multiple-access cycle, all signals are controlled according to their related control timing value and according to the CYCLETIME counter status.

When a delay larger than two GPMC clocks must be observed between wait-pin deactivation time and data valid time (including the required GPMC and the device data setup time), an extra delay can be added between wait-pin deassertion time detection and effective data-capture time and the effective unlock of the CYCLETIME counter. This extra delay can be programmed in the GPMC_CONFIG1_i[19-18] WAITMONITORINGTIME field.

- The WAITMONITORINGTIME parameter does not delay the wait-pin active or inactive detection, nor does it modify the two GPMC clocks pipelined detection delay.
- This extra delay is expressed as a number of GPMC_CLK clock cycles, even though the access is defined as asynchronous, and no GPMC_CLK clock is provided to the external device. Still, GPMCFCLKDIVIDER is used as a divider for the GPMC clock, so it must be programmed to define the correct WAITMONITORINGTIME delay.

Figure 7-7 shows wait behavior during an asynchronous single read access.

Figure 7-7. Wait Behavior During an Asynchronous Single Read Access (GPMCFCLKDivider = 1)



The WAIT signal is active low. GPMC_CONFIG1_i[19-18] WAITMONITORINGTIME = 00b or 01b.

7.1.3.3.3.3 Wait Monitoring During an Asynchronous Write Access

When wait-pin monitoring is enabled for write accesses (GPMC_CONFIG1_i[21] WAITWRITEMONITORING bit = 1), the WAIT-invalid timing window is defined by the WRACCESSTIME field. WRACCESSTIME must be set so that the wait pin is at a valid state two GPMC clock cycles before WRACCESSTIME completes. The advance pipelining of the two GPMC clock cycles is the result of the internal synchronization requirements for the WAIT signal.

- WAIT monitored as active freezes the CYCLETIME counter. This informs the GPMC that the data bus is not captured by the external device. The control signals are kept in their current state. The data bus still drives the data.
- WAIT monitored as inactive unfreezes the CYCLETIME counter. This informs that the data bus is correctly captured by the external device. All signals, including the data bus, are controlled according to their related control timing value and to the CYCLETIME counter status.

When a delay larger than two GPMC clock cycles must be observed between wait-pin deassertion time and the effective data write into the external device (including the required GPMC data setup time and the device data setup time), an extra delay can be added between wait-pin deassertion time detection and effective data write time into the external device and the effective unfreezing of the CYCLETIME counter. This extra delay can be programmed in the GPMC_CONFIG1_i[19-18] WAITMONITORINGTIME fields.

- The WAITMONITORINGTIME parameter does not delay the wait-pin assertion or deassertion detection, nor does it modify the two GPMC clock cycles pipelined detection delay.
- This extra delay is expressed as a number of GPMC_CLK clock cycles, even though the access is defined as asynchronous, and even though no clock is provided to the external device. Still, GPMC_CONFIG1_i[1-0] GPMCFCLKDIVIDER is used as a divider for the GPMC clock and so it must be programmed to define the correct WAITMONITORINGTIME delay.

7.1.3.3.8.3.4 Wait Monitoring During a Synchronous Read Access

During synchronous accesses with wait-pin monitoring enabled, the wait pin is captured synchronously with GPMC_CLK, using the rising edge of this clock.

The WAIT signal can be programmed to apply to the same clock cycle it is captured in. Alternatively, it can be sampled one or two GPMC_CLK cycles ahead of the clock cycle it applies to. This pipelining is applicable to the entire burst access, and to all data phase in the burst access. This WAIT pipelining depth is programmed in the GPMC_CONFIG1_i[19-18] WAITMONITORINGTIME field, and is expressed as a number of GPMC_CLK clock cycles.

In synchronous mode, when wait-pin monitoring is enabled (GPMC_CONFIG1_i[22] WAITREADMONITORING bit), the effective access time is a logical AND combination of the RDACCESSTIME timing completion and the WAIT deasserted-state detection.

Depending on the programmed WAITMONITORINGTIME value, the wait pin should be at a valid level, either asserted or deasserted:

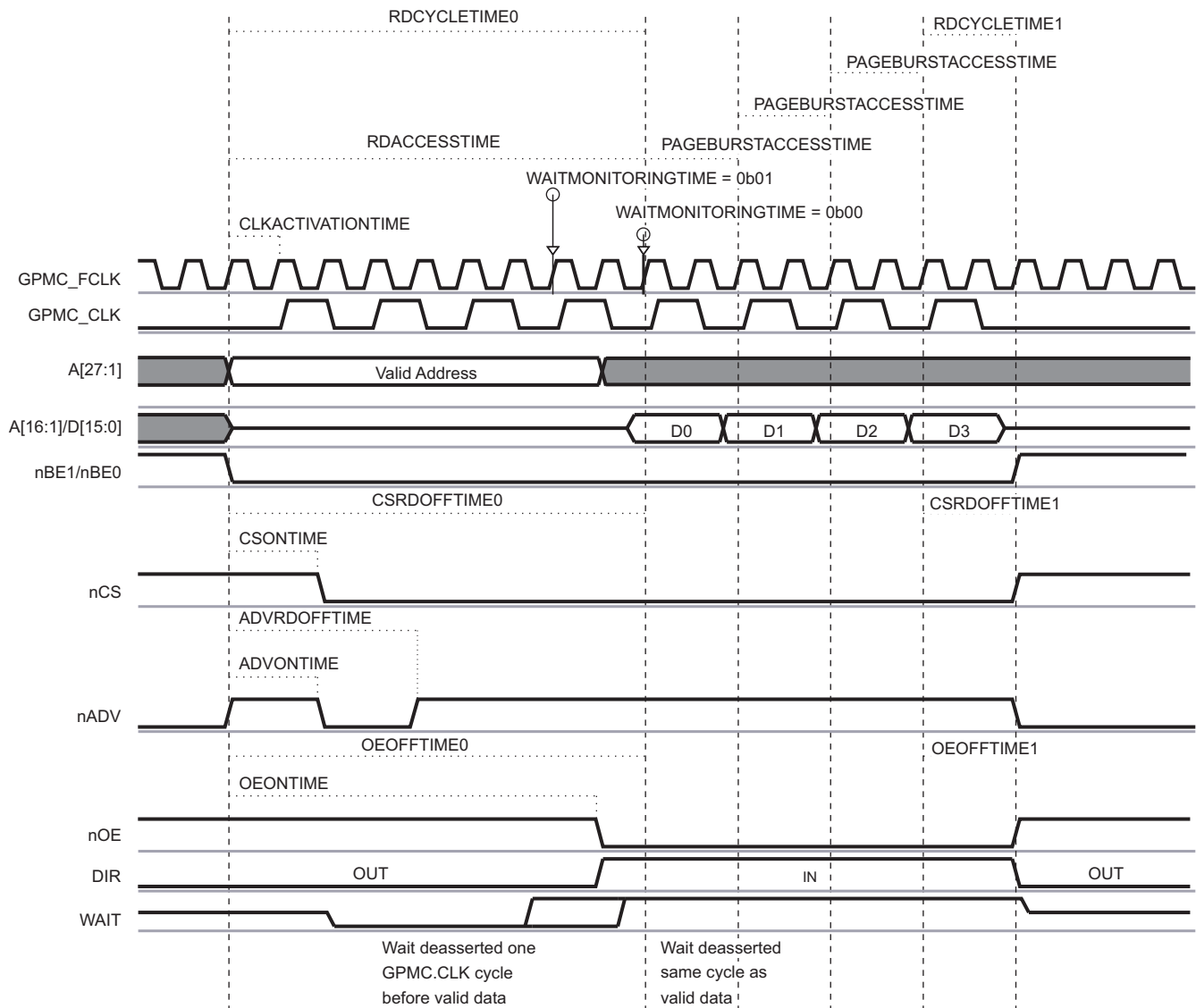
- In the same clock cycle the data is valid if WAITMONITORINGTIME = 0 (at RDACCESSTIME completion)
- In the WAITMONITORINGTIME x (GPMCFCLKDIVIDER + 1) GPMC_FCLK clock cycles before RDACCESSTIME completion if WAITMONITORINGTIME not equal to 0

Similarly, during a multiple-access cycle (burst mode), the effective access time is a logical AND combination of PAGEBURSTACCESSTIME timing completion and the wait-inactive state. The Wait pipelining depth programming applies to the whole burst access.

- WAIT monitored as active freezes the CYCLETIME counter. For an access within a burst (when the CYCLETIME counter is by definition in a lock state), WAIT monitored as active extends the current access time in the burst. Control signals are kept in their current state. The data bus is considered invalid, and no data are captured during this clock cycle.
- WAIT monitored as inactive unfreezes the CYCLETIME counter. For an access within a burst (when the CYCLETIME counter is by definition in lock state), WAIT monitored as inactive completes the current access time and starts the next access phase in the burst. The data bus is considered valid, and data are captured during this clock cycle. In a single access or if this was the last access in a multiple-access cycle, all signals are controlled according to their relative control timing value and the CYCLETIME counter status.

Figure 7-8 shows wait behavior during a synchronous read burst access.

Figure 7-8. Wait Behavior During a Synchronous Read Burst Access



The WAIT signal is active low. WAITMONITORINGTIME = 00b or 01b.

7.1.3.3.8.3.5 Wait Monitoring During a Synchronous Write Access

During synchronous accesses with wait-pin monitoring enabled (the WAITWRITEMONITORING bit), the wait pin is captured synchronously with GPMC_CLK, using the rising edge of this clock.

If enabled, external wait-pin monitoring can be used in combination with WRACCESSTIME to delay the effective memory device GPMC_CLK capture edge.

Wait-monitoring pipelining depth is similar to synchronous read access:

- At WRACCESSTIME completion if WAITMONITORINGTIME = 0
- In the WAITMONITORINGTIME x (GPMCFCLKDIVIDER + 1) GPMC_FCLK cycles before WRACCESSTIME completion if WAITMONITORINGTIME not equal to 0.

Wait-monitoring pipelining definition applies to whole burst accesses:

- WAIT monitored as active freezes the CYCLETIME counter. For accesses within a burst, when the CYCLETIME counter is by definition in a lock state, WAIT monitored as active indicates that the data bus is not being captured by the external device. Control signals are kept in their current state. The data bus is kept in its current state.
- WAIT monitored as inactive unfreezes the CYCLETIME counter. For accesses within a burst, when the CYCLETIME counter is by definition in a lock state, WAIT monitored as inactive indicates the effective data capture of the bus by the external device and starts the next access of the burst. In case of a single access or if this was the last access in a multiple access cycle, all signals, including the data bus, are controlled according to their related control timing value and the CYCLETIME counter status.

Wait monitoring is supported for all configurations except for GPMC_CONFIG1_i[19-18]
 WAITMONITORINGTIME = 0 for write bursts with a clock divider of 1 or 2 (GPMC_CONFIG1_i[1-0]
 GPMCFCLKDIVIDER field equal to 0 or 1, respectively).

7.1.3.3.8.3.6 WAIT With NAND Device

For details about the use of the wait pin for communication with a NAND flash external device, see [Section 7.1.3.3.12.2](#).

7.1.3.3.8.3.7 Idle Cycle Control Between Successive Accesses

7.1.3.3.8.3.7.1 Bus Turnaround (BUSTURNAROUND)

To prevent data-bus contention, an access that follows a read access to a slow memory/device must be delayed (in other words, control the CSn/OEn de-assertion to data bus in high-impedance delay).

The bus turnaround is a time-out counter starting after CSn or OEn de-assertion time, whichever occurs first, and delays the next access start-cycle time. The counter is programmed through the GPMC_CONFIG6_i[3-0] BUSTURNAROUND bit field.

After a read access to a chip-select with a non zero BUSTURNAROUND, the next access is delayed until the BUSTURNAROUND delay completes, if the next access is one of the following:

- A write access to any chip-select (same or different from the chip-select data was read from)
- A read access to a different chip-select from the chip-select data was read access from
- A read or write access to a chip-select associated with an address/data-multiplexed device

Bus keeping starts after bus turnaround completion so that DIR changes from IN to OUT after bus turnaround. The bus will not have enough time to go into high-impedance even though it could be driven with the same value before bus turnaround timing.

BUSTURNAROUND delay runs in parallel with GPMC_CONFIG6_i[3-0] CYCLE2CYCLEDELAY delays. It should be noted that BUSTURNAROUND is a timing parameter for the ending chip-select access while CYCLE2CYCLEDELAY is a timing parameter for the following chip-select access. The effective minimum delay between successive accesses is driven by these delay timing parameters and by the access type of the following access. See [Figure 7-9](#) to [Figure 7-11](#).

Another way to prevent bus contention is to define an earlier CSn or OEn deassertion time for slow devices or to extend the value of RDCYCLETIME. Doing this prevents bus contention, but affects all accesses of this specific chip-select.

Figure 7-9. Read to Read for an Address-Data Multiplexed Device, On Different CS, Without Bus Turnaround (CS0n Attached to Fast Device)

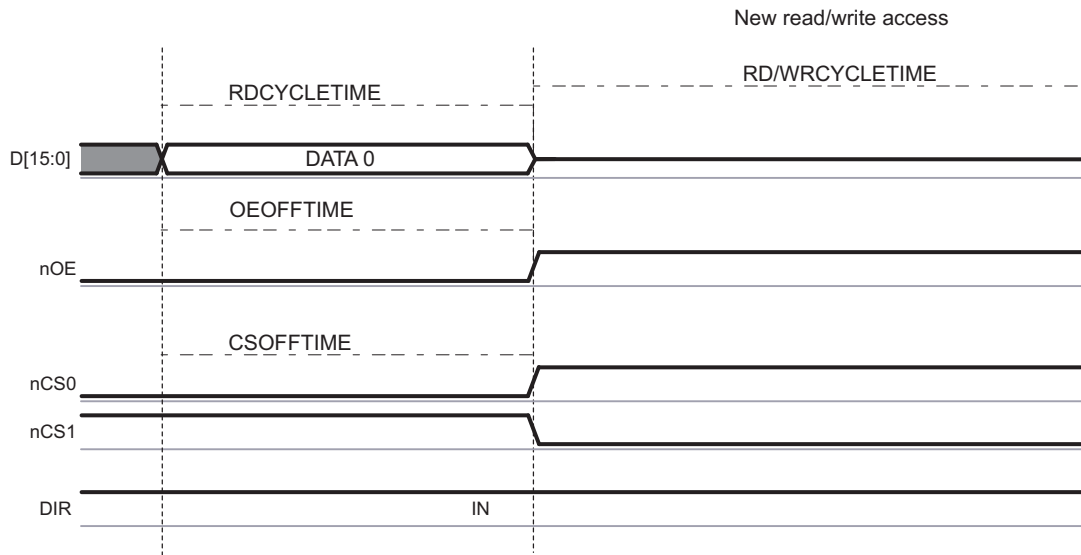


Figure 7-10. Read to Read / Write for an Address-Data Multiplexed Device, On Different CS, With Bus Turnaround

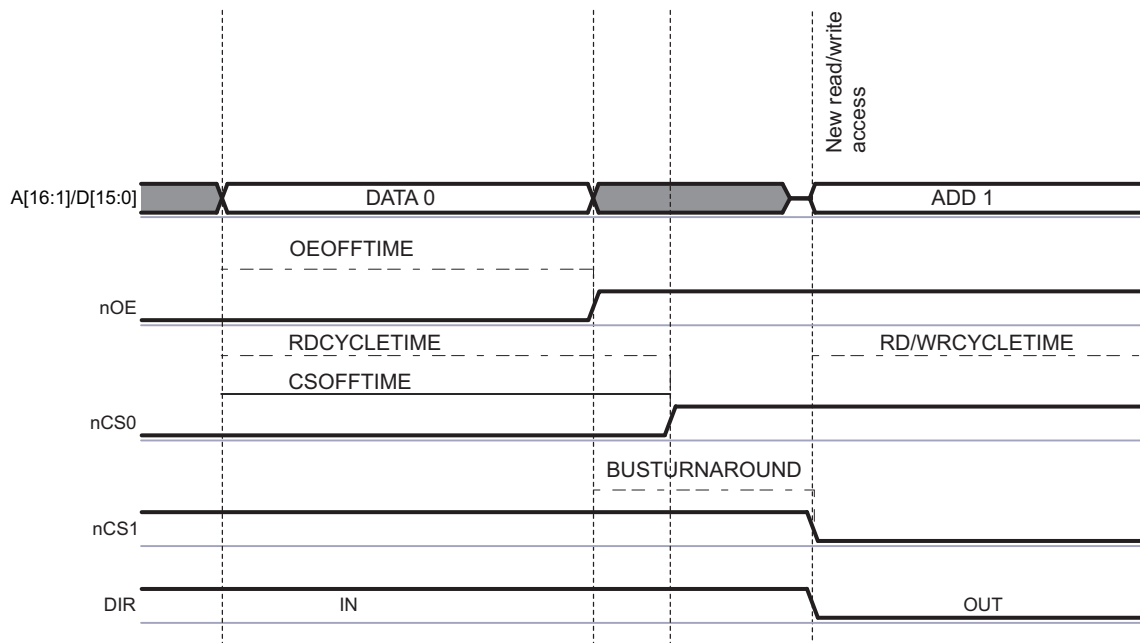
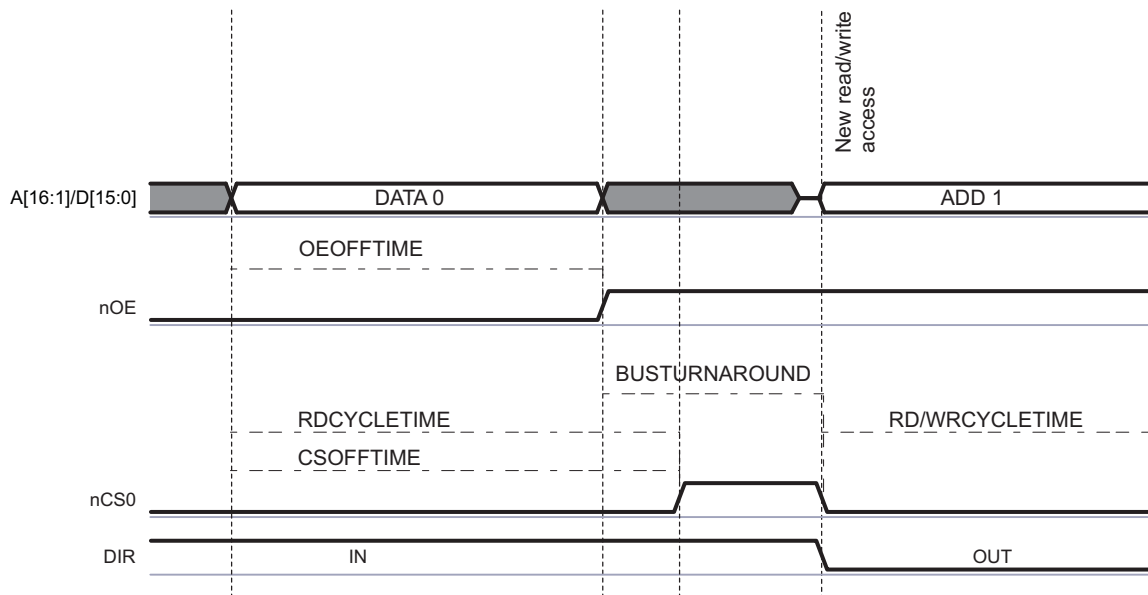


Figure 7-11. Read to Read / Write for a Address-Data or AAD-Multiplexed Device, On Same CS, With Bus Turnaround



7.1.3.3.8.3.7.2 Idle Cycles Between Accesses to Same Chip-Select (**CYCLE2CYCLESAMECSSEN**, **CYCLE2CYCLEDELAY**)

Some devices require a minimum chip-select signal inactive time between accesses. The GPMC_CONFIG6_i[7] CYCLE2CYCLESAMECSSEN bit enables insertion of a minimum number of GPMC_FCLK cycles, defined by the GPMC_CONFIG6_i[11-8] CYCLE2CYCLEDELAY field, between successive accesses of any type (read or write) to the same chip-select.

If CYCLE2CYCLESAMECSSEN is enabled, any subsequent access to the same chip-select is delayed until its CYCLE2CYCLEDELAY completes. The CYCLE2CYCLEDELAY counter starts when CSRDOFFTIME/CSWROFFTIME completes.

The same applies to successive accesses occurring during 32-bit word or burst accesses split into successive single accesses when the single-access mode is used (GPMC_CONFIG1_i[30] READMULTIPLE = 0 or GPMC_CONFIG1_i[28] WRITEMULTIPLE = 0).

All control signals are kept in their default states during these idle GPMC_FCLK cycles. This prevents back-to-back accesses to the same chip-select without idle cycles between accesses.

7.1.3.3.8.3.7.3 Idle Cycles Between Accesses to Different Chip-Select (**CYCLE2CYCLEDIFFCSSEN**, **CYCLE2CYCLEDELAY**)

Because of the pipelined behavior of the system, successive accesses to different chip-selects can occur back-to-back with no idle cycles between accesses. Depending on the control signals (CSn, ADV_ALEn, BE0_CLEn, OE_REn, WEn) assertion and de-assertion timing parameters and on the IC timing parameters, some control signals assertion times may overlap between the successive accesses to different CS. Similarly, some control signals (WEn, OE_REn) may not respect required transition times.

To work around the overlapping and to observe the required control-signal transitions, a minimum of CYCLE2CYCLEDELAY inactive cycles is inserted between the access being initiated to this chip-select and the previous access ending for a different chip-select. This applies to any type of access (read or write).

If GPMC_CONFIG6_i[6] CYCLE2CYCLEDIFFCSEN is enabled, the chip-select access is delayed until CYCLE2CYCLEDELAY cycles have expired since the end of a previous access to a different chip-select. CYCLE2CYCLEDELAY count starts at CSRDOFFTIME/CSWROFFTIME completion. All control signals are kept inactive during the idle GPMC_FCLK cycles.

CYCLE2CYCLESAMECSEN and CYCLE2CYCLEDIFFCSEN should be set in registers to respectively get idle cycles inserted between accesses on this chip-select and after accesses to a different chip-select.

The CYCLE2CYCLEDELAY delay runs in parallel with the BUSTURNAROUND delay. It should be noted that BUSTURNAROUND is a timing parameter defined for the ending chip-select access, whereas CYCLE2CYCLEDELAY is a timing parameter defined for the starting chip-select access. The effective minimum delay between successive accesses is based on the larger delay timing parameter and on access type combination, since bus turnaround does not apply to all access types. See [Section 7.1.3.3.8.3.7.1](#) for more details on bus turnaround.

[Table 7-10](#) describes the configuration required for idle cycle insertion.

Table 7-10. Idle Cycle Insertion Configuration

First Access Type	BUSTURN AROUND Timing Parameter	Second Access Type	Chip-Select	Addr/Data Multiplexed	CYCLE2 CYCLE SAMECSEN Parameter	CYCLE2 CYCLE DIFFCSEN Parameter	Idle Cycle Insertion Between the Two Accesses
R/W	0	R/W	Any	Any	0	x	No idle cycles are inserted if the two accesses are well pipelined.
R	>0	R	Same	Nonmuxed	x	0	No idle cycles are inserted if the two accesses are well pipelined.
R	>0	R	Different	Nonmuxed	0	0	BUSTURNAROUND cycles are inserted.
R	>0	R/W	Any	Muxed	0	0	BUSTURNAROUND cycles are inserted.
R	>0	W	Any	Any	0	0	BUSTURNAROUND cycles are inserted.
W	>0	R/W	Any	Any	0	0	No idle cycles are inserted if the two accesses are well pipelined.
R/W	0	R/W	Same	Any	1	x	CYCLE2CYCLEDELAY cycles are inserted.
R/W	0	R/W	Different	Any	x	1	CYCLE2CYCLEDELAY cycles are inserted.
R/W	>0	R/W	Same	Any	1	x	CYCLE2CYCLEDELAY cycles are inserted. If BTA idle cycles already apply on these two back-to-back accesses, the effective delay is max (BUSTURNAROUND, CYCLE2CYCLEDELAY).
R/W	>0	R/W	Different	Any	x	1	CYCLE2CYCLEDELAY cycles are inserted. If BTA idle cycles already apply on these two back-to-back accesses, the effective delay is maximum (BUSTURNAROUND, CYCLE2CYCLEDELAY).

7.1.3.3.8.3.8 Slow Device Support (TIMEPARAGRANULARITY Parameter)

All access-timing parameters can be multiplied by 2 by setting the GPMC_CONFIG1_i[4] TIMEPARAGRANULARITY bit. Increasing all access timing parameters allows support of slow devices.

7.1.3.3.8.3.9 GPMC_DIR Pin

The GPMC_DIR pin is used to control I/O direction on the GPMC data bus GPMC_D[15-0]. Depending on top-level pad multiplexing, this signal can be output and used externally to the device, if required. The GPMC_DIR pin is low during transmit (OUT) and high during receive (IN).

For write accesses, the GPMC_DIR pin stays OUT from start-cycle time to end-cycle time.

For read accesses, the GPMC_DIR pin goes from OUT to IN at OEn assertion time and stays IN until:

- BUSTURNAROUND is enabled
 - The GPMC_DIR pin goes from IN to OUT at end-cycle time plus programmable bus turnaround time.
- BUSTURNAROUND is disabled
 - After an asynchronous read access, the GPMC_DIR pin goes from IN to OUT at RDACCESSTIME + 1 GPMC_FCLK cycle or when RDCYCLETIME completes, whichever occurs last.
 - After a synchronous read access, the GPMC_DIR pin goes from IN to OUT at RDACCESSTIME + 2 GPMC_FCLK cycles or when RDCYCLETIME completes, whichever occurs last.

Because of the bus-keeping feature of the GPMC, after a read or write access and with no other accesses pending, the default value of the GPMC_DIR pin is OUT (see [Section 7.1.3.3.9.10](#)). In nonmultiplexed devices, the GPMC_DIR pin stays IN between two successive read accesses to prevent unnecessary toggling.

7.1.3.3.8.3.10 Reset

No reset signal is sent to the external memory device by the GPMC. For more information about external-device reset, see [Chapter 8, Power, Reset, and Clock Management \(PRCM\)](#).

The PRCM module provides an input pin, global_rst_n, to the GPMC:

- The global_rst_n pin is activated during device warm reset and cold reset.
- The global_rst_n pin initializes the internal state-machine and the internal configuration registers.

7.1.3.3.8.3.11 Write Protect Signal (WPn)

When connected to the attached memory device, the write protect signal can enable or disable the lockdown function of the attached memory. The GPMC_WPn output pin value is controlled through the GPMC_CONFIG[4] WRITEPROTECT bit, which is common to all CS.

7.1.3.3.8.3.12 Byte Enable (BE1n/BE0n)

Byte enable signals (BE1n/BE0n) are:

- Valid (asserted or nonasserted according to the incoming system request) from access start to access completion for asynchronous and synchronous single accesses
- Asserted low from access start to access completion for asynchronous and synchronous multiple read accesses
- Valid (asserted or nonasserted, according to the incoming system request) synchronously to each written data for synchronous multiple write accesses

7.1.3.3.8.4 Error Handling

When an error occurs in the GPMC, the error information is stored in the GPMC_ERR_TYPE register and the address of the illegal access is stored in the GPMC_ERR_ADDRESS register. The GPMC keeps only the first error abort information until the GPMC_ERR_TYPE register is reset. Subsequent accesses that cause errors are not logged until the error is cleared by hardware with the GPMC_ERR_TYPE[0]ERRORVALID bit.

- **ERRORNOTSUPPADD** occurs when an incoming system request address decoding does not match any valid chip-select region, or if two chip-select regions are defined as overlapped, or if a register file access is tried outside the valid address range of 1KB.
- **ERRORNOTSUPPMCMD** occurs when an unsupported command request is decoded at the L3 Slow interconnect interface
- **ERRORTIMEOUT**: A time-out mechanism prevents the system from hanging. The start value of the 9-bit time-out counter is defined in the GPMC_TIMEOUT_CONTROL register and enabled with the GPMC_TIMEOUT_CONTROL[0] TIMEOUTENABLE bit. When enabled, the counter starts at start-cycle time until it reaches 0 and data is not responded to from memory, and then a time-out error occurs. When data are sent from memory, this counter is reset to its start value. With multiple accesses (asynchronous page mode or synchronous burst mode), the counter is reset to its start value for each data access within the burst.

The GPMC does not generate interrupts on these errors. True abort to the MPU or interrupt generation is handled at the interconnect level.

7.1.3.3.9 Timing Setting

The GPMC offers the maximum flexibility to support various access protocols. Most of the timing parameters of the protocol access used by the GPMC to communicate with attached memories or devices are programmable on a chip-select basis. Assertion and deassertion times of control signals are defined to match the attached memory or device timing specifications and to get maximum performance during accesses. For more information on GPMC_CLK and GPMC_FCLK see [Section 7.1.3.3.9.6](#).

In the following sections, the start access time refer to the time at which the access begins.

7.1.3.3.9.1 Read Cycle Time and Write Cycle Time (RDCYCLETIME / WRCYCLETIME)

The GPMC_CONFIG5_i[4-0] RDCYCLETIME and GPMC_CONFIG5_i[12-8] WRCYCLETIME fields define the address bus and byte enables valid times for read and write accesses. To ensure a correct duty cycle of GPMC_CLK between accesses, RDCYCLETIME and WRCYCLETIME are expressed in GPMC_FCLK cycles and must be multiples of the GPMC_CLK cycle. RDCYCLETIME and WRCYCLETIME bit fields can be set with a granularity of 1 or 2 through GPMC_CONFIG1_i[4] TIMEPARAGRANULARITY.

When either RDCYCLETIME or WRCYCLETIME completes, if they are not already deasserted, all control signals (CSn, ADV_ALEn, OE_REn, WEn, and BE0_CLEn) are deasserted to their reset values, regardless of their deassertion time parameters.

An exception to this forced deassertion occurs when a pipelined request to the same chip-select or to a different chip-select is pending. In such a case, it is not necessary to deassert a control signal with deassertion time parameters equal to the cycle-time parameter. This exception to forced deassertion prevents any unnecessary glitches. This requirement also applies to BE signals, thus avoiding an unnecessary BE glitch transition when pipelining requests.

If no inactive cycles are required between successive accesses to the same or to a different chip-select (GPMC_CONFIG6_i[7] CYCLE2CYCLESAMECSEN = 0 or GPMC_CONFIG6_i[6] CYCLE2CYCLEDIFFCSEN = 0, where i = 0 to 3), and if assertion-time parameters associated with the pipelined access are equal to 0, asserted control signals (CSn, ADV_ALEn, BE0_CLEn, WEn, and OE_REn) are kept asserted. This applies to any read/write to read/write access combination.

If inactive cycles are inserted between successive accesses, that is, CYCLE2CYCLESAMECSEN = 1 or CYCLE2CYCLEDIFFCSEN = 1, the control signals are forced to their respective default reset values for the number of GPMC_FCLK cycles defined in CYCLE2CYCLEDELAY.

7.1.3.3.9.2 CSn: Chip-Select Signal Control Assertion/Deassertion Time (CSONTIME / CSRDOFFTIME / CSWROFFTIME / CSEXTRADELAY)

The GPMC_CONFIG2_i[3-0] CSONTIME field defines the CSn signal-assertion time relative to the start access time. It is common for read and write accesses.

The GPMC_CONFIG2_i[12-8] CSRDOFFTIME (read access) and GPMC_CONFIG2_i[20-16] CSWROFFTIME (write access) bit fields define the CSn signal deassertion time relative to start access time.

CSONTIME, CSRDOFFTIME and CSWROFFTIME parameters are applicable to synchronous and asynchronous modes. CSONTIME can be used to control an address and byte enable setup time before chip-select assertion. CSRDOFFTIME and CSWROFFTIME can be used to control an address and byte enable hold time after chip-select deassertion.

CSn signal transitions as controlled through CSONTIME, CSRDOFFTIME, and CSWROFFTIME can be delayed by half a GPMC_FCLK period by enabling the GPMC_CONFIG2_i[7] CSEXTRADELAY bit. This half of a GPMC_FCLK period provides more granularity on the CSn assertion and deassertion time to guarantee proper setup and hold time relative to GPMC_CLK. CSEXTRADELAY is especially useful in configurations where GPMC_CLK and GPMC_FCLK have the same frequency, but can be used for all GPMC configurations. If enabled, CSEXTRADELAY applies to all parameters controlling CSn transitions.

The CSEXTRADELAY bit must be used carefully to avoid control-signal overlap between successive accesses to different chip-selects. This implies the need to program the RDCYCLETIME and WRCYCLETIME bit fields to be greater than the CSn signal-deassertion time, including the extra half-GPMC_FCLK-period delay.

7.1.3.3.9.3 ADVn/ALE: Address Valid/Address Latch Enable Signal Control Assertion/Deassertion Time (ADVONTIME / ADVRDOFFTIME / ADVWROFFTIME / ADVEXTRADELAY/ADVAADMUXONTIME/ADVAADMUXRDOFFTIME/ADVAADMUXWROFFTIME)

The GPMC_CONFIG3_i[3-0] ADVONTIME field defines the ADVn_ALE signal-assertion time relative to start access time. It is common to read and write accesses.

The GPMC_CONFIG3_i[12-8] ADVRDOFFTIME (read access) and GPMC_CONFIG3_i[20-16] ADVWROFFTIME (write access) bit fields define the ADVn_ALE signal-deassertion time relative to start access time.

ADVONTIME can be used to control an address and byte enable valid setup time control before ADVn_ALE assertion. ADVRDOFFTIME and ADVWROFFTIME can be used to control an address and byte enable valid hold time control after ADVn_ALE de-assertion. ADVRDOFFTIME and ADVWROFFTIME are applicable to both synchronous and asynchronous modes.

ADVn_ALE signal transitions as controlled through ADVONTIME, ADVRDOFFTIME, and ADVWROFFTIME can be delayed by half a GPMC_FCLK period by enabling the GPMC_CONFIG3_i[7] ADVEXTRADELAY bit. This half of a GPMC_FCLK period provides more granularity on ADVn_ALE assertion and deassertion time to assure proper setup and hold time relative to GPMC_CLK. The ADVEXTRADELAY configuration parameter is especially useful in configurations where GPMC_CLK and GPMC_FCLK have the same frequency, but can be used for all GPMC configurations. If enabled, ADVEXTRADELAY applies to all parameters controlling ADVn_ALE transitions.

ADVEXTRADELAY must be used carefully to avoid control-signal overlap between successive accesses to different chip-selects. This implies the need to program the RDCYCLETIME and WRCYCLETIME bit fields to be greater than ADVn_ALE signal-deassertion time, including the extra half-GPMC_FCLK-period delay.

The GPMC_CONFIG3_i[6-4] ADVAADMUXONTIME, GPMC_CONFIG3_i[26-24] ADVAADMUXRDOFFTIME, and GPMC_CONFIG3_i[30-28] ADVAADMUXWROFFTIME parameters have the same functions as ADVONTIME, ADVRDOFFTIME, and ADVWROFFTIME, but apply to the first address phase in the AAD-multiplexed protocol. It is the user responsibility to make sure ADVAADMUXxxOFFTIME is programmed to a value lower than or equal to ADVxxOFFTIME. Functionality in AAD-mux mode is undefined if the settings do not comply with this requirement. ADVAADMUXxxOFFTIME can be programmed to the same value as ADVONTIME if no high ADVn pulse is needed between the two AAD-mux address phases, which is the typical case in synchronous mode. In this configuration, ADVn is kept low until it reaches the correct ADVxxOFFTIME.

See [Section 7.1.3.3.12](#) for more details on ADVONTIME, ADVRDOFFTIME, ADVWROFFTIME, and ADVAADMUXRDOFFTIME, ADVAADMUXWROFFTIME usage for CLE and ALE (Command / Address Latch Enable) usage for a NAND Flash interface.

7.1.3.3.9.4 OEn/REn: Output Enable / Read Enable Signal Control Assertion / Deassertion Time (OEONTIME / OEOFFTIME / OEEXTRADELAY / OEAADMUXONTIME / OEAADMUXOFFTIME)

The GPMC_CONFIG4_i[3-0] OEONTIME field defines the OEn_REn signal assertion time relative to start access time. It is applicable only to read accesses.

The GPMC_CONFIG4_i[12-8] OEOFFTIME field defines the OEn_REn signal deassertion time relative to start access time. It is applicable only to read accesses. OEn_REn is not asserted during a write cycle.

OEONTIME, OEOFFTIME, OEAADMUXONTIME and OEAADMUXOFFTIME parameters are applicable to synchronous and asynchronous modes. OEONTIME can be used to control an address and byte enable valid setup time control before OEn_REn assertion. OEOFFTIME can be used to control an address and byte enable valid hold time control after OEn_REn assertion.

OEAADMUXONTIME and OEAADMUXOFFTIME parameters have the same functions as OEONTIME and OEOFFTIME, but apply to the first OE assertion in the AAD-multiplexed protocol for a read phase, or to the only OE assertion for a write phase. It is the user responsibility to make sure OEAADMUXOFFTIME is programmed to a value lower than OEONTIME. Functionality in AAD-mux mode is undefined if the settings do not comply with this requirement. OEAADMUXOFFTIME shall never be equal to OEONTIME because the AAD-mux protocol requires a second address phase with the OEn signal de-asserted before OEn can be asserted again to define a read command.

The OEn_REn signal transitions as controlled through OEONTIME, OEOFFTIME, OEAADMUXONTIME and OEAADMUXOFFTIME can be delayed by half a GPMC_FCLK period by enabling the GPMC_CONFIG4_i[7] OEEXTRADELAY bit. This half of a GPMC_FCLK period provides more granularity on OEn_REn assertion and deassertion time to assure proper setup and hold time relative to GPMC_CLK. If enabled, OEEXTRADELAY applies to all parameters controlling OEn_REn transitions.

OEEXTRADELAY must be used carefully, to avoid control-signal overlap between successive accesses to different chip-selects. This implies the need to program RDCYCLETIME and WRCYCLETIME to be greater than OEn_REn signal-deassertion time, including the extra half-GPMC_FCLK-period delay.

When the GPMC generates a read access to an address-/data-multiplexed device, it drives the address bus until OEn assertion time.

7.1.3.3.9.5 WEn: Write Enable Signal Control Assertion / Deassertion Time (WEONTIME / WEOFFTIME / WEEXTRADELAY)

The GPMC_CONFIG4_i[19-16] WEONTIME field (where i = 0 to 3) defines the WEn signal-assertion time relative to start access time. The GPMC_CONFIG4_i[28-24] WEOFFTIME field defines the WEn signal-deassertion time relative to start access time. These bit fields only apply to write accesses. WEn is not asserted during a read cycle.

WEONTIME can be used to control an address and byte enable valid setup time control before WEn assertion. WEOFFTIME can be used to control an address and byte enable valid hold time control after WEn assertion.

WEn signal transitions as controlled through WEONTIME, and WEOFFTIME can be delayed by half a GPMC_FCLK period by enabling the GPMC_CONFIG4_i[23] WEEXTRADELAY bit. This half of a GPMC_FCLK period provides more granularity on WEn assertion and deassertion time to guaranty proper setup and hold time relative to GPMC_CLK. If enabled, WEEXTRADELAY applies to all parameters controlling WEn transitions.

The WEEXTRADELAY bit must be used carefully to avoid control-signal overlap between successive accesses to different chip-selects. This implies the need to program the WRCYCLETIME bit field to be greater than the WEn signal-deassertion time, including the extra half-GPMC_FCLK-period delay.

7.1.3.3.9.6 GPMC_CLK

GPMC_CLK is the external clock provided to the attached synchronous memory or device.

- The GPMC_CLK clock frequency is the GPMC_FCLK functional clock frequency divided by 1, 2, 3, or 4, depending on the GPMC_CONFIG1_i[1-0] GPMCFCLKDIVIDER bit field, with a guaranteed 50-percent duty cycle.
- The GPMC_CLK clock is only activated when the access in progress is defined as synchronous (read or write access).
- The GPMC_CONFIG1_i[26-25] CLKACTIVATIONTIME field defines the number of GPMC_FCLK cycles from start access time to GPMC_CLK activation.
- The GPMC_CLK clock is stopped when cycle time completes and is asserted low between accesses.
- The GPMC_CLK clock is kept low when access is defined as asynchronous.
- When the GPMC is configured for synchronous mode, the GPMC_CLK signal (which is an output) must also be set as an input in the Pin Mux configuration for the pin. GPMC_CLK is looped back through the output and input buffers of the corresponding GPMC_CLK pad at the device boundary. The looped-back clock is used to synchronize the sampling of the memory signals.

When cycle time completes, the GPMC_CLK may be high because of the GPMCFCLKDIVIDER bit field. To ensure correct stoppage of the GPMC_CLK clock within the 50-percent required duty cycle, it is the user's responsibility to extend the RDCYCLETIME or WRCYCLETIME value.

To ensure a correct external clock cycle, the following rules must be applied:

- $(RDCYCLETIME - CLKACTIVATIONTIME)$ must be a multiple of $(GPMCFCLKDIVIDER + 1)$.
- The PAGEBURSTACCESSTIME value must be a multiple of $(GPMCFCLKDIVIDER + 1)$.

7.1.3.3.9.7 GPMC_CLK and Control Signals Setup and Hold

Control-signal transition (assertion and deassertion) setup and hold values with respect to the GPMC_CLK edge can be controlled in the following ways:

- For the GPMC_CLK signal, the GPMC_CONFIG1_i[26-25] CLKACTIVATIONTIME field allows setup and hold control of control-signal assertion time.
- The use of a divided GPMC_CLK allows setup and hold control of control-signal assertion and deassertion times.
- When GPMC_CLK runs at the GPMC_FCLK frequency so that GPMC_CLK edge and control-signal transitions refer to the same GPMC_FCLK edge, the control-signal transitions can be delayed by half of a GPMC_FCLK period to provide minimum setup and hold times. This half-GPMC_FCLK delay is enabled with the CSEXTRADELAY, ADVEXTRADELAY, OEXTRADELAY, or WEEXTRADELAY parameter. This delay must be used carefully to prevent control-signal overlap between successive accesses to different chip-selects. This implies that the RDCYCLETIME and WRCYCLETIME are greater than the last control-signal deassertion time, including the extra half-GPMC_FCLK cycle.

7.1.3.3.9.8 Access Time (RDACCESSTIME / WRACCESSTIME)

The read access time and write access time durations can be programmed independently through GPMC_CONFIG5_i[20-16] RDACCESSTIME and GPMC_CONFIG6_i[28-24] WRACCESSTIME. This allows OEn and GPMC data capture timing parameters to be independent of WEn and memory device data capture timing parameters. RDACCESSTIME and WRACCESSTIME bit fields can be set with a granularity of 1 or 2 through GPMC_CONFIG1_i[4] TIMEPARAGRANULARITY.

7.1.3.3.9.8.1 Access Time on Read Access

In asynchronous read mode, for single and paged accesses, GPMC_CONFIG5_i[[20-16] RDACCESSTIME field defines the number of GPMC_FCLK cycles from start access time to the GPMC_FCLK rising edge used for the first data capture. RDACCESSTIME must be programmed to the rounded greater value (in GPMC_FCLK cycles) of the read access time of the attached memory device.

In synchronous read mode, for single or burst accesses, RDACCESSTIME defines the number of GPMC_FCLK cycles from start access time to the GPMC_FCLK rising edge corresponding to the GPMC_CLK rising edge used for the first data capture.

GPMC_CLK which is sent to the memory device for synchronization with the GPMC controller, is internally retimed to correctly latch the returned data. GPMC_CONFIG5_i[4-0] RDCYCLETIME must be greater than RDACCESSTIME in order to let the GPMC latch the last return data using the internally retimed GPMC_CLK.

The external WAIT signal can be used in conjunction with RDACCESSTIME to control the effective GPMC data-capture GPMC_FCLK edge on read access in both asynchronous mode and synchronous mode. For details about wait monitoring, see [Section 7.1.3.3.8.1](#).

7.1.3.3.9.8.2 Access Time on Write Access

In asynchronous write mode, the GPMC_CONFIG6_i[[28-24] WRACCESSTIME timing parameter is not used to define the effective write access time. Instead, it is used as a WAIT invalid timing window, and must be set to a correct value so that the gpmc_wait pin is at a valid state two GPMC_CLK cycles before WRACCESSTIME completes. For details about wait monitoring, see [Section 7.1.3.3.8.1](#).

In synchronous write mode, for single or burst accesses, WRACCESSTIME defines the number of GPMC_FCLK cycles from start access time to the GPMC_CLK rising edge used by the memory device for the first data capture.

The external WAIT signal can be used in conjunction with WRACCESSTIME to control the effective memory device data capture GPMC_CLK edge for a synchronous write access. For details about wait monitoring, see [Section 7.1.3.3.8.1](#).

7.1.3.3.9.9 Page Burst Access Time (PAGEBURSTACCESSTIME)

GPMC_CONFIG5_i[27-24] PAGEBURSTACCESSTIME bit field can be set with a granularity of 1 or 2 through the GPMC_CONFIG1_i[[4] TIMEPARAGRANULARITY.

7.1.3.3.9.9.1 Page Burst Access Time on Read Access

In asynchronous page read mode, the delay between successive word captures in a page is controlled through the PAGEBURSTACCESSTIME bit field. The PAGEBURSTACCESSTIME parameter must be programmed to the rounded greater value (in GPMC_FCLK cycles) of the read access time of the attached device.

In synchronous burst read mode, the delay between successive word captures in a burst is controlled through the PAGEBURSTACCESSTIME field.

The external WAIT signal can be used in conjunction with PAGEBURSTACCESSTIME to control the effective GPMC data capture GPMC_FCLK edge on read access. For details about wait monitoring, see [Section 7.1.3.3.8.1](#).

7.1.3.3.9.9.2 Page Burst Access Time on Write Access

Asynchronous page write mode is not supported. PAGEBURSTACCESSTIME is irrelevant in this case.

In synchronous burst write mode, PAGEBURSTACCESSTIME controls the delay between successive memory device word captures in a burst.

The external WAIT signal can be used in conjunction with PAGEBURSTACCESSTIME to control the effective memory-device data capture GPMC_CLK edge in synchronous write mode. For details about wait monitoring, see [Section 7.1.3.3.8.1](#).

7.1.3.3.9.10 Bus Keeping Support

At the end-cycle time of a read access, if no other access is pending, the GPMC drives the bus with the last data read after RDCYCLETIME completion time to prevent bus floating and reduce power consumption.

After a write access, if no other access is pending, the GPMC keeps driving the data bus after WRCYCLETIME completes with the same data to prevent bus floating and power consumption.

7.1.3.3.10 NOR Access Description

For each chip-select configuration, the read access can be specified as either asynchronous or synchronous access through the GPMC_CONFIG1_j[29] READTYPE bit. For each chip-select configuration, the write access can be specified as either synchronous or asynchronous access through the GPMC_CONFIG1_j[27] WRITETYPE bit.

Asynchronous and synchronous read and write access time and related control signals are controlled through timing parameters that refer to GPMC_FCLK. The primary difference of synchronous mode is the availability of a configurable clock interface (GPMC_CLK) to control the external device. Synchronous mode also affects data-capture and wait-pin monitoring schemes in read access.

For details about asynchronous and synchronous access, see the descriptions of GPMC_CLK, RdAccessTime, WrAccessTime, and wait-pin monitoring.

For more information about timing-parameter settings, see the sample timing diagrams in this chapter.

The address bus and BE[1:0]n are fixed for the duration of a synchronous burst read access, but they are updated for each beat of an asynchronous page-read access.

7.1.3.3.10.1 Asynchronous Access Description

This section describes:

- Asynchronous single read operation on an address/data multiplexed device
- Asynchronous single write operation on an address/data-multiplexed device
- Asynchronous single read operation on an AAD-multiplexed device
- Asynchronous single write operation on an AAD-multiplexed device
- Asynchronous multiple (page) read operation on a non-multiplexed device

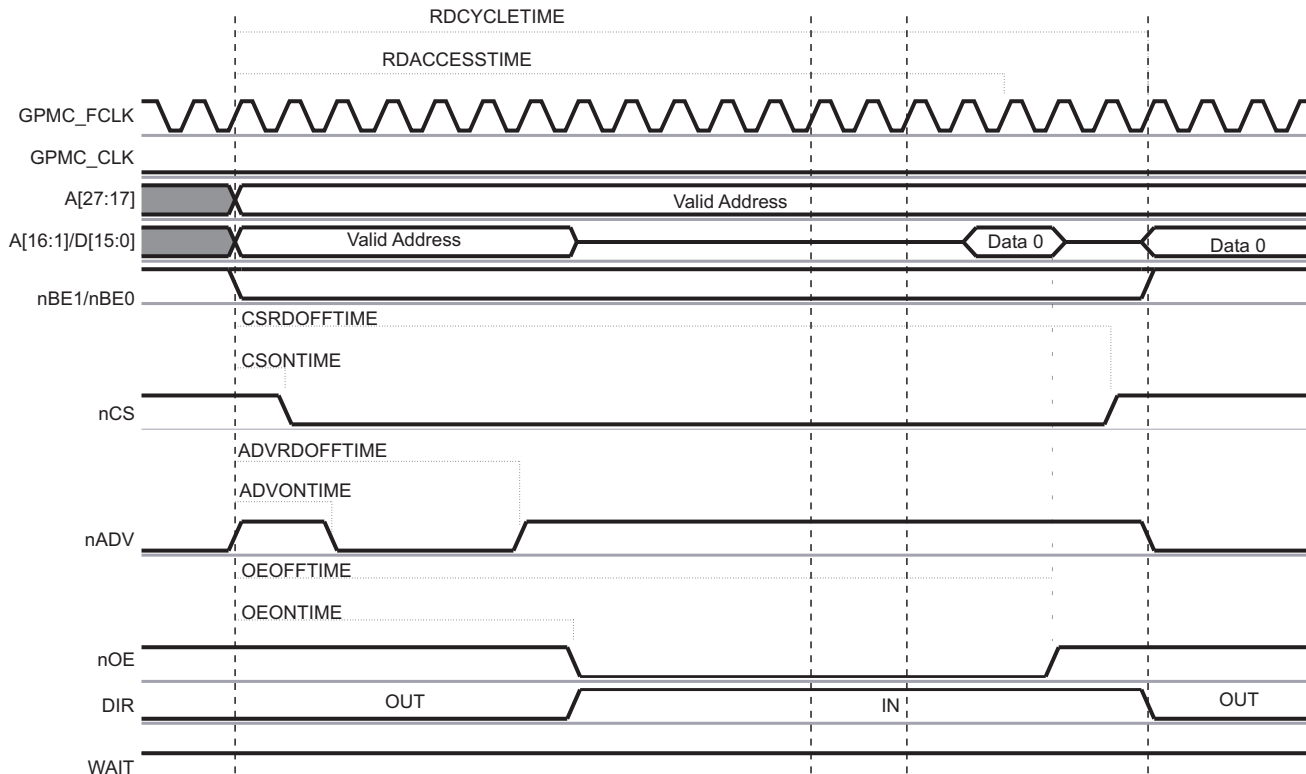
In asynchronous operations GPMC_CLK is not provided outside the GPMC and is kept low.

7.1.3.3.10.1.1 Access on Address/Data Multiplexed Devices

7.1.3.3.10.1.1.1 Asynchronous Single-Read Operation on an Address/Data Multiplexed Device

Figure 7-12 shows an asynchronous single read operation on an address/data-multiplexed device.

Figure 7-12. Asynchronous Single Read Operation on an Address/Data Multiplexed Device



7.1.3.3.10.1.1.2 Asynchronous Single Read on an Address/Data-Multiplexed Device

See the device-specific datasheet for formulas to calculate timing parameters.

Table 7-41 lists the timing bit fields to set up in order to configure the GPMC in asynchronous single read mode.

When the GPMC generates a read access to an address/data-multiplexed device, it drives the address bus until OEn assertion time. For details, see Section 7.1.3.3.8.2.3.

Address bits (A[16:1] from a GPMC perspective, A[15:0] from an external device perspective) are placed on the address/data bus, and the remaining address bits GPMC_A[25:16] are placed on the address bus. The address phase ends at OEn assertion, when the DIR signal goes from OUT to IN.

- Chip-select signal CSn
 - CSn assertion time is controlled by the GPMC_CONFIG2_i[3-0] CSONTIME field. It controls the address setup time to CSn assertion.
 - CSn deassertion time is controlled by the GPMC_CONFIG2_i[12-8] CSRDOFFTIME field. It controls the address hold time from CSn deassertion
- Address valid signal ADVn
 - ADVn assertion time is controlled by the GPMC_CONFIG3_i[3-0] ADVONTIME field.
 - ADVn deassertion time is controlled by the GPMC_CONFIG3_i[[12-8] ADVRDOFFTIME field.

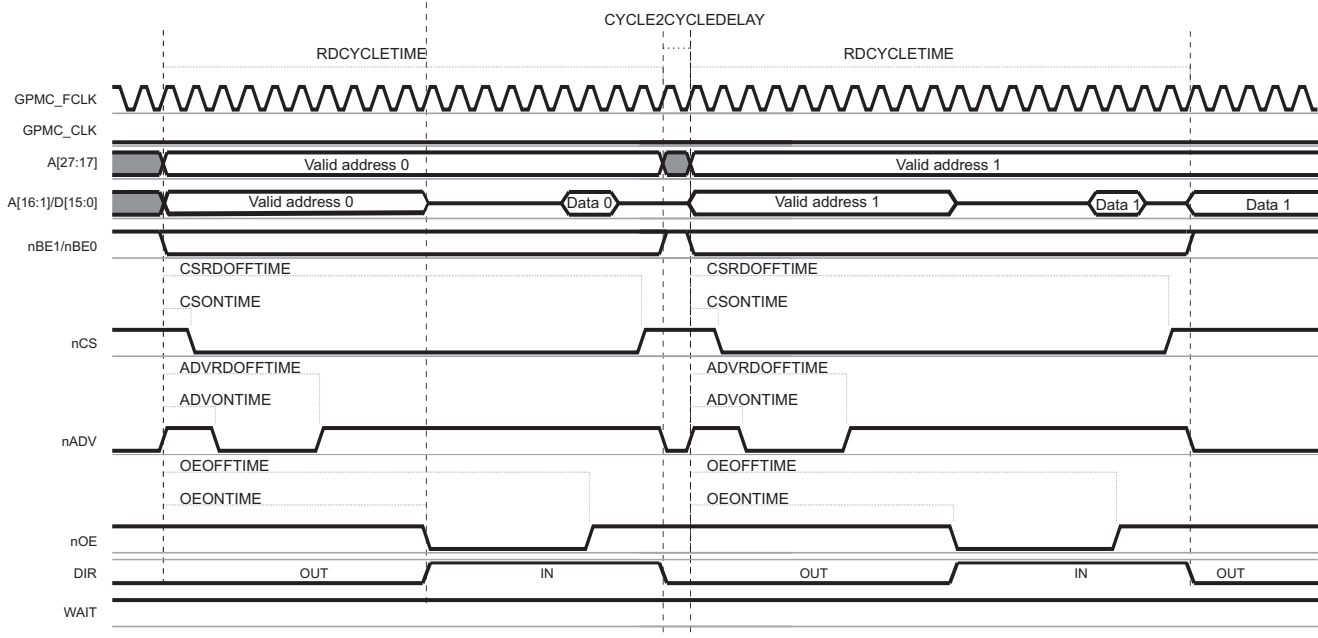
- Output enable signal OEn
 - OEn assertion indicates a read cycle.
 - OEn assertion time is controlled by the GPMC_CONFIG4_i[[3-0] OEONTIME field.
 - OEn deassertion time is controlled by the GPMC_CONFIG4_i[[12-8] OEOFFTIME field.
- Read data is latched when RDACCESSTIME completes. Access time is defined in the GPMC_CONFIG5_i[[20-16] RDACCESSTIME field.
- Direction signal DIR: DIR goes from OUT to IN at the same time that OEn is asserted.
- The end of the access is defined by the GPMC_CONFIG5_i[[4-0] RDCYCLETIME parameter.

In the GPMC, when a 16-bit wide device is attached to the controller, a 32-bit word write access is split into two 16-bit word write accesses. For more information about GPMC access size and type adaptation, see [Section 7.1.3.3.10.5](#). Between two successive accesses, if a OEn pulse is needed:

- The GPMC_CONFIG6_i[[11-8] CYCLE2CYCLEDELAY field can be programmed with GPMC_CONFIG6_i[[7] CYCLE2CYCLESAMECSSEN enabled.
- The CSWROFFTIME and CSONTIME parameters also allow a chip-select pulse, but this affects all other types of access.

Figure 7-13 shows two asynchronous single-read accesses on an address/data-multiplexed devices.

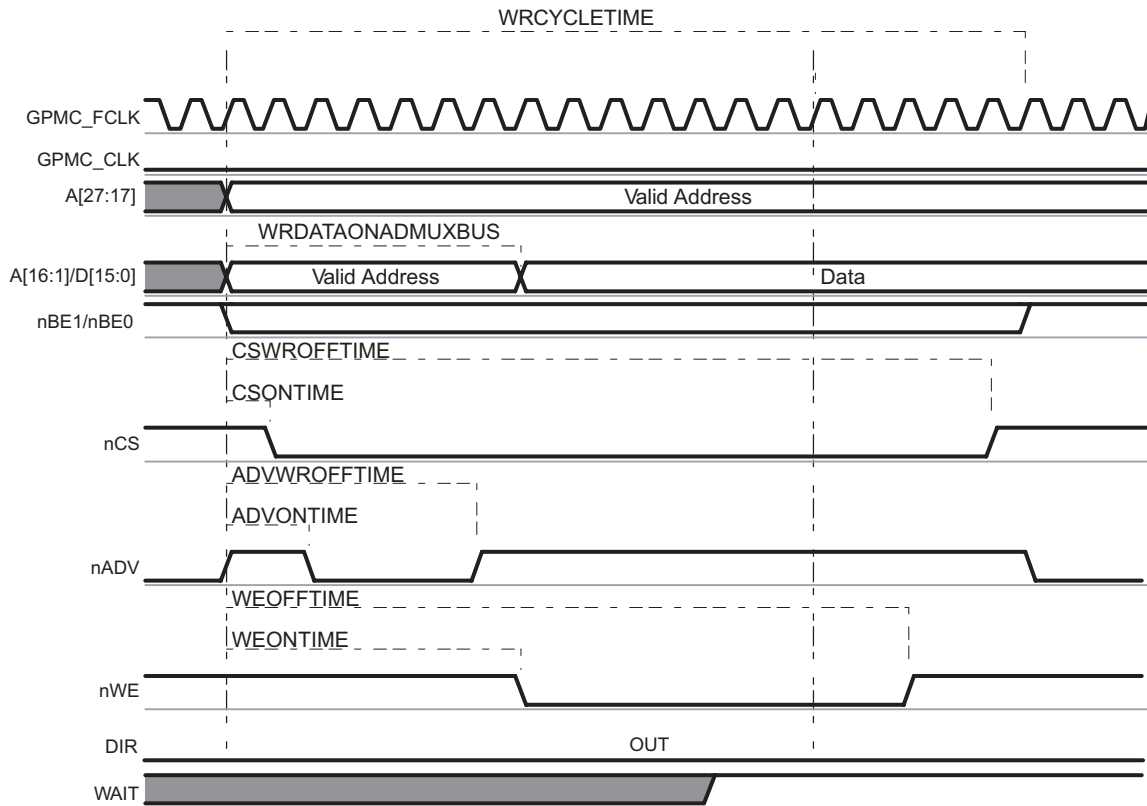
Figure 7-13. Two Asynchronous Single Read Accesses on an Address/Data Multiplexed Device (32-Bit Read Split Into 2 × 16-Bit Read)



7.1.3.3.10.1.1.3 Asynchronous Single Write Operation on an Address/Data-Multiplexed Device

Figure 7-14 shows an asynchronous single write operation on an address/data-multiplexed device.

Figure 7-14. Asynchronous Single Write on an Address/Data-Multiplexed Device



7.1.3.3.10.1.1.4 Asynchronous Single Write on an Address/Data-Multiplexed Device

See the device-specific datasheet for formulas to calculate timing parameters.

Table 7-41 lists the timing bit fields to set up in order to configure the GPMC in asynchronous single write mode. When the GPMC generates a write access to an address/data-multiplexed device, it drives the address bus until WEn assertion time. For more information, see Section 7.1.3.3.8.2.3.

The CSn and ADVn signals are controlled in the same way as for asynchronous single read operation on an address/data-multiplexed device.

- Write enable signal WEn
 - WEn assertion indicates a write cycle.
 - WEn assertion time is controlled by the GPMC_CONFIG4_i[19-16] WEONTIME field.
 - WEn deassertion time is controlled by the GPMC_CONFIG4_i[28-24] WEOFFTIME field.
- Direction signal DIR: DIR signal is OUT during the entire access.
- The end of the access is defined by the GPMC_CONFIG5_i[12-8] WRCYCLETIME parameter.

Address bits A[16:1] (GPMC point of view) are placed on the address/data bus at the start of cycle time, and the remaining address bits A[26:17] are placed on the address bus.

Data is driven on the address/data bus at a GPMC_CONFIG6_i[19-16] WRDATAONADMUXBUS time.

Write multiple access in asynchronous mode is not supported. If WRITEMULTIPLE is enabled with WRITETYPE as asynchronous, the GPMC processes single asynchronous accesses.

After a write operation, if no other access (read or write) is pending, the data bus keeps its previous value. See [Section 7.1.3.3.9.10](#).

7.1.3.3.10.1.1.5 Asynchronous Multiple (Page) Write Operation on an Address/Data-Multiplexed Device

Write multiple (page) access in asynchronous mode is not supported for address/data-multiplexed devices. If GPMC_CONFIG1_i[28] WRITEMULTIPLE is enabled (1) with GPMC_CONFIG1_i[27] WRITETYPE as asynchronous (0), the GPMC processes single asynchronous accesses.

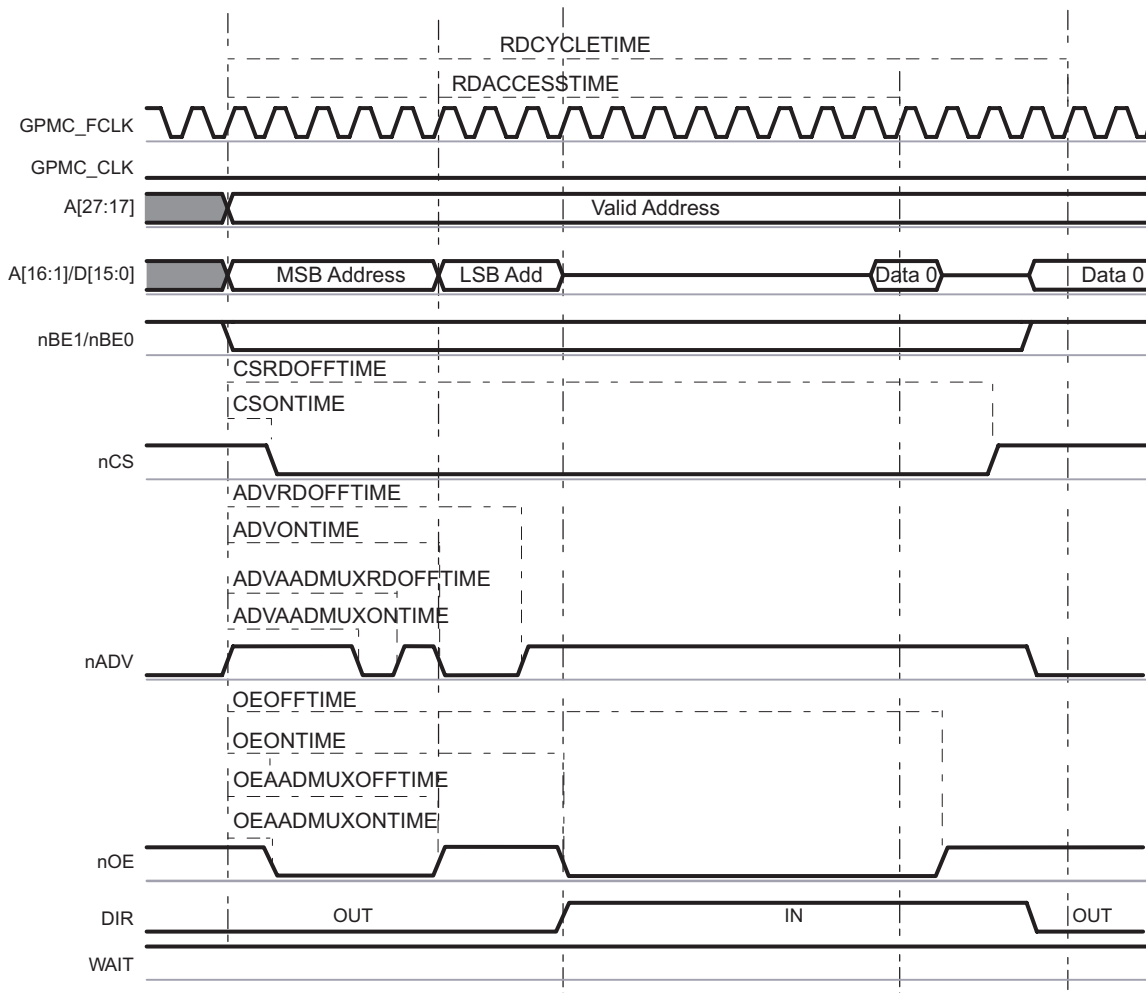
For accesses on non-multiplexed devices, see [Section 7.1.3.3.10.3](#).

7.1.3.3.10.1.2 Access on Address/Address/Data (AAD) Multiplexed Devices

7.1.3.3.10.1.2.1 Asynchronous Single Read Operation on an AAD-Multiplexed Device

[Figure 7-15](#) shows an asynchronous single read operation on an AAD-multiplexed device.

Figure 7-15. Asynchronous Single-Read on an AAD-Multiplexed Device



7.1.3.3.10.1.2.2 Asynchronous Single Read on an AAD-Multiplexed Device

See the device-specific datasheet for formulas to calculate timing parameters.

[Table 7-41](#) lists the timing bit fields to set up in order to configure the GPMC in asynchronous single write mode.

When the GPMC generates a read access to an AAD-multiplexed device, all address bits are driven onto the address/data bus in two separate phases. The first phase is used for the MSB address and is qualified with OEn driven low. The first address phase ends at the first OEn deassertion time. The second phase for LSB address is qualified with OEn driven high. The second address phase ends at the second OEn assertion time, when the DIR signal goes from OUT to IN.

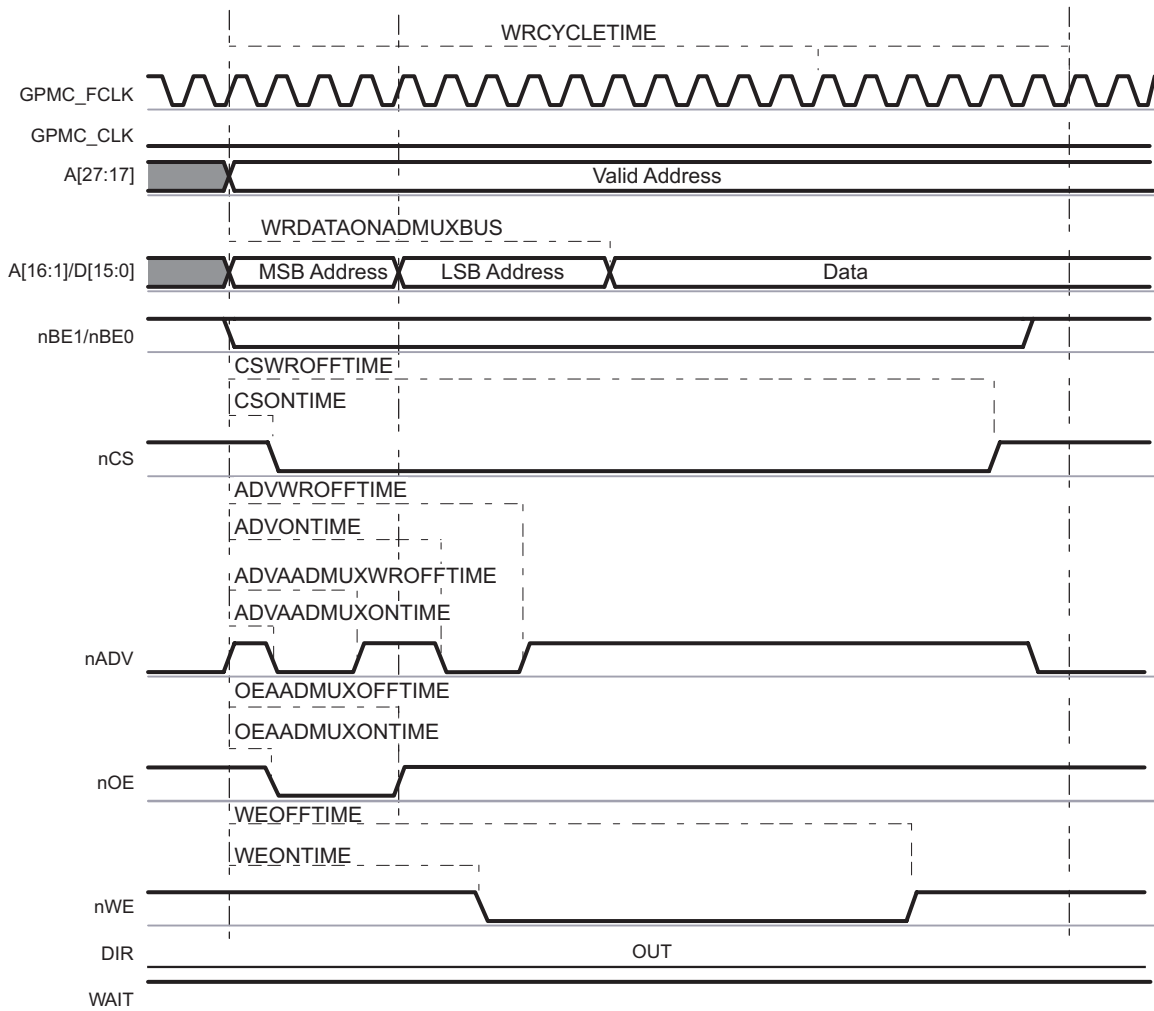
The CSn and DIR signals are controlled in the same way as for asynchronous single read operation on an address/data-multiplexed device.

- Address valid signal ADVn. ADVn is asserted and deasserted twice during a read transaction:
 - ADVn first assertion time is controlled by the GPMC_CONFIG3_i[6-4] ADVAADMUXONTIME field.
 - ADVn first deassertion time is controlled by the GPMC_CONFIG3_i[26-24] ADVAADMUXRDOFFTIME field.
 - ADVn second assertion time is controlled by the GPMC_CONFIG3_i[3-0] ADVONTIME field.
 - ADVn second deassertion time is controlled by the GPMC_CONFIG3_i[12-8] ADVRDOFFTIME field.
- Output Enable signal OEn. OEn is asserted and deasserted twice during a read transaction (OEn second assertion indicates a read cycle):
 - OEn first assertion time is controlled by the GPMC_CONFIG4_i[6-4] OEAADMUXONTIME field.
 - OEn first deassertion time is controlled by the GPMC_CONFIG3_i[15-13] OEAADMUXOFFTIME field.
 - OEn second assertion time is controlled by the GPMC_CONFIG4_i[3-0] OEONTIME field.
 - OEn second deassertion time is controlled by the GPMC_CONFIG4_i[12-8] OEOFFTIME field.

7.1.3.3.10.1.2.3 Asynchronous Single Write Operation on an AAD-Multiplexed Device

Figure 7-16 shows an asynchronous single write operation on an AAD-multiplexed device.

Figure 7-16. Asynchronous Single Write on an AAD-Multiplexed Device



See the device-specific datasheet for formulas to calculate timing parameters.

[Table 7-41](#) lists the timing bit fields to set up to configure the GPMC in asynchronous single write mode.

When the GPMC generates a write access to an AAD-multiplexed device, all address bits are driven onto the address/data bus in two separate phases. The first phase is used for the MSB address and is qualified with OEn driven low. The second phase for LSB address is qualified with OEn driven high. The address phase ends at WEn assertion time.

The CSn, WEn, and DIR signals are controlled in the same way as for asynchronous single write operation on an address/data-multiplexed device.

- Address valid signal ADVn is asserted and deasserted twice during a write transaction
 - ADVn first assertion time is controlled by the GPMC_CONFIG3_i[6-4] ADVAADMUXONTIME field.
 - ADVn first deassertion time is controlled by the GPMC_CONFIG3_i[30-28] ADVAADMUXWROFFTIME field.
 - ADVn second assertion time is controlled by the GPMC_CONFIG3_i[3-0] ADVONTIME field.
 - ADVn second deassertion time is controlled by the GPMC_CONFIG3_i[20-16] ADVWROFFTIME field.
- Output Enable signal OEn is asserted during the address phase of a write transaction
 - OEn assertion time is controlled by the GPMC_CONFIG4_i[6-4] OEAADMUXONTIME field.
 - OEn deassertion time is controlled by the GPMC_CONFIG3_i[15-13] OEAADMUXOFFTIME field.

The address bits for the first address phase are driven onto the data bus until OEn deassertion. Data is driven onto the address/data bus at the clock edge defined by the GPMC_CONFIG6_i[19-16] WRDATAONADMUXBUS parameter.

7.1.3.3.10.1.2.4 Asynchronous Multiple (Page) Read Operation on an AAD-Multiplexed Device

Write multiple (page) access in asynchronous mode is not supported for AAD-multiplexed devices.

If GPMC_CONFIG1_i[28] WRITEMULTIPLE is enabled (1) with GPMC_CONFIG1_i[27] WRITETYPE as asynchronous (0), the GPMC processes single asynchronous accesses.

For accesses on non-multiplexed devices, see [Section 7.1.3.3.10.3](#).

7.1.3.3.10.2 Synchronous Access Description

This section details read and write synchronous accesses on address/data multiplexed. All information in this section can be applied to any type of memory - non-multiplexed, address and data multiplexed or AAD-multiplexed - with a difference limited to the address phase. For accesses on non-multiplexed devices, see [Section 7.1.3.3.10.3](#).

In synchronous operations:

- The GPMC_CLK clock is provided outside the GPMC when accessing the memory device.
- The GPMC_CLK clock is derived from the GPMC_FCLK clock using the GPMC_CONFIG1_i[1-0] GPMCFCLKDIVIDER field. In the following section, i stands for the chip-select number, i = 0 to 3.
- The GPMC_CONFIG1_i[26-25] CLKACTIVATIONTIME field specifies that the GPMC_CLK is provided outside the GPMC 0, 1, or 2 GPMC_FCLK cycles after start access time until RDCYCLETIME or WRCYCLETIME completion.

7.1.3.3.10.2.1 Synchronous Single Read

Figure 7-17 and Figure 7-18 show a synchronous single-read operation with GPMCFCLKDIVIDER equal to 0 and 1, respectively.

Figure 7-17. Synchronous Single Read (GPMCFCLKDIVIDER = 0)

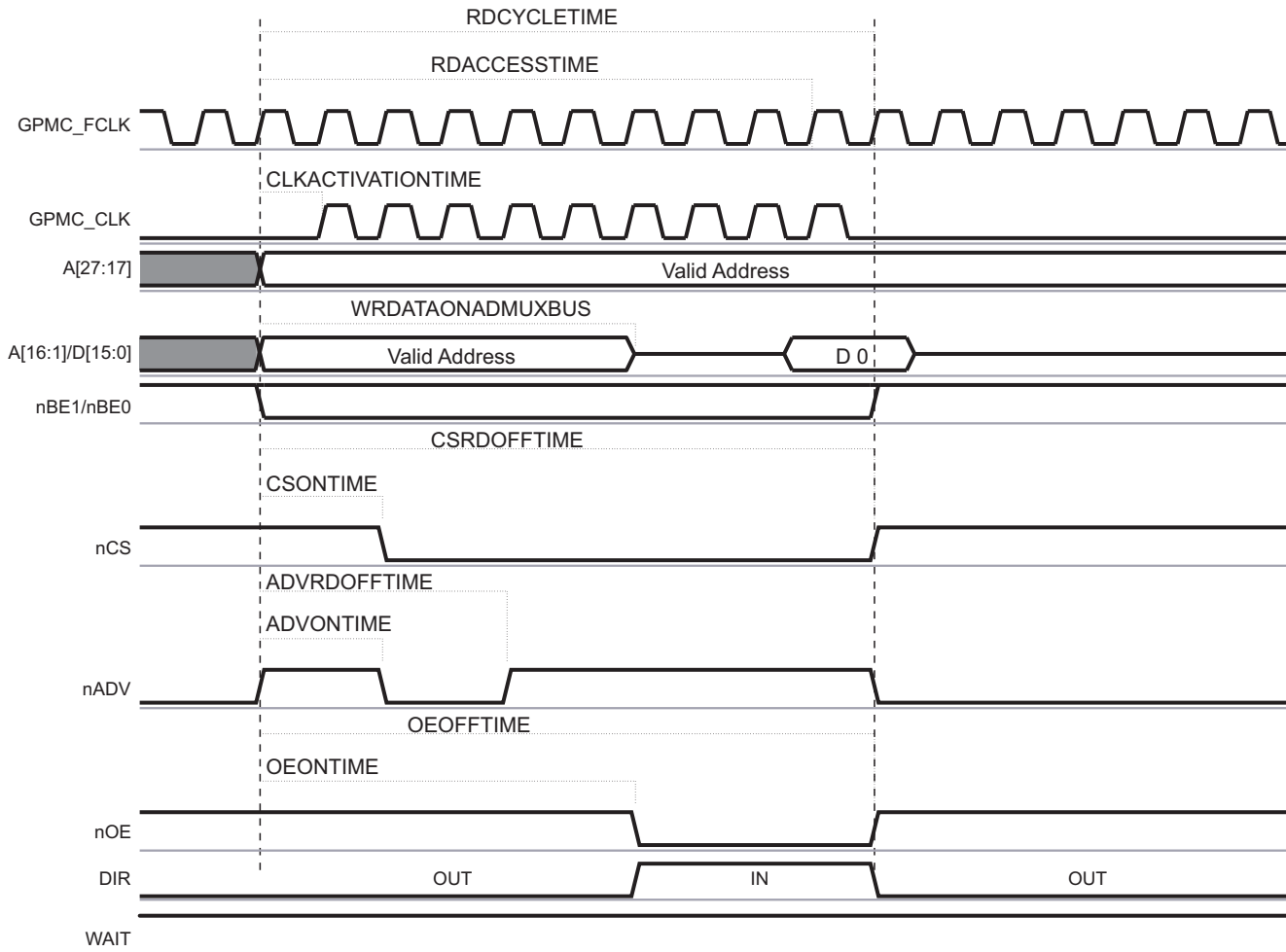
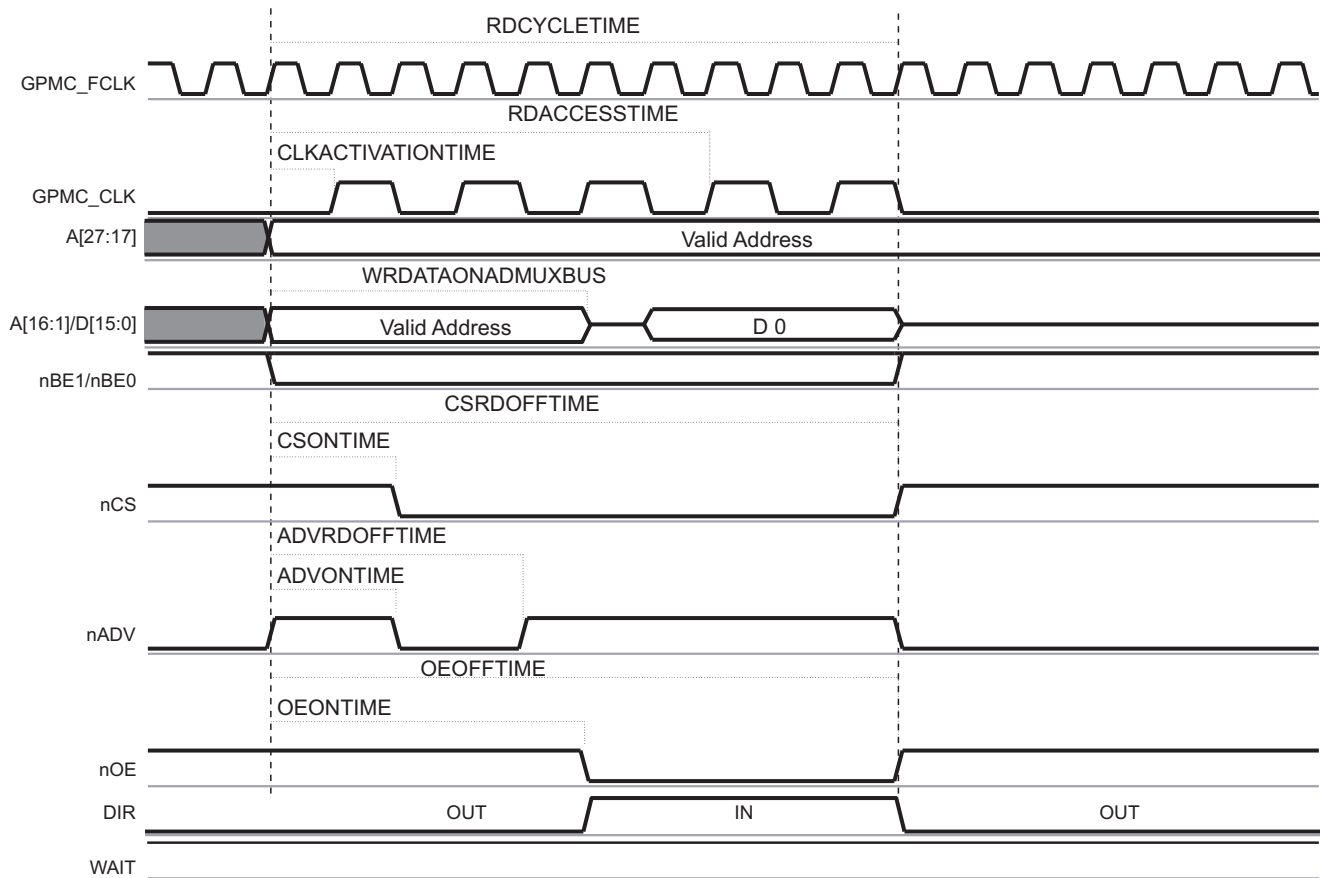


Figure 7-18. Synchronous Single Read (GPMCFCLKDIVIDER = 1)



See the device-specific datasheet for formulas to calculate timing parameters.

Table 7-41 lists the timing bit fields to set up in order to configure the GPMC in asynchronous single read mode.

When the GPMC generates a read access to an address/data-multiplexed device, it drives the address bus until OEn assertion time. For details, see Section 7.1.3.3.8.2.3.

- Chip-select signal CSn
 - CSn assertion time is controlled by the GPMC_CONFIG2_i[3-0] CSONTIME field and ensures address setup time to CSn assertion.
 - CSn deassertion time is controlled by the GPMC_CONFIG2_i[12-8] CSRDOFFTIME field and ensures address hold time to CSn deassertion.
- Address valid signal ADVn
 - ADVn assertion time is controlled by the GPMC_CONFIG3_i[3-0] ADVONTIME field.
 - ADVn deassertion time is controlled by the GPMC_CONFIG3_i[12-8] ADVRDOFFTIME field.
- Output enable signal OEn
 - OEn assertion indicates a read cycle.
 - OEn assertion time is controlled by the GPMC_CONFIG4_i[3-0] OEONTIME field.
 - OEn deassertion time is controlled by the GPMC_CONFIG4_i[12-8] OEOFFTIME field.
- Initial latency for the first read data is controlled by GPMC_CONFIG5_i[20-16] RDACCESSTIME or by monitoring the WAIT signal.
- Total access time (GPMC_CONFIG5_i[4-0] RDCYCLETIME) corresponds to RDACCESSTIME plus the address hold time from CSn deassertion, plus time from RDACCESSTIME to CSRDOFFTIME.

- Direction signal DIR: DIR goes from OUT to IN at the same time as OEn assertion.

When the GPMC generates a write access to an AAD-multiplexed device, all address bits are driven onto the address/data bus in two separate phases. The first phase is used for the MSB address and is qualified with OEn driven low. The second phase for LSB address is qualified with OEn driven high. The address phase ends at WEn assertion time.

The CSn and DIR signals are controlled in the same way as for synchronous single read operation on an address/data-multiplexed device.

- Address valid signal ADVn is asserted and deasserted twice during a read transaction
 - ADVn first assertion time is controlled by the GPMC_CONFIG3_i[6-4] ADVAADMUXONTIME field.
 - ADVn first deassertion time is controlled by the GPMC_CONFIG3_i[26-24] ADVAADMUXRDOFFTIME field.
 - ADVn second assertion time is controlled by the GPMC_CONFIG3_i[3-0] ADVONTIME field.
 - ADVn second deassertion time is controlled by the GPMC_CONFIG3_i[12-8] ADVRDOFFTIME field.
- Output Enable signal OEn is asserted and deasserted twice during a read transaction (OEn second assertion indicates a read cycle)
 - OEn first assertion time is controlled by the GPMC_CONFIG4_i[6-4] OEAADMUXONTIME field.
 - OEn first deassertion time is controlled by the GPMC_CONFIG3_i[15-13] OEAADMUXOFFTIME field.
 - OEn second assertion time is controlled by the GPMC_CONFIG4_i[3-0] OEONTIME field.
 - OEn second deassertion time is controlled by the GPMC_CONFIG4_i[12-8] OEOFFTIME field.

After a read operation, if no other access (read or write) is pending, the data bus is driven with the previous read value. See [Section 7.1.3.3.9.10](#).

7.1.3.3.10.2.2 Synchronous Multiple (Burst) Read (4-, 8-, 16-Word 16 Burst With Wraparound Capability)

Figure 7-19 and Figure 7-20 show a synchronous multiple read operation with GPMCFCLKDivider equal to 0 and 1, respectively.

Figure 7-19. Synchronous Multiple (Burst) Read (GPMCFCLKDIVIDER = 0)

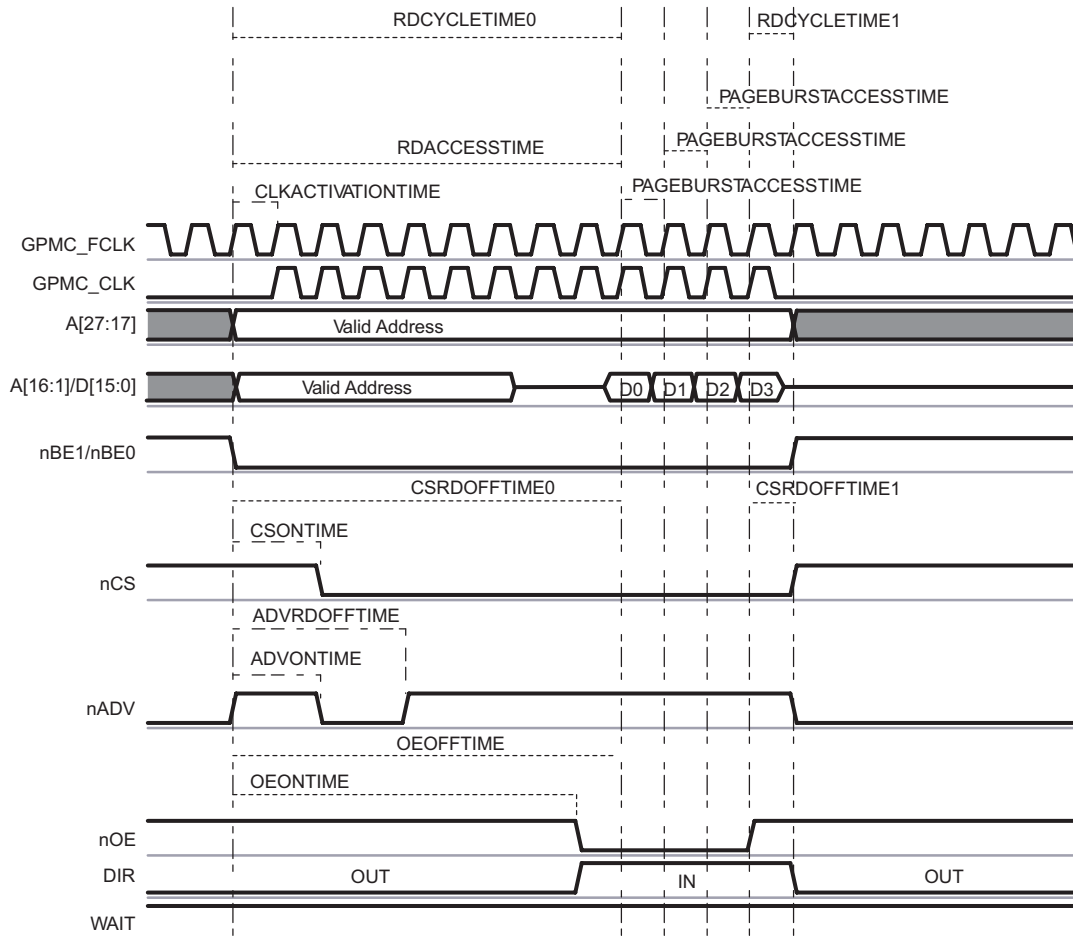
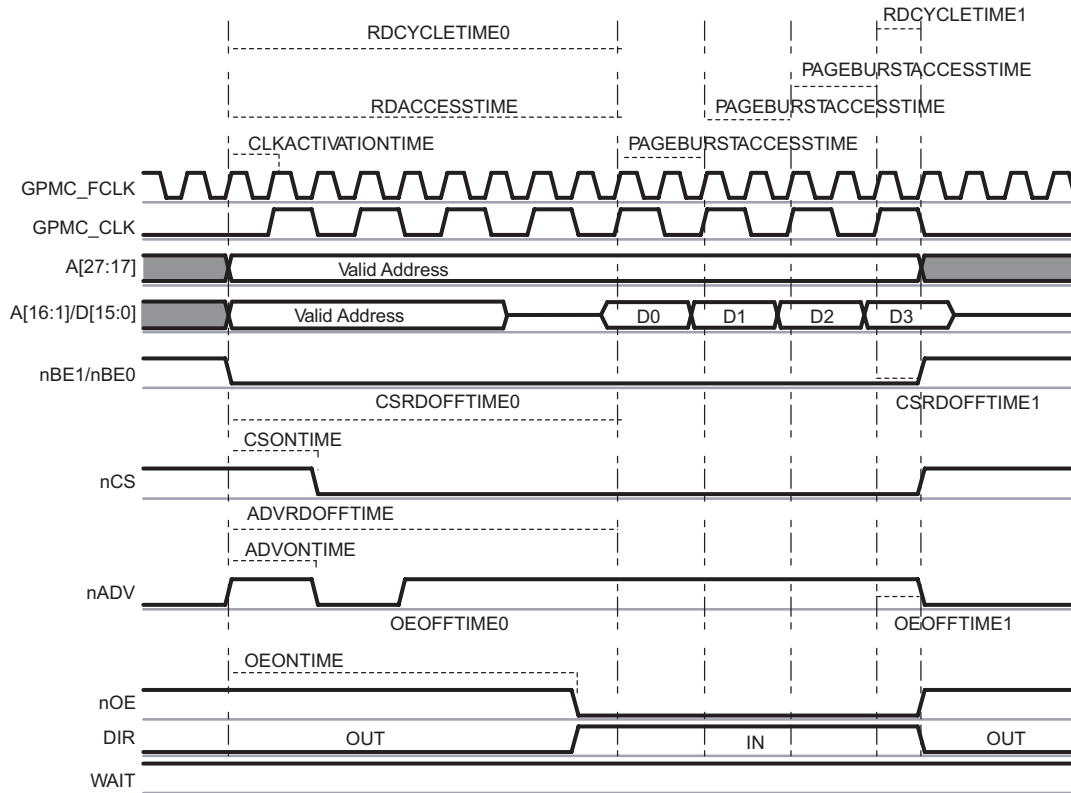


Figure 7-20. Synchronous Multiple (Burst) Read (GPMCFCLKDIVIDER = 1)


When GPMC_CONFIG5_i[20-16] RDACCESSTIME completes, control-signal timings are frozen during the multiple data transactions, corresponding to GPMC_CONFIG5_i[27-24] PAGEBURSTACCESSTIME multiplied by the number of remaining data transactions.

The CSn, ADVn, OEn and DIR signals are controlled in the same way as for synchronous single read operation. See [Section 7.1.3.3.10.2.1](#).

Initial latency for the first read data is controlled by RDACCESSTIME or by monitoring the WAIT signal. Successive read data are provided by the memory device each one or two GPMC_CLK cycles. The PAGEBURSTACCESSTIME parameter must be set accordingly with GPMC_CONFIG1_i[1-0] GPMCFCLKDIVIDER and the memory-device internal configuration. Depending on the device page length, the GPMC checks device page crossing during a new burst request and purposely insert initial latency (of RDACCESSTIME) when required.

Total access time GPMC_CONFIG5_i[4-0] RDCYCLETIME corresponds to RDACCESSTIME plus the address hold time from CSn deassertion. In [Figure 7-19](#), RDCYCLETIME programmed value equals to RDCYCLETIME0 + RDCYCLETIME1.

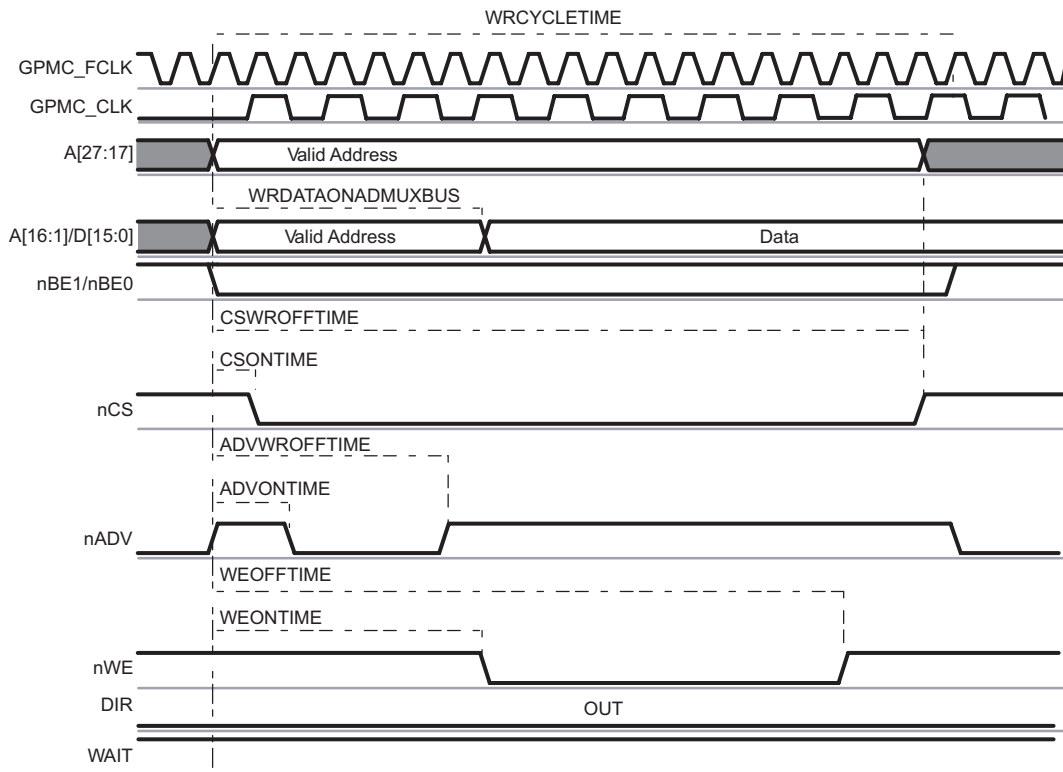
After a read operation, if no other access (read or write) is pending, the data bus is driven with the previous read value. See [Section 7.1.3.3.9.10](#).

Burst wraparound is enabled through the GPMC_CONFIG1_i[31] WRAPBURST bit and allows a 4-, 8-, or 16-Word16 linear burst access to wrap within its burst-length boundary through GPMC_CONFIG1_i[24-23] ATTACHEDDEVICEPAGELENGTH.

7.1.3.3.10.2.3 Synchronous Single Write

Burst write mode is used for synchronous single or burst accesses (see Figure 7-21).

Figure 7-21. Synchronous Single Write on an Address/Data-Multiplexed Device



When the GPMC generates a write access to an address/data-multiplexed device, it drives the data bus (with address bits A[16:1]) until [19:16] WRDATAONADMUXBUS time. First data of the burst is driven on the address/data bus at WRDATAONADMUXBUS time.

7.1.3.3.10.2.4 Synchronous Multiple (Burst) Write

Synchronous burst write mode provides synchronous single or consecutive accesses. Figure 7-22 shows a synchronous burst write access when the chip-select is configured in address/data-multiplexed mode.

Figure 7-22. Synchronous Multiple Write (Burst Write) in Address/Data-Multiplexed Mode

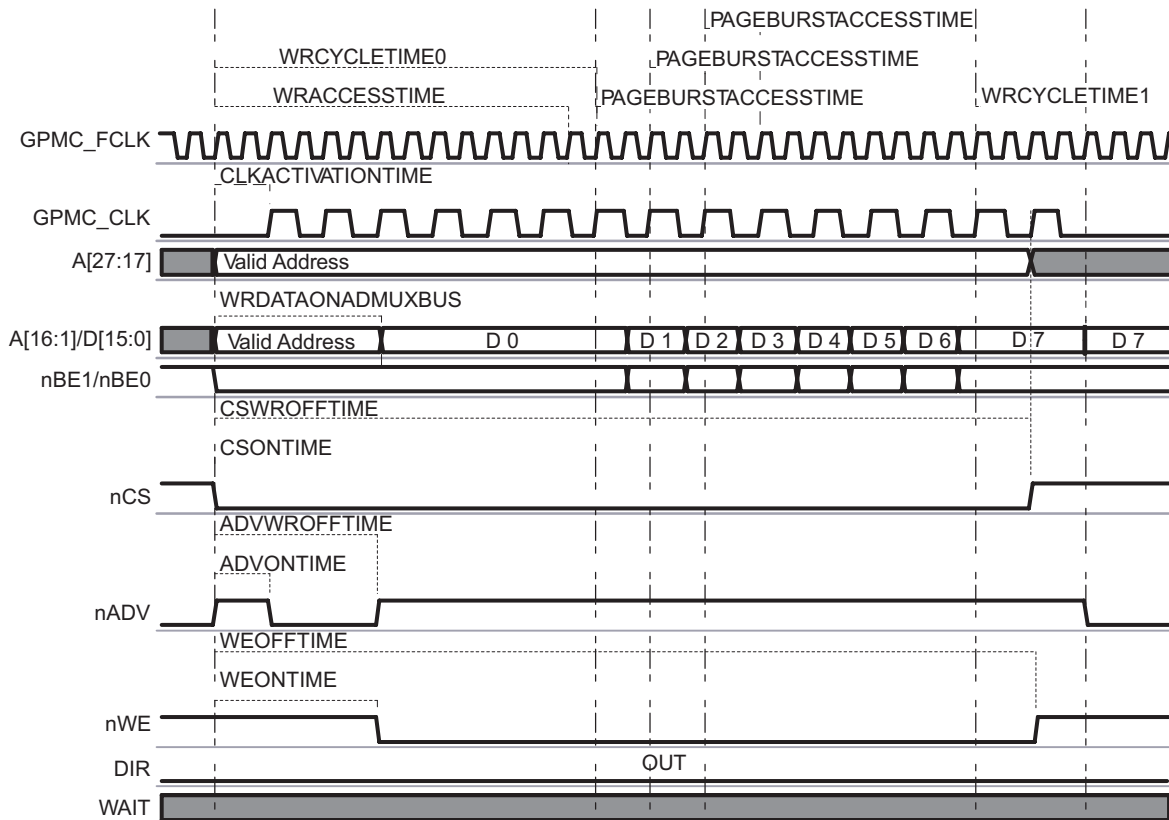
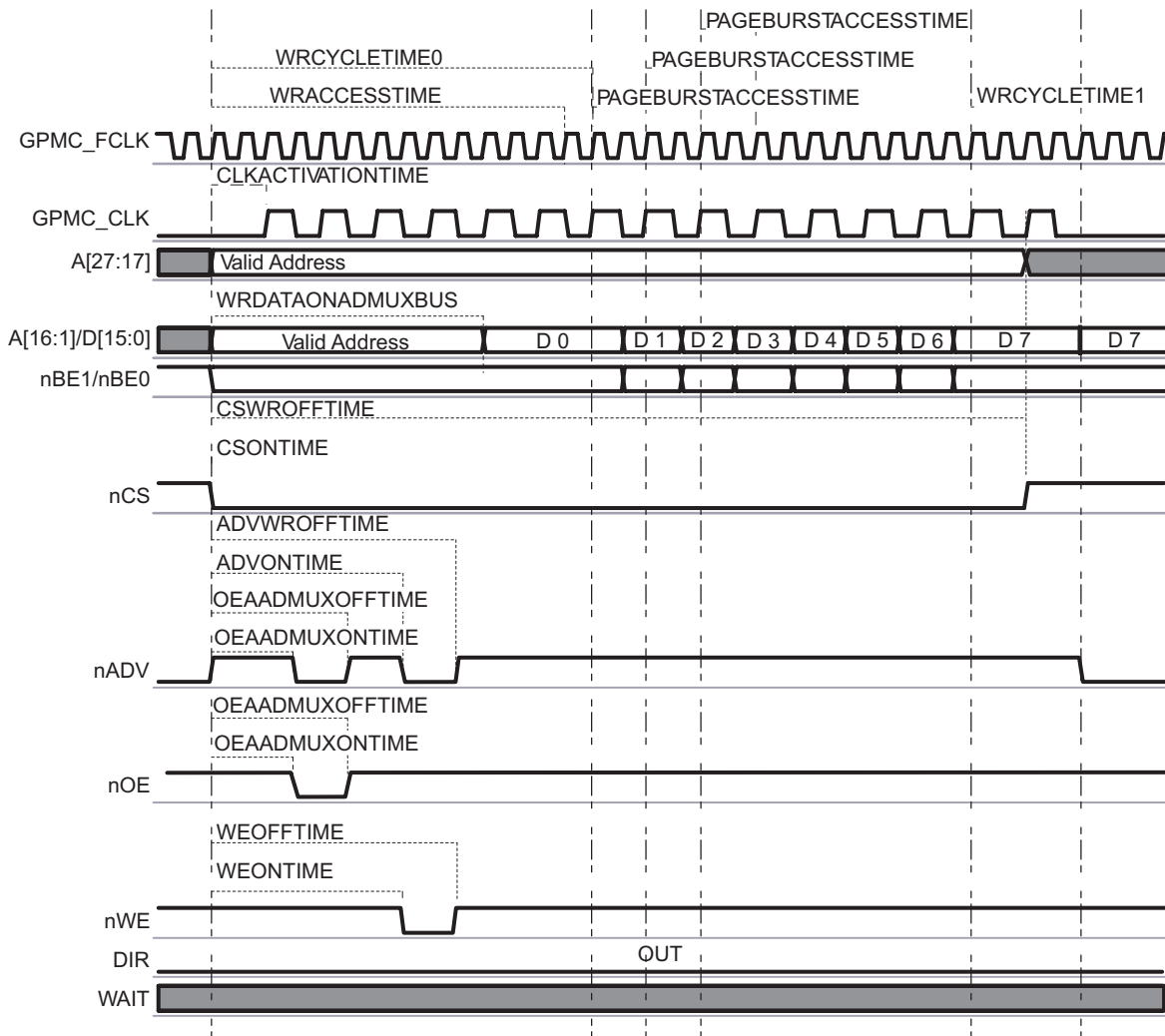


Figure 7-23 shows the same synchronous burst write access when the chip-select is configured in address/address/data-multiplexed (AAD-multiplexed) mode.

Figure 7-23. Synchronous Multiple Write (Burst Write) in Address/Address/Data-Multiplexed Mode



The first data of the burst is driven on the A/D bus at GPMC_CONFIG6_i[19:16] WRDATAONADMUXBUS.

When WRACCESTIME completes, control-signal timings are frozen during the multiple data transactions, corresponding to the GPMC_CONFIG5_i[27-24] PAGEBURSTACCESSTIME multiplied by the number of remaining data transactions.

When the GPMC generates a read access to an address/data-multiplexed device, it drives the address bus until OEn assertion time. For details, see [Section 7.1.3.3.8.2.3](#).

- Chip-select signal CSn
 - CSn assertion time is controlled by the GPMC_CONFIG2_i[3-0] CSONTIME field and ensures address setup time to CSn assertion.
 - CSn deassertion time controlled by the GPMC_CONFIG2_i[20-16] CSWROFFTIME field and ensures address hold time to CSn deassertion.
- Address valid signal ADVn
 - ADVn assertion time is controlled by the GPMC_CONFIG3_i[3-0] ADVONTIME field.
 - ADVn deassertion time is controlled by the GPMC_CONFIG3_i[20-16] ADVWROFFTIME field.

- Write enable signal WEn
 - WEn assertion indicates a read cycle.
 - WEn assertion time is controlled by the GPMC_CONFIG4_i[19-16] WEONTIME field.
 - WEn deassertion time is controlled by the GPMC_CONFIG4_i[28-24] WEOFFTIME field.

The WEn falling edge must not be used to control the time when the burst first data is driven in the address/data bus because some new devices require the WEn signal at low during the address phase.
- Direction signal DIR is OUT during the entire access.

When the GPMC generates a write access to an AAD-multiplexed device, all address bits are driven onto the address/data bus in two separate phases. The first phase is used for the MSB address and is qualified with OEn driven low. The second phase for LSB address is qualified with OEn driven high. The address phase ends at WEn assertion time.

The CSn and DIR signals are controlled as detailed above.

- Address valid signal ADVn is asserted and deasserted twice during a read transaction
 - ADVn first assertion time is controlled by the GPMC_CONFIG3_i[[6-4] ADVAADMUXONTIME field.
 - ADVn first deassertion time is controlled by the GPMC_CONFIG3_i[[26-24] ADVAADMUXRDOFFTIME field.
 - ADVn second assertion time is controlled by the GPMC_CONFIG3_i[[3-0] ADVONTIME field.
 - ADVn second deassertion time is controlled by the GPMC_CONFIG3_i[[12-8] ADVRDOFFTIME field.
- Output Enable signal OEn is asserted and deasserted twice during a read transaction (OEn second assertion indicates a read cycle)
 - OEn first assertion time is controlled by the GPMC_CONFIG4_i[[6-4] OEAADMUXONTIME field.
 - OEn first deassertion time is controlled by the GPMC_CONFIG4_i[[15-13] OEAADMUXOFFTIME field.
 - OEn second assertion time is controlled by the GPMC_CONFIG4_i[3-0] OEONTIME field.
 - OEn second deassertion time is controlled by the GPMC_CONFIG4_i[12-8] OEOFFTIME field.

First write data is driven by the GPMC at GPMC_CONFIG6_i[19-16] WRDATAONADMUXBUS, when in address/data mux configuration. The next write data of the burst is driven on the bus at WRACCESSTIME + 1 during GPMC_CONFIG5_i[27-24] PAGEBURSTACCESSTIME GPMC_FCLK cycles. The last data of the synchronous burst write is driven until GPMC_CONFIG5_i[12-8] WRCYCLETIME completes.

- WRACCESSTIME is defined in the GPMC_CONFIG6_i[28-24] register.
- The PAGEBURSTACCESSTIME parameter must be set accordingly with GPMCFCLKDIVIDER and the memory-device internal configuration.

Total access time GPMC_CONFIG5_i[12-8] WRCYCLETIME corresponds to WRACCESSTIME plus the address hold time from CSn deassertion. In [Figure 7-23](#) the WRCYCLETIME programmed value equals WRCYCLETIME0 + WRCYCLETIME1. WRCYCLETIME0 and WRCYCLETIME1 delays are not actual parameters and are only a graphical representation of the full WRCYCLETIME value.

After a write operation, if no other access (read or write) is pending, the data bus keeps the previous value. See [Section 7.1.3.3.9.10](#).

7.1.3.3.10.3 Asynchronous and Synchronous Accesses in Nonmultiplexed Mode

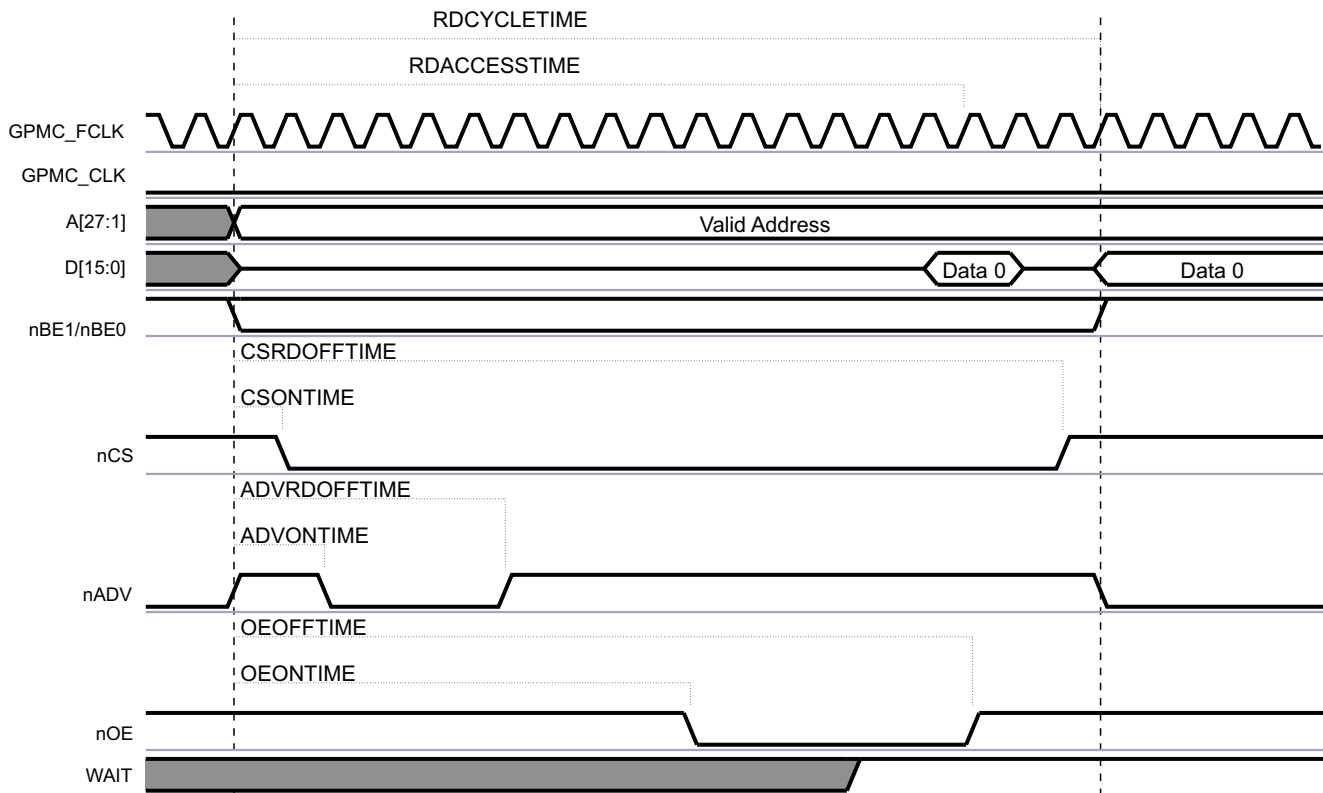
Page mode is only available in non-multiplexed mode.

- Asynchronous single read operation on a nonmultiplexed device
- Asynchronous single write operation on a nonmultiplexed device
- Asynchronous multiple (page mode) read operation on a nonmultiplexed device
- Synchronous operations on a nonmultiplexed device

7.1.3.3.10.3.1 Asynchronous Single Read Operation on a Nonmultiplexed Device

Figure 7-24 shows an asynchronous single read operation on a nonmultiplexed device.

Figure 7-24. Asynchronous Single Read on an Address/Data-Nonmultiplexed Device



The 27-bit address is driven onto the address bus A[27:1] and the 16-bit data is driven onto the data bus D[15:0].

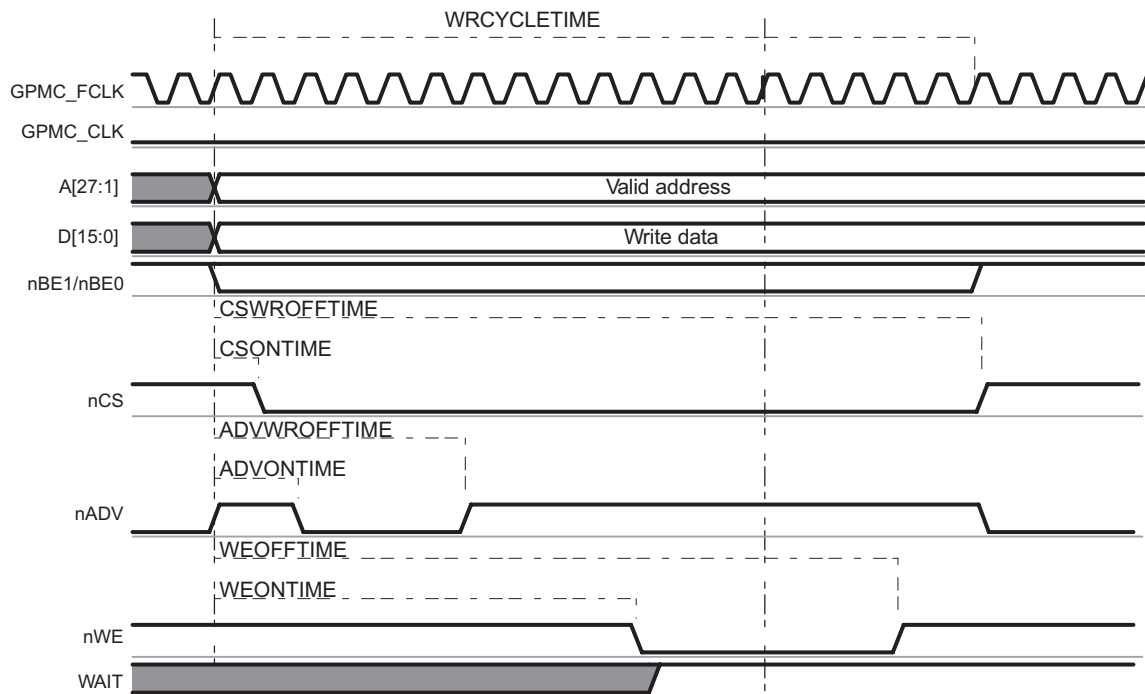
Read data is latched at GPMC_CONFIG1_5[20-16] RDACCESSTIME completion time. The end of the access is defined by the GPMC_CONFIG1_5[4-0] RDCYCLETIME parameter.

CSn, ADVn, OEn and DIR signals are controlled in the same way as address/data multiplexed accesses, see Section 7.1.3.3.10.1.1.2.

7.1.3.3.10.3.2 Asynchronous Single Write Operation on a Nonmultiplexed Device

Figure 7-25 shows an asynchronous single write operation on a nonmultiplexed device.

Figure 7-25. Asynchronous Single Write on an Address/Data-Nonmultiplexed Device



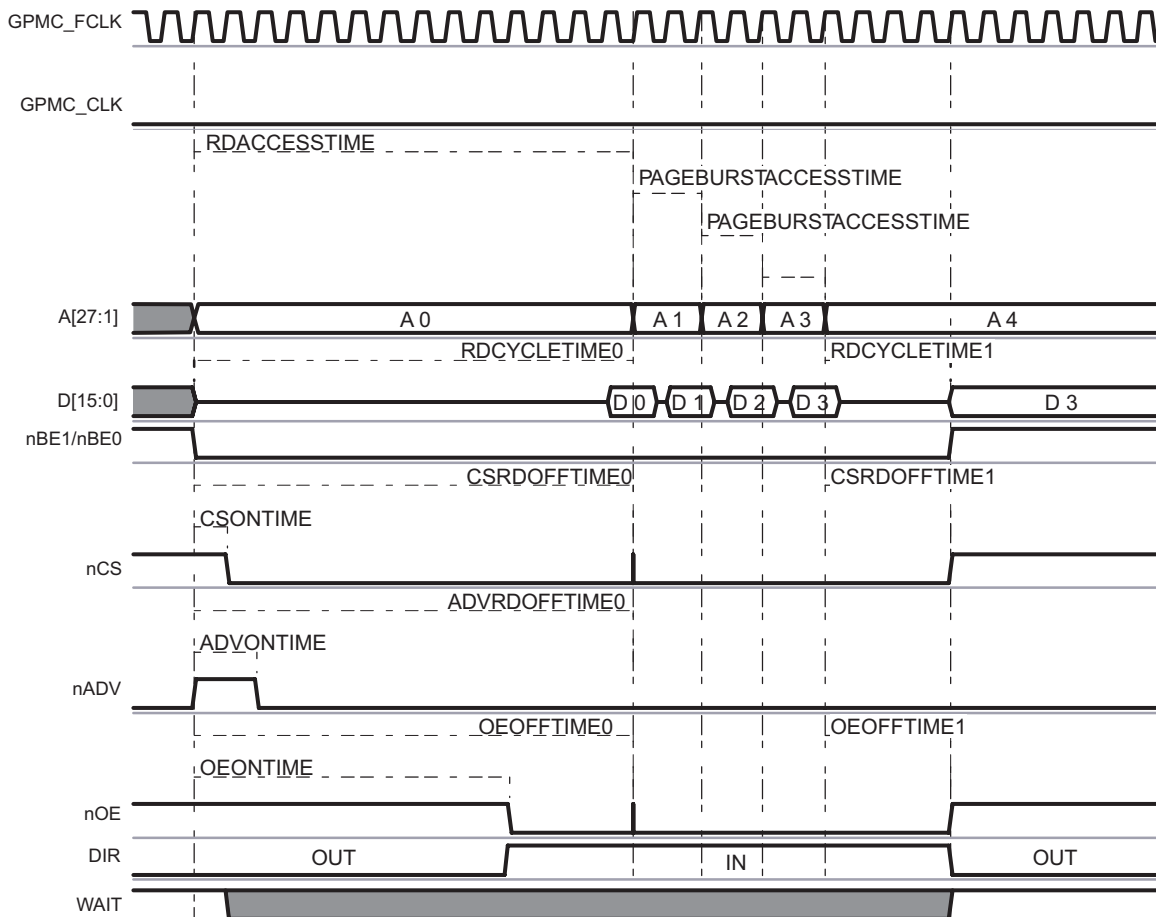
The 27-bit address is driven onto the address bus A[27:1] and the 16-bit data is driven onto the data bus D[15:0].

CSn, ADVn, WEn and DIR signals are controlled in the same way as address/data multiplexed accesses, see [Section 7.1.3.3.10.1.1.3](#).

7.1.3.3.10.3.3 Asynchronous Multiple (Page Mode) Read Operation on a Nonmultiplexed Device

Figure 7-26 shows an asynchronous multiple read operation on a Nonmultiplexed Device, in which two word32 host read accesses to the GPMC are split into one multiple (page mode of 4 word16) read access to the attached device.

Figure 7-26. Asynchronous Multiple (Page Mode) Read



The WAIT signal is active low.

CSn, ADVn, OEn and DIR signals are controlled in the same way as address/data multiplexed accesses, see Section 7.1.3.3.10.1.1.2.

When RDACCESSTIME completes, control-signal timings are frozen during the multiple data transactions, corresponding to PAGEBURSTACCESSTIME multiplied by the number of remaining data transactions.

Read data is latched at GPMC_CONFIG5_i[20-16] RDACCESSTIME completion time. The end of the access is defined by the GPMC_CONFIG5_i[4-0] RDCYCLETIME parameter.

During consecutive accesses, the GPMC increments the address after each data read completes.

Delay between successive read data in the page is controlled by the GPMC_CONFIG5_i[27-24] PAGEBURSTACCESSTIME parameter. Depending on the device page length, the GPMC can control device page crossing during a burst request and insert initial RDACCESSTIME latency. Note that page crossing is only possible with a new burst access, meaning a new initial access phase is initiated.

Total access time RDCYCLETIME corresponds to RDACCESSTIME plus the address hold time starting from the CSn deassertion.

- The read cycle time is defined in the GPMC_CONFIG5_i[4-0] RDCYCLETIME field.
- In Figure 7-26, the RDCYCLETIME programmed value equals RDCYCLETIME0 (before paged accesses) + RDCYCLETIME1 (after paged accesses).

7.1.3.3.10.3.4 Synchronous Operations on a Nonmultiplexed Device

All information for this section is equivalent to similar operations for address/data- or AAD-multiplexed accesses. The only difference resides in the address phase. See [Section 7.1.4.2](#).

7.1.3.3.10.4 Page and Burst Support

Each chip-select can be configured to process system single or burst requests into successive single accesses or asynchronous page/synchronous burst accesses, with appropriate access size adaptation.

Depending on the external device page or burst capability, read and write accesses can be independently configured through the GPMC. The GPMC_CONFIG1_i[30] READMULTIPLE and GPMC_CONFIG1_i[28] WRITMULTIPLE bits are associated with the READTYPE and WRITETYPE parameters.

- Asynchronous write page mode is not supported.
- 8-bit wide device support is limited to nonburstable devices (READMULTIPLE and WRITEMULTIPLE are ignored).
- Not applicable to NAND device interfacing.

7.1.3.3.10.5 System Burst Versus External Device Burst Support

The device system can issue the following requests to the GPMC:

- Byte, 16-bit word, 32-bit word requests (byte enable controlled). This is always a single request from the interconnect point of view.
- Incrementing fixed-length bursts of two words, four words, and eight words
- Wrapped (critical word access first) fixed-length burst of two, four, or eight words

To process a system request with the optimal protocol, the READMULTIPLE (and READTYPE) and WRITEMULTIPLE (and WRITETYPE) parameters must be set according to the burstable capability (synchronous or asynchronous) of the attached device.

The GPMC access engine issues only fixed-length burst. The maximum length that can be issued is defined per CS by the GPMC_CONFIG1_i[24-23] ATTACHEDDEVICEPAGELENGTH field. When the ATTACHEDDEVICEPAGELENGTH value is less than the system burst request length (including the appropriate access size adaptation according to the device width), the GPMC splits the system burst request into multiple bursts. Within the specified 4-, 8-, or 16-word value, the ATTACHEDDEVICEPAGELENGTH field value must correspond to the maximum-length burst supported by the memory device configured in fixed-length burst mode (as opposed to continuous burst mode).

To get optimal performance from memory devices that natively support 16 Word16-length-wrapping burst capability (critical word access first), the ATTACHEDDEVICEPAGELENGTH parameter must be set to 16 words and the GPMC_CONFIG1_i[31] WRAPBURST bit must be set to 1. Similarly DEVICESPAGELENGTH is set to 4 and 8 for memories supporting respectively 4 and 8 Word16-length-wrapping burst.

When the memory device does not offer (or is not configured to offer) native 16 Word16-length-wrapping burst, the WRAPBURST parameter must be cleared, and the GPMC access engine emulates the wrapping burst by issuing the appropriate burst sequences according to the ATTACHEDDEVICEPAGELENGTH value.

When the memory device does not support native-wrapping burst, there is usually no difference in behavior between a fixed burst length mode and a continuous burst mode configuration (except for a potential power increase from a memory-speculative data prefetch in a continuous burst read). However, even though continuous burst mode is compatible with GPMC behavior, because the GPMC access engine issues only fixed-length burst and does not benefit from continuous burst mode, it is best to configure the memory device in fixed-length burst mode.

The memory device maximum-length burst (configured in fixed-length burst wrap or nonwrap mode) usually corresponds to the memory device data buffer size. Memory devices with a minimum of 16 half-word buffers are the most appropriate (especially with wrap support), but memory devices with smaller buffer size (4 or 8) are also supported, assuming that the GPMC_CONFIG1_i[24-23] ATTACHEDDEVICEPAGELENGTH field is set accordingly to 4 or 8 words.

The device system issues only requests with addresses or starting addresses for nonwrapping burst requests; that is, the request size boundary is aligned. In case of an eight-word-wrapping burst, the wrapping address always occurs on the eight-words boundary. As a consequence, all words requested must be available from the memory data buffer when the buffer size is equal to or greater than the ATTACHEDDEVICEPAGELENGTH value. This usually means that data can be read from or written to the buffer at a constant rate (number of cycles between data) without wait states between data accesses. If the memory does not behave this way (nonzero wait state burstable memory), wait-pin monitoring must be enabled to dynamically control data-access completion within the burst.

When the system burst request length is less than the ATTACHEDDEVICEPAGELENGTH value, the GPMC proceeds with the required accesses.

7.1.3.3.11 pSRAM Access Specificities

pSRAM devices are SRAM-pin-compatible low-power memories that contain a self-refreshed DRAM memory array. The GPMC_CONFIG1_i[[11-10] DEVICETYPE field shall be cleared to 0b00.

The pSRAM devices uses the NOR protocol. It support the following operations:

- Asynchronous single read
- Asynchronous page read
- Asynchronous single write
- Synchronous single read and write
- Synchronous burst read
- Synchronous burst write (not supported by NOR Flash memory)

pSRAM devices must be powered up and initialized in a predefined manner according to the specifications of the attached device.

pSRAM devices can be programmed to use either mode: fixed or variable latency. pSRAM devices can either automatically schedule autorefresh operations, which force the GPMC to use its WAIT signal capability when read or write operations occur during an internal self-refresh operation, or pSRAM devices automatically include the autorefresh operation in the access time. These devices do not require additional WAIT signal capability or a minimum CSn high pulse width between consecutive accesses to ensure that the correct internal refresh operation is scheduled.

7.1.3.3.12 NAND Access Description

NAND (8-bit and 16-bit) memory devices using a standard NAND asynchronous address/data-multiplexing scheme can be supported on any chip-select with the appropriate asynchronous configuration settings

As for any other type of memory compatible with the GPMC interface, accesses to a chip-select allocated to a NAND device can be interleaved with accesses to chip-selects allocated to other external devices.

This interleaved capability limits the system to *chip enable don't care* NAND devices, because the chip-select allocated to the NAND device must be de-asserted if accesses to other chip-selects are requested.

7.1.3.3.1.1 NAND Memory Device in Byte or 16-Bit Word Stream Mode

NAND devices require correct command and address programming before data array read or write accesses. The GPMC does not include specific hardware to translate a random address system request into a NAND-specific multiphase access. In that sense, GPMC NAND support, as opposed to random memory-map device support, is data-stream-oriented (byte or 16-bit word).

The GPMC NAND programming model relies on a software driver for address and command formatting with the correct data address pointer value according to the block and page structure. Because of NAND structure and protocol interface diversity, the GPMC does not support automatic command and address phase programming, and software drivers must access the NAND device ID to ensure that correct command and address formatting are used for the identified device.

NAND device data read and write accesses are achieved through an asynchronous read or write access. The associated chip-select signal timing control must be programmed according to the NAND device timing specification.

Any chip-select region can be qualified as a NAND region to constrain the ADV_n_ALE signal as Address Latch Enable (ALE active high, default state value at low) during address program access, and the BE0_n_CLE signal as Command Latch Enable (CLE active high, default state value at low) during command program access. GPMC address lines are not used (the previous value is not changed) during NAND access.

7.1.3.3.12.1.1 Chip-Select Configuration for NAND Interfacing in Byte or Word Stream Mode

The GPMC_CONFIG7_i register associated with a NAND device region interfaced in byte or word stream mode can be initialized with a minimum size of 16 Mbytes, because any address location in the chip-select memory region can be used to access a NAND data array. The NAND Flash protocol specifies an address sequence where address bits are passed through the data bus in a series of write accesses with the ALE pin asserted. After this address phase, all operations are streamed and the system requests address is irrelevant.

To allow correct command, address, and data-access controls, the GPMC_CONFIG1_i register associated with a NAND device region must be initialized in asynchronous read and write modes with the parameters shown in [Table 7-11](#). Failure to comply with these settings corrupts the NAND interface protocol.

The GPMC_CONFIG1_i to GPMC_CONFIG4_i register associated with a NAND device region must be initialized with the correct control-signal timing value according to the NAND device timing parameters.

Table 7-11. Chip-Select Configuration for NAND Interfacing

Bit Field	Register	Value	Comments
WRAPBURST	GPMC_CONFIG1 _i	0	No wrap
READMULTIPLE	GPMC_CONFIG1 _i	0	Single access
READTYPE	GPMC_CONFIG1 _i	0	Asynchronous mode
WRITEMULTIPLE	GPMC_CONFIG1 _i	0	Single access
WRITETYPE	GPMC_CONFIG1 _i	0	Asynchronous mode
CLKACTIVATIONTIME	GPMC_CONFIG1 _i	0b00	
ATTACHEDDEVICEPAGELENGTH	GPMC_CONFIG1 _i	Don't care	Single-access mode
WAITREADMONITORING	GPMC_CONFIG1 _i	0	Wait not monitored by GPMC access engine
WAITWRITEMONITORING	GPMC_CONFIG1 _i	0	Wait not monitored by GPMC access engine
WAITMONITORINGTIME	GPMC_CONFIG1 _i	Don't care	Wait not monitored by GPMC access engine
WAITPINSELECT	GPMC_CONFIG1 _i		Select which wait is monitored by edge detectors
DEVICESIZE	GPMC_CONFIG1 _i	0b00 or 0b01	8- or 16-bit interface
DEVICETYPE	GPMC_CONFIG1 _i	0b10	NAND device in stream mode
MUXADDDATA	GPMC_CONFIG1 _i	0b00	Nonmultiplexed mode
TIMEPARAGRANULARITY	GPMC_CONFIG1 _i	0	Timing achieved with best GPMC clock granularity
GPMCFCLKDIVIDER	GPMC_CONFIG1 _i	Don't care	Asynchronous mode

7.1.3.3.12.1.2 NAND Device Command and Address Phase Control

NAND devices require multiple address programming phases. The MPU software driver is responsible for issuing the correct number of command and address program accesses, according to the device command set and the device address-mapping scheme.

NAND device-command and address-phase programming is achieved through write requests to the GPMC_NAND_COMMAND_i and GPMC_NAND_ADDRESS_i register locations with the correct command and address values. These locations are mapped in the associated chip-select register region. The associated chip-select signal timing control must be programmed according to the NAND device timing specification.

Command and address values are not latched during the access and cannot be read back at the register location.

- Only write accesses must be issued to these locations, but the GPMC does not discard any read access. Accessing a NAND device with OEn and CLE or ALE asserted (read access) can produce undefined results.
- Write accesses to the GPMC_NAND_COMMAND_i register location and to the GPMC_NAND_ADDRESS_i register location must be posted for faster operations. The GPMC_CONFIG[0] NANDFORCEPOSTEDWRITE bit enables write accesses to these locations as posted, even if they are defined as nonposted.

A write buffer is used to store write transaction information before the external device is accessed:

- Up to eight consecutive posted write accesses can be accepted and stored in the write buffer.
- For nonposted write, the pipeline is one deep.
- A GPMC_STATUS[0] EMPTYWRITEBUFFERSTATUS bit stores the empty status of the write buffer.

The GPMC_NAND_COMMAND_i and GPMC_NAND_ADDRESS_i registers are 32-bit word locations, which means any 32-bit word or 16-bit word access is split into 4- or 2-byte accesses if an 8-bit wide NAND device is attached. For multiple-command phase or multiple-address phase, the software driver can use 32-bit word or 16-bit word access to these registers, but it must account for the splitting and little-endian ordering scheme. When only one byte command or address phase is required, only byte write access to a GPMC_NAND_COMMAND_i and GPMC_NAND_ADDRESS_i can be used, and any of the four byte locations of the registers are valid.

The same applies to GPMC_NAND_COMMAND_i and GPMC_NAND_ADDRESS_i 32-bit word write access to a 16-bit wide NAND device (split into two 16-bit word accesses). In the case of a 16-bit word write access, the MSByte of the 16-bit word value must be set according to the NAND device requirement (usually 0). Either 16-bit word location or any one of the four byte locations of the registers is valid

7.1.3.3.12.1.3 Command Latch Cycle

Writing data at the GPMC_NAND_COMMAND_i location places the data as the NAND command value on the bus, using a regular asynchronous write access.

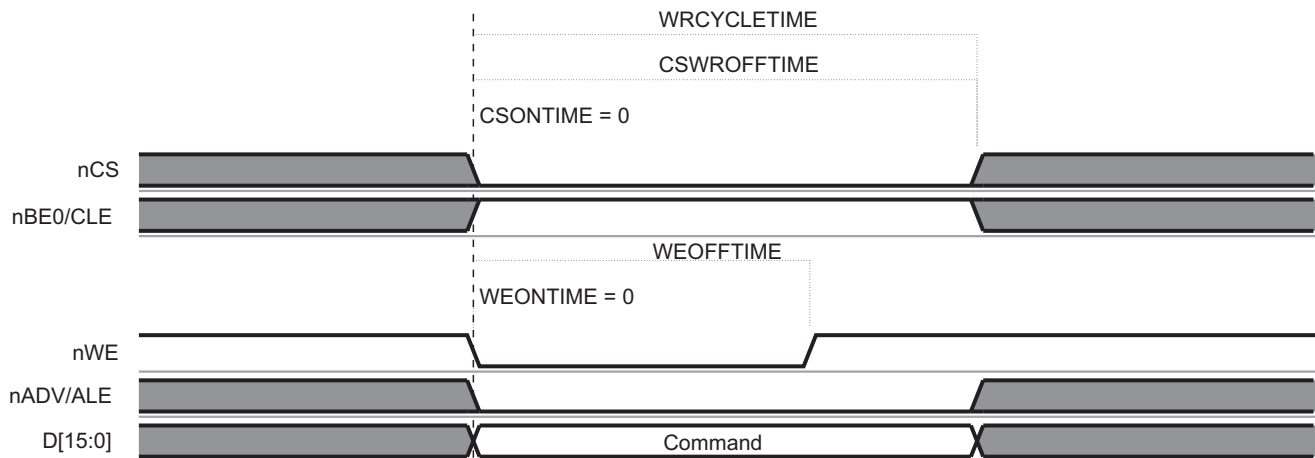
- CSn[j] is controlled by the CSONTIME and CSWROFFTIME timing parameters.
- CLE is controlled by the ADVONTIME and ADVWROFFTIME timing parameters.
- WE is controlled by the WEONTIME and WEOFFTIME timing parameters.
- ALE and REn (OEn) are maintained inactive.

Figure 7-27 shows the NAND command latch cycle.

CLE is shared with the BE0n output signal and has an inverted polarity from BE0n. The NAND qualifier deals with this. During the asynchronous NAND data access cycle, BE0n (also BE1n) must not toggle, because it is shared with CLE.

NAND Flash memories do not use byte enable signals at all.

Figure 7-27. NAND Command Latch Cycle



7.1.3.3.12.1.4 Address Latch Cycle

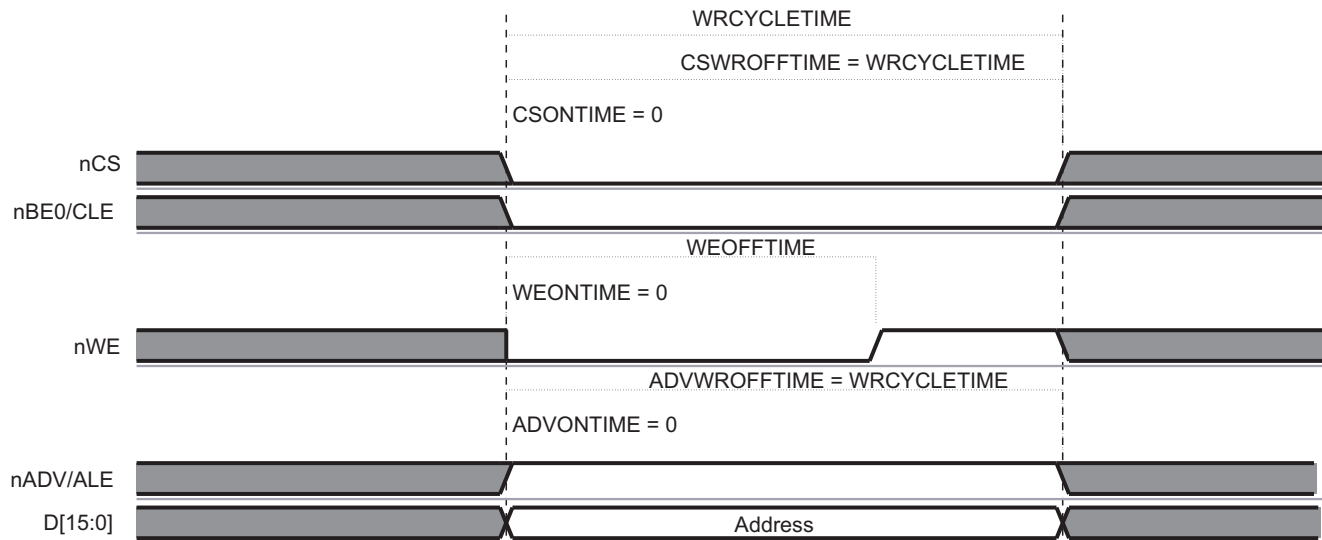
Writing data at the GPMC_NAND_ADDRESS_i location places the data as the NAND partial address value on the bus, using a regular asynchronous write access.

- CSn is controlled by the CSONTIME and CSWROFFTIME timing parameters.
- ALE is controlled by the ADVONTIME and ADVWROFFTIME timing parameters.
- WEn is controlled by the WEONTIME and WEOFFTIME timing parameters.
- CLE and REn (OEn) are maintained inactive.

Figure 7-28 shows the NAND address latch cycle.

ALE is shared with the ADVn output signal and has an inverted polarity from ADVn. The NAND qualifier deals with this. During the asynchronous NAND data access cycle, ALE is kept stable.

Figure 7-28. NAND Address Latch Cycle



7.1.3.3.12.1.5 NAND Device Data Read and Write Phase Control in Stream Mode

NAND device data read and write accesses are achieved through a read or write request to the chip-select-associated memory region at any address location in the region or through a read or write request to the GPMC_NAND_DATA_i location mapped in the chip-select-associated control register region. GPMC_NAND_DATA_i is not a true register, but an address location to enable REn or WEn signal control. The associated chip-select signal timing control must be programmed according to the NAND device timing specification.

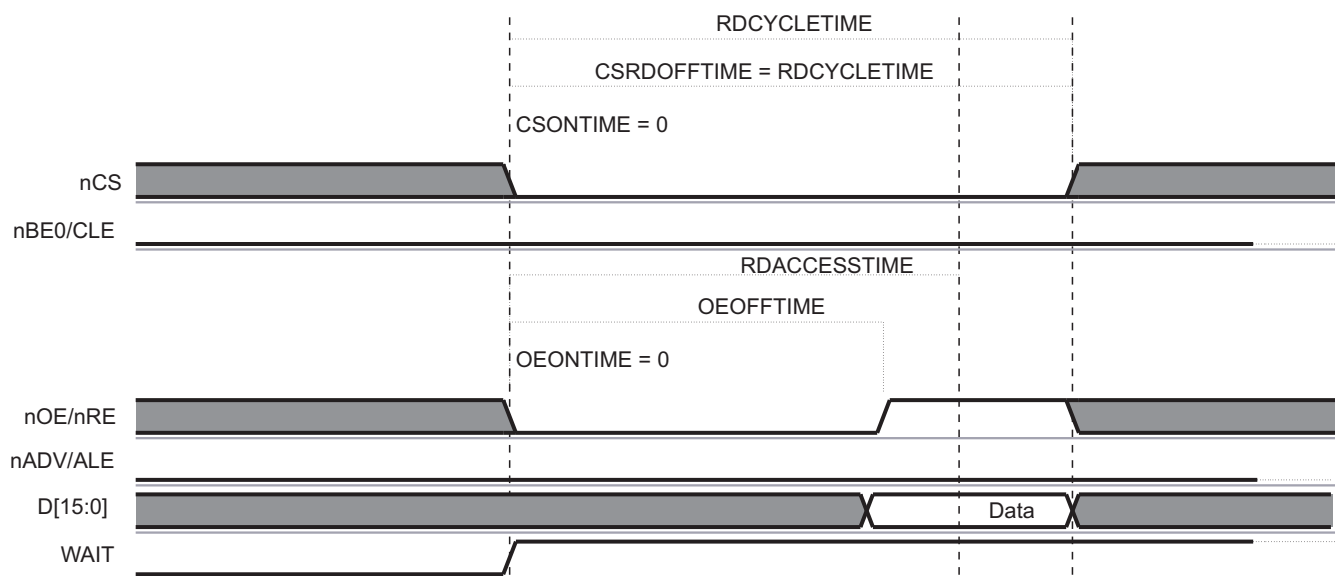
Reading data from the GPMC_NAND_DATA_i location or from any location in the associated chip-select memory region activates an asynchronous read access.

- CSn is controlled by the CSONTIME and CSRDOFFTIME timing parameters.
- REn is controlled by the OEONTIME and OEOFFTIME timing parameters.
- To take advantage of REn high-to-data invalid minimum timing value, the RDACCESSTIME can be set so that data are effectively captured after REn deassertion. This allows optimization of NAND read access cycle time completion. For optimal timing parameter settings, see the NAND device and the device IC timing parameters.

ALE, CLE, and WEn are maintained inactive.

Figure 7-29 shows the NAND data read cycle.

Figure 7-29. NAND Data Read Cycle

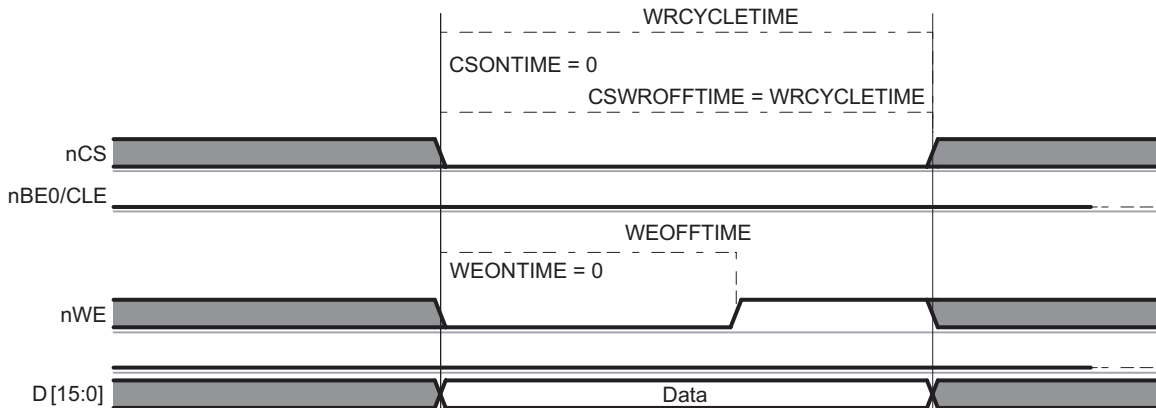


Writing data to the GPMC_NAND_DATA_i location or to any location in the associated chip-select memory region activates an asynchronous write access.

- CSn is controlled by the CSONTIME and CSWROFFTIME timing parameters.
- WEn is controlled by the WEONTIME and WEOFFTIME timing parameters.
- ALE, CLE, and REn (OEn) are maintained inactive.

Figure 7-30 shows the NAND data write cycle.

Figure 7-30. NAND Data Write Cycle



7.1.3.3.12.1.6 NAND Device General Chip-Select Timing Control Requirement

For most NAND devices, read data access time is dominated by CSn-to-data-valid timing and has faster REn-to-data-valid timing. Successive accesses with CSn deassertions between accesses are affected by this timing constraint. Because accesses to a NAND device can be interleaved with other chip-select accesses, there is no certainty that CSn always stays low between two accesses to the same chip-select. Moreover, an CSn deassertion time between the same chip-select NAND accesses is likely to be required as follows: the CSn deassertion requires programming CYCLETIME and RDACCESSTIME according to the CSn-to-data-valid critical timing.

To get full performance from NAND read and write accesses, the prefetch engine can dynamically reduce RDCYCLETIME, WRCYCLETIME, RDACCESSTIME, WRACCESSTIME, CSRDOFFTIME, CSWROFFTIME, ADVRDOFFTIME, ADVWROFFTIME, OEOFFTIME, and WEOFFTIME on back-to-back NAND accesses (to the same memory) and suppress the minimum CSn high pulse width between accesses. For more information about optimal prefetch engine access, see [Section 7.1.3.3.12.4](#).

Some NAND devices require minimum write-to-read idle time, especially for device-status read accesses following status-read command programming (write access). If such write-to-read transactions are used, a minimum CSn high pulse width must be set. For this, CYCLE2CYCLESAMECSEN and CYCLE2CYCLEDELAY must be set according to the appropriate timing requirement to prevent any timing violation.

NAND devices usually have an important REn high to data bus in tristate mode. This requires a bus turnaround setting (BUSTURNAROUND = 1), so that the next access to a different chip-select is delayed until the BUSTURNAROUND delay completes. Back-to-back NAND read accesses to the same NAND Flash are not affected by the programmed bus turnaround delay.

7.1.3.3.12.1.7 Read and Write Access Size Adaptation

7.1.3.3.12.1.7.1 8-Bit Wide NAND Device

Host 16-bit word and 32-bit word read and write access requests to a chip-select associated with an 8-bit wide NAND device are split into successive read and write byte accesses to the NAND memory device. Byte access is ordered according to little-endian organization. A NAND 8-bit wide device must be interfaced on the D0D7 interface bus lane. GPMC data accesses are justified on this bus lane when the chip-select is associated with an 8-bit wide NAND device.

7.1.3.3.12.1.7.2 16-Bit Wide NAND Device

Host 32-bit word read and write access requests to a chip-select associated with a 16-bit wide NAND device are split into successive read and write 16-bit word accesses to the NAND memory device. 16-bit word access is ordered according to little-endian organization.

Host byte read and write access requests to a 16-bit wide NAND device are completed as 16-bit accesses on the device itself, because there is no byte-addressing capability on 16-bit wide NAND devices. This means that the NAND device address pointer is incremented on a 16-bit word basis and not on a byte basis. For a read access, only the requested byte is given back to the host, but the remaining byte is not stored or saved by the GPMC, and the next byte or 16-bit word read access gets the next 16-bit word NAND location. For a write access, the invalid byte part of the 16-bit word is driven to FF, and the next byte or 16-bit word write access programs the next 16-bit word NAND location.

Generally, byte access to a 16-bit wide NAND device should be avoided, especially when ECC calculation is enabled. 8-bit or 16-bit ECC-based computations are corrupted by a byte read to a 16-bit wide NAND device, because the nonrequested byte is considered invalid on a read access (not captured on the external data bus; FF is fed to the ECC engine) and is set to FF on a write access.

Host requests (read/write) issued in the chip-select memory region are translated in successive single or split accesses (read/write) to the attached device. Therefore, incrementing 32-bit burst requests are translated in multiple 32-bit sequential accesses following the access adaptation of the 32-bit to 8- or 16-bit device.

7.1.3.3.12.2 NAND Device-Ready Pin

The NAND memory device provides a ready pin to indicate data availability after a block/page opening and to indicate that data programming is complete. The ready pin can be connected to one of the WAIT GPMC input pins; data read accesses must not be tried when the ready pin is sampled inactive (device is not ready) even if the associated chip-select WAITREADMONITORING bit field is set. The duration of the NAND device busy state after the block/page opening is so long (up to 50 μ s) that accesses occurring when the ready pin is sampled inactive can stall GPMC access and eventually cause a system time-out.

If a read access to a NAND flash is done using the wait monitoring mode, the device is blocked during a page opening, and so is the GPMC. If the correct settings are used, other chip-selects can be used while the memory processes the page opening command.

To avoid a time-out caused by a block/page opening delay in NAND flash, disable the wait pin monitoring for read and write accesses (that is, set the GPMC_CONFIG1_i[[21] WAITWRITEMONITORING and GPMC_CONFIG1_i[[22] WAITREADMONITORING bits to 0 and use one of the following methods instead:

- Use software to poll the WAITnSTATUS bit ($n = 0$ to 1) of the GPMC_STATUS register.
- Configure an interrupt that is generated on the WAIT signal change (through the GPMC_IRQENABLE [11-8]bits).

Even if the READWAITMONITORING bit is not set, the external memory nR/B pin status is captured in the programmed WAIT bit in the GPMC_STATUS register.

The READWAITMONITORING bit method must be used for other memories than NAND flash, if they require the use of a WAIT signal.

7.1.3.3.12.2.1 Ready Pin Monitored by Software Polling

The ready signal state can be monitored through the GPMC_STATUS WAITxSTATUS bit ($x = 0$ or 1). The software must monitor the ready pin only when the signal is declared valid. Refer to the NAND device timing parameters to set the correct software temporization to monitor ready only after the invalid window is complete from the last read command written to the NAND device.

7.1.3.3.12.2.2 Ready Pin Monitored by Hardware Interrupt

Each gpmc_wait input pin can generate an interrupt when a wait-to-no-wait transition is detected. Depending on whether the GPMC_CONFIG WAITxPINPOLARITY bits ($x = 0$ or 1) is active low or active high, the wait-to-no-wait transition is a low-to-high external WAIT signal transition or a high-to-low external WAIT signal transition, respectively.

The wait transition pin detector must be cleared before any transition detection. This is done by writing 1 to the WAITxEDGEDETECTIONSTATUS bit (x = 0 or 1) of the GPMC_IRQSTATUS register according to the gpmc_wait pin used for the NAND device-ready signal monitoring. To detect a wait-to-no-wait transition, the transition detector requires a wait active time detection of a minimum of two GPMC_FCLK cycles. Software must incorporate precautions to clear the wait transition pin detector before wait (busy) time completes.

A wait-to-no-wait transition detection can issue a GPMC interrupt if the WAITxEDGEDETECTIONENABLE bit in the GPMC_IRQENABLE register is set and if the WAITxEDGEDETECTIONSTATUS bit field in the GPMC_IRQSTATUS register is set.

The WAITMONITORINGTIME field does not affect wait-to-no-wait transition time detection.

It is also possible to poll the WAITxEDGEDETECTIONSTATUS bit field in the GPMC_IRQSTATUS register according to the gpmc_wait pin used for the NAND device ready signal monitoring.

7.1.3.3.12.3 ECC Calculator

The General Purpose Memory Controller includes an Error Code Correction (ECC) calculator circuitry that enables on the fly ECC calculation during data read or data program (that is, write) operations. The page size supported by the ECC calculator in one calculation/context is 512 bytes.

The user can choose from two different algorithms with different error correction capabilities through the GPMC_ECC_CONFIG[16] ECCALGORITHM bit:

- Hamming code for 1-bit error code correction on 8- or 16-bit NAND Flash organized with page size greater than 512 bytes
- BCH (Bose-Chaudhuri-Hocquenghem) code for 4- to 16-bit error correction

The GPMC does not directly handle the error code correction itself. During writes, the GPMC computes parity bits. During reads, the GPMC provides enough information for the processor to correct errors without reading the data buffer all over again.

The Hamming code ECC is based on a 2-dimensional (row and column) bit parity accumulation. This parity accumulation is either accomplished on the programmed number of bytes or 16-bit words read from the memory device, or written to the memory device in stream mode.

Because the ECC engine includes only one accumulation context, it can be allocated to only one chip-select at a time through the GPMC_ECC_CONFIG[3-1] ECCCS bit field. Even if two CS use different ECC algorithms, one the Hamming code and the other a BCH code, they must define separate ECC contexts because some of the ECC registers are common to all types of algorithms.

7.1.3.3.12.3.1 Hamming Code

All references to Error Code Correction (ECC) in this subsection refer to the 1-bit error correction Hamming code.

The ECC is based on a two-dimensional (row and column) bit parity accumulation known as Hamming Code. The parity accumulation is done for a programmed number of bytes or 16-bit word read from the memory device or written to the memory device in stream mode.

There is no automatic error detection or correction, and it is the software NAND driver responsibility to read the multiple ECC calculation results, compare them to the expected code value, and take the appropriate corrective actions according to the error handling strategy (ECC storage in spare byte, error correction on read, block invalidation).

The ECC engine includes a single accumulation context. It can be allocated to a single designated chip-select at a time and parallel computations on different chip-selects are not possible. Since it is allocated to a single chip-select, the ECC computation is not affected by interleaved GPMC accesses to other chip-selects and devices. The ECC accumulation is sequentially processed in the order of data read from or written to the memory on the designated chip-select. The ECC engine does not differentiate read accesses from write accesses and does not differentiate data from command or status information. It is the software responsibility to make sure only relevant data are passed to the NAND flash memory while the ECC computation engine is active.

The starting NAND page location must be programmed first, followed by an ECC accumulation context reset with an ECC enabling, if required. The NAND device accesses discussed in the following sections must be limited to data read or write until the specified number of ECC calculations is completed.

7.1.3.3.12.3.1.1 ECC Result Register and ECC Computation Accumulation Size

The GPMC includes up to nine ECC result registers (GPMC_ECCj_RESULT, j = 1 to 9) to store ECC computation results when the specified number of bytes or 16-bit words has been computed.

The ECC result registers are used sequentially; one ECC result is stored in one ECC result register on the list, the next ECC result is stored in the next ECC result register on the list, and so forth, until the last ECC computation. The value of the GPMC_ECCj_RESULT register value is valid only when the programmed number of bytes or 16-bit words has been accumulated, which means that the same number of bytes or 16-bit words has been read from or written to the NAND device in sequence.

The GPMC_ECC_CONTROL[3-0] ECCPOINTER field must be set to the correct value to select the ECC result register to be used first in the list for the incoming ECC computation process. The ECCPointer can be read to determine which ECC register is used in the next ECC result storage for the ongoing ECC computation. The value of the GPMC_ECCj_RESULT register (j = 1 to 9) can be considered valid when ECCPOINTER equals j + 1. When the GPMC_ECCj_RESULT (where j = 9) is updated, ECCPOINTER is frozen at 10, and ECC computing is stopped (ECCENABLE = 0).

The ECC accumulator must be reset before any ECC computation accumulation process. The GPMC_ECC_CONTROL[8] ECCCLEAR bit must be set to 1 (nonpersistent bit) to clear the accumulator and all ECC result registers.

For each ECC result (each register, j = 1 to 9), the number of bytes or 16-bit words used for ECC computing accumulation can be selected from between two programmable values.

The ECCjRESULTSIZESIZE bits (j = 1 to 9) in the GPMC_ECC_SIZE_CONFIG register select which programmable size value (ECCSIZE0 or ECCSIZE1) must be used for this ECC result (stored in GPMC_ECCj_RESULT register).

The ECCSIZE0 and ECCSIZE1 fields allow selection of the number of bytes or 16-bit words used for ECC computation accumulation. Any even values from 2 to 512 are allowed.

Flexibility in the number of ECCs computed and the number of bytes or 16-bit words used in the successive ECC computations enables different NAND page error-correction strategies. Usually based on 256 or 512 bytes and on 128 or 256 16-bit word, the number of ECC results required is a function of the NAND device page size. Specific ECC accumulation size can be used when computing the ECC on the NAND spare byte.

For example, with a 2 Kbyte data page 8-bit wide NAND device, eight ECCs accumulated on 256 bytes can be computed and added to one extra ECC computed on the 24 spare bytes area where the eight ECC results used for comparison and correction with the computed data page ECC are stored. The GPMC then provides nine GPMC_ECCj_RESULT registers (j= 1 to 9) to store the results. In this case, ECCSIZE0 is set to 256, and ECCSIZE1 is set to 24; the ECC[1-8]RESULTSIZESIZE bits are cleared to 0, and the ECC9RESULTSIZESIZE bit is set to 1.

7.1.3.3.12.3.1.2 ECC Enabling

The GPMC_ECC_CONFIG[3-1] ECCCS field selects the allocated chip-select. The GPMC_ECC_CONFIG[0] ECCENABLE bit enables ECC computation on the next detected read or write access to the selected chip-select.

The ECCPOINTER, ECCCLEAR, ECCSIZE, ECCjRESULTSIZESIZE (where j = 1 to 9), ECC16B, and ECCCS fields must not be changed or cleared while an ECC computation is in progress.

The ECC accumulator and ECC result register must not be changed or cleared while an ECC computation is in progress.

[Table 7-12](#) describes the ECC enable settings.

Table 7-12. ECC Enable Settings

Bit Field	Register	Value	Comments
ECCCS	GPMC_ECC_CONFIG	0-3h	Selects the chip-select where ECC is computed
ECC16B	GPMC_ECC_CONFIG	0/1	Selects column number for ECC calculation
ECCCLEAR	GPMC_ECC_CONTROL	0-7h	Clears all ECC result registers
ECCPOINTER	GPMC_ECC_CONTROL	0-7h	A write to this bit field selects the ECC result register where the first ECC computation is stored. Set to 1 by default.
ECCSIZE1	GPMC_ECC_SIZE_CONFIG	0-FFh	Defines ECCSIZE1
ECCSIZE0	GPMC_ECC_SIZE_CONFIG	0-FFh	Defines ECCSIZE0
ECCjRESULTSIZE (j from 1 to 9)	GPMC_ECC_SIZE_CONFIG	0/1	Selects the size of ECCn result register
ECCENABLE	GPMC_ECC_CONFIG	1	Enables the ECC computation

7.1.3.3.12.3.1.3 ECC Computation

The ECC algorithm is a multiple parity bit accumulation computed on the odd and even bit streams extracted from the byte or Word 16 streams. The parity accumulation is split into row and column accumulations, as shown in Figure 7-31 and Figure 7-32. The intermediate row and column parities are used to compute the upper level row and column parities. Only the final computation of each parity bit is used for ECC comparison and correction.

$P1o = \text{bit7 XOR bit5 XOR bit3 XOR bit1}$ on each byte of the data stream

$P1e = \text{bit6 XOR bit4 XOR bit2 XOR bit0}$ on each byte of the data stream

$P2o = \text{bit7 XOR bit6 XOR bit3 XOR bit2}$ on each byte of the data stream

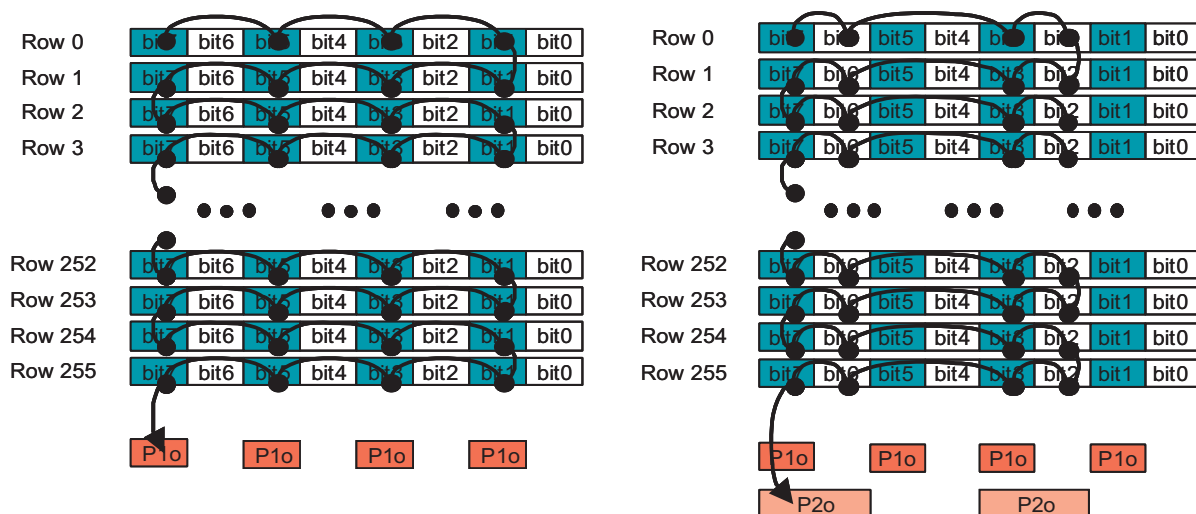
$P2e = \text{bit5 XOR bit4 XOR bit1 XOR bit0}$ on each byte of the data stream

$P4o = \text{bit7 XOR bit6 XOR bit5 XOR bit4}$ on each byte of the data stream

$P4e = \text{bit3 XOR bit2 XOR bit1 XOR bit0}$ on each byte of the data stream

Each column parity bit is XORed with the previous accumulated value.

Figure 7-31. Hamming Code Accumulation Algorithm (1 of 2)



For line parities, the bits of each new data are XORed together, and line parity bits are computed as:

$$P8e = \text{row0 XOR row2 XOR row4 XOR ... XOR row254}$$

$$P8o = \text{row1 XOR row3 XOR row5 XOR ... XOR row255}$$

$$P16e = \text{row0 XOR row1 XOR row4 XOR row5 XOR ... XOR row252 XOR row 253}$$

$$P16o = \text{row2 XOR row3 XOR row6 XOR row7 XOR ... XOR row254 XOR row 255}$$

Unused parity bits in the result registers are cleared to 0.

Figure 7-32. Hamming Code Accumulation Algorithm (2 of 2)

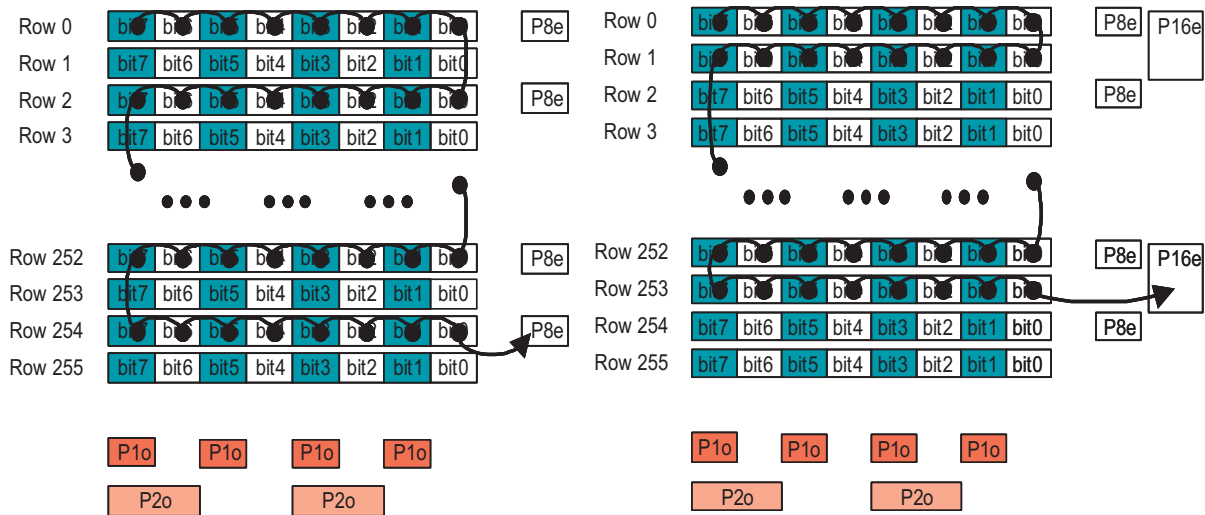


Figure 7-33 shows ECC computation for a 256-byte data stream (read or write). The result includes six column parity bits (P1o-P2o-P4o for odd parities, and P1e-P2e-P4e for even parities) and sixteen row parity bits (P8o-P16o-P32o--P1024o for odd parities, and P8e-P16e-P32e--P1024e for even parities).

Figure 7-33. ECC Computation for a 256-Byte Data Stream (Read or Write)

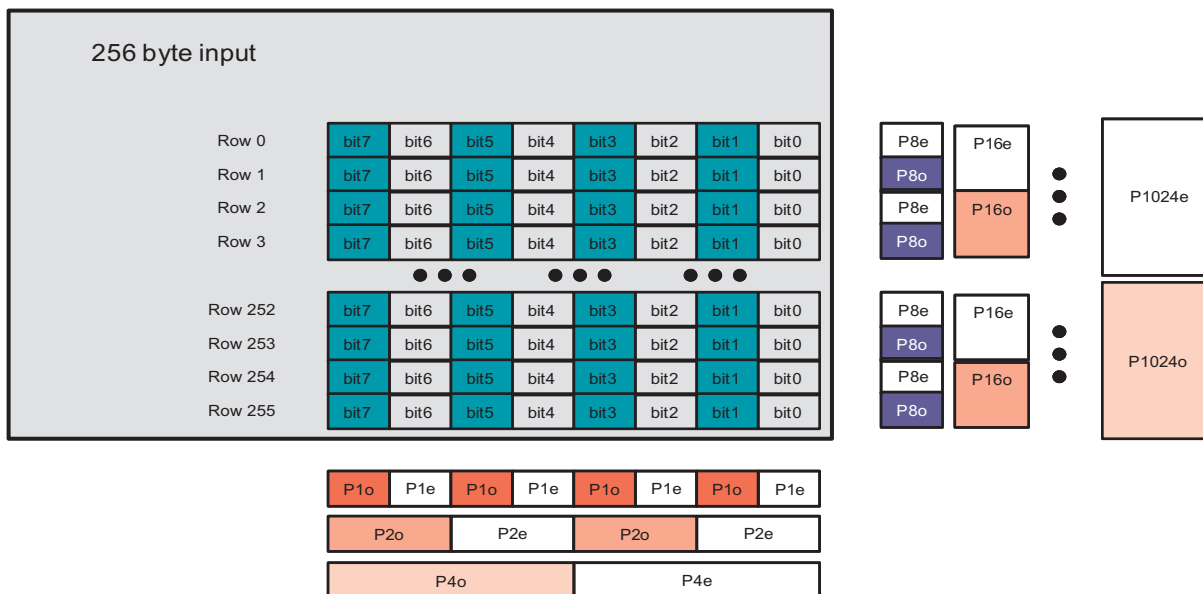
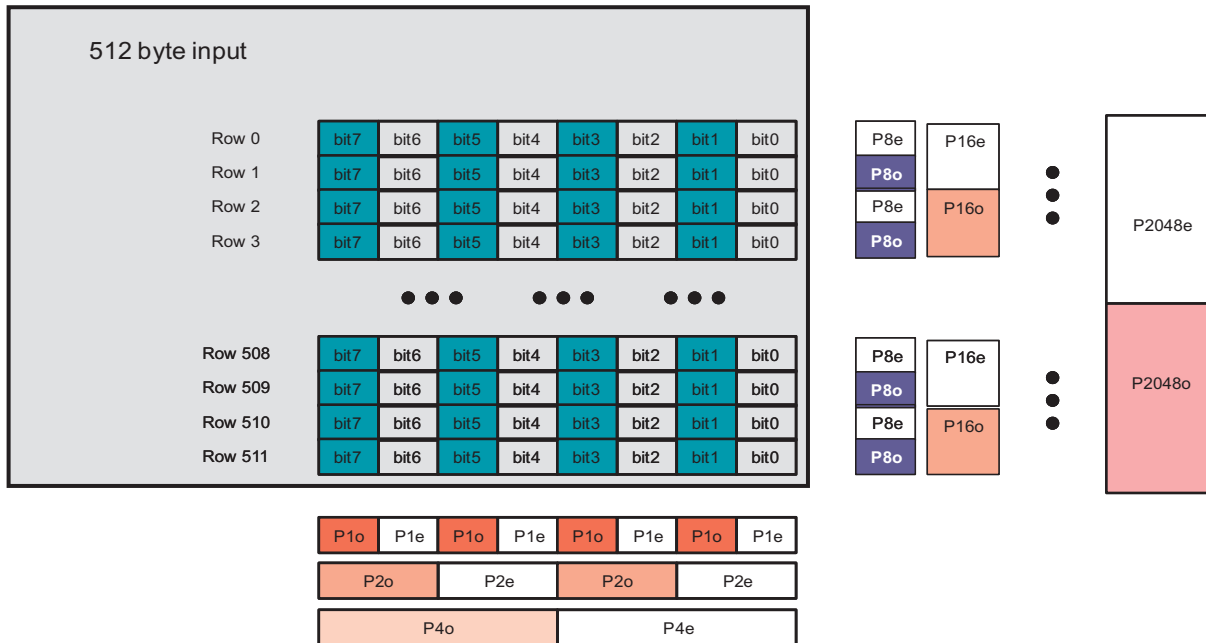


Figure 7-34 shows ECC computation for a 512-byte data stream (read or write). The result includes six column parity bits (P1o-P2o-P4o for odd parities, and P1e-P2e-P4e for even parities) and eighteen row parity bits (P8o-P16o-P32o--P1024o - P2048o for odd parities, and P8e-P16e-P32e--P1024e- P2048e for even parities).

For a 2 Kbytes page, four 512 bytes ECC calculations plus one for the spare area are required. Results are stored in the GPMC_ECCj_RESULT registers (j = 1 to 9).

Figure 7-34. ECC Computation for a 512-Byte Data Stream (Read or Write)



7.1.3.3.12.3.1.4 ECC Comparison and Correction

To detect an error, the computed ECC result must be XORed with the parity value stored in the spare area of the accessed page.

- If the result of this logical XOR is all 0s, no error is detected and the read data is correct.
- If every second bit in the parity result is a 1, one bit is corrupted and is located at bit address (P2048o, P1024o, P512o, P256o, P128o, P64o, P32o, P16o, P8o, P4o, P2o, P1o). The software must correct the corresponding bit.
- If only one bit in the parity result is 1, it is an ECC error and the read data is correct.

7.1.3.3.12.3.1.5 ECC Calculation Based on 8-Bit Word

The 8-bit based ECC computation is used for 8-bit wide NAND device interfacing.

The 8-bit based ECC computation can be used for 16-bit wide NAND device interfacing to get backward compatibility on the error-handling strategy used with 8-bit wide NAND devices. In this case, the 16-bit wide data read from or written to the NAND device is fragmented into 2 bytes. According to little-endian access, the least significant bit (LSB) of the 16-bit wide data is ordered first in the byte stream used for 8-bit based ECC computation.

7.1.3.3.12.3.1.6 ECC Calculation Based on 16-Bit Word

ECC computation based on a 16-bit word is used for 16-bit wide NAND device interfacing. This ECC computation is not supported when interfacing an 8-bit wide NAND device, and the GPMC_ECC_CONFIG[7] ECC16B bit must be cleared to 0 when interfacing an 8-bit wide NAND device.

The parity computation based on 16-bit words affects the row and column parity mapping. The main difference is that the odd and even parity bits P8o and P8e are computed on rows for an 8-bit based ECC while there are computed on columns for a 16-bit based ECC. Figure 7-35 and Figure 7-36.

Figure 7-35. 128 Word16 ECC Computation

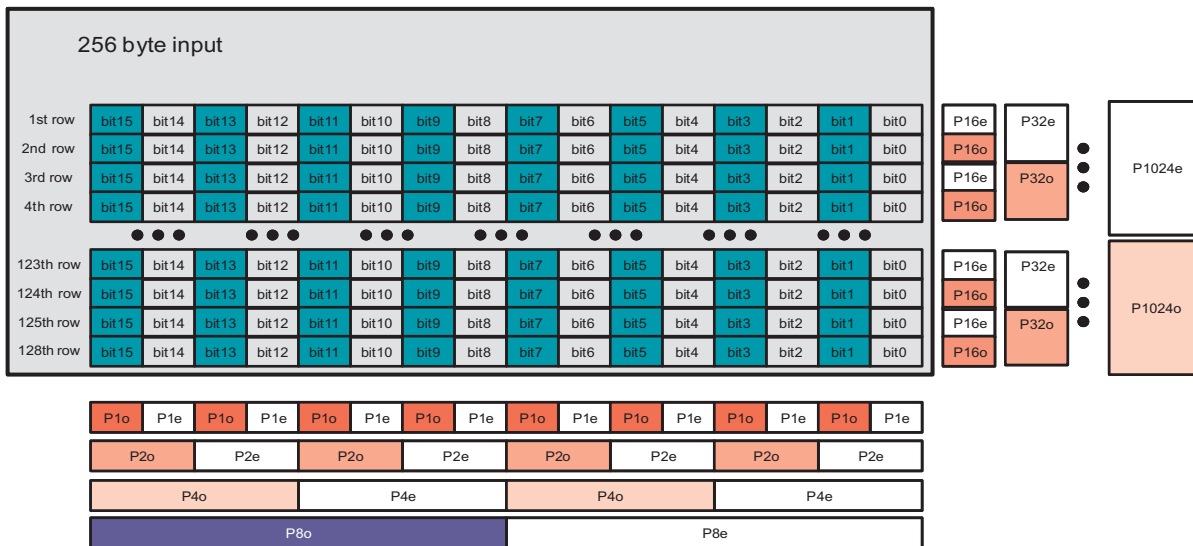
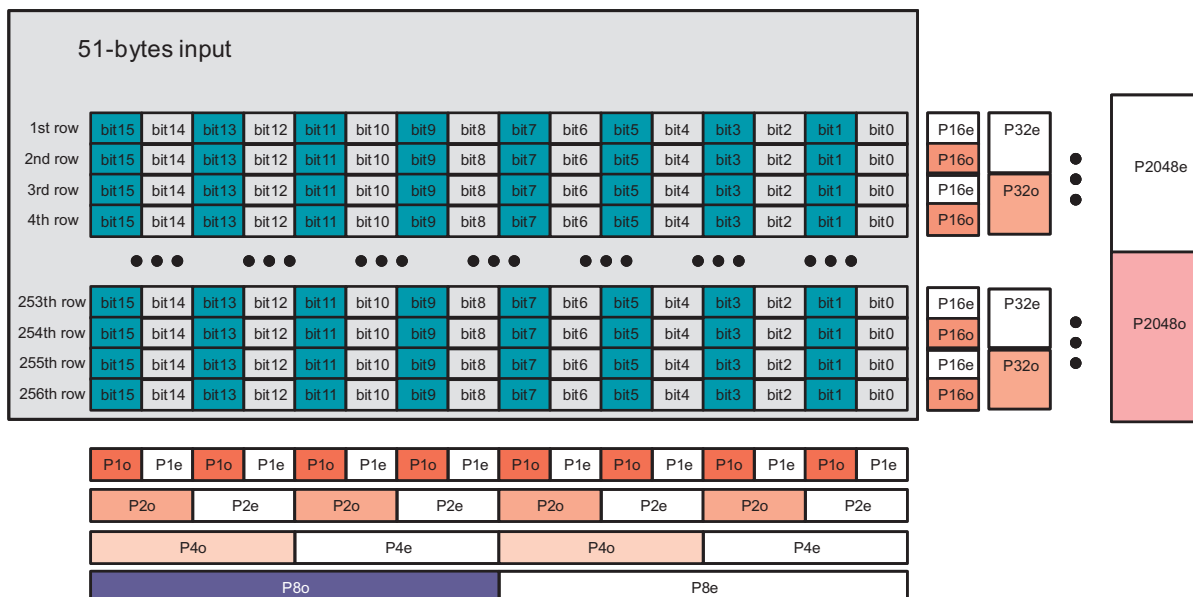


Figure 7-36. 256 Word16 ECC Computation



7.1.3.3.12.3.2 BCH Code (Bose-Chaudhuri-Hocquenghem)

All references to Error Code Correction (ECC) in this subsection refer to the 4- to 16-bit error correction BCH code.

7.1.3.3.12.3.2.1 Requirements

Read and write accesses to a NAND flash take place by whole pages, in a predetermined sequence: first the data byte page itself, then some spare bytes, including the BCH ECC (and other information). The NAND IC can cache a full page, including spares, for read and write accesses.

Typical page write sequence:

- Sequential write to NAND cache of main data + spare data, for a page. ECC is calculated on the fly. Calculated ECC may be inserted on the fly in the spares, or replaced by dummy accesses.
- When the calculated ECC is replaced by dummy accesses, it must be written to the cache in a second, separate phase. The ECC module is disabled during that time.
- NAND writes its cache line (page) to the array

Typical page read sequence:

- Sequential read of a page. ECC is calculated on the fly.
- ECC module buffers status determines the presence of errors.
- Accesses to several memories may be interleaved by the GPMC, but only one of those memories can be a NAND using the BCH engine at a time; in other words, only one BCH calculation (for example, for a single page) can be on-going at any time. Note also that the sequential nature of NAND accesses guarantees that the data is always written / read out in the same order. BCH-relevant accesses are selected by the GPMCs chip-select.
- Each page may hold up to 4 Kbytes of data, spare bytes not included. This means up to 8 x 512-byte BCH messages. Since all the data is written / read out first, followed by the BCH ECC, this means that the BCH engine must be able to hold 8 104-bit remainders or syndromes (or smaller, 52-bit ones) at the same time.

The BCH module has the capacity to store all remainders internally. After the page start, an internal counter is used to detect the 512-byte sector boundaries. On those boundaries, the current remainder is stored and the divider reset for the next calculation. At the end of the page, the BCH module contains all remainders.

- NAND access cycles hold 8 or 16 bits of data each (1 or 2 bytes); Each NAND cycle takes at least 4 cycles of the GPMCs internal clock. This means the NAND flash timing parameters must define a RDCYCLETIME and a WRCYCLETIME of at least 4 clock cycles after optimization when using the BCH calculator.
- The spare area is assumed to be large enough to hold the BCH ECC, that is, to have at least a message of 13 bytes available per 512-byte sector of data. The zone of unused spare area by the ECC may or may not be protected by the same ECC scheme, by extending the BCH message beyond 512 bytes (maximum codeword is 1023-byte long, ECC included, which leaves a lot of space to cover some spares bytes).

7.1.3.3.12.3.2.2 Memory-Mapping of the BCH Codeword

BCH encoding considers a block of data to protect as a polynomial message $M(x)$. In our standard case, 512 bytes of data (that is, 2 bits = 4096 bits) are seen as a polynomial of degree $2 - 1 = 4095$, with parameters ranging from M_0 to M_{4095} . For 512 bytes of data, 52 bits are required for 4-bit error correction, and 104 bits are required for 8-bit error correction and 207 bits are required for 16-bit error correction. The ECC is a remainder polynomial $R(x)$ of degree 103 (or 51, depending on the selected mode). The complete codeword $C(x)$ is the concatenation of $M(x)$ and $R(x)$ as shown in [Table 7-13](#).

Table 7-13. Flattened BCH Codeword Mapping (512 Bytes + 104 Bits)

Bit number	Message $M(x)$	ECC $R(x)$				
	M_{4095}	...	M_0	R_{103}	...	R_0

If the message is extended by the addition of spare bytes to be protected by the same ECC, the principle is still valid. For example, a 3-byte extension of the message gives a polynomial message $M(x)$ of degree $((512 + 3) \times 8) - 1 = 4119$, for a total of $3 + 13 = 16$ spare bytes of spare, all protected as part of the same codeword.

The message and the ECC bits are manipulated and mapped in the GPMC byte-oriented system. The ECC bits are stored in:

- GPMC_BCH_RESULT0_i
- GPMC_BCH_RESULT1_i
- GPMC_BCH_RESULT2_i
- GPMC_BCH_RESULT3_i

7.1.3.3.12.3.2.3 Memory Mapping of the Data Message

The data message mapping shall follow the following rules:

- Bit endianness within a byte is little-endian, that is, the bytes LS bit is also the lowest-degree polynomial parameter: a byte b_7 - b_0 (with b_0 the LS bit) represents a segment of polynomial $b_7 * x + b_6 * x + \dots + b_0 * x$
- The message is mapped in the NAND starting with the highest-order parameters, that is, in the lowest addresses of a NAND page.
- Byte endianness within the NANDs 16-bit words is big endian. This means that the same message mapped in 8- and 16-bit memories has the same content at the same byte address.

The BCH module has no visibility over actual addresses. The most important point is the sequence of data word the BCH sees. However, the NAND page is always scanned incrementally in read and write accesses, and this produces the mapping patterns described in the following.

[Table 7-14](#) and [Table 7-15](#) show the mapping of the same 512-byte vector (typically a BCH message) in the NAND memory space. Note that the byte 'address' is only an offset modulo 512 (200h), since the same page may contain several contiguous 512-byte sectors (BCH blocks). The LSB and MSB are respectively the bits M_0 and $M(2^{12}-1)$ of the codeword mapping given above. In both cases the data vectors are aligned, that is, their boundaries coincide with the RAMs data word boundaries.

Table 7-14. Aligned Message Byte Mapping in 8-bit NAND

Byte Offset	8-Bit Word
0	(msb) Byte 511 (1FFh)
1h	Byte 510 (1FEh)
⋮	⋮
1FFh	Byte 0 (0) (LSB)

Table 7-15. Aligned Message Byte Mapping in 16-bit NAND

Byte Offset	16-Bit Words MSB	16-Bit Words LSB
0	Byte 510 (1FEh)	(msb) Byte 511 (1FFh)
2h	Byte 508 (1FCh)	Byte 509 (1FDh)
⋮	⋮	⋮
1FEh	Byte 0 (0)	(lsb) Byte 1 (1)

Table 7-16 and Table 7-17 show the mapping in memory of arbitrarily-sized messages, starting on access (byte or 16-bit word) boundaries for more clarity. Note that message may actually start and stop on arbitrary nibbles. A nibble is a 4-bit entity. The unused nibbles are not discarded, and they can still be used by the BCH module, but as part of the next message section (for example, on another sectors ECC).

Table 7-16. Aligned Nibble Mapping of Message in 8-bit NAND

Byte Offset	8-Bit Word	
	4-Bit Most Significant Nibble	4-Bit Less Significant Nibble
1	(MSB) Nibble S-1	Nibble S-2
2	Nibble S-3	Nibble S-4
⋮	⋮	⋮
S/2 - 2	Nibble 3	Nibble 2
S/2 - 1	Nibble 1	Nibble 0 (LSB)

Table 7-17. Misaligned Nibble Mapping of Message in 8-bit NAND

Byte Offset	8-Bit Word	
	4-Bit Most Significant Nibble	4-Bit Less Significant Nibble
1	(MSB) Nibble S-1	Nibble S-2
2	Nibble S-3	Nibble S-4
⋮	⋮	⋮
(S+1)/2 - 2	Nibble 2	Nibble 1
(S+1)/2 - 1	Nibble 0 (LSB)	

Table 7-18. Aligned Nibble Mapping of Message in 16-bit NAND

Byte Offset	16-Bit Word			
	4-Bit Most Significant Nibble		4-Bit Less Significant Nibble	
0	Nibble S-3	Nibble S-4	(MSB) Nibble S-1	Nibble S-2
2	Nibble S-7	Nibble S-8	Nibble S-5	Nibble S-6
⋮	⋮	⋮	⋮	⋮
S/2 - 4	Nibble 5	Nibble 4	Nibble 7	Nibble 6
S/2 - 2	Nibble 1	Nibble 0 (LSB)	Nibble 3	Nibble 2

Table 7-19. Misaligned Nibble Mapping of Message in 16-bit NAND (1 Unused Nibble)

Byte Offset	16-Bit Word			
	4-Bit Most Significant Nibble		4-Bit Less Significant Nibble	
0	Nibble S-3	Nibble S-4	(MSB) Nibble S-1	Nibble S-2
2	Nibble S-7	Nibble S-8	Nibble S-5	Nibble S-6
⋮	⋮	⋮	⋮	⋮
$(S+1)/2 - 4$	Nibble 4	Nibble 3	Nibble 6	Nibble 5
$(S+1)/2 - 2$	Nibble 0 (LSB)		Nibble 2	Nibble 1

Table 7-20. Misaligned Nibble Mapping of Message in 16-bit NAND (2 Unused Nibble)

Byte Offset	16-Bit Word			
	4-Bit Most Significant Nibble		4-Bit Less Significant Nibble	
0	Nibble S-3	Nibble S-4	(MSB) Nibble S-1	Nibble S-2
2	Nibble S-7	Nibble S-8	Nibble S-5	Nibble S-6
⋮	⋮	⋮	⋮	⋮
$(S+2)/2 - 4$	Nibble 3	Nibble 2	Nibble 5	Nibble 4
$(S+2)/2 - 2$			Nibble 1	Nibble 0 (LSB)

Table 7-21. Misaligned Nibble Mapping of Message in 16-bit NAND (3 Unused Nibble)

Byte Offset	16-Bit Word			
	4-Bit Most Significant Nibble		4-Bit Less Significant Nibble	
0	Nibble S-3	Nibble S-4	(MSB) Nibble S-1	Nibble S-2
2	Nibble S-7	Nibble S-8	Nibble S-5	Nibble S-6
⋮	⋮	⋮	⋮	⋮
$(S+3)/2 - 4$	Nibble 2	Nibble 1	Nibble 4	Nibble 3
$(S+3)/2 - 2$			Nibble 0 (LSB)	

Note that many other cases exist than the ones represented above, for example, where the message does not start on a word boundary.

7.1.3.3.12.3.2.4 Memory Mapping of the ECC

The ECC (or remainder) is presented by the BCH module as a single 104-bit (or 52-bit), little-endian vector. It is up to the software to fetch those 13 bytes (or 6 bytes) from the modules interface, then store them to the NANDs spare area (page write) or to an intermediate buffer for comparison with the stored ECC (page read). There are no constraints on the ECC mapping inside the spare area: it is a softwarecontrolled operation.

However, it is advised to maintain a coherence in the respective formats of the message or the ECC remainder once they have been read out of the NAND. The error correction algorithm works from the complete codeword (concatenated message and remainder) once an error as been detected. The creation of this codeword should be made as straightforward as possible.

There are cases where the same NAND access contains both data and the ECC protecting that data. This is the case when the data/ECC boundary (which can be on any nibble) does not coincide with an access boundary. The ECC is calculated on-the-fly following the write. In that case, the write must also contain part of the ECC because it is impossible to insert the ECC on-the-fly. Instead:

- During the initial page write (BCH encoding), the ECC is replaced by dummy bits. The BCH encoder is by definition turned OFF during the ECC section, so the BCH result is unmodified.
- During a second phase, the ECC is written to the correct location, next to the actual data.
- The completed line buffer is then written to the NAND array.

7.1.3.3.12.3.2.5 Wrapping Modes

For a given wrapping mode, the module automatically goes through a specific number of sections, as data is being fed into the module. For each section, the BCH core can be enabled (in which case the data is fed to the BCH divider) or not (in which case the BCH simply counts to the end of the section). When enabled, the data is added to the ongoing calculation for a given sector number (for example, number 0).

Wrapping modes are described below. To get a better understanding and see the real-life read and write sequences implemented with each mode, see [Section 7.1.3.3.12.3.3](#).

For each mode:

- A sequence describes the mode in pseudo-language, with for each section the size and the buffer used for ECC processing (if ON). The programmable lengths are size, size0 and size1.
- A checksum condition is given. If the checksum condition is not respected for a given mode, the modules behavior is unpredictable. S is the number of sectors in the page; size0 and size1 are the section sizes programmed for the mode, in nibbles.

Note that wrapping modes 8, 9, 10, and 11 insert a 1-nibble padding where the BCH processing is OFF. This is intended for t = 4 ECC, where ECC is 6 bytes long and the ECC area is expected to include (at least) 1 unused nibble to remain byte-aligned.

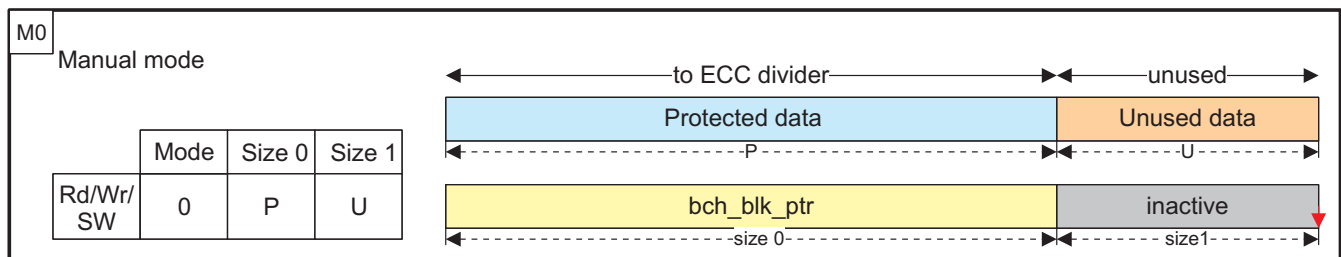
7.1.3.3.12.3.2.6 Manual Mode (0x0)

This mode is intended for short sequences, added manually to a given buffer through the software data port input. A complete page may be built out of several such sequences.

To process an arbitrary sequence of 4-bit nibbles, accesses to the software data port shall be made, containing the appropriate data. If the sequence end does not coincide with an access boundary (for example, to process 5 nibbles = 20 bits in 16-bit access mode) and those nibbles need to be skipped, a number of unused nibbles shall be programmed in size1 (in the same example: 5 nibbles to process + 3 to discard = 8 nibbles = exactly 2 x 16-bit accesses: we must program size0 = 5, size1 = 3).

[Figure 7-37](#) shows the manual mode sequence and mapping. In this figure, size and size0 are the same parameter.

Figure 7-37. Manual Mode Sequence and Mapping



Section processing sequence:

- One time with buffer
 - size0 nibbles of data, processing ON
 - size1 nibbles of unused data, processing OFF

Checksum: size0 + size1 nibbles must fit in a whole number of accesses.

In the following sections, S is the number of sectors in the page.

7.1.3.3.12.3.2.7 Mode 0x1

Page processing sequence:

- Repeat with buffer 0 to S-1
 - 512-byte data, processing ON
- Repeat with buffer 0 to S-1
 - size0 nibbles spare, processing ON
 - size1 nibbles spare, processing OFF

Checksum: Spare area size (nibbles) = S - (size0 + size1)

7.1.3.3.12.3.2.8 Mode 0xA (10)

Page processing sequence:

- Repeat with buffer 0 to S-1
 - 512-byte data, processing ON
- Repeat with buffer 0 to S-1
 - size0 nibbles spare, processing ON
 - 1 nibble pad spare, processing OFF
 - size1 nibbles spare, processing OFF

Checksum: Spare area size (nibbles) = S - (size0 + 1 + size1)

7.1.3.3.12.3.2.9 Mode 0x2

Page processing sequence:

- Repeat with buffer 0 to S-1
 - 512-byte data, processing ON
- Repeat with buffer 0 to S-1
 - size0 nibbles spare, processing OFF
 - size1 nibbles spare, processing ON

Checksum: Spare area size (nibbles) = S - (size0 + size1)

7.1.3.3.12.3.2.10 Mode 0x3

Page processing sequence:

- Repeat with buffer 0 to S-1
 - 512-byte data, processing ON
- One time with buffer 0
 - size0 nibbles spare, processing ON
- Repeat with buffer 0 to S-1
 - size1 nibbles spare, processing ON

Checksum: Spare area size (nibbles) = size0 + (S - size1)

7.1.3.3.12.3.2.11 Mode 0x7

Page processing sequence:

- Repeat with buffer 0 to S-1
 - 512-byte data, processing ON
- One time with buffer 0
 - size0 nibbles spare, processing ON
- Repeat S times (no buffer used)
 - size1 nibbles spare, processing OFF

Checksum: Spare area size (nibbles) = size0 + (S - size1)

7.1.3.3.12.3.2.12 Mode 0x8

Page processing sequence:

- Repeat with buffer 0 to S-1
 - 512-byte data, processing ON
- One time with buffer 0
 - size0 nibbles spare, processing ON
- Repeat with buffer 0 to S-1
 - 1 nibble padding spare, processing OFF
 - size1 nibbles spare, processing ON

Checksum: Spare area size (nibbles) = size0 + (S - (1+size1))

7.1.3.3.12.3.2.13 Mode 0x4

Page processing sequence:

- Repeat with buffer 0 to S-1
 - 512-byte data, processing ON
- One time (no buffer used)
 - size0 nibbles spare, processing OFF
- Repeat with buffer 0 to S-1
 - size1 nibbles spare, processing ON

Checksum: Spare area size (nibbles) = size0 + (S - size1)

7.1.3.3.12.3.2.14 Mode 0x9

Page processing sequence:

- Repeat with buffer 0 to S-1
 - 512-byte data, processing ON
- One time (no buffer used)
 - size0 nibbles spare, processing OFF
- Repeat with buffer 0 to S-1
 - 1 nibble padding spare, processing OFF
 - size1 nibbles spare, processing ON

Checksum: Spare area size (nibbles) = size0 + (S - (1+size1))

7.1.3.3.12.3.2.15 Mode 0x5

Page processing sequence:

- Repeat with buffer 0 to S-1
 - 512-byte data, processing ON
- Repeat with buffer 0 to S-1
 - size0 nibbles spare, processing ON
- Repeat with buffer 0 to S-1
 - size1 nibbles spare, processing ON

Checksum: Spare area size (nibbles) = S - (size0 + size1)

7.1.3.3.12.3.2.16 Mode 0xB (11)

Page processing sequence:

- Repeat with buffer 0 to S-1
 - 512-byte data, processing ON
- Repeat with buffer 0 to S-1
 - size0 nibbles spare, processing ON
- Repeat with buffer 0 to S-1
 - 1 nibble padding spare, processing OFF
 - size1 nibbles spare, processing ON

Checksum: Spare area size (nibbles) = S - (size0 + 1 + size1)

7.1.3.3.12.3.2.17 Mode 0x6

Page processing sequence:

- Repeat with buffer 0 to S-1
 - 512-byte data, processing ON
- Repeat with buffer 0 to S-1
 - size0 nibbles spare, processing ON
- Repeat S times (no buffer used)
 - size1 nibbles spare, processing OFF

Checksum: Spare area size (nibbles) = S - (size0 + size1)

7.1.3.3.12.3.3 Supported NAND Page Mappings and ECC Schemes

The following rules apply throughout the entire mapping description:

- Main data area (sectors) size is hardcoded to 512 bytes.
- Spare area size is programmable.
- All page sections (of main area data bytes, protected spare bytes, unprotected spare bytes, and ECC) are defined as explained in [Section 7.1.3.3.12.3.2.3](#).

Each one of the following sections shows a NAND page mapping example (per-sector spare mappings, pooled spare mapping, per-sector spare mapping, with ECC separated at the end of the page).

In the mapping diagrams, sections that belong to the same BCH codeword have the same color (blue or green); unprotected sections are not covered (orange) by the BCH scheme.

Below each mapping diagram, a write (encoding) and read (decoding: syndrome generation) sequence is given, with the number of the active buffers at each point in time (yellow). In the inactive zones (grey), no computing is taking place but the data counter is still active.

In [Figure 7-38](#) to [Figure 7-40](#), tables on the left summarize the mode, size0, size1 parameters to program for respectively write and read processing of a page, with the given mapping, where:

- P is the size of spare byte section Protected by the ECC (in nibbles)
- U is the size of spare byte section Unprotected by the ECC (in nibbles)
- E is the size of the ECC itself (in nibbles)
- S is the number of Sectors per page (2 in the current diagrams)

Each time the processing of a BCH block is complete (ECC calculation for write/encoding, syndrome generation for read/decoding, indicated by red arrows), the update pointer is pulsed. Note that the processing for block 0 can be the first or the last to complete, depending on the NAND page mapping and operation (read or write). All examples show a page size of 1kByte + spares, that is, $S = 2$ sectors of 512 bytes. The same principles can be extended to larger pages by adding more sectors.

The actual BCH codeword size is used during the error location work to restrict the search range: by definition, errors can only happen in the codeword that was actually written to the NAND, and not in the mathematical codeword of $n = 2 - 1 = 8191$ bits. That codeword (higher-order bits) is all-zero and implicit during computations.

The actual BCH codeword size depends on the mode, on the programmed sizes and on the sector number (all sizes in nibbles):

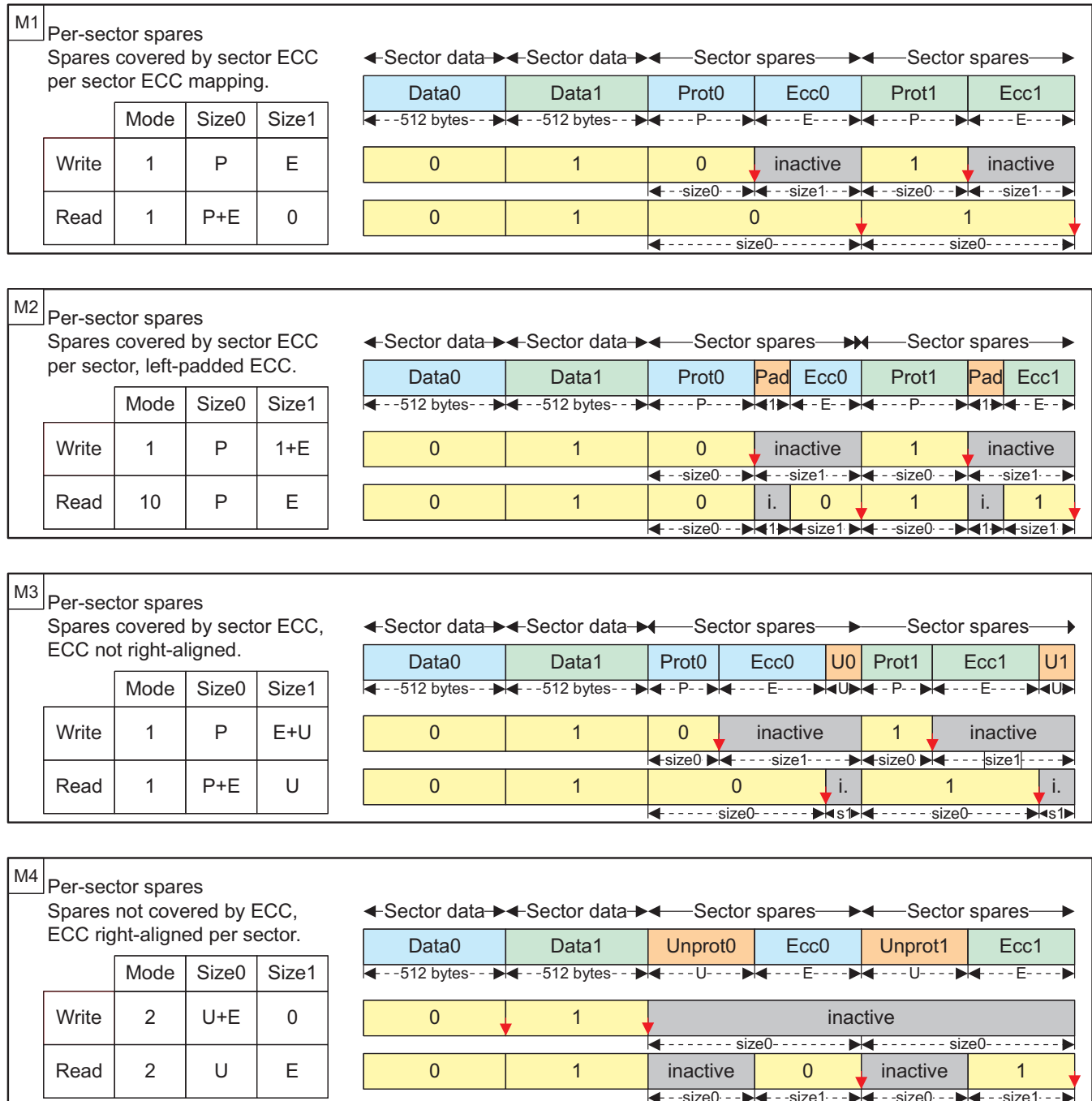
- Spares mapped and protected per sector ([Figure 7-38](#): see M1-M2-M3-M9-M10):
 - all sectors: $(512) + P + E$
- Spares pooled and protected by sector 0 ([Figure 7-38](#): see M5-M6):
 - sector 0 codeword: $(512) + P + E$
 - other sectors: $(512) + E$
- Unprotected spares ([Figure 7-38](#): see M4-M7-M8-M11-M12):
 - all codewords $(512) + E$

7.1.3.3.1.3.3.1 Per-Sector Spare Mappings

In these schemes (Figure 7-38), each 512-byte sector of the main area has its own dedicated section of the spare area. The spare area of each sector is composed of:

- ECC, which must be located after the data it protects
- other data, which may or may not be protected by the sectors ECC

Figure 7-38. NAND Page Mapping and ECC: Per-Sector Schemes

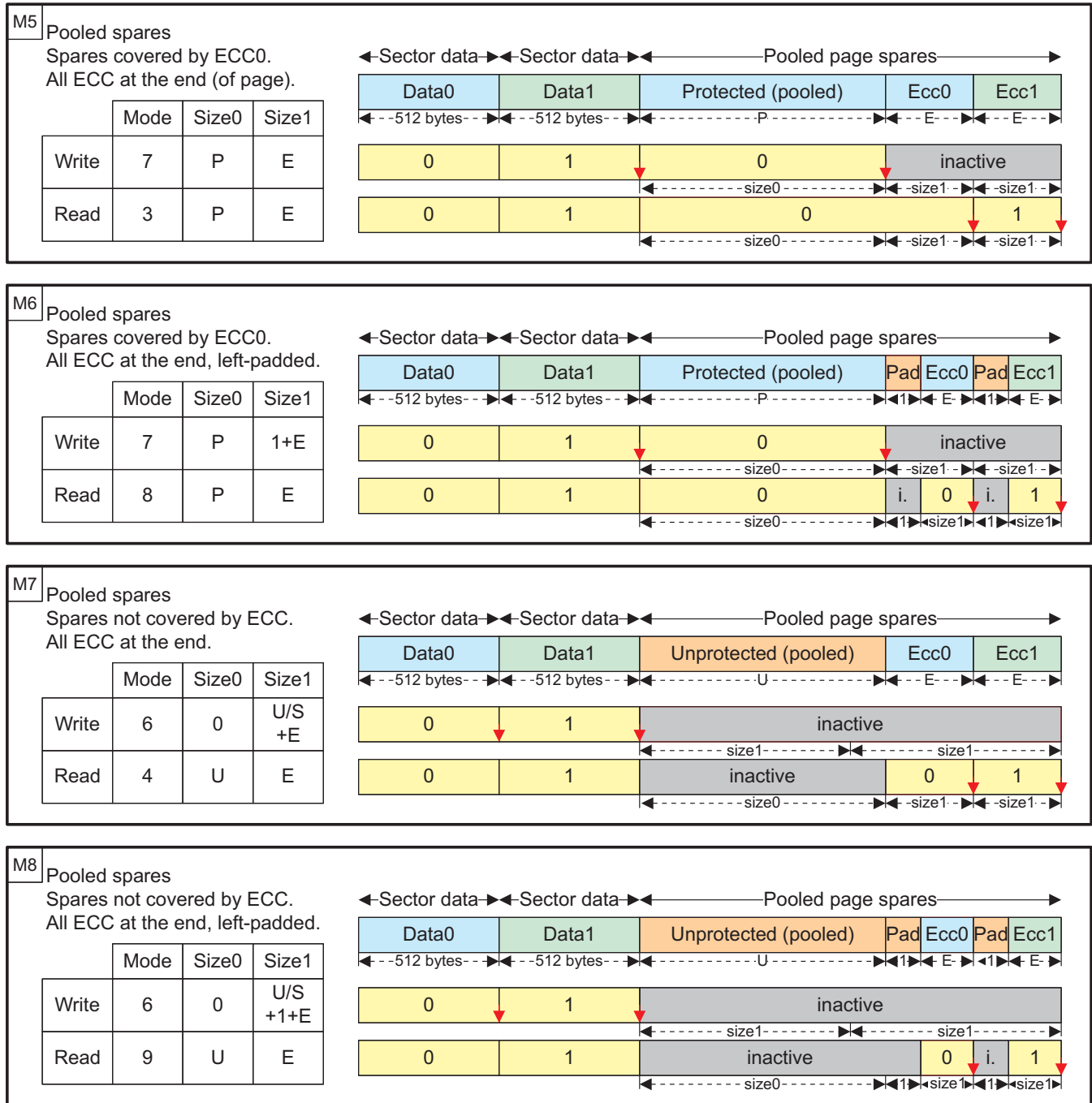


7.1.3.12.3.3.2 Pooled Spare Mapping

In these schemes (Figure 7-39), the spare area is pooled for the page.

- The ECC of each sector is aligned at the end of the spare area.
- The non-ECC spare data may or may not be covered by the ECC of sector 0

Figure 7-39. NAND Page Mapping and ECC: Pooled Spare Schemes

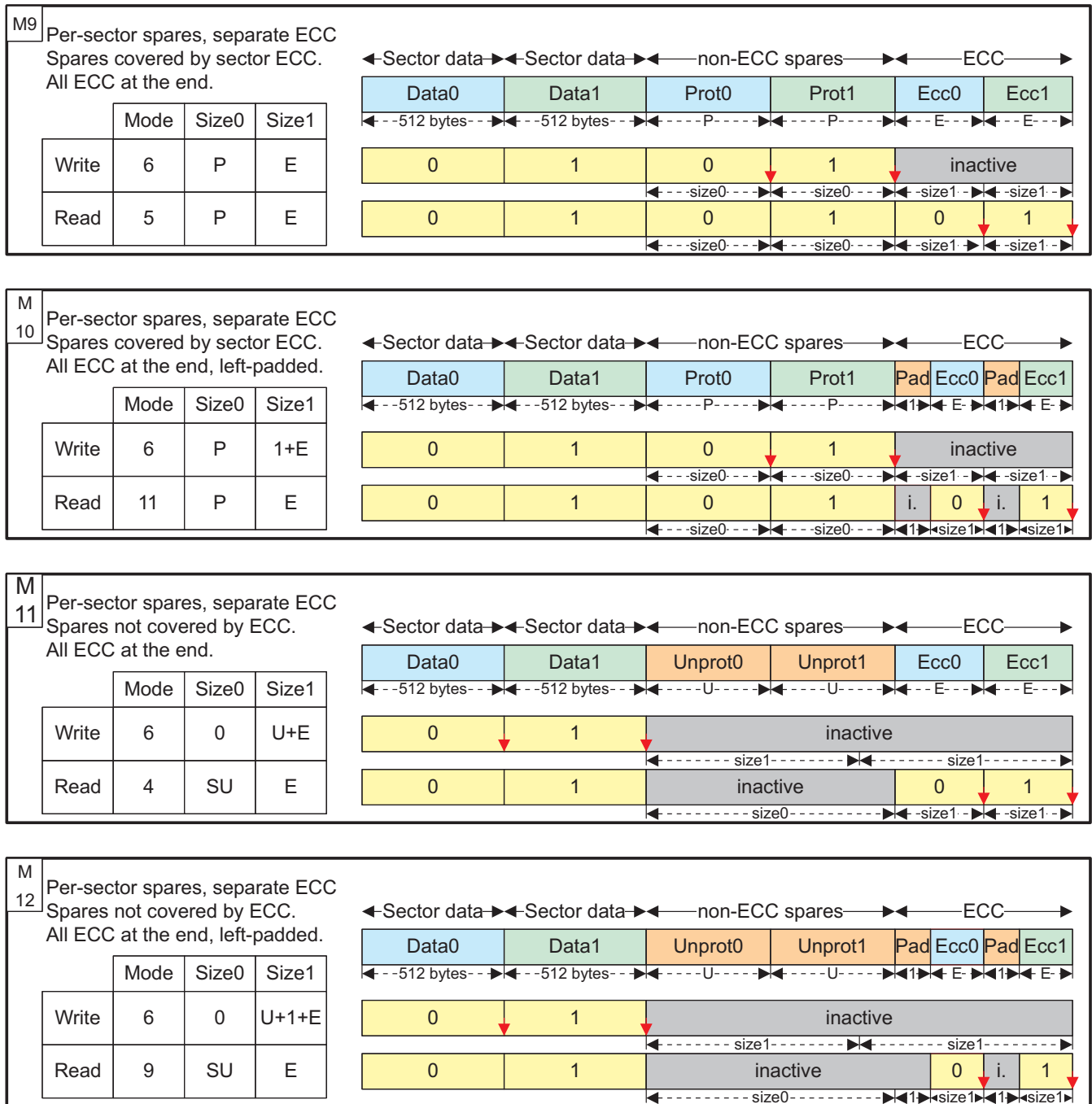


7.1.3.3.12.3.3.3 Per-Sector Spare Mapping, With ECC Separated at the End of the Page

In these schemes (Figure 7-40), each 512-byte sector of the main area is associated with two sections of the spare area.

- ECC section, all aligned at the end of the page
- other data section, aligned before the ECCs, each of which may or may not be protected by its sectors ECC

Figure 7-40. NAND Page Mapping and ECC: Per-Sector Schemes, with Separate ECC



7.1.3.3.12.4 Prefetch and Write-Posting Engine

NAND device data access cycles are usually much slower than the MPU system frequency; such NAND read or write accesses issued by the processor will impact the overall system performance, especially considering long read or write sequences required for NAND page loading or programming. To minimize this effect on system performance, the GPMC includes a prefetch and write-posting engine, which can be used to read from or write to any chip-select location in a buffered manner.

The prefetch and write-posting engine is a simplified embedded-access requester that presents requests to the access engine on a user-defined chip-select target. The access engine interleaves these requests with any request coming from the L3 interface; as a default the prefetch and write-posting engine has the lowest priority.

The prefetch and write-posting engine is dedicated to data-stream access (as opposed to random data access); thus, it is primarily dedicated to NAND support. The engine does not include an address generator; the request is limited to chip-select target identification. It includes a 64-byte FIFO associated with a DMA request synchronization line, for optimal DMA-based use.

The prefetch and write-posting engine uses an embedded 64 bytes (32 16-bit word) FIFO to prefetch data from the NAND device in read mode (prefetch mode) or to store host data to be programmed into the NAND device in write mode (write-posting mode). The FIFO draining and filling (read and write) can be controlled either by the MPU through interrupt synchronization (an interrupt is triggered whenever a programmable threshold is reached) or the sDMA through DMA request synchronization, with a programmable request byte size in both prefetch or posting mode.

The prefetch and write-posting engine includes a single memory pool. Therefore, only one mode, read or write, can be used at any given time. In other words, the prefetch and write-posting engine is a single-context engine that can be allocated to only one chip-select at a time for a read prefetch or a write-posting process.

The engine does not support atomic command and address phase programming and is limited to linear memory read or write access. In consequence, it is limited to NAND data-stream access. The engine relies on the MPU NAND software driver to control block and page opening with the correct data address pointer initialization, before the engine can read from or write to the NAND memory device.

Once started, the engine data reads and writes sequencing is solely based on FIFO location availability and until the total programmed number of bytes is read or written.

Any host-concurrent accesses to a different chip-select are correctly interleaved with ongoing engine accesses. The engine has the lowest priority access so that host accesses to a different chip-select do not suffer a large latency.

A round-robin arbitration scheme can be enabled to ensure minimum bandwidth to the prefetch and write-posting engine in the case of back-to-back direct memory requests to a different chip-select. If the GPMC_PREFETCH_CONFIG1[23] PFPWENROUNDROBIN bit is enabled, the arbitration grants the prefetch and write posting engine access to the GPMC bus for a number of requests programmed in the GPMC_PREFETCH_CONFIG1[19-16] PFPWWEIGHTEDPRIO field.

The prefetch/write-posting engine read or write request is routed to the access engine with the chip-select destination ID. After the required arbitration phase, the access engine processes the request as a single access with the data access size equal to the device size specified in the corresponding chip-select configuration.

The destination chip-select configuration must be set to the NAND protocol-compatible configuration for which address lines are not used (the address bus is not changed from its current value). Selecting a different chip-select configuration can produce undefined behavior.

7.1.3.3.12.4.1 General Facts About the Engine Configuration

The engine can be configured only if the GPMC_PREFETCH_CONTROL[0] STARTENGINE bit is de-asserted.

The engine must be correctly configured in prefetch or write-posting mode and must be linked to a NAND chip-select before it can be started. The chip-select is linked using the GPMC_PREFETCH_CONFIG1[26-24] ENGINECSSELECTOR field.

In both prefetch and write-posting modes, the engine respectively uses byte or 16-bit word access requests for an 8- or 16-bit wide NAND device attached to the linked chip-select. The FIFOTHRESHOLD and TRANSFERCOUNT fields must be programmed accordingly as a number of bytes or a number of 16-bit word.

When the GPMC_PREFETCH_CONFIG1[7] ENABLEENGINE bit is set, the FIFO entry on the L3 interconnect port side is accessible at any address in the associated chip-select memory region. When the ENABLEENGINE bit is set, any host access to this chip-select is rerouted to the FIFO input. Directly accessing the NAND device linked to this chip-select from the host is still possible through these registers:

- GPMC_NAND_COMMAND_i
- GPMC_NAND_ADDRESS_i
- GPMC_NAND_DATA_i

The FIFO entry on the L3 interconnect port can be accessed with Byte, 16-bit word, or 32-bit word access size, according to little-endian format, even though the FIFO input is 32-bit wide.

The FIFO control is made easier through the use of interrupts or DMA requests associated with the FIFOTHRESHOLD bit field. The GPMC_PREFETCH_STATUS[30-24] FIFOPOINTER field monitors the number of available bytes to be read in prefetch mode or the number of free empty slots which can be written in write-posting mode. The GPMC_PREFETCH_STATUS[13-0] COUNTVALUE field monitors the number of remaining bytes to be read or written by the engine according to the TRANSFERCOUNT value. The FIFOPOINTER and COUNTVALUE bit fields are always expressed as a number of bytes even if a 16-bit wide NAND device is attached to the linked chip-select.

In prefetch mode, when the FIFOPOINTER equals 0, that is, the FIFO is empty, a host read access receives the byte last read from the FIFO as its response. In case of 32-bit word or 16-bit word read accesses, the last byte read from the FIFO is copied the required number of times to fit the requested word size. In write-posting mode, when the FIFOPOINTER equals 0, that is, the FIFO is full, a host write overwrites the last FIFO byte location. There is no underflow or overflow error reporting in the GPMC.

7.1.3.3.12.4.2 Prefetch Mode

The prefetch mode is selected when the GPMC_PREFETCH_CONFIG1[0] ACCESSMODE bit is cleared.

The MPU NAND software driver must issue the block and page opening (READ) command with the correct data address pointer initialization before the engine can be started to read from the NAND memory device. The engine is started by asserting the GPMC_PREFETCH_CONTROL[0] STARTENGINE bit. The STARTENGINE bit automatically clears when the prefetch process completes.

If required, the ECC calculator engine must be initialized (i.e., reset, configured, and enabled) before the prefetch engine is started, so that the ECC is correctly computed on all data read by the prefetch engine.

When the GPMC_PREFETCH_CONFIG1[3] SYNCHROMODE bit is cleared, the prefetch engine starts requesting data as soon as the STARTENGINE bit is set. If using this configuration, the host must monitor the NAND device-ready pin so that it only sets the STARTENGINE bit when the NAND device is in a ready state, meaning data is valid for prefetching.

When the SYNCHROMODE bit is set, the prefetch engine starts requesting data when an active to inactive wait signal transition is detected. The transition detector must be cleared before any transition detection; see [Section 7.1.3.3.12.2.2](#). The GPMC_PREFETCH_CONFIG1[5-4] WAITPINSELECTOR field selects which gpmc_wait pin edge detector triggers the prefetch engine in this synchronized mode.

If the STARTENGINE bit is set after the NAND address phase (page opening command), the engine is effectively started only after the actual NAND address phase completion. To prevent GPMC stall during this NAND address phase, set the STARTENGINE bit field before NAND address phase completion when in synchronized mode. The prefetch engine will start when an active to inactive wait signal transition is detected. The STARTENGINE bit is automatically cleared on prefetch process completion.

The prefetch engine issues a read request to fill the FIFO with the amount of data specified by GPMC_PREFETCH_CONFIG2[13-0] TRANSFERCOUNT field.

[Table 7-22](#) describes the prefetch mode configuration.

Table 7-22. Prefetch Mode Configuration

Bit Field	Register	Value	Comments
STARTENGINE	GPMC_PREFETCH_CONTROL	0	Prefetch engine can be configured only if STARTENGINE is cleared to 0.
ENGINECSSELECTOR	GPMC_PREFETCH_CONFIG1	0 to 3h	Selects the chip-select associated with a NAND device where the prefetch engine is active.
ACCESSMODE	GPMC_PREFETCH_CONFIG1	0	Selects prefetch mode
FIFOTHRESHOLD	GPMC_PREFETCH_CONFIG1		Selects the maximum number of bytes read or written by the host on DMA or interrupt request
TRANSFERCOUNT	GPMC_PREFETCH_CONFIG1		Selects the number of bytes to be read or written by the engine to the selected chip-select
SYNCHROMODE	GPMC_PREFETCH_CONFIG1	0/1	Selects when the engine starts the access to the chip-select
WAITPINSELECT	GPMC_PREFETCH_CONFIG1	0 to 1	Selects wait pin edge detector (if GPMC_PREFETCH_CONFIG1[3] SYNCHROMODE = 1)
ENABLEOPTIMIZEDACCESS	GPMC_PREFETCH_CONFIG1	0/1	See Section 7.1.3.3.12.4.6
CYCLEOPTIMIZATION	GPMC_PREFETCH_CONFIG1		Number of clock cycle removed to timing parameters
ENABLEENGINE	GPMC_PREFETCH_CONFIG1	1	Engine enabled
STARTENGINE	GPMC_PREFETCH_CONFIG1	1	Starts the prefetch engine

7.1.3.3.12.4.3 FIFO Control in Prefetch Mode

The FIFO can be drained directly by the MPU or by an eDMA channel.

In MPU draining mode, the FIFO status can be monitored through the GPMC_PREFETCH_STATUS[30-24] FIFOPINTER field or through the GPMC_PREFETCH_STATUS[16] FIFOTHRESHOLDSTATUS bit. The FIFOPINTER indicates the current number of available data to be read; FIFOTHRESHOLDSTATUS set to 1 indicates that at least FIFOTHRESHOLD bytes are available from the FIFO.

An interrupt can be triggered by the GPMC if the GPMC_IRQENABLE[0] FIFOEVENTENABLE bit is set. The FIFO interrupt event is logged, and the GPMC_IRQSTATUS[0] FIFOEVENTSTATUS bit is set. To clear the interrupt, the MPU must read all the available bytes, or at least enough bytes to get below the programmed FIFO threshold, and the FIFOEVENTSTATUS bit must be cleared to enable further interrupt events. The FIFOEVENTSTATUS bit must always be reset prior to asserting the FIFOEVENTENABLE bit to clear any out-of-date logged interrupt event. This interrupt generation must be enabled after enabling the STARTENGINE bit.

Prefetch completion can be monitored through the GPMC_PREFETCH_STATUS[13-0] COUNTVALUE field. COUNTVALUE indicates the number of currently remaining data to be requested according to the TRANSFERCOUNT value. An interrupt can be triggered by the GPMC when the prefetch process is complete (that is, COUNTVALUE equals 0) if the GPMC_IRQENABLE[1] TERMINALCOUNTEVENTENABLE bit is set. At prefetch completion, the TERMINALCOUNT interrupt event is also logged, and the GPMC_IRQSTATUS[1] TERMINALCOUNTSTATUS bit is set. To clear the interrupt, the MPU must clear the TERMINALCOUNTSTATUS bit. The TERMINALCOUNTSTATUS bit must always be cleared prior to asserting the TERMINALCOUNTEVENTENABLE bit to clear any out-of-date logged interrupt event.

NOTE: The COUNTVALUE value is only valid when the prefetch engine is active (started), and an interrupt is only triggered when COUNTVALUE reaches 0, that is, when the prefetch engine automatically goes from an active to an inactive state.

The number of bytes to be prefetched (programmed in TRANSFERCOUNT) must be a multiple of the programmed FIFOTHRESHOLD to trigger the correct number of interrupts allowing a deterministic and transparent FIFO control. If this guideline is respected, the number of ISR accesses is always required and the FIFO is always empty after the last interrupt is triggered. In other cases, the TERMINALCOUNT interrupt must be used to read the remaining bytes in the FIFO (the number of remaining bytes being lower than the FIFOTHRESHOLD value).

In DMA draining mode, the GPMC_PREFETCH_CONFIG1[2] DMAMODE bit must be set so that the GPMC issues a DMA hardware request when at least FIFOTHRESHOLD bytes are ready to be read from the FIFO. The DMA channel owning this DMA request must be programmed so that the number of bytes programmed in FIFOTHRESHOLD is read from the FIFO during the DMA request process. The DMA request is kept active until this number of bytes has effectively been read from the FIFO, and no other DMA request can be issued until the ongoing active request is complete.

In prefetch mode, the TERMINALCOUNT event is also a source of DMA requests if the number of bytes to be prefetched is not a multiple of FIFOTHRESHOLD, the remaining bytes in the FIFO can be read by the DMA channel using the last DMA request. This assumes that the number of remaining bytes to be read is known and controlled through the DMA channel programming model.

Any potentially active DMA request is cleared when the prefetch engine goes from inactive to active prefetch (the STARTENGINE bit is set to 1). The associated DMA channel must always be enabled by the MPU after setting the STARTENGINE bit so that the out-of-date active DMA request does not trigger spurious DMA transfers.

7.1.3.3.12.4.4 Write-Posting Mode

The write-posting mode is selected when the GPMC_PREFETCH_CONFIG1[0] ACCESSMODE bit is set.

The MPU NAND software driver must issue the correct address pointer initialization command (page program) before the engine can start writing data into the NAND memory device. The engine starts when the GPMC_PREFETCH_CONTROL[0] STARTENGINE bit is set to 1. The STARTENGINE bit clears automatically when posting completes. When all data have been written to the NAND memory device, the MPU NAND software driver must issue the second cycle program command and monitor the status for programming process completion (adding ECC handling, if required).

If used, the ECC calculator engine must be started (configured, reset, and enabled) before the posting engine is started so that the ECC parities are properly calculated on all data written by the prefetch engine to the associated chip-select.

In write-posting mode, the GPMC_PREFETCH_CONFIG1[3] SYNCHROMODE bit must be cleared so that posting starts as soon as the STARTENGINE bit is set and the FIFO is not empty.

If the STARTENGINE bit is set after the NAND address phase (page program command), the STARTENGINE setting is effective only after the actual NAND command completion. To prevent GPMC stall during this NAND command phase, set the STARTENGINE bit field before the NAND address completion and ensure that the associated DMA channel is enabled after the NAND address phase.

The posting engine issues a write request when valid data are available from the FIFO and until the programmed GPMC_PREFETCH_CONFIG2[13-0] TRANSFERCOUNT accesses have been completed.

The STARTENGINE bit clears automatically when posting completes. When all data have been written to the NAND memory device, the MPU NAND software driver must issue the second cycle program command and monitor the status for programming process completion. The closing program command phase must only be issued when the full NAND page has been written into the NAND flash write buffer, including the spare area data and the ECC parities, if used.

Table 7-23. Write-Posting Mode Configuration

Bit Field	Register	Value	Comments
STARTENGINE	GPMC_PREFETCH_CONTROL	0	Write-posting engine can be configured only if STARTENGINE is cleared to 0.
ENGINECSSELECTOR	GPMC_PREFETCH_CONFIG1	0 to 3h	Selects the chip-select associated with a NAND device where the prefetch engine is active
ACCESSMODE	GPMC_PREFETCH_CONFIG1	1	Selects write-posting mode
FIFOTHRESHOLD	GPMC_PREFETCH_CONFIG1		Selects the maximum number of bytes read or written by the host on DMA or interrupt request
TRANSFERCOUNT	GPMC_PREFETCH_CONFIG2		Selects the number of bytes to be read or written by the engine from/to the selected chip-select
SYNCHROMODE	GPMC_PREFETCH_CONFIG1	0	Engine starts the access to chip-select as soon as STARTENGINE is set.
ENABLEOPTIMIZEDACCESS	GPMC_PREFETCH_CONFIG1	0/1	See Section 7.1.3.3.12.4.6
CYCLEOPTIMIZATION	GPMC_PREFETCH_CONFIG		
ENABLEENGINE	GPMC_PREFETCH_CONFIG1	1	Engine enabled
STARTENGINE	GPMC_PREFETCH_CONTROL	1	Starts the prefetch engine

7.1.3.3.12.4.5 FIFO Control in Write-Posting Mode

The FIFO can be filled directly by the MPU or by an sDMA channel.

In MPU filling mode, the FIFO status can be monitored through the FIFOPINTER or through the GPMC_PREFETCH_STATUS[16] FIFOTHRESHOLDSTATUS bit. FIFOPINTER indicates the current number of available free byte places in the FIFO, and the FIFOTHRESHOLDSTATUS bit, when set, indicates that at least FIFOTHRESHOLD free byte places are available in the FIFO.

An interrupt can be issued by the GPMC if the GPMC_IRQENABLE[0] FIFOEVENTENABLE bit is set. When the interrupt is fired, the GPMC_IRQSTATUS[0] FIFOEVENTSTATUS bit is set. To clear the interrupt, the MPU must write enough bytes to fill the FIFO, or enough bytes to get below the programmed threshold, and the FIFOEVENTSTATUS bit must be cleared to get further interrupt events. The FIFOEVENTSTATUS bit must always be cleared prior to asserting the FIFOEVENTENABLE bit to clear any out-of-date logged interrupt event. This interrupt must be enabled after enabling the STARTENGINE bit.

The posting completion can be monitored through the GPMC_PREFETCH_STATUS[13-0] COUNTVALUE field. COUNTVALUE indicates the current number of remaining data to be written based on the TRANSFERCOUNT value. An interrupt is issued by the GPMC when the write-posting process completes (that is, COUNTVALUE equal to 0) if the GPMC_IRQENABLE[1] TERMINALCOUNTEVENTENABLE bit is set. When the interrupt is fired, the GPMC_IRQSTATUS[1] TERMINALCOUNTSTATUS bit is set. To clear the interrupt, the MPU must clear the TERMINALCOUNTSTATUS bit. The TERMINALCOUNTSTATUS bit must always be cleared prior to asserting the TERMINALCOUNTEVENTENABLE bit to clear any out-of-date logged interrupt event.

NOTE: The COUNTVALUE value is only valid if the write-posting engine is active and started, and an interrupt is only issued when COUNTVALUE reaches 0, that is, when the posting engine automatically goes from active to inactive.

In DMA filling mode, the DMAMode bit field in the GPMC_PREFETCH_CONFIG1[2] DMAMODE bit must be set so that the GPMC issues a DMA hardware request when at least FIFOTHRESHOLD bytes-free places are available in the FIFO. The DMA channel owning this DMA request must be programmed so that a number of bytes equal to the value programmed in the FIFOTHRESHOLD bit field are written into the FIFO during the DMA access. The DMA request remains active until the associated number of bytes has effectively been written into the FIFO, and no other DMA request can be issued until the ongoing active request has been completed.

Any potentially active DMA request is cleared when the prefetch engine goes from inactive to active prefetch (STARTENGINE set to 1). The associated DMA channel must always be enabled by the MPU after setting the STARTENGINE bit so that an out-of-date active DMA request does not trigger spurious DMA transfers.

In write-posting mode, the DMA or the MPU fill the FIFO with no consideration to the associated byte enables. Any byte stored in the FIFO is written into the memory device.

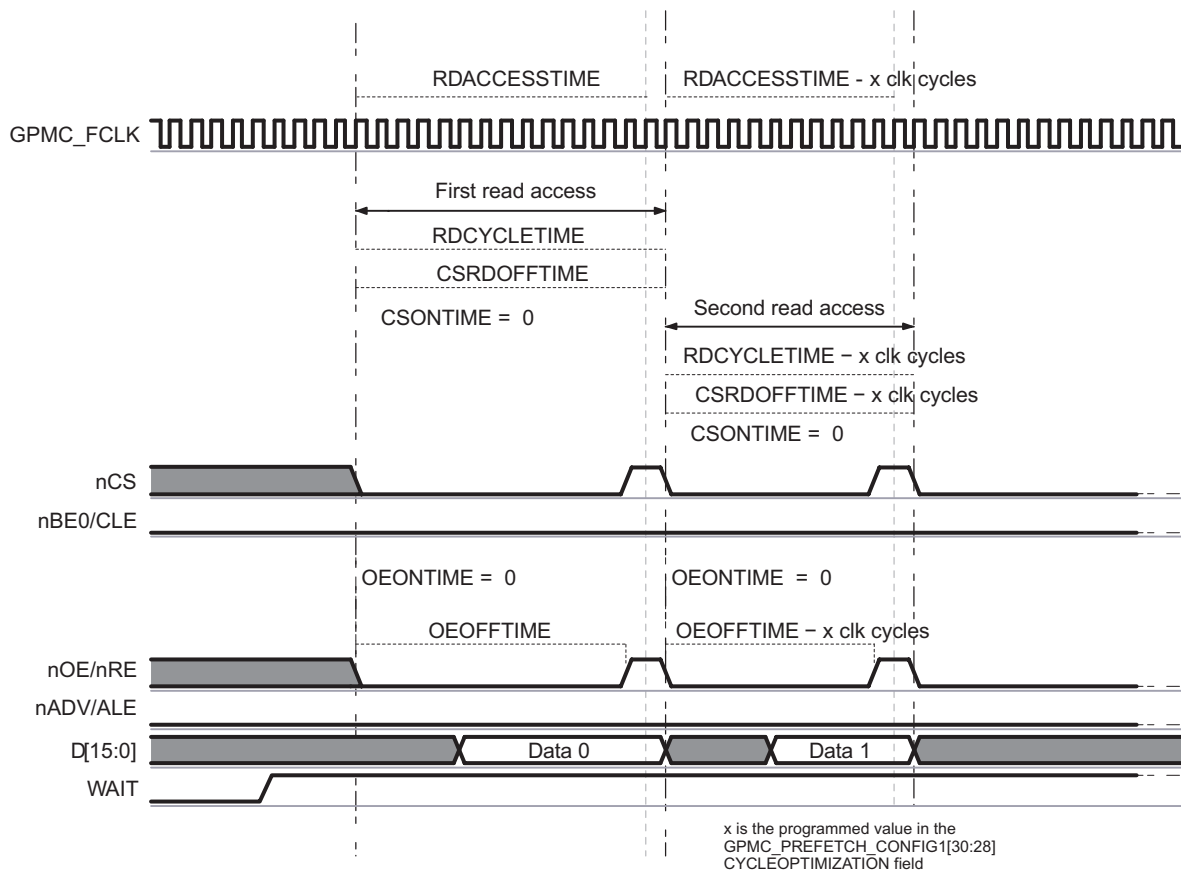
7.1.3.3.12.4.6 Optimizing NAND Access Using the Prefetch and Write-Posting Engine

Access time to a NAND memory device can be optimized for back-to-back accesses if the associated CSn signal is not deasserted between accesses. The GPMC access engine can track prefetch engine accesses to optimize the access timing parameter programmed for the allocated chip-select, if no accesses to other chip-selects (that is, interleaved accesses) occur. Similarly, the access engine also eliminates the CYCLE2CYCLEDELAY even if CYCLE2CYCLESAMEECSEN is set. This capability is limited to the prefetch and write-posting engine accesses, and MPU accesses to a NAND memory device (through the defined chip-select memory region or through the GPMC_NAND_DATA_i are never optimized.

The GPMC_PREFETCH_CONFIG1[27] ENABLEOPTIMIZEDACCESS bit must be set to enable optimized accesses. To optimize access time, the GPMC_PREFETCH_CONFIG1[30-28] CYCLEOPTIMIZATION field defines the number of GPMC_FCLK cycles to be suppressed from the RDCYCLETIME, WRCYCLETIME, RDACCESSTIME, WRACCESSTIME, CSOFFTIME, ADVOFFTIME, OEOFFTIME, and WEOFFTIME timing parameters.

Figure 7-41, in the case of back-to-back accesses to the NAND flash through the prefetch engine, CYCLE2CYCLESAMEECSEN is forced to 0 when using optimized accesses. The first access uses the regular timing settings for this chip-select. All accesses after this one use settings reduced by x clock cycles, x being defined by the GPMC_PREFETCH_CONFIG1[30-28] CYCLEOPTIMIZATION field.

Figure 7-41. NAND Read Cycle Optimization Timing Description



7.1.3.3.12.4.7 Interleaved Accesses Between Prefetch and Write-Posting Engine and Other Chip-Selects

Any on-going read or write access from the prefetch and write-posting engine is completed before an access to any other chip-select can be initiated. As a default, the arbiter uses a fixed-priority algorithm, and the prefetch and write-posting engine has the lowest priority. The maximum latency added to access starting time in this case equals the RDCYCLETIME or WRCYCLETIME (optimized or not) plus the requested BUSTURNAROUND delay for bus turnaround completion programmed for the chip-select to which the NAND device is connected to.

Alternatively, a round-robin arbitration can be used to prioritize accesses to the external bus. This arbitration scheme is enabled by setting the GPMC_PREFETCH_CONFIG1[23] PFPWENROUNDROBIN bit. When a request to another chip-select is received while the prefetch and write-posting engine is active, priority is given to the new request. The request processed thereafter is the prefetch and write-posting engine request, even if another interconnect request is passed in the mean time. The engine keeps control of the bus for an additional number of requests programmed in the GPMC_PREFETCH_CONFIG1[19-16] PFPWWEIGHTEDPRIO bit field. Control is then passed to the direct interconnect request.

As an example, the round-robin arbitration scheme is selected with PFPWWEIGHTEDPRIO set to 2h. Considering the prefetch and write-posting engine and the interconnect interface are always requesting access to the external interface, the GPMC grants priority to the direct interconnect access for one request. The GPMC then grants priority to the engine for three requests, and finally back to the direct interconnect access, until the arbiter is reset when one of the two initiators stops initiating requests.

7.1.4 GPMC High-Level Programming Model Overview

The high-level programming model introduces a top-down approach for users that need to configure the GPMC module. [Figure 7-42](#) shows a programming model top-level diagram for the GPMC. Each block of the diagram is described in one of the following subsections through a set of registers to configure. [Table 7-24](#) and [Table 7-25](#) list each step in the model.

Figure 7-42. Programming Model Top-Level Diagram

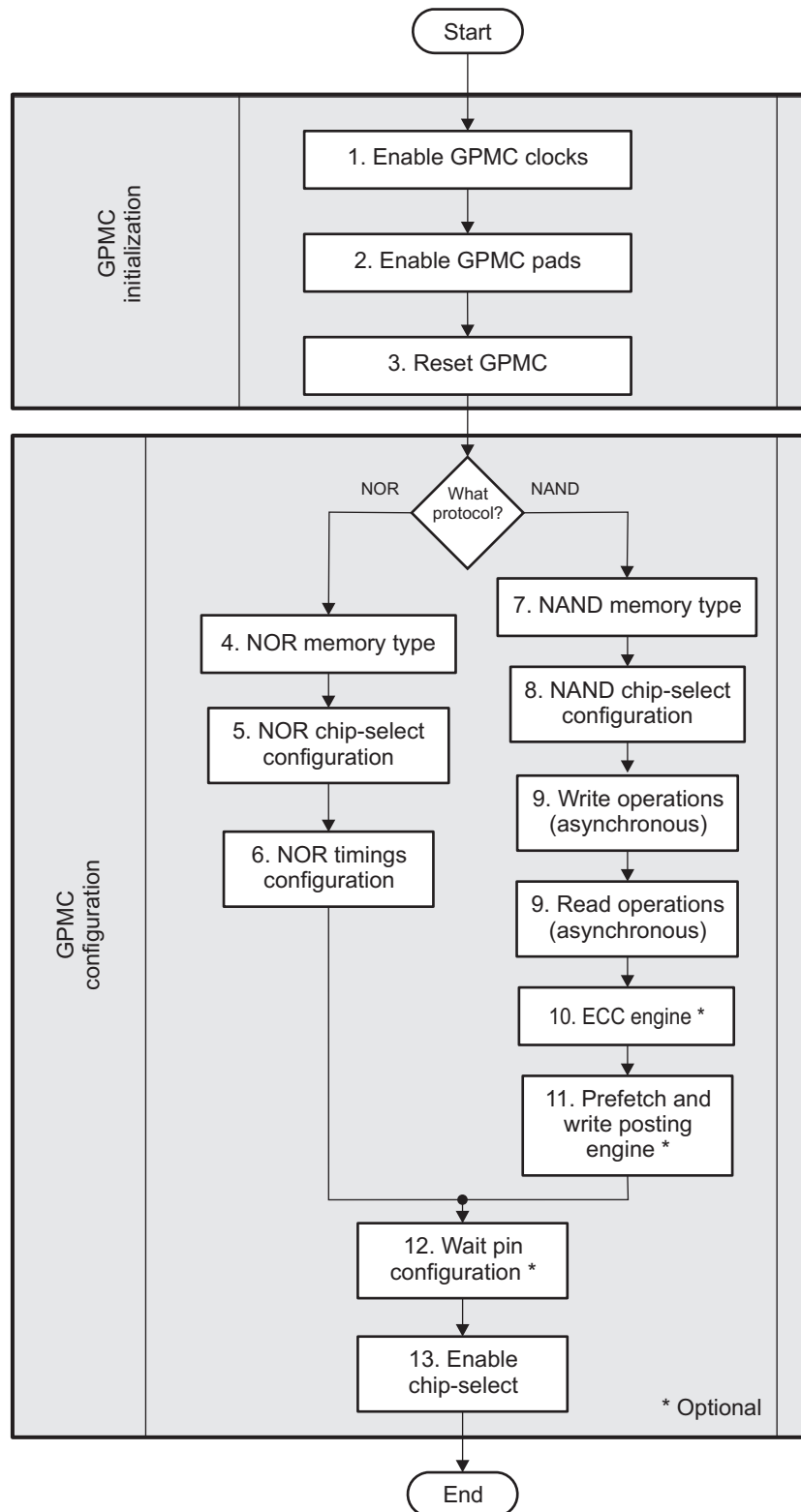


Table 7-24. GPMC Configuration in NOR Mode

Step	Description
NOR Memory Type	See Table 7-27
NOR Chip-Select Configuration	See Table 7-28
NOR Timings Configuration	See Table 7-29
Wait Pin Configuration	See Table 7-30
Enable Chip-Select	See Table 7-31

Table 7-25. GPMC Configuration in NAND Mode

Step	Description
NAND Memory Type	See Table 7-32
NAND Chip-Select Configuration	See Table 7-33
Write Operations (Asynchronous)	See Table 7-34
Read Operations (Asynchronous)	See Table 7-34
ECC Engine	See Table 7-35
Prefetch and Write-Posting Engine	See Table 7-36
Wait Pin Configuration	See Table 7-37
Enable Chip-Select	See Table 7-38

7.1.4.1 GPMC Initialization

[Table 7-26](#) describes the settings required to reset the GPMC.

Table 7-26. Reset GPMC

Sub-process Name	Register / Bitfield	Value
Start a software reset	GPMC_SYSCONFIG[1] SOFTRESET	1
Wait until	GPMC_SYSSTATUS[0] RESETDONE	1

7.1.4.2 GPMC Configuration in NOR Mode

This section gives a generic configuration for parameters related to the NOR memory connected to the GPMC. [Table 7-27](#) through [Table 7-31](#) list the steps to configure the GPMC in NOR mode.

NOTE: In the tables of this section, 'x' in Value column stands for 'depends on configuration'.

Table 7-27. NOR Memory Type

Sub-process Name	Register / Bitfield	Value
Set the NOR protocol	GPMC_CONFIG1_i[11-10] DEVICETYPE	0
Set a device size	GPMC_CONFIG1_i[13-12] DEVICESIZE	x
Select an address and data multiplexing protocol	GPMC_CONFIG1_i[9] MUXADDDATA	x
Set the attached device page length	GPMC_CONFIG1_i[24-23] ATTACHEDDEVICEPAGELENGTH	x
Set the wrapping burst capabilities	GPMC_CONFIG1_i[31] WRAPBURST	x
Select a timing signals latencies factor	GPMC_CONFIG1_i[4] TIMEPARAGRANULARITY	x
Select an output clock frequency	GPMC_CONFIG1_i[1-0] GPMCFCLKDIVIDER	x
Choose an output clock activation time	GPMC_CONFIG1_i[26-25] CLKACTIVATIONTIME	x
Set a single or multiple access for read operations	GPMC_CONFIG1_i[30] READMULTIPLE	x
Set a synchronous or asynchronous mode for read operations	GPMC_CONFIG1_i[29] READTYPE	x
Set a single or multiple access for write operations	GPMC_CONFIG1_i[28] WRITEMULTIPLE	x
Set a synchronous or asynchronous mode for write operations	GPMC_CONFIG1_i[27] WRITETYPE	x

Table 7-28. NOR Chip-Select Configuration

Sub-process Name	Register / Bitfield	Value
Select the chip-select base address	GPMC_CONFIG7_i[5-0] BASEADDRESS	x
Select the chip-select mask address	GPMC_CONFIG7_i[11-8] MASKADDRESS	x

Table 7-29. NOR Timings Configuration

Sub-process Name	Register / Bitfield	Value
Configure adequate timing parameters in various memory modes	See Section 7.1.4.5	

Table 7-30. WAIT Pin Configuration

Sub-process Name	Register / Bitfield	Value
Enable or disable wait pin monitoring for read operations	GPMC_CONFIG1_i[22] WAITREADMONITORING	x
Enable or disable wait pin monitoring for write operations	GPMC_CONFIG1_i[21] WAITWRITEMONITORING	x
Select a wait pin monitoring time	GPMC_CONFIG1_i[19-18] WAITMONITORINGTIME	x
Choose the input wait pin for the chip-select	GPMC_CONFIG1_i[17-16] WAITPINSELECT	x

Table 7-31. Enable Chip-Select

Sub-process Name	Register / Bitfield	Value
When all parameters are configured, enable the chip-select	GPMC_CONFIG7_i[6] CSVALID	x

7.1.4.3 GPMC Configuration in NAND Mode

This section gives a generic configuration for parameters related to NAND memory connected to the GPMC.

Table 7-32. NAND Memory Type

Sub-process Name	Register / Bitfield	Value
Set the NAND protocol	GPMC_CONFIG1_i[11-10] DEVICETYPE	2h
Set a device size	GPMC_CONFIG1_i[13-12] DEVICESIZE	x
Set the address and data multiplexing protocol to non-multiplexed attached device	GPMC_CONFIG1_i[9] MUXADDDATA	0
Select a timing signals latencies factor	GPMC_CONFIG1_i[4] TIMEPARAGRANULARITY	x
Set a synchronous or asynchronous mode and a single or multiple access for read and write operations	See Section 7.1.4.4	x

Table 7-33. NAND Chip-Select Configuration

Sub-process Name	Register / Bitfield	Value
Select the chip-select base address	GPMC_CONFIG7_i[5-0] BASEADDRESS	x
Select the chip-select minimum granularity (16M bytes)	GPMC_CONFIG7_i[11-8] MASKADDRESS	x

Table 7-34. Asynchronous Read and Write Operations

Sub-process Name	Register / Bitfield	Value
Configure adequate timing parameters in asynchronous modes	See Section 7.1.4.5	

Table 7-35. ECC Engine

Sub-process Name	Register / Bitfield	Value
Select the ECC result register where the first ECC computation is stored (Only applies to Hamming)	GPMC_ECC_CONTROL[3-0] ECCPOINTER	x
Clear all ECC result registers	GPMC_ECC_CONTROL[8] ECCCLEAR	Write 1 to clear
Define ECCSIZE0 and ECCSIZE1	GPMC_ECC_SIZE_CONFIG[19-12] ECCSIZE0 and GPMC_ECC_SIZE_CONFIG[29-22] ECCSIZE1	x
Select the size of each of the 9 result registers (size specified by ECCSIZE0 or ECCSIZE1)	GPMC_ECC_SIZE_CONFIG[j-1] ECCJRESULTSIZ where j = 1 to 9	x
Select the chip-select where ECC is computed	GPMC_ECC_SIZE_CONFIG[3-1] ECCCS	x
Select the Hamming code or BCH code ECC algorithm in use	GPMC_ECC_SIZE_CONFIG[16] ECCALGORITHM	x
Select word size for ECC calculation	GPMC_ECC_SIZE_CONFIG[7] ECC16B	x
If the BCH code is used, Set an error correction capability and Select a number of sectors to process	GPMC_ECC_SIZE_CONFIG[13-12] ECCBCHTSEL and GPMC_ECC_SIZE_CONFIG[6-4] ECCTOPSECTOR	x
Enable the ECC computation	GPMC_ECC_SIZE_CONFIG[0] ECCENABLE	1

Table 7-36. Prefetch and Write-Posting Engine

Sub-process Name	Register / Bitfield	Value
Disable the engine before configuration	GPMC_PREFETCH_CONTROL[0] STARTENGINE	0
Select the chip-select associated with a NAND device where the prefetch engine is active	GPMC_PREFETCH_CONFIG1[26-24] ENGINECSSELECTOR	x
Select access direction through prefetch engine, read or write.	GPMC_PREFETCH_CONFIG1[0] ACCESSMODE	x
Select the threshold used to issue a DMA request	GPMC_PREFETCH_CONFIG1[14-8] FIFOTHRESHOLD	x
Select either DMA synchronized mode or SW manual mode.	GPMC_PREFETCH_CONFIG1[2] DMAMODE	x
Select if the engine immediately starts accessing the memory upon STARTENGINE assertion or if hardware synchronization based on a WAIT signal is used.	GPMC_PREFETCH_CONFIG1[3] SYNCHROMODE	x
Select which wait pin edge detector should start the engine in synchronized mode	GPMC_PREFETCH_CONFIG1[5-4] WAITPINSELECTOR	x
Enter a number of clock cycles removed to timing parameters (For all back-to-back accesses to the NAND flash but not the first one)	GPMC_PREFETCH_CONFIG1[30-28] CYCLEOPTIMIZATION	x
Enable the prefetch postwrite engine	GPMC_PREFETCH_CONFIG1[7] ENABLEENGINE	1
Select the number of bytes to be read or written by the engine to the selected chip-select	GPMC_PREFETCH_CONFIG2[13-0] TRANSFERCOUNT	x
Start the prefetch engine	GPMC_PREFETCH_CONTROL[0] STARTENGINE	1

Table 7-37. WAIT Pin Configuration

Sub-process Name	Register / Bitfield	Value
Selects when the engine starts the access to CS	GPMC_PREFETCH_CONFIG1[3] SYNCHROMODE	x
Select which wait pin edge detector should start the engine in synchronized mode	GPMC_PREFETCH_CONFIG1[5-4] WAITPINSELECTOR	x

Table 7-38. Enable Chip-Select

Sub-process Name	Register / Bitfield	Value
When all parameters are configured, enable the chip-select	GPMC_CONFIG7_i[6] CSVALID	x

7.1.4.4 Set Memory Access

This section details the bit field to configure to set the GPMC in various memory modes.

Table 7-39. Mode Parameters Check List Table

Register	Bit	Bit Field Name	Asynchronous				Synchronous			
			Single Read Access	Single Write Access	Multiple Read (Page) Access	Multiple Write (Page) Access	Single Read Access	Single Write Access	Multiple Read (Burst) Access	Multiple Write (Burst) Access
GPMC_CONFIG1_j	30	READMULTIPLE	0	-	1	N/S	0	-	1	-
GPMC_CONFIG1_j	29	READTYPE	0	-	0	N/S	1	-	1	-
GPMC_CONFIG1_j	28	WRITEMULTIPLE	-	0		N/S	-	0	-	1
GPMC_CONFIG1_j	27	WRITETYPE	-	0		N/S	-	1	-	1

Table 7-40. Access Type Parameters Check List Table

Register	Bit	Bit Field Name	Access Type		
			Non-Mux	Address/Data Mux	AAD Mux
GPMC_CONFIG1_j	9-8	MUXADDDATA	0	2h	1

7.1.4.5 GPMC Timing Parameters

Figure 7-43 shows a programming model diagram for the NOR interfacing timing parameters.

Table 7-41 lists bit fields to configure adequate timing parameter in various memory modes.

Figure 7-43. NOR Interfacing Timing Parameters Diagram

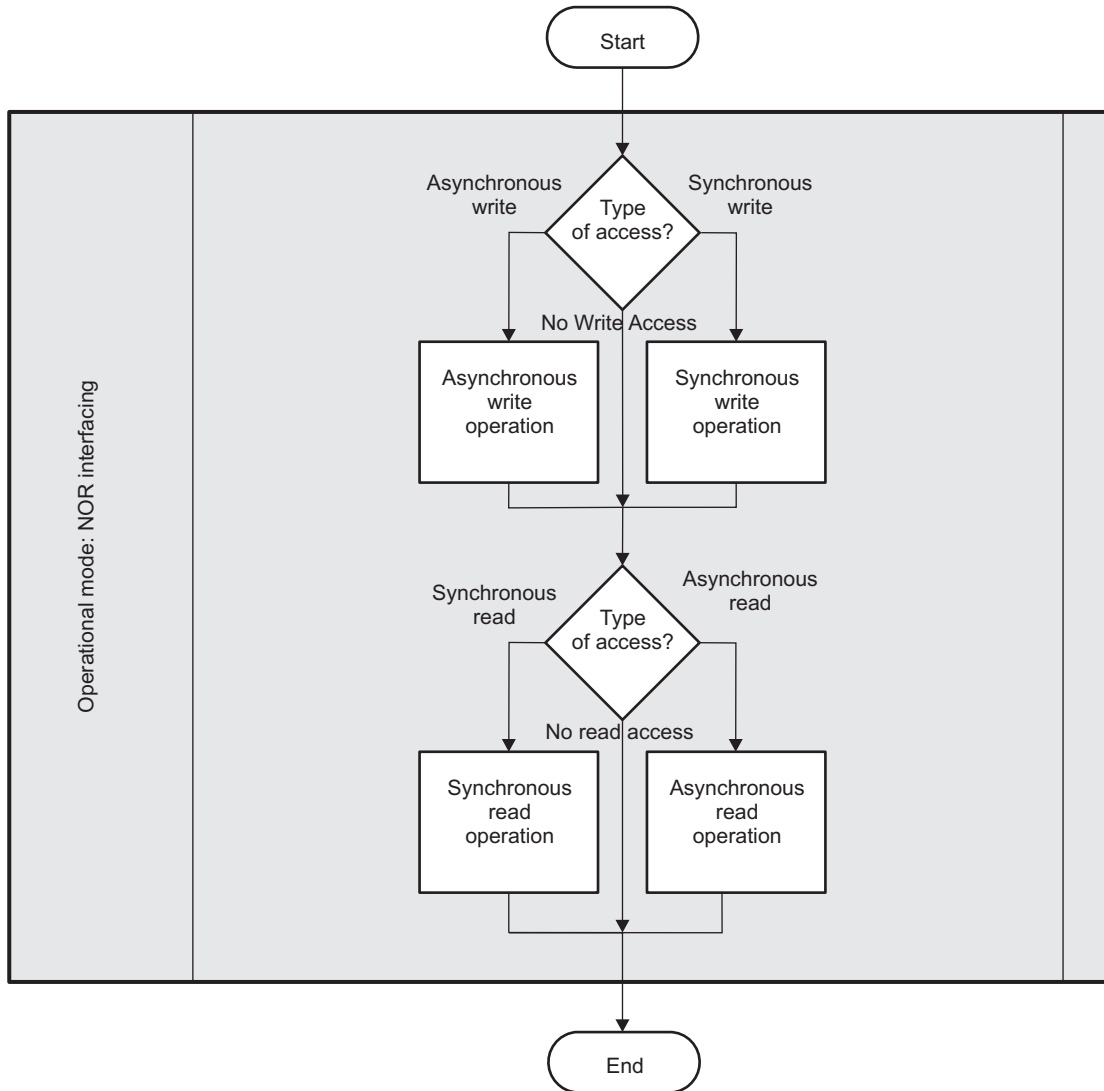


Table 7-41. Timing Parameters

Register	Bit	Bit Field Name	Asynchronous			Synchronous				Access Type		
			Single Read Access	Single Write Access	Multiple Read (Page) access	Single Read Access	Single Write Access	Multiple Read (Burst) Access	Multiple Write (Burst) Access	Non-multiplexed	Address/Data-multiplexed	AAD-multiplexed
GPMC_CONFIG1_i	9-8	MUXADDDATA	y	y	y	y	y	y	y	y	y	y
GPMC_CONFIG1_i	29	READTYPE	y		y	y		y		y	y	y
GPMC_CONFIG1_i	30	READMULTIPLE	y		y	y		y		y	y	y
GPMC_CONFIG1_i	27	WRITETYPE		y			y		y	y	y	y
GPMC_CONFIG1_i	28	WRITEMULTIPLE		y			y		y	y	y	y
GPMC_CONFIG1_i	31	WRAPBURST						y	y	y	y	y
GPMC_CONFIG1_i	26-25	CLKACTIVATIONTIME				y	y	y	y	y	y	y
GPMC_CONFIG1_i	19-18	WAITMONITORINGTIME	y	y	y	y	y	y	y	y	y	y
GPMC_CONFIG1_i	4	TIMEPARAGRANULARITY	y	y	y	y	y	y	y	y	y	y
GPMC_CONFIG2_i	20-16	CSWROFFTIME		y			y		y	y	y	y
GPMC_CONFIG2_i	12-8	CSRDOFFTIME	y		y	y		y		y	y	y
GPMC_CONFIG2_i	7	CSEXTRADelay	y	y	y	y	y	y	y	y	y	y
GPMC_CONFIG2_i	3-0	CSONTIME	y	y	y	y	y	y	y	y	y	y
GPMC_CONFIG3_i	30-28	ADVAADMUXWROFFTIME		y			y		y			y
GPMC_CONFIG3_i	26-24	ADVAADMUXRDOFFTIME	y		y	y		y				y
GPMC_CONFIG3_i	6-4	ADVAADMUXONTIME	y	y	y	y	y	y	y			y
GPMC_CONFIG3_i	20-16	ADVWROFFTIME		y			y		y	y	y	y
GPMC_CONFIG3_i	12-8	ADVRDOFFTIME	y		y	y		y		y	y	y
GPMC_CONFIG3_i	7	ADVEXTRADelay	y	y	y	y	y	y	y	y	y	y
GPMC_CONFIG3_i	3-0	ADVONTIME	y	y	y	y	y	y	y	y	y	y
GPMC_CONFIG4_i	15-13	OEAADMUXOFFTIME	y	y	y	y	y	y	y			y
GPMC_CONFIG4_i	6-4	OEAADMUXONTIME	y	y	y	y	y	y	y			y
GPMC_CONFIG4_i	28-24	WEOFFTIME		y			y		y	y	y	y
GPMC_CONFIG4_i	23	WEEXTRADelay		y			y		y	y	y	y
GPMC_CONFIG4_i	19-16	WEONTIME		y			y		y	y	y	y
GPMC_CONFIG4_i	12-8	OEOFFTIME	y		y	y		y		y	y	y
GPMC_CONFIG4_i	7	OEEXTRADelay	y		y	y		y		y	y	y
GPMC_CONFIG4_i	3-0	OEONTIME	y		y	y		y		y	y	y
GPMC_CONFIG5_i	27-24	PAGEBURSTACCESSTIME			y			y	y	y	y	y
GPMC_CONFIG5_i	20-16	RDACCESSTIME	y		y	y		y		y	y	y
GPMC_CONFIG5_i	12-8	WRCYCLETIME		y			y		y	y	y	y
GPMC_CONFIG5_i	4-0	RDCYCLETIME	y		y	y		y		y	y	y
GPMC_CONFIG6_i	28-24	WRACCESSTIME		y			y		y	y	y	y
GPMC_CONFIG6_i	19-16	WRDATAONADMUXBUS		y			y		y		y	y

Table 7-41. Timing Parameters (continued)

Register	Bit	Bit Field Name	Asynchronous			Synchronous				Access Type		
			Single Read Access	Single Write Access	Multiple Read (Page) access	Single Read Access	Single Write Access	Multiple Read (Burst) Access	Multiple Write (Burst) Access	Non-multiplexed	Address/Data-multiplexed	AAD-multiplexed
GPMC_CONFIG6_i	11-8	CYCLE2CYCLEDELAY	y	y	y	y	y	y	y	y	y	y
GPMC_CONFIG6_i	7	CYCLE2CYCLESAMECSEN	y	y	y	y	y	y	y	y	y	y
GPMC_CONFIG6_i	6	CYCLE2CYCLEDIFFCSEN	y	y	y	y	y	y	y	y	y	y
GPMC_CONFIG6_i	3-0	BUSTURNAROUND	y	y	y	y	y	y	y	y	y	y
GPMC_CONFIG7_i	6	CSVALID	y	y	y	y	y	y	y	y	y	y

7.1.5 Use Cases

7.1.5.1 How to Set GPMC Timing Parameters for Typical Accesses

7.1.5.1.1 External Memory Attached to the GPMC Module

As discussed in the introduction to this chapter, the GPMC module supports the following external memory types:

- Asynchronous or synchronous, 8-bit or 16-bit-width memory or device
- 16-bit address/data-multiplexed or not multiplexed NOR flash device
- 8- or 16-bit NAND flash device

The following examples show how to calculate GPMC timing parameters by showing a typical parameter setup for the access to be performed.

The example is based on a 512-Mb multiplexed NOR flash memory with the following characteristics:

- Type: NOR flash (address/data-multiplexed mode)
- Size: 512M bits
- Data Bus: 16 bits wide
- Speed: 104 MHz clock frequency
- Read access time: 80 ns

7.1.5.1.2 Typical GPMC Setup

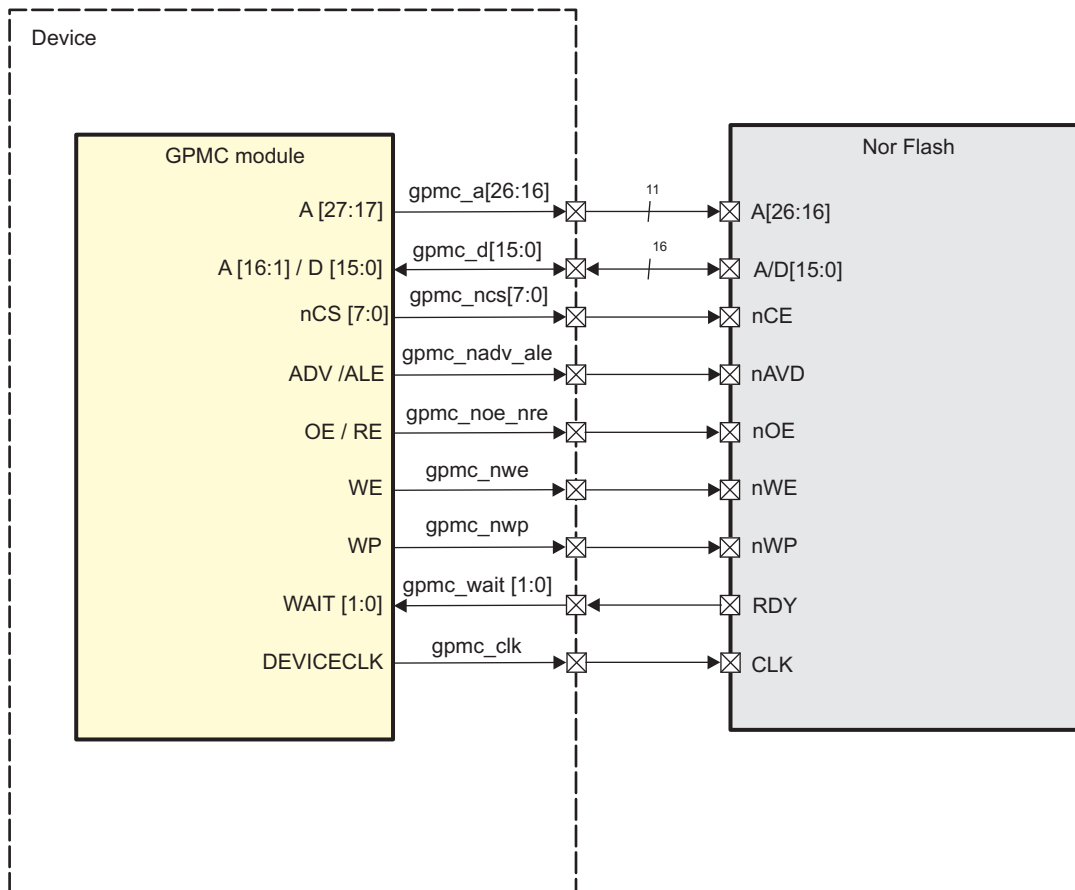
[Table 7-42](#) lists some of the I/Os of the GPMC module.

Table 7-42. GPMC Signals

Signal Name	I/O	Description
GPMC_FCLK	Internal	Functional and interface clock. Acts as the time reference.
GPMC_CLK	O	External clock provided to the external device for synchronous operations
GPMC_A[27:17]	O	Address
GPMC_AD[15: 0]	I/O	Data-multiplexed with addresses A[16:1] on memory side
GPMC_CSx _n	O	Chip-select (where x = 0, or 1)
GPMC_ADV _n _ALE	O	Address valid enable
GPMC_OE_RE _n	O	Output enable (read access only)
GPMC_WEn	O	Write enable (write access only)
GPMC_WAIT[1:0]	I	Ready signal from memory device. Indicates when valid burst data is ready to be read

Figure 7-44 shows the typical connection between the GPMC module and an attached NOR Flash memory.

Figure 7-44. GPMC Connection to an External NOR Flash Memory



The following sections demonstrate how to calculate GPMC parameters for three access types:

- Synchronous burst read
- Asynchronous read
- Asynchronous single write

7.1.5.1.3 GPMC Configuration for Synchronous Burst Read Access

The clock runs at 104 MHz ($f = 104 \text{ MHz}$; $T = 9,615 \text{ ns}$).

Table 7-43 shows the timing parameters (on the memory side) that determine the parameters on the GPMC side.

Table 7-44 shows how to calculate timings for the GPMC using the memory parameters.

Figure 7-45 shows the synchronous burst read access.

Table 7-43. Useful Timing Parameters on the Memory Side

AC Read Characteristics on the Memory Side	Description	Duration (ns)
tCES	CSn setup time to clock	0
tACS	Address setup time to clock	3
tIACC	Synchronous access time	80
tBACC	Burst access time valid clock to output delay	5,2
tCEZ	Chip-select to High-Impedance	7
tOEZ	Output enable to High-Impedance	7
tAVC	ADVn setup time	6
tAVD	AVDn pulse	6
tACH	Address hold time from clock	3

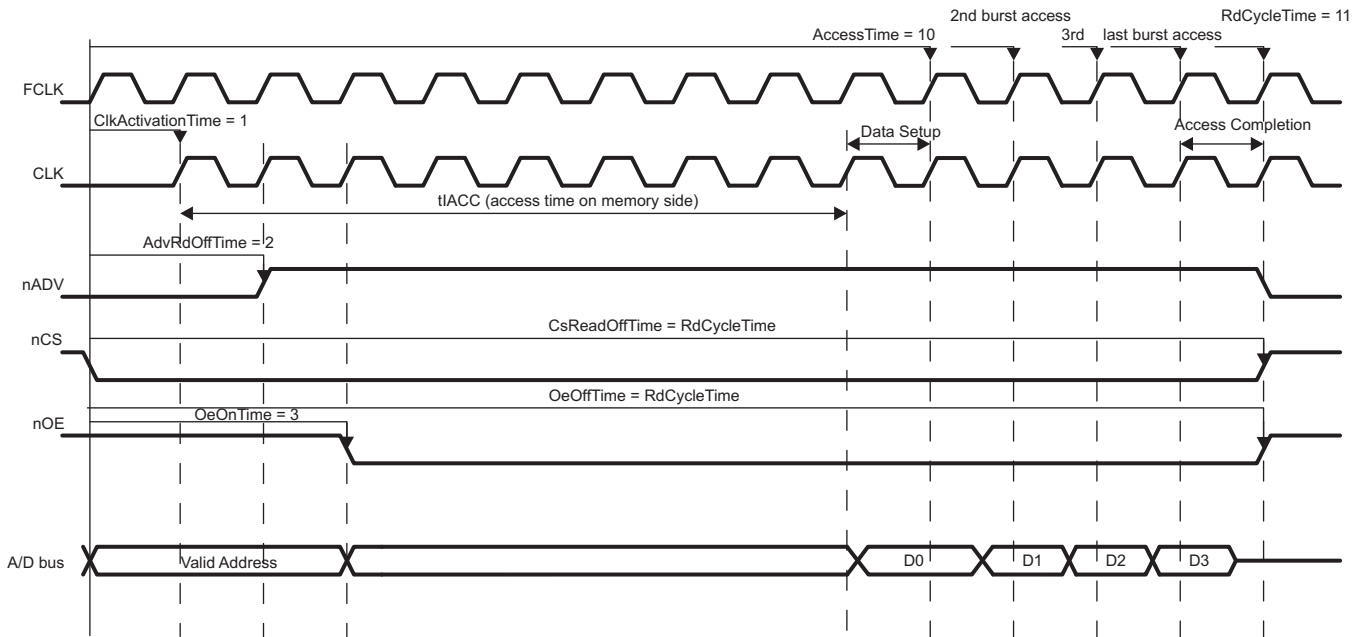
The following terms, which describe the timing interface between the controller and its attached device, are used to calculate the timing parameters on the GPMC side:

- Read Access time (GPMC side): Time required to activate the clock + read access time requested on the memory side + data setup time required for optimal capture of a burst of data
- Data setup time (GPMC side): Ensures a good capture of a burst of data (as opposed to taking a burst of data out). One word of data is processed in one clock cycle ($T = 9,615 \text{ ns}$). The read access time between 2 bursts of data is $tBACC = 5,2 \text{ ns}$. Therefore, data setup time is a clock period - $tBACC = 4,415 \text{ ns}$ of data setup.
- Access completion (GPMC side): (Different from page burst access time) Time required between the last burst access and access completion: CSn/OEn hold time (CSn and OEn must be released at the end of an access. These signals are held to allow the access to complete).
- Read cycle time (GPMC side): Read Access time + access completion
- Write cycle time for burst access: Not supported for NOR flash memory

Table 7-44. Calculating GPMC Timing Parameters

Parameter Name on GPMC Side	Formula	Duration (ns)	Number of Clock Cycles (F = 104 MHz)	GPMC Register Configurations
GPMC FCLK Divider	-	-	-	GPMCFCLKDIVIDER = 0
ClkActivationTime	min (tCES, tACS)	3	1	CLKACTIVATIONTIME = 1
RdAccessTime	roundmax (ClkActivationTime + tIACC + DataSetupTime)	94,03: (9,615 + 80 + 4,415)	10 : roundmax (94,03 / 9,615)	ACCESSTIME = Ah
PageBurstAccessTime	roundmax (tBACC)	roundmax (5,2)	1	PAGEBURSTACCESSTIME = 1
RdCycleTime	AccessTime + max (tCEZ, tOEZ)	101, 03: (94, 03 + 7)	11	RDCYCLETIME = Bh
CsOnTime	tCES	0	0	CSONTIME = 0
CsReadOffTime	RdCycleTime	-	11	CSRDOFFTIME = Bh
AdvOnTime	tAVC	0	0	ADVONTIME = 0
AdvRdOffTime	tAVD + tAVC	12	2	ADVRDOFFTIME = 2h
OeOnTime	(ClkActivationTime + tACH) < OeOnTime < (ClkActivationTime + tIACC)	-	3, for instance	OEONTIME = 3h
OeOffTime	RdCycleTime	-	11	OEOFFTIME = Bh

Figure 7-45. Synchronous Burst Read Access (Timing Parameters in Clock Cycles)



7.1.5.1.4 GPMC Configuration for Asynchronous Read Access

The clock runs at 104 MHz ($f = 104 \text{ MHz}$; $T = 9,615 \text{ ns}$).

[Table 7-45](#) shows the timing parameters (on the memory side) that determine the parameters on the GPMC side.

[Table 7-46](#) shows how to calculate timings for the GPMC using the memory parameters.

[Figure 7-46](#) shows the asynchronous read access.

Table 7-45. AC Characteristics for Asynchronous Read Access

AC Read Characteristics on the Memory Side	Description	Duration (ns)
tCE	Read Access time from CSn low	80
tAAVDS	Address setup time to rising edge of ADVn	3
tAVDP	ADVn low time	6
tCAS	CSn setup time to ADVn	0
tOE	Output enable to output valid	6
tOEZ	Output enable to High-Impedance	7

Use the following formula to calculate the RdCycleTime parameter for this typical access:

$$\text{RdCycleTime} = \text{RdAccessTime} + \text{AccessCompletion} = \text{RdAccessTime} + 1 \text{ clock cycle} + \text{tOEZ}$$

- First, on the memory side, the external memory makes the data available to the output bus. This is the memory-side read access time defined in [Table 7-46](#): the number of clock cycles between the address capture (ADVn rising edge) and the data valid on the output bus.

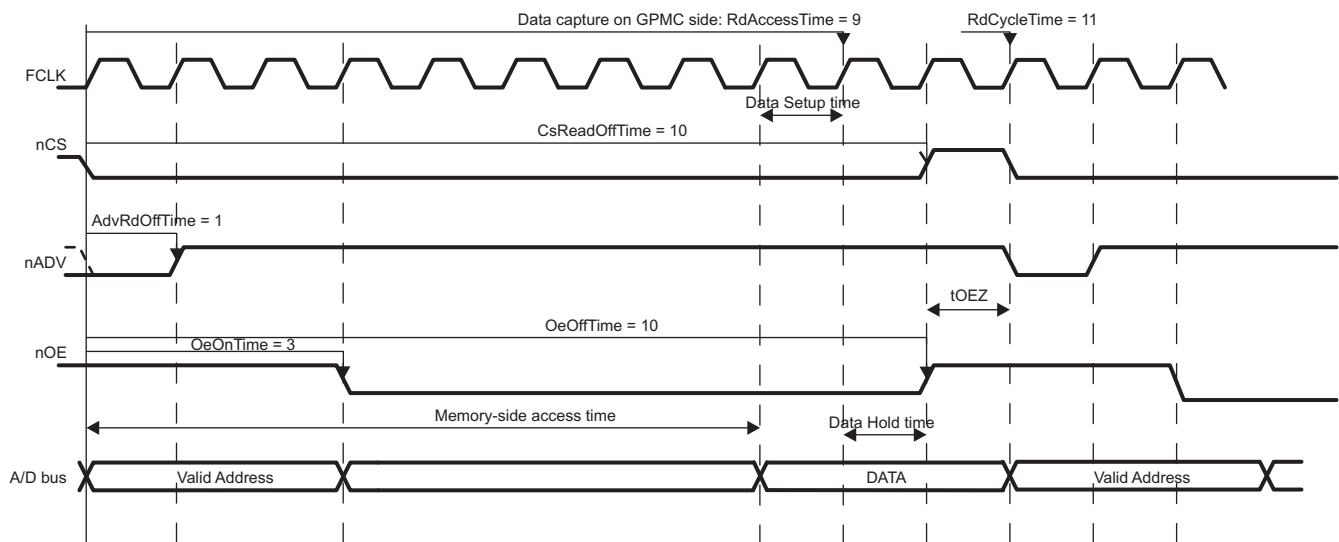
The GPMC requires some hold time to allow the data to be captured correctly and the access to be finished.

- To read the data correctly, the GPMC must be configured to meet the data setup time requirement of the memory; the GPMC module captures the data on the next rising edge. This is access time on the GPMC side.
- There must also be a data hold time for correctly reading the data (checking that there is no OEn/CSn deassertion while reading the data). This data hold time is 1 clock cycle (that is, AccessTime + 1).
- To complete the access, OEn/CSn signals are driven to high-impedance. AccessTime + 1 + tOEZ is the read cycle time.
- Addresses can now be relatched and a new read cycle begun.

Table 7-46. GPMC Timing Parameters for Asynchronous Read Access

Parameter Name on GPMC side	Formula	Duration (ns)	Number of Clock Cycles (F = 104 MHz)	GPMC Register Configurations
ClkActivationTime	n/a (asynchronous mode)			
AccessTime	round max (tCE)	80	9	ACCESSTIME = 9h
PageBurstAccessTime	n/a (single access)			
RdCycleTime	AccessTime + 1cycle + tOEZ	96, 615	11	RDCYCLETIME = Bh
CsOnTime	tCAS	0	0	CSONTIME = 0
CsReadOffTime	AccessTime + 1 cycle	89, 615	10	CSRDOFFTIME = Ah
AdvOnTime	tAAVDS	3	1	ADVONTIME = 1
AdvRdOffTime	tAAVDS + tAVDP	9	1	ADVRDOFFTIME = 1
OeOnTime	OeOnTime ≥ AdvRdOffTime (multiplexed mode)	-	3, for instance	OEONTIME = 3h
OeOffTime	AccessTime + 1cycle	89, 615	10	OEOFFTIME = Ah

Figure 7-46. Asynchronous Single Read Access (Timing Parameters in Clock Cycles)



7.1.5.1.5 GPMC Configuration for Asynchronous Single Write Access

The clock runs at 104 MHz: (f = 104 MHz; T = 9, 615 ns).

[Table 7-47](#) shows how to calculate timings for the GPMC using the memory parameters.

[Table 7-48](#) shows the timing parameters (on the memory side) that determine the parameters on the GPMC side.

[Figure 7-47](#) shows the synchronous burst write access.

Table 7-47. AC Characteristics for Asynchronous Single Write (Memory Side)

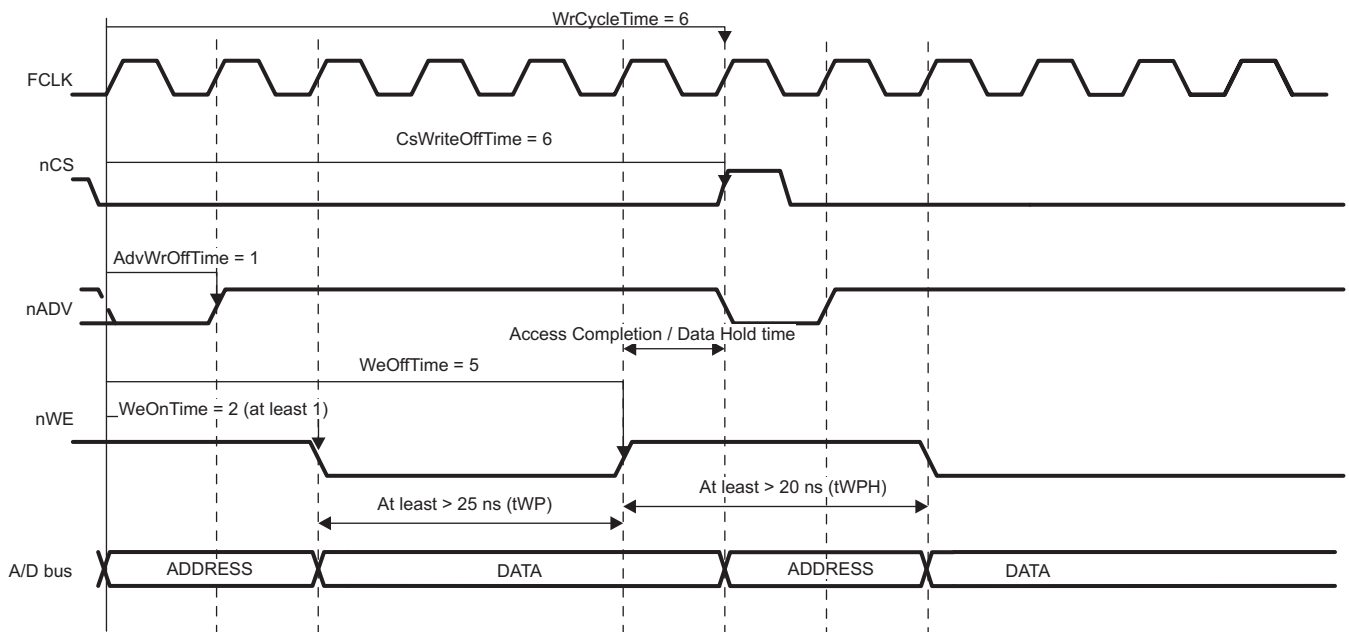
AC Characteristics on the Memory Side	Description	Duration (ns)
tWC	Write cycle time	60
tAVDP	ADVn low time	6
tWP	Write pulse width	25
tWPH	Write pulse width high	20
tCS	CSn setup time to WEn	3
tCAS	CSn setup time to ADVn	0
tAVSC	ADVn setup time	3

For asynchronous single write access, write cycle time is $WrCycleTime = WeOffTime + AccessCompletion = WeOffTime + 1$. For the AccessCompletion, the GPMC requires 1 cycle of data hold time (CSn de-assertion).

Table 7-48. GPMC Timing Parameters for Asynchronous Single Write

Parameter Name on GPMC side	Formula	Duration (ns)	Number of Clock Cycles (F = 104 MHz)	GPMC Register Configurations
ClkActivationTime	n/a (asynchronous mode)			
AccessTime	Applicable only to WAITMONITORING (the value is the same as for read access)			
PageBurstAccessTime	n/a (single access)			
WrCycleTime	WeOffTime + AccessCompletion	57, 615	6	WRCYCLETIME = 6h
CsOnTime	tCAS	0	0	CSONTIME = 0
CsWrOffTime	WeOffTime + 1	57, 615	6	CSWROFFTIME = 6h
AdvOnTime	tAVSC	3	1	ADVONTIME = 1
AdvWrOffTime	tAVSC + tAVDP	9	1	ADVWROFFTIME = 1
WeOnTime	tCS	3	1	WEONTIME = 1
WeOffTime	tCS + tWP + tWPH	48	5	WEOFFTIME = 5h

Figure 7-47. Asynchronous Single Write Access (Timing Parameters in Clock Cycles)



7.1.5.2 How to Choose a Suitable Memory to Use With the GPMC

This section is intended to help the user select a suitable memory device to interface with the GPMC controller.

7.1.5.2.1 Supported Memories or Devices

NAND flash and NOR flash architectures are the two flash technologies. The GPMC supports various types of external memory or device, basically any one that supports NAND or NOR protocols:

- 8- and 16-bit width asynchronous or synchronous memory or device (8-bit: non burst device only)
- 16-bit address and data multiplexed NOR flash devices (pSRAM)
- 8- and 16-bit NAND flash device

7.1.5.2.2 NAND Interface Protocol

NAND flash architecture, introduced in 1989, is a flash technology. NAND is a page-oriented memory device, that is, read and write accesses are done by pages. NAND achieves great density by sharing common areas of the storage transistor, which creates strings of serially connected transistors (in NOR devices, each transistor stands alone). Thanks to its high density NAND is best suited to devices requiring high capacity data storage, such as pictures, music, or data files. NAND non-volatility, makes of it a good storage solution for many applications where mobility, low power, and speed are key factors. Low pin count and simple interface are other advantages of NAND.

Table 7-49 summarizes the NAND interface signals level applied to external device or memories.

Table 7-49. NAND Interface Bus Operations Summary

Bus Operation	CLE	ALE	CEn	WEn	REn	WPn
Read (cmd input)	H	L	L	RE	H	x
Read (add input)	L	H	L	RE	H	x
Write (cmd input)	H	L	L	RE	H	H
Write (add input)	L	H	L	RE	H	H
Data input	L	L	L	RE	H	H
Data output	L	L	L	H	FE	x
Busy (during read)	x	x	H	H	H	x
Busy (during program)	x	x	x	x	x	H
Busy (during erase)	x	x	x	x	x	H
Write protect	x	x	x	x	x	L
Stand-by	x	x	H	x	x	H/L

7.1.5.2.3 NOR Interface Protocol

NOR flash architecture, introduced in 1988, is a flash technology. Unlike NAND, which is a sequential access device, NOR is directly addressable; i.e., it is designed to be a random access device. NOR is best suited to devices used to store and run code or firmware, usually in small capacities. While NOR has fast read capabilities it has slow write and erase functions compared to NAND architecture.

Table 7-50 summarizes the NOR interface signals level applied to external device or memories.

Table 7-50. NOR Interface Bus Operations Summary

Bus Operation	CLK	ADVn	CSn	OEn	WEn	WAIT	DQ[15:0]
Read (asynchronous)	x	L	L	L	H	Asserted	Output
Read (synchronous)	Running	L	L	L	H	Driven	Output
Read (burst suspend)	Halted	x	L	H	H	Active	Output
Write	x	L	L	H	L	Asserted	Input

Table 7-50. NOR Interface Bus Operations Summary (continued)

Bus Operation	CLK	ADVn	CSn	OEn	WEn	WAIT	DQ[15:0]
Output disable	x	x	L	H	H	Asserted	High-Z
Standby	x	x	H	x	x	High-Z	High-Z

7.1.5.2.4 Other Technologies

Other supported device type interact with the GPMC through the NOR interface protocol.

OneNAND Flash is a high-density and low-power memory device. It is based on single- or multi-level-cell NAND core with SRAM and logic, and interfaces as a synchronous NOR Flash, plus has synchronous write capability. It reads faster than conventional NAND and writes faster than conventional NOR flash. Hence, it is appropriate for both mass storage and code storage.

pSRAM stands for pseudo-static random access memory. pSRAM is a low-power memory device for mobile applications. pSRAM is based on the DRAM cell with internal refresh and address control features, and interfaces as a synchronous NOR Flash, plus has synchronous write capability.

7.1.5.2.5 Supported Protocols

The GPMC supports the following interface protocols when communicating with external memory or external devices:

- Asynchronous read/write access
- Asynchronous read page access (4-8-16 Word16)
- Synchronous read/write access
- Synchronous read burst access without wrap capability (4-8-16 Word16)
- Synchronous read burst access with wrap capability (4-8-16 Word16)

7.1.5.2.6 GPMC Features and Settings

This section lists GPMC features and settings:

- Supported device type: up to four NAND or NOR protocol external memories or devices
- Operating Voltage: 3.3V
- Maximum GPMC addressing capability: 512 MBytes divided into eight chip-selects
- Maximum supported memory size: 256 MBytes (must be a power-of-2)
- Minimum supported memory size: 16 MBytes (must be a power-of-2). Aliasing occurs when addressing smaller memories.
- Data path to external memory or device: 8- and 16-bit wide
- Burst and page access: burst of 4-8-16 Word16
- Supports bus keeping
- Supports bus turn around

7.1.6 GPMC Registers

[Table 7-51](#) lists the memory-mapped registers for the GPMC. All register offset addresses not listed in [Table 7-51](#) should be considered as reserved locations and the register contents should not be modified.

Table 7-51. GPMC Registers

Offset	Acronym	Register Name	Section
0h	GPMC_REVISION		Section 7.1.6.1
10h	GPMC_SYSCONFIG		Section 7.1.6.2
14h	GPMC_SYSSTATUS		Section 7.1.6.3
18h	GPMC_IRQSTATUS		Section 7.1.6.4
1Ch	GPMC_IRQENABLE		Section 7.1.6.5
40h	GPMC_TIMEOUT_CONTROL		Section 7.1.6.6
44h	GPMC_ERR_ADDRESS		Section 7.1.6.7
48h	GPMC_ERR_TYPE		Section 7.1.6.8
50h	GPMC_CONFIG		Section 7.1.6.9
54h	GPMC_STATUS		Section 7.1.6.10

Table 7-51. GPMC Registers (continued)

Offset	Acronym	Register Name	Section
60h	GPMC_CONFIG1_0		Section 7.1.6.11
64h	GPMC_CONFIG2_0		Section 7.1.6.12
68h	GPMC_CONFIG3_0		Section 7.1.6.13
6Ch	GPMC_CONFIG4_0		Section 7.1.6.14
70h	GPMC_CONFIG5_0		Section 7.1.6.15
74h	GPMC_CONFIG6_0		Section 7.1.6.16
78h	GPMC_CONFIG7_0		Section 7.1.6.17
7Ch	GPMC_NAND_COMMAND_0		Section 7.1.6.18
80h	GPMC_NAND_ADDRESS_0		Section 7.1.6.19
84h	GPMC_NAND_DATA_0		Section 7.1.6.20
90h	GPMC_CONFIG1_1		Section 7.1.6.21
94h	GPMC_CONFIG2_1		Section 7.1.6.22
98h	GPMC_CONFIG3_1		Section 7.1.6.23
9Ch	GPMC_CONFIG4_1		Section 7.1.6.24
A0h	GPMC_CONFIG5_1		Section 7.1.6.25
A4h	GPMC_CONFIG6_1		Section 7.1.6.26
A8h	GPMC_CONFIG7_1		Section 7.1.6.27
ACh	GPMC_NAND_COMMAND_1		Section 7.1.6.28
B0h	GPMC_NAND_ADDRESS_1		Section 7.1.6.29
B4h	GPMC_NAND_DATA_1		Section 7.1.6.30
C0h	GPMC_CONFIG1_2		Section 7.1.6.31
C4h	GPMC_CONFIG2_2		Section 7.1.6.32
C8h	GPMC_CONFIG3_2		Section 7.1.6.33
CCh	GPMC_CONFIG4_2		Section 7.1.6.34
D0h	GPMC_CONFIG5_2		Section 7.1.6.35
D4h	GPMC_CONFIG6_2		Section 7.1.6.36
D8h	GPMC_CONFIG7_2		Section 7.1.6.37
DCh	GPMC_NAND_COMMAND_2		Section 7.1.6.38
E0h	GPMC_NAND_ADDRESS_2		Section 7.1.6.39
E4h	GPMC_NAND_DATA_2		Section 7.1.6.40
F0h	GPMC_CONFIG1_3		Section 7.1.6.41
F4h	GPMC_CONFIG2_3		Section 7.1.6.42
F8h	GPMC_CONFIG3_3		Section 7.1.6.43
FCh	GPMC_CONFIG4_3		Section 7.1.6.44
100h	GPMC_CONFIG5_3		Section 7.1.6.45
104h	GPMC_CONFIG6_3		Section 7.1.6.46
108h	GPMC_CONFIG7_3		Section 7.1.6.47
10Ch	GPMC_NAND_COMMAND_3		Section 7.1.6.48
110h	GPMC_NAND_ADDRESS_3		Section 7.1.6.49
114h	GPMC_NAND_DATA_3		Section 7.1.6.50
120h	GPMC_CONFIG1_4		Section 7.1.6.51
124h	GPMC_CONFIG2_4		Section 7.1.6.52
128h	GPMC_CONFIG3_4		Section 7.1.6.53
12Ch	GPMC_CONFIG4_4		Section 7.1.6.54
130h	GPMC_CONFIG5_4		Section 7.1.6.55
134h	GPMC_CONFIG6_4		Section 7.1.6.56
138h	GPMC_CONFIG7_4		Section 7.1.6.57

Table 7-51. GPMC Registers (continued)

Offset	Acronym	Register Name	Section
13Ch	GPMC_NAND_COMMAND_4		Section 7.1.6.58
140h	GPMC_NAND_ADDRESS_4		Section 7.1.6.59
144h	GPMC_NAND_DATA_4		Section 7.1.6.60
150h	GPMC_CONFIG1_5		Section 7.1.6.61
154h	GPMC_CONFIG2_5		Section 7.1.6.62
158h	GPMC_CONFIG3_5		Section 7.1.6.63
15Ch	GPMC_CONFIG4_5		Section 7.1.6.64
160h	GPMC_CONFIG5_5		Section 7.1.6.65
164h	GPMC_CONFIG6_5		Section 7.1.6.66
168h	GPMC_CONFIG7_5		Section 7.1.6.67
16Ch	GPMC_NAND_COMMAND_5		Section 7.1.6.68
170h	GPMC_NAND_ADDRESS_5		Section 7.1.6.69
174h	GPMC_NAND_DATA_5		Section 7.1.6.70
180h	GPMC_CONFIG1_6		Section 7.1.6.71
184h	GPMC_CONFIG2_6		Section 7.1.6.72
188h	GPMC_CONFIG3_6		Section 7.1.6.73
18Ch	GPMC_CONFIG4_6		Section 7.1.6.74
190h	GPMC_CONFIG5_6		Section 7.1.6.75
194h	GPMC_CONFIG6_6		Section 7.1.6.76
198h	GPMC_CONFIG7_6		Section 7.1.6.77
19Ch	GPMC_NAND_COMMAND_6		Section 7.1.6.78
1A0h	GPMC_NAND_ADDRESS_6		Section 7.1.6.79
1A4h	GPMC_NAND_DATA_6		Section 7.1.6.80
1E0h	GPMC_PREFETCH_CONFIG1		Section 7.1.6.81
1E4h	GPMC_PREFETCH_CONFIG2		Section 7.1.6.82
1ECh	GPMC_PREFETCH_CONTROL		Section 7.1.6.83
1F0h	GPMC_PREFETCH_STATUS		Section 7.1.6.84
1F4h	GPMC_ECC_CONFIG		Section 7.1.6.85
1F8h	GPMC_ECC_CONTROL		Section 7.1.6.86
1FCh	GPMC_ECC_SIZE_CONFIG		Section 7.1.6.87
200h	GPMC_ECC1_RESULT		Section 7.1.6.88
204h	GPMC_ECC2_RESULT		Section 7.1.6.89
208h	GPMC_ECC3_RESULT		Section 7.1.6.90
20Ch	GPMC_ECC4_RESULT		Section 7.1.6.91
210h	GPMC_ECC5_RESULT		Section 7.1.6.92
214h	GPMC_ECC6_RESULT		Section 7.1.6.93
218h	GPMC_ECC7_RESULT		Section 7.1.6.94
21Ch	GPMC_ECC8_RESULT		Section 7.1.6.95
220h	GPMC_ECC9_RESULT		Section 7.1.6.96
240h	GPMC_BCH_RESULT0_0		Section 7.1.6.97
244h	GPMC_BCH_RESULT1_0		Section 7.1.6.98
248h	GPMC_BCH_RESULT2_0		Section 7.1.6.99
24Ch	GPMC_BCH_RESULT3_0		Section 7.1.6.100
250h	GPMC_BCH_RESULT0_1		Section 7.1.6.101
254h	GPMC_BCH_RESULT1_1		Section 7.1.6.102
258h	GPMC_BCH_RESULT2_1		Section 7.1.6.103
25Ch	GPMC_BCH_RESULT3_1		Section 7.1.6.104

Table 7-51. GPMC Registers (continued)

Offset	Acronym	Register Name	Section
260h	GPMC_BCH_RESULT0_2		Section 7.1.6.105
264h	GPMC_BCH_RESULT1_2		Section 7.1.6.106
268h	GPMC_BCH_RESULT2_2		Section 7.1.6.107
26Ch	GPMC_BCH_RESULT3_2		Section 7.1.6.108
270h	GPMC_BCH_RESULT0_3		Section 7.1.6.109
274h	GPMC_BCH_RESULT1_3		Section 7.1.6.110
278h	GPMC_BCH_RESULT2_3		Section 7.1.6.111
27Ch	GPMC_BCH_RESULT3_3		Section 7.1.6.112
280h	GPMC_BCH_RESULT0_4		Section 7.1.6.113
284h	GPMC_BCH_RESULT1_4		Section 7.1.6.114
288h	GPMC_BCH_RESULT2_4		Section 7.1.6.115
28Ch	GPMC_BCH_RESULT3_4		Section 7.1.6.116
290h	GPMC_BCH_RESULT0_5		Section 7.1.6.117
294h	GPMC_BCH_RESULT1_5		Section 7.1.6.118
298h	GPMC_BCH_RESULT2_5		Section 7.1.6.119
29Ch	GPMC_BCH_RESULT3_5		Section 7.1.6.120
2A0h	GPMC_BCH_RESULT0_6		Section 7.1.6.121
2A4h	GPMC_BCH_RESULT1_6		Section 7.1.6.122
2A8h	GPMC_BCH_RESULT2_6		Section 7.1.6.123
2ACh	GPMC_BCH_RESULT3_6		Section 7.1.6.124
2B0h	GPMC_BCH_RESULT0_7		Section 7.1.6.125
2B4h	GPMC_BCH_RESULT1_7		Section 7.1.6.126
2B8h	GPMC_BCH_RESULT2_7		Section 7.1.6.127
2BCh	GPMC_BCH_RESULT3_7		Section 7.1.6.128
2D0h	GPMC_BCH_SWDATA		Section 7.1.6.129
300h	GPMC_BCH_RESULT4_0		Section 7.1.6.130
304h	GPMC_BCH_RESULT5_0		Section 7.1.6.131
308h	GPMC_BCH_RESULT6_0		Section 7.1.6.132
310h	GPMC_BCH_RESULT4_1		Section 7.1.6.133
314h	GPMC_BCH_RESULT5_1		Section 7.1.6.134
318h	GPMC_BCH_RESULT6_1		Section 7.1.6.135
320h	GPMC_BCH_RESULT4_2		Section 7.1.6.136
324h	GPMC_BCH_RESULT5_2		Section 7.1.6.137
328h	GPMC_BCH_RESULT6_2		Section 7.1.6.138
330h	GPMC_BCH_RESULT4_3		Section 7.1.6.139
334h	GPMC_BCH_RESULT5_3		Section 7.1.6.140
338h	GPMC_BCH_RESULT6_3		Section 7.1.6.141
340h	GPMC_BCH_RESULT4_4		Section 7.1.6.142
344h	GPMC_BCH_RESULT5_4		Section 7.1.6.143
348h	GPMC_BCH_RESULT6_4		Section 7.1.6.144
350h	GPMC_BCH_RESULT4_5		Section 7.1.6.145
354h	GPMC_BCH_RESULT5_5		Section 7.1.6.146
358h	GPMC_BCH_RESULT6_5		Section 7.1.6.147
360h	GPMC_BCH_RESULT4_6		Section 7.1.6.148
364h	GPMC_BCH_RESULT5_6		Section 7.1.6.149
368h	GPMC_BCH_RESULT6_6		Section 7.1.6.150
370h	GPMC_BCH_RESULT4_7		Section 7.1.6.151

Table 7-51. GPMC Registers (continued)

Offset	Acronym	Register Name	Section
374h	GPMC_BCH_RESULT5_7		Section 7.1.6.152
378h	GPMC_BCH_RESULT6_7		Section 7.1.6.153

7.1.6.1 GPMC_REVISION Register (offset = 0h) [reset = 0h]

GPMC_REVISION is shown in [Figure 7-48](#) and described in [Table 7-52](#).

The GPMC_REVISION register contains the IP revision code.

Figure 7-48. GPMC_REVISION Register

31	30	29	28	27	26	25	24	23	22	21	20	19	18	17	16	15	14	13	12	11	10	9	8	7	6	5	4	3	2	1	0
RESERVED														REV																	
R-0h														R-0h																	

LEGEND: R/W = Read/Write; R = Read only; W1toCl = Write 1 to clear bit; -n = value after reset

Table 7-52. GPMC_REVISION Register Field Descriptions

Bit	Field	Type	Reset	Description
31-8	RESERVED	R	0h	
7-0	REV	R	0h	IP revision. Major revision is [7:4]. Minor revision is [3:0]. Examples: 10h for revision 1.0, 21h for revision 2.1.

7.1.6.2 GPMC_SYSCONFIG Register (offset = 10h) [reset = 0h]

GPMC_SYSCONFIG is shown in [Figure 7-49](#) and described in [Table 7-53](#).

The GPMC_SYSCONFIG register controls the various parameters of the OCP interface.

Figure 7-49. GPMC_SYSCONFIG Register

31	30	29	28	27	26	25	24
RESERVED							
R-0h							
23	22	21	20	19	18	17	16
RESERVED							
R-0h							
15	14	13	12	11	10	9	8
RESERVED							
R-0h							
7	6	5	4	3	2	1	0
RESERVED			SIDLEMODE		RESERVED	SOFTRESET	AUTOIDLE
R-0h			R/W-0h		R-0h	R/W-0h	R/W-0h

LEGEND: R/W = Read/Write; R = Read only; W1toCl = Write 1 to clear bit; -n = value after reset

Table 7-53. GPMC_SYSCONFIG Register Field Descriptions

Bit	Field	Type	Reset	Description
31-5	RESERVED	R	0h	
4-3	SIDLEMODE	R/W	0h	Idle mode 0h = Force-idle. An idle request is acknowledged unconditionally 1h = No-idle. An idle request is never acknowledged 2h = Smart-idle. Acknowledgment to an idle request is given based on the internal activity of the module 3h = Reserved
2	RESERVED	R	0h	
1	SOFTRESET	R/W	0h	Software reset (Set 1 to this bit triggers a module reset. This bit is automatically reset by hardware. During reads, it always returns 0). 0h = Normal mode 1h = The module is reset
0	AUTOIDLE	R/W	0h	Internal OCP clock gating strategy. 0h = Interface clock is free-running 1h = Automatic interface clock gating strategy is applied based on the interconnect activity.

7.1.6.3 GPMC_SYSSTATUS Register (offset = 14h) [reset = 0h]

GPMC_SYSSTATUS is shown in [Figure 7-50](#) and described in [Table 7-54](#).

The GPMC_SYSSTATUS register provides status information about the module, excluding the interrupt status information.

Figure 7-50. GPMC_SYSSTATUS Register

31	30	29	28	27	26	25	24
RESERVED							
R-0h							
23	22	21	20	19	18	17	16
RESERVED							
R-0h							
15	14	13	12	11	10	9	8
RESERVED							
R-0h							
7	6	5	4	3	2	1	0
RESERVED							RESETDONE
R-0h							R-0h

LEGEND: R/W = Read/Write; R = Read only; W1toCl = Write 1 to clear bit; -n = value after reset

Table 7-54. GPMC_SYSSTATUS Register Field Descriptions

Bit	Field	Type	Reset	Description
31-1	RESERVED	R	0h	
0	RESETDONE	R	0h	Internal reset monitoring 0h (R) = Internal module reset in on-going 1h (R) = Reset completed

7.1.6.4 GPMC_IRQSTATUS Register (offset = 18h) [reset = 0h]

GPMC_IRQSTATUS is shown in [Figure 7-51](#) and described in [Table 7-55](#).

The GPMC_IRQSTATUS interrupt status register regroups all the status of the module internal events that can generate an interrupt.

Figure 7-51. GPMC_IRQSTATUS Register

31	30	29	28	27	26	25	24
RESERVED							
R-0h							
23	22	21	20	19	18	17	16
RESERVED							
R-0h							
15	14	13	12	11	10	9	8
RESERVED						WAIT1EDGE DETECTIONSTA TUS	WAIT0EDGE DETECTIONSTA TUS
R-0h						R/W-0h	R/W-0h
7	6	5	4	3	2	1	0
RESERVED						TERMINALCO UNTSTATUS	FIFOEVENTST ATUS
R-0h						R/W-0h	R/W-0h

LEGEND: R/W = Read/Write; R = Read only; W1toCl = Write 1 to clear bit; -n = value after reset

Table 7-55. GPMC_IRQSTATUS Register Field Descriptions

Bit	Field	Type	Reset	Description
31-10	RESERVED	R	0h	
9	WAIT1EDGEDETECTIONSTATUS	R/W	0h	Status of the Wait1 Edge Detection interrupt 0h (W) = WAIT1EDGEDETECTIONSTATUS bit unchanged 0h (R) = A transition on WAIT1 input pin has not been detected 1h (W) = WAIT1EDGEDETECTIONSTATUS bit is reset 1h (R) = A transition on WAIT1 input pin has been detected
8	WAIT0EDGEDETECTIONSTATUS	R/W	0h	Status of the Wait0 Edge Detection interrupt 0h (W) = WAIT0EDGEDETECTIONSTATUS bit unchanged 0h (R) = A transition on WAIT0 input pin has not been detected 1h (W) = WAIT0EDGEDETECTIONSTATUS bit is reset 1h (R) = A transition on WAIT0 input pin has been detected
7-2	RESERVED	R	0h	
1	TERMINALCOUNTSTATUS	R/W	0h	Status of the TerminalCountEvent interrupt 0h = TERMINALCOUNTSTATUS bit unchanged 1h = Indicates that CountValue is equal to 0
0	FIFOEVENTSTATUS	R/W	0h	Status of the FIFOEvent interrupt 0h (W) = FIFOEVENTSTATUS bit unchanged 0h (R) = Indicates than less than GPMC_PREFETCH_STATUS[16] FIFOTHRESHOLDSTATUS bytes are available in prefetch mode and less than FIFOTHRESHOLD bytes free places are available in write-posting mode. 1h (W) = FIFOEVENTSTATUS bit is reset 1h (R) = Indicates than at least GPMC_PREFETCH_STATUS[16] FIFOTHRESHOLDSTATUS bytes are available in prefetch mode and at least FIFOTHRESHOLD bytes free places are available in write-posting mode.

7.1.6.5 GPMC_IRQENABLE Register (offset = 1Ch) [reset = 0h]

GPMC_IRQENABLE is shown in [Figure 7-52](#) and described in [Table 7-56](#).

The GPMC_IRQENABLE interrupt enable register allows to mask/unmask the module internal sources of interrupt, on a event-by-event basis.

Figure 7-52. GPMC_IRQENABLE Register

31	30	29	28	27	26	25	24
RESERVED							
R-0h							
23	22	21	20	19	18	17	16
RESERVED							
R-0h							
15	14	13	12	11	10	9	8
RESERVED						WAIT1EDGEDETECTIONENABLE	WAIT0EDGEDETECTIONENABLE
R-0h						R/W-0h	R/W-0h
7	6	5	4	3	2	1	0
RESERVED						TERMINALCOUNTEVENTENABLE	FIFOEVENTENABLE
R-0h						R/W-0h	R/W-0h

LEGEND: R/W = Read/Write; R = Read only; W1toCl = Write 1 to clear bit; -n = value after reset

Table 7-56. GPMC_IRQENABLE Register Field Descriptions

Bit	Field	Type	Reset	Description
31-10	RESERVED	R	0h	
9	WAIT1EDGEDETECTIONENABLE	R/W	0h	Enables the Wait1 Edge Detection interrupt 0h = Wait1EdgeDetection interrupt is masked 1h = Wait1EdgeDetection event generates an interrupt if occurs
8	WAIT0EDGEDETECTIONENABLE	R/W	0h	Enables the Wait0 Edge Detection interrupt 0h = Wait0EdgeDetection interrupt is masked 1h = Wait0EdgeDetection event generates an interrupt if occurs
7-2	RESERVED	R	0h	
1	TERMINALCOUNTEVENTENABLE	R/W	0h	Enables TerminalCountEvent interrupt issuing in pre-fetch or write posting mode 0h = TerminalCountEvent interrupt is masked 1h = TerminalCountEvent interrupt is not masked
0	FIFOEVENTENABLE	R/W	0h	Enables the FIFOEvent interrupt 0h = FIFOEvent interrupt is masked 1h = FIFOEvent interrupt is not masked

7.1.6.6 GPMC_TIMEOUT_CONTROL Register (offset = 40h) [reset = 0h]

GPMC_TIMEOUT_CONTROL is shown in [Figure 7-53](#) and described in [Table 7-57](#).

The GPMC_TIMEOUT_CONTROL register allows the user to set the start value of the timeout counter

Figure 7-53. GPMC_TIMEOUT_CONTROL Register

31	30	29	28	27	26	25	24
RESERVED							
R-0h							
23	22	21	20	19	18	17	16
RESERVED							
R-0h							
15	14	13	12	11	10	9	8
RESERVED				TIMEOUTSTARTVALUE			
R-0h				R/W-0h			
7	6	5	4	3	2	1	0
TIMEOUTSTARTVALUE				RESERVED			TIMEOUTENA BLE
R/W-0h				R-0h			R/W-0h

LEGEND: R/W = Read/Write; R = Read only; W1toCl = Write 1 to clear bit; -n = value after reset

Table 7-57. GPMC_TIMEOUT_CONTROL Register Field Descriptions

Bit	Field	Type	Reset	Description
31-13	RESERVED	R	0h	
12-4	TIMEOUTSTARTVALUE	R/W	0h	Start value of the time-out counter (000 corresponds to 0 GPMC.FCLK cycle, 1h corresponds to 1 GPMC.FCLK cycle, and 1FFh corresponds to 511 GPMC.FCLK cycles)
3-1	RESERVED	R	0h	
0	TIMEOUTENABLE	R/W	0h	Enable bit of the TimeOut feature 0h = TimeOut feature is disabled 1h = TimeOut feature is enabled

7.1.6.7 GPMC_ERR_ADDRESS Register (offset = 44h) [reset = 0h]

GPMC_ERR_ADDRESS is shown in [Figure 7-54](#) and described in [Table 7-58](#).

The GPMC_ERR_ADDRESS register stores the address of the illegal access when an error occurs.

Figure 7-54. GPMC_ERR_ADDRESS Register

31	30	29	28	27	26	25	24
RESERVED		ILLEGALADD					
R-0h		R/W-0h					
23	22	21	20	19	18	17	16
ILLEGALADD							
R/W-0h							
15	14	13	12	11	10	9	8
ILLEGALADD							
R/W-0h							
7	6	5	4	3	2	1	0
ILLEGALADD							
R/W-0h							

LEGEND: R/W = Read/Write; R = Read only; W1toCl = Write 1 to clear bit; -n = value after reset

Table 7-58. GPMC_ERR_ADDRESS Register Field Descriptions

Bit	Field	Type	Reset	Description
31	RESERVED	R	0h	
30-0	ILLEGALADD	R/W	0h	Address of illegal access: A30 (0 for memory region, 1 for GPMC register region) and A29 to A0 (1GByte maximum)

7.1.6.8 GPMC_ERR_TYPE Register (offset = 48h) [reset = 0h]

GPMC_ERR_TYPE is shown in [Figure 7-55](#) and described in [Table 7-59](#).

The GPMC_ERR_TYPE register stores the type of error when an error occurs.

Figure 7-55. GPMC_ERR_TYPE Register

31	30	29	28	27	26	25	24
RESERVED							
R-0h							
23	22	21	20	19	18	17	16
RESERVED							
R-0h							
15	14	13	12	11	10	9	8
RESERVED				ILLEGALMCMD			
R-0h				R/W-0h			
7	6	5	4	3	2	1	0
RESERVED			ERRORNOTSU PPADD	ERRORNOTSU PPMCMD	ERRORTIMEO UT	RESERVED	ERRORVALID
R-0h			R/W-0h	R/W-0h	R/W-0h	R-0h	R/W-0h

LEGEND: R/W = Read/Write; R = Read only; W1toCl = Write 1 to clear bit; -n = value after reset

Table 7-59. GPMC_ERR_TYPE Register Field Descriptions

Bit	Field	Type	Reset	Description
31-11	RESERVED	R	0h	
10-8	ILLEGALMCMD	R/W	0h	System Command of the transaction that caused the error
7-5	RESERVED	R	0h	
4	ERRORNOTSUPPADD	R/W	0h	Not supported Address error 0h = No error occurs 1h = The error is due to a non supported Address
3	ERRORNOTSUPPMCMD	R/W	0h	Not supported Command error 0h = No error occurs 1h = The error is due to a non supported Command
2	ERRORTIMEOUT	R/W	0h	Time-out error 0h = No error occurs 1h = The error is due to a time out
1	RESERVED	R	0h	
0	ERRORVALID	R/W	0h	Error validity status - Must be explicitly cleared with a write 1 transaction 0h = All error fields no longer valid 1h = Error detected and logged in the other error fields

7.1.6.9 GPMC_CONFIG Register (offset = 50h) [reset = 0h]

GPMC_CONFIG is shown in [Figure 7-56](#) and described in [Table 7-60](#).

The configuration register allows global configuration of the GPMC.

Figure 7-56. GPMC_CONFIG Register

31	30	29	28	27	26	25	24	
RESERVED								
R-0h								
23	22	21	20	19	18	17	16	
RESERVED								
R-0h								
15	14	13	12	11	10	9	8	
RESERVED						WAIT1PINPOLARITY	WAIT0PINPOLARITY	
R-0h						R/W-0h	R/W-0h	
7	6	5	4	3	2	1	0	
RESERVED			WRITEPROTECT	RESERVED			LIMITEDADDRESS	NANDFORCEPOSTEDWRITE
R-0h			R/W-0h	R-0h			R/W-0h	R/W-0h

LEGEND: R/W = Read/Write; R = Read only; W1toCl = Write 1 to clear bit; -n = value after reset

Table 7-60. GPMC_CONFIG Register Field Descriptions

Bit	Field	Type	Reset	Description
31-10	RESERVED	R	0h	
9	WAIT1PINPOLARITY	R/W	0h	Selects the polarity of input pin WAIT1. 0h = WAIT1 active low 1h = WAIT1 active high
8	WAIT0PINPOLARITY	R/W	0h	Selects the polarity of input pin WAIT0. 0h = WAIT0 active low 1h = WAIT0 active high
7-5	RESERVED	R	0h	
4	WRITEPROTECT	R/W	0h	Controls the WP output pin level. 0h = WP output pin is low 1h = WP output pin is high
3-2	RESERVED	R	0h	
1	LIMITEDADDRESS	R/W	0h	Limited Address device support. 0h = No effect. GPMC controls all addresses. 1h = A26-A11 are not modified during an external memory access.
0	NANDFORCEPOSTEDWRITE	R/W	0h	0h = Disables Force Posted Write 1h = Enables Force Posted Write

7.1.6.10 GPMC_STATUS Register (offset = 54h) [reset = 0h]

GPMC_STATUS is shown in [Figure 7-57](#) and described in [Table 7-61](#).

The status register provides global status bits of the GPMC.

Figure 7-57. GPMC_STATUS Register

31	30	29	28	27	26	25	24
RESERVED							
R-0h							
23	22	21	20	19	18	17	16
RESERVED							
R-0h							
15	14	13	12	11	10	9	8
RESERVED						WAIT1STATUS	WAIT0STATUS
R-0h						R/W-0h	R/W-0h
7	6	5	4	3	2	1	0
RESERVED							EMPTYWRITE BUFFERSTAT US
R-0h							R/W-0h

LEGEND: R/W = Read/Write; R = Read only; W1toCl = Write 1 to clear bit; -n = value after reset

Table 7-61. GPMC_STATUS Register Field Descriptions

Bit	Field	Type	Reset	Description
31-10	RESERVED	R	0h	
9	WAIT1STATUS	R/W	0h	Is a copy of input pin WAIT1. (Reset value is WAIT1 input pin sampled at IC reset) 0h = WAIT1 asserted (inactive state) 1h = WAIT1 de-asserted
8	WAIT0STATUS	R/W	0h	Is a copy of input pin WAIT0. (Reset value is WAIT0 input pin sampled at IC reset) 0h = WAIT0 asserted (inactive state) 1h = WAIT0 de-asserted
7-1	RESERVED	R	0h	
0	EMPTYWRITEBUFFERS TATUS	R/W	0h	Stores the empty status of the write buffer 0h = Write Buffer is not empty 1h = Write Buffer is empty

7.1.6.11 GPMC_CONFIG1_0 Register (offset = 60h) [reset = 0h]

GPMC_CONFIG1_0 is shown in [Figure 7-58](#) and described in [Table 7-62](#).

The configuration 1 register sets signal control parameters per chip select.

Figure 7-58. GPMC_CONFIG1_0 Register

31	30	29	28	27	26	25	24
WRAPBURST	READMULTIPLE	READTYPE	WRITEMULTIPLE	WRITETYPE	CLKACTIVATIONTIME	ATTACHEDDEVICEPAGELENGTH	
R/W-0h	R/W-0h	R/W-0h	R/W-0h	R/W-0h	R/W-0h	R/W-0h	
23	22	21	20	19	18	17	16
ATTACHEDDEVICEPAGELENGTH	WAITREADMONITORING	WAITWRITEMONITORING	RESERVED	WAITMONITORINGTIME		WAITPINSELECT	
R/W-0h	R/W-0h	R/W-0h	R-0h	R/W-0h		R/W-0h	
15	14	13	12	11	10	9	8
RESERVED		DEVICESTRATEGY	DEVICESTRATEGY	DEVICESTRATEGY	DEVICESTRATEGY	MUXADDDATA	
R-0h		R/W-0h	R/W-0h	R/W-0h	R/W-0h	R/W-0h	
7	6	5	4	3	2	1	0
RESERVED	RESERVED	TIMEPARAGRANULARITY	RESERVED	RESERVED	RESERVED	GPMCFCLKDIVIDER	
R-0h	R-0h	R/W-0h	R/W-0h	R-0h	R-0h	R/W-0h	

LEGEND: R/W = Read/Write; R = Read only; W1toCl = Write 1 to clear bit; -n = value after reset

Table 7-62. GPMC_CONFIG1_0 Register Field Descriptions

Bit	Field	Type	Reset	Description
31	WRAPBURST	R/W	0h	Enables the wrapping burst capability. Must be set if the attached device is configured in wrapping burst 0h = Synchronous wrapping burst not supported 1h = Synchronous wrapping burst supported
30	READMULTIPLE	R/W	0h	Selects the read single or multiple access 0h = single access 1h = multiple access (burst if synchronous, page if asynchronous)
29	READTYPE	R/W	0h	Selects the read mode operation 0h = Read Asynchronous 1h = Read Synchronous
28	WRITEMULTIPLE	R/W	0h	Selects the write single or multiple access 0h = Single access 1h = Multiple access (burst if synchronous, considered as single if asynchronous)
27	WRITETYPE	R/W	0h	Selects the write mode operation 0h = Write Asynchronous 1h = Write Synchronous
26-25	CLKACTIVATIONTIME	R/W	0h	Output GPMC.CLK activation time 0h = First rising edge of GPMC_CLK at start access time 1h = First rising edge of GPMC_CLK one GPMC_FCLK cycle after start access time 2h = First rising edge of GPMC_CLK two GPMC_FCLK cycles after start access time 3h = Reserved

Table 7-62. GPMC_CONFIG1_0 Register Field Descriptions (continued)

Bit	Field	Type	Reset	Description
24-23	ATTACHEDDEVICEPAGELENGTH	R/W	0h	Specifies the attached device page (burst) length (1 Word = Interface size) 0h = 4 Words 1h = 8 Words 2h = 16 Words 3h = Reserved
22	WAITREADMONITORING	R/W	0h	Selects the Wait monitoring configuration for Read accesses. 0h = WAIT pin is not monitored for read accesses 1h = WAIT pin is monitored for read accesses
21	WAITWRITEMONITORING	R/W	0h	Selects the Wait monitoring configuration for Write accesses 0h = WAIT pin is not monitored for write accesses 1h = WAIT pin is monitored for write accesses
20	RESERVED	R	0h	
19-18	WAITMONITORINGTIME	R/W	0h	Selects input pin Wait monitoring time 0h = WAIT pin is monitored with valid data 1h = WAIT pin is monitored one GPMC_CLK cycle before valid data 2h = WAIT pin is monitored two GPMC_CLK cycle before valid data 3h = Reserved
17-16	WAITPINSELECT	R/W	0h	Selects the input WAIT pin for this chip select. 0h = WAIT input pin is WAIT0 1h = WAIT input pin is WAIT1 2h = Reserved 3h = Reserved
15-14	RESERVED	R	0h	
13-12	DEVICESTYPE	R/W	0h	Selects the device size attached (Reset value is SYSBOOT[8] input pin sampled at IC reset for CS[0] (active low) and 01 for CS[1] to CS[6] (active low)). 0h = 8 bit 1h = 16 bit 2h = Reserved 3h = Reserved
11-10	DEVICETYPE	R/W	0h	Selects the attached device type 0h = NOR Flash like, asynchronous and synchronous devices 1h = Reserved 2h = NAND Flash like devices, stream mode 3h = Reserved
9-8	MUXADDDATA	R/W	0h	Enables the Address and data multiplexed protocol (Reset value is SYSBOOT[11] and SYSBOOT[10] input pins sampled at IC reset for CS[0] (active low) and 0 for CS[1] to CS[6] (active low)). 0h = Non-multiplexed attached device 1h = AAD-multiplexed protocol device 2h = Address and data multiplexed attached device 3h = Reserved
7-5	RESERVED	R	0h	
4	TIMEPARAGRANULARITY	R/W	0h	Signals timing latencies scalar factor (Rd/WRCycleTime, AccessTime, PageBurstAccessTime, CSOnTime, CSRd/WrOffTime, ADVOnTime, ADVRd/WrOffTime, OEOnTime, OEOffTime, WEOnTime, WEOffTime, Cycle2CycleDelay, BusTurnAround, TimeOutStartValue) 0h = x1 latencies 1h = x2 latencies
3-2	RESERVED	R	0h	

Table 7-62. GPMC_CONFIG1_0 Register Field Descriptions (continued)

Bit	Field	Type	Reset	Description
1-0	GPMCFCLKDIVIDER	R/W	0h	Divides the GPMC.FCLK clock 0h = GPMC_CLK frequency = GPMC_FCLK frequency 1h = GPMC_CLK frequency = GPMC_FCLK frequency/2 2h = GPMC_CLK frequency = GPMC_FCLK frequency/3 3h = GPMC_CLK frequency = GPMC_FCLK frequency/4

7.1.6.12 GPMC_CONFIG2_0 Register (offset = 64h) [reset = 0h]

GPMC_CONFIG2_0 is shown in [Figure 7-59](#) and described in [Table 7-63](#).

Chip-select signal timing parameter configuration.

Figure 7-59. GPMC_CONFIG2_0 Register

31	30	29	28	27	26	25	24
RESERVED							
R-0h							
23	22	21	20	19	18	17	16
RESERVED				CSWROFFTIME			
R-0h				R/W-0h			
15	14	13	12	11	10	9	8
RESERVED				CSRDOFFTIME			
R-0h				R/W-0h			
7	6	5	4	3	2	1	0
CSEXTRAD ELAY	RESERVED			CSONTIME			
R/W-0h	R-0h			R/W-0h			

LEGEND: R/W = Read/Write; R = Read only; W1toCl = Write 1 to clear bit; -n = value after reset

Table 7-63. GPMC_CONFIG2_0 Register Field Descriptions

Bit	Field	Type	Reset	Description
31-21	RESERVED	R	0h	
20-16	CSWROFFTIME	R/W	0h	CS# de-assertion time from start cycle time for write accesses 0h = 0 GPMC_FCLK cycle 1h = 1 GPMC_FCLK cycle 1Fh = 31 GPMC_FCLK cycles
15-13	RESERVED	R	0h	
12-8	CSRDOFFTIME	R/W	0h	CS# de-assertion time from start cycle time for read accesses 0h = 0 GPMC_FCLK cycle 1h = 1 GPMC_FCLK cycle 1Fh = 31 GPMC_FCLK cycles
7	CSEXTRAD ELAY	R/W	0h	CS# Add Extra Half GPMC.FCLK cycle 0h = CS i Timing control signal is not delayed 1h = CS i Timing control signal is delayed of half GPMC_FCLK clock cycle
6-4	RESERVED	R	0h	
3-0	CSONTIME	R/W	0h	CS# assertion time from start cycle time 0h = 0 GPMC_FCLK cycle 1h = 1 GPMC_FCLK cycle 1Fh = 15 GPMC_FCLK cycles

7.1.6.13 GPMC_CONFIG3_0 Register (offset = 68h) [reset = 0h]

GPMC_CONFIG3_0 is shown in Figure 7-60 and described in Table 7-64.

ADV# signal timing parameter configuration.

Figure 7-60. GPMC_CONFIG3_0 Register

31	30	29	28	27	26	25	24
RESERVED	ADVAADMUXWROFFTIME			RESERVED	ADVAADMUXRDOFFTIME		
R-0h	R/W-0h			R-0h	R/W-0h		
23	22	21	20	19	18	17	16
RESERVED				ADVWROFFTIME			
R-0h				R/W-0h			
15	14	13	12	11	10	9	8
RESERVED				ADVRDOFFTIME			
R-0h				R/W-0h			
7	6	5	4	3	2	1	0
ADVEXTRA LAY	ADVAADMUXONTIME			ADVONTIME			
R/W-0h	R/W-0h			R/W-0h			

LEGEND: R/W = Read/Write; R = Read only; W1toCl = Write 1 to clear bit; -n = value after reset

Table 7-64. GPMC_CONFIG3_0 Register Field Descriptions

Bit	Field	Type	Reset	Description
31	RESERVED	R	0h	
30-28	ADVAADMUXWROFFTIME	R/W	0h	ADV# de-assertion for first address phase when using the AAD-Mux protocol 0h = 0 GPMC_FCLK cycle 1h = 1 GPMC_FCLK cycle 7h = 7 GPMC_FCLK cycles
27	RESERVED	R	0h	
26-24	ADVAADMUXRDOFFTIME	R/W	0h	ADV# assertion for first address phase when using the AAD-Mux protocol 0h = 0 GPMC_FCLK cycle 1h = 1 GPMC_FCLK cycle 7h = 7 GPMC_FCLK cycles
23-21	RESERVED	R	0h	
20-16	ADVWROFFTIME	R/W	0h	ADV# de-assertion time from start cycle time for write accesses 0h = 0 GPMC_FCLK cycle 1h = 1 GPMC_FCLK cycle 1Fh = 31 GPMC_FCLK cycles
15-13	RESERVED	R	0h	
12-8	ADVRDOFFTIME	R/W	0h	ADV# de-assertion time from start cycle time for read accesses 0h = 0 GPMC_FCLK cycle 1h = 1 GPMC_FCLK cycle 1Fh = 31 GPMC_FCLK cycles
7	ADVEXTRADELAY	R/W	0h	ADV# Add Extra Half GPMC.FCLK cycle 0h = ADV (active low) Timing control signal is not delayed 1h = ADV (active low) Timing control signal is delayed of half GPMC_FCLK clock cycle
6-4	ADVAADMUXONTIME	R/W	0h	ADV# assertion for first address phase when using the AAD-Multiplexed protocol 0h = 0 GPMC_FCLK cycle 1h = 1 GPMC_FCLK cycle 7h = 7 GPMC_FCLK cycles

Table 7-64. GPMC_CONFIG3_0 Register Field Descriptions (continued)

Bit	Field	Type	Reset	Description
3-0	ADVONTIME	R/W	0h	ADV# assertion time from start cycle time 0h = 0 GPMC_FCLK cycle 1h = 1 GPMC_FCLK cycle Fh = 15 GPMC_FCLK cycles

7.1.6.14 GPMC_CONFIG4_0 Register (offset = 6Ch) [reset = 0h]

GPMC_CONFIG4_0 is shown in [Figure 7-61](#) and described in [Table 7-65](#).

WE# and OE# signals timing parameter configuration.

Figure 7-61. GPMC_CONFIG4_0 Register

31	30	29	28	27	26	25	24
RESERVED				WEOFFTIME			
R-0h				R/W-0h			
23	22	21	20	19	18	17	16
WEEXTRADELAY	RESERVED			WEONTIME			
R/W-0h		R-0h		R/W-0h			
15	14	13	12	11	10	9	8
OEAADMUXOFFTIME				OEOFFTIME			
R/W-0h				R/W-0h			
7	6	5	4	3	2	1	0
OEEXTRADELAY	OEAADMUXONTIME			OEONTIME			
R/W-0h		R/W-0h		R/W-0h			

LEGEND: R/W = Read/Write; R = Read only; W1toCl = Write 1 to clear bit; -n = value after reset

Table 7-65. GPMC_CONFIG4_0 Register Field Descriptions

Bit	Field	Type	Reset	Description
31-29	RESERVED	R	0h	
28-24	WEOFFTIME	R/W	0h	WE# de-assertion time from start cycle time 0h = 0 GPMC_FCLK cycle 1h = 1 GPMC_FCLK cycle 1Fh = 31 GPMC_FCLK cycles
23	WEEXTRADELAY	R/W	0h	WE# Add Extra Half GPMC.FCLK cycle 0h = WE (active low) Timing control signal is not delayed 1h = WE (active low) Timing control signal is delayed of half GPMC_FCLK clock cycle
22-20	RESERVED	R	0h	
19-16	WEONTIME	R/W	0h	WE# assertion time from start cycle time 0h = 0 GPMC_FCLK cycle 1h = 1 GPMC_FCLK cycle Fh = 15 GPMC_FCLK cycles
15-13	OEAADMUXOFFTIME	R/W	0h	OE# de-assertion time for the first address phase in an AAD-Multiplexed access 0h = 0 GPMC_FCLK cycle 1h = 1 GPMC_FCLK cycle 7h = 7 GPMC_FCLK cycles
12-8	OEOFFTIME	R/W	0h	OE# de-assertion time from start cycle time 0h = 0 GPMC_FCLK cycle 1h = 1 GPMC_FCLK cycle 7h = 31 GPMC_FCLK cycles
7	OEEXTRADELAY	R/W	0h	OE# Add Extra Half GPMC.FCLK cycle 0h = OE (active low) Timing control signal is not delayed 1h = OE (active low) Timing control signal is delayed of half GPMC_FCLK clock cycle

Table 7-65. GPMC_CONFIG4_0 Register Field Descriptions (continued)

Bit	Field	Type	Reset	Description
6-4	OEAADMUXONTIME	R/W	0h	OE# assertion time for the first address phase in an AAD-Multiplexed access 0h = 0 GPMC_FCLK cycle 1h = 1 GPMC_FCLK cycle 7h = 7 GPMC_FCLK cycles
3-0	OEONTIME	R/W	0h	OE# assertion time from start cycle time 0h = 0 GPMC_FCLK cycle 1h = 1 GPMC_FCLK cycle Fh = 15 GPMC_FCLK cycles

7.1.6.15 GPMC_CONFIG5_0 Register (offset = 70h) [reset = 0h]

GPMC_CONFIG5_0 is shown in [Figure 7-62](#) and described in [Table 7-66](#).

RdAccessTime and CycleTime timing parameters configuration.

Figure 7-62. GPMC_CONFIG5_0 Register

31	30	29	28	27	26	25	24
RESERVED				PAGEBURSTACCESSTIME			
R-0h				R/W-0h			
23	22	21	20	19	18	17	16
RESERVED				RDACCESSTIME			
R-0h				R/W-0h			
15	14	13	12	11	10	9	8
RESERVED				WRCYCLETIME			
R-0h				R/W-0h			
7	6	5	4	3	2	1	0
RESERVED				RDCYCLETIME			
R-0h				R/W-0h			

LEGEND: R/W = Read/Write; R = Read only; W1toCl = Write 1 to clear bit; -n = value after reset

Table 7-66. GPMC_CONFIG5_0 Register Field Descriptions

Bit	Field	Type	Reset	Description
31-28	RESERVED	R	0h	
27-24	PAGEBURSTACCESSTIME	R/W	0h	Delay between successive words in a multiple access 0h = 0 GPMC_FCLK cycle 1h = 1 GPMC_FCLK cycle Fh = 15 GPMC_FCLK cycles
23-21	RESERVED	R	0h	
20-16	RDACCESSTIME	R/W	0h	Delay between start cycle time and first data valid 0h = 0 GPMC_FCLK cycle 1h = 1 GPMC_FCLK cycle 1Fh = 31 GPMC_FCLK cycles
15-13	RESERVED	R	0h	
12-8	WRCYCLETIME	R/W	0h	Total write cycle time 0h = 0 GPMC_FCLK cycle 1h = 1 GPMC_FCLK cycle 1Fh = 31 GPMC_FCLK cycles
7-5	RESERVED	R	0h	
4-0	RDCYCLETIME	R/W	0h	Total read cycle time 0h = 0 GPMC_FCLK cycle 1h = 1 GPMC_FCLK cycle 1Fh = 31 GPMC_FCLK cycles

7.1.6.16 GPMC_CONFIG6_0 Register (offset = 74h) [reset = F070000h]

GPMC_CONFIG6_0 is shown in Figure 7-63 and described in Table 7-67.

WrAccessTime, WrDataOnADmuxBus, Cycle2Cycle, and BusTurnAround parameters configuration

Figure 7-63. GPMC_CONFIG6_0 Register

31	30	29	28	27	26	25	24
RESERVED				WRACCESSTIME			
R-0h				R/W-Fh			
23	22	21	20	19	18	17	16
RESERVED				WRDATAONADMUXBUS			
R-0h				R/W-7h			
15	14	13	12	11	10	9	8
RESERVED				CYCLE2CYCLEDELAY			
R-0h				R/W-0h			
7	6	5	4	3	2	1	0
CYCLE2CYCL ESAMECSEN	CYCLE2CYCL EDIFFCSEN	RESERVED		BUSTURNAROUND			
R/W-0h	R/W-0h	R-0h		R/W-0h			

LEGEND: R/W = Read/Write; R = Read only; W1toCl = Write 1 to clear bit; -n = value after reset

Table 7-67. GPMC_CONFIG6_0 Register Field Descriptions

Bit	Field	Type	Reset	Description
31-29	RESERVED	R	0h	Reset value for bit 31 is 1.
28-24	WRACCESSTIME	R/W	Fh	Delay from StartAccessTime to the GPMC.FCLK rising edge corresponding the the GPMC.CLK rising edge used by the attached memory for the first data capture. Reset value is 0xF. 0h = 0 GPMC_FCLK cycle 1h = 1 GPMC_FCLK cycle 1Fh = 31 GPMC_FCLK cycles
23-20	RESERVED	R	0h	
19-16	WRDATAONADMUXBUS	R/W	7h	Specifies on which GPMC.FCLK rising edge the first data of the synchronous burst write is driven in the add/data multiplexed bus. Reset value is 0x7.
15-12	RESERVED	R	0h	
11-8	CYCLE2CYCLEDELAY	R/W	0h	Chip select high pulse delay between two successive accesses 0h = 0 GPMC_FCLK cycle 1h = 1 GPMC_FCLK cycle Fh = 15 GPMC_FCLK cycles
7	CYCLE2CYCLESAMECSEN	R/W	0h	Add Cycle2CycleDelay between two successive accesses to the same chip-select (any access type) 0h = No delay between the two accesses 1h = Add CYCLE2CYCLEDELAY
6	CYCLE2CYCLEDIFFCSEN	R/W	0h	Add Cycle2CycleDelay between two successive accesses to a different chip-select (any access type) 0h = No delay between the two accesses 1h = Add CYCLE2CYCLEDELAY
5-4	RESERVED	R	0h	
3-0	BUSTURNAROUND	R/W	0h	Bus turn around latency between two successive accesses to the same chip-select (read to write) or to a different chip-select (read to read and read to write) 0h = 0 GPMC_FCLK cycle 1h = 1 GPMC_FCLK cycle Fh = 15 GPMC_FCLK cycles

7.1.6.17 GPMC_CONFIG7_0 Register (offset = 78h) [reset = 0h]

GPMC_CONFIG7_0 is shown in [Figure 7-64](#) and described in [Table 7-68](#).

Chip-select address mapping configuration.

Figure 7-64. GPMC_CONFIG7_0 Register

31	30	29	28	27	26	25	24
RESERVED							
R-0h							
23	22	21	20	19	18	17	16
RESERVED							
R-0h							
15	14	13	12	11	10	9	8
RESERVED				MASKADDRESS			
R-0h				R/W-0h			
7	6	5	4	3	2	1	0
RESERVED	CSVALID	BASEADDRESS					
R-0h	R/W-0h	R/W-0h					

LEGEND: R/W = Read/Write; R = Read only; W1toCl = Write 1 to clear bit; -n = value after reset

Table 7-68. GPMC_CONFIG7_0 Register Field Descriptions

Bit	Field	Type	Reset	Description
31-12	RESERVED	R	0h	
11-8	MASKADDRESS	R/W	0h	Chip-select mask address. Values not listed must be avoided as they create holes in the chip-select address space. 0h = Chip-select size of 256 Mbytes 8h = Chip-select size of 128 Mbytes Ch = Chip-select size of 64 Mbytes Eh = Chip-select size of 32 Mbytes Fh = Chip-select size of 16 Mbytes
7	RESERVED	R	0h	
6	CSVALID	R/W	0h	Chip-select enable (reset value is 1 for CS[0] (active low) and 0 for CS[1] to CS[5] (active low)). 0h = CS (active low) disabled 1h = CS (active low) enabled
5-0	BASEADDRESS	R/W	0h	Chip-select base address. CSi base address where i = 0 to 3 (16 Mbytes minimum granularity). Bits 5 to 0 correspond to A29, A28, A27, A26, A25, and A24.

7.1.6.18 GPMC_NAND_COMMAND_0 Register (offset = 7Ch) [reset = 0h]

GPMC_NAND_COMMAND_0 is shown in [Figure 7-65](#) and described in [Table 7-69](#).

This register is not a true register, just an address location.

Figure 7-65. GPMC_NAND_COMMAND_0 Register

31	30	29	28	27	26	25	24	23	22	21	20	19	18	17	16	15	14	13	12	11	10	9	8	7	6	5	4	3	2	1	0
GPMC_NAND_COMMAND_0																															
W-0h																															

LEGEND: R/W = Read/Write; R = Read only; W1toCl = Write 1 to clear bit; -n = value after reset

Table 7-69. GPMC_NAND_COMMAND_0 Register Field Descriptions

Bit	Field	Type	Reset	Description
31-0	GPMC_NAND_COMMAND_0	W	0h	Writing data at the GPMC_NAND_COMMAND_0 location places the data as the NAND command value on the bus, using a regular asynchronous write access.

7.1.6.19 GPMC_NAND_ADDRESS_0 Register (offset = 80h) [reset = 0h]

GPMC_NAND_ADDRESS_0 is shown in [Figure 7-66](#) and described in [Table 7-70](#).

This register is not a true register, just an address location.

Figure 7-66. GPMC_NAND_ADDRESS_0 Register

31	30	29	28	27	26	25	24	23	22	21	20	19	18	17	16	15	14	13	12	11	10	9	8	7	6	5	4	3	2	1	0
GPMC_NAND_ADDRESS_0																															
W-0h																															

LEGEND: R/W = Read/Write; R = Read only; W1toCl = Write 1 to clear bit; -n = value after reset

Table 7-70. GPMC_NAND_ADDRESS_0 Register Field Descriptions

Bit	Field	Type	Reset	Description
31-0	GPMC_NAND_ADDRESS_0	W	0h	Writing data at the GPMC_NAND_ADDRESS_0 location places the data as the NAND partial address value on the bus, using a regular asynchronous write access.

7.1.6.20 GPMC_NAND_DATA_0 Register (offset = 84h) [reset = 0h]

GPMC_NAND_DATA_0 is shown in [Figure 7-67](#) and described in [Table 7-71](#).

This register is not a true register, just an address location.

Figure 7-67. GPMC_NAND_DATA_0 Register

31	30	29	28	27	26	25	24	23	22	21	20	19	18	17	16	15	14	13	12	11	10	9	8	7	6	5	4	3	2	1	0
GPMC_NAND_DATA_0																															
R/W-0h																															

LEGEND: R/W = Read/Write; R = Read only; W1toCl = Write 1 to clear bit; -n = value after reset

Table 7-71. GPMC_NAND_DATA_0 Register Field Descriptions

Bit	Field	Type	Reset	Description
31-0	GPMC_NAND_DATA_0	R/W	0h	Reading data from the GPMC_NAND_DATA_0 location or from any location in the associated chip-select memory region activates an asynchronous read access.

7.1.6.21 GPMC_CONFIG1_1 Register (offset = 90h) [reset = 0h]

GPMC_CONFIG1_1 is shown in [Figure 7-68](#) and described in [Table 7-72](#).

The configuration 1 register sets signal control parameters per chip select.

Figure 7-68. GPMC_CONFIG1_1 Register

31	30	29	28	27	26	25	24
WRAPBURST	READMULTIPLE	READTYPE	WRITEMULTIPLE	WRITETYPE	CLKACTIVATIONTIME	ATTACHEDDEVICEPAGELENGTH	
R/W-0h	R/W-0h	R/W-0h	R/W-0h	R/W-0h	R/W-0h	R/W-0h	
23	22	21	20	19	18	17	16
ATTACHEDDEVICEPAGELENGTH	WAITREADMONITORING	WAITWRITEMONITORING	RESERVED	WAITMONITORINGTIME		WAITPINSELECT	
R/W-0h	R/W-0h	R/W-0h	R-0h	R/W-0h		R/W-0h	
15	14	13	12	11	10	9	8
RESERVED		DEVICESIZE		DEVICETYPE		MUXADDDATA	
R-0h		R/W-0h		R/W-0h		R/W-0h	
7	6	5	4	3	2	1	0
RESERVED			TIMEPARAGRANULARITY	RESERVED		GPMCFCLKDIVIDER	
R-0h			R/W-0h	R-0h		R/W-0h	

LEGEND: R/W = Read/Write; R = Read only; W1toCl = Write 1 to clear bit; -n = value after reset

Table 7-72. GPMC_CONFIG1_1 Register Field Descriptions

Bit	Field	Type	Reset	Description
31	WRAPBURST	R/W	0h	Enables the wrapping burst capability. Must be set if the attached device is configured in wrapping burst 0h = Synchronous wrapping burst not supported 1h = Synchronous wrapping burst supported
30	READMULTIPLE	R/W	0h	Selects the read single or multiple access 0h = single access 1h = multiple access (burst if synchronous, page if asynchronous)
29	READTYPE	R/W	0h	Selects the read mode operation 0h = Read Asynchronous 1h = Read Synchronous
28	WRITEMULTIPLE	R/W	0h	Selects the write single or multiple access 0h = Single access 1h = Multiple access (burst if synchronous, considered as single if asynchronous)
27	WRITETYPE	R/W	0h	Selects the write mode operation 0h = Write Asynchronous 1h = Write Synchronous
26-25	CLKACTIVATIONTIME	R/W	0h	Output GPMC.CLK activation time 0h = First rising edge of GPMC_CLK at start access time 1h = First rising edge of GPMC_CLK one GPMC_FCLK cycle after start access time 2h = First rising edge of GPMC_CLK two GPMC_FCLK cycles after start access time 3h = Reserved

Table 7-72. GPMC_CONFIG1_1 Register Field Descriptions (continued)

Bit	Field	Type	Reset	Description
24-23	ATTACHEDDEVICEPAGELENGTH	R/W	0h	Specifies the attached device page (burst) length (1 Word = Interface size) 0h = 4 Words 1h = 8 Words 2h = 16 Words 3h = Reserved
22	WAITREADMONITORING	R/W	0h	Selects the Wait monitoring configuration for Read accesses. 0h = WAIT pin is not monitored for read accesses 1h = WAIT pin is monitored for read accesses
21	WAITWRITEMONITORING	R/W	0h	Selects the Wait monitoring configuration for Write accesses 0h = WAIT pin is not monitored for write accesses 1h = WAIT pin is monitored for write accesses
20	RESERVED	R	0h	
19-18	WAITMONITORINGTIME	R/W	0h	Selects input pin Wait monitoring time 0h = WAIT pin is monitored with valid data 1h = WAIT pin is monitored one GPMC_CLK cycle before valid data 2h = WAIT pin is monitored two GPMC_CLK cycle before valid data 3h = Reserved
17-16	WAITPINSELECT	R/W	0h	Selects the input WAIT pin for this chip select. 0h = WAIT input pin is WAIT0 1h = WAIT input pin is WAIT1 2h = Reserved 3h = Reserved
15-14	RESERVED	R	0h	
13-12	DEVICESTYPE	R/W	0h	Selects the device size attached (Reset value is SYSBOOT[8] input pin sampled at IC reset for CS[0] (active low) and 01 for CS[1] to CS[6] (active low)). 0h = 8 bit 1h = 16 bit 2h = Reserved 3h = Reserved
11-10	DEVICETYPE	R/W	0h	Selects the attached device type. 0h = NOR Flash like, asynchronous and synchronous devices 1h = Reserved 2h = NAND Flash like devices, stream mode 3h = Reserved
9-8	MUXADDDATA	R/W	0h	Enables the Address and data multiplexed protocol (Reset value is SYSBOOT[11] and SYSBOOT[10] input pins sampled at IC reset for CS[0] (active low) and 0 for CS[1] to CS[6] (active low)). 0h = Non-multiplexed attached device 1h = AAD-multiplexed protocol device 2h = Address and data multiplexed attached device 3h = Reserved
7-5	RESERVED	R	0h	
4	TIMEPARAGRANULARITY	R/W	0h	Signals timing latencies scalar factor (Rd/WRCycleTime, AccessTime, PageBurstAccessTime, CSOnTime, CSRd/WrOffTime, ADVOnTime, ADVRd/WrOffTime, OEOnTime, OEOffTime, WEOnTime, WEOffTime, Cycle2CycleDelay, BusTurnAround, TimeOutStartValue) 0h = x1 latencies 1h = x2 latencies
3-2	RESERVED	R	0h	

Table 7-72. GPMC_CONFIG1_1 Register Field Descriptions (continued)

Bit	Field	Type	Reset	Description
1-0	GPMCFCLKDIVIDER	R/W	0h	Divides the GPMC.FCLK clock. 0h = GPMC_CLK frequency = GPMC_FCLK frequency 1h = GPMC_CLK frequency = GPMC_FCLK frequency/2 2h = GPMC_CLK frequency = GPMC_FCLK frequency/3 3h = GPMC_CLK frequency = GPMC_FCLK frequency/4

7.1.6.22 GPMC_CONFIG2_1 Register (offset = 94h) [reset = 0h]

GPMC_CONFIG2_1 is shown in [Figure 7-69](#) and described in [Table 7-73](#).

Chip-select signal timing parameter configuration.

Figure 7-69. GPMC_CONFIG2_1 Register

31	30	29	28	27	26	25	24
RESERVED							
R-0h							
23	22	21	20	19	18	17	16
RESERVED				CSWROFFTIME			
R-0h				R/W-0h			
15	14	13	12	11	10	9	8
RESERVED				CSRDOFFTIME			
R-0h				R/W-0h			
7	6	5	4	3	2	1	0
CSEXTRAD ELAY	RESERVED			CSONTIME			
R/W-0h	R-0h			R/W-0h			

LEGEND: R/W = Read/Write; R = Read only; W1toCl = Write 1 to clear bit; -n = value after reset

Table 7-73. GPMC_CONFIG2_1 Register Field Descriptions

Bit	Field	Type	Reset	Description
31-21	RESERVED	R	0h	
20-16	CSWROFFTIME	R/W	0h	CS# de-assertion time from start cycle time for write accesses 0h = 0 GPMC_FCLK cycle 1h = 1 GPMC_FCLK cycle 1Fh = 31 GPMC_FCLK cycles
15-13	RESERVED	R	0h	
12-8	CSRDOFFTIME	R/W	0h	CS# de-assertion time from start cycle time for read accesses 0h = 0 GPMC_FCLK cycle 1h = 1 GPMC_FCLK cycle 1Fh = 31 GPMC_FCLK cycles
7	CSEXTRAD ELAY	R/W	0h	CS# Add Extra Half GPMC.FCLK cycle 0h = CS i Timing control signal is not delayed 1h = CS i Timing control signal is delayed of half GPMC_FCLK clock cycle
6-4	RESERVED	R	0h	
3-0	CSONTIME	R/W	0h	CS# assertion time from start cycle time 0h = 0 GPMC_FCLK cycle 1h = 1 GPMC_FCLK cycle 1Fh = 15 GPMC_FCLK cycles

7.1.6.23 GPMC_CONFIG3_1 Register (offset = 98h) [reset = 0h]

GPMC_CONFIG3_1 is shown in [Figure 7-70](#) and described in [Table 7-74](#).

ADV# signal timing parameter configuration.

Figure 7-70. GPMC_CONFIG3_1 Register

31	30	29	28	27	26	25	24
RESERVED	ADVAADMUXWROFFTIME			RESERVED	ADVAADMUXRDOFFTIME		
R-0h	R/W-0h			R-0h	R/W-0h		
23	22	21	20	19	18	17	16
RESERVED				ADVWROFFTIME			
R-0h				R/W-0h			
15	14	13	12	11	10	9	8
RESERVED				ADVRDOFFTIME			
R-0h				R/W-0h			
7	6	5	4	3	2	1	0
ADVEXTRA LAY	ADVAADMUXONTIME			ADVONTIME			
R/W-0h	R/W-0h			R/W-0h			

LEGEND: R/W = Read/Write; R = Read only; W1toCl = Write 1 to clear bit; -n = value after reset

Table 7-74. GPMC_CONFIG3_1 Register Field Descriptions

Bit	Field	Type	Reset	Description
31	RESERVED	R	0h	
30-28	ADVAADMUXWROFFTIME	R/W	0h	ADV# de-assertion for first address phase when using the AAD-Mux protocol 0h = 0 GPMC_FCLK cycle 1h = 1 GPMC_FCLK cycle 7h = 7 GPMC_FCLK cycles
27	RESERVED	R	0h	
26-24	ADVAADMUXRDOFFTIME	R/W	0h	ADV# assertion for first address phase when using the AAD-Mux protocol 0h = 0 GPMC_FCLK cycle 1h = 1 GPMC_FCLK cycle 7h = 7 GPMC_FCLK cycles
23-21	RESERVED	R	0h	
20-16	ADVWROFFTIME	R/W	0h	ADV# de-assertion time from start cycle time for write accesses 0h = 0 GPMC_FCLK cycle 1h = 1 GPMC_FCLK cycle 1Fh = 31 GPMC_FCLK cycles
15-13	RESERVED	R	0h	
12-8	ADVRDOFFTIME	R/W	0h	ADV# de-assertion time from start cycle time for read accesses 0h = 0 GPMC_FCLK cycle 1h = 1 GPMC_FCLK cycle 1Fh = 31 GPMC_FCLK cycles
7	ADVEXTRADELAY	R/W	0h	ADV# Add Extra Half GPMC.FCLK cycle 0h = ADV (active low) Timing control signal is not delayed 1h = ADV (active low) Timing control signal is delayed of half GPMC_FCLK clock cycle
6-4	ADVAADMUXONTIME	R/W	0h	ADV# assertion for first address phase when using the AAD-Multiplexed protocol 0h = 0 GPMC_FCLK cycle 1h = 1 GPMC_FCLK cycle 7h = 7 GPMC_FCLK cycles

Table 7-74. GPMC_CONFIG3_1 Register Field Descriptions (continued)

Bit	Field	Type	Reset	Description
3-0	ADVONTIME	R/W	0h	ADV# assertion time from start cycle time 0h = 0 GPMC_FCLK cycle 1h = 1 GPMC_FCLK cycle Fh = 15 GPMC_FCLK cycles

7.1.6.24 GPMC_CONFIG4_1 Register (offset = 9Ch) [reset = 0h]

GPMC_CONFIG4_1 is shown in [Figure 7-71](#) and described in [Table 7-75](#).

WE# and OE# signals timing parameter configuration.

Figure 7-71. GPMC_CONFIG4_1 Register

31	30	29	28	27	26	25	24
RESERVED				WEOFFTIME			
R-0h				R/W-0h			
23	22	21	20	19	18	17	16
WEEXTRADELAY	RESERVED			WEONTIME			
R/W-0h		R-0h		R/W-0h			
15	14	13	12	11	10	9	8
OEAADMUXOFFTIME				OEOFFTIME			
R/W-0h				R/W-0h			
7	6	5	4	3	2	1	0
OEEXTRADELAY	OEAADMUXONTIME			OEONTIME			
R/W-0h		R/W-0h		R/W-0h			

LEGEND: R/W = Read/Write; R = Read only; W1toCl = Write 1 to clear bit; -n = value after reset

Table 7-75. GPMC_CONFIG4_1 Register Field Descriptions

Bit	Field	Type	Reset	Description
31-29	RESERVED	R	0h	
28-24	WEOFFTIME	R/W	0h	WE# de-assertion time from start cycle time 0h = 0 GPMC_FCLK cycle 1h = 1 GPMC_FCLK cycle 1Fh = 31 GPMC_FCLK cycles
23	WEEXTRADELAY	R/W	0h	WE# Add Extra Half GPMC.FCLK cycle 0h = WE (active low) Timing control signal is not delayed 1h = WE (active low) Timing control signal is delayed of half GPMC_FCLK clock cycle
22-20	RESERVED	R	0h	
19-16	WEONTIME	R/W	0h	WE# assertion time from start cycle time 0h = 0 GPMC_FCLK cycle 1h = 1 GPMC_FCLK cycle Fh = 15 GPMC_FCLK cycles
15-13	OEAADMUXOFFTIME	R/W	0h	OE# de-assertion time for the first address phase in an AAD-Multiplexed access 0h = 0 GPMC_FCLK cycle 1h = 1 GPMC_FCLK cycle 7h = 7 GPMC_FCLK cycles
12-8	OEOFFTIME	R/W	0h	OE# de-assertion time from start cycle time 0h = 0 GPMC_FCLK cycle 1h = 1 GPMC_FCLK cycle 7h = 31 GPMC_FCLK cycles
7	OEEXTRADELAY	R/W	0h	OE# Add Extra Half GPMC.FCLK cycle 0h = OE (active low) Timing control signal is not delayed 1h = OE (active low) Timing control signal is delayed of half GPMC_FCLK clock cycle

Table 7-75. GPMC_CONFIG4_1 Register Field Descriptions (continued)

Bit	Field	Type	Reset	Description
6-4	OEAADMUXONTIME	R/W	0h	OE# assertion time for the first address phase in an AAD-Multiplexed access 0h = 0 GPMC_FCLK cycle 1h = 1 GPMC_FCLK cycle 7h = 7 GPMC_FCLK cycles
3-0	OEONTIME	R/W	0h	OE# assertion time from start cycle time 0h = 0 GPMC_FCLK cycle 1h = 1 GPMC_FCLK cycle Fh = 15 GPMC_FCLK cycles

7.1.6.25 GPMC_CONFIG5_1 Register (offset = A0h) [reset = 0h]

GPMC_CONFIG5_1 is shown in [Figure 7-72](#) and described in [Table 7-76](#).

RdAccessTime and CycleTime timing parameters configuration.

Figure 7-72. GPMC_CONFIG5_1 Register

31	30	29	28	27	26	25	24
RESERVED				PAGEBURSTACCESSTIME			
R-0h				R/W-0h			
23	22	21	20	19	18	17	16
RESERVED				RDACCESSTIME			
R-0h				R/W-0h			
15	14	13	12	11	10	9	8
RESERVED				WRCYCLETIME			
R-0h				R/W-0h			
7	6	5	4	3	2	1	0
RESERVED				RDCYCLETIME			
R-0h				R/W-0h			

LEGEND: R/W = Read/Write; R = Read only; W1toCl = Write 1 to clear bit; -n = value after reset

Table 7-76. GPMC_CONFIG5_1 Register Field Descriptions

Bit	Field	Type	Reset	Description
31-28	RESERVED	R	0h	
27-24	PAGEBURSTACCESSTIME	R/W	0h	Delay between successive words in a multiple access 0h = 0 GPMC_FCLK cycle 1h = 1 GPMC_FCLK cycle Fh = 15 GPMC_FCLK cycles
23-21	RESERVED	R	0h	
20-16	RDACCESSTIME	R/W	0h	Delay between start cycle time and first data valid 0h = 0 GPMC_FCLK cycle 1h = 1 GPMC_FCLK cycle 1Fh = 31 GPMC_FCLK cycles
15-13	RESERVED	R	0h	
12-8	WRCYCLETIME	R/W	0h	Total write cycle time 0h = 0 GPMC_FCLK cycle 1h = 1 GPMC_FCLK cycle 1Fh = 31 GPMC_FCLK cycles
7-5	RESERVED	R	0h	
4-0	RDCYCLETIME	R/W	0h	Total read cycle time 0h = 0 GPMC_FCLK cycle 1h = 1 GPMC_FCLK cycle 1Fh = 31 GPMC_FCLK cycles

7.1.6.26 GPMC_CONFIG6_1 Register (offset = A4h) [reset = F070000h]

GPMC_CONFIG6_1 is shown in Figure 7-73 and described in Table 7-77.

WrAccessTime, WrDataOnADmuxBus, Cycle2Cycle, and BusTurnAround parameters configuration

Figure 7-73. GPMC_CONFIG6_1 Register

31	30	29	28	27	26	25	24
RESERVED				WRACCESSTIME			
R-0h				R/W-Fh			
23	22	21	20	19	18	17	16
RESERVED				WRDATAONADMUXBUS			
R-0h				R/W-7h			
15	14	13	12	11	10	9	8
RESERVED				CYCLE2CYCLEDELAY			
R-0h				R/W-0h			
7	6	5	4	3	2	1	0
CYCLE2CYCL ESAMECSEN	CYCLE2CYCL EDIFFCSEN	RESERVED		BUSTURNAROUND			
R/W-0h	R/W-0h	R-0h		R/W-0h			

LEGEND: R/W = Read/Write; R = Read only; W1toCl = Write 1 to clear bit; -n = value after reset

Table 7-77. GPMC_CONFIG6_1 Register Field Descriptions

Bit	Field	Type	Reset	Description
31-29	RESERVED	R	0h	Reset value for bit 31 is 1.
28-24	WRACCESSTIME	R/W	Fh	Delay from StartAccessTime to the GPMC.FCLK rising edge corresponding the the GPMC.CLK rising edge used by the attached memory for the first data capture. Reset value is 0xF. 0h = 0 GPMC_FCLK cycle 1h = 1 GPMC_FCLK cycle 1Fh = 31 GPMC_FCLK cycles
23-20	RESERVED	R	0h	
19-16	WRDATAONADMUXBUS	R/W	7h	Specifies on which GPMC.FCLK rising edge the first data of the synchronous burst write is driven in the add/data multiplexed bus. Reset value is 0x7.
15-12	RESERVED	R	0h	
11-8	CYCLE2CYCLEDELAY	R/W	0h	Chip select high pulse delay between two successive accesses 0h = 0 GPMC_FCLK cycle 1h = 1 GPMC_FCLK cycle Fh = 15 GPMC_FCLK cycles
7	CYCLE2CYCLESAMECSEN	R/W	0h	Add Cycle2CycleDelay between two successive accesses to the same chip-select (any access type) 0h = No delay between the two accesses 1h = Add CYCLE2CYCLEDELAY
6	CYCLE2CYCLEDIFFCSEN	R/W	0h	Add Cycle2CycleDelay between two successive accesses to a different chip-select (any access type) 0h = No delay between the two accesses 1h = Add CYCLE2CYCLEDELAY
5-4	RESERVED	R	0h	
3-0	BUSTURNAROUND	R/W	0h	Bus turn around latency between two successive accesses to the same chip-select (read to write) or to a different chip-select (read to read and read to write) 0h = 0 GPMC_FCLK cycle 1h = 1 GPMC_FCLK cycle Fh = 15 GPMC_FCLK cycles

7.1.6.27 GPMC_CONFIG7_1 Register (offset = A8h) [reset = 0h]

GPMC_CONFIG7_1 is shown in [Figure 7-74](#) and described in [Table 7-78](#).

Chip-select address mapping configuration.

Figure 7-74. GPMC_CONFIG7_1 Register

31	30	29	28	27	26	25	24
RESERVED							
R-0h							
23	22	21	20	19	18	17	16
RESERVED							
R-0h							
15	14	13	12	11	10	9	8
RESERVED				MASKADDRESS			
R-0h				R/W-0h			
7	6	5	4	3	2	1	0
RESERVED	CSVALID	BASEADDRESS					
R-0h	R/W-0h	R/W-0h					

LEGEND: R/W = Read/Write; R = Read only; W1toCl = Write 1 to clear bit; -n = value after reset

Table 7-78. GPMC_CONFIG7_1 Register Field Descriptions

Bit	Field	Type	Reset	Description
31-12	RESERVED	R	0h	
11-8	MASKADDRESS	R/W	0h	Chip-select mask address. Values not listed must be avoided as they create holes in the chip-select address space. 0h = Chip-select size of 256 Mbytes 8h = Chip-select size of 128 Mbytes Ch = Chip-select size of 64 Mbytes Eh = Chip-select size of 32 Mbytes Fh = Chip-select size of 16 Mbytes
7	RESERVED	R	0h	
6	CSVALID	R/W	0h	Chip-select enable (reset value is 1 for CS[0] (active low) and 0 for CS[1] to CS[5] (active low)). 0h = CS (active low) disabled 1h = CS (active low) enabled
5-0	BASEADDRESS	R/W	0h	Chip-select base address. CSi base address where i = 0 to 3 (16 Mbytes minimum granularity). Bits 5 to 0 correspond to A29, A28, A27, A26, A25, and A24.

7.1.6.28 GPMC_NAND_COMMAND_1 Register (offset = ACh) [reset = 0h]

GPMC_NAND_COMMAND_1 is shown in [Figure 7-75](#) and described in [Table 7-79](#).

This register is not a true register, just an address location.

Figure 7-75. GPMC_NAND_COMMAND_1 Register

31	30	29	28	27	26	25	24	23	22	21	20	19	18	17	16	15	14	13	12	11	10	9	8	7	6	5	4	3	2	1	0
GPMC_NAND_COMMAND_1																															
W-0h																															

LEGEND: R/W = Read/Write; R = Read only; W1toCl = Write 1 to clear bit; -n = value after reset

Table 7-79. GPMC_NAND_COMMAND_1 Register Field Descriptions

Bit	Field	Type	Reset	Description
31-0	GPMC_NAND_COMMAND_1	W	0h	Writing data at the GPMC_NAND_COMMAND_1 location places the data as the NAND command value on the bus, using a regular asynchronous write access.

7.1.6.29 GPMC_NAND_ADDRESS_1 Register (offset = B0h) [reset = 0h]

GPMC_NAND_ADDRESS_1 is shown in [Figure 7-76](#) and described in [Table 7-80](#).

This register is not a true register, just an address location.

Figure 7-76. GPMC_NAND_ADDRESS_1 Register

31	30	29	28	27	26	25	24	23	22	21	20	19	18	17	16	15	14	13	12	11	10	9	8	7	6	5	4	3	2	1	0
GPMC_NAND_ADDRESS_1																															
W-0h																															

LEGEND: R/W = Read/Write; R = Read only; W1toCl = Write 1 to clear bit; -n = value after reset

Table 7-80. GPMC_NAND_ADDRESS_1 Register Field Descriptions

Bit	Field	Type	Reset	Description
31-0	GPMC_NAND_ADDRESS_1	W	0h	Writing data at the GPMC_NAND_ADDRESS_1 location places the data as the NAND partial address value on the bus, using a regular asynchronous write access.

7.1.6.30 GPMC_NAND_DATA_1 Register (offset = B4h) [reset = 0h]

GPMC_NAND_DATA_1 is shown in [Figure 7-77](#) and described in [Table 7-81](#).

This register is not a true register, just an address location.

Figure 7-77. GPMC_NAND_DATA_1 Register

31	30	29	28	27	26	25	24	23	22	21	20	19	18	17	16	15	14	13	12	11	10	9	8	7	6	5	4	3	2	1	0
GPMC_NAND_DATA_1																															
R/W-0h																															

LEGEND: R/W = Read/Write; R = Read only; W1toCl = Write 1 to clear bit; -n = value after reset

Table 7-81. GPMC_NAND_DATA_1 Register Field Descriptions

Bit	Field	Type	Reset	Description
31-0	GPMC_NAND_DATA_1	R/W	0h	Reading data from the GPMC_NAND_DATA_1 location or from any location in the associated chip-select memory region activates an asynchronous read access.

7.1.6.31 GPMC_CONFIG1_2 Register (offset = C0h) [reset = 0h]

GPMC_CONFIG1_2 is shown in [Figure 7-78](#) and described in [Table 7-82](#).

The configuration 1 register sets signal control parameters per chip select.

Figure 7-78. GPMC_CONFIG1_2 Register

31	30	29	28	27	26	25	24
WRAPBURST	READMULTIPLE	READTYPE	WRITEMULTIPLE	WRITETYPE	CLKACTIVATIONTIME	ATTACHEDDEVICEPAGELENGTH	
R/W-0h	R/W-0h	R/W-0h	R/W-0h	R/W-0h	R/W-0h	R/W-0h	
23	22	21	20	19	18	17	16
ATTACHEDDEVICEPAGELENGTH	WAITREADMONITORING	WAITWRITEMONITORING	RESERVED	WAITMONITORINGTIME		WAITPINSELECT	
R/W-0h	R/W-0h	R/W-0h	R-0h	R/W-0h		R/W-0h	
15	14	13	12	11	10	9	8
RESERVED		DEVICESTRATEGY	DEVICESTRATEGY	DEVICESTRATEGY	DEVICESTRATEGY	MUXADDDATA	
R-0h		R/W-0h	R/W-0h	R/W-0h	R/W-0h	R/W-0h	
7	6	5	4	3	2	1	0
RESERVED	RESERVED	TIMEPARAGRANULARITY	RESERVED	RESERVED	RESERVED	GPMCFCLKDIVIDER	
R-0h	R-0h	R/W-0h	R/W-0h	R-0h	R-0h	R/W-0h	

LEGEND: R/W = Read/Write; R = Read only; W1toCl = Write 1 to clear bit; -n = value after reset

Table 7-82. GPMC_CONFIG1_2 Register Field Descriptions

Bit	Field	Type	Reset	Description
31	WRAPBURST	R/W	0h	Enables the wrapping burst capability. Must be set if the attached device is configured in wrapping burst 0h = Synchronous wrapping burst not supported 1h = Synchronous wrapping burst supported
30	READMULTIPLE	R/W	0h	Selects the read single or multiple access 0h = single access 1h = multiple access (burst if synchronous, page if asynchronous)
29	READTYPE	R/W	0h	Selects the read mode operation 0h = Read Asynchronous 1h = Read Synchronous
28	WRITEMULTIPLE	R/W	0h	Selects the write single or multiple access 0h = Single access 1h = Multiple access (burst if synchronous, considered as single if asynchronous)
27	WRITETYPE	R/W	0h	Selects the write mode operation 0h = Write Asynchronous 1h = Write Synchronous
26-25	CLKACTIVATIONTIME	R/W	0h	Output GPMC.CLK activation time 0h = First rising edge of GPMC_CLK at start access time 1h = First rising edge of GPMC_CLK one GPMC_FCLK cycle after start access time 2h = First rising edge of GPMC_CLK two GPMC_FCLK cycles after start access time 3h = Reserved

Table 7-82. GPMC_CONFIG1_2 Register Field Descriptions (continued)

Bit	Field	Type	Reset	Description
24-23	ATTACHEDDEVICEPAGELENGTH	R/W	0h	Specifies the attached device page (burst) length (1 Word = Interface size) 0h = 4 Words 1h = 8 Words 2h = 16 Words 3h = Reserved
22	WAITREADMONITORING	R/W	0h	Selects the Wait monitoring configuration for Read accesses. 0h = WAIT pin is not monitored for read accesses 1h = WAIT pin is monitored for read accesses
21	WAITWRITEMONITORING	R/W	0h	Selects the Wait monitoring configuration for Write accesses 0h = WAIT pin is not monitored for write accesses 1h = WAIT pin is monitored for write accesses
20	RESERVED	R	0h	
19-18	WAITMONITORINGTIME	R/W	0h	Selects input pin Wait monitoring time 0h = WAIT pin is monitored with valid data 1h = WAIT pin is monitored one GPMC_CLK cycle before valid data 2h = WAIT pin is monitored two GPMC_CLK cycle before valid data 3h = Reserved
17-16	WAITPINSELECT	R/W	0h	Selects the input WAIT pin for this chip select. 0h = WAIT input pin is WAIT0 1h = WAIT input pin is WAIT1 2h = Reserved 3h = Reserved
15-14	RESERVED	R	0h	
13-12	DEVICESTYPE	R/W	0h	Selects the device size attached (Reset value is SYSBOOT[8] input pin sampled at IC reset for CS[0] (active low) and 01 for CS[1] to CS[6] (active low)). 0h = 8 bit 1h = 16 bit 2h = Reserved 3h = Reserved
11-10	DEVICETYPE	R/W	0h	Selects the attached device type. 0h = NOR Flash like, asynchronous and synchronous devices 1h = Reserved 2h = NAND Flash like devices, stream mode 3h = Reserved
9-8	MUXADDDATA	R/W	0h	Enables the Address and data multiplexed protocol (Reset value is SYSBOOT[11] and SYSBOOT[10] input pins sampled at IC reset for CS[0] (active low) and 0 for CS[1] to CS[6] (active low)). 0h = Non-multiplexed attached device 1h = AAD-multiplexed protocol device 2h = Address and data multiplexed attached device 3h = Reserved
7-5	RESERVED	R	0h	
4	TIMEPARAGRANULARITY	R/W	0h	Signals timing latencies scalar factor (Rd/WRCycleTime, AccessTime, PageBurstAccessTime, CSOnTime, CSRd/WrOffTime, ADVOnTime, ADVRd/WrOffTime, OEOnTime, OEOffTime, WEOnTime, WEOffTime, Cycle2CycleDelay, BusTurnAround, TimeOutStartValue). 0h = x1 latencies 1h = x2 latencies
3-2	RESERVED	R	0h	

Table 7-82. GPMC_CONFIG1_2 Register Field Descriptions (continued)

Bit	Field	Type	Reset	Description
1-0	GPMCFCLKDIVIDER	R/W	0h	Divides the GPMC.FCLK clock. 0h = GPMC_CLK frequency = GPMC_FCLK frequency 1h = GPMC_CLK frequency = GPMC_FCLK frequency/2 2h = GPMC_CLK frequency = GPMC_FCLK frequency/3 3h = GPMC_CLK frequency = GPMC_FCLK frequency/4

7.1.6.32 GPMC_CONFIG2_2 Register (offset = C4h) [reset = 0h]

GPMC_CONFIG2_2 is shown in [Figure 7-79](#) and described in [Table 7-83](#).

Chip-select signal timing parameter configuration.

Figure 7-79. GPMC_CONFIG2_2 Register

31	30	29	28	27	26	25	24
RESERVED							
R-0h							
23	22	21	20	19	18	17	16
RESERVED				CSWROFFTIME			
R-0h				R/W-0h			
15	14	13	12	11	10	9	8
RESERVED				CSRDOFFTIME			
R-0h				R/W-0h			
7	6	5	4	3	2	1	0
CSEXTRAD ELAY	RESERVED			CSONTIME			
R/W-0h	R-0h			R/W-0h			

LEGEND: R/W = Read/Write; R = Read only; W1toCl = Write 1 to clear bit; -n = value after reset

Table 7-83. GPMC_CONFIG2_2 Register Field Descriptions

Bit	Field	Type	Reset	Description
31-21	RESERVED	R	0h	
20-16	CSWROFFTIME	R/W	0h	CS# de-assertion time from start cycle time for write accesses 0h = 0 GPMC_FCLK cycle 1h = 1 GPMC_FCLK cycle 1Fh = 31 GPMC_FCLK cycles
15-13	RESERVED	R	0h	
12-8	CSRDOFFTIME	R/W	0h	CS# de-assertion time from start cycle time for read accesses 0h = 0 GPMC_FCLK cycle 1h = 1 GPMC_FCLK cycle 1Fh = 31 GPMC_FCLK cycles
7	CSEXTRAD ELAY	R/W	0h	CS# Add Extra Half GPMC.FCLK cycle 0h = CS i Timing control signal is not delayed 1h = CS i Timing control signal is delayed of half GPMC_FCLK clock cycle
6-4	RESERVED	R	0h	
3-0	CSONTIME	R/W	0h	CS# assertion time from start cycle time 0h = 0 GPMC_FCLK cycle 1h = 1 GPMC_FCLK cycle 1Fh = 15 GPMC_FCLK cycles

7.1.6.33 GPMC_CONFIG3_2 Register (offset = C8h) [reset = 0h]

GPMC_CONFIG3_2 is shown in [Figure 7-80](#) and described in [Table 7-84](#).

ADV# signal timing parameter configuration.

Figure 7-80. GPMC_CONFIG3_2 Register

31	30	29	28	27	26	25	24
RESERVED	ADVAADMUXWROFFTIME			RESERVED	ADVAADMUXRDOFFTIME		
R-0h	R/W-0h			R-0h	R/W-0h		
23	22	21	20	19	18	17	16
RESERVED				ADVWROFFTIME			
R-0h				R/W-0h			
15	14	13	12	11	10	9	8
RESERVED				ADVRDOFFTIME			
R-0h				R/W-0h			
7	6	5	4	3	2	1	0
ADVEXTRA LAY	ADVAADMUXONTIME			ADVONTIME			
R/W-0h	R/W-0h			R/W-0h			

LEGEND: R/W = Read/Write; R = Read only; W1toCl = Write 1 to clear bit; -n = value after reset

Table 7-84. GPMC_CONFIG3_2 Register Field Descriptions

Bit	Field	Type	Reset	Description
31	RESERVED	R	0h	
30-28	ADVAADMUXWROFFTIME	R/W	0h	ADV# de-assertion for first address phase when using the AAD-Mux protocol 0h = 0 GPMC_FCLK cycle 1h = 1 GPMC_FCLK cycle 7h = 7 GPMC_FCLK cycles
27	RESERVED	R	0h	
26-24	ADVAADMUXRDOFFTIME	R/W	0h	ADV# assertion for first address phase when using the AAD-Mux protocol 0h = 0 GPMC_FCLK cycle 1h = 1 GPMC_FCLK cycle 7h = 7 GPMC_FCLK cycles
23-21	RESERVED	R	0h	
20-16	ADVWROFFTIME	R/W	0h	ADV# de-assertion time from start cycle time for write accesses 0h = 0 GPMC_FCLK cycle 1h = 1 GPMC_FCLK cycle 1Fh = 31 GPMC_FCLK cycles
15-13	RESERVED	R	0h	
12-8	ADVRDOFFTIME	R/W	0h	ADV# de-assertion time from start cycle time for read accesses 0h = 0 GPMC_FCLK cycle 1h = 1 GPMC_FCLK cycle 1Fh = 31 GPMC_FCLK cycles
7	ADVEXTRADELAY	R/W	0h	ADV# Add Extra Half GPMC.FCLK cycle 0h = ADV (active low) Timing control signal is not delayed 1h = ADV (active low) Timing control signal is delayed of half GPMC_FCLK clock cycle
6-4	ADVAADMUXONTIME	R/W	0h	ADV# assertion for first address phase when using the AAD-Multiplexed protocol 0h = 0 GPMC_FCLK cycle 1h = 1 GPMC_FCLK cycle 7h = 7 GPMC_FCLK cycles

Table 7-84. GPMC_CONFIG3_2 Register Field Descriptions (continued)

Bit	Field	Type	Reset	Description
3-0	ADVONTIME	R/W	0h	ADV# assertion time from start cycle time 0h = 0 GPMC_FCLK cycle 1h = 1 GPMC_FCLK cycle Fh = 15 GPMC_FCLK cycles

7.1.6.34 GPMC_CONFIG4_2 Register (offset = CCh) [reset = 0h]

GPMC_CONFIG4_2 is shown in Figure 7-81 and described in Table 7-85.

WE# and OE# signals timing parameter configuration.

Figure 7-81. GPMC_CONFIG4_2 Register

31	30	29	28	27	26	25	24
RESERVED				WEOFFTIME			
R-0h				R/W-0h			
23	22	21	20	19	18	17	16
WEEXTRADELAY	RESERVED			WEONTIME			
R/W-0h		R-0h		R/W-0h			
15	14	13	12	11	10	9	8
OEAADMUXOFFTIME				OEOFFTIME			
R/W-0h				R/W-0h			
7	6	5	4	3	2	1	0
OEEXTRADELAY	OEAADMUXONTIME			OEONTIME			
R/W-0h		R/W-0h		R/W-0h			

LEGEND: R/W = Read/Write; R = Read only; W1toCl = Write 1 to clear bit; -n = value after reset

Table 7-85. GPMC_CONFIG4_2 Register Field Descriptions

Bit	Field	Type	Reset	Description
31-29	RESERVED	R	0h	
28-24	WEOFFTIME	R/W	0h	WE# de-assertion time from start cycle time 0h = 0 GPMC_FCLK cycle 1h = 1 GPMC_FCLK cycle 1Fh = 31 GPMC_FCLK cycles
23	WEEXTRADELAY	R/W	0h	WE# Add Extra Half GPMC.FCLK cycle 0h = WE (active low) Timing control signal is not delayed 1h = WE (active low) Timing control signal is delayed of half GPMC_FCLK clock cycle
22-20	RESERVED	R	0h	
19-16	WEONTIME	R/W	0h	WE# assertion time from start cycle time 0h = 0 GPMC_FCLK cycle 1h = 1 GPMC_FCLK cycle Fh = 15 GPMC_FCLK cycles
15-13	OEAADMUXOFFTIME	R/W	0h	OE# de-assertion time for the first address phase in an AAD-Multiplexed access 0h = 0 GPMC_FCLK cycle 1h = 1 GPMC_FCLK cycle 7h = 7 GPMC_FCLK cycles
12-8	OEOFFTIME	R/W	0h	OE# de-assertion time from start cycle time 0h = 0 GPMC_FCLK cycle 1h = 1 GPMC_FCLK cycle 7h = 31 GPMC_FCLK cycles
7	OEEXTRADELAY	R/W	0h	OE# Add Extra Half GPMC.FCLK cycle 0h = OE (active low) Timing control signal is not delayed 1h = OE (active low) Timing control signal is delayed of half GPMC_FCLK clock cycle

Table 7-85. GPMC_CONFIG4_2 Register Field Descriptions (continued)

Bit	Field	Type	Reset	Description
6-4	OEAADMUXONTIME	R/W	0h	OE# assertion time for the first address phase in an AAD-Multiplexed access 0h = 0 GPMC_FCLK cycle 1h = 1 GPMC_FCLK cycle 7h = 7 GPMC_FCLK cycles
3-0	OEONTIME	R/W	0h	OE# assertion time from start cycle time 0h = 0 GPMC_FCLK cycle 1h = 1 GPMC_FCLK cycle Fh = 15 GPMC_FCLK cycles

7.1.6.35 GPMC_CONFIG5_2 Register (offset = D0h) [reset = 0h]

 GPMC_CONFIG5_2 is shown in [Figure 7-82](#) and described in [Table 7-86](#).

RdAccessTime and CycleTime timing parameters configuration.

Figure 7-82. GPMC_CONFIG5_2 Register

31	30	29	28	27	26	25	24
RESERVED				PAGEBURSTACCESSTIME			
R-0h				R/W-0h			
23	22	21	20	19	18	17	16
RESERVED				RDACCESSTIME			
R-0h				R/W-0h			
15	14	13	12	11	10	9	8
RESERVED				WRCYCLETIME			
R-0h				R/W-0h			
7	6	5	4	3	2	1	0
RESERVED				RDCYCLETIME			
R-0h				R/W-0h			

LEGEND: R/W = Read/Write; R = Read only; W1toCl = Write 1 to clear bit; -n = value after reset

Table 7-86. GPMC_CONFIG5_2 Register Field Descriptions

Bit	Field	Type	Reset	Description
31-28	RESERVED	R	0h	
27-24	PAGEBURSTACCESSTIME	R/W	0h	Delay between successive words in a multiple access 0h = 0 GPMC_FCLK cycle 1h = 1 GPMC_FCLK cycle Fh = 15 GPMC_FCLK cycles
23-21	RESERVED	R	0h	
20-16	RDACCESSTIME	R/W	0h	Delay between start cycle time and first data valid 0h = 0 GPMC_FCLK cycle 1h = 1 GPMC_FCLK cycle 1Fh = 31 GPMC_FCLK cycles
15-13	RESERVED	R	0h	
12-8	WRCYCLETIME	R/W	0h	Total write cycle time 0h = 0 GPMC_FCLK cycle 1h = 1 GPMC_FCLK cycle 1Fh = 31 GPMC_FCLK cycles
7-5	RESERVED	R	0h	
4-0	RDCYCLETIME	R/W	0h	Total read cycle time 0h = 0 GPMC_FCLK cycle 1h = 1 GPMC_FCLK cycle 1Fh = 31 GPMC_FCLK cycles

7.1.6.36 GPMC_CONFIG6_2 Register (offset = D4h) [reset = F070000h]

GPMC_CONFIG6_2 is shown in Figure 7-83 and described in Table 7-87.

WrAccessTime, WrDataOnADmuxBus, Cycle2Cycle, and BusTurnAround parameters configuration

Figure 7-83. GPMC_CONFIG6_2 Register

31	30	29	28	27	26	25	24
RESERVED				WRACCESSTIME			
R-0h				R/W-Fh			
23	22	21	20	19	18	17	16
RESERVED				WRDATAONADMUXBUS			
R-0h				R/W-7h			
15	14	13	12	11	10	9	8
RESERVED				CYCLE2CYCLEDELAY			
R-0h				R/W-0h			
7	6	5	4	3	2	1	0
CYCLE2CYCL ESAMECSEN	CYCLE2CYCL EDIFFCSEN	RESERVED		BUSTURNAROUND			
R/W-0h	R/W-0h	R-0h		R/W-0h			

LEGEND: R/W = Read/Write; R = Read only; W1toCl = Write 1 to clear bit; -n = value after reset

Table 7-87. GPMC_CONFIG6_2 Register Field Descriptions

Bit	Field	Type	Reset	Description
31-29	RESERVED	R	0h	Reset value for bit 31 is 1.
28-24	WRACCESSTIME	R/W	Fh	Delay from StartAccessTime to the GPMC.FCLK rising edge corresponding the the GPMC.CLK rising edge used by the attached memory for the first data capture. Reset value is 0xF. 0h = 0 GPMC_FCLK cycle 1h = 1 GPMC_FCLK cycle 1Fh = 31 GPMC_FCLK cycles
23-20	RESERVED	R	0h	
19-16	WRDATAONADMUXBUS	R/W	7h	Specifies on which GPMC.FCLK rising edge the first data of the synchronous burst write is driven in the add/data multiplexed bus. Reset value is 0x7.
15-12	RESERVED	R	0h	
11-8	CYCLE2CYCLEDELAY	R/W	0h	Chip select high pulse delay between two successive accesses 0h = 0 GPMC_FCLK cycle 1h = 1 GPMC_FCLK cycle Fh = 15 GPMC_FCLK cycles
7	CYCLE2CYCLESAMECSEN	R/W	0h	Add Cycle2CycleDelay between two successive accesses to the same chip-select (any access type) 0h = No delay between the two accesses 1h = Add CYCLE2CYCLEDELAY
6	CYCLE2CYCLEDIFFCSEN	R/W	0h	Add Cycle2CycleDelay between two successive accesses to a different chip-select (any access type) 0h = No delay between the two accesses 1h = Add CYCLE2CYCLEDELAY
5-4	RESERVED	R	0h	
3-0	BUSTURNAROUND	R/W	0h	Bus turn around latency between two successive accesses to the same chip-select (read to write) or to a different chip-select (read to read and read to write) 0h = 0 GPMC_FCLK cycle 1h = 1 GPMC_FCLK cycle Fh = 15 GPMC_FCLK cycles

7.1.6.37 GPMC_CONFIG7_2 Register (offset = D8h) [reset = 0h]

 GPMC_CONFIG7_2 is shown in [Figure 7-84](#) and described in [Table 7-88](#).

Chip-select address mapping configuration.

Figure 7-84. GPMC_CONFIG7_2 Register

31	30	29	28	27	26	25	24
RESERVED							
R-0h							
23	22	21	20	19	18	17	16
RESERVED							
R-0h							
15	14	13	12	11	10	9	8
RESERVED				MASKADDRESS			
R-0h				R/W-0h			
7	6	5	4	3	2	1	0
RESERVED	CSVALID	BASEADDRESS					
R-0h	R/W-0h	R/W-0h					

LEGEND: R/W = Read/Write; R = Read only; W1toCl = Write 1 to clear bit; -n = value after reset

Table 7-88. GPMC_CONFIG7_2 Register Field Descriptions

Bit	Field	Type	Reset	Description
31-12	RESERVED	R	0h	
11-8	MASKADDRESS	R/W	0h	Chip-select mask address. Values not listed must be avoided as they create holes in the chip-select address space. 0h = Chip-select size of 256 Mbytes 8h = Chip-select size of 128 Mbytes Ch = Chip-select size of 64 Mbytes Eh = Chip-select size of 32 Mbytes Fh = Chip-select size of 16 Mbytes
7	RESERVED	R	0h	
6	CSVALID	R/W	0h	Chip-select enable (reset value is 1 for CS[0] (active low) and 0 for CS[1] to CS[5] (active low)). 0h = CS (active low) disabled 1h = CS (active low) enabled
5-0	BASEADDRESS	R/W	0h	Chip-select base address. CSi base address where i = 0 to 3 (16 Mbytes minimum granularity). Bits 5 to 0 correspond to A29, A28, A27, A26, A25, and A24.

7.1.6.38 GPMC_NAND_COMMAND_2 Register (offset = DCh) [reset = 0h]

GPMC_NAND_COMMAND_2 is shown in [Figure 7-85](#) and described in [Table 7-89](#).

This register is not a true register, just an address location.

Figure 7-85. GPMC_NAND_COMMAND_2 Register

31	30	29	28	27	26	25	24	23	22	21	20	19	18	17	16	15	14	13	12	11	10	9	8	7	6	5	4	3	2	1	0
GPMC_NAND_COMMAND_2																															
W-0h																															

LEGEND: R/W = Read/Write; R = Read only; W1toCl = Write 1 to clear bit; -n = value after reset

Table 7-89. GPMC_NAND_COMMAND_2 Register Field Descriptions

Bit	Field	Type	Reset	Description
31-0	GPMC_NAND_COMMAND_2	W	0h	Writing data at the GPMC_NAND_COMMAND_2 location places the data as the NAND command value on the bus, using a regular asynchronous write access.

7.1.6.39 GPMC_NAND_ADDRESS_2 Register (offset = E0h) [reset = 0h]

GPMC_NAND_ADDRESS_2 is shown in [Figure 7-86](#) and described in [Table 7-90](#).

This register is not a true register, just an address location.

Figure 7-86. GPMC_NAND_ADDRESS_2 Register

31	30	29	28	27	26	25	24	23	22	21	20	19	18	17	16	15	14	13	12	11	10	9	8	7	6	5	4	3	2	1	0
GPMC_NAND_ADDRESS_2																															
W-0h																															

LEGEND: R/W = Read/Write; R = Read only; W1toCl = Write 1 to clear bit; -n = value after reset

Table 7-90. GPMC_NAND_ADDRESS_2 Register Field Descriptions

Bit	Field	Type	Reset	Description
31-0	GPMC_NAND_ADDRESS_2	W	0h	Writing data at the GPMC_NAND_ADDRESS_2 location places the data as the NAND partial address value on the bus, using a regular asynchronous write access.

7.1.6.40 GPMC_NAND_DATA_2 Register (offset = E4h) [reset = 0h]

GPMC_NAND_DATA_2 is shown in [Figure 7-87](#) and described in [Table 7-91](#).

This register is not a true register, just an address location.

Figure 7-87. GPMC_NAND_DATA_2 Register

31	30	29	28	27	26	25	24	23	22	21	20	19	18	17	16	15	14	13	12	11	10	9	8	7	6	5	4	3	2	1	0
GPMC_NAND_DATA_2																															
R/W-0h																															

LEGEND: R/W = Read/Write; R = Read only; W1toCl = Write 1 to clear bit; -n = value after reset

Table 7-91. GPMC_NAND_DATA_2 Register Field Descriptions

Bit	Field	Type	Reset	Description
31-0	GPMC_NAND_DATA_2	R/W	0h	Reading data from the GPMC_NAND_DATA_2 location or from any location in the associated chip-select memory region activates an asynchronous read access.

7.1.6.41 GPMC_CONFIG1_3 Register (offset = F0h) [reset = 0h]

GPMC_CONFIG1_3 is shown in [Figure 7-88](#) and described in [Table 7-92](#).

The configuration 1 register sets signal control parameters per chip select.

Figure 7-88. GPMC_CONFIG1_3 Register

31	30	29	28	27	26	25	24
WRAPBURST	READMULTIPLE	READTYPE	WRITEMULTIPLE	WRITETYPE	CLKACTIVATIONTIME	ATTACHEDDEVICEPAGELENGTH	
R/W-0h	R/W-0h	R/W-0h	R/W-0h	R/W-0h	R/W-0h	R/W-0h	
23	22	21	20	19	18	17	16
ATTACHEDDEVICEPAGELENGTH	WAITREADMONITORING	WAITWRITEMONITORING	RESERVED	WAITMONITORINGTIME		WAITPINSELECT	
R/W-0h	R/W-0h	R/W-0h	R-0h	R/W-0h		R/W-0h	
15	14	13	12	11	10	9	8
RESERVED		DEVICESTRATEGY		DEVICETYPE		MUXADDDATA	
R-0h		R/W-0h		R/W-0h		R/W-0h	
7	6	5	4	3	2	1	0
RESERVED			TIMEPARAGRANULARITY	RESERVED		GPMCFCLKDIVIDER	
R-0h			R/W-0h	R-0h		R/W-0h	

LEGEND: R/W = Read/Write; R = Read only; W1toCl = Write 1 to clear bit; -n = value after reset

Table 7-92. GPMC_CONFIG1_3 Register Field Descriptions

Bit	Field	Type	Reset	Description
31	WRAPBURST	R/W	0h	Enables the wrapping burst capability. Must be set if the attached device is configured in wrapping burst 0h = Synchronous wrapping burst not supported 1h = Synchronous wrapping burst supported
30	READMULTIPLE	R/W	0h	Selects the read single or multiple access 0h = single access 1h = multiple access (burst if synchronous, page if asynchronous)
29	READTYPE	R/W	0h	Selects the read mode operation 0h = Read Asynchronous 1h = Read Synchronous
28	WRITEMULTIPLE	R/W	0h	Selects the write single or multiple access 0h = Single access 1h = Multiple access (burst if synchronous, considered as single if asynchronous)
27	WRITETYPE	R/W	0h	Selects the write mode operation 0h = Write Asynchronous 1h = Write Synchronous
26-25	CLKACTIVATIONTIME	R/W	0h	Output GPMC.CLK activation time 0h = First rising edge of GPMC_CLK at start access time 1h = First rising edge of GPMC_CLK one GPMC_FCLK cycle after start access time 2h = First rising edge of GPMC_CLK two GPMC_FCLK cycles after start access time 3h = Reserved

Table 7-92. GPMC_CONFIG1_3 Register Field Descriptions (continued)

Bit	Field	Type	Reset	Description
24-23	ATTACHEDDEVICEPAGELENGTH	R/W	0h	Specifies the attached device page (burst) length (1 Word = Interface size) 0h = 4 Words 1h = 8 Words 2h = 16 Words 3h = Reserved
22	WAITREADMONITORING	R/W	0h	Selects the Wait monitoring configuration for Read accesses. 0h = WAIT pin is not monitored for read accesses 1h = WAIT pin is monitored for read accesses
21	WAITWRITEMONITORING	R/W	0h	Selects the Wait monitoring configuration for Write accesses 0h = WAIT pin is not monitored for write accesses 1h = WAIT pin is monitored for write accesses
20	RESERVED	R	0h	
19-18	WAITMONITORINGTIME	R/W	0h	Selects input pin Wait monitoring time 0h = WAIT pin is monitored with valid data 1h = WAIT pin is monitored one GPMC_CLK cycle before valid data 2h = WAIT pin is monitored two GPMC_CLK cycle before valid data 3h = Reserved
17-16	WAITPINSELECT	R/W	0h	Selects the input WAIT pin for this chip select. 0h = WAIT input pin is WAIT0 1h = WAIT input pin is WAIT1 2h = Reserved 3h = Reserved
15-14	RESERVED	R	0h	
13-12	DEVICESTYPE	R/W	0h	Selects the device size attached (Reset value is SYSBOOT[8] input pin sampled at IC reset for CS[0] (active low) and 01 for CS[1] to CS[6] (active low)). 0h = 8 bit 1h = 16 bit 2h = Reserved 3h = Reserved
11-10	DEVICETYPE	R/W	0h	Selects the attached device type 0h = NOR Flash like, asynchronous and synchronous devices 1h = Reserved 2h = NAND Flash like devices, stream mode 3h = Reserved
9-8	MUXADDDATA	R/W	0h	Enables the Address and data multiplexed protocol (Reset value is SYSBOOT[11] and SYSBOOT[10] input pins sampled at IC reset for CS[0] (active low) and 0 for CS[1] to CS[6] (active low)). 0h = Non-multiplexed attached device 1h = AAD-multiplexed protocol device 2h = Address and data multiplexed attached device 3h = Reserved
7-5	RESERVED	R	0h	
4	TIMEPARAGRANULARITY	R/W	0h	Signals timing latencies scalar factor (Rd/WRCycleTime, AccessTime, PageBurstAccessTime, CSOnTime, CSRd/WrOffTime, ADVOnTime, ADVRd/WrOffTime, OEOnTime, OEOffTime, WEOnTime, WEOffTime, Cycle2CycleDelay, BusTurnAround, TimeOutStartValue). 0h = x1 latencies 1h = x2 latencies
3-2	RESERVED	R	0h	

Table 7-92. GPMC_CONFIG1_3 Register Field Descriptions (continued)

Bit	Field	Type	Reset	Description
1-0	GPMCFCLKDIVIDER	R/W	0h	Divides the GPMC.FCLK clock. 0h = GPMC_CLK frequency = GPMC_FCLK frequency 1h = GPMC_CLK frequency = GPMC_FCLK frequency/2 2h = GPMC_CLK frequency = GPMC_FCLK frequency/3 3h = GPMC_CLK frequency = GPMC_FCLK frequency/4

7.1.6.42 GPMC_CONFIG2_3 Register (offset = F4h) [reset = 0h]

GPMC_CONFIG2_3 is shown in [Figure 7-89](#) and described in [Table 7-93](#).

Chip-select signal timing parameter configuration.

Figure 7-89. GPMC_CONFIG2_3 Register

31	30	29	28	27	26	25	24
RESERVED							
R-0h							
23	22	21	20	19	18	17	16
RESERVED				CSWROFFTIME			
R-0h				R/W-0h			
15	14	13	12	11	10	9	8
RESERVED				CSRDOFFTIME			
R-0h				R/W-0h			
7	6	5	4	3	2	1	0
CSEXTRAD ELAY	RESERVED			CSONTIME			
R/W-0h	R-0h			R/W-0h			

LEGEND: R/W = Read/Write; R = Read only; W1toCl = Write 1 to clear bit; -n = value after reset

Table 7-93. GPMC_CONFIG2_3 Register Field Descriptions

Bit	Field	Type	Reset	Description
31-21	RESERVED	R	0h	
20-16	CSWROFFTIME	R/W	0h	CS# de-assertion time from start cycle time for write accesses 0h = 0 GPMC_FCLK cycle 1h = 1 GPMC_FCLK cycle 1Fh = 31 GPMC_FCLK cycles
15-13	RESERVED	R	0h	
12-8	CSRDOFFTIME	R/W	0h	CS# de-assertion time from start cycle time for read accesses 0h = 0 GPMC_FCLK cycle 1h = 1 GPMC_FCLK cycle 1Fh = 31 GPMC_FCLK cycles
7	CSEXTRAD ELAY	R/W	0h	CS# Add Extra Half GPMC.FCLK cycle 0h = CS i Timing control signal is not delayed 1h = CS i Timing control signal is delayed of half GPMC_FCLK clock cycle
6-4	RESERVED	R	0h	
3-0	CSONTIME	R/W	0h	CS# assertion time from start cycle time 0h = 0 GPMC_FCLK cycle 1h = 1 GPMC_FCLK cycle 1Fh = 15 GPMC_FCLK cycles

7.1.6.43 GPMC_CONFIG3_3 Register (offset = F8h) [reset = 0h]

GPMC_CONFIG3_3 is shown in Figure 7-90 and described in Table 7-94.

ADV# signal timing parameter configuration.

Figure 7-90. GPMC_CONFIG3_3 Register

31	30	29	28	27	26	25	24
RESERVED	ADVAADMUXWROFFTIME			RESERVED	ADVAADMUXRDOFFTIME		
R-0h	R/W-0h			R-0h	R/W-0h		
23	22	21	20	19	18	17	16
RESERVED				ADVWROFFTIME			
R-0h				R/W-0h			
15	14	13	12	11	10	9	8
RESERVED				ADVRDOFFTIME			
R-0h				R/W-0h			
7	6	5	4	3	2	1	0
ADVEXTRA LAY	ADVAADMUXONTIME			ADVONTIME			
R/W-0h	R/W-0h			R/W-0h			

LEGEND: R/W = Read/Write; R = Read only; W1toCl = Write 1 to clear bit; -n = value after reset

Table 7-94. GPMC_CONFIG3_3 Register Field Descriptions

Bit	Field	Type	Reset	Description
31	RESERVED	R	0h	
30-28	ADVAADMUXWROFFTIME	R/W	0h	ADV# de-assertion for first address phase when using the AAD-Mux protocol 0h = 0 GPMC_FCLK cycle 1h = 1 GPMC_FCLK cycle 7h = 7 GPMC_FCLK cycles
27	RESERVED	R	0h	
26-24	ADVAADMUXRDOFFTIME	R/W	0h	ADV# assertion for first address phase when using the AAD-Mux protocol 0h = 0 GPMC_FCLK cycle 1h = 1 GPMC_FCLK cycle 7h = 7 GPMC_FCLK cycles
23-21	RESERVED	R	0h	
20-16	ADVWROFFTIME	R/W	0h	ADV# de-assertion time from start cycle time for write accesses 0h = 0 GPMC_FCLK cycle 1h = 1 GPMC_FCLK cycle 1Fh = 31 GPMC_FCLK cycles
15-13	RESERVED	R	0h	
12-8	ADVRDOFFTIME	R/W	0h	ADV# de-assertion time from start cycle time for read accesses 0h = 0 GPMC_FCLK cycle 1h = 1 GPMC_FCLK cycle 1Fh = 31 GPMC_FCLK cycles
7	ADVEXTRADELAY	R/W	0h	ADV# Add Extra Half GPMC.FCLK cycle 0h = ADV (active low) Timing control signal is not delayed 1h = ADV (active low) Timing control signal is delayed of half GPMC_FCLK clock cycle
6-4	ADVAADMUXONTIME	R/W	0h	ADV# assertion for first address phase when using the AAD-Multiplexed protocol 0h = 0 GPMC_FCLK cycle 1h = 1 GPMC_FCLK cycle 7h = 7 GPMC_FCLK cycles

Table 7-94. GPMC_CONFIG3_3 Register Field Descriptions (continued)

Bit	Field	Type	Reset	Description
3-0	ADVONTIME	R/W	0h	ADV# assertion time from start cycle time 0h = 0 GPMC_FCLK cycle 1h = 1 GPMC_FCLK cycle Fh = 15 GPMC_FCLK cycles

7.1.6.44 GPMC_CONFIG4_3 Register (offset = FCh) [reset = 0h]

GPMC_CONFIG4_3 is shown in [Figure 7-91](#) and described in [Table 7-95](#).

WE# and OE# signals timing parameter configuration.

Figure 7-91. GPMC_CONFIG4_3 Register

31	30	29	28	27	26	25	24
RESERVED				WEOFFTIME			
R-0h				R/W-0h			
23	22	21	20	19	18	17	16
WEEXTRADELAY	RESERVED			WEONTIME			
R/W-0h	R-0h			R/W-0h			
15	14	13	12	11	10	9	8
OEAADMUXOFFTIME				OEOFFTIME			
R/W-0h				R/W-0h			
7	6	5	4	3	2	1	0
OEEXTRADELAY	OEAADMUXONTIME			OEONTIME			
R/W-0h	R/W-0h			R/W-0h			

LEGEND: R/W = Read/Write; R = Read only; W1toCl = Write 1 to clear bit; -n = value after reset

Table 7-95. GPMC_CONFIG4_3 Register Field Descriptions

Bit	Field	Type	Reset	Description
31-29	RESERVED	R	0h	
28-24	WEOFFTIME	R/W	0h	WE# de-assertion time from start cycle time 0h = 0 GPMC_FCLK cycle 1h = 1 GPMC_FCLK cycle 1Fh = 31 GPMC_FCLK cycles
23	WEEXTRADELAY	R/W	0h	WE# Add Extra Half GPMC.FCLK cycle 0h = WE (active low) Timing control signal is not delayed 1h = WE (active low) Timing control signal is delayed of half GPMC_FCLK clock cycle
22-20	RESERVED	R	0h	
19-16	WEONTIME	R/W	0h	WE# assertion time from start cycle time 0h = 0 GPMC_FCLK cycle 1h = 1 GPMC_FCLK cycle Fh = 15 GPMC_FCLK cycles
15-13	OEAADMUXOFFTIME	R/W	0h	OE# de-assertion time for the first address phase in an AAD-Multiplexed access 0h = 0 GPMC_FCLK cycle 1h = 1 GPMC_FCLK cycle 7h = 7 GPMC_FCLK cycles
12-8	OEOFFTIME	R/W	0h	OE# de-assertion time from start cycle time 0h = 0 GPMC_FCLK cycle 1h = 1 GPMC_FCLK cycle 7h = 31 GPMC_FCLK cycles
7	OEEXTRADELAY	R/W	0h	OE# Add Extra Half GPMC.FCLK cycle 0h = OE (active low) Timing control signal is not delayed 1h = OE (active low) Timing control signal is delayed of half GPMC_FCLK clock cycle

Table 7-95. GPMC_CONFIG4_3 Register Field Descriptions (continued)

Bit	Field	Type	Reset	Description
6-4	OEAADMUXONTIME	R/W	0h	OE# assertion time for the first address phase in an AAD-Multiplexed access 0h = 0 GPMC_FCLK cycle 1h = 1 GPMC_FCLK cycle 7h = 7 GPMC_FCLK cycles
3-0	OEONTIME	R/W	0h	OE# assertion time from start cycle time 0h = 0 GPMC_FCLK cycle 1h = 1 GPMC_FCLK cycle Fh = 15 GPMC_FCLK cycles

7.1.6.45 GPMC_CONFIG5_3 Register (offset = 100h) [reset = 0h]

GPMC_CONFIG5_3 is shown in [Figure 7-92](#) and described in [Table 7-96](#).

RdAccessTime and CycleTime timing parameters configuration.

Figure 7-92. GPMC_CONFIG5_3 Register

31	30	29	28	27	26	25	24
RESERVED				PAGEBURSTACCESSTIME			
R-0h				R/W-0h			
23	22	21	20	19	18	17	16
RESERVED				RDACCESSTIME			
R-0h				R/W-0h			
15	14	13	12	11	10	9	8
RESERVED				WRCYCLETIME			
R-0h				R/W-0h			
7	6	5	4	3	2	1	0
RESERVED				RDCYCLETIME			
R-0h				R/W-0h			

LEGEND: R/W = Read/Write; R = Read only; W1toCl = Write 1 to clear bit; -n = value after reset

Table 7-96. GPMC_CONFIG5_3 Register Field Descriptions

Bit	Field	Type	Reset	Description
31-28	RESERVED	R	0h	
27-24	PAGEBURSTACCESSTIME	R/W	0h	Delay between successive words in a multiple access 0h = 0 GPMC_FCLK cycle 1h = 1 GPMC_FCLK cycle Fh = 15 GPMC_FCLK cycles
23-21	RESERVED	R	0h	
20-16	RDACCESSTIME	R/W	0h	Delay between start cycle time and first data valid 0h = 0 GPMC_FCLK cycle 1h = 1 GPMC_FCLK cycle 1Fh = 31 GPMC_FCLK cycles
15-13	RESERVED	R	0h	
12-8	WRCYCLETIME	R/W	0h	Total write cycle time 0h = 0 GPMC_FCLK cycle 1h = 1 GPMC_FCLK cycle 1Fh = 31 GPMC_FCLK cycles
7-5	RESERVED	R	0h	
4-0	RDCYCLETIME	R/W	0h	Total read cycle time 0h = 0 GPMC_FCLK cycle 1h = 1 GPMC_FCLK cycle 1Fh = 31 GPMC_FCLK cycles

7.1.6.46 GPMC_CONFIG6_3 Register (offset = 104h) [reset = F070000h]

GPMC_CONFIG6_3 is shown in Figure 7-93 and described in Table 7-97.

WrAccessTime, WrDataOnADmuxBus, Cycle2Cycle, and BusTurnAround parameters configuration

Figure 7-93. GPMC_CONFIG6_3 Register

31	30	29	28	27	26	25	24
RESERVED				WRACCESSTIME			
R-0h				R/W-Fh			
23	22	21	20	19	18	17	16
RESERVED				WRDATAONADMUXBUS			
R-0h				R/W-7h			
15	14	13	12	11	10	9	8
RESERVED				CYCLE2CYCLEDELAY			
R-0h				R/W-0h			
7	6	5	4	3	2	1	0
CYCLE2CYCL ESAMECSEN	CYCLE2CYCL EDIFFCSEN	RESERVED		BUSTURNAROUND			
R/W-0h	R/W-0h	R-0h		R/W-0h			

LEGEND: R/W = Read/Write; R = Read only; W1toCl = Write 1 to clear bit; -n = value after reset

Table 7-97. GPMC_CONFIG6_3 Register Field Descriptions

Bit	Field	Type	Reset	Description
31-29	RESERVED	R	0h	Reset value for bit 31 is 1.
28-24	WRACCESSTIME	R/W	Fh	Delay from StartAccessTime to the GPMC.FCLK rising edge corresponding the the GPMC.CLK rising edge used by the attached memory for the first data capture. Reset value is 0xF. 0h = 0 GPMC_FCLK cycle 1h = 1 GPMC_FCLK cycle 1Fh = 31 GPMC_FCLK cycles
23-20	RESERVED	R	0h	
19-16	WRDATAONADMUXBUS	R/W	7h	Specifies on which GPMC.FCLK rising edge the first data of the synchronous burst write is driven in the add/data multiplexed bus. Reset value is 0x7.
15-12	RESERVED	R	0h	
11-8	CYCLE2CYCLEDELAY	R/W	0h	Chip select high pulse delay between two successive accesses 0h = 0 GPMC_FCLK cycle 1h = 1 GPMC_FCLK cycle Fh = 15 GPMC_FCLK cycles
7	CYCLE2CYCLESAMECSEN	R/W	0h	Add Cycle2CycleDelay between two successive accesses to the same chip-select (any access type) 0h = No delay between the two accesses 1h = Add CYCLE2CYCLEDELAY
6	CYCLE2CYCLEDIFFCSEN	R/W	0h	Add Cycle2CycleDelay between two successive accesses to a different chip-select (any access type) 0h = No delay between the two accesses 1h = Add CYCLE2CYCLEDELAY
5-4	RESERVED	R	0h	
3-0	BUSTURNAROUND	R/W	0h	Bus turn around latency between two successive accesses to the same chip-select (read to write) or to a different chip-select (read to read and read to write) 0h = 0 GPMC_FCLK cycle 1h = 1 GPMC_FCLK cycle Fh = 15 GPMC_FCLK cycles

7.1.6.47 GPMC_CONFIG7_3 Register (offset = 108h) [reset = 0h]

GPMC_CONFIG7_3 is shown in [Figure 7-94](#) and described in [Table 7-98](#).

Chip-select address mapping configuration.

Figure 7-94. GPMC_CONFIG7_3 Register

31	30	29	28	27	26	25	24
RESERVED							
R-0h							
23	22	21	20	19	18	17	16
RESERVED							
R-0h							
15	14	13	12	11	10	9	8
RESERVED				MASKADDRESS			
R-0h				R/W-0h			
7	6	5	4	3	2	1	0
RESERVED	CSVALID	BASEADDRESS					
R-0h	R/W-0h	R/W-0h					

LEGEND: R/W = Read/Write; R = Read only; W1toCl = Write 1 to clear bit; -n = value after reset

Table 7-98. GPMC_CONFIG7_3 Register Field Descriptions

Bit	Field	Type	Reset	Description
31-12	RESERVED	R	0h	
11-8	MASKADDRESS	R/W	0h	Chip-select mask address. Values not listed must be avoided as they create holes in the chip-select address space. 0h = Chip-select size of 256 Mbytes 8h = Chip-select size of 128 Mbytes Ch = Chip-select size of 64 Mbytes Eh = Chip-select size of 32 Mbytes Fh = Chip-select size of 16 Mbytes
7	RESERVED	R	0h	
6	CSVALID	R/W	0h	Chip-select enable (reset value is 1 for CS[0] (active low) and 0 for CS[1] to CS[5] (active low)). 0h = CS (active low) disabled 1h = CS (active low) enabled
5-0	BASEADDRESS	R/W	0h	Chip-select base address. CSi base address where i = 0 to 3 (16 Mbytes minimum granularity). Bits 5 to 0 correspond to A29, A28, A27, A26, A25, and A24.

7.1.6.48 GPMC_NAND_COMMAND_3 Register (offset = 10Ch) [reset = 0h]

GPMC_NAND_COMMAND_3 is shown in [Figure 7-95](#) and described in [Table 7-99](#).

This register is not a true register, just an address location.

Figure 7-95. GPMC_NAND_COMMAND_3 Register

31	30	29	28	27	26	25	24	23	22	21	20	19	18	17	16	15	14	13	12	11	10	9	8	7	6	5	4	3	2	1	0
GPMC_NAND_COMMAND_3																															
W-0h																															

LEGEND: R/W = Read/Write; R = Read only; W1toCl = Write 1 to clear bit; -n = value after reset

Table 7-99. GPMC_NAND_COMMAND_3 Register Field Descriptions

Bit	Field	Type	Reset	Description
31-0	GPMC_NAND_COMMAND_3	W	0h	Writing data at the GPMC_NAND_COMMAND_3 location places the data as the NAND command value on the bus, using a regular asynchronous write access.

7.1.6.49 GPMC_NAND_ADDRESS_3 Register (offset = 110h) [reset = 0h]

GPMC_NAND_ADDRESS_3 is shown in [Figure 7-96](#) and described in [Table 7-100](#).

This register is not a true register, just an address location.

Figure 7-96. GPMC_NAND_ADDRESS_3 Register

31	30	29	28	27	26	25	24	23	22	21	20	19	18	17	16	15	14	13	12	11	10	9	8	7	6	5	4	3	2	1	0
GPMC_NAND_ADDRESS_3																															
W-0h																															

LEGEND: R/W = Read/Write; R = Read only; W1toCl = Write 1 to clear bit; -n = value after reset

Table 7-100. GPMC_NAND_ADDRESS_3 Register Field Descriptions

Bit	Field	Type	Reset	Description
31-0	GPMC_NAND_ADDRESS_3	W	0h	Writing data at the GPMC_NAND_ADDRESS_3 location places the data as the NAND partial address value on the bus, using a regular asynchronous write access.

7.1.6.50 GPMC_NAND_DATA_3 Register (offset = 114h) [reset = 0h]

GPMC_NAND_DATA_3 is shown in [Figure 7-97](#) and described in [Table 7-101](#).

This register is not a true register, just an address location.

Figure 7-97. GPMC_NAND_DATA_3 Register

31	30	29	28	27	26	25	24	23	22	21	20	19	18	17	16	15	14	13	12	11	10	9	8	7	6	5	4	3	2	1	0
GPMC_NAND_DATA_3																															
R/W-0h																															

LEGEND: R/W = Read/Write; R = Read only; W1toCl = Write 1 to clear bit; -n = value after reset

Table 7-101. GPMC_NAND_DATA_3 Register Field Descriptions

Bit	Field	Type	Reset	Description
31-0	GPMC_NAND_DATA_3	R/W	0h	Reading data from the GPMC_NAND_DATA_3 location or from any location in the associated chip-select memory region activates an asynchronous read access.

7.1.6.51 GPMC_CONFIG1_4 Register (offset = 120h) [reset = 0h]

GPMC_CONFIG1_4 is shown in [Figure 7-98](#) and described in [Table 7-102](#).

The configuration 1 register sets signal control parameters per chip select.

Figure 7-98. GPMC_CONFIG1_4 Register

31	30	29	28	27	26	25	24
WRAPBURST	READMULTIPLE	READTYPE	WRITEMULTIPLE	WRITETYPE	CLKACTIVATIONTIME	ATTACHEDDEVICEPAGELENGTH	
R/W-0h	R/W-0h	R/W-0h	R/W-0h	R/W-0h	R/W-0h	R/W-0h	
23	22	21	20	19	18	17	16
ATTACHEDDEVICEPAGELENGTH	WAITREADMONITORING	WAITWRITEMONITORING	RESERVED	WAITMONITORINGTIME		WAITPINSELECT	
R/W-0h	R/W-0h	R/W-0h	R-0h	R/W-0h		R/W-0h	
15	14	13	12	11	10	9	8
RESERVED		DEVICESTRATEGY		DEVICETYPE		MUXADDDATA	
R-0h		R/W-0h		R/W-0h		R/W-0h	
7	6	5	4	3	2	1	0
RESERVED			TIMEPARAGRANULARITY	RESERVED		GPMCFCLKDIVIDER	
R-0h			R/W-0h	R-0h		R/W-0h	

LEGEND: R/W = Read/Write; R = Read only; W1toCl = Write 1 to clear bit; -n = value after reset

Table 7-102. GPMC_CONFIG1_4 Register Field Descriptions

Bit	Field	Type	Reset	Description
31	WRAPBURST	R/W	0h	Enables the wrapping burst capability. Must be set if the attached device is configured in wrapping burst 0h = Synchronous wrapping burst not supported 1h = Synchronous wrapping burst supported
30	READMULTIPLE	R/W	0h	Selects the read single or multiple access 0h = single access 1h = multiple access (burst if synchronous, page if asynchronous)
29	READTYPE	R/W	0h	Selects the read mode operation 0h = Read Asynchronous 1h = Read Synchronous
28	WRITEMULTIPLE	R/W	0h	Selects the write single or multiple access 0h = Single access 1h = Multiple access (burst if synchronous, considered as single if asynchronous)
27	WRITETYPE	R/W	0h	Selects the write mode operation 0h = Write Asynchronous 1h = Write Synchronous
26-25	CLKACTIVATIONTIME	R/W	0h	Output GPMC.CLK activation time 0h = First rising edge of GPMC_CLK at start access time 1h = First rising edge of GPMC_CLK one GPMC_FCLK cycle after start access time 2h = First rising edge of GPMC_CLK two GPMC_FCLK cycles after start access time 3h = Reserved

Table 7-102. GPMC_CONFIG1_4 Register Field Descriptions (continued)

Bit	Field	Type	Reset	Description
24-23	ATTACHEDDEVICEPAGELENGTH	R/W	0h	Specifies the attached device page (burst) length (1 Word = Interface size) 0h = 4 Words 1h = 8 Words 2h = 16 Words 3h = Reserved
22	WAITREADMONITORING	R/W	0h	Selects the Wait monitoring configuration for Read accesses. 0h = WAIT pin is not monitored for read accesses 1h = WAIT pin is monitored for read accesses
21	WAITWRITEMONITORING	R/W	0h	Selects the Wait monitoring configuration for Write accesses 0h = WAIT pin is not monitored for write accesses 1h = WAIT pin is monitored for write accesses
20	RESERVED	R	0h	
19-18	WAITMONITORINGTIME	R/W	0h	Selects input pin Wait monitoring time 0h = WAIT pin is monitored with valid data 1h = WAIT pin is monitored one GPMC_CLK cycle before valid data 2h = WAIT pin is monitored two GPMC_CLK cycle before valid data 3h = Reserved
17-16	WAITPINSELECT	R/W	0h	Selects the input WAIT pin for this chip select. 0h = WAIT input pin is WAIT0 1h = WAIT input pin is WAIT1 2h = Reserved 3h = Reserved
15-14	RESERVED	R	0h	
13-12	DEVICESTYPE	R/W	0h	Selects the device size attached (Reset value is SYSBOOT[8] input pin sampled at IC reset for CS[0] (active low) and 01 for CS[1] to CS[6] (active low)). 0h = 8 bit 1h = 16 bit 2h = Reserved 3h = Reserved
11-10	DEVICETYPE	R/W	0h	Selects the attached device type 0h = NOR Flash like, asynchronous and synchronous devices 1h = Reserved 2h = NAND Flash like devices, stream mode 3h = Reserved
9-8	MUXADDDATA	R/W	0h	Enables the Address and data multiplexed protocol (Reset value is SYSBOOT[11] and SYSBOOT[10] input pins sampled at IC reset for CS[0] (active low) and 0 for CS[1] to CS[6] (active low)). 0h = Non-multiplexed attached device 1h = AAD-multiplexed protocol device 2h = Address and data multiplexed attached device 3h = Reserved
7-5	RESERVED	R	0h	
4	TIMEPARAGRANULARITY	R/W	0h	Signals timing latencies scalar factor (Rd/WRCycleTime, AccessTime, PageBurstAccessTime, CSOnTime, CSRd/WrOffTime, ADVOnTime, ADVRd/WrOffTime, OEOnTime, OEOffTime, WEOnTime, WEOffTime, Cycle2CycleDelay, BusTurnAround, TimeOutStartValue). 0h = x1 latencies 1h = x2 latencies
3-2	RESERVED	R	0h	

Table 7-102. GPMC_CONFIG1_4 Register Field Descriptions (continued)

Bit	Field	Type	Reset	Description
1-0	GPMCFCLKDIVIDER	R/W	0h	Divides the GPMC.FCLK clock. 0h = GPMC_CLK frequency = GPMC_FCLK frequency 1h = GPMC_CLK frequency = GPMC_FCLK frequency/2 2h = GPMC_CLK frequency = GPMC_FCLK frequency/3 3h = GPMC_CLK frequency = GPMC_FCLK frequency/4

7.1.6.52 GPMC_CONFIG2_4 Register (offset = 124h) [reset = 0h]

GPMC_CONFIG2_4 is shown in Figure 7-99 and described in Table 7-103.

Chip-select signal timing parameter configuration.

Figure 7-99. GPMC_CONFIG2_4 Register

31	30	29	28	27	26	25	24
RESERVED							
R-0h							
23	22	21	20	19	18	17	16
RESERVED				CSWROFFTIME			
R-0h				R/W-0h			
15	14	13	12	11	10	9	8
RESERVED				CSRDOFFTIME			
R-0h				R/W-0h			
7	6	5	4	3	2	1	0
CSEXTRAD ELAY	RESERVED			CSONTIME			
R/W-0h	R-0h			R/W-0h			

LEGEND: R/W = Read/Write; R = Read only; W1toCl = Write 1 to clear bit; -n = value after reset

Table 7-103. GPMC_CONFIG2_4 Register Field Descriptions

Bit	Field	Type	Reset	Description
31-21	RESERVED	R	0h	
20-16	CSWROFFTIME	R/W	0h	CS# de-assertion time from start cycle time for write accesses 0h = 0 GPMC_FCLK cycle 1h = 1 GPMC_FCLK cycle 1Fh = 31 GPMC_FCLK cycles
15-13	RESERVED	R	0h	
12-8	CSRDOFFTIME	R/W	0h	CS# de-assertion time from start cycle time for read accesses 0h = 0 GPMC_FCLK cycle 1h = 1 GPMC_FCLK cycle 1Fh = 31 GPMC_FCLK cycles
7	CSEXTRAD ELAY	R/W	0h	CS# Add Extra Half GPMC.FCLK cycle 0h = CS i Timing control signal is not delayed 1h = CS i Timing control signal is delayed of half GPMC_FCLK clock cycle
6-4	RESERVED	R	0h	
3-0	CSONTIME	R/W	0h	CS# assertion time from start cycle time 0h = 0 GPMC_FCLK cycle 1h = 1 GPMC_FCLK cycle 1Fh = 15 GPMC_FCLK cycles

7.1.6.53 GPMC_CONFIG3_4 Register (offset = 128h) [reset = 0h]

GPMC_CONFIG3_4 is shown in [Figure 7-100](#) and described in [Table 7-104](#).

ADV# signal timing parameter configuration.

Figure 7-100. GPMC_CONFIG3_4 Register

31	30	29	28	27	26	25	24
RESERVED	ADVAADMUXWROFFTIME			RESERVED	ADVAADMUXRDOFFTIME		
R-0h	R/W-0h			R-0h	R/W-0h		
23	22	21	20	19	18	17	16
RESERVED				ADVWROFFTIME			
R-0h				R/W-0h			
15	14	13	12	11	10	9	8
RESERVED				ADVRDOFFTIME			
R-0h				R/W-0h			
7	6	5	4	3	2	1	0
ADVEXTRA LAY	ADVAADMUXONTIME			ADVONTIME			
R/W-0h	R/W-0h			R/W-0h			

LEGEND: R/W = Read/Write; R = Read only; W1toCl = Write 1 to clear bit; -n = value after reset

Table 7-104. GPMC_CONFIG3_4 Register Field Descriptions

Bit	Field	Type	Reset	Description
31	RESERVED	R	0h	
30-28	ADVAADMUXWROFFTIME	R/W	0h	ADV# de-assertion for first address phase when using the AAD-Mux protocol 0h = 0 GPMC_FCLK cycle 1h = 1 GPMC_FCLK cycle 7h = 7 GPMC_FCLK cycles
27	RESERVED	R	0h	
26-24	ADVAADMUXRDOFFTIME	R/W	0h	ADV# assertion for first address phase when using the AAD-Mux protocol 0h = 0 GPMC_FCLK cycle 1h = 1 GPMC_FCLK cycle 7h = 7 GPMC_FCLK cycles
23-21	RESERVED	R	0h	
20-16	ADVWROFFTIME	R/W	0h	ADV# de-assertion time from start cycle time for write accesses 0h = 0 GPMC_FCLK cycle 1h = 1 GPMC_FCLK cycle 1Fh = 31 GPMC_FCLK cycles
15-13	RESERVED	R	0h	
12-8	ADVRDOFFTIME	R/W	0h	ADV# de-assertion time from start cycle time for read accesses 0h = 0 GPMC_FCLK cycle 1h = 1 GPMC_FCLK cycle 1Fh = 31 GPMC_FCLK cycles
7	ADVEXTRADELAY	R/W	0h	ADV# Add Extra Half GPMC.FCLK cycle 0h = ADV (active low) Timing control signal is not delayed 1h = ADV (active low) Timing control signal is delayed of half GPMC_FCLK clock cycle
6-4	ADVAADMUXONTIME	R/W	0h	ADV# assertion for first address phase when using the AAD-Multiplexed protocol 0h = 0 GPMC_FCLK cycle 1h = 1 GPMC_FCLK cycle 7h = 7 GPMC_FCLK cycles

Table 7-104. GPMC_CONFIG3_4 Register Field Descriptions (continued)

Bit	Field	Type	Reset	Description
3-0	ADVONTIME	R/W	0h	ADV# assertion time from start cycle time 0h = 0 GPMC_FCLK cycle 1h = 1 GPMC_FCLK cycle Fh = 15 GPMC_FCLK cycles

7.1.6.54 GPMC_CONFIG4_4 Register (offset = 12Ch) [reset = 0h]

GPMC_CONFIG4_4 is shown in [Figure 7-101](#) and described in [Table 7-105](#).

WE# and OE# signals timing parameter configuration.

Figure 7-101. GPMC_CONFIG4_4 Register

31	30	29	28	27	26	25	24
RESERVED				WEOFFTIME			
R-0h				R/W-0h			
23	22	21	20	19	18	17	16
WEEXTRADELAY	RESERVED			WEONTIME			
R/W-0h	R-0h			R/W-0h			
15	14	13	12	11	10	9	8
OEAADMUXOFFTIME				OEOFFTIME			
R/W-0h				R/W-0h			
7	6	5	4	3	2	1	0
OEEXTRADELAY	OEAADMUXONTIME			OEONTIME			
R/W-0h	R/W-0h			R/W-0h			

LEGEND: R/W = Read/Write; R = Read only; W1toCl = Write 1 to clear bit; -n = value after reset

Table 7-105. GPMC_CONFIG4_4 Register Field Descriptions

Bit	Field	Type	Reset	Description
31-29	RESERVED	R	0h	
28-24	WEOFFTIME	R/W	0h	WE# de-assertion time from start cycle time 0h = 0 GPMC_FCLK cycle 1h = 1 GPMC_FCLK cycle 1Fh = 31 GPMC_FCLK cycles
23	WEEXTRADELAY	R/W	0h	WE# Add Extra Half GPMC.FCLK cycle 0h = WE (active low) Timing control signal is not delayed 1h = WE (active low) Timing control signal is delayed of half GPMC_FCLK clock cycle
22-20	RESERVED	R	0h	
19-16	WEONTIME	R/W	0h	WE# assertion time from start cycle time 0h = 0 GPMC_FCLK cycle 1h = 1 GPMC_FCLK cycle Fh = 15 GPMC_FCLK cycles
15-13	OEAADMUXOFFTIME	R/W	0h	OE# de-assertion time for the first address phase in an AAD-Multiplexed access 0h = 0 GPMC_FCLK cycle 1h = 1 GPMC_FCLK cycle 7h = 7 GPMC_FCLK cycles
12-8	OEOFFTIME	R/W	0h	OE# de-assertion time from start cycle time 0h = 0 GPMC_FCLK cycle 1h = 1 GPMC_FCLK cycle 7h = 31 GPMC_FCLK cycles
7	OEEXTRADELAY	R/W	0h	OE# Add Extra Half GPMC.FCLK cycle 0h = OE (active low) Timing control signal is not delayed 1h = OE (active low) Timing control signal is delayed of half GPMC_FCLK clock cycle

Table 7-105. GPMC_CONFIG4_4 Register Field Descriptions (continued)

Bit	Field	Type	Reset	Description
6-4	OEAADMUXONTIME	R/W	0h	OE# assertion time for the first address phase in an AAD-Multiplexed access 0h = 0 GPMC_FCLK cycle 1h = 1 GPMC_FCLK cycle 7h = 7 GPMC_FCLK cycles
3-0	OEONTIME	R/W	0h	OE# assertion time from start cycle time 0h = 0 GPMC_FCLK cycle 1h = 1 GPMC_FCLK cycle Fh = 15 GPMC_FCLK cycles

7.1.6.55 GPMC_CONFIG5_4 Register (offset = 130h) [reset = 0h]

 GPMC_CONFIG5_4 is shown in [Figure 7-102](#) and described in [Table 7-106](#).

RdAccessTime and CycleTime timing parameters configuration.

Figure 7-102. GPMC_CONFIG5_4 Register

31	30	29	28	27	26	25	24
RESERVED				PAGEBURSTACCESSTIME			
R-0h				R/W-0h			
23	22	21	20	19	18	17	16
RESERVED				RDACCESSTIME			
R-0h				R/W-0h			
15	14	13	12	11	10	9	8
RESERVED				WRCYCLETIME			
R-0h				R/W-0h			
7	6	5	4	3	2	1	0
RESERVED				RDCYCLETIME			
R-0h				R/W-0h			

LEGEND: R/W = Read/Write; R = Read only; W1toCl = Write 1 to clear bit; -n = value after reset

Table 7-106. GPMC_CONFIG5_4 Register Field Descriptions

Bit	Field	Type	Reset	Description
31-28	RESERVED	R	0h	
27-24	PAGEBURSTACCESSTIME	R/W	0h	Delay between successive words in a multiple access 0h = 0 GPMC_FCLK cycle 1h = 1 GPMC_FCLK cycle Fh = 15 GPMC_FCLK cycles
23-21	RESERVED	R	0h	
20-16	RDACCESSTIME	R/W	0h	Delay between start cycle time and first data valid 0h = 0 GPMC_FCLK cycle 1h = 1 GPMC_FCLK cycle 1Fh = 31 GPMC_FCLK cycles
15-13	RESERVED	R	0h	
12-8	WRCYCLETIME	R/W	0h	Total write cycle time 0h = 0 GPMC_FCLK cycle 1h = 1 GPMC_FCLK cycle 1Fh = 31 GPMC_FCLK cycles
7-5	RESERVED	R	0h	
4-0	RDCYCLETIME	R/W	0h	Total read cycle time 0h = 0 GPMC_FCLK cycle 1h = 1 GPMC_FCLK cycle 1Fh = 31 GPMC_FCLK cycles

7.1.6.56 GPMC_CONFIG6_4 Register (offset = 134h) [reset = F070000h]

GPMC_CONFIG6_4 is shown in [Figure 7-103](#) and described in [Table 7-107](#).

WrAccessTime, WrDataOnADmuxBus, Cycle2Cycle, and BusTurnAround parameters configuration

Figure 7-103. GPMC_CONFIG6_4 Register

31	30	29	28	27	26	25	24
RESERVED				WRACCESSTIME			
R-0h				R/W-Fh			
23	22	21	20	19	18	17	16
RESERVED				WRDATAONADMUXBUS			
R-0h				R/W-7h			
15	14	13	12	11	10	9	8
RESERVED				CYCLE2CYCLEDELAY			
R-0h				R/W-0h			
7	6	5	4	3	2	1	0
CYCLE2CYCL ESAMECSEN	CYCLE2CYCL EDIFFCSEN	RESERVED		BUSTURNAROUND			
R/W-0h	R/W-0h	R-0h		R/W-0h			

LEGEND: R/W = Read/Write; R = Read only; W1toCl = Write 1 to clear bit; -n = value after reset

Table 7-107. GPMC_CONFIG6_4 Register Field Descriptions

Bit	Field	Type	Reset	Description
31-29	RESERVED	R	0h	Reset value for bit 31 is 1.
28-24	WRACCESSTIME	R/W	Fh	Delay from StartAccessTime to the GPMC.FCLK rising edge corresponding the the GPMC.CLK rising edge used by the attached memory for the first data capture. Reset value is 0xF. 0h = 0 GPMC_FCLK cycle 1h = 1 GPMC_FCLK cycle 1Fh = 31 GPMC_FCLK cycles
23-20	RESERVED	R	0h	
19-16	WRDATAONADMUXBUS	R/W	7h	Specifies on which GPMC.FCLK rising edge the first data of the synchronous burst write is driven in the add/data multiplexed bus. Reset value is 0x7.
15-12	RESERVED	R	0h	
11-8	CYCLE2CYCLEDELAY	R/W	0h	Chip select high pulse delay between two successive accesses 0h = 0 GPMC_FCLK cycle 1h = 1 GPMC_FCLK cycle Fh = 15 GPMC_FCLK cycles
7	CYCLE2CYCLESAMECSEN	R/W	0h	Add Cycle2CycleDelay between two successive accesses to the same chip-select (any access type) 0h = No delay between the two accesses 1h = Add CYCLE2CYCLEDELAY
6	CYCLE2CYCLEDIFFCSEN	R/W	0h	Add Cycle2CycleDelay between two successive accesses to a different chip-select (any access type) 0h = No delay between the two accesses 1h = Add CYCLE2CYCLEDELAY
5-4	RESERVED	R	0h	
3-0	BUSTURNAROUND	R/W	0h	Bus turn around latency between two successive accesses to the same chip-select (read to write) or to a different chip-select (read to read and read to write) 0h = 0 GPMC_FCLK cycle 1h = 1 GPMC_FCLK cycle Fh = 15 GPMC_FCLK cycles

7.1.6.57 GPMC_CONFIG7_4 Register (offset = 138h) [reset = 0h]

GPMC_CONFIG7_4 is shown in [Figure 7-104](#) and described in [Table 7-108](#).

Chip-select address mapping configuration.

Figure 7-104. GPMC_CONFIG7_4 Register

31	30	29	28	27	26	25	24
RESERVED							
R-0h							
23	22	21	20	19	18	17	16
RESERVED							
R-0h							
15	14	13	12	11	10	9	8
RESERVED				MASKADDRESS			
R-0h				R/W-0h			
7	6	5	4	3	2	1	0
RESERVED	CSVALID	BASEADDRESS					
R-0h	R/W-0h	R/W-0h					

LEGEND: R/W = Read/Write; R = Read only; W1toCl = Write 1 to clear bit; -n = value after reset

Table 7-108. GPMC_CONFIG7_4 Register Field Descriptions

Bit	Field	Type	Reset	Description
31-12	RESERVED	R	0h	
11-8	MASKADDRESS	R/W	0h	Chip-select mask address. Values not listed must be avoided as they create holes in the chip-select address space. 0h = Chip-select size of 256 Mbytes 8h = Chip-select size of 128 Mbytes Ch = Chip-select size of 64 Mbytes Eh = Chip-select size of 32 Mbytes Fh = Chip-select size of 16 Mbytes
7	RESERVED	R	0h	
6	CSVALID	R/W	0h	Chip-select enable (reset value is 1 for CS[0] (active low) and 0 for CS[1] to CS[5] (active low)). 0h = CS (active low) disabled 1h = CS (active low) enabled
5-0	BASEADDRESS	R/W	0h	Chip-select base address. CSi base address where i = 0 to 3 (16 Mbytes minimum granularity). Bits 5 to 0 correspond to A29, A28, A27, A26, A25, and A24.

7.1.6.58 GPMC_NAND_COMMAND_4 Register (offset = 13Ch) [reset = 0h]

GPMC_NAND_COMMAND_4 is shown in [Figure 7-105](#) and described in [Table 7-109](#).

This register is not a true register, just an address location.

Figure 7-105. GPMC_NAND_COMMAND_4 Register

31	30	29	28	27	26	25	24	23	22	21	20	19	18	17	16	15	14	13	12	11	10	9	8	7	6	5	4	3	2	1	0
GPMC_NAND_COMMAND_4																															
W-0h																															

LEGEND: R/W = Read/Write; R = Read only; W1toCl = Write 1 to clear bit; -n = value after reset

Table 7-109. GPMC_NAND_COMMAND_4 Register Field Descriptions

Bit	Field	Type	Reset	Description
31-0	GPMC_NAND_COMMAND_4	W	0h	Writing data at the GPMC_NAND_COMMAND_4 location places the data as the NAND command value on the bus, using a regular asynchronous write access.

7.1.6.59 GPMC_NAND_ADDRESS_4 Register (offset = 140h) [reset = 0h]

GPMC_NAND_ADDRESS_4 is shown in [Figure 7-106](#) and described in [Table 7-110](#).

This register is not a true register, just an address location.

Figure 7-106. GPMC_NAND_ADDRESS_4 Register

31	30	29	28	27	26	25	24	23	22	21	20	19	18	17	16	15	14	13	12	11	10	9	8	7	6	5	4	3	2	1	0
GPMC_NAND_ADDRESS_4																															
W-0h																															

LEGEND: R/W = Read/Write; R = Read only; W1toCl = Write 1 to clear bit; -n = value after reset

Table 7-110. GPMC_NAND_ADDRESS_4 Register Field Descriptions

Bit	Field	Type	Reset	Description
31-0	GPMC_NAND_ADDRESS_4	W	0h	Writing data at the GPMC_NAND_ADDRESS_4 location places the data as the NAND partial address value on the bus, using a regular asynchronous write access.

7.1.6.60 GPMC_NAND_DATA_4 Register (offset = 144h) [reset = 0h]

GPMC_NAND_DATA_4 is shown in [Figure 7-107](#) and described in [Table 7-111](#).

This register is not a true register, just an address location.

Figure 7-107. GPMC_NAND_DATA_4 Register

31	30	29	28	27	26	25	24	23	22	21	20	19	18	17	16	15	14	13	12	11	10	9	8	7	6	5	4	3	2	1	0
GPMC_NAND_DATA_4																															
R/W-0h																															

LEGEND: R/W = Read/Write; R = Read only; W1toCl = Write 1 to clear bit; -n = value after reset

Table 7-111. GPMC_NAND_DATA_4 Register Field Descriptions

Bit	Field	Type	Reset	Description
31-0	GPMC_NAND_DATA_4	R/W	0h	Reading data from the GPMC_NAND_DATA_4 location or from any location in the associated chip-select memory region activates an asynchronous read access.

7.1.6.61 GPMC_CONFIG1_5 Register (offset = 150h) [reset = 0h]

GPMC_CONFIG1_5 is shown in [Figure 7-108](#) and described in [Table 7-112](#).

The configuration 1 register sets signal control parameters per chip select.

Figure 7-108. GPMC_CONFIG1_5 Register

31	30	29	28	27	26	25	24
WRAPBURST	READMULTIPLE	READTYPE	WRITEMULTIPLE	WRITETYPE	CLKACTIVATIONTIME	ATTACHEDDEVICEPAGELENGTH	
R/W-0h	R/W-0h	R/W-0h	R/W-0h	R/W-0h	R/W-0h	R/W-0h	
23	22	21	20	19	18	17	16
ATTACHEDDEVICEPAGELENGTH	WAITREADMONITORING	WAITWRITEMONITORING	RESERVED	WAITMONITORINGTIME		WAITPINSELECT	
R/W-0h	R/W-0h	R/W-0h	R-0h	R/W-0h		R/W-0h	
15	14	13	12	11	10	9	8
RESERVED		DEVICESTRATEGY	DEVICESTRATEGY	DEVICESTRATEGY	DEVICESTRATEGY	MUXADDDATA	
R-0h		R/W-0h	R/W-0h	R/W-0h	R/W-0h	R/W-0h	
7	6	5	4	3	2	1	0
RESERVED	RESERVED	RESERVED	TIMEPARAGRANULARITY	RESERVED	RESERVED	GPMCFCLKDIVIDER	
R-0h	R-0h	R-0h	R/W-0h	R-0h	R-0h	R/W-0h	

LEGEND: R/W = Read/Write; R = Read only; W1toCl = Write 1 to clear bit; -n = value after reset

Table 7-112. GPMC_CONFIG1_5 Register Field Descriptions

Bit	Field	Type	Reset	Description
31	WRAPBURST	R/W	0h	Enables the wrapping burst capability. Must be set if the attached device is configured in wrapping burst 0h = Synchronous wrapping burst not supported 1h = Synchronous wrapping burst supported
30	READMULTIPLE	R/W	0h	Selects the read single or multiple access 0h = single access 1h = multiple access (burst if synchronous, page if asynchronous)
29	READTYPE	R/W	0h	Selects the read mode operation 0h = Read Asynchronous 1h = Read Synchronous
28	WRITEMULTIPLE	R/W	0h	Selects the write single or multiple access 0h = Single access 1h = Multiple access (burst if synchronous, considered as single if asynchronous)
27	WRITETYPE	R/W	0h	Selects the write mode operation 0h = Write Asynchronous 1h = Write Synchronous
26-25	CLKACTIVATIONTIME	R/W	0h	Output GPMC.CLK activation time 0h = First rising edge of GPMC_CLK at start access time 1h = First rising edge of GPMC_CLK one GPMC_FCLK cycle after start access time 2h = First rising edge of GPMC_CLK two GPMC_FCLK cycles after start access time 3h = Reserved

Table 7-112. GPMC_CONFIG1_5 Register Field Descriptions (continued)

Bit	Field	Type	Reset	Description
24-23	ATTACHEDDEVICEPAGELENGTH	R/W	0h	Specifies the attached device page (burst) length (1 Word = Interface size) 0h = 4 Words 1h = 8 Words 2h = 16 Words 3h = Reserved
22	WAITREADMONITORING	R/W	0h	Selects the Wait monitoring configuration for Read accesses. 0h = WAIT pin is not monitored for read accesses 1h = WAIT pin is monitored for read accesses
21	WAITWRITEMONITORING	R/W	0h	Selects the Wait monitoring configuration for Write accesses 0h = WAIT pin is not monitored for write accesses 1h = WAIT pin is monitored for write accesses
20	RESERVED	R	0h	
19-18	WAITMONITORINGTIME	R/W	0h	Selects input pin Wait monitoring time 0h = WAIT pin is monitored with valid data 1h = WAIT pin is monitored one GPMC_CLK cycle before valid data 2h = WAIT pin is monitored two GPMC_CLK cycle before valid data 3h = Reserved
17-16	WAITPINSELECT	R/W	0h	Selects the input WAIT pin for this chip select. 0h = WAIT input pin is WAIT0 1h = WAIT input pin is WAIT1 2h = Reserved 3h = Reserved
15-14	RESERVED	R	0h	
13-12	DEVICESTYPE	R/W	0h	Selects the device size attached (Reset value is SYSBOOT[8] input pin sampled at IC reset for CS[0] (active low) and 01 for CS[1] to CS[6] (active low)). 0h = 8 bit 1h = 16 bit 2h = Reserved 3h = Reserved
11-10	DEVICETYPE	R/W	0h	Selects the attached device type 0h = NOR Flash like, asynchronous and synchronous devices 1h = Reserved 2h = NAND Flash like devices, stream mode 3h = Reserved
9-8	MUXADDRESSDATA	R/W	0h	Enables the Address and data multiplexed protocol (Reset value is SYSBOOT[11] and SYSBOOT[10] input pins sampled at IC reset for CS[0] (active low) and 0 for CS[1] to CS[6] (active low)). 0h = Non-multiplexed attached device 1h = AAD-multiplexed protocol device 2h = Address and data multiplexed attached device 3h = Reserved
7-5	RESERVED	R	0h	
4	TIMEPARAMETERGRANULARITY	R/W	0h	Signals timing latencies scalar factor (Rd/WRCycleTime, AccessTime, PageBurstAccessTime, CSOnTime, CSRd/WrOffTime, ADVOnTime, ADVRd/WrOffTime, OEOnTime, OEOffTime, WEOnTime, WEOffTime, Cycle2CycleDelay, BusTurnAround, TimeOutStartValue). 0h = x1 latencies 1h = x2 latencies
3-2	RESERVED	R	0h	

Table 7-112. GPMC_CONFIG1_5 Register Field Descriptions (continued)

Bit	Field	Type	Reset	Description
1-0	GPMCFCLKDIVIDER	R/W	0h	Divides the GPMC.FCLK clock. 0h = GPMC_CLK frequency = GPMC_FCLK frequency 1h = GPMC_CLK frequency = GPMC_FCLK frequency/2 2h = GPMC_CLK frequency = GPMC_FCLK frequency/3 3h = GPMC_CLK frequency = GPMC_FCLK frequency/4

7.1.6.62 GPMC_CONFIG2_5 Register (offset = 154h) [reset = 0h]

GPMC_CONFIG2_5 is shown in [Figure 7-109](#) and described in [Table 7-113](#).

Chip-select signal timing parameter configuration.

Figure 7-109. GPMC_CONFIG2_5 Register

31	30	29	28	27	26	25	24
RESERVED							
R-0h							
23	22	21	20	19	18	17	16
RESERVED				CSWROFFTIME			
R-0h				R/W-0h			
15	14	13	12	11	10	9	8
RESERVED				CSRDOFFTIME			
R-0h				R/W-0h			
7	6	5	4	3	2	1	0
CSEXTRAD ELAY	RESERVED			CSONTIME			
R/W-0h	R-0h			R/W-0h			

LEGEND: R/W = Read/Write; R = Read only; W1toCl = Write 1 to clear bit; -n = value after reset

Table 7-113. GPMC_CONFIG2_5 Register Field Descriptions

Bit	Field	Type	Reset	Description
31-21	RESERVED	R	0h	
20-16	CSWROFFTIME	R/W	0h	CS# de-assertion time from start cycle time for write accesses 0h = 0 GPMC_FCLK cycle 1h = 1 GPMC_FCLK cycle 1Fh = 31 GPMC_FCLK cycles
15-13	RESERVED	R	0h	
12-8	CSRDOFFTIME	R/W	0h	CS# de-assertion time from start cycle time for read accesses 0h = 0 GPMC_FCLK cycle 1h = 1 GPMC_FCLK cycle 1Fh = 31 GPMC_FCLK cycles
7	CSEXTRAD ELAY	R/W	0h	CS# Add Extra Half GPMC.FCLK cycle 0h = CS i Timing control signal is not delayed 1h = CS i Timing control signal is delayed of half GPMC_FCLK clock cycle
6-4	RESERVED	R	0h	
3-0	CSONTIME	R/W	0h	CS# assertion time from start cycle time 0h = 0 GPMC_FCLK cycle 1h = 1 GPMC_FCLK cycle 1Fh = 15 GPMC_FCLK cycles

7.1.6.63 GPMC_CONFIG3_5 Register (offset = 158h) [reset = 0h]

GPMC_CONFIG3_5 is shown in [Figure 7-110](#) and described in [Table 7-114](#).

ADV# signal timing parameter configuration.

Figure 7-110. GPMC_CONFIG3_5 Register

31	30	29	28	27	26	25	24
RESERVED	ADVAADMUXWROFFTIME			RESERVED	ADVAADMUXRDOFFTIME		
R-0h	R/W-0h			R-0h	R/W-0h		
23	22	21	20	19	18	17	16
RESERVED				ADVWROFFTIME			
R-0h				R/W-0h			
15	14	13	12	11	10	9	8
RESERVED				ADVRDOFFTIME			
R-0h				R/W-0h			
7	6	5	4	3	2	1	0
ADVEXTRA LAY	ADVAADMUXONTIME			ADVONTIME			
R/W-0h	R/W-0h			R/W-0h			

LEGEND: R/W = Read/Write; R = Read only; W1toCl = Write 1 to clear bit; -n = value after reset

Table 7-114. GPMC_CONFIG3_5 Register Field Descriptions

Bit	Field	Type	Reset	Description
31	RESERVED	R	0h	
30-28	ADVAADMUXWROFFTIME	R/W	0h	ADV# de-assertion for first address phase when using the AAD-Mux protocol 0h = 0 GPMC_FCLK cycle 1h = 1 GPMC_FCLK cycle 7h = 7 GPMC_FCLK cycles
27	RESERVED	R	0h	
26-24	ADVAADMUXRDOFFTIME	R/W	0h	ADV# assertion for first address phase when using the AAD-Mux protocol 0h = 0 GPMC_FCLK cycle 1h = 1 GPMC_FCLK cycle 7h = 7 GPMC_FCLK cycles
23-21	RESERVED	R	0h	
20-16	ADVWROFFTIME	R/W	0h	ADV# de-assertion time from start cycle time for write accesses 0h = 0 GPMC_FCLK cycle 1h = 1 GPMC_FCLK cycle 1Fh = 31 GPMC_FCLK cycles
15-13	RESERVED	R	0h	
12-8	ADVRDOFFTIME	R/W	0h	ADV# de-assertion time from start cycle time for read accesses 0h = 0 GPMC_FCLK cycle 1h = 1 GPMC_FCLK cycle 1Fh = 31 GPMC_FCLK cycles
7	ADVEXTRADELAY	R/W	0h	ADV# Add Extra Half GPMC.FCLK cycle 0h = ADV (active low) Timing control signal is not delayed 1h = ADV (active low) Timing control signal is delayed of half GPMC_FCLK clock cycle
6-4	ADVAADMUXONTIME	R/W	0h	ADV# assertion for first address phase when using the AAD-Multiplexed protocol 0h = 0 GPMC_FCLK cycle 1h = 1 GPMC_FCLK cycle 7h = 7 GPMC_FCLK cycles

Table 7-114. GPMC_CONFIG3_5 Register Field Descriptions (continued)

Bit	Field	Type	Reset	Description
3-0	ADVONTIME	R/W	0h	ADV# assertion time from start cycle time 0h = 0 GPMC_FCLK cycle 1h = 1 GPMC_FCLK cycle Fh = 15 GPMC_FCLK cycles

7.1.6.64 GPMC_CONFIG4_5 Register (offset = 15Ch) [reset = 0h]

GPMC_CONFIG4_5 is shown in [Figure 7-111](#) and described in [Table 7-115](#).

WE# and OE# signals timing parameter configuration.

Figure 7-111. GPMC_CONFIG4_5 Register

31	30	29	28	27	26	25	24
RESERVED				WEOFFTIME			
R-0h				R/W-0h			
23	22	21	20	19	18	17	16
WEEXTRADELAY	RESERVED			WEONTIME			
R/W-0h	R-0h			R/W-0h			
15	14	13	12	11	10	9	8
OEAADMUXOFFTIME				OEOFFTIME			
R/W-0h				R/W-0h			
7	6	5	4	3	2	1	0
OEEXTRADELAY	OEAADMUXONTIME			OEONTIME			
R/W-0h	R/W-0h			R/W-0h			

LEGEND: R/W = Read/Write; R = Read only; W1toCl = Write 1 to clear bit; -n = value after reset

Table 7-115. GPMC_CONFIG4_5 Register Field Descriptions

Bit	Field	Type	Reset	Description
31-29	RESERVED	R	0h	
28-24	WEOFFTIME	R/W	0h	WE# de-assertion time from start cycle time 0h = 0 GPMC_FCLK cycle 1h = 1 GPMC_FCLK cycle 1Fh = 31 GPMC_FCLK cycles
23	WEEXTRADELAY	R/W	0h	WE# Add Extra Half GPMC.FCLK cycle 0h = WE (active low) Timing control signal is not delayed 1h = WE (active low) Timing control signal is delayed of half GPMC_FCLK clock cycle
22-20	RESERVED	R	0h	
19-16	WEONTIME	R/W	0h	WE# assertion time from start cycle time 0h = 0 GPMC_FCLK cycle 1h = 1 GPMC_FCLK cycle Fh = 15 GPMC_FCLK cycles
15-13	OEAADMUXOFFTIME	R/W	0h	OE# de-assertion time for the first address phase in an AAD-Multiplexed access 0h = 0 GPMC_FCLK cycle 1h = 1 GPMC_FCLK cycle 7h = 7 GPMC_FCLK cycles
12-8	OEOFFTIME	R/W	0h	OE# de-assertion time from start cycle time 0h = 0 GPMC_FCLK cycle 1h = 1 GPMC_FCLK cycle 7h = 31 GPMC_FCLK cycles
7	OEEXTRADELAY	R/W	0h	OE# Add Extra Half GPMC.FCLK cycle 0h = OE (active low) Timing control signal is not delayed 1h = OE (active low) Timing control signal is delayed of half GPMC_FCLK clock cycle

Table 7-115. GPMC_CONFIG4_5 Register Field Descriptions (continued)

Bit	Field	Type	Reset	Description
6-4	OEAADMUXONTIME	R/W	0h	OE# assertion time for the first address phase in an AAD-Multiplexed access 0h = 0 GPMC_FCLK cycle 1h = 1 GPMC_FCLK cycle 7h = 7 GPMC_FCLK cycles
3-0	OEONTIME	R/W	0h	OE# assertion time from start cycle time 0h = 0 GPMC_FCLK cycle 1h = 1 GPMC_FCLK cycle Fh = 15 GPMC_FCLK cycles

7.1.6.65 GPMC_CONFIG5_5 Register (offset = 160h) [reset = 0h]

GPMC_CONFIG5_5 is shown in [Figure 7-112](#) and described in [Table 7-116](#).

RdAccessTime and CycleTime timing parameters configuration.

Figure 7-112. GPMC_CONFIG5_5 Register

31	30	29	28	27	26	25	24
RESERVED				PAGEBURSTACCESSTIME			
R-0h				R/W-0h			
23	22	21	20	19	18	17	16
RESERVED				RDACCESSTIME			
R-0h				R/W-0h			
15	14	13	12	11	10	9	8
RESERVED				WRCYCLETIME			
R-0h				R/W-0h			
7	6	5	4	3	2	1	0
RESERVED				RDCYCLETIME			
R-0h				R/W-0h			

LEGEND: R/W = Read/Write; R = Read only; W1toCl = Write 1 to clear bit; -n = value after reset

Table 7-116. GPMC_CONFIG5_5 Register Field Descriptions

Bit	Field	Type	Reset	Description
31-28	RESERVED	R	0h	
27-24	PAGEBURSTACCESSTIME	R/W	0h	Delay between successive words in a multiple access 0h = 0 GPMC_FCLK cycle 1h = 1 GPMC_FCLK cycle Fh = 15 GPMC_FCLK cycles
23-21	RESERVED	R	0h	
20-16	RDACCESSTIME	R/W	0h	Delay between start cycle time and first data valid 0h = 0 GPMC_FCLK cycle 1h = 1 GPMC_FCLK cycle 1Fh = 31 GPMC_FCLK cycles
15-13	RESERVED	R	0h	
12-8	WRCYCLETIME	R/W	0h	Total write cycle time 0h = 0 GPMC_FCLK cycle 1h = 1 GPMC_FCLK cycle 1Fh = 31 GPMC_FCLK cycles
7-5	RESERVED	R	0h	
4-0	RDCYCLETIME	R/W	0h	Total read cycle time 0h = 0 GPMC_FCLK cycle 1h = 1 GPMC_FCLK cycle 1Fh = 31 GPMC_FCLK cycles

7.1.6.66 GPMC_CONFIG6_5 Register (offset = 164h) [reset = F070000h]

GPMC_CONFIG6_5 is shown in [Figure 7-113](#) and described in [Table 7-117](#).

WrAccessTime, WrDataOnADmuxBus, Cycle2Cycle, and BusTurnAround parameters configuration

Figure 7-113. GPMC_CONFIG6_5 Register

31	30	29	28	27	26	25	24
RESERVED				WRACCESSTIME			
R-0h				R/W-Fh			
23	22	21	20	19	18	17	16
RESERVED				WRDATAONADMUXBUS			
R-0h				R/W-7h			
15	14	13	12	11	10	9	8
RESERVED				CYCLE2CYCLEDELAY			
R-0h				R/W-0h			
7	6	5	4	3	2	1	0
CYCLE2CYCL ESAMECSEN	CYCLE2CYCL EDIFFCSEN	RESERVED		BUSTURNAROUND			
R/W-0h	R/W-0h	R-0h		R/W-0h			

LEGEND: R/W = Read/Write; R = Read only; W1toCl = Write 1 to clear bit; -n = value after reset

Table 7-117. GPMC_CONFIG6_5 Register Field Descriptions

Bit	Field	Type	Reset	Description
31-29	RESERVED	R	0h	Reset value for bit 31 is 1.
28-24	WRACCESSTIME	R/W	Fh	Delay from StartAccessTime to the GPMC.FCLK rising edge corresponding the the GPMC.CLK rising edge used by the attached memory for the first data capture. Reset value is 0xF. 0h = 0 GPMC_FCLK cycle 1h = 1 GPMC_FCLK cycle 1Fh = 31 GPMC_FCLK cycles
23-20	RESERVED	R	0h	
19-16	WRDATAONADMUXBUS	R/W	7h	Specifies on which GPMC.FCLK rising edge the first data of the synchronous burst write is driven in the add/data multiplexed bus. Reset value is 0x7.
15-12	RESERVED	R	0h	
11-8	CYCLE2CYCLEDELAY	R/W	0h	Chip select high pulse delay between two successive accesses 0h = 0 GPMC_FCLK cycle 1h = 1 GPMC_FCLK cycle Fh = 15 GPMC_FCLK cycles
7	CYCLE2CYCLESAMECSEN	R/W	0h	Add Cycle2CycleDelay between two successive accesses to the same chip-select (any access type) 0h = No delay between the two accesses 1h = Add CYCLE2CYCLEDELAY
6	CYCLE2CYCLEDIFFCSEN	R/W	0h	Add Cycle2CycleDelay between two successive accesses to a different chip-select (any access type) 0h = No delay between the two accesses 1h = Add CYCLE2CYCLEDELAY
5-4	RESERVED	R	0h	
3-0	BUSTURNAROUND	R/W	0h	Bus turn around latency between two successive accesses to the same chip-select (read to write) or to a different chip-select (read to read and read to write) 0h = 0 GPMC_FCLK cycle 1h = 1 GPMC_FCLK cycle Fh = 15 GPMC_FCLK cycles

7.1.6.67 GPMC_CONFIG7_5 Register (offset = 168h) [reset = 0h]

GPMC_CONFIG7_5 is shown in [Figure 7-114](#) and described in [Table 7-118](#).

Chip-select address mapping configuration.

Figure 7-114. GPMC_CONFIG7_5 Register

31	30	29	28	27	26	25	24
RESERVED							
R-0h							
23	22	21	20	19	18	17	16
RESERVED							
R-0h							
15	14	13	12	11	10	9	8
RESERVED				MASKADDRESS			
R-0h				R/W-0h			
7	6	5	4	3	2	1	0
RESERVED	CSVALID	BASEADDRESS					
R-0h	R/W-0h	R/W-0h					

LEGEND: R/W = Read/Write; R = Read only; W1toCl = Write 1 to clear bit; -n = value after reset

Table 7-118. GPMC_CONFIG7_5 Register Field Descriptions

Bit	Field	Type	Reset	Description
31-12	RESERVED	R	0h	
11-8	MASKADDRESS	R/W	0h	Chip-select mask address. Values not listed must be avoided as they create holes in the chip-select address space. 0h = Chip-select size of 256 Mbytes 8h = Chip-select size of 128 Mbytes Ch = Chip-select size of 64 Mbytes Eh = Chip-select size of 32 Mbytes Fh = Chip-select size of 16 Mbytes
7	RESERVED	R	0h	
6	CSVALID	R/W	0h	Chip-select enable (reset value is 1 for CS[0] (active low) and 0 for CS[1] to CS[5] (active low)). 0h = CS (active low) disabled 1h = CS (active low) enabled
5-0	BASEADDRESS	R/W	0h	Chip-select base address. CSi base address where i = 0 to 3 (16 Mbytes minimum granularity). Bits 5 to 0 correspond to A29, A28, A27, A26, A25, and A24.

7.1.6.68 GPMC_NAND_COMMAND_5 Register (offset = 16Ch) [reset = 0h]

GPMC_NAND_COMMAND_5 is shown in [Figure 7-115](#) and described in [Table 7-119](#).

This register is not a true register, just an address location.

Figure 7-115. GPMC_NAND_COMMAND_5 Register

31	30	29	28	27	26	25	24	23	22	21	20	19	18	17	16	15	14	13	12	11	10	9	8	7	6	5	4	3	2	1	0
GPMC_NAND_COMMAND_5																															
W-0h																															

LEGEND: R/W = Read/Write; R = Read only; W1toCl = Write 1 to clear bit; -n = value after reset

Table 7-119. GPMC_NAND_COMMAND_5 Register Field Descriptions

Bit	Field	Type	Reset	Description
31-0	GPMC_NAND_COMMAND_5	W	0h	Writing data at the GPMC_NAND_COMMAND_5 location places the data as the NAND command value on the bus, using a regular asynchronous write access.

7.1.6.69 GPMC_NAND_ADDRESS_5 Register (offset = 170h) [reset = 0h]

GPMC_NAND_ADDRESS_5 is shown in [Figure 7-116](#) and described in [Table 7-120](#).

This register is not a true register, just an address location.

Figure 7-116. GPMC_NAND_ADDRESS_5 Register

31	30	29	28	27	26	25	24	23	22	21	20	19	18	17	16	15	14	13	12	11	10	9	8	7	6	5	4	3	2	1	0
GPMC_NAND_ADDRESS_5																															
W-0h																															

LEGEND: R/W = Read/Write; R = Read only; W1toCl = Write 1 to clear bit; -n = value after reset

Table 7-120. GPMC_NAND_ADDRESS_5 Register Field Descriptions

Bit	Field	Type	Reset	Description
31-0	GPMC_NAND_ADDRESS_5	W	0h	Writing data at the GPMC_NAND_ADDRESS_5 location places the data as the NAND partial address value on the bus, using a regular asynchronous write access.

7.1.6.70 GPMC_NAND_DATA_5 Register (offset = 174h) [reset = 0h]

GPMC_NAND_DATA_5 is shown in [Figure 7-117](#) and described in [Table 7-121](#).

This register is not a true register, just an address location.

Figure 7-117. GPMC_NAND_DATA_5 Register

31	30	29	28	27	26	25	24	23	22	21	20	19	18	17	16	15	14	13	12	11	10	9	8	7	6	5	4	3	2	1	0
GPMC_NAND_DATA_5																															
R/W-0h																															

LEGEND: R/W = Read/Write; R = Read only; W1toCl = Write 1 to clear bit; -n = value after reset

Table 7-121. GPMC_NAND_DATA_5 Register Field Descriptions

Bit	Field	Type	Reset	Description
31-0	GPMC_NAND_DATA_5	R/W	0h	Reading data from the GPMC_NAND_DATA_5 location or from any location in the associated chip-select memory region activates an asynchronous read access.

7.1.6.71 GPMC_CONFIG1_6 Register (offset = 180h) [reset = 0h]

GPMC_CONFIG1_6 is shown in [Figure 7-118](#) and described in [Table 7-122](#).

The configuration 1 register sets signal control parameters per chip select.

Figure 7-118. GPMC_CONFIG1_6 Register

31	30	29	28	27	26	25	24
WRAPBURST	READMULTIPLE	READTYPE	WRITEMULTIPLE	WRITETYPE	CLKACTIVATIONTIME	ATTACHEDDEVICEPAGELENGTH	
R/W-0h	R/W-0h	R/W-0h	R/W-0h	R/W-0h	R/W-0h	R/W-0h	
23	22	21	20	19	18	17	16
ATTACHEDDEVICEPAGELENGTH	WAITREADMONITORING	WAITWRITEMONITORING	RESERVED	WAITMONITORINGTIME		WAITPINSELECT	
R/W-0h	R/W-0h	R/W-0h	R-0h	R/W-0h		R/W-0h	
15	14	13	12	11	10	9	8
RESERVED		DEVICESTRATEGY	DEVICESTRATEGY	DEVICESTRATEGY	DEVICESTRATEGY	MUXADDDATA	
R-0h		R/W-0h	R/W-0h	R/W-0h	R/W-0h	R/W-0h	
7	6	5	4	3	2	1	0
RESERVED	RESERVED	TIMEPARAGRANULARITY	RESERVED	RESERVED	RESERVED	GPMCFCLKDIVIDER	
R-0h	R-0h	R/W-0h	R/W-0h	R-0h	R-0h	R/W-0h	

LEGEND: R/W = Read/Write; R = Read only; W1toCl = Write 1 to clear bit; -n = value after reset

Table 7-122. GPMC_CONFIG1_6 Register Field Descriptions

Bit	Field	Type	Reset	Description
31	WRAPBURST	R/W	0h	Enables the wrapping burst capability. Must be set if the attached device is configured in wrapping burst 0h = Synchronous wrapping burst not supported 1h = Synchronous wrapping burst supported
30	READMULTIPLE	R/W	0h	Selects the read single or multiple access 0h = single access 1h = multiple access (burst if synchronous, page if asynchronous)
29	READTYPE	R/W	0h	Selects the read mode operation 0h = Read Asynchronous 1h = Read Synchronous
28	WRITEMULTIPLE	R/W	0h	Selects the write single or multiple access 0h = Single access 1h = Multiple access (burst if synchronous, considered as single if asynchronous)
27	WRITETYPE	R/W	0h	Selects the write mode operation 0h = Write Asynchronous 1h = Write Synchronous
26-25	CLKACTIVATIONTIME	R/W	0h	Output GPMC.CLK activation time 0h = First rising edge of GPMC_CLK at start access time 1h = First rising edge of GPMC_CLK one GPMC_FCLK cycle after start access time 2h = First rising edge of GPMC_CLK two GPMC_FCLK cycles after start access time 3h = Reserved

Table 7-122. GPMC_CONFIG1_6 Register Field Descriptions (continued)

Bit	Field	Type	Reset	Description
24-23	ATTACHEDDEVICEPAGELENGTH	R/W	0h	Specifies the attached device page (burst) length (1 Word = Interface size) 0h = 4 Words 1h = 8 Words 2h = 16 Words 3h = Reserved
22	WAITREADMONITORING	R/W	0h	Selects the Wait monitoring configuration for Read accesses. 0h = WAIT pin is not monitored for read accesses 1h = WAIT pin is monitored for read accesses
21	WAITWRITEMONITORING	R/W	0h	Selects the Wait monitoring configuration for Write accesses 0h = WAIT pin is not monitored for write accesses 1h = WAIT pin is monitored for write accesses
20	RESERVED	R	0h	
19-18	WAITMONITORINGTIME	R/W	0h	Selects input pin Wait monitoring time 0h = WAIT pin is monitored with valid data 1h = WAIT pin is monitored one GPMC_CLK cycle before valid data 2h = WAIT pin is monitored two GPMC_CLK cycle before valid data 3h = Reserved
17-16	WAITPINSELECT	R/W	0h	Selects the input WAIT pin for this chip select. 0h = WAIT input pin is WAIT0 1h = WAIT input pin is WAIT1 2h = Reserved 3h = Reserved
15-14	RESERVED	R	0h	
13-12	DEVICESTYPE	R/W	0h	Selects the device size attached (Reset value is SYSBOOT[8] input pin sampled at IC reset for CS[0] (active low) and 01 for CS[1] to CS[6] (active low)). 0h = 8 bit 1h = 16 bit 2h = Reserved 3h = Reserved
11-10	DEVICETYPE	R/W	0h	Selects the attached device type 0h = NOR Flash like, asynchronous and synchronous devices 1h = Reserved 2h = NAND Flash like devices, stream mode 3h = Reserved
9-8	MUXADDDATA	R/W	0h	Enables the Address and data multiplexed protocol (Reset value is SYSBOOT[11] and SYSBOOT[10] input pin sampled at IC reset for CS[0] (active low) and 0 for CS[1] to CS[6] (active low)). 0h = Non-multiplexed attached device 1h = AAD-multiplexed protocol device 2h = Address and data multiplexed attached device 3h = Reserved
7-5	RESERVED	R	0h	
4	TIMEPARAGRANULARITY	R/W	0h	Signals timing latencies scalar factor (Rd/WRCycleTime, AccessTime, PageBurstAccessTime, CSOnTime, CSRd/WrOffTime, ADVOnTime, ADVRd/WrOffTime, OEOnTime, OEOffTime, WEOnTime, WEOffTime, Cycle2CycleDelay, BusTurnAround, TimeOutStartValue). 0h = x1 latencies 1h = x2 latencies
3-2	RESERVED	R	0h	

Table 7-122. GPMC_CONFIG1_6 Register Field Descriptions (continued)

Bit	Field	Type	Reset	Description
1-0	GPMCFCLKDIVIDER	R/W	0h	Divides the GPMC.FCLK clock. 0h = GPMC_CLK frequency = GPMC_FCLK frequency 1h = GPMC_CLK frequency = GPMC_FCLK frequency/2 2h = GPMC_CLK frequency = GPMC_FCLK frequency/3 3h = GPMC_CLK frequency = GPMC_FCLK frequency/4

7.1.6.72 GPMC_CONFIG2_6 Register (offset = 184h) [reset = 0h]

GPMC_CONFIG2_6 is shown in [Figure 7-119](#) and described in [Table 7-123](#).

Chip-select signal timing parameter configuration.

Figure 7-119. GPMC_CONFIG2_6 Register

31	30	29	28	27	26	25	24
RESERVED							
R-0h							
23	22	21	20	19	18	17	16
RESERVED				CSWROFFTIME			
R-0h				R/W-0h			
15	14	13	12	11	10	9	8
RESERVED				CSRDOFFTIME			
R-0h				R/W-0h			
7	6	5	4	3	2	1	0
CSEXTRAD ELAY	RESERVED			CSONTIME			
R/W-0h	R-0h			R/W-0h			

LEGEND: R/W = Read/Write; R = Read only; W1toCl = Write 1 to clear bit; -n = value after reset

Table 7-123. GPMC_CONFIG2_6 Register Field Descriptions

Bit	Field	Type	Reset	Description
31-21	RESERVED	R	0h	
20-16	CSWROFFTIME	R/W	0h	CS# de-assertion time from start cycle time for write accesses 0h = 0 GPMC_FCLK cycle 1h = 1 GPMC_FCLK cycle 1Fh = 31 GPMC_FCLK cycles
15-13	RESERVED	R	0h	
12-8	CSRDOFFTIME	R/W	0h	CS# de-assertion time from start cycle time for read accesses 0h = 0 GPMC_FCLK cycle 1h = 1 GPMC_FCLK cycle 1Fh = 31 GPMC_FCLK cycles
7	CSEXTRAD ELAY	R/W	0h	CS# Add Extra Half GPMC.FCLK cycle 0h = CS i Timing control signal is not delayed 1h = CS i Timing control signal is delayed of half GPMC_FCLK clock cycle
6-4	RESERVED	R	0h	
3-0	CSONTIME	R/W	0h	CS# assertion time from start cycle time 0h = 0 GPMC_FCLK cycle 1h = 1 GPMC_FCLK cycle 1Fh = 15 GPMC_FCLK cycles

7.1.6.73 GPMC_CONFIG3_6 Register (offset = 188h) [reset = 0h]

GPMC_CONFIG3_6 is shown in [Figure 7-120](#) and described in [Table 7-124](#).

ADV# signal timing parameter configuration.

Figure 7-120. GPMC_CONFIG3_6 Register

31	30	29	28	27	26	25	24
RESERVED	ADVAADMUXWROFFTIME			RESERVED	ADVAADMUXRDOFFTIME		
R-0h	R/W-0h			R-0h	R/W-0h		
23	22	21	20	19	18	17	16
RESERVED				ADVWROFFTIME			
R-0h				R/W-0h			
15	14	13	12	11	10	9	8
RESERVED				ADVRDOFFTIME			
R-0h				R/W-0h			
7	6	5	4	3	2	1	0
ADVEXTRA LAY	ADVAADMUXONTIME			ADVONTIME			
R/W-0h	R/W-0h			R/W-0h			

LEGEND: R/W = Read/Write; R = Read only; W1toCl = Write 1 to clear bit; -n = value after reset

Table 7-124. GPMC_CONFIG3_6 Register Field Descriptions

Bit	Field	Type	Reset	Description
31	RESERVED	R	0h	
30-28	ADVAADMUXWROFFTIME	R/W	0h	ADV# de-assertion for first address phase when using the AAD-Mux protocol 0h = 0 GPMC_FCLK cycle 1h = 1 GPMC_FCLK cycle 7h = 7 GPMC_FCLK cycles
27	RESERVED	R	0h	
26-24	ADVAADMUXRDOFFTIME	R/W	0h	ADV# assertion for first address phase when using the AAD-Mux protocol 0h = 0 GPMC_FCLK cycle 1h = 1 GPMC_FCLK cycle 7h = 7 GPMC_FCLK cycles
23-21	RESERVED	R	0h	
20-16	ADVWROFFTIME	R/W	0h	ADV# de-assertion time from start cycle time for write accesses 0h = 0 GPMC_FCLK cycle 1h = 1 GPMC_FCLK cycle 1Fh = 31 GPMC_FCLK cycles
15-13	RESERVED	R	0h	
12-8	ADVRDOFFTIME	R/W	0h	ADV# de-assertion time from start cycle time for read accesses 0h = 0 GPMC_FCLK cycle 1h = 1 GPMC_FCLK cycle 1Fh = 31 GPMC_FCLK cycles
7	ADVEXTRADELAY	R/W	0h	ADV# Add Extra Half GPMC.FCLK cycle 0h = ADV (active low) Timing control signal is not delayed 1h = ADV (active low) Timing control signal is delayed of half GPMC_FCLK clock cycle
6-4	ADVAADMUXONTIME	R/W	0h	ADV# assertion for first address phase when using the AAD-Multiplexed protocol 0h = 0 GPMC_FCLK cycle 1h = 1 GPMC_FCLK cycle 7h = 7 GPMC_FCLK cycles

Table 7-124. GPMC_CONFIG3_6 Register Field Descriptions (continued)

Bit	Field	Type	Reset	Description
3-0	ADVONTIME	R/W	0h	ADV# assertion time from start cycle time 0h = 0 GPMC_FCLK cycle 1h = 1 GPMC_FCLK cycle Fh = 15 GPMC_FCLK cycles

7.1.6.74 GPMC_CONFIG4_6 Register (offset = 18Ch) [reset = 0h]

GPMC_CONFIG4_6 is shown in [Figure 7-121](#) and described in [Table 7-125](#).

WE# and OE# signals timing parameter configuration.

Figure 7-121. GPMC_CONFIG4_6 Register

31	30	29	28	27	26	25	24
RESERVED				WEOFFTIME			
R-0h				R/W-0h			
23	22	21	20	19	18	17	16
WEEXTRADELAY	RESERVED			WEONTIME			
R/W-0h		R-0h		R/W-0h			
15	14	13	12	11	10	9	8
OEAADMUXOFFTIME				OEOFFTIME			
R/W-0h				R/W-0h			
7	6	5	4	3	2	1	0
OEEXTRADELAY	OEAADMUXONTIME			OEONTIME			
R/W-0h		R/W-0h		R/W-0h			

LEGEND: R/W = Read/Write; R = Read only; W1toCl = Write 1 to clear bit; -n = value after reset

Table 7-125. GPMC_CONFIG4_6 Register Field Descriptions

Bit	Field	Type	Reset	Description
31-29	RESERVED	R	0h	
28-24	WEOFFTIME	R/W	0h	WE# de-assertion time from start cycle time 0h = 0 GPMC_FCLK cycle 1h = 1 GPMC_FCLK cycle 1Fh = 31 GPMC_FCLK cycles
23	WEEXTRADELAY	R/W	0h	WE# Add Extra Half GPMC.FCLK cycle 0h = WE (active low) Timing control signal is not delayed 1h = WE (active low) Timing control signal is delayed of half GPMC_FCLK clock cycle
22-20	RESERVED	R	0h	
19-16	WEONTIME	R/W	0h	WE# assertion time from start cycle time 0h = 0 GPMC_FCLK cycle 1h = 1 GPMC_FCLK cycle Fh = 15 GPMC_FCLK cycles
15-13	OEAADMUXOFFTIME	R/W	0h	OE# de-assertion time for the first address phase in an AAD-Multiplexed access 0h = 0 GPMC_FCLK cycle 1h = 1 GPMC_FCLK cycle 7h = 7 GPMC_FCLK cycles
12-8	OEOFFTIME	R/W	0h	OE# de-assertion time from start cycle time 0h = 0 GPMC_FCLK cycle 1h = 1 GPMC_FCLK cycle 7h = 31 GPMC_FCLK cycles
7	OEEXTRADELAY	R/W	0h	OE# Add Extra Half GPMC.FCLK cycle 0h = OE (active low) Timing control signal is not delayed 1h = OE (active low) Timing control signal is delayed of half GPMC_FCLK clock cycle

Table 7-125. GPMC_CONFIG4_6 Register Field Descriptions (continued)

Bit	Field	Type	Reset	Description
6-4	OEAADMUXONTIME	R/W	0h	OE# assertion time for the first address phase in an AAD-Multiplexed access 0h = 0 GPMC_FCLK cycle 1h = 1 GPMC_FCLK cycle 7h = 7 GPMC_FCLK cycles
3-0	OEONTIME	R/W	0h	OE# assertion time from start cycle time 0h = 0 GPMC_FCLK cycle 1h = 1 GPMC_FCLK cycle Fh = 15 GPMC_FCLK cycles

7.1.6.75 GPMC_CONFIG5_6 Register (offset = 190h) [reset = 0h]

GPMC_CONFIG5_6 is shown in [Figure 7-122](#) and described in [Table 7-126](#).

RdAccessTime and CycleTime timing parameters configuration.

Figure 7-122. GPMC_CONFIG5_6 Register

31	30	29	28	27	26	25	24
RESERVED				PAGEBURSTACCESSTIME			
R-0h				R/W-0h			
23	22	21	20	19	18	17	16
RESERVED				RDACCESSTIME			
R-0h				R/W-0h			
15	14	13	12	11	10	9	8
RESERVED				WRCYCLETIME			
R-0h				R/W-0h			
7	6	5	4	3	2	1	0
RESERVED				RDCYCLETIME			
R-0h				R/W-0h			

LEGEND: R/W = Read/Write; R = Read only; W1toCl = Write 1 to clear bit; -n = value after reset

Table 7-126. GPMC_CONFIG5_6 Register Field Descriptions

Bit	Field	Type	Reset	Description
31-28	RESERVED	R	0h	
27-24	PAGEBURSTACCESSTIME	R/W	0h	Delay between successive words in a multiple access 0h = 0 GPMC_FCLK cycle 1h = 1 GPMC_FCLK cycle Fh = 15 GPMC_FCLK cycles
23-21	RESERVED	R	0h	
20-16	RDACCESSTIME	R/W	0h	Delay between start cycle time and first data valid 0h = 0 GPMC_FCLK cycle 1h = 1 GPMC_FCLK cycle 1Fh = 31 GPMC_FCLK cycles
15-13	RESERVED	R	0h	
12-8	WRCYCLETIME	R/W	0h	Total write cycle time 0h = 0 GPMC_FCLK cycle 1h = 1 GPMC_FCLK cycle 1Fh = 31 GPMC_FCLK cycles
7-5	RESERVED	R	0h	
4-0	RDCYCLETIME	R/W	0h	Total read cycle time 0h = 0 GPMC_FCLK cycle 1h = 1 GPMC_FCLK cycle 1Fh = 31 GPMC_FCLK cycles

7.1.6.76 GPMC_CONFIG6_6 Register (offset = 194h) [reset = F070000h]

GPMC_CONFIG6_6 is shown in [Figure 7-123](#) and described in [Table 7-127](#).

WrAccessTime, WrDataOnADmuxBus, Cycle2Cycle, and BusTurnAround parameters configuration

Figure 7-123. GPMC_CONFIG6_6 Register

31	30	29	28	27	26	25	24
RESERVED				WRACCESSTIME			
R-0h				R/W-Fh			
23	22	21	20	19	18	17	16
RESERVED				WRDATAONADMUXBUS			
R-0h				R/W-7h			
15	14	13	12	11	10	9	8
RESERVED				CYCLE2CYCLEDELAY			
R-0h				R/W-0h			
7	6	5	4	3	2	1	0
CYCLE2CYCL ESAMECSEN	CYCLE2CYCL EDIFFCSEN	RESERVED		BUSTURNAROUND			
R/W-0h	R/W-0h	R-0h		R/W-0h			

LEGEND: R/W = Read/Write; R = Read only; W1toCl = Write 1 to clear bit; -n = value after reset

Table 7-127. GPMC_CONFIG6_6 Register Field Descriptions

Bit	Field	Type	Reset	Description
31-29	RESERVED	R	0h	Reset value for bit 31 is 1.
28-24	WRACCESSTIME	R/W	Fh	Delay from StartAccessTime to the GPMC.FCLK rising edge corresponding the the GPMC.CLK rising edge used by the attached memory for the first data capture. Reset value is 0xF. 0h = 0 GPMC_FCLK cycle 1h = 1 GPMC_FCLK cycle 1Fh = 31 GPMC_FCLK cycles
23-20	RESERVED	R	0h	
19-16	WRDATAONADMUXBUS	R/W	7h	Specifies on which GPMC.FCLK rising edge the first data of the synchronous burst write is driven in the add/data multiplexed bus. Reset value is 0x7.
15-12	RESERVED	R	0h	
11-8	CYCLE2CYCLEDELAY	R/W	0h	Chip select high pulse delay between two successive accesses 0h = 0 GPMC_FCLK cycle 1h = 1 GPMC_FCLK cycle Fh = 15 GPMC_FCLK cycles
7	CYCLE2CYCLESAMECSEN	R/W	0h	Add Cycle2CycleDelay between two successive accesses to the same chip-select (any access type) 0h = No delay between the two accesses 1h = Add CYCLE2CYCLEDELAY
6	CYCLE2CYCLEDIFFCSEN	R/W	0h	Add Cycle2CycleDelay between two successive accesses to a different chip-select (any access type) 0h = No delay between the two accesses 1h = Add CYCLE2CYCLEDELAY
5-4	RESERVED	R	0h	
3-0	BUSTURNAROUND	R/W	0h	Bus turn around latency between two successive accesses to the same chip-select (read to write) or to a different chip-select (read to read and read to write) 0h = 0 GPMC_FCLK cycle 1h = 1 GPMC_FCLK cycle Fh = 15 GPMC_FCLK cycles

7.1.6.77 GPMC_CONFIG7_6 Register (offset = 198h) [reset = 0h]

GPMC_CONFIG7_6 is shown in [Figure 7-124](#) and described in [Table 7-128](#).

Chip-select address mapping configuration.

Figure 7-124. GPMC_CONFIG7_6 Register

31	30	29	28	27	26	25	24
RESERVED							
R-0h							
23	22	21	20	19	18	17	16
RESERVED							
R-0h							
15	14	13	12	11	10	9	8
RESERVED				MASKADDRESS			
R-0h				R/W-0h			
7	6	5	4	3	2	1	0
RESERVED	CSVALID	BASEADDRESS					
R-0h	R/W-0h	R/W-0h					

LEGEND: R/W = Read/Write; R = Read only; W1toCl = Write 1 to clear bit; -n = value after reset

Table 7-128. GPMC_CONFIG7_6 Register Field Descriptions

Bit	Field	Type	Reset	Description
31-12	RESERVED	R	0h	
11-8	MASKADDRESS	R/W	0h	Chip-select mask address. Values not listed must be avoided as they create holes in the chip-select address space. 0h = Chip-select size of 256 Mbytes 8h = Chip-select size of 128 Mbytes Ch = Chip-select size of 64 Mbytes Eh = Chip-select size of 32 Mbytes Fh = Chip-select size of 16 Mbytes
7	RESERVED	R	0h	
6	CSVALID	R/W	0h	Chip-select enable (reset value is 1 for CS[0] (active low) and 0 for CS[1] to CS[5] (active low)). 0h = CS (active low) disabled 1h = CS (active low) enabled
5-0	BASEADDRESS	R/W	0h	Chip-select base address. CSi base address where i = 0 to 3 (16 Mbytes minimum granularity). Bits 5 to 0 correspond to A29, A28, A27, A26, A25, and A24.

7.1.6.78 GPMC_NAND_COMMAND_6 Register (offset = 19Ch) [reset = 0h]

GPMC_NAND_COMMAND_6 is shown in [Figure 7-125](#) and described in [Table 7-129](#).

This register is not a true register, just an address location.

Figure 7-125. GPMC_NAND_COMMAND_6 Register

31	30	29	28	27	26	25	24	23	22	21	20	19	18	17	16	15	14	13	12	11	10	9	8	7	6	5	4	3	2	1	0
GPMC_NAND_COMMAND_6																															
W-0h																															

LEGEND: R/W = Read/Write; R = Read only; W1toCl = Write 1 to clear bit; -n = value after reset

Table 7-129. GPMC_NAND_COMMAND_6 Register Field Descriptions

Bit	Field	Type	Reset	Description
31-0	GPMC_NAND_COMMAND_6	W	0h	Writing data at the GPMC_NAND_COMMAND_6 location places the data as the NAND command value on the bus, using a regular asynchronous write access.

7.1.6.79 GPMC_NAND_ADDRESS_6 Register (offset = 1A0h) [reset = 0h]

GPMC_NAND_ADDRESS_6 is shown in [Figure 7-126](#) and described in [Table 7-130](#).

This register is not a true register, just an address location.

Figure 7-126. GPMC_NAND_ADDRESS_6 Register

31	30	29	28	27	26	25	24	23	22	21	20	19	18	17	16	15	14	13	12	11	10	9	8	7	6	5	4	3	2	1	0
GPMC_NAND_ADDRESS_6																															
W-0h																															

LEGEND: R/W = Read/Write; R = Read only; W1toCl = Write 1 to clear bit; -n = value after reset

Table 7-130. GPMC_NAND_ADDRESS_6 Register Field Descriptions

Bit	Field	Type	Reset	Description
31-0	GPMC_NAND_ADDRESS_6	W	0h	Writing data at the GPMC_NAND_ADDRESS_6 location places the data as the NAND partial address value on the bus, using a regular asynchronous write access.

7.1.6.80 GPMC_NAND_DATA_6 Register (offset = 1A4h) [reset = 0h]

GPMC_NAND_DATA_6 is shown in [Figure 7-127](#) and described in [Table 7-131](#).

This register is not a true register, just an address location.

Figure 7-127. GPMC_NAND_DATA_6 Register

31	30	29	28	27	26	25	24	23	22	21	20	19	18	17	16	15	14	13	12	11	10	9	8	7	6	5	4	3	2	1	0
GPMC_NAND_DATA_6																															
R/W-0h																															

LEGEND: R/W = Read/Write; R = Read only; W1toCl = Write 1 to clear bit; -n = value after reset

Table 7-131. GPMC_NAND_DATA_6 Register Field Descriptions

Bit	Field	Type	Reset	Description
31-0	GPMC_NAND_DATA_6	R/W	0h	Reading data from the GPMC_NAND_DATA_6 location or from any location in the associated chip-select memory region activates an asynchronous read access.

7.1.6.81 GPMC_PREFETCH_CONFIG1 Register (offset = 1E0h) [reset = 0h]

GPMC_PREFETCH_CONFIG1 is shown in [Figure 7-128](#) and described in [Table 7-132](#).

Figure 7-128. GPMC_PREFETCH_CONFIG1 Register

31	30	29	28	27	26	25	24
RESERVED	CYCLEOPTIMIZATION			ENABLEOPTIMIZEDACCESS	ENGINECSSELECTOR		
R-0h	R/W-0h			R/W-0h	R/W-0h		
23	22	21	20	19	18	17	16
PFPWENROUNDROBIN	RESERVED			PFPWWEIGHTEDPRIO			
R/W-0h	R-0h			R/W-0h			
15	14	13	12	11	10	9	8
RESERVED	FIFOTHRESHOLD						
R-0h							
7	6	5	4	3	2	1	0
ENABLEENGINE	RESERVED	WAITPINSELECTOR		SYNCHROMODE	DMAMODE	RESERVED	ACCESSMODE
R/W-0h	R-0h	R/W-0h		R/W-0h	R/W-0h	R-0h	R/W-0h

LEGEND: R/W = Read/Write; R = Read only; W1toCl = Write 1 to clear bit; -n = value after reset

Table 7-132. GPMC_PREFETCH_CONFIG1 Register Field Descriptions

Bit	Field	Type	Reset	Description
31	RESERVED	R	0h	
30-28	CYCLEOPTIMIZATION	R/W	0h	Define the number of GPMC.FCLK cycles to be subtracted from RdCycleTime, WrCycleTime, AccessTime, CSRdOffTime, CSWrOffTime, ADVRdOffTime, ADVWrOffTime, OEOffTime, WEOffTime 0h = 0 GPMC_FCLK cycle 1h = 1 GPMC_FCLK cycle 7h = 7 GPMC_FCLK cycles
27	ENABLEOPTIMIZEDACCESS	R/W	0h	Enables access cycle optimization 0h = Access cycle optimization is disabled 1h = Access cycle optimization is enabled
26-24	ENGINECSSELECTOR	R/W	0h	Selects the CS (active low) where Prefetch Postwrite engine is active 0h = CS0 (active low) 1h = CS1 (active low) 2h = CS2 (active low) 3h = CS3 (active low) 4h = CS4 (active low) 5h = CS5 (active low) 6h = CS6 (active low)
23	PFPWENROUNDROBIN	R/W	0h	0h = Prefetch Postwrite engine round robin arbitration is disabled 1h = Prefetch Postwrite engine round robin arbitration is enabled
22-20	RESERVED	R	0h	
19-16	PFPWWEIGHTEDPRIO	R/W	0h	0h = The next access is granted to the PFPW engine 1h = The two next accesses are granted to the PFPW engine Fh = The 16 next accesses are granted to the PFPW engine
15	RESERVED	R	0h	
14-8	FIFOTHRESHOLD	R/W	0h	0h = 0 byte 1h = 1 byte 40h = 64 bytes

Table 7-132. GPMC_PREFETCH_CONFIG1 Register Field Descriptions (continued)

Bit	Field	Type	Reset	Description
7	ENABLEENGINE	R/W	0h	0h = Prefetch Postwrite engine is disabled 1h = Prefetch Postwrite engine is enabled
6	RESERVED	R	0h	
5-4	WAITPINSELECTOR	R/W	0h	0h = Selects Wait0EdgeDetection 1h = Selects Wait1EdgeDetection 2h = Reserved 3h = Reserved
3	SYNCHROMODE	R/W	0h	0h = Engine starts the access to CS as soon as STARTENGINE is set 1h = Engine starts the access to CS as soon as STARTENGINE is set AND wait to non wait edge detection on the selected wait pin
2	DMAMODE	R/W	0h	0h = Interrupt synchronization is enabled. Only interrupt line will be activated on FIFO threshold crossing. 1h = DMA request synchronization is enabled. A DMA request protocol is used.
1	RESERVED	R	0h	
0	ACCESSMODE	R/W	0h	0h = Prefetch read mode 1h = Write-posting mode

7.1.6.82 GPMC_PREFETCH_CONFIG2 Register (offset = 1E4h) [reset = 0h]

 GPMC_PREFETCH_CONFIG2 is shown in [Figure 7-129](#) and described in [Table 7-133](#).

Figure 7-129. GPMC_PREFETCH_CONFIG2 Register

31	30	29	28	27	26	25	24	23	22	21	20	19	18	17	16	15	14	13	12	11	10	9	8	7	6	5	4	3	2	1	0
RESERVED																		TRANSFERCOUNT													
R-0h																		R/W-0h													

LEGEND: R/W = Read/Write; R = Read only; W1toCl = Write 1 to clear bit; -n = value after reset

Table 7-133. GPMC_PREFETCH_CONFIG2 Register Field Descriptions

Bit	Field	Type	Reset	Description
31-14	RESERVED	R	0h	
13-0	TRANSFERCOUNT	R/W	0h	Selects the number of bytes to be read or written by the engine to the selected CS (active low) 0h = 0 byte 1h = 1 byte 2000h = 8 Kbytes

7.1.6.83 GPMC_PREFETCH_CONTROL Register (offset = 1ECh) [reset = 0h]

GPMC_PREFETCH_CONTROL is shown in [Figure 7-130](#) and described in [Table 7-134](#).

Figure 7-130. GPMC_PREFETCH_CONTROL Register

31	30	29	28	27	26	25	24
RESERVED							
R-0h							
23	22	21	20	19	18	17	16
RESERVED							
R-0h							
15	14	13	12	11	10	9	8
RESERVED							
R-0h							
7	6	5	4	3	2	1	0
RESERVED							STARTENGINE
R-0h							R/W-0h

LEGEND: R/W = Read/Write; R = Read only; W1toCl = Write 1 to clear bit; -n = value after reset

Table 7-134. GPMC_PREFETCH_CONTROL Register Field Descriptions

Bit	Field	Type	Reset	Description
31-1	RESERVED	R	0h	
0	STARTENGINE	R/W	0h	Resets the FIFO pointer and starts the engine 0h (W) = Stops the engine 0h (R) = Engine is stopped 1h (W) = Resets the FIFO pointer to 0 in prefetch mode and 40h in postwrite mode and starts the engine 1h (R) = Engine is running

7.1.6.84 GPMC_PREFETCH_STATUS Register (offset = 1F0h) [reset = 0h]

GPMC_PREFETCH_STATUS is shown in [Figure 7-131](#) and described in [Table 7-135](#).

Figure 7-131. GPMC_PREFETCH_STATUS Register

31	30	29	28	27	26	25	24
RESERVED		FIFOPOINTER					
R-0h		R-0h					
23	22	21	20	19	18	17	16
RESERVED							FIFOTHRESHOLDSTATUS
R-0h							R-0h
15	14	13	12	11	10	9	8
RESERVED		COUNTVALUE					
R-0h		R-0h					
7	6	5	4	3	2	1	0
COUNTVALUE							
R-0h							

LEGEND: R/W = Read/Write; R = Read only; W1toCl = Write 1 to clear bit; -n = value after reset

Table 7-135. GPMC_PREFETCH_STATUS Register Field Descriptions

Bit	Field	Type	Reset	Description
31	RESERVED	R	0h	
30-24	FIFOPOINTER	R	0h	FIFOPOINTER. 0h = 0 byte available to be read or 0 free empty place to be written 40h = 64 bytes available to be read or 64 empty places to be written
23-17	RESERVED	R	0h	
16	FIFOTHRESHOLDSTATUS	R	0h	Set when FIFOPointer exceeds FIFOThreshold value. 0h = FIFOPointer smaller or equal to FIFOThreshold. Writing to this bit has no effect 1h = FIFOPointer greater than FIFOThreshold. Writing to this bit has no effect
15-14	RESERVED	R	0h	
13-0	COUNTVALUE	R	0h	Number of remaining bytes to be read or to be written by the engine according to the TransferCount value. 0h = 0 byte remaining to be read or to be written 1h = 1 byte remaining to be read or to be written 2000h = 8 Kbytes remaining to be read or to be written

7.1.6.85 GPMC_ECC_CONFIG Register (offset = 1F4h) [reset = 0h]

GPMC_ECC_CONFIG is shown in [Figure 7-132](#) and described in [Table 7-136](#).

Figure 7-132. GPMC_ECC_CONFIG Register

31	30	29	28	27	26	25	24
RESERVED							
R-0h							
23	22	21	20	19	18	17	16
RESERVED							ECCALGORIT HM
R-0h							R/W-0h
15	14	13	12	11	10	9	8
RESERVED		ECCBCHTSEL		ECCWRAPMODE			
R-0h		R/W-0h		R/W-0h			
7	6	5	4	3	2	1	0
ECC16B	ECCTOPSECTOR			ECCCS			ECCENABLE
R/W-0h	R/W-0h			R/W-0h			R/W-0h

LEGEND: R/W = Read/Write; R = Read only; W1toCl = Write 1 to clear bit; -n = value after reset

Table 7-136. GPMC_ECC_CONFIG Register Field Descriptions

Bit	Field	Type	Reset	Description
31-17	RESERVED	R	0h	
16	ECCALGORITHM	R/W	0h	ECC algorithm used 0h = Hamming code 1h = BCH code
15-14	RESERVED	R	0h	
13-12	ECCBCHTSEL	R/W	0h	Error correction capability used for BCH 0h = Up to 4 bits error correction (t = 4) 1h = Up to 8 bits error correction (t = 8) 2h = Up to 16 bits error correction (t = 16) 3h = Reserved
11-8	ECCWRAPMODE	R/W	0h	Spare area organization definition for the BCH algorithm. See the BCH syndrome/parity calculator module functional specification for more details
7	ECC16B	R/W	0h	Selects an ECC calculated on 16 columns 0h = ECC calculated on 8 columns 1h = ECC calculated on 16 columns
6-4	ECCTOPSECTOR	R/W	0h	Number of sectors to process with the BCH algorithm 0h = 1 sector (512kB page) 1h = 2 sectors 3h = 4 sectors (2kB page) 7h = 8 sectors (4kB page)
3-1	ECCCS	R/W	0h	Selects the Chip-select where ECC is computed 0h = Chip-select 0 1h = Chip-select 1 2h = Chip-select 2 3h = Chip-select 3 4h = Chip-select 4 5h = Chip-select 5 6h = Reserved 7h = Reserved

Table 7-136. GPMC_ECC_CONFIG Register Field Descriptions (continued)

Bit	Field	Type	Reset	Description
0	ECCENABLE	R/W	0h	Enables the ECC feature 0h = ECC disabled 1h = ECC enabled

7.1.6.86 GPMC_ECC_CONTROL Register (offset = 1F8h) [reset = 0h]

GPMC_ECC_CONTROL is shown in [Figure 7-133](#) and described in [Table 7-137](#).

Figure 7-133. GPMC_ECC_CONTROL Register

31	30	29	28	27	26	25	24
RESERVED							
R-0h							
23	22	21	20	19	18	17	16
RESERVED							
R-0h							
15	14	13	12	11	10	9	8
RESERVED							ECCCLEAR
R-0h							R/W-0h
7	6	5	4	3	2	1	0
RESERVED				ECCPOINTER			
R-0h				R/W-0h			

LEGEND: R/W = Read/Write; R = Read only; W1toCl = Write 1 to clear bit; -n = value after reset

Table 7-137. GPMC_ECC_CONTROL Register Field Descriptions

Bit	Field	Type	Reset	Description
31-9	RESERVED	R	0h	
8	ECCCLEAR	R/W	0h	Clear all ECC result registers 0h (W) = Ignored 0h (R) = All reads return 0 1h (W) = Clears all ECC result registers
7-4	RESERVED	R	0h	
3-0	ECCPOINTER	R/W	0h	Selects ECC result register (Reads to this field give the dynamic position of the ECC pointer - Writes to this field select the ECC result register where the first ECC computation will be stored). Writing values not listed disables the ECC engine (ECCENABLE bit of GPMC_ECC_CONFIG cleared to 0). 0h = Writing 0 disables the ECC engine (ECCENABLE bit of GPMC_ECC_CONFIG cleared to 0) 1h = ECC result register 1 selected 2h = ECC result register 2 selected 3h = ECC result register 3 selected 4h = ECC result register 4 selected 5h = ECC result register 5 selected 6h = ECC result register 6 selected 7h = ECC result register 7 selected 8h = ECC result register 8 selected 9h = ECC result register 9 selected

7.1.6.87 GPMC_ECC_SIZE_CONFIG Register (offset = 1FCh) [reset = 0h]

GPMC_ECC_SIZE_CONFIG is shown in [Figure 7-134](#) and described in [Table 7-138](#).

Figure 7-134. GPMC_ECC_SIZE_CONFIG Register

31	30	29	28	27	26	25	24
RESERVED			ECCSIZE1				
R-0h			R/W-0h				
23	22	21	20	19	18	17	16
ECCSIZE1		RESERVED			ECCSIZE0		
R/W-0h		R-0h			R/W-0h		
15	14	13	12	11	10	9	8
ECCSIZE0				RESERVED			ECC9RESULT SIZE
R/W-0h				R-0h			R/W-0h
7	6	5	4	3	2	1	0
ECC8RESULT SIZE	ECC7RESULT SIZE	ECC6RESULT SIZE	ECC5RESULT SIZE	ECC4RESULT SIZE	ECC3RESULT SIZE	ECC2RESULT SIZE	ECC1RESULT SIZE
R/W-0h	R/W-0h	R/W-0h	R/W-0h	R/W-0h	R/W-0h	R/W-0h	R/W-0h

LEGEND: R/W = Read/Write; R = Read only; W1toCl = Write 1 to clear bit; -n = value after reset

Table 7-138. GPMC_ECC_SIZE_CONFIG Register Field Descriptions

Bit	Field	Type	Reset	Description
31-30	RESERVED	R	0h	
29-22	ECCSIZE1	R/W	0h	Defines ECC size 1 0h = 2 Bytes 1h = 4 Bytes 2h = 6 Bytes 3h = 8 Bytes FFh = 512 Bytes
21-20	RESERVED	R	0h	
19-12	ECCSIZE0	R/W	0h	Defines ECC size 0 0h = 2 Bytes 1h = 4 Bytes 2h = 6 Bytes 3h = 8 Bytes FFh = 512 Bytes
11-9	RESERVED	R	0h	
8	ECC9RESULTSIZ	R/W	0h	Selects ECC size for ECC 9 result register 0h = ECCSIZE0 selected 1h = ECCSIZE1 selected
7	ECC8RESULTSIZ	R/W	0h	Selects ECC size for ECC 8 result register 0h = ECCSIZE0 selected 1h = ECCSIZE1 selected
6	ECC7RESULTSIZ	R/W	0h	Selects ECC size for ECC 7 result register 0h = ECCSIZE0 selected 1h = ECCSIZE1 selected
5	ECC6RESULTSIZ	R/W	0h	Selects ECC size for ECC 6 result register 0h = ECCSIZE0 selected 1h = ECCSIZE1 selected
4	ECC5RESULTSIZ	R/W	0h	Selects ECC size for ECC 5 result register 0h = ECCSIZE0 selected 1h = ECCSIZE1 selected

Table 7-138. GPMC_ECC_SIZE_CONFIG Register Field Descriptions (continued)

Bit	Field	Type	Reset	Description
3	ECC4RESULTSIZ	R/W	0h	Selects ECC size for ECC 4 result register 0h = ECCSIZE0 selected 1h = ECCSIZE1 selected
2	ECC3RESULTSIZ	R/W	0h	Selects ECC size for ECC 3 result register 0h = ECCSIZE0 selected 1h = ECCSIZE1 selected
1	ECC2RESULTSIZ	R/W	0h	Selects ECC size for ECC 2 result register 0h = ECCSIZE0 selected 1h = ECCSIZE1 selected
0	ECC1RESULTSIZ	R/W	0h	Selects ECC size for ECC 1 result register 0h = ECCSIZE0 selected 1h = ECCSIZE1 selected

7.1.6.88 GPMC_ECC1_RESULT Register (offset = 200h) [reset = 0h]

GPMC_ECC1_RESULT is shown in [Figure 7-135](#) and described in [Table 7-139](#).

Figure 7-135. GPMC_ECC1_RESULT Register

31	30	29	28	27	26	25	24
RESERVED				P2048O	P1024O	P512O	P256O
R-0h				R-0h	R-0h	R-0h	R-0h
23	22	21	20	19	18	17	16
P128O	P64O	P32O	P16O	P8O	P4O	P2O	P1O
R-0h	R-0h	R-0h	R-0h	R-0h	R-0h	R-0h	R-0h
15	14	13	12	11	10	9	8
RESERVED				P2048E	P1024E	P512E	P256E
R-0h				R-0h	R-0h	R-0h	R-0h
7	6	5	4	3	2	1	0
P128E	P64E	P32E	P16E	P8E	P4E	P2E	P1E
R-0h	R-0h	R-0h	R-0h	R-0h	R-0h	R-0h	R-0h

LEGEND: R/W = Read/Write; R = Read only; W1toCl = Write 1 to clear bit; -n = value after reset

Table 7-139. GPMC_ECC1_RESULT Register Field Descriptions

Bit	Field	Type	Reset	Description
31-28	RESERVED	R	0h	
27	P2048O	R	0h	Odd Row Parity bit 2048, only used for ECC computed on 512 Bytes
26	P1024O	R	0h	Odd Row Parity bit 1024
25	P512O	R	0h	Odd Row Parity bit 512
24	P256O	R	0h	Odd Row Parity bit 256
23	P128O	R	0h	Odd Row Parity bit 128
22	P64O	R	0h	Odd Row Parity bit 64
21	P32O	R	0h	Odd Row Parity bit 32
20	P16O	R	0h	Odd Row Parity bit 16
19	P8O	R	0h	Odd Row Parity bit 8
18	P4O	R	0h	Odd Column Parity bit 4
17	P2O	R	0h	Odd Column Parity bit 2
16	P1O	R	0h	Odd Column Parity bit 1
15-12	RESERVED	R	0h	
11	P2048E	R	0h	Even Row Parity bit 2048, only used for ECC computed on 512 Bytes
10	P1024E	R	0h	Even Row Parity bit 1024
9	P512E	R	0h	Even Row Parity bit 512
8	P256E	R	0h	Even Row Parity bit 256
7	P128E	R	0h	Even Row Parity bit 128
6	P64E	R	0h	Even Row Parity bit 64
5	P32E	R	0h	Even Row Parity bit 32
4	P16E	R	0h	Even Row Parity bit 16
3	P8E	R	0h	Even Row Parity bit 8
2	P4E	R	0h	Even Column Parity bit 4
1	P2E	R	0h	Even Column Parity bit 2

Table 7-139. GPMC_ECC1_RESULT Register Field Descriptions (continued)

Bit	Field	Type	Reset	Description
0	P1E	R	0h	Even Column Parity bit 1

7.1.6.89 GPMC_ECC2_RESULT Register (offset = 204h) [reset = 0h]

GPMC_ECC2_RESULT is shown in [Figure 7-136](#) and described in [Table 7-140](#).

Figure 7-136. GPMC_ECC2_RESULT Register

31	30	29	28	27	26	25	24
RESERVED				P2048O	P1024O	P512O	P256O
R-0h				R-0h	R-0h	R-0h	R-0h
23	22	21	20	19	18	17	16
P128O	P64O	P32O	P16O	P8O	P4O	P2O	P1O
R-0h	R-0h	R-0h	R-0h	R-0h	R-0h	R-0h	R-0h
15	14	13	12	11	10	9	8
RESERVED				P2048E	P1024E	P512E	P256E
R-0h				R-0h	R-0h	R-0h	R-0h
7	6	5	4	3	2	1	0
P128E	P64E	P32E	P16E	P8E	P4E	P2E	P1E
R-0h	R-0h	R-0h	R-0h	R-0h	R-0h	R-0h	R-0h

LEGEND: R/W = Read/Write; R = Read only; W1toCl = Write 1 to clear bit; -n = value after reset

Table 7-140. GPMC_ECC2_RESULT Register Field Descriptions

Bit	Field	Type	Reset	Description
31-28	RESERVED	R	0h	
27	P2048O	R	0h	Odd Row Parity bit 2048, only used for ECC computed on 512 Bytes
26	P1024O	R	0h	Odd Row Parity bit 1024
25	P512O	R	0h	Odd Row Parity bit 512
24	P256O	R	0h	Odd Row Parity bit 256
23	P128O	R	0h	Odd Row Parity bit 128
22	P64O	R	0h	Odd Row Parity bit 64
21	P32O	R	0h	Odd Row Parity bit 32
20	P16O	R	0h	Odd Row Parity bit 16
19	P8O	R	0h	Odd Row Parity bit 8
18	P4O	R	0h	Odd Column Parity bit 4
17	P2O	R	0h	Odd Column Parity bit 2
16	P1O	R	0h	Odd Column Parity bit 1
15-12	RESERVED	R	0h	
11	P2048E	R	0h	Even Row Parity bit 2048, only used for ECC computed on 512 Bytes
10	P1024E	R	0h	Even Row Parity bit 1024
9	P512E	R	0h	Even Row Parity bit 512
8	P256E	R	0h	Even Row Parity bit 256
7	P128E	R	0h	Even Row Parity bit 128
6	P64E	R	0h	Even Row Parity bit 64
5	P32E	R	0h	Even Row Parity bit 32
4	P16E	R	0h	Even Row Parity bit 16
3	P8E	R	0h	Even Row Parity bit 8
2	P4E	R	0h	Even Column Parity bit 4
1	P2E	R	0h	Even Column Parity bit 2

Table 7-140. GPMC_ECC2_RESULT Register Field Descriptions (continued)

Bit	Field	Type	Reset	Description
0	P1E	R	0h	Even Column Parity bit 1

7.1.6.90 GPMC_ECC3_RESULT Register (offset = 208h) [reset = 0h]

GPMC_ECC3_RESULT is shown in [Figure 7-137](#) and described in [Table 7-141](#).

Figure 7-137. GPMC_ECC3_RESULT Register

31	30	29	28	27	26	25	24
RESERVED				P2048O	P1024O	P512O	P256O
R-0h				R-0h	R-0h	R-0h	R-0h
23	22	21	20	19	18	17	16
P128O	P64O	P32O	P16O	P8O	P4O	P2O	P1O
R-0h	R-0h	R-0h	R-0h	R-0h	R-0h	R-0h	R-0h
15	14	13	12	11	10	9	8
RESERVED				P2048E	P1024E	P512E	P256E
R-0h				R-0h	R-0h	R-0h	R-0h
7	6	5	4	3	2	1	0
P128E	P64E	P32E	P16E	P8E	P4E	P2E	P1E
R-0h	R-0h	R-0h	R-0h	R-0h	R-0h	R-0h	R-0h

LEGEND: R/W = Read/Write; R = Read only; W1toCl = Write 1 to clear bit; -n = value after reset

Table 7-141. GPMC_ECC3_RESULT Register Field Descriptions

Bit	Field	Type	Reset	Description
31-28	RESERVED	R	0h	
27	P2048O	R	0h	Odd Row Parity bit 2048, only used for ECC computed on 512 Bytes
26	P1024O	R	0h	Odd Row Parity bit 1024
25	P512O	R	0h	Odd Row Parity bit 512
24	P256O	R	0h	Odd Row Parity bit 256
23	P128O	R	0h	Odd Row Parity bit 128
22	P64O	R	0h	Odd Row Parity bit 64
21	P32O	R	0h	Odd Row Parity bit 32
20	P16O	R	0h	Odd Row Parity bit 16
19	P8O	R	0h	Odd Row Parity bit 8
18	P4O	R	0h	Odd Column Parity bit 4
17	P2O	R	0h	Odd Column Parity bit 2
16	P1O	R	0h	Odd Column Parity bit 1
15-12	RESERVED	R	0h	
11	P2048E	R	0h	Even Row Parity bit 2048, only used for ECC computed on 512 Bytes
10	P1024E	R	0h	Even Row Parity bit 1024
9	P512E	R	0h	Even Row Parity bit 512
8	P256E	R	0h	Even Row Parity bit 256
7	P128E	R	0h	Even Row Parity bit 128
6	P64E	R	0h	Even Row Parity bit 64
5	P32E	R	0h	Even Row Parity bit 32
4	P16E	R	0h	Even Row Parity bit 16
3	P8E	R	0h	Even Row Parity bit 8
2	P4E	R	0h	Even Column Parity bit 4
1	P2E	R	0h	Even Column Parity bit 2

Table 7-141. GPMC_ECC3_RESULT Register Field Descriptions (continued)

Bit	Field	Type	Reset	Description
0	P1E	R	0h	Even Column Parity bit 1

7.1.6.91 GPMC_ECC4_RESULT Register (offset = 20Ch) [reset = 0h]

GPMC_ECC4_RESULT is shown in [Figure 7-138](#) and described in [Table 7-142](#).

Figure 7-138. GPMC_ECC4_RESULT Register

31	30	29	28	27	26	25	24
RESERVED				P2048O	P1024O	P512O	P256O
R-0h				R-0h	R-0h	R-0h	R-0h
23	22	21	20	19	18	17	16
P128O	P64O	P32O	P16O	P8O	P4O	P2O	P1O
R-0h	R-0h	R-0h	R-0h	R-0h	R-0h	R-0h	R-0h
15	14	13	12	11	10	9	8
RESERVED				P2048E	P1024E	P512E	P256E
R-0h				R-0h	R-0h	R-0h	R-0h
7	6	5	4	3	2	1	0
P128E	P64E	P32E	P16E	P8E	P4E	P2E	P1E
R-0h	R-0h	R-0h	R-0h	R-0h	R-0h	R-0h	R-0h

LEGEND: R/W = Read/Write; R = Read only; W1toCl = Write 1 to clear bit; -n = value after reset

Table 7-142. GPMC_ECC4_RESULT Register Field Descriptions

Bit	Field	Type	Reset	Description
31-28	RESERVED	R	0h	
27	P2048O	R	0h	Odd Row Parity bit 2048, only used for ECC computed on 512 Bytes
26	P1024O	R	0h	Odd Row Parity bit 1024
25	P512O	R	0h	Odd Row Parity bit 512
24	P256O	R	0h	Odd Row Parity bit 256
23	P128O	R	0h	Odd Row Parity bit 128
22	P64O	R	0h	Odd Row Parity bit 64
21	P32O	R	0h	Odd Row Parity bit 32
20	P16O	R	0h	Odd Row Parity bit 16
19	P8O	R	0h	Odd Row Parity bit 8
18	P4O	R	0h	Odd Column Parity bit 4
17	P2O	R	0h	Odd Column Parity bit 2
16	P1O	R	0h	Odd Column Parity bit 1
15-12	RESERVED	R	0h	
11	P2048E	R	0h	Even Row Parity bit 2048, only used for ECC computed on 512 Bytes
10	P1024E	R	0h	Even Row Parity bit 1024
9	P512E	R	0h	Even Row Parity bit 512
8	P256E	R	0h	Even Row Parity bit 256
7	P128E	R	0h	Even Row Parity bit 128
6	P64E	R	0h	Even Row Parity bit 64
5	P32E	R	0h	Even Row Parity bit 32
4	P16E	R	0h	Even Row Parity bit 16
3	P8E	R	0h	Even Row Parity bit 8
2	P4E	R	0h	Even Column Parity bit 4
1	P2E	R	0h	Even Column Parity bit 2

Table 7-142. GPMC_ECC4_RESULT Register Field Descriptions (continued)

Bit	Field	Type	Reset	Description
0	P1E	R	0h	Even Column Parity bit 1

7.1.6.92 GPMC_ECC5_RESULT Register (offset = 210h) [reset = 0h]

GPMC_ECC5_RESULT is shown in [Figure 7-139](#) and described in [Table 7-143](#).

Figure 7-139. GPMC_ECC5_RESULT Register

31	30	29	28	27	26	25	24
RESERVED				P2048O	P1024O	P512O	P256O
R-0h				R-0h	R-0h	R-0h	R-0h
23	22	21	20	19	18	17	16
P128O	P64O	P32O	P16O	P8O	P4O	P2O	P1O
R-0h	R-0h	R-0h	R-0h	R-0h	R-0h	R-0h	R-0h
15	14	13	12	11	10	9	8
RESERVED				P2048E	P1024E	P512E	P256E
R-0h				R-0h	R-0h	R-0h	R-0h
7	6	5	4	3	2	1	0
P128E	P64E	P32E	P16E	P8E	P4E	P2E	P1E
R-0h	R-0h	R-0h	R-0h	R-0h	R-0h	R-0h	R-0h

LEGEND: R/W = Read/Write; R = Read only; W1toCl = Write 1 to clear bit; -n = value after reset

Table 7-143. GPMC_ECC5_RESULT Register Field Descriptions

Bit	Field	Type	Reset	Description
31-28	RESERVED	R	0h	
27	P2048O	R	0h	Odd Row Parity bit 2048, only used for ECC computed on 512 Bytes
26	P1024O	R	0h	Odd Row Parity bit 1024
25	P512O	R	0h	Odd Row Parity bit 512
24	P256O	R	0h	Odd Row Parity bit 256
23	P128O	R	0h	Odd Row Parity bit 128
22	P64O	R	0h	Odd Row Parity bit 64
21	P32O	R	0h	Odd Row Parity bit 32
20	P16O	R	0h	Odd Row Parity bit 16
19	P8O	R	0h	Odd Row Parity bit 8
18	P4O	R	0h	Odd Column Parity bit 4
17	P2O	R	0h	Odd Column Parity bit 2
16	P1O	R	0h	Odd Column Parity bit 1
15-12	RESERVED	R	0h	
11	P2048E	R	0h	Even Row Parity bit 2048, only used for ECC computed on 512 Bytes
10	P1024E	R	0h	Even Row Parity bit 1024
9	P512E	R	0h	Even Row Parity bit 512
8	P256E	R	0h	Even Row Parity bit 256
7	P128E	R	0h	Even Row Parity bit 128
6	P64E	R	0h	Even Row Parity bit 64
5	P32E	R	0h	Even Row Parity bit 32
4	P16E	R	0h	Even Row Parity bit 16
3	P8E	R	0h	Even Row Parity bit 8
2	P4E	R	0h	Even Column Parity bit 4
1	P2E	R	0h	Even Column Parity bit 2

Table 7-143. GPMC_ECC5_RESULT Register Field Descriptions (continued)

Bit	Field	Type	Reset	Description
0	P1E	R	0h	Even Column Parity bit 1

7.1.6.93 GPMC_ECC6_RESULT Register (offset = 214h) [reset = 0h]

GPMC_ECC6_RESULT is shown in [Figure 7-140](#) and described in [Table 7-144](#).

Figure 7-140. GPMC_ECC6_RESULT Register

31		30		29		28		27		26		25		24	
RESERVED								P2048O	P1024O	P512O	P256O				
R-0h								R-0h	R-0h	R-0h	R-0h				
23		22		21		20		19		18		17		16	
P128O	P64O	P32O	P16O		P8O		P4O		P2O		P1O				
R-0h	R-0h	R-0h	R-0h		R-0h		R-0h		R-0h		R-0h				
15		14		13		12		11		10		9		8	
RESERVED								P2048E	P1024E	P512E	P256E				
R-0h								R-0h	R-0h	R-0h	R-0h				
7		6		5		4		3		2		1		0	
P128E	P64E	P32E	P16E		P8E		P4E		P2E		P1E				
R-0h	R-0h	R-0h	R-0h		R-0h		R-0h		R-0h		R-0h				

LEGEND: R/W = Read/Write; R = Read only; W1toCl = Write 1 to clear bit; -n = value after reset

Table 7-144. GPMC_ECC6_RESULT Register Field Descriptions

Bit	Field	Type	Reset	Description
31-28	RESERVED	R	0h	
27	P2048O	R	0h	Odd Row Parity bit 2048, only used for ECC computed on 512 Bytes
26	P1024O	R	0h	Odd Row Parity bit 1024
25	P512O	R	0h	Odd Row Parity bit 512
24	P256O	R	0h	Odd Row Parity bit 256
23	P128O	R	0h	Odd Row Parity bit 128
22	P64O	R	0h	Odd Row Parity bit 64
21	P32O	R	0h	Odd Row Parity bit 32
20	P16O	R	0h	Odd Row Parity bit 16
19	P8O	R	0h	Odd Row Parity bit 8
18	P4O	R	0h	Odd Column Parity bit 4
17	P2O	R	0h	Odd Column Parity bit 2
16	P1O	R	0h	Odd Column Parity bit 1
15-12	RESERVED	R	0h	
11	P2048E	R	0h	Even Row Parity bit 2048, only used for ECC computed on 512 Bytes
10	P1024E	R	0h	Even Row Parity bit 1024
9	P512E	R	0h	Even Row Parity bit 512
8	P256E	R	0h	Even Row Parity bit 256
7	P128E	R	0h	Even Row Parity bit 128
6	P64E	R	0h	Even Row Parity bit 64
5	P32E	R	0h	Even Row Parity bit 32
4	P16E	R	0h	Even Row Parity bit 16
3	P8E	R	0h	Even Row Parity bit 8
2	P4E	R	0h	Even Column Parity bit 4
1	P2E	R	0h	Even Column Parity bit 2

Table 7-144. GPMC_ECC6_RESULT Register Field Descriptions (continued)

Bit	Field	Type	Reset	Description
0	P1E	R	0h	Even Column Parity bit 1

7.1.6.94 GPMC_ECC7_RESULT Register (offset = 218h) [reset = 0h]

GPMC_ECC7_RESULT is shown in [Figure 7-141](#) and described in [Table 7-145](#).

Figure 7-141. GPMC_ECC7_RESULT Register

31		30		29		28		27		26		25		24	
RESERVED								P2048O		P1024O		P512O		P256O	
R-0h								R-0h		R-0h		R-0h		R-0h	
23		22		21		20		19		18		17		16	
P128O		P64O		P32O		P16O		P8O		P4O		P2O		P1O	
R-0h		R-0h		R-0h		R-0h		R-0h		R-0h		R-0h		R-0h	
15		14		13		12		11		10		9		8	
RESERVED								P2048E		P1024E		P512E		P256E	
R-0h								R-0h		R-0h		R-0h		R-0h	
7		6		5		4		3		2		1		0	
P128E		P64E		P32E		P16E		P8E		P4E		P2E		P1E	
R-0h		R-0h		R-0h		R-0h		R-0h		R-0h		R-0h		R-0h	

LEGEND: R/W = Read/Write; R = Read only; W1toCl = Write 1 to clear bit; -n = value after reset

Table 7-145. GPMC_ECC7_RESULT Register Field Descriptions

Bit	Field	Type	Reset	Description
31-28	RESERVED	R	0h	
27	P2048O	R	0h	Odd Row Parity bit 2048, only used for ECC computed on 512 Bytes
26	P1024O	R	0h	Odd Row Parity bit 1024
25	P512O	R	0h	Odd Row Parity bit 512
24	P256O	R	0h	Odd Row Parity bit 256
23	P128O	R	0h	Odd Row Parity bit 128
22	P64O	R	0h	Odd Row Parity bit 64
21	P32O	R	0h	Odd Row Parity bit 32
20	P16O	R	0h	Odd Row Parity bit 16
19	P8O	R	0h	Odd Row Parity bit 8
18	P4O	R	0h	Odd Column Parity bit 4
17	P2O	R	0h	Odd Column Parity bit 2
16	P1O	R	0h	Odd Column Parity bit 1
15-12	RESERVED	R	0h	
11	P2048E	R	0h	Even Row Parity bit 2048, only used for ECC computed on 512 Bytes
10	P1024E	R	0h	Even Row Parity bit 1024
9	P512E	R	0h	Even Row Parity bit 512
8	P256E	R	0h	Even Row Parity bit 256
7	P128E	R	0h	Even Row Parity bit 128
6	P64E	R	0h	Even Row Parity bit 64
5	P32E	R	0h	Even Row Parity bit 32
4	P16E	R	0h	Even Row Parity bit 16
3	P8E	R	0h	Even Row Parity bit 8
2	P4E	R	0h	Even Column Parity bit 4
1	P2E	R	0h	Even Column Parity bit 2

Table 7-145. GPMC_ECC7_RESULT Register Field Descriptions (continued)

Bit	Field	Type	Reset	Description
0	P1E	R	0h	Even Column Parity bit 1

7.1.6.95 GPMC_ECC8_RESULT Register (offset = 21Ch) [reset = 0h]

GPMC_ECC8_RESULT is shown in [Figure 7-142](#) and described in [Table 7-146](#).

Figure 7-142. GPMC_ECC8_RESULT Register

31	30	29	28	27	26	25	24
RESERVED				P2048O	P1024O	P512O	P256O
R-0h				R-0h	R-0h	R-0h	R-0h
23	22	21	20	19	18	17	16
P128O	P64O	P32O	P16O	P8O	P4O	P2O	P1O
R-0h	R-0h	R-0h	R-0h	R-0h	R-0h	R-0h	R-0h
15	14	13	12	11	10	9	8
RESERVED				P2048E	P1024E	P512E	P256E
R-0h				R-0h	R-0h	R-0h	R-0h
7	6	5	4	3	2	1	0
P128E	P64E	P32E	P16E	P8E	P4E	P2E	P1E
R-0h	R-0h	R-0h	R-0h	R-0h	R-0h	R-0h	R-0h

LEGEND: R/W = Read/Write; R = Read only; W1toCl = Write 1 to clear bit; -n = value after reset

Table 7-146. GPMC_ECC8_RESULT Register Field Descriptions

Bit	Field	Type	Reset	Description
31-28	RESERVED	R	0h	
27	P2048O	R	0h	Odd Row Parity bit 2048, only used for ECC computed on 512 Bytes
26	P1024O	R	0h	Odd Row Parity bit 1024
25	P512O	R	0h	Odd Row Parity bit 512
24	P256O	R	0h	Odd Row Parity bit 256
23	P128O	R	0h	Odd Row Parity bit 128
22	P64O	R	0h	Odd Row Parity bit 64
21	P32O	R	0h	Odd Row Parity bit 32
20	P16O	R	0h	Odd Row Parity bit 16
19	P8O	R	0h	Odd Row Parity bit 8
18	P4O	R	0h	Odd Column Parity bit 4
17	P2O	R	0h	Odd Column Parity bit 2
16	P1O	R	0h	Odd Column Parity bit 1
15-12	RESERVED	R	0h	
11	P2048E	R	0h	Even Row Parity bit 2048, only used for ECC computed on 512 Bytes
10	P1024E	R	0h	Even Row Parity bit 1024
9	P512E	R	0h	Even Row Parity bit 512
8	P256E	R	0h	Even Row Parity bit 256
7	P128E	R	0h	Even Row Parity bit 128
6	P64E	R	0h	Even Row Parity bit 64
5	P32E	R	0h	Even Row Parity bit 32
4	P16E	R	0h	Even Row Parity bit 16
3	P8E	R	0h	Even Row Parity bit 8
2	P4E	R	0h	Even Column Parity bit 4
1	P2E	R	0h	Even Column Parity bit 2

Table 7-146. GPMC_ECC8_RESULT Register Field Descriptions (continued)

Bit	Field	Type	Reset	Description
0	P1E	R	0h	Even Column Parity bit 1

7.1.6.96 GPMC_ECC9_RESULT Register (offset = 220h) [reset = 0h]

GPMC_ECC9_RESULT is shown in [Figure 7-143](#) and described in [Table 7-147](#).

Figure 7-143. GPMC_ECC9_RESULT Register

31	30	29	28	27	26	25	24
RESERVED				P2048O	P1024O	P512O	P256O
R-0h				R-0h	R-0h	R-0h	R-0h
23	22	21	20	19	18	17	16
P128O	P64O	P32O	P16O	P8O	P4O	P2O	P1O
R-0h	R-0h	R-0h	R-0h	R-0h	R-0h	R-0h	R-0h
15	14	13	12	11	10	9	8
RESERVED				P2048E	P1024E	P512E	P256E
R-0h				R-0h	R-0h	R-0h	R-0h
7	6	5	4	3	2	1	0
P128E	P64E	P32E	P16E	P8E	P4E	P2E	P1E
R-0h	R-0h	R-0h	R-0h	R-0h	R-0h	R-0h	R-0h

LEGEND: R/W = Read/Write; R = Read only; W1toCl = Write 1 to clear bit; -n = value after reset

Table 7-147. GPMC_ECC9_RESULT Register Field Descriptions

Bit	Field	Type	Reset	Description
31-28	RESERVED	R	0h	
27	P2048O	R	0h	Odd Row Parity bit 2048, only used for ECC computed on 512 Bytes
26	P1024O	R	0h	Odd Row Parity bit 1024
25	P512O	R	0h	Odd Row Parity bit 512
24	P256O	R	0h	Odd Row Parity bit 256
23	P128O	R	0h	Odd Row Parity bit 128
22	P64O	R	0h	Odd Row Parity bit 64
21	P32O	R	0h	Odd Row Parity bit 32
20	P16O	R	0h	Odd Row Parity bit 16
19	P8O	R	0h	Odd Row Parity bit 8
18	P4O	R	0h	Odd Column Parity bit 4
17	P2O	R	0h	Odd Column Parity bit 2
16	P1O	R	0h	Odd Column Parity bit 1
15-12	RESERVED	R	0h	
11	P2048E	R	0h	Even Row Parity bit 2048, only used for ECC computed on 512 Bytes
10	P1024E	R	0h	Even Row Parity bit 1024
9	P512E	R	0h	Even Row Parity bit 512
8	P256E	R	0h	Even Row Parity bit 256
7	P128E	R	0h	Even Row Parity bit 128
6	P64E	R	0h	Even Row Parity bit 64
5	P32E	R	0h	Even Row Parity bit 32
4	P16E	R	0h	Even Row Parity bit 16
3	P8E	R	0h	Even Row Parity bit 8
2	P4E	R	0h	Even Column Parity bit 4
1	P2E	R	0h	Even Column Parity bit 2

Table 7-147. GPMC_ECC9_RESULT Register Field Descriptions (continued)

Bit	Field	Type	Reset	Description
0	P1E	R	0h	Even Column Parity bit 1

7.1.6.97 GPMC_BCH_RESULT0_0 Register (offset = 240h) [reset = 0h]

GPMC_BCH_RESULT0_0 is shown in [Figure 7-144](#) and described in [Table 7-148](#).

Figure 7-144. GPMC_BCH_RESULT0_0 Register

31	30	29	28	27	26	25	24	23	22	21	20	19	18	17	16	15	14	13	12	11	10	9	8	7	6	5	4	3	2	1	0
BCH_RESULT0_0																															
R/W-0h																															

LEGEND: R/W = Read/Write; R = Read only; W1toCl = Write 1 to clear bit; -n = value after reset

Table 7-148. GPMC_BCH_RESULT0_0 Register Field Descriptions

Bit	Field	Type	Reset	Description
31-0	BCH_RESULT0_0	R/W	0h	BCH ECC result, bits 0 to 31

7.1.6.98 GPMC_BCH_RESULT1_0 Register (offset = 244h) [reset = 0h]

GPMC_BCH_RESULT1_0 is shown in [Figure 7-145](#) and described in [Table 7-149](#).

Figure 7-145. GPMC_BCH_RESULT1_0 Register

31	30	29	28	27	26	25	24	23	22	21	20	19	18	17	16	15	14	13	12	11	10	9	8	7	6	5	4	3	2	1	0
BCH_RESULT1_0																															
R/W-0h																															

LEGEND: R/W = Read/Write; R = Read only; W1toCl = Write 1 to clear bit; -n = value after reset

Table 7-149. GPMC_BCH_RESULT1_0 Register Field Descriptions

Bit	Field	Type	Reset	Description
31-0	BCH_RESULT1_0	R/W	0h	BCH ECC result, bits 32 to 63

7.1.6.99 GPMC_BCH_RESULT2_0 Register (offset = 248h) [reset = 0h]

GPMC_BCH_RESULT2_0 is shown in [Figure 7-146](#) and described in [Table 7-150](#).

Figure 7-146. GPMC_BCH_RESULT2_0 Register

31	30	29	28	27	26	25	24	23	22	21	20	19	18	17	16	15	14	13	12	11	10	9	8	7	6	5	4	3	2	1	0
BCH_RESULT2_0																															
R/W-0h																															

LEGEND: R/W = Read/Write; R = Read only; W1toCl = Write 1 to clear bit; -n = value after reset

Table 7-150. GPMC_BCH_RESULT2_0 Register Field Descriptions

Bit	Field	Type	Reset	Description
31-0	BCH_RESULT2_0	R/W	0h	BCH ECC result, bits 64 to 95

7.1.6.100 GPMC_BCH_RESULT3_0 Register (offset = 24Ch) [reset = 0h]

GPMC_BCH_RESULT3_0 is shown in [Figure 7-147](#) and described in [Table 7-151](#).

Figure 7-147. GPMC_BCH_RESULT3_0 Register

31	30	29	28	27	26	25	24	23	22	21	20	19	18	17	16	15	14	13	12	11	10	9	8	7	6	5	4	3	2	1	0
BCH_RESULT3_0																															
R/W-0h																															

LEGEND: R/W = Read/Write; R = Read only; W1toCl = Write 1 to clear bit; -n = value after reset

Table 7-151. GPMC_BCH_RESULT3_0 Register Field Descriptions

Bit	Field	Type	Reset	Description
31-0	BCH_RESULT3_0	R/W	0h	BCH ECC result, bits 96 to 127

7.1.6.101 GPMC_BCH_RESULT0_1 Register (offset = 250h) [reset = 0h]

GPMC_BCH_RESULT0_1 is shown in [Figure 7-148](#) and described in [Table 7-152](#).

Figure 7-148. GPMC_BCH_RESULT0_1 Register

31	30	29	28	27	26	25	24	23	22	21	20	19	18	17	16	15	14	13	12	11	10	9	8	7	6	5	4	3	2	1	0
BCH_RESULT0_1																															
R/W-0h																															

LEGEND: R/W = Read/Write; R = Read only; W1toCl = Write 1 to clear bit; -n = value after reset

Table 7-152. GPMC_BCH_RESULT0_1 Register Field Descriptions

Bit	Field	Type	Reset	Description
31-0	BCH_RESULT0_1	R/W	0h	BCH ECC result, bits 0 to 31

7.1.6.102 GPMC_BCH_RESULT1_1 Register (offset = 254h) [reset = 0h]

GPMC_BCH_RESULT1_1 is shown in [Figure 7-149](#) and described in [Table 7-153](#).

Figure 7-149. GPMC_BCH_RESULT1_1 Register

31	30	29	28	27	26	25	24	23	22	21	20	19	18	17	16	15	14	13	12	11	10	9	8	7	6	5	4	3	2	1	0
BCH_RESULT1_1																															
R/W-0h																															

LEGEND: R/W = Read/Write; R = Read only; W1toCl = Write 1 to clear bit; -n = value after reset

Table 7-153. GPMC_BCH_RESULT1_1 Register Field Descriptions

Bit	Field	Type	Reset	Description
31-0	BCH_RESULT1_1	R/W	0h	BCH ECC result, bits 32 to 63

7.1.6.103 GPMC_BCH_RESULT2_1 Register (offset = 258h) [reset = 0h]

GPMC_BCH_RESULT2_1 is shown in [Figure 7-150](#) and described in [Table 7-154](#).

Figure 7-150. GPMC_BCH_RESULT2_1 Register

31	30	29	28	27	26	25	24	23	22	21	20	19	18	17	16	15	14	13	12	11	10	9	8	7	6	5	4	3	2	1	0
BCH_RESULT2_1																															
R/W-0h																															

LEGEND: R/W = Read/Write; R = Read only; W1toCl = Write 1 to clear bit; -n = value after reset

Table 7-154. GPMC_BCH_RESULT2_1 Register Field Descriptions

Bit	Field	Type	Reset	Description
31-0	BCH_RESULT2_1	R/W	0h	BCH ECC result, bits 64 to 95

7.1.6.104 GPMC_BCH_RESULT3_1 Register (offset = 25Ch) [reset = 0h]

GPMC_BCH_RESULT3_1 is shown in [Figure 7-151](#) and described in [Table 7-155](#).

Figure 7-151. GPMC_BCH_RESULT3_1 Register

31	30	29	28	27	26	25	24	23	22	21	20	19	18	17	16	15	14	13	12	11	10	9	8	7	6	5	4	3	2	1	0
BCH_RESULT3_1																															
R/W-0h																															

LEGEND: R/W = Read/Write; R = Read only; W1toCl = Write 1 to clear bit; -n = value after reset

Table 7-155. GPMC_BCH_RESULT3_1 Register Field Descriptions

Bit	Field	Type	Reset	Description
31-0	BCH_RESULT3_1	R/W	0h	BCH ECC result, bits 96 to 127

7.1.6.105 GPMC_BCH_RESULT0_2 Register (offset = 260h) [reset = 0h]

 GPMC_BCH_RESULT0_2 is shown in [Figure 7-152](#) and described in [Table 7-156](#).

Figure 7-152. GPMC_BCH_RESULT0_2 Register

31	30	29	28	27	26	25	24	23	22	21	20	19	18	17	16	15	14	13	12	11	10	9	8	7	6	5	4	3	2	1	0
BCH_RESULT0_2																															
R/W-0h																															

LEGEND: R/W = Read/Write; R = Read only; W1toCl = Write 1 to clear bit; -n = value after reset

Table 7-156. GPMC_BCH_RESULT0_2 Register Field Descriptions

Bit	Field	Type	Reset	Description
31-0	BCH_RESULT0_2	R/W	0h	BCH ECC result, bits 0 to 31

7.1.6.106 GPMC_BCH_RESULT1_2 Register (offset = 264h) [reset = 0h]

GPMC_BCH_RESULT1_2 is shown in [Figure 7-153](#) and described in [Table 7-157](#).

Figure 7-153. GPMC_BCH_RESULT1_2 Register

31	30	29	28	27	26	25	24	23	22	21	20	19	18	17	16	15	14	13	12	11	10	9	8	7	6	5	4	3	2	1	0
BCH_RESULT1_2																															
R/W-0h																															

LEGEND: R/W = Read/Write; R = Read only; W1toCl = Write 1 to clear bit; -n = value after reset

Table 7-157. GPMC_BCH_RESULT1_2 Register Field Descriptions

Bit	Field	Type	Reset	Description
31-0	BCH_RESULT1_2	R/W	0h	BCH ECC result, bits 32 to 63

7.1.6.107 GPMC_BCH_RESULT2_2 Register (offset = 268h) [reset = 0h]

 GPMC_BCH_RESULT2_2 is shown in [Figure 7-154](#) and described in [Table 7-158](#).

Figure 7-154. GPMC_BCH_RESULT2_2 Register

31	30	29	28	27	26	25	24	23	22	21	20	19	18	17	16	15	14	13	12	11	10	9	8	7	6	5	4	3	2	1	0
BCH_RESULT2_2																															
R/W-0h																															

LEGEND: R/W = Read/Write; R = Read only; W1toCl = Write 1 to clear bit; -n = value after reset

Table 7-158. GPMC_BCH_RESULT2_2 Register Field Descriptions

Bit	Field	Type	Reset	Description
31-0	BCH_RESULT2_2	R/W	0h	BCH ECC result, bits 64 to 95

7.1.6.108 GPMC_BCH_RESULT3_2 Register (offset = 26Ch) [reset = 0h]

GPMC_BCH_RESULT3_2 is shown in [Figure 7-155](#) and described in [Table 7-159](#).

Figure 7-155. GPMC_BCH_RESULT3_2 Register

31	30	29	28	27	26	25	24	23	22	21	20	19	18	17	16	15	14	13	12	11	10	9	8	7	6	5	4	3	2	1	0
BCH_RESULT3_2																															
R/W-0h																															

LEGEND: R/W = Read/Write; R = Read only; W1toCl = Write 1 to clear bit; -n = value after reset

Table 7-159. GPMC_BCH_RESULT3_2 Register Field Descriptions

Bit	Field	Type	Reset	Description
31-0	BCH_RESULT3_2	R/W	0h	BCH ECC result, bits 96 to 127

7.1.6.109 GPMC_BCH_RESULT0_3 Register (offset = 270h) [reset = 0h]

 GPMC_BCH_RESULT0_3 is shown in [Figure 7-156](#) and described in [Table 7-160](#).

Figure 7-156. GPMC_BCH_RESULT0_3 Register

31	30	29	28	27	26	25	24	23	22	21	20	19	18	17	16	15	14	13	12	11	10	9	8	7	6	5	4	3	2	1	0
BCH_RESULT0_3																															
R/W-0h																															

LEGEND: R/W = Read/Write; R = Read only; W1toCl = Write 1 to clear bit; -n = value after reset

Table 7-160. GPMC_BCH_RESULT0_3 Register Field Descriptions

Bit	Field	Type	Reset	Description
31-0	BCH_RESULT0_3	R/W	0h	BCH ECC result, bits 0 to 31

7.1.6.110 GPMC_BCH_RESULT1_3 Register (offset = 274h) [reset = 0h]

GPMC_BCH_RESULT1_3 is shown in [Figure 7-157](#) and described in [Table 7-161](#).

Figure 7-157. GPMC_BCH_RESULT1_3 Register

31	30	29	28	27	26	25	24	23	22	21	20	19	18	17	16	15	14	13	12	11	10	9	8	7	6	5	4	3	2	1	0
BCH_RESULT1_3																															
R/W-0h																															

LEGEND: R/W = Read/Write; R = Read only; W1toCl = Write 1 to clear bit; -n = value after reset

Table 7-161. GPMC_BCH_RESULT1_3 Register Field Descriptions

Bit	Field	Type	Reset	Description
31-0	BCH_RESULT1_3	R/W	0h	BCH ECC result, bits 32 to 63

7.1.6.111 GPMC_BCH_RESULT2_3 Register (offset = 278h) [reset = 0h]

 GPMC_BCH_RESULT2_3 is shown in [Figure 7-158](#) and described in [Table 7-162](#).

Figure 7-158. GPMC_BCH_RESULT2_3 Register

31	30	29	28	27	26	25	24	23	22	21	20	19	18	17	16	15	14	13	12	11	10	9	8	7	6	5	4	3	2	1	0
BCH_RESULT2_3																															
R/W-0h																															

LEGEND: R/W = Read/Write; R = Read only; W1toCl = Write 1 to clear bit; -n = value after reset

Table 7-162. GPMC_BCH_RESULT2_3 Register Field Descriptions

Bit	Field	Type	Reset	Description
31-0	BCH_RESULT2_3	R/W	0h	BCH ECC result, bits 64 to 95

7.1.6.112 GPMC_BCH_RESULT3_3 Register (offset = 27Ch) [reset = 0h]

GPMC_BCH_RESULT3_3 is shown in [Figure 7-159](#) and described in [Table 7-163](#).

Figure 7-159. GPMC_BCH_RESULT3_3 Register

31	30	29	28	27	26	25	24	23	22	21	20	19	18	17	16	15	14	13	12	11	10	9	8	7	6	5	4	3	2	1	0
BCH_RESULT3_3																															
R/W-0h																															

LEGEND: R/W = Read/Write; R = Read only; W1toCl = Write 1 to clear bit; -n = value after reset

Table 7-163. GPMC_BCH_RESULT3_3 Register Field Descriptions

Bit	Field	Type	Reset	Description
31-0	BCH_RESULT3_3	R/W	0h	BCH ECC result, bits 96 to 127

7.1.6.113 GPMC_BCH_RESULT0_4 Register (offset = 280h) [reset = 0h]

GPMC_BCH_RESULT0_4 is shown in [Figure 7-160](#) and described in [Table 7-164](#).

Figure 7-160. GPMC_BCH_RESULT0_4 Register

31	30	29	28	27	26	25	24	23	22	21	20	19	18	17	16	15	14	13	12	11	10	9	8	7	6	5	4	3	2	1	0
BCH_RESULT0_4																															
R/W-0h																															

LEGEND: R/W = Read/Write; R = Read only; W1toCl = Write 1 to clear bit; -n = value after reset

Table 7-164. GPMC_BCH_RESULT0_4 Register Field Descriptions

Bit	Field	Type	Reset	Description
31-0	BCH_RESULT0_4	R/W	0h	BCH ECC result, bits 0 to 31

7.1.6.114 GPMC_BCH_RESULT1_4 Register (offset = 284h) [reset = 0h]

GPMC_BCH_RESULT1_4 is shown in [Figure 7-161](#) and described in [Table 7-165](#).

Figure 7-161. GPMC_BCH_RESULT1_4 Register

31	30	29	28	27	26	25	24	23	22	21	20	19	18	17	16	15	14	13	12	11	10	9	8	7	6	5	4	3	2	1	0
BCH_RESULT1_4																															
R/W-0h																															

LEGEND: R/W = Read/Write; R = Read only; W1toCl = Write 1 to clear bit; -n = value after reset

Table 7-165. GPMC_BCH_RESULT1_4 Register Field Descriptions

Bit	Field	Type	Reset	Description
31-0	BCH_RESULT1_4	R/W	0h	BCH ECC result, bits 32 to 63

7.1.6.115 GPMC_BCH_RESULT2_4 Register (offset = 288h) [reset = 0h]

GPMC_BCH_RESULT2_4 is shown in [Figure 7-162](#) and described in [Table 7-166](#).

Figure 7-162. GPMC_BCH_RESULT2_4 Register

31	30	29	28	27	26	25	24	23	22	21	20	19	18	17	16	15	14	13	12	11	10	9	8	7	6	5	4	3	2	1	0
BCH_RESULT2_4																															
R/W-0h																															

LEGEND: R/W = Read/Write; R = Read only; W1toCl = Write 1 to clear bit; -n = value after reset

Table 7-166. GPMC_BCH_RESULT2_4 Register Field Descriptions

Bit	Field	Type	Reset	Description
31-0	BCH_RESULT2_4	R/W	0h	BCH ECC result, bits 64 to 95

7.1.6.116 GPMC_BCH_RESULT3_4 Register (offset = 28Ch) [reset = 0h]

GPMC_BCH_RESULT3_4 is shown in [Figure 7-163](#) and described in [Table 7-167](#).

Figure 7-163. GPMC_BCH_RESULT3_4 Register

31	30	29	28	27	26	25	24	23	22	21	20	19	18	17	16	15	14	13	12	11	10	9	8	7	6	5	4	3	2	1	0
BCH_RESULT3_4																															
R/W-0h																															

LEGEND: R/W = Read/Write; R = Read only; W1toCl = Write 1 to clear bit; -n = value after reset

Table 7-167. GPMC_BCH_RESULT3_4 Register Field Descriptions

Bit	Field	Type	Reset	Description
31-0	BCH_RESULT3_4	R/W	0h	BCH ECC result, bits 96 to 127

7.1.6.117 GPMC_BCH_RESULT0_5 Register (offset = 290h) [reset = 0h]

GPMC_BCH_RESULT0_5 is shown in [Figure 7-164](#) and described in [Table 7-168](#).

Figure 7-164. GPMC_BCH_RESULT0_5 Register

31	30	29	28	27	26	25	24	23	22	21	20	19	18	17	16	15	14	13	12	11	10	9	8	7	6	5	4	3	2	1	0
BCH_RESULT0_5																															
R/W-0h																															

LEGEND: R/W = Read/Write; R = Read only; W1toCl = Write 1 to clear bit; -n = value after reset

Table 7-168. GPMC_BCH_RESULT0_5 Register Field Descriptions

Bit	Field	Type	Reset	Description
31-0	BCH_RESULT0_5	R/W	0h	BCH ECC result, bits 0 to 31

7.1.6.118 GPMC_BCH_RESULT1_5 Register (offset = 294h) [reset = 0h]

GPMC_BCH_RESULT1_5 is shown in [Figure 7-165](#) and described in [Table 7-169](#).

Figure 7-165. GPMC_BCH_RESULT1_5 Register

31	30	29	28	27	26	25	24	23	22	21	20	19	18	17	16	15	14	13	12	11	10	9	8	7	6	5	4	3	2	1	0
BCH_RESULT1_5																															
R/W-0h																															

LEGEND: R/W = Read/Write; R = Read only; W1toCl = Write 1 to clear bit; -n = value after reset

Table 7-169. GPMC_BCH_RESULT1_5 Register Field Descriptions

Bit	Field	Type	Reset	Description
31-0	BCH_RESULT1_5	R/W	0h	BCH ECC result, bits 32 to 63

7.1.6.119 GPMC_BCH_RESULT2_5 Register (offset = 298h) [reset = 0h]

GPMC_BCH_RESULT2_5 is shown in [Figure 7-166](#) and described in [Table 7-170](#).

Figure 7-166. GPMC_BCH_RESULT2_5 Register

31	30	29	28	27	26	25	24	23	22	21	20	19	18	17	16	15	14	13	12	11	10	9	8	7	6	5	4	3	2	1	0
BCH_RESULT2_5																															
R/W-0h																															

LEGEND: R/W = Read/Write; R = Read only; W1toCl = Write 1 to clear bit; -n = value after reset

Table 7-170. GPMC_BCH_RESULT2_5 Register Field Descriptions

Bit	Field	Type	Reset	Description
31-0	BCH_RESULT2_5	R/W	0h	BCH ECC result, bits 64 to 95

7.1.6.120 GPMC_BCH_RESULT3_5 Register (offset = 29Ch) [reset = 0h]

GPMC_BCH_RESULT3_5 is shown in [Figure 7-167](#) and described in [Table 7-171](#).

Figure 7-167. GPMC_BCH_RESULT3_5 Register

31	30	29	28	27	26	25	24	23	22	21	20	19	18	17	16	15	14	13	12	11	10	9	8	7	6	5	4	3	2	1	0
BCH_RESULT3_5																															
R/W-0h																															

LEGEND: R/W = Read/Write; R = Read only; W1toCl = Write 1 to clear bit; -n = value after reset

Table 7-171. GPMC_BCH_RESULT3_5 Register Field Descriptions

Bit	Field	Type	Reset	Description
31-0	BCH_RESULT3_5	R/W	0h	BCH ECC result, bits 96 to 127

7.1.6.121 GPMC_BCH_RESULT0_6 Register (offset = 2A0h) [reset = 0h]

GPMC_BCH_RESULT0_6 is shown in [Figure 7-168](#) and described in [Table 7-172](#).

Figure 7-168. GPMC_BCH_RESULT0_6 Register

31	30	29	28	27	26	25	24	23	22	21	20	19	18	17	16	15	14	13	12	11	10	9	8	7	6	5	4	3	2	1	0
BCH_RESULT0_6																															
R/W-0h																															

LEGEND: R/W = Read/Write; R = Read only; W1toCl = Write 1 to clear bit; -n = value after reset

Table 7-172. GPMC_BCH_RESULT0_6 Register Field Descriptions

Bit	Field	Type	Reset	Description
31-0	BCH_RESULT0_6	R/W	0h	BCH ECC result, bits 0 to 31

7.1.6.122 GPMC_BCH_RESULT1_6 Register (offset = 2A4h) [reset = 0h]

GPMC_BCH_RESULT1_6 is shown in [Figure 7-169](#) and described in [Table 7-173](#).

Figure 7-169. GPMC_BCH_RESULT1_6 Register

31	30	29	28	27	26	25	24	23	22	21	20	19	18	17	16	15	14	13	12	11	10	9	8	7	6	5	4	3	2	1	0
BCH_RESULT1_6																															
R/W-0h																															

LEGEND: R/W = Read/Write; R = Read only; W1toCl = Write 1 to clear bit; -n = value after reset

Table 7-173. GPMC_BCH_RESULT1_6 Register Field Descriptions

Bit	Field	Type	Reset	Description
31-0	BCH_RESULT1_6	R/W	0h	BCH ECC result, bits 32 to 63

7.1.6.123 GPMC_BCH_RESULT2_6 Register (offset = 2A8h) [reset = 0h]

GPMC_BCH_RESULT2_6 is shown in [Figure 7-170](#) and described in [Table 7-174](#).

Figure 7-170. GPMC_BCH_RESULT2_6 Register

31	30	29	28	27	26	25	24	23	22	21	20	19	18	17	16	15	14	13	12	11	10	9	8	7	6	5	4	3	2	1	0
BCH_RESULT2_6																															
R/W-0h																															

LEGEND: R/W = Read/Write; R = Read only; W1toCl = Write 1 to clear bit; -n = value after reset

Table 7-174. GPMC_BCH_RESULT2_6 Register Field Descriptions

Bit	Field	Type	Reset	Description
31-0	BCH_RESULT2_6	R/W	0h	BCH ECC result, bits 64 to 95

7.1.6.124 GPMC_BCH_RESULT3_6 Register (offset = 2ACh) [reset = 0h]

GPMC_BCH_RESULT3_6 is shown in [Figure 7-171](#) and described in [Table 7-175](#).

Figure 7-171. GPMC_BCH_RESULT3_6 Register

31	30	29	28	27	26	25	24	23	22	21	20	19	18	17	16	15	14	13	12	11	10	9	8	7	6	5	4	3	2	1	0
BCH_RESULT3_6																															
R/W-0h																															

LEGEND: R/W = Read/Write; R = Read only; W1toCl = Write 1 to clear bit; -n = value after reset

Table 7-175. GPMC_BCH_RESULT3_6 Register Field Descriptions

Bit	Field	Type	Reset	Description
31-0	BCH_RESULT3_6	R/W	0h	BCH ECC result, bits 96 to 127

7.1.6.125 GPMC_BCH_RESULT0_7 Register (offset = 2B0h) [reset = 0h]

 GPMC_BCH_RESULT0_7 is shown in [Figure 7-172](#) and described in [Table 7-176](#).

Figure 7-172. GPMC_BCH_RESULT0_7 Register

31	30	29	28	27	26	25	24	23	22	21	20	19	18	17	16	15	14	13	12	11	10	9	8	7	6	5	4	3	2	1	0
BCH_RESULT0_7																															
R/W-0h																															

LEGEND: R/W = Read/Write; R = Read only; W1toCl = Write 1 to clear bit; -n = value after reset

Table 7-176. GPMC_BCH_RESULT0_7 Register Field Descriptions

Bit	Field	Type	Reset	Description
31-0	BCH_RESULT0_7	R/W	0h	BCH ECC result, bits 0 to 31

7.1.6.126 GPMC_BCH_RESULT1_7 Register (offset = 2B4h) [reset = 0h]

GPMC_BCH_RESULT1_7 is shown in [Figure 7-173](#) and described in [Table 7-177](#).

Figure 7-173. GPMC_BCH_RESULT1_7 Register

31	30	29	28	27	26	25	24	23	22	21	20	19	18	17	16	15	14	13	12	11	10	9	8	7	6	5	4	3	2	1	0
BCH_RESULT1_7																															
R/W-0h																															

LEGEND: R/W = Read/Write; R = Read only; W1toCl = Write 1 to clear bit; -n = value after reset

Table 7-177. GPMC_BCH_RESULT1_7 Register Field Descriptions

Bit	Field	Type	Reset	Description
31-0	BCH_RESULT1_7	R/W	0h	BCH ECC result, bits 32 to 63

7.1.6.127 GPMC_BCH_RESULT2_7 Register (offset = 2B8h) [reset = 0h]

GPMC_BCH_RESULT2_7 is shown in [Figure 7-174](#) and described in [Table 7-178](#).

Figure 7-174. GPMC_BCH_RESULT2_7 Register

31	30	29	28	27	26	25	24	23	22	21	20	19	18	17	16	15	14	13	12	11	10	9	8	7	6	5	4	3	2	1	0
BCH_RESULT2_7																															
R/W-0h																															

LEGEND: R/W = Read/Write; R = Read only; W1toCl = Write 1 to clear bit; -n = value after reset

Table 7-178. GPMC_BCH_RESULT2_7 Register Field Descriptions

Bit	Field	Type	Reset	Description
31-0	BCH_RESULT2_7	R/W	0h	BCH ECC result, bits 64 to 95

7.1.6.128 GPMC_BCH_RESULT3_7 Register (offset = 2BCh) [reset = 0h]

GPMC_BCH_RESULT3_7 is shown in [Figure 7-175](#) and described in [Table 7-179](#).

Figure 7-175. GPMC_BCH_RESULT3_7 Register

31	30	29	28	27	26	25	24	23	22	21	20	19	18	17	16	15	14	13	12	11	10	9	8	7	6	5	4	3	2	1	0
BCH_RESULT3_7																															
R/W-0h																															

LEGEND: R/W = Read/Write; R = Read only; W1toCl = Write 1 to clear bit; -n = value after reset

Table 7-179. GPMC_BCH_RESULT3_7 Register Field Descriptions

Bit	Field	Type	Reset	Description
31-0	BCH_RESULT3_7	R/W	0h	BCH ECC result, bits 96 to 127

7.1.6.129 GPMC_BCH_SWDATA Register (offset = 2D0h) [reset = 0h]

GPMC_BCH_SWDATA is shown in [Figure 7-176](#) and described in [Table 7-180](#).

This register is used to directly pass data to the BCH ECC calculator without accessing the actual NAND flash interface.

Figure 7-176. GPMC_BCH_SWDATA Register

31	30	29	28	27	26	25	24	23	22	21	20	19	18	17	16	15	14	13	12	11	10	9	8	7	6	5	4	3	2	1	0
RESERVED																BCH_DATA															
R-0h																R/W-0h															

LEGEND: R/W = Read/Write; R = Read only; W1toCl = Write 1 to clear bit; -n = value after reset

Table 7-180. GPMC_BCH_SWDATA Register Field Descriptions

Bit	Field	Type	Reset	Description
31-16	RESERVED	R	0h	
15-0	BCH_DATA	R/W	0h	Data to be included in the BCH calculation. Only bits 0 to 7 are taken into account, if the calculator is configured to use 8 bits data (GPMC_ECC_CONFIG[7] ECC16B = 0).

7.1.6.130 GPMC_BCH_RESULT4_0 Register (offset = 300h) [reset = 0h]

GPMC_BCH_RESULT4_0 is shown in [Figure 7-177](#) and described in [Table 7-181](#).

Figure 7-177. GPMC_BCH_RESULT4_0 Register

31	30	29	28	27	26	25	24	23	22	21	20	19	18	17	16	15	14	13	12	11	10	9	8	7	6	5	4	3	2	1	0
BCH_RESULT4_0																															
R/W-0h																															

LEGEND: R/W = Read/Write; R = Read only; W1toCl = Write 1 to clear bit; -n = value after reset

Table 7-181. GPMC_BCH_RESULT4_0 Register Field Descriptions

Bit	Field	Type	Reset	Description
31-0	BCH_RESULT4_0	R/W	0h	BCH ECC result, bits 128 to 159

7.1.6.131 GPMC_BCH_RESULT5_0 Register (offset = 304h) [reset = 0h]

GPMC_BCH_RESULT5_0 is shown in [Figure 7-178](#) and described in [Table 7-182](#).

Figure 7-178. GPMC_BCH_RESULT5_0 Register

31	30	29	28	27	26	25	24	23	22	21	20	19	18	17	16	15	14	13	12	11	10	9	8	7	6	5	4	3	2	1	0
BCH_RESULT5_0																															
R/W-0h																															

LEGEND: R/W = Read/Write; R = Read only; W1toCl = Write 1 to clear bit; -n = value after reset

Table 7-182. GPMC_BCH_RESULT5_0 Register Field Descriptions

Bit	Field	Type	Reset	Description
31-0	BCH_RESULT5_0	R/W	0h	BCH ECC result, bits 160 to 191

7.1.6.132 GPMC_BCH_RESULT6_0 Register (offset = 308h) [reset = 0h]

GPMC_BCH_RESULT6_0 is shown in [Figure 7-179](#) and described in [Table 7-183](#).

Figure 7-179. GPMC_BCH_RESULT6_0 Register

31	30	29	28	27	26	25	24	23	22	21	20	19	18	17	16	15	14	13	12	11	10	9	8	7	6	5	4	3	2	1	0
BCH_RESULT6_0																															
R/W-0h																															

LEGEND: R/W = Read/Write; R = Read only; W1toCl = Write 1 to clear bit; -n = value after reset

Table 7-183. GPMC_BCH_RESULT6_0 Register Field Descriptions

Bit	Field	Type	Reset	Description
31-0	BCH_RESULT6_0	R/W	0h	BCH ECC result, bits 192 to 207

7.1.6.133 GPMC_BCH_RESULT4_1 Register (offset = 310h) [reset = 0h]

 GPMC_BCH_RESULT4_1 is shown in [Figure 7-180](#) and described in [Table 7-184](#).

Figure 7-180. GPMC_BCH_RESULT4_1 Register

31	30	29	28	27	26	25	24	23	22	21	20	19	18	17	16	15	14	13	12	11	10	9	8	7	6	5	4	3	2	1	0
BCH_RESULT4_1																															
R/W-0h																															

LEGEND: R/W = Read/Write; R = Read only; W1toCl = Write 1 to clear bit; -n = value after reset

Table 7-184. GPMC_BCH_RESULT4_1 Register Field Descriptions

Bit	Field	Type	Reset	Description
31-0	BCH_RESULT4_1	R/W	0h	BCH ECC result, bits 128 to 159

7.1.6.134 GPMC_BCH_RESULT5_1 Register (offset = 314h) [reset = 0h]

GPMC_BCH_RESULT5_1 is shown in [Figure 7-181](#) and described in [Table 7-185](#).

Figure 7-181. GPMC_BCH_RESULT5_1 Register

31	30	29	28	27	26	25	24	23	22	21	20	19	18	17	16	15	14	13	12	11	10	9	8	7	6	5	4	3	2	1	0
BCH_RESULT5_1																															
R/W-0h																															

LEGEND: R/W = Read/Write; R = Read only; W1toCl = Write 1 to clear bit; -n = value after reset

Table 7-185. GPMC_BCH_RESULT5_1 Register Field Descriptions

Bit	Field	Type	Reset	Description
31-0	BCH_RESULT5_1	R/W	0h	BCH ECC result, bits 160 to 191

7.1.6.135 GPMC_BCH_RESULT6_1 Register (offset = 318h) [reset = 0h]

 GPMC_BCH_RESULT6_1 is shown in [Figure 7-182](#) and described in [Table 7-186](#).

Figure 7-182. GPMC_BCH_RESULT6_1 Register

31	30	29	28	27	26	25	24	23	22	21	20	19	18	17	16	15	14	13	12	11	10	9	8	7	6	5	4	3	2	1	0
BCH_RESULT6_1																															
R/W-0h																															

LEGEND: R/W = Read/Write; R = Read only; W1toCl = Write 1 to clear bit; -n = value after reset

Table 7-186. GPMC_BCH_RESULT6_1 Register Field Descriptions

Bit	Field	Type	Reset	Description
31-0	BCH_RESULT6_1	R/W	0h	BCH ECC result, bits 192 to 207

7.1.6.136 GPMC_BCH_RESULT4_2 Register (offset = 320h) [reset = 0h]

GPMC_BCH_RESULT4_2 is shown in [Figure 7-183](#) and described in [Table 7-187](#).

Figure 7-183. GPMC_BCH_RESULT4_2 Register

31	30	29	28	27	26	25	24	23	22	21	20	19	18	17	16	15	14	13	12	11	10	9	8	7	6	5	4	3	2	1	0
BCH_RESULT4_2																															
R/W-0h																															

LEGEND: R/W = Read/Write; R = Read only; W1toCl = Write 1 to clear bit; -n = value after reset

Table 7-187. GPMC_BCH_RESULT4_2 Register Field Descriptions

Bit	Field	Type	Reset	Description
31-0	BCH_RESULT4_2	R/W	0h	BCH ECC result, bits 128 to 159

7.1.6.137 GPMC_BCH_RESULT5_2 Register (offset = 324h) [reset = 0h]

GPMC_BCH_RESULT5_2 is shown in [Figure 7-184](#) and described in [Table 7-188](#).

Figure 7-184. GPMC_BCH_RESULT5_2 Register

31	30	29	28	27	26	25	24	23	22	21	20	19	18	17	16	15	14	13	12	11	10	9	8	7	6	5	4	3	2	1	0
BCH_RESULT5_2																															
R/W-0h																															

LEGEND: R/W = Read/Write; R = Read only; W1toCl = Write 1 to clear bit; -n = value after reset

Table 7-188. GPMC_BCH_RESULT5_2 Register Field Descriptions

Bit	Field	Type	Reset	Description
31-0	BCH_RESULT5_2	R/W	0h	BCH ECC result, bits 160 to 191

7.1.6.138 GPMC_BCH_RESULT6_2 Register (offset = 328h) [reset = 0h]

GPMC_BCH_RESULT6_2 is shown in [Figure 7-185](#) and described in [Table 7-189](#).

Figure 7-185. GPMC_BCH_RESULT6_2 Register

31	30	29	28	27	26	25	24	23	22	21	20	19	18	17	16	15	14	13	12	11	10	9	8	7	6	5	4	3	2	1	0
BCH_RESULT6_2																															
R/W-0h																															

LEGEND: R/W = Read/Write; R = Read only; W1toCl = Write 1 to clear bit; -n = value after reset

Table 7-189. GPMC_BCH_RESULT6_2 Register Field Descriptions

Bit	Field	Type	Reset	Description
31-0	BCH_RESULT6_2	R/W	0h	BCH ECC result, bits 192 to 207

7.1.6.139 GPMC_BCH_RESULT4_3 Register (offset = 330h) [reset = 0h]

GPMC_BCH_RESULT4_3 is shown in [Figure 7-186](#) and described in [Table 7-190](#).

Figure 7-186. GPMC_BCH_RESULT4_3 Register

31	30	29	28	27	26	25	24	23	22	21	20	19	18	17	16	15	14	13	12	11	10	9	8	7	6	5	4	3	2	1	0
BCH_RESULT4_3																															
R/W-0h																															

LEGEND: R/W = Read/Write; R = Read only; W1toCl = Write 1 to clear bit; -n = value after reset

Table 7-190. GPMC_BCH_RESULT4_3 Register Field Descriptions

Bit	Field	Type	Reset	Description
31-0	BCH_RESULT4_3	R/W	0h	BCH ECC result, bits 128 to 159

7.1.6.140 GPMC_BCH_RESULT5_3 Register (offset = 334h) [reset = 0h]

GPMC_BCH_RESULT5_3 is shown in [Figure 7-187](#) and described in [Table 7-191](#).

Figure 7-187. GPMC_BCH_RESULT5_3 Register

31	30	29	28	27	26	25	24	23	22	21	20	19	18	17	16	15	14	13	12	11	10	9	8	7	6	5	4	3	2	1	0
BCH_RESULT5_3																															
R/W-0h																															

LEGEND: R/W = Read/Write; R = Read only; W1toCl = Write 1 to clear bit; -n = value after reset

Table 7-191. GPMC_BCH_RESULT5_3 Register Field Descriptions

Bit	Field	Type	Reset	Description
31-0	BCH_RESULT5_3	R/W	0h	BCH ECC result, bits 160 to 191

7.1.6.141 GPMC_BCH_RESULT6_3 Register (offset = 338h) [reset = 0h]

 GPMC_BCH_RESULT6_3 is shown in [Figure 7-188](#) and described in [Table 7-192](#).

Figure 7-188. GPMC_BCH_RESULT6_3 Register

31	30	29	28	27	26	25	24	23	22	21	20	19	18	17	16	15	14	13	12	11	10	9	8	7	6	5	4	3	2	1	0
BCH_RESULT6_3																															
R/W-0h																															

LEGEND: R/W = Read/Write; R = Read only; W1toCl = Write 1 to clear bit; -n = value after reset

Table 7-192. GPMC_BCH_RESULT6_3 Register Field Descriptions

Bit	Field	Type	Reset	Description
31-0	BCH_RESULT6_3	R/W	0h	BCH ECC result, bits 192 to 207

7.1.6.142 GPMC_BCH_RESULT4_4 Register (offset = 340h) [reset = 0h]

GPMC_BCH_RESULT4_4 is shown in [Figure 7-189](#) and described in [Table 7-193](#).

Figure 7-189. GPMC_BCH_RESULT4_4 Register

31	30	29	28	27	26	25	24	23	22	21	20	19	18	17	16	15	14	13	12	11	10	9	8	7	6	5	4	3	2	1	0
BCH_RESULT4_4																															
R/W-0h																															

LEGEND: R/W = Read/Write; R = Read only; W1toCl = Write 1 to clear bit; -n = value after reset

Table 7-193. GPMC_BCH_RESULT4_4 Register Field Descriptions

Bit	Field	Type	Reset	Description
31-0	BCH_RESULT4_4	R/W	0h	BCH ECC result, bits 128 to 159

7.1.6.143 GPMC_BCH_RESULT5_4 Register (offset = 344h) [reset = 0h]

GPMC_BCH_RESULT5_4 is shown in [Figure 7-190](#) and described in [Table 7-194](#).

Figure 7-190. GPMC_BCH_RESULT5_4 Register

31	30	29	28	27	26	25	24	23	22	21	20	19	18	17	16	15	14	13	12	11	10	9	8	7	6	5	4	3	2	1	0
BCH_RESULT5_4																															
R/W-0h																															

LEGEND: R/W = Read/Write; R = Read only; W1toCl = Write 1 to clear bit; -n = value after reset

Table 7-194. GPMC_BCH_RESULT5_4 Register Field Descriptions

Bit	Field	Type	Reset	Description
31-0	BCH_RESULT5_4	R/W	0h	BCH ECC result, bits 160 to 191

7.1.6.144 GPMC_BCH_RESULT6_4 Register (offset = 348h) [reset = 0h]

GPMC_BCH_RESULT6_4 is shown in [Figure 7-191](#) and described in [Table 7-195](#).

Figure 7-191. GPMC_BCH_RESULT6_4 Register

31	30	29	28	27	26	25	24	23	22	21	20	19	18	17	16	15	14	13	12	11	10	9	8	7	6	5	4	3	2	1	0
BCH_RESULT6_4																															
R/W-0h																															

LEGEND: R/W = Read/Write; R = Read only; W1toCl = Write 1 to clear bit; -n = value after reset

Table 7-195. GPMC_BCH_RESULT6_4 Register Field Descriptions

Bit	Field	Type	Reset	Description
31-0	BCH_RESULT6_4	R/W	0h	BCH ECC result, bits 192 to 207

7.1.6.145 GPMC_BCH_RESULT4_5 Register (offset = 350h) [reset = 0h]

GPMC_BCH_RESULT4_5 is shown in [Figure 7-192](#) and described in [Table 7-196](#).

Figure 7-192. GPMC_BCH_RESULT4_5 Register

31	30	29	28	27	26	25	24	23	22	21	20	19	18	17	16	15	14	13	12	11	10	9	8	7	6	5	4	3	2	1	0
BCH_RESULT4_5																															
R/W-0h																															

LEGEND: R/W = Read/Write; R = Read only; W1toCl = Write 1 to clear bit; -n = value after reset

Table 7-196. GPMC_BCH_RESULT4_5 Register Field Descriptions

Bit	Field	Type	Reset	Description
31-0	BCH_RESULT4_5	R/W	0h	BCH ECC result, bits 128 to 159

7.1.6.146 GPMC_BCH_RESULT5_5 Register (offset = 354h) [reset = 0h]

GPMC_BCH_RESULT5_5 is shown in [Figure 7-193](#) and described in [Table 7-197](#).

Figure 7-193. GPMC_BCH_RESULT5_5 Register

31	30	29	28	27	26	25	24	23	22	21	20	19	18	17	16	15	14	13	12	11	10	9	8	7	6	5	4	3	2	1	0
BCH_RESULT5_5																															
R/W-0h																															

LEGEND: R/W = Read/Write; R = Read only; W1toCl = Write 1 to clear bit; -n = value after reset

Table 7-197. GPMC_BCH_RESULT5_5 Register Field Descriptions

Bit	Field	Type	Reset	Description
31-0	BCH_RESULT5_5	R/W	0h	BCH ECC result, bits 160 to 191

7.1.6.147 GPMC_BCH_RESULT6_5 Register (offset = 358h) [reset = 0h]

GPMC_BCH_RESULT6_5 is shown in [Figure 7-194](#) and described in [Table 7-198](#).

Figure 7-194. GPMC_BCH_RESULT6_5 Register

31	30	29	28	27	26	25	24	23	22	21	20	19	18	17	16	15	14	13	12	11	10	9	8	7	6	5	4	3	2	1	0
BCH_RESULT6_5																															
R/W-0h																															

LEGEND: R/W = Read/Write; R = Read only; W1toCl = Write 1 to clear bit; -n = value after reset

Table 7-198. GPMC_BCH_RESULT6_5 Register Field Descriptions

Bit	Field	Type	Reset	Description
31-0	BCH_RESULT6_5	R/W	0h	BCH ECC result, bits 192 to 207

7.1.6.148 GPMC_BCH_RESULT4_6 Register (offset = 360h) [reset = 0h]

GPMC_BCH_RESULT4_6 is shown in [Figure 7-195](#) and described in [Table 7-199](#).

Figure 7-195. GPMC_BCH_RESULT4_6 Register

31	30	29	28	27	26	25	24	23	22	21	20	19	18	17	16	15	14	13	12	11	10	9	8	7	6	5	4	3	2	1	0
BCH_RESULT4_6																															
R/W-0h																															

LEGEND: R/W = Read/Write; R = Read only; W1toCl = Write 1 to clear bit; -n = value after reset

Table 7-199. GPMC_BCH_RESULT4_6 Register Field Descriptions

Bit	Field	Type	Reset	Description
31-0	BCH_RESULT4_6	R/W	0h	BCH ECC result, bits 128 to 159

7.1.6.149 GPMC_BCH_RESULT5_6 Register (offset = 364h) [reset = 0h]

GPMC_BCH_RESULT5_6 is shown in [Figure 7-196](#) and described in [Table 7-200](#).

Figure 7-196. GPMC_BCH_RESULT5_6 Register

31	30	29	28	27	26	25	24	23	22	21	20	19	18	17	16	15	14	13	12	11	10	9	8	7	6	5	4	3	2	1	0
BCH_RESULT5_6																															
R/W-0h																															

LEGEND: R/W = Read/Write; R = Read only; W1toCl = Write 1 to clear bit; -n = value after reset

Table 7-200. GPMC_BCH_RESULT5_6 Register Field Descriptions

Bit	Field	Type	Reset	Description
31-0	BCH_RESULT5_6	R/W	0h	BCH ECC result, bits 160 to 191

7.1.6.150 GPMC_BCH_RESULT6_6 Register (offset = 368h) [reset = 0h]

GPMC_BCH_RESULT6_6 is shown in [Figure 7-197](#) and described in [Table 7-201](#).

Figure 7-197. GPMC_BCH_RESULT6_6 Register

31	30	29	28	27	26	25	24	23	22	21	20	19	18	17	16	15	14	13	12	11	10	9	8	7	6	5	4	3	2	1	0
BCH_RESULT6_6																															
R/W-0h																															

LEGEND: R/W = Read/Write; R = Read only; W1toCl = Write 1 to clear bit; -n = value after reset

Table 7-201. GPMC_BCH_RESULT6_6 Register Field Descriptions

Bit	Field	Type	Reset	Description
31-0	BCH_RESULT6_6	R/W	0h	BCH ECC result, bits 192 to 207

7.1.6.151 GPMC_BCH_RESULT4_7 Register (offset = 370h) [reset = 0h]

GPMC_BCH_RESULT4_7 is shown in [Figure 7-198](#) and described in [Table 7-202](#).

Figure 7-198. GPMC_BCH_RESULT4_7 Register

31	30	29	28	27	26	25	24	23	22	21	20	19	18	17	16	15	14	13	12	11	10	9	8	7	6	5	4	3	2	1	0
BCH_RESULT4_7																															
R/W-0h																															

LEGEND: R/W = Read/Write; R = Read only; W1toCl = Write 1 to clear bit; -n = value after reset

Table 7-202. GPMC_BCH_RESULT4_7 Register Field Descriptions

Bit	Field	Type	Reset	Description
31-0	BCH_RESULT4_7	R/W	0h	BCH ECC result, bits 128 to 159

7.1.6.152 GPMC_BCH_RESULT5_7 Register (offset = 374h) [reset = 0h]

GPMC_BCH_RESULT5_7 is shown in [Figure 7-199](#) and described in [Table 7-203](#).

Figure 7-199. GPMC_BCH_RESULT5_7 Register

31	30	29	28	27	26	25	24	23	22	21	20	19	18	17	16	15	14	13	12	11	10	9	8	7	6	5	4	3	2	1	0
BCH_RESULT5_7																															
R/W-0h																															

LEGEND: R/W = Read/Write; R = Read only; W1toCl = Write 1 to clear bit; -n = value after reset

Table 7-203. GPMC_BCH_RESULT5_7 Register Field Descriptions

Bit	Field	Type	Reset	Description
31-0	BCH_RESULT5_7	R/W	0h	BCH ECC result, bits 160 to 191

7.1.6.153 GPMC_BCH_RESULT6_7 Register (offset = 378h) [reset = 0h]

GPMC_BCH_RESULT6_7 is shown in [Figure 7-200](#) and described in [Table 7-204](#).

Figure 7-200. GPMC_BCH_RESULT6_7 Register

31	30	29	28	27	26	25	24	23	22	21	20	19	18	17	16	15	14	13	12	11	10	9	8	7	6	5	4	3	2	1	0
BCH_RESULT6_7																															
R/W-0h																															

LEGEND: R/W = Read/Write; R = Read only; W1toCl = Write 1 to clear bit; -n = value after reset

Table 7-204. GPMC_BCH_RESULT6_7 Register Field Descriptions

Bit	Field	Type	Reset	Description
31-0	BCH_RESULT6_7	R/W	0h	BCH ECC result, bits 192 to 207

7.2 OCMC-RAM

7.2.1 Introduction

7.2.1.1 OCMC-RAM Features

The on-chip memory controller consists of two separate modules that are OCP to memory wrappers. The first wrapper is for a ROM; the second is for a RAM. Each wrapper has its own dedicated interface to the L3 interconnect.

- 32- or 64-bit width
- Initial latency max 2 cycles (due to OCP to memory core wrapper).
- Multiple memory bank control based on address MSBs
- Full OCP IP 2.0 Burst support. No wait state.

7.2.1.2 Unsupported OCMC-RAM Features

For this device, the OCMC-RAM implementation does not support parity.

7.2.2 Integration

This device includes a single instantiation of the on-chip memory controller interfacing to a single 64K bank of RAM.

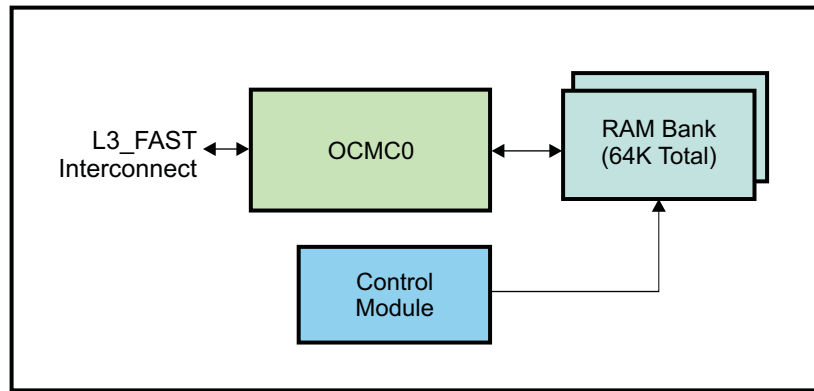


Figure 7-201. OCMC RAM Integration

7.2.2.1 OCMC RAM Connectivity Attributes

The general connectivity attributes for the OCMC RAM modules are summarized in [Table 7-205](#).

Table 7-205. OCMC RAM Connectivity Attributes

Attributes	Type
Power Domain	Peripheral Domain
Clock Domain	PD_PER_L3_GCLK
Reset Signals	PER_DOM_RST_N
Idle/Wakeup Signals	Smart Idle
Interrupt Requests	None
DMA Requests	None
Physical Address	L3 Fast slave port

7.2.2.2 OCMC RAM Clock and Reset Management

The OCMC module uses a single clock for the module and its OCP interface.

Table 7-206. OCMC RAM Clock Signals

Clock Signal	Max Freq	Reference / Source	Comments
prcm_ocmc_clock Interface / Functional clock	200 MHz	CORE_CLKOUTM4	pd_per_l3_gclk From PRCM

7.2.2.3 OCMC RAM Pin List

The OCMC RAM module does not include any external interface pins.

7.3 EMIF

7.3.1 Introduction

7.3.1.1 Features

The general features of the EMIF module are as follows:

- 16-bit data path to external SDRAM memory
- One 128-bit OCPIP 2.2 interface
- Support for the following memory types:
 - mDDR (LPDDR1)
 - DDR2
 - DDR3

External memory configurations supported:

- Memory device capacity
 - Up to 1G Byte addressability
- Flexible bank/row/column/chip-select address multiplexing schemes
- Device driver strength feature for mobile DDR supported
- Supports following CAS latencies:
 - DDR2 => 2, 3, 4, 5, 6, and 7
 - DDR3 => 5, 6, 7, 8, 9, 10, and 11
 - mDDR => 2, 3, and 4
- Supports following number of internal banks:
 - DDR2 => 1, 2, 4, and 8
 - DDR3 => 1, 2, 4, and 8
 - mDDR => 1, 2, and 4
- Supports 256, 512, 1024, and 2048-word page sizes
- Supports burst length of 8 (sequential burst)
- Write/read leveling/calibration and data eye training in conjunction with DID
- Self Refresh and Power-Down modes for low power:
 - Flexible OCP to DDR address mapping to support Partial Array Self Refresh in LPDDR1, DDR2 and DDR3.
 - Temperature Controlled Self Refresh for LPDDR1 and DDR3 having on-chip temperature sensor.
- Periodic ZQ calibration for DDR3
- ODT on DDR2 and DDR3
- Prioritized refresh scheduling
- Programmable SDRAM refresh rate and backlog counter
- Programmable SDRAM timing parameters
- Big and little endian modes

7.3.1.2 Unsupported EMIF Features

The following EMIF4DC module features are not supported in this device.

Table 7-207. Unsupported EMIF Features

Feature	Reason
32-bit data	Only 16 bits pinned out
Multiple DDR banks	Only 1 CS/ODT pinned out
DDR2 CAS Latency 2	Not supported by DID
Hardware leveling	Silicon bug. Must use software leveling procedure. See <i>AM335x ARM Cortex-A8 Microprocessors (MPUs) Silicon Errata</i> (literature number SPRZ360).

7.3.2 Integration

EMIF Connectivity Attributes

The general connectivity attributes for the EMIF are shown in [EMIF Connectivity Attributes](#).

EMIF Connectivity Attributes

Attributes	Type
Power Domain	Peripheral Domain
Clock Domain	PD_PER_L3_GCLK (OCP) PD_PER_EMIF_GCLK (Func)
Reset Signals	POR_N
Idle/Wakeup Signals	Smart Idle
Interrupt Requests	1 interrupt to MPU Subsystem (DDRERR0)
DMA Requests	None
Physical Address	L3 Fast Slave Port

EMIF Clock Management

The EMIF4 OCP interface (*ocp_clk*) is clocked by the L3 Fast clock sourced from the Core PLL. The DDR Command and Data macros are clocked by the DDR PLL. The PRCM divides this clock by two to create the EMIF functional clock (*m_clk*).

The OCP and functional clocks may be asynchronous because synchronization is managed in the EMIF4 internal FIFO (EMIF4 is set in asynchronous mode).

EMIF Clock Signals

Clock Signal	Maximum Frequency	Reference Source	Comments
<i>ocp_clk</i> (Interface clock)	200 MHz	CORE_CLKOUTM4	<i>pd_per_l3_gclk</i> From PRCM
<i>m_clk</i> (EMIF functional clock)	200 MHz ⁽¹⁾	DDR PLL CLKOUT / 2	<i>pd_per_emif_gclk</i> From PRCM
<i>cmd0_dfi_clk</i> <i>cmd1_dfi_clk</i> <i>cmd2_dfi_clk</i> <i>data0_dfi_clk</i> <i>data1_dfi_clk</i> (Macro clocks)	400 MHz ⁽¹⁾	DDR PLL CLKOUT	<i>clkout_po</i> From DDR PLL

⁽¹⁾ The maximum frequency depends on the type of DDR. See the maximum DDR frequency for your device in the device datasheet *AM335x Sitara Processors* (literature number [SPRS717](#)).

EMIF Pin List

The EMIF/DDR external interface signals are shown in [EMIF Pin List](#).

EMIF Pin List

Pin	Type	Description
DDR_CK DDR_NCK	O	Differential clock pair
DDR_CKE	O	Clock enable
DDR_CS _{n0}	O	Chip select
DDR_RAS _n	O	Row address strobe
DDR_CAS _n	O	Column address strobe
DDR_WEn	O	Write enable
DDR_BA[2:0]	O	Bank address
DDR_A[15:0]	O	Row/column address

EMIF Pin List (continued)

Pin	Type	Description
DDR_DQS[1:0]	I/O	Data strobes
DDR_DQSn[1:0]	I/O	Complimentary data strobes
DDR_DQM[1:0]	O	Data masks
DDR_D[15:0]	I/O	Data
DDR_ODT	O	On-die termination
DDR_RESETn	O	DDR device reset
DDR_VREF	I	I/O Voltage reference
DDR_VTP	I	VTP compensation pin

7.3.3 Functional Description

7.3.3.1 Signal Descriptions

The DDR2/3/mDDR memory controller signals are shown in [Figure 7-202](#) and described in [Table 7-208](#). The following features are included:

- The maximum width for the data bus (DDR_D[15:0]) is 16-bits
- The address bus (DDR_A[15:0]) is 16-bits wide with an additional 3 bank address pins (DDR_BA[2:0])
- Two differential output clocks (DDR_CLK and DDR_nCK) driven by internal clock sources
- Command signals: Row and column address strobe (DDR_RASn and DDR_CASn), write enable strobe

(DDR_WEn), data strobe (DDR_DQS[1:0] and DDR_DQSn[1:0]), and data mask (DDR_DQM[1:0]).

- One chip select signal (DDR_CSN0) and one clock enable signal (DDR_CKE)
- One on-die termination output signals (DDR_ODT).

Figure 7-202. DDR2/3/mDDR Memory Controller Signals

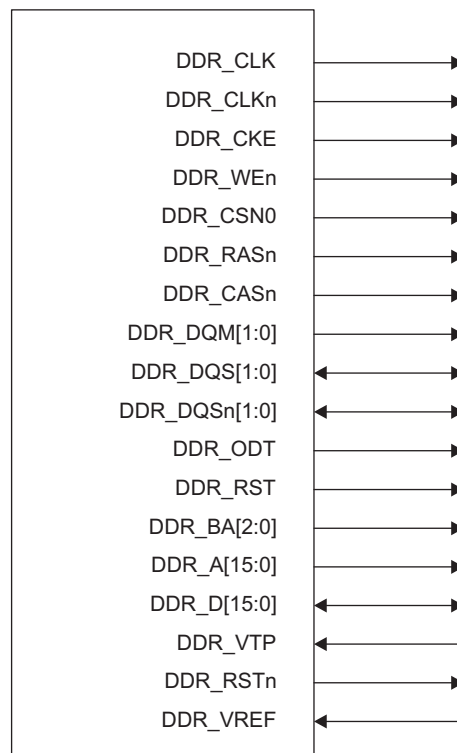


Table 7-208. DDR2/3/mDDR Memory Controller Signal Descriptions

Pin	Description
DDR_D[15:0]	Bidirectional data bus. Input for data reads and output for data writes.
DDR_A[15:0]	External address output.
DDR_CSN0	Chip select output.
DDR_DQM[1:0]	Active-low output data mask.
DDR_CLK/DDR_CLKn	Differential clock outputs. All DDR2/3/mDDR interface signals are synchronous to these clocks.
DDR_CKE	Clock enable. Used to select Power-Down and Self-Refresh operations.
DDR_CASn	Active-low column address strobe.
DDR_RASn	Active-low row address strobe.
DDR_WEn	Active-low write enable.

Table 7-208. DDR2/3/mDDR Memory Controller Signal Descriptions (continued)

Pin	Description
DDR_DQS[1:0]/DDR_DQSn[1:0]	Differential data strobe bidirectional signals. Edge-aligned inputs on reads and center-aligned outputs on writes.
DDR_ODT	On-die termination signal to external DDR2/3 SDRAM. ODT is not supported for mDDR.
DDR_BA[2:0]	Bank-address control outputs.
DDR_VREF	Memory Controller reference voltage. This voltage must be supplied externally. See the device-specific data manual for more details.
DDR_VTP	DDR2/3/mDDR VTP Compensation Resistor Connection.
DDR_RESEt _n	Reset output. Asynchronous reset for DDR3 devices.

7.3.3.2 Clock Control

DDR2/3/mDDR clock is derived directly from the DDR PLL's VCO output. The frequency of DDR_CLK can be determined by using the following formula:

$$\text{DDR_CLK frequency} = (\text{DDRPLL input clock frequency} \times \text{multiplier}) / ((\text{pre-divider} + 1) \times \text{post-divider})$$

The second output clock of the DDR2/3/mDDR memory controller DDR_CLK_n, is the inverse of DDR_CLK. You can change the multiplier, pre-divider and post-divider to get the desired DDR_CLK frequency.

For detailed information on DDR PLL, see [Section 8.1, Power Management and Clock Module \(PRCM\)](#).

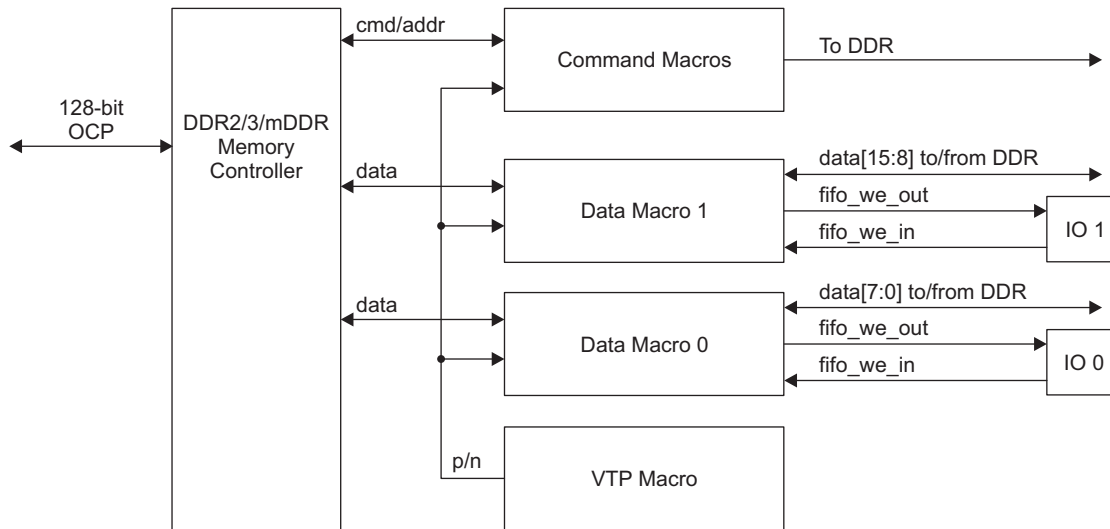
7.3.3.3 DDR2/3/mDDR Memory Controller Subsystem Overview

The DDR2/3/mDDR memory controller can gluelessly interface to most standard DDR2/3/mDDR SDRAM devices and supports such features as self-refresh mode and prioritized refresh. In addition, it provides flexibility through programmable parameters such as the refresh rate, CAS latency, and many SDRAM timing parameters. The DDR2/3/mDDR subsystem consists of the following:

- DDR2/3/mDDR memory controller
- Command macro
- Data macro
- VTP controller macro
- IOs for DQS gate

The subsystem supports JEDEC standard compliant DDR2/DDR3 and mDDR(LPDDR1) devices. It does not support CAS latency of 2 for DDR2 due to data and command macro limitations. It supports a 128-bit wide OCP interface on the core side for programmability. The subsystem can be used to connect to 16-bit memory devices.

[Figure 7-203](#) shows the DDR2/3/mDDR subsystem block diagram.

Figure 7-203. DDR2/3/mDDR Subsystem Block Diagram


Where

fifo_we_out = DQS enable output for timing match between DQS and system (Memory) clock.

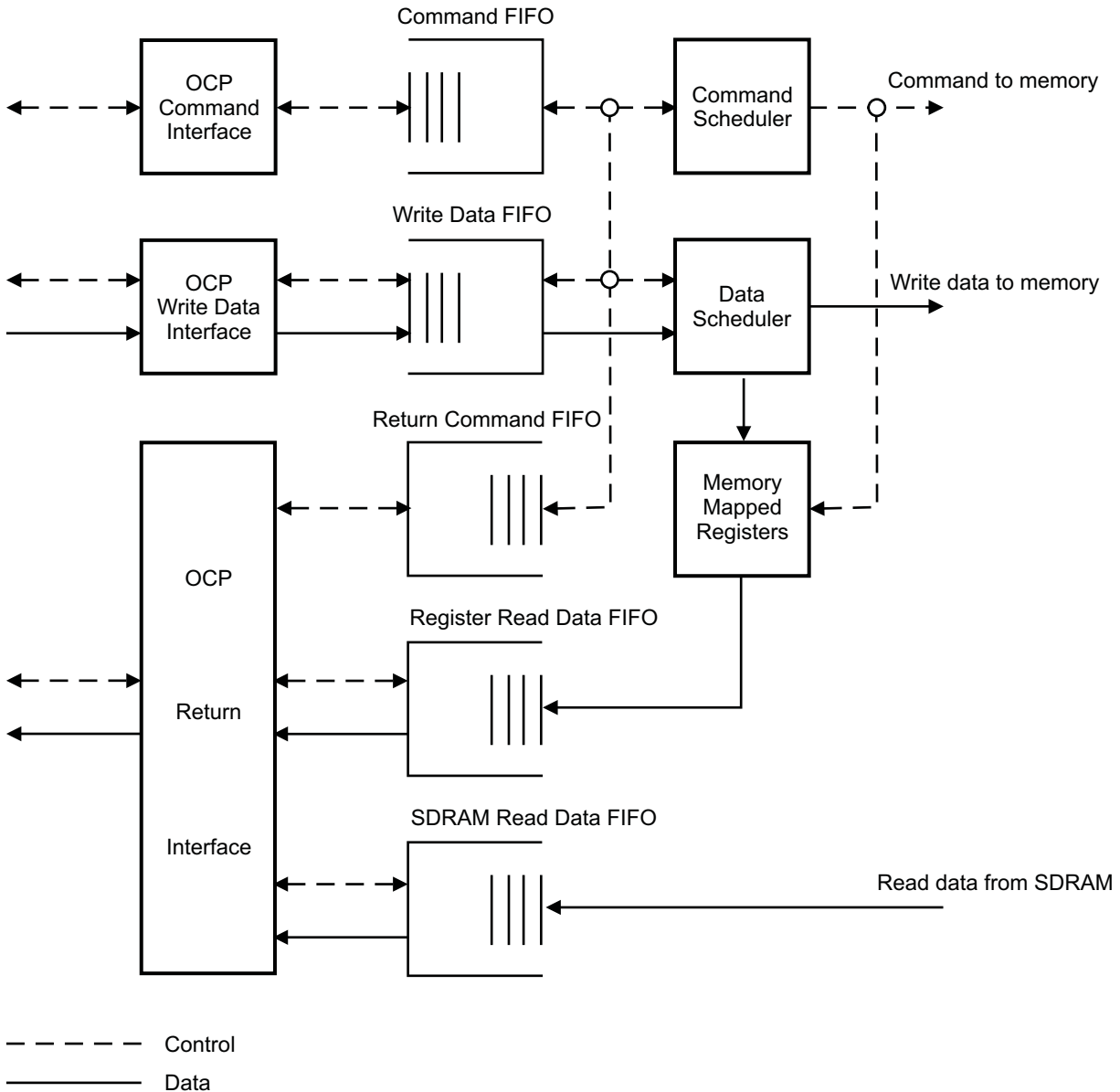
fifo_we_in = DQS enable input for timing match between DQS and system (Memory) clock.

7.3.3.3.1 DDR2/3/mDDR Memory Controller Interface

To move data efficiently from on-chip resources to external DDR2/3/mDDR SDRAM device, the DDR2/3/mDDR memory controller makes use of a command FIFO, a write data FIFO, a return command FIFO, and two Read Data FIFOs. Purpose of each FIFO is described below.

Figure 7-204 shows the block diagram of the DDR2/3/mDDR memory controller FIFOs. Commands, write data, and read data arrive at the DDR2 memory controller parallel to each other. The same peripheral bus is used to write and read data from external memory as well as internal memory-mapped registers.

Figure 7-204. DDR2/3/mDDR Memory Controller FIFO Block Diagram



The command FIFO stores all the commands coming in on the OCP command interface.

The Write Data FIFO stores the write data for all the write transactions coming in on the OCP write data interface.

The Return Command FIFO stores all the return transactions that are to be issued to the OCP return interface. These include the write status return and the read data return commands.

There are two Read Data FIFOs that store the read data to be sent to the OCP return interface. One Read Data FIFO stores read data from the memory mapped registers and other Read Data FIFO stores read data from external memory.

7.3.3.3.2 Data Macro

The data macro consists of 8 data channels, one pair of complementary strobes (one pair for 8 bits of data), and one data mask channel (one for 8 bits of data).

The data macros consists of PHY Data Macro, DLLs and IOs integrated into a macro.

The data macro is a bidirectional interface. It is used to transmit data from the memory controller to the external memory chip during a write operation and receive data from memory and transmit it to the memory controller during a read operation.

During a write operation, the data macro translates 32/16-bit words from memory controller to 8-bit words and transmits them at double the bit rate to the memory along with the strobe. The strobe is center-aligned to the data. Data can be prevented from writing to the memory using data mask signal.

During a read operation, the data macro receives 8-bit DDR data along with the strobe and converts it to 32/16-bit words and transmits them to the memory controller along with the read-valid signals.

7.3.3.3.3 Command Macro

It consists of PHY Command Macro, DLLs and the IOs integrated together. The command macro acts as a unidirectional macro that transmits address and control bits from memory controller to the memory chip. The clocks DDR_CLK and DDR_CLKn are used by the memory to register the command and address transmitted on the transmit channels. All address and control signals are transmitted clock-centered with respect to DDR_CLK and DDR_CLKn. The memory, on the positive edge of DDR_CLK and the negative edge of DDR_CLKn, samples all address and control signals.

7.3.3.3.4 VTP Controller Macro

The VTP controller macro evaluates silicon performance at current voltage, temperature, and process (VTP) to enable IO drivers to set constant predetermined output driver impedance. The controller operates by comparing driver impedances to the external reference resistor and adjusting driver impedance to obtain an impedance match. VTP Controller supports the following features:

- The VTP controller generates information regarding the Voltage, temperature, and process(VTP) on a chip to be shared with the device's IO drivers
- Requires a Clock input from the core running at 20MHz or less
- 56 Clock cycles are needed to guarantee the VTP outputs are initially set after reset is removed
- Can be used in static or dynamic update mode of operation
- The VTP controller has internal noise filtering which allows it to control spurious update requests due to noise

Impedance of the drivers and terminations must be updated often even while in operation. In such scenarios where Voltage and Temperature are variables VTP macro can be configured in dynamic update mode. In contrast, static mode of operation does not allow dynamic calibration of IO impedance, and hence consumes lesser power compared to dynamic update mode.

It is possible that under noisy conditions, dynamic update controller can generate too frequent update requests. Noise can cause the controller to request a change in the impedance that can again be quickly reversed on subsequent clock cycles. To prevent the controller from making excessive numbers of impedance changes, a digital filter is included which can be configured to regulate the update rate. For example if the user configures the filter value as F2=0,F1=1 and F0=1, then an impedance update will be performed only if four successive update requests are generated from the VTP controller. It is recommended to use a filter value of 011'b.

Table 7-209 shows the configuration details of the digital filter.

Table 7-209. Digital Filter Configuration

F2	F1	F0	Description
0	0	0	Off
0	0	1	Update on 2 consecutive update requests
0	1	0	Update on 3 consecutive update requests
0	1	1	Update on 4 consecutive update requests
1	0	0	Update on 5 consecutive update requests
1	0	1	Update on 6 consecutive update requests
1	1	0	Update on 7 consecutive update requests

Table 7-209. Digital Filter Configuration (continued)

F2	F1	F0	Description
1	1	1	Update on 8 consecutive update requests

7.3.3.3.5 DQS-Gate IOs

To effectively model the I/O delay on the DQS gating signal during a read request (the DQS receiver and the CLK driver I/Os), the signal is expected to be looped on a single I/O connecting `fifo_we_in` to `fifo_we_out`. The board and memory delay, being fairly constant across PTV variations, are calibrated within the IDID using a compensated delay line. The loop-back is done at the die level without bringing the signals out to the package level. Each Data Macro supports delay compensation independent of each other.

The data and command macros are responsible for System level flight time compensation. The following controls are supported by the DDR2/3/mDDR controller Sub System.

- Aligning DDR_DQS w.r.t DDR_CLK during Write Cycle: For DDR3 operation, initiate the write leveling state machine on each rank in turn to capture the proper delay settings to align DDR_DQS with DDR_CLK clock for each memory chip. If one wants to do this in a manual way one can write to the control register that controls the delay of DDR_DQS vs DDR_CLK Clock position. To produce a given amount of skew to center the DDR_DQS vs. Clock at the SDRAM the following register can be programmed.

Data Macro 0/1 Write DQS Slave Ratio Register = $256 \times ([\text{command delay}] - [\text{DDR_DQS delay}]) / \text{DDR_CLK Clock period}$.

- Aligning ADDR/CMD w.r.t DDR_CLK
- Aligning DDR_DQ[15:0] w.r.t DDR_DQS during Write Operation
- Offset DDR_D[15:0] w.r.t DDR_DQS during Read Operation
- Align FIFO WE Window

7.3.3.4 Address Mapping

The DDR2/3/mDDR memory controller views external DDR2/3/mDDR SDRAM as one continuous block of memory. This statement is true regardless of the number of memory devices located on the chip select space. The DDR2/3/mDDR memory controller receives DDR2/3/mDDR memory access requests along with a 32-bit logical address from the rest of the system. In turn, DDR2/3/mDDR memory controller uses the logical address to generate a row/page, column, and bank address for the DDR2/3/mDDR SDRAM. The number of column, row and bank address bits used is determined by the IBANK, RSIZE and PAGESIZE fields (see [Table 7-210](#)). The DDR2/3/mDDR memory controller uses up to 16 bits for the row/page address.

Table 7-210. IBANK, RSIZE and PAGESIZE Fields Information

Bit Field	Bit Value	Bit Description
RSIZE		Defines the number of address lines to be connected to DDR2/3/mDDR memory device
	0	9 row bits
	1h	10 row bits
	2h	11 row bits
	3h	12 row bits
	4h	13 row bits
	5h	14 row bits
	6h	15 row bits
7h	16 row bits	

Table 7-210. IBANK, RSIZE and PAGESIZE Fields Information (continued)

Bit Field	Bit Value	Bit Description
PAGESIZE		Defines the page size of each page of the external DDR2/3/mDDR memory device
	0	256 words (requires 8 column address bits)
	1h	512 words (requires 9 column address bits)
	2h	1024 words (requires 10 column address bits)
	3h	2048 words (requires 11 column address bits)
IBANK		Defines the number of internal banks on the external DDR2/3/mDDR memory device
	0	1 bank
	1h	2 banks
	2h	4 banks
	3h	8 banks
EBANK		Defines the number of DDR2/3/mDDR memory controller chip selects
	0	CS0 only
	1h	Reserved

When addressing SDRAM, if the REG_IBANK_POS field in the SDRAM Config register is set to 0, and the REG_EBANK_POS field in the SDRAM Config 2 register is also set to 0, the DDR2/3/mDDR memory controller uses the three fields, IBANK, EBANK and PAGESIZE in the SDRAM Config register to determine the mapping from source address to SDRAM row, column, bank, and chip select. If the REG_IBANK_POS field in the SDRAM Config register is set to 1, 2, or 3, or the REG_EBANK_POS field in the SDRAM Config 2 register is set to 1, the DDR2/3/mDDR memory controller uses the 4 fields - IBANK, EBANK, PAGESIZE, and ROWSIZE in the SDRAM Config register to determine the mapping from source address to SDRAM row, column, bank, and chip select. In all cases the DDR2/3/mDDR memory controller considers its SDRAM address space to be a single logical block regardless of the number of physical devices or whether the devices are mapped across 1 or 2 DDR2/3/mDDR memory controller chip selects.

7.3.3.4.1 Address Mapping when REG_IBANK_POS=0 and REG_EBANK_POS=0

For REG_IBANK_POS=0 and REG_EBANK_POS=0, the effect of address mapping scheme is that as the source address increments across DDR2/3/mDDR memory device page boundaries, the DDR2/3/mDDR controller moves onto the same page in the next bank in the current device DDR_CS_n[0]. This movement along the banks of the current proceeds to the same page in the next device (if EBANK=1, DDR_CS_n[1]) and proceeds through the same page in all its banks before moving over to the next page in the first device (DDR_CS_n[0]). The DDR2/3/mDDR controller exploits this traversal across internal banks and chip selects while remaining on the same page to maximize the number of open DDR2/3/mDDR memory device banks within the overall DDR2/3/mDDR memory device space.

Thus, the DDR2/3/mDDR controller can keep a maximum of 16 banks (8 internal banks across 2 chip selects) open at a time, and can interleave among all of them.

Table 7-211. OCP Address to DDR2/3/mDDR Address Mapping for REG_IBANK_POS=0 and REG_EBANK_POS=0

Logical Address			
Row Address	Chip Select	Bank Address	Column Address
	# of bits defined by EBANK of SDRCR	# of bits defined by IBANK of SDRCR	# of bits defined by PAGESIZE of SDRCR
16 bits	EBANK=0 => 0 bits	IBANK=0 => 0 bits	PAGESIZE=0 => 8 bits
	EBANK=1 => 1 bit	IBANK=1 => 1 bit	PAGESIZE=1 => 9 bits
		IBANK=2 => 2 bits	PAGESIZE=2 => 10 bits
		IBANK=3 => 3 bits	PAGESIZE=3 => 11 bits

7.3.3.4.2 Address Mapping when REG_IBANK_POS = 1 and REG_EBANK_POS = 0

For REG_IBANK_POS = 1 and REG_EBANK_POS = 0, the interleaving of banks within a device (per chip select) is limited to 4 banks. However, it can still interleave banks between the two chip selects. Thus, the DDR2/3/mDDR controller can keep a maximum of 16 banks (8 internal banks across 2 chip selects) open at a time, but can only interleave among eight of them.

Table 7-212. OCP Address to DDR2/3/mDDR Address Mapping for REG_IBANK_POS=1 and REG_EBANK_POS=0

Logical Address				
Bank Address[2]	Row Address	Chip Select	Bank Address[1:0]	Column Address
# of bits defined by IBANK of SDRCR	# of bits defined by RSIZE of SDRCR	# of bits defined by EBANK of SDRCR	# of bits defined by IBANK of SDRCR	# of bits defined by PAGESIZE of SDRCR
IBANK=0 => 0 bits	RSIZE=0 => 9 bits	EBANK=0 => 0 bits	IBANK=0 => 0 bits	PAGESIZE=0 => 8 bits
IBANK=1 => 0 bits	RSIZE=1 => 10 bits	EBANK=1 => 1 bit	IBANK=1 => 1 bit	PAGESIZE=1 => 9 bits
IBANK=2 => 0 bits	RSIZE=2 => 11 bits		IBANK=2 => 2 bits	PAGESIZE=2 => 10 bits
IBANK=3 => 1 bit	RSIZE=3 => 12 bits		IBANK=3 => 3 bits	PAGESIZE=3 => 11 bits
	RSIZE=4 => 13 bits			
	RSIZE=5 => 14 bits			
	RSIZE=6 => 15 bits			
	RSIZE=7 => 16 bits			

7.3.3.4.3 Address Mapping when REG_IBANK_POS=2 and REG_EBANK_POS = 0

For REG_IBANK_POS=2 and REG_EBANK_POS = 0, the interleaving of banks within a device (per chip select) is limited to 2 banks. However, it can still interleave banks between the two chip selects. Thus, the DDR2/3/mDDR controller can keep a maximum of 16 banks (eight internal banks across 2 chip selects) open at a time, but can only interleave among four of them.

Table 7-213. OCP Address to DDR2/3/mDDR Address Mapping for REG_IBANK_POS=2 and REG_EBANK_POS=0

Logical Address				
Bank Address[2:1]	Row Address	Chip Select	Bank Address[0]	Column Address
# of bits defined by IBANK of SDRCR	# of bits defined by RSIZE of SDRCR	# of bits defined by EBANK of SDRCR	# of bits defined by IBANK of SDRCR	# of bits defined by PAGESIZE of SDRCR
IBANK=0 => 0 bits	RSIZE=0 => 9 bits	EBANK=0 => 0 bits	IBANK=0 => 0 bits	PAGESIZE=0 => 8 bits
IBANK=1 => 0 bits	RSIZE=1 => 10 bits	EBANK=1 => 1 bit	IBANK=1 => 1 bit	PAGESIZE=1 => 9 bits
IBANK=2 => 1 bit	RSIZE=2 => 11 bits		IBANK=2 => 1 bit	PAGESIZE=2 => 10 bits
IBANK=3 => 2 bits	RSIZE=3 => 12 bits		IBANK=3 => 1 bit	PAGESIZE=3 => 11 bits
	RSIZE=4 => 13 bits			
	RSIZE=5 => 14 bits			
	RSIZE=6 => 15 bits			
	RSIZE=7 => 16 bits			

7.3.3.4.4 Address Mapping when REG_IBANK_POS= 3 and REG_EBANK_POS = 0

For REG_IBANK_POS= 3 and REG_EBANK_POS = 0, the DDR2/3/mDDR controller cannot interleave banks within a device (per chip select). However, it can still interleave banks between the two chip selects. Thus, the DDR2/3/mDDR controller can keep a maximum of 16 banks (8 internal banks across 2 chip selects) open at a time, but can only interleave among two of them.

Table 7-214. OCP Address to DDR2/3/mDDR Address Mapping for REG_IBANK_POS=3 and REG_EBANK_POS=0

Logical Address			
Bank Address	Row Address	Chip Select	Column Address
# of bits defined by IBANK of SDRCR	# of bits defined by RSIZE of SDRCR	# of bits defined by EBANK of SDRCR	# of bits defined by PAGESIZE of SDRCR
IBANK=0 => 0 bits	RSIZE=0 => 9 bits	EBANK=0 => 0 bits	PAGESIZE=0 => 8 bits
IBANK=1 => 1 bit	RSIZE=1 => 10 bits	EBANK=1 => 1 bit	PAGESIZE=1 => 9 bits
IBANK=2 => 2 bits	RSIZE=2 => 11 bits		PAGESIZE=2 => 10 bits
IBANK=3 => 3 bits	RSIZE=3 => 12 bits		PAGESIZE=3 => 11 bits
	RSIZE=4 => 13 bits		
	RSIZE=5 => 14 bits		
	RSIZE=6 => 15 bits		
	RSIZE=7 => 16 bits		

7.3.3.4.5 Address Mapping when REG_IBANK_POS = 0 and REG_EBANK_POS = 1

For REG_IBANK_POS = 0 and REG_EBANK_POS = 1, the DDR2/3/mDDR memory controller interleaves among all the banks within a device (per chip select). However, the DDR2/3/mDDR memory controller cannot interleave banks between the two chip selects. Thus, the DDR2/3/mDDR memory controller can keep a maximum of 16 banks (8 internal banks across 2 chip selects) open at a time, but can only interleave among 8 of them.

Table 7-215. OCP Address to DDR2/3/mDDR Address Mapping for REG_IBANK_POS=0 and REG_EBANK_POS=1

Logical Address			
Chip Select	Row Address	Bank Address	Column Address
# of bits defined by EBANK of SDRCR	# of bits defined by RSIZE of SDRCR	# of bits defined by IBANK of SDRCR	# of bits defined by PAGESIZE of SDRCR
EBANK=0 => 0 bits	RSIZE=0 => 9 bits	IBANK=0 => 0 bits	PAGESIZE=0 => 8 bits
EBANK=1 => 1 bit	RSIZE=1 => 10 bits	IBANK=1 => 1 bit	PAGESIZE=1 => 9 bits
	RSIZE=2 => 11 bits	IBANK=2 => 2 bits	PAGESIZE=2 => 10 bits
	RSIZE=3 => 12 bits	IBANK=3 => 3 bits	PAGESIZE=3 => 11 bits
	RSIZE=4 => 13 bits		
	RSIZE=5 => 14 bits		
	RSIZE=6 => 15 bits		
	RSIZE=7 => 16 bits		

7.3.3.4.6 Address Mapping when REG_IBANK_POS = 1 and REG_EBANK_POS = 1

For REG_IBANK_POS = 1 and REG_EBANK_POS = 1, the interleaving of banks within a device (per chip select) is limited to 4 banks. Also, the DDR2/3/mDDR memory controller cannot interleave banks between the two chip selects. Thus, the DDR2/3/mDDR memory controller can keep a maximum of 16 banks (8 internal banks across 2 chip selects) open at a time, but can only interleave among four of them.

Table 7-216. OCP Address to DDR2/3/mDDR Address Mapping for REG_IBANK_POS=1 and REG_EBANK_POS = 1

Logical Address				
Chip Select	Bank Address[2]	Row Address	Bank Address[1:0]	Column Address
# of bits defined by EBANK of SDRCR	# of bits defined by IBANK of SDRCR	# of bits defined by RSIZE of SDRCR	# of bits defined by IBANK of SDRCR	# of bits defined by PAGESIZE of SDRCR
EBANK=0 => 0 bits	IBANK=0 => 0 bits	RSIZE=0 => 9 bits	IBANK=0 => 0 bits	PAGESIZE=0 => 8 bits

Table 7-216. OCP Address to DDR2/3/mDDR Address Mapping for REG_IBANK_POS=1 and REG_EBANK_POS = 1 (continued)

Logical Address				
Chip Select	Bank Address[2]	Row Address	Bank Address[1:0]	Column Address
EBANK=1 => 1 bit	IBANK=1 => 0 bits	RSIZE=1 => 10 bits	IBANK=1 => 1 bit	PAGESIZE=1 => 9 bits
	IBANK=2 => 0 bits	RSIZE=2 => 11 bits	IBANK=2 => 2 bits	PAGESIZE=2 => 10 bits
	IBANK=3 => 1 bit	RSIZE=3 => 12 bits	IBANK=3 => 2 bits	PAGESIZE=3 => 11 bits
		RSIZE=4 => 13 bits		
		RSIZE=5 => 14 bits		
		RSIZE=6 => 15 bits		
		RSIZE=7 => 16 bits		

7.3.3.4.7 Address Mapping when REG_IBANK_POS = 2 and REG_EBANK_POS = 1

For REG_IBANK_POS = 2 and REG_EBANK_POS = 1, the interleaving of banks within a device (per chip select) is limited to 2 banks. Also, the DDR2/3/mDDR memory controller cannot interleave banks between the two chip selects. Thus, the DDR2/3/mDDR memory controller can keep a maximum of 16 banks (8 internal banks across 2 chip selects) open at a time, but can only interleave among two of them.

Table 7-217. OCP Address to DDR2/3/mDDR Address Mapping for REG_IBANK_POS=2 and REG_EBANK_POS = 1

Logical Address				
Chip Select	Bank Address[2:1]	Row Address	Bank Address[0]	Column Address
# of bits defined by EBANK of SDRCR	# of bits defined by IBANK of SDRCR	# of bits defined by RSIZE of SDRCR	# of bits defined by IBANK of SDRCR	# of bits defined by PAGESIZE of SDRCR
EBANK=0 => 0 bits	IBANK=0 => 0 bits	RSIZE=0 => 9 bits	IBANK=0 => 0 bits	PAGESIZE=0 => 8 bits
EBANK=1 => 1 bit	IBANK=1 => 0 bits	RSIZE=1 => 10 bits	IBANK=1 => 1 bit	PAGESIZE=1 => 9 bits
	IBANK=2 => 1 bit	RSIZE=2 => 11 bits	IBANK=2 => 1 bit	PAGESIZE=2 => 10 bits
	IBANK=3 => 2 bits	RSIZE=3 => 12 bits	IBANK=3 => 1 bit	PAGESIZE=3 => 11 bits
		RSIZE=4 => 13 bits		
		RSIZE=5 => 14 bits		
		RSIZE=6 => 15 bits		
		RSIZE=7 => 16 bits		

7.3.3.4.8 Address Mapping when REG_IBANK_POS = 3 and REG_EBANK_POS = 1

For REG_IBANK_POS = 3 and REG_EBANK_POS = 1, the DDR2/3/mDDR memory controller cannot interleave banks within a device (per chip select) or between the two chip selects. Thus, the DDR2/3/mDDR memory controller can keep a maximum of 16 banks (8 internal banks across two chip selects) open at a time, but cannot interleave among of them.

Table 7-218. OCP Address to DDR2/3/mDDR Address Mapping for REG_IBANK_POS=3 and REG_EBANK_POS=1

Logical Address			
Chip Select	Bank Address	Row Address	Column Address
# of bits defined by EBANK of SDRCR	# of bits defined by IBANK of SDRCR	# of bits defined by RSIZE of SDRCR	# of bits defined by PAGESIZE of SDRCR
EBANK=0 => 0 bits	IBANK=0 => 0 bits	RSIZE=0 => 9 bits	PAGESIZE=0 => 8 bits
EBANK=1 => 1 bit	IBANK=1 => 1 bit	RSIZE=1 => 10 bits	PAGESIZE=1 => 9 bits
	IBANK=2 => 2 bits	RSIZE=2 => 11 bits	PAGESIZE=2 => 10 bits
	IBANK=3 => 3 bits	RSIZE=3 => 12 bits	PAGESIZE=3 => 11 bits

Table 7-218. OCP Address to DDR2/3/mDDR Address Mapping for REG_IBANK_POS=3 and REG_EBANK_POS=1 (continued)

Logical Address			
Chip Select	Bank Address	Row Address	Column Address
		RSIZE=4 => 13 bits	
		RSIZE=5 => 14 bits	
		RSIZE=6 => 15 bits	
		RSIZE=7 => 16 bits	

Since the DDR2/3/mDDR memory controller interleaves among less number of banks when IBANK_POS!= 0 or EBANK_POS= 1, these cases are lower in performance than the IBANK_POS= 0 case. Thus these cases are only recommended to be used along with partial array self-refresh where performance can be traded off for power savings.

7.3.3.5 Performance Management

7.3.3.5.1 Command Ordering and Scheduling

The DDR2/3/mDDR memory controller performs command re-ordering and scheduling in an attempt to achieve efficient transfers with maximum throughput. The goal is to maximize the utilization of the data, address, and command buses while hiding the overhead of opening and closing DDR2/3/mDDR SDRAM rows. Command re-ordering takes place within the command FIFO.

The DDR2/3/mDDR memory controller examines all the commands stored in the command FIFO to schedule commands to the external memory. All commands from same master will complete in order, regardless of the master priority. The memory controller does not guarantee ordering between commands from different masters. However, the memory controller will maintain data coherency. Therefore, the memory controller will block a command, regardless of master priority, if that command is to the same block address (2048 bytes) as an older command. Thus, the memory controller might have one or more pending read or write for each master. Among all pending reads, the memory controller selects all reads that have their corresponding SDRAM banks already open. Similarly, among all pending writes, the memory controller selects all writes that have their corresponding SDRAM banks already open.

As a result of the above reordering, at any point of time the memory controller might have several pending reads and writes that have their corresponding banks open. The memory controller then selects the highest priority read from pending reads, and the highest priority write from pending writes. If two or more commands have the highest priority, the memory controller selects the oldest command. As a result, the memory controller might now have a final read and a final write command. The memory controller will pick either the read or the write command depending on the value programmed in the Read Write Execution Threshold register. The memory controller will keep executing reads until the read threshold is met and then switch to executing writes. The memory controller will then keep executing writes until the write threshold is met and then switch back to executing reads. The memory controller will satisfy meeting the threshold values only if that type of command is available for execution, otherwise it will switch to the other type. Similarly, the memory controller will satisfy meeting the threshold value only if the FIFOs for that type have space (Read Data FIFO for reads and Write Status FIFO for writes), otherwise it will switch to the other type.

The memory controller completes executing an OCP command before it switches to another command.

All the accesses to an SDRAM are pipe-lined to maximize the external bus utilization. In other words accesses to an SDRAM are issued back to back such that there are minimum idle cycles between any two accesses. This includes the scheduling listed above to minimize the overhead of opening and closing of SDRAM banks. All of these is done while fulfilling the access timing requirements of an SDRAM.

Besides commands received from on-chip resources, the DDR2/3/mDDR memory controller also issues refresh commands. The DDR2/3/mDDR memory controller attempts to delay refresh commands as long as possible to maximize performance while meeting the SDRAM refresh requirements. As the DDR2/3/mDDR memory controller issues read, write, and refresh commands to DDR2/3/mDDR SDRAM device, it follows the following priority scheme:

1. (Highest priority) SDRAM refresh request due to Refresh Must level of refresh urgency reached (see [Section 7.3.3.5.5](#)).
2. Request for a read or a write.
3. SDRAM Activate commands.
4. SDRAM Deactivate commands.
5. SDRAM Deep Power-Down request.
6. SDRAM clock stop or Power-Down request.
7. SDRAM refresh request due to Refresh May or Release level of refresh urgency reached (Refer Section Refresh Scheduling)
8. (Lowest priority) SDRAM self-refresh request.

7.3.3.5.2 Command Starvation

The reordering and scheduling rules listed above may lead to command starvation, which is the prevention of certain commands from being processed by the DDR2/3/mDDR memory controller. Command starvation results from the following conditions:

- A continuous stream of high-priority read commands can block a low-priority write command
- A continuous stream of DDR2/3/mDDR SDRAM commands to a row in an open bank can block commands to the closed row in the same bank.

To avoid these conditions, the DDR2/3/mDDR memory controller can momentarily raise the priority of the oldest command in the command FIFO after a set number of transfers have been made. The REG_COS_COUNT_1,REG_COS_COUNT_2 field in the Interface Configuration Register (INT_CONFIG) sets the number of the transfers that must be made before the DDR2/3/mDDR memory controller will raise the priority of the oldest command. See Class of Service (COS) section for more details.

NOTE: Leaving the REG_COS bits at their default value (FFh) in the Interface Configuration register (INT_CONFIG) disables this feature of the DDR2/3/mDDR memory controller. This means commands can stay in the command FIFO indefinitely. Therefore, these bits should be set to FEh immediately following reset to enable this feature with the highest level of allowable memory transfers. It is suggested that system-level prioritization be set to avoid placing high-bandwidth masters on the highest priority levels. These bits can be left as FEh unless advanced bandwidth/prioritization control is required.

7.3.3.5.3 Possible Race Condition

A race condition may exist when certain masters write data to the DDR2/3/mDDR memory controller. For example, if master A passes a software message via a buffer in DDR2/3/mDDR memory and does not wait for indication that the write completes, when master B attempts to read the software message it may read stale data and therefore receive an incorrect message. In order to confirm that a write from master A has landed before a read from master B is performed, master A must wait for the write completion status from the DDR2/3/mDDR memory controller before indicating to master B that the data is ready to be read. If master A does not wait for indication that a write is complete, it must perform the following workaround:

1. Perform the required write.
2. Perform a dummy write to the DDR2 memory controller module ID and revision register.
3. Perform a dummy read to the DDR2 memory controller module ID and revision register.
4. Indicate to master B that the data is ready to be read after completion of the read in step 3.

The completion of the read in step 3 ensures that the previous write was done.

For a list of the master peripherals that need this workaround, see the device-specific data sheet.

7.3.3.5.4 Class of Service (COS)

The commands in the Command FIFO can be mapped to 2 classes of service namely 1 and 2. The mapping of commands to a particular class of service can be done based on the priority or the connection ID.

The mapping based on priority can be done by setting the appropriate values in the Priority to Class of Service Mapping register (PRI_COS_MAP).

The mapping based on connection ID can be done by setting the appropriate values of connection ID and the masks in the Connection ID to Class of Service Mapping registers (CONNID_COS_1_MAP and CONNID_COS_2_MAP).

There are 3 connection ID and mask values that can be set for each class of service. In conjunction with the masks, each class of service can have a maximum of 144 connection IDs mapped to it. For example, a connection ID value of 0xFF along with a mask value of 0x3 will map all connection IDs from 0xF8 to 0xFF to that particular class of service.

Each class of service has an associated latency counter (REG_COS_COUNT). The value of this counter can be set in the Interface Configuration Register. When the latency counter for a command expires, i.e., reaches the value programmed for the class of service that the command belongs to, that command will be the one that is executed next. If there are more than one commands that have expired latency counters, the command with the highest priority will be executed first. One exception to this rule is, if the oldest command in the queue has an expired reg_pr_old_count, that command will be executed first irrespective of priority or class of service. This is done to prevent a continuous block effect.

The connection ID mapping allows the same connection ID to be put in both class of service 1 and 2. Also, a transaction might belong to one class of service if viewed by connection ID and might belong to another class of service if viewed by priority. In these cases, the command will belong to both class of service. The DDR2/3/mDDR memory controller will try executing the command as soon as possible, when the smaller of the two counters (REG_COS_COUNT_1 OR REG_COS_COUNT_2) expire.

7.3.3.5.5 Refresh Scheduling

The DDR2/3/mDDR memory controller issues autorefresh (REFR) commands to DDR2/3/mDDR SDRAM devices at a rate defined in the refresh rate (REFRESH_RATE) bit field in the SDRAM refresh control register (SDRFC). A refresh interval counter is loaded with the value of the REFRESH_RATE bit field and decrements by 1 each cycle until it reaches zero. Once the interval counter reaches zero, it reloads with the value of the REFRESH_RATE bit. Each time the interval counter expires, a refresh backlog counter increments by 1. Conversely, each time the DDR2/3/mDDR memory controller performs a REFR command, the backlog counter decrements by 1. This means the refresh backlog counter records the number of REFR commands the DDR2/3/mDDR memory controller currently has outstanding.

The DDR2/3/mDDR memory controller issues REFR commands based on the level of urgency. The level of urgency is defined below. Whenever the refresh level of urgency is reached, the DDR2/3/mDDR memory controller issues a REFR command before servicing any new memory access requests. Following a REFR command, the DDR2/3/mDDR memory controller waits T_RFC cycles, defined in the SDRAM timing 1 register (SDRTIM1), before rechecking the refresh urgency level.

The refresh counters do not operate when the SDRAM memory is in self-refresh mode.

Table 7-219. Refresh Modes

Urgency Level	Description
Refresh May	Backlog count is greater than 0. Indicates there is a backlog of REFR commands, when the DDR2/3/mDDR memory controller is not busy it will issue the REFR command.
Refresh Release	Backlog count is greater than 4. Indicates that the refresh backlog of REFR commands is getting high and when DDR2/3/mDDR memory controller is not busy it should issue the REFR command.
Refresh Must	Backlog count is greater than 7. Indicates that the refresh backlog of REFR commands is getting excessive and DDR2/3/mDDR memory controller should perform an auto refresh cycle before servicing any new memory access requests.

The DDR2/3/mDDR memory controller starts servicing new memory accesses after Refresh Release level is cleared. If any of the commands in the Command FIFO have class of service latency counters that are expired, the DDR2/3/mDDR memory controller will not wait for Refresh Release level to be cleared but will only perform one refresh command and exit the refresh state.

7.3.3.5.6 Performance Counter Configuration

Table 7-220 shows the possible filter configurations for the two performance counters (REG_CNTR1_CFG and REG_CNTR2_CFG). These filter configurations can be used in conjunction with an OCP connection ID and/or an external chip select to obtain performance statistics for a particular OCP master and/or an external chip select.

Table 7-220. Filter Configurations for Performance Counters

cntrN_cfg ⁽¹⁾	cntrN_region_en	cntrN_mconnid_en	Description
0x0	0x0	0x0 or 0x1	Count total SDRAM accesses.
0x1	0x0	0x0 or 0x1	Count total SDRAM activations.
0x2	0x0 or 0x1	0x0 or 0x1	Count total reads.
0x3	0x0 or 0x1	0x0 or 0x1	Count total writes.
0x4	0x0	0x0	Count number of DDR clock cycles OCP Command FIFO is full.
0x5	0x0	0x0	Count number of DDR clock cycles OCP Write Data FIFO is full.
0x6	0x0	0x0	Count number of DDR clock cycles OCP Read Data FIFO is full.
0x7	0x0	0x0	Count number of DDR clock cycles OCP Return Command FIFO is full.
0x8	0x0 or 0x1	0x0 or 0x1	Count number of priority elevations.
0x9	0x0	0x0	Count number of DDR clock cycles that a command was pending.
0xA	0x0	0x0	Count number of DDR clock cycles for which the memory data bus was transferring data.
0xB - 0xF	0x0	0x0	Reserved for future use.

⁽¹⁾ When MReqDebug is set to a 1 for a particular OCP command, the performance counters will not be incremented for that particular command if the cntrN_cfg values are equal to 0x0, 0x1, 0x2, 0x3, or 0xA.

7.3.3.6 DDR3 Read-Write Leveling

The DDR2/3/mDDR memory controller supports read-write leveling in conjunction with the DDR PHY. The DDR2/3/mDDR memory controller supports two types of write/read leveling:

1. Full leveling
2. Incremental leveling

NOTE: Please refer the device specific data sheet to know the type of leveling supported.

Each leveling type has three parts:

1. Write leveling
2. Read DQS gate training
3. Read data eye training

Read and write leveling is only supported to DDR3 memory.

The DDR2/3/mDDR memory controller does not perform full leveling after initialization upon reset deassertion. Full leveling must be triggered by software after the DDR2/3/mDDR memory controller registers are properly configured. The DDR2/3/mDDR memory controller supports triggering of full leveling through software through the use of the REG_RDWRLVLFULL_START field in the Read-Write Leveling Control register (RWLCR). Since full leveling takes considerable amount of time and refreshes cannot be issued to DDR3 when DDR3 is put in leveling mode, refresh interval will be violated and data inside DDR3 can be lost. Although, this is not an issue at power-up, this might be an issue if full leveling is triggered when DDR3 is functional.

The memory controller supports incremental leveling to better track voltage and temperature changes during normal operation. The incremental leveling can be enabled by writing a non-zero value to the REG_WRLVLINC_INT, REG_RDLVLGATEINC_INT, and REG_RDLVLINC_INT fields in the Read-Write Leveling Control register (RWLCR). The memory controller periodically triggers incremental write leveling every time REG_WRLVLINC_INT expires. In other words, the REG_WRLVLINC_INT defines the interval between successive incremental write leveling.

Similarly, the memory controller periodically triggers incremental read DQS gate training every time REG_RDLVLGATEINC_INT expires, and triggers incremental read data eye training every time REG_RDLVLINC_INT expires.

To minimize impact on bandwidth, the software can program these intervals such that these three intervals do not expire at same time. The value of interval programmed is dependent on the slope of voltage and temperature changes.

The memory controller supports increasing the rate of incremental leveling automatically for a defined period of time. This can be achieved by programming the Read-Write Leveling Ramp Window register (RDWR_LVL_RMP_WIN) and the Read-Write Leveling Ramp Control register (RDWR_LVL_RMP_CTRL). Whenever a pulse is received, the memory controller would use the intervals programmed in the Read-Write Leveling Ramp Control register until the REG_RDWRLVLINC_RMP_WIN in the Read-Write Leveling Ramp Window register expires. After the expiration of REG_RDWRLVLINC_RMP_WIN the memory controller switches back to use the intervals programmed in the Read-Write Leveling Control register.

To guarantee none of the incremental leveling events are missed, the REG_RDWRLVLINC_RMP_WIN must be programmed greater than the intervals in the Read-Write Leveling Ramp Control register.

If the memory controller is in Self-Refresh or Power-Down modes when any of the incremental leveling intervals expire, the memory controller will exit Self-Refresh or Power-Down mode, perform the required leveling, and then re-enter the Self-Refresh or Power-Down mode. The memory controller also triggers incremental leveling on Self-Refresh exit.

7.3.3.7 PRCM Sequence for DDR2/3/mDDR Memory controller

The memory controller clock, reset and power are handled by the device PRCM module. Refer to the Power Reset Clock Management (PRCM) chapter for the PRCM register details.

7.3.3.8 Interrupt Support

The DDR2/3/mDDR controller is compliant with Open Core Protocol Specification (OCP-IP 2.2). The controller supports only Idle, Write, Read, and WriteNonPost command types. Also, the controller supports only incrementing, wrapping, and 2-dimensional block addressing modes. The controller supports generation of an error interrupt if an unsupported command or a command with unsupported addressing mode is received.

7.3.3.9 EDMA Event Support

The DDR2/3/mDDR memory controller is a DMA slave peripheral and therefore does not generate EDMA events. Data read and write requests may be made directly by masters including the EDMA controller.

7.3.3.10 Emulation Considerations

The DDR2/3/mDDR memory controller will remain fully functional during emulation halts to allow emulation access to external memory.

7.3.3.11 Power Management

This section defines the power management capabilities and requirements.

7.3.3.11.1 Clock Stop Mode

The memory controller supports Clock Stop mode for LPDDR1/mDDR. The memory controller automatically stops the clocks to the memory, after the memory controller is idle for REG_CS_TIM number of DDR clock cycles and the REG_LP_MODE field is set to 1. The REG_LP_MODE and REG_CS_TIM fields can be programmed in the power management control register (PMCR).

When the clock to the memory is stopped, the memory controller services register accesses as normal. If an SDRAM access is requested, or the Refresh Must level is reached while in the Clock Stop mode, the memory controller will start the clocks. The memory controller now can issue any commands. If the power saving mode is changed by changing REG_LP_MODE from 1 to some other value, the memory controller will exit Clock Stop mode and enter the new power saving mode.

7.3.3.11.2 Self-Refresh Mode

The DDR2/3/mDDR memory controller supports self-refresh mode for low power. The memory controller automatically puts the SDRAM into self-refresh after the memory controller is idle for REG_SR_TIM number of DDR clock cycles and the REG_LP_MODE field is set to 2. The REG_LP_MODE and REG_SR_TIM fields can be programmed in the Power Management Control register (PMCR). The memory controller will complete all pending refreshes before it puts the SDRAM into self-refresh. Therefore, after the expiration of REG_SR_TIM, the memory controller will start issuing refreshes to complete the refresh backlog, and then issue a SELF-REFRESH command to the SDRAM.

In self-refresh mode, the memory controller automatically stops the clocks DDR_CLK to the SDRAM. The memory controller maintains DDR_CKE low to maintain the self-refresh state. When the SDRAM is in self-refresh, the memory controller services register accesses as normal. If the REG_LP_MODE field is set not equal to 2, or an SDRAM access is requested while it is in self-refresh, and T_CKE + 1 cycles have elapsed since the SELF-REFRESH command was issued, the memory controller will bring the SDRAM out of self-refresh. The value of T_CKE is taken from SDRAM Timing 2 register. For DDR3, memory controller will also exit self-refresh to perform incremental leveling.

Exit sequence of self-refresh mode for LPDDR1 device: The memory controller:

- Enables clocks.
- Drives DDR_CKE high.
- Waits for T_XSNR + 1 cycles. The value of T_XSNR is taken from SDRAM Timing 2 register.
- Starts an auto-refresh cycle in the next cycle.
- Enters its idle state and can issue any commands.

Exit sequence of self-refresh mode for DDR2 device: The memory controller:

- Enables clocks.
- Drives DDR_CKE high.
- Waits for T_XSNR + 1 cycles. The value of T_XSNR is taken from SDRAM Timing 2 register.
- If the REG_DDR_DISABLE_DLL bit in the SDRAM Config register is 1, issues a LOAD MODE REGISTER command to the extended mode register 1 with the pad_a_o bits set as follows:

Bits	Value	Description
DDR_A[15:13]	0x0	!reg_dds2_ddqs
DDR_A[12]	0x0	Output buffer enabled
DDR_A[11]	0x0	RDQS disable
DDR_A[10]	!reg_dds2_ddqs	Differential DQS enable value from SDRAM Config register
DDR_A[9:7]	0x0	Exit OCD calibration mode
DDR_A[6]	reg_dds2_term[1]	DDR2 termination resistor value from SDRAM Config register
DDR_A[5:3]	0x0	Additive latency = 0
DDR_A[2]	reg_dds2_term[0]	DDR2 termination resistor value from SDRAM Config register

Bits	Value	Description
DDR_A[1]	reg_sdram_drive	SDRAM drive strength from SDRAM Config register
DDR_A[0]	0x1	Disable DLL

- Starts an auto-refresh cycle in the next cycle.
- Enters its idle state and can issue any other commands except a write or a read. A write or a read will only be issued after T_XSRD + 1 clock cycles have elapsed since DDR_CKE is driven high. The value of T_XSRD is taken from SDRAM Timing 2 register.

Exit sequence of self-refresh mode for DDR3 device: The memory controller:

- Enables clocks.
- Drives DDR_CKE high.
- Waits for T_XSNR + 1 cycles. The value of T_XSNR is taken from SDRAM Timing 2 register.
- If the REG_DDR_DISABLE_DLL bit in the SDRAM Config register is 1, issues a LOAD MODE REGISTER command to the extended mode register 1 with the pad_a_o bits set as follows:

Bits	Value	Description
DDR_A[15:13]	0x0	Reserved
DDR_A[12]	0x0	Output buffer enabled
DDR_A[11]	0x0	TDQS disable
DDR_A[10]	0x0	Reserved
DDR_A[9]	reg_ddr_term[2]	DDR3 termination resistor value from SDRAM Config register
DDR_A[8]	0x0	Reserved
DDR_A[7]	0x0	Write leveling disabled
DDR_A[6]	reg_ddr_term[1]	DDR3 termination resistor value from SDRAM Config register
DDR_A[5]	reg_sdram_drive[1]	SDRAM drive strength from SDRAM Config register
DDR_A[4:3]	0x0	Additive latency = 0
DDR_A[2]	reg_ddr_term[0]	DDR3 termination resistor value from SDRAM Config register
DDR_A[1]	reg_sdram_drive[0]	SDRAM drive strength from SDRAM Config register
DDR_A[0]	0x1	Disable DLL

- Starts an auto-refresh cycle in the next cycle.
- Performs one write incremental leveling.
- Performs read DQS incremental training.
- Performs read data-eye incremental training.
- Enters its idle state and can issue any other commands except a write or a read. A write or a read will only be issued after T_XSRD + 1 clock cycles have elapsed since DDR_CKE is driven high. The value of T_XSRD is taken from SDRAM Timing 2 register.

7.3.3.11.3 Power Down Mode

The memory controller also supports power-down mode for low power. The memory controller automatically puts the SDRAM into power-sDown after the memory controller is idle for REG_PD_TIM number of DDR clock cycles and the REG_LP_MODE field is set to 4. The REG_LP_MODE and REG_PD_TIM fields can be programmed in the Power Management Control register (PMCR). If the Refresh Must level is not reached before the entry into power-down, the memory controller will not precharge all banks before issuing the POWER-DOWN command. This will result in SDRAM entering active power-down mode.

If the Refresh Must level is reached before the entry into power-down, the memory controller will precharge all banks and issue refreshes until the Refresh Release Level is reached before issuing the POWER-DOWN command. This will result in SDRAM entering precharge power-down mode.

In power-down mode, the memory controller does not stop the clocks DDR_CLK to the SDRAM. The memory controller maintains DDR_CKE low to maintain the power-down state.

When the SDRAM is in power-down, the memory controller services register accesses as normal. If the REG_LP_MODE field is set not equal to 4, or an SDRAM access is requested, or the Refresh Must level is reached while the SDRAM is in power-down, the memory controller will bring the SDRAM out of power-down. For DDR3, memory controller will also exit power-down to perform incremental leveling.

Exit sequence of power-down mode for DDR2, DDR3 and LPDDR1: The memory controller

- Drives DDR_CKE high after T_CKE + 1 cycles have elapsed since the POWER-DOWN command was issued. The value of T_CKE is taken from SDRAM Timing 2 register.
- Waits for T_XP + 1 cycles. The value of T_XP is taken from SDRAM Timing 2 register.
- Enters its idle state and can issue any commands.

7.3.3.11.4 Deep Power-Down Mode

For ultimate power savings, the memory controller supports deep power-down mode for LPDDR1.

The SDRAM can be forced into deep power-down through software by setting the reg_dpd_en field in the Power Management Control register to 1. In this case, the memory controller will continue normal operation until all SDRAM memory access requests have been serviced. At this point the memory controller will issue a DEEP POWER-DOWN command. The memory controller then maintains pad_cke_o low to maintain the Deep Power-Down state. In deep power-down mode, the memory controller automatically stops the clocks to the SDRAM.

Setting the REG_DPD_EN field to 1 overrides the setting of REG_LP_MODE field. Therefore, if the SDRAM is in Clock Stop, Self Refresh, or Power-Down mode, and REG_DPD_EN field is set to 1, the memory controller will exit those modes and go into deep power-down mode.

When the SDRAM is in deep power-down, the memory controller services register accesses as normal.

If the REG_DPD_EN field is set to 0, or an SDRAM access is requested, the memory controller will bring the SDRAM out of deep power-down.

Exit sequence for LPDDR1: The memory controller:

- Performs SDRAM initialization as specified in the LPDDR1(mDDR) SDRAM Memory Initialization section.
- Enters its idle state and can issue any commands.

Since the memory controller performs initialization upon deep power-down exit, the REG_REFRESH_RATE field in the SDRAM Refresh Control register must be set appropriately to meet the 200µs wait requirement for LPDDR1.

7.3.3.11.5 Save and Restore Mode

The DDR2/3/mDDR memory controller supports save and restore mechanism to completely switch off power to the DDR2/3/mDDR memory controller. The following sequence of operations is followed to put DDR2/3/mDDR memory controller in off mode:

An external master reads the following memory mapped registers and saves their value external to the DDR2/3/mDDR memory controller.

1. SDRAM Config register (SDRCR)
2. SDRAM Config 2 register
3. SDRAM Refresh Control register (SDRRCR)
4. SDRAM Refresh Control Shadow register (SDRRCSR)
5. SDRAM Timing 1 register (SDRTIM1)
6. SDRAM Timing 1 Shadow register (SDRTIM1SR)
7. SDRAM Timing 2 register (SDRTIM2)
8. SDRAM Timing 2 Shadow register (SDRTIM2SR)
9. SDRAM Timing 3 register (SDRTIM3)
10. SDRAM Timing 3 Shadow register (SDRTIM3SR)
11. Power Management Control register (PMCR)

12. Power Management Control Shadow register (PMCSR)
 13. Interface Configuration register (INT_CONFIG)
 14. System OCP Interrupt Enable Set Register (SOIESR)
 15. DDR PHY Control 1 register (DDRPHYCR)
 16. DDR PHY Control 1 Shadow register (DDRPHYCSR)
- Memory controller completes all pending transactions and drains all its FIFOs.
 - Memory controller puts the SDRAM in Self Refresh.
 - Memory controller copies all shadow memory mapped registers to its main registers. It is assumed that the shadow register always has the same value as its corresponding main register.
 - Memory controller waits for all interrupts to be serviced.
 - Memory controller acknowledges assertion of internal power down request.
 - The internal module reset signal is asserted.
 - The clocks and power to the memory controller can now be switched off.

To restore power to the memory controller, the following sequence of operations is followed:

- The power and clocks to the Memory controller are switched on.
- The internal module reset signal is deasserted, indicating to the Memory controller that it is waking up from off mode.
- The memory controller does not perform SDRAM initialization and forces its state machine to be in self-refresh.
- The external master restores all of the above memory mapped registers.
- The external master restores all of the above memory mapped registers.
- The system can now perform access to the external memory.

7.3.3.11.6 EMIF PHY Clock Gating

The clock to the DDR2/3/mDDR PHY can be gated off to achieve power saving. For more information, see the EMIF0/1 Clock Gate Control register (EMIF_CLK_GATE).

7.3.4 Use Cases

For details on connecting this device to mDDR/DDR2/DDR3 devices, see the device-specific data sheet, which will include specific instructions and routing guidelines for interfacing to mDDR (LPDDR), DDR2, and DDR3 devices.

7.3.5 EMIF4D Registers

[Table 7-221](#) lists the memory-mapped registers for the EMIF4D. All register offset addresses not listed in [Table 7-221](#) should be considered as reserved locations and the register contents should not be modified.

Table 7-221. EMIF4D Registers

Offset	Acronym	Register Name	Section
0h	EMIF_MOD_ID_REV		Section 7.3.5.1
4h	STATUS		Section 7.3.5.2
8h	SDRAM_CONFIG		Section 7.3.5.3
Ch	SDRAM_CONFIG_2		Section 7.3.5.4
10h	SDRAM_REF_CTRL		Section 7.3.5.5
14h	SDRAM_REF_CTRL_SHDW		Section 7.3.5.6
18h	SDRAM_TIM_1		Section 7.3.5.7
1Ch	SDRAM_TIM_1_SHDW		Section 7.3.5.8
20h	SDRAM_TIM_2		Section 7.3.5.9
24h	SDRAM_TIM_2_SHDW		Section 7.3.5.10

Table 7-221. EMIF4D Registers (continued)

Offset	Acronym	Register Name	Section
28h	SDRAM_TIM_3		Section 7.3.5.11
2Ch	SDRAM_TIM_3_SHDW		Section 7.3.5.12
38h	PWR_MGMT_CTRL		Section 7.3.5.13
3Ch	PWR_MGMT_CTRL_SHDW		Section 7.3.5.14
54h	Interface Configuration		Section 7.3.5.15
58h	Interface Configuration Value 1		Section 7.3.5.16
5Ch	Interface Configuration Value 2		Section 7.3.5.17
80h	PERF_CNT_1		Section 7.3.5.18
84h	PERF_CNT_2		Section 7.3.5.19
88h	PERF_CNT_CFG		Section 7.3.5.20
8Ch	PERF_CNT_SEL		Section 7.3.5.21
90h	PERF_CNT_TIM		Section 7.3.5.22
98h	READ_IDLE_CTRL		Section 7.3.5.23
9Ch	READ_IDLE_CTRL_SHDW		Section 7.3.5.24
A4h	IRQSTATUS_RAW_SYS		Section 7.3.5.25
ACh	IRQSTATUS_SYS		Section 7.3.5.26
B4h	IRQENABLE_SET_SYS		Section 7.3.5.27
BCh	IRQENABLE_CLR_SYS		Section 7.3.5.28
C8h	ZQ_CONFIG		Section 7.3.5.29
D4h	Read-Write Leveling Ramp Window		Section 7.3.5.30
D8h	Read-Write Leveling Ramp Control		Section 7.3.5.31
DCh	Read-Write Leveling Control		Section 7.3.5.32
E4h	DDR_PHY_CTRL_1		Section 7.3.5.33
E8h	DDR_PHY_CTRL_1_SHDW		Section 7.3.5.34
100h	Priority to Class of Service Mapping		Section 7.3.5.35
104h	Connection ID to Class of Service 1 Mapping		Section 7.3.5.36
108h	Connection ID to Class of Service 2 Mapping		Section 7.3.5.37
120h	Read Write Execution Threshold		Section 7.3.5.38

7.3.5.1 EMIF_MOD_ID_REV Register (offset = 0h) [reset = 40440C03h]

EMIF_MOD_ID_REV is shown in [Figure 7-205](#) and described in [Table 7-222](#).

Figure 7-205. EMIF_MOD_ID_REV Register

31	30	29	28	27	26	25	24
reg_scheme		RESERVED		reg_module_id			
R-1h		R-0h		R-44h			
23	22	21	20	19	18	17	16
reg_module_id							
R-44h							
15	14	13	12	11	10	9	8
reg_rtl_version				reg_major_revision			
R-1h				R-4h			
7	6	5	4	3	2	1	0
RESERVED		reg_minor_revision					
R-0h		R-3h					

LEGEND: R/W = Read/Write; R = Read only; W1toCl = Write 1 to clear bit; -n = value after reset

Table 7-222. EMIF_MOD_ID_REV Register Field Descriptions

Bit	Field	Type	Reset	Description
31-30	reg_scheme	R	1h	Used to distinguish between old and current schemes.
29-28	RESERVED	R	0h	
27-16	reg_module_id	R	44h	EMIF module ID.
15-11	reg_rtl_version	R	1h	RTL Version.
10-8	reg_major_revision	R	4h	Major Revision.
7-6	RESERVED	R	0h	
5-0	reg_minor_revision	R	3h	Minor Revision.

7.3.5.2 STATUS Register (offset = 4h) [reset = 0h]

STATUS is shown in [Figure 7-206](#) and described in [Table 7-223](#).

Figure 7-206. STATUS Register

31	30	29	28	27	26	25	24
reg_be	reg_dual_clk_mode	reg_fast_init	RESERVED				
R-0h	R-0h	R-0h	R-0h				
23	22	21	20	19	18	17	16
RESERVED							
R-0h							
15	14	13	12	11	10	9	8
RESERVED							
R-0h							
7	6	5	4	3	2	1	0
RESERVED					reg_phy_dll_ready	RESERVED	
R-0h					R-0h	R-0h	

LEGEND: R/W = Read/Write; R = Read only; W1toCl = Write 1 to clear bit; -n = value after reset

Table 7-223. STATUS Register Field Descriptions

Bit	Field	Type	Reset	Description
31	reg_be	R	0h	Big Endian. Reflects the value on the config_big_endian port that defines whether the EMIF is in big or little endian mode. 0 = Little endian. 1 = Big endian.
30	reg_dual_clk_mode	R	0h	Dual Clock mode. Reflects the value on the config_dual_clk_mode port that defines whether the ocp_clk and m_clk are asynchronous. 0 = ocp_clk = m_clk. 1 = Asynchronous ocp_clk and m_clk.
29	reg_fast_init	R	0h	Fast Init. Reflects the value on the config_fast_init port that defines whether the EMIF fast initialization mode has been enabled. 0 = Fast init disabled. 1 = Fast init enabled.
28-3	RESERVED	R	0h	
2	reg_phy_dll_ready	R	0h	DDR PHY Ready. Reflects the value on the phy_ready port (active high) that defines whether the DDR PHY is ready for normal operation.
1-0	RESERVED	R	0h	

7.3.5.3 SDRAM_CONFIG Register (offset = 8h) [reset = 0h]

SDRAM_CONFIG is shown in [Figure 7-207](#) and described in [Table 7-224](#).

Figure 7-207. SDRAM_CONFIG Register

31	30	29	28	27	26	25	24
reg_sdram_type			reg_ibank_pos			reg_ddr_term	
R/W-0h			R/W-0h			R/W-0h	
23	22	21	20	19	18	17	16
reg_ddr2_ddqs	reg_dyn_odt		reg_ddr_disabl e_dll	reg_sdram_drive		reg_cwl	
R/W-0h		R/W-0h		R/W-0h		R/W-0h	
15	14	13	12	11	10	9	8
reg_narrow_mode		reg_cl				reg_rowsize	
R/W-0h		R/W-0h				R/W-0h	
7	6	5	4	3	2	1	0
reg_rowsize	reg_ibank			reg_ebank	reg_pagesize		
R/W-0h		R/W-0h			R/W-0h		R/W-0h

LEGEND: R/W = Read/Write; R = Read only; W1toCl = Write 1 to clear bit; -n = value after reset

Table 7-224. SDRAM_CONFIG Register Field Descriptions

Bit	Field	Type	Reset	Description
31-29	reg_sdram_type	R/W	0h	SDRAM Type selection. Set to 0 for DDR1, set to 1 for LPDDR1, set to 2 for DDR2, set to 3 for DDR3. All other values are reserved.
28-27	reg_ibank_pos	R/W	0h	Internal bank position. Set to 0 to assign internal bank address bits from lower OCP address bits, as shown in the tables for OCP Address to DDR2/3/mDDR Address Mapping. Set to 1, 2, or 3 to assign internal bank address bits from higher OCP address, as shown in the tables for OCP Address to DDR2/3/mDDR Address Mapping.
26-24	reg_ddr_term	R/W	0h	DDR2 and DDR3 termination resistor value. Set to 0 to disable termination. For DDR2, set to 1 for 75 ohm, set to 2 for 150 ohm, and set to 3 for 50 ohm. For DDR3, set to 1 for RZQ/4, set to 2 for RZQ/2, set to 3 for RZQ/6, set to 4 for RZQ/12, and set to 5 for RZQ/8. All other values are reserved.
23	reg_ddr2_ddqs	R/W	0h	DDR2 differential DQS enable. Set to 0 for single ended DQS. Set to 1 for differential DQS.
22-21	reg_dyn_odt	R/W	0h	DDR3 Dynamic ODT. Set to 0 to turn off dynamic ODT. Set to 1 for RZQ/4 and set to 2 for RZQ/2. All other values are reserved.
20	reg_ddr_disable_dll	R/W	0h	Disable DLL select. Set to 1 to disable DLL inside SDRAM.
19-18	reg_sdram_drive	R/W	0h	SDRAM drive strength. For DDR1/DDR2, set to 0 for normal, and set to 1 for weak drive strength. For DDR3, set to 0 for RZQ/6 and set to 1 for RZQ/7. For LPDDR1, set to 0 for full, set to 1 for 1/2, set to 2 for 1/4, and set to 3 for 1/8 drive strength. All other values are reserved.
17-16	reg_cwl	R/W	0h	DDR3 CAS Write latency. Value of 0, 1, 2, and 3 (CAS write latency of 5, 6, 7, and 8) are supported. Use the lowest value supported for best performance. All other values are reserved.

Table 7-224. SDRAM_CONFIG Register Field Descriptions (continued)

Bit	Field	Type	Reset	Description
15-14	reg_narrow_mode	R/W	0h	SDRAM data bus width. Set to 0 for 32-bit and set to 1 for 16-bit. All other values are reserved.
13-10	reg_cl	R/W	0h	CAS Latency. The value of this field defines the CAS latency to be used when accessing connected SDRAM devices. Value of 2, 3, 5, and 6 (CAS latency of 2, 3, 1.5, and 2.5) are supported for DDR1. Value of 2, 3, 4, and 5 (CAS latency of 2, 3, 4, and 5) are supported for DDR2. Value of 2, 4, 6, 8, 10, 12, and 14 (CAS latency of 5, 6, 7, 8, 9, 10, and 11) are supported for DDR3. Value of 2 and 3 (CAS latency of 2 and 3) are supported for LPDDR1. All other values are reserved.
9-7	reg_rowsize	R/W	0h	Row Size. Defines the number of row address bits of connected SDRAM devices. Set to 0 for 9 row bits, set to 1 for 10 row bits, set to 2 for 11 row bits, set to 3 for 12 row bits, set to 4 for 13 row bits, set to 5 for 14 row bits, set to 6 for 15 row bits, and set to 7 for 16 row bits. This field is only used when reg_ibank_pos field in SDRAM Config register is set to 1, 2, or 3, or reg_ebank_pos field in SDRAM Config_2 register is set to 1.
6-4	reg_ibank	R/W	0h	Internal Bank setup. Defines number of banks inside connected SDRAM devices. Set to 0 for 1 bank, set to 1 for 2 banks, set to 2 for 4 banks, and set to 3 for 8 banks. All other values are reserved.
3	reg_ebank	R/W	0h	External chip select setup. Defines whether SDRAM accesses will use 1 or 2 chip select lines. Set to 0 to use pad_cs_o_n[0] only. All other values reserved.
2-0	reg_pagesize	R/W	0h	Page Size. Defines the internal page size of connected SDRAM devices. Set to 0 for 256-word page (8 column bits), set to 1 for 512-word page (9 column bits), set to 2 for 1024-word page (10 column bits), and set to 3 for 2048-word page (11 column bits). All other values are reserved.

7.3.5.4 SDRAM_CONFIG_2 Register (offset = Ch) [reset = 0h]

SDRAM_CONFIG_2 is shown in [Figure 7-208](#) and described in [Table 7-225](#).

Figure 7-208. SDRAM_CONFIG_2 Register

31	30	29	28	27	26	25	24
RESERVED	RESERVED	RESERVED		reg_ebank_pos	RESERVED		
R-0h	R/W-0h	R-0h		R/W-0h	R-0h		
23	22	21	20	19	18	17	16
RESERVED							
R-0h							
15	14	13	12	11	10	9	8
RESERVED							
R-0h							
7	6	5	4	3	2	1	0
RESERVED		RESERVED		RESERVED	RESERVED		
R-0h		R/W-0h		R-0h	R/W-0h		

LEGEND: R/W = Read/Write; R = Read only; W1toCl = Write 1 to clear bit; -n = value after reset

Table 7-225. SDRAM_CONFIG_2 Register Field Descriptions

Bit	Field	Type	Reset	Description
31	RESERVED	R	0h	
30	RESERVED	R/W	0h	Reserved.
29-28	RESERVED	R	0h	
27	reg_ebank_pos	R/W	0h	External bank position. Set to 0 to assign external bank address bits from lower OCP address, as shown in the tables for OCP Address to DDR2/3/mDDR Address Mapping. Set to 1 to assign external bank address bits from higher OCP address bits, as shown in the tables for OCP Address to DDR2/3/mDDR Address Mapping.
26-6	RESERVED	R	0h	
5-4	RESERVED	R/W	0h	Reserved.
3	RESERVED	R	0h	
2-0	RESERVED	R/W	0h	Reserved.

7.3.5.5 SDRAM_REF_CTRL Register (offset = 10h) [reset = 0h]

SDRAM_REF_CTRL is shown in [Figure 7-209](#) and described in [Table 7-226](#).

Figure 7-209. SDRAM_REF_CTRL Register

31	30	29	28	27	26	25	24
reg_initref_dis	RESERVED	reg_srt	reg_asr	RESERVED	reg_pasr		
R/W-0h	R-0h	R/W-0h	R/W-0h	R-0h	R/W-0h		
23	22	21	20	19	18	17	16
RESERVED							
R-0h							
15	14	13	12	11	10	9	8
reg_refresh_rate							
R/W-0h							
7	6	5	4	3	2	1	0
reg_refresh_rate							
R/W-0h							

LEGEND: R/W = Read/Write; R = Read only; W1toCl = Write 1 to clear bit; -n = value after reset

Table 7-226. SDRAM_REF_CTRL Register Field Descriptions

Bit	Field	Type	Reset	Description
31	reg_initref_dis	R/W	0h	Initialization and Refresh disable. When set to 1, EMIF will disable SDRAM initialization and refreshes, but will carry out SDRAM write/read transactions.
30	RESERVED	R	0h	
29	reg_srt	R/W	0h	DDR2 and DDR3 self-refresh temperature range. Set to 0 for normal operating temperature range. Set to 1 for extended operating temperature range. For DDR3, this bit must be set to 0 if the reg_asr field is set to 1. A write to this field will cause the EMIF to start the SDRAM initialization sequence.
28	reg_asr	R/W	0h	DDR3 Auto Self Refresh enable. Set to 1 for auto Self Refresh enable. Set to 0 for manual Self Refresh reference indicated by the reg_srt field. A write to this field will cause the EMIF to start the SDRAM initialization sequence.
27	RESERVED	R	0h	
26-24	reg_pasr	R/W	0h	Partial Array Self Refresh. These bits get loaded into the Extended Mode Register of an LPDDR1 or DDR3 during initialization. For LPDDR1, set to 0 for full array, set to 1 for 1/2 array, set to 2 for 1/4 array, set to 5 for 1/8 array, and set to 6 for 1/16 array to be refreshed. For DDR3, set to 0 for full array, set to 1 or 5 for 1/2 array, set to 2 or 6 for 1/4 array, set to 3 or 7 for 1/8 array, and set to 4 for 3/4 array to be refreshed. All other values are reserved. A write to this field will cause the EMIF to start the SDRAM initialization sequence.
23-16	RESERVED	R	0h	
15-0	reg_refresh_rate	R/W	0h	Refresh Rate. Value in this field is used to define the rate at which connected SDRAM devices will be refreshed. SDRAM refresh rate = EMIF rate / reg_refresh_rate where EMIF rate is equal to DDR clock rate. If $reg_refresh_rate < (8 * reg_t_rfc) + reg_t_rp + reg_t_rcd + 20$ then it will be loaded with $(8 * reg_t_rfc) + reg_t_rp + reg_t_rcd + 20$. This is done to avoid lock-up situations when illegal values are programmed.

7.3.5.6 SDRAM_REF_CTRL_SHDW Register (offset = 14h) [reset = 0h]

SDRAM_REF_CTRL_SHDW is shown in [Figure 7-210](#) and described in [Table 7-227](#).

Figure 7-210. SDRAM_REF_CTRL_SHDW Register

31	30	29	28	27	26	25	24	23	22	21	20	19	18	17	16
RESERVED															
R-0h															
15	14	13	12	11	10	9	8	7	6	5	4	3	2	1	0
reg_refresh_rate_shdw															
R/W-0h															

LEGEND: R/W = Read/Write; R = Read only; W1toCl = Write 1 to clear bit; -n = value after reset

Table 7-227. SDRAM_REF_CTRL_SHDW Register Field Descriptions

Bit	Field	Type	Reset	Description
31-16	RESERVED	R	0h	
15-0	reg_refresh_rate_shdw	R/W	0h	Shadow field for reg_refresh_rate. This field is loaded into reg_refresh_rate field in SDRAM Refresh Control register when SideAck is asserted. This register is not auto corrected when the value is invalid.

7.3.5.7 SDRAM_TIM_1 Register (offset = 18h) [reset = 0h]

SDRAM_TIM_1 is shown in [Figure 7-211](#) and described in [Table 7-228](#).

Figure 7-211. SDRAM_TIM_1 Register

31	30	29	28	27	26	25	24	23	22	21	20	19	18	17	16
RESERVED			reg_t_rp				reg_t_rcd				reg_t_wr			reg_t_ras	
R-0h			R/W-0h				R/W-0h				R/W-0h			R/W-0h	
15	14	13	12	11	10	9	8	7	6	5	4	3	2	1	0
reg_t_ras			reg_t_rc				reg_t_rrd			reg_t_wtr					
R/W-0h			R/W-0h				R/W-0h			R/W-0h					

LEGEND: R/W = Read/Write; R = Read only; W1toCl = Write 1 to clear bit; -n = value after reset

Table 7-228. SDRAM_TIM_1 Register Field Descriptions

Bit	Field	Type	Reset	Description
31-29	RESERVED	R	0h	
28-25	reg_t_rp	R/W	0h	Minimum number of DDR clock cycles from Precharge to Activate or Refresh, minus one.
24-21	reg_t_rcd	R/W	0h	Minimum number of DDR clock cycles from Activate to Read or Write, minus one.
20-17	reg_t_wr	R/W	0h	Minimum number of DDR clock cycles from last Write transfer to Pre-charge, minus one. The SDRAM initialization sequence will be started when the value of this field is changed from the previous value and the EMIF is in DDR2 mode.
16-12	reg_t_ras	R/W	0h	Minimum number of DDR clock cycles from Activate to Pre-charge, minus one. reg_t_ras >= reg_t_rcd.
11-6	reg_t_rc	R/W	0h	Minimum number of DDR clock cycles from Activate to Activate, minus one.
5-3	reg_t_rrd	R/W	0h	Minimum number of DDR clock cycles from Activate to Activate for a different bank, minus one. For an 8 bank DDR2 and DDR3, this field must be equal to ((tFAW/(4*tCK))-1).
2-0	reg_t_wtr	R/W	0h	Minimum number of DDR clock cycles from last Write to Read, minus one.

7.3.5.8 SDRAM_TIM_1_SHDW Register (offset = 1Ch) [reset = 0h]

SDRAM_TIM_1_SHDW is shown in [Figure 7-212](#) and described in [Table 7-229](#).

Figure 7-212. SDRAM_TIM_1_SHDW Register

31	30	29	28	27	26	25	24
RESERVED			reg_t_rp_shdw			reg_t_rcd_shdw	
R-0h			R/W-0h			R/W-0h	
23	22	21	20	19	18	17	16
reg_t_rcd_shdw			reg_t_wr_shdw			reg_t_ras_shdw	
R/W-0h			R/W-0h			R/W-0h	
15	14	13	12	11	10	9	8
reg_t_ras_shdw				reg_t_rc_shdw			
R/W-0h				R/W-0h			
7	6	5	4	3	2	1	0
reg_t_rc_shdw		reg_t_rrd_shdw			reg_t_wtr_shdw		
R/W-0h		R/W-0h			R/W-0h		

LEGEND: R/W = Read/Write; R = Read only; W1toCl = Write 1 to clear bit; -n = value after reset

Table 7-229. SDRAM_TIM_1_SHDW Register Field Descriptions

Bit	Field	Type	Reset	Description
31-29	RESERVED	R	0h	
28-25	reg_t_rp_shdw	R/W	0h	Shadow field for reg_t_rp. This field is loaded into reg_t_rp field in SDRAM Timing 1 register when SldleAck is asserted.
24-21	reg_t_rcd_shdw	R/W	0h	Shadow field for reg_t_rcd. This field is loaded into reg_t_rcd field in SDRAM Timing 1 register when SldleAck is asserted.
20-17	reg_t_wr_shdw	R/W	0h	Shadow field for reg_t_wr. This field is loaded into reg_t_wr field in SDRAM Timing 1 register when SldleAck is asserted. initialization sequence will be started when the value of this field is changed from the previous value and the EMIF is in DDR2 mode.
16-12	reg_t_ras_shdw	R/W	0h	Shadow field for reg_t_ras. This field is loaded into reg_t_ras field in SDRAM Timing 1 register when SldleAck is asserted.
11-6	reg_t_rc_shdw	R/W	0h	Shadow field for reg_t_rc. This field is loaded into reg_t_rc field in SDRAM Timing 1 register when SldleAck is asserted.
5-3	reg_t_rrd_shdw	R/W	0h	Shadow field for reg_t_rrd. This field is loaded into reg_t_rrd field in SDRAM Timing 1 register when SldleAck is asserted.
2-0	reg_t_wtr_shdw	R/W	0h	Shadow field for reg_t_wtr. This field is loaded into reg_t_wtr field in SDRAM Timing 1 register when SldleAck is asserted.

7.3.5.9 SDRAM_TIM_2 Register (offset = 20h) [reset = 0h]

SDRAM_TIM_2 is shown in [Figure 7-213](#) and described in [Table 7-230](#).

Figure 7-213. SDRAM_TIM_2 Register

31	30	29	28	27	26	25	24
RESERVED	reg_t_xp			reg_t_odt		reg_t_xsnr	
R-0h	R/W-0h			R/W-0h		R/W-0h	
23	22	21	20	19	18	17	16
reg_t_xsnr							
R/W-0h							
15	14	13	12	11	10	9	8
reg_t_xsrd							
R/W-0h							
7	6	5	4	3	2	1	0
reg_t_xsrd		reg_t_rtp			reg_t_cke		
R/W-0h		R/W-0h			R/W-0h		

LEGEND: R/W = Read/Write; R = Read only; W1toCl = Write 1 to clear bit; -n = value after reset

Table 7-230. SDRAM_TIM_2 Register Field Descriptions

Bit	Field	Type	Reset	Description
31	RESERVED	R	0h	
30-28	reg_t_xp	R/W	0h	Minimum number of DDR clock cycles from Powerdown exit to any command other than a Read command, minus one. For DDR2 and LPDDR1, this field must satisfy greater of tXP or tCKE.
27-25	reg_t_odt	R/W	0h	Minimum number of DDR clock cycles from ODT enable to write data driven for DDR2 and DDR3. reg_t_odt must be equal to tAOND.
24-16	reg_t_xsnr	R/W	0h	Minimum number of DDR clock cycles from Self-Refresh exit to any command other than a Read command, minus one.
15-6	reg_t_xsrd	R/W	0h	Minimum number of DDR clock cycles from Self-Refresh exit to a Read command, minus one.
5-3	reg_t_rtp	R/W	0h	Minimum number of DDR clock cycles from the last Read command to a Pre-charge command for DDR2 and DDR3, minus one.
2-0	reg_t_cke	R/W	0h	Minimum number of DDR clock cycles between pad_cke_o changes, minus one.

7.3.5.10 SDRAM_TIM_2_SHDW Register (offset = 24h) [reset = 0h]

SDRAM_TIM_2_SHDW is shown in [Figure 7-214](#) and described in [Table 7-231](#).

Figure 7-214. SDRAM_TIM_2_SHDW Register

31	30	29	28	27	26	25	24
RESERVED	reg_t_xp_shdw			reg_t_odt_shdw			reg_t_xsnr_shdw
R-0h	R/W-0h			R/W-0h			R/W-0h
23	22	21	20	19	18	17	16
reg_t_xsnr_shdw							
R/W-0h							
15	14	13	12	11	10	9	8
reg_t_xsrd_shdw							
R/W-0h							
7	6	5	4	3	2	1	0
reg_t_xsrd_shdw		reg_t_rtp_shdw			reg_t_cke_shdw		
R/W-0h		R/W-0h			R/W-0h		

LEGEND: R/W = Read/Write; R = Read only; W1toCl = Write 1 to clear bit; -n = value after reset

Table 7-231. SDRAM_TIM_2_SHDW Register Field Descriptions

Bit	Field	Type	Reset	Description
31	RESERVED	R	0h	
30-28	reg_t_xp_shdw	R/W	0h	Shadow field for reg_t_xp. This field is loaded into reg_t_xp field in SDRAM Timing 2 register when SldleAck is asserted.
27-25	reg_t_odt_shdw	R/W	0h	Shadow field for reg_t_odt. This field is loaded into reg_t_odt field in SDRAM Timing 2 register when SldleAck is asserted.
24-16	reg_t_xsnr_shdw	R/W	0h	Shadow field for reg_t_xsnr. This field is loaded into reg_t_xsnr field in SDRAM Timing 2 register when SldleAck is asserted.
15-6	reg_t_xsrd_shdw	R/W	0h	Shadow field for reg_t_xsrd. This field is loaded into reg_t_xsrd field in SDRAM Timing 2 register when SldleAck is asserted.
5-3	reg_t_rtp_shdw	R/W	0h	Shadow field for reg_t_rtp. This field is loaded into reg_t_rtp field in SDRAM Timing 2 register when SldleAck is asserted.
2-0	reg_t_cke_shdw	R/W	0h	Shadow field for reg_t_cke. This field is loaded into reg_t_cke field in SDRAM Timing 2 register when SldleAck is asserted.

7.3.5.11 SDRAM_TIM_3 Register (offset = 28h) [reset = 0h]

SDRAM_TIM_3 is shown in [Figure 7-215](#) and described in [Table 7-232](#).

Figure 7-215. SDRAM_TIM_3 Register

31	30	29	28	27	26	25	24
reg_t_pdll_ul				RESERVED			
R/W-0h				R-0h			
23	22	21	20	19	18	17	16
RESERVED				reg_zq_zqcs			
R/W-0h				R/W-0h			
15	14	13	12	11	10	9	8
reg_zq_zqcs	RESERVED			reg_t_rfc			
R/W-0h	R/W-0h			R/W-0h			
7	6	5	4	3	2	1	0
reg_t_rfc				reg_t_ras_max			
R/W-0h				R/W-0h			

LEGEND: R/W = Read/Write; R = Read only; W1toCl = Write 1 to clear bit; -n = value after reset

Table 7-232. SDRAM_TIM_3 Register Field Descriptions

Bit	Field	Type	Reset	Description
31-28	reg_t_pdll_ul	R/W	0h	Minimum number of DDR clock cycles for PHY DLL to unlock. A value of N will be equal to N x 128 clocks.
27-24	RESERVED	R	0h	
23-21	RESERVED	R/W	0h	Reserved.
20-15	reg_zq_zqcs	R/W	0h	Number of DDR clock cycles for a ZQCS command, minus one.
14-13	RESERVED	R/W	0h	Reserved.
12-4	reg_t_rfc	R/W	0h	Minimum number of DDR clock cycles from Refresh or Load Mode to Refresh or Activate, minus one.
3-0	reg_t_ras_max	R/W	0h	Maximum number of reg_refresh_rate intervals from Activate to Precharge command. This field must be equal to ((tRASmax / tREFI)-1) rounded down to the next lower integer. This field is only applicable for mDDR. This field must be programmed to 0xF for other SDRAM types.

7.3.5.12 SDRAM_TIM_3_SHDW Register (offset = 2Ch) [reset = 0h]

SDRAM_TIM_3_SHDW is shown in [Figure 7-216](#) and described in [Table 7-233](#).

Figure 7-216. SDRAM_TIM_3_SHDW Register

31	30	29	28	27	26	25	24
reg_t_pdll_ul_shdw				RESERVED			
R/W-0h				R-0h			
23	22	21	20	19	18	17	16
RESERVED				reg_zq_zqcs_shdw			
R/W-0h				R/W-0h			
15	14	13	12	11	10	9	8
reg_zq_zqcs_s hdw	RESERVED			reg_t_rfc_shdw			
R/W-0h	R/W-0h			R/W-0h			
7	6	5	4	3	2	1	0
reg_t_rfc_shdw				reg_t_ras_max_shdw			
R/W-0h				R/W-0h			

LEGEND: R/W = Read/Write; R = Read only; W1toCl = Write 1 to clear bit; -n = value after reset

Table 7-233. SDRAM_TIM_3_SHDW Register Field Descriptions

Bit	Field	Type	Reset	Description
31-28	reg_t_pdll_ul_shdw	R/W	0h	Shadow field for reg_t_pdll_ul. This field is loaded into reg_t_pdll_ul field in SDRAM Timing 3 register when SldleAck is asserted.
27-24	RESERVED	R	0h	
23-21	RESERVED	R/W	0h	Reserved.
20-15	reg_zq_zqcs_shdw	R/W	0h	Shadow field for reg_zq_zqcs. This field is loaded into reg_zq_zqcs field in SDRAM Timing 3 register when SldleAck is asserted.
14-13	RESERVED	R/W	0h	Reserved.
12-4	reg_t_rfc_shdw	R/W	0h	Shadow field for reg_t_rfc. This field is loaded into reg_t_rfc field in SDRAM Timing 3 register when SldleAck is asserted.
3-0	reg_t_ras_max_shdw	R/W	0h	Shadow field for reg_t_ras_max. This field is loaded into reg_t_ras_max field in SDRAM Timing 3 register when SldleAck is asserted.

7.3.5.13 PWR_MGMT_CTRL Register (offset = 38h) [reset = 0h]

PWR_MGMT_CTRL is shown in [Figure 7-217](#) and described in [Table 7-234](#).

Figure 7-217. PWR_MGMT_CTRL Register

31	30	29	28	27	26	25	24
RESERVED							
R-0h							
23	22	21	20	19	18	17	16
RESERVED							
R-0h							
15	14	13	12	11	10	9	8
reg_pd_tim				reg_dpd_en		reg_lp_mode	
R/W-0h				R/W-0h		R/W-0h	
7	6	5	4	3	2	1	0
reg_sr_tim				reg_cs_tim			
R/W-0h				R/W-0h			

LEGEND: R/W = Read/Write; R = Read only; W1toCl = Write 1 to clear bit; -n = value after reset

Table 7-234. PWR_MGMT_CTRL Register Field Descriptions

Bit	Field	Type	Reset	Description
31-16	RESERVED	R	0h	
15-12	reg_pd_tim	R/W	0h	Power Mangement timer for Power-Down. The EMIF will put the external SDRAM in Power-Down mode after the EMIF is idle for these number of DDR clock cycles and if reg_lp_mode field is set to 4. Set to 0 to immediately enter Power-Down mode. Set to 1 for 16 clocks. Set to 2 for 32 clocks. Set to 3 for 64 clocks. Set to 4 for 128 clocks. Set to 5 for 256 clocks. Set to 6 for 512 clocks. Set to 7 for 1024 clocks. Set to 8 for 2048 clocks. Set to 9 for 4096 clocks. Set to 10 for 8192 clocks. Set to 11 for 16384 clocks. Set to 12 for 32768 clocks. Set to 13 for 65536 clocks. Set to 14 for 131072 clocks. Set to 15 for 262144 clocks. Note: After updating this field, at least one dummy read access to SDRAM is required for the new value to take affect.
11	reg_dpd_en	R/W	0h	Deep Power Down enable. Set to 0 for normal operation. Set to 1 to enter deep power down mode. This mode will override the reg_lp_mode field setting.
10-8	reg_lp_mode	R/W	0h	Automatic Power Management enable. Set to 1 for Clock Stop, set to 2 for Self Refresh, and set to 4 for Power-Down. All other values will disable automatic power management.

Table 7-234. PWR_MGMT_CTRL Register Field Descriptions (continued)

Bit	Field	Type	Reset	Description
7-4	reg_sr_tim	R/W	0h	<p>Power Mangement timer for Self Refresh. The EMIF will put the external SDRAM in Self Refresh mode after the EMIF is idle for these number of DDR clock cycles and if reg_lp_mode field is set to 2. Set to 0 to immediately enter Self Refresh mode. Set to 1 for 16 clocks. Set to 2 for 32 clocks. Set to 3 for 64 clocks. Set to 4 for 128 clocks. Set to 5 for 256 clocks. Set to 6 for 512 clocks. Set to 7 for 1024 clocks. Set to 8 for 2048 clocks. Set to 9 for 4096 clocks. Set to 10 for 8192 clocks. Set to 11 for 16384 clocks. Set to 12 for 32768 clocks. Set to 13 for 65536 clocks. Set to 14 for 131072 clocks. Set to 15 for 262144 clocks. Note: After updating this field, at least one dummy read access to SDRAM is required for the new value to take affect.</p>
3-0	reg_cs_tim	R/W	0h	<p>Power Mangement timer for Clock Stop. The EMIF will put the external SDRAM in Clock Stop mode after the EMIF is idle for these number of DDR clock cycles and if reg_lp_mode field is set to 1. Set to 0 to immediately enter Clock Stop mode. Set to 1 for 16 clocks. Set to 2 for 32 clocks. Set to 3 for 64 clocks. Set to 4 for 128 clocks. Set to 5 for 256 clocks. Set to 6 for 512 clocks. Set to 7 for 1024 clocks. Set to 8 for 2048 clocks. Set to 9 for 4096 clocks. Set to 10 for 8192 clocks. Set to 11 for 16384 clocks. Set to 12 for 32768 clocks. Set to 13 for 65536 clocks. Set to 14 for 131072 clocks. Set to 15 for 262144 clocks. Note: After updating this field, at least one dummy read access to SDRAM is required for the new value to take affect.</p>

7.3.5.14 PWR_MGMT_CTRL_SHDW Register (offset = 3Ch) [reset = 0h]

PWR_MGMT_CTRL_SHDW is shown in [Figure 7-218](#) and described in [Table 7-235](#).

Figure 7-218. PWR_MGMT_CTRL_SHDW Register

31	30	29	28	27	26	25	24
RESERVED							
R-0h							
23	22	21	20	19	18	17	16
RESERVED							
R-0h							
15	14	13	12	11	10	9	8
RESERVED				reg_pd_tim_shdw			
R-0h				R/W-0h			
7	6	5	4	3	2	1	0
reg_sr_tim_shdw				reg_cs_tim_shdw			
R/W-0h				R/W-0h			

LEGEND: R/W = Read/Write; R = Read only; W1toCl = Write 1 to clear bit; -n = value after reset

Table 7-235. PWR_MGMT_CTRL_SHDW Register Field Descriptions

Bit	Field	Type	Reset	Description
31-12	RESERVED	R	0h	
11-8	reg_pd_tim_shdw	R/W	0h	Shadow field for reg_pd_tim. This field is loaded into reg_pd_tim field in Power Management Control register when SideAck is asserted.
7-4	reg_sr_tim_shdw	R/W	0h	Shadow field for reg_sr_tim. This field is loaded into reg_sr_tim field in Power Management Control register when SideAck is asserted.
3-0	reg_cs_tim_shdw	R/W	0h	Shadow field for reg_cs_tim. This field is loaded into reg_cs_tim field in Power Management Control register when SideAck is asserted.

7.3.5.15 Interface Configuration Register (offset = 54h) [reset = FFh]

Interface Configuration is shown in [Figure 7-219](#) and described in [Table 7-236](#).

Figure 7-219. Interface Configuration Register

31	30	29	28	27	26	25	24	23	22	21	20	19	18	17	16
Reserved								REG_COS_COUNT_1							
R-0h								R/W-0h							
15	14	13	12	11	10	9	8	7	6	5	4	3	2	1	0
REG_COS_COUNT_2								REG_PR_OLD_COUNT							
R/W-0h								R/W-FFh							

LEGEND: R/W = Read/Write; R = Read only; W1toCl = Write 1 to clear bit; -n = value after reset

Table 7-236. Interface Configuration Register Field Descriptions

Bit	Field	Type	Reset	Description
31-24	Reserved	R	0h	Reserved for future use.
23-16	REG_COS_COUNT_1	R/W	0h	Priority Raise Counter for class of service 1. Number of m_clk cycles after which the EMIF momentarily raises the priority of the class of service 1 commands in the Command FIFO. A value of N will be equal to N x 16 clocks.
15-8	REG_COS_COUNT_2	R/W	0h	Priority Raise Counter for class of service 2. Number of m_clk cycles after which the EMIF momentarily raises the priority of the class of service 2 commands in the Command FIFO. A value of N will be equal to N x 16 clocks.
7-0	REG_PR_OLD_COUNT	R/W	FFh	Priority Raise Old Counter. Number of m_clk cycles after which the EMIF momentarily raises the priority of the oldest command in the OCP Command FIFO. A value of N will be equal to N x 16 clocks.

7.3.5.16 Interface Configuration Value 1 Register (offset = 58h) [reset = 0h]

Interface Configuration Value 1 is shown in [Figure 7-220](#) and described in [Table 7-237](#).

Figure 7-220. Interface Configuration Value 1 Register

31	30	29	28	27	26	25	24
REG_SYS_BUS_WIDTH		RESERVED					
R-		R-					
23	22	21	20	19	18	17	16
RESERVED							
R-							
15	14	13	12	11	10	9	8
REG_WR_FIFO_DEPTH							
R-							
7	6	5	4	3	2	1	0
REG_CMD_FIFO_DEPTH							
R-							

LEGEND: R/W = Read/Write; R = Read only; W1toCl = Write 1 to clear bit; -n = value after reset

Table 7-237. Interface Configuration Value 1 Register Field Descriptions

Bit	Field	Type	Reset	Description
31-30	REG_SYS_BUS_WIDTH	R		L3 OCP data bus width for a particular configuration. 0 = 32 bit wide. 1 = 64 bit wide. 2 = 128 bit wide. 3 = 256 bit wide.
29-16	RESERVED	R		Reserved for future use.
15-8	REG_WR_FIFO_DEPTH	R		Write Data FIFO depth for a particular configuration.
7-0	REG_CMD_FIFO_DEPTH	R		Command FIFO depth for a particular configuration.

7.3.5.17 Interface Configuration Value 2 Register (offset = 5Ch) [reset = 0h]

Interface Configuration Value 2 is shown in [Figure 7-221](#) and described in [Table 7-238](#).

Figure 7-221. Interface Configuration Value 2 Register

31	30	29	28	27	26	25	24	23	22	21	20	19	18	17	16
RESERVED								REG_RREG_FIFO_DEPTH							
R-								R-							
15	14	13	12	11	10	9	8	7	6	5	4	3	2	1	0
REG_RSD_FIFO_DEPTH								REG_RCMD_FIFO_DEPTH							
R-								R-							

LEGEND: R/W = Read/Write; R = Read only; W1toCl = Write 1 to clear bit; -n = value after reset

Table 7-238. Interface Configuration Value 2 Register Field Descriptions

Bit	Field	Type	Reset	Description
31-24	RESERVED	R		Reserved for future use.
23-16	REG_RREG_FIFO_DEPTH	R		Register Read Data FIFO depth for a particular configuration.
15-8	REG_RSD_FIFO_DEPTH	R		SDRAM Read Data FIFO depth for a particular configuration.
7-0	REG_RCMD_FIFO_DEPTH	R		Read Command FIFO depth for a particular configuration.

7.3.5.18 PERF_CNT_1 Register (offset = 80h) [reset = 0h]

PERF_CNT_1 is shown in [Figure 7-222](#) and described in [Table 7-239](#).

Figure 7-222. PERF_CNT_1 Register

31	30	29	28	27	26	25	24	23	22	21	20	19	18	17	16	15	14	13	12	11	10	9	8	7	6	5	4	3	2	1	0
reg_counter1																															
R-0h																															

LEGEND: R/W = Read/Write; R = Read only; W1toCl = Write 1 to clear bit; -n = value after reset

Table 7-239. PERF_CNT_1 Register Field Descriptions

Bit	Field	Type	Reset	Description
31-0	reg_counter1	R	0h	32-bit counter that can be configured as specified in the Performance Counter Config Register and Performance Counter Master Region Select Register.

7.3.5.19 PERF_CNT_2 Register (offset = 84h) [reset = 0h]

PERF_CNT_2 is shown in [Figure 7-223](#) and described in [Table 7-240](#).

Figure 7-223. PERF_CNT_2 Register

31	30	29	28	27	26	25	24	23	22	21	20	19	18	17	16	15	14	13	12	11	10	9	8	7	6	5	4	3	2	1	0
reg_counter2																															
R-0h																															

LEGEND: R/W = Read/Write; R = Read only; W1toCl = Write 1 to clear bit; -n = value after reset

Table 7-240. PERF_CNT_2 Register Field Descriptions

Bit	Field	Type	Reset	Description
31-0	reg_counter2	R	0h	32-bit counter that can be configured as specified in the Performance Counter Config Register and Performance Counter Master Region Select Register.

7.3.5.20 PERF_CNT_CFG Register (offset = 88h) [reset = 10000h]

PERF_CNT_CFG is shown in [Figure 7-224](#) and described in [Table 7-241](#).

Figure 7-224. PERF_CNT_CFG Register

31		30		29		28		27		26		25		24	
reg_cntr2_mconnid_en		reg_cntr2_region_en		RESERVED											
R/W-0h		R/W-0h		R-0h											
23		22		21		20		19		18		17		16	
RESERVED								reg_cntr2_cfg							
R-0h								R/W-1h							
15		14		13		12		11		10		9		8	
reg_cntr1_mconnid_en		reg_cntr1_region_en		RESERVED											
R/W-0h		R/W-0h		R-0h											
7		6		5		4		3		2		1		0	
RESERVED								reg_cntr1_cfg							
R-0h								R/W-0h							

LEGEND: R/W = Read/Write; R = Read only; W1toCl = Write 1 to clear bit; -n = value after reset

Table 7-241. PERF_CNT_CFG Register Field Descriptions

Bit	Field	Type	Reset	Description
31	reg_cntr2_mconnid_en	R/W	0h	MConnID filter enable for Performance Counter 2 register.
30	reg_cntr2_region_en	R/W	0h	Chip Select filter enable for Performance Counter 2 register.
29-20	RESERVED	R	0h	
19-16	reg_cntr2_cfg	R/W	1h	Filter configuration for Performance Counter 2. Refer to table for details.
15	reg_cntr1_mconnid_en	R/W	0h	MConnID filter enable for Performance Counter 1 register.
14	reg_cntr1_region_en	R/W	0h	Chip Select filter enable for Performance Counter 1 register.
13-4	RESERVED	R	0h	
3-0	reg_cntr1_cfg	R/W	0h	Filter configuration for Performance Counter 1. For details, see the table titled "Filter Configurations for Performance Counters".

7.3.5.21 PERF_CNT_SEL Register (offset = 8Ch) [reset = 0h]

PERF_CNT_SEL is shown in [Figure 7-225](#) and described in [Table 7-242](#).

Figure 7-225. PERF_CNT_SEL Register

31	30	29	28	27	26	25	24
reg_mconnid2							
R/W-0h							
23	22	21	20	19	18	17	16
RESERVED						reg_region_sel2	
R-0h						R/W-0h	
15	14	13	12	11	10	9	8
reg_mconnid1							
R/W-0h							
7	6	5	4	3	2	1	0
RESERVED						reg_region_sel1	
R-0h						R/W-0h	

LEGEND: R/W = Read/Write; R = Read only; W1toCl = Write 1 to clear bit; -n = value after reset

Table 7-242. PERF_CNT_SEL Register Field Descriptions

Bit	Field	Type	Reset	Description
31-24	reg_mconnid2	R/W	0h	MConnID for Performance Counter 2 register.
23-18	RESERVED	R	0h	
17-16	reg_region_sel2	R/W	0h	MAddrSpace for Performance Counter 2 register.
15-8	reg_mconnid1	R/W	0h	MConnID for Performance Counter 1 register.
7-2	RESERVED	R	0h	
1-0	reg_region_sel1	R/W	0h	MAddrSpace for Performance Counter 1 register.

7.3.5.22 PERF_CNT_TIM Register (offset = 90h) [reset = 0h]

PERF_CNT_TIM is shown in [Figure 7-226](#) and described in [Table 7-243](#).

Figure 7-226. PERF_CNT_TIM Register

31	30	29	28	27	26	25	24	23	22	21	20	19	18	17	16	15	14	13	12	11	10	9	8	7	6	5	4	3	2	1	0
reg_total_time																															
R-0h																															

LEGEND: R/W = Read/Write; R = Read only; W1toCl = Write 1 to clear bit; -n = value after reset

Table 7-243. PERF_CNT_TIM Register Field Descriptions

Bit	Field	Type	Reset	Description
31-0	reg_total_time	R	0h	32-bit counter that continuously counts number for m_clk cycles elapsed after EMIF is brought out of reset.

7.3.5.23 READ_IDLE_CTRL Register (offset = 98h) [reset = 50000h]

READ_IDLE_CTRL is shown in [Figure 7-227](#) and described in [Table 7-244](#).

Figure 7-227. READ_IDLE_CTRL Register

31	30	29	28	27	26	25	24
RESERVED							
R-0h							
23	22	21	20	19	18	17	16
RESERVED				reg_read_idle_len			
R-0h				R/W-5h			
15	14	13	12	11	10	9	8
RESERVED							reg_read_idle_i nterval
R-0h							R/W-0h
7	6	5	4	3	2	1	0
reg_read_idle_interval							
R/W-0h							

LEGEND: R/W = Read/Write; R = Read only; W1toCl = Write 1 to clear bit; -n = value after reset

Table 7-244. READ_IDLE_CTRL Register Field Descriptions

Bit	Field	Type	Reset	Description
31-20	RESERVED	R	0h	
19-16	reg_read_idle_len	R/W	5h	The Read Idle Length field determines the minimum size (reg_read_idle_len-1 clock cycles) of Read Idle window for the read idle detection as well as the force read idle time.
15-9	RESERVED	R	0h	
8-0	reg_read_idle_interval	R/W	0h	The Read Idle Interval field determines the maximum interval ((reg_read_idle_interval-1)*64 clock cycles) between read idle detections or force. A value of zero disables the read idle function.

7.3.5.24 READ_IDLE_CTRL_SHDW Register (offset = 9Ch) [reset = 5000h]

READ_IDLE_CTRL_SHDW is shown in [Figure 7-228](#) and described in [Table 7-245](#).

Figure 7-228. READ_IDLE_CTRL_SHDW Register

31	30	29	28	27	26	25	24
RESERVED							
R-0h							
23	22	21	20	19	18	17	16
RESERVED				reg_read_idle_len_shdw			
R-0h				R/W-5h			
15	14	13	12	11	10	9	8
RESERVED							reg_read_idle_i nterval_shdw
R-0h							R/W-0h
7	6	5	4	3	2	1	0
reg_read_idle_interval_shdw							
R/W-0h							

LEGEND: R/W = Read/Write; R = Read only; W1toCl = Write 1 to clear bit; -n = value after reset

Table 7-245. READ_IDLE_CTRL_SHDW Register Field Descriptions

Bit	Field	Type	Reset	Description
31-20	RESERVED	R	0h	
19-16	reg_read_idle_len_shdw	R/W	5h	Shadow field for reg_read_idle_len. This field is loaded into reg_read_idle_len field in Read Idle Control register when SldleAck is asserted
15-9	RESERVED	R	0h	
8-0	reg_read_idle_interval_shdw	R/W	0h	Shadow field for reg_read_idle_interval. This field is loaded into reg_read_idle_interval field in Read Idle Control register when SldleAck is asserted.

7.3.5.25 IRQSTATUS_RAW_SYS Register (offset = A4h) [reset = 0h]

IRQSTATUS_RAW_SYS is shown in [Figure 7-229](#) and described in [Table 7-246](#).

Figure 7-229. IRQSTATUS_RAW_SYS Register

31	30	29	28	27	26	25	24
RESERVED							
R-0h							
23	22	21	20	19	18	17	16
RESERVED							
R-0h							
15	14	13	12	11	10	9	8
RESERVED							
R-0h							
7	6	5	4	3	2	1	0
RESERVED				RESERVED		reg_ta_sys	reg_err_sys
R-0h				R/W-0h		R/W-0h	R/W-0h

LEGEND: R/W = Read/Write; R = Read only; W1toCl = Write 1 to clear bit; -n = value after reset

Table 7-246. IRQSTATUS_RAW_SYS Register Field Descriptions

Bit	Field	Type	Reset	Description
31-3	RESERVED	R	0h	
2	RESERVED	R/W	0h	Reserved.
1	reg_ta_sys	R/W	0h	Raw status of system OCP interrupt. Write 1 to set the (raw) status, mostly for debug. Writing a 0 has no effect.
0	reg_err_sys	R/W	0h	Raw status of system OCP interrupt. Write 1 to set the (raw) status, mostly for debug. Writing a 0 has no effect.

7.3.5.26 IRQSTATUS_SYS Register (offset = ACh) [reset = 0h]

 IRQSTATUS_SYS is shown in [Figure 7-230](#) and described in [Table 7-247](#).

Figure 7-230. IRQSTATUS_SYS Register

31	30	29	28	27	26	25	24
RESERVED							
R-0h							
23	22	21	20	19	18	17	16
RESERVED							
R-0h							
15	14	13	12	11	10	9	8
RESERVED							
R-0h							
7	6	5	4	3	2	1	0
RESERVED				RESERVED		reg_ta_sys	reg_err_sys
R-0h				R/W-0h		R/W-0h	R/W-0h

LEGEND: R/W = Read/Write; R = Read only; W1toCl = Write 1 to clear bit; -n = value after reset

Table 7-247. IRQSTATUS_SYS Register Field Descriptions

Bit	Field	Type	Reset	Description
31-3	RESERVED	R	0h	
2	RESERVED	R/W	0h	Reserved.
1	reg_ta_sys	R/W	0h	Enabled status of system OCP interrupt. Write 1 to clear the status after interrupt has been serviced (raw status gets cleared, i.e. even if not enabled). Writing a 0 has no effect.
0	reg_err_sys	R/W	0h	Enabled status of system OCP interrupt. Write 1 to clear the status after interrupt has been serviced (raw status gets cleared, i.e. even if not enabled). Writing a 0 has no effect.

7.3.5.27 IRQENABLE_SET_SYS Register (offset = B4h) [reset = 0h]

IRQENABLE_SET_SYS is shown in [Figure 7-231](#) and described in [Table 7-248](#).

Figure 7-231. IRQENABLE_SET_SYS Register

31	30	29	28	27	26	25	24
RESERVED							
R-0h							
23	22	21	20	19	18	17	16
RESERVED							
R-0h							
15	14	13	12	11	10	9	8
RESERVED							
R-0h							
7	6	5	4	3	2	1	0
RESERVED				RESERVED		reg_en_ta_sys	reg_en_err_sys
R-0h				R/W-0h		R/W-0h	R/W-0h

LEGEND: R/W = Read/Write; R = Read only; W1toCl = Write 1 to clear bit; -n = value after reset

Table 7-248. IRQENABLE_SET_SYS Register Field Descriptions

Bit	Field	Type	Reset	Description
31-3	RESERVED	R	0h	
2	RESERVED	R/W	0h	Reserved.
1	reg_en_ta_sys	R/W	0h	Enable set for system OCP interrupt. Writing a 1 will enable the interrupt, and set this bit as well as the corresponding Interrupt Enable Clear Register. Writing a 0 has no effect.
0	reg_en_err_sys	R/W	0h	Enable set for system OCP interrupt. Writing a 1 will enable the interrupt, and set this bit as well as the corresponding Interrupt Enable Clear Register. Writing a 0 has no effect.

7.3.5.28 IRQENABLE_CLR_SYS Register (offset = BCh) [reset = 0h]

IRQENABLE_CLR_SYS is shown in [Figure 7-232](#) and described in [Table 7-249](#).

Figure 7-232. IRQENABLE_CLR_SYS Register

31	30	29	28	27	26	25	24
RESERVED							
R-0h							
23	22	21	20	19	18	17	16
RESERVED							
R-0h							
15	14	13	12	11	10	9	8
RESERVED							
R-0h							
7	6	5	4	3	2	1	0
RESERVED				RESERVED		reg_en_ta_sys	reg_en_err_sys
R-0h				R/W-0h		R/W-0h	R/W-0h

LEGEND: R/W = Read/Write; R = Read only; W1toCl = Write 1 to clear bit; -n = value after reset

Table 7-249. IRQENABLE_CLR_SYS Register Field Descriptions

Bit	Field	Type	Reset	Description
31-3	RESERVED	R	0h	
2	RESERVED	R/W	0h	Reserved.
1	reg_en_ta_sys	R/W	0h	Enable clear for system OCP interrupt. Writing a 1 will disable the interrupt, and clear this bit as well as the corresponding Interrupt Enable Set Register. Writing a 0 has no effect.
0	reg_en_err_sys	R/W	0h	Enable clear for system OCP interrupt. Writing a 1 will disable the interrupt, and clear this bit as well as the corresponding Interrupt Enable Set Register. Writing a 0 has no effect.

7.3.5.29 ZQ_CONFIG Register (offset = C8h) [reset = 0h]

ZQ_CONFIG is shown in [Figure 7-233](#) and described in [Table 7-250](#).

Figure 7-233. ZQ_CONFIG Register

31	30	29	28	27	26	25	24
reg_zq_cs1en	reg_zq_cs0en	reg_zq_dualcalen	reg_zq_sfexiten	RESERVED			
R/W-0h	R/W-0h	R/W-0h	R/W-0h	R-0h			
23	22	21	20	19	18	17	16
RESERVED				reg_zq_zqinit_mult		reg_zq_zqcl_mult	
R-0h				R/W-0h		R/W-0h	
15	14	13	12	11	10	9	8
reg_zq_refinterval							
R/W-0h							
7	6	5	4	3	2	1	0
reg_zq_refinterval							
R/W-0h							

LEGEND: R/W = Read/Write; R = Read only; W1toCl = Write 1 to clear bit; -n = value after reset

Table 7-250. ZQ_CONFIG Register Field Descriptions

Bit	Field	Type	Reset	Description
31	reg_zq_cs1en	R/W	0h	Writing a 1 enables ZQ calibration for CS1.
30	reg_zq_cs0en	R/W	0h	Writing a 1 enables ZQ calibration for CS0.
29	reg_zq_dualcalen	R/W	0h	ZQ Dual Calibration enable. Allows both ranks to be ZQ calibrated simultaneously. Setting this bit requires both chip selects to have a seerate calibration resistor per device.
28	reg_zq_sfexiten	R/W	0h	ZQCL on Self Refresh, Active Power-Down, and Precharge Power-Down exit enable. Writing a 1 enables the issuing of ZQCL on Self-Refresh, Active Power-Down, and Precharge Power-Down exit.
27-20	RESERVED	R	0h	
19-18	reg_zq_zqinit_mult	R/W	0h	Indicates the number of ZQCL intervals that make up a ZQINIT interval, minus one.
17-16	reg_zq_zqcl_mult	R/W	0h	Indicates the number of ZQCS intervals that make up a ZQCL interval, minus one. ZQCS interval is defined by reg_zq_zqcs in SDRAM Timing 3 Register.
15-0	reg_zq_refinterval	R/W	0h	Number of refresh periods between ZQCS commans. This field supports between one refresh period to 256 ms between ZQCS calibration commands. Refresh period is defined by reg_refresh_rate in SDRAM Refresh Control register.

7.3.5.30 Read-Write Leveling Ramp Window Register (offset = D4h) [reset = 0h]

Read-Write Leveling Ramp Window is shown in [Figure 7-234](#) and described in [Table 7-251](#).

Figure 7-234. Read-Write Leveling Ramp Window Register

31	30	29	28	27	26	25	24	23	22	21	20	19	18	17	16
RESERVED															
R-															
15	14	13	12	11	10	9	8	7	6	5	4	3	2	1	0
RESERVED				REG_RDWRLVLINC_RMP_WIN											
R-				R-											

LEGEND: R/W = Read/Write; R = Read only; W1toCl = Write 1 to clear bit; -n = value after reset

Table 7-251. Read-Write Leveling Ramp Window Register Field Descriptions

Bit	Field	Type	Reset	Description
31-13	RESERVED	R		Reserved.
12-0	REG_RDWRLVLINC_RMP_WIN	R		Incremental leveling ramp window in number of refresh periods. The value programmed is minus one the required value. Refresh period is defined by reg_refresh_rate in SDRAM Refresh Control register.

7.3.5.31 Read-Write Leveling Ramp Control Register (offset = D8h) [reset = 0h]

Read-Write Leveling Ramp Control is shown in [Figure 7-235](#) and described in [Table 7-252](#).

Figure 7-235. Read-Write Leveling Ramp Control Register

31	30	29	28	27	26	25	24
REG_RDWRLV L_EN		REG_RDWRLVLINC_RMP_PRE					
R/W-							
23	22	21	20	19	18	17	16
REG_RDLVLINC_RMP_INT							
R/W-							
15	14	13	12	11	10	9	8
REG_RDLVLGATEINC_RMP_INT							
R/W-							
7	6	5	4	3	2	1	0
REG_WRLVLINC_RMP_INT							

LEGEND: R/W = Read/Write; R = Read only; W1toCl = Write 1 to clear bit; -n = value after reset

Table 7-252. Read-Write Leveling Ramp Control Register Field Descriptions

Bit	Field	Type	Reset	Description
31	REG_RDWRLVL_EN	R/W		Read-Write Leveling enable. Set 1 to enable leveling. Set 0 to disable leveling.
30-24	REG_RDWRLVLINC_RMP_PRE			Incremental leveling pre-scalar in number of refresh periods during ramp window. The value programmed is minus one the required value. Refresh period is defined by reg_refresh_rate in SDRAM Refresh Control register.
23-16	REG_RDLVLINC_RMP_INT	R/W		Incremental read data eye training interval during ramp window. Number of reg_rdwrvlinc_rmp_pre intervals between incremental read data eye training. A value of 0 will disable incremental read data eye training during ramp window.
15-8	REG_RDLVLGATEINC_RMP_INT	R/W		Incremental read DQS gate training interval during ramp window. Number of reg_rdwrvlinc_rmp_pre intervals between incremental read DQS gate training. A value of 0 will disable incremental read DQS gate training during ramp window.
7-0	REG_WRLVLINC_RMP_INT			Incremental write leveling interval during ramp window. Number of reg_rdwrvlinc_rmp_pre intervals between incremental write leveling. A value of 0 will disable incremental write leveling during ramp window.

7.3.5.32 Read-Write Leveling Control Register (offset = DCh) [reset = 0h]

Read-Write Leveling Control is shown in [Figure 7-236](#) and described in [Table 7-253](#).

Read-Write Leveling Control Register

Figure 7-236. Read-Write Leveling Control Register

31	30	29	28	27	26	25	24
REG_RDWRLVLFULL_START		REG_RDWRLVLINC_PRE					
R/W-		R/W-					
23	22	21	20	19	18	17	16
REG_RDLVLINC_INT							
R/W-							
15	14	13	12	11	10	9	8
REG_RDLVLGATEINC_INT							
R/W-							
7	6	5	4	3	2	1	0
REG_WRLVLINC_INT							
R/W-							

LEGEND: R/W = Read/Write; R = Read only; W1toCl = Write 1 to clear bit; -n = value after reset

Table 7-253. Read-Write Leveling Control Register Field Descriptions

Bit	Field	Type	Reset	Description
31	REG_RDWRLVLFULL_START	R/W		Full leveling trigger. Writing a 1 to this field triggers full read and write leveling. This bit will self-clear to 0.
30-24	REG_RDWRLVLINC_PRE	R/W		Incremental leveling pre-scalar in number of refresh periods. The value programmed is minus one the required value. Refresh period is defined by reg_refresh_rate in SDRAM Refresh Control register.
23-16	REG_RDLVLINC_INT	R/W		Incremental read data eye training interval. Number of reg_rdwrvlinc_pre intervals between incremental read data eye training. A value of 0 will disable incremental read data eye training.
15-8	REG_RDLVLGATEINC_INT	R/W		Incremental read DQS gate training interval. Number of reg_rdwrvlinc_pre intervals between incremental read DQS gate training. A value of 0 will disable incremental read DQS gate training.
7-0	REG_WRLVLINC_INT	R/W		Incremental write leveling interval. Number of reg_rdwrvlinc_pre intervals between incremental write leveling. A value of 0 will disable incremental write leveling.

7.3.5.33 DDR_PHY_CTRL_1 Register (offset = E4h) [reset = 0h]

DDR_PHY_CTRL_1 is shown in [Figure 7-237](#) and described in [Table 7-254](#).

A write to the DDR PHY Control 1 register must be followed by a write to the SDRAM_CONFIG register to ensure that the control update/acknowledge protocol is performed on the DID. If CAS latency = 5, the minimum read latency = 5 + 2 = 7 and reg_read_latency must be programmed as 7 - 1 = 6. The maximum read latency = 5 + 7 = 12 and reg_read_latency must be programmed as 12 - 1 = 11.

Figure 7-237. DDR_PHY_CTRL_1 Register

31	30	29	28	27	26	25	24
RESERVED							
R/W-0h							
23	22	21	20	19	18	17	16
RESERVED			reg_phy_enable_dynamic_pwr_dn	RESERVED			
R/W-0h			R/W-0h	R/W-0h			
15	14	13	12	11	10	9	8
reg_phy_rst_n	RESERVED	reg_phy_idle_local_odt		reg_phy_wr_local_odt		reg_phy_rd_local_odt	
R/W-0h	R/W-0h	R/W-0h		R/W-0h		R/W-0h	
7	6	5	4	3	2	1	0
RESERVED			reg_read_latency				
R/W-0h			R/W-0h				

LEGEND: R/W = Read/Write; R = Read only; W1toCl = Write 1 to clear bit; -n = value after reset

Table 7-254. DDR_PHY_CTRL_1 Register Field Descriptions

Bit	Field	Type	Reset	Description
31-21	RESERVED	R/W	0h	Reserved.
20	reg_phy_enable_dynamic_pwr_dn	R/W	0h	Dynamically enables powering down the IO receiver when not performing a read. 0 = IO receivers always powered up. 1 = IO receives only powered up during a read.
19-16	RESERVED	R/W	0h	Reserved.
15	reg_phy_rst_n	R/W	0h	Writing a 1 to this bit will hold the PHY macros in reset. Writing a 0 will bring PHY macros out of reset.
14	RESERVED	R/W	0h	Reserved.
13-12	reg_phy_idle_local_odt	R/W	0h	Value to drive on the 2-bit local_odt (On-Die Termination) PHY outputs when reg_phy_dynamic_pwr_dn_enable is asserted and a read is not in progress and reg_phy_dynamic_pwr_dn_enable. Typically this is the value required to disable termination (00) to save power when idle.
11-10	reg_phy_wr_local_odt	R/W	0h	This bit controls the value assigned to the reg_phy_wr_local_odt input on the data macros. Always set to 00.

Table 7-254. DDR_PHY_CTRL_1 Register Field Descriptions (continued)

Bit	Field	Type	Reset	Description
9-8	reg_phy_rd_local_odt	R/W	0h	Value to drive on the 2-bit local_odt (On-Die Termination) PHY outputs when output enable is not asserted and a read is in progress (where in progress is defined as after a read command is issued and until all read data has been returned all the way to the controller.) Typically this is set to the value required to enable termination at the desired strength for read usage. 00 = ODT off. 01 = ODT off. 10 = Full thevenin load Effective ODT is equivalent to 1x the output driver impedance setting in DDR_DATAx_IOCTRL.io_config_i register bits. 11 = Half thevenin load Effective ODT is equivalent to 2x the output driver impedance setting in DDR_DATAx_IOCTRL.io_config_i register bits..
7-5	RESERVED	R/W	0h	Reserved.
4-0	reg_read_latency	R/W	0h	This field defines the latency for read data from DDR SDRAM in number of DDR clock cycles. The value applied should be equal to the required value minus one. The maximum read latency supported by the DDR PHY is equal to CAS latency plus 7 clock cycles. The minimum read latency must be equal to CAS latency plus 2 clock cycle.

7.3.5.34 DDR_PHY_CTRL_1_SHDW Register (offset = E8h) [reset = 0h]

DDR_PHY_CTRL_1_SHDW is shown in [Figure 7-238](#) and described in [Table 7-255](#).

A write to the DDR PHY Control 1 register must be followed by a write to the SDRAM_CONFIG register to ensure that the control update/acknowledge protocol is performed on the DID. If CAS latency = 5, the minimum read latency = 5 + 2 = 7 and reg_read_latency must be programmed as 7 - 1 = 6. The maximum read latency = 5 + 7 = 12 and reg_read_latency must be programmed as 12 - 1 = 11.

Figure 7-238. DDR_PHY_CTRL_1_SHDW Register

31	30	29	28	27	26	25	24
RESERVED							
R/W-0h							
23	22	21	20	19	18	17	16
RESERVED			reg_phy_enable_dynamic_pwr_dn	RESERVED			
R/W-0h			R/W-0h	R/W-0h			
15	14	13	12	11	10	9	8
reg_phy_rst_n	RESERVED	reg_phy_idle_local_odt		reg_phy_wr_local_odt		reg_phy_rd_local_odt	
R/W-0h	R/W-0h	R/W-0h		R/W-0h		R/W-0h	
7	6	5	4	3	2	1	0
RESERVED			reg_read_latency				
R/W-0h			R/W-0h				

LEGEND: R/W = Read/Write; R = Read only; W1toCl = Write 1 to clear bit; -n = value after reset

Table 7-255. DDR_PHY_CTRL_1_SHDW Register Field Descriptions

Bit	Field	Type	Reset	Description
31-21	RESERVED	R/W	0h	Reserved.
20	reg_phy_enable_dynamic_pwr_dn	R/W	0h	Dynamically enables powering down the IO receiver when not performing a read. 0 = IO receivers always powered up. 1 = IO receives only powered up during a read.
19-16	RESERVED	R/W	0h	Reserved.
15	reg_phy_rst_n	R/W	0h	Writing a 1 to this bit will hold the PHY macros in reset. Writing a 0 will bring PHY macros out of reset.
14	RESERVED	R/W	0h	Reserved.
13-12	reg_phy_idle_local_odt	R/W	0h	Value to drive on the 2-bit local_odt PHY outputs when reg_phy_dynamic_pwr_dn_enable is asserted and a read is not in progress and reg_phy_dynamic_pwr_dn_enable. Typically this is the value required to disable termination (00) to save power when idle.
11-10	reg_phy_wr_local_odt	R/W	0h	This bit controls the value assigned to the reg_phy_wr_local_odt input on the data macros. Always set to 00.
9-8	reg_phy_rd_local_odt	R/W	0h	Value to drive on the 2-bit local_odt PHY outputs when output enable is not asserted and a read is in progress (where in progress is defined as after a read command is issued and until all read data has been returned all the way to the controller.) Typically this is set to the value required to enable termination at the desired strength for read usage. 00 = ODT off. 01 = ODT off. 10 = Full thevenin load. 11 = Half thevenin load.
7-5	RESERVED	R/W	0h	Reserved.

Table 7-255. DDR_PHY_CTRL_1_SHDW Register Field Descriptions (continued)

Bit	Field	Type	Reset	Description
4-0	reg_read_latency	R/W	0h	This field defines the latency for read data from DDR SDRAM in number of DDR clock cycles. The value applied should be equal to the required value minus one. The maximum read latency supported by the DDR PHY is equal to CAS latency plus 7 clock cycles. The minimum read latency must be equal to CAS latency plus 2 clock cycle.

7.3.5.35 Priority to Class of Service Mapping Register (offset = 100h) [reset = 0h]

Priority to Class of Service Mapping is shown in [Figure 7-239](#) and described in [Table 7-256](#).

Figure 7-239. Priority to Class of Service Mapping Register

31	30	29	28	27	26	25	24
REG_PRI_COS_MAP_EN	RESERVED						
R/W-	R-						
23	22	21	20	19	18	17	16
RESERVED							
R-							
15	14	13	12	11	10	9	8
REG_PRI_7_COS		REG_PRI_6_COS		REG_PRI_5_COS		REG_PRI_4_COS	
R/W-		R/W-		R/W-		R/W-	
7	6	5	4	3	2	1	0
REG_PRI_3_COS		REG_PRI_2_COS		REG_PRI_1_COS		REG_PRI_0_COS	
R/W-		R/W-		R/W-		R/W-	

LEGEND: R/W = Read/Write; R = Read only; W1toCl = Write 1 to clear bit; -n = value after reset

Table 7-256. Priority to Class of Service Mapping Register Field Descriptions

Bit	Field	Type	Reset	Description
31	REG_PRI_COS_MAP_EN	R/W		Set 1 to enable priority to class of service mapping. Set 0 to disable mapping.
30-16	RESERVED	R		Reserved.
15-14	REG_PRI_7_COS	R/W		Class of service for commands with priority of 7. Value can be 1 or 2. Setting a value of 0 or 3 will not assign any class of service.
13-12	REG_PRI_6_COS	R/W		Class of service for commands with priority of 6. Value can be 1 or 2. Setting a value of 0 or 3 will not assign any class of service.
11-10	REG_PRI_5_COS	R/W		Class of service for commands with priority of 5. Value can be 1 or 2. Setting a value of 0 or 3 will not assign any class of service.
9-8	REG_PRI_4_COS	R/W		Class of service for commands with priority of 4. Value can be 1 or 2. Setting a value of 0 or 3 will not assign any class of service.
7-6	REG_PRI_3_COS	R/W		Class of service for commands with priority of 3. Value can be 1 or 2. Setting a value of 0 or 3 will not assign any class of service.
5-4	REG_PRI_2_COS	R/W		Class of service for commands with priority of 2. Value can be 1 or 2. Setting a value of 0 or 3 will not assign any class of service.
3-2	REG_PRI_1_COS	R/W		Class of service for commands with priority of 1. Value can be 1 or 2. Setting a value of 0 or 3 will not assign any class of service.
1-0	REG_PRI_0_COS	R/W		Class of service for commands with priority of 0. Value can be 1 or 2. Setting a value of 0 or 3 will not assign any class of service.

7.3.5.36 Connection ID to Class of Service 1 Mapping Register (offset = 104h) [reset = 0h]

Connection ID to Class of Service 1 Mapping is shown in [Figure 7-240](#) and described in [Table 7-257](#).

Figure 7-240. Connection ID to Class of Service 1 Mapping Register

31	30	29	28	27	26	25	24
REG_CONNID_COS_1_MAP_EN		REG_CONNID_1_COS_1					
R/W-		R/W-					
23	22	21	20	19	18	17	16
REG_CONNID_1_COS_1		REG_MSK_1_COS_1		REG_CONNID_2_COS_1			
R/W-		R/W-		R/W-			
15	14	13	12	11	10	9	8
REG_CONNID_2_COS_1				REG_MSK_2_COS_1		REG_CONNID_3_COS_1	
R/W-				R/W-		R/W-	
7	6	5	4	3	2	1	0
REG_CONNID_3_COS_1						REG_MSK_3_COS_1	
R/W-						R/W-	

LEGEND: R/W = Read/Write; R = Read only; W1toCl = Write 1 to clear bit; -n = value after reset

Table 7-257. Connection ID to Class of Service 1 Mapping Register Field Descriptions

Bit	Field	Type	Reset	Description
31	REG_CONNID_COS_1_MAP_EN	R/W		Set 1 to enable connection ID to class of service 1 mapping. Set 0 to disable mapping.
30-23	REG_CONNID_1_COS_1	R/W		Connection ID value 1 for class of service 1.
22-20	REG_MSK_1_COS_1	R/W		Mask for connection ID value 1 for class of service 1. 0 = disable masking. 1 = mask connection ID bit 0. 2 = mask connection ID bits 1:0. 3 = mask connection ID bits 2:0. 4 = mask connection ID bits 3:0. 5 = mask connection ID bits 4:0. 6 = mask connection ID bits 5:0. 7 = mask connection ID bits 6:0.
19-12	REG_CONNID_2_COS_1	R/W		Connection ID value 2 for class of service 1.
11-10	REG_MSK_2_COS_1	R/W		Mask for connection ID value 2 for class of service 1. 0 = disable masking. 1 = mask connection ID bit 0. 2 = mask connection ID bits 1:0. 3 = mask connection ID bits 2:0.
9-2	REG_CONNID_3_COS_1	R/W		Connection ID value 3 for class of service 1.
1-0	REG_MSK_3_COS_1	R/W		Mask for connection ID. Value 3 for class of service 1. 0 = disable masking. 1 = mask connection ID bit 0. 2 = mask connection ID bits 1:0. 3 = mask connection ID bits 2:0.

7.3.5.37 Connection ID to Class of Service 2 Mapping Register (offset = 108h) [reset = 0h]

Connection ID to Class of Service 2 Mapping is shown in [Figure 7-241](#) and described in [Table 7-258](#).

Figure 7-241. Connection ID to Class of Service 2 Mapping Register

31	30	29	28	27	26	25	24
REG_CONNID_COS_2_MAP_EN		REG_CONNID_1_COS_2					
R/W-		R/W-					
23	22	21	20	19	18	17	16
REG_CONNID_1_COS_2		REG_MSK_1_COS_2		REG_CONNID_2_COS_2			
R/W-		R/W-		R/W-			
15	14	13	12	11	10	9	8
REG_CONNID_2_COS_2				REG_MSK_2_COS_2		REG_CONNID_3_COS_2	
R/W-				R/W-		R/W-	
7	6	5	4	3	2	1	0
REG_CONNID_3_COS_2						REG_MSK_3_COS_2	
R/W-						R/W-	

LEGEND: R/W = Read/Write; R = Read only; W1toCl = Write 1 to clear bit; -n = value after reset

Table 7-258. Connection ID to Class of Service 2 Mapping Register Field Descriptions

Bit	Field	Type	Reset	Description
31	REG_CONNID_COS_2_MAP_EN	R/W		Set 1 to enable connection ID to class of service 2 mapping. Set 0 to disable mapping.
30-23	REG_CONNID_1_COS_2	R/W		Connection ID value 1 for class of service 2.
22-20	REG_MSK_1_COS_2	R/W		Mask for connection ID. Value 1 for class of service 2. 0 = disable masking. 1 = mask connection ID bit 0. 2= mask connection ID bits 1:0. 3= mask connection ID bits 2:0. 4 = mask connection ID bits 3:0. 5 = mask connection ID bits 4:0. 6 = mask connection ID bits 5:0. 7 = mask connection ID bits 6:0.
19-12	REG_CONNID_2_COS_2	R/W		Connection ID value 2 for class of service 2.
11-10	REG_MSK_2_COS_2	R/W		Mask for connection ID. Value 2 for class of service 2. 0 = disable masking. 1 = mask connection ID bit 0. 2 = mask connection ID bits 1:0. 3 = mask connection ID bits 2:0.
9-2	REG_CONNID_3_COS_2	R/W		Connection ID value 3 for class of service 2.
1-0	REG_MSK_3_COS_2	R/W		Mask for connection ID. Value 3 for class of service 2. 0 = disable masking. 1 = mask connection ID bit 0. 2 = mask connection ID bits 1:0. 3 = mask connection ID bits 2:0.

7.3.5.38 Read Write Execution Threshold Register (offset = 120h) [reset = 0h]

Read Write Execution Threshold is shown in [Figure 7-242](#) and described in [Table 7-259](#).

Figure 7-242. Read Write Execution Threshold Register

31	30	29	28	27	26	25	24	23	22	21	20	19	18	17	16
RESERVED															
R-															
15	14	13	12	11	10	9	8	7	6	5	4	3	2	1	0
RESERVED				REG_WR_THRSH				RESERVED				REG_RD_THRSH			
R-				R/W-				R-				R/W-			

LEGEND: R/W = Read/Write; R = Read only; W1toCl = Write 1 to clear bit; -n = value after reset

Table 7-259. Read Write Execution Threshold Register Field Descriptions

Bit	Field	Type	Reset	Description
31-13	RESERVED	R		Reserved.
12-8	REG_WR_THRSH	R/W		Write Threshold. Number of SDRAM write bursts after which the EMIF arbitration will switch to executing read commands. The value programmed is always minus one the required number.
7-5	RESERVED	R		Reserved.
4-0	REG_RD_THRSH	R/W		Read Threshold. Number of SDRAM read bursts after which the EMIF arbitration will switch to executing write commands. The value programmed is always minus one the required number.

7.3.6 DDR2/3/mDDR PHY Registers

Table 7-260 lists the memory-mapped registers for the DDR2/3 mDDR PHY. Configure the DDR PHY Control Register for calibration of board delay and other parameters to get the SDRAM device working at a different speed.

Note: These registers are write-only due to a silicon bug. The contents of these registers cannot be read.

Table 7-260. Memory-Mapped Registers for DDR2/3/mDDR PHY

Register Name	Type	Register	Register	Address
		Description	Reset	Offset
CMD0_REG_PHY_CTRL_SLAVE_RATIO_0	W	DDR PHY Command 0 Address/Command Slave Ratio Register	0x80	0x01C
CMD0_REG_PHY_DLL_LOCK_DIFF_0	W	DDR PHY Command 0 Address/Command DLL Lock Difference Register	0x4	0x028
CMD0_REG_PHY_INVERT_CLKOUT_0	W	DDR PHY Command 0 Invert Clockout Selection Register	0x0	0x02C
CMD1_REG_PHY_CTRL_SLAVE_RATIO_0	W	DDR PHY Command 1 Address/Command Slave Ratio Register	0x80	0x050
CMD1_REG_PHY_DLL_LOCK_DIFF_0	W	DDR PHY Command 1 Address/Command DLL Lock Difference Register	0x4	0x05C
CMD1_REG_PHY_INVERT_CLKOUT_0	W	DDR PHY Command 1 Invert Clockout Selection Register	0x0	0x060
CMD2_REG_PHY_CTRL_SLAVE_RATIO_0	W	DDR PHY Command 2 Address/Command Slave Ratio Register	0x80	0x084
CMD2_REG_PHY_DLL_LOCK_DIFF_0	W	DDR PHY Command 2 Address/Command DLL Lock Difference Register	0x4	0x090
CMD2_REG_PHY_INVERT_CLKOUT_0	W	DDR PHY Command 2 Invert Clockout Selection Register	0x0	0x094
DATA0_REG_PHY_RD_DQS_SLAVE_RATIO_0	W	DDR PHY Data Macro 0 Read DQS Slave Ratio Register	0x04010040	0x0C8
DATA0_REG_PHY_WR_DQS_SLAVE_RATIO_0	W	DDR PHY Data Macro 0 Write DQS Slave Ratio Register	0x0	0x0DC
DATA0_REG_PHY_WRLVL_INIT_RATIO_0	W	DDR PHY Data Macro 0 Write Leveling Init Ratio Register	0x0	0x0F0
DATA0_REG_PHY_WRLVL_INIT_MODE_0	W	DDR PHY Data Macro 0 Write Leveling Init Mode Ratio Selection Register	0x0	0x0F8
DATA0_REG_PHY_GATELVL_INIT_RATIO_0	W	DDR PHY Data Macro 0 DQS Gate Training Init Ratio Register	0x0	0x0FC
DATA0_REG_PHY_GATELVL_INIT_MODE_0	W	DDR PHY Data Macro 0 DQS Gate Training Init Mode Ratio Selection Register	0x0	0x104

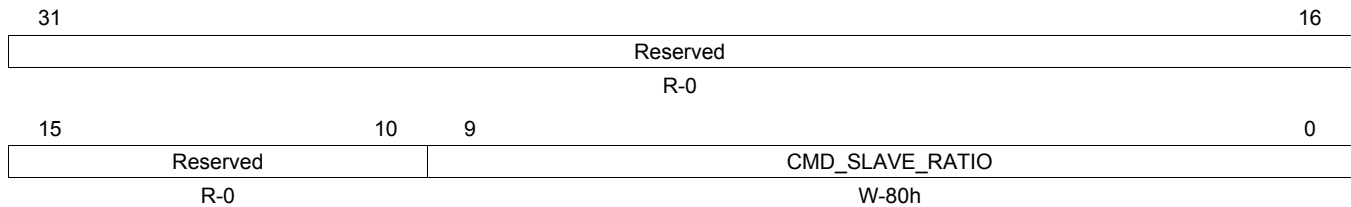
Table 7-260. Memory-Mapped Registers for DDR2/3/mDDR PHY (continued)

Register Name	Type	Register	Register	Address
DATA0_REG_PHY_FIFO_WE_SLAVE_RATIO_0	W	DDR PHY Data Macro 0 DQS Gate Slave Ratio Register	0x0	0x108
DATA0_REG_PHY_DQ_OFFSET_0	W	Offset value from DQS to DQ for Data Macro 0	0x40	0x11C
DATA0_REG_PHY_WR_DATA_SLAVE_RATIO_0	W	DDR PHY Data Macro 0 Write Data Slave Ratio Register	0x04010040	0x120
DATA0_REG_PHY_USE_RANK0_DELAYS	W	DDR PHY Data Macro 0 Delay Selection Register	0x0	0x134
DATA0_REG_PHY_DLL_LOCK_DIFF_0	W	DDR PHY Data Macro 0 DLL Lock Difference Register	0x4	0x138
DATA1_REG_PHY_RD_DQS_SLAVE_RATIO_0	W	DDR PHY Data Macro 1 Read DQS Slave Ratio Register	0x04010040	0x16C
DATA1_REG_PHY_WR_DQS_SLAVE_RATIO_0	W	DDR PHY Data Macro 1 Write DQS Slave Ratio Register	0x0	0x180
DATA1_REG_PHY_WRLVL_INIT_RATIO_0	W	DDR PHY Data Macro 1 Write Leveling Init Ratio Register	0x0	0x194
DATA1_REG_PHY_WRLVL_INIT_MODE_0	W	DDR PHY Data Macro 1 Write Leveling Init Mode Ratio Selection Register	0x0	0x19C
DATA1_REG_PHY_GATELVL_INIT_RATIO_0	W	DDR PHY Data Macro 1 DQS Gate Training Init Ratio Register	0x0	0x1A0
DATA1_REG_PHY_GATELVL_INIT_MODE_0	W	DDR PHY Data Macro 1 DQS Gate Training Init Mode Ratio Selection Register	0x0	0x1A8
DATA1_REG_PHY_FIFO_WE_SLAVE_RATIO_0	W	DDR PHY Data Macro 1 DQS Gate Slave Ratio Register	0x0	0x1AC
DATA1_REG_PHY_DQ_OFFSET_1	W	Offset value from DQS to DQ for Data Macro 1	0x40	0x1C0
DATA1_REG_PHY_WR_DATA_SLAVE_RATIO_0	W	DDR PHY Data Macro 1 Write Data Slave Ratio Register	0x04010040	0x1C4
DATA1_REG_PHY_USE_RANK0_DELAYS	W	DDR PHY Data Macro 1 Delay Selection Register	0x0	0x1D8
DATA1_REG_PHY_DLL_LOCK_DIFF_0	W	DDR PHY Data Macro 1 DLL Lock Difference Register	0x4	0x1DC

7.3.6.1 DDR PHY Command 0/1/2 Address/Command Slave Ratio Register (CMD0/1/2_REG_PHY_CTRL_SLAVE_RATIO_0)

The DDR PHY Command 0/1/2 Address/Command Slave Ratio Register (CMD0/1/2_REG_PHY_CTRL_SLAVE_RATIO_0) is shown in the figure and table below.

**Figure 7-243. DDR PHY Command 0/1/2 Address/Command Slave Ratio Register
(CMD0/1/2_REG_PHY_CTRL_SLAVE_RATIO_0)**



LEGEND: R/W = Read/Write; R = Read only; -n = value after reset

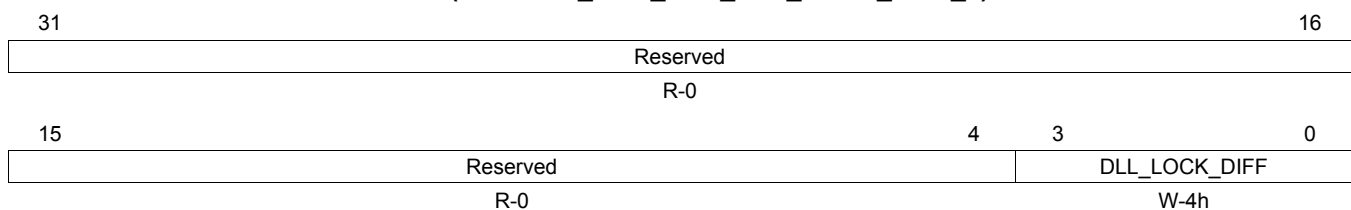
**Table 7-261. DDR PHY Command 0/1/2 Address/Command Slave Ratio Register
(CMD0/1/2_REG_PHY_CTRL_SLAVE_RATIO_0) Field Descriptions**

Bit	Field	Value	Description
31-10	Reserved		Reserved
9-0	CMD_SLAVE_RATIO	0-80h	Ratio value for address/command launch timing in DDR PHY macro. This is the fraction of a clock cycle represented by the shift to be applied to the read DQS in units of 256ths. In other words, the full-cycle tap value from the master DLL will be scaled by this number over 256 to get the delay value for the slave delay line.

7.3.6.2 DDR PHY Command 0/1/2 Address/Command DLL Lock Difference Register (CMD0/1/2_REG_PHY_DLL_LOCK_DIFF_0)

The DDR PHY Command 0/1/2 Address/Command DLL Lock Difference Register (CMD0/1/2_REG_PHY_DLL_LOCK_DIFF_0) is shown in the figure and table below.

**Figure 7-244. DDR PHY Command 0/1/2 Address/Command DLL Lock Difference Register
(CMD0/1/2_REG_PHY_DLL_LOCK_DIFF_0)**



LEGEND: R/W = Read/Write; R = Read only; -n = value after reset

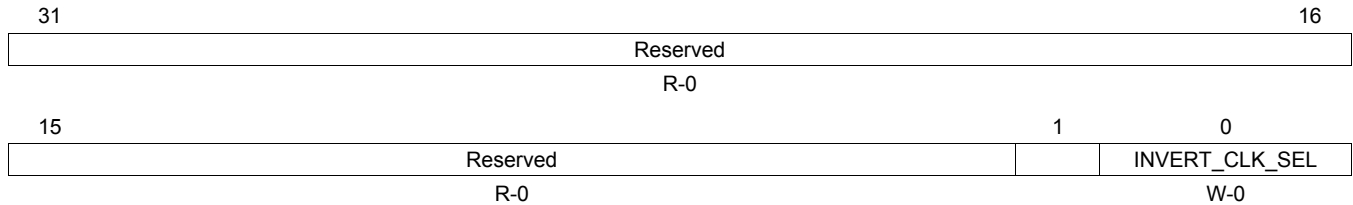
**Table 7-262. DDR PHY Command 0/1/2 Address/Command DLL Lock Difference Register
(CMD0/1/2_REG_PHY_DLL_LOCK_DIFF_0) Field Descriptions**

Bit	Field	Value	Description
31-4	Reserved		Reserved
3-0	DLL_LOCK_DIFF	0-4h	The max number of delay line taps variation allowed while maintaining the master DLL lock. This is calculated as total jitter/ delay line tap size, where total jitter is half of (incoming clock jitter (pp) + delay line jitter (pp)).

7.3.6.3 DDR PHY Command 0/1/2 Invert Clockout Selection Register(CMD0/1/2_REG_PHY_INVERT_CLKOUT_0)

The CDDR PHY Command 0/1/2 Invert Clockout Selection Register(CMD0/1/2_REG_PHY_INVERT_CLKOUT_0) is shown in the figure and table below.

Figure 7-245. DDR PHY Command 0/1/2 Invert Clockout Selection Register(CMD0/1/2_REG_PHY_INVERT_CLKOUT_0)



LEGEND: R/W = Read/Write; R = Read only; -n = value after reset

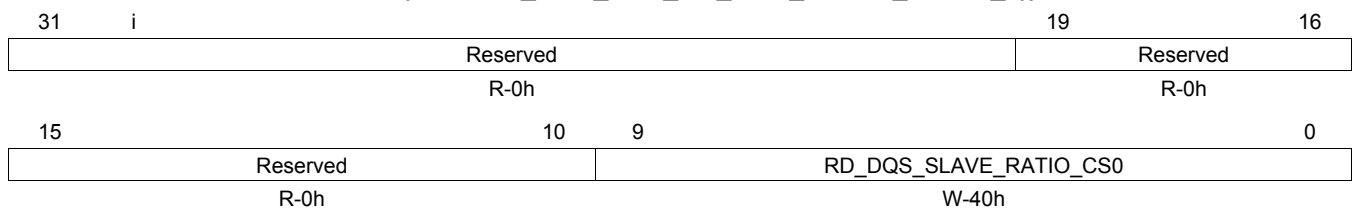
Table 7-263. DDR PHY Command 0/1/2 Invert Clockout Selection Register(CMD0/1/2_REG_PHY_INVERT_CLKOUT_0) Field Descriptions

Bit	Field	Value	Description
31-1	Reserved	0	Reserved
0	INVERT_CLK_SEL	0	Inverts the polarity of DRAM clock. Core clock is passed on to DRAM
		1	inverted core clock is passed on to DRAM

7.3.6.4 DDR PHY Data Macro 0/1 Read DQS Slave Ratio Register (DATA0/1_REG_PHY_RD_DQS_SLAVE_RATIO_0)

The DDR PHY Data Macro 0/1 Read DQS Slave Ratio Register(DATA0/1_REG_PHY_RD_DQS_SLAVE_RATIO_0) is shown in the figure and table below.

Figure 7-246. DDR PHY Data Macro 0/1 Read DQS Slave Ratio Register (DATA0/1_REG_PHY_RD_DQS_SLAVE_RATIO_0)



LEGEND: R/W = Read/Write; R = Read only; -n = value after reset

Table 7-264. DDR PHY Data Macro 0/1 Read DQS Slave Ratio Register (DATA0/1_REG_PHY_RD_DQS_SLAVE_RATIO_0) Field Descriptions

Bit	Field	Value	Description
31-20	Reserved		Reserved
19-10	Reserved	0h	Reserved
9-0	RD_DQS_SLAVE_RATIO_CS0	40h	Ratio value for Read DQS slave DLL for CS0. This is the fraction of a clock cycle represented by the shift to be applied to the read DQS in units of 256ths. In other words, the full-cycle tap value from the master DLL will be scaled by this number over 256 to get the delay value for the slave delay line.

7.3.6.5 DDR PHY Data Macro 0/1 Write DQS Slave Ratio Register (DATA0/1_REG_PHY_WR_DQS_SLAVE_RATIO_0)

The DDR PHY Data Macro 0/1 Write DQS Slave Ratio Register (DATA0/1_REG_PHY_WR_DQS_SLAVE_RATIO_0) is shown in the figure and table below.

Table 7-265. DDR PHY Data Macro 0/1 Write DQS Slave Ratio Register (DATA0/1_REG_PHY_WR_DQS_SLAVE_RATIO_0)

31	Reserved	20	19	Reserved	16
	R-0			R-0h	
15	Reserved	10	9	WR_DQS_SLAVE_RATIO_CS0	0
	R-0			W-0h	

LEGEND: R/W = Read/Write; R = Read only; -n = value after reset

Table 7-266. DDR PHY Data Macro 0/1 Write DQS Slave Ratio Register (DATA0/1_REG_PHY_WR_DQS_SLAVE_RATIO_0) Field Descriptions

Bit	Field	Value	Description
31-20	Reserved	0	Reserved
19-10	Reserved		Reserved
9-0	WR_DQS_SLAVE_RATIO_CS0		Ratio value for Write DQS slave DLL for CS0. This is the fraction of a clock cycle represented by the shift to be applied to the write DQS in units of 256ths. In other words, the full-cycle tap value from the master DLL will be scaled by this number over 256 to get the delay value for the slave delay line.

7.3.6.6 DDR PHY Data Macro 0/1 Write Leveling Init Ratio Register (DATA0/1_REG_PHY_WRLVL_INIT_RATIO_0)

The DDR PHY Data Macro 0/1 Write Leveling Init Ratio Register (DATA0/1_REG_PHY_WRLVL_INIT_RATIO_0) is shown in the figure and table below.

Figure 7-247. DDR PHY Data Macro 0/1 Write Leveling Init Ratio Register (DATA0/1_REG_PHY_WRLVL_INIT_RATIO_0)

31	Reserved	20	19	Reserved	16
	R-0			R-0	
15	Reserved	10	9	WRLVL_INIT_RATIO_CS0	0
	R-0			W-0	

LEGEND: R/W = Read/Write; R = Read only; -n = value after reset

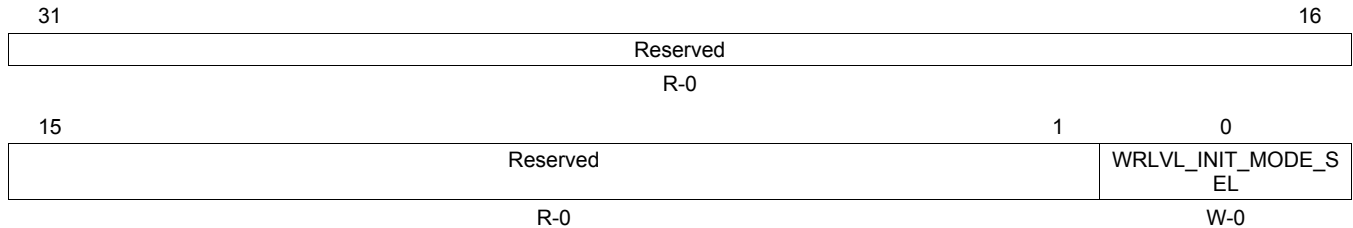
Table 7-267. DDR PHY Data Macro 0/1 Write Leveling Init Ratio Register (DATA0/1_REG_PHY_WRLVL_INIT_RATIO_0) Field Descriptions

Bit	Field	Value	Description
31-20	Reserved	0	Reserved
19-10	Reserved	0h	Reserved
9-0	WRLVL_INIT_RATIO_CS0	0h	The user programmable init ratio used by Write Leveling FSM when DATA0/1_REG_PHY_WRLVL_INIT_MODE_0 register value set to 1

7.3.6.7 DDR PHY Data Macro 0 Write Leveling Init Mode Ratio Selection Register (DATA0/1_REG_PHY_WRLVL_INIT_MODE_0)

The DDR PHY Data Macro 0 Write Leveling Init Mode Ratio Selection Register (DATA0/1_REG_PHY_WRLVL_INIT_MODE_0) is shown in the figure and table below.

Figure 7-248. DDR PHY Data Macro 0 Write Leveling Init Mode Ratio Selection Register (DATA0/1_REG_PHY_WRLVL_INIT_MODE_0)



LEGEND: R/W = Read/Write; R = Read only; -n = value after reset

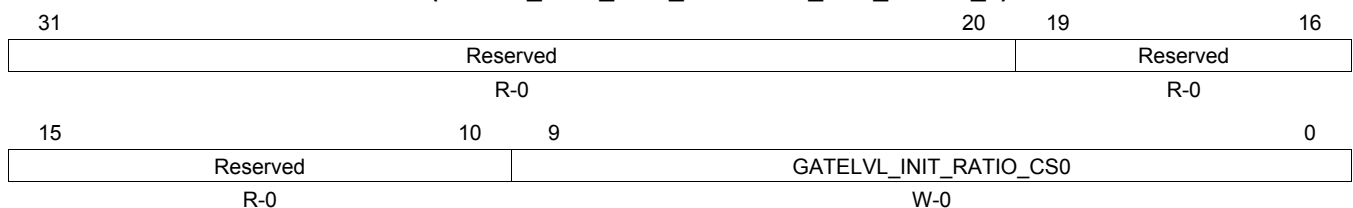
Table 7-268. DDR PHY Data Macro 0 Write Leveling Init Mode Ratio Selection Register (DATA0/1_REG_PHY_WRLVL_INIT_MODE_0)

Bit	Field	Value	Description
31-1	Reserved	0	Reserved
0	WRLVL_INIT_MODE_SEL	0	The user programmable init ratio selection mode for Write Leveling FSM. Selects a starting ratio value based on Write Leveling of previous data slice.
		1	Selects a starting ratio value based in register DATA0/1_REG_PHY_WRLVL_INIT_RATIO_0 value programmed by the user.

7.3.6.8 DDR PHY Data Macro 0 DQS Gate Training Init Ratio Register (DATA0_REG_PHY_GATELVL_INIT_RATIO_0)

The DDR PHY Data Macro 0 DQS Gate Training Init Ratio Register (DATA0_REG_PHY_GATELVL_INIT_RATIO_0) is shown in the figure and table below.

Figure 7-249. DDR PHY Data Macro 0 DQS Gate Training Init Ratio Register (DATA0_REG_PHY_GATELVL_INIT_RATIO_0)



LEGEND: R/W = Read/Write; R = Read only; -n = value after reset

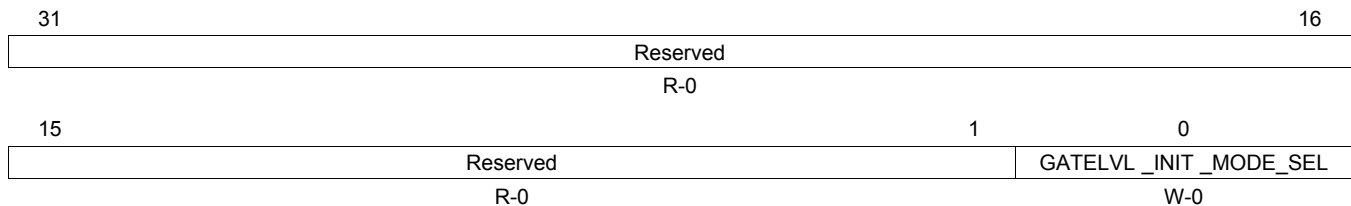
Table 7-269. DDR PHY Data Macro 0 DQS Gate Training Init Ratio Register (DATA0_REG_PHY_GATELVL_INIT_RATIO_0) Field Descriptions

Bit	Field	Value	Description
31-20	Reserved		Reserved
19-10	Reserved	0h	Reserved
9-0	GATELVL_INIT_RATIO_CS0	0h	The user programmable init ratio used by DQS Gate Training FSM when DATA0/1_REG_PHY_GATELVL_INIT_MODE_0 register value set to 1.

7.3.6.9 DDR PHY Data Macro 0/1 DQS Gate Training Init Mode Ratio Selection Register (DATA0/1_REG_PHY_GATELVL_INIT_MODE_0)

The DDR PHY Data Macro 0/1 DQS Gate Training Init Mode Ratio Selection Register(DATA0/1_REG_PHY_GATELVL_INIT_MODE_0) is shown in the figure and table below.

Figure 7-250. DDR PHY Data Macro 0/1 DQS Gate Training Init Mode Ratio Selection Register (DATA0/1_REG_PHY_GATELVL_INIT_MODE_0)



LEGEND: R/W = Read/Write; R = Read only; -n = value after reset

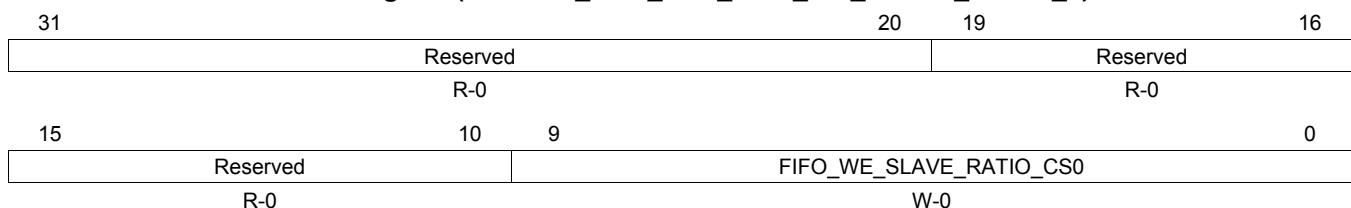
Table 7-270. DDR PHY Data Macro 0/1 DQS Gate Training Init Mode Ratio Selection Register (DATA0/1_REG_PHY_GATELVL_INIT_MODE_0) Field Descriptions

Bit	Field	Value	Description
31-1	Reserved	0	Reserved
0	GATELVL_INIT_MODE_SEL	0 1	User programmable init ratio selection mode for DQS Gate Training FSM. Selects a starting ratio value based on Write Leveling of the same data slice. selects a starting ratio value based on DATA0/1_REG_PHY_GATELVL_INIT_RATIO_0 value programmed by the user.

7.3.6.10 DDR PHY Data Macro 0/1 DQS Gate Slave Ratio Register (DATA0/1_REG_PHY_FIFO_WE_SLAVE_RATIO_0)

The DDR PHY Data Macro 0/1 DQS Gate Slave Ratio Register (DATA0/1_REG_PHY_FIFO_WE_SLAVE_RATIO_0) is shown in the figure and table below.

Figure 7-251. DDR PHY Data Macro 0/1 DQS Gate Slave Ratio Register (DATA0/1_REG_PHY_FIFO_WE_SLAVE_RATIO_0)



LEGEND: R/W = Read/Write; R = Read only; -n = value after reset

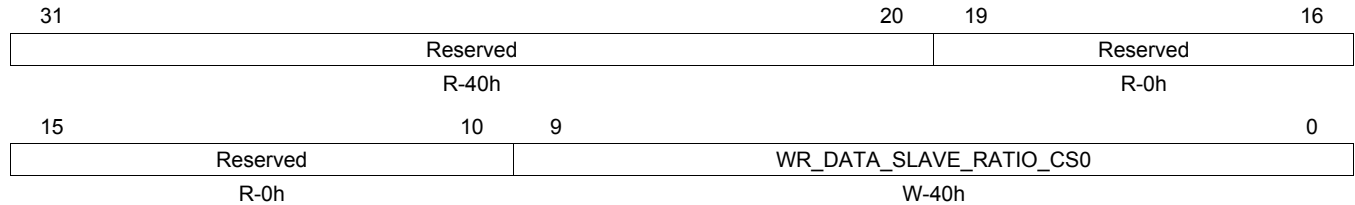
Table 7-271. DDR PHY Data Macro 0/1 DQS Gate Slave Ratio Register (DATA0/1_REG_PHY_FIFO_WE_SLAVE_RATIO_0) Field Descriptions

Bit	Field	Value	Description
31-20	Reserved	0	Reserved
19-10	Reserved	0h	Reserved
9-0	RD_DQS_GATE_SLAVE_RATIO_CS0	0h	Ratio value for fifo we for CS0.

7.3.6.11 DDR PHY Data Macro 0/1 Write Data Slave Ratio Register (DATA0/1_REG_PHY_WR_DATA_SLAVE_RATIO_0)

The DDR PHY Data Macro 0/1 Write Data Slave Ratio Register (DATA0/1_REG_PHY_WR_DATA_SLAVE_RATIO_0) is shown in the figure and table below.

Figure 7-252. DDR PHY Data Macro 0/1 Write Data Slave Ratio Register (DATA0/1_REG_PHY_WR_DATA_SLAVE_RATIO_0)



LEGEND: R/W = Read/Write; R = Read only; -n = value after reset

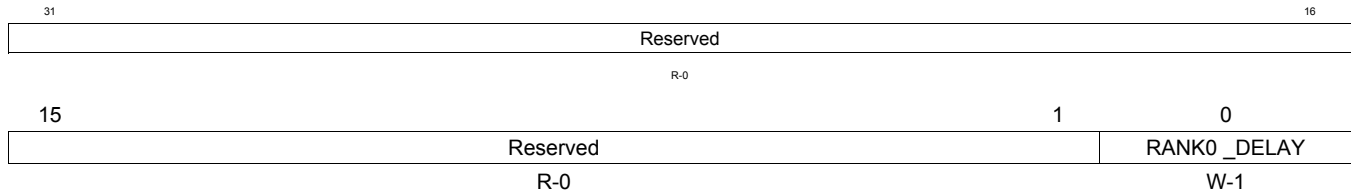
Table 7-272. DDR PHY Data Macro 0/1 Write Data Slave Ratio Register (DATA0/1_REG_PHY_WR_DATA_SLAVE_RATIO_0) Field Descriptions

Bit	Field	Value	Description
31-20	Reserved	40h	Reserved
19-10	Reserved	0	
9-0	WR_DATA_SLAVE_RATIO_CS0	40h	Ratio value for write data slave DLL for CS0. This is the fraction of a clock cycle represented by the shift to be applied to the write DQ muxes in units of 256ths. In other words, the full-cycle tap value from the master DLL will be scaled by this number over 256 to get the delay value for the slave delay line.

7.3.6.12 DDR PHY Data Macro 0/1 Delay Selection Register (DATA0/1_REG_PHY_USE_RANK0_DELAYS)

The DATA0/1_REG_PHY_USE_RANK0_DELAYS is shown in [Figure 7-253](#) and described in [Table 7-273](#).

Figure 7-253. DDR PHY Data Macro 0/1 Delay Selection Register (DATA0/1_REG_PHY_USE_RANK0_DELAYS)



LEGEND: R/W = Read/Write; R = Read only; -n = value after reset

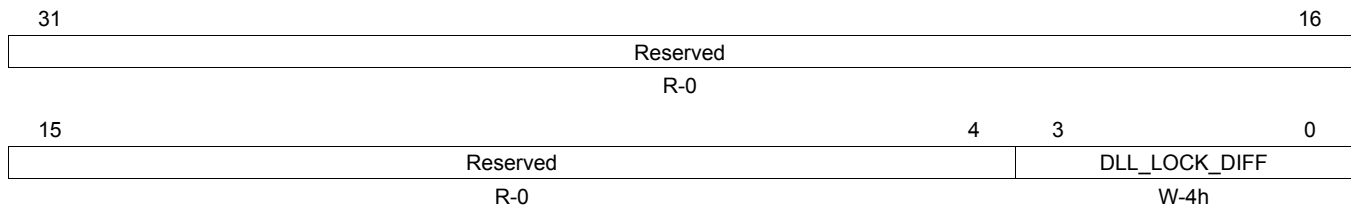
Table 7-273. DDR PHY Data Macro 0/1 Delay Selection Register (DATA0/1_REG_PHY_USE_RANK0_DELAYS) Field Descriptions

Bit	Field	Value	Description
31-1	Reserved	0	Reserved
0	PHY_USE_RANK0_DELAYS_0	0	Delay Selection Each Rank uses its own delay. (Recommended). This is applicable only in case of DDR3
		1	Rank 0 delays are used for all ranks. This must be set to 1 for DDR2 and mDDR.

7.3.6.13 DDR PHY Data 0/1 DLL Lock Difference Register (DATA0/1_REG_PHY_DLL_LOCK_DIFF_0)

The DDR PHY Data 0/1 DLL Lock Difference Register (DATA0/1_REG_PHY_DLL_LOCK_DIFF_0) is shown in the figure and table below.

Figure 7-254. DDR PHY Data 0/1 DLL Lock Difference Register (DATA0/1_REG_PHY_DLL_LOCK_DIFF_0)



LEGEND: R/W = Read/Write; R = Read only; -n = value after reset

Table 7-274. DDR PHY Data 0/1 DLL Lock Difference Register (DATA0/1_REG_PHY_DLL_LOCK_DIFF_0) Field Descriptions

Bit	Field	Value	Description
31-4	Reserved		Reserved
3-0	DLL_LOCK_DIFF	0-4h	The max number of delay line taps variation allowed while maintaining the master DLL lock. This is calculated as total jitter/ delay line tap size, where total jitter is half of (incoming clock jitter (pp) + delay line jitter (pp)).

7.4 ELM

7.4.1 Introduction

Non-managed NAND flash memories can be dense and nonvolatile in their own nature, but error-prone. When reading from NAND flash memories, some level of error-correction is required. In the case of NAND modules with no internal correction capability, sometimes referred to as bare NANDs, the correction process is delegated to the memory controller.

The general-purpose memory controller (GPMC) probes data read from an external NAND flash and uses this to compute checksum-like information, called syndrome polynomials, on a per-block basis. Each syndrome polynomial gives a status of the read operations for a full block, including 512 bytes of data, parity bits, and an optional spare-area data field, with a maximum block size of 1023 bytes. Computation is based on a Bose-Chaudhuri-Hocquenghem (BCH) algorithm. The error-location module (ELM) extracts error addresses from these syndrome polynomials.

Based on the syndrome polynomial value, the ELM can detect errors, compute the number of errors, and give the location of each error bit. The actual data is not required to complete the error-correction algorithm. Errors can be reported anywhere in the NAND flash block, including in the parity bits.

The maximum acceptable number of errors that can be corrected depends on a programmable configuration parameter. 4-, 8-, and 16-bit error-correction levels are supported. The ELM relies on a static and fixed definition of the generator polynomial for each error-correction level that corresponds to the generator polynomials defined in the GPMC (there are three fixed polynomial for the three correction error levels). A larger number of errors than the programmed error-correction level may be detected, but the ELM cannot correct them all. The offending block is then tagged as uncorrectable in the associated computation exit status register. If the computation is successful, that is, if the number of errors detected does not exceed the maximum value authorized for the chosen correction capability, the exit status register contains the information on the number of detected errors.

When the error-location process completes, an interrupt is triggered to inform the central processing unit (CPU) that its status can be checked. The number of detected errors and their locations in the NAND block can be retrieved from the module through register accesses.

7.4.1.1 ELM Features

The ELM has the following features:

- 4, 8, and 16 bits per 512-byte block error-location based on BCH algorithms
- Eight simultaneous processing contexts
- Page-based and continuous modes
- Interrupt generation on error-location process completion:
 - When the full page has been processed in page mode
 - For each syndrome polynomial in continuous mode

7.4.1.2 Unsupported ELM Features

There are no unsupported ELM features in this device.

7.4.2 Integration

The error location module (ELM) is used to extract error addresses from syndrome polynomials generated using a BCH algorithm. Each of these polynomials gives a status of the read operations for a 512 bytes block from a NAND flash and its associated BCH parity bits, plus optionally some spare area information.

The ELM is intended to be used in conjunction with the GPMC. Syndrome polynomials generated on-the-fly when reading a NAND Flash page and stored in GPMC registers are passed to the ELM module. The MPU can then easily correct the data block by flipping the bits pointed to by the ELM error locations outputs.

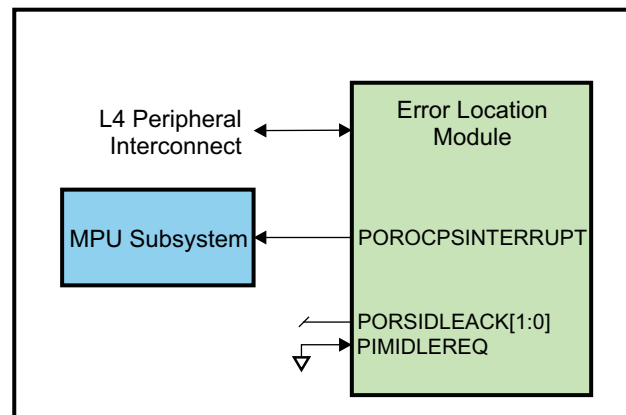


Figure 7-255. ELM Integration

7.4.2.1 ELM Connectivity Attributes

The general connectivity for the ELM module in this device is summarized in [Table 7-275](#).

Table 7-275. ELM Connectivity Attributes

Attributes	Type
Power Domain	Peripheral Domain
Clock Domain	L4PER_L4LS_GCLK
Reset Signals	PER_DOM_RST_N
Idle/Wakeup Signals	Smart Idle
Interrupt Requests	1 interrupt to MPU Subsystem
DMA Requests	None
Physical Address	L4 Peripheral slave port

7.4.2.2 ELM Clock and Reset Management

The ELM operates from a single OCP interface clock.

Table 7-276. ELM Clock Signals

Clock Signal	Max Freq	Reference / Source	Comments
Functional/interface clock	100 MHz	CORE_CLKOUTM4 / 2	pd_per_l4ls_gclk From PRCM

7.4.2.3 ELM Pin List

The ELM module does not include any external interface pins.

7.4.3 Functional Description

The ELM is designed around the error-location engine, which handles the computation based on the input syndrome polynomials.

The ELM maps the error-location engine to a standard interconnect interface by using a set of registers to control inputs and outputs.

7.4.3.1 ELM Software Reset

To perform a software reset, write a 1 to the ELM_SYSCONFIG[1] SOFTRESET bit. The ELM_SYSSTATUS[0] RESETDONE bit indicates that the software reset is complete when its value is 1. When the software reset completes, the ELM_SYSCONFIG[1] SOFTRESET bit is automatically reset.

7.4.3.2 ELM Power Management

[Table 7-277](#) describes the power-management features available to the ELM module.

Table 7-277. Local Power Management Features

Feature	Registers	Description
Clock autogating	ELM_SYSCONFIG[0] AUTOGATING bit	This bit allows a local power optimization inside the module by gating the ELM_FCLK clock upon the interface activity.
Slave idle modes	ELM_SYSCONFIG[4:3] SIDLEMODE bit field	Force-idle, No-idle, and Smart-idle modes are available.
Clock activity	ELM_SYSCONFIG[8] CLOCKACTIVITY bit	The clock can be switched-off or maintained during the wake-up period.
Master Standby modes	N/A	
Global Wake-up Enable	N/A	
Wake-up Sources Enable	N/A	

CAUTION

The PRCM module has no hardware means of reading CLOCKACTIVITY settings. Thus, software must ensure consistent programming between the ELM CLOCKACTIVITY and ELM clock PRCM control bits.

7.4.3.3 ELM Interrupt Requests

[Table 7-278](#) lists the event flags, and their masks, that can cause module interrupts.

Table 7-278. Events

Event Flag	Event Mask	Map to	Description
ELM_IRQSTATUS[8] PAGE_VALID	ELM_IRQENABLE[8] PAGE_MASK	ELM_IRQ	Page interrupt
ELM_IRQSTATUS[7] LOC_VALID_7	ELM_IRQENABLE[7] LOCATION_MASK_7	ELM_IRQ	Error-location interrupt for syndrome polynomial 7
ELM_IRQSTATUS[6] LOC_VALID_6	ELM_IRQENABLE[6] LOCATION_MASK_6	ELM_IRQ	Error-location interrupt for syndrome polynomial 6
ELM_IRQSTATUS[5] LOC_VALID_5	ELM_IRQENABLE[5] LOCATION_MASK_5	ELM_IRQ	Error-location interrupt for syndrome polynomial 5
ELM_IRQSTATUS[4] LOC_VALID_4	ELM_IRQENABLE[4] LOCATION_MASK_4	ELM_IRQ	Error-location interrupt for syndrome polynomial 4
ELM_IRQSTATUS[3] LOC_VALID_3	ELM_IRQENABLE[3] LOCATION_MASK_3	ELM_IRQ	Error-location interrupt for syndrome polynomial 3
ELM_IRQSTATUS[2] LOC_VALID_2	ELM_IRQENABLE[2] LOCATION_MASK_2	ELM_IRQ	Error-location interrupt for syndrome polynomial 2

Table 7-278. Events (continued)

Event Flag	Event Mask	Map to	Description
ELM_IRQSTATUS[1] LOC_VALID_1	ELM_IRQENABLE[1] LOCATION_MASK_1	ELM_IRQ	Error-location interrupt for syndrome polynomial 1
ELM_IRQSTATUS[0] LOC_VALID_0	ELM_IRQENABLE[0] LOCATION_MASK_0	ELM_IRQ	Error-location interrupt for syndrome polynomial 0

7.4.3.4 Processing Initialization

ELM_LOCATION_CONFIG global setting parameters must be set before using the error-location engine. The ELM_LOCATION_CONFIG[1:0] ECC_BCH_LEVEL bit defines the error-correction level used (4-, 8-, or 16-bit error-correction). The ELM_LOCATION_CONFIG[26:16] ECC_SIZE bit field defines the maximum buffer length beyond which the engine processing no longer looks for errors.

The CPU can choose to use the ELM in continuous mode or page mode. If all ELM_PAGE_CTRL[i] SECTOR_i bits are reset (i is the syndrome polynomial number, i = 0 to 7), continuous mode is used. In any other case, page mode is implicitly selected.

- Continuous mode: Each syndrome polynomial is processed independently – results for a syndrome can be retrieved and acknowledged at any time, whatever the status of the other seven processing contexts.
- Page mode: Syndrome polynomials are grouped into atomic entities – only one page can be processed at any given time, even if all eight contexts are not used for this page. Unused contexts are lost and cannot be affected to any other processing. The full page must be acknowledged and cleared before moving to the next page.

For completion interrupts to be generated correctly, all ELM_IRQENABLE[i] LOCATION_MASK_i bits (i = 0 to 7) must be forced to 0 when in page mode, and set to 1 in continuous mode. Additionally, the ELM_IRQENABLE[8] PAGE_MASK bit must be set to 1 when in page mode.

The CPU initiates error-location processing by writing a syndrome polynomial into one of the eight possible register sets. Each of these register sets includes seven registers: ELM_SYNDROME_FRAGMENT_0_i to ELM_SYNDROME_FRAGMENT_6_i. The first six registers can be written in any order, but ELM_SYNDROME_FRAGMENT_6_i must be written last because it includes the validity bit, which instructs the ELM that this syndrome polynomial must be processed (the ELM_SYNDROME_FRAGMENT_6_i[16] SYNDROME_VALID bit).

As soon as one validity bit is asserted (ELM_SYNDROME_FRAGMENT_6_i[16] SYNDROME_VALID = 0x1, with i = 0 to 7), error-location processing can start for the corresponding syndrome polynomial. The associated ELM_LOCATION_STATUS_i and ELM_ERROR_LOCATION_0_i to ELM_ERROR_LOCATION_15_i registers are not reset (i = 0 to 7). The software must not consider them until the corresponding ELM_IRQSTATUS[i] LOC_VALID_i bit is set.

7.4.3.5 Processing Sequence

While the error-location engine is busy processing one syndrome polynomial, further syndrome polynomials can be written. They are processed when the current processing completes.

The engine completes early when:

- No error is detected; that is, when the ELM_LOCATION_STATUS_i[8] ECC_CORRECTABLE bit is set to 1 and the ELM_LOCATION_STATUS_i[4:0] ECC_NB_ERRORS bit field is set to 0x0.
- Too many errors are detected; that is, when the ELM_LOCATION_STATUS_i[8] ECC_CORRECTABLE bit is set to 0 while the ELM_LOCATION_STATUS_i[4:0] ECC_NB_ERRORS bit field is set with the value output by the error-location engine. The reported number of errors is not ensured if ECC_CORRECTABLE is 0.

If the engine completes early, the associated error-location registers ELM_ERROR_LOCATION_0_i to ELM_ERROR_LOCATION_15_i are not updated (i = 0 to 7).

In all other cases, the engine goes through the entire error-location process. Each time an error-location is found, it is logged in the associated ECC_ERROR_LOCATION bit field. The first error detected is logged in the ELM_ERROR_LOCATION_0_i[12:0] ECC_ERROR_LOCATION bit field; the second in the ELM_ERROR_LOCATION_1_i[12:0] ECC_ERROR_LOCATION bit field, and so on.

Table 7-279. ELM_LOCATION_STATUS_i Value Decoding Table

ECC_CORRECTABLE Value	ECC_NB_ERRORS Value	Status	Number of Errors Detected	Action Required
1	0	OK	0	None
1	≠ 0	OK	ECC_NB_ERRORS	Correct the data buffer read based on the ELM_ERROR_LOCATION_0_i to ELM_ERROR_LOCATION_15_i results.
0	Any	Failed	Unknown	Software-dependant

7.4.3.6 Processing Completion

When the processing for a given syndrome polynomial completes, its ELM_SYNDROME_FRAGMENT_6_i[16] SYNDROME_VALID bit is reset. It must not be set again until the exit status registers, ELM_LOCATION_STATUS_i (i = 0 to 7), for this processing are checked. Failure to comply with this rule leads to potential loss of the first polynomial process data output.

The error-location engine signals the process completion to the ELM. When this event is detected, the corresponding ELM_IRQSTATUS[i] LOC_VALID_i bit is set (i = 0 to 7). The processing-exit status is available from the associated ELM_LOCATION_STATUS_i register, and error locations are stored in order in the ECC_ERROR_LOCATION fields. The software must only read valid error-location registers based on the number of errors detected and located.

Immediately after the error-location engine completes, a new syndrome polynomial can be processed, if any is available, as reported by the ELM_SYNDROME_FRAGMENT_6_i[16] SYNDROME_VALID validity bit, depending on the configured error-correction level. If several syndrome polynomials are available, a round-robin arbitration is used to select one for processing.

In continuous mode (that is, all bits in ELM_PAGE_CTRL are reset), an interrupt is triggered whenever a ELM_IRQSTATUS[i] LOC_VALID_i bit is asserted. The CPU must read the ELM_IRQSTATUS register to determine which polynomial is processed and retrieve the exit status and error locations (ELM_LOCATION_STATUS_i and ELM_ERROR_LOCATION_0_i to ELM_ERROR_LOCATION_15_i). When done, the CPU must clear the corresponding ELM_IRQSTATUS[i] LOC_VALID_i bit by writing it to 1. Other status bits must be written to 0 so that other interrupts are not unintentionally cleared. When using this mode, the ELM_IRQSTATUS[8] PAGE_VALID interrupt is never triggered.

In page mode, the module does not trigger interrupts for the processing completion of each polynomial because the ELM_IRQENABLE[i] LOCATION_MASK_i bits are cleared. A page is defined using the ELM_PAGE_CTRL register. Each SECTOR_i bit set means the corresponding polynomial i is part of the page processing. A page is fully processed when all tagged polynomials have been processed, as logged in the ELM_IRQSTATUS[i] LOC_VALID_i bit fields. The module triggers an ELM_IRQSTATUS[8] PAGE_VALID interrupt whenever it detects that the full page has been processed. To make sure the next page can be correctly processed, all status bits in the ELM_IRQSTATUS register must be cleared by using a single atomic-write access.

NOTE: Do not modify page setting parameters in the ELM_PAGE_CTRL register unless the engine is idle, no polynomial input is valid, and all interrupts have been cleared.

Because no polynomial-level interrupt is triggered in page mode, polynomials cleared in the ELM_PAGE_CTRL[i] SECTOR_i bit fields (i = 0 to 7) are processed as usual, but are essentially ignored. The CPU must manually poll the ELM_IRQSTATUS bits to check for their status.

7.4.4 Basic Programming Model

7.4.4.1 ELM Low Level Programming Model

7.4.4.1.1 Processing Initialization

Table 7-280. ELM Processing Initialization

Step	Register/ Bit Field / Programming Model	Value
Resets the module	ELM_SYSCONFIG[1] SOFTRESET	0x1
Wait until reset is done.	ELM_SYSSTATUS[0] RESETDONE	0x1
Configure the slave interface power management.	ELM_SYSCONFIG[4:3] SIDLEMODE	Set value
Defines the error-correction level used	ELM_LOCATION_CONFIG[1:0] ECC_BCH_LEVEL	Set value
Defines the maximum buffer length	ELM_LOCATION_CONFIG[26:16] ECC_SIZE	Set value
Sets the ELM in continuous mode or page mode	ELM_PAGE_CTRL	Set value
If continuous mode is used	All ELM_PAGE_CTRL[i] SECTOR_i (i = 0 to 7)	0x0
Enables interrupt for syndrome polynomial i	ELM_IRQENABLE[i] LOCATION_MASK_i	0x1
else (page mode is used)	One syndrome polynomial i is set ELM_PAGE_CTRL[i] SECTOR_i (i = 0 to 7)	0x1
Disable all interrupts for syndrome polynomial and enable PAGE_MASK interrupt.	All ELM_IRQENABLE[i] LOCATION_MASK_i = 0x0 and ELM_IRQENABLE[8] PAGE_MASK = 0x1	Set value
endif		Set value
Set the input syndrome polynomial i.	ELM_SYNDROME_FRAGMENT_0_i	Set value
	ELM_SYNDROME_FRAGMENT_1_i	Set value
	ELM_SYNDROME_FRAGMENT_5_i	Set value
	ELM_SYNDROME_FRAGMENT_6_i	Set value
Initiates the computation process	ELM_SYNDROME_FRAGMENT_6_i[16] SYNDROME_VALID	0x1

7.4.4.1.2 Read Results

The engine goes through the entire error-location process and results can be read. [Table 7-281](#) and [Table 7-282](#) describe the processing completion for continuous and page modes, respectively.

Table 7-281. ELM Processing Completion for Continuous Mode

Step	Register/ Bit Field / Programming Model	Value
Wait until process is complete for syndrome polynomial i: Wait until the ELM_IRQ interrupt is generated, or poll the status register.		
Read for which i the error-location process is complete.	ELM_IRQSTATUS[i] LOC_VALID_i	0x1
if the process fails (too many errors) It is software dependant.	ELM_LOCATION_STATUS_i[8] ECC_CORRECTABLE	0x0
else (process successful, the engine completes)	ELM_LOCATION_STATUS_i[8] ECC_CORRECTABLE	0x1
Read the number of errors.	ELM_LOCATION_STATUS_i[4:0] ECC_NB_ERRORS	
Read the error-location bit addresses for syndrome polynomial i of the ECC_NB_ERRORS first registers. It is the software responsibility to correct errors in the data buffer.	ELM_ERROR_LOCATION_0_i[12:0] ECC_ERROR_LOCATION	
	ELM_ERROR_LOCATION_1_i[12:0] ECC_ERROR_LOCATION	
	...	
	ELM_ERROR_LOCATION_15_i[12:0] ECC_ERROR_LOCATION	

Table 7-281. ELM Processing Completion for Continuous Mode (continued)

Step	Register/ Bit Field / Programming Model	Value
endif		
Clear the corresponding i interrupt.	ELM_IRQSTATUS[i] LOC_VALID_i	0x1

A new syndrome polynomial can be processed after the end of processing (ELM_SYNDROME_FRAGMENT_6_i[16] SYNDROME_VALID = 0x0) and after the exit status register check (ELM_LOCATION_STATUS_i).

Table 7-282. ELM Processing Completion for Page Mode

Step	Register/ Bit Field / Programming Model	Value
Wait until process is complete for syndrome polynomial i: Wait until the ELM_IRQ interrupt is generated, or poll the status register.		
Wait for page completed interrupt: All error locations are valid.	ELM_IRQSTATUS[8] PAGE_VALID	0x1
Repeat the following actions the necessary number of times. That is, once for each valid defined block in the page.		
Read the process exit status.	ELM_LOCATION_STATUS_i[8] ECC_CORRECTABLE	
if the process fails (too many errors)	ELM_LOCATION_STATUS_i[8] ECC_CORRECTABLE	0x0
It is software dependant.		
else (process successful, the engine completes)	ELM_LOCATION_STATUS_i[8] ECC_CORRECTABLE	0x1
Read the number of errors.	ELM_LOCATION_STATUS_i[4:0] ECC_NB_ERRORS	
Read the error-location bit addresses for syndrome polynomial i of the ECC_NB_ERRORS first registers.	ELM_ERROR_LOCATION_0_i[12:0] ECC_ERROR_LOCATION	
	ELM_ERROR_LOCATION_1_i[12:0] ECC_ERROR_LOCATION	
	...	
	ELM_ERROR_LOCATION_15_i[12:0] ECC_ERROR_LOCATION	
endif		
End Repeat		
Clear the ELM_IRQSTATUS register.	ELM_IRQSTATUS	0x1FF

Next page can be correctly processed after a page is fully processed, when all tagged polynomials have been processed (ELM_IRQSTATUS[i] LOC_VALID_i = 0x1 for all syndrome polynomials i used in the page).

7.4.4.2 Use Case: ELM Used in Continuous Mode

In this example, the ELM module is programmed for an 8-bit error-correction capability in continuous mode. After reading a 528-byte NAND flash sector (512B data plus 16B spare area) with a 16-bit interface, a non-zero polynomial syndrome is reported from the GPMC (Polynomial syndrome 0 is used in the ELM):

- P = 0x0A16ABE115E44F767BFB0D0980

Table 7-283. Use Case: Continuous Mode

Step	Register/ Bit Field / Programming Model	Value
Resets the module	ELM_SYSCONFIG[1] SOFTRESET	0x1
Wait until reset is done.	ELM_SYSSTATUS[0] RESETDONE	0x1
Configure the slave interface power management: Smart idle is used.	ELM_SYSCONFIG[4:3] SIDLEMODE	0x2

Table 7-283. Use Case: Continuous Mode (continued)

Step	Register/ Bit Field / Programming Model	Value
Defines the error-correction level used: 8 bits	ELM_LOCATION_CONFIG[1:0] ECC_BCH_LEVEL	0x1
Defines the maximum buffer length: 528 bytes (2x528 = 1056)	ELM_LOCATION_CONFIG[26:16] ECC_SIZE	0x420
Sets the ELM in continuous mode	ELM_PAGE_CTRL	0
Enables interrupt for syndrome polynomial 0	ELM_IRQENABLE[0] LOCATION_MASK_0	0x1
Set the input syndrome polynomial 0.	ELM_SYNDROME_FRAGMENT_0_i (i=0)	0xFB0D0980
	ELM_SYNDROME_FRAGMENT_1_i (i=0)	0xE44F767B
	ELM_SYNDROME_FRAGMENT_2_i (i=0)	0x16ABE115
	ELM_SYNDROME_FRAGMENT_3_i (i=0)	0x0000000A
Initiates the computation process	ELM_SYNDROME_FRAGMENT_6_i[16] SYNDROME_VALID (i=0)	0x1
Wait until process is complete for syndrome polynomial 0: IRQ_ELM is generated or poll the status register.		
Read that error-location process is complete for syndrome polynomial 0.	ELM_IRQSTATUS[0] LOC_VALID_0	0x1
Read the process exit status: All errors were successfully located.	ELM_LOCATION_STATUS_i[8] ECC_CORRECTABLE (i=0)	0x1
Read the number of errors: Four errors detected.	ELM_LOCATION_STATUS_i[4:0] ECC_NB_ERRORS (i=0)	0x4
Read the error-location bit addresses for syndrome polynomial 0 of the 4 first registers: Errors are located in the data buffer at decimal addresses 431, 1062, 1909, 3452.	ELM_ERROR_LOCATION_0_i (i=0)	0x1AF
	ELM_ERROR_LOCATION_1_i (i=0)	0x426
	ELM_ERROR_LOCATION_2_i (i=0)	0x775
	ELM_ERROR_LOCATION_3_i (i=0)	0xD7C
Clear the corresponding interrupt for polynomial 0.	ELM_IRQSTATUS[0] LOC_VALID_0	0x1

The NAND flash data in the sector are seen as a polynomial of degree 4223 (number of bits in a 528 byte buffer minus 1), with each data bit being a coefficient in the polynomial. When reading from a NAND flash using the GPMC module, computation of the polynomial syndrome assumes that the first NAND word read at address 0x0 contains the highest-order coefficient in the message. Furthermore, in the 16-bit NAND word, bits are ordered from bit 7 to bit 0, then from bit 15 to bit 8. Based on this convention, an address table of the data buffer can be built. NAND memory addresses in [Table 7-284](#) are given in decimal format.

Table 7-284. 16-bit NAND Sector Buffer Address Map

NAND Memory Address	Message bit addresses in the memory word															
	15	14	13	12	11	10	9	8	7	6	5	4	3	2	1	0
0	4215	4214	4213	4212	4211	4210	4209	4208	4223	4222	4221	4220	4219	4218	4217	4216
1	4175	4174	4173	4172	4171	4170	4169	4168	4183	4182	4181	4180	4179	4178	4177	4176
...																
47	3463	3462	3461	3460	3459	3458	3457	3456	3471	3470	3469	3468	3467	3466	3465	3464
48	3447	3446	3445	3444	3443	3442	3441	3440	3455	3454	3453	3452	3451	3450	3449	3448
49	3431	3430	3429	3428	3427	3426	3425	3424	3439	3438	3437	3436	3435	3434	3433	3432
50	3415	3414	3413	3412	3411	3410	3409	3408	3423	3422	3421	3420	3419	3418	3417	3416
...																
255	135	134	133	132	131	130	129	128	143	142	141	140	139	138	137	136
256	119	118	117	116	115	114	113	112	127	126	125	124	123	122	121	120
257	103	102	101	100	99	98	97	96	111	110	109	108	107	106	105	104
258	87	86	85	84	83	82	81	80	95	94	93	92	91	90	89	88
259	71	70	69	68	67	66	65	64	79	78	77	76	75	74	73	72
260	55	54	53	52	51	50	49	48	63	62	61	60	59	58	57	56
261	39	38	37	36	35	34	33	32	47	46	45	44	43	42	41	40
262	23	22	21	20	19	18	17	16	31	30	29	28	27	26	25	24
263	7	6	5	4	3	2	1	0	15	14	13	12	11	10	9	8

The table can now be used to determine which bits in the buffer were incorrect and must be flipped. In this example, the first bit to be flipped is bit 4 from the 49th byte read from memory. It is up to the processor to correctly map this word to the copied buffer and to flip this bit. The same process must be repeated for all detected errors.

7.4.4.3 Use Case: ELM Used in Page Mode

In this example, the ELM module is programmed for an 16-bit error-correction capability in page mode. After reading a 528-byte NAND flash sector (512B data plus 16B spare area) with a 16-bit interface, four non-zero polynomial syndromes are reported from the GPMC (Polynomial syndrome 0, 1, 2, and 3 are used in the ELM):

- P0 = 0xE8B0 12ADDB5A318E05BE B0693DB28330B5CC A329AA05E0B718EF
- P1 = 0xBAD0 49A0D932C22E6669 0948DF08BE093336 79C6BA10E5F935EB
- P2 = 0x69D9 B86ABCD5EC3697FA A6498FEE54556EA0 1579EF7D60BA3189
- P3 = 0x0

Table 7-285. Use Case: Page Mode

Step	Register/ Bit Field / Programming Model	Value
Resets the module	ELM_SYSCONFIG[1] SOFTRESET	0x1
Wait until reset is done.	ELM_SYSSTATUS[0] RESETDONE	0x1
Configure the slave interface power management: Smart idle is used.	ELM_SYSCONFIG[4:3] SIDLEMODE	0x2
Defines the error-correction level used: 16 bits	ELM_LOCATION_CONFIG[1:0] ECC_BCH_LEVEL	0x2
Defines the maximum buffer length: 528 bytes	ELM_LOCATION_CONFIG[26:16] ECC_SIZE	0x420
Sets the ELM in page mode (4 blocks in a page)	ELM_PAGE_CTRL[0] SECTOR_0	0x1
	ELM_PAGE_CTRL[1] SECTOR_1	0x1
	ELM_PAGE_CTRL[2] SECTOR_2	0x1
	ELM_PAGE_CTRL[3] SECTOR_3	0x1

Table 7-285. Use Case: Page Mode (continued)

Step	Register/ Bit Field / Programming Model	Value
Disable all interrupts for syndrome polynomial and enable PAGE_MASK interrupt.	ELM_IRQENABLE	0x100
Set the input syndrome polynomial 0.	ELM_SYNDROME_FRAGMENT_0_i (i=0)	0xE0B718EF
	ELM_SYNDROME_FRAGMENT_1_i (i=0)	0xA329AA05
	ELM_SYNDROME_FRAGMENT_2_i (i=0)	0x8330B5CC
	ELM_SYNDROME_FRAGMENT_3_i (i=0)	0xB0693DB2
	ELM_SYNDROME_FRAGMENT_4_i (i=0)	0x318E05BE
	ELM_SYNDROME_FRAGMENT_5_i (i=0)	0x12ADB5A
	ELM_SYNDROME_FRAGMENT_6_i (i=0)	0xE8B0
Set the input syndrome polynomial 1.	ELM_SYNDROME_FRAGMENT_0_i (i=1)	0xE5F935EB
	ELM_SYNDROME_FRAGMENT_1_i (i=1)	0x79C6BA10
	ELM_SYNDROME_FRAGMENT_2_i (i=1)	0xBE093336
	ELM_SYNDROME_FRAGMENT_3_i (i=1)	0x0948DF08
	ELM_SYNDROME_FRAGMENT_4_i (i=1)	0xC22E6669
	ELM_SYNDROME_FRAGMENT_5_i (i=1)	0x49A0D932
	ELM_SYNDROME_FRAGMENT_6_i (i=1)	0xBAD0
Set the input syndrome polynomial 2.	ELM_SYNDROME_FRAGMENT_0_i (i=2)	0x60BA3189
	ELM_SYNDROME_FRAGMENT_1_i (i=2)	0x1579EF7D
	ELM_SYNDROME_FRAGMENT_2_i (i=2)	0x54556EA0
	ELM_SYNDROME_FRAGMENT_3_i (i=2)	0xA6498FEE
	ELM_SYNDROME_FRAGMENT_4_i (i=2)	0xEC3697FA
	ELM_SYNDROME_FRAGMENT_5_i (i=2)	0xB86ABCD5
	ELM_SYNDROME_FRAGMENT_6_i (i=2)	0x69D9
Set the input syndrome polynomial 3.	ELM_SYNDROME_FRAGMENT_0_i (i=3)	0x0
	ELM_SYNDROME_FRAGMENT_1_i (i=3)	0x0
	ELM_SYNDROME_FRAGMENT_2_i (i=3)	0x0
	ELM_SYNDROME_FRAGMENT_3_i (i=3)	0x0
	ELM_SYNDROME_FRAGMENT_4_i (i=3)	0x0
	ELM_SYNDROME_FRAGMENT_5_i (i=3)	0x0
	ELM_SYNDROME_FRAGMENT_6_i (i=3)	0x0
Initiates the computation process for syndrome polynomial 0	ELM_SYNDROME_FRAGMENT_6_i[16] SYNDROME_VALID (i=0)	0x1
Initiates the computation process for syndrome polynomial 1	ELM_SYNDROME_FRAGMENT_6_i[16] SYNDROME_VALID (i=1)	0x1
Initiates the computation process for syndrome polynomial 2	ELM_SYNDROME_FRAGMENT_6_i[16] SYNDROME_VALID (i=2)	0x1
Initiates the computation process for syndrome polynomial 3	ELM_SYNDROME_FRAGMENT_6_i[16] SYNDROME_VALID (i=3)	0x1
Wait until process is complete for syndrome polynomial 0, 1, 2, and 3: Wait until the ELM_IRQ interrupt is generated or poll the status register.		
Wait for page completed interrupt: All error locations are valid.	ELM_IRQSTATUS[8] PAGE_VALID	0x1
Read the process exit status for syndrome polynomial 0: All errors were successfully located.	ELM_LOCATION_STATUS_i[8] ECC_CORRECTABLE (i=0)	0x1
Read the process exit status for syndrome polynomial 1: All errors were successfully located.	ELM_LOCATION_STATUS_i[8] ECC_CORRECTABLE (i=1)	0x1

Table 7-285. Use Case: Page Mode (continued)

Step	Register/ Bit Field / Programming Model	Value
Read the process exit status for syndrome polynomial 2: All errors were successfully located.	ELM_LOCATION_STATUS_i[8] ECC_CORRECTABLE (i=2)	0x1
Read the process exit status for syndrome polynomial 3: All errors were successfully located.	ELM_LOCATION_STATUS_i[8] ECC_CORRECTABLE (i=3)	0x1
Read the number of errors for syndrome polynomial 0: 4 errors detected.	ELM_LOCATION_STATUS_i[4:0] ECC_NB_ERRORS (i=0)	0x4
Read the number of errors for syndrome polynomial 1: 2 errors detected.	ELM_LOCATION_STATUS_i[4:0] ECC_NB_ERRORS (i=1)	0x2
Read the number of errors for syndrome polynomial 2: 1 error detected.	ELM_LOCATION_STATUS_i[4:0] ECC_NB_ERRORS (i=2)	0x1
Read the number of errors for syndrome polynomial 3: 0 errors detected.	ELM_LOCATION_STATUS_i[4:0] ECC_NB_ERRORS (i=3)	0x0
Read the error-location bit addresses for syndrome polynomial 0 of the 4 first registers:	ELM_ERROR_LOCATION_0_i (i=0)	0x1FE
	ELM_ERROR_LOCATION_1_i (i=0)	0x617
	ELM_ERROR_LOCATION_2_i (i=0)	0x650
	ELM_ERROR_LOCATION_3_i (i=0)	0xA83
Read the error-location bit addresses for syndrome polynomial 1 of the 2 first registers:	ELM_ERROR_LOCATION_0_i (i=1)	0x4
	ELM_ERROR_LOCATION_1_i (i=1)	0x1036
Read the errors location bit addresses for syndrome polynomial 2 of the first registers:	ELM_ERROR_LOCATION_0_i (i=1)	0x3E8
Clear the ELM_IRQSTATUS register.	ELM_IRQSTATUS	0x1FF

7.4.5 ELM Registers

Table 7-286 lists the memory-mapped registers for the ELM. All register offset addresses not listed in Table 7-286 should be considered as reserved locations and the register contents should not be modified.

Table 7-286. ELM Registers

Offset	Acronym	Register Name	Section
0h	ELM_REVISION	ELM Revision Register	Section 7.4.5.1
10h	ELM_SYSCONFIG	ELM System Configuration Register	Section 7.4.5.2
14h	ELM_SYSSTATUS	ELM System Status Register	Section 7.4.5.3
18h	ELM_IRQSTATUS	ELM Interrupt Status Register	Section 7.4.5.4
1Ch	ELM_IRQENABLE	ELM Interrupt Enable Register	Section 7.4.5.5
20h	ELM_LOCATION_CONFIG	ELM Location Configuration Register	Section 7.4.5.6
80h	ELM_PAGE_CTRL	ELM Page Definition Register	Section 7.4.5.7
400h	ELM_SYNDROME_FRAGMENT_0_0	ELM_SYNDROME_FRAGMENT_0_0 Register	Section 7.4.5.8
404h	ELM_SYNDROME_FRAGMENT_1_0	ELM_SYNDROME_FRAGMENT_1_0 Register	Section 7.4.5.9
408h	ELM_SYNDROME_FRAGMENT_2_0	ELM_SYNDROME_FRAGMENT_2_0 Register	Section 7.4.5.10
40Ch	ELM_SYNDROME_FRAGMENT_3_0	ELM_SYNDROME_FRAGMENT_3_0 Register	Section 7.4.5.11
410h	ELM_SYNDROME_FRAGMENT_4_0	ELM_SYNDROME_FRAGMENT_4_0 Register	Section 7.4.5.12
414h	ELM_SYNDROME_FRAGMENT_5_0	ELM_SYNDROME_FRAGMENT_5_0 Register	Section 7.4.5.13
418h	ELM_SYNDROME_FRAGMENT_6_0	ELM_SYNDROME_FRAGMENT_6_0 Register	Section 7.4.5.14
440h	ELM_SYNDROME_FRAGMENT_0_1	ELM_SYNDROME_FRAGMENT_0_1 Register	Section 7.4.5.15
444h	ELM_SYNDROME_FRAGMENT_1_1	ELM_SYNDROME_FRAGMENT_1_1 Register	Section 7.4.5.16
448h	ELM_SYNDROME_FRAGMENT_2_1	ELM_SYNDROME_FRAGMENT_2_1 Register	Section 7.4.5.17

Table 7-286. ELM Registers (continued)

Offset	Acronym	Register Name	Section
44Ch	ELM_SYNDROME_FRAGMENT_3_1	ELM_SYNDROME_FRAGMENT_3_1 Register	Section 7.4.5.18
450h	ELM_SYNDROME_FRAGMENT_4_1	ELM_SYNDROME_FRAGMENT_4_1 Register	Section 7.4.5.19
454h	ELM_SYNDROME_FRAGMENT_5_1	ELM_SYNDROME_FRAGMENT_5_1 Register	Section 7.4.5.20
458h	ELM_SYNDROME_FRAGMENT_6_1	ELM_SYNDROME_FRAGMENT_6_1 Register	Section 7.4.5.21
480h	ELM_SYNDROME_FRAGMENT_0_2	ELM_SYNDROME_FRAGMENT_0_2 Register	Section 7.4.5.22
484h	ELM_SYNDROME_FRAGMENT_1_2	ELM_SYNDROME_FRAGMENT_1_2 Register	Section 7.4.5.23
488h	ELM_SYNDROME_FRAGMENT_2_2	ELM_SYNDROME_FRAGMENT_2_2 Register	Section 7.4.5.24
48Ch	ELM_SYNDROME_FRAGMENT_3_2	ELM_SYNDROME_FRAGMENT_3_2 Register	Section 7.4.5.25
490h	ELM_SYNDROME_FRAGMENT_4_2	ELM_SYNDROME_FRAGMENT_4_2 Register	Section 7.4.5.26
494h	ELM_SYNDROME_FRAGMENT_5_2	ELM_SYNDROME_FRAGMENT_5_2 Register	Section 7.4.5.27
498h	ELM_SYNDROME_FRAGMENT_6_2	ELM_SYNDROME_FRAGMENT_6_2 Register	Section 7.4.5.28
4C0h	ELM_SYNDROME_FRAGMENT_0_3	ELM_SYNDROME_FRAGMENT_0_3 Register	Section 7.4.5.29
4C4h	ELM_SYNDROME_FRAGMENT_1_3	ELM_SYNDROME_FRAGMENT_1_3 Register	Section 7.4.5.30
4C8h	ELM_SYNDROME_FRAGMENT_2_3	ELM_SYNDROME_FRAGMENT_2_3 Register	Section 7.4.5.31
4CCh	ELM_SYNDROME_FRAGMENT_3_3	ELM_SYNDROME_FRAGMENT_3_3 Register	Section 7.4.5.32
4D0h	ELM_SYNDROME_FRAGMENT_4_3	ELM_SYNDROME_FRAGMENT_4_3 Register	Section 7.4.5.33
4D4h	ELM_SYNDROME_FRAGMENT_5_3	ELM_SYNDROME_FRAGMENT_5_3 Register	Section 7.4.5.34
4D8h	ELM_SYNDROME_FRAGMENT_6_3	ELM_SYNDROME_FRAGMENT_6_3 Register	Section 7.4.5.35
500h	ELM_SYNDROME_FRAGMENT_0_4	ELM_SYNDROME_FRAGMENT_0_4 Register	Section 7.4.5.36
504h	ELM_SYNDROME_FRAGMENT_1_4	ELM_SYNDROME_FRAGMENT_1_4 Register	Section 7.4.5.37
508h	ELM_SYNDROME_FRAGMENT_2_4	ELM_SYNDROME_FRAGMENT_2_4 Register	Section 7.4.5.38
50Ch	ELM_SYNDROME_FRAGMENT_3_4	ELM_SYNDROME_FRAGMENT_3_4 Register	Section 7.4.5.39
510h	ELM_SYNDROME_FRAGMENT_4_4	ELM_SYNDROME_FRAGMENT_4_4 Register	Section 7.4.5.40
514h	ELM_SYNDROME_FRAGMENT_5_4	ELM_SYNDROME_FRAGMENT_5_4 Register	Section 7.4.5.41
518h	ELM_SYNDROME_FRAGMENT_6_4	ELM_SYNDROME_FRAGMENT_6_4 Register	Section 7.4.5.42
540h	ELM_SYNDROME_FRAGMENT_0_5	ELM_SYNDROME_FRAGMENT_0_5 Register	Section 7.4.5.43
544h	ELM_SYNDROME_FRAGMENT_1_5	ELM_SYNDROME_FRAGMENT_1_5 Register	Section 7.4.5.44
548h	ELM_SYNDROME_FRAGMENT_2_5	ELM_SYNDROME_FRAGMENT_2_5 Register	Section 7.4.5.45
54Ch	ELM_SYNDROME_FRAGMENT_3_5	ELM_SYNDROME_FRAGMENT_3_5 Register	Section 7.4.5.46
550h	ELM_SYNDROME_FRAGMENT_4_5	ELM_SYNDROME_FRAGMENT_4_5 Register	Section 7.4.5.47
554h	ELM_SYNDROME_FRAGMENT_5_5	ELM_SYNDROME_FRAGMENT_5_5 Register	Section 7.4.5.48
558h	ELM_SYNDROME_FRAGMENT_6_5	ELM_SYNDROME_FRAGMENT_6_5 Register	Section 7.4.5.49
580h	ELM_SYNDROME_FRAGMENT_0_6	ELM_SYNDROME_FRAGMENT_0_6 Register	Section 7.4.5.50
584h	ELM_SYNDROME_FRAGMENT_1_6	ELM_SYNDROME_FRAGMENT_1_6 Register	Section 7.4.5.51
588h	ELM_SYNDROME_FRAGMENT_2_6	ELM_SYNDROME_FRAGMENT_2_6 Register	Section 7.4.5.52
58Ch	ELM_SYNDROME_FRAGMENT_3_6	ELM_SYNDROME_FRAGMENT_3_6 Register	Section 7.4.5.53
590h	ELM_SYNDROME_FRAGMENT_4_6	ELM_SYNDROME_FRAGMENT_4_6 Register	Section 7.4.5.54
594h	ELM_SYNDROME_FRAGMENT_5_6	ELM_SYNDROME_FRAGMENT_5_6 Register	Section 7.4.5.55
598h	ELM_SYNDROME_FRAGMENT_6_6	ELM_SYNDROME_FRAGMENT_6_6 Register	Section 7.4.5.56
5C0h	ELM_SYNDROME_FRAGMENT_0_7	ELM_SYNDROME_FRAGMENT_0_7 Register	Section 7.4.5.57
5C4h	ELM_SYNDROME_FRAGMENT_1_7	ELM_SYNDROME_FRAGMENT_1_7 Register	Section 7.4.5.58
5C8h	ELM_SYNDROME_FRAGMENT_2_7	ELM_SYNDROME_FRAGMENT_2_7 Register	Section 7.4.5.59
5CCh	ELM_SYNDROME_FRAGMENT_3_7	ELM_SYNDROME_FRAGMENT_3_7 Register	Section 7.4.5.60
5D0h	ELM_SYNDROME_FRAGMENT_4_7	ELM_SYNDROME_FRAGMENT_4_7 Register	Section 7.4.5.61
5D4h	ELM_SYNDROME_FRAGMENT_5_7	ELM_SYNDROME_FRAGMENT_5_7 Register	Section 7.4.5.62
5D8h	ELM_SYNDROME_FRAGMENT_6_7	ELM_SYNDROME_FRAGMENT_6_7 Register	Section 7.4.5.63
800h	ELM_LOCATION_STATUS_0	ELM_LOCATION_STATUS_0 Register	Section 7.4.5.64

Table 7-286. ELM Registers (continued)

Offset	Acronym	Register Name	Section
880h	ELM_ERROR_LOCATION_0_0	ELM_ERROR_LOCATION_0_0 Register	Section 7.4.5.65
884h	ELM_ERROR_LOCATION_1_0	ELM_ERROR_LOCATION_1_0 Register	Section 7.4.5.66
888h	ELM_ERROR_LOCATION_2_0	ELM_ERROR_LOCATION_2_0 Register	Section 7.4.5.67
88Ch	ELM_ERROR_LOCATION_3_0	ELM_ERROR_LOCATION_3_0 Register	Section 7.4.5.68
890h	ELM_ERROR_LOCATION_4_0	ELM_ERROR_LOCATION_4_0 Register	Section 7.4.5.69
894h	ELM_ERROR_LOCATION_5_0	ELM_ERROR_LOCATION_5_0 Register	Section 7.4.5.70
898h	ELM_ERROR_LOCATION_6_0	ELM_ERROR_LOCATION_6_0 Register	Section 7.4.5.71
89Ch	ELM_ERROR_LOCATION_7_0	ELM_ERROR_LOCATION_7_0 Register	Section 7.4.5.72
8A0h	ELM_ERROR_LOCATION_8_0	ELM_ERROR_LOCATION_8_0 Register	Section 7.4.5.73
8A4h	ELM_ERROR_LOCATION_9_0	ELM_ERROR_LOCATION_9_0 Register	Section 7.4.5.74
8A8h	ELM_ERROR_LOCATION_10_0	ELM_ERROR_LOCATION_10_0 Register	Section 7.4.5.75
8ACh	ELM_ERROR_LOCATION_11_0	ELM_ERROR_LOCATION_11_0 Register	Section 7.4.5.76
8B0h	ELM_ERROR_LOCATION_12_0	ELM_ERROR_LOCATION_12_0 Register	Section 7.4.5.77
8B4h	ELM_ERROR_LOCATION_13_0	ELM_ERROR_LOCATION_13_0 Register	Section 7.4.5.78
8B8h	ELM_ERROR_LOCATION_14_0	ELM_ERROR_LOCATION_14_0 Register	Section 7.4.5.79
8BCh	ELM_ERROR_LOCATION_15_0	ELM_ERROR_LOCATION_15_0 Register	Section 7.4.5.80
900h	ELM_LOCATION_STATUS_1	ELM_LOCATION_STATUS_1 Register	Section 7.4.5.81
980h	ELM_ERROR_LOCATION_0_1	ELM_ERROR_LOCATION_0_1 Register	Section 7.4.5.82
984h	ELM_ERROR_LOCATION_1_1	ELM_ERROR_LOCATION_1_1 Register	Section 7.4.5.83
988h	ELM_ERROR_LOCATION_2_1	ELM_ERROR_LOCATION_2_1 Register	Section 7.4.5.84
98Ch	ELM_ERROR_LOCATION_3_1	ELM_ERROR_LOCATION_3_1 Register	Section 7.4.5.85
990h	ELM_ERROR_LOCATION_4_1	ELM_ERROR_LOCATION_4_1 Register	Section 7.4.5.86
994h	ELM_ERROR_LOCATION_5_1	ELM_ERROR_LOCATION_5_1 Register	Section 7.4.5.87
998h	ELM_ERROR_LOCATION_6_1	ELM_ERROR_LOCATION_6_1 Register	Section 7.4.5.88
99Ch	ELM_ERROR_LOCATION_7_1	ELM_ERROR_LOCATION_7_1 Register	Section 7.4.5.89
9A0h	ELM_ERROR_LOCATION_8_1	ELM_ERROR_LOCATION_8_1 Register	Section 7.4.5.90
9A4h	ELM_ERROR_LOCATION_9_1	ELM_ERROR_LOCATION_9_1 Register	Section 7.4.5.91
9A8h	ELM_ERROR_LOCATION_10_1	ELM_ERROR_LOCATION_10_1 Register	Section 7.4.5.92
9ACh	ELM_ERROR_LOCATION_11_1	ELM_ERROR_LOCATION_11_1 Register	Section 7.4.5.93
9B0h	ELM_ERROR_LOCATION_12_1	ELM_ERROR_LOCATION_12_1 Register	Section 7.4.5.94
9B4h	ELM_ERROR_LOCATION_13_1	ELM_ERROR_LOCATION_13_1 Register	Section 7.4.5.95
9B8h	ELM_ERROR_LOCATION_14_1	ELM_ERROR_LOCATION_14_1 Register	Section 7.4.5.96
9BCh	ELM_ERROR_LOCATION_15_1	ELM_ERROR_LOCATION_15_1 Register	Section 7.4.5.97
A00h	ELM_LOCATION_STATUS_2	ELM_LOCATION_STATUS_2 Register	Section 7.4.5.98
A80h	ELM_ERROR_LOCATION_0_2	ELM_ERROR_LOCATION_0_2 Register	Section 7.4.5.99
A84h	ELM_ERROR_LOCATION_1_2	ELM_ERROR_LOCATION_1_2 Register	Section 7.4.5.100
A88h	ELM_ERROR_LOCATION_2_2	ELM_ERROR_LOCATION_2_2 Register	Section 7.4.5.101
A8Ch	ELM_ERROR_LOCATION_3_2	ELM_ERROR_LOCATION_3_2 Register	Section 7.4.5.102
A90h	ELM_ERROR_LOCATION_4_2	ELM_ERROR_LOCATION_4_2 Register	Section 7.4.5.103
A94h	ELM_ERROR_LOCATION_5_2	ELM_ERROR_LOCATION_5_2 Register	Section 7.4.5.104
A98h	ELM_ERROR_LOCATION_6_2	ELM_ERROR_LOCATION_6_2 Register	Section 7.4.5.105
A9Ch	ELM_ERROR_LOCATION_7_2	ELM_ERROR_LOCATION_7_2 Register	Section 7.4.5.106
AA0h	ELM_ERROR_LOCATION_8_2	ELM_ERROR_LOCATION_8_2 Register	Section 7.4.5.107
AA4h	ELM_ERROR_LOCATION_9_2	ELM_ERROR_LOCATION_9_2 Register	Section 7.4.5.108
AA8h	ELM_ERROR_LOCATION_10_2	ELM_ERROR_LOCATION_10_2 Register	Section 7.4.5.109
AACH	ELM_ERROR_LOCATION_11_2	ELM_ERROR_LOCATION_11_2 Register	Section 7.4.5.110
AB0h	ELM_ERROR_LOCATION_12_2	ELM_ERROR_LOCATION_12_2 Register	Section 7.4.5.111

Table 7-286. ELM Registers (continued)

Offset	Acronym	Register Name	Section
AB4h	ELM_ERROR_LOCATION_13_2	ELM_ERROR_LOCATION_13_2 Register	Section 7.4.5.112
AB8h	ELM_ERROR_LOCATION_14_2	ELM_ERROR_LOCATION_14_2 Register	Section 7.4.5.113
ABCh	ELM_ERROR_LOCATION_15_2	ELM_ERROR_LOCATION_15_2 Register	Section 7.4.5.114
B80h	ELM_ERROR_LOCATION_0_3	ELM_ERROR_LOCATION_0_3 Register	Section 7.4.5.115
B84h	ELM_ERROR_LOCATION_1_3	ELM_ERROR_LOCATION_1_3 Register	Section 7.4.5.116
B88h	ELM_ERROR_LOCATION_2_3	ELM_ERROR_LOCATION_2_3 Register	Section 7.4.5.117
B8Ch	ELM_ERROR_LOCATION_3_3	ELM_ERROR_LOCATION_3_3 Register	Section 7.4.5.118
B90h	ELM_ERROR_LOCATION_4_3	ELM_ERROR_LOCATION_4_3 Register	Section 7.4.5.119
B94h	ELM_ERROR_LOCATION_5_3	ELM_ERROR_LOCATION_5_3 Register	Section 7.4.5.120
B98h	ELM_ERROR_LOCATION_6_3	ELM_ERROR_LOCATION_6_3 Register	Section 7.4.5.121
B9Ch	ELM_ERROR_LOCATION_7_3	ELM_ERROR_LOCATION_7_3 Register	Section 7.4.5.122
BA0h	ELM_ERROR_LOCATION_8_3	ELM_ERROR_LOCATION_8_3 Register	Section 7.4.5.123
BA4h	ELM_ERROR_LOCATION_9_3	ELM_ERROR_LOCATION_9_3 Register	Section 7.4.5.124
BA8h	ELM_ERROR_LOCATION_10_3	ELM_ERROR_LOCATION_10_3 Register	Section 7.4.5.125
BACh	ELM_ERROR_LOCATION_11_3	ELM_ERROR_LOCATION_11_3 Register	Section 7.4.5.126
BB0h	ELM_ERROR_LOCATION_12_3	ELM_ERROR_LOCATION_12_3 Register	Section 7.4.5.127
BB4h	ELM_ERROR_LOCATION_13_3	ELM_ERROR_LOCATION_13_3 Register	Section 7.4.5.128
BB8h	ELM_ERROR_LOCATION_14_3	ELM_ERROR_LOCATION_14_3 Register	Section 7.4.5.129
BBCh	ELM_ERROR_LOCATION_15_3	ELM_ERROR_LOCATION_15_3 Register	Section 7.4.5.130
B00h	ELM_LOCATION_STATUS_3	ELM_LOCATION_STATUS_3 Register	Section 7.4.5.131
C80h	ELM_ERROR_LOCATION_0_4	ELM_ERROR_LOCATION_0_4 Register	Section 7.4.5.132
C84h	ELM_ERROR_LOCATION_1_4	ELM_ERROR_LOCATION_1_4 Register	Section 7.4.5.133
C88h	ELM_ERROR_LOCATION_2_4	ELM_ERROR_LOCATION_2_4 Register	Section 7.4.5.134
C8Ch	ELM_ERROR_LOCATION_3_4	ELM_ERROR_LOCATION_3_4 Register	Section 7.4.5.135
C90h	ELM_ERROR_LOCATION_4_4	ELM_ERROR_LOCATION_4_4 Register	Section 7.4.5.136
C94h	ELM_ERROR_LOCATION_5_4	ELM_ERROR_LOCATION_5_4 Register	Section 7.4.5.137
C98h	ELM_ERROR_LOCATION_6_4	ELM_ERROR_LOCATION_6_4 Register	Section 7.4.5.138
C9Ch	ELM_ERROR_LOCATION_7_4	ELM_ERROR_LOCATION_7_4 Register	Section 7.4.5.139
CA0h	ELM_ERROR_LOCATION_8_4	ELM_ERROR_LOCATION_8_4 Register	Section 7.4.5.140
CA4h	ELM_ERROR_LOCATION_9_4	ELM_ERROR_LOCATION_9_4 Register	Section 7.4.5.141
CA8h	ELM_ERROR_LOCATION_10_4	ELM_ERROR_LOCATION_10_4 Register	Section 7.4.5.142
CACh	ELM_ERROR_LOCATION_11_4	ELM_ERROR_LOCATION_11_4 Register	Section 7.4.5.143
CB0h	ELM_ERROR_LOCATION_12_4	ELM_ERROR_LOCATION_12_4 Register	Section 7.4.5.144
CB4h	ELM_ERROR_LOCATION_13_4	ELM_ERROR_LOCATION_13_4 Register	Section 7.4.5.145
CB8h	ELM_ERROR_LOCATION_14_4	ELM_ERROR_LOCATION_14_4 Register	Section 7.4.5.146
CBCh	ELM_ERROR_LOCATION_15_4	ELM_ERROR_LOCATION_15_4 Register	Section 7.4.5.147
D80h	ELM_ERROR_LOCATION_0_5	ELM_ERROR_LOCATION_0_5 Register	Section 7.4.5.148
D84h	ELM_ERROR_LOCATION_1_5	ELM_ERROR_LOCATION_1_5 Register	Section 7.4.5.149
D88h	ELM_ERROR_LOCATION_2_5	ELM_ERROR_LOCATION_2_5 Register	Section 7.4.5.150
D8Ch	ELM_ERROR_LOCATION_3_5	ELM_ERROR_LOCATION_3_5 Register	Section 7.4.5.151
D90h	ELM_ERROR_LOCATION_4_5	ELM_ERROR_LOCATION_4_5 Register	Section 7.4.5.152
D94h	ELM_ERROR_LOCATION_5_5	ELM_ERROR_LOCATION_5_5 Register	Section 7.4.5.153
D98h	ELM_ERROR_LOCATION_6_5	ELM_ERROR_LOCATION_6_5 Register	Section 7.4.5.154
D9Ch	ELM_ERROR_LOCATION_7_5	ELM_ERROR_LOCATION_7_5 Register	Section 7.4.5.155
DA0h	ELM_ERROR_LOCATION_8_5	ELM_ERROR_LOCATION_8_5 Register	Section 7.4.5.156
DA4h	ELM_ERROR_LOCATION_9_5	ELM_ERROR_LOCATION_9_5 Register	Section 7.4.5.157
DA8h	ELM_ERROR_LOCATION_10_5	ELM_ERROR_LOCATION_10_5 Register	Section 7.4.5.158

Table 7-286. ELM Registers (continued)

Offset	Acronym	Register Name	Section
DACh	ELM_ERROR_LOCATION_11_5	ELM_ERROR_LOCATION_11_5 Register	Section 7.4.5.159
DB0h	ELM_ERROR_LOCATION_12_5	ELM_ERROR_LOCATION_12_5 Register	Section 7.4.5.160
DB4h	ELM_ERROR_LOCATION_13_5	ELM_ERROR_LOCATION_13_5 Register	Section 7.4.5.161
DB8h	ELM_ERROR_LOCATION_14_5	ELM_ERROR_LOCATION_14_5 Register	Section 7.4.5.162
DBCh	ELM_ERROR_LOCATION_15_5	ELM_ERROR_LOCATION_15_5 Register	Section 7.4.5.163
C00h	ELM_LOCATION_STATUS_4	ELM_LOCATION_STATUS_4 Register	Section 7.4.5.164
E80h	ELM_ERROR_LOCATION_0_6	ELM_ERROR_LOCATION_0_6 Register	Section 7.4.5.165
E84h	ELM_ERROR_LOCATION_1_6	ELM_ERROR_LOCATION_1_6 Register	Section 7.4.5.166
E88h	ELM_ERROR_LOCATION_2_6	ELM_ERROR_LOCATION_2_6 Register	Section 7.4.5.167
E8Ch	ELM_ERROR_LOCATION_3_6	ELM_ERROR_LOCATION_3_6 Register	Section 7.4.5.168
E90h	ELM_ERROR_LOCATION_4_6	ELM_ERROR_LOCATION_4_6 Register	Section 7.4.5.169
E94h	ELM_ERROR_LOCATION_5_6	ELM_ERROR_LOCATION_5_6 Register	Section 7.4.5.170
E98h	ELM_ERROR_LOCATION_6_6	ELM_ERROR_LOCATION_6_6 Register	Section 7.4.5.171
E9Ch	ELM_ERROR_LOCATION_7_6	ELM_ERROR_LOCATION_7_6 Register	Section 7.4.5.172
EA0h	ELM_ERROR_LOCATION_8_6	ELM_ERROR_LOCATION_8_6 Register	Section 7.4.5.173
EA4h	ELM_ERROR_LOCATION_9_6	ELM_ERROR_LOCATION_9_6 Register	Section 7.4.5.174
EA8h	ELM_ERROR_LOCATION_10_6	ELM_ERROR_LOCATION_10_6 Register	Section 7.4.5.175
EACh	ELM_ERROR_LOCATION_11_6	ELM_ERROR_LOCATION_11_6 Register	Section 7.4.5.176
EB0h	ELM_ERROR_LOCATION_12_6	ELM_ERROR_LOCATION_12_6 Register	Section 7.4.5.177
EB4h	ELM_ERROR_LOCATION_13_6	ELM_ERROR_LOCATION_13_6 Register	Section 7.4.5.178
EB8h	ELM_ERROR_LOCATION_14_6	ELM_ERROR_LOCATION_14_6 Register	Section 7.4.5.179
EBCh	ELM_ERROR_LOCATION_15_6	ELM_ERROR_LOCATION_15_6 Register	Section 7.4.5.180
F80h	ELM_ERROR_LOCATION_0_7	ELM_ERROR_LOCATION_0_7 Register	Section 7.4.5.181
F84h	ELM_ERROR_LOCATION_1_7	ELM_ERROR_LOCATION_1_7 Register	Section 7.4.5.182
F88h	ELM_ERROR_LOCATION_2_7	ELM_ERROR_LOCATION_2_7 Register	Section 7.4.5.183
F8Ch	ELM_ERROR_LOCATION_3_7	ELM_ERROR_LOCATION_3_7 Register	Section 7.4.5.184
F90h	ELM_ERROR_LOCATION_4_7	ELM_ERROR_LOCATION_4_7 Register	Section 7.4.5.185
F94h	ELM_ERROR_LOCATION_5_7	ELM_ERROR_LOCATION_5_7 Register	Section 7.4.5.186
F98h	ELM_ERROR_LOCATION_6_7	ELM_ERROR_LOCATION_6_7 Register	Section 7.4.5.187
F9Ch	ELM_ERROR_LOCATION_7_7	ELM_ERROR_LOCATION_7_7 Register	Section 7.4.5.188
FA0h	ELM_ERROR_LOCATION_8_7	ELM_ERROR_LOCATION_8_7 Register	Section 7.4.5.189
FA4h	ELM_ERROR_LOCATION_9_7	ELM_ERROR_LOCATION_9_7 Register	Section 7.4.5.190
FA8h	ELM_ERROR_LOCATION_10_7	ELM_ERROR_LOCATION_10_7 Register	Section 7.4.5.191
FACh	ELM_ERROR_LOCATION_11_7	ELM_ERROR_LOCATION_11_7 Register	Section 7.4.5.192
FB0h	ELM_ERROR_LOCATION_12_7	ELM_ERROR_LOCATION_12_7 Register	Section 7.4.5.193
FB4h	ELM_ERROR_LOCATION_13_7	ELM_ERROR_LOCATION_13_7 Register	Section 7.4.5.194
FB8h	ELM_ERROR_LOCATION_14_7	ELM_ERROR_LOCATION_14_7 Register	Section 7.4.5.195
FBCh	ELM_ERROR_LOCATION_15_7	ELM_ERROR_LOCATION_15_7 Register	Section 7.4.5.196
D00h	ELM_LOCATION_STATUS_5	ELM_LOCATION_STATUS_5 Register	Section 7.4.5.197
E00h	ELM_LOCATION_STATUS_6	ELM_LOCATION_STATUS_6 Register	Section 7.4.5.198
F00h	ELM_LOCATION_STATUS_7	ELM_LOCATION_STATUS_7 Register	Section 7.4.5.199

7.4.5.1 ELM_REVISION Register (offset = 0h) [reset = 0h]

ELM_REVISION is shown in [Figure 7-256](#) and described in [Table 7-287](#).

This register contains the IP revision code.

Figure 7-256. ELM_REVISION Register

31	30	29	28	27	26	25	24	23	22	21	20	19	18	17	16	15	14	13	12	11	10	9	8	7	6	5	4	3	2	1	0
REVISION																															
R-0h																															

LEGEND: R/W = Read/Write; R = Read only; W1toCl = Write 1 to clear bit; -n = value after reset

Table 7-287. ELM_REVISION Register Field Descriptions

Bit	Field	Type	Reset	Description
31-0	REVISION	R	0h	IP Revision, value 0 to FFFF FFFFh.

7.4.5.2 ELM_SYSCONFIG Register (offset = 10h) [reset = 11h]

ELM_SYSCONFIG is shown in [Figure 7-257](#) and described in [Table 7-288](#).

This register allows controlling various parameters of the OCP interface.

Figure 7-257. ELM_SYSCONFIG Register

31	30	29	28	27	26	25	24
RESERVED							
R-0h							
23	22	21	20	19	18	17	16
RESERVED							
R-0h							
15	14	13	12	11	10	9	8
RESERVED							CLOCKACTIVITYOCPz
R-0h							R/W-0h
7	6	5	4	3	2	1	0
RESERVED			SIDLEMODE		RESERVED	SOFTRESET	AUTOGATING
R-0h			R/W-2h		R-0h	R/W-0h	R/W-1h

LEGEND: R/W = Read/Write; R = Read only; W1toCl = Write 1 to clear bit; -n = value after reset

Table 7-288. ELM_SYSCONFIG Register Field Descriptions

Bit	Field	Type	Reset	Description
31-9	RESERVED	R	0h	
8	CLOCKACTIVITYOCPz	R/W	0h	OCP Clock activity when module is in IDLE mode (during wake up mode period). 0h = OCP Clock can be switch-off 1h = OCP Clock is maintained during wake up period
7-5	RESERVED	R	0h	
4-3	SIDLEMODE	R/W	2h	Slave interface power management (IDLE req/ack control). 0h = FORCE Idle. IDLE request is acknowledged unconditionally and immediately. (Default Dumb mode for safety) 1h = NO idle. IDLE request is never acknowledged. 2h = SMART Idle. The acknowledgment to an IDLE request is given based on the internal activity. 3h = Reserved - do not use
2	RESERVED	R	0h	
1	SOFTRESET	R/W	0h	Module software reset. This bit is automatically reset by hardware (During reads, it always returns 0.). It has same effect as the OCP hardware reset. 0h = Normal mode. 1h = Start soft reset sequence.
0	AUTOGATING	R/W	1h	Internal OCP clock gating strategy. (No module visible impact other than saving power.) 0h = OCP clock is free-running. 1h = Automatic internal OCP clock gating strategy is applied based on the OCP interface activity.

7.4.5.3 ELM_SYSSTATUS Register (offset = 14h) [reset = 0h]

ELM_SYSSTATUS is shown in [Figure 7-258](#) and described in [Table 7-289](#).

Figure 7-258. ELM_SYSSTATUS Register

31	30	29	28	27	26	25	24
RESERVED							
R-0h							
23	22	21	20	19	18	17	16
RESERVED							
R-0h							
15	14	13	12	11	10	9	8
RESERVED							
R-0h							
7	6	5	4	3	2	1	0
RESERVED							RESETDONE
R-0h							R-0h

LEGEND: R/W = Read/Write; R = Read only; W1toCl = Write 1 to clear bit; -n = value after reset

Table 7-289. ELM_SYSSTATUS Register Field Descriptions

Bit	Field	Type	Reset	Description
31-1	RESERVED	R	0h	
0	RESETDONE	R	0h	Internal reset monitoring (OCP domain). Undefined since: From hardware perspective, the reset state is 0. From software user perspective, when the accessible module is 1. 0h = Reset is on-going 1h = Reset is done (completed)

7.4.5.4 ELM_IRQSTATUS Register (offset = 18h) [reset = 0h]

ELM_IRQSTATUS is shown in [Figure 7-259](#) and described in [Table 7-290](#).

This register doubles as a status register for the error-location processes.

Figure 7-259. ELM_IRQSTATUS Register

31	30	29	28	27	26	25	24
RESERVED							
R-0h							
23	22	21	20	19	18	17	16
RESERVED							
R-0h							
15	14	13	12	11	10	9	8
RESERVED							PAGE_VALID
R-0h							R/W-0h
7	6	5	4	3	2	1	0
LOC_VALID_7	LOC_VALID_6	LOC_VALID_5	LOC_VALID_4	LOC_VALID_3	LOC_VALID_2	LOC_VALID_1	LOC_VALID_0
R/W-0h	R/W-0h	R/W-0h	R/W-0h	R/W-0h	R/W-0h	R/W-0h	R/W-0h

LEGEND: R/W = Read/Write; R = Read only; W1toCl = Write 1 to clear bit; -n = value after reset

Table 7-290. ELM_IRQSTATUS Register Field Descriptions

Bit	Field	Type	Reset	Description
31-9	RESERVED	R	0h	
8	PAGE_VALID	R/W	0h	Error-location status for a full page, based on the mask definition. 0h (W) = Write: No effect. 0h (R) = Read: Error locations invalid for all polynomials enabled in the ECC_INTERRUPT_MASK register. 1h (W) = Write: Clear interrupt. 1h (R) = Read: All error locations valid.
7	LOC_VALID_7	R/W	0h	Error-location status for syndrome polynomial 7. 0h (W) = Write: No effect. 0h (R) = Read: No syndrome processed or process in progress. 1h (W) = Write: Clear interrupt. 1h (R) = Read: Error-location process completed.
6	LOC_VALID_6	R/W	0h	Error-location status for syndrome polynomial 6. 0h (W) = Write: No effect. 0h (R) = Read: No syndrome processed or process in progress. 1h (W) = Write: Clear interrupt. 1h (R) = Read: Error-location process completed.
5	LOC_VALID_5	R/W	0h	Error-location status for syndrome polynomial 5. 0h (W) = Write: No effect. 0h (R) = Read: No syndrome processed or process in progress. 1h (W) = Write: Clear interrupt. 1h (R) = Read: Error-location process completed.
4	LOC_VALID_4	R/W	0h	Error-location status for syndrome polynomial 4. 0h (W) = Write: No effect. 0h (R) = Read: No syndrome processed or process in progress. 1h (W) = Write: Clear interrupt. 1h (R) = Read: Error-location process completed.

Table 7-290. ELM_IRQSTATUS Register Field Descriptions (continued)

Bit	Field	Type	Reset	Description
3	LOC_VALID_3	R/W	0h	Error-location status for syndrome polynomial 3. 0h (W) = Write: No effect. 0h (R) = Read: No syndrome processed or process in progress. 1h (W) = Write: Clear interrupt. 1h (R) = Read: Error-location process completed.
2	LOC_VALID_2	R/W	0h	Error-location status for syndrome polynomial 2. 0h (W) = Write: No effect. 0h (R) = Read: No syndrome processed or process in progress. 1h (W) = Write: Clear interrupt. 1h (R) = Read: Error-location process completed.
1	LOC_VALID_1	R/W	0h	Error-location status for syndrome polynomial 1. 0h (W) = Write: No effect. 0h (R) = Read: No syndrome processed or process in progress. 1h (W) = Write: Clear interrupt. 1h (R) = Read: Error-location process completed.
0	LOC_VALID_0	R/W	0h	Error-location status for syndrome polynomial 0. 0h (W) = No effect. 0h (R) = No syndrome processed or process in progress. 1h (W) = Clear interrupt. 1h (R) = Error-location process completed.

7.4.5.5 ELM_IRQENABLE Register (offset = 1Ch) [reset = 0h]

ELM_IRQENABLE is shown in [Figure 7-260](#) and described in [Table 7-291](#).

Figure 7-260. ELM_IRQENABLE Register

31	30	29	28	27	26	25	24
RESERVED							
R-0h							
23	22	21	20	19	18	17	16
RESERVED							
R-0h							
15	14	13	12	11	10	9	8
RESERVED							PAGE_MASK
R-0h							R/W-0h
7	6	5	4	3	2	1	0
LOCATION_M ASK_7	LOCATION_M ASK_6	LOCATION_M ASK_5	LOCATION_M ASK_4	LOCATION_M ASK_3	LOCATION_M ASK_2	LOCATION_M ASK_1	LOCATION_M ASK_0
R/W-0h	R/W-0h	R/W-0h	R/W-0h	R/W-0h	R/W-0h	R/W-0h	R/W-0h

LEGEND: R/W = Read/Write; R = Read only; W1toCl = Write 1 to clear bit; -n = value after reset

Table 7-291. ELM_IRQENABLE Register Field Descriptions

Bit	Field	Type	Reset	Description
31-9	RESERVED	R	0h	
8	PAGE_MASK	R/W	0h	Page interrupt mask bit 0h = Disable interrupt. 1h = Enable interrupt.
7	LOCATION_MASK_7	R/W	0h	Error-location interrupt mask bit for syndrome polynomial 7. 0h = Disable interrupt. 1h = Enable interrupt.
6	LOCATION_MASK_6	R/W	0h	Error-location interrupt mask bit for syndrome polynomial 6. 0h = Disable interrupt. 1h = Enable interrupt.
5	LOCATION_MASK_5	R/W	0h	Error-location interrupt mask bit for syndrome polynomial 5. 0h = Disable interrupt. 1h = Enable interrupt.
4	LOCATION_MASK_4	R/W	0h	Error-location interrupt mask bit for syndrome polynomial 4. 0h = Disable interrupt. 1h = Enable interrupt.
3	LOCATION_MASK_3	R/W	0h	Error-location interrupt mask bit for syndrome polynomial 3. 0h = Disable interrupt. 1h = Enable interrupt.
2	LOCATION_MASK_2	R/W	0h	Error-location interrupt mask bit for syndrome polynomial 2. 0h = Disable interrupt. 1h = Enable interrupt.
1	LOCATION_MASK_1	R/W	0h	Error-location interrupt mask bit for syndrome polynomial 1. 0h = Disable interrupt. 1h = Enable interrupt.
0	LOCATION_MASK_0	R/W	0h	Error-location interrupt mask bit for syndrome polynomial 0. 0h = Disable interrupt. 1h = Enable interrupt.

7.4.5.6 ELM_LOCATION_CONFIG Register (offset = 20h) [reset = 0h]

ELM_LOCATION_CONFIG is shown in [Figure 7-261](#) and described in [Table 7-292](#).

Figure 7-261. ELM_LOCATION_CONFIG Register

31	30	29	28	27	26	25	24
RESERVED					ECC_SIZE		
R-0h					R/W-0h		
23	22	21	20	19	18	17	16
ECC_SIZE					R/W-0h		
15	14	13	12	11	10	9	8
RESERVED							
R-0h							
7	6	5	4	3	2	1	0
RESERVED					ECC_BCH_LEVEL		
R-0h					R/W-0h		

LEGEND: R/W = Read/Write; R = Read only; W1toCl = Write 1 to clear bit; -n = value after reset

Table 7-292. ELM_LOCATION_CONFIG Register Field Descriptions

Bit	Field	Type	Reset	Description
31-27	RESERVED	R	0h	
26-16	ECC_SIZE	R/W	0h	Maximum size of the buffers for which the error-location engine is used, in number of nibbles (4 bits entities), value 0 to 7FFh.
15-2	RESERVED	R	0h	
1-0	ECC_BCH_LEVEL	R/W	0h	Error correction level. 0h = 4 bits. 1h = 8 bits. 2h = 16 bits. 3h = Reserved.

7.4.5.7 ELM_PAGE_CTRL Register (offset = 80h) [reset = 0h]

 ELM_PAGE_CTRL is shown in [Figure 7-262](#) and described in [Table 7-293](#).

Figure 7-262. ELM_PAGE_CTRL Register

31	30	29	28	27	26	25	24
RESERVED							
R-0h							
23	22	21	20	19	18	17	16
RESERVED							
R-0h							
15	14	13	12	11	10	9	8
RESERVED							
R-0h							
7	6	5	4	3	2	1	0
SECTOR_7	SECTOR_6	SECTOR_5	SECTOR_4	SECTOR_3	SECTOR_2	SECTOR_1	SECTOR_0
R/W-0h	R/W-0h	R/W-0h	R/W-0h	R/W-0h	R/W-0h	R/W-0h	R/W-0h

LEGEND: R/W = Read/Write; R = Read only; W1toCl = Write 1 to clear bit; -n = value after reset

Table 7-293. ELM_PAGE_CTRL Register Field Descriptions

Bit	Field	Type	Reset	Description
31-8	RESERVED	R	0h	
7	SECTOR_7	R/W	0h	Set to 1 if syndrome polynomial 7 is part of the page in page mode. Must be 0 in continuous mode.
6	SECTOR_6	R/W	0h	Set to 1 if syndrome polynomial 6 is part of the page in page mode. Must be 0 in continuous mode.
5	SECTOR_5	R/W	0h	Set to 1 if syndrome polynomial 5 is part of the page in page mode. Must be 0 in continuous mode.
4	SECTOR_4	R/W	0h	Set to 1 if syndrome polynomial 4 is part of the page in page mode. Must be 0 in continuous mode.
3	SECTOR_3	R/W	0h	Set to 1 if syndrome polynomial 3 is part of the page in page mode. Must be 0 in continuous mode.
2	SECTOR_2	R/W	0h	Set to 1 if syndrome polynomial 2 is part of the page in page mode. Must be 0 in continuous mode.
1	SECTOR_1	R/W	0h	Set to 1 if syndrome polynomial 1 is part of the page in page mode. Must be 0 in continuous mode.
0	SECTOR_0	R/W	0h	Set to 1 if syndrome polynomial 0 is part of the page in page mode. Must be 0 in continuous mode.

7.4.5.8 ELM_SYNDROME_FRAGMENT_0_0 Register (offset = 400h) [reset = 0h]

ELM_SYNDROME_FRAGMENT_0_0 is shown in [Figure 7-263](#) and described in [Table 7-294](#).

Figure 7-263. ELM_SYNDROME_FRAGMENT_0_0 Register

31	30	29	28	27	26	25	24	23	22	21	20	19	18	17	16	15	14	13	12	11	10	9	8	7	6	5	4	3	2	1	0
SYNDROME_0																															
R/W-0h																															

LEGEND: R/W = Read/Write; R = Read only; W1toCl = Write 1 to clear bit; -n = value after reset

Table 7-294. ELM_SYNDROME_FRAGMENT_0_0 Register Field Descriptions

Bit	Field	Type	Reset	Description
31-0	SYNDROME_0	R/W	0h	Syndrome bits 0 to 31, value 0 to FFFF FFFFh.

7.4.5.9 ELM_SYNDROME_FRAGMENT_1_0 Register (offset = 404h) [reset = 0h]

ELM_SYNDROME_FRAGMENT_1_0 is shown in [Figure 7-264](#) and described in [Table 7-295](#).

Figure 7-264. ELM_SYNDROME_FRAGMENT_1_0 Register

31	30	29	28	27	26	25	24	23	22	21	20	19	18	17	16	15	14	13	12	11	10	9	8	7	6	5	4	3	2	1	0
SYNDROME_1																															
R/W-0h																															

LEGEND: R/W = Read/Write; R = Read only; W1toCl = Write 1 to clear bit; -n = value after reset

Table 7-295. ELM_SYNDROME_FRAGMENT_1_0 Register Field Descriptions

Bit	Field	Type	Reset	Description
31-0	SYNDROME_1	R/W	0h	Syndrome bits 32 to 63, value 0 to FFFF FFFFh.

7.4.5.10 ELM_SYNDROME_FRAGMENT_2_0 Register (offset = 408h) [reset = 0h]

 ELM_SYNDROME_FRAGMENT_2_0 is shown in [Figure 7-265](#) and described in [Table 7-296](#).

Figure 7-265. ELM_SYNDROME_FRAGMENT_2_0 Register

31	30	29	28	27	26	25	24	23	22	21	20	19	18	17	16	15	14	13	12	11	10	9	8	7	6	5	4	3	2	1	0
SYNDROME_2																															
R/W-0h																															

LEGEND: R/W = Read/Write; R = Read only; W1toCl = Write 1 to clear bit; -n = value after reset

Table 7-296. ELM_SYNDROME_FRAGMENT_2_0 Register Field Descriptions

Bit	Field	Type	Reset	Description
31-0	SYNDROME_2	R/W	0h	Syndrome bits 64 to 95, value 0 to FFFF FFFFh.

7.4.5.11 ELM_SYNDROME_FRAGMENT_3_0 Register (offset = 40Ch) [reset = 0h]

ELM_SYNDROME_FRAGMENT_3_0 is shown in [Figure 7-266](#) and described in [Table 7-297](#).

Figure 7-266. ELM_SYNDROME_FRAGMENT_3_0 Register

31	30	29	28	27	26	25	24	23	22	21	20	19	18	17	16	15	14	13	12	11	10	9	8	7	6	5	4	3	2	1	0
SYNDROME_3																															
R/W-0h																															

LEGEND: R/W = Read/Write; R = Read only; W1toCl = Write 1 to clear bit; -n = value after reset

Table 7-297. ELM_SYNDROME_FRAGMENT_3_0 Register Field Descriptions

Bit	Field	Type	Reset	Description
31-0	SYNDROME_3	R/W	0h	Syndrome bits 96 to 127, value 0 to FFFF FFFFh.

7.4.5.12 ELM_SYNDROME_FRAGMENT_4_0 Register (offset = 410h) [reset = 0h]

ELM_SYNDROME_FRAGMENT_4_0 is shown in [Figure 7-267](#) and described in [Table 7-298](#).

Figure 7-267. ELM_SYNDROME_FRAGMENT_4_0 Register

31	30	29	28	27	26	25	24	23	22	21	20	19	18	17	16	15	14	13	12	11	10	9	8	7	6	5	4	3	2	1	0
SYNDROME_4																															
R/W-0h																															

LEGEND: R/W = Read/Write; R = Read only; W1toCl = Write 1 to clear bit; -n = value after reset

Table 7-298. ELM_SYNDROME_FRAGMENT_4_0 Register Field Descriptions

Bit	Field	Type	Reset	Description
31-0	SYNDROME_4	R/W	0h	Syndrome bits 128 to 159, value 0 to FFFF FFFFh.

7.4.5.13 ELM_SYNDROME_FRAGMENT_5_0 Register (offset = 414h) [reset = 0h]

ELM_SYNDROME_FRAGMENT_5_0 is shown in [Figure 7-268](#) and described in [Table 7-299](#).

Figure 7-268. ELM_SYNDROME_FRAGMENT_5_0 Register

31	30	29	28	27	26	25	24	23	22	21	20	19	18	17	16	15	14	13	12	11	10	9	8	7	6	5	4	3	2	1	0
SYNDROME_5																															
R/W-0h																															

LEGEND: R/W = Read/Write; R = Read only; W1toCl = Write 1 to clear bit; -n = value after reset

Table 7-299. ELM_SYNDROME_FRAGMENT_5_0 Register Field Descriptions

Bit	Field	Type	Reset	Description
31-0	SYNDROME_5	R/W	0h	Syndrome bits 160 to 191, value 0 to FFFF FFFFh.

7.4.5.14 ELM_SYNDROME_FRAGMENT_6_0 Register (offset = 418h) [reset = 0h]

ELM_SYNDROME_FRAGMENT_6_0 is shown in [Figure 7-269](#) and described in [Table 7-300](#).

Figure 7-269. ELM_SYNDROME_FRAGMENT_6_0 Register

31	30	29	28	27	26	25	24
RESERVED							
R-0h							
23	22	21	20	19	18	17	16
RESERVED							SYNDROME_VALID
R-0h							R/W-0h
15	14	13	12	11	10	9	8
SYNDROME_6							
R/W-0h							
7	6	5	4	3	2	1	0
SYNDROME_6							
R/W-0h							

LEGEND: R/W = Read/Write; R = Read only; W1toCl = Write 1 to clear bit; -n = value after reset

Table 7-300. ELM_SYNDROME_FRAGMENT_6_0 Register Field Descriptions

Bit	Field	Type	Reset	Description
31-17	RESERVED	R	0h	
16	SYNDROME_VALID	R/W	0h	Syndrome valid bit. 0h = This syndrome polynomial should not be processed. 1h = This syndrome polynomial must be processed.
15-0	SYNDROME_6	R/W	0h	Syndrome bits 192 to 207, value 0 to FFFFh.

7.4.5.15 ELM_SYNDROME_FRAGMENT_0_1 Register (offset = 440h) [reset = 0h]

 ELM_SYNDROME_FRAGMENT_0_1 is shown in [Figure 7-270](#) and described in [Table 7-301](#).

Figure 7-270. ELM_SYNDROME_FRAGMENT_0_1 Register

31	30	29	28	27	26	25	24	23	22	21	20	19	18	17	16	15	14	13	12	11	10	9	8	7	6	5	4	3	2	1	0
SYNDROME_0																															
R/W-0h																															

LEGEND: R/W = Read/Write; R = Read only; W1toCl = Write 1 to clear bit; -n = value after reset

Table 7-301. ELM_SYNDROME_FRAGMENT_0_1 Register Field Descriptions

Bit	Field	Type	Reset	Description
31-0	SYNDROME_0	R/W	0h	Syndrome bits 0 to 31, value 0 to FFFF FFFFh.

7.4.5.16 ELM_SYNDROME_FRAGMENT_1_1 Register (offset = 444h) [reset = 0h]

ELM_SYNDROME_FRAGMENT_1_1 is shown in [Figure 7-271](#) and described in [Table 7-302](#).

Figure 7-271. ELM_SYNDROME_FRAGMENT_1_1 Register

31	30	29	28	27	26	25	24	23	22	21	20	19	18	17	16	15	14	13	12	11	10	9	8	7	6	5	4	3	2	1	0
SYNDROME_1																															
R/W-0h																															

LEGEND: R/W = Read/Write; R = Read only; W1toCl = Write 1 to clear bit; -n = value after reset

Table 7-302. ELM_SYNDROME_FRAGMENT_1_1 Register Field Descriptions

Bit	Field	Type	Reset	Description
31-0	SYNDROME_1	R/W	0h	Syndrome bits 32 to 63, value 0 to FFFF FFFFh.

7.4.5.17 ELM_SYNDROME_FRAGMENT_2_1 Register (offset = 448h) [reset = 0h]

 ELM_SYNDROME_FRAGMENT_2_1 is shown in [Figure 7-272](#) and described in [Table 7-303](#).

Figure 7-272. ELM_SYNDROME_FRAGMENT_2_1 Register

31	30	29	28	27	26	25	24	23	22	21	20	19	18	17	16	15	14	13	12	11	10	9	8	7	6	5	4	3	2	1	0
SYNDROME_2																															
R/W-0h																															

LEGEND: R/W = Read/Write; R = Read only; W1toCl = Write 1 to clear bit; -n = value after reset

Table 7-303. ELM_SYNDROME_FRAGMENT_2_1 Register Field Descriptions

Bit	Field	Type	Reset	Description
31-0	SYNDROME_2	R/W	0h	Syndrome bits 64 to 95, value 0 to FFFF FFFFh.

7.4.5.18 ELM_SYNDROME_FRAGMENT_3_1 Register (offset = 44Ch) [reset = 0h]

 ELM_SYNDROME_FRAGMENT_3_1 is shown in [Figure 7-273](#) and described in [Table 7-304](#).

Figure 7-273. ELM_SYNDROME_FRAGMENT_3_1 Register

31	30	29	28	27	26	25	24	23	22	21	20	19	18	17	16	15	14	13	12	11	10	9	8	7	6	5	4	3	2	1	0
SYNDROME_3																															
R/W-0h																															

LEGEND: R/W = Read/Write; R = Read only; W1toCl = Write 1 to clear bit; -n = value after reset

Table 7-304. ELM_SYNDROME_FRAGMENT_3_1 Register Field Descriptions

Bit	Field	Type	Reset	Description
31-0	SYNDROME_3	R/W	0h	Syndrome bits 96 to 127, value 0 to FFFF FFFFh.

7.4.5.19 ELM_SYNDROME_FRAGMENT_4_1 Register (offset = 450h) [reset = 0h]

 ELM_SYNDROME_FRAGMENT_4_1 is shown in [Figure 7-274](#) and described in [Table 7-305](#).

Figure 7-274. ELM_SYNDROME_FRAGMENT_4_1 Register

31	30	29	28	27	26	25	24	23	22	21	20	19	18	17	16	15	14	13	12	11	10	9	8	7	6	5	4	3	2	1	0
SYNDROME_4																															
R/W-0h																															

LEGEND: R/W = Read/Write; R = Read only; W1toCl = Write 1 to clear bit; -n = value after reset

Table 7-305. ELM_SYNDROME_FRAGMENT_4_1 Register Field Descriptions

Bit	Field	Type	Reset	Description
31-0	SYNDROME_4	R/W	0h	Syndrome bits 128 to 159, value 0 to FFFF FFFFh.

7.4.5.20 ELM_SYNDROME_FRAGMENT_5_1 Register (offset = 454h) [reset = 0h]

ELM_SYNDROME_FRAGMENT_5_1 is shown in [Figure 7-275](#) and described in [Table 7-306](#).

Figure 7-275. ELM_SYNDROME_FRAGMENT_5_1 Register

31	30	29	28	27	26	25	24	23	22	21	20	19	18	17	16	15	14	13	12	11	10	9	8	7	6	5	4	3	2	1	0
SYNDROME_5																															
R/W-0h																															

LEGEND: R/W = Read/Write; R = Read only; W1toCl = Write 1 to clear bit; -n = value after reset

Table 7-306. ELM_SYNDROME_FRAGMENT_5_1 Register Field Descriptions

Bit	Field	Type	Reset	Description
31-0	SYNDROME_5	R/W	0h	Syndrome bits 160 to 191, value 0 to FFFF FFFFh.

7.4.5.21 ELM_SYNDROME_FRAGMENT_6_1 Register (offset = 458h) [reset = 0h]

ELM_SYNDROME_FRAGMENT_6_1 is shown in [Figure 7-276](#) and described in [Table 7-307](#).

Figure 7-276. ELM_SYNDROME_FRAGMENT_6_1 Register

31	30	29	28	27	26	25	24
RESERVED							
R-0h							
23	22	21	20	19	18	17	16
RESERVED							SYNDROME_VALID
R-0h							R/W-0h
15	14	13	12	11	10	9	8
SYNDROME_6							
R/W-0h							
7	6	5	4	3	2	1	0
SYNDROME_6							
R/W-0h							

LEGEND: R/W = Read/Write; R = Read only; W1toCl = Write 1 to clear bit; -n = value after reset

Table 7-307. ELM_SYNDROME_FRAGMENT_6_1 Register Field Descriptions

Bit	Field	Type	Reset	Description
31-17	RESERVED	R	0h	
16	SYNDROME_VALID	R/W	0h	Syndrome valid bit. 0h = This syndrome polynomial should not be processed. 1h = This syndrome polynomial must be processed.
15-0	SYNDROME_6	R/W	0h	Syndrome bits 192 to 207, value 0 to FFFFh.

7.4.5.22 ELM_SYNDROME_FRAGMENT_0_2 Register (offset = 480h) [reset = 0h]

ELM_SYNDROME_FRAGMENT_0_2 is shown in [Figure 7-277](#) and described in [Table 7-308](#).

Figure 7-277. ELM_SYNDROME_FRAGMENT_0_2 Register

31	30	29	28	27	26	25	24	23	22	21	20	19	18	17	16	15	14	13	12	11	10	9	8	7	6	5	4	3	2	1	0
SYNDROME_0																															
R/W-0h																															

LEGEND: R/W = Read/Write; R = Read only; W1toCl = Write 1 to clear bit; -n = value after reset

Table 7-308. ELM_SYNDROME_FRAGMENT_0_2 Register Field Descriptions

Bit	Field	Type	Reset	Description
31-0	SYNDROME_0	R/W	0h	Syndrom bits 0 to 31, value 0 to FFFF FFFFh.

7.4.5.23 ELM_SYNDROME_FRAGMENT_1_2 Register (offset = 484h) [reset = 0h]

ELM_SYNDROME_FRAGMENT_1_2 is shown in [Figure 7-278](#) and described in [Table 7-309](#).

Figure 7-278. ELM_SYNDROME_FRAGMENT_1_2 Register

31	30	29	28	27	26	25	24	23	22	21	20	19	18	17	16	15	14	13	12	11	10	9	8	7	6	5	4	3	2	1	0
SYNDROME_1																															
R/W-0h																															

LEGEND: R/W = Read/Write; R = Read only; W1toCl = Write 1 to clear bit; -n = value after reset

Table 7-309. ELM_SYNDROME_FRAGMENT_1_2 Register Field Descriptions

Bit	Field	Type	Reset	Description
31-0	SYNDROME_1	R/W	0h	Syndrome bits 32 to 63, value 0 to FFFF FFFFh.

7.4.5.24 ELM_SYNDROME_FRAGMENT_2_2 Register (offset = 488h) [reset = 0h]

ELM_SYNDROME_FRAGMENT_2_2 is shown in [Figure 7-279](#) and described in [Table 7-310](#).

Figure 7-279. ELM_SYNDROME_FRAGMENT_2_2 Register

31	30	29	28	27	26	25	24	23	22	21	20	19	18	17	16	15	14	13	12	11	10	9	8	7	6	5	4	3	2	1	0
SYNDROME_2																															
R/W-0h																															

LEGEND: R/W = Read/Write; R = Read only; W1toCl = Write 1 to clear bit; -n = value after reset

Table 7-310. ELM_SYNDROME_FRAGMENT_2_2 Register Field Descriptions

Bit	Field	Type	Reset	Description
31-0	SYNDROME_2	R/W	0h	Syndrome bits 64 to 95, value 0 to FFFF FFFFh.

7.4.5.25 ELM_SYNDROME_FRAGMENT_3_2 Register (offset = 48Ch) [reset = 0h]

ELM_SYNDROME_FRAGMENT_3_2 is shown in [Figure 7-280](#) and described in [Table 7-311](#).

Figure 7-280. ELM_SYNDROME_FRAGMENT_3_2 Register

31	30	29	28	27	26	25	24	23	22	21	20	19	18	17	16	15	14	13	12	11	10	9	8	7	6	5	4	3	2	1	0
SYNDROME_3																															
R/W-0h																															

LEGEND: R/W = Read/Write; R = Read only; W1toCl = Write 1 to clear bit; -n = value after reset

Table 7-311. ELM_SYNDROME_FRAGMENT_3_2 Register Field Descriptions

Bit	Field	Type	Reset	Description
31-0	SYNDROME_3	R/W	0h	Syndrome bits 96 to 127, value 0 to FFFF FFFFh.

7.4.5.26 ELM_SYNDROME_FRAGMENT_4_2 Register (offset = 490h) [reset = 0h]

ELM_SYNDROME_FRAGMENT_4_2 is shown in [Figure 7-281](#) and described in [Table 7-312](#).

Figure 7-281. ELM_SYNDROME_FRAGMENT_4_2 Register

31	30	29	28	27	26	25	24	23	22	21	20	19	18	17	16	15	14	13	12	11	10	9	8	7	6	5	4	3	2	1	0
SYNDROME_4																															
R/W-0h																															

LEGEND: R/W = Read/Write; R = Read only; W1toCl = Write 1 to clear bit; -n = value after reset

Table 7-312. ELM_SYNDROME_FRAGMENT_4_2 Register Field Descriptions

Bit	Field	Type	Reset	Description
31-0	SYNDROME_4	R/W	0h	Syndrome bits 128 to 159, value 0 to FFFF FFFFh.

7.4.5.27 ELM_SYNDROME_FRAGMENT_5_2 Register (offset = 494h) [reset = 0h]

 ELM_SYNDROME_FRAGMENT_5_2 is shown in [Figure 7-282](#) and described in [Table 7-313](#).

Figure 7-282. ELM_SYNDROME_FRAGMENT_5_2 Register

31	30	29	28	27	26	25	24	23	22	21	20	19	18	17	16	15	14	13	12	11	10	9	8	7	6	5	4	3	2	1	0
SYNDROME_5																															
R/W-0h																															

LEGEND: R/W = Read/Write; R = Read only; W1toCl = Write 1 to clear bit; -n = value after reset

Table 7-313. ELM_SYNDROME_FRAGMENT_5_2 Register Field Descriptions

Bit	Field	Type	Reset	Description
31-0	SYNDROME_5	R/W	0h	Syndrome bits 160 to 191, value 0 to FFFF FFFFh.

7.4.5.28 ELM_SYNDROME_FRAGMENT_6_2 Register (offset = 498h) [reset = 0h]

 ELM_SYNDROME_FRAGMENT_6_2 is shown in [Figure 7-283](#) and described in [Table 7-314](#).

Figure 7-283. ELM_SYNDROME_FRAGMENT_6_2 Register

31	30	29	28	27	26	25	24
RESERVED							
R-0h							
23	22	21	20	19	18	17	16
RESERVED							SYNDROME_VALID
R-0h							R/W-0h
15	14	13	12	11	10	9	8
SYNDROME_6							
R/W-0h							
7	6	5	4	3	2	1	0
SYNDROME_6							
R/W-0h							

LEGEND: R/W = Read/Write; R = Read only; W1toCl = Write 1 to clear bit; -n = value after reset

Table 7-314. ELM_SYNDROME_FRAGMENT_6_2 Register Field Descriptions

Bit	Field	Type	Reset	Description
31-17	RESERVED	R	0h	
16	SYNDROME_VALID	R/W	0h	Syndrome valid bit. 0h = This syndrome polynomial should not be processed. 1h = This syndrome polynomial must be processed.
15-0	SYNDROME_6	R/W	0h	Syndrome bits 192 to 207, value 0 to FFFFh.

7.4.5.29 ELM_SYNDROME_FRAGMENT_0_3 Register (offset = 4C0h) [reset = 0h]

ELM_SYNDROME_FRAGMENT_0_3 is shown in [Figure 7-284](#) and described in [Table 7-315](#).

Figure 7-284. ELM_SYNDROME_FRAGMENT_0_3 Register

31	30	29	28	27	26	25	24	23	22	21	20	19	18	17	16	15	14	13	12	11	10	9	8	7	6	5	4	3	2	1	0
SYNDROME_0																															
R/W-0h																															

LEGEND: R/W = Read/Write; R = Read only; W1toCl = Write 1 to clear bit; -n = value after reset

Table 7-315. ELM_SYNDROME_FRAGMENT_0_3 Register Field Descriptions

Bit	Field	Type	Reset	Description
31-0	SYNDROME_0	R/W	0h	Syndrome bits 0 to 31, value 0 to FFFF FFFFh.

7.4.5.30 ELM_SYNDROME_FRAGMENT_1_3 Register (offset = 4C4h) [reset = 0h]

ELM_SYNDROME_FRAGMENT_1_3 is shown in [Figure 7-285](#) and described in [Table 7-316](#).

Figure 7-285. ELM_SYNDROME_FRAGMENT_1_3 Register

31	30	29	28	27	26	25	24	23	22	21	20	19	18	17	16	15	14	13	12	11	10	9	8	7	6	5	4	3	2	1	0
SYNDROME_1																															
R/W-0h																															

LEGEND: R/W = Read/Write; R = Read only; W1toCl = Write 1 to clear bit; -n = value after reset

Table 7-316. ELM_SYNDROME_FRAGMENT_1_3 Register Field Descriptions

Bit	Field	Type	Reset	Description
31-0	SYNDROME_1	R/W	0h	Syndrome bits 32 to 63, value 0 to FFFF FFFFh.

7.4.5.31 ELM_SYNDROME_FRAGMENT_2_3 Register (offset = 4C8h) [reset = 0h]

 ELM_SYNDROME_FRAGMENT_2_3 is shown in [Figure 7-286](#) and described in [Table 7-317](#).

Figure 7-286. ELM_SYNDROME_FRAGMENT_2_3 Register

31	30	29	28	27	26	25	24	23	22	21	20	19	18	17	16	15	14	13	12	11	10	9	8	7	6	5	4	3	2	1	0
SYNDROME_2																															
R/W-0h																															

LEGEND: R/W = Read/Write; R = Read only; W1toCl = Write 1 to clear bit; -n = value after reset

Table 7-317. ELM_SYNDROME_FRAGMENT_2_3 Register Field Descriptions

Bit	Field	Type	Reset	Description
31-0	SYNDROME_2	R/W	0h	Syndrome bits 64 to 95, value 0 to FFFF FFFFh.

7.4.5.32 ELM_SYNDROME_FRAGMENT_3_3 Register (offset = 4CCh) [reset = 0h]

 ELM_SYNDROME_FRAGMENT_3_3 is shown in [Figure 7-287](#) and described in [Table 7-318](#).

Figure 7-287. ELM_SYNDROME_FRAGMENT_3_3 Register

31	30	29	28	27	26	25	24	23	22	21	20	19	18	17	16	15	14	13	12	11	10	9	8	7	6	5	4	3	2	1	0
SYNDROME_3																															
R/W-0h																															

LEGEND: R/W = Read/Write; R = Read only; W1toCl = Write 1 to clear bit; -n = value after reset

Table 7-318. ELM_SYNDROME_FRAGMENT_3_3 Register Field Descriptions

Bit	Field	Type	Reset	Description
31-0	SYNDROME_3	R/W	0h	Syndrome bits 96 to 127, value 0 to FFFF FFFFh.

7.4.5.33 ELM_SYNDROME_FRAGMENT_4_3 Register (offset = 4D0h) [reset = 0h]

ELM_SYNDROME_FRAGMENT_4_3 is shown in [Figure 7-288](#) and described in [Table 7-319](#).

Figure 7-288. ELM_SYNDROME_FRAGMENT_4_3 Register

31	30	29	28	27	26	25	24	23	22	21	20	19	18	17	16	15	14	13	12	11	10	9	8	7	6	5	4	3	2	1	0
SYNDROME_4																															
R/W-0h																															

LEGEND: R/W = Read/Write; R = Read only; W1toCl = Write 1 to clear bit; -n = value after reset

Table 7-319. ELM_SYNDROME_FRAGMENT_4_3 Register Field Descriptions

Bit	Field	Type	Reset	Description
31-0	SYNDROME_4	R/W	0h	Syndrome bits 128 to 159, value 0 to FFFF FFFFh.

7.4.5.34 ELM_SYNDROME_FRAGMENT_5_3 Register (offset = 4D4h) [reset = 0h]

ELM_SYNDROME_FRAGMENT_5_3 is shown in [Figure 7-289](#) and described in [Table 7-320](#).

Figure 7-289. ELM_SYNDROME_FRAGMENT_5_3 Register

31	30	29	28	27	26	25	24	23	22	21	20	19	18	17	16	15	14	13	12	11	10	9	8	7	6	5	4	3	2	1	0
SYNDROME_5																															
R/W-0h																															

LEGEND: R/W = Read/Write; R = Read only; W1toCl = Write 1 to clear bit; -n = value after reset

Table 7-320. ELM_SYNDROME_FRAGMENT_5_3 Register Field Descriptions

Bit	Field	Type	Reset	Description
31-0	SYNDROME_5	R/W	0h	Syndrome bits 160 to 191, value 0 to FFFF FFFFh.

7.4.5.35 ELM_SYNDROME_FRAGMENT_6_3 Register (offset = 4D8h) [reset = 0h]

ELM_SYNDROME_FRAGMENT_6_3 is shown in [Figure 7-290](#) and described in [Table 7-321](#).

Figure 7-290. ELM_SYNDROME_FRAGMENT_6_3 Register

31	30	29	28	27	26	25	24
RESERVED							
R-0h							
23	22	21	20	19	18	17	16
RESERVED							SYNDROME_VALID
R-0h							R/W-0h
15	14	13	12	11	10	9	8
SYNDROME_6							
R/W-0h							
7	6	5	4	3	2	1	0
SYNDROME_6							
R/W-0h							

LEGEND: R/W = Read/Write; R = Read only; W1toCl = Write 1 to clear bit; -n = value after reset

Table 7-321. ELM_SYNDROME_FRAGMENT_6_3 Register Field Descriptions

Bit	Field	Type	Reset	Description
31-17	RESERVED	R	0h	
16	SYNDROME_VALID	R/W	0h	Syndrome valid bit. 0h = This syndrome polynomial should not be processed. 1h = This syndrome polynomial must be processed.
15-0	SYNDROME_6	R/W	0h	Syndrome bits 192 to 207, value 0 to FFFFh.

7.4.5.36 ELM_SYNDROME_FRAGMENT_0_4 Register (offset = 500h) [reset = 0h]

ELM_SYNDROME_FRAGMENT_0_4 is shown in [Figure 7-291](#) and described in [Table 7-322](#).

Figure 7-291. ELM_SYNDROME_FRAGMENT_0_4 Register

31	30	29	28	27	26	25	24	23	22	21	20	19	18	17	16	15	14	13	12	11	10	9	8	7	6	5	4	3	2	1	0
SYNDROME_0																															
R/W-0h																															

LEGEND: R/W = Read/Write; R = Read only; W1toCl = Write 1 to clear bit; -n = value after reset

Table 7-322. ELM_SYNDROME_FRAGMENT_0_4 Register Field Descriptions

Bit	Field	Type	Reset	Description
31-0	SYNDROME_0	R/W	0h	Syndrom bits 0 to 31, value 0 to FFFF FFFFh.

7.4.5.37 ELM_SYNDROME_FRAGMENT_1_4 Register (offset = 504h) [reset = 0h]

ELM_SYNDROME_FRAGMENT_1_4 is shown in [Figure 7-292](#) and described in [Table 7-323](#).

Figure 7-292. ELM_SYNDROME_FRAGMENT_1_4 Register

31	30	29	28	27	26	25	24	23	22	21	20	19	18	17	16	15	14	13	12	11	10	9	8	7	6	5	4	3	2	1	0
SYNDROME_1																															
R/W-0h																															

LEGEND: R/W = Read/Write; R = Read only; W1toCl = Write 1 to clear bit; -n = value after reset

Table 7-323. ELM_SYNDROME_FRAGMENT_1_4 Register Field Descriptions

Bit	Field	Type	Reset	Description
31-0	SYNDROME_1	R/W	0h	Syndrome bits 32 to 63, value 0 to FFFF FFFFh.

7.4.5.38 ELM_SYNDROME_FRAGMENT_2_4 Register (offset = 508h) [reset = 0h]

ELM_SYNDROME_FRAGMENT_2_4 is shown in [Figure 7-293](#) and described in [Table 7-324](#).

Figure 7-293. ELM_SYNDROME_FRAGMENT_2_4 Register

31	30	29	28	27	26	25	24	23	22	21	20	19	18	17	16	15	14	13	12	11	10	9	8	7	6	5	4	3	2	1	0
SYNDROME_2																															
R/W-0h																															

LEGEND: R/W = Read/Write; R = Read only; W1toCl = Write 1 to clear bit; -n = value after reset

Table 7-324. ELM_SYNDROME_FRAGMENT_2_4 Register Field Descriptions

Bit	Field	Type	Reset	Description
31-0	SYNDROME_2	R/W	0h	Syndrome bits 64 to 95, value 0 to FFFF FFFFh.

7.4.5.39 ELM_SYNDROME_FRAGMENT_3_4 Register (offset = 50Ch) [reset = 0h]

 ELM_SYNDROME_FRAGMENT_3_4 is shown in [Figure 7-294](#) and described in [Table 7-325](#).

Figure 7-294. ELM_SYNDROME_FRAGMENT_3_4 Register

31	30	29	28	27	26	25	24	23	22	21	20	19	18	17	16	15	14	13	12	11	10	9	8	7	6	5	4	3	2	1	0
SYNDROME_3																															
R/W-0h																															

LEGEND: R/W = Read/Write; R = Read only; W1toCl = Write 1 to clear bit; -n = value after reset

Table 7-325. ELM_SYNDROME_FRAGMENT_3_4 Register Field Descriptions

Bit	Field	Type	Reset	Description
31-0	SYNDROME_3	R/W	0h	Syndrome bits 96 to 127, value 0 to FFFF FFFFh.

7.4.5.40 ELM_SYNDROME_FRAGMENT_4_4 Register (offset = 510h) [reset = 0h]

 ELM_SYNDROME_FRAGMENT_4_4 is shown in [Figure 7-295](#) and described in [Table 7-326](#).

Figure 7-295. ELM_SYNDROME_FRAGMENT_4_4 Register

31	30	29	28	27	26	25	24	23	22	21	20	19	18	17	16	15	14	13	12	11	10	9	8	7	6	5	4	3	2	1	0
SYNDROME_4																															
R/W-0h																															

LEGEND: R/W = Read/Write; R = Read only; W1toCl = Write 1 to clear bit; -n = value after reset

Table 7-326. ELM_SYNDROME_FRAGMENT_4_4 Register Field Descriptions

Bit	Field	Type	Reset	Description
31-0	SYNDROME_4	R/W	0h	Syndrome bits 128 to 159, value 0 to FFFF FFFFh.

7.4.5.41 ELM_SYNDROME_FRAGMENT_5_4 Register (offset = 514h) [reset = 0h]

 ELM_SYNDROME_FRAGMENT_5_4 is shown in [Figure 7-296](#) and described in [Table 7-327](#).

Figure 7-296. ELM_SYNDROME_FRAGMENT_5_4 Register

31	30	29	28	27	26	25	24	23	22	21	20	19	18	17	16	15	14	13	12	11	10	9	8	7	6	5	4	3	2	1	0
SYNDROME_5																															
R/W-0h																															

LEGEND: R/W = Read/Write; R = Read only; W1toCl = Write 1 to clear bit; -n = value after reset

Table 7-327. ELM_SYNDROME_FRAGMENT_5_4 Register Field Descriptions

Bit	Field	Type	Reset	Description
31-0	SYNDROME_5	R/W	0h	Syndrome bits 160 to 191, value 0 to FFFF FFFFh.

7.4.5.42 ELM_SYNDROME_FRAGMENT_6_4 Register (offset = 518h) [reset = 0h]

ELM_SYNDROME_FRAGMENT_6_4 is shown in [Figure 7-297](#) and described in [Table 7-328](#).

Figure 7-297. ELM_SYNDROME_FRAGMENT_6_4 Register

31	30	29	28	27	26	25	24
RESERVED							
R-0h							
23	22	21	20	19	18	17	16
RESERVED							SYNDROME_VALID
R-0h							R/W-0h
15	14	13	12	11	10	9	8
SYNDROME_6							
R/W-0h							
7	6	5	4	3	2	1	0
SYNDROME_6							
R/W-0h							

LEGEND: R/W = Read/Write; R = Read only; W1toCl = Write 1 to clear bit; -n = value after reset

Table 7-328. ELM_SYNDROME_FRAGMENT_6_4 Register Field Descriptions

Bit	Field	Type	Reset	Description
31-17	RESERVED	R	0h	
16	SYNDROME_VALID	R/W	0h	Syndrome valid bit. 0h = This syndrome polynomial should not be processed. 1h = This syndrome polynomial must be processed.
15-0	SYNDROME_6	R/W	0h	Syndrome bits 192 to 207, value 0 to FFFFh.

7.4.5.43 ELM_SYNDROME_FRAGMENT_0_5 Register (offset = 540h) [reset = 0h]

ELM_SYNDROME_FRAGMENT_0_5 is shown in [Figure 7-298](#) and described in [Table 7-329](#).

Figure 7-298. ELM_SYNDROME_FRAGMENT_0_5 Register

31	30	29	28	27	26	25	24	23	22	21	20	19	18	17	16	15	14	13	12	11	10	9	8	7	6	5	4	3	2	1	0
SYNDROME_0																															
R/W-0h																															

LEGEND: R/W = Read/Write; R = Read only; W1toCl = Write 1 to clear bit; -n = value after reset

Table 7-329. ELM_SYNDROME_FRAGMENT_0_5 Register Field Descriptions

Bit	Field	Type	Reset	Description
31-0	SYNDROME_0	R/W	0h	Syndrome bits 0 to 31, value 0 to FFFF FFFFh.

7.4.5.44 ELM_SYNDROME_FRAGMENT_1_5 Register (offset = 544h) [reset = 0h]

ELM_SYNDROME_FRAGMENT_1_5 is shown in [Figure 7-299](#) and described in [Table 7-330](#).

Figure 7-299. ELM_SYNDROME_FRAGMENT_1_5 Register

31	30	29	28	27	26	25	24	23	22	21	20	19	18	17	16	15	14	13	12	11	10	9	8	7	6	5	4	3	2	1	0
SYNDROME_1																															
R/W-0h																															

LEGEND: R/W = Read/Write; R = Read only; W1toCl = Write 1 to clear bit; -n = value after reset

Table 7-330. ELM_SYNDROME_FRAGMENT_1_5 Register Field Descriptions

Bit	Field	Type	Reset	Description
31-0	SYNDROME_1	R/W	0h	Syndrome bits 32 to 63, value 0 to FFFF FFFFh.

7.4.5.45 ELM_SYNDROME_FRAGMENT_2_5 Register (offset = 548h) [reset = 0h]

 ELM_SYNDROME_FRAGMENT_2_5 is shown in [Figure 7-300](#) and described in [Table 7-331](#).

Figure 7-300. ELM_SYNDROME_FRAGMENT_2_5 Register

31	30	29	28	27	26	25	24	23	22	21	20	19	18	17	16	15	14	13	12	11	10	9	8	7	6	5	4	3	2	1	0
SYNDROME_2																															
R/W-0h																															

LEGEND: R/W = Read/Write; R = Read only; W1toCl = Write 1 to clear bit; -n = value after reset

Table 7-331. ELM_SYNDROME_FRAGMENT_2_5 Register Field Descriptions

Bit	Field	Type	Reset	Description
31-0	SYNDROME_2	R/W	0h	Syndrome bits 64 to 95, value 0 to FFFF FFFFh.

7.4.5.46 ELM_SYNDROME_FRAGMENT_3_5 Register (offset = 54Ch) [reset = 0h]

 ELM_SYNDROME_FRAGMENT_3_5 is shown in [Figure 7-301](#) and described in [Table 7-332](#).

Figure 7-301. ELM_SYNDROME_FRAGMENT_3_5 Register

31	30	29	28	27	26	25	24	23	22	21	20	19	18	17	16	15	14	13	12	11	10	9	8	7	6	5	4	3	2	1	0
SYNDROME_3																															
R/W-0h																															

LEGEND: R/W = Read/Write; R = Read only; W1toCl = Write 1 to clear bit; -n = value after reset

Table 7-332. ELM_SYNDROME_FRAGMENT_3_5 Register Field Descriptions

Bit	Field	Type	Reset	Description
31-0	SYNDROME_3	R/W	0h	Syndrome bits 96 to 127, value 0 to FFFF FFFFh.

7.4.5.47 ELM_SYNDROME_FRAGMENT_4_5 Register (offset = 550h) [reset = 0h]

 ELM_SYNDROME_FRAGMENT_4_5 is shown in [Figure 7-302](#) and described in [Table 7-333](#).

Figure 7-302. ELM_SYNDROME_FRAGMENT_4_5 Register

31	30	29	28	27	26	25	24	23	22	21	20	19	18	17	16	15	14	13	12	11	10	9	8	7	6	5	4	3	2	1	0
SYNDROME_4																															
R/W-0h																															

LEGEND: R/W = Read/Write; R = Read only; W1toCl = Write 1 to clear bit; -n = value after reset

Table 7-333. ELM_SYNDROME_FRAGMENT_4_5 Register Field Descriptions

Bit	Field	Type	Reset	Description
31-0	SYNDROME_4	R/W	0h	Syndrome bits 128 to 159, value 0 to FFFF FFFFh.

7.4.5.48 ELM_SYNDROME_FRAGMENT_5_5 Register (offset = 554h) [reset = 0h]

ELM_SYNDROME_FRAGMENT_5_5 is shown in [Figure 7-303](#) and described in [Table 7-334](#).

Figure 7-303. ELM_SYNDROME_FRAGMENT_5_5 Register

31	30	29	28	27	26	25	24	23	22	21	20	19	18	17	16	15	14	13	12	11	10	9	8	7	6	5	4	3	2	1	0
SYNDROME_5																															
R/W-0h																															

LEGEND: R/W = Read/Write; R = Read only; W1toCl = Write 1 to clear bit; -n = value after reset

Table 7-334. ELM_SYNDROME_FRAGMENT_5_5 Register Field Descriptions

Bit	Field	Type	Reset	Description
31-0	SYNDROME_5	R/W	0h	Syndrome bits 160 to 191, value 0 to FFFF FFFFh.

7.4.5.49 ELM_SYNDROME_FRAGMENT_6_5 Register (offset = 558h) [reset = 0h]

ELM_SYNDROME_FRAGMENT_6_5 is shown in [Figure 7-304](#) and described in [Table 7-335](#).

Figure 7-304. ELM_SYNDROME_FRAGMENT_6_5 Register

31	30	29	28	27	26	25	24
RESERVED							
R-0h							
23	22	21	20	19	18	17	16
RESERVED							SYNDROME_VALID
R-0h							R/W-0h
15	14	13	12	11	10	9	8
SYNDROME_6							
R/W-0h							
7	6	5	4	3	2	1	0
SYNDROME_6							
R/W-0h							

LEGEND: R/W = Read/Write; R = Read only; W1toCl = Write 1 to clear bit; -n = value after reset

Table 7-335. ELM_SYNDROME_FRAGMENT_6_5 Register Field Descriptions

Bit	Field	Type	Reset	Description
31-17	RESERVED	R	0h	
16	SYNDROME_VALID	R/W	0h	Syndrome valid bit. 0h = This syndrome polynomial should not be processed. 1h = This syndrome polynomial must be processed.
15-0	SYNDROME_6	R/W	0h	Syndrome bits 192 to 207, value 0 to FFFFh.

7.4.5.50 ELM_SYNDROME_FRAGMENT_0_6 Register (offset = 580h) [reset = 0h]

ELM_SYNDROME_FRAGMENT_0_6 is shown in [Figure 7-305](#) and described in [Table 7-336](#).

Figure 7-305. ELM_SYNDROME_FRAGMENT_0_6 Register

31	30	29	28	27	26	25	24	23	22	21	20	19	18	17	16	15	14	13	12	11	10	9	8	7	6	5	4	3	2	1	0
SYNDROME_0																															
R/W-0h																															

LEGEND: R/W = Read/Write; R = Read only; W1toCl = Write 1 to clear bit; -n = value after reset

Table 7-336. ELM_SYNDROME_FRAGMENT_0_6 Register Field Descriptions

Bit	Field	Type	Reset	Description
31-0	SYNDROME_0	R/W	0h	Syndrom bits 0 to 31, value 0 to FFFF FFFFh.

7.4.5.51 ELM_SYNDROME_FRAGMENT_1_6 Register (offset = 584h) [reset = 0h]

 ELM_SYNDROME_FRAGMENT_1_6 is shown in [Figure 7-306](#) and described in [Table 7-337](#).

Figure 7-306. ELM_SYNDROME_FRAGMENT_1_6 Register

31	30	29	28	27	26	25	24	23	22	21	20	19	18	17	16	15	14	13	12	11	10	9	8	7	6	5	4	3	2	1	0
SYNDROME_1																															
R/W-0h																															

LEGEND: R/W = Read/Write; R = Read only; W1toCl = Write 1 to clear bit; -n = value after reset

Table 7-337. ELM_SYNDROME_FRAGMENT_1_6 Register Field Descriptions

Bit	Field	Type	Reset	Description
31-0	SYNDROME_1	R/W	0h	Syndrome bits 32 to 63, value 0 to FFFF FFFFh.

7.4.5.52 ELM_SYNDROME_FRAGMENT_2_6 Register (offset = 588h) [reset = 0h]

 ELM_SYNDROME_FRAGMENT_2_6 is shown in [Figure 7-307](#) and described in [Table 7-338](#).

Figure 7-307. ELM_SYNDROME_FRAGMENT_2_6 Register

31	30	29	28	27	26	25	24	23	22	21	20	19	18	17	16	15	14	13	12	11	10	9	8	7	6	5	4	3	2	1	0
SYNDROME_2																															
R/W-0h																															

LEGEND: R/W = Read/Write; R = Read only; W1toCl = Write 1 to clear bit; -n = value after reset

Table 7-338. ELM_SYNDROME_FRAGMENT_2_6 Register Field Descriptions

Bit	Field	Type	Reset	Description
31-0	SYNDROME_2	R/W	0h	Syndrome bits 64 to 95, value 0 to FFFF FFFFh.

7.4.5.53 ELM_SYNDROME_FRAGMENT_3_6 Register (offset = 58Ch) [reset = 0h]

 ELM_SYNDROME_FRAGMENT_3_6 is shown in [Figure 7-308](#) and described in [Table 7-339](#).

Figure 7-308. ELM_SYNDROME_FRAGMENT_3_6 Register

31	30	29	28	27	26	25	24	23	22	21	20	19	18	17	16	15	14	13	12	11	10	9	8	7	6	5	4	3	2	1	0
SYNDROME_3																															
R/W-0h																															

LEGEND: R/W = Read/Write; R = Read only; W1toCl = Write 1 to clear bit; -n = value after reset

Table 7-339. ELM_SYNDROME_FRAGMENT_3_6 Register Field Descriptions

Bit	Field	Type	Reset	Description
31-0	SYNDROME_3	R/W	0h	Syndrome bits 96 to 127, value 0 to FFFF FFFFh.

7.4.5.54 ELM_SYNDROME_FRAGMENT_4_6 Register (offset = 590h) [reset = 0h]

ELM_SYNDROME_FRAGMENT_4_6 is shown in [Figure 7-309](#) and described in [Table 7-340](#).

Figure 7-309. ELM_SYNDROME_FRAGMENT_4_6 Register

31	30	29	28	27	26	25	24	23	22	21	20	19	18	17	16	15	14	13	12	11	10	9	8	7	6	5	4	3	2	1	0
SYNDROME_4																															
R/W-0h																															

LEGEND: R/W = Read/Write; R = Read only; W1toCl = Write 1 to clear bit; -n = value after reset

Table 7-340. ELM_SYNDROME_FRAGMENT_4_6 Register Field Descriptions

Bit	Field	Type	Reset	Description
31-0	SYNDROME_4	R/W	0h	Syndrome bits 128 to 159, value 0 to FFFF FFFFh.

7.4.5.55 ELM_SYNDROME_FRAGMENT_5_6 Register (offset = 594h) [reset = 0h]

 ELM_SYNDROME_FRAGMENT_5_6 is shown in [Figure 7-310](#) and described in [Table 7-341](#).

Figure 7-310. ELM_SYNDROME_FRAGMENT_5_6 Register

31	30	29	28	27	26	25	24	23	22	21	20	19	18	17	16	15	14	13	12	11	10	9	8	7	6	5	4	3	2	1	0
SYNDROME_5																															
R/W-0h																															

LEGEND: R/W = Read/Write; R = Read only; W1toCl = Write 1 to clear bit; -n = value after reset

Table 7-341. ELM_SYNDROME_FRAGMENT_5_6 Register Field Descriptions

Bit	Field	Type	Reset	Description
31-0	SYNDROME_5	R/W	0h	Syndrome bits 160 to 191, value 0 to FFFF FFFFh.

7.4.5.56 ELM_SYNDROME_FRAGMENT_6_6 Register (offset = 598h) [reset = 0h]

 ELM_SYNDROME_FRAGMENT_6_6 is shown in [Figure 7-311](#) and described in [Table 7-342](#).

Figure 7-311. ELM_SYNDROME_FRAGMENT_6_6 Register

31	30	29	28	27	26	25	24
RESERVED							
R-0h							
23	22	21	20	19	18	17	16
RESERVED							SYNDROME_VALID
R-0h							R/W-0h
15	14	13	12	11	10	9	8
SYNDROME_6							
R/W-0h							
7	6	5	4	3	2	1	0
SYNDROME_6							
R/W-0h							

LEGEND: R/W = Read/Write; R = Read only; W1toCl = Write 1 to clear bit; -n = value after reset

Table 7-342. ELM_SYNDROME_FRAGMENT_6_6 Register Field Descriptions

Bit	Field	Type	Reset	Description
31-17	RESERVED	R	0h	
16	SYNDROME_VALID	R/W	0h	Syndrome valid bit. 0h = This syndrome polynomial should not be processed. 1h = This syndrome polynomial must be processed.
15-0	SYNDROME_6	R/W	0h	Syndrome bits 192 to 207, value 0 to FFFFh.

7.4.5.57 ELM_SYNDROME_FRAGMENT_0_7 Register (offset = 5C0h) [reset = 0h]

 ELM_SYNDROME_FRAGMENT_0_7 is shown in [Figure 7-312](#) and described in [Table 7-343](#).

Figure 7-312. ELM_SYNDROME_FRAGMENT_0_7 Register

31	30	29	28	27	26	25	24	23	22	21	20	19	18	17	16	15	14	13	12	11	10	9	8	7	6	5	4	3	2	1	0
SYNDROME_0																															
R/W-0h																															

LEGEND: R/W = Read/Write; R = Read only; W1toCl = Write 1 to clear bit; -n = value after reset

Table 7-343. ELM_SYNDROME_FRAGMENT_0_7 Register Field Descriptions

Bit	Field	Type	Reset	Description
31-0	SYNDROME_0	R/W	0h	Syndrome bits 0 to 31, value 0 to FFFF FFFFh.

7.4.5.58 ELM_SYNDROME_FRAGMENT_1_7 Register (offset = 5C4h) [reset = 0h]

 ELM_SYNDROME_FRAGMENT_1_7 is shown in [Figure 7-313](#) and described in [Table 7-344](#).

Figure 7-313. ELM_SYNDROME_FRAGMENT_1_7 Register

31	30	29	28	27	26	25	24	23	22	21	20	19	18	17	16	15	14	13	12	11	10	9	8	7	6	5	4	3	2	1	0
SYNDROME_1																															
R/W-0h																															

LEGEND: R/W = Read/Write; R = Read only; W1toCl = Write 1 to clear bit; -n = value after reset

Table 7-344. ELM_SYNDROME_FRAGMENT_1_7 Register Field Descriptions

Bit	Field	Type	Reset	Description
31-0	SYNDROME_1	R/W	0h	Syndrome bits 32 to 63, value 0 to FFFF FFFFh.

7.4.5.59 ELM_SYNDROME_FRAGMENT_2_7 Register (offset = 5C8h) [reset = 0h]

ELM_SYNDROME_FRAGMENT_2_7 is shown in [Figure 7-314](#) and described in [Table 7-345](#).

Figure 7-314. ELM_SYNDROME_FRAGMENT_2_7 Register

31	30	29	28	27	26	25	24	23	22	21	20	19	18	17	16	15	14	13	12	11	10	9	8	7	6	5	4	3	2	1	0
SYNDROME_2																															
R/W-0h																															

LEGEND: R/W = Read/Write; R = Read only; W1toCl = Write 1 to clear bit; -n = value after reset

Table 7-345. ELM_SYNDROME_FRAGMENT_2_7 Register Field Descriptions

Bit	Field	Type	Reset	Description
31-0	SYNDROME_2	R/W	0h	Syndrome bits 64 to 95, value 0 to FFFF FFFFh.

7.4.5.60 ELM_SYNDROME_FRAGMENT_3_7 Register (offset = 5CCh) [reset = 0h]

 ELM_SYNDROME_FRAGMENT_3_7 is shown in [Figure 7-315](#) and described in [Table 7-346](#).

Figure 7-315. ELM_SYNDROME_FRAGMENT_3_7 Register

31	30	29	28	27	26	25	24	23	22	21	20	19	18	17	16	15	14	13	12	11	10	9	8	7	6	5	4	3	2	1	0
SYNDROME_3																															
R/W-0h																															

LEGEND: R/W = Read/Write; R = Read only; W1toCl = Write 1 to clear bit; -n = value after reset

Table 7-346. ELM_SYNDROME_FRAGMENT_3_7 Register Field Descriptions

Bit	Field	Type	Reset	Description
31-0	SYNDROME_3	R/W	0h	Syndrome bits 96 to 127, value 0 to FFFF FFFFh.

7.4.5.61 ELM_SYNDROME_FRAGMENT_4_7 Register (offset = 5D0h) [reset = 0h]

 ELM_SYNDROME_FRAGMENT_4_7 is shown in [Figure 7-316](#) and described in [Table 7-347](#).

Figure 7-316. ELM_SYNDROME_FRAGMENT_4_7 Register

31	30	29	28	27	26	25	24	23	22	21	20	19	18	17	16	15	14	13	12	11	10	9	8	7	6	5	4	3	2	1	0
SYNDROME_4																															
R/W-0h																															

LEGEND: R/W = Read/Write; R = Read only; W1toCl = Write 1 to clear bit; -n = value after reset

Table 7-347. ELM_SYNDROME_FRAGMENT_4_7 Register Field Descriptions

Bit	Field	Type	Reset	Description
31-0	SYNDROME_4	R/W	0h	Syndrome bits 128 to 159, value 0 to FFFF FFFFh.

7.4.5.62 ELM_SYNDROME_FRAGMENT_5_7 Register (offset = 5D4h) [reset = 0h]

 ELM_SYNDROME_FRAGMENT_5_7 is shown in [Figure 7-317](#) and described in [Table 7-348](#).

Figure 7-317. ELM_SYNDROME_FRAGMENT_5_7 Register

31	30	29	28	27	26	25	24	23	22	21	20	19	18	17	16	15	14	13	12	11	10	9	8	7	6	5	4	3	2	1	0
SYNDROME_5																															
R/W-0h																															

LEGEND: R/W = Read/Write; R = Read only; W1toCl = Write 1 to clear bit; -n = value after reset

Table 7-348. ELM_SYNDROME_FRAGMENT_5_7 Register Field Descriptions

Bit	Field	Type	Reset	Description
31-0	SYNDROME_5	R/W	0h	Syndrome bits 160 to 191, value 0 to FFFF FFFFh.

7.4.5.63 ELM_SYNDROME_FRAGMENT_6_7 Register (offset = 5D8h) [reset = 0h]

ELM_SYNDROME_FRAGMENT_6_7 is shown in [Figure 7-318](#) and described in [Table 7-349](#).

Figure 7-318. ELM_SYNDROME_FRAGMENT_6_7 Register

31	30	29	28	27	26	25	24
RESERVED							
R-0h							
23	22	21	20	19	18	17	16
RESERVED							SYNDROME_VALID
R-0h							R/W-0h
15	14	13	12	11	10	9	8
SYNDROME_6							
R/W-0h							
7	6	5	4	3	2	1	0
SYNDROME_6							
R/W-0h							

LEGEND: R/W = Read/Write; R = Read only; W1toCl = Write 1 to clear bit; -n = value after reset

Table 7-349. ELM_SYNDROME_FRAGMENT_6_7 Register Field Descriptions

Bit	Field	Type	Reset	Description
31-17	RESERVED	R	0h	
16	SYNDROME_VALID	R/W	0h	Syndrome valid bit. 0h = This syndrome polynomial should not be processed. 1h = This syndrome polynomial must be processed.
15-0	SYNDROME_6	R/W	0h	Syndrome bits 192 to 207, value 0 to FFFFh.

7.4.5.64 ELM_LOCATION_STATUS_0 Register (offset = 800h) [reset = 0h]

 ELM_LOCATION_STATUS_0 is shown in [Figure 7-319](#) and described in [Table 7-350](#).

Figure 7-319. ELM_LOCATION_STATUS_0 Register

31	30	29	28	27	26	25	24
RESERVED							
R-0h							
23	22	21	20	19	18	17	16
RESERVED							
R-0h							
15	14	13	12	11	10	9	8
RESERVED							ECC_CORREC TABL
R-0h							R-0h
7	6	5	4	3	2	1	0
RESERVED			ECC_NB_ERRORS				
R-0h			R-0h				

LEGEND: R/W = Read/Write; R = Read only; W1toCl = Write 1 to clear bit; -n = value after reset

Table 7-350. ELM_LOCATION_STATUS_0 Register Field Descriptions

Bit	Field	Type	Reset	Description
31-9	RESERVED	R	0h	
8	ECC_CORRECTABL	R	0h	Error-location process exit status. 0h = ECC error-location process failed. Number of errors and error locations are invalid. 1h = All errors were successfully located. Number of errors and error locations are valid.
7-5	RESERVED	R	0h	
4-0	ECC_NB_ERRORS	R	0h	Number of errors detected and located, value 0 to 1Fh.

7.4.5.65 ELM_ERROR_LOCATION_0_0 Register (offset = 880h) [reset = 0h]

ELM_ERROR_LOCATION_0_0 is shown in [Figure 7-320](#) and described in [Table 7-351](#).

Figure 7-320. ELM_ERROR_LOCATION_0_0 Register

31	30	29	28	27	26	25	24	23	22	21	20	19	18	17	16
RESERVED															
R-0h															
15	14	13	12	11	10	9	8	7	6	5	4	3	2	1	0
RESERVED				ECC_ERROR_LOCATION											
R-0h				R-0h											

LEGEND: R/W = Read/Write; R = Read only; W1toCl = Write 1 to clear bit; -n = value after reset

Table 7-351. ELM_ERROR_LOCATION_0_0 Register Field Descriptions

Bit	Field	Type	Reset	Description
31-13	RESERVED	R	0h	
12-0	ECC_ERROR_LOCATION	R	0h	Error-location bit address, 0 to 1FFFh.

7.4.5.66 ELM_ERROR_LOCATION_1_0 Register (offset = 884h) [reset = 0h]

ELM_ERROR_LOCATION_1_0 is shown in [Figure 7-321](#) and described in [Table 7-352](#).

Figure 7-321. ELM_ERROR_LOCATION_1_0 Register

31	30	29	28	27	26	25	24	23	22	21	20	19	18	17	16
RESERVED															
R-0h															
15	14	13	12	11	10	9	8	7	6	5	4	3	2	1	0
RESERVED				ECC_ERROR_LOCATION											
R-0h				R-0h											

LEGEND: R/W = Read/Write; R = Read only; W1toCl = Write 1 to clear bit; -n = value after reset

Table 7-352. ELM_ERROR_LOCATION_1_0 Register Field Descriptions

Bit	Field	Type	Reset	Description
31-13	RESERVED	R	0h	
12-0	ECC_ERROR_LOCATION	R	0h	Error-location bit address, 0 to 1FFFh.

7.4.5.67 ELM_ERROR_LOCATION_2_0 Register (offset = 888h) [reset = 0h]

ELM_ERROR_LOCATION_2_0 is shown in [Figure 7-322](#) and described in [Table 7-353](#).

Figure 7-322. ELM_ERROR_LOCATION_2_0 Register

31	30	29	28	27	26	25	24	23	22	21	20	19	18	17	16
RESERVED															
R-0h															
15	14	13	12	11	10	9	8	7	6	5	4	3	2	1	0
RESERVED				ECC_ERROR_LOCATION											
R-0h				R-0h											

LEGEND: R/W = Read/Write; R = Read only; W1toCl = Write 1 to clear bit; -n = value after reset

Table 7-353. ELM_ERROR_LOCATION_2_0 Register Field Descriptions

Bit	Field	Type	Reset	Description
31-13	RESERVED	R	0h	
12-0	ECC_ERROR_LOCATION	R	0h	Error-location bit address, 0 to 1FFFh.

7.4.5.68 ELM_ERROR_LOCATION_3_0 Register (offset = 88Ch) [reset = 0h]

 ELM_ERROR_LOCATION_3_0 is shown in [Figure 7-323](#) and described in [Table 7-354](#).

Figure 7-323. ELM_ERROR_LOCATION_3_0 Register

31	30	29	28	27	26	25	24	23	22	21	20	19	18	17	16
RESERVED															
R-0h															
15	14	13	12	11	10	9	8	7	6	5	4	3	2	1	0
RESERVED			ECC_ERROR_LOCATION												
R-0h			R-0h												

LEGEND: R/W = Read/Write; R = Read only; W1toCl = Write 1 to clear bit; -n = value after reset

Table 7-354. ELM_ERROR_LOCATION_3_0 Register Field Descriptions

Bit	Field	Type	Reset	Description
31-13	RESERVED	R	0h	
12-0	ECC_ERROR_LOCATION	R	0h	Error-location bit address, 0 to 1FFFh.

7.4.5.69 ELM_ERROR_LOCATION_4_0 Register (offset = 890h) [reset = 0h]

ELM_ERROR_LOCATION_4_0 is shown in [Figure 7-324](#) and described in [Table 7-355](#).

Figure 7-324. ELM_ERROR_LOCATION_4_0 Register

31	30	29	28	27	26	25	24	23	22	21	20	19	18	17	16
RESERVED															
R-0h															
15	14	13	12	11	10	9	8	7	6	5	4	3	2	1	0
RESERVED				ECC_ERROR_LOCATION											
R-0h				R-0h											

LEGEND: R/W = Read/Write; R = Read only; W1toCl = Write 1 to clear bit; -n = value after reset

Table 7-355. ELM_ERROR_LOCATION_4_0 Register Field Descriptions

Bit	Field	Type	Reset	Description
31-13	RESERVED	R	0h	
12-0	ECC_ERROR_LOCATION	R	0h	Error-location bit address, 0 to 1FFFh.

7.4.5.70 ELM_ERROR_LOCATION_5_0 Register (offset = 894h) [reset = 0h]

ELM_ERROR_LOCATION_5_0 is shown in [Figure 7-325](#) and described in [Table 7-356](#).

Figure 7-325. ELM_ERROR_LOCATION_5_0 Register

31	30	29	28	27	26	25	24	23	22	21	20	19	18	17	16
RESERVED															
R-0h															
15	14	13	12	11	10	9	8	7	6	5	4	3	2	1	0
RESERVED				ECC_ERROR_LOCATION											
R-0h				R-0h											

LEGEND: R/W = Read/Write; R = Read only; W1toCl = Write 1 to clear bit; -n = value after reset

Table 7-356. ELM_ERROR_LOCATION_5_0 Register Field Descriptions

Bit	Field	Type	Reset	Description
31-13	RESERVED	R	0h	
12-0	ECC_ERROR_LOCATION	R	0h	Error-location bit address, 0 to 1FFFh.

7.4.5.71 ELM_ERROR_LOCATION_6_0 Register (offset = 898h) [reset = 0h]

ELM_ERROR_LOCATION_6_0 is shown in [Figure 7-326](#) and described in [Table 7-357](#).

Figure 7-326. ELM_ERROR_LOCATION_6_0 Register

31	30	29	28	27	26	25	24	23	22	21	20	19	18	17	16
RESERVED															
R-0h															
15	14	13	12	11	10	9	8	7	6	5	4	3	2	1	0
RESERVED				ECC_ERROR_LOCATION											
R-0h				R-0h											

LEGEND: R/W = Read/Write; R = Read only; W1toCl = Write 1 to clear bit; -n = value after reset

Table 7-357. ELM_ERROR_LOCATION_6_0 Register Field Descriptions

Bit	Field	Type	Reset	Description
31-13	RESERVED	R	0h	
12-0	ECC_ERROR_LOCATION	R	0h	Error-location bit address, 0 to 1FFFh.

7.4.5.72 ELM_ERROR_LOCATION_7_0 Register (offset = 89Ch) [reset = 0h]

 ELM_ERROR_LOCATION_7_0 is shown in [Figure 7-327](#) and described in [Table 7-358](#).

Figure 7-327. ELM_ERROR_LOCATION_7_0 Register

31	30	29	28	27	26	25	24	23	22	21	20	19	18	17	16
RESERVED															
R-0h															
15	14	13	12	11	10	9	8	7	6	5	4	3	2	1	0
RESERVED			ECC_ERROR_LOCATION												
R-0h			R-0h												

LEGEND: R/W = Read/Write; R = Read only; W1toCl = Write 1 to clear bit; -n = value after reset

Table 7-358. ELM_ERROR_LOCATION_7_0 Register Field Descriptions

Bit	Field	Type	Reset	Description
31-13	RESERVED	R	0h	
12-0	ECC_ERROR_LOCATION	R	0h	Error-location bit address, 0 to 1FFFh.

7.4.5.73 ELM_ERROR_LOCATION_8_0 Register (offset = 8A0h) [reset = 0h]

ELM_ERROR_LOCATION_8_0 is shown in [Figure 7-328](#) and described in [Table 7-359](#).

Figure 7-328. ELM_ERROR_LOCATION_8_0 Register

31	30	29	28	27	26	25	24	23	22	21	20	19	18	17	16
RESERVED															
R-0h															
15	14	13	12	11	10	9	8	7	6	5	4	3	2	1	0
RESERVED				ECC_ERROR_LOCATION											
R-0h				R-0h											

LEGEND: R/W = Read/Write; R = Read only; W1toCl = Write 1 to clear bit; -n = value after reset

Table 7-359. ELM_ERROR_LOCATION_8_0 Register Field Descriptions

Bit	Field	Type	Reset	Description
31-13	RESERVED	R	0h	
12-0	ECC_ERROR_LOCATION	R	0h	Error-location bit address, 0 to 1FFFh.

7.4.5.74 ELM_ERROR_LOCATION_9_0 Register (offset = 8A4h) [reset = 0h]

ELM_ERROR_LOCATION_9_0 is shown in [Figure 7-329](#) and described in [Table 7-360](#).

Figure 7-329. ELM_ERROR_LOCATION_9_0 Register

31	30	29	28	27	26	25	24	23	22	21	20	19	18	17	16
RESERVED															
R-0h															
15	14	13	12	11	10	9	8	7	6	5	4	3	2	1	0
RESERVED				ECC_ERROR_LOCATION											
R-0h				R-0h											

LEGEND: R/W = Read/Write; R = Read only; W1toCl = Write 1 to clear bit; -n = value after reset

Table 7-360. ELM_ERROR_LOCATION_9_0 Register Field Descriptions

Bit	Field	Type	Reset	Description
31-13	RESERVED	R	0h	
12-0	ECC_ERROR_LOCATION	R	0h	Error-location bit address, 0 to 1FFFh.

7.4.5.75 ELM_ERROR_LOCATION_10_0 Register (offset = 8A8h) [reset = 0h]

 ELM_ERROR_LOCATION_10_0 is shown in [Figure 7-330](#) and described in [Table 7-361](#).

Figure 7-330. ELM_ERROR_LOCATION_10_0 Register

31	30	29	28	27	26	25	24	23	22	21	20	19	18	17	16
RESERVED															
R-0h															
15	14	13	12	11	10	9	8	7	6	5	4	3	2	1	0
RESERVED				ECC_ERROR_LOCATION											
R-0h				R-0h											

LEGEND: R/W = Read/Write; R = Read only; W1toCl = Write 1 to clear bit; -n = value after reset

Table 7-361. ELM_ERROR_LOCATION_10_0 Register Field Descriptions

Bit	Field	Type	Reset	Description
31-13	RESERVED	R	0h	
12-0	ECC_ERROR_LOCATION	R	0h	Error-location bit address, 0 to 1FFFh.

7.4.5.76 ELM_ERROR_LOCATION_11_0 Register (offset = 8ACh) [reset = 0h]

 ELM_ERROR_LOCATION_11_0 is shown in [Figure 7-331](#) and described in [Table 7-362](#).

Figure 7-331. ELM_ERROR_LOCATION_11_0 Register

31	30	29	28	27	26	25	24	23	22	21	20	19	18	17	16
RESERVED															
R-0h															
15	14	13	12	11	10	9	8	7	6	5	4	3	2	1	0
RESERVED				ECC_ERROR_LOCATION											
R-0h				R-0h											

LEGEND: R/W = Read/Write; R = Read only; W1toCl = Write 1 to clear bit; -n = value after reset

Table 7-362. ELM_ERROR_LOCATION_11_0 Register Field Descriptions

Bit	Field	Type	Reset	Description
31-13	RESERVED	R	0h	
12-0	ECC_ERROR_LOCATION	R	0h	Error-location bit address, 0 to 1FFFh.

7.4.5.77 ELM_ERROR_LOCATION_12_0 Register (offset = 8B0h) [reset = 0h]

ELM_ERROR_LOCATION_12_0 is shown in [Figure 7-332](#) and described in [Table 7-363](#).

Figure 7-332. ELM_ERROR_LOCATION_12_0 Register

31	30	29	28	27	26	25	24	23	22	21	20	19	18	17	16
RESERVED															
R-0h															
15	14	13	12	11	10	9	8	7	6	5	4	3	2	1	0
RESERVED				ECC_ERROR_LOCATION											
R-0h				R-0h											

LEGEND: R/W = Read/Write; R = Read only; W1toCl = Write 1 to clear bit; -n = value after reset

Table 7-363. ELM_ERROR_LOCATION_12_0 Register Field Descriptions

Bit	Field	Type	Reset	Description
31-13	RESERVED	R	0h	
12-0	ECC_ERROR_LOCATION	R	0h	Error-location bit address, 0 to 1FFFh.

7.4.5.78 ELM_ERROR_LOCATION_13_0 Register (offset = 8B4h) [reset = 0h]

ELM_ERROR_LOCATION_13_0 is shown in [Figure 7-333](#) and described in [Table 7-364](#).

Figure 7-333. ELM_ERROR_LOCATION_13_0 Register

31	30	29	28	27	26	25	24	23	22	21	20	19	18	17	16
RESERVED															
R-0h															
15	14	13	12	11	10	9	8	7	6	5	4	3	2	1	0
RESERVED				ECC_ERROR_LOCATION											
R-0h				R-0h											

LEGEND: R/W = Read/Write; R = Read only; W1toCl = Write 1 to clear bit; -n = value after reset

Table 7-364. ELM_ERROR_LOCATION_13_0 Register Field Descriptions

Bit	Field	Type	Reset	Description
31-13	RESERVED	R	0h	
12-0	ECC_ERROR_LOCATION	R	0h	Error-location bit address, 0 to 1FFFh.

7.4.5.79 ELM_ERROR_LOCATION_14_0 Register (offset = 8B8h) [reset = 0h]

 ELM_ERROR_LOCATION_14_0 is shown in [Figure 7-334](#) and described in [Table 7-365](#).

Figure 7-334. ELM_ERROR_LOCATION_14_0 Register

31	30	29	28	27	26	25	24	23	22	21	20	19	18	17	16
RESERVED															
R-0h															
15	14	13	12	11	10	9	8	7	6	5	4	3	2	1	0
RESERVED				ECC_ERROR_LOCATION											
R-0h				R-0h											

LEGEND: R/W = Read/Write; R = Read only; W1toCl = Write 1 to clear bit; -n = value after reset

Table 7-365. ELM_ERROR_LOCATION_14_0 Register Field Descriptions

Bit	Field	Type	Reset	Description
31-13	RESERVED	R	0h	
12-0	ECC_ERROR_LOCATION	R	0h	Error-location bit address, 0 to 1FFFh.

7.4.5.80 ELM_ERROR_LOCATION_15_0 Register (offset = 8BCh) [reset = 0h]

ELM_ERROR_LOCATION_15_0 is shown in [Figure 7-335](#) and described in [Table 7-366](#).

Figure 7-335. ELM_ERROR_LOCATION_15_0 Register

31	30	29	28	27	26	25	24	23	22	21	20	19	18	17	16
RESERVED															
R-0h															
15	14	13	12	11	10	9	8	7	6	5	4	3	2	1	0
RESERVED				ECC_ERROR_LOCATION											
R-0h				R-0h											

LEGEND: R/W = Read/Write; R = Read only; W1toCl = Write 1 to clear bit; -n = value after reset

Table 7-366. ELM_ERROR_LOCATION_15_0 Register Field Descriptions

Bit	Field	Type	Reset	Description
31-13	RESERVED	R	0h	
12-0	ECC_ERROR_LOCATION	R	0h	Error-location bit address, 0 to 1FFFh.

7.4.5.81 ELM_LOCATION_STATUS_1 Register (offset = 900h) [reset = 0h]

ELM_LOCATION_STATUS_1 is shown in [Figure 7-336](#) and described in [Table 7-367](#).

Figure 7-336. ELM_LOCATION_STATUS_1 Register

31	30	29	28	27	26	25	24
RESERVED							
R-0h							
23	22	21	20	19	18	17	16
RESERVED							
R-0h							
15	14	13	12	11	10	9	8
RESERVED							ECC_CORREC TABL
R-0h							R-0h
7	6	5	4	3	2	1	0
RESERVED			ECC_NB_ERRORS				
R-0h			R-0h				

LEGEND: R/W = Read/Write; R = Read only; W1toCl = Write 1 to clear bit; -n = value after reset

Table 7-367. ELM_LOCATION_STATUS_1 Register Field Descriptions

Bit	Field	Type	Reset	Description
31-9	RESERVED	R	0h	
8	ECC_CORRECTABL	R	0h	Error-location process exit status. 0h = ECC error-location process failed. Number of errors and error locations are invalid. 1h = All errors were successfully located. Number of errors and error locations are valid.
7-5	RESERVED	R	0h	
4-0	ECC_NB_ERRORS	R	0h	Number of errors detected and located, value 0 to 1Fh.

7.4.5.82 ELM_ERROR_LOCATION_0_1 Register (offset = 980h) [reset = 0h]

ELM_ERROR_LOCATION_0_1 is shown in [Figure 7-337](#) and described in [Table 7-368](#).

Figure 7-337. ELM_ERROR_LOCATION_0_1 Register

31	30	29	28	27	26	25	24	23	22	21	20	19	18	17	16
RESERVED															
R-0h															
15	14	13	12	11	10	9	8	7	6	5	4	3	2	1	0
RESERVED				ECC_ERROR_LOCATION											
R-0h				R-0h											

LEGEND: R/W = Read/Write; R = Read only; W1toCl = Write 1 to clear bit; -n = value after reset

Table 7-368. ELM_ERROR_LOCATION_0_1 Register Field Descriptions

Bit	Field	Type	Reset	Description
31-13	RESERVED	R	0h	
12-0	ECC_ERROR_LOCATION	R	0h	Error-location bit address, 0 to 1FFFh.

7.4.5.83 ELM_ERROR_LOCATION_1_1 Register (offset = 984h) [reset = 0h]

ELM_ERROR_LOCATION_1_1 is shown in [Figure 7-338](#) and described in [Table 7-369](#).

Figure 7-338. ELM_ERROR_LOCATION_1_1 Register

31	30	29	28	27	26	25	24	23	22	21	20	19	18	17	16
RESERVED															
R-0h															
15	14	13	12	11	10	9	8	7	6	5	4	3	2	1	0
RESERVED				ECC_ERROR_LOCATION											
R-0h				R-0h											

LEGEND: R/W = Read/Write; R = Read only; W1toCl = Write 1 to clear bit; -n = value after reset

Table 7-369. ELM_ERROR_LOCATION_1_1 Register Field Descriptions

Bit	Field	Type	Reset	Description
31-13	RESERVED	R	0h	
12-0	ECC_ERROR_LOCATION	R	0h	Error-location bit address, 0 to 1FFFh.

7.4.5.84 ELM_ERROR_LOCATION_2_1 Register (offset = 988h) [reset = 0h]

ELM_ERROR_LOCATION_2_1 is shown in [Figure 7-339](#) and described in [Table 7-370](#).

Figure 7-339. ELM_ERROR_LOCATION_2_1 Register

31	30	29	28	27	26	25	24	23	22	21	20	19	18	17	16
RESERVED															
R-0h															
15	14	13	12	11	10	9	8	7	6	5	4	3	2	1	0
RESERVED				ECC_ERROR_LOCATION											
R-0h				R-0h											

LEGEND: R/W = Read/Write; R = Read only; W1toCl = Write 1 to clear bit; -n = value after reset

Table 7-370. ELM_ERROR_LOCATION_2_1 Register Field Descriptions

Bit	Field	Type	Reset	Description
31-13	RESERVED	R	0h	
12-0	ECC_ERROR_LOCATION	R	0h	Error-location bit address, 0 to 1FFFh.

7.4.5.85 ELM_ERROR_LOCATION_3_1 Register (offset = 98Ch) [reset = 0h]

ELM_ERROR_LOCATION_3_1 is shown in [Figure 7-340](#) and described in [Table 7-371](#).

Figure 7-340. ELM_ERROR_LOCATION_3_1 Register

31	30	29	28	27	26	25	24	23	22	21	20	19	18	17	16
RESERVED															
R-0h															
15	14	13	12	11	10	9	8	7	6	5	4	3	2	1	0
RESERVED				ECC_ERROR_LOCATION											
R-0h				R-0h											

LEGEND: R/W = Read/Write; R = Read only; W1toCl = Write 1 to clear bit; -n = value after reset

Table 7-371. ELM_ERROR_LOCATION_3_1 Register Field Descriptions

Bit	Field	Type	Reset	Description
31-13	RESERVED	R	0h	
12-0	ECC_ERROR_LOCATION	R	0h	Error-location bit address, 0 to 1FFFh.

7.4.5.86 ELM_ERROR_LOCATION_4_1 Register (offset = 990h) [reset = 0h]

ELM_ERROR_LOCATION_4_1 is shown in [Figure 7-341](#) and described in [Table 7-372](#).

Figure 7-341. ELM_ERROR_LOCATION_4_1 Register

31	30	29	28	27	26	25	24	23	22	21	20	19	18	17	16
RESERVED															
R-0h															
15	14	13	12	11	10	9	8	7	6	5	4	3	2	1	0
RESERVED				ECC_ERROR_LOCATION											
R-0h				R-0h											

LEGEND: R/W = Read/Write; R = Read only; W1toCl = Write 1 to clear bit; -n = value after reset

Table 7-372. ELM_ERROR_LOCATION_4_1 Register Field Descriptions

Bit	Field	Type	Reset	Description
31-13	RESERVED	R	0h	
12-0	ECC_ERROR_LOCATION	R	0h	Error-location bit address, 0 to 1FFFh.

7.4.5.87 ELM_ERROR_LOCATION_5_1 Register (offset = 994h) [reset = 0h]

ELM_ERROR_LOCATION_5_1 is shown in [Figure 7-342](#) and described in [Table 7-373](#).

Figure 7-342. ELM_ERROR_LOCATION_5_1 Register

31	30	29	28	27	26	25	24	23	22	21	20	19	18	17	16
RESERVED															
R-0h															
15	14	13	12	11	10	9	8	7	6	5	4	3	2	1	0
RESERVED			ECC_ERROR_LOCATION												
R-0h			R-0h												

LEGEND: R/W = Read/Write; R = Read only; W1toCl = Write 1 to clear bit; -n = value after reset

Table 7-373. ELM_ERROR_LOCATION_5_1 Register Field Descriptions

Bit	Field	Type	Reset	Description
31-13	RESERVED	R	0h	
12-0	ECC_ERROR_LOCATION	R	0h	Error-location bit address, 0 to 1FFFh.

7.4.5.88 ELM_ERROR_LOCATION_6_1 Register (offset = 998h) [reset = 0h]

 ELM_ERROR_LOCATION_6_1 is shown in [Figure 7-343](#) and described in [Table 7-374](#).

Figure 7-343. ELM_ERROR_LOCATION_6_1 Register

31	30	29	28	27	26	25	24	23	22	21	20	19	18	17	16
RESERVED															
R-0h															
15	14	13	12	11	10	9	8	7	6	5	4	3	2	1	0
RESERVED				ECC_ERROR_LOCATION											
R-0h				R-0h											

LEGEND: R/W = Read/Write; R = Read only; W1toCl = Write 1 to clear bit; -n = value after reset

Table 7-374. ELM_ERROR_LOCATION_6_1 Register Field Descriptions

Bit	Field	Type	Reset	Description
31-13	RESERVED	R	0h	
12-0	ECC_ERROR_LOCATION	R	0h	Error-location bit address, 0 to 1FFFh.

7.4.5.89 ELM_ERROR_LOCATION_7_1 Register (offset = 99Ch) [reset = 0h]

ELM_ERROR_LOCATION_7_1 is shown in [Figure 7-344](#) and described in [Table 7-375](#).

Figure 7-344. ELM_ERROR_LOCATION_7_1 Register

31	30	29	28	27	26	25	24	23	22	21	20	19	18	17	16
RESERVED															
R-0h															
15	14	13	12	11	10	9	8	7	6	5	4	3	2	1	0
RESERVED				ECC_ERROR_LOCATION											
R-0h				R-0h											

LEGEND: R/W = Read/Write; R = Read only; W1toCl = Write 1 to clear bit; -n = value after reset

Table 7-375. ELM_ERROR_LOCATION_7_1 Register Field Descriptions

Bit	Field	Type	Reset	Description
31-13	RESERVED	R	0h	
12-0	ECC_ERROR_LOCATION	R	0h	Error-location bit address, 0 to 1FFFh.

7.4.5.90 ELM_ERROR_LOCATION_8_1 Register (offset = 9A0h) [reset = 0h]

ELM_ERROR_LOCATION_8_1 is shown in [Figure 7-345](#) and described in [Table 7-376](#).

Figure 7-345. ELM_ERROR_LOCATION_8_1 Register

31	30	29	28	27	26	25	24	23	22	21	20	19	18	17	16
RESERVED															
R-0h															
15	14	13	12	11	10	9	8	7	6	5	4	3	2	1	0
RESERVED				ECC_ERROR_LOCATION											
R-0h				R-0h											

LEGEND: R/W = Read/Write; R = Read only; W1toCl = Write 1 to clear bit; -n = value after reset

Table 7-376. ELM_ERROR_LOCATION_8_1 Register Field Descriptions

Bit	Field	Type	Reset	Description
31-13	RESERVED	R	0h	
12-0	ECC_ERROR_LOCATION	R	0h	Error-location bit address, 0 to 1FFFh.

7.4.5.91 ELM_ERROR_LOCATION_9_1 Register (offset = 9A4h) [reset = 0h]

ELM_ERROR_LOCATION_9_1 is shown in [Figure 7-346](#) and described in [Table 7-377](#).

Figure 7-346. ELM_ERROR_LOCATION_9_1 Register

31	30	29	28	27	26	25	24	23	22	21	20	19	18	17	16
RESERVED															
R-0h															
15	14	13	12	11	10	9	8	7	6	5	4	3	2	1	0
RESERVED				ECC_ERROR_LOCATION											
R-0h				R-0h											

LEGEND: R/W = Read/Write; R = Read only; W1toCl = Write 1 to clear bit; -n = value after reset

Table 7-377. ELM_ERROR_LOCATION_9_1 Register Field Descriptions

Bit	Field	Type	Reset	Description
31-13	RESERVED	R	0h	
12-0	ECC_ERROR_LOCATION	R	0h	Error-location bit address, 0 to 1FFFh.

7.4.5.92 ELM_ERROR_LOCATION_10_1 Register (offset = 9A8h) [reset = 0h]

ELM_ERROR_LOCATION_10_1 is shown in [Figure 7-347](#) and described in [Table 7-378](#).

Figure 7-347. ELM_ERROR_LOCATION_10_1 Register

31	30	29	28	27	26	25	24	23	22	21	20	19	18	17	16
RESERVED															
R-0h															
15	14	13	12	11	10	9	8	7	6	5	4	3	2	1	0
RESERVED				ECC_ERROR_LOCATION											
R-0h				R-0h											

LEGEND: R/W = Read/Write; R = Read only; W1toCl = Write 1 to clear bit; -n = value after reset

Table 7-378. ELM_ERROR_LOCATION_10_1 Register Field Descriptions

Bit	Field	Type	Reset	Description
31-13	RESERVED	R	0h	
12-0	ECC_ERROR_LOCATION	R	0h	Error-location bit address, 0 to 1FFFh.

7.4.5.93 ELM_ERROR_LOCATION_11_1 Register (offset = 9ACh) [reset = 0h]

ELM_ERROR_LOCATION_11_1 is shown in [Figure 7-348](#) and described in [Table 7-379](#).

Figure 7-348. ELM_ERROR_LOCATION_11_1 Register

31	30	29	28	27	26	25	24	23	22	21	20	19	18	17	16
RESERVED															
R-0h															
15	14	13	12	11	10	9	8	7	6	5	4	3	2	1	0
RESERVED				ECC_ERROR_LOCATION											
R-0h				R-0h											

LEGEND: R/W = Read/Write; R = Read only; W1toCl = Write 1 to clear bit; -n = value after reset

Table 7-379. ELM_ERROR_LOCATION_11_1 Register Field Descriptions

Bit	Field	Type	Reset	Description
31-13	RESERVED	R	0h	
12-0	ECC_ERROR_LOCATION	R	0h	Error-location bit address, 0 to 1FFFh.

7.4.5.94 ELM_ERROR_LOCATION_12_1 Register (offset = 9B0h) [reset = 0h]

ELM_ERROR_LOCATION_12_1 is shown in [Figure 7-349](#) and described in [Table 7-380](#).

Figure 7-349. ELM_ERROR_LOCATION_12_1 Register

31	30	29	28	27	26	25	24	23	22	21	20	19	18	17	16
RESERVED															
R-0h															
15	14	13	12	11	10	9	8	7	6	5	4	3	2	1	0
RESERVED				ECC_ERROR_LOCATION											
R-0h				R-0h											

LEGEND: R/W = Read/Write; R = Read only; W1toCl = Write 1 to clear bit; -n = value after reset

Table 7-380. ELM_ERROR_LOCATION_12_1 Register Field Descriptions

Bit	Field	Type	Reset	Description
31-13	RESERVED	R	0h	
12-0	ECC_ERROR_LOCATION	R	0h	Error-location bit address, 0 to 1FFFh.

7.4.5.95 ELM_ERROR_LOCATION_13_1 Register (offset = 9B4h) [reset = 0h]

ELM_ERROR_LOCATION_13_1 is shown in [Figure 7-350](#) and described in [Table 7-381](#).

Figure 7-350. ELM_ERROR_LOCATION_13_1 Register

31	30	29	28	27	26	25	24	23	22	21	20	19	18	17	16
RESERVED															
R-0h															
15	14	13	12	11	10	9	8	7	6	5	4	3	2	1	0
RESERVED				ECC_ERROR_LOCATION											
R-0h				R-0h											

LEGEND: R/W = Read/Write; R = Read only; W1toCl = Write 1 to clear bit; -n = value after reset

Table 7-381. ELM_ERROR_LOCATION_13_1 Register Field Descriptions

Bit	Field	Type	Reset	Description
31-13	RESERVED	R	0h	
12-0	ECC_ERROR_LOCATION	R	0h	Error-location bit address, 0 to 1FFFh.

7.4.5.96 ELM_ERROR_LOCATION_14_1 Register (offset = 9B8h) [reset = 0h]

ELM_ERROR_LOCATION_14_1 is shown in [Figure 7-351](#) and described in [Table 7-382](#).

Figure 7-351. ELM_ERROR_LOCATION_14_1 Register

31	30	29	28	27	26	25	24	23	22	21	20	19	18	17	16
RESERVED															
R-0h															
15	14	13	12	11	10	9	8	7	6	5	4	3	2	1	0
RESERVED				ECC_ERROR_LOCATION											
R-0h				R-0h											

LEGEND: R/W = Read/Write; R = Read only; W1toCl = Write 1 to clear bit; -n = value after reset

Table 7-382. ELM_ERROR_LOCATION_14_1 Register Field Descriptions

Bit	Field	Type	Reset	Description
31-13	RESERVED	R	0h	
12-0	ECC_ERROR_LOCATION	R	0h	Error-location bit address, 0 to 1FFFh.

7.4.5.97 ELM_ERROR_LOCATION_15_1 Register (offset = 9BCh) [reset = 0h]

ELM_ERROR_LOCATION_15_1 is shown in [Figure 7-352](#) and described in [Table 7-383](#).

Figure 7-352. ELM_ERROR_LOCATION_15_1 Register

31	30	29	28	27	26	25	24	23	22	21	20	19	18	17	16
RESERVED															
R-0h															
15	14	13	12	11	10	9	8	7	6	5	4	3	2	1	0
RESERVED				ECC_ERROR_LOCATION											
R-0h				R-0h											

LEGEND: R/W = Read/Write; R = Read only; W1toCl = Write 1 to clear bit; -n = value after reset

Table 7-383. ELM_ERROR_LOCATION_15_1 Register Field Descriptions

Bit	Field	Type	Reset	Description
31-13	RESERVED	R	0h	
12-0	ECC_ERROR_LOCATION	R	0h	Error-location bit address, 0 to 1FFFh.

7.4.5.98 ELM_LOCATION_STATUS_2 Register (offset = A00h) [reset = 0h]

ELM_LOCATION_STATUS_2 is shown in [Figure 7-353](#) and described in [Table 7-384](#).

Figure 7-353. ELM_LOCATION_STATUS_2 Register

31	30	29	28	27	26	25	24
RESERVED							
R-0h							
23	22	21	20	19	18	17	16
RESERVED							
R-0h							
15	14	13	12	11	10	9	8
RESERVED							ECC_CORREC TABL
R-0h							R-0h
7	6	5	4	3	2	1	0
RESERVED			ECC_NB_ERRORS				
R-0h			R-0h				

LEGEND: R/W = Read/Write; R = Read only; W1toCl = Write 1 to clear bit; -n = value after reset

Table 7-384. ELM_LOCATION_STATUS_2 Register Field Descriptions

Bit	Field	Type	Reset	Description
31-9	RESERVED	R	0h	
8	ECC_CORRECTABL	R	0h	Error-location process exit status. 0h = ECC error-location process failed. Number of errors and error locations are invalid. 1h = All errors were successfully located. Number of errors and error locations are valid.
7-5	RESERVED	R	0h	
4-0	ECC_NB_ERRORS	R	0h	Number of errors detected and located, value 0 to 1Fh.

7.4.5.99 ELM_ERROR_LOCATION_0_2 Register (offset = A80h) [reset = 0h]

ELM_ERROR_LOCATION_0_2 is shown in [Figure 7-354](#) and described in [Table 7-385](#).

Figure 7-354. ELM_ERROR_LOCATION_0_2 Register

31	30	29	28	27	26	25	24	23	22	21	20	19	18	17	16
RESERVED															
R-0h															
15	14	13	12	11	10	9	8	7	6	5	4	3	2	1	0
RESERVED				ECC_ERROR_LOCATION											
R-0h				R-0h											

LEGEND: R/W = Read/Write; R = Read only; W1toCl = Write 1 to clear bit; -n = value after reset

Table 7-385. ELM_ERROR_LOCATION_0_2 Register Field Descriptions

Bit	Field	Type	Reset	Description
31-13	RESERVED	R	0h	
12-0	ECC_ERROR_LOCATION	R	0h	Error-location bit address, 0 to 1FFFh.

7.4.5.100 ELM_ERROR_LOCATION_1_2 Register (offset = A84h) [reset = 0h]

ELM_ERROR_LOCATION_1_2 is shown in [Figure 7-355](#) and described in [Table 7-386](#).

Figure 7-355. ELM_ERROR_LOCATION_1_2 Register

31	30	29	28	27	26	25	24	23	22	21	20	19	18	17	16
RESERVED															
R-0h															
15	14	13	12	11	10	9	8	7	6	5	4	3	2	1	0
RESERVED				ECC_ERROR_LOCATION											
R-0h				R-0h											

LEGEND: R/W = Read/Write; R = Read only; W1toCl = Write 1 to clear bit; -n = value after reset

Table 7-386. ELM_ERROR_LOCATION_1_2 Register Field Descriptions

Bit	Field	Type	Reset	Description
31-13	RESERVED	R	0h	
12-0	ECC_ERROR_LOCATION	R	0h	Error-location bit address, 0 to 1FFFh.

7.4.5.101 ELM_ERROR_LOCATION_2_2 Register (offset = A88h) [reset = 0h]

ELM_ERROR_LOCATION_2_2 is shown in [Figure 7-356](#) and described in [Table 7-387](#).

Figure 7-356. ELM_ERROR_LOCATION_2_2 Register

31	30	29	28	27	26	25	24	23	22	21	20	19	18	17	16
RESERVED															
R-0h															
15	14	13	12	11	10	9	8	7	6	5	4	3	2	1	0
RESERVED				ECC_ERROR_LOCATION											
R-0h				R-0h											

LEGEND: R/W = Read/Write; R = Read only; W1toCl = Write 1 to clear bit; -n = value after reset

Table 7-387. ELM_ERROR_LOCATION_2_2 Register Field Descriptions

Bit	Field	Type	Reset	Description
31-13	RESERVED	R	0h	
12-0	ECC_ERROR_LOCATION	R	0h	Error-location bit address, 0 to 1FFFh.

7.4.5.102 ELM_ERROR_LOCATION_3_2 Register (offset = A8Ch) [reset = 0h]

ELM_ERROR_LOCATION_3_2 is shown in [Figure 7-357](#) and described in [Table 7-388](#).

Figure 7-357. ELM_ERROR_LOCATION_3_2 Register

31	30	29	28	27	26	25	24	23	22	21	20	19	18	17	16
RESERVED															
R-0h															
15	14	13	12	11	10	9	8	7	6	5	4	3	2	1	0
RESERVED				ECC_ERROR_LOCATION											
R-0h				R-0h											

LEGEND: R/W = Read/Write; R = Read only; W1toCl = Write 1 to clear bit; -n = value after reset

Table 7-388. ELM_ERROR_LOCATION_3_2 Register Field Descriptions

Bit	Field	Type	Reset	Description
31-13	RESERVED	R	0h	
12-0	ECC_ERROR_LOCATION	R	0h	Error-location bit address, 0 to 1FFFh.

7.4.5.103 ELM_ERROR_LOCATION_4_2 Register (offset = A90h) [reset = 0h]

 ELM_ERROR_LOCATION_4_2 is shown in [Figure 7-358](#) and described in [Table 7-389](#).

Figure 7-358. ELM_ERROR_LOCATION_4_2 Register

31	30	29	28	27	26	25	24	23	22	21	20	19	18	17	16
RESERVED															
R-0h															
15	14	13	12	11	10	9	8	7	6	5	4	3	2	1	0
RESERVED				ECC_ERROR_LOCATION											
R-0h				R-0h											

LEGEND: R/W = Read/Write; R = Read only; W1toCl = Write 1 to clear bit; -n = value after reset

Table 7-389. ELM_ERROR_LOCATION_4_2 Register Field Descriptions

Bit	Field	Type	Reset	Description
31-13	RESERVED	R	0h	
12-0	ECC_ERROR_LOCATION	R	0h	Error-location bit address, 0 to 1FFFh.

7.4.5.104 ELM_ERROR_LOCATION_5_2 Register (offset = A94h) [reset = 0h]

ELM_ERROR_LOCATION_5_2 is shown in [Figure 7-359](#) and described in [Table 7-390](#).

Figure 7-359. ELM_ERROR_LOCATION_5_2 Register

31	30	29	28	27	26	25	24	23	22	21	20	19	18	17	16
RESERVED															
R-0h															
15	14	13	12	11	10	9	8	7	6	5	4	3	2	1	0
RESERVED				ECC_ERROR_LOCATION											
R-0h				R-0h											

LEGEND: R/W = Read/Write; R = Read only; W1toCl = Write 1 to clear bit; -n = value after reset

Table 7-390. ELM_ERROR_LOCATION_5_2 Register Field Descriptions

Bit	Field	Type	Reset	Description
31-13	RESERVED	R	0h	
12-0	ECC_ERROR_LOCATION	R	0h	Error-location bit address, 0 to 1FFFh.

7.4.5.105 ELM_ERROR_LOCATION_6_2 Register (offset = A98h) [reset = 0h]

 ELM_ERROR_LOCATION_6_2 is shown in [Figure 7-360](#) and described in [Table 7-391](#).

Figure 7-360. ELM_ERROR_LOCATION_6_2 Register

31	30	29	28	27	26	25	24	23	22	21	20	19	18	17	16
RESERVED															
R-0h															
15	14	13	12	11	10	9	8	7	6	5	4	3	2	1	0
RESERVED				ECC_ERROR_LOCATION											
R-0h				R-0h											

LEGEND: R/W = Read/Write; R = Read only; W1toCl = Write 1 to clear bit; -n = value after reset

Table 7-391. ELM_ERROR_LOCATION_6_2 Register Field Descriptions

Bit	Field	Type	Reset	Description
31-13	RESERVED	R	0h	
12-0	ECC_ERROR_LOCATION	R	0h	Error-location bit address, 0 to 1FFFh.

7.4.5.106 ELM_ERROR_LOCATION_7_2 Register (offset = A9Ch) [reset = 0h]

ELM_ERROR_LOCATION_7_2 is shown in [Figure 7-361](#) and described in [Table 7-392](#).

Figure 7-361. ELM_ERROR_LOCATION_7_2 Register

31	30	29	28	27	26	25	24	23	22	21	20	19	18	17	16
RESERVED															
R-0h															
15	14	13	12	11	10	9	8	7	6	5	4	3	2	1	0
RESERVED				ECC_ERROR_LOCATION											
R-0h				R-0h											

LEGEND: R/W = Read/Write; R = Read only; W1toCl = Write 1 to clear bit; -n = value after reset

Table 7-392. ELM_ERROR_LOCATION_7_2 Register Field Descriptions

Bit	Field	Type	Reset	Description
31-13	RESERVED	R	0h	
12-0	ECC_ERROR_LOCATION	R	0h	Error-location bit address, 0 to 1FFFh.

7.4.5.107 ELM_ERROR_LOCATION_8_2 Register (offset = AA0h) [reset = 0h]

ELM_ERROR_LOCATION_8_2 is shown in [Figure 7-362](#) and described in [Table 7-393](#).

Figure 7-362. ELM_ERROR_LOCATION_8_2 Register

31	30	29	28	27	26	25	24	23	22	21	20	19	18	17	16
RESERVED															
R-0h															
15	14	13	12	11	10	9	8	7	6	5	4	3	2	1	0
RESERVED				ECC_ERROR_LOCATION											
R-0h				R-0h											

LEGEND: R/W = Read/Write; R = Read only; W1toCl = Write 1 to clear bit; -n = value after reset

Table 7-393. ELM_ERROR_LOCATION_8_2 Register Field Descriptions

Bit	Field	Type	Reset	Description
31-13	RESERVED	R	0h	
12-0	ECC_ERROR_LOCATION	R	0h	Error-location bit address, 0 to 1FFFh.

7.4.5.108 ELM_ERROR_LOCATION_9_2 Register (offset = AA4h) [reset = 0h]

ELM_ERROR_LOCATION_9_2 is shown in [Figure 7-363](#) and described in [Table 7-394](#).

Figure 7-363. ELM_ERROR_LOCATION_9_2 Register

31	30	29	28	27	26	25	24	23	22	21	20	19	18	17	16
RESERVED															
R-0h															
15	14	13	12	11	10	9	8	7	6	5	4	3	2	1	0
RESERVED				ECC_ERROR_LOCATION											
R-0h				R-0h											

LEGEND: R/W = Read/Write; R = Read only; W1toCl = Write 1 to clear bit; -n = value after reset

Table 7-394. ELM_ERROR_LOCATION_9_2 Register Field Descriptions

Bit	Field	Type	Reset	Description
31-13	RESERVED	R	0h	
12-0	ECC_ERROR_LOCATION	R	0h	Error-location bit address, 0 to 1FFFh.

7.4.5.109 ELM_ERROR_LOCATION_10_2 Register (offset = AA8h) [reset = 0h]

ELM_ERROR_LOCATION_10_2 is shown in [Figure 7-364](#) and described in [Table 7-395](#).

Figure 7-364. ELM_ERROR_LOCATION_10_2 Register

31	30	29	28	27	26	25	24	23	22	21	20	19	18	17	16
RESERVED															
R-0h															
15	14	13	12	11	10	9	8	7	6	5	4	3	2	1	0
RESERVED				ECC_ERROR_LOCATION											
R-0h				R-0h											

LEGEND: R/W = Read/Write; R = Read only; W1toCl = Write 1 to clear bit; -n = value after reset

Table 7-395. ELM_ERROR_LOCATION_10_2 Register Field Descriptions

Bit	Field	Type	Reset	Description
31-13	RESERVED	R	0h	
12-0	ECC_ERROR_LOCATION	R	0h	Error-location bit address, 0 to 1FFFh.

7.4.5.110 ELM_ERROR_LOCATION_11_2 Register (offset = AACH) [reset = 0h]

 ELM_ERROR_LOCATION_11_2 is shown in [Figure 7-365](#) and described in [Table 7-396](#).

Figure 7-365. ELM_ERROR_LOCATION_11_2 Register

31	30	29	28	27	26	25	24	23	22	21	20	19	18	17	16
RESERVED															
R-0h															
15	14	13	12	11	10	9	8	7	6	5	4	3	2	1	0
RESERVED				ECC_ERROR_LOCATION											
R-0h				R-0h											

LEGEND: R/W = Read/Write; R = Read only; W1toCl = Write 1 to clear bit; -n = value after reset

Table 7-396. ELM_ERROR_LOCATION_11_2 Register Field Descriptions

Bit	Field	Type	Reset	Description
31-13	RESERVED	R	0h	
12-0	ECC_ERROR_LOCATION	R	0h	Error-location bit address, 0 to 1FFFh.

7.4.5.111 ELM_ERROR_LOCATION_12_2 Register (offset = AB0h) [reset = 0h]

 ELM_ERROR_LOCATION_12_2 is shown in [Figure 7-366](#) and described in [Table 7-397](#).

Figure 7-366. ELM_ERROR_LOCATION_12_2 Register

31	30	29	28	27	26	25	24	23	22	21	20	19	18	17	16
RESERVED															
R-0h															
15	14	13	12	11	10	9	8	7	6	5	4	3	2	1	0
RESERVED				ECC_ERROR_LOCATION											
R-0h				R-0h											

LEGEND: R/W = Read/Write; R = Read only; W1toCl = Write 1 to clear bit; -n = value after reset

Table 7-397. ELM_ERROR_LOCATION_12_2 Register Field Descriptions

Bit	Field	Type	Reset	Description
31-13	RESERVED	R	0h	
12-0	ECC_ERROR_LOCATION	R	0h	Error-location bit address, 0 to 1FFFh.

7.4.5.112 ELM_ERROR_LOCATION_13_2 Register (offset = AB4h) [reset = 0h]

ELM_ERROR_LOCATION_13_2 is shown in [Figure 7-367](#) and described in [Table 7-398](#).

Figure 7-367. ELM_ERROR_LOCATION_13_2 Register

31	30	29	28	27	26	25	24	23	22	21	20	19	18	17	16
RESERVED															
R-0h															
15	14	13	12	11	10	9	8	7	6	5	4	3	2	1	0
RESERVED				ECC_ERROR_LOCATION											
R-0h				R-0h											

LEGEND: R/W = Read/Write; R = Read only; W1toCl = Write 1 to clear bit; -n = value after reset

Table 7-398. ELM_ERROR_LOCATION_13_2 Register Field Descriptions

Bit	Field	Type	Reset	Description
31-13	RESERVED	R	0h	
12-0	ECC_ERROR_LOCATION	R	0h	Error-location bit address, 0 to 1FFFh.

7.4.5.113 ELM_ERROR_LOCATION_14_2 Register (offset = AB8h) [reset = 0h]

ELM_ERROR_LOCATION_14_2 is shown in [Figure 7-368](#) and described in [Table 7-399](#).

Figure 7-368. ELM_ERROR_LOCATION_14_2 Register

31	30	29	28	27	26	25	24	23	22	21	20	19	18	17	16
RESERVED															
R-0h															
15	14	13	12	11	10	9	8	7	6	5	4	3	2	1	0
RESERVED				ECC_ERROR_LOCATION											
R-0h				R-0h											

LEGEND: R/W = Read/Write; R = Read only; W1toCl = Write 1 to clear bit; -n = value after reset

Table 7-399. ELM_ERROR_LOCATION_14_2 Register Field Descriptions

Bit	Field	Type	Reset	Description
31-13	RESERVED	R	0h	
12-0	ECC_ERROR_LOCATION	R	0h	Error-location bit address, 0 to 1FFFh.

7.4.5.114 ELM_ERROR_LOCATION_15_2 Register (offset = ABCh) [reset = 0h]

ELM_ERROR_LOCATION_15_2 is shown in [Figure 7-369](#) and described in [Table 7-400](#).

Figure 7-369. ELM_ERROR_LOCATION_15_2 Register

31	30	29	28	27	26	25	24	23	22	21	20	19	18	17	16
RESERVED															
R-0h															
15	14	13	12	11	10	9	8	7	6	5	4	3	2	1	0
RESERVED				ECC_ERROR_LOCATION											
R-0h				R-0h											

LEGEND: R/W = Read/Write; R = Read only; W1toCl = Write 1 to clear bit; -n = value after reset

Table 7-400. ELM_ERROR_LOCATION_15_2 Register Field Descriptions

Bit	Field	Type	Reset	Description
31-13	RESERVED	R	0h	
12-0	ECC_ERROR_LOCATION	R	0h	Error-location bit address, 0 to 1FFFh.

7.4.5.115 ELM_ERROR_LOCATION_0_3 Register (offset = B80h) [reset = 0h]

 ELM_ERROR_LOCATION_0_3 is shown in [Figure 7-370](#) and described in [Table 7-401](#).

Figure 7-370. ELM_ERROR_LOCATION_0_3 Register

31	30	29	28	27	26	25	24	23	22	21	20	19	18	17	16
RESERVED															
R-0h															
15	14	13	12	11	10	9	8	7	6	5	4	3	2	1	0
RESERVED				ECC_ERROR_LOCATION											
R-0h				R-0h											

LEGEND: R/W = Read/Write; R = Read only; W1toCl = Write 1 to clear bit; -n = value after reset

Table 7-401. ELM_ERROR_LOCATION_0_3 Register Field Descriptions

Bit	Field	Type	Reset	Description
31-13	RESERVED	R	0h	
12-0	ECC_ERROR_LOCATION	R	0h	Error-location bit address, 0 to 1FFFh.

7.4.5.116 ELM_ERROR_LOCATION_1_3 Register (offset = B84h) [reset = 0h]

ELM_ERROR_LOCATION_1_3 is shown in [Figure 7-371](#) and described in [Table 7-402](#).

Figure 7-371. ELM_ERROR_LOCATION_1_3 Register

31	30	29	28	27	26	25	24	23	22	21	20	19	18	17	16
RESERVED															
R-0h															
15	14	13	12	11	10	9	8	7	6	5	4	3	2	1	0
RESERVED				ECC_ERROR_LOCATION											
R-0h				R-0h											

LEGEND: R/W = Read/Write; R = Read only; W1toCl = Write 1 to clear bit; -n = value after reset

Table 7-402. ELM_ERROR_LOCATION_1_3 Register Field Descriptions

Bit	Field	Type	Reset	Description
31-13	RESERVED	R	0h	
12-0	ECC_ERROR_LOCATION	R	0h	Error-location bit address, 0 to 1FFFh.

7.4.5.117 ELM_ERROR_LOCATION_2_3 Register (offset = B88h) [reset = 0h]

 ELM_ERROR_LOCATION_2_3 is shown in [Figure 7-372](#) and described in [Table 7-403](#).

Figure 7-372. ELM_ERROR_LOCATION_2_3 Register

31	30	29	28	27	26	25	24	23	22	21	20	19	18	17	16
RESERVED															
R-0h															
15	14	13	12	11	10	9	8	7	6	5	4	3	2	1	0
RESERVED				ECC_ERROR_LOCATION											
R-0h				R-0h											

LEGEND: R/W = Read/Write; R = Read only; W1toCl = Write 1 to clear bit; -n = value after reset

Table 7-403. ELM_ERROR_LOCATION_2_3 Register Field Descriptions

Bit	Field	Type	Reset	Description
31-13	RESERVED	R	0h	
12-0	ECC_ERROR_LOCATION	R	0h	Error-location bit address, 0 to 1FFFh.

7.4.5.118 ELM_ERROR_LOCATION_3_3 Register (offset = B8Ch) [reset = 0h]

ELM_ERROR_LOCATION_3_3 is shown in [Figure 7-373](#) and described in [Table 7-404](#).

Figure 7-373. ELM_ERROR_LOCATION_3_3 Register

31	30	29	28	27	26	25	24	23	22	21	20	19	18	17	16
RESERVED															
R-0h															
15	14	13	12	11	10	9	8	7	6	5	4	3	2	1	0
RESERVED				ECC_ERROR_LOCATION											
R-0h				R-0h											

LEGEND: R/W = Read/Write; R = Read only; W1toCl = Write 1 to clear bit; -n = value after reset

Table 7-404. ELM_ERROR_LOCATION_3_3 Register Field Descriptions

Bit	Field	Type	Reset	Description
31-13	RESERVED	R	0h	
12-0	ECC_ERROR_LOCATION	R	0h	Error-location bit address, 0 to 1FFFh.

7.4.5.119 ELM_ERROR_LOCATION_4_3 Register (offset = B90h) [reset = 0h]

 ELM_ERROR_LOCATION_4_3 is shown in [Figure 7-374](#) and described in [Table 7-405](#).

Figure 7-374. ELM_ERROR_LOCATION_4_3 Register

31	30	29	28	27	26	25	24	23	22	21	20	19	18	17	16
RESERVED															
R-0h															
15	14	13	12	11	10	9	8	7	6	5	4	3	2	1	0
RESERVED				ECC_ERROR_LOCATION											
R-0h				R-0h											

LEGEND: R/W = Read/Write; R = Read only; W1toCl = Write 1 to clear bit; -n = value after reset

Table 7-405. ELM_ERROR_LOCATION_4_3 Register Field Descriptions

Bit	Field	Type	Reset	Description
31-13	RESERVED	R	0h	
12-0	ECC_ERROR_LOCATION	R	0h	Error-location bit address, 0 to 1FFFh.

7.4.5.120 ELM_ERROR_LOCATION_5_3 Register (offset = B94h) [reset = 0h]

ELM_ERROR_LOCATION_5_3 is shown in [Figure 7-375](#) and described in [Table 7-406](#).

Figure 7-375. ELM_ERROR_LOCATION_5_3 Register

31	30	29	28	27	26	25	24	23	22	21	20	19	18	17	16
RESERVED															
R-0h															
15	14	13	12	11	10	9	8	7	6	5	4	3	2	1	0
RESERVED				ECC_ERROR_LOCATION											
R-0h				R-0h											

LEGEND: R/W = Read/Write; R = Read only; W1toCl = Write 1 to clear bit; -n = value after reset

Table 7-406. ELM_ERROR_LOCATION_5_3 Register Field Descriptions

Bit	Field	Type	Reset	Description
31-13	RESERVED	R	0h	
12-0	ECC_ERROR_LOCATION	R	0h	Error-location bit address, 0 to 1FFFh.

7.4.5.121 ELM_ERROR_LOCATION_6_3 Register (offset = B98h) [reset = 0h]

ELM_ERROR_LOCATION_6_3 is shown in [Figure 7-376](#) and described in [Table 7-407](#).

Figure 7-376. ELM_ERROR_LOCATION_6_3 Register

31	30	29	28	27	26	25	24	23	22	21	20	19	18	17	16
RESERVED															
R-0h															
15	14	13	12	11	10	9	8	7	6	5	4	3	2	1	0
RESERVED				ECC_ERROR_LOCATION											
R-0h				R-0h											

LEGEND: R/W = Read/Write; R = Read only; W1toCl = Write 1 to clear bit; -n = value after reset

Table 7-407. ELM_ERROR_LOCATION_6_3 Register Field Descriptions

Bit	Field	Type	Reset	Description
31-13	RESERVED	R	0h	
12-0	ECC_ERROR_LOCATION	R	0h	Error-location bit address, 0 to 1FFFh.

7.4.5.122 ELM_ERROR_LOCATION_7_3 Register (offset = B9Ch) [reset = 0h]

ELM_ERROR_LOCATION_7_3 is shown in [Figure 7-377](#) and described in [Table 7-408](#).

Figure 7-377. ELM_ERROR_LOCATION_7_3 Register

31	30	29	28	27	26	25	24	23	22	21	20	19	18	17	16
RESERVED															
R-0h															
15	14	13	12	11	10	9	8	7	6	5	4	3	2	1	0
RESERVED				ECC_ERROR_LOCATION											
R-0h				R-0h											

LEGEND: R/W = Read/Write; R = Read only; W1toCl = Write 1 to clear bit; -n = value after reset

Table 7-408. ELM_ERROR_LOCATION_7_3 Register Field Descriptions

Bit	Field	Type	Reset	Description
31-13	RESERVED	R	0h	
12-0	ECC_ERROR_LOCATION	R	0h	Error-location bit address, 0 to 1FFFh.

7.4.5.123 ELM_ERROR_LOCATION_8_3 Register (offset = BA0h) [reset = 0h]

ELM_ERROR_LOCATION_8_3 is shown in [Figure 7-378](#) and described in [Table 7-409](#).

Figure 7-378. ELM_ERROR_LOCATION_8_3 Register

31	30	29	28	27	26	25	24	23	22	21	20	19	18	17	16
RESERVED															
R-0h															
15	14	13	12	11	10	9	8	7	6	5	4	3	2	1	0
RESERVED				ECC_ERROR_LOCATION											
R-0h				R-0h											

LEGEND: R/W = Read/Write; R = Read only; W1toCl = Write 1 to clear bit; -n = value after reset

Table 7-409. ELM_ERROR_LOCATION_8_3 Register Field Descriptions

Bit	Field	Type	Reset	Description
31-13	RESERVED	R	0h	
12-0	ECC_ERROR_LOCATION	R	0h	Error-location bit address, 0 to 1FFFh.

7.4.5.124 ELM_ERROR_LOCATION_9_3 Register (offset = BA4h) [reset = 0h]

ELM_ERROR_LOCATION_9_3 is shown in [Figure 7-379](#) and described in [Table 7-410](#).

Figure 7-379. ELM_ERROR_LOCATION_9_3 Register

31	30	29	28	27	26	25	24	23	22	21	20	19	18	17	16
RESERVED															
R-0h															
15	14	13	12	11	10	9	8	7	6	5	4	3	2	1	0
RESERVED				ECC_ERROR_LOCATION											
R-0h				R-0h											

LEGEND: R/W = Read/Write; R = Read only; W1toCl = Write 1 to clear bit; -n = value after reset

Table 7-410. ELM_ERROR_LOCATION_9_3 Register Field Descriptions

Bit	Field	Type	Reset	Description
31-13	RESERVED	R	0h	
12-0	ECC_ERROR_LOCATION	R	0h	Error-location bit address, 0 to 1FFFh.

7.4.5.125 ELM_ERROR_LOCATION_10_3 Register (offset = BA8h) [reset = 0h]

ELM_ERROR_LOCATION_10_3 is shown in [Figure 7-380](#) and described in [Table 7-411](#).

Figure 7-380. ELM_ERROR_LOCATION_10_3 Register

31	30	29	28	27	26	25	24	23	22	21	20	19	18	17	16
RESERVED															
R-0h															
15	14	13	12	11	10	9	8	7	6	5	4	3	2	1	0
RESERVED				ECC_ERROR_LOCATION											
R-0h				R-0h											

LEGEND: R/W = Read/Write; R = Read only; W1toCl = Write 1 to clear bit; -n = value after reset

Table 7-411. ELM_ERROR_LOCATION_10_3 Register Field Descriptions

Bit	Field	Type	Reset	Description
31-13	RESERVED	R	0h	
12-0	ECC_ERROR_LOCATION	R	0h	Error-location bit address, 0 to 1FFFh.

7.4.5.126 ELM_ERROR_LOCATION_11_3 Register (offset = BACH) [reset = 0h]

ELM_ERROR_LOCATION_11_3 is shown in [Figure 7-381](#) and described in [Table 7-412](#).

Figure 7-381. ELM_ERROR_LOCATION_11_3 Register

31	30	29	28	27	26	25	24	23	22	21	20	19	18	17	16
RESERVED															
R-0h															
15	14	13	12	11	10	9	8	7	6	5	4	3	2	1	0
RESERVED				ECC_ERROR_LOCATION											
R-0h				R-0h											

LEGEND: R/W = Read/Write; R = Read only; W1toCl = Write 1 to clear bit; -n = value after reset

Table 7-412. ELM_ERROR_LOCATION_11_3 Register Field Descriptions

Bit	Field	Type	Reset	Description
31-13	RESERVED	R	0h	
12-0	ECC_ERROR_LOCATION	R	0h	Error-location bit address, 0 to 1FFFh.

7.4.5.127 ELM_ERROR_LOCATION_12_3 Register (offset = BB0h) [reset = 0h]

ELM_ERROR_LOCATION_12_3 is shown in [Figure 7-382](#) and described in [Table 7-413](#).

Figure 7-382. ELM_ERROR_LOCATION_12_3 Register

31	30	29	28	27	26	25	24	23	22	21	20	19	18	17	16
RESERVED															
R-0h															
15	14	13	12	11	10	9	8	7	6	5	4	3	2	1	0
RESERVED				ECC_ERROR_LOCATION											
R-0h				R-0h											

LEGEND: R/W = Read/Write; R = Read only; W1toCl = Write 1 to clear bit; -n = value after reset

Table 7-413. ELM_ERROR_LOCATION_12_3 Register Field Descriptions

Bit	Field	Type	Reset	Description
31-13	RESERVED	R	0h	
12-0	ECC_ERROR_LOCATION	R	0h	Error-location bit address, 0 to 1FFFh.

7.4.5.128 ELM_ERROR_LOCATION_13_3 Register (offset = BB4h) [reset = 0h]

ELM_ERROR_LOCATION_13_3 is shown in [Figure 7-383](#) and described in [Table 7-414](#).

Figure 7-383. ELM_ERROR_LOCATION_13_3 Register

31	30	29	28	27	26	25	24	23	22	21	20	19	18	17	16
RESERVED															
R-0h															
15	14	13	12	11	10	9	8	7	6	5	4	3	2	1	0
RESERVED				ECC_ERROR_LOCATION											
R-0h				R-0h											

LEGEND: R/W = Read/Write; R = Read only; W1toCl = Write 1 to clear bit; -n = value after reset

Table 7-414. ELM_ERROR_LOCATION_13_3 Register Field Descriptions

Bit	Field	Type	Reset	Description
31-13	RESERVED	R	0h	
12-0	ECC_ERROR_LOCATION	R	0h	Error-location bit address, 0 to 1FFFh.

7.4.5.129 ELM_ERROR_LOCATION_14_3 Register (offset = BB8h) [reset = 0h]

ELM_ERROR_LOCATION_14_3 is shown in [Figure 7-384](#) and described in [Table 7-415](#).

Figure 7-384. ELM_ERROR_LOCATION_14_3 Register

31	30	29	28	27	26	25	24	23	22	21	20	19	18	17	16
RESERVED															
R-0h															
15	14	13	12	11	10	9	8	7	6	5	4	3	2	1	0
RESERVED				ECC_ERROR_LOCATION											
R-0h				R-0h											

LEGEND: R/W = Read/Write; R = Read only; W1toCl = Write 1 to clear bit; -n = value after reset

Table 7-415. ELM_ERROR_LOCATION_14_3 Register Field Descriptions

Bit	Field	Type	Reset	Description
31-13	RESERVED	R	0h	
12-0	ECC_ERROR_LOCATION	R	0h	Error-location bit address, 0 to 1FFFh.

7.4.5.130 ELM_ERROR_LOCATION_15_3 Register (offset = BBCh) [reset = 0h]

 ELM_ERROR_LOCATION_15_3 is shown in [Figure 7-385](#) and described in [Table 7-416](#).

Figure 7-385. ELM_ERROR_LOCATION_15_3 Register

31	30	29	28	27	26	25	24	23	22	21	20	19	18	17	16
RESERVED															
R-0h															
15	14	13	12	11	10	9	8	7	6	5	4	3	2	1	0
RESERVED				ECC_ERROR_LOCATION											
R-0h				R-0h											

LEGEND: R/W = Read/Write; R = Read only; W1toCl = Write 1 to clear bit; -n = value after reset

Table 7-416. ELM_ERROR_LOCATION_15_3 Register Field Descriptions

Bit	Field	Type	Reset	Description
31-13	RESERVED	R	0h	
12-0	ECC_ERROR_LOCATION	R	0h	Error-location bit address, 0 to 1FFFh.

7.4.5.131 ELM_LOCATION_STATUS_3 Register (offset = B00h) [reset = 0h]

 ELM_LOCATION_STATUS_3 is shown in [Figure 7-386](#) and described in [Table 7-417](#).

Figure 7-386. ELM_LOCATION_STATUS_3 Register

31	30	29	28	27	26	25	24
RESERVED							
R-0h							
23	22	21	20	19	18	17	16
RESERVED							
R-0h							
15	14	13	12	11	10	9	8
RESERVED							ECC_CORREC TABL
R-0h							R-0h
7	6	5	4	3	2	1	0
RESERVED			ECC_NB_ERRORS				
R-0h			R-0h				

LEGEND: R/W = Read/Write; R = Read only; W1toCl = Write 1 to clear bit; -n = value after reset

Table 7-417. ELM_LOCATION_STATUS_3 Register Field Descriptions

Bit	Field	Type	Reset	Description
31-9	RESERVED	R	0h	
8	ECC_CORRECTABL	R	0h	Error-location process exit status. 0h = ECC error-location process failed. Number of errors and error locations are invalid. 1h = All errors were successfully located. Number of errors and error locations are valid.
7-5	RESERVED	R	0h	
4-0	ECC_NB_ERRORS	R	0h	Number of errors detected and located, value 0 to 1Fh.

7.4.5.132 ELM_ERROR_LOCATION_0_4 Register (offset = C80h) [reset = 0h]

ELM_ERROR_LOCATION_0_4 is shown in [Figure 7-387](#) and described in [Table 7-418](#).

Figure 7-387. ELM_ERROR_LOCATION_0_4 Register

31	30	29	28	27	26	25	24	23	22	21	20	19	18	17	16
RESERVED															
R-0h															
15	14	13	12	11	10	9	8	7	6	5	4	3	2	1	0
RESERVED				ECC_ERROR_LOCATION											
R-0h				R-0h											

LEGEND: R/W = Read/Write; R = Read only; W1toCl = Write 1 to clear bit; -n = value after reset

Table 7-418. ELM_ERROR_LOCATION_0_4 Register Field Descriptions

Bit	Field	Type	Reset	Description
31-13	RESERVED	R	0h	
12-0	ECC_ERROR_LOCATION	R	0h	Error-location bit address, 0 to 1FFFh.

7.4.5.133 ELM_ERROR_LOCATION_1_4 Register (offset = C84h) [reset = 0h]

 ELM_ERROR_LOCATION_1_4 is shown in [Figure 7-388](#) and described in [Table 7-419](#).

Figure 7-388. ELM_ERROR_LOCATION_1_4 Register

31	30	29	28	27	26	25	24	23	22	21	20	19	18	17	16
RESERVED															
R-0h															
15	14	13	12	11	10	9	8	7	6	5	4	3	2	1	0
RESERVED				ECC_ERROR_LOCATION											
R-0h				R-0h											

LEGEND: R/W = Read/Write; R = Read only; W1toCl = Write 1 to clear bit; -n = value after reset

Table 7-419. ELM_ERROR_LOCATION_1_4 Register Field Descriptions

Bit	Field	Type	Reset	Description
31-13	RESERVED	R	0h	
12-0	ECC_ERROR_LOCATION	R	0h	Error-location bit address, 0 to 1FFFh.

7.4.5.134 ELM_ERROR_LOCATION_2_4 Register (offset = C88h) [reset = 0h]

ELM_ERROR_LOCATION_2_4 is shown in [Figure 7-389](#) and described in [Table 7-420](#).

Figure 7-389. ELM_ERROR_LOCATION_2_4 Register

31	30	29	28	27	26	25	24	23	22	21	20	19	18	17	16
RESERVED															
R-0h															
15	14	13	12	11	10	9	8	7	6	5	4	3	2	1	0
RESERVED				ECC_ERROR_LOCATION											
R-0h				R-0h											

LEGEND: R/W = Read/Write; R = Read only; W1toCl = Write 1 to clear bit; -n = value after reset

Table 7-420. ELM_ERROR_LOCATION_2_4 Register Field Descriptions

Bit	Field	Type	Reset	Description
31-13	RESERVED	R	0h	
12-0	ECC_ERROR_LOCATION	R	0h	Error-location bit address, 0 to 1FFFh.

7.4.5.135 ELM_ERROR_LOCATION_3_4 Register (offset = C8Ch) [reset = 0h]

 ELM_ERROR_LOCATION_3_4 is shown in [Figure 7-390](#) and described in [Table 7-421](#).

Figure 7-390. ELM_ERROR_LOCATION_3_4 Register

31	30	29	28	27	26	25	24	23	22	21	20	19	18	17	16
RESERVED															
R-0h															
15	14	13	12	11	10	9	8	7	6	5	4	3	2	1	0
RESERVED				ECC_ERROR_LOCATION											
R-0h				R-0h											

LEGEND: R/W = Read/Write; R = Read only; W1toCl = Write 1 to clear bit; -n = value after reset

Table 7-421. ELM_ERROR_LOCATION_3_4 Register Field Descriptions

Bit	Field	Type	Reset	Description
31-13	RESERVED	R	0h	
12-0	ECC_ERROR_LOCATION	R	0h	Error-location bit address, 0 to 1FFFh.

7.4.5.136 ELM_ERROR_LOCATION_4_4 Register (offset = C90h) [reset = 0h]

ELM_ERROR_LOCATION_4_4 is shown in [Figure 7-391](#) and described in [Table 7-422](#).

Figure 7-391. ELM_ERROR_LOCATION_4_4 Register

31	30	29	28	27	26	25	24	23	22	21	20	19	18	17	16
RESERVED															
R-0h															
15	14	13	12	11	10	9	8	7	6	5	4	3	2	1	0
RESERVED				ECC_ERROR_LOCATION											
R-0h				R-0h											

LEGEND: R/W = Read/Write; R = Read only; W1toCl = Write 1 to clear bit; -n = value after reset

Table 7-422. ELM_ERROR_LOCATION_4_4 Register Field Descriptions

Bit	Field	Type	Reset	Description
31-13	RESERVED	R	0h	
12-0	ECC_ERROR_LOCATION	R	0h	Error-location bit address, 0 to 1FFFh.

7.4.5.137 ELM_ERROR_LOCATION_5_4 Register (offset = C94h) [reset = 0h]

 ELM_ERROR_LOCATION_5_4 is shown in [Figure 7-392](#) and described in [Table 7-423](#).

Figure 7-392. ELM_ERROR_LOCATION_5_4 Register

31	30	29	28	27	26	25	24	23	22	21	20	19	18	17	16
RESERVED															
R-0h															
15	14	13	12	11	10	9	8	7	6	5	4	3	2	1	0
RESERVED				ECC_ERROR_LOCATION											
R-0h				R-0h											

LEGEND: R/W = Read/Write; R = Read only; W1toCl = Write 1 to clear bit; -n = value after reset

Table 7-423. ELM_ERROR_LOCATION_5_4 Register Field Descriptions

Bit	Field	Type	Reset	Description
31-13	RESERVED	R	0h	
12-0	ECC_ERROR_LOCATION	R	0h	Error-location bit address, 0 to 1FFFh.

7.4.5.138 ELM_ERROR_LOCATION_6_4 Register (offset = C98h) [reset = 0h]

ELM_ERROR_LOCATION_6_4 is shown in [Figure 7-393](#) and described in [Table 7-424](#).

Figure 7-393. ELM_ERROR_LOCATION_6_4 Register

31	30	29	28	27	26	25	24	23	22	21	20	19	18	17	16
RESERVED															
R-0h															
15	14	13	12	11	10	9	8	7	6	5	4	3	2	1	0
RESERVED				ECC_ERROR_LOCATION											
R-0h				R-0h											

LEGEND: R/W = Read/Write; R = Read only; W1toCl = Write 1 to clear bit; -n = value after reset

Table 7-424. ELM_ERROR_LOCATION_6_4 Register Field Descriptions

Bit	Field	Type	Reset	Description
31-13	RESERVED	R	0h	
12-0	ECC_ERROR_LOCATION	R	0h	Error-location bit address, 0 to 1FFFh.

7.4.5.139 ELM_ERROR_LOCATION_7_4 Register (offset = C9Ch) [reset = 0h]

 ELM_ERROR_LOCATION_7_4 is shown in [Figure 7-394](#) and described in [Table 7-425](#).

Figure 7-394. ELM_ERROR_LOCATION_7_4 Register

31	30	29	28	27	26	25	24	23	22	21	20	19	18	17	16
RESERVED															
R-0h															
15	14	13	12	11	10	9	8	7	6	5	4	3	2	1	0
RESERVED				ECC_ERROR_LOCATION											
R-0h				R-0h											

LEGEND: R/W = Read/Write; R = Read only; W1toCl = Write 1 to clear bit; -n = value after reset

Table 7-425. ELM_ERROR_LOCATION_7_4 Register Field Descriptions

Bit	Field	Type	Reset	Description
31-13	RESERVED	R	0h	
12-0	ECC_ERROR_LOCATION	R	0h	Error-location bit address, 0 to 1FFFh.

7.4.5.140 ELM_ERROR_LOCATION_8_4 Register (offset = CA0h) [reset = 0h]

ELM_ERROR_LOCATION_8_4 is shown in [Figure 7-395](#) and described in [Table 7-426](#).

Figure 7-395. ELM_ERROR_LOCATION_8_4 Register

31	30	29	28	27	26	25	24	23	22	21	20	19	18	17	16
RESERVED															
R-0h															
15	14	13	12	11	10	9	8	7	6	5	4	3	2	1	0
RESERVED				ECC_ERROR_LOCATION											
R-0h				R-0h											

LEGEND: R/W = Read/Write; R = Read only; W1toCl = Write 1 to clear bit; -n = value after reset

Table 7-426. ELM_ERROR_LOCATION_8_4 Register Field Descriptions

Bit	Field	Type	Reset	Description
31-13	RESERVED	R	0h	
12-0	ECC_ERROR_LOCATION	R	0h	Error-location bit address, 0 to 1FFFh.

7.4.5.141 ELM_ERROR_LOCATION_9_4 Register (offset = CA4h) [reset = 0h]

ELM_ERROR_LOCATION_9_4 is shown in [Figure 7-396](#) and described in [Table 7-427](#).

Figure 7-396. ELM_ERROR_LOCATION_9_4 Register

31	30	29	28	27	26	25	24	23	22	21	20	19	18	17	16
RESERVED															
R-0h															
15	14	13	12	11	10	9	8	7	6	5	4	3	2	1	0
RESERVED				ECC_ERROR_LOCATION											
R-0h				R-0h											

LEGEND: R/W = Read/Write; R = Read only; W1toCl = Write 1 to clear bit; -n = value after reset

Table 7-427. ELM_ERROR_LOCATION_9_4 Register Field Descriptions

Bit	Field	Type	Reset	Description
31-13	RESERVED	R	0h	
12-0	ECC_ERROR_LOCATION	R	0h	Error-location bit address, 0 to 1FFFh.

7.4.5.142 ELM_ERROR_LOCATION_10_4 Register (offset = CA8h) [reset = 0h]

ELM_ERROR_LOCATION_10_4 is shown in [Figure 7-397](#) and described in [Table 7-428](#).

Figure 7-397. ELM_ERROR_LOCATION_10_4 Register

31	30	29	28	27	26	25	24	23	22	21	20	19	18	17	16
RESERVED															
R-0h															
15	14	13	12	11	10	9	8	7	6	5	4	3	2	1	0
RESERVED				ECC_ERROR_LOCATION											
R-0h				R-0h											

LEGEND: R/W = Read/Write; R = Read only; W1toCl = Write 1 to clear bit; -n = value after reset

Table 7-428. ELM_ERROR_LOCATION_10_4 Register Field Descriptions

Bit	Field	Type	Reset	Description
31-13	RESERVED	R	0h	
12-0	ECC_ERROR_LOCATION	R	0h	Error-location bit address, 0 to 1FFFh.

7.4.5.143 ELM_ERROR_LOCATION_11_4 Register (offset = CACH) [reset = 0h]

ELM_ERROR_LOCATION_11_4 is shown in [Figure 7-398](#) and described in [Table 7-429](#).

Figure 7-398. ELM_ERROR_LOCATION_11_4 Register

31	30	29	28	27	26	25	24	23	22	21	20	19	18	17	16
RESERVED															
R-0h															
15	14	13	12	11	10	9	8	7	6	5	4	3	2	1	0
RESERVED				ECC_ERROR_LOCATION											
R-0h				R-0h											

LEGEND: R/W = Read/Write; R = Read only; W1toCl = Write 1 to clear bit; -n = value after reset

Table 7-429. ELM_ERROR_LOCATION_11_4 Register Field Descriptions

Bit	Field	Type	Reset	Description
31-13	RESERVED	R	0h	
12-0	ECC_ERROR_LOCATION	R	0h	Error-location bit address, 0 to 1FFFh.

7.4.5.144 ELM_ERROR_LOCATION_12_4 Register (offset = CB0h) [reset = 0h]

ELM_ERROR_LOCATION_12_4 is shown in [Figure 7-399](#) and described in [Table 7-430](#).

Figure 7-399. ELM_ERROR_LOCATION_12_4 Register

31	30	29	28	27	26	25	24	23	22	21	20	19	18	17	16
RESERVED															
R-0h															
15	14	13	12	11	10	9	8	7	6	5	4	3	2	1	0
RESERVED				ECC_ERROR_LOCATION											
R-0h				R-0h											

LEGEND: R/W = Read/Write; R = Read only; W1toCl = Write 1 to clear bit; -n = value after reset

Table 7-430. ELM_ERROR_LOCATION_12_4 Register Field Descriptions

Bit	Field	Type	Reset	Description
31-13	RESERVED	R	0h	
12-0	ECC_ERROR_LOCATION	R	0h	Error-location bit address, 0 to 1FFFh.

7.4.5.145 ELM_ERROR_LOCATION_13_4 Register (offset = CB4h) [reset = 0h]

ELM_ERROR_LOCATION_13_4 is shown in [Figure 7-400](#) and described in [Table 7-431](#).

Figure 7-400. ELM_ERROR_LOCATION_13_4 Register

31	30	29	28	27	26	25	24	23	22	21	20	19	18	17	16
RESERVED															
R-0h															
15	14	13	12	11	10	9	8	7	6	5	4	3	2	1	0
RESERVED				ECC_ERROR_LOCATION											
R-0h				R-0h											

LEGEND: R/W = Read/Write; R = Read only; W1toCl = Write 1 to clear bit; -n = value after reset

Table 7-431. ELM_ERROR_LOCATION_13_4 Register Field Descriptions

Bit	Field	Type	Reset	Description
31-13	RESERVED	R	0h	
12-0	ECC_ERROR_LOCATION	R	0h	Error-location bit address, 0 to 1FFFh.

7.4.5.146 ELM_ERROR_LOCATION_14_4 Register (offset = CB8h) [reset = 0h]

ELM_ERROR_LOCATION_14_4 is shown in [Figure 7-401](#) and described in [Table 7-432](#).

Figure 7-401. ELM_ERROR_LOCATION_14_4 Register

31	30	29	28	27	26	25	24	23	22	21	20	19	18	17	16
RESERVED															
R-0h															
15	14	13	12	11	10	9	8	7	6	5	4	3	2	1	0
RESERVED				ECC_ERROR_LOCATION											
R-0h				R-0h											

LEGEND: R/W = Read/Write; R = Read only; W1toCl = Write 1 to clear bit; -n = value after reset

Table 7-432. ELM_ERROR_LOCATION_14_4 Register Field Descriptions

Bit	Field	Type	Reset	Description
31-13	RESERVED	R	0h	
12-0	ECC_ERROR_LOCATION	R	0h	Error-location bit address, 0 to 1FFFh.

7.4.5.147 ELM_ERROR_LOCATION_15_4 Register (offset = CBCh) [reset = 0h]

ELM_ERROR_LOCATION_15_4 is shown in [Figure 7-402](#) and described in [Table 7-433](#).

Figure 7-402. ELM_ERROR_LOCATION_15_4 Register

31	30	29	28	27	26	25	24	23	22	21	20	19	18	17	16
RESERVED															
R-0h															
15	14	13	12	11	10	9	8	7	6	5	4	3	2	1	0
RESERVED				ECC_ERROR_LOCATION											
R-0h				R-0h											

LEGEND: R/W = Read/Write; R = Read only; W1toCl = Write 1 to clear bit; -n = value after reset

Table 7-433. ELM_ERROR_LOCATION_15_4 Register Field Descriptions

Bit	Field	Type	Reset	Description
31-13	RESERVED	R	0h	
12-0	ECC_ERROR_LOCATION	R	0h	Error-location bit address, 0 to 1FFFh.

7.4.5.148 ELM_ERROR_LOCATION_0_5 Register (offset = D80h) [reset = 0h]

ELM_ERROR_LOCATION_0_5 is shown in [Figure 7-403](#) and described in [Table 7-434](#).

Figure 7-403. ELM_ERROR_LOCATION_0_5 Register

31	30	29	28	27	26	25	24	23	22	21	20	19	18	17	16
RESERVED															
R-0h															
15	14	13	12	11	10	9	8	7	6	5	4	3	2	1	0
RESERVED				ECC_ERROR_LOCATION											
R-0h				R-0h											

LEGEND: R/W = Read/Write; R = Read only; W1toCl = Write 1 to clear bit; -n = value after reset

Table 7-434. ELM_ERROR_LOCATION_0_5 Register Field Descriptions

Bit	Field	Type	Reset	Description
31-13	RESERVED	R	0h	
12-0	ECC_ERROR_LOCATION	R	0h	Error-location bit address, 0 to 1FFFh.

7.4.5.149 ELM_ERROR_LOCATION_1_5 Register (offset = D84h) [reset = 0h]

 ELM_ERROR_LOCATION_1_5 is shown in [Figure 7-404](#) and described in [Table 7-435](#).

Figure 7-404. ELM_ERROR_LOCATION_1_5 Register

31	30	29	28	27	26	25	24	23	22	21	20	19	18	17	16
RESERVED															
R-0h															
15	14	13	12	11	10	9	8	7	6	5	4	3	2	1	0
RESERVED				ECC_ERROR_LOCATION											
R-0h				R-0h											

LEGEND: R/W = Read/Write; R = Read only; W1toCl = Write 1 to clear bit; -n = value after reset

Table 7-435. ELM_ERROR_LOCATION_1_5 Register Field Descriptions

Bit	Field	Type	Reset	Description
31-13	RESERVED	R	0h	
12-0	ECC_ERROR_LOCATION	R	0h	Error-location bit address, 0 to 1FFFh.

7.4.5.150 ELM_ERROR_LOCATION_2_5 Register (offset = D88h) [reset = 0h]

ELM_ERROR_LOCATION_2_5 is shown in [Figure 7-405](#) and described in [Table 7-436](#).

Figure 7-405. ELM_ERROR_LOCATION_2_5 Register

31	30	29	28	27	26	25	24	23	22	21	20	19	18	17	16
RESERVED															
R-0h															
15	14	13	12	11	10	9	8	7	6	5	4	3	2	1	0
RESERVED				ECC_ERROR_LOCATION											
R-0h				R-0h											

LEGEND: R/W = Read/Write; R = Read only; W1toCl = Write 1 to clear bit; -n = value after reset

Table 7-436. ELM_ERROR_LOCATION_2_5 Register Field Descriptions

Bit	Field	Type	Reset	Description
31-13	RESERVED	R	0h	
12-0	ECC_ERROR_LOCATION	R	0h	Error-location bit address, 0 to 1FFFh.

7.4.5.151 ELM_ERROR_LOCATION_3_5 Register (offset = D8Ch) [reset = 0h]

ELM_ERROR_LOCATION_3_5 is shown in [Figure 7-406](#) and described in [Table 7-437](#).

Figure 7-406. ELM_ERROR_LOCATION_3_5 Register

31	30	29	28	27	26	25	24	23	22	21	20	19	18	17	16
RESERVED															
R-0h															
15	14	13	12	11	10	9	8	7	6	5	4	3	2	1	0
RESERVED				ECC_ERROR_LOCATION											
R-0h				R-0h											

LEGEND: R/W = Read/Write; R = Read only; W1toCl = Write 1 to clear bit; -n = value after reset

Table 7-437. ELM_ERROR_LOCATION_3_5 Register Field Descriptions

Bit	Field	Type	Reset	Description
31-13	RESERVED	R	0h	
12-0	ECC_ERROR_LOCATION	R	0h	Error-location bit address, 0 to 1FFFh.

7.4.5.152 ELM_ERROR_LOCATION_4_5 Register (offset = D90h) [reset = 0h]

ELM_ERROR_LOCATION_4_5 is shown in [Figure 7-407](#) and described in [Table 7-438](#).

Figure 7-407. ELM_ERROR_LOCATION_4_5 Register

31	30	29	28	27	26	25	24	23	22	21	20	19	18	17	16
RESERVED															
R-0h															
15	14	13	12	11	10	9	8	7	6	5	4	3	2	1	0
RESERVED				ECC_ERROR_LOCATION											
R-0h				R-0h											

LEGEND: R/W = Read/Write; R = Read only; W1toCl = Write 1 to clear bit; -n = value after reset

Table 7-438. ELM_ERROR_LOCATION_4_5 Register Field Descriptions

Bit	Field	Type	Reset	Description
31-13	RESERVED	R	0h	
12-0	ECC_ERROR_LOCATION	R	0h	Error-location bit address, 0 to 1FFFh.

7.4.5.153 ELM_ERROR_LOCATION_5_5 Register (offset = D94h) [reset = 0h]

ELM_ERROR_LOCATION_5_5 is shown in [Figure 7-408](#) and described in [Table 7-439](#).

Figure 7-408. ELM_ERROR_LOCATION_5_5 Register

31	30	29	28	27	26	25	24	23	22	21	20	19	18	17	16
RESERVED															
R-0h															
15	14	13	12	11	10	9	8	7	6	5	4	3	2	1	0
RESERVED				ECC_ERROR_LOCATION											
R-0h				R-0h											

LEGEND: R/W = Read/Write; R = Read only; W1toCl = Write 1 to clear bit; -n = value after reset

Table 7-439. ELM_ERROR_LOCATION_5_5 Register Field Descriptions

Bit	Field	Type	Reset	Description
31-13	RESERVED	R	0h	
12-0	ECC_ERROR_LOCATION	R	0h	Error-location bit address, 0 to 1FFFh.

7.4.5.154 ELM_ERROR_LOCATION_6_5 Register (offset = D98h) [reset = 0h]

ELM_ERROR_LOCATION_6_5 is shown in [Figure 7-409](#) and described in [Table 7-440](#).

Figure 7-409. ELM_ERROR_LOCATION_6_5 Register

31	30	29	28	27	26	25	24	23	22	21	20	19	18	17	16
RESERVED															
R-0h															
15	14	13	12	11	10	9	8	7	6	5	4	3	2	1	0
RESERVED				ECC_ERROR_LOCATION											
R-0h				R-0h											

LEGEND: R/W = Read/Write; R = Read only; W1toCl = Write 1 to clear bit; -n = value after reset

Table 7-440. ELM_ERROR_LOCATION_6_5 Register Field Descriptions

Bit	Field	Type	Reset	Description
31-13	RESERVED	R	0h	
12-0	ECC_ERROR_LOCATION	R	0h	Error-location bit address, 0 to 1FFFh.

7.4.5.155 ELM_ERROR_LOCATION_7_5 Register (offset = D9Ch) [reset = 0h]

 ELM_ERROR_LOCATION_7_5 is shown in [Figure 7-410](#) and described in [Table 7-441](#).

Figure 7-410. ELM_ERROR_LOCATION_7_5 Register

31	30	29	28	27	26	25	24	23	22	21	20	19	18	17	16
RESERVED															
R-0h															
15	14	13	12	11	10	9	8	7	6	5	4	3	2	1	0
RESERVED				ECC_ERROR_LOCATION											
R-0h				R-0h											

LEGEND: R/W = Read/Write; R = Read only; W1toCl = Write 1 to clear bit; -n = value after reset

Table 7-441. ELM_ERROR_LOCATION_7_5 Register Field Descriptions

Bit	Field	Type	Reset	Description
31-13	RESERVED	R	0h	
12-0	ECC_ERROR_LOCATION	R	0h	Error-location bit address, 0 to 1FFFh.

7.4.5.156 ELM_ERROR_LOCATION_8_5 Register (offset = DA0h) [reset = 0h]

ELM_ERROR_LOCATION_8_5 is shown in [Figure 7-411](#) and described in [Table 7-442](#).

Figure 7-411. ELM_ERROR_LOCATION_8_5 Register

31	30	29	28	27	26	25	24	23	22	21	20	19	18	17	16
RESERVED															
R-0h															
15	14	13	12	11	10	9	8	7	6	5	4	3	2	1	0
RESERVED				ECC_ERROR_LOCATION											
R-0h				R-0h											

LEGEND: R/W = Read/Write; R = Read only; W1toCl = Write 1 to clear bit; -n = value after reset

Table 7-442. ELM_ERROR_LOCATION_8_5 Register Field Descriptions

Bit	Field	Type	Reset	Description
31-13	RESERVED	R	0h	
12-0	ECC_ERROR_LOCATION	R	0h	Error-location bit address, 0 to 1FFFh.

7.4.5.157 ELM_ERROR_LOCATION_9_5 Register (offset = DA4h) [reset = 0h]

ELM_ERROR_LOCATION_9_5 is shown in [Figure 7-412](#) and described in [Table 7-443](#).

Figure 7-412. ELM_ERROR_LOCATION_9_5 Register

31	30	29	28	27	26	25	24	23	22	21	20	19	18	17	16
RESERVED															
R-0h															
15	14	13	12	11	10	9	8	7	6	5	4	3	2	1	0
RESERVED				ECC_ERROR_LOCATION											
R-0h				R-0h											

LEGEND: R/W = Read/Write; R = Read only; W1toCl = Write 1 to clear bit; -n = value after reset

Table 7-443. ELM_ERROR_LOCATION_9_5 Register Field Descriptions

Bit	Field	Type	Reset	Description
31-13	RESERVED	R	0h	
12-0	ECC_ERROR_LOCATION	R	0h	Error-location bit address, 0 to 1FFFh.

7.4.5.158 ELM_ERROR_LOCATION_10_5 Register (offset = DA8h) [reset = 0h]

ELM_ERROR_LOCATION_10_5 is shown in [Figure 7-413](#) and described in [Table 7-444](#).

Figure 7-413. ELM_ERROR_LOCATION_10_5 Register

31	30	29	28	27	26	25	24	23	22	21	20	19	18	17	16
RESERVED															
R-0h															
15	14	13	12	11	10	9	8	7	6	5	4	3	2	1	0
RESERVED				ECC_ERROR_LOCATION											
R-0h				R-0h											

LEGEND: R/W = Read/Write; R = Read only; W1toCl = Write 1 to clear bit; -n = value after reset

Table 7-444. ELM_ERROR_LOCATION_10_5 Register Field Descriptions

Bit	Field	Type	Reset	Description
31-13	RESERVED	R	0h	
12-0	ECC_ERROR_LOCATION	R	0h	Error-location bit address, 0 to 1FFFh.

7.4.5.159 ELM_ERROR_LOCATION_11_5 Register (offset = DACH) [reset = 0h]

 ELM_ERROR_LOCATION_11_5 is shown in [Figure 7-414](#) and described in [Table 7-445](#).

Figure 7-414. ELM_ERROR_LOCATION_11_5 Register

31	30	29	28	27	26	25	24	23	22	21	20	19	18	17	16
RESERVED															
R-0h															
15	14	13	12	11	10	9	8	7	6	5	4	3	2	1	0
RESERVED				ECC_ERROR_LOCATION											
R-0h				R-0h											

LEGEND: R/W = Read/Write; R = Read only; W1toCl = Write 1 to clear bit; -n = value after reset

Table 7-445. ELM_ERROR_LOCATION_11_5 Register Field Descriptions

Bit	Field	Type	Reset	Description
31-13	RESERVED	R	0h	
12-0	ECC_ERROR_LOCATION	R	0h	Error-location bit address, 0 to 1FFFh.

7.4.5.160 ELM_ERROR_LOCATION_12_5 Register (offset = DB0h) [reset = 0h]

ELM_ERROR_LOCATION_12_5 is shown in [Figure 7-415](#) and described in [Table 7-446](#).

Figure 7-415. ELM_ERROR_LOCATION_12_5 Register

31	30	29	28	27	26	25	24	23	22	21	20	19	18	17	16
RESERVED															
R-0h															
15	14	13	12	11	10	9	8	7	6	5	4	3	2	1	0
RESERVED				ECC_ERROR_LOCATION											
R-0h				R-0h											

LEGEND: R/W = Read/Write; R = Read only; W1toCl = Write 1 to clear bit; -n = value after reset

Table 7-446. ELM_ERROR_LOCATION_12_5 Register Field Descriptions

Bit	Field	Type	Reset	Description
31-13	RESERVED	R	0h	
12-0	ECC_ERROR_LOCATION	R	0h	Error-location bit address, 0 to 1FFFh.

7.4.5.161 ELM_ERROR_LOCATION_13_5 Register (offset = DB4h) [reset = 0h]

ELM_ERROR_LOCATION_13_5 is shown in [Figure 7-416](#) and described in [Table 7-447](#).

Figure 7-416. ELM_ERROR_LOCATION_13_5 Register

31	30	29	28	27	26	25	24	23	22	21	20	19	18	17	16
RESERVED															
R-0h															
15	14	13	12	11	10	9	8	7	6	5	4	3	2	1	0
RESERVED				ECC_ERROR_LOCATION											
R-0h				R-0h											

LEGEND: R/W = Read/Write; R = Read only; W1toCl = Write 1 to clear bit; -n = value after reset

Table 7-447. ELM_ERROR_LOCATION_13_5 Register Field Descriptions

Bit	Field	Type	Reset	Description
31-13	RESERVED	R	0h	
12-0	ECC_ERROR_LOCATION	R	0h	Error-location bit address, 0 to 1FFFh.

7.4.5.162 ELM_ERROR_LOCATION_14_5 Register (offset = DB8h) [reset = 0h]

ELM_ERROR_LOCATION_14_5 is shown in [Figure 7-417](#) and described in [Table 7-448](#).

Figure 7-417. ELM_ERROR_LOCATION_14_5 Register

31	30	29	28	27	26	25	24	23	22	21	20	19	18	17	16
RESERVED															
R-0h															
15	14	13	12	11	10	9	8	7	6	5	4	3	2	1	0
RESERVED				ECC_ERROR_LOCATION											
R-0h				R-0h											

LEGEND: R/W = Read/Write; R = Read only; W1toCl = Write 1 to clear bit; -n = value after reset

Table 7-448. ELM_ERROR_LOCATION_14_5 Register Field Descriptions

Bit	Field	Type	Reset	Description
31-13	RESERVED	R	0h	
12-0	ECC_ERROR_LOCATION	R	0h	Error-location bit address, 0 to 1FFFh.

7.4.5.163 ELM_ERROR_LOCATION_15_5 Register (offset = DBCh) [reset = 0h]

ELM_ERROR_LOCATION_15_5 is shown in [Figure 7-418](#) and described in [Table 7-449](#).

Figure 7-418. ELM_ERROR_LOCATION_15_5 Register

31	30	29	28	27	26	25	24	23	22	21	20	19	18	17	16
RESERVED															
R-0h															
15	14	13	12	11	10	9	8	7	6	5	4	3	2	1	0
RESERVED				ECC_ERROR_LOCATION											
R-0h				R-0h											

LEGEND: R/W = Read/Write; R = Read only; W1toCl = Write 1 to clear bit; -n = value after reset

Table 7-449. ELM_ERROR_LOCATION_15_5 Register Field Descriptions

Bit	Field	Type	Reset	Description
31-13	RESERVED	R	0h	
12-0	ECC_ERROR_LOCATION	R	0h	Error-location bit address, 0 to 1FFFh.

7.4.5.164 ELM_LOCATION_STATUS_4 Register (offset = C00h) [reset = 0h]

ELM_LOCATION_STATUS_4 is shown in [Figure 7-419](#) and described in [Table 7-450](#).

Figure 7-419. ELM_LOCATION_STATUS_4 Register

31	30	29	28	27	26	25	24
RESERVED							
R-0h							
23	22	21	20	19	18	17	16
RESERVED							
R-0h							
15	14	13	12	11	10	9	8
RESERVED							ECC_CORREC TABL
R-0h							R-0h
7	6	5	4	3	2	1	0
RESERVED			ECC_NB_ERRORS				
R-0h			R-0h				

LEGEND: R/W = Read/Write; R = Read only; W1toCl = Write 1 to clear bit; -n = value after reset

Table 7-450. ELM_LOCATION_STATUS_4 Register Field Descriptions

Bit	Field	Type	Reset	Description
31-9	RESERVED	R	0h	
8	ECC_CORRECTABL	R	0h	Error-location process exit status. 0h = ECC error-location process failed. Number of errors and error locations are invalid. 1h = All errors were successfully located. Number of errors and error locations are valid.
7-5	RESERVED	R	0h	
4-0	ECC_NB_ERRORS	R	0h	Number of errors detected and located, value 0 to 1Fh.

7.4.5.165 ELM_ERROR_LOCATION_0_6 Register (offset = E80h) [reset = 0h]

 ELM_ERROR_LOCATION_0_6 is shown in [Figure 7-420](#) and described in [Table 7-451](#).

Figure 7-420. ELM_ERROR_LOCATION_0_6 Register

31	30	29	28	27	26	25	24	23	22	21	20	19	18	17	16
RESERVED															
R-0h															
15	14	13	12	11	10	9	8	7	6	5	4	3	2	1	0
RESERVED				ECC_ERROR_LOCATION											
R-0h				R-0h											

LEGEND: R/W = Read/Write; R = Read only; W1toCl = Write 1 to clear bit; -n = value after reset

Table 7-451. ELM_ERROR_LOCATION_0_6 Register Field Descriptions

Bit	Field	Type	Reset	Description
31-13	RESERVED	R	0h	
12-0	ECC_ERROR_LOCATION	R	0h	Error-location bit address, 0 to 1FFFh.

7.4.5.166 ELM_ERROR_LOCATION_1_6 Register (offset = E84h) [reset = 0h]

ELM_ERROR_LOCATION_1_6 is shown in [Figure 7-421](#) and described in [Table 7-452](#).

Figure 7-421. ELM_ERROR_LOCATION_1_6 Register

31	30	29	28	27	26	25	24	23	22	21	20	19	18	17	16
RESERVED															
R-0h															
15	14	13	12	11	10	9	8	7	6	5	4	3	2	1	0
RESERVED				ECC_ERROR_LOCATION											
R-0h				R-0h											

LEGEND: R/W = Read/Write; R = Read only; W1toCl = Write 1 to clear bit; -n = value after reset

Table 7-452. ELM_ERROR_LOCATION_1_6 Register Field Descriptions

Bit	Field	Type	Reset	Description
31-13	RESERVED	R	0h	
12-0	ECC_ERROR_LOCATION	R	0h	Error-location bit address, 0 to 1FFFh.

7.4.5.167 ELM_ERROR_LOCATION_2_6 Register (offset = E88h) [reset = 0h]

ELM_ERROR_LOCATION_2_6 is shown in [Figure 7-422](#) and described in [Table 7-453](#).

Figure 7-422. ELM_ERROR_LOCATION_2_6 Register

31	30	29	28	27	26	25	24	23	22	21	20	19	18	17	16
RESERVED															
R-0h															
15	14	13	12	11	10	9	8	7	6	5	4	3	2	1	0
RESERVED				ECC_ERROR_LOCATION											
R-0h				R-0h											

LEGEND: R/W = Read/Write; R = Read only; W1toCl = Write 1 to clear bit; -n = value after reset

Table 7-453. ELM_ERROR_LOCATION_2_6 Register Field Descriptions

Bit	Field	Type	Reset	Description
31-13	RESERVED	R	0h	
12-0	ECC_ERROR_LOCATION	R	0h	Error-location bit address, 0 to 1FFFh.

7.4.5.168 ELM_ERROR_LOCATION_3_6 Register (offset = E8Ch) [reset = 0h]

ELM_ERROR_LOCATION_3_6 is shown in [Figure 7-423](#) and described in [Table 7-454](#).

Figure 7-423. ELM_ERROR_LOCATION_3_6 Register

31	30	29	28	27	26	25	24	23	22	21	20	19	18	17	16
RESERVED															
R-0h															
15	14	13	12	11	10	9	8	7	6	5	4	3	2	1	0
RESERVED				ECC_ERROR_LOCATION											
R-0h				R-0h											

LEGEND: R/W = Read/Write; R = Read only; W1toCl = Write 1 to clear bit; -n = value after reset

Table 7-454. ELM_ERROR_LOCATION_3_6 Register Field Descriptions

Bit	Field	Type	Reset	Description
31-13	RESERVED	R	0h	
12-0	ECC_ERROR_LOCATION	R	0h	Error-location bit address, 0 to 1FFFh.

7.4.5.169 ELM_ERROR_LOCATION_4_6 Register (offset = E90h) [reset = 0h]

 ELM_ERROR_LOCATION_4_6 is shown in [Figure 7-424](#) and described in [Table 7-455](#).

Figure 7-424. ELM_ERROR_LOCATION_4_6 Register

31	30	29	28	27	26	25	24	23	22	21	20	19	18	17	16
RESERVED															
R-0h															
15	14	13	12	11	10	9	8	7	6	5	4	3	2	1	0
RESERVED				ECC_ERROR_LOCATION											
R-0h				R-0h											

LEGEND: R/W = Read/Write; R = Read only; W1toCl = Write 1 to clear bit; -n = value after reset

Table 7-455. ELM_ERROR_LOCATION_4_6 Register Field Descriptions

Bit	Field	Type	Reset	Description
31-13	RESERVED	R	0h	
12-0	ECC_ERROR_LOCATION	R	0h	Error-location bit address, 0 to 1FFFh.

7.4.5.170 ELM_ERROR_LOCATION_5_6 Register (offset = E94h) [reset = 0h]

 ELM_ERROR_LOCATION_5_6 is shown in [Figure 7-425](#) and described in [Table 7-456](#).

Figure 7-425. ELM_ERROR_LOCATION_5_6 Register

31	30	29	28	27	26	25	24	23	22	21	20	19	18	17	16
RESERVED															
R-0h															
15	14	13	12	11	10	9	8	7	6	5	4	3	2	1	0
RESERVED				ECC_ERROR_LOCATION											
R-0h				R-0h											

LEGEND: R/W = Read/Write; R = Read only; W1toCl = Write 1 to clear bit; -n = value after reset

Table 7-456. ELM_ERROR_LOCATION_5_6 Register Field Descriptions

Bit	Field	Type	Reset	Description
31-13	RESERVED	R	0h	
12-0	ECC_ERROR_LOCATION	R	0h	Error-location bit address, 0 to 1FFFh.

7.4.5.171 ELM_ERROR_LOCATION_6_6 Register (offset = E98h) [reset = 0h]

 ELM_ERROR_LOCATION_6_6 is shown in [Figure 7-426](#) and described in [Table 7-457](#).

Figure 7-426. ELM_ERROR_LOCATION_6_6 Register

31	30	29	28	27	26	25	24	23	22	21	20	19	18	17	16
RESERVED															
R-0h															
15	14	13	12	11	10	9	8	7	6	5	4	3	2	1	0
RESERVED				ECC_ERROR_LOCATION											
R-0h				R-0h											

LEGEND: R/W = Read/Write; R = Read only; W1toCl = Write 1 to clear bit; -n = value after reset

Table 7-457. ELM_ERROR_LOCATION_6_6 Register Field Descriptions

Bit	Field	Type	Reset	Description
31-13	RESERVED	R	0h	
12-0	ECC_ERROR_LOCATION	R	0h	Error-location bit address, 0 to 1FFFh.

7.4.5.172 ELM_ERROR_LOCATION_7_6 Register (offset = E9Ch) [reset = 0h]

 ELM_ERROR_LOCATION_7_6 is shown in [Figure 7-427](#) and described in [Table 7-458](#).

Figure 7-427. ELM_ERROR_LOCATION_7_6 Register

31	30	29	28	27	26	25	24	23	22	21	20	19	18	17	16
RESERVED															
R-0h															
15	14	13	12	11	10	9	8	7	6	5	4	3	2	1	0
RESERVED				ECC_ERROR_LOCATION											
R-0h				R-0h											

LEGEND: R/W = Read/Write; R = Read only; W1toCl = Write 1 to clear bit; -n = value after reset

Table 7-458. ELM_ERROR_LOCATION_7_6 Register Field Descriptions

Bit	Field	Type	Reset	Description
31-13	RESERVED	R	0h	
12-0	ECC_ERROR_LOCATION	R	0h	Error-location bit address, 0 to 1FFFh.

7.4.5.173 ELM_ERROR_LOCATION_8_6 Register (offset = EA0h) [reset = 0h]

 ELM_ERROR_LOCATION_8_6 is shown in [Figure 7-428](#) and described in [Table 7-459](#).

Figure 7-428. ELM_ERROR_LOCATION_8_6 Register

31	30	29	28	27	26	25	24	23	22	21	20	19	18	17	16
RESERVED															
R-0h															
15	14	13	12	11	10	9	8	7	6	5	4	3	2	1	0
RESERVED				ECC_ERROR_LOCATION											
R-0h				R-0h											

LEGEND: R/W = Read/Write; R = Read only; W1toCl = Write 1 to clear bit; -n = value after reset

Table 7-459. ELM_ERROR_LOCATION_8_6 Register Field Descriptions

Bit	Field	Type	Reset	Description
31-13	RESERVED	R	0h	
12-0	ECC_ERROR_LOCATION	R	0h	Error-location bit address, 0 to 1FFFh.

7.4.5.174 ELM_ERROR_LOCATION_9_6 Register (offset = EA4h) [reset = 0h]

ELM_ERROR_LOCATION_9_6 is shown in [Figure 7-429](#) and described in [Table 7-460](#).

Figure 7-429. ELM_ERROR_LOCATION_9_6 Register

31	30	29	28	27	26	25	24	23	22	21	20	19	18	17	16
RESERVED															
R-0h															
15	14	13	12	11	10	9	8	7	6	5	4	3	2	1	0
RESERVED				ECC_ERROR_LOCATION											
R-0h				R-0h											

LEGEND: R/W = Read/Write; R = Read only; W1toCl = Write 1 to clear bit; -n = value after reset

Table 7-460. ELM_ERROR_LOCATION_9_6 Register Field Descriptions

Bit	Field	Type	Reset	Description
31-13	RESERVED	R	0h	
12-0	ECC_ERROR_LOCATION	R	0h	Error-location bit address, 0 to 1FFFh.

7.4.5.175 ELM_ERROR_LOCATION_10_6 Register (offset = EA8h) [reset = 0h]

ELM_ERROR_LOCATION_10_6 is shown in [Figure 7-430](#) and described in [Table 7-461](#).

Figure 7-430. ELM_ERROR_LOCATION_10_6 Register

31	30	29	28	27	26	25	24	23	22	21	20	19	18	17	16
RESERVED															
R-0h															
15	14	13	12	11	10	9	8	7	6	5	4	3	2	1	0
RESERVED				ECC_ERROR_LOCATION											
R-0h				R-0h											

LEGEND: R/W = Read/Write; R = Read only; W1toCl = Write 1 to clear bit; -n = value after reset

Table 7-461. ELM_ERROR_LOCATION_10_6 Register Field Descriptions

Bit	Field	Type	Reset	Description
31-13	RESERVED	R	0h	
12-0	ECC_ERROR_LOCATION	R	0h	Error-location bit address, 0 to 1FFFh.

7.4.5.176 ELM_ERROR_LOCATION_11_6 Register (offset = ECh) [reset = 0h]

ELM_ERROR_LOCATION_11_6 is shown in [Figure 7-431](#) and described in [Table 7-462](#).

Figure 7-431. ELM_ERROR_LOCATION_11_6 Register

31	30	29	28	27	26	25	24	23	22	21	20	19	18	17	16
RESERVED															
R-0h															
15	14	13	12	11	10	9	8	7	6	5	4	3	2	1	0
RESERVED				ECC_ERROR_LOCATION											
R-0h				R-0h											

LEGEND: R/W = Read/Write; R = Read only; W1toCl = Write 1 to clear bit; -n = value after reset

Table 7-462. ELM_ERROR_LOCATION_11_6 Register Field Descriptions

Bit	Field	Type	Reset	Description
31-13	RESERVED	R	0h	
12-0	ECC_ERROR_LOCATION	R	0h	Error-location bit address, 0 to 1FFFh.

7.4.5.177 ELM_ERROR_LOCATION_12_6 Register (offset = EB0h) [reset = 0h]

ELM_ERROR_LOCATION_12_6 is shown in [Figure 7-432](#) and described in [Table 7-463](#).

Figure 7-432. ELM_ERROR_LOCATION_12_6 Register

31	30	29	28	27	26	25	24	23	22	21	20	19	18	17	16
RESERVED															
R-0h															
15	14	13	12	11	10	9	8	7	6	5	4	3	2	1	0
RESERVED				ECC_ERROR_LOCATION											
R-0h				R-0h											

LEGEND: R/W = Read/Write; R = Read only; W1toCl = Write 1 to clear bit; -n = value after reset

Table 7-463. ELM_ERROR_LOCATION_12_6 Register Field Descriptions

Bit	Field	Type	Reset	Description
31-13	RESERVED	R	0h	
12-0	ECC_ERROR_LOCATION	R	0h	Error-location bit address, 0 to 1FFFh.

7.4.5.178 ELM_ERROR_LOCATION_13_6 Register (offset = EB4h) [reset = 0h]

ELM_ERROR_LOCATION_13_6 is shown in [Figure 7-433](#) and described in [Table 7-464](#).

Figure 7-433. ELM_ERROR_LOCATION_13_6 Register

31	30	29	28	27	26	25	24	23	22	21	20	19	18	17	16
RESERVED															
R-0h															
15	14	13	12	11	10	9	8	7	6	5	4	3	2	1	0
RESERVED				ECC_ERROR_LOCATION											
R-0h				R-0h											

LEGEND: R/W = Read/Write; R = Read only; W1toCl = Write 1 to clear bit; -n = value after reset

Table 7-464. ELM_ERROR_LOCATION_13_6 Register Field Descriptions

Bit	Field	Type	Reset	Description
31-13	RESERVED	R	0h	
12-0	ECC_ERROR_LOCATION	R	0h	Error-location bit address, 0 to 1FFFh.

7.4.5.179 ELM_ERROR_LOCATION_14_6 Register (offset = EB8h) [reset = 0h]

ELM_ERROR_LOCATION_14_6 is shown in [Figure 7-434](#) and described in [Table 7-465](#).

Figure 7-434. ELM_ERROR_LOCATION_14_6 Register

31	30	29	28	27	26	25	24	23	22	21	20	19	18	17	16
RESERVED															
R-0h															
15	14	13	12	11	10	9	8	7	6	5	4	3	2	1	0
RESERVED				ECC_ERROR_LOCATION											
R-0h				R-0h											

LEGEND: R/W = Read/Write; R = Read only; W1toCl = Write 1 to clear bit; -n = value after reset

Table 7-465. ELM_ERROR_LOCATION_14_6 Register Field Descriptions

Bit	Field	Type	Reset	Description
31-13	RESERVED	R	0h	
12-0	ECC_ERROR_LOCATION	R	0h	Error-location bit address, 0 to 1FFFh.

7.4.5.180 ELM_ERROR_LOCATION_15_6 Register (offset = EBCh) [reset = 0h]

 ELM_ERROR_LOCATION_15_6 is shown in [Figure 7-435](#) and described in [Table 7-466](#).

Figure 7-435. ELM_ERROR_LOCATION_15_6 Register

31	30	29	28	27	26	25	24	23	22	21	20	19	18	17	16
RESERVED															
R-0h															
15	14	13	12	11	10	9	8	7	6	5	4	3	2	1	0
RESERVED				ECC_ERROR_LOCATION											
R-0h				R-0h											

LEGEND: R/W = Read/Write; R = Read only; W1toCl = Write 1 to clear bit; -n = value after reset

Table 7-466. ELM_ERROR_LOCATION_15_6 Register Field Descriptions

Bit	Field	Type	Reset	Description
31-13	RESERVED	R	0h	
12-0	ECC_ERROR_LOCATION	R	0h	Error-location bit address, 0 to 1FFFh.

7.4.5.181 ELM_ERROR_LOCATION_0_7 Register (offset = F80h) [reset = 0h]

ELM_ERROR_LOCATION_0_7 is shown in [Figure 7-436](#) and described in [Table 7-467](#).

Figure 7-436. ELM_ERROR_LOCATION_0_7 Register

31	30	29	28	27	26	25	24	23	22	21	20	19	18	17	16
RESERVED															
R-0h															
15	14	13	12	11	10	9	8	7	6	5	4	3	2	1	0
RESERVED				ECC_ERROR_LOCATION											
R-0h				R-0h											

LEGEND: R/W = Read/Write; R = Read only; W1toCl = Write 1 to clear bit; -n = value after reset

Table 7-467. ELM_ERROR_LOCATION_0_7 Register Field Descriptions

Bit	Field	Type	Reset	Description
31-13	RESERVED	R	0h	
12-0	ECC_ERROR_LOCATION	R	0h	Error-location bit address, 0 to 1FFFh.

7.4.5.182 ELM_ERROR_LOCATION_1_7 Register (offset = F84h) [reset = 0h]

ELM_ERROR_LOCATION_1_7 is shown in [Figure 7-437](#) and described in [Table 7-468](#).

Figure 7-437. ELM_ERROR_LOCATION_1_7 Register

31	30	29	28	27	26	25	24	23	22	21	20	19	18	17	16
RESERVED															
R-0h															
15	14	13	12	11	10	9	8	7	6	5	4	3	2	1	0
RESERVED				ECC_ERROR_LOCATION											
R-0h				R-0h											

LEGEND: R/W = Read/Write; R = Read only; W1toCl = Write 1 to clear bit; -n = value after reset

Table 7-468. ELM_ERROR_LOCATION_1_7 Register Field Descriptions

Bit	Field	Type	Reset	Description
31-13	RESERVED	R	0h	
12-0	ECC_ERROR_LOCATION	R	0h	Error-location bit address, 0 to 1FFFh.

7.4.5.183 ELM_ERROR_LOCATION_2_7 Register (offset = F88h) [reset = 0h]

ELM_ERROR_LOCATION_2_7 is shown in [Figure 7-438](#) and described in [Table 7-469](#).

Figure 7-438. ELM_ERROR_LOCATION_2_7 Register

31	30	29	28	27	26	25	24	23	22	21	20	19	18	17	16
RESERVED															
R-0h															
15	14	13	12	11	10	9	8	7	6	5	4	3	2	1	0
RESERVED				ECC_ERROR_LOCATION											
R-0h				R-0h											

LEGEND: R/W = Read/Write; R = Read only; W1toCl = Write 1 to clear bit; -n = value after reset

Table 7-469. ELM_ERROR_LOCATION_2_7 Register Field Descriptions

Bit	Field	Type	Reset	Description
31-13	RESERVED	R	0h	
12-0	ECC_ERROR_LOCATION	R	0h	Error-location bit address, 0 to 1FFFh.

7.4.5.184 ELM_ERROR_LOCATION_3_7 Register (offset = F8Ch) [reset = 0h]

ELM_ERROR_LOCATION_3_7 is shown in [Figure 7-439](#) and described in [Table 7-470](#).

Figure 7-439. ELM_ERROR_LOCATION_3_7 Register

31	30	29	28	27	26	25	24	23	22	21	20	19	18	17	16
RESERVED															
R-0h															
15	14	13	12	11	10	9	8	7	6	5	4	3	2	1	0
RESERVED			ECC_ERROR_LOCATION												
R-0h			R-0h												

LEGEND: R/W = Read/Write; R = Read only; W1toCl = Write 1 to clear bit; -n = value after reset

Table 7-470. ELM_ERROR_LOCATION_3_7 Register Field Descriptions

Bit	Field	Type	Reset	Description
31-13	RESERVED	R	0h	
12-0	ECC_ERROR_LOCATION	R	0h	Error-location bit address, 0 to 1FFFh.

7.4.5.185 ELM_ERROR_LOCATION_4_7 Register (offset = F90h) [reset = 0h]

ELM_ERROR_LOCATION_4_7 is shown in [Figure 7-440](#) and described in [Table 7-471](#).

Figure 7-440. ELM_ERROR_LOCATION_4_7 Register

31	30	29	28	27	26	25	24	23	22	21	20	19	18	17	16
RESERVED															
R-0h															
15	14	13	12	11	10	9	8	7	6	5	4	3	2	1	0
RESERVED				ECC_ERROR_LOCATION											
R-0h				R-0h											

LEGEND: R/W = Read/Write; R = Read only; W1toCl = Write 1 to clear bit; -n = value after reset

Table 7-471. ELM_ERROR_LOCATION_4_7 Register Field Descriptions

Bit	Field	Type	Reset	Description
31-13	RESERVED	R	0h	
12-0	ECC_ERROR_LOCATION	R	0h	Error-location bit address, 0 to 1FFFh.

7.4.5.186 ELM_ERROR_LOCATION_5_7 Register (offset = F94h) [reset = 0h]

ELM_ERROR_LOCATION_5_7 is shown in [Figure 7-441](#) and described in [Table 7-472](#).

Figure 7-441. ELM_ERROR_LOCATION_5_7 Register

31	30	29	28	27	26	25	24	23	22	21	20	19	18	17	16
RESERVED															
R-0h															
15	14	13	12	11	10	9	8	7	6	5	4	3	2	1	0
RESERVED				ECC_ERROR_LOCATION											
R-0h				R-0h											

LEGEND: R/W = Read/Write; R = Read only; W1toCl = Write 1 to clear bit; -n = value after reset

Table 7-472. ELM_ERROR_LOCATION_5_7 Register Field Descriptions

Bit	Field	Type	Reset	Description
31-13	RESERVED	R	0h	
12-0	ECC_ERROR_LOCATION	R	0h	Error-location bit address, 0 to 1FFFh.

7.4.5.187 ELM_ERROR_LOCATION_6_7 Register (offset = F98h) [reset = 0h]

 ELM_ERROR_LOCATION_6_7 is shown in [Figure 7-442](#) and described in [Table 7-473](#).

Figure 7-442. ELM_ERROR_LOCATION_6_7 Register

31	30	29	28	27	26	25	24	23	22	21	20	19	18	17	16
RESERVED															
R-0h															
15	14	13	12	11	10	9	8	7	6	5	4	3	2	1	0
RESERVED				ECC_ERROR_LOCATION											
R-0h				R-0h											

LEGEND: R/W = Read/Write; R = Read only; W1toCl = Write 1 to clear bit; -n = value after reset

Table 7-473. ELM_ERROR_LOCATION_6_7 Register Field Descriptions

Bit	Field	Type	Reset	Description
31-13	RESERVED	R	0h	
12-0	ECC_ERROR_LOCATION	R	0h	Error-location bit address, 0 to 1FFFh.

7.4.5.188 ELM_ERROR_LOCATION_7_7 Register (offset = F9Ch) [reset = 0h]

ELM_ERROR_LOCATION_7_7 is shown in [Figure 7-443](#) and described in [Table 7-474](#).

Figure 7-443. ELM_ERROR_LOCATION_7_7 Register

31	30	29	28	27	26	25	24	23	22	21	20	19	18	17	16
RESERVED															
R-0h															
15	14	13	12	11	10	9	8	7	6	5	4	3	2	1	0
RESERVED				ECC_ERROR_LOCATION											
R-0h				R-0h											

LEGEND: R/W = Read/Write; R = Read only; W1toCl = Write 1 to clear bit; -n = value after reset

Table 7-474. ELM_ERROR_LOCATION_7_7 Register Field Descriptions

Bit	Field	Type	Reset	Description
31-13	RESERVED	R	0h	
12-0	ECC_ERROR_LOCATION	R	0h	Error-location bit address, 0 to 1FFFh.

7.4.5.189 ELM_ERROR_LOCATION_8_7 Register (offset = FA0h) [reset = 0h]

 ELM_ERROR_LOCATION_8_7 is shown in [Figure 7-444](#) and described in [Table 7-475](#).

Figure 7-444. ELM_ERROR_LOCATION_8_7 Register

31	30	29	28	27	26	25	24	23	22	21	20	19	18	17	16
RESERVED															
R-0h															
15	14	13	12	11	10	9	8	7	6	5	4	3	2	1	0
RESERVED			ECC_ERROR_LOCATION												
R-0h			R-0h												

LEGEND: R/W = Read/Write; R = Read only; W1toCl = Write 1 to clear bit; -n = value after reset

Table 7-475. ELM_ERROR_LOCATION_8_7 Register Field Descriptions

Bit	Field	Type	Reset	Description
31-13	RESERVED	R	0h	
12-0	ECC_ERROR_LOCATION	R	0h	Error-location bit address, 0 to 1FFFh.

7.4.5.190 ELM_ERROR_LOCATION_9_7 Register (offset = FA4h) [reset = 0h]

ELM_ERROR_LOCATION_9_7 is shown in [Figure 7-445](#) and described in [Table 7-476](#).

Figure 7-445. ELM_ERROR_LOCATION_9_7 Register

31	30	29	28	27	26	25	24	23	22	21	20	19	18	17	16
RESERVED															
R-0h															
15	14	13	12	11	10	9	8	7	6	5	4	3	2	1	0
RESERVED				ECC_ERROR_LOCATION											
R-0h				R-0h											

LEGEND: R/W = Read/Write; R = Read only; W1toCl = Write 1 to clear bit; -n = value after reset

Table 7-476. ELM_ERROR_LOCATION_9_7 Register Field Descriptions

Bit	Field	Type	Reset	Description
31-13	RESERVED	R	0h	
12-0	ECC_ERROR_LOCATION	R	0h	Error-location bit address, 0 to 1FFFh.

7.4.5.191 ELM_ERROR_LOCATION_10_7 Register (offset = FA8h) [reset = 0h]

ELM_ERROR_LOCATION_10_7 is shown in [Figure 7-446](#) and described in [Table 7-477](#).

Figure 7-446. ELM_ERROR_LOCATION_10_7 Register

31	30	29	28	27	26	25	24	23	22	21	20	19	18	17	16
RESERVED															
R-0h															
15	14	13	12	11	10	9	8	7	6	5	4	3	2	1	0
RESERVED				ECC_ERROR_LOCATION											
R-0h				R-0h											

LEGEND: R/W = Read/Write; R = Read only; W1toCl = Write 1 to clear bit; -n = value after reset

Table 7-477. ELM_ERROR_LOCATION_10_7 Register Field Descriptions

Bit	Field	Type	Reset	Description
31-13	RESERVED	R	0h	
12-0	ECC_ERROR_LOCATION	R	0h	Error-location bit address, 0 to 1FFFh.

7.4.5.192 ELM_ERROR_LOCATION_11_7 Register (offset = FACH) [reset = 0h]

ELM_ERROR_LOCATION_11_7 is shown in [Figure 7-447](#) and described in [Table 7-478](#).

Figure 7-447. ELM_ERROR_LOCATION_11_7 Register

31	30	29	28	27	26	25	24	23	22	21	20	19	18	17	16
RESERVED															
R-0h															
15	14	13	12	11	10	9	8	7	6	5	4	3	2	1	0
RESERVED				ECC_ERROR_LOCATION											
R-0h				R-0h											

LEGEND: R/W = Read/Write; R = Read only; W1toCl = Write 1 to clear bit; -n = value after reset

Table 7-478. ELM_ERROR_LOCATION_11_7 Register Field Descriptions

Bit	Field	Type	Reset	Description
31-13	RESERVED	R	0h	
12-0	ECC_ERROR_LOCATION	R	0h	Error-location bit address, 0 to 1FFFh.

7.4.5.193 ELM_ERROR_LOCATION_12_7 Register (offset = FB0h) [reset = 0h]

ELM_ERROR_LOCATION_12_7 is shown in [Figure 7-448](#) and described in [Table 7-479](#).

Figure 7-448. ELM_ERROR_LOCATION_12_7 Register

31	30	29	28	27	26	25	24	23	22	21	20	19	18	17	16
RESERVED															
R-0h															
15	14	13	12	11	10	9	8	7	6	5	4	3	2	1	0
RESERVED				ECC_ERROR_LOCATION											
R-0h				R-0h											

LEGEND: R/W = Read/Write; R = Read only; W1toCl = Write 1 to clear bit; -n = value after reset

Table 7-479. ELM_ERROR_LOCATION_12_7 Register Field Descriptions

Bit	Field	Type	Reset	Description
31-13	RESERVED	R	0h	
12-0	ECC_ERROR_LOCATION	R	0h	Error-location bit address, 0 to 1FFFh.

7.4.5.194 ELM_ERROR_LOCATION_13_7 Register (offset = FB4h) [reset = 0h]

ELM_ERROR_LOCATION_13_7 is shown in [Figure 7-449](#) and described in [Table 7-480](#).

Figure 7-449. ELM_ERROR_LOCATION_13_7 Register

31	30	29	28	27	26	25	24	23	22	21	20	19	18	17	16
RESERVED															
R-0h															
15	14	13	12	11	10	9	8	7	6	5	4	3	2	1	0
RESERVED				ECC_ERROR_LOCATION											
R-0h				R-0h											

LEGEND: R/W = Read/Write; R = Read only; W1toCl = Write 1 to clear bit; -n = value after reset

Table 7-480. ELM_ERROR_LOCATION_13_7 Register Field Descriptions

Bit	Field	Type	Reset	Description
31-13	RESERVED	R	0h	
12-0	ECC_ERROR_LOCATION	R	0h	Error-location bit address, 0 to 1FFFh.

7.4.5.195 ELM_ERROR_LOCATION_14_7 Register (offset = FB8h) [reset = 0h]

ELM_ERROR_LOCATION_14_7 is shown in [Figure 7-450](#) and described in [Table 7-481](#).

Figure 7-450. ELM_ERROR_LOCATION_14_7 Register

31	30	29	28	27	26	25	24	23	22	21	20	19	18	17	16
RESERVED															
R-0h															
15	14	13	12	11	10	9	8	7	6	5	4	3	2	1	0
RESERVED				ECC_ERROR_LOCATION											
R-0h				R-0h											

LEGEND: R/W = Read/Write; R = Read only; W1toCl = Write 1 to clear bit; -n = value after reset

Table 7-481. ELM_ERROR_LOCATION_14_7 Register Field Descriptions

Bit	Field	Type	Reset	Description
31-13	RESERVED	R	0h	
12-0	ECC_ERROR_LOCATION	R	0h	Error-location bit address, 0 to 1FFFh.

7.4.5.196 ELM_ERROR_LOCATION_15_7 Register (offset = FBCh) [reset = 0h]

ELM_ERROR_LOCATION_15_7 is shown in [Figure 7-451](#) and described in [Table 7-482](#).

Figure 7-451. ELM_ERROR_LOCATION_15_7 Register

31	30	29	28	27	26	25	24	23	22	21	20	19	18	17	16
RESERVED															
R-0h															
15	14	13	12	11	10	9	8	7	6	5	4	3	2	1	0
RESERVED				ECC_ERROR_LOCATION											
R-0h				R-0h											

LEGEND: R/W = Read/Write; R = Read only; W1toCl = Write 1 to clear bit; -n = value after reset

Table 7-482. ELM_ERROR_LOCATION_15_7 Register Field Descriptions

Bit	Field	Type	Reset	Description
31-13	RESERVED	R	0h	
12-0	ECC_ERROR_LOCATION	R	0h	Error-location bit address, 0 to 1FFFh.

7.4.5.197 ELM_LOCATION_STATUS_5 Register (offset = D00h) [reset = 0h]

ELM_LOCATION_STATUS_5 is shown in [Figure 7-452](#) and described in [Table 7-483](#).

Figure 7-452. ELM_LOCATION_STATUS_5 Register

31	30	29	28	27	26	25	24
RESERVED							
R-0h							
23	22	21	20	19	18	17	16
RESERVED							
R-0h							
15	14	13	12	11	10	9	8
RESERVED							ECC_CORREC TABL
R-0h							R-0h
7	6	5	4	3	2	1	0
RESERVED			ECC_NB_ERRORS				
R-0h			R-0h				

LEGEND: R/W = Read/Write; R = Read only; W1toCl = Write 1 to clear bit; -n = value after reset

Table 7-483. ELM_LOCATION_STATUS_5 Register Field Descriptions

Bit	Field	Type	Reset	Description
31-9	RESERVED	R	0h	
8	ECC_CORRECTABL	R	0h	Error-location process exit status. 0h = ECC error-location process failed. Number of errors and error locations are invalid. 1h = All errors were successfully located. Number of errors and error locations are valid.
7-5	RESERVED	R	0h	
4-0	ECC_NB_ERRORS	R	0h	Number of errors detected and located, value 0 to 1Fh.

7.4.5.198 ELM_LOCATION_STATUS_6 Register (offset = E00h) [reset = 0h]

ELM_LOCATION_STATUS_6 is shown in [Figure 7-453](#) and described in [Table 7-484](#).

Figure 7-453. ELM_LOCATION_STATUS_6 Register

31	30	29	28	27	26	25	24
RESERVED							
R-0h							
23	22	21	20	19	18	17	16
RESERVED							
R-0h							
15	14	13	12	11	10	9	8
RESERVED							ECC_CORREC TABL
R-0h							R-0h
7	6	5	4	3	2	1	0
RESERVED			ECC_NB_ERRORS				
R-0h			R-0h				

LEGEND: R/W = Read/Write; R = Read only; W1toCl = Write 1 to clear bit; -n = value after reset

Table 7-484. ELM_LOCATION_STATUS_6 Register Field Descriptions

Bit	Field	Type	Reset	Description
31-9	RESERVED	R	0h	
8	ECC_CORRECTABL	R	0h	Error-location process exit status. 0h = ECC error-location process failed. Number of errors and error locations are invalid. 1h = All errors were successfully located. Number of errors and error locations are valid.
7-5	RESERVED	R	0h	
4-0	ECC_NB_ERRORS	R	0h	Number of errors detected and located, value 0 to 1Fh.

7.4.5.199 ELM_LOCATION_STATUS_7 Register (offset = F00h) [reset = 0h]

ELM_LOCATION_STATUS_7 is shown in [Figure 7-454](#) and described in [Table 7-485](#).

Figure 7-454. ELM_LOCATION_STATUS_7 Register

31	30	29	28	27	26	25	24
RESERVED							
R-0h							
23	22	21	20	19	18	17	16
RESERVED							
R-0h							
15	14	13	12	11	10	9	8
RESERVED							ECC_CORREC TABL
R-0h							R-0h
7	6	5	4	3	2	1	0
RESERVED			ECC_NB_ERRORS				
R-0h			R-0h				

LEGEND: R/W = Read/Write; R = Read only; W1toCl = Write 1 to clear bit; -n = value after reset

Table 7-485. ELM_LOCATION_STATUS_7 Register Field Descriptions

Bit	Field	Type	Reset	Description
31-9	RESERVED	R	0h	
8	ECC_CORRECTABL	R	0h	Error-location process exit status. 0h = ECC error-location process failed. Number of errors and error locations are invalid. 1h = All errors were successfully located. Number of errors and error locations are valid.
7-5	RESERVED	R	0h	
4-0	ECC_NB_ERRORS	R	0h	Number of errors detected and located, value 0 to 1Fh.

Power, Reset, and Clock Management (PRCM)

This chapter describes the PRCM of the device.

Topic	Page
8.1 Power, Reset, and Clock Management.....	1113

8.1 Power, Reset, and Clock Management

8.1.1 Introduction

The device power-management architecture ensures maximum performance and operation time for user satisfaction (audio/video support) while offering versatile power-management techniques for maximum design flexibility, depending on application requirements. This introduction contains the following information:

- Power-management architecture building blocks for the device
- State-of-the-art power-management techniques supported by the power-management architecture of the device

8.1.2 Device Power-Management Architecture Building Blocks

To provide a versatile architecture supporting multiple power-management techniques, the power-management framework is built with three levels of resource management: clock, power, and voltage management.

These management levels are enforced by defining the managed entities or building blocks of the power-management architecture, called the clock, power, and voltage domains. A domain is a group of modules or subsections of the device that share a common entity (for example, common clock source, common voltage source, or common power switch). The group forming the domain is managed by a policy manager. For example, a clock for a clock domain is managed by a dedicated clock manager within the power, reset, and clock management (PRCM) module. The clock manager considers the joint clocking constraints of all the modules belonging to that clock domain (and, hence, receiving that clock).

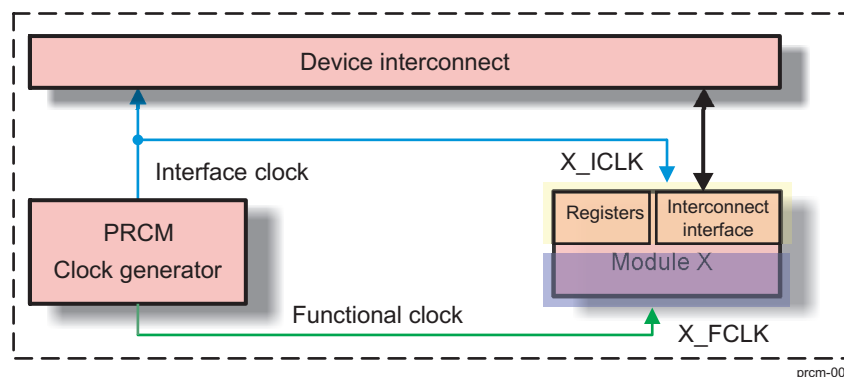
8.1.3 Clock Management

The PRCM module along with the control module manages the gating (that is, switching off) and enabling of the clocks to the device modules. The clocks are managed based on the requirement constraints of the associated modules. The following sections identify the module clock characteristics, management policy, clock domains, and clock domain management

8.1.3.1 Module Interface and Functional Clocks

Each module within the device has specific clock input characteristic requirements. Based on the characteristics of the clocks delivered to the modules, the clocks are divided into two categories: interface clocks and functional clocks

Figure 8-1. Functional and Interface Clocks



The interface clocks have the following characteristics:

- They ensure proper communication between any module/subsystem and interconnect.
- In most cases, they supply the system interconnect interface and registers of the module.
- A typical module has one interface clock, but modules with multiple interface clocks may also exist (that is, when connected to multiple interconnect buses).

- Interface clock management is done at the device level.
- From the standpoint of the PRCM module, an interface clock is identified by an `_ICLK` suffix.

Functional clocks have the following characteristics:

- They supply the functional part of a module or subsystem.
- A module can have one or more functional clocks. Some functional clocks are mandatory, while others are optional. A module needs its mandatory clock(s) to be operational. The optional clocks are used for specific features and can be shut down without stopping the module activity
- From the standpoint of the PRCM module, a functional clock is distributed directly to the related modules through a dedicated clock tree. It is identified with an `_FCLK` suffix

8.1.3.2 Module-Level Clock Management

Each module in the device may also have specific clock requirements. Certain module clocks must be active when operating in specific modes, or may be gated otherwise. Globally, the activation and gating of the module clocks are managed by the PRCM module. Hence, the PRCM module must be aware of when to activate and when to gate the module clocks. The PRCM module differentiates the clock-management behavior for device modules based on whether the module can initiate transactions on the device interconnect (called master module or initiators) or cannot initiate transactions and only responds to the transactions initiated by the master (called slave module or targets). Thus, two hardware-based power-management protocols are used:

- Master standby protocol: Clock-management protocol between the PRCM and master modules.
- Slave idle protocol: Clock-management protocol between the PRCM and slave modules.

8.1.3.2.1 Master Standby Protocol

Master standby protocol is used to indicate that a master module must initiate a transaction on the device interconnect and requests specific (functional and interface) clocks for the purpose. The PRCM module ensures that the required clocks are active when the master module requests the PRCM module to enable them. This is called a module wake-up transition and the module is said to be functional after this transition completes. Similarly, when the master module no longer requires the clocks, it informs the PRCM module, which can then gate the clocks to the module. The master module is then said to be in standby mode. Although the protocol is completely hardware-controlled, software must configure the clock-management behavior for the module. This is done by setting the module register bit field `<Module>_SYSCONFIG.MIDDLEMODE` or `<Module>_SYSCONFIG.STANDBYMODE`. The behavior, identified by standby mode values, must be configured.

Table 8-1. Master Module Standby-Mode Settings

Standby Mode Value	Selected Mode	Description
0x0	Force-standby	The module unconditionally asserts the standby request to the PRCM module, regardless of its internal operations. The PRCM module may gate the functional and interface clocks to the module. This mode must be used carefully because it does not prevent the loss of data at the time the clocks are gated.
0x1	No-standby	The module never asserts the standby request to the PRCM module. This mode is safe from a module point of view because it ensures that the clocks remain active. However, it is not efficient from a power-saving perspective because it never allows the output clocks of the PRCM module to be gated

Table 8-1. Master Module Standby-Mode Settings (continued)

Standby Mode Value	Selected Mode	Description
0x2	Smart-standby	The module asserts the standby request based on its internal activity status. The standby signal is asserted only when all ongoing transactions are complete and the module is idled. The PRCM module can then gate the clocks to the module.
0x3	Smart-standbywakeup-capable mode	The module asserts the standby request based on its internal activity status. The standby signal is asserted only when all ongoing transactions are complete and the module is idle. The PRCM module can then gate the clocks to the module. The module may generate (master-related) wake-up events when in STANDBY state. The mode is relevant only if the appropriate module mwakeup output is implemented.

The standby status of a master module is indicated by the CM_<Power_domain>_<Module>_CLKCTRL[x]. STBYST bit in the PRCM module.

Table 8-2. Master Module Standby Status

STBYST Bit Value	Description
0x0	The module is functional.
0x1	The module is in standby mode

8.1.3.2.2 Slave Idle Protocol

This hardware protocol allows the PRCM module to control the state of a slave module. The PRCM module informs the slave module, through assertion of an idle request, when its clocks (interface and functional) can be gated. The slave can then acknowledge the request from the PRCM module and the PRCM module is then allowed to gate the clocks to the module. A slave module is said to be in IDLE state when its clocks are gated by the PRCM module. Similarly, an idled slave module may need to be wakened because of a service request from a master module or as a result of an event (called a wake-up event; for example, interrupt or DMA request) received by the slave module. In this situation the PRCM module enables the clocks to the module and then deasserts the idle request to signal the module to wake up. Although the protocol is completely hardware-controlled, software must configure the clock-management behavior for the slave module. This is done by setting the module register bit field <Module>_SYSCONFIG.SIDLEMODE or <Module>_SYSCONFIG.IDLEMODE. The behavior, listed in the Idle Mode Value column, must be configured by software.

Table 8-3. Module Idle Mode Settings

Idle Mode Value	Selected Mode	Description
0x0	Force-idle	The module unconditionally acknowledges the idle request from the PRCM module, regardless of its internal operations. This mode must be used carefully because it does not prevent the loss of data at the time the clock is switched off.
0x1	No-idle	The module never acknowledges any idle request from the PRCM module. This mode is safe from a module point of view because it ensures that the clocks remain active. However, it is not efficient from a power-saving perspective because it does not allow the PRCM module output clock to be shut off, and thus the power domain to be set to a lower power state.

Table 8-3. Module Idle Mode Settings (continued)

Idle Mode Value	Selected Mode	Description
0x2	Smart-idle	The module acknowledges the idle request basing its decision on its internal activity. Namely, the acknowledge signal is asserted only when all pending transactions, interrupts, or direct memory access (DMA) requests are processed. This is the best approach to efficient system power management.
0x3	Smart-idle wakeup-capable mode	The module acknowledges the idle request basing its decision on its internal wakeup-capable mode activity. Namely, the acknowledge signal is asserted only when all pending transactions, interrupts, or DMA requests are processed. This is the best approach to efficient system power management. The module may generate (IRQ- or DMA-request-related) wake-up events when in IDLE state. The mode is relevant only if the appropriate module wakeup output(s) is implemented.

The idle status of a slave module is indicated by the CM_<Powerdomain>_<Module>_CLKCTRL[x] IDLEST bit field in the PRCM module.

Table 8-4. Idle States for a Slave Module

IDLEST Bit VALUE	Idle Status	Description
0x0	Functional	The module is fully functional. The interface and functional clocks are active.
0x1	In transition	The module is performing a wake-up or a sleep transition.
0x2	Interface idle	The module interface clock is idled. The module may remain functional if using a separate functional clock.
0x3	Full idle	The module is fully idle. The interface and functional clocks are gated in the module.

For the idle protocol management on the PRCM module side, the behavior of the PRCM module is configured in the CM_<Power domain>_<module>_CLKCTRL[x] MODULEMODE bit field. Based on the configured behavior, the PRCM module asserts the idle request to the module unconditionally (that is, immediately when the software requests).

Table 8-5. Slave Module Mode Settings in PRCM

MODULEMODE Bit VALUE	Selected Mode	Description
0x0	Disabled	The PRCM module unconditionally asserts the module idle request. This request applies to the gating of the functional and interface clocks to the module. If acknowledged by the module, the PRCM module can gate all clocks to the module (that is, the module is completely disabled)..
0x1	Reserved	NA

Table 8-5. Slave Module Mode Settings in PRCM (continued)

MODULEMODE Bit VALUE	Selected Mode	Description
0x2	Enabled	This mode applies to a module when the PRCM module manages its interface and functional clocks. The functional clock to the module remains active unconditionally, while the PRCM module automatically asserts/deasserts the module idle request based on the clock-domain transitions. If acknowledged by the module, the PRCM module can gate only the interface clock to the module.
0x3	Reserved	NA

In addition to the IDLE and STANDBY protocol, PRCM offers also the possibility to manage optional clocks, through a direct SW control: “OptFclken” bit from programming register.

Table 8-6. Module Clock Enabling Condition

Clock Enabling		
Clock associated with STANDBY protocol	AND	Clock Domain is ready
		OR
		MStandby is de-asserted Mwakeup is asserted
Clock associated with IDLE protocol, as interface clock	AND	Clock Domain is ready
		OR
		Idle status = FUNCT Idle status = TRANS SWakeup is asserted
Clock associated with IDLE protocol, as functional clock	AND	Clock Domain is ready
		OR
		Idle status = FUNCT Idle status = IDLE Idle status = TRANS SWakeup is asserted
Optional clock	AND	Clock domain is ready
		OptFclken=Enabled ('1')

8.1.3.3 Clock Domain

A clock domain is a group of modules fed by clock signals controlled by the same clock manager in the PRCM module. By gating the clocks in a clock domain, the clocks to all the modules belonging to that clock domain can be cut to lower their active power consumption (that is, the device is on and the clocks to the modules are dynamically switched to ACTIVE or INACTIVE (GATED) states). Thus, a clock domain allows control of the dynamic power consumption of the device. The device is partitioned into multiple clock domains, and each clock domain is controlled by an associated clock manager within the PRCM module. This allows the PRCM module to individually activate and gate each clock domain of the device.

Figure 8-2. Generic Clock Domain

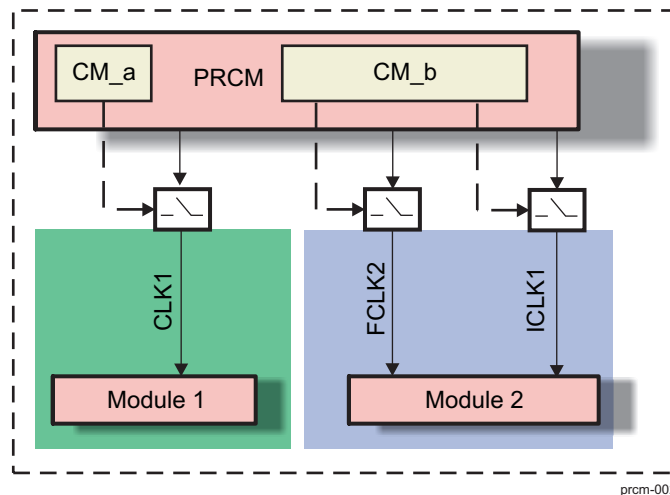


Figure above is an example of two clock managers: CM_a and CM_b. Each clock manager manages a clock domain. The clock domain of CM_b is composed of two clocks: a functional clock (FCLK2) and an interface clock (ICLK1), while the clock domain of CM_a consists of a clock (CLK1) that is used by the module as a functional and interface clock. The clocks to Module 2 can be gated independently of the clock to Module 1, thus ensuring power savings when Module 2 is not in use. The PRCM module lets software check the status of the clock domain functional clocks. The CM_<Clock domain>_CLKSTCTRL[x] CLKACTIVITY_<FCLK/Clock name_FCLK> bit in the PRCM module identifies the state of the functional clock(s) within the clock domain. Table shows the possible states of the functional clock.

Table 8-7. Clock Domain Functional Clock States

CLKACTIVITY BIT Value	Status	Description
0x0	Gated	The functional clock of the clock domain is inactive
0x1	Active	The functional clock of the clock domain is running

8.1.3.3.1 Clock Domain-Level Clock Management

The domain clock manager can automatically (that is, based on hardware conditions) and jointly manage the interface clocks within the clock domain. The functional clocks within the clock domain are managed through software settings. A clock domain can switch between three possible states: ACTIVE, IDLE_TRANSITION, and INACTIVE. Figure 8-3 shows the sleep and wake-up transitions of the clock domain between ACTIVE and INACTIVE states.

Figure 8-3. Clock Domain State Transitions

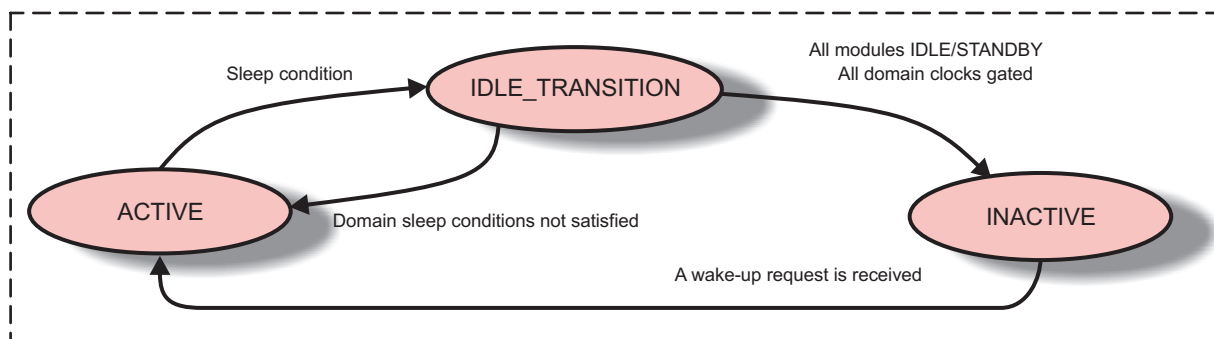


Table 8-8. Clock Domain States

State	Description
ACTIVE	Every nondisabled slave module (that is, those whose MODULEMODE value is not set to disabled) is put out of IDLE state. All interface clocks to the nondisabled slave modules in the clock domain are provided. All functional and interface clocks to the active master modules (that is, not in STANDBY) in the clock domain are provided. All enabled optional clocks to the modules in the clock domain are provided.
IDLE_TRANSITION	This is a transitory state. Every master module in the clock domain is in STANDBY state. Every idle request to all the slave modules in the clock domain is asserted. The functional clocks to the slave module in enabled state (that is, those whose MODULEMODE values are set to enabled) remain active. All enabled optional clocks to the modules in the clock domain are provided.
INACTIVE	All clocks within the clock domain are gated. Every slave module in the clock is in IDLE state and set to disabled. Every slave module in the clock domain (that is, those whose MODULEMODE is set to disabled) is in IDLE state and set to disabled. Every optional functional clock in the clock domain is gated

Each clock domain transition behavior is managed by an associated register bit field in the CM_<Clock domain>_CLKSTCTRL[x] CLKTRCTRL PRCM module

Table 8-9. Clock Transition Mode Settings

CLKTRCTRL Bit Value	Selected Mode	Description
0x0	NO_SLEEP	Sleep transition cannot be initiated. Wakeup transition may however occur.
0x1	SW_SLEEP	A software-forced sleep transition. The transition is initiated when the associated hardware conditions are satisfied
0x2	SW_WKUP	A software-forced clock domain wake-up transition is initiated
0x3	Reserved	NA

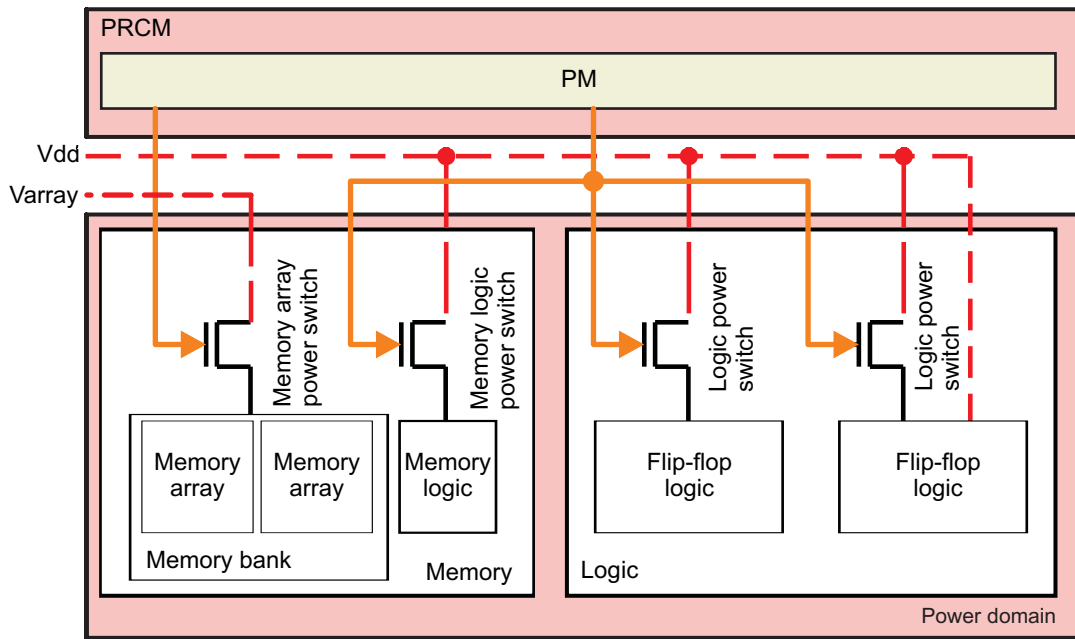
8.1.4 Power Management

The PRCM module manages the switching on and off of the power supply to the device modules. To minimize device power consumption, the power to the modules can be switched off when they are not in use. Independent power control of sections of the device allows the PRCM module to turn on and off specific sections of the device without affecting the others.

8.1.4.1 Power Domain

A power domain is a section (that is, a group of modules) of the device with an independent and dedicated power manager (see Figure). A power domain can be turned on and off without affecting the other parts of the device.

Figure 8-4. Generic Power Domain Architecture



prcm-008

To minimize device power consumption, the modules are grouped into power domains. A power domain can be split into a logic area and a memory area.

Table 8-10. States of a Memory Area in a Power Domain

State	Description
ON	The memory array is powered and fully functional
OFF	The memory array is powered down

Table 8-11. States of a Logic Area in a Power Domain

State	Description
ON	Logic is fully powered
OFF	Logic power switches are off. All the logic (DFF) is lost

8.1.4.2 Power Domain Management

The power manager associated with each power domain is assigned the task of managing the domain power transitions. It ensures that all hardware conditions are satisfied before it can initiate a power domain transition from a source to a target power state

Table 8-12. Power Domain Control and Status Registers

Register/Bit Field	Type	Description
PM_<Power domain>_PWRSTCTRL[1:0] POWERSTATE	Control	Selects the target power state of the power domain among OFF, ON, or RETENTION.
PM_<Power domain>_PWRSTST[1:0] POWERSTATEST	Status	Identifies the current state of the power domain. It can be OFF, ON, or RETENTION.
PM_<Power domain>_PWRSTST[2] LOGICSTATEST	Status	Identifies the current state of the logic area in the power domain. It can be OFF or ON.
PM_<Power domain>_PWRSTST[5:4] MEMSTATEST	Status	Identifies the current state of the memory area in the power domain. It can be OFF, ON, or RETENTION

8.1.4.2.1 Power-Management Techniques

The following section describes the state-of-the-art power-management techniques supported by the device.

8.1.4.2.1.1 Adaptive Voltage Scaling

AVS is a power-management technique based in Smart Reflex that is used for automatic control of the operating voltages of the device to reduce active power consumption. With Smart Reflex, power-supply voltage is adapted to silicon performance, either statically (based on performance points predefined in the manufacturing process of a given device) or dynamically (based on the temperature-induced real-time performance of the device). A comparison of these predefined performance points to the real-time on-chip measured performance determines whether to raise or lower the power-supply voltage. AVS achieves the optimal performance/power trade-off for all devices across the technology process spectrum and across temperature variation. The device voltage is automatically adapted to maintain performance of the device

8.1.4.3 Power Modes

The following is a high-level description of the different power modes of the device. They are listed in order from highest power consumption, lowest wakeup latency (Standby), to lowest power consumption, highest wakeup latency (RTC-only). If your application requires some sort of power management, you must determine which power mode level described below satisfies your requirements. Each level must be evaluated based on power consumed and latency (the time it takes to wakeup to Active mode). Specific values are detailed in the device-specific data sheet. Note that not all modes are supported by software packages supplied by Texas Instruments.

Table 8-13. Typical Power Modes

Power Modes	Application State	Power Domains, Clocks, and Voltage Supply States
Active	All Features	Power supplies: All power supplies are ON. VDD_MPU = 1.1 V (nom) VDD_CORE = 1.1 V (nom) Clocks: Main Oscillator (OSC0) = ON All DPLLs are locked. Power domains: PD_PER = ON PD_MPU = ON PD_GFX = ON or OFF (depending on use case) PD_WKUP = ON DDR is active.
Standby	DDR memory is in self-refresh and contents are preserved. Wakeup from any GPIO. CortexA8 context/register contents are lost and must be saved before entering standby. On exit, context must be restored from DDR. For wakeup, boot ROM executes and branches to system resume.	Power supplies: All power supplies are ON. VDD_MPU = 0.95 V (nom) VDD_CORE = 0.95 V (nom) Clocks: Main Oscillator (OSC0) = ON All DPLLs are in bypass. Power domains: PD_PER = ON PD_MPU = OFF PD_GFX = OFF PD_WKUP = ON DDR is in self-refresh.
Deepsleep1	On-chip peripheral registers are preserved. Cortex-A8 context/registers are lost, so the application needs to save them to the L3 OCMC RAM or DDR before entering DeepSleep. DDR is in self-refresh. For wakeup, boot ROM executes and branches to system resume.	Power supplies: All power supplies are ON. VDD_MPU = 0.95 V (nom) VDD_CORE = 0.95 V (nom) Clocks: Main Oscillator (OSC0) = OFF All DPLLs are in bypass. Power domains: PD_PER = ON PD_MPU = OFF PD_GFX = OFF PD_WKUP = ON DDR is in self-refresh.

Table 8-13. Typical Power Modes (continued)

Power Modes	Application State	Power Domains, Clocks, and Voltage Supply States
Deepsleep0	PD_PER peripheral and Cortex-A8/MPU register information will be lost. On-chip peripheral register (context) information of PD-PER domain needs to be saved by application to SDRAM before entering this mode. DDR is in self-refresh. For wakeup, boot ROM executes and branches to peripheral context restore followed by system resume.	Power supplies: All power supplies are ON. VDD_MPU = 0.95 V (nom) VDD_CORE = 0.95 V (nom) Clocks: Main Oscillator (OSC0) = OFF All DPLLs are in bypass. Power domains: PD_PER = OFF PD_MPU = OFF PD_GFX = OFF PD_WKUP = ON DDR is in self-refresh.
RTC-Only	RTC timer remains active and all other device functionality is disabled.	Power supplies: All power supplies are OFF except VDDS_RTC. VDD_MPU = 0 V VDD_CORE = 0 V Clocks: Main Oscillator (OSC0) = OFF Power domains: All power domains are OFF.

8.1.4.3.1 Active

In Active mode, the supply to all voltage rails must be maintained. All power domains come up in ON state and the device is fully functional.

8.1.4.3.2 Standby

The device can be placed in Standby mode to reduce power consumption during low activity levels. This first level of power management allows you to maintain the device context for fast resume times. The main characteristics of this mode which distinguish it from Active mode are:

- All modules are clock gated except GPIOs
- PLLs may be placed in bypass mode if downstream clocking does not require full performance
- Voltage domains VDD_MPU and VDD_CORE voltage levels can be reduced to OPP50 levels because the required performance of the entire device is reduced
- MPU power domain (PD_MPU) is in OFF state
- DDR memory is in low power self-refresh mode.

Further power reduction can be achieved in this mode if the RTC function is not required. See [Section 8.1.4.3.6, Internal RTC LDO](#).

The above conditions result in lower power consumption than Active mode but require the user to save the MPU context to OCMC RAM or DDR to resume properly upon wakeup. Contents of the internal SRAM are lost because PD_MPU is turned OFF. Wakeup in Standby mode is achieved using any GPIO. GPIO wakeup is possible by switching the pad to GPIO mode and configuring the corresponding GPIO bank for generating an interrupt to the MPUSS. Note that pads that do not have a GPIO muxmode (for example, ADC or USB), cannot cause these wakeups. If additional or other wakeup sources are required, the associated peripheral module clock and interconnect clock domain should remain enabled (this may require the associated PLL to remain locked) and the module must be configured appropriately for wakeup by configuring it to generate an interrupt to the MPUSS.

8.1.4.3.3 DeepSleep1

DeepSleep1 mode enables lower power consumption than Standby mode. The main characteristic of this mode which distinguishes it from Standby mode is the main oscillator (OSC0) is disabled.

DeepSleep1 is the lowest sleep mode required for certain USB wakeup modes. See [Section 8.1.4.3.7, Supported Low Power USB Wakeup Scenarios](#), for more information.

Further power reduction can be achieved in this mode if the RTC function is not required. See [Section 8.1.4.3.6, Internal RTC LDO](#).

Similar to Standby mode, the contents of the internal SRAM are lost because PD_MPU is turned OFF. In addition, the contents of the SDRAM are preserved by placing the SDRAM in self-refresh. Activity on wakeup peripherals via wake-up events enables the master crystal oscillator using the oscillator control circuit. The wakeup events also interrupt Cortex-M3. See [Section 8.1.4.5, Wakeup Sources/Events](#), for details on wakeup sources.

8.1.4.3.4 DeepSleep0

DeepSleep0 mode enables lower power consumption than DeepSleep1. The main characteristics of the mode which distinguish it from other higher power modes are:

- All on-chip power domains are shut off (except PD_WKUP and PD_RTC remain ON) to reduce power leakage
- VDD_CORE power (except VDDA analog) to DPLLs is turned OFF using `dpll_pwr_sw_ctrl` register (PG 2.x only)
- VDDS_SRAM_CORE_BG is in retention using `SMA2.vslido_core_auto_ramp_en` (PG2.x only)

DeepSleep0 mode is typically used during periods of inactivity when the user requires very low power while waiting for an event that requires processing or higher performance. This is the lowest power mode which still includes DDR in self-refresh, so wakeup events do not require a full cold boot, which greatly reduces wakeup latencies over RTC-only mode.

Further power reduction can be achieved in this mode if the RTC function is not required. See [Section 8.1.4.3.6, Internal RTC LDO](#).

Similar to DeepSleep1 mode, the contents of the internal SRAM are lost because PD_MPU is turned OFF.

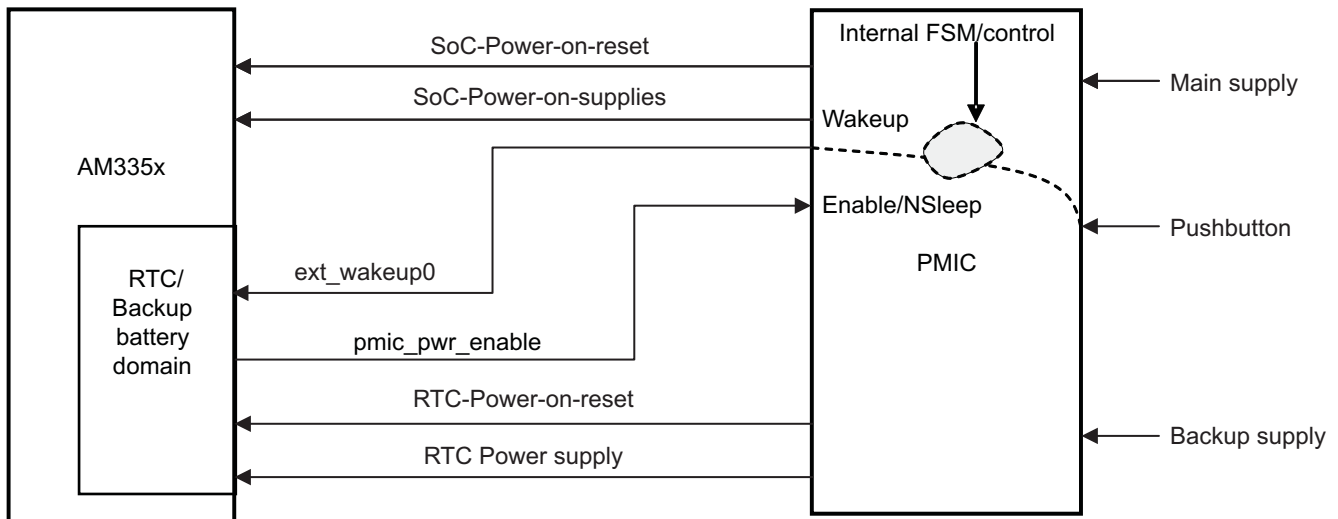
Before entering DeepSleep0 mode, peripheral and MPU context must be saved in the DDR. Upon wakeup, the boot ROM executes and checks to see if it has resumed from a DeepSleep0 state. If so, it redirects to the DDR to continue the resume process. Because power to PD_WKUP is ON throughout DeepSleep0, power to key modules such as GPIO0, I2C, and others is maintained to allow wakeup events to exit out of this mode. In addition, power to OCMC RAM is maintained to preserve information internally during DeepSleep0.

Activity on wakeup peripherals via wakeup events enables the master crystal oscillator using the oscillator control circuit. The wakeup events also interrupt Cortex M3 which controls proper enabling of power domains and clocks in the PRCM. See [Section 8.1.4.5, Wakeup Sources/Events](#), for details on wakeup sources during DeepSleep0 and other low power modes mentioned.

8.1.4.3.5 RTC-Only

RTC-only mode is an ultra-low power mode which allows the user to maintain power and clocks to the real-time clock (RTC) domain while the rest of the device is powered down. All context and memories will be lost, and the only portion of the chip that will be maintained is the RTC. Only the RTC power supply must be ON. All the remaining supplies must be OFF. The RTC battery backup domain consists of the RTC subsystem (RTCSS), a dedicated, on-chip 32.768 Hz crystal oscillator and I/Os associated with the RTCSS: `pmic_power_en` and `ext_wakeup`.

[Figure 8-5](#) gives a high level view of system which implements the RTC-only mode.

Figure 8-5. High Level System View for RTC-only Mode


Wakeup from RTC-only mode can only be achieved using the `ext_wakeup0` signal. Once a wakeup is triggered using this signal, the device drives `pmic_pwr_enable` to initiate a power-up sequence by the PMIC. The device must go through a full cold boot upon wakeup from RTC-only mode.

8.1.4.3.6 Internal RTC LDO

The device contains an internal LDO (low dropout) regulator which powers the RTC digital core. Depending on your application, you may be able to disable this regulator to save power in low power use cases.

If your application never uses the RTC functionality, connect `RTC_KALDO_ENn` to `VDDS_RTC`, `CAP_VDD_RTC` to `VDD_CORE`, and `RTC_PWRONRSTn` to ground. These connections disable the internal RTC LDO because `RTC_KALDO_ENn` is high, and they use the external `VDD_CORE` supply to power the RTC digital core. The RTC LDO must be disabled for internal power sequencing even though the RTC is not used. Grounding the reset signal will ensure the RTC stays in reset. Disabling the internal LDO will allow the application to achieve lower power consumption in all the low power modes.

If your application uses the RTC functionality and never needs RTC-only mode, the hardware scenario is similar to the previous description, but the RTC reset signal can be connected to the device `PWRONRSTn`. Note that `PWRONRSTn` and `RTC_PWRONRSTn` may be at different voltage levels, so `PWRONRSTn` may require level shifting before connecting to `RTC_PWRONRSTn`. This connection allows full functionality of the RTC subsystem without the internal RTC LDO consuming power.

If your application uses the RTC functionality and requires RTC-only mode, the internal LDO is required to enable proper wakeup signaling from the RTC domain. The proper wakeup signaling requires the following connections:

- `RTC_KALDO_ENn` is grounded
- `CAP_VDD_RTC` is connected to 1uF decoupling capacitor to ground
- `RTC_PWRONRSTn` is connected to 1.8V RTC power on reset
- `PMIC_POWER_EN` is connected to power input of PMIC
- `EXT_WAKEUP0` is connected to a wakeup source

See the device datasheet for more information on these signals.

8.1.4.3.7 Supported Low Power USB Wakeup Scenarios

Table 8-14 summarizes different USB wakeup use cases which are supported in each system sleep state (DeepSleep0, DeepSleep1, or Standby). Three use case scenarios exist:

- USB Connect: Wakeup is caused by physically inserting the USB cable.
- USB Disconnect: Wakeup is caused by physically removing the USB cable.
- USB Suspend/Resume: Wakeup is caused by a USB suspend or resume command. For example, a USB mouse click can cause a USB resume command.

Within each wakeup use case, each row describes whether or not that type of wakeup is supported in each system sleep mode. USB mode (host or device) is also considered.

There are two possible Wakeup events that are generated:

- PHY WKUP: this is an internal wakeup signal to the Cortex M3 that is generated by the USB PHY based off of USB signaling.
- VBUS2GPIO: this is an external wakeup signal coming from a level change on VBUS voltage. This event requires an external board solution which routes VBUS to a GPIO on the device. Ensure you level shift the voltage to conform to the I/O requirements. When VBUS transitions from 0V to 5V (or vice versa), the transition on a GPIO will trigger a wakeup.

Table 8-14. USB Wakeup Use Cases Supported in System Sleep States

No.	USB Wakeup Use Case	System Sleep State	USB Controller State	USB Mode	Supported	USB Wakeup Event
1	USB Connect	DS0	POWER OFF	Host	No	N/A
2		DS0	POWER OFF	Device	Yes	VBUS2GPIO
3		DS1/ Standby	Clock Gated	Host	Yes	PHY WKUP
4		DS1/ Standby	Clock Gated	Device	Yes	VBUS2GPIO
5	USB Suspend / Resume	DS0	POWER OFF	Host	No	N/A
6		DS0	POWER OFF	Device	No	N/A
7		DS1/ Standby	Clock Gated	Host	Yes	PHY WKUP
8		DS1/ Standby	Clock Gated	Device	Yes	PHY WKUP
9	USB Disconnect	DS0	POWER OFF	Host	No	N/A
10		DS0	POWER OFF	Device	No	N/A
11		DS1/ Standby	Clock Gated	Host	Yes	PHY WKUP
12		DS1/ Standby	Clock Gated	Device	Yes	VBUS2GPIO

8.1.4.4 Main Oscillator Control During Deep Sleep

The DeepSleep oscillator circuit is used to control the main oscillator by disabling it during deep sleep and enabling during active/wakeup. By default during reset, the oscillator is enabled and the oscillator control circuit comes up disabled (in-active). In order to activate the oscillator control circuit for deepsleep, DSENABLE bit of DEEPSLEEP_CTRL register must set. Once this is set and whenever wake M3 enters standby, the oscillator control will disable the oscillator causing the clock to be shut OFF. Any async event from the wakeup sources will cause the oscillator control to re-enable the oscillator after a period of DSCOUNT configured in DEEPSLEEP_CTRL register.

8.1.4.5 Wakeup Sources/Events

Following events will wake up the device from Deep sleep(low power) modes. These are part of the Wakeup Power domain and remain always ON.

Note: For differences in operation based on AM335x silicon revision, see [Silicon Revision Functional Differences and Enhancements](#), *Silicon Revision Functional Differences and Enhancements*.

- GPIO0 bank
- dmtimer1_1ms (timer based wakeup)
- USB2PHY (USB resume signaling from suspend) – Both USB ports supported.
- TSC (touch screen controller, ADC monitor functions)
- UART0 (Infra-red support)
- I2C0
- RTC alarm

These wake events apply on any of the deep sleep modes and standby mode.

8.1.4.6 Functional Sequencing for Power Management with Cortex M3

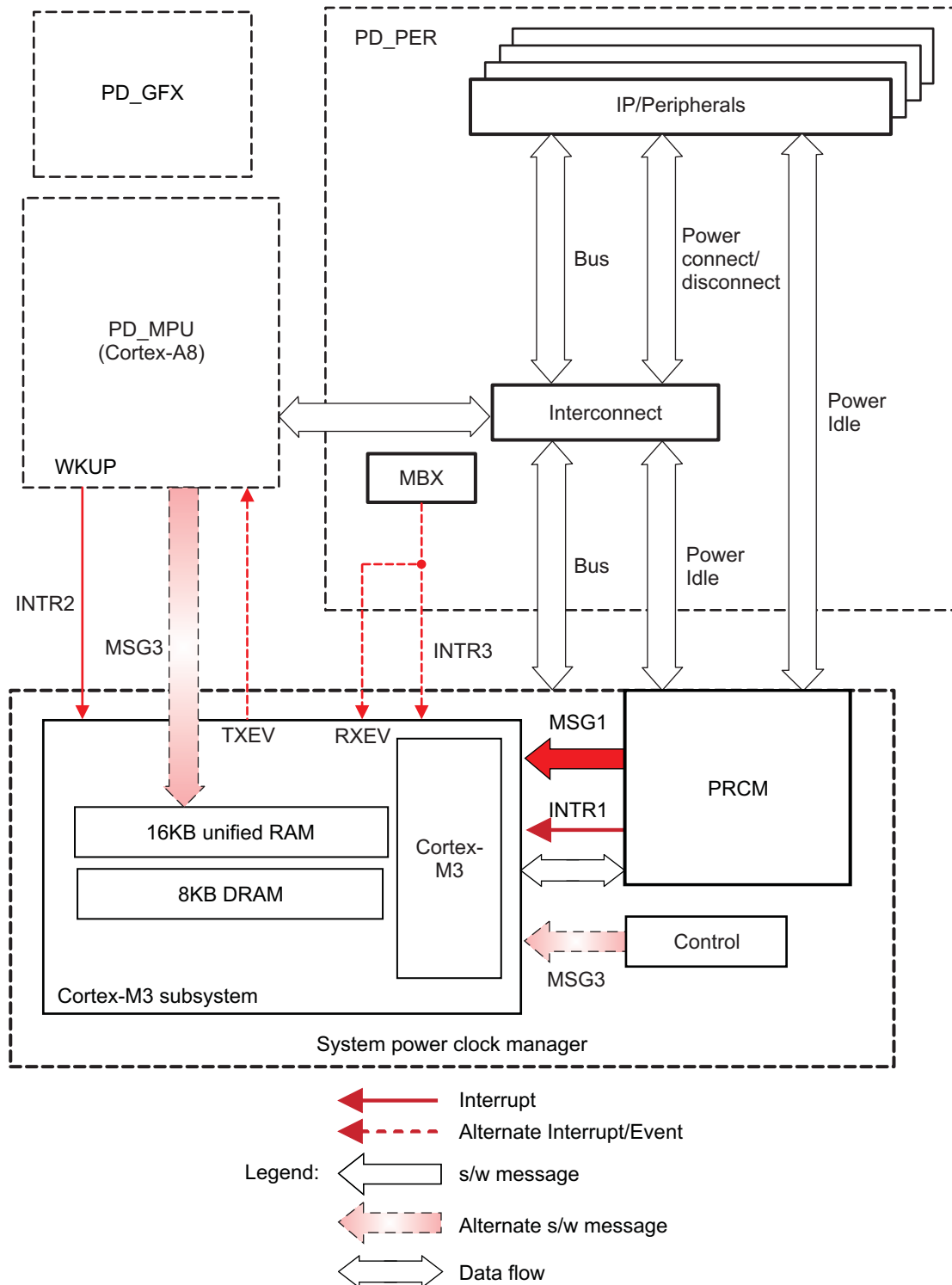
The AM335x device contains a dedicated Cortex M3 processor to handle the power management transitions. It is part of the Wake up Power domain (PD_WKUP). Implementing the Power modes are part of the MPU and Cortex A8 processors.

The power management sequence kicks off with Cortex A8 MPU executing a WFI instruction with the following steps:

1. During Active power mode, the Cortex A8 MPU executes a WFI instruction to enter IDLE mode.
2. Cortex M3 gets an interrupts and gets active, It powers down the MPU power domain(if required).
3. Registers interrupt for the Wake up peripheral(which is listed in Wake up sources in previous section).
4. Executes WFI and goes into idle state.
5. The wake up event triggers an interrupt to Cortex M3 system and it wakes up the Cortex A8 MPU.

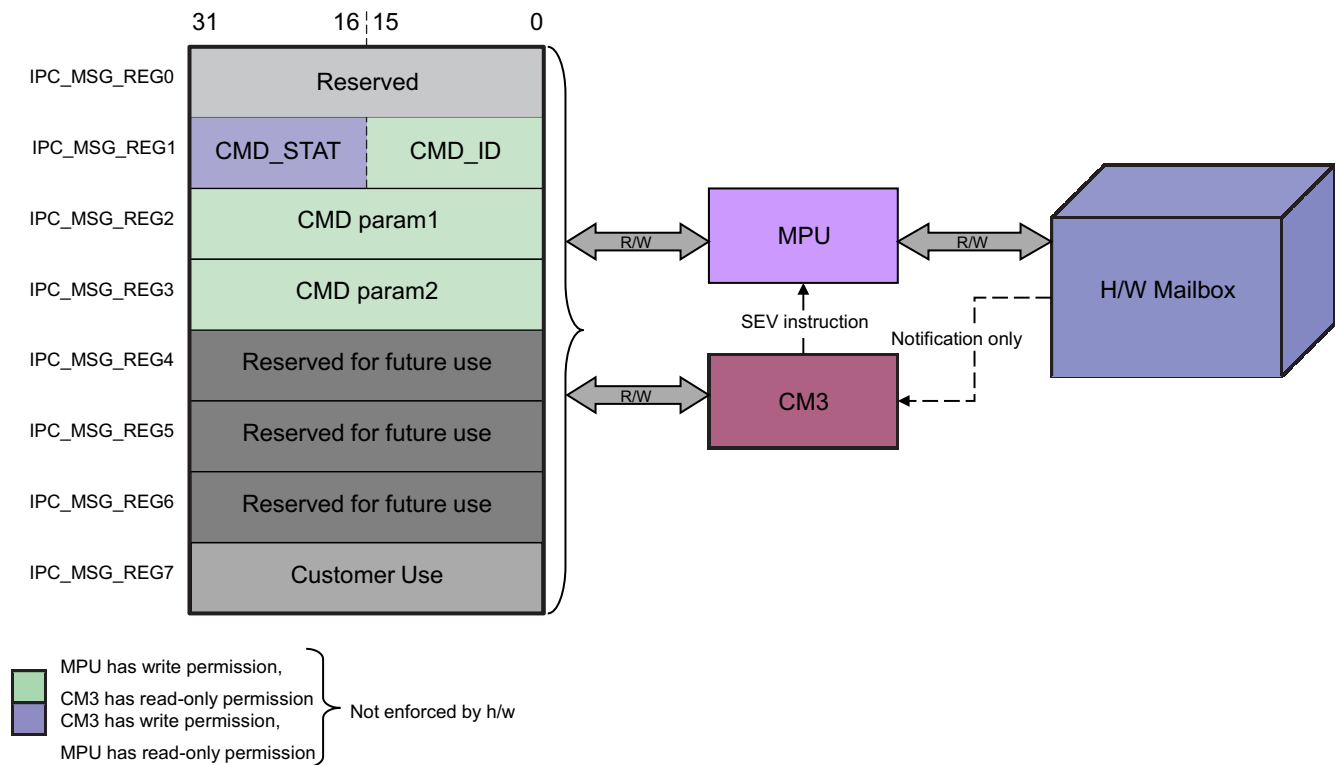
Generally, A8 and Cortex M3 are not expected to be active at the same time Cortex M3 along with PRCM is the power manager primarily for PD_MPU and PD_PER. Other power domains (e.g., PD_GFX) may be handled directly using Cortex A8 MPU software. [Figure 8-6](#) gives a system level view of the Power management system between Cortex A8 MPU and Cortex M3.

Figure 8-6. System Level View of Power Management of Cortex A8 MPU and Cortex M3



The Cortex-M3 handles all of the low-level power management control of the AM335x. A firmware binary is provided by Texas Instruments that includes all of the necessary functions to achieve low power modes. Inter-Processor Communication (IPC) registers (`ipc_msg_regx`, located in the [Control Module Registers](#)) are available to communicate with the Cortex-M3 so the user can provide certain configuration parameters based on the level of low power that is required. [Figure 8-7](#) provides a mapping of these registers.

Figure 8-7. IPC Mechanism



IPC_MSG_REG1 contains the CMD_STAT and CMD_ID parameters as described in [Table 8-15](#) and [Table 8-16](#).

Table 8-15. CMD_STAT Field

CMD_STAT	Value	Description
PASS	0x0	In the initialization phase, PASS (0x1) denotes that the CM3 was successfully initialized.
FAIL	0x1	In the initialization phase, 0x2 denotes CM3 could not properly initialize. When other tasks are to be done, FAIL (0x3) indicates some error in carrying out the task. Check trace vector for details.
WAIT4OK	0x2	CM3 INTC will catch the next WFI of A8 and continue with the pre-defined sequence.

Table 8-16. CMD_ID Field

CMD_ID	Value	Description
CMD_RTC	0x1	<ol style="list-style-type: none"> 1. Initiates force_sleep on interconnect clocks. 2. Turns off MPU and PER power domains. 3. Programs the RTC alarm register for deasserting pmic_pwr_enable.
CMD_RTC_FAST	0x2	Programs the RTC alarm register for deasserting pmic_pwr_enable.
CMD_DS0	0x3	<ol style="list-style-type: none"> 1. Initiates force_sleep on interconnect clocks. 2. Turns off the MPU and PER power domains. 3. Configures the system for disabling MOSC when CM3 executes WFI.
CMD_DS1	0x5	<ol style="list-style-type: none"> 1. Initiates force_sleep on interconnect clocks. 2. Turns off the MPU power domains. 3. Configures the system for disabling MOSC when CM3 executes WFI.

8.1.4.6.1 Periodic Idling of Cortex A8 MPU

To implement Cortex A8 MPU periodic ON/OFF in the use case, the control flow could be implemented according to the following steps:

1. Cortex A8 MPU executes WFI instruction
2. Any peripheral interrupt in any of the next steps will trigger a wake interrupt to Cortex M3 via MPU Subsystem's WKUP signal (INTR2 shown on the diagram). Cortex M3 powers down the MPU(PD_MPU)
3. On receiving an interrupt Cortex M3 switches ON the MPU power domain by turning on PD_MPU
4. Cortex M3 goes into idle mode using WFI instruction

8.1.4.6.2 Sleep Sequencing

This section gives the system level guidelines for sleep sequencing. The guidelines can serve as an example for implementing the sleep mode sequencing. The user can opt to implement a sequence with certain steps interchanged between the MPU and Cortex M3 processor.

1. Application saves context of peripherals to memories supporting retention and DDR – this step is only required for DeepSleep0.
2. MPU OCMC_RAM remains in retention
3. Unused power domains are turned OFF - program clock/power domains PWRSTCTRL, save contexts etc
4. Software populates L3_OCMC_RAM for wakeup restoration viz Save EMIF settings, public restoration pointers, etc.
5. Execute WFI from SRAM
6. Any peripheral interrupt will trigger a wake interrupt to Cortex M3 via Cortex A8 MPU's WKUP signal (INTR2 shown on the diagram).
7. After MPU power domain is clock gated PRCM will provide an interrupt to Cortex M3 (using INTR1 shown in the block diagram)
8. Cortex M3 starts execution and performs low level power sequencing to turn off certain power domain, and eventually executes WFI.
9. Hardware oscillator control circuit disables the oscillator once Cortex M3 goes into WFI

8.1.4.6.3 Wakeup Sequencing

This section gives the guidelines for Wakeup sequencing.

1. One of the wakeup event triggers (which was configured during the sleep sequencing) will initiate a wakeup sequence
2. The wake up event will switch on the oscillator (if it was configured to go OFF during sleep)
3. The wake up event will also trigger interrupt to Cortex M3
4. On the wakeup event due to interrupt Cortex M3 execute the following
 - Restore the voltages to normal Operating voltage
 - Enable PLL locking
 - Cortex M3 will switch ON the power domains and/or enable clocks for PD_PER
 - Cortex M3 will switch ON the power domains and/or enable clocks for PD_MPU
 - Executes WFI
5. Cortex A8 MPU starts executing from ROM reset vector
6. Restore the application context(only for Deep sleep 0)

8.1.5 PRCM Module Overview

The PRCM is structured using the architectural concepts presented in the 5000x Power Management Framework. This framework provides:

A set of modular, re-usable FSM blocks to be assembled into the full clock and power management mechanism. A register set and associated programming model. Functional sub-block definitions for clock management, power management, system clock source generation, and master clock generation.

The device supports an enhanced power management scheme based on four functional power domains:

Generic Domains

- WAKEUP
- MPU
- PER
- RTC

The PRCM provides the following functional features:

- Software configurable for direct, automatic, or a combination thereof, functional power domain state transition control
- Device power-up sequence control
- Device sleep / wake-up sequence control
- Centralized reset generation and management
- Centralized clock generation and management

The PRCM modules implement these general functional interfaces:

- OCP configuration ports
- Direct interface to device boundary
- Power switch control signals
- Device control signals
- Clocks control signals
- Resets signals
- A set of power management protocol signals for each module to control and monitor standby, idle and wake-up modes (CM and PRM)
- Emulation signals

8.1.5.1 Interface Descriptions

This section lists and shortly describes the different interfaces that allow PRCM to communicate with other modules or external devices.

8.1.5.1.1 OCP Interfaces

The PRCM has 1 target OCP interfaces, compliant with respect to the OCP/IP2 standard. The OCP port, for the PRCM module is used to control power, reset and wake-up Management.

8.1.5.1.2 OCP Slave Interfaces

PRCM implements a 32-bit OCP target interface compliant to the OCP/IP2.0 standard.

8.1.5.1.3 Power Control Interface

The Device does has power domain switches over the device, this interface provides PRCM control over power domain switches and receives responses from the power domains which indicate the switch status. It also controls the isolation signals. The control for power domain switches will be latched in PRCM Status Registers

8.1.5.1.4 Device Control Interface

This interface provides PRM management of several device-level features which are not specific to any single power domain. This PRM interface controls signals to/from the device for global control:

- Device Type coding
- IOs isolation control

8.1.5.1.5 Clocks Interface

This interface gathers all clock inputs and outputs managed by PRCM modules.

8.1.5.1.6 Resets Interface

This interface gathers all resets inputs and outputs managed by PRCM module.

8.1.5.1.7 Modules Power Management Control Interface

Modules or subsystems in the device are split over 2 categories:

- Initiator: an initiator is a module able to generate traffic on the device interconnects (typically: processors, MMU, EDMA).
- Target: a target is a module that cannot generate traffic on the device interconnects, but that can generate interrupts or DMA request to the system (typically: peripherals). PRCM handles a power management handshake protocol with each module or sub-system. This protocol allows performing proper clock and power transition taking into account each module activity or state.

8.1.5.1.8 Initiator Modules Interface

PRCM module handle all initiator modules power management interfaces: MStandby signal MWait signal

8.1.5.1.9 Targets Modules Interface

PRCM module handle all target modules power management interfaces: SIdleReq signal SIdleAck signal FCLKEN signal

Note: USB Support for SWakeUp

8.1.6 Clock Generation and Management

PRCM provides a centralized control for the generation, distribution and gating of most clocks in the device. PRCM gathers external clocks and internally generated clocks for distribution to the other modules in the device. PRCM manages the system clock generation

8.1.6.1 Terminology

The PRCM produces 2 types of clock:

Interface clocks: these clocks primarily provide clocking for the system interconnect modules and the portions of device's functional modules which interface to the system interconnect modules. In most cases, the interface clock supplies the functional module's system interconnect interface and registers. For some modules, interface clock is also used as functional clock. In this document, interface clocks are represented by blue lines.

Functional clock: this clock supplies the functional part of a module or a sub-system. In some cases, a module or a subsystem may require several functional clocks: 1 or several main functional clock(s), 1 or several optional clock(s). A module needs its main clock(s) to be operational. Optional clocks are used for specific features and can be shutdown without stopping the module

8.1.6.2 Clock Structure

To generate high-frequency clocks, the device supports multiple on-chip DLLs controlled directly by the PRCM module. They are of two types of PLLs, referred to ADPLLS and ADPLLLJ throughout this document.

The ADPLLS module is used for the Core, Display, ARM Subsystem and DDR PLLs

The ADPLLLJ module is used for the peripheral functional clocks

The device has two reference clocks which are generated by on-chip oscillators or externally. These are for the main clock tree and RTC block, respectively.

In the case of an external oscillator, a clock can directly be connected to XTALIN pin and the oscillator will be put in bypass mode. The 32-Khz crystal oscillator is controlled and configurable by RTC IP. This device also contains an on-chip RC oscillator. This oscillator is not configurable and is always on.

The main oscillator on the device (see [Chapter 26, Initialization](#), for possible frequencies) produces the master high frequency clock CLK_M_OSC.

8.1.6.3 ADPLLs

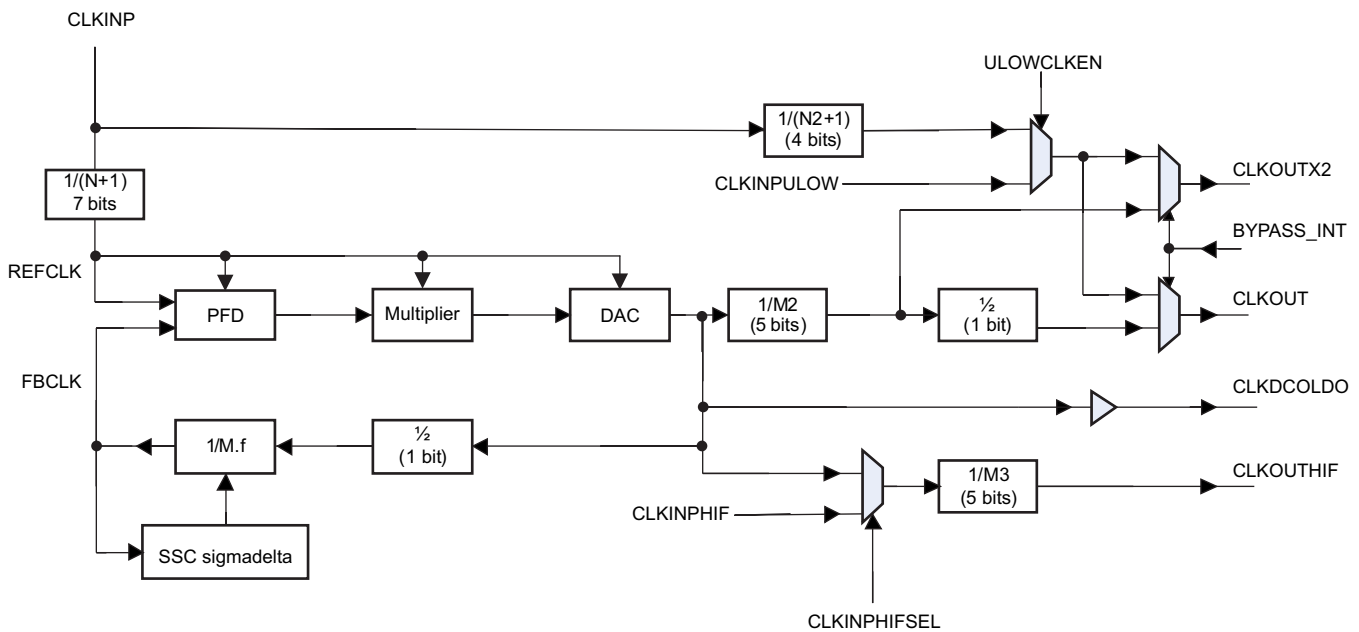
The ADPLLs is a high resolution frequency synthesizer PLL with built in level shifters which allows the generation of PLL locked frequencies up to 2 GHz. ADPLLs has a predivide feature which allows user to divide, for instance, a 24- or 26-MHz reference clock to 1-MHz and then multiply up to 2-GHz maximum.

All PLLs will come-up in bypass mode at reset. SW needs to program all the PLL settings appropriately and then wait for PLL to be locked. For more details, see the configuration procedure for each PLL.

The following PLLs are:

- MPU PLL
- Core PLL
- Display PLL
- DDR PLL

Figure 8-8. ADPLLs



The ADPLLs has three input clocks:

- CLKINP: Reference input clock
- CLKINPULOW: Low frequency input clock for bypass mode only.
- CLKINPHIF: High Frequency Input Clock for post-divider M3

The ADPLLs has four output clocks:

- CLKOUTHIF: High Frequency Output Clock from Post divider M3
- CLKOUTX2: Secondary 2x Output
- CLKOUT: Primary output clock
- CLKDCOLDO: Oscillator (DCO) output clock with no bypass

The DPLL has two internal clocks:

- REFCLK (Internal reference clock): This is generated by dividing the input clock CLKINP by the programmed value N+1. The entire loop of the PLL runs on the REFCLK.
Here, REFCLK = CLKINP/(N+1).
- BCLK: Bus clock which is used for programming the various settings using registers

The ADPLL lock frequency is defined as follows: $f_{DPLL} = \text{CLKDCOLDO}$

8.1.6.3.1 Clock Functions

Table 8-17. Output Clocks in Locked Condition

Pin Name	Frequency	Comments
REGM4XEN='0'		
CLKOUT	$[M / (N+1)] * \text{CLKINP} * [1/M2]$	
CLKOUTX2	$2 * [M / (N+1)] * \text{CLKINP} * [1/M2]$	
CLKDCOLDO	$2 * [M / (N+1)] * \text{CLKINP}$	
CLKOUTHIF	CLKINPHIF / M3	CLKINPHIFSEL='1'
	$2 * [M / (N+1)] * \text{CLKINP} * [1/M3]$	CLKINPHIFSEL='0'
REGM4XEN='1'		
CLKOUT	$[4M / (N+1)] * \text{CLKINP} * [1/M2]$	
CLKOUTX2	$2 * [4M / (N+1)] * \text{CLKINP} * [1/M2]$	
CLKDCOLDO	$2 * [4M / (N+1)] * \text{CLKINP}$	
CLKOUTHIF	CLKINPHIF / M3	CLKINPHIFSEL='1'
	$2 * [4M / (N+1)] * \text{CLKINP} * [1/M3]$	CLKINPHIFSEL='0'

Table 8-18. Output Clocks Before Lock and During Relock Modes

Pin Name	Frequency	Comments
CLKOUT	CLKINP / (N2+1)	ULOWCLKEN='0'
	CLKINPULOW	ULOWCLKEN='1'
CLKOUTX2	CLKINP / (N2+1)	ULOWCLKEN='0'
	CLKINPULOW	ULOWCLKEN='1'
CLKDCOLDO	Low	
CLKOUTHIF	CLKINPHIF/M3	ULOWCLKEN='1'
	Low	ULOWCLKEN='0'

Note: Since M3 divider is running on the internal LDO domain, in the case when CLKINPHIFSEL='1', CLKOUTHIF could be active only when internal LDO is ON. Hence, whenever LDOPWDN goes low to high to powerdown LDO (happens when TINITZ activated / when entering slow relock bypass mode), output CLKOUTHIF will glitch and stop. To avoid this glitch, it is recommended to gate CLKOUTHIF using control CLKOUTHIFEN before asserting TINITZ / entering any slow relock bypass mode Frequency Range (MHz)

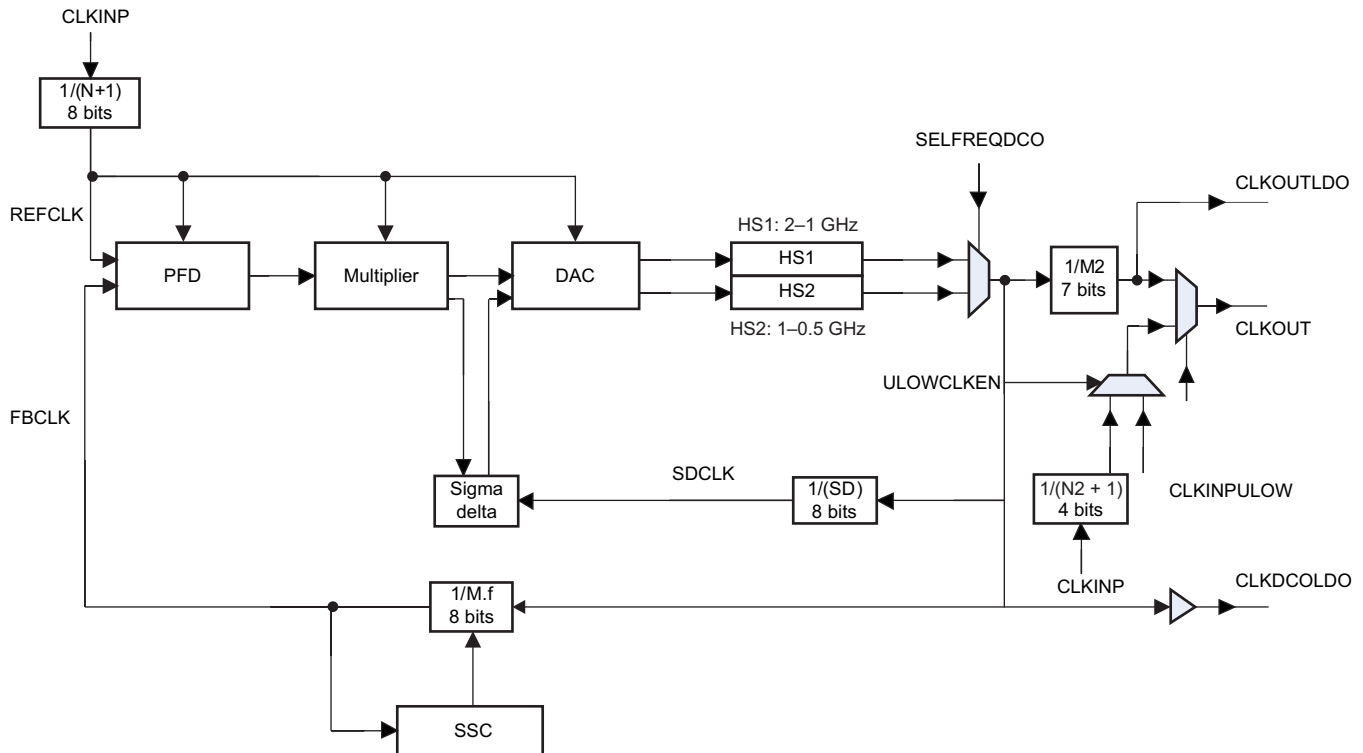
See the device-specific data manual for details on operating performance points (OPPs) supported by your device.

8.1.6.4 ADPLLLJ (Low Jitter DPLL)

The ADPLLLJ is a low jitter PLL with a 2-GHz maximum output. ADPLLLJ has a predivide feature which allows user to divide, for instance, a 24-MHz or 26-MHz reference clock to 1 MHz and then multiply up to 2 GHz maximum.

All PLLs will come-up in bypass mode at reset. SW needs to program all the PLL settings appropriately and then wait for PLL to be locked. For more details, see the configuration procedure for each PLL.

Figure 8-9. Basic Structure of the ADPLLJ



The Peripheral PLL belongs to type ADPLLJ:

The DPLL has two input clocks:

- CLKINP: Reference input clock
- CLKINPULOW: Bypass input clock.

The DPLL has two internal clocks:

- REFCLK (Internal reference clock): This is generated by dividing the input clock CLKINP by the programmed value N+1. The entire loop of the PLL runs on the REFCLK. Here, $REFCLK = CLKINP / (N + 1)$.
- CLKDCOLDO (Internal Oscillator clock.): This is the raw clock directly out of the digitally controlled oscillator (DCO) before the post-divider. The PLL output clock is synthesized by an internal oscillator which is phase locked to the refclk. There are two oscillators built within ADPLLJ. The oscillators are user selectable based on the synthesized output clock frequency requirement. In locked condition, $CLKDCOLDO = CLKINP * [M / (N + 1)]$.

The ADPLLJ lock frequency is defined as follows: $f_{DPLL} = CLKDCOLDO$

The DPLL has three external output clocks:

- CLKOUTLDO: Primary output clock in VDDLDOOUT domain. Bypass option not available on this output.
 $CLKOUTLDO = (M / (N + 1)) * CLKINP * (1/M2)$
- CLKOUT: Primary output clock on digital core domain
 $CLKOUT = (M / (N + 1)) * CLKINP * (1/M2)$
- CLKDCOLDO: Oscillator (DCO) output clock before post-division in VDDLDOOUT domain. Bypass option is not available on this output.
 $CLKDCOLDO = (M / (N + 1)) * CLKINP$.

All clock outputs of the DPLL can be gated. The Control module provides the DPLL with a clock gating control signal to enable or disable the clock, and the DPLL provides the PRCM module with a clock activity status signal to let the PRCM module hardware know when the clock is effectively running or effectively gated. Output clock gating control for various clockouts: CLKOUTEN/CLKOUTLDOEN/CLKDCOLDOEN.

8.1.6.4.1 Clock Functions

Table 8-19. Output Clocks in Locked Condition

Pin Name	Frequency
CLKOUT	$[M / (N+1)] * CLKINP * [1/M2]$
CLKOUTLDO	$[M / (N+1)] * CLKINP * [1/M2]$
CLKDCOLDO	$[M / (N+1)] * CLKINP$

Table 8-20. Output Clocks Before Lock and During Relock Modes

Pin Name	Frequency	Comments
CLKOUT	$CLKINP/(N2+1)$	ULOWCLKEN='0'
	CLKINPLOW	ULOWCLKEN='1'
CLKDCOLDO	LOW	
CLKOUTLDO	LOW	

8.1.6.5 M2 Change On-the-Fly

The divider M2 is designed to change on the fly and provide a glitch-free frequency switch from the old to new frequencies. It can be changed while the PLL is in a locked condition without having to switch to bypass mode. A status toggle bit will give an indication if the new divisor was accepted. The divider M2 can also be changed in bypass mode, and the new divisor value will be reflected on output after the PLL relocks. For more details, see the PLL configuration procedures for each PLL.

8.1.6.6 Spread Spectrum Clocking (SSC)

The module supports spread spectrum clocking (SSC) on its output clocks. SSC is used to spread the spectral peaking of the clock to reduce any electromagnetic interference (EMI) that may be caused due to the clock's fundamental or any of its harmonics. When SSC is enabled the clock's spectrum is spread by the amount of frequency spread, and the attenuation is given by the ratio of the frequency spread (Δf) and the modulation frequency (f_m), i.e., $[10 * \log_{10}(\Delta f / f_m) - 10]$ dB.

SSC is performed by changing the feedback divider (M) in a triangular pattern. Implying, the frequency of the output clock would vary in a triangular pattern. The frequency of this pattern would be modulation frequency (f_m). The peak (ΔM) or the amplitude of the triangular pattern as a percent of M would be equal to the percent of the output frequency spread (Δf); that is, $\Delta M / M = \Delta f / f_c$. Next mark with F_{inP} the frequency of the clock signal at the input of the DPLL. Because it is divided to N+1 before entering the phase detector, so the internal reference frequency is $F_{ref} = F_{inP} / (N + 1)$.

Assume the central frequency f_c to be equal to the DPLL output frequency F_{out} , or $f_c = F_{out} = (F_{inP} / (N + 1)) * (M / M2)$. Since this is in band modulation for the DPLL, the modulation frequency is required to be within the DPLL's loop bandwidth (lowest BW of $F_{ref} / 70$). A higher modulation frequency would result in lesser spreading in the output clock.

SSC can be enabled/disabled using bit `CM_CLKMODE_DPLL_xxx.DPLL_SSC_EN` (where xxx can be any one of the following DPLLs: MPU, DDR, DISP, CORE, PER). An acknowledge signal `CM_CLKMODE_DPLL_xxx.DPLL_SSC_ACK` notifies the exact start and end of SSC. When `SSC_EN` is de-asserted, SSC is disabled only after completion of one full cycle of the triangular pattern given by the modulation frequency. This is done in order to maintain the average frequency.

Modulation frequency (f_m) can be programmed as a ratio of $F_{ref} / 4$; that is, the value that needs to be programmed $ModFreqDivider = F_{ref} / (4 * f_m)$. The $ModFreqDivider$ is split into Mantissa and $2^{Exponent}$ ($ModFreqDivider = ModFreqDividerMantissa * 2^{ModFreqDividerExponent}$). The mantissa is controlled by 7-bit signal $ModFreqDividerMantissa$ through $CM_SSC_MODFREQDIV_DPLL_xxx.MODFREQDEV_MANTISSA$ bit field. The exponent is controlled by 3-bit signal $ModFreqDividerExponent$ through the $CM_SSC_MODFREQDIV_DPLL_xxx.MODFREQDEV_EXPONENT$ bit field.

Note: Although the same value of $ModFreqDivider$ can be obtained by different combinations of mantissa and exponent values, it is recommended to get the target $ModFreqDivider$ by programming maximum mantissa and a minimum exponent. To define the Frequency spread (Δf), ΔM must be controlled as explained previously. To define ΔM , the step size of M for each F_{ref} during the triangular pattern must be programmed; that is,

$$\Delta M = (2^{ModFreqDividerExponent}) * ModFreqDividerMantissa * DeltaMStep$$

$$ModFreqDividerExponent \leq 3 \Delta M = 8 * ModFreqDividerMantissa * DeltaMStep$$

$$ModFreqDividerExponent > 3$$

$DeltaMStep$ is split into integer part and fractional part. Integer part is controlled by 2-bit signal $DeltaMStepInteger$ through the $CM_SSC_DELTAMSTEP_DPLL_xxx.DELTAMSTEP_INTEGER$ bit field. Fractional part is controlled by 18-bit signal $DeltaMStepFraction$ through the $CM_SSC_DELTAMSTEP_DPLL_xxx.DELTAMSTEP_FRACTION$ bit field.

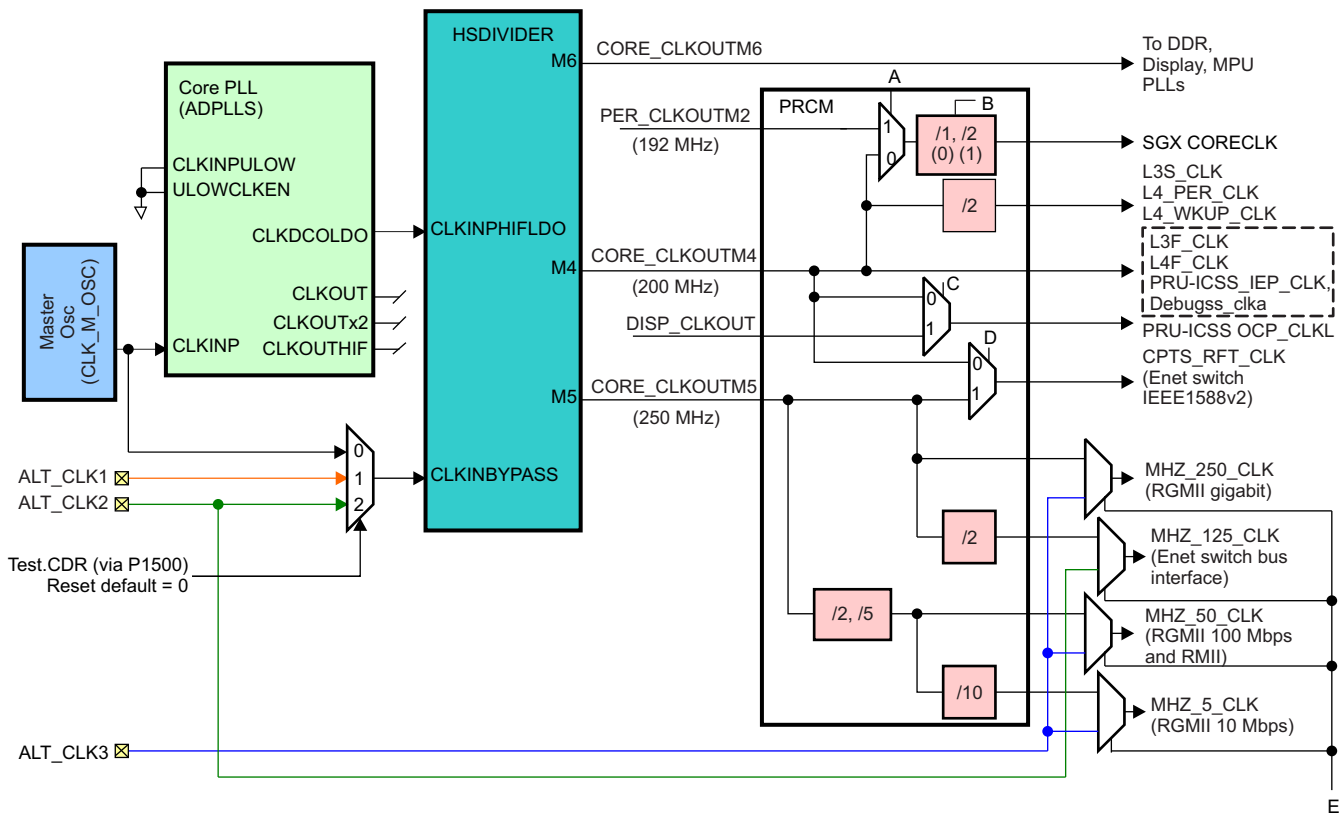
The frequency spread achieved has an overshoot of 20 percent or an inaccuracy of +20 percent. If the $CM_CLKMODE_DPLL.DPLL_SSC_DOWNSPREAD$ is set to 1, the frequency spread on lower side is twice the programmed value. The frequency spread on higher side is 0 (except for the overshoot as described previously).

There is restriction of range of M values. The restriction is $M - \Delta M$ should be ≥ 20 . Also, $M + \Delta M$ should be ≤ 2045 . In case the downspread feature is enabled, $M - 2 * \Delta M$ should be ≥ 20 and $M \leq 2045$.

8.1.6.7 Core PLL Description

The Core PLL provides the source for a majority of the device infrastructure and peripheral clocks. The Core PLL comprises an ADPLLs with HSDIVIDER and additional dividers and muxes located in the PRCM as shown in [Figure 8-10](#).

Figure 8-10. Core PLL



ALT_CLKs are to be used for internal test purpose and should not be used in functional mode.

Table 8-21. PLL and Clock Frequencies

Mux Select	Register BitSection 9.2.4.4
A	PRCM.CLKSEL_GFX_FCLK[1]
B	PRCM.CLKSEL_GFX_FCLK[0]
C	PRCM.CLKSEL_PRU-ICSS_OCP_CLK[0]
D	PRCM.CM_CPTS_RFT_CLKSEL[0]
E	TEST.CDR (via P1500)

Table 8-22 gives the typical PLL and clock frequencies. The HSDIVIDER is used to generate three divided clocks M4, M5 & M6. M4 & M5 are nominally 200 & 250 MHz, respectively.

Table 8-22. Core PLL Typical Frequencies (MHz)

CLOCK	Source	Power-On-Reset / HSDIVIDER Bypass		OPP100		OPP50 ⁽¹⁾⁽²⁾	
		DIV	Freq	DIV Value	Freq (MHz)	DIV Value	Freq (MHz)
CLKDCOLDO (PLL Lock frequency)	APLLS	-	-	-	2000	-	100
CORE_CLKOUTM4	HSDIVIDER-M4	-	Mstr Xtal	10	200	1	100
L3F_CLK, L4F_CLK, PRU-ICSS IEP_CLK, DebugSS clka, SGX.MEMCLK, SGX.SYSCLK	CORE_CLKO UTM4	-	Mstr Xtal	-	200	-	100
L4_PER, L4_WKUP	CORE_CLKO UTM4	2	Mstr Xtal / 2	2	100	2	50
SGX CORECLK	CORE_CLKO UTM4	1	Mstr Xtal	1	200	1	100
				2	100	2	50
CORE_CLKOUTM5	HSDIVIDER-M5	-	Mstr Xtal	8	250	1	100
MHZ_250_CLK (Gigabit RGMII)	CORE_CLKO UTM5	-	NA	-	250	-	NA
MHZ_125_CLK (Ethernet Switch Bus Clk)	CORE_CLKO UTM5	2	Mstr Xtal / 2	2	125	2	50
MHZ_50_CLK (100 mbps RGMII or 10/100 RMII)	CORE_CLKO UTM5	5	Mstr Xtal / 5	5	50	2	50
MHZ_5_CLK (10 mbps RGMII)	MHZ_50_CLK	10	Mstr Xtal / 50	10	5	10	5
CORE_CLKOUTM6	HSDIVIDER M6	-	Mstr Xtal	4	500	1	100

⁽¹⁾ Not all interfaces and peripheral modules are available in OPP50. For more information, see the device specific datasheet.

⁽²⁾ For limitations using OPP50, see *AM335x ARM Cortex-A8 Microprocessors (MPUs) Silicon Errata* (literature number [SPRZ360](#)).

The ADPLLs module supports two different bypass modes via their internal MNBypass mode and their external Low Power Idle bypass mode. The PLLs are in the MNBypass mode after power-on reset and can be configured by software to enter Low Power Idle bypass mode for power-down.

When the Core PLL is configured in bypass mode, the HSDIVIDER enters bypass mode and the CLKINBYPASS input is driven on the M4, M5, and M6 outputs. CLKINBYPASS defaults to the master oscillator input (typically 24 MHz).

Table 8-23. Bus Interface Clocks

L3F_CLK	SGX530 (MEMCLK & SYSCLK), LCDC, MPU Subsystem, GEMAC Switch (Ethernet), DAP, PRU-ICSS, EMIF, TPTC, TPCC, OCMC RAM, DEBUGSS
L3S_CLK	USB, TSC, GPMC, MMCHS2, McASP0, McASP1
L4_PER_CLK	DCAN0, DCAN1 DMTIMER2, DMTIMER3, DMTIMER4, DMTIMER5, DMTIMER6, DMTIMER7 eCAP/eQEP/ePWM0, eCAP/eQEP/ePWM1, eCAP/eQEP/ePWM2, eFuse ELM, GPIO1, GPIO2, GPIO3 I2C1, I2C2, IIEEE1500, LCD, Mailbox0 McASP0, McASP1 MMCHS0, MMCHS1, OCP Watchpoint, SPI0, SPI1, Spinlock UART1, UART2, UART3, UART4, UART5
L4_WKUP_CLK	ADC_TSC, Clock Manager, Control Module DMTIMER0, DMTIMER1_1MS, GPIO0 I2C0, M3UMEM, M3DMEM, SmartReflex0, SmartReflex1 UART0, WDT1

8.1.6.7.1 Core PLL Configuration

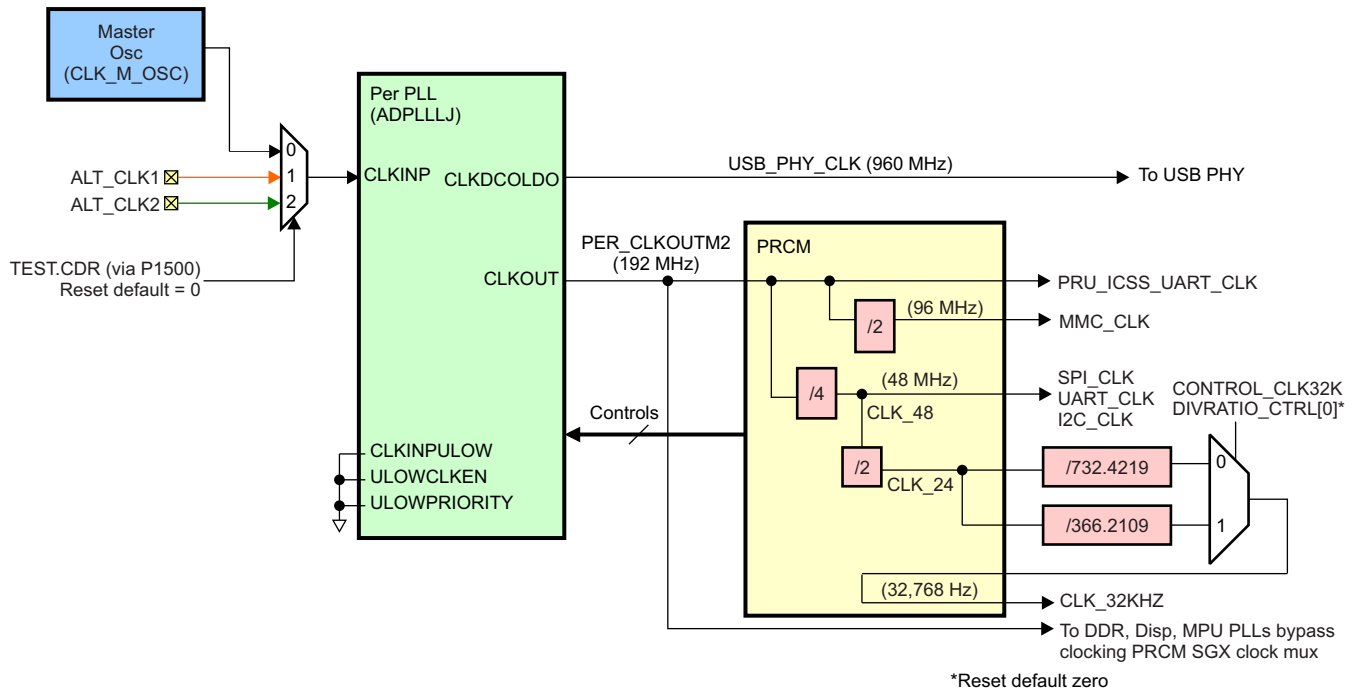
1. Switch PLL to bypass mode by setting CM_CLKMODE_DPLL_CORE.DPLL_EN to 0x4.
2. Wait for CM_IDLEST_DPLL_CORE.ST_MN_BYPASS = 1 to ensure PLL is in bypass (CM_IDLEST_DPLL_CORE.ST_DPLL_CLK should also change to 0 to denote the PLL is unlocked).
3. Configure Multiply and Divide values by setting CM_CLKSEL_DPLL_CORE.DPLL_MULT and DPLL_DIV to the desired values.
4. Configure M4, M5 and M6 dividers by setting HSDIVIDER_CLKOUT1_DIV bits in CM_DIV_M4_DPLL_CORE, CM_DIV_M5_DPLL_CORE, and CM_DIV_M6_DPLL_CORE to the desired values.
5. Switch over to lock mode by setting CM_CLKMODE_DPLL_CORE.DPLL_EN to 0x7.
6. Wait for CM_IDLEST_DPLL_CORE.ST_DPLL_CLK = 1 to ensure PLL is locked (CM_IDLEST_DPLL_CORE.ST_MN_BYPASS should also change to 0 to denote the PLL is out of bypass mode).

Note: M4, M5, and M6 dividers can also be changed on-the-fly so that there is no need to put the PLL in bypass and back to lock mode. After changing CM_DIV_Mx_DPLL_CORE.DPLL_CLKOUT_DIV, check CM_DIV_Mx_DPLL_CORE.DPLL_HSDIVIDER_CLKOUT1_DIVCHACK for a toggle (a change from 0 to 1 or 1 to 0) to see if the change was acknowledged by the PLL.

8.1.6.8 Peripheral PLL Description

The Per PLL provides the source for peripheral functional clocks. The Per PLL comprises an ADPLLJ and additional dividers and muxes located in the PRCM as shown

Figure 8-11. Peripheral PLL Structure



ALT_CLKs are to be used for internal test purpose and should not be used in functional mode.

The PLL is locked at 960 MHz. The PLL output is divided by the M2 divider to generate a 192-MHz CLKOUT. This clock is gated in the PRCM to form the PRU-ICSS UART clock. There is a /2 divider to create 96 MHz for MMC_CLK. The clock is also divided within the PRCM by a fixed /4 divider to create a 48-MHz clock for the SPI, UART and I2C modules. The 48-MHz clock is further divided by a fixed /2 divider and a fixed /732.4219 divider to create an accurate 32.768-KHz clock for Timer and debounce use.

Table 8-24. Per PLL Typical Frequencies (MHz)

Clock	Source	Power-On-Reset / PLL Bypass		OPP100		OPP50 ⁽¹⁾⁽²⁾	
		DIV Value	Freq	DIV Value	Freq (MHz)	DIV Value	Freq (MHz)
PLL Lock frequency	PLL	-	-	-	960	-	960
USB_PHY_CLK	CLKDCOLDO	-	Held Low	-	960	-	960
PER_CLKOUTM2	CLKOUT of ADPLLJ CLKOUT uses PLL's M2 Divider when PLL is locked and PLL's N2 divider when PLL Bypass	N2 is 0 on power-on-reset	Mstr Xtal/ (N2+1)	5	192	10	96
MMC_CLK	PER_CLKOUTM2	2	Mstr Xtal/ ((N2+1)*2)	2	96	2	48
SPI_CLK, UART_CLK, I2C_CLK	PER_CLKOUTM2	4	Mstr Xtal/ ((N2+1)*4)	4	48	4	24
CLK_24	CLK_48	2	CLK_48 /2	2	24	2	12
CLK_32KHZ	CLK_24 (output of CLK_48/2)	732.4219	CLK_24 / <CLK32_DIV>	732.4219	0.032768	366.2109	0.032768

(1) For limitations using OPP50, see AM335x ARM Cortex-A8 Microprocessors (MPUs) Silicon Errata (literature number [SPRZ360](#)).

(2) Not all interfaces and peripheral modules are available in OPP50. For more information, see AM335x ARM Cortex-A8 Microprocessors (MPUs) Silicon Errata (literature number [SPRZ360](#)).

The ADPLLJ module supports two different bypass modes via their internal MNBypass mode and their external Low Power Idle bypass mode. The PLLs are in the MNBypass mode after power-on reset and can be configured by software to enter Low Power Idle bypass mode for power-down.

The PER PLL can use the Low Power Idle bypass mode. When the internal bypass mode is selected, the CLKOUT output is driven by $CLKINP/(N2+1)$ where N2 is driven by the PRCM. CLKINP defaults to the master oscillator input (typically 24 MHz)

8.1.6.8.1 Configuring the Peripheral PLL

The following steps detail how to configure the peripheral PLL.

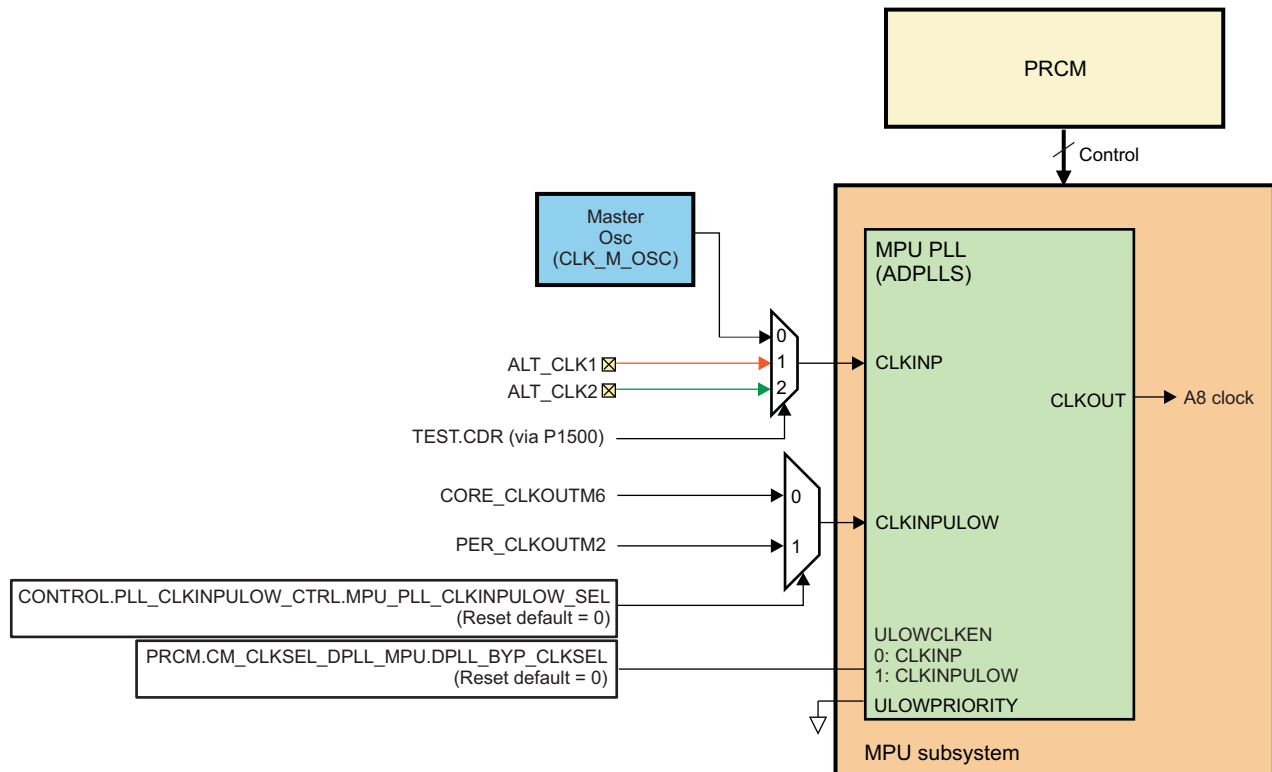
1. Switch PLL to bypass mode by setting CM_CLKMODE_DPLL_PER.DPLL_EN to 0x4.
2. Wait for CM_IDLEST_DPLL_PER.ST_MN_BYPASS = 1 to ensure PLL is in bypass (CM_IDLEST_DPLL_PER.ST_DPLL_CLK should also change to 0 to denote the PLL is unlocked).
3. Configure Multiply and Divide values by setting CM_CLKSEL_DPLL_PER.DPLL_MULT and DPLL_DIV to the desired values.
4. Configure M2 divider by setting CM_DIV_M2_DPLL_PER.DPLL_CLKOUT_DIV to the desired value.
5. Switch over to lock mode by setting CM_CLKMODE_DPLL_PER.DPLL_EN to 0x7.
6. Wait for CM_IDLEST_DPLL_PER.ST_DPLL_CLK = 1 to ensure PLL is locked (CM_IDLEST_DPLL_PER.ST_MN_BYPASS should also change to 0 to denote the PLL is out of bypass mode).

Note: M2 divider can also be changed on-the-fly (ie., there is no need to put the PLL in bypass and back to lock mode). After changing CM_DIV_M2_DPLL_PER.DPLL_CLKOUT_DIV, check CM_DIV_M2_DPLL_PER.DPLL_CLKOUT_DIVCHACK for a toggle (a change from 0 to 1 or 1 to 0) to see if the change was acknowledged by the PLL.

8.1.6.9 MPU PLL Description

The Cortex A8 MPU subsystem includes an internal ADPLLs for generating the required Cortex A8 MPU clocks. This PLL is driven by the master oscillator output with control provided by PRCM registers.

Figure 8-12. MPU Subsystem PLL Structure



For example:

For a frequency for MPU, say 600 MHz, the ADPLLS is configured (PLL locked at 1200 MHz and M2 Divider =1) so as to expect CLKOUT = 600 MHz .

The ULOWCLKEN input from a programmable PRCM register selects whether CLKINP or CLKINPULOW is the bypass clock source. This is a glitch free switch. When CLKINP is selected it is sourced through the ADPLLS 1/(N2+1) divider. The PRCM register defaults to 0 on power-up to select the CLKINP source.

The CLKINPULOW input may be sourced from the CORE_CLKOUTM6 from the Core PLL, or PER_CLKOUTM2 from the Per PLL. These PLL output clocks can be used as alternate clock sources in low power active use cases for the MPU Subsystem clock when the PLL is in bypass mode.

8.1.6.9.1 Configuring the MPU PLL

The following steps detail how to configure the MPU PLL.

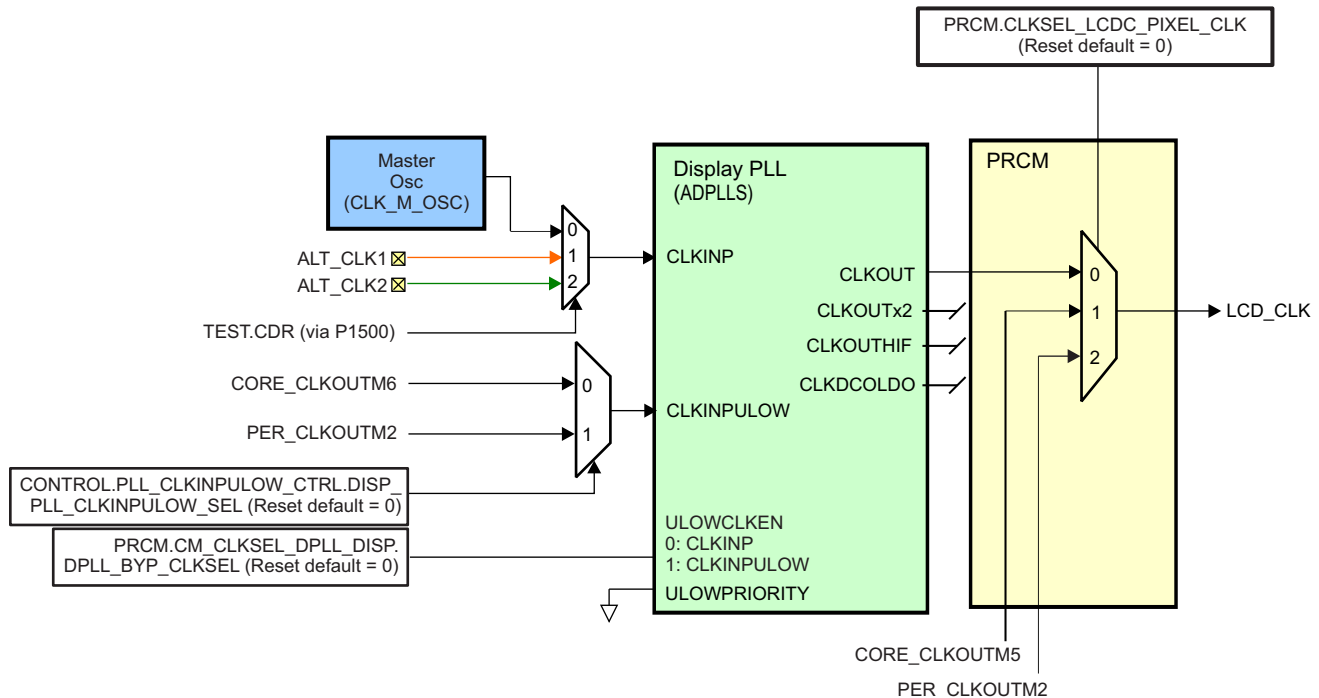
1. Switch PLL to bypass mode by setting CM_CLKMODE_DPLL_MPU.DPLL_EN to 0x4.
2. Wait for CM_IDLEST_DPLL_MPU.ST_MN_BYPASS = 1 to ensure PLL is in bypass (CM_IDLEST_DPLL_MPU.ST_DPLL_CLK should also change to 0 to denote the PLL is unlocked).
3. Configure Multiply and Divide values by setting CM_CLKSEL_DPLL_MPU.DPLL_MULT and DPLL_DIV to the desired values.
4. Configure M2 divider by setting CM_DIV_M2_DPLL_MPU.DPLL_CLKOUT_DIV to the desired value.
5. Switch over to lock mode by setting CM_CLKMODE_DPLL_MPU.DPLL_EN to 0x7.
6. Wait for CM_IDLEST_DPLL_MPU.ST_DPLL_CLK = 1 to ensure PLL is locked (CM_IDLEST_DPLL_MPU.ST_MN_BYPASS should also change to 0 to denote the PLL is out of bypass mode).

Note: M2 divider can also be changed on-the-fly (ie., there is no need to put the PLL in bypass and back to lock mode). After changing CM_DIV_M2_DPLL_MPU.DPLL_CLKOUT_DIV, check CM_DIV_M2_DPLL_MPU.DPLL_CLKOUT_DIVCHACK for a toggle (a change from 0 to 1 or 1 to 0) to see if the change was acknowledged by the PLL.

8.1.6.10 Display PLL Description

The Display PLL provides the pixel clock required for the LCD display and is independent from the other peripheral and infrastructure clocks. The PLL is clocked from the Master Oscillator. The ADPLLs M2 divider determines the output clock frequency which is clock gated by the PRCM as shown in Figure 8-13.

Figure 8-13. Display PLL Structure



For example: say frequency for pixel clock 100 MHz, the ADPLLs is configured (PLL locked at 200 MHz and M2 Divider = 1) so as to expect CLKOUT = 100 MHz.

The ULOWCLKEN input from a programmable PRCM register selects whether CLKINP or CLKINPULOW is the bypass clock source. This is a glitch free switch. When CLKINP is selected it is sourced through the ADPLLs 1/(N2+1) divider. The PRCM register defaults to 0 on power-up to select the CLKINP source.

The CLKINPULOW input is sourced from the CORE_CLKOUTM6 from the Core PLL or PER_CLKOUTM2 from the Per PLL. This PLL output clock can be used as an alternate clock source in low power active use cases for the pixel clock when the Display PLL is in bypass mode.

8.1.6.10.1 Configuring the Display PLL

The following steps detail how to configure the display PLL.

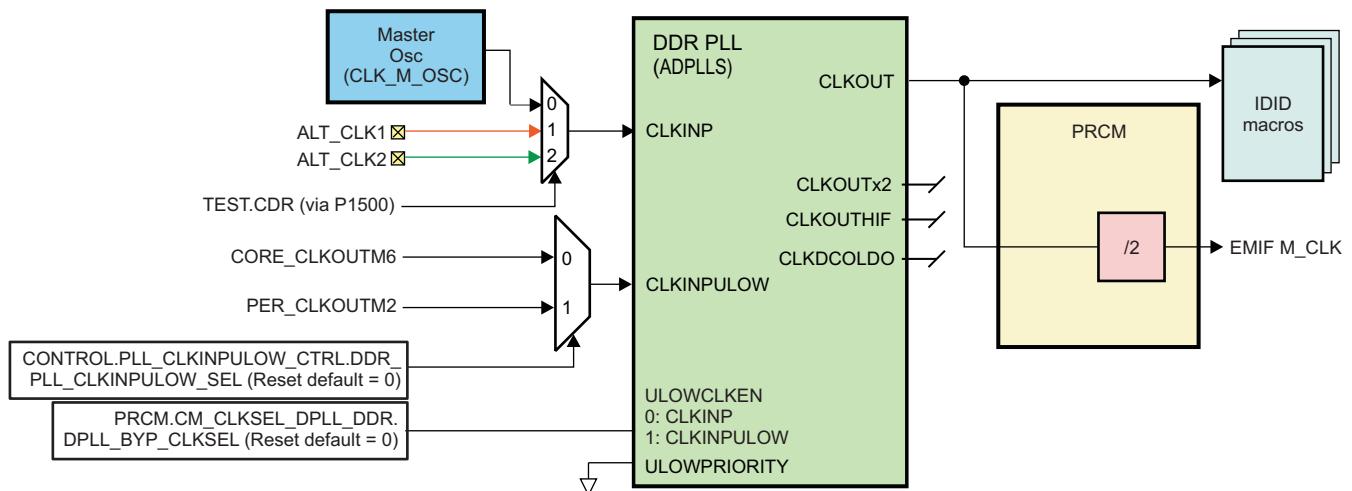
1. Switch PLL to bypass mode by setting CM_CLKMODE_DPLL_DISP.DPLL_EN to 0x4.
2. Wait for CM_IDLEST_DPLL_DISP.ST_MN_BYPASS = 1 to ensure PLL is in bypass (CM_IDLEST_DPLL_DISP.ST_DPLL_CLK should also change to 0 to denote the PLL is unlocked).
3. Configure Multiply and Divide values by setting CM_CLKSEL_DPLL_DISP.DPLL_MULT and DPLL_DIV to the desired values.
4. Configure M2 divider by setting CM_DIV_M2_DPLL_DISP.DPLL_CLKOUT_DIV to the desired value.
5. Switch over to lock mode by setting CM_CLKMODE_DPLL_DISP.DPLL_EN to 0x7.
6. Wait for CM_IDLEST_DPLL_DISP.ST_DPLL_CLK = 1 to ensure PLL is locked (CM_IDLEST_DPLL_DISP.ST_MN_BYPASS should also change to 0 to denote the PLL is out of bypass mode).

Note: M2 divider can also be changed on-the-fly (ie., there is no need to put the PLL in bypass and back to lock mode). After changing `CM_DIV_M2_DPLL_DISP.DPLL_CLKOUT_DIV`, check `CM_DIV_M2_DPLL_DISP.DPLL_CLKOUT_DIVCHACK` for a toggle (a change from 0 to 1 or 1 to 0) to see if the change was acknowledged by the PLL.

8.1.6.11 DDR PLL Description

The DDR PLL provides the clocks required by the DDR macros and the EMIF and is independent from the other peripheral and infrastructure clocks. The PLL is clocked from the Master Oscillator. The ADPLLs M2 divider determines the output clock frequency which is connected directly to the DDR Macros. The clock is also routed through the PRCM where a fixed /2 divider is used to create the M_CLK used by the EMIF as shown in Figure 8-14.

Figure 8-14. DDR PLL Structure



For OPP information, see the device-specific data manual.

Example frequency for DDR clock, say 266 MHz, the ADPLLs is configured (PLL locked at 532 MHz and M2 Divider = 1) so as to expect $CLKOUT = 266$ MHz.

The ULOWCLKEN input from a programmable PRCM register selects whether CLKINP or CLKINPULOW is the bypass clock source. This is a glitch free switch. When CLKINP is selected it is sourced through the ADPLLs $1/(N2+1)$ divider. The PRCM register defaults to 0 on power-up to select the CLKINP source.

The CLKINPULOW input may be sourced from the CORE_CLKOUTM6 from the Core PLL, or PER_CLKOUTM2 from the Per PLL. These PLL output clocks can be used as alternate clock sources in low power active use cases for the DDR clocks when PLL is in bypass mode

8.1.6.11.1 Configuring the DDR PLL

The following steps detail how to configure the DDR PLL.

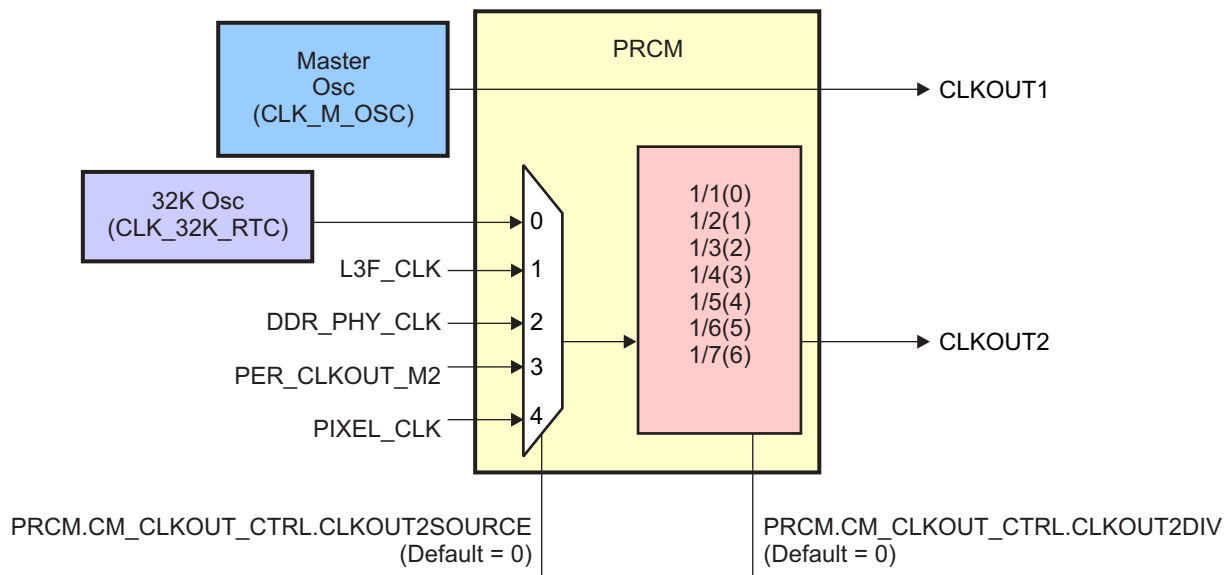
1. Switch PLL to bypass mode by setting `CM_CLKMODE_DPLL_DDR.DPLL_EN` to 0x4.
2. Wait for `CM_IDLEST_DPLL_DDR.ST_MN_BYPASS = 1` to ensure PLL is in bypass (`CM_IDLEST_DPLL_DDR.ST_DPLL_CLK` should also change to 0 to denote the PLL is unlocked).
3. Configure Multiply and Divide values by setting `CM_CLKSEL_DPLL_DDR.DPLL_MULT` and `DPLL_DIV` to the desired values.
4. Configure M2 divider by setting `CM_DIV_M2_DPLL_DDR.DPLL_CLKOUT_DIV` to the desired value.
5. Switch over to lock mode by setting `CM_CLKMODE_DPLL_DDR.DPLL_EN` to 0x7.
6. Wait for `CM_IDLEST_DPLL_DDR.ST_DPLL_CLK = 1` to ensure PLL is locked (`CM_IDLEST_DPLL_DDR.ST_MN_BYPASS` should also change to 0 to denote the PLL is out of bypass mode).

Note: M2 divider can also be changed on-the-fly (i.e., there is no need to put the PLL in bypass and back to lock mode). After changing CM_DIV_M2_DPLL_DDR.DPLL_CLKOUT_DIV, check CM_DIV_M2_DPLL_DDR.DPLL_CLKOUT_DIVCHACK for a toggle (a change from 0 to 1 or 1 to 0) to see if the change was acknowledged by the PLL.

8.1.6.12 CLKOUT Signals

The CLKOUT1 and CLKOUT2 signals go device pads and should mainly be used as debug testpoints. Using these signals for time-critical external circuits is discouraged because of unpredictable jitter performance. For more information, see the device datasheet, *AM335x Sitara Processors* (literature number [SPRS717](#)). CLKOUT1 is created from the master oscillator. CLKOUT2 can be sourced from the 32-KHz crystal oscillator or any of the PLL (except MPU PLL) outputs. The selected output can be further modified by a programmable divider to create the desired output frequency.

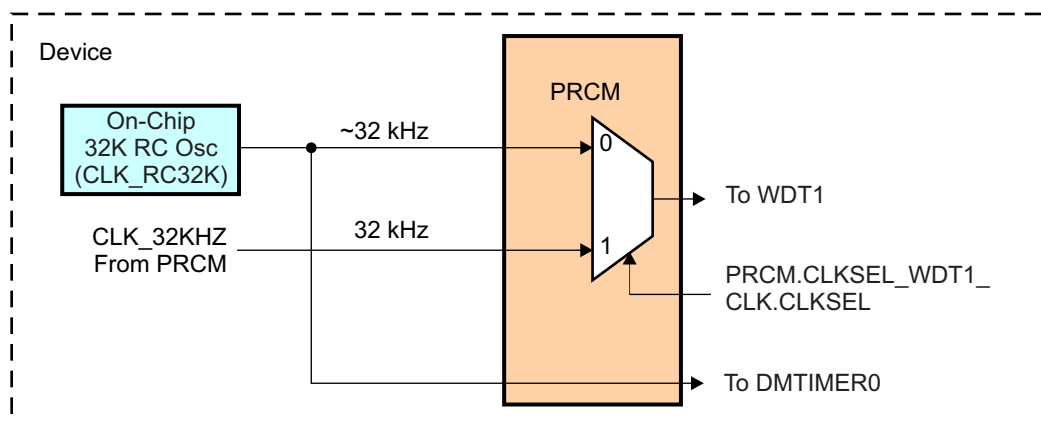
Figure 8-15. CLKOUT Signals



8.1.6.13 Timer Clock Structure

The CLK_32KHZ clock is an accurate 32.768-kHz clock derived from the PER PLL and can also be selected for the WDT1. The DMTIMER0 can only be clocked from the internal RC oscillator (CLK_RC32K). The clock options are shown in [Figure 8-16](#).

Figure 8-16. Watchdog Timer Clock Selection

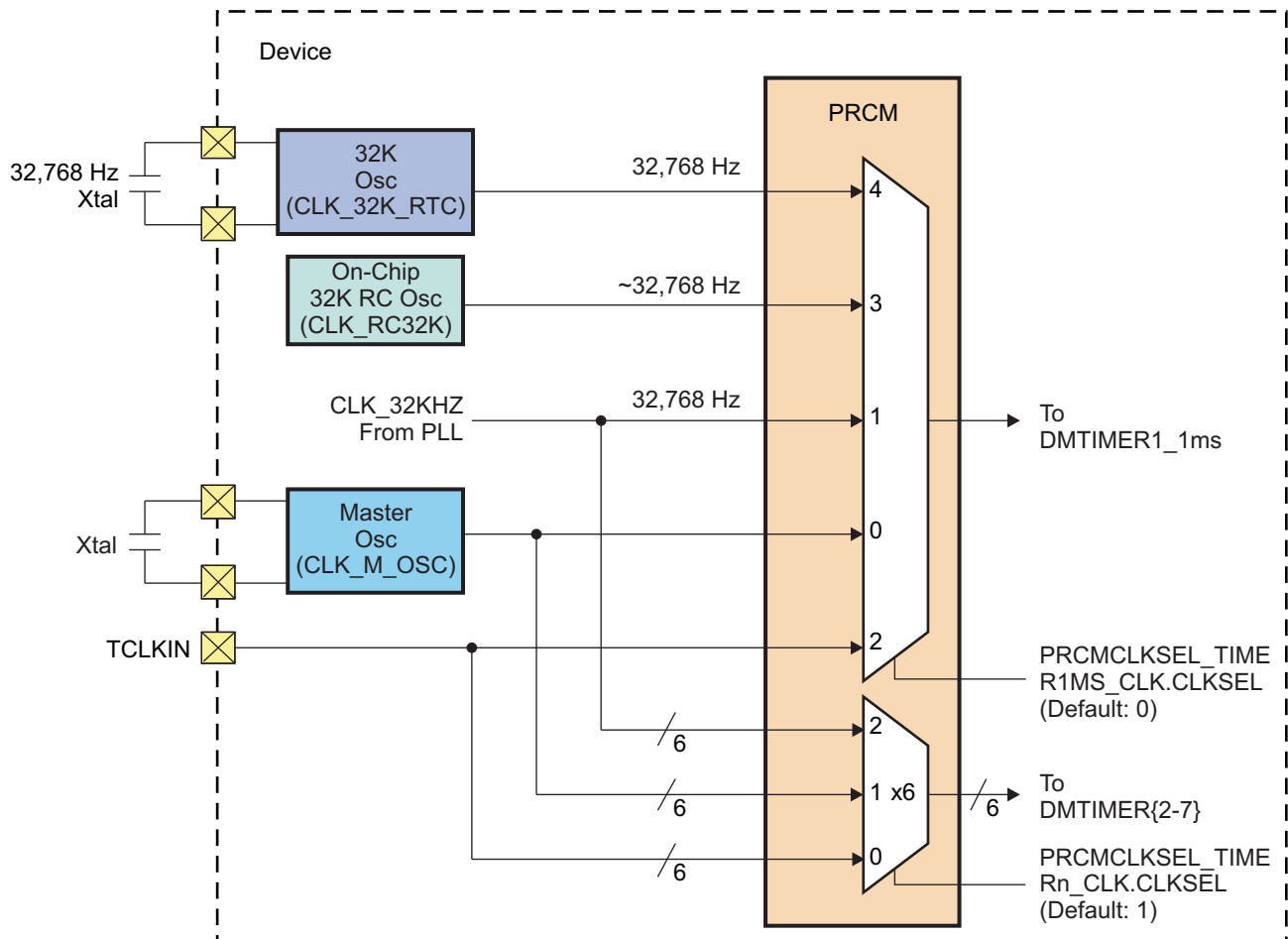


All mux selections are in PRCM unless explicitly shown otherwise in the diagrams.

The clock selections for the other device Timer modules are shown in [Figure 8-17](#). CLK_32KHZ, the master oscillator, and the external pin (TCLKIN) are optional clocks available for timers which may be selected based on end use application.

DMTIMER1 is implemented using the DMTimer_1ms module which is capable of generating an accurate 1ms tick using a 32.768 KHz clock. During low power modes, the Master Oscillator is disabled. CLK_32KHZ also would not be available in this scenario since it is sourced from the Master Osc based PER PLL. Hence, in low power modes DMTIMER1 in the WKUP domain can use the 32K RC oscillator for generating the OS (operating system) 1ms tick generation and timer based wakeup. Since most applications expect an accurate 1ms OS tick which the inaccurate 32K RC (16-60 KHz) oscillator cannot provide, a separate 32768 Hz oscillator (32K Osc) is provided as another option.

Figure 8-17. Timer Clock Selection

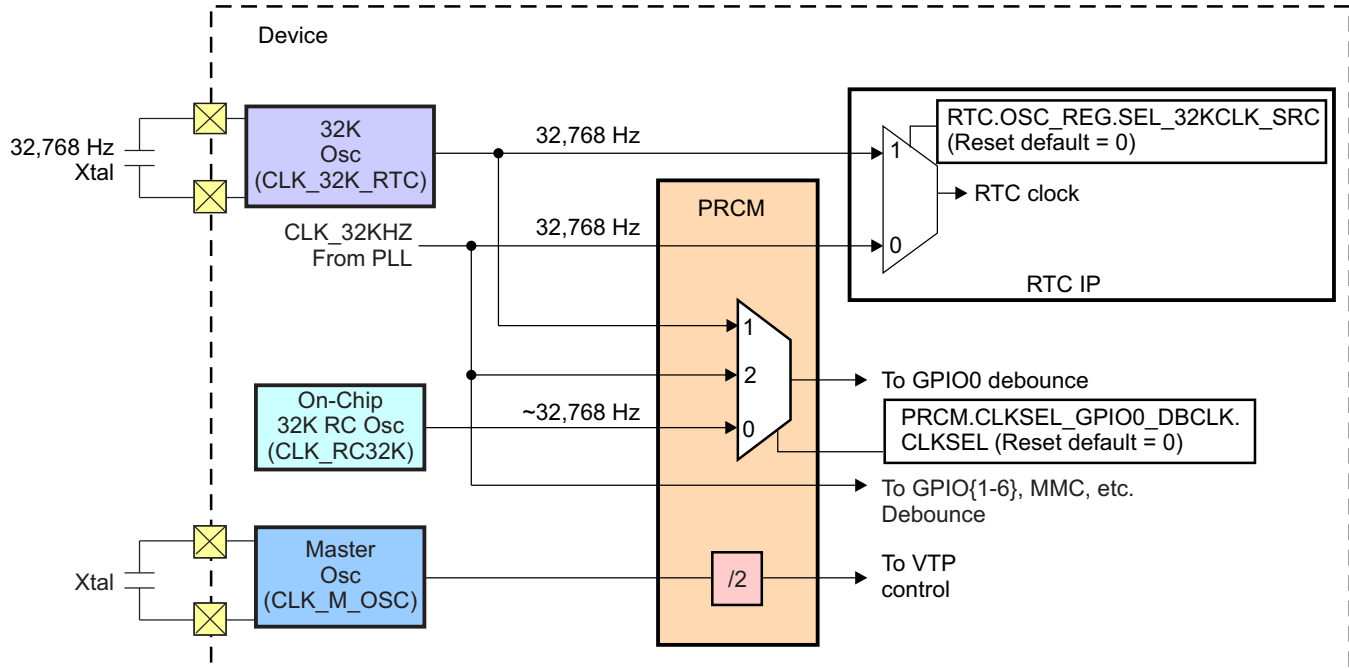


All mux selections are in PRCM unless explicitly shown otherwise in the diagrams.

The RTC, Debounce and VTP clock options are shown in [Figure 8-18](#). In low power modes, the debounce for GPIO0 in WKUP domain can use the accurate 32768 Hz crystal oscillator or the inaccurate (16 KHz to 60 KHz) 32K RC oscillator when the Master Osc is powered down.

The 32K Osc requires an external 32768-Hz crystal.

All mux selections are in PRCM unless explicitly shown otherwise in the diagrams.

Figure 8-18. RTC, VTP, and Debounce Clock Selection


All mux selections are in PRCM unless explicitly shown otherwise in the diagrams.

8.1.7 Reset Management

8.1.7.1 Overview

The PRCM manages the resets to all power domains inside device and generation of a single reset output signal through device pin, WARMRSTn, for external use. The PRCM has no knowledge of or control over resets generated locally within a module, e.g., via the OCP configuration register bit IPName_SYSCONFIG.SoftReset.

All PRM reset outputs are asynchronously asserted. These outputs are active-low except for the PLL resets. Deassertion is synchronous to the clock which runs a counter used to stall, or delay, reset deassertion upon source deactivation. This clock will be CLK_M_OSC used by all the reset managers. All modules receiving a PRCM generated reset are expected to treat the reset as asynchronous and implement local re-synchronization upon de-activation as needed.

One or more Reset Managers are required per power domain. Independent management of multiple reset domains is required to meet the reset sequencing requirements of all modules in the power domain

8.1.7.2 Reset Concepts and Definitions

The PRCM collects many sources of reset. Here below is a list of qualifiers of the source of reset:

- Cold reset: it affects all the logic in a given entity
- Warm reset: it is a partial reset which doesn't affect all the logic in a given entity
- Global reset: it affects the entire device
- Local reset: it affects part of the device (1 power domain for example)
- S/W reset: it is initiated by software
- H/W reset: it is hardware driven

Each reset source is specified as being a cold or warm type. Cold types are synonymous with power-on-reset (POR) types. Such sources are applied globally within each receiving entity (i.e., sub-system, module, macro-cell) upon assertion. Cold reset events include: device power-up, power-domain power-up, and eFuse programming failures.

Warm reset types are not necessarily applied globally within each receiving entity. A module may use a warm reset to reset a subset of its logic. This is often done to speed-up reset recovery time, i.e., the time to transition to a safe operating state, compared to the time required upon receipt of a cold reset. Warm reset events include: software initiated per power-domain, watch-dog time-out, externally triggered, and emulation initiated.

Reset sources, warm or cold types, intended for device-wide effect are classified as global sources. Reset sources intended for regional effect are classified as local sources.

Each Reset Manager provides two reset outputs. One is a cold reset generated from the group of global and local cold reset sources it receives. The other is a warm+cold reset generated from the combined groups of, global and local, cold and warm reset sources it receives.

The Reset Manager asserts one, or both, of its reset outputs asynchronously upon reset source assertion. Reset deassertion is extended beyond the time the source gets de-asserted. The reset manager will then extend the active period of the reset outputs beyond the release of the reset source, according to the PRCM's internal constraints and device's constraints. Some reset durations can be software-configured. Most (but not all) reset sources are logged by PRCM's reset status registers. The same reset output can generally be activated by several reset sources and the same reset source can generally activate several reset outputs. All the reset signals output of the PRCM are active low. Several conventions are used in this document for signal and port names. They include:

- "_RST" in a signal or port name is used to denote reset signal.
- "_PWRON_RST" in a signal or port name is used to denote a cold reset source

8.1.7.3 Global Power On Reset (Cold Reset)

There are several cold reset sources. See [Table 8-25](#) for a summary of the different reset sources.

8.1.7.3.1 Power On Reset (PORz)

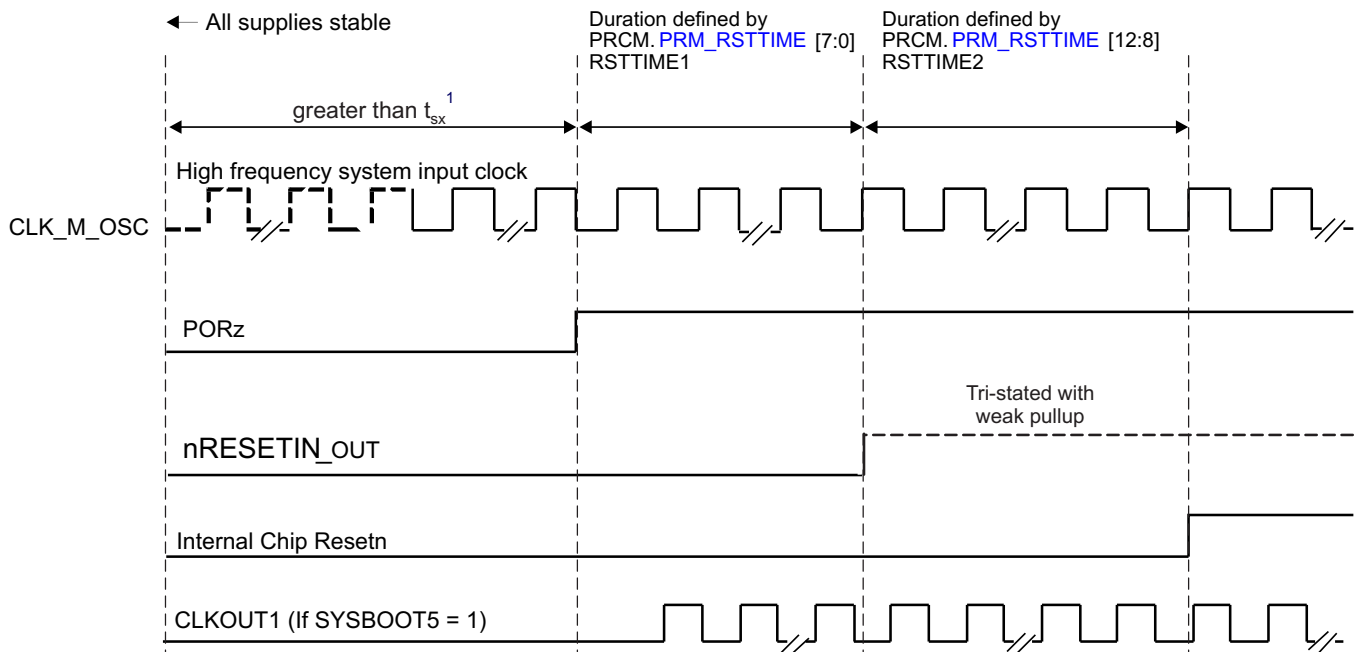
The source of power on reset is PORz signal on the device. Everything on device is reset with assertion of power on reset. This reset is non-blockable. PORz can be driven by external power management devices or power supervisor circuitry. During power-up, when power supplies to the device are ramping up, PORz needs to be driven Low. When the ramp-up is complete and supplies reach their steady-state values, PORz need to be driven High. During normal operation when any of the device power supplies are turned OFF, PORz must be driven Low.

8.1.7.3.2 PORz Sequence

- PORz pin at chip boundary gets asserted (goes low). **Note:** The state of nRESETIN_OUT during PORz assertion should be a don't care, it should not affect PORz (only implication is if they are both asserted and nRESETIN_OUT is deasserted after PORz you will get re-latching of boot config pins and may see warm nRESETIN_OUT flag set in PRCM versus POR).
- All IOs will go to a known state, as defined in the device datasheet, *AM335x Sitara Processors* (literature number [SPRS717](#))
- When power comes-up, PORz value will propagate to the PRCM.
- PRCM will fan out reset to the complete chip and all logic which uses async reset will get reset. nRESETIN_OUT will go low to indicate reset-in-progress.
- External clocks will start toggling and PRCM will propagate these clocks to the chip keeping PLLs in bypass mode.
- All logic using sync reset will get reset.
- When power and clocks to the chip are stable, PORz must be de-asserted.
- Boot configuration pins are latched upon de-assertion of PORz pin
- IO cell controls from IPs for all the IOs with a few exceptions (see datasheet for details) are driven by GPIO module. GPIO puts all IOs in input mode.
- FuseFarm reset will be de-asserted to start eFuse scanning.
- Once eFuse scanning is complete, reset to the host processor and to all other peripherals (peripherals without local processor) will be de-asserted.

- nRESETIN_OUT will be de-asserted after time defined by PRM_RSTTIME.RSTTIME1.
- Once host processors finish booting then all remaining peripherals will see reset de-assertion.

Note that all modules with local CPUs will have local reset asserted by default at PORz and reset de-assertion would require host processor to write to respective registers in PRM.

Figure 8-19. PORz


(1) For information on t_{sx} , see *AM335x Sitara Processors* (literature number [SPRS717](#)).

8.1.7.3.3 Bad Device Reset

This reset is asserted whenever the DEVICE_TYPE encodes an unsupported device type, such as the code for a "bad" device.

8.1.7.3.4 Global Cold Software Reset (GLOBAL_COLD_SW_RST)

The source for GLOBAL_COLD_SW_RST is generated internally by the PRM. It is activated upon setting the PRM_RSTCTRL.RST_GLOBAL_COLD_SW bit in the PRM memory map. This bit is self-clearing, i.e., it is automatically cleared by the hardware.

8.1.7.4 Global Warm Reset

8.1.7.4.1 External Warm Reset

nRESETIN_OUT is a bidirectional warm reset signal. As an input, it is typically used by an external source as a device reset. Refer to Table 8-24 for a summary of the differences between a warm reset and cold reset. Some of these differences are:

- The warm reset can be blocked to the EMAC switch and its reference clock source PLL using the RESET_ISO register in the Control Module.
- The warm reset assumes that clocks and power to the chip are stable from assertion through deassertion, whereas during the cold reset, the power supplies can become stable during assertion.
- Some PRM and Control module registers are warm reset insensitive and maintain their value throughout a warm reset.
- SYSBOOT pins are not latched with a warm reset. The device will boot with the SYSBOOT values from the previous cold reset.

- Most debug subsystem logic is not affected by warm reset. This allows you to maintain any debug sessions throughout a warm reset event.
- PLLs are not affected by warm reset

As an output, nRESETIN_OUT can be used to reset external devices. nRESET_OUT will drive low during a cold reset or an internally generated warm reset. After completion of a cold or warm reset, nRESETIN_OUT will continue to drive low for a period defined by PRM_RSTTIME.RSTTIME1. RSTTIME1 is a timer that counts down to zero at a rate equal to the high frequency system input clock CLK_M_OSC. This allows external devices to be held in reset for some time after the AM335x comes out of reset.

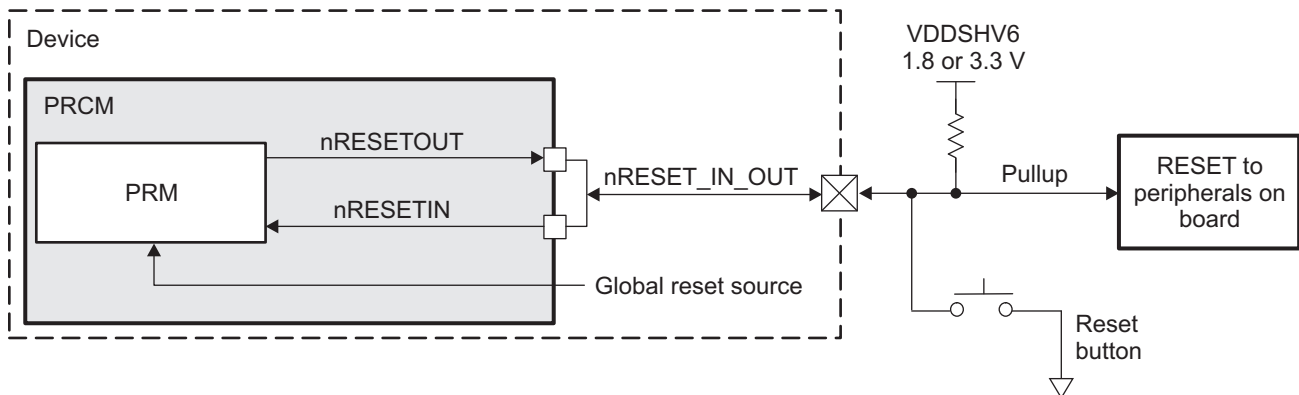
Caution must be used when implementing the nRESETIN_OUT as an bi-directional reset signal. Because of the short maximum time allowed using RSTTIME1, it does not supply an adequate debounce time for an external push button circuit. The processor could potentially start running while external components are still in reset. It is recommended that this signal be used as input only (do not connect to other devices as a reset) to implement a push button reset circuit to the AM335x, or an output only to be able to reset other devices after an AM335x reset completes.

8.1.7.4.1.1 Warm Reset Input/Reset Output (nRESETIN_OUT)

Any global reset source (internal or external) causes nRESETIN_OUT to be driven and maintained at the boundary of the device for at least the amount of time configured in the PRCM.PRM_RSTTIME.RSTTIME1 bit field. This ensures that the device and its related peripherals are reset together. The nRESETIN_OUT output buffer is configured as an open-drain; consequently, an external pull-up resistor is required.

After the de-assertion, the bi-directional pin nRESETIN_OUT is tri-stated to allow for assertion from off chip source (externally).

Figure 8-20. External System Reset



Note: It is recommended to implement warm reset as an input only (for example, push button) or an output only (to reset external peripherals), not both.

The device will have one pin nRESETIN_OUT which reflects chip reset status. This output will always assert asynchronously when any chip watchdog timer reset occurs if any of the following reset events occurs:

- POR (only internal stretched portion of reset event after bootstrap is latched)
- External Warm reset (nRESETIN_OUT pin, only internal stretched portion of reset event after bootstrap is latched)
- Emulation reset (Cold or warm from ICEPICK)
- Reset requestor
- SW cold/warm reset

This output will remain asserted as long as PRCM keeps reset to the host processor asserted.

Note: TRST does not cause RSTOUTn assertion

8.1.7.4.1.2 Warm Reset Sequence

1. nRESETIN_OUT pin at chip boundary gets asserted (goes low). NOTE: For Warm Reset sequence to work as described, it is expected that PORz pin is always inactive, otherwise you will get PORz functionality as described in previous section.
2. All IOs (except test and emulation) will go to tri-state immediately.
3. Chip clocks are not affected as both PLL and dividers are intact.
4. nRESETIN_OUT gets de-asserted after 30 cycles
5. PRCM de-asserts reset to the host processor and all other peripherals without local CPUs.
6. Note that all IPs with local CPUs will have local reset asserted by default at Warm Reset and reset de-assertion would require host processor to write to respective registers in PRCM.

Figure 8-21 shows the nRESETIN_OUT waveform when using nRESETIN_OUT as warm reset source. For the duration when external warm reset switch is closed, both the device and chip will be driving zero.

Figure 8-21. Warm Reset Sequence (External Warm Reset Source)

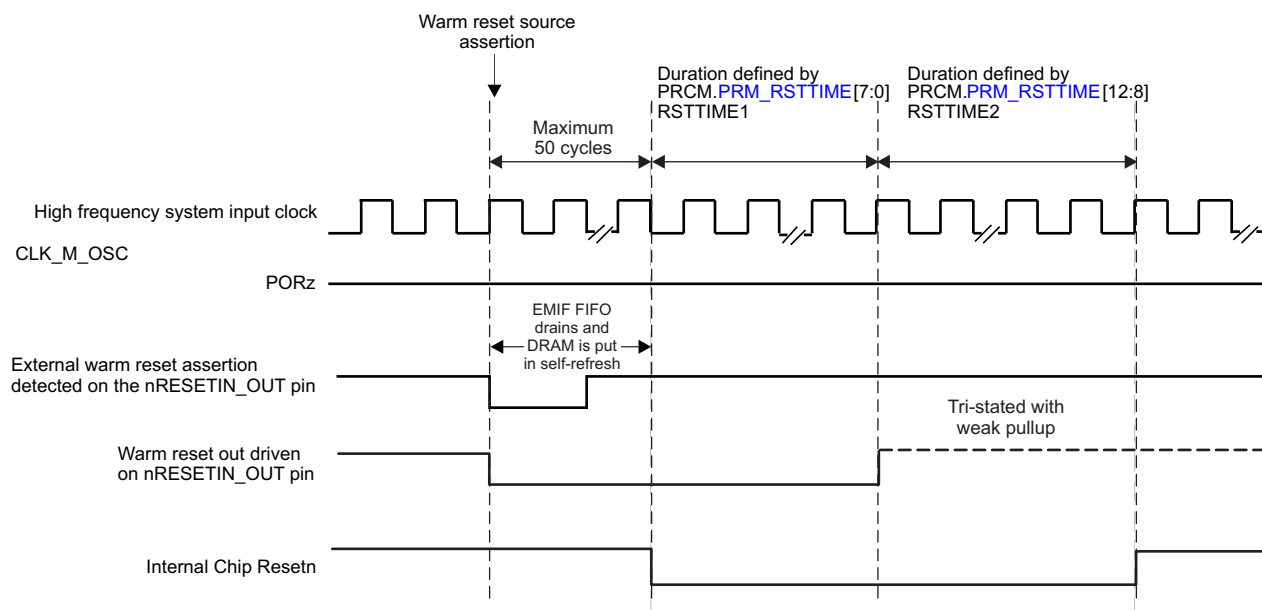
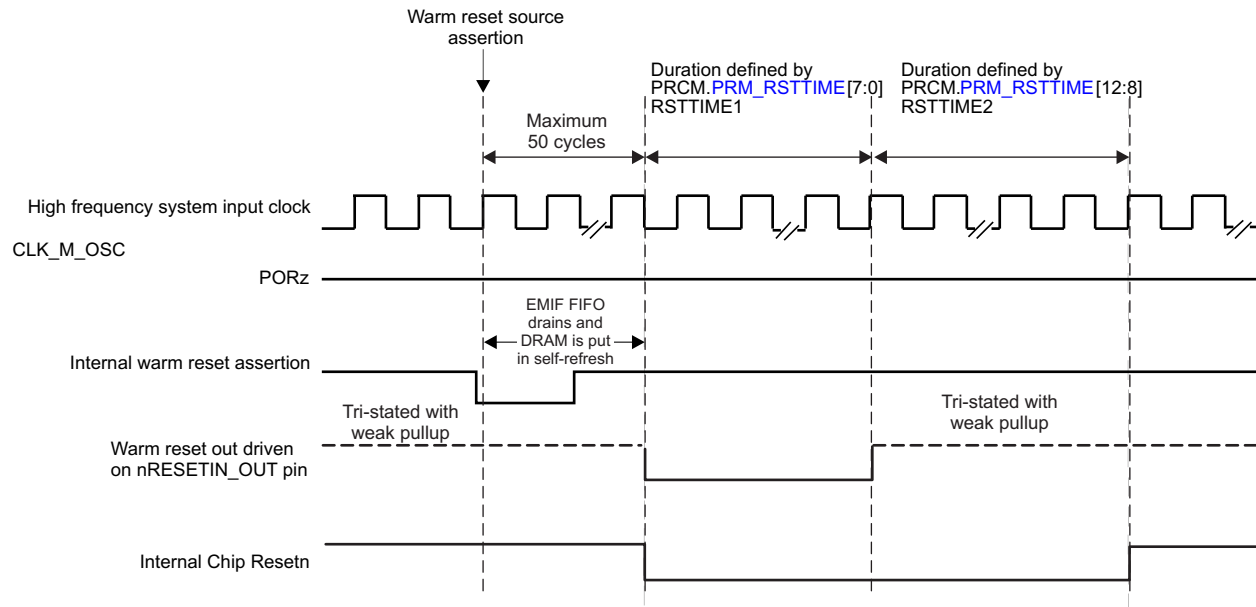


Figure 8-22 shows the nRESETIN_OUT waveform when any one of the warm reset sources captured except using nRESETIN_OUT itself as warm reset source.

Figure 8-22. Warm Reset Sequence (Internal Warm Reset Source)



8.1.7.4.2 Watchdog Timer

There is one watchdog timer on the device. The reset is not blockable.

8.1.7.4.3 Global Warm Software Reset (GLOBAL_SW_WARM_RST)

8.1.7.4.4 Test Reset (TRSTz)

This reset is triggered from TRSTz pin on JTAG interface. This is a non-blockable reset and it resets test and emulation logic.

NOTE: A PORz reset assertion should cause entire device to reset including all test and emulation logic regardless of the state of TRSTz. Therefore, PORz assertion will achieve full reset of the device even if TRSTz pin is pulled permanently high and no special toggling of TRSTz pin is required during power ramp to achieve full POR reset to the device. Further, it is acceptable for TRSTz input to be pulled permanently low during normal functional usage of the device in the end-system to ensure that all test and emulation logic is kept in reset.

8.1.7.5 Reset Characteristics

The following table shows characteristic of each reset source.

Table 8-25. Reset Sources

Characteristic	Cold Reset Sources			Warm Reset sources			
	Pin PORz	SW Cold Reset	Bad Device	Pin Warm Reset	Watchdog Timer	SW Warm Reset	TRSTz
Boot pins latched	Y	N	N	N	N	N	N
Resets Standard Efuses	Y	N	N	N	N	N	N
Resets Customer Efuses	Y	Y	Y	Y	Y	Y	N
DRAM contents preserved	N	N	N	Y ⁽¹⁾	Y ⁽¹⁾	Y ⁽¹⁾	Y
Resets PLLs ⁽²⁾	Y	Y	Y	N	N	N	N
Resets Clock Dividers ⁽²⁾	Y	Y	Y	N	N	N	N
PLLs enter bypass mode ⁽²⁾	Y	Y	Y	Y	Y	Y	N
Reset source blockable by emulation	N	N	N	Y	Y	Y	Y
Resets test and emulation logic	Y	Y	Y	N	N	N	N
Resets GMAC switch and related chip logic	Y	N ⁽³⁾	Y	N ⁽³⁾	N ⁽³⁾	N ⁽³⁾	
Resets Chip Functional Logic ⁽⁴⁾	Y	Y	Y	Y	Y	Y	N
Puts IOs in Tri-state	Y	Y	Y	Y	Y	Y	N
Resets Pinmux Registers	Y	Y	Y ⁽⁵⁾	Y ⁽⁵⁾	Y ⁽⁵⁾	Y ⁽⁵⁾	N
Reset out Assertion (nRESETIN_OUT Pin)	Y	Y	Y ⁽⁵⁾	Y ⁽⁵⁾	Y ⁽⁵⁾	Y ⁽⁵⁾	N
Resets RTC	N	N	N	N	N	N	N

⁽¹⁾ The ROM software does not utilize this feature of DRAM content preservation. Hence, the AM335x re-boots like a cold boot for warm reset as well.

⁽²⁾ CORE PLL is an exception when EMAC switch reset isolation is enabled

⁽³⁾ Only true if GMAC switch reset isolation is enabled in control registers, otherwise will be reset.

⁽⁴⁾ There are exception details in control module & PRCM registers which are captured in the register specifications in [Chapter 8](#) and [Chapter 9](#). This includes some pinmux registers which are warm reset in-sensitive.

⁽⁵⁾ Some special IOs/Muxing registers like test, emulation, GEMAC Switch (When under reset isolation mode), etc related will not be affected under warm reset conditions.

Note: The Bandgap macros for the LDOs will be reset on PORz only.

8.1.7.6 EMAC Switch Reset Isolation

The device will support reset isolation for the Ethernet Switch IP. This allows the device to undergo a warm reset without disrupting the switch or traffic being routed through the switch during the reset condition.

If configured by registers in control module that EMAC reset isolation is active, then behavior is as follows:

Any “Warm” reset source(except the software warm reset) will be blocked to the EMAC switch logic in the IP (the IP has two reset inputs to support such isolation) and to PLL (and it’s control bits) which is sourcing the EMAC switch clocks as required by the IP (50- or 125-MHz reference clocks). Also, the EMAC switch related IO pins must retain their pin muxing and not glitch (continuously controlled by the EMAC switch IP) by blocking reset to the controlling register bits.

If configured by registers in control module that EMAC reset isolation is NOT active (default state), then the warm reset sources are allowed to propagate as normal including to the EMAC Switch IP (both reset inputs to the IP).

All cold or POR resets will always propagate to the EMAC switch IP as normal (as otherwise defined in this document).

8.1.7.7 Reset Priority

If more than one of these reset sources are asserted simultaneously then the following priority order should be used:

1. POR
2. TRSTz
3. External warm reset
4. Emulation
5. Reset requestors
6. Software resets

8.1.7.8 Trace Functionality Across Reset

Other than POR, TRSTz and SW cold reset, none of the other resets will affect trace functionality. This requires that Debug_SS has required reset isolation for the trace logic. Also the los and muxing control (if any) for trace los should not get affected by any other reset. Since none of the PLLs getting reset with other resets, clocks will be any way stable.

8.1.7.9 RTC PORz

AM335x supports RTC only mode by supplying dedicated power to RTC module. The RTC module has a dedicated PORz signal (RTC_PORz) to reset RTC logic and circuitry during powerup. RTC_PORz is expected to be driven low when the RTC power supply is ramping up. After the power supply reaches its stable value, the RTC_PORz can be de-asserted. The RTC module is not affected by the device PORz. Similarly RTC_PORz does not affect the device reset.

For power-up sequencing with respect to RTC_PORz, see the device specific datasheet.

8.1.8 Power-Up/Down Sequence

Each power domain has dedicated warm and cold reset.

Warm reset gets asserted each time there is any warm reset source requesting reset. Warm reset is also asserted when power domain moves from ON to OFF state.

Cold reset for the domain is asserted in response to cold reset sources. When domain moves from OFF to ON state then also cold reset gets asserted as this is similar to power-up condition for that domain.

8.1.9 IO State

All IOs except for JTAG i/f and Reset output (and any special cases mentioned in pinlist) should have their output drivers tri-state and internal pulls enabled during assertion of all reset sources. JTAG i/f IO is affected only by TRSTz.

Note: The PRUs and Cortex M3 processor are held under reset after global warm reset by assertion of software source of reset. Other domains are held under reset after global warm reset until the MPU software enables their respective interface clock.

8.1.10 Voltage and Power Domains

The following table shows how the device core logic is partitioned into two core logic voltage domains and four power domains. The table lists which voltage and power domain a functional module belongs.

Table 8-26. Core Logic Voltage and Power Domains

Logic Voltage Domain Name	Module
CORE	All Core Modules
RTC	RTC

8.1.10.1 Voltage Domains

The core logic is divided into two voltage domains: VDD_CORE and VDD_RTC.

8.1.10.2 Power Domains

In order to reduce power due to leakage, the core logic supply voltage to 4 of these power domains can be turned OFF with internal power switches. The internal power switches are controlled through memory mapped registers in Control Module.

In a use case whereby all the modules within a power domain are not used that power domain can be placed in the OFF state.

Error: Reference source not found shows the allowable combination power domain ON/OFF states and which power domains are switched via internal power switches. At power-on-reset, all domains except always-on will be in the power domain OFF state.

Table 8-27. Power Domain State Table

MODE	POWER DOMAIN					
	WAKEUP	MPU	GFX	PER	RTC	EFUSE
No Voltage Supply	N/A	N/A	N/A	N/A	N/A	N/A
Power On Reset	ON	OFF	OFF	OFF	OFF	OFF
ALL OTHER FUNCTIONAL MODES	ON	DON'T CARE	DON'T CARE	DON'T CARE	DON'T CARE	DON'T CARE
Internal Power Switch	NO	YES	YES	YES	YES	YES

8.1.11 Device Modules and Power Management Attributes List
Table 8-28. Power Domain of Various Modules

Power Supply	Power Domain	Modules OR Supply Destinations (sinks)
VDD_CORE	PD_WKUP This is non-switchable and cannot be shut OFF	Wake-Cortex M3 Subsystem
		L4_WKUP peripherals
		PRCM
		Control Module
		GPIO0
		DMTIMER0_dmc
		DMTIMER1
		UART0
		I2C0
		TSC
		WDT1
		SmartReflex_c2_0
		SmartReflex_c2_1
		L4_WKUP
		Top level: Pinmux gates/logic, oscillator wake logic
		DDR PHY (DIDs)
		WKUP_DFTSS
Debugs		
Digital section (VDD) of CORE PLL, PER PLL, Display PLL and DDR PLL		
Emulation sections of MPU		
VDD of all IOs including crystal oscillators		
RC Oscillator		

Table 8-28. Power Domain of Various Modules (continued)

Power Supply	Power Domain	Modules OR Supply Destinations (sinks)
VDD_CORE	PD_PER	Infrastructure
		L3
		L4_PER, L4_Fast
		EMIF4
		EDMA
		GPMC
		OCMC controller
		L3 / L4_PER / L4_Fast Peripherals
		PRU-ICSS
		LCD controller
		Ethernet Switch
		USB Controller
		GPMC
		MMC0-2
		DMTIMER2-7
		UART1-5
		SPI0, 1
		I2C1, 2
		DCAN0, 1
		McASP0, 1
		ePWM0-2
		eCAP0-2
		eQEP0,1
		GPIO1-3
		ELM
		Mailbox0, Spinlock
		OCP_WP
		Others
		USB2PHYCORE (VDD/digital section)
		USB2PHYCM (VDD/digital section)
	PD_GFX	SGX530
VDD_MPU	PD_MPU	CPU, L1, L2 of MPU
	PD_WKUP	Interrupt controller of MPU Subsystem Digital Portion (VDD) of MPU PLL
VDD_RTC	PD_RTC	1. RTC
		VDD for 32 768 Hz Crystal Osc
		VDD for IO for the alarm pin

8.1.11.1 Power Domain Power Down Sequence

The following sequence of steps happen during the power down of a power domain

All IPs (belonging to a power domain) with STANDBY interface will assert STANDBY. STANDBY assertion should get triggered by IP based on its activity on OCP initiator port. IP should assert STANDBY whenever initiator port is IDLE. Some of the IPs may not have this feature and they will require SW write to standby-mode register to get STANDBY assertion from IP.

1. SW will request all modules in given power domain to go to disable state by programming module control register inside PRCM.
2. PRCM will start and wait for completion of power management handshake with IPs (IdleReq/IdleAck).
3. PRCM will gate-off all the clocks to the power domain.
4. SW will request all clock domains in given power domain to go to “force sleep” mode by programming functional clock domain register in PRCM. Note that PRCM has already gated-off clocks and this register programming may look redundant.
5. SW will request PRCM to take this power domain to OFF state by programming PWRSTCTRL register. Note that this step can be skipped if PWRSTCTRL is permanently programmed to OFF state. When this is done, functional clock domain register decides when power domain will be taken to OFF state. Only reason not to have OFF state in PWRSTCTRL is to take power domain to just clock gate state without power gating.
6. PSCON specific to this power domain will assert isolation enable for the domain.
7. PRCM will assert warm and cold reset to the power domain.
8. PSCON will assert control signals to switch-off power using on-die switches.
9. On-die switches will send acknowledge back to PSCON.

8.1.11.2 Power Domain Power-Up Sequence

The following sequence of steps occurs during power-up of a power domain. This sequence is not relevant to always-on domain as this domain will never go to OFF state as long as the device is powered. This sequence will be repeated each time a domain is taken to ON state from OFF (including first time power-up). Note that some of the details are intentionally taken out here to simplify things.

There can be multiple reasons to start power-up sequence for a domain. For example it can be due to an interrupt from one of the IPs which is powered-up.

1. SW will request required clock domains inside this power domain to go to force wake-up state by programming functional clock domain register.
2. PRCM will enable clocks to the required clock domains.
3. PSCON specific to this power domain will assert control signal to un-gate the power.
4. Once power is un-gated, on die switches will send acknowledge back to PSCON.
5. PRCM will de-assert cold and warm reset to the power domain.
6. PRCM will turn-off isolation cells.
7. SW will request PRCM to enable required module in the power domain by programming module control register.
8. PRCM will initiate and wait for completion of PM protocol to enable the modules (IdleReq/IdleAck).

8.1.12 Clock Module Registers

8.1.12.1 CM_PER Registers

[Table 8-29](#) lists the memory-mapped registers for the CM_PER. All register offset addresses not listed in [Table 8-29](#) should be considered as reserved locations and the register contents should not be modified.

Table 8-29. CM_PER REGISTERS

Offset	Acronym	Register Name	Section
0h	CM_PER_L4LS_CLKSTCTRL		Section 8.1.12.1.1
4h	CM_PER_L3S_CLKSTCTRL		Section 8.1.12.1.2
Ch	CM_PER_L3_CLKSTCTRL		Section 8.1.12.1.3
14h	CM_PER_CPGMAC0_CLKCTRL		Section 8.1.12.1.4
18h	CM_PER_LCDC_CLKCTRL		Section 8.1.12.1.5
1Ch	CM_PER_USB0_CLKCTRL		Section 8.1.12.1.6
24h	CM_PER_TPTC0_CLKCTRL		Section 8.1.12.1.7
28h	CM_PER_EMIF_CLKCTRL		Section 8.1.12.1.8
2Ch	CM_PER_OCMCRAM_CLKCTRL		Section 8.1.12.1.9
30h	CM_PER_GPMC_CLKCTRL		Section 8.1.12.1.10
34h	CM_PER_MCASP0_CLKCTRL		Section 8.1.12.1.11
38h	CM_PER_UART5_CLKCTRL		Section 8.1.12.1.12
3Ch	CM_PER_MMC0_CLKCTRL		Section 8.1.12.1.13
40h	CM_PER_ELM_CLKCTRL		Section 8.1.12.1.14
44h	CM_PER_I2C2_CLKCTRL		Section 8.1.12.1.15
48h	CM_PER_I2C1_CLKCTRL		Section 8.1.12.1.16
4Ch	CM_PER_SPI0_CLKCTRL		Section 8.1.12.1.17
50h	CM_PER_SPI1_CLKCTRL		Section 8.1.12.1.18
60h	CM_PER_L4LS_CLKCTRL		Section 8.1.12.1.19
68h	CM_PER_MCASP1_CLKCTRL		Section 8.1.12.1.20
6Ch	CM_PER_UART1_CLKCTRL		Section 8.1.12.1.21
70h	CM_PER_UART2_CLKCTRL		Section 8.1.12.1.22
74h	CM_PER_UART3_CLKCTRL		Section 8.1.12.1.23
78h	CM_PER_UART4_CLKCTRL		Section 8.1.12.1.24
7Ch	CM_PER_TIMER7_CLKCTRL		Section 8.1.12.1.25
80h	CM_PER_TIMER2_CLKCTRL		Section 8.1.12.1.26
84h	CM_PER_TIMER3_CLKCTRL		Section 8.1.12.1.27
88h	CM_PER_TIMER4_CLKCTRL		Section 8.1.12.1.28
ACh	CM_PER_GPIO1_CLKCTRL		Section 8.1.12.1.29
B0h	CM_PER_GPIO2_CLKCTRL		Section 8.1.12.1.30
B4h	CM_PER_GPIO3_CLKCTRL		Section 8.1.12.1.31
BCh	CM_PER_TPCC_CLKCTRL		Section 8.1.12.1.32
C0h	CM_PER_DCAN0_CLKCTRL		Section 8.1.12.1.33
C4h	CM_PER_DCAN1_CLKCTRL		Section 8.1.12.1.34
CCh	CM_PER_EPWMSS1_CLKCTRL		Section 8.1.12.1.35
D4h	CM_PER_EPWMSS0_CLKCTRL		Section 8.1.12.1.36
D8h	CM_PER_EPWMSS2_CLKCTRL		Section 8.1.12.1.37
DCh	CM_PER_L3_INSTR_CLKCTRL		Section 8.1.12.1.38
E0h	CM_PER_L3_CLKCTRL		Section 8.1.12.1.39
E4h	CM_PER_IEEE5000_CLKCTRL		Section 8.1.12.1.40
E8h	CM_PER_PRU_ICSS_CLKCTRL		Section 8.1.12.1.41
ECh	CM_PER_TIMER5_CLKCTRL		Section 8.1.12.1.42

Table 8-29. CM_PER REGISTERS (continued)

Offset	Acronym	Register Name	Section
F0h	CM_PER_TIMER6_CLKCTRL		Section 8.1.12.1.43
F4h	CM_PER_MMC1_CLKCTRL		Section 8.1.12.1.44
F8h	CM_PER_MMC2_CLKCTRL		Section 8.1.12.1.45
FCh	CM_PER_TPTC1_CLKCTRL		Section 8.1.12.1.46
100h	CM_PER_TPTC2_CLKCTRL		Section 8.1.12.1.47
10Ch	CM_PER_SPINLOCK_CLKCTRL		Section 8.1.12.1.48
110h	CM_PER_MAILBOX0_CLKCTRL		Section 8.1.12.1.49
11Ch	CM_PER_L4HS_CLKSTCTRL		Section 8.1.12.1.50
120h	CM_PER_L4HS_CLKCTRL		Section 8.1.12.1.51
12Ch	CM_PER_OCPWP_L3_CLKSTCTRL		Section 8.1.12.1.52
130h	CM_PER_OCPWP_CLKCTRL		Section 8.1.12.1.53
140h	CM_PER_PRU_ICSS_CLKSTCTRL		Section 8.1.12.1.54
144h	CM_PER_CPSW_CLKSTCTRL		Section 8.1.12.1.55
148h	CM_PER_LCDC_CLKSTCTRL		Section 8.1.12.1.56
14Ch	CM_PER_CLKDIV32K_CLKCTRL		Section 8.1.12.1.57
150h	CM_PER_CLK_24MHZ_CLKSTCTRL		Section 8.1.12.1.58

8.1.12.1.1 CM_PER_L4LS_CLKSTCTRL Register (offset = 0h) [reset = C0102h]

CM_PER_L4LS_CLKSTCTRL is shown in [Figure 8-23](#) and described in [Table 8-30](#).

This register enables the domain power state transition. It controls the SW supervised clock domain state transition between ON-PER and ON-INPER states. It also hold one status bit per clock input of the domain.

Figure 8-23. CM_PER_L4LS_CLKSTCTRL Register

31	30	29	28	27	26	25	24
Reserved			CLKACTIVITY_TIMER6_GCLK	CLKACTIVITY_TIMER5_GCLK	Reserved	CLKACTIVITY_SPI_GCLK	CLKACTIVITY_I2C_FCLK
R-0h			R-0h	R-0h	R-0h	R-0h	R-0h
23	22	21	20	19	18	17	16
Reserved	Reserved	CLKACTIVITY_GPIO_3_GDBCLK	CLKACTIVITY_GPIO_2_GDBCLK	CLKACTIVITY_GPIO_1_GDBCLK	Reserved	CLKACTIVITY_LCDC_GCLK	CLKACTIVITY_TIMER4_GCLK
R-0h	R-0h	R-0h	R-0h	R-1h	R-1h	R-0h	R-0h
15	14	13	12	11	10	9	8
CLKACTIVITY_TIMER3_GCLK	CLKACTIVITY_TIMER2_GCLK	CLKACTIVITY_TIMER7_GCLK	Reserved	CLKACTIVITY_CAN_CLK	CLKACTIVITY_UART_GFCLK	Reserved	CLKACTIVITY_L4LS_GCLK
R-0h	R-0h	R-0h	R-0h	R-0h	R-0h	R-0h	R-1h
7	6	5	4	3	2	1	0
Reserved						CLKTRCTRL	
R-0h						R/W-2h	

LEGEND: R/W = Read/Write; R = Read only; W1toCl = Write 1 to clear bit; -n = value after reset

Table 8-30. CM_PER_L4LS_CLKSTCTRL Register Field Descriptions

Bit	Field	Type	Reset	Description
31-29	Reserved	R	0h	
28	CLKACTIVITY_TIMER6_GCLK	R	0h	This field indicates the state of the TIMER6 CLKTIMER clock in the domain. 0x0 = Inact : Corresponding clock is gated 0x1 = Act : Corresponding clock is active
27	CLKACTIVITY_TIMER5_GCLK	R	0h	This field indicates the state of the TIMER5 CLKTIMER clock in the domain. 0x0 = Inact : Corresponding clock is gated 0x1 = Act : Corresponding clock is active
26	Reserved	R	0h	Reserved.
25	CLKACTIVITY_SPI_GCLK	R	0h	This field indicates the state of the SPI_GCLK clock in the domain. 0x0 = Inact : Corresponding clock is gated 0x1 = Act : Corresponding clock is active
24	CLKACTIVITY_I2C_FCLK	R	0h	This field indicates the state of the I2C_FCLK clock in the domain. 0x0 = Inact : Corresponding clock is gated 0x1 = Act : Corresponding clock is active
23	Reserved	R	0h	
22	Reserved	R	0h	Reserved.
21	CLKACTIVITY_GPIO_3_GDBCLK	R	0h	This field indicates the state of the GPIO3_GDBCLK clock in the domain. 0x0 = Inact : Corresponding clock is gated 0x1 = Act : Corresponding clock is active

Table 8-30. CM_PER_L4LS_CLKSTCTRL Register Field Descriptions (continued)

Bit	Field	Type	Reset	Description
20	CLKACTIVITY_GPIO_2_GDBCLK	R	0h	This field indicates the state of the GPIO2_GDBCLK clock in the domain. 0x0 = Inact : Corresponding clock is gated 0x1 = Act : Corresponding clock is active
19	CLKACTIVITY_GPIO_1_GDBCLK	R	1h	This field indicates the state of the GPIO1_GDBCLK clock in the domain. 0x0 = Inact : Corresponding clock is gated 0x1 = Act : Corresponding clock is active
18	Reserved	R	1h	Reserved.
17	CLKACTIVITY_LCDC_GCLK	R	0h	This field indicates the state of the LCD clock in the domain. 0x0 = Inact : Corresponding clock is gated 0x1 = Act : Corresponding clock is active
16	CLKACTIVITY_TIMER4_GCLK	R	0h	This field indicates the state of the TIMER4 CLKTIMER clock in the domain. 0x0 = Inact : Corresponding clock is gated 0x1 = Act : Corresponding clock is active
15	CLKACTIVITY_TIMER3_GCLK	R	0h	This field indicates the state of the TIMER3 CLKTIMER clock in the domain. 0x0 = Inact : Corresponding clock is gated 0x1 = Act : Corresponding clock is active
14	CLKACTIVITY_TIMER2_GCLK	R	0h	This field indicates the state of the TIMER2 CLKTIMER clock in the domain. 0x0 = Inact : Corresponding clock is gated 0x1 = Act : Corresponding clock is active
13	CLKACTIVITY_TIMER7_GCLK	R	0h	This field indicates the state of the TIMER7 CLKTIMER clock in the domain. 0x0 = Inact : Corresponding clock is gated 0x1 = Act : Corresponding clock is active
12	Reserved	R	0h	
11	CLKACTIVITY_CAN_CLK	R	0h	This field indicates the state of the CAN_CLK clock in the domain. 0x0 = Inact : Corresponding clock is gated 0x1 = Act : Corresponding clock is active
10	CLKACTIVITY_UART_GFCLK	R	0h	This field indicates the state of the UART_GFCLK clock in the domain. 0x0 = Inact : Corresponding clock is gated 0x1 = Act : Corresponding clock is active
9	Reserved	R	0h	
8	CLKACTIVITY_L4LS_GCLK	R	1h	This field indicates the state of the L4LS_GCLK clock in the domain. 0x0 = Inact : Corresponding clock is gated 0x1 = Act : Corresponding clock is active
7-2	Reserved	R	0h	
1-0	CLKTRCTRL	R/W	2h	Controls the clock state transition of the L4 SLOW clock domain in PER power domain. 0x0 = NO_SLEEP : NO_SLEEP: Sleep transition cannot be initiated. Wakeup transition may however occur. 0x1 = SW_SLEEP : SW_SLEEP: Start a software forced sleep transition on the domain. 0x2 = SW_WKUP : SW_WKUP: Start a software forced wake-up transition on the domain. 0x3 = Reserved : Reserved.

8.1.12.1.2 CM_PER_L3S_CLKSTCTRL Register (offset = 4h) [reset = Ah]

CM_PER_L3S_CLKSTCTRL is shown in Figure 8-24 and described in Table 8-31.

This register enables the domain power state transition. It controls the SW supervised clock domain state transition between ON-ACTIVE and ON-INACTIVE states. It also hold one status bit per clock input of the domain.

Figure 8-24. CM_PER_L3S_CLKSTCTRL Register

31	30	29	28	27	26	25	24
Reserved						Reserved	
R-0h						R-0h	
23	22	21	20	19	18	17	16
Reserved							
R-0h							
15	14	13	12	11	10	9	8
Reserved					Reserved	Reserved	Reserved
R-0h					R-0h	R-0h	R-0h
7	6	5	4	3	2	1	0
Reserved		Reserved	CLKACTIVITY_	Reserved	CLKTRCTRL		
R-0h		R-0h	L3S_GCLK	R-0h	R/W-2h		
			R-1h				

LEGEND: R/W = Read/Write; R = Read only; W1toCl = Write 1 to clear bit; -n = value after reset

Table 8-31. CM_PER_L3S_CLKSTCTRL Register Field Descriptions

Bit	Field	Type	Reset	Description
31-26	Reserved	R	0h	
25-11	Reserved	R	0h	
10	Reserved	R	0h	
9	Reserved	R	0h	
8	Reserved	R	0h	
7-5	Reserved	R	0h	
4	Reserved	R	0h	
3	CLKACTIVITY_L3S_GCLK	R	1h	This field indicates the state of the L3S_GCLK clock in the domain. 0x0 = Inact 0x1 = Act
2	Reserved	R	0h	
1-0	CLKTRCTRL	R/W	2h	Controls the clock state transition of the L3 Slow clock domain. 0x0 = NO_SLEEP : NO_SLEEP: Sleep transition cannot be initiated. Wakeup transition may however occur. 0x1 = SW_SLEEP : SW_SLEEP: Start a software forced sleep transition on the domain. 0x2 = SW_WKUP : SW_WKUP: Start a software forced wake-up transition on the domain. 0x3 = Reserved : Reserved.

8.1.12.1.3 CM_PER_L3_CLKSTCTRL Register (offset = Ch) [reset = 12h]

CM_PER_L3_CLKSTCTRL is shown in [Figure 8-25](#) and described in [Table 8-32](#).

This register enables the domain power state transition. It controls the SW supervised clock domain state transition between ON-ACTIVE and ON-INACTIVE states. It also hold one status bit per clock input of the domain.

Figure 8-25. CM_PER_L3_CLKSTCTRL Register

31	30	29	28	27	26	25	24
Reserved							
R-0h							
23	22	21	20	19	18	17	16
Reserved							
R-0h							
15	14	13	12	11	10	9	8
Reserved							
R-0h							
7	6	5	4	3	2	1	0
CLKACTIVITY_ MCASP_GCLK	CLKACTIVITY_ CPTS_RFT_G CLK	Reserved	CLKACTIVITY_ L3_GCLK	CLKACTIVITY_ MMC_FCLK	CLKACTIVITY_ EMIF_GCLK	CLKTRCTRL	
R-0h	R-0h	R-0h	R-1h	R-0h	R-0h	R/W-2h	

LEGEND: R/W = Read/Write; R = Read only; W1toCl = Write 1 to clear bit; -n = value after reset

Table 8-32. CM_PER_L3_CLKSTCTRL Register Field Descriptions

Bit	Field	Type	Reset	Description
31-8	Reserved	R	0h	
7	CLKACTIVITY_MCASP_GCLK	R	0h	This field indicates the state of the MCASP_GCLK clock in the domain. 0x0 = Inact 0x1 = Act
6	CLKACTIVITY_CPTS_RFT_GCLK	R	0h	This field indicates the state of the CLKACTIVITY_CPTS_RFT_GCLK clock in the domain. 0x0 = Inact 0x1 = Act
5	Reserved	R	0h	
4	CLKACTIVITY_L3_GCLK	R	1h	This field indicates the state of the L3_GCLK clock in the domain. 0x0 = Inact 0x1 = Act
3	CLKACTIVITY_MMC_FCLK	R	0h	This field indicates the state of the MMC_GCLK clock in the domain. 0x0 = Inact 0x1 = Act
2	CLKACTIVITY_EMIF_GCLK	R	0h	This field indicates the state of the EMIF_GCLK clock in the domain. 0x0 = Inact 0x1 = Act
1-0	CLKTRCTRL	R/W	2h	Controls the clock state transition of the L3 clock domain. 0x0 = NO_SLEEP : NO_SLEEP: Sleep transition cannot be initiated. Wakeup transition may however occur. 0x1 = SW_SLEEP : SW_SLEEP: Start a software forced sleep transition on the domain. 0x2 = SW_WKUP : SW_WKUP: Start a software forced wake-up transition on the domain. 0x3 = Reserved : Reserved.

8.1.12.1.4 CM_PER_CPGMAC0_CLKCTRL Register (offset = 14h) [reset = 70000h]

CM_PER_CPGMAC0_CLKCTRL is shown in [Figure 8-26](#) and described in [Table 8-33](#).

This register manages the CPSW clocks.

Figure 8-26. CM_PER_CPGMAC0_CLKCTRL Register

31	30	29	28	27	26	25	24
Reserved							
R-0h							
23	22	21	20	19	18	17	16
Reserved				STBYST		IDLEST	
R-0h				R-1h		R-3h	
15	14	13	12	11	10	9	8
Reserved							
R-0h							
7	6	5	4	3	2	1	0
Reserved						MODULEMODE	
R-0h						R/W-0h	

LEGEND: R/W = Read/Write; R = Read only; W1toCl = Write 1 to clear bit; -n = value after reset

Table 8-33. CM_PER_CPGMAC0_CLKCTRL Register Field Descriptions

Bit	Field	Type	Reset	Description
31-19	Reserved	R	0h	
18	STBYST	R	1h	Module standby status. This bit is warm reset insensitive when CPSW RESET_ISO is enabled 0x0 = Func : Module is functional (not in standby) 0x1 = Standby : Module is in standby
17-16	IDLEST	R	3h	Module idle status. This bit is warm reset insensitive when CPSW RESET_ISO is enabled 0x0 = Func : Module is fully functional, including OCP 0x1 = Trans : Module is performing transition: wakeup, or sleep, or sleep abortion 0x2 = Idle : Module is in Idle mode (only OCP part). It is functional if using separate functional clock 0x3 = Disable : Module is disabled and cannot be accessed
15-2	Reserved	R	0h	
1-0	MODULEMODE	R/W	0h	Control the way mandatory clocks are managed. This bit is warm reset insensitive when CPSW RESET_ISO is enabled 0x0 = DISABLED : Module is disable by SW. Any OCP access to module results in an error, except if resulting from a module wakeup (asynchronous wakeup). 0x1 = RESERVED_1 : Reserved 0x2 = ENABLE : Module is explicitly enabled. Interface clock (if not used for functions) may be gated according to the clock domain state. Functional clocks are guaranteed to stay present. As long as in this configuration, power domain sleep transition cannot happen. 0x3 = RESERVED : Reserved

8.1.12.1.5 CM_PER_LCDC_CLKCTRL Register (offset = 18h) [reset = 7000h]

 CM_PER_LCDC_CLKCTRL is shown in [Figure 8-27](#) and described in [Table 8-34](#).

This register manages the LCD clocks.

Figure 8-27. CM_PER_LCDC_CLKCTRL Register

31	30	29	28	27	26	25	24
Reserved							
R-0h							
23	22	21	20	19	18	17	16
Reserved					STBYST	IDLEST	
R-0h					R-1h	R-3h	
15	14	13	12	11	10	9	8
Reserved							
R-0h							
7	6	5	4	3	2	1	0
Reserved						MODULEMODE	
R-0h						R/W-0h	

LEGEND: R/W = Read/Write; R = Read only; W1toCl = Write 1 to clear bit; -n = value after reset

Table 8-34. CM_PER_LCDC_CLKCTRL Register Field Descriptions

Bit	Field	Type	Reset	Description
31-19	Reserved	R	0h	
18	STBYST	R	1h	Module standby status. 0x0 = Func : Module is functional (not in standby) 0x1 = Standby : Module is in standby
17-16	IDLEST	R	3h	Module idle status. 0x0 = Func : Module is fully functional, including OCP 0x1 = Trans : Module is performing transition: wakeup, or sleep, or sleep abortion 0x2 = Idle : Module is in Idle mode (only OCP part). It is functional if using separate functional clock 0x3 = Disable : Module is disabled and cannot be accessed
15-2	Reserved	R	0h	
1-0	MODULEMODE	R/W	0h	Control the way mandatory clocks are managed. 0x0 = DISABLED : Module is disable by SW. Any OCP access to module results in an error, except if resulting from a module wakeup (asynchronous wakeup). 0x1 = RESERVED_1 : Reserved 0x2 = ENABLE : Module is explicitly enabled. Interface clock (if not used for functions) may be gated according to the clock domain state. Functional clocks are guaranteed to stay present. As long as in this configuration, power domain sleep transition cannot happen. 0x3 = RESERVED : Reserved

8.1.12.1.6 CM_PER_USB0_CLKCTRL Register (offset = 1Ch) [reset = 70000h]

CM_PER_USB0_CLKCTRL is shown in [Figure 8-28](#) and described in [Table 8-35](#).

This register manages the USB clocks.

Figure 8-28. CM_PER_USB0_CLKCTRL Register

31	30	29	28	27	26	25	24
Reserved							
R-0h							
23	22	21	20	19	18	17	16
Reserved				STBYST		IDLEST	
R-0h				R-1h		R-3h	
15	14	13	12	11	10	9	8
Reserved							
R-0h							
7	6	5	4	3	2	1	0
Reserved						MODULEMODE	
R-0h						R/W-0h	

LEGEND: R/W = Read/Write; R = Read only; W1toCl = Write 1 to clear bit; -n = value after reset

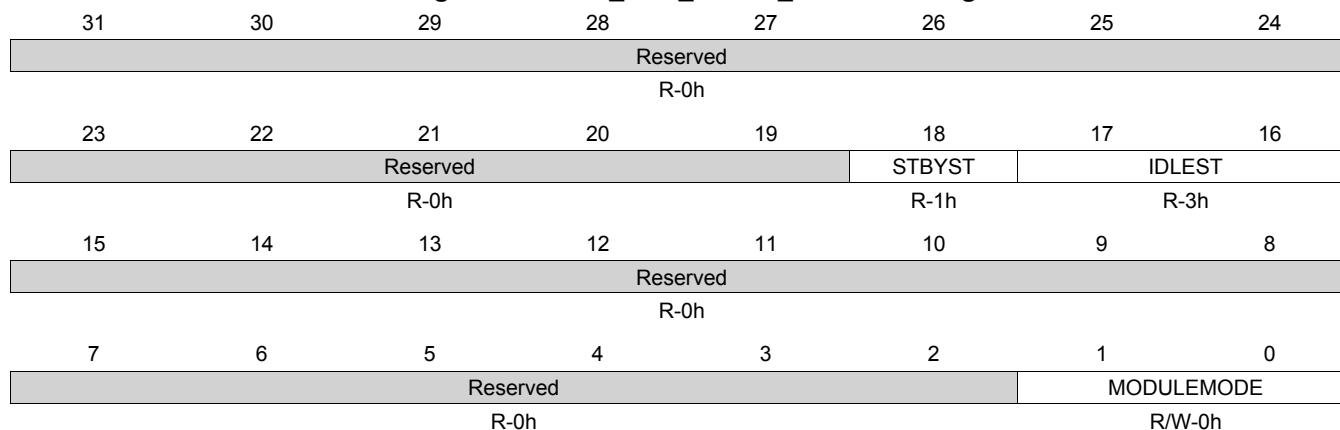
Table 8-35. CM_PER_USB0_CLKCTRL Register Field Descriptions

Bit	Field	Type	Reset	Description
31-19	Reserved	R	0h	
18	STBYST	R	1h	Module standby status. 0x0 = Func : Module is functional (not in standby) 0x1 = Standby : Module is in standby
17-16	IDLEST	R	3h	Module idle status. 0x0 = Func : Module is fully functional, including OCP 0x1 = Trans : Module is performing transition: wakeup, or sleep, or sleep abortion 0x2 = Idle : Module is in Idle mode (only OCP part). It is functional if using separate functional clock 0x3 = Disable : Module is disabled and cannot be accessed
15-2	Reserved	R	0h	
1-0	MODULEMODE	R/W	0h	Control the way mandatory clocks are managed. 0x0 = DISABLED : Module is disable by SW. Any OCP access to module results in an error, except if resulting from a module wakeup (asynchronous wakeup). 0x1 = RESERVED_1 : Reserved 0x2 = ENABLE : Module is explicitly enabled. Interface clock (if not used for functions) may be gated according to the clock domain state. Functional clocks are guaranteed to stay present. As long as in this configuration, power domain sleep transition cannot happen. 0x3 = RESERVED : Reserved

8.1.12.1.7 CM_PER_TPTC0_CLKCTRL Register (offset = 24h) [reset = 70000h]

 CM_PER_TPTC0_CLKCTRL is shown in [Figure 8-29](#) and described in [Table 8-36](#).

This register manages the TPTC clocks.

Figure 8-29. CM_PER_TPTC0_CLKCTRL Register


LEGEND: R/W = Read/Write; R = Read only; W1toCl = Write 1 to clear bit; -n = value after reset

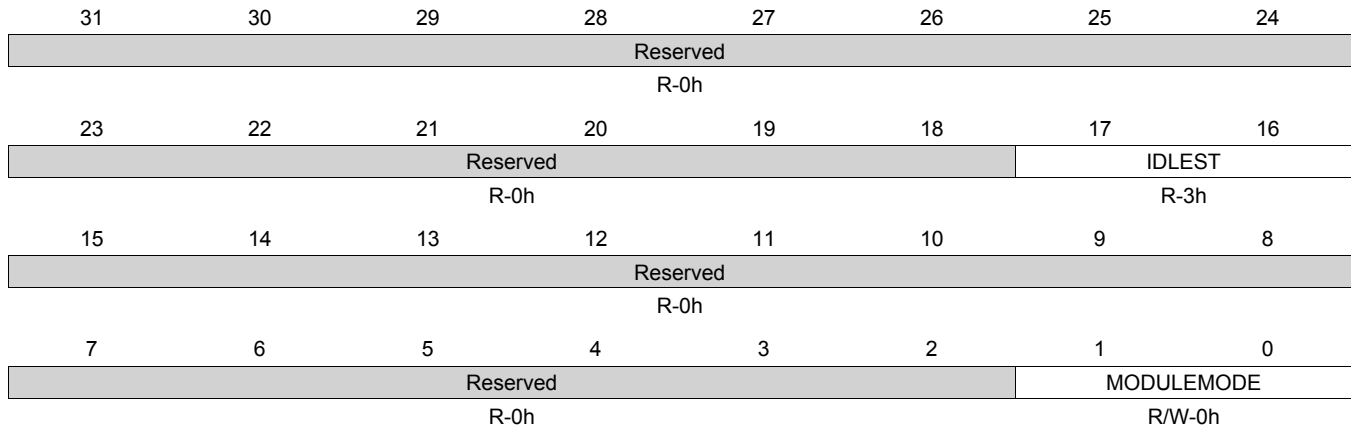
Table 8-36. CM_PER_TPTC0_CLKCTRL Register Field Descriptions

Bit	Field	Type	Reset	Description
31-19	Reserved	R	0h	
18	STBYST	R	1h	Module standby status. 0x0 = Func : Module is functional (not in standby) 0x1 = Standby : Module is in standby
17-16	IDLEST	R	3h	Module idle status. 0x0 = Func : Module is fully functional, including OCP 0x1 = Trans : Module is performing transition: wakeup, or sleep, or sleep abortion 0x2 = Idle : Module is in Idle mode (only OCP part). It is functional if using separate functional clock 0x3 = Disable : Module is disabled and cannot be accessed
15-2	Reserved	R	0h	
1-0	MODULEMODE	R/W	0h	Control the way mandatory clocks are managed. 0x0 = DISABLED : Module is disable by SW. Any OCP access to module results in an error, except if resulting from a module wakeup (asynchronous wakeup). 0x1 = RESERVED_1 : Reserved 0x2 = ENABLE : Module is explicitly enabled. Interface clock (if not used for functions) may be gated according to the clock domain state. Functional clocks are guaranteed to stay present. As long as in this configuration, power domain sleep transition cannot happen. 0x3 = RESERVED : Reserved

8.1.12.1.8 CM_PER_EMIF_CLKCTRL Register (offset = 28h) [reset = 30000h]

CM_PER_EMIF_CLKCTRL is shown in [Figure 8-30](#) and described in [Table 8-37](#).

This register manages the EMIF clocks.

Figure 8-30. CM_PER_EMIF_CLKCTRL Register


LEGEND: R/W = Read/Write; R = Read only; W1toCl = Write 1 to clear bit; -n = value after reset

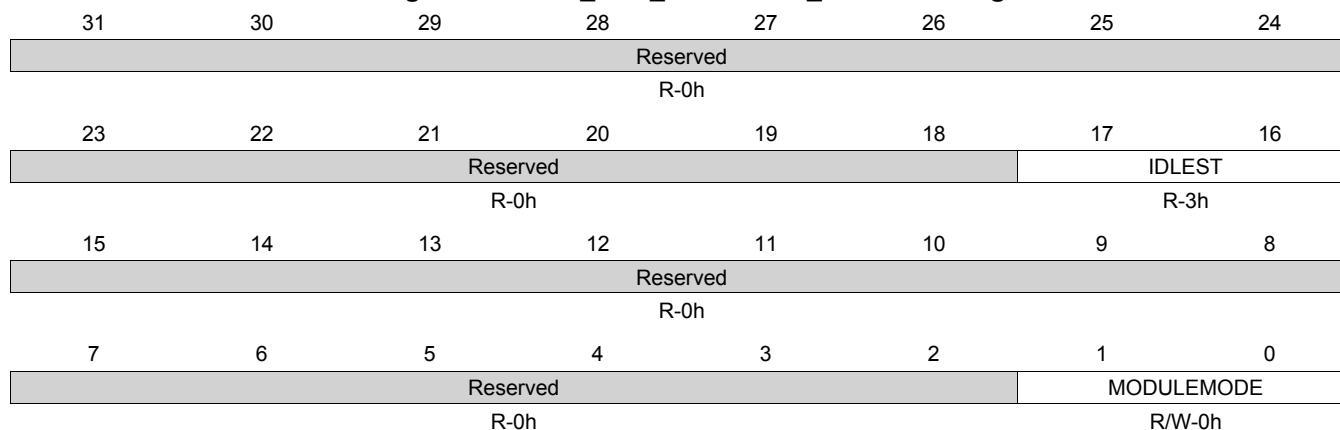
Table 8-37. CM_PER_EMIF_CLKCTRL Register Field Descriptions

Bit	Field	Type	Reset	Description
31-18	Reserved	R	0h	
17-16	IDLEST	R	3h	Module idle status. 0x0 = Func : Module is fully functional, including OCP 0x1 = Trans : Module is performing transition: wakeup, or sleep, or sleep abortion 0x2 = Idle : Module is in Idle mode (only OCP part). It is functional if using separate functional clock 0x3 = Disable : Module is disabled and cannot be accessed
15-2	Reserved	R	0h	
1-0	MODULEMODE	R/W	0h	Control the way mandatory clocks are managed. 0x0 = DISABLED : Module is disable by SW. Any OCP access to module results in an error, except if resulting from a module wakeup (asynchronous wakeup). 0x1 = RESERVED_1 : Reserved 0x2 = ENABLE : Module is explicitly enabled. Interface clock (if not used for functions) may be gated according to the clock domain state. Functional clocks are guaranteed to stay present. As long as in this configuration, power domain sleep transition cannot happen. 0x3 = RESERVED : Reserved

8.1.12.1.9 CM_PER_OCMCRAM_CLKCTRL Register (offset = 2Ch) [reset = 30000h]

CM_PER_OCMCRAM_CLKCTRL is shown in Figure 8-31 and described in Table 8-38.

This register manages the OCMC clocks.

Figure 8-31. CM_PER_OCMCRAM_CLKCTRL Register


LEGEND: R/W = Read/Write; R = Read only; W1toCl = Write 1 to clear bit; -n = value after reset

Table 8-38. CM_PER_OCMCRAM_CLKCTRL Register Field Descriptions

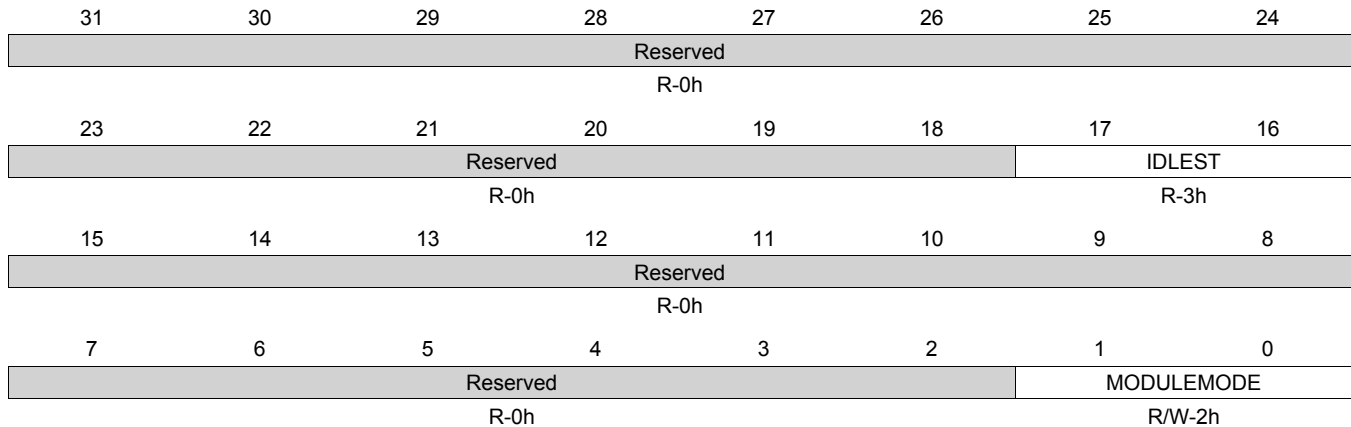
Bit	Field	Type	Reset	Description
31-18	Reserved	R	0h	
17-16	IDLEST	R	3h	Module idle status. 0x0 = Func : Module is fully functional, including OCP 0x1 = Trans : Module is performing transition: wakeup, or sleep, or sleep abortion 0x2 = Idle : Module is in Idle mode (only OCP part). It is functional if using separate functional clock 0x3 = Disable : Module is disabled and cannot be accessed
15-2	Reserved	R	0h	
1-0	MODULEMODE	R/W	0h	Control the way mandatory clocks are managed. 0x0 = DISABLED : Module is disable by SW. Any OCP access to module results in an error, except if resulting from a module wakeup (asynchronous wakeup). 0x1 = RESERVED_1 : Reserved 0x2 = ENABLE : Module is explicitly enabled. Interface clock (if not used for functions) may be gated according to the clock domain state. Functional clocks are guaranteed to stay present. As long as in this configuration, power domain sleep transition cannot happen. 0x3 = RESERVED : Reserved

8.1.12.1.10 CM_PER_GPMC_CLKCTRL Register (offset = 30h) [reset = 3002h]

CM_PER_GPMC_CLKCTRL is shown in [Figure 8-32](#) and described in [Table 8-39](#).

This register manages the GPMC clocks.

Figure 8-32. CM_PER_GPMC_CLKCTRL Register



LEGEND: R/W = Read/Write; R = Read only; W1toCl = Write 1 to clear bit; -n = value after reset

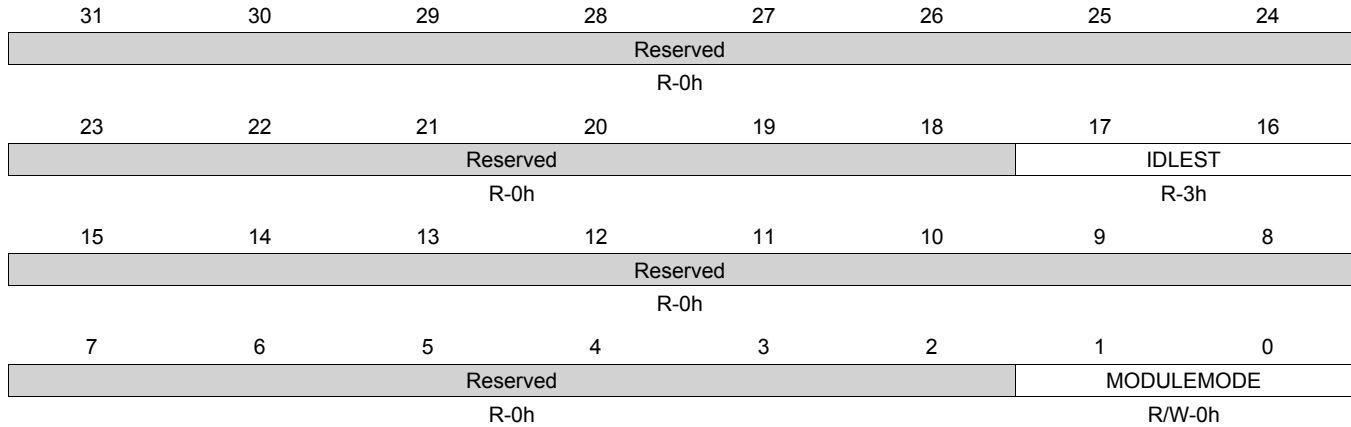
Table 8-39. CM_PER_GPMC_CLKCTRL Register Field Descriptions

Bit	Field	Type	Reset	Description
31-18	Reserved	R	0h	
17-16	IDLEST	R	3h	Module idle status. 0x0 = Func : Module is fully functional, including OCP 0x1 = Trans : Module is performing transition: wakeup, or sleep, or sleep abortion 0x2 = Idle : Module is in Idle mode (only OCP part). It is functional if using separate functional clock 0x3 = Disable : Module is disabled and cannot be accessed
15-2	Reserved	R	0h	
1-0	MODULEMODE	R/W	2h	Control the way mandatory clocks are managed. 0x0 = DISABLED : Module is disable by SW. Any OCP access to module results in an error, except if resulting from a module wakeup (asynchronous wakeup). 0x1 = RESERVED_1 : Reserved 0x2 = ENABLE : Module is explicitly enabled. Interface clock (if not used for functions) may be gated according to the clock domain state. Functional clocks are guaranteed to stay present. As long as in this configuration, power domain sleep transition cannot happen. 0x3 = RESERVED : Reserved

8.1.12.1.11 CM_PER_MCASP0_CLKCTRL Register (offset = 34h) [reset = 30000h]

 CM_PER_MCASP0_CLKCTRL is shown in [Figure 8-33](#) and described in [Table 8-40](#).

This register manages the MCASP0 clocks.

Figure 8-33. CM_PER_MCASP0_CLKCTRL Register


LEGEND: R/W = Read/Write; R = Read only; W1toCl = Write 1 to clear bit; -n = value after reset

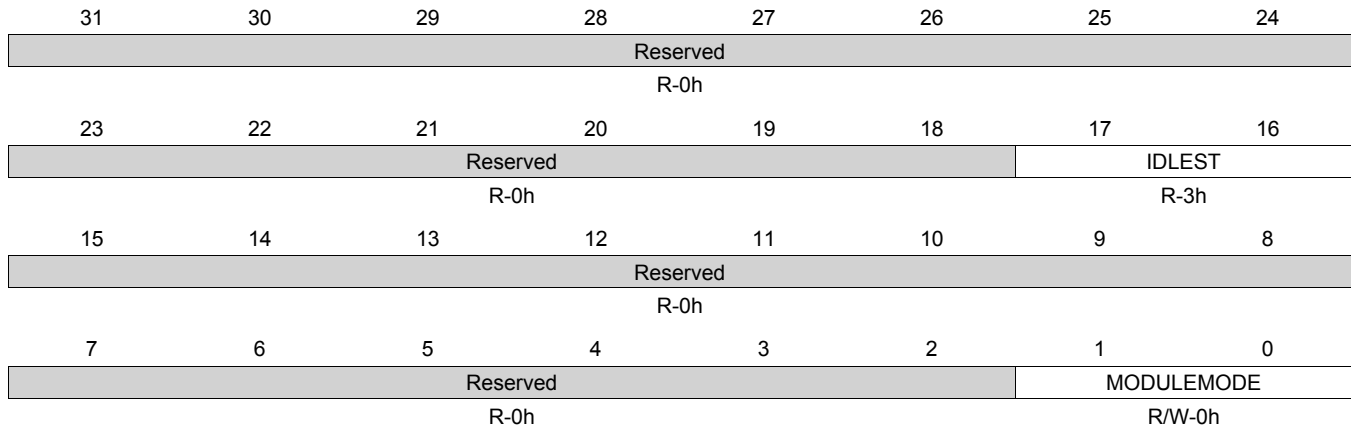
Table 8-40. CM_PER_MCASP0_CLKCTRL Register Field Descriptions

Bit	Field	Type	Reset	Description
31-18	Reserved	R	0h	
17-16	IDLEST	R	3h	Module idle status. 0x0 = Func : Module is fully functional, including OCP 0x1 = Trans : Module is performing transition: wakeup, or sleep, or sleep abortion 0x2 = Idle : Module is in Idle mode (only OCP part). It is functional if using separate functional clock 0x3 = Disable : Module is disabled and cannot be accessed
15-2	Reserved	R	0h	
1-0	MODULEMODE	R/W	0h	Control the way mandatory clocks are managed. 0x0 = DISABLED : Module is disable by SW. Any OCP access to module results in an error, except if resulting from a module wakeup (asynchronous wakeup). 0x1 = RESERVED_1 : Reserved 0x2 = ENABLE : Module is explicitly enabled. Interface clock (if not used for functions) may be gated according to the clock domain state. Functional clocks are guaranteed to stay present. As long as in this configuration, power domain sleep transition cannot happen. 0x3 = RESERVED : Reserved

8.1.12.1.12 CM_PER_UART5_CLKCTRL Register (offset = 38h) [reset = 30000h]

CM_PER_UART5_CLKCTRL is shown in [Figure 8-34](#) and described in [Table 8-41](#).

This register manages the UART5 clocks.

Figure 8-34. CM_PER_UART5_CLKCTRL Register


LEGEND: R/W = Read/Write; R = Read only; W1toCl = Write 1 to clear bit; -n = value after reset

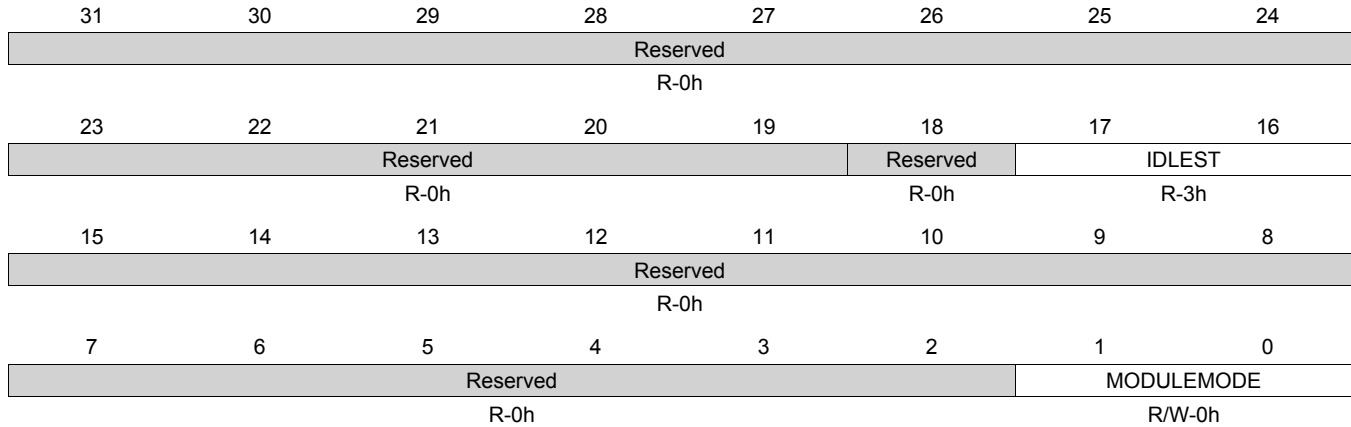
Table 8-41. CM_PER_UART5_CLKCTRL Register Field Descriptions

Bit	Field	Type	Reset	Description
31-18	Reserved	R	0h	
17-16	IDLEST	R	3h	Module idle status. 0x0 = Func : Module is fully functional, including OCP 0x1 = Trans : Module is performing transition: wakeup, or sleep, or sleep abortion 0x2 = Idle : Module is in Idle mode (only OCP part). It is functional if using separate functional clock 0x3 = Disable : Module is disabled and cannot be accessed
15-2	Reserved	R	0h	
1-0	MODULEMODE	R/W	0h	Control the way mandatory clocks are managed. 0x0 = DISABLED : Module is disable by SW. Any OCP access to module results in an error, except if resulting from a module wakeup (asynchronous wakeup). 0x1 = RESERVED_1 : Reserved 0x2 = ENABLE : Module is explicitly enabled. Interface clock (if not used for functions) may be gated according to the clock domain state. Functional clocks are guaranteed to stay present. As long as in this configuration, power domain sleep transition cannot happen. 0x3 = RESERVED : Reserved

8.1.12.1.13 CM_PER_MMC0_CLKCTRL Register (offset = 3Ch) [reset = 30000h]

CM_PER_MMC0_CLKCTRL is shown in [Figure 8-35](#) and described in [Table 8-42](#).

This register manages the MMC0 clocks.

Figure 8-35. CM_PER_MMC0_CLKCTRL Register


LEGEND: R/W = Read/Write; R = Read only; W1toCl = Write 1 to clear bit; -n = value after reset

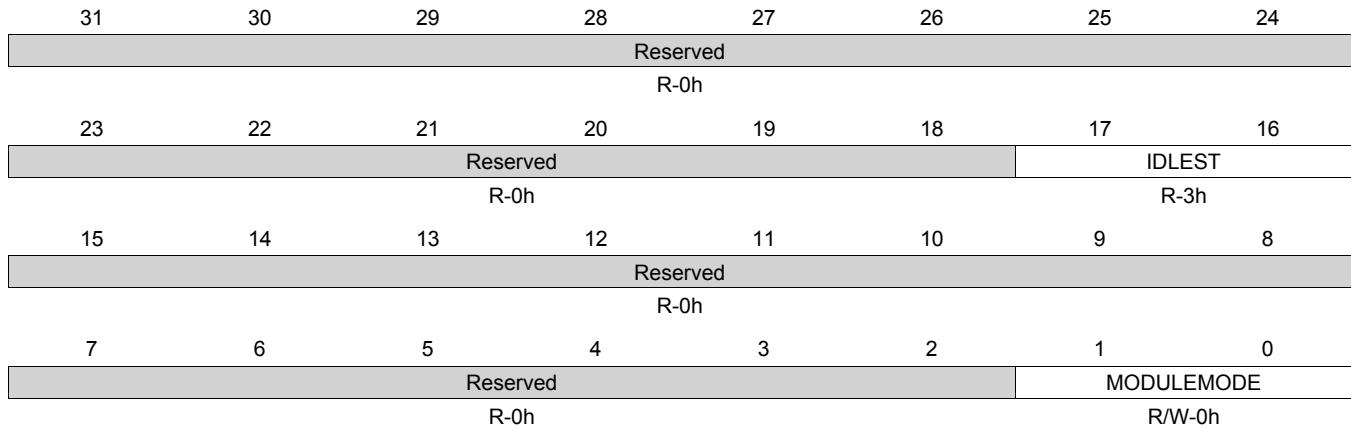
Table 8-42. CM_PER_MMC0_CLKCTRL Register Field Descriptions

Bit	Field	Type	Reset	Description
31-19	Reserved	R	0h	
18	Reserved	R	0h	
17-16	IDLEST	R	3h	Module idle status. 0x0 = Func : Module is fully functional, including OCP 0x1 = Trans : Module is performing transition: wakeup, or sleep, or sleep abortion 0x2 = Idle : Module is in Idle mode (only OCP part). It is functional if using separate functional clock 0x3 = Disable : Module is disabled and cannot be accessed
15-2	Reserved	R	0h	
1-0	MODULEMODE	R/W	0h	Control the way mandatory clocks are managed. 0x0 = DISABLED : Module is disable by SW. Any OCP access to module results in an error, except if resulting from a module wakeup (asynchronous wakeup). 0x1 = RESERVED_1 : Reserved 0x2 = ENABLE : Module is explicitly enabled. Interface clock (if not used for functions) may be gated according to the clock domain state. Functional clocks are guaranteed to stay present. As long as in this configuration, power domain sleep transition cannot happen. 0x3 = RESERVED : Reserved

8.1.12.1.14 CM_PER_ELM_CLKCTRL Register (offset = 40h) [reset = 30000h]

CM_PER_ELM_CLKCTRL is shown in [Figure 8-36](#) and described in [Table 8-43](#).

This register manages the ELM clocks.

Figure 8-36. CM_PER_ELM_CLKCTRL Register


LEGEND: R/W = Read/Write; R = Read only; W1toCl = Write 1 to clear bit; -n = value after reset

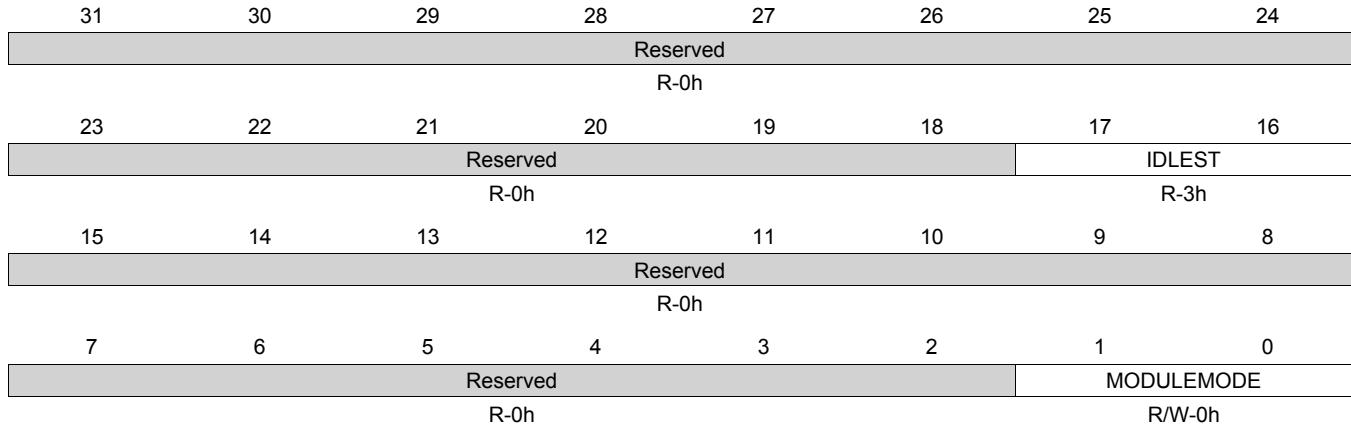
Table 8-43. CM_PER_ELM_CLKCTRL Register Field Descriptions

Bit	Field	Type	Reset	Description
31-18	Reserved	R	0h	
17-16	IDLEST	R	3h	Module idle status. 0x0 = Func : Module is fully functional, including OCP 0x1 = Trans : Module is performing transition: wakeup, or sleep, or sleep abortion 0x2 = Idle : Module is in Idle mode (only OCP part). It is functional if using separate functional clock 0x3 = Disable : Module is disabled and cannot be accessed
15-2	Reserved	R	0h	
1-0	MODULEMODE	R/W	0h	Control the way mandatory clocks are managed. 0x0 = DISABLED : Module is disable by SW. Any OCP access to module results in an error, except if resulting from a module wakeup (asynchronous wakeup). 0x1 = RESERVED_1 : Reserved 0x2 = ENABLE : Module is explicitly enabled. Interface clock (if not used for functions) may be gated according to the clock domain state. Functional clocks are guaranteed to stay present. As long as in this configuration, power domain sleep transition cannot happen. 0x3 = RESERVED : Reserved

8.1.12.1.15 CM_PER_I2C2_CLKCTRL Register (offset = 44h) [reset = 30000h]

CM_PER_I2C2_CLKCTRL is shown in [Figure 8-37](#) and described in [Table 8-44](#).

This register manages the I2C2 clocks.

Figure 8-37. CM_PER_I2C2_CLKCTRL Register


LEGEND: R/W = Read/Write; R = Read only; W1toCl = Write 1 to clear bit; -n = value after reset

Table 8-44. CM_PER_I2C2_CLKCTRL Register Field Descriptions

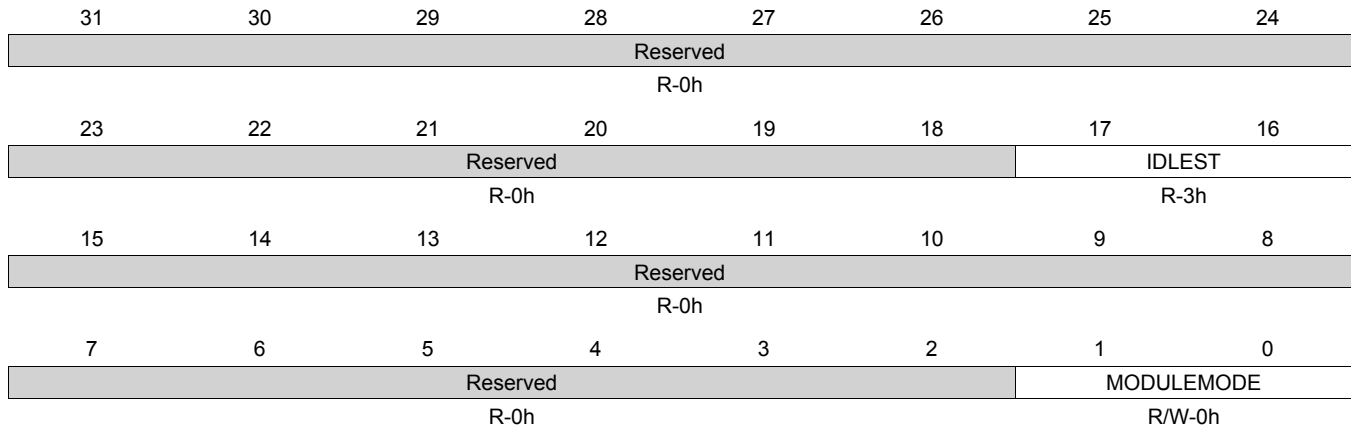
Bit	Field	Type	Reset	Description
31-18	Reserved	R	0h	
17-16	IDLEST	R	3h	Module idle status. 0x0 = Func : Module is fully functional, including OCP 0x1 = Trans : Module is performing transition: wakeup, or sleep, or sleep abortion 0x2 = Idle : Module is in Idle mode (only OCP part). It is functional if using separate functional clock 0x3 = Disable : Module is disabled and cannot be accessed
15-2	Reserved	R	0h	
1-0	MODULEMODE	R/W	0h	Control the way mandatory clocks are managed. 0x0 = DISABLED : Module is disable by SW. Any OCP access to module results in an error, except if resulting from a module wakeup (asynchronous wakeup). 0x1 = RESERVED_1 : Reserved 0x2 = ENABLE : Module is explicitly enabled. Interface clock (if not used for functions) may be gated according to the clock domain state. Functional clocks are guaranteed to stay present. As long as in this configuration, power domain sleep transition cannot happen. 0x3 = RESERVED : Reserved

8.1.12.1.16 CM_PER_I2C1_CLKCTRL Register (offset = 48h) [reset = 30000h]

CM_PER_I2C1_CLKCTRL is shown in [Figure 8-38](#) and described in [Table 8-45](#).

This register manages the I2C1 clocks.

Figure 8-38. CM_PER_I2C1_CLKCTRL Register



LEGEND: R/W = Read/Write; R = Read only; W1toCl = Write 1 to clear bit; -n = value after reset

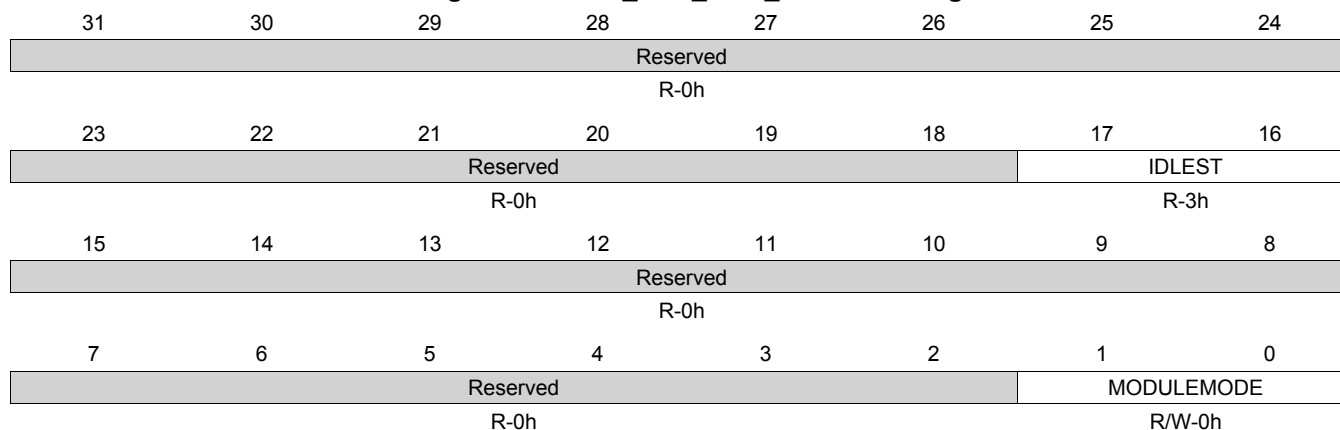
Table 8-45. CM_PER_I2C1_CLKCTRL Register Field Descriptions

Bit	Field	Type	Reset	Description
31-18	Reserved	R	0h	
17-16	IDLEST	R	3h	Module idle status. 0x0 = Func : Module is fully functional, including OCP 0x1 = Trans : Module is performing transition: wakeup, or sleep, or sleep abortion 0x2 = Idle : Module is in Idle mode (only OCP part). It is functional if using separate functional clock 0x3 = Disable : Module is disabled and cannot be accessed
15-2	Reserved	R	0h	
1-0	MODULEMODE	R/W	0h	Control the way mandatory clocks are managed. 0x0 = DISABLED : Module is disable by SW. Any OCP access to module results in an error, except if resulting from a module wakeup (asynchronous wakeup). 0x1 = RESERVED_1 : Reserved 0x2 = ENABLE : Module is explicitly enabled. Interface clock (if not used for functions) may be gated according to the clock domain state. Functional clocks are guaranteed to stay present. As long as in this configuration, power domain sleep transition cannot happen. 0x3 = RESERVED : Reserved

8.1.12.1.17 CM_PER_SPI0_CLKCTRL Register (offset = 4Ch) [reset = 30000h]

CM_PER_SPI0_CLKCTRL is shown in [Figure 8-39](#) and described in [Table 8-46](#).

This register manages the SPI0 clocks.

Figure 8-39. CM_PER_SPI0_CLKCTRL Register


LEGEND: R/W = Read/Write; R = Read only; W1toCl = Write 1 to clear bit; -n = value after reset

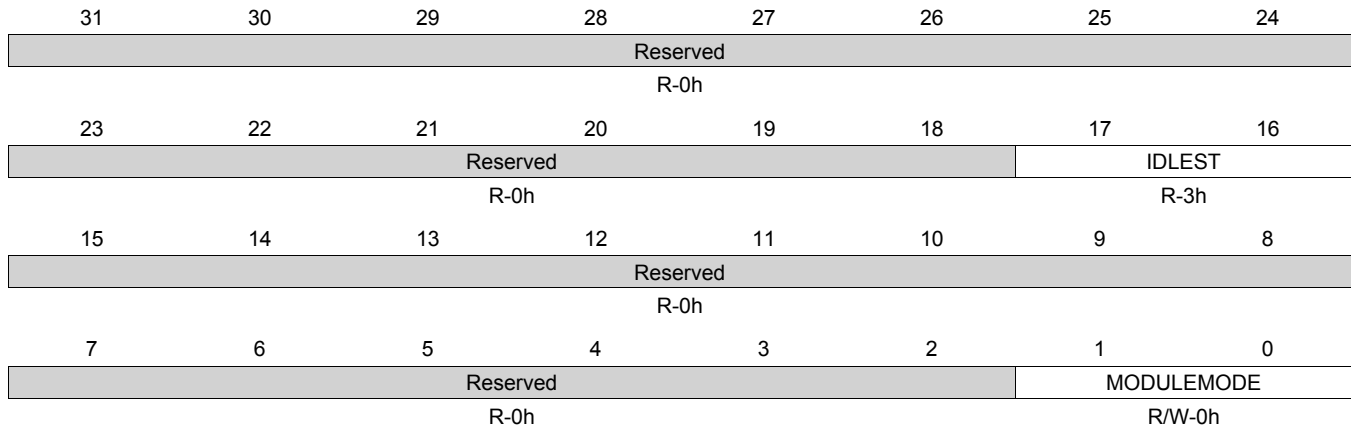
Table 8-46. CM_PER_SPI0_CLKCTRL Register Field Descriptions

Bit	Field	Type	Reset	Description
31-18	Reserved	R	0h	
17-16	IDLEST	R	3h	Module idle status. 0x0 = Func : Module is fully functional, including OCP 0x1 = Trans : Module is performing transition: wakeup, or sleep, or sleep abortion 0x2 = Idle : Module is in Idle mode (only OCP part). It is functional if using separate functional clock 0x3 = Disable : Module is disabled and cannot be accessed
15-2	Reserved	R	0h	
1-0	MODULEMODE	R/W	0h	Control the way mandatory clocks are managed. 0x0 = DISABLED : Module is disable by SW. Any OCP access to module results in an error, except if resulting from a module wakeup (asynchronous wakeup). 0x1 = RESERVED_1 : Reserved 0x2 = ENABLE : Module is explicitly enabled. Interface clock (if not used for functions) may be gated according to the clock domain state. Functional clocks are guaranteed to stay present. As long as in this configuration, power domain sleep transition cannot happen. 0x3 = RESERVED : Reserved

8.1.12.1.18 CM_PER_SPI1_CLKCTRL Register (offset = 50h) [reset = 30000h]

CM_PER_SPI1_CLKCTRL is shown in [Figure 8-40](#) and described in [Table 8-47](#).

This register manages the SPI1 clocks.

Figure 8-40. CM_PER_SPI1_CLKCTRL Register


LEGEND: R/W = Read/Write; R = Read only; W1toCl = Write 1 to clear bit; -n = value after reset

Table 8-47. CM_PER_SPI1_CLKCTRL Register Field Descriptions

Bit	Field	Type	Reset	Description
31-18	Reserved	R	0h	
17-16	IDLEST	R	3h	Module idle status. 0x0 = Func : Module is fully functional, including OCP 0x1 = Trans : Module is performing transition: wakeup, or sleep, or sleep abortion 0x2 = Idle : Module is in Idle mode (only OCP part). It is functional if using separate functional clock 0x3 = Disable : Module is disabled and cannot be accessed
15-2	Reserved	R	0h	
1-0	MODULEMODE	R/W	0h	Control the way mandatory clocks are managed. 0x0 = DISABLED : Module is disable by SW. Any OCP access to module results in an error, except if resulting from a module wakeup (asynchronous wakeup). 0x1 = RESERVED_1 : Reserved 0x2 = ENABLE : Module is explicitly enabled. Interface clock (if not used for functions) may be gated according to the clock domain state. Functional clocks are guaranteed to stay present. As long as in this configuration, power domain sleep transition cannot happen. 0x3 = RESERVED : Reserved

8.1.12.1.19 CM_PER_L4LS_CLKCTRL Register (offset = 60h) [reset = 2h]

CM_PER_L4LS_CLKCTRL is shown in [Figure 8-41](#) and described in [Table 8-48](#).

This register manages the L4LS clocks.

Figure 8-41. CM_PER_L4LS_CLKCTRL Register

31	30	29	28	27	26	25	24
Reserved							
R-0h							
23	22	21	20	19	18	17	16
Reserved						IDLEST	
R-0h						R-0h	
15	14	13	12	11	10	9	8
Reserved							
R-0h							
7	6	5	4	3	2	1	0
Reserved						MODULEMODE	
R-0h						R/W-2h	

LEGEND: R/W = Read/Write; R = Read only; W1toCl = Write 1 to clear bit; -n = value after reset

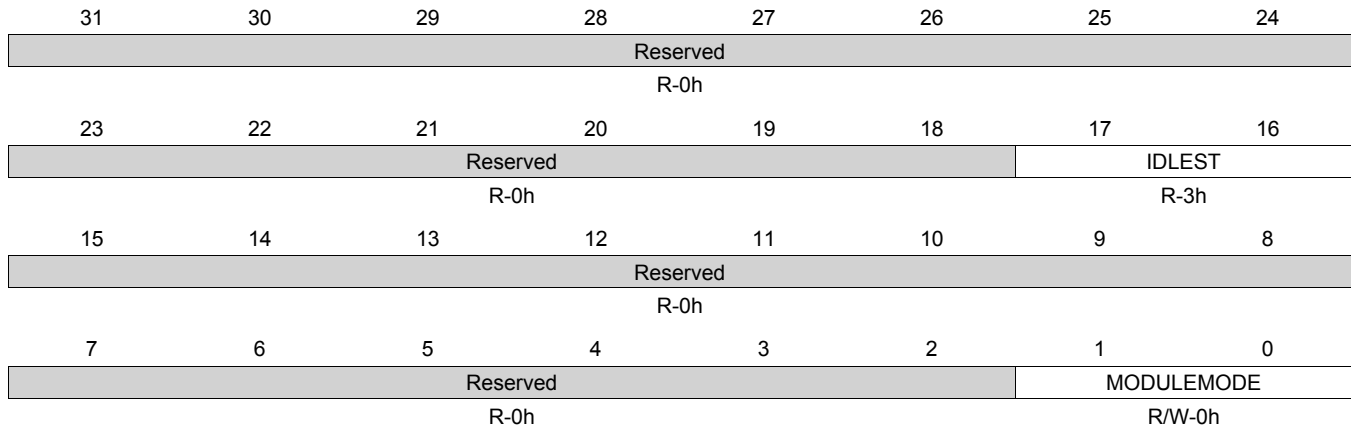
Table 8-48. CM_PER_L4LS_CLKCTRL Register Field Descriptions

Bit	Field	Type	Reset	Description
31-18	Reserved	R	0h	
17-16	IDLEST	R	0h	Module idle status. 0x0 = Func : Module is fully functional, including OCP 0x1 = Trans : Module is performing transition: wakeup, or sleep, or sleep abortion 0x2 = Idle : Module is in Idle mode (only OCP part). It is functional if using separate functional clock 0x3 = Disable : Module is disabled and cannot be accessed
15-2	Reserved	R	0h	
1-0	MODULEMODE	R/W	2h	Control the way mandatory clocks are managed. 0x0 = DISABLED : Module is disable by SW. Any OCP access to module results in an error, except if resulting from a module wakeup (asynchronous wakeup). 0x1 = RESERVED_1 : Reserved 0x2 = ENABLE : Module is explicitly enabled. Interface clock (if not used for functions) may be gated according to the clock domain state. Functional clocks are guaranteed to stay present. As long as in this configuration, power domain sleep transition cannot happen. 0x3 = RESERVED : Reserved

8.1.12.1.20 CM_PER_MCASP1_CLKCTRL Register (offset = 68h) [reset = 30000h]

CM_PER_MCASP1_CLKCTRL is shown in [Figure 8-42](#) and described in [Table 8-49](#).

This register manages the MCASP1 clocks.

Figure 8-42. CM_PER_MCASP1_CLKCTRL Register


LEGEND: R/W = Read/Write; R = Read only; W1toCl = Write 1 to clear bit; -n = value after reset

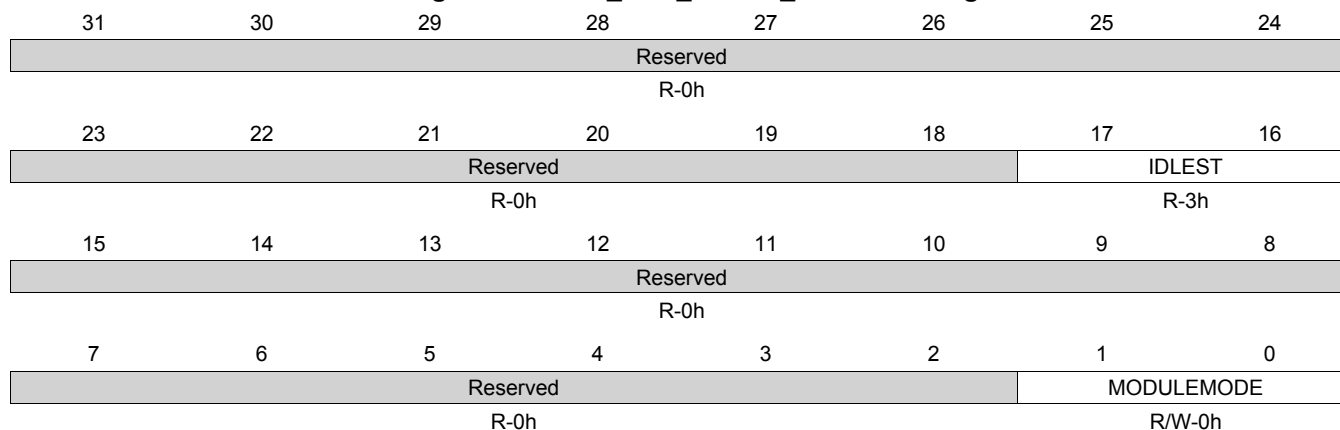
Table 8-49. CM_PER_MCASP1_CLKCTRL Register Field Descriptions

Bit	Field	Type	Reset	Description
31-18	Reserved	R	0h	
17-16	IDLEST	R	3h	Module idle status. 0x0 = Func : Module is fully functional, including OCP 0x1 = Trans : Module is performing transition: wakeup, or sleep, or sleep abortion 0x2 = Idle : Module is in Idle mode (only OCP part). It is functional if using separate functional clock 0x3 = Disable : Module is disabled and cannot be accessed
15-2	Reserved	R	0h	
1-0	MODULEMODE	R/W	0h	Control the way mandatory clocks are managed. 0x0 = DISABLED : Module is disable by SW. Any OCP access to module results in an error, except if resulting from a module wakeup (asynchronous wakeup). 0x1 = RESERVED_1 : Reserved 0x2 = ENABLE : Module is explicitly enabled. Interface clock (if not used for functions) may be gated according to the clock domain state. Functional clocks are guaranteed to stay present. As long as in this configuration, power domain sleep transition cannot happen. 0x3 = RESERVED : Reserved

8.1.12.1.21 CM_PER_UART1_CLKCTRL Register (offset = 6Ch) [reset = 30000h]

CM_PER_UART1_CLKCTRL is shown in [Figure 8-43](#) and described in [Table 8-50](#).

This register manages the UART1 clocks.

Figure 8-43. CM_PER_UART1_CLKCTRL Register


LEGEND: R/W = Read/Write; R = Read only; W1toCl = Write 1 to clear bit; -n = value after reset

Table 8-50. CM_PER_UART1_CLKCTRL Register Field Descriptions

Bit	Field	Type	Reset	Description
31-18	Reserved	R	0h	
17-16	IDLEST	R	3h	Module idle status. 0x0 = Func : Module is fully functional, including OCP 0x1 = Trans : Module is performing transition: wakeup, or sleep, or sleep abortion 0x2 = Idle : Module is in Idle mode (only OCP part). It is functional if using separate functional clock 0x3 = Disable : Module is disabled and cannot be accessed
15-2	Reserved	R	0h	
1-0	MODULEMODE	R/W	0h	Control the way mandatory clocks are managed. 0x0 = DISABLED : Module is disable by SW. Any OCP access to module results in an error, except if resulting from a module wakeup (asynchronous wakeup). 0x1 = RESERVED_1 : Reserved 0x2 = ENABLE : Module is explicitly enabled. Interface clock (if not used for functions) may be gated according to the clock domain state. Functional clocks are guaranteed to stay present. As long as in this configuration, power domain sleep transition cannot happen. 0x3 = RESERVED : Reserved

8.1.12.1.22 CM_PER_UART2_CLKCTRL Register (offset = 70h) [reset = 30000h]

CM_PER_UART2_CLKCTRL is shown in [Figure 8-44](#) and described in [Table 8-51](#).

This register manages the UART2 clocks.

Figure 8-44. CM_PER_UART2_CLKCTRL Register

31	30	29	28	27	26	25	24
Reserved							
R-0h							
23	22	21	20	19	18	17	16
Reserved						IDLEST	
R-0h						R-3h	
15	14	13	12	11	10	9	8
Reserved							
R-0h							
7	6	5	4	3	2	1	0
Reserved						MODULEMODE	
R-0h						R/W-0h	

LEGEND: R/W = Read/Write; R = Read only; W1toCl = Write 1 to clear bit; -n = value after reset

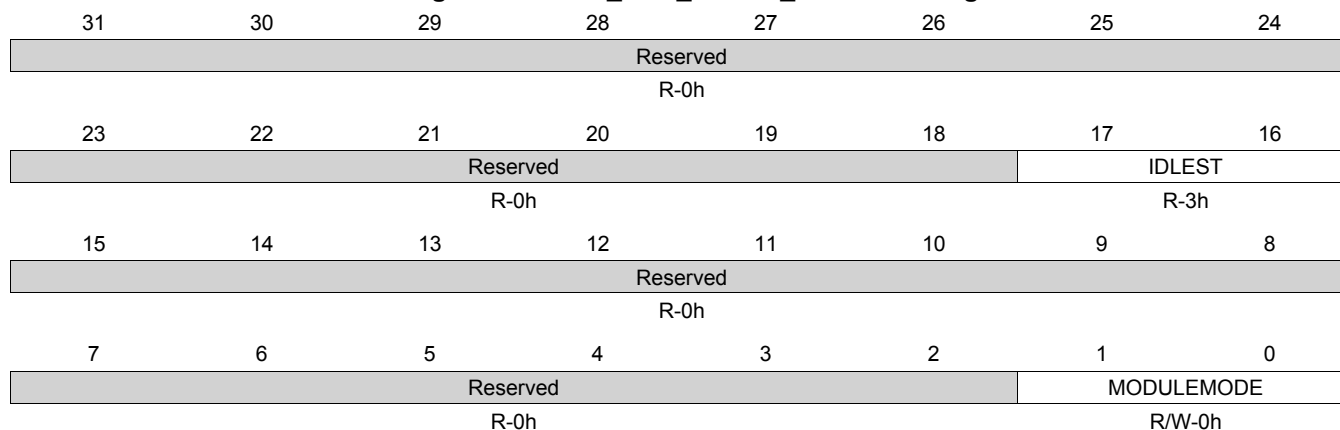
Table 8-51. CM_PER_UART2_CLKCTRL Register Field Descriptions

Bit	Field	Type	Reset	Description
31-18	Reserved	R	0h	
17-16	IDLEST	R	3h	Module idle status. 0x0 = Func : Module is fully functional, including OCP 0x1 = Trans : Module is performing transition: wakeup, or sleep, or sleep abortion 0x2 = Idle : Module is in Idle mode (only OCP part). It is functional if using separate functional clock 0x3 = Disable : Module is disabled and cannot be accessed
15-2	Reserved	R	0h	
1-0	MODULEMODE	R/W	0h	Control the way mandatory clocks are managed. 0x0 = DISABLED : Module is disable by SW. Any OCP access to module results in an error, except if resulting from a module wakeup (asynchronous wakeup). 0x1 = RESERVED_1 : Reserved 0x2 = ENABLE : Module is explicitly enabled. Interface clock (if not used for functions) may be gated according to the clock domain state. Functional clocks are guaranteed to stay present. As long as in this configuration, power domain sleep transition cannot happen. 0x3 = RESERVED : Reserved

8.1.12.1.23 CM_PER_UART3_CLKCTRL Register (offset = 74h) [reset = 30000h]

CM_PER_UART3_CLKCTRL is shown in [Figure 8-45](#) and described in [Table 8-52](#).

This register manages the UART3 clocks.

Figure 8-45. CM_PER_UART3_CLKCTRL Register


LEGEND: R/W = Read/Write; R = Read only; W1toCl = Write 1 to clear bit; -n = value after reset

Table 8-52. CM_PER_UART3_CLKCTRL Register Field Descriptions

Bit	Field	Type	Reset	Description
31-18	Reserved	R	0h	
17-16	IDLEST	R	3h	Module idle status. 0x0 = Func : Module is fully functional, including OCP 0x1 = Trans : Module is performing transition: wakeup, or sleep, or sleep abortion 0x2 = Idle : Module is in Idle mode (only OCP part). It is functional if using separate functional clock 0x3 = Disable : Module is disabled and cannot be accessed
15-2	Reserved	R	0h	
1-0	MODULEMODE	R/W	0h	Control the way mandatory clocks are managed. 0x0 = DISABLED : Module is disable by SW. Any OCP access to module results in an error, except if resulting from a module wakeup (asynchronous wakeup). 0x1 = RESERVED_1 : Reserved 0x2 = ENABLE : Module is explicitly enabled. Interface clock (if not used for functions) may be gated according to the clock domain state. Functional clocks are guaranteed to stay present. As long as in this configuration, power domain sleep transition cannot happen. 0x3 = RESERVED : Reserved

8.1.12.1.24 CM_PER_UART4_CLKCTRL Register (offset = 78h) [reset = 30000h]

CM_PER_UART4_CLKCTRL is shown in [Figure 8-46](#) and described in [Table 8-53](#).

This register manages the UART4 clocks.

Figure 8-46. CM_PER_UART4_CLKCTRL Register

31	30	29	28	27	26	25	24
Reserved							
R-0h							
23	22	21	20	19	18	17	16
Reserved						IDLEST	
R-0h						R-3h	
15	14	13	12	11	10	9	8
Reserved							
R-0h							
7	6	5	4	3	2	1	0
Reserved						MODULEMODE	
R-0h						R/W-0h	

LEGEND: R/W = Read/Write; R = Read only; W1toCl = Write 1 to clear bit; -n = value after reset

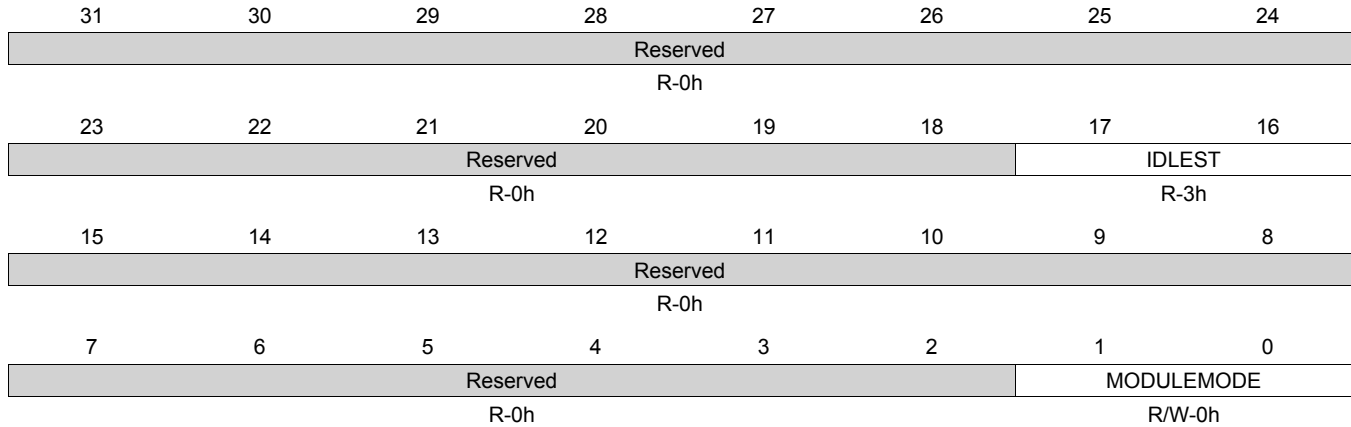
Table 8-53. CM_PER_UART4_CLKCTRL Register Field Descriptions

Bit	Field	Type	Reset	Description
31-18	Reserved	R	0h	
17-16	IDLEST	R	3h	Module idle status. 0x0 = Func : Module is fully functional, including OCP 0x1 = Trans : Module is performing transition: wakeup, or sleep, or sleep abortion 0x2 = Idle : Module is in Idle mode (only OCP part). It is functional if using separate functional clock 0x3 = Disable : Module is disabled and cannot be accessed
15-2	Reserved	R	0h	
1-0	MODULEMODE	R/W	0h	Control the way mandatory clocks are managed. 0x0 = DISABLED : Module is disable by SW. Any OCP access to module results in an error, except if resulting from a module wakeup (asynchronous wakeup). 0x1 = RESERVED_1 : Reserved 0x2 = ENABLE : Module is explicitly enabled. Interface clock (if not used for functions) may be gated according to the clock domain state. Functional clocks are guaranteed to stay present. As long as in this configuration, power domain sleep transition cannot happen. 0x3 = RESERVED : Reserved

8.1.12.1.25 CM_PER_TIMER7_CLKCTRL Register (offset = 7Ch) [reset = 30000h]

 CM_PER_TIMER7_CLKCTRL is shown in [Figure 8-47](#) and described in [Table 8-54](#).

This register manages the TIMER7 clocks.

Figure 8-47. CM_PER_TIMER7_CLKCTRL Register


LEGEND: R/W = Read/Write; R = Read only; W1toCl = Write 1 to clear bit; -n = value after reset

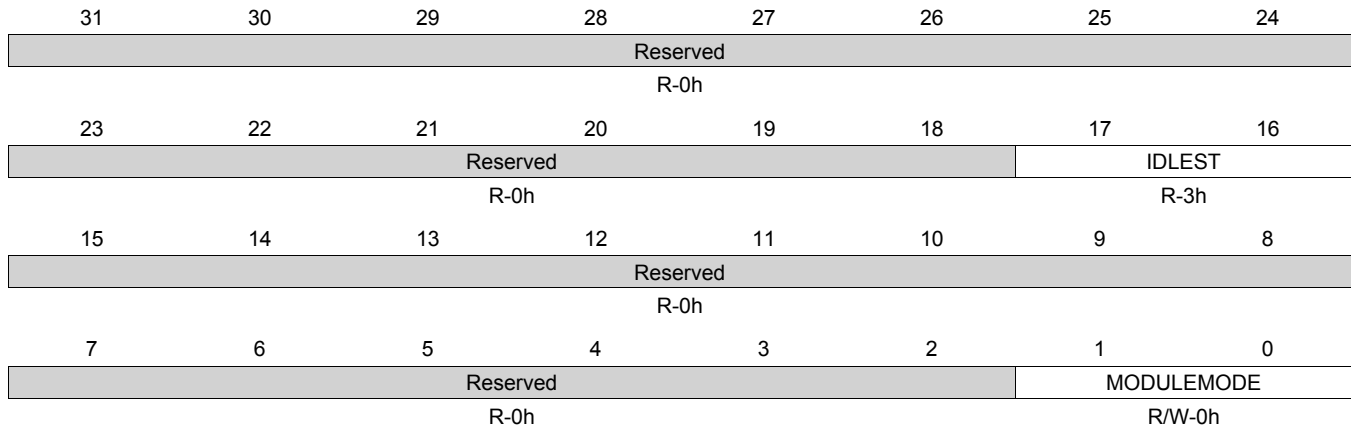
Table 8-54. CM_PER_TIMER7_CLKCTRL Register Field Descriptions

Bit	Field	Type	Reset	Description
31-18	Reserved	R	0h	
17-16	IDLEST	R	3h	Module idle status. 0x0 = Func : Module is fully functional, including OCP 0x1 = Trans : Module is performing transition: wakeup, or sleep, or sleep abortion 0x2 = Idle : Module is in Idle mode (only OCP part). It is functional if using separate functional clock 0x3 = Disable : Module is disabled and cannot be accessed
15-2	Reserved	R	0h	
1-0	MODULEMODE	R/W	0h	Control the way mandatory clocks are managed. 0x0 = DISABLED : Module is disable by SW. Any OCP access to module results in an error, except if resulting from a module wakeup (asynchronous wakeup). 0x1 = RESERVED_1 : Reserved 0x2 = ENABLE : Module is explicitly enabled. Interface clock (if not used for functions) may be gated according to the clock domain state. Functional clocks are guaranteed to stay present. As long as in this configuration, power domain sleep transition cannot happen. 0x3 = RESERVED : Reserved

8.1.12.1.26 CM_PER_TIMER2_CLKCTRL Register (offset = 80h) [reset = 30000h]

CM_PER_TIMER2_CLKCTRL is shown in [Figure 8-48](#) and described in [Table 8-55](#).

This register manages the TIMER2 clocks.

Figure 8-48. CM_PER_TIMER2_CLKCTRL Register


LEGEND: R/W = Read/Write; R = Read only; W1toCl = Write 1 to clear bit; -n = value after reset

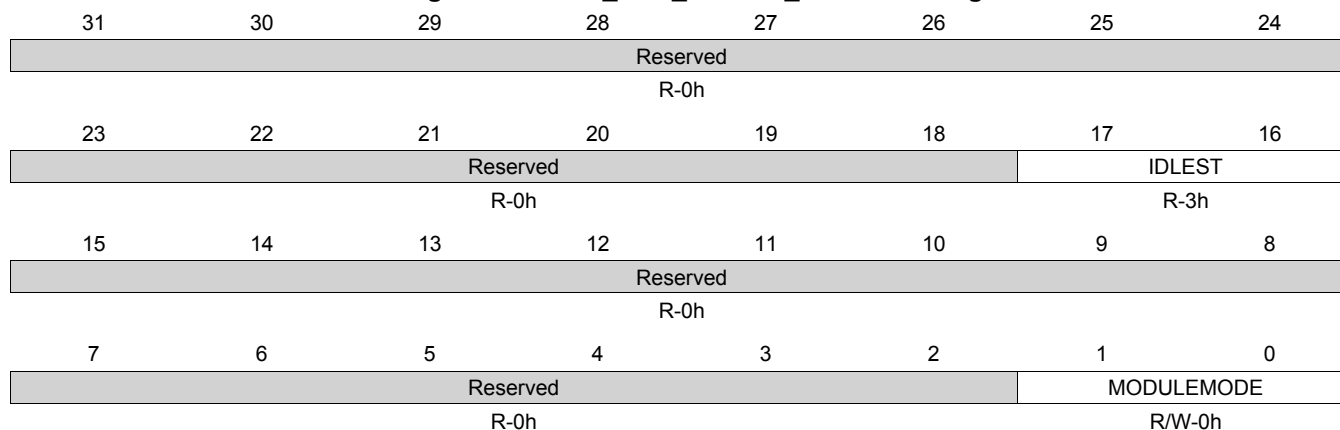
Table 8-55. CM_PER_TIMER2_CLKCTRL Register Field Descriptions

Bit	Field	Type	Reset	Description
31-18	Reserved	R	0h	
17-16	IDLEST	R	3h	Module idle status. 0x0 = Func : Module is fully functional, including OCP 0x1 = Trans : Module is performing transition: wakeup, or sleep, or sleep abortion 0x2 = Idle : Module is in Idle mode (only OCP part). It is functional if using separate functional clock 0x3 = Disable : Module is disabled and cannot be accessed
15-2	Reserved	R	0h	
1-0	MODULEMODE	R/W	0h	Control the way mandatory clocks are managed. 0x0 = DISABLED : Module is disable by SW. Any OCP access to module results in an error, except if resulting from a module wakeup (asynchronous wakeup). 0x1 = RESERVED_1 : Reserved 0x2 = ENABLE : Module is explicitly enabled. Interface clock (if not used for functions) may be gated according to the clock domain state. Functional clocks are guaranteed to stay present. As long as in this configuration, power domain sleep transition cannot happen. 0x3 = RESERVED : Reserved

8.1.12.1.27 CM_PER_TIMER3_CLKCTRL Register (offset = 84h) [reset = 30000h]

 CM_PER_TIMER3_CLKCTRL is shown in [Figure 8-49](#) and described in [Table 8-56](#).

This register manages the TIMER3 clocks.

Figure 8-49. CM_PER_TIMER3_CLKCTRL Register


LEGEND: R/W = Read/Write; R = Read only; W1toCl = Write 1 to clear bit; -n = value after reset

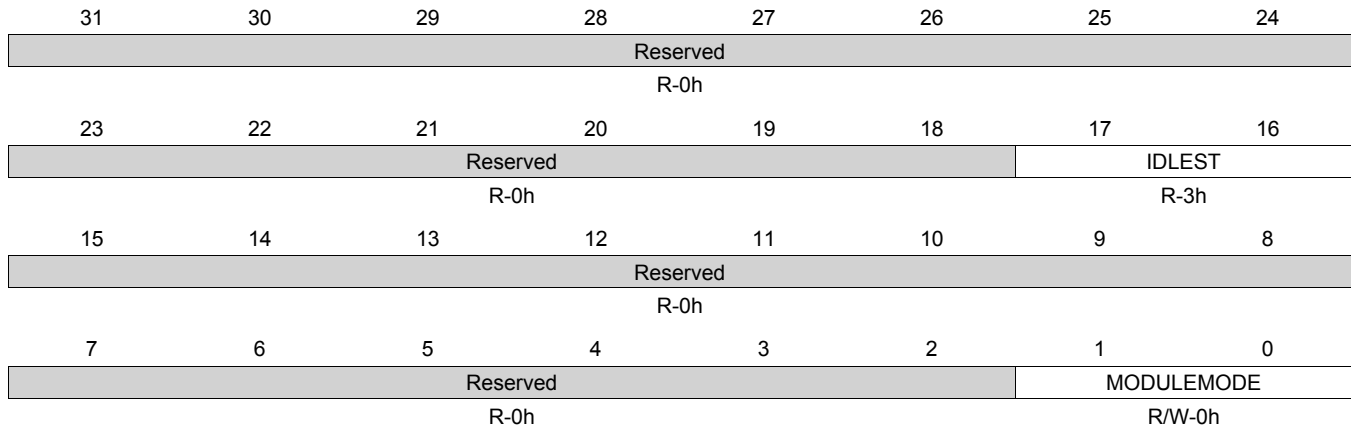
Table 8-56. CM_PER_TIMER3_CLKCTRL Register Field Descriptions

Bit	Field	Type	Reset	Description
31-18	Reserved	R	0h	
17-16	IDLEST	R	3h	Module idle status. 0x0 = Func : Module is fully functional, including OCP 0x1 = Trans : Module is performing transition: wakeup, or sleep, or sleep abortion 0x2 = Idle : Module is in Idle mode (only OCP part). It is functional if using separate functional clock 0x3 = Disable : Module is disabled and cannot be accessed
15-2	Reserved	R	0h	
1-0	MODULEMODE	R/W	0h	Control the way mandatory clocks are managed. 0x0 = DISABLED : Module is disable by SW. Any OCP access to module results in an error, except if resulting from a module wakeup (asynchronous wakeup). 0x1 = RESERVED_1 : Reserved 0x2 = ENABLE : Module is explicitly enabled. Interface clock (if not used for functions) may be gated according to the clock domain state. Functional clocks are guaranteed to stay present. As long as in this configuration, power domain sleep transition cannot happen. 0x3 = RESERVED : Reserved

8.1.12.1.28 CM_PER_TIMER4_CLKCTRL Register (offset = 88h) [reset = 30000h]

CM_PER_TIMER4_CLKCTRL is shown in [Figure 8-50](#) and described in [Table 8-57](#).

This register manages the TIMER4 clocks.

Figure 8-50. CM_PER_TIMER4_CLKCTRL Register


LEGEND: R/W = Read/Write; R = Read only; W1toCl = Write 1 to clear bit; -n = value after reset

Table 8-57. CM_PER_TIMER4_CLKCTRL Register Field Descriptions

Bit	Field	Type	Reset	Description
31-18	Reserved	R	0h	
17-16	IDLEST	R	3h	Module idle status. 0x0 = Func : Module is fully functional, including OCP 0x1 = Trans : Module is performing transition: wakeup, or sleep, or sleep abortion 0x2 = Idle : Module is in Idle mode (only OCP part). It is functional if using separate functional clock 0x3 = Disable : Module is disabled and cannot be accessed
15-2	Reserved	R	0h	
1-0	MODULEMODE	R/W	0h	Control the way mandatory clocks are managed. 0x0 = DISABLED : Module is disable by SW. Any OCP access to module results in an error, except if resulting from a module wakeup (asynchronous wakeup). 0x1 = RESERVED_1 : Reserved 0x2 = ENABLE : Module is explicitly enabled. Interface clock (if not used for functions) may be gated according to the clock domain state. Functional clocks are guaranteed to stay present. As long as in this configuration, power domain sleep transition cannot happen. 0x3 = RESERVED : Reserved

8.1.12.1.29 CM_PER_GPIO1_CLKCTRL Register (offset = ACh) [reset = 30000h]

 CM_PER_GPIO1_CLKCTRL is shown in [Figure 8-51](#) and described in [Table 8-58](#).

This register manages the GPIO1 clocks.

Figure 8-51. CM_PER_GPIO1_CLKCTRL Register

31	30	29	28	27	26	25	24
Reserved							
R-0h							
23	22	21	20	19	18	17	16
Reserved					OPTFCLKEN_ GPIO_1_GDBC LK	IDLEST	
R-0h					R/W-0h	R-3h	
15	14	13	12	11	10	9	8
Reserved							
R-0h							
7	6	5	4	3	2	1	0
Reserved						MODULEMODE	
R-0h						R/W-0h	

LEGEND: R/W = Read/Write; R = Read only; W1toCl = Write 1 to clear bit; -n = value after reset

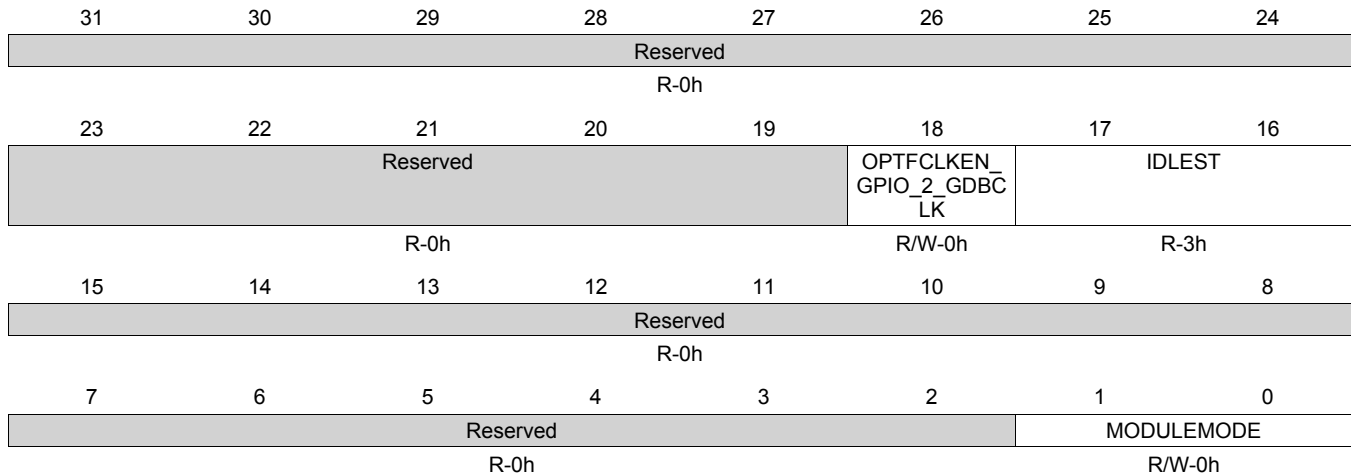
Table 8-58. CM_PER_GPIO1_CLKCTRL Register Field Descriptions

Bit	Field	Type	Reset	Description
31-19	Reserved	R	0h	
18	OPTFCLKEN_GPIO_1_GDBCLK	R/W	0h	Optional functional clock control. 0x0 = FCLK_DIS : Optional functional clock is disabled 0x1 = FCLK_EN : Optional functional clock is enabled
17-16	IDLEST	R	3h	Module idle status. 0x0 = Func : Module is fully functional, including OCP 0x1 = Trans : Module is performing transition: wakeup, or sleep, or sleep abortion 0x2 = Idle : Module is in Idle mode (only OCP part). It is functional if using separate functional clock 0x3 = Disable : Module is disabled and cannot be accessed
15-2	Reserved	R	0h	
1-0	MODULEMODE	R/W	0h	Control the way mandatory clocks are managed. 0x0 = DISABLED : Module is disable by SW. Any OCP access to module results in an error, except if resulting from a module wakeup (asynchronous wakeup). 0x1 = RESERVED_1 : Reserved 0x2 = ENABLE : Module is explicitly enabled. Interface clock (if not used for functions) may be gated according to the clock domain state. Functional clocks are guaranteed to stay present. As long as in this configuration, power domain sleep transition cannot happen. 0x3 = RESERVED : Reserved

8.1.12.1.30 CM_PER_GPIO2_CLKCTRL Register (offset = B0h) [reset = 30000h]

CM_PER_GPIO2_CLKCTRL is shown in [Figure 8-52](#) and described in [Table 8-59](#).

This register manages the GPIO2 clocks.

Figure 8-52. CM_PER_GPIO2_CLKCTRL Register


LEGEND: R/W = Read/Write; R = Read only; W1toCl = Write 1 to clear bit; -n = value after reset

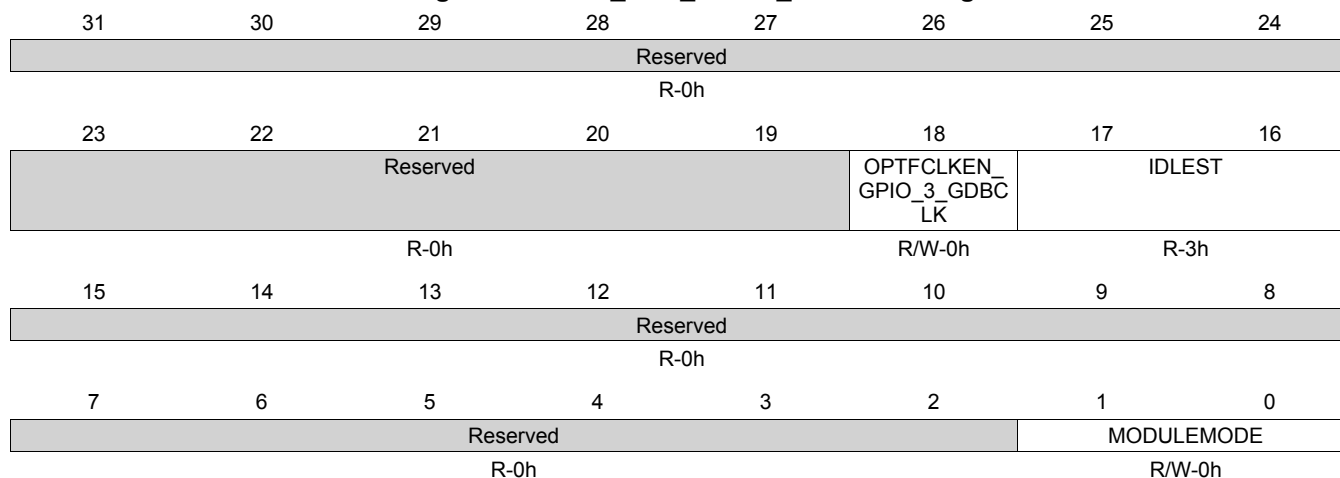
Table 8-59. CM_PER_GPIO2_CLKCTRL Register Field Descriptions

Bit	Field	Type	Reset	Description
31-19	Reserved	R	0h	
18	OPTFCLKEN_GPIO_2_GDBCLK	R/W	0h	Optional functional clock control. 0x0 = FCLK_DIS : Optional functional clock is disabled 0x1 = FCLK_EN : Optional functional clock is enabled
17-16	IDLEST	R	3h	Module idle status. 0x0 = Func : Module is fully functional, including OCP 0x1 = Trans : Module is performing transition: wakeup, or sleep, or sleep abortion 0x2 = Idle : Module is in Idle mode (only OCP part). It is functional if using separate functional clock 0x3 = Disable : Module is disabled and cannot be accessed
15-2	Reserved	R	0h	
1-0	MODULEMODE	R/W	0h	Control the way mandatory clocks are managed. 0x0 = DISABLED : Module is disable by SW. Any OCP access to module results in an error, except if resulting from a module wakeup (asynchronous wakeup). 0x1 = RESERVED_1 : Reserved 0x2 = ENABLE : Module is explicitly enabled. Interface clock (if not used for functions) may be gated according to the clock domain state. Functional clocks are guaranteed to stay present. As long as in this configuration, power domain sleep transition cannot happen. 0x3 = RESERVED : Reserved

8.1.12.1.31 CM_PER_GPIO3_CLKCTRL Register (offset = B4h) [reset = 30000h]

CM_PER_GPIO3_CLKCTRL is shown in [Figure 8-53](#) and described in [Table 8-60](#).

This register manages the GPIO3 clocks.

Figure 8-53. CM_PER_GPIO3_CLKCTRL Register


LEGEND: R/W = Read/Write; R = Read only; W1toCl = Write 1 to clear bit; -n = value after reset

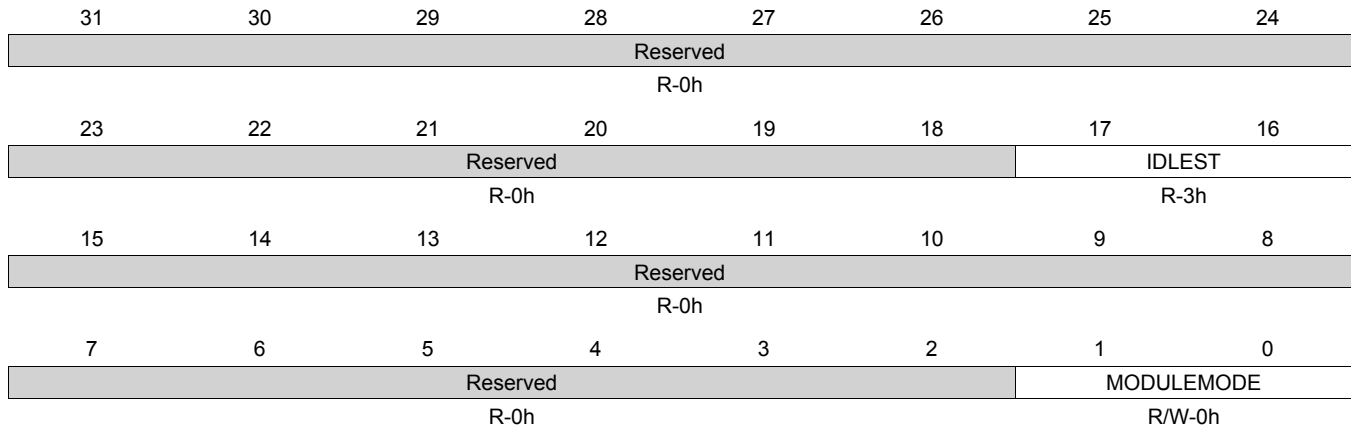
Table 8-60. CM_PER_GPIO3_CLKCTRL Register Field Descriptions

Bit	Field	Type	Reset	Description
31-19	Reserved	R	0h	
18	OPTFCLKEN_GPIO_3_GDBCLK	R/W	0h	Optional functional clock control. 0x0 = FCLK_DIS : Optional functional clock is disabled 0x1 = FCLK_EN : Optional functional clock is enabled
17-16	IDLEST	R	3h	Module idle status. 0x0 = Func : Module is fully functional, including OCP 0x1 = Trans : Module is performing transition: wakeup, or sleep, or sleep abortion 0x2 = Idle : Module is in Idle mode (only OCP part). It is functional if using separate functional clock 0x3 = Disable : Module is disabled and cannot be accessed
15-2	Reserved	R	0h	
1-0	MODULEMODE	R/W	0h	Control the way mandatory clocks are managed. 0x0 = DISABLED : Module is disable by SW. Any OCP access to module results in an error, except if resulting from a module wakeup (asynchronous wakeup). 0x1 = RESERVED_1 : Reserved 0x2 = ENABLE : Module is explicitly enabled. Interface clock (if not used for functions) may be gated according to the clock domain state. Functional clocks are guaranteed to stay present. As long as in this configuration, power domain sleep transition cannot happen. 0x3 = RESERVED : Reserved

8.1.12.1.32 CM_PER_TPCC_CLKCTRL Register (offset = BCh) [reset = 30000h]

CM_PER_TPCC_CLKCTRL is shown in [Figure 8-54](#) and described in [Table 8-61](#).

This register manages the TPCC clocks.

Figure 8-54. CM_PER_TPCC_CLKCTRL Register


LEGEND: R/W = Read/Write; R = Read only; W1toCl = Write 1 to clear bit; -n = value after reset

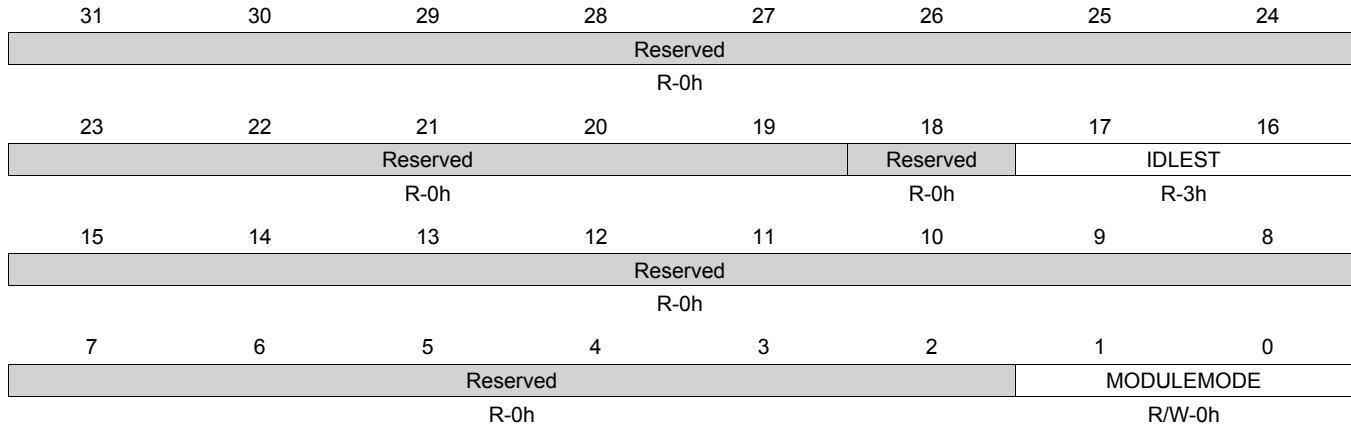
Table 8-61. CM_PER_TPCC_CLKCTRL Register Field Descriptions

Bit	Field	Type	Reset	Description
31-18	Reserved	R	0h	
17-16	IDLEST	R	3h	Module idle status. 0x0 = Func : Module is fully functional, including OCP 0x1 = Trans : Module is performing transition: wakeup, or sleep, or sleep abortion 0x2 = Idle : Module is in Idle mode (only OCP part). It is functional if using separate functional clock 0x3 = Disable : Module is disabled and cannot be accessed
15-2	Reserved	R	0h	
1-0	MODULEMODE	R/W	0h	Control the way mandatory clocks are managed. 0x0 = DISABLED : Module is disable by SW. Any OCP access to module results in an error, except if resulting from a module wakeup (asynchronous wakeup). 0x1 = RESERVED_1 : Reserved 0x2 = ENABLE : Module is explicitly enabled. Interface clock (if not used for functions) may be gated according to the clock domain state. Functional clocks are guaranteed to stay present. As long as in this configuration, power domain sleep transition cannot happen. 0x3 = RESERVED : Reserved

8.1.12.1.33 CM_PER_DCAN0_CLKCTRL Register (offset = C0h) [reset = 30000h]

 CM_PER_DCAN0_CLKCTRL is shown in [Figure 8-55](#) and described in [Table 8-62](#).

This register manages the DCAN0 clocks.

Figure 8-55. CM_PER_DCAN0_CLKCTRL Register


LEGEND: R/W = Read/Write; R = Read only; W1toCl = Write 1 to clear bit; -n = value after reset

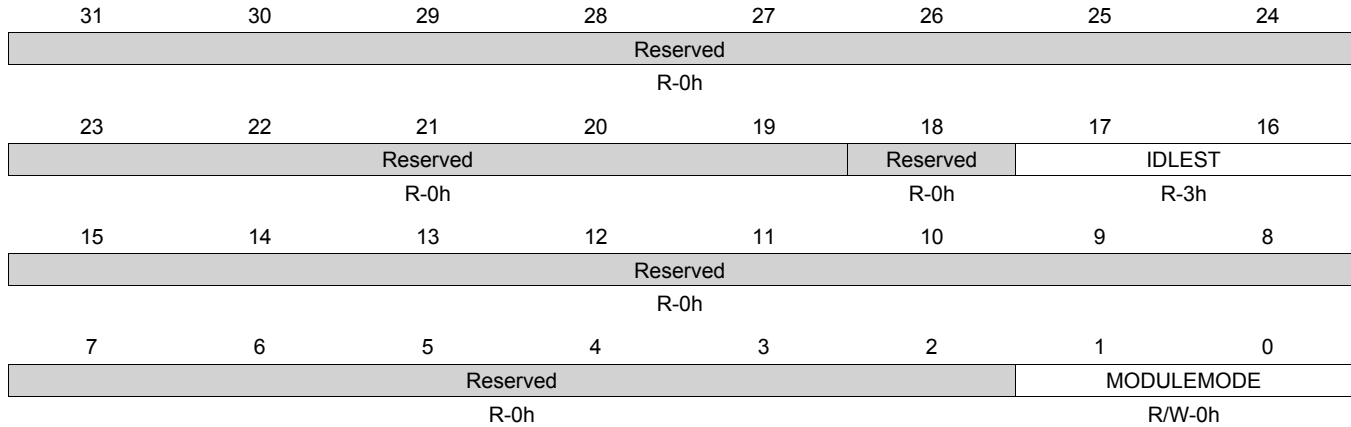
Table 8-62. CM_PER_DCAN0_CLKCTRL Register Field Descriptions

Bit	Field	Type	Reset	Description
31-19	Reserved	R	0h	
18	Reserved	R	0h	
17-16	IDLEST	R	3h	Module idle status. 0x0 = Func : Module is fully functional, including OCP 0x1 = Trans : Module is performing transition: wakeup, or sleep, or sleep abortion 0x2 = Idle : Module is in Idle mode (only OCP part). It is functional if using separate functional clock 0x3 = Disable : Module is disabled and cannot be accessed
15-2	Reserved	R	0h	
1-0	MODULEMODE	R/W	0h	Control the way mandatory clocks are managed. 0x0 = DISABLED : Module is disable by SW. Any OCP access to module results in an error, except if resulting from a module wakeup (asynchronous wakeup). 0x1 = RESERVED_1 : Reserved 0x2 = ENABLE : Module is explicitly enabled. Interface clock (if not used for functions) may be gated according to the clock domain state. Functional clocks are guaranteed to stay present. As long as in this configuration, power domain sleep transition cannot happen. 0x3 = RESERVED : Reserved

8.1.12.1.34 CM_PER_DCAN1_CLKCTRL Register (offset = C4h) [reset = 3000h]

 CM_PER_DCAN1_CLKCTRL is shown in [Figure 8-56](#) and described in [Table 8-63](#).

This register manages the DCAN1 clocks.

Figure 8-56. CM_PER_DCAN1_CLKCTRL Register


LEGEND: R/W = Read/Write; R = Read only; W1toCl = Write 1 to clear bit; -n = value after reset

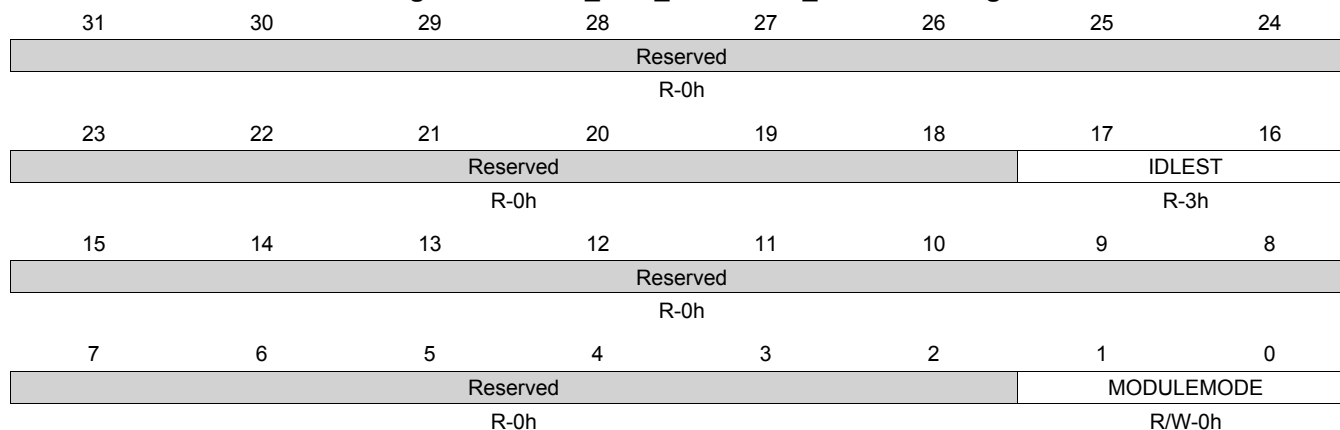
Table 8-63. CM_PER_DCAN1_CLKCTRL Register Field Descriptions

Bit	Field	Type	Reset	Description
31-19	Reserved	R	0h	
18	Reserved	R	0h	
17-16	IDLEST	R	3h	Module idle status. 0x0 = Func : Module is fully functional, including OCP 0x1 = Trans : Module is performing transition: wakeup, or sleep, or sleep abortion 0x2 = Idle : Module is in Idle mode (only OCP part). It is functional if using separate functional clock 0x3 = Disable : Module is disabled and cannot be accessed
15-2	Reserved	R	0h	
1-0	MODULEMODE	R/W	0h	Control the way mandatory clocks are managed. 0x0 = DISABLED : Module is disable by SW. Any OCP access to module results in an error, except if resulting from a module wakeup (asynchronous wakeup). 0x1 = RESERVED_1 : Reserved 0x2 = ENABLE : Module is explicitly enabled. Interface clock (if not used for functions) may be gated according to the clock domain state. Functional clocks are guaranteed to stay present. As long as in this configuration, power domain sleep transition cannot happen. 0x3 = RESERVED : Reserved

8.1.12.1.35 CM_PER_EPWMSS1_CLKCTRL Register (offset = CCh) [reset = 30000h]

CM_PER_EPWMSS1_CLKCTRL is shown in [Figure 8-57](#) and described in [Table 8-64](#).

This register manages the PWMSS1 clocks.

Figure 8-57. CM_PER_EPWMSS1_CLKCTRL Register


LEGEND: R/W = Read/Write; R = Read only; W1toCl = Write 1 to clear bit; -n = value after reset

Table 8-64. CM_PER_EPWMSS1_CLKCTRL Register Field Descriptions

Bit	Field	Type	Reset	Description
31-18	Reserved	R	0h	
17-16	IDLEST	R	3h	Module idle status. 0x0 = Func : Module is fully functional, including OCP 0x1 = Trans : Module is performing transition: wakeup, or sleep, or sleep abortion 0x2 = Idle : Module is in Idle mode (only OCP part). It is functional if using separate functional clock 0x3 = Disable : Module is disabled and cannot be accessed
15-2	Reserved	R	0h	
1-0	MODULEMODE	R/W	0h	Control the way mandatory clocks are managed. 0x0 = DISABLED : Module is disable by SW. Any OCP access to module results in an error, except if resulting from a module wakeup (asynchronous wakeup). 0x1 = RESERVED_1 : Reserved 0x2 = ENABLE : Module is explicitly enabled. Interface clock (if not used for functions) may be gated according to the clock domain state. Functional clocks are guaranteed to stay present. As long as in this configuration, power domain sleep transition cannot happen. 0x3 = RESERVED : Reserved

8.1.12.1.36 CM_PER_EPWMSS0_CLKCTRL Register (offset = D4h) [reset = 30000h]

CM_PER_EPWMSS0_CLKCTRL is shown in [Figure 8-58](#) and described in [Table 8-65](#).

This register manages the PWMSS0 clocks.

Figure 8-58. CM_PER_EPWMSS0_CLKCTRL Register

31	30	29	28	27	26	25	24
Reserved							
R-0h							
23	22	21	20	19	18	17	16
Reserved						IDLEST	
R-0h						R-3h	
15	14	13	12	11	10	9	8
Reserved							
R-0h							
7	6	5	4	3	2	1	0
Reserved						MODULEMODE	
R-0h						R/W-0h	

LEGEND: R/W = Read/Write; R = Read only; W1toCl = Write 1 to clear bit; -n = value after reset

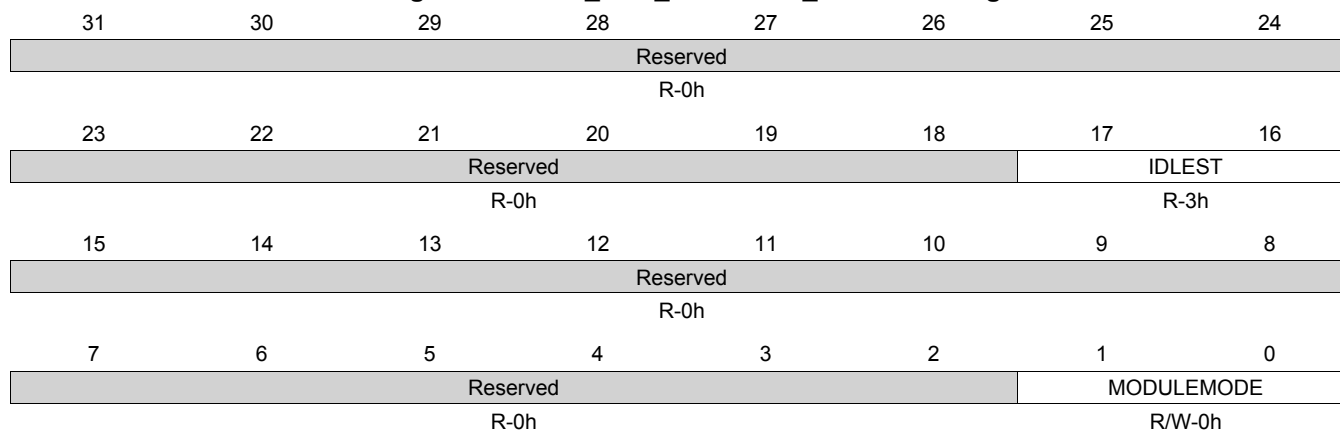
Table 8-65. CM_PER_EPWMSS0_CLKCTRL Register Field Descriptions

Bit	Field	Type	Reset	Description
31-18	Reserved	R	0h	
17-16	IDLEST	R	3h	Module idle status. 0x0 = Func : Module is fully functional, including OCP 0x1 = Trans : Module is performing transition: wakeup, or sleep, or sleep abortion 0x2 = Idle : Module is in Idle mode (only OCP part). It is functional if using separate functional clock 0x3 = Disable : Module is disabled and cannot be accessed
15-2	Reserved	R	0h	
1-0	MODULEMODE	R/W	0h	Control the way mandatory clocks are managed. 0x0 = DISABLED : Module is disable by SW. Any OCP access to module results in an error, except if resulting from a module wakeup (asynchronous wakeup). 0x1 = RESERVED_1 : Reserved 0x2 = ENABLE : Module is explicitly enabled. Interface clock (if not used for functions) may be gated according to the clock domain state. Functional clocks are guaranteed to stay present. As long as in this configuration, power domain sleep transition cannot happen. 0x3 = RESERVED : Reserved

8.1.12.1.37 CM_PER_EPWMSS2_CLKCTRL Register (offset = D8h) [reset = 30000h]

CM_PER_EPWMSS2_CLKCTRL is shown in [Figure 8-59](#) and described in [Table 8-66](#).

This register manages the PWMSS2 clocks.

Figure 8-59. CM_PER_EPWMSS2_CLKCTRL Register


LEGEND: R/W = Read/Write; R = Read only; W1toCl = Write 1 to clear bit; -n = value after reset

Table 8-66. CM_PER_EPWMSS2_CLKCTRL Register Field Descriptions

Bit	Field	Type	Reset	Description
31-18	Reserved	R	0h	
17-16	IDLEST	R	3h	Module idle status. 0x0 = Func : Module is fully functional, including OCP 0x1 = Trans : Module is performing transition: wakeup, or sleep, or sleep abortion 0x2 = Idle : Module is in Idle mode (only OCP part). It is functional if using separate functional clock 0x3 = Disable : Module is disabled and cannot be accessed
15-2	Reserved	R	0h	
1-0	MODULEMODE	R/W	0h	Control the way mandatory clocks are managed. 0x0 = DISABLED : Module is disable by SW. Any OCP access to module results in an error, except if resulting from a module wakeup (asynchronous wakeup). 0x1 = RESERVED_1 : Reserved 0x2 = ENABLE : Module is explicitly enabled. Interface clock (if not used for functions) may be gated according to the clock domain state. Functional clocks are guaranteed to stay present. As long as in this configuration, power domain sleep transition cannot happen. 0x3 = RESERVED : Reserved

8.1.12.1.38 CM_PER_L3_INSTR_CLKCTRL Register (offset = DCh) [reset = 2h]

CM_PER_L3_INSTR_CLKCTRL is shown in [Figure 8-60](#) and described in [Table 8-67](#).

This register manages the L3 INSTR clocks.

Figure 8-60. CM_PER_L3_INSTR_CLKCTRL Register

31	30	29	28	27	26	25	24
Reserved							
R-0h							
23	22	21	20	19	18	17	16
Reserved						IDLEST	
R-0h						R-0h	
15	14	13	12	11	10	9	8
Reserved							
R-0h							
7	6	5	4	3	2	1	0
Reserved						MODULEMODE	
R-0h						R/W-2h	

LEGEND: R/W = Read/Write; R = Read only; W1toCl = Write 1 to clear bit; -n = value after reset

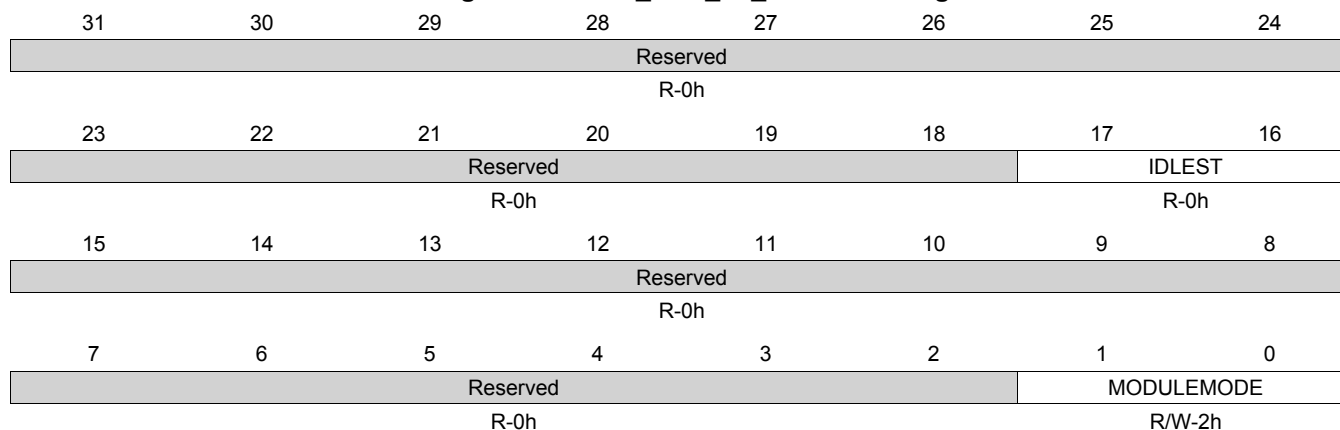
Table 8-67. CM_PER_L3_INSTR_CLKCTRL Register Field Descriptions

Bit	Field	Type	Reset	Description
31-18	Reserved	R	0h	
17-16	IDLEST	R	0h	Module idle status. 0x0 = Func : Module is fully functional, including OCP 0x1 = Trans : Module is performing transition: wakeup, or sleep, or sleep abortion 0x2 = Idle : Module is in Idle mode (only OCP part). It is functional if using separate functional clock 0x3 = Disable : Module is disabled and cannot be accessed
15-2	Reserved	R	0h	
1-0	MODULEMODE	R/W	2h	Control the way mandatory clocks are managed. 0x0 = DISABLED : Module is disable by SW. Any OCP access to module results in an error, except if resulting from a module wakeup (asynchronous wakeup). 0x1 = RESERVED_1 : Reserved 0x2 = ENABLE : Module is explicitly enabled. Interface clock (if not used for functions) may be gated according to the clock domain state. Functional clocks are guaranteed to stay present. As long as in this configuration, power domain sleep transition cannot happen. 0x3 = RESERVED : Reserved

8.1.12.1.39 CM_PER_L3_CLKCTRL Register (offset = E0h) [reset = 2h]

CM_PER_L3_CLKCTRL is shown in [Figure 8-61](#) and described in [Table 8-68](#).

This register manages the L3 Interconnect clocks.

Figure 8-61. CM_PER_L3_CLKCTRL Register


LEGEND: R/W = Read/Write; R = Read only; W1toCl = Write 1 to clear bit; -n = value after reset

Table 8-68. CM_PER_L3_CLKCTRL Register Field Descriptions

Bit	Field	Type	Reset	Description
31-18	Reserved	R	0h	
17-16	IDLEST	R	0h	Module idle status. 0x0 = Func : Module is fully functional, including OCP 0x1 = Trans : Module is performing transition: wakeup, or sleep, or sleep abortion 0x2 = Idle : Module is in Idle mode (only OCP part). It is functional if using separate functional clock 0x3 = Disable : Module is disabled and cannot be accessed
15-2	Reserved	R	0h	
1-0	MODULEMODE	R/W	2h	Control the way mandatory clocks are managed. 0x0 = DISABLED : Module is disable by SW. Any OCP access to module results in an error, except if resulting from a module wakeup (asynchronous wakeup). 0x1 = RESERVED_1 : Reserved 0x2 = ENABLE : Module is explicitly enabled. Interface clock (if not used for functions) may be gated according to the clock domain state. Functional clocks are guaranteed to stay present. As long as in this configuration, power domain sleep transition cannot happen. 0x3 = RESERVED : Reserved

8.1.12.1.40 CM_PER_IEEE5000_CLKCTRL Register (offset = E4h) [reset = 70002h]

CM_PER_IEEE5000_CLKCTRL is shown in Figure 8-62 and described in Table 8-69.

This register manages the IEEE1500 clocks.

Figure 8-62. CM_PER_IEEE5000_CLKCTRL Register

31	30	29	28	27	26	25	24
Reserved							
R-0h							
23	22	21	20	19	18	17	16
Reserved					STBYST	IDLEST	
R-0h					R-1h	R-3h	
15	14	13	12	11	10	9	8
Reserved							
R-0h							
7	6	5	4	3	2	1	0
Reserved						MODULEMODE	
R-0h						R/W-2h	

LEGEND: R/W = Read/Write; R = Read only; W1toCl = Write 1 to clear bit; -n = value after reset

Table 8-69. CM_PER_IEEE5000_CLKCTRL Register Field Descriptions

Bit	Field	Type	Reset	Description
31-19	Reserved	R	0h	
18	STBYST	R	1h	Module standby status. 0x0 = Func : Module is functional (not in standby) 0x1 = Standby : Module is in standby
17-16	IDLEST	R	3h	Module idle status. 0x0 = Func : Module is fully functional, including OCP 0x1 = Trans : Module is performing transition: wakeup, or sleep, or sleep abortion 0x2 = Idle : Module is in Idle mode (only OCP part). It is functional if using separate functional clock 0x3 = Disable : Module is disabled and cannot be accessed
15-2	Reserved	R	0h	
1-0	MODULEMODE	R/W	2h	Control the way mandatory clocks are managed. 0x0 = DISABLED : Module is disable by SW. Any OCP access to module results in an error, except if resulting from a module wakeup (asynchronous wakeup). 0x1 = RESERVED_1 : Reserved 0x2 = ENABLE : Module is explicitly enabled. Interface clock (if not used for functions) may be gated according to the clock domain state. Functional clocks are guaranteed to stay present. As long as in this configuration, power domain sleep transition cannot happen. 0x3 = RESERVED : Reserved

8.1.12.1.41 CM_PER_PRU_ICSS_CLKCTRL Register (offset = E8h) [reset = 7000h]

CM_PER_PRU_ICSS_CLKCTRL is shown in [Figure 8-63](#) and described in [Table 8-70](#).

This register manages the PRU-ICSS clocks.

Figure 8-63. CM_PER_PRU_ICSS_CLKCTRL Register

31	30	29	28	27	26	25	24
Reserved							
R-0h							
23	22	21	20	19	18	17	16
Reserved				STBYST		IDLEST	
R-0h				R-1h		R-3h	
15	14	13	12	11	10	9	8
Reserved							
R-0h							
7	6	5	4	3	2	1	0
Reserved						MODULEMODE	
R-0h						R/W-0h	

LEGEND: R/W = Read/Write; R = Read only; W1toCl = Write 1 to clear bit; -n = value after reset

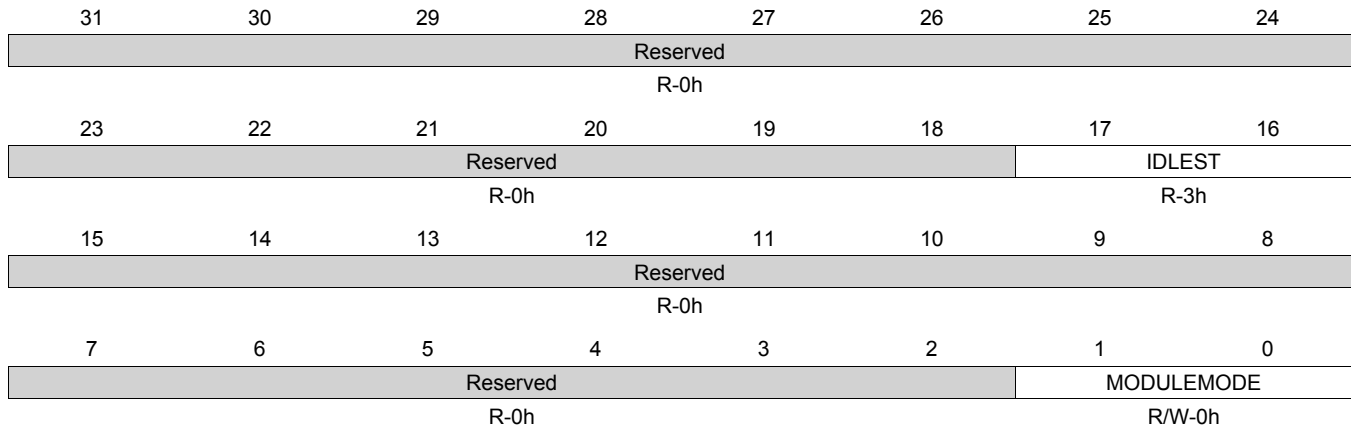
Table 8-70. CM_PER_PRU_ICSS_CLKCTRL Register Field Descriptions

Bit	Field	Type	Reset	Description
31-19	Reserved	R	0h	
18	STBYST	R	1h	Module standby status. 0x0 = Func : Module is functional (not in standby) 0x1 = Standby : Module is in standby
17-16	IDLEST	R	3h	Module idle status. 0x0 = Func : Module is fully functional, including OCP 0x1 = Trans : Module is performing transition: wakeup, or sleep, or sleep abortion 0x2 = Idle : Module is in Idle mode (only OCP part). It is functional if using separate functional clock 0x3 = Disable : Module is disabled and cannot be accessed
15-2	Reserved	R	0h	
1-0	MODULEMODE	R/W	0h	Control the way mandatory clocks are managed. 0x0 = DISABLED : Module is disable by SW. Any OCP access to module results in an error, except if resulting from a module wakeup (asynchronous wakeup). 0x1 = RESERVED_1 : Reserved 0x2 = ENABLE : Module is explicitly enabled. Interface clock (if not used for functions) may be gated according to the clock domain state. Functional clocks are guaranteed to stay present. As long as in this configuration, power domain sleep transition cannot happen. 0x3 = RESERVED : Reserved

8.1.12.1.42 CM_PER_TIMER5_CLKCTRL Register (offset = ECh) [reset = 30000h]

CM_PER_TIMER5_CLKCTRL is shown in [Figure 8-64](#) and described in [Table 8-71](#).

This register manages the TIMER5 clocks.

Figure 8-64. CM_PER_TIMER5_CLKCTRL Register


LEGEND: R/W = Read/Write; R = Read only; W1toCl = Write 1 to clear bit; -n = value after reset

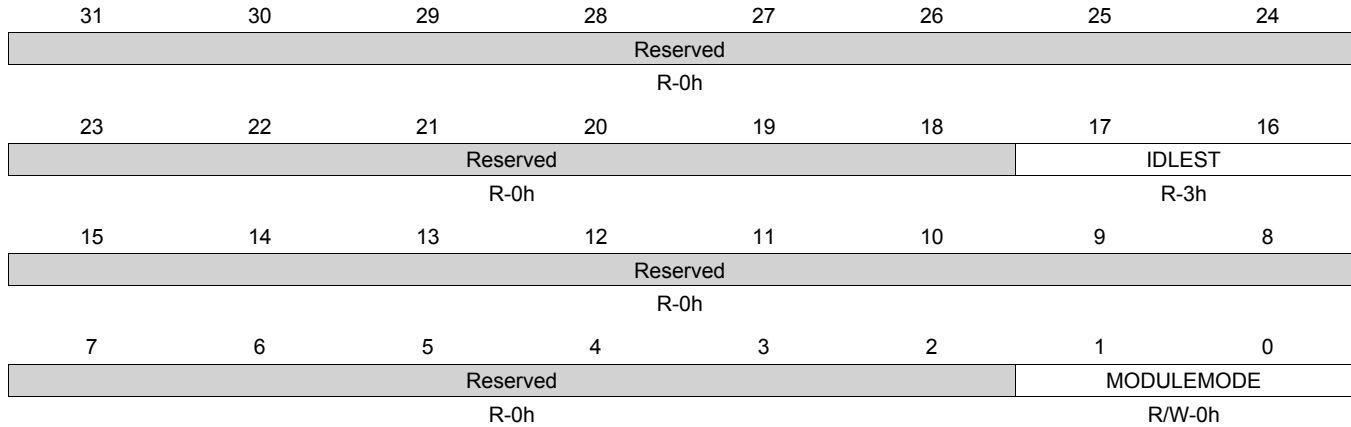
Table 8-71. CM_PER_TIMER5_CLKCTRL Register Field Descriptions

Bit	Field	Type	Reset	Description
31-18	Reserved	R	0h	
17-16	IDLEST	R	3h	Module idle status. 0x0 = Func : Module is fully functional, including OCP 0x1 = Trans : Module is performing transition: wakeup, or sleep, or sleep abortion 0x2 = Idle : Module is in Idle mode (only OCP part). It is functional if using separate functional clock 0x3 = Disable : Module is disabled and cannot be accessed
15-2	Reserved	R	0h	
1-0	MODULEMODE	R/W	0h	Control the way mandatory clocks are managed. 0x0 = DISABLED : Module is disable by SW. Any OCP access to module results in an error, except if resulting from a module wakeup (asynchronous wakeup). 0x1 = RESERVED_1 : Reserved 0x2 = ENABLE : Module is explicitly enabled. Interface clock (if not used for functions) may be gated according to the clock domain state. Functional clocks are guaranteed to stay present. As long as in this configuration, power domain sleep transition cannot happen. 0x3 = RESERVED : Reserved

8.1.12.1.43 CM_PER_TIMER6_CLKCTRL Register (offset = F0h) [reset = 3000h]

 CM_PER_TIMER6_CLKCTRL is shown in [Figure 8-65](#) and described in [Table 8-72](#).

This register manages the TIMER6 clocks.

Figure 8-65. CM_PER_TIMER6_CLKCTRL Register


LEGEND: R/W = Read/Write; R = Read only; W1toCl = Write 1 to clear bit; -n = value after reset

Table 8-72. CM_PER_TIMER6_CLKCTRL Register Field Descriptions

Bit	Field	Type	Reset	Description
31-18	Reserved	R	0h	
17-16	IDLEST	R	3h	Module idle status. 0x0 = Func : Module is fully functional, including OCP 0x1 = Trans : Module is performing transition: wakeup, or sleep, or sleep abortion 0x2 = Idle : Module is in Idle mode (only OCP part). It is functional if using separate functional clock 0x3 = Disable : Module is disabled and cannot be accessed
15-2	Reserved	R	0h	
1-0	MODULEMODE	R/W	0h	Control the way mandatory clocks are managed. 0x0 = DISABLED : Module is disable by SW. Any OCP access to module results in an error, except if resulting from a module wakeup (asynchronous wakeup). 0x1 = RESERVED_1 : Reserved 0x2 = ENABLE : Module is explicitly enabled. Interface clock (if not used for functions) may be gated according to the clock domain state. Functional clocks are guaranteed to stay present. As long as in this configuration, power domain sleep transition cannot happen. 0x3 = RESERVED : Reserved

8.1.12.1.44 CM_PER_MMC1_CLKCTRL Register (offset = F4h) [reset = 30000h]

 CM_PER_MMC1_CLKCTRL is shown in [Figure 8-66](#) and described in [Table 8-73](#).

This register manages the MMC1 clocks.

Figure 8-66. CM_PER_MMC1_CLKCTRL Register

31	30	29	28	27	26	25	24
Reserved							
R-0h							
23	22	21	20	19	18	17	16
Reserved				Reserved		IDLEST	
R-0h				R-0h		R-3h	
15	14	13	12	11	10	9	8
Reserved							
R-0h							
7	6	5	4	3	2	1	0
Reserved						MODULEMODE	
R-0h						R/W-0h	

LEGEND: R/W = Read/Write; R = Read only; W1toCl = Write 1 to clear bit; -n = value after reset

Table 8-73. CM_PER_MMC1_CLKCTRL Register Field Descriptions

Bit	Field	Type	Reset	Description
31-19	Reserved	R	0h	
18	Reserved	R	0h	
17-16	IDLEST	R	3h	Module idle status. 0x0 = Func : Module is fully functional, including OCP 0x1 = Trans : Module is performing transition: wakeup, or sleep, or sleep abortion 0x2 = Idle : Module is in Idle mode (only OCP part). It is functional if using separate functional clock 0x3 = Disable : Module is disabled and cannot be accessed
15-2	Reserved	R	0h	
1-0	MODULEMODE	R/W	0h	Control the way mandatory clocks are managed. 0x0 = DISABLED : Module is disable by SW. Any OCP access to module results in an error, except if resulting from a module wakeup (asynchronous wakeup). 0x1 = RESERVED_1 : Reserved 0x2 = ENABLE : Module is explicitly enabled. Interface clock (if not used for functions) may be gated according to the clock domain state. Functional clocks are guaranteed to stay present. As long as in this configuration, power domain sleep transition cannot happen. 0x3 = RESERVED : Reserved

8.1.12.1.45 CM_PER_MMC2_CLKCTRL Register (offset = F8h) [reset = 30000h]

CM_PER_MMC2_CLKCTRL is shown in [Figure 8-67](#) and described in [Table 8-74](#).

This register manages the MMC2 clocks.

Figure 8-67. CM_PER_MMC2_CLKCTRL Register

31	30	29	28	27	26	25	24
Reserved							
R-0h							
23	22	21	20	19	18	17	16
Reserved				Reserved		IDLEST	
R-0h				R-0h		R-3h	
15	14	13	12	11	10	9	8
Reserved							
R-0h							
7	6	5	4	3	2	1	0
Reserved						MODULEMODE	
R-0h						R/W-0h	

LEGEND: R/W = Read/Write; R = Read only; W1toCl = Write 1 to clear bit; -n = value after reset

Table 8-74. CM_PER_MMC2_CLKCTRL Register Field Descriptions

Bit	Field	Type	Reset	Description
31-19	Reserved	R	0h	
18	Reserved	R	0h	
17-16	IDLEST	R	3h	Module idle status. 0x0 = Func : Module is fully functional, including OCP 0x1 = Trans : Module is performing transition: wakeup, or sleep, or sleep abortion 0x2 = Idle : Module is in Idle mode (only OCP part). It is functional if using separate functional clock 0x3 = Disable : Module is disabled and cannot be accessed
15-2	Reserved	R	0h	
1-0	MODULEMODE	R/W	0h	Control the way mandatory clocks are managed. 0x0 = DISABLED : Module is disable by SW. Any OCP access to module results in an error, except if resulting from a module wakeup (asynchronous wakeup). 0x1 = RESERVED_1 : Reserved 0x2 = ENABLE : Module is explicitly enabled. Interface clock (if not used for functions) may be gated according to the clock domain state. Functional clocks are guaranteed to stay present. As long as in this configuration, power domain sleep transition cannot happen. 0x3 = RESERVED : Reserved

8.1.12.1.46 CM_PER_TPTC1_CLKCTRL Register (offset = FCh) [reset = 70000h]

CM_PER_TPTC1_CLKCTRL is shown in [Figure 8-68](#) and described in [Table 8-75](#).

This register manages the TPTC1 clocks.

Figure 8-68. CM_PER_TPTC1_CLKCTRL Register

31	30	29	28	27	26	25	24
Reserved							
R-0h							
23	22	21	20	19	18	17	16
Reserved					STBYST	IDLEST	
R-0h					R-1h	R-3h	
15	14	13	12	11	10	9	8
Reserved							
R-0h							
7	6	5	4	3	2	1	0
Reserved						MODULEMODE	
R-0h						R/W-0h	

LEGEND: R/W = Read/Write; R = Read only; W1toCl = Write 1 to clear bit; -n = value after reset

Table 8-75. CM_PER_TPTC1_CLKCTRL Register Field Descriptions

Bit	Field	Type	Reset	Description
31-19	Reserved	R	0h	
18	STBYST	R	1h	Module standby status. 0x0 = Func : Module is functional (not in standby) 0x1 = Standby : Module is in standby
17-16	IDLEST	R	3h	Module idle status. 0x0 = Func : Module is fully functional, including OCP 0x1 = Trans : Module is performing transition: wakeup, or sleep, or sleep abortion 0x2 = Idle : Module is in Idle mode (only OCP part). It is functional if using separate functional clock 0x3 = Disable : Module is disabled and cannot be accessed
15-2	Reserved	R	0h	
1-0	MODULEMODE	R/W	0h	Control the way mandatory clocks are managed. 0x0 = DISABLED : Module is disable by SW. Any OCP access to module results in an error, except if resulting from a module wakeup (asynchronous wakeup). 0x1 = RESERVED_1 : Reserved 0x2 = ENABLE : Module is explicitly enabled. Interface clock (if not used for functions) may be gated according to the clock domain state. Functional clocks are guaranteed to stay present. As long as in this configuration, power domain sleep transition cannot happen. 0x3 = RESERVED : Reserved

8.1.12.1.47 CM_PER_TPTC2_CLKCTRL Register (offset = 100h) [reset = 70000h]

 CM_PER_TPTC2_CLKCTRL is shown in [Figure 8-69](#) and described in [Table 8-76](#).

This register manages the TPTC2 clocks.

Figure 8-69. CM_PER_TPTC2_CLKCTRL Register

31	30	29	28	27	26	25	24
Reserved							
R-0h							
23	22	21	20	19	18	17	16
Reserved				STBYST		IDLEST	
R-0h				R-1h		R-3h	
15	14	13	12	11	10	9	8
Reserved							
R-0h							
7	6	5	4	3	2	1	0
Reserved						MODULEMODE	
R-0h						R/W-0h	

LEGEND: R/W = Read/Write; R = Read only; W1toCl = Write 1 to clear bit; -n = value after reset

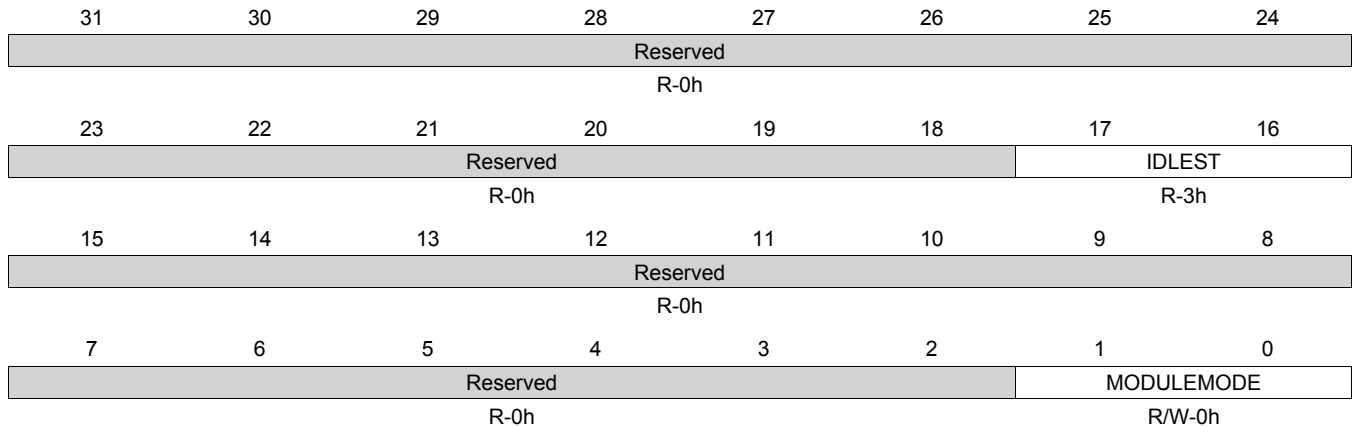
Table 8-76. CM_PER_TPTC2_CLKCTRL Register Field Descriptions

Bit	Field	Type	Reset	Description
31-19	Reserved	R	0h	
18	STBYST	R	1h	Module standby status. 0x0 = Func : Module is functional (not in standby) 0x1 = Standby : Module is in standby
17-16	IDLEST	R	3h	Module idle status. 0x0 = Func : Module is fully functional, including OCP 0x1 = Trans : Module is performing transition: wakeup, or sleep, or sleep abortion 0x2 = Idle : Module is in Idle mode (only OCP part). It is functional if using separate functional clock 0x3 = Disable : Module is disabled and cannot be accessed
15-2	Reserved	R	0h	
1-0	MODULEMODE	R/W	0h	Control the way mandatory clocks are managed. 0x0 = DISABLED : Module is disable by SW. Any OCP access to module results in an error, except if resulting from a module wakeup (asynchronous wakeup). 0x1 = RESERVED_1 : Reserved 0x2 = ENABLE : Module is explicitly enabled. Interface clock (if not used for functions) may be gated according to the clock domain state. Functional clocks are guaranteed to stay present. As long as in this configuration, power domain sleep transition cannot happen. 0x3 = RESERVED : Reserved

8.1.12.1.48 CM_PER_SPINLOCK_CLKCTRL Register (offset = 10Ch) [reset = 30000h]

CM_PER_SPINLOCK_CLKCTRL is shown in [Figure 8-70](#) and described in [Table 8-77](#).

This register manages the SPINLOCK clocks.

Figure 8-70. CM_PER_SPINLOCK_CLKCTRL Register


LEGEND: R/W = Read/Write; R = Read only; W1toCl = Write 1 to clear bit; -n = value after reset

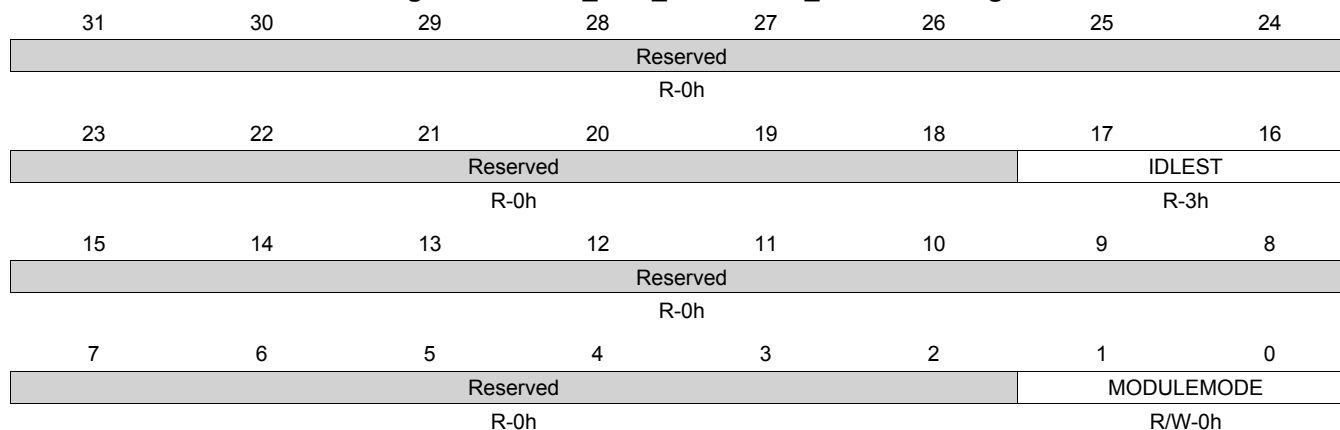
Table 8-77. CM_PER_SPINLOCK_CLKCTRL Register Field Descriptions

Bit	Field	Type	Reset	Description
31-18	Reserved	R	0h	
17-16	IDLEST	R	3h	Module idle status. 0x0 = Func : Module is fully functional, including OCP 0x1 = Trans : Module is performing transition: wakeup, or sleep, or sleep abortion 0x2 = Idle : Module is in Idle mode (only OCP part). It is functional if using separate functional clock 0x3 = Disable : Module is disabled and cannot be accessed
15-2	Reserved	R	0h	
1-0	MODULEMODE	R/W	0h	Control the way mandatory clocks are managed. 0x0 = DISABLED : Module is disable by SW. Any OCP access to module results in an error, except if resulting from a module wakeup (asynchronous wakeup). 0x1 = RESERVED_1 : Reserved 0x2 = ENABLE : Module is explicitly enabled. Interface clock (if not used for functions) may be gated according to the clock domain state. Functional clocks are guaranteed to stay present. As long as in this configuration, power domain sleep transition cannot happen. 0x3 = RESERVED : Reserved

8.1.12.1.49 CM_PER_MAILBOX0_CLKCTRL Register (offset = 110h) [reset = 30000h]

CM_PER_MAILBOX0_CLKCTRL is shown in [Figure 8-71](#) and described in [Table 8-78](#).

This register manages the MAILBOX0 clocks.

Figure 8-71. CM_PER_MAILBOX0_CLKCTRL Register


LEGEND: R/W = Read/Write; R = Read only; W1toCl = Write 1 to clear bit; -n = value after reset

Table 8-78. CM_PER_MAILBOX0_CLKCTRL Register Field Descriptions

Bit	Field	Type	Reset	Description
31-18	Reserved	R	0h	
17-16	IDLEST	R	3h	Module idle status. 0x0 = Func : Module is fully functional, including OCP 0x1 = Trans : Module is performing transition: wakeup, or sleep, or sleep abortion 0x2 = Idle : Module is in Idle mode (only OCP part). It is functional if using separate functional clock 0x3 = Disable : Module is disabled and cannot be accessed
15-2	Reserved	R	0h	
1-0	MODULEMODE	R/W	0h	Control the way mandatory clocks are managed. 0x0 = DISABLED : Module is disable by SW. Any OCP access to module results in an error, except if resulting from a module wakeup (asynchronous wakeup). 0x1 = RESERVED_1 : Reserved 0x2 = ENABLE : Module is explicitly enabled. Interface clock (if not used for functions) may be gated according to the clock domain state. Functional clocks are guaranteed to stay present. As long as in this configuration, power domain sleep transition cannot happen. 0x3 = RESERVED : Reserved

8.1.12.1.50 CM_PER_L4HS_CLKSTCTRL Register (offset = 11Ch) [reset = 7Ah]

CM_PER_L4HS_CLKSTCTRL is shown in [Figure 8-72](#) and described in [Table 8-79](#).

This register enables the domain power state transition. It controls the SW supervised clock domain state transition between ON-ACTIVE and ON-INACTIVE states. It also hold one status bit per clock input of the domain.

Figure 8-72. CM_PER_L4HS_CLKSTCTRL Register

31	30	29	28	27	26	25	24
Reserved							
R-0h							
23	22	21	20	19	18	17	16
Reserved							
R-0h							
15	14	13	12	11	10	9	8
Reserved							
R-0h							
7	6	5	4	3	2	1	0
Reserved	CLKACTIVITY_CPSW_5MHZ_GCLK	CLKACTIVITY_CPSW_50MHZ_GCLK	CLKACTIVITY_CPSW_250MHZ_GCLK	CLKACTIVITY_L4HS_GCLK	Reserved	CLKTRCTRL	
R-0h	R-1h	R-1h	R-1h	R-1h	R-0h	R/W-2h	

LEGEND: R/W = Read/Write; R = Read only; W1toCl = Write 1 to clear bit; -n = value after reset

Table 8-79. CM_PER_L4HS_CLKSTCTRL Register Field Descriptions

Bit	Field	Type	Reset	Description
31-7	Reserved	R	0h	
6	CLKACTIVITY_CPSW_5MHZ_GCLK	R	1h	This field indicates the state of the CPSW_5MHZ_GCLK clock in the domain. 0x0 = Inact 0x1 = Act
5	CLKACTIVITY_CPSW_50MHZ_GCLK	R	1h	This field indicates the state of the CPSW_50MHZ_GCLK clock in the domain. 0x0 = Inact 0x1 = Act
4	CLKACTIVITY_CPSW_250MHZ_GCLK	R	1h	This field indicates the state of the CPSW_250MHZ_GCLK clock in the domain. 0x0 = Inact 0x1 = Act
3	CLKACTIVITY_L4HS_GCLK	R	1h	This field indicates the state of the L4HS_GCLK clock in the domain. 0x0 = Inact 0x1 = Act
2	Reserved	R	0h	
1-0	CLKTRCTRL	R/W	2h	Controls the clock state transition of the L4 Fast clock domain. 0x0 = NO_SLEEP : NO_SLEEP: Sleep transition cannot be initiated. Wakeup transition may however occur. 0x1 = SW_SLEEP : SW_SLEEP: Start a software forced sleep transition on the domain. 0x2 = SW_WKUP : SW_WKUP: Start a software forced wake-up transition on the domain. 0x3 = Reserved : Reserved.

8.1.12.1.51 CM_PER_L4HS_CLKCTRL Register (offset = 120h) [reset = 2h]

 CM_PER_L4HS_CLKCTRL is shown in [Figure 8-73](#) and described in [Table 8-80](#).

This register manages the L4 Fast clocks.

Figure 8-73. CM_PER_L4HS_CLKCTRL Register

31	30	29	28	27	26	25	24
Reserved							
R-0h							
23	22	21	20	19	18	17	16
Reserved						IDLEST	
R-0h						R-0h	
15	14	13	12	11	10	9	8
Reserved							
R-0h							
7	6	5	4	3	2	1	0
Reserved						MODULEMODE	
R-0h						R/W-2h	

LEGEND: R/W = Read/Write; R = Read only; W1toCl = Write 1 to clear bit; -n = value after reset

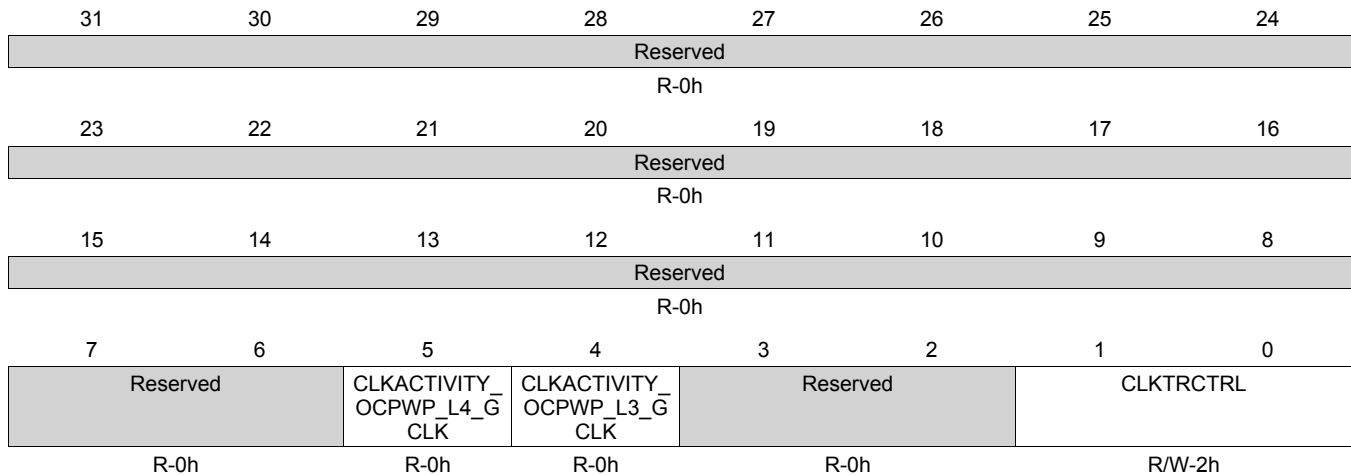
Table 8-80. CM_PER_L4HS_CLKCTRL Register Field Descriptions

Bit	Field	Type	Reset	Description
31-18	Reserved	R	0h	
17-16	IDLEST	R	0h	Module idle status. 0x0 = Func : Module is fully functional, including OCP 0x1 = Trans : Module is performing transition: wakeup, or sleep, or sleep abortion 0x2 = Idle : Module is in Idle mode (only OCP part). It is functional if using separate functional clock 0x3 = Disable : Module is disabled and cannot be accessed
15-2	Reserved	R	0h	
1-0	MODULEMODE	R/W	2h	Control the way mandatory clocks are managed. 0x0 = DISABLED : Module is disable by SW. Any OCP access to module results in an error, except if resulting from a module wakeup (asynchronous wakeup). 0x1 = RESERVED_1 : Reserved 0x2 = ENABLE : Module is explicitly enabled. Interface clock (if not used for functions) may be gated according to the clock domain state. Functional clocks are guaranteed to stay present. As long as in this configuration, power domain sleep transition cannot happen. 0x3 = RESERVED : Reserved

8.1.12.1.52 CM_PER_OCPWP_L3_CLKSTCTRL Register (offset = 12Ch) [reset = 2h]

CM_PER_OCPWP_L3_CLKSTCTRL is shown in [Figure 8-74](#) and described in [Table 8-81](#).

This register enables the domain power state transition. It controls the SW supervised clock domain state transition between ON-ACTIVE and ON-INACTIVE states. It also hold one status bit per clock input of the domain.

Figure 8-74. CM_PER_OCPWP_L3_CLKSTCTRL Register


LEGEND: R/W = Read/Write; R = Read only; W1toCl = Write 1 to clear bit; -n = value after reset

Table 8-81. CM_PER_OCPWP_L3_CLKSTCTRL Register Field Descriptions

Bit	Field	Type	Reset	Description
31-6	Reserved	R	0h	
5	CLKACTIVITY_OCPWP_L4_GCLK	R	0h	This field indicates the state of the OCPWP L4 clock in the domain. 0x0 = Inact 0x1 = Act
4	CLKACTIVITY_OCPWP_L3_GCLK	R	0h	This field indicates the state of the OCPWP L3 clock in the domain. 0x0 = Inact 0x1 = Act
3-2	Reserved	R	0h	
1-0	CLKTRCTRL	R/W	2h	Controls the clock state transition of the OCPWP clock domain. 0x0 = NO_SLEEP : NO_SLEEP: Sleep transition cannot be initiated. Wakeup transition may however occur. 0x1 = SW_SLEEP : SW_SLEEP: Start a software forced sleep transition on the domain. 0x2 = SW_WKUP : SW_WKUP: Start a software forced wake-up transition on the domain. 0x3 = Reserved : Reserved.

8.1.12.1.53 CM_PER_OCPWP_CLKCTRL Register (offset = 130h) [reset = 70002h]

 CM_PER_OCPWP_CLKCTRL is shown in [Figure 8-75](#) and described in [Table 8-82](#).

This register manages the OCPWP clocks.

Figure 8-75. CM_PER_OCPWP_CLKCTRL Register

31	30	29	28	27	26	25	24
Reserved							
R-0h							
23	22	21	20	19	18	17	16
Reserved				STBYST		IDLEST	
R-0h				R-1h		R-3h	
15	14	13	12	11	10	9	8
Reserved							
R-0h							
7	6	5	4	3	2	1	0
Reserved						MODULEMODE	
R-0h						R/W-2h	

LEGEND: R/W = Read/Write; R = Read only; W1toCl = Write 1 to clear bit; -n = value after reset

Table 8-82. CM_PER_OCPWP_CLKCTRL Register Field Descriptions

Bit	Field	Type	Reset	Description
31-19	Reserved	R	0h	
18	STBYST	R	1h	Module standby status. 0x0 = Func : Module is functional (not in standby) 0x1 = Standby : Module is in standby
17-16	IDLEST	R	3h	Module idle status. 0x0 = Func : Module is fully functional, including OCP 0x1 = Trans : Module is performing transition: wakeup, or sleep, or sleep abortion 0x2 = Idle : Module is in Idle mode (only OCP part). It is functional if using separate functional clock 0x3 = Disable : Module is disabled and cannot be accessed
15-2	Reserved	R	0h	
1-0	MODULEMODE	R/W	2h	Control the way mandatory clocks are managed. 0x0 = DISABLED : Module is disable by SW. Any OCP access to module results in an error, except if resulting from a module wakeup (asynchronous wakeup). 0x1 = RESERVED_1 : Reserved 0x2 = ENABLE : Module is explicitly enabled. Interface clock (if not used for functions) may be gated according to the clock domain state. Functional clocks are guaranteed to stay present. As long as in this configuration, power domain sleep transition cannot happen. 0x3 = RESERVED : Reserved

8.1.12.1.54 CM_PER_PRU_ICSS_CLKSTCTRL Register (offset = 140h) [reset = 2h]

CM_PER_PRU_ICSS_CLKSTCTRL is shown in [Figure 8-76](#) and described in [Table 8-83](#).

This register enables the clock domain state transition. It controls the SW supervised clock domain state transition between ON-ACTIVE and ON-INACTIVE states. It also hold one status bit per clock input of the domain.

Figure 8-76. CM_PER_PRU_ICSS_CLKSTCTRL Register

31	30	29	28	27	26	25	24
Reserved							
R-0h							
23	22	21	20	19	18	17	16
Reserved							
R-0h							
15	14	13	12	11	10	9	8
Reserved							
R-0h							
7	6	5	4	3	2	1	0
Reserved	CLKACTIVITY_ PRU_ICSS_UA RT_GCLK	CLKACTIVITY_ PRU_ICSS_I \bar{E} P_GCLK	CLKACTIVITY_ PRU_ICSS_OC P_GCLK	Reserved		CLKTRCTRL	
R-0h	R-0h	R-0h	R-0h	R-0h		R/W-2h	

LEGEND: R/W = Read/Write; R = Read only; W1toCl = Write 1 to clear bit; -n = value after reset

Table 8-83. CM_PER_PRU_ICSS_CLKSTCTRL Register Field Descriptions

Bit	Field	Type	Reset	Description
31-7	Reserved	R	0h	
6	CLKACTIVITY_PRU_ICSS_UA RT_GCLK	R	0h	This field indicates the state of the PRU-ICSS UART clock in the domain. 0x0 = Inact 0x1 = Act
5	CLKACTIVITY_PRU_ICSS_I \bar{E} P_GCLK	R	0h	This field indicates the state of the PRU-ICSS IEP clock in the domain. 0x0 = Inact 0x1 = Act
4	CLKACTIVITY_PRU_ICSS_OC P_GCLK	R	0h	This field indicates the state of the PRU-ICSS OCP clock in the domain. 0x0 = Inact 0x1 = Act
3-2	Reserved	R	0h	
1-0	CLKTRCTRL	R/W	2h	Controls the clock state transition of the PRU-ICSS OCP clock domain. 0x0 = NO_SLEEP : NO_SLEEP: Sleep transition cannot be initiated. Wakeup transition may however occur. 0x1 = SW_SLEEP : SW_SLEEP: Start a software forced sleep transition on the domain. 0x2 = SW_WKUP : SW_WKUP: Start a software forced wake-up transition on the domain. 0x3 = Reserved : Reserved.

8.1.12.1.55 CM_PER_CPSW_CLKSTCTRL Register (offset = 144h) [reset = 2h]

CM_PER_CPSW_CLKSTCTRL is shown in [Figure 8-77](#) and described in [Table 8-84](#).

This register enables the clock domain state transition. It controls the SW supervised clock domain state transition between ON-ACTIVE and ON-INACTIVE states. It also hold one status bit per clock input of the domain.

Figure 8-77. CM_PER_CPSW_CLKSTCTRL Register

31	30	29	28	27	26	25	24
Reserved							
R-0h							
23	22	21	20	19	18	17	16
Reserved							
R-0h							
15	14	13	12	11	10	9	8
Reserved							
R-0h							
7	6	5	4	3	2	1	0
Reserved			CLKACTIVITY_CPSW_125MHz_GCLK	Reserved		CLKTRCTRL	
R-0h			R-0h	R-0h		R/W-2h	

LEGEND: R/W = Read/Write; R = Read only; W1toCl = Write 1 to clear bit; -n = value after reset

Table 8-84. CM_PER_CPSW_CLKSTCTRL Register Field Descriptions

Bit	Field	Type	Reset	Description
31-5	Reserved	R	0h	
4	CLKACTIVITY_CPSW_125MHz_GCLK	R	0h	This field indicates the state of the CPSW 125 MHz OCP clock in the domain. 0x0 = Inact 0x1 = Act
3-2	Reserved	R	0h	
1-0	CLKTRCTRL	R/W	2h	Controls the clock state transition of the CPSW OCP clock domain. 0x0 = NO_SLEEP : NO_SLEEP: Sleep transition cannot be initiated. Wakeup transition may however occur. 0x1 = SW_SLEEP : SW_SLEEP: Start a software forced sleep transition on the domain. 0x2 = SW_WKUP : SW_WKUP: Start a software forced wake-up transition on the domain. 0x3 = Reserved : Reserved.

8.1.12.1.56 CM_PER_LCDC_CLKSTCTRL Register (offset = 148h) [reset = 2h]

CM_PER_LCDC_CLKSTCTRL is shown in Figure 8-78 and described in Table 8-85.

This register enables the clock domain state transition. It controls the SW supervised clock domain state transition between ON-ACTIVE and ON-INACTIVE states. It also hold one status bit per clock input of the domain.

Figure 8-78. CM_PER_LCDC_CLKSTCTRL Register

31	30	29	28	27	26	25	24
Reserved							
R-0h							
23	22	21	20	19	18	17	16
Reserved							
R-0h							
15	14	13	12	11	10	9	8
Reserved							
R-0h							
7	6	5	4	3	2	1	0
Reserved		CLKACTIVITY_LCDC_L4_OCP_GCLK	CLKACTIVITY_LCDC_L3_OCP_GCLK	Reserved		CLKTRCTRL	
R-0h		R-0h	R-0h	R-0h		R/W-2h	

LEGEND: R/W = Read/Write; R = Read only; W1toCl = Write 1 to clear bit; -n = value after reset

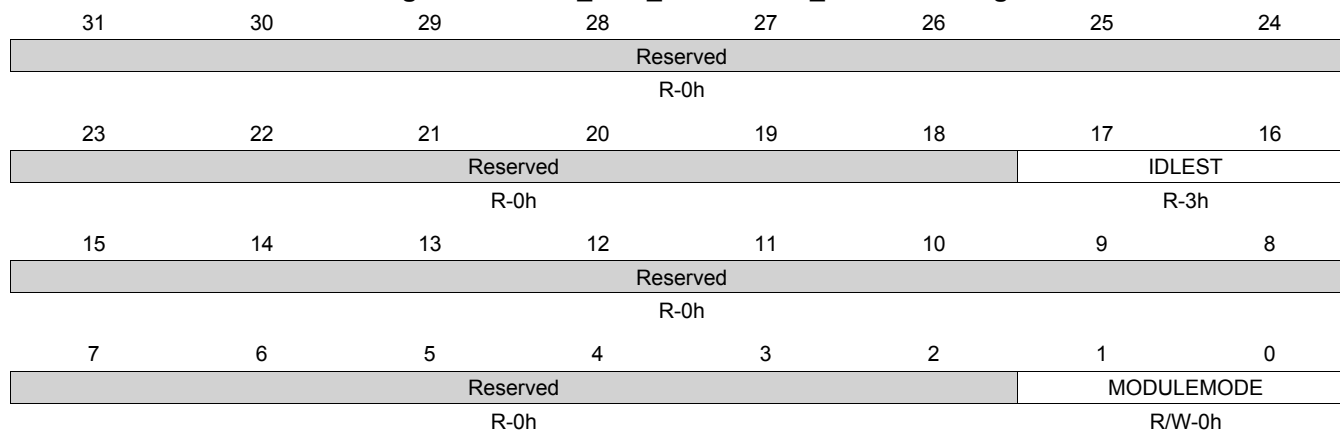
Table 8-85. CM_PER_LCDC_CLKSTCTRL Register Field Descriptions

Bit	Field	Type	Reset	Description
31-6	Reserved	R	0h	
5	CLKACTIVITY_LCDC_L4_OCP_GCLK	R	0h	This field indicates the state of the LCDC L4 OCP clock in the domain. 0x0 = Inact 0x1 = Act
4	CLKACTIVITY_LCDC_L3_OCP_GCLK	R	0h	This field indicates the state of the LCDC L3 OCP clock in the domain. 0x0 = Inact 0x1 = Act
3-2	Reserved	R	0h	
1-0	CLKTRCTRL	R/W	2h	Controls the clock state transition of the LCDC OCP clock domain. 0x0 = NO_SLEEP : NO_SLEEP: Sleep transition cannot be initiated. Wakeup transition may however occur. 0x1 = SW_SLEEP : SW_SLEEP: Start a software forced sleep transition on the domain. 0x2 = SW_WKUP : SW_WKUP: Start a software forced wake-up transition on the domain. 0x3 = Reserved : Reserved.

8.1.12.1.57 CM_PER_CLKDIV32K_CLKCTRL Register (offset = 14Ch) [reset = 30000h]

CM_PER_CLKDIV32K_CLKCTRL is shown in [Figure 8-79](#) and described in [Table 8-86](#).

This register manages the CLKDIV32K clocks.

Figure 8-79. CM_PER_CLKDIV32K_CLKCTRL Register


LEGEND: R/W = Read/Write; R = Read only; W1toCl = Write 1 to clear bit; -n = value after reset

Table 8-86. CM_PER_CLKDIV32K_CLKCTRL Register Field Descriptions

Bit	Field	Type	Reset	Description
31-18	Reserved	R	0h	
17-16	IDLEST	R	3h	Module idle status. 0x0 = Func : Module is fully functional, including OCP 0x1 = Trans : Module is performing transition: wakeup, or sleep, or sleep abortion 0x2 = Idle : Module is in Idle mode (only OCP part). It is functional if using separate functional clock 0x3 = Disable : Module is disabled and cannot be accessed
15-2	Reserved	R	0h	
1-0	MODULEMODE	R/W	0h	Control the way mandatory clocks are managed. 0x0 = DISABLED : Module is disable by SW. Any OCP access to module results in an error, except if resulting from a module wakeup (asynchronous wakeup). 0x1 = RESERVED_1 : Reserved 0x2 = ENABLE : Module is explicitly enabled. Interface clock (if not used for functions) may be gated according to the clock domain state. Functional clocks are guaranteed to stay present. As long as in this configuration, power domain sleep transition cannot happen. 0x3 = RESERVED : Reserved

8.1.12.1.58 CM_PER_CLK_24MHZ_CLKSTCTRL Register (offset = 150h) [reset = 2h]

CM_PER_CLK_24MHZ_CLKSTCTRL is shown in [Figure 8-80](#) and described in [Table 8-87](#).

This register enables the clock domain state transition. It controls the SW supervised clock domain state transition between ON-ACTIVE and ON-INACTIVE states. It also hold one status bit per clock input of the domain.

Figure 8-80. CM_PER_CLK_24MHZ_CLKSTCTRL Register

31	30	29	28	27	26	25	24
Reserved							
R-0h							
23	22	21	20	19	18	17	16
Reserved							
R-0h							
15	14	13	12	11	10	9	8
Reserved							
R-0h							
7	6	5	4	3	2	1	0
Reserved			CLKACTIVITY_ CLK_24MHZ_G CLK	Reserved		CLKTRCTRL	
R-0h			R-0h	R-0h		R/W-2h	

LEGEND: R/W = Read/Write; R = Read only; W1toCl = Write 1 to clear bit; -n = value after reset

Table 8-87. CM_PER_CLK_24MHZ_CLKSTCTRL Register Field Descriptions

Bit	Field	Type	Reset	Description
31-5	Reserved	R	0h	
4	CLKACTIVITY_CLK_24MHZ_GCLK	R	0h	This field indicates the state of the 24MHz clock in the domain. 0x0 = Inact 0x1 = Act
3-2	Reserved	R	0h	
1-0	CLKTRCTRL	R/W	2h	Controls the clock state transition of the 24MHz clock domain. 0x0 = NO_SLEEP : NO_SLEEP: Sleep transition cannot be initiated. Wakeup transition may however occur. 0x1 = SW_SLEEP : SW_SLEEP: Start a software forced sleep transition on the domain. 0x2 = SW_WKUP : SW_WKUP: Start a software forced wake-up transition on the domain. 0x3 = Reserved : Reserved.

8.1.12.2 CM_WKUP Registers

[Table 8-88](#) lists the memory-mapped registers for the CM_WKUP. All register offset addresses not listed in [Table 8-88](#) should be considered as reserved locations and the register contents should not be modified.

Table 8-88. CM_WKUP Registers

Offset	Acronym	Register Name	Section
0h	CM_WKUP_CLKSTCTRL		Section 8.1.12.2.1
4h	CM_WKUP_CONTROL_CLKCTRL		Section 8.1.12.2.2
8h	CM_WKUP_GPIO0_CLKCTRL		Section 8.1.12.2.3
Ch	CM_WKUP_L4WKUP_CLKCTRL		Section 8.1.12.2.4
10h	CM_WKUP_TIMER0_CLKCTRL		Section 8.1.12.2.5

Table 8-88. CM_WKUP Registers (continued)

Offset	Acronym	Register Name	Section
14h	CM_WKUP_DEBUGSS_CLKCTRL		Section 8.1.12.2.6
18h	CM_L3_AON_CLKSTCTRL		Section 8.1.12.2.7
1Ch	CM_AUTOIDLE_DPLL_MPU		Section 8.1.12.2.8
20h	CM_IDLEST_DPLL_MPU		Section 8.1.12.2.9
24h	CM_SSC_DELTAMSTEP_DPLL_MPU		Section 8.1.12.2.10
28h	CM_SSC_MODFREQDIV_DPLL_MPU		Section 8.1.12.2.11
2Ch	CM_CLKSEL_DPLL_MPU		Section 8.1.12.2.12
30h	CM_AUTOIDLE_DPLL_DDR		Section 8.1.12.2.13
34h	CM_IDLEST_DPLL_DDR		Section 8.1.12.2.14
38h	CM_SSC_DELTAMSTEP_DPLL_DDR		Section 8.1.12.2.15
3Ch	CM_SSC_MODFREQDIV_DPLL_DDR		Section 8.1.12.2.16
40h	CM_CLKSEL_DPLL_DDR		Section 8.1.12.2.17
44h	CM_AUTOIDLE_DPLL_DISP		Section 8.1.12.2.18
48h	CM_IDLEST_DPLL_DISP		Section 8.1.12.2.19
4Ch	CM_SSC_DELTAMSTEP_DPLL_DISP		Section 8.1.12.2.20
50h	CM_SSC_MODFREQDIV_DPLL_DISP		Section 8.1.12.2.21
54h	CM_CLKSEL_DPLL_DISP		Section 8.1.12.2.22
58h	CM_AUTOIDLE_DPLL_CORE		Section 8.1.12.2.23
5Ch	CM_IDLEST_DPLL_CORE		Section 8.1.12.2.24
60h	CM_SSC_DELTAMSTEP_DPLL_CORE		Section 8.1.12.2.25
64h	CM_SSC_MODFREQDIV_DPLL_CORE		Section 8.1.12.2.26
68h	CM_CLKSEL_DPLL_CORE		Section 8.1.12.2.27
6Ch	CM_AUTOIDLE_DPLL_PER		Section 8.1.12.2.28
70h	CM_IDLEST_DPLL_PER		Section 8.1.12.2.29
74h	CM_SSC_DELTAMSTEP_DPLL_PER		Section 8.1.12.2.30
78h	CM_SSC_MODFREQDIV_DPLL_PER		Section 8.1.12.2.31
7Ch	CM_CLKDCOLDO_DPLL_PER		Section 8.1.12.2.32
80h	CM_DIV_M4_DPLL_CORE		Section 8.1.12.2.33
84h	CM_DIV_M5_DPLL_CORE		Section 8.1.12.2.34
88h	CM_CLKMODE_DPLL_MPU		Section 8.1.12.2.35

Table 8-88. CM_WKUP Registers (continued)

Offset	Acronym	Register Name	Section
8Ch	CM_CLKMODE_DPLL_PER		Section 8.1.12.2.36
90h	CM_CLKMODE_DPLL_CORE		Section 8.1.12.2.37
94h	CM_CLKMODE_DPLL_DDR		Section 8.1.12.2.38
98h	CM_CLKMODE_DPLL_DISP		Section 8.1.12.2.39
9Ch	CM_CLKSEL_DPLL_PERIPH		Section 8.1.12.2.40
A0h	CM_DIV_M2_DPLL_DDR		Section 8.1.12.2.41
A4h	CM_DIV_M2_DPLL_DISP		Section 8.1.12.2.42
A8h	CM_DIV_M2_DPLL_MPU		Section 8.1.12.2.43
ACh	CM_DIV_M2_DPLL_PER		Section 8.1.12.2.44
B0h	CM_WKUP_WKUP_M3_CLKCTRL		Section 8.1.12.2.45
B4h	CM_WKUP_UART0_CLKCTRL		Section 8.1.12.2.46
B8h	CM_WKUP_I2C0_CLKCTRL		Section 8.1.12.2.47
BCh	CM_WKUP_ADC_TSC_CLKCTRL		Section 8.1.12.2.48
C0h	CM_WKUP_SMARTREFLEX0_CLKCTRL		Section 8.1.12.2.49
C4h	CM_WKUP_TIMER1_CLKCTRL		Section 8.1.12.2.50
C8h	CM_WKUP_SMARTREFLEX1_CLKCTRL		Section 8.1.12.2.51
CCh	CM_L4_WKUP_AON_CLKSTCTRL		Section 8.1.12.2.52
D4h	CM_WKUP_WDT1_CLKCTRL		Section 8.1.12.2.53
D8h	CM_DIV_M6_DPLL_CORE		Section 8.1.12.2.54

8.1.12.2.1 CM_WKUP_CLKSTCTRL Register (offset = 0h) [reset = 6h]

Register mask: FFFFFFFFh

 CM_WKUP_CLKSTCTRL is shown in [Figure 8-81](#) and described in [Table 8-89](#).

This register enables the domain power state transition. It controls the SW supervised clock domain state transition between ON-ACTIVE and ON-INACTIVE states. It also hold one status bit per clock input of the domain.

Figure 8-81. CM_WKUP_CLKSTCTRL Register

31								30								29								28								27								26								25								24							
RESERVED																																																															
Rreturns0s-0h																																																															
23								22								21								20								19								18								17								16							
RESERVED																																																															
Rreturns0s-0h																																																															
15								14								13								12								11								10								9								8							
RESERVED								CLKACTIVITY_ADC_FCLK								CLKACTIVITY_TIMER1_GCLK								CLKACTIVITY_UART0_GFCLK								CLKACTIVITY_I2C0_GFCLK								CLKACTIVITY_TIMER0_GCLK								RESERVED								CLKACTIVITY_GPIO0_GDBCLK							
Rreturns0s-0h								R-0h								R-0h								R-0h								R-0h								R-0h								R-0h								R-0h							
7								6								5								4								3								2								1								0							
RESERVED																CLKACTIVITY_WDT1_GCLK								CLKACTIVITY_SR_SYSCLK								CLKACTIVITY_L4_WKUP_GCLK								CLKTRCTRL																							
Rreturns0s-0h																R-0h								R-0h								R-1h								R/W-2h																							

LEGEND: R/W = Read/Write; R = Read only; W1toCl = Write 1 to clear bit; -n = value after reset

Table 8-89. CM_WKUP_CLKSTCTRL Register Field Descriptions

Bit	Field	Type	Reset	Description
31-15	RESERVED	Rreturns0s	0h	
14	CLKACTIVITY_ADC_FCLK	R	0h	This field indicates the state of the ADC clock in the domain. 0h (R) = Corresponding clock is gated 1h (R) = Corresponding clock is active
13	CLKACTIVITY_TIMER1_GCLK	R	0h	This field indicates the state of the TIMER1 clock in the domain. 0h (R) = Corresponding clock is gated 1h (R) = Corresponding clock is active
12	CLKACTIVITY_UART0_GFCLK	R	0h	This field indicates the state of the UART0 clock in the domain. 0h (R) = Corresponding clock is gated 1h (R) = Corresponding clock is active
11	CLKACTIVITY_I2C0_GFCLK	R	0h	This field indicates the state of the I2C0 clock in the domain. 0h (R) = Corresponding clock is gated 1h (R) = Corresponding clock is active
10	CLKACTIVITY_TIMER0_GCLK	R	0h	This field indicates the state of the WKUPTIMER_GCLK clock in the domain. 0h (R) = Corresponding clock is gated 1h (R) = Corresponding clock is active
9	RESERVED	R	0h	
8	CLKACTIVITY_GPIO0_GDBCLK	R	0h	This field indicates the state of the WKUPGPIO_DBGICLK clock in the domain. 0h (R) = Corresponding clock is gated 1h (R) = Corresponding clock is active
7-5	RESERVED	Rreturns0s	0h	

Table 8-89. CM_WKUP_CLKSTCTRL Register Field Descriptions (continued)

Bit	Field	Type	Reset	Description
4	CLKACTIVITY_WDT1_GCLK	R	0h	This field indicates the state of the WDT1_GCLK clock in the domain. 0h (R) = Corresponding clock is gated 1h (R) = Corresponding clock is active
3	CLKACTIVITY_SR_SYSCLK	R	0h	This field indicates the state of the SMARTREFGLEX SYSCLK clock in the domain. 0h (R) = Corresponding clock is gated 1h (R) = Corresponding clock is active
2	CLKACTIVITY_L4_WKUP_GCLK	R	1h	This field indicates the state of the L4_WKUP clock in the domain. 0h (R) = Corresponding clock is gated 1h (R) = Corresponding clock is active
1-0	CLKTRCTRL	R/W	2h	Controls the clock state transition of the always on clock domain. 0h (R/W) = NO_SLEEP: Sleep transition cannot be initiated. Wakeup transition may however occur. 1h (R/W) = SW_SLEEP: Start a software forced sleep transition on the domain. 2h (R/W) = SW_WKUP: Start a software forced wake-up transition on the domain. 3h (R/W) = Reserved.

8.1.12.2.2 CM_WKUP_CONTROL_CLKCTRL Register (offset = 4h) [reset = 30000h]

Register mask: FFFFFFFFh

 CM_WKUP_CONTROL_CLKCTRL is shown in [Figure 8-82](#) and described in [Table 8-90](#).

This register manages the Control Module clocks.

Figure 8-82. CM_WKUP_CONTROL_CLKCTRL Register

31	30	29	28	27	26	25	24
RESERVED							
Rreturns0s-0h							
23	22	21	20	19	18	17	16
RESERVED				RESERVED		IDLEST	
Rreturns0s-0h				Rreturns0s-0h		R-3h	
15	14	13	12	11	10	9	8
RESERVED							
Rreturns0s-0h							
7	6	5	4	3	2	1	0
RESERVED						MODULEMODE	
Rreturns0s-0h						R/W-0h	

LEGEND: R/W = Read/Write; R = Read only; W1toCl = Write 1 to clear bit; -n = value after reset

Table 8-90. CM_WKUP_CONTROL_CLKCTRL Register Field Descriptions

Bit	Field	Type	Reset	Description
31-19	RESERVED	Rreturns0s	0h	
18	RESERVED	Rreturns0s	0h	
17-16	IDLEST	R	3h	Module idle status. 0h (R) = Module is fully functional, including OCP 1h (R) = Module is performing transition: wakeup, or sleep, or sleep abortion 2h (R) = Module is in Idle mode (only OCP part). It is functional if using separate functional clock 3h (R) = Module is disabled and cannot be accessed
15-2	RESERVED	Rreturns0s	0h	
1-0	MODULEMODE	R/W	0h	Control the way mandatory clocks are managed. 0h (R/W) = Module is disable by SW. Any OCP access to module results in an error, except if resulting from a module wakeup (asynchronous wakeup). 1h (R/W) = Reserved 2h (R/W) = Module is explicitly enabled. Interface clock (if not used for functions) may be gated according to the clock domain state. Functional clocks are guaranteed to stay present. As long as in this configuration, power domain sleep transition cannot happen. 3h (R) = Reserved

8.1.12.2.3 CM_WKUP_GPIO0_CLKCTRL Register (offset = 8h) [reset = 30000h]

Register mask: FFFFFFFFh

CM_WKUP_GPIO0_CLKCTRL is shown in [Figure 8-83](#) and described in [Table 8-91](#).

This register manages the GPIO0 clocks.

Figure 8-83. CM_WKUP_GPIO0_CLKCTRL Register

31	30	29	28	27	26	25	24
RESERVED							
Rreturns0s-0h							
23	22	21	20	19	18	17	16
RESERVED					OPTFCLKEN_ GPIO0_GDBCL K	IDLEST	
Rreturns0s-0h				R/W-0h		R-3h	
15	14	13	12	11	10	9	8
RESERVED							
Rreturns0s-0h							
7	6	5	4	3	2	1	0
RESERVED						MODULEMODE	
Rreturns0s-0h						R/W-0h	

LEGEND: R/W = Read/Write; R = Read only; W1toCl = Write 1 to clear bit; -n = value after reset

Table 8-91. CM_WKUP_GPIO0_CLKCTRL Register Field Descriptions

Bit	Field	Type	Reset	Description
31-19	RESERVED	Rreturns0s	0h	
18	OPTFCLKEN_GPIO0_GDBCLK	R/W	0h	Optional functional clock control. 0h (R/W) = Optional functional clock is disabled 1h (R/W) = Optional functional clock is enabled
17-16	IDLEST	R	3h	Module idle status. 0h (R) = Module is fully functional, including OCP 1h (R) = Module is performing transition: wakeup, or sleep, or sleep abortion 2h (R) = Module is in Idle mode (only OCP part). It is functional if using separate functional clock 3h (R) = Module is disabled and cannot be accessed
15-2	RESERVED	Rreturns0s	0h	
1-0	MODULEMODE	R/W	0h	Control the way mandatory clocks are managed. 0h (R/W) = Module is disable by SW. Any OCP access to module results in an error, except if resulting from a module wakeup (asynchronous wakeup). 1h (R/W) = Reserved 2h (R/W) = Module is explicitly enabled. Interface clock (if not used for functions) may be gated according to the clock domain state. Functional clocks are guaranteed to stay present. As long as in this configuration, power domain sleep transition cannot happen. 3h (R) = Reserved

8.1.12.2.4 CM_WKUP_L4WKUP_CLKCTRL Register (offset = Ch) [reset = 2h]

Register mask: FFFFFFFFh

 CM_WKUP_L4WKUP_CLKCTRL is shown in [Figure 8-84](#) and described in [Table 8-92](#).

This register manages the L4WKUP clocks.

Figure 8-84. CM_WKUP_L4WKUP_CLKCTRL Register

31	30	29	28	27	26	25	24
RESERVED							
Rreturns0s-0h							
23	22	21	20	19	18	17	16
RESERVED				RESERVED		IDLEST	
Rreturns0s-0h				Rreturns0s-0h		R-0h	
15	14	13	12	11	10	9	8
RESERVED							
Rreturns0s-0h							
7	6	5	4	3	2	1	0
RESERVED						MODULEMODE	
Rreturns0s-0h						R-2h	

LEGEND: R/W = Read/Write; R = Read only; W1toCl = Write 1 to clear bit; -n = value after reset

Table 8-92. CM_WKUP_L4WKUP_CLKCTRL Register Field Descriptions

Bit	Field	Type	Reset	Description
31-19	RESERVED	Rreturns0s	0h	
18	RESERVED	Rreturns0s	0h	
17-16	IDLEST	R	0h	Module idle status. 0h (R) = Module is fully functional, including OCP 1h (R) = Module is performing transition: wakeup, or sleep, or sleep abortion 2h (R) = Module is in Idle mode (only OCP part). It is functional if using separate functional clock 3h (R) = Module is disabled and cannot be accessed
15-2	RESERVED	Rreturns0s	0h	
1-0	MODULEMODE	R	2h	Control the way mandatory clocks are managed.

8.1.12.2.5 CM_WKUP_TIMER0_CLKCTRL Register (offset = 10h) [reset = 30002h]

Register mask: FFFFFFFFh

CM_WKUP_TIMER0_CLKCTRL is shown in [Figure 8-85](#) and described in [Table 8-93](#).

This register manages the TIMER0 clocks.

Figure 8-85. CM_WKUP_TIMER0_CLKCTRL Register

31	30	29	28	27	26	25	24
RESERVED							
Rreturns0s-0h							
23	22	21	20	19	18	17	16
RESERVED				RESERVED		IDLEST	
Rreturns0s-0h				Rreturns0s-0h		R-3h	
15	14	13	12	11	10	9	8
RESERVED							
Rreturns0s-0h							
7	6	5	4	3	2	1	0
RESERVED						MODULEMODE	
Rreturns0s-0h						R/W-2h	

LEGEND: R/W = Read/Write; R = Read only; W1toCl = Write 1 to clear bit; -n = value after reset

Table 8-93. CM_WKUP_TIMER0_CLKCTRL Register Field Descriptions

Bit	Field	Type	Reset	Description
31-19	RESERVED	Rreturns0s	0h	
18	RESERVED	Rreturns0s	0h	
17-16	IDLEST	R	3h	Module idle status. 0h (R) = Module is fully functional, including OCP 1h (R) = Module is performing transition: wakeup, or sleep, or sleep abortion 2h (R) = Module is in Idle mode (only OCP part). It is functional if using separate functional clock 3h (R) = Module is disabled and cannot be accessed
15-2	RESERVED	Rreturns0s	0h	
1-0	MODULEMODE	R/W	2h	Control the way mandatory clocks are managed. 0h (R/W) = Module is disable by SW. Any OCP access to module results in an error, except if resulting from a module wakeup (asynchronous wakeup). 1h (R/W) = Reserved 2h (R/W) = Module is explicitly enabled. Interface clock (if not used for functions) may be gated according to the clock domain state. Functional clocks are guaranteed to stay present. As long as in this configuration, power domain sleep transition cannot happen. 3h (R) = Reserved

8.1.12.2.6 CM_WKUP_DEBUGSS_CLKCTRL Register (offset = 14h) [reset = 52580002h]

Register mask: FFFFFFFFh

 CM_WKUP_DEBUGSS_CLKCTRL is shown in [Figure 8-86](#) and described in [Table 8-94](#).

This register manages the DEBUGSS clocks.

Figure 8-86. CM_WKUP_DEBUGSS_CLKCTRL Register

31	30	29	28	27	26	25	24
RESERVED	OPTCLK_DEBUG_CLKA	STM_PMD_CLKDIVSEL			TRC_PMD_CLKDIVSEL		
Rreturns0s-0h	R/W-1h	R/W-2h			R/W-2h		
23	22	21	20	19	18	17	16
STM_PMD_CLKSEL		TRC_PMD_CLKSEL		OPTFCLKEN_DBGSYCLK	STBYST	IDLEST	
R/W-1h		R/W-1h		R/W-1h	R-0h	R-0h	
15	14	13	12	11	10	9	8
RESERVED							
Rreturns0s-0h							
7	6	5	4	3	2	1	0
RESERVED						MODULEMODE	
Rreturns0s-0h						R/W-2h	

LEGEND: R/W = Read/Write; R = Read only; W1toCl = Write 1 to clear bit; -n = value after reset

Table 8-94. CM_WKUP_DEBUGSS_CLKCTRL Register Field Descriptions

Bit	Field	Type	Reset	Description
31	RESERVED	Rreturns0s	0h	
30	OPTCLK_DEBUG_CLKA	R/W	1h	Optional functional clock control. 0h = Optional functional clock is disabled. 1h = Optional functional clock is enabled.
29-27	STM_PMD_CLKDIVSEL	R/W	2h	
26-24	TRC_PMD_CLKDIVSEL	R/W	2h	
23-22	STM_PMD_CLKSEL	R/W	1h	
21-20	TRC_PMD_CLKSEL	R/W	1h	
19	OPTFCLKEN_DBGSYCLK	R/W	1h	Optional functional clock control. 0h (R/W) = Optional functional clock is disabled 1h (R/W) = Optional functional clock is enabled
18	STBYST	R	0h	Module standby status. 0h (R) = Module is functional (not in standby) 1h (R) = Module is in standby
17-16	IDLEST	R	0h	Module idle status. 0h (R) = Module is fully functional, including OCP 1h (R) = Module is performing transition: wakeup, or sleep, or sleep abortion 2h (R) = Module is in Idle mode (only OCP part). It is functional if using separate functional clock 3h (R) = Module is disabled and cannot be accessed
15-2	RESERVED	Rreturns0s	0h	

Table 8-94. CM_WKUP_DEBUGSS_CLKCTRL Register Field Descriptions (continued)

Bit	Field	Type	Reset	Description
1-0	MODULEMODE	R/W	2h	Control the way mandatory clocks are managed. 0h (R/W) = Module is disable by SW. Any OCP access to module results in an error, except if resulting from a module wakeup (asynchronous wakeup). 1h (R/W) = Reserved 2h (R/W) = Module is explicitly enabled. Interface clock (if not used for functions) may be gated according to the clock domain state. Functional clocks are guaranteed to stay present. As long as in this configuration, power domain sleep transition cannot happen. 3h (R) = Reserved

8.1.12.2.7 CM_L3_AON_CLKSTCTRL Register (offset = 18h) [reset = 1Ah]

Register mask: FFFFFFFFh

 CM_L3_AON_CLKSTCTRL is shown in [Figure 8-87](#) and described in [Table 8-95](#).

This register enables the domain power state transition. It controls the SW supervised clock domain state transition between ON-ACTIVE and ON-INACTIVE states. It also hold one status bit per clock input of the domain.

Figure 8-87. CM_L3_AON_CLKSTCTRL Register

31	30	29	28	27	26	25	24
RESERVED						RESERVED	
Rreturns0s-0h						Rreturns0s-0h	
23	22	21	20	19	18	17	16
RESERVED							
Rreturns0s-0h							
15	14	13	12	11	10	9	8
RESERVED				RESERVED			
Rreturns0s-0h				Rreturns0s-0h			
7	6	5	4	3	2	1	0
RESERVED			CLKACTIVITY_	CLKACTIVITY_	CLKACTIVITY_	CLKTRCTRL	
Rreturns0s-0h			DEBUG_CLKA	L3_AON_GCLK	DBGSYSCLK	R/W-2h	
Rreturns0s-0h			R-1h	R-1h	R-0h	R/W-2h	

LEGEND: R/W = Read/Write; R = Read only; W1toCl = Write 1 to clear bit; -n = value after reset

Table 8-95. CM_L3_AON_CLKSTCTRL Register Field Descriptions

Bit	Field	Type	Reset	Description
31-26	RESERVED	Rreturns0s	0h	
25-11	RESERVED	Rreturns0s	0h	
10-8	RESERVED	Rreturns0s	0h	
7-5	RESERVED	Rreturns0s	0h	
4	CLKACTIVITY_DEBUG_C LKA	R	1h	This field indicates the state of the Debugss CLKA clock in the domain. 0h (R) = Corresponding clock is gated. 1h (R) = Corresponding clock is active.
3	CLKACTIVITY_L3_AON_ GCLK	R	1h	This field indicates the state of the L3_AON clock in the domain. 0h (R) = Corresponding clock is gated 1h (R) = Corresponding clock is active
2	CLKACTIVITY_DBGSYS CLK	R	0h	This field indicates the state of the Debugss sysclk clock in the domain. 0h (R) = Corresponding clock is gated 1h (R) = Corresponding clock is active
1-0	CLKTRCTRL	R/W	2h	Controls the clock state transition of the L3 AON clock domain. 0h (R/W) = NO_SLEEP: Sleep transition cannot be initiated. Wakeup transition may however occur. 1h (R/W) = SW_SLEEP: Start a software forced sleep transition on the domain. 2h (R/W) = SW_WKUP: Start a software forced wake-up transition on the domain. 3h (R/W) = Reserved.

8.1.12.2.8 CM_AUTOIDLE_DPLL_MPU Register (offset = 1Ch) [reset = 0h]

Register mask: FFFFFFFFh

CM_AUTOIDLE_DPLL_MPU is shown in [Figure 8-88](#) and described in [Table 8-96](#).

This register provides automatic control over the DPLL activity.

Figure 8-88. CM_AUTOIDLE_DPLL_MPU Register

31	30	29	28	27	26	25	24
RESERVED							
Rreturns0s-0h							
23	22	21	20	19	18	17	16
RESERVED							
Rreturns0s-0h							
15	14	13	12	11	10	9	8
RESERVED							
Rreturns0s-0h							
7	6	5	4	3	2	1	0
RESERVED				AUTO_DPLL_MODE			
Rreturns0s-0h				R/W-0h			

LEGEND: R/W = Read/Write; R = Read only; W1toCl = Write 1 to clear bit; -n = value after reset

Table 8-96. CM_AUTOIDLE_DPLL_MPU Register Field Descriptions

Bit	Field	Type	Reset	Description
31-3	RESERVED	Rreturns0s	0h	
2-0	AUTO_DPLL_MODE	R/W	0h	This feature is not supported.

8.1.12.2.9 CM_IDLEST_DPLL_MPU Register (offset = 20h) [reset = 0h]

Register mask: FFFFFFFFh

 CM_IDLEST_DPLL_MPU is shown in [Figure 8-89](#) and described in [Table 8-97](#).

This register allows monitoring the master clock activity. This register is read only and automatically updated.[warm reset insensitive]

Figure 8-89. CM_IDLEST_DPLL_MPU Register

31	30	29	28	27	26	25	24
RESERVED							
Rreturns0s-0h							
23	22	21	20	19	18	17	16
RESERVED							
Rreturns0s-0h							
15	14	13	12	11	10	9	8
RESERVED							ST_MN_BYPASS
Rreturns0s-0h							R-0h
7	6	5	4	3	2	1	0
RESERVED							ST_DPLL_CLK
Rreturns0s-0h							R-0h

LEGEND: R/W = Read/Write; R = Read only; W1toCl = Write 1 to clear bit; -n = value after reset

Table 8-97. CM_IDLEST_DPLL_MPU Register Field Descriptions

Bit	Field	Type	Reset	Description
31-9	RESERVED	Rreturns0s	0h	
8	ST_MN_BYPASS	R	0h	DPLL MN_BYPASS status 0h (R) = DPLL is not in MN_Bypass 1h (R) = DPLL is in MN_Bypass
7-1	RESERVED	Rreturns0s	0h	
0	ST_DPLL_CLK	R	0h	DPLL clock activity 0h (R) = DPLL is either in bypass mode or in stop mode. 1h (R) = DPLL is LOCKED

8.1.12.2.10 CM_SSC_DELTAMSTEP_DPLL_MPU Register (offset = 24h) [reset = 0h]

Register mask: FFFFFFFFh

CM_SSC_DELTAMSTEP_DPLL_MPU is shown in [Figure 8-90](#) and described in [Table 8-98](#).

Control the DeltaMStep parameter for Spread Spectrum Clocking technique DeltaMStep is split into fractional and integer part. [warm reset insensitive]

Figure 8-90. CM_SSC_DELTAMSTEP_DPLL_MPU Register

31	30	29	28	27	26	25	24
RESERVED							
Rreturns0s-0h							
23	22	21	20	19	18	17	16
RESERVED				DELTAMSTEP_INTEGER		DELTAMSTEP_FRACTION	
Rreturns0s-0h				R/W-0h		R/W-0h	
15	14	13	12	11	10	9	8
DELTAMSTEP_FRACTION							
R/W-0h							
7	6	5	4	3	2	1	0
DELTAMSTEP_FRACTION							
R/W-0h							

LEGEND: R/W = Read/Write; R = Read only; W1toCl = Write 1 to clear bit; -n = value after reset

Table 8-98. CM_SSC_DELTAMSTEP_DPLL_MPU Register Field Descriptions

Bit	Field	Type	Reset	Description
31-20	RESERVED	Rreturns0s	0h	
19-18	DELTAMSTEP_INTEGER	R/W	0h	Integer part for DeltaM coefficient
17-0	DELTAMSTEP_FRACTION	R/W	0h	Fractional part for DeltaM coefficient

8.1.12.2.11 CM-SSC_MODFREQDIV_DPLL_MPU Register (offset = 28h) [reset = 0h]

Register mask: FFFFFFFFh

CM-SSC_MODFREQDIV_DPLL_MPU is shown in [Figure 8-91](#) and described in [Table 8-99](#).

Control the Modulation Frequency (Fm) for Spread Spectrum Clocking technique by defining it as a ratio of DPLL_REFCLK/4 $F_m = [DPLL_REFCLK/4]/MODFREQDIV$ $MODFREQDIV = MODFREQDIV_MANTISSA * 2^{MODFREQDIV_EXPONENT}$ [warm reset insensitive]

Figure 8-91. CM-SSC_MODFREQDIV_DPLL_MPU Register

31	30	29	28	27	26	25	24
RESERVED							
Rreturns0s-0h							
23	22	21	20	19	18	17	16
RESERVED							
Rreturns0s-0h							
15	14	13	12	11	10	9	8
RESERVED					MODFREQDIV_EXPONENT		
Rreturns0s-0h					R/W-0h		
7	6	5	4	3	2	1	0
RESERVED	MODFREQDIV_MANTISSA						
Rreturns0s-0h	R/W-0h						

LEGEND: R/W = Read/Write; R = Read only; W1toCl = Write 1 to clear bit; -n = value after reset

Table 8-99. CM-SSC_MODFREQDIV_DPLL_MPU Register Field Descriptions

Bit	Field	Type	Reset	Description
31-11	RESERVED	Rreturns0s	0h	
10-8	MODFREQDIV_EXPONENT	R/W	0h	Set the Exponent component of MODFREQDIV factor
7	RESERVED	Rreturns0s	0h	
6-0	MODFREQDIV_MANTISSA	R/W	0h	Set the Mantissa component of MODFREQDIV factor

8.1.12.2.12 CM_CLKSEL_DPLL_MPU Register (offset = 2Ch) [reset = 0h]

Register mask: FFFFFFFFh

 CM_CLKSEL_DPLL_MPU is shown in [Figure 8-92](#) and described in [Table 8-100](#).

This register provides controls over the DPLL.

Figure 8-92. CM_CLKSEL_DPLL_MPU Register

31	30	29	28	27	26	25	24
RESERVED							
Rreturns0s-0h							
23	22	21	20	19	18	17	16
DPLL_BYP_CLKSEL	RESERVED				DPLL_MULT		
R/W-0h	Rreturns0s-0h				R/W-0h		
15	14	13	12	11	10	9	8
DPLL_MULT							
R/W-0h							
7	6	5	4	3	2	1	0
RESERVED	DPLL_DIV						
Rreturns0s-0h	R/W-0h						

LEGEND: R/W = Read/Write; R = Read only; W1toCl = Write 1 to clear bit; -n = value after reset

Table 8-100. CM_CLKSEL_DPLL_MPU Register Field Descriptions

Bit	Field	Type	Reset	Description
31-24	RESERVED	Rreturns0s	0h	
23	DPLL_BYP_CLKSEL	R/W	0h	Selects CLKINP or CLKINPULOW as Bypass Clock 0h (R/W) = Selects CLKINP Clock as BYPASS Clock 1h (R/W) = Selects CLKINPULOW as Bypass Clock
22-19	RESERVED	Rreturns0s	0h	
18-8	DPLL_MULT	R/W	0h	DPLL multiplier factor (2 to 2047). This register is automatically cleared to 0 when the DPLL_EN field in the *CLKMODE_DPLL* register is set to select MN Bypass mode. (equal to input M of DPLL M=2 to 2047 => DPLL multiplies by M). 0h (R/W) = 0 : Reserved 1h (R/W) = 1 : Reserved
7	RESERVED	Rreturns0s	0h	
6-0	DPLL_DIV	R/W	0h	DPLL divider factor (0 to 127) (equal to input N of DPLL actual division factor is N+1).

8.1.12.2.13 CM_AUTOIDLE_DPLL_DDR Register (offset = 30h) [reset = 0h]

Register mask: FFFFFFFFh

 CM_AUTOIDLE_DPLL_DDR is shown in [Figure 8-93](#) and described in [Table 8-101](#).

This register provides automatic control over the DPLL activity.

Figure 8-93. CM_AUTOIDLE_DPLL_DDR Register

31	30	29	28	27	26	25	24
RESERVED							
Rreturns0s-0h							
23	22	21	20	19	18	17	16
RESERVED							
Rreturns0s-0h							
15	14	13	12	11	10	9	8
RESERVED							
Rreturns0s-0h							
7	6	5	4	3	2	1	0
RESERVED					AUTO_DPLL_MODE		
Rreturns0s-0h					R/W-0h		

LEGEND: R/W = Read/Write; R = Read only; W1toCl = Write 1 to clear bit; -n = value after reset

Table 8-101. CM_AUTOIDLE_DPLL_DDR Register Field Descriptions

Bit	Field	Type	Reset	Description
31-3	RESERVED	Rreturns0s	0h	
2-0	AUTO_DPLL_MODE	R/W	0h	AUTO_DPLL_MODE is not supported.

8.1.12.2.14 CM_IDLEST_DPLL_DDR Register (offset = 34h) [reset = 0h]

Register mask: FFFFFFFFh

 CM_IDLEST_DPLL_DDR is shown in [Figure 8-94](#) and described in [Table 8-102](#).

This register allows monitoring the master clock activity. This register is read only and automatically updated. [warm reset insensitive]

Figure 8-94. CM_IDLEST_DPLL_DDR Register

31	30	29	28	27	26	25	24
RESERVED							
Rreturns0s-0h							
23	22	21	20	19	18	17	16
RESERVED							
Rreturns0s-0h							
15	14	13	12	11	10	9	8
RESERVED							ST_MN_BYPASS
Rreturns0s-0h							R-0h
7	6	5	4	3	2	1	0
RESERVED							ST_DPLL_CLK
Rreturns0s-0h							R-0h

LEGEND: R/W = Read/Write; R = Read only; W1toCl = Write 1 to clear bit; -n = value after reset

Table 8-102. CM_IDLEST_DPLL_DDR Register Field Descriptions

Bit	Field	Type	Reset	Description
31-9	RESERVED	Rreturns0s	0h	
8	ST_MN_BYPASS	R	0h	DPLL MN_BYPASS status 0h (R) = DPLL is not in MN_Bypass 1h (R) = DPLL is in MN_Bypass
7-1	RESERVED	Rreturns0s	0h	
0	ST_DPLL_CLK	R	0h	DPLL clock activity 0h (R) = DPLL is either in bypass mode or in stop mode. 1h (R) = DPLL is LOCKED

8.1.12.2.15 CM_SSC_DELTAMSTEP_DPLL_DDR Register (offset = 38h) [reset = 0h]

Register mask: FFFFFFFFh

 CM_SSC_DELTAMSTEP_DPLL_DDR is shown in [Figure 8-95](#) and described in [Table 8-103](#).

Control the DeltaMStep parameter for Spread Spectrum Clocking technique DeltaMStep is split into fractional and integer part. [warm reset insensitive]

Figure 8-95. CM_SSC_DELTAMSTEP_DPLL_DDR Register

31	30	29	28	27	26	25	24
RESERVED							
Rreturns0s-0h							
23	22	21	20	19	18	17	16
RESERVED				DELTAMSTEP_INTEGER		DELTAMSTEP_FRACTION	
Rreturns0s-0h				R/W-0h		R/W-0h	
15	14	13	12	11	10	9	8
DELTAMSTEP_FRACTION							
R/W-0h							
7	6	5	4	3	2	1	0
DELTAMSTEP_FRACTION							
R/W-0h							

LEGEND: R/W = Read/Write; R = Read only; W1toCl = Write 1 to clear bit; -n = value after reset

Table 8-103. CM_SSC_DELTAMSTEP_DPLL_DDR Register Field Descriptions

Bit	Field	Type	Reset	Description
31-20	RESERVED	Rreturns0s	0h	
19-18	DELTAMSTEP_INTEGER	R/W	0h	Integer part for DeltaM coefficient
17-0	DELTAMSTEP_FRACTION	R/W	0h	Fractional setting for DeltaMStep parameter

8.1.12.2.16 CM_SSC_MODFREQDIV_DPLL_DDR Register (offset = 3Ch) [reset = 0h]

Register mask: FFFFFFFFh

 CM_SSC_MODFREQDIV_DPLL_DDR is shown in [Figure 8-96](#) and described in [Table 8-104](#).

Control the Modulation Frequency (Fm) for Spread Spectrum Clocking technique by defining it as a ratio of DPLL_REFCLK/4 $F_m = [DPLL_REFCLK/4]/MODFREQDIV$ $MODFREQDIV = MODFREQDIV_MANTISSA * 2^{MODFREQDIV_EXPONENT}$ [warm reset insensitive]

Figure 8-96. CM_SSC_MODFREQDIV_DPLL_DDR Register

31	30	29	28	27	26	25	24
RESERVED							
Rreturns0s-0h							
23	22	21	20	19	18	17	16
RESERVED							
Rreturns0s-0h							
15	14	13	12	11	10	9	8
RESERVED					MODFREQDIV_EXPONENT		
Rreturns0s-0h					R/W-0h		
7	6	5	4	3	2	1	0
RESERVED	MODFREQDIV_MANTISSA						
Rreturns0s-0h	R/W-0h						

LEGEND: R/W = Read/Write; R = Read only; W1toCl = Write 1 to clear bit; -n = value after reset

Table 8-104. CM_SSC_MODFREQDIV_DPLL_DDR Register Field Descriptions

Bit	Field	Type	Reset	Description
31-11	RESERVED	Rreturns0s	0h	
10-8	MODFREQDIV_EXPONENT	R/W	0h	Set the Exponent component of MODFREQDIV factor
7	RESERVED	Rreturns0s	0h	
6-0	MODFREQDIV_MANTISSA	R/W	0h	Set the Mantissa component of MODFREQDIV factor

8.1.12.2.17 CM_CLKSEL_DPLL_DDR Register (offset = 40h) [reset = 0h]

Register mask: FFFFFFFFh

CM_CLKSEL_DPLL_DDR is shown in [Figure 8-97](#) and described in [Table 8-105](#).

This register provides controls over the DPLL.

Figure 8-97. CM_CLKSEL_DPLL_DDR Register

31	30	29	28	27	26	25	24
RESERVED							
Rreturns0s-0h							
23	22	21	20	19	18	17	16
DPLL_BYP_CLKSEL	RESERVED					DPLL_MULT	
R/W-0h	Rreturns0s-0h					R/W-0h	
15	14	13	12	11	10	9	8
DPLL_MULT							
R/W-0h							
7	6	5	4	3	2	1	0
RESERVED	DPLL_DIV						
Rreturns0s-0h	R/W-0h						

LEGEND: R/W = Read/Write; R = Read only; W1toCl = Write 1 to clear bit; -n = value after reset

Table 8-105. CM_CLKSEL_DPLL_DDR Register Field Descriptions

Bit	Field	Type	Reset	Description
31-24	RESERVED	Rreturns0s	0h	
23	DPLL_BYP_CLKSEL	R/W	0h	Select CLKINP orr CLKINPULOW as bypass clock 0h (R/W) = Selects CLKINP Clock as BYPASS Clock 1h (R/W) = Selects CLKINPULOW as Bypass Clock
22-19	RESERVED	Rreturns0s	0h	
18-8	DPLL_MULT	R/W	0h	DPLL multiplier factor (2 to 2047). This register is automatically cleared to 0 when the DPLL_EN field in the *CLKMODE_DPLL* register is set to select MN Bypass mode. (equal to input M of DPLL M=2 to 2047 => DPLL multiplies by M). 0h (R/W) = 0 : Reserved 1h (R/W) = 1 : Reserved
7	RESERVED	Rreturns0s	0h	
6-0	DPLL_DIV	R/W	0h	DPLL divider factor (0 to 127) (equal to input N of DPLL actual division factor is N+1).

8.1.12.2.18 CM_AUTOIDLE_DPLL_DISP Register (offset = 44h) [reset = 0h]

Register mask: FFFFFFFFh

CM_AUTOIDLE_DPLL_DISP is shown in [Figure 8-98](#) and described in [Table 8-106](#).

This register provides automatic control over the DPLL activity.

Figure 8-98. CM_AUTOIDLE_DPLL_DISP Register

31	30	29	28	27	26	25	24
RESERVED							
Rreturns0s-0h							
23	22	21	20	19	18	17	16
RESERVED							
Rreturns0s-0h							
15	14	13	12	11	10	9	8
RESERVED							
Rreturns0s-0h							
7	6	5	4	3	2	1	0
RESERVED					AUTO_DPLL_MODE		
Rreturns0s-0h					R/W-0h		

LEGEND: R/W = Read/Write; R = Read only; W1toCl = Write 1 to clear bit; -n = value after reset

Table 8-106. CM_AUTOIDLE_DPLL_DISP Register Field Descriptions

Bit	Field	Type	Reset	Description
31-3	RESERVED	Rreturns0s	0h	
2-0	AUTO_DPLL_MODE	R/W	0h	AUTO_DPLL_MODE is not supported.

8.1.12.2.19 CM_IDLEST_DPLL_DISP Register (offset = 48h) [reset = 0h]

Register mask: FFFFFFFFh

 CM_IDLEST_DPLL_DISP is shown in [Figure 8-99](#) and described in [Table 8-107](#).

This register allows monitoring the master clock activity. This register is read only and automatically updated. [warm reset insensitive]

Figure 8-99. CM_IDLEST_DPLL_DISP Register

31	30	29	28	27	26	25	24
RESERVED							
Rreturns0s-0h							
23	22	21	20	19	18	17	16
RESERVED							
Rreturns0s-0h							
15	14	13	12	11	10	9	8
RESERVED							ST_MN_BYPASS
Rreturns0s-0h							R-0h
7	6	5	4	3	2	1	0
RESERVED							ST_DPLL_CLK
Rreturns0s-0h							R-0h

LEGEND: R/W = Read/Write; R = Read only; W1toCl = Write 1 to clear bit; -n = value after reset

Table 8-107. CM_IDLEST_DPLL_DISP Register Field Descriptions

Bit	Field	Type	Reset	Description
31-9	RESERVED	Rreturns0s	0h	
8	ST_MN_BYPASS	R	0h	DPLL MN_BYPASS status 0h (R) = DPLL is not in MN_Bypass 1h (R) = DPLL is in MN_Bypass
7-1	RESERVED	Rreturns0s	0h	
0	ST_DPLL_CLK	R	0h	DPLL clock activity 0h (R) = DPLL is either in bypass mode or in stop mode. 1h (R) = DPLL is LOCKED

8.1.12.2.20 CM_SSC_DELTAMSTEP_DPLL_DISP Register (offset = 4Ch) [reset = 0h]

Register mask: FFFFFFFFh

CM_SSC_DELTAMSTEP_DPLL_DISP is shown in [Figure 8-100](#) and described in [Table 8-108](#).

Control the DeltaMStep parameter for Spread Spectrum Clocking technique DeltaMStep is split into fractional and integer part. [warm reset insensitive]

Figure 8-100. CM_SSC_DELTAMSTEP_DPLL_DISP Register

31	30	29	28	27	26	25	24
RESERVED							
Rreturns0s-0h							
23	22	21	20	19	18	17	16
RESERVED				DELTAMSTEP_INTEGER		DELTAMSTEP_FRACTION	
Rreturns0s-0h				R/W-0h		R/W-0h	
15	14	13	12	11	10	9	8
DELTAMSTEP_FRACTION							
R/W-0h							
7	6	5	4	3	2	1	0
DELTAMSTEP_FRACTION							
R/W-0h							

LEGEND: R/W = Read/Write; R = Read only; W1toCl = Write 1 to clear bit; -n = value after reset

Table 8-108. CM_SSC_DELTAMSTEP_DPLL_DISP Register Field Descriptions

Bit	Field	Type	Reset	Description
31-20	RESERVED	Rreturns0s	0h	
19-18	DELTAMSTEP_INTEGER	R/W	0h	Integer part for DeltaM coefficient
17-0	DELTAMSTEP_FRACTION	R/W	0h	Fractional setting for DeltaMStep parameter

8.1.12.2.21 CM_SSC_MODFREQDIV_DPLL_DISP Register (offset = 50h) [reset = 0h]

Register mask: FFFFFFFFh

CM_SSC_MODFREQDIV_DPLL_DISP is shown in [Figure 8-101](#) and described in [Table 8-109](#).

Control the Modulation Frequency (Fm) for Spread Spectrum Clocking technique by defining it as a ratio of DPLL_REFCLK/4 $F_m = [DPLL_REFCLK/4]/MODFREQDIV$ $MODFREQDIV = MODFREQDIV_MANTISSA * 2^{MODFREQDIV_EXPONENT}$ [warm reset insensitive]

Figure 8-101. CM_SSC_MODFREQDIV_DPLL_DISP Register

31	30	29	28	27	26	25	24
RESERVED							
Rreturns0s-0h							
23	22	21	20	19	18	17	16
RESERVED							
Rreturns0s-0h							
15	14	13	12	11	10	9	8
RESERVED					MODFREQDIV_EXPONENT		
Rreturns0s-0h					R/W-0h		
7	6	5	4	3	2	1	0
RESERVED	MODFREQDIV_MANTISSA						
Rreturns0s-0h	R/W-0h						

LEGEND: R/W = Read/Write; R = Read only; W1toCl = Write 1 to clear bit; -n = value after reset

Table 8-109. CM_SSC_MODFREQDIV_DPLL_DISP Register Field Descriptions

Bit	Field	Type	Reset	Description
31-11	RESERVED	Rreturns0s	0h	
10-8	MODFREQDIV_EXPONENT	R/W	0h	Set the Exponent component of MODFREQDIV factor
7	RESERVED	Rreturns0s	0h	
6-0	MODFREQDIV_MANTISSA	R/W	0h	Set the Mantissa component of MODFREQDIV factor

8.1.12.2.22 CM_CLKSEL_DPLL_DISP Register (offset = 54h) [reset = 0h]

Register mask: FFFFFFFFh

CM_CLKSEL_DPLL_DISP is shown in [Figure 8-102](#) and described in [Table 8-110](#).

This register provides controls over the DPLL.

Figure 8-102. CM_CLKSEL_DPLL_DISP Register

31	30	29	28	27	26	25	24
RESERVED							
Rreturns0s-0h							
23	22	21	20	19	18	17	16
DPLL_BYP_CLKSEL	RESERVED				DPLL_MULT		
R/W-0h	Rreturns0s-0h				R/W-0h		
15	14	13	12	11	10	9	8
DPLL_MULT							
R/W-0h							
7	6	5	4	3	2	1	0
RESERVED	DPLL_DIV						
Rreturns0s-0h	R/W-0h						

LEGEND: R/W = Read/Write; R = Read only; W1toCl = Write 1 to clear bit; -n = value after reset

Table 8-110. CM_CLKSEL_DPLL_DISP Register Field Descriptions

Bit	Field	Type	Reset	Description
31-24	RESERVED	Rreturns0s	0h	
23	DPLL_BYP_CLKSEL	R/W	0h	Select CLKINP or CLKINPULOW as bypass clock 0h (R/W) = Selects CLKINP Clock as BYPASS Clock 1h (R/W) = Selects CLKINPULOW as Bypass Clock
22-19	RESERVED	Rreturns0s	0h	
18-8	DPLL_MULT	R/W	0h	DPLL multiplier factor (2 to 2047). This register is automatically cleared to 0 when the DPLL_EN field in the *CLKMODE_DPLL* register is set to select MN Bypass mode. (equal to input M of DPLL M=2 to 2047 => DPLL multiplies by M). 0h (R/W) = 0 : Reserved 1h (R/W) = 1 : Reserved
7	RESERVED	Rreturns0s	0h	
6-0	DPLL_DIV	R/W	0h	DPLL divider factor (0 to 127) (equal to input N of DPLL actual division factor is N+1).

8.1.12.2.23 CM_AUTOIDLE_DPLL_CORE Register (offset = 58h) [reset = 0h]

Register mask: FFFFFFFFh

 CM_AUTOIDLE_DPLL_CORE is shown in [Figure 8-103](#) and described in [Table 8-111](#).

This register provides automatic control over the DPLL activity.

Figure 8-103. CM_AUTOIDLE_DPLL_CORE Register

31	30	29	28	27	26	25	24
RESERVED							
Rreturns0s-0h							
23	22	21	20	19	18	17	16
RESERVED							
Rreturns0s-0h							
15	14	13	12	11	10	9	8
RESERVED							
Rreturns0s-0h							
7	6	5	4	3	2	1	0
RESERVED				AUTO_DPLL_MODE			
Rreturns0s-0h				R/W-0h			

LEGEND: R/W = Read/Write; R = Read only; W1toCl = Write 1 to clear bit; -n = value after reset

Table 8-111. CM_AUTOIDLE_DPLL_CORE Register Field Descriptions

Bit	Field	Type	Reset	Description
31-3	RESERVED	Rreturns0s	0h	
2-0	AUTO_DPLL_MODE	R/W	0h	This feature is not supported.

8.1.12.2.24 CM_IDLEST_DPLL_CORE Register (offset = 5Ch) [reset = 0h]

Register mask: FFFFFFFFh

 CM_IDLEST_DPLL_CORE is shown in [Figure 8-104](#) and described in [Table 8-112](#).

This register allows monitoring the master clock activity. This register is read only and automatically updated. [warm reset insensitive]

Figure 8-104. CM_IDLEST_DPLL_CORE Register

31	30	29	28	27	26	25	24
RESERVED							
Rreturns0s-0h							
23	22	21	20	19	18	17	16
RESERVED							
Rreturns0s-0h							
15	14	13	12	11	10	9	8
RESERVED							ST_MN_BYPA SS
Rreturns0s-0h							R-0h
7	6	5	4	3	2	1	0
RESERVED							ST_DPLL_CLK
Rreturns0s-0h							R-0h

LEGEND: R/W = Read/Write; R = Read only; W1toCl = Write 1 to clear bit; -n = value after reset

Table 8-112. CM_IDLEST_DPLL_CORE Register Field Descriptions

Bit	Field	Type	Reset	Description
31-9	RESERVED	Rreturns0s	0h	
8	ST_MN_BYPASS	R	0h	DPLL MN_BYPASS status 0h (R) = DPLL is not in MN_Bypass 1h (R) = DPLL is in MN_Bypass
7-1	RESERVED	Rreturns0s	0h	
0	ST_DPLL_CLK	R	0h	DPLL clock activity 0h (R) = DPLL is either in bypass mode or in stop mode. 1h (R) = DPLL is LOCKED

8.1.12.2.25 CM_SSC_DELTAMSTEP_DPLL_CORE Register (offset = 60h) [reset = 0h]

Register mask: FFFFFFFFh

 CM_SSC_DELTAMSTEP_DPLL_CORE is shown in [Figure 8-105](#) and described in [Table 8-113](#).

Control the DeltaMStep parameter for Spread Spectrum Clocking technique DeltaMStep is split into fractional and integer part. [warm reset insensitive]

Figure 8-105. CM_SSC_DELTAMSTEP_DPLL_CORE Register

31	30	29	28	27	26	25	24
RESERVED							
Rreturns0s-0h							
23	22	21	20	19	18	17	16
RESERVED				DELTAMSTEP_INTEGER		DELTAMSTEP_FRACTION	
Rreturns0s-0h				R/W-0h		R/W-0h	
15	14	13	12	11	10	9	8
DELTAMSTEP_FRACTION							
R/W-0h							
7	6	5	4	3	2	1	0
DELTAMSTEP_FRACTION							
R/W-0h							

LEGEND: R/W = Read/Write; R = Read only; W1toCl = Write 1 to clear bit; -n = value after reset

Table 8-113. CM_SSC_DELTAMSTEP_DPLL_CORE Register Field Descriptions

Bit	Field	Type	Reset	Description
31-20	RESERVED	Rreturns0s	0h	
19-18	DELTAMSTEP_INTEGER	R/W	0h	Integer part for DeltaM coefficient
17-0	DELTAMSTEP_FRACTION	R/W	0h	Fractional setting for DeltaMStep parameter

8.1.12.2.26 CM_SSC_MODFREQDIV_DPLL_CORE Register (offset = 64h) [reset = 0h]

Register mask: FFFFFFFFh

 CM_SSC_MODFREQDIV_DPLL_CORE is shown in [Figure 8-106](#) and described in [Table 8-114](#).

Control the Modulation Frequency (Fm) for Spread Spectrum Clocking technique by defining it as a ratio of DPLL_REFCLK/4 $F_m = [DPLL_REFCLK/4]/MODFREQDIV$ $MODFREQDIV = MODFREQDIV_MANTISSA * 2^{MODFREQDIV_EXPONENT}$ [warm reset insensitive]

Figure 8-106. CM_SSC_MODFREQDIV_DPLL_CORE Register

31	30	29	28	27	26	25	24
RESERVED							
Rreturns0s-0h							
23	22	21	20	19	18	17	16
RESERVED							
Rreturns0s-0h							
15	14	13	12	11	10	9	8
RESERVED					MODFREQDIV_EXPONENT		
Rreturns0s-0h					R/W-0h		
7	6	5	4	3	2	1	0
RESERVED	MODFREQDIV_MANTISSA						
Rreturns0s-0h	R/W-0h						

LEGEND: R/W = Read/Write; R = Read only; W1toCl = Write 1 to clear bit; -n = value after reset

Table 8-114. CM_SSC_MODFREQDIV_DPLL_CORE Register Field Descriptions

Bit	Field	Type	Reset	Description
31-11	RESERVED	Rreturns0s	0h	
10-8	MODFREQDIV_EXPONENT	R/W	0h	Set the Exponent component of MODFREQDIV factor
7	RESERVED	Rreturns0s	0h	
6-0	MODFREQDIV_MANTISSA	R/W	0h	Set the Mantissa component of MODFREQDIV factor

8.1.12.2.27 CM_CLKSEL_DPLL_CORE Register (offset = 68h) [reset = 0h]

Register mask: FFFFFFFFh

 CM_CLKSEL_DPLL_CORE is shown in [Figure 8-107](#) and described in [Table 8-115](#).

This register provides controls over the DPLL.

Figure 8-107. CM_CLKSEL_DPLL_CORE Register

31	30	29	28	27	26	25	24
RESERVED							
Rreturns0s-0h							
23	22	21	20	19	18	17	16
RESERVED	RESERVED				DPLL_MULT		
Rreturns0s-0h		Rreturns0s-0h				R/W-0h	
15	14	13	12	11	10	9	8
DPLL_MULT							
R/W-0h							
7	6	5	4	3	2	1	0
RESERVED	DPLL_DIV						
Rreturns0s-0h		R/W-0h					

LEGEND: R/W = Read/Write; R = Read only; W1toCl = Write 1 to clear bit; -n = value after reset

Table 8-115. CM_CLKSEL_DPLL_CORE Register Field Descriptions

Bit	Field	Type	Reset	Description
31-23	RESERVED	Rreturns0s	0h	
22-19	RESERVED	Rreturns0s	0h	
18-8	DPLL_MULT	R/W	0h	DPLL multiplier factor (2 to 2047). This register is automatically cleared to 0 when the DPLL_EN field in the *CLKMODE_DPLL* register is set to select MN Bypass mode. (equal to input M of DPLL M=2 to 2047 => DPLL multiplies by M) 0h (R/W) = Reserved 1h (R/W) = Reserved
7	RESERVED	Rreturns0s	0h	
6-0	DPLL_DIV	R/W	0h	DPLL divider factor (0 to 127) (equal to input N of DPLL actual division factor is N+1).

8.1.12.2.28 CM_AUTOIDLE_DPLL_PER Register (offset = 6Ch) [reset = 0h]

Register mask: FFFFFFFFh

CM_AUTOIDLE_DPLL_PER is shown in [Figure 8-108](#) and described in [Table 8-116](#).

This register provides automatic control over the DPLL activity.

Figure 8-108. CM_AUTOIDLE_DPLL_PER Register

31	30	29	28	27	26	25	24
RESERVED							
Rreturns0s-0h							
23	22	21	20	19	18	17	16
RESERVED							
Rreturns0s-0h							
15	14	13	12	11	10	9	8
RESERVED							
Rreturns0s-0h							
7	6	5	4	3	2	1	0
RESERVED					AUTO_DPLL_MODE		
Rreturns0s-0h					R/W-0h		

LEGEND: R/W = Read/Write; R = Read only; W1toCl = Write 1 to clear bit; -n = value after reset

Table 8-116. CM_AUTOIDLE_DPLL_PER Register Field Descriptions

Bit	Field	Type	Reset	Description
31-3	RESERVED	Rreturns0s	0h	
2-0	AUTO_DPLL_MODE	R/W	0h	AUTO_DPLL_MODE is not supported.

8.1.12.2.29 CM_IDLEST_DPLL_PER Register (offset = 70h) [reset = 0h]

Register mask: FFFFFFFFh

 CM_IDLEST_DPLL_PER is shown in [Figure 8-109](#) and described in [Table 8-117](#).

This register allows monitoring the master clock activity. This register is read only and automatically updated. [warm reset insensitive]

Figure 8-109. CM_IDLEST_DPLL_PER Register

31	30	29	28	27	26	25	24
RESERVED							
Rreturns0s-0h							
23	22	21	20	19	18	17	16
RESERVED							
Rreturns0s-0h							
15	14	13	12	11	10	9	8
RESERVED							ST_MN_BYPASS
Rreturns0s-0h							R-0h
7	6	5	4	3	2	1	0
RESERVED							ST_DPLL_CLK
Rreturns0s-0h							R-0h

LEGEND: R/W = Read/Write; R = Read only; W1toCl = Write 1 to clear bit; -n = value after reset

Table 8-117. CM_IDLEST_DPLL_PER Register Field Descriptions

Bit	Field	Type	Reset	Description
31-9	RESERVED	Rreturns0s	0h	
8	ST_MN_BYPASS	R	0h	DPLL MN_BYPASS status 0h (R) = DPLL is not in MN_Bypass 1h (R) = DPLL is in MN_Bypass
7-1	RESERVED	Rreturns0s	0h	
0	ST_DPLL_CLK	R	0h	DPLL clock activity 0h (R) = DPLL is either in bypass mode or in stop mode. 1h (R) = DPLL is LOCKED

8.1.12.2.30 CM_SSC_DELTAMSTEP_DPLL_PER Register (offset = 74h) [reset = 0h]

Register mask: FFFFFFFFh

 CM_SSC_DELTAMSTEP_DPLL_PER is shown in [Figure 8-110](#) and described in [Table 8-118](#).

Control the DeltaMStep parameter for Spread Spectrum Clocking technique DeltaMStep is split into fractional and integer part. [warm reset insensitive]

Figure 8-110. CM_SSC_DELTAMSTEP_DPLL_PER Register

31	30	29	28	27	26	25	24
RESERVED							
Rreturns0s-0h							
23	22	21	20	19	18	17	16
RESERVED				DELTAMSTEP_INTEGER		DELTAMSTEP_FRACTION	
Rreturns0s-0h				R/W-0h		R/W-0h	
15	14	13	12	11	10	9	8
DELTAMSTEP_FRACTION							
R/W-0h							
7	6	5	4	3	2	1	0
DELTAMSTEP_FRACTION							
R/W-0h							

LEGEND: R/W = Read/Write; R = Read only; W1toCl = Write 1 to clear bit; -n = value after reset

Table 8-118. CM_SSC_DELTAMSTEP_DPLL_PER Register Field Descriptions

Bit	Field	Type	Reset	Description
31-20	RESERVED	Rreturns0s	0h	
19-18	DELTAMSTEP_INTEGER	R/W	0h	Integer part for DeltaM coefficient
17-0	DELTAMSTEP_FRACTION	R/W	0h	Fractional setting for DeltaMStep parameter

8.1.12.2.31 CM_SSC_MODFREQDIV_DPLL_PER Register (offset = 78h) [reset = 0h]

Register mask: FFFFFFFFh

 CM_SSC_MODFREQDIV_DPLL_PER is shown in [Figure 8-111](#) and described in [Table 8-119](#).

Control the Modulation Frequency (Fm) for Spread Spectrum Clocking technique by defining it as a ratio of DPLL_REFCLK/4 $F_m = [DPLL_REFCLK/4]/MODFREQDIV$ $MODFREQDIV = MODFREQDIV_MANTISSA * 2^{MODFREQDIV_EXPONENT}$ [warm reset insensitive]

Figure 8-111. CM_SSC_MODFREQDIV_DPLL_PER Register

31	30	29	28	27	26	25	24
RESERVED							
Rreturns0s-0h							
23	22	21	20	19	18	17	16
RESERVED							
Rreturns0s-0h							
15	14	13	12	11	10	9	8
RESERVED					MODFREQDIV_EXPONENT		
Rreturns0s-0h					R/W-0h		
7	6	5	4	3	2	1	0
RESERVED	MODFREQDIV_MANTISSA						
Rreturns0s-0h	R/W-0h						

LEGEND: R/W = Read/Write; R = Read only; W1toCl = Write 1 to clear bit; -n = value after reset

Table 8-119. CM_SSC_MODFREQDIV_DPLL_PER Register Field Descriptions

Bit	Field	Type	Reset	Description
31-11	RESERVED	Rreturns0s	0h	
10-8	MODFREQDIV_EXPONENT	R/W	0h	Set the Exponent component of MODFREQDIV factor
7	RESERVED	Rreturns0s	0h	
6-0	MODFREQDIV_MANTISSA	R/W	0h	Set the Mantissa component of MODFREQDIV factor

8.1.12.2.32 CM_CLKDCOLDO_DPLL_PER Register (offset = 7Ch) [reset = 0h]

Register mask: FFFFFFFFh

 CM_CLKDCOLDO_DPLL_PER is shown in [Figure 8-112](#) and described in [Table 8-120](#).

This register provides controls over the digitally controlled oscillator output of the PER DPLL.

Figure 8-112. CM_CLKDCOLDO_DPLL_PER Register

31	30	29	28	27	26	25	24
RESERVED							
Rreturns0s-0h							
23	22	21	20	19	18	17	16
RESERVED							
Rreturns0s-0h							
15	14	13	12	11	10	9	8
RESERVED			DPLL_CLKDCOLDO_PWDN	RESERVED		ST_DPLL_CLKDCOLDO	DPLL_CLKDCOLDO_GATE_CTRL
Rreturns0s-0h			R/W-0h	Rreturns0s-0h		R-0h	R/W-0h
7	6	5	4	3	2	1	0
RESERVED							
Rreturns0s-0h							

LEGEND: R/W = Read/Write; R = Read only; W1toCl = Write 1 to clear bit; -n = value after reset

Table 8-120. CM_CLKDCOLDO_DPLL_PER Register Field Descriptions

Bit	Field	Type	Reset	Description
31-13	RESERVED	Rreturns0s	0h	
12	DPLL_CLKDCOLDO_PWDN	R/W	0h	Automatic power down for CLKDCOLDO o/p when it is gated 0h (R/W) = Keep CLKDCOLDO o/p powered on even when it is gated 1h (R/W) = Automatically power down CLKDCOLDO o/p when it is gated.
11-10	RESERVED	Rreturns0s	0h	
9	ST_DPLL_CLKDCOLDO	R	0h	DPLL CLKDCOLDO status 0h (R) = The clock output is enabled 1h (R) = The clock output is gated
8	DPLL_CLKDCOLDO_GATE_CTRL	R/W	0h	Control gating of DPLL CLKDCOLDO 0h (R/W) = Automatically gate this clock when there is no dependency for it 1h (R/W) = Force this clock to stay enabled even if there is no request
7-0	RESERVED	Rreturns0s	0h	

8.1.12.2.33 CM_DIV_M4_DPLL_CORE Register (offset = 80h) [reset = 4h]

Register mask: FFFFFFFFh

 CM_DIV_M4_DPLL_CORE is shown in [Figure 8-113](#) and described in [Table 8-121](#).

This register provides controls over the CLKOUT1 o/p of the HSDIVIDER.

Figure 8-113. CM_DIV_M4_DPLL_CORE Register

31	30	29	28	27	26	25	24
RESERVED							
Rreturns0s-0h							
23	22	21	20	19	18	17	16
RESERVED							
Rreturns0s-0h							
15	14	13	12	11	10	9	8
RESERVED			HSDIVIDER_C LKOUT1_PWD N	RESERVED		ST_HSDIVIDE R_CLKOUT1	HSDIVIDER_C LKOUT1_GAT E_CTRL
Rreturns0s-0h			R/W-0h	Rreturns0s-0h		R-0h	R/W-0h
7	6	5	4	3	2	1	0
RESERVED		HSDIVIDER_C LKOUT1_DIVC HACK	HSDIVIDER_CLKOUT1_DIV				
Rreturns0s-0h		R-0h	R/W-4h				

LEGEND: R/W = Read/Write; R = Read only; W1toCl = Write 1 to clear bit; -n = value after reset

Table 8-121. CM_DIV_M4_DPLL_CORE Register Field Descriptions

Bit	Field	Type	Reset	Description
31-13	RESERVED	Rreturns0s	0h	
12	HSDIVIDER_CLKOUT1_PWDN	R/W	0h	Automatic power down for HSDIVIDER M4 divider and hence CLKOUT1 output when the o/p clock is gated. 0h (R/W) = Keep M4 divider powered on even when CLKOUT1 is gated. 1h (R/W) = Automatically power down M4 divider when CLKOUT1 is gated.
11-10	RESERVED	Rreturns0s	0h	
9	ST_HSDIVIDER_CLKOUT1	R	0h	HSDIVIDER CLKOUT1 status 0h (R) = The clock output is enabled 1h (R) = The clock output is gated
8	HSDIVIDER_CLKOUT1_GATE_CTRL	R/W	0h	Control gating of HSDIVIDER CLKOUT1 0h (R/W) = Automatically gate this clock when there is no dependency for it 1h (R/W) = Force this clock to stay enabled even if there is no request
7-6	RESERVED	Rreturns0s	0h	
5	HSDIVIDER_CLKOUT1_DIVCHACK	R	0h	Toggle on this status bit after changing HSDIVIDER_CLKOUT1_DIV indicates that the change in divider value has taken effect
4-0	HSDIVIDER_CLKOUT1_DIV	R/W	4h	DPLL post-divider factor, M4, for internal clock generation. Divide values from 1 to 31. 0h (R/W) = Reserved

8.1.12.2.34 CM_DIV_M5_DPLL_CORE Register (offset = 84h) [reset = 4h]

Register mask: FFFFFFFFh

CM_DIV_M5_DPLL_CORE is shown in [Figure 8-114](#) and described in [Table 8-122](#).

This register provides controls over the CLKOUT2 o/p of the HSDIVIDER.

Figure 8-114. CM_DIV_M5_DPLL_CORE Register

31	30	29	28	27	26	25	24
RESERVED							
Rreturns0s-0h							
23	22	21	20	19	18	17	16
RESERVED							
Rreturns0s-0h							
15	14	13	12	11	10	9	8
RESERVED			HSDIVIDER_C LKOUT2_PWD N	RESERVED		ST_HSDIVIDE R_CLKOUT2	HSDIVIDER_C LKOUT2_GAT E_CTRL
Rreturns0s-0h			R/W-0h	Rreturns0s-0h		R-0h	R/W-0h
7	6	5	4	3	2	1	0
RESERVED		HSDIVIDER_C LKOUT2_DIVC HACK	HSDIVIDER_CLKOUT2_DIV				
Rreturns0s-0h		R-0h	R/W-4h				

LEGEND: R/W = Read/Write; R = Read only; W1toCl = Write 1 to clear bit; -n = value after reset

Table 8-122. CM_DIV_M5_DPLL_CORE Register Field Descriptions

Bit	Field	Type	Reset	Description
31-13	RESERVED	Rreturns0s	0h	
12	HSDIVIDER_CLKOUT2_PWDN	R/W	0h	Automatic power down for HSDIVIDER M5 divider and hence CLKOUT2 output when the o/p clock is gated. 0h (R/W) = Keep M5 divider powered on even when CLKOUT2 is gated. 1h (R/W) = Automatically power down M5 divider when CLKOUT2 is gated.
11-10	RESERVED	Rreturns0s	0h	
9	ST_HSDIVIDER_CLKOUT2	R	0h	HSDIVIDER CLKOUT2 status 0h (R) = The clock output is enabled 1h (R) = The clock output is gated
8	HSDIVIDER_CLKOUT2_GATE_CTRL	R/W	0h	Control gating of HSDIVIDER CLKOUT2 0h (R/W) = Automatically gate this clock when there is no dependency for it 1h (R/W) = Force this clock to stay enabled even if there is no request
7-6	RESERVED	Rreturns0s	0h	
5	HSDIVIDER_CLKOUT2_DIVCHACK	R	0h	Toggle on this status bit after changing HSDIVIDER_CLKOUT2_DIV indicates that the change in divider value has taken effect
4-0	HSDIVIDER_CLKOUT2_DIV	R/W	4h	DPLL post-divider factor, M5, for internal clock generation. Divide values from 1 to 31. 0h (R/W) = Reserved

8.1.12.2.35 CM_CLKMODE_DPLL_MPU Register (offset = 88h) [reset = 4h]

Register mask: FFFFFFFFh

 CM_CLKMODE_DPLL_MPU is shown in [Figure 8-115](#) and described in [Table 8-123](#).

This register allows controlling the DPLL modes.

Figure 8-115. CM_CLKMODE_DPLL_MPU Register

31	30	29	28	27	26	25	24
RESERVED							
Rreturns0s-0h							
23	22	21	20	19	18	17	16
RESERVED							
Rreturns0s-0h							
15	14	13	12	11	10	9	8
DPLL_SSC_TY PE	DPLL_SSC_D OWNSPREAD	DPLL_SSC_AC K	DPLL_SSC_EN	DPLL_REGM4 XEN	DPLL_LPMOD E_EN	DPLL_RELOC K_RAMP_EN	DPLL_DRIFTG UARD_EN
R/W-0h	R/W-0h	R-0h	R/W-0h	Rreturns0s-0h	R/W-0h	R/W-0h	R/W-0h
7	6	5	4	3	2	1	0
DPLL_RAMP_RATE			DPLL_RAMP_LEVEL			DPLL_EN	
R/W-0h			R/W-0h			R/W-4h	

LEGEND: R/W = Read/Write; R = Read only; W1toCl = Write 1 to clear bit; -n = value after reset

Table 8-123. CM_CLKMODE_DPLL_MPU Register Field Descriptions

Bit	Field	Type	Reset	Description
31-16	RESERVED	Rreturns0s	0h	
15	DPLL_SSC_TYPE	R/W	0h	Select Triangular Spread Spectrum clocking. Always write 0. 0 = Triangular Spread Spectrum Clocking is selected. 1 = Reserved.
14	DPLL_SSC_DOWNSPRE AD	R/W	0h	Control if only low frequency spread is required 0h (R/W) = When SSC is enabled, clock frequency is spread on both sides of the programmed frequency 1h (R/W) = When SSC is enabled, clock frequency is spread only on the lower side of the programmed frequency
13	DPLL_SSC_ACK	R	0h	Acknowledgement from the DPLL regarding start and stop of Spread Spectrum Clocking feature 0h (R) = SSC has been turned off on PLL o/ps 1h (R) = SSC has been turned on on PLL o/ps
12	DPLL_SSC_EN	R/W	0h	Enable or disable Spread Spectrum Clocking 0h (R/W) = SSC disabled 1h (R/W) = SSC enabled
11	DPLL_REGM4XEN	Rreturns0s	0h	Enable the REGM4XEN mode of the DPLL. Please check the DPLL documentation to check when this mode can be enabled. 0h (R) = REGM4XEN mode of the DPLL is disabled
10	DPLL_LPMODE_EN	R/W	0h	Set the DPLL in Low Power mode. Check the DPLL documentation to see when this can be enabled. 0h (R/W) = Low power mode of the DPLL is disabled 1h (R/W) = Low power mode of the DPLL is enabled
9	DPLL_RELOCK_RAMP_E N	R/W	0h	If enabled, the clock ramping feature is used applied during the lock process, as well as the relock process. If disabled, the clock ramping feature is used only during the first lock.

Table 8-123. CM_CLKMODE_DPLL_MPU Register Field Descriptions (continued)

Bit	Field	Type	Reset	Description
8	DPLL_DRIFTGUARD_EN	R/W	0h	This bit allows to enable or disable the automatic recalibration feature of the DPLL. The DPLL will automatically start a recalibration process upon assertion of the DPLL's RECAL flag if this bit is set. 0h (R/W) = DRIFTGUARD feature is disabled 1h (R/W) = DRIFTGUARD feature is enabled
7-5	DPLL_RAMP_RATE	R/W	0h	Selects the time in terms of DPLL REFCLKs spent at each stage of the clock ramping process 0h (R/W) = 2 REFCLKs 1h (R/W) = 4 REFCLKs 2h (R/W) = 8 REFCLKs 3h (R/W) = 16 REFCLKs 4h (R/W) = 32 REFCLKs 5h (R/W) = 64 REFCLKs 6h (R/W) = 128 REFCLKs 7h (R/W) = 512 REFCLKs
4-3	DPLL_RAMP_LEVEL	R/W	0h	The DPLL provides an output clock frequency ramping feature when switching from bypass clock to normal clock during lock and re-lock. The frequency ramping will happen in a maximum of 4 steps in frequency before the DPLL's frequency lock indicator is asserted. This register is used to enable/disable the DPLL ramping feature. If enabled, it is also used to select the algorithm used for clock ramping 0h (R/W) = CLKOUT => No ramping CLKOUTX2 => No ramping 1h (R/W) = CLKOUT => Bypass clk -> Fout/8 -> Fout/4 -> Fout/2 -> Fout CLKOUTX2 => Bypass clk -> Foutx2/8 -> Foutx2/4 -> Foutx2/2 -> Foutx2 2h (R/W) = CLKOUT => Bypass clk -> Fout/4 -> Fout/2 -> Fout/1.5 -> Fout CLKOUTX2 => Bypass clk -> Foutx2/4 -> Foutx2/2 -> Foutx2/1.5 -> Foutx2 3h (R/W) = Reserved
2-0	DPLL_EN	R/W	4h	DPLL control. Upon Warm Reset, the PRCM DPLL control state machine updates this register to reflect MN Bypass mode. 0h (R/W) = Reserved 1h (R/W) = Reserved 2h (R/W) = Reserved 3h (R/W) = Reserved 4h (R/W) = Put the DPLL in MN Bypass mode. The DPLL_MULT register bits are reset to 0 automatically by putting the DPLL in this mode. 5h (R/W) = Put the DPLL in Idle Bypass Low Power mode. 6h (R/W) = Put the DPLL in Idle Bypass Fast Relock mode. 7h (R/W) = Enables the DPLL in Lock mode

8.1.12.2.36 CM_CLKMODE_DPLL_PER Register (offset = 8Ch) [reset = 4h]

Register mask: FFFFFFFFh

 CM_CLKMODE_DPLL_PER is shown in [Figure 8-116](#) and described in [Table 8-124](#).

This register allows controlling the DPLL modes.

Figure 8-116. CM_CLKMODE_DPLL_PER Register

31	30	29	28	27	26	25	24	
RESERVED								
Rreturns0s-0h								
23	22	21	20	19	18	17	16	
RESERVED								
Rreturns0s-0h								
15	14	13	12	11	10	9	8	
DPLL_SSC_TY PE	DPLL_SSC_D OWNSPREAD	DPLL_SSC_AC K	DPLL_SSC_EN	RESERVED				
R/W-0h	R/W-0h	R-0h	R/W-0h	Rreturns0s-0h				
7	6	5	4	3	2	1	0	
RESERVED					DPLL_EN			
Rreturns0s-0h					R/W-4h			

LEGEND: R/W = Read/Write; R = Read only; W1toCl = Write 1 to clear bit; -n = value after reset

Table 8-124. CM_CLKMODE_DPLL_PER Register Field Descriptions

Bit	Field	Type	Reset	Description
31-16	RESERVED	Rreturns0s	0h	
15	DPLL_SSC_TYPE	R/W	0h	Select Triangular Spread Spectrum clocking. Always write 0. 0 = Triangular Spread Spectrum Clocking is selected. 1 = Reserved.
14	DPLL_SSC_DOWNSPRE AD	R/W	0h	Control if only low frequency spread is required 0h (R/W) = When SSC is enabled, clock frequency is spread on both sides of the programmed frequency 1h (R/W) = When SSC is enabled, clock frequency is spread only on the lower side of the programmed frequency
13	DPLL_SSC_ACK	R	0h	Acknowledgement from the DPLL regarding start and stop of Spread Spectrum Clocking feature 0h (R) = SSC has been turned off on PLL o/ps 1h (R) = SSC has been turned on on PLL o/ps
12	DPLL_SSC_EN	R/W	0h	Enable or disable Spread Spectrum Clocking 0h (R/W) = SSC disabled 1h (R/W) = SSC enabled
11-3	RESERVED	Rreturns0s	0h	
2-0	DPLL_EN	R/W	4h	DPLL control. Upon Warm Reset, the PRCM DPLL control state machine updates this register to reflect DPLL Low Power Stop mode. 0h (R/W) = Reserved 1h (R/W) = Put the DPLL in Low Power Stop mode 2h (R/W) = Reserved2 3h (R/W) = Reserved 4h (R/W) = Put the DPLL in MN Bypass mode. The DPLL_MULT register bits are reset to 0 automatically by putting the DPLL in this mode. 5h (R/W) = Put the DPLL in Idle Bypass Low Power mode. 6h (R/W) = Reserved 7h (R/W) = Enables the DPLL in Lock mode

8.1.12.2.37 CM_CLKMODE_DPLL_CORE Register (offset = 90h) [reset = 4h]

Register mask: FFFFFFFFh

 CM_CLKMODE_DPLL_CORE is shown in [Figure 8-117](#) and described in [Table 8-125](#).

This register allows controlling the DPLL modes.

Figure 8-117. CM_CLKMODE_DPLL_CORE Register

31	30	29	28	27	26	25	24
RESERVED							
Rreturns0s-0h							
23	22	21	20	19	18	17	16
RESERVED							
Rreturns0s-0h							
15	14	13	12	11	10	9	8
DPLL_SSC_TY PE	DPLL_SSC_D OWNSPREAD	DPLL_SSC_AC K	DPLL_SSC_EN	DPLL_REGM4 XEN	DPLL_LPMOD E_EN	DPLL_RELOC K_RAMP_EN	DPLL_DRIFTG UARD_EN
R/W-0h	R/W-0h	R-0h	R/W-0h	Rreturns0s-0h	R/W-0h	R/W-0h	R/W-0h
7	6	5	4	3	2	1	0
DPLL_RAMP_RATE			DPLL_RAMP_LEVEL			DPLL_EN	
R/W-0h			R/W-0h			R/W-4h	

LEGEND: R/W = Read/Write; R = Read only; W1toCl = Write 1 to clear bit; -n = value after reset

Table 8-125. CM_CLKMODE_DPLL_CORE Register Field Descriptions

Bit	Field	Type	Reset	Description
31-16	RESERVED	Rreturns0s	0h	
15	DPLL_SSC_TYPE	R/W	0h	Select Triangular Spread Spectrum clocking. Always write 0. 0 = Triangular Spread Spectrum Clocking is selected. 1 = Reserved.
14	DPLL_SSC_DOWNSPRE AD	R/W	0h	Control if only low frequency spread is required 0h (R/W) = When SSC is enabled, clock frequency is spread on both sides of the programmed frequency 1h (R/W) = When SSC is enabled, clock frequency is spread only on the lower side of the programmed frequency
13	DPLL_SSC_ACK	R	0h	Acknowledgement from the DPLL regarding start and stop of Spread Spectrum Clocking feature 0h (R) = SSC has been turned off on PLL o/ps 1h (R) = SSC has been turned on on PLL o/ps
12	DPLL_SSC_EN	R/W	0h	Enable or disable Spread Spectrum Clocking 0h (R/W) = SSC disabled 1h (R/W) = SSC enabled
11	DPLL_REGM4XEN	Rreturns0s	0h	Enable the REGM4XEN mode of the DPLL. Please check the DPLL documentation to check when this mode can be enabled. 0h (R) = REGM4XEN mode of the DPLL is disabled
10	DPLL_LPMODE_EN	R/W	0h	Set the DPLL in Low Power mode. Check the DPLL documentation to see when this can be enabled. 0h (R/W) = Low power mode of the DPLL is disabled 1h (R/W) = Low power mode of the DPLL is enabled
9	DPLL_RELOCK_RAMP_E N	R/W	0h	If enabled, the clock ramping feature is used applied during the lock process, as well as the relock process. If disabled, the clock ramping feature is used only during the first lock.

Table 8-125. CM_CLKMODE_DPLL_CORE Register Field Descriptions (continued)

Bit	Field	Type	Reset	Description
8	DPLL_DRIFTGUARD_EN	R/W	0h	This bit allows to enable or disable the automatic recalibration feature of the DPLL. The DPLL will automatically start a recalibration process upon assertion of the DPLL's RECAL flag if this bit is set. 0h (R/W) = DRIFTGUARD feature is disabled 1h (R/W) = DRIFTGUARD feature is enabled
7-5	DPLL_RAMP_RATE	R/W	0h	Selects the time in terms of DPLL REFCLKs spent at each stage of the clock ramping process 0h (R/W) = 2 REFCLKs 1h (R/W) = 4 REFCLKs 2h (R/W) = 8 REFCLKs 3h (R/W) = 16 REFCLKs 4h (R/W) = 32 REFCLKs 5h (R/W) = 64 REFCLKs 6h (R/W) = 128 REFCLKs 7h (R/W) = 512 REFCLKs
4-3	DPLL_RAMP_LEVEL	R/W	0h	The DPLL provides an output clock frequency ramping feature when switching from bypass clock to normal clock during lock and re-lock. The frequency ramping will happen in a maximum of 4 steps in frequency before the DPLL's frequency lock indicator is asserted. This register is used to enable/disable the DPLL ramping feature. If enabled, it is also used to select the algorithm used for clock ramping 0h (R/W) = CLKOUT => No ramping CLKOUTX2 => No ramping 1h (R/W) = CLKOUT => Bypass clk -> Fout/8 -> Fout/4 -> Fout/2 -> Fout CLKOUTX2 => Bypass clk -> Foutx2/8 -> Foutx2/4 -> Foutx2/2 -> Foutx2 2h (R/W) = CLKOUT => Bypass clk -> Fout/4 -> Fout/2 -> Fout/1.5 -> Fout CLKOUTX2 => Bypass clk -> Foutx2/4 -> Foutx2/2 -> Foutx2/1.5 -> Foutx2 3h (R/W) = Reserved
2-0	DPLL_EN	R/W	4h	DPLL control. Upon Warm Reset, the PRCM DPLL control state machine updates this register to reflect MN Bypass mode. 0h (R/W) = Reserved 1h (R/W) = Reserved 2h (R/W) = Reserved 3h (R/W) = Reserved 4h (R/W) = Put the DPLL in MN Bypass mode. The DPLL_MULT register bits are reset to 0 automatically by putting the DPLL in this mode. 5h (R/W) = Put the DPLL in Idle Bypass Low Power mode. 6h (R/W) = Put the DPLL in Idle Bypass Fast Relock mode. 7h (R/W) = Enables the DPLL in Lock mode

8.1.12.2.38 CM_CLKMODE_DPLL_DDR Register (offset = 94h) [reset = 4h]

Register mask: FFFFFFFFh

CM_CLKMODE_DPLL_DDR is shown in [Figure 8-118](#) and described in [Table 8-126](#).

This register allows controlling the DPLL modes.

Figure 8-118. CM_CLKMODE_DPLL_DDR Register

31	30	29	28	27	26	25	24
RESERVED							
Rreturns0s-0h							
23	22	21	20	19	18	17	16
RESERVED							
Rreturns0s-0h							
15	14	13	12	11	10	9	8
DPLL_SSC_TY PE	DPLL_SSC_D OWNSPREAD	DPLL_SSC_AC K	DPLL_SSC_EN	DPLL_REGM4 XEN	DPLL_LPMOD E_EN	DPLL_RELOC K_RAMP_EN	DPLL_DRIFTG UARD_EN
R/W-0h	R/W-0h	R-0h	R/W-0h	Rreturns0s-0h	R/W-0h	R/W-0h	R/W-0h
7	6	5	4	3	2	1	0
DPLL_RAMP_RATE			DPLL_RAMP_LEVEL			DPLL_EN	
R/W-0h			R/W-0h			R/W-4h	

LEGEND: R/W = Read/Write; R = Read only; W1toCl = Write 1 to clear bit; -n = value after reset

Table 8-126. CM_CLKMODE_DPLL_DDR Register Field Descriptions

Bit	Field	Type	Reset	Description
31-16	RESERVED	Rreturns0s	0h	
15	DPLL_SSC_TYPE	R/W	0h	Select Triangular Spread Spectrum clocking. Always write 0. 0 = Triangular Spread Spectrum Clocking is selected. 1 = Reserved.
14	DPLL_SSC_DOWNSPRE AD	R/W	0h	Control if only low frequency spread is required 0h (R/W) = When SSC is enabled, clock frequency is spread on both sides of the programmed frequency 1h (R/W) = When SSC is enabled, clock frequency is spread only on the lower side of the programmed frequency
13	DPLL_SSC_ACK	R	0h	Acknowledgement from the DPLL regarding start and stop of Spread Spectrum Clocking feature 0h (R) = SSC has been turned off on PLL o/ps 1h (R) = SSC has been turned on on PLL o/ps
12	DPLL_SSC_EN	R/W	0h	Enable or disable Spread Spectrum Clocking 0h (R/W) = SSC disabled 1h (R/W) = SSC enabled
11	DPLL_REGM4XEN	Rreturns0s	0h	Enable the REGM4XEN mode of the DPLL. Please check the DPLL documentation to check when this mode can be enabled. 0h (R) = REGM4XEN mode of the DPLL is disabled
10	DPLL_LPMODE_EN	R/W	0h	Set the DPLL in Low Power mode. Check the DPLL documentation to see when this can be enabled. 0h (R/W) = Low power mode of the DPLL is disabled 1h (R/W) = Low power mode of the DPLL is enabled
9	DPLL_RELOCK_RAMP_E N	R/W	0h	If enabled, the clock ramping feature is used applied during the lock process, as well as the relock process. If disabled, the clock ramping feature is used only during the first lock.

Table 8-126. CM_CLKMODE_DPLL_DDR Register Field Descriptions (continued)

Bit	Field	Type	Reset	Description
8	DPLL_DRIFTGUARD_EN	R/W	0h	This bit allows to enable or disable the automatic recalibration feature of the DPLL. The DPLL will automatically start a recalibration process upon assertion of the DPLL's RECAL flag if this bit is set. 0h (R/W) = DRIFTGUARD feature is disabled 1h (R/W) = DRIFTGUARD feature is enabled
7-5	DPLL_RAMP_RATE	R/W	0h	Selects the time in terms of DPLL REFCLKs spent at each stage of the clock ramping process 0h (R/W) = 2 REFCLKs 1h (R/W) = 4 REFCLKs 2h (R/W) = 8 REFCLKs 3h (R/W) = 16 REFCLKs 4h (R/W) = 32 REFCLKs 5h (R/W) = 64 REFCLKs 6h (R/W) = 128 REFCLKs 7h (R/W) = 512 REFCLKs
4-3	DPLL_RAMP_LEVEL	R/W	0h	The DPLL provides an output clock frequency ramping feature when switching from bypass clock to normal clock during lock and re-lock. The frequency ramping will happen in a maximum of 4 steps in frequency before the DPLL's frequency lock indicator is asserted. This register is used to enable/disable the DPLL ramping feature. If enabled, it is also used to select the algorithm used for clock ramping 0h (R/W) = CLKOUT => No ramping CLKOUTX2 => No ramping 1h (R/W) = CLKOUT => Bypass clk -> Fout/8 -> Fout/4 -> Fout/2 -> Fout CLKOUTX2 => Bypass clk -> Foutx2/8 -> Foutx2/4 -> Foutx2/2 -> Foutx2 2h (R/W) = CLKOUT => Bypass clk -> Fout/4 -> Fout/2 -> Fout/1.5 -> Fout CLKOUTX2 => Bypass clk -> Foutx2/4 -> Foutx2/2 -> Foutx2/1.5 -> Foutx2 3h (R/W) = Reserved
2-0	DPLL_EN	R/W	4h	DPLL control. Upon Warm Reset, the PRCM DPLL control state machine updates this register to reflect MN Bypass mode. 0h (R/W) = Reserved 1h (R/W) = Reserved 2h (R/W) = Reserved 3h (R/W) = Reserved 4h (R/W) = Put the DPLL in MN Bypass mode. The DPLL_MULT register bits are reset to 0 automatically by putting the DPLL in this mode. 5h (R/W) = Put the DPLL in Idle Bypass Low Power mode. 6h (R/W) = Put the DPLL in Idle Bypass Fast Relock mode. 7h (R/W) = Enables the DPLL in Lock mode

8.1.12.2.39 CM_CLKMODE_DPLL_DISP Register (offset = 98h) [reset = 4h]

Register mask: FFFFFFFFh

CM_CLKMODE_DPLL_DISP is shown in [Figure 8-119](#) and described in [Table 8-127](#).

This register allows controlling the DPLL modes.

Figure 8-119. CM_CLKMODE_DPLL_DISP Register

31	30	29	28	27	26	25	24
RESERVED							
Rreturns0s-0h							
23	22	21	20	19	18	17	16
RESERVED							
Rreturns0s-0h							
15	14	13	12	11	10	9	8
DPLL_SSC_TY PE	DPLL_SSC_D OWNSPREAD	DPLL_SSC_AC K	DPLL_SSC_EN	DPLL_REGM4 XEN	DPLL_LPMOD E_EN	DPLL_RELOC K_RAMP_EN	DPLL_DRIFTG UARD_EN
R/W-0h	R/W-0h	R-0h	R/W-0h	Rreturns0s-0h	R/W-0h	R/W-0h	R/W-0h
7	6	5	4	3	2	1	0
DPLL_RAMP_RATE			DPLL_RAMP_LEVEL			DPLL_EN	
R/W-0h			R/W-0h			R/W-4h	

LEGEND: R/W = Read/Write; R = Read only; W1toCl = Write 1 to clear bit; -n = value after reset

Table 8-127. CM_CLKMODE_DPLL_DISP Register Field Descriptions

Bit	Field	Type	Reset	Description
31-16	RESERVED	Rreturns0s	0h	
15	DPLL_SSC_TYPE	R/W	0h	Select Triangular Spread Spectrum clocking. Always write 0. 0 = Triangular Spread Spectrum Clocking is selected. 1 = Reserved.
14	DPLL_SSC_DOWNSPRE AD	R/W	0h	Control if only low frequency spread is required 0h (R/W) = When SSC is enabled, clock frequency is spread on both sides of the programmed frequency 1h (R/W) = When SSC is enabled, clock frequency is spread only on the lower side of the programmed frequency
13	DPLL_SSC_ACK	R	0h	Acknowledgement from the DPLL regarding start and stop of Spread Spectrum Clocking feature 0h (R) = SSC has been turned off on PLL o/ps 1h (R) = SSC has been turned on on PLL o/ps
12	DPLL_SSC_EN	R/W	0h	Enable or disable Spread Spectrum Clocking 0h (R/W) = SSC disabled 1h (R/W) = SSC enabled
11	DPLL_REGM4XEN	Rreturns0s	0h	Enable the REGM4XEN mode of the DPLL. Please check the DPLL documentation to check when this mode can be enabled. 0h (R) = REGM4XEN mode of the DPLL is disabled
10	DPLL_LPMODE_EN	R/W	0h	Set the DPLL in Low Power mode. Check the DPLL documentation to see when this can be enabled. 0h (R/W) = Low power mode of the DPLL is disabled 1h (R/W) = Low power mode of the DPLL is enabled
9	DPLL_RELOCK_RAMP_E N	R/W	0h	If enabled, the clock ramping feature is used applied during the lock process, as well as the relock process. If disabled, the clock ramping feature is used only during the first lock.

Table 8-127. CM_CLKMODE_DPLL_DISP Register Field Descriptions (continued)

Bit	Field	Type	Reset	Description
8	DPLL_DRIFTGUARD_EN	R/W	0h	This bit allows to enable or disable the automatic recalibration feature of the DPLL. The DPLL will automatically start a recalibration process upon assertion of the DPLL's RECAL flag if this bit is set. 0h (R/W) = DRIFTGUARD feature is disabled 1h (R/W) = DRIFTGUARD feature is enabled
7-5	DPLL_RAMP_RATE	R/W	0h	Selects the time in terms of DPLL REFCLKs spent at each stage of the clock ramping process 0h (R/W) = 2 REFCLKs 1h (R/W) = 4 REFCLKs 2h (R/W) = 8 REFCLKs 3h (R/W) = 16 REFCLKs 4h (R/W) = 32 REFCLKs 5h (R/W) = 64 REFCLKs 6h (R/W) = 128 REFCLKs 7h (R/W) = 512 REFCLKs
4-3	DPLL_RAMP_LEVEL	R/W	0h	The DPLL provides an output clock frequency ramping feature when switching from bypass clock to normal clock during lock and re-lock. The frequency ramping will happen in a maximum of 4 steps in frequency before the DPLL's frequency lock indicator is asserted. This register is used to enable/disable the DPLL ramping feature. If enabled, it is also used to select the algorithm used for clock ramping 0h (R/W) = CLKOUT => No ramping CLKOUTX2 => No ramping 1h (R/W) = CLKOUT => Bypass clk -> Fout/8 -> Fout/4 -> Fout/2 -> Fout CLKOUTX2 => Bypass clk -> Foutx2/8 -> Foutx2/4 -> Foutx2/2 -> Foutx2 2h (R/W) = CLKOUT => Bypass clk -> Fout/4 -> Fout/2 -> Fout/1.5 -> Fout CLKOUTX2 => Bypass clk -> Foutx2/4 -> Foutx2/2 -> Foutx2/1.5 -> Foutx2 3h (R/W) = Reserved
2-0	DPLL_EN	R/W	4h	DPLL control. Upon Warm Reset, the PRCM DPLL control state machine updates this register to reflect MN Bypass mode. 0h (R/W) = Reserved 1h (R/W) = Reserved 2h (R/W) = Reserved 3h (R/W) = Reserved 4h (R/W) = Put the DPLL in MN Bypass mode. The DPLL_MULT register bits are reset to 0 automatically by putting the DPLL in this mode. 5h (R/W) = Put the DPLL in Idle Bypass Low Power mode. 6h (R/W) = Put the DPLL in Idle Bypass Fast Relock mode. 7h (R/W) = Enables the DPLL in Lock mode

8.1.12.2.40 CM_CLKSEL_DPLL_PERIPH Register (offset = 9Ch) [reset = 0h]

Register mask: FFFFFFFFh

CM_CLKSEL_DPLL_PERIPH is shown in [Figure 8-120](#) and described in [Table 8-128](#).

This register provides controls over the DPLL.

Figure 8-120. CM_CLKSEL_DPLL_PERIPH Register

31	30	29	28	27	26	25	24
DPLL_SD_DIV							
R/W-0h							
23	22	21	20	19	18	17	16
RESERVED	RESERVED			DPLL_MULT			
Rreturns0s-0h		Rreturns0s-0h			R/W-0h		
15	14	13	12	11	10	9	8
DPLL_MULT							
R/W-0h							
7	6	5	4	3	2	1	0
DPLL_DIV							
R/W-0h							

LEGEND: R/W = Read/Write; R = Read only; W1toCl = Write 1 to clear bit; -n = value after reset

Table 8-128. CM_CLKSEL_DPLL_PERIPH Register Field Descriptions

Bit	Field	Type	Reset	Description
31-24	DPLL_SD_DIV	R/W	0h	Sigma-Delta divider select (2-255). This factor must be set by s/w to ensure optimum jitter performance. $DPLL_SD_DIV = CEILING ([DPLL_MULT / (DPLL_DIV + 1)] * CLKINP / 250)$, where CLKINP is the input clock of the DPLL in MHz). Must be set with M and N factors, and must not be changed once DPLL is locked. 0h (R/W) = Reserved 1h (R/W) = Reserved
23	RESERVED	Rreturns0s	0h	
22-20	RESERVED	Rreturns0s	0h	
19-8	DPLL_MULT	R/W	0h	DPLL multiplier factor (2 to 4095). This register is automatically cleared to 0 when the DPLL_EN field in the *CLKMODE_DPLL* register is set to select MN Bypass mode. (equal to input M of DPLL M=2 to 4095 => DPLL multiplies by M). 0h (R/W) = 0 : Reserved 1h (R/W) = 1 : Reserved
7-0	DPLL_DIV	R/W	0h	DPLL divider factor (0 to 255) (equal to input N of DPLL actual division factor is N+1).

8.1.12.2.41 CM_DIV_M2_DPLL_DDR Register (offset = A0h) [reset = 1h]

Register mask: FFFFFFFFh

 CM_DIV_M2_DPLL_DDR is shown in [Figure 8-121](#) and described in [Table 8-129](#).

This register provides controls over the M2 divider of the DPLL.

Figure 8-121. CM_DIV_M2_DPLL_DDR Register

31	30	29	28	27	26	25	24
RESERVED							
Rreturns0s-0h							
23	22	21	20	19	18	17	16
RESERVED							
Rreturns0s-0h							
15	14	13	12	11	10	9	8
RESERVED						ST_DPLL_CLK OUT	DPLL_CLKOUT _GATE_CTRL
Rreturns0s-0h						R-0h	R/W-0h
7	6	5	4	3	2	1	0
RESERVED		DPLL_CLKOUT _DIVCHACK	DPLL_CLKOUT_DIV				
Rreturns0s-0h		R-0h	R/W-1h				

LEGEND: R/W = Read/Write; R = Read only; W1toCl = Write 1 to clear bit; -n = value after reset

Table 8-129. CM_DIV_M2_DPLL_DDR Register Field Descriptions

Bit	Field	Type	Reset	Description
31-10	RESERVED	Rreturns0s	0h	
9	ST_DPLL_CLKOUT	R	0h	DPLL CLKOUT status 0h (R) = The clock output is gated 1h (R) = The clock output is enabled
8	DPLL_CLKOUT_GATE_C TRL	R/W	0h	Control gating of DPLL CLKOUT 0h (R/W) = Automatically gate this clock when there is no dependency for it 1h (R/W) = Force this clock to stay enabled even if there is no request
7-6	RESERVED	Rreturns0s	0h	
5	DPLL_CLKOUT_DIVCHA CK	R	0h	Toggle on this status bit after changing DPLL_CLKOUT_DIV indicates that the change in divider value has taken effect
4-0	DPLL_CLKOUT_DIV	R/W	1h	DPLL M2 post-divider factor (1 to 31). 0h (R/W) = Reserved

8.1.12.2.42 CM_DIV_M2_DPLL_DISP Register (offset = A4h) [reset = 1h]

Register mask: FFFFFFFFh

 CM_DIV_M2_DPLL_DISP is shown in [Figure 8-122](#) and described in [Table 8-130](#).

This register provides controls over the M2 divider of the DPLL.

Figure 8-122. CM_DIV_M2_DPLL_DISP Register

31	30	29	28	27	26	25	24
RESERVED							
Rreturns0s-0h							
23	22	21	20	19	18	17	16
RESERVED							
Rreturns0s-0h							
15	14	13	12	11	10	9	8
RESERVED						ST_DPLL_CLK OUT	DPLL_CLKOUT _GATE_CTRL
Rreturns0s-0h						R-0h	R/W-0h
7	6	5	4	3	2	1	0
RESERVED		DPLL_CLKOUT _DIVCHACK	DPLL_CLKOUT_DIV				
Rreturns0s-0h		R-0h	R/W-1h				

LEGEND: R/W = Read/Write; R = Read only; W1toCl = Write 1 to clear bit; -n = value after reset

Table 8-130. CM_DIV_M2_DPLL_DISP Register Field Descriptions

Bit	Field	Type	Reset	Description
31-10	RESERVED	Rreturns0s	0h	
9	ST_DPLL_CLKOUT	R	0h	DPLL CLKOUT status 0h (R) = The clock output is gated 1h (R) = The clock output is enabled
8	DPLL_CLKOUT_GATE_C TRL	R/W	0h	Control gating of DPLL CLKOUT 0h (R/W) = Automatically gate this clock when there is no dependency for it 1h (R/W) = Force this clock to stay enabled even if there is no request
7-6	RESERVED	Rreturns0s	0h	
5	DPLL_CLKOUT_DIVCHA CK	R	0h	Toggle on this status bit after changing DPLL_CLKOUT_DIV indicates that the change in divider value has taken effect
4-0	DPLL_CLKOUT_DIV	R/W	1h	DPLL M2 post-divider factor (1 to 31). 0h (R/W) = Reserved

8.1.12.2.43 CM_DIV_M2_DPLL_MPU Register (offset = A8h) [reset = 1h]

Register mask: FFFFFFFFh

 CM_DIV_M2_DPLL_MPU is shown in [Figure 8-123](#) and described in [Table 8-131](#).

This register provides controls over the M2 divider of the DPLL.

Figure 8-123. CM_DIV_M2_DPLL_MPU Register

31	30	29	28	27	26	25	24
RESERVED							
Rreturns0s-0h							
23	22	21	20	19	18	17	16
RESERVED							
Rreturns0s-0h							
15	14	13	12	11	10	9	8
RESERVED						ST_DPLL_CLK OUT	DPLL_CLKOUT _GATE_CTRL
Rreturns0s-0h						R-0h	R/W-0h
7	6	5	4	3	2	1	0
RESERVED		DPLL_CLKOUT _DIVCHACK	DPLL_CLKOUT_DIV				
Rreturns0s-0h		R-0h	R/W-1h				

LEGEND: R/W = Read/Write; R = Read only; W1toCl = Write 1 to clear bit; -n = value after reset

Table 8-131. CM_DIV_M2_DPLL_MPU Register Field Descriptions

Bit	Field	Type	Reset	Description
31-10	RESERVED	Rreturns0s	0h	
9	ST_DPLL_CLKOUT	R	0h	DPLL CLKOUT status 0h (R) = The clock output is gated 1h (R) = The clock output is enabled
8	DPLL_CLKOUT_GATE_C TRL	R/W	0h	Control gating of DPLL CLKOUT 0h (R/W) = Automatically gate this clock when there is no dependency for it 1h (R/W) = Force this clock to stay enabled even if there is no request
7-6	RESERVED	Rreturns0s	0h	
5	DPLL_CLKOUT_DIVCHA CK	R	0h	Toggle on this status bit after changing DPLL_CLKOUT_DIV indicates that the change in divider value has taken effect
4-0	DPLL_CLKOUT_DIV	R/W	1h	DPLL M2 post-divider factor (1 to 31). 0h (R/W) = Reserved

8.1.12.2.44 CM_DIV_M2_DPLL_PER Register (offset = ACh) [reset = 1h]

Register mask: FFFFFFFFh

 CM_DIV_M2_DPLL_PER is shown in [Figure 8-124](#) and described in [Table 8-132](#).

This register provides controls over the M2 divider of the DPLL.

Figure 8-124. CM_DIV_M2_DPLL_PER Register

31	30	29	28	27	26	25	24
RESERVED							
Rreturns0s-0h							
23	22	21	20	19	18	17	16
RESERVED							
Rreturns0s-0h							
15	14	13	12	11	10	9	8
RESERVED						ST_DPLL_CLK OUT	DPLL_CLKOUT _GATE_CTRL
Rreturns0s-0h						R-0h	R/W-0h
7	6	5	4	3	2	1	0
DPLL_CLKOUT _DIVCHACK	DPLL_CLKOUT_DIV						
R-0h	R/W-1h						

LEGEND: R/W = Read/Write; R = Read only; W1toCl = Write 1 to clear bit; -n = value after reset

Table 8-132. CM_DIV_M2_DPLL_PER Register Field Descriptions

Bit	Field	Type	Reset	Description
31-10	RESERVED	Rreturns0s	0h	
9	ST_DPLL_CLKOUT	R	0h	DPLL CLKOUT status 0h (R) = The clock output is gated 1h (R) = The clock output is enabled
8	DPLL_CLKOUT_GATE_C TRL	R/W	0h	Control gating of DPLL CLKOUT 0h (R/W) = Automatically gate this clock when there is no dependency for it 1h (R/W) = Force this clock to stay enabled even if there is no request
7	DPLL_CLKOUT_DIVCHA CK	R	0h	Toggle on this status bit after changing DPLL_CLKOUT_DIV indicates that the change in divider value has taken effect
6-0	DPLL_CLKOUT_DIV	R/W	1h	DPLL M2 post-divider factor (1 to 31). 0h (R/W) = Reserved

8.1.12.2.45 CM_WKUP_WKUP_M3_CLKCTRL Register (offset = B0h) [reset = 2h]

Register mask: FFFFFFFFh

 CM_WKUP_WKUP_M3_CLKCTRL is shown in [Figure 8-125](#) and described in [Table 8-133](#).

This register manages the WKUP M3 clocks.

Figure 8-125. CM_WKUP_WKUP_M3_CLKCTRL Register

31	30	29	28	27	26	25	24
RESERVED							
Rreturns0s-0h							
23	22	21	20	19	18	17	16
RESERVED					STBYST	RESERVED	
Rreturns0s-0h					R-0h	Rreturns0s-0h	
15	14	13	12	11	10	9	8
RESERVED							
Rreturns0s-0h							
7	6	5	4	3	2	1	0
RESERVED						MODULEMODE	
Rreturns0s-0h						R-2h	

LEGEND: R/W = Read/Write; R = Read only; W1toCl = Write 1 to clear bit; -n = value after reset

Table 8-133. CM_WKUP_WKUP_M3_CLKCTRL Register Field Descriptions

Bit	Field	Type	Reset	Description
31-19	RESERVED	Rreturns0s	0h	
18	STBYST	R	0h	Module standby status. 0h (R) = Module is functional (not in standby) 1h (R) = Module is in standby
17-2	RESERVED	Rreturns0s	0h	
1-0	MODULEMODE	R	2h	Control the way mandatory clocks are managed.

8.1.12.2.46 CM_WKUP_UART0_CLKCTRL Register (offset = B4h) [reset = 30000h]

Register mask: FFFFFFFFh

 CM_WKUP_UART0_CLKCTRL is shown in [Figure 8-126](#) and described in [Table 8-134](#).

This register manages the UART0 clocks.

Figure 8-126. CM_WKUP_UART0_CLKCTRL Register

31	30	29	28	27	26	25	24
RESERVED							
Rreturns0s-0h							
23	22	21	20	19	18	17	16
RESERVED						IDLEST	
Rreturns0s-0h						R-3h	
15	14	13	12	11	10	9	8
RESERVED							
Rreturns0s-0h							
7	6	5	4	3	2	1	0
RESERVED						MODULEMODE	
Rreturns0s-0h						R/W-0h	

LEGEND: R/W = Read/Write; R = Read only; W1toCl = Write 1 to clear bit; -n = value after reset

Table 8-134. CM_WKUP_UART0_CLKCTRL Register Field Descriptions

Bit	Field	Type	Reset	Description
31-18	RESERVED	Rreturns0s	0h	
17-16	IDLEST	R	3h	Module idle status. 0h (R) = Module is fully functional, including OCP 1h (R) = Module is performing transition: wakeup, or sleep, or sleep abortion 2h (R) = Module is in Idle mode (only OCP part). It is functional if using separate functional clock 3h (R) = Module is disabled and cannot be accessed
15-2	RESERVED	Rreturns0s	0h	
1-0	MODULEMODE	R/W	0h	Control the way mandatory clocks are managed. 0h (R/W) = Module is disable by SW. Any OCP access to module results in an error, except if resulting from a module wakeup (asynchronous wakeup). 1h (R/W) = Reserved 2h (R/W) = Module is explicitly enabled. Interface clock (if not used for functions) may be gated according to the clock domain state. Functional clocks are guaranteed to stay present. As long as in this configuration, power domain sleep transition cannot happen. 3h (R) = Reserved

8.1.12.2.47 CM_WKUP_I2C0_CLKCTRL Register (offset = B8h) [reset = 30000h]

Register mask: FFFFFFFFh

 CM_WKUP_I2C0_CLKCTRL is shown in [Figure 8-127](#) and described in [Table 8-135](#).

This register manages the I2C0 clocks.

Figure 8-127. CM_WKUP_I2C0_CLKCTRL Register

31	30	29	28	27	26	25	24
RESERVED							
Rreturns0s-0h							
23	22	21	20	19	18	17	16
RESERVED						IDLEST	
Rreturns0s-0h						R-3h	
15	14	13	12	11	10	9	8
RESERVED							
Rreturns0s-0h							
7	6	5	4	3	2	1	0
RESERVED						MODULEMODE	
Rreturns0s-0h						R/W-0h	

LEGEND: R/W = Read/Write; R = Read only; W1toCl = Write 1 to clear bit; -n = value after reset

Table 8-135. CM_WKUP_I2C0_CLKCTRL Register Field Descriptions

Bit	Field	Type	Reset	Description
31-18	RESERVED	Rreturns0s	0h	
17-16	IDLEST	R	3h	Module idle status. 0h (R) = Module is fully functional, including OCP 1h (R) = Module is performing transition: wakeup, or sleep, or sleep abortion 2h (R) = Module is in Idle mode (only OCP part). It is functional if using separate functional clock 3h (R) = Module is disabled and cannot be accessed
15-2	RESERVED	Rreturns0s	0h	
1-0	MODULEMODE	R/W	0h	Control the way mandatory clocks are managed. 0h (R/W) = Module is disable by SW. Any OCP access to module results in an error, except if resulting from a module wakeup (asynchronous wakeup). 1h (R/W) = Reserved 2h (R/W) = Module is explicitly enabled. Interface clock (if not used for functions) may be gated according to the clock domain state. Functional clocks are guaranteed to stay present. As long as in this configuration, power domain sleep transition cannot happen. 3h (R) = Reserved

8.1.12.2.48 CM_WKUP_ADC_TSC_CLKCTRL Register (offset = BCh) [reset = 30000h]

Register mask: FFFFFFFFh

CM_WKUP_ADC_TSC_CLKCTRL is shown in [Figure 8-128](#) and described in [Table 8-136](#).

This register manages the ADC clocks.

Figure 8-128. CM_WKUP_ADC_TSC_CLKCTRL Register

31	30	29	28	27	26	25	24
RESERVED							
Rreturns0s-0h							
23	22	21	20	19	18	17	16
RESERVED						IDLEST	
Rreturns0s-0h						R-3h	
15	14	13	12	11	10	9	8
RESERVED							
Rreturns0s-0h							
7	6	5	4	3	2	1	0
RESERVED						MODULEMODE	
Rreturns0s-0h						R/W-0h	

LEGEND: R/W = Read/Write; R = Read only; W1toCl = Write 1 to clear bit; -n = value after reset

Table 8-136. CM_WKUP_ADC_TSC_CLKCTRL Register Field Descriptions

Bit	Field	Type	Reset	Description
31-18	RESERVED	Rreturns0s	0h	
17-16	IDLEST	R	3h	Module idle status. 0h (R) = Module is fully functional, including OCP 1h (R) = Module is performing transition: wakeup, or sleep, or sleep abortion 2h (R) = Module is in Idle mode (only OCP part). It is functional if using separate functional clock 3h (R) = Module is disabled and cannot be accessed
15-2	RESERVED	Rreturns0s	0h	
1-0	MODULEMODE	R/W	0h	Control the way mandatory clocks are managed. 0h (R/W) = Module is disable by SW. Any OCP access to module results in an error, except if resulting from a module wakeup (asynchronous wakeup). 1h (R/W) = Reserved 2h (R/W) = Module is explicitly enabled. Interface clock (if not used for functions) may be gated according to the clock domain state. Functional clocks are guaranteed to stay present. As long as in this configuration, power domain sleep transition cannot happen. 3h (R) = Reserved

8.1.12.2.49 CM_WKUP_SMARTREFLEX0_CLKCTRL Register (offset = C0h) [reset = 30000h]

Register mask: FFFFFFFFh

 CM_WKUP_SMARTREFLEX0_CLKCTRL is shown in [Figure 8-129](#) and described in [Table 8-137](#).

This register manages the SmartReflex0 clocks.

Figure 8-129. CM_WKUP_SMARTREFLEX0_CLKCTRL Register

31	30	29	28	27	26	25	24
RESERVED							
Rreturns0s-0h							
23	22	21	20	19	18	17	16
RESERVED						IDLEST	
Rreturns0s-0h						R-3h	
15	14	13	12	11	10	9	8
RESERVED							
Rreturns0s-0h							
7	6	5	4	3	2	1	0
RESERVED						MODULEMODE	
Rreturns0s-0h						R/W-0h	

LEGEND: R/W = Read/Write; R = Read only; W1toCl = Write 1 to clear bit; -n = value after reset

Table 8-137. CM_WKUP_SMARTREFLEX0_CLKCTRL Register Field Descriptions

Bit	Field	Type	Reset	Description
31-18	RESERVED	Rreturns0s	0h	
17-16	IDLEST	R	3h	Module idle status. 0h (R) = Module is fully functional, including OCP 1h (R) = Module is performing transition: wakeup, or sleep, or sleep abortion 2h (R) = Module is in Idle mode (only OCP part). It is functional if using separate functional clock 3h (R) = Module is disabled and cannot be accessed
15-2	RESERVED	Rreturns0s	0h	
1-0	MODULEMODE	R/W	0h	Control the way mandatory clocks are managed. 0h (R/W) = Module is disable by SW. Any OCP access to module results in an error, except if resulting from a module wakeup (asynchronous wakeup). 1h (R/W) = Reserved 2h (R/W) = Module is explicitly enabled. Interface clock (if not used for functions) may be gated according to the clock domain state. Functional clocks are guaranteed to stay present. As long as in this configuration, power domain sleep transition cannot happen. 3h (R) = Reserved

8.1.12.2.50 CM_WKUP_TIMER1_CLKCTRL Register (offset = C4h) [reset = 30000h]

Register mask: FFFFFFFFh

 CM_WKUP_TIMER1_CLKCTRL is shown in [Figure 8-130](#) and described in [Table 8-138](#).

This register manages the TIMER1 clocks.

Figure 8-130. CM_WKUP_TIMER1_CLKCTRL Register

31	30	29	28	27	26	25	24
RESERVED							
Rreturns0s-0h							
23	22	21	20	19	18	17	16
RESERVED				RESERVED		IDLEST	
Rreturns0s-0h				Rreturns0s-0h		R-3h	
15	14	13	12	11	10	9	8
RESERVED							
Rreturns0s-0h							
7	6	5	4	3	2	1	0
RESERVED						MODULEMODE	
Rreturns0s-0h						R/W-0h	

LEGEND: R/W = Read/Write; R = Read only; W1toCl = Write 1 to clear bit; -n = value after reset

Table 8-138. CM_WKUP_TIMER1_CLKCTRL Register Field Descriptions

Bit	Field	Type	Reset	Description
31-19	RESERVED	Rreturns0s	0h	
18	RESERVED	Rreturns0s	0h	
17-16	IDLEST	R	3h	Module idle status. 0h (R) = Module is fully functional, including OCP 1h (R) = Module is performing transition: wakeup, or sleep, or sleep abortion 2h (R) = Module is in Idle mode (only OCP part). It is functional if using separate functional clock 3h (R) = Module is disabled and cannot be accessed
15-2	RESERVED	Rreturns0s	0h	
1-0	MODULEMODE	R/W	0h	Control the way mandatory clocks are managed. 0h (R/W) = Module is disable by SW. Any OCP access to module results in an error, except if resulting from a module wakeup (asynchronous wakeup). 1h (R/W) = Reserved 2h (R/W) = Module is explicitly enabled. Interface clock (if not used for functions) may be gated according to the clock domain state. Functional clocks are guaranteed to stay present. As long as in this configuration, power domain sleep transition cannot happen. 3h (R) = Reserved

8.1.12.2.51 CM_WKUP_SMARTREFLEX1_CLKCTRL Register (offset = C8h) [reset = 30000h]

Register mask: FFFFFFFFh

 CM_WKUP_SMARTREFLEX1_CLKCTRL is shown in [Figure 8-131](#) and described in [Table 8-139](#).

This register manages the SmartReflex1 clocks.

Figure 8-131. CM_WKUP_SMARTREFLEX1_CLKCTRL Register

31	30	29	28	27	26	25	24
RESERVED							
Rreturns0s-0h							
23	22	21	20	19	18	17	16
RESERVED						IDLEST	
Rreturns0s-0h						R-3h	
15	14	13	12	11	10	9	8
RESERVED							
Rreturns0s-0h							
7	6	5	4	3	2	1	0
RESERVED						MODULEMODE	
Rreturns0s-0h						R/W-0h	

LEGEND: R/W = Read/Write; R = Read only; W1toCl = Write 1 to clear bit; -n = value after reset

Table 8-139. CM_WKUP_SMARTREFLEX1_CLKCTRL Register Field Descriptions

Bit	Field	Type	Reset	Description
31-18	RESERVED	Rreturns0s	0h	
17-16	IDLEST	R	3h	Module idle status. 0h (R) = Module is fully functional, including OCP 1h (R) = Module is performing transition: wakeup, or sleep, or sleep abortion 2h (R) = Module is in Idle mode (only OCP part). It is functional if using separate functional clock 3h (R) = Module is disabled and cannot be accessed
15-2	RESERVED	Rreturns0s	0h	
1-0	MODULEMODE	R/W	0h	Control the way mandatory clocks are managed. 0h (R/W) = Module is disable by SW. Any OCP access to module results in an error, except if resulting from a module wakeup (asynchronous wakeup). 1h (R/W) = Reserved 2h (R/W) = Module is explicitly enabled. Interface clock (if not used for functions) may be gated according to the clock domain state. Functional clocks are guaranteed to stay present. As long as in this configuration, power domain sleep transition cannot happen. 3h (R) = Reserved

8.1.12.2.52 CM_L4_WKUP_AON_CLKSTCTRL Register (offset = CCh) [reset = 6h]

Register mask: FFFFFFFFh

CM_L4_WKUP_AON_CLKSTCTRL is shown in [Figure 8-132](#) and described in [Table 8-140](#).

This register enables the domain power state transition. It controls the SW supervised clock domain state transition between ON-ACTIVE and ON-INACTIVE states. It also hold one status bit per clock input of the domain.

Figure 8-132. CM_L4_WKUP_AON_CLKSTCTRL Register

31	30	29	28	27	26	25	24
RESERVED						RESERVED	
Rreturns0s-0h						Rreturns0s-0h	
23	22	21	20	19	18	17	16
RESERVED							
Rreturns0s-0h							
15	14	13	12	11	10	9	8
RESERVED		RESERVED					
Rreturns0s-0h		Rreturns0s-0h					
7	6	5	4	3	2	1	0
RESERVED				RESERVED	CLKACTIVITY_L4_WKUP_AON_GCLK	CLKTRCTRL	
Rreturns0s-0h				Rreturns0s-0h	R-1h	R-2h	

LEGEND: R/W = Read/Write; R = Read only; W1toCl = Write 1 to clear bit; -n = value after reset

Table 8-140. CM_L4_WKUP_AON_CLKSTCTRL Register Field Descriptions

Bit	Field	Type	Reset	Description
31-26	RESERVED	Rreturns0s	0h	
25-14	RESERVED	Rreturns0s	0h	
13-8	RESERVED	Rreturns0s	0h	
7-4	RESERVED	Rreturns0s	0h	
3	RESERVED	Rreturns0s	0h	
2	CLKACTIVITY_L4_WKUP_AON_GCLK	R	1h	This field indicates the state of the L4_WKUP clock in the domain. 0h (R) = Corresponding clock is gated 1h (R) = Corresponding clock is active
1-0	CLKTRCTRL	R	2h	Controls the clock state transition of the always on L4 clock domain. 0h (R/W) = Sleep transition cannot be initiated. Wakeup transition may however occur. 1h (R/W) = Start a software forced sleep transition on the domain. 2h (R/W) = Start a software forced wake-up transition on the domain. 3h (R/W) = Reserved.

8.1.12.2.53 CM_WKUP_WDT1_CLKCTRL Register (offset = D4h) [reset = 30002h]

Register mask: FFFFFFFFh

 CM_WKUP_WDT1_CLKCTRL is shown in [Figure 8-133](#) and described in [Table 8-141](#).

This register manages the WDT1 clocks.

Figure 8-133. CM_WKUP_WDT1_CLKCTRL Register

31	30	29	28	27	26	25	24
RESERVED							
Rreturns0s-0h							
23	22	21	20	19	18	17	16
RESERVED				RESERVED		IDLEST	
Rreturns0s-0h				Rreturns0s-0h		R-3h	
15	14	13	12	11	10	9	8
RESERVED							
Rreturns0s-0h							
7	6	5	4	3	2	1	0
RESERVED						MODULEMODE	
Rreturns0s-0h						R/W-2h	

LEGEND: R/W = Read/Write; R = Read only; W1toCl = Write 1 to clear bit; -n = value after reset

Table 8-141. CM_WKUP_WDT1_CLKCTRL Register Field Descriptions

Bit	Field	Type	Reset	Description
31-19	RESERVED	Rreturns0s	0h	
18	RESERVED	Rreturns0s	0h	
17-16	IDLEST	R	3h	Module idle status. 0h (R) = Module is fully functional, including OCP 1h (R) = Module is performing transition: wakeup, or sleep, or sleep abortion 2h (R) = Module is in Idle mode (only OCP part). It is functional if using separate functional clock 3h (R) = Module is disabled and cannot be accessed
15-2	RESERVED	Rreturns0s	0h	
1-0	MODULEMODE	R/W	2h	Control the way mandatory clocks are managed. 0h (R/W) = Module is disable by SW. Any OCP access to module results in an error, except if resulting from a module wakeup (asynchronous wakeup). 1h (R/W) = Reserved 2h (R/W) = Module is explicitly enabled. Interface clock (if not used for functions) may be gated according to the clock domain state. Functional clocks are guaranteed to stay present. As long as in this configuration, power domain sleep transition cannot happen. 3h (R) = Reserved

8.1.12.2.54 CM_DIV_M6_DPLL_CORE Register (offset = D8h) [reset = 4h]

Register mask: FFFFFFFFh

CM_DIV_M6_DPLL_CORE is shown in [Figure 8-134](#) and described in [Table 8-142](#).

This register provides controls over the CLKOUT3 o/p of the HSDIVIDER. [warm reset insensitive]

Figure 8-134. CM_DIV_M6_DPLL_CORE Register

31	30	29	28	27	26	25	24
RESERVED							
Rreturns0s-0h							
23	22	21	20	19	18	17	16
RESERVED							
Rreturns0s-0h							
15	14	13	12	11	10	9	8
RESERVED			HSDIVIDER_C LKOUT3_PWD N	RESERVED		ST_HSDIVIDE R_CLKOUT3	HSDIVIDER_C LKOUT3_GAT E_CTRL
Rreturns0s-0h			R/W-0h	Rreturns0s-0h		R-0h	R/W-0h
7	6	5	4	3	2	1	0
RESERVED		HSDIVIDER_C LKOUT3_DIVC HACK	HSDIVIDER_CLKOUT3_DIV				
Rreturns0s-0h		R-0h	R/W-4h				

LEGEND: R/W = Read/Write; R = Read only; W1toCl = Write 1 to clear bit; -n = value after reset

Table 8-142. CM_DIV_M6_DPLL_CORE Register Field Descriptions

Bit	Field	Type	Reset	Description
31-13	RESERVED	Rreturns0s	0h	
12	HSDIVIDER_CLKOUT3_PWDN	R/W	0h	Automatic power down for HSDIVIDER M6 divider and hence CLKOUT3 output when the o/p clock is gated. 0h (R/W) = Keep M6 divider powered on even when CLKOUT3 is gated. 1h (R/W) = Automatically power down M6 divider when CLKOUT3 is gated.
11-10	RESERVED	Rreturns0s	0h	
9	ST_HSDIVIDER_CLKOUT3	R	0h	HSDIVIDER CLKOUT3 status 0h (R) = The clock output is enabled 1h (R) = The clock output is gated
8	HSDIVIDER_CLKOUT3_GATE_CTRL	R/W	0h	Control gating of HSDIVIDER CLKOUT3 0h (R/W) = Automatically gate this clock when there is no dependency for it 1h (R/W) = Force this clock to stay enabled even if there is no request
7-6	RESERVED	Rreturns0s	0h	
5	HSDIVIDER_CLKOUT3_DIVCHACK	R	0h	Toggle on this status bit after changing HSDIVIDER_CLKOUT3_DIV indicates that the change in divider value has taken effect
4-0	HSDIVIDER_CLKOUT3_DIV	R/W	4h	DPLL post-divider factor, M6, for internal clock generation. Divide values from 1 to 31. 0h (R/W) = Reserved

8.1.12.3 CM_DPLL Registers

[Table 8-143](#) lists the memory-mapped registers for the CM_DPLL. All register offset addresses not listed in [Table 8-143](#) should be considered as reserved locations and the register contents should not be modified.

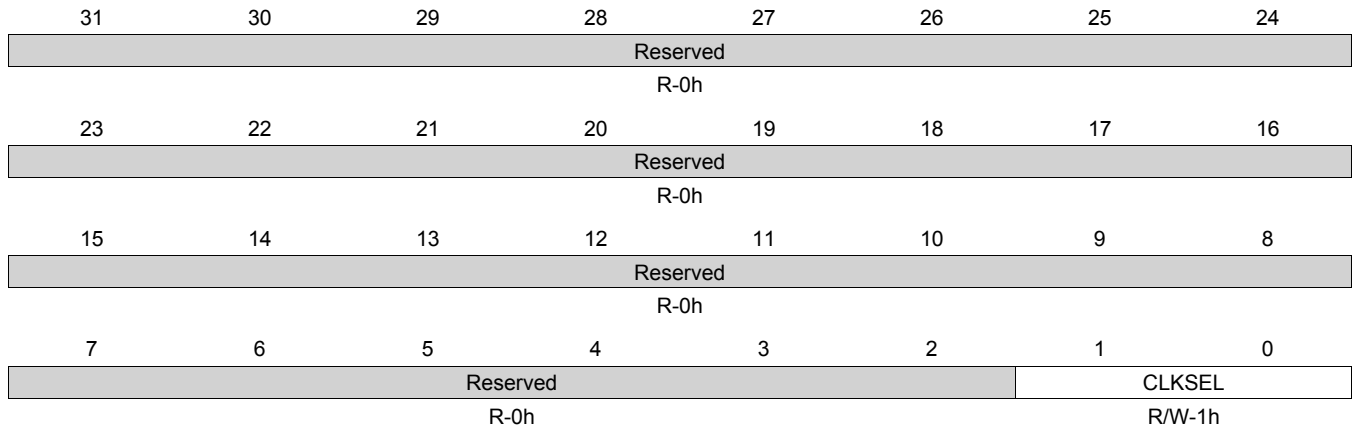
Table 8-143. CM_DPLL REGISTERS

Offset	Acronym	Register Name	Section
4h	CLKSEL_TIMER7_CLK	Selects the Mux select line for TIMER7 clock [warm reset insensitive]	Section 8.1.12.3.1
8h	CLKSEL_TIMER2_CLK	Selects the Mux select line for TIMER2 clock [warm reset insensitive]	Section 8.1.12.3.2
Ch	CLKSEL_TIMER3_CLK	Selects the Mux select line for TIMER3 clock [warm reset insensitive]	Section 8.1.12.3.3
10h	CLKSEL_TIMER4_CLK	Selects the Mux select line for TIMER4 clock [warm reset insensitive]	Section 8.1.12.3.4
14h	CM_MAC_CLKSEL	Selects the clock divide ration for MII clock [warm reset insensitive]	Section 8.1.12.3.5
18h	CLKSEL_TIMER5_CLK	Selects the Mux select line for TIMER5 clock [warm reset insensitive]	Section 8.1.12.3.6
1Ch	CLKSEL_TIMER6_CLK	Selects the Mux select line for TIMER6 clock [warm reset insensitive]	Section 8.1.12.3.7
20h	CM_CPTS_RFT_CLKSEL	Selects the Mux select line for CPTS RFT clock [warm reset insensitive]	Section 8.1.12.3.8
28h	CLKSEL_TIMER1MS_CLK	Selects the Mux select line for TIMER1 clock [warm reset insensitive]	Section 8.1.12.3.9
2Ch	CLKSEL_GFX_FCLK	Selects the divider value for GFX clock [warm reset insensitive]	Section 8.1.12.3.10
30h	CLKSEL_PRU_ICSS_OCP_CLK	Controls the Mux select line for PRU-ICSS OCP clock [warm reset insensitive]	Section 8.1.12.3.11
34h	CLKSEL_LCDC_PIXEL_CLK	Controls the Mux select line for LCDLDC PIXEL clock [warm reset insensitive]	Section 8.1.12.3.12
38h	CLKSEL_WDT1_CLK	Selects the Mux select line for Watchdog1 clock [warm reset insensitive]	Section 8.1.12.3.13
3Ch	CLKSEL_GPIO0_DBCLK	Selects the Mux select line for GPIO0 debounce clock [warm reset insensitive]	Section 8.1.12.3.14

8.1.12.3.1 CLKSEL_TIMER7_CLK Register (offset = 4h) [reset = 1h]

CLKSEL_TIMER7_CLK is shown in [Figure 8-135](#) and described in [Table 8-144](#).

Selects the Mux select line for TIMER7 clock [warm reset insensitive]

Figure 8-135. CLKSEL_TIMER7_CLK Register


LEGEND: R/W = Read/Write; R = Read only; W1toCl = Write 1 to clear bit; -n = value after reset

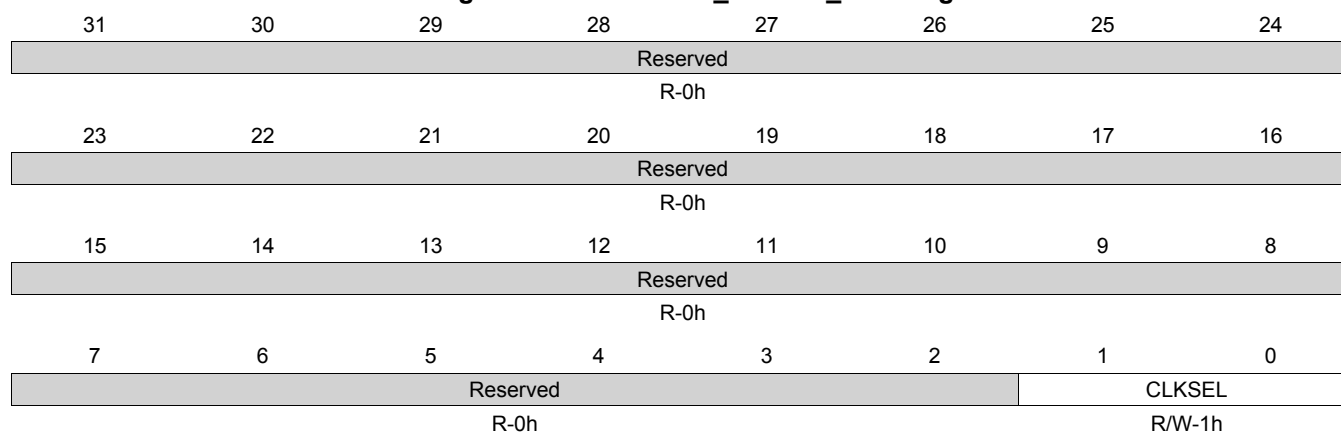
Table 8-144. CLKSEL_TIMER7_CLK Register Field Descriptions

Bit	Field	Type	Reset	Description
31-2	Reserved	R	0h	
1-0	CLKSEL	R/W	1h	Selects the Mux select line for TIMER7 clock [warm reset insensitive] 0x0 = SEL1 : Select TCLKIN clock 0x1 = SEL2 : Select CLK_M_OSC clock 0x2 = SEL3 : Select CLK_32KHZ clock 0x3 = SEL4 : Reserved

8.1.12.3.2 CLKSEL_TIMER2_CLK Register (offset = 8h) [reset = 1h]

CLKSEL_TIMER2_CLK is shown in [Figure 8-136](#) and described in [Table 8-145](#).

Selects the Mux select line for TIMER2 clock [warm reset insensitive]

Figure 8-136. CLKSEL_TIMER2_CLK Register


LEGEND: R/W = Read/Write; R = Read only; W1toCl = Write 1 to clear bit; -n = value after reset

Table 8-145. CLKSEL_TIMER2_CLK Register Field Descriptions

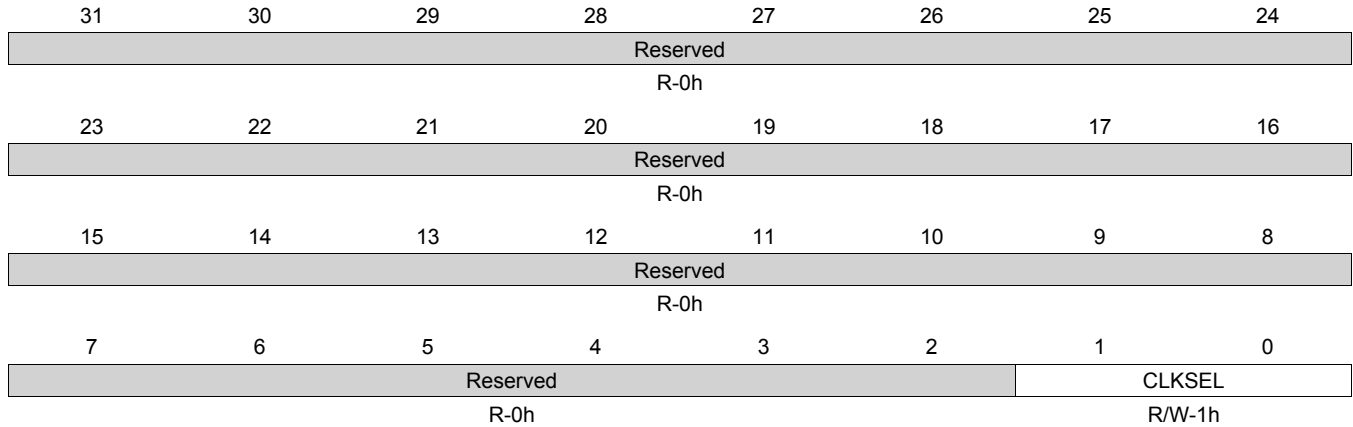
Bit	Field	Type	Reset	Description
31-2	Reserved	R	0h	
1-0	CLKSEL	R/W	1h	Selects the Mux select line for TIMER2 clock [warm reset insensitive] 0x0 = SEL1 : Select TCLKIN clock 0x1 = SEL2 : Select CLK_M_OSC clock 0x2 = SEL3 : Select CLK_32KHZ clock 0x3 = SEL4 : Reserved

8.1.12.3.3 CLKSEL_TIMER3_CLK Register (offset = Ch) [reset = 1h]

CLKSEL_TIMER3_CLK is shown in [Figure 8-137](#) and described in [Table 8-146](#).

Selects the Mux select line for TIMER3 clock [warm reset insensitive]

Figure 8-137. CLKSEL_TIMER3_CLK Register



LEGEND: R/W = Read/Write; R = Read only; W1toCl = Write 1 to clear bit; -n = value after reset

Table 8-146. CLKSEL_TIMER3_CLK Register Field Descriptions

Bit	Field	Type	Reset	Description
31-2	Reserved	R	0h	
1-0	CLKSEL	R/W	1h	Selects the Mux select line for TIMER3 clock [warm reset insensitive] 0x0 = SEL1 : Select TCLKIN clock 0x1 = SEL2 : Select CLK_M_OSC clock 0x2 = SEL3 : Select CLK_32KHZ clock 0x3 = SEL4 : Reserved

8.1.12.3.4 CLKSEL_TIMER4_CLK Register (offset = 10h) [reset = 1h]

CLKSEL_TIMER4_CLK is shown in [Figure 8-138](#) and described in [Table 8-147](#).

Selects the Mux select line for TIMER4 clock [warm reset insensitive]

Figure 8-138. CLKSEL_TIMER4_CLK Register

31	30	29	28	27	26	25	24
Reserved							
R-0h							
23	22	21	20	19	18	17	16
Reserved							
R-0h							
15	14	13	12	11	10	9	8
Reserved							
R-0h							
7	6	5	4	3	2	1	0
Reserved						CLKSEL	
R-0h						R/W-1h	

LEGEND: R/W = Read/Write; R = Read only; W1toCl = Write 1 to clear bit; -n = value after reset

Table 8-147. CLKSEL_TIMER4_CLK Register Field Descriptions

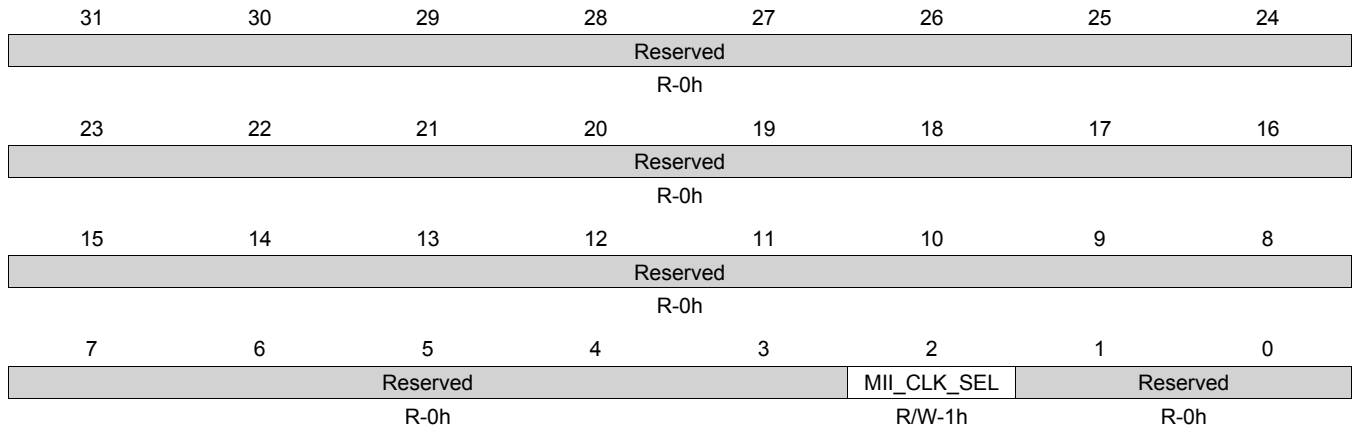
Bit	Field	Type	Reset	Description
31-2	Reserved	R	0h	
1-0	CLKSEL	R/W	1h	Selects the Mux select line for TIMER4 clock [warm reset insensitive] 0x0 = SEL1 : Select TCLKIN clock 0x1 = SEL2 : Select CLK_M_OSC clock 0x2 = SEL3 : Select CLK_32KHZ clock 0x3 = SEL4 : Reserved

8.1.12.3.5 CM_MAC_CLKSEL Register (offset = 14h) [reset = 4h]

CM_MAC_CLKSEL is shown in [Figure 8-139](#) and described in [Table 8-148](#).

Selects the clock divide ration for MII clock [warm reset insensitive]

Figure 8-139. CM_MAC_CLKSEL Register



LEGEND: R/W = Read/Write; R = Read only; W1toCl = Write 1 to clear bit; -n = value after reset

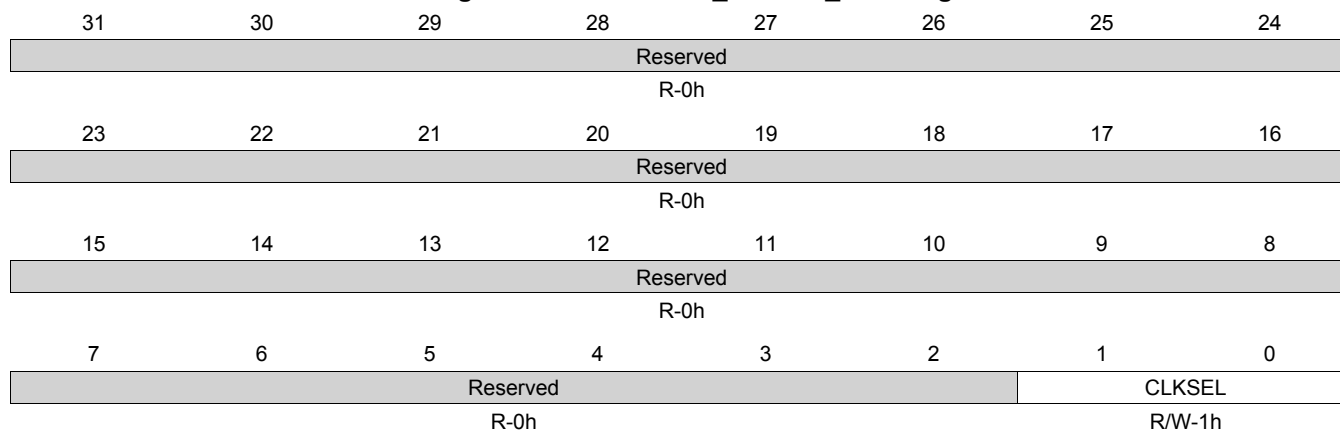
Table 8-148. CM_MAC_CLKSEL Register Field Descriptions

Bit	Field	Type	Reset	Description
31-3	Reserved	R	0h	
2	MII_CLK_SEL	R/W	1h	MII Clock Divider Selection. This bit is warm reset insensitive when CPSW RESET_ISO is enabled 0x0 = SEL0 : Selects 1/2 divider of SYSCLK2 0x1 = SEL1 : Selects 1/5 divide ratio of SYSCLK2
1-0	Reserved	R	0h	

8.1.12.3.6 CLKSEL_TIMER5_CLK Register (offset = 18h) [reset = 1h]

CLKSEL_TIMER5_CLK is shown in [Figure 8-140](#) and described in [Table 8-149](#).

Selects the Mux select line for TIMER5 clock [warm reset insensitive]

Figure 8-140. CLKSEL_TIMER5_CLK Register


LEGEND: R/W = Read/Write; R = Read only; W1toCl = Write 1 to clear bit; -n = value after reset

Table 8-149. CLKSEL_TIMER5_CLK Register Field Descriptions

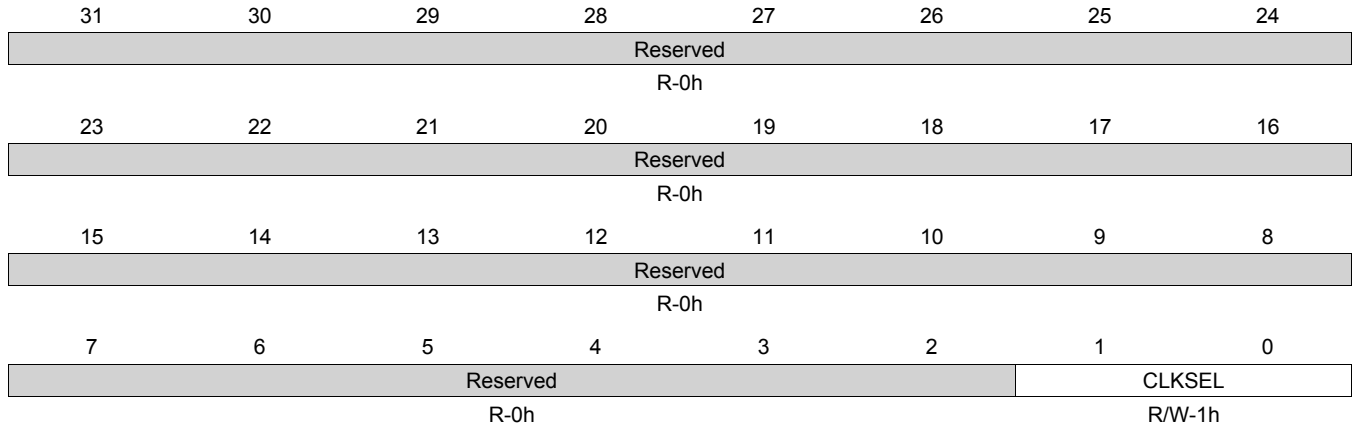
Bit	Field	Type	Reset	Description
31-2	Reserved	R	0h	
1-0	CLKSEL	R/W	1h	Selects the Mux select line for TIMER5 clock [warm reset insensitive] 0x0 = SEL1 : Select TCLKIN clock 0x1 = SEL2 : Select CLK_M_OSC clock 0x2 = SEL3 : Select CLK_32KHZ clock 0x3 = SEL4 : Reserved

8.1.12.3.7 CLKSEL_TIMER6_CLK Register (offset = 1Ch) [reset = 1h]

CLKSEL_TIMER6_CLK is shown in [Figure 8-141](#) and described in [Table 8-150](#).

Selects the Mux select line for TIMER6 clock [warm reset insensitive]

Figure 8-141. CLKSEL_TIMER6_CLK Register



LEGEND: R/W = Read/Write; R = Read only; W1toCl = Write 1 to clear bit; -n = value after reset

Table 8-150. CLKSEL_TIMER6_CLK Register Field Descriptions

Bit	Field	Type	Reset	Description
31-2	Reserved	R	0h	
1-0	CLKSEL	R/W	1h	Selects the Mux select line for TIMER6 clock [warm reset insensitive] 0x0 = SEL1 : Select TCLKIN clock 0x1 = SEL2 : Select CLK_M_OSC clock 0x2 = SEL3 : Select CLK_32KHZ clock 0x3 = SEL4 : Reserved

8.1.12.3.8 CM_CPTS_RFT_CLKSEL Register (offset = 20h) [reset = 0h]

CM_CPTS_RFT_CLKSEL is shown in [Figure 8-142](#) and described in [Table 8-151](#).

Selects the Mux select line for CPTS RFT clock [warm reset insensitive]

Figure 8-142. CM_CPTS_RFT_CLKSEL Register

31	30	29	28	27	26	25	24
Reserved							
R-0h							
23	22	21	20	19	18	17	16
Reserved							
R-0h							
15	14	13	12	11	10	9	8
Reserved							
R-0h							
7	6	5	4	3	2	1	0
Reserved				Reserved		Reserved	CLKSEL
R-0h				R-0h		R-0h	R/W-0h

LEGEND: R/W = Read/Write; R = Read only; W1toCl = Write 1 to clear bit; -n = value after reset

Table 8-151. CM_CPTS_RFT_CLKSEL Register Field Descriptions

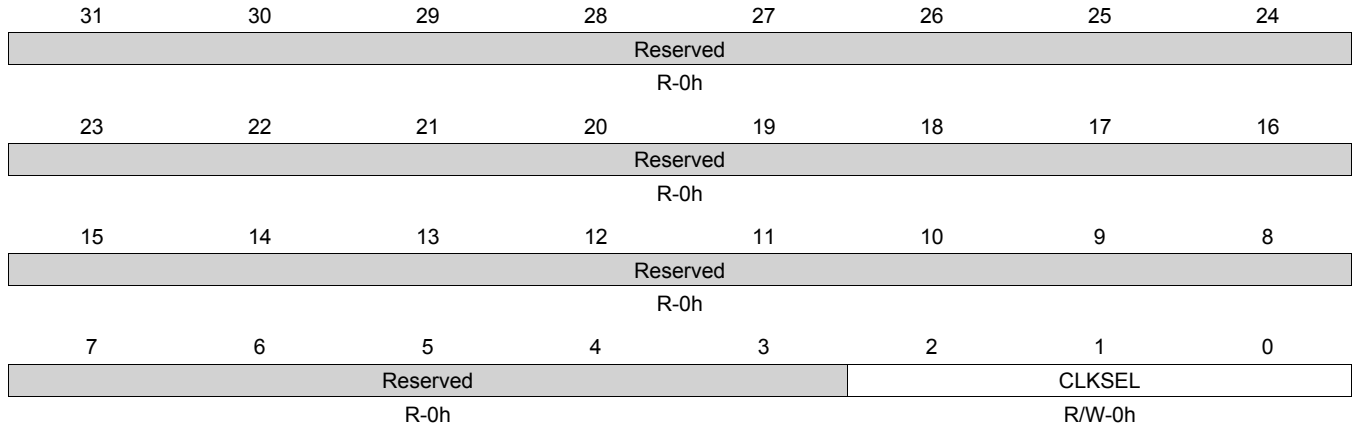
Bit	Field	Type	Reset	Description
31-3	Reserved	R	0h	
2	Reserved	R	0h	
1	Reserved	R	0h	
0	CLKSEL	R/W	0h	Selects the Mux select line for cpgmac rft clock [warm reset insensitive] 0x0 = SEL1 : Selects CORE_CLKOUTM5 0x1 = SEL2 : Selects CORE_CLKOUTM4

8.1.12.3.9 CLKSEL_TIMER1MS_CLK Register (offset = 28h) [reset = 0h]

CLKSEL_TIMER1MS_CLK is shown in [Figure 8-143](#) and described in [Table 8-152](#).

Selects the Mux select line for TIMER1 clock [warm reset insensitive]

Figure 8-143. CLKSEL_TIMER1MS_CLK Register



LEGEND: R/W = Read/Write; R = Read only; W1toCl = Write 1 to clear bit; -n = value after reset

Table 8-152. CLKSEL_TIMER1MS_CLK Register Field Descriptions

Bit	Field	Type	Reset	Description
31-3	Reserved	R	0h	
2-0	CLKSEL	R/W	0h	Selects the Mux select line for DMTIMER_1MS clock [warm reset insensitive] 0x0 = SEL1 : Select CLK_M_OSC clock 0x1 = SEL2 : Select CLK_32KHZ clock 0x2 = SEL3 : Select TCLKIN clock 0x3 = SEL4 : Select CLK_RC32K clock 0x4 = SEL5 : Selects the CLK_32768 from 32KHz Crystal Osc

8.1.12.3.10 CLKSEL_GFX_FCLK Register (offset = 2Ch) [reset = 0h]

 CLKSEL_GFX_FCLK is shown in [Figure 8-144](#) and described in [Table 8-153](#).

Selects the divider value for GFX clock [warm reset insensitive]

Figure 8-144. CLKSEL_GFX_FCLK Register

31	30	29	28	27	26	25	24
Reserved							
R-0h							
23	22	21	20	19	18	17	16
Reserved							
R-0h							
15	14	13	12	11	10	9	8
Reserved							
R-0h							
7	6	5	4	3	2	1	0
Reserved						CLKSEL_GFX_FCLK	CLKDIV_SEL_GFX_FCLK
R-0h						R/W-0h	R/W-0h

LEGEND: R/W = Read/Write; R = Read only; W1toCl = Write 1 to clear bit; -n = value after reset

Table 8-153. CLKSEL_GFX_FCLK Register Field Descriptions

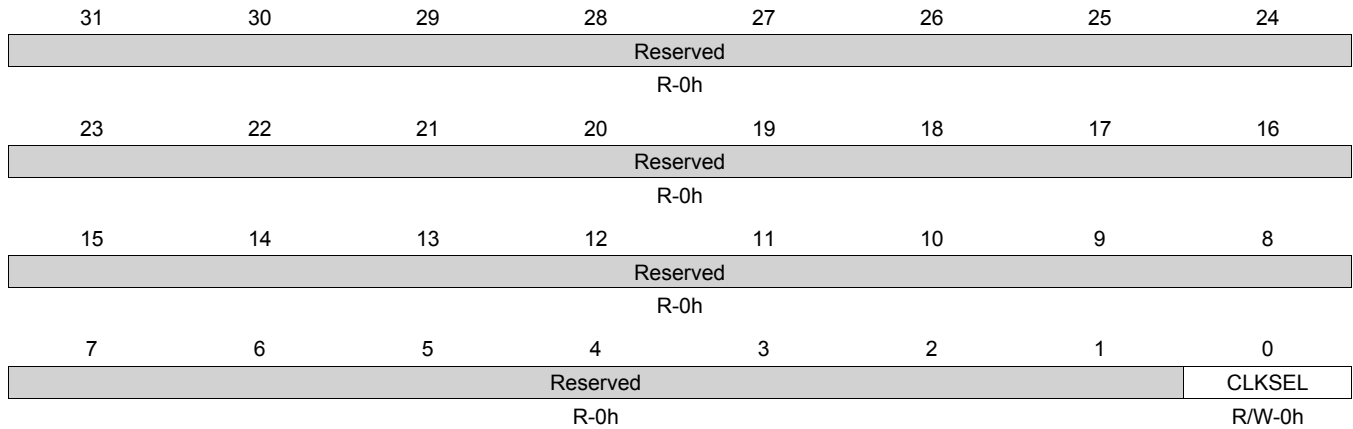
Bit	Field	Type	Reset	Description
31-2	Reserved	R	0h	
1	CLKSEL_GFX_FCLK	R/W	0h	Selects the clock on gfx fclk [warm reset insensitive] 0x0 = SEL0 : SGX FCLK is from CORE PLL (same as L3 clock) 0x1 = SEL1 : SGX FCLK is from PER PLL (192 MHz clock)
0	CLKDIV_SEL_GFX_FCLK	R/W	0h	Selects the divider value on gfx fclk [warm reset insensitive] 0x0 = DIV1 : SGX FCLK is same as L3 Clock or 192MHz Clock 0x1 = DIV2 : SGX FCLK is L3 clock/2 or 192Mhz/2

8.1.12.3.11 CLKSEL_PRU_ICSS_OCP_CLK Register (offset = 30h) [reset = 0h]

CLKSEL_PRU_ICSS_OCP_CLK is shown in [Figure 8-145](#) and described in [Table 8-154](#).

Controls the Mux select line for PRU-ICSS OCP clock [warm reset insensitive]

Figure 8-145. CLKSEL_PRU_ICSS_OCP_CLK Register



LEGEND: R/W = Read/Write; R = Read only; W1toCl = Write 1 to clear bit; -n = value after reset

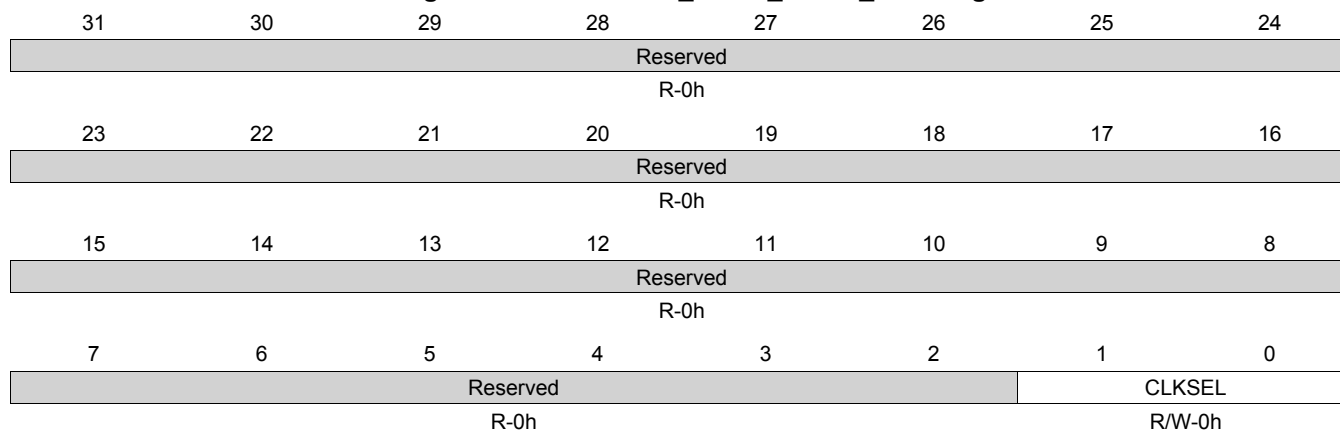
Table 8-154. CLKSEL_PRU_ICSS_OCP_CLK Register Field Descriptions

Bit	Field	Type	Reset	Description
31-1	Reserved	R	0h	
0	CLKSEL	R/W	0h	Controls Mux Select of PRU-ICSS OCP clock mux 0x0 = SEL1 : Select L3F clock as OCP Clock of PRU-ICSS 0x1 = SEL2 : Select DISP DPLL clock as OCP clock of PRU-ICSS

8.1.12.3.12 CLKSEL_LCDC_PIXEL_CLK Register (offset = 34h) [reset = 0h]

CLKSEL_LCDC_PIXEL_CLK is shown in [Figure 8-146](#) and described in [Table 8-155](#).

Controls the Mux select line for LCDC PIXEL clock [warm reset insensitive]

Figure 8-146. CLKSEL_LCDC_PIXEL_CLK Register


LEGEND: R/W = Read/Write; R = Read only; W1toCl = Write 1 to clear bit; -n = value after reset

Table 8-155. CLKSEL_LCDC_PIXEL_CLK Register Field Descriptions

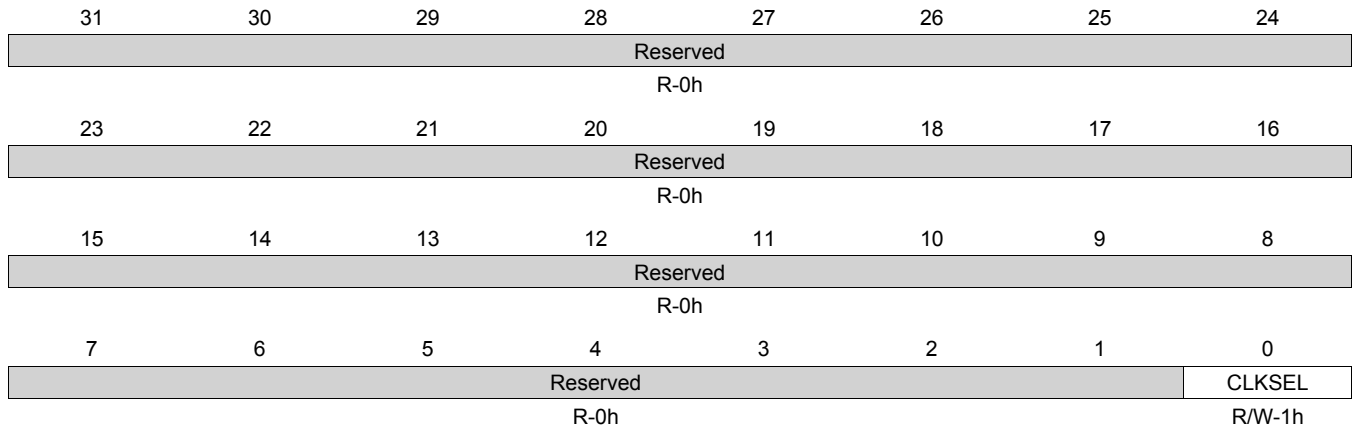
Bit	Field	Type	Reset	Description
31-2	Reserved	R	0h	
1-0	CLKSEL	R/W	0h	Controls the Mux Select of LCDC PIXEL clock 0x0 = SEL1 : Select DISP PLL CLKOUTM2 0x1 = SEL2 : Select CORE PLL CLKOUTM5 0x2 = SEL3 : Select PER PLL CLKOUTM2 0x3 = SEL4 : Reserved

8.1.12.3.13 CLKSEL_WDT1_CLK Register (offset = 38h) [reset = 1h]

CLKSEL_WDT1_CLK is shown in [Figure 8-147](#) and described in [Table 8-156](#).

Selects the Mux select line for Watchdog1 clock [warm reset insensitive]

Figure 8-147. CLKSEL_WDT1_CLK Register



LEGEND: R/W = Read/Write; R = Read only; W1toCl = Write 1 to clear bit; -n = value after reset

Table 8-156. CLKSEL_WDT1_CLK Register Field Descriptions

Bit	Field	Type	Reset	Description
31-1	Reserved	R	0h	
0	CLKSEL	R/W	1h	Selects the Mux select line for WDT1 clock [warm reset insensitive] 0x0 = SEL1 : Select 32KHZ clock from RC Oscillator 0x1 = SEL2 : Select 32KHZ from 32K Clock divider

8.1.12.3.14 CLKSEL_GPIO0_DBCLK Register (offset = 3Ch) [reset = 0h]

CLKSEL_GPIO0_DBCLK is shown in [Figure 8-148](#) and described in [Table 8-157](#).

Selects the Mux select line for GPIO0 debounce clock [warm reset insensitive]

Figure 8-148. CLKSEL_GPIO0_DBCLK Register

31	30	29	28	27	26	25	24
Reserved							
R-0h							
23	22	21	20	19	18	17	16
Reserved							
R-0h							
15	14	13	12	11	10	9	8
Reserved							
R-0h							
7	6	5	4	3	2	1	0
Reserved						CLKSEL	
R-0h						R/W-0h	

LEGEND: R/W = Read/Write; R = Read only; W1toCl = Write 1 to clear bit; -n = value after reset

Table 8-157. CLKSEL_GPIO0_DBCLK Register Field Descriptions

Bit	Field	Type	Reset	Description
31-2	Reserved	R	0h	
1-0	CLKSEL	R/W	0h	Selects the Mux select line for GPIO0 debounce clock [warm reset insensitive] 0x0 = SEL1 : Select 32KHZ clock from RC Oscillator 0x1 = SEL2 : Select 32KHZ from 32K Crystal Oscillator 0x2 = SEL3 : Select 32KHz from Clock Divider

8.1.12.4 CM_MPU Registers

[Table 8-158](#) lists the memory-mapped registers for the CM_MPU. All register offset addresses not listed in [Table 8-158](#) should be considered as reserved locations and the register contents should not be modified.

Table 8-158. CM_MPU REGISTERS

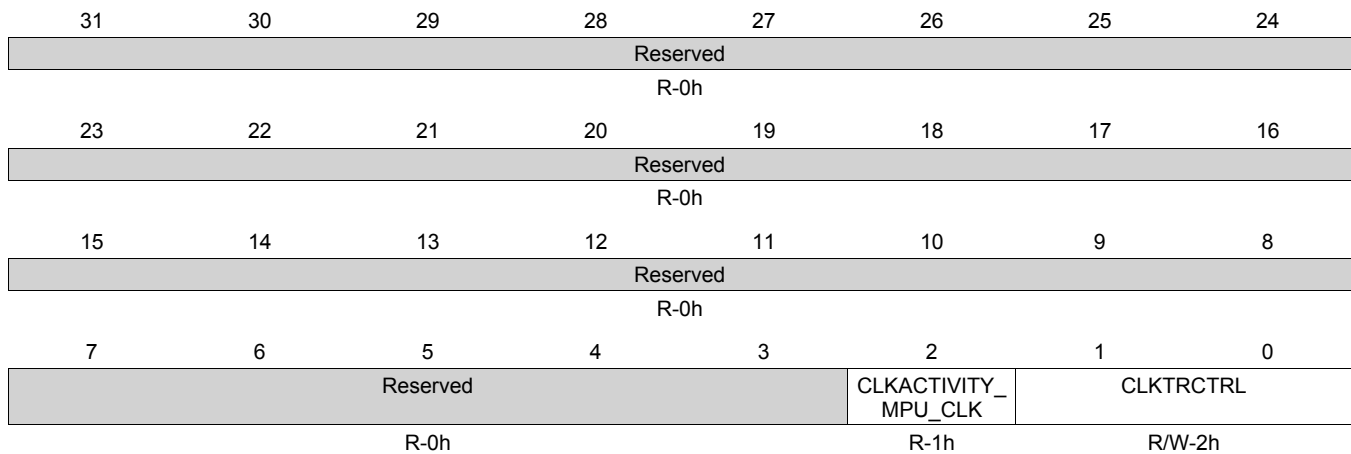
Offset	Acronym	Register Name	Section
0h	CM_MPU_CLKSTCTRL	This register enables the domain power state transition. It controls the SW supervised clock domain state transition between ON-ACTIVE and ON-INACTIVE states. It also hold one status bit per clock input of the domain.	Section 8.1.12.4.1
4h	CM_MPU_MPU_CLKCTRL	This register manages the MPU clocks.	Section 8.1.12.4.2

8.1.12.4.1 CM_MPU_CLKSTCTRL Register (offset = 0h) [reset = 6h]

CM_MPU_CLKSTCTRL is shown in [Figure 8-149](#) and described in [Table 8-159](#).

This register enables the domain power state transition. It controls the SW supervised clock domain state transition between ON-ACTIVE and ON-INACTIVE states. It also hold one status bit per clock input of the domain.

Figure 8-149. CM_MPU_CLKSTCTRL Register



LEGEND: R/W = Read/Write; R = Read only; W1toCl = Write 1 to clear bit; -n = value after reset

Table 8-159. CM_MPU_CLKSTCTRL Register Field Descriptions

Bit	Field	Type	Reset	Description
31-3	Reserved	R	0h	
2	CLKACTIVITY_MPU_CLK	R	1h	This field indicates the state of the MPU Clock 0x0 = Inact : Corresponding clock is gated 0x1 = Act : Corresponding clock is active
1-0	CLKTRCTRL	R/W	2h	Controls the clock state transition of the MPU clock domains. 0x0 = NO_SLEEP : NO_SLEEP: Sleep transition cannot be initiated. Wakeup transition may however occur. 0x1 = SW_SLEEP : SW_SLEEP: Start a software forced sleep transition on the domain. 0x2 = SW_WKUP : SW_WKUP: Start a software forced wake-up transition on the domain. 0x3 = Reserved : Reserved.

8.1.12.4.2 CM_MPU_MPU_CLKCTRL Register (offset = 4h) [reset = 2h]

CM_MPU_MPU_CLKCTRL is shown in [Figure 8-150](#) and described in [Table 8-160](#).

This register manages the MPU clocks.

Figure 8-150. CM_MPU_MPU_CLKCTRL Register

31	30	29	28	27	26	25	24
Reserved							
R-0h							
23	22	21	20	19	18	17	16
Reserved					STBYST	IDLEST	
R-0h					R-0h	R-0h	
15	14	13	12	11	10	9	8
Reserved							
R-0h							
7	6	5	4	3	2	1	0
Reserved						MODULEMODE	
R-0h						R/W-2h	

LEGEND: R/W = Read/Write; R = Read only; W1toCl = Write 1 to clear bit; -n = value after reset

Table 8-160. CM_MPU_MPU_CLKCTRL Register Field Descriptions

Bit	Field	Type	Reset	Description
31-19	Reserved	R	0h	
18	STBYST	R	0h	Module standby status. 0x0 = Func : Module is functional (not in standby) 0x1 = Standby : Module is in standby
17-16	IDLEST	R	0h	Module idle status. 0x0 = Func : Module is fully functional, including OCP 0x1 = Trans : Module is performing transition: wakeup, or sleep, or sleep abortion 0x2 = Idle : Module is in Idle mode (only OCP part). It is functional if using separate functional clock 0x3 = Disable : Module is disabled and cannot be accessed
15-2	Reserved	R	0h	
1-0	MODULEMODE	R/W	2h	Control the way mandatory clocks are managed. 0x0 = DISABLED : Module is disable by SW. Any OCP access to module results in an error, except if resulting from a module wakeup (asynchronous wakeup). 0x1 = RESERVED_1 : Reserved 0x2 = ENABLE : Module is explicitly enabled. Interface clock (if not used for functions) may be gated according to the clock domain state. Functional clocks are guaranteed to stay present. As long as in this configuration, power domain sleep transition cannot happen. 0x3 = RESERVED : Reserved

8.1.12.5 CM_DEVICE Registers

[Table 8-161](#) lists the memory-mapped registers for the CM_DEVICE. All register offset addresses not listed in [Table 8-161](#) should be considered as reserved locations and the register contents should not be modified.

Table 8-161. CM_DEVICE REGISTERS

Offset	Acronym	Register Name	Section
0h	CM_CLKOUT_CTRL	This register provides the control over CLKOUT2 output	Section 8.1.12.5.1

8.1.12.5.1 CM_CLKOUT_CTRL Register (offset = 0h) [reset = 0h]

CM_CLKOUT_CTRL is shown in [Figure 8-151](#) and described in [Table 8-162](#).

This register provides the control over CLKOUT2 output

Figure 8-151. CM_CLKOUT_CTRL Register

31	30	29	28	27	26	25	24
Reserved							
R-0h							
23	22	21	20	19	18	17	16
Reserved							
R-0h							
15	14	13	12	11	10	9	8
Reserved							
R-0h							
7	6	5	4	3	2	1	0
CLKOUT2EN	Reserved	CLKOUT2DIV			CLKOUT2SOURCE		
R/W-0h	R-0h	R/W-0h			R/W-0h		

LEGEND: R/W = Read/Write; R = Read only; W1toCl = Write 1 to clear bit; -n = value after reset

Table 8-162. CM_CLKOUT_CTRL Register Field Descriptions

Bit	Field	Type	Reset	Description
31-8	Reserved	R	0h	
7	CLKOUT2EN	R/W	0h	This bit controls the external clock activity 0x0 = DIS : SYS_CLKOUT2 is disabled 0x1 = EN : SYS_CLKOUT2 is enabled
6	Reserved	R	0h	
5-3	CLKOUT2DIV	R/W	0h	This field controls the external clock division factor 0x0 = DIV1 : SYS_CLKOUT2/1 0x1 = DIV2 : SYS_CLKOUT2/2 0x2 = DIV3 : SYS_CLKOUT2/3 0x3 = DIV4 : SYS_CLKOUT2/4 0x4 = DIV5 : SYS_CLKOUT2/5 0x5 = DIV6 : SYS_CLKOUT2/6 0x6 = DIV7 : SYS_CLKOUT2/7 0x7 = Reserved
2-0	CLKOUT2SOURCE	R/W	0h	This field selects the external output clock source 0x0 = SEL0 : Select 32KHz Oscillator O/P 0x1 = SEL1 : Select L3 Clock 0x2 = SEL2 : Select DDR PHY Clock 0x3 = SEL4 : Select 192Mhz clock from PER PLL 0x4 = SEL5 : Select LCD Pixel Clock

8.1.12.6 CM_RTC Registers

[Table 8-163](#) lists the memory-mapped registers for the CM_RTC. All register offset addresses not listed in [Table 8-163](#) should be considered as reserved locations and the register contents should not be modified.

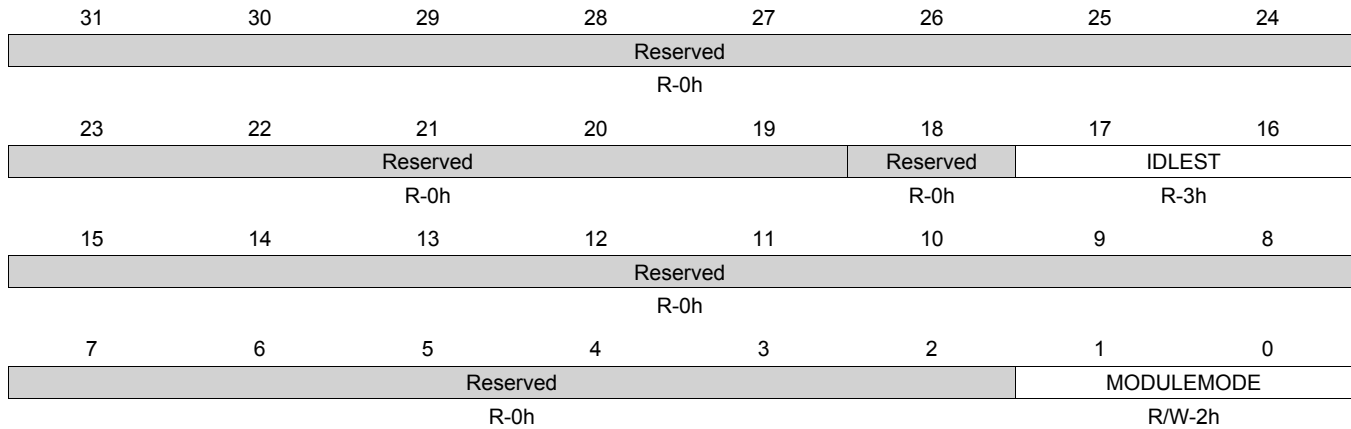
Table 8-163. CM_RTC REGISTERS

Offset	Acronym	Register Name	Section
0h	CM_RTC_RTC_CLKCTRL	This register manages the RTC clocks.	Section 8.1.12.6.1
4h	CM_RTC_CLKSTCTRL	This register enables the domain power state transition. It controls the SW supervised clock domain state transition between ON-ACTIVE and ON-INACTIVE states. It also hold one status bit per clock input of the domain.	Section 8.1.12.6.2

8.1.12.6.1 CM_RTC_RTC_CLKCTRL Register (offset = 0h) [reset = 30002h]

CM_RTC_RTC_CLKCTRL is shown in [Figure 8-152](#) and described in [Table 8-164](#).

This register manages the RTC clocks.

Figure 8-152. CM_RTC_RTC_CLKCTRL Register


LEGEND: R/W = Read/Write; R = Read only; W1toCl = Write 1 to clear bit; -n = value after reset

Table 8-164. CM_RTC_RTC_CLKCTRL Register Field Descriptions

Bit	Field	Type	Reset	Description
31-19	Reserved	R	0h	
18	Reserved	R	0h	
17-16	IDLEST	R	3h	Module idle status. 0x0 = Func : Module is fully functional, including OCP 0x1 = Trans : Module is performing transition: wakeup, or sleep, or sleep abortion 0x2 = Idle : Module is in Idle mode (only OCP part). It is functional if using separate functional clock 0x3 = Disable : Module is disabled and cannot be accessed
15-2	Reserved	R	0h	
1-0	MODULEMODE	R/W	2h	Control the way mandatory clocks are managed. 0x0 = DISABLED : Module is disable by SW. Any OCP access to module results in an error, except if resulting from a module wakeup (asynchronous wakeup). 0x1 = RESERVED_1 : Reserved 0x2 = ENABLE : Module is explicitly enabled. Interface clock (if not used for functions) may be gated according to the clock domain state. Functional clocks are guaranteed to stay present. As long as in this configuration, power domain sleep transition cannot happen. 0x3 = RESERVED : Reserved

8.1.12.6.2 CM_RTC_CLKSTCTRL Register (offset = 4h) [reset = 102h]

CM_RTC_CLKSTCTRL is shown in [Figure 8-153](#) and described in [Table 8-165](#).

This register enables the domain power state transition. It controls the SW supervised clock domain state transition between ON-ACTIVE and ON-INACTIVE states. It also hold one status bit per clock input of the domain.

Figure 8-153. CM_RTC_CLKSTCTRL Register

31	30	29	28	27	26	25	24
Reserved						Reserved	
R-0h						R-0h	
23	22	21	20	19	18	17	16
Reserved							
R-0h							
15	14	13	12	11	10	9	8
Reserved					Reserved	CLKACTIVITY_ RTC_32CLK	CLKACTIVITY_ L4_RTC_GCLK
R-0h					R-0h	R-0h	R-1h
7	6	5	4	3	2	1	0
Reserved						CLKTRCTRL	
R-0h						R/W-2h	

LEGEND: R/W = Read/Write; R = Read only; W1toCl = Write 1 to clear bit; -n = value after reset

Table 8-165. CM_RTC_CLKSTCTRL Register Field Descriptions

Bit	Field	Type	Reset	Description
31-26	Reserved	R	0h	
25-11	Reserved	R	0h	
10	Reserved	R	0h	
9	CLKACTIVITY_RTC_32K CLK	R	0h	This field indicates the state of the 32K RTC clock in the domain. 0x0 = Inact 0x1 = Act
8	CLKACTIVITY_L4_RTC_GCLK	R	1h	This field indicates the state of the L4 RTC clock in the domain. 0x0 = Inact : Corresponding clock is gated 0x1 = Act : Corresponding clock is active
7-2	Reserved	R	0h	
1-0	CLKTRCTRL	R/W	2h	Controls the clock state transition of the RTC clock domains. 0x0 = NO_SLEEP : NO_SLEEP: Sleep transition cannot be initiated. Wakeup transition may however occur. 0x1 = SW_SLEEP : SW_SLEEP: Start a software forced sleep transition on the domain. 0x2 = SW_WKUP : SW_WKUP: Start a software forced wake-up transition on the domain. 0x3 = Reserved : Reserved.

8.1.12.7 CM_GFX Registers

[Table 8-166](#) lists the memory-mapped registers for the CM_GFX. All register offset addresses not listed in [Table 8-166](#) should be considered as reserved locations and the register contents should not be modified.

Table 8-166. CM_GFX REGISTERS

Offset	Acronym	Register Name	Section
0h	CM_GFX_L3_CLKSTCTRL	This register enables the domain power state transition. It controls the SW supervised clock domain state transition between ON-ACTIVE and ON-INACTIVE states. It also hold one status bit per clock input of the domain.	Section 8.1.12.7.1
4h	CM_GFX_GFX_CLKCTRL	This register manages the GFX clocks.	Section 8.1.12.7.2
Ch	CM_GFX_L4LS_GFX_CLKSTCTRL	This register enables the domain power state transition. It controls the SW supervised clock domain state transition between ON-ACTIVE and ON-INACTIVE states. It also hold one status bit per clock input of the domain.	Section 8.1.12.7.3
10h	CM_GFX_MMUCFG_CLKCTRL	This register manages the MMU CFG clocks.	Section 8.1.12.7.4
14h	CM_GFX_MMUDATA_CLKCTRL	This register manages the MMU clocks.	Section 8.1.12.7.5

8.1.12.7.1 CM_GFX_L3_CLKSTCTRL Register (offset = 0h) [reset = 2h]

CM_GFX_L3_CLKSTCTRL is shown in [Figure 8-154](#) and described in [Table 8-167](#).

This register enables the domain power state transition. It controls the SW supervised clock domain state transition between ON-ACTIVE and ON-INACTIVE states. It also hold one status bit per clock input of the domain.

Figure 8-154. CM_GFX_L3_CLKSTCTRL Register

31	30	29	28	27	26	25	24
Reserved						Reserved	
R-0h						R-0h	
23	22	21	20	19	18	17	16
Reserved							
R-0h							
15	14	13	12	11	10	9	8
Reserved						CLKACTIVITY_	CLKACTIVITY_
R-0h						GFX_FCLK	GFX_L3_GCLK
R-0h						R-0h	R-0h
7	6	5	4	3	2	1	0
Reserved						CLKTRCTRL	
R-0h						R/W-2h	

LEGEND: R/W = Read/Write; R = Read only; W1toCl = Write 1 to clear bit; -n = value after reset

Table 8-167. CM_GFX_L3_CLKSTCTRL Register Field Descriptions

Bit	Field	Type	Reset	Description
31-26	Reserved	R	0h	
25-10	Reserved	R	0h	
9	CLKACTIVITY_GFX_FCLK	R	0h	This field indicates the state of the GFX_GCLK clock in the domain. 0x0 = Inact : Corresponding clock is gated 0x1 = Act : Corresponding clock is active
8	CLKACTIVITY_GFX_L3_GCLK	R	0h	This field indicates the state of the GFX_L3_GCLK clock in the domain. 0x0 = Inact : Corresponding clock is gated 0x1 = Act : Corresponding clock is active
7-2	Reserved	R	0h	
1-0	CLKTRCTRL	R/W	2h	Controls the clock state transition of the GFX clock domain in GFX power domain. 0x0 = NO_SLEEP : NO_SLEEP: Sleep transition cannot be initiated. Wakeup transition may however occur. 0x1 = SW_SLEEP : SW_SLEEP: Start a software forced sleep transition on the domain. 0x2 = SW_WKUP : SW_WKUP: Start a software forced wake-up transition on the domain. 0x3 = Reserved : Reserved.

8.1.12.7.2 CM_GFX_GFX_CLKCTRL Register (offset = 4h) [reset = 70000h]

CM_GFX_GFX_CLKCTRL is shown in [Figure 8-155](#) and described in [Table 8-168](#).

This register manages the GFX clocks.

Figure 8-155. CM_GFX_GFX_CLKCTRL Register

31	30	29	28	27	26	25	24
Reserved							
R-0h							
23	22	21	20	19	18	17	16
Reserved				STBYST		IDLEST	
R-0h				R-1h		R-3h	
15	14	13	12	11	10	9	8
Reserved							
R-0h							
7	6	5	4	3	2	1	0
Reserved						MODULEMODE	
R-0h						R/W-0h	

LEGEND: R/W = Read/Write; R = Read only; W1toCl = Write 1 to clear bit; -n = value after reset

Table 8-168. CM_GFX_GFX_CLKCTRL Register Field Descriptions

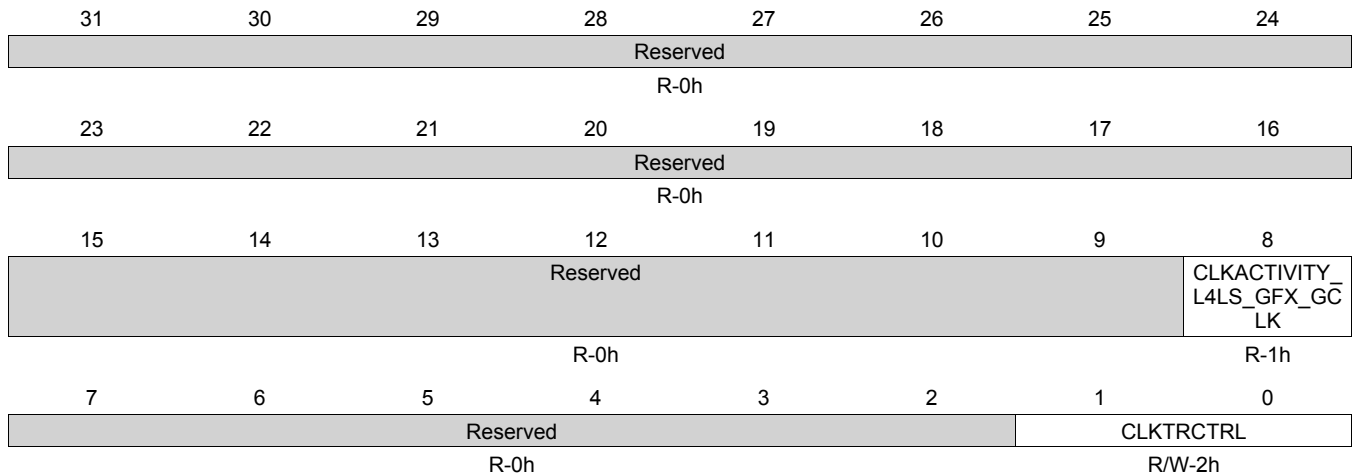
Bit	Field	Type	Reset	Description
31-19	Reserved	R	0h	
18	STBYST	R	1h	Module standby status. 0x0 = Func : Module is functional (not in standby) 0x1 = Standby : Module is in standby
17-16	IDLEST	R	3h	Module idle status. 0x0 = Func : Module is fully functional, including OCP 0x1 = Trans : Module is performing transition: wakeup, or sleep, or sleep abortion 0x2 = Idle : Module is in Idle mode (only OCP part). It is functional if using separate functional clock 0x3 = Disable : Module is disabled and cannot be accessed
15-2	Reserved	R	0h	
1-0	MODULEMODE	R/W	0h	Control the way mandatory clocks are managed. 0x0 = DISABLED : Module is disable by SW. Any OCP access to module results in an error, except if resulting from a module wakeup (asynchronous wakeup). 0x1 = RESERVED_1 : Reserved 0x2 = ENABLE : Module is explicitly enabled. Interface clock (if not used for functions) may be gated according to the clock domain state. Functional clocks are guaranteed to stay present. As long as in this configuration, power domain sleep transition cannot happen. 0x3 = RESERVED : Reserved

8.1.12.7.3 CM_GFX_L4LS_GFX_CLKSTCTRL Register (offset = Ch) [reset = 102h]

CM_GFX_L4LS_GFX_CLKSTCTRL is shown in [Figure 8-156](#) and described in [Table 8-169](#).

This register enables the domain power state transition. It controls the SW supervised clock domain state transition between ON-ACTIVE and ON-INACTIVE states. It also hold one status bit per clock input of the domain.

Figure 8-156. CM_GFX_L4LS_GFX_CLKSTCTRL Register



LEGEND: R/W = Read/Write; R = Read only; W1toCl = Write 1 to clear bit; -n = value after reset

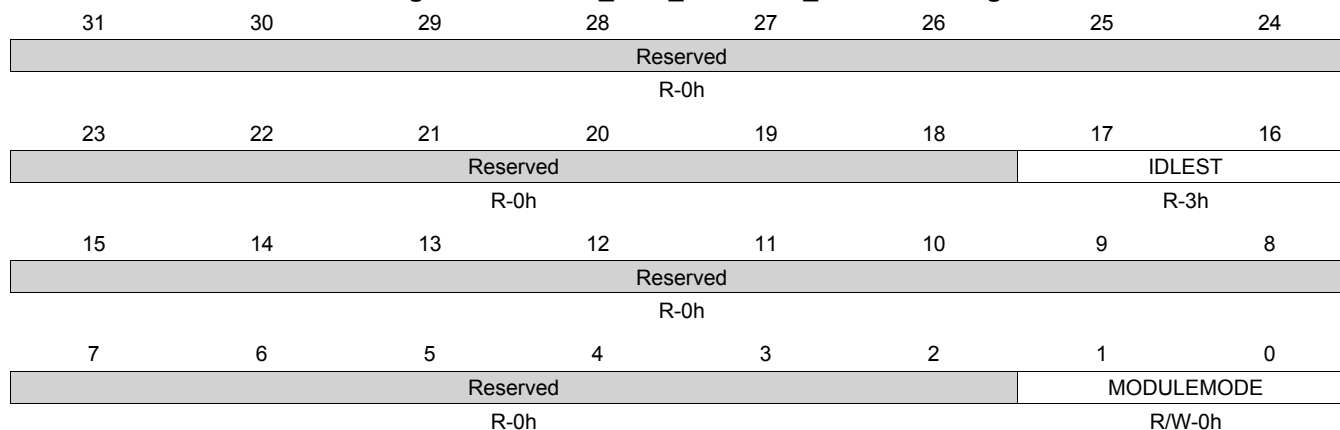
Table 8-169. CM_GFX_L4LS_GFX_CLKSTCTRL Register Field Descriptions

Bit	Field	Type	Reset	Description
31-9	Reserved	R	0h	
8	CLKACTIVITY_L4LS_GFX_GCLK	R	1h	This field indicates the state of the L4_LS clock in the domain. 0x0 = Inact 0x1 = Act
7-2	Reserved	R	0h	
1-0	CLKTRCTRL	R/W	2h	Controls the clock state transition of the L4LS clock domain in GFX power domain. 0x0 = NO_SLEEP : NO_SLEEP: Sleep transition cannot be initiated. Wakeup transition may however occur. 0x1 = SW_SLEEP : SW_SLEEP: Start a software forced sleep transition on the domain. 0x2 = SW_WKUP : SW_WKUP: Start a software forced wake-up transition on the domain. 0x3 = Reserved : Reserved.

8.1.12.7.4 CM_GFX_MMUCFG_CLKCTRL Register (offset = 10h) [reset = 30000h]

CM_GFX_MMUCFG_CLKCTRL is shown in [Figure 8-157](#) and described in [Table 8-170](#).

This register manages the MMU CFG clocks.

Figure 8-157. CM_GFX_MMUCFG_CLKCTRL Register


LEGEND: R/W = Read/Write; R = Read only; W1toCl = Write 1 to clear bit; -n = value after reset

Table 8-170. CM_GFX_MMUCFG_CLKCTRL Register Field Descriptions

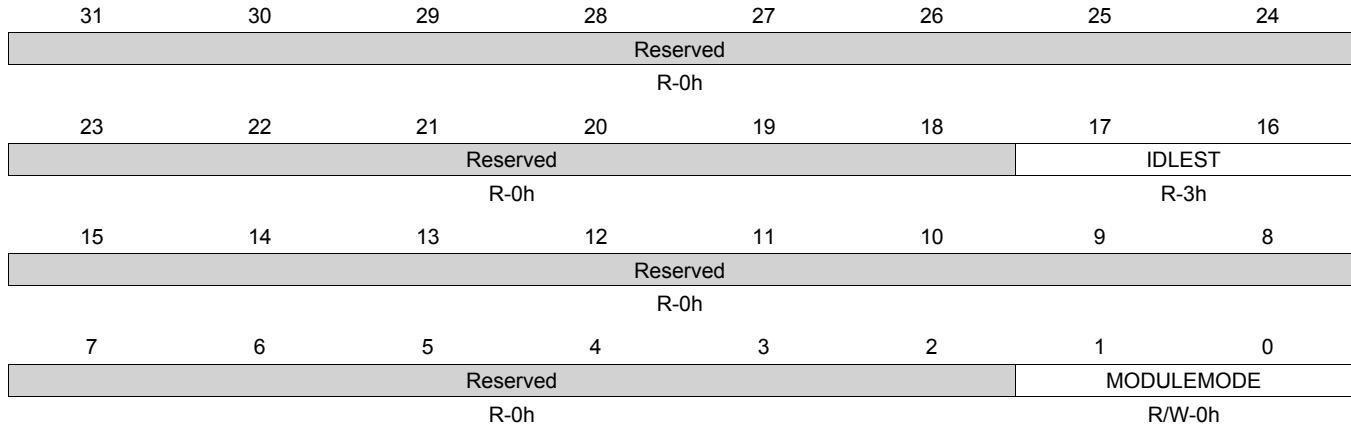
Bit	Field	Type	Reset	Description
31-18	Reserved	R	0h	
17-16	IDLEST	R	3h	Module idle status. 0x0 = Func : Module is fully functional, including OCP 0x1 = Trans : Module is performing transition: wakeup, or sleep, or sleep abortion 0x2 = Idle : Module is in Idle mode (only OCP part). It is functional if using separate functional clock 0x3 = Disable : Module is disabled and cannot be accessed
15-2	Reserved	R	0h	
1-0	MODULEMODE	R/W	0h	Control the way mandatory clocks are managed. 0x0 = DISABLED : Module is disable by SW. Any OCP access to module results in an error, except if resulting from a module wakeup (asynchronous wakeup). 0x1 = RESERVED_1 : Reserved 0x2 = ENABLE : Module is explicitly enabled. Interface clock (if not used for functions) may be gated according to the clock domain state. Functional clocks are guaranteed to stay present. As long as in this configuration, power domain sleep transition cannot happen. 0x3 = RESERVED : Reserved

8.1.12.7.5 CM_GFX_MMUDATA_CLKCTRL Register (offset = 14h) [reset = 30000h]

CM_GFX_MMUDATA_CLKCTRL is shown in [Figure 8-158](#) and described in [Table 8-171](#).

This register manages the MMU clocks.

Figure 8-158. CM_GFX_MMUDATA_CLKCTRL Register



LEGEND: R/W = Read/Write; R = Read only; W1toCl = Write 1 to clear bit; -n = value after reset

Table 8-171. CM_GFX_MMUDATA_CLKCTRL Register Field Descriptions

Bit	Field	Type	Reset	Description
31-18	Reserved	R	0h	
17-16	IDLEST	R	3h	Module idle status. 0x0 = Func : Module is fully functional, including OCP 0x1 = Trans : Module is performing transition: wakeup, or sleep, or sleep abortion 0x2 = Idle : Module is in Idle mode (only OCP part). It is functional if using separate functional clock 0x3 = Disable : Module is disabled and cannot be accessed
15-2	Reserved	R	0h	
1-0	MODULEMODE	R/W	0h	Control the way mandatory clocks are managed. 0x0 = DISABLED : Module is disable by SW. Any OCP access to module results in an error, except if resulting from a module wakeup (asynchronous wakeup). 0x1 = RESERVED_1 : Reserved 0x2 = ENABLE : Module is explicitly enabled. Interface clock (if not used for functions) may be gated according to the clock domain state. Functional clocks are guaranteed to stay present. As long as in this configuration, power domain sleep transition cannot happen. 0x3 = RESERVED : Reserved

8.1.12.8 CM_CEFUSE Registers

[Table 8-172](#) lists the memory-mapped registers for the CM_CEFUSE. All register offset addresses not listed in [Table 8-172](#) should be considered as reserved locations and the register contents should not be modified.

Table 8-172. CM_CEFUSE REGISTERS

Offset	Acronym	Register Name	Section
0h	CM_CEFUSE_CLKSTCTRL	This register enables the domain power state transition. It controls the HW supervised domain power state transition between ON-ACTIVE and ON-INACTIVE states. It also hold one status bit per clock input of the domain.	Section 8.1.12.8.1

Table 8-172. CM_CEFUSE REGISTERS (continued)

Offset	Acronym	Register Name	Section
20h	CM_CEFUSE_CEFUSE_CLKCTR L	This register manages the CEFUSE clocks.	Section 8.1.12.8.2

8.1.12.8.1 CM_CEFUSE_CLKSTCTRL Register (offset = 0h) [reset = 2h]

CM_CEFUSE_CLKSTCTRL is shown in [Figure 8-159](#) and described in [Table 8-173](#).

This register enables the domain power state transition. It controls the HW supervised domain power state transition between ON-ACTIVE and ON-INACTIVE states. It also hold one status bit per clock input of the domain.

Figure 8-159. CM_CEFUSE_CLKSTCTRL Register

31	30	29	28	27	26	25	24
Reserved							
R-0h							
23	22	21	20	19	18	17	16
Reserved							
R-0h							
15	14	13	12	11	10	9	8
Reserved						CLKACTIVITY_CUST_EFUSE_SYS_CLK	CLKACTIVITY_L4_CEFUSE_G_ICLK
R-0h						R-0h	R-0h
7	6	5	4	3	2	1	0
Reserved						CLKTRCTRL	
R-0h						R/W-2h	

LEGEND: R/W = Read/Write; R = Read only; W1toCl = Write 1 to clear bit; -n = value after reset

Table 8-173. CM_CEFUSE_CLKSTCTRL Register Field Descriptions

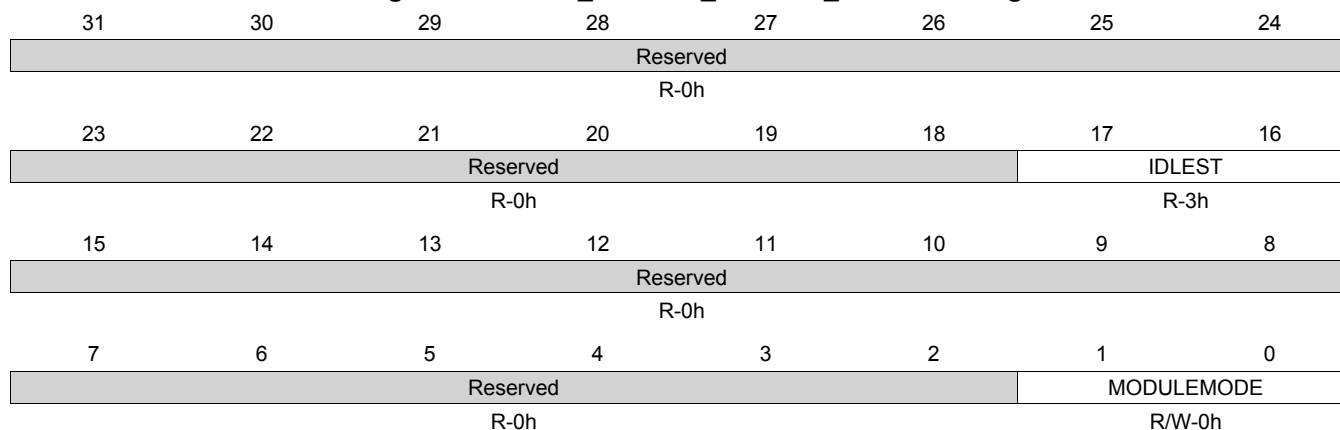
Bit	Field	Type	Reset	Description
31-10	Reserved	R	0h	
9	CLKACTIVITY_CUST_EFUSE_SYS_CLK	R	0h	This field indicates the state of the Cust_Efuse_SYSCCLK clock input of the domain. [warm reset insensitive] 0x0 = Inact : Corresponding clock is definitely gated 0x1 = Act : Corresponding clock is running or gating/ungating transition is on-going
8	CLKACTIVITY_L4_CEFUSE_G_ICLK	R	0h	This field indicates the state of the L4_CEFUSE_GCLK clock input of the domain. [warm reset insensitive] 0x0 = Inact : Corresponding clock is definitely gated 0x1 = Act : Corresponding clock is running or gating/ungating transition is on-going
7-2	Reserved	R	0h	
1-0	CLKTRCTRL	R/W	2h	Controls the clock state transition of the clock domain in customer efuse power domain. 0x0 = NO_SLEEP : NO_SLEEP: Sleep transition cannot be initiated. Wakeup transition may however occur. 0x1 = SW_SLEEP : SW_SLEEP: Start a software forced sleep transition on the domain. 0x2 = SW_WKUP : SW_WKUP: Start a software forced wake-up transition on the domain. 0x3 = Reserved : Reserved.

8.1.12.8.2 CM_CEFUSE_CEFUSE_CLKCTRL Register (offset = 20h) [reset = 30000h]

CM_CEFUSE_CEFUSE_CLKCTRL is shown in [Figure 8-160](#) and described in [Table 8-174](#).

This register manages the CEFUSE clocks.

Figure 8-160. CM_CEFUSE_CEFUSE_CLKCTRL Register



LEGEND: R/W = Read/Write; R = Read only; W1toCl = Write 1 to clear bit; -n = value after reset

Table 8-174. CM_CEFUSE_CEFUSE_CLKCTRL Register Field Descriptions

Bit	Field	Type	Reset	Description
31-18	Reserved	R	0h	
17-16	IDLEST	R	3h	Module idle status. [warm reset insensitive] 0x0 = Func : Module is fully functional, including OCP 0x1 = Trans : Module is performing transition: wakeup, or sleep, or sleep abortion 0x2 = Idle : Module is in Idle mode (only OCP part). It is functional if using separate functional clock 0x3 = Disable : Module is disabled and cannot be accessed
15-2	Reserved	R	0h	
1-0	MODULEMODE	R/W	0h	Control the way mandatory clocks are managed. 0x0 = DISABLED : Module is disable by SW. Any OCP access to module results in an error, except if resulting from a module wakeup (asynchronous wakeup). 0x1 = RESERVED_1 : Reserved 0x2 = ENABLE : Module is explicitly enabled. Interface clock (if not used for functions) may be gated according to the clock domain state. Functional clocks are guaranteed to stay present. As long as in this configuration, power domain sleep transition cannot happen. 0x3 = RESERVED : Reserved

8.1.13 Power Management Registers

8.1.13.1 PRM_IRQ Registers

[Table 8-175](#) lists the memory-mapped registers for the PRM_IRQ. All register offset addresses not listed in [Table 8-175](#) should be considered as reserved locations and the register contents should not be modified.

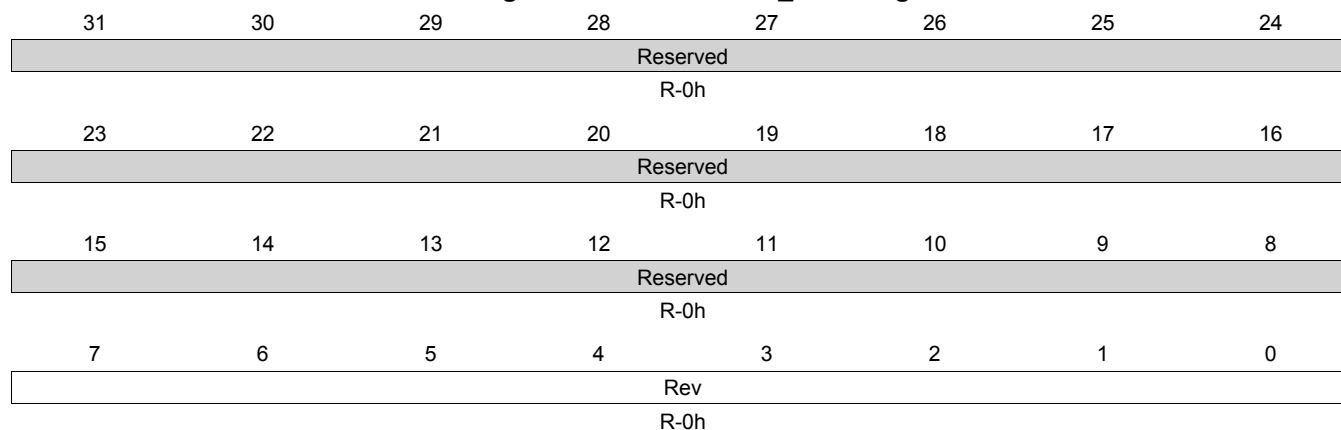
Table 8-175. PRM_IRQ REGISTERS

Offset	Acronym	Register Name	Section
0h	REVISION_PRM	This register contains the IP revision code for the PRCM	Section 8.1.13.1.1
4h	PRM_IRQSTATUS_MPU	This register provides status on MPU interrupt events. An event is logged whether interrupt generation for the event is enabled or not. SW is required to clear a set bit by writing a '1' into the bit-position to be cleared.	Section 8.1.13.1.2
8h	PRM_IRQENABLE_MPU	This register is used to enable and disable events used to trigger MPU interrupt activation.	Section 8.1.13.1.3
Ch	PRM_IRQSTATUS_M3	This register provides status on MPU interrupt events. An event is logged whether interrupt generation for the event is enabled or not. SW is required to clear a set bit by writing a '1' into the bit-position to be cleared.	Section 8.1.13.1.4
10h	PRM_IRQENABLE_M3	This register is used to enable and disable events used to trigger MPU interrupt activation.	Section 8.1.13.1.5

8.1.13.1.1 REVISION_PRM Register (offset = 0h) [reset = 0h]

REVISION_PRM is shown in [Figure 8-161](#) and described in [Table 8-176](#).

This register contains the IP revision code for the PRCM

Figure 8-161. REVISION_PRM Register


LEGEND: R/W = Read/Write; R = Read only; W1toCl = Write 1 to clear bit; -n = value after reset

Table 8-176. REVISION_PRM Register Field Descriptions

Bit	Field	Type	Reset	Description
31-8	Reserved	R	0h	Reads returns 0.
7-0	Rev	R	0h	IP revision [7:4] Major revision [3:0] Minor revision Examples: 0x10 for 1.0, 0x21 for 2.1

8.1.13.1.2 PRM_IRQSTATUS_MPU Register (offset = 4h) [reset = 0h]

PRM_IRQSTATUS_MPU is shown in [Figure 8-162](#) and described in [Table 8-177](#).

This register provides status on MPU interrupt events. An event is logged whether interrupt generation for the event is enabled or not. SW is required to clear a set bit by writing a '1' into the bit-position to be cleared.

Figure 8-162. PRM_IRQSTATUS_MPU Register

31	30	29	28	27	26	25	24
Reserved							
R-0h							
23	22	21	20	19	18	17	16
Reserved							
R-0h							
15	14	13	12	11	10	9	8
dpll_per_recal_st	dpll_ddr_recal_st	dpll_disp_recal_st	dpll_core_recal_st	dpll_mpu_recal_st	ForceWkup_st	Reserved	Transition_st
R/W-0h	R/W-0h	R/W-0h	R/W-0h	R/W-0h	R/W-0h	R-0h	R/W-0h
7	6	5	4	3	2	1	0
Reserved							
R-0h							

LEGEND: R/W = Read/Write; R = Read only; W1toCl = Write 1 to clear bit; -n = value after reset

Table 8-177. PRM_IRQSTATUS_MPU Register Field Descriptions

Bit	Field	Type	Reset	Description
31-16	Reserved	R	0h	
15	dpll_per_recal_st	R/W	0h	interrupt status for usb dpll recalibration 0 = DIS : Disables dpll recalibration 1 = EN : ENAbles dpll recalibration
14	dpll_ddr_recal_st	R/W	0h	interrupt status for ddr dpll recalibration 0 = DIS : Disables dpll recalibration 1 = EN : ENAbles dpll recalibration
13	dpll_disp_recal_st	R/W	0h	interrupt status for disp dpll recalibration 0 = DIS : Disables dpll recalibration 1 = EN : ENAbles dpll recalibration
12	dpll_core_recal_st	R/W	0h	interrupt status for core dpll recalibration 0 = DIS : Disables dpll recalibration 1 = EN : ENAbles dpll recalibration
11	dpll_mpu_recal_st	R/W	0h	interrupt status for mpu dpll recalibration 0 = DIS : Disables dpll recalibration 1 = EN : ENAbles dpll recalibration
10	ForceWkup_st	R/W	0h	Software supervised wakeup completed event interrupt status 0 = IRQ_fal : No interrupt 1 = IRQ_tru : Interrupt is pending
9	Reserved	R	0h	
8	Transition_st	R/W	0h	Software supervised transition completed event interrupt status (any domain) 0 = IRQ_fal : No interrupt 1 = IRQ_tru : Interrupt is pending
7-0	Reserved	R	0h	

8.1.13.1.3 PRM_IRQENABLE_MPU Register (offset = 8h) [reset = 0h]

PRM_IRQENABLE_MPU is shown in [Figure 8-163](#) and described in [Table 8-178](#).

This register is used to enable and disable events used to trigger MPU interrupt activation.

Figure 8-163. PRM_IRQENABLE_MPU Register

31	30	29	28	27	26	25	24
Reserved							
R-0h							
23	22	21	20	19	18	17	16
Reserved							
R-0h							
15	14	13	12	11	10	9	8
dppll_disp_recal_en	dppll_ddr_recal_en	dppll_per_recal_en	dppll_core_recal_en	dppll_mpu_recal_en	ForceWkup_en	Reserved	Transition_en
R/W-0h	R/W-0h	R/W-0h	R/W-0h	R/W-0h	R/W-0h	R-0h	R/W-0h
7	6	5	4	3	2	1	0
Reserved		Reserved					Reserved
R-0h		R-0h					R-0h

LEGEND: R/W = Read/Write; R = Read only; W1toCl = Write 1 to clear bit; -n = value after reset

Table 8-178. PRM_IRQENABLE_MPU Register Field Descriptions

Bit	Field	Type	Reset	Description
31-16	Reserved	R	0h	
15	dppll_disp_recal_en	R/W	0h	Interrupt enable for disp dppll recalibration 0 = DIS : Disables dppll recalibration 1 = EN : ENAbles dppll recalibration
14	dppll_ddr_recal_en	R/W	0h	Interrupt enable for ddr dppll recalibration 0 = DIS : Disables dppll recalibration 1 = EN : ENAbles dppll recalibration
13	dppll_per_recal_en	R/W	0h	Interrupt enable for usb dppll recalibration 0 = DIS : Disables dppll recalibration 1 = EN : ENAbles dppll recalibration
12	dppll_core_recal_en	R/W	0h	Interrupt enable for core dppll recalibration 0 = DIS : Disables dppll recalibration 1 = EN : ENAbles dppll recalibration
11	dppll_mpu_recal_en	R/W	0h	Interrupt enable for mpu dppll recalibration 0 = DIS : Disables dppll recalibration 1 = EN : ENAbles dppll recalibration
10	ForceWkup_en	R/W	0h	Software supervised Froce Wakeup completed event interrupt enable 0 = irq_msk : Interrupt is masked 1 = irq_en : Interrupt is enabled
9	Reserved	R	0h	
8	Transition_en	R/W	0h	Software supervised transition completed event interrupt enable (any domain) 0 = irq_msk : Interrupt is masked 1 = irq_en : Interrupt is enabled
7-6	Reserved	R	0h	
5-1	Reserved	R	0h	
0	Reserved	R	0h	

8.1.13.1.4 PRM_IRQSTATUS_M3 Register (offset = Ch) [reset = 0h]

PRM_IRQSTATUS_M3 is shown in [Figure 8-164](#) and described in [Table 8-179](#).

This register provides status on MPU interrupt events. An event is logged whether interrupt generation for the event is enabled or not. SW is required to clear a set bit by writing a '1' into the bit-position to be cleared.

Figure 8-164. PRM_IRQSTATUS_M3 Register

31	30	29	28	27	26	25	24
Reserved							
R-0h							
23	22	21	20	19	18	17	16
Reserved							
R-0h							
15	14	13	12	11	10	9	8
dpll_per_recal_st	dpll_ddr_recal_st	dpll_disp_recal_st	dpll_core_recal_st	dpll_mpu_recal_st	ForceWkup_st	Reserved	Transition_st
R/W-0h	R/W-0h	R/W-0h	R/W-0h	R/W-0h	R/W-0h	R-0h	R/W-0h
7	6	5	4	3	2	1	0
Reserved							
R-0h							

LEGEND: R/W = Read/Write; R = Read only; W1toCl = Write 1 to clear bit; -n = value after reset

Table 8-179. PRM_IRQSTATUS_M3 Register Field Descriptions

Bit	Field	Type	Reset	Description
31-16	Reserved	R	0h	
15	dpll_per_recal_st	R/W	0h	interrupt status for usb dpll recalibration 0 = DIS : Disables dpll recalibration 1 = EN : ENAbles dpll recalibration
14	dpll_ddr_recal_st	R/W	0h	interrupt status for ddr dpll recalibration 0 = DIS : Disables dpll recalibration 1 = EN : ENAbles dpll recalibration
13	dpll_disp_recal_st	R/W	0h	interrupt status for disp dpll recalibration 0 = DIS : Disables dpll recalibration 1 = EN : ENAbles dpll recalibration
12	dpll_core_recal_st	R/W	0h	interrupt status for core dpll recalibration 0 = DIS : Disables dpll recalibration 1 = EN : ENAbles dpll recalibration
11	dpll_mpu_recal_st	R/W	0h	interrupt status for mpu dpll recalibration 0 = DIS : Disables dpll recalibration 1 = EN : ENAbles dpll recalibration
10	ForceWkup_st	R/W	0h	Software supervised wakeup completed event interrupt status 0 = IRQ_fal : No interrupt 1 = IRQ_tru : Interrupt is pending
9	Reserved	R	0h	
8	Transition_st	R/W	0h	Software supervised transition completed event interrupt status (any domain) 0 = IRQ_fal : No interrupt 1 = IRQ_tru : Interrupt is pending
7-0	Reserved	R	0h	

8.1.13.1.5 PRM_IRQENABLE_M3 Register (offset = 10h) [reset = 0h]

PRM_IRQENABLE_M3 is shown in [Figure 8-165](#) and described in [Table 8-180](#).

This register is used to enable and disable events used to trigger MPU interrupt activation.

Figure 8-165. PRM_IRQENABLE_M3 Register

31	30	29	28	27	26	25	24
Reserved							
R-0h							
23	22	21	20	19	18	17	16
Reserved							
R-0h							
15	14	13	12	11	10	9	8
dppl_disp_recal_en	dppl_ddr_recal_en	dppl_per_recal_en	dppl_core_recal_en	dppl_mpu_recal_en	ForceWkup_en	Reserved	Transition_en
R/W-0h	R/W-0h	R/W-0h	R/W-0h	R/W-0h	R/W-0h	R-0h	R/W-0h
7	6	5	4	3	2	1	0
Reserved		Reserved					Reserved
R-0h		R-0h					R-0h

LEGEND: R/W = Read/Write; R = Read only; W1toCl = Write 1 to clear bit; -n = value after reset

Table 8-180. PRM_IRQENABLE_M3 Register Field Descriptions

Bit	Field	Type	Reset	Description
31-16	Reserved	R	0h	
15	dppl_disp_recal_en	R/W	0h	Interrupt enable for disp dppl recalibration 0 = DIS : Disables dppl recalibration 1 = EN : ENAbles dppl recalibration
14	dppl_ddr_recal_en	R/W	0h	Interrupt enable for ddr dppl recalibration 0 = DIS : Disables dppl recalibration 1 = EN : ENAbles dppl recalibration
13	dppl_per_recal_en	R/W	0h	Interrupt enable for usb dppl recalibration 0 = DIS : Disables dppl recalibration 1 = EN : ENAbles dppl recalibration
12	dppl_core_recal_en	R/W	0h	Interrupt enable for core dppl recalibration 0 = DIS : Disables dppl recalibration 1 = EN : ENAbles dppl recalibration
11	dppl_mpu_recal_en	R/W	0h	Interrupt enable for mpu dppl recalibration 0 = DIS : Disables dppl recalibration 1 = EN : ENAbles dppl recalibration
10	ForceWkup_en	R/W	0h	Software supervised Froce Wakeup completed event interrupt enable 0 = irq_msk : Interrupt is masked 1 = irq_en : Interrupt is enabled
9	Reserved	R	0h	
8	Transition_en	R/W	0h	Software supervised transition completed event interrupt enable (any domain) 0 = irq_msk : Interrupt is masked 1 = irq_en : Interrupt is enabled
7-6	Reserved	R	0h	
5-1	Reserved	R	0h	
0	Reserved	R	0h	

8.1.13.2 PRM_PER Registers

[Table 8-181](#) lists the memory-mapped registers for the PRM_PER. All register offset addresses not listed in [Table 8-181](#) should be considered as reserved locations and the register contents should not be modified.

Table 8-181. PRM_PER REGISTERS

Offset	Acronym	Register Name	Section
0h	RM_PER_RSTCTRL	This register controls the release of the PER Domain resets.	Section 8.1.13.2.1
8h	PM_PER_PWRSTST	This register provides a status on the current PER power domain state. [warm reset insensitive]	Section 8.1.13.2.2
Ch	PM_PER_PWRSTCTRL	Controls the power state of PER power domain	Section 8.1.13.2.3

8.1.13.2.1 RM_PER_RSTCTRL Register (offset = 0h) [reset = 2h]

RM_PER_RSTCTRL is shown in [Figure 8-166](#) and described in [Table 8-182](#).

This register controls the release of the PER Domain resets.

Figure 8-166. RM_PER_RSTCTRL Register

31	30	29	28	27	26	25	24
Reserved							
R-0h							
23	22	21	20	19	18	17	16
Reserved							
R-0h							
15	14	13	12	11	10	9	8
Reserved							
R-0h							
7	6	5	4	3	2	1	0
Reserved		Reserved			Reserved	PRU_ICSS_LRST	Reserved
R-0h		R-0h			R-0h	R/W-1h	R-0h

LEGEND: R/W = Read/Write; R = Read only; W1toCl = Write 1 to clear bit; -n = value after reset

Table 8-182. RM_PER_RSTCTRL Register Field Descriptions

Bit	Field	Type	Reset	Description
31-6	Reserved	R	0h	
5-3	Reserved	R	0h	
2	Reserved	R	0h	
1	PRU_ICSS_LRST	R/W	1h	PER domain PRU-ICSS local reset control 0x0 = CLEAR : Reset is cleared for the PRU-ICSS 0x1 = ASSERT : Reset is asserted for the PRU-ICSS
0	Reserved	R	0h	

8.1.13.2.2 PM_PER_PWRSTST Register (offset = 8h) [reset = 1E6007h]

PM_PER_PWRSTST is shown in [Figure 8-167](#) and described in [Table 8-183](#).

This register provides a status on the current PER power domain state. [warm reset insensitive]

Figure 8-167. PM_PER_PWRSTST Register

31	30	29	28	27	26	25	24
Reserved							pru_icss_mem_ statest
R-0h							R-3h
23	22	21	20	19	18	17	16
pru_icss_mem_ statest	ram_mem_ statest		InTransition	Reserved	PER_mem_ statest		Reserved
R-3h	R-3h		R-0h	R-0h	R-3h		R-0h
15	14	13	12	11	10	9	8
Reserved							
R-0h							
7	6	5	4	3	2	1	0
Reserved					LogicStateSt	PowerStateSt	
R-0h					R-1h	R-3h	

LEGEND: R/W = Read/Write; R = Read only; W1toCl = Write 1 to clear bit; -n = value after reset

Table 8-183. PM_PER_PWRSTST Register Field Descriptions

Bit	Field	Type	Reset	Description
31-25	Reserved	R	0h	
24-23	pru_icss_mem_ statest	R	3h	PRU-ICSS memory state status 0x0 = Mem_off : Memory is OFF 0x2 = Reserved : Reserved 0x3 = Mem_on : Memory is ON
22-21	ram_mem_ statest	R	3h	OCMC RAM memory state status 0x0 = Mem_off : Memory is OFF 0x2 = Reserved : Reserved 0x3 = Mem_on : Memory is ON
20	InTransition	R	0h	Domain transition status 0x0 = No : No on-going transition on power domain 0x1 = Ongoing : Power domain transition is in progress.
19	Reserved	R	0h	
18-17	PER_mem_ statest	R	3h	PER domain memory state status 0x0 = Mem_off : Memory is OFF 0x2 = Reserved : Reserved 0x3 = Mem_on : Memory is ON
16-3	Reserved	R	0h	
2	LogicStateSt	R	1h	Logic state status 0x0 = OFF : Logic in domain is OFF 0x1 = ON : Logic in domain is ON
1-0	PowerStateSt	R	3h	Current Power State Status 0x0 = OFF : OFF State 0x1 = RET 0x2 = Reserved1 0x3 = ON : ON State

8.1.13.2.3 PM_PER_PWRSTCTRL Register (offset = Ch) [reset = EE000EBh]

 PM_PER_PWRSTCTRL is shown in [Figure 8-168](#) and described in [Table 8-184](#).

Controls the power state of PER power domain

Figure 8-168. PM_PER_PWRSTCTRL Register

31	30	29	28	27	26	25	24
ram_mem_ONState		PER_mem_RETState	Reserved	ram_mem_RETState	PER_mem_ONState		Reserved
R/W-3h		R/W-1h	R-0h	R/W-1h	R/W-3h		R-0h
23	22	21	20	19	18	17	16
Reserved							
R-0h							
15	14	13	12	11	10	9	8
Reserved							
R-0h							
7	6	5	4	3	2	1	0
pru_icss_mem_RETState	pru_icss_mem_ONState		LowPowerStateChange	LogicRETState	Reserved	PowerState	
R/W-1h	R/W-3h		R/W-0h	R/W-1h	R-0h	R/W-3h	

LEGEND: R/W = Read/Write; R = Read only; W1toCl = Write 1 to clear bit; -n = value after reset

Table 8-184. PM_PER_PWRSTCTRL Register Field Descriptions

Bit	Field	Type	Reset	Description
31-30	ram_mem_ONState	R/W	3h	OCMC RAM memory on state 0x0 = OFF : Memory is OFF 0x1 = RET : Memory is in retention state 0x2 = RESERVED 0x3 = ON : Memory is ON
29	PER_mem_RETState	R/W	1h	Other memories in PER Domain RET state 0x0 = OFF 0x1 = RET
28	Reserved	R	0h	
27	ram_mem_RETState	R/W	1h	OCMC RAM memory RET state 0x0 = OFF : Memory is in off state 0x1 = RET : Memory is in retention state
26-25	PER_mem_ONState	R/W	3h	Other memories in PER Domain ON state 0x0 = Reserved2 0x1 = Reserved1 0x2 = Reserved : Reserved 0x3 = ON : Memory is ON
24-8	Reserved	R	0h	
7	pru_icss_mem_RETState	R/W	1h	PRU-ICSS memory RET state 0x0 = OFF : Memory is in off state 0x1 = RET : Memory is in retention state
6-5	pru_icss_mem_ONState	R/W	3h	PRU-ICSS memory ON state 0x0 = Reserved2 0x1 = Reserved1 0x2 = Reserved : Reserved 0x3 = ON : Memory is ON

Table 8-184. PM_PER_PWRSTCTRL Register Field Descriptions (continued)

Bit	Field	Type	Reset	Description
4	LowPowerStateChange	R/W	0h	Power state change request when domain has already performed a sleep transition. Allows going into deeper low power state without waking up the power domain. 0x0 = DIS : Do not request a low power state change. 0x1 = EN : Request a low power state change. This bit is automatically cleared when the power state is effectively changed or when power state is ON.
3	LogicRETState	R/W	1h	Logic state when power domain is RETENTION 0x0 = logic_off : Only retention registers are retained and remaining logic is off when the domain is in RETENTION state. 0x1 = logic_ret : Whole logic is retained when domain is in RETENTION state.
2	Reserved	R	0h	
1-0	PowerState	R/W	3h	PER domain power state control 0x0 = OFF 0x1 = RET 0x2 = Reserved 0x3 = ON

8.1.13.3 PRM_WKUP Registers

Table 8-185 lists the memory-mapped registers for the PRM_WKUP. All register offset addresses not listed in Table 8-185 should be considered as reserved locations and the register contents should not be modified.

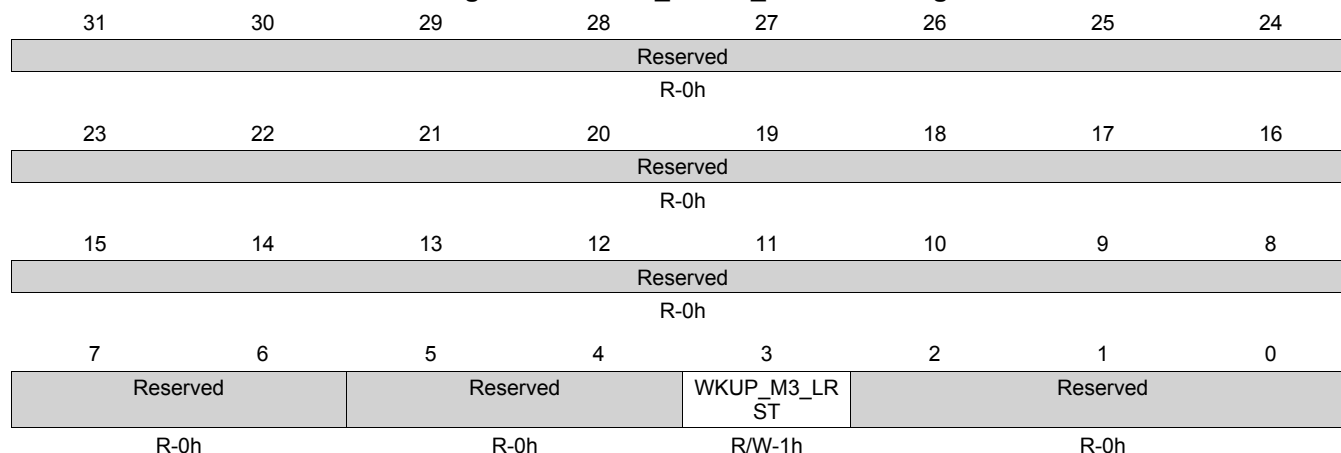
Table 8-185. PRM_WKUP REGISTERS

Offset	Acronym	Register Name	Section
0h	RM_WKUP_RSTCTRL	This register controls the release of the ALWAYS ON Domain resets.	Section 8.1.13.3.1
4h	PM_WKUP_PWRSTCTRL	Controls power state of WKUP power domain	Section 8.1.13.3.2
8h	PM_WKUP_PWRSTST	This register provides a status on the current WKUP power domain state. [warm reset insensitive]	Section 8.1.13.3.3
Ch	RM_WKUP_RSTST	This register logs the different reset sources of the ALWON domain. Each bit is set upon release of the domain reset signal. Must be cleared by software. [warm reset insensitive]	Section 8.1.13.3.4

8.1.13.3.1 RM_WKUP_RSTCTRL Register (offset = 0h) [reset = 8h]

RM_WKUP_RSTCTRL is shown in Figure 8-169 and described in Table 8-186.

This register controls the release of the ALWAYS ON Domain resets.

Figure 8-169. RM_WKUP_RSTCTRL Register


LEGEND: R/W = Read/Write; R = Read only; W1toCl = Write 1 to clear bit; -n = value after reset

Table 8-186. RM_WKUP_RSTCTRL Register Field Descriptions

Bit	Field	Type	Reset	Description
31-6	Reserved	R	0h	
5-4	Reserved	R	0h	
3	WKUP_M3_LRST	R/W	1h	Assert Reset to WKUP_M3 0x0 = CLEAR : Reset is cleared for the M3 0x1 = ASSERT : Reset is asserted for the M3 by A8
2-0	Reserved	R	0h	

8.1.13.3.2 PM_WKUP_PWRSTCTRL Register (offset = 4h) [reset = 8h]

PM_WKUP_PWRSTCTRL is shown in [Figure 8-170](#) and described in [Table 8-187](#).

Controls power state of WKUP power domain

Figure 8-170. PM_WKUP_PWRSTCTRL Register

31	30	29	28	27	26	25	24
Reserved		Reserved	Reserved	Reserved	Reserved		Reserved
R-0h		R-0h	R-0h	R-0h	R-0h		R-0h
23	22	21	20	19	18	17	16
Reserved							
R-0h							
15	14	13	12	11	10	9	8
Reserved							
R-0h							
7	6	5	4	3	2	1	0
Reserved			LowPowerState Change	LogicRETState	Reserved	Reserved	
R-0h			R/W-0h	R/W-1h	R-0h	R-0h	

LEGEND: R/W = Read/Write; R = Read only; W1toCl = Write 1 to clear bit; -n = value after reset

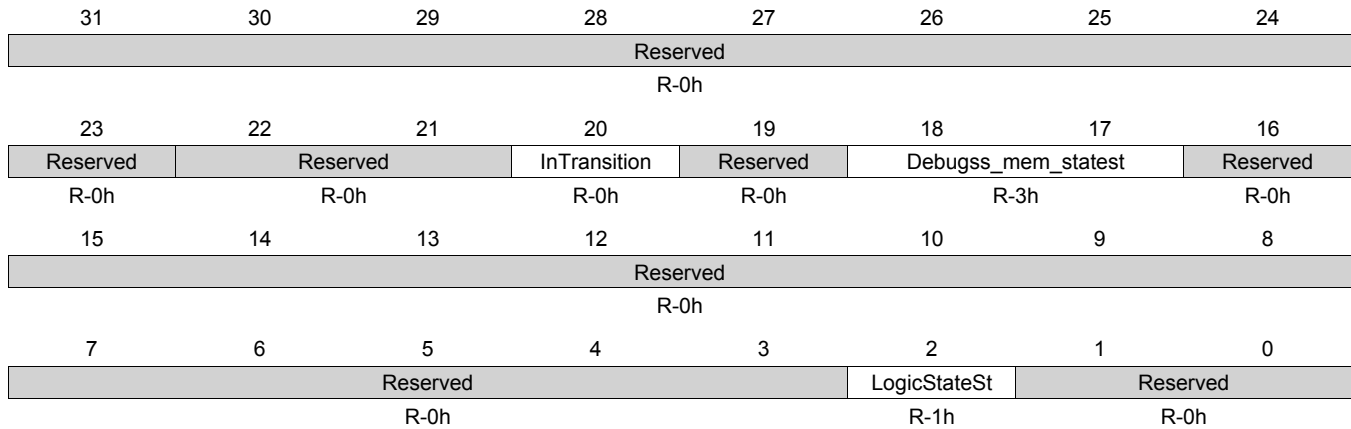
Table 8-187. PM_WKUP_PWRSTCTRL Register Field Descriptions

Bit	Field	Type	Reset	Description
31-30	Reserved	R	0h	
29	Reserved	R	0h	
28	Reserved	R	0h	
27	Reserved	R	0h	
26-25	Reserved	R	0h	
24-5	Reserved	R	0h	
4	LowPowerStateChange	R/W	0h	Power state change request when domain has already performed a sleep transition. Allows going into deeper low power state without waking up the power domain. 0x0 = DIS : Do not request a low power state change. 0x1 = EN : Request a low power state change. This bit is automatically cleared when the power state is effectively changed or when power state is ON.
3	LogicRETState	R/W	1h	Logic state when power domain is RETENTION 0x0 = logic_off : Only retention registers are retained and remaining logic is off when the domain is in RETENTION state. 0x1 = logic_ret : Whole logic is retained when domain is in RETENTION state.
2	Reserved	R	0h	
1-0	Reserved	R	0h	

8.1.13.3 PM_WKUP_PWRSTST Register (offset = 8h) [reset = 60004h]

PM_WKUP_PWRSTST is shown in [Figure 8-171](#) and described in [Table 8-188](#).

This register provides a status on the current WKUP power domain state. [warm reset insensitive]

Figure 8-171. PM_WKUP_PWRSTST Register


LEGEND: R/W = Read/Write; R = Read only; W1toCl = Write 1 to clear bit; -n = value after reset

Table 8-188. PM_WKUP_PWRSTST Register Field Descriptions

Bit	Field	Type	Reset	Description
31-23	Reserved	R	0h	
22-21	Reserved	R	0h	
20	InTransition	R	0h	Domain transition status 0x0 = No : No on-going transition on power domain 0x1 = Ongoing : Power domain transition is in progress.
19	Reserved	R	0h	
18-17	Debugss_mem_statest	R	3h	WKUP domain memory state status 0x0 = Mem_off : Memory is OFF 0x2 = Reserved : Reserved 0x3 = Mem_on : Memory is ON
16-3	Reserved	R	0h	
2	LogicStateSt	R	1h	Logic state status 0x0 = OFF : Logic in domain is OFF 0x1 = ON : Logic in domain is ON
1-0	Reserved	R	0h	

8.1.13.3.4 RM_WKUP_RSTST Register (offset = Ch) [reset = 0h]

RM_WKUP_RSTST is shown in [Figure 8-172](#) and described in [Table 8-189](#).

This register logs the different reset sources of the ALWON domain. Each bit is set upon release of the domain reset signal. Must be cleared by software. [warm reset insensitive]

Figure 8-172. RM_WKUP_RSTST Register

31	30	29	28	27	26	25	24	
Reserved								
R-0h								
23	22	21	20	19	18	17	16	
Reserved								
R-0h								
15	14	13	12	11	10	9	8	
Reserved								
R-0h								
7	6	5	4	3	2	1	0	
ICECRUSHER_M3_RST	EMULATION_M3_RST	WKUP_M3_LRST	Reserved					
R/W-0h	R/W-0h	R/W-0h	R-0h					

LEGEND: R/W = Read/Write; R = Read only; W1toCl = Write 1 to clear bit; -n = value after reset

Table 8-189. RM_WKUP_RSTST Register Field Descriptions

Bit	Field	Type	Reset	Description
31-8	Reserved	R	0h	
7	ICECRUSHER_M3_RST	R/W	0h	M3 Processor has been reset due to M3 ICECRUSHER1 reset event 0x0 = RESET_NO : No reset 0x1 = RESET_YES : M3 Processor has been reset
6	EMULATION_M3_RST	R/W	0h	M3 Processor has been reset due to emulation reset source e.g. assert reset command initiated by the icepick module 0x0 = RESET_NO : No reset 0x1 = RESET_YES : M3 Processor has been reset
5	WKUP_M3_LRST	R/W	0h	M3 Processor has been reset 0x0 = RESET_NO : No reset 0x1 = RESET_YES : M3 Processor has been reset
4-0	Reserved	R	0h	

8.1.13.4 PRM_MPU Registers

[Table 8-190](#) lists the memory-mapped registers for the PRM_MPU. All register offset addresses not listed in [Table 8-190](#) should be considered as reserved locations and the register contents should not be modified.

Table 8-190. PRM_MPU REGISTERS

Offset	Acronym	Register Name	Section
0h	PM_MPU_PWRSTCTRL	This register controls the MPU power state to reach upon mpu domain sleep transition	Section 8.1.13.4.1
4h	PM_MPU_PWRSTST	This register provides a status on the current MPU power domain state0. [warm reset insensitive]	Section 8.1.13.4.2

Table 8-190. PRM_MPU REGISTERS (continued)

Offset	Acronym	Register Name	Section
8h	RM_MPU_RSTST	This register logs the different reset sources of the ALWON domain. Each bit is set upon release of the domain reset signal. Must be cleared by software. [warm reset insensitive]	Section 8.1.13.4.3

8.1.13.4.1 PM_MPU_PWRSTCTRL Register (offset = 0h) [reset = 1FF0007h]

PM_MPU_PWRSTCTRL is shown in [Figure 8-173](#) and described in [Table 8-191](#).

This register controls the MPU power state to reach upon mpu domain sleep transition

Figure 8-173. PM_MPU_PWRSTCTRL Register

31		30		29		28		27		26		25		24	
Reserved										Reserved		mpu_ram_RET State			
R-0h										R-0h		R/W-1h			
23		22		21		20		19		18		17		16	
mpu_i2_RETState		mpu_i1_RETState		MPU_L2_ONState		MPU_L1_ONState		MPU_RAM_ONState							
R/W-1h		R/W-1h		R-3h		R-3h		R/W-3h							
15		14		13		12		11		10		9		8	
Reserved															
R-0h															
7		6		5		4		3		2		1		0	
Reserved				LowPowerState Change		Reserved		LogicRETState		PowerState					
R-0h				R/W-0h		R-0h		R/W-1h		R/W-3h					

LEGEND: R/W = Read/Write; R = Read only; W1toCl = Write 1 to clear bit; -n = value after reset

Table 8-191. PM_MPU_PWRSTCTRL Register Field Descriptions

Bit	Field	Type	Reset	Description
31-26	Reserved	R	0h	
25	Reserved	R	0h	
24	mpu_ram_RETState	R/W	1h	Default power domain memory(ram) retention state when power domain is in retention
23	mpu_i2_RETState	R/W	1h	Default power domain memory(L2) retention state when power domain is in retention
22	mpu_i1_RETState	R/W	1h	Default power domain memory(L1) retention state when power domain is in retention
21-20	MPU_L2_ONState	R	3h	Default power domain memory state when domain is ON.
19-18	MPU_L1_ONState	R	3h	Default power domain memory state when domain is ON.
17-16	MPU_RAM_ONState	R/W	3h	Default power domain memory state when domain is ON. 0x0 = Mem_off 0x2 = Reserved 0x3 = Mem_on : Memory bank is on when the domain is ON.
15-5	Reserved	R	0h	
4	LowPowerStateChange	R/W	0h	Power state change request when domain has already performed a sleep transition. Allows going into deeper low power state without waking up the power domain. 0x0 = DIS : Do not request a low power state change. 0x1 = EN : Request a low power state change. This bit is automatically cleared when the power state is effectively changed or when power state is ON.
3	Reserved	R	0h	
2	LogicRETState	R/W	1h	Logic state when power domain is RETENTION 0x0 = logic_off : Only retention registers are retained and remaining logic is off when the domain is in RETENTION state. 0x1 = logic_ret : Whole logic is retained when domain is in RETENTION state.

Table 8-191. PM_MPU_PWRSTCTRL Register Field Descriptions (continued)

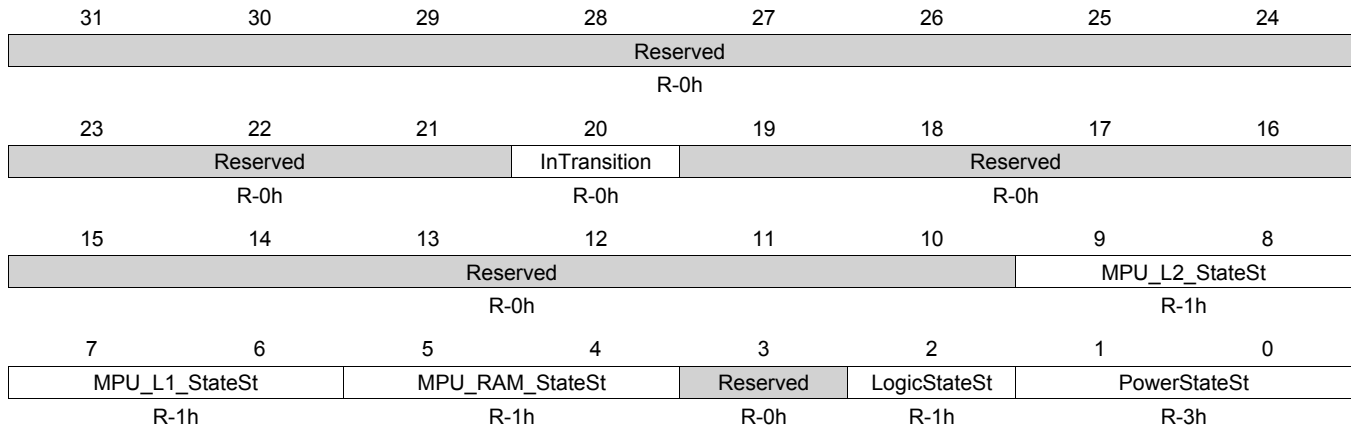
Bit	Field	Type	Reset	Description
1-0	PowerState	R/W	3h	Power state control 0x0 = OFF : OFF State 0x1 = RET 0x2 = Reserved 0x3 = ON : ON State

8.1.13.4.2 PM_MPU_PWRSTST Register (offset = 4h) [reset = 157h]

PM_MPU_PWRSTST is shown in Figure 8-174 and described in Table 8-192.

This register provides a status on the current MPU power domain state0. [warm reset insensitive]

Figure 8-174. PM_MPU_PWRSTST Register



LEGEND: R/W = Read/Write; R = Read only; W1toCl = Write 1 to clear bit; -n = value after reset

Table 8-192. PM_MPU_PWRSTST Register Field Descriptions

Bit	Field	Type	Reset	Description
31-21	Reserved	R	0h	
20	InTransition	R	0h	Domain transition status 0x0 = No : No on-going transition on power domain 0x1 = Ongoing : Power domain transition is in progress.
19-10	Reserved	R	0h	
9-8	MPU_L2_StateSt	R	1h	MPU L2 memory state status 0x0 = Mem_off : Memory is OFF 0x2 = Reserved : Reserved 0x3 = Mem_on : Memory is ON
7-6	MPU_L1_StateSt	R	1h	MPU L1 memory state status 0x0 = Mem_off : Memory is OFF 0x2 = Reserved : Reserved 0x3 = Mem_on : Memory is ON
5-4	MPU_RAM_StateSt	R	1h	MPU_RAM memory state status 0x0 = Mem_off : Memory is OFF 0x2 = Reserved : Reserved 0x3 = Mem_on : Memory is ON
3	Reserved	R	0h	
2	LogicStateSt	R	1h	Logic state status 0x0 = OFF : Logic in domain is OFF 0x1 = ON : Logic in domain is ON
1-0	PowerStateSt	R	3h	Current Power State Status 0x0 = OFF : OFF State [warm reset insensitive] 0x1 = RET : RET State 0x3 = ON : ON State [warm reset insensitive]

8.1.13.4.3 RM_MPU_RSTST Register (offset = 8h) [reset = 0h]

RM_MPU_RSTST is shown in [Figure 8-175](#) and described in [Table 8-193](#).

This register logs the different reset sources of the ALWON domain. Each bit is set upon release of the domain reset signal. Must be cleared by software. [warm reset insensitive]

Figure 8-175. RM_MPU_RSTST Register

31	30	29	28	27	26	25	24
Reserved							
R-0h							
23	22	21	20	19	18	17	16
Reserved							
R-0h							
15	14	13	12	11	10	9	8
Reserved	Reserved						
R-0h	R-0h						
7	6	5	4	3	2	1	0
Reserved	ICECRUSHER_MPU_RST	EMULATION_MPU_RST	Reserved	Reserved	Reserved	Reserved	
R-0h	R/W-0h	R/W-0h	R-0h	R-0h	R-0h	R-0h	

LEGEND: R/W = Read/Write; R = Read only; W1toCl = Write 1 to clear bit; -n = value after reset

Table 8-193. RM_MPU_RSTST Register Field Descriptions

Bit	Field	Type	Reset	Description
31-15	Reserved	R	0h	
14-8	Reserved	R	0h	
7	Reserved	R	0h	
6	ICECRUSHER_MPU_RST	R/W	0h	MPU Processor has been reset due to MPU ICECRUSHER1 reset event 0x0 = RESET_NO : No icecrusher reset 0x1 = RESET_YES : MPU Processor has been reset upon icecursher reset
5	EMULATION_MPU_RST	R/W	0h	MPU Processor has been reset due to emulation reset source e.g. assert reset command initiated by the icepick module 0x0 = RESET_NO : No emulation reset 0x1 = RESET_YES : MPU Processor has been reset upon emulation reset
4	Reserved	R	0h	
3	Reserved	R	0h	
2	Reserved	R	0h	
1-0	Reserved	R	0h	

8.1.13.5 PRM_DEVICE Registers

[Table 8-194](#) lists the memory-mapped registers for the PRM_DEVICE. All register offset addresses not listed in [Table 8-194](#) should be considered as reserved locations and the register contents should not be modified.

Table 8-194. PRM_DEVICE Registers

Offset	Acronym	Register Name	Section
0h	PRM_RSTCTRL		Section 8.1.13.5.1
4h	PRM_RSTTIME		Section 8.1.13.5.2
8h	PRM_RSTST		Section 8.1.13.5.3

Table 8-194. PRM_DEVICE Registers (continued)

Offset	Acronym	Register Name	Section
Ch	PRM_SRAM_COUNT		Section 8.1.13.5.4
10h	PRM_LDO_SRAM_CORE_SETUP		Section 8.1.13.5.5
14h	PRM_LDO_SRAM_CORE_CTRL		Section 8.1.13.5.6
18h	PRM_LDO_SRAM_MPU_SETUP		Section 8.1.13.5.7
1Ch	PRM_LDO_SRAM_MPU_CTRL		Section 8.1.13.5.8

8.1.13.5.1 PRM_RSTCTRL Register (offset = 0h) [reset = 0h]

Register mask: FFFFFFFFh

 PRM_RSTCTRL is shown in [Figure 8-176](#) and described in [Table 8-195](#).

Global software cold and warm reset control. This register is auto-cleared. Only write 1 is possible. A read returns 0 only.

Figure 8-176. PRM_RSTCTRL Register

31	30	29	28	27	26	25	24
RESERVED							
Rreturns0s-0h							
23	22	21	20	19	18	17	16
RESERVED							
Rreturns0s-0h							
15	14	13	12	11	10	9	8
RESERVED							
Rreturns0s-0h							
7	6	5	4	3	2	1	0
RESERVED						RST_GLOBAL_COLD_SW	RST_GLOBAL_WARM_SW
Rreturns0s-0h						Rreturns0s/W-0h	Rreturns0s/W-0h

LEGEND: R/W = Read/Write; R = Read only; W1toCl = Write 1 to clear bit; -n = value after reset

Table 8-195. PRM_RSTCTRL Register Field Descriptions

Bit	Field	Type	Reset	Description
31-2	RESERVED	Rreturns0s	0h	
1	RST_GLOBAL_COLD_SW	Rreturns0s/W	0h	Global COLD software reset control. This bit is reset only upon a global cold source of reset. Read returns 0. 0h = 0x0 : Global COLD software reset is cleared. 1h = 0x1 : Asserts a global COLD software reset. The software must ensure the SDRAM is properly put in self-refresh mode before applying this reset.
0	RST_GLOBAL_WARM_SW	Rreturns0s/W	0h	Global WARM software reset control. This bit is reset upon any global source of reset (warm and cold). Read returns 0. 0h = 0x0 : Global warm software reset is cleared. 1h = 0x1 : Asserts a global warm software reset.

8.1.13.5.2 PRM_RSTTIME Register (offset = 4h) [reset = 1006h]

Register mask: FFFFFFFFh

PRM_RSTTIME is shown in [Figure 8-177](#) and described in [Table 8-196](#).

Reset duration control. [warm reset insensitive]

Figure 8-177. PRM_RSTTIME Register

31	30	29	28	27	26	25	24	23	22	21	20	19	18	17	16
RESERVED															
Rreturns0s-0h															
15	14	13	12	11	10	9	8	7	6	5	4	3	2	1	0
RESERVED				RSTTIME2						RSTTIME1					
Rreturns0s-0h				R/W-10h						R/W-6h					

LEGEND: R/W = Read/Write; R = Read only; W1toCl = Write 1 to clear bit; -n = value after reset

Table 8-196. PRM_RSTTIME Register Field Descriptions

Bit	Field	Type	Reset	Description
31-13	RESERVED	Rreturns0s	0h	
12-8	RSTTIME2	R/W	10h	(Power domain) reset duration 2 (number of CLK_M_OSC clock cycles)
7-0	RSTTIME1	R/W	6h	(Global) reset duration 1 (number of CLK_M_OSC clock cycles)

8.1.13.5.3 PRM_RSTST Register (offset = 8h) [reset = 1h]

Register mask: FFFFFFFFh

 PRM_RSTST is shown in [Figure 8-178](#) and described in [Table 8-197](#).

This register logs the global reset sources. Each bit is set upon release of the domain reset signal. Must be cleared by software. [warm reset insensitive]

Figure 8-178. PRM_RSTST Register

31	30	29	28	27	26	25	24
RESERVED							
Rreturns0s-0h							
23	22	21	20	19	18	17	16
RESERVED							
Rreturns0s-0h							
15	14	13	12	11	10	9	8
RESERVED						ICEPICK_RST	RESERVED
Rreturns0s-0h						R/W1toClr-0h	Rreturns0s-0h
7	6	5	4	3	2	1	0
RESERVED	EXTERNAL_W ARM_RST	WDT1_RST	RESERVED	RESERVED	GLOBAL_WAR M_SW_RST	GLOBAL_COL D_RST	
Rreturns0s-0h	R/W1toClr-0h	R/W1toClr-0h	R/W1toClr-0h	R/W1toClr-0h	R/W1toClr-0h	R/W1toClr-1h	

LEGEND: R/W = Read/Write; R = Read only; W1toCl = Write 1 to clear bit; -n = value after reset

Table 8-197. PRM_RSTST Register Field Descriptions

Bit	Field	Type	Reset	Description
31-10	RESERVED	Rreturns0s	0h	
9	ICEPICK_RST	R/W1toClr	0h	IcePick reset event. This is a source of global warm reset initiated by the emulation. [warm reset insensitive] 0h = 0x0 : No ICEPICK reset. 1h = 0x1 : IcePick reset has occurred.
8-6	RESERVED	Rreturns0s	0h	
5	EXTERNAL_WARM_RST	R/W1toClr	0h	External warm reset event [warm reset insensitive] 0h = 0x0 : No global warm reset. 1h = 0x1 : Global external warm reset has occurred.
4	WDT1_RST	R/W1toClr	0h	Watchdog1 timer reset event. This is a source of global WARM reset. [warm reset insensitive] 0h = 0x0 : No watchdog reset. 1h = 0x1 : watchdog reset has occurred.
3	RESERVED	R/W1toClr	0h	Reserved.
2	RESERVED	R/W1toClr	0h	Reserved.
1	GLOBAL_WARM_SW_RST	R/W1toClr	0h	Global warm software reset event [warm reset insensitive] 0h = 0x0 : No global warm SW reset 1h = 0x1 : Global warm SW reset has occurred.
0	GLOBAL_COLD_RST	R/W1toClr	1h	Power-on (cold) reset event [warm reset insensitive] 0h = 0x0 : No power-on reset. 1h = 0x1 : Power-on reset has occurred.

8.1.13.5.4 PRM_SRAM_COUNT Register (offset = Ch) [reset = 7800017h]

Register mask: FFFFFFFFh

PRM_SRAM_COUNT is shown in [Figure 8-179](#) and described in [Table 8-198](#).

Common setup for SRAM LDO transition counters. Applies to all voltage domains. [warm reset insensitive]

Figure 8-179. PRM_SRAM_COUNT Register

31	30	29	28	27	26	25	24
StartUp_Count							
R/W-78h							
23	22	21	20	19	18	17	16
SLPCNT_VALUE							
R/W-0h							
15	14	13	12	11	10	9	8
VSETUPCNT_VALUE							
R/W-0h							
7	6	5	4	3	2	1	0
RESERVED				PCHARGEcnt_VALUE			
Rreturns0s-0h				R/W-17h			

LEGEND: R/W = Read/Write; R = Read only; W1toCl = Write 1 to clear bit; -n = value after reset

Table 8-198. PRM_SRAM_COUNT Register Field Descriptions

Bit	Field	Type	Reset	Description
31-24	StartUp_Count	R/W	78h	Determines the start-up duration of SRAM and ABB LDO. The duration is computed as 16 x NbCycles of system clock cycles. Target is 50us.
23-16	SLPCNT_VALUE	R/W	0h	Delay between retention/off assertion of last SRAM bank and SRAMALLRET signal to LDO is driven high. Counting on system clock. Target is 2us.
15-8	VSETUPCNT_VALUE	R/W	0h	SRAM LDO rampup time from retention to active mode. The duration is computed as 8 x NbCycles of system clock cycles. Target is 30us.
7-6	RESERVED	Rreturns0s	0h	
5-0	PCHARGEcnt_VALUE	R/W	17h	Delay between de-assertion of standby_rta_ret_on and standby_rta_ret_good. Counting on system clock. Target is 600ns.

8.1.13.5.5 PRM_LDO_SRAM_CORE_SETUP Register (offset = 10h) [reset = 0h]

Register mask: FFFFFFFFh

 PRM_LDO_SRAM_CORE_SETUP is shown in [Figure 8-180](#) and described in [Table 8-199](#).

Setup of the SRAM LDO for CORE voltage domain. [warm reset insensitive]

Figure 8-180. PRM_LDO_SRAM_CORE_SETUP Register

31	30	29	28	27	26	25	24
RESERVED							
Rreturns0s-0h							
23	22	21	20	19	18	17	16
RESERVED							
Rreturns0s-0h							
15	14	13	12	11	10	9	8
RESERVED							AIPOFF
Rreturns0s-0h							R/W-0h
7	6	5	4	3	2	1	0
ENFUNC5	ENFUNC4	ENFUNC3_EX PORT	ENFUNC2_EX PORT	ENFUNC1_EX PORT	ABBOFF_SLEE P_EXPORT	ABBOFF_ACT_ EXPORT	DISABLE_RT A_EXPORT
R/W-0h	R/W-0h	R/WSpecial-0h	R/WSpecial-0h	R/WSpecial-0h	R/WSpecial-0h	R/WSpecial-0h	R/WSpecial-0h

LEGEND: R/W = Read/Write; R = Read only; W1toCl = Write 1 to clear bit; -n = value after reset

Table 8-199. PRM_LDO_SRAM_CORE_SETUP Register Field Descriptions

Bit	Field	Type	Reset	Description
31-9	RESERVED	Rreturns0s	0h	
8	AIPOFF	R/W	0h	Override on AIPOFF input of SRAM LDO. 0h = No_Override : AIPOFF signal is not overridden 1h = Override : AIPOFF signal is overridden to '1'. Corresponding SRAM LDO is disabled and in HZ mode.
7	ENFUNC5	R/W	0h	ENFUNC5 input of SRAM LDO. 0h = One_step : Active to retention is a one step transfer 1h = Two_step : Active to retention is a two steps transfer
6	ENFUNC4	R/W	0h	ENFUNC4 input of SRAM LDO. 0h = Ext_clock : One external clock is supplied 1h = No_ext_clock : No external clock is supplied
5	ENFUNC3_EXPORT	R/WSpecial	0h	ENFUNC3 input of SRAM LDO. After PowerOn reset and Efuse sensing, this bitfield is automatically loaded with an Efuse value from control module. Bitfield remains writable after this. 0h = Sub_regul_disabled : Sub regulation is disabled 1h = Sub_regul_enabled : Sub regulation is enabled
4	ENFUNC2_EXPORT	R/WSpecial	0h	ENFUNC2 input of SRAM LDO. After PowerOn reset and Efuse sensing, this bitfield is automatically loaded with an Efuse value from control module. Bitfield remains writable after this. 0h = Ext_cap : External cap is used 1h = No_ext_cap : External cap is not used
3	ENFUNC1_EXPORT	R/WSpecial	0h	ENFUNC1 input of SRAM LDO. After PowerOn reset and Efuse sensing, this bitfield is automatically loaded with an Efuse value from control module. Bitfield remains writable after this. 0h = Short_prot_disabled : Short circuit protection is disabled 1h = Short_prot_enabled : Short circuit protection is enabled

Table 8-199. PRM_LDO_SRAM_CORE_SETUP Register Field Descriptions (continued)

Bit	Field	Type	Reset	Description
2	ABBOFF_SLEEP_EXPORT	R/WSpecial	0h	<p>Determines whether SRAMNWA is supplied by VDDS or VDDAR during deep-sleep.</p> <p>After PowerOn reset and Efuse sensing, this bitfield is automatically loaded with an Efuse value from control module. Bitfield remains writable after this.</p> <p>0h = SRAMNW_SLP_VDDS : SRAMNWA supplied with VDDS 1h(Read) = SRAMNW_SLP_VDDASRAMNWA supplied with VDDAR</p>
1	ABBOFF_ACT_EXPORT	R/WSpecial	0h	<p>Determines whether SRAMNWA is supplied by VDDS or VDDAR during active mode.</p> <p>After PowerOn reset and Efuse sensing, this bitfield is automatically loaded with an Efuse value from control module. Bitfield remains writable after this.</p> <p>0h = SRAMNW_ACT_VDDS : SRAMNWA supplied with VDDS 1h(Read) = SRAMNW_ACT_VDDASRAMNWA supplied with VDDAR</p>
0	DISABLE_RTA_EXPORT	R/WSpecial	0h	<p>Control for HD memory RTA feature.</p> <p>After PowerOn reset and Efuse sensing, this bitfield is automatically loaded with an Efuse value from control module. Bitfield remains writable after this.</p> <p>0h = RTA_ENABLED : HD memory RTA feature is enabled 1h = RTA_DISABLED : HD memory RTA feature is disabled</p>

8.1.13.5.6 PRM_LDO_SRAM_CORE_CTRL Register (offset = 14h) [reset = 0h]

Register mask: FFFFFFFFh

 PRM_LDO_SRAM_CORE_CTRL is shown in [Figure 8-181](#) and described in [Table 8-200](#).

Control and status of the SRAM LDO for CORE voltage domain. [warm reset insensitive]

Figure 8-181. PRM_LDO_SRAM_CORE_CTRL Register

31	30	29	28	27	26	25	24
RESERVED							
Rreturns0s-0h							
23	22	21	20	19	18	17	16
RESERVED							
Rreturns0s-0h							
15	14	13	12	11	10	9	8
RESERVED						SRAM_IN_TRANSITION	SRAMLDO_STATUS
Rreturns0s-0h						R-0h	R-0h
7	6	5	4	3	2	1	0
RESERVED							RETMODE_ENABLE
Rreturns0s-0h							R/W-0h

LEGEND: R/W = Read/Write; R = Read only; W1toCl = Write 1 to clear bit; -n = value after reset

Table 8-200. PRM_LDO_SRAM_CORE_CTRL Register Field Descriptions

Bit	Field	Type	Reset	Description
31-10	RESERVED	Rreturns0s	0h	
9	SRAM_IN_TRANSITION	R	0h	Status indicating SRAM LDO state machine state. 0h = IDLE : SRAM LDO state machine is stable 1h = IN_TRANSITION : SRAM LDO state machine is in transition state
8	SRAMLDO_STATUS	R	0h	SRAMLDO status 0h = ACTIVE : SRAMLDO is in ACTIVE mode. 1h = RETENTION : SRAMLDO is on RETENTION mode.
7-1	RESERVED	Rreturns0s	0h	
0	RETMODE_ENABLE	R/W	0h	Control if the SRAM LDO retention mode is used or not. 0h = Disabled : SRAM LDO is not allowed to go to RET mode 1h = Enabled : SRAM LDO go to RET mode when all memory of voltage domain are OFF or RET

8.1.13.5.7 PRM_LDO_SRAM_MPU_SETUP Register (offset = 18h) [reset = 0h]

Register mask: FFFFFFFFh

 PRM_LDO_SRAM_MPU_SETUP is shown in [Figure 8-182](#) and described in [Table 8-201](#).

Setup of the SRAM LDO for MPU voltage domain. [warm reset insensitive]

Figure 8-182. PRM_LDO_SRAM_MPU_SETUP Register

31	30	29	28	27	26	25	24
RESERVED							
Rreturns0s-0h							
23	22	21	20	19	18	17	16
RESERVED							
Rreturns0s-0h							
15	14	13	12	11	10	9	8
RESERVED							AIPOFF
Rreturns0s-0h							R/W-0h
7	6	5	4	3	2	1	0
ENFUNC5	ENFUNC4	ENFUNC3_EX PORT	ENFUNC2_EX PORT	ENFUNC1_EX PORT	ABBOFF_SLEE P_EXPORT	ABBOFF_ACT_ EXPORT	DISABLE_RTA _EXPORT
R/W-0h	R/W-0h	R/WSpecial-0h	R/WSpecial-0h	R/WSpecial-0h	R/WSpecial-0h	R/WSpecial-0h	R/WSpecial-0h

LEGEND: R/W = Read/Write; R = Read only; W1toCl = Write 1 to clear bit; -n = value after reset

Table 8-201. PRM_LDO_SRAM_MPU_SETUP Register Field Descriptions

Bit	Field	Type	Reset	Description
31-9	RESERVED	Rreturns0s	0h	
8	AIPOFF	R/W	0h	Override on AIPOFF input of SRAM LDO. 0h = No_Override : AIPOFF signal is not overridden 1h = Override : AIPOFF signal is overridden to '1'. Corresponding SRAM LDO is disabled and in HZ mode.
7	ENFUNC5	R/W	0h	ENFUNC5 input of SRAM LDO. 0h = One_step : Active to retention is a one step transfer 1h = Two_step : Active to retention is a two steps transfer
6	ENFUNC4	R/W	0h	ENFUNC4 input of SRAM LDO. 0h = Ext_clock : One external clock is supplied 1h = No_ext_clock : No external clock is supplied
5	ENFUNC3_EXPORT	R/WSpecial	0h	ENFUNC3 input of SRAM LDO. After PowerOn reset and Efuse sensing, this bitfield is automatically loaded with an Efuse value from control module. Bitfield remains writable after this. 0h = Sub_regul_disabled : Sub regulation is disabled 1h = Sub_regul_enabled : Sub regulation is enabled
4	ENFUNC2_EXPORT	R/WSpecial	0h	ENFUNC2 input of SRAM LDO. After PowerOn reset and Efuse sensing, this bitfield is automatically loaded with an Efuse value from control module. Bitfield remains writable after this. 0h = Ext_cap : External cap is used 1h = No_ext_cap : External cap is not used
3	ENFUNC1_EXPORT	R/WSpecial	0h	ENFUNC1 input of SRAM LDO. After PowerOn reset and Efuse sensing, this bitfield is automatically loaded with an Efuse value from control module. Bitfield remains writable after this. 0h = Short_prot_disabled : Short circuit protection is disabled 1h = Short_prot_enabled : Short circuit protection is enabled

Table 8-201. PRM_LDO_SRAM_MPU_SETUP Register Field Descriptions (continued)

Bit	Field	Type	Reset	Description
2	ABBOFF_SLEEP_EXPORT	R/WSpecial	0h	Determines whether SRAMNWA is supplied by VDDS or VDDAR during deep-sleep. After PowerOn reset and Efuse sensing, this bitfield is automatically loaded with an Efuse value from control module. Bitfield remains writable after this. 0h = SRAMNW_SLP_VDDS : SRAMNWA supplied with VDDS 1h(Read) = SRAMNW_SLP_VDDASRAMNWA supplied with VDDAR
1	ABBOFF_ACT_EXPORT	R/WSpecial	0h	Determines whether SRAMNWA is supplied by VDDS or VDDAR during active mode. After PowerOn reset and Efuse sensing, this bitfield is automatically loaded with an Efuse value from control module. Bitfield remains writable after this. 0h = SRAMNW_ACT_VDDS : SRAMNWA supplied with VDDS 1h(Read) = SRAMNW_ACT_VDDASRAMNWA supplied with VDDAR
0	DISABLE_RTA_EXPORT	R/WSpecial	0h	Control for HD memory RTA feature. After PowerOn reset and Efuse sensing, this bitfield is automatically loaded with an Efuse value from control module. Bitfield remains writable after this. 0h = RTA_ENABLED : HD memory RTA feature is enabled 1h = RTA_DISABLED : HD memory RTA feature is disabled

8.1.13.5.8 PRM_LDO_SRAM_MPU_CTRL Register (offset = 1Ch) [reset = 0h]

Register mask: FFFFFFFFh

 PRM_LDO_SRAM_MPU_CTRL is shown in [Figure 8-183](#) and described in [Table 8-202](#).

Control and status of the SRAM LDO for MPU voltage domain. [warm reset insensitive]

Figure 8-183. PRM_LDO_SRAM_MPU_CTRL Register

31	30	29	28	27	26	25	24
RESERVED							
Rreturns0s-0h							
23	22	21	20	19	18	17	16
RESERVED							
Rreturns0s-0h							
15	14	13	12	11	10	9	8
RESERVED						SRAM_IN_TRANSITION	SRAMLDO_STATUS
Rreturns0s-0h						R-0h	R-0h
7	6	5	4	3	2	1	0
RESERVED							RETMODE_ENABLE
Rreturns0s-0h							R/W-0h

LEGEND: R/W = Read/Write; R = Read only; W1toCl = Write 1 to clear bit; -n = value after reset

Table 8-202. PRM_LDO_SRAM_MPU_CTRL Register Field Descriptions

Bit	Field	Type	Reset	Description
31-10	RESERVED	Rreturns0s	0h	
9	SRAM_IN_TRANSITION	R	0h	Status indicating SRAM LDO state machine state. 0h = IDLE : SRAM LDO state machine is stable 1h = IN_TRANSITION : SRAM LDO state machine is in transition state
8	SRAMLDO_STATUS	R	0h	SRAMLDO status 0h = ACTIVE : SRAMLDO is in ACTIVE mode. 1h = RETENTION : SRAMLDO is on RETENTION mode.
7-1	RESERVED	Rreturns0s	0h	
0	RETMODE_ENABLE	R/W	0h	Control if the SRAM LDO retention mode is used or not. 0h = Disabled : SRAM LDO is not allowed to go to RET mode 1h = Enabled : SRAM LDO go to RET mode when all memory of voltage domain are OFF or RET

8.1.13.6 PRM_RTC Registers

[Table 8-203](#) lists the memory-mapped registers for the PRM_RTC. All register offset addresses not listed in [Table 8-203](#) should be considered as reserved locations and the register contents should not be modified.

Table 8-203. PRM_RTC REGISTERS

Offset	Acronym	Register Name	Section
0h	PM_RTC_PWRSTCTRL	This register controls the RTC power state to reach upon mpu domain sleep transition	Section 8.1.13.6.1
4h	PM_RTC_PWRSTST	This register provides a status on the current RTC power domain state0. [warm reset insensitive]	Section 8.1.13.6.2

8.1.13.6.1 PM_RTC_PWRSTCTRL Register (offset = 0h) [reset = 4h]

PM_RTC_PWRSTCTRL is shown in [Figure 8-184](#) and described in [Table 8-204](#).

This register controls the RTC power state to reach upon mpu domain sleep transition

Figure 8-184. PM_RTC_PWRSTCTRL Register

31	30	29	28	27	26	25	24
Reserved						Reserved	
R-0h						R-0h	
23	22	21	20	19	18	17	16
Reserved							
R-0h							
15	14	13	12	11	10	9	8
Reserved							
R-0h							
7	6	5	4	3	2	1	0
Reserved			LowPowerState Change	Reserved	LogicRETState	Reserved	
R-0h			R/W-0h	R-0h	R/W-1h	R-0h	

LEGEND: R/W = Read/Write; R = Read only; W1toCl = Write 1 to clear bit; -n = value after reset

Table 8-204. PM_RTC_PWRSTCTRL Register Field Descriptions

Bit	Field	Type	Reset	Description
31-26	Reserved	R	0h	
25-16	Reserved	R	0h	
15-5	Reserved	R	0h	
4	LowPowerStateChange	R/W	0h	Power state change request when domain has already performed a sleep transition. Allows going into deeper low power state without waking up the power domain. 0x0 = DIS : Do not request a low power state change. 0x1 = EN : Request a low power state change. This bit is automatically cleared when the power state is effectively changed or when power state is ON.
3	Reserved	R	0h	
2	LogicRETState	R/W	1h	Logic state when power domain is RETENTION 0x0 = logic_off : Only retention registers are retained and remaining logic is off when the domain is in RETENTION state. 0x1 = logic_ret : Whole logic is retained when domain is in RETENTION state.
1-0	Reserved	R	0h	

8.1.13.6.2 PM_RTC_PWRSTST Register (offset = 4h) [reset = 4h]

PM_RTC_PWRSTST is shown in [Figure 8-185](#) and described in [Table 8-205](#).

This register provides a status on the current RTC power domain state0. [warm reset insensitive]

Figure 8-185. PM_RTC_PWRSTST Register

31	30	29	28	27	26	25	24
Reserved							
R-0h							
23	22	21	20	19	18	17	16
Reserved			InTransition	Reserved			
R-0h			R-0h	R-0h			
15	14	13	12	11	10	9	8
Reserved						Reserved	
R-0h						R-0h	
7	6	5	4	3	2	1	0
Reserved			Reserved	LogicStateSt	Reserved		
R-0h			R-0h	R-1h	R-0h		

LEGEND: R/W = Read/Write; R = Read only; W1toCl = Write 1 to clear bit; -n = value after reset

Table 8-205. PM_RTC_PWRSTST Register Field Descriptions

Bit	Field	Type	Reset	Description
31-21	Reserved	R	0h	
20	InTransition	R	0h	Domain transition status 0x0 = No : No on-going transition on power domain 0x1 = Ongoing : Power domain transition is in progress.
19-10	Reserved	R	0h	
9-4	Reserved	R	0h	
3	Reserved	R	0h	
2	LogicStateSt	R	1h	Logic state status 0x0 = OFF : Logic in domain is OFF 0x1 = ON : Logic in domain is ON
1-0	Reserved	R	0h	

8.1.13.7 PRM_GFX Registers

[Table 8-206](#) lists the memory-mapped registers for the PRM_GFX. All register offset addresses not listed in [Table 8-206](#) should be considered as reserved locations and the register contents should not be modified.

Table 8-206. PRM_GFX REGISTERS

Offset	Acronym	Register Name	Section
0h	PM_GFX_PWRSTCTRL	This register controls the GFX power state to reach upon a domain sleep transition.	Section 8.1.13.7.1
4h	RM_GFX_RSTCTRL	This register controls the release of the GFX Domain resets.	Section 8.1.13.7.2
10h	PM_GFX_PWRSTST	This register provides a status on the current GFX power domain state. [warm reset insensitive]	Section 8.1.13.7.3

Table 8-206. PRM_GFX REGISTERS (continued)

Offset	Acronym	Register Name	Section
14h	RM_GFX_RSTST	This register logs the different reset sources of the GFX domain. Each bit is set upon release of the domain reset signal. Must be cleared by software. [warm reset insensitive]	Section 8.1.13.7.4

8.1.13.7.1 PM_GFX_PWRSTCTRL Register (offset = 0h) [reset = 60044h]

PM_GFX_PWRSTCTRL is shown in [Figure 8-186](#) and described in [Table 8-207](#).

This register controls the GFX power state to reach upon a domain sleep transition.

Figure 8-186. PM_GFX_PWRSTCTRL Register

31	30	29	28	27	26	25	24
Reserved							
R-0h							
23	22	21	20	19	18	17	16
Reserved				GFX_MEM_ONState		Reserved	
R-0h				R-3h		R-0h	
15	14	13	12	11	10	9	8
Reserved							
R-0h							
7	6	5	4	3	2	1	0
Reserved	GFX_MEM_RETState	Reserved	LowPowerStateChange	Reserved	LogicRETState	PowerState	
R-0h	R/W-1h	R-0h	R/W-0h	R-0h	R/W-1h	R/W-0h	

LEGEND: R/W = Read/Write; R = Read only; W1toCl = Write 1 to clear bit; -n = value after reset

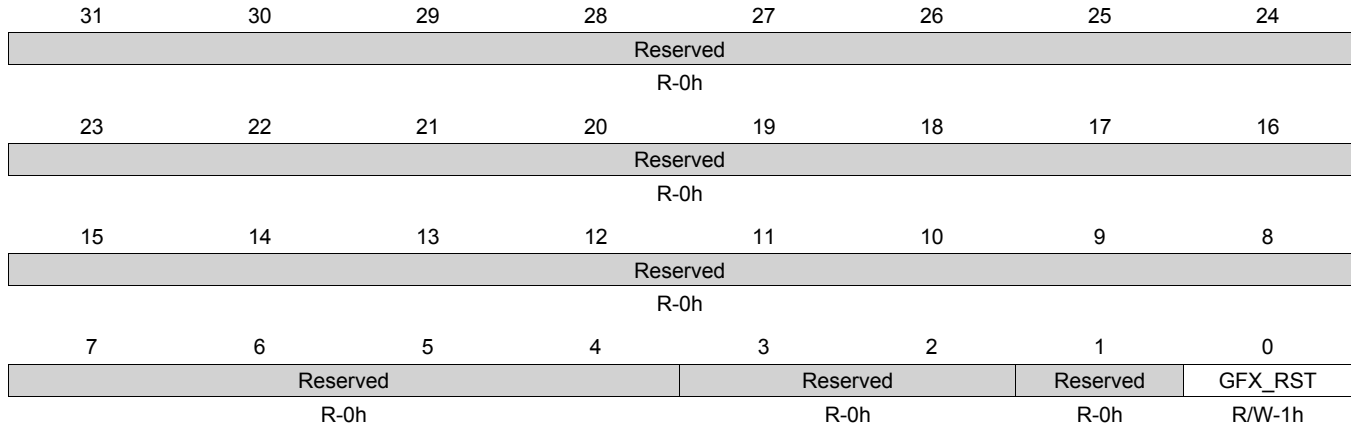
Table 8-207. PM_GFX_PWRSTCTRL Register Field Descriptions

Bit	Field	Type	Reset	Description
31-19	Reserved	R	0h	
18-17	GFX_MEM_ONState	R	3h	GFX memory state when domain is ON.
16-7	Reserved	R	0h	
6	GFX_MEM_RETState	R/W	1h	
5	Reserved	R	0h	
4	LowPowerStateChange	R/W	0h	Power state change request when domain has already performed a sleep transition. Allows going into deeper low power state without waking up the power domain. 0x0 = DIS : Do not request a low power state change. 0x1 = EN : Request a low power state change. This bit is automatically cleared when the power state is effectively changed or when power state is ON.
3	Reserved	R	0h	
2	LogicRETState	R/W	1h	Logic state when power domain is RETENTION 0x0 = logic_off : Only retention registers are retained and remaining logic is off when the domain is in RETENTION state. 0x1 = logic_ret : Whole logic is retained when domain is in RETENTION state.
1-0	PowerState	R/W	0h	Power state control 0x0 = OFF : OFF State 0x1 = RET 0x2 = reserved_1 0x3 = ON : ON State

8.1.13.7.2 RM_GFX_RSTCTRL Register (offset = 4h) [reset = 1h]

RM_GFX_RSTCTRL is shown in [Figure 8-187](#) and described in [Table 8-208](#).

This register controls the release of the GFX Domain resets.

Figure 8-187. RM_GFX_RSTCTRL Register


LEGEND: R/W = Read/Write; R = Read only; W1toCl = Write 1 to clear bit; -n = value after reset

Table 8-208. RM_GFX_RSTCTRL Register Field Descriptions

Bit	Field	Type	Reset	Description
31-4	Reserved	R	0h	
3-2	Reserved	R	0h	
1	Reserved	R	0h	
0	GFX_RST	R/W	1h	GFX domain local reset control 0x0 = CLEAR : Reset is cleared for the GFX Domain (SGX530) 0x1 = ASSERT : Reset is asserted for the GFX Domain (SGX 530)

8.1.13.7.3 PM_GFX_PWRSTST Register (offset = 10h) [reset = 17h]

PM_GFX_PWRSTST is shown in [Figure 8-188](#) and described in [Table 8-209](#).

This register provides a status on the current GFX power domain state. [warm reset insensitive]

Figure 8-188. PM_GFX_PWRSTST Register

31	30	29	28	27	26	25	24
Reserved							
R-0h							
23	22	21	20	19	18	17	16
Reserved			InTransition	Reserved			
R-0h			R-0h	R-0h			
15	14	13	12	11	10	9	8
Reserved							
R-0h							
7	6	5	4	3	2	1	0
Reserved		GFX_MEM_StateSt		Reserved	LogicStateSt	PowerStateSt	
R-0h		R-1h		R-0h	R-1h	R-3h	

LEGEND: R/W = Read/Write; R = Read only; W1toCl = Write 1 to clear bit; -n = value after reset

Table 8-209. PM_GFX_PWRSTST Register Field Descriptions

Bit	Field	Type	Reset	Description
31-21	Reserved	R	0h	
20	InTransition	R	0h	Domain transition status 0x0 = No : No on-going transition on power domain 0x1 = Ongoing : Power domain transition is in progress.
19-6	Reserved	R	0h	
5-4	GFX_MEM_StateSt	R	1h	GFX memory state status 0x0 = Mem_off : Memory is OFF 0x2 = Reserved : Reserved 0x3 = Mem_on : Memory is ON
3	Reserved	R	0h	
2	LogicStateSt	R	1h	Logic state status 0x0 = OFF : Logic in domain is OFF 0x1 = ON : Logic in domain is ON
1-0	PowerStateSt	R	3h	Current Power State Status 0x0 = OFF : OFF State [warm reset insensitive] 0x1 = RET 0x3 = ON : ON State [warm reset insensitive]

8.1.13.7.4 RM_GFX_RSTST Register (offset = 14h) [reset = 0h]

RM_GFX_RSTST is shown in [Figure 8-189](#) and described in [Table 8-210](#).

This register logs the different reset sources of the GFX domain. Each bit is set upon release of the domain reset signal. Must be cleared by software. [warm reset insensitive]

Figure 8-189. RM_GFX_RSTST Register

31	30	29	28	27	26	25	24
Reserved							
R-0h							
23	22	21	20	19	18	17	16
Reserved							
R-0h							
15	14	13	12	11	10	9	8
Reserved				Reserved			
R-0h				R-0h			
7	6	5	4	3	2	1	0
Reserved						Reserved	GFX_RST
R-0h						R-0h	R/W-0h

LEGEND: R/W = Read/Write; R = Read only; W1toCl = Write 1 to clear bit; -n = value after reset

Table 8-210. RM_GFX_RSTST Register Field Descriptions

Bit	Field	Type	Reset	Description
31-12	Reserved	R	0h	
11-2	Reserved	R	0h	
1	Reserved	R	0h	
0	GFX_RST	R/W	0h	GFX Domain Logic Reset 0x0 = RESET_NO : No SW reset occurred 0x1 = RESET_YES : GFX Domain Logic has been reset upon SW reset

8.1.13.8 PRM_CEFUSE Registers

[Table 8-211](#) lists the memory-mapped registers for the PRM_CEFUSE. All register offset addresses not listed in [Table 8-211](#) should be considered as reserved locations and the register contents should not be modified.

Table 8-211. PRM_CEFUSE REGISTERS

Offset	Acronym	Register Name	Section
0h	PM_CEFUSE_PWRSTCTRL	This register controls the CEFUSE power state to reach upon a domain sleep transition	Section 8.1.13.8.1
4h	PM_CEFUSE_PWRSTST	This register provides a status on the current CEFUSE power domain state. [warm reset insensitive]	Section 8.1.13.8.2

8.1.13.8.1 PM_CEFUSE_PWRSTCTRL Register (offset = 0h) [reset = 0h]

PM_CEFUSE_PWRSTCTRL is shown in [Figure 8-190](#) and described in [Table 8-212](#).

This register controls the CEFUSE power state to reach upon a domain sleep transition

Figure 8-190. PM_CEFUSE_PWRSTCTRL Register

31	30	29	28	27	26	25	24
Reserved							
R-0h							
23	22	21	20	19	18	17	16
Reserved							
R-0h							
15	14	13	12	11	10	9	8
Reserved							
R-0h							
7	6	5	4	3	2	1	0
Reserved			LowPowerState Change	Reserved			PowerState
R-0h			R/W-0h	R-0h			R/W-0h

LEGEND: R/W = Read/Write; R = Read only; W1toCl = Write 1 to clear bit; -n = value after reset

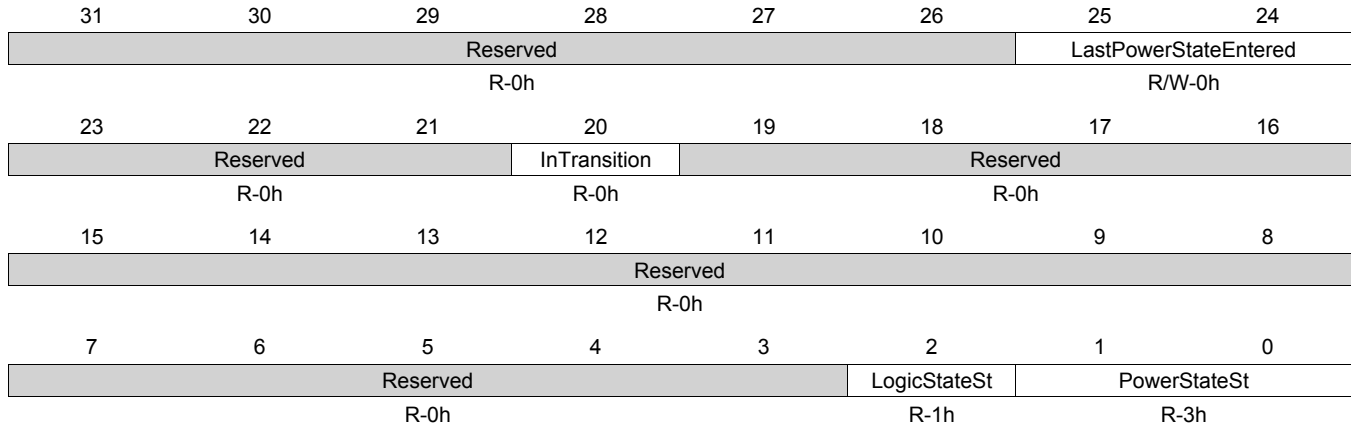
Table 8-212. PM_CEFUSE_PWRSTCTRL Register Field Descriptions

Bit	Field	Type	Reset	Description
31-5	Reserved	R	0h	
4	LowPowerStateChange	R/W	0h	Power state change request when domain has already performed a sleep transition. Allows going into deeper low power state without waking up the power domain. 0x0 = DIS : Do not request a low power state change. 0x1 = EN : Request a low power state change. This bit is automatically cleared when the power state is effectively changed or when power state is ON.
3-2	Reserved	R	0h	
1-0	PowerState	R/W	0h	Power state control 0x0 = OFF : OFF state 0x1 = Reserved : Reserved 0x2 = INACT : INACTIVE state 0x3 = ON : ON State

8.1.13.8.2 PM_CEFUSE_PWRSTST Register (offset = 4h) [reset = 7h]

 PM_CEFUSE_PWRSTST is shown in [Figure 8-191](#) and described in [Table 8-213](#).

This register provides a status on the current CEFUSE power domain state. [warm reset insensitive]

Figure 8-191. PM_CEFUSE_PWRSTST Register


LEGEND: R/W = Read/Write; R = Read only; W1toCl = Write 1 to clear bit; -n = value after reset

Table 8-213. PM_CEFUSE_PWRSTST Register Field Descriptions

Bit	Field	Type	Reset	Description
31-26	Reserved	R	0h	
25-24	LastPowerStateEntered	R/W	0h	Last low power state entered. Set to 0x3 upon write of the same only. This register is intended for debug purpose only. 0x0 = OFF : Power domain was previously OFF 0x1 = ON : Power domain was previously ON-ACTIVE
23-21	Reserved	R	0h	
20	InTransition	R	0h	Domain transition status 0x0 = No : No on-going transition on power domain 0x1 = Ongoing : Power domain transition is in progress.
19-3	Reserved	R	0h	
2	LogicStateSt	R	1h	Logic state status 0x0 = OFF : Logic in domain is OFF 0x1 = ON : Logic in domain is ON
1-0	PowerStateSt	R	3h	Current power state status 0x0 = OFF : Power domain is OFF 0x1 = RET : Power domain is in RETENTION 0x2 = INACTIVE : Power domain is ON-INACTIVE 0x3 = ON : Power domain is ON-ACTIVE

Control Module

This chapter describes the control module of the device.

Topic	Page
9.1 Introduction	1356
9.2 Functional Description	1356
9.3 Registers	1365

9.1 Introduction

The control module includes status and control logic not addressed within the peripherals or the rest of the device infrastructure. This module provides interface to control the following areas of the device:

- Functional I/O multiplexing
- Emulation controls
- Device control and status
- DDR PHY control and IO control registers
- EDMA event multiplexing control registers

Note: For writing to the control module registers, the MPU will need to be in privileged mode of operation and writes will not work from user mode.

9.2 Functional Description

9.2.1 Control Module Initialization

The control module responds only to the internal POR and device type. At power on, reset values for the registers define the safe state for the device. In the initialization mode, only modules to be used at boot time are associated with the pads. Other module inputs are internally tied and output pads are turned off. After POR, software sets the pad functional multiplexing and configuration registers to the desired values according to the requested device configuration.

General-purpose (GP) devices include features that are inaccessible or unavailable. These inaccessible registers define the default or fixed device configuration or behavior.

The CONTROL_STATUS[7:0] SYS_BOOT bit field reflects the state of the sys_boot pins captured at POR in the PRCM module.

9.2.2 Pad Control Registers

The Pad Control Registers are 32-bit registers to control the signal muxing and other aspects of each I/O pad. After POR, software must set the pad functional multiplexing and configuration registers to the desired values according to the requested device configuration. The configuration is controlled by pads or by a group of pads. Each configurable pin has its own configuration register for pullup/down control and for the assignment to a given module.

The following table shows the generic Pad Control Register Description.

Table 9-1. Pad Control Register Field Descriptions

Bit	Field	Value	Description
31-7	Reserved		Reserved. Read returns 0.
6	SLEWCTRL	0 1	Select between faster or slower slew rate. Fast Slow ⁽¹⁾
5	RXACTIVE	0 1	Input enable value for the Pad. Set to 0 for output only. Set to 1 for input or output. Receiver disabled Receiver enabled
4	PULLTYPESEL	0 1	Pad pullup/pulldown type selection Pulldown selected Pullup selected
3	PULLUDEN	0 1	Pad Pullup/pulldown enable Pullup/pulldown enabled. Pullup/pulldown disabled.
2-0	MUXMODE		Pad functional signal mux select

⁽¹⁾ Some peripherals do not support slow slew rate. To determine which interfaces support each slew rate, see *AM335x Sitara Processors* (literature number [SPRS717](#)).

9.2.2.1 Mode Selection

The MUXMODE field in the pad control registers defines the multiplexing mode applied to the pad. Modes are referred to by their decimal (from 0 to 7) or binary (from 0b000 to 0b111) representation. For most pads, the reset value for the MUXMODE field in the registers is 0b111. The exceptions are pads to be used at boot time to transfer data from selected peripherals to the external flash memory.

Table 9-2. Mode Selection

MUXMODE	Selected Mode
000b	Primary Mode = Mode 0
001b	Mode 1
010b	Mode 2
011b	Mode 3
100b	Mode 4
101b	Mode 5
110b	Mode 6
111b	Mode 7

Mode 0 is the primary mode. When mode 0 is set, the function mapped to the pin corresponds to the name of the pin. Mode 1 to mode 7 are possible modes for alternate functions. On each pin, some modes are used effectively for alternate functions, while other modes are unused and correspond to no functional configuration.

9.2.2.2 Pull Selection

There is no automatic gating control to ensure that internal weak pull-down/pull up resistors on a pad are disconnected whenever the pad is configured as output. If a pad is always configured in output mode, it is recommended for user software to disable any internal pull resistor tied to it, to avoid unnecessary consumption. The following table summarizes the various possible combinations of PULLTYPESEL and PULLUDEN fields of PAD control register.

Table 9-3. Pull Selection

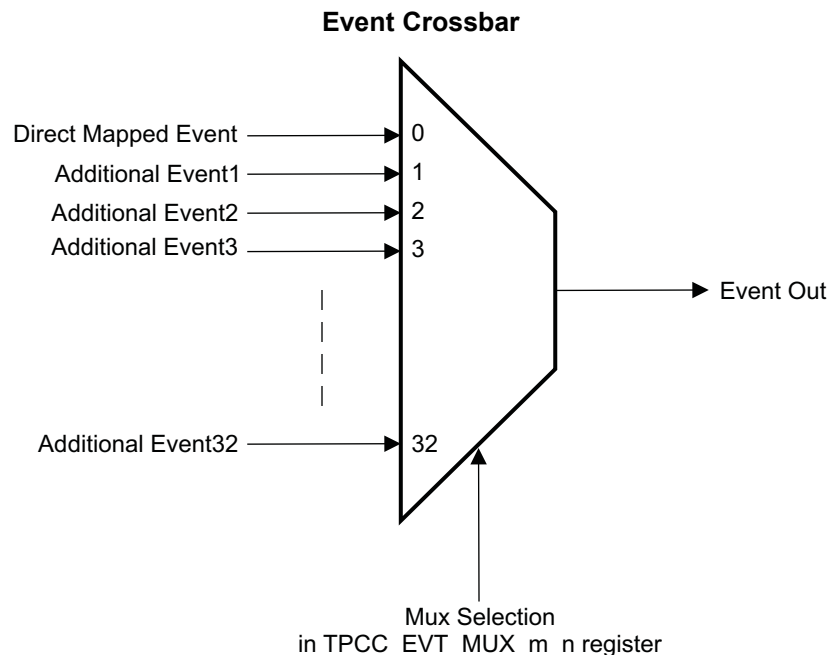
PULL TYPE		Pin Behavior
PULLTYPESEL	PULLUDENABLE	
0b	0b	Pulldown selected and activated
0b	1b	Pulldown selected but not activated
1b	0b	Pullup selected and activated
1b	1b	Pullup selected but not activated

9.2.2.3 RX Active

The RXACTIVE bit is used to enable and disable the input buffer. This control can be used to help with power leakage or device isolation through the I/O. The characteristic of the signal is ultimately dictated by the mux mode the pad is put into.

9.2.3 EDMA Event Multiplexing

The device has more DMA events than can be accommodated by the TPCC's maximum number of events, which is 64. To overcome the device has one crossbar at the top level. This module will multiplex the extra events with all of the direct mapped events. Mux control registers are defined in the Control Module to select the event to be routed to the TPCC. Direct mapped event is the default (mux selection set to '0').



For every EDMA event there is a cross bar implemented in the design as shown in the figure. The direct mapped event/interrupt will be always connected to Mux input[0], The additional events will be connected to Mux input[1], Mux input[2], etc as defined in EDMA event table. The Mux selection value is programmed into the corresponding TPCC_EVT_MUX_n register. The EVT_MUX value can take a value from 1 to 32. Other values are reserved. By default the MUX_selection value is written to 0, which means the direct mapped event is connected to the Event output.

When the additional event is selected through the Cross bar programming the direct mapped event cannot be used.

For example, when TINT0 (Timer Interrupt 0) event, which is not directly mapped to the DMA event source needs to be connected to EDMA channel no 24 (which is directly mapped to SDTXEVT0 event). The user has to program the EVT_MUX_24 field in TPCC_EVT_MUX_24_27 register to 22 (value corresponding to TINT0 interrupt in crossbar mapping). When this is set, TINT0 interrupt event will trigger the channel 24.

Please note that once this is set. The SDTXEVT0 can no longer be handled by EDMA. The user has to allocate the correct DMA event number for crossbar mapped events so that there is no compromise on the channel allocation for the used event numbers.

9.2.4 Device Control and Status

9.2.4.1 Control and Boot Status

The device configuration is set during power on or hardware reset (PORz sequence) by the configuration input pins (SYSBOOT[15:0]). The CONTROL_STATUS register reflects the system boot and the device type configuration values as sampled when the power-on reset (PORz) signal is asserted. The Configuration input pins are sampled continuously during the PORz active period and the final sampled value prior to the last rising edge is latched in the register. The CONTROL_STATUS register gives the status of the device boot process.

9.2.4.2 Interprocessor Communication

The control module has the IPC_MSG_REG (7:0) registers which is for sharing messages between Cortex M3 and the Cortex A8 MPU. The M3 TX end of event (M3_TXEV_EOI) register provides the mechanism to clear/enable the TX Event from Cortex M3 to Cortex A8 MPU Subsystem. See the M3_TXEV_EOI register description for further detail.

See [Section 8.1.4.6, Functional Sequencing for Power Management with Cortex M3](#), for specific information on how the IPC_MSG_REG registers are used to communicate with the Cortex-M3 firmware.

9.2.4.3 Initiator Priority Control

The control module provides the registers to control the bus interconnect priority and the EMIF priority.

9.2.4.3.1 Initiator Priority Control for Interconnect

The INIT_PRIORITY_n register controls the infrastructure priority at the bus interconnects. This can be used for dynamic priority escalation. There are bit fields that control the interconnect priority for each bus initiator. By default all the initiators are given equal priority and the allocation is done on a round robin basis.

The priority can take a value from 0 to 3. The following table gives the valid set of priority values.

Table 9-4. Interconnect Priority Values

Interconnect Priority Value	Remarks
00	Low priority
01	Medium priority
10	Reserved
11	High priority

9.2.4.3.2 Initiator Priority at EMIF

The MREQPRIO register provides an interface to change the access priorities for the various masters accessing the EMIF(DDR). Software can make use of this register to set the requestor priorities for required EMIF arbitration. The EMIF priority can take a value from 000b to 111b where 000b will be the highest priority and 111b will be lowest priority.

9.2.4.4 Peripheral Control and Status

9.2.4.4.1 USB Control and Status

The USB_CTRLn and USB_STSn registers reflect the Control and Status of the USB instances. The USB IO lines can be used as UART TX and RX lines the USB Control register bit field GPIOMODE has settings that configures the USB lines as GPIO lines. The other USB PHY control settings for controlling the OTG settings and PHY are part of the USB_CTRLn register.

The USB_STSn register gives the status of the USB PHY module. See the USB_STSn register description for further details.

See [Section 16.2.4, USB GPIO Details](#), for more information.

9.2.4.4.2 USB Charger Detect

Each USB PHY contains circuitry which can automatically detect the presence of a charger attached to the USB port. The charger detection circuitry is compliant to the Battery Charging Specification Revision 1.1 from the USB Implementers Forum, which can be found at www.usb.org. See this document for more details on USB charger implementation.

9.2.4.4.2.1 Features

The charger detection circuitry of each PHY has the following features:

- Contains a state machine which can automatically detect the presence of a Charging Downstream Port or a Dedicated Charging Port (see the Battery Charging Specification for the definition of these terms)
- Outputs a charger enable signal (3.3 V level active high CMOS driver) when a charger is present.
- Allows you to enable/disable the circuitry to save power
- The detection circuitry requires only a 3.3-V supply to be present to operate.
- The charger detection also has a manual mode which allows the user to implement the battery charging specification in software.

9.2.4.4.2.2 Operation

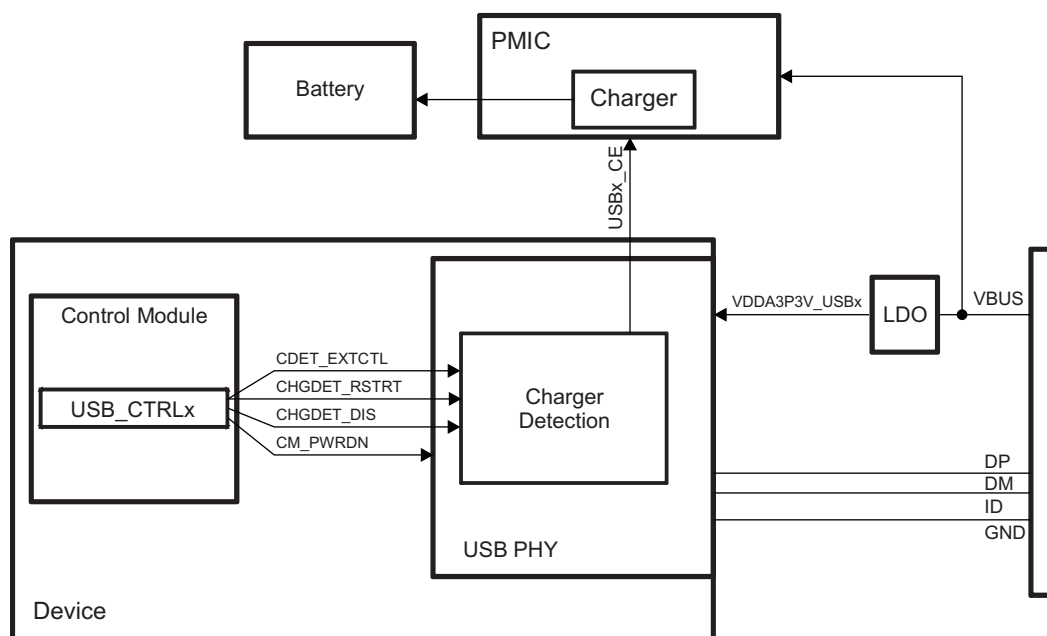
The control module gives the following interface to control the automatic charger detection circuitry:

- USB_CTRLx.CDET_EXTCTL: Turns the automatic detection on/off. Keep this bit 0 to keep the automatic detection on. Changing this to 1 enables the manual mode.
- USB_CTRLx.CHGDET_RSTRT: Restarts the charger detection state machine. To initiate the charger detection, change this bit from 1 to 0. If this bit is 1, the charger enable output (CE) is disabled.
- USB_CTRLx.CHGDET_DIS: Enables/disables the charger detection circuitry. Keep this bit 0 to keep this charger detection enabled. Setting this bit to 1 will power down the charger detection circuitry.
- USB_CTRLx.CM_PWRDN: Powers up/down the PHY which contains the charger detection circuitry. Clear this bit to 0 to enable power to the PHY.

To start the charger detection during normal operation, ensure that the PHY and charger are enabled and the automatic detection is turned on. Then, initiate a charger detection cycle by transitioning CHGDET_RSTRT from 1 to 0. If a Charging Downstream Port or a Dedicated Charging Port is detected, the charger enable signal (USBx_CE) will be driven high and remain high until the charger is disabled by either CHGDET_DIS = 1 or CHGDET_RSTRT=1. If the port remains unconnected after initiating the charger detect cycle, it will continue the detection until a charger is detected or an error condition occurs. Note that USBx_CE is not an open drain output.

To disable the charger after successful detection, you must disable the charger detect circuitry with CHGDET_DIS or CHGDET_RSTRT, even if the charger is physically disconnected.

Figure 9-1. USB Charger Detection



Charger detection can be automatically started with no power to the rest of AM335x. If VDDA3P3V_USBx is present, via an LDO powered by VBUS connected to a host, the charger detection state machine will automatically start and perform detection. If a charger is detected, USBx_CE will be driven high, otherwise it will be driven low.

The charger detection circuitry performs the following steps of the Battery Charging specification v1.1:

1. VBUS Detect
2. Data Contact Detect
3. Primary Detection

Secondary Detection (to distinguish between a Charging Downstream Port and a Dedicated Charging Port) is a newly added feature of the v1.2 spec and is not implemented in the charger detection state machine.

9.2.4.4.3 Ethernet MII Mode Selection

The control module provides a mechanism to select the Mode of operation of Ethernet MII interface. The GMII_SEL register has register bit fields to select the MII/RMII/RGMII modes, clock sources, and delay mode.

9.2.4.4.4 Ethernet Module Reset Isolation Control

This feature allows the device to undergo a warm reset without disrupting the switch or traffic being routed through the switch during the reset condition. The CPSW Reset Isolation register (RESET_ISO) has an ISO_CONTROL field which controls the reset isolation feature.

If the reset isolation is enabled, any warm reset source will be blocked to the EMAC switch. If the EMAC reset isolation is NOT active (default state), then the warm reset sources are allowed to propagate as normal including to the EMAC Switch module (both reset inputs to the IP). All cold or POR resets will always propagate to the EMAC switch module as normal.

When RESET_ISO is enabled, the following registers will not be disturbed by a warm reset:

- GMII_SEL
- CONF_GPMC_A[11:0]
- CONF_GPMC_WAIT0
- CONF_GPMC_WPN
- CONF_GPMC_BEN1
- CONF_MII1_COL
- CONF_MII1_CRS
- CONF_MII1_RX_ER
- CONF_MII1_TX_EN
- CONF_MII1_RX_DV
- CONF_MII1_TXD[3:0]
- CONF_MII1_TX_CLK
- CONF_MII1_RX_CLK
- CONF_MII1_RXD[3:0]
- CONF_RMII1_REF_CLK
- CONF_MDIO
- CONF_MDC

9.2.4.4.5 Timer/eCAP Event Capture Control

The Timer 5, 6, 7 events and the eCAP0, 1, 2 events can be selected using the TIMER_EVT_CAPTURE and ECAP_EVT_CAPTURE registers. The following table lists the available sources for those events.

Table 9-5. Available Sources for Timer[5–7] and eCAP[0–2] Events

Event No.	Source module	Interrupt Name/Pin
0	For Timer 5 MUX input from IO signal TIMER5	TIMER5 IO pin
	For Timer 6 MUX input from IO signal TIMER6	TIMER6 IO pin
	For Timer 7 MUX input from IO signal TIMER7	TIMER7 IO pin
	For eCAP 0 MUX input from IO signal eCAP0	eCAP0 IO pin
	For eCAP 1 MUX input from IO signal eCAP1	eCAP1 IO pin
	For eCAP 2 MUX input from IO signal eCAP2	eCAP2 IO pin
1	UART0	UART0INT
2	UART1	UART1INT
3	UART2	UART2INT
4	UART3	UART3INT
5	UART4	UART4INT
6	UART5	UART5INT
7	3PGSW	3PGSWRXTHRO
8	3PGSW	3PGSWRXINT0
9	3PGSW	3PGSWTXINT0
10	3PGSW	3PGSWMISCO
11	McASP0	MCATXINT0
12	McASP0	MCARXINT0
13	McASP1	MCATXINT1
14	McASP1	MCARXINT1
15	Reserved	Reserved
16	Reserved	Reserved
17	GPIO 0	GPIOINT0A
18	GPIO 0	GPIOINT0B
19	GPIO 1	GPIOINT1A
20	GPIO 1	GPIOINT1B
21	GPIO 2	GPIOINT2A
22	GPIO 2	GPIOINT2B
23	GPIO 3	GPIOINT3A
24	GPIO 3	GPIOINT3B
25	DCAN0	DCAN0_INT0
26	DCAN0	DCAN0_INT1
27	DCAN0	DCAN0_PARITY
28	DCAN1	DCAN1_INT0
29	DCAN1	DCAN1_INT1
30	DCAN1	DCAN1_PARITY

9.2.4.4.6 ADC Capture Control

The following chip level events can be connected through the software-controlled multiplexer to the TSC_ADC module.

1. PRU-ICSS Host Event 0
2. Timer 4 Event
3. Timer 5 Event
4. Timer 6 Event
5. Timer 7 Event

This pin is the external hardware trigger to start the ADC channel conversion. The ADC_EVT_CAPT register needs to be programmed to select the proper source for this conversion.

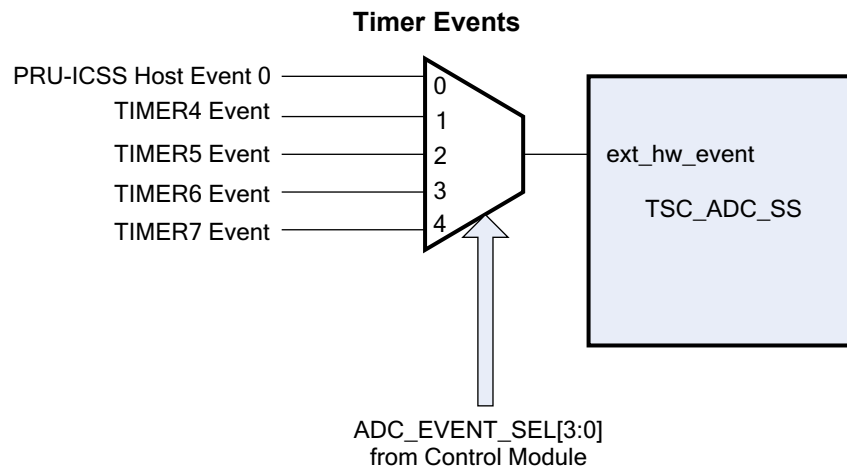


Table 9-6 contains the value to be programmed in the selection mux.

Table 9-6. Selection Mux Values

ADC_EVENT_SEL Value	ADC External event selected
000	PRU-ICSS Host Event 0
001	Timer 4 Event
010	Timer 5 Event
011	Timer 6 Event
100	Timer 7 Event
101-111	Reserved

9.2.4.4.7 SRAM LDO Control

The device incorporates two instances of the SRAM LDO (VSLDO) module. One of these LDOs powers the ARM internal SRAM and the other powers the OCMC SRAMs. In the SMA2 register, the VSLDO_CORE_AUTO_RAMP_EN bit, when set, allows the VSLDO, which powers the OCMC SRAMs, to be put into retention during deepsleep and enable lower power consumption. Since the VSLDO is shared between WKUP M3 memories and CORE memories, the VSLDO has to be brought out of retention on any wakeup event. This bit allows this functionality and should be set to allow proper sleep/wakeup operation during Standby and DeepSleep modes. Similar functionality is not necessary for the LDO powering the ARM internal SRAM. It can be put in retention mode using PRM_LDO_SRAM_MPU_CTRL.

9.2.5 DDR PHY

Table 9-7. DDR Slew Rate Control Settings⁽¹⁾⁽²⁾

sr1	sr0	Slew Rate Level
0	0	Fastest
1	0	Fast
0	1	Slow
1	1	Slowest

⁽¹⁾ These values are programmed in the following registers: ddr_cmd0_ioctrl, ddr_cmd1_ioctrl, ddr_cmd2_ioctrl, ddr_data0_ioctrl, ddr_data1_ioctrl.

⁽²⁾ Values for DDR_CMDx_IOCTL.io_config_sr_clk should be programmed to the same value.

Table 9-8. DDR Impedance Control Settings⁽¹⁾⁽²⁾⁽³⁾

I2	I1	I0	Output Impedance (R _{on})	Drive Strength I _{OH} , I _{OL}	Example: R _{on} for R _{ext} = 49.9 ohms	Example: I _{OH} , I _{OL} for R _{ext} = 49.9 ohms
0	0	0	1.6*R _{ext}	0.625*I _{out}	80 ohms	5 mA
0	0	1	1.33*R _{ext}	0.75*I _{out}	67 ohms	6 mA
0	1	0	1.14*R _{ext}	0.875*I _{out}	57 ohms	7 mA
0	1	1	R _{ext}	I _{out}	50 ohms	8 mA
1	0	0	0.88*R _{ext}	1.125*I _{out}	44 ohms	9 mA
1	0	1	0.8*R _{ext}	1.250*I _{out}	40 ohms	10 mA
1	1	0	0.73*R _{ext}	1.375*I _{out}	36 ohms	11 mA
1	1	1	0.67*R _{ext}	1.5*I _{out}	33 ohms	12 mA

⁽¹⁾ These values are programmed in the following registers: ddr_cmd0_ioctrl, ddr_cmd1_ioctrl, ddr_cmd2_ioctrl, ddr_data0_ioctrl, ddr_data1_ioctrl.

⁽²⁾ Values for DDR_CMDx_IOCTL.io_config_i_clk should be programmed to the same value.

⁽³⁾ R_{ext} is the external VTP compensation resistor connected to DDR_VTP terminal.

9.2.5.1 DDR PHY to IO Pin Mapping

The following table describes the DDR PHY to IO pin mapping.

Table 9-9. DDR PHY to IO Pin Mapping

Macro Pin	CMD0	CMD1	CMD2	DATA0	DATA1
0	ddr_ba2	Unconn	ddr_cke	ddr_d8	ddr_d0
1	ddr_wen	ddr_a15	ddr_resetn	ddr_d9	ddr_d1
2	ddr_ba0	ddr_a2	ddr_odt	ddr_d10	ddr_d2
3	ddr_a5	ddr_a12	Unconn	ddr_d11	ddr_d3
4	ddr_ck	ddr_a7	ddr_a14	ddr_d12	ddr_d4
5	ddr_ckn	ddr_ba1	ddr_a13	ddr_d13	ddr_d5
6	ddr_a3	ddr_a10	ddr_csn0	ddr_d14	ddr_d6
7	ddr_a4	ddr_a0	Unconn	ddr_d15	ddr_d7
8	ddr_a8	ddr_a11	ddr_a1	ddr_dqm1	ddr_dqm0
9	ddr_a9	ddr_casn	Unconn	ddr_dqs1	ddr_dqs0
10	ddr_a6	ddr_rasn	Unconn	ddr_dqsn1	ddr_dqsn0

9.3 Registers

9.3.1 CONTROL_MODULE Registers

Table 9-10 lists the memory-mapped registers for the CONTROL_MODULE. All other register offset addresses not listed in Table 9-10 should be considered as reserved locations and the register contents should not be modified.

Table 9-10. CONTROL_MODULE REGISTERS

Offset	Acronym	Register Description	Section
0h	control_revision		Section 9.3.1.1
4h	control_hwinfo		Section 9.3.1.2
10h	control_sysconfig		Section 9.3.1.3
40h	control_status		Section 9.3.1.4
110h	control_emif_sdram_config		control_emif_sdram_config Register (offset = 110h) [reset = 0h]
428h	core_sldo_ctrl		Section 9.3.1.5
42Ch	mpu_sldo_ctrl		Section 9.3.1.6
444h	clk32kdivratio_ctrl		Section 9.3.1.7
448h	bandgap_ctrl		Section 9.3.1.8
44Ch	bandgap_trim		Section 9.3.1.9
458h	pll_clkinpulow_ctrl		Section 9.3.1.10
468h	mosc_ctrl		Section 9.3.1.11
470h	deepsleep_ctrl		Section 9.3.1.12
50Ch	dppl_pwr_sw_status		Section 9.3.1.13
600h	device_id		Section 9.3.1.14
604h	dev_feature		Section 9.3.1.15
608h	init_priority_0		Section 9.3.1.16
60Ch	init_priority_1		Section 9.3.1.17
614h	tptc_cfg		Section 9.3.1.18
620h	usb_ctrl0		Section 9.3.1.19
624h	usb_sts0		Section 9.3.1.20
628h	usb_ctrl1		Section 9.3.1.21
62Ch	usb_sts1		Section 9.3.1.22
630h	mac_id0_lo		Section 9.3.1.23
634h	mac_id0_hi		Section 9.3.1.24
638h	mac_id1_lo		Section 9.3.1.25
63Ch	mac_id1_hi		Section 9.3.1.26
644h	dcan_raminit		Section 9.3.1.27
648h	usb_wkup_ctrl		Section 9.3.1.28
650h	gmii_sel		Section 9.3.1.29
664h	pwmss_ctrl		Section 9.3.1.30
670h	mreqprio_0		Section 9.3.1.31
674h	mreqprio_1		Section 9.3.1.32
690h	hw_event_sel_grp1		Section 9.3.1.33
694h	hw_event_sel_grp2		Section 9.3.1.34
698h	hw_event_sel_grp3		Section 9.3.1.35
69Ch	hw_event_sel_grp4		Section 9.3.1.36
6A0h	smrt_ctrl		Section 9.3.1.37
6A4h	mpuss_hw_debug_sel		Section 9.3.1.38

Table 9-10. CONTROL_MODULE REGISTERS (continued)

Offset	Acronym	Register Description	Section
6A8h	mpuss_hw_dbg_info		Section 9.3.1.39
770h	vdd_mpu_opp_050		Section 9.3.1.40
774h	vdd_mpu_opp_100		Section 9.3.1.41
778h	vdd_mpu_opp_120		Section 9.3.1.42
77Ch	vdd_mpu_opp_turbo		Section 9.3.1.43
7B8h	vdd_core_opp_050		Section 9.3.1.44
7BCh	vdd_core_opp_100		Section 9.3.1.45
7D0h	bb_scale		Section 9.3.1.46
7F4h	usb_vid_pid		Section 9.3.1.47
7FCh	efuse_sma		Section 9.3.1.48
800h	conf_gpmmc_ad0	See the device datasheet for information on default pin mux configurations. Note that the device ROM may change the default pin mux for certain pins based on the SYSBOOT mode settings.	Section 9.3.1.49
804h	conf_gpmmc_ad1		Section 9.3.1.49
808h	conf_gpmmc_ad2		Section 9.3.1.49
80Ch	conf_gpmmc_ad3		Section 9.3.1.49
810h	conf_gpmmc_ad4		Section 9.3.1.49
814h	conf_gpmmc_ad5		Section 9.3.1.49
818h	conf_gpmmc_ad6		Section 9.3.1.49
81Ch	conf_gpmmc_ad7		Section 9.3.1.49
820h	conf_gpmmc_ad8		Section 9.3.1.49
824h	conf_gpmmc_ad9		Section 9.3.1.49
828h	conf_gpmmc_ad10		Section 9.3.1.49
82Ch	conf_gpmmc_ad11		Section 9.3.1.49
830h	conf_gpmmc_ad12		Section 9.3.1.49
834h	conf_gpmmc_ad13		Section 9.3.1.49
838h	conf_gpmmc_ad14		Section 9.3.1.49
83Ch	conf_gpmmc_ad15		Section 9.3.1.49
840h	conf_gpmmc_a0		Section 9.3.1.49
844h	conf_gpmmc_a1		Section 9.3.1.49
848h	conf_gpmmc_a2		Section 9.3.1.49
84Ch	conf_gpmmc_a3		Section 9.3.1.49
850h	conf_gpmmc_a4		Section 9.3.1.49
854h	conf_gpmmc_a5		Section 9.3.1.49
858h	conf_gpmmc_a6		Section 9.3.1.49
85Ch	conf_gpmmc_a7		Section 9.3.1.49
860h	conf_gpmmc_a8		Section 9.3.1.49
864h	conf_gpmmc_a9		Section 9.3.1.49
868h	conf_gpmmc_a10		Section 9.3.1.49
86Ch	conf_gpmmc_a11		Section 9.3.1.49
870h	conf_gpmmc_wait0		Section 9.3.1.49
874h	conf_gpmmc_wpn		Section 9.3.1.49
878h	conf_gpmmc_ben1		Section 9.3.1.49
87Ch	conf_gpmmc_csn0		Section 9.3.1.49
880h	conf_gpmmc_csn1		Section 9.3.1.49
884h	conf_gpmmc_csn2		Section 9.3.1.49
888h	conf_gpmmc_csn3		Section 9.3.1.49

Table 9-10. CONTROL_MODULE REGISTERS (continued)

Offset	Acronym	Register Description	Section
88Ch	conf_gpmmc_clk		Section 9.3.1.49
890h	conf_gpmmc_advn_ale		Section 9.3.1.49
894h	conf_gpmmc_oen_ren		Section 9.3.1.49
898h	conf_gpmmc_wen		Section 9.3.1.49
89Ch	conf_gpmmc_ben0_cle		Section 9.3.1.49
8A0h	conf_lcd_data0		Section 9.3.1.49
8A4h	conf_lcd_data1		Section 9.3.1.49
8A8h	conf_lcd_data2		Section 9.3.1.49
8ACh	conf_lcd_data3		Section 9.3.1.49
8B0h	conf_lcd_data4		Section 9.3.1.49
8B4h	conf_lcd_data5		Section 9.3.1.49
8B8h	conf_lcd_data6		Section 9.3.1.49
8BCh	conf_lcd_data7		Section 9.3.1.49
8C0h	conf_lcd_data8		Section 9.3.1.49
8C4h	conf_lcd_data9		Section 9.3.1.49
8C8h	conf_lcd_data10		Section 9.3.1.49
8CCh	conf_lcd_data11		Section 9.3.1.49
8D0h	conf_lcd_data12		Section 9.3.1.49
8D4h	conf_lcd_data13		Section 9.3.1.49
8D8h	conf_lcd_data14		Section 9.3.1.49
8DCh	conf_lcd_data15		Section 9.3.1.49
8E0h	conf_lcd_vsync		Section 9.3.1.49
8E4h	conf_lcd_hsync		Section 9.3.1.49
8E8h	conf_lcd_pclk		Section 9.3.1.49
8ECh	conf_lcd_ac_bias_en		Section 9.3.1.49
8F0h	conf_mmc0_dat3		Section 9.3.1.49
8F4h	conf_mmc0_dat2		Section 9.3.1.49
8F8h	conf_mmc0_dat1		Section 9.3.1.49
8FCh	conf_mmc0_dat0		Section 9.3.1.49
900h	conf_mmc0_clk		Section 9.3.1.49
904h	conf_mmc0_cmd		Section 9.3.1.49
908h	conf_mii1_col		Section 9.3.1.49
90Ch	conf_mii1_crs		Section 9.3.1.49
910h	conf_mii1_rx_er		Section 9.3.1.49
914h	conf_mii1_tx_en		Section 9.3.1.49
918h	conf_mii1_rx_dv		Section 9.3.1.49
91Ch	conf_mii1_txd3		Section 9.3.1.49
920h	conf_mii1_txd2		Section 9.3.1.49
924h	conf_mii1_txd1		Section 9.3.1.49
928h	conf_mii1_txd0		Section 9.3.1.49
92Ch	conf_mii1_tx_clk		Section 9.3.1.49
930h	conf_mii1_rx_clk		Section 9.3.1.49
934h	conf_mii1_rxd3		Section 9.3.1.49
938h	conf_mii1_rxd2		Section 9.3.1.49
93Ch	conf_mii1_rxd1		Section 9.3.1.49
940h	conf_mii1_rxd0		Section 9.3.1.49
944h	conf_rmii1_ref_clk		Section 9.3.1.49

Table 9-10. CONTROL_MODULE REGISTERS (continued)

Offset	Acronym	Register Description	Section
948h	conf_mdio		Section 9.3.1.49
94Ch	conf_mdc		Section 9.3.1.49
950h	conf_spi0_sclk		Section 9.3.1.49
954h	conf_spi0_d0		Section 9.3.1.49
958h	conf_spi0_d1		Section 9.3.1.49
95Ch	conf_spi0_cs0		Section 9.3.1.49
960h	conf_spi0_cs1		Section 9.3.1.49
964h	conf_ecap0_in_pwm0_out		Section 9.3.1.49
968h	conf_uart0_ctsn		Section 9.3.1.49
96Ch	conf_uart0_rtsn		Section 9.3.1.49
970h	conf_uart0_rxd		Section 9.3.1.49
974h	conf_uart0_txd		Section 9.3.1.49
978h	conf_uart1_ctsn		Section 9.3.1.49
97Ch	conf_uart1_rtsn		Section 9.3.1.49
980h	conf_uart1_rxd		Section 9.3.1.49
984h	conf_uart1_txd		Section 9.3.1.49
988h	conf_i2c0_sda		Section 9.3.1.49
98Ch	conf_i2c0_scl		Section 9.3.1.49
990h	conf_mcas0_aclkx		Section 9.3.1.49
994h	conf_mcas0_fsx		Section 9.3.1.49
998h	conf_mcas0_axr0		Section 9.3.1.49
99Ch	conf_mcas0_ahclr		Section 9.3.1.49
9A0h	conf_mcas0_aclkr		Section 9.3.1.49
9A4h	conf_mcas0_fsr		Section 9.3.1.49
9A8h	conf_mcas0_axr1		Section 9.3.1.49
9ACh	conf_mcas0_ahclx		Section 9.3.1.49
9B0h	conf_xdma_event_intr0		Section 9.3.1.49
9B4h	conf_xdma_event_intr1		Section 9.3.1.49
9B8h	conf_warmrstn		Section 9.3.1.49
9C0h	conf_nnmi		Section 9.3.1.49
9D0h	conf_tms		Section 9.3.1.49
9D4h	conf_tdi		Section 9.3.1.49
9D8h	conf_tdo		Section 9.3.1.49
9DCh	conf_tck		Section 9.3.1.49
9E0h	conf_trstn		Section 9.3.1.49
9E4h	conf_emu0		Section 9.3.1.49
9E8h	conf_emu1		Section 9.3.1.49
9F8h	conf_rtc_pwrnrstn		Section 9.3.1.49
9FCh	conf_pmic_power_en		Section 9.3.1.49
A00h	conf_ext_wakeup		Section 9.3.1.49
A04h	conf_rtc_kaldo_enn		Section 9.3.1.49
A1Ch	conf_usb0_drvvbus		Section 9.3.1.49
A34h	conf_usb1_drvvbus		Section 9.3.1.49
E00h	cqdetect_status		Section 9.3.1.50
E04h	ddr_io_ctrl		Section 9.3.1.51
E0Ch	vtp_ctrl		Section 9.3.1.52
E14h	vref_ctrl		Section 9.3.1.53

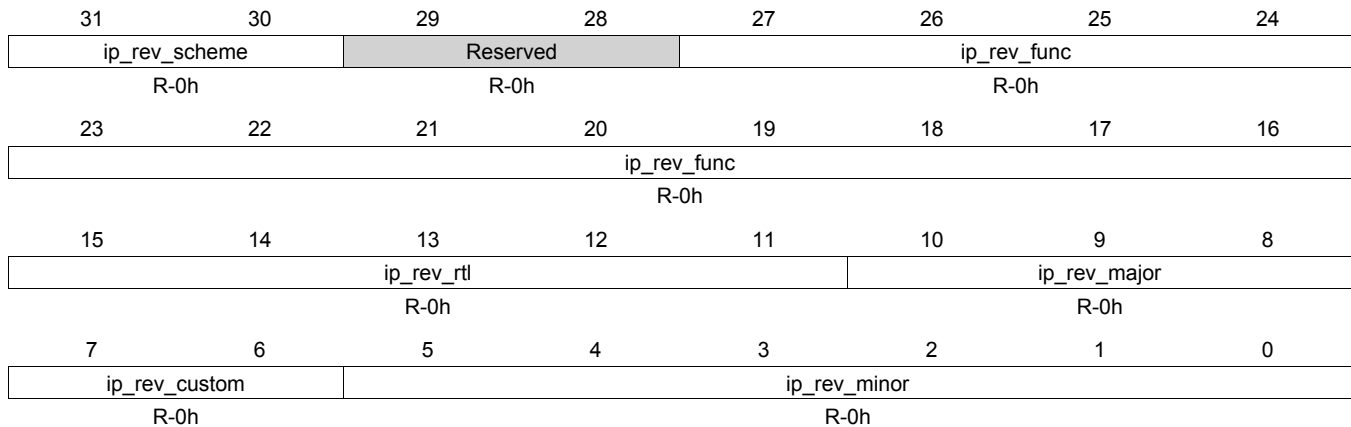
Table 9-10. CONTROL_MODULE REGISTERS (continued)

Offset	Acronym	Register Description	Section
F90h	tpcc_evt_mux_0_3		Section 9.3.1.54
F94h	tpcc_evt_mux_4_7		Section 9.3.1.55
F98h	tpcc_evt_mux_8_11		Section 9.3.1.56
F9Ch	tpcc_evt_mux_12_15		Section 9.3.1.57
FA0h	tpcc_evt_mux_16_19		Section 9.3.1.58
FA4h	tpcc_evt_mux_20_23		Section 9.3.1.59
FA8h	tpcc_evt_mux_24_27		Section 9.3.1.60
FACh	tpcc_evt_mux_28_31		Section 9.3.1.61
FB0h	tpcc_evt_mux_32_35		Section 9.3.1.62
FB4h	tpcc_evt_mux_36_39		Section 9.3.1.63
FB8h	tpcc_evt_mux_40_43		Section 9.3.1.64
FBCh	tpcc_evt_mux_44_47		Section 9.3.1.65
FC0h	tpcc_evt_mux_48_51		Section 9.3.1.66
FC4h	tpcc_evt_mux_52_55		Section 9.3.1.67
FC8h	tpcc_evt_mux_56_59		Section 9.3.1.68
FCCh	tpcc_evt_mux_60_63		Section 9.3.1.69
FD0h	timer_evt_capt		Section 9.3.1.70
FD4h	ecap_evt_capt		Section 9.3.1.71
FD8h	adc_evt_capt		Section 9.3.1.72
1000h	reset_iso		Section 9.3.1.73
1318h	dppl_pwr_sw_ctrl		Section 9.3.1.74
131Ch	ddr_cke_ctrl		Section 9.3.1.75
1320h	sma2		Section 9.3.1.76
1324h	m3_txev_eoi		Section 9.3.1.77
1328h	ipc_msg_reg0		Section 9.3.1.78
132Ch	ipc_msg_reg1		Section 9.3.1.79
1330h	ipc_msg_reg2		Section 9.3.1.80
1334h	ipc_msg_reg3		Section 9.3.1.81
1338h	ipc_msg_reg4		Section 9.3.1.82
133Ch	ipc_msg_reg5		Section 9.3.1.83
1340h	ipc_msg_reg6		Section 9.3.1.84
1344h	ipc_msg_reg7		Section 9.3.1.85
1404h	ddr_cmd0_ioctrl		Section 9.3.1.86
1408h	ddr_cmd1_ioctrl		Section 9.3.1.87
140Ch	ddr_cmd2_ioctrl		Section 9.3.1.88
1440h	ddr_data0_ioctrl		Section 9.3.1.89
1444h	ddr_data1_ioctrl		Section 9.3.1.90

9.3.1.1 control_revision Register (offset = 0h) [reset = 0h]

control_revision is shown in [Figure 9-2](#) and described in [Table 9-11](#).

Figure 9-2. control_revision Register



LEGEND: R/W = Read/Write; R = Read only; W1toCl = Write 1 to clear bit; -n = value after reset

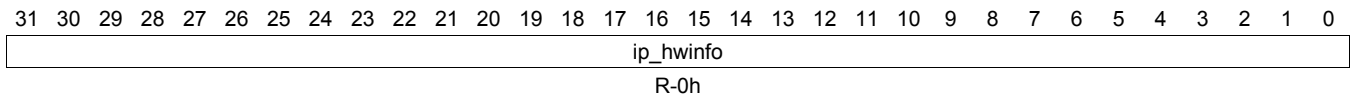
Table 9-11. control_revision Register Field Descriptions

Bit	Field	Type	Reset	Description
31-30	ip_rev_scheme	R	0h	01 - New Scheme
29-28	Reserved	R	0h	
27-16	ip_rev_func	R	0h	Function indicates a software compatible module family. If there is no level of software compatibility a new Func number (and hence REVISION) should be assigned.
15-11	ip_rev_rtl	R	0h	RTL Version (R).
10-8	ip_rev_major	R	0h	Major Revision (X).
7-6	ip_rev_custom	R	0h	Indicates a special version for a particular device. Consequence of use may avoid use of standard Chip Support Library (CSL) / Drivers - 00: Non custom (standard) revision
5-0	ip_rev_minor	R	0h	Minor Revision (Y).

9.3.1.2 control_hwinfo Register (offset = 4h) [reset = 0h]

control_hwinfo is shown in [Figure 9-3](#) and described in [Table 9-12](#).

Figure 9-3. control_hwinfo Register



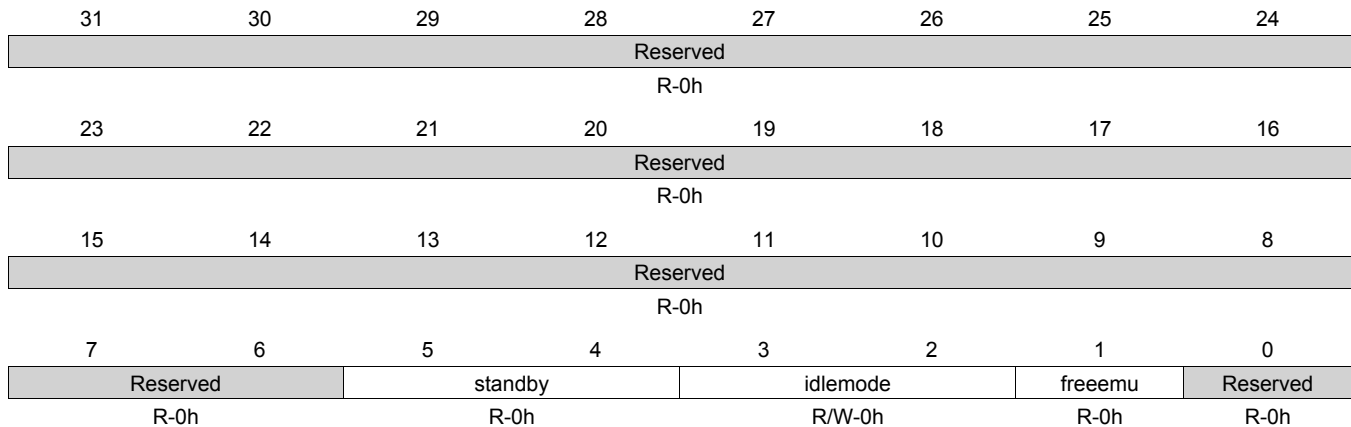
LEGEND: R/W = Read/Write; R = Read only; W1toCl = Write 1 to clear bit; -n = value after reset

Table 9-12. control_hwinfo Register Field Descriptions

Bit	Field	Type	Reset	Description
31-0	ip_hwinfo	R	0h	IP Module dependent

9.3.1.3 control_sysconfig Register (offset = 10h) [reset = 0h]

control_sysconfig is shown in [Figure 9-4](#) and described in [Table 9-13](#).

Figure 9-4. control_sysconfig Register


LEGEND: R/W = Read/Write; R = Read only; W1toCl = Write 1 to clear bit; -n = value after reset

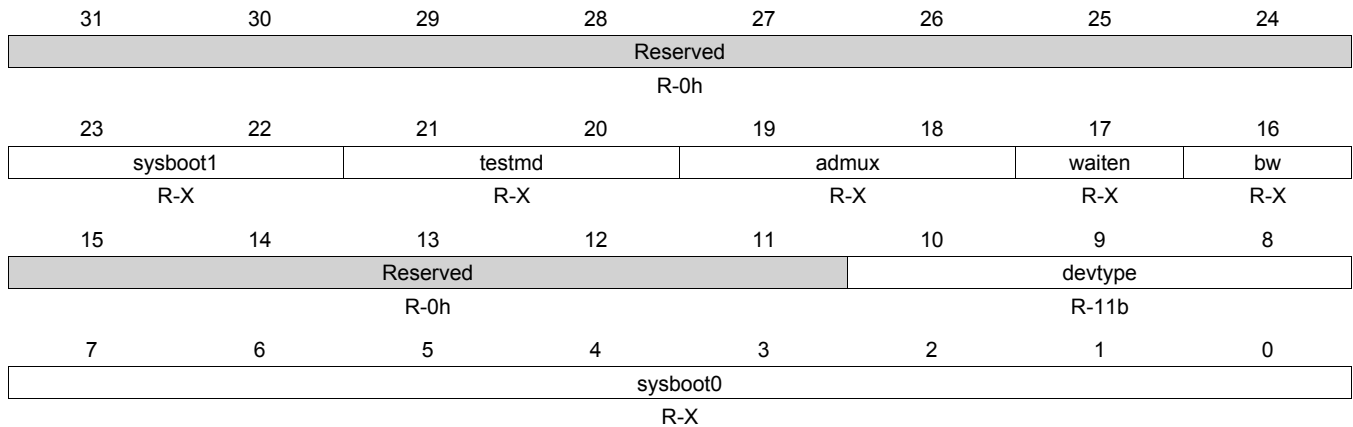
Table 9-13. control_sysconfig Register Field Descriptions

Bit	Field	Type	Reset	Description
31-6	Reserved	R	0h	
5-4	standby	R	0h	Configure local initiator state management 00: Force Standby 01: No Standby Mode 10: Smart Standby 11: Smart Standby wakeup capable Reserved in Control Module since it has no local initiator.
3-2	idlemode	R/W	0h	Configure local target state management 00: Force Idle 01: No Idle 10: Smart Idle 11: Smart Idle wakeup capable
1	freemu	R	0h	Sensitivity to Emulation suspend input. 0: Module is sensitive to EMU suspend 1: Module not sensitive to EMU suspend
0	Reserved	R	0h	

9.3.1.4 control_status Register (offset = 40h) [reset = 0h]

control_status is shown in [Figure 9-5](#) and described in [Table 9-14](#).

Figure 9-5. control_status Register



LEGEND: R/W = Read/Write; R = Read only; W1toCl = Write 1 to clear bit; -n = value after reset

Table 9-14. control_status Register Field Descriptions

Bit	Field	Type	Reset	Description
31-24	Reserved	R	0h	
23-22	sysboot1	R	X	Used to select crystal clock frequency. See SYSBOOT Configuration Pins. Reset value is from SYSBOOT[15:14].
21-20	testmd	R	X	Set to 00b. See SYSBOOT Configuration Pins for more information. Reset value is from SYSBOOT[13:12].
19-18	admux	R	X	GPMC CS0 Default Address Muxing 00: No Addr/Data Muxing 01: Addr/Addr/Data Muxing 10: Addr/Data Muxing 11: Reserved Reset value is from SYSBOOT[11:10].
17	waiten	R	X	GPMC CS0 Default Wait Enable 0: Ignore WAIT input 1: Use WAIT input See SYSBOOT Configuration Pins for more information. Reset value is from SYSBOOT[9].
16	bw	R	X	GPMC CS0 Default Bus Width 0: 8-bit data bus 1: 16-bit data bus See SYSBOOT Configuration Pins for more information. Reset value is from SYSBOOT[8].
15-11	Reserved	R	0h	
10-8	devtype	R	11b	000: Reserved 001: Reserved 010: Reserved 011: General Purpose (GP) Device 111: Reserved
7-0	sysboot0	R	X	Selected boot mode. See SYSBOOT Configuration Pins for more information. Reset value is from SYSBOOT[7:0].

control_emif_sdram_config Register (offset = 110h) [reset = 0h]

The CONTROL_EMIF_SDRAM_CONFIG register exports SDRAM configuration information to the EMIF after resuming from low power scenarios.

This register should be loaded with the same value as SDRAM_CONFIG during DDR initialization.

control_emif_sdram_config is shown in [Figure 9-6](#) and described in [Table 9-15](#).

Figure 9-6. control_emif_sdram_config Register

31	30	29	28	27	26	25	24
SDRAM_TYPE			IBANK_POS			DDR_TERM	
R/W-0h			R/W-0h			R/W-0h	
23	22	21	20	19	18	17	16
Reserved	DYN_ODT		Reserved	SDRAM_DRIVE		CWL	
R-0h	R/W-0h		R-0h	R/W-0h		R/W-0h	
15	14	13	12	11	10	9	8
NARROW_MODE		CL				ROWSIZE	
R/W-0h		R/W-0h				R/W-0h	
7	6	5	4	3	2	1	0
ROWSIZE	IBANK			EBANK	PAGESIZE		
R/W-0h	R/W-0h			R/W-0h	R/W-0h		

LEGEND: R/W = Read/Write; R = Read only; W1toCl = Write 1 to clear bit; -n = value after reset

Table 9-15. control_emif_sdram_config Register Field Descriptions

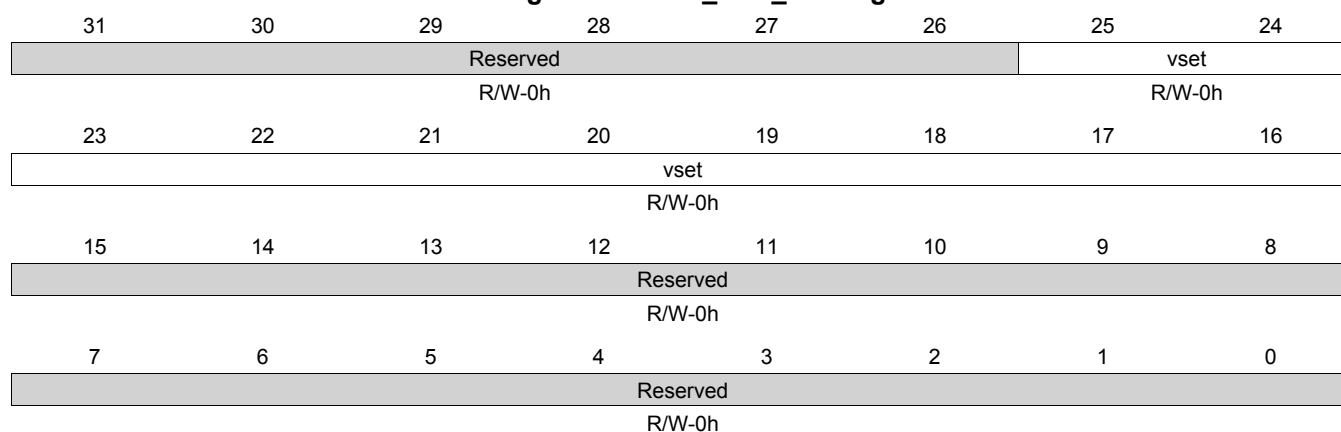
Bit	Field	Type	Reset	Description
31-29	SDRAM_TYPE	R/W	0h	SDRAM Type selection 000 – Reserved 001 – LPDDR1 010 – DDR2 011 – DDR3 100 – Reserved 101 – Reserved 110 – Reserved 111 – Reserved
28-27	IBANK_POS	R/W	0h	Internal bank position. 00 - All Bank Address bits assigned from OCP address above column address bits. 01 – Bank Address bits [1:0] assigned from OCP address above column address bits and bit [2] from OCP address bits above row address bits. 10 – Bank Address bit [0] assigned from OCP address above column address bits and bit [2:1] from OCP address bits above row address bits. 11 – All Bank Address bits assigned from OCP address bits above row address bits.
26-24	DDR_TERM	R/W	0h	DDR2 and DDR3 termination resistor value. Set to 0 to disable termination. For DDR2, set to 1 for 75 ohm, set to 2 for 150 ohm, and set to 3 for 50 ohm. For DDR3, set to 1 for RZQ/4, set to 2 for RZQ/2, set to 3 for RZQ/6, set to 4 for RZQ/12, and set to 5 for RZQ/8. All other values are reserved.
23	DDR2_DDQS	R	0h	Reserved. Defaults to 0 for single ended DQS. For differential operation, SDRAM_CONFIG register in the EMIF module must be written.

Table 9-15. control_emif_sdram_config Register Field Descriptions (continued)

Bit	Field	Type	Reset	Description
22-21	DYN_ODT	R/W	0h	DDR3 Dynamic ODT. Set to 0 to turn off dynamic ODT. Set to 1 for RZQ/4 and set to 2 for RZQ/2. All other values are reserved.
20	Reserved	R	0h	Reserved. Read returns 0.
19-18	SDRAM_DRIVE	R/W	0h	SDRAM drive strength. For DDR2, set to 0 for normal, and set to 1 for weak drive strength. For DDR3, set to 0 for RZQ/6 and set to 1 for RZQ/7. For LPDDR1, set to 0 for full, set to 1 for 1/2, set to 2 for 1/4, and set to 3 for 1/8 drive strength. All other values are reserved.
17-16	CWL	R/W	0h	DDR3 CAS Write latency. Value of 0, 1, 2, and 3 (CAS write latency of 5, 6, 7, and 8) are supported. Use the lowest value supported for best performance. All other values are reserved.
15-14	NARROW_MODE	R/W	0h	SDRAM data bus width. Set to 0 for 32-bit and set to 1 for 16-bit. All other values are reserved.
13-10	CL	R/W	0h	CAS Latency. The value of this field defines the CAS latency to be used when accessing connected SDRAM devices. Value of 2, 3, 4, and 5 (CAS latency of 2, 3, 4, and 5) are supported for DDR2. Value of 2, 4, 6, 8, 10, 12, and 14 (CAS latency of 5, 6, 7, 8, 9, 10, and 11) are supported for DDR3. All other values are reserved.
9-7	ROWSIZE	R/W	0h	Row Size. Defines the number of row address bits of connected SDRAM devices. Set to 0 for 9 row bits, set to 1 for 10 row bits, set to 2 for 11 row bits, set to 3 for 12 row bits, set to 4 for 13 row bits, set to 5 for 14 row bits, set to 6 for 15 row bits, and set to 7 for 16 row bits. This field is only used when ibank_pos field in SDRAM Config register is set to 1, 2, or 3.
6-4	IBANK	R/W	0h	Internal Bank setup. Defines number of banks inside connected SDRAM devices. Set to 0 for 1 bank, set to 1 for 2 banks, set to 2 for 4 banks, and set to 3 for 8 banks. All other values are reserved.
3	EBANK	R/W	0h	External chip select setup. Defines whether SDRAM accesses will use 1 or 2 chip select lines. Set to 0 to use pad_cs_o_n[0] only. Set to 1 to use pad_cs_o_n[1:0].
2-0	PAGESIZE	R/W	0h	Page Size. Defines the internal page size of connected SDRAM devices. Set to 0 for 256-word page (8 column bits), set to 1 for 512-word page (9 column bits), set to 2 for 1024-word page (10 column bits), and set to 3 for 2048-word page (11 column bits). All other values are reserved.

9.3.1.5 core_sldo_ctrl Register (offset = 428h) [reset = 0h]

core_sldo_ctrl is shown in [Figure 9-7](#) and described in [Table 9-16](#).

Figure 9-7. core_sldo_ctrl Register


LEGEND: R/W = Read/Write; R = Read only; W1toCl = Write 1 to clear bit; -n = value after reset

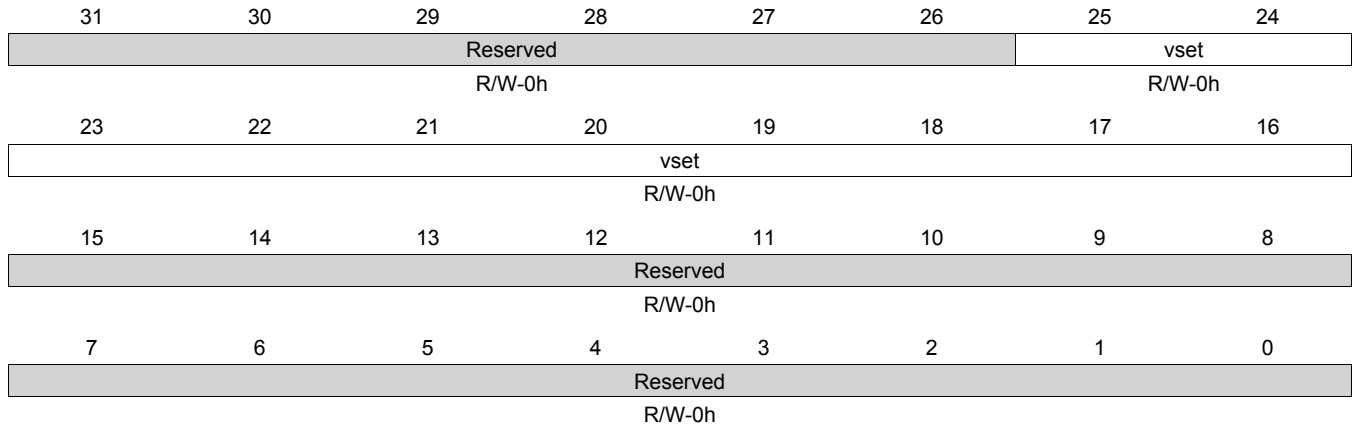
Table 9-16. core_sldo_ctrl Register Field Descriptions

Bit	Field	Type	Reset	Description
31-26	Reserved	R/W	0h	
25-16	vset	R/W	0h	Trims VDDAR
15-0	Reserved	R/W	0h	

9.3.1.6 mpu_sldo_ctrl Register (offset = 42Ch) [reset = 0h]

mpu_sldo_ctrl is shown in [Figure 9-8](#) and described in [Table 9-17](#).

Figure 9-8. mpu_sldo_ctrl Register



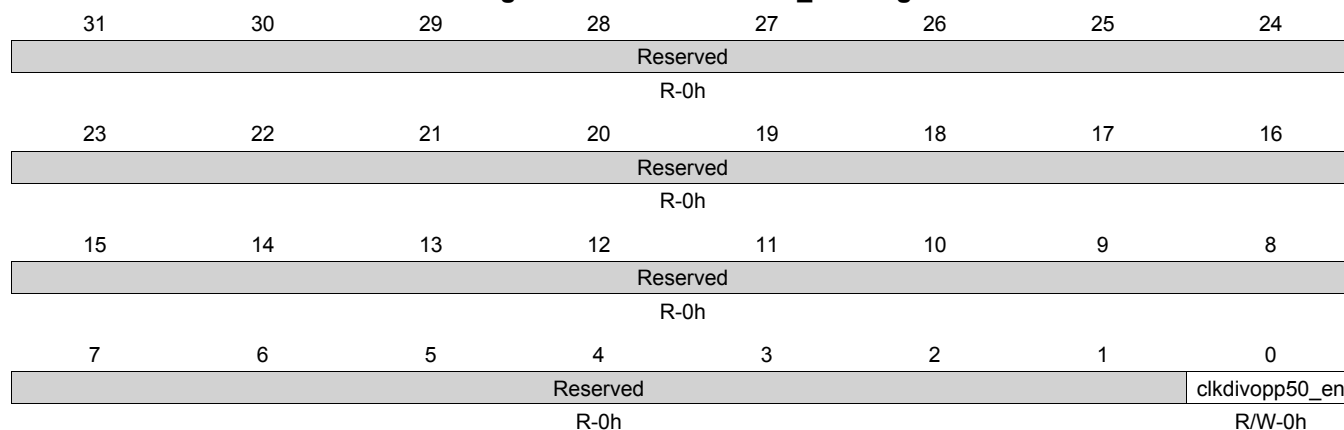
LEGEND: R/W = Read/Write; R = Read only; W1toCl = Write 1 to clear bit; -n = value after reset

Table 9-17. mpu_sldo_ctrl Register Field Descriptions

Bit	Field	Type	Reset	Description
31-26	Reserved	R/W	0h	
25-16	vset	R/W	0h	Trims VDDAR
15-0	Reserved	R/W	0h	

9.3.1.7 clk32kdivratio_ctrl Register (offset = 444h) [reset = 0h]

clk32kdivratio_ctrl is shown in [Figure 9-9](#) and described in [Table 9-18](#).

Figure 9-9. clk32kdivratio_ctrl Register


LEGEND: R/W = Read/Write; R = Read only; W1toCl = Write 1 to clear bit; -n = value after reset

Table 9-18. clk32kdivratio_ctrl Register Field Descriptions

Bit	Field	Type	Reset	Description
31-1	Reserved	R	0h	
0	clkdivopp50_en	R/W	0h	0 : OPP100 operation, use ratio for 24MHz to 32KHz division 1 : OPP50 operation, use ratio for 12MHz to 32KHz division

9.3.1.8 bandgap_ctrl Register (offset = 448h) [reset = 0h]

bandgap_ctrl is shown in [Figure 9-10](#) and described in [Table 9-19](#).

Figure 9-10. bandgap_ctrl Register

31	30	29	28	27	26	25	24
Reserved							
R-0h							
23	22	21	20	19	18	17	16
Reserved							
R-0h							
15	14	13	12	11	10	9	8
dtemp							
R-0h							
7	6	5	4	3	2	1	0
cbiassel	bgroff	tmpsoff	soc	clrz	contconv	ecoz	tshut
R/W-0h	R/W-0h	R/W-0h	R/W-0h	R/W-0h	R/W-0h	R-0h	R-0h

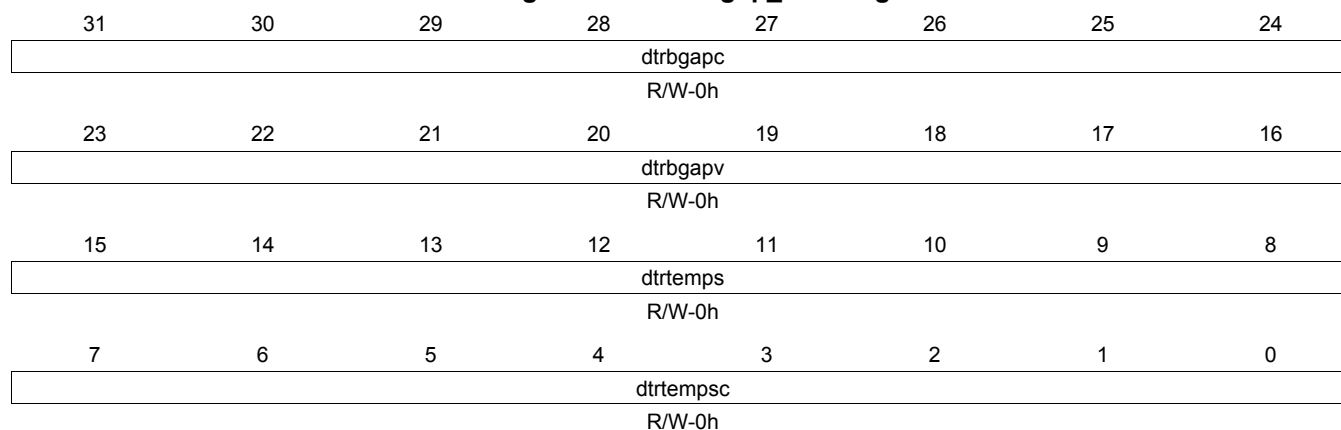
LEGEND: R/W = Read/Write; R = Read only; W1toCl = Write 1 to clear bit; -n = value after reset

Table 9-19. bandgap_ctrl Register Field Descriptions

Bit	Field	Type	Reset	Description
31-16	Reserved	R	0h	
15-8	dtemp	R	0h	Temperature data from ADC. To be used when end of conversion (EOCZ) is 0.
7	cbiassel	R/W	0h	0: Select bandgap voltage as reference 1: Select resistor divider as reference
6	bgroff	R/W	0h	0: Normal operation 1: Bandgap is OFF (OFF Mode)
5	tmpsoff	R/W	0h	0: Normal operation 1: Temperature sensor is off and thermal shutdown in OFF mode
4	soc	R/W	0h	ADC start of conversion. Transition to high starts a new ADC conversion cycle.
3	clrz	R/W	0h	0: Resets the digital outputs
2	contconv	R/W	0h	0: ADC single conversion mode 1: ADC continuous conversion mode
1	ecoz	R	0h	ADC end of conversion 0: End of conversion 1: Conversion in progress
0	tshut	R	0h	0: Normal operation 1: Thermal shutdown event (greater than 147C)

9.3.1.9 bandgap_trim Register (offset = 44Ch) [reset = 0h]

bandgap_trim is shown in [Figure 9-11](#) and described in [Table 9-20](#).

Figure 9-11. bandgap_trim Register


LEGEND: R/W = Read/Write; R = Read only; W1toCl = Write 1 to clear bit; -n = value after reset

Table 9-20. bandgap_trim Register Field Descriptions

Bit	Field	Type	Reset	Description
31-24	dtrbgapc	R/W	0h	trim the output voltage of bandgap
23-16	dtrbgapv	R/W	0h	trim the output voltage of bandgap
15-8	dtrtemps	R/W	0h	trim the temperature sensor
7-0	dtrtempsc	R/W	0h	trim the temperature sensor

9.3.1.10 pll_clkinpulow_ctrl Register (offset = 458h) [reset = 0h]

pll_clkinpulow_ctrl is shown in [Figure 9-12](#) and described in [Table 9-21](#).

Figure 9-12. pll_clkinpulow_ctrl Register

31	30	29	28	27	26	25	24
Reserved							
R-0h							
23	22	21	20	19	18	17	16
Reserved							
R-0h							
15	14	13	12	11	10	9	8
Reserved							
R-0h							
7	6	5	4	3	2	1	0
Reserved					ddr_pll_clkinpulow_sel	disp_pll_clkinpulow_sel	mpu_dpll_clkinpulow_sel
R-0h					R/W-0h	R/W-0h	R/W-0h

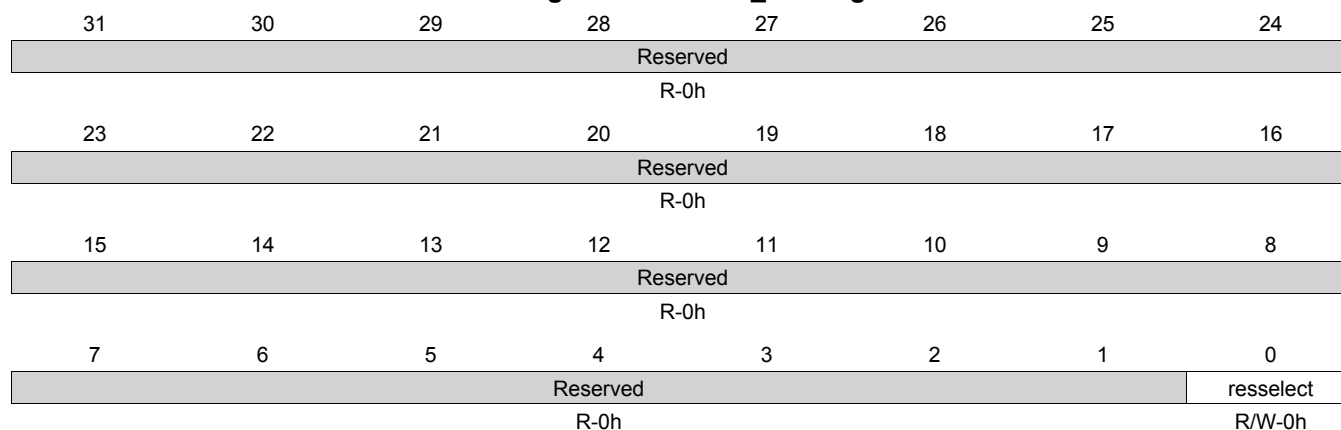
LEGEND: R/W = Read/Write; R = Read only; W1toCl = Write 1 to clear bit; -n = value after reset

Table 9-21. pll_clkinpulow_ctrl Register Field Descriptions

Bit	Field	Type	Reset	Description
31-3	Reserved	R	0h	
2	ddr_pll_clkinpulow_sel	R/W	0h	0 : Select CORE_CLKOUT_M6 clock as CLKINPULOW 1 : Select PER_CLKOUT_M2 clock as CLKINPULOW
1	disp_pll_clkinpulow_sel	R/W	0h	0 : Select CORE_CLKOUT_M6 clock as CLKINPULOW 1 : Select PER_CLKOUT_M2 clock as CLKINPULOW
0	mpu_dpll_clkinpulow_sel	R/W	0h	0 : Select CORE_CLKOUT_M6 clock as CLKINPULOW 1 : Select PER_CLKOUT_M2 clock as CLKINPULOW

9.3.1.11 mosc_ctrl Register (offset = 468h) [reset = 0h]

mosc_ctrl is shown in [Figure 9-13](#) and described in [Table 9-22](#).

Figure 9-13. mosc_ctrl Register


LEGEND: R/W = Read/Write; R = Read only; W1toCl = Write 1 to clear bit; -n = value after reset

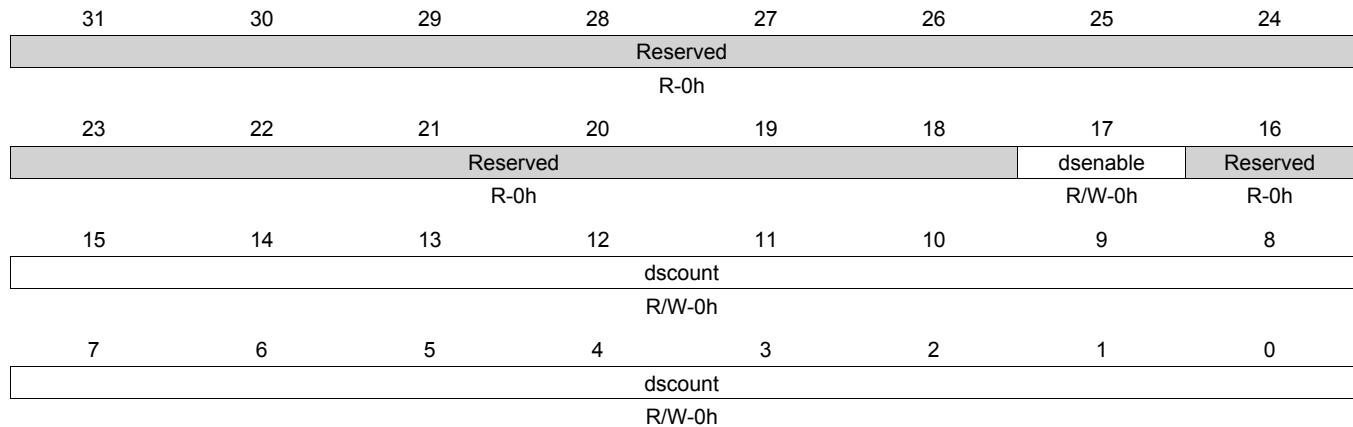
Table 9-22. mosc_ctrl Register Field Descriptions

Bit	Field	Type	Reset	Description
31-1	Reserved	R	0h	
0	resselect	R/W	0h	0: Enable 1M ohm internal resistor (connected between XTALIN and XTALOUT). 1: Disable 1M ohm internal resistor (bias resistor needs to be provided externally to device).

9.3.1.12 deepsleep_ctrl Register (offset = 470h) [reset = 0h]

deepsleep_ctrl is shown in [Figure 9-14](#) and described in [Table 9-23](#).

Figure 9-14. deepsleep_ctrl Register



LEGEND: R/W = Read/Write; R = Read only; W1toCl = Write 1 to clear bit; -n = value after reset

Table 9-23. deepsleep_ctrl Register Field Descriptions

Bit	Field	Type	Reset	Description
31-18	Reserved	R	0h	
17	dsenable	R/W	0h	Deep sleep enable 0: Normal operation 1: Master oscillator output is gated
16	Reserved	R	0h	
15-0	dscount	R/W	0h	Programmable count of how many CLK_M_OSC clocks needs to be seen before exiting deep sleep mode

9.3.1.13 dpll_pwr_sw_status (offset = 50Ch) [reset = 0h]

dpll_pwr_sw_status is shown in [Figure 9-15](#) and described in [Table 9-24](#).

Figure 9-15. dpll_pwr_sw_status Register

31	30	29	28	27	26	25	24
Reserved						pgoodout_dds	ponout_dds
R-0h						R-0h	R-0h
23	22	21	20	19	18	17	16
Reserved						pgoodout_disp	ponout_disp
R-0h						R-0h	R-0h
15	14	13	12	11	10	9	8
Reserved						pgoodout_per	ponout_per
R-0h							
7	6	5	4	3	2	1	0
Reserved							
R-0h							

LEGEND: R/W = Read/Write; R = Read only; W1toCl = Write 1 to clear bit; -n = value after reset

Table 9-24. dpll_pwr_sw_status Register Field Descriptions

Bit	Field	Type	Reset	Description
31-26	Reserved	R	0h	
25	pgoodout_dds	R	0h	Power Good status for DDR DPLL 0: Power Fault 1: Power Good
24	ponout_dds	R	0h	Power Enable status for DDR DPLL 0: Disabled 1: Enabled
23-18	Reserved	R	0h	
17	pgoodout_disp	R	0h	Power Good status for DISP DPLL 0: Power Fault 1: Power Good
16	ponout_disp	R	0h	Power Enable status for DISP DPLL 0: Disabled 1: Enabled
15-10	Reserved	R	0h	
9	pgoodout_per	R	0h	Power Good status for PER DPLL 0: Power Fault 1: Power Good
8	ponout_per	R	0h	Power Enable status for PER DPLL 0: Disabled 1: Enabled
7-0	Reserved	R	0h	

9.3.1.14 device_id Register (offset = 600h) [reset = 0x]

device_id is shown in [Figure 9-16](#) and described in [Table 9-25](#).

Figure 9-16. device_id Register

31	30	29	28	27	26	25	24
devrev				partnum			
R-0h				R-B944h			
23	22	21	20	19	18	17	16
partnum							
R-B944h							
15	14	13	12	11	10	9	8
partnum				mfgr			
R-B944h				R-017h			
7	6	5	4	3	2	1	0
mfgr							Reserved
R-017h							R-0h

LEGEND: R/W = Read/Write; R = Read only; W1toCl = Write 1 to clear bit; -n = value after reset

Table 9-25. device_id Register Field Descriptions

Bit	Field	Type	Reset	Description
31-28	devrev	R	0h	Device revision. 0000b - Silicon Revision 1.0 0001b - Silicon Revision 2.0 0010b - Silicon Revision 2.1 See device errata for detailed information on functionality in each device revision. Reset value is revision-dependent.
27-12	partnum	R	B944h	Device part number (unique JTAG ID)
11-1	mfgr	R	017h	Manufacturer's JTAG ID
0	Reserved	R	0h	

9.3.1.15 dev_feature Register (offset = 604h) [reset = 0h]

 dev_feature is shown in [Figure 9-17](#) and described in [Table 9-26](#).

Figure 9-17. dev_feature Register

31	30	29	28	27	26	25	24
Reserved		sgx	Reserved				
R-0h		R-0h	R-0h				
23	22	21	20	19	18	17	16
Reserved						pru_icss_fea[1]	pru_icss_fea[0]
R-0h						R-0h	R-0h
15	14	13	12	11	10	9	8
Reserved						Reserved	Reserved
R-0h						R-0h	R-0h
7	6	5	4	3	2	1	0
dcan	Reserved					cpsw	pru_icss
R-0h	R-0h					R-0h	R-0h

LEGEND: R/W = Read/Write; R = Read only; W1toCl = Write 1 to clear bit; -n = value after reset

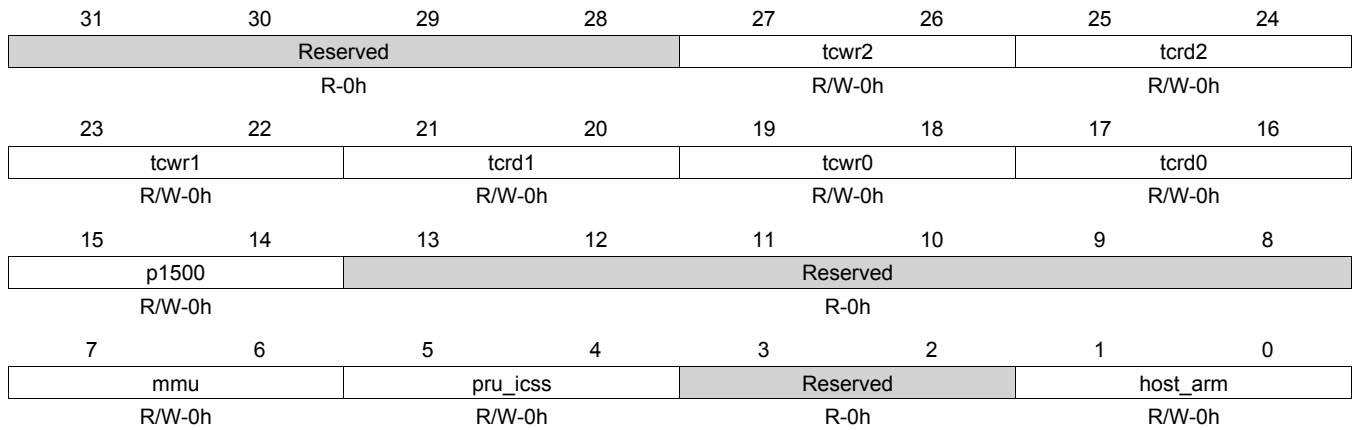
Table 9-26. dev_feature Register Field Descriptions

Bit	Field	Type	Reset	Description
31-30	Reserved	R	0h	
29	sgx	R	0h	0: 3D graphics module (SGX) is disabled 1: SGX enabled Reset value is device-dependent.
28-24	Reserved	R	0h	
23-18	Reserved	R	0h	
17	pru_icss_fea[1]	R	0h	0: TX_AUTO_SEQUENCE disabled 1: TX_AUTO_SEQUENCE enabled Reset value is device-dependent.
16	pru_icss_fea[0]	R	0h	0: EtherCAT functionality disabled, ODD_NIBBLE disabled 1: EtherCAT functionality enabled, ODD_NIBBLE enabled Reset value is device-dependent.
15-10	Reserved	R	0h	
9	Reserved	R	0h	
8	Reserved	R	0h	
7	dcan	R	0h	0: DCAN0, DCAN1 IPs are disabled 1: DCAN0, DCAN1 IPs are enabled Reset value is device-dependent.
6-2	Reserved	R	0h	
1	cpsw	R	0h	0: CP Switch IP (Ethernet) is disabled 1: CP Switch IP (Ethernet) is enabled Reset value is device-dependent.
0	pru_icss	R	0h	0: PRU-ICSS is disabled 1: PRU-ICSS is enabled Reset value is device-dependent.

9.3.1.16 init_priority_0 Register (offset = 608h) [reset = 0h]

init_priority_0 is shown in Figure 9-18 and described in Table 9-27.

Figure 9-18. init_priority_0 Register



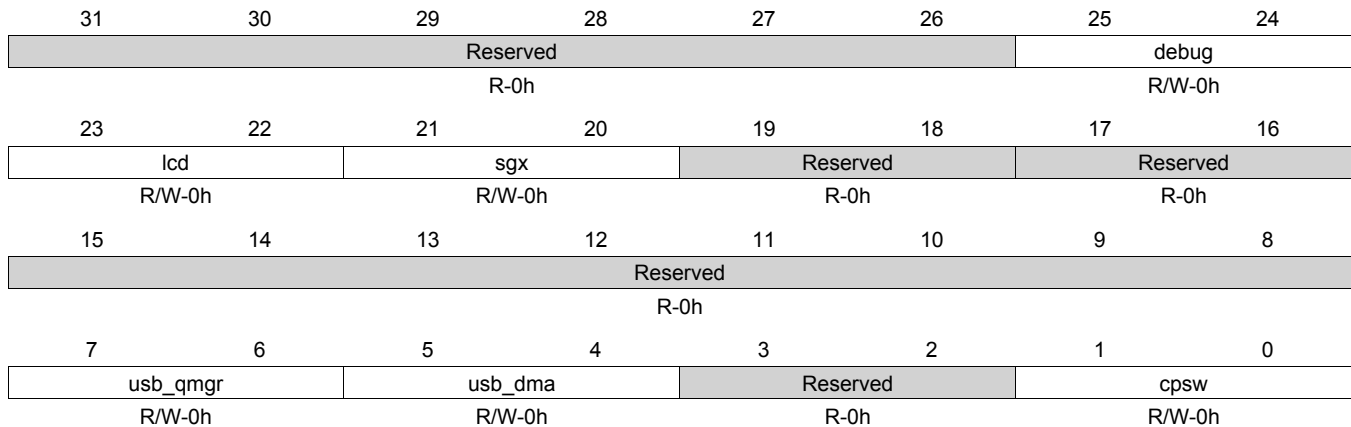
LEGEND: R/W = Read/Write; R = Read only; W1toCl = Write 1 to clear bit; -n = value after reset

Table 9-27. init_priority_0 Register Field Descriptions

Bit	Field	Type	Reset	Description
31-28	Reserved	R	0h	
27-26	tcwr2	R/W	0h	TPTC 2 Write Port initiator priority
25-24	tcrd2	R/W	0h	TPTC 2 Read Port initiator priority
23-22	tcwr1	R/W	0h	TPTC 1 Write Port initiator priority
21-20	tcrd1	R/W	0h	TPTC 1 Read Port initiator priority
19-18	tcwr0	R/W	0h	TPTC 0 Write Port initiator priority
17-16	tcrd0	R/W	0h	TPTC 0 Read Port initiator priority
15-14	p1500	R/W	0h	P1500 Port Initiator priority
13-8	Reserved	R	0h	
7-6	mmu	R/W	0h	System MMU initiator priority
5-4	pru_icss	R/W	0h	PRU-ICSS initiator priority
3-2	Reserved	R	0h	
1-0	host_arm	R/W	0h	Host Cortex A8 initiator priority

9.3.1.17 init_priority_1 Register (offset = 60Ch) [reset = 0h]

init_priority_1 is shown in Figure 9-19 and described in Table 9-28.

Figure 9-19. init_priority_1 Register


LEGEND: R/W = Read/Write; R = Read only; W1toCl = Write 1 to clear bit; -n = value after reset

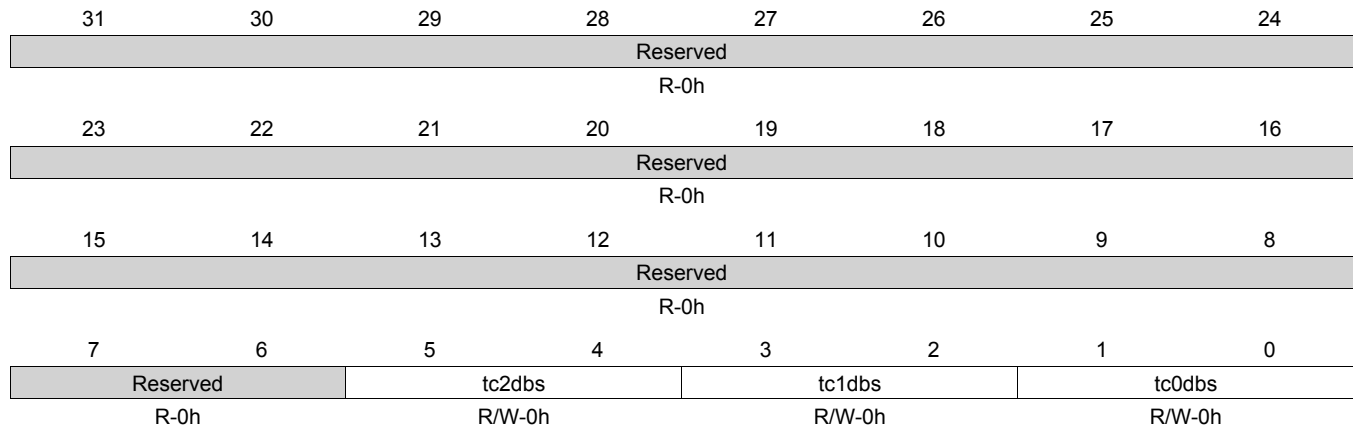
Table 9-28. init_priority_1 Register Field Descriptions

Bit	Field	Type	Reset	Description
31-26	Reserved	R	0h	
25-24	debug	R/W	0h	Debug Subsystem initiator priority
23-22	lcd	R/W	0h	LCD initiator priority
21-20	sgx	R/W	0h	SGX initiator priority
19-18	Reserved	R	0h	
17-16	Reserved	R	0h	
15-8	Reserved	R	0h	
7-6	usb_qmgr	R/W	0h	USB Queue Manager initiator priority
5-4	usb_dma	R/W	0h	USB DMA port initiator priority
3-2	Reserved	R	0h	
1-0	cpsw	R/W	0h	CPSW initiator priority

9.3.1.18 tptc_cfg Register (offset = 614h) [reset = 0h]

tptc_cfg is shown in Figure 9-20 and described in Table 9-29.

Figure 9-20. tptc_cfg Register



LEGEND: R/W = Read/Write; R = Read only; W1toCl = Write 1 to clear bit; -n = value after reset

Table 9-29. tptc_cfg Register Field Descriptions

Bit	Field	Type	Reset	Description
31-6	Reserved	R	0h	
5-4	tc2dbs	R/W	0h	TPTC2 Default Burst Size 00: 16 byte 01: 32 byte 10: 64 byte 11: 128 byte
3-2	tc1dbs	R/W	0h	TPTC1 Default Burst Size 00: 16 byte 01: 32 byte 10: 64 byte 11: 128 byte
1-0	tc0dbs	R/W	0h	TPTC0 Default Burst Size 00: 16 byte 01: 32 byte 10: 64 byte 11: 128 byte

9.3.1.19 usb_ctrl0 Register (offset = 620h) [reset = 0h]

 usb_ctrl0 is shown in [Figure 9-21](#) and described in [Table 9-30](#).

Figure 9-21. usb_ctrl0 Register

31	30	29	28	27	26	25	24
Reserved							
R/W-3Ch							
23	22	21	20	19	18	17	16
datapolarity_inv	Reserved	Reserved	otgsessenden	otgvdet_en	dmgpio_pd	dpgpio_pd	Reserved
R/W-0h	R-0h	R-0h	R/W-0h	R/W-0h	R/W-0h	R/W-0h	R/W-0h
15	14	13	12	11	10	9	8
Reserved	gpio_sig_cross	gpio_sig_inv	gpiomode	Reserved	cdet_extctl	dppullup	dmpullup
R/W-0h	R/W-0h	R/W-0h	R/W-0h	R/W-0h	R/W-0h	R/W-0h	R/W-0h
7	6	5	4	3	2	1	0
chgsrc_en	chgiskn_en	sinkondp	srcondm	chgdet_rstr	chgdet_dis	otg_pwrn	cm_pwrn
R/W-0h	R/W-0h	R/W-0h	R/W-0h	R/W-0h	R/W-0h	R/W-0h	R/W-0h

LEGEND: R/W = Read/Write; R = Read only; W1toCl = Write 1 to clear bit; -n = value after reset

Table 9-30. usb_ctrl0 Register Field Descriptions

Bit	Field	Type	Reset	Description
31-24	Reserved	R/W	3Ch	Reserved. Any writes to this register must keep these bits set to 0x3C.
23	datapolarity_inv	R/W	0h	Data Polarity Invert: 0: DP/DM (normal polarity matching port definition) 1: DM/DP (inverted polarity of port definition)
22	Reserved	R	0h	
21	Reserved	R	0h	
20	otgsessenden	R/W	0h	Session End Detect Enable 0: Disable Session End Comparator 1: Turns on Session End Comparator
19	otgvdet_en	R/W	0h	VBUS Detect Enable 0: Disable VBUS Detect Enable 1: Turns on all comparators except Session End comparator
18	dmgpio_pd	R/W	0h	Pulldown on DM in GPIO Mode 0: Enables pulldown 1: Disables pulldown
17	dpgpio_pd	R/W	0h	Pulldown on DP in GPIO Mode 0: Enables pulldown 1: Disables pulldown
16	Reserved	R/W	0h	
15	Reserved	R/W	0h	
14	gpio_sig_cross	R/W	0h	UART TX -> DM UART RX -> DP
13	gpio_sig_inv	R/W	0h	UART TX -> Invert -> DP UART RX -> Invert -> DM
12	gpiomode	R/W	0h	GPIO Mode 0: USB Mode 1: GPIO Mode (UART Mode)
11	Reserved	R/W	0h	
10	cdet_extctl	R/W	0h	Bypass the charger detection state machine 0: Charger detection on 1: Charger detection is bypassed
9	dppullup	R/W	0h	Pullup on DP line 0: No effect 1: Enable pullup on DP line

Table 9-30. usb_ctrl0 Register Field Descriptions (continued)

Bit	Field	Type	Reset	Description
8	dmpullup	R/W	0h	Pullup on DM line 0: No effect 1: Enable pullup on DM line
7	chgvsrsrc_en	R/W	0h	Enable VSRC on DP line (Host Charger case)
6	chgisink_en	R/W	0h	Enable ISINK on DM line (Host Charger case)
5	sinkondp	R/W	0h	Sink on DP 0: Sink on DM 1: Sink on DP
4	srcondm	R/W	0h	Source on DM 0: Source on DP 1: Source on DM
3	chgdet_rstrt	R/W	0h	Restart Charger Detect
2	chgdet_dis	R/W	0h	Charger Detect Disable 0: Enable 1: Disable
1	otg_pwrdn	R/W	0h	Power down the USB OTG PHY 0: PHY in normal mode 1: PHY Powered down
0	cm_pwrdn	R/W	0h	Power down the USB CM PHY 0: PHY in normal mode 1: PHY Powered down

9.3.1.20 usb_sts0 Register (offset = 624h) [reset = 0h]

 usb_sts0 is shown in [Figure 9-22](#) and described in [Table 9-31](#).

Figure 9-22. usb_sts0 Register

31	30	29	28	27	26	25	24
Reserved							
R-0h							
23	22	21	20	19	18	17	16
Reserved							
R-0h							
15	14	13	12	11	10	9	8
Reserved							
R-0h							
7	6	5	4	3	2	1	0
chgdetsts		cdet_dmdet		cdet_dpdet		cdet_datadet	
R-0h		R-0h		R-0h		R-0h	
chgdetect		chgdetdone					
R-0h		R-0h					

LEGEND: R/W = Read/Write; R = Read only; W1toCl = Write 1 to clear bit; -n = value after reset

Table 9-31. usb_sts0 Register Field Descriptions

Bit	Field	Type	Reset	Description
31-8	Reserved	R	0h	
7-5	chgdetsts	R	0h	Charge Detection Status 000: Wait State (When a D+WPU and D-15K are connected, it enters into this state and will remain in this state unless it enters into other state) 001: No Contact 010: PS/2 011: Unknown error 100: Dedicated charger(valid if CE is HIGH) 101: HOST charger (valid if CE is HIGH) 110: PC 111: Interrupt (if any of the pullup is enabled, charger detect routine gets interrupted and will restart from the beginning if the same is disabled)
4	cdet_dmdet	R	0h	DM Comparator Output
3	cdet_dpdet	R	0h	DP Comparator Output
2	cdet_datadet	R	0h	Charger Comparator Output
1	chgdetect	R	0h	Charger Detection Status 0: Charger was no detected 1: Charger was detected
0	chgdetdone	R	0h	Charger Detection Protocol Done

9.3.1.21 usb_ctrl1 Register (offset = 628h) [reset = 0h]

usb_ctrl1 is shown in [Figure 9-23](#) and described in [Table 9-32](#).

Figure 9-23. usb_ctrl1 Register

31	30	29	28	27	26	25	24
Reserved							
R/W-3Ch							
23	22	21	20	19	18	17	16
datapolarity_inv	Reserved	Reserved	otgsessenden	otgvdet_en	dmgpio_pd	dpgpio_pd	Reserved
R/W-0h	R-0h	R-0h	R/W-0h	R/W-0h	R/W-0h	R/W-0h	R/W-0h
15	14	13	12	11	10	9	8
Reserved	gpio_sig_cross	gpio_sig_inv	gpiomode	Reserved	cdet_extctl	dppullup	dmpullup
R/W-0h	R/W-0h	R/W-0h	R/W-0h	R/W-0h	R/W-0h	R/W-0h	R/W-0h
7	6	5	4	3	2	1	0
chgsrc_en	chgisk_en	sinkondp	srcondm	chgdet_rstr	chgdet_dis	otg_pwrn	cm_pwrn
R/W-0h	R/W-0h	R/W-0h	R/W-0h	R/W-0h	R/W-0h	R/W-0h	R/W-0h

LEGEND: R/W = Read/Write; R = Read only; W1toCl = Write 1 to clear bit; -n = value after reset

Table 9-32. usb_ctrl1 Register Field Descriptions

Bit	Field	Type	Reset	Description
31-24	Reserved	R/W	3Ch	Reserved. Any writes to this register must keep these bits set to 0x3C.
23	datapolarity_inv	R/W	0h	Data Polarity Invert: 0: DP/DM (normal polarity matching port definition) 1: DM/DP (inverted polarity of port definition)
22	Reserved	R	0h	
21	Reserved	R	0h	
20	otgsessenden	R/W	0h	Session End Detect Enable 0: Disable Session End Comparator 1: Turns on Session End Comparator
19	otgvdet_en	R/W	0h	VBUS Detect Enable 0: Disable VBUS Detect Enable 1: Turns on all comparators except Session End comparator
18	dmgpio_pd	R/W	0h	Pulldown on DM in GPIO Mode 0: Enables pulldown 1: Disables pulldown
17	dpgpio_pd	R/W	0h	Pulldown on DP in GPIO Mode 0: Enables pulldown 1: Disables pulldown
16	Reserved	R/W	0h	
15	Reserved	R/W	0h	
14	gpio_sig_cross	R/W	0h	UART TX -> DM UART RX -> DP
13	gpio_sig_inv	R/W	0h	UART TX -> INV -> DP UART RX -> INV -> DM
12	gpiomode	R/W	0h	GPIO Mode 0: USB Mode 1: GPIO Mode (UART)
11	Reserved	R/W	0h	
10	cdet_extctl	R/W	0h	Bypass the charger detection state machine 0: Charger detection on 1: Charger detection is bypassed
9	dppullup	R/W	0h	Pullup on DP line 0: No effect 1: Enable pullup on DP line

Table 9-32. usb_ctrl1 Register Field Descriptions (continued)

Bit	Field	Type	Reset	Description
8	dmpullup	R/W	0h	Pullup on DM line 0: No effect 1: Enable pullup on DM line
7	chgvsrsrc_en	R/W	0h	Enable VSRC on DP line (Host Charger case)
6	chgisink_en	R/W	0h	Enable ISINK on DM line (Host Charger case)
5	sinkondp	R/W	0h	Sink on DP 0: Sink on DM 1: Sink on DP
4	srcondm	R/W	0h	Source on DM 0: Source on DP 1: Source on DM
3	chgdet_rstrt	R/W	0h	Restart Charger Detect
2	chgdet_dis	R/W	0h	Charger Detect Disable 0: Enable 1: Disable
1	otg_pwrtn	R/W	0h	Power down the USB OTG PHY 0: PHY in normal mode 1: PHY Powered down
0	cm_pwrtn	R/W	0h	Power down the USB CM PHY 1: PHY Powered down 0: PHY in normal mode

9.3.1.22 usb_sts1 Register (offset = 62Ch) [reset = 0h]

usb_sts1 is shown in [Figure 9-24](#) and described in [Table 9-33](#).

Figure 9-24. usb_sts1 Register

31	30	29	28	27	26	25	24
Reserved							
R-0h							
23	22	21	20	19	18	17	16
Reserved							
R-0h							
15	14	13	12	11	10	9	8
Reserved							
R-0h							
7	6	5	4	3	2	1	0
chgdetsts		cdet_dmdet		cdet_dpdet		cdet_datadet	
R-0h		R-0h		R-0h		R-0h	
chgdetect		chgdetdone		R-0h		R-0h	

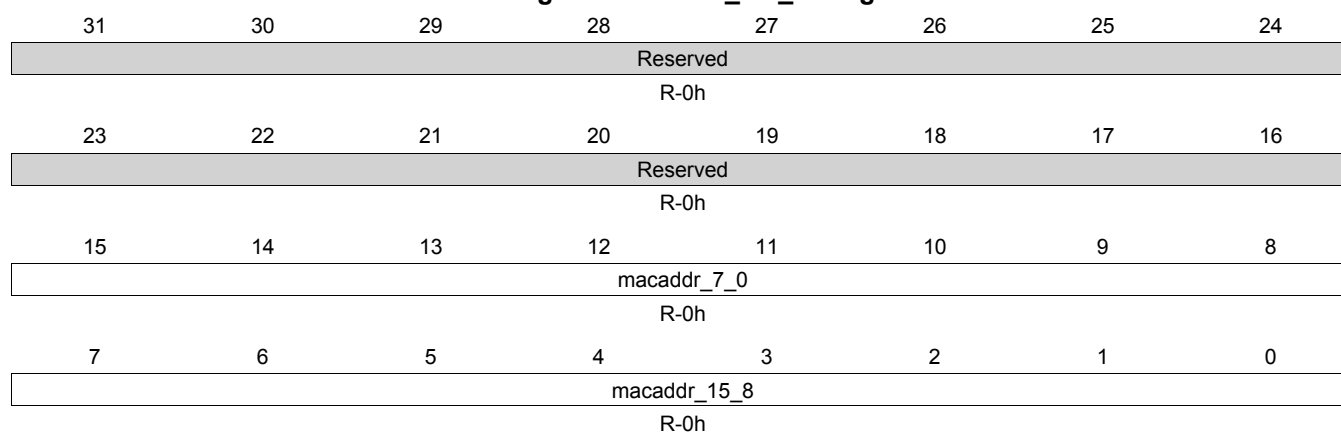
LEGEND: R/W = Read/Write; R = Read only; W1toCl = Write 1 to clear bit; -n = value after reset

Table 9-33. usb_sts1 Register Field Descriptions

Bit	Field	Type	Reset	Description
31-8	Reserved	R	0h	
7-5	chgdetsts	R	0h	Charge Detection Status 000: Wait State (When a D+WPU and D-15K are connected, it enters into this state and will remain in this state unless it enters into other state) 001: No Contact 010: PS/2 011: Unknown error 100: Dedicated charger(valid if CE is HIGH) 101: HOST charger (valid if CE is HIGH) 110: PC 111: Interrupt (if any of the pullup is enabled, charger detect routine gets interrupted and will restart from the beginning if the same is disabled)
4	cdet_dmdet	R	0h	DM Comparator Output
3	cdet_dpdet	R	0h	DP Comparator Output
2	cdet_datadet	R	0h	Charger Comparator Output
1	chgdetect	R	0h	Charger Detection Status 0: Charger was no detected 1: Charger was detected
0	chgdetdone	R	0h	Charger Detection Protocol Done

9.3.1.23 mac_id0_lo Register (offset = 630h) [reset = 0h]

mac_id0_lo is shown in [Figure 9-25](#) and described in [Table 9-34](#).

Figure 9-25. mac_id0_lo Register


LEGEND: R/W = Read/Write; R = Read only; W1toCl = Write 1 to clear bit; -n = value after reset

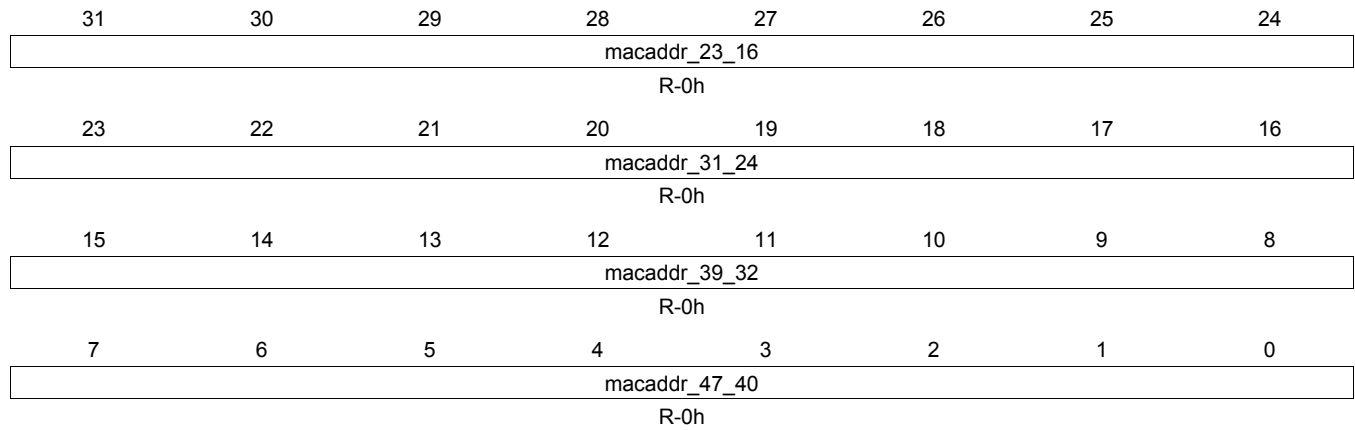
Table 9-34. mac_id0_lo Register Field Descriptions

Bit	Field	Type	Reset	Description
31-16	Reserved	R	0h	
15-8	macaddr_7_0	R	0h	MAC0 Address - Byte 0 Reset value is device-dependent.
7-0	macaddr_15_8	R	0h	MAC0 Address - Byte 1 Reset value is device-dependent.

9.3.1.24 mac_id0_hi Register (offset = 634h) [reset = 0h]

mac_id0_hi is shown in [Figure 9-26](#) and described in [Table 9-35](#).

Figure 9-26. mac_id0_hi Register



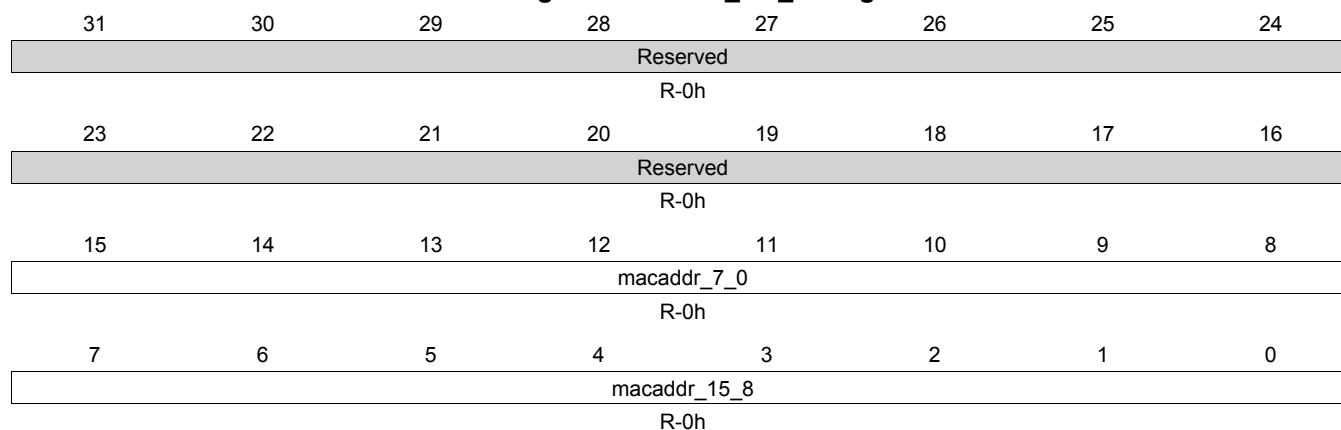
LEGEND: R/W = Read/Write; R = Read only; W1toCl = Write 1 to clear bit; -n = value after reset

Table 9-35. mac_id0_hi Register Field Descriptions

Bit	Field	Type	Reset	Description
31-24	macaddr_23_16	R	0h	MAC0 Address - Byte 2 Reset value is device-dependent.
23-16	macaddr_31_24	R	0h	MAC0 Address - Byte 3 Reset value is device-dependent.
15-8	macaddr_39_32	R	0h	MAC0 Address - Byte 4 Reset value is device-dependent.
7-0	macaddr_47_40	R	0h	MAC0 Address - Byte 5 Reset value is device-dependent.

9.3.1.25 mac_id1_lo Register (offset = 638h) [reset = 0h]

mac_id1_lo is shown in [Figure 9-27](#) and described in [Table 9-36](#).

Figure 9-27. mac_id1_lo Register


LEGEND: R/W = Read/Write; R = Read only; W1toCl = Write 1 to clear bit; -n = value after reset

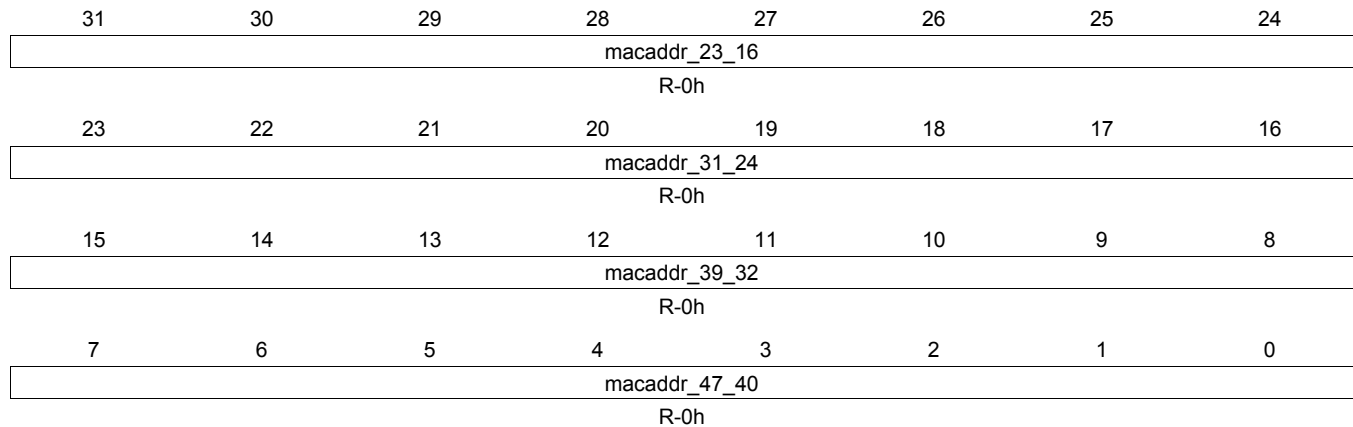
Table 9-36. mac_id1_lo Register Field Descriptions

Bit	Field	Type	Reset	Description
31-16	Reserved	R	0h	
15-8	macaddr_7_0	R	0h	MAC1 Address - Byte 0 Reset value is device-dependent.
7-0	macaddr_15_8	R	0h	MAC1 Address - Byte 1 Reset value is device-dependent.

9.3.1.26 mac_id1_hi Register (offset = 63Ch) [reset = 0h]

mac_id1_hi is shown in [Figure 9-28](#) and described in [Table 9-37](#).

Figure 9-28. mac_id1_hi Register



LEGEND: R/W = Read/Write; R = Read only; W1toCl = Write 1 to clear bit; -n = value after reset

Table 9-37. mac_id1_hi Register Field Descriptions

Bit	Field	Type	Reset	Description
31-24	macaddr_23_16	R	0h	MAC1 Address - Byte 2 Reset value is device-dependent.
23-16	macaddr_31_24	R	0h	MAC1 Address - Byte 3 Reset value is device-dependent.
15-8	macaddr_39_32	R	0h	MAC1 Address - Byte 4 Reset value is device-dependent.
7-0	macaddr_47_40	R	0h	MAC1 Address - Byte 5 Reset value is device-dependent.

9.3.1.27 dcan_raminit Register (offset = 644h) [reset = 0h]

dcan_raminit is shown in Figure 9-29 and described in Table 9-38.

Figure 9-29. dcan_raminit Register

31	30	29	28	27	26	25	24
Reserved							
R-0h							
23	22	21	20	19	18	17	16
Reserved							
R-0h							
15	14	13	12	11	10	9	8
Reserved						dcan1_raminit_	dcan0_raminit_
						done	done
R-0h						R/W1toClr	R/W1toClr
7	6	5	4	3	2	1	0
Reserved						dcan1_raminit_	dcan0_raminit_
						start	start
R-0h						R/W-0h	R/W-0h

LEGEND: R/W = Read/Write; R = Read only; W1toCl = Write 1 to clear bit; -n = value after reset

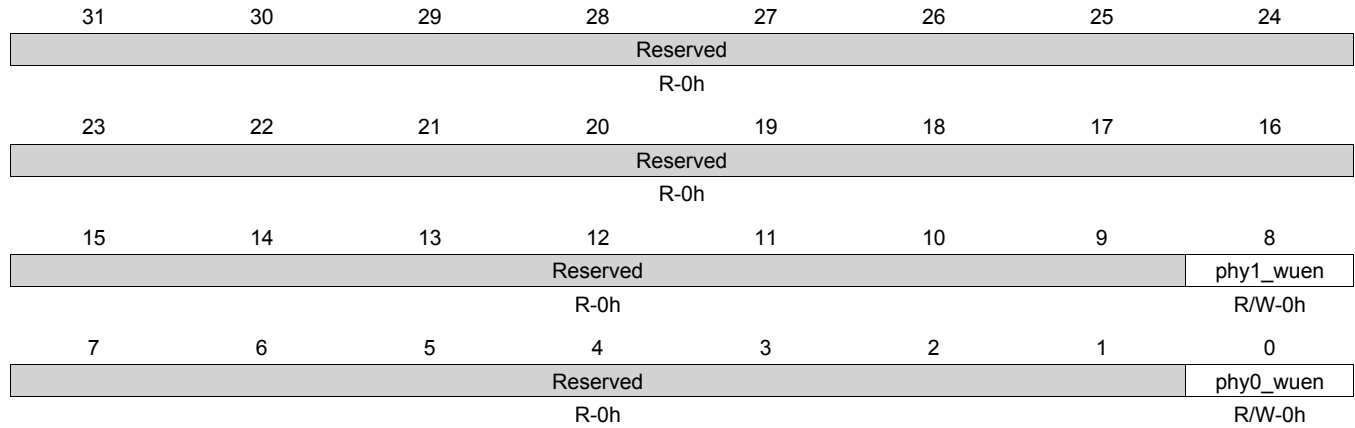
Table 9-38. dcan_raminit Register Field Descriptions

Bit	Field	Type	Reset	Description
31-10	Reserved	R	0h	
9	dcan1_raminit_done	R/W1toClr	0h	0: DCAN1 RAM Initialization NOT complete 1: DCAN1 RAM Initialization complete
8	dcan0_raminit_done	R/W1toClr	0h	0: DCAN0 RAM Initialization NOT complete 1: DCAN0 RAM Initialization complete
7-2	Reserved	R	0h	
1	dcan1_raminit_start	R/W	0h	A transition from 0 to 1 will start DCAN1 RAM initialization sequence.
0	dcan0_raminit_start	R/W	0h	A transition from 0 to 1 will start DCAN0 RAM initialization sequence.

9.3.1.28 usb_wkup_ctrl Register (offset = 648h) [reset = 0h]

usb_wkup_ctrl is shown in [Figure 9-30](#) and described in [Table 9-39](#).

Figure 9-30. usb_wkup_ctrl Register



LEGEND: R/W = Read/Write; R = Read only; W1toCl = Write 1 to clear bit; -n = value after reset

Table 9-39. usb_wkup_ctrl Register Field Descriptions

Bit	Field	Type	Reset	Description
31-9	Reserved	R	0h	
8	phy1_wuen	R/W	0h	PHY1 Wakeup Enable. Write to 1 enables WKUP from USB PHY1
7-1	Reserved	R	0h	
0	phy0_wuen	R/W	0h	PHY0 Wakeup Enable. Write to 1 enables WKUP from USB PHY0

9.3.1.29 gmii_sel Register (offset = 650h) [reset = 0h]

 gmii_sel is shown in [Figure 9-31](#) and described in [Table 9-40](#).

Figure 9-31. gmii_sel Register

31	30	29	28	27	26	25	24
Reserved							
R-0h							
23	22	21	20	19	18	17	16
Reserved							
R-0h							
15	14	13	12	11	10	9	8
Reserved							
R-0h							
7	6	5	4	3	2	1	0
rmii2_io_clk_en	rmii1_io_clk_en	rgmii2_idmoe	rgmii1_idmode	gmii2_sel		gmii1_sel	
R/W-0h	R/W-0h	R/W-0h	R/W-0h	R/W-0h		R/W-0h	

LEGEND: R/W = Read/Write; R = Read only; W1toCl = Write 1 to clear bit; -n = value after reset

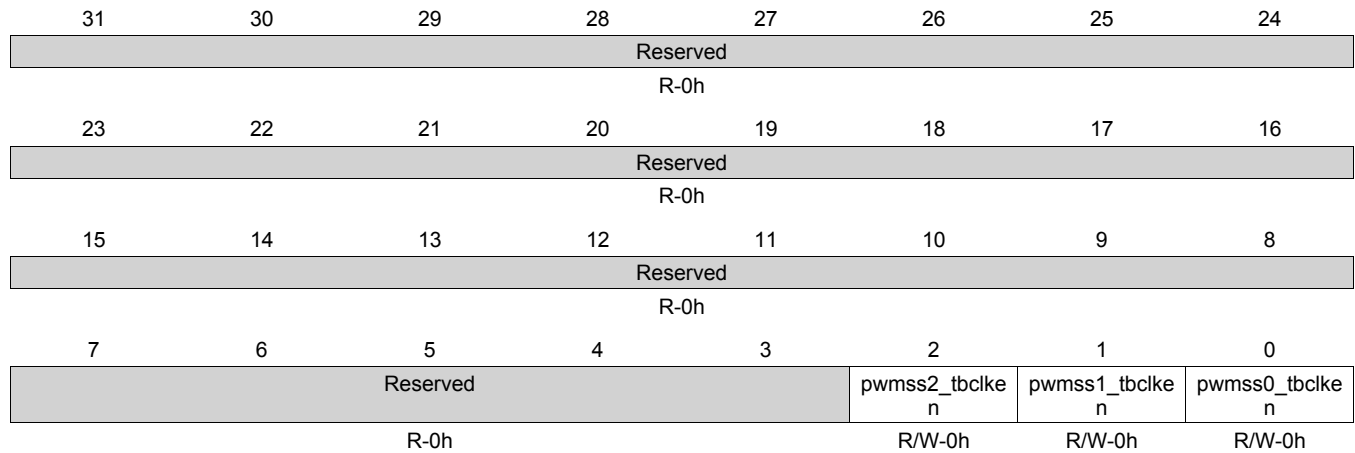
Table 9-40. gmii_sel Register Field Descriptions

Bit	Field	Type	Reset	Description
31-8	Reserved	R	0h	
7	rmii2_io_clk_en	R/W	1h	0: RMII Reference Clock Output mode. Enable RMII clock to be sourced from PLL. 1: RMII Reference Clock Input mode. Enable RMII clock to be sourced from chip pin. See "Silicon Revision Functional Differences and Enhancements" for differences in operation based on AM335x silicon revision.
6	rmii1_io_clk_en	R/W	1h	0: RMII Reference Clock Output mode. Enable RMII clock to be sourced from PLL 1: RMII Reference Clock Input mode. Enable RMII clock to be sourced from chip pin See "Silicon Revision Functional Differences and Enhancements" for differences in operation based on AM335x silicon revision.
5	rgmii2_idmode	R/W	1h	RGMI2 Internal Delay Mode 0: Reserved 1: No Internal Delay See "Silicon Revision Functional Differences and Enhancements" for differences in operation based on AM335x silicon revision.
4	rgmii1_idmode	R/W	1h	RGMI1 Internal Delay Mode 0: Reserved 1: No Internal Delay See "Silicon Revision Functional Differences and Enhancements" for differences in operation based on AM335x silicon revision.
3-2	gmii2_sel	R/W	0h	00: Port2 GMII/MII Mode 01: Port2 RMII Mode 10: Port2 RGMII Mode 11: Not Used
1-0	gmii1_sel	R/W	0h	00: Port1 GMII/MII Mode 01: Port1 RMII Mode 10: Port1 RGMII Mode 11: Not Used

9.3.1.30 pwmss_ctrl Register (offset = 664h) [reset = 0h]

pwmss_ctrl is shown in [Figure 9-32](#) and described in [Table 9-41](#).

Figure 9-32. pwmss_ctrl Register



LEGEND: R/W = Read/Write; R = Read only; W1toCl = Write 1 to clear bit; -n = value after reset

Table 9-41. pwmss_ctrl Register Field Descriptions

Bit	Field	Type	Reset	Description
31-3	Reserved	R	0h	
2	pwmss2_tbclock	R/W	0h	Timebase clock enable for PWMSS2
1	pwmss1_tbclock	R/W	0h	Timebase clock enable for PWMSS1
0	pwmss0_tbclock	R/W	0h	Timebase clock enable for PWMSS0

9.3.1.31 mreqprio_0 Register (offset = 670h) [reset = 0h]

mreqprio_0 is shown in [Figure 9-33](#) and described in [Table 9-42](#).

Figure 9-33. mreqprio_0 Register

31	30	29	28	27	26	25	24
Reserved	sgx			Reserved	usb1		
R-0h	R/W-0h			R-0h	R/W-0h		
23	22	21	20	19	18	17	16
Reserved	usb0			Reserved	cpsw		
R-0h	R/W-0h			R-0h	R/W-0h		
15	14	13	12	11	10	9	8
Reserved	Reserved			Reserved	pru_icss_pru0		
R-0h	R-0h			R-0h	R/W-0h		
7	6	5	4	3	2	1	0
Reserved	sab_init1			Reserved	sab_init0		
R-0h	R/W-0h			R-0h	R/W-0h		

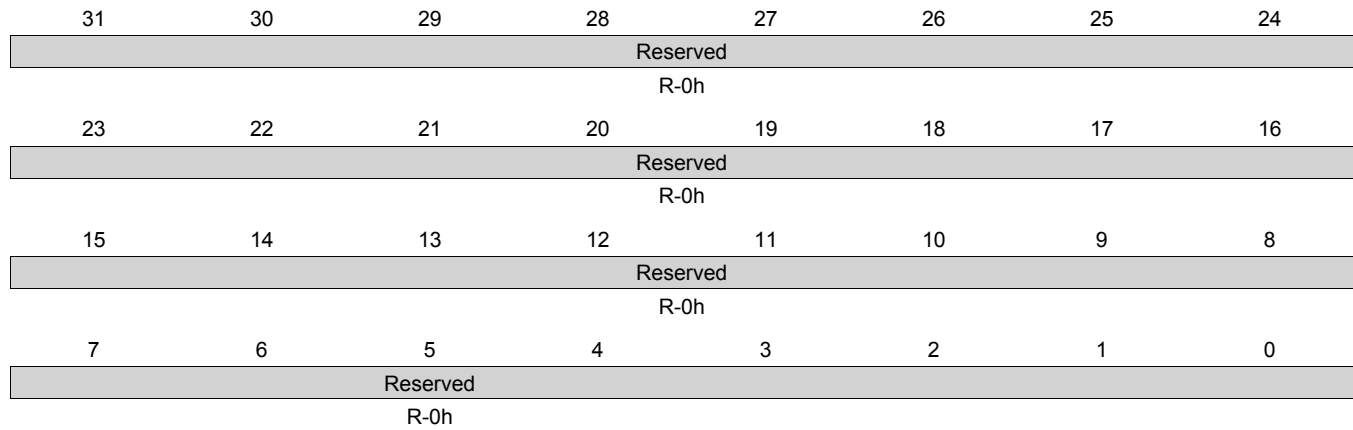
LEGEND: R/W = Read/Write; R = Read only; W1toCl = Write 1 to clear bit; -n = value after reset

Table 9-42. mreqprio_0 Register Field Descriptions

Bit	Field	Type	Reset	Description
31	Reserved	R	0h	
30-28	sgx	R/W	0h	MReqPriority for SGX Initiator OCP Interface
27	Reserved	R	0h	
26-24	usb1	R/W	0h	MReqPriority for USB1 Initiator OCP Interface
23	Reserved	R	0h	
22-20	usb0	R/W	0h	MReqPriority for USB0 Initiator OCP Interface
19	Reserved	R	0h	
18-16	cpsw	R/W	0h	MReqPriority for CPSW Initiator OCP Interface
15	Reserved	R	0h	
14-12	Reserved	R	0h	
11	Reserved	R	0h	
10-8	pru_icss_pru0	R/W	0h	MReqPriority for PRU-ICSS PRU0 Initiator OCP Interface
7	Reserved	R	0h	
6-4	sab_init1	R/W	0h	MReqPriority for MPU Initiator 1 OCP Interface
3	Reserved	R	0h	
2-0	sab_init0	R/W	0h	MReqPriority for MPU Initiator 0 OCP Interface

9.3.1.32 mreqprio_1 Register (offset = 674h) [reset = 0h]

mreqprio_1 is shown in [Figure 9-34](#) and described in [Table 9-43](#).

Figure 9-34. mreqprio_1 Register


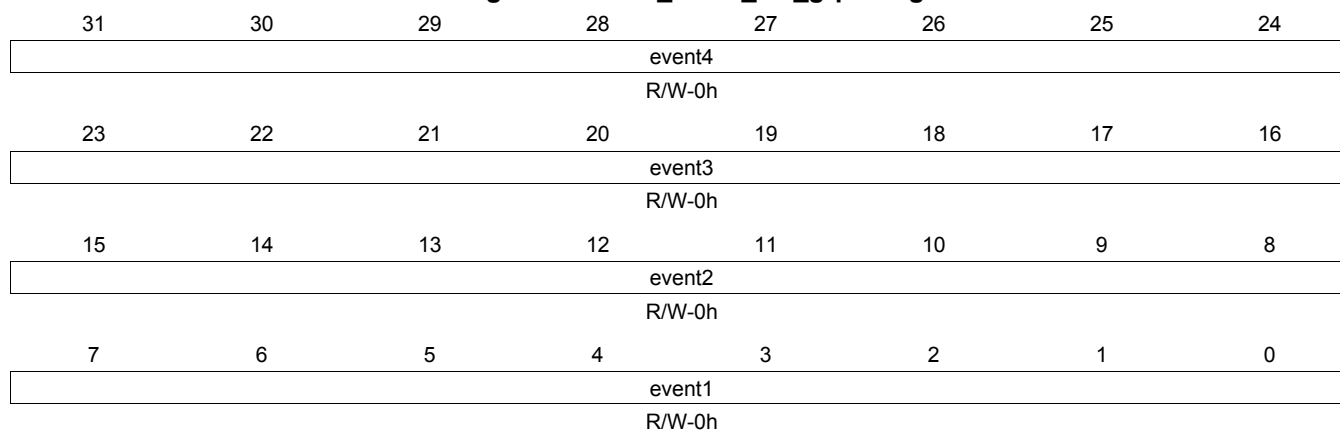
LEGEND: R/W = Read/Write; R = Read only; W1toCl = Write 1 to clear bit; -n = value after reset

Table 9-43. mreqprio_1 Register Field Descriptions

Bit	Field	Type	Reset	Description
31-0	Reserved	R	0h	

9.3.1.33 hw_event_sel_grp1 Register (offset = 690h) [reset = 0h]

hw_event_sel_grp1 is shown in [Figure 9-35](#) and described in [Table 9-44](#).

Figure 9-35. hw_event_sel_grp1 Register


LEGEND: R/W = Read/Write; R = Read only; W1toCl = Write 1 to clear bit; -n = value after reset

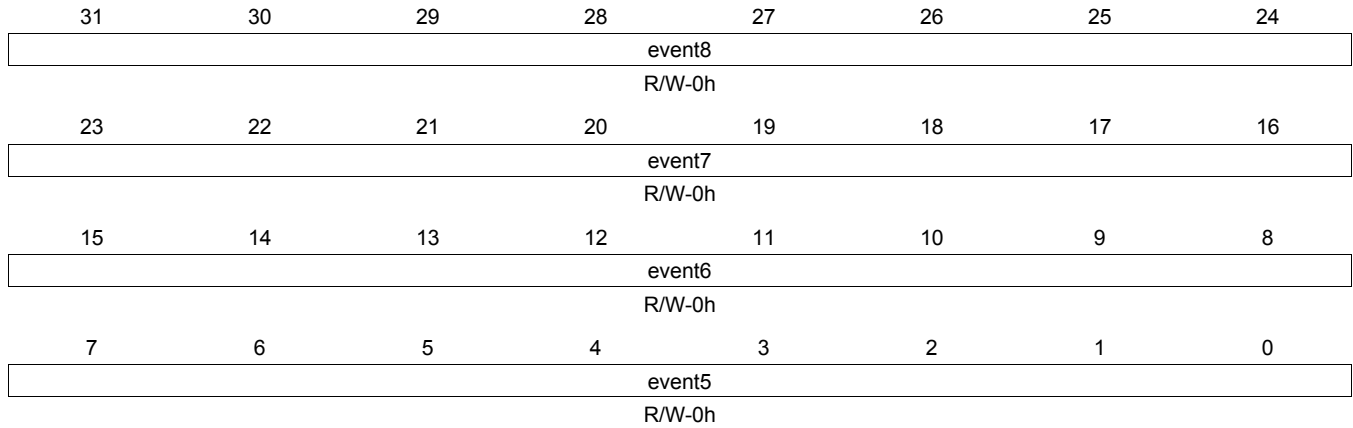
Table 9-44. hw_event_sel_grp1 Register Field Descriptions

Bit	Field	Type	Reset	Description
31-24	event4	R/W	0h	Select 4th trace event from group 1
23-16	event3	R/W	0h	Select 3rd trace event from group 1
15-8	event2	R/W	0h	Select 2nd trace event from group 1
7-0	event1	R/W	0h	Select 1st trace event from group 1

9.3.1.34 hw_event_sel_grp2 Register (offset = 694h) [reset = 0h]

hw_event_sel_grp2 is shown in [Figure 9-36](#) and described in [Table 9-45](#).

Figure 9-36. hw_event_sel_grp2 Register



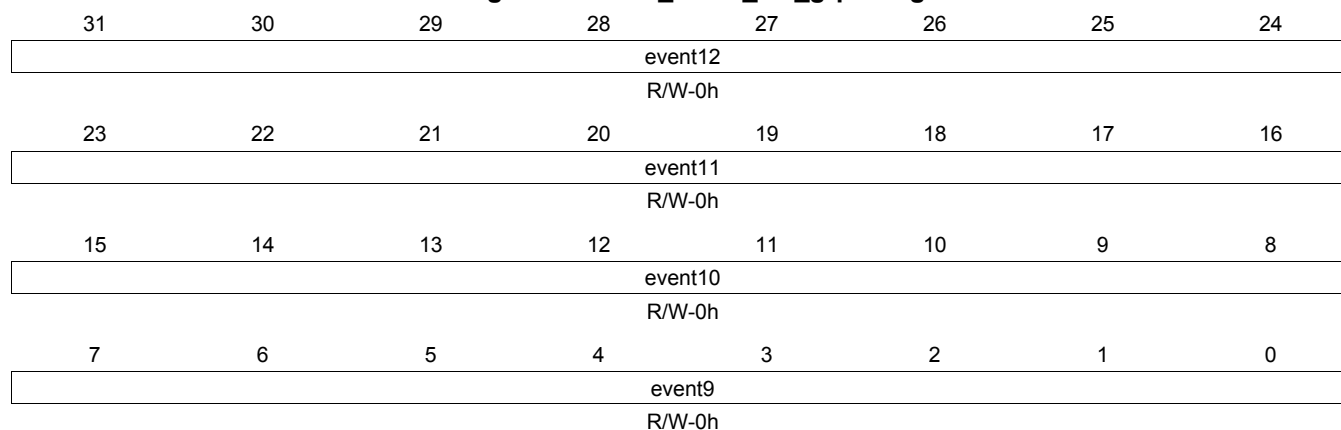
LEGEND: R/W = Read/Write; R = Read only; W1toCl = Write 1 to clear bit; -n = value after reset

Table 9-45. hw_event_sel_grp2 Register Field Descriptions

Bit	Field	Type	Reset	Description
31-24	event8	R/W	0h	Select 8th trace event from group 2
23-16	event7	R/W	0h	Select 7th trace event from group 2
15-8	event6	R/W	0h	Select 6th trace event from group 2
7-0	event5	R/W	0h	Select 5th trace event from group 2

9.3.1.35 hw_event_sel_grp3 Register (offset = 698h) [reset = 0h]

hw_event_sel_grp3 is shown in [Figure 9-37](#) and described in [Table 9-46](#).

Figure 9-37. hw_event_sel_grp3 Register


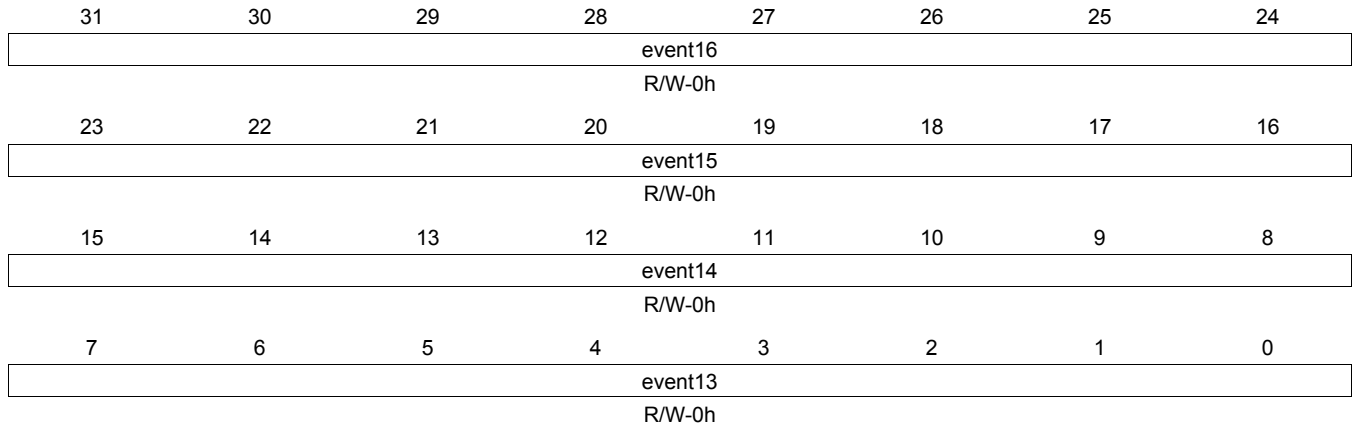
LEGEND: R/W = Read/Write; R = Read only; W1toCl = Write 1 to clear bit; -n = value after reset

Table 9-46. hw_event_sel_grp3 Register Field Descriptions

Bit	Field	Type	Reset	Description
31-24	event12	R/W	0h	Select 12th trace event from group 3
23-16	event11	R/W	0h	Select 11th trace event from group 3
15-8	event10	R/W	0h	Select 10th trace event from group 3
7-0	event9	R/W	0h	Select 9th trace event from group 3

9.3.1.36 hw_event_sel_grp4 Register (offset = 69Ch) [reset = 0h]

hw_event_sel_grp4 is shown in [Figure 9-38](#) and described in [Table 9-47](#).

Figure 9-38. hw_event_sel_grp4 Register


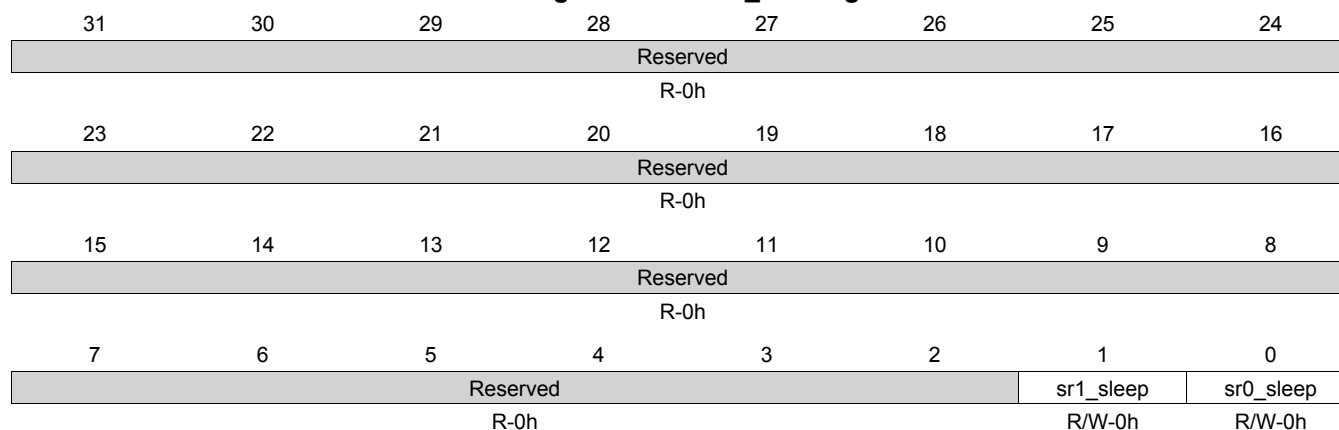
LEGEND: R/W = Read/Write; R = Read only; W1toCl = Write 1 to clear bit; -n = value after reset

Table 9-47. hw_event_sel_grp4 Register Field Descriptions

Bit	Field	Type	Reset	Description
31-24	event16	R/W	0h	Select 16th trace event from group 4
23-16	event15	R/W	0h	Select 15th trace event from group 4
15-8	event14	R/W	0h	Select 14th trace event from group 4
7-0	event13	R/W	0h	Select 13th trace event from group 4

9.3.1.37 smrt_ctrl Register (offset = 6A0h) [reset = 0h]

 smrt_ctrl is shown in [Figure 9-39](#) and described in [Table 9-48](#).

Figure 9-39. smrt_ctrl Register


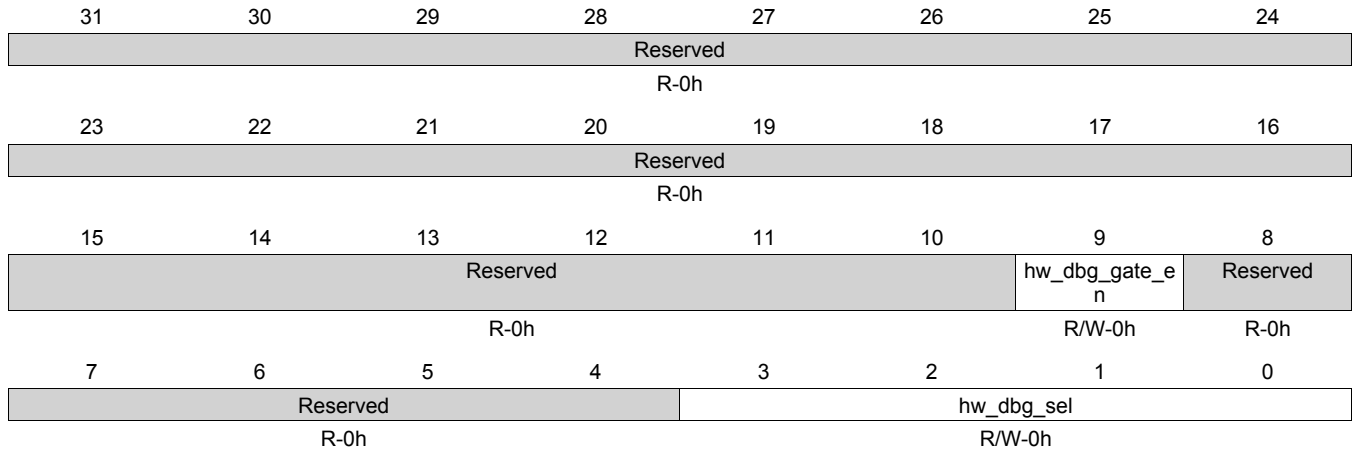
LEGEND: R/W = Read/Write; R = Read only; W1toCl = Write 1 to clear bit; -n = value after reset

Table 9-48. smrt_ctrl Register Field Descriptions

Bit	Field	Type	Reset	Description
31-2	Reserved	R	0h	
1	sr1_sleep	R/W	0h	0: Disable sensor (SRSLEEP on sensor driven to 1) 1: Enable sensor (SRSLEEP on sensor driven to 0).
0	sr0_sleep	R/W	0h	0: Disable sensor (SRSLEEP on sensor driven to 1) 1: Enable sensor (SRSLEEP on sensor driven to 0).

9.3.1.38 mpuss_hw_debug_sel Register (offset = 6A4h) [reset = 0h]

 mpuss_hw_debug_sel is shown in [Figure 9-40](#) and described in [Table 9-49](#).

Figure 9-40. mpuss_hw_debug_sel Register


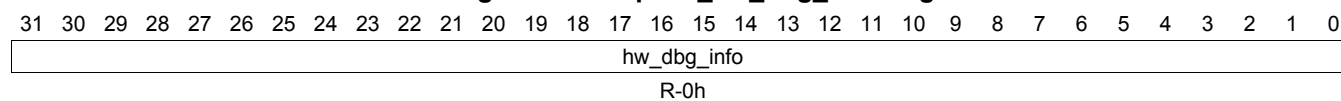
LEGEND: R/W = Read/Write; R = Read only; W1toCl = Write 1 to clear bit; -n = value after reset

Table 9-49. mpuss_hw_debug_sel Register Field Descriptions

Bit	Field	Type	Reset	Description
31-10	Reserved	R	0h	
9	hw_dbg_gate_en	R/W	0h	To save power input to MPUSS_HW_DBG_INFO is gated off to all zeros when HW_DBG_GATE_EN bit is low. 0: Debug info gated off 1: Debug info not gated off
8	Reserved	R	0h	
7-4	Reserved	R	0h	
3-0	hw_dbg_sel	R/W	0h	Selects which Group of signals are sent out to the MODENA_HW_DBG_INFO register. Please see MPU functional spec for more details 0000: Group 0 0001: Group 1 0010: Group 2 0011: Group 3 0100: Group 4 0101: Group 5 0110: Group 6 0111: Group 7 1xxx: Reserved

9.3.1.39 mpuss_hw_dbg_info Register (offset = 6A8h) [reset = 0h]

mpuss_hw_dbg_info is shown in [Figure 9-41](#) and described in [Table 9-50](#).

Figure 9-41. mpuss_hw_dbg_info Register


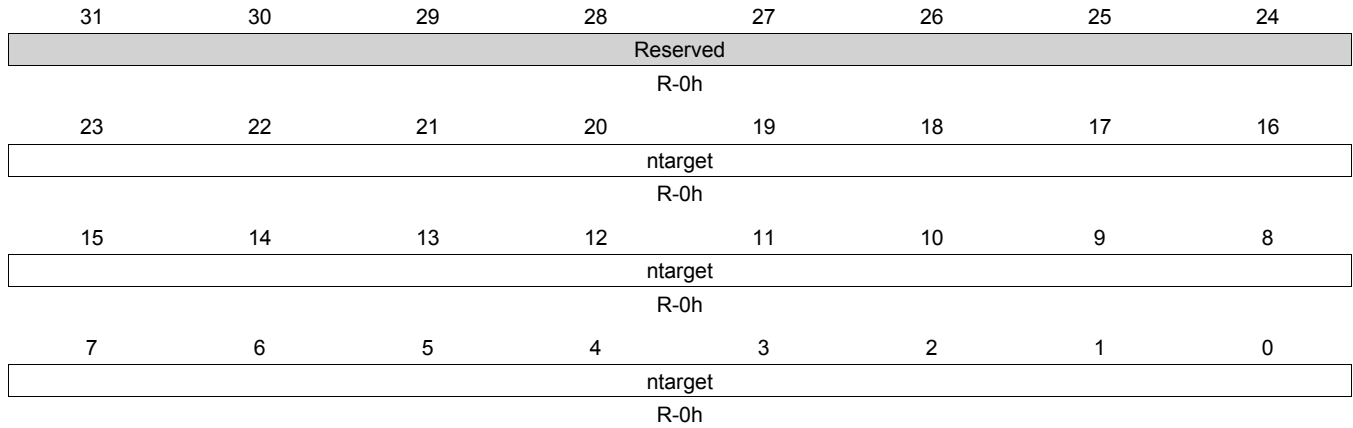
LEGEND: R/W = Read/Write; R = Read only; W1toCl = Write 1 to clear bit; -n = value after reset

Table 9-50. mpuss_hw_dbg_info Register Field Descriptions

Bit	Field	Type	Reset	Description
31-0	hw_dbg_info	R	0h	Hardware Debug Info from MPU.

9.3.1.40 vdd_mpu_opp_050 Register (offset = 770h) [reset = 0h]

vdd_mpu_opp_050 is shown in [Figure 9-42](#) and described in [Table 9-51](#).

Figure 9-42. vdd_mpu_opp_050 Register


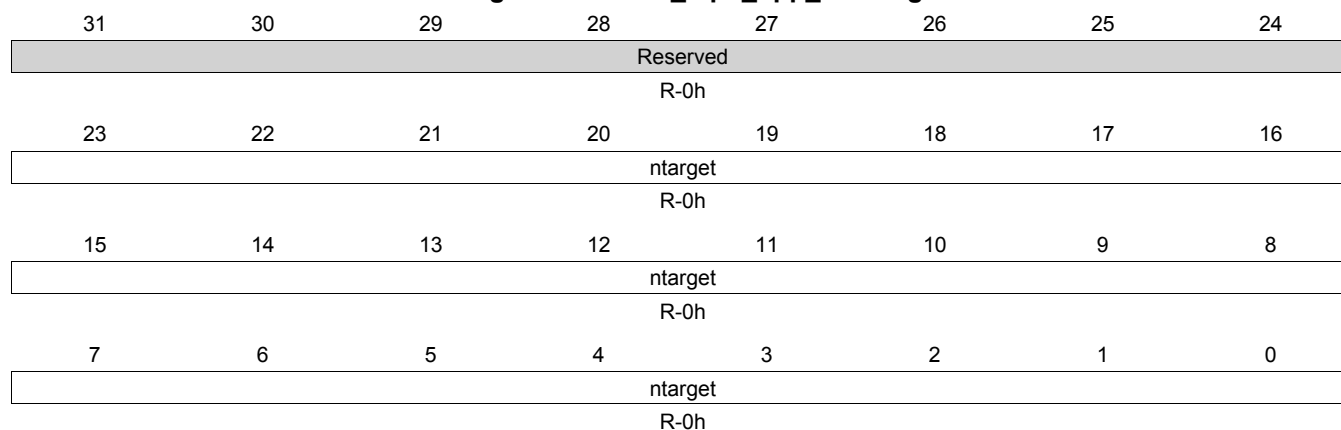
LEGEND: R/W = Read/Write; R = Read only; W1toCl = Write 1 to clear bit; -n = value after reset

Table 9-51. vdd_mpu_opp_050 Register Field Descriptions

Bit	Field	Type	Reset	Description
31-24	Reserved	R	0h	
23-0	ntarget	R	0h	Ntarget value for MPU Voltage domain OPP50 Reset value is device-dependent.

9.3.1.41 vdd_mpu_opp_100 Register (offset = 774h) [reset = 0h]

vdd_mpu_opp_100 is shown in [Figure 9-43](#) and described in [Table 9-52](#).

Figure 9-43. vdd_mpu_opp_100 Register


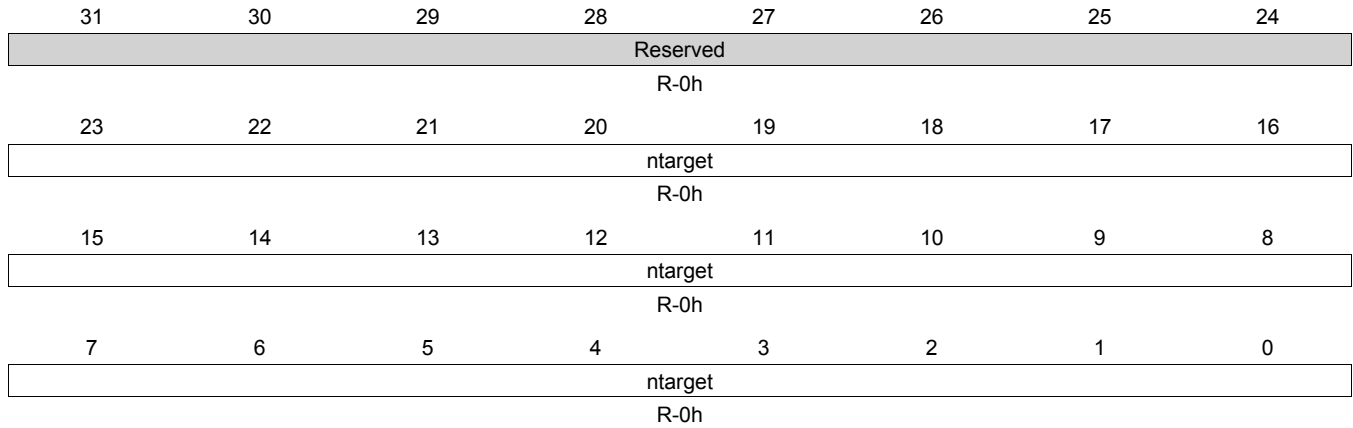
LEGEND: R/W = Read/Write; R = Read only; W1toCl = Write 1 to clear bit; -n = value after reset

Table 9-52. vdd_mpu_opp_100 Register Field Descriptions

Bit	Field	Type	Reset	Description
31-24	Reserved	R	0h	
23-0	ntarget	R	0h	Ntarget value for MPU Voltage domain OPP100 Reset value is device-dependent.

9.3.1.42 vdd_mpu_opp_120 Register (offset = 778h) [reset = 0h]

vdd_mpu_opp_120 is shown in [Figure 9-44](#) and described in [Table 9-53](#).

Figure 9-44. vdd_mpu_opp_120 Register


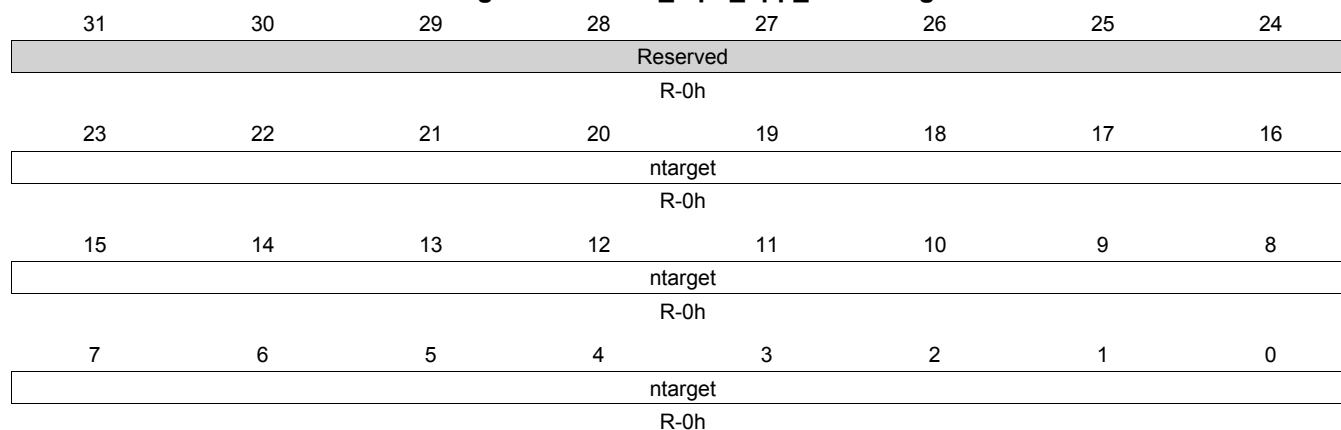
LEGEND: R/W = Read/Write; R = Read only; W1toCl = Write 1 to clear bit; -n = value after reset

Table 9-53. vdd_mpu_opp_120 Register Field Descriptions

Bit	Field	Type	Reset	Description
31-24	Reserved	R	0h	
23-0	ntarget	R	0h	Ntarget value for MPU Voltage domain OPP120 Reset value is device-dependent.

9.3.1.43 vdd_mpu_opp_turbo Register (offset = 77Ch) [reset = 0h]

vdd_mpu_opp_turbo is shown in [Figure 9-45](#) and described in [Table 9-54](#).

Figure 9-45. vdd_mpu_opp_turbo Register


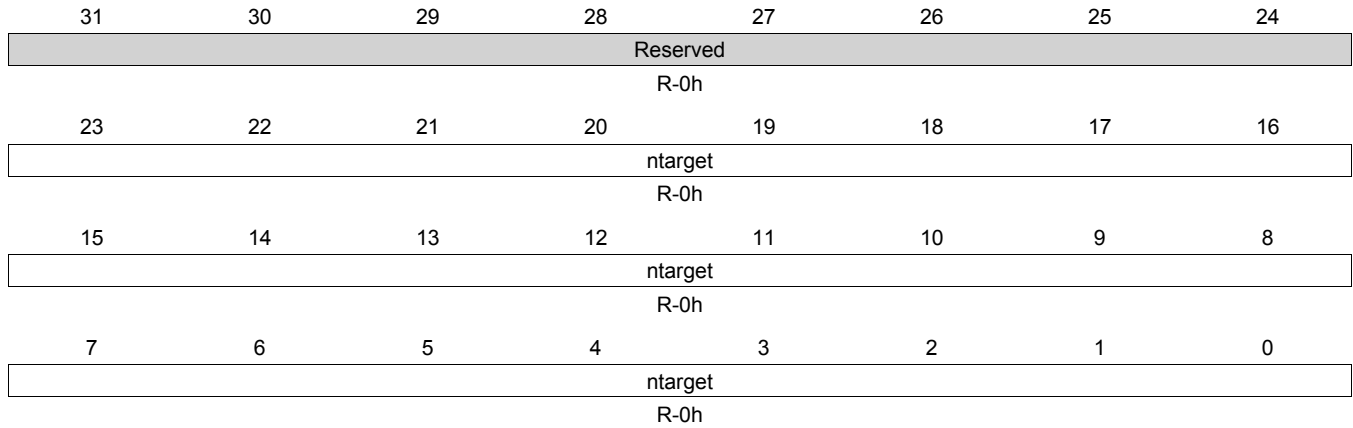
LEGEND: R/W = Read/Write; R = Read only; W1toCl = Write 1 to clear bit; -n = value after reset

Table 9-54. vdd_mpu_opp_turbo Register Field Descriptions

Bit	Field	Type	Reset	Description
31-24	Reserved	R	0h	
23-0	ntarget	R	0h	Ntarget value for MPU Voltage domain OPPTURBO Reset value is device-dependent.

9.3.1.44 vdd_core_opp_050 Register (offset = 7B8h) [reset = 0h]

vdd_core_opp_050 is shown in [Figure 9-46](#) and described in [Table 9-55](#).

Figure 9-46. vdd_core_opp_050 Register


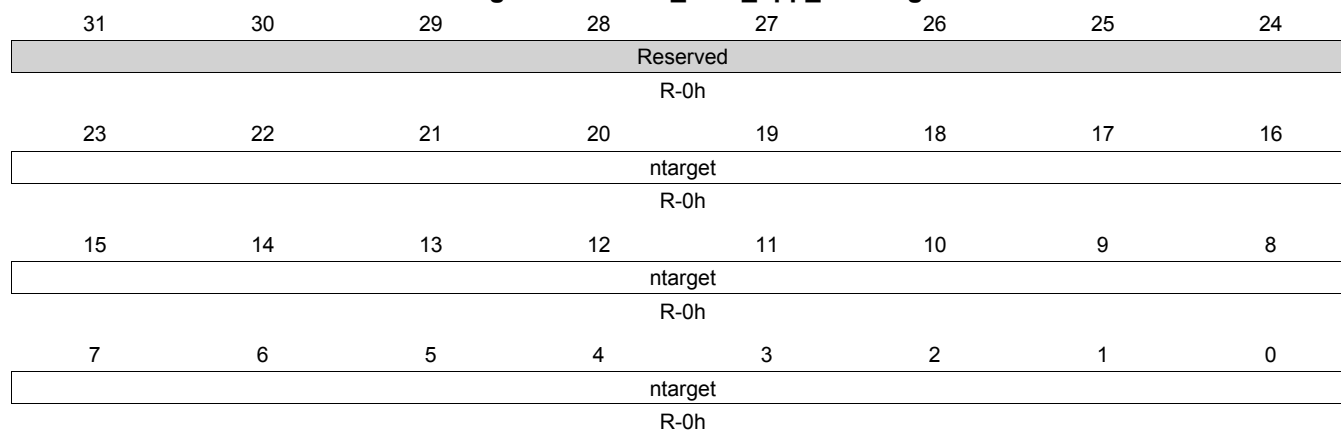
LEGEND: R/W = Read/Write; R = Read only; W1toCl = Write 1 to clear bit; -n = value after reset

Table 9-55. vdd_core_opp_050 Register Field Descriptions

Bit	Field	Type	Reset	Description
31-24	Reserved	R	0h	
23-0	ntarget	R	0h	Ntarget value for CORE Voltage domain OPP50 Reset value is device-dependent.

9.3.1.45 vdd_core_opp_100 Register (offset = 7BCh) [reset = 0h]

vdd_core_opp_100 is shown in [Figure 9-47](#) and described in [Table 9-56](#).

Figure 9-47. vdd_core_opp_100 Register


LEGEND: R/W = Read/Write; R = Read only; W1toCl = Write 1 to clear bit; -n = value after reset

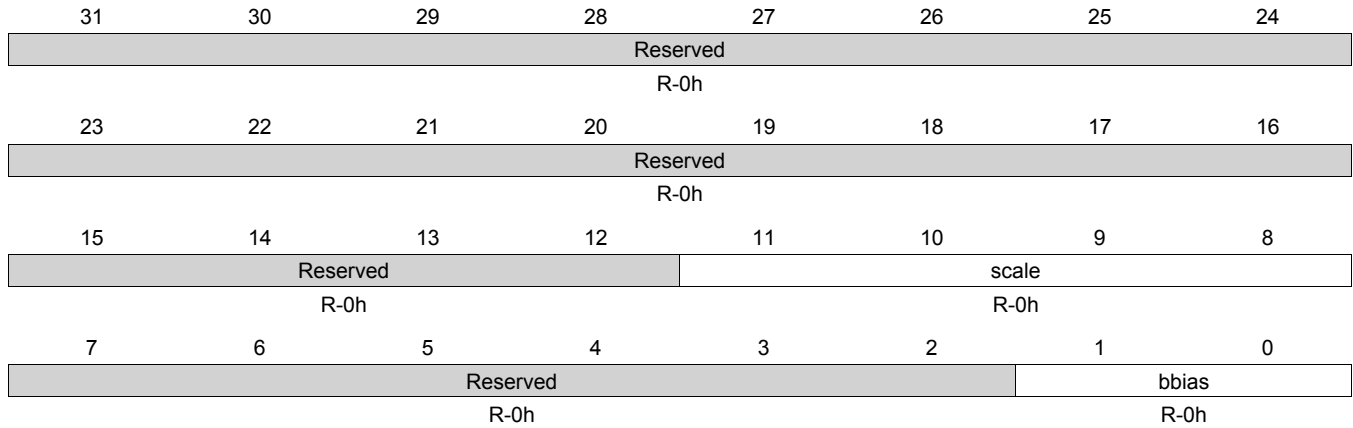
Table 9-56. vdd_core_opp_100 Register Field Descriptions

Bit	Field	Type	Reset	Description
31-24	Reserved	R	0h	
23-0	ntarget	R	0h	Ntarget value for CORE Voltage domain OPP100 Reset value is device-dependent.

9.3.1.46 bb_scale Register (offset = 7D0h) [reset = 0h]

bb_scale is shown in [Figure 9-48](#) and described in [Table 9-57](#).

Figure 9-48. bb_scale Register



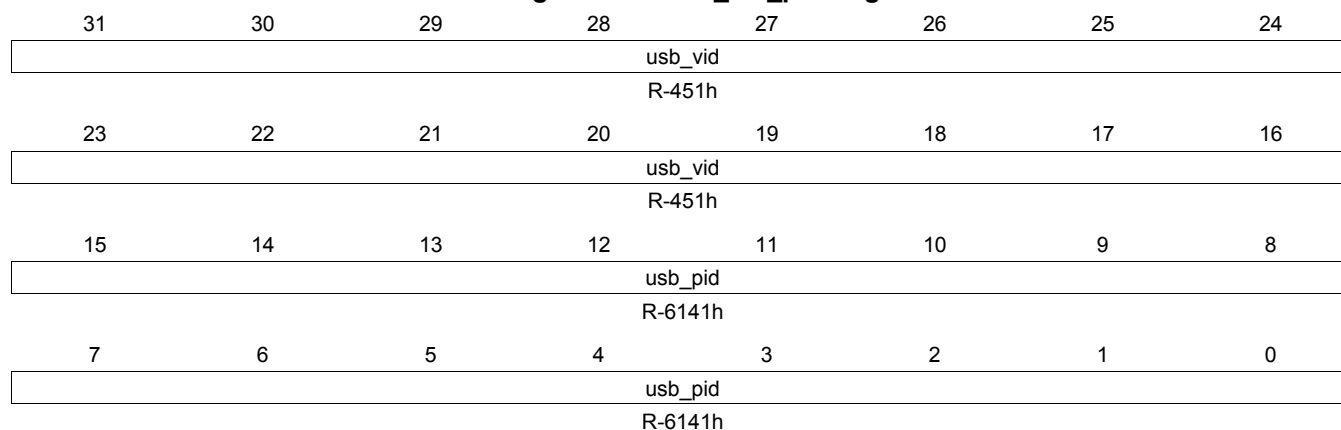
LEGEND: R/W = Read/Write; R = Read only; W1toCl = Write 1 to clear bit; -n = value after reset

Table 9-57. bb_scale Register Field Descriptions

Bit	Field	Type	Reset	Description
31-12	Reserved	R	0h	
11-8	scale	R	0h	Dynamic core voltage scaling for class 0
7-2	Reserved	R	0h	
1-0	bbias	R	0h	BBIAS value from Efuse

9.3.1.47 usb_vid_pid Register (offset = 7F4h) [reset = 4516141h]

usb_vid_pid is shown in [Figure 9-49](#) and described in [Table 9-58](#).

Figure 9-49. usb_vid_pid Register


LEGEND: R/W = Read/Write; R = Read only; W1toCl = Write 1 to clear bit; -n = value after reset

Table 9-58. usb_vid_pid Register Field Descriptions

Bit	Field	Type	Reset	Description
31-16	usb_vid	R	0x451	USB Vendor ID
15-0	usb_pid	R	0x6141	USB Product ID

9.3.1.48 efuse_sma Register (offset = 7FCh) [reset = 0h]

This register describes the device's ARM maximum frequency capabilities and package type. Note that this register is only applicable in PG2.x. The contents of this register is not applicable in PG1.0 devices.

efuse_sma is shown in [Figure 9-50](#) and described in [Table 9-59](#).

Figure 9-50. efuse_sma Register

31	30	29	28	27	26	25	24
Reserved							
R							
23	22	21	20	19	18	17	16
Reserved						package_type	
R						R-package-dependent	
15	14	13	12	11	10	9	8
Reserved				arm_mpu_max_freq			
R				R-device-dependent			
7	6	5	4	3	2	1	0
arm_mpu_max_freq							
R-device-dependent							

LEGEND: R/W = Read/Write; R = Read only; W1toCl = Write 1 to clear bit; -n = value after reset

Table 9-59. efuse_sma Register Field Descriptions

Bit	Field	Type	Reset	Description
31-18	Reserved	R		These bits are undefined and contents can vary from device to device.
17-16	package_type	R	Package-dependent	Designates the Package type of the device (PG2.x only). 00b - Undefined 01b - ZCZ Package 10b - ZCE Package 11b - Reserved
15-13	Reserved	R		These bits are undefined and contents can vary from device to device.
12-0	arm_mpu_max_freq	R	Device-dependent	Designates the ARM MPU Maximum Frequency supported by the device (PG2.x only). There are also voltage requirements that accompany each frequency (OPPs). See the device specific data manual for this information and for information on device variants. 0x1FEF - 300 MHz ARM MPU Maximum (ZCZ Package only) 0x1FAF - 600 MHz ARM MPU Maximum (ZCZ Package only) 0x1F2F - 720 MHz ARM MPU Maximum (ZCZ Package only) 0x1E2F - 800 MHz ARM MPU Maximum (ZCZ Package only) 0x1C2F - 1 GHz ARM MPU Maximum (ZCZ Package only) 0x1FDF - 300 MHz ARM MPU Maximum (ZCE Package only) 0x1F9F - 600 MHz ARM MPU Maximum (ZCE Package only) All other values are reserved.

9.3.1.49 conf_<module>_<pin> Register (offset = 800h–A34h)

See the device datasheet for information on default pin mux configurations. Note that the device ROM may change the default pin mux for certain pins based on the SYSBOOT mode settings.

See [Table 9-10, Control Module Registers Table](#), for the full list of offsets for each module/pin configuration.

conf_<module>_<pin> is shown in [Figure 9-51](#) and described in [Table 9-60](#).

Figure 9-51. conf_<module>_<pin> Register

31	30	29	28	27	26	25	24
Reserved							
R-0h							
23	22	21	20	19	18	17	16
Reserved				Reserved			
R-0h				R-0h			
15	14	13	12	11	10	9	8
Reserved							
R-0h							
7	6	5	4	3	2	1	0
Reserved	conf_<module>_<pin>_slewctrl	conf_<module>_<pin>_rxactive	conf_<module>_<pin>_putypesel	conf_<module>_<pin>_puden	conf_<module>_<pin>_mmode		
R-0h	R/W-0h	R/W-1h	R/W-0h	R/W-0h	R/W-0h		

LEGEND: R/W = Read/Write; R = Read only; W1toCl = Write 1 to clear bit; -n = value after reset

Table 9-60. conf_<module>_<pin> Register Field Descriptions

Bit	Field	Type	Reset	Description
31-20	Reserved	R	0h	
19-7	Reserved	R	0h	
6	conf_<module>_<pin>_slewctrl	R/W	X	Select between faster or slower slew rate 0: Fast 1: Slow Reset value is pad-dependent.
5	conf_<module>_<pin>_rxactive	R/W	1h	Input enable value for the PAD 0: Receiver disabled 1: Receiver enabled
4	conf_<module>_<pin>_putypesel	R/W	X	Pad pullup/pulldown type selection 0: Pulldown selected 1: Pullup selected Reset value is pad-dependent.
3	conf_<module>_<pin>_puden	R/W	X	Pad pullup/pulldown enable 0: Pullup/pulldown enabled 1: Pullup/pulldown disabled Reset value is pad-dependent.
2-0	conf_<module>_<pin>_mmode	R/W	X	Pad functional signal mux select. Reset value is pad-dependent.

9.3.1.50 cqdetect_status Register (offset = E00h) [reset = 0h]

cqdetect_status is shown in [Figure 9-52](#) and described in [Table 9-61](#).

Figure 9-52. cqdetect_status Register

31	30	29	28	27	26	25	24
Reserved							
R-0h							
23	22	21	20	19	18	17	16
Reserved		Reserved		Reserved		Reserved	
R-0h		R-0h		R-0h		R-0h	
15	14	13	12	11	10	9	8
Reserved		cqerr_general	cqerr_gemac_b	cqerr_gemac_a	cqerr_mmcsd_b	cqerr_mmcsd_a	cqerr_gpmc
R-0h		R-0h	R-0h	R-0h	R-0h	R-0h	R-0h
7	6	5	4	3	2	1	0
Reserved		cqstat_general	cqstat_gemac_b	cqstat_gemac_a	cqstat_mmcsd_b	cqstat_mmcsd_a	cqstat_gpmc
R-0h		R-0h	R-0h	R-0h	R-0h	R-0h	R-0h

LEGEND: R/W = Read/Write; R = Read only; W1toCl = Write 1 to clear bit; -n = value after reset

Table 9-61. cqdetect_status Register Field Descriptions

Bit	Field	Type	Reset	Description
31-22	Reserved	R	0h	
21	Reserved	R	0h	
20	Reserved	R	0h	
19	Reserved	R	0h	
18	Reserved	R	0h	
17	Reserved	R	0h	
16	Reserved	R	0h	
15-14	Reserved	R	0h	
13	cqerr_general	R	0h	CQDetect Mode Error Status
12	cqerr_gemac_b	R	0h	CQDetect Mode Error Status
11	cqerr_gemac_a	R	0h	CQDetect Mode Error Status
10	cqerr_mmcsd_b	R	0h	CQDetect Mode Error Status
9	cqerr_mmcsd_a	R	0h	CQDetect Mode Error Status
8	cqerr_gpmc	R	0h	CQDetect Mode Error Status
7-6	Reserved	R	0h	
5	cqstat_general	R	0h	1: IOs are 3.3V mode 0: IOs are 1.8V mode
4	cqstat_gemac_b	R	0h	1: IOs are 3.3V mode 0: IOs are 1.8V mode
3	cqstat_gemac_a	R	0h	1: IOs are 3.3V mode 0: IOs are 1.8V mode
2	cqstat_mmcsd_b	R	0h	1: IOs are 3.3V mode 0: IOs are 1.8V mode
1	cqstat_mmcsd_a	R	0h	1: IOs are 3.3V mode 0: IOs are 1.8V mode
0	cqstat_gpmc	R	0h	1: IOs are 3.3V mode 0: IOs are 1.8V mode

9.3.1.51 ddr_io_ctrl Register (offset = E04h) [reset = 0h]

ddr_io_ctrl is shown in Figure 9-53 and described in Table 9-62.

Figure 9-53. ddr_io_ctrl Register

31	30	29	28	27	26	25	24
ddr3_rst_def_val	ddr_wuclk_disable	Reserved	mddr_sel	Reserved			
R/W-0h	R/W-0h	R-0h	R/W-0h	R/W-0h			
23	22	21	20	19	18	17	16
Reserved							
R/W-0h							
15	14	13	12	11	10	9	8
Reserved							
R/W-0h							
7	6	5	4	3	2	1	0
Reserved							
R/W-0h							

LEGEND: R/W = Read/Write; R = Read only; W1toCl = Write 1 to clear bit; -n = value after reset

Table 9-62. ddr_io_ctrl Register Field Descriptions

Bit	Field	Type	Reset	Description
31	ddr3_rst_def_val	R/W	0h	DDR3 reset default value
30	ddr_wuclk_disable	R/W	0h	Disables the slow clock to WUCLKIN and ISOCLKIN of DDR emif SS and IOs (required for proper initialization, after which clock could be shut off). 0 = free running SLOW (32k) clock 1 = clock is synchronously gated
29	Reserved	R	0h	
28	mddr_sel	R/W	0h	0: IOs set for DDR2/DDR3 (STL mode) 1: IOs set for mDDR (CMOS mode)
27-0	Reserved	R/W	0h	

9.3.1.52 vtp_ctrl Register (offset = E0Ch) [reset = 0h]

vtp_ctrl is shown in [Figure 9-54](#) and described in [Table 9-63](#).

Figure 9-54. vtp_ctrl Register

31	30	29	28	27	26	25	24
Reserved							
R-0h							
23	22	21	20	19	18	17	16
Reserved				pcin			
R-0h				R-0h			
15	14	13	12	11	10	9	8
Reserved				ncin			
R-0h				R-0h			
7	6	5	4	3	2	1	0
Reserved	enable	ready	lock	filter		clrz	
R-0h	R/W-0h	R-0h	R/W-0h	R/W-0h		R/W-0h	

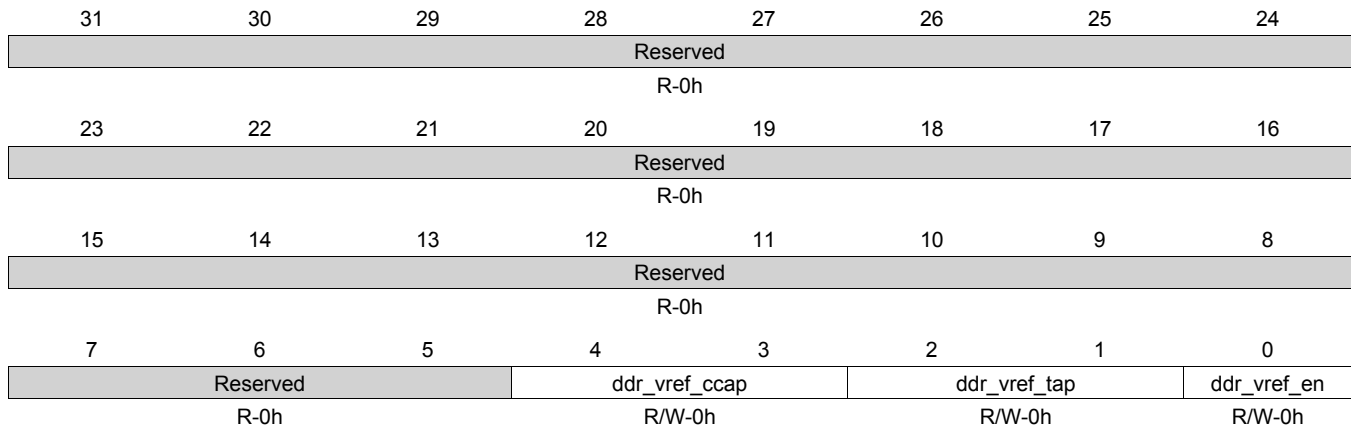
LEGEND: R/W = Read/Write; R = Read only; W1toCl = Write 1 to clear bit; -n = value after reset

Table 9-63. vtp_ctrl Register Field Descriptions

Bit	Field	Type	Reset	Description
31-23	Reserved	R	0h	
22-16	pcin	R	1h	Default/reset values of 'P' for the VTP controller. See "Silicon Revision Functional Differences and Enhancements" for differences in operation based on AM335x silicon revision.
15	Reserved	R	0h	
14-8	ncin	R	1h	Default/reset values of 'N' for the VTP controller. See "Silicon Revision Functional Differences and Enhancements" for differences in operation based on AM335x silicon revision.
7	Reserved	R	0h	
6	enable	R/W	0h	0: VTP macro in bypass mode. P and N are driven from PCIN and NCIN. 1: Dynamic VTP compensation mode
5	ready	R	0h	0: Training sequence is not complete 1: Training sequence is complete
4	lock	R/W	0h	0: Normal operation dynamic update 1: freeze dynamic update, pwrndn controller
3-1	filter	R/W	0h	Digital filter bits to prevent the controller from making excessive number of changes. 000: Filter off 001: Update on two consecutive update requests 010: Update on three consecutive update requests 011: Update on four consecutive update requests 100: Update on five consecutive update requests 101: Update on six consecutive update requests 110: Update on seven consecutive update requests 111: Update on eight consecutive update requests
0	clrz	R/W	0h	clears flops, start count again, after low going pulse

9.3.1.53 vref_ctrl Register (offset = E14h) [reset = 0h]

vref_ctrl is shown in [Figure 9-55](#) and described in [Table 9-64](#).

Figure 9-55. vref_ctrl Register


LEGEND: R/W = Read/Write; R = Read only; W1toCl = Write 1 to clear bit; -n = value after reset

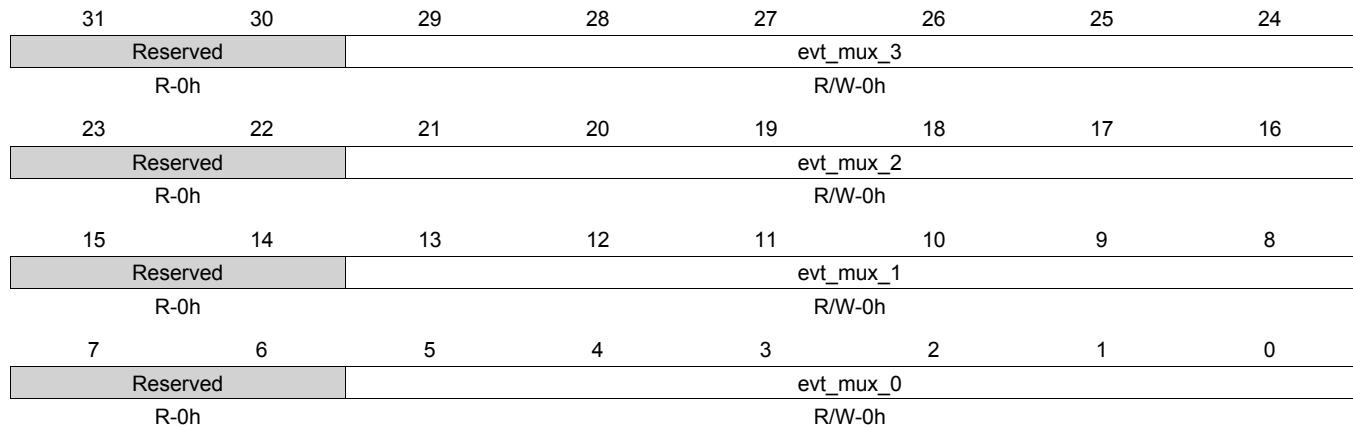
Table 9-64. vref_ctrl Register Field Descriptions

Bit	Field	Type	Reset	Description
31-5	Reserved	R	0h	
4-3	ddr_vref_ccap	R/W	0h	select for coupling cap for DDR 00 : No capacitor connected 01 : Capacitor between BIAS2 and VSS 10 : Capacitor between BIAS2 and VDDS 11: Capacitor between BIAS2 and VSS andamp Capacitor between BIAS2 and VDDS
2-1	ddr_vref_tap	R/W	0h	select for int ref for DDR 00 : Pad/Bias2 connected to internal reference VDDS/2 for 2uA current load 01 : Pad/Bias2 connected to internal reference VDDS/2 for 4uA current load 10 : Pad/Bias2 connected to internal reference VDDS/2 for 6uA current load 11 : Pad/Bias2 connected to internal reference VDDS/2 for 8uA current load
0	ddr_vref_en	R/W	0h	active high internal reference enable for DDR

9.3.1.54 tpcc_evt_mux_0_3 Register (offset = F90h) [reset = 0h]

tpcc_evt_mux_0_3 is shown in [Figure 9-56](#) and described in [Table 9-65](#).

Figure 9-56. tpcc_evt_mux_0_3 Register



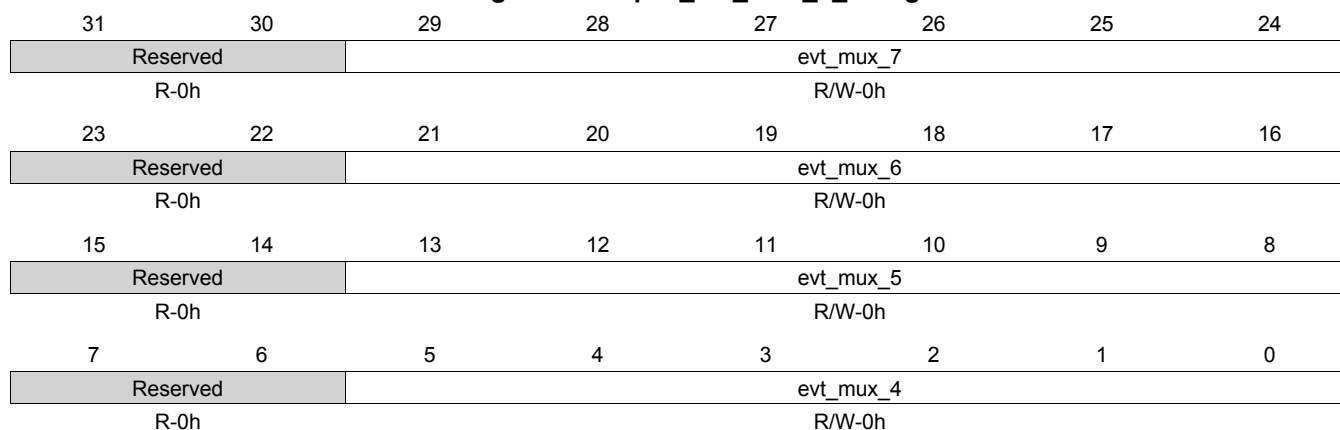
LEGEND: R/W = Read/Write; R = Read only; W1toCl = Write 1 to clear bit; -n = value after reset

Table 9-65. tpcc_evt_mux_0_3 Register Field Descriptions

Bit	Field	Type	Reset	Description
31-30	Reserved	R	0h	
29-24	evt_mux_3	R/W	0h	Selects 1 of 64 inputs for DMA event 3
23-22	Reserved	R	0h	
21-16	evt_mux_2	R/W	0h	Selects 1 of 64 inputs for DMA event 2
15-14	Reserved	R	0h	
13-8	evt_mux_1	R/W	0h	Selects 1 of 64 inputs for DMA event 1
7-6	Reserved	R	0h	
5-0	evt_mux_0	R/W	0h	Selects 1 of 64 inputs for DMA event 0

9.3.1.55 tpcc_evt_mux_4_7 Register (offset = F94h) [reset = 0h]

tpcc_evt_mux_4_7 is shown in [Figure 9-57](#) and described in [Table 9-66](#).

Figure 9-57. tpcc_evt_mux_4_7 Register


LEGEND: R/W = Read/Write; R = Read only; W1toCl = Write 1 to clear bit; -n = value after reset

Table 9-66. tpcc_evt_mux_4_7 Register Field Descriptions

Bit	Field	Type	Reset	Description
31-30	Reserved	R	0h	
29-24	evt_mux_7	R/W	0h	Selects 1 of 64 inputs for DMA event 7
23-22	Reserved	R	0h	
21-16	evt_mux_6	R/W	0h	Selects 1 of 64 inputs for DMA event 6
15-14	Reserved	R	0h	
13-8	evt_mux_5	R/W	0h	Selects 1 of 64 inputs for DMA event 5
7-6	Reserved	R	0h	
5-0	evt_mux_4	R/W	0h	Selects 1 of 64 inputs for DMA event 4

9.3.1.56 tpcc_evt_mux_8_11 Register (offset = F98h) [reset = 0h]

tpcc_evt_mux_8_11 is shown in Figure 9-58 and described in Table 9-67.

Figure 9-58. tpcc_evt_mux_8_11 Register

31	30	29	28	27	26	25	24
Reserved		evt_mux_11					
R-0h		R/W-0h					
23	22	21	20	19	18	17	16
Reserved		evt_mux_10					
R-0h		R/W-0h					
15	14	13	12	11	10	9	8
Reserved		evt_mux_9					
R-0h		R/W-0h					
7	6	5	4	3	2	1	0
Reserved		evt_mux_8					
R-0h		R/W-0h					

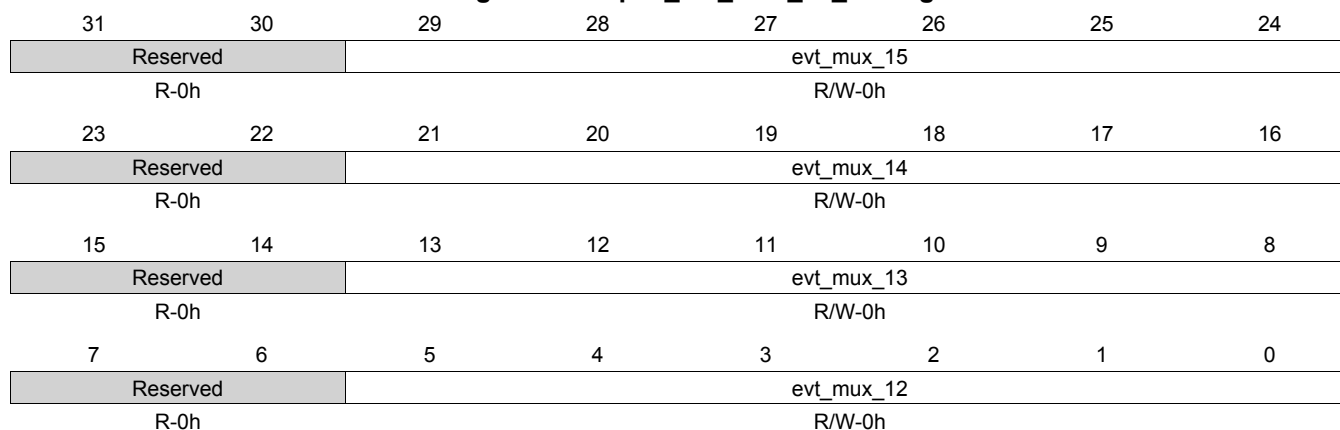
LEGEND: R/W = Read/Write; R = Read only; W1toCl = Write 1 to clear bit; -n = value after reset

Table 9-67. tpcc_evt_mux_8_11 Register Field Descriptions

Bit	Field	Type	Reset	Description
31-30	Reserved	R	0h	
29-24	evt_mux_11	R/W	0h	Selects 1 of 64 inputs for DMA event 11
23-22	Reserved	R	0h	
21-16	evt_mux_10	R/W	0h	Selects 1 of 64 inputs for DMA event 10
15-14	Reserved	R	0h	
13-8	evt_mux_9	R/W	0h	Selects 1 of 64 inputs for DMA event 9
7-6	Reserved	R	0h	
5-0	evt_mux_8	R/W	0h	Selects 1 of 64 inputs for DMA event 8

9.3.1.57 tpcc_evt_mux_12_15 Register (offset = F9Ch) [reset = 0h]

tpcc_evt_mux_12_15 is shown in [Figure 9-59](#) and described in [Table 9-68](#).

Figure 9-59. tpcc_evt_mux_12_15 Register


LEGEND: R/W = Read/Write; R = Read only; W1toCl = Write 1 to clear bit; -n = value after reset

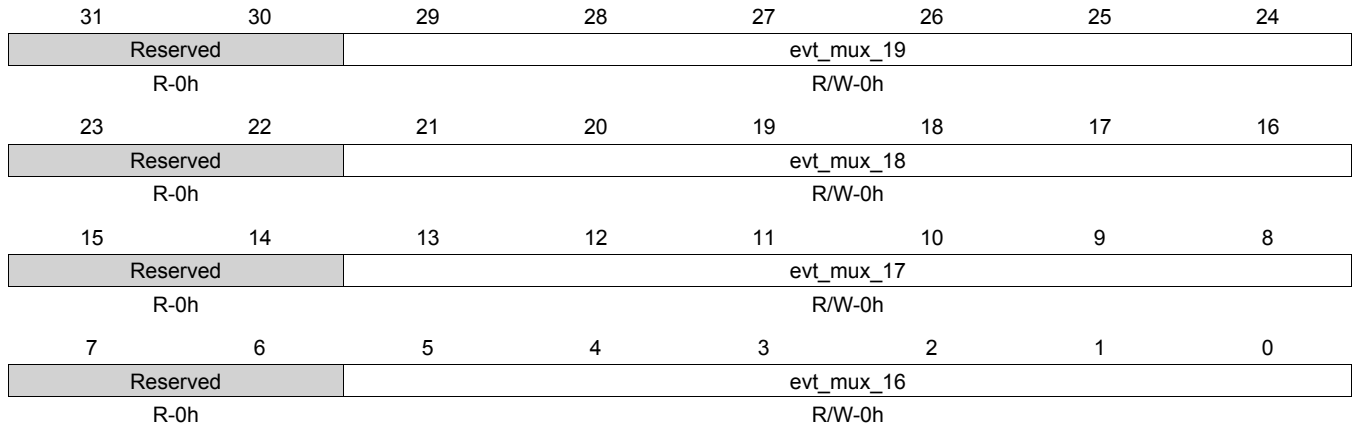
Table 9-68. tpcc_evt_mux_12_15 Register Field Descriptions

Bit	Field	Type	Reset	Description
31-30	Reserved	R	0h	
29-24	evt_mux_15	R/W	0h	Selects 1 of 64 inputs for DMA event 15
23-22	Reserved	R	0h	
21-16	evt_mux_14	R/W	0h	Selects 1 of 64 inputs for DMA event 14
15-14	Reserved	R	0h	
13-8	evt_mux_13	R/W	0h	Selects 1 of 64 inputs for DMA event 13
7-6	Reserved	R	0h	
5-0	evt_mux_12	R/W	0h	Selects 1 of 64 inputs for DMA event 12

9.3.1.58 tpcc_evt_mux_16_19 Register (offset = FA0h) [reset = 0h]

tpcc_evt_mux_16_19 is shown in [Figure 9-60](#) and described in [Table 9-69](#).

Figure 9-60. tpcc_evt_mux_16_19 Register



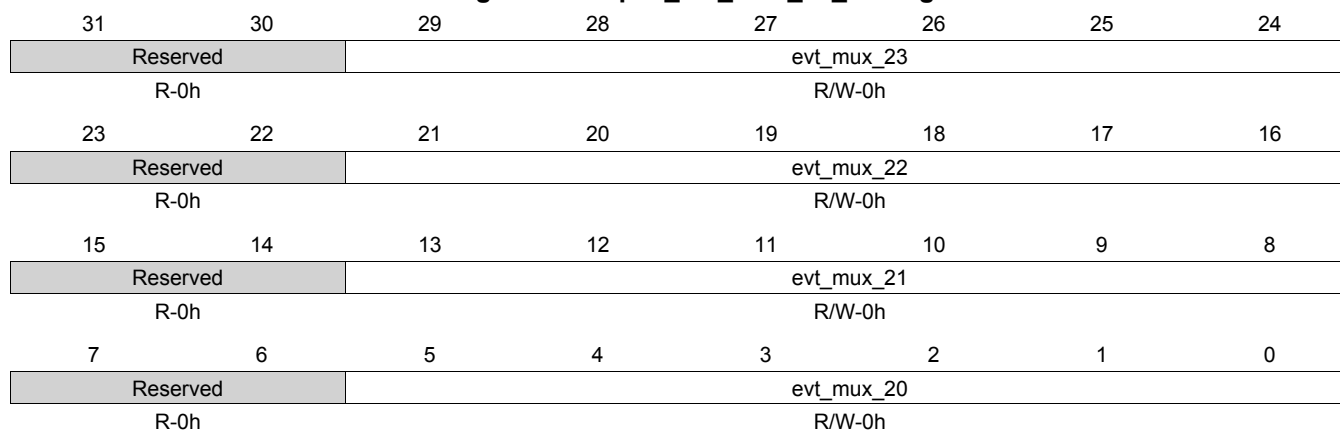
LEGEND: R/W = Read/Write; R = Read only; W1toCl = Write 1 to clear bit; -n = value after reset

Table 9-69. tpcc_evt_mux_16_19 Register Field Descriptions

Bit	Field	Type	Reset	Description
31-30	Reserved	R	0h	
29-24	evt_mux_19	R/W	0h	Selects 1 of 64 inputs for DMA event 19
23-22	Reserved	R	0h	
21-16	evt_mux_18	R/W	0h	Selects 1 of 64 inputs for DMA event 18
15-14	Reserved	R	0h	
13-8	evt_mux_17	R/W	0h	Selects 1 of 64 inputs for DMA event 17
7-6	Reserved	R	0h	
5-0	evt_mux_16	R/W	0h	Selects 1 of 64 inputs for DMA event 16

9.3.1.59 tpcc_evt_mux_20_23 Register (offset = FA4h) [reset = 0h]

tpcc_evt_mux_20_23 is shown in [Figure 9-61](#) and described in [Table 9-70](#).

Figure 9-61. tpcc_evt_mux_20_23 Register


LEGEND: R/W = Read/Write; R = Read only; W1toCl = Write 1 to clear bit; -n = value after reset

Table 9-70. tpcc_evt_mux_20_23 Register Field Descriptions

Bit	Field	Type	Reset	Description
31-30	Reserved	R	0h	
29-24	evt_mux_23	R/W	0h	Selects 1 of 64 inputs for DMA event 23
23-22	Reserved	R	0h	
21-16	evt_mux_22	R/W	0h	Selects 1 of 64 inputs for DMA event 22
15-14	Reserved	R	0h	
13-8	evt_mux_21	R/W	0h	Selects 1 of 64 inputs for DMA event 21
7-6	Reserved	R	0h	
5-0	evt_mux_20	R/W	0h	Selects 1 of 64 inputs for DMA event 20

9.3.1.60 tpcc_evt_mux_24_27 Register (offset = FA8h) [reset = 0h]

tpcc_evt_mux_24_27 is shown in [Figure 9-62](#) and described in [Table 9-71](#).

Figure 9-62. tpcc_evt_mux_24_27 Register

31	30	29	28	27	26	25	24
Reserved		evt_mux_27					
R-0h		R/W-0h					
23	22	21	20	19	18	17	16
Reserved		evt_mux_26					
R-0h		R/W-0h					
15	14	13	12	11	10	9	8
Reserved		evt_mux_25					
R-0h		R/W-0h					
7	6	5	4	3	2	1	0
Reserved		evt_mux_24					
R-0h		R/W-0h					

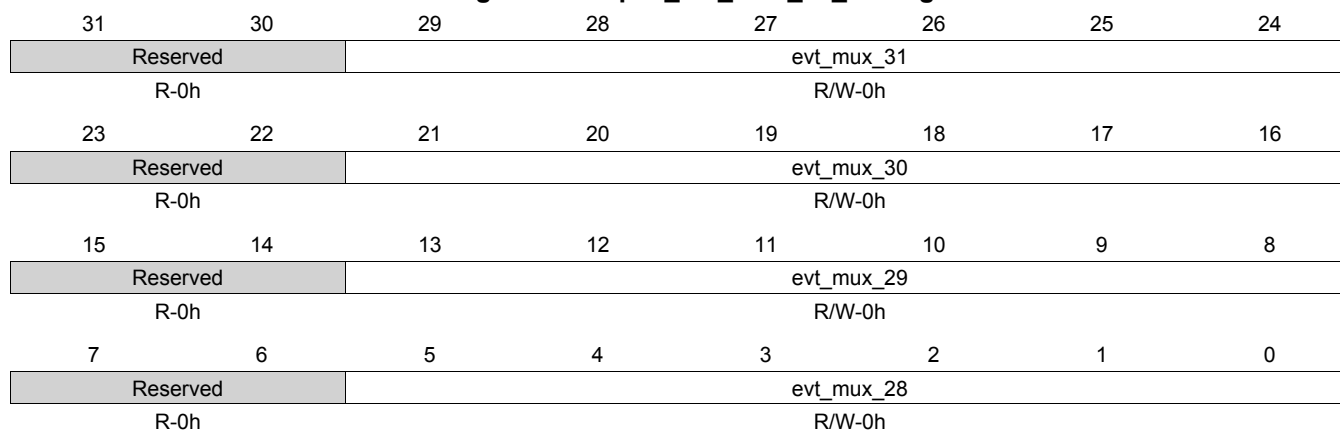
LEGEND: R/W = Read/Write; R = Read only; W1toCl = Write 1 to clear bit; -n = value after reset

Table 9-71. tpcc_evt_mux_24_27 Register Field Descriptions

Bit	Field	Type	Reset	Description
31-30	Reserved	R	0h	
29-24	evt_mux_27	R/W	0h	Selects 1 of 64 inputs for DMA event 27
23-22	Reserved	R	0h	
21-16	evt_mux_26	R/W	0h	Selects 1 of 64 inputs for DMA event 26
15-14	Reserved	R	0h	
13-8	evt_mux_25	R/W	0h	Selects 1 of 64 inputs for DMA event 25
7-6	Reserved	R	0h	
5-0	evt_mux_24	R/W	0h	Selects 1 of 64 inputs for DMA event 24

9.3.1.61 tpcc_evt_mux_28_31 Register (offset = FACH) [reset = 0h]

tpcc_evt_mux_28_31 is shown in [Figure 9-63](#) and described in [Table 9-72](#).

Figure 9-63. tpcc_evt_mux_28_31 Register


LEGEND: R/W = Read/Write; R = Read only; W1toCl = Write 1 to clear bit; -n = value after reset

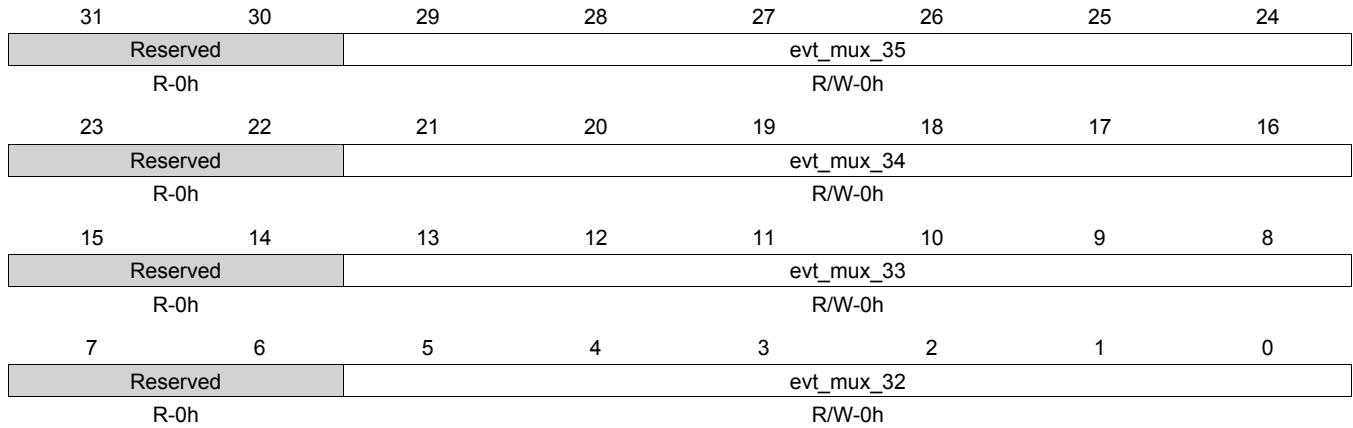
Table 9-72. tpcc_evt_mux_28_31 Register Field Descriptions

Bit	Field	Type	Reset	Description
31-30	Reserved	R	0h	
29-24	evt_mux_31	R/W	0h	Selects 1 of 64 inputs for DMA event 31
23-22	Reserved	R	0h	
21-16	evt_mux_30	R/W	0h	Selects 1 of 64 inputs for DMA event 30
15-14	Reserved	R	0h	
13-8	evt_mux_29	R/W	0h	Selects 1 of 64 inputs for DMA event 29
7-6	Reserved	R	0h	
5-0	evt_mux_28	R/W	0h	Selects 1 of 64 inputs for DMA event 28

9.3.1.62 tpcc_evt_mux_32_35 Register (offset = FB0h) [reset = 0h]

tpcc_evt_mux_32_35 is shown in [Figure 9-64](#) and described in [Table 9-73](#).

Figure 9-64. tpcc_evt_mux_32_35 Register



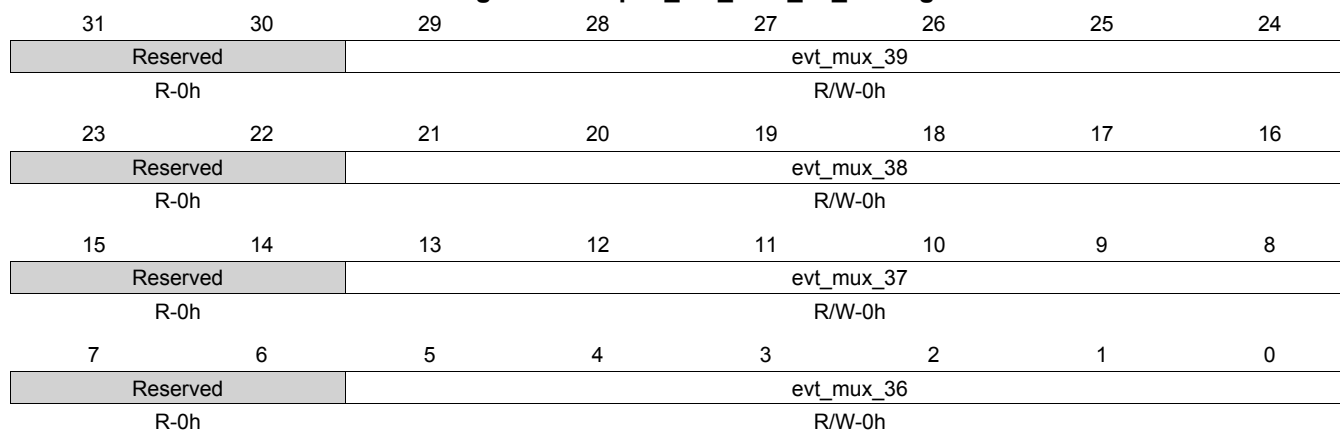
LEGEND: R/W = Read/Write; R = Read only; W1toCl = Write 1 to clear bit; -n = value after reset

Table 9-73. tpcc_evt_mux_32_35 Register Field Descriptions

Bit	Field	Type	Reset	Description
31-30	Reserved	R	0h	
29-24	evt_mux_35	R/W	0h	Selects 1 of 64 inputs for DMA event 35
23-22	Reserved	R	0h	
21-16	evt_mux_34	R/W	0h	Selects 1 of 64 inputs for DMA event 34
15-14	Reserved	R	0h	
13-8	evt_mux_33	R/W	0h	Selects 1 of 64 inputs for DMA event 33
7-6	Reserved	R	0h	
5-0	evt_mux_32	R/W	0h	Selects 1 of 64 inputs for DMA event 32

9.3.1.63 tpcc_evt_mux_36_39 Register (offset = FB4h) [reset = 0h]

 tpcc_evt_mux_36_39 is shown in [Figure 9-65](#) and described in [Table 9-74](#).

Figure 9-65. tpcc_evt_mux_36_39 Register


LEGEND: R/W = Read/Write; R = Read only; W1toCl = Write 1 to clear bit; -n = value after reset

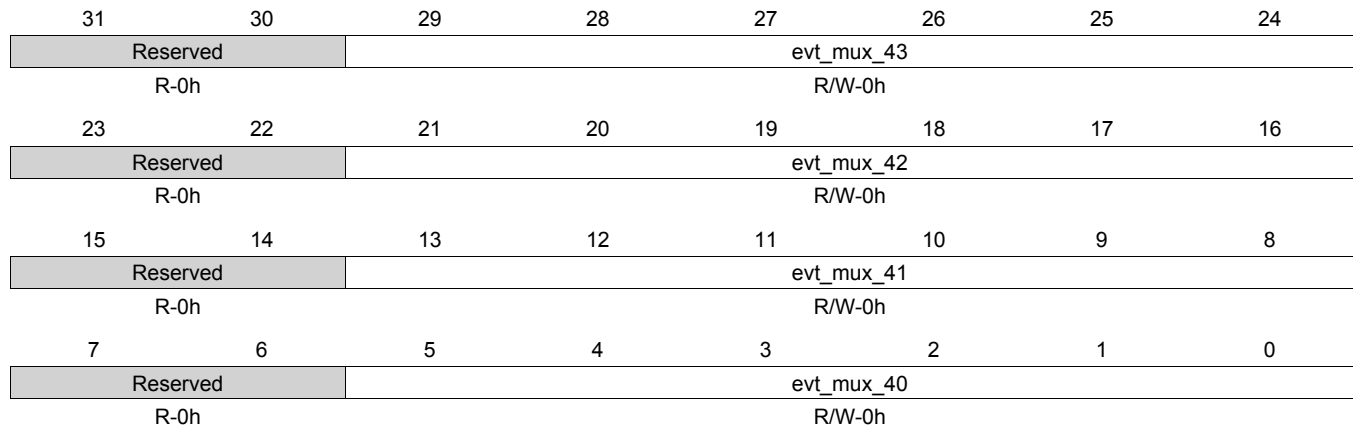
Table 9-74. tpcc_evt_mux_36_39 Register Field Descriptions

Bit	Field	Type	Reset	Description
31-30	Reserved	R	0h	
29-24	evt_mux_39	R/W	0h	Selects 1 of 64 inputs for DMA event 39
23-22	Reserved	R	0h	
21-16	evt_mux_38	R/W	0h	Selects 1 of 64 inputs for DMA event 38
15-14	Reserved	R	0h	
13-8	evt_mux_37	R/W	0h	Selects 1 of 64 inputs for DMA event 37
7-6	Reserved	R	0h	
5-0	evt_mux_36	R/W	0h	Selects 1 of 64 inputs for DMA event 36

9.3.1.64 tpcc_evt_mux_40_43 Register (offset = FB8h) [reset = 0h]

tpcc_evt_mux_40_43 is shown in [Figure 9-66](#) and described in [Table 9-75](#).

Figure 9-66. tpcc_evt_mux_40_43 Register



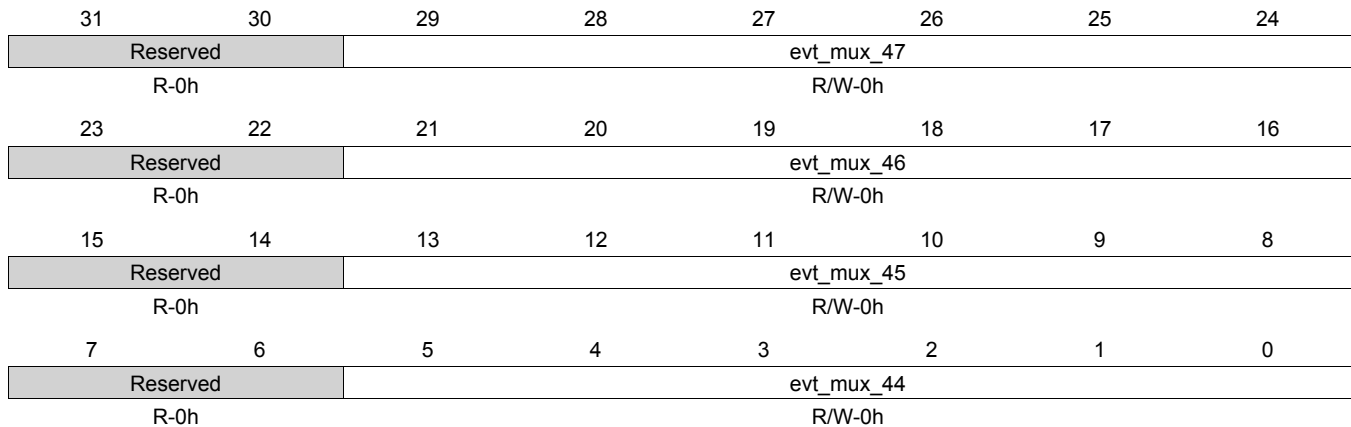
LEGEND: R/W = Read/Write; R = Read only; W1toCl = Write 1 to clear bit; -n = value after reset

Table 9-75. tpcc_evt_mux_40_43 Register Field Descriptions

Bit	Field	Type	Reset	Description
31-30	Reserved	R	0h	
29-24	evt_mux_43	R/W	0h	Selects 1 of 64 inputs for DMA event 43
23-22	Reserved	R	0h	
21-16	evt_mux_42	R/W	0h	Selects 1 of 64 inputs for DMA event 42
15-14	Reserved	R	0h	
13-8	evt_mux_41	R/W	0h	Selects 1 of 64 inputs for DMA event 41
7-6	Reserved	R	0h	
5-0	evt_mux_40	R/W	0h	Selects 1 of 64 inputs for DMA event 40

9.3.1.65 tpcc_evt_mux_44_47 Register (offset = FBCh) [reset = 0h]

tpcc_evt_mux_44_47 is shown in [Figure 9-67](#) and described in [Table 9-76](#).

Figure 9-67. tpcc_evt_mux_44_47 Register


LEGEND: R/W = Read/Write; R = Read only; W1toCl = Write 1 to clear bit; -n = value after reset

Table 9-76. tpcc_evt_mux_44_47 Register Field Descriptions

Bit	Field	Type	Reset	Description
31-30	Reserved	R	0h	
29-24	evt_mux_47	R/W	0h	Selects 1 of 64 inputs for DMA event 47
23-22	Reserved	R	0h	
21-16	evt_mux_46	R/W	0h	Selects 1 of 64 inputs for DMA event 46
15-14	Reserved	R	0h	
13-8	evt_mux_45	R/W	0h	Selects 1 of 64 inputs for DMA event 45
7-6	Reserved	R	0h	
5-0	evt_mux_44	R/W	0h	Selects 1 of 64 inputs for DMA event 44

9.3.1.66 tpcc_evt_mux_48_51 Register (offset = FC0h) [reset = 0h]

tpcc_evt_mux_48_51 is shown in [Figure 9-68](#) and described in [Table 9-77](#).

Figure 9-68. tpcc_evt_mux_48_51 Register

31	30	29	28	27	26	25	24
Reserved		evt_mux_51					
R-0h		R/W-0h					
23	22	21	20	19	18	17	16
Reserved		evt_mux_50					
R-0h		R/W-0h					
15	14	13	12	11	10	9	8
Reserved		evt_mux_49					
R-0h		R/W-0h					
7	6	5	4	3	2	1	0
Reserved		evt_mux_48					
R-0h		R/W-0h					

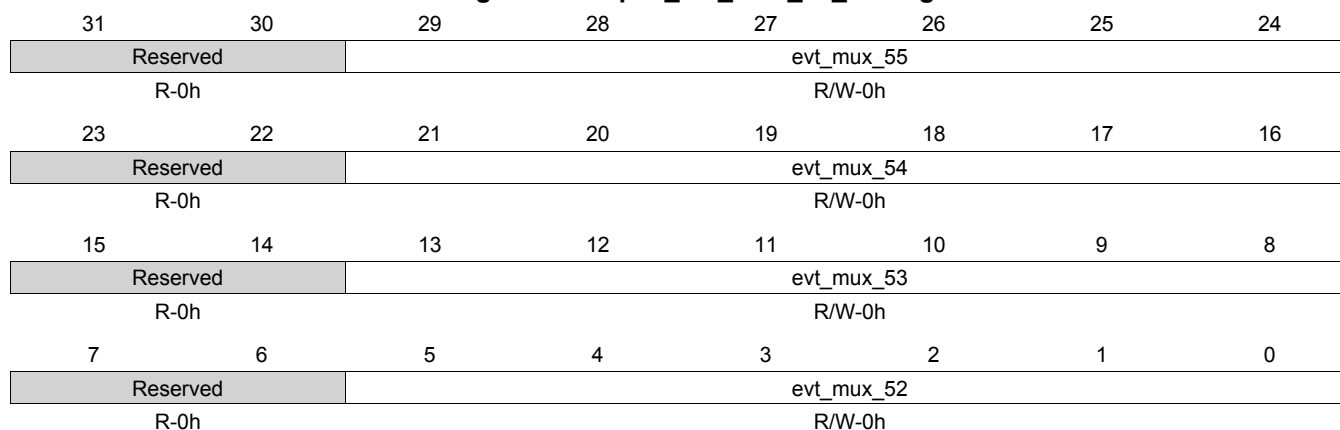
LEGEND: R/W = Read/Write; R = Read only; W1toCl = Write 1 to clear bit; -n = value after reset

Table 9-77. tpcc_evt_mux_48_51 Register Field Descriptions

Bit	Field	Type	Reset	Description
31-30	Reserved	R	0h	
29-24	evt_mux_51	R/W	0h	Selects 1 of 64 inputs for DMA event 51
23-22	Reserved	R	0h	
21-16	evt_mux_50	R/W	0h	Selects 1 of 64 inputs for DMA event 50
15-14	Reserved	R	0h	
13-8	evt_mux_49	R/W	0h	Selects 1 of 64 inputs for DMA event 49
7-6	Reserved	R	0h	
5-0	evt_mux_48	R/W	0h	Selects 1 of 64 inputs for DMA event 48

9.3.1.67 tpcc_evt_mux_52_55 Register (offset = FC4h) [reset = 0h]

tpcc_evt_mux_52_55 is shown in [Figure 9-69](#) and described in [Table 9-78](#).

Figure 9-69. tpcc_evt_mux_52_55 Register


LEGEND: R/W = Read/Write; R = Read only; W1toCl = Write 1 to clear bit; -n = value after reset

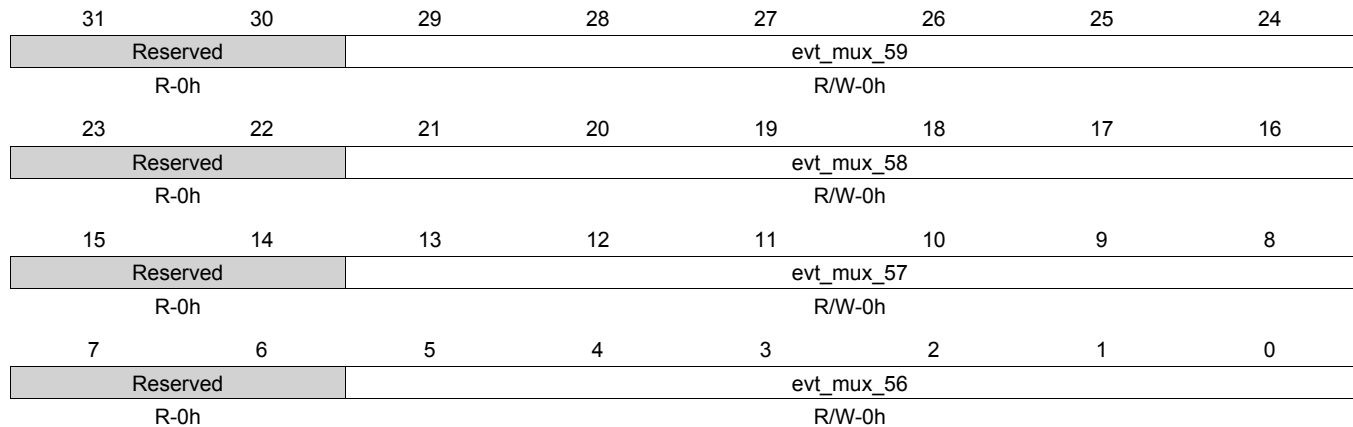
Table 9-78. tpcc_evt_mux_52_55 Register Field Descriptions

Bit	Field	Type	Reset	Description
31-30	Reserved	R	0h	
29-24	evt_mux_55	R/W	0h	Selects 1 of 64 inputs for DMA event 55
23-22	Reserved	R	0h	
21-16	evt_mux_54	R/W	0h	Selects 1 of 64 inputs for DMA event 54
15-14	Reserved	R	0h	
13-8	evt_mux_53	R/W	0h	Selects 1 of 64 inputs for DMA event 53
7-6	Reserved	R	0h	
5-0	evt_mux_52	R/W	0h	Selects 1 of 64 inputs for DMA event 52

9.3.1.68 tpcc_evt_mux_56_59 Register (offset = FC8h) [reset = 0h]

tpcc_evt_mux_56_59 is shown in [Figure 9-70](#) and described in [Table 9-79](#).

Figure 9-70. tpcc_evt_mux_56_59 Register



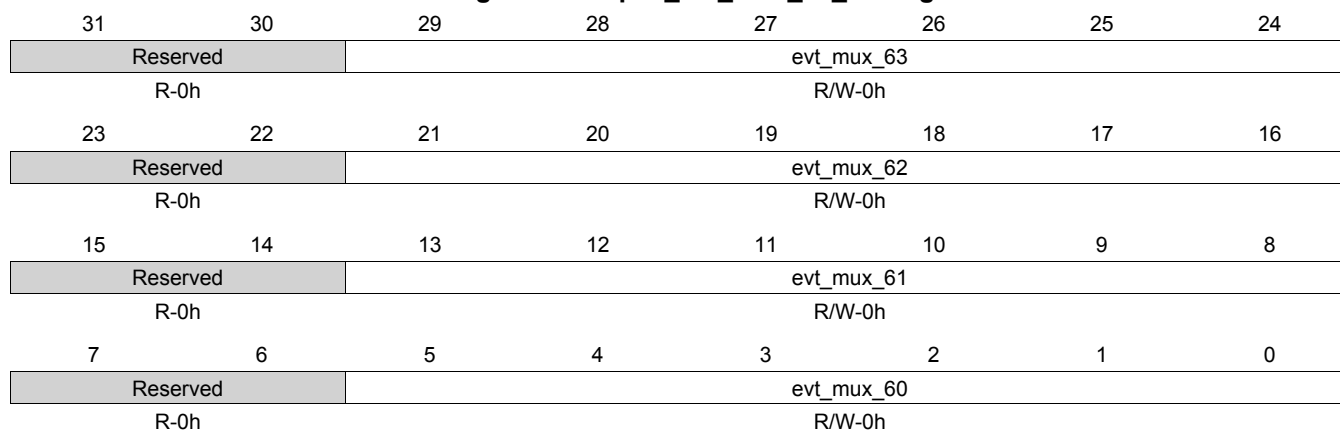
LEGEND: R/W = Read/Write; R = Read only; W1toCl = Write 1 to clear bit; -n = value after reset

Table 9-79. tpcc_evt_mux_56_59 Register Field Descriptions

Bit	Field	Type	Reset	Description
31-30	Reserved	R	0h	
29-24	evt_mux_59	R/W	0h	Selects 1 of 64 inputs for DMA event 59
23-22	Reserved	R	0h	
21-16	evt_mux_58	R/W	0h	Selects 1 of 64 inputs for DMA event 58
15-14	Reserved	R	0h	
13-8	evt_mux_57	R/W	0h	Selects 1 of 64 inputs for DMA event 57
7-6	Reserved	R	0h	
5-0	evt_mux_56	R/W	0h	Selects 1 of 64 inputs for DMA event 56

9.3.1.69 tpcc_evt_mux_60_63 Register (offset = FCCh) [reset = 0h]

tpcc_evt_mux_60_63 is shown in [Figure 9-71](#) and described in [Table 9-80](#).

Figure 9-71. tpcc_evt_mux_60_63 Register


LEGEND: R/W = Read/Write; R = Read only; W1toCl = Write 1 to clear bit; -n = value after reset

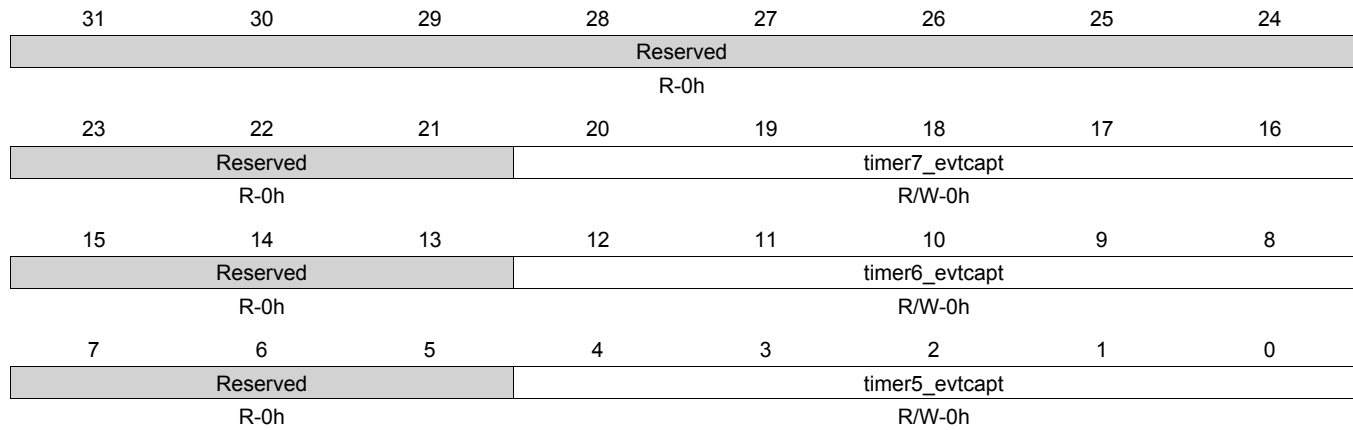
Table 9-80. tpcc_evt_mux_60_63 Register Field Descriptions

Bit	Field	Type	Reset	Description
31-30	Reserved	R	0h	
29-24	evt_mux_63	R/W	0h	Selects 1 of 64 inputs for DMA event 63
23-22	Reserved	R	0h	
21-16	evt_mux_62	R/W	0h	Selects 1 of 64 inputs for DMA event 62
15-14	Reserved	R	0h	
13-8	evt_mux_61	R/W	0h	Selects 1 of 64 inputs for DMA event 61
7-6	Reserved	R	0h	
5-0	evt_mux_60	R/W	0h	Selects 1 of 64 inputs for DMA event 60

9.3.1.70 timer_evt_capt Register (offset = FD0h) [reset = 0h]

timer_evt_capt is shown in [Figure 9-72](#) and described in [Table 9-81](#).

Figure 9-72. timer_evt_capt Register



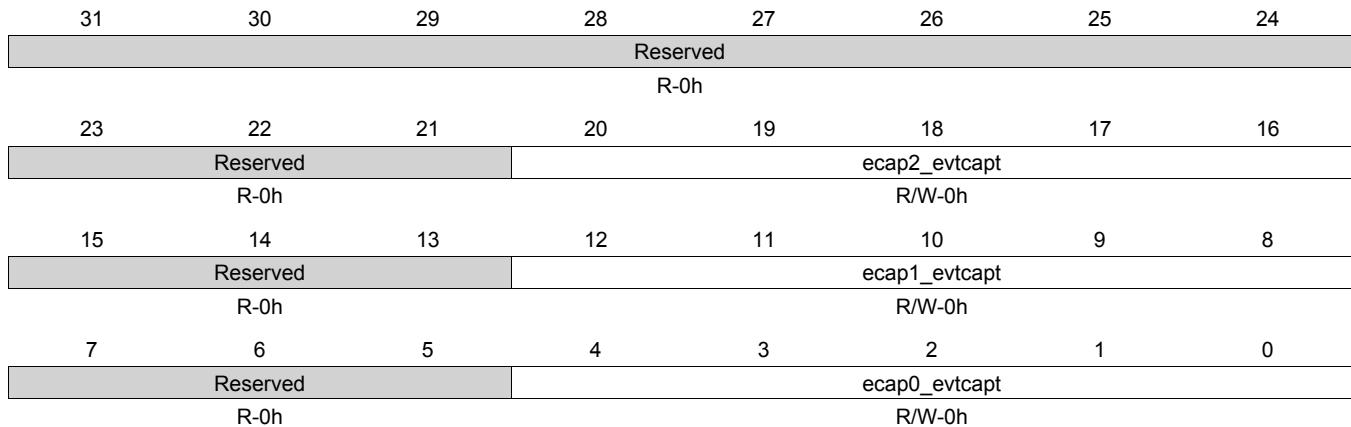
LEGEND: R/W = Read/Write; R = Read only; W1toCl = Write 1 to clear bit; -n = value after reset

Table 9-81. timer_evt_capt Register Field Descriptions

Bit	Field	Type	Reset	Description
31-21	Reserved	R	0h	
20-16	timer7_evtcapt	R/W	0h	Timer 7 event capture mux
15-13	Reserved	R	0h	
12-8	timer6_evtcapt	R/W	0h	Timer 6 event capture mux
7-5	Reserved	R	0h	
4-0	timer5_evtcapt	R/W	0h	Timer 5 event capture mux

9.3.1.71 ecap_evt_capt Register (offset = FD4h) [reset = 0h]

ecap_evt_capt is shown in [Figure 9-73](#) and described in [Table 9-82](#).

Figure 9-73. ecap_evt_capt Register


LEGEND: R/W = Read/Write; R = Read only; W1toCl = Write 1 to clear bit; -n = value after reset

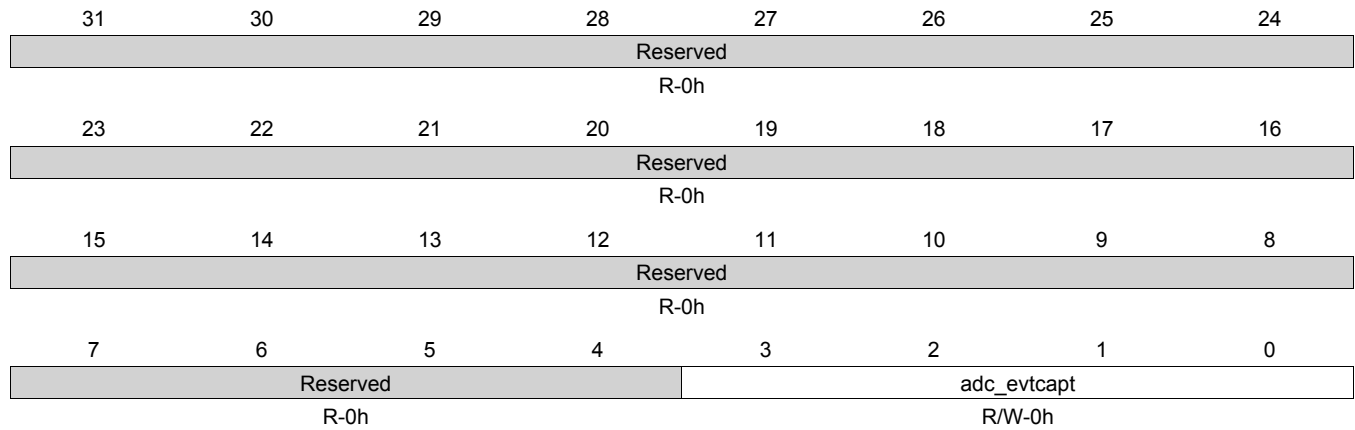
Table 9-82. ecap_evt_capt Register Field Descriptions

Bit	Field	Type	Reset	Description
31-21	Reserved	R	0h	
20-16	ecap2_evtcapt	R/W	0h	ECAP2 event capture mux
15-13	Reserved	R	0h	
12-8	ecap1_evtcapt	R/W	0h	ECAP1 event capture mux
7-5	Reserved	R	0h	
4-0	ecap0_evtcapt	R/W	0h	ECAP0 event capture mux

9.3.1.72 adc_evt_capt Register (offset = FD8h) [reset = 0h]

adc_evt_capt is shown in Figure 9-74 and described in Table 9-83.

Figure 9-74. adc_evt_capt Register



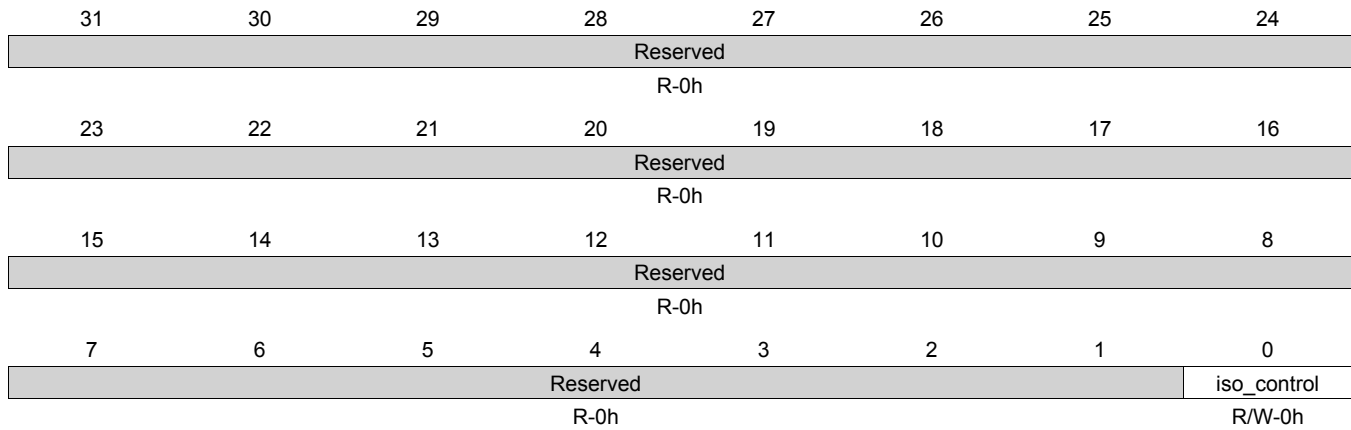
LEGEND: R/W = Read/Write; R = Read only; W1toCl = Write 1 to clear bit; -n = value after reset

Table 9-83. adc_evt_capt Register Field Descriptions

Bit	Field	Type	Reset	Description
31-4	Reserved	R	0h	
3-0	adc_evtcapt	R/W	0h	ECAP0 event capture mux

9.3.1.73 reset_iso Register (offset = 1000h) [reset = 0h]

reset_iso is shown in [Figure 9-75](#) and described in [Table 9-84](#).

Figure 9-75. reset_iso Register


LEGEND: R/W = Read/Write; R = Read only; W1toCl = Write 1 to clear bit; -n = value after reset

Table 9-84. reset_iso Register Field Descriptions

Bit	Field	Type	Reset	Description
31-1	Reserved	R	0h	
0	iso_control	R/W	0h	0 : Ethernet Switch is not isolated 1 : Ethernet Switch is isolated

9.3.1.74 dpll_pwr_sw_ctrl Register (offset = 1318h) [reset = 0h]

The DPLL_PWR_SW_CTRL register, in conjunction with the DPLL_PWR_SW_STATUS register, can be used to power off the digital power domain of the 3 DPLLs – DDR, DISP, PER to save leakage power in deep-sleep power modes. This register gives control over the power switch signals of the individual DPLLs.

A specific sequence has to be followed while programming the RET, PONIN, PGOODIN, ISO and RESET signals to put the PLLs in to low power mode and bring it out of low power mode.

In normal operating mode, the PRCM controls the RESET of the DPLLs. The RET, PONIN, PGOODIN and ISO are tied off. An over-ride bit is provided in this register SW_CTRL_*_RESET, which when set allows S/W to control the RESET, RET, PONIN, PGOODIN and ISO of the DPLLs to enable entry/exit into DPLL low power modes.

dpll_pwr_sw_ctrl is shown in [Figure 9-76](#) and described in [Table 9-85](#).

Figure 9-76. dpll_pwr_sw_ctrl Register

31	30	29	28	27	26	25	24
sw_ctrl_dds_pll	Reserved	isoscanner_dds	ret_dds	reset_dds	iso_dds	pgoodin_dds	ponin_dds
R-0h	R-0h	R-0h	R-0h	R-0h	R-0h	R-1h	R-1h
23	22	21	20	19	18	17	16
sw_ctrl_disp_pll	Reserved	isoscanner_disp	ret_disp	reset_disp	iso_disp	pgoodin_disp	ponin_disp
R-0h	R-0h	R-0h	R-0h	R-0h	R-0h	R-1h	R-1h
15	14	13	12	11	10	9	8
sw_ctrl_per_dpll	Reserved	isoscanner_per	ret_per	reset_per	iso_per	pgoodin_per	ponin_per
R-0h	R-0h	R-0h	R-0h	R-0h	R-0h	R-1h	R-1h
7	6	5	4	3	2	1	0
Reserved							
R-0h							

LEGEND: R/W = Read/Write; R = Read only; W1toCl = Write 1 to clear bit; -n = value after reset

Table 9-85. dpll_pwr_sw_ctrl Register Field Descriptions

Bit	Field	Type	Reset	Description
31	sw_ctrl_dds_pll	R/W	0h	Enable software control over DDR DPLL RET, RESET, ISO, PGOODIN, PONIN for power savings. 0: PRCM controls the DPLL reset, RET = 0, ISO = 0, PGOODIN = 1, PONIN = 1. 1: Controlled by corresponding bits in this register.
30	Reserved	R	0h	
29	isoscanner_dds	R/W	0h	Drives ISOSCAN of DDR PLL.
28	ret_dds	R/W	0h	Drives RET signal of DDR PLL.
27	reset_dds	R/W	0h	Drives RESET of DDR DPLL.
26	iso_dds	R/W	0h	Drives ISO of DDR DPLL.
25	pgoodin_dds	R/W	1h	Drives PGOODIN of DDR DPLL.
24	ponin_dds	R/W	1h	Drives PONIN of DDR DPLL.
23	sw_ctrl_disp_pll	R/W	0h	Enable software control over DISP DPLL RET, RESET, ISO, PGOODIN, PONIN for power savings. 0: PRCM controls the DPLL reset, RET = 0, ISO = 0, PGOODIN = 1, PONIN = 1. 1: Controlled by corresponding bits in this register.
22	Reserved	R	0h	
21	isoscanner_disp	R/W	0h	Drives ISOSCAN of DISP PLL.
20	ret_disp	R/W	0h	Drives RET of DISP DPLL.

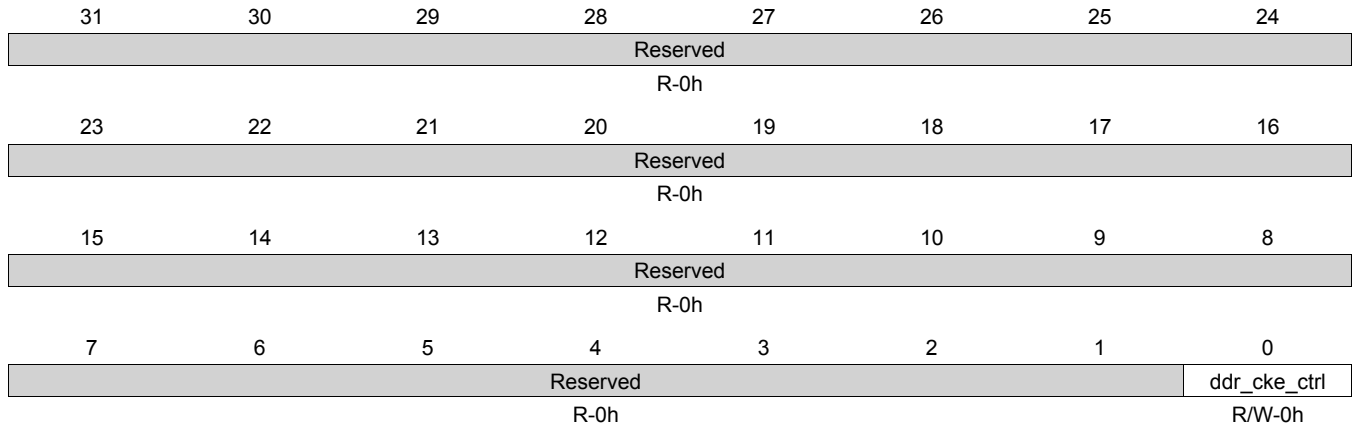
Table 9-85. dpll_pwr_sw_ctrl Register Field Descriptions (continued)

Bit	Field	Type	Reset	Description
19	reset_disp	R/W	0h	Drives RESET of DISP DPLL.
18	iso_disp	R/W	0h	Drives ISO of DISP DPLL.
17	pgoodin_disp	R/W	1h	Drives PGOODIN of DISP DPLL.
16	ponin_disp	R/W	1h	Drives PONIN of DISP DPLL.
15	sw_ctrl_per_dpll	R/W	0h	Enable software control over PER DPLL RET, RESET, ISO, PGOODIN, PONIN for power savings. 0: PRCM controls the DPLL reset, RET = 0, ISO = 0, PGOODIN = 1, PONIN = 1. 1: Controlled by corresponding bits in this register.
14	Reserved	R	0h	
13	isoscan_per	R/W	0h	Drives ISOSCAN of PER PLL.
12	ret_per	R/W	0h	Drives RET of PER DPLL.
11	reset_per	R/W	0h	Drives RESET signal of PER DPLL.
10	iso_per	R/W	0h	Drives ISO signal of PER DPLL.
9	pgoodin_per	R/W	1h	Drives PGOODIN signal of PER DPLL.
8	ponin_per	R/W	1h	Drives PONIN signal of PER DPLL.
7-0	Reserved	R	0h	

9.3.1.75 ddr_cke_ctrl Register (offset = 131Ch) [reset = 0h]

ddr_cke_ctrl is shown in [Figure 9-77](#) and described in [Table 9-86](#).

Figure 9-77. ddr_cke_ctrl Register



LEGEND: R/W = Read/Write; R = Read only; W1toCl = Write 1 to clear bit; -n = value after reset

Table 9-86. ddr_cke_ctrl Register Field Descriptions

Bit	Field	Type	Reset	Description
31-1	Reserved	R	0h	
0	ddr_cke_ctrl	R/W	0h	CKE from EMIF/DDRPHY is ANDed with this bit. 0: CKE to memories gated off to zero. External DRAM memories will not be able to register DDR commands from device 1: Normal operation. CKE is now controlled by EMIF/DDR PHY.

9.3.1.76 sma2 Register (offset = 1320h) [reset = 0h]

 sma2 is shown in [Figure 9-78](#) and described in [Table 9-87](#).

Figure 9-78. sma2 Register

31	30	29	28	27	26	25	24
Reserved							
R-0h							
23	22	21	20	19	18	17	16
Reserved							
R-0h							
15	14	13	12	11	10	9	8
Reserved							
R-0h							
7	6	5	4	3	2	1	0
Reserved						vslido_core_au to_ramp_en	rmii2_crs_dv_m ode_sel
R-0h						R/W0h	R/W-0h

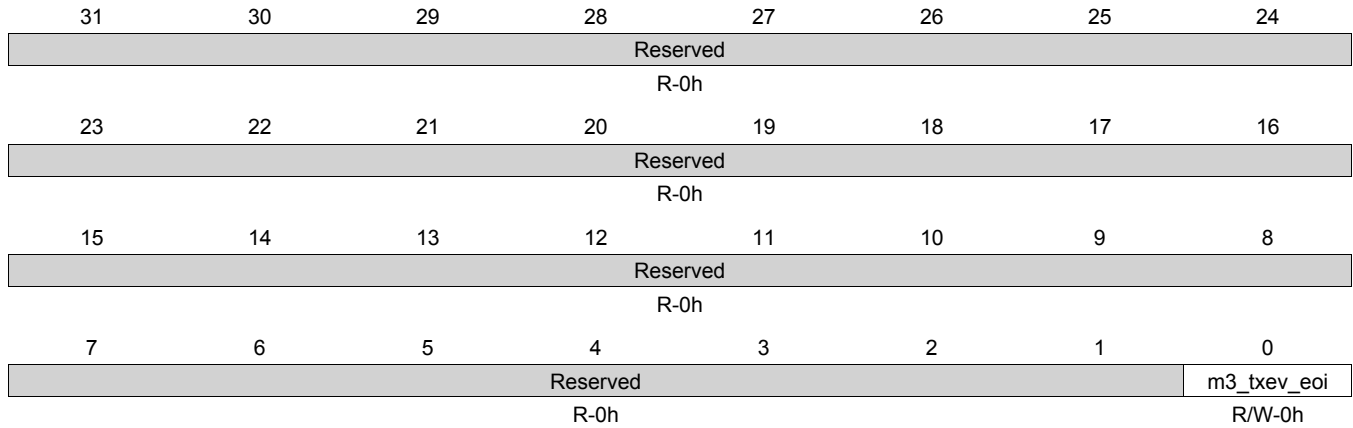
LEGEND: R/W = Read/Write; R = Read only; W1toCl = Write 1 to clear bit; -n = value after reset

Table 9-87. sma2 Register Field Descriptions

Bit	Field	Type	Reset	Description
31-2	Reserved	R	0h	
1	vslido_core_auto_ramp_en	R/W	0h	0: PRCM controls VSLDO. 1: Allows hardware to bring VSLDO out of retention on wakeup from deep-sleep.
0	rmii2_crs_dv_mode_sel	R/W	0h	0: Select MMC2_DAT7 on GPMC_A9 pin in MODE3. 1: Select RMII2_CRD_V on GPMC_A9 pin in MODE3.

9.3.1.77 m3_txev_eoi Register (offset = 1324h) [reset = 0h]

m3_txev_eoi is shown in [Figure 9-79](#) and described in [Table 9-88](#).

Figure 9-79. m3_txev_eoi Register


LEGEND: R/W = Read/Write; R = Read only; W1toCl = Write 1 to clear bit; -n = value after reset

Table 9-88. m3_txev_eoi Register Field Descriptions

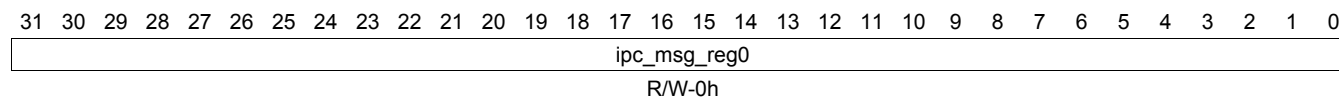
Bit	Field	Type	Reset	Description
31-1	Reserved	R	0h	
0	m3_txev_eoi	R/W	0h	TXEV (Event) from M3 processor is a pulse signal connected as interrupt to MPU IRQ(78) Since MPU expects level signals. The TXEV pulse from M3 is converted to a level in glue logic. The logic works as follows: -On a 0-1 transition on TXEV, the IRQ[78] is set. -For clearing the interrupt, S/W must do the following: S/W must clear the IRQ[78] by writing a 1 to M3_TXEV_EOI bit in this register This bit is sticky and for re-arming the IRQ[78], S/W must write a 0 to this field in the ISR

9.3.1.78 ipc_msg_reg0 Register (offset = 1328h) [reset = 0h]

ipc_msg_reg0 is shown in [Figure 9-80](#) and described in [Table 9-89](#). This register is typically used for messaging between Cortex A8 and CortexM3 (WKUP).

See the section "Functional Sequencing for Power Management with Cortex M3" for specific information on how the IPC_MSG_REG registers are used to communicate with the Cortex-M3 firmware.

Figure 9-80. ipc_msg_reg0 Register



LEGEND: R/W = Read/Write; R = Read only; W1toCl = Write 1 to clear bit; -n = value after reset

Table 9-89. ipc_msg_reg0 Register Field Descriptions

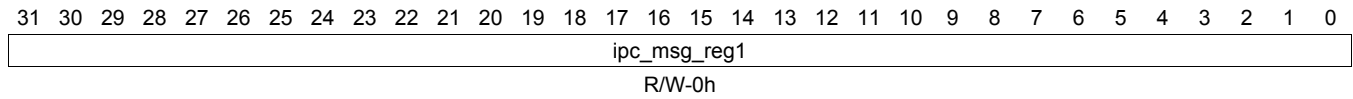
Bit	Field	Type	Reset	Description
31-0	ipc_msg_reg0	R/W	0h	Inter Processor Messaging Register

9.3.1.79 ipc_msg_reg1 Register (offset = 132Ch) [reset = 0h]

ipc_msg_reg1 is shown in [Figure 9-81](#) and described in [Table 9-90](#). This register is typically used for messaging between Cortex A8 and CortexM3 (WKUP).

See the section "Functional Sequencing for Power Management with Cortex M3" for specific information on how the IPC_MSG_REG registers are used to communicate with the Cortex-M3 firmware.

Figure 9-81. ipc_msg_reg1 Register



LEGEND: R/W = Read/Write; R = Read only; W1toCl = Write 1 to clear bit; -n = value after reset

Table 9-90. ipc_msg_reg1 Register Field Descriptions

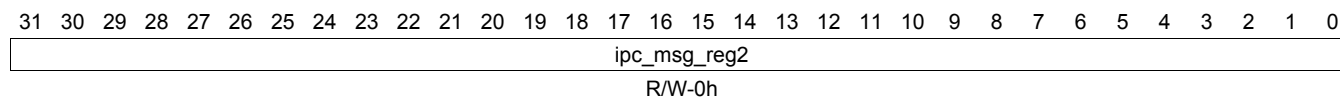
Bit	Field	Type	Reset	Description
31-0	ipc_msg_reg1	R/W	0h	Inter Processor Messaging Register

9.3.1.80 ipc_msg_reg2 Register (offset = 1330h) [reset = 0h]

ipc_msg_reg2 is shown in [Figure 9-82](#) and described in [Table 9-91](#). This register is typically used for messaging between Cortex A8 and CortexM3 (WKUP).

See the section "Functional Sequencing for Power Management with Cortex M3" for specific information on how the IPC_MSG_REG registers are used to communicate with the Cortex-M3 firmware.

Figure 9-82. ipc_msg_reg2 Register



LEGEND: R/W = Read/Write; R = Read only; W1toCl = Write 1 to clear bit; -n = value after reset

Table 9-91. ipc_msg_reg2 Register Field Descriptions

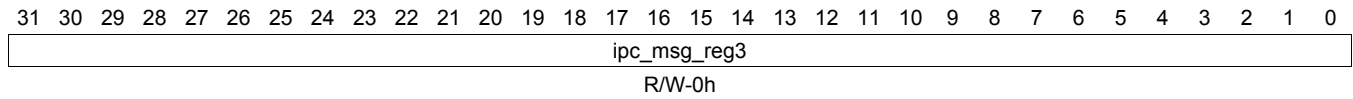
Bit	Field	Type	Reset	Description
31-0	ipc_msg_reg2	R/W	0h	Inter Processor Messaging Register

9.3.1.81 ipc_msg_reg3 Register (offset = 1334h) [reset = 0h]

ipc_msg_reg3 is shown in [Figure 9-83](#) and described in [Table 9-92](#). This register is typically used for messaging between Cortex A8 and CortexM3 (WKUP).

See the section "Functional Sequencing for Power Management with Cortex M3" for specific information on how the IPC_MSG_REG registers are used to communicate with the Cortex-M3 firmware.

Figure 9-83. ipc_msg_reg3 Register



LEGEND: R/W = Read/Write; R = Read only; W1toCl = Write 1 to clear bit; -n = value after reset

Table 9-92. ipc_msg_reg3 Register Field Descriptions

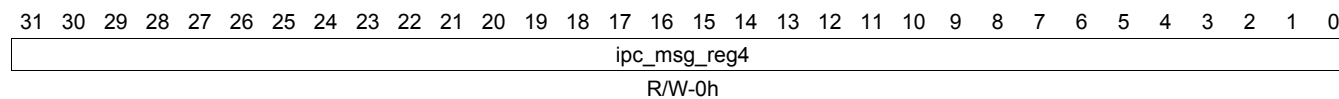
Bit	Field	Type	Reset	Description
31-0	ipc_msg_reg3	R/W	0h	Inter Processor Messaging Register

9.3.1.82 ipc_msg_reg4 Register (offset = 1338h) [reset = 0h]

ipc_msg_reg4 is shown in [Figure 9-84](#) and described in [Table 9-93](#). This register is typically used for messaging between Cortex A8 and CortexM3 (WKUP).

See the section "Functional Sequencing for Power Management with Cortex M3" for specific information on how the IPC_MSG_REG registers are used to communicate with the Cortex-M3 firmware.

Figure 9-84. ipc_msg_reg4 Register



LEGEND: R/W = Read/Write; R = Read only; W1toCl = Write 1 to clear bit; -n = value after reset

Table 9-93. ipc_msg_reg4 Register Field Descriptions

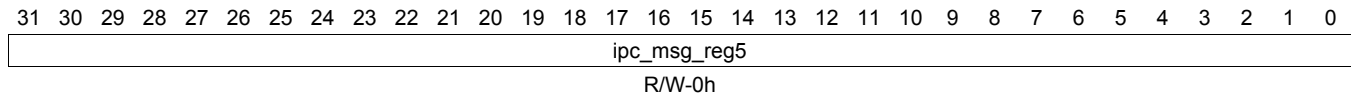
Bit	Field	Type	Reset	Description
31-0	ipc_msg_reg4	R/W	0h	Inter Processor Messaging Register

9.3.1.83 ipc_msg_reg5 Register (offset = 133Ch) [reset = 0h]

ipc_msg_reg5 is shown in [Figure 9-85](#) and described in [Table 9-94](#). This register is typically used for messaging between Cortex A8 and CortexM3 (WKUP).

See the section "Functional Sequencing for Power Management with Cortex M3" for specific information on how the IPC_MSG_REG registers are used to communicate with the Cortex-M3 firmware.

Figure 9-85. ipc_msg_reg5 Register



LEGEND: R/W = Read/Write; R = Read only; W1toCl = Write 1 to clear bit; -n = value after reset

Table 9-94. ipc_msg_reg5 Register Field Descriptions

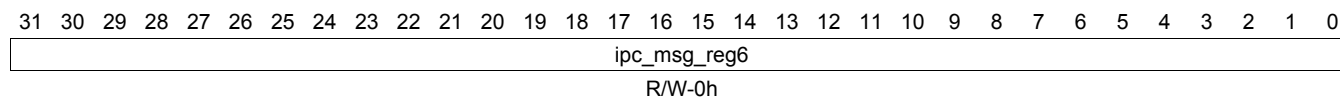
Bit	Field	Type	Reset	Description
31-0	ipc_msg_reg5	R/W	0h	Inter Processor Messaging Register

9.3.1.84 ipc_msg_reg6 Register (offset = 1340h) [reset = 0h]

ipc_msg_reg6 is shown in [Figure 9-86](#) and described in [Table 9-95](#). This register is typically used for messaging between Cortex A8 and CortexM3 (WKUP).

See the section "Functional Sequencing for Power Management with Cortex M3" for specific information on how the IPC_MSG_REG registers are used to communicate with the Cortex-M3 firmware.

Figure 9-86. ipc_msg_reg6 Register



LEGEND: R/W = Read/Write; R = Read only; W1toCl = Write 1 to clear bit; -n = value after reset

Table 9-95. ipc_msg_reg6 Register Field Descriptions

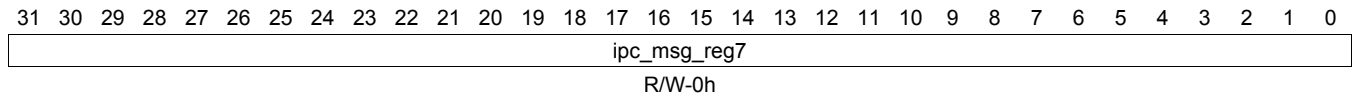
Bit	Field	Type	Reset	Description
31-0	ipc_msg_reg6	R/W	0h	Inter Processor Messaging Register

9.3.1.85 ipc_msg_reg7 Register (offset = 1344h) [reset = 0h]

ipc_msg_reg7 is shown in [Figure 9-87](#) and described in [Table 9-96](#). This register is typically used for messaging between Cortex A8 and CortexM3 (WKUP).

See the section "Functional Sequencing for Power Management with Cortex M3" for specific information on how the IPC_MSG_REG registers are used to communicate with the Cortex-M3 firmware.

Figure 9-87. ipc_msg_reg7 Register



LEGEND: R/W = Read/Write; R = Read only; W1toCl = Write 1 to clear bit; -n = value after reset

Table 9-96. ipc_msg_reg7 Register Field Descriptions

Bit	Field	Type	Reset	Description
31-0	ipc_msg_reg7	R/W	0h	Inter Processor Messaging Register

9.3.1.86 ddr_cmd0_ioctrl Register (offset = 1404h) [reset = 0h]

 ddr_cmd0_ioctrl is shown in [Figure 9-88](#) and described in [Table 9-97](#).

Figure 9-88. ddr_cmd0_ioctrl Register

31	30	29	28	27	26	25	24
io_config_gp_wd1							
R/W-0h							
23	22	21	20	19	18	17	16
io_config_gp_wd1				io_config_gp_wd0			
R/W-0h				R/W-0h			
15	14	13	12	11	10	9	8
io_config_gp_wd0						io_config_sr_clk	
R/W-0h						R-0h	
7	6	5	4	3	2	1	0
io_config_i_clk			io_config_sr		io_config_i		
R/W-0h			R/W-0h		R/W-0h		

LEGEND: R/W = Read/Write; R = Read only; W1toCl = Write 1 to clear bit; -n = value after reset

Table 9-97. ddr_cmd0_ioctrl Register Field Descriptions

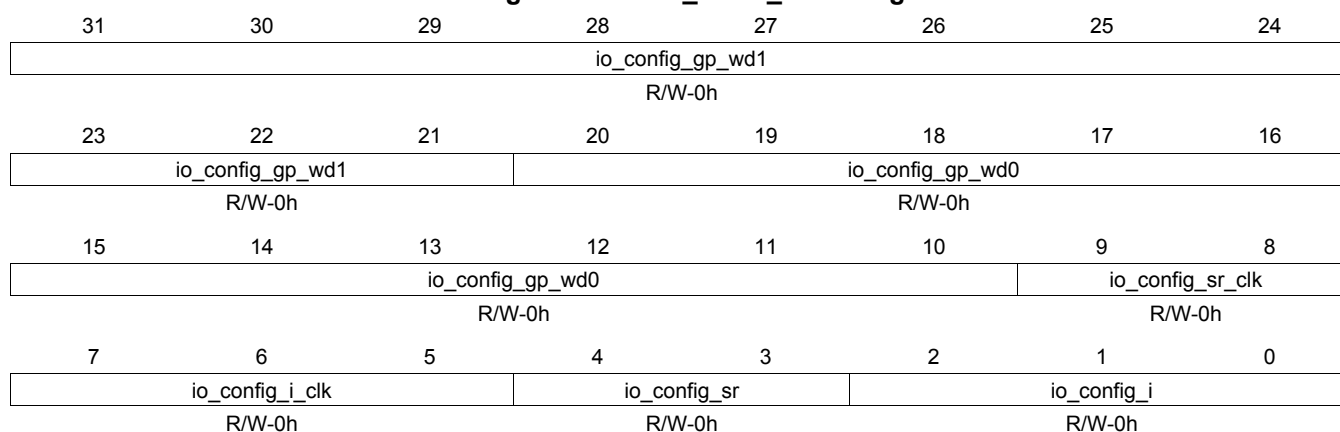
Bit	Field	Type	Reset	Description
31-21	io_config_gp_wd1	R/W	0h	There are 2 bits per IO: io_config_gp_wd1 and io_config_gp_wd0. For example: macro pin 0: WD1 is bit 21, WD0 is bit 10 macro pin 1: WD1 is bit 22, WD0 is bit 11 ... macro pin 10: WD1 is bit 31, WD0 is bit 20 See the DDR PHY to IO Pin Mapping table in the Control Module Functional Description section for a mapping of macro bits to I/Os. WD1:WD0 00: Pullup/Pulldown disabled 01: Weak pullup enabled 10: Weak pulldown enabled 11: Weak keeper enabled
20-10	io_config_gp_wd0	R/W	0h	There are 2 bits per IO: io_config_gp_wd1 and io_config_gp_wd0. For example: macro pin 0: WD1 is bit 21, WD0 is bit 10 macro pin 1: WD1 is bit 22, WD0 is bit 11 ... macro pin 10: WD1 is bit 31, WD0 is bit 20 See the DDR PHY to IO Pin Mapping table in the Control Module Functional Description section for a mapping of macro bits to I/Os. WD1:WD0 00: Pullup/Pulldown disabled 01: Weak pullup enabled 10: Weak pulldown enabled 11: Weak keeper enabled
9-8	io_config_sr_clk	R	0h	2 bit to program clock IO Pads (DDR_CK/DDR_CKN) output slew rate. These connect as SR1, SR0 to the corresponding DDR IO buffer. See the DDR Slew Rate Control Settings table in the Control Module Functional Description section for a definition of these bits.
7-5	io_config_i_clk	R/W	0h	3-bit configuration input to program clock IO pads (DDR_CK/DDR_CKN) output impedance. These connect as I2, I1, I0 to the corresponding DDR IO buffer. See the DDR Impedance Control Settings table in the Control Module Functional Description section for a definition of these bits.

Table 9-97. ddr_cmd0_ioctrl Register Field Descriptions (continued)

Bit	Field	Type	Reset	Description
4-3	io_config_sr	R/W	0h	2 bit to program addr/cmd IO Pads output slew rate. These connect as SR1, SR0 to the corresponding DDR IO buffer. See the DDR Slew Rate Control Settings table in the Control Module Functional Description section for a definition of these bits.
2-0	io_config_i	R/W	0h	3-bit configuration input to program addr/cmd IO output impedance. These connect as I2, I1, I0 to the corresponding DDR IO buffer. See the DDR Impedance Control Settings table in the Control Module Functional Description section for a definition of these bits.

9.3.1.87 ddr_cmd1_ioctrl Register (offset = 1408h) [reset = 0h]

ddr_cmd1_ioctrl is shown in Figure 9-89 and described in Table 9-98.

Figure 9-89. ddr_cmd1_ioctrl Register


LEGEND: R/W = Read/Write; R = Read only; W1toCl = Write 1 to clear bit; -n = value after reset

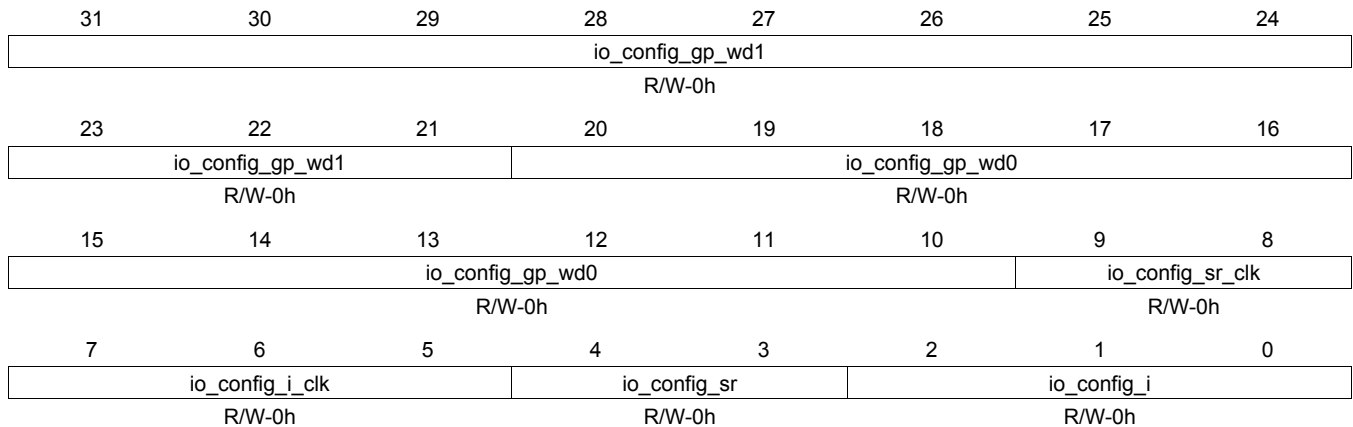
Table 9-98. ddr_cmd1_ioctrl Register Field Descriptions

Bit	Field	Type	Reset	Description
31-21	io_config_gp_wd1	R/W	0h	There are 2 bits per IO: io_config_gp_wd1 and io_config_gp_wd0. For example: macro pin 0: WD1 is bit 21, WD0 is bit 10 macro pin 1: WD1 is bit 22, WD0 is bit 11 ... macro pin 10: WD1 is bit 31, WD0 is bit 20 See the DDR PHY to IO Pin Mapping table in the Control Module Functional Description section for a mapping of macro bits to I/Os. WD1:WD0 00: Pullup/Pulldown disabled 01: Weak pullup enabled 10: Weak pulldown enabled 11: Weak keeper enabled
20-10	io_config_gp_wd0	R/W	0h	There are 2 bits per IO: io_config_gp_wd1 and io_config_gp_wd0. For example: macro pin 0: WD1 is bit 21, WD0 is bit 10 macro pin 1: WD1 is bit 22, WD0 is bit 11 ... macro pin 10: WD1 is bit 31, WD0 is bit 20 See the DDR PHY to IO Pin Mapping table in the Control Module Functional Description section for a mapping of macro bits to I/Os. WD1:WD0 00: Pullup/Pulldown disabled 01: Weak pullup enabled 10: Weak pulldown enabled 11: Weak keeper enabled
9-8	io_config_sr_clk	R/W	0h	Only ddr_cmd0_ioctrl[9:8] are used to control io_config_sr_clk.
7-5	io_config_i_clk	R/W	0h	Only ddr_cmd0_ioctrl[7:5] are used to control io_config_i_clk.
4-3	io_config_sr	R/W	0h	2 bit to program addr/cmd IO Pads output slew rate. These connect as SR1, SR0 to the corresponding DDR IO buffer. See the DDR Slew Rate Control Settings table in the Control Module Functional Description section for a definition of these bits.
2-0	io_config_i	R/W	0h	3-bit configuration input to program addr/cmd IO output impedance. These connect as I2, I1, I0 to the corresponding DDR IO buffer. See the DDR Impedance Control Settings table in the Control Module Functional Description section for a definition of these bits.

9.3.1.88 ddr_cmd2_ioctrl Register (offset = 140Ch) [reset = 0h]

ddr_cmd2_ioctrl is shown in [Figure 9-90](#) and described in [Table 9-99](#).

Figure 9-90. ddr_cmd2_ioctrl Register



LEGEND: R/W = Read/Write; R = Read only; W1toCl = Write 1 to clear bit; -n = value after reset

Table 9-99. ddr_cmd2_ioctrl Register Field Descriptions

Bit	Field	Type	Reset	Description
31-21	io_config_gp_wd1	R/W	0h	There are 2 bits per IO: io_config_gp_wd1 and io_config_gp_wd0. For example: macro pin 0: WD1 is bit 21, WD0 is bit 10 macro pin 1: WD1 is bit 22, WD0 is bit 11 ... macro pin 10: WD1 is bit 31, WD0 is bit 20 See the DDR PHY to IO Pin Mapping table in the Control Module Functional Description section for a mapping of macro bits to I/Os. WD1:WD0 00: Pullup/Pulldown disabled 01: Weak pullup enabled 10: Weak pulldown enabled 11: Weak keeper enabled
20-10	io_config_gp_wd0	R/W	0h	There are 2 bits per IO: io_config_gp_wd1 and io_config_gp_wd0. For example: macro pin 0: WD1 is bit 21, WD0 is bit 10 macro pin 1: WD1 is bit 22, WD0 is bit 11 ... macro pin 10: WD1 is bit 31, WD0 is bit 20 See the DDR PHY to IO Pin Mapping table in the Control Module Functional Description section for a mapping of macro bits to I/Os. WD1:WD0 00: Pullup/Pulldown disabled 01: Weak pullup enabled 10: Weak pulldown enabled 11: Weak keeper enabled
9-8	io_config_sr_clk	R/W	0h	Only ddr_cmd2_ioctrl[9:8] are used to control io_config_sr_clk.
7-5	io_config_i_clk	R/W	0h	Only ddr_cmd2_ioctrl[7:5] are used to control io_config_i_clk.
4-3	io_config_sr	R/W	0h	2 bit to program addr/cmd IO Pads output slew rate. These connect as SR1, SR0 to the corresponding DDR IO buffer. See the DDR Slew Rate Control Settings table in the Control Module Functional Description section for a definition of these bits.
2-0	io_config_i	R/W	0h	3-bit configuration input to program addr/cmd IO output impedance. These connect as I2, I1, I0 to the corresponding DDR IO buffer. See the DDR Impedance Control Settings table in the Control Module Functional Description section for a definition of these bits.

9.3.1.89 ddr_data0_ioctrl Register (offset = 1440h) [reset = 0h]

 ddr_data0_ioctrl is shown in [Figure 9-91](#) and described in [Table 9-100](#).

Figure 9-91. ddr_data0_ioctrl Register

31	30	29	28	27	26	25	24
Reserved		io_config_wd1_ dqs	io_config_wd1_ dm	io_config_wd1_dq			
R-0h		R/W-0h	R/W-0h	R/W-0h			
23	22	21	20	19	18	17	16
io_config_wd1_dq			io_config_wd0_ dqs	io_config_wd0_ dm	io_config_wd0_dq		
R/W-0h			R/W-0h	R/W-0h	R/W-0h		
15	14	13	12	11	10	9	8
io_config_wd0_dq						io_config_sr_clk	
R/W-0h						R/W-0h	
7	6	5	4	3	2	1	0
io_config_i_clk			io_config_sr		io_config_i		
R/W-0h			R/W-0h		R/W-0h		

LEGEND: R/W = Read/Write; R = Read only; W1toCl = Write 1 to clear bit; -n = value after reset

Table 9-100. ddr_data0_ioctrl Register Field Descriptions

Bit	Field	Type	Reset	Description
31-30	Reserved	R	0h	
29	io_config_wd1_dqs	R/W	0h	Input that selects pullup or pulldown for DDR_DQS0 and DDR_DQSn0. Used with io_config_wd0_dqs to define pullup/pulldown according to the following: WD1: WD0 00b: Pullup/Pulldown disabled for both DDR_DQS0 and DDR_DQSn0 01b: Enable weak pullup for DDR_DQS0 and weak pulldown for DDR_DQSn0 10b: Enable weak pulldown for DDR_DQS0 and weak pullup for DDR_DQSn0 11b: Weak keeper enabled for both DDR_DQS0 and DDR_DQSn0
28	io_config_wd1_dm	R/W	0h	Input that selects pullup or pulldown for DM. Used with io_config_wd0_dm to define pullup/pulldown according to the following: WD1:WD0 00: Pullup/Pulldown disabled 01: Weak pullup enabled 10: Weak pulldown enabled 11: Weak keeper enabled
27-20	io_config_wd1_dq	R/W	0h	Input that selects pullup or pulldown for DQ. There are 2 bits per IO: io_config_wd1_dq and io_config_wd0_dq. For example: macro pin 0: WD1 is bit 20 WD0 is bit 10 macro pin 1: WD1 is bit 21, WD0 is bit 11 ... macro pin 7: WD1 is bit 27, WD0 is bit 17 See the DDR PHY to IO Pin Mapping table in the Control Module Functional Description section for a mapping of macro bits to I/Os. WD1:WD0 00: Pullup/Pulldown disabled 01: Weak pullup enabled 10: Weak pulldown enabled 11: Weak keeper enabled

Table 9-100. ddr_data0_ioctrl Register Field Descriptions (continued)

Bit	Field	Type	Reset	Description
19	io_config_wd0_dqs	R/W	0h	Input that selects pullup or pulldown for DDR_DQS0 and DDR_DQSn0. Used with io_config_wd1_dqs to define pullup/pulldown according to the following: WD1:WD0 00b: Pullup/Pulldown disabled for both DDR_DQS0 and DDR_DQSn0 01b: Enable weak pullup for DDR_DQS0 and weak pulldown for DDR_DQSn0 10b: Enable weak pulldown for DDR_DQS0 and weak pullup for DDR_DQSn0 11b: Weak keeper enabled for both DDR_DQS0 and DDR_DQSn0
18	io_config_wd0_dm	R/W	0h	Input that selects pullup or pulldown for DM. Used with io_config_wd1_dm to define pullup/pulldown according to the following: WD1:WD0 00: Pullup/Pulldown disabled 01: Weak pullup enabled 10: Weak pulldown enabled 11: Weak keeper enabled
17-10	io_config_wd0_dq	R/W	0h	Input that selects pullup or pulldown for DQ. There are 2 bits per IO: io_config_wd1_dq and io_config_wd0_dq. For example: macro pin 0: WD1 is bit 20, WD0 is bit 10 macro pin 1: WD1 is bit 21, WD0 is bit 11 ... macro pin 7: WD1 is bit 27, WD0 is bit 17 See the DDR PHY to IO Pin Mapping table in the Control Module Functional Description section for a mapping of macro bits to I/Os. WD1:WD0 00: Pullup/Pulldown disabled 01: Weak pullup enabled 10: Weak pulldown enabled 11: Weak keeper enabled
9-8	io_config_sr_clk	R/W	0h	2 bit to program clock IO Pads (DDR_DQS/DDR_DQSn) output slew rate. These connect as SR1, SR0 of the corresponding IO buffer. See the DDR Slew Rate Control Settings table in the Control Module Functional Description section for a definition of these bits.
7-5	io_config_i_clk	R/W	0h	3-bit configuration input to program clock IO pads (DDR_DQS/DDR_DQSn) output impedance. These connect as I2, I1, I0 of the corresponding buffer. See the DDR Impedance Control Settings table in the Control Module Functional Description section for a definition of these bits.
4-3	io_config_sr	R/W	0h	2 bit to program data IO Pads output slew rate. These connect as SR1, SR0 of the corresponding IO buffer. See the DDR Slew Rate Control Settings table in the Control Module Functional Description section for a definition of these bits.
2-0	io_config_i	R/W	0h	3-bit configuration input to program data IO output impedance. These connect as I2, I1, I0 of the corresponding IO buffer. See the DDR Impedance Control Settings table in the Control Module Functional Description section for a definition of these bits.

9.3.1.90 ddr_data1_ioctrl Register (offset = 1444h) [reset = 0h]

 ddr_data1_ioctrl is shown in [Figure 9-92](#) and described in [Table 9-101](#).

Figure 9-92. ddr_data1_ioctrl Register

31	30	29	28	27	26	25	24
Reserved		io_config_wd1_ dqs	io_config_wd1_ dm	io_config_wd1_dq			
R-0h		R/W-0h	R/W-0h	R/W-0h			
23	22	21	20	19	18	17	16
io_config_wd1_dq			io_config_wd0_ dqs	io_config_wd0_ dm	io_config_wd0_dq		
R/W-0h			R/W-0h	R/W-0h	R/W-0h		
15	14	13	12	11	10	9	8
io_config_wd0_dq						io_config_sr_clk	
R/W-0h						R/W-0h	
7	6	5	4	3	2	1	0
io_config_i_clk			io_config_sr		io_config_i		
R/W-0h			R/W-0h		R/W-0h		

LEGEND: R/W = Read/Write; R = Read only; W1toCl = Write 1 to clear bit; -n = value after reset

Table 9-101. ddr_data1_ioctrl Register Field Descriptions

Bit	Field	Type	Reset	Description
31-30	Reserved	R	0h	
29	io_config_wd1_dqs	R/W	0h	Input that selects pullup or pulldown for DDR_DQS1 and DDR_DQSn1. Used with io_config_wd0_dqs to define pullup/pulldown according to the following: WD1:WD0 00b: Pullup/Pulldown disabled for both DDR_DQS1 and DDR_DQSn1 01b: Enable weak pullup for DDR_DQS1 and weak pulldown for DDR_DQSn1 10b: Enable weak pulldown for DDR_DQS1 and weak pullup for DDR_DQSn1 11b: Weak keeper enabled for both DDR_DQS1 and DDR_DQSn1
28	io_config_wd1_dm	R/W	0h	Input that selects pullup or pulldown for DM. Used with io_config_wd0_dm to define pullup/pulldown according to the following: WD1:WD0 00: Pullup/Pulldown disabled 01: Weak pullup enabled 10: Weak pulldown enabled 11: Weak keeper enabled
27-20	io_config_wd1_dq	R/W	0h	Input that selects pullup or pulldown for DQ. There are 2 bits per IO: io_config_wd1_dq and io_config_wd0_dq. For example: macro pin 0: WD1 is bit 20, WD0 is bit 10 macro pin 1: WD1 is bit 21, WD0 is bit 11 ... macro pin 7: WD1 is bit 27, WD0 is bit 17 See the DDR PHY to IO Pin Mapping table in the Control Module Functional Description section for a mapping of macro bits to I/Os. WD1:WD0 00: Pullup/Pulldown disabled 01: Weak pullup enabled 10: Weak pulldown enabled 11: Weak keeper enabled

Table 9-101. ddr_data1_ioctrl Register Field Descriptions (continued)

Bit	Field	Type	Reset	Description
19	io_config_wd0_dqs	R/W	0h	Input that selects pullup or pulldown for DDR_DQS1 and DDR_DQSn1. Used with io_config_wd1_dqs to define pullup/pulldown according to the following: WD1:WD0 00b: Pullup/Pulldown disabled for both DDR_DQS1 and DDR_DQSn1 01b: Enable weak pullup for DDR_DQS1 and weak pulldown for DDR_DQSn1 10b: Enable weak pulldown for DDR_DQS1 and weak pullup for DDR_DQSn1 11b: Weak keeper enabled for both DDR_DQS1 and DDR_DQSn1
18	io_config_wd0_dm	R/W	0h	Input that selects pullup or pulldown for DM. Used with io_config_wd1_dm to define pullup/pulldown according to the following: WD1:WD0 00: Pullup/Pulldown disabled 01: Weak pullup enabled 10: Weak pulldown enabled 11: Weak keeper enabled
17-10	io_config_wd0_dq	R/W	0h	Input that selects pullup or pulldown for DQ. There are 2 bits per IO: io_config_wd1_dq and io_config_wd0_dq. For example: macro pin 0: WD1 is bit 20, WD0 is bit 10 macro pin 1: WD1 is bit 21, WD0 is bit 11 ... macro pin 7: WD1 is bit 27, WD0 is bit 17 See the DDR PHY to IO Pin Mapping table in the Control Module Functional Description section for a mapping of macro bits to I/Os. WD1:WD0 00: Pullup/Pulldown disabled 01: Weak pullup enabled 10: Weak pulldown enabled 11: Weak keeper enabled
9-8	io_config_sr_clk	R/W	0h	2 bit to program clock IO Pads (DDR_DQS/DDR_DQSn) output slew rate. These connect as SR1, SR0 of the corresponding IO buffer. See the DDR Slew Rate Control Settings table in the Control Module Functional Description section for a definition of these bits.
7-5	io_config_i_clk	R/W	0h	3-bit configuration input to program clock IO pads (DDR_DQS/DDR_DQSn) output impedance. These connect as I2, I1, I0 of the corresponding buffer. See the DDR Impedance Control Settings table in the Control Module Functional Description section for a definition of these bits.
4-3	io_config_sr	R/W	0h	2 bit to program data IO Pads output slew rate. These connect as SR1, SR0 of the corresponding IO buffer. See the DDR Slew Rate Control Settings table in the Control Module Functional Description section for a definition of these bits.
2-0	io_config_i	R/W	0h	3-bit configuration input to program data IO output impedance. These connect as I2, I1, I0 of the corresponding IO buffer. See the DDR Impedance Control Settings table in the Control Module Functional Description section for a definition of these bits.

Interconnects

This chapter describes the interconnects of the device.

Topic	Page
10.1 Introduction	1469

10.1 Introduction

The system interconnect is based on a 2-level hierarchical architecture (L3, L4) driven by system performance. The L4 interconnect is based on a fully native OCP infrastructure, directly complying with the OCPIP2.2 reference standard.

10.1.1 Terminology

The following is a brief explanation of some terms used in this document:

Initiator: Module able to initiate read and write requests to the chip interconnect (typically: processors, DMA, etc.).

Target: Unlike an initiator, a target module cannot generate read/write requests to the chip interconnect, but it can respond to these requests. However, it may generate interrupts or a DMA request to the system (typically: peripherals, memory controllers). **Note:** A module can have several separate ports; therefore, a module can be an initiator and a target.

Agent: Each connection of one module to one interconnect is done using an agent, which is an adaptation (sometimes configurable) between the module and the interconnect. A target module is connected by a target agent (TA), and an initiator module is connected by an initiator agent (IA).

Interconnect: The decoding, routing, and arbitration logic that enable the connection between multiple initiator modules and multiple target modules connected on it.

Register Target (RT): Special TA used to access the interconnect internal configuration registers.

Data-flow Signal: Any signal that is part of a clearly identified transfer or data flow (typically: command, address, byte enables, etc.). Signal behavior is defined by the protocol semantics.

Sideband Signal: Any signal whose behavior is not associated to a precise transaction or data flow.

Command Slot: A command slot is a subset of the command list. It is the memory buffer for a single command. A total of 32 command slots exist.

Out-of-band Error: Any signal whose behavior is associated to a device error-reporting scheme, as opposed to in-band errors. Note: Interrupt requests and DMA requests are not routed by the interconnect in the device.

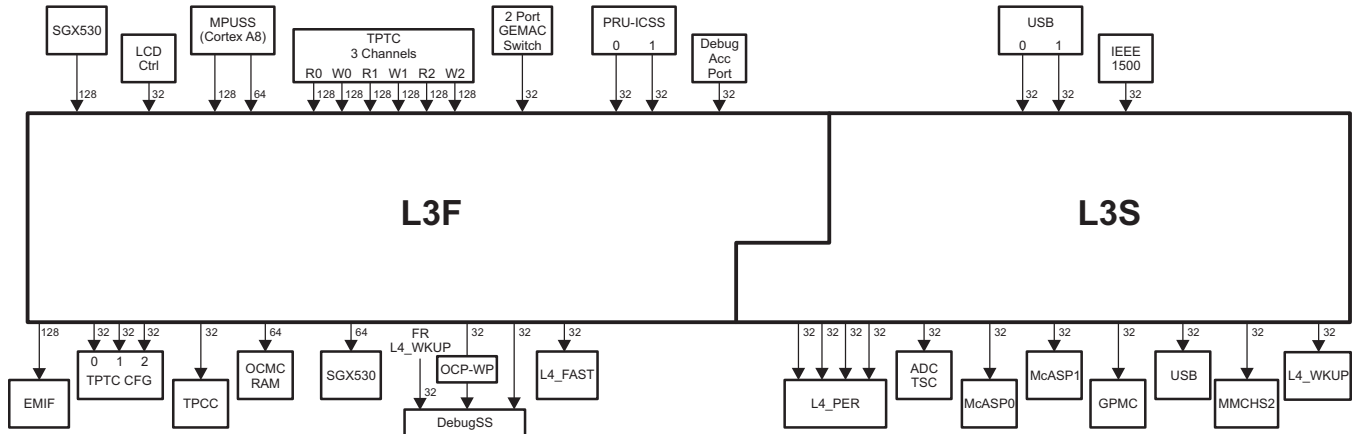
ConnID: Any transaction in the system interconnect is tagged by an in-band qualifier ConnID, which uniquely identifies the initiator at a given interconnect point. A ConnID is transmitted in band with the request and is used for error-logging mechanism.

10.1.2 L3 Interconnect

The L3 high-performance interconnect is based on a Network-On-Chip (NoC) interconnect infrastructure. The NoC uses an internal packet-based protocol for forward (read command, write command with data payload) and backward (read response with data payload, write response) transactions. All exposed interfaces of this NoC interconnect, both for Targets and Initiators; comply with the OCPIP2.2 reference standard.

10.1.2.1 L3 Topology

The L3 topology is driven by performance requirements, bus types, and clocking structure. The main L3 paths are shown in [Figure 10-1](#). Arrows indicate the master/slave relationship not data flow. L3 is partitioned into two separate clock domains: L3F corresponds to L3 Fast clock domain and L3S corresponds to L3 Slow clock domain.

Figure 10-1. L3 Topology


10.1.2.2 L3 Port Mapping

Each initiator and target core is connected to the L3 interconnect through a Network Interface Unit (NIU). The NIUs act as entry and exit points to the L3 Network on Chip – converting between the IP's OCP protocol and the NoC's internal protocol, and also include various programming registers. All ports are single threaded with tags used to enable pipelined transactions. The interconnect includes:

Initiator Ports:

- L3F
 - Cortex-A8 MPUSS 128-bit initiator port0 and 64-bit initiator port1
 - SGX530 128-bit initiator port
 - 3 TPTC 128-bit read initiator ports
 - 3 TPTC 128-bit write initiator ports
 - LCDC 32-bit initiator port
 - 2 PRU-ICSS1 32-bit initiator ports
 - 2 port Gigabit Ethernet Switch (2PGSW) 32-bit initiator port
 - Debug Subsystem 32-bit initiator port
- L3S
 - USB 32-bit CPPI DMA initiator port
 - USB 32-bit Queue Manager initiator port
 - P1500 32-bit initiator port

Target Ports:

- L3F
 - EMIF 128-bit target port
 - 3 TPTC CFG 32-bit target ports
 - TPCC CFG 32-bit target port
 - OCM RAM0 64-bit target port
 - DebugSS 32-bit target port
 - SGX530 64-bit target port
 - L4_FAST 32-bit target port
- L3S
 - 4 L4_PER peripheral 32-bit target ports
 - GPMC 32-bit target port
 - McASP0 32-bit target port

- McASP1 32-bit target port
- ADC_TSC 32-bit target port
- USB 32-bit target port
- MMHCS2 32-bit target port
- L4_WKUP wakeup 32-bit target port

10.1.2.3 Interconnect Requirements

The required L3 connections between bus masters and slave ports are shown in [Table 10-1](#). The L3 interconnect will return an address-hole error if any initiator attempts to access a target to which it has no connection.

Table 10-1. L3 Master — Slave Connectivity

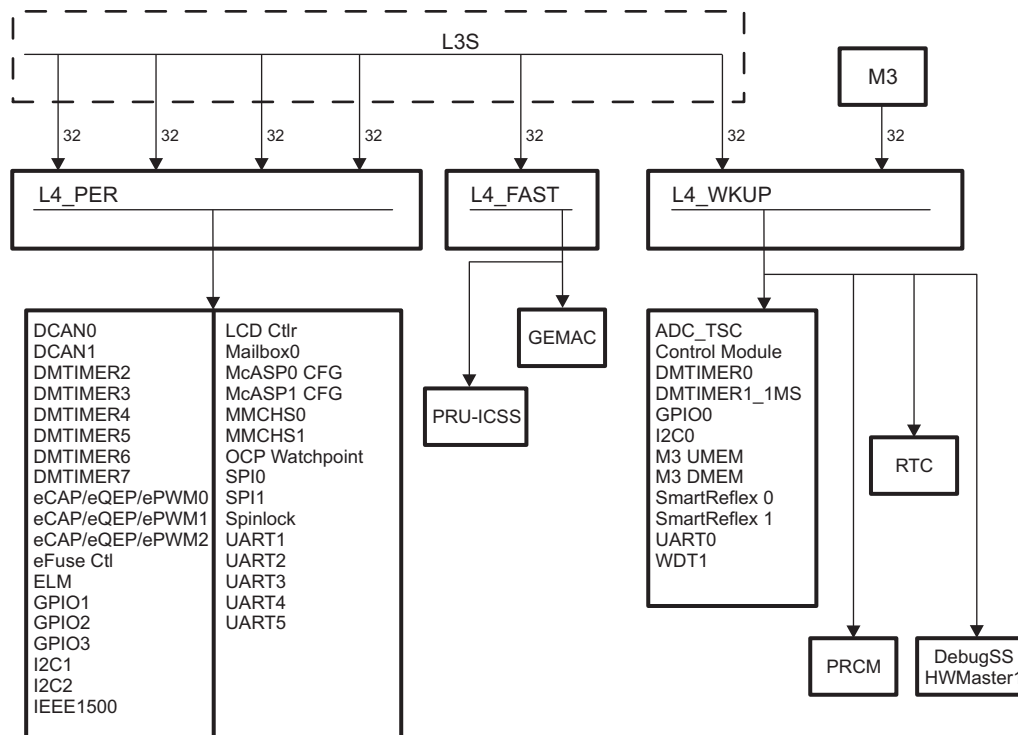
Master ID	Masters	Slaves																		
		EMIF	OCMC-RAM	TPTC0-2 FG	TGCC	SGX530	Expansion Slot	L4_Fast	L4_PER ort0	L4_PER Port1	L4_PER Port 2	L4_PER Port 3	GPMC	ADC / TSC	USBCFG	MMCHS2	L4_WKUP	DebugSS	NOC Registers	
0x00	MPUSS M1 (128-bit)	R																		
0x00	MPUSS M2 (64-bit)	R	R	R	R	R	R	R	R				R	R	R	R	R	R	R	R
0x18	TPTC0 RD	R	R		R		R	R			R		R	R	R	R	R			
0x19	TPTC0 WR	R	R		R		R	R			R		R	R	R	R	R	R		
0x1A	TPTC1 RD	R	R		R		R	R			R		R	R	R	R	R			
0x1B	TPTC1 WR	R	R		R		R	R			R		R	R	R	R	R			
0x1C	TPTC2 RD	R	R		R		R	R				R	R	R	R	R	R			
0x1D	TPTC2 WR	R	R		R		R	R				R	R	R	R	R	R			
0x24	LCD Controller	R	R										R							
0x0E	PRU-ICSS (PRU0)	R	R	R	R		R	R		R			R	R				R	R	R
0x0F	PRU-ICSS (PRU1)	R	R	R	R		R	R		R			R	R				R	R	R
0x30	GEMAC	R	R										R							
0x20	SGX530	R	R										R							
0x34	USB0 DMA	R	R																	
0x35	USB1 Queue Mgr	R	R										R							
0x04	EMU (DAP)	R	R	R	R	R	R	R				R	R	R	R	R	R	R	R	R
0x05	IEEE1500	R	R	R	R	R	R	R				R	R	R	R	R	R	R	R	R

10.1.3 L4 Interconnect

The L4 interconnect is a non-blocking peripheral interconnect that provides low latency access to a large number of low bandwidth, physically dispersed target cores. The L4 can handle incoming traffic from up to four initiators and can distribute those communication requests to and collect related responses from up to 63 targets.

This device provides three interfaces with L3 interconnect for High Speed Peripheral, Standard Peripheral, and Wakeup Peripherals. . [Figure 10-2](#) shows the L4 bus architecture and memory-mapped peripherals.

Figure 10-2. L4 Topology



Enhanced Direct Memory Access (EDMA)

This chapter describes the EDMA of the device.

Topic	Page
11.1 Introduction	1474
11.2 Integration	1477
11.3 Functional Description	1480
11.4 EDMA3 Registers	1543
11.5 Appendix A	1731

11.1 Introduction

The enhanced direct memory access (EDMA3) controller's primary purpose is to service user-programmed data transfers between two memory-mapped slave endpoints on the device.

Typical usage includes, but is not limited to the following:

- Servicing software-driven paging transfers (e.g., transfers from external memory, such as DDR2 to internal device memory).
- Servicing event-driven peripherals, such as a serial port.
- Performing sorting or sub-frame extraction of various data structures.
- Offloading data transfers from the main device CPU(s).

The EDMA3 controller consists of two principal blocks:

- EDMA3 channel controller (EDMA3CC).
- EDMA3 transfer controller(s) (EDMA3TC).

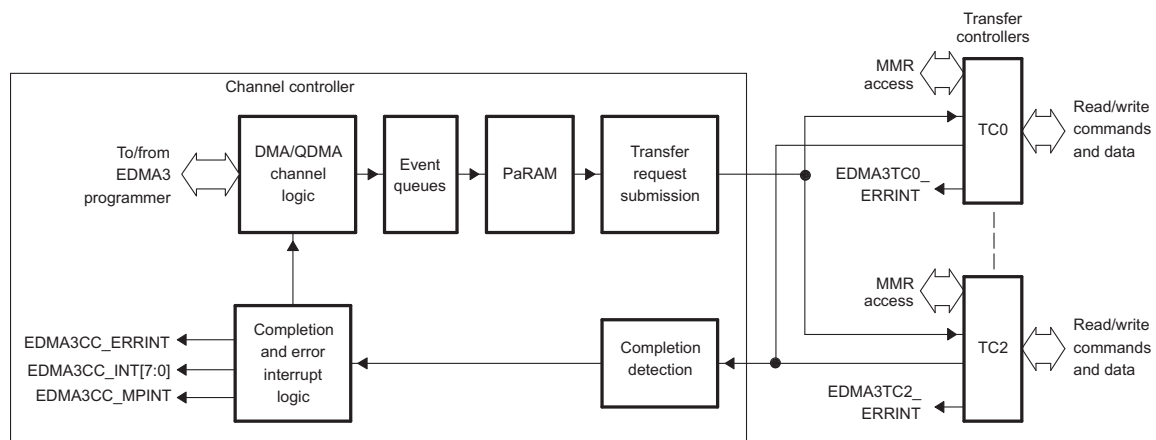
The EDMA3 channel controller serves as the user interface for the EDMA3 controller. The EDMA3CC includes parameter RAM (PaRAM), channel control registers, and interrupt control registers. The EDMA3CC serves to prioritize incoming software requests or events from peripherals and submits transfer requests (TRs) to the transfer controller.

The EDMA3 transfer controllers are slaves to the EDMA3 channel controller that is responsible for data movement. The transfer controller issues read/write commands to the source and destination addresses that are programmed for a given transfer. The operation is transparent to user.

11.1.1 EDMA3 Controller Block Diagram

Figure 11-1 shows a block diagram for the EDMA3 controller.

Figure 11-1. EDMA3 Controller Block Diagram



11.1.2 Third-Party Channel Controller (TPCC) Overview

11.1.2.1 TPCC Features

The general features of the TPCC module are:

- Up to 64 DMA Channels
 - Channels triggered by:
 - Event Synchronization
 - Manual Synchronization (CPU write to 'Event Set Register')
 - Chain Synchronization (completion of one transfer chains to the next)
 - Parameterizable support for programmable DMA Channel to PaRAM mapping
- Up to 8 QDMA Channels
 - QDMA Channels are triggered automatically upon writing to PaRAM
 - Support for programmable QDMA Channel to PaRAM mapping
- Up to 64 Event Inputs
- Up to 8 Interrupt outputs for multi-core support
- Up to 256 PaRAM entries
 - Each PaRAM entry can be used as DMA Entry (up to 64), QDMA Entry (up to 8), or Link Entry (remaining)
- 8 Priority Levels for mapping CC/TC priority relative to priority of other masters in the system.
- Up to 3 Event Queues
- 16 Event Entries per Event Queue
- Supports three-transfer dimensions
 - A-synchronized transfers—one dimension serviced per event
 - AB-synchronized transfers—two dimensions serviced per event
 - Independent Indexes on Source and Destination
 - Does not support direct submission of 3D transfer to TC
 - Chaining feature allows 3D transfer based on single event
- Increment and FIFO transfer addressing modes (TC feature)
- Linking mechanism allows automatic PaRAM Entry update
- Transfer Completion Signaling between TC and CC for Chaining and Interrupt generation.
- Programmable assignment of Priority to TC channel.
- Proxied Memory Protection for TR submission
- Parameterizable support for Active Memory Protection for accesses to PaRAM and registers.
- Queue Watermarking
- Missed Event Detection
- Error and status recording to facilitate debug
- Single Clock domain for all interfaces
- Parameterizable number of Write Completion interfaces (up to 8) (set to number of TC Channels)
- AET Event generation

11.1.2.2 Unsupported TPCC Features

This device does not support AET event generation because output is not connected.

11.1.3 Third-Party Transfer Controller (TPTC) Overview

11.1.3.1 TPTC Features

The TPTC module includes the following features:

- Up to eight independent channels
- External event control use model (TPCC)
- Read and Write Master ports per Channel 64- or 128-bit configuration.
- Parameterizable FIFO size
- Up to four in-flight Transfer Requests
- Proxied Memory protection for data transfers
- Programmable Priority levels (up to 8)
- Background programming capability
- Supports 2-dimensional transfers with independent indexes on Source and Destination.
- Support for increment or FIFO-mode transfers
- Interrupt and error support
- Single clock domain for all interfaces

11.1.3.2 Unsupported TPTC Features

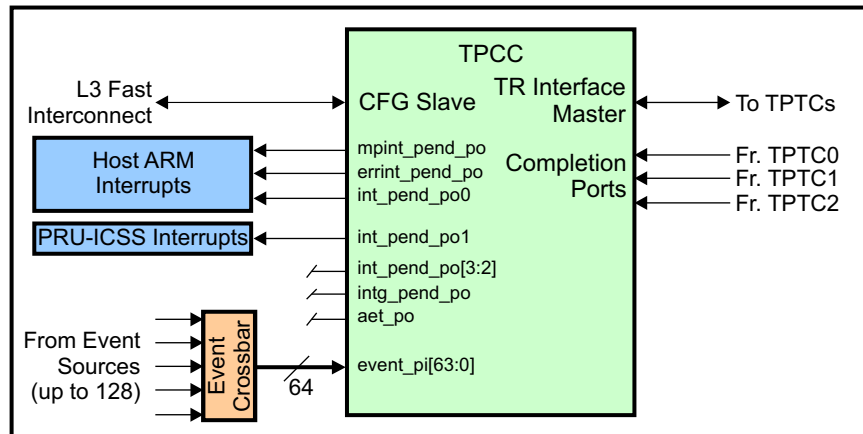
There are no unsupported TPTC features on this device.

11.2 Integration

11.2.1 Third-Party Channel Controller (TPCC) Integration

This device uses the TPCC peripheral to provide control over its third-party transfer channels (TPTCs). Figure 11-2 shows the integration of the TPCC module.

Figure 11-2. TPCC Integration



11.2.1.1 TPCC Connectivity Attributes

The general connectivity attributes of the TPCC are summarized in Table 11-1.

Table 11-1. TPCC Connectivity Attributes

Attributes	Type
Power domain	Peripheral Domain
Clock domain	PD_PER_L3_GCLK
Reset signals	PER_DOM_RST_N
Idle/Wakeup signals	Smart Idle
Interrupt request	4 Regional Completion Interrupts: int_pend_po0 (EDMACOMPINT) – to MPU Subsystem int_pend_po1 (tpcc_int_pend_po1) – to PRU-ICSS Int_pend_po[3:2] - unused Error Interrupt: errint_po (EDMAERRINT) – to MPU Subsystem Memory Protection Error Interrupt: mpint_p0 (EDMAMPERR) – to MPU Subsystem
DMA request	none
Physical address	L3 Fast slave port

11.2.1.2 TPCC Clock and Reset Management

The TPCC operates from a single clock and runs at the L3_Fast clock rate.

Table 11-2. TPCC Clock Signals

Clock Signal	Max Freq	Reference / Source	Comments
tpcc_clk_pi Interface / Functional clock	200 MHz	CORE_CLKOUTM4	pd_per_l3_gclk From PRCM

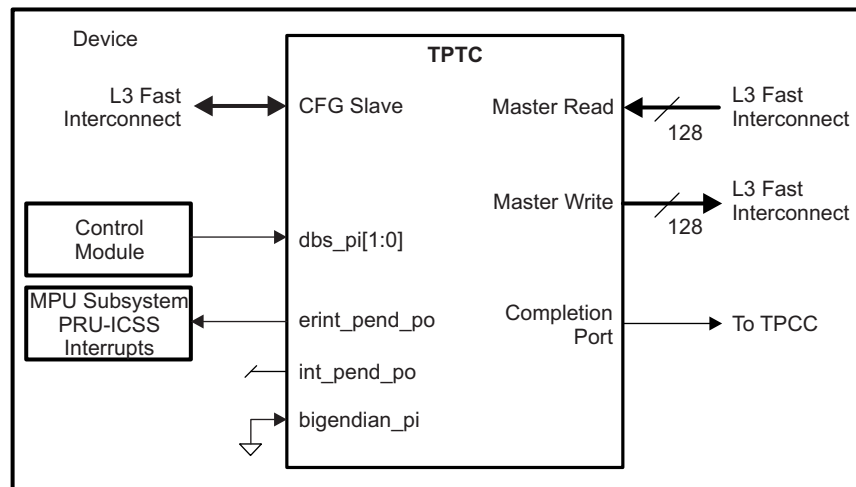
11.2.1.3 TPCC Pin List

The TPCC module does not include any external interface pins.

11.2.2 Third-Party Transfer Controller (TPTC) Integration

This device uses the three TPTC peripherals (TC0–TC2; TC3 is not supported) to perform EDMA transfers between slave peripherals. The submission of transfer requests to the TPTCs is controlled by the TPCC. [Figure 11-3](#) shows the integration of the TPTC modules

Figure 11-3. TPTC Integration



11.2.2.1 TPTC Connectivity Attributes

The general connectivity attributes for the TPTCs are shown in [Table 11-3](#).

Table 11-3. TPTC Connectivity Attributes

Attributes	Type
Power domain	Peripheral Domain
Clock domain	PD_PER_L3_GCLK
Reset signals	PER_DOM_RST_N
Idle/Wakeup signals	Standby Smart Idle
Interrupt request	Error interrupt per instance erint_pend_po (TCERRINTx) – to MPU Subsystem and PRU-ICSS (tpc_erint_pend_po, TPTC0 only)
DMA request	none
Physical address	L3 Fast slave port

11.2.2.2 TPTC Clock and Reset Management

The TPTC operates from a single clock and runs at the L3_Fast clock rate.

Table 11-4. TPTC Clock Signals

Clock Signal	Max Freq	Reference / Source	Comments
tpc_clk_pi Interface / Functional clock	200 MHz	CORE_CLKOUTM4	pd_per_l3_gclk From PRCM

11.2.2.3 TPTC Pin List

The TPTC module does not include any external interface pins.

11.3 Functional Description

This chapter discusses the architecture of the EDMA3 controller.

11.3.1 Functional Overview

11.3.1.1 EDMA3 Channel Controller (EDMA3CC)

[Figure 11-4](#) shows a functional block diagram of the EDMA3 channel controller (EDMA3CC).

The main blocks of the EDMA3CC are as follows:

- **Parameter RAM (PaRAM):** The PaRAM maintains parameter sets for channel and reload parameter sets. You must write the PaRAM with the transfer context for the desired channels and link parameter sets. EDMA3CC processes sets based on a trigger event and submits a transfer request (TR) to the transfer controller.
- **EDMA3 event and interrupt processing registers:** Allows mapping of events to parameter sets, enable/disable events, enable/disable interrupt conditions, and clearing interrupts.
- **Completion detection:** The completion detect block detects completion of transfers by the EDMA3TC and/or slave peripherals. You can optionally use completion of transfers to chain trigger new transfers or to assert interrupts.
- **Event queues:** Event queues form the interface between the event detection logic and the transfer request submission logic.
- **Memory protection registers:** Memory protection registers define the accesses (privilege level and requestor(s)) that are allowed to access the DMA channel shadow region view(s) and regions of PaRAM.

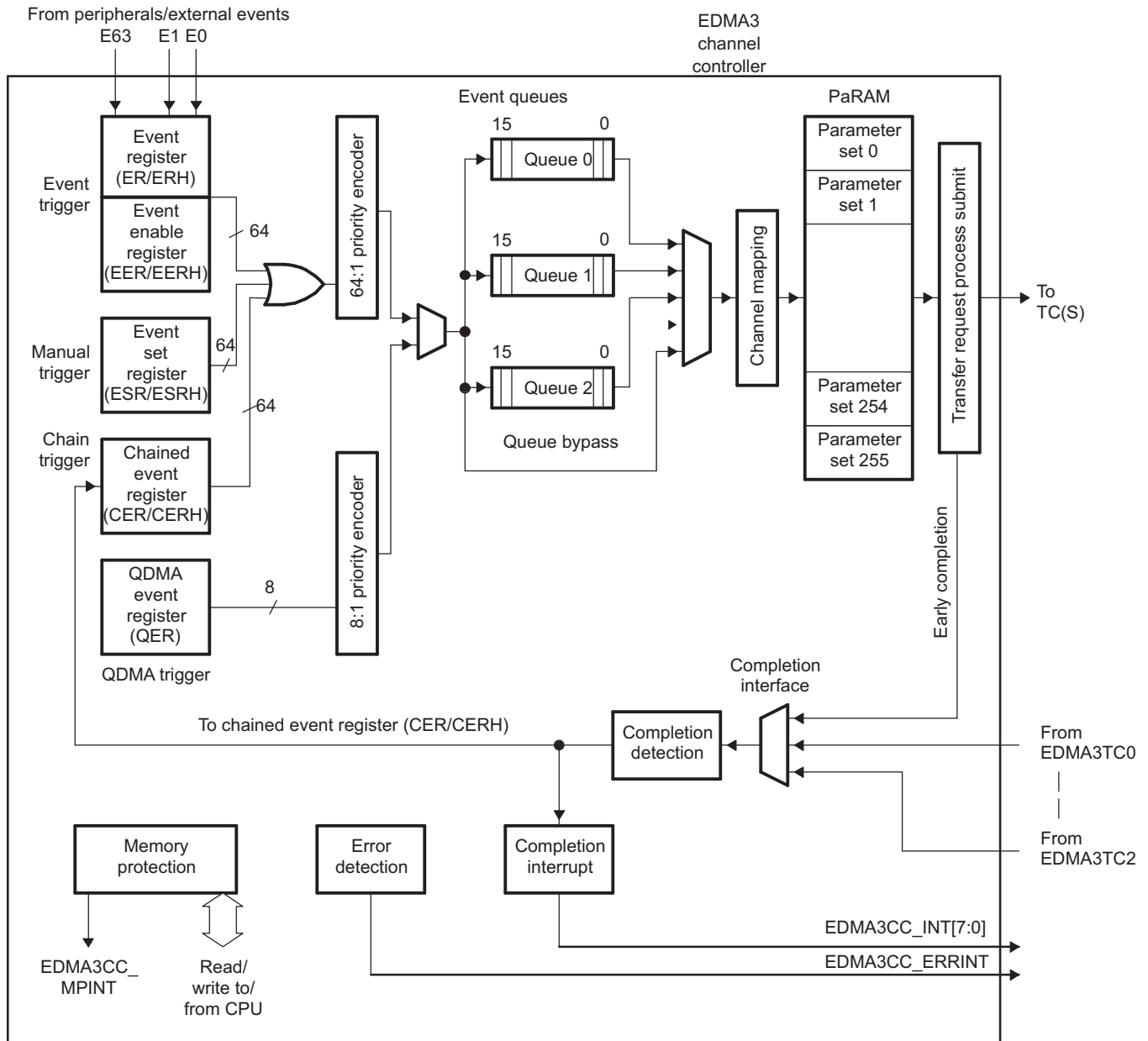
Other functions include the following:

- **Region registers:** Region registers allow DMA resources (DMA channels and interrupts) to be assigned to unique regions that different EDMA3 programmers own (for example, ARM).
- **Debug registers:** Debug registers allow debug visibility by providing registers to read the queue status, controller status, and missed event status.

The EDMA3CC includes two channel types: DMA channels (64 channels) and QDMA channels (8 channels).

Each channel is associated with a given event queue/transfer controller and with a given PaRAM set. The main thing that differentiates a DMA channel from a QDMA channel is the method that the system uses to trigger transfers. See [Section 11.3.4](#).

Figure 11-4. EDMA3 Channel Controller (EDMA3CC) Block Diagram



A trigger event is needed to initiate a transfer. A trigger event may be due to an external event, manual write to the event set register, or chained event for DMA channels. QDMA channels auto-trigger when a write to the trigger word that you program occurs on the associated PaRAM set. All such trigger events are logged into appropriate registers upon recognition.

Once a trigger event is recognized, the appropriate event gets queued in the EDMA3CC event queue. The assignment of each DMA/QDMA channel to an event queue is programmable. Each queue is 16 events deep; therefore, you can queue up to 16 events (on a single queue) in the EDMA3CC at a time. Additional pending events that are mapped to a full queue are queued when the event queue space becomes available. See [Section 11.3.11](#).

If events on different channels are detected simultaneously, the events are queued based on a fixed priority arbitration scheme with the DMA channels being higher priority events than the QDMA channels. Among the two groups of channels, the lowest-numbered channel is the highest priority.

Each event in the event queue is processed in FIFO order. When the head of the queue is reached, the PaRAM associated with that channel is read to determine the transfer details. The TR submission logic evaluates the validity of the TR and is responsible for submitting a valid transfer request (TR) to the appropriate EDMA3TC (based on the event queue to the EDMA3TC association, Q0 goes to TC0, Q1 goes to TC1, and Q2 goes to TC2). For more information, refer to [Section 11.3.3](#).

The EDMA3TC receives the request and is responsible for data movement, as specified in the transfer request packet (TRP), other necessary tasks like buffering, and ensuring transfers are carried out in an optimal fashion wherever possible. For more information on EDMA3TC, refer to [Section 11.3.1.2](#).

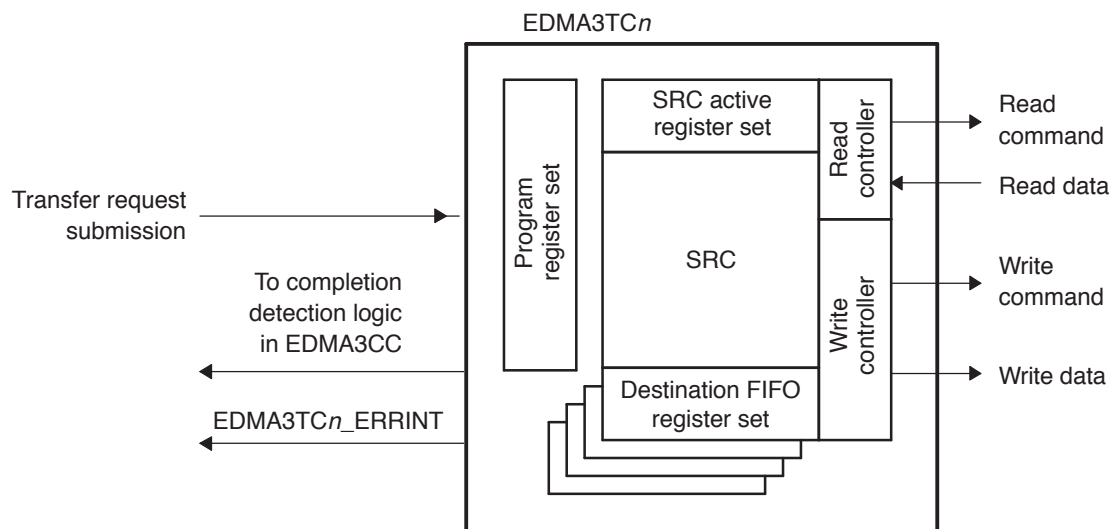
If you have decided to receive an interrupt or to chain to another channel on completion of the current transfer, the EDMA3TC signals completion to the EDMA3CC completion detection logic when the transfer is complete. You can alternately choose to trigger completion when a TR leaves the EDMA3CC boundary, rather than wait for all of the data transfers to complete. Based on the setting of the EDMA3CC interrupt registers, the completion interrupt generation logic is responsible for generating EDMA3CC completion interrupts to the CPU. For more information, refer to [Section 11.3.5](#).

Additionally, the EDMA3CC also has an error detection logic that causes an error interrupt generation on various error conditions (like missed events, exceeding event queue thresholds, etc.). For more information on error interrupts, refer to [Section 11.3.9.4](#).

11.3.1.2 EDMA3 Transfer Controller (EDMA3TC)

[Section 11.3.9.4](#) shows a functional block diagram of the EDMA3 transfer controller (EDMA3TC).

Figure 11-5. EDMA3 Transfer Controller (EDMA3TC) Block Diagram



The main blocks of the EDMA3TC are:

- **DMA program register set:** The DMA program register set stores the transfer requests received from the EDMA3 channel controller (EDMA3CC).
- **DMA source active register set:** The DMA source active register set stores the context for the DMA transfer request currently in progress in the read controller.
- **Read controller:** The read controller issues read commands to the source address.
- **Destination FIFO register set:** The destination (DST) FIFO register set stores the context for the DMA transfer request(s) currently in progress in the write controller.
- **Write controller:** The write controller issues write commands/write data to the destination slave.
- **Data FIFO:** The data FIFO exists for holding temporary in-flight data.
- **Completion interface:** The completion interface sends completion codes to the EDMA3CC when a transfer completes, and generates interrupts and chained events (also, see [Section 11.3.1.1](#) for more information on transfer completion reporting).

When the EDMA3TC is idle and receives its first TR, DMA program register set receives the TR, where it transitions to the DMA source active set and the destination FIFO register set immediately. The second TR (if pending from EDMA3CC) is loaded into the DMA program set, ensuring it can start as soon as possible when the active transfer completes. As soon as the current active set is exhausted, the TR is loaded from the DMA program register set into the DMA source active register set as well as to the appropriate entry in the destination FIFO register set.

The read controller issues read commands governed by the rules of command fragmentation and optimization. These are issued only when the data FIFO has space available for the data read. When sufficient data is in the data FIFO, the write controller starts issuing a write command again following the rules for command fragmentation and optimization. For more information on command fragmentation and optimization, refer to [Section 11.3.12.1.1](#).

Depending on the number of entries, the read controller can process up to two or four transfer requests ahead of the destination subject to the amount of free data FIFO.

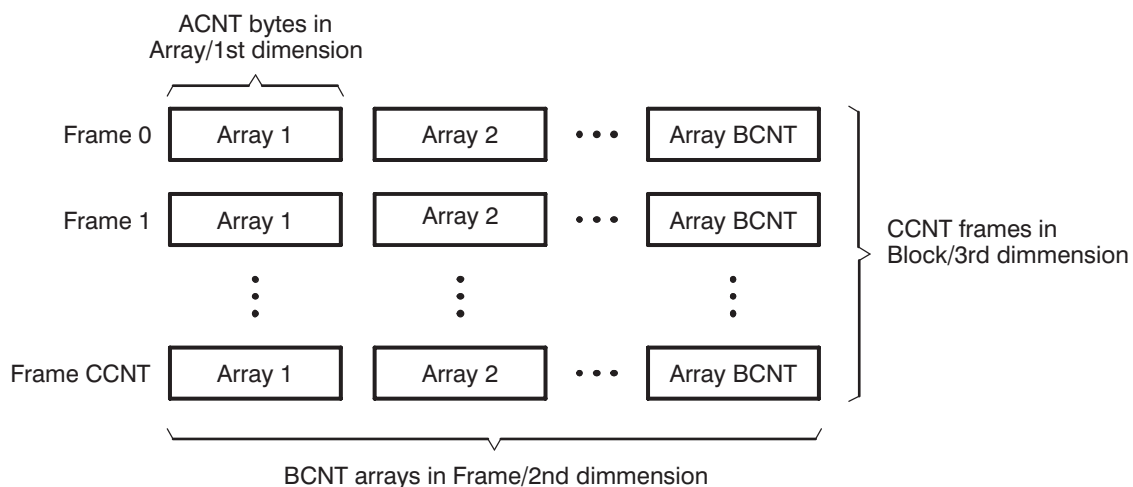
11.3.2 Types of EDMA3 Transfers

An EDMA3 transfer is always defined in terms of three dimensions. [Figure 11-6](#) shows the three dimensions used by EDMA3 transfers. These three dimensions are defined as:

- 1st Dimension or Array (A): The 1st dimension in a transfer consists of ACNT contiguous bytes.
- 2nd Dimension or Frame (B): The 2nd dimension in a transfer consists of BCNT arrays of ACNT bytes. Each array transfer in the 2nd dimension is separated from each other by an index programmed using SRCBIDX or DSTBIDX.
- 3rd Dimension or Block (C): The 3rd dimension in a transfer consists of CCNT frames of BCNT arrays of ACNT bytes. Each transfer in the 3rd dimension is separated from the previous by an index programmed using SRCCIDX or DSTCIDX.

Note that the reference point for the index depends on the synchronization type. The amount of data transferred upon receipt of a trigger/synchronization event is controlled by the synchronization types (SYNCDIM bit in OPT). Of the three dimensions, only two synchronization types are supported: A-synchronized transfers and AB-synchronized transfers.

Figure 11-6. Definition of ACNT, BCNT, and CCNT



11.3.2.1 A-Synchronized Transfers

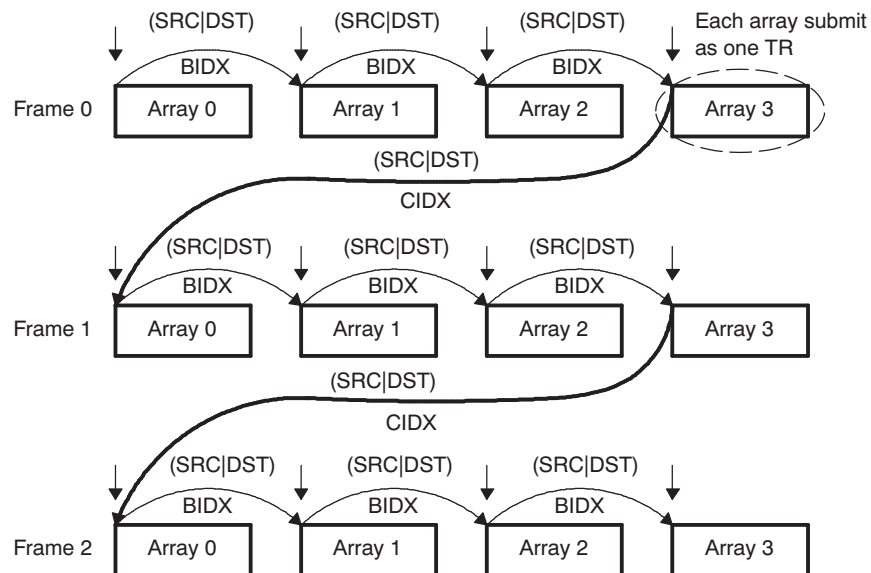
In an A-synchronized transfer, each EDMA3 sync event initiates the transfer of the 1st dimension of ACNT bytes, or one array of ACNT bytes. In other words, each event/TR packet conveys the transfer information for one array only. Thus, $BCNT \times CCNT$ events are needed to completely service a PaRAM set.

Arrays are always separated by SRCBIDX and DSTBIDX, as shown in Figure 11-7, where the start address of Array N is equal to the start address of Array N – 1 plus source (SRC) or destination (DST) BIDX.

Frames are always separated by SRCCIDX and DSTCIDX. For A-synchronized transfers, after the frame is exhausted, the address is updated by adding SRCCIDX/DSTCIDX to the beginning address of the last array in the frame. As in Figure 11-7, SRCCIDX/DSTCIDX is the difference between the start of Frame 0 Array 3 to the start of Frame 1 Array 0.

Figure 11-7 shows an A-synchronized transfer of 3 (CCNT) frames of 4 (BCNT) arrays of n (ACNT) bytes. In this example, a total of 12 sync events ($BCNT \times CCNT$) exhaust a PaRAM set. See Section 11.3.3.6 for details on parameter set updates.

Figure 11-7. A-Synchronized Transfers (ACNT = n, BCNT = 4, CCNT = 3)



11.3.2.2 AB-Synchronized Transfers

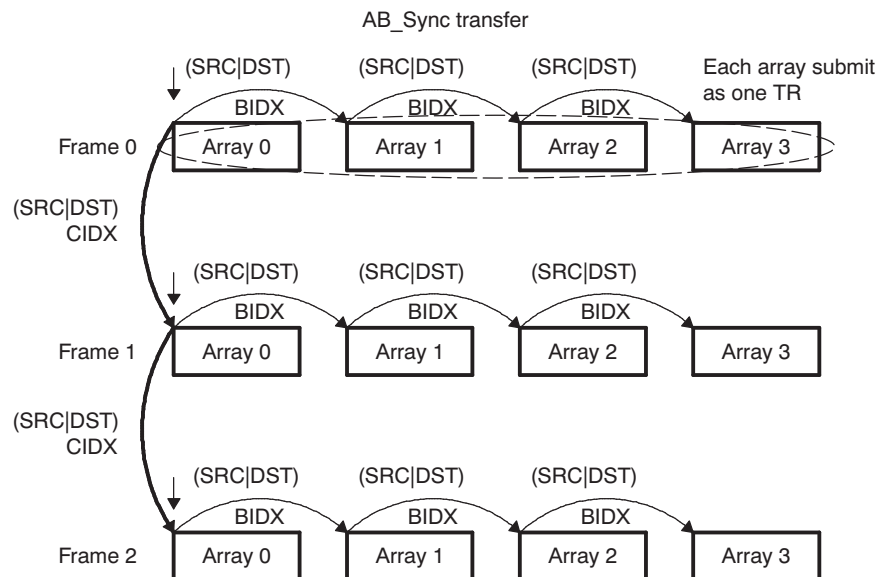
In a AB-synchronized transfer, each EDMA3 sync event initiates the transfer of 2 dimensions or one frame. In other words, each event/TR packet conveys information for one entire frame of BCNT arrays of ACNT bytes. Thus, CCNT events are needed to completely service a PaRAM set.

Arrays are always separated by SRCBIDX and DSTBIDX as shown in Figure 11-8. Frames are always separated by SRCCIDX and DSTCIDX.

Note that for AB-synchronized transfers, after a TR for the frame is submitted, the address update is to add SRCCIDX/DSTCIDX to the beginning address of the beginning array in the frame. This is different from A-synchronized transfers where the address is updated by adding SRCCIDX/DSTCIDX to the start address of the last array in the frame. See Section 11.3.3.6 for details on parameter set updates.

Figure 11-8 shows an AB-synchronized transfer of 3 (CCNT) frames of 4 (BCNT) arrays of *n* (ACNT) bytes. In this example, a total of 3 sync events (CCNT) exhaust a PaRAM set; that is, a total of 3 transfers of 4 arrays each completes the transfer.

Figure 11-8. AB-Synchronized Transfers (ACNT = n, BCNT = 4, CCNT = 3)



NOTE: ABC-synchronized transfers are not directly supported. But can be logically achieved by chaining between multiple AB-synchronized transfers.

11.3.3 Parameter RAM (PaRAM)

The EDMA3 controller is a RAM-based architecture. The transfer context (source/destination addresses, count, indexes, etc.) for DMA or QDMA channels is programmed in a parameter RAM table within EDMA3CC, referred to as PaRAM. The PaRAM table is segmented into multiple PaRAM sets. Each PaRAM set includes eight four-byte PaRAM set entries (32-bytes total per PaRAM set), which includes typical DMA transfer parameters such as source address, destination address, transfer counts, indexes, options, etc.

The PaRAM structure supports flexible ping-pong, circular buffering, channel chaining, and auto-reloading (linking).

The contents of the PaRAM include the following:

- 256 PaRAM sets
- 64 channels that are direct mapped and can be used as link or QDMA sets if not used for DMA channels
- 64 channels remain for link or QDMA sets

By default, all channels map to PaRAM set to 0. These should be remapped before use. For more information, see (DCHMAP registers) and (QCHMAP registers).

Table 11-5. EDMA3 Parameter RAM Contents

PaRAM Set Number	Address	Parameters
0	EDMA Base Address + 4000h to EDMA Base Address + 401Fh	PaRAM set 0
1	EDMA Base Address + 4020h to EDMA Base Address + 403Fh	PaRAM set 1
2	EDMA Base Address + 4040h to EDMA Base Address + 405Fh	PaRAM set 2
3	EDMA Base Address + 4060h to EDMA Base Address + 407Fh	PaRAM set 3
4	EDMA Base Address + 4080h to EDMA Base Address + 409Fh	PaRAM set 4
5	EDMA Base Address + 40A0h to EDMA Base Address + 40BFh	PaRAM set 5
6	EDMA Base Address + 40C0h to EDMA Base Address + 40DFh	PaRAM set 6
7	EDMA Base Address + 40E0h to EDMA Base Address + 40FFh	PaRAM set 7
8	EDMA Base Address + 4100h to EDMA Base Address + 411Fh	PaRAM set 8
9	EDMA Base Address + 4120h to EDMA Base Address + 413Fh	PaRAM set 9
...
63	EDMA Base Address + 47E0h to EDMA Base Address + 47FFh	PaRAM set 63
64	EDMA Base Address + 4800h to EDMA Base Address + 481Fh	PaRAM set 64
65	EDMA Base Address + 4820h to EDMA Base Address + 483Fh	PaRAM set 65
...
254	EDMA Base Address + 5FC0h to EDMA Base Address + 5FDFh	PaRAM set 254
255	EDMA Base Address + 5FE0h to EDMA Base Address + 5FFFh	PaRAM set 255

11.3.3.1 PaRAM

Each parameter set of PaRAM is organized into eight 32-bit words or 32 bytes, as shown in [Figure 11-9](#) and described in [Table 11-6](#). Each PaRAM set consists of 16-bit and 32-bit parameters.

Figure 11-9. PaRAM Set

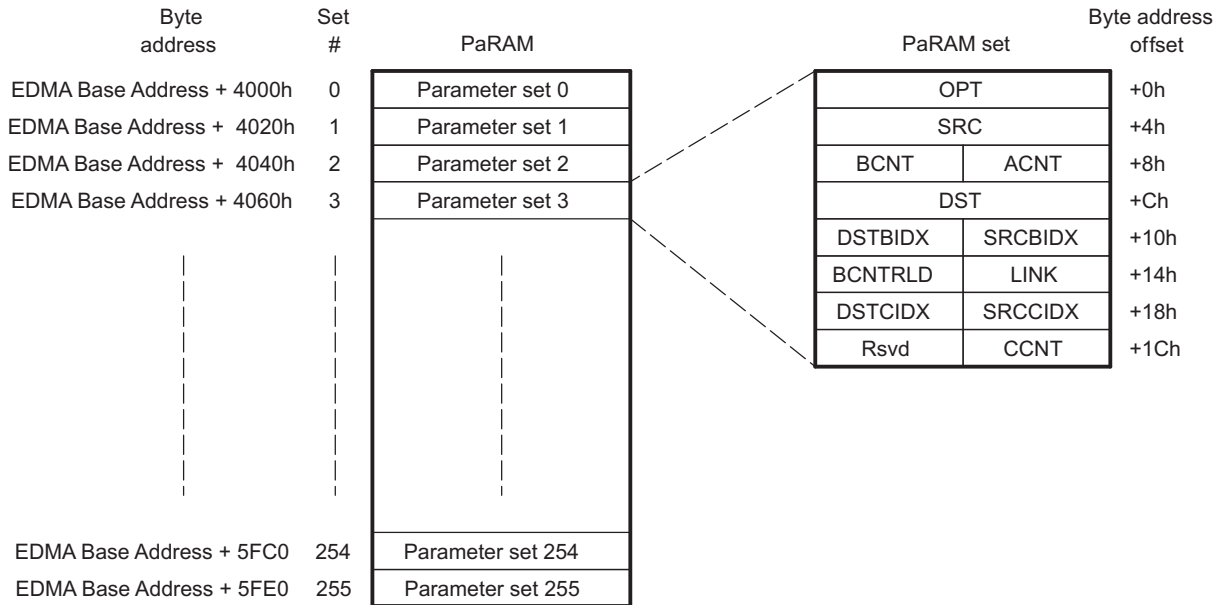


Table 11-6. EDMA3 Channel Parameter Description

Offset Address (bytes)	Acronym	Parameter	Description
0h	OPT	Channel Options	Transfer configuration options
4h	SRC	Channel Source Address	The byte address from which data is transferred
8h ⁽¹⁾	ACNT	Count for 1st Dimension	Unsigned value specifying the number of contiguous bytes within an array (first dimension of the transfer). Valid values range from 1 to 65 535.
	BCNT	Count for 2nd Dimension	Unsigned value specifying the number of arrays in a frame, where an array is ACNT bytes. Valid values range from 1 to 65 535.
Ch	DST	Channel Destination Address	The byte address to which data is transferred
10h ⁽¹⁾	SRCBIDX	Source BCNT Index	Signed value specifying the byte address offset between source arrays within a frame (2nd dimension). Valid values range from –32 768 and 32 767.
	DSTBIDX	Destination BCNT Index	Signed value specifying the byte address offset between destination arrays within a frame (2nd dimension). Valid values range from –32 768 and 32 767.
14h ⁽¹⁾	LINK	Link Address	The PaRAM address containing the PaPARAM set to be linked (copied from) when the current PaPARAM set is exhausted. A value of FFFFh specifies a null link.
	BCNTRLD	BCNT Reload	The count value used to reload BCNT when BCNT decrements to 0 (TR is submitted for the last array in 2nd dimension). Only relevant in A-synchronized transfers.
18h ⁽¹⁾	SRCCIDX	Source CCNT Index	Signed value specifying the byte address offset between frames within a block (3rd dimension). Valid values range from –32 768 and 32 767. A-synchronized transfers: The byte address offset from the beginning of the last source array in a frame to the beginning of the first source array in the next frame. AB-synchronized transfers: The byte address offset from the beginning of the first source array in a frame to the beginning of the first source array in the next frame.
	DSTCIDX	Destination CCNT index	Signed value specifying the byte address offset between frames within a block (3rd dimension). Valid values range from –32 768 and 32 767. A-synchronized transfers: The byte address offset from the beginning of the last destination array in a frame to the beginning of the first destination array in the next frame. AB-synchronized transfers: The byte address offset from the beginning of the first destination array in a frame to the beginning of the first destination array in the next frame.
1Ch	CCNT	Count for 3rd Dimension	Unsigned value specifying the number of frames in a block, where a frame is BCNT arrays of ACNT bytes. Valid values range from 1 to 65 535.
	RSVD	Reserved	Reserved. Always write 0 to this bit; writes of 1 to this bit are not supported and attempts to do so may result in undefined behavior.

⁽¹⁾ It is recommended to access the parameter set sets as 32-bit words whenever possible.

11.3.3.2 EDMA3 Channel PaRAM Set Entry Fields

11.3.3.2.1 Channel Options Parameter (OPT)

The channel options parameter (OPT) is shown in [Figure 11-10](#) and described in [Table 11-7](#).

Figure 11-10. Channel Options Parameter (OPT)

31	30	28	27	24	23	22	21	20	19	18	17	16
PRIV	Reserved	PRIVID		ITCCHEN	TCCHEN	ITCINTEN	TCINTEN	Reserved		TCC		
R-0	R-0	R-0		R/W-0	R/W-0	R/W-0	R/W-0	R/W-0		R/W-0		
15		12	11	10	8	7	4		3	2	1	0
TCC		TCCMOD E	FWID	Reserved				STATIC	SYNCDIM	DAM	SAM	
R/W-0		R/W-0	R/W-0	R/W-0				R/W-0	R/W-0	R/W-0	R/W-0	

Table 11-7. Channel Options Parameters (OPT) Field Descriptions

Bit	Field	Value	Description
31	PRIV	0 1	Privilege level (supervisor versus user) for the host/CPU/DMA that programmed this PaRAM set. This value is set with the EDMA3 master's privilege value when any part of the PaRAM set is written. User level privilege. Supervisor level privilege.
30-28	Reserved	0	Reserved. Always write 0 to this bit; writes of 1 to this bit are not supported and attempts to do so may result in undefined behavior.
27-24	PRIVID	0-Fh	Privilege identification for the external host/CPU/DMA that programmed this PaRAM set. This value is set with the EDMA3 master's privilege identification value when any part of the PaRAM set is written.
23	ITCCHEN	0 1	Intermediate transfer completion chaining enable. 0 Intermediate transfer complete chaining is disabled. 1 Intermediate transfer complete chaining is enabled. When enabled, the chained event register (CER/CERH) bit is set on every intermediate chained transfer completion (upon completion of every intermediate TR in the PaRAM set, except the final TR in the PaRAM set). The bit (position) set in CER or CERH is the TCC value specified.
22	TCCHEN	0 1	Transfer complete chaining enable. 0 Transfer complete chaining is disabled. 1 Transfer complete chaining is enabled. When enabled, the chained event register (CER/CERH) bit is set on final chained transfer completion (upon completion of the final TR in the PaRAM set). The bit (position) set in CER or CERH is the TCC value specified.
21	ITCINTEN	0 1	Intermediate transfer completion interrupt enable. 0 Intermediate transfer complete interrupt is disabled. 1 Intermediate transfer complete interrupt is enabled. When enabled, the interrupt pending register (IPR / IPRH) bit is set on every intermediate transfer completion (upon completion of every intermediate TR in the PaRAM set, except the final TR in the PaRAM set). The bit (position) set in IPR or IPRH is the TCC value specified. To generate a completion interrupt to the CPU, the corresponding IER [TCC] / IERH [TCC] bit must be set.
20	TCINTEN	0 1	Transfer complete interrupt enable. 0 Transfer complete interrupt is disabled. 1 Transfer complete interrupt is enabled. When enabled, the interrupt pending register (IPR / IPRH) bit is set on transfer completion (upon completion of the final TR in the PaRAM set). The bit (position) set in IPR or IPRH is the TCC value specified. To generate a completion interrupt to the CPU, the corresponding IER[TCC] / IERH [TCC] bit must be set.
19-18	Reserved	0	Reserved. Always write 0 to this bit; writes of 1 to this bit are not supported and attempts to do so may result in undefined behavior.

Table 11-7. Channel Options Parameters (OPT) Field Descriptions (continued)

Bit	Field	Value	Description
17-12	TCC	0-3Fh	Transfer complete code. This 6-bit code sets the relevant bit in the chaining enable register (CER [TCC] / CERH [TCC]) for chaining or in the interrupt pending register (IPR [TCC] / IPRH [TCC]) for interrupts.
11	TCCMODE	0 1	Transfer complete code mode. Indicates the point at which a transfer is considered completed for chaining and interrupt generation. 0 Normal completion: A transfer is considered completed after the data has been transferred. 1 Early completion: A transfer is considered completed after the EDMA3CC submits a TR to the EDMA3TC. TC may still be transferring data when the interrupt/chain is triggered.
10-8	FWID	0-7h 0 1h 2h 3h 4h 5h 6h-7h	FIFO Width. Applies if either SAM or DAM is set to constant addressing mode. 0 FIFO width is 8-bit. 1h FIFO width is 16-bit. 2h FIFO width is 32-bit. 3h FIFO width is 64-bit. 4h FIFO width is 128-bit. 5h FIFO width is 256-bit. 6h-7h Reserved.
7-4	Reserved	0	Reserved. Always write 0 to this bit; writes of 1 to this bit are not supported and attempts to do so may result in undefined behavior.
3	STATIC	0 1	Static set. 0 Set is not static. The PaRAM set is updated or linked after a TR is submitted. A value of 0 should be used for DMA channels and for non-final transfers in a linked list of QDMA transfers. 1 Set is static. The PaRAM set is not updated or linked after a TR is submitted. A value of 1 should be used for isolated QDMA transfers or for the final transfer in a linked list of QDMA transfers.
2	SYNCDIM	0 1	Transfer synchronization dimension. 0 A-synchronized. Each event triggers the transfer of a single array of ACNT bytes. 1 AB-synchronized. Each event triggers the transfer of BCNT arrays of ACNT bytes.
1	DAM	0 1	Destination address mode. 0 Increment (INCR) mode. Destination addressing within an array increments. Destination is not a FIFO. 1 Constant addressing (CONST) mode. Destination addressing within an array wraps around upon reaching FIFO width.
0	SAM	0 1	Source address mode. 0 Increment (INCR) mode. Source addressing within an array increments. Source is not a FIFO. 1 Constant addressing (CONST) mode. Source addressing within an array wraps around upon reaching FIFO width.

11.3.3.2.2 Channel Source Address (SRC)

The 32-bit source address parameter specifies the starting byte address of the source. For SAM in increment mode, there are no alignment restrictions imposed by EDMA3. For SAM in constant addressing mode, you must program the source address to be aligned to a 256-bit aligned address (5 LSBs of address must be 0). The EDMA3TC will signal an error, if this rule is violated. See [Section 11.3.12.3](#) for additional details.

11.3.3.2.3 Channel Destination Address (DST)

The 32-bit destination address parameter specifies the starting byte address of the destination. For DAM in increment mode, there are no alignment restrictions imposed by EDMA3. For DAM in constant addressing mode, you must program the destination address to be aligned to a 256-bit aligned address (5 LSBs of address must be 0). The EDMA3TC will signal an error, if this rule is violated. See [Section 11.3.12.3](#) for additional details.

11.3.3.2.4 Count for 1st Dimension (ACNT)

ACNT represents the number of bytes within the 1st dimension of a transfer. ACNT is a 16-bit unsigned value with valid values between 0 and 65 535. Therefore, the maximum number of bytes in an array is 65 535 bytes (64K – 1 bytes). ACNT must be greater than or equal to 1 for a TR to be submitted to EDMA3TC. A transfer with ACNT equal to 0 is considered either a null or dummy transfer. A dummy or null transfer generates a completion code depending on the settings of the completion bit fields in OPT.

See [Section 11.3.3.5](#) and [Section 11.3.5.3](#) for details on dummy/null completion conditions.

11.3.3.2.5 Count for 2nd Dimension (BCNT)

BCNT is a 16-bit unsigned value that specifies the number of arrays of length ACNT. For normal operation, valid values for BCNT are between 1 and 65 535. Therefore, the maximum number of arrays in a frame is 65 535 (64K – 1 arrays). A transfer with BCNT equal to 0 is considered either a null or dummy transfer. A dummy or null transfer generates a completion code depending on the settings of the completion bit fields in OPT.

See [Section 11.3.3.5](#) and [Section 11.3.5.3](#) for details on dummy/null completion conditions.

11.3.3.2.6 Count for 3rd Dimension (CCNT)

CCNT is a 16-bit unsigned value that specifies the number of frames in a block. Valid values for CCNT are between 1 and 65 535. Therefore, the maximum number of frames in a block is 65 535 (64K – 1 frames). A transfer with CCNT equal to 0 is considered either a null or dummy transfer. A dummy or null transfer generates a completion code depending on the settings of the completion bit fields in OPT.

A CCNT value of 0 is considered either a null or dummy transfer. See [Section 11.3.3.5](#) and [Section 11.3.5.3](#) for details on dummy/null completion conditions.

11.3.3.2.7 BCNT Reload (BCNTRLD)

BCNTRLD is a 16-bit unsigned value used to reload the BCNT field once the last array in the 2nd dimension is transferred. This field is only used for A-synchronized transfers. In this case, the EDMA3CC decrements the BCNT value by 1 on each TR submission. When BCNT reaches 0, the EDMA3CC decrements CCNT and uses the BCNTRLD value to reinitialize the BCNT value.

For AB-synchronized transfers, the EDMA3CC submits the BCNT in the TR and the EDMA3TC decrements BCNT appropriately. For AB-synchronized transfers, BCNTRLD is not used.

11.3.3.2.8 Source B Index (SRCBIDX)

SRCBIDX is a 16-bit signed value (2s complement) used for source address modification between each array in the 2nd dimension. Valid values for SRCBIDX are between –32 768 and 32 767. It provides a byte address offset from the beginning of the source array to the beginning of the next source array. It applies to both A-synchronized and AB-synchronized transfers. Some examples:

- SRCBIDX = 0000h (0): no address offset from the beginning of an array to the beginning of the next array. All arrays are fixed to the same beginning address.
- SRCBIDX = 0003h (+3): the address offset from the beginning of an array to the beginning of the next array in a frame is 3 bytes. For example, if the current array begins at address 1000h, the next array begins at 1003h.
- SRCBIDX = FFFFh (–1): the address offset from the beginning of an array to the beginning of the next array in a frame is –1 byte. For example, if the current array begins at address 5054h, the next array begins at 5053h.

11.3.3.2.9 Destination B Index (DSTBIDX)

DSTBIDX is a 16-bit signed value (2s complement) used for destination address modification between each array in the 2nd dimension. Valid values for DSTBIDX are between –32 768 and 32 767. It provides a byte address offset from the beginning of the destination array to the beginning of the next destination array within the current frame. It applies to both A-synchronized and AB-synchronized transfers. See SRCBIDX for examples.

11.3.3.2.10 Source C Index (SRCCIDX)

SRCCIDX is a 16-bit signed value (2s complement) used for source address modification in the 3rd dimension. Valid values for SRCCIDX are between $-32\,768$ and $32\,767$. It provides a byte address offset from the beginning of the current array (pointed to by SRC address) to the beginning of the first source array in the next frame. It applies to both A-synchronized and AB-synchronized transfers. Note that when SRCCIDX is applied, the current array in an A-synchronized transfer is the last array in the frame (Figure 11-7), while the current array in an AB-synchronized transfer is the first array in the frame (Figure 11-8).

11.3.3.2.11 Destination C Index (DSTCIDX)

DSTCIDX is a 16-bit signed value (2s complement) used for destination address modification in the 3rd dimension. Valid values are between $-32\,768$ and $32\,767$. It provides a byte address offset from the beginning of the current array (pointed to by DST address) to the beginning of the first destination array TR in the next frame. It applies to both A-synchronized and AB-synchronized transfers. Note that when DSTCIDX is applied, the current array in an A-synchronized transfer is the last array in the frame (Figure 11-7), while the current array in a AB-synchronized transfer is the first array in the frame (Figure 11-8).

11.3.3.2.12 Link Address (LINK)

The EDMA3CC provides a mechanism, called linking, to reload the current PaRAM set upon its natural termination (that is, after the count fields are decremented to 0) with a new PaRAM set. The 16-bit parameter LINK specifies the byte address offset in the PaRAM from which the EDMA3CC loads/reloads the next PaRAM set during linking.

You must program the link address to point to a valid aligned 32-byte PaRAM set. The 5 LSBs of the LINK field should be cleared to 0.

The EDMA3CC ignores the upper 2 bits of the LINK entry, allowing the programmer the flexibility of programming the link address as either an absolute/literal byte address or use the PaRAM-base-relative offset address. Therefore, if you make use of the literal address with a range from 4000h to 7FFFh, it will be treated as a PaRAM-base-relative value of 0000h to 3FFFh.

You should make sure to program the LINK field correctly, so that link update is requested from a PaRAM address that falls in the range of the available PaRAM addresses on the device.

A LINK value of FFFFh is referred to as a NULL link that should cause the EDMA3CC to perform an internal write of 0 to all entries of the current PaRAM set, except for the LINK field that is set to FFFFh. Also, see Section 11.3.5 for details on terminating a transfer.

11.3.3.3 Null PaRAM Set

A null PaRAM set is defined as a PaRAM set where all count fields (ACNT, BCNT, and CCNT) are cleared to 0. If a PaRAM set associated with a channel is a NULL set, then when serviced by the EDMA3CC, the bit corresponding to the channel is set in the associated event missed register (EMR, EMRH, or QEMR). This bit remains set in the associated secondary event register (SER, SERH, or QSER). *This implies that any future events on the same channel are ignored by the EDMA3CC and you are required to clear the bit in SER, SERH, or QSER for the channel.* This is considered an error condition, since events are not expected on a channel that is configured as a null transfer. See and for more information on the SER and EMR registers, respectively.

11.3.3.4 Dummy PaRAM Set

A dummy PaRAM set is defined as a PaRAM set where at least one of the count fields (ACNT, BCNT, or CCNT) is cleared to 0 and at least one of the count fields is nonzero.

If a PaRAM set associated with a channel is a dummy set, then when serviced by the EDMA3CC, it will not set the bit corresponding to the channel (DMA/QDMA) in the event missed register (EMR, EMRH, or QEMR) and the secondary event register (SER, SERH, or QSER) bit gets cleared similar to a normal transfer. Future events on that channel are serviced. A dummy transfer is a legal transfer of 0 bytes. For more information, see the SER and EMR registers.

11.3.3.5 Dummy Versus Null Transfer Comparison

There are some differences in the way the EDMA3CC logic treats a dummy versus a null transfer request. A null transfer request is an error condition, but a dummy transfer is a legal transfer of 0 bytes. A null transfer causes an error bit (En) in EMR to get set and the En bit in SER remains set, essentially preventing any further transfers on that channel without clearing the associated error registers.

[Table 11-8](#) summarizes the conditions and effects of null and dummy transfer requests.

Table 11-8. Dummy and Null Transfer Request

Feature	Null TR	Dummy TR
EMR/EMRH/QEMR is set	Yes	No
SER/SERH/QSER remains set	Yes	No
Link update (STATIC = 0 in OPT)	Yes	Yes
QER is set	Yes	Yes
IPR/IPRH CER/CERH is set using early completion	Yes	Yes

11.3.3.6 Parameter Set Updates

When a TR is submitted for a given DMA/QDMA channel and its corresponding PaRAM set, the EDMA3CC is responsible for updating the PaRAM set in anticipation of the next trigger event. For events that are not final, this includes address and count updates; for final events, this includes the link update.

The specific PaRAM set entries that are updated depend on the channel's synchronization type (A-synchronized or B-synchronized) and the current state of the PaRAM set. A B-update refers to the decrementing of BCNT in the case of A-synchronized transfers after the submission of successive TRs. A C-update refers to the decrementing of CCNT in the case of A-synchronized transfers after BCNT TRs for ACNT byte transfers have submitted. For AB-synchronized transfers, a C-update refers to the decrementing of CCNT after submission of every transfer request.

See [Table 11-9](#) for details and conditions on the parameter updates. A link update occurs when the PaRAM set is exhausted, as described in [Section 11.3.3.7](#).

After the TR is read from the PaRAM (and is in process of being submitted to EDMA3TC), the following fields are updated if needed:

- A-synchronized: BCNT, CCNT, SRC, DST.
- AB-synchronized: CCNT, SRC, DST.

The following fields are not updated (except for during linking, where all fields are overwritten by the link PaRAM set):

- A-synchronized: ACNT, BCNTRLD, SRCBIDX, DSTBIDX, SRCCIDX, DSTCIDX, OPT, LINK.
- AB-synchronized: ACNT, BCNT, BCNTRLD, SRCBIDX, DSTBIDX, SRCCIDX, DSTCIDX, OPT, LINK.

Note that PaRAM updates only pertain to the information that is needed to properly submit the next transfer request to the EDMA3TC. Updates that occur while data is moved within a transfer request are tracked within the transfer controller, and is detailed in [Section 11.3.12](#). For A-synchronized transfers, the EDMA3CC always submits a TRP for ACNT bytes (BCNT = 1 and CCNT = 1). For AB-synchronized transfers, the EDMA3CC always submits a TRP for ACNT bytes of BCNT arrays (CCNT = 1). The EDMA3TC is responsible for updating source and destination addresses within the array based on ACNT and FWID (in OPT). For AB-synchronized transfers, the EDMA3TC is also responsible to update source and destination addresses between arrays based on SRCBIDX and DSTBIDX.

[Table 11-9](#) shows the details of parameter updates that occur within EDMA3CC for A-synchronized and AB-synchronized transfers.

Table 11-9. Parameter Updates in EDMA3CC (for Non-Null, Non-Dummy PaRAM Set)

	A-Synchronized Transfer			AB-Synchronized Transfer		
	B-Update	C-Update	Link Update	B-Update	C-Update	Link Update
Condition:	BCNT > 1	BCNT == 1 && CCNT > 1	BCNT == 1 && CCNT == 1	N/A	CCNT > 1	CCNT == 1
SRC	+= SRCBIDX	+= SRCCIDX	= Link.SRC	in EDMA3TC	+= SRCCIDX	= Link.SRC
DST	+= DSTBIDX	+= DSTCIDX	= Link.DST	in EDMA3TC	+= DSTCIDX	= Link.DST
ACNT	None	None	= Link.ACNT	None	None	= Link.ACNT
BCNT	--= 1	= BCNTRLD	= Link.BCNT	in EDMA3TC	N/A	= Link.BCNT
CCNT	None	--= 1	= Link.CCNT	in EDMA3TC	--=1	= Link.CCNT
SRCBIDX	None	None	= Link.SRCBIDX	in EDMA3TC	None	= Link.SRCBIDX
DSTBIDX	None	None	= Link.DSTBIDX	None	None	= Link.DSTBIDX
SRCCIDX	None	None	= Link.SRCBIDX	in EDMA3TC	None	= Link.SRCBIDX
DSTCIDX	None	None	= Link.DSTBIDX	None	None	= Link.DSTBIDX
LINK	None	None	= Link.LINK	None	None	= Link.LINK
BCNTRLD	None	None	= Link.BCNTRLD	None	None	= Link.BCNTRLD
OPT ⁽¹⁾	None	None	= LINK.OPT	None	None	= LINK.OPT

⁽¹⁾ In all cases, no updates occur if OPT.STATIC == 1 for the current PaRAM set.

NOTE: The EDMA3CC includes no special hardware to detect when an indexed address update calculation overflows/underflows. The address update will wrap across boundaries as programmed by the user. You should ensure that no transfer is allowed to cross internal port boundaries between peripherals. A single TR must target a single source/destination slave endpoint.

11.3.3.7 Linking Transfers

The EDMA3CC provides a mechanism known as linking, which allows the entire PaRAM set to be reloaded from a location within the PaRAM memory map (for both DMA and QDMA channels). Linking is especially useful for maintaining ping-pong buffers, circular buffering, and repetitive/continuous transfers with no CPU intervention. Upon completion of a transfer, the current transfer parameters are reloaded with the parameter set pointed that the 16-bit link address field of the current parameter set points to. Linking only occurs when the STATIC bit in OPT is cleared.

NOTE: You should always link a transfer (EDMA3 or QDMA) to another useful transfer. If you must terminate a transfer, then you should link the transfer to a NULL parameter set. See [Section 11.3.3.3](#).

The link update occurs after the current PaRAM set event parameters have been exhausted. An event's parameters are exhausted when the EDMA3 channel controller has submitted all of the transfers that are associated with the PaRAM set.

A link update occurs for null and dummy transfers depending on the state of the STATIC bit in OPT and the LINK field. In both cases (null or dummy), if the value of LINK is FFFFh, then a null PaRAM set (with all 0s and LINK set to FFFFh) is written to the current PaRAM set. Similarly, if LINK is set to a value other than FFFFh, then the appropriate PaRAM location that LINK points to is copied to the current PaRAM set.

Once the channel completion conditions are met for an event, the transfer parameters that are located at the link address are loaded into the current DMA or QDMA channel's associated parameter set. This indicates that the EDMA3CC reads the entire set (eight words) from the PaRAM set specified by LINK and writes all eight words to the PaRAM set that is associated with the current channel. [Figure 11-11](#) shows an example of a linked transfer.

Any PaRAM set in the PaRAM can be used as a link/reload parameter set. The PaRAM sets associated with peripheral synchronization events (see [Section 11.3.6](#)) should only be used for linking if the corresponding events are disabled.

If a PaRAM set location is defined as a QDMA channel PaRAM set (by QCHMAP n), then copying the link PaRAM set into the current QDMA channel PaRAM set is recognized as a trigger event. It is latched in QER because a write to the trigger word was performed. You can use this feature to create a linked list of transfers using a single QDMA channel and multiple PaRAM sets. See [Section 11.3.4.2](#).

Linking to itself replicates the behavior of auto-initialization, thus facilitating the use of circular buffering and repetitive transfers. After an EDMA3 channel exhausts its current PaRAM set, it reloads all of the parameter set entries from another PaRAM set, which is initialized with values that are identical to the original PaRAM set. [Figure 11-11](#) shows an example of a linked to self transfer. Here, the PaRAM set 255 has the link field pointing to the address of parameter set 255 (linked to self).

NOTE: If the STATIC bit in OPT is set for a PaRAM set, then link updates are not performed.

11.3.3.8 Constant Addressing Mode Transfers/Alignment Issues

If either SAM or DAM is set (constant addressing mode), then the source or destination address must be aligned to a 256-bit aligned address, respectively, and the corresponding BIDX should be an even multiple of 32 bytes (256 bits). The EDMA3CC does not recognize errors here, but the EDMA3TC asserts an error if this is not true. See [Section 11.3.12.3](#).

NOTE: The constant addressing (CONST) mode has limited applicability. The EDMA3 should be configured for the constant addressing mode (SAM/DAM = 1) only if the transfer source or destination (on-chip memory, off-chip memory controllers, slave peripherals) support the constant addressing mode. See the device-specific data manual and/or peripheral user's guide to verify if the constant addressing mode is supported. If the constant addressing mode is not supported, the similar logical transfer can be achieved using the increment (INCR) mode (SAM/DAM =0) by appropriately programming the count and indices values.

11.3.3.9 Element Size

The EDMA3 controller does not use element-size and element-indexing. Instead, all transfers are defined in terms of all three dimensions: ACNT, BCNT, and CCNT. An element-indexed transfer is logically achieved by programming ACNT to the size of the element and BCNT to the number of elements that need to be transferred. For example, if you have 16-bit audio data and 256 audio samples that must be transferred to a serial port, you can only do this by programming the ACNT = 2 (2 bytes) and BCNT = 256.

Figure 11-11. Linked Transfer

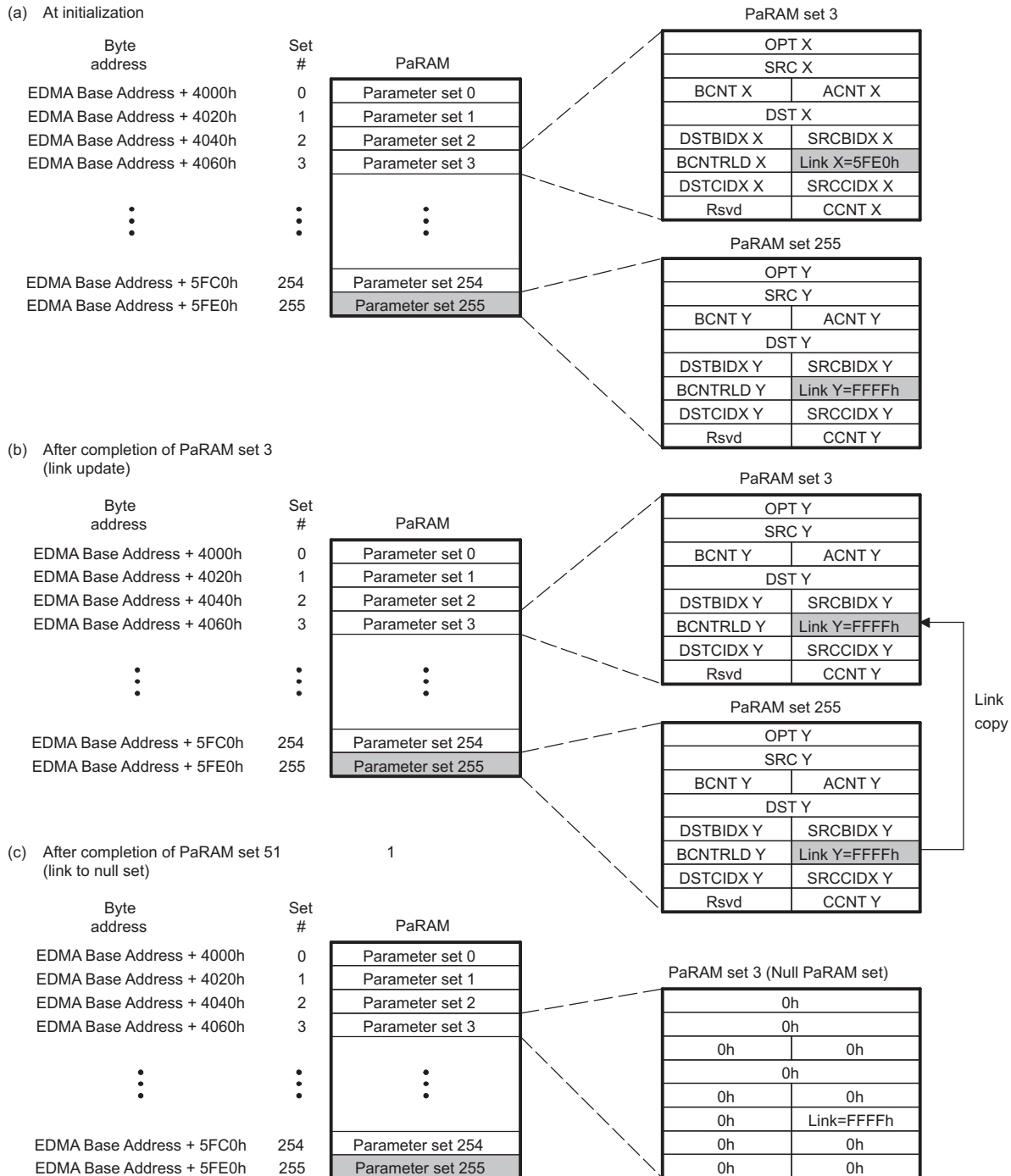
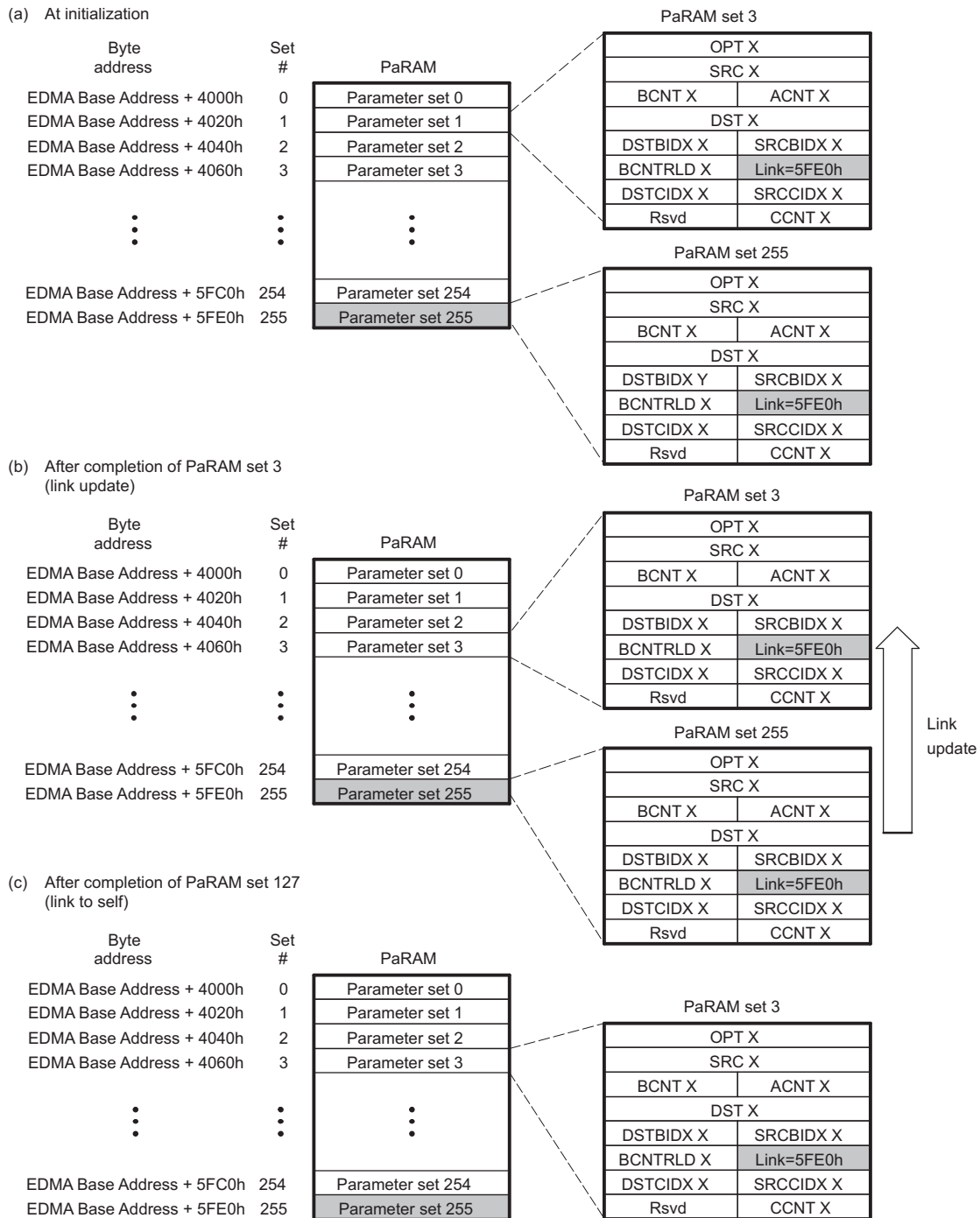


Figure 11-12. Link-to-Self Transfer



11.3.4 Initiating a DMA Transfer

There are multiple ways to initiate a programmed data transfer using the EDMA3 channel controller. Transfers on DMA channels are initiated by three sources.

They are listed as follows:

- **Event-triggered transfer request** (this is the more typical usage of EDMA3): A peripheral, system, or externally-generated event triggers a transfer request.
- **Manually-triggered transfer request:**The CPU to manually triggers a transfer by writing a 1 to the

corresponding bit in the event set register (ESR/ESRH).

- **Chain-triggered transfer request:** A transfer is triggered on the completion of another transfer or sub-transfer.

Transfers on QDMA channels are initiated by two sources. They are as follows:

- **Auto-triggered transfer request:** Writing to the programmed trigger word triggers a transfer.
- **Link-triggered transfer requests:** Writing to the trigger word triggers the transfer when linking occurs.

11.3.4.1 DMA Channel

11.3.4.1.1 Event-Triggered Transfer Request

When an event is asserted from a peripheral or device pins, it gets latched in the corresponding bit of the event register ($ER.En = 1$). If the corresponding event in the event enable register (EER) is enabled ($EER.En = 1$), then the EDMA3CC prioritizes and queues the event in the appropriate event queue. When the event reaches the head of the queue, it is evaluated for submission as a transfer request to the transfer controller.

If the PaPARAM set is valid (not a NULL set), then a transfer request packet (TRP) is submitted to the EDMA3TC and the En bit in ER is cleared. At this point, a new event can be safely received by the EDMA3CC.

If the PaPARAM set associated with the channel is a NULL set (see [Section 11.3.3.3](#)), then no transfer request (TR) is submitted and the corresponding En bit in ER is cleared and simultaneously the corresponding channel bit is set in the event miss register ($EMR.En = 1$) to indicate that the event was discarded due to a null TR being serviced. Good programming practices should include cleaning the event missed error before re-triggering the DMA channel.

When an event is received, the corresponding event bit in the event register is set ($ER.En = 1$), regardless of the state of $EER.En$. If the event is disabled when an external event is received ($ER.En = 1$ and $EER.En = 0$), the $ER.En$ bit remains set. If the event is subsequently enabled ($EER.En = 1$), then the pending event is processed by the EDMA3CC and the TR is processed/submitted, after which the $ER.En$ bit is cleared.

If an event is being processed (prioritized or is in the event queue) and another sync event is received for the same channel prior to the original being cleared ($ER.En \neq 0$), then the second event is registered as a missed event in the corresponding bit of the event missed register ($EMR.En = 1$).

See [Section 9.2.3, EDMA Event Multiplexing](#), for a description of how DMA events map to the EDMA event crossbar. See [Section 11.3.19, EDMA Events](#), for a table of direct and crossbar mapped EDMA events.

11.3.4.1.2 Manually Triggered Transfer Request

The CPU or any EDMA programmer initiates a DMA transfer by writing to the event set register (ESR). Writing a 1 to an event bit in the ESR results in the event being prioritized/queued in the appropriate event queue, regardless of the state of the $EER.En$ bit. When the event reaches the head of the queue, it is evaluated for submission as a transfer request to the transfer controller.

As in the event-triggered transfers, if the PaPARAM set associated with the channel is valid (it is not a null set) then the TR is submitted to the associated EDMA3TC and the channel can be triggered again.

If the PaPARAM set associated with the channel is a NULL set (see [Section 11.3.3.3](#)), then no transfer request (TR) is submitted and the corresponding En bit in ER is cleared and simultaneously the corresponding channel bit is set in the event miss register ($EMR.En = 1$) to indicate that the event was discarded due to a null TR being serviced. Good programming practices should include clearing the event missed error before re-triggering the DMA channel.

If an event is being processed (prioritized or is in the event queue) and the same channel is manually set by a write to the corresponding channel bit of the event set register ($ESR.En = 1$) prior to the original being cleared ($ESR.En = 0$), then the second event is registered as a missed event in the corresponding bit of the event missed register ($EMR.En = 1$).

11.3.4.1.3 Chain-Triggered Transfer Request

Chaining is a mechanism by which the completion of one transfer automatically sets the event for another channel. When a chained completion code is detected, the value of which is dictated by the transfer completion code (TCC[5:0] in OPT of the PaRAM set associated with the channel), it results in the corresponding bit in the chained event register (CER) to be set (CER.E[TCC] = 1).

Once a bit is set in CER, the EDMA3CC prioritizes and queues the event in the appropriate event queue. When the event reaches the head of the queue, it is evaluated for submission as a transfer request to the transfer controller.

As in the event-triggered transfers, if the PaRAM set associated with the channel is valid (it is not a null set) then the TR is submitted to the associated EDMA3TC and the channel can be triggered again.

If the PaRAM set associated with the channel is a NULL set (see [Section 11.3.3.3](#)), then no transfer request (TR) is submitted and the corresponding *En* bit in CER is cleared and simultaneously the corresponding channel bit is set in the event miss register (EMR.*En* = 1) to indicate that the event was discarded due to a null TR being serviced. In this case, the error condition must be cleared by you before the DMA channel can be re-triggered. Good programming practices might include clearing the event missed error before re-triggering the DMA channel.

If a chaining event is being processed (prioritized or queued) and another chained event is received for the same channel prior to the original being cleared (CER.*En* != 0), then the second chained event is registered as a missed event in the corresponding channel bit of the event missed register (EMR.*En* = 1).

NOTE: Chained event registers, event registers, and event set registers operate independently. An event (*En*) can be triggered by any of the trigger sources (event-triggered, manually-triggered, or chain-triggered).

11.3.4.2 QDMA Channels

11.3.4.2.1 Auto-triggered and Link-Triggered Transfer Request

QDMA-based transfer requests are issued when a QDMA event gets latched in the QDMA event register (QER.*En* = 1). A bit corresponding to a QDMA channel is set in the QDMA event register (QER) when the following occurs:

- A CPU (or any EDMA3 programmer) write occurs to a PaRAM address that is defined as a QDMA channel trigger word (programmed in the QDMA channel mapping register (QCHMAP n)) for the particular QDMA channel and the QDMA channel is enabled via the QDMA event enable register (QEER.*En* = 1).
- EDMA3CC performs a link update on a PaRAM set address that is configured as a QDMA channel (matches QCHMAP n settings) and the corresponding channel is enabled via the QDMA event enable register (QEER.*En* = 1).

Once a bit is set in QER, the EDMA3CC prioritizes and queues the event in the appropriate event queue. When the event reaches the head of the queue, it is evaluated for submission as a transfer request to the transfer controller.

As in the event-triggered transfers, if the PaRAM set associated with the channel is valid (it is not a null set) then the TR is submitted to the associated EDMA3TC and the channel can be triggered again.

If a bit is already set in QER (QER.*En* = 1) and a second QDMA event for the same QDMA channel occurs prior to the original being cleared, the second QDMA event gets captured in the QDMA event miss register (QEMR.*En* = 1).

11.3.4.3 Comparison Between DMA and QDMA Channels

The primary difference between DMA and QDMA channels is the event/channel synchronization. QDMA events are either auto-triggered or link triggered. auto-triggering allows QDMA channels to be triggered by CPU(s) with a minimum number of linear writes to PaRAM. Link triggering allows a linked list of transfers to be executed, using a single QDMA PaRAM set and multiple link PaRAM sets.

A QDMA transfer is triggered when a CPU (or other EDMA3 programmer) writes to the trigger word of the QDMA channel parameter set (auto-triggered) or when the EDMA3CC performs a link update on a PaRAM set that has been mapped to a QDMA channel (link triggered). Note that for CPU triggered (manually triggered) DMA channels, in addition to writing to the PaRAM set, it is required to write to the event set register (ESR) to kick-off the transfer.

QDMA channels are typically for cases where a single event will accomplish a complete transfer since the CPU (or EDMA3 programmer) must reprogram some portion of the QDMA PaRAM set in order to re-trigger the channel. In other words, QDMA transfers are programmed with BCNT = CCNT = 1 for A-synchronized transfers, and CCNT = 1 for AB-synchronized transfers.

Additionally, since linking is also supported (if STATIC = 0 in OPT) for QDMA transfers, it allows you to initiate a linked list of QDMAs, so when EDMA3CC copies over a link PaRAM set (including the write to the trigger word), the current PaRAM set mapped to the QDMA channel will automatically be recognized as a valid QDMA event and initiate another set of transfers as specified by the linked set.

11.3.5 Completion of a DMA Transfer

A parameter set for a given channel is complete when the required number of transfer requests is submitted (based on receiving the number of synchronization events). The expected number of TRs for a non-null/non-dummy transfer is shown in [Table 11-10](#) for both synchronization types along with state of the PaRAM set prior to the final TR being submitted. When the counts (BCNT and/or CCNT) are this value, the next TR results in a:

- Final chaining or interrupt codes to be sent by the transfer controllers (instead of intermediate).
- Link updates (linking to either null or another valid link set).

Table 11-10. Expected Number of Transfers for Non-Null Transfer

Sync Mode	Counts at time 0	Total # Transfers	Counts prior to final TR
A-synchronized	ACNT BCNT CCNT	(BCNT × CCNT) TRs of ACNT bytes each	BCNT == 1 && CCNT == 1
AB-synchronized	ACNT BCNT CCNT	CCNT TRs for ACNT × BCNT bytes each	CCNT == 1

You must program the PaRAM OPT field with a specific transfer completion code (TCC) along with the other OPT fields (TCCHEN, TCINTEN, ITCCHEN, and ITCINTEN bits) to indicate whether the completion code is to be used for generating a chained event or/and for generating an interrupt upon completion of a transfer.

The specific TCC value (6-bit binary value) programmed dictates which of the 64-bits in the chain event register (CER[TCC]) and/or interrupt pending register (IPR[TCC]) is set.

You can also selectively program whether the transfer controller sends back completion codes on completion of the final transfer request (TR) of a parameter set (TCCHEN or TCINTEN), for all but the final transfer request (TR) of a parameter set (ITCCHEN or ITCINTEN), or for all TRs of a parameter set (both). See [Section 11.3.8](#) for details on chaining (intermediate/final chaining) and [Section 11.3.9](#) for details on intermediate/final interrupt completion.

A completion detection interface exists between the EDMA3 channel controller and transfer controller(s). This interface sends back information from the transfer controller to the channel controller to indicate that a specific transfer is completed. Completion of a transfer is used for generating chained events and/or generating interrupts to the CPU(s).

All DMA/QDMA PaRAM sets must also specify a link address value. For repetitive transfers such as ping-pong buffers, the link address value should point to another predefined PaRAM set. Alternatively, a non-repetitive transfer should set the link address value to the null link value. The null link value is defined as FFFFh. See [Section 11.3.3.7](#) for more details.

NOTE: Any incoming events that are mapped to a null PaRAM set results in an error condition. The error condition should be cleared before the corresponding channel is used again. See [Section 11.3.3.5](#).

There are three ways the EDMA3CC gets updated/informed about a transfer completion: normal completion, early completion, and dummy/null completion. This applies to both chained events and completion interrupt generation.

11.3.5.1 Normal Completion

In normal completion mode (TCCMODE = 0 in OPT), the transfer or sub-transfer is considered to be complete when the EDMA3 channel controller receives the completion codes from the EDMA3 transfer controller. In this mode, the completion code to the channel controller is posted by the transfer controller after it receives a signal from the destination peripheral. Normal completion is typically used to generate an interrupt to inform the CPU that a set of data is ready for processing.

11.3.5.2 Early Completion

In early completion mode (TCCMODE = 1 in OPT), the transfer is considered to be complete when the EDMA3 channel controller submits the transfer request (TR) to the EDMA3 transfer controller. In this mode, the channel controller generates the completion code internally. Early completion is typically useful for chaining, as it allows subsequent transfers to be chained-triggered while the previous transfer is still in progress within the transfer controller, maximizing the overall throughput of the set of the transfers.

11.3.5.3 Dummy or Null Completion

This is a variation of early completion. Dummy or null completion is associated with a dummy set ([Section 11.3.3.4](#)) or null set ([Section 11.3.3.3](#)). In both cases, the EDMA3 channel controller does not submit the associated transfer request to the EDMA3 transfer controller(s). However, if the set (dummy/null) has the OPT field programmed to return completion code (intermediate/final interrupt/chaining completion), then it will set the appropriate bits in the interrupt pending registers (IPR/IPRH) or chained event register (CER/CERH). The internal early completion path is used by the channel controller to return the completion codes internally (that is, EDMA3CC generates the completion code).

11.3.6 Event, Channel, and PaRAM Mapping

Several of the 64 DMA channels are tied to a specific hardware event, thus allowing events from device peripherals or external hardware to trigger transfers. A DMA channel typically requests a data transfer when it receives its event (apart from manually-triggered, chain-triggered, and other transfers). The amount of data transferred per synchronization event depends on the channel's configuration (ACNT, BCNT, CCNT, etc.) and the synchronization type (A-synchronized or AB-synchronized).

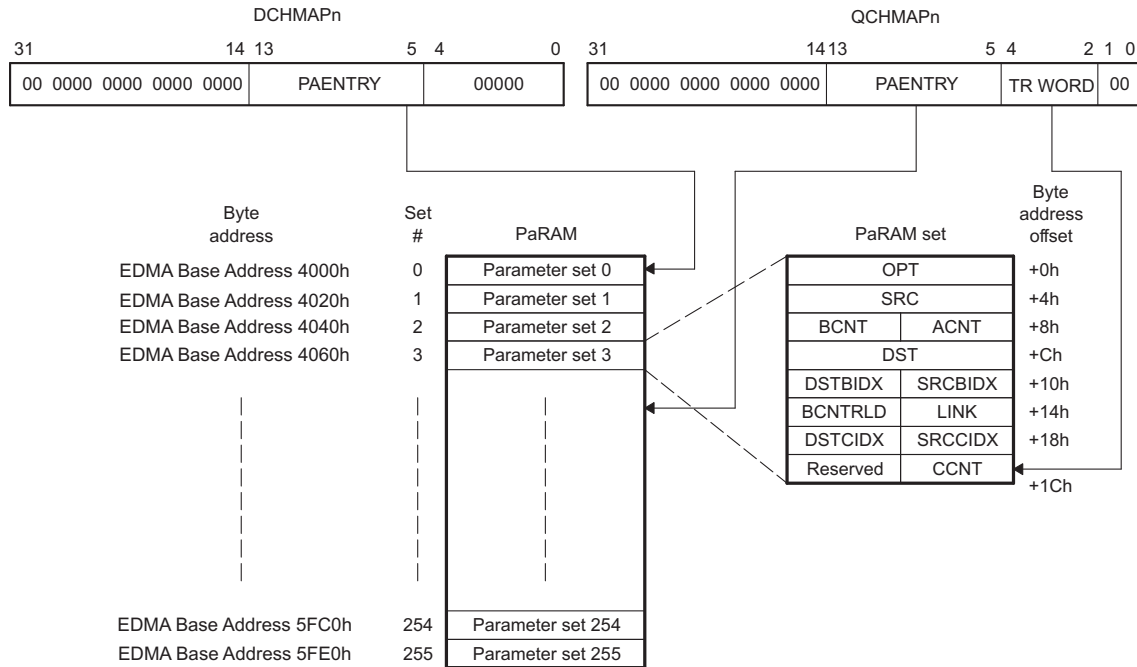
The association of an event to a channel is fixed, each DMA channel has one specific event associated with it. See [Section 9.2.3, EDMA Event Multiplexing](#), for a description of how DMA events map to the EDMA event crossbar. See [Section 11.3.19, EDMA Events](#), for a table of direct and crossbar mapped EDMA events.

In an application, if a channel does not use the associated synchronization event or if it does not have an associated synchronization event (unused), that channel can be used for manually-triggered or chained-triggered transfers, for linking/reloading, or as a QDMA channel.

11.3.6.1 DMA Channel to PaRAM Mapping

The mapping between the DMA channel numbers and the PaRAM sets is programmable (see [Table 11-5](#)). The DMA channel mapping registers (DCHMAPn) in the EDMA3CC provide programmability that allows the DMA channels to be mapped to any of the PaRAM sets in the PaRAM memory map. [Figure 11-13](#) illustrates the use of DCHMAP. There is one DCHMAP register per channel.

Figure 11-13. DMA Channel and QDMA Channel to PaRAM Mapping

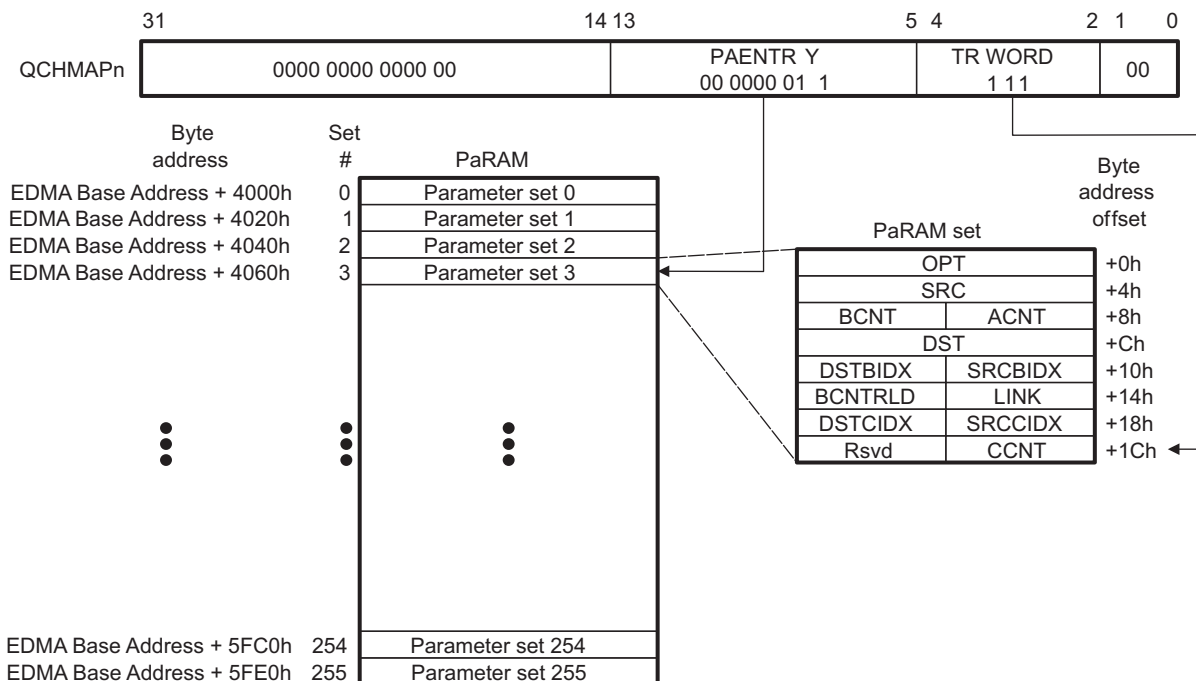


11.3.6.2 QDMA Channel to PaRAM Mapping

The mapping between the QDMA channels and the PaRAM sets is programmable. The QDMA channel mapping register (QCHMAP) in the EDMA3CC allows you to map the QDMA channels to any of the PaRAM sets in the PaRAM memory map. [Figure 11-14](#) illustrates the use of QCHMAP.

Additionally, QCHMAP allows you to program the trigger word in the PaRAM set for the QDMA channel. A trigger word is one of the eight words in the PaRAM set. For a QDMA transfer to occur, a valid TR synchronization event for EDMA3CC is a write to the trigger word in the PaRAM set pointed to by QCHMAP for a particular QDMA channel. By default, QDMA channels are mapped to PaRAM set 0. You must appropriately re-map PaRAM set 0 before you use it.

Figure 11-14. QDMA Channel to PaRAM Mapping



11.3.7 EDMA3 Channel Controller Regions

The EDMA3 channel controller divides its address space into eight regions. Individual channel resources are assigned to a specific region, where each region is typically assigned to a specific EDMA programmer.

You can design the application software to use regions or to ignore them altogether. You can use active memory protection in conjunction with regions so that only a specific EDMA programmer (for example, privilege identification) or privilege level (for example, user vs. supervisor) is allowed access to a given region, and thus to a given DMA or QDMA channel. This allows robust system-level DMA code where each EDMA programmer only modifies the state of the assigned resources. Memory protection is described in [Section 11.3.10](#).

11.3.7.1 Region Overview

The EDMA3 channel controller memory-mapped registers are divided in three main categories:

1. Global registers
2. Global region channel registers
3. Shadow region channel registers

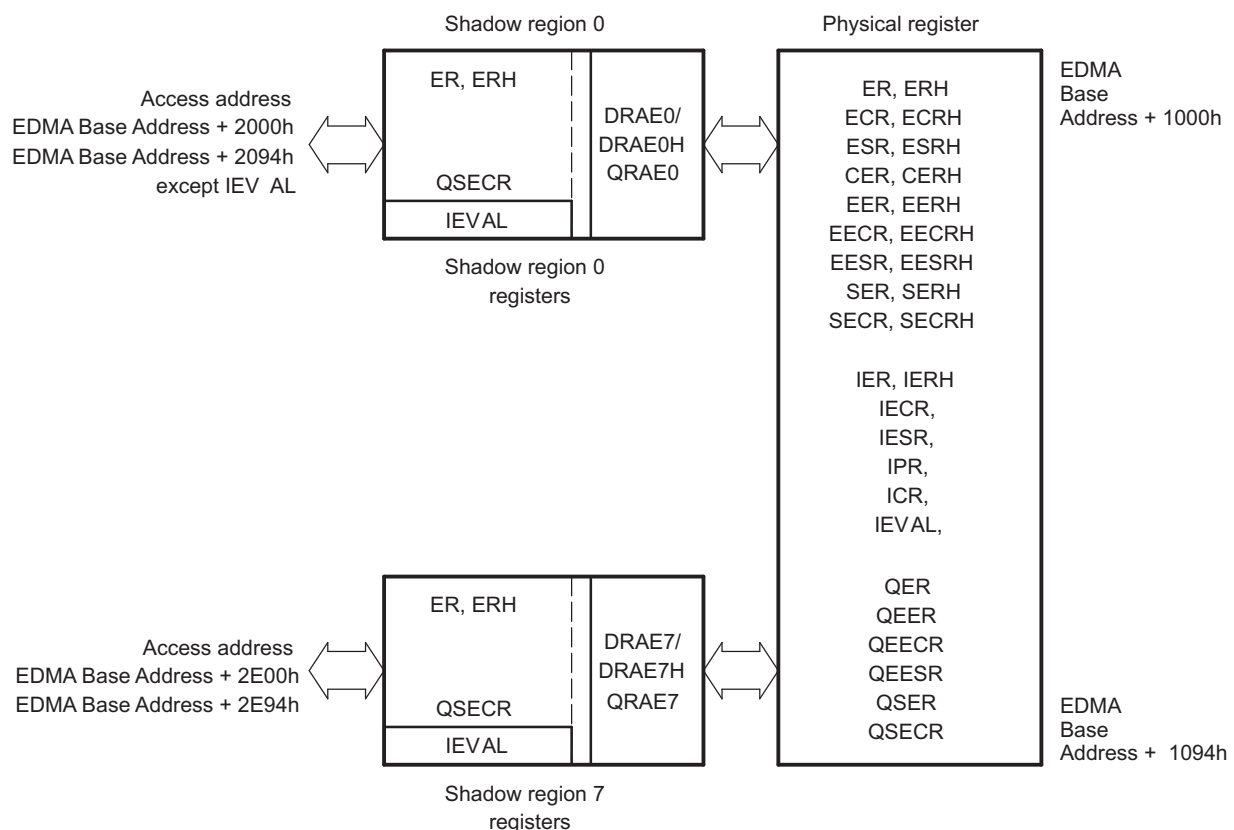
The global registers are located at a single/fixed location in the EDMA3CC memory map. These registers control EDMA3 resource mapping and provide debug visibility and error tracking information.

The channel registers (including DMA, QDMA, and interrupt registers) are accessible via the global channel region address range, or in the shadow *n* channel region address range(s). For example, the event enable register (EER) is visible at the global address of EDMA Base Address + 1020h or region addresses of EDMA Base Address + 2020h for region 0, EDMA Base Address + 2220h for region 1, EDMA Base Address + 2E20h for region 7.

The DMA region access enable registers (DRAEm) and the QDMA region access enable registers (QRAEn) control the underlying control register bits that are accessible via the shadow region address space (except for IEVALn). [Table 11-11](#) lists the registers in the shadow region memory map. See the EDMA3CC memory map () for the complete global and shadow region memory maps. [Figure 11-15](#) illustrates the conceptual view of the regions.

Table 11-11. Shadow Region Registers

DRAE_m	DRAEH_m	QRAE_n
ER	ERH	QER
ECR	ECRH	QEER
ESR	ESRH	QEECR
CER	CERH	QEESR
EER	EERH	
EECR	EECRH	
EESR	EESRH	
SER	SERH	
SECR	SECRH	
IER	IERH	
IECR	IECRH	
IESR	IESRH	
IPR	IPRH	
ICR	ICRH	
Register not affected by DRAE\DRAEH		
IEVAL		

Figure 11-15. Shadow Region Registers


11.3.7.2 Channel Controller Regions

There are eight EDMA3 shadow regions (and associated memory maps). Associated with each shadow region are a set of registers defining which channels and interrupt completion codes belong to that region. These registers are user-programmed per region to assign ownership of the DMA/QDMA channels to a region.

- **DRAEm** and **DRAEHm**: One register pair exists for each of the shadow regions. The number of bits in each register pair matches the number of DMA channels (64 DMA channels). These registers need to be programmed to assign ownership of DMA channels and interrupt (or TCC codes) to the respective region. Accesses to DMA and interrupt registers via the shadow region address view are filtered through the DRAE/DRAEH pair. A value of 1 in the corresponding DRAE(H) bit implies that the corresponding DMA/interrupt channel is accessible; a value of 0 in the corresponding DRAE(H) bit forces writes to be discarded and returns a value of 0 for reads.
- **QRAEn**: One register exists for every region. The number of bits in each register matches the number of QDMA channels (4 QDMA channels). These registers must be programmed to assign ownership of QDMA channels to the respective region. To enable a channel in a shadow region using shadow region 0 QEER, the respective bit in QRAE must be set or writing into QEESR will not have the desired effect.
- **MPPAn** and **MPPAG**: One register exists for every region. This register defines the privilege level, requestor, and types of accesses allowed to a region's memory-mapped registers.

It is typical for an application to have a unique assignment of QDMA/DMA channels (and, therefore, a given bit position) to a given region.

The use of shadow regions allows for restricted access to EDMA3 resources (DMA channels, QDMA channels, TCC, interrupts) by tasks in a system by setting or clearing bits in the DRAE/ORAE registers. If exclusive access to any given channel / TCC code is required for a region, then only that region's DRAE/ORAE should have the associated bit set.

Example 11-1. Resource Pool Division Across Two Regions

This example illustrates a judicious resource pool division across two regions, assuming region 0 must be allocated 16 DMA channels (0-15) and 1 QDMA channel (0) and 32 TCC codes (0-15 and 48-63). Region 1 needs to be allocated 16 DMA channels (16-32) and the remaining 7 QDMA channels (1-7) and TCC codes (16-47). DRAE should be equal to the OR of the bits that are required for the DMA channels and the TCC codes:

```
Region 0: DRAEH, DRAE = 0xFFFF0000, 0x0000FFFF QRAE = 0x0000001
Region 1: DRAEH, DRAE = 0x0000FFFF, 0xFFFF0000 QRAE = 0x00000FE
```

11.3.7.3 Region Interrupts

In addition to the EDMA3CC global completion interrupt, there is an additional completion interrupt line that is associated with every shadow region. Along with the interrupt enable register (IER), DRAE acts as a secondary interrupt enable for the respective shadow region interrupts. See [Section 11.3.9](#) for more information.

11.3.8 Chaining EDMA3 Channels

The channel chaining capability for the EDMA3 allows the completion of an EDMA3 channel transfer to trigger another EDMA3 channel transfer. The purpose is to allow you the ability to chain several events through one event occurrence.

Chaining is different from linking ([Section 11.3.3.7](#)). The EDMA3 link feature reloads the current channel parameter set with the linked parameter set. The EDMA3 chaining feature does not modify or update any channel parameter set; it provides a synchronization event to the chained channel (see [Section 11.3.4.1.3](#) for chain-triggered transfer requests).

Chaining is achieved at either final transfer completion or intermediate transfer completion, or both, of the current channel. Consider a channel *m* (DMA/QDMA) required to chain to channel *n*. Channel number *n* (0-63) needs to be programmed into the TCC bit of channel *m* channel options parameter (OPT) set.

- If final transfer completion chaining (TCCHEN = 1 in OPT) is enabled, the chain-triggered event occurs after the submission of the last transfer request of channel *m* is either submitted or completed (depending on early or normal completion).
- If intermediate transfer completion chaining (ITCCHEN = 1 in OPT) is enabled, the chain-triggered event occurs after every transfer request, except the last of channel *m* is either submitted or completed

(depending on early or normal completion).

- If both final and intermediate transfer completion chaining (TCCHEN = 1 and ITCCHEN = 1 in OPT) are enabled, then the chain-trigger event occurs after every transfer request is submitted or completed (depending on early or normal completion).

Table 11-12 illustrates the number of chain event triggers occurring in different synchronized scenarios. Consider channel 31 programmed with ACNT = 3, BCNT = 4, CCNT = 5, and TCC = 30.

Table 11-12. Chain Event Triggers

Options	(Number of chained event triggers on channel 30)	
	A-Synchronized	AB-Synchronized
TCCHEN = 1, ITCCHEN = 0	1 (Owing to the last TR)	1 (Owing to the last TR)
TCCHEN = 0, ITCCHEN = 1	19 (Owing to all but the last TR)	4 (Owing to all but the last TR)
TCCHEN = 1, ITCCHEN = 1	20 (Owing to a total of 20 TRs)	5 (Owing to a total of 5 TRs)

11.3.9 EDMA3 Interrupts

The EDMA3 interrupts are divided into 2 categories: transfer completion interrupts and error interrupts.

There are nine region interrupts, eight shadow regions and one global region. The transfer completion interrupts are listed in Table 11-13. The transfer completion interrupts and the error interrupts from the transfer controllers are all routed to the ARM interrupt controllers.

Table 11-13. EDMA3 Transfer Completion Interrupts

Name	Description
EDMA3CC_INT0	EDMA3CC Transfer Completion Interrupt Shadow Region 0
EDMA3CC_INT1	EDMA3CC Transfer Completion Interrupt Shadow Region 1
EDMA3CC_INT2	EDMA3CC Transfer Completion Interrupt Shadow Region 2
EDMA3CC_INT3	EDMA3CC Transfer Completion Interrupt Shadow Region 3
EDMA3CC_INT4	EDMA3CC Transfer Completion Interrupt Shadow Region 4
EDMA3CC_INT5	EDMA3CC Transfer Completion Interrupt Shadow Region 5
EDMA3CC_INT6	EDMA3CC Transfer Completion Interrupt Shadow Region 6
EDMA3CC_INT7	EDMA3CC Transfer Completion Interrupt Shadow Region 7

Table 11-14. EDMA3 Error Interrupts

Name	Description
EDMA3CC_ERRINT	EDMA3CC Error Interrupt
EDMA3CC_MPINT	EDMA3CC Memory Protection Interrupt
EDMA3TC0_ERRINT	TC0 Error Interrupt
EDMA3TC1_ERRINT	TC1 Error Interrupt
EDMA3TC2_ERRINT	TC2 Error Interrupt

11.3.9.1 Transfer Completion Interrupts

The EDMA3CC is responsible for generating transfer completion interrupts to the CPU(s) (and other EDMA3 masters). The EDMA3 generates a single completion interrupt per shadow region, as well as one for the global region on behalf of all 64 channels. The various control registers and bit fields facilitate EDMA3 interrupt generation.

The software architecture should either use the global interrupt or the shadow interrupts, but not both.

The transfer completion code (TCC) value is directly mapped to the bits of the interrupt pending register (IPR/IPRH). For example, if TCC = 10 0001b, IPRH[1] is set after transfer completion, and results in interrupt generation to the CPU(s) if the completion interrupt is enabled for the CPU. See [Section 11.3.9.1.1](#) for details on enabling EDMA3 transfer completion interrupts.

When a completion code is returned (as a result of early or normal completions), the corresponding bit in IPR/IPRH is set if transfer completion interrupt (final/intermediate) is enabled in the channel options parameter (OPT) for a PaRAM set associated with the transfer.

Table 11-15. Transfer Complete Code (TCC) to EDMA3CC Interrupt Mapping

TCC Bits in OPT (TCINTEN/ITCINTEN = 1)	IPR Bit Set	TCC Bits in OPT (TCINTEN/ITCINTEN = 1)	IPRH Bit Set ⁽¹⁾
0	IPR0	20h	IPR32/IPRH0
1	IPR1	21h	IPR33/IPRH1
2h	IPR2	22h	IPR34/IPRH2
3h	IPR3	23h	IPR35/IPRH3
4h	IPR4	24h	IPR36/IPRH4
...
1Eh	IPR30	3Eh	IPR62/IPRH30
1Fh	IPR31	3Fh	IPR63/IPRH31

⁽¹⁾ Bit fields IPR[32-63] correspond to bits 0 to 31 in IPRH, respectively.

You can program the transfer completion code (TCC) to any value for a DMA/QDMA channel. A direct relation between the channel number and the transfer completion code value does not need to exist. This allows multiple channels having the same transfer completion code value to cause a CPU to execute the same interrupt service routine (ISR) for different channels.

If the channel is used in the context of a shadow region and you intend for the shadow region interrupt to be asserted, then ensure that the bit corresponding to the TCC code is enabled in IER/IERH and in the corresponding shadow region's DMA region access registers (DRAE/DRAEH).

You can enable Interrupt generation at either final transfer completion or intermediate transfer completion, or both. Consider channel *m* as an example.

- If the final transfer interrupt (TCCINT = 1 in OPT) is enabled, the interrupt occurs after the last transfer request of channel *m* is either submitted or completed (depending on early or normal completion).
- If the intermediate transfer interrupt (ITCCINT = 1 in OPT) is enabled, the interrupt occurs after every transfer request, except the last TR of channel *m* is either submitted or completed (depending on early or normal completion).
- If both final and intermediate transfer completion interrupts (TCCINT = 1, and ITCCINT = 1 in OPT) are enabled, then the interrupt occurs after every transfer request is submitted or completed (depending on early or normal completion).

[Table 11-16](#) shows the number of interrupts that occur in different synchronized scenarios. Consider channel 31, programmed with ACNT = 3, BCNT = 4, CCNT = 5, and TCC = 30.

Table 11-16. Number of Interrupts

Options	A-Synchronized	AB-Synchronized
TCINTEN = 1, ITCINTEN = 0	1 (Last TR)	1 (Last TR)
TCINTEN = 0, ITCINTEN = 1	19 (All but the last TR)	4 (All but the last TR)
TCINTEN = 1, ITCINTEN = 1	20 (All TRs)	5 (All TRs)

11.3.9.1.1 Enabling Transfer Completion Interrupts

For the EDMA3 channel controller to assert a transfer completion to the external environment, the interrupts must be enabled in the EDMA3CC. This is in addition to setting up the TCINTEN and ITCINTEN bits in OPT of the associated PaRAM set.

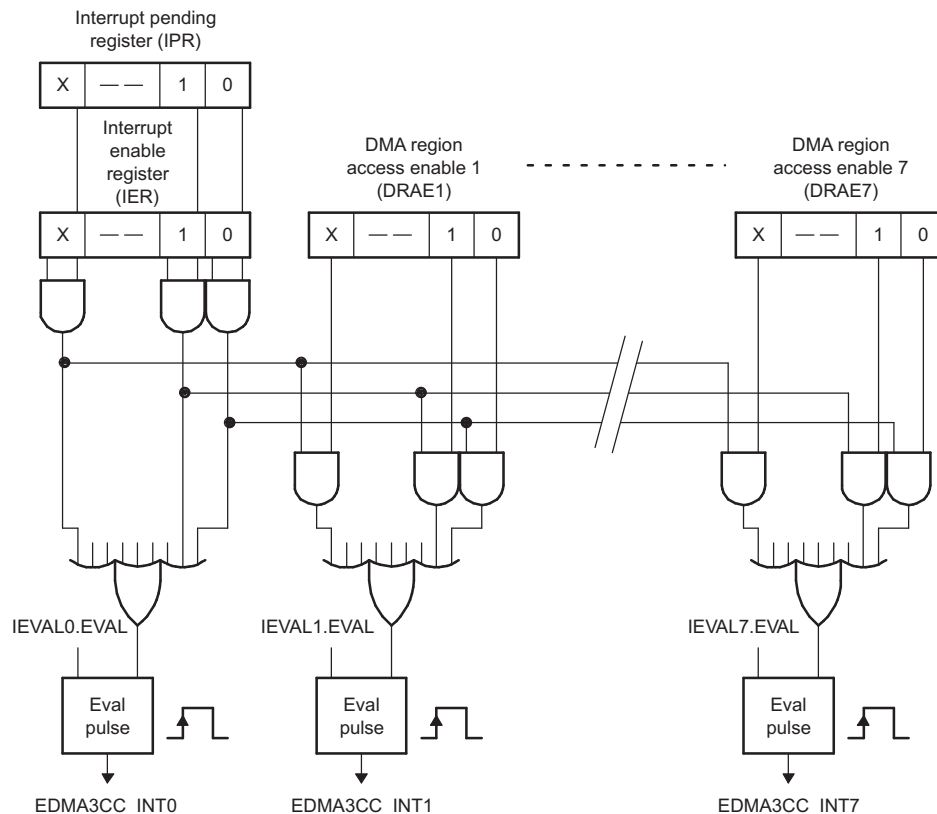
The EDMA3 channel controller has interrupt enable registers (IER/IERH) and each bit location in IER/IERH serves as a primary enable for the corresponding interrupt pending registers (IPR/IPRH).

All of the interrupt registers (IER, IESR, IECR, and IPR) are either manipulated from the global DMA channel region, or by the DMA channel shadow regions. The shadow regions provide a view to the same set of physical registers that are in the global region.

The EDMA3 channel controller has a hierarchical completion interrupt scheme that uses a single set of interrupt pending registers (IPR/IPRH) and single set of interrupt enable registers (IER/IERH). The programmable DMA region access enable registers (DRAE/DRAEH) provides a second level of interrupt masking. The global region interrupt output is gated based on the enable mask that is provided by IER/IERH. see [Figure 11-16](#)

The region interrupt outputs are gated by IER and the specific DRAE/DRAEH associated with the region. See [Figure 11-16](#).

Figure 11-16. Interrupt Diagram



For the EDMA3CC to generate the transfer completion interrupts that are associated with each shadow region, the following conditions must be true:

- EDMA3CC_INT0: (IPR.E0 & IER.E0 & DRAE0.E0) | (IPR.E1 & IER.E1 & DRAE0.E1) | ((IPRH.E63 & IERH.E63 & DRAHE0.E63)
- EDMA3CC_INT1: (IPR.E0 & IER.E0 & DRAE1.E0) | (IPR.E1 & IER.E1 & DRAE1.E1) | | (IPRH.E63 & IERH.E63 & DRAHE1.E63)
- EDMA3CC_INT2 : (IPR.E0 & IER.E0 & DRAE2.E0) | (IPR.E1 & IER.E1 & DRAE2.E1) | |(IPRH.E63 & IERH.E63 & DRAHE2.E63)....

- Up to EDMA3CC_INT7 : (IPR.E0 & IER.E0 & DRAE7.E0) | (IPR.E1 & IER.E1 & DRAE7.E1) | (IPRH.E63 & IERH.E63 & DRAEH7.E63)

NOTE: The DRAE/DRAEH for all regions are expected to be set up at system initialization and to remain static for an extended period of time. The interrupt enable registers should be used for dynamic enable/disable of individual interrupts.

Because there is no relation between the TCC value and the DMA/QDMA channel, it is possible, for example, for DMA channel 0 to have the OPT.TCC = 63 in its associated PaRAM set. This would mean that if a transfer completion interrupt is enabled (OPT.TCINTEN or OPT.ITCINTEN is set), then based on the TCC value, IPRH.E63 is set up on completion. For proper channel operations and interrupt generation using the shadow region map, you must program the DRAE/DRAEH that is associated with the shadow region to have read/write access to both bit 0 (corresponding to channel 0) and bit 63 (corresponding to IPRH bit that is set upon completion).

11.3.9.1.2 Clearing Transfer Completion Interrupts

Transfer completion interrupts that are latched to the interrupt pending registers (IPR/IPRH) are cleared by writing a 1 to the corresponding bit in the interrupt pending clear register (ICR/ICRH). For example, a write of 1 to ICR.E0 clears a pending interrupt in IPR.E0.

If an incoming transfer completion code (TCC) gets latched to a bit in IPR/IPRH, then additional bits that get set due to a subsequent transfer completion will not result in asserting the EDMA3CC completion interrupt. In order for the completion interrupt to be pulsed, the required transition is from a state where no enabled interrupts are set to a state where at least one enabled interrupt is set.

11.3.9.2 EDMA3 Interrupt Servicing

Upon completion of a transfer (early or normal completion), the EDMA3 channel controller sets the appropriate bit in the interrupt pending registers (IPR/IPRH), as the transfer completion codes specify. If the completion interrupts are appropriately enabled, then the CPU enters the interrupt service routine (ISR) when the completion interrupt is asserted.

After servicing the interrupt, the ISR should clear the corresponding bit in IPR/IPRH, thereby enabling recognition of future interrupts. The EDMA3CC will only assert additional completion interrupts when all IPR/IPRH bits clear.

When one interrupt is serviced many other transfer completions may result in additional bits being set in IPR/IPRH, thereby resulting in additional interrupts. Each of the bits in IPR/IPRH may need different types of service; therefore, the ISR may check all pending interrupts and continue until all of the posted interrupts are serviced appropriately.

Examples of pseudo code for a CPU interrupt service routine for an EDMA3CC completion interrupt are shown in [Example 11-2](#) and [Example 11-3](#).

The ISR routine in [Example 11-2](#) is more exhaustive and incurs a higher latency.

Example 11-2. Interrupt Servicing

The pseudo code:

1. Reads the interrupt pending register (IPR/IPRH).
2. Performs the operations needed.
3. Writes to the interrupt pending clear register (ICR/ICRH) to clear the corresponding IPR/IPRH bit(s).
4. Reads IPR/IPRH again:
 - (a) If IPR/IPRH is not equal to 0, repeat from step 2 (implies occurrence of new event between step 2 to step 4).
 - (b) If IPR/IPRH is equal to 0, this should assure you that all of the enabled interrupts are inactive.

Example 11-2. Interrupt Servicing (continued)

NOTE: An event may occur during step 4 while the IPR/IPRH bits are read as 0 and the application is still in the interrupt service routine. If this happens, a new interrupt is recorded in the device interrupt controller and a new interrupt generates as soon as the application exits in the interrupt service routine.

[Example 11-3](#) is less rigorous, with less burden on the software in polling for set interrupt bits, but can occasionally cause a race condition as mentioned above.

Example 11-3. Interrupt Servicing

If you want to leave any enabled and pending (possibly lower priority) interrupts; you must force the interrupt logic to reassert the interrupt pulse by setting the EVAL bit in the interrupt evaluation register (IEVAL).

The pseudo code is as follows:

1. Enters ISR.
2. Reads IPR/IPRH.
3. For the condition that is set in IPR/IPRH that you want to service, do the following:
 - (a) Service interrupt as the application requires.
 - (b) Clear the bit for serviced conditions (others may still be set, and other transfers may have resulted in returning the TCC to EDMA3CC after step 2).
4. Reads IPR/IPRH prior to exiting the ISR:
 - (a) If IPR/IPRH is equal to 0, then exit the ISR.
 - (b) If IPR/IPRH is not equal to 0, then set IEVAL so that upon exit of ISR, a new interrupt triggers if any enabled interrupts are still pending.

11.3.9.3 Interrupt Evaluation Operations

The EDMA3CC has interrupt evaluate registers (IEVAL) that exist in the global region and in each shadow region. The registers in the shadow region are the only registers in the DMA channel shadow region memory map that are not affected by the settings for the DMA region access enable registers (DRAE/DRAEH). Writing a 1 to the EVAL bit in the registers that are associated with a particular shadow region results in pulsing the associated region interrupt (global or shadow), if any enabled interrupt (via IER/IERH) is still pending (IPR/IPRH). This register assures that the CPU does not miss the interrupts (or the EDMA3 master associated with the shadow region) if the software architecture chooses not to use all interrupts. See [Example 11-3](#) for the use of IEVAL in the EDMA3 interrupt service routine (ISR).

Similarly, an error evaluation register (EEVAL) exists in the global region. Writing a 1 to the EVAL bit in EEVAL causes the pulsing of the error interrupt if any pending errors are in EMR/EMRH, QEMR, or CCERR. The EVAL bit must be written with 1 to clear interrupts to the INTC, even when all error interrupt registers are cleared. See [Section 11.3.9.4, Error Interrupts](#), for additional information regarding error interrupts.

NOTE: While using IEVAL for shadow region completion interrupts, ensure that the IEVAL operated upon is from that particular shadow region memory map.

11.3.9.4 Error Interrupts

The EDMA3CC error registers provide the capability to differentiate error conditions (event missed, threshold exceed, etc.). Additionally, setting the error bits in these registers results in asserting the EDMA3CC error interrupt. If the EDMA3CC error interrupt is enabled in the device interrupt controller(s), then it allows the CPU(s) to handle the error conditions.

The EDMA3CC has a single error interrupt (EDMA3CC_ERRINT) that is asserted for all EDMA3CC error conditions. There are four conditions that cause the error interrupt to pulse:

- DMA missed events: for all 64 DMA channels. DMA missed events are latched in the event missed registers (EMR/EMRH).
- QDMA missed events: for all 8 QDMA channels. QDMA missed events are latched in the QDMA event missed register (QEMR).
- Threshold exceed: for all event queues. These are latched in EDMA3CC error register (CCERR).
- TCC error: for outstanding transfer requests that are expected to return completion code (TCCHEN or TCINTEN bit in OPT is set to 1) exceeding the maximum limit of 63. This is also latched in the EDMA3CC error register (CCERR).

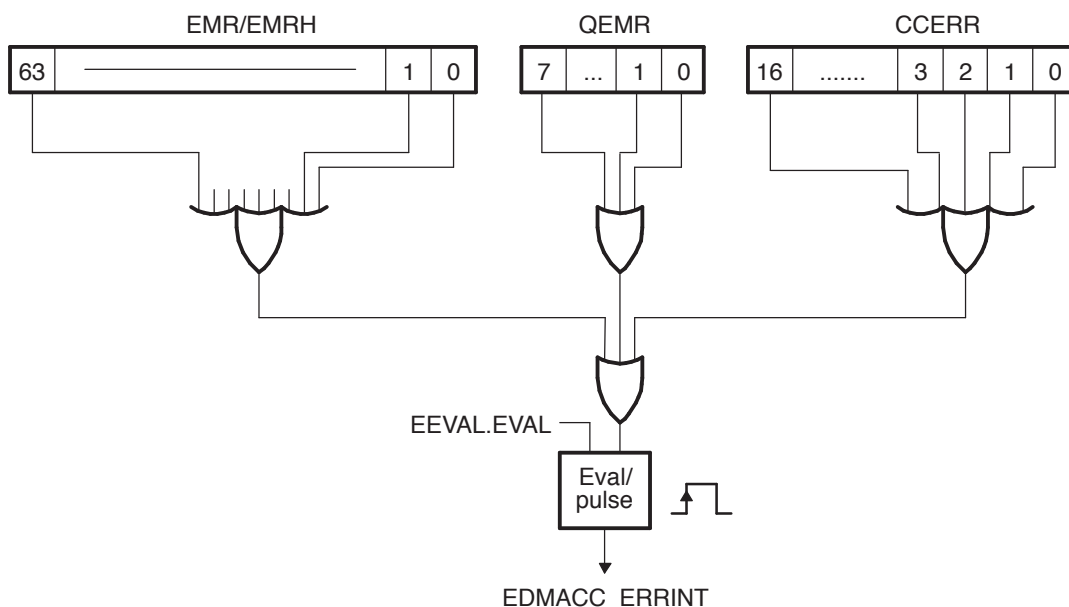
Figure 11-17 illustrates the EDMA3CC error interrupt generation operation.

If any of the bits are set in the error registers due to any error condition, the EDMA3CC_ERRINT is always asserted, as there are no enables for masking these error events. Similar to transfer completion interrupts (EDMA3CC_INT), the error interrupt also only pulses when the error interrupt condition transitions from no errors being set to at least one error being set. If additional error events are latched prior to the original error bits clearing, the EDMA3CC does not generate additional interrupt pulses.

To reduce the burden on the software, there is an error evaluate register (EEVAL) that allows re-evaluation of pending set error events/bits, similar to the interrupt evaluate register (IEVAL). You can use this so that the CPU(s) does not miss any error events. You must write a 1 to the EEVAL.EVAL bit to clear interrupts to the INTC after all error registers have been cleared.

NOTE: It is good practice to enable the error interrupt in the device interrupt controller and to associate an interrupt service routine with it to address the various error conditions appropriately. Doing so puts less burden on the software (polling for error status); additionally, it provides a good debug mechanism for unexpected error conditions.

Figure 11-17. Error Interrupt Operation



11.3.10 Memory Protection

The EDMA3 channel controller supports two kinds of memory protection: active and proxy.

11.3.10.1 Active Memory Protection

Active memory protection is a feature that allows or prevents read and write accesses (by any EDMA3 programmer) to the EDMA3CC registers (based on permission characteristics that you program). Active memory protection is achieved by a set of memory protection permissions attribute (MPPA) registers.

The EDMA3CC register map is divided into three categories:

- a global region.
- a global channel region.
- eight shadow regions.

Each shadow region consists of the respective shadow region registers and the associated PaRAM. For more detailed information regarding the contents of a shadow region, refer to section [Table 11-11](#).

Each of the eight shadow regions has an associated MPPA register (MPPAn) that defines the specific requestor(s) and types of requests that are allowed to the regions resources.

The global channel region is also protected with a memory-mapped register (MPPAG). The MPPAG applies to the global region and to the global channel region, except the other MPPA registers themselves. For more detailed information on the list of the registers in each region, refer to the register memory-map in section [Table 11-18](#).

See for the bit field descriptions of MPPAn. The MPPAn have a certain set of access rules.

[Table 11-17](#) shows the accesses that are allowed or not allowed to the MPPAG and MPPAn. The active memory protection uses the PRIV and PRIVID attributes of the EDMA programmer. The PRIV is the privilege level (i.e., user vs. supervisor). The PRIVID refers to a privilege ID with a number that is associated with an EDMA3 programmer. See the device-specific data manual for the PRIVIDs that are associated with potential EDMA3 programmers.

Table 11-17. Allowed Accesses

Access	Supervisor	User
Read	Yes	Yes
Write	Yes	No

[Table 11-18](#) describes the MPPA register mapping for the shadow regions (which includes shadow region registers and PaRAM addresses).

The region-based MPPA registers are used to protect accesses to the DMA shadow regions and the associated region PaRAM. Because there are eight regions, there are eight MPPA region registers (MPPA[0-7]).

Table 11-18. MPPA Registers to Region Assignment

Register	Registers Protect	Address Range	PaRAM Protect ⁽¹⁾	Address Range
MPPAG	Global Range	0000h-1FFCh	N/A	N/A
MPPA0	DMA Shadow 0	2000h-21FCh	1st octant	4000h-47FCh
MPPA1	DMA Shadow 1	2200h-23FCh	2nd octant	4800h-4FFCh
MPPA2	DMA Shadow 2	2400h-25FCh	3rd octant	5000h-57FCh
MPPA3	DMA Shadow 3	2600h-27FCh	4th octant	5800h-5FFCh
MPPA4	DMA Shadow 4	2800h-29FCh	5th octant	6000h-67FCh
MPPA5	DMA Shadow 5	2A00h-2BFCh	6th octant	6800h-6FFCh
MPPA6	DMA Shadow 6	2C00h-2DFCh	7th octant	7000h-77FCh
MPPA7	DMA Shadow 7	2E00h-2FFCh	8th octant	7800h-7FFCh

⁽¹⁾ The PARAM region is divided into 8 regions referred to as an octant.

Example Access denied.

Write access to shadow region 7's event enable set register (EESR):

1. The original value of the event enable register (EER) at address offset 0x1020 is 0x0.
2. The MPPA[7] is set to prevent user level accesses (UW = 0, UR = 0), but it allows supervisor level accesses (SW = 1, SR = 1) with a privilege ID of 0. (AID0 = 1).
3. An EDMA3 programmer with a privilege ID of 0 attempts to perform a user-level write of a value of 0xFF00FF00 to shadow region 7's event enable set register (EESR) at address offset 0x2E30. Note that the EER is a read-only register and the only way that you can write to it is by writing to the EESR. Also remember that there is only one physical register for EER, EESR, etc. and that the shadow regions only provide to the same physical set.
4. Since the MPPA[7] has UW = 0, though the privilege ID of the write access is set to 0, the access is not allowed and the EER is not written to.

Table 11-19. Example Access Denied

Register	Value	Description
EER (offset 0x1020)	0x0000 0000	Value in EER to begin with.
EESR (offset 0x2E30)	0xFF00 FF00 ↓	Value attempted to be written to shadow region 7's EESR. This is done by an EDMA3 programmer with a privilege level of User and Privilege ID of 0.
MPPA[7] (offset 0x082C)	0x0000 04B0	Memory Protection Filter AID0 = 1, UW = 0, UR = 0, SW = 1, SR = 1.
	X	Access Denied
EER (offset 0x1020)	0x0000 0000	Final value of EER

Example Access Allowed

Write access to shadow region 7's event enable set register (EESR):

1. The original value of the event enable register (EER) at address offset 0x1020 is 0x0.
2. The MPPA[7] is set to allow user-level accesses (UW = 1, UR = 1) and supervisor-level accesses (SW = 1, SR = 1) with a privilege ID of 0. (AID0 = 1).
3. An EDMA3 programmer with a privilege ID of 0, attempts to perform a user-level write of a value of 0xABCD0123 to shadow region 7's event enable set register (EESR) at address offset 0x2E30. Note that the EER is a read-only register and the only way that you can write to it is by writing to the EESR. Also remember that there is only one physical register for EER, EESR, etc. and that the shadow regions only provide to the same physical set.
4. Since the MPPA[7] has UW = 1 and AID0 = 1, the user-level write access is allowed.
5. Remember that accesses to shadow region registers are masked by their respective DRAE register. In this example, the DRAE[7] is set of 0x9FF00FC2.
6. The value finally written to EER is 0x8BC00102.

Table 11-20. Example Access Allowed

Register	Value	Description
EER (offset 0x1020)	0x0000 0000	Value in EER to begin with.
EESR (offset 0x2E30)	0xFF00 FF00	Value attempted to be written to shadow region 7's EESR. This is done by an EDMA3 programmer with a privilege level of User and Privilege ID of 0.
MPPA[7] (offset 0x082C)	0x0000 04B3	Memory Protection Filter AID = 1, UW = 1, UR = 1, SW = 1, SR = 1.
	√ ↓	Access allowed.
DRAE[7] (offset 0x0378)	0x9FF0 0FC2	DMA Region Access Enable Filter
EESR (offset 0x2E30)	0x8BC0 0102	Value written to shadow region 7's EESR. This is done by an EDMA3 programmer with a privilege level of User and a Privilege ID of 0.
EER (offset 0x1020)	↓ 0xBC0 0102	Final value of EER.

11.3.10.2 Proxy Memory Protection

Proxy memory protection allows an EDMA3 transfer programmed by a given EDMA3 programmer to have its permissions travel with the transfer through the EDMA3TC. The permissions travel along with the read transactions to the source and the write transactions to the destination endpoints. The PRIV bit and PRIVID bit in the channel options parameter (OPT) is set with the EDMA3 programmer's PRIV value and PRIVID values, respectively, when any part of the PaRAM set is written.

The PRIV is the privilege level (i.e., user vs. supervisor). The PRIVID refers to a privilege ID with a number that is associated with an EDMA3 programmer.

See the data manual for the PRIVIDs that are associated with potential EDMA3 programmers.

These options are part of the TR that are submitted to the transfer controller. The transfer controller uses the above values on their respective read and write command bus so that the target endpoints can perform memory protection checks based on these values.

Consider a parameter set that is programmed by a CPU in user privilege level for a simple transfer with the source buffer on an L2 page and the destination buffer on an L1D page. The PRIV is 0 for user-level and the CPU has a PRIVID of 0.

The PaRAM set is shown in [Figure 11-18](#).

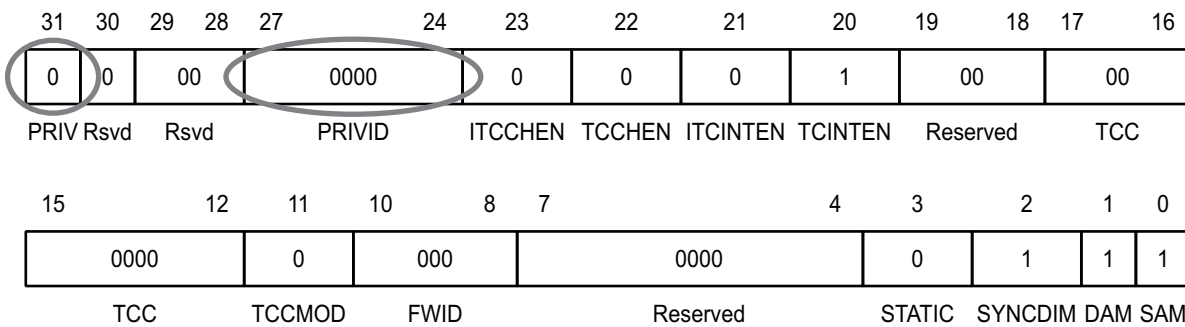
Figure 11-18. PaRAM Set Content for Proxy Memory Protection Example

(a) EDMA3 Parameters

Parameter Contents		Parameter	
0010 0007h		Channel Options Parameter (OPT)	
009F 0000h		Channel Source Address (SRC)	
0001h	0004h	Count for 2nd Dimension (BCNT)	Count for 1st Dimension (ACNT)
00F0 7800h		Channel Destination Address (DST)	
0001h	0001h	Destination BCNT Index (DSTBIDX)	Source BCNT Index (SRCBIDX)
0000h	FFFFh	BCNT Reload (BCNTRLD)	Link Address (LINK)
0001h	1000h	Destination CCNT Index (DSTCIDX)	Source CCNT Index (SRCCIDX)
0000h	0001h	Reserved	Count for 3rd Dimension (CCNT)

Figure 11-19. Channel Options Parameter (OPT) Example

(b) Channel Options Parameter (OPT) Content

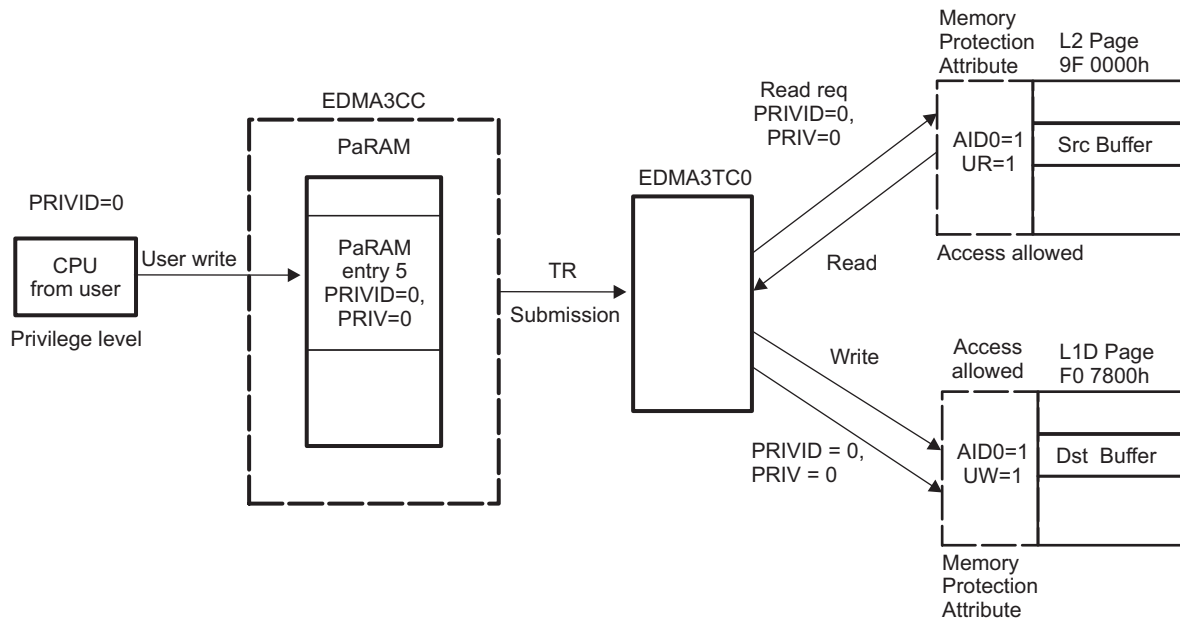


The PRIV and PRIVID information travels along with the read and write requests that are issued to the source and destination memories.

For example, if the access attributes that are associated with the L2 page with the source buffer only allow supervisor read, write accesses (SR,SW), the user-level read request above is refused. Similarly, if the access attributes that are associated with the L1D page with the destination buffer only allow supervisor read and write accesses (SR, SW), the user-level write request above is refused. For the transfer to succeed, the source and destination pages should have user-read and user-write permissions, respectively, along with allowing accesses from a PRIVID 0.

Because the programmer's privilege level and privilege identification travel with the read and write requests, EDMA3 acts as a proxy.

Figure 11-20 illustrates the propagation of PRIV and PRIVID at the boundaries of all the interacting entities (CPU, EDMA3CC, EDMA3TC, and slave memories).

Figure 11-20. Proxy Memory Protection Example


11.3.11 Event Queues

Event queues are a part of the EDMA3 channel controller. Event queues form the interface between the event detection logic in the EDMA3CC and the transfer request (TR) submission logic of the EDMA3CC. Each queue is 16 entries deep; thus, each event queue can queue a maximum of 16 events. If there are more than 16 events, then the events that cannot find a place in the event queue remain set in the associated event register and the CPU does not stall.

There are three event queues for the device: Queue0, Queue1, and Queue2. Events in Queue0 result in submission of its associated transfer requests (TRs) to TC0. Similarly, transfer requests that are associated with events in Queue2 are submitted to TC2.

An event that wins prioritization against other DMA and/or QDMA pending events is placed at the tail of the appropriate event queue. Each event queue is serviced in FIFO order. Once the event reaches the head of its queue and the corresponding transfer controller is ready to receive another TR, the event is de-queued and the PaRAM set corresponding to the de-queued event is processed and submitted as a transfer request packet (TRP) to the associated EDMA3 transfer controller.

Queue0 has highest priority and Queue2 has the lowest priority, if Queue0 and Queue1 both have at least one event entry and if both TC0 and TC1 can accept transfer requests, then the event in Queue0 is de-queued first and its associated PaRAM set is processed and submitted as a transfer request (TR) to TC0.

See [Section 11.3.11.4](#) for system-level performance considerations. All of the event entries in all of the event queues are software readable (not writeable) by accessing the event entry registers (Q0E0, Q0E1, Q1E15, etc.). Each event entry register characterizes the queued event in terms of the type of event (manual, event, chained or auto-triggered) and the event number. See for a description of the bit fields in the queue event entry registers.

11.3.11.1 DMA/QDMA Channel to Event Queue Mapping

Each of the 64 DMA channels and eight QDMA channels are programmed independently to map to a specific queue, using the DMA queue number register (DMAQNUM) and the QDMA queue number register (QDMANUM). The mapping of DMA/QDMA channels is critical to achieving the desired performance level for the EDMA and most importantly, in meeting real-time deadlines. See [Section 11.3.11.4](#).

NOTE: If an event is ready to be queued and both the event queue and the EDMA3 transfer controller that is associated to the event queue are empty, then the event bypasses the event queue, and moves the PaRAM processing logic, and eventually to the transfer request submission logic for submission to the EDMA3TC. In this case, the event is not logged in the event queue status registers.

11.3.11.2 Queue RAM Debug Visibility

There are three event queues and each queue has 16 entries. These 16 entries are managed in a circular FIFO manner. There is a queue status register (QSTAT) associated with each queue. These along with all of the 16 entries per queue can be read via registers QSTAT n and QxEy, respectively.

These registers provide user visibility and may be helpful while debugging real-time issues (typically post-mortem), involving multiple events and event sources. The event queue entry register (QxEy) uniquely identifies the specific event type (event-triggered, manually-triggered, chain-triggered, and QDMA events) along with the event number (for all DMA/QDMA event channels) that are in the queue or have been de-queued (passed through the queue).

Each of the 16 entries in the event queue are read using the EDMA3CC memory-mapped register. By reading the event queue, you see the history of the last 16 TRs that have been processed by the EDMA3 on a given queue. This provides user/software visibility and is helpful for debugging real-time issues (typically post-mortem), involving multiple events and event sources.

The queue status register (QSTAT n) includes fields for the start pointer (STRTPTR) which provides the offset to the head entry of an event. It also includes a field called NUMVAL that provides the total number of valid entries residing in the event queue at a given instance of time. The STRTPTR may be used to index appropriately into the 16 event entries. NUMVAL number of entries starting from STRTPTR are indicative of events still queued in the respective queue. The remaining entry may be read to determine what's already de-queued and submitted to the associated transfer controller.

11.3.11.3 Queue Resource Tracking

The EDMA3CC event queue includes watermarking/threshold logic that allows you to keep track of maximum usage of all event queues. This is useful for debugging real-time deadline violations that may result from head-of-line blocking on a given EDMA3 event queue.

You can program the maximum number of events that can queue up in an event queue by programming the threshold value (between 0 to 15) in the queue watermark threshold A register (QWMTHRA). The maximum queue usage is recorded actively in the watermark (WM) field of the queue status register (QSTAT n) that keeps getting updated based on a comparison of number of valid entries, which is also visible in the NUMVAL bit in QSTAT n and the maximum number of entries (WM bit in QSTAT n).

If the queue usage is exceeded, this status is visible in the EDMA3CC registers: the QTHRXCD n bit in the channel controller error register (CCERR) and the THRXCD bit in QSTAT n , where n stands for the event queue number. Any bits that are set in CCERR also generate an EDMA3CC error interrupt.

11.3.11.4 Performance Considerations

The main system bus infrastructure (L3) arbitrates bus requests from all of the masters (TCs, CPU(S), and other bus masters) to the shared slave resources (peripherals and memories).

The priorities of transfer requests (read and write commands) from the EDMA3 transfer controllers with respect to other masters within the system crossbar are programmed using the queue priority register (QUEPRI). QUEPRI programs the priority of the event queues (or indirectly, TC0-TC2, because Queue N transfer requests are submitted to TCM).

Therefore, the priority of unloading queues has a secondary affect compared to the priority of the transfers as they are executed by the EDMA3TC (dictated by the priority set using QUEPRI).

11.3.12 EDMA3 Transfer Controller (EDMA3TC)

The EDMA3 channel controller is the user-interface of the EDMA3 and the EDMA3 transfer controller (EDMA3TC) is the data movement engine of the EDMA3. The EDMA3CC submits transfer requests (TR) to the EDMA3TC and the EDMA3TC performs the data transfers dictated by the TR; thus, the EDMA3TC is a slave to the EDMA3CC.

11.3.12.1 Architecture Details

11.3.12.1.1 Command Fragmentation

The TC read and write controllers in conjunction with the source and destination register sets are responsible for issuing optimally-sized reads and writes to the slave endpoints. An optimally-sized command is defined by the transfer controller default burst size (DBS), which is defined in [Section 11.3.12.5](#).

The EDMA3TC attempts to issue the largest possible command size as limited by the DBS value or the ACNT/BCNT value of the TR. EDMA3TC obeys the following rules:

- The read/write controllers always issue commands less than or equal to the DBS value.
- The first command of a 1D transfer command always aligns the address of subsequent commands to the DBS value.

[Table 11-21](#) lists the TR segmentation rules that are followed by the EDMA3TC. In summary, if the ACNT value is larger than the DBS value, then the EDMA3TC breaks the ACNT array into DBS-sized commands to the source/destination addresses. Each BCNT number of arrays are then serviced in succession.

For BCNT arrays of ACNT bytes (that is, a 2D transfer), if the ACNT value is less than or equal to the DBS value, then the TR may be optimized into a 1D-transfer in order to maximize efficiency. The optimization takes place if the EDMA3TC recognizes that the 2D-transfer is organized as a single dimension (ACNT == BIDX) and the ACNT value is a power of 2.

[Table 11-21](#) lists conditions in which the optimizations are performed.

Table 11-21. Read/Write Command Optimization Rules

ACNT ≤ DBS	ACNT is power of 2	BIDX = ACNT	BCNT ≤ 1023	SAM/DAM = Increment	Description
Yes	Yes	Yes	Yes	Yes	Optimized
No	x	x	x	x	Not Optimized
x	No	x	x	x	Not Optimized
x	x	No	x	x	Not Optimized
x	x	x	No	x	Not Optimized
x	x	x	x	No	Not Optimized

11.3.12.1.2 TR Pipelining

TR pipelining refers to the ability of the source active set to proceed ahead of the destination active set. Essentially, the reads for a given TR may already be in progress while the writes of a previous TR may not have completed.

The number of outstanding TRs is limited by the number of destination FIFO register entries.

TR pipelining is useful for maintaining throughput on back-to-back small TRs. It minimizes the startup overhead because reads start in the background of a previous TR writes.

Example 11-4. Command Fragmentation (DBS = 64)

The pseudo code:

1. ACNT = 8, BCNT = 8, SRCBIDX = 8, DSTBIDX = 10, SRCADDR = 64, DSTADDR = 191

Read Controller: This is optimized from a 2D-transfer to a 1D-transfer such that the read side is equivalent to ACNT = 64, BCNT = 1.

Cmd0 = 64 byte

Write Controller: Because DSTBIDX != ACNT, it is not optimized.

Cmd0 = 8 byte, Cmd1 = 8 byte, Cmd2 = 8 byte, Cmd3 = 8 byte, Cmd4 = 8 byte, Cmd5 = 8 byte, Cmd6 = 8 byte, Cmd7 = 8 byte.

2. ACNT=128, BCNT = 1, SRCADDR = 63, DSTADDR = 513

Read Controller: Read address is not aligned.

Cmd0 = 1 byte, (now the SRCADDR is aligned to 64 for the next command)

Cmd1 = 64 bytes

Cmd2 = 63 bytes

Write Controller: The write address is also not aligned.

Cmd0 = 63 bytes, (now the DSTADDR is aligned to 64 for the next command)

Cmd1 = 64 bytes

Cmd2 = 1 byte

11.3.12.1.3 Performance Tuning

By default, reads are as issued as fast as possible. In some cases, the reads issued by the EDMA3TC could fill the available command buffering for a slave, delaying other (potentially higher priority) masters from successfully submitting commands to that slave. The rate at which read commands are issued by the EDMA3TC is controlled by the RDRATE register. The RDRATE register defines the number of cycles that the EDMA3TC read controller waits before issuing subsequent commands for a given TR, thus minimizing the chance of the EDMA3TC consuming all available slave resources. The RDRATE value should be set to a relatively small value if the transfer controller is targeted for high priority transfers and to a higher value if the transfer controller is targeted for low priority transfers.

In contrast, the Write Interface does not have any performance turning knobs because writes always have an interval between commands as write commands are submitted along with the associated write data.

11.3.12.2 Memory Protection

The transfer controller plays an important role in handling proxy memory protection. There are two access properties associated with a transfer: for instance, the privilege id (system-wide identification assigned to a master) of the master initiating the transfer, and the privilege level (user versus supervisor) used to program the transfer. This information is maintained in the PaRAM set when it is programmed in the channel controller. When a TR is submitted to the transfer controller, this information is made available to the EDMA3TC and used by the EDMA3TC while issuing read and write commands. The read or write commands have the same privilege identification, and privilege level as that programmed in the EDMA3 transfer in the channel controller.

11.3.12.3 Error Generation

Errors are generated if enabled under three conditions:

- EDMA3TC detection of an error signaled by the source or destination address.
- Attempt to read or write to an invalid address in the configuration memory map.
- Detection of a constant addressing mode TR violating the constant addressing mode transfer rules (the source/destination addresses and source/destination indexes must be aligned to 32 bytes).

Either or all error types may be disabled. If an error bit is set and enabled, the error interrupt for the concerned transfer controller is pulsed.

11.3.12.4 Debug Features

The DMA program register set, DMA source active register set, and the destination FIFO register set are used to derive a brief history of TRs serviced through the transfer controller.

Additionally, the EDMA3TC status register (TCSTAT) has dedicated bit fields to indicate the ongoing activity within different parts of the transfer controller:

- The SRCACTV bit indicates whether the source active set is active.
- The DSTACTV bit indicates the number of TRs resident in the destination register active set at a given instance.
- The PROGBUSY bit indicates whether a valid TR is present in the DMA program set.

If the TRs are in progression, caution must be used and you must realize that there is a chance that the values read from the EDMA3TC status registers will be inconsistent since the EDMA3TC may change the values of these registers due to ongoing activities.

It is recommended that you ensure no additional submission of TRs to the EDMA3TC in order to facilitate ease of debug.

11.3.12.4.1 Destination FIFO Register Pointer

The destination FIFO register pointer is implemented as a circular buffer with the start pointer being DFSTRTPTR and a buffer depth of usually 2 or 4. The EDMA3TC maintains two important status details in TCSTAT that may be used during advanced debugging, if necessary. The DFSTRTPTR is a start pointer, that is, the index to the head of the destination FIFO register. The DSTACTV is a counter for the number of valid (occupied) entries. These registers may be used to get a brief history of transfers.

Examples of some register field values and their interpretation:

- DFSTRTPTR = 0 and DSTACTV = 0 implies that no TRs are stored in the destination FIFO register.
- DFSTRTPTR = 1 and DSTACTV = 2h implies that two TRs are present. The first pending TR is read from the destination FIFO register entry 1 and the second pending TR is read from the destination FIFO register entry 2.
- DFSTRTPTR = 3h and DSTACTV = 2h implies that two TRs are present. The first pending TR is read from the destination FIFO register entry 3 and the second pending TR is read from the destination FIFO register entry 0.

11.3.12.5 EDMA3TC Configuration

[Table 11-22](#) provides the configuration of the individual EDMA3 transfer controllers present on the device. The default burst size (DBS) for each transfer controller is configurable using the TPTC_CFG register in the control module.

Table 11-22. EDMA3 Transfer Controller Configurations

Name	TC0	TC1	TC2
FIFOSIZE	512 bytes	512 bytes	512 bytes
BUSWIDTH	16 bytes	16 bytes	16 bytes
DSTREGDEPTH	4 entries	4 entries	4 entries
DBS	Configurable	Configurable	Configurable

11.3.13 Event Dataflow

This section summarizes the data flow of a single event, from the time the event is latched to the channel controller to the time the transfer completion code is returned. The following steps list the sequence of EDMA3CC activity:

1. Event is asserted from an external source (peripheral or external interrupt). This also is similar for a manually-triggered, chained-triggered, or QDMA-triggered event. The event is latched into the ER.En/ERH.En (or CER.En/CERH.En, ESR.En/ESRH.En, QER.En) bit.
2. Once an event is prioritized and queued into the appropriate event queue, the SER.En/SERH.En (or QSER.En) bit is set to inform the event prioritization/processing logic to disregard this event since it is already in the queue. Alternatively, if the transfer controller and the event queue are empty, then the event bypasses the queue.
3. The EDMA3CC processing and the submission logic evaluates the appropriate PaRAM set and determines whether it is a non-null and non-dummy transfer request (TR).
4. The EDMA3CC clears the ER.En/ERH.En (or CER.En/CERH.En, ESR.En/ESRH.En, QER.En) bit and the SER.En/SERH.En bit as soon as it determines the TR is non-null. In the case of a null set, the SER.En/SERH.En bit remains set. It submits the non-null/non-dummy TR to the associated transfer controller. If the TR was programmed for early completion, the EDMA3CC immediately sets the interrupt pending register (IPR.I[TCC]/IPRH.I[TCC]-32).
5. If the TR was programmed for normal completion, the EDMA3CC sets the interrupt pending register (IPR.I[TCC]/IPRH.I[TCC]) when the EDMA3TC informs the EDMA3CC about completion of the transfer (returns transfer completion codes).
6. The EDMA3CC programs the associated EDMA3TCn's Program Register Set with the TR.
7. The TR is then passed to the Source Active set and the DST FIFO Register Set, if both the register sets are available.
8. The Read Controller processes the TR by issuing read commands to the source slave endpoint. The Read Data lands in the Data FIFO of the EDMA3TCn.
9. As soon as sufficient data is available, the Write Controller begins processing the TR by issuing write commands to the destination slave endpoint.
10. This continues until the TR completes and the EDMA3TCn then signals completion status to the EDMA3CC.

11.3.14 EDMA3 Prioritization

The EDMA3 controller has many implementation rules to deal with concurrent events/channels, transfers, etc. The following subsections detail various arbitration details whenever there might be occurrence of concurrent activity. [Figure 11-21](#) shows the different places EDMA3 priorities come into play.

11.3.14.1 Channel Priority

The DMA event registers (ER and ERH) capture up to 64 events; likewise, the QDMA event register (QER) captures QDMA events for all QDMA channels; therefore, it is possible for events to occur simultaneously on the DMA/QDMA event inputs. For events arriving simultaneously, the event associated with the lowest channel number is prioritized for submission to the event queues (for DMA events, channel 0 has the highest priority and channel 63 has the lowest priority; similarly, for QDMA events, channel 0 has the highest priority and channel 7 has the lowest priority). This mechanism only sorts simultaneous events for submission to the event queues.

If a DMA and QDMA event occurs simultaneously, the DMA event always has prioritization against the QDMA event for submission to the event queues.

11.3.14.2 Trigger Source Priority

If a DMA channel is associated with more than one trigger source (event trigger, manual trigger, and chain trigger), and if multiple events are set simultaneously for the same channel ($ER.En = 1$, $ESR.En = 1$, $CER.En = 1$), then the EDMA3CC always services these events in the following priority order: event trigger (via ER) is higher priority than chain trigger (via CER) and chain trigger is higher priority than manual trigger (via ESR).

This implies that if for channel 0, both $ER.E0 = 1$ and $CER.E0 = 1$ at the same time, then the $ER.E0$ event is always queued before the $CER.E0$ event.

11.3.14.3 Dequeue Priority

The priority of the associated transfer request (TR) is further mitigated by which event queue is being used for event submission (dictated by DMAQNUM and QDMAQNUM). For submission of a TR to the transfer request, events need to be de-queued from the event queues. Queue 0 has the highest dequeue priority and Queue 2 the lowest.

11.3.14.4 System (Transfer Controller) Priority

INIT_PRIORITY_0 and INIT_PRIORITY_1 registers in the chip configuration module are used to configure the EDMA TC's priority through the system bus infrastructure.

NOTE: The default priority for all TCs is the same, 0 or highest priority relative to other masters. It is recommended that this priority be changed based on system level considerations, such as real-time deadlines for all masters including the priority of the transfer controllers with respect to each other.

11.3.15 EDMA3 Operating Frequency (Clock Control)

The EDMA3 channel controller and transfer controller are clocked from PLL_L3 SYSCLK4. The EDMA3 system runs at the L3 clock frequency.

11.3.16 Reset Considerations

A hardware reset resets the EDMA3 (EDMA3CC and EDMA3TC) and the EDMA3 configuration registers. The PaRAM memory contents are undefined after device reset and you should not rely on parameters to be reset to a known state. The PaRAM entry must be initialized to a desired value before it is used.

11.3.17 Power Management

The EDMA3 (EDMA3CC and EDMA3TC) can be placed in reduced-power modes to conserve power during periods of low activity. The power management of the peripheral is controlled by the power reset clock management (PRCM). The PRCM acts as a master controller for power management for all peripherals on the device.

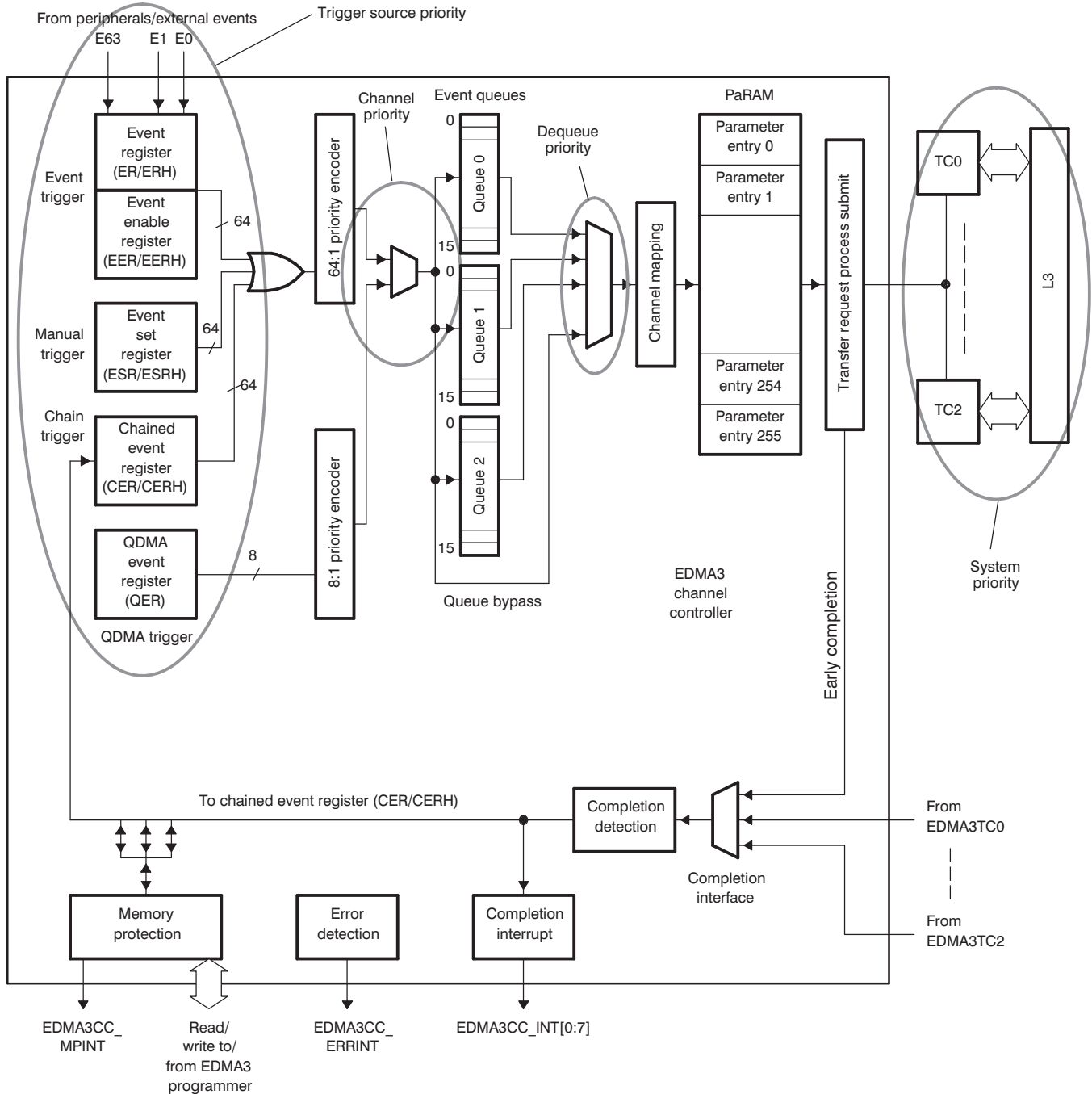
The EDMA3 controller can be idled on receiving a clock stop request from the PRCM. The requests to EDMA3CC and EDMA3TC are separate. In general, it should be verified that there are no pending activities in the EDMA3 controller

11.3.18 Emulation Considerations

During debug when using the emulator, the CPU(s) may be halted on an execute packet boundary for single-stepping, benchmarking, profiling, or other debug purposes. During an emulation halt, the EDMA3 channel controller and transfer controller operations continue. Events continue to be latched and processed and transfer requests continue to be submitted and serviced.

Since EDMA3 is involved in servicing multiple master and slave peripherals, it is not feasible to have an independent behavior of the EDMA3 for emulation halts. EDMA3 functionality would be coupled with the peripherals it is servicing, which might have different behavior during emulation halts. For example, if a McASP is halted during an emulation access (FREE = 0 and SOFT = 0 or 1 in McASP registers), the McASP stops generating the McASP receive or transmit events (REVT or XEVT) to the EDMA. From the point of view of the McASP, the EDMA3 is suspended, but other peripherals (for example, a timer) still assert events and will be serviced by the EDMA.

Figure 11-21. EDMA3 Prioritization



EDMA Transfer Examples

The EDMA3 channel controller performs a variety of transfers depending on the parameter configuration. The following sections provide a description and PaRAM configuration for some typical use case scenarios.

11.3.18.1 Block Move Example

The most basic transfer performed by the EDMA3 is a block move. During device operation it is often necessary to transfer a block of data from one location to another, usually between on-chip and off-chip memory.

In this example, a section of data is to be copied from external memory to internal L2 SRAM as shown in Figure 11-22. Figure 11-23 shows the parameters for this transfer.

The source address for the transfer is set to the start of the data block in external memory, and the destination address is set to the start of the data block in L2. If the data block is less than 64K bytes, the PaRAM configuration shown in Figure 11-23 holds true with the synchronization type set to A-synchronized and indexes cleared to 0. If the amount of data is greater than 64K bytes, BCNT and the B-indexes need to be set appropriately with the synchronization type set to AB-synchronized. The STATIC bit in OPT is set to prevent linking.

This transfer example may also be set up using QDMA. For successive transfer submissions, of a similar nature, the number of cycles used to submit the transfer are fewer depending on the number of changing transfer parameters. You may program the QDMA trigger word to be the highest numbered offset in the PaRAM set that undergoes change.

Figure 11-22. Block Move Example

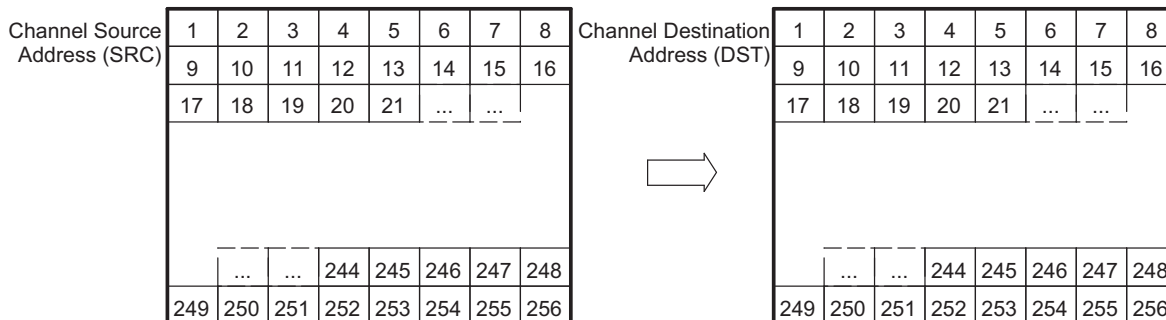


Figure 11-23. Block Move Example PaRAM Configuration

(a) EDMA Parameters

Parameter Contents	Parameter
0010 0008h	Channel Options Parameter (OPT)
Channel Source Address (SRC)	Channel Source Address (SRC)
0001h 0100h	Count for 2nd Dimension (BCNT) Count for 1st Dimension (ACNT)
Channel Destination Address (DST)	Channel Destination Address (DST)
0000h 0000h	Destination BCNT Index (DSTBIDX) Source BCNT Index (SRCBIDX)
0000h FFFFh	BCNT Reload (BCNTRLD) Link Address (LINK)
0000h 0000h	Destination CCNT Index (DSTCIDX) Source CCNT Index (SRCCIDX)
0000h 0001h	Reserved Count for 3rd Dimension (CCNT)

(b) Channel Options Parameter (OPT) Content

31	30	28	27	24	23	22	21	20	19	18	17	16
0	000	0000	0	0	0	1	00	00				
PRIV	Reserved	PRIVID	ITCCHEN	TCCHEN	ITCINTEN	TCINTEN	Reserved	TCC				
15	12	11	10	8	7	4	3	2	1	0		
0000	0	000	0000	1	0	0	0					
TCC	TCCMOD	FWID	Reserved	STATIC	SYNCDIM	DAM	SAM					

11.3.18.2 Subframe Extraction Example

The EDMA3 can efficiently extract a small frame of data from a larger frame of data. By performing a 2D-to-1D transfer, the EDMA3 retrieves a portion of data for the CPU to process. In this example, a 640 × 480-pixel frame of video data is stored in external memory. Each pixel is represented by a 16-bit halfword. The CPU extracts a 16 × 12-pixel subframe of the image for processing. To facilitate more efficient processing time by the CPU, the EDMA3 places the subframe in internal L2 SRAM. Figure 11-24 shows the transfer of a subframe from external memory to L2. Figure 11-25 shows the parameters for this transfer.

The same PaPARAM entry options are used for QDMA channels, as well as DMA channels. The STATIC bit in OPT is set to prevent linking. For successive transfers, only changed parameters need to be programmed before triggering the channel.

Figure 11-24. Subframe Extraction Example

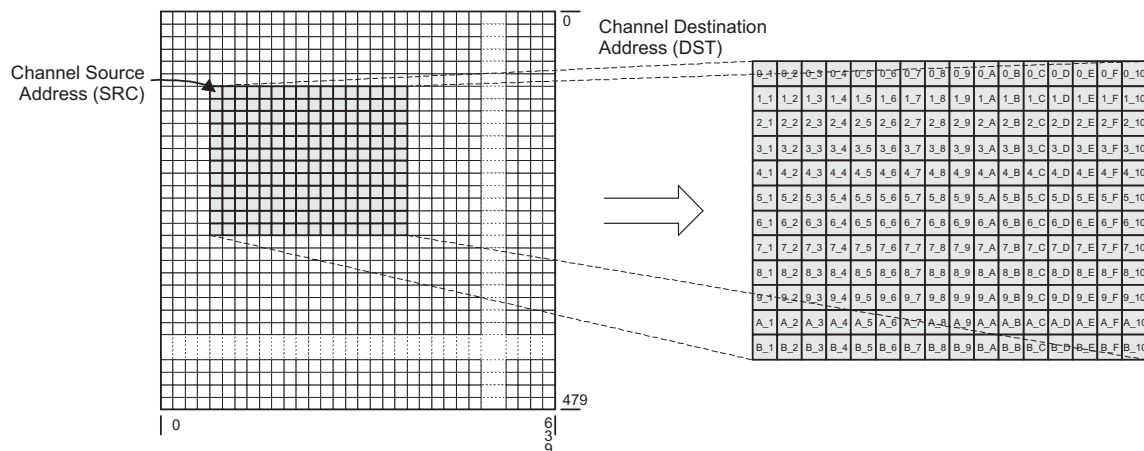


Figure 11-25. Subframe Extraction Example PaPARAM Configuration

(a) EDMA Parameters

Parameter Contents		Parameter	
0010 000Ch		Channel Options Parameter (OPT)	
Channel Source Address (SRC)		Channel Source Address (SRC)	
000Ch	0020h	Count for 2nd Dimension (BCNT)	Count for 1st Dimension (ACNT)
Channel Destination Address (DST)		Channel Destination Address (DST)	
0020h	0500h	Destination BCNT Index (DSTBIDX)	Source BCNT Index (SRCBIDX)
0000h	FFFFh	BCNT Reload (BCNTRLD)	Link Address (LINK)
0000h	0000h	Destination CCNT Index (DSTCIDX)	Source CCNT Index (SRCCIDX)
0000h	0001h	Reserved	Count for 3rd Dimension (CCNT)

(b) Channel Options Parameter (OPT) Content

31	30	28	27	24	23	22	21	20	19	18	17	16
0	000	0000	0	0	0	1	00	00				
PRIV	Reserved	PRIVID	ITCCHEN	TCCHEN	ITCINTEN	TCINTEN	Reserved	TCC				
15	12	11	10	8	7	4	3	2	1	0		
0000	0	000	0000	1	1	0	0					
TCC	TCCMOD	FWID	Reserved	STATIC	SYNCDIM	DAM	SAM					

11.3.18.3 Data Sorting Example

Many applications require the use of multiple data arrays; it is often desirable to have the arrays arranged such that the first elements of each array are adjacent, the second elements are adjacent, and so on. Often this is not how the data is presented to the device. Either data is transferred via a peripheral with the data arrays arriving one after the other or the arrays are located in memory with each array occupying a portion of contiguous memory spaces. For these instances, the EDMA3 can reorganize the data into the desired format. [Figure 11-26](#) shows the data sorting.

To determine the parameter set values, the following need to be considered:

- ACNT - Program this to be the size in bytes of an element.
- BCNT - Program this to be the number of elements in a frame.
- CCNT - Program this to be the number of frames.
- SRCBIDX - Program this to be the size of the element or ACNT.
- DSTBIDX - CCNT × ACNT
- SRCCDX - ACNT × BCNT
- DSTCIDX - ACNT

The synchronization type needs to be AB-synchronized and the STATIC bit is 0 to allow updates to the parameter set. It is advised to use normal EDMA3 channels for sorting.

It is not possible to sort this with a single trigger event. Instead, the channel can be programmed to be chained to itself. After BCNT elements get sorted, intermediate chaining could be used to trigger the channel again causing the transfer of the next BCNT elements and so on. [Figure 11-27](#) shows the parameter set programming for this transfer, assuming channel 0 and an element size of 4 bytes.

Figure 11-26. Data Sorting Example

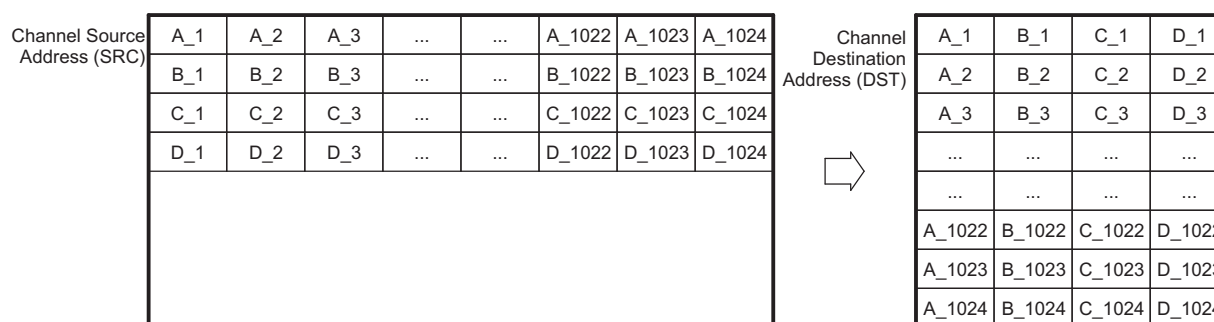


Figure 11-27. Data Sorting Example PaRAM Configuration

(a) EDMA Parameters

Parameter Contents		Parameter	
0090 0004h		Channel Options Parameter (OPT)	
Channel Source Address (SRC)		Channel Source Address (SRC)	
0400h	0004h	Count for 2nd Dimension (BCNT)	Count for 1st Dimension (ACNT)
Channel Destination Address (DST)		Channel Destination Address (DST)	
0010h	0004h	Destination BCNT Index (DSTBIDX)	Source BCNT Index (SRCBIDX)
0000h	FFFFh	BCNT Reload (BCNTRLD)	Link Address (LINK)
0004h	1000h	Destination CCNT Index (DSTCIDX)	Source CCNT Index (SRCCIDX)
0000h	0004h	Reserved	Count for 3rd Dimension (CCNT)

(b) Channel Options Parameter (OPT) Content

31	30	28	27	24	23	22	21	20	19	18	17	16
0	000	0000		1	0	0	1	00		00		
PRIV	Reserved		PRIVID	ITCCHEN	TCCHEN	ITCINTEN	TCINTEN	Reserved		TCC		
15	12	11	10	8	7	4		3	2	1	0	
0000		0	000	0000			0	1	0	0		
TCC		TCCMOD	FWID	Reserved			STATIC	SYNCDIM	DAM	SAM		

11.3.18.4 Peripheral Servicing Example

The EDMA3 channel controller also services peripherals in the background of CPU operation, without requiring any CPU intervention. Through proper initialization of the EDMA3 channels, they can be configured to continuously service on-chip and off-chip peripherals throughout the device operation. Each event available to the EDMA3 has its own dedicated channel, and all channels operate simultaneously. The only requirements are to use the proper channel for a particular transfer and to enable the channel event in the event enable register (EER). When programming an EDMA3 channel to service a peripheral, it is necessary to know how data is to be presented to the processor. Data is always provided with some kind of synchronization event as either one element per event (non-bursting) or multiple elements per event (bursting).

11.3.18.4.1 Non-bursting Peripherals

Non-bursting peripherals include the on-chip multichannel audio serial port (McASP) and many external devices, such as codecs. Regardless of the peripheral, the EDMA3 channel configuration is the same.

The McASP transmit and receive data streams are treated independently by the EDMA3. The transmit and receive data streams can have completely different counts, data sizes, and formats. [Figure 11-28](#) shows servicing incoming McASP data.

To transfer the incoming data stream to its proper location in DDR memory, the EDMA3 channel must be set up for a 1D-to-1D transfer with A-synchronization. Because an event (AREVT) is generated for every word as it arrives, it is necessary to have the EDMA3 issue the transfer request for each element individually. [Figure 11-29](#) shows the parameters for this transfer. The source address of the EDMA3 channel is set to the data port address (DAT) for McASP, and the destination address is set to the start of the data block in DDR. Because the address of serializer buffer is fixed, the source B index is cleared to 0 (no modification) and the destination B index is set to 01b (increment).

Based on the premise that serial data is typically a high priority, the EDMA3 channel should be programmed to be on queue 0.

Figure 11-28. Servicing Incoming McASP Data Example

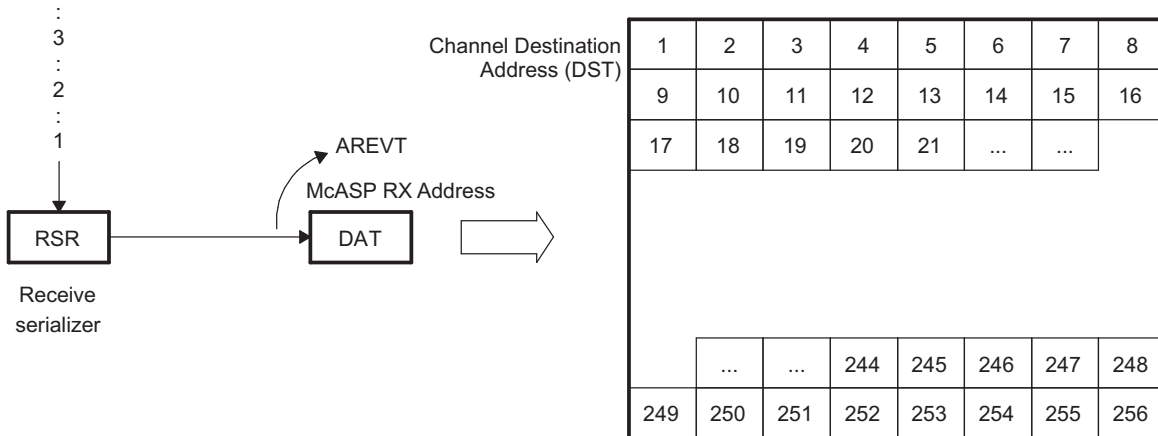


Figure 11-29. Servicing Incoming McASP Data Example PaRAM Configuration

(a) EDMA Parameters

Parameter Contents		Parameter	
0010 0000h		Channel Options Parameter (OPT)	
McASP RX Address		Channel Source Address (SRC)	
0100h	0001h	Count for 2nd Dimension (BCNT)	Count for 1st Dimension (ACNT)
Channel Destination Address (DST)		Channel Destination Address (DST)	
0001h	0000h	Destination BCNT Index (DSTBIDX)	Source BCNT Index (SRCBIDX)
0000h	FFFFh	BCNT Reload (BCNTRLD)	Link Address (LINK)
0000h	0000h	Destination CCNT Index (DSTCIDX)	Source CCNT Index (SRCCIDX)
0000h	0004h	Reserved	Count for 3rd Dimension (CCNT)

(b) Channel Options Parameter (OPT) Content

31	30	28	27	24	23	22	21	20	19	18	17	16
0	000	0000	0	0	0	0	1	00	00			
PRIV	Reserved	PRIVID	ITCCHEN	TCCHEN	ITCINTEN	TCINTEN	Reserved	TCC				
15	12	11	10	8	7		4	3	2	1	0	
0000	0	000		0000			0	0	0	0		
TCC	TCCMOD	FWID	Reserved	STATIC	SYNCDIM	DAM	SAM					

11.3.18.4.2 Bursting Peripherals

Higher bandwidth applications require that multiple data elements be presented to the processor core for every synchronization event. This frame of data can either be from multiple sources that are working simultaneously or from a single high-throughput peripheral that streams data to/from the processor.

In this example, a port is receiving a video frame from a camera and presenting it to the processor one array at a time. The video image is 640 × 480 pixels, with each pixel represented by a 16-bit element. The image is to be stored in external memory. Figure 11-30 shows this example.

To transfer data from an external peripheral to an external buffer one array at a time based on EVT_n , channel n must be configured. Due to the nature of the data (a video frame made up of arrays of pixels) the destination is essentially a 2D entity. Figure 11-31 shows the parameters to service the incoming data with a 1D-to-2D transfer using AB-synchronization. The source address is set to the location of the video framer peripheral, and the destination address is set to the start of the data buffer. Because the input address is static, the SRCBIDX is 0 (no modification to the source address). The destination is made up of arrays of contiguous, linear elements; therefore, the DSTBIDX is set to pixel size, 2 bytes. ANCT is equal to the pixel size, 2 bytes. BCNT is set to the number of pixels in an array, 640. CCNT is equal to the total number of arrays in the block, 480. SRCCIDX is 0 because the source address undergoes no increment. The DSTCIDX is equal to the difference between the starting addresses of each array. Because a pixel is 16 bits (2 bytes), DSTCIDX is equal to 640×2 .

Figure 11-30. Servicing Peripheral Burst Example

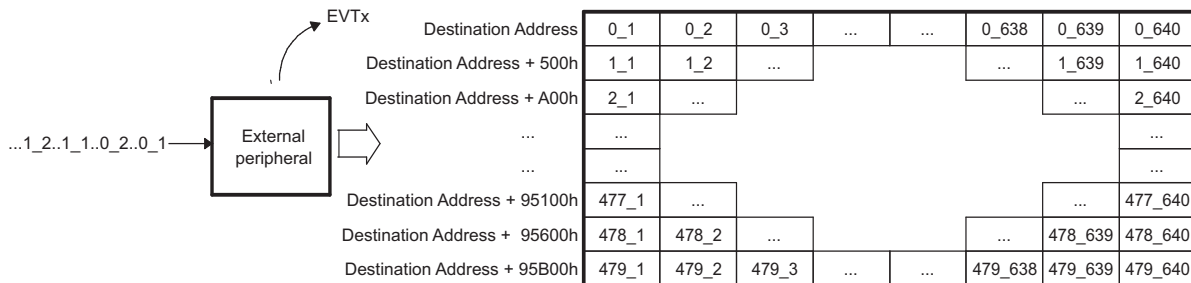


Figure 11-31. Servicing Peripheral Burst Example PaRAM Configuration

(a) EDMA Parameters

Parameter Contents		Parameter	
0010 0004h		Channel Options Parameter (OPT)	
Channel Source Address		Channel Source Address (SRC)	
0280h	0002h	Count for 2nd Dimension (BCNT)	Count for 1st Dimension (ACNT)
Channel Destination Address		Channel Destination Address (DST)	
0002h	0000h	Destination BCNT Index (DSTBIDX)	Source BCNT Index (SRCBIDX)
0000h	FFFFh	BCNT Reload (BCNTRLD)	Link Address (LINK)
0500h	0000h	Destination CCNT Index (DSTCIDX)	Source CCNT Index (SRCCIDX)
0000h	01E0h	Reserved	Count for 3rd Dimension (CCNT)

(b) Channel Options Parameter (OPT) Content

31	30	28	27	24	23	22	21	20	19	18	17	16
0	000	0000		0	0	0	1	00		00		
PRIV	Reserved		PRIVID	ITCCHEN	TCCHEN	ITCINTEN	TCINTEN	Reserved		TCC		
15	12	11	10	8	7	4		3	2	1	0	
0000		0	000	0000			0	1	0	0	0	
TCC		TCCMOD	FWID	Reserved			STATIC	SYNCDIM	DAM	SAM		

11.3.18.4.3 Continuous Operation

Configuring an EDMA3 channel to receive a single frame of data is useful, and is applicable to some systems. A majority of the time, however, data is going to be continuously transmitted and received throughout the entire operation of the processor. In this case, it is necessary to implement some form of linking such that the EDMA3 channels continuously reload the necessary parameter sets. In this example, McASP is configured to transmit and receive data on a T1 array. To simplify the example, only two channels are active for both transmit and receive data streams. Each channel receives packets of 128 elements. The packets are transferred from the serial port to internal memory and from internal memory to the serial port, as shown Figure 11-32.

The McASP generates AREVT for every element received and generates AXEVT for every element transmitted. To service the data streams, the DMA channels associated with the McASP must be setup for 1D-to-1D transfers with A-synchronization.

Figure 11-33 shows the parameter entries for the channel for these transfers. To service the McASP continuously, the channels must be linked to a duplicate PaPARAM set in the PaPARAM. After all frames have been transferred, the EDMA3 channels reload and continue. Figure 11-34 shows the reload parameters for the channel.

11.3.18.4.3.1 Receive Channel

EDMA3 channel 15 services the incoming data stream of McASP. The source address is set to that of the receive serializer buffer, and the destination address is set to the first element of the data block. Because there are two data channels being serviced, A and B, they are to be located separately within the L2 SRAM.

To facilitate continuous operation, a copy of the PaPARAM set for the channel is placed in PaPARAM set 64. The LINK option is set and the link address is provided in the PaPARAM set. Upon exhausting the channel 15 parameter set, the parameters located at the link address are loaded into the channel 15 parameter set and operation continues. This function continues throughout device operation until halted by the CPU.

11.3.18.4.3.2 Transmit Channel

EDMA3 channel 12 services the outgoing data stream of McASP. In this case the destination address needs no update, hence, the parameter set changes accordingly. Linking is also used to allow continuous operation by the EDMA3 channel, with duplicate PaPARAM set entries at PaPARAM set 65.

Figure 11-32. Servicing Continuous McASP Data Example

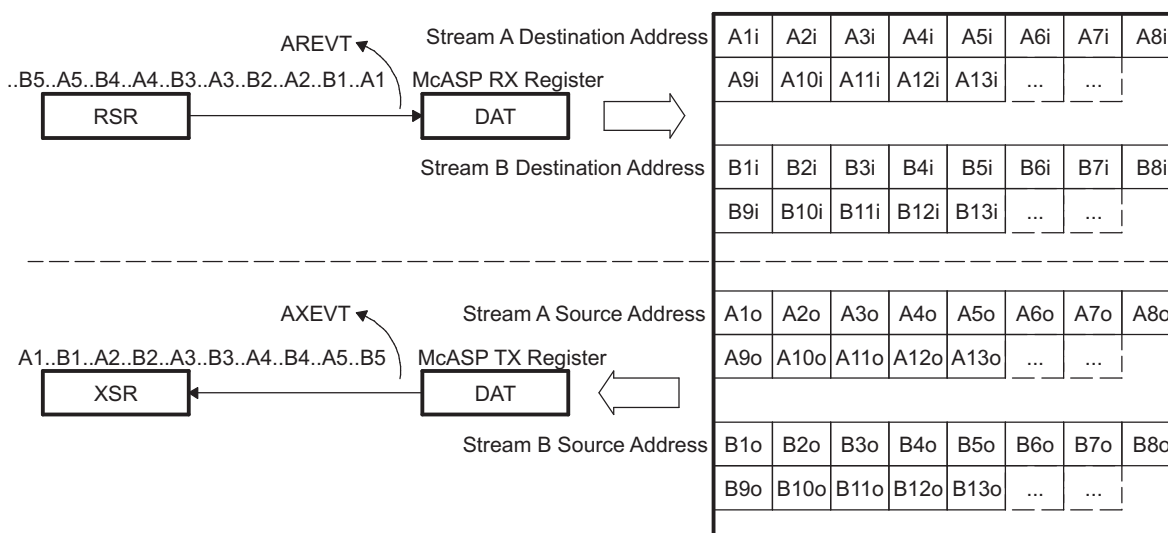


Figure 11-33. Servicing Continuous McASP Data Example PaRAM Configuration

(a) EDMA Parameters for Receive Channel (PaRAM Set 15) being Linked to PaRAM Set 64

Parameter Contents		Parameter	
0010 0000h		Channel Options Parameter (OPT)	
McASP RX Register		Channel Source Address (SRC)	
0080h	0001h	Count for 2nd Dimension (BCNT)	Count for 1st Dimension (ACNT)
Channel Destination Address (DST)		Channel Destination Address (DST)	
0001h	0000h	Destination BCNT Index (DSTBIDX)	Source BCNT Index (SRCBIDX)
0080h	4800h	BCNT Reload (BCNTRLD)	Link Address (LINK)
0000h	0000h	Destination CCNT Index (DSTCIDX)	Source CCNT Index (SRCCIDX)
0000h	FFFFh	Reserved	Count for 3rd Dimension (CCNT)

(b) Channel Options Parameter (OPT) Content for Receive Channel (PaRAM Set 15)

31	30	28	27	24	23	22	21	20	19	18	17	16
0	000	0000	0	0	0	1	00	00				
PRIV	Reserved	PRIVID	ITCCHEN	TCCHEN	ITCINTEN	TCINTEN	Reserved	TCC				
15	12	11	10	8	7	4	3	2	1	0		
0000	0	000	0000	0	0	0	0	0	0	0		
TCC	TCCMOD	FWID	Reserved	STATIC	SYNCDIM	DAM	SAM					

(c) EDMA Parameters for Transmit Channel (PaRAM Set 12) being Linked to PaRAM Set 65

Parameter Contents		Parameter	
0010 1000h		Channel Options Parameter (OPT)	
Channel Source Address (SRC)		Channel Source Address (SRC)	
0080h	0001h	Count for 2nd Dimension (BCNT)	Count for 1st Dimension (ACNT)
McASP TX Register		Channel Destination Address (DST)	
0000h	0001h	Destination BCNT Index (DSTBIDX)	Source BCNT Index (SRCBIDX)
0080h	4860h	BCNT Reload (BCNTRLD)	Link Address (LINK)
0000h	0000h	Destination CCNT Index (DSTCIDX)	Source CCNT Index (SRCCIDX)
0000h	FFFFh	Reserved	Count for 3rd Dimension (CCNT)

(d) Channel Options Parameter (OPT) Content for Transmit Channel (PaRAM Set 12)

31	30	28	27	24	23	22	21	20	19	18	17	16
0	000	0000	0	0	0	1	00	00				
PRIV	Reserved	PRIVID	ITCCHEN	TCCHEN	ITCINTEN	TCINTEN	Reserved	TCC				
15	12	11	10	8	7	4	3	2	1	0		
0001	0	000	0000	0	0	0	0	0	0	0		
TCC	TCCMOD	FWID	Reserved	STATIC	SYNCDIM	DAM	SAM					

Figure 11-34. Servicing Continuous McASP Data Example Reload PaRAM Configuration

(a) EDMA Reload Parameters (PaRAM Set 64) for Receive Channel

Parameter Contents		Parameter	
0010 0000h		Channel Options Parameter (OPT)	
McASP RX Register		Channel Source Address (SRC)	
0080h	0001h	Count for 2nd Dimension (BCNT)	Count for 1st Dimension (ACNT)
Channel Destination Address (DST)		Channel Destination Address (DST)	
0001h	0000h	Destination BCNT Index (DSTBIDX)	Source BCNT Index (SRCBIDX)
0080h	4800h	BCNT Reload (BCNTRLD)	Link Address (LINK)
0000h	0000h	Destination CCNT Index (DSTCIDX)	Source CCNT Index (SRCCIDX)
0000h	FFFFh	Reserved	Count for 3rd Dimension (CCNT)

(b) Channel Options Parameter (OPT) Content for Receive Channel (PaRAM Set 64)

31	30	28	27	24	23	22	21	20	19	18	17	16
0	000	0000		0	0	0	1	00		00		
PRIV	Reserved	PRIVID		ITCCHEN	TCCHEN	ITCINTEN	TCINTEN	Reserved		TCC		
15	12	11	10	8	7	4		3	2	1	0	
0000		0	000	0000			0	0	0	0		
TCC		TCCMOD	FWID	Reserved			STATIC	SYNCDIM	DAM	SAM		

(c) EDMA Reload Parameters (PaRAM Set 65) for Transmit Channel

Parameter Contents		Parameter	
0010 1000h		Channel Options Parameter (OPT)	
Channel Source Address (SRC)		Channel Source Address (SRC)	
0080h	0001h	Count for 2nd Dimension (BCNT)	Count for 1st Dimension (ACNT)
McASP TX Register		Channel Destination Address (DST)	
0000h	0001h	Destination BCNT Index (DSTBIDX)	Source BCNT Index (SRCBIDX)
0080h	4860h	BCNT Reload (BCNTRLD)	Link Address (LINK)
0000h	0000h	Destination CCNT Index (DSTCIDX)	Source CCNT Index (SRCCIDX)
0000h	FFFFh	Reserved	Count for 3rd Dimension (CCNT)

(d) Channel Options Parameter (OPT) Content for Transmit Channel (PaRAM Set 65)

31	30	28	27	24	23	22	21	20	19	18	17	16
0	000	0000		0	0	0	1	00		00		
PRIV	Reserved	PRIVID		ITCCHEN	TCCHEN	ITCINTEN	TCINTEN	Reserved		TCC		
15	12	11	10	8	7	4		3	2	1	0	
0001		0	000	0000			0	0	0	0		
TCC		TCCMOD	FWID	Reserved			STATIC	SYNCDIM	DAM	SAM		

11.3.18.4.4 Ping-Pong Buffering

Although the previous configuration allows the EDMA3 to service a peripheral continuously, it presents a number of restrictions to the CPU. Because the input and output buffers are continuously being filled/emptied, the CPU must match the pace of the EDMA3 very closely to process the data. The EDMA3 receive data must always be placed in memory before the CPU accesses it, and the CPU must provide the output data before the EDMA3 transfers it. Though not impossible, this is an unnecessary challenge. It is particularly difficult in a 2-level cache scheme.

Ping-pong buffering is a simple technique that allows the CPU activity to be distanced from the EDMA3 activity. This means that there are multiple (usually two) sets of data buffers for all incoming and outgoing data streams. While the EDMA3 transfers the data into and out of the ping buffers, the CPU manipulates the data in the pong buffers. When both CPU and EDMA3 activity completes, they switch. The EDMA3 then writes over the old input data and transfers the new output data. [Figure 11-35](#) shows the ping-pong scheme for this example.

To change the continuous operation example, such that a ping-pong buffering scheme is used, the EDMA3 channels need only a moderate change. Instead of one parameter set, there are two; one for transferring data to/from the ping buffers and one for transferring data to/from the pong buffers. As soon as one transfer completes, the channel loads the PaRAM set for the other and the data transfers continue. [Figure 11-36](#) shows the EDMA3 channel configuration required.

Each channel has two parameter sets, ping and pong. The EDMA3 channel is initially loaded with the ping parameters ([Figure 11-36](#)). The link address for the ping set is set to the PaRAM offset of the pong parameter set ([Figure 11-37](#)). The link address for the pong set is set to the PaRAM offset of the ping parameter set ([Figure 11-38](#)). The channel options, count values, and index values are all identical between the ping and pong parameters for each channel. The only differences are the link address provided and the address of the data buffer.

11.3.18.4.4.1 Synchronization with the CPU

To utilize the ping-pong buffering technique, the system must signal the CPU when to begin to access the new data set. After the CPU finishes processing an input buffer (ping), it waits for the EDMA3 to complete before switching to the alternate (pong) buffer. In this example, both channels provide their channel numbers as their report word and set the TCINTEN bit to generate an interrupt after completion. When channel 15 fills an input buffer, the E15 bit in the interrupt pending register (IPR) is set; when channel 12 empties an output buffer, the E12 bit in IPR is set. The CPU must manually clear these bits. With the channel parameters set, the CPU polls IPR to determine when to switch. The EDMA3 and CPU could alternatively be configured such that the channel completion interrupts the CPU. By doing this, the CPU could service a background task while waiting for the EDMA3 to complete.

Figure 11-35. Ping-Pong Buffering for McASP Data Example

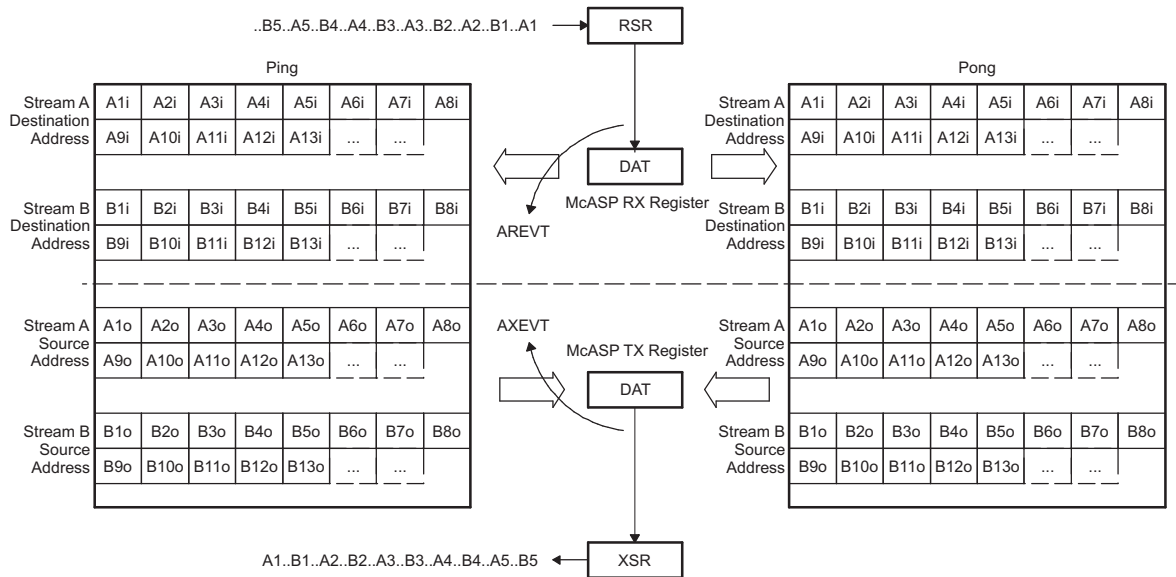


Figure 11-36. Ping-Pong Buffering for McASP Example PaRAM Configuration

(a) EDMA Parameters for Channel 15 (Using PaRAM Set 15 Linked to Pong Set 64)

Parameter Contents		Parameter	
0010 D000h		Channel Options Parameter (OPT)	
McASP RX Register		Channel Source Address (SRC)	
0080h	0001h	Count for 2nd Dimension (BCNT)	Count for 1st Dimension (ACNT)
Channel Destination Address (DST)		Channel Destination Address (DST)	
0001h	0000h	Destination BCNT Index (DSTBIDX)	Source BCNT Index (SRCBIDX)
0080h	4800h	BCNT Reload (BCNTRLD)	Link Address (LINK)
0000h	0000h	Destination CCNT Index (DSTCIDX)	Source CCNT Index (SRCCIDX)
0000h	0001h	Reserved	Count for 3rd Dimension (CCNT)

(b) Channel Options Parameter (OPT) Content for Channel 15

31	30	28	27	24	23	22	21	20	19	18	17	16
0	000	0000	0	0	0	1	00	00				
PRIV	Reserved	PRIVID	ITCCHEN	TCCHEN	ITCINTEN	TCINTEN	Reserved	TCC				
15	12	11	10	8	7	4	3	2	1	0		
1101	0	000	0000	0000	0000	0	0	0	0	0		
TCC	TCCMOD	FWID	Reserved	Reserved	Reserved	STATIC	SYNCDIM	DAM	SAM			

(c) EDMA Parameters for Channel 12 (Using PaRAM Set 12 Linked to Pong Set 66)

Parameter Contents		Parameter	
0010 C000h		Channel Options Parameter (OPT)	
Channel Source Address (SRC)		Channel Source Address (SRC)	
0080h	0001h	Count for 2nd Dimension (BCNT)	Count for 1st Dimension (ACNT)
McASP TX Register		Channel Destination Address (DST)	
0000h	0001h	Destination BCNT Index (DSTBIDX)	Source BCNT Index (SRCBIDX)
0080h	4840h	BCNT Reload (BCNTRLD)	Link Address (LINK)
0000h	0000h	Destination CCNT Index (DSTCIDX)	Source CCNT Index (SRCCIDX)
0000h	0001h	Reserved	Count for 3rd Dimension (CCNT)

(d) Channel Options Parameter (OPT) Content for Channel 12

31	30	28	27	24	23	22	21	20	19	18	17	16
0	000	0000		0	0	0	1	00		00		
PRIV	Reserved	PRIVID		ITCCHEN	TCCHEN	ITCINTEN	TCINTEN	Reserved		TCC		
15	12	11	10	8	7	4		3	2	1	0	
1100		0	000	0000			0	0	0	0		
TCC		TCCMOD	FWID	Reserved			STATIC	SYNCDIM	DAM	SAM		

Figure 11-37. Ping-Pong Buffering for McASP Example Pong PaRAM Configuration
(a) EDMA Pong Parameters for Channel 15 at Set 64 Linked to Set 65

Parameter Contents		Parameter	
0010 D000h		Channel Options Parameter (OPT)	
McASP RX Register		Channel Source Address (SRC)	
0080h	0001h	Count for 2nd Dimension (BCNT)	Count for 1st Dimension (ACNT)
Channel Destination Address (DST)		Channel Destination Address (DST)	
0001h	0000h	Destination BCNT Index (DSTBIDX)	Source BCNT Index (SRCBIDX)
0080h	4820h	BCNT Reload (BCNTRLD)	Link Address (LINK)
0000h	0000h	Destination CCNT Index (DSTCIDX)	Source CCNT Index (SRCCIDX)
0000h	0001h	Reserved	Count for 3rd Dimension (CCNT)

(b) EDMA Pong Parameters for Channel 12 at Set 66 Linked to Set 67

Parameter Contents		Parameter	
0010 C000h		Channel Options Parameter (OPT)	
Channel Source Address (SRC)		Channel Source Address (SRC)	
0080h	0001h	Count for 2nd Dimension (BCNT)	Count for 1st Dimension (ACNT)
McASP TX Register		Channel Destination Address (DST)	
0000h	0001h	Destination BCNT Index (DSTBIDX)	Source BCNT Index (SRCBIDX)
0080h	4860h	BCNT Reload (BCNTRLD)	Link Address (LINK)
0000h	0000h	Destination CCNT Index (DSTCIDX)	Source CCNT Index (SRCCIDX)
0000h	0001h	Reserved	Count for 3rd Dimension (CCNT)

Figure 11-38. Ping-Pong Buffering for McASP Example Ping PaRAM Configuration

(a) EDMA Ping Parameters for Channel 15 at Set 65 Linked to Set 64

Parameter Contents		Parameter	
0010 D000h		Channel Options Parameter (OPT)	
McASP RX Register		Channel Source Address (SRC)	
0080h	0001h	Count for 2nd Dimension (BCNT)	Count for 1st Dimension (ACNT)
Channel Destination Address (DST)		Channel Destination Address (DST)	
0001h	0000h	Destination BCNT Index (DSTBIDX)	Source BCNT Index (SRCBIDX)
0080h	4800h	BCNT Reload (BCNTRLD)	Link Address (LINK)
0000h	0000h	Destination CCNT Index (DSTCIDX)	Source CCNT Index (SRCCIDX)
0000h	0001h	Reserved	Count for 3rd Dimension (CCNT)

(b) EDMA Ping Parameters for Channel 12 at Set 67 Linked to Set 66

Parameter Contents		Parameter	
0010 C000h		Channel Options Parameter (OPT)	
Channel Source Address (SRC)		Channel Source Address (SRC)	
0080h	0001h	Count for 2nd Dimension (BCNT)	Count for 1st Dimension (ACNT)
McASP TX Register		Channel Destination Address (DST)	
0000h	0001h	Destination BCNT Index (DSTBIDX)	Source BCNT Index (SRCBIDX)
0080h	4840h	BCNT Reload (BCNTRLD)	Link Address (LINK)
0000h	0000h	Destination CCNT Index (DSTCIDX)	Source CCNT Index (SRCCIDX)
0000h	0001h	Reserved	Count for 3rd Dimension (CCNT)

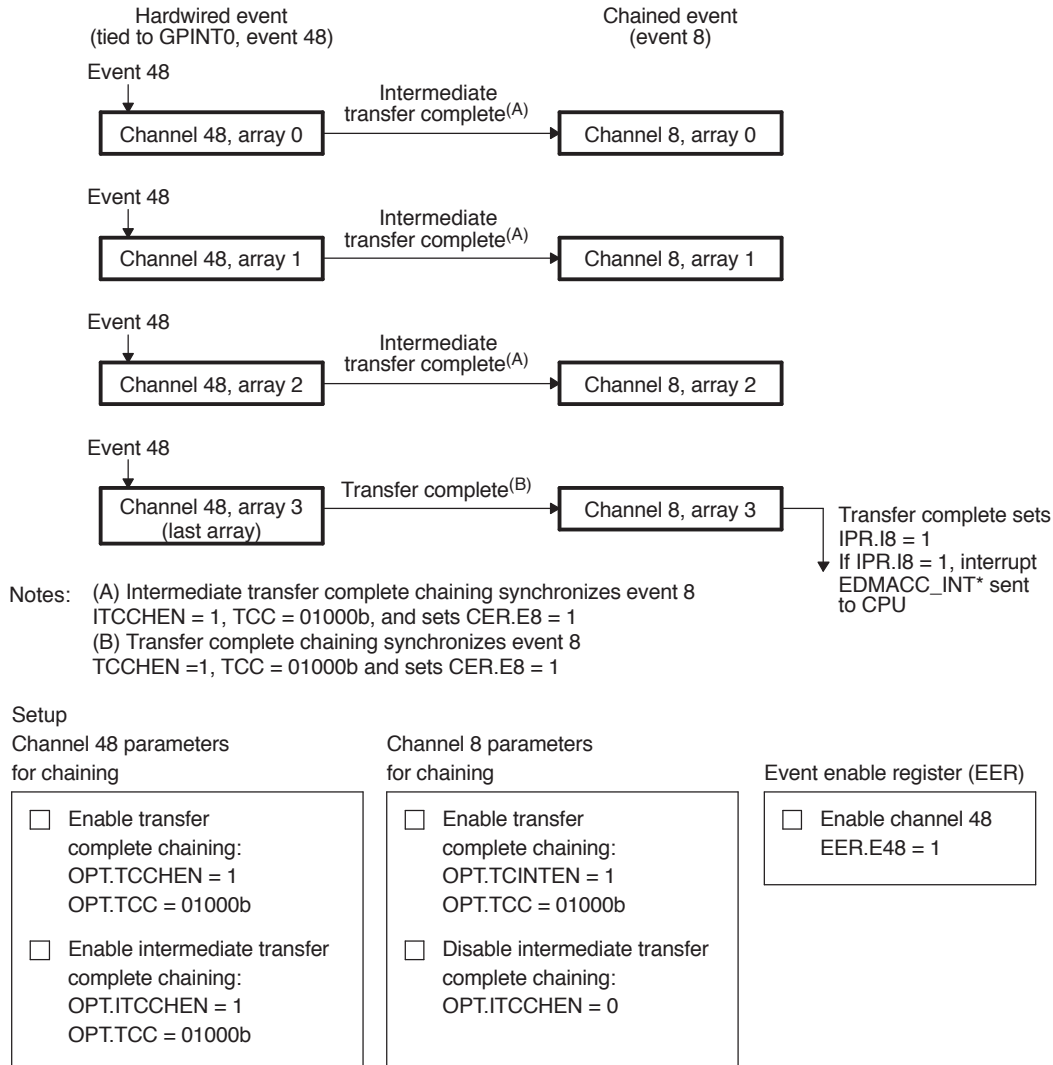
11.3.18.4.5 Transfer Chaining Examples

The following examples explain the intermediate transfer complete chaining function.

11.3.18.4.5.1 Servicing Input/Output FIFOs with a Single Event

Many systems require the use of a pair of external FIFOs that must be serviced at the same rate. One FIFO buffers data input, and the other buffers data output. The EDMA3 channels that service these FIFOs can be set up for AB-synchronized transfers. While each FIFO is serviced with a different set of parameters, both can be signaled from a single event. For example, an external interrupt pin can be tied to the status flags of one of the FIFOs. When this event arrives, the EDMA3 needs to perform servicing for both the input and output streams. Without the intermediate transfer complete chaining feature this would require two events, and thus two external interrupt pins. The intermediate transfer complete chaining feature allows the use of a single external event (for example, a GPIO event). [Figure 11-39](#) shows the EDMA3 setup and illustration for this example.

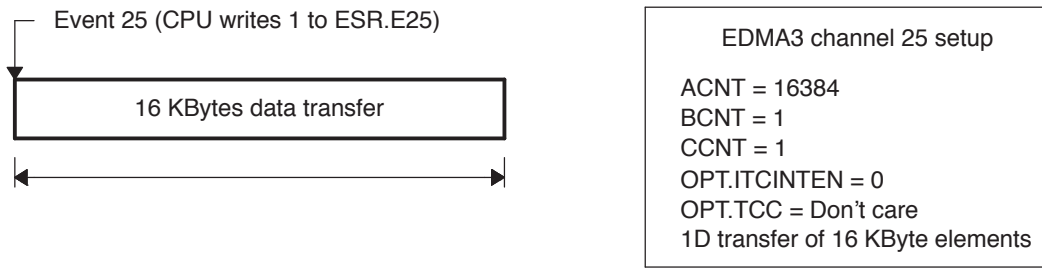
A GPIO event (in this case, GPINT0) triggers an array transfer. Upon completion of each intermediate array transfer of channel 48, intermediate transfer complete chaining sets the E8 bit (specified by TCC of 8) in the chained event register (CER) and provides a synchronization event to channel 8. Upon completion of the last array transfer of channel 48, transfer complete chaining—not intermediate transfer complete chaining—sets the E8 bit in CER (specified by TCCMODE:TCC) and provides a synchronization event to channel 8. The completion of channel 8 sets the I8 bit (specified by TCCMODE:TCC) in the interrupt pending register (IPR), which can generate an interrupt to the CPU, if the I8 bit in the interrupt enable register (IER) is set.

Figure 11-39. Intermediate Transfer Completion Chaining Example


11.3.18.4.5.2 Breaking Up Large Transfers with Intermediate Chaining

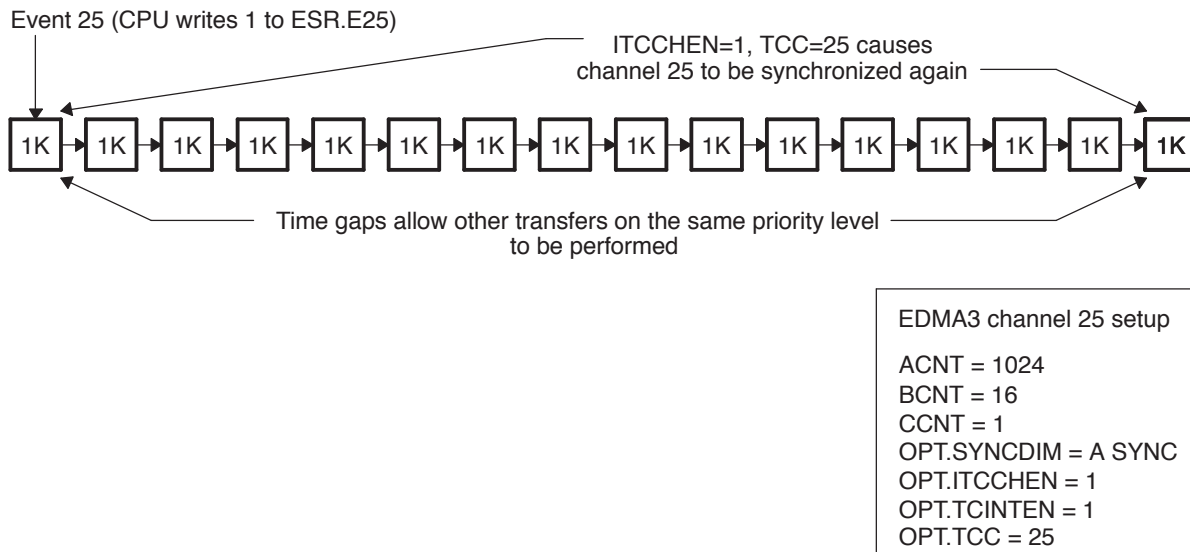
Another feature of intermediate transfer chaining (ITCCHEN) is for breaking up large transfers. A large transfer may lock out other transfers of the same priority level for the duration of the transfer. For example, a large transfer on queue 0 from the internal memory to the external memory using the EMIF may starve other EDMA3 transfers on the same queue. In addition, this large high-priority transfer may prevent the EMIF for a long duration to service other lower priority transfers. When a large transfer is considered to be high priority, it should be split into multiple smaller transfers. [Figure 11-40](#) shows the EDMA3 setup and illustration of an example single large block transfer.

Figure 11-40. Single Large Block Transfer Example



The intermediate transfer chaining enable (ITCCHEN) provides a method to break up a large transfer into smaller transfers. For example, to move a single large block of memory (16K bytes), the EDMA3 performs an A-synchronized transfer. The element count is set to a reasonable value, where reasonable derives from the amount of time it would take to move this smaller amount of data. Assume 1 Kbyte is a reasonable small transfer in this example. The EDMA3 is set up to transfer 16 arrays of 1 Kbyte elements, for a total of 16K byte elements. The TCC field in the channel options parameter (OPT) is set to the same value as the channel number and ITCCHEN are set. In this example, EDMA3 channel 25 is used and TCC is also set to 25. The TCINTEN may also be set to trigger interrupt 25 when the last 1 Kbyte array is transferred. The CPU starts the EDMA3 transfer by writing to the appropriate bit of the event set register (ESR.E25). The EDMA3 transfers the first 1 Kbyte array. Upon completion of the first array, intermediate transfer complete code chaining generates a synchronization event to channel 25, a value specified by the TCC field. This intermediate transfer completion chaining event causes EDMA3 channel 25 to transfer the next 1 Kbyte array. This process continues until the transfer parameters are exhausted, at which point the EDMA3 has completed the 16K byte transfer. This method breaks up a large transfer into smaller packets, thus providing natural time slices in the transfer such that other events may be processed. [Figure 11-41](#) shows the EDMA3 setup and illustration of the broken up smaller packet transfers.

Figure 11-41. Smaller Packet Data Transfers Example



11.3.19 EDMA Events
Table 11-23. Direct Mapped

Event Number	Event Name	Source Module
0	pr1_host[7] ⁽¹⁾	PRU-ICSS
1	pr1_host[6] ⁽¹⁾	PRU-ICSS
2	SDTXEVT1	MMCHS1
3	SDRXEVT1	MMCHS1
4	Reserved	Reserved
5	Reserved	Reserved
6	Reserved	Reserved
7	Reserved	Reserved
8	AXEVT0	McASP0
9	AREVT0	McASP0
10	AXEVT1	McASP1
11	AREVT1	McASP1
12	Open	Open
13	Open	Open
14	ePWMEVT0	ePWM 0
15	ePWMEVT1	ePWM 1
16	SPIXEVT0	McSPI0
17	SPIREVT0	McSPI0
18	SPIXEVT1	McSPI0
19	SPIREVT1	McSPI0
20	Open	Open
21	Open	Open
22	GPIOEVT0	GPIO0
23	GPIOEVT1	GPIO1
24	SDTXEVT0	MMCHS0
25	SDRXEVT0	MMCHS0
26	UTXEVT0	UART0
27	URXEVT0	UART0
28	UTXEVT1	UART1
29	URXEVT1	UART1
30	UTXEVT2	UART2
31	URXEVT2	UART2
32	Open	Open
33	Open	Open
34	Open	Open
35	Open	Open
36	Open	Open
37	Open	Open
38	eCAPEVT0	eCAP 0
39	eCAPEVT1	eCAP 1
40	CAN_IF1DMA	DCAN 0
41	CAN_IF2DMA	DCAN 0
42	SPIXEVT0	McSPI1
43	SPIREVT0	McSPI1
44	SPIXEVT1	McSPI1

⁽¹⁾ pr1_host_intr[0:7] corresponds to Host-2 to Host-9 of the PRU-ICSS interrupt controller.

Table 11-23. Direct Mapped (continued)

Event Number	Event Name	Source Module
45	SPIREVT1	McSPI1
46	eQEPEVT0	eQEP 0
47	CAN_IF3DMA	DCAN 0
48	TINT4	Timer 4
49	TINT5	Timer 5
50	TINT6	Timer 6
51	TINT7	Timer 7
52	GPMCEVT	GPMC
53	tsc_adc_FIFO0	ADC/TSC
54	Open	
55	Open	
56	eQEPEVT1	eQEP 1
57	tsc_adc_FIFO1	ADC/TSC
58	I2CTXEVT0	I2C0
59	I2CRXEVT0	I2C0
60	I2CTXEVT1	I2C1
61	I2CRXEVT1	I2C1
62	eCAPEVT2	eCAP 2
63	eHRPWMEVT2	eHRPWM 2

Table 11-24. Crossbar Mapped

Event Number	Event Name	Source Module
1	SDTXEVT2	MMCHS2
2	SDRXEVT2	MMCHS2
3	I2CTXEVT2	I2C2
4	I2CRXEVT2	I2C2
5	Open	Open
6	Open	Open
7	UTXEVT3	UART3
8	URXEVT3	UART3
9	UTXEVT4	UART4
10	URXEVT4	UART4
11	UTXEVT5	UART5
12	URXEVT5	UART5
13	CAN_IF1DMA	DCAN 1
14	CAN_IF2DMA	DCAN 1
15	CAN_IF3DMA	DCAN 1
16	Open	Open
17	Open	Open
18	Open	Open
19	Open	Open
20	Open	Open
21	Open	Open
22	TINT0	Timer 0
23		
24	TINT2	Timer 2

Table 11-24. Crossbar Mapped (continued)

Event Number	Event Name	Source Module
25	TINT3	Timer 3
26	Open	Open
27	Open	Open
28	pi_x_dma_event_intr0	External pin (XDMA_EVENT_INTR0)
29	pi_x_dma_event_intr1	External pin (XDMA_EVENT_INTR1)
30	pi_x_dma_event_intr2	External pin (XDMA_EVENT_INTR2)
31	eQEPEVT2	eQEP 2
32	GPIOEVT2	GPIO2
33	Open	
34	Open	
35	Open	
36	Open	
37	Open	
38	Open	
39	Open	
40	Open	
41	Open	
42	Open	
43	Open	
44	Open	
45	Open	
46	Open	
47	Open	
48	Open	
49	Open	
50	Open	
51	Open	
52	Open	
53	Open	
54	Open	
55	Open	
56	Open	
57	Open	
58	Open	
59	Open	
60	Open	
61	Open	
62	Open	
63	Open	

11.4 EDMA3 Registers

11.4.1 EDMA3CC Registers

Table 11-25 lists the memory-mapped registers for the EDMA3CC. All register offset addresses not listed in Table 11-25 should be considered as reserved locations and the register contents should not be modified.

Table 11-25. EDMA3CC Registers

Offset	Acronym	Register Name	Section
0h	PID	Peripheral Identification Register	Section 13.5.1.1
4h	CCCFG	EDMA3CC Configuration Register	Section 11.4.1.2
10h	SYSCONFIG	EDMA3CC System Configuration Register	Section 15.1.2.2
100h to 1FCh	DCHMAP_0 to DCHMAP_63	DMA Channel Mapping Registers 0-63	Section 11.4.1.4
200h to 21Ch	QCHMAP_0 to QCHMAP_7	QDMA Channel Mapping Registers 0-7	Section 11.4.1.5
240h to 25Ch	DMAQNUM_0 to DMAQNUM_7	DMA Queue Number Registers 0-7	Section 11.4.1.6
260h	QDMAQNUM	QDMA Queue Number Register	Section 11.4.1.7
284h	QUEPRI	Queue Priority Register	Section 11.4.1.8
300h	EMR	Event Missed Register	Section 11.4.1.9
304h	EMRH	Event Missed Register High	Section 11.4.1.10
308h	EMCR	Event Missed Clear Register	Section 11.4.1.11
30Ch	EMCRH	Event Missed Clear Register High	Section 11.4.1.12
310h	QEMR	QDMA Event Missed Register	Section 11.4.1.13
314h	QEMCR	QDMA Event Missed Clear Register	Section 11.4.1.14
318h	CCERR	EDMA3CC Error Register	Section 11.4.1.15
31Ch	CCERRCLR	EDMA3CC Error Clear Register	Section 11.4.1.16
320h	EEVAL	Error Evaluate Register	Section 11.4.1.17
340h	DRAE0	DMA Region Access Enable Register for Region 0	Section 11.4.1.18
344h	DRAEH0	DMA Region Access Enable Register High for Region 0	Section 11.4.1.19
348h	DRAE1	DMA Region Access Enable Register for Region 1	Section 11.4.1.20
34Ch	DRAEH1	DMA Region Access Enable Register High for Region 1	Section 11.4.1.21
350h	DRAE2	DMA Region Access Enable Register for Region 2	Section 11.4.1.22
354h	DRAEH2	DMA Region Access Enable Register High for Region 2	Section 11.4.1.23
358h	DRAE3	DMA Region Access Enable Register for Region 3	Section 11.4.1.24
35Ch	DRAEH3	DMA Region Access Enable Register High for Region 3	Section 11.4.1.25
360h	DRAE4	DMA Region Access Enable Register for Region 4	Section 11.4.1.26
364h	DRAEH4	DMA Region Access Enable Register High for Region 4	Section 11.4.1.27
368h	DRAE5	DMA Region Access Enable Register for Region 5	Section 11.4.1.28
36Ch	DRAEH5	DMA Region Access Enable Register High for Region 5	Section 11.4.1.29
370h	DRAE6	DMA Region Access Enable Register for Region 6	Section 11.4.1.30
374h	DRAEH6	DMA Region Access Enable Register High for Region 6	Section 11.4.1.31
378h	DRAE7	DMA Region Access Enable Register for Region 7	Section 11.4.1.32
37Ch	DRAEH7	DMA Region Access Enable Register High for Region 7	Section 11.4.1.33

Table 11-25. EDMA3CC Registers (continued)

Offset	Acronym	Register Name	Section
380h to 39Ch	QRAE_0 to QRAE_7	QDMA Region Access Enable Registers for Region 0-7	Section 11.4.1.34
400h	Q0E0	Event Queue 0 Entry 0 Register	Section 11.4.1.35
404h	Q0E1	Event Queue 0 Entry 1 Register	Section 11.4.1.36
408h	Q0E2	Event Queue 0 Entry 2 Register	Section 11.4.1.37
40Ch	Q0E3	Event Queue 0 Entry 3 Register	Section 11.4.1.38
410h	Q0E4	Event Queue 0 Entry 4 Register	Section 11.4.1.39
414h	Q0E5	Event Queue 0 Entry 5 Register	Section 11.4.1.40
418h	Q0E6	Event Queue 0 Entry 6 Register	Section 11.4.1.41
41Ch	Q0E7	Event Queue 0 Entry 7 Register	Section 11.4.1.42
420h	Q0E8	Event Queue 0 Entry 8 Register	Section 11.4.1.43
424h	Q0E9	Event Queue 0 Entry 9 Register	Section 11.4.1.44
428h	Q0E10	Event Queue 0 Entry 10 Register	Section 11.4.1.45
42Ch	Q0E11	Event Queue 0 Entry 11 Register	Section 11.4.1.46
430h	Q0E12	Event Queue 0 Entry 12 Register	Section 11.4.1.47
434h	Q0E13	Event Queue 0 Entry 13 Register	Section 11.4.1.48
438h	Q0E14	Event Queue 0 Entry 14 Register	Section 11.4.1.49
43Ch	Q0E15	Event Queue 0 Entry 15 Register	Section 11.4.1.50
440h	Q1E0	Event Queue 1 Entry 0 Register	Section 11.4.1.51
444h	Q1E1	Event Queue 1 Entry 1 Register	Section 11.4.1.52
448h	Q1E2	Event Queue 1 Entry 2 Register	Section 11.4.1.53
44Ch	Q1E3	Event Queue 1 Entry 3 Register	Section 11.4.1.54
450h	Q1E4	Event Queue 1 Entry 4 Register	Section 11.4.1.55
454h	Q1E5	Event Queue 1 Entry 5 Register	Section 11.4.1.56
458h	Q1E6	Event Queue 1 Entry 6 Register	Section 11.4.1.57
45Ch	Q1E7	Event Queue 1 Entry 7 Register	Section 11.4.1.58
460h	Q1E8	Event Queue 1 Entry 8 Register	Section 11.4.1.59
464h	Q1E9	Event Queue 1 Entry 9 Register	Section 11.4.1.60
468h	Q1E10	Event Queue 1 Entry 10 Register	Section 11.4.1.61
46Ch	Q1E11	Event Queue 1 Entry 11 Register	Section 11.4.1.62
470h	Q1E12	Event Queue 1 Entry 12 Register	Section 11.4.1.63
474h	Q1E13	Event Queue 1 Entry 13 Register	Section 11.4.1.64
478h	Q1E14	Event Queue 1 Entry 14 Register	Section 11.4.1.65
47Ch	Q1E15	Event Queue 1 Entry 15 Register	Section 11.4.1.66
480h	Q2E0	Event Queue 2 Entry 0 Register	Section 11.4.1.67
484h	Q2E1	Event Queue 2 Entry 1 Register	Section 11.4.1.68
488h	Q2E2	Event Queue 2 Entry 2 Register	Section 11.4.1.69
48Ch	Q2E3	Event Queue 2 Entry 3 Register	Section 11.4.1.70
490h	Q2E4	Event Queue 2 Entry 4 Register	Section 11.4.1.71
494h	Q2E5	Event Queue 2 Entry 5 Register	Section 11.4.1.72
498h	Q2E6	Event Queue 2 Entry 6 Register	Section 11.4.1.73
49Ch	Q2E7	Event Queue 2 Entry 7 Register	Section 11.4.1.74
4A0h	Q2E8	Event Queue 2 Entry 8 Register	Section 11.4.1.75
4A4h	Q2E9	Event Queue 2 Entry 9 Register	Section 11.4.1.76
4A8h	Q2E10	Event Queue 2 Entry 10 Register	Section 11.4.1.77
4ACh	Q2E11	Event Queue 2 Entry 11 Register	Section 11.4.1.78
4B0h	Q2E12	Event Queue 2 Entry 12 Register	Section 11.4.1.79
4B4h	Q2E13	Event Queue 2 Entry 13 Register	Section 11.4.1.80

Table 11-25. EDMA3CC Registers (continued)

Offset	Acronym	Register Name	Section
4B8h	Q2E14	Event Queue 2 Entry 14 Register	Section 11.4.1.81
4BCh	Q2E15	Event Queue 2 Entry 15 Register	Section 11.4.1.82
600h to 608h	QSTAT_0 to QSTAT_2	Queue Status Registers 0-2	Section 11.4.1.83
620h	QWMTHRA	Queue Watermark Threshold A Register	Section 11.4.1.84
640h	CCSTAT	EDMA3CC Status Register	Section 11.4.1.85
800h	MPFAR	Memory Protection Fault Address Register	Section 11.4.1.86
804h	MPFSR	Memory Protection Fault Status Register	Section 11.4.1.87
808h	MPFCR	Memory Protection Fault Command Register	Section 11.4.1.88
80Ch	MPPAG	Memory Protection Page Attribute Register Global	Section 11.4.1.89
810h to 82Ch	MPPA_0 to MPPA_7	Memory Protection Page Attribute Registers	Section 11.4.1.90
1000h	ER	Event Register	Section 11.4.1.91
1004h	ERH	Event Register High	Section 11.4.1.92
1008h	ECR	Event Clear Register	Section 11.4.1.93
100Ch	ECRH	Event Clear Register High	Section 11.4.1.94
1010h	ESR	Event Set Register	Section 11.4.1.95
1014h	ESRH	Event Set Register High	Section 11.4.1.96
1018h	CER	Chained Event Register	Section 11.4.1.97
101Ch	CERH	Chained Event Register High	Section 11.4.1.98
1020h	EER	Event Enable Register	Section 11.4.1.99
1024h	EERH	Event Enable Register High	Section 11.4.1.100
1028h	EECR	Event Enable Clear Register	Section 11.4.1.101
102Ch	EECRH	Event Enable Clear Register High	Section 11.4.1.102
1030h	EESR	Event Enable Set Register	Section 11.4.1.103
1034h	EESRH	Event Enable Set Register High	Section 11.4.1.104
1038h	SER	Secondary Event Register	Section 11.4.1.105
103Ch	SERH	Secondary Event Register High	Section 11.4.1.106
1040h	SECR	Secondary Event Clear Register	Section 11.4.1.107
1044h	SECRH	Secondary Event Clear Register High	Section 11.4.1.108
1050h	IER	Interrupt Enable Register	Section 11.4.1.109
1054h	IERH	Interrupt Enable Register High	Section 11.4.1.110
1058h	IECR	Interrupt Enable Clear Register	Section 11.4.1.111
105Ch	IECRH	Interrupt Enable Clear Register High	Section 11.4.1.112
1060h	IESR	Interrupt Enable Set Register	Section 11.4.1.113
1064h	IESRH	Interrupt Enable Set Register High	Section 11.4.1.114
1068h	IPR	Interrupt Pending Register	Section 11.4.1.115
106Ch	IPRH	Interrupt Pending Register High	Section 11.4.1.116
1070h	ICR	Interrupt Clear Register	Section 11.4.1.117
1074h	ICRH	Interrupt Clear Register High	Section 11.4.1.118
1078h	IEVAL	Interrupt Evaluate Register	Section 11.4.1.119
1080h	QER	QDMA Event Register	Section 11.4.1.120
1084h	QEER	QDMA Event Enable Register	Section 11.4.1.121
1088h	QEECR	QDMA Event Enable Clear Register	Section 11.4.1.122
108Ch	QEESR	QDMA Event Enable Set Register	Section 11.4.1.123
1090h	QSER	QDMA Secondary Event Register	Section 11.4.1.124
1094h	QSECR	QDMA Secondary Event Clear Register	Section 11.4.1.125

11.4.1.1 PID Register (offset = 0h) [reset = 0h]

PID is shown in [Figure 13-19](#) and described in [Table 13-14](#).

The peripheral identification register (PID) uniquely identifies the EDMA3CC and the specific revision of the EDMA3CC.

Figure 11-42. PID Register

15	14	13	12	11	10	9	8	7	6	5	4	3	2	1	0
PID															
R-0h															

LEGEND: R/W = Read/Write; R = Read only; W1toCl = Write 1 to clear bit; -n = value after reset

Table 11-26. PID Register Field Descriptions

Bit	Field	Type	Reset	Description
15-0	PID	R	0h	Peripheral identifier uniquely identifies the EDMA3CC and the specific revision of the EDMA3CC. Value 0 to FFFF FFFFh. Reset value for PID[31] to PID[16] is 4001h. Peripheral identifier uniquely identifies the EDMA3CC and the specific revision of the EDMA3CC. Value 0 to FFFF FFFFh. Reset value for PID[15] to PID[0] is 4C00h.

11.4.1.2 CCCFG Register (offset = 4h) [reset = 3224445h]

CCCFG is shown in [Figure 11-43](#) and described in [Table 11-27](#).

The EDMA3CC configuration register (CCCFG) provides the features/resources for the EDMA3CC in a particular device.

Figure 11-43. CCCFG Register

31	30	29	28	27	26	25	24
RESERVED						MP_EXIST	CHMAP_EXIST
R-0h						R-1h	R-1h
23	22	21	20	19	18	17	16
RESERVED		NUM_REGN		RESERVED	NUM_EVQUE		
R-0h		R-2h		R-0h	R-2h		
15	14	13	12	11	10	9	8
RESERVED	NUM_PAENTRY			RESERVED	NUM_INTCH		
R-0h	R-4h			R-0h	R-4h		
7	6	5	4	3	2	1	0
RESERVED	NUM_QDMACH			RESERVED	NUM_DMACH		
R-0h	R-4h			R-0h	R-5h		

LEGEND: R/W = Read/Write; R = Read only; W1toCl = Write 1 to clear bit; -n = value after reset

Table 11-27. CCCFG Register Field Descriptions

Bit	Field	Type	Reset	Description
31-26	RESERVED	R	0h	
25	MP_EXIST	R	1h	Memory protection existence. 0h = Reserved. 1h = Memory protection logic included.
24	CHMAP_EXIST	R	1h	Channel mapping existence. 0h = Reserved. 1h = Channel mapping logic included.
23-22	RESERVED	R	0h	
21-20	NUM_REGN	R	2h	Number of MP and shadow regions. 0h = Reserved. 1h = Reserved 2h = 4 regions. 3h = Reserved.
19	RESERVED	R	0h	
18-16	NUM_EVQUE	R	2h	Number of queues/number of TCs. 0h = Reserved. 1h = Reserved. 2h = 3 EDMA3TCs/Event Queues 3h = Reserved from 3h to 7h. 7h = Reserved.
15	RESERVED	R	0h	
14-12	NUM_PAENTRY	R	4h	Number of PaRAM sets. 0h = Reserved from 0h to 3h. 3h = Reserved 4h = 256 PaRAM sets. 5h = Reserved from 5h to 7h. 7h = Reserved.
11	RESERVED	R	0h	

Table 11-27. CCCFG Register Field Descriptions (continued)

Bit	Field	Type	Reset	Description
10-8	NUM_INTCH	R	4h	Number of interrupt channels. 0h = Reserved from 0h to 3h. 3h = Reserved. 4h = 64 interrupt channels. 5h = Reserved from 5h to 7. 7h = Reserved.
7	RESERVED	R	0h	
6-4	NUM_QDMACH	R	4h	Number of QDMA channels. 0h = Reserved from 0h to 3h. 3h = Reserved. 4h = 8 QDMA channels. 5h = Reserved from 5h to 7. 7h = Reserved.
3	RESERVED	R	0h	
2-0	NUM_DMACH	R	5h	Number of DMA channels. 0h = Reserved from 0h to 4h. 4h = Reserved. 5h = 64 DMA channels. 6h = Reserved. 7h = Reserved.

11.4.1.3 SYSCONFIG Register (offset = 10h) [reset = 8h]

 SYSCONFIG is shown in [Figure 15-4](#) and described in [Table 15-6](#).

The EDMA3CC system configuration register is used for clock management configuration.

Figure 11-44. SYSCONFIG Register

31	30	29	28	27	26	25	24
RESERVED							
R-0h							
23	22	21	20	19	18	17	16
RESERVED							
R-0h							
15	14	13	12	11	10	9	8
RESERVED							
R-0h							
7	6	5	4	3	2	1	0
RESERVED		RESERVED		IDLEMODE		RESERVED	RESERVED
R-0h		R-0h		R/W-2h		R-0h	R-0h

LEGEND: R/W = Read/Write; R = Read only; W1toCl = Write 1 to clear bit; -n = value after reset

Table 11-28. SYSCONFIG Register Field Descriptions

Bit	Field	Type	Reset	Description
31-6	RESERVED	R	0h	
5-4	RESERVED	R	0h	
3-2	IDLEMODE	R/W	2h	Configuration of the local target state management mode. By definition, target can handle read/write transaction as long as it is out of IDLE state. 0h = Force-idle mode: local target's idle state follows (acknowledges) the system's idle requests unconditionally, i.e. regardless of the IP module's internal requirements. Backup mode, for debug only. 1h = No-idle mode: local target never enters idle state. Backup mode, for debug only. 2h = Smart-idle mode: local target's idle state eventually follows (acknowledges) the system's idle requests, depending on the IP module's internal requirements. IP module shall not generate (IRQ- or DMA-request-related) wakeup events. 3h = Smart-idle wakeup-capable mode: local target's idle state eventually follows (acknowledges) the system's idle requests, depending on the IP module's internal requirements. IP module may generate (IRQ- or DMA-request-related) wakeup events when in idle state. Mode is only relevant if the appropriate IP module "swakeup" output(s) is (are) implemented.
1	RESERVED	R	0h	
0	RESERVED	R	0h	

11.4.1.4 DCHMAP_0 to DCHMAP_63 Register (offset = 100h to 1FCh) [reset = 0h]

DCHMAP_0 to DCHMAP_63 is shown in [Figure 11-45](#) and described in [Table 11-29](#).

Figure 11-45. DCHMAP_0 to DCHMAP_63 Register

31	30	29	28	27	26	25	24	23	22	21	20	19	18	17	16
RESERVED															
R-0h															
15	14	13	12	11	10	9	8	7	6	5	4	3	2	1	0
RESERVED		PAENTRY									RESERVED				
R-0h		R/W-0h									R-0h				

LEGEND: R/W = Read/Write; R = Read only; W1toCl = Write 1 to clear bit; -n = value after reset

Table 11-29. DCHMAP_0 to DCHMAP_63 Register Field Descriptions

Bit	Field	Type	Reset	Description
31-14	RESERVED	R	0h	
13-5	PAENTRY	R/W	0h	Points to the PaRAM set number for DMA channel n. Value 0 to FFh.
4-0	RESERVED	R	0h	

11.4.1.5 QCHMAP_0 to QCHMAP_7 Register (offset = 200h to 21Ch) [reset = 0h]

QCHMAP_0 to QCHMAP_7 is shown in [Figure 11-46](#) and described in [Table 11-30](#).

Each QDMA channel in EDMA3CC can be associated with any PaRAM set available on the device. Furthermore, the specific trigger word (0-7) of the PaRAM set can be programmed. The PaRAM set association and trigger word for every QDMA channel register is configurable using the QDMA channel map register (QCHMAPn). At reset the QDMA channel map registers for all QDMA channels point to PaRAM set 0. If an application makes use of both a DMA channel that points to PaRAM set 0 and any QDMA channels, ensure that QCHMAP is programmed appropriately to point to a different PaRAM entry.

Figure 11-46. QCHMAP_0 to QCHMAP_7 Register

31	30	29	28	27	26	25	24
RESERVED							
R-0h							
23	22	21	20	19	18	17	16
RESERVED							
R-0h							
15	14	13	12	11	10	9	8
RESERVED		PAENTRY					
R-0h		R/W-0h					
7	6	5	4	3	2	1	0
PAENTRY			TRWORD			RESERVED	
R/W-0h			R/W-0h			R-0h	

LEGEND: R/W = Read/Write; R = Read only; W1toCl = Write 1 to clear bit; -n = value after reset

Table 11-30. QCHMAP_0 to QCHMAP_7 Register Field Descriptions

Bit	Field	Type	Reset	Description
31-14	RESERVED	R	0h	
13-5	PAENTRY	R/W	0h	PAENTRY points to the PaRAM set number for QDMA channel . 0h = Parameter entry 0 through 255, from 0 to FFh. 1h = Reserved, from 100h to 1FFh. Always write 0 to this bit. Writes of 1 to this bit are not supported and attempts to do so may result in undefine behavior.
4-2	TRWORD	R/W	0h	Points to the specific trigger word of the PaRAM set defined by PAENTRY. A write to the trigger word results in a QDMA event being recognized.
1-0	RESERVED	R	0h	

11.4.1.6 DMAQNUM_0 to DMAQNUM_7 Register (offset = 240h to 25Ch) [reset = 0h]

DMAQNUM_0 to DMAQNUM_7 is shown in [Figure 11-47](#) and described in [Table 11-31](#).

The DMA channel queue number register (DMAQNUMn) allows programmability of each of the 64 DMA channels in the EDMA3CC to submit its associated synchronization event to any event queue in the EDMA3CC. At reset, all channels point to event queue 0. Because the event queues in EDMA3CC have a fixed association to the transfer controllers, that is, Q0 TRs are submitted to TC0, Q1 TRs are submitted to TC1, etc., by programming DMAQNUM for a particular DMA channel also dictates which transfer controller is utilized for the data movement (or which EDMA3TC receives the TR request).

Figure 11-47. DMAQNUM_0 to DMAQNUM_7 Register

31	30	29	28	27	26	25	24
RESERVED	E7			RESERVED	E6		
R-0h	R/W-0h			R-0h	R/W-0h		
23	22	21	20	19	18	17	16
RESERVED	E5			RESERVED	E4		
R-0h	R/W-0h			R-0h	R/W-0h		
15	14	13	12	11	10	9	8
RESERVED	E3			RESERVED	E2		
R-0h	R/W-0h			R-0h	R/W-0h		
7	6	5	4	3	2	1	0
RESERVED	E1			RESERVED	E0		
R-0h	R/W-0h			R-0h	R/W-0h		

LEGEND: R/W = Read/Write; R = Read only; W1toCl = Write 1 to clear bit; -n = value after reset

Table 11-31. DMAQNUM_0 to DMAQNUM_7 Register Field Descriptions

Bit	Field	Type	Reset	Description
31	RESERVED	R	0h	
30-28	E7	R/W	0h	DMA queue number. Contains the event queue number to be used for the corresponding DMA channel. Programming DMAQNUM for an event queue number to a value more than the number of queues available in the EDMA3CC results in undefined behavior. On DMAQNUM0, E[30] to E[28] is E7. On DMAQNUM1, E[30] to E[28] is E15. On DMAQNUM2, E[30] to E[28] is E23. On DMAQNUM3, E[30] to E[28] is E31. On DMAQNUM4, E[30] to E[28] is E39. On DMAQNUM5, E[30] to E[28] is E47. On DMAQNUM6, E[30] to E[28] is E55. On DMAQNUM7, E[30] to E[28] is E63. 0h = Event n is queued on Q0. 1h = Event n is queued on Q1. 2h = Event n is queued on Q2. 3h = Reserved, from 3h to 7h. Always write 0 to this bit; writes of 1 to this bit are not supported and attempts to do so may result in undefined behavior. 7h = Reserved. Always write 0 to this bit; writes of 1 to this bit are not supported and attempts to do so may result in undefined behavior.
27	RESERVED	R	0h	

Table 11-31. DMAQNUM_0 to DMAQNUM_7 Register Field Descriptions (continued)

Bit	Field	Type	Reset	Description
26-24	E6	R/W	0h	<p>DMA queue number. Contains the event queue number to be used for the corresponding DMA channel. Programming DMAQNUM for an event queue number to a value more than the number of queues available in the EDMA3CC results in undefined behavior.</p> <p>On DMAQNUM0, E[26] to E[24] is E6. On DMAQNUM1, E[26] to E[24] is E14. On DMAQNUM2, E[26] to E[24] is E22. On DMAQNUM3, E[26] to E[24] is E30. On DMAQNUM4, E[26] to E[24] is E38. On DMAQNUM5, E[26] to E[24] is E46. On DMAQNUM6, E[26] to E[24] is E54. On DMAQNUM7, E[26] to E[24] is E62.</p> <p>0h = Event n is queued on Q0. 1h = Event n is queued on Q1. 2h = Event n is queued on Q2. 3h = Reserved, from 3h to 7h. Always write 0 to this bit; writes of 1 to this bit are not supported and attempts to do so may result in undefined behavior. 7h = Reserved. Always write 0 to this bit; writes of 1 to this bit are not supported and attempts to do so may result in undefined behavior.</p>
23	RESERVED	R	0h	
22-20	E5	R/W	0h	<p>DMA queue number. Contains the event queue number to be used for the corresponding DMA channel. Programming DMAQNUM for an event queue number to a value more than the number of queues available in the EDMA3CC results in undefined behavior.</p> <p>On DMAQNUM0, E[22] to E[20] is E5. On DMAQNUM1, E[22] to E[20] is E13. On DMAQNUM2, E[22] to E[20] is E21. On DMAQNUM3, E[22] to E[20] is E29. On DMAQNUM4, E[22] to E[20] is E37. On DMAQNUM5, E[22] to E[20] is E45. On DMAQNUM6, E[22] to E[20] is E53. On DMAQNUM7, E[22] to E[20] is E61.</p> <p>0h = Event n is queued on Q0. 1h = Event n is queued on Q1. 2h = Event n is queued on Q2. 3h = Reserved, from 3h to 7h. Always write 0 to this bit; writes of 1 to this bit are not supported and attempts to do so may result in undefined behavior. 7h = Reserved. Always write 0 to this bit; writes of 1 to this bit are not supported and attempts to do so may result in undefined behavior.</p>
19	RESERVED	R	0h	

Table 11-31. DMAQNUM_0 to DMAQNUM_7 Register Field Descriptions (continued)

Bit	Field	Type	Reset	Description
18-16	E4	R/W	0h	DMA queue number. Contains the event queue number to be used for the corresponding DMA channel. Programming DMAQNUM for an event queue number to a value more than the number of queues available in the EDMA3CC results in undefined behavior. On DMAQNUM0, E[18] to E[16] is E4. On DMAQNUM1, E[18] to E[16] is E12. On DMAQNUM2, E[18] to E[16] is E20. On DMAQNUM3, E[18] to E[16] is E28. On DMAQNUM4, E[18] to E[16] is E36. On DMAQNUM5, E[18] to E[16] is E44. On DMAQNUM6, E[18] to E[16] is E52. On DMAQNUM7, E[18] to E[16] is E60. 0h = Event n is queued on Q0. 1h = Event n is queued on Q1. 2h = Event n is queued on Q2. 3h = Reserved, from 3h to 7h. Always write 0 to this bit; writes of 1 to this bit are not supported and attempts to do so may result in undefined behavior. 7h = Reserved. Always write 0 to this bit; writes of 1 to this bit are not supported and attempts to do so may result in undefined behavior.
15	RESERVED	R	0h	
14-12	E3	R/W	0h	DMA queue number. Contains the event queue number to be used for the corresponding DMA channel. Programming DMAQNUM for an event queue number to a value more than the number of queues available in the EDMA3CC results in undefined behavior. On DMAQNUM0, E[14] to E[12] is E3. On DMAQNUM1, E[14] to E[12] is E11. On DMAQNUM2, E[14] to E[12] is E19. On DMAQNUM3, E[14] to E[12] is E27. On DMAQNUM4, E[14] to E[12] is E35. On DMAQNUM5, E[14] to E[12] is E43. On DMAQNUM6, E[14] to E[12] is E51. On DMAQNUM7, E[14] to E[12] is E59. 0h = Event n is queued on Q0. 1h = Event n is queued on Q1. 2h = Event n is queued on Q2. 3h = Reserved, from 3h to 7h. Always write 0 to this bit; writes of 1 to this bit are not supported and attempts to do so may result in undefined behavior. 7h = Reserved. Always write 0 to this bit; writes of 1 to this bit are not supported and attempts to do so may result in undefined behavior.
11	RESERVED	R	0h	

Table 11-31. DMAQNUM_0 to DMAQNUM_7 Register Field Descriptions (continued)

Bit	Field	Type	Reset	Description
10-8	E2	R/W	0h	<p>DMA queue number. Contains the event queue number to be used for the corresponding DMA channel. Programming DMAQNUM for an event queue number to a value more than the number of queues available in the EDMA3CC results in undefined behavior.</p> <p>On DMAQNUM0, E[10] to E[8] is E2. On DMAQNUM1, E[10] to E[8] is E10. On DMAQNUM2, E[10] to E[8] is E18. On DMAQNUM3, E[10] to E[8] is E26. On DMAQNUM4, E[10] to E[8] is E34. On DMAQNUM5, E[10] to E[8] is E42. On DMAQNUM6, E[10] to E[8] is E50. On DMAQNUM7, E[10] to E[8] is E58.</p> <p>0h = Event n is queued on Q0. 1h = Event n is queued on Q1. 2h = Event n is queued on Q2. 3h = Reserved, from 3h to 7h. Always write 0 to this bit; writes of 1 to this bit are not supported and attempts to do so may result in undefined behavior. 7h = Reserved. Always write 0 to this bit; writes of 1 to this bit are not supported and attempts to do so may result in undefined behavior.</p>
7	RESERVED	R	0h	
6-4	E1	R/W	0h	<p>DMA queue number. Contains the event queue number to be used for the corresponding DMA channel. Programming DMAQNUM for an event queue number to a value more than the number of queues available in the EDMA3CC results in undefined behavior.</p> <p>On DMAQNUM0, E[6] to E[4] is E1. On DMAQNUM1, E[6] to E[4] is E9. On DMAQNUM2, E[6] to E[4] is E17. On DMAQNUM3, E[6] to E[4] is E25. On DMAQNUM4, E[6] to E[4] is E33. On DMAQNUM5, E[6] to E[4] is E41. On DMAQNUM6, E[6] to E[4] is E49. On DMAQNUM7, E[6] to E[4] is E57.</p> <p>0h = Event n is queued on Q0. 1h = Event n is queued on Q1. 2h = Event n is queued on Q2. 3h = Reserved, from 3h to 7h. Always write 0 to this bit; writes of 1 to this bit are not supported and attempts to do so may result in undefined behavior. 7h = Reserved. Always write 0 to this bit; writes of 1 to this bit are not supported and attempts to do so may result in undefined behavior.</p>
3	RESERVED	R	0h	

Table 11-31. DMAQNUM_0 to DMAQNUM_7 Register Field Descriptions (continued)

Bit	Field	Type	Reset	Description
2-0	E0	R/W	0h	DMA queue number. Contains the event queue number to be used for the corresponding DMA channel. Programming DMAQNUM for an event queue number to a value more than the number of queues available in the EDMA3CC results in undefined behavior. On DMAQNUM0, E[2] to E[0] is E0. On DMAQNUM1, E[2] to E[0] is E8. On DMAQNUM2, E[2] to E[0] is E16. On DMAQNUM3, E[2] to E[0] is E24. On DMAQNUM4, E[2] to E[0] is E32. On DMAQNUM5, E[2] to E[0] is E40. On DMAQNUM6, E[2] to E[0] is E48. On DMAQNUM7, E[2] to E[0] is E56. 0h = Event n is queued on Q0. 1h = Event n is queued on Q1. 2h = Event n is queued on Q2. 3h = Reserved, from 3h to 7h. Always write 0 to this bit; writes of 1 to this bit are not supported and attempts to do so may result in undefined behavior. 7h = Reserved. Always write 0 to this bit; writes of 1 to this bit are not supported and attempts to do so may result in undefined behavior.

11.4.1.7 QDMAQNUM Register (offset = 260h) [reset = 0h]

QDMAQNUM is shown in [Figure 11-48](#) and described in [Table 11-32](#).

The QDMA channel queue number register (QDMAQNUMn) is used to program all the QDMA channels in the EDMA3CC to submit the associated QDMA event to any of the event queues in the EDMA3CC.

Figure 11-48. QDMAQNUM Register

31	30	29	28	27	26	25	24
RESERVED		E7		RESERVED		E6	
R-0h		R/W-0h		R-0h		R/W-0h	
23	22	21	20	19	18	17	16
RESERVED		E5		RESERVED		E4	
R-0h		R/W-0h		R-0h		R/W-0h	
15	14	13	12	11	10	9	8
RESERVED		E3		RESERVED		E2	
R-0h		R/W-0h		R-0h		R/W-0h	
7	6	5	4	3	2	1	0
RESERVED		E1		RESERVED		E0	
R-0h		R/W-0h		R-0h		R/W-0h	

LEGEND: R/W = Read/Write; R = Read only; W1toCl = Write 1 to clear bit; -n = value after reset

Table 11-32. QDMAQNUM Register Field Descriptions

Bit	Field	Type	Reset	Description
31	RESERVED	R	0h	
30-28	E7	R/W	0h	QDMA queue number. Contains the event queue number to be used for the corresponding QDMA channel. 0h = Event n is queued on Q0. 1h = Event n is queued on Q1. 2h = Event n is queued on Q2. 3h = Reserved, from 3h to 7h. Always write 0 to this bit; writes of 1 to this bit are not supported and attempts to do so may result in undefined behavior. 7h = Reserved. Always write 0 to this bit; writes of 1 to this bit are not supported and attempts to do so may result in undefined behavior.
27	RESERVED	R	0h	
26-24	E6	R/W	0h	QDMA queue number. Contains the event queue number to be used for the corresponding QDMA channel. 0h = Event n is queued on Q0. 1h = Event n is queued on Q1. 2h = Event n is queued on Q2. 3h = Reserved, from 3h to 7h. Always write 0 to this bit; writes of 1 to this bit are not supported and attempts to do so may result in undefined behavior. 7h = Reserved. Always write 0 to this bit; writes of 1 to this bit are not supported and attempts to do so may result in undefined behavior.
23	RESERVED	R	0h	

Table 11-32. QDMAQNUM Register Field Descriptions (continued)

Bit	Field	Type	Reset	Description
22-20	E5	R/W	0h	QDMA queue number. Contains the event queue number to be used for the corresponding QDMA channel. 0h = Event n is queued on Q0. 1h = Event n is queued on Q1. 2h = Event n is queued on Q2. 3h = Reserved, from 3h to 7h. Always write 0 to this bit; writes of 1 to this bit are not supported and attempts to do so may result in undefined behavior. 7h = Reserved. Always write 0 to this bit; writes of 1 to this bit are not supported and attempts to do so may result in undefined behavior.
19	RESERVED	R	0h	
18-16	E4	R/W	0h	QDMA queue number. Contains the event queue number to be used for the corresponding QDMA channel. 0h = Event n is queued on Q0. 1h = Event n is queued on Q1. 2h = Event n is queued on Q2. 3h = Reserved, from 3h to 7h. Always write 0 to this bit; writes of 1 to this bit are not supported and attempts to do so may result in undefined behavior. 7h = Reserved. Always write 0 to this bit; writes of 1 to this bit are not supported and attempts to do so may result in undefined behavior.
15	RESERVED	R	0h	
14-12	E3	R/W	0h	QDMA queue number. Contains the event queue number to be used for the corresponding QDMA channel. 0h = Event n is queued on Q0. 1h = Event n is queued on Q1. 2h = Event n is queued on Q2. 3h = Reserved, from 3h to 7h. Always write 0 to this bit; writes of 1 to this bit are not supported and attempts to do so may result in undefined behavior. 7h = Reserved. Always write 0 to this bit; writes of 1 to this bit are not supported and attempts to do so may result in undefined behavior.
11	RESERVED	R	0h	
10-8	E2	R/W	0h	QDMA queue number. Contains the event queue number to be used for the corresponding QDMA channel. 0h = Event n is queued on Q0. 1h = Event n is queued on Q1. 2h = Event n is queued on Q2. 3h = Reserved, from 3h to 7h. Always write 0 to this bit; writes of 1 to this bit are not supported and attempts to do so may result in undefined behavior. 7h = Reserved. Always write 0 to this bit; writes of 1 to this bit are not supported and attempts to do so may result in undefined behavior.
7	RESERVED	R	0h	

Table 11-32. QDMAQNUM Register Field Descriptions (continued)

Bit	Field	Type	Reset	Description
6-4	E1	R/W	0h	QDMA queue number. Contains the event queue number to be used for the corresponding QDMA channel. 0h = Event n is queued on Q0. 1h = Event n is queued on Q1. 2h = Event n is queued on Q2. 3h = Reserved, from 3h to 7h. Always write 0 to this bit; writes of 1 to this bit are not supported and attempts to do so may result in undefined behavior. 7h = Reserved. Always write 0 to this bit; writes of 1 to this bit are not supported and attempts to do so may result in undefined behavior.
3	RESERVED	R	0h	
2-0	E0	R/W	0h	QDMA queue number. Contains the event queue number to be used for the corresponding QDMA channel. 0h = Event n is queued on Q0. 1h = Event n is queued on Q1. 2h = Event n is queued on Q2. 3h = Reserved, from 3h to 7h. Always write 0 to this bit; writes of 1 to this bit are not supported and attempts to do so may result in undefined behavior. 7h = Reserved. Always write 0 to this bit; writes of 1 to this bit are not supported and attempts to do so may result in undefined behavior.

11.4.1.8 QUEPRI Register (offset = 284h) [reset = 777h]

QUEPRI is shown in [Figure 11-49](#) and described in [Table 11-33](#).

The queue priority register (QUEPRI) allows you to change the priority of the individual queues and the priority of the transfer request (TR) associated with the events queued in the queue. Because the queue to EDMA3TC mapping is fixed, programming QUEPRI essentially governs the priority of the associated transfer controller(s) read/write commands with respect to the other bus masters in the device. You can modify the EDMA3TC priority to obtain the desired system performance.

Figure 11-49. QUEPRI Register

31	30	29	28	27	26	25	24
RESERVED							
R-0h							
23	22	21	20	19	18	17	16
RESERVED							
R-0h							
15	14	13	12	11	10	9	8
RESERVED						PRIQ2	
R-0h						R/W-7h	
7	6	5	4	3	2	1	0
RESERVED	PRIQ1			RESERVED	PRIQ0		
R-0h	R/W-7h			R-0h	R/W-7h		

LEGEND: R/W = Read/Write; R = Read only; W1toCl = Write 1 to clear bit; -n = value after reset

Table 11-33. QUEPRI Register Field Descriptions

Bit	Field	Type	Reset	Description
31-11	RESERVED	R	0h	
10-8	PRIQ2	R/W	7h	Priority level for queue 2. Dictates the priority level used by TC2 relative to other masters in the device. A value of 0 means highest priority and a value of 7 means lowest priority.
7	RESERVED	R	0h	
6-4	PRIQ1	R/W	7h	Priority level for queue 1. Dictates the priority level used by TC1 relative to other masters in the device. A value of 0 means highest priority and a value of 7 means lowest priority.
3	RESERVED	R	0h	
2-0	PRIQ0	R/W	7h	Priority level for queue 0. Dictates the priority level used by TC0 relative to other masters in the device. A value of 0 means highest priority and a value of 7 means lowest priority.

11.4.1.9 EMR Register (offset = 300h) [reset = 0h]

EMR is shown in [Figure 11-50](#) and described in [Table 11-34](#).

For a particular DMA channel, if a second event is received prior to the first event getting cleared/serviced, the bit corresponding to that channel is set/asserted in the event missed registers (EMR/EMRH). All trigger types are treated individually, that is, manual triggered (ESR/ESRH), chain triggered (CER/CERH), and event triggered (ER/ERH) are all treated separately. The EMR/EMRH bits for a channel are also set if an event on that channel encounters a NULL entry (or a NULL TR is serviced). If any EMR/EMRH bit is set (and all errors, including bits in other error registers (QEMR, CCERR) were previously cleared), the EDMA3CC generates an error interrupt. For details on EDMA3CC error interrupt generation, see Error Interrupts. This register is part of a set of registers that provide information on missed DMA and/or QDMA events, and instances when event queue thresholds are exceeded. If any of the bits in these registers is set, it results in the EDMA3CC generating an error interrupt.

Figure 11-50. EMR Register

31	30	29	28	27	26	25	24	23	22	21	20	19	18	17	16	15	14	13	12	11	10	9	8	7	6	5	4	3	2	1	0
En																															
R-0h																															

LEGEND: R/W = Read/Write; R = Read only; W1toCl = Write 1 to clear bit; -n = value after reset

Table 11-34. EMR Register Field Descriptions

Bit	Field	Type	Reset	Description
31-0	En	R	0h	Channel 0 to 31 event missed. En is cleared by writing a 1 to the corresponding bit in the event missed clear register (EMCR). 0h = No missed event. 1h = Missed event occurred.

11.4.1.10 EMRH Register (offset = 304h) [reset = 0h]

EMRH is shown in [Figure 11-51](#) and described in [Table 11-35](#).

For a particular DMA channel, if a second event is received prior to the first event getting cleared/serviced, the bit corresponding to that channel is set/asserted in the event missed registers (EMR/EMRH). All trigger types are treated individually, that is, manual triggered (ESR/ESRH), chain triggered (CER/CERH), and event triggered (ER/ERH) are all treated separately. The EMR/EMRH bits for a channel are also set if an event on that channel encounters a NULL entry (or a NULL TR is serviced). If any EMR/EMRH bit is set (and all errors, including bits in other error registers (QEMR, CCERR) were previously cleared), the EDMA3CC generates an error interrupt. For details on EDMA3CC error interrupt generation, see Error Interrupts. This register is part of a set of registers that provide information on missed DMA and/or QDMA events, and instances when event queue thresholds are exceeded. If any of the bits in these registers is set, it results in the EDMA3CC generating an error interrupt.

Figure 11-51. EMRH Register

31	30	29	28	27	26	25	24	23	22	21	20	19	18	17	16	15	14	13	12	11	10	9	8	7	6	5	4	3	2	1	0
En																															
R-0h																															

LEGEND: R/W = Read/Write; R = Read only; W1toCl = Write 1 to clear bit; -n = value after reset

Table 11-35. EMRH Register Field Descriptions

Bit	Field	Type	Reset	Description
31-0	En	R	0h	Channel 32 to 63 event missed. En is cleared by writing a 1 to the corresponding bit in the event missed clear register high (EMCRH). 0h = No missed event. 1h = Missed event occurred.

11.4.1.11 EMCR Register (offset = 308h) [reset = 0h]

EMCR is shown in [Figure 11-52](#) and described in [Table 11-36](#).

Once a missed event is posted in the event missed registers (EMR/EMRH), the bit remains set and you need to clear the set bit(s). This is done by way of CPU writes to the event missed clear registers (EMCR/EMCRH). Writing a 1 to any of the bits clears the corresponding missed event (bit) in EMR/EMRH; writing a 0 has no effect. This register is part of a set of registers that provide information on missed DMA and/or QDMA events, and instances when event queue thresholds are exceeded. If any of the bits in these registers is set, it results in the EDMA3CC generating an error interrupt.

Figure 11-52. EMCR Register

31	30	29	28	27	26	25	24	23	22	21	20	19	18	17	16	15	14	13	12	11	10	9	8	7	6	5	4	3	2	1	0
En																															
W-0h																															

LEGEND: R/W = Read/Write; R = Read only; W1toCl = Write 1 to clear bit; -n = value after reset

Table 11-36. EMCR Register Field Descriptions

Bit	Field	Type	Reset	Description
31-0	En	W	0h	Event missed 0 to 31 clear. All error bits must be cleared before additional error interrupts will be asserted by the EDMA3CC. 0h = No effect. 1h = Corresponding missed event bit in the event missed register (EMR) is cleared (En = 0).

11.4.1.12 EMCRH Register (offset = 30Ch) [reset = 0h]

EMCRH is shown in [Figure 11-53](#) and described in [Table 11-37](#).

Once a missed event is posted in the event missed registers (EMR/EMRH), the bit remains set and you need to clear the set bit(s). This is done by way of CPU writes to the event missed clear registers (EMCR/EMCRH). Writing a 1 to any of the bits clears the corresponding missed event (bit) in EMR/EMRH; writing a 0 has no effect. This register is part of a set of registers that provide information on missed DMA and/or QDMA events, and instances when event queue thresholds are exceeded. If any of the bits in these registers is set, it results in the EDMA3CC generating an error interrupt.

Figure 11-53. EMCRH Register

31	30	29	28	27	26	25	24	23	22	21	20	19	18	17	16	15	14	13	12	11	10	9	8	7	6	5	4	3	2	1	0
En																															
W-0h																															

LEGEND: R/W = Read/Write; R = Read only; W1toCl = Write 1 to clear bit; -n = value after reset

Table 11-37. EMCRH Register Field Descriptions

Bit	Field	Type	Reset	Description
31-0	En	W	0h	Event missed 32 to 63 clear. All error bits must be cleared before additional error interrupts will be asserted by the EDMA3CC. 0h = No effect. 1h = Corresponding missed event bit in the event missed register high (EMRH) is cleared (En = 0).

11.4.1.13 QEMR Register (offset = 310h) [reset = 0h]

QEMR is shown in [Figure 11-54](#) and described in [Table 11-38](#).

For a particular QDMA channel, if two QDMA events are detected without the first event getting cleared/serviced, the bit corresponding to that channel is set/asserted in the QDMA event missed register (QEMR). The QEMR bits for a channel are also set if a QDMA event on the channel encounters a NULL entry (or a NULL TR is serviced). If any QEMR bit is set (and all errors, including bits in other error registers (EMR/EMRH, CCERR) were previously cleared), the EDMA3CC generates an error interrupt. For details on EDMA3CC error interrupt generation, see Error Interrupts. This register is part of a set of registers that provide information on missed DMA and/or QDMA events, and instances when event queue thresholds are exceeded. If any of the bits in these registers is set, it results in the EDMA3CC generating an error interrupt.

Figure 11-54. QEMR Register

31	30	29	28	27	26	25	24	23	22	21	20	19	18	17	16	15	14	13	12	11	10	9	8	7	6	5	4	3	2	1	0
RESERVED																								En							
R-0h																								R-0h							

LEGEND: R/W = Read/Write; R = Read only; W1toCl = Write 1 to clear bit; -n = value after reset

Table 11-38. QEMR Register Field Descriptions

Bit	Field	Type	Reset	Description
31-8	RESERVED	R	0h	
7-0	En	R	0h	Channel 0 to 7 QDMA event missed. En is cleared by writing a 1 to the corresponding bit in the QDMA event missed clear register (QEMCR). 0h = No missed event. 1h = Missed event occurred.

11.4.1.14 QEMCR Register (offset = 314h) [reset = 0h]

QEMCR is shown in [Figure 11-55](#) and described in [Table 11-39](#).

Once a missed event is posted in the QDMA event missed registers (QEMR), the bit remains set and you need to clear the set bit(s). This is done by way of CPU writes to the QDMA event missed clear registers (QEMCR). Writing a 1 to any of the bits clears the corresponding missed event (bit) in QEMR; writing a 0 has no effect. This register is part of a set of registers that provide information on missed DMA and/or QDMA events, and instances when event queue thresholds are exceeded. If any of the bits in these registers is set, it results in the EDMA3CC generating an error interrupt.

Figure 11-55. QEMCR Register

31	30	29	28	27	26	25	24	23	22	21	20	19	18	17	16	15	14	13	12	11	10	9	8	7	6	5	4	3	2	1	0
RESERVED														En																	
R-0h														W-0h																	

LEGEND: R/W = Read/Write; R = Read only; W1toCl = Write 1 to clear bit; -n = value after reset

Table 11-39. QEMCR Register Field Descriptions

Bit	Field	Type	Reset	Description
31-8	RESERVED	R	0h	
7-0	En	W	0h	QDMA event missed clear. All error bits must be cleared before additional error interrupts will be asserted by the EDMA3CC. 0h = No effect. 1h = Corresponding missed event bit in the QDMA event missed register (QEMR) is cleared (En= 0).

11.4.1.15 CCERR Register (offset = 318h) [reset = 0h]

CCERR is shown in [Figure 11-56](#) and described in [Table 11-40](#).

The EDMA3CC error register (CCERR) indicates whether or not at any instant of time the number of events queued up in any of the event queues exceeds or equals the threshold/watermark value that is set in the queue watermark threshold register (QWMTHRA). Additionally, CCERR also indicates if when the number of outstanding TRs that have been programmed to return transfer completion code (TRs which have the TCINTEN or TCCHEN bit in OPT set) to the EDMA3CC has exceeded the maximum allowed value of 63. If any bit in CCERR is set (and all errors, including bits in other error registers (EMR/EMRH, QEMR) were previously cleared), the EDMA3CC generates an error interrupt. For details on EDMA3CC error interrupt generation, see Error Interrupts. Once the error bits are set in CCERR, they can only be cleared by writing to the corresponding bits in the EDMA3CC error clear register (CCERRCLR). This register is part of a set of registers that provide information on missed DMA and/or QDMA events, and instances when event queue thresholds are exceeded. If any of the bits in these registers is set, it results in the EDMA3CC generating an error interrupt.

Figure 11-56. CCERR Register

31	30	29	28	27	26	25	24
RESERVED							
R-0h							
23	22	21	20	19	18	17	16
RESERVED							TCCERR
R-0h							R-0h
15	14	13	12	11	10	9	8
RESERVED							
R-0h							
7	6	5	4	3	2	1	0
RESERVED					QTHRXC2	QTHRXC1	QTHRXC0
R-0h					R-0h	R-0h	R-0h

LEGEND: R/W = Read/Write; R = Read only; W1toCl = Write 1 to clear bit; -n = value after reset

Table 11-40. CCERR Register Field Descriptions

Bit	Field	Type	Reset	Description
31-17	RESERVED	R	0h	
16	TCCERR	R	0h	Transfer completion code error. TCCERR is cleared by writing a 1 to the corresponding bit in the EDMA3CC error clear register (CCERRCLR). 0h = Total number of allowed TCCs outstanding has not been reached. 1h = Total number of allowed TCCs has been reached.
15-3	RESERVED	R	0h	
2	QTHRXC2	R	0h	Queue threshold error for queue 2. QTHRXC2 is cleared by writing a 1 to the corresponding bit in the EDMA3CC error clear register (CCERRCLR). 0h = Watermark/threshold has not been exceeded. 1h = Watermark/threshold has been exceeded.
1	QTHRXC1	R	0h	Queue threshold error for queue 1. QTHRXC1 is cleared by writing a 1 to the corresponding bit in the EDMA3CC error clear register (CCERRCLR). 0h = Watermark/threshold has not been exceeded. 1h = Watermark/threshold has been exceeded.
0	QTHRXC0	R	0h	Queue threshold error for queue 0. QTHRXC0 is cleared by writing a 1 to the corresponding bit in the EDMA3CC error clear register (CCERRCLR). 0h = Watermark/threshold has not been exceeded. 1h = Watermark/threshold has been exceeded.

11.4.1.16 CCERRCLR Register (offset = 31Ch) [reset = 0h]

CCERRCLR is shown in [Figure 11-57](#) and described in [Table 11-41](#).

The EDMA3CC error clear register (CCERRCLR) is used to clear any error bits that are set in the EDMA3CC error register (CCERR). In addition, CCERRCLR also clears the values of some bit fields in the queue status registers (QSTATn) associated with a particular event queue. Writing a 1 to any of the bits clears the corresponding bit in CCERR; writing a 0 has no effect. This register is part of a set of registers that provide information on missed DMA and/or QDMA events, and instances when event queue thresholds are exceeded. If any of the bits in these registers is set, it results in the EDMA3CC generating an error interrupt.

Figure 11-57. CCERRCLR Register

31	30	29	28	27	26	25	24
RESERVED							
R-0h							
23	22	21	20	19	18	17	16
RESERVED							TCCERR
R-0h							W-0h
15	14	13	12	11	10	9	8
RESERVED							
R-0h							
7	6	5	4	3	2	1	0
RESERVED					QTHRCD2	QTHRCD1	QTHRCD0
R-0h					W-0h	W-0h	W-0h

LEGEND: R/W = Read/Write; R = Read only; W1toCl = Write 1 to clear bit; -n = value after reset

Table 11-41. CCERRCLR Register Field Descriptions

Bit	Field	Type	Reset	Description
31-17	RESERVED	R	0h	
16	TCCERR	W	0h	Transfer completion code error clear. 0h = No effect. 1h = Clears the TCCERR bit in the EDMA3CC error register (CCERR).
15-3	RESERVED	R	0h	
2	QTHRCD2	W	0h	Queue threshold error clear for queue 2. 0h = No effect. 1h = Clears the QTHRCD2 bit in the EDMA3CC error register (CCERR) and the WM and THRXCD bits in the queue status register 2 (QSTAT2).
1	QTHRCD1	W	0h	Queue threshold error clear for queue 1. 0h = No effect. 1h = Clears the QTHRCD1 bit in the EDMA3CC error register (CCERR) and the WM and THRXCD bits in the queue status register 1 (QSTAT1).
0	QTHRCD0	W	0h	Queue threshold error clear for queue 0. 0h = No effect. 1h = Clears the QTHRCD0 bit in the EDMA3CC error register (CCERR) and the WM and THRXCD bits in the queue status register 0 (QSTAT0).

11.4.1.17 EEVAL Register (offset = 320h) [reset = 0h]

EEVAL is shown in [Figure 11-58](#) and described in [Table 11-42](#).

The EDMA3CC error interrupt is asserted whenever an error bit is set in any of the error registers (EMR/EMRH, QEMR, and CCERR). For subsequent error bits that get set, the EDMA3CC error interrupt is reasserted only when transitioning from an all the error bits cleared to at least one error bit is set. Alternatively, a CPU write of 1 to the EVAL bit in the error evaluation register (EEVAL) results in reasserting the EDMA3CC error interrupt, if there are any outstanding error bits set due to subsequent error conditions. Writes of 0 have no effect. This register is part of a set of registers that provide information on missed DMA and/or QDMA events, and instances when event queue thresholds are exceeded. If any of the bits in these registers is set, it results in the EDMA3CC generating an error interrupt.

Figure 11-58. EEVAL Register

31	30	29	28	27	26	25	24
RESERVED							
R-0h							
23	22	21	20	19	18	17	16
RESERVED							
R-0h							
15	14	13	12	11	10	9	8
RESERVED							
R-0h							
7	6	5	4	3	2	1	0
RESERVED						RESERVED	EVAL
R-0h						R-0h	W-0h

LEGEND: R/W = Read/Write; R = Read only; W1toCl = Write 1 to clear bit; -n = value after reset

Table 11-42. EEVAL Register Field Descriptions

Bit	Field	Type	Reset	Description
31-2	RESERVED	R	0h	
1	RESERVED	R	0h	
0	EVAL	W	0h	Error interrupt evaluate. 0h = No effect. 1h = Write 1 to clear interrupts when all error registers have been cleared. EDMA3CC error interrupt will remain if any errors have not been cleared in any of the error registers (EMR/EMRH, CCERR, QEMR)

11.4.1.18 DRAE0 Register (offset = 340h) [reset = 0h]

DRAE0 is shown in [Figure 11-59](#) and described in [Table 11-43](#).

The DMA region access enable register for shadow region 0 is programmed to allow or disallow read/write accesses on a bit-by-bit bases for all DMA registers in the shadow region 0 view of the DMA channel registers. Additionally, the DRAE0 configuration determines completion of which DMA channels will result in assertion of the shadow region 0 DMA completion interrupt. The DRAE registers are part of the group of the region access enable registers, which includes DRAEm and QRAEm. Where m is the number of shadow regions in the EDMA3CC memory map for a device. You can configure these registers to assign ownership of DMA/QDMA channels to a particular shadow region.

Figure 11-59. DRAE0 Register

31	30	29	28	27	26	25	24	23	22	21	20	19	18	17	16	15	14	13	12	11	10	9	8	7	6	5	4	3	2	1	0
En																															
R/W-0h																															

LEGEND: R/W = Read/Write; R = Read only; W1toCl = Write 1 to clear bit; -n = value after reset

Table 11-43. DRAE0 Register Field Descriptions

Bit	Field	Type	Reset	Description
31-0	En	R/W	0h	DMA region access enable for bit 31 to 0 in region 0. 0h = Accesses via region 0 address space to bit 31 to 0 in any DMA channel register are not allowed. Reads return 0 on bit n and writes do not modify the state of bit 31 to 0. Enabled interrupt bits for bit n do not contribute to the generation of a transfer completion interrupt for shadow region 0. 1h = Accesses via region 0 address space to bit 31 to 0 in any DMA channel register are allowed. Reads return the value from bit n and writes modify the state of bit 31 to 0. Enabled interrupt bits for bit n contribute to the generation of a transfer completion interrupt for shadow region 0.

11.4.1.19 DRAEH0 Register (offset = 344h) [reset = 0h]

DRAEH0 is shown in [Figure 11-60](#) and described in [Table 11-44](#).

The DMA region access enable register for shadow region 0 is programmed to allow or disallow read/write accesses on a bit-by-bit bases for all DMA registers in the shadow region 0 view of the DMA channel registers. Additionally, the DRAE0 configuration determines completion of which DMA channels will result in assertion of the shadow region 0 DMA completion interrupt. The DRAE registers are part of the group of the region access enable registers, which includes DRAEm and QRAEm. Where m is the number of shadow regions in the EDMA3CC memory map for a device. You can configure these registers to assign ownership of DMA/QDMA channels to a particular shadow region.

Figure 11-60. DRAEH0 Register

31	30	29	28	27	26	25	24	23	22	21	20	19	18	17	16	15	14	13	12	11	10	9	8	7	6	5	4	3	2	1	0
En																															
R/W-0h																															

LEGEND: R/W = Read/Write; R = Read only; W1toCl = Write 1 to clear bit; -n = value after reset

Table 11-44. DRAEH0 Register Field Descriptions

Bit	Field	Type	Reset	Description
31-0	En	R/W	0h	DMA region access enable for bit 63 to 32 in region 0. 0h = Accesses via region 0 address space to bit 63 to 32 in any DMA channel register are not allowed. Reads return 0 on bit n and writes do not modify the state of bit 63 to 32. Enabled interrupt bits for bit 31 to 0 do not contribute to the generation of a transfer completion interrupt for shadow region 0. 1h = Accesses via region 0 address space to bit 63 to 32 in any DMA channel register are allowed. Reads return the value from bit n and writes modify the state of bit 63 to 32. Enabled interrupt bits for bit 31 to 0 contribute to the generation of a transfer completion interrupt for shadow region 0.

11.4.1.20 DRAE1 Register (offset = 348h) [reset = 0h]

DRAE1 is shown in [Figure 11-61](#) and described in [Table 11-45](#).

The DMA region access enable register for shadow region 1 is programmed to allow or disallow read/write accesses on a bit-by-bit bases for all DMA registers in the shadow region 1 view of the DMA channel registers. Additionally, the DRAE1 configuration determines completion of which DMA channels will result in assertion of the shadow region 1 DMA completion interrupt. The DRAE registers are part of the group of the region access enable registers, which includes DRAEm and QRAEm. Where m is the number of shadow regions in the EDMA3CC memory map for a device. You can configure these registers to assign ownership of DMA/QDMA channels to a particular shadow region.

Figure 11-61. DRAE1 Register

31	30	29	28	27	26	25	24	23	22	21	20	19	18	17	16	15	14	13	12	11	10	9	8	7	6	5	4	3	2	1	0
En																															
R/W-0h																															

LEGEND: R/W = Read/Write; R = Read only; W1toCl = Write 1 to clear bit; -n = value after reset

Table 11-45. DRAE1 Register Field Descriptions

Bit	Field	Type	Reset	Description
31-0	En	R/W	0h	DMA region access enable for bit 31 to 0 in region 1. 0h = Accesses via region 1 address space to bit 31 to 0 in any DMA channel register are not allowed. Reads return 0 on bit n and writes do not modify the state of bit 31 to 0. Enabled interrupt bits for bit n do not contribute to the generation of a transfer completion interrupt for shadow region 1. 1h = Accesses via region 1 address space to bit 31 to 0 in any DMA channel register are allowed. Reads return the value from bit n and writes modify the state of bit 31 to 0. Enabled interrupt bits for bit n contribute to the generation of a transfer completion interrupt for shadow region 1.

11.4.1.21 DRAEH1 Register (offset = 34Ch) [reset = 0h]

DRAEH1 is shown in [Figure 11-62](#) and described in [Table 11-46](#).

The DMA region access enable register for shadow region 1 is programmed to allow or disallow read/write accesses on a bit-by-bit bases for all DMA registers in the shadow region 1 view of the DMA channel registers. Additionally, the DRAE1 configuration determines completion of which DMA channels will result in assertion of the shadow region 1 DMA completion interrupt. The DRAE registers are part of the group of the region access enable registers, which includes DRAEm and QRAEm. Where m is the number of shadow regions in the EDMA3CC memory map for a device. You can configure these registers to assign ownership of DMA/QDMA channels to a particular shadow region.

Figure 11-62. DRAEH1 Register

31	30	29	28	27	26	25	24	23	22	21	20	19	18	17	16	15	14	13	12	11	10	9	8	7	6	5	4	3	2	1	0
En																															
R/W-0h																															

LEGEND: R/W = Read/Write; R = Read only; W1toCl = Write 1 to clear bit; -n = value after reset

Table 11-46. DRAEH1 Register Field Descriptions

Bit	Field	Type	Reset	Description
31-0	En	R/W	0h	DMA region access enable for bit 63 to 32 in region 1. 0h = Accesses via region 1 address space to bit 63 to 32 in any DMA channel register are not allowed. Reads return 0 on bit n and writes do not modify the state of bit 63 to 32. Enabled interrupt bits for bit 31 to 0 do not contribute to the generation of a transfer completion interrupt for shadow region 1. 1h = Accesses via region 1 address space to bit 63 to 32 in any DMA channel register are allowed. Reads return the value from bit n and writes modify the state of bit 63 to 32. Enabled interrupt bits for bit 31 to 0 contribute to the generation of a transfer completion interrupt for shadow region 1.

11.4.1.22 DRAE2 Register (offset = 350h) [reset = 0h]

DRAE2 is shown in [Figure 11-63](#) and described in [Table 11-47](#).

The DMA region access enable register for shadow region 2 is programmed to allow or disallow read/write accesses on a bit-by-bit bases for all DMA registers in the shadow region 2 view of the DMA channel registers. Additionally, the DRAE2 configuration determines completion of which DMA channels will result in assertion of the shadow region 2 DMA completion interrupt. The DRAE registers are part of the group of the region access enable registers, which includes DRAEm and QRAEm. Where m is the number of shadow regions in the EDMA3CC memory map for a device. You can configure these registers to assign ownership of DMA/QDMA channels to a particular shadow region.

Figure 11-63. DRAE2 Register

31	30	29	28	27	26	25	24	23	22	21	20	19	18	17	16	15	14	13	12	11	10	9	8	7	6	5	4	3	2	1	0
En																															
R/W-0h																															

LEGEND: R/W = Read/Write; R = Read only; W1toCl = Write 1 to clear bit; -n = value after reset

Table 11-47. DRAE2 Register Field Descriptions

Bit	Field	Type	Reset	Description
31-0	En	R/W	0h	DMA region access enable for bit 31 to 0 in region 2. 0h = Accesses via region 2 address space to bit 31 to 0 in any DMA channel register are not allowed. Reads return 0 on bit n and writes do not modify the state of bit 31 to 0. Enabled interrupt bits for bit n do not contribute to the generation of a transfer completion interrupt for shadow region 2. 1h = Accesses via region 2 address space to bit 31 to 0 in any DMA channel register are allowed. Reads return the value from bit n and writes modify the state of bit 31 to 0. Enabled interrupt bits for bit n contribute to the generation of a transfer completion interrupt for shadow region 2.

11.4.1.23 DRAEH2 Register (offset = 354h) [reset = 0h]

DRAEH2 is shown in [Figure 11-64](#) and described in [Table 11-48](#).

The DMA region access enable register for shadow region 2 is programmed to allow or disallow read/write accesses on a bit-by-bit bases for all DMA registers in the shadow region 2 view of the DMA channel registers. Additionally, the DRAE2 configuration determines completion of which DMA channels will result in assertion of the shadow region 2 DMA completion interrupt. The DRAE registers are part of the group of the region access enable registers, which includes DRAEm and QRAEm. Where m is the number of shadow regions in the EDMA3CC memory map for a device. You can configure these registers to assign ownership of DMA/QDMA channels to a particular shadow region.

Figure 11-64. DRAEH2 Register

31	30	29	28	27	26	25	24	23	22	21	20	19	18	17	16	15	14	13	12	11	10	9	8	7	6	5	4	3	2	1	0
En																															
R/W-0h																															

LEGEND: R/W = Read/Write; R = Read only; W1toCl = Write 1 to clear bit; -n = value after reset

Table 11-48. DRAEH2 Register Field Descriptions

Bit	Field	Type	Reset	Description
31-0	En	R/W	0h	DMA region access enable for bit 63 to 32 in region 2. 0h = Accesses via region 2 address space to bit 63 to 32 in any DMA channel register are not allowed. Reads return 0 on bit n and writes do not modify the state of bit 63 to 32. Enabled interrupt bits for bit 31 to 0 do not contribute to the generation of a transfer completion interrupt for shadow region 2. 1h = Accesses via region 2 address space to bit 63 to 32 in any DMA channel register are allowed. Reads return the value from bit n and writes modify the state of bit 63 to 32. Enabled interrupt bits for bit 31 to 0 contribute to the generation of a transfer completion interrupt for shadow region 2.

11.4.1.24 DRAE3 Register (offset = 358h) [reset = 0h]

DRAE3 is shown in [Figure 11-65](#) and described in [Table 11-49](#).

The DMA region access enable register for shadow region 3 is programmed to allow or disallow read/write accesses on a bit-by-bit bases for all DMA registers in the shadow region 3 view of the DMA channel registers. Additionally, the DRAE3 configuration determines completion of which DMA channels will result in assertion of the shadow region 3 DMA completion interrupt. The DRAE registers are part of the group of the region access enable registers, which includes DRAEm and QRAEm. Where m is the number of shadow regions in the EDMA3CC memory map for a device. You can configure these registers to assign ownership of DMA/QDMA channels to a particular shadow region.

Figure 11-65. DRAE3 Register

31	30	29	28	27	26	25	24	23	22	21	20	19	18	17	16	15	14	13	12	11	10	9	8	7	6	5	4	3	2	1	0
En																															
R/W-0h																															

LEGEND: R/W = Read/Write; R = Read only; W1toCl = Write 1 to clear bit; -n = value after reset

Table 11-49. DRAE3 Register Field Descriptions

Bit	Field	Type	Reset	Description
31-0	En	R/W	0h	DMA region access enable for bit 31 to 0 in region 3. 0h = Accesses via region 3 address space to bit 31 to 0 in any DMA channel register are not allowed. Reads return 0 on bit n and writes do not modify the state of bit 31 to 0. Enabled interrupt bits for bit n do not contribute to the generation of a transfer completion interrupt for shadow region 3. 1h = Accesses via region 3 address space to bit 31 to 0 in any DMA channel register are allowed. Reads return the value from bit n and writes modify the state of bit 31 to 0. Enabled interrupt bits for bit n contribute to the generation of a transfer completion interrupt for shadow region 3.

11.4.1.25 DRAEH3 Register (offset = 35Ch) [reset = 0h]

DRAEH3 is shown in [Figure 11-66](#) and described in [Table 11-50](#).

The DMA region access enable register for shadow region 3 is programmed to allow or disallow read/write accesses on a bit-by-bit bases for all DMA registers in the shadow region 3 view of the DMA channel registers. Additionally, the DRAE3 configuration determines completion of which DMA channels will result in assertion of the shadow region 3 DMA completion interrupt. The DRAE registers are part of the group of the region access enable registers, which includes DRAEm and QRAEm. Where m is the number of shadow regions in the EDMA3CC memory map for a device. You can configure these registers to assign ownership of DMA/QDMA channels to a particular shadow region.

Figure 11-66. DRAEH3 Register

31	30	29	28	27	26	25	24	23	22	21	20	19	18	17	16	15	14	13	12	11	10	9	8	7	6	5	4	3	2	1	0
En																															
R/W-0h																															

LEGEND: R/W = Read/Write; R = Read only; W1toCl = Write 1 to clear bit; -n = value after reset

Table 11-50. DRAEH3 Register Field Descriptions

Bit	Field	Type	Reset	Description
31-0	En	R/W	0h	DMA region access enable for bit 63 to 32 in region 3. 0h = Accesses via region 3 address space to bit 63 to 32 in any DMA channel register are not allowed. Reads return 0 on bit n and writes do not modify the state of bit 63 to 32. Enabled interrupt bits for bit 31 to 0 do not contribute to the generation of a transfer completion interrupt for shadow region 3. 1h = Accesses via region 3 address space to bit 63 to 32 in any DMA channel register are allowed. Reads return the value from bit n and writes modify the state of bit 63 to 32. Enabled interrupt bits for bit 31 to 0 contribute to the generation of a transfer completion interrupt for shadow region 3.

11.4.1.26 DRAE4 Register (offset = 360h) [reset = 0h]

DRAE4 is shown in [Figure 11-67](#) and described in [Table 11-51](#).

The DMA region access enable register for shadow region 4 is programmed to allow or disallow read/write accesses on a bit-by-bit bases for all DMA registers in the shadow region 4 view of the DMA channel registers. Additionally, the DRAE4 configuration determines completion of which DMA channels will result in assertion of the shadow region 4 DMA completion interrupt. The DRAE registers are part of the group of the region access enable registers, which includes DRAEm and QRAEm. Where m is the number of shadow regions in the EDMA3CC memory map for a device. You can configure these registers to assign ownership of DMA/QDMA channels to a particular shadow region.

Figure 11-67. DRAE4 Register

31	30	29	28	27	26	25	24	23	22	21	20	19	18	17	16	15	14	13	12	11	10	9	8	7	6	5	4	3	2	1	0
En																															
R/W-0h																															

LEGEND: R/W = Read/Write; R = Read only; W1toCl = Write 1 to clear bit; -n = value after reset

Table 11-51. DRAE4 Register Field Descriptions

Bit	Field	Type	Reset	Description
31-0	En	R/W	0h	DMA region access enable for bit 31 to 0 in region 4. 0h = Accesses via region 4 address space to bit 31 to 0 in any DMA channel register are not allowed. Reads return 0 on bit n and writes do not modify the state of bit 31 to 0. Enabled interrupt bits for bit n do not contribute to the generation of a transfer completion interrupt for shadow region 4. 1h = Accesses via region 4 address space to bit 31 to 0 in any DMA channel register are allowed. Reads return the value from bit n and writes modify the state of bit 31 to 0. Enabled interrupt bits for bit n contribute to the generation of a transfer completion interrupt for shadow region 4.

11.4.1.27 DRAEH4 Register (offset = 364h) [reset = 0h]

DRAEH4 is shown in [Figure 11-68](#) and described in [Table 11-52](#).

The DMA region access enable register for shadow region 4 is programmed to allow or disallow read/write accesses on a bit-by-bit bases for all DMA registers in the shadow region 4 view of the DMA channel registers. Additionally, the DRAE4 configuration determines completion of which DMA channels will result in assertion of the shadow region 4 DMA completion interrupt. The DRAE registers are part of the group of the region access enable registers, which includes DRAEm and QRAEm. Where m is the number of shadow regions in the EDMA3CC memory map for a device. You can configure these registers to assign ownership of DMA/QDMA channels to a particular shadow region.

Figure 11-68. DRAEH4 Register

31	30	29	28	27	26	25	24	23	22	21	20	19	18	17	16	15	14	13	12	11	10	9	8	7	6	5	4	3	2	1	0
En																															
R/W-0h																															

LEGEND: R/W = Read/Write; R = Read only; W1toCl = Write 1 to clear bit; -n = value after reset

Table 11-52. DRAEH4 Register Field Descriptions

Bit	Field	Type	Reset	Description
31-0	En	R/W	0h	DMA region access enable for bit 63 to 32 in region 4. 0h = Accesses via region 4 address space to bit 63 to 32 in any DMA channel register are not allowed. Reads return 0 on bit n and writes do not modify the state of bit 63 to 32. Enabled interrupt bits for bit 31 to 0 do not contribute to the generation of a transfer completion interrupt for shadow region 4. 1h = Accesses via region 4 address space to bit 63 to 32 in any DMA channel register are allowed. Reads return the value from bit n and writes modify the state of bit 63 to 32. Enabled interrupt bits for bit 31 to 0 contribute to the generation of a transfer completion interrupt for shadow region 4.

11.4.1.28 DRAE5 Register (offset = 368h) [reset = 0h]

DRAE5 is shown in [Figure 11-69](#) and described in [Table 11-53](#).

The DMA region access enable register for shadow region 5 is programmed to allow or disallow read/write accesses on a bit-by-bit bases for all DMA registers in the shadow region 5 view of the DMA channel registers. Additionally, the DRAE5 configuration determines completion of which DMA channels will result in assertion of the shadow region 5 DMA completion interrupt. The DRAE registers are part of the group of the region access enable registers, which includes DRAEm and QRAEm. Where m is the number of shadow regions in the EDMA3CC memory map for a device. You can configure these registers to assign ownership of DMA/QDMA channels to a particular shadow region.

Figure 11-69. DRAE5 Register

31	30	29	28	27	26	25	24	23	22	21	20	19	18	17	16	15	14	13	12	11	10	9	8	7	6	5	4	3	2	1	0
En																															
R/W-0h																															

LEGEND: R/W = Read/Write; R = Read only; W1toCl = Write 1 to clear bit; -n = value after reset

Table 11-53. DRAE5 Register Field Descriptions

Bit	Field	Type	Reset	Description
31-0	En	R/W	0h	DMA region access enable for bit 31 to 0 in region 5. 0h = Accesses via region 5 address space to bit 31 to 0 in any DMA channel register are not allowed. Reads return 0 on bit n and writes do not modify the state of bit 31 to 0. Enabled interrupt bits for bit n do not contribute to the generation of a transfer completion interrupt for shadow region 5. 1h = Accesses via region 5 address space to bit 31 to 0 in any DMA channel register are allowed. Reads return the value from bit n and writes modify the state of bit 31 to 0. Enabled interrupt bits for bit n contribute to the generation of a transfer completion interrupt for shadow region 5.

11.4.1.29 DRAEH5 Register (offset = 36Ch) [reset = 0h]

DRAEH5 is shown in [Figure 11-70](#) and described in [Table 11-54](#).

The DMA region access enable register for shadow region 5 is programmed to allow or disallow read/write accesses on a bit-by-bit bases for all DMA registers in the shadow region 5 view of the DMA channel registers. Additionally, the DRAE5 configuration determines completion of which DMA channels will result in assertion of the shadow region 5 DMA completion interrupt. The DRAE registers are part of the group of the region access enable registers, which includes DRAEm and QRAEm. Where m is the number of shadow regions in the EDMA3CC memory map for a device. You can configure these registers to assign ownership of DMA/QDMA channels to a particular shadow region.

Figure 11-70. DRAEH5 Register

31	30	29	28	27	26	25	24	23	22	21	20	19	18	17	16	15	14	13	12	11	10	9	8	7	6	5	4	3	2	1	0
En																															
R/W-0h																															

LEGEND: R/W = Read/Write; R = Read only; W1toCl = Write 1 to clear bit; -n = value after reset

Table 11-54. DRAEH5 Register Field Descriptions

Bit	Field	Type	Reset	Description
31-0	En	R/W	0h	DMA region access enable for bit 63 to 32 in region 5. 0h = Accesses via region 5 address space to bit 63 to 32 in any DMA channel register are not allowed. Reads return 0 on bit n and writes do not modify the state of bit 63 to 32. Enabled interrupt bits for bit 31 to 0 do not contribute to the generation of a transfer completion interrupt for shadow region 5. 1h = Accesses via region 5 address space to bit 63 to 32 in any DMA channel register are allowed. Reads return the value from bit n and writes modify the state of bit 63 to 32. Enabled interrupt bits for bit 31 to 0 contribute to the generation of a transfer completion interrupt for shadow region 5.

11.4.1.30 DRAE6 Register (offset = 370h) [reset = 0h]

DRAE6 is shown in [Figure 11-71](#) and described in [Table 11-55](#).

The DMA region access enable register for shadow region 6 is programmed to allow or disallow read/write accesses on a bit-by-bit bases for all DMA registers in the shadow region 6 view of the DMA channel registers. Additionally, the DRAE6 configuration determines completion of which DMA channels will result in assertion of the shadow region 6 DMA completion interrupt. The DRAE registers are part of the group of the region access enable registers, which includes DRAEm and QRAEm. Where m is the number of shadow regions in the EDMA3CC memory map for a device. You can configure these registers to assign ownership of DMA/QDMA channels to a particular shadow region.

Figure 11-71. DRAE6 Register

31	30	29	28	27	26	25	24	23	22	21	20	19	18	17	16	15	14	13	12	11	10	9	8	7	6	5	4	3	2	1	0
En																															
R/W-0h																															

LEGEND: R/W = Read/Write; R = Read only; W1toCl = Write 1 to clear bit; -n = value after reset

Table 11-55. DRAE6 Register Field Descriptions

Bit	Field	Type	Reset	Description
31-0	En	R/W	0h	DMA region access enable for bit 31 to 0 in region 6. 0h = Accesses via region 6 address space to bit 31 to 0 in any DMA channel register are not allowed. Reads return 0 on bit n and writes do not modify the state of bit 31 to 0. Enabled interrupt bits for bit n do not contribute to the generation of a transfer completion interrupt for shadow region 6. 1h = Accesses via region 6 address space to bit 31 to 0 in any DMA channel register are allowed. Reads return the value from bit n and writes modify the state of bit 31 to 0. Enabled interrupt bits for bit n contribute to the generation of a transfer completion interrupt for shadow region 6.

11.4.1.31 DRAEH6 Register (offset = 374h) [reset = 0h]

DRAEH6 is shown in [Figure 11-72](#) and described in [Table 11-56](#).

The DMA region access enable register for shadow region 6 is programmed to allow or disallow read/write accesses on a bit-by-bit bases for all DMA registers in the shadow region 6 view of the DMA channel registers. Additionally, the DRAE6 configuration determines completion of which DMA channels will result in assertion of the shadow region 6 DMA completion interrupt. The DRAE registers are part of the group of the region access enable registers, which includes DRAEm and QRAEm. Where m is the number of shadow regions in the EDMA3CC memory map for a device. You can configure these registers to assign ownership of DMA/QDMA channels to a particular shadow region.

Figure 11-72. DRAEH6 Register

31	30	29	28	27	26	25	24	23	22	21	20	19	18	17	16	15	14	13	12	11	10	9	8	7	6	5	4	3	2	1	0
En																															
R/W-0h																															

LEGEND: R/W = Read/Write; R = Read only; W1toCl = Write 1 to clear bit; -n = value after reset

Table 11-56. DRAEH6 Register Field Descriptions

Bit	Field	Type	Reset	Description
31-0	En	R/W	0h	DMA region access enable for bit 63 to 32 in region 6. 0h = Accesses via region 6 address space to bit 63 to 32 in any DMA channel register are not allowed. Reads return 0 on bit n and writes do not modify the state of bit 63 to 32. Enabled interrupt bits for bit 31 to 0 do not contribute to the generation of a transfer completion interrupt for shadow region 6. 1h = Accesses via region 6 address space to bit 63 to 32 in any DMA channel register are allowed. Reads return the value from bit n and writes modify the state of bit 63 to 32. Enabled interrupt bits for bit 31 to 0 contribute to the generation of a transfer completion interrupt for shadow region 6.

11.4.1.32 DRAE7 Register (offset = 378h) [reset = 0h]

DRAE7 is shown in [Figure 11-73](#) and described in [Table 11-57](#).

The DMA region access enable register for shadow region 7 is programmed to allow or disallow read/write accesses on a bit-by-bit bases for all DMA registers in the shadow region 7 view of the DMA channel registers. Additionally, the DRAE7 configuration determines completion of which DMA channels will result in assertion of the shadow region 7 DMA completion interrupt. The DRAE registers are part of the group of the region access enable registers, which includes DRAEm and QRAEm. Where m is the number of shadow regions in the EDMA3CC memory map for a device. You can configure these registers to assign ownership of DMA/QDMA channels to a particular shadow region.

Figure 11-73. DRAE7 Register

31	30	29	28	27	26	25	24	23	22	21	20	19	18	17	16	15	14	13	12	11	10	9	8	7	6	5	4	3	2	1	0
En																															
R/W-0h																															

LEGEND: R/W = Read/Write; R = Read only; W1toCl = Write 1 to clear bit; -n = value after reset

Table 11-57. DRAE7 Register Field Descriptions

Bit	Field	Type	Reset	Description
31-0	En	R/W	0h	DMA region access enable for bit 31 to 0 in region 7. 0h = Accesses via region 7 address space to bit 31 to 0 in any DMA channel register are not allowed. Reads return 0 on bit n and writes do not modify the state of bit 31 to 0. Enabled interrupt bits for bit n do not contribute to the generation of a transfer completion interrupt for shadow region 7. 1h = Accesses via region 7 address space to bit 31 to 0 in any DMA channel register are allowed. Reads return the value from bit n and writes modify the state of bit 31 to 0. Enabled interrupt bits for bit n contribute to the generation of a transfer completion interrupt for shadow region 7.

11.4.1.33 DRAEH7 Register (offset = 37Ch) [reset = 0h]

DRAEH7 is shown in [Figure 11-74](#) and described in [Table 11-58](#).

The DMA region access enable register for shadow region 7 is programmed to allow or disallow read/write accesses on a bit-by-bit bases for all DMA registers in the shadow region 7 view of the DMA channel registers. Additionally, the DRAE7 configuration determines completion of which DMA channels will result in assertion of the shadow region 7 DMA completion interrupt. The DRAE registers are part of the group of the region access enable registers, which includes DRAEm and QRAEm. Where m is the number of shadow regions in the EDMA3CC memory map for a device. You can configure these registers to assign ownership of DMA/QDMA channels to a particular shadow region.

Figure 11-74. DRAEH7 Register

31	30	29	28	27	26	25	24	23	22	21	20	19	18	17	16	15	14	13	12	11	10	9	8	7	6	5	4	3	2	1	0
En																															
R/W-0h																															

LEGEND: R/W = Read/Write; R = Read only; W1toCl = Write 1 to clear bit; -n = value after reset

Table 11-58. DRAEH7 Register Field Descriptions

Bit	Field	Type	Reset	Description
31-0	En	R/W	0h	DMA region access enable for bit 63 to 32 in region 7. 0h = Accesses via region 7 address space to bit 63 to 32 in any DMA channel register are not allowed. Reads return 0 on bit n and writes do not modify the state of bit 63 to 32. Enabled interrupt bits for bit 31 to 0 do not contribute to the generation of a transfer completion interrupt for shadow region 7. 1h = Accesses via region 7 address space to bit 63 to 32 in any DMA channel register are allowed. Reads return the value from bit n and writes modify the state of bit 63 to 32. Enabled interrupt bits for bit 31 to 0 contribute to the generation of a transfer completion interrupt for shadow region 7.

11.4.1.34 QRAE_0 to QRAE_7 Register (offset = 380h to 39Ch) [reset = 0h]

QRAE_0 to QRAE_7 is shown in [Figure 11-75](#) and described in [Table 11-59](#).

The QDMA region access enable register for shadow region m (QRAEm) is programmed to allow or disallow read/write accesses on a bit-by-bit bases for all QDMA registers in the shadow region m view of the QDMA registers. This includes all 4-bit QDMA registers. The QRAE register is part of the group of the region access enable registers, which includes DRAEm and QRAEm. Where m is the number of shadow regions in the EDMA3CC memory map for a device. You can configure these registers to assign ownership of DMA/QDMA channels to a particular shadow region.

Figure 11-75. QRAE_0 to QRAE_7 Register

31	30	29	28	27	26	25	24	23	22	21	20	19	18	17	16	15	14	13	12	11	10	9	8	7	6	5	4	3	2	1	0
RESERVED														En																	
R-0h														R/W-0h																	

LEGEND: R/W = Read/Write; R = Read only; W1toCl = Write 1 to clear bit; -n = value after reset

Table 11-59. QRAE_0 to QRAE_7 Register Field Descriptions

Bit	Field	Type	Reset	Description
31-8	RESERVED	R	0h	
7-0	En	R/W	0h	QDMA region access enable for bit n/QDMA channel n in region m. 0h = Accesses via region m address space to bit n in any QDMA channel register are not allowed. Reads return 0 on bit n and writes do not modify the state of bit n. 1h = Accesses via region m address space to bit n in any QDMA channel register are allowed. Reads return the value from bit n and writes modify the state of bit n.

11.4.1.35 Q0E0 Register (offset = 400h) [reset = 0h]

Q0E0 is shown in [Figure 11-76](#) and described in [Table 11-60](#).

The event queue entry registers (QxEy) exist for all 16 queue entries (the maximum allowed queue entries) for all event queues in the EDMA3CC. The event queue entry registers range from Q0E0 to Q0E15, Q1E0 to Q1E15, and Q2E0 to Q2E15. Each register details the event number (ENUM) and the event type (ETYPE). For example, if the value in Q1E4 is read as 000 004Fh, this means the 4th entry in queue 1 is a manually-triggered event on DMA channel 15. The Q0E0 register provides visibility into the event queues and a TR life cycle. These are useful for system debug as they provide in-depth visibility for the events queued up in the event queue and also provide information on what parts of the EDMA3CC logic are active once the event has been received by the EDMA3CC.

Figure 11-76. Q0E0 Register

31	30	29	28	27	26	25	24	23	22	21	20	19	18	17	16
RESERVED															
R-0h															
15	14	13	12	11	10	9	8	7	6	5	4	3	2	1	0
RESERVED								ETYPE				ENUM			
R-0h								R-0h				R-0h			

LEGEND: R/W = Read/Write; R = Read only; W1toCl = Write 1 to clear bit; -n = value after reset

Table 11-60. Q0E0 Register Field Descriptions

Bit	Field	Type	Reset	Description
31-8	RESERVED	R	0h	
7-6	ETYPE	R	0h	Event entry 0 in queue 0. Specifies the specific event type for the given entry in the event queue. 0h = Event triggered via ER. 1h = Auto-triggered via QER.
5-0	ENUM	R	0h	Event entry 0 in queue 0. Event number: QDMA channel number (0 to 3). DMA channel/event number (0 to 63).

11.4.1.36 Q0E1 Register (offset = 404h) [reset = 0h]

Q0E1 is shown in [Figure 11-77](#) and described in [Table 11-61](#).

The event queue entry registers (QxEy) exist for all 16 queue entries (the maximum allowed queue entries) for all event queues in the EDMA3CC. The event queue entry registers range from Q0E0 to Q0E15, Q1E0 to Q1E15, and Q2E0 to Q2E15. Each register details the event number (ENUM) and the event type (ETYPE). For example, if the value in Q1E4 is read as 000 004Fh, this means the 4th entry in queue 1 is a manually-triggered event on DMA channel 15. The Q0E1 register provides visibility into the event queues and a TR life cycle. These are useful for system debug as they provide in-depth visibility for the events queued up in the event queue and also provide information on what parts of the EDMA3CC logic are active once the event has been received by the EDMA3CC.

Figure 11-77. Q0E1 Register

31	30	29	28	27	26	25	24	23	22	21	20	19	18	17	16
RESERVED															
R-0h															
15	14	13	12	11	10	9	8	7	6	5	4	3	2	1	0
RESERVED								ETYPE				ENUM			
R-0h								R-0h				R-0h			

LEGEND: R/W = Read/Write; R = Read only; W1toCl = Write 1 to clear bit; -n = value after reset

Table 11-61. Q0E1 Register Field Descriptions

Bit	Field	Type	Reset	Description
31-8	RESERVED	R	0h	
7-6	ETYPE	R	0h	Event entry 1 in queue 0. Specifies the specific event type for the given entry in the event queue. 0h = Event triggered via ER. 1h = Auto-triggered via QER.
5-0	ENUM	R	0h	Event entry 1 in queue 0. Event number: QDMA channel number (0 to 3). DMA channel/event number (0 to 63).

11.4.1.37 Q0E2 Register (offset = 408h) [reset = 0h]

Q0E2 is shown in [Figure 11-78](#) and described in [Table 11-62](#).

The event queue entry registers (QxEy) exist for all 16 queue entries (the maximum allowed queue entries) for all event queues in the EDMA3CC. The event queue entry registers range from Q0E0 to Q0E15, Q1E0 to Q1E15, and Q2E0 to Q2E15. Each register details the event number (ENUM) and the event type (ETYPE). For example, if the value in Q1E4 is read as 000 004Fh, this means the 4th entry in queue 1 is a manually-triggered event on DMA channel 15. The Q0E2 register provides visibility into the event queues and a TR life cycle. These are useful for system debug as they provide in-depth visibility for the events queued up in the event queue and also provide information on what parts of the EDMA3CC logic are active once the event has been received by the EDMA3CC.

Figure 11-78. Q0E2 Register

31	30	29	28	27	26	25	24	23	22	21	20	19	18	17	16
RESERVED															
R-0h															
15	14	13	12	11	10	9	8	7	6	5	4	3	2	1	0
RESERVED								ETYPE				ENUM			
R-0h								R-0h				R-0h			

LEGEND: R/W = Read/Write; R = Read only; W1toCl = Write 1 to clear bit; -n = value after reset

Table 11-62. Q0E2 Register Field Descriptions

Bit	Field	Type	Reset	Description
31-8	RESERVED	R	0h	
7-6	ETYPE	R	0h	Event entry 2 in queue 0. Specifies the specific event type for the given entry in the event queue. 0h = Event triggered via ER. 1h = Auto-triggered via QER.
5-0	ENUM	R	0h	Event entry 2 in queue 0. Event number: QDMA channel number (0 to 3). DMA channel/event number (0 to 63).

11.4.1.38 Q0E3 Register (offset = 40Ch) [reset = 0h]

Q0E3 is shown in [Figure 11-79](#) and described in [Table 11-63](#).

The event queue entry registers (QxEy) exist for all 16 queue entries (the maximum allowed queue entries) for all event queues in the EDMA3CC. The event queue entry registers range from Q0E0 to Q0E15, Q1E0 to Q1E15, and Q2E0 to Q2E15. Each register details the event number (ENUM) and the event type (ETYPE). For example, if the value in Q1E4 is read as 000 004Fh, this means the 4th entry in queue 1 is a manually-triggered event on DMA channel 15. The Q0E3 register provides visibility into the event queues and a TR life cycle. These are useful for system debug as they provide in-depth visibility for the events queued up in the event queue and also provide information on what parts of the EDMA3CC logic are active once the event has been received by the EDMA3CC.

Figure 11-79. Q0E3 Register

31	30	29	28	27	26	25	24	23	22	21	20	19	18	17	16
RESERVED															
R-0h															
15	14	13	12	11	10	9	8	7	6	5	4	3	2	1	0
RESERVED								ETYPE				ENUM			
R-0h								R-0h				R-0h			

LEGEND: R/W = Read/Write; R = Read only; W1toCl = Write 1 to clear bit; -n = value after reset

Table 11-63. Q0E3 Register Field Descriptions

Bit	Field	Type	Reset	Description
31-8	RESERVED	R	0h	
7-6	ETYPE	R	0h	Event entry 3 in queue 0. Specifies the specific event type for the given entry in the event queue. 0h = Event triggered via ER. 1h = Auto-triggered via QER.
5-0	ENUM	R	0h	Event entry 3 in queue 0. Event number: QDMA channel number (0 to 3). DMA channel/event number (0 to 63).

11.4.1.39 Q0E4 Register (offset = 410h) [reset = 0h]

Q0E4 is shown in [Figure 11-80](#) and described in [Table 11-64](#).

The event queue entry registers (QxEy) exist for all 16 queue entries (the maximum allowed queue entries) for all event queues in the EDMA3CC. The event queue entry registers range from Q0E0 to Q0E15, Q1E0 to Q1E15, and Q2E0 to Q2E15. Each register details the event number (ENUM) and the event type (ETYPE). For example, if the value in Q1E4 is read as 000 004Fh, this means the 4th entry in queue 1 is a manually-triggered event on DMA channel 15. The Q0E4 register provides visibility into the event queues and a TR life cycle. These are useful for system debug as they provide in-depth visibility for the events queued up in the event queue and also provide information on what parts of the EDMA3CC logic are active once the event has been received by the EDMA3CC.

Figure 11-80. Q0E4 Register

31	30	29	28	27	26	25	24	23	22	21	20	19	18	17	16
RESERVED															
R-0h															
15	14	13	12	11	10	9	8	7	6	5	4	3	2	1	0
RESERVED								ETYPE				ENUM			
R-0h								R-0h				R-0h			

LEGEND: R/W = Read/Write; R = Read only; W1toCl = Write 1 to clear bit; -n = value after reset

Table 11-64. Q0E4 Register Field Descriptions

Bit	Field	Type	Reset	Description
31-8	RESERVED	R	0h	
7-6	ETYPE	R	0h	Event entry 4 in queue 0. Specifies the specific event type for the given entry in the event queue. 0h = Event triggered via ER. 1h = Auto-triggered via QER.
5-0	ENUM	R	0h	Event entry 4 in queue 0. Event number: QDMA channel number (0 to 3). DMA channel/event number (0 to 63).

11.4.1.40 Q0E5 Register (offset = 414h) [reset = 0h]

Q0E5 is shown in [Figure 11-81](#) and described in [Table 11-65](#).

The event queue entry registers (QxEy) exist for all 16 queue entries (the maximum allowed queue entries) for all event queues in the EDMA3CC. The event queue entry registers range from Q0E0 to Q0E15, Q1E0 to Q1E15, and Q2E0 to Q2E15. Each register details the event number (ENUM) and the event type (ETYPE). For example, if the value in Q1E4 is read as 000 004Fh, this means the 4th entry in queue 1 is a manually-triggered event on DMA channel 15. The Q0E5 register provides visibility into the event queues and a TR life cycle. These are useful for system debug as they provide in-depth visibility for the events queued up in the event queue and also provide information on what parts of the EDMA3CC logic are active once the event has been received by the EDMA3CC.

Figure 11-81. Q0E5 Register

31	30	29	28	27	26	25	24	23	22	21	20	19	18	17	16
RESERVED															
R-0h															
15	14	13	12	11	10	9	8	7	6	5	4	3	2	1	0
RESERVED								ETYPE				ENUM			
R-0h								R-0h				R-0h			

LEGEND: R/W = Read/Write; R = Read only; W1toCl = Write 1 to clear bit; -n = value after reset

Table 11-65. Q0E5 Register Field Descriptions

Bit	Field	Type	Reset	Description
31-8	RESERVED	R	0h	
7-6	ETYPE	R	0h	Event entry 5 in queue 0. Specifies the specific event type for the given entry in the event queue. 0h = Event triggered via ER. 1h = Auto-triggered via QER.
5-0	ENUM	R	0h	Event entry 5 in queue 0. Event number: QDMA channel number (0 to 3). DMA channel/event number (0 to 63).

11.4.1.41 Q0E6 Register (offset = 418h) [reset = 0h]

Q0E6 is shown in [Figure 11-82](#) and described in [Table 11-66](#).

The event queue entry registers (QxEy) exist for all 16 queue entries (the maximum allowed queue entries) for all event queues in the EDMA3CC. The event queue entry registers range from Q0E0 to Q0E15, Q1E0 to Q1E15, and Q2E0 to Q2E15. Each register details the event number (ENUM) and the event type (ETYPE). For example, if the value in Q1E4 is read as 000 004Fh, this means the 4th entry in queue 1 is a manually-triggered event on DMA channel 15. The Q0E6 register provides visibility into the event queues and a TR life cycle. These are useful for system debug as they provide in-depth visibility for the events queued up in the event queue and also provide information on what parts of the EDMA3CC logic are active once the event has been received by the EDMA3CC.

Figure 11-82. Q0E6 Register

31	30	29	28	27	26	25	24	23	22	21	20	19	18	17	16
RESERVED															
R-0h															
15	14	13	12	11	10	9	8	7	6	5	4	3	2	1	0
RESERVED								ETYPE				ENUM			
R-0h								R-0h				R-0h			

LEGEND: R/W = Read/Write; R = Read only; W1toCl = Write 1 to clear bit; -n = value after reset

Table 11-66. Q0E6 Register Field Descriptions

Bit	Field	Type	Reset	Description
31-8	RESERVED	R	0h	
7-6	ETYPE	R	0h	Event entry 6 in queue 0. Specifies the specific event type for the given entry in the event queue. 0h = Event triggered via ER. 1h = Auto-triggered via QER.
5-0	ENUM	R	0h	Event entry 6 in queue 0. Event number: QDMA channel number (0 to 3). DMA channel/event number (0 to 63).

11.4.1.42 Q0E7 Register (offset = 41Ch) [reset = 0h]

Q0E7 is shown in [Figure 11-83](#) and described in [Table 11-67](#).

The event queue entry registers (QxEy) exist for all 16 queue entries (the maximum allowed queue entries) for all event queues in the EDMA3CC. The event queue entry registers range from Q0E0 to Q0E15, Q1E0 to Q1E15, and Q2E0 to Q2E15. Each register details the event number (ENUM) and the event type (ETYPE). For example, if the value in Q1E4 is read as 000 004Fh, this means the 4th entry in queue 1 is a manually-triggered event on DMA channel 15. The Q0E7 register provides visibility into the event queues and a TR life cycle. These are useful for system debug as they provide in-depth visibility for the events queued up in the event queue and also provide information on what parts of the EDMA3CC logic are active once the event has been received by the EDMA3CC.

Figure 11-83. Q0E7 Register

31	30	29	28	27	26	25	24	23	22	21	20	19	18	17	16
RESERVED															
R-0h															
15	14	13	12	11	10	9	8	7	6	5	4	3	2	1	0
RESERVED								ETYPE				ENUM			
R-0h								R-0h				R-0h			

LEGEND: R/W = Read/Write; R = Read only; W1toCl = Write 1 to clear bit; -n = value after reset

Table 11-67. Q0E7 Register Field Descriptions

Bit	Field	Type	Reset	Description
31-8	RESERVED	R	0h	
7-6	ETYPE	R	0h	Event entry 7 in queue 0. Specifies the specific event type for the given entry in the event queue. 0h = Event triggered via ER. 1h = Auto-triggered via QER.
5-0	ENUM	R	0h	Event entry 7 in queue 0. Event number: QDMA channel number (0 to 3). DMA channel/event number (0 to 63).

11.4.1.43 Q0E8 Register (offset = 420h) [reset = 0h]

Q0E8 is shown in [Figure 11-84](#) and described in [Table 11-68](#).

The event queue entry registers (QxEy) exist for all 16 queue entries (the maximum allowed queue entries) for all event queues in the EDMA3CC. The event queue entry registers range from Q0E0 to Q0E15, Q1E0 to Q1E15, and Q2E0 to Q2E15. Each register details the event number (ENUM) and the event type (ETYPE). For example, if the value in Q1E4 is read as 000 004Fh, this means the 4th entry in queue 1 is a manually-triggered event on DMA channel 15. The Q0E8 register provides visibility into the event queues and a TR life cycle. These are useful for system debug as they provide in-depth visibility for the events queued up in the event queue and also provide information on what parts of the EDMA3CC logic are active once the event has been received by the EDMA3CC.

Figure 11-84. Q0E8 Register

31	30	29	28	27	26	25	24	23	22	21	20	19	18	17	16
RESERVED															
R-0h															
15	14	13	12	11	10	9	8	7	6	5	4	3	2	1	0
RESERVED								ETYPE		ENUM					
R-0h								R-0h		R-0h					

LEGEND: R/W = Read/Write; R = Read only; W1toCl = Write 1 to clear bit; -n = value after reset

Table 11-68. Q0E8 Register Field Descriptions

Bit	Field	Type	Reset	Description
31-8	RESERVED	R	0h	
7-6	ETYPE	R	0h	Event entry 8 in queue 0. Specifies the specific event type for the given entry in the event queue. 0h = Event triggered via ER. 1h = Auto-triggered via QER.
5-0	ENUM	R	0h	Event entry 8 in queue 0. Event number: QDMA channel number (0 to 3). DMA channel/event number (0 to 63).

11.4.1.44 Q0E9 Register (offset = 424h) [reset = 0h]

Q0E9 is shown in [Figure 11-85](#) and described in [Table 11-69](#).

The event queue entry registers (QxEy) exist for all 16 queue entries (the maximum allowed queue entries) for all event queues in the EDMA3CC. The event queue entry registers range from Q0E0 to Q0E15, Q1E0 to Q1E15, and Q2E0 to Q2E15. Each register details the event number (ENUM) and the event type (ETYPE). For example, if the value in Q1E4 is read as 000 004Fh, this means the 4th entry in queue 1 is a manually-triggered event on DMA channel 15. The Q0E9 register provides visibility into the event queues and a TR life cycle. These are useful for system debug as they provide in-depth visibility for the events queued up in the event queue and also provide information on what parts of the EDMA3CC logic are active once the event has been received by the EDMA3CC.

Figure 11-85. Q0E9 Register

31	30	29	28	27	26	25	24	23	22	21	20	19	18	17	16
RESERVED															
R-0h															
15	14	13	12	11	10	9	8	7	6	5	4	3	2	1	0
RESERVED								ETYPE				ENUM			
R-0h								R-0h				R-0h			

LEGEND: R/W = Read/Write; R = Read only; W1toCl = Write 1 to clear bit; -n = value after reset

Table 11-69. Q0E9 Register Field Descriptions

Bit	Field	Type	Reset	Description
31-8	RESERVED	R	0h	
7-6	ETYPE	R	0h	Event entry 9 in queue 0. Specifies the specific event type for the given entry in the event queue. 0h = Event triggered via ER. 1h = Auto-triggered via QER.
5-0	ENUM	R	0h	Event entry 9 in queue 0. Event number: QDMA channel number (0 to 3). DMA channel/event number (0 to 63).

11.4.1.45 Q0E10 Register (offset = 428h) [reset = 0h]

Q0E10 is shown in [Figure 11-86](#) and described in [Table 11-70](#).

The event queue entry registers (QxEy) exist for all 16 queue entries (the maximum allowed queue entries) for all event queues in the EDMA3CC. The event queue entry registers range from Q0E0 to Q0E15, Q1E0 to Q1E15, and Q2E0 to Q2E15. Each register details the event number (ENUM) and the event type (ETYPE). For example, if the value in Q1E4 is read as 000 004Fh, this means the 4th entry in queue 1 is a manually-triggered event on DMA channel 15. The Q0E10 register provides visibility into the event queues and a TR life cycle. These are useful for system debug as they provide in-depth visibility for the events queued up in the event queue and also provide information on what parts of the EDMA3CC logic are active once the event has been received by the EDMA3CC.

Figure 11-86. Q0E10 Register

31	30	29	28	27	26	25	24	23	22	21	20	19	18	17	16
RESERVED															
R-0h															
15	14	13	12	11	10	9	8	7	6	5	4	3	2	1	0
RESERVED								ETYPE				ENUM			
R-0h								R-0h				R-0h			

LEGEND: R/W = Read/Write; R = Read only; W1toCl = Write 1 to clear bit; -n = value after reset

Table 11-70. Q0E10 Register Field Descriptions

Bit	Field	Type	Reset	Description
31-8	RESERVED	R	0h	
7-6	ETYPE	R	0h	Event entry 10 in queue 0. Specifies the specific event type for the given entry in the event queue. 0h = Event triggered via ER. 1h = Auto-triggered via QER.
5-0	ENUM	R	0h	Event entry 10 in queue 0. Event number: QDMA channel number (0 to 3). DMA channel/event number (0 to 63).

11.4.1.46 Q0E11 Register (offset = 42Ch) [reset = 0h]

Q0E11 is shown in [Figure 11-87](#) and described in [Table 11-71](#).

The event queue entry registers (QxEy) exist for all 16 queue entries (the maximum allowed queue entries) for all event queues in the EDMA3CC. The event queue entry registers range from Q0E0 to Q0E15, Q1E0 to Q1E15, and Q2E0 to Q2E15. Each register details the event number (ENUM) and the event type (ETYPE). For example, if the value in Q1E4 is read as 000 004Fh, this means the 4th entry in queue 1 is a manually-triggered event on DMA channel 15. The Q0E11 register provides visibility into the event queues and a TR life cycle. These are useful for system debug as they provide in-depth visibility for the events queued up in the event queue and also provide information on what parts of the EDMA3CC logic are active once the event has been received by the EDMA3CC.

Figure 11-87. Q0E11 Register

31	30	29	28	27	26	25	24	23	22	21	20	19	18	17	16
RESERVED															
R-0h															
15	14	13	12	11	10	9	8	7	6	5	4	3	2	1	0
RESERVED								ETYPE				ENUM			
R-0h								R-0h				R-0h			

LEGEND: R/W = Read/Write; R = Read only; W1toCl = Write 1 to clear bit; -n = value after reset

Table 11-71. Q0E11 Register Field Descriptions

Bit	Field	Type	Reset	Description
31-8	RESERVED	R	0h	
7-6	ETYPE	R	0h	Event entry 11 in queue 0. Specifies the specific event type for the given entry in the event queue. 0h = Event triggered via ER. 1h = Auto-triggered via QER.
5-0	ENUM	R	0h	Event entry 11 in queue 0. Event number: QDMA channel number (0 to 3). DMA channel/event number (0 to 63).

11.4.1.47 Q0E12 Register (offset = 430h) [reset = 0h]

Q0E12 is shown in [Figure 11-88](#) and described in [Table 11-72](#).

The event queue entry registers (QxEy) exist for all 16 queue entries (the maximum allowed queue entries) for all event queues in the EDMA3CC. The event queue entry registers range from Q0E0 to Q0E15, Q1E0 to Q1E15, and Q2E0 to Q2E15. Each register details the event number (ENUM) and the event type (ETYPE). For example, if the value in Q1E4 is read as 000 004Fh, this means the 4th entry in queue 1 is a manually-triggered event on DMA channel 15. The Q0E12 register provides visibility into the event queues and a TR life cycle. These are useful for system debug as they provide in-depth visibility for the events queued up in the event queue and also provide information on what parts of the EDMA3CC logic are active once the event has been received by the EDMA3CC.

Figure 11-88. Q0E12 Register

31	30	29	28	27	26	25	24	23	22	21	20	19	18	17	16
RESERVED															
R-0h															
15	14	13	12	11	10	9	8	7	6	5	4	3	2	1	0
RESERVED								ETYPE		ENUM					
R-0h								R-0h		R-0h					

LEGEND: R/W = Read/Write; R = Read only; W1toCl = Write 1 to clear bit; -n = value after reset

Table 11-72. Q0E12 Register Field Descriptions

Bit	Field	Type	Reset	Description
31-8	RESERVED	R	0h	
7-6	ETYPE	R	0h	Event entry 12 in queue 0. Specifies the specific event type for the given entry in the event queue. 0h = Event triggered via ER. 1h = Auto-triggered via QER.
5-0	ENUM	R	0h	Event entry 12 in queue 0. Event number: QDMA channel number (0 to 3). DMA channel/event number (0 to 63).

11.4.1.48 Q0E13 Register (offset = 434h) [reset = 0h]

Q0E13 is shown in [Figure 11-89](#) and described in [Table 11-73](#).

The event queue entry registers (QxEy) exist for all 16 queue entries (the maximum allowed queue entries) for all event queues in the EDMA3CC. The event queue entry registers range from Q0E0 to Q0E15, Q1E0 to Q1E15, and Q2E0 to Q2E15. Each register details the event number (ENUM) and the event type (ETYPE). For example, if the value in Q1E4 is read as 000 004Fh, this means the 4th entry in queue 1 is a manually-triggered event on DMA channel 15. The Q0E13 register provides visibility into the event queues and a TR life cycle. These are useful for system debug as they provide in-depth visibility for the events queued up in the event queue and also provide information on what parts of the EDMA3CC logic are active once the event has been received by the EDMA3CC.

Figure 11-89. Q0E13 Register

31	30	29	28	27	26	25	24	23	22	21	20	19	18	17	16
RESERVED															
R-0h															
15	14	13	12	11	10	9	8	7	6	5	4	3	2	1	0
RESERVED								ETYPE				ENUM			
R-0h								R-0h				R-0h			

LEGEND: R/W = Read/Write; R = Read only; W1toCl = Write 1 to clear bit; -n = value after reset

Table 11-73. Q0E13 Register Field Descriptions

Bit	Field	Type	Reset	Description
31-8	RESERVED	R	0h	
7-6	ETYPE	R	0h	Event entry 13 in queue 0. Specifies the specific event type for the given entry in the event queue. 0h = Event triggered via ER. 1h = Auto-triggered via QER.
5-0	ENUM	R	0h	Event entry 13 in queue 0. Event number: QDMA channel number (0 to 3). DMA channel/event number (0 to 63).

11.4.1.49 Q0E14 Register (offset = 438h) [reset = 0h]

Q0E14 is shown in [Figure 11-90](#) and described in [Table 11-74](#).

The event queue entry registers (QxEy) exist for all 16 queue entries (the maximum allowed queue entries) for all event queues in the EDMA3CC. The event queue entry registers range from Q0E0 to Q0E15, Q1E0 to Q1E15, and Q2E0 to Q2E15. Each register details the event number (ENUM) and the event type (ETYPE). For example, if the value in Q1E4 is read as 000 004Fh, this means the 4th entry in queue 1 is a manually-triggered event on DMA channel 15. The Q0E14 register provides visibility into the event queues and a TR life cycle. These are useful for system debug as they provide in-depth visibility for the events queued up in the event queue and also provide information on what parts of the EDMA3CC logic are active once the event has been received by the EDMA3CC.

Figure 11-90. Q0E14 Register

31	30	29	28	27	26	25	24	23	22	21	20	19	18	17	16
RESERVED															
R-0h															
15	14	13	12	11	10	9	8	7	6	5	4	3	2	1	0
RESERVED								ETYPE				ENUM			
R-0h								R-0h				R-0h			

LEGEND: R/W = Read/Write; R = Read only; W1toCl = Write 1 to clear bit; -n = value after reset

Table 11-74. Q0E14 Register Field Descriptions

Bit	Field	Type	Reset	Description
31-8	RESERVED	R	0h	
7-6	ETYPE	R	0h	Event entry 14 in queue 0. Specifies the specific event type for the given entry in the event queue. 0h = Event triggered via ER. 1h = Auto-triggered via QER.
5-0	ENUM	R	0h	Event entry 14 in queue 0. Event number: QDMA channel number (0 to 3). DMA channel/event number (0 to 63).

11.4.1.50 Q0E15 Register (offset = 43Ch) [reset = 0h]

Q0E15 is shown in [Figure 11-91](#) and described in [Table 11-75](#).

The event queue entry registers (QxEy) exist for all 16 queue entries (the maximum allowed queue entries) for all event queues in the EDMA3CC. The event queue entry registers range from Q0E0 to Q0E15, Q1E0 to Q1E15, and Q2E0 to Q2E15. Each register details the event number (ENUM) and the event type (ETYPE). For example, if the value in Q1E4 is read as 000 004Fh, this means the 4th entry in queue 1 is a manually-triggered event on DMA channel 15. The Q0E15 register provides visibility into the event queues and a TR life cycle. These are useful for system debug as they provide in-depth visibility for the events queued up in the event queue and also provide information on what parts of the EDMA3CC logic are active once the event has been received by the EDMA3CC.

Figure 11-91. Q0E15 Register

31	30	29	28	27	26	25	24	23	22	21	20	19	18	17	16
RESERVED															
R-0h															
15	14	13	12	11	10	9	8	7	6	5	4	3	2	1	0
RESERVED								ETYPE				ENUM			
R-0h								R-0h				R-0h			

LEGEND: R/W = Read/Write; R = Read only; W1toCl = Write 1 to clear bit; -n = value after reset

Table 11-75. Q0E15 Register Field Descriptions

Bit	Field	Type	Reset	Description
31-8	RESERVED	R	0h	
7-6	ETYPE	R	0h	Event entry 15 in queue 0. Specifies the specific event type for the given entry in the event queue. 0h = Event triggered via ER. 1h = Auto-triggered via QER.
5-0	ENUM	R	0h	Event entry 15 in queue 0. Event number: QDMA channel number (0 to 3). DMA channel/event number (0 to 63).

11.4.1.51 Q1E0 Register (offset = 440h) [reset = 0h]

Q1E0 is shown in [Figure 11-92](#) and described in [Table 11-76](#).

The event queue entry registers (QxEy) exist for all 16 queue entries (the maximum allowed queue entries) for all event queues in the EDMA3CC. The event queue entry registers range from Q0E0 to Q0E15, Q1E0 to Q1E15, and Q2E0 to Q2E15. Each register details the event number (ENUM) and the event type (ETYPE). For example, if the value in Q1E4 is read as 000 004Fh, this means the 4th entry in queue 1 is a manually-triggered event on DMA channel 15. The Q1E0 register provides visibility into the event queues and a TR life cycle. These are useful for system debug as they provide in-depth visibility for the events queued up in the event queue and also provide information on what parts of the EDMA3CC logic are active once the event has been received by the EDMA3CC.

Figure 11-92. Q1E0 Register

31	30	29	28	27	26	25	24	23	22	21	20	19	18	17	16
RESERVED															
R-0h															
15	14	13	12	11	10	9	8	7	6	5	4	3	2	1	0
RESERVED								ETYPE				ENUM			
R-0h								R-0h				R-0h			

LEGEND: R/W = Read/Write; R = Read only; W1toCl = Write 1 to clear bit; -n = value after reset

Table 11-76. Q1E0 Register Field Descriptions

Bit	Field	Type	Reset	Description
31-8	RESERVED	R	0h	
7-6	ETYPE	R	0h	Event entry 0 in queue 1. Specifies the specific event type for the given entry in the event queue. 0h = Event triggered via ER. 1h = Auto-triggered via QER.
5-0	ENUM	R	0h	Event entry 0 in queue 1. Event number: QDMA channel number (0 to 3). DMA channel/event number (0 to 63).

11.4.1.52 Q1E1 Register (offset = 444h) [reset = 0h]

Q1E1 is shown in [Figure 11-93](#) and described in [Table 11-77](#).

The event queue entry registers (QxEy) exist for all 16 queue entries (the maximum allowed queue entries) for all event queues in the EDMA3CC. The event queue entry registers range from Q0E0 to Q0E15, Q1E0 to Q1E15, and Q2E0 to Q2E15. Each register details the event number (ENUM) and the event type (ETYPE). For example, if the value in Q1E4 is read as 000 004Fh, this means the 4th entry in queue 1 is a manually-triggered event on DMA channel 15. The Q1E1 register provides visibility into the event queues and a TR life cycle. These are useful for system debug as they provide in-depth visibility for the events queued up in the event queue and also provide information on what parts of the EDMA3CC logic are active once the event has been received by the EDMA3CC.

Figure 11-93. Q1E1 Register

31	30	29	28	27	26	25	24	23	22	21	20	19	18	17	16
RESERVED															
R-0h															
15	14	13	12	11	10	9	8	7	6	5	4	3	2	1	0
RESERVED								ETYPE				ENUM			
R-0h								R-0h				R-0h			

LEGEND: R/W = Read/Write; R = Read only; W1toCl = Write 1 to clear bit; -n = value after reset

Table 11-77. Q1E1 Register Field Descriptions

Bit	Field	Type	Reset	Description
31-8	RESERVED	R	0h	
7-6	ETYPE	R	0h	Event entry 1 in queue 1. Specifies the specific event type for the given entry in the event queue. 0h = Event triggered via ER. 1h = Auto-triggered via QER.
5-0	ENUM	R	0h	Event entry 1 in queue 1. Event number: QDMA channel number (0 to 3). DMA channel/event number (0 to 63).

11.4.1.53 Q1E2 Register (offset = 448h) [reset = 0h]

Q1E2 is shown in [Figure 11-94](#) and described in [Table 11-78](#).

The event queue entry registers (QxEy) exist for all 16 queue entries (the maximum allowed queue entries) for all event queues in the EDMA3CC. The event queue entry registers range from Q0E0 to Q0E15, Q1E0 to Q1E15, and Q2E0 to Q2E15. Each register details the event number (ENUM) and the event type (ETYPE). For example, if the value in Q1E4 is read as 000 004Fh, this means the 4th entry in queue 1 is a manually-triggered event on DMA channel 15. The Q1E2 register provides visibility into the event queues and a TR life cycle. These are useful for system debug as they provide in-depth visibility for the events queued up in the event queue and also provide information on what parts of the EDMA3CC logic are active once the event has been received by the EDMA3CC.

Figure 11-94. Q1E2 Register

31	30	29	28	27	26	25	24	23	22	21	20	19	18	17	16
RESERVED															
R-0h															
15	14	13	12	11	10	9	8	7	6	5	4	3	2	1	0
RESERVED								ETYPE				ENUM			
R-0h								R-0h				R-0h			

LEGEND: R/W = Read/Write; R = Read only; W1toCl = Write 1 to clear bit; -n = value after reset

Table 11-78. Q1E2 Register Field Descriptions

Bit	Field	Type	Reset	Description
31-8	RESERVED	R	0h	
7-6	ETYPE	R	0h	Event entry 2 in queue 1. Specifies the specific event type for the given entry in the event queue. 0h = Event triggered via ER. 1h = Auto-triggered via QER.
5-0	ENUM	R	0h	Event entry 2 in queue 1. Event number: QDMA channel number (0 to 3). DMA channel/event number (0 to 63).

11.4.1.54 Q1E3 Register (offset = 44Ch) [reset = 0h]

Q1E3 is shown in [Figure 11-95](#) and described in [Table 11-79](#).

The event queue entry registers (QxEy) exist for all 16 queue entries (the maximum allowed queue entries) for all event queues in the EDMA3CC. The event queue entry registers range from Q0E0 to Q0E15, Q1E0 to Q1E15, and Q2E0 to Q2E15. Each register details the event number (ENUM) and the event type (ETYPE). For example, if the value in Q1E4 is read as 000 004Fh, this means the 4th entry in queue 1 is a manually-triggered event on DMA channel 15. The Q1E3 register provides visibility into the event queues and a TR life cycle. These are useful for system debug as they provide in-depth visibility for the events queued up in the event queue and also provide information on what parts of the EDMA3CC logic are active once the event has been received by the EDMA3CC.

Figure 11-95. Q1E3 Register

31	30	29	28	27	26	25	24	23	22	21	20	19	18	17	16
RESERVED															
R-0h															
15	14	13	12	11	10	9	8	7	6	5	4	3	2	1	0
RESERVED								ETYPE		ENUM					
R-0h								R-0h		R-0h					

LEGEND: R/W = Read/Write; R = Read only; W1toCl = Write 1 to clear bit; -n = value after reset

Table 11-79. Q1E3 Register Field Descriptions

Bit	Field	Type	Reset	Description
31-8	RESERVED	R	0h	
7-6	ETYPE	R	0h	Event entry 3 in queue 1. Specifies the specific event type for the given entry in the event queue. 0h = Event triggered via ER. 1h = Auto-triggered via QER.
5-0	ENUM	R	0h	Event entry 3 in queue 1. Event number: QDMA channel number (0 to 3). DMA channel/event number (0 to 63).

11.4.1.55 Q1E4 Register (offset = 450h) [reset = 0h]

Q1E4 is shown in [Figure 11-96](#) and described in [Table 11-80](#).

The event queue entry registers (QxEy) exist for all 16 queue entries (the maximum allowed queue entries) for all event queues in the EDMA3CC. The event queue entry registers range from Q0E0 to Q0E15, Q1E0 to Q1E15, and Q2E0 to Q2E15. Each register details the event number (ENUM) and the event type (ETYPE). For example, if the value in Q1E4 is read as 000 004Fh, this means the 4th entry in queue 1 is a manually-triggered event on DMA channel 15. The Q1E4 register provides visibility into the event queues and a TR life cycle. These are useful for system debug as they provide in-depth visibility for the events queued up in the event queue and also provide information on what parts of the EDMA3CC logic are active once the event has been received by the EDMA3CC.

Figure 11-96. Q1E4 Register

31	30	29	28	27	26	25	24	23	22	21	20	19	18	17	16
RESERVED															
R-0h															
15	14	13	12	11	10	9	8	7	6	5	4	3	2	1	0
RESERVED								ETYPE				ENUM			
R-0h								R-0h				R-0h			

LEGEND: R/W = Read/Write; R = Read only; W1toCl = Write 1 to clear bit; -n = value after reset

Table 11-80. Q1E4 Register Field Descriptions

Bit	Field	Type	Reset	Description
31-8	RESERVED	R	0h	
7-6	ETYPE	R	0h	Event entry 4 in queue 1. Specifies the specific event type for the given entry in the event queue. 0h = Event triggered via ER. 1h = Auto-triggered via QER.
5-0	ENUM	R	0h	Event entry 4 in queue 1. Event number: QDMA channel number (0 to 3). DMA channel/event number (0 to 63).

11.4.1.56 Q1E5 Register (offset = 454h) [reset = 0h]

Q1E5 is shown in [Figure 11-97](#) and described in [Table 11-81](#).

The event queue entry registers (QxEy) exist for all 16 queue entries (the maximum allowed queue entries) for all event queues in the EDMA3CC. The event queue entry registers range from Q0E0 to Q0E15, Q1E0 to Q1E15, and Q2E0 to Q2E15. Each register details the event number (ENUM) and the event type (ETYPE). For example, if the value in Q1E4 is read as 000 004Fh, this means the 4th entry in queue 1 is a manually-triggered event on DMA channel 15. The Q1E5 register provides visibility into the event queues and a TR life cycle. These are useful for system debug as they provide in-depth visibility for the events queued up in the event queue and also provide information on what parts of the EDMA3CC logic are active once the event has been received by the EDMA3CC.

Figure 11-97. Q1E5 Register

31	30	29	28	27	26	25	24	23	22	21	20	19	18	17	16
RESERVED															
R-0h															
15	14	13	12	11	10	9	8	7	6	5	4	3	2	1	0
RESERVED								ETYPE				ENUM			
R-0h								R-0h				R-0h			

LEGEND: R/W = Read/Write; R = Read only; W1toCl = Write 1 to clear bit; -n = value after reset

Table 11-81. Q1E5 Register Field Descriptions

Bit	Field	Type	Reset	Description
31-8	RESERVED	R	0h	
7-6	ETYPE	R	0h	Event entry 5 in queue 1. Specifies the specific event type for the given entry in the event queue. 0h = Event triggered via ER. 1h = Auto-triggered via QER.
5-0	ENUM	R	0h	Event entry 5 in queue 1. Event number: QDMA channel number (0 to 3). DMA channel/event number (0 to 63).

11.4.1.57 Q1E6 Register (offset = 458h) [reset = 0h]

Q1E6 is shown in [Figure 11-98](#) and described in [Table 11-82](#).

The event queue entry registers (QxEy) exist for all 16 queue entries (the maximum allowed queue entries) for all event queues in the EDMA3CC. The event queue entry registers range from Q0E0 to Q0E15, Q1E0 to Q1E15, and Q2E0 to Q2E15. Each register details the event number (ENUM) and the event type (ETYPE). For example, if the value in Q1E4 is read as 000 004Fh, this means the 4th entry in queue 1 is a manually-triggered event on DMA channel 15. The Q1E6 register provides visibility into the event queues and a TR life cycle. These are useful for system debug as they provide in-depth visibility for the events queued up in the event queue and also provide information on what parts of the EDMA3CC logic are active once the event has been received by the EDMA3CC.

Figure 11-98. Q1E6 Register

31	30	29	28	27	26	25	24	23	22	21	20	19	18	17	16
RESERVED															
R-0h															
15	14	13	12	11	10	9	8	7	6	5	4	3	2	1	0
RESERVED								ETYPE				ENUM			
R-0h								R-0h				R-0h			

LEGEND: R/W = Read/Write; R = Read only; W1toCl = Write 1 to clear bit; -n = value after reset

Table 11-82. Q1E6 Register Field Descriptions

Bit	Field	Type	Reset	Description
31-8	RESERVED	R	0h	
7-6	ETYPE	R	0h	Event entry 6 in queue 1. Specifies the specific event type for the given entry in the event queue. 0h = Event triggered via ER. 1h = Auto-triggered via QER.
5-0	ENUM	R	0h	Event entry 6 in queue 1. Event number: QDMA channel number (0 to 3). DMA channel/event number (0 to 63).

11.4.1.58 Q1E7 Register (offset = 45Ch) [reset = 0h]

Q1E7 is shown in [Figure 11-99](#) and described in [Table 11-83](#).

The event queue entry registers (QxEy) exist for all 16 queue entries (the maximum allowed queue entries) for all event queues in the EDMA3CC. The event queue entry registers range from Q0E0 to Q0E15, Q1E0 to Q1E15, and Q2E0 to Q2E15. Each register details the event number (ENUM) and the event type (ETYPE). For example, if the value in Q1E4 is read as 000 004Fh, this means the 4th entry in queue 1 is a manually-triggered event on DMA channel 15. The Q1E7 register provides visibility into the event queues and a TR life cycle. These are useful for system debug as they provide in-depth visibility for the events queued up in the event queue and also provide information on what parts of the EDMA3CC logic are active once the event has been received by the EDMA3CC.

Figure 11-99. Q1E7 Register

31	30	29	28	27	26	25	24	23	22	21	20	19	18	17	16
RESERVED															
R-0h															
15	14	13	12	11	10	9	8	7	6	5	4	3	2	1	0
RESERVED								ETYPE				ENUM			
R-0h								R-0h				R-0h			

LEGEND: R/W = Read/Write; R = Read only; W1toCl = Write 1 to clear bit; -n = value after reset

Table 11-83. Q1E7 Register Field Descriptions

Bit	Field	Type	Reset	Description
31-8	RESERVED	R	0h	
7-6	ETYPE	R	0h	Event entry 7 in queue 1. Specifies the specific event type for the given entry in the event queue. 0h = Event triggered via ER. 1h = Auto-triggered via QER.
5-0	ENUM	R	0h	Event entry 7 in queue 1. Event number: QDMA channel number (0 to 3). DMA channel/event number (0 to 63).

11.4.1.59 Q1E8 Register (offset = 460h) [reset = 0h]

Q1E8 is shown in [Figure 11-100](#) and described in [Table 11-84](#).

The event queue entry registers (QxEy) exist for all 16 queue entries (the maximum allowed queue entries) for all event queues in the EDMA3CC. The event queue entry registers range from Q0E0 to Q0E15, Q1E0 to Q1E15, and Q2E0 to Q2E15. Each register details the event number (ENUM) and the event type (ETYPE). For example, if the value in Q1E4 is read as 000 004Fh, this means the 4th entry in queue 1 is a manually-triggered event on DMA channel 15. The Q1E8 register provides visibility into the event queues and a TR life cycle. These are useful for system debug as they provide in-depth visibility for the events queued up in the event queue and also provide information on what parts of the EDMA3CC logic are active once the event has been received by the EDMA3CC.

Figure 11-100. Q1E8 Register

31	30	29	28	27	26	25	24	23	22	21	20	19	18	17	16
RESERVED															
R-0h															
15	14	13	12	11	10	9	8	7	6	5	4	3	2	1	0
RESERVED								ETYPE		ENUM					
R-0h								R-0h		R-0h					

LEGEND: R/W = Read/Write; R = Read only; W1toCl = Write 1 to clear bit; -n = value after reset

Table 11-84. Q1E8 Register Field Descriptions

Bit	Field	Type	Reset	Description
31-8	RESERVED	R	0h	
7-6	ETYPE	R	0h	Event entry 8 in queue 1. Specifies the specific event type for the given entry in the event queue. 0h = Event triggered via ER. 1h = Auto-triggered via QER.
5-0	ENUM	R	0h	Event entry 8 in queue 1. Event number: QDMA channel number (0 to 3). DMA channel/event number (0 to 63).

11.4.1.60 Q1E9 Register (offset = 464h) [reset = 0h]

Q1E9 is shown in [Figure 11-101](#) and described in [Table 11-85](#).

The event queue entry registers (QxEy) exist for all 16 queue entries (the maximum allowed queue entries) for all event queues in the EDMA3CC. The event queue entry registers range from Q0E0 to Q0E15, Q1E0 to Q1E15, and Q2E0 to Q2E15. Each register details the event number (ENUM) and the event type (ETYPE). For example, if the value in Q1E4 is read as 000 004Fh, this means the 4th entry in queue 1 is a manually-triggered event on DMA channel 15. The Q1E9 register provides visibility into the event queues and a TR life cycle. These are useful for system debug as they provide in-depth visibility for the events queued up in the event queue and also provide information on what parts of the EDMA3CC logic are active once the event has been received by the EDMA3CC.

Figure 11-101. Q1E9 Register

31	30	29	28	27	26	25	24	23	22	21	20	19	18	17	16
RESERVED															
R-0h															
15	14	13	12	11	10	9	8	7	6	5	4	3	2	1	0
RESERVED								ETYPE				ENUM			
R-0h								R-0h				R-0h			

LEGEND: R/W = Read/Write; R = Read only; W1toCl = Write 1 to clear bit; -n = value after reset

Table 11-85. Q1E9 Register Field Descriptions

Bit	Field	Type	Reset	Description
31-8	RESERVED	R	0h	
7-6	ETYPE	R	0h	Event entry 9 in queue 1. Specifies the specific event type for the given entry in the event queue. 0h = Event triggered via ER. 1h = Auto-triggered via QER.
5-0	ENUM	R	0h	Event entry 9 in queue 1. Event number: QDMA channel number (0 to 3). DMA channel/event number (0 to 63).

11.4.1.61 Q1E10 Register (offset = 468h) [reset = 0h]

Q1E10 is shown in [Figure 11-102](#) and described in [Table 11-86](#).

The event queue entry registers (QxEy) exist for all 16 queue entries (the maximum allowed queue entries) for all event queues in the EDMA3CC. The event queue entry registers range from Q0E0 to Q0E15, Q1E0 to Q1E15, and Q2E0 to Q2E15. Each register details the event number (ENUM) and the event type (ETYPE). For example, if the value in Q1E4 is read as 000 004Fh, this means the 4th entry in queue 1 is a manually-triggered event on DMA channel 15. The Q1E10 register provides visibility into the event queues and a TR life cycle. These are useful for system debug as they provide in-depth visibility for the events queued up in the event queue and also provide information on what parts of the EDMA3CC logic are active once the event has been received by the EDMA3CC.

Figure 11-102. Q1E10 Register

31	30	29	28	27	26	25	24	23	22	21	20	19	18	17	16
RESERVED															
R-0h															
15	14	13	12	11	10	9	8	7	6	5	4	3	2	1	0
RESERVED								ETYPE				ENUM			
R-0h								R-0h				R-0h			

LEGEND: R/W = Read/Write; R = Read only; W1toCl = Write 1 to clear bit; -n = value after reset

Table 11-86. Q1E10 Register Field Descriptions

Bit	Field	Type	Reset	Description
31-8	RESERVED	R	0h	
7-6	ETYPE	R	0h	Event entry 10 in queue 1. Specifies the specific event type for the given entry in the event queue. 0h = Event triggered via ER. 1h = Auto-triggered via QER.
5-0	ENUM	R	0h	Event entry 10 in queue 1. Event number: QDMA channel number (0 to 3). DMA channel/event number (0 to 63).

11.4.1.62 Q1E11 Register (offset = 46Ch) [reset = 0h]

Q1E11 is shown in [Figure 11-103](#) and described in [Table 11-87](#).

The event queue entry registers (QxEy) exist for all 16 queue entries (the maximum allowed queue entries) for all event queues in the EDMA3CC. The event queue entry registers range from Q0E0 to Q0E15, Q1E0 to Q1E15, and Q2E0 to Q2E15. Each register details the event number (ENUM) and the event type (ETYPE). For example, if the value in Q1E4 is read as 000 004Fh, this means the 4th entry in queue 1 is a manually-triggered event on DMA channel 15. The Q1E11 register provides visibility into the event queues and a TR life cycle. These are useful for system debug as they provide in-depth visibility for the events queued up in the event queue and also provide information on what parts of the EDMA3CC logic are active once the event has been received by the EDMA3CC.

Figure 11-103. Q1E11 Register

31	30	29	28	27	26	25	24	23	22	21	20	19	18	17	16
RESERVED															
R-0h															
15	14	13	12	11	10	9	8	7	6	5	4	3	2	1	0
RESERVED								ETYPE				ENUM			
R-0h								R-0h				R-0h			

LEGEND: R/W = Read/Write; R = Read only; W1toCl = Write 1 to clear bit; -n = value after reset

Table 11-87. Q1E11 Register Field Descriptions

Bit	Field	Type	Reset	Description
31-8	RESERVED	R	0h	
7-6	ETYPE	R	0h	Event entry 11 in queue 1. Specifies the specific event type for the given entry in the event queue. 0h = Event triggered via ER. 1h = Auto-triggered via QER.
5-0	ENUM	R	0h	Event entry 11 in queue 1. Event number: QDMA channel number (0 to 3). DMA channel/event number (0 to 63).

11.4.1.63 Q1E12 Register (offset = 470h) [reset = 0h]

Q1E12 is shown in [Figure 11-104](#) and described in [Table 11-88](#).

The event queue entry registers (QxEy) exist for all 16 queue entries (the maximum allowed queue entries) for all event queues in the EDMA3CC. The event queue entry registers range from Q0E0 to Q0E15, Q1E0 to Q1E15, and Q2E0 to Q2E15. Each register details the event number (ENUM) and the event type (ETYPE). For example, if the value in Q1E4 is read as 000 004Fh, this means the 4th entry in queue 1 is a manually-triggered event on DMA channel 15. The Q1E12 register provides visibility into the event queues and a TR life cycle. These are useful for system debug as they provide in-depth visibility for the events queued up in the event queue and also provide information on what parts of the EDMA3CC logic are active once the event has been received by the EDMA3CC.

Figure 11-104. Q1E12 Register

31	30	29	28	27	26	25	24	23	22	21	20	19	18	17	16
RESERVED															
R-0h															
15	14	13	12	11	10	9	8	7	6	5	4	3	2	1	0
RESERVED								ETYPE		ENUM					
R-0h								R-0h		R-0h					

LEGEND: R/W = Read/Write; R = Read only; W1toCl = Write 1 to clear bit; -n = value after reset

Table 11-88. Q1E12 Register Field Descriptions

Bit	Field	Type	Reset	Description
31-8	RESERVED	R	0h	
7-6	ETYPE	R	0h	Event entry 12 in queue 1. Specifies the specific event type for the given entry in the event queue. 0h = Event triggered via ER. 1h = Auto-triggered via QER.
5-0	ENUM	R	0h	Event entry 12 in queue 1. Event number: QDMA channel number (0 to 3). DMA channel/event number (0 to 63).

11.4.1.64 Q1E13 Register (offset = 474h) [reset = 0h]

Q1E13 is shown in [Figure 11-105](#) and described in [Table 11-89](#).

The event queue entry registers (QxEy) exist for all 16 queue entries (the maximum allowed queue entries) for all event queues in the EDMA3CC. The event queue entry registers range from Q0E0 to Q0E15, Q1E0 to Q1E15, and Q2E0 to Q2E15. Each register details the event number (ENUM) and the event type (ETYPE). For example, if the value in Q1E4 is read as 000 004Fh, this means the 4th entry in queue 1 is a manually-triggered event on DMA channel 15. The Q1E13 register provides visibility into the event queues and a TR life cycle. These are useful for system debug as they provide in-depth visibility for the events queued up in the event queue and also provide information on what parts of the EDMA3CC logic are active once the event has been received by the EDMA3CC.

Figure 11-105. Q1E13 Register

31	30	29	28	27	26	25	24	23	22	21	20	19	18	17	16
RESERVED															
R-0h															
15	14	13	12	11	10	9	8	7	6	5	4	3	2	1	0
RESERVED								ETYPE				ENUM			
R-0h								R-0h				R-0h			

LEGEND: R/W = Read/Write; R = Read only; W1toCl = Write 1 to clear bit; -n = value after reset

Table 11-89. Q1E13 Register Field Descriptions

Bit	Field	Type	Reset	Description
31-8	RESERVED	R	0h	
7-6	ETYPE	R	0h	Event entry 13 in queue 1. Specifies the specific event type for the given entry in the event queue. 0h = Event triggered via ER. 1h = Auto-triggered via QER.
5-0	ENUM	R	0h	Event entry 13 in queue 1. Event number: QDMA channel number (0 to 3). DMA channel/event number (0 to 63).

11.4.1.65 Q1E14 Register (offset = 478h) [reset = 0h]

Q1E14 is shown in [Figure 11-106](#) and described in [Table 11-90](#).

The event queue entry registers (QxEy) exist for all 16 queue entries (the maximum allowed queue entries) for all event queues in the EDMA3CC. The event queue entry registers range from Q0E0 to Q0E15, Q1E0 to Q1E15, and Q2E0 to Q2E15. Each register details the event number (ENUM) and the event type (ETYPE). For example, if the value in Q1E4 is read as 000 004Fh, this means the 4th entry in queue 1 is a manually-triggered event on DMA channel 15. The Q1E14 register provides visibility into the event queues and a TR life cycle. These are useful for system debug as they provide in-depth visibility for the events queued up in the event queue and also provide information on what parts of the EDMA3CC logic are active once the event has been received by the EDMA3CC.

Figure 11-106. Q1E14 Register

31	30	29	28	27	26	25	24	23	22	21	20	19	18	17	16
RESERVED															
R-0h															
15	14	13	12	11	10	9	8	7	6	5	4	3	2	1	0
RESERVED								ETYPE				ENUM			
R-0h								R-0h				R-0h			

LEGEND: R/W = Read/Write; R = Read only; W1toCl = Write 1 to clear bit; -n = value after reset

Table 11-90. Q1E14 Register Field Descriptions

Bit	Field	Type	Reset	Description
31-8	RESERVED	R	0h	
7-6	ETYPE	R	0h	Event entry 14 in queue 1. Specifies the specific event type for the given entry in the event queue. 0h = Event triggered via ER. 1h = Auto-triggered via QER.
5-0	ENUM	R	0h	Event entry 14 in queue 1. Event number: QDMA channel number (0 to 3). DMA channel/event number (0 to 63).

11.4.1.66 Q1E15 Register (offset = 47Ch) [reset = 0h]

Q1E15 is shown in [Figure 11-107](#) and described in [Table 11-91](#).

The event queue entry registers (QxEy) exist for all 16 queue entries (the maximum allowed queue entries) for all event queues in the EDMA3CC. The event queue entry registers range from Q0E0 to Q0E15, Q1E0 to Q1E15, and Q2E0 to Q2E15. Each register details the event number (ENUM) and the event type (ETYPE). For example, if the value in Q1E4 is read as 000 004Fh, this means the 4th entry in queue 1 is a manually-triggered event on DMA channel 15. The Q1E15 register provides visibility into the event queues and a TR life cycle. These are useful for system debug as they provide in-depth visibility for the events queued up in the event queue and also provide information on what parts of the EDMA3CC logic are active once the event has been received by the EDMA3CC.

Figure 11-107. Q1E15 Register

31	30	29	28	27	26	25	24	23	22	21	20	19	18	17	16
RESERVED															
R-0h															
15	14	13	12	11	10	9	8	7	6	5	4	3	2	1	0
RESERVED								ETYPE				ENUM			
R-0h								R-0h				R-0h			

LEGEND: R/W = Read/Write; R = Read only; W1toCl = Write 1 to clear bit; -n = value after reset

Table 11-91. Q1E15 Register Field Descriptions

Bit	Field	Type	Reset	Description
31-8	RESERVED	R	0h	
7-6	ETYPE	R	0h	Event entry 15 in queue 1. Specifies the specific event type for the given entry in the event queue. 0h = Event triggered via ER. 1h = Auto-triggered via QER.
5-0	ENUM	R	0h	Event entry 15 in queue 1. Event number: QDMA channel number (0 to 3). DMA channel/event number (0 to 63).

11.4.1.67 Q2E0 Register (offset = 480h) [reset = 0h]

Q2E0 is shown in [Figure 11-108](#) and described in [Table 11-92](#).

The event queue entry registers (QxEy) exist for all 16 queue entries (the maximum allowed queue entries) for all event queues in the EDMA3CC. The event queue entry registers range from Q0E0 to Q0E15, Q1E0 to Q1E15, and Q2E0 to Q2E15. Each register details the event number (ENUM) and the event type (ETYPE). For example, if the value in Q1E4 is read as 000 004Fh, this means the 4th entry in queue 1 is a manually-triggered event on DMA channel 15. The Q2E0 register provides visibility into the event queues and a TR life cycle. These are useful for system debug as they provide in-depth visibility for the events queued up in the event queue and also provide information on what parts of the EDMA3CC logic are active once the event has been received by the EDMA3CC.

Figure 11-108. Q2E0 Register

31	30	29	28	27	26	25	24	23	22	21	20	19	18	17	16
RESERVED															
R-0h															
15	14	13	12	11	10	9	8	7	6	5	4	3	2	1	0
RESERVED								ETYPE				ENUM			
R-0h								R-0h				R-0h			

LEGEND: R/W = Read/Write; R = Read only; W1toCl = Write 1 to clear bit; -n = value after reset

Table 11-92. Q2E0 Register Field Descriptions

Bit	Field	Type	Reset	Description
31-8	RESERVED	R	0h	
7-6	ETYPE	R	0h	Event entry 0 in queue 2. Specifies the specific event type for the given entry in the event queue. 0h = Event triggered via ER. 1h = Auto-triggered via QER.
5-0	ENUM	R	0h	Event entry 0 in queue 2. Event number: QDMA channel number (0 to 3). DMA channel/event number (0 to 63).

11.4.1.68 Q2E1 Register (offset = 484h) [reset = 0h]

Q2E1 is shown in [Figure 11-109](#) and described in [Table 11-93](#).

The event queue entry registers (QxEy) exist for all 16 queue entries (the maximum allowed queue entries) for all event queues in the EDMA3CC. The event queue entry registers range from Q0E0 to Q0E15, Q1E0 to Q1E15, and Q2E0 to Q2E15. Each register details the event number (ENUM) and the event type (ETYPE). For example, if the value in Q1E4 is read as 000 004Fh, this means the 4th entry in queue 1 is a manually-triggered event on DMA channel 15. The Q2E1 register provides visibility into the event queues and a TR life cycle. These are useful for system debug as they provide in-depth visibility for the events queued up in the event queue and also provide information on what parts of the EDMA3CC logic are active once the event has been received by the EDMA3CC.

Figure 11-109. Q2E1 Register

31	30	29	28	27	26	25	24	23	22	21	20	19	18	17	16
RESERVED															
R-0h															
15	14	13	12	11	10	9	8	7	6	5	4	3	2	1	0
RESERVED								ETYPE				ENUM			
R-0h								R-0h				R-0h			

LEGEND: R/W = Read/Write; R = Read only; W1toCl = Write 1 to clear bit; -n = value after reset

Table 11-93. Q2E1 Register Field Descriptions

Bit	Field	Type	Reset	Description
31-8	RESERVED	R	0h	
7-6	ETYPE	R	0h	Event entry 1 in queue 2. Specifies the specific event type for the given entry in the event queue. 0h = Event triggered via ER. 1h = Auto-triggered via QER.
5-0	ENUM	R	0h	Event entry 1 in queue 2. Event number: QDMA channel number (0 to 3). DMA channel/event number (0 to 63).

11.4.1.69 Q2E2 Register (offset = 488h) [reset = 0h]

Q2E2 is shown in [Figure 11-110](#) and described in [Table 11-94](#).

The event queue entry registers (QxEy) exist for all 16 queue entries (the maximum allowed queue entries) for all event queues in the EDMA3CC. The event queue entry registers range from Q0E0 to Q0E15, Q1E0 to Q1E15, and Q2E0 to Q2E15. Each register details the event number (ENUM) and the event type (ETYPE). For example, if the value in Q1E4 is read as 000 004Fh, this means the 4th entry in queue 1 is a manually-triggered event on DMA channel 15. The Q2E2 register provides visibility into the event queues and a TR life cycle. These are useful for system debug as they provide in-depth visibility for the events queued up in the event queue and also provide information on what parts of the EDMA3CC logic are active once the event has been received by the EDMA3CC.

Figure 11-110. Q2E2 Register

31	30	29	28	27	26	25	24	23	22	21	20	19	18	17	16
RESERVED															
R-0h															
15	14	13	12	11	10	9	8	7	6	5	4	3	2	1	0
RESERVED								ETYPE				ENUM			
R-0h								R-0h				R-0h			

LEGEND: R/W = Read/Write; R = Read only; W1toCl = Write 1 to clear bit; -n = value after reset

Table 11-94. Q2E2 Register Field Descriptions

Bit	Field	Type	Reset	Description
31-8	RESERVED	R	0h	
7-6	ETYPE	R	0h	Event entry 2 in queue 2. Specifies the specific event type for the given entry in the event queue. 0h = Event triggered via ER. 1h = Auto-triggered via QER.
5-0	ENUM	R	0h	Event entry 2 in queue 2. Event number: QDMA channel number (0 to 3). DMA channel/event number (0 to 63).

11.4.1.70 Q2E3 Register (offset = 48Ch) [reset = 0h]

Q2E3 is shown in [Figure 11-111](#) and described in [Table 11-95](#).

The event queue entry registers (QxEy) exist for all 16 queue entries (the maximum allowed queue entries) for all event queues in the EDMA3CC. The event queue entry registers range from Q0E0 to Q0E15, Q1E0 to Q1E15, and Q2E0 to Q2E15. Each register details the event number (ENUM) and the event type (ETYPE). For example, if the value in Q1E4 is read as 000 004Fh, this means the 4th entry in queue 1 is a manually-triggered event on DMA channel 15. The Q2E3 register provides visibility into the event queues and a TR life cycle. These are useful for system debug as they provide in-depth visibility for the events queued up in the event queue and also provide information on what parts of the EDMA3CC logic are active once the event has been received by the EDMA3CC.

Figure 11-111. Q2E3 Register

31	30	29	28	27	26	25	24	23	22	21	20	19	18	17	16
RESERVED															
R-0h															
15	14	13	12	11	10	9	8	7	6	5	4	3	2	1	0
RESERVED								ETYPE				ENUM			
R-0h								R-0h				R-0h			

LEGEND: R/W = Read/Write; R = Read only; W1toCl = Write 1 to clear bit; -n = value after reset

Table 11-95. Q2E3 Register Field Descriptions

Bit	Field	Type	Reset	Description
31-8	RESERVED	R	0h	
7-6	ETYPE	R	0h	Event entry 3 in queue 2. Specifies the specific event type for the given entry in the event queue. 0h = Event triggered via ER. 1h = Auto-triggered via QER.
5-0	ENUM	R	0h	Event entry 3 in queue 2. Event number: QDMA channel number (0 to 3). DMA channel/event number (0 to 63).

11.4.1.71 Q2E4 Register (offset = 490h) [reset = 0h]

Q2E4 is shown in [Figure 11-112](#) and described in [Table 11-96](#).

The event queue entry registers (QxEy) exist for all 16 queue entries (the maximum allowed queue entries) for all event queues in the EDMA3CC. The event queue entry registers range from Q0E0 to Q0E15, Q1E0 to Q1E15, and Q2E0 to Q2E15. Each register details the event number (ENUM) and the event type (ETYPE). For example, if the value in Q1E4 is read as 000 004Fh, this means the 4th entry in queue 1 is a manually-triggered event on DMA channel 15. The Q2E4 register provides visibility into the event queues and a TR life cycle. These are useful for system debug as they provide in-depth visibility for the events queued up in the event queue and also provide information on what parts of the EDMA3CC logic are active once the event has been received by the EDMA3CC.

Figure 11-112. Q2E4 Register

31	30	29	28	27	26	25	24	23	22	21	20	19	18	17	16
RESERVED															
R-0h															
15	14	13	12	11	10	9	8	7	6	5	4	3	2	1	0
RESERVED								ETYPE				ENUM			
R-0h								R-0h				R-0h			

LEGEND: R/W = Read/Write; R = Read only; W1toCl = Write 1 to clear bit; -n = value after reset

Table 11-96. Q2E4 Register Field Descriptions

Bit	Field	Type	Reset	Description
31-8	RESERVED	R	0h	
7-6	ETYPE	R	0h	Event entry 4 in queue 2. Specifies the specific event type for the given entry in the event queue. 0h = Event triggered via ER. 1h = Auto-triggered via QER.
5-0	ENUM	R	0h	Event entry 4 in queue 2. Event number: QDMA channel number (0 to 3). DMA channel/event number (0 to 63).

11.4.1.72 Q2E5 Register (offset = 494h) [reset = 0h]

Q2E5 is shown in [Figure 11-113](#) and described in [Table 11-97](#).

The event queue entry registers (QxEy) exist for all 16 queue entries (the maximum allowed queue entries) for all event queues in the EDMA3CC. The event queue entry registers range from Q0E0 to Q0E15, Q1E0 to Q1E15, and Q2E0 to Q2E15. Each register details the event number (ENUM) and the event type (ETYPE). For example, if the value in Q1E4 is read as 000 004Fh, this means the 4th entry in queue 1 is a manually-triggered event on DMA channel 15. The Q2E5 register provides visibility into the event queues and a TR life cycle. These are useful for system debug as they provide in-depth visibility for the events queued up in the event queue and also provide information on what parts of the EDMA3CC logic are active once the event has been received by the EDMA3CC.

Figure 11-113. Q2E5 Register

31	30	29	28	27	26	25	24	23	22	21	20	19	18	17	16
RESERVED															
R-0h															
15	14	13	12	11	10	9	8	7	6	5	4	3	2	1	0
RESERVED								ETYPE				ENUM			
R-0h								R-0h				R-0h			

LEGEND: R/W = Read/Write; R = Read only; W1toCl = Write 1 to clear bit; -n = value after reset

Table 11-97. Q2E5 Register Field Descriptions

Bit	Field	Type	Reset	Description
31-8	RESERVED	R	0h	
7-6	ETYPE	R	0h	Event entry 5 in queue 2. Specifies the specific event type for the given entry in the event queue. 0h = Event triggered via ER. 1h = Auto-triggered via QER.
5-0	ENUM	R	0h	Event entry 5 in queue 2. Event number: QDMA channel number (0 to 3). DMA channel/event number (0 to 63).

11.4.1.73 Q2E6 Register (offset = 498h) [reset = 0h]

Q2E6 is shown in [Figure 11-114](#) and described in [Table 11-98](#).

The event queue entry registers (QxEy) exist for all 16 queue entries (the maximum allowed queue entries) for all event queues in the EDMA3CC. The event queue entry registers range from Q0E0 to Q0E15, Q1E0 to Q1E15, and Q2E0 to Q2E15. Each register details the event number (ENUM) and the event type (ETYPE). For example, if the value in Q1E4 is read as 000 004Fh, this means the 4th entry in queue 1 is a manually-triggered event on DMA channel 15. The Q2E6 register provides visibility into the event queues and a TR life cycle. These are useful for system debug as they provide in-depth visibility for the events queued up in the event queue and also provide information on what parts of the EDMA3CC logic are active once the event has been received by the EDMA3CC.

Figure 11-114. Q2E6 Register

31	30	29	28	27	26	25	24	23	22	21	20	19	18	17	16
RESERVED															
R-0h															
15	14	13	12	11	10	9	8	7	6	5	4	3	2	1	0
RESERVED								ETYPE		ENUM					
R-0h								R-0h		R-0h					

LEGEND: R/W = Read/Write; R = Read only; W1toCl = Write 1 to clear bit; -n = value after reset

Table 11-98. Q2E6 Register Field Descriptions

Bit	Field	Type	Reset	Description
31-8	RESERVED	R	0h	
7-6	ETYPE	R	0h	Event entry 6 in queue 2. Specifies the specific event type for the given entry in the event queue. 0h = Event triggered via ER. 1h = Auto-triggered via QER.
5-0	ENUM	R	0h	Event entry 6 in queue 2. Event number: QDMA channel number (0 to 3). DMA channel/event number (0 to 63).

11.4.1.74 Q2E7 Register (offset = 49Ch) [reset = 0h]

Q2E7 is shown in [Figure 11-115](#) and described in [Table 11-99](#).

The event queue entry registers (QxEy) exist for all 16 queue entries (the maximum allowed queue entries) for all event queues in the EDMA3CC. The event queue entry registers range from Q0E0 to Q0E15, Q1E0 to Q1E15, and Q2E0 to Q2E15. Each register details the event number (ENUM) and the event type (ETYPE). For example, if the value in Q1E4 is read as 000 004Fh, this means the 4th entry in queue 1 is a manually-triggered event on DMA channel 15. The Q2E7 register provides visibility into the event queues and a TR life cycle. These are useful for system debug as they provide in-depth visibility for the events queued up in the event queue and also provide information on what parts of the EDMA3CC logic are active once the event has been received by the EDMA3CC.

Figure 11-115. Q2E7 Register

31	30	29	28	27	26	25	24	23	22	21	20	19	18	17	16
RESERVED															
R-0h															
15	14	13	12	11	10	9	8	7	6	5	4	3	2	1	0
RESERVED								ETYPE				ENUM			
R-0h								R-0h				R-0h			

LEGEND: R/W = Read/Write; R = Read only; W1toCl = Write 1 to clear bit; -n = value after reset

Table 11-99. Q2E7 Register Field Descriptions

Bit	Field	Type	Reset	Description
31-8	RESERVED	R	0h	
7-6	ETYPE	R	0h	Event entry 7 in queue 2. Specifies the specific event type for the given entry in the event queue. 0h = Event triggered via ER. 1h = Auto-triggered via QER.
5-0	ENUM	R	0h	Event entry 7 in queue 2. Event number: QDMA channel number (0 to 3). DMA channel/event number (0 to 63).

11.4.1.75 Q2E8 Register (offset = 4A0h) [reset = 0h]

Q2E8 is shown in [Figure 11-116](#) and described in [Table 11-100](#).

The event queue entry registers (QxEy) exist for all 16 queue entries (the maximum allowed queue entries) for all event queues in the EDMA3CC. The event queue entry registers range from Q0E0 to Q0E15, Q1E0 to Q1E15, and Q2E0 to Q2E15. Each register details the event number (ENUM) and the event type (ETYPE). For example, if the value in Q1E4 is read as 000 004Fh, this means the 4th entry in queue 1 is a manually-triggered event on DMA channel 15. The Q2E8 register provides visibility into the event queues and a TR life cycle. These are useful for system debug as they provide in-depth visibility for the events queued up in the event queue and also provide information on what parts of the EDMA3CC logic are active once the event has been received by the EDMA3CC.

Figure 11-116. Q2E8 Register

31	30	29	28	27	26	25	24	23	22	21	20	19	18	17	16
RESERVED															
R-0h															
15	14	13	12	11	10	9	8	7	6	5	4	3	2	1	0
RESERVED								ETYPE		ENUM					
R-0h								R-0h		R-0h					

LEGEND: R/W = Read/Write; R = Read only; W1toCl = Write 1 to clear bit; -n = value after reset

Table 11-100. Q2E8 Register Field Descriptions

Bit	Field	Type	Reset	Description
31-8	RESERVED	R	0h	
7-6	ETYPE	R	0h	Event entry 8 in queue 2. Specifies the specific event type for the given entry in the event queue. 0h = Event triggered via ER. 1h = Auto-triggered via QER.
5-0	ENUM	R	0h	Event entry 8 in queue 2. Event number: QDMA channel number (0 to 3). DMA channel/event number (0 to 63).

11.4.1.76 Q2E9 Register (offset = 4A4h) [reset = 0h]

Q2E9 is shown in [Figure 11-117](#) and described in [Table 11-101](#).

The event queue entry registers (QxEy) exist for all 16 queue entries (the maximum allowed queue entries) for all event queues in the EDMA3CC. The event queue entry registers range from Q0E0 to Q0E15, Q1E0 to Q1E15, and Q2E0 to Q2E15. Each register details the event number (ENUM) and the event type (ETYPE). For example, if the value in Q1E4 is read as 000 004Fh, this means the 4th entry in queue 1 is a manually-triggered event on DMA channel 15. The Q2E9 register provides visibility into the event queues and a TR life cycle. These are useful for system debug as they provide in-depth visibility for the events queued up in the event queue and also provide information on what parts of the EDMA3CC logic are active once the event has been received by the EDMA3CC.

Figure 11-117. Q2E9 Register

31	30	29	28	27	26	25	24	23	22	21	20	19	18	17	16
RESERVED															
R-0h															
15	14	13	12	11	10	9	8	7	6	5	4	3	2	1	0
RESERVED								ETYPE				ENUM			
R-0h								R-0h				R-0h			

LEGEND: R/W = Read/Write; R = Read only; W1toCl = Write 1 to clear bit; -n = value after reset

Table 11-101. Q2E9 Register Field Descriptions

Bit	Field	Type	Reset	Description
31-8	RESERVED	R	0h	
7-6	ETYPE	R	0h	Event entry 9 in queue 2. Specifies the specific event type for the given entry in the event queue. 0h = Event triggered via ER. 1h = Auto-triggered via QER.
5-0	ENUM	R	0h	Event entry 9 in queue 2. Event number: QDMA channel number (0 to 3). DMA channel/event number (0 to 63).

11.4.1.77 Q2E10 Register (offset = 4A8h) [reset = 0h]

Q2E10 is shown in [Figure 11-118](#) and described in [Table 11-102](#).

The event queue entry registers (QxEy) exist for all 16 queue entries (the maximum allowed queue entries) for all event queues in the EDMA3CC. The event queue entry registers range from Q0E0 to Q0E15, Q1E0 to Q1E15, and Q2E0 to Q2E15. Each register details the event number (ENUM) and the event type (ETYPE). For example, if the value in Q1E4 is read as 000 004Fh, this means the 4th entry in queue 1 is a manually-triggered event on DMA channel 15. The Q2E10 register provides visibility into the event queues and a TR life cycle. These are useful for system debug as they provide in-depth visibility for the events queued up in the event queue and also provide information on what parts of the EDMA3CC logic are active once the event has been received by the EDMA3CC.

Figure 11-118. Q2E10 Register

31	30	29	28	27	26	25	24	23	22	21	20	19	18	17	16
RESERVED															
R-0h															
15	14	13	12	11	10	9	8	7	6	5	4	3	2	1	0
RESERVED								ETYPE				ENUM			
R-0h								R-0h				R-0h			

LEGEND: R/W = Read/Write; R = Read only; W1toCl = Write 1 to clear bit; -n = value after reset

Table 11-102. Q2E10 Register Field Descriptions

Bit	Field	Type	Reset	Description
31-8	RESERVED	R	0h	
7-6	ETYPE	R	0h	Event entry 10 in queue 2. Specifies the specific event type for the given entry in the event queue. 0h = Event triggered via ER. 1h = Auto-triggered via QER.
5-0	ENUM	R	0h	Event entry 10 in queue 2. Event number: QDMA channel number (0 to 3). DMA channel/event number (0 to 63).

11.4.1.78 Q2E11 Register (offset = 4ACh) [reset = 0h]

Q2E11 is shown in [Figure 11-119](#) and described in [Table 11-103](#).

The event queue entry registers (QxEy) exist for all 16 queue entries (the maximum allowed queue entries) for all event queues in the EDMA3CC. The event queue entry registers range from Q0E0 to Q0E15, Q1E0 to Q1E15, and Q2E0 to Q2E15. Each register details the event number (ENUM) and the event type (ETYPE). For example, if the value in Q1E4 is read as 000 004Fh, this means the 4th entry in queue 1 is a manually-triggered event on DMA channel 15. The Q2E11 register provides visibility into the event queues and a TR life cycle. These are useful for system debug as they provide in-depth visibility for the events queued up in the event queue and also provide information on what parts of the EDMA3CC logic are active once the event has been received by the EDMA3CC.

Figure 11-119. Q2E11 Register

31	30	29	28	27	26	25	24	23	22	21	20	19	18	17	16
RESERVED															
R-0h															
15	14	13	12	11	10	9	8	7	6	5	4	3	2	1	0
RESERVED								ETYPE				ENUM			
R-0h								R-0h				R-0h			

LEGEND: R/W = Read/Write; R = Read only; W1toCl = Write 1 to clear bit; -n = value after reset

Table 11-103. Q2E11 Register Field Descriptions

Bit	Field	Type	Reset	Description
31-8	RESERVED	R	0h	
7-6	ETYPE	R	0h	Event entry 11 in queue 2. Specifies the specific event type for the given entry in the event queue. 0h = Event triggered via ER. 1h = Auto-triggered via QER.
5-0	ENUM	R	0h	Event entry 11 in queue 2. Event number: QDMA channel number (0 to 3). DMA channel/event number (0 to 63).

11.4.1.79 Q2E12 Register (offset = 4B0h) [reset = 0h]

Q2E12 is shown in [Figure 11-120](#) and described in [Table 11-104](#).

The event queue entry registers (QxEy) exist for all 16 queue entries (the maximum allowed queue entries) for all event queues in the EDMA3CC. The event queue entry registers range from Q0E0 to Q0E15, Q1E0 to Q1E15, and Q2E0 to Q2E15. Each register details the event number (ENUM) and the event type (ETYPE). For example, if the value in Q1E4 is read as 000 004Fh, this means the 4th entry in queue 1 is a manually-triggered event on DMA channel 15. The Q2E12 register provides visibility into the event queues and a TR life cycle. These are useful for system debug as they provide in-depth visibility for the events queued up in the event queue and also provide information on what parts of the EDMA3CC logic are active once the event has been received by the EDMA3CC.

Figure 11-120. Q2E12 Register

31	30	29	28	27	26	25	24	23	22	21	20	19	18	17	16
RESERVED															
R-0h															
15	14	13	12	11	10	9	8	7	6	5	4	3	2	1	0
RESERVED								ETYPE				ENUM			
R-0h								R-0h				R-0h			

LEGEND: R/W = Read/Write; R = Read only; W1toCl = Write 1 to clear bit; -n = value after reset

Table 11-104. Q2E12 Register Field Descriptions

Bit	Field	Type	Reset	Description
31-8	RESERVED	R	0h	
7-6	ETYPE	R	0h	Event entry 12 in queue 2. Specifies the specific event type for the given entry in the event queue. 0h = Event triggered via ER. 1h = Auto-triggered via QER.
5-0	ENUM	R	0h	Event entry 12 in queue 2. Event number: QDMA channel number (0 to 3). DMA channel/event number (0 to 63).

11.4.1.80 Q2E13 Register (offset = 4B4h) [reset = 0h]

Q2E13 is shown in [Figure 11-121](#) and described in [Table 11-105](#).

The event queue entry registers (QxEy) exist for all 16 queue entries (the maximum allowed queue entries) for all event queues in the EDMA3CC. The event queue entry registers range from Q0E0 to Q0E15, Q1E0 to Q1E15, and Q2E0 to Q2E15. Each register details the event number (ENUM) and the event type (ETYPE). For example, if the value in Q1E4 is read as 000 004Fh, this means the 4th entry in queue 1 is a manually-triggered event on DMA channel 15. The Q2E13 register provides visibility into the event queues and a TR life cycle. These are useful for system debug as they provide in-depth visibility for the events queued up in the event queue and also provide information on what parts of the EDMA3CC logic are active once the event has been received by the EDMA3CC.

Figure 11-121. Q2E13 Register

31	30	29	28	27	26	25	24	23	22	21	20	19	18	17	16
RESERVED															
R-0h															
15	14	13	12	11	10	9	8	7	6	5	4	3	2	1	0
RESERVED								ETYPE				ENUM			
R-0h								R-0h				R-0h			

LEGEND: R/W = Read/Write; R = Read only; W1toCl = Write 1 to clear bit; -n = value after reset

Table 11-105. Q2E13 Register Field Descriptions

Bit	Field	Type	Reset	Description
31-8	RESERVED	R	0h	
7-6	ETYPE	R	0h	Event entry 13 in queue 2. Specifies the specific event type for the given entry in the event queue. 0h = Event triggered via ER. 1h = Auto-triggered via QER.
5-0	ENUM	R	0h	Event entry 13 in queue 2. Event number: QDMA channel number (0 to 3). DMA channel/event number (0 to 63).

11.4.1.81 Q2E14 Register (offset = 4B8h) [reset = 0h]

Q2E14 is shown in [Figure 11-122](#) and described in [Table 11-106](#).

The event queue entry registers (QxEy) exist for all 16 queue entries (the maximum allowed queue entries) for all event queues in the EDMA3CC. The event queue entry registers range from Q0E0 to Q0E15, Q1E0 to Q1E15, and Q2E0 to Q2E15. Each register details the event number (ENUM) and the event type (ETYPE). For example, if the value in Q1E4 is read as 000 004Fh, this means the 4th entry in queue 1 is a manually-triggered event on DMA channel 15. The Q2E14 register provides visibility into the event queues and a TR life cycle. These are useful for system debug as they provide in-depth visibility for the events queued up in the event queue and also provide information on what parts of the EDMA3CC logic are active once the event has been received by the EDMA3CC.

Figure 11-122. Q2E14 Register

31	30	29	28	27	26	25	24	23	22	21	20	19	18	17	16
RESERVED															
R-0h															
15	14	13	12	11	10	9	8	7	6	5	4	3	2	1	0
RESERVED								ETYPE				ENUM			
R-0h								R-0h				R-0h			

LEGEND: R/W = Read/Write; R = Read only; W1toCl = Write 1 to clear bit; -n = value after reset

Table 11-106. Q2E14 Register Field Descriptions

Bit	Field	Type	Reset	Description
31-8	RESERVED	R	0h	
7-6	ETYPE	R	0h	Event entry 14 in queue 2. Specifies the specific event type for the given entry in the event queue. 0h = Event triggered via ER. 1h = Auto-triggered via QER.
5-0	ENUM	R	0h	Event entry 14 in queue 2. Event number: QDMA channel number (0 to 3). DMA channel/event number (0 to 63).

11.4.1.82 Q2E15 Register (offset = 4BCh) [reset = 0h]

Q2E15 is shown in [Figure 11-123](#) and described in [Table 11-107](#).

The event queue entry registers (QxEy) exist for all 16 queue entries (the maximum allowed queue entries) for all event queues in the EDMA3CC. The event queue entry registers range from Q0E0 to Q0E15, Q1E0 to Q1E15, and Q2E0 to Q2E15. Each register details the event number (ENUM) and the event type (ETYPE). For example, if the value in Q1E4 is read as 000 004Fh, this means the 4th entry in queue 1 is a manually-triggered event on DMA channel 15. The Q2E15 register provides visibility into the event queues and a TR life cycle. These are useful for system debug as they provide in-depth visibility for the events queued up in the event queue and also provide information on what parts of the EDMA3CC logic are active once the event has been received by the EDMA3CC.

Figure 11-123. Q2E15 Register

31	30	29	28	27	26	25	24	23	22	21	20	19	18	17	16
RESERVED															
R-0h															
15	14	13	12	11	10	9	8	7	6	5	4	3	2	1	0
RESERVED								ETYPE		ENUM					
R-0h								R-0h		R-0h					

LEGEND: R/W = Read/Write; R = Read only; W1toCl = Write 1 to clear bit; -n = value after reset

Table 11-107. Q2E15 Register Field Descriptions

Bit	Field	Type	Reset	Description
31-8	RESERVED	R	0h	
7-6	ETYPE	R	0h	Event entry 15 in queue 2. Specifies the specific event type for the given entry in the event queue. 0h = Event triggered via ER. 1h = Auto-triggered via QER.
5-0	ENUM	R	0h	Event entry 15 in queue 2. Event number: QDMA channel number (0 to 3). DMA channel/event number (0 to 63).

11.4.1.83 QSTAT_0 to QSTAT_2 Register (offset = 600h to 608h) [reset = Fh]

QSTAT_0 to QSTAT_2 is shown in [Figure 11-124](#) and described in [Table 11-108](#).

The queue status register (QSTAT) provides visibility into the event queues and a TR life cycle. These are useful for system debug as they provide in-depth visibility for the events queued up in the event queue and also provide information on what parts of the EDMA3CC logic are active once the event has been received by the EDMA3CC.

Figure 11-124. QSTAT_0 to QSTAT_2 Register

31	30	29	28	27	26	25	24
RESERVED							THRXCd
R-0h							R-0h
23	22	21	20	19	18	17	16
RESERVED				WM			
R-0h				R-0h			
15	14	13	12	11	10	9	8
RESERVED				NUMVAL			
R-0h				R-0h			
7	6	5	4	3	2	1	0
RESERVED				STRTPTR			
R-0h				R-Fh			

LEGEND: R/W = Read/Write; R = Read only; W1toCl = Write 1 to clear bit; -n = value after reset

Table 11-108. QSTAT_0 to QSTAT_2 Register Field Descriptions

Bit	Field	Type	Reset	Description
31-25	RESERVED	R	0h	
24	THRXCd	R	0h	Threshold exceeded. THRXCd is cleared by writing a 1 to the corresponding QTHRXCdn bit in the EDMA3CC error clear register (CCERRCLR). 0h = Threshold specified by the Qn bit in the queue watermark threshold A register (QWMTHRA) has not been exceeded. 1h = Threshold specified by the Qn bit in the queue watermark threshold A register (QWMTHRA) has been exceeded.
23-21	RESERVED	R	0h	
20-16	WM	R	0h	Watermark for maximum queue usage. Watermark tracks the most entries that have been in queue n since reset or since the last time that the watermark (WM) bit was cleared. WM is cleared by writing a 1 to the corresponding QTHRXCdn bit in the EDMA3CC error clear register (CCERRCLR). 0h = Legal values are 0 (empty) to 10h (full). 1h = Reserved, from 11h to 1Fh. Always write 0 to this bit; writes of 1 to this bit are not supported and attempts to do so may result in undefined behavior.
15-13	RESERVED	R	0h	
12-8	NUMVAL	R	0h	Number of valid entries in queue n. The total number of entries residing in the queue manager FIFO at a given instant. Always enabled. 0h = Legal values are 0 (empty) to 10h (full). 1h = Reserved, from 11h to 1Fh. Always write 0 to this bit; writes of 1 to this bit are not supported and attempts to do so may result in undefined behavior.
7-4	RESERVED	R	0h	
3-0	STRTPTR	R	Fh	Start pointer. The offset to the head entry of queue n, in units of entries. Always enabled. Legal values are 0 (0th entry) to Fh (15th entry).

11.4.1.84 QWMTHRA Register (offset = 620h) [reset = A0A0Ah]

QWMTHRA is shown in [Figure 11-125](#) and described in [Table 11-109](#).

The queue watermark threshold A register (QWMTHRA) provides visibility into the event queues and a TR life cycle. These are useful for system debug as they provide in-depth visibility for the events queued up in the event queue and also provide information on what parts of the EDMA3CC logic are active once the event has been received by the EDMA3CC.

Figure 11-125. QWMTHRA Register

31	30	29	28	27	26	25	24	23	22	21	20	19	18	17	16
RESERVED											Q2				
R-0h											R/W-Ah				
15	14	13	12	11	10	9	8	7	6	5	4	3	2	1	0
RESERVED				Q1				RESERVED				Q0			
R-0h				R/W-Ah				R-0h				R/W-Ah			

LEGEND: R/W = Read/Write; R = Read only; W1toCl = Write 1 to clear bit; -n = value after reset

Table 11-109. QWMTHRA Register Field Descriptions

Bit	Field	Type	Reset	Description
31-21	RESERVED	R	0h	
20-16	Q2	R/W	Ah	Queue threshold for queue 2 value. The QTHRCD2 bit in the EDMA3CC error register (CCERR) and the THRXCD bit in the queue status register 2 (QSTAT2) are set when the number of events in queue 2 at an instant in time (visible via the NUMVAL bit in QSTAT2) equals or exceeds the value specified by Q2. 0h = From 0h to 10h, The default is 16 (maximum allowed). 11h = Disables the threshold errors. 12h = From 12h to 1Fh, Reserved. Always write 0 to this bit; writes of 1 to this bit are not supported and attempts to do so may result in undefined behavior.
15-13	RESERVED	R	0h	
12-8	Q1	R/W	Ah	Queue threshold for queue 1 value. The QTHRCD1 bit in the EDMA3CC error register (CCERR) and the THRXCD bit in the queue status register 1 (QSTAT1) are set when the number of events in queue 1 at an instant in time (visible via the NUMVAL bit in QSTAT1) equals or exceeds the value specified by Q1. 0h = From 0h to 10h, The default is 16 (maximum allowed). 11h = Disables the threshold errors. 12h = From 12h to 1Fh, Reserved. Always write 0 to this bit; writes of 1 to this bit are not supported and attempts to do so may result in undefined behavior.
7-5	RESERVED	R	0h	
4-0	Q0	R/W	Ah	Queue threshold for queue 0 value. The QTHRCD0 bit in the EDMA3CC error register (CCERR) and the THRXCD bit in the queue status register 0 (QSTAT0) are set when the number of events in queue 0 at an instant in time (visible via the NUMVAL bit in QSTAT0) equals or exceeds the value specified by Q0. 0h = From 0h to 10h, The default is 16 (maximum allowed). 11h = Disables the threshold errors. 12h = From 12h to 1Fh, Reserved. Always write 0 to this bit; writes of 1 to this bit are not supported and attempts to do so may result in undefined behavior.

11.4.1.85 CCSTAT Register (offset = 640h) [reset = 0h]

CCSTAT is shown in [Figure 11-126](#) and described in [Table 11-110](#).

The EDMA3CC status register (CCSTAT) has a number of status bits that reflect which parts of the EDMA3CC logic is active at any given instant of time. CCSTAT provides visibility into the event queues and a TR life cycle. These are useful for system debug as they provide in-depth visibility for the events queued up in the event queue and also provide information on what parts of the EDMA3CC logic are active once the event has been received by the EDMA3CC.

Figure 11-126. CCSTAT Register

31	30	29	28	27	26	25	24
RESERVED							
R-0h							
23	22	21	20	19	18	17	16
RESERVED					QUEACTV2	QUEACTV1	QUEACTV0
R-0h					R-0h	R-0h	R-0h
15	14	13	12	11	10	9	8
RESERVED		COMPACTV					
R-0h		R-0h					
7	6	5	4	3	2	1	0
RESERVED			ACTV	RESERVED	TRACTV	QEV TACTV	EVTACTV
R-0h			R-0h	R-0h	R-0h	R-0h	R-0h

LEGEND: R/W = Read/Write; R = Read only; W1toCl = Write 1 to clear bit; -n = value after reset

Table 11-110. CCSTAT Register Field Descriptions

Bit	Field	Type	Reset	Description
31-19	RESERVED	R	0h	
18	QUEACTV2	R	0h	Queue 2 active. 0h = No events are queued in queue 2. 1h = At least one TR is queued in queue 2.
17	QUEACTV1	R	0h	Queue 1 active. 0h = No events are queued in queue 1. 1h = At least one TR is queued in queue 1.
16	QUEACTV0	R	0h	Queue 0 active. 0h = No events are queued in queue 0. 1h = At least one TR is queued in queue 0.
15-14	RESERVED	R	0h	
13-8	COMPACTV	R	0h	Completion request active. The COMPACTV field reflects the count for the number of completion requests submitted to the transfer controllers. This count increments every time a TR is submitted and is programmed to report completion (the TCINTEN or TCCCHEN bits in OPT in the parameter entry associated with the TR are set). The counter decrements for every valid TCC received back from the transfer controllers. If at any time the count reaches a value of 63, the EDMA3CC will not service any new TRs until the count is less than 63 (or return a transfer completion code from a transfer controller, which would decrement the count). 0h = No completion requests outstanding. 1h = Total of 1 completion request to 63 completion requests are outstanding, from 1h to 3Fh.
7-5	RESERVED	R	0h	

Table 11-110. CCSTAT Register Field Descriptions (continued)

Bit	Field	Type	Reset	Description
4	ACTV	R	0h	Channel controller active. Channel controller active is a logical-OR of each of the *ACTV bits. The ACTV bit remains high through the life of a TR. 0h = Channel is idle.. 1h = Channel is busy.
3	RESERVED	R	0h	
2	TRACTV	R	0h	Transfer request active. 0h = Transfer request processing/submission logic is inactive. 1h = Transfer request processing/submission logic is active.
1	QEVTACTV	R	0h	QDMA event active. 0h = No enabled QDMA events are active within the EDMA3CC. 1h = At least one enabled QDMA event (QER) is active within the EDMA3CC.
0	EVTACTV	R	0h	DMA event active. 0h = No enabled DMA events are active within the EDMA3CC. 1h = At least one enabled DMA event (ER and EER, ESR, CER) is active within the EDMA3CC.

11.4.1.86 MPFAR Register (offset = 800h) [reset = 0h]

MPFAR is shown in [Figure 11-127](#) and described in [Table 11-111](#).

A CPU write of 1 to the MPFCLR bit in the memory protection fault command register (MPFCR) causes any error conditions stored in MPFAR to be cleared.

Figure 11-127. MPFAR Register

31	30	29	28	27	26	25	24	23	22	21	20	19	18	17	16	15	14	13	12	11	10	9	8	7	6	5	4	3	2	1	0
FADDR																															
R-0h																															

LEGEND: R/W = Read/Write; R = Read only; W1toCl = Write 1 to clear bit; -n = value after reset

Table 11-111. MPFAR Register Field Descriptions

Bit	Field	Type	Reset	Description
31-0	FADDR	R	0h	Fault address. This 32 bit read-only status register contains the fault address when a memory protection violation is detected. This register can only be cleared via the memory protection fault command register (MPFCR). Value 0 to FFFF FFFFh.

11.4.1.87 MPFSR Register (offset = 804h) [reset = 0h]

MPFSR is shown in [Figure 11-128](#) and described in [Table 11-112](#).

A CPU write of 1 to the MPFCLR bit in the memory protection fault command register (MPFCR) causes any error conditions stored in MPFSR to be cleared.

Figure 11-128. MPFSR Register

31	30	29	28	27	26	25	24	23	22	21	20	19	18	17	16	
RESERVED																
R-0h																
15	14	13	12	11	10	9	8	7	6	5	4	3	2	1	0	
RESERVED				FID				RESERVED			SRE	SWE	SXE	URE	UWE	UXE
R-0h				R-0h				R-0h			R-0h	R-0h	R-0h	R-0h	R-0h	R-0h

LEGEND: R/W = Read/Write; R = Read only; W1toCl = Write 1 to clear bit; -n = value after reset

Table 11-112. MPFSR Register Field Descriptions

Bit	Field	Type	Reset	Description
31-13	RESERVED	R	0h	
12-9	FID	R	0h	Faulted identification. FID contains valid information if any of the MP error bits (UXE, UWE, URE, SXE, SWE, SRE) are nonzero (that is, if an error has been detected.) The FID field contains the privilege ID for the specific request/requestor that resulted in an MP error. Value 0 to Fh.
8-6	RESERVED	R	0h	
5	SRE	R	0h	Supervisor read error. 0h = No error detected. 1h = Supervisor level task attempted to read from a MP page without SR permissions.
4	SWE	R	0h	Supervisor write error. 0h = No error detected. 1h = Supervisor level task attempted to write to a MP page without SW permissions.
3	SXE	R	0h	Supervisor execute error. 0h = No error detected. 1h = Supervisor level task attempted to execute from a MP page without SX permissions.
2	URE	R	0h	User read error. 0h = No error detected. 1h = User level task attempted to read from a MP page without UR permissions.
1	UWE	R	0h	User write error. 0h = No error detected. 1h = User level task attempted to write to a MP page without UW permissions.
0	UXE	R	0h	User execute error. 0h = No error detected. 1h = User level task attempted to execute from a MP page without UX permissions.

11.4.1.88 MPFCR Register (offset = 808h) [reset = 0h]

 MPFCR is shown in [Figure 11-129](#) and described in [Table 11-113](#).

Figure 11-129. MPFCR Register

31	30	29	28	27	26	25	24
RESERVED							
R-0h							
23	22	21	20	19	18	17	16
RESERVED							
R-0h							
15	14	13	12	11	10	9	8
RESERVED							
R-0h							
7	6	5	4	3	2	1	0
RESERVED							MPFCLR
R-0h							W-0h

LEGEND: R/W = Read/Write; R = Read only; W1toCl = Write 1 to clear bit; -n = value after reset

Table 11-113. MPFCR Register Field Descriptions

Bit	Field	Type	Reset	Description
31-1	RESERVED	R	0h	
0	MPFCLR	W	0h	Fault clear register. 0h = CPU write of 0 has no effect. 1h = CPU write of 1 to the MPFCLR bit causes any error conditions stored in the memory protection fault address register (MPFAR) and the memory protection fault status register (MPFSR) to be cleared.

11.4.1.89 MPPAG Register (offset = 80Ch) [reset = 676h]

 MPPAG is shown in [Figure 11-130](#) and described in [Table 11-114](#).

Figure 11-130. MPPAG Register

31	30	29	28	27	26	25	24
RESERVED							
R-0h							
23	22	21	20	19	18	17	16
RESERVED							
R-0h							
15	14	13	12	11	10	9	8
AIDm						EXT	RESERVED
R/W-1h						R/W-1h	R-0h
7	6	5	4	3	2	1	0
RESERVED		SR	SW	SX	UR	UW	UX
R-1h		R/W-1h	R/W-1h	R/W-0h	R/W-1h	R/W-1h	R/W-0h

LEGEND: R/W = Read/Write; R = Read only; W1toCl = Write 1 to clear bit; -n = value after reset

Table 11-114. MPPAG Register Field Descriptions

Bit	Field	Type	Reset	Description
31-16	RESERVED	R	0h	
15-10	AIDm	R/W	1h	Allowed ID 'N' 0h = Requests with Privilege ID == N are not allowed to region M, regardless of permission settings (UW, UR, SW, SR). 1h = Requests with Privilege ID == N are permitted, if access type is allowed as defined by permission settings (UW, UR, SW, SR).
9	EXT	R/W	1h	External Allowed ID. 0h = Requests with Privilege ID >= 6 are not allowed to region M, regardless of permission settings (UW, UR, SW, SR). 1h = Requests with Privilege ID >= 6 are permitted, if access type is allowed as defined by permission settings (UW, UR, SW, SR).
8	RESERVED	R	0h	
7-6	RESERVED	R	1h	
5	SR	R/W	1h	Supervisor read permission. 0h = Supervisor read accesses are not allowed from region M. 1h = Supervisor write accesses are allowed from region M addresses.
4	SW	R/W	1h	Supervisor write permission. 0h = Supervisor write accesses are not allowed to region M. 1h = Supervisor write accesses are allowed to region N addresses.
3	SX	R/W	0h	Supervisor execute permission. 0h = Supervisor execute accesses are not allowed from region M. 1h = Supervisor execute accesses are allowed from region M addresses.
2	UR	R/W	1h	User read permission. 0h = User read accesses are not allowed from region M. 1h = User read accesses are allowed from region N addresses.
1	UW	R/W	1h	User write permission. 0h = User write accesses are not allowed to region M. 1h = User write accesses are allowed to region M addresses.
0	UX	R/W	0h	User execute permission. 0h = User execute accesses are not allowed from region M. 1h = User execute accesses are allowed from region M addresses.

11.4.1.90 MPPA_0 to MPPA_7 Register (offset = 810h to 82Ch) [reset = 676h]

MPPA_0 to MPPA_7 is shown in [Figure 11-131](#) and described in [Table 11-115](#).

Figure 11-131. MPPA_0 to MPPA_7 Register

31	30	29	28	27	26	25	24
RESERVED							
R-0h							
23	22	21	20	19	18	17	16
RESERVED							
R-0h							
15	14	13	12	11	10	9	8
AIDm						EXT	RESERVED
R/W-1h						R/W-1h	R-0h
7	6	5	4	3	2	1	0
RESERVED		SR	SW	SX	UR	UW	UX
R-1h		R/W-1h	R/W-1h	R/W-0h	R/W-1h	R/W-1h	R/W-0h

LEGEND: R/W = Read/Write; R = Read only; W1toCl = Write 1 to clear bit; -n = value after reset

Table 11-115. MPPA_0 to MPPA_7 Register Field Descriptions

Bit	Field	Type	Reset	Description
31-16	RESERVED	R	0h	
15-10	AIDm	R/W	1h	Allowed ID 'N' 0h = Requests with Privilege ID == N are not allowed to region M, regardless of permission settings (UW, UR, SW, SR). 1h = Requests with Privilege ID == N are permitted, if access type is allowed as defined by permission settings (UW, UR, SW, SR).
9	EXT	R/W	1h	External Allowed ID. 0h = Requests with Privilege ID >= 6 are not allowed to region M, regardless of permission settings (UW, UR, SW, SR). 1h = Requests with Privilege ID >= 6 are permitted, if access type is allowed as defined by permission settings (UW, UR, SW, SR).
8	RESERVED	R	0h	
7-6	RESERVED	R	1h	
5	SR	R/W	1h	Supervisor read permission. 0h = Supervisor read accesses are not allowed from region M. 1h = Supervisor write accesses are allowed from region M addresses.
4	SW	R/W	1h	Supervisor write permission. 0h = Supervisor write accesses are not allowed to region M. 1h = Supervisor write accesses are allowed to region N addresses.
3	SX	R/W	0h	Supervisor execute permission. 0h = Supervisor execute accesses are not allowed from region M. 1h = Supervisor execute accesses are allowed from region M addresses.
2	UR	R/W	1h	User read permission. 0h = User read accesses are not allowed from region M. 1h = User read accesses are allowed from region N addresses.
1	UW	R/W	1h	User write permission. 0h = User write accesses are not allowed to region M. 1h = User write accesses are allowed to region M addresses.
0	UX	R/W	0h	User execute permission. 0h = User execute accesses are not allowed from region M. 1h = User execute accesses are allowed from region M addresses.

11.4.1.91 ER Register (offset = 1000h) [reset = 0h]

ER is shown in [Figure 11-132](#) and described in [Table 11-116](#).

All external events are captured in the event register (ER/ERH). The events are latched even when the events are not enabled. If the event bit corresponding to the latched event is enabled (EER.En/EERH.En = 1), then the event is evaluated by the EDMA3CC logic for an associated transfer request submission to the transfer controllers. The event register bits are automatically cleared (ER.En/ERH.En = 0) once the corresponding events are prioritized and serviced. If ER.En/ERH.En are already set and another event is received on the same channel/event, then the corresponding event is latched in the event miss register (EMR.En/EMRH.En), provided that the event was enabled (EER.En/EERH.En = 1). Event n can be cleared by the CPU writing a 1 to corresponding event bit in the event clear register (ECR/ECRH). The setting of an event is a higher priority relative to clear operations (via hardware or software). If set and clear conditions occur concurrently, the set condition wins. If the event was previously set, then EMR/EMRH would be set because an event is lost. If the event was previously clear, then the event remains set and is prioritized for submission to the event queues. The Debug List table provides the type of synchronization events and the EDMA3CC channels associated to each of these external events. This register is part of a set of registers that pertain to the 64 DMA channels. The 64 DMA channels consist of a set of registers (with exception of DMAQNUMn) that each have 64 bits and the bit position of each register matches the DMA channel number. Each register is named with the format reg_name that corresponds to DMA channels 0 through 31 and reg_name_High that corresponds to DMA channels 32 through 64. For example, the event register (ER) corresponds to DMA channel 0 through 31 and the event register high register (ERH) corresponds to DMA channel 32 through 63. The register is typically called the event register. The DMA channel registers are accessible via read/writes to the global address range. They are also accessible via read/writes to the shadow address range. The read/write ability to the registers in the shadow region are controlled by the DMA region access registers (DRAEm/DRAEHm).

Figure 11-132. ER Register

31	30	29	28	27	26	25	24	23	22	21	20	19	18	17	16	15	14	13	12	11	10	9	8	7	6	5	4	3	2	1	0
En																															
R-0h																															

LEGEND: R/W = Read/Write; R = Read only; W1toCl = Write 1 to clear bit; -n = value after reset

Table 11-116. ER Register Field Descriptions

Bit	Field	Type	Reset	Description
31-0	En	R	0h	Event 0 to 31. Events 0 to 31 are captured by the EDMA3CC and are latched into ER. The events are set (En = 1) even when events are disabled (En = 0 in the event enable register, EER). 0h = EDMA3CC event is not asserted. 1h = EDMA3CC event is asserted. Corresponding DMA event is prioritized versus other pending DMA/QDMA events for submission to the EDMA3TC.

11.4.1.92 ERH Register (offset = 1004h) [reset = 0h]

ERH is shown in [Figure 11-133](#) and described in [Table 11-117](#).

All external events are captured in the event register (ER/ERH). The events are latched even when the events are not enabled. If the event bit corresponding to the latched event is enabled (EER.En/EERH.En = 1), then the event is evaluated by the EDMA3CC logic for an associated transfer request submission to the transfer controllers. The event register bits are automatically cleared (ER.En/ERH.En = 0) once the corresponding events are prioritized and serviced. If ER.En/ERH.En are already set and another event is received on the same channel/event, then the corresponding event is latched in the event miss register (EMR.En/EMRH.En), provided that the event was enabled (EER.En/EERH.En = 1). Event n can be cleared by the CPU writing a 1 to corresponding event bit in the event clear register (ECR/ECRH). The setting of an event is a higher priority relative to clear operations (via hardware or software). If set and clear conditions occur concurrently, the set condition wins. If the event was previously set, then EMR/EMRH would be set because an event is lost. If the event was previously clear, then the event remains set and is prioritized for submission to the event queues. The Debug List table provides the type of synchronization events and the EDMA3CC channels associated to each of these external events. This register is part of a set of registers that pertain to the 64 DMA channels. The 64 DMA channels consist of a set of registers (with exception of DMAQNUMn) that each have 64 bits and the bit position of each register matches the DMA channel number. Each register is named with the format reg_name that corresponds to DMA channels 0 through 31 and reg_name_High that corresponds to DMA channels 32 through 64. For example, the event register (ER) corresponds to DMA channel 0 through 31 and the event register high register (ERH) corresponds to DMA channel 32 through 63. The register is typically called the event register. The DMA channel registers are accessible via read/writes to the global address range. They are also accessible via read/writes to the shadow address range. The read/write ability to the registers in the shadow region are controlled by the DMA region access registers (DRAEm/DRAEHm).

Figure 11-133. ERH Register

31	30	29	28	27	26	25	24	23	22	21	20	19	18	17	16	15	14	13	12	11	10	9	8	7	6	5	4	3	2	1	0
																En															
																R-0h															

LEGEND: R/W = Read/Write; R = Read only; W1toCl = Write 1 to clear bit; -n = value after reset

Table 11-117. ERH Register Field Descriptions

Bit	Field	Type	Reset	Description
31-0	En	R	0h	<p>Event 32 to 63. Events 32 to 63 are captured by the EDMA3CC and are latched into ERH. The events are set (En = 1) even when events are disabled (En = 0 in the event enable register high, EERH). 0h = EDMA3CC event is not asserted. 1h = EDMA3CC event is asserted. Corresponding DMA event is prioritized versus other pending DMA/QDMA events for submission to the EDMA3TC.</p>

11.4.1.93 ECR Register (offset = 1008h) [reset = 0h]

ECR is shown in [Figure 11-134](#) and described in [Table 11-118](#).

Once an event has been posted in the event registers (ER/ERH), the event is cleared in two ways. If the event is enabled in the event enable register (EER/EERH) and the EDMA3CC submits a transfer request for the event to the EDMA3TC, it clears the corresponding event bit in the event register. If the event is disabled in the event enable register (EER/EERH), the CPU can clear the event by way of the event clear registers (ECR/ECRH). Writing a 1 to any of the bits clears the corresponding event; writing a 0 has no effect. Once an event bit is set in the event register, it remains set until EDMA3CC submits a transfer request for that event or the CPU clears the event by setting the corresponding bit in ECR/ECRH. This register is part of a set of registers that pertain to the 64 DMA channels. The 64 DMA channels consist of a set of registers (with exception of DMAQNUMn) that each have 64 bits and the bit position of each register matches the DMA channel number. Each register is named with the format `reg_name` that corresponds to DMA channels 0 through 31 and `reg_name_High` that corresponds to DMA channels 32 through 64. For example, the event register (ER) corresponds to DMA channel 0 through 31 and the event register high register (ERH) corresponds to DMA channel 32 through 63. The register is typically called the event register. The DMA channel registers are accessible via read/writes to the global address range. They are also accessible via read/writes to the shadow address range. The read/write ability to the registers in the shadow region are controlled by the DMA region access registers (DRAEm/DRAEHm).

Figure 11-134. ECR Register

31	30	29	28	27	26	25	24	23	22	21	20	19	18	17	16	15	14	13	12	11	10	9	8	7	6	5	4	3	2	1	0
En																															
W-0h																															

LEGEND: R/W = Read/Write; R = Read only; W1toCl = Write 1 to clear bit; -n = value after reset

Table 11-118. ECR Register Field Descriptions

Bit	Field	Type	Reset	Description
31-0	En	W	0h	Event clear for event 0 to 31. Any of the event bits in ECR is set to clear the event (En) in the event register (ER). A write of 0 has no effect. 0h = No effect. 1h = EDMA3CC event is cleared in the event register (ER).

11.4.1.94 ECRH Register (offset = 100Ch) [reset = 0h]

ECRH is shown in [Figure 11-135](#) and described in [Table 11-119](#).

Once an event has been posted in the event registers (ER/ERH), the event is cleared in two ways. If the event is enabled in the event enable register (EER/EERH) and the EDMA3CC submits a transfer request for the event to the EDMA3TC, it clears the corresponding event bit in the event register. If the event is disabled in the event enable register (EER/EERH), the CPU can clear the event by way of the event clear registers (ECR/ECRH). Writing a 1 to any of the bits clears the corresponding event; writing a 0 has no effect. Once an event bit is set in the event register, it remains set until EDMA3CC submits a transfer request for that event or the CPU clears the event by setting the corresponding bit in ECR/ECRH. This register is part of a set of registers that pertain to the 64 DMA channels. The 64 DMA channels consist of a set of registers (with exception of DMAQNUMn) that each have 64 bits and the bit position of each register matches the DMA channel number. Each register is named with the format reg_name that corresponds to DMA channels 0 through 31 and reg_name_High that corresponds to DMA channels 32 through 64. For example, the event register (ER) corresponds to DMA channel 0 through 31 and the event register high register (ERH) corresponds to DMA channel 32 through 63. The register is typically called the event register. The DMA channel registers are accessible via read/writes to the global address range. They are also accessible via read/writes to the shadow address range. The read/write ability to the registers in the shadow region are controlled by the DMA region access registers (DRAEm/DRAEHm).

Figure 11-135. ECRH Register

31	30	29	28	27	26	25	24	23	22	21	20	19	18	17	16	15	14	13	12	11	10	9	8	7	6	5	4	3	2	1	0
En																															
W-0h																															

LEGEND: R/W = Read/Write; R = Read only; W1toCl = Write 1 to clear bit; -n = value after reset

Table 11-119. ECRH Register Field Descriptions

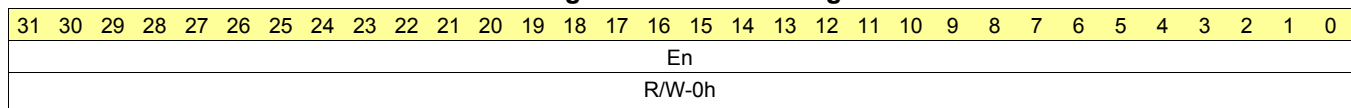
Bit	Field	Type	Reset	Description
31-0	En	W	0h	Event clear for event 32 to 63. Any of the event bits in ECRH are set to clear the event (En) in the event register high (ERH). A write of 0 has no effect. 0h = No effect. 1h = EDMA3CC event is cleared in the event register high (ERH).

11.4.1.95 ESR Register (offset = 1010h) [reset = 0h]

ESR is shown in [Figure 11-136](#) and described in [Table 11-120](#).

The event set registers (ESR/ESRH) allow the CPU (EDMA3 programmers) to manually set events to initiate DMA transfer requests. CPU writes of 1 to any event set register (En) bits set the corresponding bits in the registers. The set event is evaluated by the EDMA3CC logic for an associated transfer request submission to the transfer controllers. Writing a 0 has no effect. The event set registers operate independent of the event registers (ER/ERH), and a write of 1 is always considered a valid event regardless of whether the event is enabled (the corresponding event bits are set or cleared in EER.En/EERH.En). Once the event is set in the event set registers, it cannot be cleared by CPU writes, in other words, the event clear registers (ECR/ECRH) have no effect on the state of ESR/ESRH. The bits will only be cleared once the transfer request corresponding to the event has been submitted to the transfer controller. The setting of an event is a higher priority relative to clear operations (via hardware). If set and clear conditions occur concurrently, the set condition wins. If the event was previously set, then EMR/EMRH would be set because an event is lost. If the event was previously clear, then the event remains set and is prioritized for submission to the event queues. Manually-triggered transfers via writes to ESR/ESRH allow the CPU to submit DMA requests in the system, these are relevant for memory-to-memory transfer scenarios. If the ESR.En/ESRH.En bit is already set and another CPU write of 1 is attempted to the same bit, then the corresponding event is latched in the event missed registers (EMR.En/EMRH.En = 1). This register is part of a set of registers that pertain to the 64 DMA channels. The 64 DMA channels consist of a set of registers (with exception of DMAQNUMn) that each have 64 bits and the bit position of each register matches the DMA channel number. Each register is named with the format reg_name that corresponds to DMA channels 0 through 31 and reg_name_High that corresponds to DMA channels 32 through 64. For example, the event register (ER) corresponds to DMA channel 0 through 31 and the event register high register (ERH) corresponds to DMA channel 32 through 63. The register is typically called the event register. The DMA channel registers are accessible via read/writes to the global address range. They are also accessible via read/writes to the shadow address range. The read/write ability to the registers in the shadow region are controlled by the DMA region access registers (DRAEm/DRAEHm).

Figure 11-136. ESR Register



LEGEND: R/W = Read/Write; R = Read only; W1toCl = Write 1 to clear bit; -n = value after reset

Table 11-120. ESR Register Field Descriptions

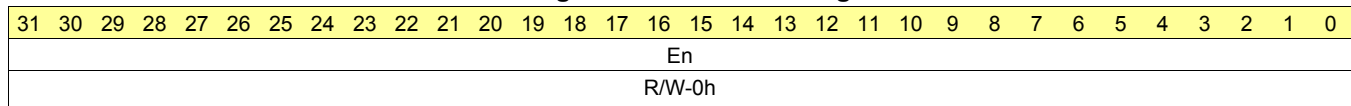
Bit	Field	Type	Reset	Description
31-0	En	R/W	0h	Event set for event 0 to 31. 0h = No effect. 1h = Corresponding DMA event is prioritized versus other pending DMA/QDMA events for submission to the EDMA3TC.

11.4.1.96 ESRH Register (offset = 1014h) [reset = 0h]

ESRH is shown in [Figure 11-137](#) and described in [Table 11-121](#).

The event set registers (ESR/ESRH) allow the CPU (EDMA3 programmers) to manually set events to initiate DMA transfer requests. CPU writes of 1 to any event set register (En) bits set the corresponding bits in the registers. The set event is evaluated by the EDMA3CC logic for an associated transfer request submission to the transfer controllers. Writing a 0 has no effect. The event set registers operate independent of the event registers (ER/ERH), and a write of 1 is always considered a valid event regardless of whether the event is enabled (the corresponding event bits are set or cleared in EER.En/EERH.En). Once the event is set in the event set registers, it cannot be cleared by CPU writes, in other words, the event clear registers (ECR/ECRH) have no effect on the state of ESR/ESRH. The bits will only be cleared once the transfer request corresponding to the event has been submitted to the transfer controller. The setting of an event is a higher priority relative to clear operations (via hardware). If set and clear conditions occur concurrently, the set condition wins. If the event was previously set, then EMR/EMRH would be set because an event is lost. If the event was previously clear, then the event remains set and is prioritized for submission to the event queues. Manually-triggered transfers via writes to ESR/ESRH allow the CPU to submit DMA requests in the system, these are relevant for memory-to-memory transfer scenarios. If the ESR.En/ESRH.En bit is already set and another CPU write of 1 is attempted to the same bit, then the corresponding event is latched in the event missed registers (EMR.En/EMRH.En = 1). This register is part of a set of registers that pertain to the 64 DMA channels. The 64 DMA channels consist of a set of registers (with exception of DMAQNUMn) that each have 64 bits and the bit position of each register matches the DMA channel number. Each register is named with the format reg_name that corresponds to DMA channels 0 through 31 and reg_name_High that corresponds to DMA channels 32 through 64. For example, the event register (ER) corresponds to DMA channel 0 through 31 and the event register high register (ERH) corresponds to DMA channel 32 through 63. The register is typically called the event register. The DMA channel registers are accessible via read/writes to the global address range. They are also accessible via read/writes to the shadow address range. The read/write ability to the registers in the shadow region are controlled by the DMA region access registers (DRAEm/DRAEHm).

Figure 11-137. ESRH Register



LEGEND: R/W = Read/Write; R = Read only; W1toCl = Write 1 to clear bit; -n = value after reset

Table 11-121. ESRH Register Field Descriptions

Bit	Field	Type	Reset	Description
31-0	En	R/W	0h	Event set for event 32 to 63. 0h = No effect. 1h = Corresponding DMA event is prioritized versus other pending DMA/QDMA events for submission to the EDMA3TC.

11.4.1.97 CER Register (offset = 1018h) [reset = 0h]

CER is shown in [Figure 11-138](#) and described in [Table 11-122](#).

When the OPTIONS parameter for a PaRAM entry is programmed to returned a chained completion code (ITCCHEN = 1 and/or TCCHEN = 1), then the value dictated by the TCC[5:0] (also programmed in OPT) forces the corresponding event bit to be set in the chained event registers (CER/CERH). The set chained event is evaluated by the EDMA3CC logic for an associated transfer request submission to the transfer controllers. This results in a chained-triggered transfer. The chained event registers do not have any enables. The generation of a chained event is essentially enabled by the PaRAM entry that has been configured for intermediate and/or final chaining on transfer completion. The En bit is set (regardless of the state of EER.En/EERH.En) when a chained completion code is returned from one of the transfer controllers or is generated by the EDMA3CC via the early completion path. The bits in the chained event register are cleared when the corresponding events are prioritized and serviced. If the En bit is already set and another chaining completion code is return for the same event, then the corresponding event is latched in the event missed registers (EMR.En/EMRH.En= 1). The setting of an event is a higher priority relative to clear operations (via hardware). If set and clear conditions occur concurrently, the set condition wins. If the event was previously set, then EMR/EMRH would be set because an event is lost. If the event was previously clear, then the event remains set and is prioritized for submission to the event queues. This register is part of a set of registers that pertain to the 64 DMA channels. The 64 DMA channels consist of a set of registers (with exception of DMAQNUMn) that each have 64 bits and the bit position of each register matches the DMA channel number. Each register is named with the format reg_name that corresponds to DMA channels 0 through 31 and reg_name_High that corresponds to DMA channels 32 through 64. For example, the event register (ER) corresponds to DMA channel 0 through 31 and the event register high register (ERH) corresponds to DMA channel 32 through 63. The register is typically called the event register. The DMA channel registers are accessible via read/writes to the global address range. They are also accessible via read/writes to the shadow address range. The read/write ability to the registers in the shadow region are controlled by the DMA region access registers (DRAEm/DRAEHm).

Figure 11-138. CER Register

31	30	29	28	27	26	25	24	23	22	21	20	19	18	17	16	15	14	13	12	11	10	9	8	7	6	5	4	3	2	1	0
En																															
R-0h																															

LEGEND: R/W = Read/Write; R = Read only; W1toCl = Write 1 to clear bit; -n = value after reset

Table 11-122. CER Register Field Descriptions

Bit	Field	Type	Reset	Description
31-0	En	R	0h	Chained event for event 0 to 31. 0h = No effect. 1h = Corresponding DMA event is prioritized versus other pending DMA/QDMA events for submission to the EDMA3TC.

11.4.1.98 CERH Register (offset = 101Ch) [reset = 0h]

CERH is shown in [Figure 11-139](#) and described in [Table 11-123](#).

When the OPTIONS parameter for a PaRAM entry is programmed to returned a chained completion code (ITCCHEN = 1 and/or TCCHEN = 1), then the value dictated by the TCC[5:0] (also programmed in OPT) forces the corresponding event bit to be set in the chained event registers (CER/CERH). The set chained event is evaluated by the EDMA3CC logic for an associated transfer request submission to the transfer controllers. This results in a chained-triggered transfer. The chained event registers do not have any enables. The generation of a chained event is essentially enabled by the PaPARAM entry that has been configured for intermediate and/or final chaining on transfer completion. The En bit is set (regardless of the state of EER.En/EERH.En) when a chained completion code is returned from one of the transfer controllers or is generated by the EDMA3CC via the early completion path. The bits in the chained event register are cleared when the corresponding events are prioritized and serviced. If the En bit is already set and another chaining completion code is return for the same event, then the corresponding event is latched in the event missed registers (EMR.En/EMRH.En= 1). The setting of an event is a higher priority relative to clear operations (via hardware). If set and clear conditions occur concurrently, the set condition wins. If the event was previously set, then EMR/EMRH would be set because an event is lost. If the event was previously clear, then the event remains set and is prioritized for submission to the event queues. This register is part of a set of registers that pertain to the 64 DMA channels. The 64 DMA channels consist of a set of registers (with exception of DMAQNUMn) that each have 64 bits and the bit position of each register matches the DMA channel number. Each register is named with the format reg_name that corresponds to DMA channels 0 through 31 and reg_name_High that corresponds to DMA channels 32 through 64. For example, the event register (ER) corresponds to DMA channel 0 through 31 and the event register high register (ERH) corresponds to DMA channel 32 through 63. The register is typically called the event register. The DMA channel registers are accessible via read/writes to the global address range. They are also accessible via read/writes to the shadow address range. The read/write ability to the registers in the shadow region are controlled by the DMA region access registers (DRAEm/DRAEHm).

Figure 11-139. CERH Register

31	30	29	28	27	26	25	24	23	22	21	20	19	18	17	16	15	14	13	12	11	10	9	8	7	6	5	4	3	2	1	0
En																															
R-0h																															

LEGEND: R/W = Read/Write; R = Read only; W1toCl = Write 1 to clear bit; -n = value after reset

Table 11-123. CERH Register Field Descriptions

Bit	Field	Type	Reset	Description
31-0	En	R	0h	Chained event set for event 32 to 63. 0h = No effect. 1h = Corresponding DMA event is prioritized versus other pending DMA/QDMA events for submission to the EDMA3TC.

11.4.1.99 EER Register (offset = 1020h) [reset = 0h]

EER is shown in [Figure 11-140](#) and described in [Table 11-124](#).

The EDMA3CC provides the option of selectively enabling/disabling each event in the event registers (ER/ERH) by using the event enable registers (EER/EERH). If an event bit in EER/EERH is set (using the event enable set registers, EESR/EESRH), it will enable that corresponding event. Alternatively, if an event bit in EER/EERH is cleared (using the event enable clear registers, EECR/EECRH), it will disable the corresponding event. The event registers latch all events that are captured by EDMA3CC, even if the events are disabled (although EDMA3CC does not process it). Enabling an event with a pending event already set in the event registers enables the EDMA3CC to process the already set event like any other new event. The EER/EERH settings do not have any effect on chained events (CER.En/CERH.En= 1) and manually set events (ESR.En/ESRH.En= 1). This register is part of a set of registers that pertain to the 64 DMA channels. The 64 DMA channels consist of a set of registers (with exception of DMAQNUMn) that each have 64 bits and the bit position of each register matches the DMA channel number. Each register is named with the format reg_name that corresponds to DMA channels 0 through 31 and reg_name_High that corresponds to DMA channels 32 through 64. For example, the event register (ER) corresponds to DMA channel 0 through 31 and the event register high register (ERH) corresponds to DMA channel 32 through 63. The register is typically called the event register. The DMA channel registers are accessible via read/writes to the global address range. They are also accessible via read/writes to the shadow address range. The read/write ability to the registers in the shadow region are controlled by the DMA region access registers (DRAEm/DRAEHm).

Figure 11-140. EER Register

31	30	29	28	27	26	25	24	23	22	21	20	19	18	17	16	15	14	13	12	11	10	9	8	7	6	5	4	3	2	1	0
En																															
R-0h																															

LEGEND: R/W = Read/Write; R = Read only; W1toCl = Write 1 to clear bit; -n = value after reset

Table 11-124. EER Register Field Descriptions

Bit	Field	Type	Reset	Description
31-0	En	R	0h	Event enable for events 0 to 31. 0h = Event is not enabled. An external event latched in the event register (ER) is not evaluated by the EDMA3CC. 1h = Event is enabled. An external event latched in the event register (ER) is evaluated by the EDMA3CC.

11.4.1.100 EERH Register (offset = 1024h) [reset = 0h]

EERH is shown in [Figure 11-141](#) and described in [Table 11-125](#).

The EDMA3CC provides the option of selectively enabling/disabling each event in the event registers (ER/ERH) by using the event enable registers (EER/EERH). If an event bit in EER/EERH is set (using the event enable set registers, EESR/EESRH), it will enable that corresponding event. Alternatively, if an event bit in EER/EERH is cleared (using the event enable clear registers, EECR/EECRH), it will disable the corresponding event. The event registers latch all events that are captured by EDMA3CC, even if the events are disabled (although EDMA3CC does not process it). Enabling an event with a pending event already set in the event registers enables the EDMA3CC to process the already set event like any other new event. The EER/EERH settings do not have any effect on chained events (CER.En/CERH.En= 1) and manually set events (ESR.En/ESRH.En= 1). This register is part of a set of registers that pertain to the 64 DMA channels. The 64 DMA channels consist of a set of registers (with exception of DMAQNUMn) that each have 64 bits and the bit position of each register matches the DMA channel number. Each register is named with the format reg_name that corresponds to DMA channels 0 through 31 and reg_name_High that corresponds to DMA channels 32 through 64. For example, the event register (ER) corresponds to DMA channel 0 through 31 and the event register high register (ERH) corresponds to DMA channel 32 through 63. The register is typically called the event register. The DMA channel registers are accessible via read/writes to the global address range. They are also accessible via read/writes to the shadow address range. The read/write ability to the registers in the shadow region are controlled by the DMA region access registers (DRAEm/DRAEHm).

Figure 11-141. EERH Register

31	30	29	28	27	26	25	24	23	22	21	20	19	18	17	16	15	14	13	12	11	10	9	8	7	6	5	4	3	2	1	0
En																															
R-0h																															

LEGEND: R/W = Read/Write; R = Read only; W1toCl = Write 1 to clear bit; -n = value after reset

Table 11-125. EERH Register Field Descriptions

Bit	Field	Type	Reset	Description
31-0	En	R	0h	Event enable for events 32 to 63. 0h = Event is not enabled. An external event latched in the event register high (ERH) is not evaluated by the EDMA3CC. 1h = Event is enabled. An external event latched in the event register high (ERH) is evaluated by the EDMA3CC.

11.4.1.101 EECR Register (offset = 1028h) [reset = 0h]

EECR is shown in [Figure 11-142](#) and described in [Table 11-126](#).

The event enable registers (EER/EERH) cannot be modified by directly writing to them. The intent is to ease the software burden for the case where multiple tasks are attempting to simultaneously modify these registers. The event enable clear registers (EECR/EECRH) are used to disable events. Writes of 1 to the bits in EECR/EECRH clear the corresponding event bits in EER/EERH; writes of 0 have no effect. This register is part of a set of registers that pertain to the 64 DMA channels. The 64 DMA channels consist of a set of registers (with exception of DMAQNUMn) that each have 64 bits and the bit position of each register matches the DMA channel number. Each register is named with the format reg_name that corresponds to DMA channels 0 through 31 and reg_name_High that corresponds to DMA channels 32 through 64. For example, the event register (ER) corresponds to DMA channel 0 through 31 and the event register high register (ERH) corresponds to DMA channel 32 through 63. The register is typically called the event register. The DMA channel registers are accessible via read/writes to the global address range. They are also accessible via read/writes to the shadow address range. The read/write ability to the registers in the shadow region are controlled by the DMA region access registers (DRAEm/DRAEHm).

Figure 11-142. EECR Register

31	30	29	28	27	26	25	24	23	22	21	20	19	18	17	16	15	14	13	12	11	10	9	8	7	6	5	4	3	2	1	0
En																															
W-0h																															

LEGEND: R/W = Read/Write; R = Read only; W1toCl = Write 1 to clear bit; -n = value after reset

Table 11-126. EECR Register Field Descriptions

Bit	Field	Type	Reset	Description
31-0	En	W	0h	Event enable clear for events 0 to 31. 0h = No effect. 1h = Event is disabled. Corresponding bit in the event enable register (EER) is cleared (En = 0).

11.4.1.102 EECRH Register (offset = 102Ch) [reset = 0h]

EECRH is shown in [Figure 11-143](#) and described in [Table 11-127](#).

The event enable registers (EER/EERH) cannot be modified by directly writing to them. The intent is to ease the software burden for the case where multiple tasks are attempting to simultaneously modify these registers. The event enable clear registers (EECR/EECRH) are used to disable events. Writes of 1 to the bits in EECR/EECRH clear the corresponding event bits in EER/EERH; writes of 0 have no effect. This register is part of a set of registers that pertain to the 64 DMA channels. The 64 DMA channels consist of a set of registers (with exception of DMAQNUMn) that each have 64 bits and the bit position of each register matches the DMA channel number. Each register is named with the format reg_name that corresponds to DMA channels 0 through 31 and reg_name_High that corresponds to DMA channels 32 through 64. For example, the event register (ER) corresponds to DMA channel 0 through 31 and the event register high register (ERH) corresponds to DMA channel 32 through 63. The register is typically called the event register. The DMA channel registers are accessible via read/writes to the global address range. They are also accessible via read/writes to the shadow address range. The read/write ability to the registers in the shadow region are controlled by the DMA region access registers (DRAEm/DRAEHm).

Figure 11-143. EECRH Register

31	30	29	28	27	26	25	24	23	22	21	20	19	18	17	16	15	14	13	12	11	10	9	8	7	6	5	4	3	2	1	0
En																															
W-0h																															

LEGEND: R/W = Read/Write; R = Read only; W1toCl = Write 1 to clear bit; -n = value after reset

Table 11-127. EECRH Register Field Descriptions

Bit	Field	Type	Reset	Description
31-0	En	W	0h	Event enable clear for events 32 to 63. 0h = No effect. 1h = Event is disabled. Corresponding bit in the event enable register high (EERH) is cleared (En = 0).

11.4.1.103 EESR Register (offset = 1030h) [reset = 0h]

EESR is shown in [Figure 11-144](#) and described in [Table 11-128](#).

The event enable registers (EER/EERH) cannot be modified by directly writing to them. The intent is to ease the software burden for the case where multiple tasks are attempting to simultaneously modify these registers. The event enable set registers (EESR/EESRH) are used to enable events. Writes of 1 to the bits in EESR/EESRH set the corresponding event bits in EER/EERH; writes of 0 have no effect. This register is part of a set of registers that pertain to the 64 DMA channels. The 64 DMA channels consist of a set of registers (with exception of DMAQNUMn) that each have 64 bits and the bit position of each register matches the DMA channel number. Each register is named with the format reg_name that corresponds to DMA channels 0 through 31 and reg_name_High that corresponds to DMA channels 32 through 64. For example, the event register (ER) corresponds to DMA channel 0 through 31 and the event register high register (ERH) corresponds to DMA channel 32 through 63. The register is typically called the event register. The DMA channel registers are accessible via read/writes to the global address range. They are also accessible via read/writes to the shadow address range. The read/write ability to the registers in the shadow region are controlled by the DMA region access registers (DRAEm/DRAEHm).

Figure 11-144. EESR Register

31	30	29	28	27	26	25	24	23	22	21	20	19	18	17	16	15	14	13	12	11	10	9	8	7	6	5	4	3	2	1	0
En																															
W-0h																															

LEGEND: R/W = Read/Write; R = Read only; W1toCl = Write 1 to clear bit; -n = value after reset

Table 11-128. EESR Register Field Descriptions

Bit	Field	Type	Reset	Description
31-0	En	W	0h	Event enable set for events 0 to 31. 0h = No effect. 1h = Event is enabled. Corresponding bit in the event enable register (EER) is set (En = 1).

11.4.1.104 EESRH Register (offset = 1034h) [reset = 0h]

EESRH is shown in [Figure 11-145](#) and described in [Table 11-129](#).

The event enable registers (EER/EERH) cannot be modified by directly writing to them. The intent is to ease the software burden for the case where multiple tasks are attempting to simultaneously modify these registers. The event enable set registers (EESR/EESRH) are used to enable events. Writes of 1 to the bits in EESR/EESRH set the corresponding event bits in EER/EERH; writes of 0 have no effect. This register is part of a set of registers that pertain to the 64 DMA channels. The 64 DMA channels consist of a set of registers (with exception of DMAQNUMn) that each have 64 bits and the bit position of each register matches the DMA channel number. Each register is named with the format reg_name that corresponds to DMA channels 0 through 31 and reg_name_High that corresponds to DMA channels 32 through 64. For example, the event register (ER) corresponds to DMA channel 0 through 31 and the event register high register (ERH) corresponds to DMA channel 32 through 63. The register is typically called the event register. The DMA channel registers are accessible via read/writes to the global address range. They are also accessible via read/writes to the shadow address range. The read/write ability to the registers in the shadow region are controlled by the DMA region access registers (DRAEm/DRAEHm).

Figure 11-145. EESRH Register

31	30	29	28	27	26	25	24	23	22	21	20	19	18	17	16	15	14	13	12	11	10	9	8	7	6	5	4	3	2	1	0
En																															
W-0h																															

LEGEND: R/W = Read/Write; R = Read only; W1toCl = Write 1 to clear bit; -n = value after reset

Table 11-129. EESRH Register Field Descriptions

Bit	Field	Type	Reset	Description
31-0	En	W	0h	Event enable set for events 32 to 63. 0h = No effect. 1h = Event is enabled. Corresponding bit in the event enable register high (EERH) is set (En= 1).

11.4.1.105 SER Register (offset = 1038h) [reset = 0h]

SER is shown in [Figure 11-146](#) and described in [Table 11-130](#).

The secondary event registers (SER/SERH) provide information on the state of a DMA channel or event (0 through 63). If the EDMA3CC receives a TR synchronization due to a manual-trigger, event-trigger, or chained-trigger source (ESR.En/ESRH.En= 1, ER.En/ERH.En= 1, or CER.En/CERH.En= 1), which results in the setting of a corresponding event bit in SER/SERH (SER.En/SERH.En = 1), it implies that the corresponding DMA event is in the queue. Once a bit corresponding to an event is set in SER/SERH, the EDMA3CC does not prioritize additional events on the same DMA channel. Depending on the condition that lead to the setting of the SER bits, either the EDMA3CC hardware or the software (using SECR/SECRH) needs to clear the SER/SERH bits for the EDMA3CC to evaluate subsequent events (subsequent transfers) on the same channel. For additional conditions that can cause the secondary event registers to be set, see EDMA Overview. This register is part of a set of registers that pertain to the 64 DMA channels. The 64 DMA channels consist of a set of registers (with exception of DMAQNUMn) that each have 64 bits and the bit position of each register matches the DMA channel number. Each register is named with the format reg_name that corresponds to DMA channels 0 through 31 and reg_name_High that corresponds to DMA channels 32 through 64. For example, the event register (ER) corresponds to DMA channel 0 through 31 and the event register high register (ERH) corresponds to DMA channel 32 through 63. The register is typically called the event register. The DMA channel registers are accessible via read/writes to the global address range. They are also accessible via read/writes to the shadow address range. The read/write ability to the registers in the shadow region are controlled by the DMA region access registers (DRAEm/DRAEHm).

Figure 11-146. SER Register

31	30	29	28	27	26	25	24	23	22	21	20	19	18	17	16	15	14	13	12	11	10	9	8	7	6	5	4	3	2	1	0
En																															
R-0h																															

LEGEND: R/W = Read/Write; R = Read only; W1toCl = Write 1 to clear bit; -n = value after reset

Table 11-130. SER Register Field Descriptions

Bit	Field	Type	Reset	Description
31-0	En	R	0h	Secondary event register. The secondary event register is used along with the event register (ER) to provide information on the state of an event. 0h = Event is not currently stored in the event queue. 1h = Event is currently stored in the event queue. Event arbiter will not prioritize additional events.

11.4.1.106 SERH Register (offset = 103Ch) [reset = 0h]

SERH is shown in [Figure 11-147](#) and described in [Table 11-131](#).

The secondary event registers (SER/SERH) provide information on the state of a DMA channel or event (0 through 63). If the EDMA3CC receives a TR synchronization due to a manual-trigger, event-trigger, or chained-trigger source (ESR.En/ESRH.En= 1, ER.En/ERH.En= 1, or CER.En/CERH.En= 1), which results in the setting of a corresponding event bit in SER/SERH (SER.En/SERH.En = 1), it implies that the corresponding DMA event is in the queue. Once a bit corresponding to an event is set in SER/SERH, the EDMA3CC does not prioritize additional events on the same DMA channel. Depending on the condition that lead to the setting of the SER bits, either the EDMA3CC hardware or the software (using SECR/SECRH) needs to clear the SER/SERH bits for the EDMA3CC to evaluate subsequent events (subsequent transfers) on the same channel. For additional conditions that can cause the secondary event registers to be set, see EDMA Overview. This register is part of a set of registers that pertain to the 64 DMA channels. The 64 DMA channels consist of a set of registers (with exception of DMAQNUMn) that each have 64 bits and the bit position of each register matches the DMA channel number. Each register is named with the format reg_name that corresponds to DMA channels 0 through 31 and reg_name_High that corresponds to DMA channels 32 through 64. For example, the event register (ER) corresponds to DMA channel 0 through 31 and the event register high register (ERH) corresponds to DMA channel 32 through 63. The register is typically called the event register. The DMA channel registers are accessible via read/writes to the global address range. They are also accessible via read/writes to the shadow address range. The read/write ability to the registers in the shadow region are controlled by the DMA region access registers (DRAEm/DRAEHm).

Figure 11-147. SERH Register

31	30	29	28	27	26	25	24	23	22	21	20	19	18	17	16	15	14	13	12	11	10	9	8	7	6	5	4	3	2	1	0
En																															
R-0h																															

LEGEND: R/W = Read/Write; R = Read only; W1toCl = Write 1 to clear bit; -n = value after reset

Table 11-131. SERH Register Field Descriptions

Bit	Field	Type	Reset	Description
31-0	En	R	0h	Secondary event register. The secondary event register is used along with the event register high (ERH) to provide information on the state of an event. 0h = Event is not currently stored in the event queue. 1h = Event is currently stored in the event queue. Event submission/prioritization logic will not prioritize additional events.

11.4.1.107 SECR Register (offset = 1040h) [reset = 0h]

SECR is shown in [Figure 11-148](#) and described in [Table 11-132](#).

The secondary event clear registers (SECR/SECRH) clear the status of the secondary event registers (SER/SERH). CPU writes of 1 clear the corresponding set bits in SER/SERH. Writes of 0 have no effect. This register is part of a set of registers that pertain to the 64 DMA channels. The 64 DMA channels consist of a set of registers (with exception of DMAQNUMn) that each have 64 bits and the bit position of each register matches the DMA channel number. Each register is named with the format reg_name that corresponds to DMA channels 0 through 31 and reg_name_High that corresponds to DMA channels 32 through 64. For example, the event register (ER) corresponds to DMA channel 0 through 31 and the event register high register (ERH) corresponds to DMA channel 32 through 63. The register is typically called the event register. The DMA channel registers are accessible via read/writes to the global address range. They are also accessible via read/writes to the shadow address range. The read/write ability to the registers in the shadow region are controlled by the DMA region access registers (DRAEm/DRAEHm).

Figure 11-148. SECR Register

31	30	29	28	27	26	25	24	23	22	21	20	19	18	17	16	15	14	13	12	11	10	9	8	7	6	5	4	3	2	1	0
En																															
W-0h																															

LEGEND: R/W = Read/Write; R = Read only; W1toCl = Write 1 to clear bit; -n = value after reset

Table 11-132. SECR Register Field Descriptions

Bit	Field	Type	Reset	Description
31-0	En	W	0h	Secondary event clear register. 0h = No effect. 1h = Corresponding bit in the secondary event register (SER) is cleared (En = 0).

11.4.1.108 SECRH Register (offset = 1044h) [reset = 0h]

SECRH is shown in [Figure 11-149](#) and described in [Table 11-133](#).

The secondary event clear registers (SECR/SECRH) clear the status of the secondary event registers (SER/SERH). CPU writes of 1 clear the corresponding set bits in SER/SERH. Writes of 0 have no effect. This register is part of a set of registers that pertain to the 64 DMA channels. The 64 DMA channels consist of a set of registers (with exception of DMAQNUMn) that each have 64 bits and the bit position of each register matches the DMA channel number. Each register is named with the format reg_name that corresponds to DMA channels 0 through 31 and reg_name_High that corresponds to DMA channels 32 through 64. For example, the event register (ER) corresponds to DMA channel 0 through 31 and the event register high register (ERH) corresponds to DMA channel 32 through 63. The register is typically called the event register. The DMA channel registers are accessible via read/writes to the global address range. They are also accessible via read/writes to the shadow address range. The read/write ability to the registers in the shadow region are controlled by the DMA region access registers (DRAEm/DRAEHm).

Figure 11-149. SECRH Register

31	30	29	28	27	26	25	24	23	22	21	20	19	18	17	16	15	14	13	12	11	10	9	8	7	6	5	4	3	2	1	0
En																															
W-0h																															

LEGEND: R/W = Read/Write; R = Read only; W1toCl = Write 1 to clear bit; -n = value after reset

Table 11-133. SECRH Register Field Descriptions

Bit	Field	Type	Reset	Description
31-0	En	W	0h	Secondary event clear register. 0h = No effect. 1h = Corresponding bit in the secondary event registers high (SERH) is cleared (En = 0).

11.4.1.109 IER Register (offset = 1050h) [reset = 0h]

IER is shown in [Figure 11-150](#) and described in [Table 11-134](#).

Interrupt enable registers (IER/IERH) are used to enable/disable the transfer completion interrupt generation by the EDMA3CC for all DMA/QDMA channels. The IER/IERH cannot be written to directly. To set any interrupt bit in IER/IERH, a 1 must be written to the corresponding interrupt bit in the interrupt enable set registers (IESR/IESRH). Similarly, to clear any interrupt bit in IER/IERH, a 1 must be written to the corresponding interrupt bit in the interrupt enable clear registers (IECR/IECRH). All DMA/QDMA channels can be set to assert an EDMA3CC completion interrupt to the CPU on transfer completion, by appropriately configuring the PaRAM entry associated with the channels. This register is used for the transfer completion interrupt reporting/generating by the EDMA3CC. For more details on EDMA3CC completion interrupt generation, see EDMA3 Interrupts.

Figure 11-150. IER Register

31	30	29	28	27	26	25	24	23	22	21	20	19	18	17	16	15	14	13	12	11	10	9	8	7	6	5	4	3	2	1	0
In_																															
R-0h																															

LEGEND: R/W = Read/Write; R = Read only; W1toCl = Write 1 to clear bit; -n = value after reset

Table 11-134. IER Register Field Descriptions

Bit	Field	Type	Reset	Description
31-0	In_	R	0h	Interrupt enable for channels 0 to 31. 0h = Interrupt is not enabled. 1h = Interrupt is enabled.

11.4.1.110 IERH Register (offset = 1054h) [reset = 0h]

IERH is shown in [Figure 11-151](#) and described in [Table 11-135](#).

Interrupt enable registers (IER/IERH) are used to enable/disable the transfer completion interrupt generation by the EDMA3CC for all DMA/QDMA channels. The IER/IERH cannot be written to directly. To set any interrupt bit in IER/IERH, a 1 must be written to the corresponding interrupt bit in the interrupt enable set registers (IESR/IESRH). Similarly, to clear any interrupt bit in IER/IERH, a 1 must be written to the corresponding interrupt bit in the interrupt enable clear registers (IECR/IECRH). All DMA/QDMA channels can be set to assert an EDMA3CC completion interrupt to the CPU on transfer completion, by appropriately configuring the PaRAM entry associated with the channels. This register is used for the transfer completion interrupt reporting/generating by the EDMA3CC. For more details on EDMA3CC completion interrupt generation, see EDMA3 Interrupts.

Figure 11-151. IERH Register

31	30	29	28	27	26	25	24	23	22	21	20	19	18	17	16	15	14	13	12	11	10	9	8	7	6	5	4	3	2	1	0
In																															
R-0h																															

LEGEND: R/W = Read/Write; R = Read only; W1toCl = Write 1 to clear bit; -n = value after reset

Table 11-135. IERH Register Field Descriptions

Bit	Field	Type	Reset	Description
31-0	In	R	0h	Interrupt enable for channels 32 to 63. 0h = Interrupt is not enabled. 1h = Interrupt is enabled.

11.4.1.111 IECR Register (offset = 1058h) [reset = 0h]

IECR is shown in [Figure 11-152](#) and described in [Table 11-136](#).

The interrupt enable clear registers (IECR/IECRH) are used to clear interrupts. Writes of 1 to the bits in IECR/IECRH clear the corresponding interrupt bits in the interrupt enable registers (IER/IERH); writes of 0 have no effect. All DMA/QDMA channels can be set to assert an EDMA3CC completion interrupt to the CPU on transfer completion, by appropriately configuring the PaRAM entry associated with the channels. This register is used for the transfer completion interrupt reporting/generating by the EDMA3CC. For more details on EDMA3CC completion interrupt generation, see EDMA3 Interrupts.

Figure 11-152. IECR Register

31	30	29	28	27	26	25	24	23	22	21	20	19	18	17	16	15	14	13	12	11	10	9	8	7	6	5	4	3	2	1	0
In																															
W-0h																															

LEGEND: R/W = Read/Write; R = Read only; W1toCl = Write 1 to clear bit; -n = value after reset

Table 11-136. IECR Register Field Descriptions

Bit	Field	Type	Reset	Description
31-0	In	W	0h	Interrupt enable clear for channels 0 to 31. 0h = No effect. 1h = Corresponding bit in the interrupt enable register (IER) is cleared (In = 0).

11.4.1.112 IECRH Register (offset = 105Ch) [reset = 0h]

IECRH is shown in [Figure 11-153](#) and described in [Table 11-137](#).

The interrupt enable clear registers (IECR/IECRH) are used to clear interrupts. Writes of 1 to the bits in IECR/IECRH clear the corresponding interrupt bits in the interrupt enable registers (IER/IERH); writes of 0 have no effect. All DMA/QDMA channels can be set to assert an EDMA3CC completion interrupt to the CPU on transfer completion, by appropriately configuring the PaRAM entry associated with the channels. This register is used for the transfer completion interrupt reporting/generating by the EDMA3CC. For more details on EDMA3CC completion interrupt generation, see EDMA3 Interrupts.

Figure 11-153. IECRH Register

31	30	29	28	27	26	25	24	23	22	21	20	19	18	17	16	15	14	13	12	11	10	9	8	7	6	5	4	3	2	1	0		
In																																	
W-0h																																	

LEGEND: R/W = Read/Write; R = Read only; W1toCl = Write 1 to clear bit; -n = value after reset

Table 11-137. IECRH Register Field Descriptions

Bit	Field	Type	Reset	Description
31-0	In	W	0h	Interrupt enable clear for channels 32 to 63. 0h = No effect. 1h = Corresponding bit in the interrupt enable register high (IERH) is cleared (In = 0).

11.4.1.113 IESR Register (offset = 1060h) [reset = 0h]

IESR is shown in [Figure 11-154](#) and described in [Table 11-138](#).

The interrupt enable set registers (IESR/IESRH) are used to enable interrupts. Writes of 1 to the bits in IESR/IESRH set the corresponding interrupt bits in the interrupt enable registers (IER/IERH); writes of 0 have no effect. All DMA/QDMA channels can be set to assert an EDMA3CC completion interrupt to the CPU on transfer completion, by appropriately configuring the PaRAM entry associated with the channels. This register is used for the transfer completion interrupt reporting/generating by the EDMA3CC. For more details on EDMA3CC completion interrupt generation, see EDMA3 Interrupts.

Figure 11-154. IESR Register

31	30	29	28	27	26	25	24	23	22	21	20	19	18	17	16	15	14	13	12	11	10	9	8	7	6	5	4	3	2	1	0
In																															
W-0h																															

LEGEND: R/W = Read/Write; R = Read only; W1toCl = Write 1 to clear bit; -n = value after reset

Table 11-138. IESR Register Field Descriptions

Bit	Field	Type	Reset	Description
31-0	In	W	0h	Interrupt enable set for channels 0 to 31. 0h = No effect. 1h = Corresponding bit in the interrupt enable register (IER) is set (In = 1).

11.4.1.114 IESRH Register (offset = 1064h) [reset = 0h]

IESRH is shown in [Figure 11-155](#) and described in [Table 11-139](#).

The interrupt enable set registers (IESR/IESRH) are used to enable interrupts. Writes of 1 to the bits in IESR/IESRH set the corresponding interrupt bits in the interrupt enable registers (IER/IERH); writes of 0 have no effect. All DMA/QDMA channels can be set to assert an EDMA3CC completion interrupt to the CPU on transfer completion, by appropriately configuring the PaRAM entry associated with the channels. This register is used for the transfer completion interrupt reporting/generating by the EDMA3CC. For more details on EDMA3CC completion interrupt generation, see EDMA3 Interrupts.

Figure 11-155. IESRH Register

31	30	29	28	27	26	25	24	23	22	21	20	19	18	17	16	15	14	13	12	11	10	9	8	7	6	5	4	3	2	1	0
In																															
W-0h																															

LEGEND: R/W = Read/Write; R = Read only; W1toCl = Write 1 to clear bit; -n = value after reset

Table 11-139. IESRH Register Field Descriptions

Bit	Field	Type	Reset	Description
31-0	In	W	0h	Interrupt enable clear for channels 32 to 63. 0h = No effect. 1h = Corresponding bit in the interrupt enable register high (IERH) is set (In = 1).

11.4.1.115 IPR Register (offset = 1068h) [reset = 0h]

IPR is shown in [Figure 11-156](#) and described in [Table 11-140](#).

If the TCINTEN and/or ITCINTEN bit in the channel option parameter (OPT) is set in the PaRAM entry associated with the channel (DMA or QDMA), then the EDMA3TC (for normal completion) or the EDMA3CC (for early completion) returns a completion code on transfer or intermediate transfer completion. The value of the returned completion code is equal to the TCC bit in OPT for the PaRAM entry associated with the channel. When an interrupt transfer completion code with TCC = n is detected by the EDMA3CC, then the corresponding bit is set in the interrupt pending register (IPR.In, if n = 0 to 31; IPRH.In, if n = 32 to 63). Note that once a bit is set in the interrupt pending registers, it remains set; it is your responsibility to clear these bits. The bits set in IPR/IPRH are cleared by writing a 1 to the corresponding bits in the interrupt clear registers (ICR/ICRH). All DMA/QDMA channels can be set to assert an EDMA3CC completion interrupt to the CPU on transfer completion, by appropriately configuring the PaRAM entry associated with the channels. This register is used for the transfer completion interrupt reporting/generating by the EDMA3CC. For more details on EDMA3CC completion interrupt generation, see EDMA3 Interrupts.

Figure 11-156. IPR Register

31	30	29	28	27	26	25	24	23	22	21	20	19	18	17	16	15	14	13	12	11	10	9	8	7	6	5	4	3	2	1	0
																	In														
																	R-0h														

LEGEND: R/W = Read/Write; R = Read only; W1toCl = Write 1 to clear bit; -n = value after reset

Table 11-140. IPR Register Field Descriptions

Bit	Field	Type	Reset	Description
31-0	In	R	0h	Interrupt pending for TCC = 0 to 31. 0h = Interrupt transfer completion code is not detected or was cleared. 1h = Interrupt transfer completion code is detected (In = 1, n = EDMA3TC[2:0]).

11.4.1.116 IPRH Register (offset = 106Ch) [reset = 0h]

IPRH is shown in [Figure 11-157](#) and described in [Table 11-141](#).

If the TCINTEN and/or ITCINTEN bit in the channel option parameter (OPT) is set in the PaRAM entry associated with the channel (DMA or QDMA), then the EDMA3TC (for normal completion) or the EDMA3CC (for early completion) returns a completion code on transfer or intermediate transfer completion. The value of the returned completion code is equal to the TCC bit in OPT for the PaRAM entry associated with the channel. When an interrupt transfer completion code with TCC = n is detected by the EDMA3CC, then the corresponding bit is set in the interrupt pending register (IPR.In, if n = 0 to 31; IPRH.In, if n = 32 to 63). Note that once a bit is set in the interrupt pending registers, it remains set; it is your responsibility to clear these bits. The bits set in IPR/IPRH are cleared by writing a 1 to the corresponding bits in the interrupt clear registers (ICR/ICRH). All DMA/QDMA channels can be set to assert an EDMA3CC completion interrupt to the CPU on transfer completion, by appropriately configuring the PaRAM entry associated with the channels. This register is used for the transfer completion interrupt reporting/generating by the EDMA3CC. For more details on EDMA3CC completion interrupt generation, see EDMA3 Interrupts.

Figure 11-157. IPRH Register

31	30	29	28	27	26	25	24	23	22	21	20	19	18	17	16	15	14	13	12	11	10	9	8	7	6	5	4	3	2	1	0
																	In														
R-0h																															

LEGEND: R/W = Read/Write; R = Read only; W1toCl = Write 1 to clear bit; -n = value after reset

Table 11-141. IPRH Register Field Descriptions

Bit	Field	Type	Reset	Description
31-0	In	R	0h	Interrupt pending for TCC = 32 to 63. 0h = Interrupt transfer completion code is not detected or was cleared. 1h = Interrupt transfer completion code is detected (In = 1, n = EDMA3TC[2:0]).

11.4.1.117 ICR Register (offset = 1070h) [reset = 0h]

ICR is shown in [Figure 11-158](#) and described in [Table 11-142](#).

The bits in the interrupt pending registers (IPR/IPRH) are cleared by writing a 1 to the corresponding bits in the interrupt clear registers(ICR/ICRH). Writes of 0 have no effect. All set bits in IPR/IPRH must be cleared to allow EDMA3CC to assert additional transfer completion interrupts. All DMA/QDMA channels can be set to assert an EDMA3CC completion interrupt to the CPU on transfer completion, by appropriately configuring the PaRAM entry associated with the channels. This register is used for the transfer completion interrupt reporting/generating by the EDMA3CC. For more details on EDMA3CC completion interrupt generation, see EDMA3 Interrupts.

Figure 11-158. ICR Register

31	30	29	28	27	26	25	24	23	22	21	20	19	18	17	16	15	14	13	12	11	10	9	8	7	6	5	4	3	2	1	0
In																															
W-0h																															

LEGEND: R/W = Read/Write; R = Read only; W1toCl = Write 1 to clear bit; -n = value after reset

Table 11-142. ICR Register Field Descriptions

Bit	Field	Type	Reset	Description
31-0	In	W	0h	Interrupt clear register for TCC = 0 to 31. 0h = No effect. 1h = Corresponding bit in the interrupt pending register (IPR) is cleared (In = 0).

11.4.1.118 ICRH Register (offset = 1074h) [reset = 0h]

ICRH is shown in [Figure 11-159](#) and described in [Table 11-143](#).

The bits in the interrupt pending registers (IPR/IPRH) are cleared by writing a 1 to the corresponding bits in the interrupt clear registers(ICR/ICRH). Writes of 0 have no effect. All set bits in IPR/IPRH must be cleared to allow EDMA3CC to assert additional transfer completion interrupts. All DMA/QDMA channels can be set to assert an EDMA3CC completion interrupt to the CPU on transfer completion, by appropriately configuring the PaRAM entry associated with the channels. This register is used for the transfer completion interrupt reporting/generating by the EDMA3CC. For more details on EDMA3CC completion interrupt generation, see EDMA3 Interrupts.

Figure 11-159. ICRH Register

31	30	29	28	27	26	25	24	23	22	21	20	19	18	17	16	15	14	13	12	11	10	9	8	7	6	5	4	3	2	1	0
In																															
W-0h																															

LEGEND: R/W = Read/Write; R = Read only; W1toCl = Write 1 to clear bit; -n = value after reset

Table 11-143. ICRH Register Field Descriptions

Bit	Field	Type	Reset	Description
31-0	In	W	0h	Interrupt clear register for TCC = 32 to 63. 0h = No effect. 1h = Corresponding bit in the interrupt pending register high (IPRH) is cleared (In = 0).

11.4.1.119 IEVAL Register (offset = 1078h) [reset = 0h]

IEVAL is shown in [Figure 11-160](#) and described in [Table 11-144](#).

The interrupt evaluate register (IEVAL) is the only register that physically exists in both the global region and the shadow regions. In other words, the read/write accessibility for the shadow region IEVAL is not affected by the DMA/QDMA region access registers (DRAEm/DRAEHm, QRAEn/QRAEHn). IEVAL is needed for robust ISR operations to ensure that interrupts are not missed by the CPU. All DMA/QDMA channels can be set to assert an EDMA3CC completion interrupt to the CPU on transfer completion, by appropriately configuring the PaRAM entry associated with the channels. This register is used for the transfer completion interrupt reporting/generating by the EDMA3CC. For more details on EDMA3CC completion interrupt generation, see EDMA3 Interrupts.

Figure 11-160. IEVAL Register

31	30	29	28	27	26	25	24
RESERVED							
R-0h							
23	22	21	20	19	18	17	16
RESERVED							
R-0h							
15	14	13	12	11	10	9	8
RESERVED							
R-0h							
7	6	5	4	3	2	1	0
RESERVED						RESERVED	EVAL
R-0h						R-0h	W-0h

LEGEND: R/W = Read/Write; R = Read only; W1toCl = Write 1 to clear bit; -n = value after reset

Table 11-144. IEVAL Register Field Descriptions

Bit	Field	Type	Reset	Description
31-2	RESERVED	R	0h	
1	RESERVED	R	0h	
0	EVAL	W	0h	Interrupt evaluate. The EDMA3CC completion interrupt that is pulsed depends on which IEVAL is being exercised. For example, writing to the EVAL bit in IEVAL pulses the global completion interrupt, but writing to the EVAL bit in IEVAL0 pulses the region 0 completion interrupt. 0h = No effect. 1h = Causes EDMA3CC completion interrupt to be pulsed, if any enabled (IERn/IERHn = 1) interrupts are still pending (IPRn/IPRHn = 1).

11.4.1.120 QER Register (offset = 1080h) [reset = 0h]

QER is shown in [Figure 11-161](#) and described in [Table 11-145](#).

The QDMA event register (QER) channel n bit is set (En = 1) when the CPU or any EDMA3 programmer (including EDMA3) performs a write to the trigger word (using the QDMA channel mapping register (QCHMAPn)) in the PaRAM entry associated with QDMA channel n (which is also programmed using QCHMAPn). The En bit is also set when the EDMA3CC performs a link update on a PaRAM address that matches the QCHMAPn settings. The QDMA event is latched only if the QDMA event enable register (QEER) channel n bit is also enabled (QEER.En = 1). Once a bit is set in QER, then the corresponding QDMA event (auto-trigger) is evaluated by the EDMA3CC logic for an associated transfer request submission to the transfer controllers. For additional conditions that can lead to the setting of QER bits, see EDMA Overview. The setting of an event is a higher priority relative to clear operations (via hardware). If set and clear conditions occur concurrently, the set condition wins. If the event was previously set, then the QDMA event missed register (QEMR) would be set because an event is lost. If the event was previously clear, then the event remains set and is prioritized for submission to the event queues. The set bits in QER are only cleared when the transfer request associated with the corresponding channels has been processed by the EDMA3CC and submitted to the transfer controller. If the En bit is already set and a QDMA event for the same QDMA channel occurs prior to the original being cleared, then the second missed event is latched in QEMR (En = 1). QER is part of a set of register that control the QDMA channels in EDMA3CC. QDMA channels (with the exception of the QDMA queue number register) consist of a set of registers, each of which have a bit location. Each bit position corresponds to a QDMA channel number. The QDMA channel registers are accessible via read/writes to the global address range. They are also accessible via read/writes to the shadow address range. The read/write accessibility in the shadow region address region is controlled by the QDMA region access registers (QRAEn/QRAEHn).

Figure 11-161. QER Register

31	30	29	28	27	26	25	24	23	22	21	20	19	18	17	16	15	14	13	12	11	10	9	8	7	6	5	4	3	2	1	0
RESERVED																								En							
R-0h																								R-0h							

LEGEND: R/W = Read/Write; R = Read only; W1toCl = Write 1 to clear bit; -n = value after reset

Table 11-145. QER Register Field Descriptions

Bit	Field	Type	Reset	Description
31-8	RESERVED	R	0h	
7-0	En	R	0h	QDMA event for channels 0 to 7. 0h = No effect. 1h = Corresponding QDMA event is prioritized versus other pending DMA/QDMA events for submission to the EDMA3TC.

11.4.1.121 QEER Register (offset = 1084h) [reset = 0h]

QEER is shown in [Figure 11-162](#) and described in [Table 11-146](#).

The EDMA3CC provides the option of selectively enabling/disabling each channel in the QDMA event register (QER) by using the QDMA event enable register (QEER). If any of the event bits in QEER is set (using the QDMA event enable set register, QEESR), it will enable that corresponding event. Alternatively, if any event bit in QEER is cleared (using the QDMA event enable clear register, QEECR), it will disable the corresponding QDMA channel. The QDMA event register will not latch any event for a QDMA channel, if it is not enabled via QEER. QEER is part of a set of register that control the QDMA channels in EDMA3CC. QDMA channels (with the exception of the QDMA queue number register) consist of a set of registers, each of which have a bit location. Each bit position corresponds to a QDMA channel number. The QDMA channel registers are accessible via read/writes to the global address range. They are also accessible via read/writes to the shadow address range. The read/write accessibility in the shadow region address region is controlled by the QDMA region access registers (QRAEn/QRAEHn).

Figure 11-162. QEER Register

31	30	29	28	27	26	25	24	23	22	21	20	19	18	17	16	15	14	13	12	11	10	9	8	7	6	5	4	3	2	1	0
RESERVED														En																	
R-0h														R-0h																	

LEGEND: R/W = Read/Write; R = Read only; W1toCl = Write 1 to clear bit; -n = value after reset

Table 11-146. QEER Register Field Descriptions

Bit	Field	Type	Reset	Description
31-8	RESERVED	R	0h	
7-0	En	R	0h	QDMA event enable for channels 0 to 7. 0h = QDMA channel n is not enabled. QDMA event will not be recognized and will not latch in the QDMA event register (QER). 1h = QDMA channel n is enabled. QDMA events will be recognized and will get latched in the QDMA event register (QER).

11.4.1.122 QEECR Register (offset = 1088h) [reset = 0h]

QEECR is shown in [Figure 11-163](#) and described in [Table 11-147](#).

The QDMA event enable register (QEER) cannot be modified by directly writing to the register, to ease the software burden when multiple tasks are attempting to simultaneously modify these registers. The QDMA event enable clear register (QEECR) is used to disable events. Writes of 1 to the bits in QEECR clear the corresponding QDMA channel bits in QEER; writes of 0 have no effect. QEECR is part of a set of registers that control the QDMA channels in EDMA3CC. QDMA channels (with the exception of the QDMA queue number register) consist of a set of registers, each of which have a bit location. Each bit position corresponds to a QDMA channel number. The QDMA channel registers are accessible via read/writes to the global address range. They are also accessible via read/writes to the shadow address range. The read/write accessibility in the shadow region address region is controlled by the QDMA region access registers (QRAEn/QRAEHn).

Figure 11-163. QEECR Register

31	30	29	28	27	26	25	24	23	22	21	20	19	18	17	16	15	14	13	12	11	10	9	8	7	6	5	4	3	2	1	0
RESERVED																								En							
R-0h																								W-0h							

LEGEND: R/W = Read/Write; R = Read only; W1toCl = Write 1 to clear bit; -n = value after reset

Table 11-147. QEECR Register Field Descriptions

Bit	Field	Type	Reset	Description
31-8	RESERVED	R	0h	
7-0	En	W	0h	QDMA event enable clear for channels 0 to 7. 0h = No effect. 1h = QDMA event is disabled. Corresponding bit in the QDMA event enable register (QEER) is cleared (En = 0).

11.4.1.123 QEESR Register (offset = 108Ch) [reset = 0h]

QEESR is shown in [Figure 11-164](#) and described in [Table 11-148](#).

The QDMA event enable register (QEER) cannot be modified by directly writing to the register, to ease the software burden when multiple tasks are attempting to simultaneously modify these registers. The QDMA event enable set register (QEESR) is used to enable events. Writes of 1 to the bits in QEESR set the corresponding QDMA channel bits in QEER; writes of 0 have no effect.

Figure 11-164. QEESR Register

31	30	29	28	27	26	25	24	23	22	21	20	19	18	17	16	15	14	13	12	11	10	9	8	7	6	5	4	3	2	1	0
RESERVED														En																	
R-0h														W-0h																	

LEGEND: R/W = Read/Write; R = Read only; W1toCl = Write 1 to clear bit; -n = value after reset

Table 11-148. QEESR Register Field Descriptions

Bit	Field	Type	Reset	Description
31-8	RESERVED	R	0h	
7-0	En	W	0h	QDMA event enable set for channels 0 to 7. 0h = No effect. 1h = QDMA event is enabled. Corresponding bit in the QDMA event enable register (QEER) is set (En = 1).

11.4.1.124 QSER Register (offset = 1090h) [reset = 0h]

QSER is shown in [Figure 11-165](#) and described in [Table 11-149](#).

The QDMA secondary event register (QSER) provides information on the state of a QDMA event. If at any time a bit corresponding to a QDMA channel is set in QSER, that implies that the corresponding QDMA event is in the queue. Once a bit corresponding to a QDMA channel is set in QSER, the EDMA3CC does not prioritize additional events on the same QDMA channel. Depending on the condition that lead to the setting of the QSER bits, either the EDMA3CC hardware or the software (using QSECR) needs to clear the QSER bits for the EDMA3CC to evaluate subsequent QDMA events on the channel. Based on whether the associated TR request is valid, or it is a null or dummy TR, the implications on the state of QSER and the required user actions to submit another QDMA transfer might be different. For additional conditions that can cause the secondary event registers (QSER\SER) to be set, see EDMA Overview. QSER is part of a set of register that control the QDMA channels in EDMA3CC. QDMA channels (with the exception of the QDMA queue number register) consist of a set of registers, each of which have a bit location. Each bit position corresponds to a QDMA channel number. The QDMA channel registers are accessible via read/writes to the global address range. They are also accessible via read/writes to the shadow address range. The read/write accessibility in the shadow region address region is controlled by the QDMA region access registers (QRAEn/QRAEHn).

Figure 11-165. QSER Register

31	30	29	28	27	26	25	24	23	22	21	20	19	18	17	16	15	14	13	12	11	10	9	8	7	6	5	4	3	2	1	0
RESERVED																								En							
R-0h																								R-0h							

LEGEND: R/W = Read/Write; R = Read only; W1toCl = Write 1 to clear bit; -n = value after reset

Table 11-149. QSER Register Field Descriptions

Bit	Field	Type	Reset	Description
31-8	RESERVED	R	0h	
7-0	En	R	0h	QDMA secondary event register for channels 0 to 7. 0h = QDMA event is not currently stored in the event queue. 1h = QDMA event is currently stored in the event queue. EDMA3CC will not prioritize additional events.

11.4.1.125 QSECR Register (offset = 1094h) [reset = 0h]

QSECR is shown in [Figure 11-166](#) and described in [Table 11-150](#).

The QDMA secondary event clear register (QSECR) clears the status of the QDMA secondary event register (QSER) and the QDMA event register (QER). CPU writes of 1 clear the corresponding set bits in QSER and QER. Writes of 0 have no effect. Note that this differs from the secondary event clear register (SECR) operation, which only clears the secondary event register (SER) bits and does not affect the event registers. QSECR is part of a set of register that control the QDMA channels in EDMA3CC. QDMA channels (with the exception of the QDMA queue number register) consist of a set of registers, each of which have a bit location. Each bit position corresponds to a QDMA channel number. The QDMA channel registers are accessible via read/writes to the global address range. They are also accessible via read/writes to the shadow address range. The read/write accessibility in the shadow region address region is controlled by the QDMA region access registers (QRAEn/QRAEHn).

Figure 11-166. QSECR Register

31	30	29	28	27	26	25	24	23	22	21	20	19	18	17	16	15	14	13	12	11	10	9	8	7	6	5	4	3	2	1	0
RESERVED																								En							
R-0h																								W-0h							

LEGEND: R/W = Read/Write; R = Read only; W1toCl = Write 1 to clear bit; -n = value after reset

Table 11-150. QSECR Register Field Descriptions

Bit	Field	Type	Reset	Description
31-8	RESERVED	R	0h	
7-0	En	W	0h	QDMA secondary event clear register for channels 0 to 7. 0h = No effect. 1h = Corresponding bit in the QDMA secondary event register (QSER) and the QDMA event register (QER) is cleared (En = 0).

11.4.2 EDMA3TC Registers

[Table 11-151](#) lists the memory-mapped registers for the EDMA3TC. All register offset addresses not listed in [Table 11-151](#) should be considered as reserved locations and the register contents should not be modified.

Table 11-151. EDMA3TC Registers

Offset	Acronym	Register Name	Section
0h	PID	Peripheral Identification Register	Section 13.5.1.1
4h	TCCFG	EDMA3TC Configuration Register	Section 11.4.2.2
10h	SYSCONFIG	EDMA3TC System Configuration Register	Section 15.1.2.2
100h	TCSTAT	EDMA3TC Channel Status Register	Section 11.4.2.4
120h	ERRSTAT	Error Register	Section 11.4.2.5
124h	ERREN	Error Enable Register	Section 11.4.2.6
128h	ERRCLR	Error Clear Register	Section 11.4.2.7
12Ch	ERRDET	Error Details Register	Section 11.4.2.8
130h	ERRCMD	Error Interrupt Command Register	Section 11.4.2.9
140h	RDRATE	Read Rate Register	Section 11.4.2.10
240h	SAOPT	Source Active Options Register	Section 11.4.2.11
244h	SASRC	Source Active Source Address Register	Section 11.4.2.12
248h	SACNT	Source Active Count Register	Section 11.4.2.13
24Ch	SADST	Source Active Destination Address Register	Section 11.4.2.14
250h	SABIDX	Source Active Source B-Index Register	Section 11.4.2.15
254h	SAMPPTY	Source Active Memory Protection Proxy Register	Section 11.4.2.16
258h	SACNTRLD	Source Active Count Reload Register	Section 11.4.2.17

Table 11-151. EDMA3TC Registers (continued)

Offset	Acronym	Register Name	Section
25Ch	SASRCBREF	Source Active Source Address B-Reference Register	Section 11.4.2.18
260h	SADSTBREF	Source Active Destination Address B-Reference Register	Section 11.4.2.19
280h	DFCNTRLD	Destination FIFO Set Count Reload	Section 11.4.2.20
284h	DFSRCBREF	Destination FIFO Set Destination Address B Reference Register	Section 11.4.2.21
288h	DFDSTBREF	Destination FIFO Set Destination Address B Reference Register	Section 11.4.2.22
300h	DFOPT0	Destination FIFO Options Register 0	Section 11.4.2.23
304h	DFSRC0	Destination FIFO Source Address Register 0	Section 11.4.2.24
308h	DFCNT0	Destination FIFO Count Register 0	Section 11.4.2.25
30Ch	DFDST0	Destination FIFO Destination Address Register 0	Section 11.4.2.26
310h	DFBIDX0	Destination FIFO BIDX Register 0	Section 11.4.2.27
314h	DFMPPRXY0	Destination FIFO Memory Protection Proxy Register 0	Section 11.4.2.28
340h	DFOPT1	Destination FIFO Options Register 1	Section 11.4.2.29
344h	DFSRC1	Destination FIFO Source Address Register 1	Section 11.4.2.30
348h	DFCNT1	Destination FIFO Count Register 1	Section 11.4.2.31
34Ch	DFDST1	Destination FIFO Destination Address Register 1	Section 11.4.2.32
350h	DFBIDX1	Destination FIFO BIDX Register 1	Section 11.4.2.33
354h	DFMPPRXY1	Destination FIFO Memory Protection Proxy Register 1	Section 11.4.2.34
380h	DFOPT2	Destination FIFO Options Register 2	Section 11.4.2.35
384h	DFSRC2	Destination FIFO Source Address Register 2	Section 11.4.2.36
388h	DFCNT2	Destination FIFO Count Register 2	Section 11.4.2.37
38Ch	DFDST2	Destination FIFO Destination Address Register 2	Section 11.4.2.38
390h	DFBIDX2	Destination FIFO BIDX Register 2	Section 11.4.2.39
394h	DFMPPRXY2	Destination FIFO Memory Protection Proxy Register 2	Section 11.4.2.40
3C0h	DFOPT3	Destination FIFO Options Register 3	Section 11.4.2.41
3C4h	DFSRC3	Destination FIFO Source Address Register 3	Section 11.4.2.42
3C8h	DFCNT3	Destination FIFO Count Register 3	Section 11.4.2.43
3CCh	DFDST3	Destination FIFO Destination Address Register 3	Section 11.4.2.44
3D0h	DFBIDX3	Destination FIFO BIDX Register 3	Section 11.4.2.45
3D4h	DFMPPRXY3	Destination FIFO Memory Protection Proxy Register 3	Section 11.4.2.46

11.4.2.1 PID Register (offset = 0h) [reset = 0h]

PID is shown in [Figure 13-19](#) and described in [Table 13-14](#).

The peripheral identification register (PID) is a constant register that uniquely identifies the EDMA3TC and specific revision of the EDMA3TC.

Figure 11-167. PID Register

31	30	29	28	27	26	25	24	23	22	21	20	19	18	17	16	15	14	13	12	11	10	9	8	7	6	5	4	3	2	1	0
RESERVED																PID															
R-0h																R-0h															

LEGEND: R/W = Read/Write; R = Read only; W1toCl = Write 1 to clear bit; -n = value after reset

Table 11-152. PID Register Field Descriptions

Bit	Field	Type	Reset	Description
31-16	RESERVED	R	0h	
15-0	PID	R	0h	Peripheral identifier, value 0 to FFFF FFFFh. Reset for PID[31] to PID[16] is 4000h. Reset for PID[15] to PID[0] is 7C00h.

11.4.2.2 TCCFG Register (offset = 4h) [reset = 224h]

TCCFG is shown in [Figure 11-168](#) and described in [Table 11-153](#).

Figure 11-168. TCCFG Register

31	30	29	28	27	26	25	24
RESERVED							
R-0h							
23	22	21	20	19	18	17	16
RESERVED							
R-0h							
15	14	13	12	11	10	9	8
RESERVED						DREGDEPTH	
R-0h						R-2h	
7	6	5	4	3	2	1	0
RESERVED		BUSWIDTH		RESERVED		FIFOSIZE	
R-0h		R-2h		R-0h		R-4h	

LEGEND: R/W = Read/Write; R = Read only; W1toCl = Write 1 to clear bit; -n = value after reset

Table 11-153. TCCFG Register Field Descriptions

Bit	Field	Type	Reset	Description
31-10	RESERVED	R	0h	
9-8	DREGDEPTH	R	2h	Destination register FIFO depth parameterization. 0h = Reserved. 1h = Reserved. 2h = 4 entry (for TC0, TC1, and TC2) 3h = Reserved.
7-6	RESERVED	R	0h	
5-4	BUSWIDTH	R	2h	Bus width parameterization. 0h = Reserved. 1h = Reserved. 2h = 128-bit. 3h = Reserved.
3	RESERVED	R	0h	
2-0	FIFOSIZE	R	4h	FIFO size 0h = Reserved. 1h = Reserved. 2h = Reserved. 3h = Reserved. 4h = 512 byte FIFO 5h = Reserved. 6h = Reserved. 7h = Reserved.

11.4.2.3 SYSCONFIG Register (offset = 10h) [reset = 28h]

 SYSCONFIG is shown in [Figure 15-4](#) and described in [Table 15-6](#).

Figure 11-169. SYSCONFIG Register

31	30	29	28	27	26	25	24
RESERVED							
R-0h							
23	22	21	20	19	18	17	16
RESERVED							
R-0h							
15	14	13	12	11	10	9	8
RESERVED							
R-0h							
7	6	5	4	3	2	1	0
RESERVED		STANDBYMODE		IDLEMODE		RESERVED	
R-0h		R/W-2h		R/W-2h		R-0h	

LEGEND: R/W = Read/Write; R = Read only; W1toCl = Write 1 to clear bit; -n = value after reset

Table 11-154. SYSCONFIG Register Field Descriptions

Bit	Field	Type	Reset	Description
31-6	RESERVED	R	0h	
5-4	STANDBYMODE	R/W	2h	Configuration of the local initiator state management mode. By definition, initiator may generate read/write transaction as long as it is out of STANDBY state. 0h = Force-standby mode: local initiator is unconditionally placed in standby state. Backup mode, for debug only. 1h = No-standby mode: local initiator is unconditionally placed out of standby state. Backup mode, for debug only. 2h = Smart-standby mode: local initiator standby status depends on local conditions, i.e., the module's functional requirement from the initiator. IP module should not generate (initiator-related) wakeup events. 3h = Reserved.
3-2	IDLEMODE	R/W	2h	Configuration of the local target state management mode. By definition, target can handle read/write transaction as long as it is out of IDLE state. 0h = Force-idle mode: local target's idle state follows (acknowledges) the system's idle requests unconditionally, i.e. regardless of the IP module's internal requirements. Backup mode, for debug only. 1h = No-idle mode: local target never enters idle state. Backup mode, for debug only. 2h = Smart-idle mode: local target's idle state eventually follows (acknowledges) the system's idle requests, depending on the IP module's internal requirements. IP module shall not generate (IRQ or DMA-request-related) wakeup events. 3h = Reserved.
1-0	RESERVED	R	0h	

11.4.2.4 TCSTAT Register (offset = 100h) [reset = 100h]

TCSTAT is shown in [Figure 11-170](#) and described in [Table 11-155](#).

Figure 11-170. TCSTAT Register

31	30	29	28	27	26	25	24
RESERVED							
R-0h							
23	22	21	20	19	18	17	16
RESERVED							
R-0h							
15	14	13	12	11	10	9	8
RESERVED		DFSTRTPTR		RESERVED		RESERVED	
R-0h		R-0h		R-0h		R-1h	
7	6	5	4	3	2	1	0
RESERVED	DSTACTV			RESERVED	WSACTV	SRACTV	PROGBUSY
R-0h	R-0h			R-0h	R-0h	R-0h	R-0h

LEGEND: R/W = Read/Write; R = Read only; W1toCl = Write 1 to clear bit; -n = value after reset

Table 11-155. TCSTAT Register Field Descriptions

Bit	Field	Type	Reset	Description
31-14	RESERVED	R	0h	
13-12	DFSTRTPTR	R	0h	Destination FIFO start pointer. Represents the offset to the head entry of the destination register FIFO, in units of entries. Value 0 to 3h.
11-9	RESERVED	R	0h	
8	RESERVED	R	1h	
7	RESERVED	R	0h	
6-4	DSTACTV	R	0h	Destination active state. Specifies the number of transfer requests (TRs) that are resident in the destination register FIFO at a given instant. This bit field can be primarily used for advanced debugging. Legal values are constrained by the destination register FIFO depth parameterization (DSTREGDEPTH) parameter. 0h = Destination FIFO is empty. 1h = Destination FIFO contains 1 TR. 2h = Destination FIFO contains 2 TRs. 3h = Destination FIFO contains 3 TRs. 4h = Destination FIFO contains 4 TRs. (Full if DSTREGDEPTH==4). If the destination register FIFO is empty, then any TR written to Prog Set immediately transitions to the destination register FIFO. If the destination register FIFO is not empty and not full, then any TR written to Prog Set immediately transitions to the destination register FIFO set if the source active state (SRACTV) bit is set to idle. If the destination register FIFO is full, then TRs cannot transition to the destination register FIFO. The destination register FIFO becomes not full when the TR at the head of the destination register FIFO is completed. 5h = Reserved. 6h = Reserved. 7h = Reserved.
3	RESERVED	R	0h	
2	WSACTV	R	0h	Write status active 0h = Write status is not pending. Write status has been received for all previously issued write commands. 1h = Write status is pending. Write status has not been received for all previously issued write commands.

Table 11-155. TCSTAT Register Field Descriptions (continued)

Bit	Field	Type	Reset	Description
1	SRCACTV	R	0h	Source active state 0h = Source controller is idle. Source active register set contains a previously processed transfer request. 1h = Source controller is busy servicing a transfer request.
0	PROGBUSY	R	0h	Program register set busy 0h = Program set idle and is available for programming by the EDMA3CC. 1h = Program set busy

11.4.2.5 ERRSTAT Register (offset = 120h) [reset = 0h]

 ERRSTAT is shown in [Figure 11-171](#) and described in [Table 11-156](#).

Figure 11-171. ERRSTAT Register

31	30	29	28	27	26	25	24
RESERVED							
R-0h							
23	22	21	20	19	18	17	16
RESERVED							
R-0h							
15	14	13	12	11	10	9	8
RESERVED							
R-0h							
7	6	5	4	3	2	1	0
RESERVED				MMRAERR	TRERR	RESERVED	BUSERR
R-0h				R-0h	R-0h	R-0h	R-0h

LEGEND: R/W = Read/Write; R = Read only; W1toCl = Write 1 to clear bit; -n = value after reset

Table 11-156. ERRSTAT Register Field Descriptions

Bit	Field	Type	Reset	Description
31-4	RESERVED	R	0h	
3	MMRAERR	R	0h	MMR address error. 0h = Condition is not detected. 1h = User attempted to read or write to an invalid address in configuration memory map.
2	TRERR	R	0h	Transfer request (TR) error event. 0h = Condition is not detected. 1h = TR detected that violates constant addressing mode transfer (SAM or DAM is set) alignment rules or has ACNT or BCNT == 0.
1	RESERVED	R	0h	
0	BUSERR	R	0h	Bus error event. 0h = Condition is not detected. 1h = EDMA3TC has detected an error at source or destination address. Error information can be read from the error details register (ERRDET).

11.4.2.6 ERREN Register (offset = 124h) [reset = 0h]

ERREN is shown in [Figure 11-172](#) and described in [Table 11-157](#).

When any of the enable bits are set, a bit set in the corresponding ERRSTAT causes an assertion of the EDMA3TC interrupt.

Figure 11-172. ERREN Register

31	30	29	28	27	26	25	24
RESERVED							
R-0h							
23	22	21	20	19	18	17	16
RESERVED							
R-0h							
15	14	13	12	11	10	9	8
RESERVED							
R-0h							
7	6	5	4	3	2	1	0
RESERVED				MMRAERR	TRERR	RESERVED	BUSERR
R-0h				R/W-0h	R/W-0h	R-0h	R/W-0h

LEGEND: R/W = Read/Write; R = Read only; W1toCl = Write 1 to clear bit; -n = value after reset

Table 11-157. ERREN Register Field Descriptions

Bit	Field	Type	Reset	Description
31-4	RESERVED	R	0h	
3	MMRAERR	R/W	0h	Interrupt enable for MMR address error (MMRAERR). 0h = MMRAERR is disabled. 1h = MMRAERR is enabled and contributes to the state of EDMA3TC error interrupt generation
2	TRERR	R/W	0h	Interrupt enable for transfer request error (TRERR). 0h = TRERR is disabled. 1h = TRERR is enabled and contributes to the state of EDMA3TC error interrupt generation.
1	RESERVED	R	0h	
0	BUSERR	R/W	0h	Interrupt enable for bus error (BUSERR). 0h = BUSERR is disabled. 1h = BUSERR is enabled and contributes to the state of EDMA3TC error interrupt generation.

11.4.2.7 ERRCLR Register (offset = 128h) [reset = 0h]

 ERRCLR is shown in [Figure 11-173](#) and described in [Table 11-158](#).

Figure 11-173. ERRCLR Register

31	30	29	28	27	26	25	24
RESERVED							
R-0h							
23	22	21	20	19	18	17	16
RESERVED							
R-0h							
15	14	13	12	11	10	9	8
RESERVED							
R-0h							
7	6	5	4	3	2	1	0
RESERVED				MMRAERR	TRERR	RESERVED	BUSERR
R-0h				W-0h	W-0h	R-0h	W-0h

LEGEND: R/W = Read/Write; R = Read only; W1toCl = Write 1 to clear bit; -n = value after reset

Table 11-158. ERRCLR Register Field Descriptions

Bit	Field	Type	Reset	Description
31-4	RESERVED	R	0h	
3	MMRAERR	W	0h	Interrupt enable clear for the MMRAERR bit in the error status register (ERRSTAT). 0h = No effect. 1h = Clears the MMRAERR bit in ERRSTAT but does not clear the error details register (ERRDET).
2	TRERR	W	0h	Interrupt enable clear for the TRERR bit in the error status register (ERRSTAT). 0h = No effect. 1h = Clears the TRERR bit in ERRSTAT but does not clear the error details register (ERRDET).
1	RESERVED	R	0h	
0	BUSERR	W	0h	Interrupt clear for the BUSERR bit in the error status register (ERRSTAT). 0h = No effect. 1h = Clears the BUSERR bit in ERRSTAT and clears the error details register (ERRDET).

11.4.2.8 ERRDET Register (offset = 12Ch) [reset = 0h]

 ERRDET is shown in [Figure 11-174](#) and described in [Table 11-159](#).

Figure 11-174. ERRDET Register

31	30	29	28	27	26	25	24
RESERVED							
R-0h							
23	22	21	20	19	18	17	16
RESERVED						TCCHEN	TCINTEN
R-0h						R-0h	R-0h
15	14	13	12	11	10	9	8
RESERVED				TCC			
R-0h				R-0h			
7	6	5	4	3	2	1	0
RESERVED						STAT	
R-0h						R-0h	

LEGEND: R/W = Read/Write; R = Read only; W1toCl = Write 1 to clear bit; -n = value after reset

Table 11-159. ERRDET Register Field Descriptions

Bit	Field	Type	Reset	Description
31-18	RESERVED	R	0h	
17	TCCHEN	R	0h	Transfer completion chaining enable. Contains the TCCHEN value in the channel options parameter (OPT) programmed by the channel controller for the read or write transaction that resulted in an error.
16	TCINTEN	R	0h	Transfer completion interrupt enable. Contains the TCINTEN value in the channel options parameter (OPT) programmed by the channel controller for the read or write transaction that resulted in an error.
15-14	RESERVED	R	0h	
13-8	TCC	R	0h	Transfer complete code. Contains the TCC value in the channel options parameter (OPT) programmed by the channel controller for the read or write transaction that resulted in an error.
7-4	RESERVED	R	0h	
3-0	STAT	R	0h	Transaction status. Stores the nonzero status/error code that was detected on the read status or write status bus. If read status and write status are returned on the same cycle, then the EDMA3TC chooses nonzero version. If both are nonzero, then the write status is treated as higher priority. 0h = No error. 1h = From 1h to 7h, Read error. 8h = From 8h to Fh, Write error.

11.4.2.9 ERRCMD Register (offset = 130h) [reset = 0h]

ERRCMD is shown in [Figure 11-175](#) and described in [Table 11-160](#).

Figure 11-175. ERRCMD Register

31	30	29	28	27	26	25	24
RESERVED							
R-0h							
23	22	21	20	19	18	17	16
RESERVED							
R-0h							
15	14	13	12	11	10	9	8
RESERVED							
R-0h							
7	6	5	4	3	2	1	0
RESERVED						RESERVED	EVAL
R-0h						R-0h	W-0h

LEGEND: R/W = Read/Write; R = Read only; W1toCl = Write 1 to clear bit; -n = value after reset

Table 11-160. ERRCMD Register Field Descriptions

Bit	Field	Type	Reset	Description
31-2	RESERVED	R	0h	
1	RESERVED	R	0h	
0	EVAL	W	0h	Error evaluate 0h = No effect 1h = EDMA3TC error line is pulsed if any of the error status register (ERRSTAT) bits are set.

11.4.2.10 RDRATE Register (offset = 140h) [reset = 0h]

RDRATE is shown in [Figure 11-176](#) and described in [Table 11-161](#).

The EDMA3 transfer controller issues read commands at a rate controlled by the read rate register (RDRATE). The RDRATE defines the number of idle cycles that the read controller must wait before issuing subsequent commands. This applies both to commands within a transfer request packet (TRP) and for commands that are issued for different transfer requests (TRs). For instance, if RDRATE is set to 4 cycles between reads, there are 3 inactive cycles between reads. RDRATE allows flexibility in transfer controller access requests to an endpoint. For an application, RDRATE can be manipulated to slow down the access rate, so that the endpoint may service requests from other masters during the inactive EDMA3TC cycles. Note: The RDRATE value for a transfer controller is expected to be static, as it is decided based on the application requirement. It is not recommended to change the RDRATE value on the fly.

Figure 11-176. RDRATE Register

31	30	29	28	27	26	25	24	23	22	21	20	19	18	17	16
RESERVED															
R-0h															
15	14	13	12	11	10	9	8	7	6	5	4	3	2	1	0
RESERVED													RDRATE		
R-0h													R/W-0h		

LEGEND: R/W = Read/Write; R = Read only; W1toCl = Write 1 to clear bit; -n = value after reset

Table 11-161. RDRATE Register Field Descriptions

Bit	Field	Type	Reset	Description
31-3	RESERVED	R	0h	
2-0	RDRATE	R/W	0h	Read rate. Controls the number of cycles between read commands. This is a global setting that applies to all TRs for this EDMA3TC. 0h = Reads issued as fast as possible. 1h = 4 cycles between reads. 2h = 8 cycles between reads. 3h = 16 cycles between reads. 4h = 32 cycles between reads. 5h = Reserved. 6h = Reserved. 7h = Reserved.

11.4.2.11 SAOPT Register (offset = 240h) [reset = 0h]

SAOPT is shown in [Figure 11-177](#) and described in [Table 11-162](#).

The Source Active Options Register (SAOPT) is an EDMA3TC channel register. This EDMA3TC channel register is part of the Source Active Register Set. It is read-only and provided to facilitate debugging by providing a window into how the transfer controller (TC) was programmed by the channel controller (CC), as well as showing the status of the transfer controller (TC) during a transfer.

Figure 11-177. SAOPT Register

31	30	29	28	27	26	25	24
RESERVED							
R-0h							
23	22	21	20	19	18	17	16
RESERVED	TCCHEN	RESERVED	TCINTEN	RESERVED		TCC	
R-0h	R-0h	R-0h	R-0h	R-0h		R-0h	
15	14	13	12	11	10	9	8
TCC				RESERVED	FWID		
R-0h				R-0h	R-0h		
7	6	5	4	3	2	1	0
RESERVED	PRI		RESERVED			DAM	SAM
R-0h	R-0h		R-0h			R-0h	R-0h

LEGEND: R/W = Read/Write; R = Read only; W1toCl = Write 1 to clear bit; -n = value after reset

Table 11-162. SAOPT Register Field Descriptions

Bit	Field	Type	Reset	Description
31-23	RESERVED	R	0h	
22	TCCHEN	R	0h	Transfer complete chaining enable 0h = Transfer complete chaining is disabled. 1h = Transfer complete chaining is enabled.
21	RESERVED	R	0h	
20	TCINTEN	R	0h	Transfer complete interrupt enable. 0h = Transfer complete interrupt is disabled. 1h = Transfer complete interrupt is enabled.
19-18	RESERVED	R	0h	
17-12	TCC	R	0h	Transfer complete code. This 6 bit code is used to set the relevant bit in CER or IPR of the EDMA3PCC module.
11	RESERVED	R	0h	
10-8	FWID	R	0h	FIFO width. Applies if either SAM or DAM is set to constant addressing mode. 0h = FIFO width is 8-bit. 1h = FIFO width is 16-bit. 2h = FIFO width is 32-bit. 3h = FIFO width is 64-bit. 4h = FIFO width is 128-bit. 5h = FIFO width is 256-bit. 6h = Reserved. 7h = Reserved.
7	RESERVED	R	0h	

Table 11-162. SAOPT Register Field Descriptions (continued)

Bit	Field	Type	Reset	Description
6-4	PRI	R	0h	Transfer priority. Reflects the values programmed in the QUEPRI register in the EDMACC. 0h = Priority 0 - Highest priority 1h = From 1h to 6h, Priority 1 to priority 6 7h = Priority 7 - Lowest priority
3-2	RESERVED	R	0h	
1	DAM	R	0h	Destination address mode within an array 0h = Increment (INCR) mode. Destination addressing within an array increments. 1h = Constant addressing (CONST) mode. Destination addressing within an array wraps around upon reaching FIFO width.
0	SAM	R	0h	Source address mode within an array 0h = Increment (INCR) mode. Source addressing within an array increments. 1h = Constant addressing (CONST) mode. Source addressing within an array wraps around upon reaching FIFO width.

11.4.2.12 SASRC Register (offset = 244h) [reset = 0h]

SASRC is shown in [Figure 11-178](#) and described in [Table 11-163](#).

The Source Active Source Address Register (SASRC) is an EDMA3TC channel register. This EDMA3TC channel register is part of the Source Active Register Set. It is read-only and provided to facilitate debugging by providing a window into how the transfer controller (TC) was programmed by the channel controller (CC), as well as showing the status of the transfer controller (TC) during a transfer.

Figure 11-178. SASRC Register

31	30	29	28	27	26	25	24	23	22	21	20	19	18	17	16	15	14	13	12	11	10	9	8	7	6	5	4	3	2	1	0
SADDR																															
R-0h																															

LEGEND: R/W = Read/Write; R = Read only; W1toCl = Write 1 to clear bit; -n = value after reset

Table 11-163. SASRC Register Field Descriptions

Bit	Field	Type	Reset	Description
31-0	SADDR	R	0h	Source address for Source Active Register Set. EDMA3TC updates value according to source addressing mode (SAM bit in the source active options register, SAOPT). This register does not update during a transfer. Value 0 to FFFFh.

11.4.2.13 SACNT Register (offset = 248h) [reset = 0h]

SACNT is shown in [Figure 11-179](#) and described in [Table 11-164](#).

The Source Active Count Register (SACNT) is an EDMA3TC channel register. This EDMA3TC channel register is part of the Source Active Register Set. It is read-only and provided to facilitate debugging by providing a window into how the transfer controller (TC) was programmed by the channel controller (CC), as well as showing the status of the transfer controller (TC) during a transfer.

Figure 11-179. SACNT Register

31	30	29	28	27	26	25	24	23	22	21	20	19	18	17	16	15	14	13	12	11	10	9	8	7	6	5	4	3	2	1	0
BCNT																ACNT															
R-0h																R-0h															

LEGEND: R/W = Read/Write; R = Read only; W1toCl = Write 1 to clear bit; -n = value after reset

Table 11-164. SACNT Register Field Descriptions

Bit	Field	Type	Reset	Description
31-16	BCNT	R	0h	B dimension count remaining for the Source Active Register Set. Number of arrays to be transferred, where each array is ACNT in length. TC decrements BCNT as necessary after each read command is issued. The final value should be 0 when TR is complete. Note that BCNT is always read as 0x0 in the Source Address Register Set.
15-0	ACNT	R	0h	A dimension count remaining for the Source Active Register Set. Number of bytes to be transferred in first dimension. Represents the amount of data remaining to be read. TC decrements ACNT as necessary after each read command is issued. The final value should be 0 when TR is complete.

11.4.2.14 SADST Register (offset = 24Ch) [reset = 0h]

SADST is shown in [Figure 11-180](#) and described in [Table 11-165](#).

The Source Active Destination Address Register (SADST) is an EDMA3TC channel register. This EDMA3TC channel register is part of the Source Active Register Set. It is read-only and provided to facilitate debugging by providing a window into how the transfer controller (TC) was programmed by the channel controller (CC), as well as showing the status of the transfer controller (TC) during a transfer.

Note: Destination address is not applicable for Source Active Register Set. Read returns 0.

Figure 11-180. SADST Register

31	30	29	28	27	26	25	24	23	22	21	20	19	18	17	16	15	14	13	12	11	10	9	8	7	6	5	4	3	2	1	0
RESERVED																															
R-0h																															

LEGEND: R/W = Read/Write; R = Read only; W1toCl = Write 1 to clear bit; -n = value after reset

Table 11-165. SADST Register Field Descriptions

Bit	Field	Type	Reset	Description
31-0	RESERVED	R	0h	

11.4.2.15 SABIDX Register (offset = 250h) [reset = 0h]

SABIDX is shown in [Figure 11-181](#) and described in [Table 11-166](#).

The Source Active Source B-Dimension Index Register (SABIDX) is an EDMA3TC channel register. This EDMA3TC channel register is part of the Source Active Register Set. It is read-only and provided to facilitate debugging by providing a window into how the transfer controller (TC) was programmed by the channel controller (CC), as well as showing the status of the transfer controller (TC) during a transfer.

Figure 11-181. SABIDX Register

31	30	29	28	27	26	25	24	23	22	21	20	19	18	17	16	15	14	13	12	11	10	9	8	7	6	5	4	3	2	1	0
DBIDX																SBIDX															
R-0h																R-0h															

LEGEND: R/W = Read/Write; R = Read only; W1toCl = Write 1 to clear bit; -n = value after reset

Table 11-166. SABIDX Register Field Descriptions

Bit	Field	Type	Reset	Description
31-16	DBIDX	R	0h	B-Index offset between destination arrays. Represents the offset in bytes between the starting address of each destination array (there are BCND arrays of ACNT elements). DBIDX is always used regardless of whether DAM is in Increment or FIFO mode.
15-0	SBIDX	R	0h	B-Index offset between source arrays. Represents the offset in bytes between the starting address of each source array (there are BCNT arrays of ACNT elements). SBIDX is always used regardless of whether SAM is in Increment or FIFO mode. Value 0 to FFFFh.

11.4.2.16 SAMPPRXY Register (offset = 254h) [reset = 0h]

SAMPPRXY is shown in [Figure 11-182](#) and described in [Table 11-167](#).

The Source Active Memory Protection Proxy Register (SAMPPRXY) is an EDMA3TC channel register. This EDMA3TC channel register is part of the Source Active Register Set. It is read-only and provided to facilitate debugging by providing a window into how the transfer controller (TC) was programmed by the channel controller (CC), as well as showing the status of the transfer controller (TC) during a transfer.

Figure 11-182. SAMPPRXY Register

31	30	29	28	27	26	25	24
RESERVED							
R-0h							
23	22	21	20	19	18	17	16
RESERVED							
R-0h							
15	14	13	12	11	10	9	8
RESERVED							PRIV
R-0h							R-0h
7	6	5	4	3	2	1	0
RESERVED				PRIVID			
R-0h				R-0h			

LEGEND: R/W = Read/Write; R = Read only; W1toCl = Write 1 to clear bit; -n = value after reset

Table 11-167. SAMPPRXY Register Field Descriptions

Bit	Field	Type	Reset	Description
31-9	RESERVED	R	0h	
8	PRIV	R	0h	Privilege level. The privilege level used by the host to set up the parameter entry in the channel controller. This field is set up when the associated TR is submitted to the EDMA3TC. The privilege ID is used while issuing read and write command to the target endpoints so that the target endpoints can perform memory protection checks based on the PRIV of the host that set up the DMA transaction. 0h = User-level privilege. 1h = Supervisor-level privilege.
7-4	RESERVED	R	0h	
3-0	PRIVID	R	0h	Privilege ID. This contains the privilege ID of the host that set up the parameter entry in the channel controller. This field is set up when the associated TR is submitted to the EDMA3TC. This PRIVID value is used while issuing read and write commands to the target endpoints so that the target endpoints can perform memory protection checks based on the PRIVID of the host that set up the DMA transaction. Value 0 to Fh.

11.4.2.17 SACNTRLD Register (offset = 258h) [reset = 0h]

SACNTRLD is shown in [Figure 11-183](#) and described in [Table 11-168](#).

The Source Active Count Reload Register (SACNTRLD) is an EDMA3TC channel register. This EDMA3TC channel register is part of the Source Active Register Set. It is read-only and provided to facilitate debugging by providing a window into how the transfer controller (TC) was programmed by the channel controller (CC), as well as showing the status of the transfer controller (TC) during a transfer.

Figure 11-183. SACNTRLD Register

31	30	29	28	27	26	25	24	23	22	21	20	19	18	17	16	15	14	13	12	11	10	9	8	7	6	5	4	3	2	1	0
RESERVED																ACNTRLD															
R-0h																R-0h															

LEGEND: R/W = Read/Write; R = Read only; W1toCl = Write 1 to clear bit; -n = value after reset

Table 11-168. SACNTRLD Register Field Descriptions

Bit	Field	Type	Reset	Description
31-16	RESERVED	R	0h	
15-0	ACNTRLD	R	0h	A-count reload value. Represents the originally programmed value of ACNT. The reload value is used to reinitialize ACNT after each array is serviced (that is, ACNT decrements to 0) by the source offset in bytes between the starting address or each source array (there are BCNT arrays of ACNT bytes). Value 0 to FFFFh.

11.4.2.18 SASRCBREF Register (offset = 25Ch) [reset = 0h]

SASRCBREF is shown in [Figure 11-184](#) and described in [Table 11-169](#).

The Source Active Source Address B-Reference Register (SASRCBREF) is an EDMA3TC channel register. This EDMA3TC channel register is part of the Source Active Register Set. It is read-only and provided to facilitate debugging by providing a window into how the transfer controller (TC) was programmed by the channel controller (CC), as well as showing the status of the transfer controller (TC) during a transfer.

Figure 11-184. SASRCBREF Register

31	30	29	28	27	26	25	24	23	22	21	20	19	18	17	16	15	14	13	12	11	10	9	8	7	6	5	4	3	2	1	0
SADDRBREF																															
R-0h																															

LEGEND: R/W = Read/Write; R = Read only; W1toCl = Write 1 to clear bit; -n = value after reset

Table 11-169. SASRCBREF Register Field Descriptions

Bit	Field	Type	Reset	Description
31-0	SADDRBREF	R	0h	Source address B-reference. Represents the starting address for the array currently being read. The next array's starting address is calculated as the reference address plus the source b-idx value. Value 0 to FFFF FFFFh.

11.4.2.19 SADSTBREF Register (offset = 260h) [reset = 0h]

SADSTBREF is shown in [Figure 11-185](#) and described in [Table 11-170](#).

The Source Active Destination Address B-Reference Register (SADSTBREF) is an EDMA3TC channel register. This EDMA3TC channel register is part of the Source Active Register Set. It is read-only and provided to facilitate debugging by providing a window into how the transfer controller (TC) was programmed by the channel controller (CC), as well as showing the status of the transfer controller (TC) during a transfer.

Note: Destination address is not applicable for Source Active Register Set. Read returns 0.

Figure 11-185. SADSTBREF Register

31	30	29	28	27	26	25	24	23	22	21	20	19	18	17	16	15	14	13	12	11	10	9	8	7	6	5	4	3	2	1	0
RESERVED																															
R-0h																															

LEGEND: R/W = Read/Write; R = Read only; W1toCl = Write 1 to clear bit; -n = value after reset

Table 11-170. SADSTBREF Register Field Descriptions

Bit	Field	Type	Reset	Description
31-0	RESERVED	R	0h	

11.4.2.20 DFCNTRLD Register (offset = 280h) [reset = 0h]

DFCNTRLD is shown in [Figure 11-186](#) and described in [Table 11-171](#).

The Destination FIFO Count Reload Register (DFCNTRLD) is an EDMA3TC channel register. This EDMA3TC channel register is part of the Destination Register FIFO Register Set. It is read-only and provided to facilitate debugging by providing a window into how the transfer controller (TC) was programmed by the channel controller (CC), as well as showing status of the transfer controller (TC) during a transfer. The number of destination FIFO register sets depends on the destination FIFO depth. TC0, TC1, and TC2 each have a destination FIFO depth of 4, so there are four sets of destination FIFO registers for each of these transfer controllers.

Figure 11-186. DFCNTRLD Register

31	30	29	28	27	26	25	24	23	22	21	20	19	18	17	16	15	14	13	12	11	10	9	8	7	6	5	4	3	2	1	0
RESERVED																ACNTRLD															
R-0h																R-0h															

LEGEND: R/W = Read/Write; R = Read only; W1toCl = Write 1 to clear bit; -n = value after reset

Table 11-171. DFCNTRLD Register Field Descriptions

Bit	Field	Type	Reset	Description
31-16	RESERVED	R	0h	
15-0	ACNTRLD	R	0h	A-count reload value for the Destination FIFO Register Set. Represents the originally programmed value of ACNT. The reload value is used to reinitialize ACNT after each array is serviced (that is, ACNT decrements to 0) by the source offset in bytes between the starting address of each source array (there are BCNT arrays of ACNT bytes). Value 0 to FFFFh.

11.4.2.21 DFSRCBREF Register (offset = 284h) [reset = 0h]

DFSRCBREF is shown in [Figure 11-187](#) and described in [Table 11-172](#).

The Destination FIFO Source Address B-Reference Register (DFSRCBREF) is an EDMA3TC channel register. This EDMA3TC channel register is part of the Destination Register FIFO Register Set. It is read-only and provided to facilitate debugging by providing a window into how the transfer controller (TC) was programmed by the channel controller (CC), as well as showing status of the transfer controller (TC) during a transfer. The number of destination FIFO register sets depends on the destination FIFO depth. TC0, TC1, and TC2 each have a destination FIFO depth of 4, so there are four sets of destination FIFO registers for each of these transfer controllers.

Note: Source address reference is not applicable for Destination FIFO Register Set. Read returns 0.

Figure 11-187. DFSRCBREF Register

31	30	29	28	27	26	25	24	23	22	21	20	19	18	17	16	15	14	13	12	11	10	9	8	7	6	5	4	3	2	1	0
RESERVED																															
R-0h																															

LEGEND: R/W = Read/Write; R = Read only; W1toCl = Write 1 to clear bit; -n = value after reset

Table 11-172. DFSRCBREF Register Field Descriptions

Bit	Field	Type	Reset	Description
31-0	RESERVED	R	0h	

11.4.2.22 DFDSTBREF Register (offset = 288h) [reset = 0h]

DFDSTBREF is shown in [Figure 11-188](#) and described in [Table 11-173](#).

The Destination FIFO Destination Address B-Reference Register (DFDSTBREF) is an EDMA3TC channel register. This EDMA3TC channel register is part of the Destination Register FIFO Register Set. It is read-only and provided to facilitate debugging by providing a window into how the transfer controller (TC) was programmed by the channel controller (CC), as well as showing status of the transfer controller (TC) during a transfer. The number of destination FIFO register sets depends on the destination FIFO depth. TC0, TC1, and TC2 each have a destination FIFO depth of 4, so there are four sets of destination FIFO registers for each of these transfer controllers.

Figure 11-188. DFDSTBREF Register

31	30	29	28	27	26	25	24	23	22	21	20	19	18	17	16	15	14	13	12	11	10	9	8	7	6	5	4	3	2	1	0
DADDRBREF																															
R-0h																															

LEGEND: R/W = Read/Write; R = Read only; W1toCl = Write 1 to clear bit; -n = value after reset

Table 11-173. DFDSTBREF Register Field Descriptions

Bit	Field	Type	Reset	Description
31-0	DADDRBREF	R	0h	Destination address reference for the destination FIFO register set. Represents the starting address for the array currently being written. The next array's starting address is calculated as the reference address plus the destination B-Index value. Value 0 to FFFF FFFFh.

11.4.2.23 DFOPT0 Register (offset = 300h) [reset = 0h]

DFOPT0 is shown in [Figure 11-189](#) and described in [Table 11-174](#).

The Destination FIFO Options Register (DFOPT) is an EDMA3TC channel register. This EDMA3TC channel register is part of the Destination Register FIFO Register Set. It is read-only and provided to facilitate debugging by providing a window into how the transfer controller (TC) was programmed by the channel controller (CC), as well as showing status of the transfer controller (TC) during a transfer. The number of destination FIFO register sets depends on the destination FIFO depth. TC0, TC1, and TC2 each have a destination FIFO depth of 4, so there are four sets of destination FIFO registers for each of these transfer controllers.

Figure 11-189. DFOPT0 Register

31	30	29	28	27	26	25	24
RESERVED							
R-0h							
23	22	21	20	19	18	17	16
RESERVED	TCCHEN	RESERVED	TCINTEN	RESERVED		TCC	
R-0h	R-0h	R-0h	R-0h	R-0h		R-0h	
15	14	13	12	11	10	9	8
TCC				RESERVED	FWID		
R-0h				R-0h	R-0h		
7	6	5	4	3	2	1	0
RESERVED	PRI			RESERVED		DAM	SAM
R-0h	R-0h			R-0h		R-0h	R-0h

LEGEND: R/W = Read/Write; R = Read only; W1toCl = Write 1 to clear bit; -n = value after reset

Table 11-174. DFOPT0 Register Field Descriptions

Bit	Field	Type	Reset	Description
31-23	RESERVED	R	0h	
22	TCCHEN	R	0h	Transfer complete chaining enable 0h = Transfer complete chaining is disabled 1h = Transfer complete chaining is enabled
21	RESERVED	R	0h	
20	TCINTEN	R	0h	Transfer complete interrupt enable. 0h = Transfer complete interrupt is disabled. 1h = Transfer complete interrupt is enabled.
19-18	RESERVED	R	0h	
17-12	TCC	R	0h	Transfer complete code. This 6 bit code is used to set the relevant bit in CER or IPR of the EDMA3PCC module.
11	RESERVED	R	0h	
10-8	FWID	R	0h	FIFO width. Applies if either SAM or DAM is set to constant addressing mode. 0h = FIFO width is 8-bit. 1h = FIFO width is 16-bit. 2h = FIFO width is 32-bit. 3h = FIFO width is 64-bit. 4h = FIFO width is 128-bit. 5h = FIFO width is 256-bit. 6h = Reserved. 7h = Reserved.
7	RESERVED	R	0h	

Table 11-174. DFOPT0 Register Field Descriptions (continued)

Bit	Field	Type	Reset	Description
6-4	PRI	R	0h	Transfer priority 0h = Priority 0 - Highest priority 1h = From 1h to 6h, Priority 1 to priority 6 7h = Priority 7 - Lowest priority
3-2	RESERVED	R	0h	
1	DAM	R	0h	Destination address mode within an array 0h = Increment (INCR) mode. Destination addressing within an array increments. 1h = Constant addressing (CONST) mode. Destination addressing within an array wraps around upon reaching FIFO width.
0	SAM	R	0h	Source address mode within an array 0h = Increment (INCR) mode. Source addressing within an array increments. 1h = Constant addressing (CONST) mode. Source addressing within an array wraps around upon reaching FIFO width.

11.4.2.24 DFSRC0 Register (offset = 304h) [reset = 0h]

DFSRC0 is shown in [Figure 11-190](#) and described in [Table 11-175](#).

The Destination FIFO Source Address Register (DFSRC) is an EDMA3TC channel register. This EDMA3TC channel register is part of the Destination Register FIFO Register Set. It is read-only and provided to facilitate debugging by providing a window into how the transfer controller (TC) was programmed by the channel controller (CC), as well as showing status of the transfer controller (TC) during a transfer. The number of destination FIFO register sets depends on the destination FIFO depth. TC0, TC1, and TC2 each have a destination FIFO depth of 4, so there are four sets of destination FIFO registers for each of these transfer controllers.

Note: Source address reference is not applicable for Destination FIFO Register Set. Read returns 0.

Figure 11-190. DFSRC0 Register

31	30	29	28	27	26	25	24	23	22	21	20	19	18	17	16	15	14	13	12	11	10	9	8	7	6	5	4	3	2	1	0
RESERVED																															
R-0h																															

LEGEND: R/W = Read/Write; R = Read only; W1toCl = Write 1 to clear bit; -n = value after reset

Table 11-175. DFSRC0 Register Field Descriptions

Bit	Field	Type	Reset	Description
31-0	RESERVED	R	0h	

11.4.2.25 DFCNT0 Register (offset = 308h) [reset = 0h]

DFCNT0 is shown in [Figure 11-191](#) and described in [Table 11-176](#).

The Destination FIFO Count Register (DFCNT) is an EDMA3TC channel register. This EDMA3TC channel register is part of the Destination Register FIFO Register Set. It is read-only and provided to facilitate debugging by providing a window into how the transfer controller (TC) was programmed by the channel controller (CC), as well as showing status of the transfer controller (TC) during a transfer. The number of destination FIFO register sets depends on the destination FIFO depth. TC0, TC1, and TC2 each have a destination FIFO depth of 4, so there are four sets of destination FIFO registers for each of these transfer controllers.

Figure 11-191. DFCNT0 Register

31	30	29	28	27	26	25	24	23	22	21	20	19	18	17	16	15	14	13	12	11	10	9	8	7	6	5	4	3	2	1	0
BCNT																ACNT															
R-0h																R-0h															

LEGEND: R/W = Read/Write; R = Read only; W1toCl = Write 1 to clear bit; -n = value after reset

Table 11-176. DFCNT0 Register Field Descriptions

Bit	Field	Type	Reset	Description
31-16	BCNT	R	0h	B-dimension count remaining for Destination Register Set. Represents the amount of data remaining to be written. For the final TR in the Destination Register FIFO: TC decrements ACNT and BCNT as necessary after each write dataphase is issued. The final value should be 0 when TR is complete. For a non-final TR in the Destination Register FIFO: CNT will hold the originally programmed value or the optimized BCNT value after 2D optimization calculation.
15-0	ACNT	R	0h	A-dimension count remaining for Destination Register Set. Represents the amount of data remaining to be written. For the final TR in the Destination Register FIFO: TC decrements ACNT and BCNT as necessary after each write dataphase is issued. The final value should be 0 when TR is complete. For a non-final TR in the Destination Register FIFO: CNT will hold the originally programmed value or the optimized BCNT value after 2D optimization calculation. Value 0 to FFFFh.

11.4.2.26 DFDST0 Register (offset = 30Ch) [reset = 0h]

DFDST0 is shown in [Figure 11-192](#) and described in [Table 11-177](#).

The Destination FIFO Destination Address Register (DFDST) is an EDMA3TC channel register. This EDMA3TC channel register is part of the Destination Register FIFO Register Set. It is read-only and provided to facilitate debugging by providing a window into how the transfer controller (TC) was programmed by the channel controller (CC), as well as showing status of the transfer controller (TC) during a transfer. The number of destination FIFO register sets depends on the destination FIFO depth. TC0, TC1, and TC2 each have a destination FIFO depth of 4, so there are four sets of destination FIFO registers for each of these transfer controllers.

Figure 11-192. DFDST0 Register

31	30	29	28	27	26	25	24	23	22	21	20	19	18	17	16	15	14	13	12	11	10	9	8	7	6	5	4	3	2	1	0
DADDR																															
R-0h																															

LEGEND: R/W = Read/Write; R = Read only; W1toCl = Write 1 to clear bit; -n = value after reset

Table 11-177. DFDST0 Register Field Descriptions

Bit	Field	Type	Reset	Description
31-0	DADDR	R	0h	Destination address for the destination FIFO register set. TC updates the value according to both the destination addressing mode (OPT.SAM) or destination index value (BIDX.DBIDX) after each write command is issued. When a TR is complete, the final value should be the address of the last write command issued. Note: If DAM == CONST, the 'active' address will increment internally as if the transfer were an 'Increment' transfer. The address issued on the write command interface will correctly issue the same address programmed by the user.

11.4.2.27 DFBIDX0 Register (offset = 310h) [reset = 0h]

DFBIDX0 is shown in [Figure 11-193](#) and described in [Table 11-178](#).

The Destination FIFO B-Index Register (DFBIDX) is an EDMA3TC channel register. This EDMA3TC channel register is part of the Destination Register FIFO Register Set. It is read-only and provided to facilitate debugging by providing a window into how the transfer controller (TC) was programmed by the channel controller (CC), as well as showing status of the transfer controller (TC) during a transfer. The number of destination FIFO register sets depends on the destination FIFO depth. TC0, TC1, and TC2 each have a destination FIFO depth of 4, so there are four sets of destination FIFO registers for each of these transfer controllers.

Figure 11-193. DFBIDX0 Register

31	30	29	28	27	26	25	24	23	22	21	20	19	18	17	16	15	14	13	12	11	10	9	8	7	6	5	4	3	2	1	0
DBIDX																SBIDX															
R-0h																R-0h															

LEGEND: R/W = Read/Write; R = Read only; W1toCl = Write 1 to clear bit; -n = value after reset

Table 11-178. DFBIDX0 Register Field Descriptions

Bit	Field	Type	Reset	Description
31-16	DBIDX	R	0h	B-Index offset between destination arrays for the Destination FIFO Register Set. Represents the offset in bytes between the starting address of each destination array (there are BCNT arrays of ACNT elements). DBIDX is always used regardless of whether DAM is in Increment or FIFO mode. Value 0 to FFFFh.
15-0	SBIDX	R	0h	B-Index offset between source arrays for the Destination FIFO Register Set. Represents the offset in bytes between the starting address of each source array (there are BCNT arrays of ACNT elements). SBIDX is always used regardless of whether SAM is in Increment or FIFO mode.

11.4.2.28 DFMPPRXY0 Register (offset = 314h) [reset = 0h]

DFMPPRXY0 is shown in [Figure 11-194](#) and described in [Table 11-179](#).

The Destination FIFO Memory Protection Proxy Register (DFMPPRXY) is an EDMA3TC channel register. This EDMA3TC channel register is part of the Destination Register FIFO Register Set. It is read-only and provided to facilitate debugging by providing a window into how the transfer controller (TC) was programmed by the channel controller (CC), as well as showing status of the transfer controller (TC) during a transfer. The number of destination FIFO register sets depends on the destination FIFO depth. TC0, TC1, and TC2 each have a destination FIFO depth of 4, so there are four sets of destination FIFO registers for each of these transfer controllers.

Figure 11-194. DFMPPRXY0 Register

31	30	29	28	27	26	25	24
RESERVED							
R-0h							
23	22	21	20	19	18	17	16
RESERVED							
R-0h							
15	14	13	12	11	10	9	8
RESERVED							PRIV
R-0h							R-0h
7	6	5	4	3	2	1	0
RESERVED				PRIVID			
R-0h				R-0h			

LEGEND: R/W = Read/Write; R = Read only; W1toCl = Write 1 to clear bit; -n = value after reset

Table 11-179. DFMPPRXY0 Register Field Descriptions

Bit	Field	Type	Reset	Description
31-9	RESERVED	R	0h	
8	PRIV	R	0h	Privilege level. This contains the Privilege level used by the EDMA3 programmer to set up the parameter entry in the channel controller. This field is set up when the associated TR is submitted to the EDMA3TC. The privilege ID is used while issuing read and write command to the target endpoints so that the target endpoints can perform memory protection checks based on the PRIV of the host that set up the DMA transaction. 0h = User-level privilege 1h = Supervisor-level privilege
7-4	RESERVED	R	0h	
3-0	PRIVID	R	0h	Privilege ID. This contains the Privilege ID of the EDMA3 programmer that set up the parameter entry in the channel controller. This field is set up when the associated TR is submitted to the EDMA3TC. This PRIVID value is used while issuing read and write commands to the target endpoints so that the target endpoints can perform memory protection checks based on the PRIVID of the host that set up the DMA transaction. Value 0 to Fh.

11.4.2.29 DFOPT1 Register (offset = 340h) [reset = 0h]

DFOPT1 is shown in [Figure 11-195](#) and described in [Table 11-180](#).

The Destination FIFO Options Register (DFOPT) is an EDMA3TC channel register. This EDMA3TC channel register is part of the Destination Register FIFO Register Set. It is read-only and provided to facilitate debugging by providing a window into how the transfer controller (TC) was programmed by the channel controller (CC), as well as showing status of the transfer controller (TC) during a transfer. The number of destination FIFO register sets depends on the destination FIFO depth. TC0, TC1, and TC2 each have a destination FIFO depth of 4, so there are four sets of destination FIFO registers for each of these transfer controllers.

Figure 11-195. DFOPT1 Register

31	30	29	28	27	26	25	24
RESERVED							
R-0h							
23	22	21	20	19	18	17	16
RESERVED	TCCHEN	RESERVED	TCINTEN	RESERVED		TCC	
R-0h	R-0h	R-0h	R-0h	R-0h		R-0h	
15	14	13	12	11	10	9	8
TCC				RESERVED	FWID		
R-0h				R-0h	R-0h		
7	6	5	4	3	2	1	0
RESERVED	PRI			RESERVED		DAM	SAM
R-0h	R-0h			R-0h		R-0h	R-0h

LEGEND: R/W = Read/Write; R = Read only; W1toCl = Write 1 to clear bit; -n = value after reset

Table 11-180. DFOPT1 Register Field Descriptions

Bit	Field	Type	Reset	Description
31-23	RESERVED	R	0h	
22	TCCHEN	R	0h	Transfer complete chaining enable 0h = Transfer complete chaining is disabled 1h = Transfer complete chaining is enabled
21	RESERVED	R	0h	
20	TCINTEN	R	0h	Transfer complete interrupt enable. 0h = Transfer complete interrupt is disabled. 1h = Transfer complete interrupt is enabled.
19-18	RESERVED	R	0h	
17-12	TCC	R	0h	Transfer complete code. This 6 bit code is used to set the relevant bit in CER or IPR of the EDMA3PCC module.
11	RESERVED	R	0h	
10-8	FWID	R	0h	FIFO width. Applies if either SAM or DAM is set to constant addressing mode. 0h = FIFO width is 8-bit. 1h = FIFO width is 16-bit. 2h = FIFO width is 32-bit. 3h = FIFO width is 64-bit. 4h = FIFO width is 128-bit. 5h = FIFO width is 256-bit. 6h = Reserved. 7h = Reserved.
7	RESERVED	R	0h	

Table 11-180. DFOPT1 Register Field Descriptions (continued)

Bit	Field	Type	Reset	Description
6-4	PRI	R	0h	Transfer priority 0h = Priority 0 - Highest priority 1h = From 1h to 6h, Priority 1 to priority 6 7h = Priority 7 - Lowest priority
3-2	RESERVED	R	0h	
1	DAM	R	0h	Destination address mode within an array 0h = Increment (INCR) mode. Destination addressing within an array increments. 1h = Constant addressing (CONST) mode. Destination addressing within an array wraps around upon reaching FIFO width.
0	SAM	R	0h	Source address mode within an array 0h = Increment (INCR) mode. Source addressing within an array increments. 1h = Constant addressing (CONST) mode. Source addressing within an array wraps around upon reaching FIFO width.

11.4.2.30 DFSRC1 Register (offset = 344h) [reset = 0h]

DFSRC1 is shown in [Figure 11-196](#) and described in [Table 11-181](#).

The Destination FIFO Source Address Register (DFSRC) is an EDMA3TC channel register. This EDMA3TC channel register is part of the Destination Register FIFO Register Set. It is read-only and provided to facilitate debugging by providing a window into how the transfer controller (TC) was programmed by the channel controller (CC), as well as showing status of the transfer controller (TC) during a transfer. The number of destination FIFO register sets depends on the destination FIFO depth. TC0, TC1, and TC2 each have a destination FIFO depth of 4, so there are four sets of destination FIFO registers for each of these transfer controllers. Note: Source address is not applicable for the Destination FIFO Register Set. Read returns 0.

Note: Source address reference is not applicable for Destination FIFO Register Set. Read returns 0.

Figure 11-196. DFSRC1 Register

31	30	29	28	27	26	25	24	23	22	21	20	19	18	17	16	15	14	13	12	11	10	9	8	7	6	5	4	3	2	1	0
RESERVED																															
R-0h																															

LEGEND: R/W = Read/Write; R = Read only; W1toCl = Write 1 to clear bit; -n = value after reset

Table 11-181. DFSRC1 Register Field Descriptions

Bit	Field	Type	Reset	Description
31-0	RESERVED	R	0h	

11.4.2.31 DFCNT1 Register (offset = 348h) [reset = 0h]

DFCNT1 is shown in [Figure 11-197](#) and described in [Table 11-182](#).

The Destination FIFO Count Register (DFCNT) is an EDMA3TC channel register. This EDMA3TC channel register is part of the Destination Register FIFO Register Set. It is read-only and provided to facilitate debugging by providing a window into how the transfer controller (TC) was programmed by the channel controller (CC), as well as showing status of the transfer controller (TC) during a transfer. The number of destination FIFO register sets depends on the destination FIFO depth. TC0, TC1, and TC2 each have a destination FIFO depth of 4, so there are four sets of destination FIFO registers for each of these transfer controllers.

Figure 11-197. DFCNT1 Register

31	30	29	28	27	26	25	24	23	22	21	20	19	18	17	16	15	14	13	12	11	10	9	8	7	6	5	4	3	2	1	0
BCNT																ACNT															
R-0h																R-0h															

LEGEND: R/W = Read/Write; R = Read only; W1toCl = Write 1 to clear bit; -n = value after reset

Table 11-182. DFCNT1 Register Field Descriptions

Bit	Field	Type	Reset	Description
31-16	BCNT	R	0h	B-dimension count remaining for Destination Register Set. Represents the amount of data remaining to be written. For the final TR in the Destination Register FIFO: TC decrements ACNT and BCNT as necessary after each write dataphase is issued. The final value should be 0 when TR is complete. For a non-final TR in the Destination Register FIFO: CNT will hold the originally programmed value or the optimized BCNT value after 2D optimization calculation.
15-0	ACNT	R	0h	A-dimension count remaining for Destination Register Set. Represents the amount of data remaining to be written. For the final TR in the Destination Register FIFO: TC decrements ACNT and BCNT as necessary after each write dataphase is issued. The final value should be 0 when TR is complete. For a non-final TR in the Destination Register FIFO: CNT will hold the originally programmed value or the optimized BCNT value after 2D optimization calculation. Value 0 to FFFFh.

11.4.2.32 DFDST1 Register (offset = 34Ch) [reset = 0h]

DFDST1 is shown in [Figure 11-198](#) and described in [Table 11-183](#).

The Destination FIFO Destination Address Register (DFDST) is an EDMA3TC channel register. This EDMA3TC channel register is part of the Destination Register FIFO Register Set. It is read-only and provided to facilitate debugging by providing a window into how the transfer controller (TC) was programmed by the channel controller (CC), as well as showing status of the transfer controller (TC) during a transfer. The number of destination FIFO register sets depends on the destination FIFO depth. TC0, TC1, and TC2 each have a destination FIFO depth of 4, so there are four sets of destination FIFO registers for each of these transfer controllers.

Figure 11-198. DFDST1 Register

31	30	29	28	27	26	25	24	23	22	21	20	19	18	17	16	15	14	13	12	11	10	9	8	7	6	5	4	3	2	1	0
DADDR																															
R-0h																															

LEGEND: R/W = Read/Write; R = Read only; W1toCl = Write 1 to clear bit; -n = value after reset

Table 11-183. DFDST1 Register Field Descriptions

Bit	Field	Type	Reset	Description
31-0	DADDR	R	0h	ARRAY(0x245d830) Note: If DAM == CONST, the 'active' address will increment internally as if the transfer were an 'Increment' transfer. The address issued on the write command interface will correctly issue the same address programmed by the user.

11.4.2.33 DFBIDX1 Register (offset = 350h) [reset = 0h]

DFBIDX1 is shown in [Figure 11-199](#) and described in [Table 11-184](#).

The Destination FIFO B-Index Register (DFBIDX) is an EDMA3TC channel register. This EDMA3TC channel register is part of the Destination Register FIFO Register Set. It is read-only and provided to facilitate debugging by providing a window into how the transfer controller (TC) was programmed by the channel controller (CC), as well as showing status of the transfer controller (TC) during a transfer. The number of destination FIFO register sets depends on the destination FIFO depth. TC0, TC1, and TC2 each have a destination FIFO depth of 4, so there are four sets of destination FIFO registers for each of these transfer controllers.

Figure 11-199. DFBIDX1 Register

31	30	29	28	27	26	25	24	23	22	21	20	19	18	17	16	15	14	13	12	11	10	9	8	7	6	5	4	3	2	1	0
DBIDX																SBIDX															
R-0h																R-0h															

LEGEND: R/W = Read/Write; R = Read only; W1toCl = Write 1 to clear bit; -n = value after reset

Table 11-184. DFBIDX1 Register Field Descriptions

Bit	Field	Type	Reset	Description
31-16	DBIDX	R	0h	B-Index offset between destination arrays for the Destination FIFO Register Set. Represents the offset in bytes between the starting address of each destination array (there are BCNT arrays of ACNT elements). DBIDX is always used regardless of whether DAM is in Increment or FIFO mode. Value 0 to FFFFh.
15-0	SBIDX	R	0h	B-Index offset between source arrays for the Destination FIFO Register Set. Represents the offset in bytes between the starting address of each source array (there are BCNT arrays of ACNT elements). SBIDX is always used regardless of whether SAM is in Increment or FIFO mode.

11.4.2.34 DFMPPRXY1 Register (offset = 354h) [reset = 0h]

DFMPPRXY1 is shown in [Figure 11-200](#) and described in [Table 11-185](#).

The Destination FIFO Memory Protection Proxy Register (DFMPPRXY) is an EDMA3TC channel register. This EDMA3TC channel register is part of the Destination Register FIFO Register Set. It is read-only and provided to facilitate debugging by providing a window into how the transfer controller (TC) was programmed by the channel controller (CC), as well as showing status of the transfer controller (TC) during a transfer. The number of destination FIFO register sets depends on the destination FIFO depth. TC0, TC1, and TC2 each have a destination FIFO depth of 4, so there are four sets of destination FIFO registers for each of these transfer controllers.

Figure 11-200. DFMPPRXY1 Register

31	30	29	28	27	26	25	24
RESERVED							
R-0h							
23	22	21	20	19	18	17	16
RESERVED							
R-0h							
15	14	13	12	11	10	9	8
RESERVED							PRIV
R-0h							R-0h
7	6	5	4	3	2	1	0
RESERVED				PRIVID			
R-0h				R-0h			

LEGEND: R/W = Read/Write; R = Read only; W1toCl = Write 1 to clear bit; -n = value after reset

Table 11-185. DFMPPRXY1 Register Field Descriptions

Bit	Field	Type	Reset	Description
31-9	RESERVED	R	0h	
8	PRIV	R	0h	Privilege level. This contains the Privilege level used by the EDMA3 programmer to set up the parameter entry in the channel controller. This field is set up when the associated TR is submitted to the EDMA3TC. The privilege ID is used while issuing read and write command to the target endpoints so that the target endpoints can perform memory protection checks based on the PRIV of the host that set up the DMA transaction. 0h = User-level privilege 1h = Supervisor-level privilege
7-4	RESERVED	R	0h	
3-0	PRIVID	R	0h	Privilege ID. This contains the Privilege ID of the EDMA3 programmer that set up the parameter entry in the channel controller. This field is set up when the associated TR is submitted to the EDMA3TC. This PRIVID value is used while issuing read and write commands to the target endpoints so that the target endpoints can perform memory protection checks based on the PRIVID of the host that set up the DMA transaction. Value 0 to Fh.

11.4.2.35 DFOPT2 Register (offset = 380h) [reset = 0h]

DFOPT2 is shown in [Figure 11-201](#) and described in [Table 11-186](#).

The Destination FIFO Options Register (DFOPT) is an EDMA3TC channel register. This EDMA3TC channel register is part of the Destination Register FIFO Register Set. It is read-only and provided to facilitate debugging by providing a window into how the transfer controller (TC) was programmed by the channel controller (CC), as well as showing status of the transfer controller (TC) during a transfer. The number of destination FIFO register sets depends on the destination FIFO depth. TC0, TC1, and TC2 each have a destination FIFO depth of 4, so there are four sets of destination FIFO registers for each of these transfer controllers.

Figure 11-201. DFOPT2 Register

31	30	29	28	27	26	25	24
RESERVED							
R-0h							
23	22	21	20	19	18	17	16
RESERVED	TCCHEN	RESERVED	TCINTEN	RESERVED		TCC	
R-0h	R-0h	R-0h	R-0h	R-0h		R-0h	
15	14	13	12	11	10	9	8
TCC				RESERVED	FWID		
R-0h				R-0h	R-0h		
7	6	5	4	3	2	1	0
RESERVED	PRI		RESERVED			DAM	SAM
R-0h	R-0h		R-0h			R-0h	R-0h

LEGEND: R/W = Read/Write; R = Read only; W1toCl = Write 1 to clear bit; -n = value after reset

Table 11-186. DFOPT2 Register Field Descriptions

Bit	Field	Type	Reset	Description
31-23	RESERVED	R	0h	
22	TCCHEN	R	0h	Transfer complete chaining enable 0h = Transfer complete chaining is disabled 1h = Transfer complete chaining is enabled
21	RESERVED	R	0h	
20	TCINTEN	R	0h	Transfer complete interrupt enable. 0h = Transfer complete interrupt is disabled. 1h = Transfer complete interrupt is enabled.
19-18	RESERVED	R	0h	
17-12	TCC	R	0h	Transfer complete code. This 6 bit code is used to set the relevant bit in CER or IPR of the EDMA3PCC module.
11	RESERVED	R	0h	
10-8	FWID	R	0h	FIFO width. Applies if either SAM or DAM is set to constant addressing mode. 0h = FIFO width is 8-bit. 1h = FIFO width is 16-bit. 2h = FIFO width is 32-bit. 3h = FIFO width is 64-bit. 4h = FIFO width is 128-bit. 5h = FIFO width is 256-bit. 6h = Reserved. 7h = Reserved.
7	RESERVED	R	0h	

Table 11-186. DFOPT2 Register Field Descriptions (continued)

Bit	Field	Type	Reset	Description
6-4	PRI	R	0h	Transfer priority 0h = Priority 0 - Highest priority 1h = From 1h to 6h, Priority 1 to priority 6 7h = Priority 7 - Lowest priority
3-2	RESERVED	R	0h	
1	DAM	R	0h	Destination address mode within an array 0h = Increment (INCR) mode. Destination addressing within an array increments. 1h = Constant addressing (CONST) mode. Destination addressing within an array wraps around upon reaching FIFO width.
0	SAM	R	0h	Source address mode within an array 0h = Increment (INCR) mode. Source addressing within an array increments. 1h = Constant addressing (CONST) mode. Source addressing within an array wraps around upon reaching FIFO width.

11.4.2.36 DFSRC2 Register (offset = 384h) [reset = 0h]

DFSRC2 is shown in [Figure 11-202](#) and described in [Table 11-187](#).

The Destination FIFO Source Address Register (DFSRC) is an EDMA3TC channel register. This EDMA3TC channel register is part of the Destination Register FIFO Register Set. It is read-only and provided to facilitate debugging by providing a window into how the transfer controller (TC) was programmed by the channel controller (CC), as well as showing status of the transfer controller (TC) during a transfer. The number of destination FIFO register sets depends on the destination FIFO depth. TC0, TC1, and TC2 each have a destination FIFO depth of 4, so there are four sets of destination FIFO registers for each of these transfer controllers. Note: Source address is not applicable for Destination FIFO Register Set. Read returns 0.

Note: Source address reference is not applicable for Destination FIFO Register Set. Read returns 0.

Figure 11-202. DFSRC2 Register

31	30	29	28	27	26	25	24	23	22	21	20	19	18	17	16	15	14	13	12	11	10	9	8	7	6	5	4	3	2	1	0
RESERVED																															
R-0h																															

LEGEND: R/W = Read/Write; R = Read only; W1toCl = Write 1 to clear bit; -n = value after reset

Table 11-187. DFSRC2 Register Field Descriptions

Bit	Field	Type	Reset	Description
31-0	RESERVED	R	0h	

11.4.2.37 DFCNT2 Register (offset = 388h) [reset = 0h]

DFCNT2 is shown in [Figure 11-203](#) and described in [Table 11-188](#).

The Destination FIFO Count Register (DFCNT) is an EDMA3TC channel register. This EDMA3TC channel register is part of the Destination Register FIFO Register Set. It is read-only and provided to facilitate debugging by providing a window into how the transfer controller (TC) was programmed by the channel controller (CC), as well as showing status of the transfer controller (TC) during a transfer. The number of destination FIFO register sets depends on the destination FIFO depth. TC0, TC1, and TC2 each have a destination FIFO depth of 4, so there are four sets of destination FIFO registers for each of these transfer controllers.

Figure 11-203. DFCNT2 Register

31	30	29	28	27	26	25	24	23	22	21	20	19	18	17	16	15	14	13	12	11	10	9	8	7	6	5	4	3	2	1	0
BCNT																ACNT															
R-0h																R-0h															

LEGEND: R/W = Read/Write; R = Read only; W1toCl = Write 1 to clear bit; -n = value after reset

Table 11-188. DFCNT2 Register Field Descriptions

Bit	Field	Type	Reset	Description
31-16	BCNT	R	0h	B-dimension count remaining for Destination Register Set. Represents the amount of data remaining to be written. For the final TR in the Destination Register FIFO: TC decrements ACNT and BCNT as necessary after each write dataphase is issued. The final value should be 0 when TR is complete. For a non-final TR in the Destination Register FIFO: CNT will hold the originally programmed value or the optimized BCNT value after 2D optimization calculation.
15-0	ACNT	R	0h	A-dimension count remaining for Destination Register Set. Represents the amount of data remaining to be written. For the final TR in the Destination Register FIFO: TC decrements ACNT and BCNT as necessary after each write dataphase is issued. The final value should be 0 when TR is complete. For a non-final TR in the Destination Register FIFO: CNT will hold the originally programmed value or the optimized BCNT value after 2D optimization calculation. Value 0 to FFFFh.

11.4.2.38 DFDST2 Register (offset = 38Ch) [reset = 0h]

DFDST2 is shown in [Figure 11-204](#) and described in [Table 11-189](#).

The Destination FIFO Destination Address Register (DFDST) is an EDMA3TC channel register. This EDMA3TC channel register is part of the Destination Register FIFO Register Set. It is read-only and provided to facilitate debugging by providing a window into how the transfer controller (TC) was programmed by the channel controller (CC), as well as showing status of the transfer controller (TC) during a transfer. The number of destination FIFO register sets depends on the destination FIFO depth. TC0, TC1, and TC2 each have a destination FIFO depth of 4, so there are four sets of destination FIFO registers for each of these transfer controllers.

Figure 11-204. DFDST2 Register

31	30	29	28	27	26	25	24	23	22	21	20	19	18	17	16	15	14	13	12	11	10	9	8	7	6	5	4	3	2	1	0
DADDR																															
R-0h																															

LEGEND: R/W = Read/Write; R = Read only; W1toCl = Write 1 to clear bit; -n = value after reset

Table 11-189. DFDST2 Register Field Descriptions

Bit	Field	Type	Reset	Description
31-0	DADDR	R	0h	ARRAY(0x248ac60) Note: If DAM == CONST, the 'active' address will increment internally as if the transfer were an 'Increment' transfer. The address issued on the write command interface will correctly issue the same address programmed by the user.

11.4.2.39 DFBIDX2 Register (offset = 390h) [reset = 0h]

DFBIDX2 is shown in [Figure 11-205](#) and described in [Table 11-190](#).

The Destination FIFO B-Index Register (DFBIDX) is an EDMA3TC channel register. This EDMA3TC channel register is part of the Destination Register FIFO Register Set. It is read-only and provided to facilitate debugging by providing a window into how the transfer controller (TC) was programmed by the channel controller (CC), as well as showing status of the transfer controller (TC) during a transfer. The number of destination FIFO register sets depends on the destination FIFO depth. TC0, TC1, and TC2 each have a destination FIFO depth of 4, so there are four sets of destination FIFO registers for each of these transfer controllers.

Figure 11-205. DFBIDX2 Register

31	30	29	28	27	26	25	24	23	22	21	20	19	18	17	16	15	14	13	12	11	10	9	8	7	6	5	4	3	2	1	0
DBIDX																SBIDX															
R-0h																R-0h															

LEGEND: R/W = Read/Write; R = Read only; W1toCl = Write 1 to clear bit; -n = value after reset

Table 11-190. DFBIDX2 Register Field Descriptions

Bit	Field	Type	Reset	Description
31-16	DBIDX	R	0h	B-Index offset between destination arrays for the Destination FIFO Register Set. Represents the offset in bytes between the starting address of each destination array (there are BCNT arrays of ACNT elements). DBIDX is always used regardless of whether DAM is in Increment or FIFO mode. Value 0 to FFFFh.
15-0	SBIDX	R	0h	B-Index offset between source arrays for the Destination FIFO Register Set. Represents the offset in bytes between the starting address of each source array (there are BCNT arrays of ACNT elements). SBIDX is always used regardless of whether SAM is in Increment or FIFO mode.

11.4.2.40 DFMPPRXY2 Register (offset = 394h) [reset = 0h]

DFMPPRXY2 is shown in [Figure 11-206](#) and described in [Table 11-191](#).

The Destination FIFO Memory Protection Proxy Register (DFMPPRXY) is an EDMA3TC channel register. This EDMA3TC channel register is part of the Destination Register FIFO Register Set. It is read-only and provided to facilitate debugging by providing a window into how the transfer controller (TC) was programmed by the channel controller (CC), as well as showing status of the transfer controller (TC) during a transfer. The number of destination FIFO register sets depends on the destination FIFO depth. TC0, TC1, and TC2 each have a destination FIFO depth of 4, so there are four sets of destination FIFO registers for each of these transfer controllers.

Figure 11-206. DFMPPRXY2 Register

31	30	29	28	27	26	25	24
RESERVED							
R-0h							
23	22	21	20	19	18	17	16
RESERVED							
R-0h							
15	14	13	12	11	10	9	8
RESERVED							PRIV
R-0h							R-0h
7	6	5	4	3	2	1	0
RESERVED				PRIVID			
R-0h				R-0h			

LEGEND: R/W = Read/Write; R = Read only; W1toCl = Write 1 to clear bit; -n = value after reset

Table 11-191. DFMPPRXY2 Register Field Descriptions

Bit	Field	Type	Reset	Description
31-9	RESERVED	R	0h	
8	PRIV	R	0h	Privilege level. This contains the Privilege level used by the EDMA3 programmer to set up the parameter entry in the channel controller. This field is set up when the associated TR is submitted to the EDMA3TC. The privilege ID is used while issuing read and write command to the target endpoints so that the target endpoints can perform memory protection checks based on the PRIV of the host that set up the DMA transaction. 0h = User-level privilege 1h = Supervisor-level privilege
7-4	RESERVED	R	0h	
3-0	PRIVID	R	0h	Privilege ID. This contains the Privilege ID of the EDMA3 programmer that set up the parameter entry in the channel controller. This field is set up when the associated TR is submitted to the EDMA3TC. This PRIVID value is used while issuing read and write commands to the target endpoints so that the target endpoints can perform memory protection checks based on the PRIVID of the host that set up the DMA transaction. Value 0 to Fh.

11.4.2.41 DFOPT3 Register (offset = 3C0h) [reset = 0h]

DFOPT3 is shown in [Figure 11-207](#) and described in [Table 11-192](#).

The Destination FIFO Options Register (DFOPT) is an EDMA3TC channel register. This EDMA3TC channel register is part of the Destination Register FIFO Register Set. It is read-only and provided to facilitate debugging by providing a window into how the transfer controller (TC) was programmed by the channel controller (CC), as well as showing status of the transfer controller (TC) during a transfer. The number of destination FIFO register sets depends on the destination FIFO depth. TC0, TC1, and TC2 each have a destination FIFO depth of 4, so there are four sets of destination FIFO registers for each of these transfer controllers.

Figure 11-207. DFOPT3 Register

31	30	29	28	27	26	25	24
RESERVED							
R-0h							
23	22	21	20	19	18	17	16
RESERVED	TCCHEN	RESERVED	TCINTEN	RESERVED		TCC	
R-0h	R-0h	R-0h	R-0h	R-0h		R-0h	
15	14	13	12	11	10	9	8
TCC				RESERVED	FWID		
R-0h				R-0h	R-0h		
7	6	5	4	3	2	1	0
RESERVED	PRI		RESERVED			DAM	SAM
R-0h	R-0h		R-0h			R-0h	R-0h

LEGEND: R/W = Read/Write; R = Read only; W1toCl = Write 1 to clear bit; -n = value after reset

Table 11-192. DFOPT3 Register Field Descriptions

Bit	Field	Type	Reset	Description
31-23	RESERVED	R	0h	
22	TCCHEN	R	0h	Transfer complete chaining enable 0h = Transfer complete chaining is disabled 1h = Transfer complete chaining is enabled
21	RESERVED	R	0h	
20	TCINTEN	R	0h	Transfer complete interrupt enable. 0h = Transfer complete interrupt is disabled. 1h = Transfer complete interrupt is enabled.
19-18	RESERVED	R	0h	
17-12	TCC	R	0h	Transfer complete code. This 6 bit code is used to set the relevant bit in CER or IPR of the EDMA3PCC module.
11	RESERVED	R	0h	
10-8	FWID	R	0h	FIFO width. Applies if either SAM or DAM is set to constant addressing mode. 0h = FIFO width is 8-bit. 1h = FIFO width is 16-bit. 2h = FIFO width is 32-bit. 3h = FIFO width is 64-bit. 4h = FIFO width is 128-bit. 5h = FIFO width is 256-bit. 6h = Reserved. 7h = Reserved.
7	RESERVED	R	0h	

Table 11-192. DFOPT3 Register Field Descriptions (continued)

Bit	Field	Type	Reset	Description
6-4	PRI	R	0h	Transfer priority 0h = Priority 0 - Highest priority 1h = From 1h to 6h, Priority 1 to priority 6 7h = Priority 7 - Lowest priority
3-2	RESERVED	R	0h	
1	DAM	R	0h	Destination address mode within an array 0h = Increment (INCR) mode. Destination addressing within an array increments. 1h = Constant addressing (CONST) mode. Destination addressing within an array wraps around upon reaching FIFO width.
0	SAM	R	0h	Source address mode within an array 0h = Increment (INCR) mode. Source addressing within an array increments. 1h = Constant addressing (CONST) mode. Source addressing within an array wraps around upon reaching FIFO width.

11.4.2.42 DFSRC3 Register (offset = 3C4h) [reset = 0h]

DFSRC3 is shown in [Figure 11-208](#) and described in [Table 11-193](#).

The Destination FIFO Source Address Register (DFSRC) is an EDMA3TC channel register. This EDMA3TC channel register is part of the Destination Register FIFO Register Set. It is read-only and provided to facilitate debugging by providing a window into how the transfer controller (TC) was programmed by the channel controller (CC), as well as showing status of the transfer controller (TC) during a transfer. The number of destination FIFO register sets depends on the destination FIFO depth. TC0, TC1, and TC2 each have a destination FIFO depth of 4, so there are four sets of destination FIFO registers for each of these transfer controllers. Note: Source address is not applicable for Destination FIFO Register Set. Read returns 0.

Note: Source address reference is not applicable for Destination FIFO Register Set. Read returns 0.

Figure 11-208. DFSRC3 Register

31	30	29	28	27	26	25	24	23	22	21	20	19	18	17	16	15	14	13	12	11	10	9	8	7	6	5	4	3	2	1	0
RESERVED																															
R-0h																															

LEGEND: R/W = Read/Write; R = Read only; W1toCl = Write 1 to clear bit; -n = value after reset

Table 11-193. DFSRC3 Register Field Descriptions

Bit	Field	Type	Reset	Description
31-0	RESERVED	R	0h	

11.4.2.43 DFCNT3 Register (offset = 3C8h) [reset = 0h]

DFCNT3 is shown in [Figure 11-209](#) and described in [Table 11-194](#).

The Destination FIFO Count Register (DFCNT) is an EDMA3TC channel register. This EDMA3TC channel register is part of the Destination Register FIFO Register Set. It is read-only and provided to facilitate debugging by providing a window into how the transfer controller (TC) was programmed by the channel controller (CC), as well as showing status of the transfer controller (TC) during a transfer. The number of destination FIFO register sets depends on the destination FIFO depth. TC0, TC1, and TC2 each have a destination FIFO depth of 4, so there are four sets of destination FIFO registers for each of these transfer controllers.

Figure 11-209. DFCNT3 Register

31	30	29	28	27	26	25	24	23	22	21	20	19	18	17	16	15	14	13	12	11	10	9	8	7	6	5	4	3	2	1	0
BCNT																ACNT															
R-0h																R-0h															

LEGEND: R/W = Read/Write; R = Read only; W1toCl = Write 1 to clear bit; -n = value after reset

Table 11-194. DFCNT3 Register Field Descriptions

Bit	Field	Type	Reset	Description
31-16	BCNT	R	0h	B-dimension count remaining for Destination Register Set. Represents the amount of data remaining to be written. For the final TR in the Destination Register FIFO: TC decrements ACNT and BCNT as necessary after each write dataphase is issued. The final value should be 0 when TR is complete. For a non-final TR in the Destination Register FIFO: CNT will hold the originally programmed value or the optimized BCNT value after 2D optimization calculation.
15-0	ACNT	R	0h	A-dimension count remaining for Destination Register Set. Represents the amount of data remaining to be written. For the final TR in the Destination Register FIFO: TC decrements ACNT and BCNT as necessary after each write dataphase is issued. The final value should be 0 when TR is complete. For a non-final TR in the Destination Register FIFO: CNT will hold the originally programmed value or the optimized BCNT value after 2D optimization calculation. Value 0 to FFFFh.

11.4.2.44 DFDST3 Register (offset = 3CCh) [reset = 0h]

DFDST3 is shown in [Figure 11-210](#) and described in [Table 11-195](#).

The Destination FIFO Destination Address Register (DFDST) is an EDMA3TC channel register. This EDMA3TC channel register is part of the Destination Register FIFO Register Set. It is read-only and provided to facilitate debugging by providing a window into how the transfer controller (TC) was programmed by the channel controller (CC), as well as showing status of the transfer controller (TC) during a transfer. The number of destination FIFO register sets depends on the destination FIFO depth. TC0, TC1, and TC2 each have a destination FIFO depth of 4, so there are four sets of destination FIFO registers for each of these transfer controllers.

Figure 11-210. DFDST3 Register

31	30	29	28	27	26	25	24	23	22	21	20	19	18	17	16	15	14	13	12	11	10	9	8	7	6	5	4	3	2	1	0
DADDR																															
R-0h																															

LEGEND: R/W = Read/Write; R = Read only; W1toCl = Write 1 to clear bit; -n = value after reset

Table 11-195. DFDST3 Register Field Descriptions

Bit	Field	Type	Reset	Description
31-0	DADDR	R	0h	ARRAY(0x24b1d10) Note: If DAM == CONST, the 'active' address will increment internally as if the transfer were an 'Increment' transfer. The address issued on the write command interface will correctly issue the same address programmed by the user.

11.4.2.45 DFBIDX3 Register (offset = 3D0h) [reset = 0h]

DFBIDX3 is shown in [Figure 11-211](#) and described in [Table 11-196](#).

The Destination FIFO B-Index Register (DFBIDX) is an EDMA3TC channel register. This EDMA3TC channel register is part of the Destination Register FIFO Register Set. It is read-only and provided to facilitate debugging by providing a window into how the transfer controller (TC) was programmed by the channel controller (CC), as well as showing status of the transfer controller (TC) during a transfer. The number of destination FIFO register sets depends on the destination FIFO depth. TC0, TC1, and TC2 each have a destination FIFO depth of 4, so there are four sets of destination FIFO registers for each of these transfer controllers.

Figure 11-211. DFBIDX3 Register

31	30	29	28	27	26	25	24	23	22	21	20	19	18	17	16	15	14	13	12	11	10	9	8	7	6	5	4	3	2	1	0
DBIDX																SBIDX															
R-0h																R-0h															

LEGEND: R/W = Read/Write; R = Read only; W1toCl = Write 1 to clear bit; -n = value after reset

Table 11-196. DFBIDX3 Register Field Descriptions

Bit	Field	Type	Reset	Description
31-16	DBIDX	R	0h	B-Index offset between destination arrays for the Destination FIFO Register Set. Represents the offset in bytes between the starting address of each destination array (there are BCNT arrays of ACNT elements). DBIDX is always used regardless of whether DAM is in Increment or FIFO mode. Value 0 to FFFFh.
15-0	SBIDX	R	0h	B-Index offset between source arrays for the Destination FIFO Register Set. Represents the offset in bytes between the starting address of each source array (there are BCNT arrays of ACNT elements). SBIDX is always used regardless of whether SAM is in Increment or FIFO mode.

11.4.2.46 DFMPPRXY3 Register (offset = 3D4h) [reset = 0h]

DFMPPRXY3 is shown in [Figure 11-212](#) and described in [Table 11-197](#).

The Destination FIFO Memory Protection Proxy Register (DFMPPRXY) is an EDMA3TC channel register. This EDMA3TC channel register is part of the Destination Register FIFO Register Set. It is read-only and provided to facilitate debugging by providing a window into how the transfer controller (TC) was programmed by the channel controller (CC), as well as showing status of the transfer controller (TC) during a transfer. The number of destination FIFO register sets depends on the destination FIFO depth. TC0, TC1, and TC2 each have a destination FIFO depth of 4, so there are four sets of destination FIFO registers for each of these transfer controllers.

Figure 11-212. DFMPPRXY3 Register

31	30	29	28	27	26	25	24
RESERVED							
R-0h							
23	22	21	20	19	18	17	16
RESERVED							
R-0h							
15	14	13	12	11	10	9	8
RESERVED							PRIV
R-0h							R-0h
7	6	5	4	3	2	1	0
RESERVED				PRIVID			
R-0h				R-0h			

LEGEND: R/W = Read/Write; R = Read only; W1toCl = Write 1 to clear bit; -n = value after reset

Table 11-197. DFMPPRXY3 Register Field Descriptions

Bit	Field	Type	Reset	Description
31-9	RESERVED	R	0h	
8	PRIV	R	0h	Privilege level. This contains the Privilege level used by the EDMA3 programmer to set up the parameter entry in the channel controller. This field is set up when the associated TR is submitted to the EDMA3TC. The privilege ID is used while issuing read and write command to the target endpoints so that the target endpoints can perform memory protection checks based on the PRIV of the host that set up the DMA transaction. 0h = User-level privilege 1h = Supervisor-level privilege
7-4	RESERVED	R	0h	
3-0	PRIVID	R	0h	Privilege ID. This contains the Privilege ID of the EDMA3 programmer that set up the parameter entry in the channel controller. This field is set up when the associated TR is submitted to the EDMA3TC. This PRIVID value is used while issuing read and write commands to the target endpoints so that the target endpoints can perform memory protection checks based on the PRIVID of the host that set up the DMA transaction. Value 0 to Fh.

11.5 Appendix A

11.5.1 Debug Checklist

This section lists some tips to keep in mind while debugging applications using the EDMA3.

The following table provides some common issues and their probable causes and resolutions.

Table 11-198. Debug List

Issue	Description/Solution
The transfer associated with the channel does not happen. The channel does not get serviced.	The EDMA3CC may not service a transfer request, even though the associated PaRAM set is programmed appropriately. Check for the following: 1) Verify that events are enabled, i.e., if an external/peripheral event is latched in Event Registers (ER/ERH), make sure that the event is enabled in the Event Enable Registers (EER/EERH). Similarly, for QDMA channels, make sure that QDMA events are appropriately enabled in the QDMA Event Enable Register (QEER). 2) Verify that the DMA or QDMA Secondary Event Register (SER/SERH/QSERH) bits corresponding to the particular event or channel are not set.
The Secondary Event Registers bits are set, not allowing additional transfers to occur on a channel.	It is possible that a trigger event was received when the parameter set associated with the channel/event was a NULL set for a previous transfer on the channel. This is typical in two cases: 1) QDMA channels: Typically if the parameter set is non-static and expected to be terminated by a NULL set (i.e., OPT.STATIC = 0, LINK = 0xFFFF), the parameter set is updated with a NULL set after submission of the last TR. Because QDMA channels are auto-triggered, this update caused the generation of an event. An event generated for a NULL set causes an error condition and results in setting the bits corresponding to the QDMA channel in the QEMR and QSER. This will disable further prioritization of the channel. 2) DMA channels used in a continuous mode: The peripheral may be set up to continuously generate infinite events (for instance, in case of McASP, every time the data shifts out from the DXR register, it generates an XEVT). The parameter set may be programmed to expect only a finite number of events and to be terminated by a NULL link. After the expected number of events, the parameter set is reloaded with a NULL parameter set. Because the peripheral will generate additional events, an error condition is set in the SER.Ex and EMR.Ex set, preventing further event prioritization. You must ensure that the number of events received is limited to the expected number of events for which the parameter set is programmed, or you must ensure that bits corresponding to particular channel or event are not set in the Secondary event registers (SER/SERH/QSER) and Event Missed Registers (EMR/EMRH/QEMR) before trying to perform subsequent transfers for the event/channel.
Completion interrupts are not asserted, or no further interrupts are received after the first completion interrupt.	You must ensure the following: 1) The interrupt generation is enabled in the OPT of the associated PaRAM set (TCINTEN = 1 and/or ITCINTEN = 1). 2) The interrupts are enabled in the EDMA3 Channel Controller, via the Interrupt Enable Registers (IER/IERH). 3) The corresponding interrupts are enabled in the device interrupt controller. 4) The set interrupts are cleared in the interrupt pending registers (IPR/IPRH) before exiting the transfer completion interrupt service routine (ISR). See Section 11.3.9.1.2 for details on writing EDMA3 ISRs. 5) If working with shadow region interrupts, make sure that the DMA Region Access registers (DRAE/DRAEH) are set up properly, because the DRAE/DRAEH registers act as secondary enables for shadow region completion interrupts, along with the IER/IERH registers. If working with shadow region interrupts, make sure that the bits corresponding to the transfer completion code (TCC) value are also enabled in the DRAE/DRAEH registers. For instance, if the PaRAM set associated with Channel 0 returns a completion code of 63 (OPT.TCC=63), ensure that DRAEH.E63 is also set for a shadow region completion interrupt because the interrupt pending register bit set will be IPRH.I63 (not IPR.I0).

11.5.2 Miscellaneous Programming/Debug Tips

- For several registers, the setting and clearing of bits needs to be done via separate dedicated registers. For example, the Event Register (ER/ERH) can only be cleared by writing a 1 to the corresponding bits in the Event Clear Registers (ECR/ECRH). Similarly, the Event Enable Register (EER/EERH) bits can only be set with writes of 1 to the Event Enable Set Registers (EESR/EESRH) and cleared with writes of 1 to the corresponding bits in the Event Enable Clear Register (EECR/EECRH).
- Writes to the shadow region memory maps are governed by region access registers (DRAE/DRAEH/QRAE). If the appropriate channels are not enabled in these registers, read/write access to the shadow region memory map is not enabled.
- When working with shadow region completion interrupts, ensure that the DMA Region Access Registers (DRAE/DRAEH) for every region are set in a mutually exclusive way (unless it is a requirement for an application). If there is an overlap in the allocated channels and transfer completion codes (setting of Interrupt Pending Register bits) in the region resource allocation, it results in multiple

shadow region completion interrupts. For example, if DRAE0.E0 and DRAE1.E0 are both set, then on completion of a transfer that returns a TCC=0, they will generate both shadow region 0 and 1 completion interrupts.

4. While programming a non-dummy parameter set, ensure the CCNT is not left to zero.
5. Enable the EDMA3CC error interrupt in the device controller and attach an interrupt service routine (ISR) to ensure that error conditions are not missed in an application and are appropriately addressed with the ISR.
6. Depending on the application, you may want to break large transfers into smaller transfers and use self-chaining to prevent starvation of other events in an event queue.
7. In applications where a large transfer is broken into sets of small transfers using chaining or other methods, you might choose to use the early chaining option to reduce the time between the sets of transfers and increase the throughput. However, keep in mind that with early completion, all data might have not been received at the end point when completion is reported because the EDMA3CC internally signals completion when the TR is submitted to the EDMA3TC, potentially before any data has been transferred.
8. The event queue entries can be observed to determine the last few events if there is a system failure (provided the entries were not bypassed).

11.5.3 Setting Up a Transfer

The following list provides a quick guide for the typical steps involved in setting up a transfer.

- Step 1. Initiating a DMA/QDMA channel
- (a) Determine the type of channel (QDMA or DMA) to be used.
 - (b) Channel mapping
 - (i) If using a QDMA channel, program the QCHMAP with the parameter set number to which the channel maps and the trigger word.
 - (ii) If using a DMA channel, program the DCHMAP with the parameter set number to which the channel maps.
 - (c) If the channel is being used in the context of a shadow region, ensure the DRAE/DRAEH for the region is properly set up to allow read write accesses to bits in the event registers and interrupt registers in the Shadow region memory map. The subsequent steps in this process should be done using the respective shadow region registers. (Shadow region descriptions and usage are provided in [Section 11.3.7.1](#).)
 - (d) Determine the type of triggering used.
 - (i) If external events are used for triggering (DMA channels), enable the respective event in EER/EERH by writing into EESR/EESRH.
 - (ii) If QDMA Channel is used, enable the channel in QEER by writing into QEESR.
 - (e) Queue setup
 - (i) If a QDMA channel is used, set up the QDMAQNUM to map the channel to the respective event queue.
 - (ii) If a DMA channel is used, set up the DMAQNUM to map the event to the respective event queue.
- Step 2. Parameter set setup
- (a) Program the PaPARAM set number associated with the channel. Note that if it is a QDMA channel, the PaPARAM entry that is configured as trigger word is written to last. Alternatively, enable the QDMA channel (step 1-b-ii above) just before the write to the trigger word.
See [EDMA Transfer Examples](#) for parameter set field setups for different types of transfers. See the sections on chaining ([Section 11.3.8](#)) and interrupt completion ([Section 11.3.9](#)) on how to set up final/intermediate completion chaining and/or interrupts.
- Step 3. Interrupt setup
- (a) Enable the interrupt in the IER/IERH by writing into IESR/IESRH.
 - (b) Ensure that the EDMA3CC completion interrupt (either the global or the shadow region interrupt) is enabled properly in the device interrupt controller.
 - (c) Ensure the EDMA3CC completion interrupt (this refers to either the Global interrupt or the shadow region interrupt) is enabled properly in the Device Interrupt controller.
 - (d) Set up the interrupt controller properly to receive the expected EDMA3 interrupt.

Step 4. Initiate transfer

(a) This step is highly dependent on the event trigger source:

- (i) If the source is an external event coming from a peripheral, the peripheral will be enabled to start generating relevant EDMA3 events that can be latched to the ER transfer.
- (ii) For QDMA events, writes to the trigger word (step 2-a above) will initiate the transfer.
- (iii) Manually triggered transfers will be initiated by writes to the Event Set Registers (ESR/ESRH).
- (iv) Chained-trigger events initiate when a previous transfer returns a transfer completion code equal to the chained channel number.

Step 5. Wait for completion

- (a) If the interrupts are enabled as mentioned in step 3 above, then the EDMA3CC will generate a completion interrupt to the CPU whenever transfer completion results in setting the corresponding bits in the interrupt pending register (IPR/IPRH). The set bits must be cleared in the IPR\IPRH by writing to corresponding bit in ICR\ICRH.
- (b) If polling for completion (interrupts not enabled in the device controller), then the application code can wait on the expected bits to be set in the IPR\IPRH. Again, the set bits in the IPR\IPRH must be manually cleared via ICR\ICRH before the next set of transfers is performed for the same transfer completion code values.

Touchscreen Controller

This chapter describes the touchscreen controller of the device.

Topic	Page
12.1 Introduction	1737
12.2 Integration	1738
12.3 Functional Description	1740
12.4 Operational Modes	1743
12.5 Touchscreen Controller Registers	1747

12.1 Introduction

The touchscreen controller and analog-to-digital converter subsystem (TSC_ADC_SS) is an 8-channel general-purpose analog-to-digital converter (ADC) with optional support for interleaving touchscreen (TS) conversions for a 4-wire, 5-wire, or 8-wire resistive panel. The TSC_ADC_SS can be configured for use in one of the following applications:

- 8 general-purpose ADC channels
- 4-wire TSC with 4 general-purpose ADC channels
- 5-wire TSC with 3 general-purpose ADC channels
- 8-wire TSC

12.1.1 TSC_ADC Features

The main features of the TSC_ADC_SS include:

- Support for 4-wire, 5-wire, and 8-wire resistive TS panels
- Support for interleaving TS capture and general-purpose ADC modes
- Programmable FSM sequencer that supports 16 steps:
 - Software register bit for start of conversion
 - Optional start of conversion HW synchronized to Pen touch or external HW event (but not both)
 - Single conversion (one-shot)
 - Continuous conversions
 - Sequence through all input channels based on a mask
 - Programmable OpenDelay before sampling each channel
 - Programmable sampling delay for each channel
 - Programmable averaging of input samples - 16/8/4/2/1
 - Differential or singled ended mode setting for each channel
 - Store data in either of two FIFO groups
 - Option to encode channel number with data
 - Support for servicing FIFOs via DMA or CPU
 - Programmable DMA Request event (for each FIFO)
 - Dynamically enable or disable channel inputs during operation
 - Stop bit to end conversion
- Support for the following interrupts and status, with masking:
 - Interrupt for HW pen (touch) event
 - Interrupt for HW Pen Up event
 - Interrupt after a sequence of conversions (all non-masked channels)
 - Interrupt for FIFO threshold levels
 - Interrupt if sampled data is out of a programmable range
 - Interrupt for FIFO overflow and underflow conditions
 - Status bit to indicate if ADC is busy converting

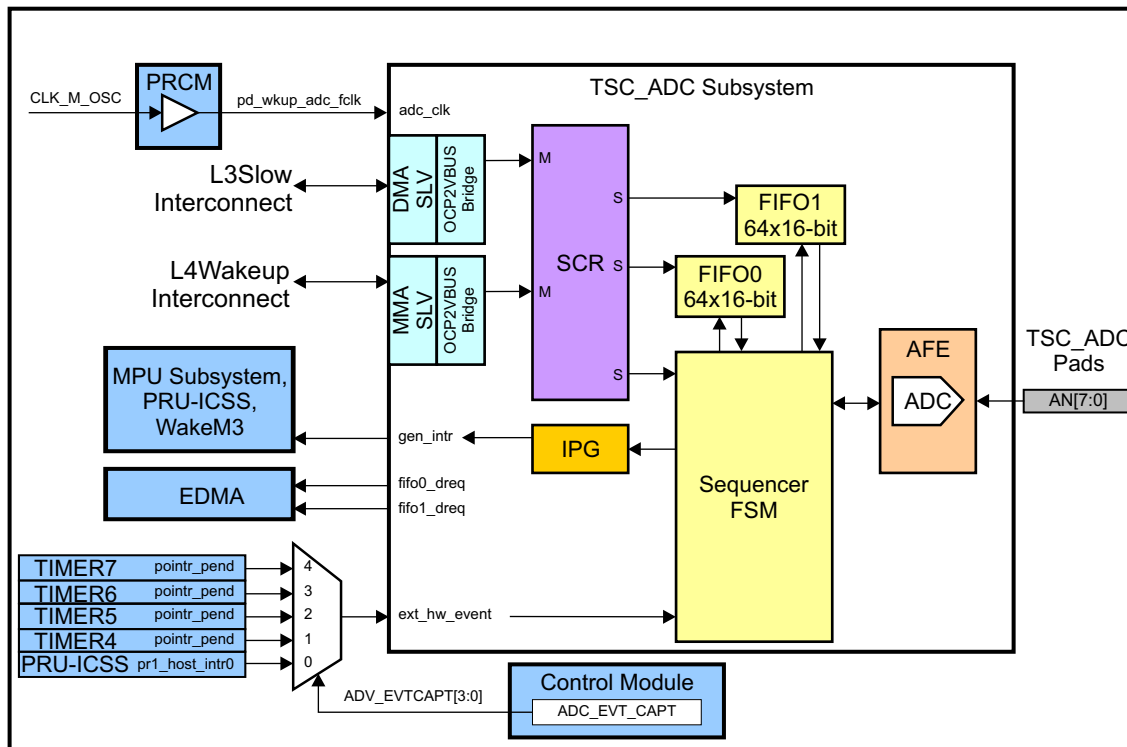
12.1.2 Unsupported TSC_ADC_SS Features

This device supports all TSC_ADC_SS features.

12.2 Integration

Figure 12-1 shows the integration of the TSC_ADC module in the device.

Figure 12-1. TSC_ADC Integration



pr1_host_intr[0:7] corresponds to Host-2 to Host-9 of the PRU-ICSS interrupt controller.

12.2.1 TSC_ADC Connectivity Attributes

The general connectivity attributes for the TSC_ADC module are summarized in Table 12-1.

Table 12-1. TSC_ADC Connectivity Attributes

Attributes	Type
Power domain	Wakeup Domain
Clock domain	PD_WKUP_L4_WKUP_GCLK (OCP) PD_WKUP_ADC_FCLK (Func)
Reset signals	WKUP_DOM_RST_N
Idle/Wakeup signals	Smart idle Wakeup
Interrupt request	1 interrupt to MPU Subsystem (ADC_TSC_GENINT), PRU-ICSS (gen_intr_pend), and WakeM3
DMA request	2 Events (tsc_adc_FIFO0, tsc_adc_FIFO1)
Physical address	L3 Slow slave port (DMA) L4 Wkup slave port (MMR)

12.2.2 TSC_ADC Clock and Reset Management

The TSC_ADC has two clock domains. The ADC uses the `adc_clk`. The bus interfaces, FIFOs, sequencer, and all other logic use the `ocp_clk`.

Table 12-2. TSC_ADC Clock Signals

Clock Signal	Max Freq	Reference / Source	Comments
<code>ocp_clk</code> OCP / Functional clock	100 MHz	CORE_CLKOUTM4 / 2	<code>pd_pwkup_l4_wkup_gclk</code> From PRCM
<code>adc_clk</code> ADC clock	24 MHz ⁽¹⁾	CLK_M_OSC	<code>pd_wkup_adc_fclk</code> From PRCM

⁽¹⁾ When using master input clock frequencies (CLK_M_OSC) above 24 MHz (that is, 25 or 26 MHz), the ADC clock must be divided down using the ADC_CLKDIV register, which will reduce the maximum potential sample rate. The maximum sample rate can only be achieved using a 24-MHz master input clock.

12.2.3 TSC_ADC Pin List

The TSC_ADC external interface signals are shown in [Table 12-3](#).

Table 12-3. TSC_ADC Pin List

Pin	Type	Description
AN[7:0]	I	Analog Input
VREFN	Power	Analog Reference Input Negative Terminal
VREFP	Power	Analog Reference Input Positive Terminal

12.3 Functional Description

Before enabling the TSC_ADC_SS module, the user must first program the Step Configuration registers in order to configure a channel input to be sampled. There are 16 programmable Step Configuration registers which are used by the sequencer to control which switches to turn on or off (inputs to the AFE), which channel to sample, and which mode to use (hardware-triggered or software-enabled, one-shot or continuous, averaging, where to save the FIFO data, and more).

12.3.1 Hardware-Synchronized or Software-Enabled

The user can control the start behavior of each step by deciding if a channel should be sampled immediately (software-enabled) after it is enabled, or if the channel should wait for a hardware (HW) event to occur first (a HW event must either be mapped to the touch screen PEN event or mapped to the HW event input signal, but not both). Each step can be configured independently using the STEPCONFIGx register.

12.3.2 Open Delay and Sample Delay

The user can program the delay between driving the inputs to the AFE and the time to send the start of conversion signal. This delay can be used to allow the voltages to stabilize on the touch screen panel before sampling. This delay is called “open delay” and can also be programmed to zero. The user also has control of the sampling time (width of the start of conversion signal) to the AFE which is called the “sample delay”. The open delay and sample delay for each step can be independently configured using the STEPDELAYx register.

12.3.3 Averaging of Samples (1, 2, 4, 8, and 16)

Each step has the capability to average the sampled data. The valid averaging options are 1 (no average), 2, 4, 8, and 16. If averaging is turned on, then the channel is immediately sampled again (up to 16 times) and final averaged sample data is stored in the FIFO. Each step can be independently configured using the STEPCONFIGx registers.

12.3.4 One-Shot (Single) or Continuous Mode

When the sequencer finishes cycling through all the enabled steps, the user can decide if the sequencer should stop (one-shot), or loop back and schedule the step again (continuous).

If one-shot mode is selected, the sequencer will take care of disabling the step enable bit after the conversion. If continuous mode is selected, it is the software’s responsibility to turn off the step enable bit.

12.3.5 Interrupts

The following interrupts are supported through enable bits and are maskable.

The HW Pen event interrupt, also known as the Pen-down interrupt, is generated when the user presses the touchscreen. This can only occur if the AFE is configured properly (that is, one of the Pen Ctrl bits must be enabled, and also the correct setting for a path to ground in the STEPCONFIGx registers). Although the HW Pen interrupt can be disabled by the software (SW), the event will still trigger the sequencer to start if the step is configured as a HW-synchronized event. The Pen-down interrupt is an asynchronous event and can be used even if the TSC_ADC_SS clocks are disabled. The Pen-down interrupt can be used as a wakeup source.

An END_OF_SEQUENCE interrupt is generated after the sequencer finishes servicing the last enabled step.

A Pen-up event interrupt, also known as the Pen-up interrupt, can only be generated when using HW steps with the charge steps enabled. If a Pen-down event caused the HW steps to be scheduled and no Pen-down is present after the sequencer finished servicing the charge step, then a Pen-up interrupt is generated. To detect Pen-up interrupts, the charge step must share the same configuration as the idle step.

Each FIFO has support for generating interrupts when the FIFO word count has reached a programmable threshold level. The user can program the desired word count at which the CPU should be interrupted. Whenever the threshold counter value is reached, it sets the FIFOxTHRESHOLD interrupt flag, and the CPU is interrupted if the FIFOxTHRESHOLD interrupt enable bit is set. The user can clear the interrupt flag, after emptying the FIFO, by writing a '1' to the FIFOxTHRESHOLD interrupt status bit. To determine how many samples are currently in the FIFO at a given moment, the FIFOxCOUNT register can be read by the CPU.

The FIFO can also generate FIFOx_OVERRUN and FIFOx_UNDERFLOW interrupts. The user can mask these events by programming the IRQENABLE_CLR register. To clear a FIFO underflow or FIFO overrun interrupt, the user should write a '1' to the status bit in the IRQSTS register. The TSC_ADC_SS does not recover from these conditions automatically. Therefore, the software will need to disable and then again enable the TSC_ADC_SS. Before the user can turn the module back on, the user must read the ADCSTAT register to check if the status of the ADC FSM is idle and the current step is the idle step.

12.3.6 DMA Requests

Each FIFO group can be serviced by either a DMA or by the CPU. To generate DMA requests, the user must set the enable bit in the DMAENABLE_SET Register. Also, the user can program the desired number of words to generate a DMA request using the DMAxREQ register. When the FIFO level reaches or exceeds that value, a DMA request is generated.

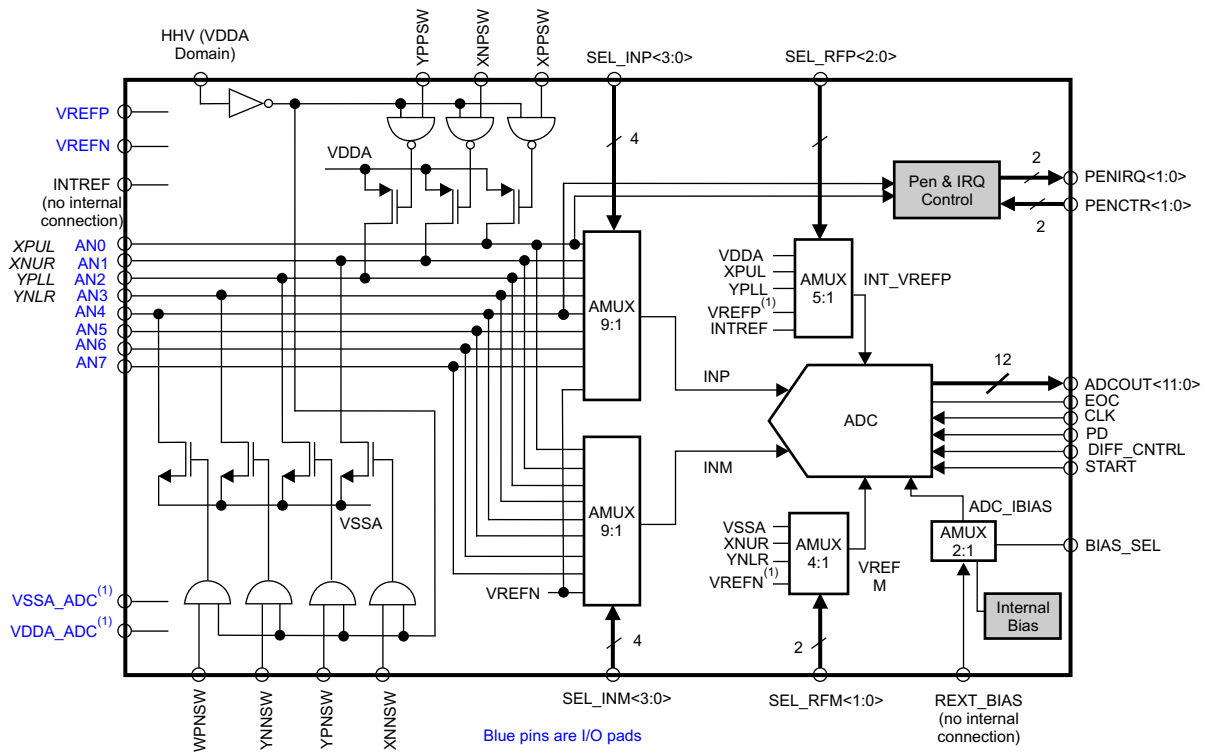
The DMA slave port allows for burst reads in order to effectively move the FIFO data. Internally, the OCP DMA address (MSB) is decoded for either FIFO 0 or FIFO 1. The lower bits of the DMA addresses are ignored since the FIFO pointers are incremented internally.

12.3.7 Analog Front End (AFE) Functional Block Diagram

The AFE features are listed below, and some are controlled by the TSC_ADC_SS:

- 12-bit ADC
- Sampling rate can be as fast as every 15 ADC clock cycles
- Support for internal ADC clock divider logic
- Support for configuring the delay between samples also the sampling time

Figure 12-2. Functional Block Diagram



(1) In the device-specific datasheet:

- VDDA_ADC and VSSA_ADC are referred to as "Internal References"
- VREFP and VREFN are referred to as "External References"

12.4 Operational Modes

The sequencer is completely controlled by software and behaves accordingly to how the **Step Registers** are programmed. A **step** is the general term for sampling a channel input. It is defined by the programmer who decides which input values to send to the AFE as well as how and when to sample a channel input.

The choices for each step can all be programmed using the STEPCONFIGx registers.

A step requires using these registers:

- STEPENABLE: Enables or disables the step
- STEPCONFIGx: Controls the input values to the ADC (the reference voltages, the pull up/down transistor biasing, which input channel to sample, differential control, HW synchronized or SW enabled, averaging, and which FIFO group to save the data)
- STEPDELAYx: Controls the OpenDelay (the time between driving the AFE inputs until sending the SOC signal to the AFE), and also controls the SampleDelay (the time for the ADC to sample the input signal)

The sequencer supports a total of 16 programmable steps, a touchscreen charge step, and an idle step. Each step requires using the registers listed above. However, the idle step does not have an enable bit, so it will always be enabled, or a delay register. In addition, the ADC does not actually sample a channel during the idle and touchscreen charge steps.

Assuming all the steps are configured as general-purpose mode (no touchscreen), then the steps would be configured as SW enabled. When the TSC_ADC_SS is first enabled, the sequencer will always start in the Idle step and then wait for a STEPENABLE[n] bit to turn on. After a step is enabled, the sequencer will start with the lowest step (1) and continue until step (16). If a step is not enabled, then sequencer will skip to the next step. If all steps are disabled, then the sequencer will remain in the IDLE state and continue to apply the settings in the IDLECONFIG register.

Assuming a touchscreen-only mode (no general-purpose channels) the steps could be configured as HW synchronized triggered (mapped to the Pen event). The sequencer would wait in the IDLE state until a Pen-down event occurred and then begin the HW step conversions. The charge step, which occurs after the last HW-synchronized step is finished, is designed to charge the capacitance in a touch panel when the appropriate bias transistor is enabled. The purpose of the charge step is to prepare the TSC for the next Pen-down event.

Assuming a mixed mode application (touchscreen and general-purpose channels), the user can configure the steps as either HW-triggered (mapped to a Pen event) or SW-enabled. If the sequencer is in the idle state and a Pen-down event occurs, the HW-synchronized steps are always scheduled first, followed by the charge step, and cannot be preempted by SW steps. If there is no HW event, then the SW-enabled steps are scheduled instead.

If a Pen-down event occurs while the sequencer is in the middle of scheduling the SW steps, the user can program the scheduler to allow preemption. If the HW preemption control bit is enabled in the CTRL register, the sequencer will stop the scheduled SW sequence and schedule the HW steps. After the last HW step and charge step are completed, the sequencer will continue from the next SW step (before the preemption occurred). If the HW preemption is disabled, then the touch event will be ignored until the last software step is completed; if the touch event is removed before the last software step is finished, then the touch event will be missed.

Even if a touchscreen is not present, the user can still configure the steps to be HW-synchronized by mapping to the ext_hw_event signal shown in [Figure 12-1](#). This HW event input signal can be driven at the SOC from a number of external inputs chosen by the ADC_EVT_CAPT register in the Control Module.

When mapping is set for the ext_hw_event signal, then the TSC_ADC_SS will wait for a rising edge transition (from low to high) before starting. The ext_hw_event signal is captured on the internal L4 OCP clock domain. The ext_hw_event signal should be held for at least two TSC_ADC_SS OCP clocks (L4 frequency).

An END_OF_SEQUENCE interrupt is generated after the last active step is completed before going back to the IDLE state. The END_OF_SEQUENCE interrupt does not mean data is in the FIFO (should use the FIFO interrupts and FIFOxCOUNT register).

12.4.1 PenCtrl and PenIRQ

The Pen IRQ can only occur if the correct AFE_Pen_Ctrl bits are high in the CTRL register and if the correct ground transistor biasing is set in the STEPCONFIGx and IDLECONFIG registers.

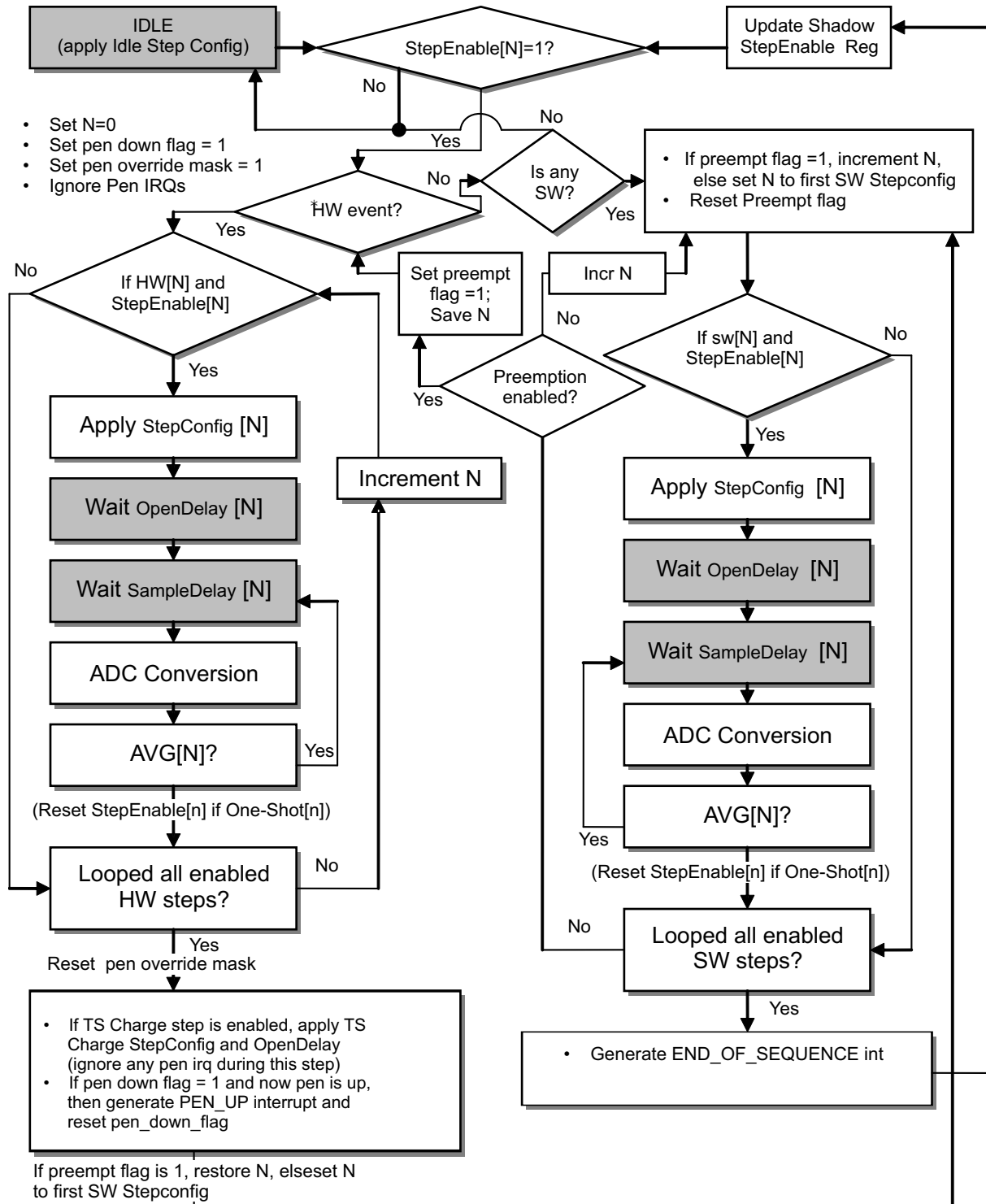
Setting the AFE_Pen_Ctrl bits in the CTRL register will enable a weak internal pull-up resistor on AIN0 for 4-wire configurations and AIN4 for 5-wire.

If a step is configured as HW-synchronized, the sequencer will override the AFE_Pen_Ctrl bits set by the software (bits 6:5) once it transitions from the Idle step. The sequencer will automatically mask the AFE_Pen_Ctrl bits (override them and turn them off) so that the ADC can get an accurate measurement from the x and y-axes. After the last HW-synchronized step, the sequence will go to the Charge step and the pen override mask is removed and the values set by the software (bits 6:5) will have control. The Pen-down events will be temporarily ignored during the Charge step (HW will mask any potential glitches that may occur)

If the sequencer is not using the HW synchronized approach, (all the steps are configured as software enabled), then it is the software programmer's responsibility to correctly turn on and off the AFE_Pen_Ctrl bits to receive the correct measurements from the touchscreen. The software must enable the Charge step and ignore any potential glitches.

It is also possible to detect the Pen-down event even if all the STEPENABLE[n] bits are off. By setting the appropriate AFE_Pen_Ctrl bit to 1, and configuring the IDLECONFIG register to bias the correct transistor to ground, the Pen-down event will generate. The flowchart for the sequencer is shown in [Figure 12-3](#) and an example timing diagram in [Figure 12-4](#).

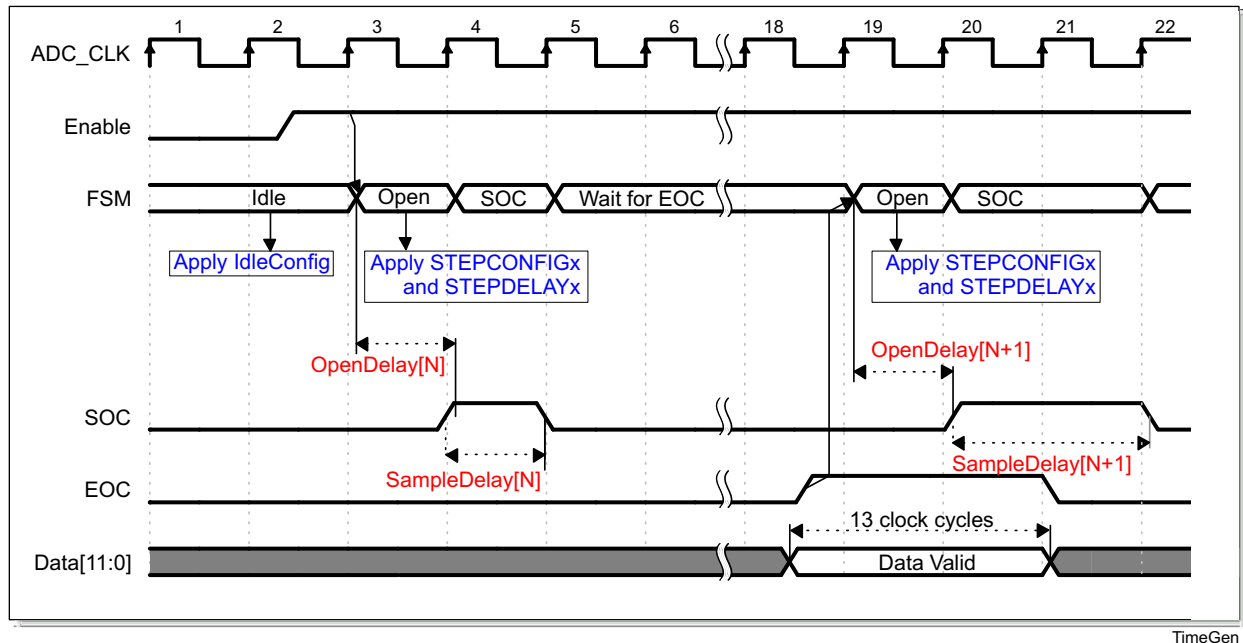
Figure 12-3. Sequencer FSM



* HW event can either be Pen-down or input HW event, but not both

Figure 12-3 does not actually represent clock cycles but instead illustrates how the scheduler will work. However, each shaded box above does represent a FSM state and will use a clock cycle. Using the minimum delay values, the ADC can sample at 15 ADC clocks per sample. Below is an example timing diagram illustrating the states of the sequencer and also the showing when the STEPCONFIGx and the STEPDELAYx registers values are applied. The below example assumes the steps are software controlled, and averaging is turned off.

Figure 12-4. Example Timing Diagram for Sequencer



The idle step is always enabled and applied when the FSM is in the IDLE state (that is, either waiting for a HW event or waiting for a step to be enabled). The idle step cannot be disabled.

Once the TSC_ADC_SS is enabled and assuming at least one step is active, the FSM will transition from the idle state and apply the first active STEPCONFIGx and STEPDELAYx register settings. It is possible for the Open Delay value to be 0, and the FSM will immediately skip to the Sample Delay state, which is a minimum of one clock cycle. The ADC will begin the sampling on the falling edge of the SOC signal. After the ADC is finished converting the channel data (13 cycles later), the EOC signal is sent and the FSM will then apply the next active step.

This process is repeated and continued (from step 1 to step 16) until the last active step is completed.

12.5 Touchscreen Controller Registers

12.5.1 TSC_ADC_SS Registers

Table 12-4 lists the memory-mapped registers for the TSC_ADC_SS. All register offset addresses not listed in Table 12-4 should be considered as reserved locations and the register contents should not be modified.

Table 12-4. TSC_ADC_SS Registers

Offset	Acronym	Register Name	Section
0h	REVISION		Section 12.5.1.1
10h	SYSCONFIG		Section 12.5.1.2
24h	IRQSTATUS_RAW		Section 12.5.1.3
28h	IRQSTATUS		Section 12.5.1.4
2Ch	IRQENABLE_SET		Section 12.5.1.5
30h	IRQENABLE_CLR		Section 12.5.1.6
34h	IRQWAKEUP		Section 12.5.1.7
38h	DMAENABLE_SET		Section 12.5.1.8
3Ch	DMAENABLE_CLR		Section 12.5.1.9
40h	CTRL		Section 12.5.1.10
44h	ADCSTAT		Section 12.5.1.11
48h	ADCRANGE		Section 12.5.1.12
4Ch	ADC_CLKDIV		Section 12.5.1.13
50h	ADC_MISC		Section 12.5.1.14
54h	STEPENABLE		Section 12.5.1.15
58h	IDLECONFIG		Section 12.5.1.16
5Ch	TS_CHARGE_STEPCONFIG		Section 12.5.1.17
60h	TS_CHARGE_DELAY		Section 12.5.1.18
64h	STEPCONFIG1		Section 12.5.1.19
68h	STEPDELAY1		Section 12.5.1.20
6Ch	STEPCONFIG2		Section 12.5.1.21
70h	STEPDELAY2		Section 12.5.1.22
74h	STEPCONFIG3		Section 12.5.1.23
78h	STEPDELAY3		Section 12.5.1.24
7Ch	STEPCONFIG4		Section 12.5.1.25
80h	STEPDELAY4		Section 12.5.1.26
84h	STEPCONFIG5		Section 12.5.1.27
88h	STEPDELAY5		Section 12.5.1.28
8Ch	STEPCONFIG6		Section 12.5.1.29
90h	STEPDELAY6		Section 12.5.1.30
94h	STEPCONFIG7		Section 12.5.1.31
98h	STEPDELAY7		Section 12.5.1.32
9Ch	STEPCONFIG8		Section 12.5.1.33
A0h	STEPDELAY8		Section 12.5.1.34
A4h	STEPCONFIG9		Section 12.5.1.35
A8h	STEPDELAY9		Section 12.5.1.36
ACH	STEPCONFIG10		Section 12.5.1.37
B0h	STEPDELAY10		Section 12.5.1.38
B4h	STEPCONFIG11		Section 12.5.1.39
B8h	STEPDELAY11		Section 12.5.1.40
BCh	STEPCONFIG12		Section 12.5.1.41

Table 12-4. TSC_ADC_SS Registers (continued)

Offset	Acronym	Register Name	Section
C0h	STEPDELAY12		Section 12.5.1.42
C4h	STEPCONFIG13		Section 12.5.1.43
C8h	STEPDELAY13		Section 12.5.1.44
CCh	STEPCONFIG14		Section 12.5.1.45
D0h	STEPDELAY14		Section 12.5.1.46
D4h	STEPCONFIG15		Section 12.5.1.47
D8h	STEPDELAY15		Section 12.5.1.48
DCh	STEPCONFIG16		Section 12.5.1.49
E0h	STEPDELAY16		Section 12.5.1.50
E4h	FIFO0COUNT		Section 12.5.1.51
E8h	FIFO0THRESHOLD		Section 12.5.1.52
ECh	DMA0REQ		Section 12.5.1.53
F0h	FIFO1COUNT		Section 12.5.1.54
F4h	FIFO1THRESHOLD		Section 12.5.1.55
F8h	DMA1REQ		Section 12.5.1.56
100h	FIFO0DATA		Section 12.5.1.57
200h	FIFO1DATA		Section 12.5.1.58

12.5.1.1 REVISION Register (offset = 0h) [reset = 47300001h]

Register mask: FFFFFFFFh

 REVISION is shown in [Figure 12-5](#) and described in [Table 12-5](#).

Revision Register

Figure 12-5. REVISION Register

31	30	29	28	27	26	25	24
SCHEME		RESERVED				FUNC	
R-1h		R-0h				R-730h	
23	22	21	20	19	18	17	16
FUNC							
R-730h							
15	14	13	12	11	10	9	8
R_RTL					X_MAJOR		
R-0h					R-0h		
7	6	5	4	3	2	1	0
CUSTOM		Y_MINOR					
R-0h		R-1h					

LEGEND: R/W = Read/Write; R = Read only; W1toCl = Write 1 to clear bit; -n = value after reset

Table 12-5. REVISION Register Field Descriptions

Bit	Field	Type	Reset	Description
31-30	SCHEME	R	1h	HL 0.8 scheme
29-28	RESERVED	R	0h	Always read as 0. Writes have no affect.
27-16	FUNC	R	730h	Functional Number
15-11	R_RTL	R	0h	RTL revision. Will vary depending on release.
10-8	X_MAJOR	R	0h	Major revision.
7-6	CUSTOM	R	0h	Custom revision.
5-0	Y_MINOR	R	1h	Minor revision

12.5.1.2 SYSCONFIG Register (offset = 10h) [reset = 0h]

Register mask: FFFFFFFFh

 SYSCONFIG is shown in [Figure 12-6](#) and described in [Table 12-6](#).

SysConfig Register

Figure 12-6. SYSCONFIG Register

31	30	29	28	27	26	25	24
RESERVED							
R/W-0h							
23	22	21	20	19	18	17	16
RESERVED							
R/W-0h							
15	14	13	12	11	10	9	8
RESERVED							
R/W-0h							
7	6	5	4	3	2	1	0
RESERVED				IdleMode		RESERVED	
R/W-0h				R/W-0h		R/W-0h	

LEGEND: R/W = Read/Write; R = Read only; W1toCl = Write 1 to clear bit; -n = value after reset

Table 12-6. SYSCONFIG Register Field Descriptions

Bit	Field	Type	Reset	Description
31-4	RESERVED	R/W	0h	
3-2	IdleMode	R/W	0h	00 = Force Idle (always acknowledges). 01 = No Idle Mode (never acknowledges). 10 = Smart-Idle Mode. 11 = Smart Idle with Wakeup.
1-0	RESERVED	R/W	0h	

12.5.1.3 IRQSTATUS_RAW Register (offset = 24h) [reset = 0h]

Register mask: FFFFFFFFh

 IRQSTATUS_RAW is shown in [Figure 12-7](#) and described in [Table 12-7](#).

IRQ status (unmasked)

Figure 12-7. IRQSTATUS_RAW Register

31	30	29	28	27	26	25	24
RESERVED							
R/W-0h							
23	22	21	20	19	18	17	16
RESERVED							
R/W-0h							
15	14	13	12	11	10	9	8
RESERVED					PEN_IRQ_synchronized	Pen_Up_Event	Out_of_Range
R/W-0h				R/W-0h		R/W-0h	R/W-0h
7	6	5	4	3	2	1	0
FIFO1_Underflow	FIFO1_Overrun	FIFO1_Threshold	FIFO0_Underflow	FIFO0_Overrun	FIFO0_Threshold	End_of_Sequence	HW_Pen_Event_asynchronous
R/W-0h	R/W-0h	R/W-0h	R/W-0h	R/W-0h	R/W-0h	R/W-0h	R/W-0h

LEGEND: R/W = Read/Write; R = Read only; W1toCl = Write 1 to clear bit; -n = value after reset

Table 12-7. IRQSTATUS_RAW Register Field Descriptions

Bit	Field	Type	Reset	Description
31-11	RESERVED	R/W	0h	
10	PEN_IRQ_synchronized	R/W	0h	Write 0 = No action. Write 1 = Set event (debug). Read 0 = No event pending. Read 1 = Event pending.
9	Pen_Up_Event	R/W	0h	Write 0 = No action. Write 1 = Set event (debug). Read 0 = No event pending. Read 1 = Event pending.
8	Out_of_Range	R/W	0h	Write 0 = No action. Write 1 = Set event (debug). Read 0 = No event pending. Read 1 = Event pending.
7	FIFO1_Underflow	R/W	0h	Write 0 = No action. Write 1 = Set event (debug). Read 0 = No event pending. Read 1 = Event pending.
6	FIFO1_Overrun	R/W	0h	Write 0 = No action. Write 1 = Set event (debug). Read 0 = No event pending. Read 1 = Event pending.
5	FIFO1_Threshold	R/W	0h	Write 0 = No action. Write 1 = Set event (debug). Read 0 = No event pending. Read 1 = Event pending.
4	FIFO0_Underflow	R/W	0h	Write 0 = No action. Write 1 = Set event (debug). Read 0 = No event pending. Read 1 = Event pending.
3	FIFO0_Overrun	R/W	0h	Write 0 = No action. Write 1 = Set event (debug). Read 0 = No event pending. Read 1 = Event pending.

Table 12-7. IRQSTATUS_RAW Register Field Descriptions (continued)

Bit	Field	Type	Reset	Description
2	FIFO0_Threshold	R/W	0h	Write 0 = No action. Write 1 = Set event (debug). Read 0 = No event pending. Read 1 = Event pending.
1	End_of_Sequence	R/W	0h	Write 0 = No action. Write 1 = Set event (debug). Read 0 = No event pending. Read 1 = Event pending.
0	HW_Pen_Event_asynchronous	R/W	0h	Write 0 = No action. Write 1 = Set event (debug). Read 0 = No event pending. Read 1 = Event pending.

12.5.1.4 IRQSTATUS Register (offset = 28h) [reset = 0h]

Register mask: FFFFFFFFh

IRQSTATUS is shown in [Figure 12-8](#) and described in [Table 12-8](#).

IRQ status (masked)

Figure 12-8. IRQSTATUS Register

31	30	29	28	27	26	25	24
RESERVED							
R/W-0h							
23	22	21	20	19	18	17	16
RESERVED							
R/W-0h							
15	14	13	12	11	10	9	8
RESERVED					HW_Pen_Event_synchronous	Pen_Up_event	Out_of_Range
R/W-0h			R/W-0h		R/W-0h	R/W-0h	
7	6	5	4	3	2	1	0
FIFO1_Underflow	FIFO1_Overrun	FIFO1_Threshold	FIFO0_Underflow	FIFO0_Overrun	FIFO0_Threshold	End_of_Sequence	HW_Pen_Event_asynchronous
R/W-0h	R/W-0h	R/W-0h	R/W-0h	R/W-0h	R/W-0h	R/W-0h	R/W-0h

LEGEND: R/W = Read/Write; R = Read only; W1toCl = Write 1 to clear bit; -n = value after reset

Table 12-8. IRQSTATUS Register Field Descriptions

Bit	Field	Type	Reset	Description
31-11	RESERVED	R/W	0h	
10	HW_Pen_Event_synchronous	R/W	0h	Write 0 = No action. Read 0 = No (enabled) event pending. Read 1 = Event pending. Write 1 = Clear (raw) event.
9	Pen_Up_event	R/W	0h	Write 0 = No action. Read 0 = No (enabled) event pending. Read 1 = Event pending. Write 1 = Clear (raw) event.
8	Out_of_Range	R/W	0h	Write 0 = No action. Read 0 = No (enabled) event pending. Read 1 = Event pending. Write 1 = Clear (raw) event.
7	FIFO1_Underflow	R/W	0h	Write 0 = No action. Read 0 = No (enabled) event pending. Read 1 = Event pending. Write 1 = Clear (raw) event.
6	FIFO1_Overrun	R/W	0h	Write 0 = No action. Read 0 = No (enabled) event pending. Read 1 = Event pending. Write 1 = Clear (raw) event.
5	FIFO1_Threshold	R/W	0h	Write 0 = No action. Read 0 = No (enabled) event pending. Read 1 = Event pending. Write 1 = Clear (raw) event.
4	FIFO0_Underflow	R/W	0h	Write 0 = No action. Read 0 = No (enabled) event pending. Read 1 = Event pending. Write 1 = Clear (raw) event.
3	FIFO0_Overrun	R/W	0h	Write 0 = No action. Read 0 = No (enabled) event pending. Read 1 = Event pending. Write 1 = Clear (raw) event.

Table 12-8. IRQSTATUS Register Field Descriptions (continued)

Bit	Field	Type	Reset	Description
2	FIFO0_Threshold	R/W	0h	Write 0 = No action. Read 0 = No (enabled) event pending. Read 1 = Event pending. Write 1 = Clear (raw) event.
1	End_of_Sequence	R/W	0h	Write 0 = No action. Read 0 = No (enabled) event pending. Read 1 = Event pending. Write 1 = Clear (raw) event.
0	HW_Pen_Event_asynchronous	R/W	0h	Write 0 = No action. Read 0 = No (enabled) event pending. Read 1 = Event pending. Write 1 = Clear (raw) event.

12.5.1.5 IRQENABLE_SET Register (offset = 2Ch) [reset = 0h]

Register mask: FFFFFFFFh

 IRQENABLE_SET is shown in [Figure 12-9](#) and described in [Table 12-9](#).

IRQ enable set bits

Figure 12-9. IRQENABLE_SET Register

31	30	29	28	27	26	25	24
RESERVED							
R/W-0h							
23	22	21	20	19	18	17	16
RESERVED							
R/W-0h							
15	14	13	12	11	10	9	8
RESERVED					HW_Pen_Event_synchronous	Pen_Up_event	Out_of_Range
R/W-0h				R/W-0h		R/W-0h	R/W-0h
7	6	5	4	3	2	1	0
FIFO1_Underflow	FIFO1_Overrun	FIFO1_Threshold	FIFO0_Underflow	FIFO0_Overrun	FIFO0_Threshold	End_of_Sequence	HW_Pen_Event_asynchronous
R/W-0h	R/W-0h	R/W-0h	R/W-0h	R/W-0h	R/W-0h	R/W-0h	R/W-0h

LEGEND: R/W = Read/Write; R = Read only; W1toCl = Write 1 to clear bit; -n = value after reset

Table 12-9. IRQENABLE_SET Register Field Descriptions

Bit	Field	Type	Reset	Description
31-11	RESERVED	R/W	0h	
10	HW_Pen_Event_synchronous	R/W	0h	Write 0 = No action. Read 0 = Interrupt disabled (masked). Read 1 = Interrupt enabled. Write 1 = Enable interrupt.
9	Pen_Up_event	R/W	0h	Write 0 = No action. Read 0 = Interrupt disabled (masked). Read 1 = Interrupt enabled. Write 1 = Enable interrupt.
8	Out_of_Range	R/W	0h	Write 0 = No action. Read 0 = Interrupt disabled (masked). Read 1 = Interrupt enabled. Write 1 = Enable interrupt.
7	FIFO1_Underflow	R/W	0h	Write 0 = No action. Read 0 = Interrupt disabled (masked). Read 1 = Interrupt enabled. Write 1 = Enable interrupt.
6	FIFO1_Overrun	R/W	0h	Write 0 = No action. Read 0 = Interrupt disabled (masked). Read 1 = Interrupt enabled. Write 1 = Enable interrupt.
5	FIFO1_Threshold	R/W	0h	Write 0 = No action. Read 0 = Interrupt disabled (masked). Read 1 = Interrupt enabled. Write 1 = Enable interrupt.
4	FIFO0_Underflow	R/W	0h	Write 0 = No action. Read 0 = Interrupt disabled (masked). Read 1 = Interrupt enabled. Write 1 = Enable interrupt.
3	FIFO0_Overrun	R/W	0h	Write 0 = No action. Read 0 = Interrupt disabled (masked). Read 1 = Interrupt enabled. Write 1 = Enable interrupt.

Table 12-9. IRQENABLE_SET Register Field Descriptions (continued)

Bit	Field	Type	Reset	Description
2	FIFO0_Threshold	R/W	0h	Write 0 = No action. Read 0 = Interrupt disabled (masked). Read 1 = Interrupt enabled. Write 1 = Enable interrupt.
1	End_of_Sequence	R/W	0h	Write 0 = No action. Read 0 = Interrupt disabled (masked). Read 1 = Interrupt enabled. Write 1 = Enable interrupt.
0	HW_Pen_Event_asynchronous	R/W	0h	Write 0 = No action. Read 0 = Interrupt disabled (masked). Read 1 = Interrupt enabled. Write 1 = Enable interrupt.

12.5.1.6 IRQENABLE_CLR Register (offset = 30h) [reset = 0h]

Register mask: FFFFFFFFh

 IRQENABLE_CLR is shown in [Figure 12-10](#) and described in [Table 12-10](#).

IRQ enable clear bits

Figure 12-10. IRQENABLE_CLR Register

31	30	29	28	27	26	25	24
RESERVED							
R/W-0h							
23	22	21	20	19	18	17	16
RESERVED							
R/W-0h							
15	14	13	12	11	10	9	8
RESERVED					HW_Pen_Event_synchronous	Pen_Up_Event	Out_of_Range
R/W-0h			R/W-0h		R/W-0h	R/W-0h	
7	6	5	4	3	2	1	0
FIFO1_Underflow	FIFO1_Overrun	FIFO1_Threshold	FIFO0_Underflow	FIFO0_Overrun	FIFO0_Threshold	End_of_Sequence	HW_Pen_Event_asynchronous
R/W-0h	R/W-0h	R/W-0h	R/W-0h	R/W-0h	R/W-0h	R/W-0h	R/W-0h

LEGEND: R/W = Read/Write; R = Read only; W1toCl = Write 1 to clear bit; -n = value after reset

Table 12-10. IRQENABLE_CLR Register Field Descriptions

Bit	Field	Type	Reset	Description
31-11	RESERVED	R/W	0h	
10	HW_Pen_Event_synchronous	R/W	0h	Write 0 = No action. Read 0 = Interrupt disabled (masked). Read 1 = Interrupt enabled. Write 1 = Disable interrupt.
9	Pen_Up_Event	R/W	0h	Write 0 = No action. Read 0 = Interrupt disabled (masked). Read 1 = Interrupt enabled. Write 1 = Disable interrupt.
8	Out_of_Range	R/W	0h	Write 0 = No action. Read 0 = Interrupt disabled (masked). Read 1 = Interrupt enabled. Write 1 = Disable interrupt.
7	FIFO1_Underflow	R/W	0h	Write 0 = No action. Read 0 = Interrupt disabled (masked). Read 1 = Interrupt enabled. Write 1 = Disable interrupt.
6	FIFO1_Overrun	R/W	0h	Write 0 = No action. Read 0 = Interrupt disabled (masked). Read 1 = Interrupt enabled. Write 1 = Disable interrupt.
5	FIFO1_Threshold	R/W	0h	Write 0 = No action. Read 0 = Interrupt disabled (masked). Read 1 = Interrupt enabled. Write 1 = Disable interrupt.
4	FIFO0_Underflow	R/W	0h	Write 0 = No action. Read 0 = Interrupt disabled (masked). Read 1 = Interrupt enabled. Write 1 = Disable interrupt.
3	FIFO0_Overrun	R/W	0h	Write 0 = No action. Read 0 = Interrupt disabled (masked). Read 1 = Interrupt enabled. Write 1 = Disable interrupt.

Table 12-10. IRQENABLE_CLR Register Field Descriptions (continued)

Bit	Field	Type	Reset	Description
2	FIFO0_Threshold	R/W	0h	Write 0 = No action. Read 0 = Interrupt disabled (masked). Read 1 = Interrupt enabled. Write 1 = Disable interrupt.
1	End_of_Sequence	R/W	0h	Write 0 = No action. Read 0 = Interrupt disabled (masked). Read 1 = Interrupt enabled. Write 1 = Disable interrupt.
0	HW_Pen_Event_asynchronous	R/W	0h	Write 0 = No action. Read 0 = Interrupt disabled (masked). Read 1 = Interrupt enabled. Write 1 = Disable interrupt.

12.5.1.7 IRQWAKEUP Register (offset = 34h) [reset = 0h]

Register mask: FFFFFFFFh

 IRQWAKEUP is shown in [Figure 12-11](#) and described in [Table 12-11](#).

IRQ wakeup enable

Figure 12-11. IRQWAKEUP Register

31	30	29	28	27	26	25	24
RESERVED							
R/W-0h							
23	22	21	20	19	18	17	16
RESERVED							
R/W-0h							
15	14	13	12	11	10	9	8
RESERVED							
R/W-0h							
7	6	5	4	3	2	1	0
RESERVED							WAKEEN0
R/W-0h							R/W-0h

LEGEND: R/W = Read/Write; R = Read only; W1toCl = Write 1 to clear bit; -n = value after reset

Table 12-11. IRQWAKEUP Register Field Descriptions

Bit	Field	Type	Reset	Description
31-1	RESERVED	R/W	0h	
0	WAKEEN0	R/W	0h	Wakeup generation for HW Pen event. 0 = Wakeup disabled. 1 = Wakeup enabled.

12.5.1.8 DMAENABLE_SET Register (offset = 38h) [reset = 0h]

Register mask: FFFFFFFFh

 DMAENABLE_SET is shown in [Figure 12-12](#) and described in [Table 12-12](#).

Per-Line DMA set

Figure 12-12. DMAENABLE_SET Register

31	30	29	28	27	26	25	24
RESERVED							
R/W-0h							
23	22	21	20	19	18	17	16
RESERVED							
R/W-0h							
15	14	13	12	11	10	9	8
RESERVED							
R/W-0h							
7	6	5	4	3	2	1	0
RESERVED						Enable_1	Enable_0
R/W-0h						R/W-0h	R/W-0h

LEGEND: R/W = Read/Write; R = Read only; W1toCl = Write 1 to clear bit; -n = value after reset

Table 12-12. DMAENABLE_SET Register Field Descriptions

Bit	Field	Type	Reset	Description
31-2	RESERVED	R/W	0h	
1	Enable_1	R/W	0h	Enable DMA request FIFO 1. Write 0 = No action. Read 0 = DMA line disabled. Read 1 = DMA line enabled. Write 1 = Enable DMA line.
0	Enable_0	R/W	0h	Enable DMA request FIFO 0. Write 0 = No action. Read 0 = DMA line disabled. Read 1 = DMA line enabled. Write 1 = Enable DMA line.

12.5.1.9 DMAENABLE_CLR Register (offset = 3Ch) [reset = 0h]

Register mask: FFFFFFFFh

 DMAENABLE_CLR is shown in [Figure 12-13](#) and described in [Table 12-13](#).

Per-Line DMA clr

Figure 12-13. DMAENABLE_CLR Register

31	30	29	28	27	26	25	24
RESERVED							
R/W-0h							
23	22	21	20	19	18	17	16
RESERVED							
R/W-0h							
15	14	13	12	11	10	9	8
RESERVED							
R/W-0h							
7	6	5	4	3	2	1	0
RESERVED						Enable_1	Enable_0
R/W-0h						R/W-0h	R/W-0h

LEGEND: R/W = Read/Write; R = Read only; W1toCl = Write 1 to clear bit; -n = value after reset

Table 12-13. DMAENABLE_CLR Register Field Descriptions

Bit	Field	Type	Reset	Description
31-2	RESERVED	R/W	0h	
1	Enable_1	R/W	0h	Disable DMA request FIFO 1. Write 0 = No action. Read 0 = DMA line disabled. Read 1 = DMA line enabled. Write 1 = Disable DMA line.
0	Enable_0	R/W	0h	Disable DMA request FIFO 0. Write 0 = No action. Read 0 = DMA line disabled. Read 1 = DMA line enabled. Write 1 = Disable DMA line.

12.5.1.10 CTRL Register (offset = 40h) [reset = 0h]

Register mask: FFFFFFFFh

 CTRL is shown in [Figure 12-14](#) and described in [Table 12-14](#).

@TSC_ADC_SS Control Register

Figure 12-14. CTRL Register

31	30	29	28	27	26	25	24
RESERVED							
R-0h							
23	22	21	20	19	18	17	16
RESERVED							
R-0h							
15	14	13	12	11	10	9	8
RESERVED						HW_preempt	HW_event_ma pping
R-0h						R/W-0h	R/W-0h
7	6	5	4	3	2	1	0
Touch_Screen_En able	AFE_Pen_Ctrl		Power_Down	ADC_Bias_Sel ect	StepConfig_Wri teProtect_n_act ive_low	Step_ID_tag	Enable
R/W-0h	R/W-0h		R/W-0h	R/W-0h	R/W-0h	R/W-0h	R/W-0h

LEGEND: R/W = Read/Write; R = Read only; W1toCl = Write 1 to clear bit; -n = value after reset

Table 12-14. CTRL Register Field Descriptions

Bit	Field	Type	Reset	Description
31-10	RESERVED	R	0h	
9	HW_preempt	R/W	0h	0 = SW steps are not pre-empted by HW events. 1 = SW steps are pre-empted by HW events
8	HW_event_mapping	R/W	0h	0 = Map HW event to Pen touch irq (from AFE). 1 = Map HW event to HW event input.
7	Touch_Screen_Enable	R/W	0h	0 = Touchscreen transistors disabled. 1 = Touchscreen transistors enabled
6-5	AFE_Pen_Ctrl	R/W	0h	These two bits are sent directly to the AFE Pen Ctrl inputs. Bit 6 controls the Wiper touch (5 wire modes)Bit 5 controls the X+ touch (4 wire modes)User also needs to make sure the ground path is connected properly for pen interrupt to occur (using the StepConfig registers)Refer to section 4 interrupts for more information
4	Power_Down	R/W	0h	ADC Power Down control. 0 = AFE is powered up (default). 1 = Write 1 to power down AFE (the tsc_adc_ss enable (bit 0) should also be set to off)
3	ADC_Bias_Select	R/W	0h	Select Bias to AFE. 0 = Internal. 1 = Reserved.
2	StepConfig_WriteProtect_n_active_low	R/W	0h	0 = Step configuration registers are protected (not writable). 1 = Step configuration registers are not protected (writable).
1	Step_ID_tag	R/W	0h	Writing 1 to this bit will store the Step ID number with the captured ADC data in the FIFO. 0 = Write zeroes. 1 = Store the channel ID tag.
0	Enable	R/W	0h	TSC_ADC_SS module enable bit. After programming all the steps and configuration registers, write a 1 to this bit to turn on TSC_ADC_SS. Writing a 0 will disable the module (after the current conversion).

12.5.1.11 ADCSTAT Register (offset = 44h) [reset = 10h]

Register mask: FFFFFFFFh

ADCSTAT is shown in [Figure 12-15](#) and described in [Table 12-15](#).

General Status bits @TSC_ADC_SS_Sequencer_Status Register

Figure 12-15. ADCSTAT Register

31	30	29	28	27	26	25	24
RESERVED							
R-0h							
23	22	21	20	19	18	17	16
RESERVED							
R-0h							
15	14	13	12	11	10	9	8
RESERVED							
R-0h							
7	6	5	4	3	2	1	0
PEN_IRQ1	PEN_IRQ0	FSM_BUSY	STEP_ID				
R-0h	R-0h	R-0h	R-10h				

LEGEND: R/W = Read/Write; R = Read only; W1toCl = Write 1 to clear bit; -n = value after reset

Table 12-15. ADCSTAT Register Field Descriptions

Bit	Field	Type	Reset	Description
31-8	RESERVED	R	0h	-
7	PEN_IRQ1	R	0h	PEN_IRQ[1] status
6	PEN_IRQ0	R	0h	PEN_IRQ[0] status
5	FSM_BUSY	R	0h	Status of OCP FSM and ADC FSM. 0 = Idle. 1 = Busy.
4-0	STEP_ID	R	10h	Encoded values: 10000 = Idle. 10001 = Charge. 00000 = Step 1. 00001 = Step 2. 00010 = Step 3. 00011 = Step 4. 00100 = Step 5. 00101 = Step 6. 00110 = Step 7. 00111 = Step 8. 01000 = Step 9. 01001 = Step 10. 01010 = Step 11. 01011 = Step 12. 01100 = Step 13. 01101 = Step 14. 01110 = Step 15. 01111 = Step 16.

12.5.1.12 ADCRANGE Register (offset = 48h) [reset = 0h]

Register mask: FFFFFFFFh

 ADCRANGE is shown in [Figure 12-16](#) and described in [Table 12-16](#).

High and Low Range Threshold@TSC_ADC_SS_Range_Check Register

Figure 12-16. ADCRANGE Register

31	30	29	28	27	26	25	24	23	22	21	20	19	18	17	16
RESERVED				High_Range_Data											
R-0h				R/W-0h											
15	14	13	12	11	10	9	8	7	6	5	4	3	2	1	0
RESERVED				Low_Range_Data											
R/W-0h				R/W-0h											

LEGEND: R/W = Read/Write; R = Read only; W1toCl = Write 1 to clear bit; -n = value after reset

Table 12-16. ADCRANGE Register Field Descriptions

Bit	Field	Type	Reset	Description
31-28	RESERVED	R	0h	
27-16	High_Range_Data	R/W	0h	Sampled ADC data is compared to this value. If the sampled data is greater than the value, then an interrupt is generated.
15-12	RESERVED	R/W	0h	Reserved.
11-0	Low_Range_Data	R/W	0h	Sampled ADC data is compared to this value. If the sampled data is less than the value, then an interrupt is generated.

12.5.1.13 ADC_CLKDIV Register (offset = 4Ch) [reset = 0h]

Register mask: FFFFFFFFh

 ADC_CLKDIV is shown in [Figure 12-17](#) and described in [Table 12-17](#).

ADC clock divider register@TSC_ADC_SS_Clock_Divider Register

Figure 12-17. ADC_CLKDIV Register

31	30	29	28	27	26	25	24	23	22	21	20	19	18	17	16	15	14	13	12	11	10	9	8	7	6	5	4	3	2	1	0
RESERVED																ADC_ClkDiv															
R-0h																R/W-0h															

LEGEND: R/W = Read/Write; R = Read only; W1toCl = Write 1 to clear bit; -n = value after reset

Table 12-17. ADC_CLKDIV Register Field Descriptions

Bit	Field	Type	Reset	Description
31-16	RESERVED	R	0h	
15-0	ADC_ClkDiv	R/W	0h	The input ADC clock will be divided by this value and sent to the AFE. Program to the value minus 1

12.5.1.14 ADC_MISC Register (offset = 50h) [reset = 0h]

Register mask: FFFFFFFFh

 ADC_MISC is shown in [Figure 12-18](#) and described in [Table 12-18](#).

AFE misc debug@TSC_ADC_SS_MISC Register

Figure 12-18. ADC_MISC Register

31	30	29	28	27	26	25	24
RESERVED							
R-0h							
23	22	21	20	19	18	17	16
RESERVED							
R-0h							
15	14	13	12	11	10	9	8
RESERVED							
R-0h							
7	6	5	4	3	2	1	0
AFE_Spare_Output				AFE_Spare_Input			
R-0h				R/W-0h			

LEGEND: R/W = Read/Write; R = Read only; W1toCl = Write 1 to clear bit; -n = value after reset

Table 12-18. ADC_MISC Register Field Descriptions

Bit	Field	Type	Reset	Description
31-8	RESERVED	R	0h	RESERVED.
7-4	AFE_Spare_Output	R	0h	Connected to AFE Spare Output pins. Reserved in normal operation.
3-0	AFE_Spare_Input	R/W	0h	Connected to AFE Spare Input pins. Reserved in normal operation.

12.5.1.15 STEPENABLE Register (offset = 54h) [reset = 0h]

Register mask: FFFFFFFFh

STEPENABLE is shown in [Figure 12-19](#) and described in [Table 12-19](#).

Step Enable

Figure 12-19. STEPENABLE Register

31	30	29	28	27	26	25	24
RESERVED							
R-0h							
23	22	21	20	19	18	17	16
RESERVED							STEP16
R-0h							R/W-0h
15	14	13	12	11	10	9	8
STEP15	STEP14	STEP13	STEP12	STEP11	STEP10	STEP9	STEP8
R/W-0h	R/W-0h	R/W-0h	R/W-0h	R/W-0h	R/W-0h	R/W-0h	R/W-0h
7	6	5	4	3	2	1	0
STEP7	STEP6	STEP5	STEP4	STEP3	STEP2	STEP1	TS_Charge
R/W-0h	R/W-0h	R/W-0h	R/W-0h	R/W-0h	R/W-0h	R/W-0h	R/W-0h

LEGEND: R/W = Read/Write; R = Read only; W1toCl = Write 1 to clear bit; -n = value after reset

Table 12-19. STEPENABLE Register Field Descriptions

Bit	Field	Type	Reset	Description
31-17	RESERVED	R	0h	RESERVED.
16	STEP16	R/W	0h	Enable step 16
15	STEP15	R/W	0h	Enable step 15
14	STEP14	R/W	0h	Enable step 14
13	STEP13	R/W	0h	Enable step 13
12	STEP12	R/W	0h	Enable step 12
11	STEP11	R/W	0h	Enable step 11
10	STEP10	R/W	0h	Enable step 10
9	STEP9	R/W	0h	Enable step 9
8	STEP8	R/W	0h	Enable step 8
7	STEP7	R/W	0h	Enable step 7
6	STEP6	R/W	0h	Enable step 6
5	STEP5	R/W	0h	Enable step 5
4	STEP4	R/W	0h	Enable step 4
3	STEP3	R/W	0h	Enable step 3
2	STEP2	R/W	0h	Enable step 2
1	STEP1	R/W	0h	Enable step 1
0	TS_Charge	R/W	0h	Enable TS Charge step

12.5.1.16 IDLECONFIG Register (offset = 58h) [reset = 0h]

Register mask: FFFFFFFFh

 IDLECONFIG is shown in [Figure 12-20](#) and described in [Table 12-20](#).

Idle Step configuration@TSC_ADC_SS_IDLE_StepConfig Register

Figure 12-20. IDLECONFIG Register

31	30	29	28	27	26	25	24
RESERVED						Diff_CNTRL	SEL_RFM_SW C_1_0
R/W-0h						R/W-0h	R/W-0h
23	22	21	20	19	18	17	16
SEL_RFM_SW C_1_0	SEL_INP_SWC_3_0			SEL_INM_SWC_3_0			
R/W-0h	R/W-0h			R/W-0h			
15	14	13	12	11	10	9	8
SEL_INM_SW C_3_0	SEL_RFP_SWC_2_0			WPNSW_SWC	YPNSW_SWC	XNPSW_SWC	YNNSW_SWC
R/W-0h	R/W-0h			R/W-0h	R/W-0h	R/W-0h	R/W-0h
7	6	5	4	3	2	1	0
YPPSW_SWC	XNNSW_SWC	XPPSW_SWC	RESERVED				
R/W-0h	R/W-0h	R/W-0h	R/W-0h				

LEGEND: R/W = Read/Write; R = Read only; W1toCl = Write 1 to clear bit; -n = value after reset

Table 12-20. IDLECONFIG Register Field Descriptions

Bit	Field	Type	Reset	Description
31-26	RESERVED	R/W	0h	
25	Diff_CNTRL	R/W	0h	Differential Control Pin. 0 = Single Ended. 1 = Differential Pair Enable.
24-23	SEL_RFM_SWC_1_0	R/W	0h	SEL_RFM pins SW configuration. 00 = VSSA_ADC. 01 = XNUR. 10 = YNLR. 11 = VREFN.
22-19	SEL_INP_SWC_3_0	R/W	0h	SEL_INP pins SW configuration. 0000 = Channel 1. 0111 = Channel 8. 1xxx = VREFN.
18-15	SEL_INM_SWC_3_0	R/W	0h	SEL_INM pins for neg differential. 0000 = Channel 1. 0111 = Channel 8. 1xxx = VREFN.
14-12	SEL_RFP_SWC_2_0	R/W	0h	SEL_RFP pins SW configuration. 000 = VDPA_ADC. 001 = XPUL. 010 = YPLL. 011 = VREFP. 1xx = Reserved.
11	WPNSW_SWC	R/W	0h	WPNSW pin SW configuration
10	YPNSW_SWC	R/W	0h	YPNSW pin SW configuration
9	XNPSW_SWC	R/W	0h	XNPSW pin SW configuration
8	YNNSW_SWC	R/W	0h	YNNSW pin SW configuration
7	YPPSW_SWC	R/W	0h	YPPSW pin SW configuration
6	XNNSW_SWC	R/W	0h	XNNSW pin SW configuration

Table 12-20. IDLECONFIG Register Field Descriptions (continued)

Bit	Field	Type	Reset	Description
5	XPPSW_SWC	R/W	0h	XPPSW pin SW configuration
4-0	RESERVED	R/W	0h	

12.5.1.17 TS_CHARGE_STEPCONFIG Register (offset = 5Ch) [reset = 0h]

Register mask: FFFFFFFFh

 TS_CHARGE_STEPCONFIG is shown in [Figure 12-21](#) and described in [Table 12-21](#).

TS Charge StepConfiguration@TSC_ADC_SS_TS_Charge_StepConfig Register

Figure 12-21. TS_CHARGE_STEPCONFIG Register

31	30	29	28	27	26	25	24	
RESERVED						Diff_CNTRL	SEL_RFM_SW C_1_0	
R/W-0h						R/W-0h	R/W-0h	
23	22	21	20	19	18	17	16	
SEL_RFM_SW C_1_0	SEL_INP_SWC_3_0				SEL_INM_SWM3_0			
R/W-0h	R/W-0h				R/W-0h			
15	14	13	12	11	10	9	8	
SEL_INM_SW M3_0	SEL_RFP_SWC_2_0			WPNSW_SWC	YPNSW_SWC	XNPSW_SWC	YNNSW_SWC	
R/W-0h	R/W-0h			R/W-0h	R/W-0h	R/W-0h	R/W-0h	
7	6	5	4	3	2	1	0	
YPPSW_SWC	XNNSW_SWC	XPPSW_SWC	RESERVED					
R/W-0h	R/W-0h	R/W-0h	R/W-0h					

LEGEND: R/W = Read/Write; R = Read only; W1toCl = Write 1 to clear bit; -n = value after reset

Table 12-21. TS_CHARGE_STEPCONFIG Register Field Descriptions

Bit	Field	Type	Reset	Description
31-26	RESERVED	R/W	0h	
25	Diff_CNTRL	R/W	0h	Differential Control Pin. 0 = Single Ended. 1 = Differential Pair Enable.
24-23	SEL_RFM_SWC_1_0	R/W	0h	SEL_RFM pins SW configuration. 00 = VSSA. 01 = XNUR. 10 = YNLR. 11 = VREFN.
22-19	SEL_INP_SWC_3_0	R/W	0h	SEL_INP pins SW configuration. 0000 = Channel 1. 0111 = Channel 8. 1xxx = VREFN.
18-15	SEL_INM_SWM3_0	R/W	0h	SEL_INM pins for neg differential. 0000 = Channel 1. 0111 = Channel 8. 1xxx = VREFN.
14-12	SEL_RFP_SWC_2_0	R/W	0h	SEL_RFP pins SW configuration. 000 = VDPA. 001 = XPUL. 010 = YPLL. 011 = VREFP. 1xx = INTREF.
11	WPNSW_SWC	R/W	0h	WPNSW pin SW configuration
10	YPNSW_SWC	R/W	0h	YPNSW pin SW configuration
9	XNPSW_SWC	R/W	0h	XNPSW pin SW configuration
8	YNNSW_SWC	R/W	0h	YNNSW pin SW configuration
7	YPPSW_SWC	R/W	0h	YPPSW pin SW configuration
6	XNNSW_SWC	R/W	0h	XNNSW pin SW configuration

Table 12-21. TS_CHARGE_STEPCONFIG Register Field Descriptions (continued)

Bit	Field	Type	Reset	Description
5	XPPSW_SWC	R/W	0h	XPPSW pin SW configuration
4-0	RESERVED	R/W	0h	

12.5.1.18 TS_CHARGE_DELAY Register (offset = 60h) [reset = 1h]

Register mask: FFFFFFFFh

 TS_CHARGE_DELAY is shown in [Figure 12-22](#) and described in [Table 12-22](#).

TS Charge Delay Register@TSC_ADC_SS_TS_Charge_StepDelay Register

Figure 12-22. TS_CHARGE_DELAY Register

31	30	29	28	27	26	25	24	23	22	21	20	19	18	17	16	15	14	13	12	11	10	9	8	7	6	5	4	3	2	1	0
RESERVED														OpenDelay																	
R/W-0h														R/W-1h																	

LEGEND: R/W = Read/Write; R = Read only; W1toCl = Write 1 to clear bit; -n = value after reset

Table 12-22. TS_CHARGE_DELAY Register Field Descriptions

Bit	Field	Type	Reset	Description
31-18	RESERVED	R/W	0h	
17-0	OpenDelay	R/W	1h	Program the # of ADC clock cycles to wait between applying the step configuration registers and going back to the IDLE state. (Value must be greater than 0.)

12.5.1.19 STEPCONFIG1 Register (offset = 64h) [reset = 0h]

Register mask: FFFFFFFFh

STEPCONFIG1 is shown in [Figure 12-23](#) and described in [Table 12-23](#).

Step Configuration 1

Figure 12-23. STEPCONFIG1 Register

31	30	29	28	27	26	25	24
RESERVED				Range_check	FIFO_select	Diff_CNTRL	SEL_RFM_SW C_1_0
R/W-0h				R/W-0h	R/W-0h	R/W-0h	R/W-0h
23	22	21	20	19	18	17	16
SEL_RFM_SW C_1_0	SEL_INP_SWC_3_0				SEL_INM_SWC_3_0		
R/W-0h		R/W-0h			R/W-0h		
15	14	13	12	11	10	9	8
SEL_INM_SW C_3_0	SEL_RFP_SWC_2_0			WPNSW_SWC	YPNSW_SWC	XNPSW_SWC	YNNSW_SWC
R/W-0h		R/W-0h		R/W-0h	R/W-0h	R/W-0h	R/W-0h
7	6	5	4	3	2	1	0
YPPSW_SWC	XNNSW_SWC	XPPSW_SWC	Averaging		Mode		
R/W-0h	R/W-0h	R/W-0h	R/W-0h		R/W-0h		

LEGEND: R/W = Read/Write; R = Read only; W1toCl = Write 1 to clear bit; -n = value after reset

Table 12-23. STEPCONFIG1 Register Field Descriptions

Bit	Field	Type	Reset	Description
31-28	RESERVED	R/W	0h	
27	Range_check	R/W	0h	0 = Disable out-of-range check. 1 = Compare ADC data with range check register.
26	FIFO_select	R/W	0h	Sampled data will be stored in FIFO. 0 = FIFO. 1 = FIFO 1.
25	Diff_CNTRL	R/W	0h	Differential Control Pin
24-23	SEL_RFM_SWC_1_0	R/W	0h	SEL_RFM pins SW configuration. 00 = VSSA. 01 = XNUR. 10 = YNLR. 11 = VREFN.
22-19	SEL_INP_SWC_3_0	R/W	0h	SEL_INP pins SW configuration. 0000 = Channel 1. 0111 = Channel 8. 1xxx = VREFN.
18-15	SEL_INM_SWC_3_0	R/W	0h	SEL_INM pins for negative differential. 0000 = Channel 1. 0111 = Channel 8. 1xxx = VREFN.
14-12	SEL_RFP_SWC_2_0	R/W	0h	SEL_RFP pins SW configuration. 000 = VDDA_ADC. 001 = XPUL. 010 = YPLL. 011 = VREFP. 1xx = Reserved.
11	WPNSW_SWC	R/W	0h	WPNSW pin SW configuration
10	YPNSW_SWC	R/W	0h	YPNSW pin SW configuration
9	XNPSW_SWC	R/W	0h	XNPSW pin SW configuration
8	YNNSW_SWC	R/W	0h	YNNSW pin SW configuration

Table 12-23. STEPCONFIG1 Register Field Descriptions (continued)

Bit	Field	Type	Reset	Description
7	YPPSW_SWC	R/W	0h	YPPSW pin SW configuration
6	XNNSW_SWC	R/W	0h	XNNSW pin SW configuration
5	XPPSW_SWC	R/W	0h	XPPSW pin SW configuration
4-2	Averaging	R/W	0h	Number of samplings to average: 000 = No average. 001 = 2 samples average. 010 = 4 samples average. 011 = 8 samples average. 100 = 16 samples average.
1-0	Mode	R/W	0h	00 = SW enabled, one-shot. 01 = SW enabled, continuous. 10 = HW synchronized, one-shot. 11 = HW synchronized, continuous.

12.5.1.20 STEPDELAY1 Register (offset = 68h) [reset = 0h]

Register mask: FFFFFFFFh

 STEPDELAY1 is shown in [Figure 12-24](#) and described in [Table 12-24](#).

Step Delay Register 1

Figure 12-24. STEPDELAY1 Register

31	30	29	28	27	26	25	24	23	22	21	20	19	18	17	16
SampleDelay								RESERVED						OpenDelay	
R/W-0h								R/W-0h						R/W-0h	
15	14	13	12	11	10	9	8	7	6	5	4	3	2	1	0
OpenDelay															
R/W-0h															

LEGEND: R/W = Read/Write; R = Read only; W1toCl = Write 1 to clear bit; -n = value after reset

Table 12-24. STEPDELAY1 Register Field Descriptions

Bit	Field	Type	Reset	Description
31-24	SampleDelay	R/W	0h	This register will control the number of ADC clock cycles to sample (hold SOC high). Any value programmed here will be added to the minimum requirement of 1 clock cycle.
23-18	RESERVED	R/W	0h	
17-0	OpenDelay	R/W	0h	Program the number of ADC clock cycles to wait after applying the step configuration registers and before sending the start of ADC conversion

12.5.1.21 STEPCONFIG2 Register (offset = 6Ch) [reset = 0h]

Register mask: FFFFFFFFh

 STEPCONFIG2 is shown in [Figure 12-25](#) and described in [Table 12-25](#).

Step Configuration 2

Figure 12-25. STEPCONFIG2 Register

31	30	29	28	27	26	25	24
RESERVED				Range_check	FIFO_select	Diff_CNTRL	SEL_RFM_SW C_1_0
R/W-0h				R/W-0h	R/W-0h	R/W-0h	R/W-0h
23	22	21	20	19	18	17	16
SEL_RFM_SW C_1_0	SEL_INP_SWC_3_0			SEL_INM_SWC_3_0			
R/W-0h	R/W-0h			R/W-0h			
15	14	13	12	11	10	9	8
SEL_INM_SW C_3_0	SEL_RFP_SWC_2_0			WPNSW_SWC	YPNSW_SWC	XNPSW_SWC	YNNSW_SWC
R/W-0h	R/W-0h			R/W-0h	R/W-0h	R/W-0h	R/W-0h
7	6	5	4	3	2	1	0
YPPSW_SWC	XNNSW_SWC	XPPSW_SWC	Averaging		Mode		
R/W-0h	R/W-0h	R/W-0h	R/W-0h		R/W-0h		

LEGEND: R/W = Read/Write; R = Read only; W1toCl = Write 1 to clear bit; -n = value after reset

Table 12-25. STEPCONFIG2 Register Field Descriptions

Bit	Field	Type	Reset	Description
31-28	RESERVED	R/W	0h	
27	Range_check	R/W	0h	0 = Disable out-of-range check. 1 = Compare ADC data with range check register.
26	FIFO_select	R/W	0h	Sampled data will be stored in FIFO. 0 = FIFO. 1 = FIFO1.
25	Diff_CNTRL	R/W	0h	Differential Control Pin
24-23	SEL_RFM_SWC_1_0	R/W	0h	SEL_RFM pins SW configuration. 00 = VSSA. 01 = XNUR. 10 = YNLR. 11 = VREFN.
22-19	SEL_INP_SWC_3_0	R/W	0h	SEL_INP pins SW configuration. 0000 = Channel 1. 0111 = Channel 8. 1xxx = VREFN.
18-15	SEL_INM_SWC_3_0	R/W	0h	SEL_INM pins for negative differential. 0000 = Channel 1. 0111 = Channel 8. 1xxx = VREFN.
14-12	SEL_RFP_SWC_2_0	R/W	0h	SEL_RFP pins SW configuration. 000 = VDDA_ADC. 001 = XPUL. 010 = YPLL. 011 = VREFP. 1xx = Reserved.
11	WPNSW_SWC	R/W	0h	WPNSW pin SW configuration
10	YPNSW_SWC	R/W	0h	YPNSW pin SW configuration
9	XNPSW_SWC	R/W	0h	XNPSW pin SW configuration
8	YNNSW_SWC	R/W	0h	YNNSW pin SW configuration

Table 12-25. STEPCONFIG2 Register Field Descriptions (continued)

Bit	Field	Type	Reset	Description
7	YPPSW_SWC	R/W	0h	YPPSW pin SW configuration
6	XNNSW_SWC	R/W	0h	XNNSW pin SW configuration
5	XPPSW_SWC	R/W	0h	XPPSW pin SW configuration
4-2	Averaging	R/W	0h	Number of samples to average: 000 = No average. 001 = 2 samples average. 010 = 4 samples average. 011 = 8 samples average. 100 = 16 samples average.
1-0	Mode	R/W	0h	00 = SW enabled, one-shot. 01 = SW enabled, continuous. 10 = HW synchronized, one-shot. 11 = HW synchronized, continuous.

12.5.1.22 STEPDELAY2 Register (offset = 70h) [reset = 0h]

Register mask: FFFFFFFFh

 STEPDELAY2 is shown in [Figure 12-26](#) and described in [Table 12-26](#).

Step Delay Register 2

Figure 12-26. STEPDELAY2 Register

31	30	29	28	27	26	25	24	23	22	21	20	19	18	17	16
SampleDelay								RESERVED						OpenDelay	
R/W-0h								R/W-0h						R/W-0h	
15	14	13	12	11	10	9	8	7	6	5	4	3	2	1	0
OpenDelay															
R/W-0h															

LEGEND: R/W = Read/Write; R = Read only; W1toCl = Write 1 to clear bit; -n = value after reset

Table 12-26. STEPDELAY2 Register Field Descriptions

Bit	Field	Type	Reset	Description
31-24	SampleDelay	R/W	0h	This register will control the number of ADC clock cycles to sample (hold SOC high). Any value programmed here will be added to the minimum requirement of 1 clock cycle.
23-18	RESERVED	R/W	0h	
17-0	OpenDelay	R/W	0h	Program the number of ADC clock cycles to wait after applying the step configuration registers and before sending the start of ADC conversion

12.5.1.23 STEPCONFIG3 Register (offset = 74h) [reset = 0h]

Register mask: FFFFFFFFh

STEPCONFIG3 is shown in [Figure 12-27](#) and described in [Table 12-27](#).

Step Configuration 3

Figure 12-27. STEPCONFIG3 Register

31	30	29	28	27	26	25	24
RESERVED				Range_check	FIFO_select	Diff_CNTRL	SEL_RFM_SW C_1_0
R/W-0h				R/W-0h	R/W-0h	R/W-0h	R/W-0h
23	22	21	20	19	18	17	16
SEL_RFM_SW C_1_0	SEL_INP_SWC_3_0				SEL_INM_SWC_3_0		
R/W-0h		R/W-0h			R/W-0h		
15	14	13	12	11	10	9	8
SEL_INM_SW C_3_0	SEL_RFP_SWC_2_0			WPNSW_SWC	YPNSW_SWC	XNPSW_SWC	YNNSW_SWC
R/W-0h		R/W-0h		R/W-0h	R/W-0h	R/W-0h	R/W-0h
7	6	5	4	3	2	1	0
YPPSW_SWC	XNNSW_SWC	XPPSW_SWC	Averaging		Mode		
R/W-0h		R/W-0h		R/W-0h		R/W-0h	

LEGEND: R/W = Read/Write; R = Read only; W1toCl = Write 1 to clear bit; -n = value after reset

Table 12-27. STEPCONFIG3 Register Field Descriptions

Bit	Field	Type	Reset	Description
31-28	RESERVED	R/W	0h	
27	Range_check	R/W	0h	0 = Disable out-of-range check. 1 = Compare ADC data with range check register.
26	FIFO_select	R/W	0h	Sampled data will be stored in FIFO. 0 = FIFO. 1 = FIFO1.
25	Diff_CNTRL	R/W	0h	Differential Control Pin
24-23	SEL_RFM_SWC_1_0	R/W	0h	SEL_RFM pins SW configuration. 00 = VSSA. 01 = XNUR. 10 = YNLR. 11 = VREFN.
22-19	SEL_INP_SWC_3_0	R/W	0h	SEL_INP pins SW configuration. 0000 = Channel 1. 0111 = Channel 8. 1xxx = VREFN.
18-15	SEL_INM_SWC_3_0	R/W	0h	SEL_INM pins for negative differential. 0000 = Channel 1. 0111 = Channel 8. 1xxx = VREFN.
14-12	SEL_RFP_SWC_2_0	R/W	0h	SEL_RFP pins SW configuration. 000 = VDDA_ADC. 001 = XPUL. 010 = YPLL. 011 = VREFP. 1xx = Reserved.
11	WPNSW_SWC	R/W	0h	WPNSW pin SW configuration
10	YPNSW_SWC	R/W	0h	YPNSW pin SW configuration
9	XNPSW_SWC	R/W	0h	XNPSW pin SW configuration
8	YNNSW_SWC	R/W	0h	YNNSW pin SW configuration

Table 12-27. STEPCONFIG3 Register Field Descriptions (continued)

Bit	Field	Type	Reset	Description
7	YPPSW_SWC	R/W	0h	YPPSW pin SW configuration
6	XNNSW_SWC	R/W	0h	XNNSW pin SW configuration
5	XPPSW_SWC	R/W	0h	XPPSW pin SW configuration
4-2	Averaging	R/W	0h	Number of samples to average: 000 = No average. 001 = 2 samples average. 010 = 4 samples average. 011 = 8 samples average. 100 = 16 samples average.
1-0	Mode	R/W	0h	00 = SW enabled, one-shot. 01 = SW enabled, continuous. 10 = HW synchronized, one-shot. 11 = HW synchronized, continuous.

12.5.1.24 STEPDELAY3 Register (offset = 78h) [reset = 0h]

Register mask: FFFFFFFFh

 STEPDELAY3 is shown in [Figure 12-28](#) and described in [Table 12-28](#).

Step Delay Register 3

Figure 12-28. STEPDELAY3 Register

31	30	29	28	27	26	25	24	23	22	21	20	19	18	17	16
SampleDelay								RESERVED						OpenDelay	
R/W-0h								R/W-0h						R/W-0h	
15	14	13	12	11	10	9	8	7	6	5	4	3	2	1	0
OpenDelay															
R/W-0h															

LEGEND: R/W = Read/Write; R = Read only; W1toCl = Write 1 to clear bit; -n = value after reset

Table 12-28. STEPDELAY3 Register Field Descriptions

Bit	Field	Type	Reset	Description
31-24	SampleDelay	R/W	0h	This register will control the number of ADC clock cycles to sample (hold SOC high). Any value programmed here will be added to the minimum requirement of 1 clock cycle.
23-18	RESERVED	R/W	0h	
17-0	OpenDelay	R/W	0h	Program the number of ADC clock cycles to wait after applying the step configuration registers and before sending the start of ADC conversion

12.5.1.25 STEPCONFIG4 Register (offset = 7Ch) [reset = 0h]

Register mask: FFFFFFFFh

 STEPCONFIG4 is shown in [Figure 12-29](#) and described in [Table 12-29](#).

Step Configuration 4

Figure 12-29. STEPCONFIG4 Register

31	30	29	28	27	26	25	24
RESERVED				Range_check	FIFO_select	Diff_CNTRL	SEL_RFM_SW C_1_0
R/W-0h				R/W-0h	R/W-0h	R/W-0h	R/W-0h
23	22	21	20	19	18	17	16
SEL_RFM_SW C_1_0	SEL_INP_SWC_3_0			SEL_INM_SWC_3_0			
R/W-0h	R/W-0h			R/W-0h			
15	14	13	12	11	10	9	8
SEL_INM_SW C_3_0	SEL_RFP_SWC_2_0			WPNSW_SWC	YPNSW_SWC	XNPSW_SWC	YNNSW_SWC
R/W-0h	R/W-0h			R/W-0h	R/W-0h	R/W-0h	R/W-0h
7	6	5	4	3	2	1	0
YPPSW_SWC	XNNSW_SWC	XPPSW_SWC	Averaging			Mode	
R/W-0h	R/W-0h	R/W-0h	R/W-0h			R/W-0h	

LEGEND: R/W = Read/Write; R = Read only; W1toCl = Write 1 to clear bit; -n = value after reset

Table 12-29. STEPCONFIG4 Register Field Descriptions

Bit	Field	Type	Reset	Description
31-28	RESERVED	R/W	0h	
27	Range_check	R/W	0h	0 = Disable out-of-range check. 1 = Compare ADC data with range check register.
26	FIFO_select	R/W	0h	Sampled data will be stored in FIFO. 0 = FIFO. 1 = FIFO1.
25	Diff_CNTRL	R/W	0h	Differential Control Pin
24-23	SEL_RFM_SWC_1_0	R/W	0h	SEL_RFM pins SW configuration. 00 = VSSA. 01 = XNUR. 10 = YNLR. 11 = VREFN.
22-19	SEL_INP_SWC_3_0	R/W	0h	SEL_INP pins SW configuration. 0000 = Channel 1. 0111 = Channel 8. 1xxx = VREFN.
18-15	SEL_INM_SWC_3_0	R/W	0h	SEL_INM pins for negative differential. 0000 = Channel 1. 0111 = Channel 8. 1xxx = VREFN.
14-12	SEL_RFP_SWC_2_0	R/W	0h	SEL_RFP pins SW configuration. 000 = VDDA_ADC. 001 = XPUL. 010 = YPLL. 011 = VREFP. 1xx = Reserved.
11	WPNSW_SWC	R/W	0h	WPNSW pin SW configuration
10	YPNSW_SWC	R/W	0h	YPNSW pin SW configuration
9	XNPSW_SWC	R/W	0h	XNPSW pin SW configuration
8	YNNSW_SWC	R/W	0h	YNNSW pin SW configuration

Table 12-29. STEPCONFIG4 Register Field Descriptions (continued)

Bit	Field	Type	Reset	Description
7	YPPSW_SWC	R/W	0h	YPPSW pin SW configuration
6	XNNSW_SWC	R/W	0h	XNNSW pin SW configuration
5	XPPSW_SWC	R/W	0h	XPPSW pin SW configuration
4-2	Averaging	R/W	0h	Number of samples to average: 000 = No average. 001 = 2 samples average. 010 = 4 samples average. 011 = 8 samples average. 100 = 16 samples average.
1-0	Mode	R/W	0h	00 = SW enabled, one-shot. 01 = SW enabled, continuous. 10 = HW synchronized, one-shot. 11 = HW synchronized, continuous.

12.5.1.26 STEPDELAY4 Register (offset = 80h) [reset = 0h]

Register mask: FFFFFFFFh

 STEPDELAY4 is shown in [Figure 12-30](#) and described in [Table 12-30](#).

Step Delay Register 4

Figure 12-30. STEPDELAY4 Register

31	30	29	28	27	26	25	24	23	22	21	20	19	18	17	16
SampleDelay								RESERVED						OpenDelay	
R/W-0h								R/W-0h						R/W-0h	
15	14	13	12	11	10	9	8	7	6	5	4	3	2	1	0
OpenDelay															
R/W-0h															

LEGEND: R/W = Read/Write; R = Read only; W1toCl = Write 1 to clear bit; -n = value after reset

Table 12-30. STEPDELAY4 Register Field Descriptions

Bit	Field	Type	Reset	Description
31-24	SampleDelay	R/W	0h	This register will control the number of ADC clock cycles to sample (hold SOC high). Any value programmed here will be added to the minimum requirement of 1 clock cycle.
23-18	RESERVED	R/W	0h	
17-0	OpenDelay	R/W	0h	Program the number of ADC clock cycles to wait after applying the step configuration registers and before sending the start of ADC conversion

12.5.1.27 STEPCONFIG5 Register (offset = 84h) [reset = 0h]

Register mask: FFFFFFFFh

STEPCONFIG5 is shown in [Figure 12-31](#) and described in [Table 12-31](#).

Step Configuration 5

Figure 12-31. STEPCONFIG5 Register

31	30	29	28	27	26	25	24
RESERVED				Range_check	FIFO_select	Diff_CNTRL	SEL_RFM_SW C_1_0
R/W-0h				R/W-0h	R/W-0h	R/W-0h	R/W-0h
23	22	21	20	19	18	17	16
SEL_RFM_SW C_1_0	SEL_INP_SWC_3_0			SEL_INM_SWC_3_0			
R/W-0h		R/W-0h			R/W-0h		
15	14	13	12	11	10	9	8
SEL_INM_SW C_3_0	SEL_RFP_SWC_2_0			WPNSW_SWC	YPNSW_SWC	XNPSW_SWC	YNNSW_SWC
R/W-0h		R/W-0h		R/W-0h	R/W-0h	R/W-0h	R/W-0h
7	6	5	4	3	2	1	0
YPPSW_SWC	XNNSW_SWC	XPPSW_SWC	Averaging		Mode		
R/W-0h	R/W-0h	R/W-0h	R/W-0h		R/W-0h		

LEGEND: R/W = Read/Write; R = Read only; W1toCl = Write 1 to clear bit; -n = value after reset

Table 12-31. STEPCONFIG5 Register Field Descriptions

Bit	Field	Type	Reset	Description
31-28	RESERVED	R/W	0h	
27	Range_check	R/W	0h	0 = Disable out-of-range check. 1 = Compare ADC data with range check register.
26	FIFO_select	R/W	0h	Sampled data will be stored in FIFO. 0 = FIFO. 1 = FIFO1.
25	Diff_CNTRL	R/W	0h	Differential Control Pin
24-23	SEL_RFM_SWC_1_0	R/W	0h	SEL_RFM pins SW configuration. 00 = VSSA. 01 = XNUR. 10 = YNLR. 11 = VREFN.
22-19	SEL_INP_SWC_3_0	R/W	0h	SEL_INP pins SW configuration. 0000 = Channel 1. 0111 = Channel 8. 1xxx = VREFN.
18-15	SEL_INM_SWC_3_0	R/W	0h	SEL_INM pins for negative differential. 0000 = Channel 1. 0111 = Channel 8. 1xxx = VREFN.
14-12	SEL_RFP_SWC_2_0	R/W	0h	SEL_RFP pins SW configuration. 000 = VDDA_ADC. 001 = XPUL. 010 = YPLL. 011 = VREFP. 1xx = Reserved.
11	WPNSW_SWC	R/W	0h	WPNSW pin SW configuration
10	YPNSW_SWC	R/W	0h	YPNSW pin SW configuration
9	XNPSW_SWC	R/W	0h	XNPSW pin SW configuration
8	YNNSW_SWC	R/W	0h	YNNSW pin SW configuration

Table 12-31. STEPCONFIG5 Register Field Descriptions (continued)

Bit	Field	Type	Reset	Description
7	YPPSW_SWC	R/W	0h	YPPSW pin SW configuration
6	XNNSW_SWC	R/W	0h	XNNSW pin SW configuration
5	XPPSW_SWC	R/W	0h	XPPSW pin SW configuration
4-2	Averaging	R/W	0h	Number of samples to average: 000 = No average. 001 = 2 samples average. 010 = 4 samples average. 011 = 8 samples average. 100 = 16 samples average.
1-0	Mode	R/W	0h	00 = SW enabled, one-shot. 01 = SW enabled, continuous. 10 = HW synchronized, one-shot. 11 = HW synchronized, continuous.

12.5.1.28 STEPDELAY5 Register (offset = 88h) [reset = 0h]

Register mask: FFFFFFFFh

 STEPDELAY5 is shown in [Figure 12-32](#) and described in [Table 12-32](#).

Step Delay Register 5

Figure 12-32. STEPDELAY5 Register

31	30	29	28	27	26	25	24	23	22	21	20	19	18	17	16
SampleDelay								RESERVED						OpenDelay	
R/W-0h								R/W-0h						R/W-0h	
15	14	13	12	11	10	9	8	7	6	5	4	3	2	1	0
OpenDelay															
R/W-0h															

LEGEND: R/W = Read/Write; R = Read only; W1toCl = Write 1 to clear bit; -n = value after reset

Table 12-32. STEPDELAY5 Register Field Descriptions

Bit	Field	Type	Reset	Description
31-24	SampleDelay	R/W	0h	This register will control the number of ADC clock cycles to sample (hold SOC high). Any value programmed here will be added to the minimum requirement of 1 clock cycle.
23-18	RESERVED	R/W	0h	
17-0	OpenDelay	R/W	0h	Program the number of ADC clock cycles to wait after applying the step configuration registers and before sending the start of ADC conversion

12.5.1.29 STEPCONFIG6 Register (offset = 8Ch) [reset = 0h]

Register mask: FFFFFFFFh

 STEPCONFIG6 is shown in [Figure 12-33](#) and described in [Table 12-33](#).

Step Configuration 6

Figure 12-33. STEPCONFIG6 Register

31	30	29	28	27	26	25	24
RESERVED				Range_check	FIFO_select	Diff_CNTRL	SEL_RFM_SW C_1_0
R/W-0h				R/W-0h	R/W-0h	R/W-0h	R/W-0h
23	22	21	20	19	18	17	16
SEL_RFM_SW C_1_0	SEL_INP_SWC_3_0			SEL_INM_SWC_3_0			
R/W-0h	R/W-0h			R/W-0h			
15	14	13	12	11	10	9	8
SEL_INM_SW C_3_0	SEL_RFP_SWC_2_0			WPNSW_SWC	YPNSW_SWC	XNPSW_SWC	YNNSW_SWC
R/W-0h	R/W-0h			R/W-0h	R/W-0h	R/W-0h	R/W-0h
7	6	5	4	3	2	1	0
YPPSW_SWC	XNNSW_SWC	XPPSW_SWC	Averaging			Mode	
R/W-0h	R/W-0h	R/W-0h	R/W-0h			R/W-0h	

LEGEND: R/W = Read/Write; R = Read only; W1toCl = Write 1 to clear bit; -n = value after reset

Table 12-33. STEPCONFIG6 Register Field Descriptions

Bit	Field	Type	Reset	Description
31-28	RESERVED	R/W	0h	
27	Range_check	R/W	0h	0 = Disable out-of-range check. 1 = Compare ADC data with range check register.
26	FIFO_select	R/W	0h	Sampled data will be stored in FIFO. 0 = FIFO. 1 = FIFO1.
25	Diff_CNTRL	R/W	0h	Differential Control Pin
24-23	SEL_RFM_SWC_1_0	R/W	0h	SEL_RFM pins SW configuration. 00 = VSSA. 01 = XNUR. 10 = YNLR. 11 = VREFN.
22-19	SEL_INP_SWC_3_0	R/W	0h	SEL_INP pins SW configuration. 0000 = Channel 1. 0111 = Channel 8. 1xxx = VREFN.
18-15	SEL_INM_SWC_3_0	R/W	0h	SEL_INM pins for negative differential. 0000 = Channel 1. 0111 = Channel 8. 1xxx = VREFN.
14-12	SEL_RFP_SWC_2_0	R/W	0h	SEL_RFP pins SW configuration. 000 = VDDA_ADC. 001 = XPUL. 010 = YPLL. 011 = VREFP. 1xx = Reserved.
11	WPNSW_SWC	R/W	0h	WPNSW pin SW configuration
10	YPNSW_SWC	R/W	0h	YPNSW pin SW configuration
9	XNPSW_SWC	R/W	0h	XNPSW pin SW configuration
8	YNNSW_SWC	R/W	0h	YNNSW pin SW configuration

Table 12-33. STEPCONFIG6 Register Field Descriptions (continued)

Bit	Field	Type	Reset	Description
7	YPPSW_SWC	R/W	0h	YPPSW pin SW configuration
6	XNNSW_SWC	R/W	0h	XNNSW pin SW configuration
5	XPPSW_SWC	R/W	0h	XPPSW pin SW configuration
4-2	Averaging	R/W	0h	Number of samples to average: 000 = No average. 001 = 2 samples average. 010 = 4 samples average. 011 = 8 samples average. 100 = 16 samples average.
1-0	Mode	R/W	0h	00 = SW enabled, one-shot. 01 = SW enabled, continuous. 10 = HW synchronized, one-shot. 11 = HW synchronized, continuous.

12.5.1.30 STEPDELAY6 Register (offset = 90h) [reset = 0h]

Register mask: FFFFFFFFh

 STEPDELAY6 is shown in [Figure 12-34](#) and described in [Table 12-34](#).

Step Delay Register 6

Figure 12-34. STEPDELAY6 Register

31	30	29	28	27	26	25	24	23	22	21	20	19	18	17	16
SampleDelay								RESERVED						OpenDelay	
R/W-0h								R/W-0h						R/W-0h	
15	14	13	12	11	10	9	8	7	6	5	4	3	2	1	0
OpenDelay															
R/W-0h															

LEGEND: R/W = Read/Write; R = Read only; W1toCl = Write 1 to clear bit; -n = value after reset

Table 12-34. STEPDELAY6 Register Field Descriptions

Bit	Field	Type	Reset	Description
31-24	SampleDelay	R/W	0h	This register will control the number of ADC clock cycles to sample (hold SOC high). Any value programmed here will be added to the minimum requirement of 1 clock cycle.
23-18	RESERVED	R/W	0h	
17-0	OpenDelay	R/W	0h	Program the number of ADC clock cycles to wait after applying the step configuration registers and before sending the start of ADC conversion

12.5.1.31 STEPCONFIG7 Register (offset = 94h) [reset = 0h]

Register mask: FFFFFFFFh

STEPCONFIG7 is shown in [Figure 12-35](#) and described in [Table 12-35](#).

Step Configuration 7

Figure 12-35. STEPCONFIG7 Register

31	30	29	28	27	26	25	24
RESERVED				Range_check	FIFO_select	Diff_CNTRL	SEL_RFM_SW C_1_0
R/W-0h				R/W-0h	R/W-0h	R/W-0h	R/W-0h
23	22	21	20	19	18	17	16
SEL_RFM_SW C_1_0	SEL_INP_SWC_3_0				SEL_INM_SWC_3_0		
R/W-0h	R/W-0h				R/W-0h		
15	14	13	12	11	10	9	8
SEL_INM_SW C_3_0	SEL_RFP_SWC_2_0			WPNSW_SWC	YPNSW_SWC	XNPSW_SWC	YNNSW_SWC
R/W-0h	R/W-0h			R/W-0h	R/W-0h	R/W-0h	R/W-0h
7	6	5	4	3	2	1	0
YPPSW_SWC	XNNSW_SWC	XPPSW_SWC	Averaging			Mode	
R/W-0h	R/W-0h	R/W-0h	R/W-0h			R/W-0h	

LEGEND: R/W = Read/Write; R = Read only; W1toCl = Write 1 to clear bit; -n = value after reset

Table 12-35. STEPCONFIG7 Register Field Descriptions

Bit	Field	Type	Reset	Description
31-28	RESERVED	R/W	0h	
27	Range_check	R/W	0h	0 = Disable out-of-range check. 1 = Compare ADC data with range check register.
26	FIFO_select	R/W	0h	Sampled data will be stored in FIFO. 0 = FIFO. 1 = FIFO1.
25	Diff_CNTRL	R/W	0h	Differential Control Pin
24-23	SEL_RFM_SWC_1_0	R/W	0h	SEL_RFM pins SW configuration. 00 = VSSA. 01 = XNUR. 10 = YNLR. 11 = VREFN.
22-19	SEL_INP_SWC_3_0	R/W	0h	SEL_INP pins SW configuration. 0000 = Channel 1. 0111 = Channel 8. 1xxx = VREFN.
18-15	SEL_INM_SWC_3_0	R/W	0h	SEL_INM pins for negative differential. 0000 = Channel 1. 0111 = Channel 8. 1xxx = VREFN.
14-12	SEL_RFP_SWC_2_0	R/W	0h	SEL_RFP pins SW configuration. 000 = VDDA_ADC. 001 = XPUL. 010 = YPLL. 011 = VREFP. 1xx = Reserved.
11	WPNSW_SWC	R/W	0h	WPNSW pin SW configuration
10	YPNSW_SWC	R/W	0h	YPNSW pin SW configuration
9	XNPSW_SWC	R/W	0h	XNPSW pin SW configuration
8	YNNSW_SWC	R/W	0h	YNNSW pin SW configuration

Table 12-35. STEPCONFIG7 Register Field Descriptions (continued)

Bit	Field	Type	Reset	Description
7	YPPSW_SWC	R/W	0h	YPPSW pin SW configuration
6	XNNSW_SWC	R/W	0h	XNNSW pin SW configuration
5	XPPSW_SWC	R/W	0h	XPPSW pin SW configuration
4-2	Averaging	R/W	0h	Number of samples to average: 000 = No average. 001 = 2 samples average. 010 = 4 samples average. 011 = 8 samples average. 100 = 16 samples average.
1-0	Mode	R/W	0h	00 = SW enabled, one-shot. 01 = SW enabled, continuous. 10 = HW synchronized, one-shot. 11 = HW synchronized, continuous.

12.5.1.32 STEPDELAY7 Register (offset = 98h) [reset = 0h]

Register mask: FFFFFFFFh

 STEPDELAY7 is shown in [Figure 12-36](#) and described in [Table 12-36](#).

Step Delay Register 7

Figure 12-36. STEPDELAY7 Register

31	30	29	28	27	26	25	24	23	22	21	20	19	18	17	16
SampleDelay								RESERVED						OpenDelay	
R/W-0h								R/W-0h						R/W-0h	
15	14	13	12	11	10	9	8	7	6	5	4	3	2	1	0
OpenDelay															
R/W-0h															

LEGEND: R/W = Read/Write; R = Read only; W1toCl = Write 1 to clear bit; -n = value after reset

Table 12-36. STEPDELAY7 Register Field Descriptions

Bit	Field	Type	Reset	Description
31-24	SampleDelay	R/W	0h	This register will control the number of ADC clock cycles to sample (hold SOC high). Any value programmed here will be added to the minimum requirement of 1 clock cycle.
23-18	RESERVED	R/W	0h	
17-0	OpenDelay	R/W	0h	Program the number of ADC clock cycles to wait after applying the step configuration registers and before sending the start of ADC conversion

12.5.1.33 STEPCONFIG8 Register (offset = 9Ch) [reset = 0h]

Register mask: FFFFFFFFh

 STEPCONFIG8 is shown in [Figure 12-37](#) and described in [Table 12-37](#).

Step Configuration 8

Figure 12-37. STEPCONFIG8 Register

31	30	29	28	27	26	25	24
RESERVED				Range_check	FIFO_select	Diff_CNTRL	SEL_RFM_SW_C_1_0
R/W-0h				R/W-0h	R/W-0h	R/W-0h	R/W-0h
23	22	21	20	19	18	17	16
SEL_RFM_SW_C_1_0	SEL_INP_SWC_3_0			SEL_INM_SWC_3_0			
R/W-0h		R/W-0h			R/W-0h		
15	14	13	12	11	10	9	8
SEL_INM_SW_C_3_0	SEL_RFP_SWC_2_0			WPNSW_SWC	YPNSW_SWC	XNPSW_SWC	YNNSW_SWC
R/W-0h		R/W-0h		R/W-0h	R/W-0h	R/W-0h	R/W-0h
7	6	5	4	3	2	1	0
YPPSW_SWC	XNNSW_SWC	XPPSW_SWC	Averaging		Mode		
R/W-0h	R/W-0h	R/W-0h	R/W-0h		R/W-0h		

LEGEND: R/W = Read/Write; R = Read only; W1toCl = Write 1 to clear bit; -n = value after reset

Table 12-37. STEPCONFIG8 Register Field Descriptions

Bit	Field	Type	Reset	Description
31-28	RESERVED	R/W	0h	
27	Range_check	R/W	0h	0 = Disable out-of-range check. 1 = Compare ADC data with range check register.
26	FIFO_select	R/W	0h	Sampled data will be stored in FIFO. 0 = FIFO. 1 = FIFO1.
25	Diff_CNTRL	R/W	0h	Differential Control Pin
24-23	SEL_RFM_SWC_1_0	R/W	0h	SEL_RFM pins SW configuration. 00 = VSSA. 01 = XNUR. 10 = YNLR. 11 = VREFN.
22-19	SEL_INP_SWC_3_0	R/W	0h	SEL_INP pins SW configuration. 0000 = Channel 1. 0111 = Channel 8. 1xxx = VREFN.
18-15	SEL_INM_SWC_3_0	R/W	0h	SEL_INM pins for negative differential. 0000 = Channel 1. 0111 = Channel 8. 1xxx = VREFN.
14-12	SEL_RFP_SWC_2_0	R/W	0h	SEL_RFP pins SW configuration. 000 = VDDA_ADC. 001 = XPUL. 010 = YPLL. 011 = VREFP. 1xx = Reserved.
11	WPNSW_SWC	R/W	0h	WPNSW pin SW configuration
10	YPNSW_SWC	R/W	0h	YPNSW pin SW configuration
9	XNPSW_SWC	R/W	0h	XNPSW pin SW configuration
8	YNNSW_SWC	R/W	0h	YNNSW pin SW configuration

Table 12-37. STEPCONFIG8 Register Field Descriptions (continued)

Bit	Field	Type	Reset	Description
7	YPPSW_SWC	R/W	0h	YPPSW pin SW configuration
6	XNNSW_SWC	R/W	0h	XNNSW pin SW configuration
5	XPPSW_SWC	R/W	0h	XPPSW pin SW configuration
4-2	Averaging	R/W	0h	Number of samples to average: 000 = No average. 001 = 2 samples average. 010 = 4 samples average. 011 = 8 samples average. 100 = 16 samples average.
1-0	Mode	R/W	0h	00 = SW enabled, one-shot. 01 = SW enabled, continuous. 10 = HW synchronized, one-shot. 11 = HW synchronized, continuous.

12.5.1.34 STEPDELAY8 Register (offset = A0h) [reset = 0h]

Register mask: FFFFFFFFh

 STEPDELAY8 is shown in [Figure 12-38](#) and described in [Table 12-38](#).

Step Delay Register 8

Figure 12-38. STEPDELAY8 Register

31	30	29	28	27	26	25	24	23	22	21	20	19	18	17	16
SampleDelay								RESERVED						OpenDelay	
R/W-0h								R/W-0h						R/W-0h	
15	14	13	12	11	10	9	8	7	6	5	4	3	2	1	0
OpenDelay															
R/W-0h															

LEGEND: R/W = Read/Write; R = Read only; W1toCl = Write 1 to clear bit; -n = value after reset

Table 12-38. STEPDELAY8 Register Field Descriptions

Bit	Field	Type	Reset	Description
31-24	SampleDelay	R/W	0h	This register will control the number of ADC clock cycles to sample (hold SOC high). Any value programmed here will be added to the minimum requirement of 1 clock cycle.
23-18	RESERVED	R/W	0h	
17-0	OpenDelay	R/W	0h	Program the number of ADC clock cycles to wait after applying the step configuration registers and before sending the start of ADC conversion

12.5.1.35 STEPCONFIG9 Register (offset = A4h) [reset = 0h]

Register mask: FFFFFFFFh

STEPCONFIG9 is shown in [Figure 12-39](#) and described in [Table 12-39](#).

Step Configuration 9

Figure 12-39. STEPCONFIG9 Register

31	30	29	28	27	26	25	24
RESERVED				Range_check	FIFO_select	Diff_CNTRL	SEL_RFM_SW C_1_0
R/W-0h				R/W-0h	R/W-0h	R/W-0h	R/W-0h
23	22	21	20	19	18	17	16
SEL_RFM_SW C_1_0	SEL_INP_SWC_3_0			SEL_INM_SWC_3_0			
R/W-0h	R/W-0h			R/W-0h			
15	14	13	12	11	10	9	8
SEL_INM_SW C_3_0	SEL_RFP_SWC_2_0			WPNSW_SWC	YPNSW_SWC	XNPSW_SWC	YNNSW_SWC
R/W-0h	R/W-0h			R/W-0h	R/W-0h	R/W-0h	R/W-0h
7	6	5	4	3	2	1	0
YPPSW_SWC	XNNSW_SWC	XPPSW_SWC	Averaging			Mode	
R/W-0h	R/W-0h	R/W-0h	R/W-0h			R/W-0h	

LEGEND: R/W = Read/Write; R = Read only; W1toCl = Write 1 to clear bit; -n = value after reset

Table 12-39. STEPCONFIG9 Register Field Descriptions

Bit	Field	Type	Reset	Description
31-28	RESERVED	R/W	0h	
27	Range_check	R/W	0h	0 = Disable out-of-range check. 1 = Compare ADC data with range check register.
26	FIFO_select	R/W	0h	Sampled data will be stored in FIFO. 0 = FIFO 1. = FIFO1.
25	Diff_CNTRL	R/W	0h	Differential Control Pin
24-23	SEL_RFM_SWC_1_0	R/W	0h	SEL_RFM pins SW configuration. 00 = VSSA. 01 = XNUR. 10 = YNLR. 11 = VREFN.
22-19	SEL_INP_SWC_3_0	R/W	0h	SEL_INP pins SW configuration. 0000 = Channel 1. 0111 = Channel 8. 1xxx = VREFN.
18-15	SEL_INM_SWC_3_0	R/W	0h	SEL_INM pins for negative differential. 0000 = Channel 1. 0111 = Channel 8. 1xxx = VREFN.
14-12	SEL_RFP_SWC_2_0	R/W	0h	SEL_RFP pins SW configuration. 000 = VDDA_ADC. 001 = XPUL. 010 = YPLL. 011 = VREFP. 1xx = Reserved.
11	WPNSW_SWC	R/W	0h	WPNSW pin SW configuration
10	YPNSW_SWC	R/W	0h	YPNSW pin SW configuration
9	XNPSW_SWC	R/W	0h	XNPSW pin SW configuration
8	YNNSW_SWC	R/W	0h	YNNSW pin SW configuration

Table 12-39. STEPCONFIG9 Register Field Descriptions (continued)

Bit	Field	Type	Reset	Description
7	YPPSW_SWC	R/W	0h	YPPSW pin SW configuration
6	XNNSW_SWC	R/W	0h	XNNSW pin SW configuration
5	XPPSW_SWC	R/W	0h	XPPSW pin SW configuration
4-2	Averaging	R/W	0h	Number of samples to average: 000 = No average. 001 = 2 samples average. 010 = 4 samples average. 011 = 8 samples average. 100 = 16 samples average.
1-0	Mode	R/W	0h	00 = SW enabled, one-shot. 01 = SW enabled, continuous. 10 = HW synchronized, one-shot. 11 = HW synchronized, continuous.

12.5.1.36 STEPDELAY9 Register (offset = A8h) [reset = 0h]

Register mask: FFFFFFFFh

 STEPDELAY9 is shown in [Figure 12-40](#) and described in [Table 12-40](#).

Step Delay Register 9

Figure 12-40. STEPDELAY9 Register

31	30	29	28	27	26	25	24	23	22	21	20	19	18	17	16
SampleDelay								RESERVED						OpenDelay	
R/W-0h								R/W-0h						R/W-0h	
15	14	13	12	11	10	9	8	7	6	5	4	3	2	1	0
OpenDelay															
R/W-0h															

LEGEND: R/W = Read/Write; R = Read only; W1toCl = Write 1 to clear bit; -n = value after reset

Table 12-40. STEPDELAY9 Register Field Descriptions

Bit	Field	Type	Reset	Description
31-24	SampleDelay	R/W	0h	This register will control the number of ADC clock cycles to sample (hold SOC high). Any value programmed here will be added to the minimum requirement of 1 clock cycle.
23-18	RESERVED	R/W	0h	
17-0	OpenDelay	R/W	0h	Program the number of ADC clock cycles to wait after applying the step configuration registers and before sending the start of ADC conversion

12.5.1.37 STEPCONFIG10 Register (offset = ACh) [reset = 0h]

Register mask: FFFFFFFFh

 STEPCONFIG10 is shown in [Figure 12-41](#) and described in [Table 12-41](#).

Step Configuration 10

Figure 12-41. STEPCONFIG10 Register

31	30	29	28	27	26	25	24
RESERVED				Range_check	FIFO_select	Diff_CNTRL	SEL_RFM_SW_C_1_0
R/W-0h				R/W-0h	R/W-0h	R/W-0h	R/W-0h
23	22	21	20	19	18	17	16
SEL_RFM_SW_C_1_0	SEL_INP_SWC_3_0				SEL_INM_SWC_3_0		
R/W-0h		R/W-0h			R/W-0h		
15	14	13	12	11	10	9	8
SEL_INM_SW_C_3_0	SEL_RFP_SWC_2_0			WPNSW_SWC	YPNSW_SWC	XNPSW_SWC	YNNSW_SWC
R/W-0h		R/W-0h		R/W-0h	R/W-0h	R/W-0h	R/W-0h
7	6	5	4	3	2	1	0
YPPSW_SWC	XNNSW_SWC	XPPSW_SWC	Averaging		Mode		
R/W-0h	R/W-0h	R/W-0h	R/W-0h		R/W-0h		

LEGEND: R/W = Read/Write; R = Read only; W1toCl = Write 1 to clear bit; -n = value after reset

Table 12-41. STEPCONFIG10 Register Field Descriptions

Bit	Field	Type	Reset	Description
31-28	RESERVED	R/W	0h	
27	Range_check	R/W	0h	0 = Disable out-of-range check. 1 = Compare ADC data with range check register.
26	FIFO_select	R/W	0h	Sampled data will be stored in FIFO. 0 = FIFO. 1 = FIFO1.
25	Diff_CNTRL	R/W	0h	Differential Control Pin
24-23	SEL_RFM_SWC_1_0	R/W	0h	SEL_RFM pins SW configuration. 00 = VSSA. 01 = XNUR. 10 = YNLR. 11 = VREFN.
22-19	SEL_INP_SWC_3_0	R/W	0h	SEL_INP pins SW configuration. 0000 = Channel 1. 0111 = Channel 8. 1xxx = VREFN.
18-15	SEL_INM_SWC_3_0	R/W	0h	SEL_INM pins for negative differential. 0000 = Channel 1. 0111 = Channel 8. 1xxx = VREFN.
14-12	SEL_RFP_SWC_2_0	R/W	0h	SEL_RFP pins SW configuration. 000 = VDDA_ADC. 001 = XPUL. 010 = YPLL. 011 = VREFP. 1xx = Reserved.
11	WPNSW_SWC	R/W	0h	WPNSW pin SW configuration
10	YPNSW_SWC	R/W	0h	YPNSW pin SW configuration
9	XNPSW_SWC	R/W	0h	XNPSW pin SW configuration
8	YNNSW_SWC	R/W	0h	YNNSW pin SW configuration

Table 12-41. STEPCONFIG10 Register Field Descriptions (continued)

Bit	Field	Type	Reset	Description
7	YPPSW_SWC	R/W	0h	YPPSW pin SW configuration
6	XNNSW_SWC	R/W	0h	XNNSW pin SW configuration
5	XPPSW_SWC	R/W	0h	XPPSW pin SW configuration
4-2	Averaging	R/W	0h	Number of samples to average: 000 = No average. 001 = 2 samples average. 010 = 4 samples average. 011 = 8 samples average. 100 = 16 samples average.
1-0	Mode	R/W	0h	00 = SW enabled, one-shot. 01 = SW enabled, continuous. 10 = HW synchronized, one-shot. 11 = HW synchronized, continuous.

12.5.1.38 STEPDELAY10 Register (offset = B0h) [reset = 0h]

Register mask: FFFFFFFFh

 STEPDELAY10 is shown in [Figure 12-42](#) and described in [Table 12-42](#).

Step Delay Register 10

Figure 12-42. STEPDELAY10 Register

31	30	29	28	27	26	25	24	23	22	21	20	19	18	17	16
SampleDelay								RESERVED						OpenDelay	
R/W-0h								R/W-0h						R/W-0h	
15	14	13	12	11	10	9	8	7	6	5	4	3	2	1	0
OpenDelay															
R/W-0h															

LEGEND: R/W = Read/Write; R = Read only; W1toCl = Write 1 to clear bit; -n = value after reset

Table 12-42. STEPDELAY10 Register Field Descriptions

Bit	Field	Type	Reset	Description
31-24	SampleDelay	R/W	0h	This register will control the number of ADC clock cycles to sample (hold SOC high). Any value programmed here will be added to the minimum requirement of 1 clock cycle.
23-18	RESERVED	R/W	0h	
17-0	OpenDelay	R/W	0h	Program the number of ADC clock cycles to wait after applying the step configuration registers and before sending the start of ADC conversion

12.5.1.39 STEPCONFIG11 Register (offset = B4h) [reset = 0h]

Register mask: FFFFFFFFh

STEPCONFIG11 is shown in [Figure 12-43](#) and described in [Table 12-43](#).

Step Configuration 11

Figure 12-43. STEPCONFIG11 Register

31	30	29	28	27	26	25	24
RESERVED				Range_check	FIFO_select	Diff_CNTRL	SEL_RFM_SW C_1_0
R/W-0h				R/W-0h	R/W-0h	R/W-0h	R/W-0h
23	22	21	20	19	18	17	16
SEL_RFM_SW C_1_0	SEL_INP_SWC_3_0			SEL_INM_SWC_3_0			
R/W-0h		R/W-0h			R/W-0h		
15	14	13	12	11	10	9	8
SEL_INM_SW C_3_0	SEL_RFP_SWC_2_0			WPNSW_SWC	YPNSW_SWC	XNPSW_SWC	YNNSW_SWC
R/W-0h		R/W-0h		R/W-0h	R/W-0h	R/W-0h	R/W-0h
7	6	5	4	3	2	1	0
YPPSW_SWC	XNNSW_SWC	XPPSW_SWC	Averaging		Mode		
R/W-0h	R/W-0h	R/W-0h	R/W-0h		R/W-0h		

LEGEND: R/W = Read/Write; R = Read only; W1toCl = Write 1 to clear bit; -n = value after reset

Table 12-43. STEPCONFIG11 Register Field Descriptions

Bit	Field	Type	Reset	Description
31-28	RESERVED	R/W	0h	
27	Range_check	R/W	0h	0 = Disable out-of-range check. 1 = Compare ADC data with range check register.
26	FIFO_select	R/W	0h	Sampled data will be stored in FIFO. 0 = FIFO. 1 = FIFO1.
25	Diff_CNTRL	R/W	0h	Differential Control Pin
24-23	SEL_RFM_SWC_1_0	R/W	0h	SEL_RFM pins SW configuration. 00 = VSSA. 01 = XNUR. 10 = YNLR. 11 = VREFN.
22-19	SEL_INP_SWC_3_0	R/W	0h	SEL_INP pins SW configuration. 0000 = Channel 1. 0111 = Channel 8. 1xxx = VREFN.
18-15	SEL_INM_SWC_3_0	R/W	0h	SEL_INM pins for negative differential. 0000 = Channel 1. 0111 = Channel 8. 1xxx = VREFN.
14-12	SEL_RFP_SWC_2_0	R/W	0h	SEL_RFP pins SW configuration. 000 = VDDA_ADC. 001 = XPUL. 010 = YPLL. 011 = VREFP. 1xx = Reserved.
11	WPNSW_SWC	R/W	0h	WPNSW pin SW configuration
10	YPNSW_SWC	R/W	0h	YPNSW pin SW configuration
9	XNPSW_SWC	R/W	0h	XNPSW pin SW configuration
8	YNNSW_SWC	R/W	0h	YNNSW pin SW configuration

Table 12-43. STEPCONFIG11 Register Field Descriptions (continued)

Bit	Field	Type	Reset	Description
7	YPPSW_SWC	R/W	0h	YPPSW pin SW configuration
6	XNNSW_SWC	R/W	0h	XNNSW pin SW configuration
5	XPPSW_SWC	R/W	0h	XPPSW pin SW configuration
4-2	Averaging	R/W	0h	Number of samples to average: 000 = No average. 001 = 2 samples average. 010 = 4 samples average. 011 = 8 samples average. 100 = 16 samples average.
1-0	Mode	R/W	0h	00 = SW enabled, one-shot. 01 = SW enabled, continuous. 10 = HW synchronized, one-shot. 11 = HW synchronized, continuous.

12.5.1.40 STEPDELAY11 Register (offset = B8h) [reset = 0h]

Register mask: FFFFFFFFh

 STEPDELAY11 is shown in [Figure 12-44](#) and described in [Table 12-44](#).

Step Delay Register 11

Figure 12-44. STEPDELAY11 Register

31	30	29	28	27	26	25	24	23	22	21	20	19	18	17	16
SampleDelay								RESERVED						OpenDelay	
R/W-0h								R/W-0h						R/W-0h	
15	14	13	12	11	10	9	8	7	6	5	4	3	2	1	0
OpenDelay															
R/W-0h															

LEGEND: R/W = Read/Write; R = Read only; W1toCl = Write 1 to clear bit; -n = value after reset

Table 12-44. STEPDELAY11 Register Field Descriptions

Bit	Field	Type	Reset	Description
31-24	SampleDelay	R/W	0h	This register will control the number of ADC clock cycles to sample (hold SOC high). Any value programmed here will be added to the minimum requirement of 1 clock cycle.
23-18	RESERVED	R/W	0h	
17-0	OpenDelay	R/W	0h	Program the number of ADC clock cycles to wait after applying the step configuration registers and before sending the start of ADC conversion

12.5.1.41 STEPCONFIG12 Register (offset = BCh) [reset = 0h]

Register mask: FFFFFFFFh

 STEPCONFIG12 is shown in [Figure 12-45](#) and described in [Table 12-45](#).

Step Configuration 12

Figure 12-45. STEPCONFIG12 Register

31	30	29	28	27	26	25	24
RESERVED				Range_check	FIFO_select	Diff_CNTRL	SEL_RFM_SW C_1_0
R/W-0h				R/W-0h	R/W-0h	R/W-0h	R/W-0h
23	22	21	20	19	18	17	16
SEL_RFM_SW C_1_0	SEL_INP_SWC_3_0			SEL_INM_SWC_3_0			
R/W-0h	R/W-0h			R/W-0h			
15	14	13	12	11	10	9	8
SEL_INM_SW C_3_0	SEL_RFP_SWC_2_0			WPNSW_SWC	YPNSW_SWC	XNPSW_SWC	YNNSW_SWC
R/W-0h	R/W-0h			R/W-0h	R/W-0h	R/W-0h	R/W-0h
7	6	5	4	3	2	1	0
YPPSW_SWC	XNNSW_SWC	XPPSW_SWC	Averaging			Mode	
R/W-0h	R/W-0h	R/W-0h	R/W-0h			R/W-0h	

LEGEND: R/W = Read/Write; R = Read only; W1toCl = Write 1 to clear bit; -n = value after reset

Table 12-45. STEPCONFIG12 Register Field Descriptions

Bit	Field	Type	Reset	Description
31-28	RESERVED	R/W	0h	
27	Range_check	R/W	0h	0 = Disable out-of-range check. 1 = Compare ADC data with range check register.
26	FIFO_select	R/W	0h	Sampled data will be stored in FIFO. 0 = FIFO. 1 = FIFO1.
25	Diff_CNTRL	R/W	0h	Differential Control Pin
24-23	SEL_RFM_SWC_1_0	R/W	0h	SEL_RFM pins SW configuration. 00 = VSSA. 01 = XNUR. 10 = YNLR. 11 = VREFN.
22-19	SEL_INP_SWC_3_0	R/W	0h	SEL_INP pins SW configuration. 0000 = Channel 1. 0111 = Channel 8. 1xxx = VREFN.
18-15	SEL_INM_SWC_3_0	R/W	0h	SEL_INM pins for negative differential. 0000 = Channel 1. 0111 = Channel 8. 1xxx = VREFN.
14-12	SEL_RFP_SWC_2_0	R/W	0h	SEL_RFP pins SW configuration. 000 = VDDA_ADC. 001 = XPUL. 010 = YPLL. 011 = VREFP. 1xx = Reserved.
11	WPNSW_SWC	R/W	0h	WPNSW pin SW configuration
10	YPNSW_SWC	R/W	0h	YPNSW pin SW configuration
9	XNPSW_SWC	R/W	0h	XNPSW pin SW configuration
8	YNNSW_SWC	R/W	0h	YNNSW pin SW configuration

Table 12-45. STEPCONFIG12 Register Field Descriptions (continued)

Bit	Field	Type	Reset	Description
7	YPPSW_SWC	R/W	0h	YPPSW pin SW configuration
6	XNNSW_SWC	R/W	0h	XNNSW pin SW configuration
5	XPPSW_SWC	R/W	0h	XPPSW pin SW configuration
4-2	Averaging	R/W	0h	Number of samples to average: 000 = No average. 001 = 2 samples average. 010 = 4 samples average. 011 = 8 samples average. 100 = 16 samples average.
1-0	Mode	R/W	0h	00 = SW enabled, one-shot. 01 = SW enabled, continuous. 10 = HW synchronized, one-shot. 11 = HW synchronized, continuous.

12.5.1.42 STEPDELAY12 Register (offset = C0h) [reset = 0h]

Register mask: FFFFFFFFh

 STEPDELAY12 is shown in [Figure 12-46](#) and described in [Table 12-46](#).

Step Delay Register 12

Figure 12-46. STEPDELAY12 Register

31	30	29	28	27	26	25	24	23	22	21	20	19	18	17	16
SampleDelay								RESERVED						OpenDelay	
R/W-0h								R/W-0h						R/W-0h	
15	14	13	12	11	10	9	8	7	6	5	4	3	2	1	0
OpenDelay															
R/W-0h															

LEGEND: R/W = Read/Write; R = Read only; W1toCl = Write 1 to clear bit; -n = value after reset

Table 12-46. STEPDELAY12 Register Field Descriptions

Bit	Field	Type	Reset	Description
31-24	SampleDelay	R/W	0h	This register will control the number of ADC clock cycles to sample (hold SOC high). Any value programmed here will be added to the minimum requirement of 1 clock cycle.
23-18	RESERVED	R/W	0h	
17-0	OpenDelay	R/W	0h	Program the number of ADC clock cycles to wait after applying the step configuration registers and before sending the start of ADC conversion

12.5.1.43 STEPCONFIG13 Register (offset = C4h) [reset = 0h]

Register mask: FFFFFFFFh

STEPCONFIG13 is shown in [Figure 12-47](#) and described in [Table 12-47](#).

Step Configuration 13

Figure 12-47. STEPCONFIG13 Register

31	30	29	28	27	26	25	24
RESERVED				Range_check	FIFO_select	Diff_CNTRL	SEL_RFM_SW C_1_0
R/W-0h				R/W-0h	R/W-0h	R/W-0h	R/W-0h
23	22	21	20	19	18	17	16
SEL_RFM_SW C_1_0	SEL_INP_SWC_3_0			SEL_INM_SWC_3_0			
R/W-0h		R/W-0h			R/W-0h		
15	14	13	12	11	10	9	8
SEL_INM_SW C_3_0	SEL_RFP_SWC_2_0			WPNSW_SWC	YPNSW_SWC	XNPSW_SWC	YNNSW_SWC
R/W-0h		R/W-0h		R/W-0h	R/W-0h	R/W-0h	R/W-0h
7	6	5	4	3	2	1	0
YPPSW_SWC	XNNSW_SWC	XPPSW_SWC	Averaging		Mode		
R/W-0h	R/W-0h	R/W-0h	R/W-0h		R/W-0h		

LEGEND: R/W = Read/Write; R = Read only; W1toCl = Write 1 to clear bit; -n = value after reset

Table 12-47. STEPCONFIG13 Register Field Descriptions

Bit	Field	Type	Reset	Description
31-28	RESERVED	R/W	0h	
27	Range_check	R/W	0h	0 = Disable out-of-range check. 1 = Compare ADC data with range check register.
26	FIFO_select	R/W	0h	Sampled data will be stored in FIFO. 0 = FIFO. 1 = FIFO1.
25	Diff_CNTRL	R/W	0h	Differential Control Pin
24-23	SEL_RFM_SWC_1_0	R/W	0h	SEL_RFM pins SW configuration. 00 = VSSA. 01 = XNUR. 10 = YNLR. 11 = VREFN.
22-19	SEL_INP_SWC_3_0	R/W	0h	SEL_INP pins SW configuration. 0000 = Channel 1. 0111 = Channel 8. 1xxx = VREFN.
18-15	SEL_INM_SWC_3_0	R/W	0h	SEL_INM pins for negative differential. 0000 = Channel 1. 0111 = Channel 8. 1xxx = VREFN.
14-12	SEL_RFP_SWC_2_0	R/W	0h	SEL_RFP pins SW configuration. 000 = VDDA_ADC. 001 = XPUL. 010 = YPLL. 011 = VREFP. 1xx = Reserved.
11	WPNSW_SWC	R/W	0h	WPNSW pin SW configuration
10	YPNSW_SWC	R/W	0h	YPNSW pin SW configuration
9	XNPSW_SWC	R/W	0h	XNPSW pin SW configuration
8	YNNSW_SWC	R/W	0h	YNNSW pin SW configuration

Table 12-47. STEPCONFIG13 Register Field Descriptions (continued)

Bit	Field	Type	Reset	Description
7	YPPSW_SWC	R/W	0h	YPPSW pin SW configuration
6	XNNSW_SWC	R/W	0h	XNNSW pin SW configuration
5	XPPSW_SWC	R/W	0h	XPPSW pin SW configuration
4-2	Averaging	R/W	0h	Number of samples to average: 000 = No average. 001 = 2 samples average. 010 = 4 samples average. 011 = 8 samples average. 100 = 16 samples average.
1-0	Mode	R/W	0h	00 = SW enabled, one-shot. 01 = SW enabled, continuous. 10 = HW synchronized, one-shot. 11 = HW synchronized, continuous.

12.5.1.44 STEPDELAY13 Register (offset = C8h) [reset = 0h]

Register mask: FFFFFFFFh

 STEPDELAY13 is shown in [Figure 12-48](#) and described in [Table 12-48](#).

Step Delay Register 13

Figure 12-48. STEPDELAY13 Register

31	30	29	28	27	26	25	24	23	22	21	20	19	18	17	16
SampleDelay								RESERVED						OpenDelay	
R/W-0h								R/W-0h						R/W-0h	
15	14	13	12	11	10	9	8	7	6	5	4	3	2	1	0
OpenDelay															
R/W-0h															

LEGEND: R/W = Read/Write; R = Read only; W1toCl = Write 1 to clear bit; -n = value after reset

Table 12-48. STEPDELAY13 Register Field Descriptions

Bit	Field	Type	Reset	Description
31-24	SampleDelay	R/W	0h	This register will control the number of ADC clock cycles to sample (hold SOC high). Any value programmed here will be added to the minimum requirement of 1 clock cycle.
23-18	RESERVED	R/W	0h	
17-0	OpenDelay	R/W	0h	Program the number of ADC clock cycles to wait after applying the step configuration registers and before sending the start of ADC conversion

12.5.1.45 STEPCONFIG14 Register (offset = CCh) [reset = 0h]

Register mask: FFFFFFFFh

 STEPCONFIG14 is shown in [Figure 12-49](#) and described in [Table 12-49](#).

Step Configuration 14

Figure 12-49. STEPCONFIG14 Register

31	30	29	28	27	26	25	24
RESERVED				Range_check	FIFO_select	Diff_CNTRL	SEL_RFM_SW C_1_0
R/W-0h				R/W-0h	R/W-0h	R/W-0h	R/W-0h
23	22	21	20	19	18	17	16
SEL_RFM_SW C_1_0	SEL_INP_SWC_3_0				SEL_INM_SWC_3_0		
R/W-0h	R/W-0h				R/W-0h		
15	14	13	12	11	10	9	8
SEL_INM_SW C_3_0	SEL_RFP_SWC_2_0			WPNSW_SWC	YPNSW_SWC	XNPSW_SWC	YNNSW_SWC
R/W-0h	R/W-0h			R/W-0h	R/W-0h	R/W-0h	R/W-0h
7	6	5	4	3	2	1	0
YPPSW_SWC	XNNSW_SWC	XPPSW_SWC	Averaging		Mode		
R/W-0h	R/W-0h	R/W-0h	R/W-0h		R/W-0h		

LEGEND: R/W = Read/Write; R = Read only; W1toCl = Write 1 to clear bit; -n = value after reset

Table 12-49. STEPCONFIG14 Register Field Descriptions

Bit	Field	Type	Reset	Description
31-28	RESERVED	R/W	0h	
27	Range_check	R/W	0h	0 = Disable out-of-range check. 1 = Compare ADC data with range check register.
26	FIFO_select	R/W	0h	Sampled data will be stored in FIFO. 0 = FIFO. 1 = FIFO1.
25	Diff_CNTRL	R/W	0h	Differential Control Pin
24-23	SEL_RFM_SWC_1_0	R/W	0h	SEL_RFM pins SW configuration. 00 = VSSA. 01 = XNUR. 10 = YNLR. 11 = VREFN.
22-19	SEL_INP_SWC_3_0	R/W	0h	SEL_INP pins SW configuration. 0000 = Channel 1. 0111 = Channel 8. 1xxx = VREFN.
18-15	SEL_INM_SWC_3_0	R/W	0h	SEL_INM pins for negative differential. 0000 = Channel 1. 0111 = Channel 8. 1xxx = VREFN.
14-12	SEL_RFP_SWC_2_0	R/W	0h	SEL_RFP pins SW configuration. 000 = VDDA_ADC. 001 = XPUL. 010 = YPLL. 011 = VREFP. 1xx = Reserved.
11	WPNSW_SWC	R/W	0h	WPNSW pin SW configuration
10	YPNSW_SWC	R/W	0h	YPNSW pin SW configuration
9	XNPSW_SWC	R/W	0h	XNPSW pin SW configuration
8	YNNSW_SWC	R/W	0h	YNNSW pin SW configuration

Table 12-49. STEPCONFIG14 Register Field Descriptions (continued)

Bit	Field	Type	Reset	Description
7	YPPSW_SWC	R/W	0h	YPPSW pin SW configuration
6	XNNSW_SWC	R/W	0h	XNNSW pin SW configuration
5	XPPSW_SWC	R/W	0h	XPPSW pin SW configuration
4-2	Averaging	R/W	0h	Number of samples to average: 000 = No average. 001 = 2 samples average. 010 = 4 samples average. 011 = 8 samples average. 100 = 16 samples average.
1-0	Mode	R/W	0h	00 = SW enabled, one-shot. 01 = SW enabled, continuous. 10 = HW synchronized, one-shot. 11 = HW synchronized, continuous.

12.5.1.46 STEPDELAY14 Register (offset = D0h) [reset = 0h]

Register mask: FFFFFFFFh

 STEPDELAY14 is shown in [Figure 12-50](#) and described in [Table 12-50](#).

Step Delay Register 14

Figure 12-50. STEPDELAY14 Register

31	30	29	28	27	26	25	24	23	22	21	20	19	18	17	16
SampleDelay								RESERVED						OpenDelay	
R/W-0h								R/W-0h						R/W-0h	
15	14	13	12	11	10	9	8	7	6	5	4	3	2	1	0
OpenDelay															
R/W-0h															

LEGEND: R/W = Read/Write; R = Read only; W1toCl = Write 1 to clear bit; -n = value after reset

Table 12-50. STEPDELAY14 Register Field Descriptions

Bit	Field	Type	Reset	Description
31-24	SampleDelay	R/W	0h	This register will control the number of ADC clock cycles to sample (hold SOC high). Any value programmed here will be added to the minimum requirement of 1 clock cycle.
23-18	RESERVED	R/W	0h	
17-0	OpenDelay	R/W	0h	Program the number of ADC clock cycles to wait after applying the step configuration registers and before sending the start of ADC conversion

12.5.1.47 STEPCONFIG15 Register (offset = D4h) [reset = 0h]

Register mask: FFFFFFFFh

STEPCONFIG15 is shown in [Figure 12-51](#) and described in [Table 12-51](#).

Step Configuration 15

Figure 12-51. STEPCONFIG15 Register

31	30	29	28	27	26	25	24
RESERVED				Range_check	FIFO_select	Diff_CNTRL	SEL_RFM_SW_C_1_0
R/W-0h				R/W-0h	R/W-0h	R/W-0h	R/W-0h
23	22	21	20	19	18	17	16
SEL_RFM_SW_C_1_0	SEL_INP_SWC_3_0				SEL_INM_SWC_3_0		
R/W-0h		R/W-0h			R/W-0h		
15	14	13	12	11	10	9	8
SEL_INM_SW_C_3_0	SEL_RFP_SWC_2_0			WPNSW_SWC	YPNSW_SWC	XNPSW_SWC	YNNSW_SWC
R/W-0h		R/W-0h		R/W-0h	R/W-0h	R/W-0h	R/W-0h
7	6	5	4	3	2	1	0
YPPSW_SWC	XNNSW_SWC	XPPSW_SWC	Averaging		Mode		
R/W-0h	R/W-0h	R/W-0h	R/W-0h		R/W-0h		

LEGEND: R/W = Read/Write; R = Read only; W1toCl = Write 1 to clear bit; -n = value after reset

Table 12-51. STEPCONFIG15 Register Field Descriptions

Bit	Field	Type	Reset	Description
31-28	RESERVED	R/W	0h	
27	Range_check	R/W	0h	0 = Disable out-of-range check. 1 = Compare ADC data with range check register.
26	FIFO_select	R/W	0h	Sampled data will be stored in FIFO. 0 = FIFO. 1 = FIFO1.
25	Diff_CNTRL	R/W	0h	Differential Control Pin
24-23	SEL_RFM_SWC_1_0	R/W	0h	SEL_RFM pins SW configuration. 00 = VSSA. 01 = XNUR. 10 = YNLR. 11 = VREFN.
22-19	SEL_INP_SWC_3_0	R/W	0h	SEL_INP pins SW configuration. 0000 = Channel 1. 0111 = Channel 8. 1xxx = VREFN.
18-15	SEL_INM_SWC_3_0	R/W	0h	SEL_INM pins for negative differential. 0000 = Channel 1. 0111 = Channel 8. 1xxx = VREFN.
14-12	SEL_RFP_SWC_2_0	R/W	0h	SEL_RFP pins SW configuration. 000 = VDDA_ADC. 001 = XPUL. 010 = YPLL. 011 = VREFP. 1xx = Reserved.
11	WPNSW_SWC	R/W	0h	WPNSW pin SW configuration
10	YPNSW_SWC	R/W	0h	YPNSW pin SW configuration
9	XNPSW_SWC	R/W	0h	XNPSW pin SW configuration
8	YNNSW_SWC	R/W	0h	YNNSW pin SW configuration

Table 12-51. STEPCONFIG15 Register Field Descriptions (continued)

Bit	Field	Type	Reset	Description
7	YPPSW_SWC	R/W	0h	YPPSW pin SW configuration
6	XNNSW_SWC	R/W	0h	XNNSW pin SW configuration
5	XPPSW_SWC	R/W	0h	XPPSW pin SW configuration
4-2	Averaging	R/W	0h	Number of samples to average: 000 = No average. 001 = 2 samples average. 010 = 4 samples average. 011 = 8 samples average. 100 = 16 samples average.
1-0	Mode	R/W	0h	00 = SW enabled, one-shot. 01 = SW enabled, continuous. 10 = HW synchronized, one-shot. 11 = HW synchronized, continuous.

12.5.1.48 STEPDELAY15 Register (offset = D8h) [reset = 0h]

Register mask: FFFFFFFFh

 STEPDELAY15 is shown in [Figure 12-52](#) and described in [Table 12-52](#).

Step Delay Register 15

Figure 12-52. STEPDELAY15 Register

31	30	29	28	27	26	25	24	23	22	21	20	19	18	17	16
SampleDelay								RESERVED						OpenDelay	
R/W-0h								R/W-0h						R/W-0h	
15	14	13	12	11	10	9	8	7	6	5	4	3	2	1	0
OpenDelay															
R/W-0h															

LEGEND: R/W = Read/Write; R = Read only; W1toCl = Write 1 to clear bit; -n = value after reset

Table 12-52. STEPDELAY15 Register Field Descriptions

Bit	Field	Type	Reset	Description
31-24	SampleDelay	R/W	0h	This register will control the number of ADC clock cycles to sample (hold SOC high). Any value programmed here will be added to the minimum requirement of 1 clock cycle.
23-18	RESERVED	R/W	0h	
17-0	OpenDelay	R/W	0h	Program the number of ADC clock cycles to wait after applying the step configuration registers and before sending the start of ADC conversion

12.5.1.49 STEPCONFIG16 Register (offset = DCh) [reset = 0h]

Register mask: FFFFFFFFh

 STEPCONFIG16 is shown in [Figure 12-53](#) and described in [Table 12-53](#).

Step Configuration 16

Figure 12-53. STEPCONFIG16 Register

31	30	29	28	27	26	25	24
RESERVED				Range_check	FIFO_select	Diff_CNTRL	SEL_RFM_SW_C_1_0
R/W-0h				R/W-0h	R/W-0h	R/W-0h	R/W-0h
23	22	21	20	19	18	17	16
SEL_RFM_SW_C_1_0	SEL_INP_SWC_3_0				SEL_INM_SWC_3_0		
R/W-0h		R/W-0h			R/W-0h		
15	14	13	12	11	10	9	8
SEL_INM_SW_C_3_0	SEL_RFP_SWC_2_0			WPNSW_SWC	YPNSW_SWC	XNPSW_SWC	YNNSW_SWC
R/W-0h		R/W-0h		R/W-0h	R/W-0h	R/W-0h	R/W-0h
7	6	5	4	3	2	1	0
YPPSW_SWC	XNNSW_SWC	XPPSW_SWC	Averaging		Mode		
R/W-0h	R/W-0h	R/W-0h	R/W-0h		R/W-0h		

LEGEND: R/W = Read/Write; R = Read only; W1toCl = Write 1 to clear bit; -n = value after reset

Table 12-53. STEPCONFIG16 Register Field Descriptions

Bit	Field	Type	Reset	Description
31-28	RESERVED	R/W	0h	
27	Range_check	R/W	0h	0 = Disable out-of-range check. 1 = Compare ADC data with range check register.
26	FIFO_select	R/W	0h	Sampled data will be stored in FIFO. 0 = FIFO. 1 = FIFO1.
25	Diff_CNTRL	R/W	0h	Differential Control Pin
24-23	SEL_RFM_SWC_1_0	R/W	0h	SEL_RFM pins SW configuration. 00 = VSSA. 01 = XNUR. 10 = YNLR. 11 = VREFN.
22-19	SEL_INP_SWC_3_0	R/W	0h	SEL_INP pins SW configuration. 0000 = Channel 1. 0111 = Channel 8. 1xxx = VREFN.
18-15	SEL_INM_SWC_3_0	R/W	0h	SEL_INM pins for negative differential. 0000 = Channel 1. 0111 = Channel 8. 1xxx = VREFN.
14-12	SEL_RFP_SWC_2_0	R/W	0h	SEL_RFP pins SW configuration. 000 = VDDA_ADC. 001 = XPUL. 010 = YPLL. 011 = VREFP. 1xx = Reserved.
11	WPNSW_SWC	R/W	0h	WPNSW pin SW configuration
10	YPNSW_SWC	R/W	0h	YPNSW pin SW configuration
9	XNPSW_SWC	R/W	0h	XNPSW pin SW configuration
8	YNNSW_SWC	R/W	0h	YNNSW pin SW configuration

Table 12-53. STEPCONFIG16 Register Field Descriptions (continued)

Bit	Field	Type	Reset	Description
7	YPPSW_SWC	R/W	0h	YPPSW pin SW configuration
6	XNNSW_SWC	R/W	0h	XNNSW pin SW configuration
5	XPPSW_SWC	R/W	0h	XPPSW pin SW configuration
4-2	Averaging	R/W	0h	Number of samples to average: 000 = No average. 001 = 2 samples average. 010 = 4 samples average. 011 = 8 samples average. 100 = 16 samples average.
1-0	Mode	R/W	0h	00 = SW enabled, one-shot. 01 = SW enabled, continuous. 10 = HW synchronized, one-shot. 11 = HW synchronized, continuous.

12.5.1.50 STEPDELAY16 Register (offset = E0h) [reset = 0h]

Register mask: FFFFFFFFh

 STEPDELAY16 is shown in [Figure 12-54](#) and described in [Table 12-54](#).

Step Delay Register 16

Figure 12-54. STEPDELAY16 Register

31	30	29	28	27	26	25	24	23	22	21	20	19	18	17	16
SampleDelay								RESERVED						OpenDelay	
R/W-0h								R/W-0h						R/W-0h	
15	14	13	12	11	10	9	8	7	6	5	4	3	2	1	0
OpenDelay															
R/W-0h															

LEGEND: R/W = Read/Write; R = Read only; W1toCl = Write 1 to clear bit; -n = value after reset

Table 12-54. STEPDELAY16 Register Field Descriptions

Bit	Field	Type	Reset	Description
31-24	SampleDelay	R/W	0h	This register will control the number of ADC clock cycles to sample (hold SOC high). Any value programmed here will be added to the minimum requirement of 1 clock cycle.
23-18	RESERVED	R/W	0h	
17-0	OpenDelay	R/W	0h	Program the number of ADC clock cycles to wait after applying the step configuration registers and before sending the start of ADC conversion

12.5.1.51 FIFO0COUNT Register (offset = E4h) [reset = 0h]

Register mask: FFFFFFFFh

FIFO0COUNT is shown in [Figure 12-55](#) and described in [Table 12-55](#).

FIFO0 word count@TSC_ADC_SS_FIFO0 Word Count Register

Figure 12-55. FIFO0COUNT Register

31	30	29	28	27	26	25	24	23	22	21	20	19	18	17	16
RESERVED															
R-0h															
15	14	13	12	11	10	9	8	7	6	5	4	3	2	1	0
RESERVED									Words_in_FIFO0						
R-0h									R-0h						

LEGEND: R/W = Read/Write; R = Read only; W1toCl = Write 1 to clear bit; -n = value after reset

Table 12-55. FIFO0COUNT Register Field Descriptions

Bit	Field	Type	Reset	Description
31-7	RESERVED	R	0h	RESERVED
6-0	Words_in_FIFO0	R	0h	Number of words currently in the FIFO0

12.5.1.52 FIFO0THRESHOLD Register (offset = E8h) [reset = 0h]

Register mask: FFFFFFFFh

 FIFO0THRESHOLD is shown in [Figure 12-56](#) and described in [Table 12-56](#).

FIFO0 Threshold trigger@TSC_ADC_SS_FIFO0 Threshold Level Register

Figure 12-56. FIFO0THRESHOLD Register

31	30	29	28	27	26	25	24
RESERVED							
R-0h							
23	22	21	20	19	18	17	16
RESERVED							
R-0h							
15	14	13	12	11	10	9	8
RESERVED							
R-0h							
7	6	5	4	3	2	1	0
RESERVED		FIFO0_threshold_Level					
R-0h		R/W-0h					

LEGEND: R/W = Read/Write; R = Read only; W1toCl = Write 1 to clear bit; -n = value after reset

Table 12-56. FIFO0THRESHOLD Register Field Descriptions

Bit	Field	Type	Reset	Description
31-6	RESERVED	R	0h	
5-0	FIFO0_threshold_Level	R/W	0h	Program the desired FIFO0 data sample level to reach before generating interrupt to CPU (program to value minus 1)

12.5.1.53 DMA0REQ Register (offset = ECh) [reset = 0h]

Register mask: FFFFFFFFh

 DMA0REQ is shown in [Figure 12-57](#) and described in [Table 12-57](#).

FIFO0 DMA req0 trigger@TSC_ADC_SS_FIFO0 DMA REQUEST Register

Figure 12-57. DMA0REQ Register

31	30	29	28	27	26	25	24	23	22	21	20	19	18	17	16
RESERVED															
R-0h															
15	14	13	12	11	10	9	8	7	6	5	4	3	2	1	0
RESERVED										DMA_Request_Level					
R-0h										R/W-0h					

LEGEND: R/W = Read/Write; R = Read only; W1toCl = Write 1 to clear bit; -n = value after reset

Table 12-57. DMA0REQ Register Field Descriptions

Bit	Field	Type	Reset	Description
31-6	RESERVED	R	0h	RESERVED
5-0	DMA_Request_Level	R/W	0h	Number of words in FIFO0 before generating a DMA request (program to value minus 1)

12.5.1.54 FIFO1COUNT Register (offset = F0h) [reset = 0h]

Register mask: FFFFFFFFh

 FIFO1COUNT is shown in [Figure 12-58](#) and described in [Table 12-58](#).

FIFO1 word count@TSC_ADC_SS_FIFO1 Word Count Register

Figure 12-58. FIFO1COUNT Register

31	30	29	28	27	26	25	24	23	22	21	20	19	18	17	16
RESERVED															
R-0h															
15	14	13	12	11	10	9	8	7	6	5	4	3	2	1	0
RESERVED									Words_in_FIFO0						
R-0h									R-0h						

LEGEND: R/W = Read/Write; R = Read only; W1toCl = Write 1 to clear bit; -n = value after reset

Table 12-58. FIFO1COUNT Register Field Descriptions

Bit	Field	Type	Reset	Description
31-7	RESERVED	R	0h	RESERVED
6-0	Words_in_FIFO0	R	0h	Number of words currently in the FIFO0

12.5.1.55 FIFO1THRESHOLD Register (offset = F4h) [reset = 0h]

Register mask: FFFFFFFFh

FIFO1THRESHOLD is shown in [Figure 12-59](#) and described in [Table 12-59](#).

FIFO1 Threshold trigger@TSC_ADC_SS_FIFO1 Threshold Level Register

Figure 12-59. FIFO1THRESHOLD Register

31	30	29	28	27	26	25	24
RESERVED							
R-0h							
23	22	21	20	19	18	17	16
RESERVED							
R-0h							
15	14	13	12	11	10	9	8
RESERVED							
R-0h							
7	6	5	4	3	2	1	0
RESERVED		FIFO0_threshold_Level					
R-0h		R/W-0h					

LEGEND: R/W = Read/Write; R = Read only; W1toCl = Write 1 to clear bit; -n = value after reset

Table 12-59. FIFO1THRESHOLD Register Field Descriptions

Bit	Field	Type	Reset	Description
31-6	RESERVED	R	0h	
5-0	FIFO0_threshold_Level	R/W	0h	Program the desired FIFO0 data sample level to reach before generating interrupt to CPU (program to value minus 1)

12.5.1.56 DMA1REQ Register (offset = F8h) [reset = 0h]

Register mask: FFFFFFFFh

 DMA1REQ is shown in [Figure 12-60](#) and described in [Table 12-60](#).

FIFO1 DMA req1 trigger@TSC_ADC_SS_FIFO1 DMA Request Register

Figure 12-60. DMA1REQ Register

31	30	29	28	27	26	25	24	23	22	21	20	19	18	17	16
RESERVED															
R-0h															
15	14	13	12	11	10	9	8	7	6	5	4	3	2	1	0
RESERVED										DMA_Request_Level					
R-0h										R/W-0h					

LEGEND: R/W = Read/Write; R = Read only; W1toCl = Write 1 to clear bit; -n = value after reset

Table 12-60. DMA1REQ Register Field Descriptions

Bit	Field	Type	Reset	Description
31-6	RESERVED	R	0h	RESERVED
5-0	DMA_Request_Level	R/W	0h	Number of words in FIFO0 before generating a DMA request (program to value minus 1)

12.5.1.57 FIFO0DATA Register (offset = 100h) [reset = 0h]

Register mask: FFFFFFFFh

 FIFO0DATA is shown in [Figure 12-61](#) and described in [Table 12-61](#).

ADC_FIFO0_READ Data @TSC_ADC_SS_FIFO0 READ Register

Figure 12-61. FIFO0DATA Register

31	30	29	28	27	26	25	24	23	22	21	20	19	18	17	16
RESERVED												ADCCHNLID			
R-0h												R-0h			
15	14	13	12	11	10	9	8	7	6	5	4	3	2	1	0
RESERVED				ADCDATA											
R-0h				R-0h											

LEGEND: R/W = Read/Write; R = Read only; W1toCl = Write 1 to clear bit; -n = value after reset

Table 12-61. FIFO0DATA Register Field Descriptions

Bit	Field	Type	Reset	Description
31-20	RESERVED	R	0h	RESERVED.
19-16	ADCCHNLID	R	0h	Optional ID tag of channel that captured the data. If tag option is disabled, these bits will be 0.
15-12	RESERVED	R	0h	
11-0	ADCDATA	R	0h	12 bit sampled ADC converted data value stored in FIFO 0.

12.5.1.58 FIFO1DATA Register (offset = 200h) [reset = 0h]

Register mask: FFFFFFFFh

 FIFO1DATA is shown in [Figure 12-62](#) and described in [Table 12-62](#).

ADC FIFO1_READ Data@TSC_ADC_SS_FIFO1 READ Register

Figure 12-62. FIFO1DATA Register

31	30	29	28	27	26	25	24	23	22	21	20	19	18	17	16
RESERVED												ADCCHNLID			
R-0h												R-0h			
15	14	13	12	11	10	9	8	7	6	5	4	3	2	1	0
RESERVED				ADCDATA											
R-0h				R-0h											

LEGEND: R/W = Read/Write; R = Read only; W1toCl = Write 1 to clear bit; -n = value after reset

Table 12-62. FIFO1DATA Register Field Descriptions

Bit	Field	Type	Reset	Description
31-20	RESERVED	R	0h	RESERVED
19-16	ADCCHNLID	R	0h	Optional ID tag of channel that captured the data. If tag option is disabled, these bits will be 0.
15-12	RESERVED	R	0h	RESERVED
11-0	ADCDATA	R	0h	12 bit sampled ADC converted data value stored in FIFO 1.

LCD Controller

This chapter describes the LCD controller of the device.

Topic	Page
13.1 Introduction	1830
13.2 Integration	1832
13.3 Functional Description	1834
13.4 Programming Model	1855
13.5 Registers	1862

13.1 Introduction

13.1.1 Purpose of the Peripheral

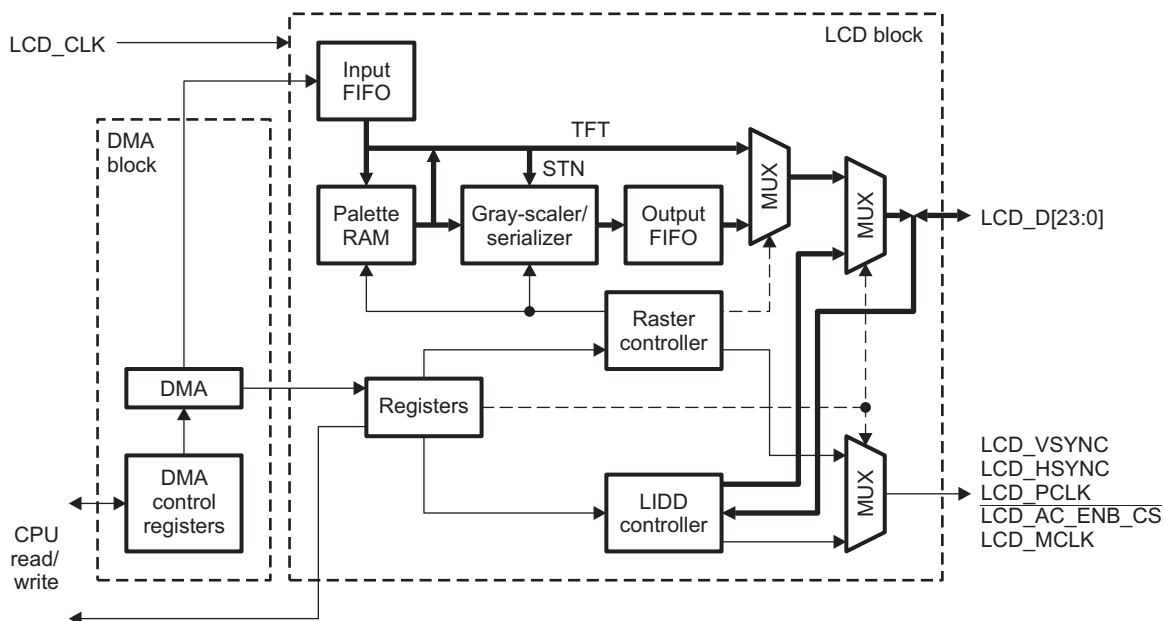
The LCD controller consists of two independent controllers, the Raster Controller and the LCD Interface Display Driver (LIDD) controller. Each controller operates independently from the other and only one of them is active at any given time.

- The Raster Controller handles the synchronous LCD interface. It provides timing and data for constant graphics refresh to a passive display. It supports a wide variety of monochrome and full-color display types and sizes by use of programmable timing controls, a built-in palette, and a gray-scale/serializer. Graphics data is processed and stored in frame buffers. A frame buffer is a contiguous memory block in the system. A built-in DMA engine supplies the graphics data to the Raster engine which, in turn, outputs to the external LCD device.
- The LIDD Controller supports the asynchronous LCD interface. It provides full-timing programmability of control signals (CS, WE, OE, ALE) and output data.

Figure 13-1 shows the LCD controller details. The raster and LIDD Controllers are responsible for generating the correct external timing. The DMA engine provides a constant flow of data from the frame buffer(s) to the external LCD panel via the Raster and LIDD Controllers. In addition, CPU access is provided to read and write registers.

The solid, thick lines in Figure 13-1 indicate the data path. The Raster Controller's data path is fairly complicated, for a thorough description of the Raster Controller data path, see Section 13.3.5.

Figure 13-1. LCD Controller



13.1.2 Features

General features of the LCD Controller include:

- Supports up to 24-bit data output; 8 bits-per-pixel (RGB).
- Supports up to 2048x2048 resolution.
- Integrated DMA engine to pull data from the external frame buffer without burdening the processor via interrupts or a firmware timer.
- 512 word deep internal FIFO with programmable threshold values.
- Character Based Panels
 - Supports 2 Character Panels (CS0 and CS1) with independent and programmable bus timing parameters when in asynchronous Hitachi, Motorola and Intel modes
 - Supports 1 Character Panel (CS0) with programmable bus timing parameters when in synchronous Motorola and Intel modes
 - Can be used as a generic 16 bit address/data interleaved MPU bus master with no external stall
- Passive Matrix LCD Panels
 - Panel types including STN, DSTN, and C-DSTN
 - AC Bias Control
- Active Matrix LCD Panels
 - Panel types including TN TFT
- OLED Panels
 - Passive Matrix (PM OLED) with frame buffer and controller IC inside the Panel
 - Active Matrix (AM OLED)

13.2 Integration

The device includes an LCD Controller that reads display data from external memory and drives several different types of LCD displays. The LCD Controller integration is shown in [Figure 13-2](#).

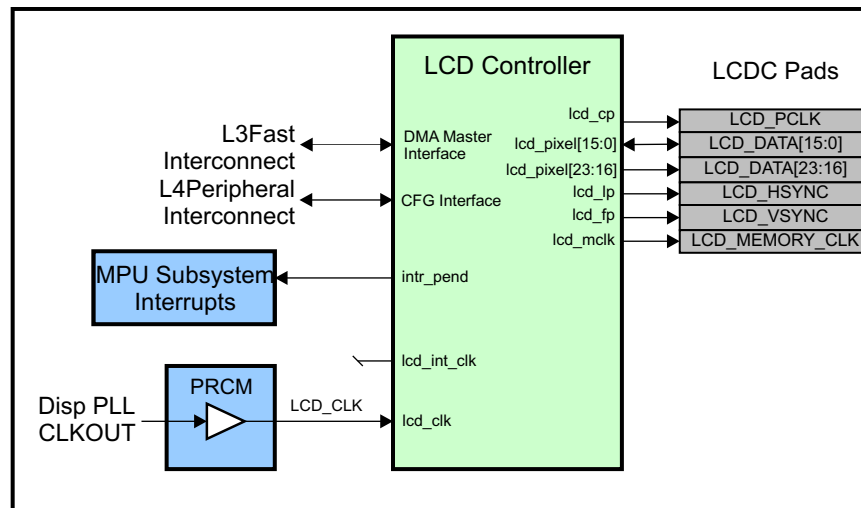


Figure 13-2. LCD Controller Integration

13.2.1 LCD Controller Connectivity Attributes

The general connectivity attributes for the LCDC subsystems are shown in [Table 13-1](#).

Table 13-1. LCD Controller Connectivity Attributes

Attributes	Type
Power Domain	Peripheral Domain
Clock Domain	PD_PER_LCD_L3_GCLK (OCP Master Clock) PD_PER_LCD_L3_GCLK (OCP Slave Clock) PD_PER_LCD_GCLK (Functional Clock)
Reset Signals	PER_DOM_RST_N
Idle/Wakeup Signals	Standby Smart Idle
Interrupt Requests	1 Interrupt to MPU Subsystem (LCDCINT)
DMA Requests	None
Physical Address	L4 Peripheral Slave Port

13.2.2 LCD Controller Clock and Reset Management

The LCD module uses the following functional and OCP interface clocks. The L4 Slave interface runs at half the frequency of the L3 Master interface but uses the same clock. The clock is divided within the LCD through the `l4_clkdiv` input using the `pd_per_lcd_l4s_gclk_ien` signal from the PRCM. The functional clock comes from the Display PLL. When the Display PLL is in bypass mode, its output is sourced by either `CORE_CLKOUTM6` or `PER_CLKOUTM2`.

Table 13-2. LCD Controller Clock Signals

Clock Signal	Max Freq	Reference / Source	Comments
<code>l3_clk</code> Master Interface Clock	200 MHz	<code>CORE_CLKOUTM4</code>	<code>pd_per_lcd_l3_gclk</code> From PRCM
<code>l4_clk</code> Slave Interface Clock	100 MHz	<code>CORE_CLKOUTM4</code> (divided within LCD)	<code>pd_per_lcd_l3_gclk</code> From PRCM
<code>lcd_clk</code> Functional Clock	200 MHz	Display PLL CLKOUT	<code>pd_per_lcd_gclk</code> From PRCM

13.2.3 LCD Controller Pin List

The LCD Controller external interface signals are shown in [Table 13-3](#).

Table 13-3. LCD Controller Pin List

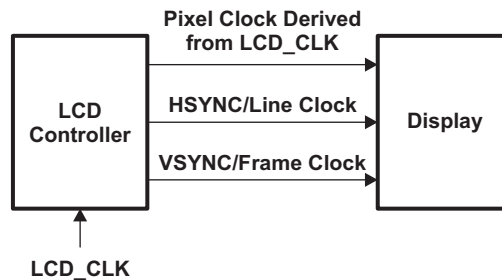
Pin	Type	Description
<code>lcd_cp</code>	O	Pixel Clock in Raster mode Read Strobe or Read/Write Strobe in LIDD mode
<code>lcd_pixel_i[15:0]</code>	I	LCD Data Bus input (for LIDD mode only)
<code>lcd_pixel_o[23:0]</code>	O	LCD Data Bus output
<code>lcd_lp</code>	O	Line Clock or HSYNC in Raster mode; Write Strobe or Direction bit in LIDD mode
<code>lcd_fp</code>	O	Frame Clock or VSYNC in Raster mode; Address Latch Enable in LIDD mode
<code>lcd_ac</code>	O	AC bias or Latch Enable in Raster mode; Primary Chip Select/Primary Enable in LIDD MPU/Hitachi mode
<code>lcd_mclk</code>	O	N/A in Raster mode; Memory Clock/Secondary chip Select/Secondary Enable in LIDD Synchronous/Async MPU/Hitachi mode

13.3 Functional Description

13.3.1 Clocking

This section details the various clocks and signals. [Figure 13-3](#) shows input and output LCD controller clocks.

Figure 13-3. Input and Output Clocks



13.3.1.1 Pixel Clock (LCD_PCLK)

The pixel clock (LCD_PCLK) frequency is derived from LCD_CLK, the reference clock to this LCD module (see [Figure 13-3](#)). The pixel clock is used by the LCD display to clock the pixel data into the line shift register.

$$\text{LCD_PCLK} = \frac{\text{LCD_CLK}}{\text{CLKDIV}}$$

where CLKDIV is a field in the LCD_CTRL register and should not be 0 or 1.

- **Passive (STN) mode.** LCD_PCLK only transitions when valid data is available for output. It does not transition when the horizontal clock (HSYNC) is asserted or during wait state insertion.
- **Active (TFT) mode.** LCD_PCLK continuously toggles as long as the Raster Controller is enabled.

13.3.1.2 Horizontal Clock (LCD_HSYNC)

LCD_HSYNC toggles after all pixels in a horizontal line have been transmitted to the LCD and a programmable number of pixel clock wait states has elapsed both at the beginning and end of each line.

The RASTER_TIMING_0 register fully defines the behavior of this signal.

LCD_HSYNC can be programmed to be synchronized with the rising or falling edge of LCD_PCLK. The configuration field is bits 24 and 25 in the RASTER_TIMING_2 register.

Active (TFT) mode: The horizontal clock or the line clock is also used by TFT displays as the horizontal synchronization signal (LCD_HSYNC).

The timings of the horizontal clock (line clock) pins are programmable to support:

- Delay insertion both at the beginning and end of each line.
- Line clock polarity.
- Line clock pulse width, driven on rising or falling edge of pixel clock.

13.3.1.3 Vertical Clock (LCD_VSYNC)

LCD_VSYNC toggles after all lines in a frame have been transmitted to the LCD and a programmable number of line clock cycles has elapsed both at the beginning and end of each frame.

The RASTER_TIMING_1 register fully defines the behavior of this signal.

LCD_VSYNC can be programmed to be synchronized with the rising or falling edge of LCD_PCLK. The configuration field is bits 24 and 25 in the RASTER_TIMING_2 register.

- **Passive (STN) mode.** The vertical, or frame, clock toggles during the first line of the screen.
- **Active (TFT) mode.** The vertical, or frame, clock is also used by TFT displays as the vertical synchronization signal (LCD_VSYNC).

The timings of the vertical clock pins are programmable to support:

- Delay insertion both at the beginning and end of each frame
- Frame clock polarity

13.3.1.4 LCD_AC_BIAS_EN

- **Passive (STN) mode.** To prevent a dc charge within the screen pixels, the power and ground supplies of the display are periodically switched. The Raster Controller signals the LCD to switch the polarity by toggling this pin (LCD_AC_BIAS_EN).
- **Active (TFT) mode.** This signal acts as an output enable (OE) signal. It is used to signal the external LCD that the data is valid on the data bus (LCD_DATA).

13.3.2 LCD External I/O Signals

Table 13-4 shows the details of the LCD controller external signals.

Table 13-4. LCD External I/O Signals

Signal	Type	Description
LCD_VSYNC	OUT	<p>Raster controller: Frame clock the LCD uses to signal the start of a new frame of pixels. Also used by TFT displays as the vertical synchronization signal.</p> <p>LIDD character: Register select (RS) or address latch enable (ALE)</p> <p>LIDD graphics: Address bit 0 (A0) or command/data select (C/D)</p>
LCD_HSYNC	OUT	<p>Raster controller: Line clock the LCD uses to signal the end of a line of pixels that transfers line data from the shift register to the screen and to increment the line pointer(s). Also used by TFT displays as the horizontal synchronization signal.</p> <p>LIDD character: not used.</p> <p>LIDD graphics:</p> <ul style="list-style-type: none"> • 6800 mode = read or write enable • 8080 mode = not write strobe
LCD_PCLK	OUT	<p>Raster controller: Pixel clock the LCD uses to clock the pixel data into the line shift register. In passive mode, the pixel clock transitions only when valid data is available on the data lines. In active mode, the pixel clock transitions continuously, and the ac-bias pin is used as an output enable to signal when data is available on the LCD pin.</p> <p>LIDD character: not used.</p> <p>LIDD graphics:</p> <ul style="list-style-type: none"> • 6800 mode = enable strobe • 8080 mode = not read strobe
LCD_AC_BIAS_EN	OUT	<p>Raster controller: ac-bias used to signal the LCD to switch the polarity of the power supplies to the row and column axis of the screen to counteract DC offset. Used in TFT mode as the output enable to signal when data is latched from the data pins using the pixel clock.</p> <p>LIDD character: Primary enable strobe</p> <p>LIDD graphics: Chip select 0 (CS0)</p>
LCD_MCLK	OUT	<p>Raster controller: not used.</p> <p>LIDD character: Secondary enable strobe</p> <p>LIDD graphics: Chip select 1 (CS1)</p>
LCD_D[23:0]	Raster: OUT	<p>LCD data bus, providing a 4-, 8-, 16- or 24-bit data path.</p> <p>Raster controller: For monochrome displays, each signal represents a pixel; for passive color displays, groupings of three signals represent one pixel (red, green, and blue). LCD_DATA[3:0] is used for monochrome displays of 2, 4, and 8 BPP; LCD_DATA[7:0] is used for color STN displays and LCD_DATA[15:0] or LCD_DATA[23:0] is used for active (TFT) mode.</p> <p>LIDD: OUT/IN LIDD character: LCD_DATA[15:0] Read and write the command and data registers.</p> <p>LIDD graphics: LCD_DATA[15:0] Read and write the command and data registers.</p>

NOTE: Due to a silicon bug, pin mapping for the data signals for RGB888 and RGB565 are not as designed. Refer to the AM335x Silicon Errata ([SPRZ360](#)) for proper pin mapping when using these modes with an LCD panel.

13.3.3 DMA Engine

The DMA engine provides the capability to output graphics data to constantly refresh LCDs, without burdening the CPU, via interrupts or a firmware timer. It operates on one or two frame buffers, which are set up during initialization. Using two frame buffers (ping-pong buffers) enables the simultaneous operation of outputting the current video frame to the external display and updating the next video frame. The ping-pong buffering approach is preferred in most applications.

When the Raster Controller is used, the DMA engine reads data from a frame buffer and writes it to the input FIFO (as shown in [Figure 13-1](#)). The Raster Controller requests data from the FIFO for frame refresh; as a result, the DMA's job is to ensure that the FIFO is always kept full.

When the LIDD Controller is used, the DMA engine accesses the LIDD Controller's address and/or data registers.

To program the DMA engine, configure the following registers, as shown in [Table 13-5](#).

Table 13-5. Register Configuration for DMA Engine Programming

Register	Configuration
LCDDMA_CTRL	Configure DMA data format
LCDDMA_FB0_BASE	Configure frame buffer 0
LCDDMA_FB0_CEILING	
LCDDMA_FB1_BASE	Configure frame buffer 1. (If only one frame buffer is used, these two registers will not be used.)
LCDDMA_FB1_CEILING	

In addition, the LIDD_CTRL register (for LIDD Controller) or the RASTER_CTRL register (for Raster Controller) should also be configured appropriately, along with all the timing registers.

To enable DMA transfers, the LIDD_DMA_EN bit (in the LIDD_CTRL register) or the LCDEN bit (in the RASTER_CTRL register) should be written with 1.

13.3.3.1 Interrupts

Interrupts in this LCD module are related to DMA engine operation. Four registers are used to control and monitor the interrupts:

- The IRQENABLE_SET register allows the user to enable any of the interrupt sources.
- The IRQENABLE_CLEAR register allows the user to disable interrupt sources.
- The IRQSTATUS_RAW register collects all the interrupt status information.
- The IRQSTATUS register collects the interrupt status information for all enabled interrupts. Any interrupt source not enabled in the IRQENABLE_SET register is masked out.

13.3.3.1.1 LIDD Mode

When operating in LIDD mode, the DMA engine generates one interrupt signal every time the specified frame buffer has been transferred completely.

- The DONE bit in the LIDD_CTRL register specifies if the interrupt signal is delivered to the system interrupt controller, which in turn may or may not generate an interrupt to CPU.
- The EOF1, EOF0, and DONE bits in the IRQSTATUS_RAW register reflect the interrupt signal, regardless of being delivered to the system interrupt controller or not.

13.3.3.1.2 Raster Mode

When operating in Raster mode, the DMA engine can generate the interrupts in the following scenarios:

1. **Output FIFO under-run.** This occurs when the DMA engine cannot keep up with the data rate consumed by the LCD (which is determined by the LCD_PCLK.) This is likely due to a system memory throughput issue or an incorrect LCD_PCLK setting. The FUF bit in IRQSTATUS_RAW is set when this error occurs. This bit is cleared by writing a 1 to the FUF bit in the IRQSTATUS register.

2. **Frame synchronization lost.** This error happens when the DMA engine attempts to read what it believes to be the first word of the video buffer but it cannot be recognized as such. This could be caused by an invalid frame buffer address or an invalid BPP value (for more details, see [Section 13.3.5.2](#)). The SYNC bit in the IRQSTATUS_RAW register is set when such an error is detected. This bit is cleared by writing a 1 to the SYNC bit in the IRQSTATUS register.
3. **Palette loaded.** When using palette-only or palette+data modes, the PL bit in the IRQSTATUS_RAW register will be set when the palette portion of a DMA transfer has been loaded into palette RAM. This interrupt can be cleared by writing a '1' to the PL bit in the IRQSTATUS register.
4. **AC bias transition.** If the ACB_I bit in the RASTER_TIMING_2 register is programmed with a non-zero value, an internal counter will be loaded with this value and starts to decrement each time LCD_AC_BIAS_EN (AC-bias signal) switches its state. When the counter reaches zero, the ACB bit in the IRQSTATUS_RAW register is set, which will deliver an interrupt signal to the system interrupt controller (if the interrupt is enabled.) The counter reloads the value in field ACB_I, but does not start to decrement until the ACB bit is cleared by writing 1 to this bit in the IRQSTATUS register.
5. **Frame transfer completed.** When one frame of data is transferred completely, the DONE bit in the IRQSTATUS_RAW register is set. Note that the EOF0 and EOF1 bits in the IRQSTATUS_RAW register will be set accordingly. This bit is cleared by writing a 1 to the corresponding interrupt in the IRQSTATUS register.

Note that the interrupt enable bits are in the IRQENABLE_SET register. The corresponding enable bit must be set in order to generate an interrupt to the CPU. However, the IRQSTATUS_RAW register reflects the interrupt signal regardless of the interrupt enable bits settings.

13.3.3.1.3 Interrupt Handling

See [Chapter 6, Interrupts](#), for information about LCD interrupt number to CPU. The interrupt service routine needs to determine the interrupt source by examining the IRQSTATUS_RAW register and clearing the interrupt properly.

13.3.4 LIDD Controller

The LIDD Controller is designed to support LCD panels with a memory-mapped interface. The types of displays range from low-end character monochrome LCD panels to high-end TFT smart LCD panels.

LIDD mode (and the use of this logic) is enabled by clearing the MODESEL bit in the LCD control register (LCD_CTRL).

LIDD Controller operation is summarized as follows:

- During initialization, the LCD LIDD CS0/CS1 configuration registers (LIDD_CS0_CONF and LIDD_CS1_CONF) are configured to match the requirements of the LCD panel being used.
- During normal operation, the CPU writes display data to the LCD data registers (LIDD_CS0_DATA and LIDD_CS1_DATA). The LIDD interface converts the CPU write into the proper signal transition sequence for the display, as programmed earlier. Note that the first CPU write should send the beginning address of the update to the LCD panel and the subsequent writes update data at display locations starting from the first address and continuing sequentially. Note that DMA may be used instead of CPU.
- The LIDD Controller is also capable of reading back status or data from the LCD panel, if the latter has this capability. This is set up and activated in a similar manner to the write function described above.

NOTE: If an LCD panel is not used, this interface can be used to control any MCU-like peripheral.

See your device-specific data manual to check the LIDD features supported by the LCD controller.

[Table 13-6](#) describes how the signals are used to interface external LCD modules, which are configured by the LIDD_CTRL register.

Table 13-6. LIDD I/O Name Map

Display Type	Interface Type	Data Bits	LIDD_CTRL [2:0]	I/O Name	Display I/O Name	Comment
Character Display	HD44780 Type	4	100	LCD_DATA[7:4]	DATA[7:4]	Data Bus (length defined by Instruction)
				$\overline{\text{LCD_AC_BIAS_EN}}$	E (or E0)	Enable Strobe (first display)
				LCD_HSYNC	R/ $\overline{\text{W}}$	Read/ $\overline{\text{Write}}$
				LCD_VSYNC	RS	Register Select (Data/not Instruction)
				LCD_MCLK	E1	Enable Strobe (second display optional)
Character Display	HD44780 Type	8	100	LCD_DATA[7:0]	DATA[7:0]	Data Bus (length defined by Instruction)
				$\overline{\text{LCD_AC_BIAS_EN}}$	E (or E0)	Enable Strobe (first display)
				LCD_HSYNC	R/ $\overline{\text{W}}$	Read/ $\overline{\text{Write}}$
				LCD_VSYNC	RS	Register Select (Data/not Instruction)
				LCD_MCLK	E1	Enable Strobe (second display optional)
Micro Interface Graphic Display	6800 Family	Up to 16	001	LCD_DATA[15:0]	DATA[7:0]	Data Bus (16 bits always available)
				LCD_PCLK	E	Enable Clock
				LCD_HSYNC	R/ $\overline{\text{W}}$	Read/ $\overline{\text{Write}}$
				LCD_VSYNC	A0	Address/Data Select
				$\overline{\text{LCD_AC_BIAS_EN}}$	CS (or CS0)	Chip Select (first display)
				LCD_MCLK	CS1	Chip Select (second display optional)
				LCD_MCLK	None	Synchronous Clock (optional)
Micro Interface Graphic Display	8080 Family	Up to 16	011	LCD_DATA[15:0]	DATA[7:0]	Data Bus (16 bits always available)
				LCD_PCLK	RD	Read Strobe
				LCD_HSYNC	WR	Write Strobe
				LCD_VSYNC	A0	Address/Data Select
				$\overline{\text{LCD_AC_BIAS_EN}}$	CS (or CS0)	Chip Select (first display)
				LCD_MCLK	CS1	Chip Select (second display optional)
				LCD_MCLK	None	Synchronous Clock (optional)
			010	LCD_MCLK	None	Synchronous Clock (optional)

The timing parameters are defined by the LIDD_CS0_CONF and LIDD_CS1_CONF registers, which are described in and .

The timing configuration is based on an internal reference clock, MCLK. The MCLK is generated out of LCD_CLK, which is determined by the CLKDIV bit in the LCD_CTRL register.

$$\text{MCLK} = \text{LCD_CLK} \text{ when } \text{CLKDIV} = 0.$$

$$\text{MCLK} = \frac{\text{LCD_CLK}}{\text{CLKDIV}} \text{ when } \text{CLKDIV} \neq 0.$$

See your device-specific data manual for the timing configurations supported by the LCD controller.

13.3.5 Raster Controller

Raster mode (and the use of this logic) is enabled by setting the MODESEL bit in the LCD control register (LCD_CTRL). [Table 13-7](#) shows the active external signals when this mode is active.

Table 13-7. Operation Modes Supported by Raster Controller

Interface	Data Bus Width	Register Bits RASTER_CTRL[9, 7, 1]	Signal Name	Description
Passive (STN) Mono 4-bit	4	001	LCD_DATA[3:0]	Data bus
			LCD_PCLK	Pixel clock
			LCD_HSYNC	Horizontal clock(Line Clock)
			LCD_VSYNC	Vertical clock (Frame Clock)
			$\overline{\text{LCD_AC_BIAS_EN}}$	AC Bias
			LCD_MCLK	Not used
Passive (STN) Mono 8-bit	8	101	LCD_DATA[7:0]	Data bus
			LCD_PCLK	Pixel clock
			LCD_HSYNC	Horizontal clock(Line Clock)
			LCD_VSYNC	Vertical clock (Frame Clock)
			$\overline{\text{LCD_AC_BIAS_EN}}$	AC Bias
			LCD_MCLK	Not used
Passive (STN) Color	8	100	LCD_DATA[7:0]	Data bus
			LCD_PCLK	Pixel clock
			LCD_HSYNC	Horizontal clock(Line Clock)
			LCD_VSYNC	Vertical clock (Frame Clock)
			$\overline{\text{LCD_AC_BIAS_EN}}$	AC Bias
			LCD_MCLK	Not used
Active (TFT) Color	16	x10	LCD_DATA[15:0]	Data bus
			LCD_PCLK	Pixel clock
			LCD_HSYNC	Horizontal clock(Line Clock)
			LCD_VSYNC	Vertical clock (Frame Clock)
			$\overline{\text{LCD_AC_BIAS_EN}}$	Output enable
			LCD_MCLK	Not used

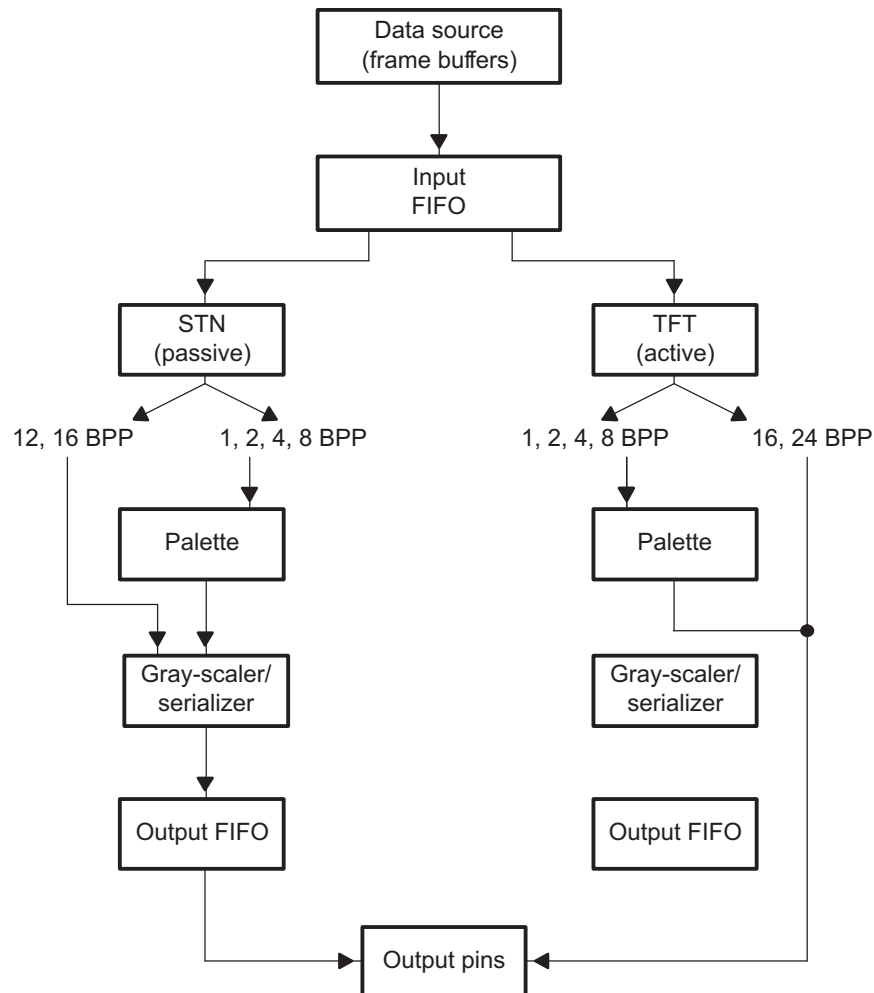
13.3.5.1 Logical Data Path

The block diagram of the Raster Controller is shown in [Figure 13-1](#). [Figure 13-4](#) illustrates its logical data path for various operation modes (passive (STN) versus active (TFT), various BPP size).

[Figure 13-4](#) shows that:

- The gray-scaler/serializer and output FIFO blocks are bypassed in active (TFT) modes.
- The palette is bypassed in both 12- and 16-BPP modes.

Figure 13-4. Logical Data Path for Raster Controller



In summary:

- The display image is stored in frame buffers.
- The built-in DMA engine constantly transfers the data stored in the frame buffers to the Input FIFO.
- The Raster Controller relays data to the external pins according to the specified format.

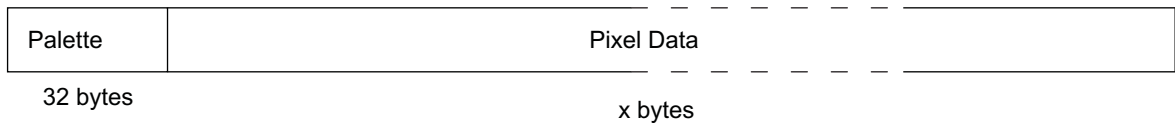
The remainder of this section describes the functioning blocks in [Figure 13-4](#), including frame buffers, palette, and gray-scaler/serializer. Their operation and programming techniques are covered in detail. The output format is also described in [Section 13.3.5.5](#).

13.3.5.2 Frame Buffer

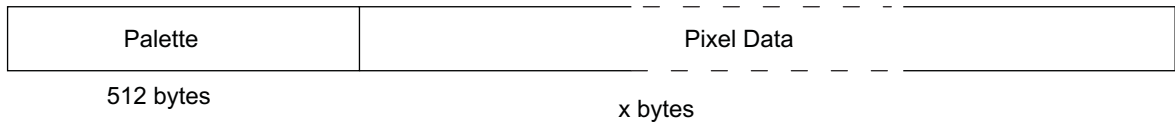
A frame buffer is a contiguous memory block, storing enough data to fill a full LCD screen. For this device, external memory needs to be used for the frame buffer. For specific details on which external memory interface (EMIF) controller can be accessed by the LCD controller, see your device-specific data manual. The data in the frame buffer consists of pixel values as well as a look-up palette. [Figure 13-5](#) shows the frame buffer structure.

Figure 13-5. Frame Buffer Structure

1, 2, 4, 12, 16, 24 BPP Modes



8 BPP Mode



NOTE:

- 8-BPP mode uses the first 512 bytes in the frame buffer as the palette while the other modes use 32 bytes.
- 12-, 16-, and 24-BPP modes do not need a palette; i.e., the pixel data is the desired RGB value. However, the first 32 bytes are still considered a palette. The first entry should be 4000h (bit 14 is 1) while the remaining entries must be filled with 0. (For details, see [Table 13-8](#).)
- Each entry in a palette occupies 2 bytes. As a result, 8-BPP mode palette has 256 color entries while the other palettes have up to 16 color entries.
- 4-BPP mode uses up the all the 16 entries in a palette.
- 1-BPP mode uses the first 2 entries in a palette while 2-BPP mode uses the first 4 entries. The remaining entries are not used and must be filled with 0.
- In 12- and 16-BPP modes, pixel data is RGB data. For all the other modes, pixel data is actually an index of the palette entry.

Table 13-8. Bits-Per-Pixel Encoding for Palette Entry 0 Buffer

Bit	Name	Value	Description ^{(1) (2) (3)}
14-12	BPP		Bits-per-pixel.
		000	1 BPP
		001	2 BPP
		010	4 BPP
		011	8 BPP
		1xx	12 BPP in passive mode (TFT_STN = 0 and STN_565 = 0 in RASTER_CTRL) 16 BPP in passive mode (TFT_STN = 0 and STN_565 = 1 in RASTER_CTRL) 16 BPP in active mode (LCDTFT = 1 and TFT24 = 0 in RASTER_CTRL) 24 BPP in active mode (LCDTFT = 1 and TFT24 = 1 in RASTER_CTRL)

⁽¹⁾ Eight 1-bit pixels, four 2-bit pixels, and two 4-bit pixels are packed into each byte, and 12-bit pixels are right justified on (16-bit) word boundaries (in the same format as palette entry).

⁽²⁾ For STN565, see the 16 BPP STN mode bit ().

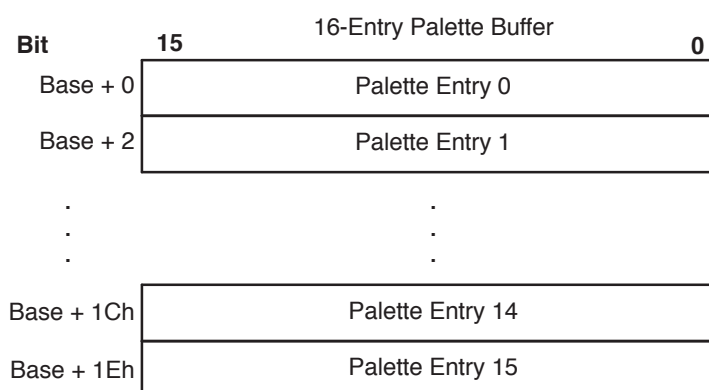
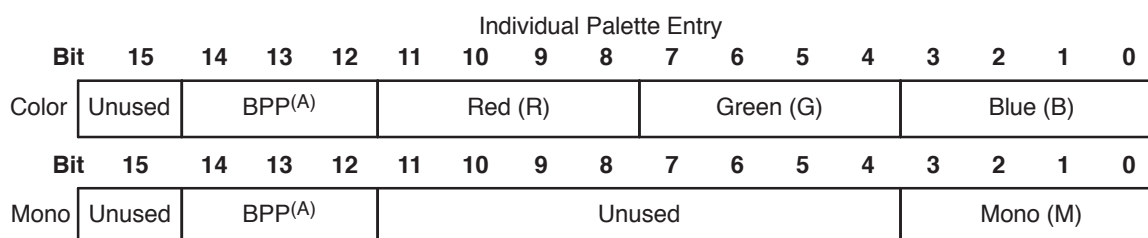
⁽³⁾ For Raw Data (12/16/24 bpp) framebuffer, no Palette lookup is employed therefore PALMODE = 0x10 in RASTER_CTRL.

The equations shown in [Table 13-9](#) are used to calculate the total frame buffer size (in bytes) based on varying pixel size encoding and screen sizes.

[Figure 13-6](#) and [Figure 13-7](#) show more detail of the palette entry organization.

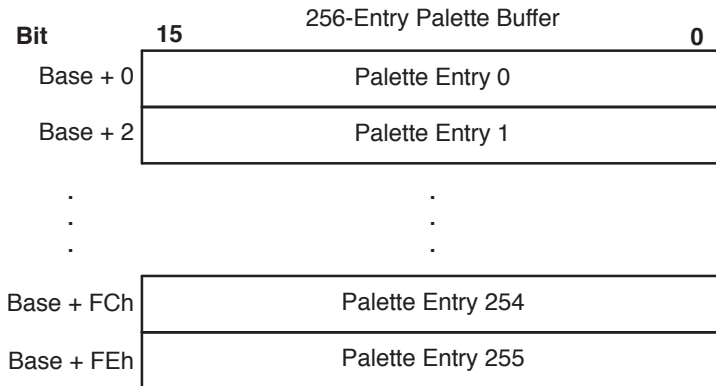
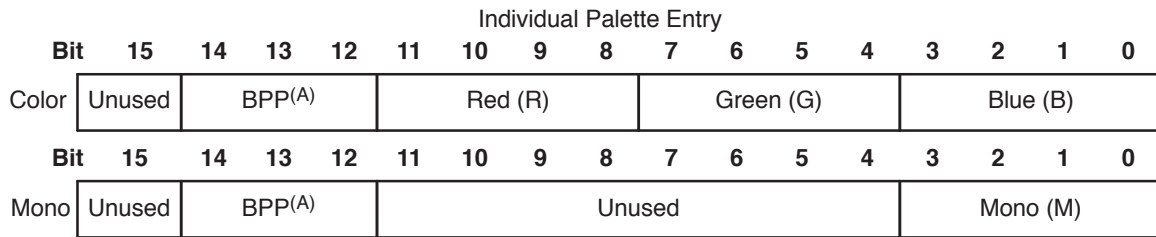
Table 13-9. Frame Buffer Size According to BPP

BPP	Frame Buffer Size
1	$32 + (\text{Lines} \times \text{Columns})/8$
2	$32 + (\text{Lines} \times \text{Columns})/4$
4	$32 + (\text{Lines} \times \text{Columns})/2$
8	$512 + (\text{Lines} \times \text{Columns})$
12/16	$32 + 2 \times (\text{Lines} \times \text{Columns})$

Figure 13-6. 16-Entry Palette/Buffer Format (1, 2, 4, 12, 16 BPP)


A. Bits-per-pixels (BPP) is only contained within the first palette entry (palette entry 0).

Figure 13-7. 256-Entry Palette/Buffer Format (8 BPP)



A. Bits-per-pixels (BPP) is only contained within the first palette entry (palette entry 0).

Bits 12, 13, and 14 of the first palette entry select the number of bits-per-pixel to be used in the following frame and thus the number of palette RAM entries. The palette entry is used by the Raster Controller to correctly unpack pixel data.

Figure 13-8 through Figure 13-13 show the memory organization within the frame buffer for each pixel encoding size.

Figure 13-8. 16-BPP Data Memory Organization (TFT Mode Only)—Little Endian

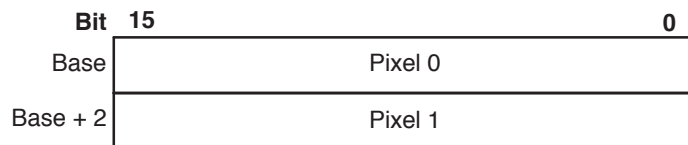
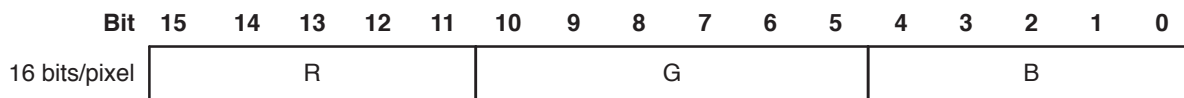
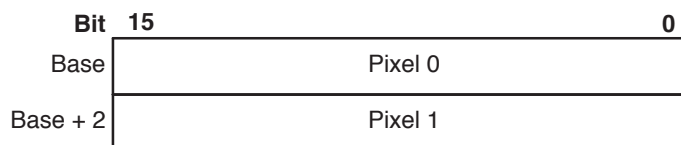
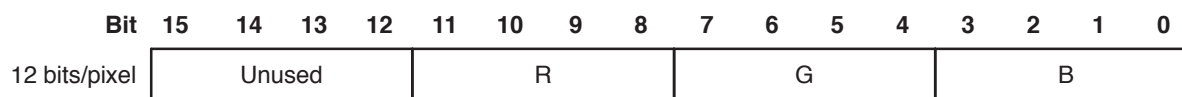


Figure 13-9. 12-BPP Data Memory Organization—Little Endian


Unused [15-12] bits are filled with zeroes in TFT mode.

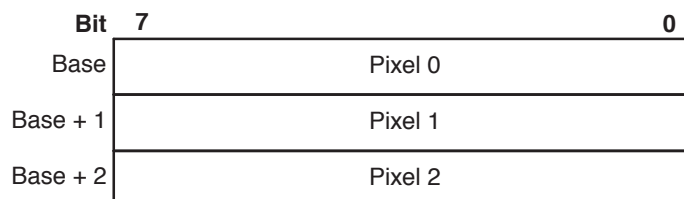
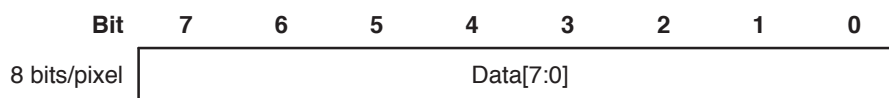
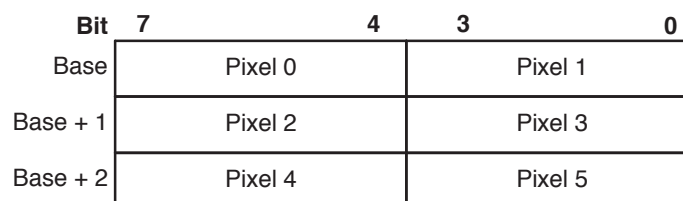
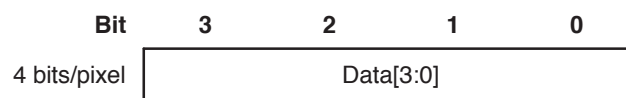
Figure 13-10. 8-BPP Data Memory Organization

Figure 13-11. 4-BPP Data Memory Organization


Figure 13-12. 2-BPP Data Memory Organization

Bit	7	6	5	4	3	2	1	0
Base	Pixel 0	Pixel 1	Pixel 2	Pixel 3	Pixel 4	Pixel 5	Pixel 6	Pixel 7
Base + 1	Pixel 8	Pixel 9	Pixel 10	Pixel 11	Pixel 12	Pixel 13	Pixel 14	Pixel 15
Base + 2	Pixel 16	Pixel 17	Pixel 18	Pixel 19	Pixel 20	Pixel 21	Pixel 22	Pixel 23

Figure 13-13. 1-BPP Data Memory Organization

Bit	7	6	5	4	3	2	1	0
Base	P0	P1	P2	P3	P4	P5	P6	P7
Base + 1	P8	P9	P10	P11	P12	P13	P14	P15

13.3.5.3 Palette

As explained in the previous section, the pixel data is an index of palette entry (when palette is used). The number of colors supported is given by $2^{\text{number of BPP}}$. However, due to a limitation of the gray-scaler/serializer block, fewer grayscales or colors may be supported.

The PLM field (in RASTER_CTRL) affects the palette loading:

- If PLM is 00b (palette-plus-data mode) or 01b (palette-only mode), the palette is loaded by the DMA engine at the very beginning, which is followed by the loading of pixel data.
- If PLM is 10b (data-only mode), the palette is not loaded. Instead, the DMA engine loads the pixel data immediately.

13.3.5.4 Gray-Scaler/Serializer

13.3.5.4.1 Passive (STN) Mode

Once a palette entry is selected from the look-up palette by the pixel data, its content is sent to the gray-scaler/serializer. If it is monochrome data, it is encoded as 4 bits. If it is color data, it is encoded as 4 bits (Red), 4 bits (Green), and 4 bits (Blue).

These 4-bit values are used to select one of the 16 intensity levels, as shown in [Table 13-10](#). A patented algorithm is used during this processing to provide an optimized intensity value that matches the eye's visual perception of color/gray gradations.

13.3.5.4.2 Active (TFT) Mode

The gray-scaler/serializer is bypassed.

Table 13-10. Color/Grayscale Intensities and Modulation Rates

Dither Value (4-Bit Value from Palette)	Intensity (0% is White)	Modulation Rate (Ratio of ON to ON+OFF Pixels)
0000	0.0%	0
0001	14.3%	1/7
0010	20.0%	1/5
0011	25%	1/4
0100	33.3%	3/9
0101	40.0%	2/5
0110	44.4%	4/9
0111	50.0%	1/2
1000	55.6%	5/9
1001	60.0%	3/5
1010	66.6%	6/9
1011	75%	3/4
1100	80.0%	4/5
1101	85.7%	6/7
1110	93.3%	14/15
1111	100.0%	1

13.3.5.4.3 Summary of Color Depth

Table 13-11. Number of Colors/Shades of Gray Available on Screen

Number of BPP	Passive Mode (LCDTFT = 0)		Active Mode (LCDTFT = 1)
	Monochrome (LCDBW = 1)	Color (LCDBW = 0)	Color Only (LCDBW = 0)
1	2 palette entries to select within 15 grayscales	2 palette entries to select within 3375 possible colors	2 palette entries to select within 4096 possible colors
2	4 palette entries to select within 15 grayscales	4 palette entries to select within 3375 possible colors	4 palette entries to select within 4096 possible colors
4	16 palette entries to select within 15 grayscales	16 palette entries to select within 3375 possible colors	16 palette entries to select within 4096 possible colors
8	Not relevant since it would consist in 256 palette entries to select within 15 grayscales, but exists anyway	256 palette entries to select 3375 possible colors	256 palette entries to select within 4096 possible colors
12	x	3375 possible colors	4096 possible colors
16	x	3375 possible colors (STN_565 = 1)	Up to 65536 possible colors
24	X	X	Up to 16.7 million colors

13.3.5.5 Output Format

13.3.5.5.1 Passive (STN) Mode

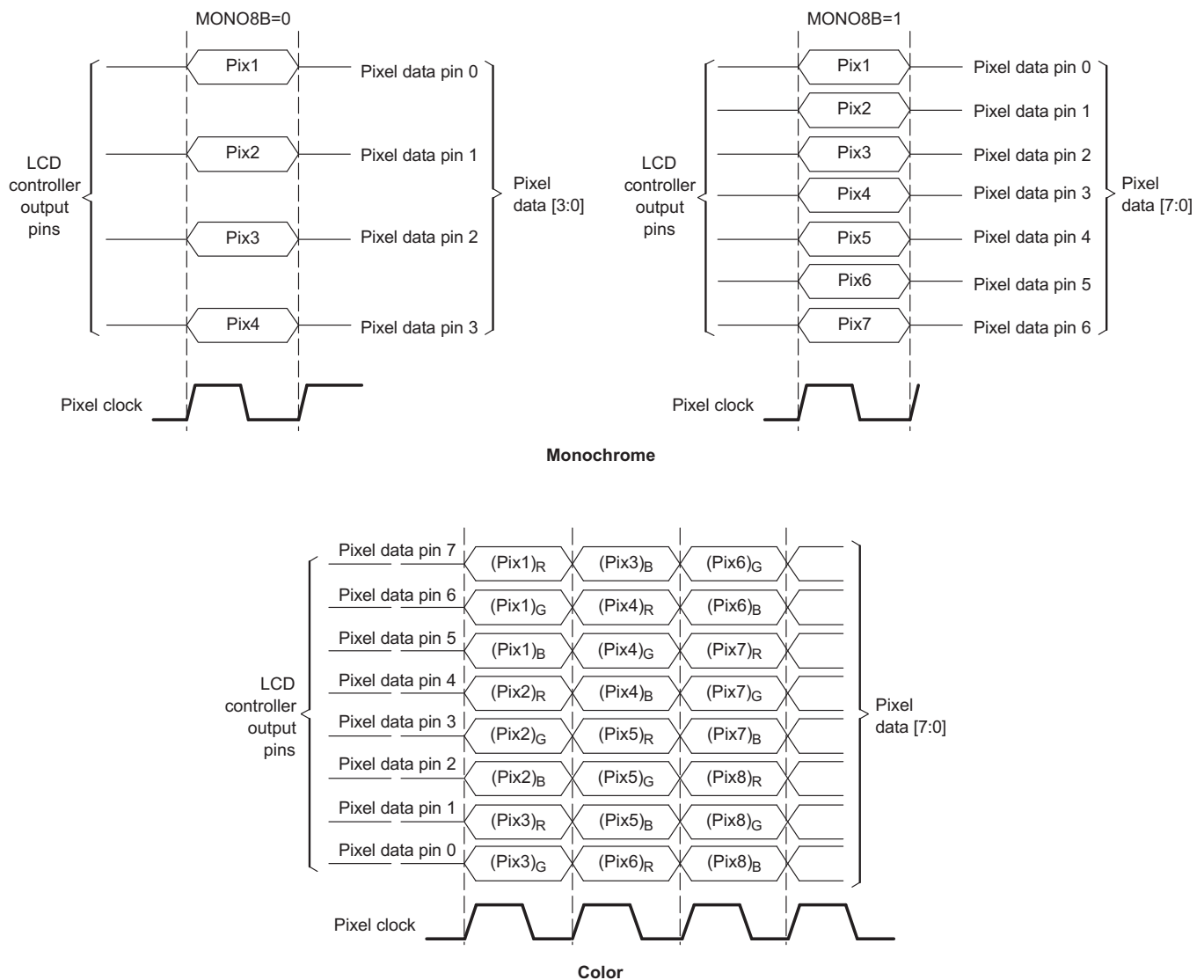
As shown in Figure 13-4, the pixel data stored in frame buffers go through palette (if applicable) and gray-scaler/serializer before reaching the Output FIFO. As a result, it is likely that the data fed to the Output FIFO is numerically different from the data in the frame buffers. (However, they represent the same color or grayscale.)

The output FIFO formats the received data according to display modes (see Table 13-7). Figure 13-14 shows the actual data output on the external pins.

13.3.5.5.2 Active (TFT) Mode

As shown in Figure 13-4, the gray-scaler/serializer and output FIFO are bypassed in active (TFT) mode. Namely, at each pixel clock, one pixel data (16 bits) is output to the external LCD.

Figure 13-14. Monochrome and Color Output

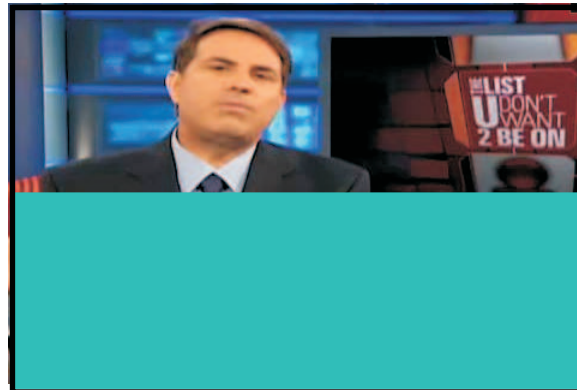


13.3.5.6 Subpicture Feature

A feature exists in the LCD to cover either the top or lower portion of the display with a default color. This feature is called a subpicture and is illustrated in [Figure 13-15](#). Subpictures are only allowed for Active Matrix mode (cfg_lcdftf = '1').

Subpictures reduce the bandwidth to the DDR since lines containing default pixel data are not read from memory. For example, suppose the panel has 100 lines of which 50 are default pixel data lines. Then, only 50 lines of data are DMAed from DDR for this subpicture setup. That is, the cfg_fbx_base and cfg_fbx_ceiling registers only encompass 50 lines of data instead of 100.

Figure 13-15. Example of Subpicture



The subpicture feature is enabled when the spen MMR control bit is set to '1'. The hols bit, when set to '0,' puts the Default Pixel Data lines at the top of the screen and the active video lines at the bottom of the screen.

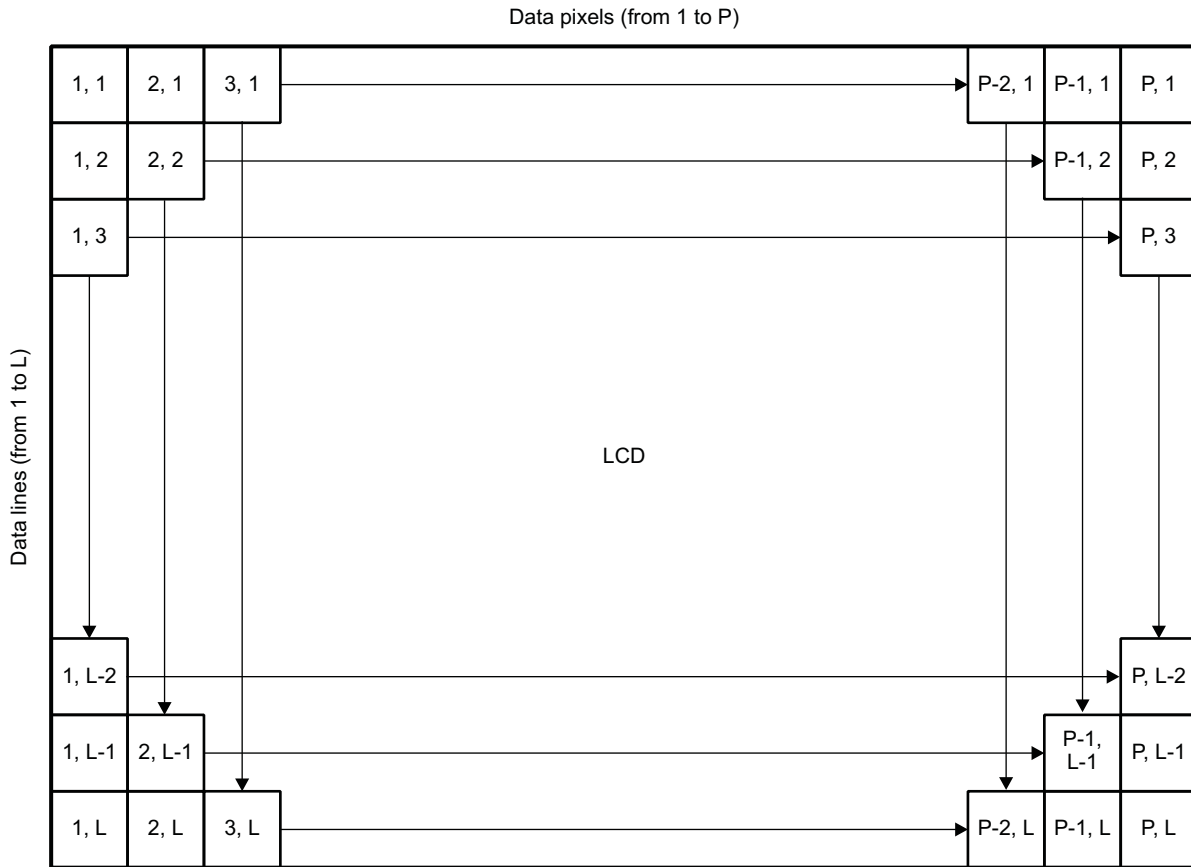
When the hols bit is set to '1,' Active video lines are at the top of the screen and Default Pixel Data lines are at the bottom of the screen. The hols bit behavior is shown in [Figure 13-16](#).

Figure 13-16. Subpicture HOLS Bit



The lines per panel threshold (LPPT) bitfield defines the number of lines at the bottom of the picture for both hols = '1' or '0'. LPPT is an encoded value in the range {0:2047} used to represent the number of lines in the range {1:2048}.

Figure 13-17. Raster Mode Display Format



13.3.6 Interrupt Conditions

13.3.6.1 Highlander 0.8 Interrupts

13.3.6.1.1 Highlander Interrupt Basics

The interrupt mechanism is Highlander 0.8-compliant and relies on the ipgvmodirq IP Generic. The ipgvmodirq module supports hardware-initiated interrupts, each of which can also be individually triggered by software. An interrupt mask function allows each interrupt to be masked or enabled. The software can read all of the raw interrupts or only those that are unmasked.

All pending interrupts in the LCD module must be serviced by the Host's Interrupt Service Routine before it exits.

The Interrupt Module registers are described in the following table.

Table 13-12. Highlander 0.8 Interrupt Module Control Registers

Address Offset	Name	Description
0x58	Reg22	Interrupt Raw Status Register
0x5C	Reg23	Interrupt Masked Status Register
0x60	Reg24	Interrupt Enable Set (Unmask)
0x64	Reg25	Interrupt Enable Clear (Mask)
0x68	Reg26	End of Interrupt Indicator

13.3.6.1.2 Raw Status Register

Interrupts are associated with a bit position. For instance, Hardware Interrupt 0 is physically connected to bit 0 of the interrupt controller and all Sets, Clears, and Masks to this interrupt will reference the Bit 0 location of the interrupt vector. Likewise, Hardware Interrupt 1 is referenced by bit 1 of the interrupt vector, and so on.

The Host CPU can see all the interrupts that have been set, regardless of the interrupt mask, by reading Reg22, the Raw Status Register.

If the Host CPU writes a '1' to a bit position in Reg 22, it will do a software set for the interrupt associated with that bit position.

13.3.6.1.3 Masked Status Register

The Masked Status Register contains all the pending interrupts that are unmasked (enabled). The Interrupt Service Routine should read this register to determine which interrupts must be serviced.

13.3.6.1.4 Interrupt Enable Set Register

To unmask an interrupt, the Host CPU writes a '1' to the appropriate bit position of the Enable Set (Unmask) register.

13.3.6.1.5 Interrupt Enable Clear Register

To mask an interrupt, the Host CPU writes a '1' to the appropriate bit position of the Enable Clear (Mask) register.

13.3.6.1.6 End of Interrupt Register

The ipgvmodirq module supports level or pulse interrupts to the CPU. For pulse interrupts, the Host must write to an end-of-interrupt (EOI), memory-mapped address to indicate that the Interrupt Service Routine has completed and is exiting. Any pending interrupts that have not been serviced will trigger another interrupt pulse to the Host CPU.

13.3.6.2 Interrupt Sources

13.3.6.2.1 Overview of Interrupt Sources

The interrupt sources include:

- DMA End of Frame 0
- DMA End of Frame 1
- Palette Loaded
- FIFO Underflow
- AC Bias Count
- Sync Lost
- Recurrent Frame Done
- LIDD or Raster Frame Done

13.3.6.2.1.1 DMA End of Frame 0 and End of Frame 1 Interrupt

The DMA End of Frame 0 and End of Frame 1 interrupts are triggered when the DMA module has completed transferring the contents of a frame buffer bounded by `cfg_fb0_base/cfg_bf0_ceil` or `cfg_fb1_base/cfg_fb1_ceil`.

13.3.6.2.1.2 Palette Loaded Interrupt

When `cfg_palmode` is set to Palette-only or Palette+data, the Palette Loaded interrupt is triggered when the palette portion of the DMA transfer has been stored in the Palette RAM.

13.3.6.2.1.3 FIFO Underflow Interrupt

The FIFO Underflow interrupt is triggered when the real-time output needs to send a value for pixel data but one cannot be found in the FIFO.

13.3.6.2.1.4 AC Bias Count Interrupt

For Passive Matrix displays, a count can be kept of the number of times the AC Bias line toggles. Once the specified number of transitions has been seen, the AC Bias Count interrupt is triggered. The module will not post any further interrupts or keep counting AC Bias transitions until the interrupt has been cleared.

13.3.6.2.1.5 Sync Lost Interrupt

When the DMA module reads a frame buffer and stores it in the FIFO, it sets a start frame and an end frame indicator embedded with the data. On retrieving the data from the FIFO in the `lcd_clk` domain, the Sync Lost interrupt is triggered if the start indicator is not found at the first pixel of a new frame.

13.3.6.2.1.6 Recurrent Frame Done Interrupt

In raster mode, the Recurrent Frame Done interrupt is triggered each time a complete frame has been sent to the interface pins.

13.3.6.2.1.7 LIDD or Raster Frame Done Interrupt

In LIDD DMA mode, a frame buffer of data is sent. When the frame buffer has completed, the LIDD Frame Done interrupt is triggered. In order to do another LIDD DMA, the DMA engine must be disabled and then re-enabled.

In Raster mode, the interrupt is triggered after `cfg_lcden` is set to '0' and after the last frame is sent to the pins. After the Raster mode DMA is running, the interrupt occurs only once after the module is disabled.

13.3.7 DMA

DDR access is handled internally by the DMA module. For Character Displays, the DMA module can transfer a sequence of data transactions from the DDR to LCD panel. By using the DMA instead of the Host CPU, the Host will not be stalled waiting for the slow external peripheral to complete.

For Passive and Active Matrix displays, the DMA is used to read frame buffers with associated palette information from DDR. The DMA parses the frame buffer according to the frame buffer type and supplies the raster processing chain with Palette information and pixel data as needed.

13.3.8 Power Management

Power management within the DSS can be accomplished in several ways:

1. L4 OCP MConnect/SConnect can disable the internal L4 clock network.
2. L3 OCP MConnect/Sconnect can disable the internal L3 clock network.
3. Within the Clock Control register, there are clock enable registers to disable the clock networks to all major internal functional paths.
4. Power Compiler clock gates are automatically instantiated within datapaths to minimize active power.

Items 1 and 2 are accomplished using the standard IDLE (for L4) and STANDBY (for L3) IPGeneric modules. When these modules are instructed to disable clocks for the internal L3 or L4 (MMR) clock domains, the internal clock networks will be shut down. This shutdown applies to the external clock pins I3_clk and I4_clk.

All other internal clock domains (Item 3) can only be shut down by writing the appropriate register bit within the Clock Enable register. This software clock control applies to all other clock inputs.

Power Compiler clock gating is done automatically as a function of the design. There is no special control required for this operation.

Because the LCD normally drives displays, and because all video is sourced from the L3 clock domain, shutting down the L3 domain using the IPGenerics can cause undesirable display effects. In most circumstances, it will be necessary to hardware/software reset the LCD module after such an event has occurred.

13.4 Programming Model

13.4.1 LCD Character Displays

13.4.1.1 Configuration Registers, Setup, and Settings

13.4.1.1.1 Configuration Registers

Set the following to appropriate values for the target LCD character panel:

- `cfg_cs1_e1_pol`
- `cfg_cs0_e0_pol`
- `ws_dir_pol`
- `cfg_rs_en_pol`
- `cfg_alepol`

`cfg_lidd_mode_sel[2:0]` defines the type of CPU bus that will be used in interfacing with the LCD character panel. Note that the clocked bus styles only support a single panel using CS0 since the clock pin takes a device pin that is otherwise used for CS1.

Set the following to appropriate bus timing parameters for the target LCD character panel:

- `cfg_w_su`
- `cfg_w_strobe`
- `cfg_w_hold`, `cfg_r_su`
- `cfg_r_strobe`
- `cfg_r_hold`
- `cfg_ta`

A set of bus timing parameters are individually available for CS0 and CS1 such that the bus transactions can be customized for each of the two supported LCD character displays.

13.4.1.1.2 Defining Panel Commands and Panel Data

In the Hitachi interface mode used for the example panel, whether the Character Panel understands a data transfer as Command or Data depends on the state of the REGSEL input pin. Writing to the `cfg_adr_indx` register will output a Command transfer. Writing to the `cfg_data` register will result in a Data transfer.

Functionally, the ALE (`lcd_fp` pin) from the LCD controller is tied to the REGSEL input of the character panel.

For example, to send byte 0xAB as a command to the previously described character panel, the CPU would write 0x00AB to the `adr_indx` register. To send byte 0xAB as data, the CPU would write 0x00AB to the data register.

13.4.1.2 CPU Initiated Data Bus Transactions

13.4.1.2.1 Initiating Data Bus Transactions

Writing to `cfg_cs0_data` will initiate a write transfer to the CS0 panel. Reading from `cfg_cs0_data` will initiate a read transfer from the CS0 panel.

Writing to `cfg_cs1_data` will initiate a write transfer to the CS1 panel. Reading from `cfg_cs1_data` will initiate a read transfer from the CS0 panel.

NOTE: Writes to CS1 translate to valid bus transactions only if `cfg_lidd_mode_sel[2:0]` is configured for an asynchronous mode.

13.4.1.3 DMA Initiated Data Bus Transactions for LIDD

13.4.1.3.1 DMA Overview for MPU Bus Output

Writing a long sequence of data to the Character Display Panel will ensure that the CPU will be occupied for a long time. However, the DMA module supports a mode in which this sequence of data elements can first be written in DRAM by the CPU.

The DMA can read this sequence of commands or data from the DRAM and send it to the LCD Interface Display Driver (LIDD) module such that each data element becomes a write bus transaction to the external Character Panel/MPU Bus. The data bus write transaction can target either CS0 or CS1 and use the appropriate bus timing parameters.

Functionally, in this DMA LIDD mode, the DMA module sends the sequence of data to the LIDD module by acting as another CPU.

The DMA can only perform write bus transactions. It cannot read from the external character panel a series of data elements and store them in the DRAM.

When the LIDD module is controlled by the DMA module by setting `cfg_lidd_dma_en = '1'`, CPU reads or writes to `cfg_adr_index` and `cfg_data` are not allowed.

The `fb0_base` and `fb0_ceil` registers define the address boundary of data elements to be sent out the character display by the DMA engine. Setting `cfg_lidd_dma_en` from '0' to '1' will initiate the DMA as if a virtual CPU is reading data from the DDR and writing the values to Reg6 or Reg9. `cfg_dma_cs0_cs1` determines whether the virtual CPU writes to Reg6 (CS0) or Reg7 (CS1).

NOTE: Writes to CS1 translate to valid bus transactions only if `cfg_lidd_mode_sel[2:0]` is configured for an asynchronous mode.

The DMA module requires the start and end DDR addresses to be on word-aligned byte addresses. The MPU/LIDD bus is a halfword (16 bit) output, so both the upper and lower halfwords of the DDR memory will be sent out. Thus, the number of data elements sent to the LIDD by the DMA must always result in an even number of bus MPU bus transactions. In other words, a transfer of three 32-bit words from DDR will result in six 16-bit bus transactions.

13.4.1.3.2 MCU/LIDD DMA Setup: Example Pseudo Code

Suppose we want to send by DMA a section of DDR memory from byte address 0x4 to byte address 0x3C to the MCU bus using chip select 0. The pseudo code for such an operation is listed below.

```
// Enable Clocks
wr 006C 0000_0007

// LCD Control Register
wr 0004 0000_8000 // set clock divisor

// LIDD Control Register
wr 000C 0000_000C // set output bus polarities and lidd_mode_sel

// LIDD CS0 Register
wr 0010 0822_1044 // set bus timing parameters for CS0

// DMA Control Register
wr 0040 0000_0030 // set DMA parameters like burst size, memory layout

// DMA FB0 Base Register
wr 0044 0000_0004 // DMA start byte address

// DMA FB0 Ceiling Register
wr 0048 0000_003C // DMA end byte address

// LIDD Control Register - enable DMA
wr 000C 0000_010C // Flip LIDD DMA enable bit
```

Once the DMA completes sending data to the Async FIFO, the Eof0 interrupt will occur. The Done interrupt will occur when the last word is written out the MPU bus.

The CPU must bring `cfg_lidd_dma_en` low before the CPU can directly initiate MPU bus transactions or for the DMA module to start again.

13.4.1.4 Passive Matrix

13.4.1.4.1 Monochrome Bitrate Awareness

In a mostly testbench related note, care must be taken when configuring the module for Passive Matrix (`cfg_lcdtft = '0'`) monochrome (`cfg_lcdbw = '1'`) modes. In passive matrix mode, the Blue component of the Grayscale output is used as the quantized value for each scan order pixel.

When `cfg_mono8b='1'`, eight pixel values must be sent through the grayscale before one 8-bit output is ready. This output data represents the passive matrix output states for eight pixels.

Likewise, when `cfg_mono8b='0'`, four pixel values must be sent through the grayscale before one 4-bit output is ready. This output data represents the passive matrix output states for four pixels.

The problem arises when the output clock is fast (`cfg_clkdiv=0x2`). The data path must output a value every two system clocks. However, it takes four or eight system clocks to generate a data element to be output. In this case, the LCD module returns an underflow interrupt.

In practice, such a situation does not occur because passive matrix panels are slow by design.

13.4.2 Active Matrix Displays

13.4.2.1 Interfacing to Dual LVDS Transmitters

The pixel clock rate for HD-sized pictures is approximately 148.5 MHz. At this speed, the LVDS link requires a double-wide data bus for transferring the even and odd pixels at half the pixel rate. The LCD Controller outputs one pixel per pixel clock cycle. Some LVDS transmitters accept a high speed, single pixel input and output to dual LVDS drivers, in which case external glue logic is unnecessary. For those LVDS transmitters that require the even and odd pixel to enter the LVDS transmitter at half the pixel clock rate, external logic is required.

13.4.3 System Interaction

13.4.3.1 DMA End of Frame Interrupts

The LCD module works with the DMA such that data is fetched from DDR and sent to a FIFO memory. The DMA module does this fetching independently of the logic on the output side of the FIFO.

For LIDD mode DMA, the module fetches frame buffer 0. When the last word of frame buffer 0 is stored in the FIFO memory, the Eof0 interrupt is triggered (if `cfg_eof_inten='1'`) and the DMA stops. The CPU has to set `cfg_lidd_dma_en='0'`, followed by a `cfg_lidd_dma_en='1'`, before the next burst from frame buffer 0 is read from DDR.

For Raster mode DMA, the module fetches frame buffer 0. When the last word of frame buffer 0 is stored in the FIFO memory, the Eof0 interrupt is triggered (if `cfg_eof_inten='1'`) but the DMA does not stop. The DMA module ping pongs immediately to frame buffer 1 if `cfg_frame_mode='1'`. Otherwise, the DMA fetches the frame buffer 0 address range from DDR. When the DMA module fetches frame buffer 1, and the last word of frame buffer 1 is stored in the FIFO memory, the Eof1 interrupt is triggered (if `cfg_eof_inten='1'`). This pattern would repeat.

13.4.4 Palette Lookup

For Active Matrix and Passive Matrix modes, the 12-bit Palette RAM Lookup can be used. For Active Matrix (`cfg_lcdtft = '1'`), palette lookup is enabled when `cfg_tft24 = '0'` and the `bpp` field in the Palette RAM is set to "000," "001," "010," or "011" (1, 2, 4, or 8 bpp). Palette lookup cannot be used when the `bpp` field is set to "100" (12/16 bpp).

For Passive Matrix (`cfg_lcdtft = '0'`), palette lookup is enabled when the `bpp` field in the Palette RAM is set to "000," "001," "010," or "011" (1, 2, 4, or 8 bpp). Palette lookup cannot be used when the `bpp` field is set to "100" (12/16 bpp).

Palette lookup scenarios are illustrated in [Figure 13-18](#).

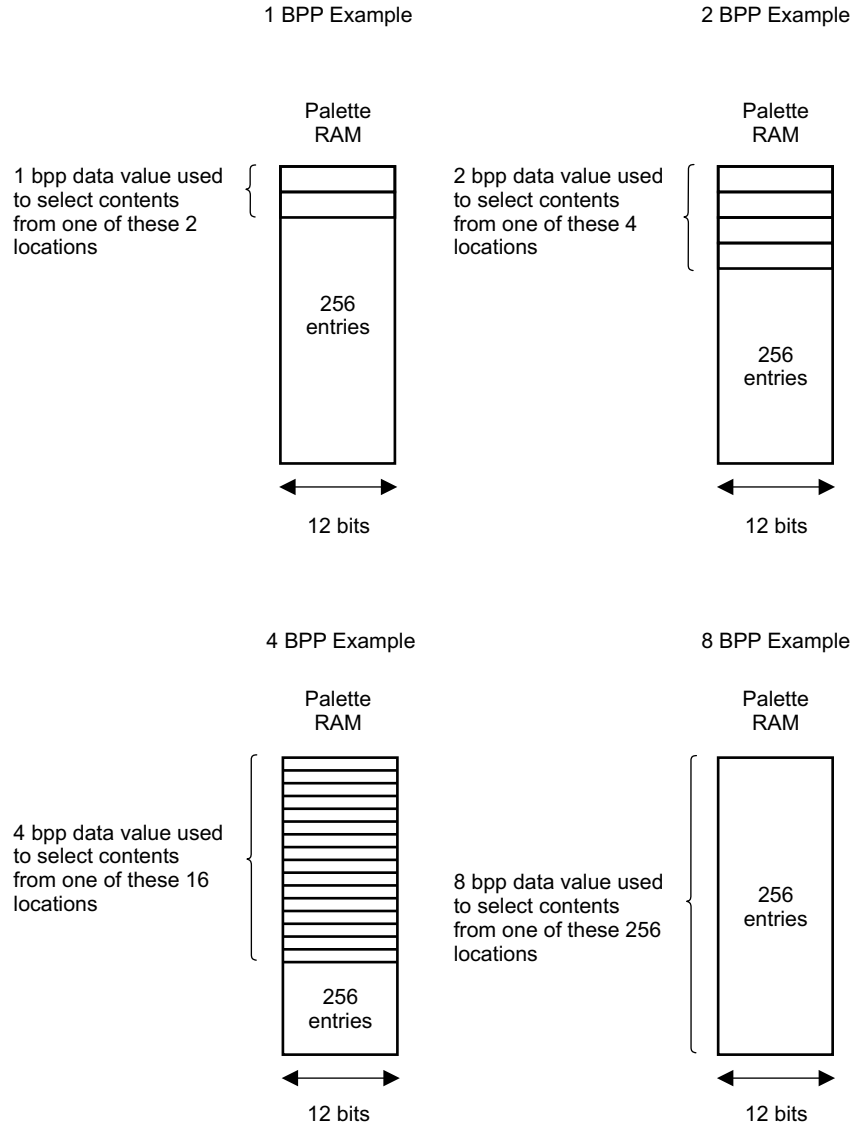
When the `bpp` encoding is set to 1 bpp, each bit in a 16-bit frame buffer halfword is used to index the two bottom locations of the palette RAM. Suppose the frame buffer bit value is '0', this '0' indicates that the address 0 entry in the Palette RAM should be read. If the frame buffer bit value is '1,' the address 1 entry in the Palette RAM is used. The resulting 12-bit output from the Palette RAM is the quantized pixel value of a 4-bit per color component quantized pixel value.

When the `bpp` encoding is set to 2 bpp, every two bits in a 16 bit frame buffer halfword is used to index the bottom 4 locations of the palette RAM. Suppose the frame buffer bit value is "00." This "00" indicates that the address 0 entry in the Palette RAM should be read. If the frame buffer bit value is "01," the address 1 entry in the Palette RAM is used. When the frame buffer bit value is "10," the address 2 entry in the Palette RAM is read. Finally, if the frame buffer bit value is "11," the address 3 entry in the Palette RAM is read. The resulting 12 bit output from the Palette RAM is the quantized pixel value of the 4 bit per color component.

The 4 bpp encoding allows every four bits from a frame buffer halfword to address 16 entries in the Palette RAM.

The 8 bpp encoding enables every byte from a frame buffer halfword to address one of the 256 entries in the Palette RAM.

Figure 13-18. Palette Lookup Examples



A 16-bit halfword is read from the DDR frame buffer. This halfword can be byte lane and halfword swapped using the DMA configuration values `cfg_byte_swap` and `cfg_bigendian`. This section will deal with the frame buffer data as it is returned post swapped from the DMA module.

The DMA module actually outputs a 32-bit word. The Palette Lookup logic uses the lower halfword first, followed by the upper halfword. The `cfg_rddorder` and `cfg_nibmode` registers determine the raster read ordering of the frame buffer data to be sent to the palette lookup table.

There are precedence rules for the hardware as it parses each 16-bit word from the frame buffer.

1. If `cfg_rddorder = '0'`, the data halfword is parsed from the least significant bit to the most significant bit.
2. Else, if `cfg_nibmode = '1'`, the data halfword is parsed byte swapped with the scan order going from the most significant bit of each byte to the least significant bit of each byte.
3. Otherwise, the data halfword is parsed from the most significant bit to the least significant bit.

The bitwise scan order for each halfword fetched from the frame buffer is shown in the following lists. The bitfields returned are used to determine the addressing of the Palette RAM.

Frame buffer halfword scan order for 1 bpp

1. If `cfg_rdorder = 0`, scan order is [0] [1] [2] [3] [4] [5] [6] [7] [8] [9] [10] [11] [12] [13] [14] [15]
2. Else if `cfg_nibmode=1`, scan order is [7] [6] [5] [4] [3] [2] [1] [0] [15] [14] [13] [12] [11] [10] [9] [8]
3. Otherwise, scan order is [15] [14] [13] [12] [11] [10] [9] [8] [7] [6] [5] [4] [3] [2] [1] [0]

Frame buffer halfword scan order for 2 bpp

1. If `cfg_rdorder = 0`, scan order is [1:0] [3:2] [5:4] [7:6] [9:8] [11:10] [13:12] [15:14]
2. Else if `cfg_nibmode=1`, scan order is [7:6] [5:4] [3:2] [1:0] [15:14] [13:12] [11:10] [9:8]
3. Otherwise, scan order is [15:14] [13:12] [11:10] [9:8] [7:6] [5:4] [3:2] [1:0]

Frame buffer halfword scan order for 4 bpp

1. If `cfg_rdorder = 0`, scan order is [3:0] [7:4] [11:8] [15:12]
2. Else if `cfg_nibmode=1`, scan order is [7:4] [3:0] [15:12] [11:8]
3. Otherwise, scan order is [15:12] [11:8] [7:4] [3:0]

Frame buffer halfword scan order for 8 bpp

1. If `cfg_rdorder = 0`, scan order is [7:0] [15:8]
2. Else if `cfg_nibmode=1`, scan order is [7:0] [15:8]
3. Otherwise, scan order is [15:8] [7:0]

13.4.5 Test Logic

13.4.6 Disable and Software Reset Sequence

In Raster Modes, the module must be disabled before applying a software reset. When `cfg_lcden` is set to '0' to disable the module, the output continues to the end of the current frame.

The Done interrupt will trigger once the frame is complete. The software reset can then be applied to the module.

The software reset will clear all the frame information in the FIFO. Upon a restart, the L3 DMA will fetch from the `fb0_base` address.

To summarize:

- Set `cfg_lcden='0'`.
- Wait for the Done interrupt.
- Set the software reset bits high (`cfg_main_rst='1'` or [`cfg_dma_rst='1'` and `cfg_core_rst='1'`]) for several cycles.
- Set the resets back low.
- Set `cfg_lcden='1'`.

The disable and reset sequence must be done in this order to properly operate the LCD module and the EMIF.

13.4.7 Precedence Order for Determining Frame Buffer Type

The precedence order for determining frame buffer type is specified as follows:

```
If (cfg_lcdtft == 1) // active matrix
  If (cfg_tft24 == 1) // 24 bpp
    If (cfg_tft24_unpacked == 1)
      4 pixels in 4 words
    else
      4 pixels in 3 words
  else // 1/2/4/8/12/16 bpp
    if (bpp[2] == 1)
      12/16 bpp data
    else
      if (bpp == 0)
        1 bpp data
      else if (bpp == 1)
        2 bpp data
      else if (bpp == 2)
        4 bpp data
      else // if (bpp == 3)
        8 bpp data
  else // passive matrix
    if (bpp[2] == 1)
      12/16 bpp data
    else
      if (bpp == 0)
        1 bpp data
      else if (bpp == 1)
        2 bpp data
      else if (bpp == 2)
        4 bpp data
      else // if (bpp == 3)
        8 bpp data
```

13.5 Registers

13.5.1 LCD Registers

Table 13-13 lists the memory-mapped registers for the LCD. All register offset addresses not listed in Table 13-13 should be considered as reserved locations and the register contents should not be modified.

Table 13-13. LCD Registers

Offset	Acronym	Register Name	Section
0h	PID		Section 13.5.1.1
4h	CTRL		Section 13.5.1.2
Ch	LIDD_CTRL		Section 13.5.1.3
10h	LIDD_CS0_CONF		Section 13.5.1.4
14h	LIDD_CS0_ADDR		Section 13.5.1.5
18h	LIDD_CS0_DATA		Section 13.5.1.6
1Ch	LIDD_CS1_CONF		Section 13.5.1.7
20h	LIDD_CS1_ADDR		Section 13.5.1.8
24h	LIDD_CS1_DATA		Section 13.5.1.9
28h	RASTER_CTRL		Section 13.5.1.10
2Ch	RASTER_TIMING_0		Section 13.5.1.11
30h	RASTER_TIMING_1		Section 13.5.1.12
34h	RASTER_TIMING_2		Section 13.5.1.13
38h	RASTER_SUBPANEL		Section 13.5.1.14
3Ch	RASTER_SUBPANEL2		Section 13.5.1.15
40h	LCDDMA_CTRL		Section 13.5.1.16
44h	LCDDMA_FB0_BASE		Section 13.5.1.17
48h	LCDDMA_FB0_CEILING		Section 13.5.1.18
4Ch	LCDDMA_FB1_BASE		Section 13.5.1.19
50h	LCDDMA_FB1_CEILING		Section 13.5.1.20
54h	SYSCONFIG		Section 15.1.2.2
58h	IRQSTATUS_RAW		Section 20.1.5.4
5Ch	IRQSTATUS		Section 20.1.5.5
60h	IRQENABLE_SET		Section 20.1.5.6
64h	IRQENABLE_CLEAR		Section 13.5.1.25
6Ch	CLKC_ENABLE		Section 13.5.1.26
70h	CLKC_RESET		Section 13.5.1.27

13.5.1.1 PID Register (offset = 0h) [reset = 0h]

PID is shown in [Figure 13-19](#) and described in [Table 13-14](#).

Figure 13-19. PID Register

31	30	29	28	27	26	25	24
scheme		RESERVED				func	
R-0h		R-0h				R-0h	
23	22	21	20	19	18	17	16
func							
R-0h							
15	14	13	12	11	10	9	8
rtl					major		
R-0h					R-0h		
7	6	5	4	3	2	1	0
custom		minor					
R-0h		R-0h					

LEGEND: R/W = Read/Write; R = Read only; W1toCl = Write 1 to clear bit; -n = value after reset

Table 13-14. PID Register Field Descriptions

Bit	Field	Type	Reset	Description
31-30	scheme	R	0h	The scheme of the register used. This field indicates the 3.5 Method.
29-28	RESERVED	R	0h	
27-16	func	R	0h	The function of the module being used.
15-11	rtl	R	0h	The Release number for this IP.
10-8	major	R	0h	Major Release Number
7-6	custom	R	0h	Custom IP
5-0	minor	R	0h	Minor Release Number

13.5.1.2 CTRL Register (offset = 4h) [reset = 0h]

 CTRL is shown in [Figure 13-20](#) and described in [Table 13-15](#).

Figure 13-20. CTRL Register

31	30	29	28	27	26	25	24
RESERVED							
R-0h							
23	22	21	20	19	18	17	16
RESERVED							
R-0h							
15	14	13	12	11	10	9	8
clkdiv							
R/W-0h							
7	6	5	4	3	2	1	0
RESERVED						auto_uflow_restart	modesel
R/W-0h						R/W-0h	R/W-0h

LEGEND: R/W = Read/Write; R = Read only; W1toCl = Write 1 to clear bit; -n = value after reset

Table 13-15. CTRL Register Field Descriptions

Bit	Field	Type	Reset	Description
31-16	RESERVED	R	0h	
15-8	clkdiv	R/W	0h	Clock divisor. Raster mode: Values of 2 through 255 are permitted and resulting pixel clock is lcd_clk/2 through lcd_clk/255. LIDD mode: Values of 0 through 255 are permitted with resulting MCLK of lcd_clk/1 through lcd_clk/255 where both 0 and 1 result in lcd_clk/1.
7-2	RESERVED	R/W	0h	
1	auto_uflow_restart	R/W	0h	0 = On an underflow, the software has to restart the module. 1 = On an underflow, the hardware will restart on the next frame.
0	modesel	R/W	0h	LCD Mode select. 0 = LCD Controller in LIDD Mode. 1 = LCD Controller in Raster Mode.

13.5.1.3 LIDD_CTRL Register (offset = Ch) [reset = 0h]

LIDD_CTRL is shown in [Figure 13-21](#) and described in [Table 13-16](#).

Figure 13-21. LIDD_CTRL Register

31	30	29	28	27	26	25	24
RESERVED							
R-0h							
23	22	21	20	19	18	17	16
RESERVED							
R-0h							
15	14	13	12	11	10	9	8
RESERVED						dma_cs0_cs1	lidd_dma_en
R-0h						R/W-0h	R/W-0h
7	6	5	4	3	2	1	0
cs1_e1_pol	cs0_e0_pol	ws_dir_pol	rs_en_pol	alepol	lidd_mode_sel		
R/W-0h	R/W-0h	R/W-0h	R/W-0h	R/W-0h	R/W-0h		

LEGEND: R/W = Read/Write; R = Read only; W1toCl = Write 1 to clear bit; -n = value after reset

Table 13-16. LIDD_CTRL Register Field Descriptions

Bit	Field	Type	Reset	Description
31-10	RESERVED	R	0h	
9	dma_cs0_cs1	R/W	0h	CS0/CS1 Select for LIDD DMA writes. 0 = DMA writes to LIDD CS0. 1 = DMA writes for LIDD CS1.
8	lidd_dma_en	R/W	0h	LIDD DMA Enable. 0 = Deactivate DMA control of LIDD interface. DMA control is released upon completion of transfer of the current frame of data (LIDD Frame Done) after this bit is cleared. The MPU has direct read/write access to the panel in this mode. 1 = Activate DMA to drive LIDD interface to support streaming data to smart panels. The MPU cannot access the panel directly in this mode.
7	cs1_e1_pol	R/W	0h	Chip Select 1/Enable 1 (Secondary) Polarity Control. 0 = Do Not Invert Chip Select 1/Enable 1. Chip Select 1 is active low by default. Enable 1 is active high by default. 1 = Invert Chip Select 1/Enable 1.
6	cs0_e0_pol	R/W	0h	Chip Select 0/Enable 0 (Secondary) Polarity Control. 0 = Do Not Invert Chip Select 0/Enable 0. Chip Select 0 is active low by default. Enable 0 is active high by default. 1 = Invert Chip Select 0/Enable 0.
5	ws_dir_pol	R/W	0h	Write Strobe/Direction Polarity Control. 0 = Do Not Invert Write Strobe/Direction. Write Strobe/Direction is active low/write low by default. 1 = Invert Write Strobe/Direction.
4	rs_en_pol	R/W	0h	Read Strobe/Direction Polarity Control. 0 = Do Not Invert Read Strobe/Direction. Read Strobe/Direction is active low/write low by default. 1 = Invert Read Strobe/Direction.
3	alepol	R/W	0h	Address Latch Enable (ALE) Polarity Control. 0 = Do Not Invert ALE. ALE is active low by default. 1 = Invert.

Table 13-16. LIDD_CTRL Register Field Descriptions (continued)

Bit	Field	Type	Reset	Description
2-0	lidd_mode_sel	R/W	0h	LIDD Mode Select. Selects type of LCD display interface for the LIDD to drive. 000b = Sync MPU68. 001b = Async MPU68. 010b = Sync MPU80. 011b = Async MPU80. 100b = Hitachi (Async). 101b = N/A. 110b = N/A. 111b = N/A.

13.5.1.4 LIDD_CS0_CONF Register (offset = 10h) [reset = 0h]

LIDD_CS0_CONF is shown in [Figure 13-22](#) and described in [Table 13-17](#).

Figure 13-22. LIDD_CS0_CONF Register

31	30	29	28	27	26	25	24	23	22	21	20	19	18	17	16
w_su				w_strobe						w_hold				r_su	
R/W-0h				R/W-0h						R/W-0h				R/W-0h	
15	14	13	12	11	10	9	8	7	6	5	4	3	2	1	0
r_su				r_strobe						r_hold				ta	
R/W-0h				R/W-0h						R/W-0h				R/W-0h	

LEGEND: R/W = Read/Write; R = Read only; W1toCl = Write 1 to clear bit; -n = value after reset

Table 13-17. LIDD_CS0_CONF Register Field Descriptions

Bit	Field	Type	Reset	Description
31-27	w_su	R/W	0h	Write Strobe Set-Up cycles. When performing a write access, this field defines the number of memclk cycles that Data Bus/Pad Output Enable, the Direction bit, and Chip Select 0 have to be ready before the Write Strobe is asserted. The minimum value is 0x0.
26-21	w_strobe	R/W	0h	Write Strobe Duration cycles. Field value defines the number of memclk cycles for which the Write Strobe is held active when performing a write access. The minimum value is 0x1.
20-17	w_hold	R/W	0h	Write Strobe Hold cycles. Field value defines the number of memclk cycles for which Data Bus/Pas Output Enable, ALE, the Direction bit, and Chip Select 0 are held after the Write Strobe is de-asserted when performing write access. The minimum value is 0x1.
16-12	r_su	R/W	0h	Read Strobe Set-Up cycles. When performing a read access, this field defines the number of memclk cycles that Data Bus/Pad Output Enable, the Direction bit, and Chip Select 0 have to be ready before the Read Strobe is asserted.
11-6	r_strobe	R/W	0h	Read Strobe Duration cycles. Field value defines the number of memclk cycles for which the Read Strobe is held active when performing a read access. The minimum value is 0x1.
5-2	r_hold	R/W	0h	Read Strobe Hold cycles. Field value defines the number of memclk cycles for which Data Bus/Pad Output Enable, the Direction bit, and Chip Select 0 are held after the Read Strobe is deasserted when performing a read access. The minimum value is 0x1.
1-0	ta	R/W	0h	Field value defines the number of memclk (ta+1) cycles between the end of one CS0 device access and the start of another CS0 device access unless the two accesses are both Reads. In this case, this delay is not incurred. The minimum value is 0x0.

13.5.1.5 LIDD_CS0_ADDR Register (offset = 14h) [reset = 0h]

LIDD_CS0_ADDR is shown in [Figure 13-23](#) and described in [Table 13-18](#).

Figure 13-23. LIDD_CS0_ADDR Register

31	30	29	28	27	26	25	24	23	22	21	20	19	18	17	16	15	14	13	12	11	10	9	8	7	6	5	4	3	2	1	0
RESERVED																adr_indx															
R-0h																R/W-0h															

LEGEND: R/W = Read/Write; R = Read only; W1toCl = Write 1 to clear bit; -n = value after reset

Table 13-18. LIDD_CS0_ADDR Register Field Descriptions

Bit	Field	Type	Reset	Description
31-16	RESERVED	R	0h	
15-0	adr_indx	R/W	0h	<p>The LCD Controller supports a shared Address/Data output bus. A write to this register would initiate a bus write transaction. A read from this register would initiate a bus read transaction. CPU reads and writes to this register are not permitted if the LIDD module is in DMA mode (cfg_lidd_dma_en = 1). If the LIDD is being used as a generic bus interface, writing to this register can store adr_indx to an external transparent latch holding a 16-bit address.</p> <p>If the LIDD is being used to interface with a character based LCD panel in configuration mode, reading and writing to this register can be used to access the command instruction area of the panel.</p>

13.5.1.6 LIDD_CS0_DATA Register (offset = 18h) [reset = 0h]

LIDD_CS0_DATA is shown in [Figure 13-24](#) and described in [Table 13-19](#).

Figure 13-24. LIDD_CS0_DATA Register

31	30	29	28	27	26	25	24	23	22	21	20	19	18	17	16	15	14	13	12	11	10	9	8	7	6	5	4	3	2	1	0
RESERVED																data															
R-0h																R/W-0h															

LEGEND: R/W = Read/Write; R = Read only; W1toCl = Write 1 to clear bit; -n = value after reset

Table 13-19. LIDD_CS0_DATA Register Field Descriptions

Bit	Field	Type	Reset	Description
31-16	RESERVED	R	0h	
15-0	data	R/W	0h	<p>The LCD Controller supports a shared Address/Data output bus. A write to this register would initiate a bus write transaction. A read from this register would initiate a bus read transaction. CPU reads and writes to this register are not permitted if the LIDD module is in DMA mode (<code>cfg_lidd_dma_en = 1</code>).</p> <p>If the LIDD is being used as a generic bus interface, writing to this register can store <code>adr_indx</code> to an external transparent latch holding a 16-bit address.</p> <p>If the LIDD is being used to interface with a character based LCD panel in configuration mode, reading and writing to this register can be used to access the command instruction area of the panel.</p>

13.5.1.7 LIDD_CS1_CONF Register (offset = 1Ch) [reset = 0h]

 LIDD_CS1_CONF is shown in [Figure 13-25](#) and described in [Table 13-20](#).

Figure 13-25. LIDD_CS1_CONF Register

31	30	29	28	27	26	25	24	23	22	21	20	19	18	17	16
w_su					w_strobe					w_hold					r_su
R/W-0h					R/W-0h					R/W-0h					R/W-0h
15	14	13	12	11	10	9	8	7	6	5	4	3	2	1	0
r_su					r_strobe					r_hold					ta
R/W-0h					R/W-0h					R/W-0h					R/W-0h

LEGEND: R/W = Read/Write; R = Read only; W1toCl = Write 1 to clear bit; -n = value after reset

Table 13-20. LIDD_CS1_CONF Register Field Descriptions

Bit	Field	Type	Reset	Description
31-27	w_su	R/W	0h	Write Strobe Set-Up cycles. When performing a write access, this field defines the number of memclk cycles that Data Bus/Pad Output Enable, , the Direction bit, and Chip Select 1 have to be ready before the Write Strobe is asserted. The minimum value is 0x0.
26-21	w_strobe	R/W	0h	Write Strobe Duration cycles. Field value defines the number of memclk cycles for which the Write Strobe is held active when performing a write access. The minimum value is 0x1.
20-17	w_hold	R/W	0h	Write Strobe Hold cycles. Field value defines the number of memclk cycles for which Data Bus/Pad Output Enable, ALE, the Direction bit, and Chip Select 1 are held after the Write Strobe is deasserted when performing a write access. The minimum value is 0x1.
16-12	r_su	R/W	0h	Read Strobe Set-Up cycles. When performing a read access, this field defines the number of memclk cycles that Data Bus/Pad Output Enable, , the Direction bit, and Chip Select 1 have to be ready before the Read Strobe is asserted. The minimum value is 0x0.
11-6	r_strobe	R/W	0h	Read Strobe Duration cycles. Field value defines the number of memclk cycles for which the Read Strobe is held active when performing a read access. The minimum value is 0x1.
5-2	r_hold	R/W	0h	Read Strobe Hold cycles. Field value defines the number of memclk cycles for which Data Bus/Pad Output Enable, , the Direction bit, and Chip Select 1 are held after the Read Strobe is deasserted when performing a read access. The minimum value is 0x1.
1-0	ta	R/W	0h	Field value defines the number of memclk (ta+1) cycles between the end of one CS1 device access and the start of another CS1 device access unless the two accesses are both Reads. In this case, this delay is not incurred. The minimum value is 0x0.

13.5.1.8 LIDD_CS1_ADDR Register (offset = 20h) [reset = 0h]

LIDD_CS1_ADDR is shown in [Figure 13-26](#) and described in [Table 13-21](#).

Figure 13-26. LIDD_CS1_ADDR Register

31	30	29	28	27	26	25	24	23	22	21	20	19	18	17	16	15	14	13	12	11	10	9	8	7	6	5	4	3	2	1	0
RESERVED																adr_indx															
R-0h																R/W-0h															

LEGEND: R/W = Read/Write; R = Read only; W1toCl = Write 1 to clear bit; -n = value after reset

Table 13-21. LIDD_CS1_ADDR Register Field Descriptions

Bit	Field	Type	Reset	Description
31-16	RESERVED	R	0h	
15-0	adr_indx	R/W	0h	<p>The LCD Controller supports a shared Address/Data output bus. A write to this register would initiate a bus write transaction. A read from this register would initiate a bus read transaction. CPU reads and writes to this register are not permitted if the LIDD module is in DMA mode (cfg_lidd_dma_en = 1). If the LIDD is being used as a generic bus interface, writing to this register can store adr_indx to an external transparent latch holding a 16-bit address.</p> <p>If the LIDD is being used to interface with a character based LCD panel in configuration mode, reading and writing to this register can be used to access the command instruction area of the panel.</p>

13.5.1.9 LIDD_CS1_DATA Register (offset = 24h) [reset = 0h]

LIDD_CS1_DATA is shown in [Figure 13-27](#) and described in [Table 13-22](#).

Figure 13-27. LIDD_CS1_DATA Register

31	30	29	28	27	26	25	24	23	22	21	20	19	18	17	16	15	14	13	12	11	10	9	8	7	6	5	4	3	2	1	0
RESERVED																data															
R-0h																R/W-0h															

LEGEND: R/W = Read/Write; R = Read only; W1toCl = Write 1 to clear bit; -n = value after reset

Table 13-22. LIDD_CS1_DATA Register Field Descriptions

Bit	Field	Type	Reset	Description
31-16	RESERVED	R	0h	
15-0	data	R/W	0h	<p>The LCD Controller supports a shared Address/Data output bus. A write to this register would initiate a bus write transaction. A read from this register would initiate a bus read transaction. CPU reads and writes to this register are not permitted if the LIDD module is in DMA mode (<code>cfg_lidd_dma_en = 1</code>).</p> <p>If the LIDD is being used as a generic bus interface, writing to this register can store <code>adr_indx</code> to an external transparent latch holding a 16-bit address.</p> <p>If the LIDD is being used to interface with a character based LCD panel in configuration mode, reading and writing to this register can be used to access the command instruction area of the panel.</p>

13.5.1.10 RASTER_CTRL Register (offset = 28h) [reset = 0h]

RASTER_CTRL is shown in Figure 13-28 and described in Table 13-23.

Figure 13-28. RASTER_CTRL Register

31	30	29	28	27	26	25	24
RESERVED					tft24unpacked	tft24	stn565
R/W-0h					R/W-0h	R/W-0h	R/W-0h
23	22	21	20	19	18	17	16
tftmap	nibmode	palmode		reqdly			
R/W-0h	R/W-0h	R/W-0h		R/W-0h			
15	14	13	12	11	10	9	8
reqdly				RESERVED		mono8b	rdorder
R/W-0h				R/W-0h		R/W-0h	R/W-0h
7	6	5	4	3	2	1	0
lcdtft	RESERVED					lcdbw	lcden
R/W-0h	R/W-0h					R/W-0h	R/W-0h

LEGEND: R/W = Read/Write; R = Read only; W1toCl = Write 1 to clear bit; -n = value after reset

Table 13-23. RASTER_CTRL Register Field Descriptions

Bit	Field	Type	Reset	Description
31-27	RESERVED	R/W	0h	
26	tft24unpacked	R/W	0h	<p>24 bit Mode Packing. Only used when cfg_tft 24=1 and cfg_lcdtft=1. 0 = 24-bit pixels are packed into 32 bit boundaries, which means 4 pixels are saved in every three words. Word 0: pix1 [7:0], pix0 [23:0]. Word 1: pix2 [15:0], pix1 [23:8]. Word 2: pix3 [23:0], pix2 [23:16]. 1 = 24-bit pixels are stored unpacked in with the uppermost byte unused. Word 0: Unused [7:0], pix0 [23:0]. Word 1: Unused [7:0], pix1 [23:0]. Word 2: Unused [7:0], pix2 [23:0]. Word 3: Unused [7:0], pix3 [23:0].</p>
25	tft24	R/W	0h	<p>24 bit mode. 0 = off 1 = on (24-bit data in active mode). The format of the framebuffer data depends on cfg_tft24unpacked.</p>

Table 13-23. RASTER_CTRL Register Field Descriptions (continued)

Bit	Field	Type	Reset	Description
24	stn565	R/W	0h	<p>Passive Matrix Mode only (cfg_lcdtft='0') and 16 bpp raw data framebuffer (bpp = '00').</p> <p>If the bpp field in the framebuffer palette header is '00' (12/16/24 bpp source), then the DDR contains raw data and the palette lookup is bypassed.</p> <p>Only for this case, this bit selects whether the framebuffer format is 16 bpp 565 or 12 bpp.</p> <p>The Grayscale can only take 12 bits per pixel.</p> <p>The framebuffer data is 16 bits per pixel 565 when stn565 is set to '1' and only the 4 most significant bits of each color component are sent to the Grayscale input.</p> <p>0 = Framebuffer is 12 bpp packed in bits [11:0].</p> <p>1 = Framebuffer is 16 bpp 565.</p>
23	ftmap	R/W	0h	<p>TFT Mode Alternate Signal Mapping for Palettized framebuffer. Must be '0' for all 12/16/24 bpp raw data formats.</p> <p>Can only be '1' for 1/2/4/8 bpp Palette Lookup data.</p> <p>Valid only in Active Matrix mode when cfg_lcdtft='1'.</p> <p>0 = 4 bits per component output data for 1, 2, 4, and 8 bpp modes will be right aligned on lcd_pins (11:0).</p> <p>1 = 4 bits per component output data for 1, 2, 4, and 8 bpp will be converted to 5,6,5, format and use pins (15:0) R3 R2 R1 R0 R3 G3 G2 G1 G0 G3 G2 B3 B2 B1 B0 B3</p>
22	nibmode	R/W	0h	<p>Nibble Mode.</p> <p>This bit is used to determine palette indexing and is used in conjunction with cfg_rdorder.</p> <p>0 = Nibble mode is disabled.</p> <p>1 = Nibble mode is enabled.</p>
21-20	palmode	R/W	0h	<p>Palette Loading Mode.</p> <p>00 = Palette and data loading, reset value.</p> <p>01 = Palette loading only.</p> <p>10 = Data loading only For Raw Data (12/16/24 bpp) framebuffers, no palette lookup is employed.</p> <p>Thus, these framebuffers should use the data-only loading mode.</p>
19-12	reqdly	R/W	0h	<p>Palette Loading Delay When loading the Palette from DDR, palette data is burst into the internal Palette SRAM from the Async FIFO.</p> <p>1-, 2-, and 4-bit per pixel framebuffer encodings use a fixed 16-word entry palette residing above the video data.</p> <p>The 8 bit per pixel framebuffer encoding uses a 256-word entry palette residing above the video data.</p> <p>Likewise, 12, 16, and 24 bit per pixel framebuffer encodings also define a 256-word entry palette even though these encodings will not do a full bit-depth palette lookup.</p> <p>However, the 256-word palette entry must still be read from DDR as a framebuffer is fetched.</p> <p>Bursting in 256 words in sequential lcd_clk cycles may cause the Async FIFO to underflow depending on the SOC DDR burst bandwidth.</p> <p>This 8-bit reqdly parameter pauses reading of the Palette data from the Async FIFO between each burst of 16 words.</p> <p>The delay is in terms of lcd_clk (system clock) cycles.</p> <p>Value (0-255) used to specify the number of system clock cycles that should be paused between bursts of 16 word reads from the Async FIFO while loading the Palette SRAM.</p> <p>Programming reqdly=00h disables this pause when loading the palette table.</p>
11-10	RESERVED	R/W	0h	

Table 13-23. RASTER_CTRL Register Field Descriptions (continued)

Bit	Field	Type	Reset	Description
9	mono8b	R/W	0h	Mono 8 bit. 0 = lcd_pixel_o [3:0] is used to output four pixel values to the panel each pixel clock transition. 1 = lcd_pixel_o [7:0] is used to output eight pixel values to the panel each pixel clock transition. This bit is ignored in all other modes.
8	rdorder	R/W	0h	Raster Data Order Select. 0 = The frame buffer parsing for Palette Data lookup is from Bit 0 to bit 31 of the input word from the DMA output. 1 = The fame buffer parsing for Palette Data lookup is from Bit 31 to Bit 0 of the input word from the DMA output. This bit has no effect on raw data framebuffers (12/16/24 bpp). This bit is used to determine palette indexing and is used in conjunction with cfg_nibmode.
7	lcdtft	R/W	0h	0 = Passive or display operation enabled, dither logic is enabled. 1 = Active or display operation enabled, external palette and DAC required, dither logic bypassed, pin timing changes to support continuous pixel clock, output enable, vsync, and hsync.
6-2	RESERVED	R/W	0h	
1	lcdbw	R/W	0h	Only Applies for Passive Matrix Panels LCD Monochrome. 0 = Color operation enabled. 1 = Monochrome operation enabled.
0	lcden	R/W	0h	LCD Controller Enable. 0 = LCD controller disabled. 1 = LCD controller enabled.

13.5.1.11 RASTER_TIMING_0 Register (offset = 2Ch) [reset = 0h]

 RASTER_TIMING_0 is shown in [Figure 13-29](#) and described in [Table 13-24](#).

Figure 13-29. RASTER_TIMING_0 Register

31	30	29	28	27	26	25	24
hbp							
R/W-0h							
23	22	21	20	19	18	17	16
hfp							
R/W-0h							
15	14	13	12	11	10	9	8
hsw						ppllsb	
R/W-0h						R/W-0h	
7	6	5	4	3	2	1	0
ppllsb				pplmsb		RESERVED	
R/W-0h				R/W-0h		R-0h	

LEGEND: R/W = Read/Write; R = Read only; W1toCl = Write 1 to clear bit; -n = value after reset

Table 13-24. RASTER_TIMING_0 Register Field Descriptions

Bit	Field	Type	Reset	Description
31-24	hbp	R/W	0h	Horizontal Back Porch Lowbits Bits 7 to 0 of the horizontal back porch field. Encoded value (from 1-1024) used to specify the number of pixel clock periods to add to the beginning of a line transmission before the first set of pixels is output to the display (programmed value plus 1). Note that pixel clock is held in its inactive state during the beginning of the line wait period in passive display mode, and is permitted to transition in active display mode.
23-16	hfp	R/W	0h	Horizontal Front Porch Lowbits Encoded value (from 1 to 1024) used to specify the number of pixel clock periods to add to the end of a line transmission before line clock is asserted (programmed value plus 1). Note that pixel clock is held in its inactive state during the end of line wait period in passive display mode, and is permitted to transition in active display mode.
15-10	hsw	R/W	0h	Horizontal Sync Pulse Width Lowbits Bits 5 to 0 of the horizontal sync pulse width field. Encoded value (from 1-1024) used to specify the number of pixel clock periods to pulse the line clock at the end of each line (programmed value plus 1). Note that pixel clock is held in its inactive state during the generation of line clock in passive display mode, and is permitted to transition in active display mode.
9-4	ppllsb	R/W	0h	Pixels-per-line LSB [9:4]. Encoded LSB value (from 1-1024) used to specify the number of pixels contained within each line on the LCD display (programmed to value minus one). $PPL = 11'b\{pplmsb, ppllsb, 4'b1111\} + 1$ ex: pplmsb=1'b1, ppllsb=6'0001000 $PPL = 11'b\{1, 000100, 1111\} + 1 = 1104d$ (decimal) pixels per line. In other words, $PPL = 16 * (\{pplmsb, ppllsb\} + 1)$.
3	pplmsb	R/W	0h	Pixels-per-line MSB[10]. Needed in order to support up to 2048 ppl.
2-0	RESERVED	R	0h	

13.5.1.12 RASTER_TIMING_1 Register (offset = 30h) [reset = 0h]

RASTER_TIMING_1 is shown in [Figure 13-30](#) and described in [Table 13-25](#).

Figure 13-30. RASTER_TIMING_1 Register

31	30	29	28	27	26	25	24	23	22	21	20	19	18	17	16	15	14	13	12	11	10	9	8	7	6	5	4	3	2	1	0
vbp								vfp								vsw				lpp											
R/W-0h								R/W-0h								R/W-0h				R/W-0h											

LEGEND: R/W = Read/Write; R = Read only; W1toCl = Write 1 to clear bit; -n = value after reset

Table 13-25. RASTER_TIMING_1 Register Field Descriptions

Bit	Field	Type	Reset	Description
31-24	vbp	R/W	0h	Vertical Back Porch Value (from 0-255) use to specify the number of line clock periods to add to the beginning of a frame before the first set of pixels is output to the display. Note that line clock transitions during the insertion of the extra line clock periods.
23-16	vfp	R/W	0h	Vertical Front Porch Value (from 0-255) used to specify the number of line clock periods to add to the end of each frame. Note that the line clock transitions during the insertion of the extra line clock periods.
15-10	vsw	R/W	0h	Vertical Sync Width Pulse In active mode (lcdtft=1), encoded value (from 1-64) used to specify the number of line clock periods to set the lcd_fp pin active at the end of each frame after the (vfp) period elapses. The number of clock cycles is programmed value plus one. The frame clock is used as the VSYNC signal in active mode. In passive mode (lcdtft=0), encoded value (from 1-64) used to specify the number of extra line clock periods to insert after the vertical front porch (vfp) period has elapsed. Note that the width of lcd_fp is not affected by vsw in passive mode and line clock transitions during the insertion of the extra line clock periods (programmed value plus one).
9-0	lpp	R/W	0h	Lines Per Panel Encoded value (programmed value range of { 0:2047} represents an actual range of { 1:2048}) used to specify the number of lines per panel. It represents the total number of lines on the LCD (programmed value plus one). Bit 10 of this field is in RASTER_TIMING_2.

13.5.1.13 RASTER_TIMING_2 Register (offset = 34h) [reset = 0h]

 RASTER_TIMING_2 is shown in [Figure 13-31](#) and described in [Table 13-26](#).

Figure 13-31. RASTER_TIMING_2 Register

31	30	29	28	27	26	25	24
RESERVED	hsw_highbits				lpp_b10	phsvs_on_off	phsvs_rf
R-0h	R/W-0h				R/W-0h	R/W-0h	R/W-0h
23	22	21	20	19	18	17	16
ieo	ipc	ihs	ivs	acbi			
R/W-0h	R/W-0h	R/W-0h	R/W-0h	R/W-0h			
15	14	13	12	11	10	9	8
acb							
R/W-0h							
7	6	5	4	3	2	1	0
RESERVED		hbp_highbits		RESERVED		hfp_highbits	
R-0h		R/W-0h		R-0h		R/W-0h	

LEGEND: R/W = Read/Write; R = Read only; W1toCl = Write 1 to clear bit; -n = value after reset

Table 13-26. RASTER_TIMING_2 Register Field Descriptions

Bit	Field	Type	Reset	Description
31	RESERVED	R	0h	
30-27	hsw_highbits	R/W	0h	Bits 9 to 6 of the horizontal sync width field.
26	lpp_b10	R/W	0h	Lines Per Panel Bit 10. Bit 10 of the lpp field in RASTER_TIMING_1.
25	phsvs_on_off	R/W	0h	Hsync/Vsync Pixel Clock Control On/Off. 0 = lcd_lp and lcd_fp are driven on opposite edges of pixel clock than the lcd_pixel_o. 1 = lcd_lp and lcd_fp are driven according to bit 24. Note that this bit MUST be set to '0' for Passive Matrix displays. The edge timing is fixed.
24	phsvs_rf	R/W	0h	Program HSYNC/VSYNC Rise or Fall. 0 = lcd_lp and lcd_fp are driven on the rising edge of pixel clock (bit 25 must be set to 1). 1 = lcd_lp and lcd_fp are driven on the falling edge of pixel clock (bit 25 must be set to 1).
23	ieo	R/W	0h	Invert Output Enable. 0 = lcd_ac pin is active high in active display mode. 1 = lcd_ac pin is active low in active display mode. Active display mode: data driven out of the LCD's data lines on programmed pixel clock edge where AC-bias is active. Note that ieo is ignored in passive display mode.
22	ipc	R/W	0h	Invert Pixel Clock. 0 = Data is driven on the LCD's data lines on the rising edge of lcd_cp. 1 = Data is driven on the LCD's data lines in the falling edge of lcd_cp. For Active Matrix output (cfg_lcdftf='1'), the Output Pixel Clock is a free running clock in that it transitions in horizontal blanking (including horizontal front porch, horizontal back porch) areas and all vertical blanking times. For Passive Matrix output (cfg_lcdftf='0'), the Output Pixel Clock on occurs when an output data value is written. It is in a return-to-zero state when cfg_ipc='0' and a return-to-one state when cfg_ipc='1'.
21	ihs	R/W	0h	Invert Hsync. 0 = lcd_lp pin is active high and inactive low. 1 = lcd_lp pin is active low and inactive high. Active and passive mode: horizontal sync pulse/line clock active between lines, after the end of line wait period

Table 13-26. RASTER_TIMING_2 Register Field Descriptions (continued)

Bit	Field	Type	Reset	Description
20	ivs	R/W	0h	Invert Vsync. 0 = lcd_fp pin is active high and inactive low. 1 = lcd_fp pin is active low and inactive high. Active mode: vertical sync pulse active between frames, after end of frame wait period. Passive mode: frame clock active during first line of each frame.
19-16	acbi	R/W	0h	AC Bias Pins Transitions per Interrupt. Value (from 0 to 15) used to specify the number of AC Bias pin transitions to count before setting the line count status (lcs) bit, signaling an interrupt request. Counter frozen when lcd is set, and is restarted when lcs is cleared by software. This function is disabled when acbi = b'0000'.
15-8	acb	R/W	0h	AC Bias Pin Frequency. Value (from 0-255) used to specify the number of line clocks to count before transitioning the AC Bias pin. This pin is used to periodically invert the polarity of the power supply to prevent DC charge build-up within the display. acb = Number of line clocks/toggle of the lcd_ac pin.
7-6	RESERVED	R	0h	
5-4	hbp_highbits	R/W	0h	Bits 9:8 of the horizontal back porch field.
3-2	RESERVED	R	0h	
1-0	hfp_highbits	R/W	0h	Bits 9:8 of the horizontal front porch field.

13.5.1.14 RASTER_SUBPANEL Register (offset = 38h) [reset = 0h]

 RASTER_SUBPANEL is shown in [Figure 13-32](#) and described in [Table 13-27](#).

Figure 13-32. RASTER_SUBPANEL Register

31	30	29	28	27	26	25	24
spen	RESERVED	hols	RESERVED			lppt	
R/W-0h	R-0h	R/W-0h	R/W-0h			R/W-0h	
23	22	21	20	19	18	17	16
lppt							
R/W-0h							
15	14	13	12	11	10	9	8
dpdlsb							
R/W-0h							
7	6	5	4	3	2	1	0
dpdlsb							
R/W-0h							

LEGEND: R/W = Read/Write; R = Read only; W1toCl = Write 1 to clear bit; -n = value after reset

Table 13-27. RASTER_SUBPANEL Register Field Descriptions

Bit	Field	Type	Reset	Description
31	spen	R/W	0h	Sub Panel Enable. 0 = function disabled. 1 = sub-panel function mode enabled.
30	RESERVED	R	0h	
29	hols	R/W	0h	High or Low Signal This field indicates the position of the sub-panel based on the LPPT value. 0 = Default Pixel Data lines are at the top of the screen and the active video lines are at the bottom of the screen. 1 = Active video lines are at the top of the screen and Default Pixel Data lines are at the bottom of the screen.
28-26	RESERVED	R/W	0h	
25-16	lppt	R/W	0h	Line Per Panel Threshold Encoded value (programmed value range of { 0:2047} represents an actual range of { 1:2048}) used to specify the number of lines on the bottom part of the panel. Bit10 of this field is in RASTER_SUBPANEL2. Hols determines whether Default Pixel Data is on the top (hols='0') or on the bottom (hols='1'). Lppt defines the number of lines on the bottom part of the output.
15-0	dpdlsb	R/W	0h	Default Pixel Data LSB [15:0] DPD defines the default value of the pixel data sent to the panel for the lines until LPPT is reach or after passing LPPT.

13.5.1.15 RASTER_SUBPANEL2 Register (offset = 3Ch) [reset = 0h]

RASTER_SUBPANEL2 is shown in [Figure 13-33](#) and described in [Table 13-28](#).

Figure 13-33. RASTER_SUBPANEL2 Register

31	30	29	28	27	26	25	24
RESERVED							
R-0h							
23	22	21	20	19	18	17	16
RESERVED							
R-0h							
15	14	13	12	11	10	9	8
RESERVED							lppt_b10
R-0h							R/W-0h
7	6	5	4	3	2	1	0
dpdmsb							
R/W-0h							

LEGEND: R/W = Read/Write; R = Read only; W1toCl = Write 1 to clear bit; -n = value after reset

Table 13-28. RASTER_SUBPANEL2 Register Field Descriptions

Bit	Field	Type	Reset	Description
31-9	RESERVED	R	0h	
8	lppt_b10	R/W	0h	Lines Per Panel Threshold Bit 10 This register is Bit 10 of the lppt field in RASTER_SUBPANEL.
7-0	dpdmsb	R/W	0h	Default Pixel Data MSB [23:16] DPD defines the default value of the pixel data sent to the panel for the lines until LPPT is reached or after passing the LPPT.

13.5.1.16 LCDDMA_CTRL Register (offset = 40h) [reset = 0h]

 LCDDMA_CTRL is shown in [Figure 13-34](#) and described in [Table 13-29](#).

Figure 13-34. LCDDMA_CTRL Register

31	30	29	28	27	26	25	24
RESERVED							
R/W-0h							
23	22	21	20	19	18	17	16
RESERVED					dma_master_prio		
R/W-0h					R/W-0h		
15	14	13	12	11	10	9	8
RESERVED					th_fifo_ready		
R/W-0h					R/W-0h		
7	6	5	4	3	2	1	0
RESERVED	burst_size			byte_swap	RESERVED	bigendian	frame_mode
R/W-0h	R/W-0h			R/W-0h	R-0h	R/W-0h	R/W-0h

LEGEND: R/W = Read/Write; R = Read only; W1toCl = Write 1 to clear bit; -n = value after reset

Table 13-29. LCDDMA_CTRL Register Field Descriptions

Bit	Field	Type	Reset	Description
31-19	RESERVED	R/W	0h	
18-16	dma_master_prio	R/W	0h	Priority for the L3 OCP Master Bus. 000b = Highest priority. 111b = Lowest priority.
15-11	RESERVED	R/W	0h	
10-8	th_fifo_ready	R/W	0h	DMA FIFO threshold. The DMA FIFO becomes ready when the number of words specified by this register from the frame buffer have been loaded. 000b = 8. 001b = 16. 010b = 32. 011b = 64. 100b = 128. 101b = 256. 110b = 512. 111b = Reserved.
7	RESERVED	R/W	0h	
6-4	burst_size	R/W	0h	Burst Size setting for DMA transfers (all DMA transfers are 32 bits wide). 000b = burst size of 1. 001b = burst size of 2. 010b = burst size of 4. 011b = burst size of 8. 100b = burst size of 16. 101b = N/A. 110b = N/A. 111b = N/A. burst_size cannot be changed once the DMA is enabled in LIDD or Raster modes. In this case, the DMA must be disabled and the Done Interrupt must occur before the value in this register can be changed.
3	byte_swap	R/W	0h	This bit controls the bytelane ordering of the data on the output of the DMA module. It works in conjunction with the big-endian bit. See the big-endian description for configuration guidelines.
2	RESERVED	R	0h	

Table 13-29. LCDDMA_CTRL Register Field Descriptions (continued)

Bit	Field	Type	Reset	Description
1	bigendian	R/W	0h	Big Endian Enable. Use this bit when the processor is operating in Big Endian mode AND writes to the frame buffer(s) are less than 32 bits wide. Only in this scenario do we need to change the byte alignment for data coming into the FIFO from the frame buffer(s). 0 = Big Endian data reordering disabled. 1 = Big Endian data reordering enabled.
0	frame_mode	R/W	0h	Frame Mode. 0 = one frame buffer (FB0 only) used. 1 = two frame buffers used DMA ping-pongs between FB0 and FB1 in this mode.

13.5.1.17 LCDDMA_FB0_BASE Register (offset = 44h) [reset = 0h]

 LCDDMA_FB0_BASE is shown in [Figure 13-35](#) and described in [Table 13-30](#).

Figure 13-35. LCDDMA_FB0_BASE Register

31	30	29	28	27	26	25	24
fb0_base							
R/W-0h							
23	22	21	20	19	18	17	16
fb0_base							
R/W-0h							
15	14	13	12	11	10	9	8
fb0_base							
R/W-0h							
7	6	5	4	3	2	1	0
fb0_base						RESERVED	
R/W-0h						R-0h	

LEGEND: R/W = Read/Write; R = Read only; W1toCl = Write 1 to clear bit; -n = value after reset

Table 13-30. LCDDMA_FB0_BASE Register Field Descriptions

Bit	Field	Type	Reset	Description
31-2	fb0_base	R/W	0h	Frame Buffer 0 Base Address pointer.
1-0	RESERVED	R	0h	

13.5.1.18 LCDDMA_FB0_CEILING Register (offset = 48h) [reset = 0h]

LCDDMA_FB0_CEILING is shown in [Figure 13-36](#) and described in [Table 13-31](#).

Figure 13-36. LCDDMA_FB0_CEILING Register

31	30	29	28	27	26	25	24
fb0_ceil							
R/W-0h							
23	22	21	20	19	18	17	16
fb0_ceil							
R/W-0h							
15	14	13	12	11	10	9	8
fb0_ceil							
R/W-0h							
7	6	5	4	3	2	1	0
fb0_ceil						RESERVED	
R/W-0h						R-0h	

LEGEND: R/W = Read/Write; R = Read only; W1toCl = Write 1 to clear bit; -n = value after reset

Table 13-31. LCDDMA_FB0_CEILING Register Field Descriptions

Bit	Field	Type	Reset	Description
31-2	fb0_ceil	R/W	0h	Frame Buffer 0 Ceiling Address pointer.
1-0	RESERVED	R	0h	

13.5.1.19 LCDDMA_FB1_BASE Register (offset = 4Ch) [reset = 0h]

 LCDDMA_FB1_BASE is shown in [Figure 13-37](#) and described in [Table 13-32](#).

Figure 13-37. LCDDMA_FB1_BASE Register

31	30	29	28	27	26	25	24
fb1_base							
R/W-0h							
23	22	21	20	19	18	17	16
fb1_base							
R/W-0h							
15	14	13	12	11	10	9	8
fb1_base							
R/W-0h							
7	6	5	4	3	2	1	0
fb1_base						RESERVED	
R/W-0h						R-0h	

LEGEND: R/W = Read/Write; R = Read only; W1toCl = Write 1 to clear bit; -n = value after reset

Table 13-32. LCDDMA_FB1_BASE Register Field Descriptions

Bit	Field	Type	Reset	Description
31-2	fb1_base	R/W	0h	Frame Buffer 1 Base Address pointer.
1-0	RESERVED	R	0h	

13.5.1.20 LCDDMA_FB1_CEILING Register (offset = 50h) [reset = 0h]

LCDDMA_FB1_CEILING is shown in [Figure 13-38](#) and described in [Table 13-33](#).

Figure 13-38. LCDDMA_FB1_CEILING Register

31	30	29	28	27	26	25	24
fb1_ceil							
R/W-0h							
23	22	21	20	19	18	17	16
fb1_ceil							
R/W-0h							
15	14	13	12	11	10	9	8
fb1_ceil							
R/W-0h							
7	6	5	4	3	2	1	0
fb1_ceil						RESERVED	
R/W-0h						R-0h	

LEGEND: R/W = Read/Write; R = Read only; W1toCl = Write 1 to clear bit; -n = value after reset

Table 13-33. LCDDMA_FB1_CEILING Register Field Descriptions

Bit	Field	Type	Reset	Description
31-2	fb1_ceil	R/W	0h	Frame Buffer 1 Ceiling Address pointer.
1-0	RESERVED	R	0h	

13.5.1.21 SYSCONFIG Register (offset = 54h) [reset = 0h]

 SYSCONFIG is shown in [Figure 15-4](#) and described in [Table 15-6](#).

Figure 13-39. SYSCONFIG Register

31	30	29	28	27	26	25	24
RESERVED							
R-0h							
23	22	21	20	19	18	17	16
RESERVED							
R-0h							
15	14	13	12	11	10	9	8
RESERVED							
R-0h							
7	6	5	4	3	2	1	0
RESERVED		standbymode		idlemode		RESERVED	
R-0h		R/W-0h		R/W-0h		R/W-0h	

LEGEND: R/W = Read/Write; R = Read only; W1toCl = Write 1 to clear bit; -n = value after reset

Table 13-34. SYSCONFIG Register Field Descriptions

Bit	Field	Type	Reset	Description
31-6	RESERVED	R	0h	
5-4	standbymode	R/W	0h	Configuration of the local initiator state management mode. By definition, initiator may generate read/write transaction as long as it is out of STANDBY state. 0 = Force-standby mode: local initiator is unconditionally placed in standby state. Backup mode, for debug only. 1 = No-standby mode: local initiator is unconditionally placed out of standby state. Backup mode, for debug only. 2 = Smart-standby mode: local initiator standby status depends on local conditions, that is, the module's functional requirement from the initiator. IP module shall not generate (initiator-related) wakeup events. 3 = Reserved.
3-2	idlemode	R/W	0h	Configuration of the local target state management mode. By definition, target can handle read/write transaction as long as it is out of IDLE state. 0 = Force-idle mode: local target's idle state follows (acknowledges) the system's idle requests unconditionally, i.e. regardless of the IP module's internal requirements. Backup mode, for debug only. 1 = No-idle mode: local target never enters idle state. Backup mode, for debug only. 2 = Smart-idle mode: local target's idle state eventually follows (acknowledges) the system's idle requests, depending on the IP module's internal requirements. IP module shall not generate (IRQ- or DMA-request-related) wakeup events. 3 = Reserved.
1-0	RESERVED	R/W	0h	

13.5.1.22 IRQSTATUS_RAW Register (offset = 58h) [reset = 0h]

IRQSTATUS_RAW is shown in [Figure 20-9](#) and described in [Table 20-14](#).

Figure 13-40. IRQSTATUS_RAW Register

31	30	29	28	27	26	25	24
RESERVED							
R/W-0h							
23	22	21	20	19	18	17	16
RESERVED							
R/W-0h							
15	14	13	12	11	10	9	8
RESERVED						eof1_raw_set	eof0_raw_set
R/W-0h						R/W-0h	R/W-0h
7	6	5	4	3	2	1	0
RESERVED	pl_raw_set	fuf_raw_set	RESERVED	acb_raw_set	sync_raw_set	recurrent_raster_done_raw_set	done_raw_set
R/W-0h	R/W-0h	R/W-0h	R-0h	R/W-0h	R/W-0h	R/W-0h	R/W-0h

LEGEND: R/W = Read/Write; R = Read only; W1toCl = Write 1 to clear bit; -n = value after reset

Table 13-35. IRQSTATUS_RAW Register Field Descriptions

Bit	Field	Type	Reset	Description
31-10	RESERVED	R/W	0h	
9	eof1_raw_set	R/W	0h	DMA End-of-Frame 1 Raw Interrupt Status and Set Read indicates raw status. 0 = Inactive. 1 = Active. Writing 1 will set status. Writing 0 has no effect.
8	eof0_raw_set	R/W	0h	DMA End-of-Frame 0 Raw Interrupt Status and Set Read indicates raw status. 0 = inactive. 1 = active. Writing 1 will set status. Writing 0 has no effect.
7	RESERVED	R/W	0h	
6	pl_raw_set	R/W	0h	DMA Palette Loaded Raw Interrupt Status and Set Read indicates raw status. 0 = inactive. 1 = active. Writing 1 will set status. Writing 0 has no effect.
5	fuf_raw_set	R/W	0h	DMA FIFO Underflow Raw Interrupt Status and Set LCD dithering logic not supplying data to FIFO at a sufficient rate, FIFO has completely emptied and data pin driver logic has attempted to take added data from FIFO. Read indicates raw status. 0 = Inactive. 1 = Active. Writing 1 will set status. Writing 0 has no effect.
4	RESERVED	R	0h	

Table 13-35. IRQSTATUS_RAW Register Field Descriptions (continued)

Bit	Field	Type	Reset	Description
3	acb_raw_set	R/W	0h	For Passive Matrix Panels Only AC Bias Count Raw Interrupt Status and Set AC bias transition counter has decremented to zero, indicating that the lcd_ac_o line has transitioned the number of times which is specified by the acbi control bit-field. The counter is reloaded with the value in acbi but it is disabled until the user clears ABC. Read indicates raw status. 0 = inactive. 1 = active. Writing 1 will set status. Writing 0 has no effect.
2	sync_raw_set	R/W	0h	Frame Synchronization Lost Raw Interrupt Status and Set Read indicates raw status. 0 = inactive. 1 = active. Writing 1 will set status. Writing 0 has no effect.
1	recurrent_raster_done_raw_set	R/W	0h	Raster Mode Frame Done Interrupt. Read indicates raw status. 0 = Inactive. 1 = Active. Writing 1 will set status. Writing 0 has no effect.
0	done_raw_set	R/W	0h	Raster or LIDD Frame Done (shared, depends on whether Raster or LIDD mode enabled). Raw Interrupt Status and Set Read indicates raw status. 0 = inactive. 1 = active. Writing 1 will set status. Writing 0 has no effect.

13.5.1.23 IRQSTATUS Register (offset = 5Ch) [reset = 0h]

IRQSTATUS is shown in [Figure 20-10](#) and described in [Table 20-15](#).

Figure 13-41. IRQSTATUS Register

31	30	29	28	27	26	25	24
RESERVED							
R/W-0h							
23	22	21	20	19	18	17	16
RESERVED							
R/W-0h							
15	14	13	12	11	10	9	8
RESERVED						eof1_en_clr	eof0_en_clr
R/W-0h						R/W-0h	R/W-0h
7	6	5	4	3	2	1	0
RESERVED	pl_en_clr	fuf_en_clr	RESERVED	acb_en_clr	sync_en_clr	recurrent_raster_done_en_clr	done_en_clr
R/W-0h	R/W-0h	R/W-0h	R/W-0h	R/W-0h	R/W-0h	R/W-0h	R/W-0h

LEGEND: R/W = Read/Write; R = Read only; W1toCl = Write 1 to clear bit; -n = value after reset

Table 13-36. IRQSTATUS Register Field Descriptions

Bit	Field	Type	Reset	Description
31-10	RESERVED	R/W	0h	
9	eof1_en_clr	R/W	0h	DMA End-of-Frame 1 Enabled Interrupt and Clear Read indicates enabled (masked) status. 0 = inactive. 1 = active. Writing 1 will clear interrupt enable. Writing 0 has no effect.
8	eof0_en_clr	R/W	0h	DMA End-of-Frame 0 Enabled Interrupt and Clear Read indicates enabled (masked) status. 0 = inactive. 1 = active. Writing 1 will clear interrupt enable. Writing 0 has no effect.
7	RESERVED	R/W	0h	
6	pl_en_clr	R/W	0h	DMA Palette Loaded Enabled Interrupt and Clear Read indicates enabled (masked) status. 0 = inactive. 1 = active. Writing 1 will clear interrupt enable. Writing 0 has no effect.
5	fuf_en_clr	R/W	0h	DMA FIFO Underflow Enabled Interrupt and Clear LCD dithering logic not supplying data to FIFO at a sufficient rate, FIFO has completely emptied and data pin driver logic has attempted to take added data from FIFO. Read indicates enabled (masked) status. 0 = inactive. 1 = active. Writing 1 will clear interrupt enable. Writing 0 has no effect.
4	RESERVED	R/W	0h	

Table 13-36. IRQSTATUS Register Field Descriptions (continued)

Bit	Field	Type	Reset	Description
3	acb_en_clr	R/W	0h	For Passive Matrix Panels Only. AC Bias Count Enabled Interrupt and Clear AC bias transition counter has decremented to zero, indicating that the lcd_ac_o line has transitioned the number of times which is specified by the acbi control bit-field. The counter is reloaded with the value in acbi but it is disabled until the user clears ABC. Read indicates enabled (masked) status. 0 = inactive. 1 = active. Writing 1 will clear interrupt enable. Writing 0 has no effect.
2	sync_en_clr	R/W	0h	Frame Synchronization Lost Enabled Interrupt and Clear Read indicates enabled status. 0 = inactive. 1 = active. Writing 1 will clear interrupt enable. Writing 0 has no effect.
1	recurrent_raster_done_en_clr	R/W	0h	Raster Frame Done Interrupt. Read indicates enabled status. 0 = Inactive. 1 = Active. Writing 1 will clear interrupt enable. Writing 0 has no effect.
0	done_en_clr	R/W	0h	Raster or LIDD Frame Done (shared, depends on whether Raster or LIDD mode enabled) Enabled Interrupt and Clear Read indicates enabled status. 0 = inactive. 1 = active. Writing 1 will clear interrupt enable. Writing 0 has no effect.

13.5.1.24 IRQENABLE_SET Register (offset = 60h) [reset = 0h]

IRQENABLE_SET is shown in [Figure 20-11](#) and described in [Table 20-16](#).

Figure 13-42. IRQENABLE_SET Register

31	30	29	28	27	26	25	24
RESERVED							
R/W-0h							
23	22	21	20	19	18	17	16
RESERVED							
R/W-0h							
15	14	13	12	11	10	9	8
RESERVED						eof1_en_set	eof0_en_set
R/W-0h						R/W-0h	R/W-0h
7	6	5	4	3	2	1	0
RESERVED	pl_en_set	fuf_en_set	RESERVED	acb_en_set	sync_en_set	recurrent_raster_done_en_set	done_en_set
R/W-0h	R/W-0h	R/W-0h	R-0h	R/W-0h	R/W-0h	R/W-0h	R/W-0h

LEGEND: R/W = Read/Write; R = Read only; W1toCl = Write 1 to clear bit; -n = value after reset

Table 13-37. IRQENABLE_SET Register Field Descriptions

Bit	Field	Type	Reset	Description
31-10	RESERVED	R/W	0h	
9	eof1_en_set	R/W	0h	DMA End-of-Frame 1 Interrupt Enable Set Read indicates enabled (mask) status. 0 = disabled. 1 = enabled. Writing 1 will set interrupt enable. Writing 0 has no effect.
8	eof0_en_set	R/W	0h	DMA End-of-Frame 0 Interrupt Enable Set Read indicates enabled (mask) status. 0 = disabled. 1 = enabled. Writing 1 will set interrupt enable. Writing 0 has no effect.
7	RESERVED	R/W	0h	
6	pl_en_set	R/W	0h	DMA Palette Loaded Interrupt Enable Set Read indicates enabled (mask) status. 0 = disabled. 1 = enabled. Writing 1 will set interrupt enable. Writing 0 has no effect.
5	fuf_en_set	R/W	0h	DMA FIFO Underflow Interrupt Enable Set LCD dithering logic not supplying data to FIFO at a sufficient rate, FIFO has completely emptied and data pin driver logic has attempted to take added data from FIFO. Read indicates enabled (mask) status. 0 = disabled. 1 = enabled. Writing 1 will set interrupt enable. Writing 0 has no effect.
4	RESERVED	R	0h	

Table 13-37. IRQENABLE_SET Register Field Descriptions (continued)

Bit	Field	Type	Reset	Description
3	acb_en_set	R/W	0h	For Passive Matrix Panels Only AC Bias Count Interrupt Enable Set AC bias transition counter has decremented to zero, indicating that the lcd_ac_o line has transitioned the number of times which is specified by the acbi control bit-field. The counter is reloaded with the value in acbi but it is disabled until the user clears ABC. Read indicates enabled (mask) status. 0 = disabled. 1 = enabled. Writing 1 will set interrupt enable. Writing 0 has no effect.
2	sync_en_set	R/W	0h	Frame Synchronization Lost Interrupt Enable Set Read indicates enabled (mask) status. 0 = disabled. 1 = enabled. Writing 1 will set interrupt enable. Writing 0 has no effect.
1	recurrent_raster_done_en_set	R/W	0h	Raster Done Interrupt Enable Set. Read indicates enabled (mask) status. 0 = Disabled. 1 = Enabled. Writing 1 will set interrupt enable. Writing 0 has no effect.
0	done_en_set	R/W	0h	Raster or LIDD Frame Done (shared, depends on whether Raster or LIDD mode enabled) Interrupt Enable Set Read indicates enabled (mask) status. 0 = disabled. 1 = enabled. Writing 1 will set interrupt enable.

13.5.1.25 IRQENABLE_CLEAR Register (offset = 64h) [reset = 0h]

IRQENABLE_CLEAR is shown in Figure 13-43 and described in Table 13-38.

Figure 13-43. IRQENABLE_CLEAR Register

31	30	29	28	27	26	25	24
RESERVED							
R/W-0h							
23	22	21	20	19	18	17	16
RESERVED							
R/W-0h							
15	14	13	12	11	10	9	8
RESERVED						eof1_en_clr	eof0_en_clr
R/W-0h						R/W-0h	R/W-0h
7	6	5	4	3	2	1	0
RESERVED	pl_en_clr	fuf_en_clr	RESERVED	acb_en_clr	sync_en_clr	recurrent_raster_done_en_clr	done_en_clr
R/W-0h	R/W-0h	R/W-0h	R/W-0h	R/W-0h	R/W-0h	R/W-0h	R/W-0h

LEGEND: R/W = Read/Write; R = Read only; W1toCl = Write 1 to clear bit; -n = value after reset

Table 13-38. IRQENABLE_CLEAR Register Field Descriptions

Bit	Field	Type	Reset	Description
31-10	RESERVED	R/W	0h	
9	eof1_en_clr	R/W	0h	DMA End-of-Frame 1 Interrupt Enable Clear. Read indicates enabled status. 0 = disabled. 1 = enabled. Writing 1 will clear interrupt enable. Writing 0 has no effect.
8	eof0_en_clr	R/W	0h	DMA End-of-Frame 0 Interrupt Enable Clear. Read indicates enabled status. 0 = disabled. 1 = enabled. Writing 1 will clear interrupt enable. Writing 0 has no effect.
7	RESERVED	R/W	0h	
6	pl_en_clr	R/W	0h	DMA Palette Loaded Interrupt Enable Clear. Read indicates enabled status. 0 = disabled. 1 = enabled. Writing 1 will clear interrupt enable. Writing 0 has no effect.
5	fuf_en_clr	R/W	0h	DMA FIFO Underflow Interrupt Enable Clear. LCD dithering logic not supplying data to FIFO at a sufficient rate, FIFO has completely emptied and data pin driver logic has attempted to take added data from FIFO. Read indicates enabled status. 0 = disabled. 1 = enabled. Writing 1 will clear interrupt enable. Writing 0 has no effect.
4	RESERVED	R/W	0h	

Table 13-38. IRQENABLE_CLEAR Register Field Descriptions (continued)

Bit	Field	Type	Reset	Description
3	acb_en_clr	R/W	0h	For Passive Matrix Panels Only. AC Bias Count Interrupt Enable Clear AC bias transition counter has decremented to zero, indicating that the lcd_ac_o line has transitioned the number of times which is specified by the acbi control bit-field. The counter is reloaded with the value in acbi but it is disabled until the user clears ABC. Read indicates enabled status. 0 = disabled. 1 = enabled. Writing 1 will clear interrupt enable. Writing 0 has no effect.
2	sync_en_clr	R/W	0h	Frame Synchronization Lost Interrupt Enable Clear Read indicates enabled status. 0 = disabled. 1 = enabled. Writing 1 will clear interrupt enable. Writing 0 has no effect.
1	recurrent_raster_done_en_clr	R/W	0h	Raster Done Interrupt Enable Clear. Read indicates enabled status. 0 = Disabled. 1 = Enabled. Writing 1 will clear interrupt enable. Writing 0 has no effect.
0	done_en_clr	R/W	0h	Raster or LIDD Frame Done (shared, depends on whether Raster or LIDD mode enabled) Interrupt Enable Clear. Read indicates enabled status. 0 = disabled. 1 = enabled. Writing 1 will clear interrupt enable. Writing 0 has no effect.

13.5.1.26 CLKC_ENABLE Register (offset = 6Ch) [reset = 0h]

CLKC_ENABLE is shown in [Figure 13-44](#) and described in [Table 13-39](#).

Figure 13-44. CLKC_ENABLE Register

31	30	29	28	27	26	25	24
RESERVED							
R-0h							
23	22	21	20	19	18	17	16
RESERVED							
R-0h							
15	14	13	12	11	10	9	8
RESERVED							
R-0h							
7	6	5	4	3	2	1	0
RESERVED					dma_clk_en	lidd_clk_en	core_clk_en
R-0h					R/W-0h	R/W-0h	R/W-0h

LEGEND: R/W = Read/Write; R = Read only; W1toCl = Write 1 to clear bit; -n = value after reset

Table 13-39. CLKC_ENABLE Register Field Descriptions

Bit	Field	Type	Reset	Description
31-3	RESERVED	R	0h	
2	dma_clk_en	R/W	0h	Software Clock Enable for the DMA submodule. The DMA submodule runs on the L3 Clock domain.
1	lidd_clk_en	R/W	0h	Software Clock Enable for the LIDD submodule (character displays). The LIDD submodule runs on the System Clock (lcd_clk) domain.
0	core_clk_en	R/W	0h	Software Clock Enable for the Core, which encompasses the Raster Active Matrix and Passive Matrix logic. The Core runs on the System Clock (lcd_clk) domain.

13.5.1.27 CLKC_RESET Register (offset = 70h) [reset = 0h]

 CLKC_RESET is shown in [Figure 13-45](#) and described in [Table 13-40](#).

Figure 13-45. CLKC_RESET Register

31	30	29	28	27	26	25	24
RESERVED							
R/W-0h							
23	22	21	20	19	18	17	16
RESERVED							
R/W-0h							
15	14	13	12	11	10	9	8
RESERVED							
R/W-0h							
7	6	5	4	3	2	1	0
RESERVED				main_rst	dma_rst	lidd_rst	core_rst
R/W-0h				R/W-0h	R/W-0h	R/W-0h	R/W-0h

LEGEND: R/W = Read/Write; R = Read only; W1toCl = Write 1 to clear bit; -n = value after reset

Table 13-40. CLKC_RESET Register Field Descriptions

Bit	Field	Type	Reset	Description
31-4	RESERVED	R/W	0h	
3	main_rst	R/W	0h	Software Reset for the entire LCD module. 1 = Reset Enable. 0 = Reset Disable.
2	dma_rst	R/W	0h	Software Reset for the DMA submodule. 1 = Reset Enable. 0 = Reset Disable.
1	lidd_rst	R/W	0h	Software Reset for the LIDD submodule (character displays). 1 = Reset Enable. 0 = Reset Disable.
0	core_rst	R/W	0h	Software Reset for the Core, which encompasses the Raster Active Matrix and Passive Matrix logic. 1 = Reset Enable. 0 = Reset Disable.

Ethernet Subsystem

This chapter describes the ethernet subsystem of the device.

Topic	Page
14.1 Introduction	1900
14.2 Integration	1902
14.3 Functional Description	1912
14.4 Software Operation	1972
14.5 Ethernet Subsystem Registers	1977

14.1 Introduction

Described in the following sections is the Layer 2 3-port switch (3PSW) Ethernet subsystem. The 3-port switch gigabit ethernet subsystem provides ethernet packet communication and can be configured as an ethernet switch. It provides the gigabit media independent interface (GMII), reduced gigabit media independent interface (RGMII), reduced media independent interface (RMII), the management data input output (MDIO) for physical layer device (PHY) management.

As a Layer 2 switch, this device is capable of supporting all higher layers and various protocols (e.g., IPV4, IPV6, 802.3x) in software.

14.1.1 Features

The general features of the ethernet switch subsystem are:

- Two 10/100/1000 Ethernet ports with GMII, RMII and RGMII interfaces
- Wire rate switching (802.1d)
- Non Blocking switch fabric
- Flexible logical FIFO based packet buffer structure
- Four priority level QOS support (802.1p)
- CPPI 3.1 compliant DMA controllers
- Support for IEEE 1588v2 Clock Synchronization (2008 Annex D and Annex F)
 - Timing FIFO and time stamping logic inside the SS
- Device Level Ring (DLR) Support
- Address Lookup Engine
 - 1024 addresses plus VLANs
 - Wire rate lookup
 - VLAN support
 - Host controlled time-based aging
 - Spanning tree support
 - L2 address lock and L2 filtering support
 - MAC authentication (802.1x)
 - Receive or destination based Multicast and Broadcast limits
 - MAC address blocking
 - Source port locking
 - OUI host accept/deny feature
- Flow Control Support (802.3x)
- EtherStats and 802.3Stats RMON statistics gathering (shared)
- Support for external packet dropping engine
- CPGMAC_SL transmit to CPGMAC_SL receive Loopback mode (digital loopback) supported
- CPGMAC_SL receive to CPGMAC_SL transmit Loopback mode (FIFO loopback) supported
- Maximum frame size 2016 bytes (2020 with VLAN)
- 8k (2048 x 32) internal CPPI buffer descriptor memory
- MDIO module for PHY Management
- Programmable interrupt control with selected interrupt pacing
- Emulation Support.
- Programmable transmit Inter-Packet Gap (IPG)
- Reset isolation

14.1.2 Unsupported Features

There are 18 level interrupts from the CPGMAC module and 2 (used) level interrupts from the MDIO module. The CPSW_3GSS includes an interrupt combiner/pacer to combine these interrupts together to produce 4 interrupt outputs (per processing core). This device does not split processing among multiple cores but allows servicing of the Core0 interrupts by the Cortex-A8 or the PRU-ICSS.

The unsupported CPGMAC features in the device are shown in the following table.

Table 14-1. Unsupported CPGMAC Features

Feature	Reason
Multi-core split processing	Core 1 and Core 2 interrupts not connected.
GMII	Only 4 Rx/Tx data pins are pinned out for each port. The device supports MII (on GMII interface), RGMII, and RMII interfaces only
Phy link status	The MLINK inputs are not pinned out. Phy link status outputs can be connected to device GPIOs.
Internal Delay mode for RGMII	RGMII Internal Delay mode is not supported.
RMII reference clock output mode	RMII reference clock does not satisfy input requirements of RMII Ethernet PHYs.
Reset isolation	Silicon bug. For more information, see <i>AM335x ARM Cortex-A8 Microprocessors (MPUs) Silicon Errata</i> (literature number SPRZ360).

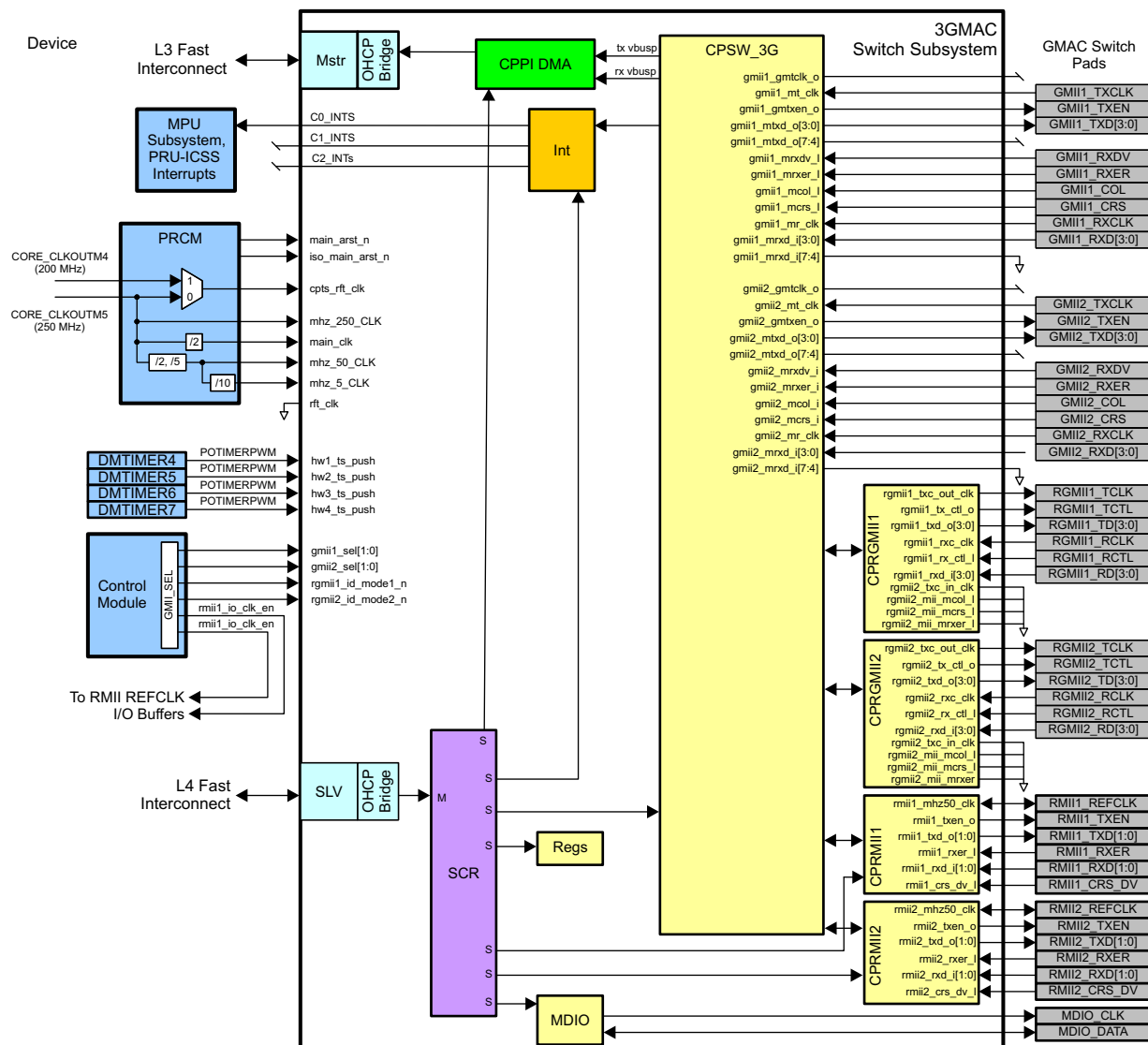
14.2 Integration

This device includes a single instantiation of the three-port Gigabit Ethernet Switch Subsystem (CPSW_3GSS_RG). The switch provides 2 external ethernet ports (ports 1 and 2) and an internal CPPI interface port (port 0) with IEEE 1588v2 and 802.1ae support. The subsystem consists of:

- One instance of the 3-port Gigabit switch CPSW-3G, which contains:
 - 2 CPGMAC_SL 10/100/1000 ethernet port modules with GMII interface
- Two RGMII interface modules
- Two RMII interface modules
- One MDIO interface module
- One Interrupt Controller module
- Local CPPI memory of size 8K Bytes

The integration of the Ethernet Switch is shown in [Figure 14-1](#)

Figure 14-1. Ethernet Switch Integration



14.2.1 Ethernet Switch Connectivity Attributes

The general connectivity attributes for the Ethernet Switch module are shown in [Table 14-2](#).

Table 14-2. Ethernet Switch Connectivity Attributes

Attributes	Type
Power Domain	Peripheral Domain
Clock Domain	PD_PER_CPSW_125MHZ_GCLK (Main) PD_PER_CPSW_250MHZ_GCLK (MHZ_250_CLK) PD_PER_CPSW_50MHZ_GCLK (MHZ_50_CLK) PD_PER_CPSW_5MHZ_GCLK (MHZ_5_CLK) PD_PER_CPSW_CPTS_RFT_CLK (CPTS_RFT_CLK)
Reset Signals	CPSW_MAIN_ARST_N CPSW_ISO_MAIN_ARST_N
Idle/Wakeup Signals	Idle Standby
Interrupt Requests	4 Interrupts RX_THRESH (3PGSWRXTHR0) – Receive Threshold interrupt (nonpaced) RX (3PGSWRXINT0) – Receive interrupt (paced) TX (3PGSWTXINT0) – Transmit interrupt (paced) Misc (3PGSWMISC0) – Other interrupts All Ethernet Switch interrupts go to MPU Subsystem and PRU-ICSS. The Subsystem contains 3 sets of interrupts C0, C1, and C2 to allow for split core processing of packets. On this device, only the C0 version of the interrupts is used.
DMA Requests	None
Physical Address	L4 Fast slave port L3 Fast initiator port

14.2.2 Ethernet Switch Clock and Reset Management

The ethernet switch controller operates in its own clock domain and its initiator and target interfaces are connected to the L3/L4 through asynchronous bridges. The OCP interfaces are driven by the MAIN clock input. Additional reference clock inputs are provided for operating the various ethernet ports at different rates.

Table 14-3. Ethernet Switch Clock Signals

Clock Signal	Max Freq	Reference / Source	Comments
rft_clk Gigabit GMII Tx Reference clock	125 MHz	Tied low	not supported
main_clk Logic/Interface clock	125 MHz	CORE_CLKOUTM5 / 2	pd_per_cpsw_125mhz_gclk from PRCM
mhz250_clk Gigabit RGMII Reference clock	250 MHz	CORE_CLKOUTM5	pd_per_cpsw_250mhz_gclk from PRCM
mhz50_clk RMII and 100mbps RGMII Reference clock	50 MHz	CORE_CLKOUTM5 / 5	pd_per_cpsw_50mhz_gclk from PRCM
mhz5_clk 10 mbpsRGMII Reference clock	5 MHz	CORE_CLKOUTM5 / 50	pd_per_cpsw_5mhz_gclk from PRCM
cpts_rft_clk IEEE 1588v2 clock	250 MHz	CORE_CLKOUTM4 CORE_CLKOUTM5	pd_per_cpsw_cpts_rft_clk from PRCM
gmii1_mr_clk GMII Port 1 Receive clock	25 MHz	External Pin	gmii1_rxclk_in from GMII1_RCLK pad
gmii2_mr_clk GMII Port 2 Receive clock	25 MHz	External Pin	gmii2_rxclk_in from GMII2_RCLK pad
gmii1_mt_clk GMII Port 1 Transmit clock	25 MHz	External Pin	gmii1_txclk_in from GMII1_TCLK pad
gmii2_mt_clk GMII Port 2 Transmit clock	25 MHz	External Pin	gmii2_txclk_in from GMII2_TCLK pad
rgmii1_rxc_clk RGMII Port 1 Receive clock	250 MHz	External Pin	rgmii1_rclk_in from RGMII1_RCLK pad
rgmii2_rxc_clk RGMII Port 2 Receive clock	250 MHz	External Pin	rgmii2_rclk_in from RGMII2_RCLK pad
rmii1_mhz_50_clk RMII Port 1 Reference clock	50 MHz	External Pin	rmii1_refclk_in from RMII1_REFCLK pad
rmii2_mhz_50_clk RMII Port 2 Reference clock	50 MHz	External Pin	rmii2_refclk_in from RMII2_REFCLK pad

14.2.3 Ethernet Switch Pin List

The external signals for the Ethernet Switch module are shown in the following table.

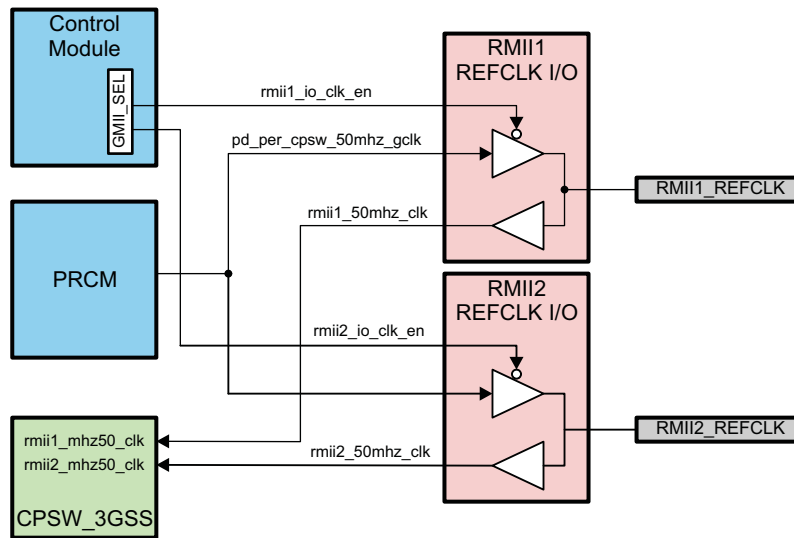
Table 14-4. Ethernet Switch Pin List

Pin	Type*	Description
GMIIx_RXCLK	I	GMII/MII Receive clock
GMIIx_RXD[3:0]	I	GMII/MII Receive data
GMIIx_RXDV	I	GMII/MII Receive data valid
GMIIx_RXER	I	GMII/MII Receive error
GMIIx_COL	I	GMII/MII Collision detect
GMIIx_CRS	I	GMII/MII Carrier sense
GMIIx_TXCLK	I	GMII/MII Transmit clock
GMIIx_TXD[3:0]	O	GMII/MII Transmit data
GMIIx_TXEN	O	GMII/MII Transmit enable
RGMIIx_RCLK	I	RGMII Receive clock
RGMIIx_RCTL	I	RGMII Receive control
RGMIIx_RD[3:0]	I	RGMII Receive data
RGMIIx_TCLK	O	RGMII Transmit clock
RGMIIx_TCTL	O	RGMII Transmit control
RGMIIx_TD[3:0]	O	RGMII Transmit data
RMIIx_RXD[1:0]	I	RMII Receiver data
RMIIx_RXER	I	RMII Receiver error
RMIIx_CRS_DV	I	RMII Carrier sense / Data valid
RMIIx_TXEN	O	RMII Transmit enable
RMIIx_REFCLK	I/O	RMII Reference clock
RMIIx_TXD[1:0]	O	RMII Transmit data
MDIO_CLK	O	MDIO Serial clock
MDIO_DATA	I/O	MDIO Serial data

14.2.4 Ethernet Switch RMII Clocking Details

The RMII interface reference clock pin operates as an input. When used as an input, the clock is driven by the I/O pad. The operation is controlled by the GMII_SEL[RMIIx_IO_CLK_EN] fields in the Control Module, as shown in [Figure 14-2](#).

Figure 14-2. Ethernet Switch RMII Clock Detail



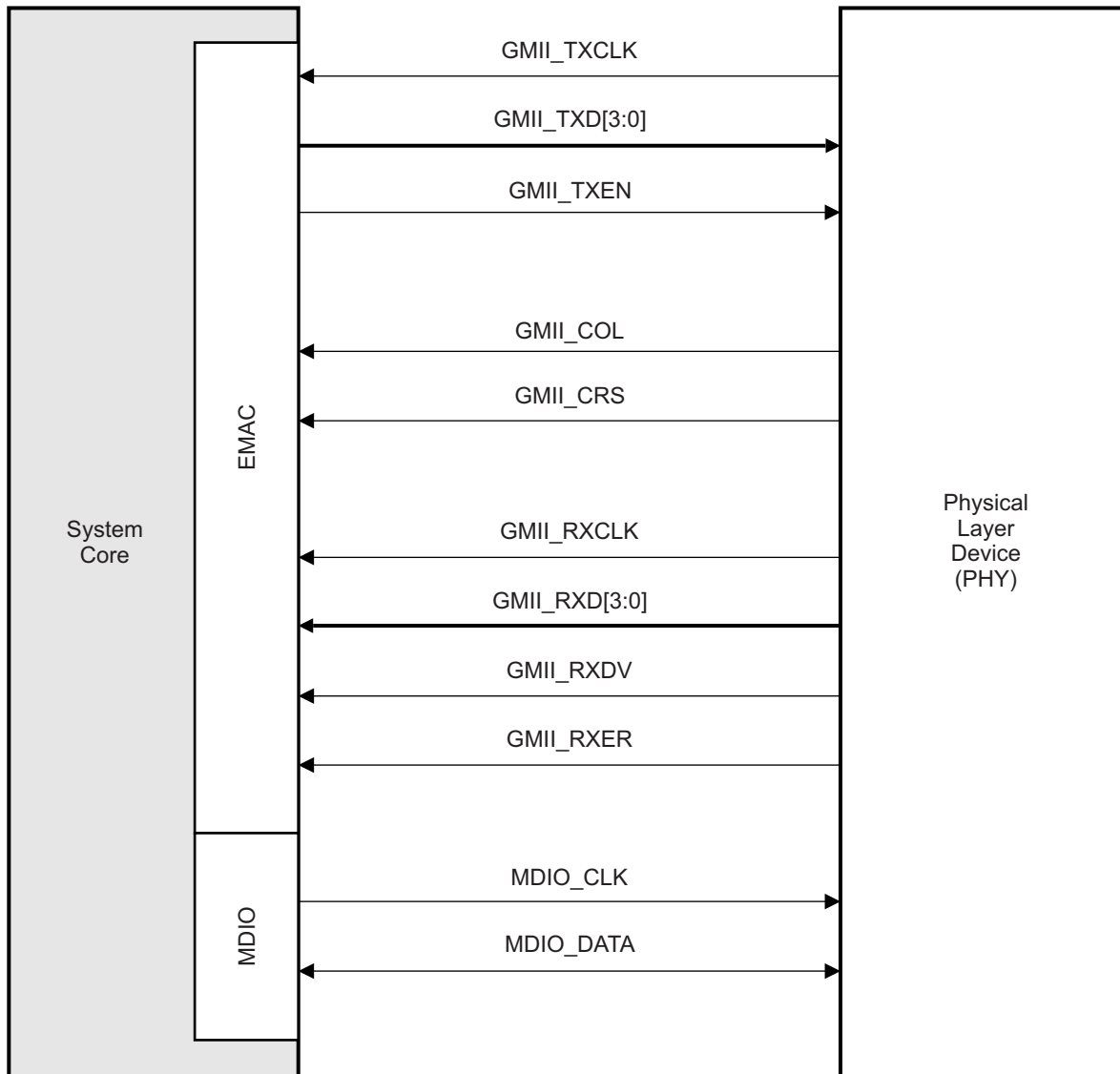
14.2.5 GMII Interface Signal Connections and Descriptions

GMII Interface can operate in MII mode.

In MII Mode(100/10 Mbps) 3PSW operates in Full duplex and Half Duplex.

The pin connections of the GMII Interface are shown in [Figure 14-3](#).

Figure 14-3. MII Interface Connections



See the detailed description of the signals in MII mode in the following sections.

Table 14-5. GMII Interface Signal Descriptions in MII (100/10Mbps) Mode

Signal	Type	Description
GMII_TXCLK	I	The transmit clock is a continuous clock that provides the timing reference for transmit operations. The GMII_TXD and GMII_TXEN signals are tied to this clock. The clock is generated by the PHY and is 2.5 MHz at 10 Mbps operation and 25 MHz at 100 Mbps operation.
GMII_TXD[3:0]	O	The transmit data pins are a collection of 4 data signals GMII_TXD[3:0] comprising 4 bits of data. GMII_TXD[0] is the least-significant bit (LSB). The signals are synchronized by GMII_TXCLK and valid only when GMII_TXEN is asserted.
GMII_TXEN	O	The transmit enable signal indicates that the GMII_TXD[3:0] pins are generating 4-bit data for use by the PHY. It is driven synchronously by GMII_TXCLK
GMII_COL	I	In half-duplex operation, the GMII_COL pin is asserted by the PHY when it detects a collision on the network. It remains asserted while the collision condition persists. This signal is not necessarily synchronous to GMII_TXCLK nor GMII_RXCLK In full-duplex operation, the GMII_COL pin is used for hardware transmit flow control. Asserting the GMII_COL pin stops packet transmissions; packets transmitting when MCOL is asserted will complete transmission. The GMII_COL pin should be held low if hardware transmit flow control is not used
GMII_CRS	I	In half-duplex operation, the GMII_CRS pin is asserted by the PHY when the network is not idle in either transmit or receive. The pin is deasserted when both transmit and receive are idle. This signal is not necessarily synchronous to GMII_TXCLK nor GMII_RXCLK. In full-duplex operation, the GMII_CRS pin should be held low.
GMII_RXCLK	I	The receive clock is a continuous clock that provides the timing reference for receive operations. The GMII_RXD, GMII_RXDV, and MRXER signals are tied to this clock. The clock is generated by the PHY and is 2.5 MHz at 10 Mbps operation and 25 MHz at 100 Mbps operation.
GMII_RXD[3:0]	I	The receive data pins are a collection of 4 data signals comprising 4 bits of data. GMII_RXD[0] is the least-significant bit (LSB). The signals are synchronized by GMII_RXCLK and valid only when GMII_RXDV is asserted.
GMII_RXDV	I	The receive data valid signal indicates that the GMII_RXD pins are generating nibble data for use by the 3PSW. It is driven synchronously to GMII_RXCLK
MDIO_CLK	O	Management data clock (MDIO_CLK). The MDIO data clock is sourced by the MDIO module on the system. It is used to synchronize MDIO data access operations done on the MDIO_DATA pin.
MDIO_DATA	I/O	The MDIO_DATA pin drives PHY management data into and out of the PHY by way of an access frame consisting of start of frame, read/write indication, PHY address, register address, and data bit cycles. The MDIO_DATA pin acts as an output for all but the data bit cycles at which time it is an input for read operations.

14.2.6 RMII Signal Connections and Descriptions

Figure 14-4 shows a device with integrated 3PSW and MDIO interfaced via a RMII connection in a typical system.

The individual CPSW and MDIO signals for the RMII interface are summarized in Table 14-6.

For more information, see either the IEEE 802.3 standard or ISO/IEC 8802-3:2000(E).

Figure 14-4. RMI Interface Connections

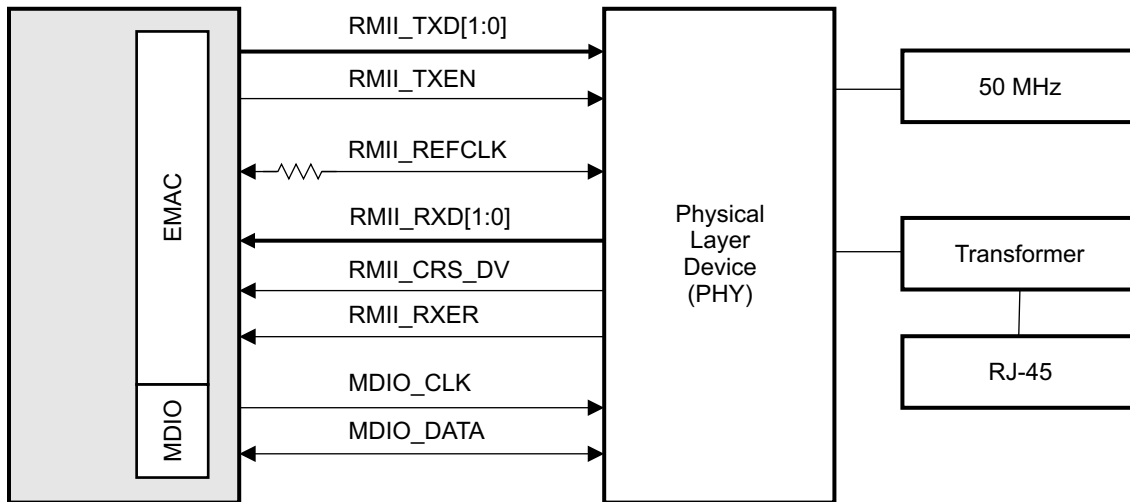


Table 14-6. RMI Interface Signal Descriptions

Signal	Type	Description
RMI_TXD[1-0]	O	Transmit data. The transmit data pins are a collection of 2 bits of data. RMI_TXD0 is the least-significant bit (LSB). The signals are synchronized by RMI_REFCLK and valid only when RMI_TXEN is asserted.
RMI_TXEN	O	Transmit enable. The transmit enable signal indicates that the RMI_TXD pins are generating data for use by the PHY. RMI_TXEN is synchronous to RMI_MHZ_50_CLK.
RMI_REFCLK	I	RMI reference clock. The reference clock is used to synchronize all RMI signals. RMI_REFCLK must be continuous and fixed at 50 MHz.
RMI_RXD[1-0]	I	Receive data. The receive data pins are a collection of 2 bits of data. RMI_RXD0 is the least-significant bit (LSB). The signals are synchronized by RMI_REFCLK and valid only when RMI_CRS_DV is asserted and RMI_RXER is deasserted.
RMI_CRS_DV	I	Carrier sense/receive data valid. Multiplexed signal between carrier sense and receive data valid.
RMI_RXER	I	Receive error. The receive error signal is asserted to indicate that an error was detected in the received frame.
MDIO_CLK	O	Management data clock. The MDIO data clock is sourced by the MDIO module on the system. It is used to synchronize MDIO data access operations done on the MDIO pin.
MDIO_DATA	I/O	MDIO DATA. MDIO data pin drives PHY management data into and out of the PHY by way of an access frame consisting of start of frame, read/write indication, PHY address, register address, and data bit cycles. The MDIO_DATA signal acts as an output for all but the data bit cycles at which time it is an input for read operations.

14.2.7 RGMII Signal Connections and Descriptions

Figure 14-5 shows a device with integrated CPSW and MDIO interfaced via a RGMII connection in a typical system.

Figure 14-5. RGMII Interface Connections

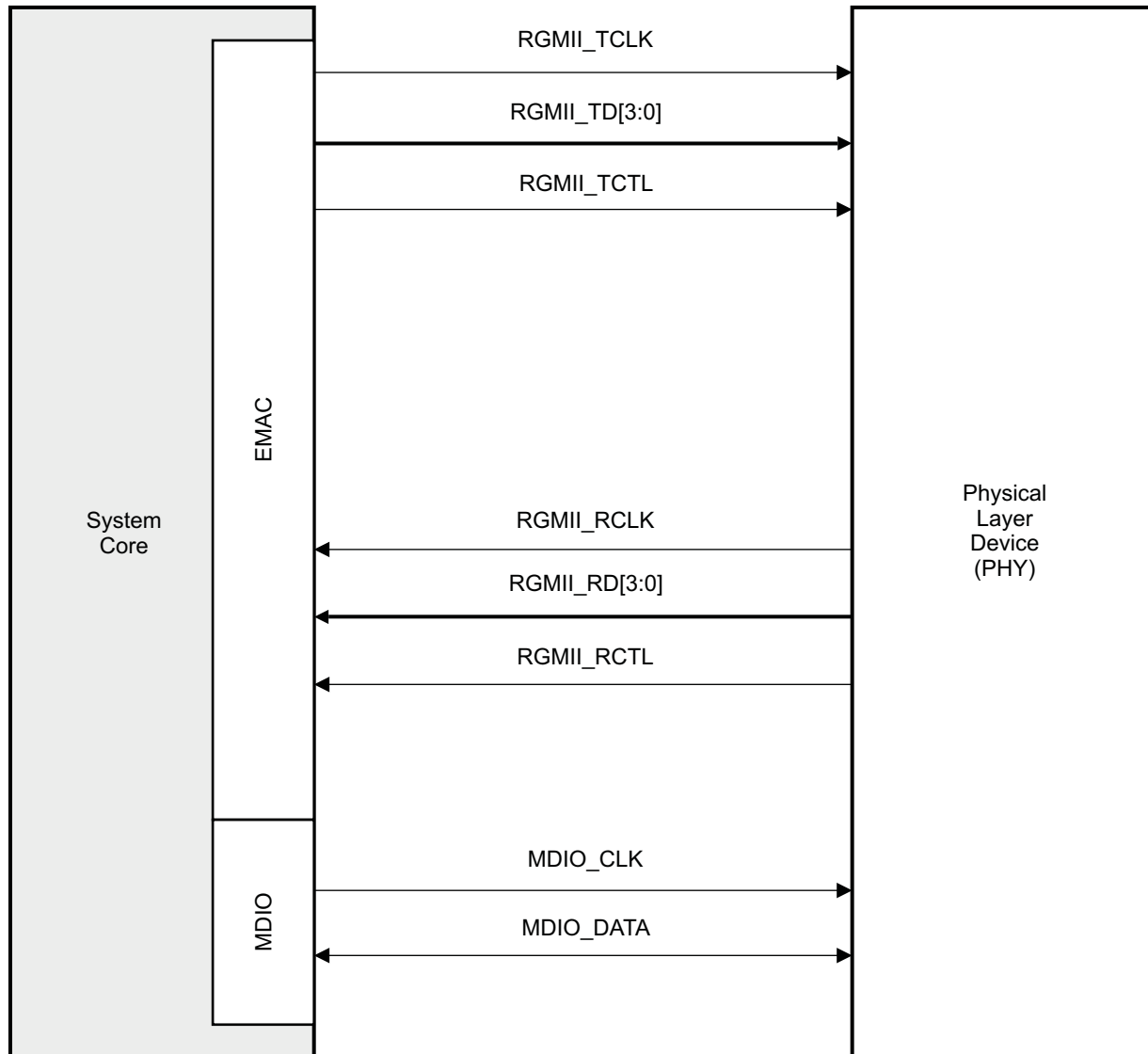


Table 14-7. RGMII Interface Signal Descriptions

Signal	Type	Description
RGMII_TD[3-0]	O	The transmit data pins are a collection of 4 bits of data. RGMII_RD0 is the least-significant bit (LSB). The signals are valid only when RGMII_TCTL is asserted.
RGMII_TCTL	O	Transmit Control/enable. The transmit enable signal indicates that the RGMII_TD pins are generating data for use by the PHY.
RGMII_TCLK	O	The transmit reference clock will be 125Mhz, 25Mhz, or 2.5Mhz depending on speed of operation.
RGMII_RD[3-0]	I	The receive data pins are a collection of 4 bits of data. RGMII_RD is the least-significant bit (LSB). The signals are valid only when RGMII_RCTL is asserted.

Table 14-7. RGMII Interface Signal Descriptions (continued)

Signal	Type	Description
RGMII_RCTL	I	The receive data valid/control signal indicates that the RGMII_RD pins are nibble data for use by the 3PSW.
RGMII_RCLK	I	The receive clock is a continuous clock that provides the timing reference for receive operations. The clock is generated by the PHY and is 2.5 MHz at 10 Mbps operation and 25 MHz at 100 Mbps operation, 125 MHz at 1000Mbps of operation.
MDIO_CLK	O	Management data clock. The MDIO data clock is sourced by the MDIO module on the system. It is used to synchronize MDIO data access operations done on the MDIO pin.
MDIO_DATA	I/O	MDIO DATA. MDIO data pin drives PHY management data into and out of the PHY by way of an access frame consisting of start of frame, read/write indication, PHY address, register address, and data bit cycles. The MDIO_DATA pin acts as an output for all but the data bit cycles at which time it is an input for read operations.

14.3 Functional Description

The 3 port switch (3PSW) Ethernet Subsystem peripheral are compliant to the IEEE Std 802.3 Specification. The 3PSW Ethernet Subsystem contains two RGMII/RMII interfaces, one CPPI 3.0 interface, Interrupt Controller, MDIO and CPSW_3G which contains two GMII interfaces as shown in [Figure 14-6](#).

The subsystem modules are discussed in detail in the following sections.

14.3.1 CPSW_3G Subsystem

14.3.1.1 Interrupt Pacing

The receive and transmit pulse interrupts can be paced. The receive threshold and miscellaneous interrupts are not paced. The Interrupt pacing feature limits the number of interrupts that occur during a given period of time. For heavily loaded systems in which interrupts can occur at a very high rate (e.g. 148,800 packets per second for Ethernet), the performance benefit is significant due to minimizing the overhead associated with servicing each interrupt. Interrupt pacing increases the CPU cache hit ratio by minimizing the number of times that large interrupt service routines are moved to and from the CPU instruction cache.

Each CPU receive and transmit pulse interrupt contains an interrupt pacing sub-block (six total). Each sub-block is disabled by default allowing the selected interrupt inputs to pass through unaffected. The interrupt pacing module counts the number of interrupts that occur over a 1ms interval of time. At the end of each 1ms interval, the current number of interrupts is compared with a target number of interrupts (specified by the associated maximum number of interrupts register).

Based on the results of the comparison, the length of time during which interrupts are blocked is dynamically adjusted. The 1ms interval is derived from a 4us pulse that is created from a prescale counter whose value is set in the `int_prescale` value in the `Int_Control` register. The `int_prescale` value should be written with the number of `VBUSP_CLK` periods in 4us. The pacing timer determines the interval during which interrupts are blocked and decrements every 4us. It is reloaded each time a zero count is reached. The value loaded into the pacing timer is calculated by hardware every 1ms according to the following algorithm:

```

if (intr_count > 2*intr_max)
    pace_timer = 255;
else if (intr_count > 1.5*intr_max)
    pace_timer = last_pace_timer*2 + 1;
else if (intr_count > 1.0*intr_max)
    pace_timer = last_pace_timer + 1;
else if (intr_count > 0.5*intr_max)
    pace_timer = last_pace_timer - 1;
else if (intr_count != 0)
    pace_timer = last_pace_timer/2;
else
    pace_timer = 0;
  
```

If the rate of interrupt inputs is much less than the target interrupt rate specified in the associated maximum interrupts register, then the interrupt is not blocked. If the interrupt rate is greater than the target rate, the interrupt will be “paced” at the rate specified in the interrupt maximum register. The interrupt maximum register should be written with a value between 2 and 63 inclusive indicating the target number of interrupts per milli-second.

14.3.1.2 Reset Isolation

Reset isolation for the Ethernet switch on Device is that the switch function of the ethernet IP remains active even in case of all device resets except for POR pin reset and ICEPICK COLD reset. Packet traffic to/from the 3PSW host will be flushed/dropped, but the ethernet switch will remain operational for all traffic between external devices on the switch even though the device is under-going a device reset. Pin mux configuration for ethernet related IO and reference clocks needed by the Ethernet switch IP to be active is controlled by a protected control module bit. If reset isolation is enabled, then only a POR pin or ICEPICK COLD reset event should fully reset the Ethernet switch IP including the actual switch and also the reference clocks and pin mux control specifically associated with the Ethernet IP.

14.3.1.2.1 Modes of Operation

The device has two modes of operation concerning the reset of the 3PSW Ethernet switch.

The mode is controlled by the ISO_CONTROL bit in **RESET_ISO** register of the **device control module**. This bit should default to '0'. Writes to the ISO_CONTROL bit must be supervisor mode writes.

Mode 1: ISO_CONTROL=0 (reset isolation disabled)

- This mode is selected when ISO_CONTROL bit of control module is = 0. This should be the default state of the bit after control module reset.
- Upon any device level resets, the entire CPSW_3GSS_R IP, L3/L4, control module (including all pin mux control and the ISO_CONTROL bit) is immediately reset.

Mode 2: ISO_CONTROL=1 (reset isolation enabled)

- This mode is selected when ISO_CONTROL bit of control module is = 1.
- Upon any device reset source other than POR pin or ICEPICK cold (so this includes SW global cold, any watchdog reset, warm RESETn pin, ICEPICK warm, SW global warm), the following should be true:
 - The CPSW_3GSS_R is put into 'isolate' mode and non-switch related portions of the IP are reset.
 - The 50-MHz and 125-MHz reference clocks to the 3PSW Ethernet Subsystem remains active throughout the entire reset condition.
 - The control for pin multiplexing for all of the signals should maintain their current configuration throughout the entire reset condition.
 - The reset isolated logic inside 3PSW Ethernet Subsystem IP which maintains the switch functionality
 -
- Upon any cold reset sources, the entire 3PSW Ethernet Subsystem, control module (including all pin mux control and the ISO_CONTROL bit itself) is reset.

14.3.1.3 Interrupts

The 3 Port Switch Ethernet Subsystem generates four interrupt events.

14.3.1.3.1 Receive Packet Completion Pulse Interrupt (RX_PULSE)

The RX_PULSE interrupt is a paced pulse interrupt selected from the 3PSW RX_PEND [7:0] interrupts. The receive DMA controller has eight channels with each channel having a corresponding (RX_PEND[7:0]).

The following steps will enable the receive packet completion interrupt.

- Enable the required channel interrupts of the DMA engine by setting 1 to the appropriate bit in the RX_INTMASK_SET register.
- The receive completion interrupt(s) to be routed to RX_PULSE is selected by setting one or more bits in the receive interrupt enable register Cn_RX_EN. The masked interrupt status can be read in the Receive Interrupt Masked Interrupt Status (Cn_RX_STAT) register.

When the 3PSW completes a packet reception, the subsystem issues an interrupt to the CPU by writing the packet's last buffer descriptor address to the appropriate channel queue's receive completion pointer located in the state RAM block. The interrupt is generated by the write when enabled by the interrupt mask, regardless of the value written.

Upon interrupt reception, the CPU processes one or more packets from the buffer chain and then acknowledges one or more interrupt(s) by writing the address of the last buffer descriptor processed to the queue's associated receive completion pointer (RXn_CP) in the receive DMA state RAM.

Upon reception of an interrupt, software should perform the following:

- Read the RX_STAT register to determine which channel(s) caused the interrupt.
- Process received packets for the interrupting channel(s).
- Write the 3PSW completion pointer(s) (RXn_CP). The data written by the host (buffer descriptor address of the last processed buffer) is compared to the data in the register written by the subsystem (address of last buffer descriptor used by the subsystem). If the two values are not equal (which means that the 3PSW has received more packets than the CPU has processed), the receive packet completion interrupt signal remains asserted. If the two values are equal (which means that the host has processed all packets that the system has received), the pending interrupt is de-asserted. The value that the 3PSW is expecting is found by reading the receive channeln completion pointer register (RXn_CP).
- Write the value 1h to the CPDMA_EOI_VECTOR register.

To disable the interrupt:

- The eight channel interrupts may be individually disabled by writing to 1 the appropriate bit in the RX_INTMASK_CLEAR
- The receive completion pulse interrupt could be disabled by clearing to 0 all the bits of the RX_EN.

The software could still poll for the RX_INTSTAT_RAW and RX_INTSTAT_MASKED registers if the corresponding interrupts are enabled.

14.3.1.3.2 Transmit Packet Completion Pulse Interrupt (TX_PULSE)

The TX_PULSE interrupt is a paced pulse interrupt selected from the 3PSW TX_PEND [7:0] interrupts. The transmit DMA controller has eight channels with each channel having a corresponding (TX_PEND[7:0]).

To enable the transmit packet completion interrupt:

- Enable the required channel interrupts of the DMA engine by setting 1 to the appropriate bit in the TX_INTMASK_SET register.
- The transmit completion interrupt(s) to be routed to TX_PULSE is selected by setting one or more bits in the transmit interrupt enable register Cn_TX_EN. The masked interrupt status can be read in the Transmit Interrupt Masked Interrupt Status (Cn_TX_STAT) register.

When the 3PSW completes the transmission of a packet, the 3PSW subsystem issues an interrupt to the CPU by writing the packet's last buffer descriptor address to the appropriate channel queue's transmit completion pointer located in the state RAM block. The interrupt is generated by the write when enabled by the interrupt mask, regardless of the value written.

Upon receiving an interrupt, software should perform the following:

- Read the TX_STAT register to determine which channel(s) caused the interrupt
- Process received packets for the interrupting channel(s).
- Write the 3PSW completion pointer(s) (TX_n_CP). The data written by the host (buffer descriptor address of the last processed buffer) is compared to the data in the register written by the 3PSW (address of last buffer descriptor used by the 3PSW). If the two values are not equal (which means that the 3PSW has transmitted more packets than the CPU has processed), the transmit packet completion interrupt signal remains asserted. If the two values are equal (which means that the host has processed all packets that the subsystem has transferred), the pending interrupt is cleared. The value that the 3PSW is expecting is found by reading the transmit channel_n completion pointer register (TX_n_CP).
- Write the 2h to the CPDMA_EOI_VECTOR register.

To disable the interrupt:

- The eight channel interrupts may be individually disabled by writing to 1 the appropriate bit in the TX_INTMASK_CLEAR.
- The receive completion pulse interrupt could be disabled by clearing to 0 all the bits of the TX_EN. The software could still poll for the TX_INTSTAT_RAW and TX_INTSTAT_MASKED registers if the corresponding interrupts are enabled.

14.3.1.3.3 Receive Threshold Pulse Interrupt (RX_THRESH_PULSE)

The RX_THRESH_PULSE interrupt is an immediate (non-paced) pulse interrupt selected from the CPSW_3G RX_THRESH_PEND[7:0] interrupts. The receive DMA controller has eight channels with each channel having a corresponding threshold pulse interrupt (RX_THRESH_PEND [7:0]).

To enable the receive threshold pulse Interrupt:

- Enable the required channel interrupts of the DMA engine by setting 1 to the appropriate bit in the RX_INTMASK_SET register.
- The receive threshold interrupt(s) to be routed to RX_THRESH_PULSE is selected by setting one or more bits in the receive threshold interrupt enable register RX_THRESH_EN. The masked interrupt status can be read in the Receive Threshold Masked Interrupt Status (C_n_RX_THRESH_STAT) register.

The RX_THRESH_PULSE is asserted when enabled when the channel's associated free buffer count RX_n_FREEBUFFER is less than or equal to the corresponding RX_n_PENDTHRESH register.

Upon receiving an interrupt, software should perform the following:

- Read the C_n_RX_THRESH_STAT bit address location to determine which channel(s) caused the interrupt.
- Process the received packets in order to add more buffers to any channel that is below the threshold value.
- Write the CPSW_3G completion pointer(s).
- Write the value 0h to the CPDMA_EOI_VECTOR register.

The threshold pulse interrupt is an immediate interrupt intended to indicate that software should immediately process packets to preclude an overrun condition from occurring for the particular channels.

To disable the interrupt:

- The eight channel receive threshold interrupts may be individually disabled by writing to 1 the appropriate bit in the RX_INTMASK_CLEAR register.
- The receive threshold pulse interrupt could be disabled by clearing to Zero the corresponding bits of the RX_THRESH_EN. The software could still poll for the RX_INTSTAT_RAW and INTSTAT_MASKED registers if the corresponding interrupts are enabled.

14.3.1.3.4 Miscellaneous Pulse Interrupt (MISC_PULSE)

The MISC_PULSE interrupt is an immediate, non-paced, pulse interrupt selected from the miscellaneous interrupts (EVNT_PEND, STAT_PEND, HOST_PEND, MDIO_LINKINT, MDIO_USERINT). The miscellaneous interrupt(s) is selected by setting one or more bits in the $Cn_MISC_EN[4:0]$ register. The masked interrupt status can be read in the $Cn_MISC_STAT[4:0]$ register. Upon reception of an interrupt, software should perform the following:

- Read the $Misc_Stat[4:0]$ register to determine which caused the interrupt.
- Process the interrupt.
- Write the appropriate value (0x3) to the CPDMA_EOI_VECTOR register.
- Write a 1 to the appropriate bit in the MDIOLINKINTRAW register.

This device does not support multiple link interrupts. Only MDIO_LINKINT[0] and MDIO_USERINT[0] are used. MDIO_LINKINT[1] and MDIO_USERINT[1] are not used.

14.3.1.3.4.1 EVNT_PEND (CPTS_PEND) Interrupt

See [Section 14.3.7, Common Platform Time Sync \(CPTS\)](#), for information on the time sync event interrupt.

14.3.1.3.4.2 Statistics Interrupt

The statistics level interrupt (STAT_PEND) will be asserted if enabled when any statistics value is greater than or equal to 0x80000000. The statistics interrupt is cleared by writing to decrement all statistics values greater than 0x80000000 (such that their new values are less than 0x80000000). The statistics interrupt is enabled by setting to one the appropriate bit in the INTMASK_SET register in the CPDMA submodule.

The statistics interrupt is disabled by writing one to the appropriate bit in the INTMASK_CLEAR register. The raw and masked statistics interrupt status may be read by reading the TX_IntStat_Raw and TX_IntStat_Masked registers, respectively

14.3.1.3.4.3 Host Error Interrupt

The host error interrupt (HOST_PEND) will be asserted if enabled when a host error is detected during transmit or receive CPDMA transactions. The host error interrupt is intended for software debug, and is cleared by a warm reset or a system reset. The raw and masked statistics interrupt status can be read by reading the TX_INTSTAT_RAW and TXINTSTAT_MASKED registers, respectively.

The following list shows the transmit host error conditions:

- SOP error
- OWNERSHIP bit not set in SOP buffer
- next buffer descriptor pointer without EOP set to 0
- buffer pointer set to 0
- buffer length set to 0
- packet length error

The receive host error conditions are show in the following list:

- Ownership bit not set in input buffer.
- Zero buffer pointer.
- Zero buffer Length on non-SOP descriptor.
- SOP buffer length not greater than offset.

The host error interrupt is disabled by clearing to 0 the appropriate bit in the CPDMA_INTMASK_CLEAR register.

14.3.1.3.4.4 MDIO Interrupts

MDIO_LINKINT is set if there is a change in the link state of the PHY corresponding to the address in the PHYADDRMON field of the MDIOUSERPHYSEL_n register and the corresponding LINKINTENB bit is set. The MDIO_LINKINT event is also captured in the MDIOLINKINTMASKED register. When the GO bit in the MDIOUSERACCESS_n registers transitions from 1 to 0, indicating the completion of a user access, and the corresponding USERINTMASKSET bit in the MDIOUSERINTMASKSET register is set, the MDIO_USERINT signal is asserted 1. The MDIO_USERINT event is also captured in the MDIOUSERINTMASKED register.

To enable the miscellaneous pulse interrupt:

The miscellaneous interrupt(s) is selected by setting one or more bits in the miscellaneous interrupt enable register (MISC_EN).

- The Statistics interrupt is enabled by setting to 1 the STAT_INT_MASK bit in the DMA_INTMASK_SET register.
- The HOST_PEND is enabled by setting to 1 the HOST_ERR_INT_MASK in the DMA_INTMASK_SET register.

Upon receiving of an interrupt, software should perform the following:

- Read the C_n_MISC_STAT register to determine the source of the interrupt.
- Process the interrupt.
- Write the value 3h to the CPDMA_EOI_VECTOR register.

14.3.1.4 Embedded Memories

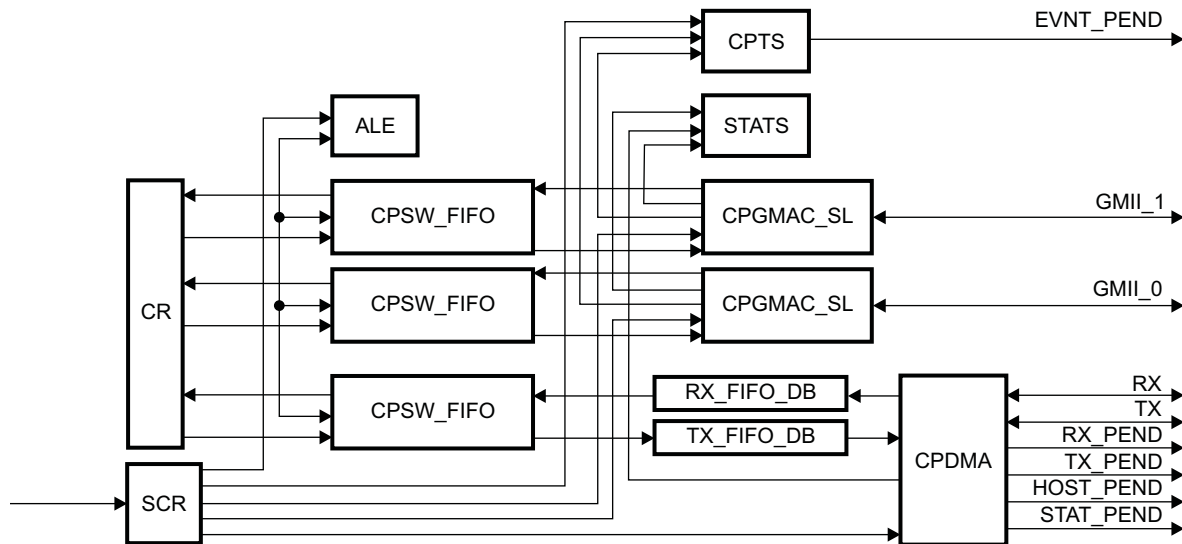
Memory Type Description	Number of Instances
Single port 2560 by 64 RAM	3 (Packet FIFOs)
Single port 64-word by 1152-bit RAM	1 (ALE)
Single port 2048-word by 32-bit RAM	1 (CPPI)

14.3.2 CPSW_3G

The CPSW_3G GMII interfaces are compliant to the IEEE Std 802.3 Specification.

The CPSW_3G contains two CPGMAC_SL interfaces (ports 1 and 2), one CPPI 3.0 interface Host Port (port 0), Common Platform Time Sync (CPTS), ALE Engine and CPDMA.

The top level block diagram of CPSW_3G is shown below:

Figure 14-6. CPSW_3G Block Diagram


14.3.2.1 Media Independent Interface (GMII)

The CPSW_3G contains two CPGMAC_SL submodules. Each CPGMAC_SL has a single GMII interface. The CPGMAC_SL submodules are ports 1 and 2. For more details, see [Section 14.3.3, Ethernet Mac Sliver \(CPGMAC_SL\)](#).

14.3.2.2 IEEE 1588v2 Clock Synchronization Support

The CPSW_3G supports IEEE 1588v2 clock synchronization. Ethernet GMII Transmit (egress) and receive (ingress) time sync operation are also supported.

14.3.2.2.1 IEEE 1588v2 Receive Packet Operation

There are two CPSW_3G receive time sync interfaces for each ethernet port. The first is the TS_RX_MII interface and the second is the TS_RX_DEC interface. Both interfaces are generated in the switch and are input to the CPTS module. There are register bits in the CPSW_3G that control time sync operations in addition to the registers in the CPTS module. The `pX_ts_rx_en` bit in the switch `Px_Control` register must be set for receive time sync operation to be enabled (TS_RX_MII).

The TS_RX_MII interface issues a record signal (`pX_ts_rx_mii_rec`) along with a handle (`pX_ts_rx_mii_hndl[3:0]`) to the CPTS controller for each packet that is received. The record signal is a single clock pulse indicating that a receive packet has been detected at the associated port MII interface.

The handle value is incremented with each packet and rolls over to zero after 15. There are 16 possible handle values so there can be a maximum of 16 packets “in flight” from the TS_RX_MII to the TS_RX_DEC block (through the CPGMAC_SL) at any given time. A handle value is reused (not incremented) for any received packet that is shorter than about 31 octets (including preamble). Handle reuse on short packets prevents any possible overrun condition if multiple fragments are consecutively received.

The TS_RX_MII logic is in the receive wireside clock domain. There is no decode logic in the TS_RX_MII to determine if the packet is a time sync event packet or not. Each received packet generates a record signal and new handle. The handle is sent to the CPTS controller with the record pulse and the handle is also sent to the TS_RX_DEC block along with the packet. The packet decode is performed in the TS_RX_DEC block. The decode function is separated from the record function because in some systems the incoming packet can be encrypted. The decode function would be after packet decryption in those systems.

The TS_RX_DEC function decodes each received packet and determines if the packet meets the time sync event packet criteria. If the packet is determined to be a time sync event packet, then the time sync event packet is signaled to the CPTS controller via the TS_RX_DEC interface (pX_ts_rx_dec_evt, pX_ts_rx_dec_hdl[3:0], pX_ts_rx_dec_msg_type, pX_ts_rx_dec_seq_id). The event signal is a single clock pulse indicating that the packet matched the time sync event packet criteria and that the associated packet handle, message type, and sequence ID are valid. No indication is given for received packets that do not meet the time sync event criteria. The 16-bit sequence ID is found in the time sync event packet at the sequence ID offset into the PTP message header (pX_ts_seq_id_offset). A packet is determined to be a receive event packet under the following conditions:

14.3.2.2.1.1 Annex F

1. Receive time sync is enabled (pX_ts_rx_en is set in the switch Px_Control register).
2. One of the following sequences is true:
 - Where the first packet ltype matches:
 - ts_ltype1 and pX_ts_ltype1_en is set
 - ts_ltype2 and pX_ts_ltype2_en is set
 - vlan_ltype1 and pX_vlan_ltype1_en is set and the second packet ltype matches ts_ltype1 and pX_ts_ltype1_en is set
 - vlan_ltype1 and pX_vlan_ltype1_en is set and the second packet ltype matches ts_ltype2 and pX_ts_ltype2_en is set
 - vlan_ltype2 and pX_vlan_ltype2_en is set and the second packet ltype matches ts_ltype1 and pX_ts_ltype1_en is set
 - vlan_ltype2 and pX_vlan_ltype2_en is set and the second packet ltype matches ts_ltype2 and pX_ts_ltype2_en is set
 - vlan_ltype1 and pX_vlan_ltype1_en is set and the second packet ltype matches vlan_ltype2 and pX_vlan_ltype2_en is set and the third packet ltype matches ts_ltype1 and pX_ts_ltype1_en is set
 - vlan_ltype1 and pX_vlan_ltype1_en is set and the second packet ltype matches vlan_ltype2 and pX_vlan_ltype2_en is set and the third packet ltype matches ts_ltype2 and pX_ts_ltype2_en is set
3. The PTP message begins in the byte after the LTYPE.
4. The packet message type is enabled in the pX_ts_msg_type_en field in the Px_TS_SEQ_MTYPE register.
5. The packet was received without error (not long/short/mac_ctl/crc/code/align).
6. The ALE determined that the packet is to be sent only to the host (port 0).

14.3.2.2.1.2 Annex D

1. Receive time sync is enabled (pX_ts_rx_en is set in the switch Px_Control register).
2. One of the following sequences is true:
 - Where the first packet ltype matches:
 - 0x0800 and pX_ts_annex_d_en is set
 - vlan_ltype1 and pX_vlan_ltype1_en is set and the second packet ltype matches 0x0800 and pX_ts_annex_d_en is set
 - vlan_ltype2 and pX_vlan_ltype2_en is set and the second packet ltype matches 0x0800 and pX_ts_annex_d_en is set
 - vlan_ltype1 and pX_vlan_ltype1_en is set and the second packet ltype matches vlan_ltype2 and pX_vlan_ltype2_en is set and the third packet ltype matches 0x0800 and pX_ts_annex_d_en is set
3. Byte 14 (the byte after the LTYPE) contains 0x45 (IP_VERSION).

Note: The byte numbering assumes that there are no vlans. The byte number is intended to show the relative order of the bytes.
4. Byte 22 contains 0x00 if the pX_ts_ttl_nonzero bit in the switch Px_Control register is zero or byte 22 contains any value if pX_ts_ttl_nonzero is set. Byte 22 is the time to live field.

5. Byte 23 contains 0x11 (UDP Fixed).
6. Byte 30 contains decimal 224 (0xe0).
7. Byte 31 contains 0x00.
8. Byte 32 contains 0x01.
9. Byte 33 contains one of the following:
 - Decimal 129 and the pX_ts_129 bit in the switch Px_Control register is set
 - Decimal 130 and the pX_ts_130 bit in the switch Px_Control register is set
 - Decimal 131 and the pX_ts_131 bit in the switch Px_Control register is set
 - Decimal 129 and the pX_ts_132 bit in the switch Px_Control register is set
10. Bytes 36 and 37 contain one of the following:
 - Decimal 0x01 and 0x3f respectively and the pX_ts_319 bit in the switch Px_Control register is set.
 - Decimal 0x01 and 0x40 respectively and the pX_ts_320 bit in the switch Px_Control register is set.
11. The PTP message begins in byte 42.
12. The packet message type is enabled in the pX_ts_msg_type_en field in Px_Control.
13. The packet was received without error (not long/short/mac_ctl/crc/code/align).
14. The ALE determined that the packet is to be sent only to the host (port 0).

14.3.2.2.2 IEEE 1588v2 Transmit Packet Operation

There are two CPSW_3G transmit time sync interfaces for each ethernet port. The first is the TS_TX_DEC interface and the second is the TS_TX_MII interface. Both interfaces are generated in the switch and are input to the CPTS module. The pX_ts_tx_en bit in the Px_Control register must be set for transmit time sync operation to be enabled.

The TS_TX_DEC function decodes each packet to be transmitted and determines if the packet meets the time sync event packet criteria. If the packet is determined to be a time sync event packet, then the time sync event is signaled to the CPTS controller via the TS_TX_DEC interface (pX_ts_tx_dec_evt, pX_ts_tx_dec_hdl[3:0], pX_ts_tx_dec_msg_type, pX_ts_tx_dec_seq_id). The event signal is a single clock pulse indicating that the packet matched the time sync event packet criteria and that the associated packet handle, message type, and sequence ID are valid.

The 16-bit sequence ID is found in the time sync event packet at the sequence ID offset into the message header (pX_ts_seq_id_offset). No indication is given for transmit packets that do not meet the time sync event criteria. The time sync event packet handle is also passed along with the packet to the TS_TX_MII with an indication that the packet is a time sync event packet. Unlike receive, only transmit event packets increment the handle value. The decode function is separated from the record function because some systems may encrypt the packet. The encryption is after the decode function on transmit (egress). A packet is determined to be a transmit event packet if the following is met:

14.3.2.2.2.1 Annex F

1. Transmit time sync is enabled (pX_ts_tx_en is set in the switch Px_Control register).
2. One of the following sequences is true:
 - The first packet ltype matches ts_ltype1 and pX_ts_ltype1_en is set
 - The first packet ltype matches ts_ltype2 and pX_ts_ltype2_en is set
 - The first packet ltype matches vlan_ltype1 and pX_vlan_ltype1_en is set and the second packet matches ts_ltype1 and pX_ts_ltype1_en is set
 - The first packet ltype matches vlan_ltype1 and pX_vlan_ltype1_en is set and the second packet ltype matches ts_ltype2 and pX_ts_ltype2_en is set
 - The first packet ltype matches vlan_ltype2 and pX_vlan_ltype2_en is set and the second packet ltype matches ts_ltype1 and pX_ts_ltype1_en is set
 - The first packet ltype matches vlan_ltype2 and pX_vlan_ltype2_en is set and the second packet

- ltype matches ts_ltype2 and pX_ts_ltype2_en is set
 - The first packet ltype matches vlan_ltype1 and pX_vlan_ltype1_en is set and the second packet ltype matches vlan_ltype2 and pX_vlan_ltype2_en is set and the third packet ltype matches ts_ltype1 and pX_ts_ltype1_en is set
 - The first packet ltype matches vlan_ltype1 and pX_vlan_ltype1_en is set and the second packet ltype matches vlan_ltype2 and pX_vlan_ltype2_en is set and the third packet ltype matches ts_ltype2 and pX_ts_ltype2_en is set
3. The packet message type is enabled in pX_ts_msg_type_en.
 4. The packet was received by the host (port 0).

14.3.2.2.2 Annex D

1. Transmit time sync is enabled (pX_ts_tx_en is set in the switch Px_Control register).
2. One of the following sequences is true:
 - The first packet ltype matches 0x0800 and pX_ts_annex_d_en is set
 - The first packet ltype matches vlan_ltype1 and pX_vlan_ltype1_en is set and the second packet ltype matches 0x0800 and pX_ts_annex_d_en is set
 - The first packet ltype matches vlan_ltype2 and pX_vlan_ltype2_en is set and the second packet ltype matches 0x0800 and pX_ts_annex_d_en is set
 - The first packet ltype matches vlan_ltype1 and pX_vlan_ltype1_en is set and the second packet ltype matches vlan_ltype2 and pX_vlan_ltype2_en is set and the third packet ltype matches 0x0800 and pX_ts_annex_d_en is set
3. Byte 14 (the byte after the LTYPE) contains 0x45 (IP_VERSION).

Note: The byte numbering assumes that there are no vlans. The byte number is intended to show the relative order of the bytes. If VLAN(s) are present, then the byte numbers push down.
4. Byte 22 contains 0x00 if the pX_ts_ttl_nonzero bit in the switch Px_Control register is zero or byte 22 contains any value if pX_ts_ttl_nonzero is set. Byte 22 is the time to live field.
5. Byte 23 contains 0x11 (UDP Fixed).
6. Byte 30 contains decimal 224 (0xe0)
7. Byte 31 contains 0x00
8. Byte 32 contains 0x01
9. Byte 33 contains one of the following:
 - Decimal 129 and the pX_ts_129 bit in the switch Px_Control register is set
 - Decimal 130 and the pX_ts_130 bit in the switch Px_Control register is set
 - Decimal 131 and the pX_ts_131 bit in the switch Px_Control register is set
 - Decimal 132 and the pX_ts_132 bit in the switch Px_Control register is set
10. Bytes 36 and 37 contain either of the following:
 - Decimal 1 (hex 0x01) and decimal 63 (hex 0x3f) respectively and the pX_ts_319 bit in the switch Px_Control register is set
 - Decimal 1 (hex 0x01) and decimal 64 (hex 0x40) respectively and the pX_ts_320 bit in the switch Px_Control register is set
11. The PTP message begins in byte 42 (this is offset 0).
12. The packet message type is enabled in pX_ts_msg_type_en.
13. The packet was received by the host (port 0).

The TS_TX_MII interface issues a single clock record signal (pX_ts_tx_mii_rec) at the beginning of each transmitted packet. If the packet is a time sync event packet then a single clock event signal (pX_ts_tx_mii_evnt) along with a handle (pX_ts_rx_mii_hndl[2:0]) will be issued before the next record signal for the next packet. The event signal will not be issued for packets that did not meet the time sync event criteria in the TS_TX_DEC function. If consecutive record indications occur without an interleaving event indication, then the packet associated with the first record was not a time sync event packet.

The record signal is a single clock pulse indicating that a transmit packet egress has been detected at the associated port MII interface. The handle value is incremented with each time sync event packet and rolls over to zero after 7. There are 8 possible handle values so there can be a maximum of eight time sync event packets “in flight” from the TS_TX_DEC to the TS_TX_MII block at any given time. The handle value increments only on time sync event packets. The TS_TX_MII logic is in the transmit wireside clock domain.

14.3.2.3 Device Level Ring (DLR) Support

Device Level Ring (DLR) support is enabled by setting the `dlr_en` bit in the `CPSW_Control` register. When enabled, incoming received DLR packets are detected and sent to queue 3 (highest priority) of the egress port(s). If the host port is the egress port for a DLR packet then the packet is sent on the CPDMA Rx channel selected by the `p0_dlr_cpdma_ch` field in the `P0_Control` register. The supervisor node MAC address feature is supported with the `dlr_unicast` bit in the unicast address table entry.

When set, the `dlr_unicast` bit causes a packet with the matching destination address to be flooded to the `vlan_member_list` minus the receive port and minus the host port (the `port_number` field in the unicast address table entry is a don't care). Matching `dlr_unicast` packets are flooded regardless of whether the packet is a DLR packet or not. The `en_p0_uni_flood` bit in the `ALE_Control` register has no effect on DLR unicast packets. Packets are determined to be DLR packets, as shown:

1. DLR is enabled (`dlr_en` is set in the switch `CPSW_Control` register).
2. One of the following sequences is true:
 - The first packet `ltype` matches `vlan_ltype1` and `pX_vlan_ltype1_en` is set and the second packet `ltype` matches `dlr_ltype`.
 - The first packet `ltype` matches `vlan_ltype2` and `pX_vlan_ltype2_en` is set and the second packet `ltype` matches `dlr_ltype`.
 - The first packet `ltype` matches `vlan_ltype1` and `pX_vlan_ltype1_en` is set and the second packet `ltype` matches `vlan_ltype2` and `pX_vlan_ltype2_en` is set and the third packet `ltype` matches `dlr_ltype`.

14.3.2.4 CPDMA RX and TX Interfaces

The CPDMA submodule is a CPPI 3.0 compliant packet DMA transfer controller. The CPPI 3.0 interface is port 0.

After reset, initialization, and configuration the host may initiate transmit operations. Transmit operations are initiated by host writes to the appropriate transmit channel head descriptor pointer contained in the STATERAM block. The transmit DMA controller then fetches the first packet in the packet chain from memory in accordance with CPPI 3.0 protocol. The DMA controller writes the packet into the external transmit FIFO in 64-byte bursts (maximum).

Receive operations are initiated by host writes to the appropriate receive channel head descriptor pointer after host initialization and configuration. The receive DMA controller writes the receive packet data to external memory in accordance with CPPI 3.0 protocol. See the CPPI Buffer Descriptors section for detailed description of Buffer Descriptors

14.3.2.4.1 CPPI Buffer Descriptors

The buffer descriptor is a central part of the 3PSW Ethernet Subsystem and is how the application software describes Ethernet packets to be sent and empty buffers to be filled with incoming packet data.

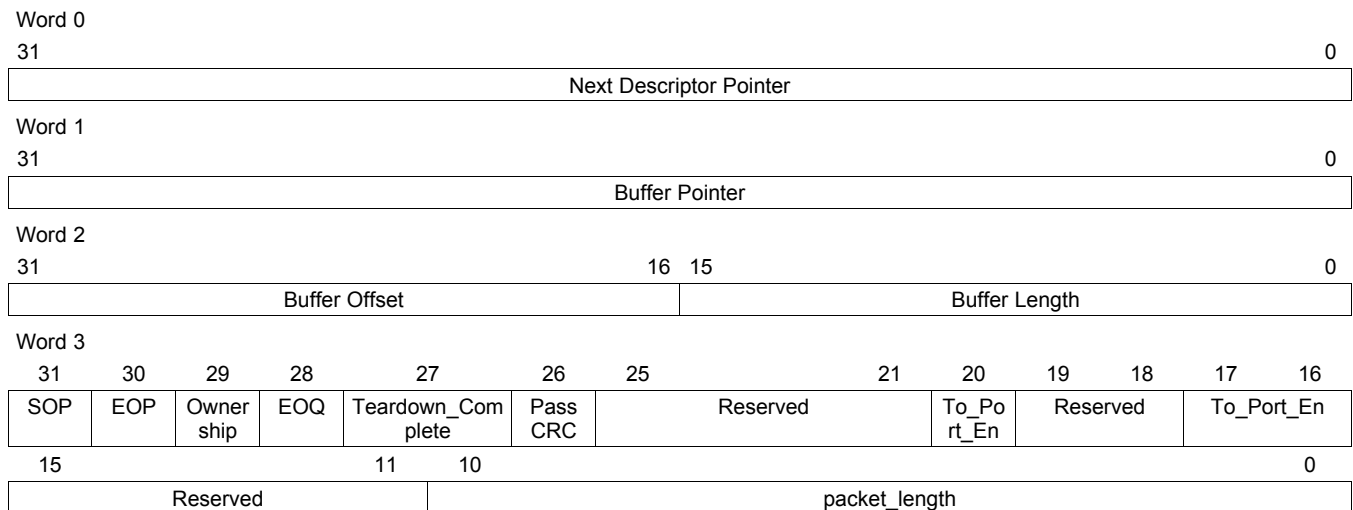
Host Software sends and receives network frames via the CPPI 3.0 compliant host interface. The host interface includes module registers and host memory data structures. The host memory data structures are buffer descriptors and data buffers. Buffer descriptors are data structures that contain information about a single data buffer. Buffer descriptors may be linked together to describe frames or queues of frames for transmission of data and free buffer queues available for received data.

Note: The 8k bytes of Ethernet Subsystem CPPI RAM begin at address 0x4a102000 and end at 0x4a103FFF from the 3PSW perspective. The buffer descriptors programmed to access the CPPI RAM memory should use the address range from 0x4a102000.

14.3.2.4.1.1 TX Buffer Descriptors

A TX buffer descriptor is a contiguous block of four 32-bit data words aligned on a 32-bit word boundary.

Figure 14-7. Tx Buffer Descriptor Format



14.3.2.4.1.1.1 CPPI Tx Data Word – 0

Next Descriptor Pointer

The next descriptor pointer points to the 32-bit word aligned memory address of the next buffer descriptor in the transmit queue. This pointer is used to create a linked list of buffer descriptors. If the value of this pointer is zero, then the current buffer is the last buffer in the queue. The software application must set this value prior to adding the descriptor to the active transmit list. This pointer is not altered by the EMAC. The value of pNext should never be altered once the descriptor is in an active transmit queue, unless its current value is NULL.

If the pNext pointer is initially NULL, and more packets need to be queued for transmit, the software application may alter this pointer to point to a newly appended descriptor. The EMAC will use the new pointer value and proceed to the next descriptor unless the pNext value has already been read. In this latter case, the transmitter will halt on the transmit channel in question, and the software application may restart it at that time. The software can detect this case by checking for an end of queue (EOQ) condition flag on the updated packet descriptor when it is returned by the EMAC.

14.3.2.4.1.1.2 CPPI Tx Data Word – 1

Buffer Pointer

The byte aligned memory address of the buffer associated with the buffer descriptor. The host sets the **buffer_pointer**. The software application must set this value prior to adding the descriptor to the active transmit list. This pointer is not altered by the EMAC.

14.3.2.4.1.1.3 CPPI Tx Data Word – 2

Buffer_Offset

Buffer Offset – Indicates how many unused bytes are at the start of the buffer. A value of 0x0000 indicates that no unused bytes are at the start of the buffer and that valid data begins on the first byte of the buffer. A value of 0x000F (decimal 15) indicates that the first 15 bytes of the buffer are to be ignored by the port and that valid buffer data starts on byte 16 of the buffer. The host sets the `buffer_offset` value (which may be zero to the buffer length minus 1). Valid only on sop.

Buffer_Length

Buffer Length – Indicates how many valid data bytes are in the buffer. Unused or protocol specific bytes at the beginning of the buffer are not counted in the Buffer Length field. The host sets the `buffer_length`. The `buffer_length` must be greater than zero.

14.3.2.4.1.1.4 CPPI Tx Data Word – 3

Start of Packet (SOP) Flag

When set, this flag indicates that the descriptor points to a packet buffer that is the start of a new packet. In the case of a single fragment packet, both the SOP and end of packet (EOP) flags are set. Otherwise, the descriptor pointing to the last packet buffer for the packet sets the EOP flag. This bit is set by the software application and is not altered by the EMAC.

0 - Not start of packet buffer

1 - Start of packet buffer

End of Packet (EOP) Flag

When set, this flag indicates that the descriptor points to a packet buffer that is last for a given packet. In the case of a single fragment packet, both the start of packet (SOP) and EOP flags are set. Otherwise, the descriptor pointing to the last packet buffer for the packet sets the EOP flag. This bit is set by the software application and is not altered by the EMAC.

0 - Not end of packet buffer.

1 - End of packet buffer.

Ownership

When set this flag indicates that all the descriptors for the given packet (from SOP to EOP) are currently owned by the EMAC. This flag is set by the software application on the SOP packet descriptor before adding the descriptor to the transmit descriptor queue. For a single fragment packet, the SOP, EOP, and OWNER flags are all set. The OWNER flag is cleared by the EMAC once it is finished with all the descriptors for the given packet. Note that this flag is valid on SOP descriptors only.

0 - The packet is owned by the host

1 - The packet is owned by the port

EOQ

When set, this flag indicates that the descriptor in question was the last descriptor in the transmit queue for a given transmit channel, and that the transmitter has halted. This flag is initially cleared by the software application prior to adding the descriptor to the transmit queue. This bit is set by the EMAC when the EMAC identifies that a descriptor is the last for a given packet (the EOP flag is set), and there are no more descriptors in the transmit list (next descriptor pointer is NULL).

The software application can use this bit to detect when the EMAC transmitter for the corresponding channel has halted. This is useful when the application appends additional packet descriptors to a transmit queue list that is already owned by the EMAC. Note that this flag is valid on EOP descriptors only.

0 - The Tx queue has more packets to transfer.

1 - The Descriptor buffer is the last buffer in the last packet in the queue.

teardown_Complete

This flag is used when a transmit queue is being torn down, or aborted, instead of allowing it to be transmitted. This would happen under device driver reset or shutdown conditions. The EMAC sets this bit in the SOP descriptor of each packet as it is aborted from transmission. Note that this flag is valid on SOP descriptors only. Also note that only the first packet in an unsend list has the TDOWNCMPLT flag set. Subsequent descriptors are not processed by the EMAC.

0 - The port has not completed the teardown process.

1 - The port has completed the commanded teardown process.

pass_crc

This flag is set by the software application in the SOP packet descriptor before it adds the descriptor to the transmit queue. Setting this bit indicates to the EMAC that the 4 byte Ethernet CRC is already present in the packet data, and that the EMAC should not generate its own version of the CRC. When the CRC flag is cleared, the EMAC generates and appends the 4-byte CRC. The buffer length and packet length fields do not include the CRC bytes. When the CRC flag is set, the 4-byte CRC is supplied by the software application and is already appended to the end of the packet data. The buffer length and packet length fields include the CRC bytes, as they are part of the valid packet data. Note that this flag is valid on SOP descriptors only.

0 – The CRC is not included with the packet data and packet length.

1 – The CRC is included with the packet data and packet length.

to_port

To Port – Port number to send the directed packet to. This field is set by the host. This field is valid on SOP. Directed packets go to the directed port, but an ALE lookup is performed to determine untagged egress in VLAN_AWARE mode.

1 – Send the packet to port 1 if to_port_en is asserted.

2 – Send the packet to port 2 if to_port_en is asserted.

To_port_enable

To Port Enable – Indicates when set that the packet is a directed packet to be sent to the to_port field port number. This field is set by the host. The packet is sent to one port only (index not mask). This bit is valid on SOP.

0 – not a directed packet

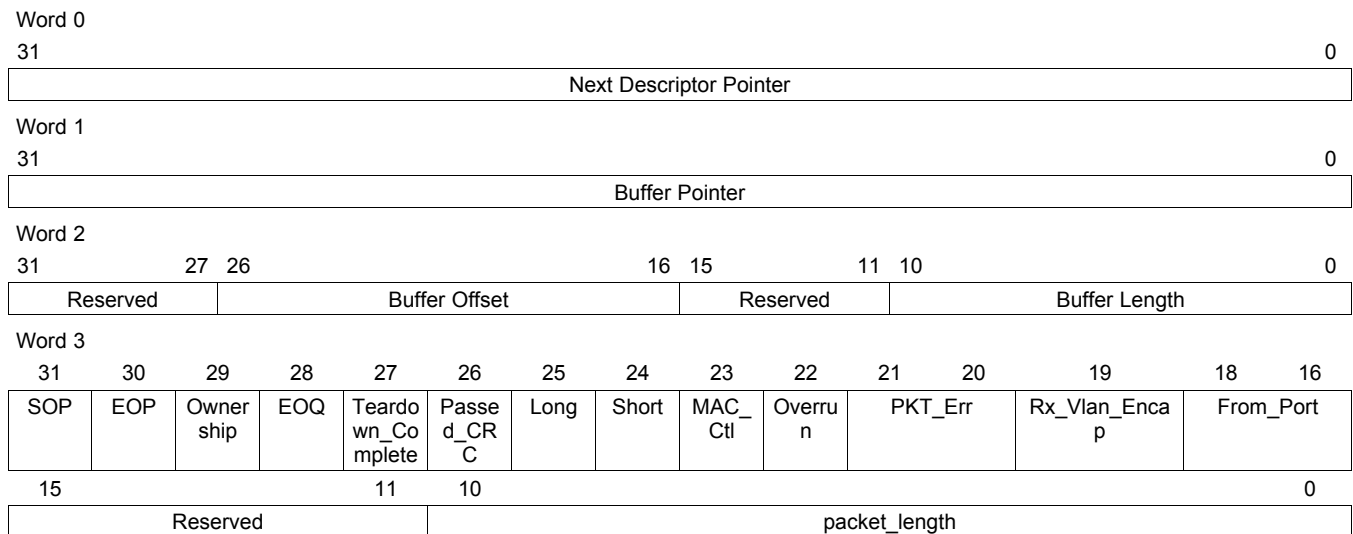
1 – directed packet

Packet Length

Specifies the number of bytes in the entire packet. Offset bytes are not included. The sum of the buffer_length fields should equal the packet_length. Valid only on SOP. The packet length must be greater than zero. The packet data will be truncated to the packet length if the packet length is shorter than the sum of the packet buffer descriptor buffer lengths. A host error occurs if the packet length is greater than the sum of the packet buffer descriptor buffer lengths

14.3.2.4.1.2 RX Buffer Descriptors

An RX buffer descriptor is a contiguous block of four 32-bit data words aligned on a 32-bit word boundary.

Figure 14-8. Rx Buffer Descriptor Format


14.3.2.4.1.2.1 CPPI Rx Data Word – 0

next_descriptor_pointer

The 32-bit word aligned memory address of the next buffer descriptor in the RX queue. This is the mechanism used to reference the next buffer descriptor from the current buffer descriptor. If the value of this pointer is zero then the current buffer is the last buffer in the queue. The host sets the **next_descriptor_pointer**.

14.3.2.4.1.2.2 CPPI Rx Data Word – 1

buffer_pointer

The byte aligned memory address of the buffer associated with the buffer descriptor. The host sets the **buffer_pointer**.

14.3.2.4.1.2.3 CPPI Rx Data Word – 2

Buffer_Offset

Buffer Offset – Indicates how many unused bytes are at the start of the buffer. A value of 0x0000 indicates that there are no unused bytes at the start of the buffer and that valid data begins on the first byte of the buffer. A value of 0x000F (decimal 15) indicates that the first 15 bytes of the buffer are to be ignored by the port and that valid buffer data starts on byte 16 of the buffer. The port writes the **buffer_offset** with the value from the **rx_buffer_offset** register value. The host initializes the **buffer_offset** to zero for free buffers. The **buffer_length** must be greater than the **rx_buffer_offset** value. The buffer offset is valid only on **sop**.

Buffer_Length

Buffer Length – Indicates how many valid data bytes are in the buffer. Unused or protocol specific bytes at the beginning of the buffer are not counted in the Buffer Length field. The host initializes the **buffer_length**, but the port may overwrite the host initiated value with the actual buffer length value on SOP and/or EOP buffer descriptors. SOP buffer length values will be overwritten if the packet size is less than the size of the buffer or if the offset is nonzero. EOP buffer length values will be overwritten if the entire buffer is not filled up with data. The **buffer_length** must be greater than zero.

14.3.2.4.1.2.4 CPPI Rx Data Word – 3

Start of Packet (SOP) Flag

When set, this flag indicates that the descriptor points to a packet buffer that is the start of a new packet. In the case of a single fragment packet, both the SOP and end of packet (EOP) flags are set. Otherwise, the descriptor pointing to the last packet buffer for the packet has the EOP flag set. This flag is initially cleared by the software application before adding the descriptor to the receive queue. This bit is set by the EMAC on SOP descriptors.

End of Packet (EOP) Flag

When set, this flag indicates that the descriptor points to a packet buffer that is last for a given packet. In the case of a single fragment packet, both the start of packet (SOP) and EOP flags are set. Otherwise, the descriptor pointing to the last packet buffer for the packet has the EOP flag set. This flag is initially cleared by the software application before adding the descriptor to the receive queue. This bit is set by the EMAC on EOP descriptors.

Ownership (OWNER) Flag

When set, this flag indicates that the descriptor is currently owned by the EMAC. This flag is set by the software application before adding the descriptor to the receive descriptor queue. This flag is cleared by the EMAC once it is finished with a given set of descriptors, associated with a received packet. The flag is updated by the EMAC on SOP descriptor only. So when the application identifies that the OWNER flag is cleared on an SOP descriptor, it may assume that all descriptors up to and including the first with the EOP flag set have been released by the EMAC. (Note that in the case of single buffer packets, the same descriptor will have both the SOP and EOP flags set.)

End of Queue (EOQ) Flag

When set, this flag indicates that the descriptor in question was the last descriptor in the receive queue for a given receive channel, and that the corresponding receiver channel has halted. This flag is initially cleared by the software application prior to adding the descriptor to the receive queue. This bit is set by the EMAC when the EMAC identifies that a descriptor is the last for a given packet received (also sets the EOP flag), and there are no more descriptors in the receive list (next descriptor pointer is NULL). The software application can use this bit to detect when the EMAC receiver for the corresponding channel has halted. This is useful when the application appends additional free buffer descriptors to an active receive queue. Note that this flag is valid on EOP descriptors only.

Tardown Complete (TDOWNCMPLT) Flag

This flag is used when a receive queue is being torn down, or aborted, instead of being filled with received data. This would happen under device driver reset or shutdown conditions. The EMAC sets this bit in the descriptor of the first free buffer when the tear down occurs. No additional queue processing is performed.

Pass CRC (PASSCRC) Flag

This flag is set by the EMAC in the SOP buffer descriptor if the received packet includes the 4-byte CRC. This flag should be cleared by the software application before submitting the descriptor to the receive queue.

Long (Jabber) Flag

This flag is set by the EMAC in the SOP buffer descriptor, if the received packet is a jabber frame and was not discarded because the RX_CEF_EN bit was set in the MacControl. Jabber frames are frames that exceed the RXMAXLEN in length, and have CRC, code, or alignment errors.

Short (Fragment) Flag

This flag is set by the EMAC in the SOP buffer descriptor, if the received packet is only a packet fragment and was not discarded because the RX_CSF_EN bit was set in the MacControl.

Control Flag

This flag is set by the EMAC in the SOP buffer descriptor, if the received packet is an EMAC control frame and was not discarded because the RX_CMF_EN bit was set in the MacControl.

Overrun Flag

This flag is set by the EMAC in the SOP buffer descriptor, if the received packet was aborted due to a receive overrun.

Pkt_error Flag

Packet Contained Error on Ingress –

00 – no error

01 – CRC error on ingress

10 – Code error on ingress

11 – Align error on ingress

rx_vlan_encap

VLAN Encapsulated Packet – Indicates when set that the packet data contains a 32-bit VLAN header word that is included in the packet byte count. This field is set by the port to be the value of the CPSW control register rx_vlan_encap bit

from_port

From Port – Indicates the port number that the packet was received on (ingress to the switch).

Packet Length

Specifies the number of bytes in the entire packet. The packet length is reduced to 12-bits. Offset bytes are not included. The sum of the buffer_length fields should equal the packet_length. Valid only on SOP.

14.3.2.4.2 Receive DMA Interface

The Receive DMA is an eight channel CPPI 3.0 compliant interface. Each channel has a single queue for frame reception.

14.3.2.4.2.1 Receive DMA Host Configuration

To configure the Rx DMA for operation the host must perform the following:

- Initialize the receive addresses.
- Initialize the Rx_HDP Registers to zero.
- Enable the desired receive interrupts in the IntMask register.
- Write the rx_buffer_offset register value.
- Setup the receive channel(s) buffer descriptors in host memory as required by CPPI 3.0.
- Enable the RX DMA controller by setting the rx_en bit in the Rx_Control register.

14.3.2.4.2.2 Receive Channel Teardown

The host commands a receive channel teardown by writing the channel number to the Rx_Teardown register. When a teardown command is issued to an enabled receive channel the following will occur:

- Any current frame in reception will complete normally.
- The teardown_complete bit will be set in the next buffer descriptor in the chain

if there is one.

- The channel head descriptor pointer will be cleared to zero
- A receive interrupt for the channel will be issued to the host.
- The host should acknowledge a teardown interrupt with a 0xffffffc acknowledge value.

Channel teardown may be commanded on any channel at any time. The host is informed of the teardown completion by the set teardown complete buffer descriptor bit. The port does not clear any channel enables due to a teardown command. A teardown command to an inactive channel issues an interrupt that software should acknowledge with a 0xffffffff acknowledge value (note that there is no buffer descriptor in this case). Software may read the interrupt acknowledge location to determine if the interrupt was due to a commanded teardown. The read value will be 0xffffffff if the interrupt was due to a teardown command.

14.3.2.4.3 Transmit DMA Interface

The Transmit DMA is an eight channel CPPI 3.0 compliant interface. Priority between the eight queues may be either fixed or round robin as selected by tx_ptype in the DMAControl register. If the priority type is fixed, then channel 7 has the highest priority and channel 0 has the lowest priority. Round robin priority proceeds from channel 0 to channel 7. Packet Data transfers occur on the TX_VBUSP interface in 64-byte maximum burst transfers

14.3.2.4.3.1 Transmit DMA Host Configuration

To configure the TX DMA for operation the host must do the following:

- Initialize the Tx_HDP registers to a zero value.
- Enable the desired transmit interrupts in the IntMask register.
- Setup the transmit channel(s) buffer descriptors in host memory as defined in CPPI 3.0.
- Configure and enable the transmit operation as desired in the TxControl register.
- Write the appropriate Tx_HDP registers with the appropriate values to start transmit operations.

14.3.2.4.3.2 Transmit Channel Teardown

The host commands a transmit channel teardown by writing the channel number to the Tx_Teardown register. When a teardown command is issued to an enabled transmit channel the following will occur:

- Any frame currently in transmission will complete normally
- The teardown complete bit will be set in the next sop buffer descriptor (if there is one).
- The channel head descriptor pointer will be set to zero.
- An interrupt will be issued to inform the host of the channel teardown.
- The host should acknowledge a teardown interrupt with a 0xffffffff acknowledge value

Channel teardown may be commanded on any channel at any time. The host is informed of the teardown completion by the set teardown complete buffer descriptor bit. The port does not clear any channel enables due to a teardown command. A teardown command to an inactive channel issues an interrupt that software should acknowledge with a 0xffffffff acknowledge value (note that there is no buffer descriptor in this case). Software may read the interrupt acknowledge location to determine if the interrupt was due to a commanded teardown. The read value will be 0xffffffff if the interrupt was due to a teardown command.

14.3.2.4.4 Transmit Rate Limiting

Transmit operations can be configured to rate limit the transmit data for each transmit priority. Rate limiting is enabled for a channel when the tx_rlim[7:0] bit associated with that channel is set in the DMAControl register. Rate limited channels must be the highest priority channels. For example, if two rate limited channels are required then tx_rlim[7:0] should be set to 11000000 with the msb corresponding to channel 7.

When any channels are configured to be rate-limiting, the priority type must be fixed for transmit. Round-robin priority type is not allowed when rate-limiting. Each of the eight transmit priorities has an associated register to control the rate at which the priority is allowed to send data (Tx_Pri(7..0)_Rate) when the channel is rate-limiting. Each priority has a send count (pri(7..0)_send_cnt[13:0]) and an idle count (pri(7..0)_idle_cnt[13:0]). The transfer rate includes the inter-packet gap (12 bytes) and the preamble (8 bytes). The rate in Mbits/second that each priority is allowed to send is controlled by the below equation.

Priority Transfer rate in Mbit/s = ((priN_idle_cnt/(priN_idle_cnt + priN_send_cnt)) * frequency * 32

Where the frequency is the CLK frequency.

14.3.2.4.5 Command IDLE

The cmd_idle bit in the DMA_Control register allows CPDMA operation to be suspended. When the idle state is commanded, the CPDMA will stop processing receive and transmit frames at the next frame boundary. Any frame currently in reception or transmission will be completed normally without suspension. For transmission, any complete or partial frame in the tx cell fifo will be transmitted. For receive, frames that are detected by the CPDMA after the suspend state is entered are ignored. No statistics will be kept for ignored frames. Commanded idle is similar in operation to emulation control and clock stop.

14.3.2.5 VLAN Aware Mode

The CPSW_3G is in VLAN aware mode when the CPSW Control register vlan_aware bit is set. In VLAN aware mode ports 0 receive packets (out of the CPSW_3G) may or may not be VLAN encapsulated depending on the CPSW Control register rx_vlan_encap bit. The header packet VLAN is generated as described in [Section 14.3.3, Ethernet Mac Sliver \(CPGMAC_SL\)](#). Port 0 receive packet data is never modified. VLAN is not removed regardless of the force untagged egress bit for Port 0. VLAN encapsulated receive packets have a 32-bit VLAN header encapsulation word added to the packet data. VLAN encapsulated packets are specified by a set rx_vlan_encap bit in the packet buffer descriptor.

Port 0 transmit packets are never VLAN encapsulated (encapsulation is not allowed).

In VLAN aware mode, transmitted packet data is changed depending on the packet type (pkt_type), packet priority (pkt_pri), and VLAN information as shown in the below tables:

Figure 14-9. VLAN Header Encapsulation Word

31	29	28	27									16	
HDR_PKT_Priority		HDR_PKT_CFI	HDR_PKT_Vid										
15			10	9	8	7	6	5	4	3	2	1	0
Reserved			PKT_Type			Reserved							

Table 14-8. VLAN Header Encapsulation Word Field Descriptions

Field	Description
HDR_PKT_Priority	Header Packet VLAN priority (Highest priority: 7)
HDR_PKT_CFI	Header Packet VLAN CFI bit.
HDR_PKT_Vid	Header Packet VLAN ID
PKT_Type	Packet Type. Indicates whether the packet is VLAN-tagged, priority-tagged, or non-tagged. 00: VLAN-tagged packet 01: Reserved 10: Priority-tagged packet 11: Non-tagged packet

14.3.2.6 VLAN Unaware Mode

The CPSW_3G is in VLAN unaware mode when the CPSW Control register vlan_aware bit is cleared. Port 0 receive packets (out of the CPSW_3G) may or may not be VLAN encapsulated depending on the CPSW Control register rx_vlan_encap bit. Port 0 transmit packets are never VLAN encapsulated.

14.3.2.7 Address Lookup Engine (ALE)

The address lookup engine (ALE) processes all received packets to determine which port(s) if any that the packet should be forwarded to. The ALE uses the incoming packet received port number, destination address, source address, length/type, and VLAN information to determine how the packet should be forwarded. The ALE outputs the port mask to the switch fabric that indicates the port(s) the packet should be forwarded to. The ALE is enabled when the ale_enable bit in the ALE_Control register is set. All packets are dropped when the ale_enable bit is cleared to zero.

In normal operation, the CPGMAC_SL modules are configured to issue an abort, instead of an end of packet, at the end of a packet that contains an error (runt, frag, oversize, jabber, crc, alignment, code etc.) or at the end of a mac control packet. However, when the CPGMAC_SL configuration bit(s) cef, csf, or cmf are set, error frames, short frames or mac control frames have a normal end of packet instead of an abort at the end of the packet. When the ALE receives a packet that contains errors (due to a set header error bit), or a mac control frame and does not receive an abort, the packet will be forwarded only to the host port (port 0). No ALE learning occurs on packets with errors or mac control frames. Learning is based on source address and lookup is based on destination address.

The ALE may be configured to operate in bypass mode by setting the ale_bypass bit in the ALE_Control register. When in bypass mode, all CPGMAC_SL received packets are forwarded only to the host port (port 0). Packets from the two ports can be on separate Rx DMA channels by configuring the CPDMA_Rx_Ch_Map register. In bypass mode, the ALE processes host port transmit packets the same as in normal mode. In general, packets would be directed by the host in bypass mode.

The ALE may be configured to operate in OUI deny mode by setting the enable_oui_deny bit in the ALE_Control register. When in OUI deny mode, a packet with a non-matching OUI source address will be dropped unless the destination address matches a multicast table entry with the super bit set. Broadcast packets will be dropped unless the broadcast address is entered into the table with the super bit set. Unicast packets will be dropped unless the unicast address is in the table with block and secure both set (supervisory unicast packet).

Multicast supervisory packets are designated by the super bit in the table entry. Unicast supervisory packets are indicated when block and secure are both set. Supervisory packets are not dropped due to rate limiting, OUI, or VLAN processing.

14.3.2.7.1 Address Table Entry

The ALE table contains 1024 entries. Each table entry represents a free entry, an address, a VLAN, an address/VLAN pair, or an OUI address. Software should ensure that there are not double address entries in the table. The double entry used would be indeterminate. Reserved table bits must be written with zeroes.

Source Address learning occurs for packets with a unicast, multicast or broadcast destination address and a unicast or multicast (including broadcast) source address. Multicast source addresses have the group bit (bit 40) cleared before ALE processing begins, changing the multicast source address to a unicast source address. A multicast address of all ones is the broadcast address which may be added to the table. A learned unicast source address is added to the table with the following control bits:

Table 14-9. Learned Address Control Bits

unicast_type	11
Block	0
Secure	0

If a received packet has a source address that is equal to the destination address then the following occurs:

- The address is learned if the address is not found in the table.
- The address is updated if the address is found.
- The packet is dropped.

14.3.2.7.1.1 Free Table Entry

Table 14-10. Free (Unused) Address Table Entry Bit Values

71:62	61:60	59:0
Reserved	Entry Type (00)	Reserved

14.3.2.7.1.2 Multicast Address Table Entry

Table 14-11. Multicast Address Table Entry Bit Values

71:70	68:66	65	64	63:62	61:60	59:48	47:0
Reserved	Port Mask	Super	Reserved	Mcast Fwd State	Entry Type (01)	Reserved	Multicast Address

Table Entry Type

00: Free Entry

01: Address Entry : unicast or multicast determined by dest **address bit 40** .

10: VLAN entry

11: VLAN Address Entry : unicast or multicast determined by **address bit 40**.

Supervisory Packet (SUPER)

When set, this field indicates that the packet with a matching multicast destination address is a supervisory packet.

0: Non-supervisory packet

1: Supervisory packet

Port Mask(2:0) (PORT_MASK)

This three bit field is the port bit mask that is returned with a found multicast destination address. There may be multiple bits set indicating that the multicast packet may be forwarded to multiple ports (but not the receiving port).

Multicast Forward State (MCAST_FWD_STATE)

Multicast Forward State – Indicates the port state(s) required for the received port on a destination address lookup in order for the multicast packet to be forwarded to the transmit port(s). A transmit port must be in the Forwarding state in order to forward the packet. If the transmit port_mask has multiple set bits then each forward decision is independent of the other transmit port(s) forward decision.

00: Forwarding

01: Blocking/Forwarding/Learning

10: Forwarding/Learning

11: Forwarding

The forward state test returns a true value if both the Rx and Tx ports are in the required state.

Table Entry Type (ENTRY_TYPE)

Address entry type. Unicast or multicast determined by address bit 40.

01: Address entry. Unicast or multicast determined by address bit 40.

Packet Address (MULTICAST_ADDRESS)

This is the 48-bit packet MAC address. For an OUI address, only the upper 24-bits of the address are used in the source or destination address lookup. Otherwise, all 48-bits are used in the lookup.

14.3.2.7.1.3 VLAN/Multicast Address Table Entry

Table 14-12. VLAN/Multicast Address Table Entry Bit Values

71:69	68:66	65	64	63:62	61:60	59:48	47:0
Reserved	Port Mask	Super	Reserved	Mcast Fwd State	Entry Type (11)	vlan_id	Multicast Address

Supervisory Packet (SUPER)

When set, this field indicates that the packet with a matching multicast destination address is a supervisory packet.

0: Non-supervisory packet

1: Supervisory packet

Port Mask(2:0) (PORT_MASK)

This three bit field is the port bit mask that is returned with a found multicast destination address. There may be multiple bits set indicating that the multicast packet may be forwarded to multiple ports (but not the receiving port).

Multicast Forward State (MCAST_FWD_STATE)

Multicast Forward State – Indicates the port state(s) required for the received port on a destination address lookup in order for the multicast packet to be forwarded to the transmit port(s). A transmit port must be in the Forwarding state in order to forward the packet. If the transmit port_mask has multiple set bits then each forward decision is independent of the other transmit port(s) forward decision.

00 – Forwarding

01 – Blocking/Forwarding/Learning

10 – Forwarding/Learning

11 – Forwarding

The forward state test returns a true value if both the Rx and Tx ports are in the required state.

Table Entry Type (ENTRY_TYPE)

Address entry type. Unicast or multicast determined by address bit 40.

11: VLAN address entry. Unicast or multicast determined by address bit 40.

VLAN ID (VLAN_ID)

The unique identifier for VLAN identification. This is the 12-bit VLAN ID.

Packet Address (MULTICAST_ADDRESS)

This is the 48-bit packet MAC address. For an OUI address, only the upper 24-bits of the address are used in the source or destination address lookup. Otherwise, all 48-bits are used in the lookup.

14.3.2.7.1.4 Unicast Address Table Entry

Table 14-13. Unicast Address Table Entry Bit Values

71:70	69	68	67:66	65	64	63:62	61:60	59:48	47:0
Reserved	DLR Unicast	Reserved	Port Number	Block	Secure	Unicast Type (00) or (X1)	Entry Type (01)	Reserved	Unicast Address

DLR Unicast

DLR Unicast – When set, this bit indicates that the address is a Device Level Ring (DLR) unicast address. Received packets with a matching destination address will be flooded to the vlan_member_list (minus the receive port and the host port). The port_number field is a don't care when this bit is set. Matching packets received on port 1 egress on port 2. Matching packets received on port 2 egress on port 1. Matching packets received on port 0 egress on ports 1 and 2.

Port Number (PORT_NUMBER)

Port Number – This field indicates the port number (not port mask) that the packet with a unicast destination address may be forwarded to. Packets with unicast destination addresses are forwarded only to a single port (but not the receiving port).

Block (BLOCK)

Block – The block bit indicates that a packet with a matching source or destination address should be dropped (block the address).

0 – Address is not blocked.

1 – Drop a packet with a matching source or destination address (secure must be zero)

If block and secure are both set, then they no longer mean block and secure. When both are set, the block and secure bits indicate that the packet is a unicast supervisory (super) packet and they determine the unicast forward state test criteria. If both bits are set then the packet is forwarded if the receive port is in the Forwarding/Blocking/Learning state. If both bits are not set then the packet is forwarded if the receive port is in the Forwarding state.

Secure (SECURE)

Secure – This bit indicates that a packet with a matching source address should be dropped if the received port number is not equal to the table entry port_number.

0 – Received port number is a don't care.

1 – Drop the packet if the received port is not the secure port for the source address and do not update the address (block must be zero)

Unicast Type (UNICAST_TYPE)

Unicast Type – This field indicates the type of unicast address the table entry contains.

00 – Unicast address that is not ageable.

01 – Ageable unicast address that has not been touched.

10 – OUI address - lower 24-bits are don't cares (not ageable).

11 – Ageable unicast address that has been touched.

Table Entry Type (ENTRY_TYPE)

Address entry. Unicast or multicast determined by address bit 40.

01: Address entry. Unicast or multicast determined by address bit 40.

Packet Address (UNICAST_ADDRESS)

This is the 48-bit packet MAC address. All 48-bits are used in the lookup.

14.3.2.7.1.5 OUI Unicast Address Table Entry
Table 14-14. OUI Unicast Address Table Entry Bit Values

71:64	63:62	61:60	59:48	47:24	23:0
Reserved	Unicast Type (10)	Entry Type (01)	Reserved	Unicast OUI	Reserved

Unicast Type (UNICAST_TYPE)

Unicast Type – This field indicates the type of unicast address the table entry contains.

00 – Unicast address that is not ageable.

01 – Ageable unicast address that has not been touched.

10 – OUI address - lower 24-bits are don't cares (not ageable).

11 – Ageable unicast address that has been touched.

Table Entry Type (ENTRY_TYPE)

Address entry. Unicast or multicast determined by address bit 40.

01: Address entry. Unicast or multicast determined by address bit 40.

Packet Address (UNICAST_OUI)

For an OUI address, only the upper 24-bits of the address are used in the source or destination address lookup.

14.3.2.7.1.6 VLAN/Unicast Address Table Entry

Table 14-15. Unicast Address Table Entry Bit Values

71:68	67:66	65	64	63:62	61:60	59:48	47:0
Reserved	Port Number	Block	Secure	Unicast Type (00) or (X1)	Entry Type (11)	vlan_id	Unicast Address

Port Number (PORT_NUMBER)

Port Number – This field indicates the port number (not port mask) that the packet with a unicast destination address may be forwarded to. Packets with unicast destination addresses are forwarded only to a single port (but not the receiving port).]

Block (BLOCK)

Block – The block bit indicates that a packet with a matching source or destination address should be dropped (block the address).

0 – Address is not blocked.

1 – Drop a packet with a matching source or destination address (secure must be zero)

If block and secure are both set, then they no longer mean block and secure. When both are set, the block and secure bits indicate that the packet is a unicast supervisory (super) packet and they determine the unicast forward state test criteria. If both bits are set then the packet is forwarded if the receive port is in the Forwarding/Blocking/Learning state. If both bits are not set then the packet is forwarded if the receive port is in the Forwarding state.

Secure (SECURE)

Secure – This bit indicates that a packet with a matching source address should be dropped if the received port number is not equal to the table entry port_number.

0 – Received port number is a don't care.

1 – Drop the packet if the received port is not the secure port for the source address and do not update the address (block must be zero)

Unicast Type (UNICAST_TYPE)

Unicast Type – This field indicates the type of unicast address the table entry contains.

00 – Unicast address that is not ageable.

01 – Ageable unicast address that has not been touched.

10 – OUI address - lower 24-bits are don't cares (not ageable).

11 – Ageable unicast address that has been touched.

Table Entry Type (ENTRY_TYPE)

Address entry. Unicast or multicast determined by address bit 40.

11 – VLAN address entry. Unicast or multicast determined by address bit 40.

VLAN ID (VLAN_ID)

The unique identifier for VLAN identification. This is the 12-bit VLAN ID.

Packet Address (UNICAST_ADDRESS)

This is the 48-bit packet MAC address. All 48-bits are used in the lookup.

14.3.2.7.1.7 VLAN Table Entry

Table 14-16. VLAN Table Entry

71:62	61:60	59:48	47:27	26:24	23:19	18:16	15:11	10:8	7:3	2:0
Reserved	Entry Type (10)	vlan_id	Reserved	Force Untagged Egress	Reserved	Reg Mcast Flood Mask	Reserved	Unreg Mcast Flood Mask	Reserved	Vlan Member List

Table Entry Type (ENTRY_TYPE)

10: VLAN entry

VLAN ID (VLAN_ID)

The unique identifier for VLAN identification. This is the 12-bit VLAN ID.

Force Untagged Packet Egress (FORCE_UNTAGGED_EGRESS)

This field causes the packet VLAN tag to be removed on egress (except on port 0).

Registered Multicast Flood Mask (REG_MCAST_FLOOD_MASK)

Mask used for multicast when the multicast address is found

Unregistered Multicast Flood Mask (UNREG_MCAST_FLOOD_MASK)

Mask used for multicast when the multicast address is not found

VLAN Member List (VLAN_MEMBER_LIST)

This three bit field indicates which port(s) are members of the associated VLAN.

14.3.2.7.2 Packet Forwarding Processes

There are four processes that an incoming received packet may go through to determine packet forwarding. The processes are Ingress Filtering, VLAN_Aware Lookup, VLAN_Unaware Lookup, and Egress.

Packet processing begins in the Ingress Filtering process. Each port has an associated packet forwarding state that can be one of four values (Disabled, Blocked, Learning, or Forwarding). The default state for all ports is disabled. The host sets the packet forwarding state for each port. The receive packet processes are described in the following sections.

In the packet ingress process (receive packet process), there is a forward state test for unicast destination addresses and a forward state test for multicast addresses. The multicast forward state test indicates the port states required for the receiving port in order for the multicast packet to be forwarded to the transmit port(s). A transmit port must be in the Forwarding state for the packet to be forwarded for transmission. The mcast_fwd_state indicates the required port state for the receiving port as indicated in [Table 14-12](#).

The unicast forward state test indicates the port state required for the receiving port in order to forward the unicast packet. The transmit port must be in the Forwarding state in order to forward the packet. The block and secure bits determine the unicast forward state test criteria. If both bits are set then the packet is forwarded if the receive port is in the Forwarding/Blocking/Learning state. If both bits are not set then the packet is forwarded if the receive port is in the Forwarding state. The transmit port must be in the Forwarding state regardless. The forward state test used in the ingress process is determined by the destination address packet type (multicast/unicast).

In general, packets received with errors are dropped by the address lookup engine without learning, updating, or touching the address. The error condition and the abort are indicated by the CPGMAC_SL to the ALE. Packets with errors may be passed to the host (not aborted) by a CPGMAC_SL port if the port has a set rx_cmf_en, rx_cef_en, or rx_csf_en bit(s).

Error packets that are passed to the host by the CPGMAC_SL are considered to be bypass packets by the ALE and are sent only to the host. Error packets do not learn, update, or touch addresses regardless of whether they are aborted or sent to the host. Packets with errors received by the host are forwarded as normal.

The following control bits are in the CPGMAC_SL1/2_MacControl register.

rx_cef_en: This CPGMAC_SL control bit enables frames that are fragments, long, jabber, CRC, code, and alignment errors to be forwarded.

rx_csf_en: This CPGMAC_SL bit enables short frames to be forwarded.

rx_cmf_en: This CPGMAC_SL control bit enables mac control frames to be forwarded.

14.3.2.7.2.1 Ingress Filtering Process

If (Rx port_state is Disabled) then discard the packet
if (directed packet) then use directed port number and go to Egress process
if ((ale_bypass or error packet) and (host port is not the receive port)) then use host portmask and go to Egress process
if (((block) and (unicast source address found)) or ((block) and (unicast destination address found))) then discard the packet
if ((enable_rate_limit) and (rate limit exceeded) and (not rate_limit_tx)) then if (((mcast/bcast destination address found) and (not super)) or (mcast/bcast destination address not found)) then discard the packet
if ((not forward state test valid) and (destination address found)) then discard the packet to any port not meeting the requirements <ul style="list-style-type: none"> • Unicast destination addresses use the unicast forward state test and multicast destination addresses use the multicast forward state test.
if ((destination address not found) and ((not transmit port forwarding) or (not receive port forwarding))) then discard the packet to any ports not meeting the above requirements
if (source address found) and (secure) and (receive port number != port_number) then discard the packet
if ((not super) and (drop_untagged) and ((non-tagged packet) or ((priority tagged) and not(en_vid0_mode))) then discard the packet
If (VLAN_Unaware) force_untagged_egress = "000000" reg_mcast_flood_mask = "111111" unreg_mcast_flood_mask = "111111" vlan_member_list = "111111" else if (VLAN not found) force_untagged_egress = unknown_force_untagged_egress reg_mcast_flood_mask = unknown_reg_mcast_flood_mask unreg_mcast_flood_mask = unknown_unreg_mcast_flood_mask vlan_member_list = unknown_vlan_member_list else force_untagged_egress = found_force_untagged_egress reg_mcast_flood_mask = found_reg_mcast_flood_mask unreg_mcast_flood_mask = found_unreg_mcast_flood_mask vlan_member_list = found_vlan_member_list
if ((not super) and (vid_ingress_check) and (Rx port is not VLAN member)) then discard the packet
if ((enable_auth_mode) and (source address not found) and not(destination address found and (super))) then discard the packet

if (destination address equals source address) then discard the packet
if (vlan_aware) goto VLAN_Aware_Lookup process else goto VLAN_Unaware_Lookup process

14.3.2.7.2.2 VLAN_Aware Lookup Process

if ((unicast packet) and (destination address found with or without VLAN) and dlr_unicast) then portmask is the vlan_member_list less the host port and goto Egress process
if ((unicast packet) and (destination address found with or without VLAN) and (not super)) then portmask is the logical "AND" of the port_number and the vlan_member_list and goto Egress process
if ((unicast packet) and (destination address found with or without VLAN) and (super)) then portmask is the port_number and goto Egress process
if (Unicast packet) # destination address not found then portmask is vlan_member_list less host port and goto Egress process
if ((Multicast packet) and (destination address found with or without VLAN) and (not super)) then portmask is the logical "AND" of reg_mcast_flood_mask and found destination address/VLAN portmask (port_mask) and vlan_member_list and goto Egress process
if ((Multicast packet) and (destination address found with or without VLAN) and (super)) then portmask is the port_mask and goto Egress process
if (Multicast packet) # destination address not found then portmask is the logical "AND" of unreg_mcast_flood_mask and vlan_member_list then goto Egress process
if (Broadcast packet) then use found vlan_member_list and goto Egress process

14.3.2.7.2.3 VLAN_Unaware Lookup Process

if ((unicast packet) and (destination address found with or without VLAN) and dlr_unicast) then portmask is the vlan_member_list less the host port and goto Egress process
if ((unicast packet) and (destination address found with or without VLAN) and (not super)) then portmask is the logical "AND" of the port_number and the vlan_member_list and goto Egress process
if ((unicast packet) and (destination address found with or without VLAN) and (super)) then portmask is the port_number and goto Egress process
if (Unicast packet) # destination address not found then portmask is vlan_member_list less host port and goto Egress process
if ((Multicast packet) and (destination address found with or without VLAN) and (not super)) then portmask is the logical "AND" of reg_mcast_flood_mask and found destination address/VLAN portmask (port_mask) and vlan_member_list and goto Egress process
if ((Multicast packet) and (destination address found with or without VLAN) and (super)) then portmask is the port_mask and goto Egress process
if (Multicast packet) # destination address not found then portmask is the logical "AND" of unreg_mcast_flood_mask and vlan_member_list then goto Egress process
if (Broadcast packet) then use found vlan_member_list and goto Egress process

14.3.2.7.2.4 Egress Process

Clear Rx port from portmask (don't send packet to Rx port).
Clear disabled ports from portmask.
if ((enable_oui_deny) and (OUI source address not found) and (not ale_bypass) and (not error packet) and not ((mcast destination address) and (super))) then Clear host port from portmask
if ((enable_rate_limit) and (rate_limit_tx)) then if (not super) and (rate limit exceeded on any tx port) then clear rate limited tx port from portmask If address not found then super cannot be set.
If portmask is zero then discard packet
Send packet to portmask ports.

14.3.2.7.3 Learning/Updating/Touching Processes

The learning, updating, and touching processes are applied to each receive packet that is not aborted. The processes are concurrent with the packet forwarding process. In addition to the following, a packet must be received without error in order to learn/update/touch an address.

14.3.2.7.3.1 Learning Process

If (not(Learning or Forwarding) or (enable_auth_mode) or (packet error) or (no_learn)) then do not learn address
if ((Non-tagged packet) and (drop_untagged)) then do not learn address
if ((vlan_aware) and (VLAN not found) and (unknown_vlan_member_list = "000")) then do not learn address
if ((vid_ingress_check) and (Rx port is not VLAN member) and (VLAN found)) then do not learn address
if ((source address not found) and (vlan_aware) and not(learn_no_vid)) then learn address with VLAN
if ((source address not found) and ((not vlan_aware) or (vlan_aware and learn_no_vid))) then learn address without VLAN

14.3.2.7.3.2 Updating Process

if (dir_unicast) then do not update address
If (not(Learning or Forwarding) or (enable_auth_mode) or (packet error) or (no_sa_update)) then do not update address
if ((Non-tagged packet) and (drop_untagged)) then do not update address
if ((vlan_aware) and (VLAN not found) and (unknown_vlan_member_list = "000")) then do not update address
if ((vid_ingress_check) and (Rx port is not VLAN member) and (VLAN found)) then do not update address
if ((source address found) and (receive port number != port_number) and (secure or block)) then do not update address

```
if ((source address found) and (receive port number != port_number))
then update address
```

14.3.2.7.3.3 Touching Process

```
if ((source address found) and (ageable) and (not touched))
then set touched
```

14.3.2.8 Packet Priority Handling

Packets are received on three ports, two of which are CPGMAC_SL Ethernet ports and the third port is the CPPI host port. Received packets have a received packet priority (0 to 7 with 7 being the highest priority). The received packet priority is determined as shown:

1. If the first packet LTYPE = 0x8100 then the received packet priority is the packet priority (VLAN tagged and priority tagged packets).
2. If the first packet LTYPE = 0x0800 and byte 14 (following the LTYPE) is equal to 0x45 then the received packet priority is the 6-bit TOS field in byte 15 (upper 6-bits) mapped through the port's DSCP priority mapping register (IPV4 packet).
3. The received packet priority is the source (ingress) port priority (untagged non-IPV4 packet).

The received packet priority is mapped through the receive ports associated "packet priority to header packet priority mapping register" to obtain the header packet priority (the CPDMA Rx and Tx nomenclature is reversed from the CPGMAC_SL nomenclature for legacy reasons). The header packet priority is mapped through the "header priority to switch priority mapping register" to obtain the hardware switch priority (0 to 3 with 3 being the highest priority). The header packet priority is then used as the actual transmit packet priority if the VLAN information is to be sent on egress.

14.3.2.9 FIFO Memory Control

Each of the three CPSW_3G ports has an identical associated FIFO. Each FIFO contains a single logical receive (ingress) queue and four logical transmit queues (priority 0 through 3). Each FIFO memory contains 20,480 bytes (20k) total organized as 2560 by 64-bit words contained in a single memory instance. The FIFO memory is used for the associated port transmit and receive queues. The tx_max_blks field in the FIFO's associated Max_Blks register determines the maximum number of 1k FIFO memory blocks to be allocated to the four logical transmit queues (transmit total).

The rx_max_blks field in the FIFO's associated Max_Blks register determines the maximum number of 1k memory blocks to be allocated to the logical receive queue. The tx_max_blks value plus the rx_max_blks value must sum to 20 (the total number of blocks in the FIFO). If the sum were less than 20 then some memory blocks would be unused. The default is 17 (decimal) transmit blocks and three receive blocks. The FIFO's follow the naming convention of the Ethernet ports. Host Port is Port0 and External Ports are Port1,2

14.3.2.10 FIFO Transmit Queue Control

There are four transmit queues in each transmit FIFO. Software has some flexibility in determining how packets are loaded into the queues and on how packet priorities are selected for transmission (how packets are removed and transmitted from queues). All ports on the switch have identical FIFO's. For the purposes of the below the transmit FIFO is switch egress even though the port 0 transmit FIFO is connected to the CPDMA receive (also switch egress). The CPDMA nomenclature is reversed from the CPGMAC_SL nomenclature due to legacy reasons.

14.3.2.10.1 Normal Priority Mode

When operating in normal mode, lower priority frames are dropped before higher priority frames. The intention is to give preference to higher priority frames. Priority 3 is the highest priority and is allowed to fill the FIFO. Priority 2 will drop packets if the packet is going to take space in the last 2k available. Priority 1 will drop packets if the packet is going to take space in the last 4k available. Priority 0 will drop packets if the packet is going to take space in the last 6k available. If fewer than 4 priorities are to be implemented then the priorities should be mapped such that the highest priorities are used.

For example, if two priorities are going to be used then all packets should be mapped to priorities 3 and 2 and priorities 1 and 0 should be unused. Priority escalation may be used in normal priority mode if desired. Normal priority mode is configured as described below:

- Select normal priority mode by setting `tx_in_sel[1:0] = 00` for all ports (default value in `P0/1/2_Tx_In_Ctl`)
- Configure priority mapping to use only the highest priorities if less than 4 priorities are used. Refer to the Packet Priority Handling section of this chapter.

14.3.2.10.2 Dual Mac Mode

When operating in dual mac mode the intention is to transfer packets between ports 0 and 1 and ports 0 and 2, but not between ports 1 and 2. Each CPGMAC_SL appears as a single MAC with no bridging between MAC's. Each CPGMAC_SL has at least one unique (not the same) mac address.

Dual mac mode is configured as described below:

- Set the `ale_vlan_aware` bit in the `ALE_Control` register. This bit configures the ALE to process in vlan aware mode. The `CPSW_3G_vlan_aware` bit (`vlan_aware` in `CPSW_Control`) determines how packets VLAN's are processed on CPGMAC_SL egress and does not affect how the ALE processes packets or the packet destination. The `CPSW_3G_vlan_aware` bit may be set or not as required (must be set if VLAN's are to exit the switch).

- **Configure the Port 1 to Port 0 VLAN**

Add a VLAN Table Entry with ports 0 and 1 as members (clear the flood masks).

Add a VLAN/Unicast Address Table Entry with the Port1/0 VLAN and a port number of 0. Packets received on port 1 with this unicast address will be sent only to port 0 (egress). If multiple mac addresses are desired for this port then multiple entries of this type may be configured.

- **Configure the Port 2 to Port 0 VLAN**

Add a VLAN Table Entry with ports 0 and 2 as members (clear the flood masks).

Add a VLAN/Unicast Address Table Entry with the Port2/0 VLAN and a port number of 0. Packets received on port 2 with this unicast address will be sent only to port 0 (egress). If multiple mac addresses are desired for this port then multiple entries of this type may be configured.

- Packets from the host (port 0) to ports 1 and 2 should be directed. If directed packets are not desired then VLAN with addresses can be added for both destination ports.
- Select the dual mac mode on the port 0 FIFO by setting `tx_in_sel[1:0] = 01` in `P0_Tx_In_Ctl`. The intention of this mode is to allow packets from both ethernet ports to be written into the FIFO without one port starving the other port.
- The priority levels may be configured such that packets received on port 1 egress on one CPDMA RX channel while packets received on port 2 egress on a different CPDMA RX channel.

14.3.2.10.3 Rate Limit Mode

Rate-limit mode is intended to allow some CPDMA transmit (switch ingress) channels and some CPGMAC_SL FIFO priorities (switch egress) to be rate-limited. Non rate-limited traffic (bulk traffic) is allowed on non rate-limited channels and FIFO priorities. The bulk traffic does not impact the rate-limited traffic. Rate-limited traffic must be configured to be sent to rate-limited queues (via packet priority handling).

The allocated rates for rate-limited traffic must not be oversubscribed. For example, if port 1 is sending 15% rate limited traffic to port 2 priority 3, and port 0 is also sending 10% rate-limited traffic to port 2 priority 3, then the port 2 priority 3 egress rate must be configured to be 25% plus a percent or two for margin. The switch must be configured to allow some percentage of non rate-limited traffic. Non-rate-limited traffic must be configured to be sent to non rate-limited queues. No packets from the host should be dropped, but non rate-limited traffic received on an ethernet port can be dropped. Rate-limited mode is configured as shown:

- Set `tx_in_sel[1:0] = 10` in `P1/2_Tx_In_Ctl` to enable ports 1 and 2 transmit FIFO inputs to be configured for rate-limiting queues. Enabling a queue to be rate-limiting with this field affects only the packet being loaded into the FIFO, it does not configure the transmit for queue shaping.
- Configure the number of rate-limited queues for port 1 and 2 transmit FIFO's by setting the `tx_rate_en[3:0]` field in `P1/2_Tx_In_Ctl`. Rate limited queues must be the highest number. For example, if there are two rate limited queues then 1100 would be written to this field for priorities 3 and 2. This field enables the FIFO to allow rate-limited traffic into rate-limited queues while discriminating against non rate-limited queues.
- Set `p1_priN_shape_en` and `p2_priN_shape_en` in the `CPSW_3G_PTYPE` register. These bits determine which queues actually shape the output data stream. In general, the same priorities that are set in `tx_rate_en` are set in these bits as well, but the FIFO input and output enable bits are separate to allow rate-limiting from the host to non shaped channels if desired. When queue shaping is not enabled for a queue then packets are selected for egress based on priority. When queue shaping is enabled then packets are selected for egress based on queue percentages. If shaping is required on a single queue then it must be priority 3 (priorities 2, 1 and 0 are strict priority). If shaping is required on two queues then it must be on priorities 2 and 3 (priorities 1 and 0 are strict priority). If shaping is required on three queues then it must be priorities 3, 2, and 1 (priority 0 would then get the leftovers). Priority shaping follows the requirements in the IEEE P802.1Qav/D6.0 specification. Priority shaping is not compatible with priority escalation (escalation must be disabled).
- `P0_Tx_In_Ctl[1:0]` should remain at the default 00 value. Port 0 egress (CPDMA RX) should not be rate-limited.
- The CPDMA is configured for rate-limited transmit (switch ingress) channels by setting the highest bits of the `tx_rlim[7:0]` field in the CPDMA `DMA_Control` register. If there are two rate limited channels then `tx_rlim[7:0] = 11000000` (the rate limited channels must be the highest priorities). Also, `tx_ptype` in the `DMA_Control` register must be set (fixed priority mode). Rate limited channels must go to rate-limited FIFO queues, and the FIFO queue rate must not be oversubscribed.

14.3.2.11 Packet Padding

VLAN tagged ingress packets of 64 to 67-bytes will be padded to 64-bytes on egress (all ports) if the VLAN is removed on egress.

14.3.2.12 Flow Control

There are two types of switch flow control – CPPI port flow control and Ethernet port flow control. The CPPI and Ethernet port naming conventions for data flow into and out of the switch are reversed. For the CPPI port (port 0), transmit operations move packets from external memory into the switch and then out to either or both Ethernet transmit ports (ports 1 and 2). CPPI receive operations move packets that were received on either or both Ethernet receive ports to external memory.

14.3.2.12.1 CPPI Port Flow Control

The CPPI port has flow control available for transmit (switch ingress). CPPI receive operations (switch egress) do not require flow control. CPPI Transmit flow control is initiated when enabled and triggered. CPPI transmit flow control is enabled by setting the `p0_flow_en` bit in the **CPSW_Flow_Control** register. CPPI transmit flow control is enabled by default on reset because host packets should not be dropped in any mode of operation.

14.3.2.12.2 Ethernet Port Flow Control

The Ethernet ports have flow control available for transmit and receive. Transmit flow control stops the Ethernet port from transmitting packets to the wire (switch egress) in response to a received pause frame. Transmit flow control does not depend on FIFO usage.

The ethernet ports have flow control available for receive operations (packet ingress). Ethernet port receive flow control is initiated when enabled and triggered. Packets received on an ethernet port can be sent to the other ethernet port or the CPPI port (or both). Each destination port can trigger the receive ethernet port flow control. An ethernet destination port triggers another ethernet receive flow control when the destination port is full.

When a packet is received on an ethernet port interface with enabled flow control the below occurs:

- The packet will be sent to all ports that currently have room to take the entire packet.
- The packet will be retried until successful to all ports that indicate they don't have room for the packet.

The flow control trigger to the CPGMAC_SL will be asserted until the packet has been sent, and there is room in the logical receive FIFO for packet runout from another flow control trigger (**rx_pkt_cnt** = 0). Ethernet port receive flow control is disabled by default on reset. Ethernet port receive flow control requires that the **rx_flow_en** bit in the associated CPGMAC_SL be set to one.

When receive flow control is enabled on a port, the port's associated FIFO block allocation must be adjusted. The port RX allocation must increase from the default three blocks to accommodate the flow control runout. A corresponding decrease in the TX block allocation is required. If a sending port ignores a pause frame then packets may overrun on receive (and be dropped) but will not be dropped on transmit. If flow control is disabled for gmii ports, then any packets that are dropped are dropped on transmit and not on receive.

14.3.2.12.2.1 Receive Flow Control

When enabled and triggered, receive flow control is initiated to limit the CPGMAC_SL from further frame reception. Half-duplex mode receive flow control is collision based while full duplex mode issues 802.3X pause frames. In either case, receive flow control prevents frame reception by issuing the flow control appropriate for the current mode of operation. Receive flow control is enabled by the **rx_flow_en** bit in the **MacControl** register. Receive flow control is triggered (when enabled) when the **RX_FLOW_TRIGGER** input is asserted. The CPGMAC_SL is configured for collision or IEEE 802.3X flow control via the **fullduplex** bit in the **MacControl** register.

14.3.2.12.2.1.1 Collision Based Receive Buffer Flow Control

Collision-based receive buffer flow control provides a means of preventing frame reception when the port is operating in half-duplex mode (**fullduplex** is cleared in **MacControl**). When receive flow control is enabled and triggered, the port will generate collisions for received frames. The jam sequence transmitted will be the twelve byte sequence C3.C3.C3.C3.C3.C3.C3.C3.C3.C3.C3.C3 (hex). The jam sequence will begin no later than approximately as the source address starts to be received. Note that these forced collisions will not be limited to a maximum of 16 consecutive collisions, and are independent of the normal back-off algorithm. Receive flow control does not depend on the value of the incoming frame destination address. A collision will be generated for any incoming packet, regardless of the destination address.

14.3.2.12.2.1.2 IEEE 802.3X Based Receive Flow Control

IEEE 802.3x based receive flow control provides a means of preventing frame reception when the port is operating in full-duplex mode (**fullduplex** is set in **MacControl**). When receive flow control is enabled and triggered, the port will transmit a pause frame to request that the sending station stop transmitting for the period indicated within the transmitted pause frame.

The CPGMAC_SL will transmit a pause frame to the reserved multicast address at the first available opportunity (immediately if currently idle, or following the completion of the frame currently being transmitted). The pause frame will contain the maximum possible value for the pause time (0xFFFF). The MAC will count the receive pause frame time (decrements 0xFF00 down to zero) and retransmit an outgoing pause frame if the count reaches zero. When the flow control request is removed, the MAC will transmit a pause frame with a zero pause time to cancel the pause request.

Note that transmitted pause frames are only a request to the other end station to stop transmitting. Frames that are received during the pause interval will be received normally (provided the Rx FIFO is not full).

Pause frames will be transmitted if enabled and triggered regardless of whether or not the port is observing the pause time period from an incoming pause frame.

The CPGMAC_SL will transmit pause frames as described below:

- The 48-bit reserved multicast destination address 01.80.C2.00.00.01.
- The 48-bit source address — SL_SA(47:0).
- The 16-bit length/type field containing the value 88.08
- The 16-bit pause opcode equal to 00.01
- The 16-bit pause time value FF.FF. A pause-quantum is 512 bit-times. Pause frames sent to cancel a pause request will have a pause time value of 00.00.
- Zero padding to 64-byte data length (The CPGMAC_SL will transmit only 64 byte pause frames).
- The 32-bit frame-check sequence (CRC word).

All quantities above are hexadecimal and are transmitted most-significant byte first. The least-significant bit is transferred first in each byte.

If **rx_flow_en** is cleared to zero while the pause time is nonzero, then the pause time will be cleared to zero and a zero count pause frame will be sent.

14.3.2.12.2.2 Transmit Flow Control

Incoming pause frames are acted upon, when enabled, to prevent the CPGMAC_SL from transmitting any further frames. Incoming pause frames are only acted upon when the **fullduplex** and **tx_flow_en** bits in the **MacControl** register are set. Pause frames are not acted upon in half-duplex mode. Pause frame action will be taken if enabled, but normally the frame will be filtered and not transferred to memory.

MAC control frames will be transferred to memory if the **rx_cmf_en** (Copy MAC Frames) bit in the **MacControl** register is set. The **tx_flow_en** and **fullduplex** bits effect whether or not MAC control frames are acted upon, but they have no effect upon whether or not MAC control frames are transferred to memory or filtered.

Pause frames are a subset of MAC Control Frames with an opcode field=0x0001. Incoming pause frames will only be acted upon by the port if:

- **tx_flow_en** is set in **MacControl**, and
- the frame's length is 64 to **rx_maxlen** bytes inclusive, and
- the frame contains no crc error or align/code errors.

The pause time value from valid frames will be extracted from the two bytes following the opcode. The pause time will be loaded into the port's transmit pause timer and the transmit pause time period will begin.

If a valid pause frame is received during the transmit pause time period of a previous transmit pause frame then:

- if the destination address is not equal to the reserved multicast address or any enabled or disabled unicast address, then the transmit pause timer will immediately expire, or
- if the new pause time value is zero then the transmit pause timer will immediately expire, else
- the port transmit pause timer will immediately be set to the new pause frame pause time value. (Any remaining pause time from the previous pause frame will be discarded).

If **tx_flow_en** in **MacControl** is cleared, then the pause-timer will immediately expire.

The port will not start the transmission of a new data frame any sooner than 512-bit times after a pause frame with a non-zero pause time has finished being received (**GMII_RXDV** going inactive). No transmission will begin until the pause timer has expired (the port may transmit pause frames in order to initiate outgoing flow control). Any frame already in transmission when a pause frame is received will be completed and unaffected.

Incoming pause frames consist of the below:

- A 48-bit destination address equal to:
- The reserved multicast destination address 01.80.C2.00.00.01, or
- The SL_SA(47:0) input mac source address.
- The 48-bit source address of the transmitting device.
- The 16-bit length/type field containing the value 88.08
- The 16-bit pause opcode equal to 00.01
- The 16-bit pause_time. A pause-quantum is 512 bit-times.
- Padding to 64-byte data length.
- The 32-bit frame-check sequence (CRC word).

All quantities above are hexadecimal and are transmitted most-significant byte first. The least-significant bit is transferred first in each byte.

The padding is required to make up the frame to a minimum of 64 bytes. The standard allows pause frames longer than 64 bytes to be discarded or interpreted as valid pause frames. The CPGMAC_SL will recognize any pause frame between 64 bytes and **rx_maxlen** bytes in length.

14.3.2.13 Packet Drop Interface

The packet drop interface supports an external packet drop engine. The port 1 (and port 2) CPGMAC_SL receive FIFO VBUSP interface signals are CPSW_3G outputs. The receive packet interface has an associated packet drop input P1_RFIFO_DROP (P2_RFIFO_DROP). An external packet drop engine may “snoop” the received packet header and data to determine whether or not the packet should be dropped.

If the packet is to be dropped the external logic must assert the drop signal by no later than the second clock after the end of packet (or abort) indication from the CPGMAC_SL. The drop signal should remain asserted until the second clock after the end of packet (or abort) indication. If the packet is not to be dropped then the drop signal should remain deasserted. The CPGMAC_SL section contains more information on the receive FIFO VBUSP interface signals and end of packet indication.

14.3.2.14 Short Gap

The port 1 (and port 2) transmit inter-packet gap (IPG) may be shortened by eight bit times when enabled and triggered. The **tx_short_gap_en** bit in the **SL1_MacControl (SL2_MacControl)** register enables the gap to be shortened when triggered. The condition is triggered when the port 1 (port 2) transmit FIFO has a user defined number of FIFO blocks used. The port 1 transmit FIFO blocks used determines if the port 1 gap is shortened, and the port 2 transmit FIFO blocks used determines if the port 2 gap is shortened. The **CPSW_Gap_Thresh** register value determines the port 1 short gap threshold, and the **CPSW_Gap_Thresh** register value determines the port 2 short gap threshold.

14.3.2.15 Switch Latency

The CPSW_3G is a store and forward switch. The switch latency is defined as the amount of time between the end of packet reception of the received packet to the start of the output packet transmit.

Mode	Latency
Gig (1000)	880ns
100	1.3us
10	6.5us

14.3.2.16 Emulation Control

The emulation control input (EMUSUSP) and submodule emulation control registers allow CPSW_3G operation to be completely or partially suspended. There are three CPSW_3G submodules that contain emulation control registers (CPGMAC_SL1, CPGMAC_SL2, and CPDMA). The submodule emulation control registers must be accessed to facilitate CPSW_3G emulation control. The CPSW_3G module enters the emulation suspend state if all three submodules are configured for emulation suspend and the emulation suspend input is asserted.

A partial emulation suspend state is entered if one or two submodules is configured for emulation suspend and the emulation suspend input is asserted. Emulation suspend occurs at packet boundaries. The emulation control feature is implemented for compatibility with other peripherals.

CPGMAC_SL Emulation Control

The emulation control input (**TBEMUSUP**) and register bits (**soft** and **free** in the **EMControl** register) allow CPGMAC_SL operation to be suspended. When the emulation suspend state is entered, the CPGMAC_SL will stop processing receive and transmit frames at the next frame boundary. Any frame currently in reception or transmission will be completed normally without suspension. For receive, frames that are detected by the CPGMAC_SL after the suspend state is entered are ignored. Emulation control is implemented for compatibility with other peripherals.

CPDMA Emulation Control

The emulation control input (**TBEMUSUP**) and register bits (**soft** and **free** in the **EMControl** register) allow CPDMA operation to be suspended. When the emulation suspend state is entered, the CPDMA will stop processing receive and transmit frames at the next frame boundary. Any frame currently in reception or transmission will be completed normally without suspension. For transmission, any complete or partial frame in the tx cell fifo will be transmitted. For receive, frames that are detected by the CPDMA after the suspend state is entered are ignored. No statistics will be kept for ignored frames. Emulation control is implemented for compatibility with other peripherals.

The following table shows the operations of the emulation control input and register bits:

Table 14-17. Operations of Emulation Control Input and Register Bits

EMUSUSP	soft	free	Description
0	X	X	Normal Operation
1	0	0	Normal Operation
1	1	0	Emulation Suspend
1	X	1	Normal Operation

Emulation Suspend Input

The emulation suspend input described above comes from the Debug Subsystem. See [Chapter 27, Debug Subsystem](#), to enable an emulation suspend event input for the Ethernet Subsystem (EMAC).

14.3.2.17 Software IDLE

The submodule software idle register bits enable CPSW_3G operation to be completely or partially suspended by software control. There are three CPSW_3G submodules that contain software idle register bits (CPGMAC_SL1, CPGMAC_SL2, and CPDMA). Each of the three submodules may be individually commanded to enter the idle state. The idle state is entered at packet boundaries, and no further packet operations will occur on an idled submodule until the idle command is removed. The CPSW_3G module enters the idle state when all three submodules are commanded to enter and have entered the idle state. Idle status is determined by reading or polling the three submodule idle bits. The CPSW_3G is in the idle state when all three submodules are in the idle state. The **CPSW_Soft_Idle** bit may be set if desired after the submodules are in the idle state. The **CPSW_Soft_Idle** bit causes packets to not be transferred from one FIFO to another FIFO internal to the switch.

14.3.2.18 Software Reset

The CPSW_3G software reset register, CPSW_3GSS software reset register and the three submodule software reset registers enable the CPSW_3GSS to be reset by software. There are three CPSW_3G submodules that contain software reset registers (CPGMAC_SL1, CPGMAC_SL2, and CPDMA). Each of the three submodules may be individually commanded to be reset by software.

For the CPDMA, the reset state is entered at packet boundaries, at which time the CPDMA reset occurs. The CPGMAC_SL soft reset is immediate. Submodule reset status is determined by reading or polling the submodule reset bit. If the submodule reset bit is read as a one, then the reset process has not yet completed. The submodule soft reset process could take up to 2ms each. The reset has completed if the submodule reset bit is read as a zero.

After all three submodules (in any order) have been reset and a read of each submodule reset bit indicates that the reset process is complete, the CPSW_3G software reset register bit may be written to complete the CPSW_3G module software reset operation. The CPSW_3G software reset bit controls the reset of the FIFO's, the statistics submodule, and the address lookup engine (ALE). The CPSW_3G software reset is immediate and will be indicated by reading a zero from the soft reset bit.

The CPSW_3GSS software reset bit controls the reset of the INT, REGS and CPPI. The CPSW_3GSS software reset is immediate and will be indicated by reading a zero from the soft reset bit.

14.3.2.19 FIFO Loopback

FIFO loopback mode is entered when the `fifo_loopback` bit in the CPSW_Control register is set. FIFO loopback mode causes packets received on a port to be turned around and transmitted back on the same port. Port 0 receive is fixed on channel zero in FIFO loopback mode. The RXSOFOVERRUN statistic is incremented for each packet sent in FIFO loopback mode. Packets sent in with errors are returned with errors (they are not dropped). FIFO loopback is intended as a simple mechanism for test purposes. FIFO loopback should be performed in full duplex mode only.

14.3.2.20 CPSW_3G Network Statistics

The CPSW_3G has a set of statistics that record events associated with frame traffic on selected switch ports. The statistics values are cleared to zero 38 clocks after the rising edge of VBUSP_RST_N. When one or more port enable bits (`stat_port_en[2:0]`) are set, all statistics registers are write to decrement. The value written will be subtracted from the register value with the result being stored in the register. If a value greater than the statistics value is written, then zero will be written to the register (writing 0xffffffff will clear a statistics location).

When all port enable bits are cleared to zero, all statistics registers are read/write (normal write direct, so writing 0x00000000 will clear a statistics location). All write accesses must be 32-bit accesses. In the below statistics descriptions, "the port" refers to any enabled port (with a corresponding set `stat_port_en[2:0]` bit).

The statistics interrupt (STAT_PEND) will be issued if enabled when any statistics value is greater than or equal to 0x80000000. The statistics interrupt is removed by writing to decrement any statistics value greater than 0x80000000. The statistics are mapped into internal memory space and are 32-bits wide. All statistics rollover from 0xffffffff to 0x00000000.

14.3.2.20.1 Rx-only Statistics Descriptions

14.3.2.20.1.1 Good Rx Frames (Offset = 0h)

The total number of good frames received on the port. A good frame is defined to be:

- Any data or MAC control frame which matched a unicast, broadcast or multicast address, or matched due to promiscuous mode
- Had a length of 64 to `rx_maxlen` bytes inclusive
- Had no CRC error, alignment error or code error.

See the Rx Align/Code Errors and Rx CRC errors statistic descriptions for definitions of alignment, code and CRC errors. Overruns have no effect upon this statistic.

14.3.2.20.1.2 Broadcast Rx Frames (Offset = 4h)

The total number of good broadcast frames received on the port. A good broadcast frame is defined to be:

- Any data or MAC control frame which was destined for only address 0xFFFFFFFF
- Had a length of 64 to rx_maxlen bytes inclusive
- Had no CRC error, alignment error or code error.

See the Rx Align/Code Errors and Rx CRC errors statistic descriptions for definitions of alignment, code and CRC errors. Overruns have no effect upon this statistic.

14.3.2.20.1.3 Multicast Rx Frames (Offset = 8h)

The total number of good multicast frames received on the port. A good multicast frame is defined to be:

- Any data or MAC control frame which was destined for any multicast address other than 0xFFFFFFFF
- Had a length of 64 to rx_maxlen bytes inclusive
- Had no CRC error, alignment error or code error

See the Rx Align/Code Errors and Rx CRC errors statistic descriptions for definitions of alignment, code and CRC errors. Overruns have no effect upon this statistic.

14.3.2.20.1.4 Pause Rx Frames (Offset = Ch)

The total number of IEEE 802.3X pause frames received by the port (whether acted upon or not). Such a frame:

- Contained any unicast, broadcast, or multicast address
- Contained the length/type field value 88.08 (hex) and the opcode 0x0001
- Was of length 64 to rx_maxlen bytes inclusive
- Had no CRC error, alignment error or code error
- Pause-frames had been enabled on the port (tx_flow_en = 1).

The port could have been in either half or full-duplex mode.

See the Rx Align/Code Errors and Rx CRC errors statistic descriptions for definitions of alignment, code and CRC errors. Overruns have no effect upon this statistic.

14.3.2.20.1.5 Rx CRC Errors (Offset = 10h)

The total number of frames received on the port that experienced a CRC error. Such a frame:

- Was any data or MAC control frame which matched a unicast, broadcast or multicast address, or matched due to promiscuous mode
- Was of length 64 to rx_maxlen bytes inclusive
- Had no code/align error,
- Had a CRC error

Overruns have no effect upon this statistic.

A CRC error is defined to be:

- A frame containing an even number of nibbles
- Failing the Frame Check Sequence test

14.3.2.20.1.6 Rx Align/Code Errors (Offset = 14h)

The total number of frames received on the port that experienced an alignment error or code error. Such a frame:

- Was any data or MAC control frame which matched a unicast, broadcast or multicast address, or matched due to promiscuous mode

- Was of length 64 to rx_maxlen bytes inclusive
- Had either an alignment error or a code error

Overruns have no effect upon this statistic.

An alignment error is defined to be:

- A frame containing an odd number of nibbles
- Failing the Frame Check Sequence test if the final nibble is ignored

A code error is defined to be a frame which has been discarded because the port's MRXER pin driven with a one for at least one bit-time's duration at any point during the frame's reception.

Note: RFC 1757 etherStatsCRCAAlignErrors Ref. 1.5 can be calculated by summing Rx Align/Code Errors and Rx CRC errors.

14.3.2.20.1.7 Oversize Rx Frames (Offset = 18h)

The total number of oversized frames received on the port. An oversized frame is defined to be:

- Was any data or MAC control frame which matched a unicast, broadcast or multicast address, or matched due to promiscuous mode
- Was greater than rx_maxlen in bytes
- Had no CRC error, alignment error or code error

See the Rx Align/Code Errors and Rx CRC errors statistic descriptions for definitions of alignment, code and CRC errors. Overruns have no effect upon this statistic.

14.3.2.20.1.8 Rx Jabbers (Offset = 1Ch)

The total number of jabber frames received on the port. A jabber frame:

- Was any data or MAC control frame which matched a unicast, broadcast or multicast address, or matched due to promiscuous mode
- Was greater than rx_maxlen in bytes
- Had no CRC error, alignment error or code error

See the Rx Align/Code Errors and Rx CRC errors statistic descriptions for definitions of alignment, code and CRC errors. Overruns have no effect upon this statistic.

14.3.2.20.1.9 Undersize (Short) Rx Frames (Offset = 20h)

The total number of undersized frames received on the port. An undersized frame is defined to be:

- Was any data frame which matched a unicast, broadcast or multicast address, or matched due to promiscuous mode
- Was greater than rx_maxlen in bytes
- Had no CRC error, alignment error or code error

See the Rx Align/Code Errors and Rx CRC errors statistic descriptions for definitions of alignment, code and CRC errors. Overruns have no effect upon this statistic.

14.3.2.20.1.10 Rx Fragments (Offset = 24h)

The total number of frame fragments received on the port. A frame fragment is defined to be:

- Any data frame (address matching does not matter)
- Less than 64 bytes long
- Having a CRC error, an alignment error, or a code error
- Not the result of a collision caused by half duplex, collision based flow control

See the Rx Align/Code Errors and Rx CRC errors statistic descriptions for definitions of alignment, code and CRC errors. Overruns have no effect upon this statistic.

14.3.2.20.1.11 Rx Start of Frame Overruns (Offset = 84h)

The total number of frames received on the port that had a CPDMA start of frame (SOF) overrun or were dropped by due to FIFO resource limitations. SOF overrun frame is defined to be:

- Any data or MAC control frame which matched a unicast, broadcast or multicast address, or matched due to promiscuous mode
- Any length (including less than 64 bytes and greater than rx_maxlen bytes)
- The CPDMA had a start of frame overrun or the packet was dropped due to FIFO resource limitations

14.3.2.20.1.12 Rx Middle of Frame Overruns (Offset = 88h)

The total number of frames received on the port that had a CPDMA middle of frame (MOF) overrun. MOF overrun frame is defined to be:

- Any data or MAC control frame which matched a unicast, broadcast or multicast address, or matched due to promiscuous mode
- Any length (including less than 64 bytes and greater than rx_maxlen bytes)
- The CPDMA had a middle of frame overrun

14.3.2.20.1.13 Rx DMA Overruns (Offset = 8Ch)

The total number of frames received on the port that had either a DMA start of frame (SOF) overrun or a DMA MOF overrun. An Rx DMA overrun frame is defined to be:

- Any data or MAC control frame which matched a unicast, broadcast or multicast address, or matched due to promiscuous mode
- Any length (including less than 64 bytes and greater than rx_maxlen bytes)
- The CPGMAC_SL was unable to receive it because it did not have the DMA buffer resources to receive it (zero head descriptor pointer at the start or during the middle of the frame reception)

CRC errors, alignment errors and code errors have no effect upon this statistic.

14.3.2.20.1.14 Rx Octets (Offset = 30h)

The total number of bytes in all good frames received on the port. A good frame is defined to be:

- Any data or MAC control frame which matched a unicast, broadcast or multicast address, or matched due to promiscuous mode
- Of length 64 to rx_maxlen bytes inclusive
- Had no CRC error, alignment error or code error

See the Rx Align/Code Errors and Rx CRC errors statistic descriptions for definitions of alignment, code and CRC errors. Overruns have no effect upon this statistic.

14.3.2.20.1.15 Net Octets (Offset = 80h)

The total number of bytes of frame data received and transmitted on the port. Each frame counted:

- was any data or MAC control frame destined for any unicast, broadcast or multicast address (address match does not matter)
- Any length (including less than 64 bytes and greater than rx_maxlen bytes)

Also counted in this statistic is:

- Every byte transmitted before a carrier-loss was experienced
- Every byte transmitted before each collision was experienced, (i.e. multiple retries are counted each time)
- Every byte received if the port is in half-duplex mode until a jam sequence was transmitted to initiate flow control. (The jam sequence was not counted to prevent double-counting)

Error conditions such as alignment errors, CRC errors, code errors, overruns and underruns do not affect the recording of bytes by this statistic.

The objective of this statistic is to give a reasonable indication of ethernet utilization

14.3.2.20.2 Tx-only Statistics Descriptions

The maximum and minimum transmit frame size is software controllable.

14.3.2.20.2.1 Good Tx Frames (Offset = 34h)

The total number of good frames received on the port. A good frame is defined to be:

- Any data or MAC control frame which matched a unicast, broadcast or multicast address, or matched due to promiscuous mode
- Any length
- Had no late or excessive collisions, no carrier loss and no underrun

14.3.2.20.2.2 Broadcast Tx Frames (Offset = 38h)

The total number of good broadcast frames received on the port. A good broadcast frame is defined to be:

- Any data or MAC control frame which was destined for only address 0xFFFFFFFFFFFF
- Any length
- Had no late or excessive collisions, no carrier loss and no underrun

14.3.2.20.2.3 Multicast Tx Frames (Offset = 3Ch)

The total number of good multicast frames received on the port. A good multicast frame is defined to be:

- Any data or MAC control frame which was destined for any multicast address other than 0xFFFFFFFFFFFF
- Any length
- Had no late or excessive collisions, no carrier loss and no underrun

14.3.2.20.2.4 Pause Tx Frames (Offset = 40h)

This statistic indicates the number of IEEE 802.3X pause frames transmitted by the port.

Pause frames cannot underrun or contain a CRC error because they are created in the transmitting MAC, so these error conditions have no effect upon the statistic. Pause frames sent by software will not be included in this count.

Since pause frames are only transmitted in full duplex carrier loss and collisions have no effect upon this statistic.

Transmitted pause frames are always 64 byte multicast frames so will appear in the Tx Multicast Frames and 64octet Frames statistics.

14.3.2.20.2.5 Collisions (Offset = 48h)

This statistic records the total number of times that the port experienced a collision. Collisions occur under two circumstances.

1. When a transmit data or MAC control frame:
 - Was destined for any unicast, broadcast or multicast address
 - Was any size
 - Had no carrier loss and no underrun
 - Experienced a collision. A jam sequence is sent for every non-late collision, so this statistic will increment on each occasion if a frame experiences multiple collisions (and increments on late collisions)

CRC errors have no effect upon this statistic.

2. When the port is in half-duplex mode, flow control is active, and a frame reception begins.

14.3.2.20.2.6 Single Collision Tx Frames (Offset = 4Ch)

The total number of frames transmitted on the port that experienced exactly one collision. Such a frame:

- Was any data or MAC control frame destined for any unicast, broadcast or multicast address
- Was any size
- Had no carrier loss and no underrun
- Experienced one collision before successful transmission. The collision was not late.

CRC errors have no effect upon this statistic.

14.3.2.20.2.7 Multiple Collision Tx Frames (Offset = 50h)

The total number of frames transmitted on the port that experienced multiple collisions. Such a frame:

- Was any data or MAC control frame destined for any unicast, broadcast or multicast address
- Was any size
- Had no carrier loss and no underrun
- Experienced 2 to 15 collisions before being successfully transmitted. None of the collisions were late.

CRC errors have no effect upon this statistic.

14.3.2.20.2.8 Excessive Collisions (Offset = 54h)

The total number of frames for which transmission was abandoned due to excessive collisions. Such a frame:

- Was any data or MAC control frame destined for any unicast, broadcast or multicast address
- Was any size
- Had no carrier loss and no underrun
- Experienced 16 collisions before abandoning all attempts at transmitting the frame. None of the collisions were late.

CRC errors have no effect upon this statistic.

14.3.2.20.2.9 Late Collisions (Offset = 58h)

The total number of frames on the port for which transmission was abandoned because they experienced a late collision. Such a frame:

- Was any data or MAC control frame destined for any unicast, broadcast or multicast address
- Was any size
- Experienced a collision later than 512 bit-times into the transmission. There may have been up to 15 previous (non-late) collisions which had previously required the transmission to be re-attempted. The Late Collisions statistic dominates over the single, multiple and excessive Collisions statistics - if a late collision occurs the frame will not be counted in any of these other three statistics.

CRC errors have no effect upon this statistic.

14.3.2.20.2.10 Tx Underrun (Offset = 5Ch)

There should be no transmitted frames that experience underrun.

14.3.2.20.2.11 Deferred Tx Frames (Offset = 44h)

The total number of frames transmitted on the port that first experienced deferment. Such a frame:

- Was any data or MAC control frame destined for any unicast, broadcast or multicast address
- Was any size
- Had no carrier loss and no underrun
- Experienced no collisions before being successfully transmitted

- Found the medium busy when transmission was first attempted, so had to wait.
- CRC errors have no effect upon this statistic.

14.3.2.20.2.12 Carrier Sense Errors (Offset = 60h)

The total number of frames received on the port that had a CPDMA middle of frame (MOF) overrun. MOF overrun frame is defined to be:

- Was any data or MAC control frame destined for any unicast, broadcast or multicast address
- Was any size
- The carrier sense condition was lost or never asserted when transmitting the frame (the frame is not retransmitted). This is a transmit only statistic. Carrier Sense is a don't care for received frames. Transmit frames with carrier sense errors are sent until completion and are not aborted.

CRC errors have no effect upon this statistic.

14.3.2.20.2.13 Tx Octets (Offset = 64h)

The total number of bytes in all good frames transmitted on the port. A good frame is defined to be:

- Any data or MAC control frame which was destined for any unicast, broadcast or multicast address
- Was any size
- Had no late or excessive collisions, no carrier loss and no underrun.

14.3.2.20.3 Rx- and Tx-Shared Statistics Descriptions

14.3.2.20.3.1 Rx + Tx 64 Octet Frames (Offset = 68h)

The total number of 64-byte frames received and transmitted on the port. Such a frame is defined to be:

- Any data or MAC control frame which was destined for any unicast, broadcast or multicast address
- Did not experience late collisions, excessive collisions, or carrier sense error
- Was exactly 64 bytes long. (If the frame was being transmitted and experienced carrier loss that resulted in a frame of this size being transmitted, then the frame will be recorded in this statistic).

CRC errors, code/align errors and overruns do not affect the recording of frames in this statistic.

14.3.2.20.3.2 Rx + Tx 65–127 Octet Frames (Offset = 6Ch)

The total number of frames of size 65 to 127 bytes received and transmitted on the port. Such a frame is defined to be:

- Any data or MAC control frame which was destined for any unicast, broadcast or multicast address
- Did not experience late collisions, excessive collisions, or carrier sense error
- Was 65 to 127 bytes long

CRC errors, code/align errors, underruns and overruns do not affect the recording of frames in this statistic.

14.3.2.20.3.3 Rx + Tx 128–255 Octet Frames (Offset = 70h)

The total number of frames of size 128 to 255 bytes received and transmitted on the port. Such a frame is defined to be:

- Any data or MAC control frame which was destined for any unicast, broadcast or multicast address
- Did not experience late collisions, excessive collisions, or carrier sense error
- Was 128 to 255 bytes long

CRC errors, code/align errors, underruns and overruns do not affect the recording of frames in this statistic.

14.3.2.20.3.4 Rx + Tx 256–511 Octet Frames (Offset = 74h)

The total number of frames of size 256 to 511 bytes received and transmitted on the port. Such a frame is defined to be:

- Any data or MAC control frame which was destined for any unicast, broadcast or multicast address
- Did not experience late collisions, excessive collisions, or carrier sense error
- Was 256 to 511 bytes long

CRC errors, code/align errors, underruns and overruns do not affect the recording of frames in this statistic.

14.3.2.20.3.5 Rx + Tx 512–1023 Octet Frames (Offset = 78h)

The total number of frames of size 512 to 1023 bytes received and transmitted on the port. Such a frame is defined to be:

- Any data or MAC control frame which was destined for any unicast, broadcast or multicast address
- Did not experience late collisions, excessive collisions, or carrier sense error
- Was 512 to 1023 bytes long

CRC errors, code/align errors, underruns and overruns do not affect the recording of frames in this statistic.

14.3.2.20.3.6 Rx + Tx 1024_Up Octet Frames (Offset = 7Ch)

The total number of frames of size 1024 to rx_maxlen bytes for receive or 1024 up for transmit on the port. Such a frame is defined to be:

- Any data or MAC control frame which was destined for any unicast, broadcast or multicast address
- Did not experience late collisions, excessive collisions, or carrier sense error
- Was 1024 to rx_maxlen bytes long on receive, or any size on transmit

CRC errors, code/align errors, underruns and overruns do not affect the recording of frames in this statistic.

Table 14-18. Rx Statistics Summary

Rx Statistic	Frame/ Oct	Rx/ Rx+T x	Frame Type					Frame Size (bytes)								Event					
			MAC control		Data			<64	64	65- 127	128- 255	256- 511	512- 1023	1024- rx_ maxlen	>rx_ maxle n	Flow Coll.	CRC Error	Align/ Code	Over- run	Addr. Disc.	
			Pause frame	Non- pau se	Multi- cast	Broad- cast	Uni- cast														
Good Rx Frames	F	Rx	(y	y	y	y	y)	n	(y	y	y	y	y	y	y)	n	-	n	n	-	n
Broadcast Rx Frames	F	Rx	(%	%	n	y)	n	n	(y	y	y	y	y	y	y)	n	-	n	n	-	n
Multicast Rx Frames	F	Rx	(%	%	y)	n	n	n	(y	y	y	y	y	y	y)	n	-	n	n	-	n
Pause Rx Frames	F	Rx	y	n	n	n	n	n	(y	y	y	y	y	y	y)	n	-	n	n	-	-
Rx CRC Errors	F	Rx	(y	y	y	y	y)	n	(y	y	y	y	y	y	y)	n	-	y	n	-	n
Rx Align/Code Errors	F	Rx	(y	y	y	y	y)	n	(y	y	y	y	y	y	y)	n	-	-	y	-	n
Oversized Rx Frames	F	Rx	(y	y	y	y	y)	n	n	n	n	n	n	n	y	-	n	n	-	n	
Rx Jabbers	F	Rx	(y	y	y	y	y)	n	n	n	n	n	n	n	y	-	(y	y)	-	n	
Undersized Rx Frames	F	Rx	n	n	(y	y	y)	y	n	n	n	n	n	n	n	-	n	n	-	n	
Rx Fragments	F	Rx	n	n	(y	y	y)	y^	n	n	n	n	n	n	n	-	(y	y)	-	-	
Rx Overruns	F	Rx	(y	y	y	y	y)	(y	y	y	y	y	y	y	y)	-	-	-	y	n	
64octet Frames	F	Rx+T x	(y	y	y	y	y)	n	y	n	n	n	n	n	n	-	-	-	-	n	
65-127octet Frames	F	Rx+T x	(y	y	y	y	y)	n	n	y	n	n	n	n	n	-	-	-	-	n	
128-255octet Frames	F	Rx+T x	(y	y	y	y	y)	n	n		y	n	n	n	n	-	-	-	-	n	
256-511octet Frames	F	Rx+T x	(y	y	y	y	y)	n	n	n	n	y	n	n	n	-	-	-	-	n	
512-1023octet Frames	F	Rx+T x	(y	y	y	y	y)	n	n	n	n	n	y	n	n	-	-	-	-	n	
1024-UPoctet Frames	F	Rx+T x	(y	y	y	y	y)	n	n	n	n	n	n	y	n	-	-	-	-	n	
Rx Octets	O	Rx	(y	y	y	y	y)	n	(y	y	y	y	y	y	y)	n	-	n	n	-	n
Net Octets	O	Rx+T x	(y	y	y	y	y)	(y	y	y	y	y	y	y	y	y)	-	-	-	-	

Notes for the Rx Statistics Summary:

1. “AND” is assumed horizontally across the table between all conditions which form the statistic (marked y or n) except where (y|y), meaning “OR” is indicated. Parentheses are significant.
2. “-“ indicates conditions which are ignored in the formations of the statistic.
3. Statistics marked “Rx+Tx” are formed by summing the Rx and Tx statistics, each of which is formed independently.
4. The non-pause column refers to all MAC control frames (i.e. frames with length/type=88.08) with opcodes other than 0x0001. The pauseframe column refers to MAC frames with the opcode=0x0001.
5. The multicast, broadcast and unicast columns in the table refer to non-MAC Control/non-pause frames (i.e. data frames).
6. “%” If either a MAC control frame or pause frame has a multicast or broadcast destination address then the appropriate statistics will be updated.
7. “y^” Frame fragments are not counted if less than 8 bytes.
8. flow coll. are half-duplex collisions forced by the MAC to achieve flow-control. A collision will be forced during the first 8 bytes so should not show in frame fragments. Some of the ‘-‘s in this column might in reality be ‘n’s.
9. The rx_overruns stat show above is for rx_mof_overruns and rx_sof_overruns added together.

Table 14-19. Tx Statistics Summary

Tx Statistic	Frame/ Oct	Tx/ Rx+ Tx	Frame Type					Frame Size (bytes)							Event									
			MAC control		Data			64	65- 127	128- 255	256- 511	512- 1023	1024 - 1535	> 1535	CRC Error	Collision Type					No Carrier	Que ued	Defer red	Und er- run
			Pause (MA C)	Any (CP U)	Multi - cast	Broad - cast	Uni- cast									Flow	1	2- 15	16	Late				
Good Tx Frames	F	Tx	(y	y	y	y	y)	(y	y	y	y	y	y	y)	-	-	-	-	n	n	n	-	-	n
Broadcast Tx Frames	F	Tx	n	(%	n	y)	n	(y	y	y	y	y	y	y)	-	-	-	-	n	n	n	-	-	n
Multicast Tx Frames	F	Tx	(y	(%	y)	n	n	y	y	y	y	y	y	y)	-	-	-	-	n	n	n	-	-	n
Pause Tx Frames	F	Tx	y	n	n	n	n	y	n	n	n	n	n	n	-	-	-	-	-	-	-	-	-	-
Collisions	F	Tx	n	(y	y	y	y)	(y	y	y	y	y	y	y)	-	(+	+	+	+	+	n	-	-	-
Single Collision Tx Frames	F	Tx	n	(y	y	y	y)	(y	y	y	y	y	y	y)	-	-	y	n	n	n	n	-	-	-
Multiple Collision Tx Frames	F	Tx	n	(y	y	y	y)	(y	y	y	y	y	y	y)	-	-	n	y	n	n	n	-	-	-
Excessive Collisions	F	Tx	n	(y	y	y	y)	(y	y	y	y	y	y	y)	-	-	n	n	y	n	n	-	-	-
Late Collisions	F	Tx	n	(y	y	y	y)	n	(y	y	y	y	y	y)	-	-	-	-	-	y	-	-	-	-
Deferred Tx Frames	F	Tx	n	(y	y	y	y)	(y	y	y	y	y	y	y)	-	-	n	n	n	n	n	-	y	n
Carrier Sense Errors	F	Tx	(y	y	y	y	y)	(y	y	y	y	y	y	y)	-	-	-	-	-	-	y	-	-	-
64octet Frames	F	Rx+ Tx	(y	y	y	y	y)	y	n	n	n	n	n	n	-	-	-	-	n	n	n	-	-	-
65-127octet Frames	F	Rx+ Tx	(y	y	y	y	y)	n	y	n	n	n	n	n	-	-	-	-	n	n	n	-	-	-
128-255octet Frames	F	Rx+ Tx	(y	y	y	y	y)	n	n	y	n	n	n	n	-	-	-	-	n	n	n	-	-	-
256-511octet Frames	F	Rx+ Tx	(y	y	y	y	y)	n	n	n	y	n	n	n	-	-	-	-	n	n	n	-	-	-
512-1023octet Frames	F	Rx+ Tx	(y	y	y	y	y)	n	n	n	n	y	n	n	-	-	-	-	n	n	n	-	-	-
1024-UPoctet Frames	F	Rx+ Tx	(y	y	y	y	y)	n	n	n	n	n	y	y	-	-	-	-	n	n	n	-	-	-
Tx Octets	O	Tx	(y	y	y	y	y)	(y	y	y	y	y	y	y)	-	-	-	-	n	n	n	-	-	n
Net Octets	O	Rx+ Tx	(y	y	y	y	y)	(y	y	y	y	y	y	y)	-	-	\$	\$	\$	\$	\$	-	-	-

Notes for the Tx Statistics Summary:

1. "AND" is assumed horizontally across the table between all conditions which form the statistic (marked y or n) except where (y|y), meaning "OR" is indicated. Parentheses are significant.
2. "-" indicates conditions which are ignored in the formations of the statistic.
3. Statistics marked "Rx+Tx" are formed by summing the Rx and Tx statistics, each of which is formed independently.
4. Pause (MAC) frames are issued in the MAC as perfect (no CRC error) 64 byte frames in full duplex only, so they cannot collide.
5. "%" If a CPU sourced MAC control frame has a multicast or broadcast destination address then the appropriate statistics will be updated.
6. "+" indicates collisions which are "summed" (i.e. every collision is counted in the Collisions statistic). Jam sequences used for halfduplex flow control are also counted.
7. "\$" Every byte written on the wire during each retry attempt is also counted in addition to frames which experience no collisions or carrier loss.
8. The flow collision type is for half-duplex collisions forced by the MAC to achieve flow control. Some of the '-'s in this column might in reality be 'n's. To prevent double-counting, Net Octets are unaffected by the jam sequence – the 'received' bytes, however, are counted. (See [Table 14-18](#).)
9. When the transmit Tx FIFO is drained due to the MAC being disabled or link being lost, then the frames being purged will not appear in the Tx statistics.

14.3.3 Ethernet Mac Sliver (CPGMAC_SL)

The CPGMAC_SL peripheral shall be compliant to the IEEE Std 802.3 Specification. Half duplex mode is supported in 10/100 Mbps mode, but not in 1000 Mbps (gigabit) mode.

Features:

- Synchronous 10/100/1000 Mbit operation.
- G/MII Interface.
- Hardware Error handling including CRC.
- Full Duplex Gigabit operation (half duplex gigabit is not supported).
- EtherStats and 802.3Stats RMON statistics gathering support for external statistics collection module.
- Transmit CRC generation selectable on a per channel basis.
- Emulation Support.
- VLAN Aware Mode Support.
- Hardware flow control.
- Programmable Inter Packet Gap (IPG)

14.3.3.1 GMII/MII Media Independent Interface

The following sections cover operation of the Media Independent Interface in 10/100/1000 Mbps modes. An IEEE 802.3 compliant Ethernet MAC controls the interface.

14.3.3.1.1 Data Reception

14.3.3.1.1.1 Receive Control

Data received from the PHY is interpreted and output. Interpretation involves detection and removal of the preamble and start of frame delimiter, extraction of the address and frame length, data handling, error checking and reporting, cyclic redundancy checking (CRC), and statistics control signal generation.

14.3.3.1.1.2 Receive Inter-Frame Interval

The 802.3 required inter-packet gap (IPG) is 24 GMII clocks (96 bit times) for 10/100 Mbit modes, and 12 GMII clocks (96 bit times) for 1000 Mbit mode. However, the MAC can tolerate a reduced IPG (2 GMII clocks in 10/100 mode and 5 GMII clocks in 1000 mode) with a correct preamble and start frame delimiter.

This interval between frames must comprise (in the following order):

- An Inter-Packet Gap (IPG).
- A seven octet preamble (all octets 0x55).
- A one octet start frame delimiter (0x5D).

14.3.3.1.2 Data Transmission

The Gigabit Ethernet Mac Sliver (GMII) passes data to the PHY when enabled. Data is synchronized to the transmit clock rate. The smallest frame that can be sent is two bytes of data with four bytes of CRC (6 byte frame).

14.3.3.1.2.1 Transmit Control

A jam sequence is output if a collision is detected on a transmit packet. If the collision was late (after the first 64 bytes have been transmitted) the collision is ignored. If the collision is not late, the controller will back off before retrying the frame transmission. When operating in full duplex mode the carrier sense (CRS) and collision sensing modes are disabled.

14.3.3.1.2.2 CRC Insertion

The MAC generates and appends a 32-bit Ethernet CRC onto the transmitted data if the transmit packet header **pass_crc** bit is zero. For the CPMAC_SL generated CRC case, a CRC at the end of the input packet data is not allowed. If a CRC is not needed, set the **pass_crc** bit to zero and adjust the packet length accordingly.

If the header word **pass_crc** bit is set, then the last four bytes of the TX data are transmitted as the frame CRC. The four CRC data bytes should be the last four bytes of the frame and should be included in the packet byte count value. The MAC performs no error checking on the outgoing CRC when the **pass_crc** bit is set.

14.3.3.1.2.3 TXER

The GMII_TXER signal is not used. If an underflow condition occurs on a transmitted frame, the frame CRC will be inverted to indicate the error to the network. Underflow is a hardware error.

14.3.3.1.2.4 Adaptive Performance Optimization (APO)

The Ethernet MAC port incorporates Adaptive Performance Optimization (APO) logic that may be enabled by setting the **tx_pace** bit in the **MacControl** register. Transmission pacing to enhance performance is enabled when set. Adaptive performance pacing introduces delays into the normal transmission of frames, delaying transmission attempts between stations, reducing the probability of collisions occurring during heavy traffic (as indicated by frame deferrals and collisions) thereby increasing the chance of successful transmission.

When a frame is deferred, suffers a single collision, multiple collisions or excessive collisions, the pacing counter is loaded with an initial value of 31. When a frame is transmitted successfully (without experiencing a deferral, single collision, multiple collision or excessive collision) the pacing counter is decremented by one, down to zero.

With pacing enabled, a new frame is permitted to immediately (after one IPG) attempt transmission only if the pacing counter is zero. If the pacing counter is non zero, the frame is delayed by the pacing delay, a delay of approximately four inter-packet gap delays. APO only affects the IPG preceding the first attempt at transmitting a frame. It does not affect the back-off algorithm for retransmitted frames.

14.3.3.1.2.5 Inter-Packet-Gap Enforcement

The measurement reference for the IPG of 96 bit times is changed depending on frame traffic conditions. If a frame is successfully transmitted without collision, and **GMII_CRS** is de-asserted within approximately 48 bit times of **GMII_TXEN** being de-asserted, then 96 bit times is measured from **GMII_TXEN**. If the frame suffered a collision, or if **GMII_CRS** is not de-asserted until more than approximately 48 bit times after **GMII_TXEN** is de-asserted, then 96 bit times (approximately, but not less) is measured from **GMII_CRS**.

The transmit IPG can be shortened by eight bit times when enabled and triggered. The **tx_short_gap_en** bit in the **MacControl** register enables the **TX_SHORT_GAP** input to determine whether the transmit IPG is shortened by eight bit times.

14.3.3.1.2.6 Back Off

The Gigabit Ethernet Mac Sliver (GMII) implements the 802.3 binary exponential back-off algorithm.

14.3.3.1.2.7 Programmable Transmit Inter-Packet Gap

The transmit inter-packet gap (IPG) is programmable through the **Tx_Gap** register. The default value is decimal 12. The transmit IPG may be increased to the maximum value of 0x1ff. Increasing the IPG is not compatible with transmit pacing. The short gap feature will override the increased gap value, so the short gap feature may not be compatible with an increased IPG.

14.3.3.1.2.8 Speed, Duplex, and Pause Frame Support Negotiation

The CPMAC_SL can operate in half duplex or full duplex in 10/100 Mbit modes, and can operate in full duplex only in 1000 Mbit mode. Pause frame support is included in 10/100/1000 Mbit modes as configured by the host.

14.3.3.2 Frame Classification

Received frames are proper (good) frames if they are between 64 and **rx_maxlen** in length (inclusive) and contain no errors (code/align/CRC).

Received frames are long frames if their frame count exceeds the value in the **rx_maxlen** register. The **rx_maxlen** register reset (default) value is 1518 (dec). Long received frames are either oversized or jabber frames. Long frames with no errors are oversized frames. Long frames with CRC, code, or alignment errors are jabber frames.

Received frames are short frames if their frame count is less than 64 bytes. Short frames that contain no errors are undersized frames. Short frames with CRC, code, or alignment errors are fragment frames.

A received long packet will always contain **rx_maxlen** number of bytes transferred to memory (if **rx_cef_en** = 1). An example with **rx_maxlen** = 1518 is below:

- If the frame length is 1518, then the packet is not a long packet and there will be 1518 bytes transferred to memory.
- If the frame length is 1519, there will be 1518 bytes transferred to memory. The last three bytes will be the first three CRC bytes.
- If the frame length is 1520, there will be 1518 bytes transferred to memory. The last two bytes will be the first two CRC bytes.
- If the frame length is 1521, there will be 1518 bytes transferred to memory. The last byte will be the first CRC byte.

If the frame length is 1522, there will be 1518 bytes transferred to memory. The last byte will be the last data byte.

14.3.4 Command IDLE

The **cmd_idle** bit in the MACCONTROL register allows CPGMAC_SL operation to be suspended. When the idle state is commanded, the CPGMAC_SL will stop processing receive and transmit frames at the next frame boundary. Any frame currently in reception or transmission will be completed normally without suspension. Received frames that are detected after the suspend state is entered are ignored. Commanded idle is similar in operation to emulation control and clock stop.

14.3.5 RMII Interface

The CPRMII peripheral shall be compliant to the RMII specification document.

Features:

- Source Synchronous 10/100 Mbit operation.
- Full and Half Duplex support.

14.3.5.1 RMII Receive (RX)

The CPRMII receive (RX) interface converts the input data from the external RMII PHY (or switch) into the required MII (CPGMAC) signals. The carrier sense and collision signals are determined from the RMII input data stream and transmit inputs as defined in the RMII specification.

An asserted **RMII_RXER** on any di-bit in the received packet will cause an **MII_RXER** assertion to the CPGMAC during the packet. In 10Mbps mode, the error is not required to be duplicated on 10 successive clocks. Any di-bit which has an asserted **RMII_RXER** during any of the 10 replications of the data will cause the error to be propagated.

Any received packet that ends with an improper nibble boundary aligned RMII_CRSDV toggle will issue an MII_RXER during the packet to the CPGMAC. Also, a change in speed or duplex mode during packet operations will cause packet corruption.

The CPRMII can accept receive packets with shortened preambles, but 0x55 followed by a 0x5d is the shortest preamble that will be recognized (1 preamble byte with the start of frame byte). At least one byte of preamble with the start of frame indicator is required to begin a packet. An asserted RMII_CRSDV without at least a single correct preamble byte followed by the start of frame indicator will be ignored.

14.3.5.2 RMII Transmit (TX)

The CPRMII transmit (TX) interface converts the 3PSW MII input data into the RMII transmit format. The data is then output to the external RMII PHY.

The 3PSW does not source the transmit error (MII_TXERR) signal. Any transmit frame from the CPGMAC with an error (ie. underrun) will be indicated as an error by an error CRC. Transmit error is assumed to be deasserted at all times and is not an input into the CPRMII module. Zeroes are output on RMII_TXD[1:0] for each clock that RMII_TXEN is deasserted.

14.3.6 RGMII Interface

The CPRGMII peripheral shall be compliant to the RGMII specification document.

Features:

- Supports 1000/100/10 Mbps Speed.
- MII mode is not supported.

If RGMII is used, and a 10Mbit operation is desired, in-band mode must be used and an ethernet PHY that supports in-band status signaling must be selected.

14.3.6.1 RGMII Receive (RX)

The CPRGMII receive (RX) interface converts the source synchronous DDR input data from the external RGMII PHY into the required G/MII (CPGMAC) signals.

14.3.6.2 In-Band Mode of Operation

The CPRGMII is operating in the in-band mode of operation when the **RGMIIRXINBAND** input is asserted. **RGMIIRXINPUT** is asserted by configuring the `ext_en` bit to 1 of the **MACCONTROL** register. The link status, duplexity, and speed are determined from the RGMII input data stream as defined in the RGMII specification. The link speed is indicated as shown in the following table:

RGMIISPEED(1:0)	Link Speed
00	10 Mbs mode
01	100 Mbs mode
10	1000 Mbs mode
11	reserved

14.3.6.3 Forced Mode of Operation

The CPRGMII is operating in the forced mode of operation when the **RGMIIRXINBAND** input is deasserted by setting **MACCONTROL.EXT_EN** to 0. In the forced mode of operation, the in-band data is ignored if present. In this mode, the contents of **RGMIICTL** are meaningless. Link status, duplexity, and speed status should be determined from the external ethernet PHY via MDIO transactions.

14.3.6.4 RGMII Transmit (TX)

The CPRGMII transmit (TX) interface converts the CPGMAC G/MII input data into the DDR RGMII format. The DDR data is then output to the external PHY.

The CPGMAC does not source the transmit error (MTXERR) signal. Any transmit frame from the CPGMAC with an error (that is, underrun) will be indicated as an error by an error CRC. Transmit error is assumed to be deasserted at all times and is not an input into the CPRGMII module.

The RGMII0/1_ID_MODE bit value in the GMII_SEL register should only be set to 1 for 'no internal delay'. The device does not support internal delay mode for RGMII.

14.3.7 Common Platform Time Sync (CPTS)

The CPTS module is used to facilitate host control of time sync operations. It enables compliance with the IEEE 1588-2008(v2) standard for a precision clock synchronization protocol.

14.3.7.1 Architecture

Figure 14-10. CPTS Block Diagram

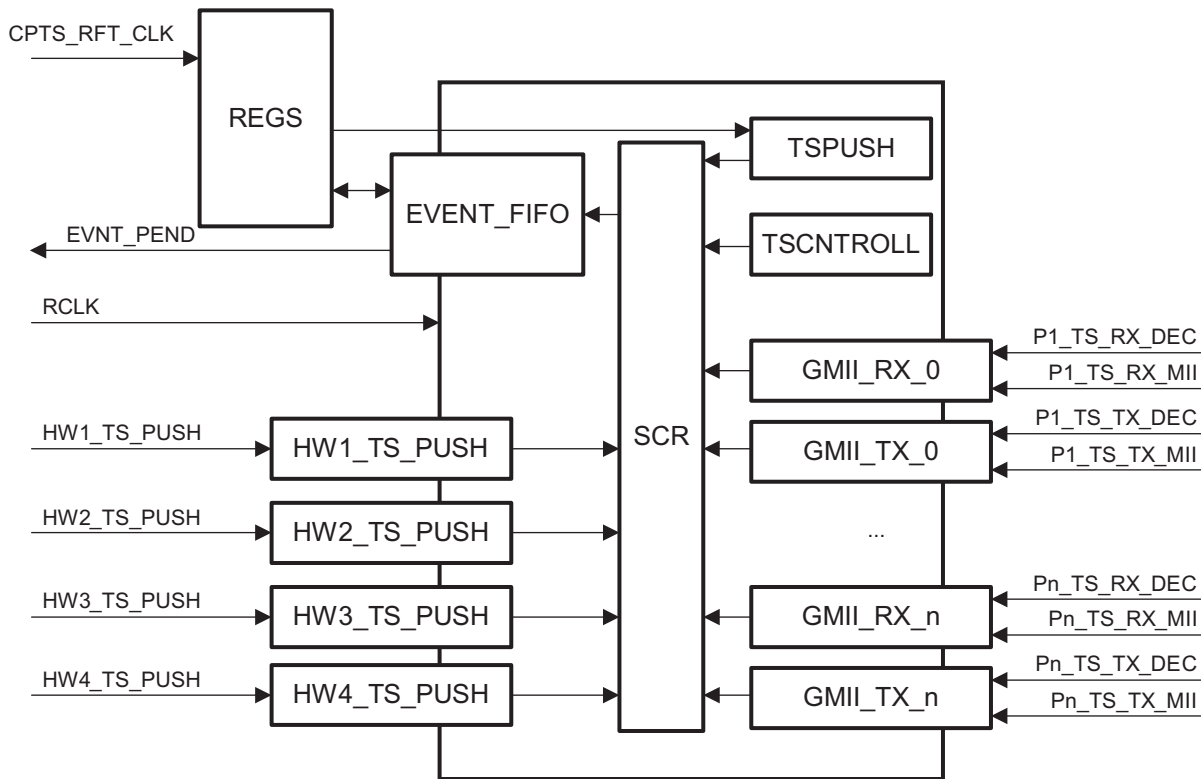


Figure 14-10 shows the architecture of the CPTS module inside the 3PSW Ethernet Subsystem. Time stamp values for every packet transmitted or received on either port of the 3PSW are recorded. At the same time, each packet is decoded to determine if it is a valid time sync event. If so, an event is loaded into the Event FIFO for processing containing the recorded time stamp value when the packet was transmitted or received.

In addition, both hardware (HWx_TS_PUSH) and software (TS_PUSH) can be used to read the current time stamp value through the Event FIFO

The reference clock used for the time stamp (RCLK) is sourced from one of the two sources, as shown in Figure 14-10. The source can be selected by configuring the CM_CPTS_RFT_CLKSEL register in the Control Module. For more details, see Chapter 9, Control Module.

14.3.7.2 Time Sync Overview

The CPTS module is used to facilitate host control of time sync operations. The CPTS collects time sync events and then presents them to the host for processing. There are five types of time sync events (ethernet receive event, ethernet transmit event, time stamp push event, time stamp rollover event, and time stamp half-rollover event). Each ethernet port can cause transmit and receive events. The time stamp push is initiated by software.

14.3.7.2.1 Time Sync Initialization

The CPTS module should be configured as shown:

- Complete the reset sequence (VBUSP_RST_N) to reset the module.
- Write the rftclk_sel[4:0] value in the RFTCLK_Sel register with the desired reference clock multiplexor value. This value is allowed to be written only when the cpts_en bit is cleared to zero.
- Write a one to the cpts_en bit in the TS_Control register. The RCLK domain is in reset while this bit is low.
- Enable the interrupt by writing a one to the ts_pend_en bit in the TS_Int_Enable register (if using interrupts and not polling).

14.3.7.2.2 Time Stamp Value

The time stamp value is a 32-bit value that increments on each RCLK rising edge when CPTS_EN is set to one. When CPTS_EN is cleared to zero the time stamp value is reset to zero. If more than 32-bits of time stamp are required by the application, the host software must maintain the necessary number of upper bits. The upper time stamp value should be incremented by the host when the rollover event is detected.

For test purposes, the time stamp can be written via the time stamp load function (CPTS_LOAD_VAL and CPTS_LOAD_EN registers).

14.3.7.2.3 Event FIFO

All time sync events are pushed onto the Event FIFO. There are 16 locations in the event FIFO with no overrun indication supported. Software must service the event FIFO in a timely manner to prevent FIFO overrun.

14.3.7.2.4 Time Sync Events

Time Sync events are 64-bit values that are pushed onto the event FIFO and read in two 32-bit reads. CPTS_EVENT_LOW and CPTS_EVENT_HIGH are defined in [Section 14.5.3.10](#) and [Section 14.5.3.11](#), respectively.

There are six types of sync events

- Time stamp push event
- Hardware time stamp push event
- Time stamp counter rollover event
- Time stamp counter half-rollover event
- Ethernet receive event
- Ethernet transmit event

14.3.7.2.4.1 Time Stamp Push Event

Software can obtain the current time stamp value (at the time of the write) by initiating a time stamp push event. The push event is initiated by setting the TS_PUSH bit of the CPTS_TS_PUSH register. The time stamp value is returned in the event, along with a time stamp push event code. Software should not push a second time stamp event on to the FIFO until the first time stamp value has been read from the event FIFO.

14.3.7.2.4.2 Time Stamp Counter Rollover Event

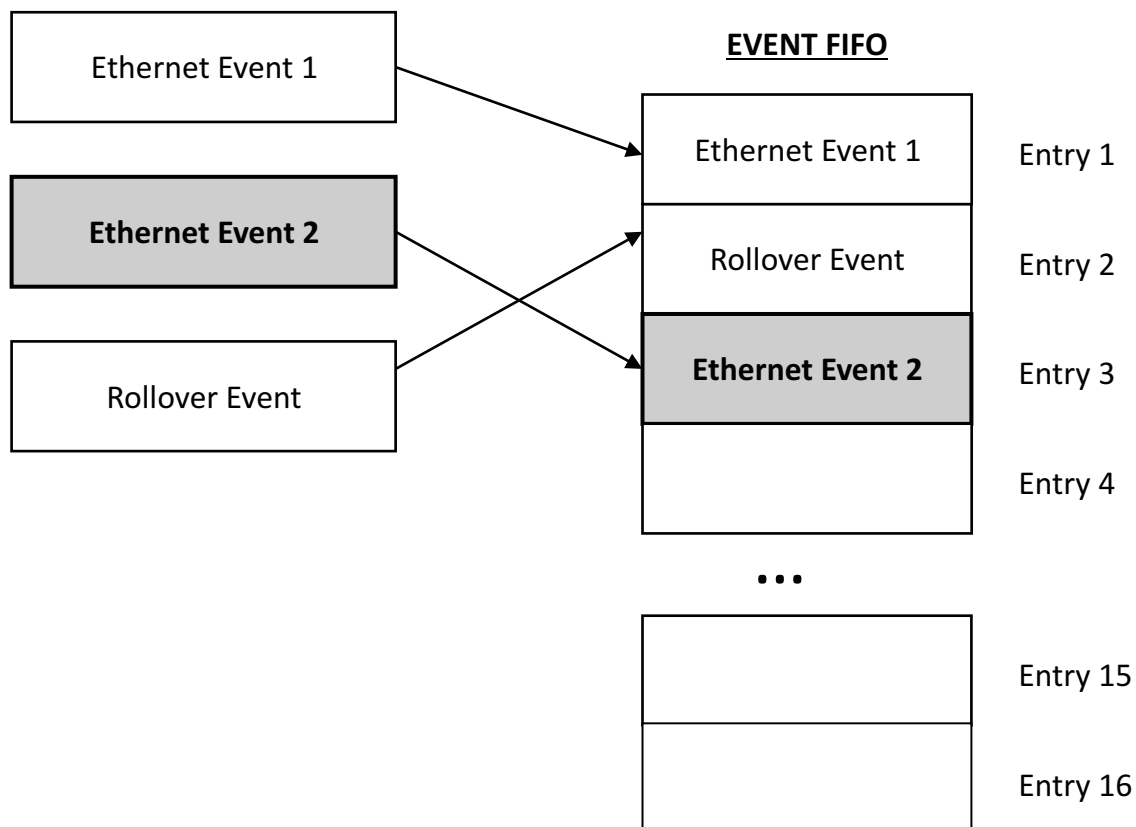
The CPTS module contains a 32-bit time stamp value. The counter upper bits are maintained by host software. The rollover event indicates to software that the time stamp counter has rolled over from 0xFFFF_FFFF to 0x0000_0000, and the software maintained upper count value should be incremented.

14.3.7.2.4.3 Time Stamp Counter Half-Rollover Event

The CPTS includes a time stamp counter half-rollover event. The half-rollover event indicates to software that the time stamp value has incremented from 0x7FFF_FFFF to 0x8000_0000. The half-rollover event is included to enable software to correct a misaligned event condition. The half-rollover event is included to enable software to determine the correct time for each event that contains a valid time stamp value – such as an Ethernet event. If an Ethernet event occurs around a counter rollover (full rollover), the rollover event could possibly be loaded into the event FIFO before the Ethernet event, even though the Ethernet event time was actually taken before the rollover. Figure 3 below shows a misalignment condition.

This misaligned event condition arises because an ethernet event time stamp occurs at the beginning of a packet and time passes before the packet is determined to be a valid synchronization packet. The misaligned event condition occurs if the rollover occurs in the middle, after the packet time stamp has been taken, but before the packet has been determined to be a valid time sync packet.

Figure 14-11. Event FIFO Misalignment Condition



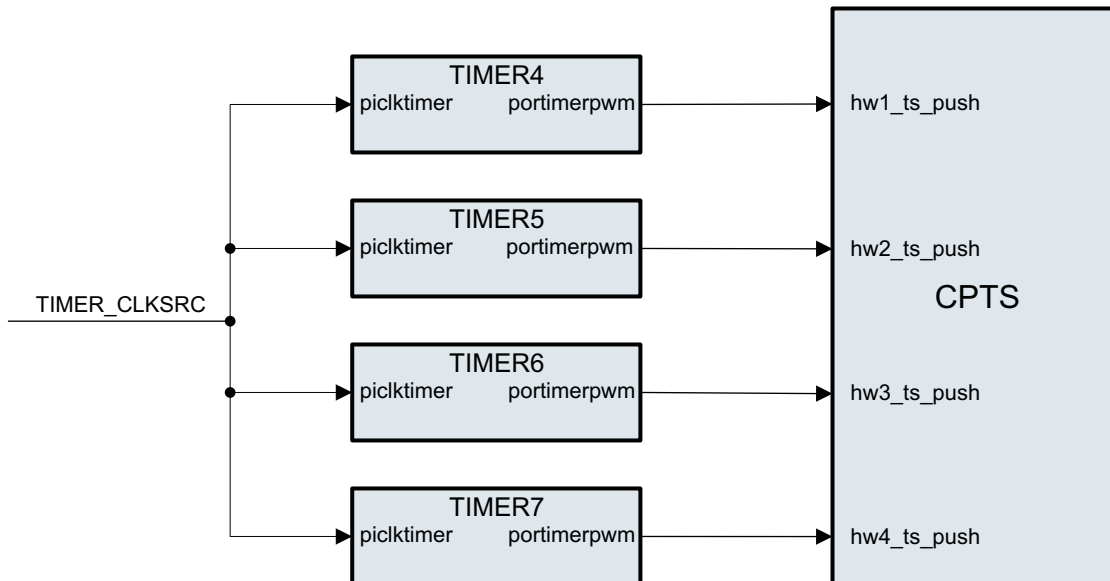
Host software must detect and correct for misaligned event conditions. For every event after a rollover and before a half-rollover, software must examine the time stamp most significant bit. If bit 31 of the time stamp value is low (0x0000_0000 through 0x7FFF_FFFF), then the event time stamp was taken after the rollover and no correction is required.

If the value is high (0x8000_0000 through 0xFFFF_FFFF), the time stamp value was taken before the rollover and a misalignment is detected. The misaligned case indicates to software that it must subtract one from the upper count value stored in software to calculate the correct time for the misaligned event. The misaligned event occurs only on the rollover boundary and not on the half-rollover boundary. Software only needs to check for misalignment from a rollover event to a half-rollover event.

14.3.7.2.4.4 Hardware Time Stamp Push Event

There are four hardware time stamp inputs (HW1/4_TS_PUSH) that can cause hardware time stamp push events to be loaded into the Event FIFO. Each hardware time stamp input is internally connected to the PORTIMERPWM output of each timer as shown in Figure 4.

Figure 14-12. HW1/4_TSP_PUSH Connection



The event is loaded into the event FIFO on the rising edge of the timer, and the PORT_NUMBER field in the EVENT_HIGH register indicates the hardware time stamp input that caused the event.

Each hardware time stamp input must be asserted for at least 10 periods of the selected RCLK clock. Each input can be enabled or disabled by setting the respective bits in the **CONTROL** register.

Hardware time stamps are intended to be an extremely low frequency signals, such that the event FIFO does not overrun. Software must keep up with the event FIFO and ensure that there is no overrun, or events will be lost.

14.3.7.2.4.5 Ethernet Port Events

14.3.7.2.4.5.1 Ethernet Port Receive Event

Each ethernet port can generate a receive ethernet event. Receive ethernet events are generated for valid received time sync packets. There are two CPTS interfaces for each ethernet receive port. The first is the Px_TS_RX_MII interface and the second is the Px_TS_RX_DEC interface. Information from these interfaces is used to generate an ethernet receive event for each ethernet time sync packet received on the associated port.

The Px_TS_RX_MII interface issues a record signal (pX_ts_rx_mii_rec) along with a handle (pX_ts_rx_mii_hdl) for each packet (every packet) that is received on the associated ethernet port. The record signal is a single clock pulse indicating that a receive packet has been detected at the associated port MII interface. The handle value is incremented with each packet and rolls over to zero after 15.

There are 16 possible handle values so there can be a maximum of 16 packets “in flight” from the TS_RX_MII to the TS_RX_DEC block at any given time. A handle value is reused (not incremented) for any received packet that is shorter than about 31 octets (including preamble). Handle reuse on short packets prevents any possible overrun condition (more than 16 “in flight” packets) if multiple fragments are consecutively received.

Valid receive ethernet time sync events are signaled to the CPTS via the Px_TS_RX_DEC interface. When the pX_ts_rx_dec_evnt is asserted, a valid event is detected and will be loaded into the event FIFO. Only valid receive time sync packets are indicated on the Px_TS_RX_DEC interface. The pX_ts_rx_dec_hdl, pX_ts_rx_dec_msg_type, and pX_ts_rx_dec_seq_id signals are registered on an asserted pX_ts_rx_dec_evnt. When a Tx_TS_RX_DEC event is asserted, the handle value is used to retrieve the time stamp that was loaded with the same handle value from the Px_TS_RX_MII interface.

14.3.7.2.4.5.2 Ethernet Port Transmit Event

Each ethernet port can generate a transmit ethernet event. Transmit ethernet events are generated for valid transmitted time sync packets. There are two CPTS interfaces for each ethernet transmit port. The first is the Px_TS_TX_DEC interface and the second is the Px_TS_TX_MII interface. Information from these interfaces is used to generate an ethernet transmit event for each ethernet time sync packet transmitted on the associated port.

Valid ethernet transmit time sync events are signaled to the CPTS via the Px_TS_TX_DEC interface. When the pX_ts_tx_dec_evnt signal is asserted, a valid time sync event has been detected and will be loaded into the event FIFO. Only valid transmit time sync packets are indicated on the Px_TS_RX_DEC interface. The pX_ts_tx_dec_hdl, pX_ts_tx_dec_msg_type, pX_ts_tx_dec_seq_id signals are registered on an asserted pX_ts_tx_dec_evnt.

The time stamp for the event will be generated and signaled from the Px_TS_TX_MII interface when the packet is actually transmitted. The event will be loaded into the event FIFO when the time stamp is recorded as controlled by the Px_TS_TX_MII interface. The handle value is incremented with each time sync event packet and rolls over to zero after 7. There are 8 possible handle values so there can be a maximum of 8 time sync event packets “in flight” from the TS_TX_DEC to the TS_TX_MII block at any given time. The handle value increments only on time sync event packets.

The Px_TS_TX_MII interface issues a single clock record signal (pX_ts_tx_mii_rec) at the beginning of each transmitted packet. If the packet is a time sync event packet then a single clock event signal (pX_ts_tx_mii_evnt) along with a handle (pX_ts_rx_mii_hdl) will be issued before the next record signal for the next transmitted packet. The event signal will not be issued for packets that were not indicated as valid time sync event packets on the Px_TS_TX_DEC interface. If consecutive record indications occur without an interleaving event indication, then the packet associated with the first record was not a time sync event packet. The record signal is a single clock pulse indicating that a transmit packet egress has been detected at the associated port MII interface.

Table 14-20. Values of messageType field

Message Type	Value (hex)
Sync	0
Delay_Req	1
Pdelay_Req	2
Pdelay_Resp	3
Reserved	4-7
Follow_Up	8
Delay_Resp	9
Pdelay_Resp_Follow_Up	A
Announce	B
Signaling	C
Management	D
Reserved	E-F

14.3.7.3 Interrupt Handling

When an event is push onto the Event FIFO, an interrupt can be generated to indicate to software that a time sync event occurred. The following steps should be taken to process time sync events using interrupts:

- Enable the TS_PEND interrupt by setting the TS_PEND_EN bit of the CPTS_INT_ENABLE register.
- Upon interrupt, read the CPTS_EVENT_LOW and CPTS_EVENT_HIGH register values.
- Set the EVENT_POP field (bit zero) of the CPTS_EVENT_POP register to pop the previously read value off of the event FIFO.
- Process the interrupt as required by the application software

Software has the option of processing more than a single event from the event FIFO in the interrupt service routine in the following way:

1. Enable the TS_PEND interrupt by setting the TS_PEND_EN bit of the CPTS_INT_ENABLE register.
2. Upon interrupt enter the CPTS service routine.
3. Read the CPTS_EVENT_LOW and CPTS_EVENT_HIGH register values.
4. Set the EVENT_POP bit of the CPTS_EVENT_POP register to pop the previously read value off of the event FIFO.
5. Wait for an amount of time greater than eight CPTS_RFT_CLK periods
6. Read the ts_pend_raw bit in the CPTS_INTSTAT_RAW register to determine if another valid event is in the event FIFO. If it is asserted then goto step 3. Otherwise goto step 7.
7. Process the interrupt(s) as required by the application software

Software also has the option of disabling the interrupt and polling the ts_pend_raw bit of the CPTS_INTSTAT_RAW register to determine if a valid event is on the event FIFO.

14.3.8 MDIO

The MII Management I/F module implements the 802.3 serial management interface to interrogate and control two Ethernet PHYs simultaneously using a shared two-wire bus. Two user access registers to control and monitor up to two PHYs simultaneously.

14.3.8.1 MII Management Interface Frame Formats

The following tables show the read and write format of the 32-bit MII Management interface frames, respectively.

Table 14-21. MDIO Read Frame Format

Preamble	Start Delimiter	Operation Code	PHY Address	Register Address	Turnaround	Data
0xFFFF FFFF	01	10	AAAAA	RRRRR	Z0	DDDD.DDDD. DDDD.DDDD

Table 14-22. MDIO Write Frame Format

Preamble	Start Delimiter	Operation Code	PHY Address	Register Address	Turnaround	Data
0xFFFF FFFF	01	01	AAAAA	RRRRR	10	DDDD.DDDD. DDDD.DDDD

The default or idle state of the two wire serial interface is a logic one. All tri-state drivers should be disabled and the PHY's pull-up resistor will pull the **MDIO_DATA** line to a logic one. Prior to initiating any other transaction, the station management entity shall send a preamble sequence of 32 contiguous logic one bits on the **MDIO_DATA** line with 32 corresponding cycles on **MDIO_CLK** to provide the PHY with a pattern that it can use to establish synchronization. A PHY shall observe a sequence of 32 contiguous logic one bits on **MDIO_DATA** with 32 corresponding **MDIO_CLK** cycles before it responds to any other transaction.

Preamble

The start of a frame is indicated by a preamble, which consists of a sequence of 32 contiguous bits all of which are a “1”. This sequence provides the PHY a pattern to use to establish synchronization.

Start Delimiter

The preamble is followed by the start delimiter which is indicated by a “01” pattern. The pattern assures transitions from the default logic one state to zero and back to one.

Operation Code

The operation code for a read is “10”, while the operation code for a write is a “01”.

PHY Address

The PHY address is 5 bits allowing 32 unique values. The first bit transmitted is the MSB of the PHY address.

Register Address

The Register address is 5 bits allowing 32 registers to be addressed within each PHY. Refer to the 10/100 PHY address map for addresses of individual registers.

Turnaround

An idle bit time during which no device actively drives the MDIO_DATA signal shall be inserted between the register address field and the data field of a read frame in order to avoid contention. During a read frame, the PHY shall drive a zero bit onto MDIO_DATA for the first bit time following the idle bit and preceding the Data field. During a write frame, this field shall consist of a one bit followed by a zero bit.

Data

The Data field is 16 bits. The first bit transmitted and received is the MSB of the data word.

14.3.8.2 Functional Description

The MII Management I/F will remain idle until enabled by setting the enable bit in the MDIOControl register. The MII Management I/F will then continuously poll the link status from within the Generic Status Register of all possible 32 PHY addresses in turn recording the results in the MDIO link register.

The linksel bit in the MDIOUserPhySel register determines the status input that is used. A change in the link status of the two PHYs being monitored will set the appropriate bit in the MDIOLinkIntRaw register and the MDIOLinkIntMasked register, if enabled by the linkint_enable bit in the MDIOUserPhySel register.

The MDIO Alive register is updated by the MII Management I/F module if the PHY acknowledged the read of the generic status register. In addition, any PHY register read transactions initiated by the host also cause the MDIOAlive register to be updated.

At any time, the host can define a transaction for the MII Management interface module to undertake using the data, phyadr, regadr, and write fields in a MDIOUserAccess register. When the host sets the go bit in this register, the MII Management interface module will begin the transaction without any further intervention from the host. Upon completion, the MII Management interface will clear the go bit and set the userintraw bit in the MDIOUserIntRaw register corresponding to the MDIOUserAccess register being used.

The corresponding bit in the MDIOUserIntMasked register may also be set depending on the mask setting in the MDIOUserIntMaskSet and MDIOUserIntMaskClr registers. A round-robin arbitration scheme is used to schedule transactions which may be queued by the host in different MDIOUserAccess registers. The host should check the status of the go bit in the MDIOUserAccess register before initiating a new transaction to ensure that the previous transaction has completed. The host can use the ack bit in the MDIOUserAccess register to determine the status of a read transaction.

It is necessary for software to use the MII Management interface module to setup the auto-negotiation parameters of each PHY attached to a MAC port, retrieve the negotiation results, and setup the MACControl register in the corresponding MAC.

14.4 Software Operation

14.4.1 Transmit Operation

After reset the host must write zeroes to all Tx DMA State head descriptor pointers. The Tx port may then be enabled. To initiate packet transmission the host constructs transmit queues in memory (one or more packets for transmission) and then writes the appropriate Tx DMA state head descriptor pointers. For each buffer added to a transmit queue, the host must initialize the Tx buffer descriptor values as follows:

1. Write the Next Descriptor Pointer with the 32-bit aligned address of the next descriptor in the queue (zero if last descriptor).
2. Write the Buffer Pointer with the byte aligned address of the buffer data.
3. Write the Buffer Length with the number of bytes in the buffer.
4. Write the Buffer Offset with the number of bytes in the offset to the data (nonzero with SOP only).
5. Set the SOP, EOP, and Ownership bits as appropriate.
6. Clear the End Of Queue bit.

The port begins Tx packet transmission on a given channel when the host writes the channel's Tx queue head descriptor pointer with the address of the first buffer descriptor in the queue (nonzero value). Each channel may have one or more queues, so each channel may have one or more head descriptor pointers. The first buffer descriptor for each Tx packet must have the Start of Packet (SOP) bit and the Ownership bit set to one by the host. The last buffer descriptor for each Tx packet must have the End of Packet (EOP) bit set to one by the host.

The port will transmit packets until all queued packets have been transmitted and the queue(s) are empty. When each packet transmission is complete, the port will clear the Ownership bit in the packet's SOP buffer descriptor and issue an interrupt to the host by writing the packet's last buffer descriptor address to the queue's Tx DMA State Completion Pointer. The interrupt is generated by the write, regardless of the value written.

When the last packet in a queue has been transmitted, the port sets the End Of Queue bit in the EOP buffer descriptor, clears the Ownership bit in the SOP Descriptor, zeroes the appropriate DMA state head descriptor pointer, and then issues a Tx interrupt to the host by writing to the queue's associated Tx completion pointer (address of the last buffer descriptor processed by the port). The port issues a maskable level interrupt (which may then be routed through external interrupt control logic to the host).

On interrupt from the port, the host processes the buffer queue, detecting transmitted packets by the status of the Ownership bit in the SOP buffer descriptor. If the Ownership bit is cleared to zero, then the packet has been transmitted and the host may reclaim the buffers associated with the packet. The host continues queue processing until the end of the queue or until a SOP buffer descriptor is read that contains a set Ownership bit indicating that the packet transmission is not complete.

The host determines that all packets in the queue have been transmitted when the last packet in the queue has a cleared Ownership bit in the SOP buffer descriptor, the End of Queue bit is set in the last packet EOP buffer descriptor, and the Next Descriptor Pointer of the last packet EOP buffer descriptor is zero. The host acknowledges an interrupt by writing the address of the last buffer descriptor to the queue's associated Tx Completion Pointer in the Tx DMA State.

If the host written buffer address value is different from the buffer address written by the port, then the level interrupt remains asserted. If the host written buffer address value is equal to the port written value, then the level interrupt is deasserted. The port write to the completion pointer actually stores the value in the state register (ram). The host written value is actually not written to the register location. The host written value is compared to the register contents (which was written by the port) and if the two values are equal, the interrupt is removed, otherwise the interrupt remains asserted. The host may process multiple packets previous to acknowledging an interrupt, or the host may acknowledge interrupts for every packet.

A misqueued packet condition may occur when the host adds a packet to a queue for transmission as the port finishes transmitting the previous last packet in the queue. The misqueued packet is detected by the host when queue processing detects a cleared Ownership bit in the SOP buffer descriptor, a set End of Queue bit in the EOP buffer descriptor, and a nonzero Next Descriptor Pointer in the EOP buffer descriptor.

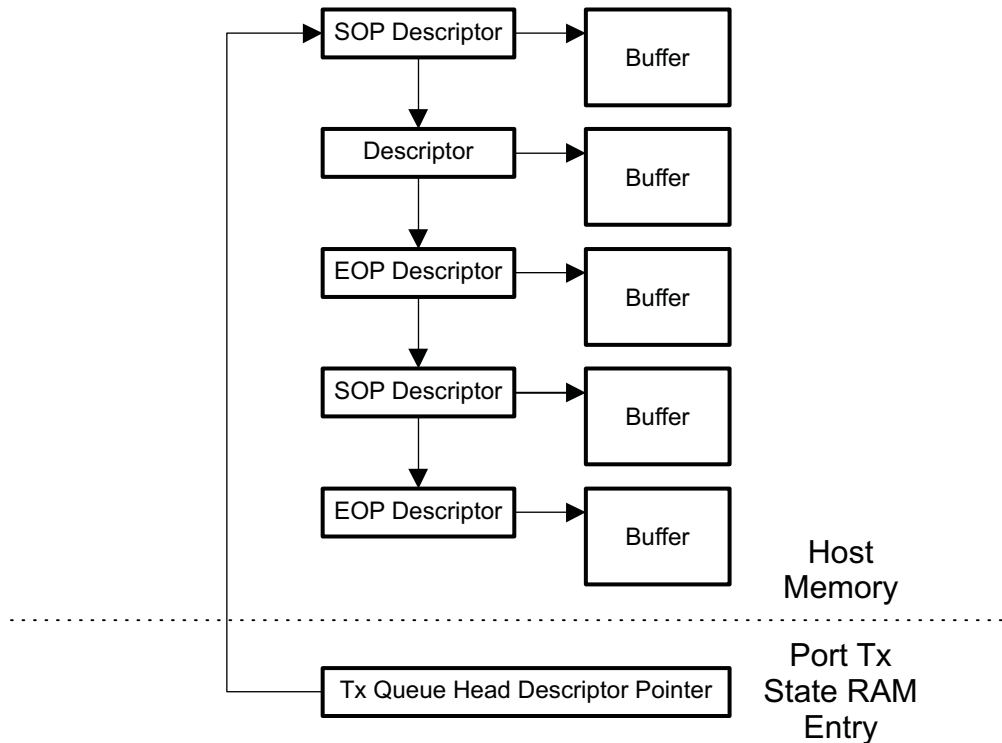
A misqueued packet means that the port read the last EOP buffer descriptor before the host added the new last packet to the queue, so the port determined queue empty just before the last packet was added. The host corrects the misqueued packet condition by initiating a new packet transfer for the misqueued packet by writing the misqueued packet's SOP buffer descriptor address to the appropriate DMA State Tx Queue head Descriptor Pointer.

The host may add packets to the tail end of an active Tx queue at any time by writing the Next Descriptor Pointer to the current last descriptor in the queue. If a Tx queue is empty (inactive), the host may initiate packet transmission at any time by writing the appropriate Tx DMA State head descriptor pointer.

The host software should always check for and reinitiate transmission for misqueued packets during queue processing on interrupt from the port. In order to preclude software underrun, the host should avoid adding buffers to an active queue for any Tx packet that is not complete and ready for transmission.

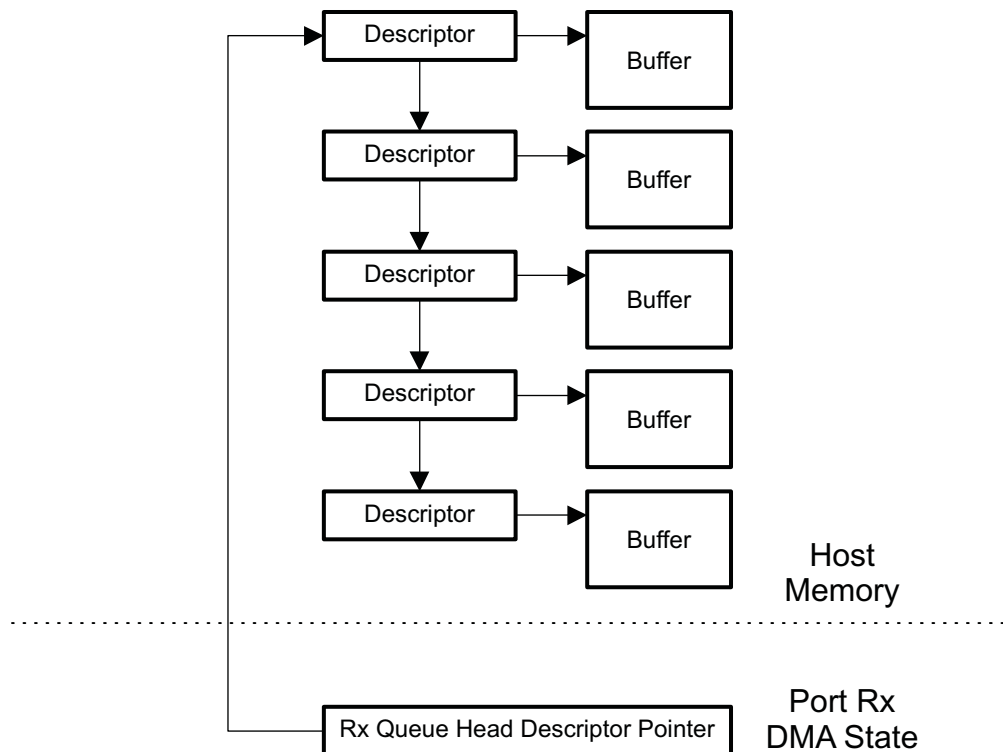
The port determines that a packet is the last packet in the queue by detecting the End of Packet bit set with a zero Next Descriptor Pointer in the packet buffer descriptor. If the End of Packet bit is set and the Next Descriptor Pointer is nonzero, then the queue still contains one or more packets to be transmitted. If the EOP bit is set with a zero Next Descriptor Pointer, then the port will set the EOQ bit in the packet's EOP buffer descriptor and then zero the appropriate head descriptor pointer previous to interrupting the port (by writing the completion pointer) when the packet transmission is complete.

Figure 14-13. Port TX State RAM Entry



14.4.2 Receive Operation

Figure 14-14. Port RX DMA State



After reset the host must write zeroes to all Rx DMA State head descriptor pointers. The Rx port may then be enabled. To initiate packet reception, the host constructs receive queues in memory and then writes the appropriate Rx DMA state head descriptor pointer. For each Rx buffer descriptor added to the queue, the host must initialize the Rx buffer descriptor values as follows:

- Write the Next Descriptor Pointer with the 32-bit aligned address of the next descriptor in the queue (zero if last descriptor)
- Write the Buffer Pointer with the byte aligned address of the buffer data
- Clear the Offset field
- Write the Buffer Length with the number of bytes in the buffer
- Clear the SOP, EOP, and EOQ bits
- Set the Ownership bit

The host enables packet reception on a given channel by writing the address of the first buffer descriptor in the queue (nonzero value) to the channel's head descriptor pointer in the channel's Rx DMA state. When packet reception begins on a given channel, the port fills each Rx buffer with data in order starting with the first buffer and proceeding through the Rx queue. If the Buffer Offset in the Rx DMA State is nonzero, then the port will begin writing data after the offset number of bytes in the SOP buffer. The port performs the following operations at the end of each packet reception:

- Overwrite the buffer length in the packet's EOP buffer descriptor with the number of bytes actually received in the packet's last buffer. The host initialized value is the buffer size. The overwritten value will be less than or equal to the host initialized value.
- Set the EOP bit in the packet's EOP buffer descriptor.
- Set the EOQ bit in the packet's EOP buffer descriptor if the current packet is the last packet in the queue.
- Overwrite the packet's SOP buffer descriptor Buffer Offset with the Rx DMA state value (the host initialized the buffer descriptor Buffer Offset value to zero). All non SOP buffer descriptors must have a zero Buffer Offset initialized by the host.

- Overwrite the packet's SOP buffer descriptor buffer length with the number of valid data bytes in the buffer. If the buffer is filled up, the buffer length will be the buffer size minus buffer offset.
- Set the SOP bit in the packet's SOP buffer descriptor.
- Write the SOP buffer descriptor Packet Length field.
- Clear the Ownership bit in the packet's SOP buffer descriptor.
- Issue an Rx host interrupt by writing the address of the packet's last buffer descriptor to the queue's Rx DMA State Completion Pointer. The interrupt is generated by the write to the Rx DMA State Completion Pointer address location, regardless of the value written.

On interrupt the host processes the Rx buffer queue detecting received packets by the status of the Ownership bit in each packet's SOP buffer descriptor. If the Ownership bit is cleared then the packet has been completely received and is available to be processed by the host.

The host may continue Rx queue processing until the end of the queue or until a buffer descriptor is read that contains a set Ownership bit indicating that the next packet's reception is not complete. The host determines that the Rx queue is empty when the last packet in the queue has a cleared Ownership bit in the SOP buffer descriptor, a set End of Queue bit in the EOP buffer descriptor, and the Next Descriptor Pointer in the EOP buffer descriptor is zero.

A misqueued buffer may occur when the host adds buffers to a queue as the port finishes the reception of the previous last packet in the queue. The misqueued buffer is detected by the host when queue processing detects a cleared Ownership bit in the SOP buffer descriptor, a set End of Queue bit in the EOP buffer descriptor, and a nonzero Next Descriptor Pointer in the EOP buffer descriptor.

A misqueued buffer means that the port read the last EOP buffer descriptor before the host added buffer descriptor(s) to the queue, so the port determined queue empty just before the host added more buffer descriptor(s). In the transmit case, the packet transmission is delayed by the time required for the host to determine the condition and reinitiate the transaction, but the packet is not actually lost. In the receive case, receive overrun condition may occur in the misqueued buffer case.

If a new packet reception is begun during the time that the port has determined the end of queue condition, then the received packet will overrun (start of packet overrun). If the misqueued buffer occurs during the middle of a packet reception then middle of packet overrun may occur. If the misqueued buffer occurs after the last packet has completed, and is corrected before the next packet reception begins, then overrun will not occur. The host acts on the misqueued buffer condition by writing the added buffer descriptor address to the appropriate Rx DMA State Head Descriptor Pointer.

14.4.3 *Initializing the MDIO Module*

The following steps are performed by the application software or device driver to initialize the MDIO device:

1. Configure the PREAMBLE and CLKDIV bits in the MDIO control register (MDIOCONTROL).
 2. Enable the MDIO module by setting the ENABLE bit in MDIOCONTROL.
 3. The MDIO PHY alive status register (MDIOALIVE) can be read in polling fashion until a PHY connected to the system responded, and the MDIO PHY link status register (MDIOLINK) can determine whether this PHY already has a link.
 4. Setup the appropriate PHY addresses in the MDIO user PHY select register (MDIOUSERPHYSEL n), and set the LINKINTENB bit to enable a link change event interrupt if desirable.
- If an interrupt on general MDIO register access is desired, set the corresponding bit in the MDIO user command complete interrupt mask set register (MDIOUSERINTMASKSET) to use the MDIO user access register (MDIOUSERACCESS n). Since only one PHY is used in this device, the application software can use one MDIOUSERACCESS n to trigger a completion interrupt; the other MDIOUSERACCESS n is not setup.

14.4.4 *Writing Data to a PHY Register*

The MDIO module includes a user access register (MDIOUSERACCESS n) to directly access a specified PHY device. To write a PHY register, perform the following:

1. Ensure the GO bit in the MDIO user access register (MDIOUSERACCESS n) is cleared.

2. Write to the GO, WRITE, REGADR, PHYADR, and DATA bits in MDIOUSERACCESS n corresponding to the PHY and PHY register you want to write.
3. The write operation to the PHY is scheduled and completed by the MDIO module. Completion of the write operation can be determined by polling the GO bit in MDIOUSERACCESS n for a 0.
4. Completion of the operation sets the corresponding USERINTRAW bit (0 or 1) in the MDIO user command complete interrupt register (MDIOUSERINTRAW) corresponding to USERACCESS n used. If interrupts have been enabled on this bit using the MDIO user command complete interrupt mask set register (MDIOUSERINTMASKSET), then the bit is also set in the MDIO user command complete interrupt register (MDIOUSERINTMASKED) and an interrupt is triggered on the CPU.

14.4.5 Reading Data from a PHY Register

The MDIO module includes a user access register (MDIOUSERACCESS n) to directly access a specified PHY device. To read a PHY register, perform the following:

1. Ensure the GO bit in the MDIO user access register (MDIOUSERACCESS n) is cleared.
2. Write to the GO, REGADR, and PHYADR bits in MDIOUSERACCESS n corresponding to the PHY and PHY register you want to read.
3. The read data value is available in the DATA bits in MDIOUSERACCESS n after the module completes the read operation on the serial bus. Completion of the read operation can be determined by polling the GO and ACK bits in MDIOUSERACCESS n . After the GO bit has cleared, the ACK bit is set on a successful read.
4. Completion of the operation sets the corresponding USERINTRAW bit (0 or 1) in the MDIO user command complete interrupt register (MDIOUSERINTRAW) corresponding to USERACCESS n used. If interrupts have been enabled on this bit using the MDIO user command complete interrupt mask set register (MDIOUSERINTMASKSET), then the bit is also set in the MDIO user command complete interrupt register (MDIOUSERINTMASKED) and an interrupt is triggered on the CPU.

14.4.6 Initialization and Configuration of CPSW

To configure the 3PSW Ethernet Subsystem for operation the host must perform the following:

- Select the Interface (GMII/RGMII/MII) Mode in the Control Module.
- Configure pads (PIN muxing) as per the Interface Selected using the appropriate pin muxing conf_XXX registers in the Control Module.
- Enable the 3PSW Ethernet Subsystem Clocks. See [Section 14.2.2](#) and [Section 8.1](#) to enable the appropriate clocks.
- Configure the PRCM registers CM_PER_CPSW_CLKSTCTRL and CM_PER_CPGMAC0_CLKCTRL to enable power and clocks to the 3PSW Ethernet Subsystem. See [Section 8.1](#) for register details.
- Apply soft reset to 3PSW Subsystem, CPSW_3G, CPGMAC_SL1/2, and CPDMA (see the soft reset registers in the following sections).
- Initialize the HDPs (Header Description Pointer) and CPs (Completion Pointer) to NULL
- Configure the Interrupts (see [Chapter 6](#)).
- Configure the CPSW_3G Control register.
- Configure the Statistics Port Enable register
- Configure the ALE. (See [Section 14.3.2.7](#).)
- Configure the MDIO.
- Configure the CPDMA receive DMA controller.
- Configure the CPDMA transmit DMA controller.
- Configure the CPPI Tx and Rx Descriptors.
- Configure CPGMAC_SL1 and CPGMAC_SL2 as per the desired mode of operations.
- Start up RX and TX DMA (write to HDP of Rx and Tx).
- Wait for the completion of the transfer (HDP cleared to zero).

14.5 Ethernet Subsystem Registers

14.5.1 CPSW_ALE Registers

Table 14-23 lists the memory-mapped registers for the CPSW_ALE. All register offset addresses not listed in Table 14-23 should be considered as reserved locations and the register contents should not be modified.

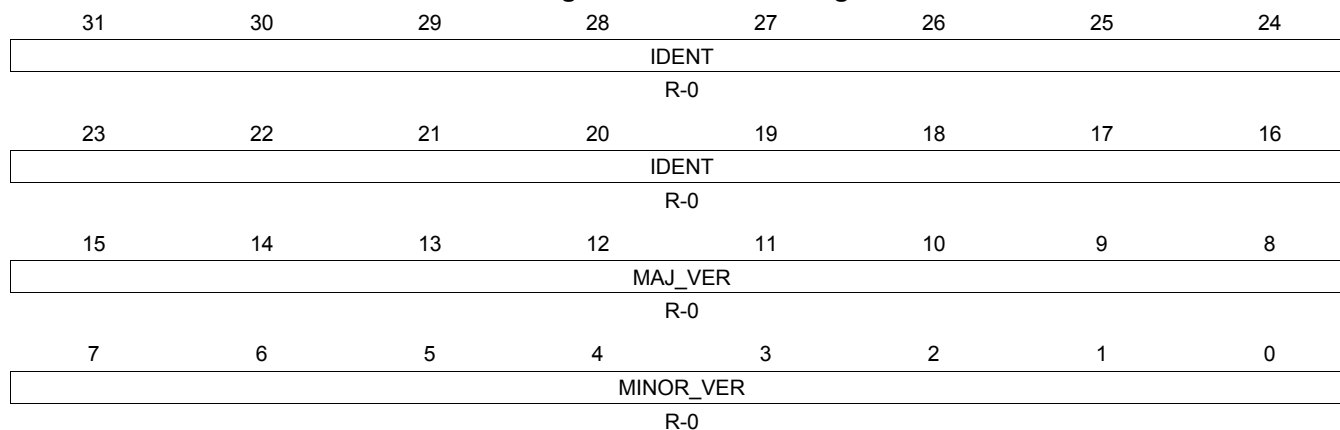
Table 14-23. CPSW_ALE REGISTERS

Offset	Acronym	Register Name	Section
0h	IDVER	ADDRESS LOOKUP ENGINE ID/VERSION REGISTER	Section 14.5.1.1
8h	CONTROL	ADDRESS LOOKUP ENGINE CONTROL REGISTER	Section 14.5.1.2
10h	PRESCALE	ADDRESS LOOKUP ENGINE PRESCALE REGISTER	Section 14.5.1.3
18h	UNKNOWN_VLAN	ADDRESS LOOKUP ENGINE UNKNOWN VLAN REGISTER	Section 14.5.1.4
20h	TBLCTL	ADDRESS LOOKUP ENGINE TABLE CONTROL	Section 14.5.1.5
34h	TBLW2	ADDRESS LOOKUP ENGINE TABLE WORD 2 REGISTER	Section 14.5.1.6
38h	TBLW1	ADDRESS LOOKUP ENGINE TABLE WORD 1 REGISTER	Section 14.5.1.7
3Ch	TBLW0	ADDRESS LOOKUP ENGINE TABLE WORD 0 REGISTER	Section 14.5.1.8
40h	PORTCTL0	ADDRESS LOOKUP ENGINE PORT 0 CONTROL REGISTER	Section 14.5.1.9
44h	PORTCTL1	ADDRESS LOOKUP ENGINE PORT 1 CONTROL REGISTER	Section 14.5.1.10
48h	PORTCTL2	ADDRESS LOOKUP ENGINE PORT 2 CONTROL REGISTER	Section 14.5.1.11
4Ch	PORTCTL3	ADDRESS LOOKUP ENGINE PORT 3 CONTROL REGISTER	Section 14.5.1.12
50h	PORTCTL4	ADDRESS LOOKUP ENGINE PORT 4 CONTROL REGISTER	Section 14.5.1.13
54h	PORTCTL5	ADDRESS LOOKUP ENGINE PORT 5 CONTROL REGISTER	Section 14.5.1.14

14.5.1.1 IDVER Register (offset = 0h) [reset = 290104h]

IDVER is shown in [Figure 14-15](#) and described in [Table 14-24](#).

ADDRESS LOOKUP ENGINE ID/VERSION REGISTER

Figure 14-15. IDVER Register


LEGEND: R/W = Read/Write; R = Read only; W1toCl = Write 1 to clear bit; -n = value after reset

Table 14-24. IDVER Register Field Descriptions

Bit	Field	Type	Reset	Description
31-16	IDENT	R-0	0	ALE Identification Value
15-8	MAJ_VER	R-0	0	ALE Major Version Value
7-0	MINOR_VER	R-0	0	ALE Minor Version Value

14.5.1.2 CONTROL Register (offset = 8h) [reset = 0h]

CONTROL is shown in [Figure 14-16](#) and described in [Table 14-25](#).

ADDRESS LOOKUP ENGINE CONTROL REGISTER

Figure 14-16. CONTROL Register

31	30	29	28	27	26	25	24
ENABLE_ALE	CLEAR_TABLE	AGE_OUT_NOW	Reserved				
R/W-0	R/W-0	R/W-0					
23	22	21	20	19	18	17	16
Reserved							
15	14	13	12	11	10	9	8
Reserved							EN_P0_UNI_FLOOD
							R/W-0
7	6	5	4	3	2	1	0
LEARN_NO_VID	EN_VID0_MODE	ENABLE_OUI_DENY	BYPASS	RATE_LIMIT_TX	VLAN_AWARE	ENABLE_AUTOH_MODE	ENABLE_RATE_LIMIT
R/W-0	R/W-0	R/W-0	R/W-0	R/W-0	R/W-0	R/W-0	R/W-0

LEGEND: R/W = Read/Write; R = Read only; W1toCl = Write 1 to clear bit; -n = value after reset

Table 14-25. CONTROL Register Field Descriptions

Bit	Field	Type	Reset	Description
31	ENABLE_ALE	R/W-0	0	Enable ALE - 0 - Drop all packets 1 - Enable ALE packet processing
30	CLEAR_TABLE	R/W-0	0	Clear ALE address table - Setting this bit causes the ALE hardware to write all table bit values to zero. Software must perform a clear table operation as part of the ALE setup/configuration process. Setting this bit causes all ALE accesses to be held up for 64 clocks while the clear is performed. Access to all ALE registers will be blocked (wait states) until the 64 clocks have completed. This bit cannot be read as one because the read is blocked until the clear table is completed at which time this bit is cleared to zero.
29	AGE_OUT_NOW	R/W-0	0	Age Out Address Table Now - Setting this bit causes the ALE hardware to remove (free up) any ageable table entry that does not have a set touch bit. This bit is cleared when the age out process has completed. This bit may be read. The age out process takes 4096 clocks best case (no ale packet processing during ageout) and 66550 clocks absolute worst case.
8	EN_P0_UNI_FLOOD	R/W-0	0	Enable Port 0 (Host Port) unicast flood 0 - do not flood unknown unicast packets to host port (p0) 1 - flood unknown unicast packets to host port (p0)
7	LEARN_NO_VID	R/W-0	0	Learn No VID - 0 - VID is learned with the source address 1 - VID is not learned with the source address (source address is not tied to VID).
6	EN_VID0_MODE	R/W-0	0	Enable VLAN ID = 0 Mode 0 - Process the packet with VID = PORT_VLAN[11:0]. 1 - Process the packet with VID = 0.
5	ENABLE_OUI_DENY	R/W-0	0	Enable OUI Deny Mode - When set this bit indicates that a packet with a non OUI table entry matching source address will be dropped to the host unless the destination address matches a multicast table entry with the super bit set.

Table 14-25. CONTROL Register Field Descriptions (continued)

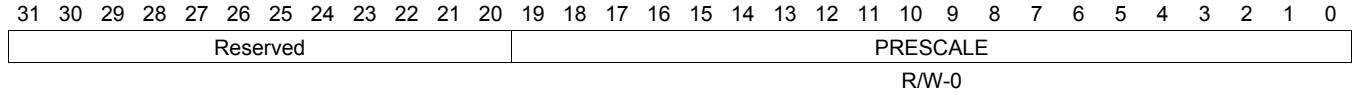
Bit	Field	Type	Reset	Description
4	BYPASS	R/W-0	0	ALE Bypass - When set, all packets received on ports 0 and 1 are sent to the host (only to the host).
3	RATE_LIMIT_TX	R/W-0	0	Rate Limit Transmit mode - 0 - Broadcast and multicast rate limit counters are received port based 1 - Broadcast and multicast rate limit counters are transmit port based.
2	VLAN_AWARE	R/W-0	0	ALE VLAN Aware - Determines what is done if VLAN not found. 0 - Flood if VLAN not found 1 - Drop packet if VLAN not found
1	ENABLE_AUTH_MODE	R/W-0	0	Enable MAC Authorization Mode - Mac authorization mode requires that all table entries be made by the host software. There are no learned address in authorization mode and the packet will be dropped if the source address is not found (and the destination address is not a multicast address with the super table entry bit set). 0 - The ALE is not in MAC authorization mode 1 - The ALE is in MAC authorization mode
0	ENABLE_RATE_LIMIT	R/W-0	0	Enable Broadcast and Multicast Rate Limit 0 - Broadcast/Multicast rates not limited 1 - Broadcast/Multicast packet reception limited to the port control register rate limit fields.

14.5.1.3 PRESCALE Register (offset = 10h) [reset = 0h]

PRESCALE is shown in [Figure 14-17](#) and described in [Table 14-26](#).

ADDRESS LOOKUP ENGINE PRESCALE REGISTER

Figure 14-17. PRESCALE Register



LEGEND: R/W = Read/Write; R = Read only; W1toCl = Write 1 to clear bit; -n = value after reset

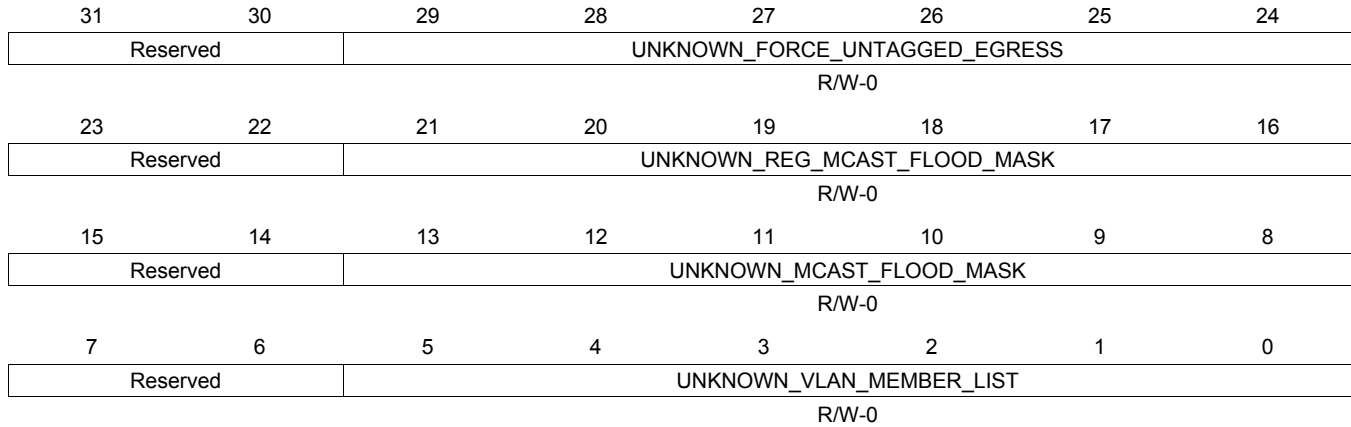
Table 14-26. PRESCALE Register Field Descriptions

Bit	Field	Type	Reset	Description
19-0	PRESCALE	R/W-0	0	ALE Prescale Register - The input clock is divided by this value for use in the multicast/broadcast rate limiters. The minimum operating value is 0x10. The prescaler is off when the value is zero.

14.5.1.4 UNKNOWN_VLAN Register (offset = 18h) [reset = 0h]

 UNKNOWN_VLAN is shown in [Figure 14-18](#) and described in [Table 14-27](#).

ADDRESS LOOKUP ENGINE UNKNOWN VLAN REGISTER

Figure 14-18. UNKNOWN_VLAN Register


LEGEND: R/W = Read/Write; R = Read only; W1toCl = Write 1 to clear bit; -n = value after reset

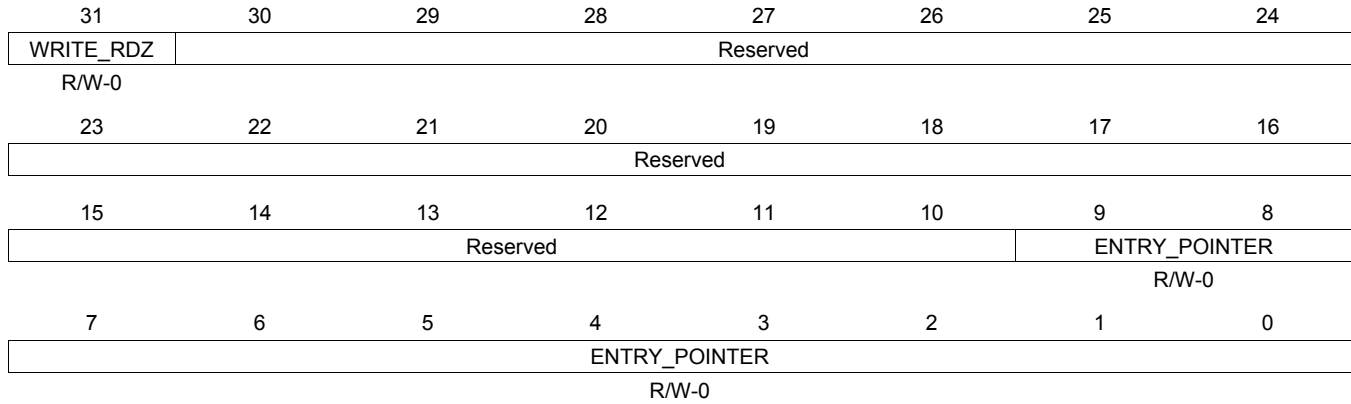
Table 14-27. UNKNOWN_VLAN Register Field Descriptions

Bit	Field	Type	Reset	Description
29-24	UNKNOWN_FORCE_UNTAGGED_EGRESS	R/W-0	0	Unknown VLAN Force Untagged Egress.
21-16	UNKNOWN_REG_MCAST_FLOOD_MASK	R/W-0	0	Unknown VLAN Registered Multicast Flood Mask
13-8	UNKNOWN_MCAST_FLOOD_MASK	R/W-0	0	Unknown VLAN Multicast Flood Mask
5-0	UNKNOWN_VLAN_MEMBER_LIST	R/W-0	0	Unknown VLAN Member List

14.5.1.5 TBLCTL Register (offset = 20h) [reset = 0h]

TBLCTL is shown in [Figure 14-19](#) and described in [Table 14-28](#).

ADDRESS LOOKUP ENGINE TABLE CONTROL

Figure 14-19. TBLCTL Register


LEGEND: R/W = Read/Write; R = Read only; W1toCl = Write 1 to clear bit; -n = value after reset

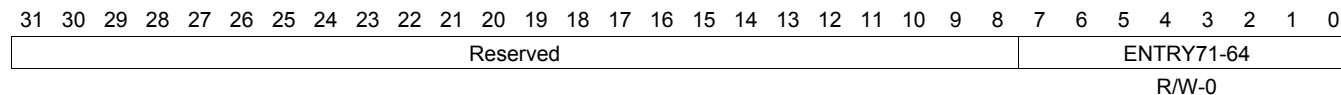
Table 14-28. TBLCTL Register Field Descriptions

Bit	Field	Type	Reset	Description
31	WRITE_RDZ	R/W-0	0	Write Bit - This bit is always read as zero. Writing a 1 to this bit causes the three table word register values to be written to the entry_pointer location in the address table. Writing a 0 to this bit causes the three table word register values to be loaded from the entry_pointer location in the address table so that they may be subsequently read. A read of any ALE address location will be stalled until the read or write has completed.
9-0	ENTRY_POINTER	R/W-0	0	Table Entry Pointer - The entry_pointer contains the table entry value that will be read/written with accesses to the table word registers.

14.5.1.6 TBLW2 Register (offset = 34h) [reset = 0h]

TBLW2 is shown in [Figure 14-20](#) and described in [Table 14-29](#).

ADDRESS LOOKUP ENGINE TABLE WORD 2 REGISTER

Figure 14-20. TBLW2 Register


LEGEND: R/W = Read/Write; R = Read only; W1toCl = Write 1 to clear bit; -n = value after reset

Table 14-29. TBLW2 Register Field Descriptions

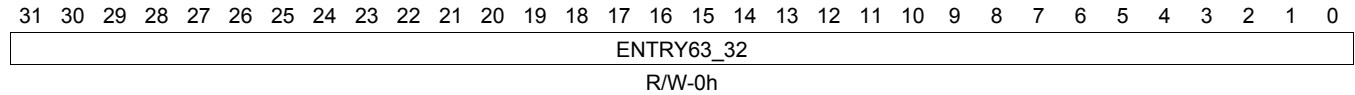
Bit	Field	Type	Reset	Description
7-0	ENTRY71-64	R/W-0	0	Table entry bits 71:64

14.5.1.7 TBLW1 Register (offset = 38h) [reset = 0h]

TBLW1 is shown in [Figure 14-21](#) and described in [Table 14-30](#).

ADDRESS LOOKUP ENGINE TABLE WORD 1 REGISTER

Figure 14-21. TBLW1 Register



LEGEND: R/W = Read/Write; R = Read only; W1toCl = Write 1 to clear bit; -n = value after reset

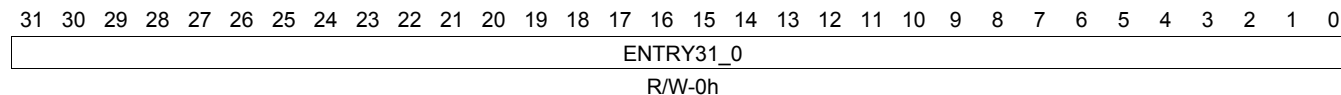
Table 14-30. TBLW1 Register Field Descriptions

Bit	Field	Type	Reset	Description
31-0	ENTRY63_32	R/W	0h	Table entry bits 63:32

14.5.1.8 TBLW0 Register (offset = 3Ch) [reset = 0h]

TBLW0 is shown in [Figure 14-22](#) and described in [Table 14-31](#).

ADDRESS LOOKUP ENGINE TABLE WORD 0 REGISTER

Figure 14-22. TBLW0 Register


LEGEND: R/W = Read/Write; R = Read only; W1toCl = Write 1 to clear bit; -n = value after reset

Table 14-31. TBLW0 Register Field Descriptions

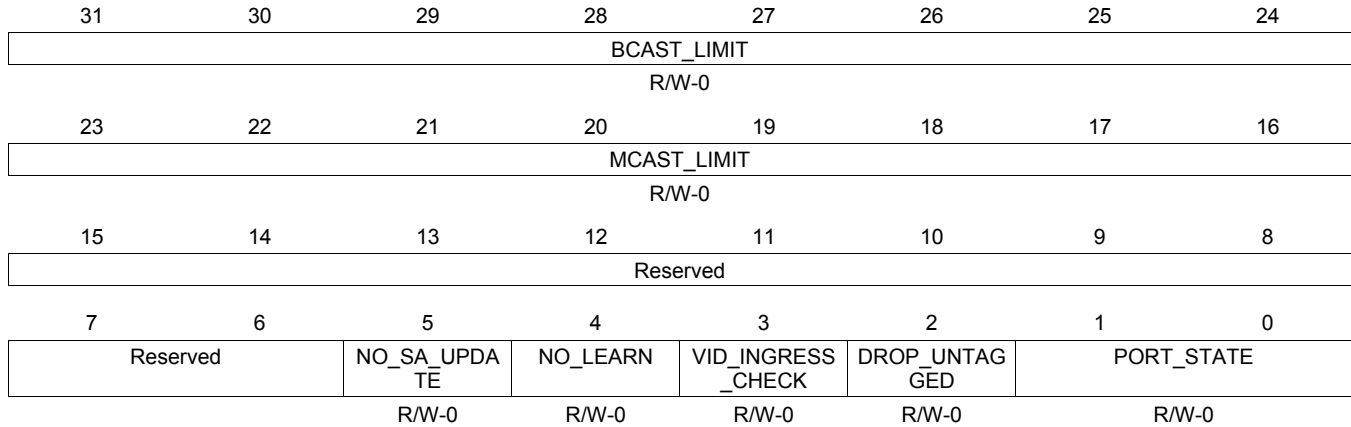
Bit	Field	Type	Reset	Description
31-0	ENTRY31_0	R/W	0h	Table entry bits 31:0

14.5.1.9 PORTCTL0 Register (offset = 40h) [reset = 0h]

PORTCTL0 is shown in [Figure 14-23](#) and described in [Table 14-32](#).

ADDRESS LOOKUP ENGINE PORT 0 CONTROL REGISTER

Figure 14-23. PORTCTL0 Register



LEGEND: R/W = Read/Write; R = Read only; W1toCl = Write 1 to clear bit; -n = value after reset

Table 14-32. PORTCTL0 Register Field Descriptions

Bit	Field	Type	Reset	Description
31-24	BCAST_LIMIT	R/W-0	0	Broadcast Packet Rate Limit - Each prescale pulse loads this field into the port broadcast rate limit counter. The port counters are decremented with each packet received or transmitted depending on whether the mode is transmit or receive. If the counters decrement to zero, then further packets are rate limited until the next prescale pulse. Broadcast rate limiting is enabled by a non-zero value in this field.
23-16	MCAST_LIMIT	R/W-0	0	Multicast Packet Rate Limit - Each prescale pulse loads this field into the port multicast rate limit counter. The port counters are decremented with each packet received or transmitted depending on whether the mode is transmit or receive. If the counters decrement to zero, then further packets are rate limited until the next prescale pulse. Multicast rate limiting is enabled by a non-zero value in this field.
5	NO_SA_UPDATE	R/W-0	0	No Source Address Update - When set the port is disabled from updating the source port number in an ALE table entry.
4	NO_LEARN	R/W-0	0	No Learn Mode - When set the port is disabled from learning an address.
3	VID_INGRESS_CHECK	R/W-0	0	VLAN ID Ingress Check - If VLAN not found then drop the packet. Packets with an unknown (default) VLAN will be dropped.
2	DROP_UNTAGGED	R/W-0	0	Drop Untagged Packets - Drop non-VLAN tagged ingress packets.
1-0	PORT_STATE	R/W-0	0	Port State 0 - Disabled 1 - Blocked 2 - Learn 3 - Forward

14.5.1.10 PORTCTL1 Register (offset = 44h) [reset = 0h]

 PORTCTL1 is shown in [Figure 14-24](#) and described in [Table 14-33](#).

ADDRESS LOOKUP ENGINE PORT 1 CONTROL REGISTER

Figure 14-24. PORTCTL1 Register

31	30	29	28	27	26	25	24
BCAST_LIMIT							
R/W-0							
23	22	21	20	19	18	17	16
MCAST_LIMIT							
R/W-0							
15	14	13	12	11	10	9	8
Reserved							
7	6	5	4	3	2	1	0
Reserved		NO_SA_UPDATE	NO_LEARN	VID_INGRESS_CHECK	DROP_UNTAGGED	PORT_STATE	
		R/W-0	R/W-0	R/W-0	R/W-0	R/W-0	

LEGEND: R/W = Read/Write; R = Read only; W1toCl = Write 1 to clear bit; -n = value after reset

Table 14-33. PORTCTL1 Register Field Descriptions

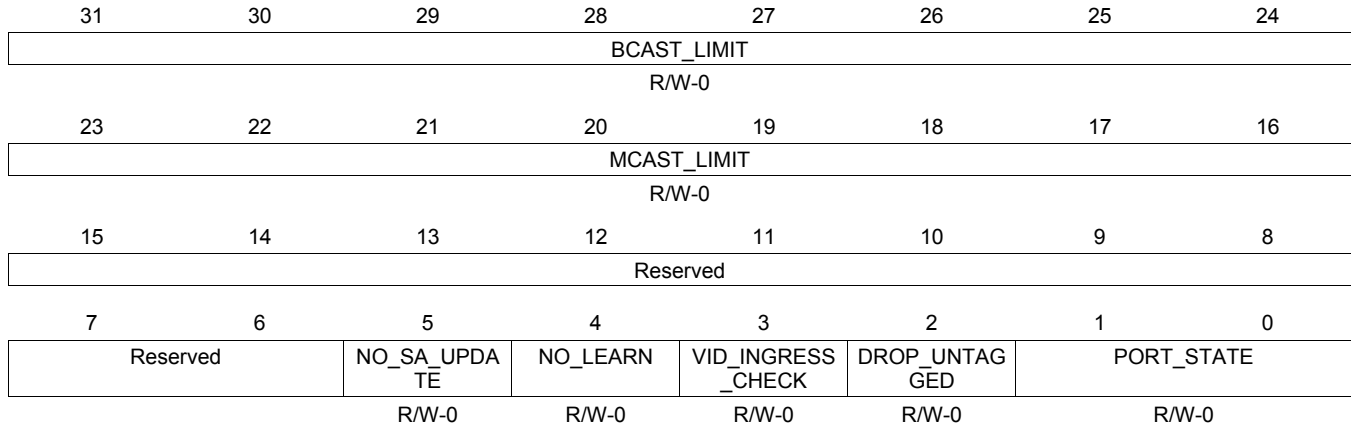
Bit	Field	Type	Reset	Description
31-24	BCAST_LIMIT	R/W-0	0	Broadcast Packet Rate Limit - Each prescale pulse loads this field into the port broadcast rate limit counter. The port counters are decremented with each packet received or transmitted depending on whether the mode is transmit or receive. If the counters decrement to zero, then further packets are rate limited until the next prescale pulse. Broadcast rate limiting is enabled by a non-zero value in this field.
23-16	MCAST_LIMIT	R/W-0	0	Multicast Packet Rate Limit - Each prescale pulse loads this field into the port multicast rate limit counter. The port counters are decremented with each packet received or transmitted depending on whether the mode is transmit or receive. If the counters decrement to zero, then further packets are rate limited until the next prescale pulse. Multicast rate limiting is enabled by a non-zero value in this field.
5	NO_SA_UPDATE	R/W-0	0	No Source Address Update - When set the port is disabled from updating the source port number in an ALE table entry.
4	NO_LEARN	R/W-0	0	No Learn Mode - When set the port is disabled from learning an address.
3	VID_INGRESS_CHECK	R/W-0	0	VLAN ID Ingress Check - If VLAN not found then drop the packet. Packets with an unknown (default) VLAN will be dropped.
2	DROP_UNTAGGED	R/W-0	0	Drop Untagged Packets - Drop non-VLAN tagged ingress packets.
1-0	PORT_STATE	R/W-0	0	Port State 0 - Disabled 1 - Blocked 2 - Learn 3 - Forward

14.5.1.11 PORTCTL2 Register (offset = 48h) [reset = 0h]

PORTCTL2 is shown in [Figure 14-25](#) and described in [Table 14-34](#).

ADDRESS LOOKUP ENGINE PORT 2 CONTROL REGISTER

Figure 14-25. PORTCTL2 Register



LEGEND: R/W = Read/Write; R = Read only; W1toCl = Write 1 to clear bit; -n = value after reset

Table 14-34. PORTCTL2 Register Field Descriptions

Bit	Field	Type	Reset	Description
31-24	BCAST_LIMIT	R/W-0	0	Broadcast Packet Rate Limit - Each prescale pulse loads this field into the port broadcast rate limit counter. The port counters are decremented with each packet received or transmitted depending on whether the mode is transmit or receive. If the counters decrement to zero, then further packets are rate limited until the next prescale pulse. Broadcast rate limiting is enabled by a non-zero value in this field.
23-16	MCAST_LIMIT	R/W-0	0	Multicast Packet Rate Limit - Each prescale pulse loads this field into the port multicast rate limit counter. The port counters are decremented with each packet received or transmitted depending on whether the mode is transmit or receive. If the counters decrement to zero, then further packets are rate limited until the next prescale pulse. Multicast rate limiting is enabled by a non-zero value in this field.
5	NO_SA_UPDATE	R/W-0	0	No Source Address Update - When set the port is disabled from updating the source port number in an ALE table entry.
4	NO_LEARN	R/W-0	0	No Learn Mode - When set the port is disabled from learning an address.
3	VID_INGRESS_CHECK	R/W-0	0	VLAN ID Ingress Check - If VLAN not found then drop the packet. Packets with an unknown (default) VLAN will be dropped.
2	DROP_UNTAGGED	R/W-0	0	Drop Untagged Packets - Drop non-VLAN tagged ingress packets.
1-0	PORT_STATE	R/W-0	0	Port State 0 - Disabled 1 - Blocked 2 - Learn 3 - Forward

14.5.1.12 PORTCTL3 Register (offset = 4Ch) [reset = 0h]

 PORTCTL3 is shown in [Figure 14-26](#) and described in [Table 14-35](#).

ADDRESS LOOKUP ENGINE PORT 3 CONTROL REGISTER

Figure 14-26. PORTCTL3 Register

31	30	29	28	27	26	25	24
BCAST_LIMIT							
R/W-0							
23	22	21	20	19	18	17	16
MCAST_LIMIT							
R/W-0							
15	14	13	12	11	10	9	8
Reserved							
7	6	5	4	3	2	1	0
Reserved		NO_SA_UPDATE	NO_LEARN	VID_INGRESS_CHECK	DROP_UNTAGGED	PORT_STATE	
		R/W-0	R/W-0	R/W-0	R/W-0	R/W-0	

LEGEND: R/W = Read/Write; R = Read only; W1toCl = Write 1 to clear bit; -n = value after reset

Table 14-35. PORTCTL3 Register Field Descriptions

Bit	Field	Type	Reset	Description
31-24	BCAST_LIMIT	R/W-0	0	Broadcast Packet Rate Limit - Each prescale pulse loads this field into the port broadcast rate limit counter. The port counters are decremented with each packet received or transmitted depending on whether the mode is transmit or receive. If the counters decrement to zero, then further packets are rate limited until the next prescale pulse. Broadcast rate limiting is enabled by a non-zero value in this field.
23-16	MCAST_LIMIT	R/W-0	0	Multicast Packet Rate Limit - Each prescale pulse loads this field into the port multicast rate limit counter. The port counters are decremented with each packet received or transmitted depending on whether the mode is transmit or receive. If the counters decrement to zero, then further packets are rate limited until the next prescale pulse. Multicast rate limiting is enabled by a non-zero value in this field.
5	NO_SA_UPDATE	R/W-0	0	No Source Address Update - When set the port is disabled from updating the source port number in an ALE table entry.
4	NO_LEARN	R/W-0	0	No Learn Mode - When set the port is disabled from learning an address.
3	VID_INGRESS_CHECK	R/W-0	0	VLAN ID Ingress Check - If VLAN not found then drop the packet. Packets with an unknown (default) VLAN will be dropped.
2	DROP_UNTAGGED	R/W-0	0	Drop Untagged Packets - Drop non-VLAN tagged ingress packets.
1-0	PORT_STATE	R/W-0	0	Port State 0 - Disabled 1 - Blocked 2 - Learn 3 - Forward

14.5.1.13 PORTCTL4 Register (offset = 50h) [reset = 0h]

PORTCTL4 is shown in [Figure 14-27](#) and described in [Table 14-36](#).

ADDRESS LOOKUP ENGINE PORT 4 CONTROL REGISTER

Figure 14-27. PORTCTL4 Register

31	30	29	28	27	26	25	24
BCAST_LIMIT							
R/W-0							
23	22	21	20	19	18	17	16
MCAST_LIMIT							
R/W-0							
15	14	13	12	11	10	9	8
Reserved							
7	6	5	4	3	2	1	0
Reserved		NO_SA_UPDATE	NO_LEARN	VID_INGRESS_CHECK	DROP_UNTAGGED	PORT_STATE	
		R/W-0	R/W-0	R/W-0	R/W-0	R/W-0	

LEGEND: R/W = Read/Write; R = Read only; W1toCl = Write 1 to clear bit; -n = value after reset

Table 14-36. PORTCTL4 Register Field Descriptions

Bit	Field	Type	Reset	Description
31-24	BCAST_LIMIT	R/W-0	0	Broadcast Packet Rate Limit - Each prescale pulse loads this field into the port broadcast rate limit counter. The port counters are decremented with each packet received or transmitted depending on whether the mode is transmit or receive. If the counters decrement to zero, then further packets are rate limited until the next prescale pulse. Broadcast rate limiting is enabled by a non-zero value in this field.
23-16	MCAST_LIMIT	R/W-0	0	Multicast Packet Rate Limit - Each prescale pulse loads this field into the port multicast rate limit counter. The port counters are decremented with each packet received or transmitted depending on whether the mode is transmit or receive. If the counters decrement to zero, then further packets are rate limited until the next prescale pulse. Multicast rate limiting is enabled by a non-zero value in this field.
5	NO_SA_UPDATE	R/W-0	0	No Source Address Update - When set the port is disabled from updating the source port number in an ALE table entry.
4	NO_LEARN	R/W-0	0	No Learn Mode - When set the port is disabled from learning an address.
3	VID_INGRESS_CHECK	R/W-0	0	VLAN ID Ingress Check - If VLAN not found then drop the packet. Packets with an unknown (default) VLAN will be dropped.
2	DROP_UNTAGGED	R/W-0	0	Drop Untagged Packets - Drop non-VLAN tagged ingress packets.
1-0	PORT_STATE	R/W-0	0	Port State 0 - Disabled 1 - Blocked 2 - Learn 3 - Forward

14.5.1.14 PORTCTL5 Register (offset = 54h) [reset = 0h]

 PORTCTL5 is shown in [Figure 14-28](#) and described in [Table 14-37](#).

ADDRESS LOOKUP ENGINE PORT 5 CONTROL REGISTER

Figure 14-28. PORTCTL5 Register

31	30	29	28	27	26	25	24
BCAST_LIMIT							
R/W-0							
23	22	21	20	19	18	17	16
MCAST_LIMIT							
R/W-0							
15	14	13	12	11	10	9	8
Reserved							
7	6	5	4	3	2	1	0
Reserved		NO_SA_UPDATE	NO_LEARN	VID_INGRESS_CHECK	DROP_UNTAGGED	PORT_STATE	
		R/W-0	R/W-0	R/W-0	R/W-0	R/W-0	

LEGEND: R/W = Read/Write; R = Read only; W1toCl = Write 1 to clear bit; -n = value after reset

Table 14-37. PORTCTL5 Register Field Descriptions

Bit	Field	Type	Reset	Description
31-24	BCAST_LIMIT	R/W-0	0	Broadcast Packet Rate Limit - Each prescale pulse loads this field into the port broadcast rate limit counter. The port counters are decremented with each packet received or transmitted depending on whether the mode is transmit or receive. If the counters decrement to zero, then further packets are rate limited until the next prescale pulse. Broadcast rate limiting is enabled by a non-zero value in this field.
23-16	MCAST_LIMIT	R/W-0	0	Multicast Packet Rate Limit - Each prescale pulse loads this field into the port multicast rate limit counter. The port counters are decremented with each packet received or transmitted depending on whether the mode is transmit or receive. If the counters decrement to zero, then further packets are rate limited until the next prescale pulse. Multicast rate limiting is enabled by a non-zero value in this field.
5	NO_SA_UPDATE	R/W-0	0	No Source Address Update - When set the port is disabled from updating the source port number in an ALE table entry.
4	NO_LEARN	R/W-0	0	No Learn Mode - When set the port is disabled from learning an address.
3	VID_INGRESS_CHECK	R/W-0	0	VLAN ID Ingress Check - If VLAN not found then drop the packet. Packets with an unknown (default) VLAN will be dropped.
2	DROP_UNTAGGED	R/W-0	0	Drop Untagged Packets - Drop non-VLAN tagged ingress packets.
1-0	PORT_STATE	R/W-0	0	Port State 0 - Disabled 1 - Blocked 2 - Learn

14.5.2 CPSW_CPDMA Registers

[Table 14-38](#) lists the memory-mapped registers for the CPSW_CPDMA. All register offset addresses not listed in [Table 14-38](#) should be considered as reserved locations and the register contents should not be modified.

Table 14-38. CPSW_CPDMA REGISTERS

Offset	Acronym	Register Name	Section
0h	TX_IDVER	CPDMA_REGS TX IDENTIFICATION AND VERSION REGISTER	Section 14.5.2.1
4h	TX_CONTROL	CPDMA_REGS TX CONTROL REGISTER	Section 14.5.2.2
8h	TX_TEARDOWN	CPDMA_REGS TX TEARDOWN REGISTER	Section 14.5.2.3
10h	RX_IDVER	CPDMA_REGS RX IDENTIFICATION AND VERSION REGISTER	Section 14.5.2.4
14h	RX_CONTROL	CPDMA_REGS RX CONTROL REGISTER	Section 14.5.2.5
18h	RX_TEARDOWN	CPDMA_REGS RX TEARDOWN REGISTER	Section 14.5.2.6
1Ch	CPDMA_SOFT_RESET	CPDMA_REGS SOFT RESET REGISTER	Section 14.5.2.7
20h	DMACONTROL	CPDMA_REGS CPDMA CONTROL REGISTER	Section 14.5.2.8
24h	DMASTATUS	CPDMA_REGS CPDMA STATUS REGISTER	Section 14.5.2.9
28h	RX_BUFFER_OFFSET	CPDMA_REGS RECEIVE BUFFER OFFSET	Section 14.5.2.10
2Ch	EMCONTROL	CPDMA_REGS EMULATION CONTROL	Section 14.5.2.11
30h	TX_PRI0_RATE	CPDMA_REGS TRANSMIT (INGRESS) PRIORITY 0 RATE	Section 14.5.2.12
34h	TX_PRI1_RATE	CPDMA_REGS TRANSMIT (INGRESS) PRIORITY 1 RATE	Section 14.5.2.13
38h	TX_PRI2_RATE	CPDMA_REGS TRANSMIT (INGRESS) PRIORITY 2 RATE	Section 14.5.2.14
3Ch	TX_PRI3_RATE	CPDMA_REGS TRANSMIT (INGRESS) PRIORITY 3 RATE	Section 14.5.2.15
40h	TX_PRI4_RATE	CPDMA_REGS TRANSMIT (INGRESS) PRIORITY 4 RATE	Section 14.5.2.16
44h	TX_PRI5_RATE	CPDMA_REGS TRANSMIT (INGRESS) PRIORITY 5 RATE	Section 14.5.2.17
48h	TX_PRI6_RATE	CPDMA_REGS TRANSMIT (INGRESS) PRIORITY 6 RATE	Section 14.5.2.18
4Ch	TX_PRI7_RATE	CPDMA_REGS TRANSMIT (INGRESS) PRIORITY 7 RATE	Section 14.5.2.19
80h	TX_INTSTAT_RAW	CPDMA_INT TX INTERRUPT STATUS REGISTER (RAW VALUE)	Section 14.5.2.20
84h	TX_INTSTAT_MASKED	CPDMA_INT TX INTERRUPT STATUS REGISTER (MASKED VALUE)	Section 14.5.2.21
88h	TX_INTMASK_SET	CPDMA_INT TX INTERRUPT MASK SET REGISTER	Section 14.5.2.22
8Ch	TX_INTMASK_CLEAR	CPDMA_INT TX INTERRUPT MASK CLEAR REGISTER	Section 14.5.2.23
90h	CPDMA_IN_VECTOR	CPDMA_INT INPUT VECTOR (READ ONLY)	Section 14.5.2.24
94h	CPDMA_EOI_VECTOR	CPDMA_INT END OF INTERRUPT VECTOR	Section 14.5.2.25
A0h	RX_INTSTAT_RAW	CPDMA_INT RX INTERRUPT STATUS REGISTER (RAW VALUE)	Section 14.5.2.26
A4h	RX_INTSTAT_MASKED	CPDMA_INT RX INTERRUPT STATUS REGISTER (MASKED VALUE)	Section 14.5.2.27
A8h	RX_INTMASK_SET	CPDMA_INT RX INTERRUPT MASK SET REGISTER	Section 14.5.2.28
ACH	RX_INTMASK_CLEAR	CPDMA_INT RX INTERRUPT MASK CLEAR REGISTER	Section 14.5.2.29
B0h	DMA_INTSTAT_RAW	CPDMA_INT DMA INTERRUPT STATUS REGISTER (RAW VALUE)	Section 14.5.2.30
B4h	DMA_INTSTAT_MASKED	CPDMA_INT DMA INTERRUPT STATUS REGISTER (MASKED VALUE)	Section 14.5.2.31
B8h	DMA_INTMASK_SET	CPDMA_INT DMA INTERRUPT MASK SET REGISTER	Section 14.5.2.32
BCh	DMA_INTMASK_CLEAR	CPDMA_INT DMA INTERRUPT MASK CLEAR REGISTER	Section 14.5.2.33
C0h	RX0_PENDTHRESH	CPDMA_INT RECEIVE THRESHOLD PENDING REGISTER CHANNEL 0	Section 14.5.2.34

Table 14-38. CPSW_CPDMA REGISTERS (continued)

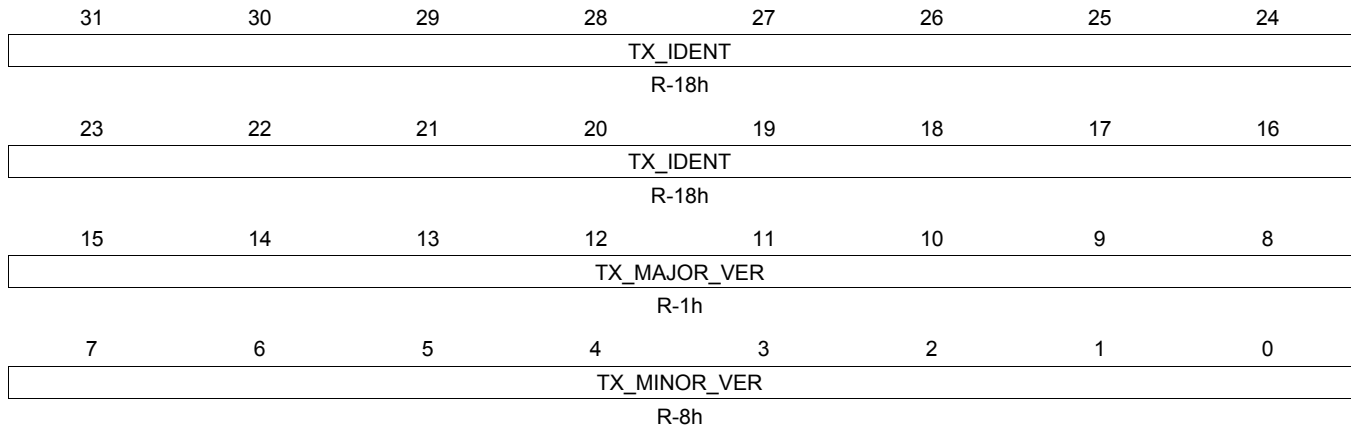
Offset	Acronym	Register Name	Section
C4h	RX1_PENDTHRESH	CPDMA_INT RECEIVE THRESHOLD PENDING REGISTER CHANNEL 1	Section 14.5.2.35
C8h	RX2_PENDTHRESH	CPDMA_INT RECEIVE THRESHOLD PENDING REGISTER CHANNEL 2	Section 14.5.2.36
CCh	RX3_PENDTHRESH	CPDMA_INT RECEIVE THRESHOLD PENDING REGISTER CHANNEL 3	Section 14.5.2.37
D0h	RX4_PENDTHRESH	CPDMA_INT RECEIVE THRESHOLD PENDING REGISTER CHANNEL 4	Section 14.5.2.38
D4h	RX5_PENDTHRESH	CPDMA_INT RECEIVE THRESHOLD PENDING REGISTER CHANNEL 5	Section 14.5.2.39
D8h	RX6_PENDTHRESH	CPDMA_INT RECEIVE THRESHOLD PENDING REGISTER CHANNEL 6	Section 14.5.2.40
DCh	RX7_PENDTHRESH	CPDMA_INT RECEIVE THRESHOLD PENDING REGISTER CHANNEL 7	Section 14.5.2.41
E0h	RX0_FREEBUFFER	CPDMA_INT RECEIVE FREE BUFFER REGISTER CHANNEL 0	Section 14.5.2.42
E4h	RX1_FREEBUFFER	CPDMA_INT RECEIVE FREE BUFFER REGISTER CHANNEL 1	Section 14.5.2.43
E8h	RX2_FREEBUFFER	CPDMA_INT RECEIVE FREE BUFFER REGISTER CHANNEL 2	Section 14.5.2.44
ECh	RX3_FREEBUFFER	CPDMA_INT RECEIVE FREE BUFFER REGISTER CHANNEL 3	Section 14.5.2.45
F0h	RX4_FREEBUFFER	CPDMA_INT RECEIVE FREE BUFFER REGISTER CHANNEL 4	Section 14.5.2.46
F4h	RX5_FREEBUFFER	CPDMA_INT RECEIVE FREE BUFFER REGISTER CHANNEL 5	Section 14.5.2.47
F8h	RX6_FREEBUFFER	CPDMA_INT RECEIVE FREE BUFFER REGISTER CHANNEL 6	Section 14.5.2.48
FCh	RX7_FREEBUFFER	CPDMA_INT RECEIVE FREE BUFFER REGISTER CHANNEL 7	Section 14.5.2.49

14.5.2.1 TX_IDVER Register (offset = 0h) [reset = 180108h]

TX_IDVER is shown in [Figure 14-29](#) and described in [Table 14-39](#).

CPDMA_REGS TX IDENTIFICATION AND VERSION REGISTER

Figure 14-29. TX_IDVER Register



LEGEND: R/W = Read/Write; R = Read only; W1toCl = Write 1 to clear bit; -n = value after reset

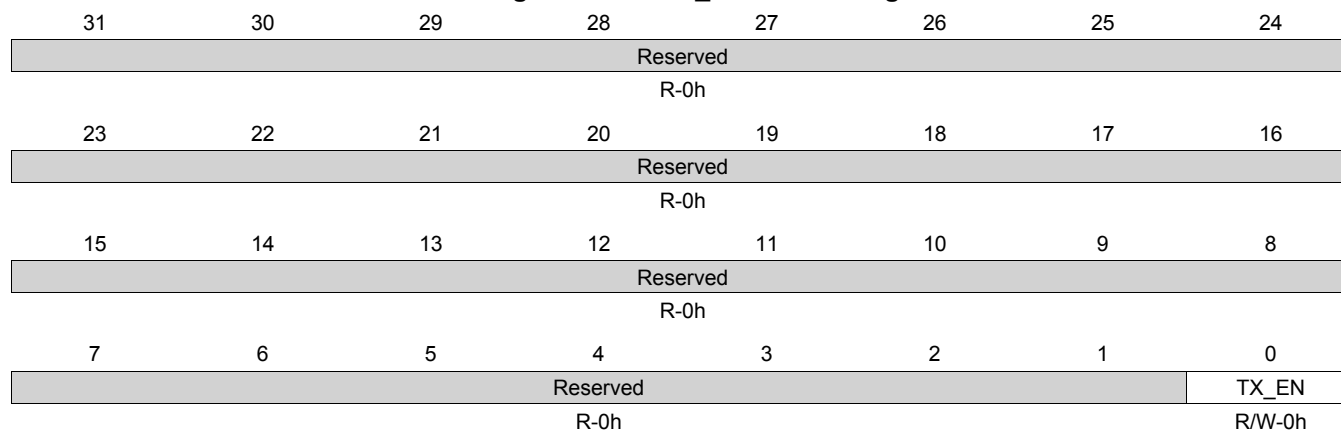
Table 14-39. TX_IDVER Register Field Descriptions

Bit	Field	Type	Reset	Description
31-16	TX_IDENT	R	18h	TX Identification Value
15-8	TX_MAJOR_VER	R	1h	TX Major Version Value - The value read is the major version number
7-0	TX_MINOR_VER	R	8h	TX Minor Version Value - The value read is the minor version number

14.5.2.2 TX_CONTROL Register (offset = 4h) [reset = 0h]

 TX_CONTROL is shown in [Figure 14-30](#) and described in [Table 14-40](#).

CPDMA_REGS TX CONTROL REGISTER

Figure 14-30. TX_CONTROL Register


LEGEND: R/W = Read/Write; R = Read only; W1toCl = Write 1 to clear bit; -n = value after reset

Table 14-40. TX_CONTROL Register Field Descriptions

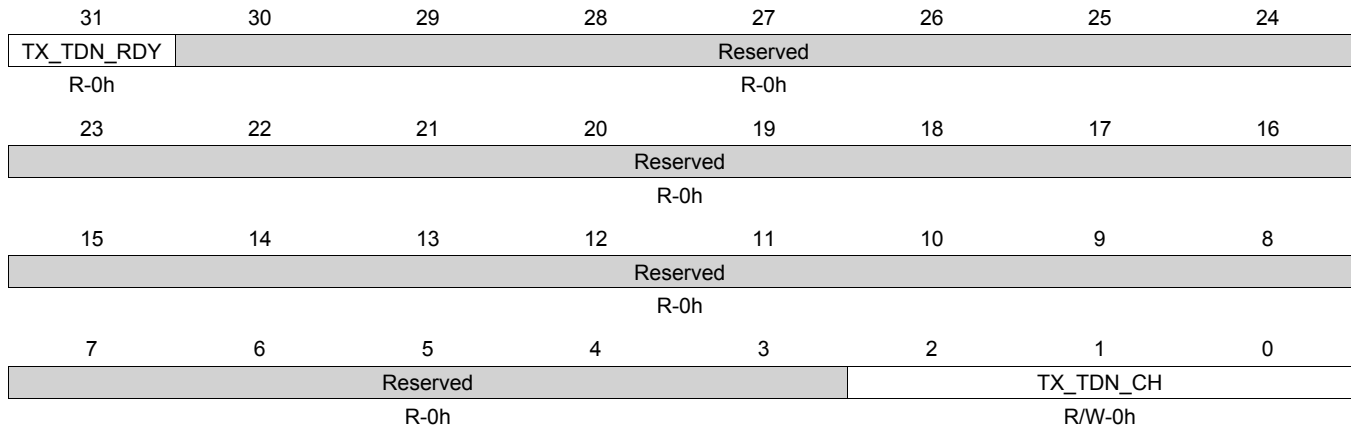
Bit	Field	Type	Reset	Description
31-1	Reserved	R	0h	
0	TX_EN	R/W	0h	TX Enable 0 - Disabled 1 - Enabled

14.5.2.3 TX_TEARDOWN Register (offset = 8h) [reset = 0h]

TX_TEARDOWN is shown in [Figure 14-31](#) and described in [Table 14-41](#).

CPDMA_REGS TX TEARDOWN REGISTER

Figure 14-31. TX_TEARDOWN Register



LEGEND: R/W = Read/Write; R = Read only; W1toCl = Write 1 to clear bit; -n = value after reset

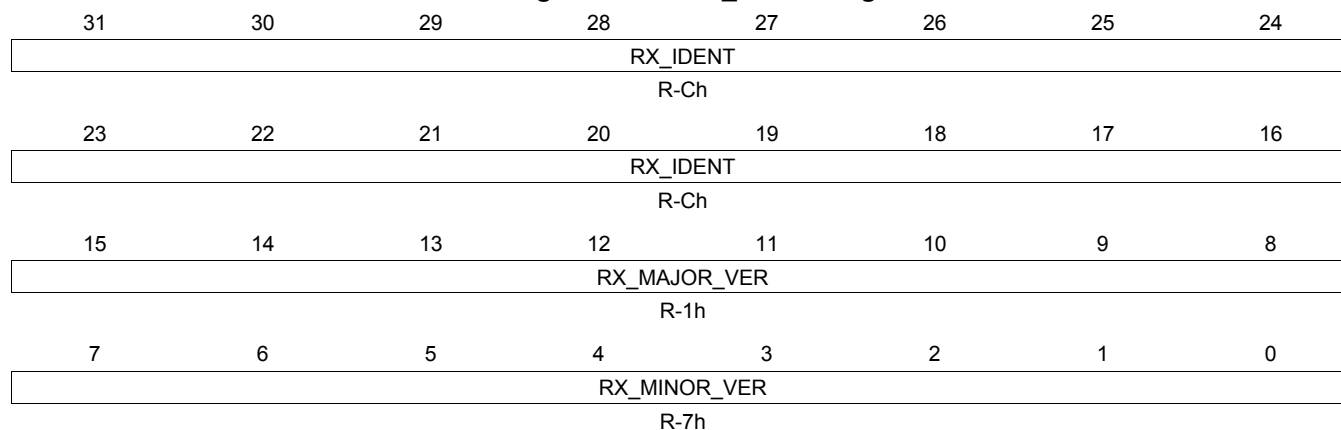
Table 14-41. TX_TEARDOWN Register Field Descriptions

Bit	Field	Type	Reset	Description
31	TX_TDN_RDY	R	0h	Tx Teardown Ready - read as zero, but is always assumed to be one (unused).
30-3	Reserved	R	0h	
2-0	TX_TDN_CH	R/W	0h	Tx Teardown Channel - Transmit channel teardown is commanded by writing the encoded value of the transmit channel to be torn down. The teardown register is read as zero. 000 - teardown transmit channel 0 ... 111 - teardown transmit channel 7

14.5.2.4 RX_IDVER Register (offset = 10h) [reset = C0107h]

 RX_IDVER is shown in [Figure 14-32](#) and described in [Table 14-42](#).

CPDMA_REGS RX IDENTIFICATION AND VERSION REGISTER

Figure 14-32. RX_IDVER Register


LEGEND: R/W = Read/Write; R = Read only; W1toCl = Write 1 to clear bit; -n = value after reset

Table 14-42. RX_IDVER Register Field Descriptions

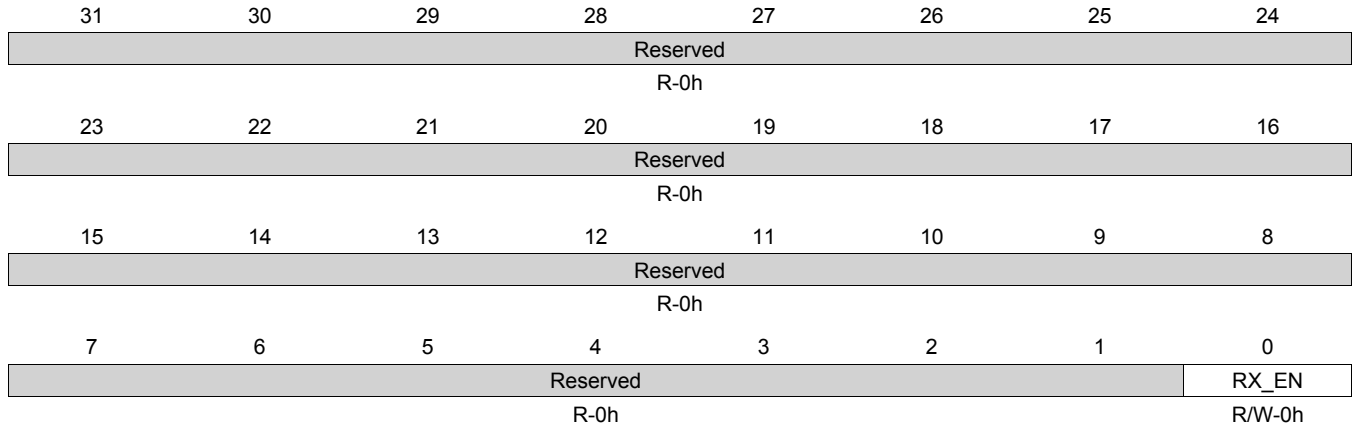
Bit	Field	Type	Reset	Description
31-16	RX_IDENT	R	Ch	RX Identification Value
15-8	RX_MAJOR_VER	R	1h	RX Major Version Value
7-0	RX_MINOR_VER	R	7h	RX Minor Version Value

14.5.2.5 RX_CONTROL Register (offset = 14h) [reset = 0h]

RX_CONTROL is shown in [Figure 14-33](#) and described in [Table 14-43](#).

CPDMA_REGS RX CONTROL REGISTER

Figure 14-33. RX_CONTROL Register



LEGEND: R/W = Read/Write; R = Read only; W1toCl = Write 1 to clear bit; -n = value after reset

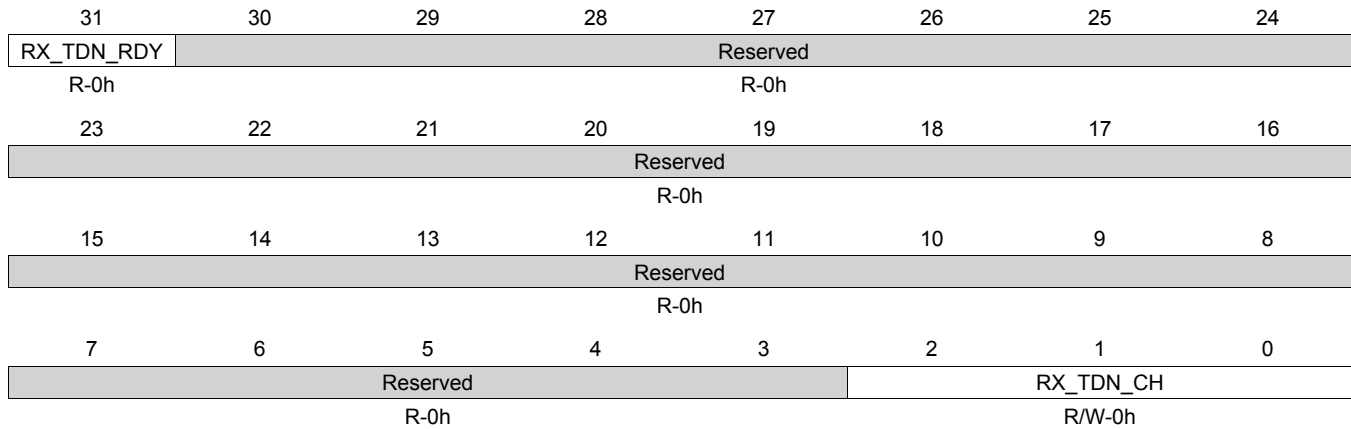
Table 14-43. RX_CONTROL Register Field Descriptions

Bit	Field	Type	Reset	Description
31-1	Reserved	R	0h	
0	RX_EN	R/W	0h	RX DMA Enable 0 - Disabled 1 - Enabled

14.5.2.6 RX_TEARDOWN Register (offset = 18h) [reset = 0h]

 RX_TEARDOWN is shown in [Figure 14-34](#) and described in [Table 14-44](#).

CPDMA_REGS RX TEARDOWN REGISTER

Figure 14-34. RX_TEARDOWN Register


LEGEND: R/W = Read/Write; R = Read only; W1toCl = Write 1 to clear bit; -n = value after reset

Table 14-44. RX_TEARDOWN Register Field Descriptions

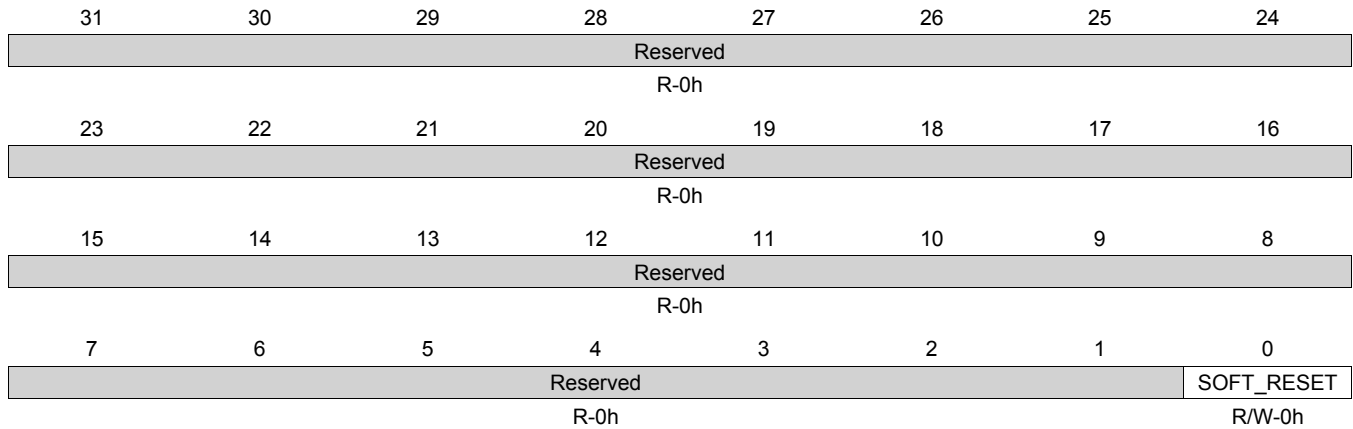
Bit	Field	Type	Reset	Description
31	RX_TDN_RDY	R	0h	Teardown Ready - read as zero, but is always assumed to be one (unused).
30-3	Reserved	R	0h	
2-0	RX_TDN_CH	R/W	0h	Rx Teardown Channel -Receive channel teardown is commanded by writing the encoded value of the receive channel to be torn down. The teardown register is read as zero. 000 - teardown receive channel 0 ... 111 - teardown receive channel 7

14.5.2.7 CPDMA_SOFT_RESET Register (offset = 1Ch) [reset = 0h]

CPDMA_SOFT_RESET is shown in [Figure 14-35](#) and described in [Table 14-45](#).

CPDMA_REGS SOFT RESET REGISTER

Figure 14-35. CPDMA_SOFT_RESET Register



LEGEND: R/W = Read/Write; R = Read only; W1toCl = Write 1 to clear bit; -n = value after reset

Table 14-45. CPDMA_SOFT_RESET Register Field Descriptions

Bit	Field	Type	Reset	Description
31-1	Reserved	R	0h	
0	SOFT_RESET	R/W	0h	Software reset - Writing a one to this bit causes the CPDMA logic to be reset. Software reset occurs when the RX and TX DMA Controllers are in an idle state to avoid locking up the VBUSP bus. After writing a one to this bit, it may be polled to determine if the reset has occurred. If a one is read, the reset has not yet occurred. If a zero is read then reset has occurred.

14.5.2.8 DMACONTROL Register (offset = 20h) [reset = 0h]

 DMACONTROL is shown in [Figure 14-36](#) and described in [Table 14-46](#).

CPDMA_REGS CPDMA CONTROL REGISTER

Figure 14-36. DMACONTROL Register

31	30	29	28	27	26	25	24
Reserved							
R-0h							
23	22	21	20	19	18	17	16
Reserved							
R-0h							
15	14	13	12	11	10	9	8
TX_RLIM							
R/W-0h							
7	6	5	4	3	2	1	0
Reserved			RX_CEF	CMD_IDLE	RX_OFFLEN_B LOCK	RX_OWNERS HIP	TX_PTYPE
R-0h			R/W-0h	R/W-0h	R/W-0h	R/W-0h	R/W-0h

LEGEND: R/W = Read/Write; R = Read only; W1toCl = Write 1 to clear bit; -n = value after reset

Table 14-46. DMACONTROL Register Field Descriptions

Bit	Field	Type	Reset	Description
31-16	Reserved	R	0h	
15-8	TX_RLIM	R/W	0h	Transmit Rate Limit Channel Bus 00000000 - no rate-limited channels 10000000 - channel 7 is rate-limited 11000000 - channels 7 downto 6 are rate-limited 11100000 - channels 7 downto 5 are rate-limited 11110000 - channels 7 downto 4 are rate-limited 11111000 - channels 7 downto 3 are rate-limited 11111100 - channels 7 downto 2 are rate-limited 11111110 - channels 7 downto 1 are rate-limited 11111111 - channels 7 downto 0 are rate-limited all others invalid - this bus must be set msb towards lsb. tx_ptype must be set if any tx_rlim bit is set for fixed priority.
7-5	Reserved	R	0h	
4	RX_CEF	R/W	0h	RX Copy Error Frames Enable - Enables DMA overrun frames to be transferred to memory (up to the point of overrun). The overrun error bit will be set in the frame EOP buffer descriptor. Overrun frame data will be filtered when rx_cef is not set. Frames coming from the receive FIFO with other error bits set are not effected by this bit. 0 - Frames containing overrun errors are filtered. 1 - Frames containing overrun errors are transferred to memory.
3	CMD_IDLE	R/W	0h	Command Idle 0 - Idle not commanded 1 - Idle Commanded (read idle in DMAStatus)
2	RX_OFFLEN_BLOCK	R/W	0h	Receive Offset/Length word write block. 0 - Do not block the DMA writes to the receive buffer descriptor offset/buffer length word. The offset/buffer length word is written as specified in CPPI 3.0. 1 - Block all CPDMA DMA controller writes to the receive buffer descriptor offset/buffer length words during CPPI packet processing. when this bit is set, the CPDMA will never write the third word to any receive buffer descriptor.

Table 14-46. DMACONTROL Register Field Descriptions (continued)

Bit	Field	Type	Reset	Description
1	RX_OWNERSHIP	R/W	0h	Receive Ownership Write Bit Value. 0 - The CPDMA writes the receive ownership bit to zero at the end of packet processing as specified in CPPI 3.0. 1 - The CPDMA writes the receive ownership bit to one at the end of packet processing. Users who do not use the ownership mechanism can use this mode to preclude the necessity of software having to set this bit each time the buffer descriptor is used.
0	TX_PTYPE	R/W	0h	Transmit Queue Priority Type 0 - The queue uses a round robin scheme to select the next channel for transmission. 1 - The queue uses a fixed (channel 7 highest priority) priority scheme to select the next channel for transmission

14.5.2.9 DMASTATUS Register (offset = 24h) [reset = 0h]

 DMASTATUS is shown in [Figure 14-37](#) and described in [Table 14-47](#).

CPDMA_REGS CPDMA STATUS REGISTER

Figure 14-37. DMASTATUS Register

31	30	29	28	27	26	25	24
IDLE	Reserved						
R-0h	R-0h						
23	22	21	20	19	18	17	16
TX_HOST_ERR_CODE				Reserved	TX_ERR_CH		
R-0h				R-0h	R-0h		
15	14	13	12	11	10	9	8
RX_HOST_ERR_CODE				Reserved	RX_ERR_CH		
R-0h				R-0h	R-0h		
7	6	5	4	3	2	1	0
Reserved							
R-0h							

LEGEND: R/W = Read/Write; R = Read only; W1toCl = Write 1 to clear bit; -n = value after reset

Table 14-47. DMASTATUS Register Field Descriptions

Bit	Field	Type	Reset	Description
31	IDLE	R	0h	Idle Status Bit - Indicates when set that the CPDMA is not transferring a packet on transmit or receive.
30-24	Reserved	R	0h	
23-20	TX_HOST_ERR_CODE	R	0h	TX Host Error Code - This field is set to indicate CPDMA detected TX DMA related host errors. The host should read this field after a HOST_ERR_INT to determine the error. Host error Interrupts require hardware reset in order to recover. A zero packet length is an error, but it is not detected. 0000 - No error 0001 - SOP error. 0010 - Ownership bit not set in SOP buffer. 0011 - Zero Next Buffer Descriptor Pointer Without EOP 0100 - Zero Buffer Pointer. 0101 - Zero Buffer Length 0110 - Packet Length Error (sum of buffers is less than packet length) 0111 - reserved ... 1111 - reserved
19	Reserved	R	0h	
18-16	TX_ERR_CH	R	0h	TX Host Error Channel - This field indicates which TX channel (if applicable) the host error occurred on. This field is cleared to zero on a host read. 000 - The host error occurred on TX channel 0 ... 111 - The host error occurred on TX channel 7
15-12	RX_HOST_ERR_CODE	R	0h	RX Host Error Code - This field is set to indicate CPDMA detected RX DMA related host errors. The host should read this field after a HOST_ERR_INT to determine the error. Host error Interrupts require hardware reset in order to recover. 0000 - No error 0001 - reserved 0010 - Ownership bit not set in input buffer. 0011 - reserved 0100 - Zero Buffer Pointer. 0101 - Zero buffer length on non-SOP descriptor 0110 - SOP buffer length not greater than offset ... 1111 - reserved

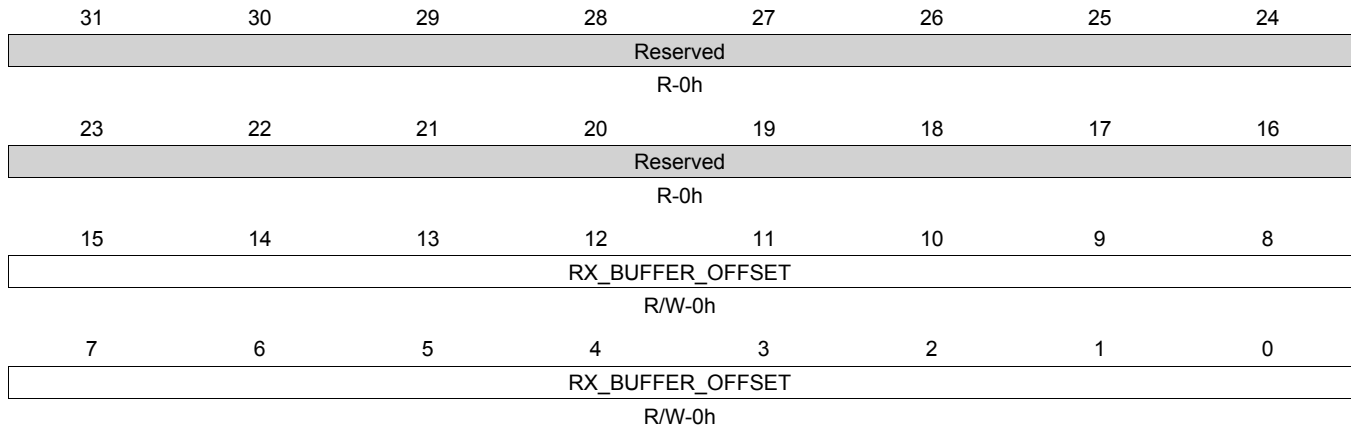
Table 14-47. DMASTATUS Register Field Descriptions (continued)

Bit	Field	Type	Reset	Description
11	Reserved	R	0h	
10-8	RX_ERR_CH	R	0h	RX Host Error Channel - This field indicates which RX channel the host error occurred on. This field is cleared to zero on a host read. 000 - The host error occurred on RX channel 0 ... 111 - The host error occurred on RX channel 7
7-0	Reserved	R	0h	

14.5.2.10 RX_BUFFER_OFFSET Register (offset = 28h) [reset = 0h]

 RX_BUFFER_OFFSET is shown in [Figure 14-38](#) and described in [Table 14-48](#).

CPDMA_REGS RECEIVE BUFFER OFFSET

Figure 14-38. RX_BUFFER_OFFSET Register


LEGEND: R/W = Read/Write; R = Read only; W1toCl = Write 1 to clear bit; -n = value after reset

Table 14-48. RX_BUFFER_OFFSET Register Field Descriptions

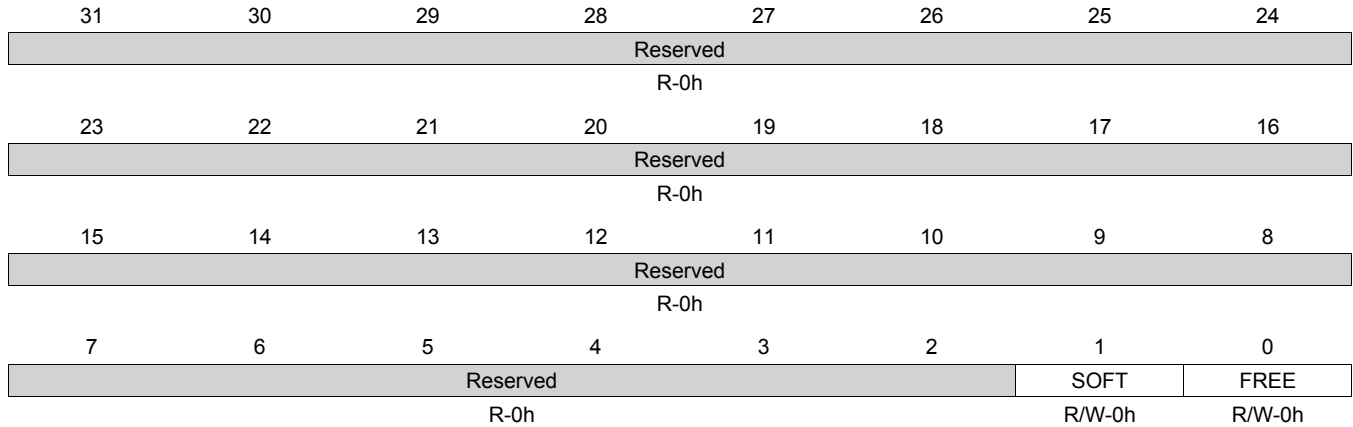
Bit	Field	Type	Reset	Description
31-16	Reserved	R	0h	
15-0	RX_BUFFER_OFFSET	R/W	0h	Receive Buffer Offset Value - The rx_buffer_offset will be written by the port into each frame SOP buffer descriptor buffer_offset field. The frame data will begin after the rx_buffer_offset value of bytes. A value of 0x0000 indicates that there are no unused bytes at the beginning of the data and that valid data begins on the first byte of the buffer. A value of 0x000F (decimal 15) indicates that the first 15 bytes of the buffer are to be ignored by the port and that valid buffer data starts on byte 16 of the buffer. This value is used for all channels.

14.5.2.11 EMCONTROL Register (offset = 2Ch) [reset = 0h]

EMCONTROL is shown in [Figure 14-39](#) and described in [Table 14-49](#).

CPDMA_REGS EMULATION CONTROL

Figure 14-39. EMCONTROL Register



LEGEND: R/W = Read/Write; R = Read only; W1toCl = Write 1 to clear bit; -n = value after reset

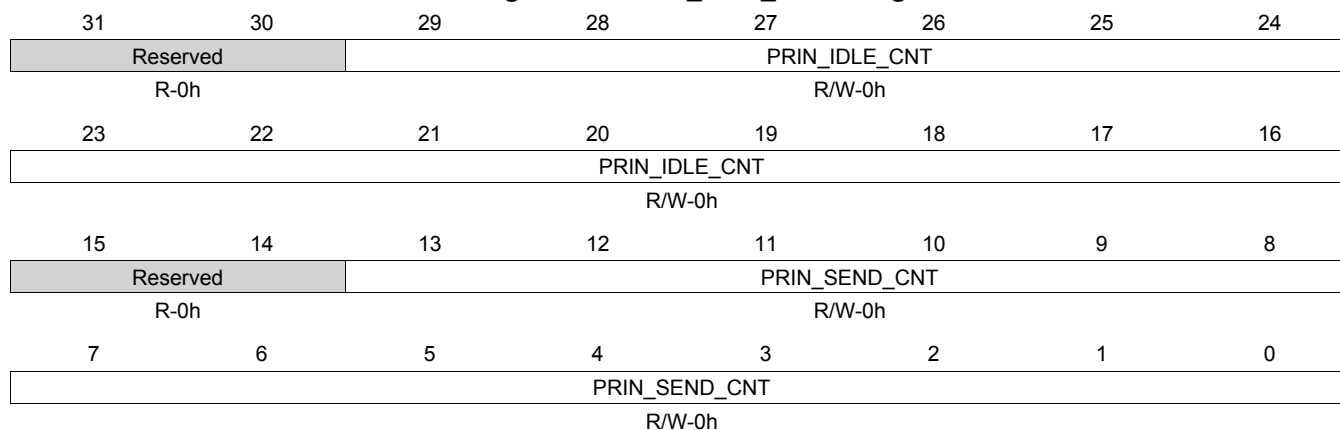
Table 14-49. EMCONTROL Register Field Descriptions

Bit	Field	Type	Reset	Description
31-2	Reserved	R	0h	
1	SOFT	R/W	0h	Emulation Soft Bit
0	FREE	R/W	0h	Emulation Free Bit

14.5.2.12 TX_PRI0_RATE Register (offset = 30h) [reset = 0h]

 TX_PRI0_RATE is shown in [Figure 14-40](#) and described in [Table 14-50](#).

CPDMA_REGS TRANSMIT (INGRESS) PRIORITY 0 RATE

Figure 14-40. TX_PRI0_RATE Register


LEGEND: R/W = Read/Write; R = Read only; W1toCl = Write 1 to clear bit; -n = value after reset

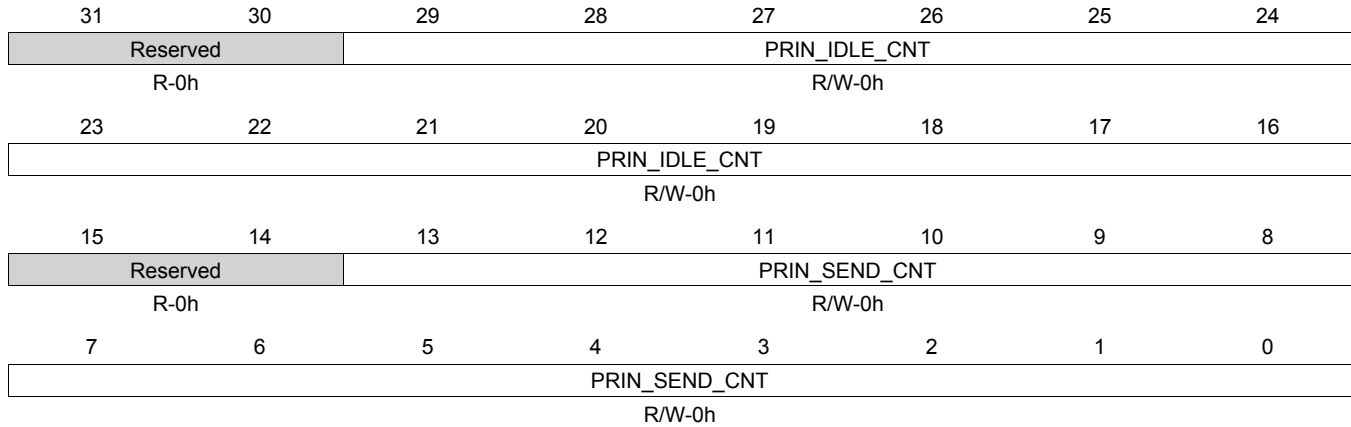
Table 14-50. TX_PRI0_RATE Register Field Descriptions

Bit	Field	Type	Reset	Description
31-30	Reserved	R	0h	
29-16	PRIN_IDLE_CNT	R/W	0h	Priority (7:0) idle count
15-14	Reserved	R	0h	
13-0	PRIN_SEND_CNT	R/W	0h	Priority (7:0) send count

14.5.2.13 TX_PRI1_RATE Register (offset = 34h) [reset = 0h]

TX_PRI1_RATE is shown in [Figure 14-41](#) and described in [Table 14-51](#).

CPDMA_REGS TRANSMIT (INGRESS) PRIORITY 1 RATE

Figure 14-41. TX_PRI1_RATE Register


LEGEND: R/W = Read/Write; R = Read only; W1toCl = Write 1 to clear bit; -n = value after reset

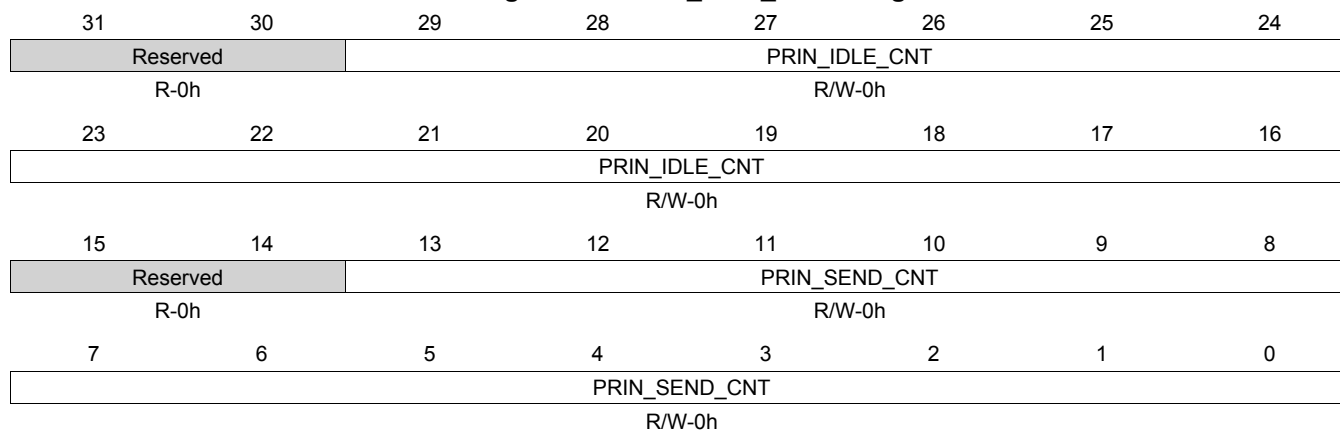
Table 14-51. TX_PRI1_RATE Register Field Descriptions

Bit	Field	Type	Reset	Description
31-30	Reserved	R	0h	
29-16	PRIN_IDLE_CNT	R/W	0h	Priority (7:0) idle count
15-14	Reserved	R	0h	
13-0	PRIN_SEND_CNT	R/W	0h	Priority (7:0) send count

14.5.2.14 TX_PRI2_RATE Register (offset = 38h) [reset = 0h]

 TX_PRI2_RATE is shown in [Figure 14-42](#) and described in [Table 14-52](#).

CPDMA_REGS TRANSMIT (INGRESS) PRIORITY 2 RATE

Figure 14-42. TX_PRI2_RATE Register


LEGEND: R/W = Read/Write; R = Read only; W1toCl = Write 1 to clear bit; -n = value after reset

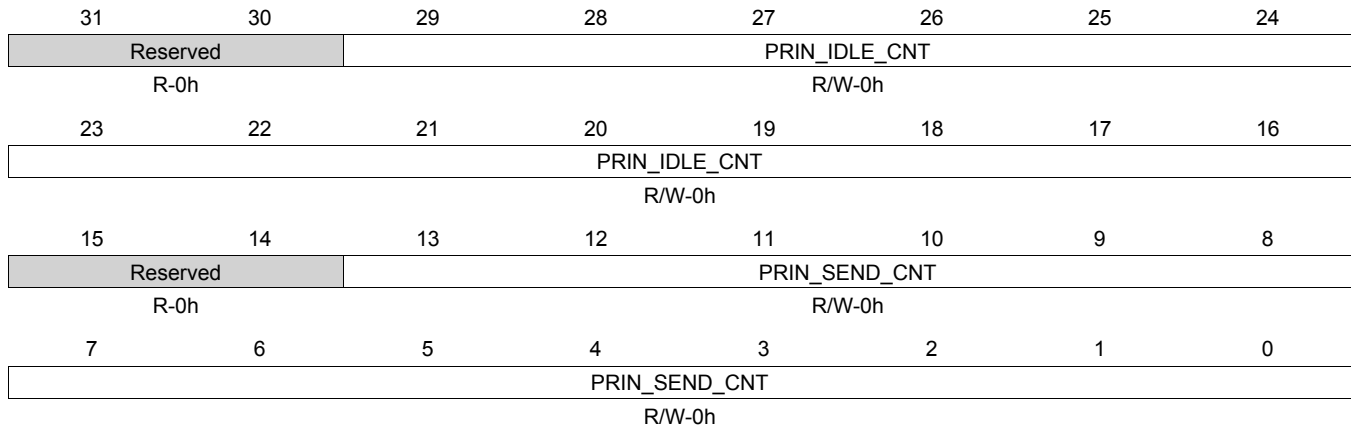
Table 14-52. TX_PRI2_RATE Register Field Descriptions

Bit	Field	Type	Reset	Description
31-30	Reserved	R	0h	
29-16	PRIN_IDLE_CNT	R/W	0h	Priority (7:0) idle count
15-14	Reserved	R	0h	
13-0	PRIN_SEND_CNT	R/W	0h	Priority (7:0) send count

14.5.2.15 TX_PRI3_RATE Register (offset = 3Ch) [reset = 0h]

TX_PRI3_RATE is shown in [Figure 14-43](#) and described in [Table 14-53](#).

CPDMA_REGS TRANSMIT (INGRESS) PRIORITY 3 RATE

Figure 14-43. TX_PRI3_RATE Register


LEGEND: R/W = Read/Write; R = Read only; W1toCl = Write 1 to clear bit; -n = value after reset

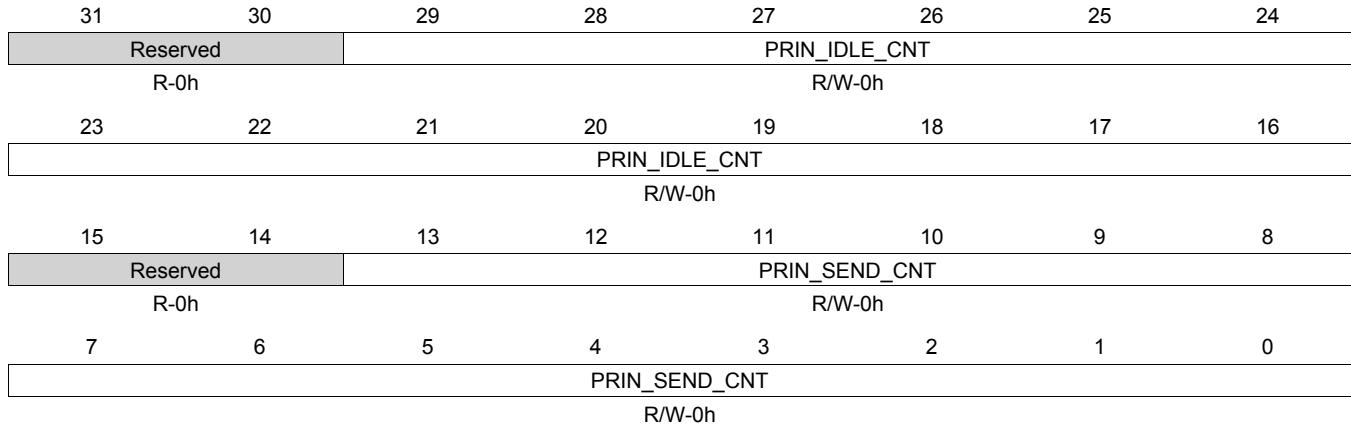
Table 14-53. TX_PRI3_RATE Register Field Descriptions

Bit	Field	Type	Reset	Description
31-30	Reserved	R	0h	
29-16	PRIN_IDLE_CNT	R/W	0h	Priority (7:0) idle count
15-14	Reserved	R	0h	
13-0	PRIN_SEND_CNT	R/W	0h	Priority (7:0) send count

14.5.2.16 TX_PRI4_RATE Register (offset = 40h) [reset = 0h]

 TX_PRI4_RATE is shown in [Figure 14-44](#) and described in [Table 14-54](#).

CPDMA_REGS TRANSMIT (INGRESS) PRIORITY 4 RATE

Figure 14-44. TX_PRI4_RATE Register


LEGEND: R/W = Read/Write; R = Read only; W1toCl = Write 1 to clear bit; -n = value after reset

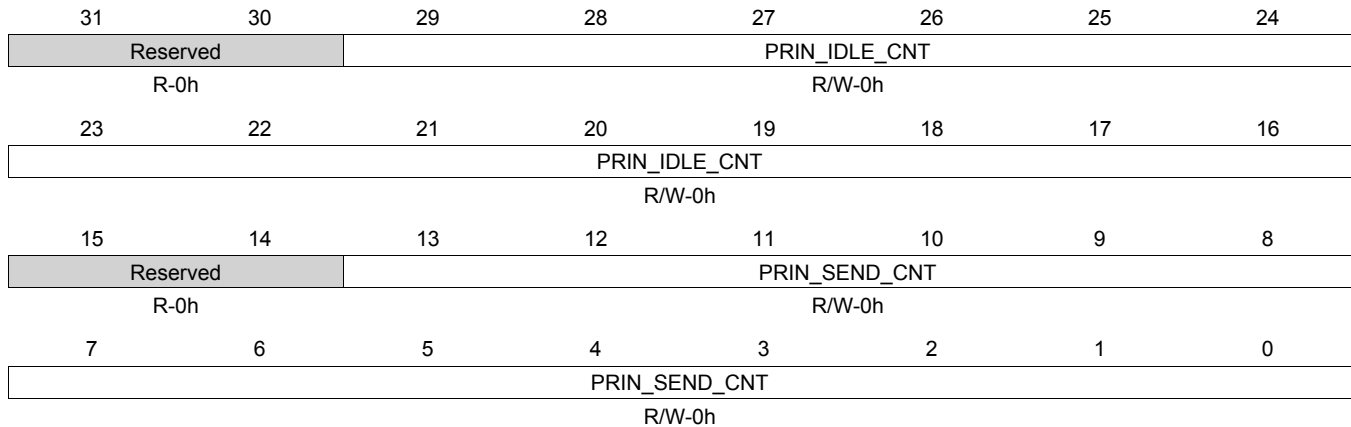
Table 14-54. TX_PRI4_RATE Register Field Descriptions

Bit	Field	Type	Reset	Description
31-30	Reserved	R	0h	
29-16	PRIN_IDLE_CNT	R/W	0h	Priority (7:0) idle count
15-14	Reserved	R	0h	
13-0	PRIN_SEND_CNT	R/W	0h	Priority (7:0) send count

14.5.2.17 TX_PRI5_RATE Register (offset = 44h) [reset = 0h]

 TX_PRI5_RATE is shown in [Figure 14-45](#) and described in [Table 14-55](#).

CPDMA_REGS TRANSMIT (INGRESS) PRIORITY 5 RATE

Figure 14-45. TX_PRI5_RATE Register


LEGEND: R/W = Read/Write; R = Read only; W1toCl = Write 1 to clear bit; -n = value after reset

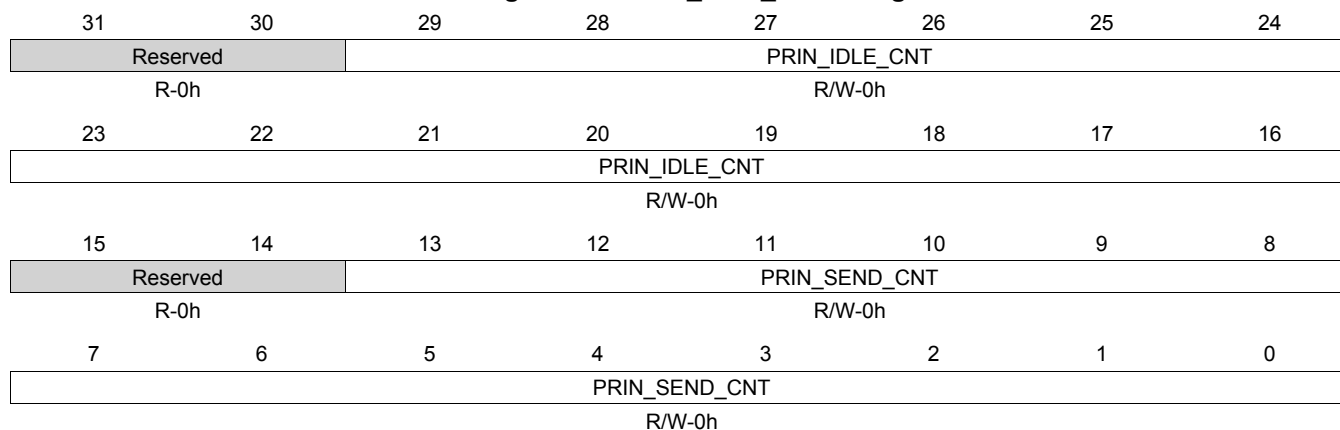
Table 14-55. TX_PRI5_RATE Register Field Descriptions

Bit	Field	Type	Reset	Description
31-30	Reserved	R	0h	
29-16	PRIN_IDLE_CNT	R/W	0h	Priority (7:0) idle count
15-14	Reserved	R	0h	
13-0	PRIN_SEND_CNT	R/W	0h	Priority (7:0) send count

14.5.2.18 TX_PRI6_RATE Register (offset = 48h) [reset = 0h]

 TX_PRI6_RATE is shown in [Figure 14-46](#) and described in [Table 14-56](#).

CPDMA_REGS TRANSMIT (INGRESS) PRIORITY 6 RATE

Figure 14-46. TX_PRI6_RATE Register


LEGEND: R/W = Read/Write; R = Read only; W1toCl = Write 1 to clear bit; -n = value after reset

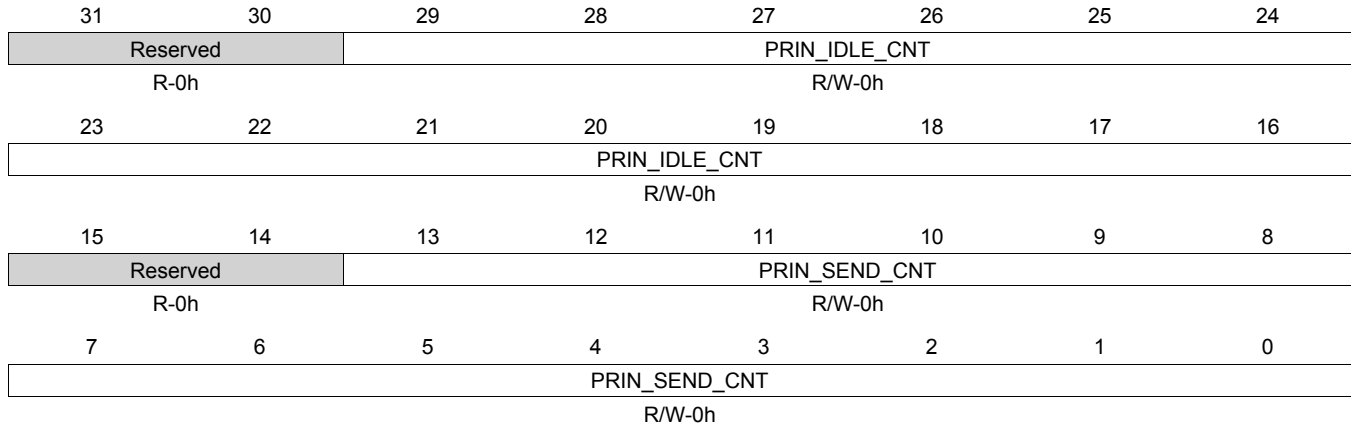
Table 14-56. TX_PRI6_RATE Register Field Descriptions

Bit	Field	Type	Reset	Description
31-30	Reserved	R	0h	
29-16	PRIN_IDLE_CNT	R/W	0h	Priority (7:0) idle count
15-14	Reserved	R	0h	
13-0	PRIN_SEND_CNT	R/W	0h	Priority (7:0) send count

14.5.2.19 TX_PRI7_RATE Register (offset = 4Ch) [reset = 0h]

TX_PRI7_RATE is shown in [Figure 14-47](#) and described in [Table 14-57](#).

CPDMA_REGS TRANSMIT (INGRESS) PRIORITY 7 RATE

Figure 14-47. TX_PRI7_RATE Register


LEGEND: R/W = Read/Write; R = Read only; W1toCl = Write 1 to clear bit; -n = value after reset

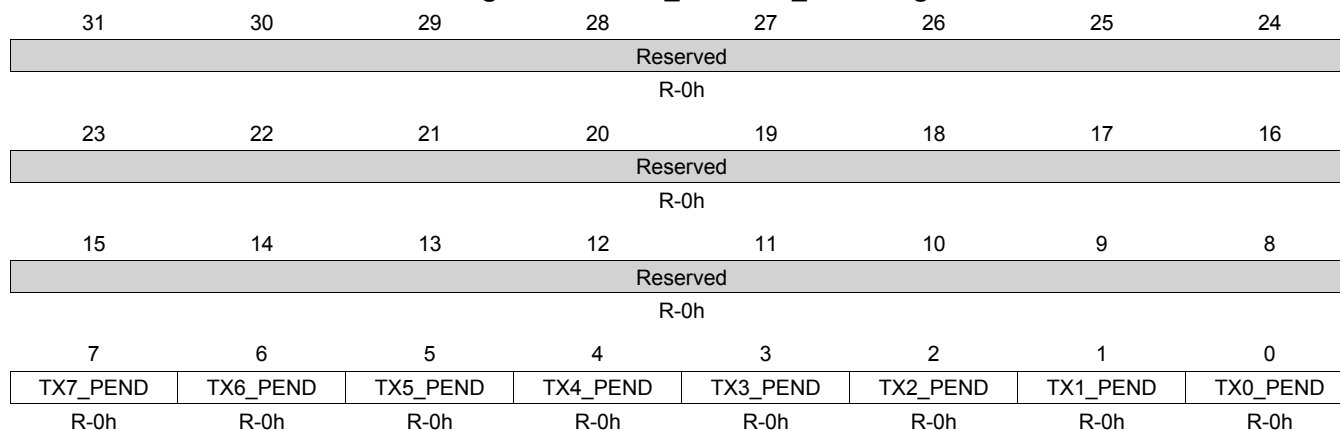
Table 14-57. TX_PRI7_RATE Register Field Descriptions

Bit	Field	Type	Reset	Description
31-30	Reserved	R	0h	
29-16	PRIN_IDLE_CNT	R/W	0h	Priority (7:0) idle count
15-14	Reserved	R	0h	
13-0	PRIN_SEND_CNT	R/W	0h	Priority (7:0) send count

14.5.2.20 TX_INTSTAT_RAW Register (offset = 80h) [reset = 0h]

 TX_INTSTAT_RAW is shown in [Figure 14-48](#) and described in [Table 14-58](#).

CPDMA_INT TX INTERRUPT STATUS REGISTER (RAW VALUE)

Figure 14-48. TX_INTSTAT_RAW Register


LEGEND: R/W = Read/Write; R = Read only; W1toCl = Write 1 to clear bit; -n = value after reset

Table 14-58. TX_INTSTAT_RAW Register Field Descriptions

Bit	Field	Type	Reset	Description
31-8	Reserved	R	0h	
7	TX7_PEND	R	0h	TX7_PEND raw int read (before mask).
6	TX6_PEND	R	0h	TX6_PEND raw int read (before mask).
5	TX5_PEND	R	0h	TX5_PEND raw int read (before mask).
4	TX4_PEND	R	0h	TX4_PEND raw int read (before mask).
3	TX3_PEND	R	0h	TX3_PEND raw int read (before mask).
2	TX2_PEND	R	0h	TX2_PEND raw int read (before mask).
1	TX1_PEND	R	0h	TX1_PEND raw int read (before mask).
0	TX0_PEND	R	0h	TX0_PEND raw int read (before mask).

14.5.2.21 TX_INTSTAT_MASKED Register (offset = 84h) [reset = 0h]

TX_INTSTAT_MASKED is shown in [Figure 14-49](#) and described in [Table 14-59](#).

CPDMA_INT TX INTERRUPT STATUS REGISTER (MASKED VALUE)

Figure 14-49. TX_INTSTAT_MASKED Register

31	30	29	28	27	26	25	24
Reserved							
R-0h							
23	22	21	20	19	18	17	16
Reserved							
R-0h							
15	14	13	12	11	10	9	8
Reserved							
R-0h							
7	6	5	4	3	2	1	0
TX7_PEND	TX6_PEND	TX5_PEND	TX4_PEND	TX3_PEND	TX2_PEND	TX1_PEND	TX0_PEND
R-0h	R-0h	R-0h	R-0h	R-0h	R-0h	R-0h	R-0h

LEGEND: R/W = Read/Write; R = Read only; W1toCl = Write 1 to clear bit; -n = value after reset

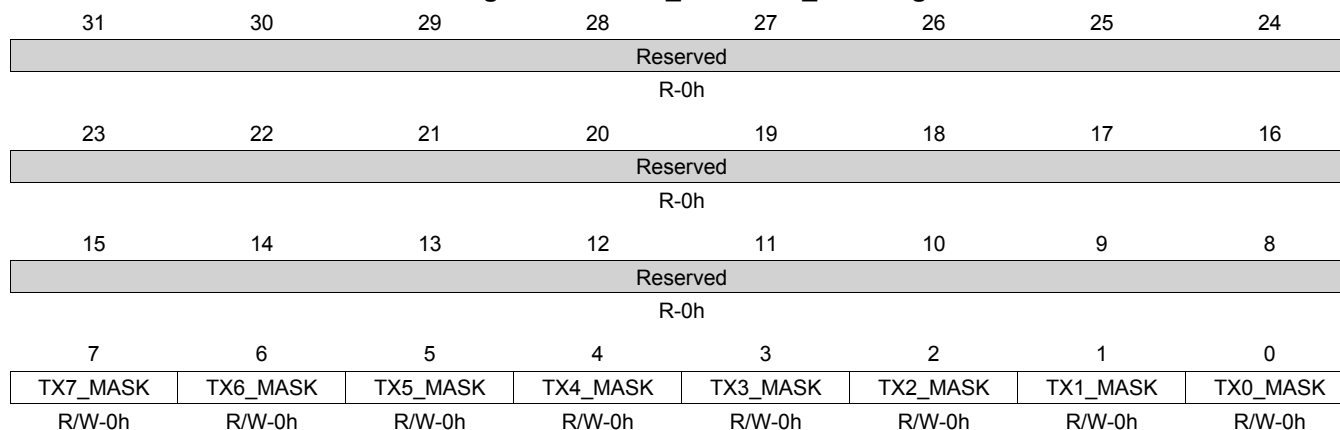
Table 14-59. TX_INTSTAT_MASKED Register Field Descriptions

Bit	Field	Type	Reset	Description
31-8	Reserved	R	0h	
7	TX7_PEND	R	0h	TX7_PEND masked interrupt read.
6	TX6_PEND	R	0h	TX6_PEND masked interrupt read.
5	TX5_PEND	R	0h	TX5_PEND masked interrupt read.
4	TX4_PEND	R	0h	TX4_PEND masked interrupt read.
3	TX3_PEND	R	0h	TX3_PEND masked interrupt read.
2	TX2_PEND	R	0h	TX2_PEND masked interrupt read.
1	TX1_PEND	R	0h	TX1_PEND masked interrupt read.
0	TX0_PEND	R	0h	TX0_PEND masked interrupt read.

14.5.2.22 TX_INTMASK_SET Register (offset = 88h) [reset = 0h]

 TX_INTMASK_SET is shown in [Figure 14-50](#) and described in [Table 14-60](#).

CPDMA_INT TX INTERRUPT MASK SET REGISTER

Figure 14-50. TX_INTMASK_SET Register


LEGEND: R/W = Read/Write; R = Read only; W1toCl = Write 1 to clear bit; -n = value after reset

Table 14-60. TX_INTMASK_SET Register Field Descriptions

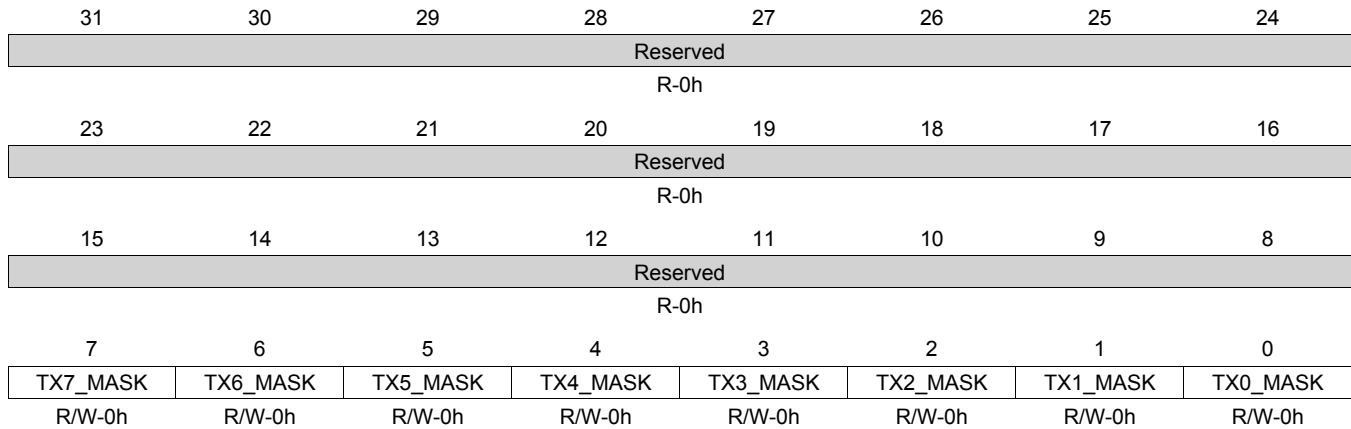
Bit	Field	Type	Reset	Description
31-8	Reserved	R	0h	
7	TX7_MASK	R/W	0h	TX Channel 7 Mask - Write one to enable interrupt.
6	TX6_MASK	R/W	0h	TX Channel 6 Mask - Write one to enable interrupt.
5	TX5_MASK	R/W	0h	TX Channel 5 Mask - Write one to enable interrupt.
4	TX4_MASK	R/W	0h	TX Channel 4 Mask - Write one to enable interrupt.
3	TX3_MASK	R/W	0h	TX Channel 3 Mask - Write one to enable interrupt.
2	TX2_MASK	R/W	0h	TX Channel 2 Mask - Write one to enable interrupt.
1	TX1_MASK	R/W	0h	TX Channel 1 Mask - Write one to enable interrupt.
0	TX0_MASK	R/W	0h	TX Channel 0 Mask - Write one to enable interrupt.

14.5.2.23 TX_INTMASK_CLEAR Register (offset = 8Ch) [reset = 0h]

TX_INTMASK_CLEAR is shown in [Figure 14-51](#) and described in [Table 14-61](#).

CPDMA_INT TX INTERRUPT MASK CLEAR REGISTER

Figure 14-51. TX_INTMASK_CLEAR Register



LEGEND: R/W = Read/Write; R = Read only; W1toCl = Write 1 to clear bit; -n = value after reset

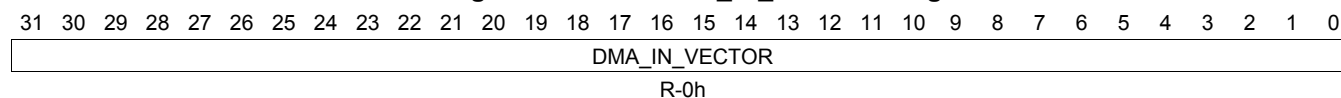
Table 14-61. TX_INTMASK_CLEAR Register Field Descriptions

Bit	Field	Type	Reset	Description
31-8	Reserved	R	0h	
7	TX7_MASK	R/W	0h	TX Channel 7 Mask - Write one to disable interrupt.
6	TX6_MASK	R/W	0h	TX Channel 6 Mask - Write one to disable interrupt.
5	TX5_MASK	R/W	0h	TX Channel 5 Mask - Write one to disable interrupt.
4	TX4_MASK	R/W	0h	TX Channel 4 Mask - Write one to disable interrupt.
3	TX3_MASK	R/W	0h	TX Channel 3 Mask - Write one to disable interrupt.
2	TX2_MASK	R/W	0h	TX Channel 2 Mask - Write one to disable interrupt.
1	TX1_MASK	R/W	0h	TX Channel 1 Mask - Write one to disable interrupt.
0	TX0_MASK	R/W	0h	TX Channel 0 Mask - Write one to disable interrupt.

14.5.2.24 CPDMA_IN_VECTOR Register (offset = 90h) [reset = 0h]

CPDMA_IN_VECTOR is shown in [Figure 14-52](#) and described in [Table 14-62](#).

CPDMA_INT INPUT VECTOR (READ ONLY)

Figure 14-52. CPDMA_IN_VECTOR Register


LEGEND: R/W = Read/Write; R = Read only; W1toCl = Write 1 to clear bit; -n = value after reset

Table 14-62. CPDMA_IN_VECTOR Register Field Descriptions

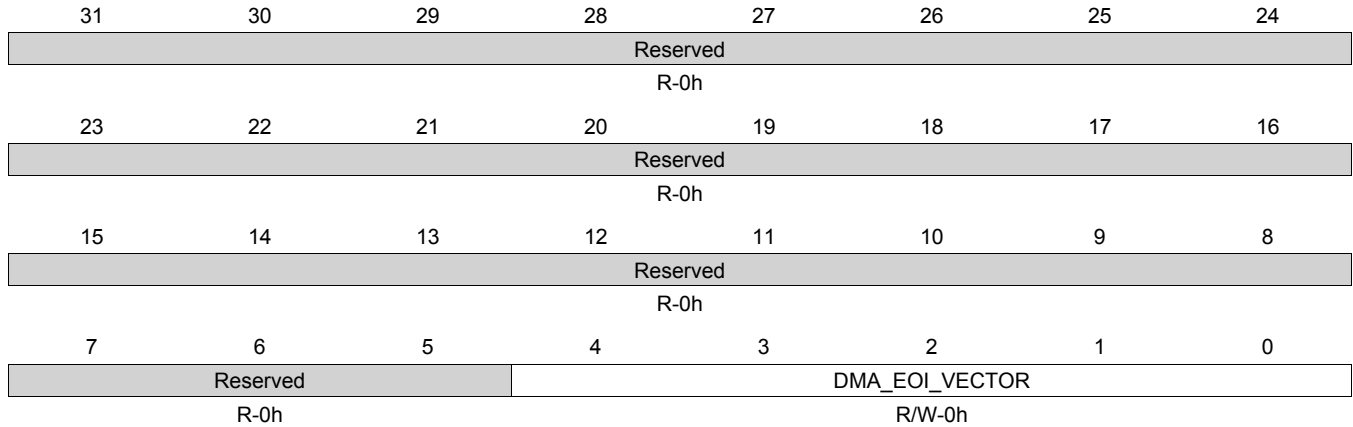
Bit	Field	Type	Reset	Description
31-0	DMA_IN_VECTOR	R	0h	DMA Input Vector - The value of DMA_In_Vector is reset to zero, but will change to the IN_VECTOR bus value one clock after reset is deasserted. Thereafter, this value will change to a new IN_VECTOR value one clock after the IN_VECTOR value changes.

14.5.2.25 CPDMA_EOI_VECTOR Register (offset = 94h) [reset = 0h]

CPDMA_EOI_VECTOR is shown in [Figure 14-53](#) and described in [Table 14-63](#).

CPDMA_INT END OF INTERRUPT VECTOR

Figure 14-53. CPDMA_EOI_VECTOR Register



LEGEND: R/W = Read/Write; R = Read only; W1toCl = Write 1 to clear bit; -n = value after reset

Table 14-63. CPDMA_EOI_VECTOR Register Field Descriptions

Bit	Field	Type	Reset	Description
31-5	Reserved	R	0h	
4-0	DMA_EOI_VECTOR	R/W	0h	DMA End of Interrupt Vector - The EOI_VECTOR(4:0) pins reflect the value written to this location one CLK cycle after a write to this location. The EOI_WR signal is asserted for a single clock cycle after a latency of two CLK cycles when a write is performed to this location.

14.5.2.26 RX_INTSTAT_RAW Register (offset = A0h) [reset = 0h]

RX_INTSTAT_RAW is shown in Figure 14-54 and described in Table 14-64.

CPDMA_INT RX INTERRUPT STATUS REGISTER (RAW VALUE)

Figure 14-54. RX_INTSTAT_RAW Register

31	30	29	28	27	26	25	24
Reserved							
R-0h							
23	22	21	20	19	18	17	16
Reserved							
R-0h							
15	14	13	12	11	10	9	8
RX7_THRESH_PEND	RX6_THRESH_PEND	RX5_THRESH_PEND	RX4_THRESH_PEND	RX3_THRESH_PEND	RX2_THRESH_PEND	RX1_THRESH_PEND	RX0_THRESH_PEND
R-0h	R-0h	R-0h	R-0h	R-0h	R-0h	R-0h	R-0h
7	6	5	4	3	2	1	0
RX7_PEND	RX6_PEND	RX5_PEND	RX4_PEND	RX3_PEND	RX2_PEND	RX1_PEND	RX0_PEND
R-0h	R-0h	R-0h	R-0h	R-0h	R-0h	R-0h	R-0h

LEGEND: R/W = Read/Write; R = Read only; W1toCl = Write 1 to clear bit; -n = value after reset

Table 14-64. RX_INTSTAT_RAW Register Field Descriptions

Bit	Field	Type	Reset	Description
31-16	Reserved	R	0h	
15	RX7_THRESH_PEND	R	0h	RX7_THRESH_PEND raw int read (before mask).
14	RX6_THRESH_PEND	R	0h	RX6_THRESH_PEND raw int read (before mask).
13	RX5_THRESH_PEND	R	0h	RX5_THRESH_PEND raw int read (before mask).
12	RX4_THRESH_PEND	R	0h	RX4_THRESH_PEND raw int read (before mask).
11	RX3_THRESH_PEND	R	0h	RX3_THRESH_PEND raw int read (before mask).
10	RX2_THRESH_PEND	R	0h	RX2_THRESH_PEND raw int read (before mask).
9	RX1_THRESH_PEND	R	0h	RX1_THRESH_PEND raw int read (before mask).
8	RX0_THRESH_PEND	R	0h	RX0_THRESH_PEND raw int read (before mask).
7	RX7_PEND	R	0h	RX7_PEND raw int read (before mask).
6	RX6_PEND	R	0h	RX6_PEND raw int read (before mask).
5	RX5_PEND	R	0h	RX5_PEND raw int read (before mask).
4	RX4_PEND	R	0h	RX4_PEND raw int read (before mask).
3	RX3_PEND	R	0h	RX3_PEND raw int read (before mask).
2	RX2_PEND	R	0h	RX2_PEND raw int read (before mask).
1	RX1_PEND	R	0h	RX1_PEND raw int read (before mask).
0	RX0_PEND	R	0h	RX0_PEND raw int read (before mask).

14.5.2.27 RX_INTSTAT_MASKED Register (offset = A4h) [reset = 0h]

RX_INTSTAT_MASKED is shown in [Figure 14-55](#) and described in [Table 14-65](#).

CPDMA_INT RX INTERRUPT STATUS REGISTER (MASKED VALUE)

Figure 14-55. RX_INTSTAT_MASKED Register

31	30	29	28	27	26	25	24
Reserved							
R-0h							
23	22	21	20	19	18	17	16
Reserved							
R-0h							
15	14	13	12	11	10	9	8
RX7_THRESH_PEND	RX6_THRESH_PEND	RX5_THRESH_PEND	RX4_THRESH_PEND	RX3_THRESH_PEND	RX2_THRESH_PEND	RX1_THRESH_PEND	RX0_THRESH_PEND
R-0h	R-0h	R-0h	R-0h	R-0h	R-0h	R-0h	R-0h
7	6	5	4	3	2	1	0
RX7_PEND	RX6_PEND	RX5_PEND	RX4_PEND	RX3_PEND	RX2_PEND	RX1_PEND	RX0_PEND
R-0h	R-0h	R-0h	R-0h	R-0h	R-0h	R-0h	R-0h

LEGEND: R/W = Read/Write; R = Read only; W1toCl = Write 1 to clear bit; -n = value after reset

Table 14-65. RX_INTSTAT_MASKED Register Field Descriptions

Bit	Field	Type	Reset	Description
31-16	Reserved	R	0h	
15	RX7_THRESH_PEND	R	0h	RX7_THRESH_PEND masked int read.
14	RX6_THRESH_PEND	R	0h	RX6_THRESH_PEND masked int read.
13	RX5_THRESH_PEND	R	0h	RX5_THRESH_PEND masked int read.
12	RX4_THRESH_PEND	R	0h	RX4_THRESH_PEND masked int read.
11	RX3_THRESH_PEND	R	0h	RX3_THRESH_PEND masked int read.
10	RX2_THRESH_PEND	R	0h	RX2_THRESH_PEND masked int read.
9	RX1_THRESH_PEND	R	0h	RX1_THRESH_PEND masked int read.
8	RX0_THRESH_PEND	R	0h	RX0_THRESH_PEND masked int read.
7	RX7_PEND	R	0h	RX7_PEND masked int read.
6	RX6_PEND	R	0h	RX6_PEND masked int read.
5	RX5_PEND	R	0h	RX5_PEND masked int read.
4	RX4_PEND	R	0h	RX4_PEND masked int read.
3	RX3_PEND	R	0h	RX3_PEND masked int read.
2	RX2_PEND	R	0h	RX2_PEND masked int read.
1	RX1_PEND	R	0h	RX1_PEND masked int read.
0	RX0_PEND	R	0h	RX0_PEND masked int read.

14.5.2.28 RX_INTMASK_SET Register (offset = A8h) [reset = 0h]

 RX_INTMASK_SET is shown in [Figure 14-56](#) and described in [Table 14-66](#).

CPDMA_INT RX INTERRUPT MASK SET REGISTER

Figure 14-56. RX_INTMASK_SET Register

31	30	29	28	27	26	25	24
Reserved							
R-0h							
23	22	21	20	19	18	17	16
Reserved							
R-0h							
15	14	13	12	11	10	9	8
RX7_THRESH_PEND_MASK	RX6_THRESH_PEND_MASK	RX5_THRESH_PEND_MASK	RX4_THRESH_PEND_MASK	RX3_THRESH_PEND_MASK	RX2_THRESH_PEND_MASK	RX1_THRESH_PEND_MASK	RX0_THRESH_PEND_MASK
R/W-0h	R/W-0h	R/W-0h	R/W-0h	R/W-0h	R/W-0h	R/W-0h	R/W-0h
7	6	5	4	3	2	1	0
RX7_PEND_MASK	RX6_PEND_MASK	RX5_PEND_MASK	RX4_PEND_MASK	RX3_PEND_MASK	RX2_PEND_MASK	RX1_PEND_MASK	RX0_PEND_MASK
R/W-0h	R/W-0h	R/W-0h	R/W-0h	R/W-0h	R/W-0h	R/W-0h	R/W-0h

LEGEND: R/W = Read/Write; R = Read only; W1toCl = Write 1 to clear bit; -n = value after reset

Table 14-66. RX_INTMASK_SET Register Field Descriptions

Bit	Field	Type	Reset	Description
31-16	Reserved	R	0h	
15	RX7_THRESH_PEND_MASK	R/W	0h	RX Channel 7 Threshold Pending Int. Mask - Write one to enable Int.
14	RX6_THRESH_PEND_MASK	R/W	0h	RX Channel 6 Threshold Pending Int. Mask - Write one to enable Int.
13	RX5_THRESH_PEND_MASK	R/W	0h	RX Channel 5 Threshold Pending Int. Mask - Write one to enable Int.
12	RX4_THRESH_PEND_MASK	R/W	0h	RX Channel 4 Threshold Pending Int. Mask - Write one to enable Int.
11	RX3_THRESH_PEND_MASK	R/W	0h	RX Channel 3 Threshold Pending Int. Mask - Write one to enable Int.
10	RX2_THRESH_PEND_MASK	R/W	0h	RX Channel 2 Threshold Pending Int. Mask - Write one to enable Int.
9	RX1_THRESH_PEND_MASK	R/W	0h	RX Channel 1 Threshold Pending Int. Mask - Write one to enable Int.
8	RX0_THRESH_PEND_MASK	R/W	0h	RX Channel 0 Threshold Pending Int. Mask - Write one to enable Int.
7	RX7_PEND_MASK	R/W	0h	RX Channel 7 Pending Int. Mask - Write one to enable Int.
6	RX6_PEND_MASK	R/W	0h	RX Channel 6 Pending Int. Mask - Write one to enable Int.
5	RX5_PEND_MASK	R/W	0h	RX Channel 5 Pending Int. Mask - Write one to enable Int.
4	RX4_PEND_MASK	R/W	0h	RX Channel 4 Pending Int. Mask - Write one to enable Int.
3	RX3_PEND_MASK	R/W	0h	RX Channel 3 Pending Int. Mask - Write one to enable Int.
2	RX2_PEND_MASK	R/W	0h	RX Channel 2 Pending Int. Mask - Write one to enable Int.
1	RX1_PEND_MASK	R/W	0h	RX Channel 1 Pending Int. Mask - Write one to enable Int.

Table 14-66. RX_INTMASK_SET Register Field Descriptions (continued)

Bit	Field	Type	Reset	Description
0	RX0_PEND_MASK	R/W	0h	RX Channel 0 Pending Int. Mask - Write one to enable Int.

14.5.2.29 RX_INTMASK_CLEAR Register (offset = ACh) [reset = 0h]

RX_INTMASK_CLEAR is shown in Figure 14-57 and described in Table 14-67.

CPDMA_INT RX INTERRUPT MASK CLEAR REGISTER

Figure 14-57. RX_INTMASK_CLEAR Register

31	30	29	28	27	26	25	24
Reserved							
R-0h							
23	22	21	20	19	18	17	16
Reserved							
R-0h							
15	14	13	12	11	10	9	8
RX7_THRESH_PEND_MASK	RX6_THRESH_PEND_MASK	RX5_THRESH_PEND_MASK	RX4_THRESH_PEND_MASK	RX3_THRESH_PEND_MASK	RX2_THRESH_PEND_MASK	RX1_THRESH_PEND_MASK	RX0_THRESH_PEND_MASK
R/W-0h	R/W-0h	R/W-0h	R/W-0h	R/W-0h	R/W-0h	R/W-0h	R/W-0h
7	6	5	4	3	2	1	0
RX7_PEND_MASK	RX6_PEND_MASK	RX5_PEND_MASK	RX4_PEND_MASK	RX3_PEND_MASK	RX2_PEND_MASK	RX1_PEND_MASK	RX0_PEND_MASK
R/W-0h	R/W-0h	R/W-0h	R/W-0h	R/W-0h	R/W-0h	R/W-0h	R/W-0h

LEGEND: R/W = Read/Write; R = Read only; W1toCl = Write 1 to clear bit; -n = value after reset

Table 14-67. RX_INTMASK_CLEAR Register Field Descriptions

Bit	Field	Type	Reset	Description
31-16	Reserved	R	0h	
15	RX7_THRESH_PEND_MASK	R/W	0h	RX Channel 7 Threshold Pending Int. Mask - Write one to disable Int.
14	RX6_THRESH_PEND_MASK	R/W	0h	RX Channel 6 Threshold Pending Int. Mask - Write one to disable Int.
13	RX5_THRESH_PEND_MASK	R/W	0h	RX Channel 5 Threshold Pending Int. Mask - Write one to disable Int.
12	RX4_THRESH_PEND_MASK	R/W	0h	RX Channel 4 Threshold Pending Int. Mask - Write one to disable Int.
11	RX3_THRESH_PEND_MASK	R/W	0h	RX Channel 3 Threshold Pending Int. Mask - Write one to disable Int.
10	RX2_THRESH_PEND_MASK	R/W	0h	RX Channel 2 Threshold Pending Int. Mask - Write one to disable Int.
9	RX1_THRESH_PEND_MASK	R/W	0h	RX Channel 1 Threshold Pending Int. Mask - Write one to disable Int.
8	RX0_THRESH_PEND_MASK	R/W	0h	RX Channel 0 Threshold Pending Int. Mask - Write one to disable Int.
7	RX7_PEND_MASK	R/W	0h	RX Channel 7 Pending Int. Mask - Write one to disable Int.
6	RX6_PEND_MASK	R/W	0h	RX Channel 6 Pending Int. Mask - Write one to disable Int.
5	RX5_PEND_MASK	R/W	0h	RX Channel 5 Pending Int. Mask - Write one to disable Int.
4	RX4_PEND_MASK	R/W	0h	RX Channel 4 Pending Int. Mask - Write one to disable Int.
3	RX3_PEND_MASK	R/W	0h	RX Channel 3 Pending Int. Mask - Write one to disable Int.
2	RX2_PEND_MASK	R/W	0h	RX Channel 2 Pending Int. Mask - Write one to disable Int.
1	RX1_PEND_MASK	R/W	0h	RX Channel 1 Pending Int. Mask - Write one to disable Int.

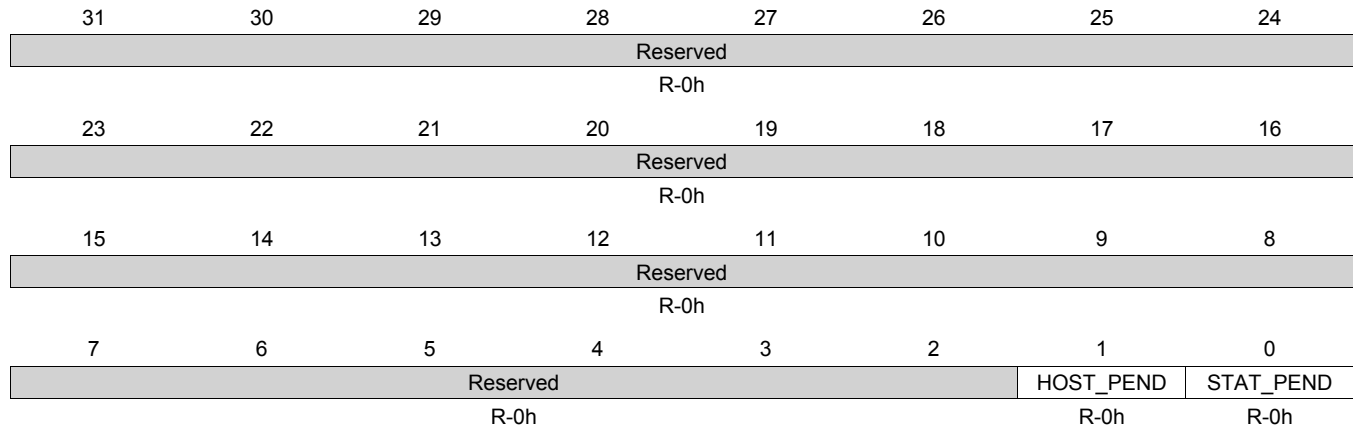
Table 14-67. RX_INTMASK_CLEAR Register Field Descriptions (continued)

Bit	Field	Type	Reset	Description
0	RX0_PEND_MASK	R/W	0h	RX Channel 0 Pending Int. Mask - Write one to disable Int.

14.5.2.30 DMA_INTSTAT_RAW Register (offset = B0h) [reset = 0h]

 DMA_INTSTAT_RAW is shown in [Figure 14-58](#) and described in [Table 14-68](#).

CPDMA_INT DMA INTERRUPT STATUS REGISTER (RAW VALUE)

Figure 14-58. DMA_INTSTAT_RAW Register


LEGEND: R/W = Read/Write; R = Read only; W1toCl = Write 1 to clear bit; -n = value after reset

Table 14-68. DMA_INTSTAT_RAW Register Field Descriptions

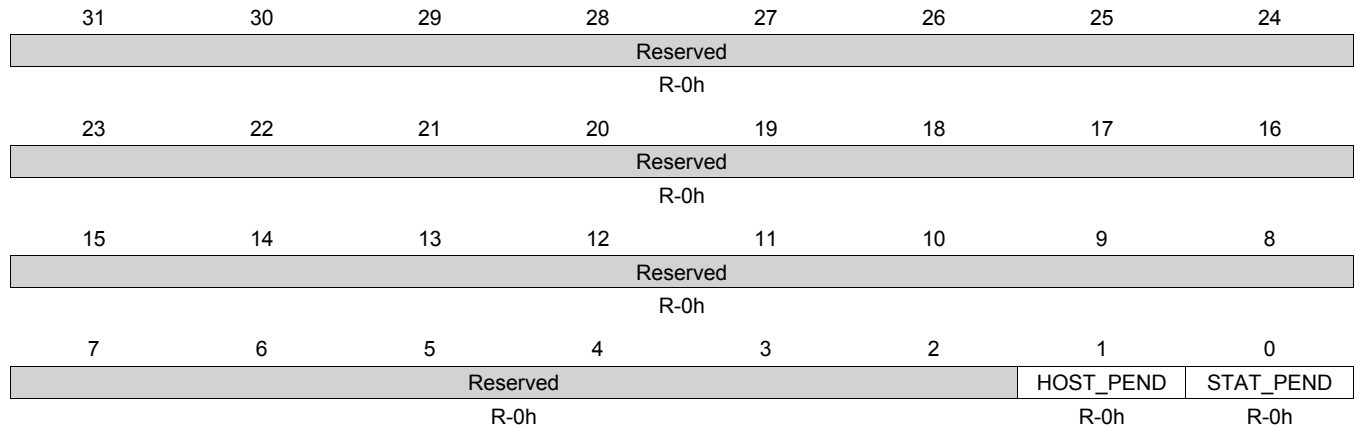
Bit	Field	Type	Reset	Description
31-2	Reserved	R	0h	
1	HOST_PEND	R	0h	Host Pending Interrupt - raw int read (before mask).
0	STAT_PEND	R	0h	Statistics Pending Interrupt - raw int read (before mask).

14.5.2.31 DMA_INTSTAT_MASKED Register (offset = B4h) [reset = 0h]

DMA_INTSTAT_MASKED is shown in [Figure 14-59](#) and described in [Table 14-69](#).

CPDMA_INT DMA INTERRUPT STATUS REGISTER (MASKED VALUE)

Figure 14-59. DMA_INTSTAT_MASKED Register



LEGEND: R/W = Read/Write; R = Read only; W1toCl = Write 1 to clear bit; -n = value after reset

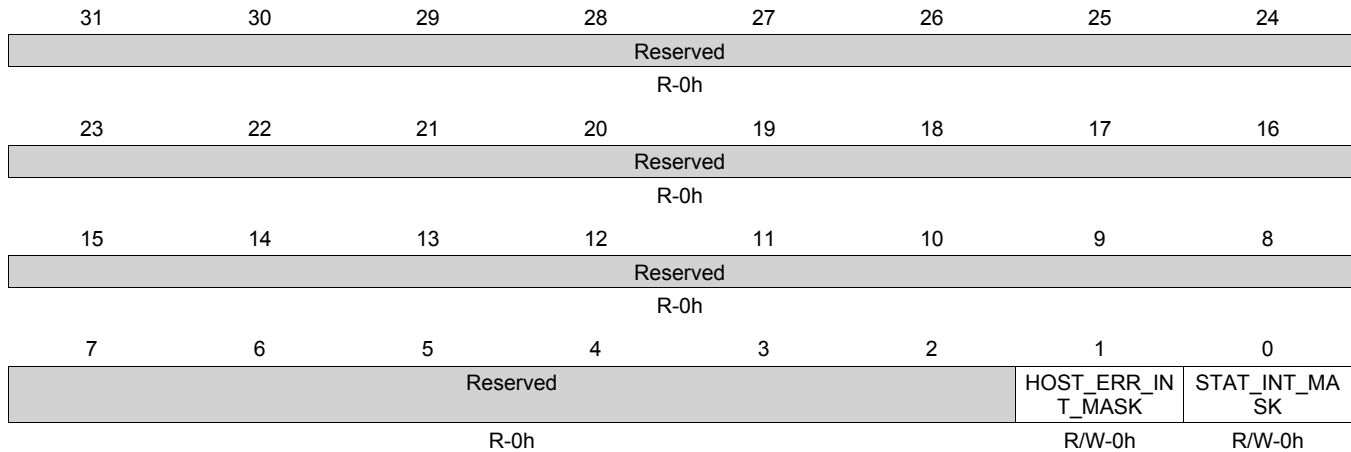
Table 14-69. DMA_INTSTAT_MASKED Register Field Descriptions

Bit	Field	Type	Reset	Description
31-2	Reserved	R	0h	
1	HOST_PEND	R	0h	Host Pending Interrupt - masked interrupt read.
0	STAT_PEND	R	0h	Statistics Pending Interrupt - masked interrupt read.

14.5.2.32 DMA_INTMASK_SET Register (offset = B8h) [reset = 0h]

 DMA_INTMASK_SET is shown in [Figure 14-60](#) and described in [Table 14-70](#).

CPDMA_INT DMA INTERRUPT MASK SET REGISTER

Figure 14-60. DMA_INTMASK_SET Register


LEGEND: R/W = Read/Write; R = Read only; W1toCl = Write 1 to clear bit; -n = value after reset

Table 14-70. DMA_INTMASK_SET Register Field Descriptions

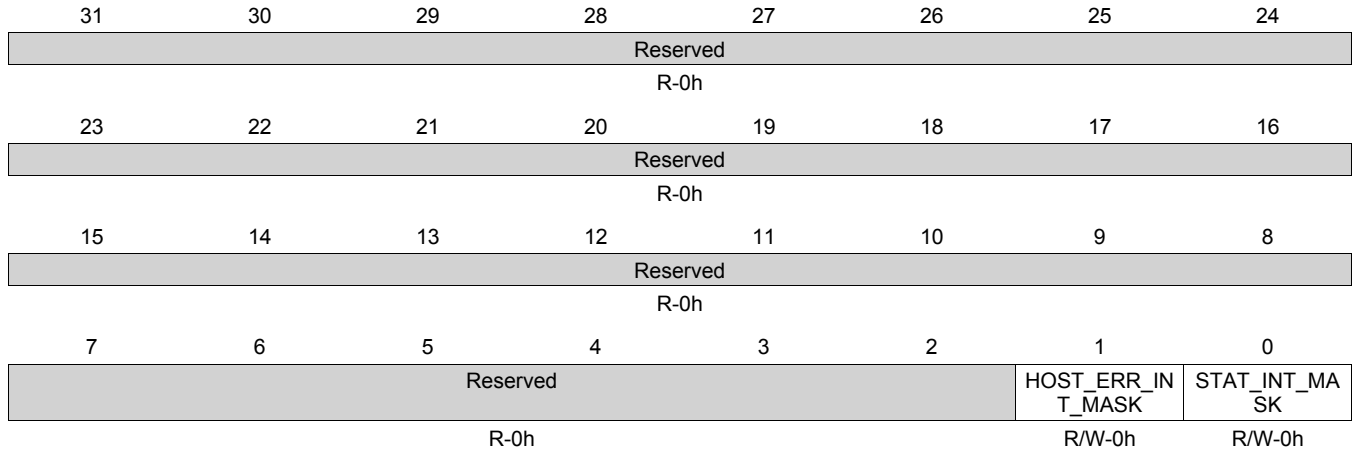
Bit	Field	Type	Reset	Description
31-2	Reserved	R	0h	
1	HOST_ERR_INT_MASK	R/W	0h	Host Error Interrupt Mask - Write one to enable interrupt.
0	STAT_INT_MASK	R/W	0h	Statistics Interrupt Mask - Write one to enable interrupt.

14.5.2.33 DMA_INTMASK_CLEAR Register (offset = BCh) [reset = 0h]

DMA_INTMASK_CLEAR is shown in [Figure 14-61](#) and described in [Table 14-71](#).

CPDMA_INT DMA INTERRUPT MASK CLEAR REGISTER

Figure 14-61. DMA_INTMASK_CLEAR Register



LEGEND: R/W = Read/Write; R = Read only; W1toCl = Write 1 to clear bit; -n = value after reset

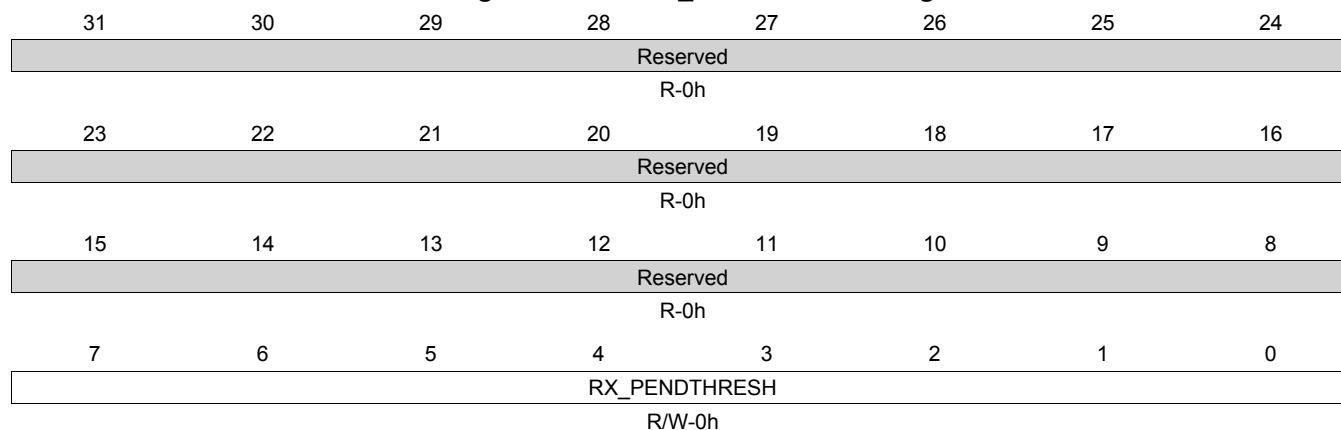
Table 14-71. DMA_INTMASK_CLEAR Register Field Descriptions

Bit	Field	Type	Reset	Description
31-2	Reserved	R	0h	
1	HOST_ERR_INT_MASK	R/W	0h	Host Error Interrupt Mask - Write one to disable interrupt.
0	STAT_INT_MASK	R/W	0h	Statistics Interrupt Mask - Write one to disable interrupt.

14.5.2.34 RX0_PENDTHRESH Register (offset = C0h) [reset = 0h]

 RX0_PENDTHRESH is shown in [Figure 14-62](#) and described in [Table 14-72](#).

CPDMA_INT RECEIVE THRESHOLD PENDING REGISTER CHANNEL 0

Figure 14-62. RX0_PENDTHRESH Register


LEGEND: R/W = Read/Write; R = Read only; W1toCl = Write 1 to clear bit; -n = value after reset

Table 14-72. RX0_PENDTHRESH Register Field Descriptions

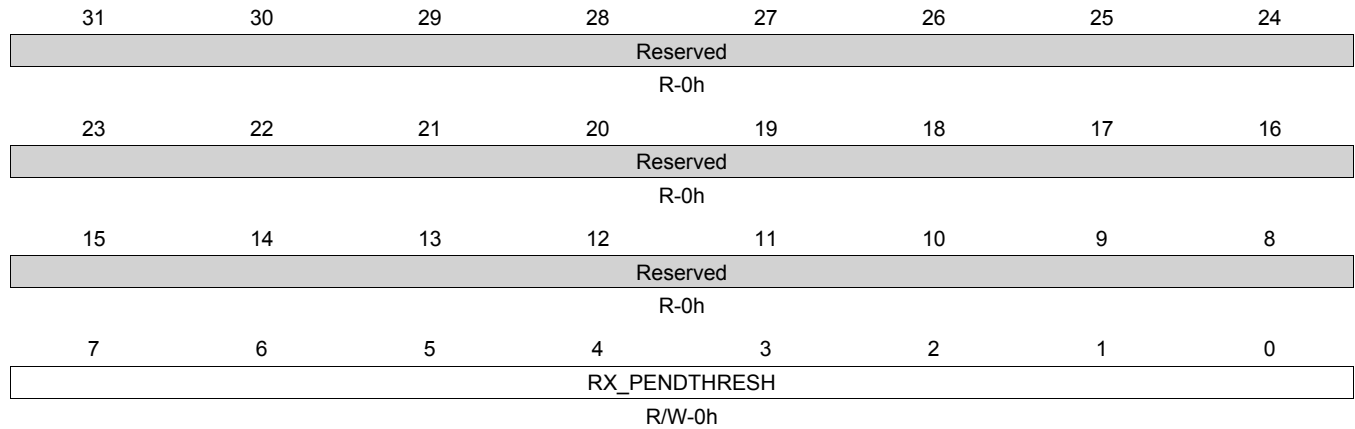
Bit	Field	Type	Reset	Description
31-8	Reserved	R	0h	
7-0	RX_PENDTHRESH	R/W	0h	Rx Flow Threshold - This field contains the threshold value for issuing receive threshold pending interrupts (when enabled).

14.5.2.35 RX1_PENDTHRESH Register (offset = C4h) [reset = 0h]

RX1_PENDTHRESH is shown in [Figure 14-63](#) and described in [Table 14-73](#).

CPDMA_INT RECEIVE THRESHOLD PENDING REGISTER CHANNEL 1

Figure 14-63. RX1_PENDTHRESH Register



LEGEND: R/W = Read/Write; R = Read only; W1toCl = Write 1 to clear bit; -n = value after reset

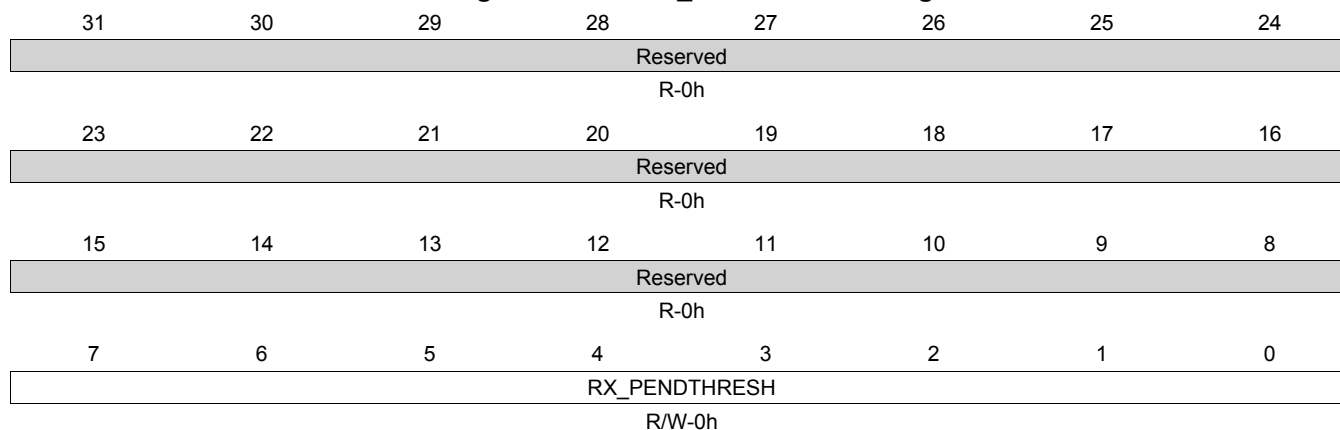
Table 14-73. RX1_PENDTHRESH Register Field Descriptions

Bit	Field	Type	Reset	Description
31-8	Reserved	R	0h	
7-0	RX_PENDTHRESH	R/W	0h	Rx Flow Threshold - This field contains the threshold value for issuing receive threshold pending interrupts (when enabled).

14.5.2.36 RX2_PENDTHRESH Register (offset = C8h) [reset = 0h]

 RX2_PENDTHRESH is shown in [Figure 14-64](#) and described in [Table 14-74](#).

CPDMA_INT RECEIVE THRESHOLD PENDING REGISTER CHANNEL 2

Figure 14-64. RX2_PENDTHRESH Register


LEGEND: R/W = Read/Write; R = Read only; W1toCl = Write 1 to clear bit; -n = value after reset

Table 14-74. RX2_PENDTHRESH Register Field Descriptions

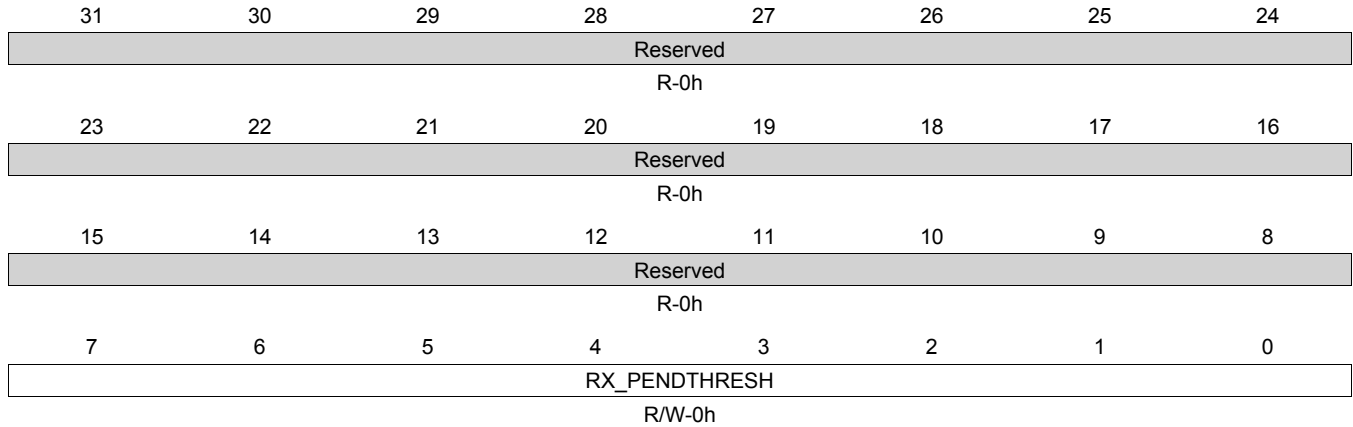
Bit	Field	Type	Reset	Description
31-8	Reserved	R	0h	
7-0	RX_PENDTHRESH	R/W	0h	Rx Flow Threshold - This field contains the threshold value for issuing receive threshold pending interrupts (when enabled).

14.5.2.37 RX3_PENDTHRESH Register (offset = CCh) [reset = 0h]

RX3_PENDTHRESH is shown in [Figure 14-65](#) and described in [Table 14-75](#).

CPDMA_INT RECEIVE THRESHOLD PENDING REGISTER CHANNEL 3

Figure 14-65. RX3_PENDTHRESH Register



LEGEND: R/W = Read/Write; R = Read only; W1toCl = Write 1 to clear bit; -n = value after reset

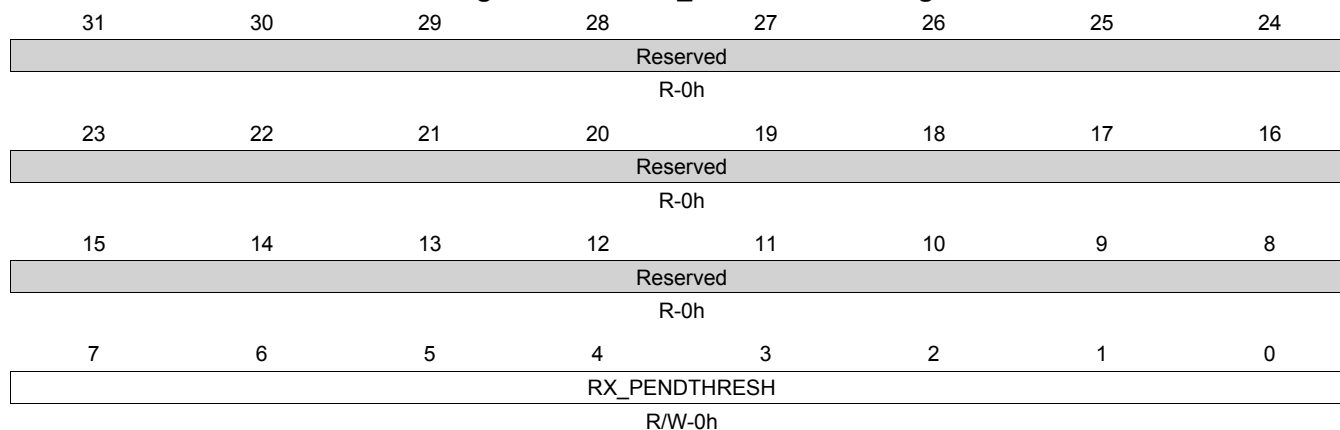
Table 14-75. RX3_PENDTHRESH Register Field Descriptions

Bit	Field	Type	Reset	Description
31-8	Reserved	R	0h	
7-0	RX_PENDTHRESH	R/W	0h	Rx Flow Threshold - This field contains the threshold value for issuing receive threshold pending interrupts (when enabled).

14.5.2.38 RX4_PENDTHRESH Register (offset = D0h) [reset = 0h]

 RX4_PENDTHRESH is shown in [Figure 14-66](#) and described in [Table 14-76](#).

CPDMA_INT RECEIVE THRESHOLD PENDING REGISTER CHANNEL 4

Figure 14-66. RX4_PENDTHRESH Register


LEGEND: R/W = Read/Write; R = Read only; W1toCl = Write 1 to clear bit; -n = value after reset

Table 14-76. RX4_PENDTHRESH Register Field Descriptions

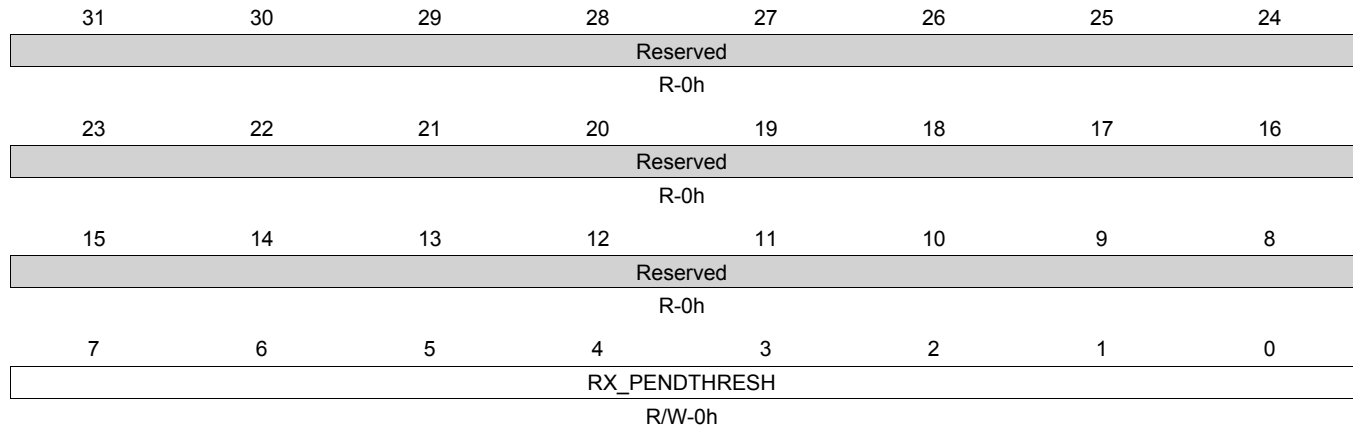
Bit	Field	Type	Reset	Description
31-8	Reserved	R	0h	
7-0	RX_PENDTHRESH	R/W	0h	Rx Flow Threshold - This field contains the threshold value for issuing receive threshold pending interrupts (when enabled).

14.5.2.39 RX5_PENDTHRESH Register (offset = D4h) [reset = 0h]

RX5_PENDTHRESH is shown in [Figure 14-67](#) and described in [Table 14-77](#).

CPDMA_INT RECEIVE THRESHOLD PENDING REGISTER CHANNEL 5

Figure 14-67. RX5_PENDTHRESH Register



LEGEND: R/W = Read/Write; R = Read only; W1toCl = Write 1 to clear bit; -n = value after reset

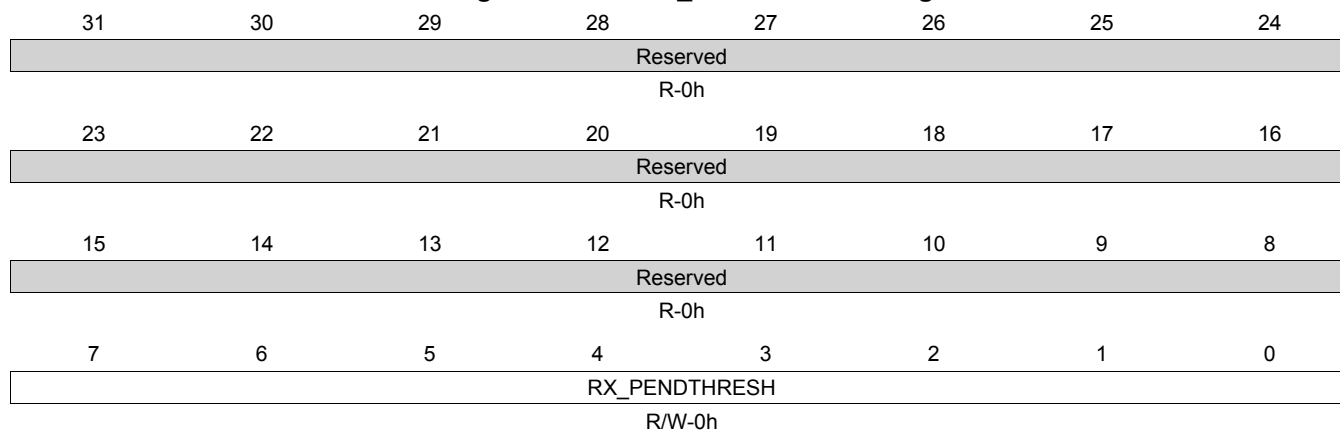
Table 14-77. RX5_PENDTHRESH Register Field Descriptions

Bit	Field	Type	Reset	Description
31-8	Reserved	R	0h	
7-0	RX_PENDTHRESH	R/W	0h	Rx Flow Threshold - This field contains the threshold value for issuing receive threshold pending interrupts (when enabled).

14.5.2.40 RX6_PENDTHRESH Register (offset = D8h) [reset = 0h]

 RX6_PENDTHRESH is shown in [Figure 14-68](#) and described in [Table 14-78](#).

CPDMA_INT RECEIVE THRESHOLD PENDING REGISTER CHANNEL 6

Figure 14-68. RX6_PENDTHRESH Register


LEGEND: R/W = Read/Write; R = Read only; W1toCl = Write 1 to clear bit; -n = value after reset

Table 14-78. RX6_PENDTHRESH Register Field Descriptions

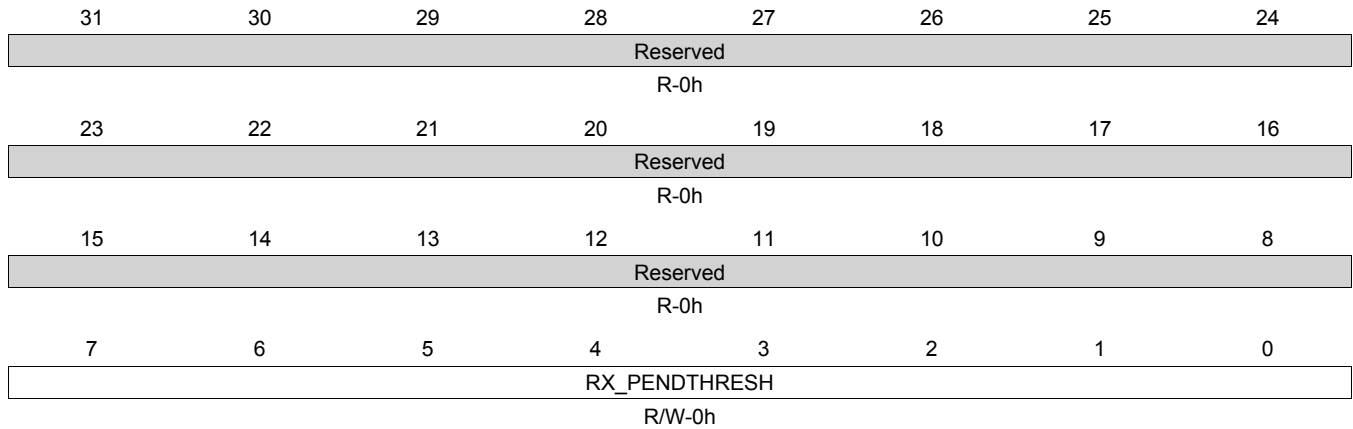
Bit	Field	Type	Reset	Description
31-8	Reserved	R	0h	
7-0	RX_PENDTHRESH	R/W	0h	Rx Flow Threshold - This field contains the threshold value for issuing receive threshold pending interrupts (when enabled).

14.5.2.41 RX7_PENDTHRESH Register (offset = DCh) [reset = 0h]

RX7_PENDTHRESH is shown in [Figure 14-69](#) and described in [Table 14-79](#).

CPDMA_INT RECEIVE THRESHOLD PENDING REGISTER CHANNEL 7

Figure 14-69. RX7_PENDTHRESH Register



LEGEND: R/W = Read/Write; R = Read only; W1toCl = Write 1 to clear bit; -n = value after reset

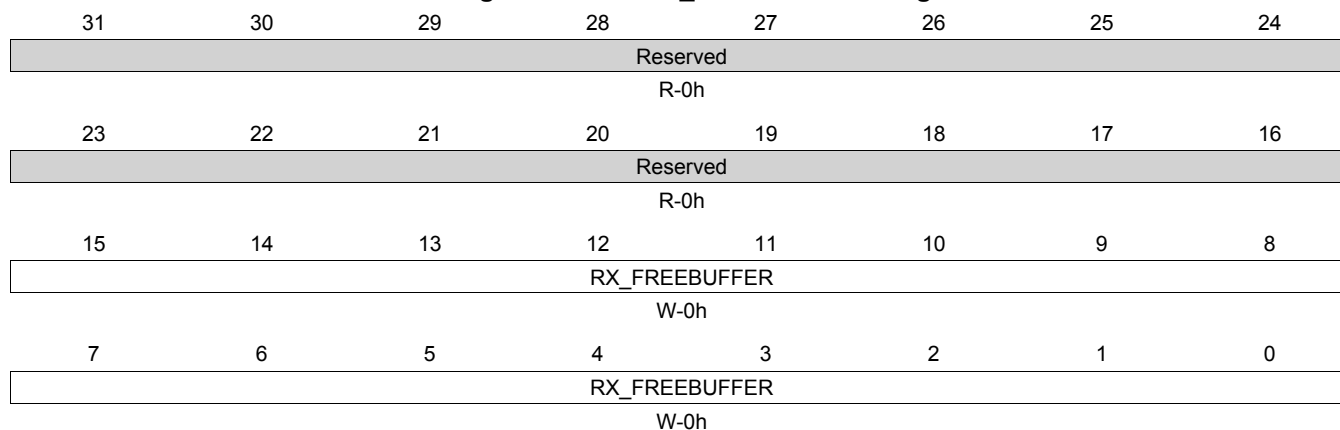
Table 14-79. RX7_PENDTHRESH Register Field Descriptions

Bit	Field	Type	Reset	Description
31-8	Reserved	R	0h	
7-0	RX_PENDTHRESH	R/W	0h	Rx Flow Threshold - This field contains the threshold value for issuing receive threshold pending interrupts (when enabled).

14.5.2.42 RX0_FREEBUFFER Register (offset = E0h) [reset = 0h]

 RX0_FREEBUFFER is shown in [Figure 14-70](#) and described in [Table 14-80](#).

CPDMA_INT RECEIVE FREE BUFFER REGISTER CHANNEL 0

Figure 14-70. RX0_FREEBUFFER Register


LEGEND: R/W = Read/Write; R = Read only; W1toCl = Write 1 to clear bit; -n = value after reset

Table 14-80. RX0_FREEBUFFER Register Field Descriptions

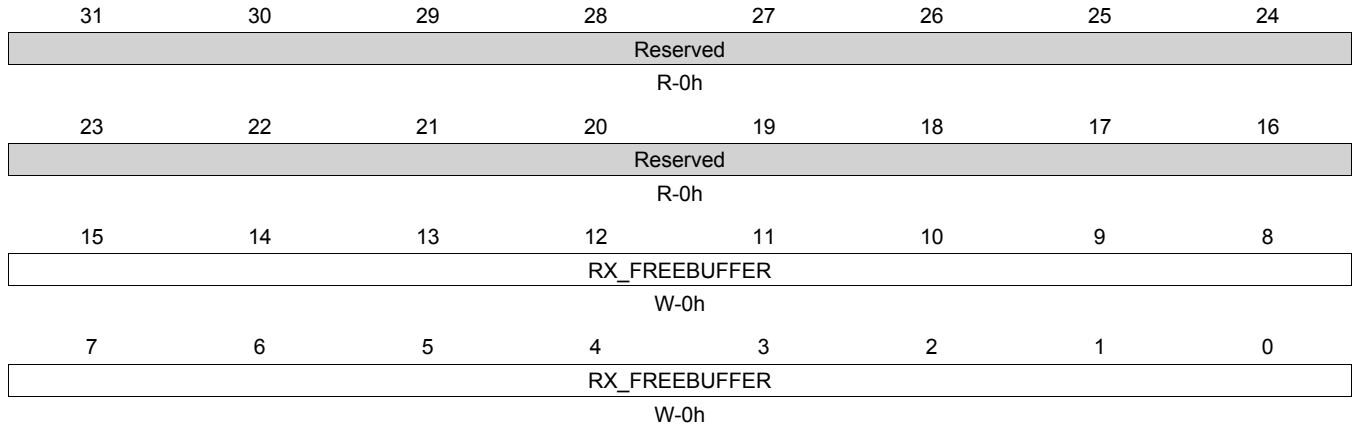
Bit	Field	Type	Reset	Description
31-16	Reserved	R	0h	
15-0	RX_FREEBUFFER	W	0h	Rx Free Buffer Count - This field contains the count of free buffers available. The rx_pendthresh value is compared with this field to determine if the receive threshold pending interrupt should be asserted (if enabled). This is a write to increment field. This field rolls over to zero on overflow. If receive threshold pending interrupts are used, the host must initialize this field to the number of available buffers (one register per channel). The port decrements (by the number of buffers in the received frame) the associated channel register for each received frame. This is a write to increment field. The host must write this field with the number of buffers that have been freed due to host processing.

14.5.2.43 RX1_FREEBUFFER Register (offset = E4h) [reset = 0h]

RX1_FREEBUFFER is shown in [Figure 14-71](#) and described in [Table 14-81](#).

CPDMA_INT RECEIVE FREE BUFFER REGISTER CHANNEL 1

Figure 14-71. RX1_FREEBUFFER Register



LEGEND: R/W = Read/Write; R = Read only; W1toCl = Write 1 to clear bit; -n = value after reset

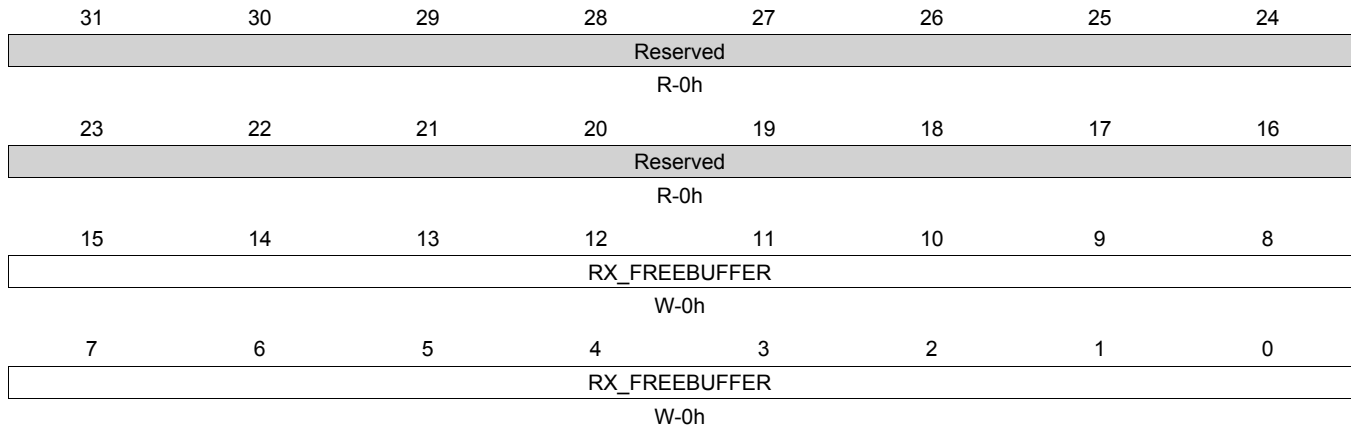
Table 14-81. RX1_FREEBUFFER Register Field Descriptions

Bit	Field	Type	Reset	Description
31-16	Reserved	R	0h	
15-0	RX_FREEBUFFER	W	0h	<p>Rx Free Buffer Count - This field contains the count of free buffers available.</p> <p>The rx_pendthresh value is compared with this field to determine if the receive threshold pending interrupt should be asserted (if enabled).</p> <p>This is a write to increment field.</p> <p>This field rolls over to zero on overflow.</p> <p>If receive threshold pending interrupts are used, the host must initialize this field to the number of available buffers (one register per channel).</p> <p>The port decrements (by the number of buffers in the received frame) the associated channel register for each received frame.</p> <p>This is a write to increment field.</p> <p>The host must write this field with the number of buffers that have been freed due to host processing.</p>

14.5.2.44 RX2_FREEBUFFER Register (offset = E8h) [reset = 0h]

 RX2_FREEBUFFER is shown in [Figure 14-72](#) and described in [Table 14-82](#).

CPDMA_INT RECEIVE FREE BUFFER REGISTER CHANNEL 2

Figure 14-72. RX2_FREEBUFFER Register


LEGEND: R/W = Read/Write; R = Read only; W1toCl = Write 1 to clear bit; -n = value after reset

Table 14-82. RX2_FREEBUFFER Register Field Descriptions

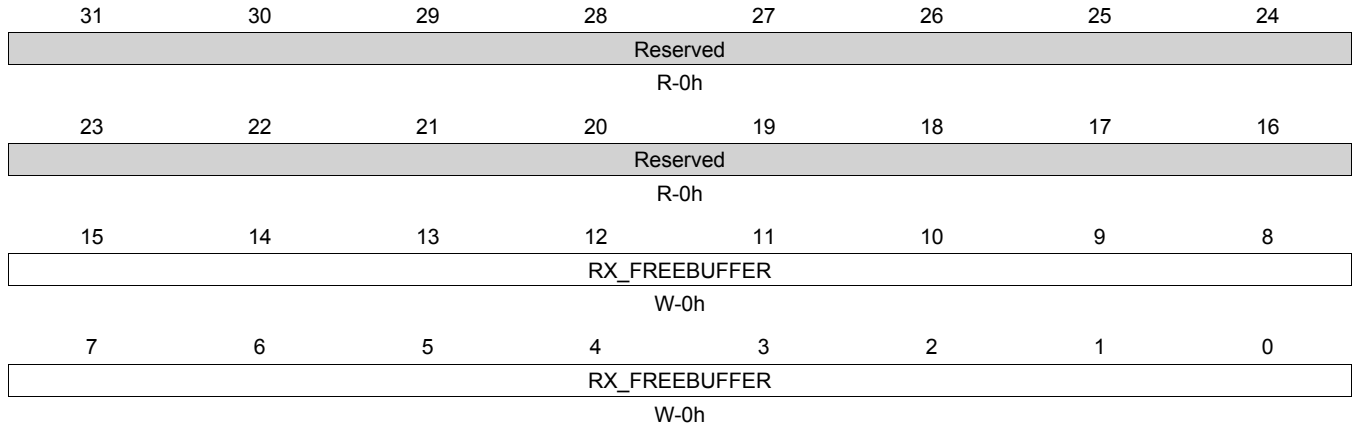
Bit	Field	Type	Reset	Description
31-16	Reserved	R	0h	
15-0	RX_FREEBUFFER	W	0h	Rx Free Buffer Count - This field contains the count of free buffers available. The rx_pendthresh value is compared with this field to determine if the receive threshold pending interrupt should be asserted (if enabled). This is a write to increment field. This field rolls over to zero on overflow. If receive threshold pending interrupts are used, the host must initialize this field to the number of available buffers (one register per channel). The port decrements (by the number of buffers in the received frame) the associated channel register for each received frame. This is a write to increment field. The host must write this field with the number of buffers that have been freed due to host processing.

14.5.2.45 RX3_FREEBUFFER Register (offset = ECh) [reset = 0h]

RX3_FREEBUFFER is shown in [Figure 14-73](#) and described in [Table 14-83](#).

CPDMA_INT RECEIVE FREE BUFFER REGISTER CHANNEL 3

Figure 14-73. RX3_FREEBUFFER Register



LEGEND: R/W = Read/Write; R = Read only; W1toCl = Write 1 to clear bit; -n = value after reset

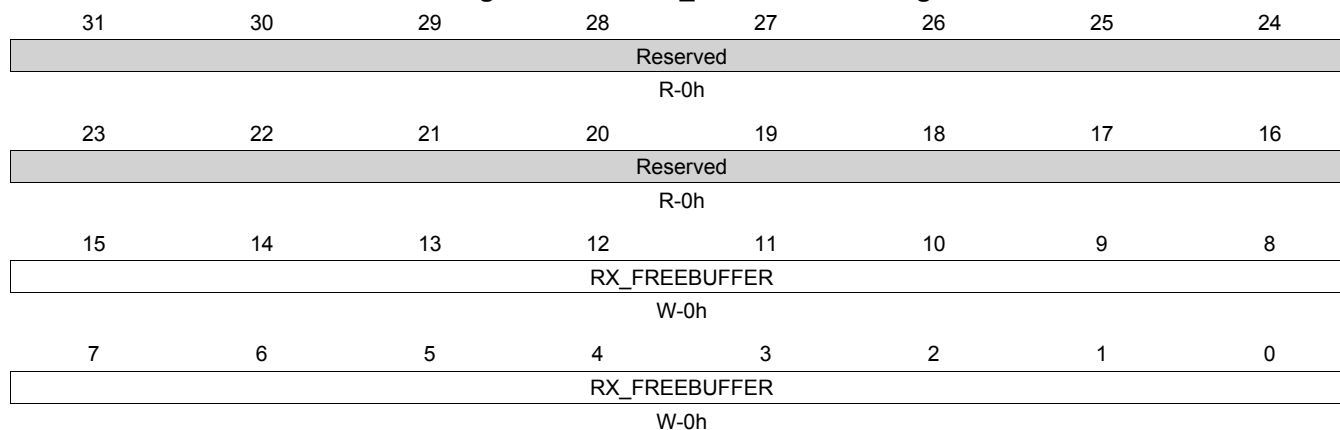
Table 14-83. RX3_FREEBUFFER Register Field Descriptions

Bit	Field	Type	Reset	Description
31-16	Reserved	R	0h	
15-0	RX_FREEBUFFER	W	0h	<p>Rx Free Buffer Count - This field contains the count of free buffers available.</p> <p>The rx_pendthresh value is compared with this field to determine if the receive threshold pending interrupt should be asserted (if enabled).</p> <p>This is a write to increment field.</p> <p>This field rolls over to zero on overflow.</p> <p>If receive threshold pending interrupts are used, the host must initialize this field to the number of available buffers (one register per channel).</p> <p>The port decrements (by the number of buffers in the received frame) the associated channel register for each received frame.</p> <p>This is a write to increment field.</p> <p>The host must write this field with the number of buffers that have been freed due to host processing.</p>

14.5.2.46 RX4_FREEBUFFER Register (offset = F0h) [reset = 0h]

 RX4_FREEBUFFER is shown in [Figure 14-74](#) and described in [Table 14-84](#).

CPDMA_INT RECEIVE FREE BUFFER REGISTER CHANNEL 4

Figure 14-74. RX4_FREEBUFFER Register


LEGEND: R/W = Read/Write; R = Read only; W1toCl = Write 1 to clear bit; -n = value after reset

Table 14-84. RX4_FREEBUFFER Register Field Descriptions

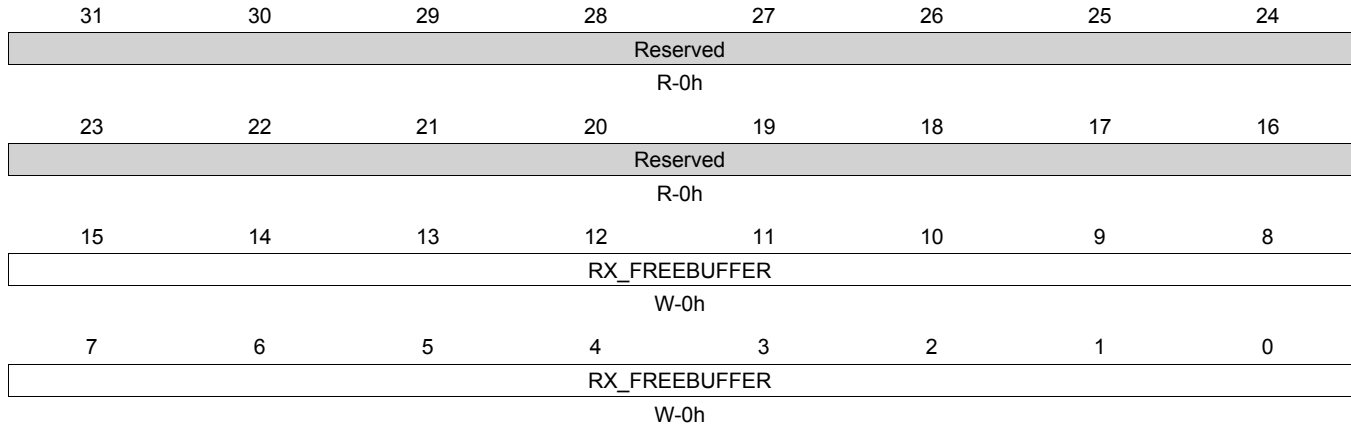
Bit	Field	Type	Reset	Description
31-16	Reserved	R	0h	
15-0	RX_FREEBUFFER	W	0h	Rx Free Buffer Count - This field contains the count of free buffers available. The rx_pendthresh value is compared with this field to determine if the receive threshold pending interrupt should be asserted (if enabled). This is a write to increment field. This field rolls over to zero on overflow. If receive threshold pending interrupts are used, the host must initialize this field to the number of available buffers (one register per channel). The port decrements (by the number of buffers in the received frame) the associated channel register for each received frame. This is a write to increment field. The host must write this field with the number of buffers that have been freed due to host processing.

14.5.2.47 RX5_FREEBUFFER Register (offset = F4h) [reset = 0h]

RX5_FREEBUFFER is shown in [Figure 14-75](#) and described in [Table 14-85](#).

CPDMA_INT RECEIVE FREE BUFFER REGISTER CHANNEL 5

Figure 14-75. RX5_FREEBUFFER Register



LEGEND: R/W = Read/Write; R = Read only; W1toCl = Write 1 to clear bit; -n = value after reset

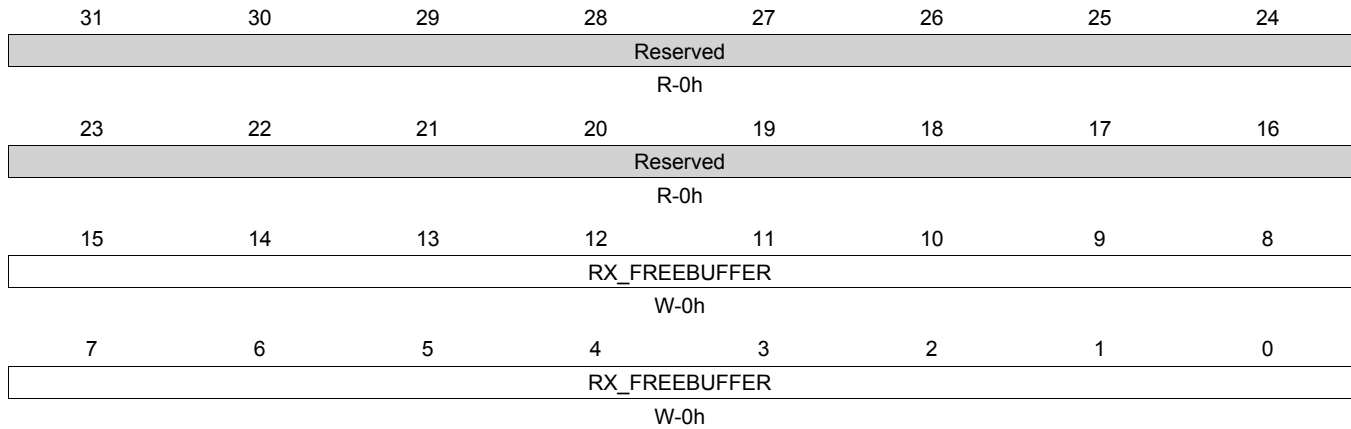
Table 14-85. RX5_FREEBUFFER Register Field Descriptions

Bit	Field	Type	Reset	Description
31-16	Reserved	R	0h	
15-0	RX_FREEBUFFER	W	0h	<p>Rx Free Buffer Count - This field contains the count of free buffers available.</p> <p>The rx_pendthresh value is compared with this field to determine if the receive threshold pending interrupt should be asserted (if enabled).</p> <p>This is a write to increment field.</p> <p>This field rolls over to zero on overflow.</p> <p>If receive threshold pending interrupts are used, the host must initialize this field to the number of available buffers (one register per channel).</p> <p>The port decrements (by the number of buffers in the received frame) the associated channel register for each received frame.</p> <p>This is a write to increment field.</p> <p>The host must write this field with the number of buffers that have been freed due to host processing.</p>

14.5.2.48 RX6_FREEBUFFER Register (offset = F8h) [reset = 0h]

 RX6_FREEBUFFER is shown in [Figure 14-76](#) and described in [Table 14-86](#).

CPDMA_INT RECEIVE FREE BUFFER REGISTER CHANNEL 6

Figure 14-76. RX6_FREEBUFFER Register


LEGEND: R/W = Read/Write; R = Read only; W1toCl = Write 1 to clear bit; -n = value after reset

Table 14-86. RX6_FREEBUFFER Register Field Descriptions

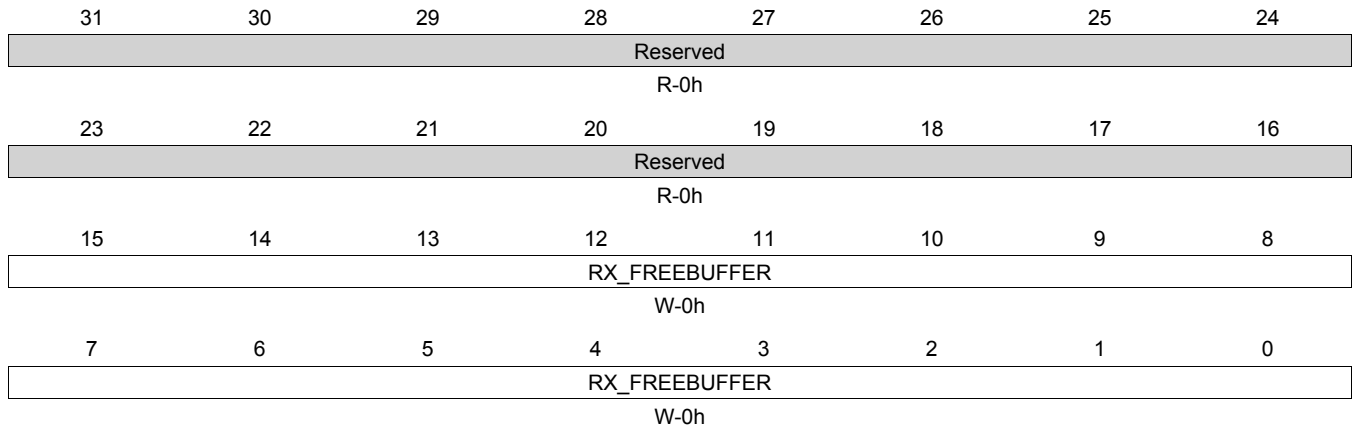
Bit	Field	Type	Reset	Description
31-16	Reserved	R	0h	
15-0	RX_FREEBUFFER	W	0h	Rx Free Buffer Count - This field contains the count of free buffers available. The rx_pendthresh value is compared with this field to determine if the receive threshold pending interrupt should be asserted (if enabled). This is a write to increment field. This field rolls over to zero on overflow. If receive threshold pending interrupts are used, the host must initialize this field to the number of available buffers (one register per channel). The port decrements (by the number of buffers in the received frame) the associated channel register for each received frame. This is a write to increment field. The host must write this field with the number of buffers that have been freed due to host processing.

14.5.2.49 RX7_FREEBUFFER Register (offset = FCh) [reset = 0h]

RX7_FREEBUFFER is shown in [Figure 14-77](#) and described in [Table 14-87](#).

CPDMA_INT RECEIVE FREE BUFFER REGISTER CHANNEL 7

Figure 14-77. RX7_FREEBUFFER Register



LEGEND: R/W = Read/Write; R = Read only; W1toCl = Write 1 to clear bit; -n = value after reset

Table 14-87. RX7_FREEBUFFER Register Field Descriptions

Bit	Field	Type	Reset	Description
31-16	Reserved	R	0h	
15-0	RX_FREEBUFFER	W	0h	Rx Free Buffer Count - This field contains the count of free buffers available. The rx_pendthresh value is compared with this field to determine if the receive threshold pending interrupt should be asserted (if enabled). This is a write to increment field. This field rolls over to zero on overflow. If receive threshold pending interrupts are used, the host must initialize this field to the number of available buffers (one register per channel). The port decrements (by the number of buffers in the received frame) the associated channel register for each received frame. This is a write to increment field. The host must write this field with the number of buffers that have been freed due to host processing.

14.5.3 CPSW_CPTS Registers

[Table 14-88](#) lists the memory-mapped registers for the CPSW_CPTS. All register offset addresses not listed in [Table 14-88](#) should be considered as reserved locations and the register contents should not be modified.

Table 14-88. CPSW_CPTS REGISTERS

Offset	Acronym	Register Name	Section
0h	CPTS_IDVER	IDENTIFICATION AND VERSION REGISTER	Section 14.5.3.1
4h	CPTS_CONTROL	TIME SYNC CONTROL REGISTER	Section 14.5.3.2
Ch	CPTS_TS_PUSH	TIME STAMP EVENT PUSH REGISTER	Section 14.5.3.3
10h	CPTS_TS_LOAD_VAL	TIME STAMP LOAD VALUE REGISTER	Section 14.5.3.4
14h	CPTS_TS_LOAD_EN	TIME STAMP LOAD ENABLE REGISTER	Section 14.5.3.5
20h	CPTS_INTSTAT_RAW	TIME SYNC INTERRUPT STATUS RAW REGISTER	Section 14.5.3.6
24h	CPTS_INTSTAT_MASKED	TIME SYNC INTERRUPT STATUS MASKED REGISTER	Section 14.5.3.7

Table 14-88. CPSW_CPTS REGISTERS (continued)

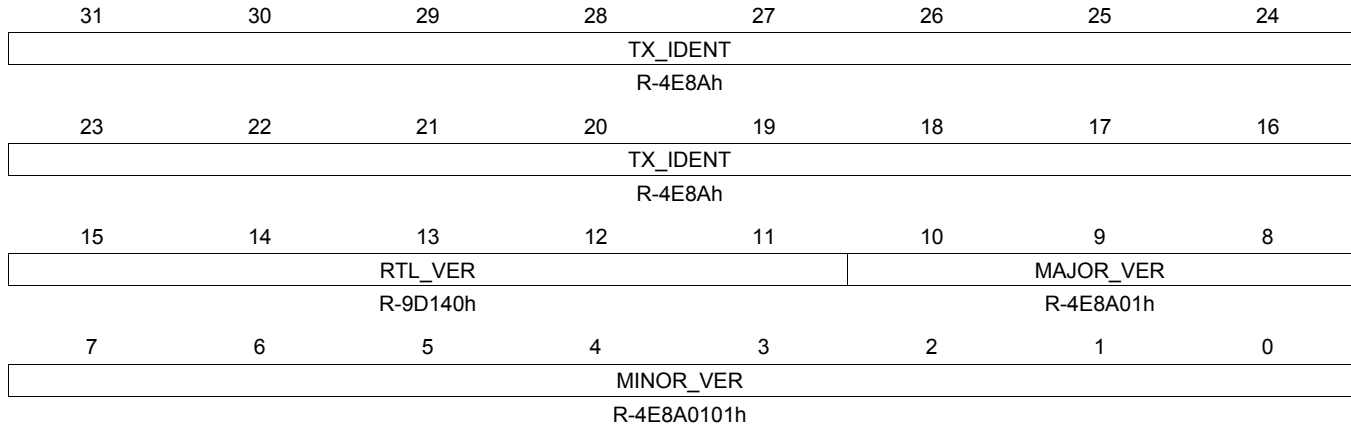
Offset	Acronym	Register Name	Section
28h	CPTS_INT_ENABLE	TIME SYNC INTERRUPT ENABLE REGISTER	Section 14.5.3.8
30h	CPTS_EVENT_POP	EVENT INTERRUPT POP REGISTER	Section 14.5.3.9
34h	CPTS_EVENT_LOW	LOWER 32-BITS OF THE EVENT VALUE	Section 14.5.3.10
38h	CPTS_EVENT_HIGH	UPPER 32-BITS OF THE EVENT VALUE	Section 14.5.3.11

14.5.3.1 CPTS_IDVER Register (offset = 0h) [reset = 4E8A0101h]

CPTS_IDVER is shown in [Figure 14-78](#) and described in [Table 14-89](#).

IDENTIFICATION AND VERSION REGISTER

Figure 14-78. CPTS_IDVER Register



LEGEND: R/W = Read/Write; R = Read only; W1toCl = Write 1 to clear bit; -n = value after reset

Table 14-89. CPTS_IDVER Register Field Descriptions

Bit	Field	Type	Reset	Description
31-16	TX_IDENT	R	4E8Ah	TX Identification Value
15-11	RTL_VER	R	9D140h	RTL Version Value
10-8	MAJOR_VER	R	4E8A01h	Major Version Value
7-0	MINOR_VER	R	4E8A0101h	Minor Version Value

14.5.3.2 CPTS_CONTROL Register (offset = 4h) [reset = 0h]

 CPTS_CONTROL is shown in [Figure 14-79](#) and described in [Table 14-90](#).

TIME SYNC CONTROL REGISTER

Figure 14-79. CPTS_CONTROL Register

31	30	29	28	27	26	25	24
Reserved							
R-0h							
23	22	21	20	19	18	17	16
Reserved							
R-0h							
15	14	13	12	11	10	9	8
Reserved				HW4_TS_PUS H_EN	HW3_TS_PUS H_EN	HW2_TS_PUS H_EN	HW1_TS_PUS H_EN
R-0h				R/W-0h	R/W-0h	R/W-0h	R/W-0h
7	6	5	4	3	2	1	0
Reserved						INT_TEST	CPTS_EN
R-0h						R/W-0h	R/W-0h

LEGEND: R/W = Read/Write; R = Read only; W1toCl = Write 1 to clear bit; -n = value after reset

Table 14-90. CPTS_CONTROL Register Field Descriptions

Bit	Field	Type	Reset	Description
31-12	Reserved	R	0h	
11	HW4_TS_PUSH_EN	R/W	0h	Hardware push 4 enable
10	HW3_TS_PUSH_EN	R/W	0h	Hardware push 3 enable
9	HW2_TS_PUSH_EN	R/W	0h	Hardware push 2 enable
8	HW1_TS_PUSH_EN	R/W	0h	Hardware push 1 enable
7-2	Reserved	R	0h	
1	INT_TEST	R/W	0h	Interrupt Test - When set, this bit allows the raw interrupt to be written to facilitate interrupt test.
0	CPTS_EN	R/W	0h	Time Sync Enable - When disabled (cleared to zero), the RCLK domain is held in reset. 0 - Time Sync Disabled 1 - Time Sync Enabled

14.5.3.3 CPTS_TS_PUSH Register (offset = Ch) [reset = 0h]

CPTS_TS_PUSH is shown in [Figure 14-80](#) and described in [Table 14-91](#).

TIME STAMP EVENT PUSH REGISTER
Figure 14-80. CPTS_TS_PUSH Register

31	30	29	28	27	26	25	24
Reserved							
R-0h							
23	22	21	20	19	18	17	16
Reserved							
R-0h							
15	14	13	12	11	10	9	8
Reserved							
R-0h							
7	6	5	4	3	2	1	0
Reserved							TS_PUSH
R-0h							W-0h

LEGEND: R/W = Read/Write; R = Read only; W1toCl = Write 1 to clear bit; -n = value after reset

Table 14-91. CPTS_TS_PUSH Register Field Descriptions

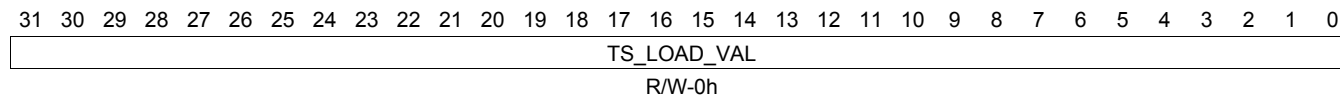
Bit	Field	Type	Reset	Description
31-1	Reserved	R	0h	
0	TS_PUSH	W	0h	Time stamp event push - When a logic high is written to this bit a time stamp event is pushed onto the event FIFO. The time stamp value is the time of the write of this register, not the time of the event read. The time stamp value can then be read on interrupt via the event registers. Software should not push a second time stamp event onto the event FIFO until the first time stamp value has been read from the event FIFO (there should be only one time stamp event in the event FIFO at any given time). This bit is write only and always reads zero.

14.5.3.4 CPTS_TS_LOAD_VAL Register (offset = 10h) [reset = 0h]

CPTS_TS_LOAD_VAL is shown in [Figure 14-81](#) and described in [Table 14-92](#).

TIME STAMP LOAD VALUE REGISTER

Figure 14-81. CPTS_TS_LOAD_VAL Register



LEGEND: R/W = Read/Write; R = Read only; W1toCl = Write 1 to clear bit; -n = value after reset

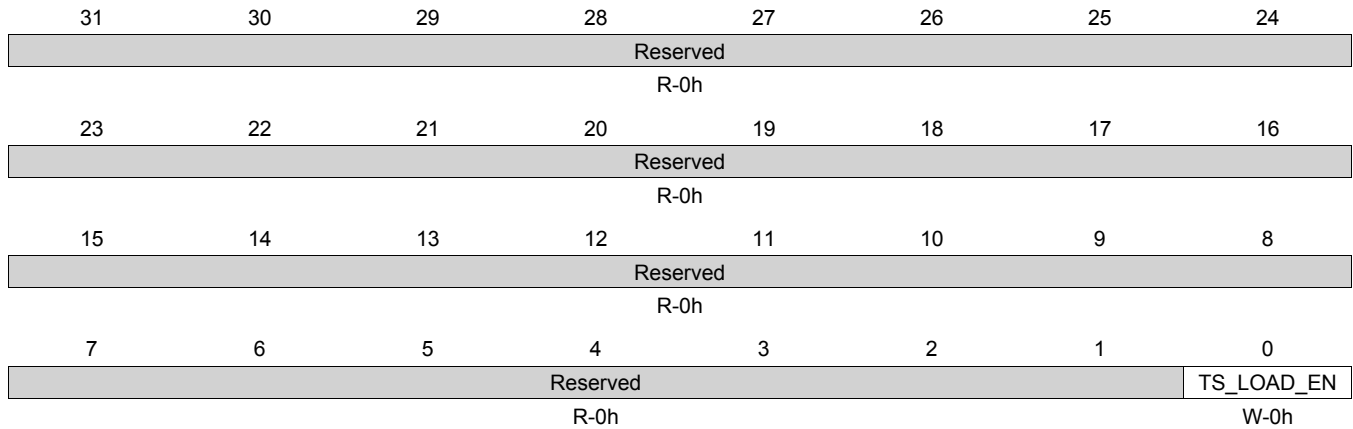
Table 14-92. CPTS_TS_LOAD_VAL Register Field Descriptions

Bit	Field	Type	Reset	Description
31-0	TS_LOAD_VAL	R/W	0h	Time Stamp Load Value - Writing the ts_load_en bit causes the value contained in this register to be written into the time stamp. The time stamp value is read by initiating a time stamp push event, not by reading this register. When reading this register, the value read is not the time stamp, but is the value that was last written to this register.

14.5.3.5 CPTS_TS_LOAD_EN Register (offset = 14h) [reset = 0h]

CPTS_TS_LOAD_EN is shown in [Figure 14-82](#) and described in [Table 14-93](#).

TIME STAMP LOAD ENABLE REGISTER

Figure 14-82. CPTS_TS_LOAD_EN Register


LEGEND: R/W = Read/Write; R = Read only; W1toCl = Write 1 to clear bit; -n = value after reset

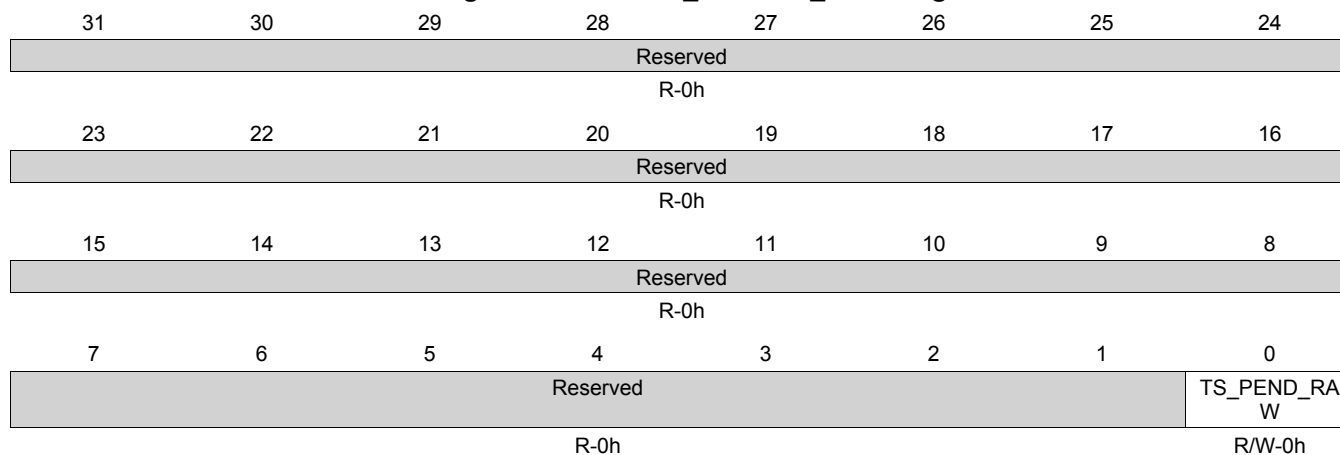
Table 14-93. CPTS_TS_LOAD_EN Register Field Descriptions

Bit	Field	Type	Reset	Description
31-1	Reserved	R	0h	
0	TS_LOAD_EN	W	0h	Time Stamp Load - Writing a one to this bit enables the time stamp value to be written via the ts_load_val[31:0] register. This feature is included for test purposes. This bit is write only.

14.5.3.6 CPTS_INTSTAT_RAW Register (offset = 20h) [reset = 0h]

 CPTS_INTSTAT_RAW is shown in [Figure 14-83](#) and described in [Table 14-94](#).

TIME SYNC INTERRUPT STATUS RAW REGISTER

Figure 14-83. CPTS_INTSTAT_RAW Register


LEGEND: R/W = Read/Write; R = Read only; W1toCl = Write 1 to clear bit; -n = value after reset

Table 14-94. CPTS_INTSTAT_RAW Register Field Descriptions

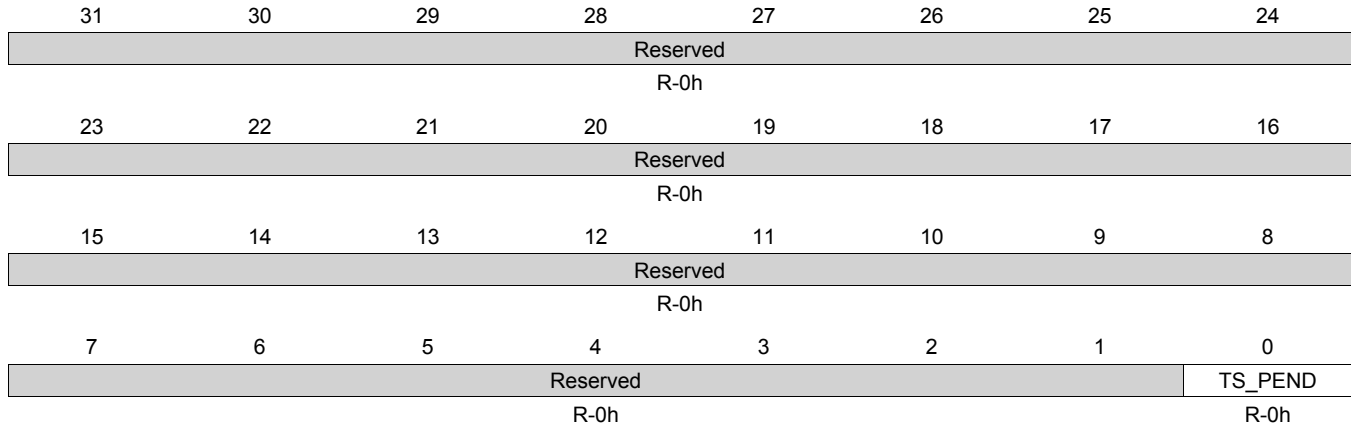
Bit	Field	Type	Reset	Description
31-1	Reserved	R	0h	
0	TS_PEND_RAW	R/W	0h	TS_PEND_RAW int read (before enable). Writable when int_test = 1 A one in this bit indicates that there is one or more events in the event FIFO.

14.5.3.7 CPTS_INTSTAT_MASKED Register (offset = 24h) [reset = 0h]

CPTS_INTSTAT_MASKED is shown in [Figure 14-84](#) and described in [Table 14-95](#).

TIME SYNC INTERRUPT STATUS MASKED REGISTER

Figure 14-84. CPTS_INTSTAT_MASKED Register



LEGEND: R/W = Read/Write; R = Read only; W1toCl = Write 1 to clear bit; -n = value after reset

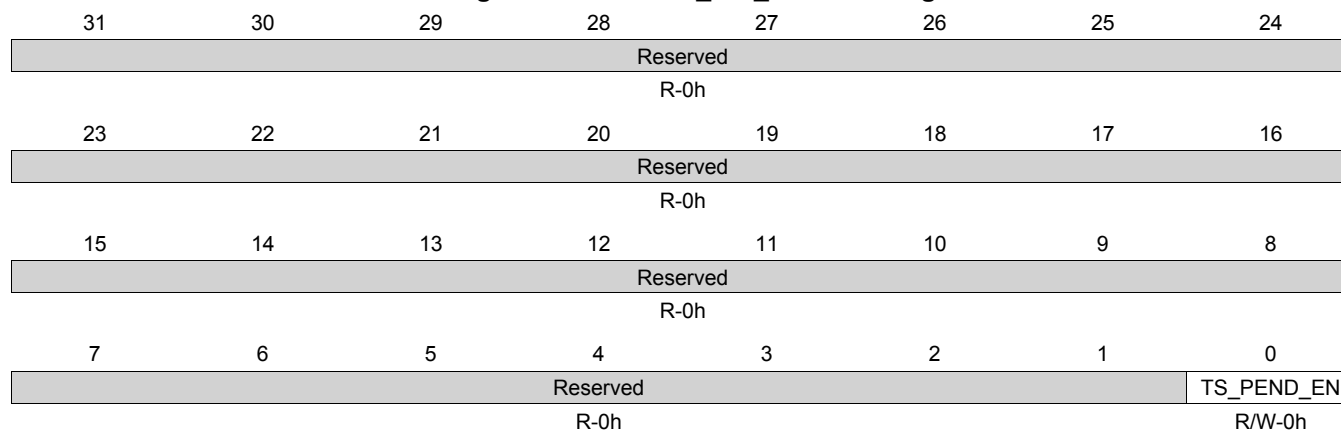
Table 14-95. CPTS_INTSTAT_MASKED Register Field Descriptions

Bit	Field	Type	Reset	Description
31-1	Reserved	R	0h	
0	TS_PEND	R	0h	TS_PEND masked interrupt read (after enable).

14.5.3.8 CPTS_INT_ENABLE Register (offset = 28h) [reset = 0h]

 CPTS_INT_ENABLE is shown in [Figure 14-85](#) and described in [Table 14-96](#).

TIME SYNC INTERRUPT ENABLE REGISTER

Figure 14-85. CPTS_INT_ENABLE Register


LEGEND: R/W = Read/Write; R = Read only; W1toCl = Write 1 to clear bit; -n = value after reset

Table 14-96. CPTS_INT_ENABLE Register Field Descriptions

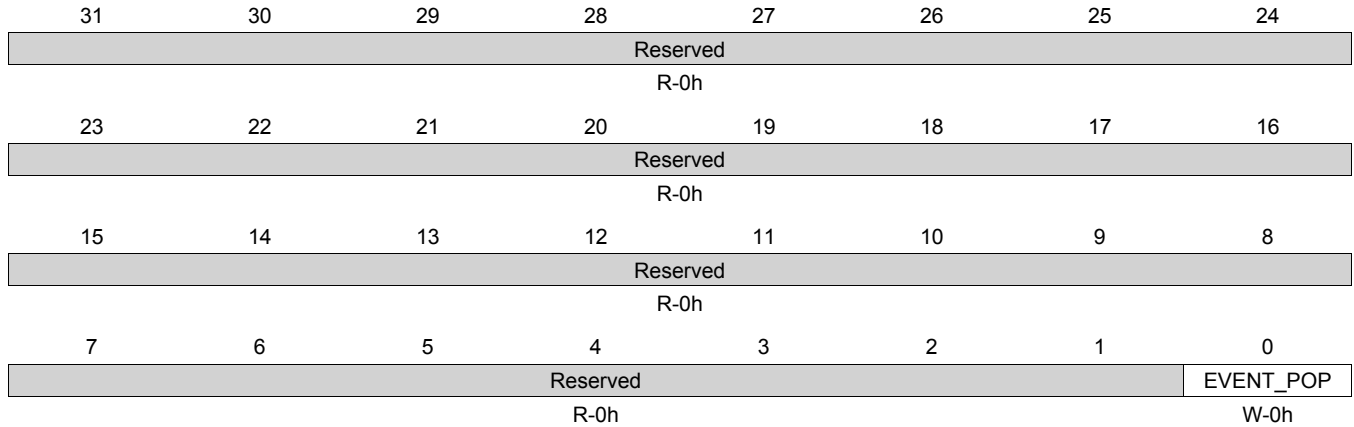
Bit	Field	Type	Reset	Description
31-1	Reserved	R	0h	
0	TS_PEND_EN	R/W	0h	TS_PEND masked interrupt enable.

14.5.3.9 CPTS_EVENT_POP Register (offset = 30h) [reset = 0h]

CPTS_EVENT_POP is shown in [Figure 14-86](#) and described in [Table 14-97](#).

EVENT INTERRUPT POP REGISTER

Figure 14-86. CPTS_EVENT_POP Register



LEGEND: R/W = Read/Write; R = Read only; W1toCl = Write 1 to clear bit; -n = value after reset

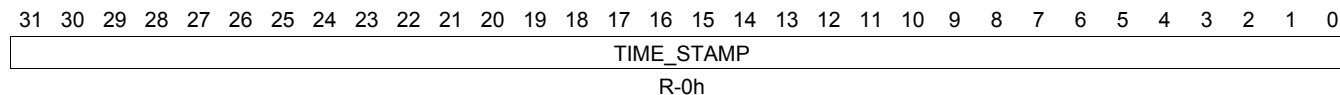
Table 14-97. CPTS_EVENT_POP Register Field Descriptions

Bit	Field	Type	Reset	Description
31-1	Reserved	R	0h	
0	EVENT_POP	W	0h	Event Pop - When a logic high is written to this bit an event is popped off the event FIFO. The event FIFO pop occurs as part of the interrupt process after the event has been read in the Event_Low and Event_High registers. Popping an event discards the event and causes the next event, if any, to be moved to the top of the FIFO ready to be read by software on interrupt.

14.5.3.10 CPTS_EVENT_LOW Register (offset = 34h) [reset = 0h]

CPTS_EVENT_LOW is shown in [Figure 14-87](#) and described in [Table 14-98](#).

LOWER 32-BITS OF THE EVENT VALUE

Figure 14-87. CPTS_EVENT_LOW Register


LEGEND: R/W = Read/Write; R = Read only; W1toCl = Write 1 to clear bit; -n = value after reset

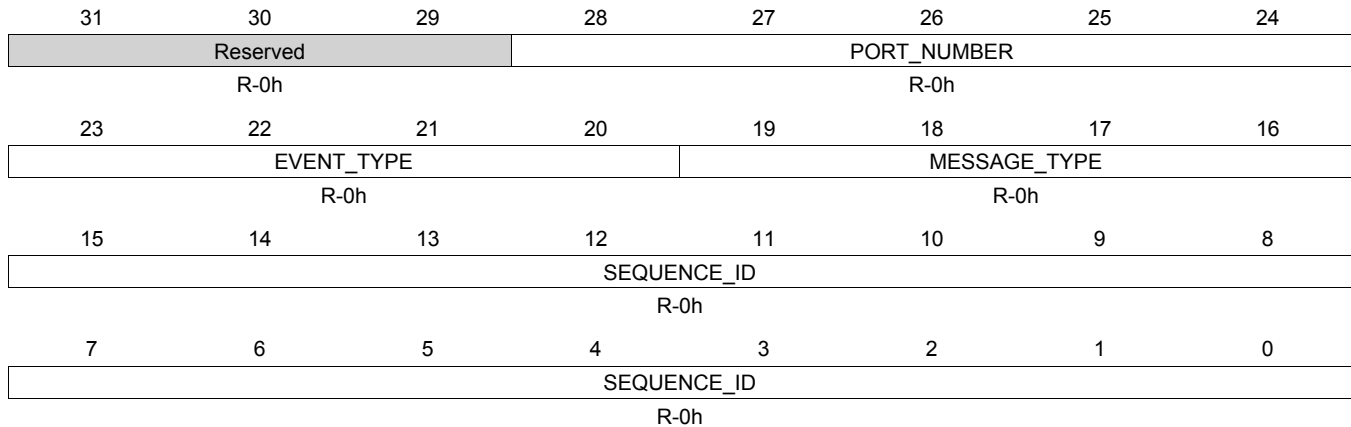
Table 14-98. CPTS_EVENT_LOW Register Field Descriptions

Bit	Field	Type	Reset	Description
31-0	TIME_STAMP	R	0h	Time Stamp - The timestamp is valid for transmit, receive, and time stamp push event types. The timestamp value is not valid for counter roll event types.

14.5.3.11 CPTS_EVENT_HIGH Register (offset = 38h) [reset = 0h]

CPTS_EVENT_HIGH is shown in [Figure 14-88](#) and described in [Table 14-99](#).

UPPER 32-BITS OF THE EVENT VALUE

Figure 14-88. CPTS_EVENT_HIGH Register


LEGEND: R/W = Read/Write; R = Read only; W1toCl = Write 1 to clear bit; -n = value after reset

Table 14-99. CPTS_EVENT_HIGH Register Field Descriptions

Bit	Field	Type	Reset	Description
31-29	Reserved	R	0h	
28-24	PORT_NUMBER	R	0h	Port Number - indicates the port number of an ethernet event or the hardware push pin number (1 to 4).
23-20	EVENT_TYPE	R	0h	Time Sync Event Type 0000 - Time Stamp Push Event 0001 - Time Stamp Rollover Event 0010 - Time Stamp Half Rollover Event 0011 - Hardware Time Stamp Push Event 0100 - Ethernet Receive Event 0101 - Ethernet Transmit Event
19-16	MESSAGE_TYPE	R	0h	Message type - The message type value that was contained in an ethernet transmit or receive time sync packet. This field is valid only for ethernet transmit or receive events.
15-0	SEQUENCE_ID	R	0h	Sequence ID - The 16-bit sequence id is the value that was contained in an ethernet transmit or receive time sync packet. This field is valid only for ethernet transmit or receive events.

14.5.4 CPSW_STATS Registers

For a full description of the CPSW_STATS registers, see [Section 14.3.2.20, CPSW_3G Network Statistics](#). The registers are summarized in [Table 14-100](#).

Table 14-100. CPSW_STATS REGISTERS

Offset	Acronym	Register Name	Section
00h		Good Rx Frames	Section 14.3.2.20.1.1
04h		Broadcast Rx Frames	Section 14.3.2.20.1.2
08h		Multicast Rx Frames	Section 14.3.2.20.1.3
0Ch		Pause Rx Frames	Section 14.3.2.20.1.4
10h		Rx CRC Errors	Section 14.3.2.20.1.5
14h		Rx Align/Code Errors	Section 14.3.2.20.1.6
18h		Oversize Rx Frames	Section 14.3.2.20.1.7
1Ch		Rx Jabbers	Section 14.3.2.20.1.8
20h		Undersize (Short) Rx Frames	Section 14.3.2.20.1.9
24h		Rx Fragments	Section 14.3.2.20.1.10
30h		Rx Octets	Section 14.3.2.20.1.14
34h		Good Tx Frames	Section 14.3.2.20.2.1
38h		Broadcast Tx Frames	Section 14.3.2.20.2.2
3Ch		Multicast Tx Frames	Section 14.3.2.20.2.3
40h		Pause Tx Frames	Section 14.3.2.20.2.4
44h		Deferred Tx Frames	Section 14.3.2.20.2.11
48h		Collisions	Section 14.3.2.20.2.5
4Ch		Single Collision Tx Frames	Section 14.3.2.20.2.6
50h		Multiple Collision Tx Frames	Section 14.3.2.20.2.7
54h		Excessive Collisions	Section 14.3.2.20.2.8
58h		Late Collisions	Section 14.3.2.20.2.9
5Ch		Tx Underrun	Section 14.3.2.20.2.10
60h		Carrier Sense Errors	Section 14.3.2.20.2.12
64h		Tx Octets	Section 14.3.2.20.2.13
68h		Rx + Tx 64 Octet Frames	Section 14.3.2.20.3.1
6Ch		Rx + Tx 65–127 Octet Frames	Section 14.3.2.20.3.2
70h		Rx + Tx 128–255 Octet Frames	Section 14.3.2.20.3.3
74h		Rx + Tx 256–511 Octet Frames	Section 14.3.2.20.3.4
78h		Rx + Tx 512–1023 Octet Frames	Section 14.3.2.20.3.5
7Ch		Rx + Tx 1024_Up Octet Frames	Section 14.3.2.20.3.6
80h		Net Octets	Section 14.3.2.20.1.15
84h		Rx Start of Frame Overruns	Section 14.3.2.20.1.11
88h		Rx Middle of Frame Overruns	Section 14.3.2.20.1.12
8Ch		Rx DMA Overruns	Section 14.3.2.20.1.13

14.5.5 CPDMA_STATRAM Registers

[Table 14-101](#) lists the memory-mapped registers for the CPSW_CPDMA. All register offset addresses not listed in [Table 14-101](#) should be considered as reserved locations and the register contents should not be modified.

Table 14-101. CPDMA_STATERAM REGISTERS

Offset	Acronym	Register Name	Section
00h	TX0_HDP	CPDMA_STATERAM TX CHANNEL 0 HEAD DESC POINTER *	Section 14.5.5.1
04h	TX1_HDP	CPDMA_STATERAM TX CHANNEL 1 HEAD DESC POINTER *	Section 14.5.5.2
08h	TX2_HDP	CPDMA_STATERAM TX CHANNEL 2 HEAD DESC POINTER *	Section 14.5.5.3
0Ch	TX3_HDP	CPDMA_STATERAM TX CHANNEL 3 HEAD DESC POINTER *	Section 14.5.5.4
10h	TX4_HDP	CPDMA_STATERAM TX CHANNEL 4 HEAD DESC POINTER *	Section 14.5.5.5
14h	TX5_HDP	CPDMA_STATERAM TX CHANNEL 5 HEAD DESC POINTER *	Section 14.5.5.6
18h	TX6_HDP	CPDMA_STATERAM TX CHANNEL 6 HEAD DESC POINTER *	Section 14.5.5.7
1Ch	TX7_HDP	CPDMA_STATERAM TX CHANNEL 7 HEAD DESC POINTER *	Section 14.5.5.8
20h	RX0_HDP	CPDMA_STATERAM RX 0 CHANNEL 0 HEAD DESC POINTER *	Section 14.5.5.9
24h	RX1_HDP	CPDMA_STATERAM RX 1 CHANNEL 1 HEAD DESC POINTER *	Section 14.5.5.10
28h	RX2_HDP	CPDMA_STATERAM RX 2 CHANNEL 2 HEAD DESC POINTER *	Section 14.5.5.11
2Ch	RX3_HDP	CPDMA_STATERAM RX 3 CHANNEL 3 HEAD DESC POINTER *	Section 14.5.5.12
30h	RX4_HDP	CPDMA_STATERAM RX 4 CHANNEL 4 HEAD DESC POINTER *	Section 14.5.5.13
34h	RX5_HDP	CPDMA_STATERAM RX 5 CHANNEL 5 HEAD DESC POINTER *	Section 14.5.5.14
38h	RX6_HDP	CPDMA_STATERAM RX 6 CHANNEL 6 HEAD DESC POINTER *	Section 14.5.5.15
3Ch	RX7_HDP	CPDMA_STATERAM RX 7 CHANNEL 7 HEAD DESC POINTER *	Section 14.5.5.16
40h	TX0_CP	CPDMA_STATERAM TX CHANNEL 0 COMPLETION POINTER REGISTER	Section 14.5.5.17
44h	TX1_CP	CPDMA_STATERAM TX CHANNEL 1 COMPLETION POINTER REGISTER *	Section 14.5.5.18
48h	TX2_CP	CPDMA_STATERAM TX CHANNEL 2 COMPLETION POINTER REGISTER *	Section 14.5.5.19
4Ch	TX3_CP	CPDMA_STATERAM TX CHANNEL 3 COMPLETION POINTER REGISTER *	Section 14.5.5.20
50h	TX4_CP	CPDMA_STATERAM TX CHANNEL 4 COMPLETION POINTER REGISTER *	Section 14.5.5.21
54h	TX5_CP	CPDMA_STATERAM TX CHANNEL 5 COMPLETION POINTER REGISTER *	Section 14.5.5.22
58h	TX6_CP	CPDMA_STATERAM TX CHANNEL 6 COMPLETION POINTER REGISTER *	Section 14.5.5.23
5Ch	TX7_CP	CPDMA_STATERAM TX CHANNEL 7 COMPLETION POINTER REGISTER *	Section 14.5.5.24
60h	RX0_CP	CPDMA_STATERAM RX CHANNEL 0 COMPLETION POINTER REGISTER *	Section 14.5.5.25
64h	RX1_CP	CPDMA_STATERAM RX CHANNEL 1 COMPLETION POINTER REGISTER *	Section 14.5.5.26
68h	RX2_CP	CPDMA_STATERAM RX CHANNEL 2 COMPLETION POINTER REGISTER *	Section 14.5.5.27
6Ch	RX3_CP	CPDMA_STATERAM RX CHANNEL 3 COMPLETION POINTER REGISTER *	Section 14.5.5.28

Table 14-101. CPDMA_STATERAM REGISTERS (continued)

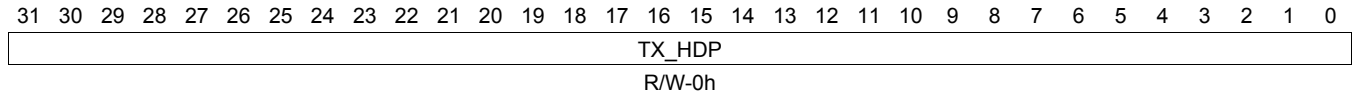
Offset	Acronym	Register Name	Section
70h	RX4_CP	CPDMA_STATERAM RX CHANNEL 4 COMPLETION POINTER REGISTER *	Section 14.5.5.29
74h	RX5_CP	CPDMA_STATERAM RX CHANNEL 5 COMPLETION POINTER REGISTER *	Section 14.5.5.30
78h	RX6_CP	CPDMA_STATERAM RX CHANNEL 6 COMPLETION POINTER REGISTER *	Section 14.5.5.31
7Ch	RX7_CP	CPDMA_STATERAM RX CHANNEL 7 COMPLETION POINTER REGISTER *	Section 14.5.5.32

14.5.5.1 TX0_HDP Register (offset = A00h) [reset = 0h]

TX0_HDP is shown in [Figure 14-89](#) and described in [Table 14-102](#).

CPDMA_STATRAM TX CHANNEL 0 HEAD DESC POINTER *

Figure 14-89. TX0_HDP Register



LEGEND: R/W = Read/Write; R = Read only; W1toCl = Write 1 to clear bit; -n = value after reset

Table 14-102. TX0_HDP Register Field Descriptions

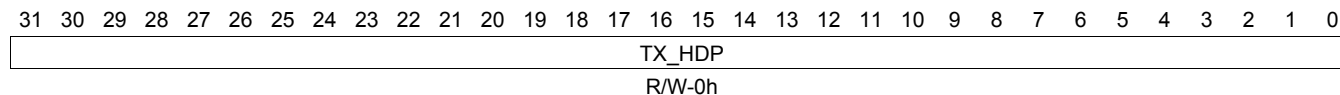
Bit	Field	Type	Reset	Description
31-0	TX_HDP	R/W	0h	TX Channel (0..7) DMA Head Descriptor Pointer - Writing a TX DMA Buffer Descriptor address to a head pointer location initiates TX DMA operations in the queue for the selected channel. Writing to these locations when they are non-zero is an error (except at reset). Host software must initialize these locations to zero on reset.

14.5.5.2 TX1_HDP Register (offset = A04h) [reset = 0h]

TX1_HDP is shown in [Figure 14-90](#) and described in [Table 14-103](#).

CPDMA_STATRAM TX CHANNEL 1 HEAD DESC POINTER *

Figure 14-90. TX1_HDP Register



LEGEND: R/W = Read/Write; R = Read only; W1toCl = Write 1 to clear bit; -n = value after reset

Table 14-103. TX1_HDP Register Field Descriptions

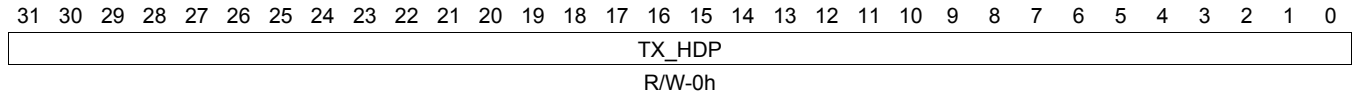
Bit	Field	Type	Reset	Description
31-0	TX_HDP	R/W	0h	TX Channel (0..7) DMA Head Descriptor Pointer - Writing a TX DMA Buffer Descriptor address to a head pointer location initiates TX DMA operations in the queue for the selected channel. Writing to these locations when they are non-zero is an error (except at reset). Host software must initialize these locations to zero on reset.

14.5.5.3 TX2_HDP Register (offset = A08h) [reset = 0h]

TX2_HDP is shown in [Figure 14-91](#) and described in [Table 14-104](#).

CPDMA_STATRAM TX CHANNEL 2 HEAD DESC POINTER *

Figure 14-91. TX2_HDP Register



LEGEND: R/W = Read/Write; R = Read only; W1toCl = Write 1 to clear bit; -n = value after reset

Table 14-104. TX2_HDP Register Field Descriptions

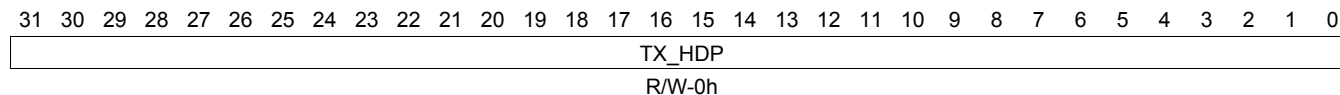
Bit	Field	Type	Reset	Description
31-0	TX_HDP	R/W	0h	TX Channel (0..7) DMA Head Descriptor Pointer - Writing a TX DMA Buffer Descriptor address to a head pointer location initiates TX DMA operations in the queue for the selected channel. Writing to these locations when they are non-zero is an error (except at reset). Host software must initialize these locations to zero on reset.

14.5.5.4 TX3_HDP Register (offset = A0Ch) [reset = 0h]

TX3_HDP is shown in [Figure 14-92](#) and described in [Table 14-105](#).

CPDMA_STATRAM TX CHANNEL 3 HEAD DESC POINTER *

Figure 14-92. TX3_HDP Register



LEGEND: R/W = Read/Write; R = Read only; W1toCl = Write 1 to clear bit; -n = value after reset

Table 14-105. TX3_HDP Register Field Descriptions

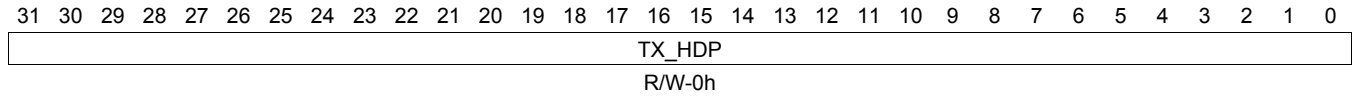
Bit	Field	Type	Reset	Description
31-0	TX_HDP	R/W	0h	TX Channel (0..7) DMA Head Descriptor Pointer - Writing a TX DMA Buffer Descriptor address to a head pointer location initiates TX DMA operations in the queue for the selected channel. Writing to these locations when they are non-zero is an error (except at reset). Host software must initialize these locations to zero on reset.

14.5.5.5 TX4_HDP Register (offset = A10h) [reset = 0h]

TX4_HDP is shown in [Figure 14-93](#) and described in [Table 14-106](#).

CPDMA_STATERAM TX CHANNEL 4 HEAD DESC POINTER *

Figure 14-93. TX4_HDP Register



LEGEND: R/W = Read/Write; R = Read only; W1toCl = Write 1 to clear bit; -n = value after reset

Table 14-106. TX4_HDP Register Field Descriptions

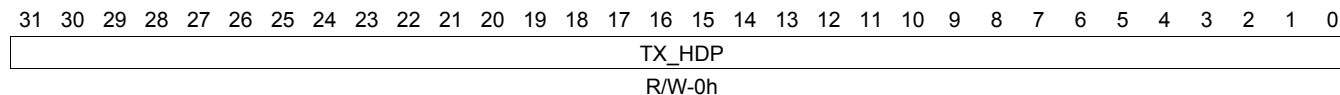
Bit	Field	Type	Reset	Description
31-0	TX_HDP	R/W	0h	TX Channel (0..7) DMA Head Descriptor Pointer - Writing a TX DMA Buffer Descriptor address to a head pointer location initiates TX DMA operations in the queue for the selected channel. Writing to these locations when they are non-zero is an error (except at reset). Host software must initialize these locations to zero on reset.

14.5.5.6 TX5_HDP Register (offset = A14h) [reset = 0h]

TX5_HDP is shown in [Figure 14-94](#) and described in [Table 14-107](#).

CPDMA_STATRAM TX CHANNEL 5 HEAD DESC POINTER *

Figure 14-94. TX5_HDP Register



LEGEND: R/W = Read/Write; R = Read only; W1toCl = Write 1 to clear bit; -n = value after reset

Table 14-107. TX5_HDP Register Field Descriptions

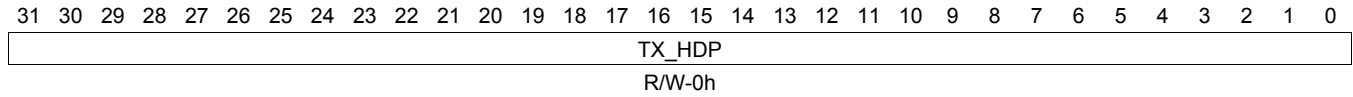
Bit	Field	Type	Reset	Description
31-0	TX_HDP	R/W	0h	TX Channel (0..7) DMA Head Descriptor Pointer - Writing a TX DMA Buffer Descriptor address to a head pointer location initiates TX DMA operations in the queue for the selected channel. Writing to these locations when they are non-zero is an error (except at reset). Host software must initialize these locations to zero on reset.

14.5.5.7 TX6_HDP Register (offset = A18h) [reset = 0h]

TX6_HDP is shown in [Figure 14-95](#) and described in [Table 14-108](#).

CPDMA_STATERAM TX CHANNEL 6 HEAD DESC POINTER *

Figure 14-95. TX6_HDP Register



LEGEND: R/W = Read/Write; R = Read only; W1toCl = Write 1 to clear bit; -n = value after reset

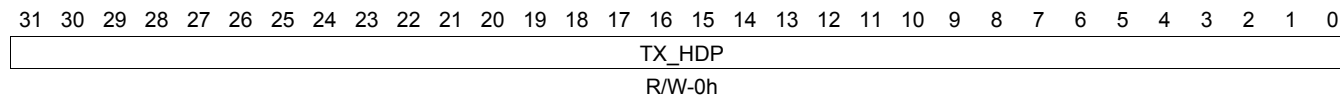
Table 14-108. TX6_HDP Register Field Descriptions

Bit	Field	Type	Reset	Description
31-0	TX_HDP	R/W	0h	TX Channel (0..7) DMA Head Descriptor Pointer - Writing a TX DMA Buffer Descriptor address to a head pointer location initiates TX DMA operations in the queue for the selected channel. Writing to these locations when they are non-zero is an error (except at reset). Host software must initialize these locations to zero on reset.

14.5.5.8 TX7_HDP Register (offset = A1Ch) [reset = 0h]

TX7_HDP is shown in [Figure 14-96](#) and described in [Table 14-109](#).

CPDMA_STATRAM TX CHANNEL 7 HEAD DESC POINTER *

Figure 14-96. TX7_HDP Register


LEGEND: R/W = Read/Write; R = Read only; W1toCl = Write 1 to clear bit; -n = value after reset

Table 14-109. TX7_HDP Register Field Descriptions

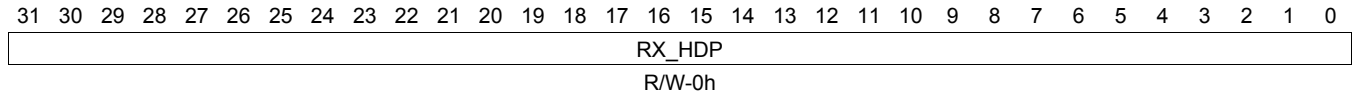
Bit	Field	Type	Reset	Description
31-0	TX_HDP	R/W	0h	TX Channel (0..7) DMA Head Descriptor Pointer - Writing a TX DMA Buffer Descriptor address to a head pointer location initiates TX DMA operations in the queue for the selected channel. Writing to these locations when they are non-zero is an error (except at reset). Host software must initialize these locations to zero on reset.

14.5.5.9 RX0_HDP Register (offset = A20h) [reset = 0h]

RX0_HDP is shown in [Figure 14-97](#) and described in [Table 14-110](#).

CPDMA_STATERAM RX 0 CHANNEL 0 HEAD DESC POINTER *

Figure 14-97. RX0_HDP Register



LEGEND: R/W = Read/Write; R = Read only; W1toCl = Write 1 to clear bit; -n = value after reset

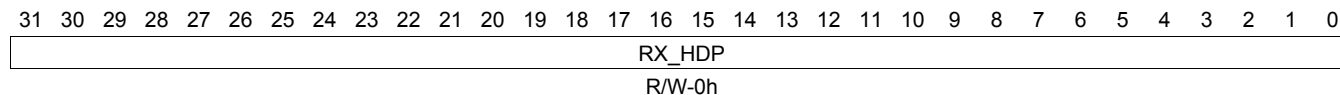
Table 14-110. RX0_HDP Register Field Descriptions

Bit	Field	Type	Reset	Description
31-0	RX_HDP	R/W	0h	RX DMA Head Descriptor Pointer - Writing an RX DMA Buffer Descriptor address to this location allows RX DMA operations in the selected channel when a channel frame is received. Writing to these locations when they are non-zero is an error (except at reset). Host software must initialize these locations to zero on reset.

14.5.5.10 RX1_HDP Register (offset = A24h) [reset = 0h]

RX1_HDP is shown in [Figure 14-98](#) and described in [Table 14-111](#).

CPDMA_STATERAM RX 1 CHANNEL 1 HEAD DESC POINTER *

Figure 14-98. RX1_HDP Register


LEGEND: R/W = Read/Write; R = Read only; W1toCl = Write 1 to clear bit; -n = value after reset

Table 14-111. RX1_HDP Register Field Descriptions

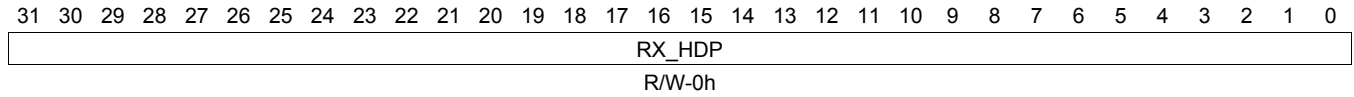
Bit	Field	Type	Reset	Description
31-0	RX_HDP	R/W	0h	RX DMA Head Descriptor Pointer - Writing an RX DMA Buffer Descriptor address to this location allows RX DMA operations in the selected channel when a channel frame is received. Writing to these locations when they are non-zero is an error (except at reset). Host software must initialize these locations to zero on reset.

14.5.5.11 RX2_HDP Register (offset = A28h) [reset = 0h]

RX2_HDP is shown in [Figure 14-99](#) and described in [Table 14-112](#).

CPDMA_STATERAM RX 2 CHANNEL 2 HEAD DESC POINTER *

Figure 14-99. RX2_HDP Register



LEGEND: R/W = Read/Write; R = Read only; W1toCl = Write 1 to clear bit; -n = value after reset

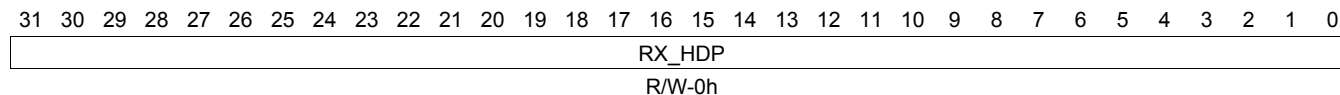
Table 14-112. RX2_HDP Register Field Descriptions

Bit	Field	Type	Reset	Description
31-0	RX_HDP	R/W	0h	RX DMA Head Descriptor Pointer - Writing an RX DMA Buffer Descriptor address to this location allows RX DMA operations in the selected channel when a channel frame is received. Writing to these locations when they are non-zero is an error (except at reset). Host software must initialize these locations to zero on reset.

14.5.5.12 RX3_HDP Register (offset = A2Ch) [reset = 0h]

RX3_HDP is shown in [Figure 14-100](#) and described in [Table 14-113](#).

CPDMA_STATERAM RX 3 CHANNEL 3 HEAD DESC POINTER *

Figure 14-100. RX3_HDP Register


LEGEND: R/W = Read/Write; R = Read only; W1toCl = Write 1 to clear bit; -n = value after reset

Table 14-113. RX3_HDP Register Field Descriptions

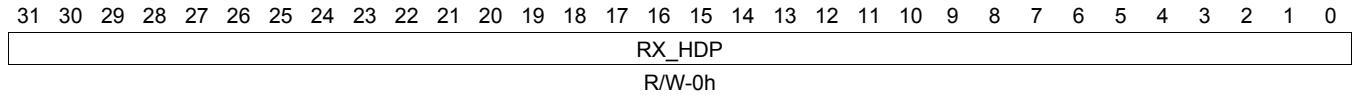
Bit	Field	Type	Reset	Description
31-0	RX_HDP	R/W	0h	RX DMA Head Descriptor Pointer - Writing an RX DMA Buffer Descriptor address to this location allows RX DMA operations in the selected channel when a channel frame is received. Writing to these locations when they are non-zero is an error (except at reset). Host software must initialize these locations to zero on reset.

14.5.5.13 RX4_HDP Register (offset = A30h) [reset = 0h]

RX4_HDP is shown in [Figure 14-101](#) and described in [Table 14-114](#).

CPDMA_STATERAM RX 4 CHANNEL 4 HEAD DESC POINTER *

Figure 14-101. RX4_HDP Register



LEGEND: R/W = Read/Write; R = Read only; W1toCl = Write 1 to clear bit; -n = value after reset

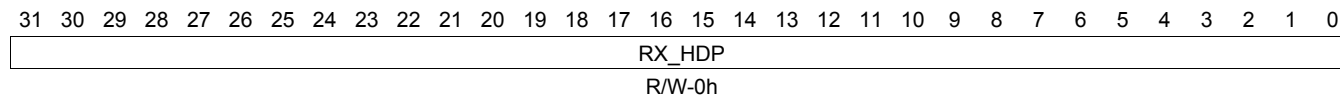
Table 14-114. RX4_HDP Register Field Descriptions

Bit	Field	Type	Reset	Description
31-0	RX_HDP	R/W	0h	RX DMA Head Descriptor Pointer - Writing an RX DMA Buffer Descriptor address to this location allows RX DMA operations in the selected channel when a channel frame is received. Writing to these locations when they are non-zero is an error (except at reset). Host software must initialize these locations to zero on reset.

14.5.5.14 RX5_HDP Register (offset = A34h) [reset = 0h]

RX5_HDP is shown in [Figure 14-102](#) and described in [Table 14-115](#).

CPDMA_STATERAM RX 5 CHANNEL 5 HEAD DESC POINTER *

Figure 14-102. RX5_HDP Register


LEGEND: R/W = Read/Write; R = Read only; W1toCl = Write 1 to clear bit; -n = value after reset

Table 14-115. RX5_HDP Register Field Descriptions

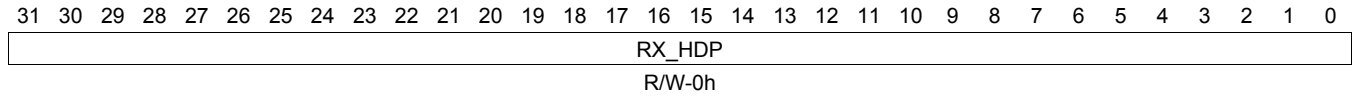
Bit	Field	Type	Reset	Description
31-0	RX_HDP	R/W	0h	RX DMA Head Descriptor Pointer - Writing an RX DMA Buffer Descriptor address to this location allows RX DMA operations in the selected channel when a channel frame is received. Writing to these locations when they are non-zero is an error (except at reset). Host software must initialize these locations to zero on reset.

14.5.5.15 RX6_HDP Register (offset = A38h) [reset = 0h]

RX6_HDP is shown in [Figure 14-103](#) and described in [Table 14-116](#).

CPDMA_STATERAM RX 6 CHANNEL 6 HEAD DESC POINTER *

Figure 14-103. RX6_HDP Register



LEGEND: R/W = Read/Write; R = Read only; W1toCl = Write 1 to clear bit; -n = value after reset

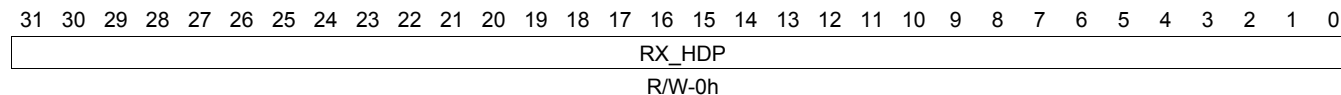
Table 14-116. RX6_HDP Register Field Descriptions

Bit	Field	Type	Reset	Description
31-0	RX_HDP	R/W	0h	RX DMA Head Descriptor Pointer - Writing an RX DMA Buffer Descriptor address to this location allows RX DMA operations in the selected channel when a channel frame is received. Writing to these locations when they are non-zero is an error (except at reset). Host software must initialize these locations to zero on reset.

14.5.5.16 RX7_HDP Register (offset = A3Ch) [reset = 0h]

RX7_HDP is shown in [Figure 14-104](#) and described in [Table 14-117](#).

CPDMA_STATERAM RX 7 CHANNEL 7 HEAD DESC POINTER *

Figure 14-104. RX7_HDP Register


LEGEND: R/W = Read/Write; R = Read only; W1toCl = Write 1 to clear bit; -n = value after reset

Table 14-117. RX7_HDP Register Field Descriptions

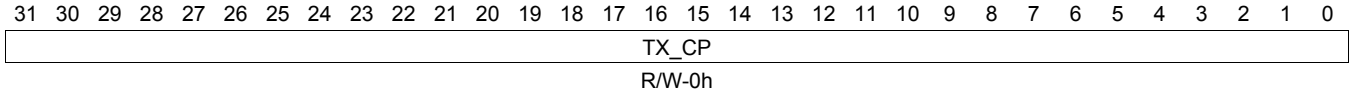
Bit	Field	Type	Reset	Description
31-0	RX_HDP	R/W	0h	RX DMA Head Descriptor Pointer - Writing an RX DMA Buffer Descriptor address to this location allows RX DMA operations in the selected channel when a channel frame is received. Writing to these locations when they are non-zero is an error (except at reset). Host software must initialize these locations to zero on reset.

14.5.5.17 TX0_CP Register (offset = A40h) [reset = 0h]

TX0_CP is shown in [Figure 14-105](#) and described in [Table 14-118](#).

CPDMA_STATRAM TX CHANNEL 0 COMPLETION POINTER REGISTER

Figure 14-105. TX0_CP Register



LEGEND: R/W = Read/Write; R = Read only; W1toCl = Write 1 to clear bit; -n = value after reset

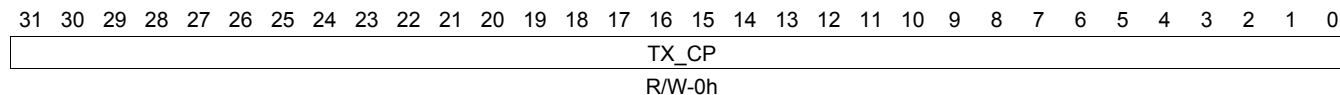
Table 14-118. TX0_CP Register Field Descriptions

Bit	Field	Type	Reset	Description
31-0	TX_CP	R/W	0h	Tx Completion Pointer Register - This register is written by the host with the buffer descriptor address for the last buffer processed by the host during interrupt processing. The port uses the value written to determine if the interrupt should be deasserted.

14.5.5.18 TX1_CP Register (offset = A44h) [reset = 0h]

TX1_CP is shown in [Figure 14-106](#) and described in [Table 14-119](#).

CPDMA_STATERAM TX CHANNEL 1 COMPLETION POINTER REGISTER *

Figure 14-106. TX1_CP Register


LEGEND: R/W = Read/Write; R = Read only; W1toCl = Write 1 to clear bit; -n = value after reset

Table 14-119. TX1_CP Register Field Descriptions

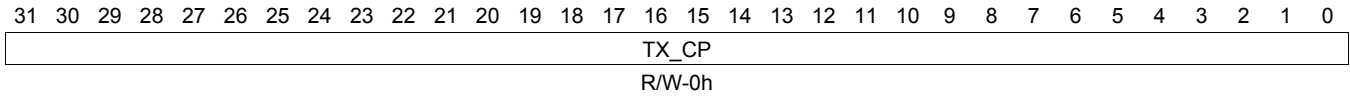
Bit	Field	Type	Reset	Description
31-0	TX_CP	R/W	0h	Tx Completion Pointer Register - This register is written by the host with the buffer descriptor address for the last buffer processed by the host during interrupt processing. The port uses the value written to determine if the interrupt should be deasserted.

14.5.5.19 TX2_CP Register (offset = A48h) [reset = 0h]

TX2_CP is shown in [Figure 14-107](#) and described in [Table 14-120](#).

CPDMA_STATRAM TX CHANNEL 2 COMPLETION POINTER REGISTER *

Figure 14-107. TX2_CP Register



LEGEND: R/W = Read/Write; R = Read only; W1toCl = Write 1 to clear bit; -n = value after reset

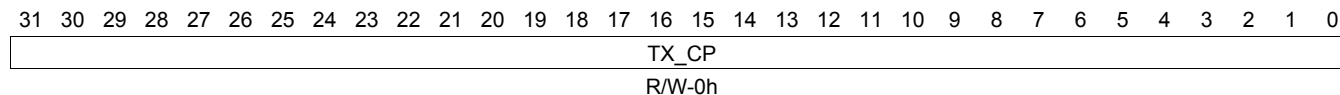
Table 14-120. TX2_CP Register Field Descriptions

Bit	Field	Type	Reset	Description
31-0	TX_CP	R/W	0h	Tx Completion Pointer Register - This register is written by the host with the buffer descriptor address for the last buffer processed by the host during interrupt processing. The port uses the value written to determine if the interrupt should be deasserted.

14.5.5.20 TX3_CP Register (offset = A4Ch) [reset = 0h]

TX3_CP is shown in [Figure 14-108](#) and described in [Table 14-121](#).

CPDMA_STATERAM TX CHANNEL 3 COMPLETION POINTER REGISTER *

Figure 14-108. TX3_CP Register


LEGEND: R/W = Read/Write; R = Read only; W1toCl = Write 1 to clear bit; -n = value after reset

Table 14-121. TX3_CP Register Field Descriptions

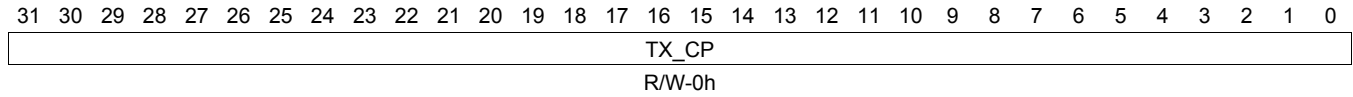
Bit	Field	Type	Reset	Description
31-0	TX_CP	R/W	0h	Tx Completion Pointer Register - This register is written by the host with the buffer descriptor address for the last buffer processed by the host during interrupt processing. The port uses the value written to determine if the interrupt should be deasserted.

14.5.5.21 TX4_CP Register (offset = A50h) [reset = 0h]

TX4_CP is shown in [Figure 14-109](#) and described in [Table 14-122](#).

CPDMA_STATERAM TX CHANNEL 4 COMPLETION POINTER REGISTER *

Figure 14-109. TX4_CP Register



LEGEND: R/W = Read/Write; R = Read only; W1toCl = Write 1 to clear bit; -n = value after reset

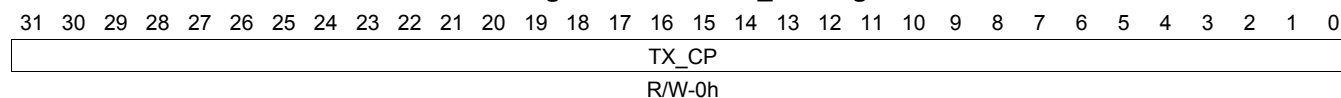
Table 14-122. TX4_CP Register Field Descriptions

Bit	Field	Type	Reset	Description
31-0	TX_CP	R/W	0h	Tx Completion Pointer Register - This register is written by the host with the buffer descriptor address for the last buffer processed by the host during interrupt processing. The port uses the value written to determine if the interrupt should be deasserted.

14.5.5.22 TX5_CP Register (offset = A54h) [reset = 0h]

TX5_CP is shown in [Figure 14-110](#) and described in [Table 14-123](#).

CPDMA_STATERAM TX CHANNEL 5 COMPLETION POINTER REGISTER *

Figure 14-110. TX5_CP Register


LEGEND: R/W = Read/Write; R = Read only; W1toCl = Write 1 to clear bit; -n = value after reset

Table 14-123. TX5_CP Register Field Descriptions

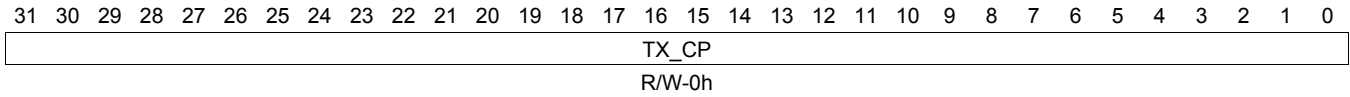
Bit	Field	Type	Reset	Description
31-0	TX_CP	R/W	0h	Tx Completion Pointer Register - This register is written by the host with the buffer descriptor address for the last buffer processed by the host during interrupt processing. The port uses the value written to determine if the interrupt should be deasserted.

14.5.5.23 TX6_CP Register (offset = A58h) [reset = 0h]

TX6_CP is shown in [Figure 14-111](#) and described in [Table 14-124](#).

CPDMA_STATERAM TX CHANNEL 6 COMPLETION POINTER REGISTER *

Figure 14-111. TX6_CP Register



LEGEND: R/W = Read/Write; R = Read only; W1toCl = Write 1 to clear bit; -n = value after reset

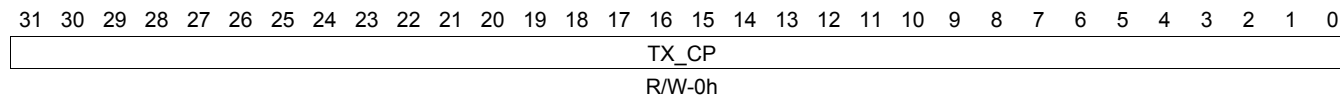
Table 14-124. TX6_CP Register Field Descriptions

Bit	Field	Type	Reset	Description
31-0	TX_CP	R/W	0h	Tx Completion Pointer Register - This register is written by the host with the buffer descriptor address for the last buffer processed by the host during interrupt processing. The port uses the value written to determine if the interrupt should be deasserted.

14.5.5.24 TX7_CP Register (offset = A5Ch) [reset = 0h]

TX7_CP is shown in [Figure 14-112](#) and described in [Table 14-125](#).

CPDMA_STATERAM TX CHANNEL 7 COMPLETION POINTER REGISTER *

Figure 14-112. TX7_CP Register


LEGEND: R/W = Read/Write; R = Read only; W1toCl = Write 1 to clear bit; -n = value after reset

Table 14-125. TX7_CP Register Field Descriptions

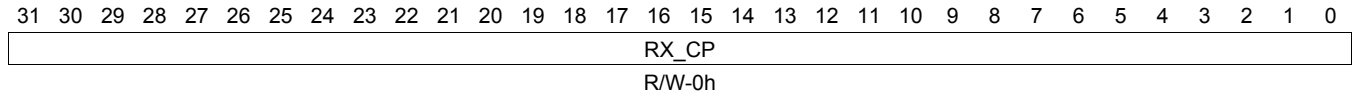
Bit	Field	Type	Reset	Description
31-0	TX_CP	R/W	0h	Tx Completion Pointer Register - This register is written by the host with the buffer descriptor address for the last buffer processed by the host during interrupt processing. The port uses the value written to determine if the interrupt should be deasserted.

14.5.5.25 RX0_CP Register (offset = A60h) [reset = 0h]

RX0_CP is shown in [Figure 14-113](#) and described in [Table 14-126](#).

CPDMA_STATERAM RX CHANNEL 0 COMPLETION POINTER REGISTER *

Figure 14-113. RX0_CP Register



LEGEND: R/W = Read/Write; R = Read only; W1toCl = Write 1 to clear bit; -n = value after reset

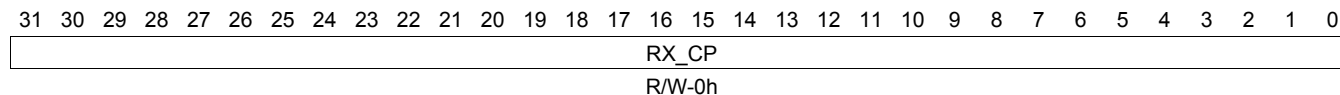
Table 14-126. RX0_CP Register Field Descriptions

Bit	Field	Type	Reset	Description
31-0	RX_CP	R/W	0h	<p>Rx Completion Pointer Register - This register is written by the host with the buffer descriptor address for the last buffer processed by the host during interrupt processing.</p> <p>The port uses the value written to determine if the interrupt should be deasserted.</p> <p>Note: The value read is the completion pointer (interrupt acknowledge) value that was written by the CPDMA DMA controller (port).</p> <p>The value written to this register by the host is compared with the value that the port wrote to determine if the interrupt should remain asserted.</p> <p>The value written is not actually stored in the location.</p> <p>The interrupt is deasserted if the two values are equal.</p>

14.5.5.26 RX1_CP Register (offset = A64h) [reset = 0h]

RX1_CP is shown in [Figure 14-114](#) and described in [Table 14-127](#).

CPDMA_STATRAM RX CHANNEL 1 COMPLETION POINTER REGISTER *

Figure 14-114. RX1_CP Register


LEGEND: R/W = Read/Write; R = Read only; W1toCl = Write 1 to clear bit; -n = value after reset

Table 14-127. RX1_CP Register Field Descriptions

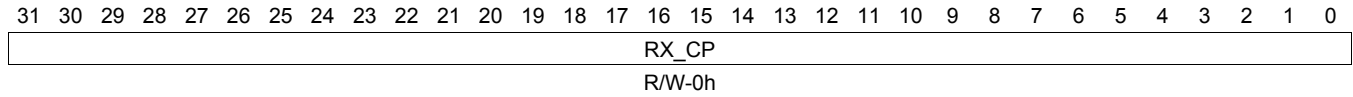
Bit	Field	Type	Reset	Description
31-0	RX_CP	R/W	0h	Rx Completion Pointer Register - This register is written by the host with the buffer descriptor address for the last buffer processed by the host during interrupt processing. The port uses the value written to determine if the interrupt should be deasserted. Note: The value read is the completion pointer (interrupt acknowledge) value that was written by the CPDMA DMA controller (port). The value written to this register by the host is compared with the value that the port wrote to determine if the interrupt should remain asserted. The value written is not actually stored in the location. The interrupt is deasserted if the two values are equal.

14.5.5.27 RX2_CP Register (offset = A68h) [reset = 0h]

RX2_CP is shown in [Figure 14-115](#) and described in [Table 14-128](#).

CPDMA_STATERAM RX CHANNEL 2 COMPLETION POINTER REGISTER *

Figure 14-115. RX2_CP Register



LEGEND: R/W = Read/Write; R = Read only; W1toCl = Write 1 to clear bit; -n = value after reset

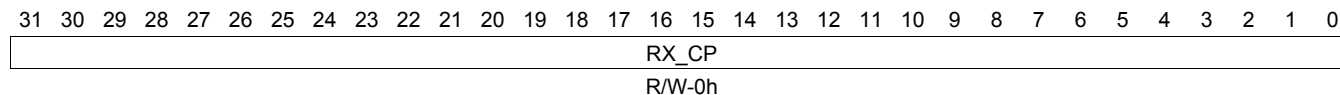
Table 14-128. RX2_CP Register Field Descriptions

Bit	Field	Type	Reset	Description
31-0	RX_CP	R/W	0h	<p>Rx Completion Pointer Register - This register is written by the host with the buffer descriptor address for the last buffer processed by the host during interrupt processing.</p> <p>The port uses the value written to determine if the interrupt should be deasserted.</p> <p>Note: The value read is the completion pointer (interrupt acknowledge) value that was written by the CPDMA DMA controller (port).</p> <p>The value written to this register by the host is compared with the value that the port wrote to determine if the interrupt should remain asserted.</p> <p>The value written is not actually stored in the location.</p> <p>The interrupt is deasserted if the two values are equal.</p>

14.5.5.28 RX3_CP Register (offset = A6Ch) [reset = 0h]

RX3_CP is shown in [Figure 14-116](#) and described in [Table 14-129](#).

CPDMA_STATERAM RX CHANNEL 3 COMPLETION POINTER REGISTER *

Figure 14-116. RX3_CP Register


LEGEND: R/W = Read/Write; R = Read only; W1toCl = Write 1 to clear bit; -n = value after reset

Table 14-129. RX3_CP Register Field Descriptions

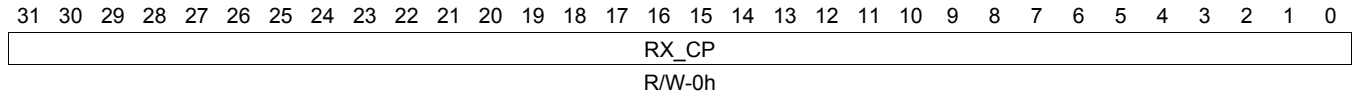
Bit	Field	Type	Reset	Description
31-0	RX_CP	R/W	0h	Rx Completion Pointer Register - This register is written by the host with the buffer descriptor address for the last buffer processed by the host during interrupt processing. The port uses the value written to determine if the interrupt should be deasserted. Note: The value read is the completion pointer (interrupt acknowledge) value that was written by the CPDMA DMA controller (port). The value written to this register by the host is compared with the value that the port wrote to determine if the interrupt should remain asserted. The value written is not actually stored in the location. The interrupt is deasserted if the two values are equal.

14.5.5.29 RX4_CP Register (offset = A70h) [reset = 0h]

RX4_CP is shown in [Figure 14-117](#) and described in [Table 14-130](#).

CPDMA_STATERAM RX CHANNEL 4 COMPLETION POINTER REGISTER *

Figure 14-117. RX4_CP Register



LEGEND: R/W = Read/Write; R = Read only; W1toCl = Write 1 to clear bit; -n = value after reset

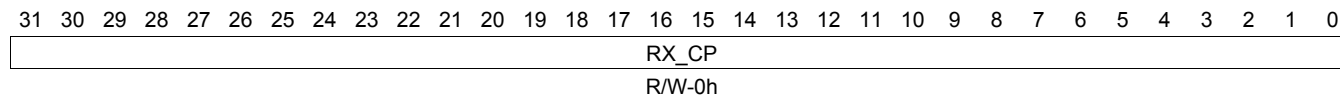
Table 14-130. RX4_CP Register Field Descriptions

Bit	Field	Type	Reset	Description
31-0	RX_CP	R/W	0h	<p>Rx Completion Pointer Register - This register is written by the host with the buffer descriptor address for the last buffer processed by the host during interrupt processing. The port uses the value written to determine if the interrupt should be deasserted.</p> <p>Note: The value read is the completion pointer (interrupt acknowledge) value that was written by the CPDMA DMA controller (port).</p> <p>The value written to this register by the host is compared with the value that the port wrote to determine if the interrupt should remain asserted.</p> <p>The value written is not actually stored in the location. The interrupt is deasserted if the two values are equal.</p>

14.5.5.30 RX5_CP Register (offset = A74h) [reset = 0h]

RX5_CP is shown in [Figure 14-118](#) and described in [Table 14-131](#).

CPDMA_STATRAM RX CHANNEL 5 COMPLETION POINTER REGISTER *

Figure 14-118. RX5_CP Register


LEGEND: R/W = Read/Write; R = Read only; W1toCl = Write 1 to clear bit; -n = value after reset

Table 14-131. RX5_CP Register Field Descriptions

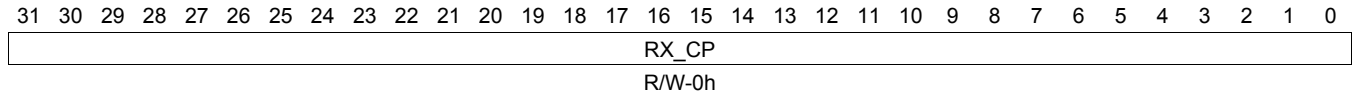
Bit	Field	Type	Reset	Description
31-0	RX_CP	R/W	0h	Rx Completion Pointer Register - This register is written by the host with the buffer descriptor address for the last buffer processed by the host during interrupt processing. The port uses the value written to determine if the interrupt should be deasserted. Note: The value read is the completion pointer (interrupt acknowledge) value that was written by the CPDMA DMA controller (port). The value written to this register by the host is compared with the value that the port wrote to determine if the interrupt should remain asserted. The value written is not actually stored in the location. The interrupt is deasserted if the two values are equal.

14.5.5.31 RX6_CP Register (offset = A78h) [reset = 0h]

RX6_CP is shown in [Figure 14-119](#) and described in [Table 14-132](#).

CPDMA_STATERAM RX CHANNEL 6 COMPLETION POINTER REGISTER *

Figure 14-119. RX6_CP Register



LEGEND: R/W = Read/Write; R = Read only; W1toCl = Write 1 to clear bit; -n = value after reset

Table 14-132. RX6_CP Register Field Descriptions

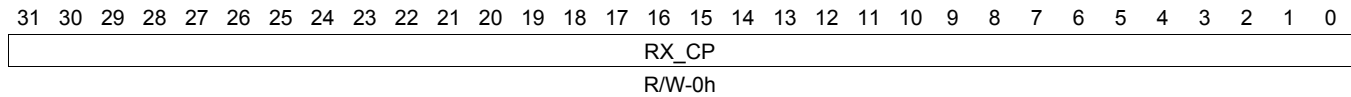
Bit	Field	Type	Reset	Description
31-0	RX_CP	R/W	0h	<p>Rx Completion Pointer Register - This register is written by the host with the buffer descriptor address for the last buffer processed by the host during interrupt processing. The port uses the value written to determine if the interrupt should be deasserted.</p> <p>Note: The value read is the completion pointer (interrupt acknowledge) value that was written by the CPDMA DMA controller (port). The value written to this register by the host is compared with the value that the port wrote to determine if the interrupt should remain asserted. The value written is not actually stored in the location. The interrupt is deasserted if the two values are equal.</p>

14.5.5.32 RX7_CP Register (offset = A7Ch) [reset = 0h]

RX7_CP is shown in [Figure 14-120](#) and described in [Table 14-133](#).

CPDMA_STATERAM RX CHANNEL 7 COMPLETION POINTER REGISTER *

Figure 14-120. RX7_CP Register



LEGEND: R/W = Read/Write; R = Read only; W1toCl = Write 1 to clear bit; -n = value after reset

Table 14-133. RX7_CP Register Field Descriptions

Bit	Field	Type	Reset	Description
31-0	RX_CP	R/W	0h	<p>Rx Completion Pointer Register - This register is written by the host with the buffer descriptor address for the last buffer processed by the host during interrupt processing. The port uses the value written to determine if the interrupt should be deasserted.</p> <p>Note: The value read is the completion pointer (interrupt acknowledge) value that was written by the CPDMA DMA controller (port).</p> <p>The value written to this register by the host is compared with the value that the port wrote to determine if the interrupt should remain asserted.</p> <p>The value written is not actually stored in the location. The interrupt is deasserted if the two values are equal.</p>

14.5.6 CPSW_PORT Registers

[Table 14-134](#) lists the memory-mapped registers for the CPSW_PORT. All register offset addresses not listed in [Table 14-134](#) should be considered as reserved locations and the register contents should not be modified.

Table 14-134. CPSW_PORT Registers

Offset	Acronym	Register Name	Section
0h	P0_CONTROL		Section 14.5.6.1
8h	P0_MAX_BLKs		Section 14.5.6.2
Ch	P0_BLK_CNT		Section 14.5.6.3
10h	P0_TX_IN_CTL		Section 14.5.6.4
14h	P0_PORT_VLAN		Section 14.5.6.5
18h	P0_TX_PRI_MAP		Section 14.5.6.6
1Ch	P0_CPDMA_TX_PRI_MAP		Section 14.5.6.7
20h	P0_CPDMA_RX_CH_MAP		Section 14.5.6.8
30h	P0_RX_DSCP_PRI_MAP0		Section 14.5.6.9
34h	P0_RX_DSCP_PRI_MAP1		Section 14.5.6.10
38h	P0_RX_DSCP_PRI_MAP2		Section 14.5.6.11
3Ch	P0_RX_DSCP_PRI_MAP3		Section 14.5.6.12
40h	P0_RX_DSCP_PRI_MAP4		Section 14.5.6.13
44h	P0_RX_DSCP_PRI_MAP5		Section 14.5.6.14
48h	P0_RX_DSCP_PRI_MAP6		Section 14.5.6.15
4Ch	P0_RX_DSCP_PRI_MAP7		Section 14.5.6.16
100h	P1_CONTROL		Section 14.5.6.17
108h	P1_MAX_BLKs		Section 14.5.6.18
10Ch	P1_BLK_CNT		Section 14.5.6.19
110h	P1_TX_IN_CTL		Section 14.5.6.20

Table 14-134. CPSW_PORT Registers (continued)

Offset	Acronym	Register Name	Section
114h	P1_PORT_VLAN		Section 14.5.6.21
118h	P1_TX_PRI_MAP		Section 14.5.6.22
11Ch	P1_TS_SEQ_MTYPE		Section 14.5.6.23
120h	P1_SA_LO		Section 14.5.6.24
124h	P1_SA_HI		Section 14.5.6.25
128h	P1_SEND_PERCENT		Section 14.5.6.26
130h	P1_RX_DSCP_PRI_MAP0		Section 14.5.6.27
134h	P1_RX_DSCP_PRI_MAP1		Section 14.5.6.28
138h	P1_RX_DSCP_PRI_MAP2		Section 14.5.6.29
13Ch	P1_RX_DSCP_PRI_MAP3		Section 14.5.6.30
140h	P1_RX_DSCP_PRI_MAP4		Section 14.5.6.31
144h	P1_RX_DSCP_PRI_MAP5		Section 14.5.6.32
148h	P1_RX_DSCP_PRI_MAP6		Section 14.5.6.33
14Ch	P1_RX_DSCP_PRI_MAP7		Section 14.5.6.34
200h	P2_CONTROL		Section 14.5.6.35
208h	P2_MAX_BLKs		Section 14.5.6.36
20Ch	P2_BLK_CNT		Section 14.5.6.37
210h	P2_TX_IN_CTL		Section 14.5.6.38
214h	P2_PORT_VLAN		Section 14.5.6.39
218h	P2_TX_PRI_MAP		Section 14.5.6.40
21Ch	P2_TS_SEQ_MTYPE		Section 14.5.6.41
220h	P2_SA_LO		Section 14.5.6.42
224h	P2_SA_HI		Section 14.5.6.43
228h	P2_SEND_PERCENT		Section 14.5.6.44
230h	P2_RX_DSCP_PRI_MAP0		Section 14.5.6.45
234h	P2_RX_DSCP_PRI_MAP1		Section 14.5.6.46
238h	P2_RX_DSCP_PRI_MAP2		Section 14.5.6.47
23Ch	P2_RX_DSCP_PRI_MAP3		Section 14.5.6.48
240h	P2_RX_DSCP_PRI_MAP4		Section 14.5.6.49
244h	P2_RX_DSCP_PRI_MAP5		Section 14.5.6.50
248h	P2_RX_DSCP_PRI_MAP6		Section 14.5.6.51
24Ch	P2_RX_DSCP_PRI_MAP7		Section 14.5.6.52

14.5.6.1 P0_CONTROL Register (offset = 0h) [reset = 0h]

 P0_CONTROL is shown in [Figure 14-121](#) and described in [Table 14-135](#).

CPSW PORT 0 CONTROL REGISTER

Figure 14-121. P0_CONTROL Register

31	30	29	28	27	26	25	24
RESERVED	P0_DLR_CPDMA_CH			RESERVED		P0_PASS_PRI_TAGGED	
R/W-0h		R/W-0h			R/W-0h		R/W-0h
23	22	21	20	19	18	17	16
RESERVED		P0_VLAN_LTY PE2_EN	P0_VLAN_LTY PE1_EN	RESERVED		P0_DSCP_PRI_EN	
R/W-0h		R/W-0h	R/W-0h	R/W-0h		R/W-0h	
15	14	13	12	11	10	9	8
RESERVED							
R/W-0h							
7	6	5	4	3	2	1	0
RESERVED							
R/W-0h							

LEGEND: R/W = Read/Write; R = Read only; W1toCl = Write 1 to clear bit; -n = value after reset

Table 14-135. P0_CONTROL Register Field Descriptions

Bit	Field	Type	Reset	Description
31	RESERVED	R/W	0h	
30-28	P0_DLR_CPDMA_CH	R/W	0h	Port 0 DLR CPDMA Channel This field indicates the CPDMA channel that DLR packets will be received on.
27-25	RESERVED	R/W	0h	
24	P0_PASS_PRI_TAGGED	R/W	0h	Port 0 Pass Priority Tagged 0 - Priority tagged packets have the zero VID replaced with the input port P0_PORT_VLAN [11:0] 1 - Priority tagged packets are processed unchanged.
23-22	RESERVED	R/W	0h	
21	P0_VLAN_LTYPE2_EN	R/W	0h	Port 0 VLAN LTYPE 2 enable 0 - disabled 1 - enabled
20	P0_VLAN_LTYPE1_EN	R/W	0h	Port 0 VLAN LTYPE 1 enable 0 - disabled 1 - enabled
19-17	RESERVED	R/W	0h	
16	P0_DSCP_PRI_EN	R/W	0h	Port 0 DSCP Priority Enable 0 - DSCP priority disabled 1 - DSCP priority enabled. All non-tagged IPV4 packets have their received packet priority determined by mapping the 6 TOS bits through the port DSCP priority mapping registers.
15-0	RESERVED	R/W	0h	

14.5.6.2 P0_MAX_BLKs Register (offset = 8h) [reset = 104h]

P0_MAX_BLKs is shown in [Figure 14-122](#) and described in [Table 14-136](#).

CPSW PORT 0 MAXIMUM FIFO BLOCKS REGISTER

Figure 14-122. P0_MAX_BLKs Register

31	30	29	28	27	26	25	24
RESERVED							
R/W-0h							
23	22	21	20	19	18	17	16
RESERVED							
R/W-0h							
15	14	13	12	11	10	9	8
RESERVED							P0_TX_MAX_B LKS
R/W-0h							R/W-10h
7	6	5	4	3	2	1	0
P0_TX_MAX_BLKs				P0_RX_MAX_BLKs			
R/W-10h				R/W-4h			

LEGEND: R/W = Read/Write; R = Read only; W1toCl = Write 1 to clear bit; -n = value after reset

Table 14-136. P0_MAX_BLKs Register Field Descriptions

Bit	Field	Type	Reset	Description
31-9	RESERVED	R/W	0h	
8-4	P0_TX_MAX_BLKs	R/W	10h	Transmit FIFO Maximum Blocks - This value is the maximum number of 1k memory blocks that may be allocated to the FIFO's logical transmit priority queues. 0x10 is the recommended value of p0_tx_max_blks. Port 0 should remain in flow control mode. 0xe is the minimum value tx max blks.
3-0	P0_RX_MAX_BLKs	R/W	4h	Receive FIFO Maximum Blocks - This value is the maximum number of 1k memory blocks that may be allocated to the FIFO's logical receive queue. 0x4 is the recommended value. 0x3 is the minimum value rx max blks and 0x6 is the maximum value.

14.5.6.3 P0_BLK_CNT Register (offset = Ch) [reset = 41h]

 P0_BLK_CNT is shown in [Figure 14-123](#) and described in [Table 14-137](#).

CPSW PORT 0 FIFO BLOCK USAGE COUNT (READ ONLY)

Figure 14-123. P0_BLK_CNT Register

31	30	29	28	27	26	25	24
RESERVED							
R-0h							
23	22	21	20	19	18	17	16
RESERVED							
R-0h							
15	14	13	12	11	10	9	8
RESERVED							P0_TX_BLK_C NT
R-0h							R-4h
7	6	5	4	3	2	1	0
P0_TX_BLK_CNT				P0_RX_BLK_CNT			
R-4h				R-1h			

LEGEND: R/W = Read/Write; R = Read only; W1toCl = Write 1 to clear bit; -n = value after reset

Table 14-137. P0_BLK_CNT Register Field Descriptions

Bit	Field	Type	Reset	Description
31-9	RESERVED	R	0h	
8-4	P0_TX_BLK_CNT	R	4h	Port 0 Transmit Block Count Usage - This value is the number of blocks allocated to the FIFO logical transmit queues.
3-0	P0_RX_BLK_CNT	R	1h	Port 0 Receive Block Count Usage - This value is the number of blocks allocated to the FIFO logical receive queues.

14.5.6.4 P0_TX_IN_CTL Register (offset = 10h) [reset = 40C0h]

P0_TX_IN_CTL is shown in [Figure 14-124](#) and described in [Table 14-138](#).

CPSW PORT 0 TRANSMIT FIFO CONTROL

Figure 14-124. P0_TX_IN_CTL Register

31	30	29	28	27	26	25	24
RESERVED							
R/W-							
23	22	21	20	19	18	17	16
TX_RATE_EN				RESERVED		TX_IN_SEL	
R/W-0h				R/W-		R/W-0h	
15	14	13	12	11	10	9	8
TX_BLKs_REM				RESERVED		TX_PRI_WDS	
R/W-4h				R/W-		R/W-C0h	
7	6	5	4	3	2	1	0
TX_PRI_WDS							
R/W-C0h							

LEGEND: R/W = Read/Write; R = Read only; W1toCl = Write 1 to clear bit; -n = value after reset

Table 14-138. P0_TX_IN_CTL Register Field Descriptions

Bit	Field	Type	Reset	Description
31-24	RESERVED	R/W		
23-20	TX_RATE_EN	R/W	0h	Transmit FIFO Input Rate Enable
19-18	RESERVED	R/W		
17-16	TX_IN_SEL	R/W	0h	Transmit FIFO Input Queue Type Select 00 - Normal priority mode 01 - Dual MAC mode 10 - Rate Limit mode 11 - reserved Note that Dual MAC mode is not compatible with escalation or shaping because dual mac mode forces round robin priority on FIFO egress.
15-12	TX_BLKs_REM	R/W	4h	Transmit FIFO Input Blocks to subtract in dual mac mode
11-10	RESERVED	R/W		
9-0	TX_PRI_WDS	R/W	C0h	Transmit FIFO Words in queue

14.5.6.5 P0_PORT_VLAN Register (offset = 14h) [reset = 0h]

P0_PORT_VLAN is shown in [Figure 14-125](#) and described in [Table 14-139](#).

CPSW PORT 0 VLAN REGISTER

Figure 14-125. P0_PORT_VLAN Register

31	30	29	28	27	26	25	24
RESERVED							
R/W-0h							
23	22	21	20	19	18	17	16
RESERVED							
R/W-0h							
15	14	13	12	11	10	9	8
PORT_PRI			PORT_CFI		PORT_VID		
R/W-0h			R/W-0h		R/W-0h		
7	6	5	4	3	2	1	0
PORT_VID							
R/W-0h							

LEGEND: R/W = Read/Write; R = Read only; W1toCl = Write 1 to clear bit; -n = value after reset

Table 14-139. P0_PORT_VLAN Register Field Descriptions

Bit	Field	Type	Reset	Description
31-16	RESERVED	R/W	0h	
15-13	PORT_PRI	R/W	0h	Port VLAN Priority (7 is highest priority)
12	PORT_CFI	R/W	0h	Port CFI bit
11-0	PORT_VID	R/W	0h	Port VLAN ID

14.5.6.6 P0_TX_PRI_MAP Register (offset = 18h) [reset = 33221001h]

P0_TX_PRI_MAP is shown in [Figure 14-126](#) and described in [Table 14-140](#).

CPSW PORT 0 TX HEADER PRI TO SWITCH PRI MAPPING REGISTER

Figure 14-126. P0_TX_PRI_MAP Register

31	30	29	28	27	26	25	24	23	22	21	20	19	18	17	16	
RESERVED	PRI7			RESERVED	PRI6		RESERVED	PRI5		RESERVED	PRI4					
R/W-0h		R/W-3h			R/W-0h		R/W-3h		R/W-0h		R/W-2h		R/W-0h		R/W-2h	
15	14	13	12	11	10	9	8	7	6	5	4	3	2	1	0	
RESERVED	PRI3			RESERVED	PRI2		RESERVED	PRI1		RESERVED	PRI0					
R/W-0h		R/W-1h			R/W-0h		R/W-0h		R/W-0h		R/W-0h		R/W-0h		R/W-1h	

LEGEND: R/W = Read/Write; R = Read only; W1toCl = Write 1 to clear bit; -n = value after reset

Table 14-140. P0_TX_PRI_MAP Register Field Descriptions

Bit	Field	Type	Reset	Description
31-30	RESERVED	R/W	0h	
29-28	PRI7	R/W	3h	Priority 7 - A packet header priority of 0x7 is given this switch queue pri.
27-26	RESERVED	R/W	0h	
25-24	PRI6	R/W	3h	Priority 6 - A packet header priority of 0x6 is given this switch queue pri.
23-22	RESERVED	R/W	0h	
21-20	PRI5	R/W	2h	Priority 5 - A packet header priority of 0x5 is given this switch queue pri.
19-18	RESERVED	R/W	0h	
17-16	PRI4	R/W	2h	Priority 4 - A packet header priority of 0x4 is given this switch queue pri.
15-14	RESERVED	R/W	0h	
13-12	PRI3	R/W	1h	Priority 3 - A packet header priority of 0x3 is given this switch queue pri.
11-10	RESERVED	R/W	0h	
9-8	PRI2	R/W	0h	Priority 2 - A packet header priority of 0x2 is given this switch queue pri.
7-6	RESERVED	R/W	0h	
5-4	PRI1	R/W	0h	Priority 1 - A packet header priority of 0x1 is given this switch queue pri.
3-2	RESERVED	R/W	0h	
1-0	PRI0	R/W	1h	Priority 0 - A packet header priority of 0x0 is given this switch queue pri.

14.5.6.7 P0_CPDMA_TX_PRI_MAP Register (offset = 1Ch) [reset = 76543210h]

 P0_CPDMA_TX_PRI_MAP is shown in [Figure 14-127](#) and described in [Table 14-141](#).

CPSW CPDMA TX (PORT 0 RX) PKT PRIORITY TO HEADER PRIORITY

Figure 14-127. P0_CPDMA_TX_PRI_MAP Register

31	30	29	28	27	26	25	24	23	22	21	20	19	18	17	16
RESE RVED	PRI7			RESE RVED	PRI6			RESE RVED	PRI5			RESE RVED	PRI4		
R/W- 0h	R/W-7h			R/W- 0h	R/W-6h			R/W- 0h	R/W-5h			R/W- 0h	R/W-4h		
15	14	13	12	11	10	9	8	7	6	5	4	3	2	1	0
RESE RVED	PRI3			RESE RVED	PRI2			RESE RVED	PRI1			RESE RVED	PRI0		
R/W- 0h	R/W-3h			R/W- 0h	R/W-2h			R/W- 0h	R/W-1h			R/W- 0h	R/W-0h		

LEGEND: R/W = Read/Write; R = Read only; W1toCl = Write 1 to clear bit; -n = value after reset

Table 14-141. P0_CPDMA_TX_PRI_MAP Register Field Descriptions

Bit	Field	Type	Reset	Description
31	RESERVED	R/W	0h	
30-28	PRI7	R/W	7h	Priority 7 - A packet pri of 0x7 is mapped (changed) to this header packet pri.
27	RESERVED	R/W	0h	
26-24	PRI6	R/W	6h	Priority 6 - A packet pri of 0x6 is mapped (changed) to this header packet pri.
23	RESERVED	R/W	0h	
22-20	PRI5	R/W	5h	Priority 5 - A packet pri of 0x5 is mapped (changed) to this header packet pri.
19	RESERVED	R/W	0h	
18-16	PRI4	R/W	4h	Priority 4 - A packet pri of 0x4 is mapped (changed) to this header packet pri.
15	RESERVED	R/W	0h	
14-12	PRI3	R/W	3h	Priority 3 - A packet pri of 0x3 is mapped (changed) to this header packet pri.
11	RESERVED	R/W	0h	
10-8	PRI2	R/W	2h	Priority 2 - A packet pri of 0x2 is mapped (changed) to this header packet pri.
7	RESERVED	R/W	0h	
6-4	PRI1	R/W	1h	Priority 1 - A packet pri of 0x1 is mapped (changed) to this header packet pri.
3	RESERVED	R/W	0h	
2-0	PRI0	R/W	0h	Priority 0 - A packet pri of 0x0 is mapped (changed) to this header packet pri.

14.5.6.8 P0_CPDMA_RX_CH_MAP Register (offset = 20h) [reset = 0h]

P0_CPDMA_RX_CH_MAP is shown in [Figure 14-128](#) and described in [Table 14-142](#).

CPSW CPDMA RX (PORT 0 TX) SWITCH PRIORITY TO DMA CHANNEL

Figure 14-128. P0_CPDMA_RX_CH_MAP Register

31	30	29	28	27	26	25	24	23	22	21	20	19	18	17	16
RESE RVED	P2_PRI3			RESE RVED	P2_PRI2			RESE RVED	P2_PRI1			RESE RVED	P2_PRI0		
R/W- 0h	R/W-0h			R/W- 0h	R/W-0h			R/W- 0h	R/W-0h			R/W- 0h	R/W-0h		
15	14	13	12	11	10	9	8	7	6	5	4	3	2	1	0
RESE RVED	P1_PRI3			RESE RVED	P1_PRI2			RESE RVED	P1_PRI1			RESE RVED	P1_PRI0		
R/W- 0h	R/W-0h			R/W- 0h	R/W-0h			R/W- 0h	R/W-0h			R/W- 0h	R/W-0h		

LEGEND: R/W = Read/Write; R = Read only; W1toCl = Write 1 to clear bit; -n = value after reset

Table 14-142. P0_CPDMA_RX_CH_MAP Register Field Descriptions

Bit	Field	Type	Reset	Description
31	RESERVED	R/W	0h	
30-28	P2_PRI3	R/W	0h	Port 2 Priority 3 packets go to this CPDMA Rx Channel
27	RESERVED	R/W	0h	
26-24	P2_PRI2	R/W	0h	Port 2 Priority 2 packets go to this CPDMA Rx Channel
23	RESERVED	R/W	0h	
22-20	P2_PRI1	R/W	0h	Port 2 Priority 1 packets go to this CPDMA Rx Channel
19	RESERVED	R/W	0h	
18-16	P2_PRI0	R/W	0h	Port 2 Priority 0 packets go to this CPDMA Rx Channel
15	RESERVED	R/W	0h	
14-12	P1_PRI3	R/W	0h	Port 1 Priority 3 packets go to this CPDMA Rx Channel
11	RESERVED	R/W	0h	
10-8	P1_PRI2	R/W	0h	Port 1 Priority 2 packets go to this CPDMA Rx Channel
7	RESERVED	R/W	0h	
6-4	P1_PRI1	R/W	0h	Port 1 Priority 1 packets go to this CPDMA Rx Channel
3	RESERVED	R/W	0h	
2-0	P1_PRI0	R/W	0h	Port 1 Priority 0 packets go to this CPDMA Rx Channel

14.5.6.9 P0_RX_DSCP_PRI_MAP0 Register (offset = 30h) [reset = 0h]

 P0_RX_DSCP_PRI_MAP0 is shown in [Figure 14-129](#) and described in [Table 14-143](#).

CPSW PORT 0 RX DSCP PRIORITY TO RX PACKET MAPPING REG 0

Figure 14-129. P0_RX_DSCP_PRI_MAP0 Register

31	30	29	28	27	26	25	24	23	22	21	20	19	18	17	16
RESE RVED	PRI7			RESE RVED	PRI6			RESE RVED	PRI5			RESE RVED	PRI4		
R/W- 0h	R/W-0h			R/W- 0h	R/W-0h			R/W- 0h	R/W-0h			R/W- 0h	R/W-0h		
15	14	13	12	11	10	9	8	7	6	5	4	3	2	1	0
RESE RVED	PRI3			RESE RVED	PRI2			RESE RVED	PRI1			RESE RVED	PRI0		
R/W- 0h	R/W-0h			R/W- 0h	R/W-0h			R/W- 0h	R/W-0h			R/W- 0h	R/W-0h		

LEGEND: R/W = Read/Write; R = Read only; W1toCl = Write 1 to clear bit; -n = value after reset

Table 14-143. P0_RX_DSCP_PRI_MAP0 Register Field Descriptions

Bit	Field	Type	Reset	Description
31	RESERVED	R/W	0h	
30-28	PRI7	R/W	0h	Priority 7 - A packet TOS of 0d7 is mapped to this received packet priority.
27	RESERVED	R/W	0h	
26-24	PRI6	R/W	0h	Priority 6 - A packet TOS of 0d6 is mapped to this received packet priority.
23	RESERVED	R/W	0h	
22-20	PRI5	R/W	0h	Priority 5 - A packet TOS of 0d5 is mapped to this received packet priority.
19	RESERVED	R/W	0h	
18-16	PRI4	R/W	0h	Priority 4 - A packet TOS of 0d4 is mapped to this received packet priority.
15	RESERVED	R/W	0h	
14-12	PRI3	R/W	0h	Priority 3 - A packet TOS of 0d3 is mapped to this received packet priority.
11	RESERVED	R/W	0h	
10-8	PRI2	R/W	0h	Priority 2 - A packet TOS of 0d2 is mapped to this received packet priority.
7	RESERVED	R/W	0h	
6-4	PRI1	R/W	0h	Priority 1 - A packet TOS of 0d1 is mapped to this received packet priority.
3	RESERVED	R/W	0h	
2-0	PRI0	R/W	0h	Priority 0 - A packet TOS of 0d0 is mapped to this received packet priority.

14.5.6.10 P0_RX_DSCP_PRI_MAP1 Register (offset = 34h) [reset = 0h]

P0_RX_DSCP_PRI_MAP1 is shown in [Figure 14-130](#) and described in [Table 14-144](#).

CPSW PORT 0 RX DSCP PRIORITY TO RX PACKET MAPPING REG 1

Figure 14-130. P0_RX_DSCP_PRI_MAP1 Register

31	30	29	28	27	26	25	24	23	22	21	20	19	18	17	16
RESE RVED	PRI15			RESE RVED	PRI14			RESE RVED	PRI13			RESE RVED	PRI12		
R/W- 0h	R/W-0h			R/W- 0h	R/W-0h			R/W- 0h	R/W-0h			R/W- 0h	R/W-0h		
15	14	13	12	11	10	9	8	7	6	5	4	3	2	1	0
RESE RVED	PRI11			RESE RVED	PRI10			RESE RVED	PRI9			RESE RVED	PRI8		
R/W- 0h	R/W-0h			R/W- 0h	R/W-0h			R/W- 0h	R/W-0h			R/W- 0h	R/W-0h		

LEGEND: R/W = Read/Write; R = Read only; W1toCl = Write 1 to clear bit; -n = value after reset

Table 14-144. P0_RX_DSCP_PRI_MAP1 Register Field Descriptions

Bit	Field	Type	Reset	Description
31	RESERVED	R/W	0h	
30-28	PRI15	R/W	0h	Priority 15 - A packet TOS of 0d15 is mapped to this received packet priority.
27	RESERVED	R/W	0h	
26-24	PRI14	R/W	0h	Priority 14 - A packet TOS of 0d14 is mapped to this received packet priority.
23	RESERVED	R/W	0h	
22-20	PRI13	R/W	0h	Priority 13 - A packet TOS of 0d13 is mapped to this received packet priority.
19	RESERVED	R/W	0h	
18-16	PRI12	R/W	0h	Priority 12 - A packet TOS of 0d12 is mapped to this received packet priority.
15	RESERVED	R/W	0h	
14-12	PRI11	R/W	0h	Priority 11 - A packet TOS of 0d11 is mapped to this received packet priority.
11	RESERVED	R/W	0h	
10-8	PRI10	R/W	0h	Priority 10 - A packet TOS of 0d10 is mapped to this received packet priority.
7	RESERVED	R/W	0h	
6-4	PRI9	R/W	0h	Priority 9 - A packet TOS of 0d9 is mapped to this received packet priority.
3	RESERVED	R/W	0h	
2-0	PRI8	R/W	0h	Priority 8 - A packet TOS of 0d8 is mapped to this received packet priority.

14.5.6.11 P0_RX_DSCP_PRI_MAP2 Register (offset = 38h) [reset = 0h]

 P0_RX_DSCP_PRI_MAP2 is shown in [Figure 14-131](#) and described in [Table 14-145](#).

CPSW PORT 0 RX DSCP PRIORITY TO RX PACKET MAPPING REG 2

Figure 14-131. P0_RX_DSCP_PRI_MAP2 Register

31	30	29	28	27	26	25	24	23	22	21	20	19	18	17	16
RESE RVED	PRI23			RESE RVED	PRI22			RESE RVED	PRI21			RESE RVED	PRI20		
R/W- 0h	R/W-0h			R/W- 0h	R/W-0h			R/W- 0h	R/W-0h			R/W- 0h	R/W-0h		
15	14	13	12	11	10	9	8	7	6	5	4	3	2	1	0
RESE RVED	PRI19			RESE RVED	PRI18			RESE RVED	PRI17			RESE RVED	PRI16		
R/W- 0h	R/W-0h			R/W- 0h	R/W-0h			R/W- 0h	R/W-0h			R/W- 0h	R/W-0h		

LEGEND: R/W = Read/Write; R = Read only; W1toCl = Write 1 to clear bit; -n = value after reset

Table 14-145. P0_RX_DSCP_PRI_MAP2 Register Field Descriptions

Bit	Field	Type	Reset	Description
31	RESERVED	R/W	0h	
30-28	PRI23	R/W	0h	Priority 23 - A packet TOS of 0d23 is mapped to this received packet priority.
27	RESERVED	R/W	0h	
26-24	PRI22	R/W	0h	Priority 22 - A packet TOS of 0d22 is mapped to this received packet priority.
23	RESERVED	R/W	0h	
22-20	PRI21	R/W	0h	Priority 21 - A packet TOS of 0d21 is mapped to this received packet priority.
19	RESERVED	R/W	0h	
18-16	PRI20	R/W	0h	Priority 20 - A packet TOS of 0d20 is mapped to this received packet priority.
15	RESERVED	R/W	0h	
14-12	PRI19	R/W	0h	Priority 19 - A packet TOS of 0d19 is mapped to this received packet priority.
11	RESERVED	R/W	0h	
10-8	PRI18	R/W	0h	Priority 18 - A packet TOS of 0d18 is mapped to this received packet priority.
7	RESERVED	R/W	0h	
6-4	PRI17	R/W	0h	Priority 17 - A packet TOS of 0d17 is mapped to this received packet priority.
3	RESERVED	R/W	0h	
2-0	PRI16	R/W	0h	Priority 16 - A packet TOS of 0d16 is mapped to this received packet priority.

14.5.6.12 P0_RX_DSCP_PRI_MAP3 Register (offset = 3Ch) [reset = 0h]

P0_RX_DSCP_PRI_MAP3 is shown in [Figure 14-132](#) and described in [Table 14-146](#).

CPSW PORT 0 RX DSCP PRIORITY TO RX PACKET MAPPING REG 3

Figure 14-132. P0_RX_DSCP_PRI_MAP3 Register

31	30	29	28	27	26	25	24	23	22	21	20	19	18	17	16
RESE RVED	PRI31			RESE RVED	PRI30			RESE RVED	PRI29			RESE RVED	PRI28		
R/W- 0h	R/W-0h			R/W- 0h	R/W-0h			R/W- 0h	R/W-0h			R/W- 0h	R/W-0h		
15	14	13	12	11	10	9	8	7	6	5	4	3	2	1	0
RESE RVED	PRI27			RESE RVED	PRI26			RESE RVED	PRI25			RESE RVED	PRI24		
R/W- 0h	R/W-0h			R/W- 0h	R/W-0h			R/W- 0h	R/W-0h			R/W- 0h	R/W-0h		

LEGEND: R/W = Read/Write; R = Read only; W1toCl = Write 1 to clear bit; -n = value after reset

Table 14-146. P0_RX_DSCP_PRI_MAP3 Register Field Descriptions

Bit	Field	Type	Reset	Description
31	RESERVED	R/W	0h	
30-28	PRI31	R/W	0h	Priority 31 - A packet TOS of 0d31 is mapped to this received packet priority.
27	RESERVED	R/W	0h	
26-24	PRI30	R/W	0h	Priority 30 - A packet TOS of 0d30 is mapped to this received packet priority.
23	RESERVED	R/W	0h	
22-20	PRI29	R/W	0h	Priority 29 - A packet TOS of 0d39 is mapped to this received packet priority.
19	RESERVED	R/W	0h	
18-16	PRI28	R/W	0h	Priority 28 - A packet TOS of 0d28 is mapped to this received packet priority.
15	RESERVED	R/W	0h	
14-12	PRI27	R/W	0h	Priority 27 - A packet TOS of 0d27 is mapped to this received packet priority.
11	RESERVED	R/W	0h	
10-8	PRI26	R/W	0h	Priority 26 - A packet TOS of 0d26 is mapped to this received packet priority.
7	RESERVED	R/W	0h	
6-4	PRI25	R/W	0h	Priority 25 - A packet TOS of 0d25 is mapped to this received packet priority.
3	RESERVED	R/W	0h	
2-0	PRI24	R/W	0h	Priority 24 - A packet TOS of 0d24 is mapped to this received packet priority.

14.5.6.13 P0_RX_DSCP_PRI_MAP4 Register (offset = 40h) [reset = 0h]

 P0_RX_DSCP_PRI_MAP4 is shown in [Figure 14-133](#) and described in [Table 14-147](#).

CPSW PORT 0 RX DSCP PRIORITY TO RX PACKET MAPPING REG 4

Figure 14-133. P0_RX_DSCP_PRI_MAP4 Register

31	30	29	28	27	26	25	24	23	22	21	20	19	18	17	16
RESE RVED	PRI39			RESE RVED	PRI38			RESE RVED	PRI37			RESE RVED	PRI36		
R/W- 0h	R/W-0h			R/W- 0h	R/W-0h			R/W- 0h	R/W-0h			R/W- 0h	R/W-0h		
15	14	13	12	11	10	9	8	7	6	5	4	3	2	1	0
RESE RVED	PRI35			RESE RVED	PRI34			RESE RVED	PRI33			RESE RVED	PRI32		
R/W- 0h	R/W-0h			R/W- 0h	R/W-0h			R/W- 0h	R/W-0h			R/W- 0h	R/W-0h		

LEGEND: R/W = Read/Write; R = Read only; W1toCl = Write 1 to clear bit; -n = value after reset

Table 14-147. P0_RX_DSCP_PRI_MAP4 Register Field Descriptions

Bit	Field	Type	Reset	Description
31	RESERVED	R/W	0h	
30-28	PRI39	R/W	0h	Priority 39 - A packet TOS of 0d39 is mapped to this received packet priority.
27	RESERVED	R/W	0h	
26-24	PRI38	R/W	0h	Priority 38 - A packet TOS of 0d38 is mapped to this received packet priority.
23	RESERVED	R/W	0h	
22-20	PRI37	R/W	0h	Priority 37 - A packet TOS of 0d37 is mapped to this received packet priority.
19	RESERVED	R/W	0h	
18-16	PRI36	R/W	0h	Priority 36 - A packet TOS of 0d36 is mapped to this received packet priority.
15	RESERVED	R/W	0h	
14-12	PRI35	R/W	0h	Priority 35 - A packet TOS of 0d35 is mapped to this received packet priority.
11	RESERVED	R/W	0h	
10-8	PRI34	R/W	0h	Priority 34 - A packet TOS of 0d34 is mapped to this received packet priority.
7	RESERVED	R/W	0h	
6-4	PRI33	R/W	0h	Priority 33 - A packet TOS of 0d33 is mapped to this received packet priority.
3	RESERVED	R/W	0h	
2-0	PRI32	R/W	0h	Priority 32 - A packet TOS of 0d32 is mapped to this received packet priority.

14.5.6.14 P0_RX_DSCP_PRI_MAP5 Register (offset = 44h) [reset = 0h]

P0_RX_DSCP_PRI_MAP5 is shown in [Figure 14-134](#) and described in [Table 14-148](#).

CPSW PORT 0 RX DSCP PRIORITY TO RX PACKET MAPPING REG 5

Figure 14-134. P0_RX_DSCP_PRI_MAP5 Register

31	30	29	28	27	26	25	24	23	22	21	20	19	18	17	16
RESE RVED	PRI47			RESE RVED	PRI46			RESE RVED	PRI45			RESE RVED	PRI44		
R/W- 0h	R/W-0h			R/W- 0h	R/W-0h			R/W- 0h	R/W-0h			R/W- 0h	R/W-0h		
15	14	13	12	11	10	9	8	7	6	5	4	3	2	1	0
RESE RVED	PRI43			RESE RVED	PRI42			RESE RVED	PRI41			RESE RVED	PRI40		
R/W- 0h	R/W-0h			R/W- 0h	R/W-0h			R/W- 0h	R/W-0h			R/W- 0h	R/W-0h		

LEGEND: R/W = Read/Write; R = Read only; W1toCl = Write 1 to clear bit; -n = value after reset

Table 14-148. P0_RX_DSCP_PRI_MAP5 Register Field Descriptions

Bit	Field	Type	Reset	Description
31	RESERVED	R/W	0h	
30-28	PRI47	R/W	0h	Priority 47 - A packet TOS of 0d47 is mapped to this received packet priority.
27	RESERVED	R/W	0h	
26-24	PRI46	R/W	0h	Priority 46 - A packet TOS of 0d46 is mapped to this received packet priority.
23	RESERVED	R/W	0h	
22-20	PRI45	R/W	0h	Priority 45 - A packet TOS of 0d45 is mapped to this received packet priority.
19	RESERVED	R/W	0h	
18-16	PRI44	R/W	0h	Priority 44 - A packet TOS of 0d44 is mapped to this received packet priority.
15	RESERVED	R/W	0h	
14-12	PRI43	R/W	0h	Priority 43 - A packet TOS of 0d43 is mapped to this received packet priority.
11	RESERVED	R/W	0h	
10-8	PRI42	R/W	0h	Priority 42 - A packet TOS of 0d42 is mapped to this received packet priority.
7	RESERVED	R/W	0h	
6-4	PRI41	R/W	0h	Priority 41 - A packet TOS of 0d41 is mapped to this received packet priority.
3	RESERVED	R/W	0h	
2-0	PRI40	R/W	0h	Priority 40 - A packet TOS of 0d40 is mapped to this received packet priority.

14.5.6.15 P0_RX_DSCP_PRI_MAP6 Register (offset = 48h) [reset = 0h]

 P0_RX_DSCP_PRI_MAP6 is shown in [Figure 14-135](#) and described in [Table 14-149](#).

CPSW PORT 0 RX DSCP PRIORITY TO RX PACKET MAPPING REG 6

Figure 14-135. P0_RX_DSCP_PRI_MAP6 Register

31	30	29	28	27	26	25	24	23	22	21	20	19	18	17	16
RESE RVED	PRI55			RESE RVED	PRI54			RESE RVED	PRI53			RESE RVED	PRI52		
R/W- 0h	R/W-0h			R/W- 0h	R/W-0h			R/W- 0h	R/W-0h			R/W- 0h	R/W-0h		
15	14	13	12	11	10	9	8	7	6	5	4	3	2	1	0
RESE RVED	PRI51			RESE RVED	PRI50			RESE RVED	PRI49			RESE RVED	PRI48		
R/W- 0h	R/W-0h			R/W- 0h	R/W-0h			R/W- 0h	R/W-0h			R/W- 0h	R/W-0h		

LEGEND: R/W = Read/Write; R = Read only; W1toCl = Write 1 to clear bit; -n = value after reset

Table 14-149. P0_RX_DSCP_PRI_MAP6 Register Field Descriptions

Bit	Field	Type	Reset	Description
31	RESERVED	R/W	0h	
30-28	PRI55	R/W	0h	Priority 55 - A packet TOS of 0d55 is mapped to this received packet priority.
27	RESERVED	R/W	0h	
26-24	PRI54	R/W	0h	Priority 54 - A packet TOS of 0d54 is mapped to this received packet priority.
23	RESERVED	R/W	0h	
22-20	PRI53	R/W	0h	Priority 53 - A packet TOS of 0d53 is mapped to this received packet priority.
19	RESERVED	R/W	0h	
18-16	PRI52	R/W	0h	Priority 52 - A packet TOS of 0d52 is mapped to this received packet priority.
15	RESERVED	R/W	0h	
14-12	PRI51	R/W	0h	Priority 51 - A packet TOS of 0d51 is mapped to this received packet priority.
11	RESERVED	R/W	0h	
10-8	PRI50	R/W	0h	Priority 50 - A packet TOS of 0d50 is mapped to this received packet priority.
7	RESERVED	R/W	0h	
6-4	PRI49	R/W	0h	Priority 49 - A packet TOS of 0d49 is mapped to this received packet priority.
3	RESERVED	R/W	0h	
2-0	PRI48	R/W	0h	Priority 48 - A packet TOS of 0d48 is mapped to this received packet priority.

14.5.6.16 P0_RX_DSCP_PRI_MAP7 Register (offset = 4Ch) [reset = 0h]

P0_RX_DSCP_PRI_MAP7 is shown in [Figure 14-136](#) and described in [Table 14-150](#).

CPSW PORT 0 RX DSCP PRIORITY TO RX PACKET MAPPING REG 7

Figure 14-136. P0_RX_DSCP_PRI_MAP7 Register

31	30	29	28	27	26	25	24	23	22	21	20	19	18	17	16
RESE RVED	PRI63			RESE RVED	PRI62			RESE RVED	PRI61			RESE RVED	PRI60		
R/W- 0h	R/W-0h			R/W- 0h	R/W-0h			R/W- 0h	R/W-0h			R/W- 0h	R/W-0h		
15	14	13	12	11	10	9	8	7	6	5	4	3	2	1	0
RESE RVED	PRI59			RESE RVED	PRI58			RESE RVED	PRI57			RESE RVED	PRI56		
R/W- 0h	R/W-0h			R/W- 0h	R/W-0h			R/W- 0h	R/W-0h			R/W- 0h	R/W-0h		

LEGEND: R/W = Read/Write; R = Read only; W1toCl = Write 1 to clear bit; -n = value after reset

Table 14-150. P0_RX_DSCP_PRI_MAP7 Register Field Descriptions

Bit	Field	Type	Reset	Description
31	RESERVED	R/W	0h	
30-28	PRI63	R/W	0h	Priority 63 - A packet TOS of 0d63 is mapped to this received packet priority.
27	RESERVED	R/W	0h	
26-24	PRI62	R/W	0h	Priority 62 - A packet TOS of 0d62 is mapped to this received packet priority.
23	RESERVED	R/W	0h	
22-20	PRI61	R/W	0h	Priority 61 - A packet TOS of 0d61 is mapped to this received packet priority.
19	RESERVED	R/W	0h	
18-16	PRI60	R/W	0h	Priority 60 - A packet TOS of 0d60 is mapped to this received packet priority.
15	RESERVED	R/W	0h	
14-12	PRI59	R/W	0h	Priority 59 - A packet TOS of 0d59 is mapped to this received packet priority.
11	RESERVED	R/W	0h	
10-8	PRI58	R/W	0h	Priority 58 - A packet TOS of 0d58 is mapped to this received packet priority.
7	RESERVED	R/W	0h	
6-4	PRI57	R/W	0h	Priority 57 - A packet TOS of 0d57 is mapped to this received packet priority.
3	RESERVED	R/W	0h	
2-0	PRI56	R/W	0h	Priority 56 - A packet TOS of 0d56 is mapped to this received packet priority.

14.5.6.17 P1_CONTROL Register (offset = 100h) [reset = 0h]

 P1_CONTROL is shown in [Figure 14-137](#) and described in [Table 14-151](#).

CPSW PORT 1 CONTROL REGISTER
Figure 14-137. P1_CONTROL Register

31	30	29	28	27	26	25	24
RESERVED							P1_PASS_PRI_TAGGED
R/W-0h							R/W-0h
23	22	21	20	19	18	17	16
RESERVED		P1_VLAN_LTY_PE2_EN	P1_VLAN_LTY_PE1_EN	RESERVED			P1_DSCP_PRI_EN
R/W-0h		R/W-0h	R/W-0h	R/W-0h			R/W-0h
15	14	13	12	11	10	9	8
RESERVED	P1_TS_320	P1_TS_319	P1_TS_132	P1_TS_131	P1_TS_130	P1_TS_129	P1_TS_TTL_NONZERO
R/W-0h	R/W-0h	R/W-0h	R/W-0h	R/W-0h	R/W-0h	R/W-0h	R/W-0h
7	6	5	4	3	2	1	0
RESERVED			P1_TS_ANNEX_D_EN	P1_TS_LTYPE_2_EN	P1_TS_LTYPE_1_EN	P1_TS_TX_EN	P1_TS_RX_EN
R/W-0h			R/W-0h	R-0h	R/W-0h	R/W-0h	R/W-0h

LEGEND: R/W = Read/Write; R = Read only; W1toCl = Write 1 to clear bit; -n = value after reset

Table 14-151. P1_CONTROL Register Field Descriptions

Bit	Field	Type	Reset	Description
31-25	RESERVED	R/W	0h	
24	P1_PASS_PRI_TAGGED	R/W	0h	Port 1 Pass Priority Tagged 0 - Priority tagged packets have the zero VID replaced with the input port P1_PORT_VLAN [11:0] 1 - Priority tagged packets are processed unchanged.
23-22	RESERVED	R/W	0h	
21	P1_VLAN_LTYPE2_EN	R/W	0h	Port 1 VLAN LTYPE 2 enable 0 - disabled 1 - VLAN LTYPE2 enabled on transmit and receive
20	P1_VLAN_LTYPE1_EN	R/W	0h	Port 1 VLAN LTYPE 1 enable 0 - disabled 1 - VLAN LTYPE1 enabled on transmit and receive
19-17	RESERVED	R/W	0h	
16	P1_DSCP_PRI_EN	R/W	0h	Port 1 DSCP Priority Enable 0 - DSCP priority disabled 1 - DSCP priority enabled. All non-tagged IPV4 packets have their received packet priority determined by mapping the 6 TOS bits through the port DSCP priority mapping registers.
15	RESERVED	R/W	0h	
14	P1_TS_320	R/W	0h	Port 1 Time Sync Destination Port Number 320 enable 0 - disabled 1 - Annex D (UDP/IPv4) time sync packet destination port number 320 (decimal) is enabled.
13	P1_TS_319	R/W	0h	Port 1 Time Sync Destination Port Number 319 enable 0 - disabled 1 - Annex D (UDP/IPv4) time sync packet destination port number 319 (decimal) is enabled.
12	P1_TS_132	R/W	0h	Port 1 Time Sync Destination IP Address 132 enable 0 - disabled 1 - Annex D (UDP/IPv4) time sync packet destination IP address number 132 (decimal) is enabled.

Table 14-151. P1_CONTROL Register Field Descriptions (continued)

Bit	Field	Type	Reset	Description
11	P1_TS_131	R/W	0h	Port 1 Time Sync Destination IP Address 131 enable 0 - disabled 1 - Annex D (UDP/IPv4) time sync packet destination IP address number 131 (decimal) is enabled.
10	P1_TS_130	R/W	0h	Port 1 Time Sync Destination IP Address 130 enable 0 - disabled 1 - Annex D (UDP/IPv4) time sync packet destination IP address number 130 (decimal) is enabled.
9	P1_TS_129	R/W	0h	Port 1 Time Sync Destination IP Address 129 enable 0 - disabled 1 - Annex D (UDP/IPv4) time sync packet destination IP address number 129 (decimal) is enabled.
8	P1_TS_TTL_NONZERO	R/W	0h	Port 1 Time Sync Time To Live Non-zero enable. 0 = TTL must be zero. 1 = TTL may be any value.
7-5	RESERVED	R/W	0h	
4	P1_TS_ANNEX_D_EN	R/W	0h	Port 1 Time Sync Annex D enable 0 - Annex D disabled 1 - Annex D enabled
3	P1_TS_LTYPE2_EN	R	0h	Port 1 Time Sync LTYPE 2 enable 0 - disabled 1 - enabled
2	P1_TS_LTYPE1_EN	R/W	0h	Port 1 Time Sync LTYPE 1 enable 0 - disabled 1 - enabled
1	P1_TS_TX_EN	R/W	0h	Port 1 Time Sync Transmit Enable 0 - disabled 1 - enabled
0	P1_TS_RX_EN	R/W	0h	Port 1 Time Sync Receive Enable 0 - Port 1 Receive Time Sync disabled 1 - Port 1 Receive Time Sync enabled

14.5.6.18 P1_MAX_BLKs Register (offset = 108h) [reset = 113h]

 P1_MAX_BLKs is shown in [Figure 14-138](#) and described in [Table 14-152](#).

CPSW PORT 1 MAXIMUM FIFO BLOCKS REGISTER

Figure 14-138. P1_MAX_BLKs Register

31	30	29	28	27	26	25	24
RESERVED							
R/W-0h							
23	22	21	20	19	18	17	16
RESERVED							
R/W-0h							
15	14	13	12	11	10	9	8
RESERVED							P1_TX_MAX_B LKS
R/W-0h							R/W-11h
7	6	5	4	3	2	1	0
P1_TX_MAX_BLKs				P1_RX_MAX_BLKs			
R/W-11h				R/W-3h			

LEGEND: R/W = Read/Write; R = Read only; W1toCl = Write 1 to clear bit; -n = value after reset

Table 14-152. P1_MAX_BLKs Register Field Descriptions

Bit	Field	Type	Reset	Description
31-9	RESERVED	R/W	0h	
8-4	P1_TX_MAX_BLKs	R/W	11h	Transmit FIFO Maximum Blocks - This value is the maximum number of 1k memory blocks that may be allocated to the FIFO's logical transmit priority queues. 0x11 is the recommended value of p1_tx_max_blks unless the port is in full duplex flow control mode. In flow control mode, the p1_rx_max_blks will need to increase in order to accept the required run out in full duplex mode. This value will need to decrease by the amount of increase in p1_rx_max_blks. 0xe is the minimum value tx max blks.
3-0	P1_RX_MAX_BLKs	R/W	3h	Receive FIFO Maximum Blocks - This value is the maximum number of 1k memory blocks that may be allocated to the FIFO's logical receive queue. This value must be greater than or equal to 0x3. It should be increased in full duplex flow control mode to 0x5 or 0x6 depending on the required runout space. The p1_tx_max_blks value must be decreased by the amount of increase in p1_rx_max_blks. 0x3 is the minimum value rx max blks and 0x6 is the maximum value.

14.5.6.19 P1_BLK_CNT Register (offset = 10Ch) [reset = 41h]

P1_BLK_CNT is shown in [Figure 14-139](#) and described in [Table 14-153](#).

CPSW PORT 1 FIFO BLOCK USAGE COUNT (READ ONLY)

Figure 14-139. P1_BLK_CNT Register

31	30	29	28	27	26	25	24
RESERVED							
R-0h							
23	22	21	20	19	18	17	16
RESERVED							
R-0h							
15	14	13	12	11	10	9	8
RESERVED							P1_TX_BLK_C NT
R-0h							R-4h
7	6	5	4	3	2	1	0
P1_TX_BLK_CNT				P1_RX_BLK_CNT			
R-4h				R-1h			

LEGEND: R/W = Read/Write; R = Read only; W1toCl = Write 1 to clear bit; -n = value after reset

Table 14-153. P1_BLK_CNT Register Field Descriptions

Bit	Field	Type	Reset	Description
31-9	RESERVED	R	0h	
8-4	P1_TX_BLK_CNT	R	4h	Port 1 Transmit Block Count Usage - This value is the number of blocks allocated to the FIFO logical transmit queues.
3-0	P1_RX_BLK_CNT	R	1h	Port 1 Receive Block Count Usage - This value is the number of blocks allocated to the FIFO logical receive queues.

14.5.6.20 P1_TX_IN_CTL Register (offset = 110h) [reset = 80040C0h]

 P1_TX_IN_CTL is shown in [Figure 14-140](#) and described in [Table 14-154](#).

CPSW PORT 1 TRANSMIT FIFO CONTROL

Figure 14-140. P1_TX_IN_CTL Register

31	30	29	28	27	26	25	24
RESERVED				HOST_BLKs_REM			
R/W-				R/W-8h			
23	22	21	20	19	18	17	16
TX_RATE_EN				RESERVED		TX_IN_SEL	
R/W-0h				R/W-		R/W-0h	
15	14	13	12	11	10	9	8
TX_BLKs_REM				RESERVED		TX_PRI_WDS	
R/W-4h				R/W-		R/W-C0h	
7	6	5	4	3	2	1	0
TX_PRI_WDS							
R/W-C0h							

LEGEND: R/W = Read/Write; R = Read only; W1toCl = Write 1 to clear bit; -n = value after reset

Table 14-154. P1_TX_IN_CTL Register Field Descriptions

Bit	Field	Type	Reset	Description
31-28	RESERVED	R/W		
27-24	HOST_BLKs_REM	R/W	8h	Transmit FIFO Blocks that must be free before a non rate-limited CPDMA channel can begin sending a packet to the FIFO.
23-20	TX_RATE_EN	R/W	0h	Transmit FIFO Input Rate Enable
19-18	RESERVED	R/W		
17-16	TX_IN_SEL	R/W	0h	Transmit FIFO Input Queue Type Select 00 - Normal priority mode 01 - reserved 10 - Rate Limit mode 11 - reserved
15-12	TX_BLKs_REM	R/W	4h	Transmit FIFO Input Blocks to subtract in dual mac mode and blocks to subtract on non rate-limited traffic in rate-limit mode.
11-10	RESERVED	R/W		
9-0	TX_PRI_WDS	R/W	C0h	Transmit FIFO Words in queue

14.5.6.21 P1_PORT_VLAN Register (offset = 114h) [reset = 0h]

P1_PORT_VLAN is shown in [Figure 14-141](#) and described in [Table 14-155](#).

CPSW PORT 1 VLAN REGISTER

Figure 14-141. P1_PORT_VLAN Register

31	30	29	28	27	26	25	24
RESERVED							
R/W-0h							
23	22	21	20	19	18	17	16
RESERVED							
R/W-0h							
15	14	13	12	11	10	9	8
PORT_PRI			PORT_CFI		PORT_VID		
R/W-0h			R/W-0h		R/W-0h		
7	6	5	4	3	2	1	0
PORT_VID							
R/W-0h							

LEGEND: R/W = Read/Write; R = Read only; W1toCl = Write 1 to clear bit; -n = value after reset

Table 14-155. P1_PORT_VLAN Register Field Descriptions

Bit	Field	Type	Reset	Description
31-16	RESERVED	R/W	0h	
15-13	PORT_PRI	R/W	0h	Port VLAN Priority (7 is highest priority)
12	PORT_CFI	R/W	0h	Port CFI bit
11-0	PORT_VID	R/W	0h	Port VLAN ID

14.5.6.22 P1_TX_PRI_MAP Register (offset = 118h) [reset = 33221001h]

 P1_TX_PRI_MAP is shown in [Figure 14-142](#) and described in [Table 14-156](#).

CPSW PORT 1 TX HEADER PRIORITY TO SWITCH PRI MAPPING REGISTER

Figure 14-142. P1_TX_PRI_MAP Register

31	30	29	28	27	26	25	24	23	22	21	20	19	18	17	16
RESERVED	PRI7			RESERVED	PRI6			RESERVED	PRI5		RESERVED	PRI4			
R/W-0h		R/W-3h			R/W-0h			R/W-3h		R/W-0h		R/W-2h		R/W-2h	
15	14	13	12	11	10	9	8	7	6	5	4	3	2	1	0
RESERVED	PRI3			RESERVED	PRI2			RESERVED	PRI1		RESERVED	PRI0			
R/W-0h		R/W-1h			R/W-0h			R/W-0h		R/W-0h		R/W-0h		R/W-1h	

LEGEND: R/W = Read/Write; R = Read only; W1toCl = Write 1 to clear bit; -n = value after reset

Table 14-156. P1_TX_PRI_MAP Register Field Descriptions

Bit	Field	Type	Reset	Description
31-30	RESERVED	R/W	0h	
29-28	PRI7	R/W	3h	Priority 7 - A packet header priority of 0x7 is given this switch queue pri.
27-26	RESERVED	R/W	0h	
25-24	PRI6	R/W	3h	Priority 6 - A packet header priority of 0x6 is given this switch queue pri.
23-22	RESERVED	R/W	0h	
21-20	PRI5	R/W	2h	Priority 5 - A packet header priority of 0x5 is given this switch queue pri.
19-18	RESERVED	R/W	0h	
17-16	PRI4	R/W	2h	Priority 4 - A packet header priority of 0x4 is given this switch queue pri.
15-14	RESERVED	R/W	0h	
13-12	PRI3	R/W	1h	Priority 3 - A packet header priority of 0x3 is given this switch queue pri.
11-10	RESERVED	R/W	0h	
9-8	PRI2	R/W	0h	Priority 2 - A packet header priority of 0x2 is given this switch queue pri.
7-6	RESERVED	R/W	0h	
5-4	PRI1	R/W	0h	Priority 1 - A packet header priority of 0x1 is given this switch queue pri.
3-2	RESERVED	R/W	0h	
1-0	PRI0	R/W	1h	Priority 0 - A packet header priority of 0x0 is given this switch queue pri.

14.5.6.23 P1_TS_SEQ_MTYPE Register (offset = 11Ch) [reset = 1E000h]

 P1_TS_SEQ_MTYPE is shown in [Figure 14-143](#) and described in [Table 14-157](#).

CPSW PORT 1 TIME SYNC SEQUENCE ID OFFSET AND MSG TYPE.

Figure 14-143. P1_TS_SEQ_MTYPE Register

31	30	29	28	27	26	25	24
RESERVED							
R/W-0h							
23	22	21	20	19	18	17	16
RESERVED		P1_TS_SEQ_ID_OFFSET					
R/W-0h		R/W-1Eh					
15	14	13	12	11	10	9	8
P1_TS_MSG_TYPE_EN							
R/W-0h							
7	6	5	4	3	2	1	0
P1_TS_MSG_TYPE_EN							
R/W-0h							

LEGEND: R/W = Read/Write; R = Read only; W1toCl = Write 1 to clear bit; -n = value after reset

Table 14-157. P1_TS_SEQ_MTYPE Register Field Descriptions

Bit	Field	Type	Reset	Description
31-22	RESERVED	R/W	0h	
21-16	P1_TS_SEQ_ID_OFFSET	R/W	1Eh	Port 1 Time Sync Sequence ID Offset This is the number of octets that the sequence ID is offset in the tx and rx time sync message header. The minimum value is 6.
15-0	P1_TS_MSG_TYPE_EN	R/W	0h	Port 1 Time Sync Message Type Enable - Each bit in this field enables the corresponding message type in receive and transmit time sync messages (Bit 0 enables message type 0 etc.).

14.5.6.24 P1_SA_LO Register (offset = 120h) [reset = 0h]

P1_SA_LO is shown in [Figure 14-144](#) and described in [Table 14-158](#).

CPSW CPGMAC_SL1 SOURCE ADDRESS LOW REGISTER

Figure 14-144. P1_SA_LO Register

31	30	29	28	27	26	25	24	23	22	21	20	19	18	17	16
RESERVED															
R/W-0h															
15	14	13	12	11	10	9	8	7	6	5	4	3	2	1	0
MACSRCADDR_7_0								MACSRCADDR_15_8							
R/W-0h								R/W-0h							

LEGEND: R/W = Read/Write; R = Read only; W1toCl = Write 1 to clear bit; -n = value after reset

Table 14-158. P1_SA_LO Register Field Descriptions

Bit	Field	Type	Reset	Description
31-16	RESERVED	R/W	0h	
15-8	MACSRCADDR_7_0	R/W	0h	Source Address Lower 8 bits (byte 0)
7-0	MACSRCADDR_15_8	R/W	0h	Source Address bits 15:8 (byte 1)

14.5.6.25 P1_SA_HI Register (offset = 124h) [reset = 0h]

 P1_SA_HI is shown in [Figure 14-145](#) and described in [Table 14-159](#).

CPSW CPGMAC_SL1 SOURCE ADDRESS HIGH REGISTER

Figure 14-145. P1_SA_HI Register

31	30	29	28	27	26	25	24	23	22	21	20	19	18	17	16
MACSRCADDR_23_16								MACSRCADDR_31_24							
R/W-0h								R/W-0h							
15	14	13	12	11	10	9	8	7	6	5	4	3	2	1	0
MACSRCADDR_39_32								MACSRCADDR_47_40							
R/W-0h								R/W-0h							

LEGEND: R/W = Read/Write; R = Read only; W1toCl = Write 1 to clear bit; -n = value after reset

Table 14-159. P1_SA_HI Register Field Descriptions

Bit	Field	Type	Reset	Description
31-24	MACSRCADDR_23_16	R/W	0h	Source Address bits 23:16 (byte 2)
23-16	MACSRCADDR_31_24	R/W	0h	Source Address bits 31:24 (byte 3)
15-8	MACSRCADDR_39_32	R/W	0h	Source Address bits 39:32 (byte 4)
7-0	MACSRCADDR_47_40	R/W	0h	Source Address bits 47:40 (byte 5)

14.5.6.26 P1_SEND_PERCENT Register (offset = 128h) [reset = 0h]

 P1_SEND_PERCENT is shown in [Figure 14-146](#) and described in [Table 14-160](#).

CPSW PORT 1 TRANSMIT QUEUE SEND PERCENTAGES

Figure 14-146. P1_SEND_PERCENT Register

31	30	29	28	27	26	25	24	23	22	21	20	19	18	17	16
RESERVED									PRI3_SEND_PERCENT						
R/W-0h									R/W-0h						
15	14	13	12	11	10	9	8	7	6	5	4	3	2	1	0
RESERVED	PRI2_SEND_PERCENT							RESERVED	PRI1_SEND_PERCENT						
R/W-0h	R/W-0h							R/W-0h	R/W-0h						

LEGEND: R/W = Read/Write; R = Read only; W1toCl = Write 1 to clear bit; -n = value after reset

Table 14-160. P1_SEND_PERCENT Register Field Descriptions

Bit	Field	Type	Reset	Description
31-23	RESERVED	R/W	0h	
22-16	PRI3_SEND_PERCENT	R/W	0h	Priority 3 Transmit Percentage - This percentage value is sent from FIFO priority 3 (maximum) when the p1_pri3_shape_en is set (queue shaping enabled). This is the percentage of the wire that packets from priority 3 receive (which includes interpacket gap and preamble bytes). If shaping is enabled on this queue then this value must be between zero and 0d100 (not inclusive).
15	RESERVED	R/W	0h	
14-8	PRI2_SEND_PERCENT	R/W	0h	Priority 2 Transmit Percentage - This percentage value is sent from FIFO priority 2 (maximum) when the p1_pri2_shape_en is set (queue shaping enabled). This is the percentage of the wire that packets from priority 2 receive (which includes interpacket gap and preamble bytes). If shaping is enabled on this queue then this value must be between zero and 0d100 (not inclusive).
7	RESERVED	R/W	0h	
6-0	PRI1_SEND_PERCENT	R/W	0h	Priority 1 Transmit Percentage - This percentage value is sent from FIFO priority 1 (maximum) when the p1_pri1_shape_en is set (queue shaping enabled). This is the percentage of the wire that packets from priority 1 receive (which includes interpacket gap and preamble bytes). If shaping is enabled on this queue then this value must be between zero and 0d100 (not inclusive).

14.5.6.27 P1_RX_DSCP_PRI_MAP0 Register (offset = 130h) [reset = 0h]

P1_RX_DSCP_PRI_MAP0 is shown in [Figure 14-147](#) and described in [Table 14-161](#).

CPSW PORT 1 RX DSCP PRIORITY TO RX PACKET MAPPING REG 0

Figure 14-147. P1_RX_DSCP_PRI_MAP0 Register

31	30	29	28	27	26	25	24	23	22	21	20	19	18	17	16
RESE RVED	PRI7			RESE RVED	PRI6			RESE RVED	PRI5			RESE RVED	PRI4		
R/W- 0h	R/W-0h			R/W- 0h	R/W-0h			R/W- 0h	R/W-0h			R/W- 0h	R/W-0h		
15	14	13	12	11	10	9	8	7	6	5	4	3	2	1	0
RESE RVED	PRI3			RESE RVED	PRI2			RESE RVED	PRI1			RESE RVED	PRI0		
R/W- 0h	R/W-0h			R/W- 0h	R/W-0h			R/W- 0h	R/W-0h			R/W- 0h	R/W-0h		

LEGEND: R/W = Read/Write; R = Read only; W1toCl = Write 1 to clear bit; -n = value after reset

Table 14-161. P1_RX_DSCP_PRI_MAP0 Register Field Descriptions

Bit	Field	Type	Reset	Description
31	RESERVED	R/W	0h	
30-28	PRI7	R/W	0h	Priority 7 - A packet TOS of 0d7 is mapped to this received packet priority.
27	RESERVED	R/W	0h	
26-24	PRI6	R/W	0h	Priority 6 - A packet TOS of 0d6 is mapped to this received packet priority.
23	RESERVED	R/W	0h	
22-20	PRI5	R/W	0h	Priority 5 - A packet TOS of 0d5 is mapped to this received packet priority.
19	RESERVED	R/W	0h	
18-16	PRI4	R/W	0h	Priority 4 - A packet TOS of 0d4 is mapped to this received packet priority.
15	RESERVED	R/W	0h	
14-12	PRI3	R/W	0h	Priority 3 - A packet TOS of 0d3 is mapped to this received packet priority.
11	RESERVED	R/W	0h	
10-8	PRI2	R/W	0h	Priority 2 - A packet TOS of 0d2 is mapped to this received packet priority.
7	RESERVED	R/W	0h	
6-4	PRI1	R/W	0h	Priority 1 - A packet TOS of 0d1 is mapped to this received packet priority.
3	RESERVED	R/W	0h	
2-0	PRI0	R/W	0h	Priority 0 - A packet TOS of 0d0 is mapped to this received packet priority.

14.5.6.28 P1_RX_DSCP_PRI_MAP1 Register (offset = 134h) [reset = 0h]

 P1_RX_DSCP_PRI_MAP1 is shown in [Figure 14-148](#) and described in [Table 14-162](#).

CPSW PORT 1 RX DSCP PRIORITY TO RX PACKET MAPPING REG 1

Figure 14-148. P1_RX_DSCP_PRI_MAP1 Register

31	30	29	28	27	26	25	24	23	22	21	20	19	18	17	16
RESE RVED	PRI15			RESE RVED	PRI14			RESE RVED	PRI13			RESE RVED	PRI12		
R/W- 0h	R/W-0h			R/W- 0h	R/W-0h			R/W- 0h	R/W-0h			R/W- 0h	R/W-0h		
15	14	13	12	11	10	9	8	7	6	5	4	3	2	1	0
RESE RVED	PRI11			RESE RVED	PRI10			RESE RVED	PRI9			RESE RVED	PRI8		
R/W- 0h	R/W-0h			R/W- 0h	R/W-0h			R/W- 0h	R/W-0h			R/W- 0h	R/W-0h		

LEGEND: R/W = Read/Write; R = Read only; W1toCl = Write 1 to clear bit; -n = value after reset

Table 14-162. P1_RX_DSCP_PRI_MAP1 Register Field Descriptions

Bit	Field	Type	Reset	Description
31	RESERVED	R/W	0h	
30-28	PRI15	R/W	0h	Priority 15 - A packet TOS of 0d15 is mapped to this received packet priority.
27	RESERVED	R/W	0h	
26-24	PRI14	R/W	0h	Priority 14 - A packet TOS of 0d14 is mapped to this received packet priority.
23	RESERVED	R/W	0h	
22-20	PRI13	R/W	0h	Priority 13 - A packet TOS of 0d13 is mapped to this received packet priority.
19	RESERVED	R/W	0h	
18-16	PRI12	R/W	0h	Priority 12 - A packet TOS of 0d12 is mapped to this received packet priority.
15	RESERVED	R/W	0h	
14-12	PRI11	R/W	0h	Priority 11 - A packet TOS of 0d11 is mapped to this received packet priority.
11	RESERVED	R/W	0h	
10-8	PRI10	R/W	0h	Priority 10 - A packet TOS of 0d10 is mapped to this received packet priority.
7	RESERVED	R/W	0h	
6-4	PRI9	R/W	0h	Priority 9 - A packet TOS of 0d9 is mapped to this received packet priority.
3	RESERVED	R/W	0h	
2-0	PRI8	R/W	0h	Priority 8 - A packet TOS of 0d8 is mapped to this received packet priority.

14.5.6.29 P1_RX_DSCP_PRI_MAP2 Register (offset = 138h) [reset = 0h]

P1_RX_DSCP_PRI_MAP2 is shown in [Figure 14-149](#) and described in [Table 14-163](#).

CPSW PORT 1 RX DSCP PRIORITY TO RX PACKET MAPPING REG 2

Figure 14-149. P1_RX_DSCP_PRI_MAP2 Register

31	30	29	28	27	26	25	24	23	22	21	20	19	18	17	16
RESE RVED	PRI23			RESE RVED	PRI22			RESE RVED	PRI21			RESE RVED	PRI20		
R/W- 0h	R/W-0h			R/W- 0h	R/W-0h			R/W- 0h	R/W-0h			R/W- 0h	R/W-0h		
15	14	13	12	11	10	9	8	7	6	5	4	3	2	1	0
RESE RVED	PRI19			RESE RVED	PRI18			RESE RVED	PRI17			RESE RVED	PRI16		
R/W- 0h	R/W-0h			R/W- 0h	R/W-0h			R/W- 0h	R/W-0h			R/W- 0h	R/W-0h		

LEGEND: R/W = Read/Write; R = Read only; W1toCl = Write 1 to clear bit; -n = value after reset

Table 14-163. P1_RX_DSCP_PRI_MAP2 Register Field Descriptions

Bit	Field	Type	Reset	Description
31	RESERVED	R/W	0h	
30-28	PRI23	R/W	0h	Priority 23 - A packet TOS of 0d23 is mapped to this received packet priority.
27	RESERVED	R/W	0h	
26-24	PRI22	R/W	0h	Priority 22 - A packet TOS of 0d22 is mapped to this received packet priority.
23	RESERVED	R/W	0h	
22-20	PRI21	R/W	0h	Priority 21 - A packet TOS of 0d21 is mapped to this received packet priority.
19	RESERVED	R/W	0h	
18-16	PRI20	R/W	0h	Priority 20 - A packet TOS of 0d20 is mapped to this received packet priority.
15	RESERVED	R/W	0h	
14-12	PRI19	R/W	0h	Priority 19 - A packet TOS of 0d19 is mapped to this received packet priority.
11	RESERVED	R/W	0h	
10-8	PRI18	R/W	0h	Priority 18 - A packet TOS of 0d18 is mapped to this received packet priority.
7	RESERVED	R/W	0h	
6-4	PRI17	R/W	0h	Priority 17 - A packet TOS of 0d17 is mapped to this received packet priority.
3	RESERVED	R/W	0h	
2-0	PRI16	R/W	0h	Priority 16 - A packet TOS of 0d16 is mapped to this received packet priority.

14.5.6.30 P1_RX_DSCP_PRI_MAP3 Register (offset = 13Ch) [reset = 0h]

 P1_RX_DSCP_PRI_MAP3 is shown in [Figure 14-150](#) and described in [Table 14-164](#).

CPSW PORT 1 RX DSCP PRIORITY TO RX PACKET MAPPING REG 3

Figure 14-150. P1_RX_DSCP_PRI_MAP3 Register

31	30	29	28	27	26	25	24	23	22	21	20	19	18	17	16
RESE RVED	PRI31			RESE RVED	PRI30			RESE RVED	PRI29			RESE RVED	PRI28		
R/W- 0h	R/W-0h			R/W- 0h	R/W-0h			R/W- 0h	R/W-0h			R/W- 0h	R/W-0h		
15	14	13	12	11	10	9	8	7	6	5	4	3	2	1	0
RESE RVED	PRI27			RESE RVED	PRI26			RESE RVED	PRI25			RESE RVED	PRI24		
R/W- 0h	R/W-0h			R/W- 0h	R/W-0h			R/W- 0h	R/W-0h			R/W- 0h	R/W-0h		

LEGEND: R/W = Read/Write; R = Read only; W1toCl = Write 1 to clear bit; -n = value after reset

Table 14-164. P1_RX_DSCP_PRI_MAP3 Register Field Descriptions

Bit	Field	Type	Reset	Description
31	RESERVED	R/W	0h	
30-28	PRI31	R/W	0h	Priority 31 - A packet TOS of 0d31 is mapped to this received packet priority.
27	RESERVED	R/W	0h	
26-24	PRI30	R/W	0h	Priority 30 - A packet TOS of 0d30 is mapped to this received packet priority.
23	RESERVED	R/W	0h	
22-20	PRI29	R/W	0h	Priority 29 - A packet TOS of 0d39 is mapped to this received packet priority.
19	RESERVED	R/W	0h	
18-16	PRI28	R/W	0h	Priority 28 - A packet TOS of 0d28 is mapped to this received packet priority.
15	RESERVED	R/W	0h	
14-12	PRI27	R/W	0h	Priority 27 - A packet TOS of 0d27 is mapped to this received packet priority.
11	RESERVED	R/W	0h	
10-8	PRI26	R/W	0h	Priority 26 - A packet TOS of 0d26 is mapped to this received packet priority.
7	RESERVED	R/W	0h	
6-4	PRI25	R/W	0h	Priority 25 - A packet TOS of 0d25 is mapped to this received packet priority.
3	RESERVED	R/W	0h	
2-0	PRI24	R/W	0h	Priority 24 - A packet TOS of 0d24 is mapped to this received packet priority.

14.5.6.31 P1_RX_DSCP_PRI_MAP4 Register (offset = 140h) [reset = 0h]

P1_RX_DSCP_PRI_MAP4 is shown in [Figure 14-151](#) and described in [Table 14-165](#).

CPSW PORT 1 RX DSCP PRIORITY TO RX PACKET MAPPING REG 4

Figure 14-151. P1_RX_DSCP_PRI_MAP4 Register

31	30	29	28	27	26	25	24	23	22	21	20	19	18	17	16
RESE RVED	PRI39			RESE RVED	PRI38			RESE RVED	PRI37			RESE RVED	PRI36		
R/W- 0h	R/W-0h			R/W- 0h	R/W-0h			R/W- 0h	R/W-0h			R/W- 0h	R/W-0h		
15	14	13	12	11	10	9	8	7	6	5	4	3	2	1	0
RESE RVED	PRI35			RESE RVED	PRI34			RESE RVED	PRI33			RESE RVED	PRI32		
R/W- 0h	R/W-0h			R/W- 0h	R/W-0h			R/W- 0h	R/W-0h			R/W- 0h	R/W-0h		

LEGEND: R/W = Read/Write; R = Read only; W1toCl = Write 1 to clear bit; -n = value after reset

Table 14-165. P1_RX_DSCP_PRI_MAP4 Register Field Descriptions

Bit	Field	Type	Reset	Description
31	RESERVED	R/W	0h	
30-28	PRI39	R/W	0h	Priority 39 - A packet TOS of 0d39 is mapped to this received packet priority.
27	RESERVED	R/W	0h	
26-24	PRI38	R/W	0h	Priority 38 - A packet TOS of 0d38 is mapped to this received packet priority.
23	RESERVED	R/W	0h	
22-20	PRI37	R/W	0h	Priority 37 - A packet TOS of 0d37 is mapped to this received packet priority.
19	RESERVED	R/W	0h	
18-16	PRI36	R/W	0h	Priority 36 - A packet TOS of 0d36 is mapped to this received packet priority.
15	RESERVED	R/W	0h	
14-12	PRI35	R/W	0h	Priority 35 - A packet TOS of 0d35 is mapped to this received packet priority.
11	RESERVED	R/W	0h	
10-8	PRI34	R/W	0h	Priority 34 - A packet TOS of 0d34 is mapped to this received packet priority.
7	RESERVED	R/W	0h	
6-4	PRI33	R/W	0h	Priority 33 - A packet TOS of 0d33 is mapped to this received packet priority.
3	RESERVED	R/W	0h	
2-0	PRI32	R/W	0h	Priority 32 - A packet TOS of 0d32 is mapped to this received packet priority.

14.5.6.32 P1_RX_DSCP_PRI_MAP5 Register (offset = 144h) [reset = 0h]

 P1_RX_DSCP_PRI_MAP5 is shown in [Figure 14-152](#) and described in [Table 14-166](#).

CPSW PORT 1 RX DSCP PRIORITY TO RX PACKET MAPPING REG 5

Figure 14-152. P1_RX_DSCP_PRI_MAP5 Register

31	30	29	28	27	26	25	24	23	22	21	20	19	18	17	16
RESE RVED	PRI47			RESE RVED	PRI46			RESE RVED	PRI45			RESE RVED	PRI44		
R/W- 0h	R/W-0h			R/W- 0h	R/W-0h			R/W- 0h	R/W-0h			R/W- 0h	R/W-0h		
15	14	13	12	11	10	9	8	7	6	5	4	3	2	1	0
RESE RVED	PRI43			RESE RVED	PRI42			RESE RVED	PRI41			RESE RVED	PRI40		
R/W- 0h	R/W-0h			R/W- 0h	R/W-0h			R/W- 0h	R/W-0h			R/W- 0h	R/W-0h		

LEGEND: R/W = Read/Write; R = Read only; W1toCl = Write 1 to clear bit; -n = value after reset

Table 14-166. P1_RX_DSCP_PRI_MAP5 Register Field Descriptions

Bit	Field	Type	Reset	Description
31	RESERVED	R/W	0h	
30-28	PRI47	R/W	0h	Priority 47 - A packet TOS of 0d47 is mapped to this received packet priority.
27	RESERVED	R/W	0h	
26-24	PRI46	R/W	0h	Priority 46 - A packet TOS of 0d46 is mapped to this received packet priority.
23	RESERVED	R/W	0h	
22-20	PRI45	R/W	0h	Priority 45 - A packet TOS of 0d45 is mapped to this received packet priority.
19	RESERVED	R/W	0h	
18-16	PRI44	R/W	0h	Priority 44 - A packet TOS of 0d44 is mapped to this received packet priority.
15	RESERVED	R/W	0h	
14-12	PRI43	R/W	0h	Priority 43 - A packet TOS of 0d43 is mapped to this received packet priority.
11	RESERVED	R/W	0h	
10-8	PRI42	R/W	0h	Priority 42 - A packet TOS of 0d42 is mapped to this received packet priority.
7	RESERVED	R/W	0h	
6-4	PRI41	R/W	0h	Priority 41 - A packet TOS of 0d41 is mapped to this received packet priority.
3	RESERVED	R/W	0h	
2-0	PRI40	R/W	0h	Priority 40 - A packet TOS of 0d40 is mapped to this received packet priority.

14.5.6.33 P1_RX_DSCP_PRI_MAP6 Register (offset = 148h) [reset = 0h]

P1_RX_DSCP_PRI_MAP6 is shown in [Figure 14-153](#) and described in [Table 14-167](#).

CPSW PORT 1 RX DSCP PRIORITY TO RX PACKET MAPPING REG 6

Figure 14-153. P1_RX_DSCP_PRI_MAP6 Register

31	30	29	28	27	26	25	24	23	22	21	20	19	18	17	16
RESE RVED	PRI55			RESE RVED	PRI54			RESE RVED	PRI53			RESE RVED	PRI52		
R/W- 0h	R/W-0h			R/W- 0h	R/W-0h			R/W- 0h	R/W-0h			R/W- 0h	R/W-0h		
15	14	13	12	11	10	9	8	7	6	5	4	3	2	1	0
RESE RVED	PRI51			RESE RVED	PRI50			RESE RVED	PRI49			RESE RVED	PRI48		
R/W- 0h	R/W-0h			R/W- 0h	R/W-0h			R/W- 0h	R/W-0h			R/W- 0h	R/W-0h		

LEGEND: R/W = Read/Write; R = Read only; W1toCl = Write 1 to clear bit; -n = value after reset

Table 14-167. P1_RX_DSCP_PRI_MAP6 Register Field Descriptions

Bit	Field	Type	Reset	Description
31	RESERVED	R/W	0h	
30-28	PRI55	R/W	0h	Priority 55 - A packet TOS of 0d55 is mapped to this received packet priority.
27	RESERVED	R/W	0h	
26-24	PRI54	R/W	0h	Priority 54 - A packet TOS of 0d54 is mapped to this received packet priority.
23	RESERVED	R/W	0h	
22-20	PRI53	R/W	0h	Priority 53 - A packet TOS of 0d53 is mapped to this received packet priority.
19	RESERVED	R/W	0h	
18-16	PRI52	R/W	0h	Priority 52 - A packet TOS of 0d52 is mapped to this received packet priority.
15	RESERVED	R/W	0h	
14-12	PRI51	R/W	0h	Priority 51 - A packet TOS of 0d51 is mapped to this received packet priority.
11	RESERVED	R/W	0h	
10-8	PRI50	R/W	0h	Priority 50 - A packet TOS of 0d50 is mapped to this received packet priority.
7	RESERVED	R/W	0h	
6-4	PRI49	R/W	0h	Priority 49 - A packet TOS of 0d49 is mapped to this received packet priority.
3	RESERVED	R/W	0h	
2-0	PRI48	R/W	0h	Priority 48 - A packet TOS of 0d48 is mapped to this received packet priority.

14.5.6.34 P1_RX_DSCP_PRI_MAP7 Register (offset = 14Ch) [reset = 0h]

 P1_RX_DSCP_PRI_MAP7 is shown in [Figure 14-154](#) and described in [Table 14-168](#).

CPSW PORT 1 RX DSCP PRIORITY TO RX PACKET MAPPING REG 7

Figure 14-154. P1_RX_DSCP_PRI_MAP7 Register

31	30	29	28	27	26	25	24	23	22	21	20	19	18	17	16
RESE RVED	PRI63			RESE RVED	PRI62			RESE RVED	PRI61			RESE RVED	PRI60		
R/W- 0h	R/W-0h			R/W- 0h	R/W-0h			R/W- 0h	R/W-0h			R/W- 0h	R/W-0h		
15	14	13	12	11	10	9	8	7	6	5	4	3	2	1	0
RESE RVED	PRI59			RESE RVED	PRI58			RESE RVED	PRI57			RESE RVED	PRI56		
R/W- 0h	R/W-0h			R/W- 0h	R/W-0h			R/W- 0h	R/W-0h			R/W- 0h	R/W-0h		

LEGEND: R/W = Read/Write; R = Read only; W1toCl = Write 1 to clear bit; -n = value after reset

Table 14-168. P1_RX_DSCP_PRI_MAP7 Register Field Descriptions

Bit	Field	Type	Reset	Description
31	RESERVED	R/W	0h	
30-28	PRI63	R/W	0h	Priority 63 - A packet TOS of 0d63 is mapped to this received packet priority.
27	RESERVED	R/W	0h	
26-24	PRI62	R/W	0h	Priority 62 - A packet TOS of 0d62 is mapped to this received packet priority.
23	RESERVED	R/W	0h	
22-20	PRI61	R/W	0h	Priority 61 - A packet TOS of 0d61 is mapped to this received packet priority.
19	RESERVED	R/W	0h	
18-16	PRI60	R/W	0h	Priority 60 - A packet TOS of 0d60 is mapped to this received packet priority.
15	RESERVED	R/W	0h	
14-12	PRI59	R/W	0h	Priority 59 - A packet TOS of 0d59 is mapped to this received packet priority.
11	RESERVED	R/W	0h	
10-8	PRI58	R/W	0h	Priority 58 - A packet TOS of 0d58 is mapped to this received packet priority.
7	RESERVED	R/W	0h	
6-4	PRI57	R/W	0h	Priority 57 - A packet TOS of 0d57 is mapped to this received packet priority.
3	RESERVED	R/W	0h	
2-0	PRI56	R/W	0h	Priority 56 - A packet TOS of 0d56 is mapped to this received packet priority.

14.5.6.35 P2_CONTROL Register (offset = 200h) [reset = 0h]

P2_CONTROL is shown in [Figure 14-155](#) and described in [Table 14-169](#).

CPSW_3GF PORT 2 CONTROL REGISTER

Figure 14-155. P2_CONTROL Register

31	30	29	28	27	26	25	24
RESERVED							P2_PASS_PRI_TAGGED
R/W-0h							R/W-0h
23	22	21	20	19	18	17	16
RESERVED		P2_VLAN_LTY_PE2_EN	P2_VLAN_LTY_PE1_EN	RESERVED			P2_DSCP_PRI_EN
R/W-0h		R/W-0h	R/W-0h	R/W-0h			R/W-0h
15	14	13	12	11	10	9	8
RESERVED	P2_TS_320	P2_TS_319	P2_TS_132	P2_TS_131	P2_TS_130	P2_TS_129	P2_TS_TTL_NONZERO
R/W-0h	R/W-0h	R/W-0h	R/W-0h	R/W-0h	R/W-0h	R/W-0h	R/W-0h
7	6	5	4	3	2	1	0
RESERVED			P2_TS_ANNEX_D_EN	P2_TS_LTYPE_2_EN	P2_TS_LTYPE_1_EN	P2_TS_TX_EN	P2_TS_RX_EN
R/W-0h			R/W-0h	R-0h	R/W-0h	R/W-0h	R/W-0h

LEGEND: R/W = Read/Write; R = Read only; W1toCl = Write 1 to clear bit; -n = value after reset

Table 14-169. P2_CONTROL Register Field Descriptions

Bit	Field	Type	Reset	Description
31-25	RESERVED	R/W	0h	
24	P2_PASS_PRI_TAGGED	R/W	0h	Port 2 Pass Priority Tagged 0 - Priority tagged packets have the zero VID replaced with the input port P2_PORT_VLAN [11:0] 1 - Priority tagged packets are processed unchanged.
23-22	RESERVED	R/W	0h	
21	P2_VLAN_LTYPE2_EN	R/W	0h	Port 2 VLAN LTYPE 2 enable 0 - disabled 1 - VLAN LTYPE2 enabled on transmit and receive
20	P2_VLAN_LTYPE1_EN	R/W	0h	Port 2 VLAN LTYPE 1 enable 0 - disabled 1 - VLAN LTYPE1 enabled on transmit and receive
19-17	RESERVED	R/W	0h	
16	P2_DSCP_PRI_EN	R/W	0h	Port 0 DSCP Priority Enable 0 - DSCP priority disabled 1 - DSCP priority enabled. All non-tagged IPV4 packets have their received packet priority determined by mapping the 6 TOS bits through the port DSCP priority mapping registers.
15	RESERVED	R/W	0h	
14	P2_TS_320	R/W	0h	Port 2 Time Sync Destination Port Number 320 enable 0 - disabled 1 - Annex D (UDP/IPv4) time sync packet destination port number 320 (decimal) is enabled.
13	P2_TS_319	R/W	0h	Port 2 Time Sync Destination Port Number 319 enable 0 - disabled 1 - Annex D (UDP/IPv4) time sync packet destination port number 319 (decimal) is enabled.
12	P2_TS_132	R/W	0h	Port 2 Time Sync Destination IP Address 132 enable 0 - disabled 1 - Annex D (UDP/IPv4) time sync packet destination IP address number 132 (decimal) is enabled.

Table 14-169. P2_CONTROL Register Field Descriptions (continued)

Bit	Field	Type	Reset	Description
11	P2_TS_131	R/W	0h	Port 2 Time Sync Destination IP Address 131 enable 0 - disabled 1 - Annex D (UDP/IPv4) time sync packet destination IP address number 131 (decimal) is enabled.
10	P2_TS_130	R/W	0h	Port 2 Time Sync Destination IP Address 130 enable 0 - disabled 1 - Annex D (UDP/IPv4) time sync packet destination IP address number 130 (decimal) is enabled.
9	P2_TS_129	R/W	0h	Port 2 Time Sync Destination IP Address 129 enable 0 - disabled 1 - Annex D (UDP/IPv4) time sync packet destination IP address number 129 (decimal) is enabled.
8	P2_TS_TTL_NONZERO	R/W	0h	Port 2 Time Sync Time To Live Non-zero enable. 0 = TTL must be zero. 1 = TTL may be any value.
7-5	RESERVED	R/W	0h	
4	P2_TS_ANNEX_D_EN	R/W	0h	Port 2 Time Sync Annex D enable 0 - Annex D disabled 1 - Annex D enabled
3	P2_TS_LTYPE2_EN	R	0h	Port 2 Time Sync LTYPE 2 enable 0 - disabled 1 - enabled
2	P2_TS_LTYPE1_EN	R/W	0h	Port 2 Time Sync LTYPE 1 enable 0 - disabled 1 - enabled
1	P2_TS_TX_EN	R/W	0h	Port 2 Time Sync Transmit Enable 0 - disabled 1 - enabled
0	P2_TS_RX_EN	R/W	0h	Port 2 Time Sync Receive Enable 0 - Port 1 Receive Time Sync disabled 1 - Port 1 Receive Time Sync enabled

14.5.6.36 P2_MAX_BLKs Register (offset = 208h) [reset = 113h]

P2_MAX_BLKs is shown in [Figure 14-156](#) and described in [Table 14-170](#).

CPSW PORT 2 MAXIMUM FIFO BLOCKS REGISTER

Figure 14-156. P2_MAX_BLKs Register

31	30	29	28	27	26	25	24		
RESERVED									
R/W-0h									
23	22	21	20	19	18	17	16		
RESERVED									
R/W-0h									
15	14	13	12	11	10	9	8		
RESERVED									P2_TX_MAX_B LKS
R/W-0h									R/W-11h
7	6	5	4	3	2	1	0		
P2_TX_MAX_BLKs				P2_RX_MAX_BLKs					
R/W-11h				R/W-3h					

LEGEND: R/W = Read/Write; R = Read only; W1toCl = Write 1 to clear bit; -n = value after reset

Table 14-170. P2_MAX_BLKs Register Field Descriptions

Bit	Field	Type	Reset	Description
31-9	RESERVED	R/W	0h	
8-4	P2_TX_MAX_BLKs	R/W	11h	Transmit FIFO Maximum Blocks - This value is the maximum number of 1k memory blocks that may be allocated to the FIFO's logical transmit priority queues. 0x11 is the recommended value of p2_tx_max_blks unless the port is in full duplex flow control mode. In flow control mode, the p2_rx_max_blks will need to increase in order to accept the required run out in full duplex mode. This value will need to decrease by the amount of increase in p2_rx_max_blks. 0xe is the minimum value tx max blks.
3-0	P2_RX_MAX_BLKs	R/W	3h	Receive FIFO Maximum Blocks - This value is the maximum number of 1k memory blocks that may be allocated to the FIFO's logical receive queue. This value must be greater than or equal to 0x3. It should be increased In full duplex flow control mode to 0x5 or 0x6 depending on the required runout space. The p2_tx_max_blks value must be decreased by the amount of increase in p2_rx_max_blks. 0x3 is the minimum value rx max blks and 0x6 is the maximum value.

14.5.6.37 P2_BLK_CNT Register (offset = 20Ch) [reset = 41h]

 P2_BLK_CNT is shown in [Figure 14-157](#) and described in [Table 14-171](#).

CPSW PORT 2 FIFO BLOCK USAGE COUNT (READ ONLY)

Figure 14-157. P2_BLK_CNT Register

31	30	29	28	27	26	25	24
RESERVED							
R-0h							
23	22	21	20	19	18	17	16
RESERVED							
R-0h							
15	14	13	12	11	10	9	8
RESERVED							P2_TX_BLK_C NT
R-0h							R-4h
7	6	5	4	3	2	1	0
P2_TX_BLK_CNT				P2_RX_BLK_CNT			
R-4h				R-1h			

LEGEND: R/W = Read/Write; R = Read only; W1toCl = Write 1 to clear bit; -n = value after reset

Table 14-171. P2_BLK_CNT Register Field Descriptions

Bit	Field	Type	Reset	Description
31-9	RESERVED	R	0h	
8-4	P2_TX_BLK_CNT	R	4h	Port 2 Transmit Block Count Usage - This value is the number of blocks allocated to the FIFO logical transmit queues.
3-0	P2_RX_BLK_CNT	R	1h	Port 2 Receive Block Count Usage - This value is the number of blocks allocated to the FIFO logical receive queues.

14.5.6.38 P2_TX_IN_CTL Register (offset = 210h) [reset = 80040C0h]

P2_TX_IN_CTL is shown in [Figure 14-158](#) and described in [Table 14-172](#).

CPSW PORT 2 TRANSMIT FIFO CONTROL

Figure 14-158. P2_TX_IN_CTL Register

31	30	29	28	27	26	25	24
RESERVED				HOST_BLKs_REM			
R/W-				R/W-8h			
23	22	21	20	19	18	17	16
TX_RATE_EN				RESERVED		TX_IN_SEL	
R/W-0h				R/W-		R/W-0h	
15	14	13	12	11	10	9	8
TX_BLKs_REM				RESERVED		TX_PRI_WDS	
R/W-4h				R/W-		R/W-C0h	
7	6	5	4	3	2	1	0
TX_PRI_WDS							
R/W-C0h							

LEGEND: R/W = Read/Write; R = Read only; W1toCl = Write 1 to clear bit; -n = value after reset

Table 14-172. P2_TX_IN_CTL Register Field Descriptions

Bit	Field	Type	Reset	Description
31-28	RESERVED	R/W		
27-24	HOST_BLKs_REM	R/W	8h	Transmit FIFO Blocks that must be free before a non rate-limited CPDMA channel can begin sending a packet to the FIFO.
23-20	TX_RATE_EN	R/W	0h	Transmit FIFO Input Rate Enable
19-18	RESERVED	R/W		
17-16	TX_IN_SEL	R/W	0h	Transmit FIFO Input Queue Type Select 00 - Normal priority mode 01 - reserved 10 - Rate Limit mode 11 - reserved
15-12	TX_BLKs_REM	R/W	4h	Transmit FIFO Input Blocks to subtract in dual mac mode and blocks to subtract on non rate-limited traffic in rate-limit mode.
11-10	RESERVED	R/W		
9-0	TX_PRI_WDS	R/W	C0h	Transmit FIFO Words in queue

14.5.6.39 P2_PORT_VLAN Register (offset = 214h) [reset = 0h]

 P2_PORT_VLAN is shown in [Figure 14-159](#) and described in [Table 14-173](#).

CPSW PORT 2 VLAN REGISTER

Figure 14-159. P2_PORT_VLAN Register

31	30	29	28	27	26	25	24
RESERVED							
R/W-0h							
23	22	21	20	19	18	17	16
RESERVED							
R/W-0h							
15	14	13	12	11	10	9	8
PORT_PRI			PORT_CFI		PORT_VID		
R/W-0h			R/W-0h		R/W-0h		
7	6	5	4	3	2	1	0
PORT_VID							
R/W-0h							

LEGEND: R/W = Read/Write; R = Read only; W1toCl = Write 1 to clear bit; -n = value after reset

Table 14-173. P2_PORT_VLAN Register Field Descriptions

Bit	Field	Type	Reset	Description
31-16	RESERVED	R/W	0h	
15-13	PORT_PRI	R/W	0h	Port VLAN Priority (7 is highest priority)
12	PORT_CFI	R/W	0h	Port CFI bit
11-0	PORT_VID	R/W	0h	Port VLAN ID

14.5.6.40 P2_TX_PRI_MAP Register (offset = 218h) [reset = 33221001h]

P2_TX_PRI_MAP is shown in [Figure 14-160](#) and described in [Table 14-174](#).

CPSW PORT 2 TX HEADER PRIORITY TO SWITCH PRI MAPPING REGISTER

Figure 14-160. P2_TX_PRI_MAP Register

31	30	29	28	27	26	25	24	23	22	21	20	19	18	17	16
RESERVED		PRI7		RESERVED		PRI6		RESERVED		PRI5		RESERVED		PRI4	
R/W-0h		R/W-3h		R/W-0h		R/W-3h		R/W-0h		R/W-2h		R/W-0h		R/W-2h	
15	14	13	12	11	10	9	8	7	6	5	4	3	2	1	0
RESERVED		PRI3		RESERVED		PRI2		RESERVED		PRI1		RESERVED		PRI0	
R/W-0h		R/W-1h		R/W-0h		R/W-0h		R/W-0h		R/W-0h		R/W-0h		R/W-1h	

LEGEND: R/W = Read/Write; R = Read only; W1toCl = Write 1 to clear bit; -n = value after reset

Table 14-174. P2_TX_PRI_MAP Register Field Descriptions

Bit	Field	Type	Reset	Description
31-30	RESERVED	R/W	0h	
29-28	PRI7	R/W	3h	Priority 7 - A packet header priority of 0x7 is given this switch queue pri.
27-26	RESERVED	R/W	0h	
25-24	PRI6	R/W	3h	Priority 6 - A packet header priority of 0x6 is given this switch queue pri.
23-22	RESERVED	R/W	0h	
21-20	PRI5	R/W	2h	Priority 5 - A packet header priority of 0x5 is given this switch queue pri.
19-18	RESERVED	R/W	0h	
17-16	PRI4	R/W	2h	Priority 4 - A packet header priority of 0x4 is given this switch queue pri.
15-14	RESERVED	R/W	0h	
13-12	PRI3	R/W	1h	Priority 3 - A packet header priority of 0x3 is given this switch queue pri.
11-10	RESERVED	R/W	0h	
9-8	PRI2	R/W	0h	Priority 2 - A packet header priority of 0x2 is given this switch queue pri.
7-6	RESERVED	R/W	0h	
5-4	PRI1	R/W	0h	Priority 1 - A packet header priority of 0x1 is given this switch queue pri.
3-2	RESERVED	R/W	0h	
1-0	PRI0	R/W	1h	Priority 0 - A packet header priority of 0x0 is given this switch queue pri.

14.5.6.41 P2_TS_SEQ_MTYPE Register (offset = 21Ch) [reset = 1E0000h]

 P2_TS_SEQ_MTYPE is shown in [Figure 14-161](#) and described in [Table 14-175](#).

CPSW_3GF PORT 2 TIME SYNC SEQUENCE ID OFFSET AND MSG TYPE.

Figure 14-161. P2_TS_SEQ_MTYPE Register

31	30	29	28	27	26	25	24
RESERVED							
R/W-0h							
23	22	21	20	19	18	17	16
RESERVED		P2_TS_SEQ_ID_OFFSET					
R/W-0h		R/W-1Eh					
15	14	13	12	11	10	9	8
P2_TS_MSG_TYPE_EN							
R/W-0h							
7	6	5	4	3	2	1	0
P2_TS_MSG_TYPE_EN							
R/W-0h							

LEGEND: R/W = Read/Write; R = Read only; W1toCl = Write 1 to clear bit; -n = value after reset

Table 14-175. P2_TS_SEQ_MTYPE Register Field Descriptions

Bit	Field	Type	Reset	Description
31-22	RESERVED	R/W	0h	
21-16	P2_TS_SEQ_ID_OFFSET	R/W	1Eh	Port 2 Time Sync Sequence ID Offset This is the number of octets that the sequence ID is offset in the tx and rx time sync message header. The minimum value is 6.
15-0	P2_TS_MSG_TYPE_EN	R/W	0h	Port 2 Time Sync Message Type Enable - Each bit in this field enables the corresponding message type in receive and transmit time sync messages (Bit 0 enables message type 0 etc.).

14.5.6.42 P2_SA_LO Register (offset = 220h) [reset = 0h]

P2_SA_LO is shown in [Figure 14-162](#) and described in [Table 14-176](#).

CPSW CPGMAC_SL2 SOURCE ADDRESS LOW REGISTER

Figure 14-162. P2_SA_LO Register

31	30	29	28	27	26	25	24	23	22	21	20	19	18	17	16
RESERVED															
R/W-0h															
15	14	13	12	11	10	9	8	7	6	5	4	3	2	1	0
MACSRCADDR_7_0								MACSRCADDR_15_8							
R/W-0h								R/W-0h							

LEGEND: R/W = Read/Write; R = Read only; W1toCl = Write 1 to clear bit; -n = value after reset

Table 14-176. P2_SA_LO Register Field Descriptions

Bit	Field	Type	Reset	Description
31-16	RESERVED	R/W	0h	
15-8	MACSRCADDR_7_0	R/W	0h	Source Address Lower 8 bits (byte 0)
7-0	MACSRCADDR_15_8	R/W	0h	Source Address bits 15:8 (byte 1)

14.5.6.43 P2_SA_HI Register (offset = 224h) [reset = 0h]

P2_SA_HI is shown in [Figure 14-163](#) and described in [Table 14-177](#).

CPSW CPGMAC_SL2 SOURCE ADDRESS HIGH REGISTER

Figure 14-163. P2_SA_HI Register

31	30	29	28	27	26	25	24	23	22	21	20	19	18	17	16
MACSRCADDR_23_16								MACSRCADDR_31_23							
R/W-0h								R/W-0h							
15	14	13	12	11	10	9	8	7	6	5	4	3	2	1	0
MACSRCADDR_39_32								MACSRCADDR_47_40							
R/W-0h								R/W-0h							

LEGEND: R/W = Read/Write; R = Read only; W1toCl = Write 1 to clear bit; -n = value after reset

Table 14-177. P2_SA_HI Register Field Descriptions

Bit	Field	Type	Reset	Description
31-24	MACSRCADDR_23_16	R/W	0h	Source Address bits 23:16 (byte 2)
23-16	MACSRCADDR_31_23	R/W	0h	Source Address bits 31:23 (byte 3)
15-8	MACSRCADDR_39_32	R/W	0h	Source Address bits 39:32 (byte 4)
7-0	MACSRCADDR_47_40	R/W	0h	Source Address bits 47:40 (byte 5)

14.5.6.44 P2_SEND_PERCENT Register (offset = 228h) [reset = 0h]

P2_SEND_PERCENT is shown in [Figure 14-164](#) and described in [Table 14-178](#).

CPSW PORT 2 TRANSMIT QUEUE SEND PERCENTAGES

Figure 14-164. P2_SEND_PERCENT Register

31	30	29	28	27	26	25	24	23	22	21	20	19	18	17	16
RESERVED									PRI3_SEND_PERCENT						
R/W-0h									R/W-0h						
15	14	13	12	11	10	9	8	7	6	5	4	3	2	1	0
RESERVED	PRI2_SEND_PERCENT							RESERVED	PRI1_SEND_PERCENT						
R/W-0h	R/W-0h							R/W-0h	R/W-0h						

LEGEND: R/W = Read/Write; R = Read only; W1toCl = Write 1 to clear bit; -n = value after reset

Table 14-178. P2_SEND_PERCENT Register Field Descriptions

Bit	Field	Type	Reset	Description
31-23	RESERVED	R/W	0h	
22-16	PRI3_SEND_PERCENT	R/W	0h	Priority 3 Transmit Percentage - This percentage value is sent from FIFO priority 3 (maximum) when the p1_pri3_shape_en is set (queue shaping enabled). This is the percentage of the wire that packets from priority 3 receive (which includes interpacket gap and preamble bytes). If shaping is enabled on this queue then this value must be between zero and 0d100 (not inclusive).
15	RESERVED	R/W	0h	
14-8	PRI2_SEND_PERCENT	R/W	0h	Priority 2 Transmit Percentage - This percentage value is sent from FIFO priority 2 (maximum) when the p1_pri2_shape_en is set (queue shaping enabled). This is the percentage of the wire that packets from priority 2 receive (which includes interpacket gap and preamble bytes). If shaping is enabled on this queue then this value must be between zero and 0d100 (not inclusive).
7	RESERVED	R/W	0h	
6-0	PRI1_SEND_PERCENT	R/W	0h	Priority 1 Transmit Percentage - This percentage value is sent from FIFO priority 1 (maximum) when the p1_pri1_shape_en is set (queue shaping enabled). This is the percentage of the wire that packets from priority 1 receive (which includes interpacket gap and preamble bytes). If shaping is enabled on this queue then this value must be between zero and 0d100 (not inclusive).

14.5.6.45 P2_RX_DSCP_PRI_MAP0 Register (offset = 230h) [reset = 0h]

 P2_RX_DSCP_PRI_MAP0 is shown in [Figure 14-165](#) and described in [Table 14-179](#).

CPSW PORT 2 RX DSCP PRIORITY TO RX PACKET MAPPING REG 0

Figure 14-165. P2_RX_DSCP_PRI_MAP0 Register

31	30	29	28	27	26	25	24	23	22	21	20	19	18	17	16
RESE RVED	PRI7			RESE RVED	PRI6			RESE RVED	PRI5			RESE RVED	PRI4		
R/W- 0h	R/W-0h			R/W- 0h	R/W-0h			R/W- 0h	R/W-0h			R/W- 0h	R/W-0h		
15	14	13	12	11	10	9	8	7	6	5	4	3	2	1	0
RESE RVED	PRI3			RESE RVED	PRI2			RESE RVED	PRI1			RESE RVED	PRI0		
R/W- 0h	R/W-0h			R/W- 0h	R/W-0h			R/W- 0h	R/W-0h			R/W- 0h	R/W-0h		

LEGEND: R/W = Read/Write; R = Read only; W1toCl = Write 1 to clear bit; -n = value after reset

Table 14-179. P2_RX_DSCP_PRI_MAP0 Register Field Descriptions

Bit	Field	Type	Reset	Description
31	RESERVED	R/W	0h	
30-28	PRI7	R/W	0h	Priority 7 - A packet TOS of 0d7 is mapped to this received packet priority.
27	RESERVED	R/W	0h	
26-24	PRI6	R/W	0h	Priority 6 - A packet TOS of 0d6 is mapped to this received packet priority.
23	RESERVED	R/W	0h	
22-20	PRI5	R/W	0h	Priority 5 - A packet TOS of 0d5 is mapped to this received packet priority.
19	RESERVED	R/W	0h	
18-16	PRI4	R/W	0h	Priority 4 - A packet TOS of 0d4 is mapped to this received packet priority.
15	RESERVED	R/W	0h	
14-12	PRI3	R/W	0h	Priority 3 - A packet TOS of 0d3 is mapped to this received packet priority.
11	RESERVED	R/W	0h	
10-8	PRI2	R/W	0h	Priority 2 - A packet TOS of 0d2 is mapped to this received packet priority.
7	RESERVED	R/W	0h	
6-4	PRI1	R/W	0h	Priority 1 - A packet TOS of 0d1 is mapped to this received packet priority.
3	RESERVED	R/W	0h	
2-0	PRI0	R/W	0h	Priority 0 - A packet TOS of 0d0 is mapped to this received packet priority.

14.5.6.46 P2_RX_DSCP_PRI_MAP1 Register (offset = 234h) [reset = 0h]

P2_RX_DSCP_PRI_MAP1 is shown in [Figure 14-166](#) and described in [Table 14-180](#).

CPSW PORT 2 RX DSCP PRIORITY TO RX PACKET MAPPING REG 1

Figure 14-166. P2_RX_DSCP_PRI_MAP1 Register

31	30	29	28	27	26	25	24	23	22	21	20	19	18	17	16
RESE RVED	PRI15			RESE RVED	PRI14			RESE RVED	PRI13			RESE RVED	PRI12		
R/W- 0h	R/W-0h			R/W- 0h	R/W-0h			R/W- 0h	R/W-0h			R/W- 0h	R/W-0h		
15	14	13	12	11	10	9	8	7	6	5	4	3	2	1	0
RESE RVED	PRI11			RESE RVED	PRI10			RESE RVED	PRI9			RESE RVED	PRI8		
R/W- 0h	R/W-0h			R/W- 0h	R/W-0h			R/W- 0h	R/W-0h			R/W- 0h	R/W-0h		

LEGEND: R/W = Read/Write; R = Read only; W1toCl = Write 1 to clear bit; -n = value after reset

Table 14-180. P2_RX_DSCP_PRI_MAP1 Register Field Descriptions

Bit	Field	Type	Reset	Description
31	RESERVED	R/W	0h	
30-28	PRI15	R/W	0h	Priority 15 - A packet TOS of 0d15 is mapped to this received packet priority.
27	RESERVED	R/W	0h	
26-24	PRI14	R/W	0h	Priority 14 - A packet TOS of 0d14 is mapped to this received packet priority.
23	RESERVED	R/W	0h	
22-20	PRI13	R/W	0h	Priority 13 - A packet TOS of 0d13 is mapped to this received packet priority.
19	RESERVED	R/W	0h	
18-16	PRI12	R/W	0h	Priority 12 - A packet TOS of 0d12 is mapped to this received packet priority.
15	RESERVED	R/W	0h	
14-12	PRI11	R/W	0h	Priority 11 - A packet TOS of 0d11 is mapped to this received packet priority.
11	RESERVED	R/W	0h	
10-8	PRI10	R/W	0h	Priority 10 - A packet TOS of 0d10 is mapped to this received packet priority.
7	RESERVED	R/W	0h	
6-4	PRI9	R/W	0h	Priority 9 - A packet TOS of 0d9 is mapped to this received packet priority.
3	RESERVED	R/W	0h	
2-0	PRI8	R/W	0h	Priority 8 - A packet TOS of 0d8 is mapped to this received packet priority.

14.5.6.47 P2_RX_DSCP_PRI_MAP2 Register (offset = 238h) [reset = 0h]

 P2_RX_DSCP_PRI_MAP2 is shown in [Figure 14-167](#) and described in [Table 14-181](#).

CPSW PORT 2 RX DSCP PRIORITY TO RX PACKET MAPPING REG 2

Figure 14-167. P2_RX_DSCP_PRI_MAP2 Register

31	30	29	28	27	26	25	24	23	22	21	20	19	18	17	16
RESE RVED	PRI23			RESE RVED	PRI22			RESE RVED	PRI21			RESE RVED	PRI20		
R/W- 0h	R/W-0h			R/W- 0h	R/W-0h			R/W- 0h	R/W-0h			R/W- 0h	R/W-0h		
15	14	13	12	11	10	9	8	7	6	5	4	3	2	1	0
RESE RVED	PRI19			RESE RVED	PRI18			RESE RVED	PRI17			RESE RVED	PRI16		
R/W- 0h	R/W-0h			R/W- 0h	R/W-0h			R/W- 0h	R/W-0h			R/W- 0h	R/W-0h		

LEGEND: R/W = Read/Write; R = Read only; W1toCl = Write 1 to clear bit; -n = value after reset

Table 14-181. P2_RX_DSCP_PRI_MAP2 Register Field Descriptions

Bit	Field	Type	Reset	Description
31	RESERVED	R/W	0h	
30-28	PRI23	R/W	0h	Priority 23 - A packet TOS of 0d23 is mapped to this received packet priority.
27	RESERVED	R/W	0h	
26-24	PRI22	R/W	0h	Priority 22 - A packet TOS of 0d22 is mapped to this received packet priority.
23	RESERVED	R/W	0h	
22-20	PRI21	R/W	0h	Priority 21 - A packet TOS of 0d21 is mapped to this received packet priority.
19	RESERVED	R/W	0h	
18-16	PRI20	R/W	0h	Priority 20 - A packet TOS of 0d20 is mapped to this received packet priority.
15	RESERVED	R/W	0h	
14-12	PRI19	R/W	0h	Priority 19 - A packet TOS of 0d19 is mapped to this received packet priority.
11	RESERVED	R/W	0h	
10-8	PRI18	R/W	0h	Priority 18 - A packet TOS of 0d18 is mapped to this received packet priority.
7	RESERVED	R/W	0h	
6-4	PRI17	R/W	0h	Priority 17 - A packet TOS of 0d17 is mapped to this received packet priority.
3	RESERVED	R/W	0h	
2-0	PRI16	R/W	0h	Priority 16 - A packet TOS of 0d16 is mapped to this received packet priority.

14.5.6.48 P2_RX_DSCP_PRI_MAP3 Register (offset = 23Ch) [reset = 0h]

P2_RX_DSCP_PRI_MAP3 is shown in [Figure 14-168](#) and described in [Table 14-182](#).

CPSW PORT 2 RX DSCP PRIORITY TO RX PACKET MAPPING REG 3

Figure 14-168. P2_RX_DSCP_PRI_MAP3 Register

31	30	29	28	27	26	25	24	23	22	21	20	19	18	17	16
RESE RVED	PRI31			RESE RVED	PRI30			RESE RVED	PRI29			RESE RVED	PRI28		
R/W- 0h	R/W-0h			R/W- 0h	R/W-0h			R/W- 0h	R/W-0h			R/W- 0h	R/W-0h		
15	14	13	12	11	10	9	8	7	6	5	4	3	2	1	0
RESE RVED	PRI27			RESE RVED	PRI26			RESE RVED	PRI25			RESE RVED	PRI24		
R/W- 0h	R/W-0h			R/W- 0h	R/W-0h			R/W- 0h	R/W-0h			R/W- 0h	R/W-0h		

LEGEND: R/W = Read/Write; R = Read only; W1toCl = Write 1 to clear bit; -n = value after reset

Table 14-182. P2_RX_DSCP_PRI_MAP3 Register Field Descriptions

Bit	Field	Type	Reset	Description
31	RESERVED	R/W	0h	
30-28	PRI31	R/W	0h	Priority 31 - A packet TOS of 0d31 is mapped to this received packet priority.
27	RESERVED	R/W	0h	
26-24	PRI30	R/W	0h	Priority 30 - A packet TOS of 0d30 is mapped to this received packet priority.
23	RESERVED	R/W	0h	
22-20	PRI29	R/W	0h	Priority 29 - A packet TOS of 0d39 is mapped to this received packet priority.
19	RESERVED	R/W	0h	
18-16	PRI28	R/W	0h	Priority 28 - A packet TOS of 0d28 is mapped to this received packet priority.
15	RESERVED	R/W	0h	
14-12	PRI27	R/W	0h	Priority 27 - A packet TOS of 0d27 is mapped to this received packet priority.
11	RESERVED	R/W	0h	
10-8	PRI26	R/W	0h	Priority 26 - A packet TOS of 0d26 is mapped to this received packet priority.
7	RESERVED	R/W	0h	
6-4	PRI25	R/W	0h	Priority 25 - A packet TOS of 0d25 is mapped to this received packet priority.
3	RESERVED	R/W	0h	
2-0	PRI24	R/W	0h	Priority 24 - A packet TOS of 0d24 is mapped to this received packet priority.

14.5.6.49 P2_RX_DSCP_PRI_MAP4 Register (offset = 240h) [reset = 0h]

 P2_RX_DSCP_PRI_MAP4 is shown in [Figure 14-169](#) and described in [Table 14-183](#).

CPSW PORT 2 RX DSCP PRIORITY TO RX PACKET MAPPING REG 4

Figure 14-169. P2_RX_DSCP_PRI_MAP4 Register

31	30	29	28	27	26	25	24	23	22	21	20	19	18	17	16
RESE RVED	PRI39			RESE RVED	PRI38			RESE RVED	PRI37			RESE RVED	PRI36		
R/W- 0h	R/W-0h			R/W- 0h	R/W-0h			R/W- 0h	R/W-0h			R/W- 0h	R/W-0h		
15	14	13	12	11	10	9	8	7	6	5	4	3	2	1	0
RESE RVED	PRI35			RESE RVED	PRI34			RESE RVED	PRI33			RESE RVED	PRI32		
R/W- 0h	R/W-0h			R/W- 0h	R/W-0h			R/W- 0h	R/W-0h			R/W- 0h	R/W-0h		

LEGEND: R/W = Read/Write; R = Read only; W1toCl = Write 1 to clear bit; -n = value after reset

Table 14-183. P2_RX_DSCP_PRI_MAP4 Register Field Descriptions

Bit	Field	Type	Reset	Description
31	RESERVED	R/W	0h	
30-28	PRI39	R/W	0h	Priority 39 - A packet TOS of 0d39 is mapped to this received packet priority.
27	RESERVED	R/W	0h	
26-24	PRI38	R/W	0h	Priority 38 - A packet TOS of 0d38 is mapped to this received packet priority.
23	RESERVED	R/W	0h	
22-20	PRI37	R/W	0h	Priority 37 - A packet TOS of 0d37 is mapped to this received packet priority.
19	RESERVED	R/W	0h	
18-16	PRI36	R/W	0h	Priority 36 - A packet TOS of 0d36 is mapped to this received packet priority.
15	RESERVED	R/W	0h	
14-12	PRI35	R/W	0h	Priority 35 - A packet TOS of 0d35 is mapped to this received packet priority.
11	RESERVED	R/W	0h	
10-8	PRI34	R/W	0h	Priority 34 - A packet TOS of 0d34 is mapped to this received packet priority.
7	RESERVED	R/W	0h	
6-4	PRI33	R/W	0h	Priority 33 - A packet TOS of 0d33 is mapped to this received packet priority.
3	RESERVED	R/W	0h	
2-0	PRI32	R/W	0h	Priority 32 - A packet TOS of 0d32 is mapped to this received packet priority.

14.5.6.50 P2_RX_DSCP_PRI_MAP5 Register (offset = 244h) [reset = 0h]

P2_RX_DSCP_PRI_MAP5 is shown in [Figure 14-170](#) and described in [Table 14-184](#).

CPSW PORT 2 RX DSCP PRIORITY TO RX PACKET MAPPING REG 5

Figure 14-170. P2_RX_DSCP_PRI_MAP5 Register

31	30	29	28	27	26	25	24	23	22	21	20	19	18	17	16
RESE RVED	PRI47			RESE RVED	PRI46			RESE RVED	PRI45			RESE RVED	PRI44		
R/W- 0h	R/W-0h			R/W- 0h	R/W-0h			R/W- 0h	R/W-0h			R/W- 0h	R/W-0h		
15	14	13	12	11	10	9	8	7	6	5	4	3	2	1	0
RESE RVED	PRI43			RESE RVED	PRI42			RESE RVED	PRI41			RESE RVED	PRI40		
R/W- 0h	R/W-0h			R/W- 0h	R/W-0h			R/W- 0h	R/W-0h			R/W- 0h	R/W-0h		

LEGEND: R/W = Read/Write; R = Read only; W1toCl = Write 1 to clear bit; -n = value after reset

Table 14-184. P2_RX_DSCP_PRI_MAP5 Register Field Descriptions

Bit	Field	Type	Reset	Description
31	RESERVED	R/W	0h	
30-28	PRI47	R/W	0h	Priority 47 - A packet TOS of 0d47 is mapped to this received packet priority.
27	RESERVED	R/W	0h	
26-24	PRI46	R/W	0h	Priority 46 - A packet TOS of 0d46 is mapped to this received packet priority.
23	RESERVED	R/W	0h	
22-20	PRI45	R/W	0h	Priority 45 - A packet TOS of 0d45 is mapped to this received packet priority.
19	RESERVED	R/W	0h	
18-16	PRI44	R/W	0h	Priority 44 - A packet TOS of 0d44 is mapped to this received packet priority.
15	RESERVED	R/W	0h	
14-12	PRI43	R/W	0h	Priority 43 - A packet TOS of 0d43 is mapped to this received packet priority.
11	RESERVED	R/W	0h	
10-8	PRI42	R/W	0h	Priority 42 - A packet TOS of 0d42 is mapped to this received packet priority.
7	RESERVED	R/W	0h	
6-4	PRI41	R/W	0h	Priority 41 - A packet TOS of 0d41 is mapped to this received packet priority.
3	RESERVED	R/W	0h	
2-0	PRI40	R/W	0h	Priority 40 - A packet TOS of 0d40 is mapped to this received packet priority.

14.5.6.51 P2_RX_DSCP_PRI_MAP6 Register (offset = 248h) [reset = 0h]

 P2_RX_DSCP_PRI_MAP6 is shown in [Figure 14-171](#) and described in [Table 14-185](#).

CPSW PORT 2 RX DSCP PRIORITY TO RX PACKET MAPPING REG 6

Figure 14-171. P2_RX_DSCP_PRI_MAP6 Register

31	30	29	28	27	26	25	24	23	22	21	20	19	18	17	16
RESE RVED	PRI55			RESE RVED	PRI54			RESE RVED	PRI53			RESE RVED	PRI52		
R/W- 0h	R/W-0h			R/W- 0h	R/W-0h			R/W- 0h	R/W-0h			R/W- 0h	R/W-0h		
15	14	13	12	11	10	9	8	7	6	5	4	3	2	1	0
RESE RVED	PRI51			RESE RVED	PRI50			RESE RVED	PRI49			RESE RVED	PRI48		
R/W- 0h	R/W-0h			R/W- 0h	R/W-0h			R/W- 0h	R/W-0h			R/W- 0h	R/W-0h		

LEGEND: R/W = Read/Write; R = Read only; W1toCl = Write 1 to clear bit; -n = value after reset

Table 14-185. P2_RX_DSCP_PRI_MAP6 Register Field Descriptions

Bit	Field	Type	Reset	Description
31	RESERVED	R/W	0h	
30-28	PRI55	R/W	0h	Priority 55 - A packet TOS of 0d55 is mapped to this received packet priority.
27	RESERVED	R/W	0h	
26-24	PRI54	R/W	0h	Priority 54 - A packet TOS of 0d54 is mapped to this received packet priority.
23	RESERVED	R/W	0h	
22-20	PRI53	R/W	0h	Priority 53 - A packet TOS of 0d53 is mapped to this received packet priority.
19	RESERVED	R/W	0h	
18-16	PRI52	R/W	0h	Priority 52 - A packet TOS of 0d52 is mapped to this received packet priority.
15	RESERVED	R/W	0h	
14-12	PRI51	R/W	0h	Priority 51 - A packet TOS of 0d51 is mapped to this received packet priority.
11	RESERVED	R/W	0h	
10-8	PRI50	R/W	0h	Priority 50 - A packet TOS of 0d50 is mapped to this received packet priority.
7	RESERVED	R/W	0h	
6-4	PRI49	R/W	0h	Priority 49 - A packet TOS of 0d49 is mapped to this received packet priority.
3	RESERVED	R/W	0h	
2-0	PRI48	R/W	0h	Priority 48 - A packet TOS of 0d48 is mapped to this received packet priority.

14.5.6.52 P2_RX_DSCP_PRI_MAP7 Register (offset = 24Ch) [reset = 0h]

P2_RX_DSCP_PRI_MAP7 is shown in [Figure 14-172](#) and described in [Table 14-186](#).

CPSW PORT 2 RX DSCP PRIORITY TO RX PACKET MAPPING REG 7

Figure 14-172. P2_RX_DSCP_PRI_MAP7 Register

31	30	29	28	27	26	25	24	23	22	21	20	19	18	17	16
RESE RVED	PRI63			RESE RVED	PRI62			RESE RVED	PRI61			RESE RVED	PRI60		
R/W- 0h	R/W-0h			R/W- 0h	R/W-0h			R/W- 0h	R/W-0h			R/W- 0h	R/W-0h		
15	14	13	12	11	10	9	8	7	6	5	4	3	2	1	0
RESE RVED	PRI59			RESE RVED	PRI58			RESE RVED	PRI57			RESE RVED	PRI56		
R/W- 0h	R/W-0h			R/W- 0h	R/W-0h			R/W- 0h	R/W-0h			R/W- 0h	R/W-0h		

LEGEND: R/W = Read/Write; R = Read only; W1toCl = Write 1 to clear bit; -n = value after reset

Table 14-186. P2_RX_DSCP_PRI_MAP7 Register Field Descriptions

Bit	Field	Type	Reset	Description
31	RESERVED	R/W	0h	
30-28	PRI63	R/W	0h	Priority 63 - A packet TOS of 0d63 is mapped to this received packet priority.
27	RESERVED	R/W	0h	
26-24	PRI62	R/W	0h	Priority 62 - A packet TOS of 0d62 is mapped to this received packet priority.
23	RESERVED	R/W	0h	
22-20	PRI61	R/W	0h	Priority 61 - A packet TOS of 0d61 is mapped to this received packet priority.
19	RESERVED	R/W	0h	
18-16	PRI60	R/W	0h	Priority 60 - A packet TOS of 0d60 is mapped to this received packet priority.
15	RESERVED	R/W	0h	
14-12	PRI59	R/W	0h	Priority 59 - A packet TOS of 0d59 is mapped to this received packet priority.
11	RESERVED	R/W	0h	
10-8	PRI58	R/W	0h	Priority 58 - A packet TOS of 0d58 is mapped to this received packet priority.
7	RESERVED	R/W	0h	
6-4	PRI57	R/W	0h	Priority 57 - A packet TOS of 0d57 is mapped to this received packet priority.
3	RESERVED	R/W	0h	
2-0	PRI56	R/W	0h	Priority 56 - A packet TOS of 0d56 is mapped to this received packet priority.

14.5.7 CPSW_SL Registers

[Table 14-187](#) lists the memory-mapped registers for the CPSW_SL. All register offset addresses not listed in [Table 14-187](#) should be considered as reserved locations and the register contents should not be modified.

Table 14-187. CPSW_SL Registers

Offset	Acronym	Register Name	Section
0h	IDVER		Section 14.5.7.1
4h	MACCONTROL		Section 14.5.7.2
8h	MACSTATUS		Section 14.5.7.3
Ch	SOFT_RESET		Section 14.5.7.4
10h	RX_MAXLEN		Section 14.5.7.5
14h	BOFFTEST		Section 14.5.7.6
18h	RX_PAUSE		Section 14.5.7.7
1Ch	TX_PAUSE		Section 14.5.7.8
20h	EMCONTROL		Section 14.5.7.9
24h	RX_PRI_MAP		Section 14.5.7.10
28h	TX_GAP		Section 14.5.7.11

14.5.7.1 IDVER Register (offset = 0h) [reset = 170112h]

Register mask: FFFFFFFFh

 IDVER is shown in [Figure 14-173](#) and described in [Table 14-188](#).

CPGMAC_SL ID/VERSION REGISTER

Figure 14-173. IDVER Register

31	30	29	28	27	26	25	24	23	22	21	20	19	18	17	16	15	14	13	12	11	10	9	8	7	6	5	4	3	2	1	0
IDENT																Z			X		Y										
R-17h																R-0h			R-1h		R-12h										

LEGEND: R/W = Read/Write; R = Read only; W1toCl = Write 1 to clear bit; -n = value after reset

Table 14-188. IDVER Register Field Descriptions

Bit	Field	Type	Reset	Description
31-16	IDENT	R	17h	Rx Identification Value
15-11	Z	R	0h	Rx Z value (X.Y.Z)
10-8	X	R	1h	Rx X value (major)
7-0	Y	R	12h	Rx Y value (minor)

14.5.7.2 MACCONTROL Register (offset = 4h) [reset = 0h]

Register mask: FFFFFFFFh

 MACCONTROL is shown in [Figure 14-174](#) and described in [Table 14-189](#).

CPGMAC_SL MAC CONTROL REGISTER

Figure 14-174. MACCONTROL Register

31		30		29		28		27		26		25		24	
RESERVED													RX_CMF_EN		
Rreturns0s-0h													R/W-0h		
23		22		21		20		19		18		17		16	
RX_CSF_EN		RX_CEF_EN		TX_SHORT_G AP_LIM_EN		RESERVED				EXT_EN		GIG_FORCE		IFCTL_B	
R/W-0h		R/W-0h		R/W-0h		Rreturns0s-0h				R/W-0h		R/W-0h		R/W-0h	
15		14		13		12		11		10		9		8	
IFCTL_A		RESERVED						CMD_IDLE		TX_SHORT_G AP_EN		RESERVED			
R/W-0h		Rreturns0s-0h						R/W-0h		R/W-0h		Rreturns0s-0h			
7		6		5		4		3		2		1		0	
GIG		TX_PACE		GMII_EN		TX_FLOW_EN		RX_FLOW_EN		MTEST		LOOPBACK		FULLDUPLEX	
R/W-0h		R/W-0h		R/W-0h		R/W-0h		R/W-0h		R/W-0h		R/W-0h		R/W-0h	

LEGEND: R/W = Read/Write; R = Read only; W1toCl = Write 1 to clear bit; -n = value after reset

Table 14-189. MACCONTROL Register Field Descriptions

Bit	Field	Type	Reset	Description
31-25	RESERVED	Rreturns0s	0h	
24	RX_CMF_EN	R/W	0h	RX Copy MAC Control Frames Enable - Enables MAC control frames to be transferred to memory. MAC control frames are normally acted upon (if enabled), but not copied to memory. MAC control frames that are pause frames will be acted upon if enabled in the MacControl register, regardless of the value of rx_cmf_en. Frames transferred to memory due to rx_cmf_en will have the control bit set in their EOP buffer descriptor. 0 - MAC control frames are filtered (but acted upon if enabled). 1 - MAC control frames are transferred to memory.
23	RX_CSF_EN	R/W	0h	RX Copy Short Frames Enable - Enables frames or fragments shorter than 64 bytes to be copied to memory. Frames transferred to memory due to rx_csf_en will have the fragment or undersized bit set in their receive footer. Fragments are short frames that contain CRC/align/code errors and undersized are short frames without errors. 0 - Short frames are filtered 1 - Short frames are transferred to memory.
22	RX_CEF_EN	R/W	0h	RX Copy Error Frames Enable - Enables frames containing errors to be transferred to memory. The appropriate error bit will be set in the frame receive footer. Frames containing errors will be filtered when rx_cef_en is not set. 0 - Frames containing errors are filtered. 1 - Frames containing errors are transferred to memory.
21	TX_SHORT_GAP_LIM_EN	R/W	0h	Transmit Short Gap Limit Enable When set this bit limits the number of short gap packets transmitted to 100ppm. Each time a short gap packet is sent, a counter is loaded with 10,000 and decremented on each wireside clock. Another short gap packet will not be sent out until the counter decrements to zero. This mode is included to preclude the host from filling up the FIFO and sending every packet out with short gap which would violate the maximum number of packets per second allowed.

Table 14-189. MACCONTROL Register Field Descriptions (continued)

Bit	Field	Type	Reset	Description
20-19	RESERVED	Rreturns0s	0h	
18	EXT_EN	R/W	0h	Mode of operation. 0 - Forced mode of operation. 1 - In-band mode of operation.
17	GIG_FORCE	R/W	0h	Gigabit Mode Force - This bit is used to force the CPGMAC_SL into gigabit mode if the input GMII_MTCLK has been stopped by the PHY.
16	IFCTL_B	R/W	0h	Connects to the speed_in input of the respective RMII gasket. When using RMII mode: 0 - 10Mbps operation 1 - 100Mbps operation
15	IFCTL_A	R/W	0h	Connects to the speed_in input of the respective RMII gasket. When using RMII mode: 0 - 10Mbps operation 1 - 100Mbps operation
14-12	RESERVED	Rreturns0s	0h	
11	CMD_IDLE	R/W	0h	Command Idle 0 - Idle not commanded 1 - Idle Commanded (read idle in MacStatus)
10	TX_SHORT_GAP_EN	R/W	0h	Transmit Short Gap Enable 0 - Transmit with a short IPG is disabled 1 - Transmit with a short IPG (when TX_SHORT_GAP input is asserted) is enabled.
9-8	RESERVED	Rreturns0s	0h	
7	GIG	R/W	0h	Gigabit Mode - 0 - 10/100 mode 1 - Gigabit mode (full duplex only) The GIG_OUT output is the value of this bit.
6	TX_PACE	R/W	0h	Transmit Pacing Enable 0 - Transmit Pacing Disabled 1 - Transmit Pacing Enabled
5	GMII_EN	R/W	0h	RX/TX enable for all modes. 0 - RX and TX held in reset. 1 - RX and TX released from reset.
4	TX_FLOW_EN	R/W	0h	Transmit Flow Control Enable - Determines if incoming pause frames are acted upon in full-duplex mode. Incoming pause frames are not acted upon in half-duplex mode regardless of this bit setting. The RX_MBP_Enable bits determine whether or not received pause frames are transferred to memory. 0 - Transmit Flow Control Disabled. Full-duplex mode - Incoming pause frames are not acted upon. 1 - Transmit Flow Control Enabled . Full-duplex mode - Incoming pause frames are acted upon.
3	RX_FLOW_EN	R/W	0h	Receive Flow Control Enable - 0 - Receive Flow Control Disabled Half-duplex mode - No flow control generated collisions are sent. Full-duplex mode - No outgoing pause frames are sent. 1 - Receive Flow Control Enabled Half-duplex mode - Collisions are initiated when receive flow control is triggered. Full-duplex mode - Outgoing pause frames are sent when receive flow control is triggered.
2	MTEST	R/W	0h	Manufacturing Test mode - This bit must be set to allow writes to the Backoff_Test and PauseTimer registers.
1	LOOPBACK	R/W	0h	Loop Back Mode - Loopback mode forces internal fullduplex mode regardless of whether the fullduplex bit is set or not. The loopback bit should be changed only when GMII_en is deasserted. 0 - Not looped back 1 - Loop Back Mode enabled

Table 14-189. MACCONTROL Register Field Descriptions (continued)

Bit	Field	Type	Reset	Description
0	FULLDUPLEX	R/W	0h	Full Duplex mode - Gigabit mode forces fullduplex mode regardless of whether the fullduplex bit is set or not. The FULLDUPLEX_OUT output is the value of this register bit 0 - half duplex mode 1 - full duplex mode

14.5.7.3 MACSTATUS Register (offset = 8h) [reset = 0h]

Register mask: FFFFFFFFh

 MACSTATUS is shown in [Figure 14-175](#) and described in [Table 14-190](#).

CPGMAC_SL MAC STATUS REGISTER

Figure 14-175. MACSTATUS Register

31	30	29	28	27	26	25	24
IDLE	RESERVED						
R-0h	Rreturns0s-0h						
23	22	21	20	19	18	17	16
RESERVED							
Rreturns0s-0h							
15	14	13	12	11	10	9	8
RESERVED							
Rreturns0s-0h							
7	6	5	4	3	2	1	0
RESERVED			EXT_GIG	EXT_FULLDUPLEX	RESERVED	RX_FLOW_ACT	TX_FLOW_ACT
Rreturns0s-0h			R-0h	R-0h	Rreturns0s-0h	R-0h	R-0h

LEGEND: R/W = Read/Write; R = Read only; W1toCl = Write 1 to clear bit; -n = value after reset

Table 14-190. MACSTATUS Register Field Descriptions

Bit	Field	Type	Reset	Description
31	IDLE	R	0h	CPGMAC_SL IDLE - The CPGMAC_SL is in the idle state (valid after an idle command) 0 - The CPGMAC_SL is not in the idle state. 1 - The CPGMAC_SL is in the idle state.
30-5	RESERVED	Rreturns0s	0h	
4	EXT_GIG	R	0h	External GIG - This is the value of the EXT_GIG input bit.
3	EXT_FULLDUPLEX	R	0h	External Fullduplex - This is the value of the EXT_FULLDUPLEX input bit.
2	RESERVED	Rreturns0s	0h	
1	RX_FLOW_ACT	R	0h	Receive Flow Control Active - When asserted, indicates that receive flow control is enabled and triggered.
0	TX_FLOW_ACT	R	0h	Transmit Flow Control Active - When asserted, this bit indicates that the pause time period is being observed for a received pause frame. No new transmissions will begin while this bit is asserted except for the transmission of pause frames. Any transmission in progress when this bit is asserted will complete.

14.5.7.4 SOFT_RESET Register (offset = Ch) [reset = 0h]

Register mask: FFFFFFFFh

 SOFT_RESET is shown in [Figure 14-176](#) and described in [Table 14-191](#).

CPGMAC_SL SOFT RESET REGISTER

Figure 14-176. SOFT_RESET Register

31	30	29	28	27	26	25	24
RESERVED							
Rreturns0s-0h							
23	22	21	20	19	18	17	16
RESERVED							
Rreturns0s-0h							
15	14	13	12	11	10	9	8
RESERVED							
Rreturns0s-0h							
7	6	5	4	3	2	1	0
RESERVED							SOFT_RESET
Rreturns0s-0h							R/W-0h

LEGEND: R/W = Read/Write; R = Read only; W1toCl = Write 1 to clear bit; -n = value after reset

Table 14-191. SOFT_RESET Register Field Descriptions

Bit	Field	Type	Reset	Description
31-1	RESERVED	Rreturns0s	0h	
0	SOFT_RESET	R/W	0h	Software reset - Writing a one to this bit causes the CPGMAC_SL logic to be reset. After writing a one to this bit, it may be polled to determine if the reset has occurred. If a one is read, the reset has not yet occurred. If a zero is read then reset has occurred.

14.5.7.5 RX_MAXLEN Register (offset = 10h) [reset = 5EEh]

Register mask: FFFFFFFFh

RX_MAXLEN is shown in [Figure 14-177](#) and described in [Table 14-192](#).

CPGMAC_SL RX MAXIMUM LENGTH REGISTER

Figure 14-177. RX_MAXLEN Register

31	30	29	28	27	26	25	24	23	22	21	20	19	18	17	16	15	14	13	12	11	10	9	8	7	6	5	4	3	2	1	0
RESERVED																		RX_MAXLEN													
Rreturns0s-0h																		R/W-5EEh													

LEGEND: R/W = Read/Write; R = Read only; W1toCl = Write 1 to clear bit; -n = value after reset

Table 14-192. RX_MAXLEN Register Field Descriptions

Bit	Field	Type	Reset	Description
31-14	RESERVED	Rreturns0s	0h	
13-0	RX_MAXLEN	R/W	5EEh	RX Maximum Frame Length - This field determines the maximum length of a received frame. The reset value is 1518 (dec). Frames with byte counts greater than rx_maxlen are long frames. Long frames with no errors are oversized frames. Long frames with CRC, code, or alignment error are jabber frames. The maximum value is 16,383.

14.5.7.6 BOFFTEST Register (offset = 14h) [reset = 0h]

Register mask: FFFFFFFFh

 BOFFTEST is shown in [Figure 14-178](#) and described in [Table 14-193](#).

CPGMAC_SL BACKOFF TEST REGISTER

Figure 14-178. BOFFTEST Register

31	30	29	28	27	26	25	24
RESERVED		PACEVAL				RNDNUM	
Rreturns0s-0h		R/W-0h				R/W-0h	
23	22	21	20	19	18	17	16
RNDNUM							
R/W-0h							
15	14	13	12	11	10	9	8
COLL_COUNT				RESERVED		TX_BACKOFF	
R-0h				Rreturns0s-0h		R-0h	
7	6	5	4	3	2	1	0
TX_BACKOFF							
R-0h							

LEGEND: R/W = Read/Write; R = Read only; W1toCl = Write 1 to clear bit; -n = value after reset

Table 14-193. BOFFTEST Register Field Descriptions

Bit	Field	Type	Reset	Description
31	RESERVED	Rreturns0s	0h	
30-26	PACEVAL	R/W	0h	Pacing Register Current Value. A non-zero value in this field indicates that transmit pacing is active. A transmit frame collision or deferral causes paceval to loaded with decimal 31, good frame transmissions (with no collisions or deferrals) cause paceval to be decremented down to zero. When paceval is nonzero, the transmitter delays 4 IPGs between new frame transmissions after each successfully transmitted frame that had no deferrals or collisions. Transmit pacing helps reduce "capture" effects improving overall network bandwidth.
25-16	RNDNUM	R/W	0h	Backoff Random Number Generator - This field allows the Backoff Random Number Generator to be read (or written in test mode only). This field can be written only when mtest has previously been set. Reading this field returns the generator's current value. The value is reset to zero and begins counting on the clock after the deassertion of reset.
15-12	COLL_COUNT	R	0h	Collision Count - The number of collisions the current frame has experienced.
11-10	RESERVED	Rreturns0s	0h	
9-0	TX_BACKOFF	R	0h	Backoff Count - This field allows the current value of the backoff counter to be observed for test purposes. This field is loaded automatically according to the backoff algorithm, and is decremented by one for each slot time after the collision.

14.5.7.7 RX_PAUSE Register (offset = 18h) [reset = 0h]

Register mask: FFFFFFFFh

RX_PAUSE is shown in [Figure 14-179](#) and described in [Table 14-194](#).

CPGMAC_SL RECEIVE PAUSE TIMER REGISTER

Figure 14-179. RX_PAUSE Register

31	30	29	28	27	26	25	24	23	22	21	20	19	18	17	16	15	14	13	12	11	10	9	8	7	6	5	4	3	2	1	0
rx_pausetimer																RESERVED															
R-0h																Rreturns0s-0h															

LEGEND: R/W = Read/Write; R = Read only; W1toCl = Write 1 to clear bit; -n = value after reset

Table 14-194. RX_PAUSE Register Field Descriptions

Bit	Field	Type	Reset	Description
31-16	rx_pausetimer	R	0h	RX Pause Timer Value - This field allows the contents of the receive pause timer to be observed (and written in test mode). The receive pause timer is loaded with 0xFF00 when the CPGMAC_SL sends an outgoing pause frame (with pause time of 0xFFFF). The receive pause timer is decremented at slot time intervals. If the receive pause timer decrements to zero, then another outgoing pause frame will be sent and the load/decrement process will be repeated.
15-0	RESERVED	Rreturns0s	0h	

14.5.7.8 TX_PAUSE Register (offset = 1Ch) [reset = 0h]

Register mask: FFFFFFFFh

 TX_PAUSE is shown in [Figure 14-180](#) and described in [Table 14-195](#).

CPGMAC_SL TRANSMIT PAUSE TIMER REGISTER

Figure 14-180. TX_PAUSE Register

31	30	29	28	27	26	25	24	23	22	21	20	19	18	17	16	15	14	13	12	11	10	9	8	7	6	5	4	3	2	1	0
tx_pausetimer																RESERVED															
R-0h																Rreturns0s-0h															

LEGEND: R/W = Read/Write; R = Read only; W1toCl = Write 1 to clear bit; -n = value after reset

Table 14-195. TX_PAUSE Register Field Descriptions

Bit	Field	Type	Reset	Description
31-16	tx_pausetimer	R	0h	TX Pause Timer Value - This field allows the contents of the transmit pause timer to be observed (and written in test mode). The transmit pause timer is loaded by a received (incoming) pause frame, and then decremented, at slottime intervals, down to zero at which time CPGMAC_SL transmit frames are again enabled.
15-0	RESERVED	Rreturns0s	0h	

14.5.7.9 EMCONTROL Register (offset = 20h) [reset = 0h]

Register mask: FFFFFFFFh

 EMCONTROL is shown in [Figure 14-181](#) and described in [Table 14-196](#).

CPGMAC_SL EMULATION CONTROL REGISTER

Figure 14-181. EMCONTROL Register

31	30	29	28	27	26	25	24
RESERVED							
Rreturns0s-0h							
23	22	21	20	19	18	17	16
RESERVED							
Rreturns0s-0h							
15	14	13	12	11	10	9	8
RESERVED							
Rreturns0s-0h							
7	6	5	4	3	2	1	0
RESERVED						SOFT	FREE
Rreturns0s-0h						R/W-0h	R/W-0h

LEGEND: R/W = Read/Write; R = Read only; W1toCl = Write 1 to clear bit; -n = value after reset

Table 14-196. EMCONTROL Register Field Descriptions

Bit	Field	Type	Reset	Description
31-2	RESERVED	Rreturns0s	0h	
1	SOFT	R/W	0h	Emulation Soft Bit
0	FREE	R/W	0h	Emulation Free Bit

14.5.7.10 RX_PRI_MAP Register (offset = 24h) [reset = 76543210h]

Register mask: FFFFFFFFh

 RX_PRI_MAP is shown in [Figure 14-182](#) and described in [Table 14-197](#).

CPGMAC_SL RX PKT PRIORITY TO HEADER PRIORITY MAPPING REGISTER

Figure 14-182. RX_PRI_MAP Register

31	30	29	28	27	26	25	24
RESERVED		PRI7		RESERVED		PRI6	
Rreturns0s-0h		R/W-7h		Rreturns0s-0h		R/W-6h	
23	22	21	20	19	18	17	16
RESERVED		PRI5		RESERVED		PRI4	
Rreturns0s-0h		R/W-5h		Rreturns0s-0h		R/W-4h	
15	14	13	12	11	10	9	8
RESERVED		PRI3		RESERVED		PRI2	
Rreturns0s-0h		R/W-3h		Rreturns0s-0h		R/W-2h	
7	6	5	4	3	2	1	0
RESERVED		PRI1		RESERVED		PRI0	
Rreturns0s-0h		R/W-1h		Rreturns0s-0h		R/W-0h	

LEGEND: R/W = Read/Write; R = Read only; W1toCl = Write 1 to clear bit; -n = value after reset

Table 14-197. RX_PRI_MAP Register Field Descriptions

Bit	Field	Type	Reset	Description
31	RESERVED	Rreturns0s	0h	
30-28	PRI7	R/W	7h	Priority 7 - A packet priority of 0x7 is mapped (changed) to this value.
27	RESERVED	Rreturns0s	0h	
26-24	PRI6	R/W	6h	Priority 6 - A packet priority of 0x6 is mapped (changed) to this value.
23	RESERVED	Rreturns0s	0h	
22-20	PRI5	R/W	5h	Priority 5 - A packet priority of 0x5 is mapped (changed) to this value.
19	RESERVED	Rreturns0s	0h	
18-16	PRI4	R/W	4h	Priority 4 - A packet priority of 0x4 is mapped (changed) to this value.
15	RESERVED	Rreturns0s	0h	
14-12	PRI3	R/W	3h	Priority 3 - A packet priority of 0x3 is mapped (changed) to this value.
11	RESERVED	Rreturns0s	0h	
10-8	PRI2	R/W	2h	Priority 2 - A packet priority of 0x2 is mapped (changed) to this value.
7	RESERVED	Rreturns0s	0h	
6-4	PRI1	R/W	1h	Priority 1 - A packet priority of 0x1 is mapped (changed) to this value.
3	RESERVED	Rreturns0s	0h	
2-0	PRI0	R/W	0h	Priority 0 - A packet priority of 0x0 is mapped (changed) to this value.

14.5.7.11 TX_GAP Register (offset = 28h) [reset = Ch]

Register mask: FFFFFFFFh

TX_GAP is shown in [Figure 14-183](#) and described in [Table 14-198](#).

TRANSMIT INTER-PACKET GAP REGISTER

Figure 14-183. TX_GAP Register

31	30	29	28	27	26	25	24	23	22	21	20	19	18	17	16	15	14	13	12	11	10	9	8	7	6	5	4	3	2	1	0
RESERVED																TX_GAP															
Rreturns0s-0h																R/W-Ch															

LEGEND: R/W = Read/Write; R = Read only; W1toCl = Write 1 to clear bit; -n = value after reset

Table 14-198. TX_GAP Register Field Descriptions

Bit	Field	Type	Reset	Description
31-9	RESERVED	Rreturns0s	0h	
8-0	TX_GAP	R/W	Ch	Transmit Inter-Packet Gap

14.5.8 CPSW_SS Registers

[Table 14-199](#) lists the memory-mapped registers for the CPSW_SS. All register offset addresses not listed in [Table 14-199](#) should be considered as reserved locations and the register contents should not be modified.

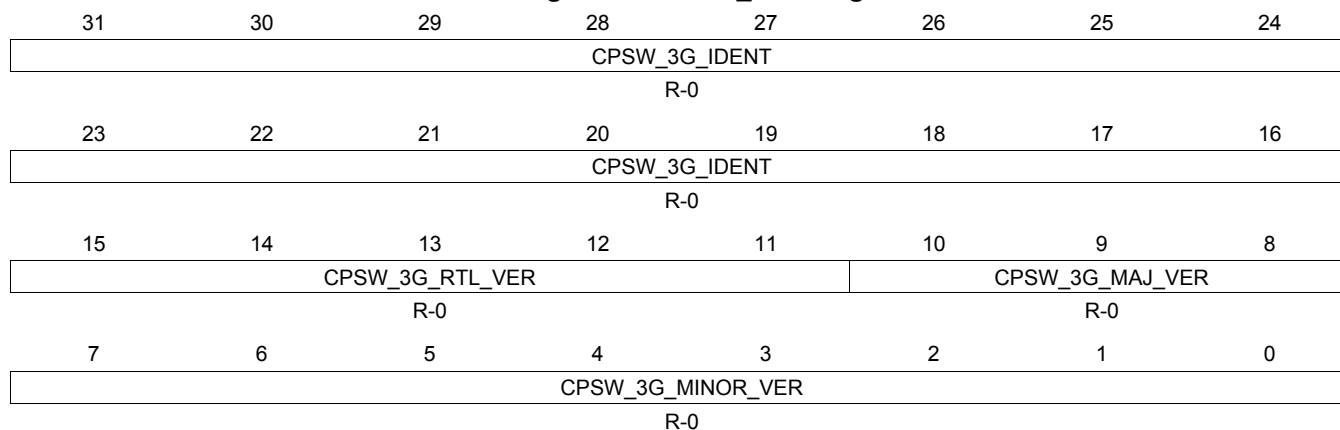
Table 14-199. CPSW_SS REGISTERS

Offset	Acronym	Register Name	Section
0h	ID_VER	ID VERSION REGISTER	Section 14.5.8.1
4h	CONTROL	SWITCH CONTROL REGISTER	Section 14.5.8.2
8h	SOFT_RESET	SOFT RESET REGISTER	Section 14.5.8.3
Ch	STAT_PORT_EN	STATISTICS PORT ENABLE REGISTER	Section 14.5.8.4
10h	PTYPE	TRANSMIT PRIORITY TYPE REGISTER	Section 14.5.8.5
14h	SOFT_IDLE	SOFTWARE IDLE	Section 14.5.8.6
18h	THRU_RATE	THROUGHPUT RATE	Section 14.5.8.7
1Ch	GAP_THRESH	CPGMAC_SL SHORT GAP THRESHOLD	Section 14.5.8.8
20h	TX_START_WDS	TRANSMIT START WORDS	Section 14.5.8.9
24h	FLOW_CONTROL	FLOW CONTROL	Section 14.5.8.10
28h	VLAN_LTYPE	LTYPE1 AND LTYPE 2 REGISTER	Section 14.5.8.11
2Ch	TS_LTYPE	VLAN_LTYPE1 AND VLAN_LTYPE2 REGISTER	Section 14.5.8.12
30h	DLR_LTYPE	DLR LTYPE REGISTER	Section 14.5.8.13

14.5.8.1 ID_VER Register (offset = 0h) [reset = 190112h]

 ID_VER is shown in [Figure 14-184](#) and described in [Table 14-200](#).

ID VERSION REGISTER

Figure 14-184. ID_VER Register


LEGEND: R/W = Read/Write; R = Read only; W1toCl = Write 1 to clear bit; -n = value after reset

Table 14-200. ID_VER Register Field Descriptions

Bit	Field	Type	Reset	Description
31-16	CPSW_3G_IDENT	R-0	0	3G Identification Value
15-11	CPSW_3G_RTL_VER	R-0	0	3G RTL Version Value
10-8	CPSW_3G_MAJ_VER	R-0	0	3G Major Version Value
7-0	CPSW_3G_MINOR_VER	R-0	0	3G Minor Version Value

14.5.8.2 CONTROL Register (offset = 4h) [reset = 0h]

CONTROL is shown in [Figure 14-185](#) and described in [Table 14-201](#).

SWITCH CONTROL REGISTER

Figure 14-185. CONTROL Register

31	30	29	28	27	26	25	24
Reserved							
23	22	21	20	19	18	17	16
Reserved							
15	14	13	12	11	10	9	8
Reserved							
7	6	5	4	3	2	1	0
Reserved				DLR_EN	RX_VLAN_EN CAP	VLAN_AWARE	FIFO_LOOPBA CK
				R/W-0	R/W-0	R/W-0	R/W-0

LEGEND: R/W = Read/Write; R = Read only; W1toCl = Write 1 to clear bit; -n = value after reset

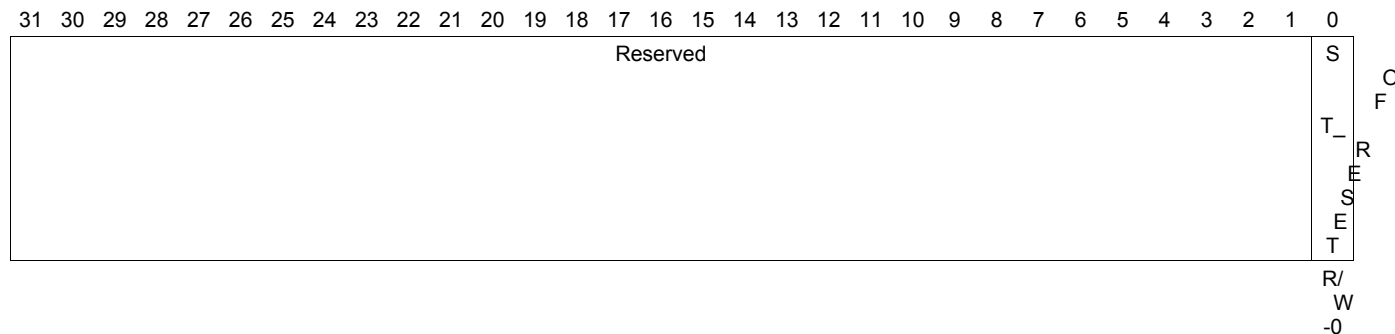
Table 14-201. CONTROL Register Field Descriptions

Bit	Field	Type	Reset	Description
3	DLR_EN	R/W-0	0	DLR enable 0 - DLR is disabled. DLR packets will not be moved to queue priority 3 and will not be separated out onto dlr_cpdma_ch. 1 - DLR is disabled. DLR packets be moved to destination port transmit queue priority 3 and will be separated out onto dlr_cpdma_ch when packet is to egress on port 0.
2	RX_VLAN_ENCAP	R/W-0	0	Port 0 VLAN Encapsulation (egress): 0 - Port 0 receive packets (from 3G) are not VLAN encapsulated. 1 - Port 0 receive packets (from 3G) are VLAN encapsulated.
1	VLAN_AWARE	R/W-0	0	VLAN Aware Mode: 0 - 3G is in the VLAN unaware mode. 1 - 3G is in the VLAN aware mode.
0	FIFO_LOOPBACK	R/W-0	0	FIFO Loopback Mode 0 - Loopback is disabled 1 - FIFO Loopback mode enabled. Each packet received is turned around and sent out on the same port's transmit path. Port 2 receive is fixed on channel zero. The RXSOFOVERRUN statistic will increment for every packet sent in FIFO loopback mode.

14.5.8.3 SOFT_RESET Register (offset = 8h) [reset = 0h]

 SOFT_RESET is shown in [Figure 14-186](#) and described in [Table 14-202](#).

SOFT RESET REGISTER

Figure 14-186. SOFT_RESET Register


LEGEND: R/W = Read/Write; R = Read only; W1toCl = Write 1 to clear bit; -n = value after reset

Table 14-202. SOFT_RESET Register Field Descriptions

Bit	Field	Type	Reset	Description
0	SOFT_RESET	R/W-0	0	Software reset - Writing a one to this bit causes the 3G logic to be reset. After writing a one to this bit, it may be polled to determine if the reset has occurred. If a one is read, the reset has not yet occurred. If a zero is read then reset has occurred.

14.5.8.4 STAT_PORT_EN Register (offset = Ch) [reset = 0h]

 STAT_PORT_EN is shown in [Figure 14-187](#) and described in [Table 14-203](#).

STATISTICS PORT ENABLE REGISTER

Figure 14-187. STAT_PORT_EN Register

31	30	29	28	27	26	25	24
Reserved							
23	22	21	20	19	18	17	16
Reserved							
15	14	13	12	11	10	9	8
Reserved							
7	6	5	4	3	2	1	0
Reserved					P2_STAT_EN	P1_STAT_EN	P0_STAT_EN
					R/W-0	R/W-0	R/W-0

LEGEND: R/W = Read/Write; R = Read only; W1toCl = Write 1 to clear bit; -n = value after reset

Table 14-203. STAT_PORT_EN Register Field Descriptions

Bit	Field	Type	Reset	Description
2	P2_STAT_EN	R/W-0	0	Port 2 (GMII2 and Port 2 FIFO) Statistics Enable 0 - Port 2 statistics are not enabled. 1 - Port 2 statistics are enabled.
1	P1_STAT_EN	R/W-0	0	Port 1 (GMII1 and Port 1 FIFO) Statistics Enable 0 - Port 1 statistics are not enabled. 1 - Port 1 statistics are enabled.
0	P0_STAT_EN	R/W-0	0	Port 0 Statistics Enable 0 - Port 0 statistics are not enabled 1 - Port 0 statistics are enabled. FIFO overruns (SOFOVERRUNS) are the only port 0 statistics that are enabled to be kept.

14.5.8.5 PTYPE Register (offset = 10h) [reset = 0h]

 PTYPE is shown in [Figure 14-188](#) and described in [Table 14-204](#).

TRANSMIT PRIORITY TYPE REGISTER
Figure 14-188. PTYPE Register

31	30	29	28	27	26	25	24
Reserved							
23	22	21	20	19	18	17	16
Reserved		P2_PRI3_SHAPE_EN	P2_PRI2_SHAPE_EN	P2_PRI1_SHAPE_EN	P1_PRI3_SHAPE_EN	P1_PRI2_SHAPE_EN	P1_PRI1_SHAPE_EN
		R/W-0	R/W-0	R/W-0	R/W-0	R/W-0	R/W-0
15	14	13	12	11	10	9	8
Reserved					P2_PTYPE_ESC	P1_PTYPE_ESC	P0_PTYPE_ESC
					R/W-0	R/W-0	R/W-0
7	6	5	4	3	2	1	0
Reserved				ESC_PRI_LD_VAL			
R/W-0							

LEGEND: R/W = Read/Write; R = Read only; W1toCl = Write 1 to clear bit; -n = value after reset

Table 14-204. PTYPE Register Field Descriptions

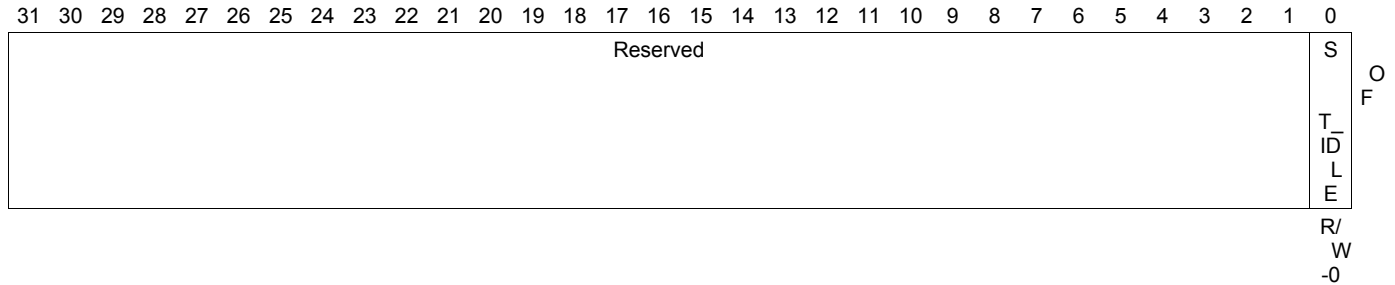
Bit	Field	Type	Reset	Description
21	P2_PRI3_SHAPE_EN	R/W-0	0	Port 2 Queue Priority 3 Transmit Shape Enable - If there is only one shaping queue then it must be priority 3.
20	P2_PRI2_SHAPE_EN	R/W-0	0	Port 2 Queue Priority 2 Transmit Shape Enable - If there are two shaping queues then they must be priorities 3 and 2.
19	P2_PRI1_SHAPE_EN	R/W-0	0	Port 2 Queue Priority 1 Transmit Shape Enable - If there are three shaping queues all three bits should be set.
18	P1_PRI3_SHAPE_EN	R/W-0	0	Port 1 Queue Priority 3 Transmit Shape Enable - If there is only one shaping queue then it must be priority 3.
17	P1_PRI2_SHAPE_EN	R/W-0	0	Port 1 Queue Priority 2 Transmit Shape Enable- If there are two shaping queues then they must be priorities 3 and 2.
16	P1_PRI1_SHAPE_EN	R/W-0	0	Port 1 Queue Priority 1 Transmit Shape Enable- If there are three shaping queues all three bits should be set.
10	P2_PTYPE_ESC	R/W-0	0	Port 2 Priority Type Escalate - 0 - Port 2 priority type fixed 1 - Port 2 priority type escalate Escalate should not be used with queue shaping.
9	P1_PTYPE_ESC	R/W-0	0	Port 1 Priority Type Escalate - 0 - Port 1 priority type fixed 1 - Port 1 priority type escalate Escalate should not be used with queue shaping.
8	P0_PTYPE_ESC	R/W-0	0	Port 0 Priority Type Escalate - 0 - Port 0 priority type fixed 1 - Port 0 priority type escalate Escalate should not be used with queue shaping.
4-0	ESC_PRI_LD_VAL	R/W-0	0	Escalate Priority Load Value When a port is in escalate priority, this is the number of higher priority packets sent before the next lower priority is allowed to send a packet. Escalate priority allows lower priority packets to be sent at a fixed rate relative to the next higher priority.

14.5.8.6 SOFT_IDLE Register (offset = 14h) [reset = 0h]

SOFT_IDLE is shown in [Figure 14-189](#) and described in [Table 14-205](#).

SOFTWARE IDLE

Figure 14-189. SOFT_IDLE Register



LEGEND: R/W = Read/Write; R = Read only; W1toCl = Write 1 to clear bit; -n = value after reset

Table 14-205. SOFT_IDLE Register Field Descriptions

Bit	Field	Type	Reset	Description
0	SOFT_IDLE	R/W-0	0	Software Idle - Setting this bit causes the switch fabric to stop forwarding packets at the next start of packet.

14.5.8.7 THRU_RATE Register (offset = 18h) [reset = 3003h]

 THRU_RATE is shown in [Figure 14-190](#) and described in [Table 14-206](#).

THROUGHPUT RATE

Figure 14-190. THRU_RATE Register

31	30	29	28	27	26	25	24
Reserved							
23	22	21	20	19	18	17	16
Reserved							
15	14	13	12	11	10	9	8
SL_RX_THRU_RATE				Reserved			
R/W-0							
7	6	5	4	3	2	1	0
Reserved				CPDMA_THRU_RATE			
R/W-0							

LEGEND: R/W = Read/Write; R = Read only; W1toCl = Write 1 to clear bit; -n = value after reset

Table 14-206. THRU_RATE Register Field Descriptions

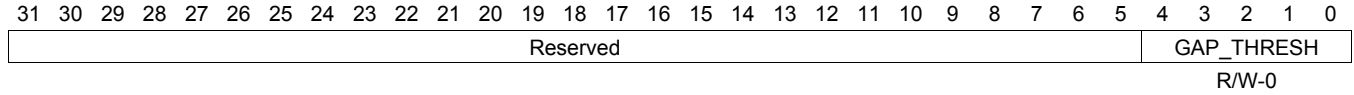
Bit	Field	Type	Reset	Description
15-12	SL_RX_THRU_RATE	R/W-0	0	CPGMAC_SL Switch FIFO receive through rate. This register value is the maximum throughput of the ethernet ports to the crossbar SCR. The default is one 8-byte word for every 3 CLK periods maximum.
3-0	CPDMA_THRU_RATE	R/W-0	0	CPDMA Switch FIFO receive through rate. This register value is the maximum throughput of the CPDMA host port to the crossbar SCR. The default is one 8-byte word for every 3 CLK periods maximum.

14.5.8.8 GAP_THRESH Register (offset = 1Ch) [reset = Bh]

GAP_THRESH is shown in [Figure 14-191](#) and described in [Table 14-207](#).

CPGMAC_SL SHORT GAP THRESHOLD

Figure 14-191. GAP_THRESH Register



LEGEND: R/W = Read/Write; R = Read only; W1toCl = Write 1 to clear bit; -n = value after reset

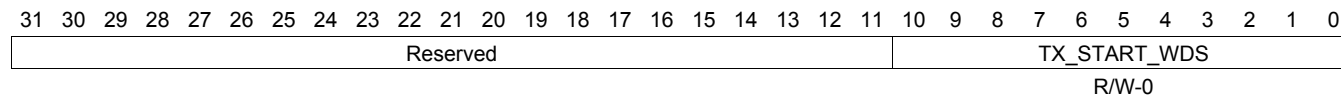
Table 14-207. GAP_THRESH Register Field Descriptions

Bit	Field	Type	Reset	Description
4-0	GAP_THRESH	R/W-0	0	CPGMAC_SL Short Gap Threshold - This is the CPGMAC_SL associated FIFO transmit block usage value for triggering TX_SHORT_GAP.

14.5.8.9 TX_START_WDS Register (offset = 20h) [reset = 20h]

TX_START_WDS is shown in [Figure 14-192](#) and described in [Table 14-208](#).

TRANSMIT START WORDS

Figure 14-192. TX_START_WDS Register


LEGEND: R/W = Read/Write; R = Read only; W1toCl = Write 1 to clear bit; -n = value after reset

Table 14-208. TX_START_WDS Register Field Descriptions

Bit	Field	Type	Reset	Description
10-0	TX_START_WDS	R/W-0	0	FIFO Packet Transmit (egress) Start Words. This value is the number of required packet words in the transmit FIFO before the packet egress will begin. This value is non-zero to preclude underrun. Decimal 32 is the recommended value. It should not be increased unnecessarily to prevent adding to the switch latency.

14.5.8.10 FLOW_CONTROL Register (offset = 24h) [reset = 1h]

FLOW_CONTROL is shown in [Figure 14-193](#) and described in [Table 14-209](#).

FLOW CONTROL

Figure 14-193. FLOW_CONTROL Register

31	30	29	28	27	26	25	24
Reserved							
23	22	21	20	19	18	17	16
Reserved							
15	14	13	12	11	10	9	8
Reserved							
7	6	5	4	3	2	1	0
Reserved					P2_FLOW_EN	P1_FLOW_EN	P0_FLOW_EN
					R/W-0	R/W-0	R/W-0

LEGEND: R/W = Read/Write; R = Read only; W1toCl = Write 1 to clear bit; -n = value after reset

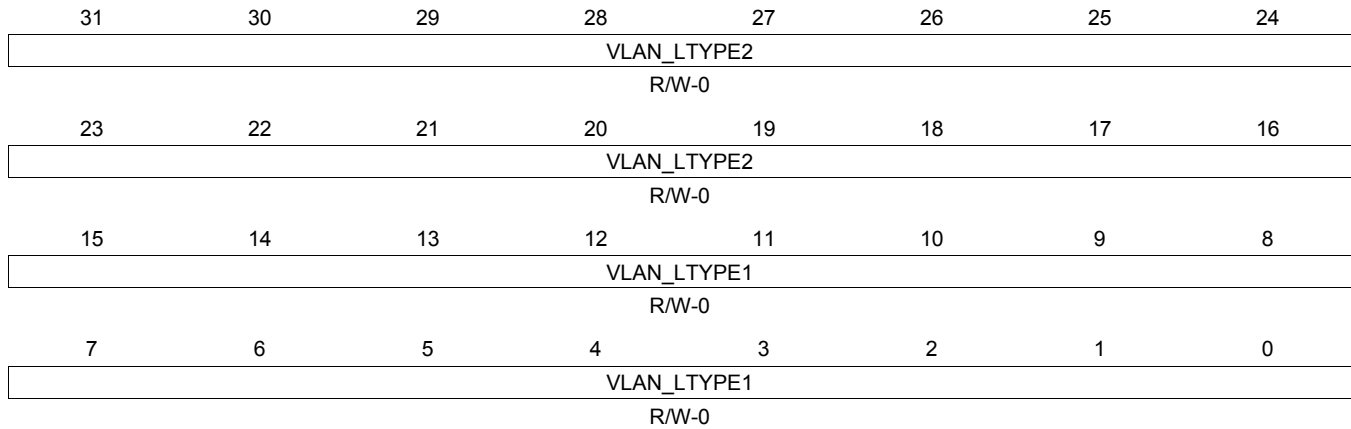
Table 14-209. FLOW_CONTROL Register Field Descriptions

Bit	Field	Type	Reset	Description
2	P2_FLOW_EN	R/W-0	0	Port 2 Receive flow control enable
1	P1_FLOW_EN	R/W-0	0	Port 1 Receive flow control enable
0	P0_FLOW_EN	R/W-0	0	Port 0 Receive flow control enable

14.5.8.11 VLAN_LTYPE Register (offset = 28h) [reset = 81008100h]

 VLAN_LTYPE is shown in [Figure 14-194](#) and described in [Table 14-210](#).

LTYPE1 AND LTYPE 2 REGISTER

Figure 14-194. VLAN_LTYPE Register


LEGEND: R/W = Read/Write; R = Read only; W1toCl = Write 1 to clear bit; -n = value after reset

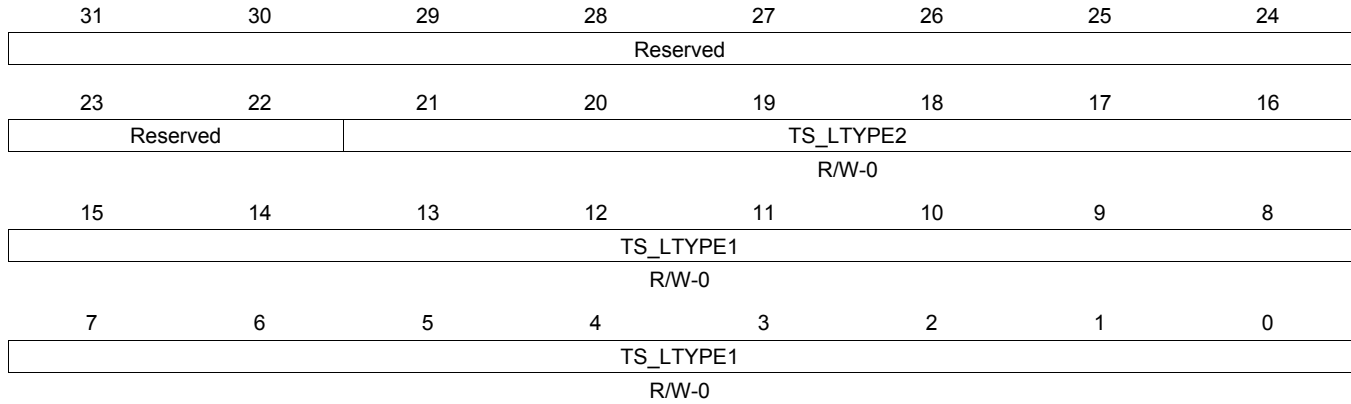
Table 14-210. VLAN_LTYPE Register Field Descriptions

Bit	Field	Type	Reset	Description
31-16	VLAN_LTYPE2	R/W-0	0	Time Sync VLAN LTYPE2 This VLAN LTYPE value is used for tx and rx. This is the inner VLAN if both are present.
15-0	VLAN_LTYPE1	R/W-0	0	Time Sync VLAN LTYPE1 This VLAN LTYPE value is used for tx and rx. This is the outer VLAN if both are present.

14.5.8.12 TS_LTYPE Register (offset = 2Ch) [reset = 0h]

 TS_LTYPE is shown in [Figure 14-195](#) and described in [Table 14-211](#).

VLAN_LTYPE1 AND VLAN_LTYPE2 REGISTER

Figure 14-195. TS_LTYPE Register


LEGEND: R/W = Read/Write; R = Read only; W1toCl = Write 1 to clear bit; -n = value after reset

Table 14-211. TS_LTYPE Register Field Descriptions

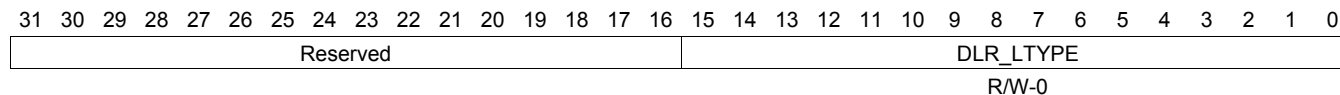
Bit	Field	Type	Reset	Description
21-16	TS_LTYPE2	R/W-0	0	Time Sync LTYPE2 This is an Ethertype value to match for tx and rx time sync packets.
15-0	TS_LTYPE1	R/W-0	0	Time Sync LTYPE1 This is an ethertype value to match for tx and rx time sync packets.

14.5.8.13 DLR_LTYPE Register (offset = 30h) [reset = 80E1h]

DLR_LTYPE is shown in [Figure 14-196](#) and described in [Table 14-212](#).

DLR LTYPE REGISTER

Figure 14-196. DLR_LTYPE Register



LEGEND: R/W = Read/Write; R = Read only; W1toCl = Write 1 to clear bit; -n = value after reset

Table 14-212. DLR_LTYPE Register Field Descriptions

Bit	Field	Type	Reset	Description
15-0	DLR_LTYPE	R/W-0	0	DLR LTYPE

14.5.9 CPSW_WR Registers

[Table 14-213](#) lists the memory-mapped registers for the CPSW_WR. All register offset addresses not listed in [Table 14-213](#) should be considered as reserved locations and the register contents should not be modified.

Table 14-213. CPSW_WR REGISTERS

Offset	Acronym	Register Name	Section
0h	IDVER		Section 14.5.9.1
4h	SOFT_RESET		Section 14.5.9.2
8h	CONTROL		Section 14.5.9.3
Ch	INT_CONTROL		Section 14.5.9.4
10h	C0_RX_THRESH_EN		Section 14.5.9.5
14h	C0_RX_EN		Section 14.5.9.6
18h	C0_TX_EN		Section 14.5.9.7
1Ch	C0_MISC_EN		Section 14.5.9.8
20h	C1_RX_THRESH_EN		Section 14.5.9.9
24h	C1_RX_EN		Section 14.5.9.10
28h	C1_TX_EN		Section 14.5.9.11
2Ch	C1_MISC_EN		Section 14.5.9.12
30h	C2_RX_THRESH_EN		Section 14.5.9.13
34h	C2_RX_EN		Section 14.5.9.14
38h	C2_TX_EN		Section 14.5.9.15
3Ch	C2_MISC_EN		Section 14.5.9.16
40h	C0_RX_THRESH_STAT		Section 14.5.9.17
44h	C0_RX_STAT		Section 14.5.9.18
48h	C0_TX_STAT		Section 14.5.9.19
4Ch	C0_MISC_STAT		Section 14.5.9.20
50h	C1_RX_THRESH_STAT		Section 14.5.9.21
54h	C1_RX_STAT		Section 14.5.9.22
58h	C1_TX_STAT		Section 14.5.9.23
5Ch	C1_MISC_STAT		Section 14.5.9.24
60h	C2_RX_THRESH_STAT		Section 14.5.9.25
64h	C2_RX_STAT		Section 14.5.9.26
68h	C2_TX_STAT		Section 14.5.9.27
6Ch	C2_MISC_STAT		Section 14.5.9.28

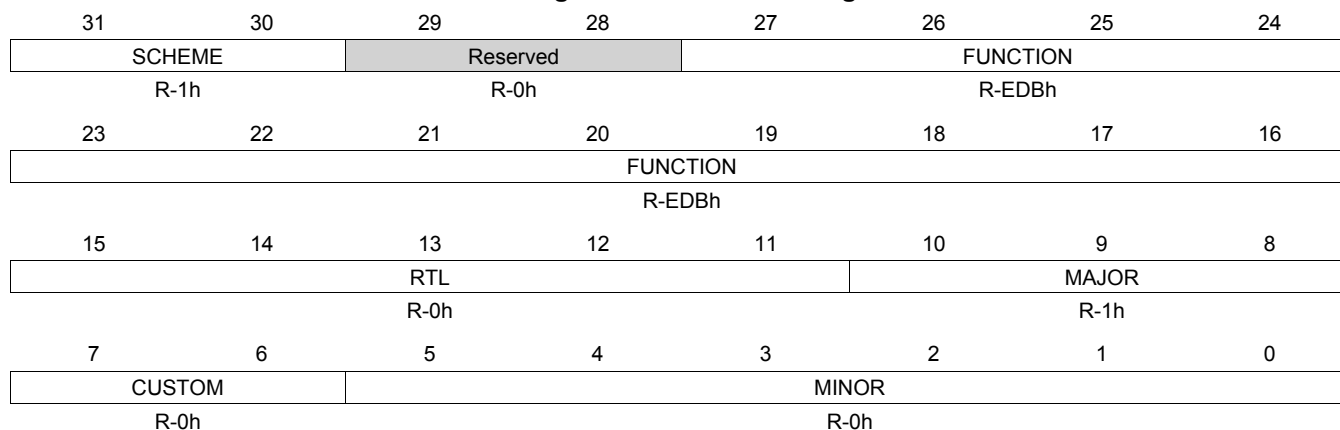
Table 14-213. CPSW_WR REGISTERS (continued)

Offset	Acronym	Register Name	Section
70h	C0_RX_IMAX		Section 14.5.9.29
74h	C0_TX_IMAX		Section 14.5.9.30
78h	C1_RX_IMAX		Section 14.5.9.31
7Ch	C1_TX_IMAX		Section 14.5.9.32
80h	C2_RX_IMAX		Section 14.5.9.33
84h	C2_TX_IMAX		Section 14.5.9.34
88h	RGMII_CTL		Section 14.5.9.35

14.5.9.1 IDVER Register (offset = 0h) [reset = 4EDB0100h]

 IDVER is shown in [Figure 14-197](#) and described in [Table 14-214](#).

SUBSYSTEM ID VERSION REGISTER

Figure 14-197. IDVER Register


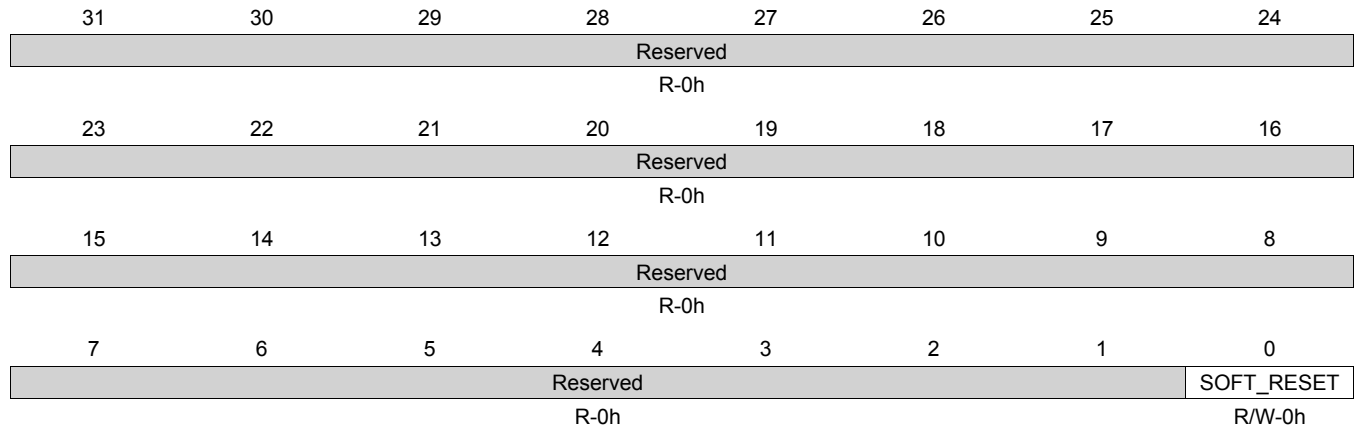
LEGEND: R/W = Read/Write; R = Read only; W1toCl = Write 1 to clear bit; -n = value after reset

Table 14-214. IDVER Register Field Descriptions

Bit	Field	Type	Reset	Description
31-30	SCHEME	R	1h	Scheme value
29-28	Reserved	R	0h	
27-16	FUNCTION	R	EDBh	function value
15-11	RTL	R	0h	rtl version
10-8	MAJOR	R	1h	major version
7-6	CUSTOM	R	0h	custom version
5-0	MINOR	R	0h	minor version

14.5.9.2 SOFT_RESET Register (offset = 4h) [reset = 0h]

 SOFT_RESET is shown in [Figure 14-198](#) and described in [Table 14-215](#).

SUBSYSTEM SOFT RESET REGISTER
Figure 14-198. SOFT_RESET Register


LEGEND: R/W = Read/Write; R = Read only; W1toCl = Write 1 to clear bit; -n = value after reset

Table 14-215. SOFT_RESET Register Field Descriptions

Bit	Field	Type	Reset	Description
31-1	Reserved	R	0h	
0	SOFT_RESET	R/W	0h	Software reset - Writing a one to this bit causes the CPGMACSS_R logic to be reset (INT, REGS, CPPI). Software reset occurs on the clock following the register bit write.

14.5.9.3 CONTROL Register (offset = 8h) [reset = 0h]

 CONTROL is shown in [Figure 14-199](#) and described in [Table 14-216](#).

SUBSYSTEM CONTROL REGISTER

Figure 14-199. CONTROL Register

31	30	29	28	27	26	25	24
Reserved							
R-0h							
23	22	21	20	19	18	17	16
Reserved							
R-0h							
15	14	13	12	11	10	9	8
Reserved							
R-0h							
7	6	5	4	3	2	1	0
Reserved				MMR_STDBYMODE		MMR_IDLEMODE	
R-0h				R/W-0h		R/W-0h	

LEGEND: R/W = Read/Write; R = Read only; W1toCl = Write 1 to clear bit; -n = value after reset

Table 14-216. CONTROL Register Field Descriptions

Bit	Field	Type	Reset	Description
31-4	Reserved	R	0h	
3-2	MMR_STDBYMODE	R/W	0h	Configuration of the local initiator state management mode. By definition, initiator may generate read/write transaction as long as it is out of STANDBY state. 0x0 = Force-standby mode : Local initiator is unconditionally placed in standby state. 0x1 = No-standby mode : Local initiator is unconditionally placed out of standby state. 0x2 = Reserved : Reserved. 0x3 = Reserved : Reserved.
1-0	MMR_IDLEMODE	R/W	0h	Configuration of the local initiator state management mode. By definition, initiator may generate read/write transaction as long as it is out of IDLE state. 0x0 = Force-idle mode : Local initiator is unconditionally placed in idle state. 0x1 = No-idle mode : Local initiator is unconditionally placed out of idle state. 0x2 = Reserved : Reserved. 0x3 = Reserved : Reserved.

14.5.9.4 INT_CONTROL Register (offset = Ch) [reset = 0h]

INT_CONTROL is shown in [Figure 14-200](#) and described in [Table 14-217](#).

SUBSYSTEM INTERRUPT CONTROL

Figure 14-200. INT_CONTROL Register

31	30	29	28	27	26	25	24
INT_TEST		Reserved					
R/W-0h		R-0h					
23	22	21	20	19	18	17	16
Reserved		INT_PACE_EN					
R-0h		R/W-0h					
15	14	13	12	11	10	9	8
Reserved				INT_PRESCALE			
R-0h				R-0h			
7	6	5	4	3	2	1	0
INT_PRESCALE							
R-0h							

LEGEND: R/W = Read/Write; R = Read only; W1toCl = Write 1 to clear bit; -n = value after reset

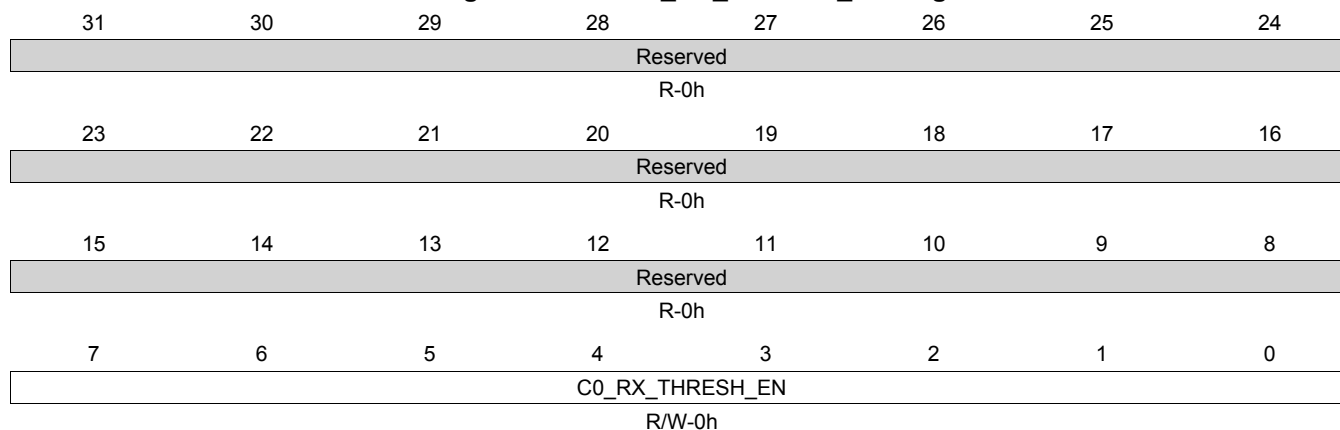
Table 14-217. INT_CONTROL Register Field Descriptions

Bit	Field	Type	Reset	Description
31	INT_TEST	R/W	0h	Interrupt Test - Test bit to the interrupt pacing blocks
30-22	Reserved	R	0h	
21-16	INT_PACE_EN	R/W	0h	Interrupt Pacing Enable Bus int_pace_en[0] - Enables C0_Rx_Pulse Pacing (0 is pacing bypass) int_pace_en[1] - Enables C0_Tx_Pulse Pacing (0 is pacing bypass) int_pace_en[2] - Enables C1_Rx_Pulse Pacing (0 is pacing bypass) int_pace_en[3] - Enables C1_Tx_Pulse Pacing (0 is pacing bypass) int_pace_en[4] - Enables C2_Rx_Pulse Pacing (0 is pacing bypass) int_pace_en[5] - Enables C2_Tx_Pulse Pacing (0 is pacing bypass)
15-12	Reserved	R	0h	
11-0	INT_PRESCALE	R	0h	Interrupt Counter Prescaler - The number of MAIN_CLK periods in 4us.

14.5.9.5 C0_RX_THRESH_EN Register (offset = 10h) [reset = 0h]

 C0_RX_THRESH_EN is shown in [Figure 14-201](#) and described in [Table 14-218](#).

SUBSYSTEM CORE 0 RECEIVE THRESHOLD INT ENABLE REGISTER

Figure 14-201. C0_RX_THRESH_EN Register


LEGEND: R/W = Read/Write; R = Read only; W1toCl = Write 1 to clear bit; -n = value after reset

Table 14-218. C0_RX_THRESH_EN Register Field Descriptions

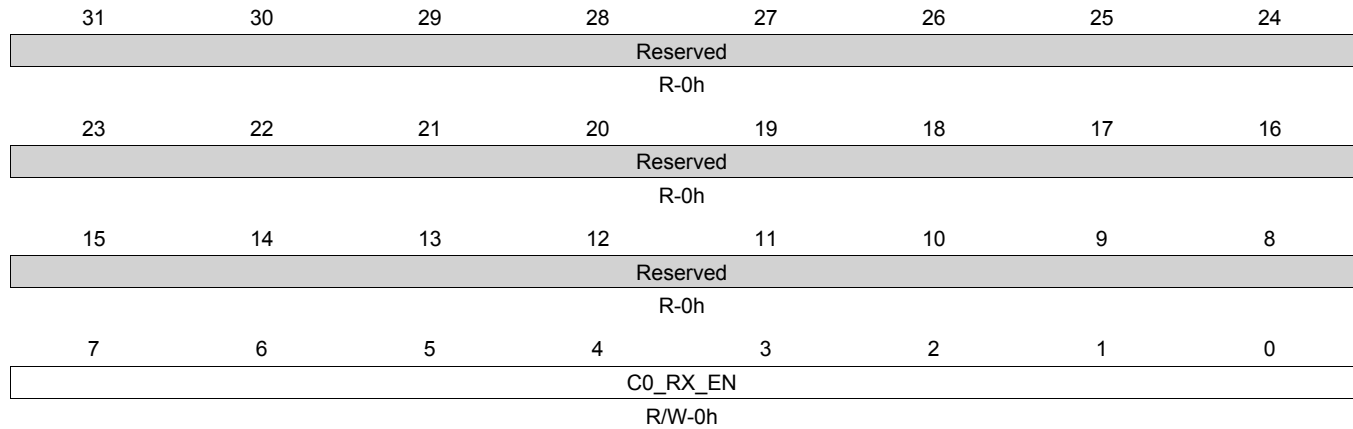
Bit	Field	Type	Reset	Description
31-8	Reserved	R	0h	
7-0	C0_RX_THRESH_EN	R/W	0h	Core 0 Receive Threshold Enable - Each bit in this register corresponds to the bit in the receive threshold interrupt that is enabled to generate an interrupt on C0_RX_THRESH_PULSE.

14.5.9.6 C0_RX_EN Register (offset = 14h) [reset = 0h]

C0_RX_EN is shown in [Figure 14-202](#) and described in [Table 14-219](#).

SUBSYSTEM CORE 0 RECEIVE INTERRUPT ENABLE REGISTER

Figure 14-202. C0_RX_EN Register



LEGEND: R/W = Read/Write; R = Read only; W1toCl = Write 1 to clear bit; -n = value after reset

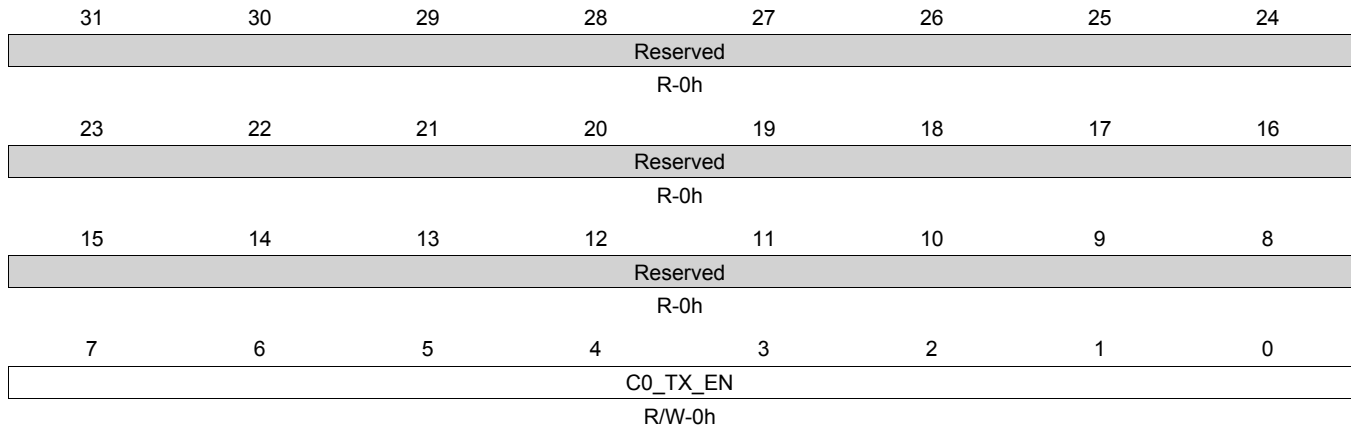
Table 14-219. C0_RX_EN Register Field Descriptions

Bit	Field	Type	Reset	Description
31-8	Reserved	R	0h	
7-0	C0_RX_EN	R/W	0h	Core 0 Receive Enable - Each bit in this register corresponds to the bit in the rx interrupt that is enabled to generate an interrupt on C0_RX_PULSE.

14.5.9.7 C0_TX_EN Register (offset = 18h) [reset = 0h]

 C0_TX_EN is shown in [Figure 14-203](#) and described in [Table 14-220](#).

SUBSYSTEM CORE 0 TRANSMIT INTERRUPT ENABLE REGISTER

Figure 14-203. C0_TX_EN Register


LEGEND: R/W = Read/Write; R = Read only; W1toCl = Write 1 to clear bit; -n = value after reset

Table 14-220. C0_TX_EN Register Field Descriptions

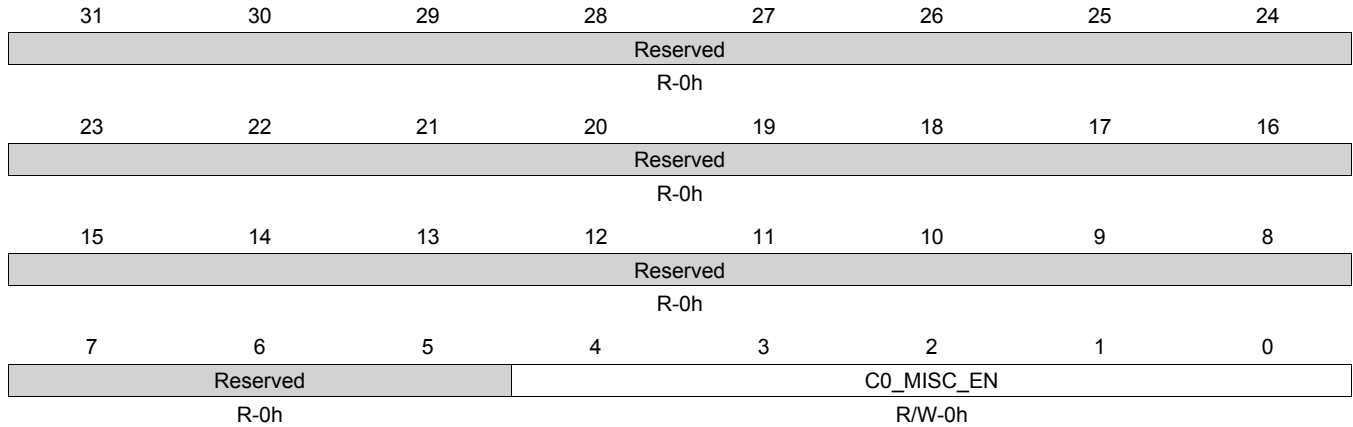
Bit	Field	Type	Reset	Description
31-8	Reserved	R	0h	
7-0	C0_TX_EN	R/W	0h	Core 0 Transmit Enable - Each bit in this register corresponds to the bit in the tx interrupt that is enabled to generate an interrupt on C0_TX_PULSE.

14.5.9.8 C0_MISC_EN Register (offset = 1Ch) [reset = 0h]

C0_MISC_EN is shown in [Figure 14-204](#) and described in [Table 14-221](#).

SUBSYSTEM CORE 0 MISC INTERRUPT ENABLE REGISTER

Figure 14-204. C0_MISC_EN Register



LEGEND: R/W = Read/Write; R = Read only; W1toCl = Write 1 to clear bit; -n = value after reset

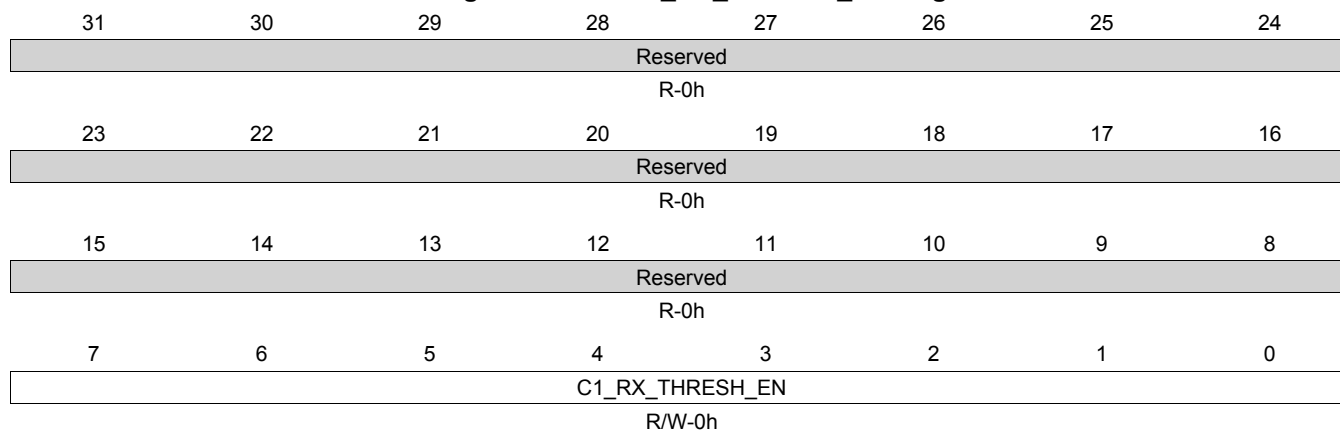
Table 14-221. C0_MISC_EN Register Field Descriptions

Bit	Field	Type	Reset	Description
31-5	Reserved	R	0h	
4-0	C0_MISC_EN	R/W	0h	Core 0 Misc Enable - Each bit in this register corresponds to the miscellaneous interrupt (evnt_pend, stat_pend, host_pend, mdio_linkint, mdio_userint) that is enabled to generate an interrupt on C0_Misc_PULSE. Bit 4 = evnt_pend Bit 3 = stat_pend Bit 2 = host_pend Bit 1 = mdio_linkint Bit 0 = mdio_userint

14.5.9.9 C1_RX_THRESH_EN Register (offset = 20h) [reset = 0h]

 C1_RX_THRESH_EN is shown in [Figure 14-205](#) and described in [Table 14-222](#).

SUBSYSTEM CORE 1 RECEIVE THRESHOLD INT ENABLE REGISTER

Figure 14-205. C1_RX_THRESH_EN Register


LEGEND: R/W = Read/Write; R = Read only; W1toCl = Write 1 to clear bit; -n = value after reset

Table 14-222. C1_RX_THRESH_EN Register Field Descriptions

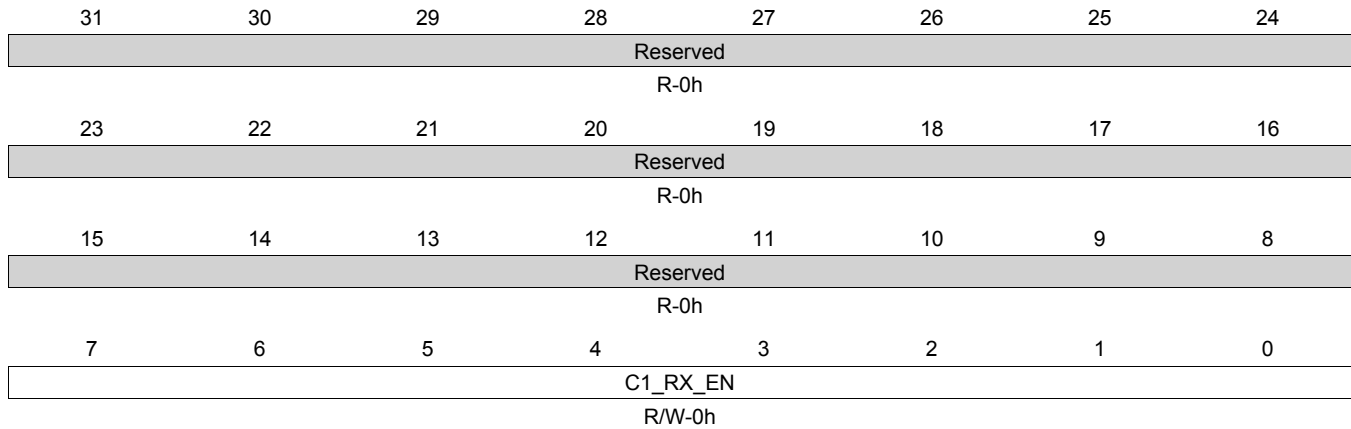
Bit	Field	Type	Reset	Description
31-8	Reserved	R	0h	
7-0	C1_RX_THRESH_EN	R/W	0h	Core 1 Receive Threshold Enable - Each bit in this register corresponds to the bit in the receive threshold interrupt that is enabled to generate an interrupt on C1_RX_THRESH_PULSE.

14.5.9.10 C1_RX_EN Register (offset = 24h) [reset = 0h]

C1_RX_EN is shown in [Figure 14-206](#) and described in [Table 14-223](#).

SUBSYSTEM CORE 1 RECEIVE INTERRUPT ENABLE REGISTER

Figure 14-206. C1_RX_EN Register



LEGEND: R/W = Read/Write; R = Read only; W1toCl = Write 1 to clear bit; -n = value after reset

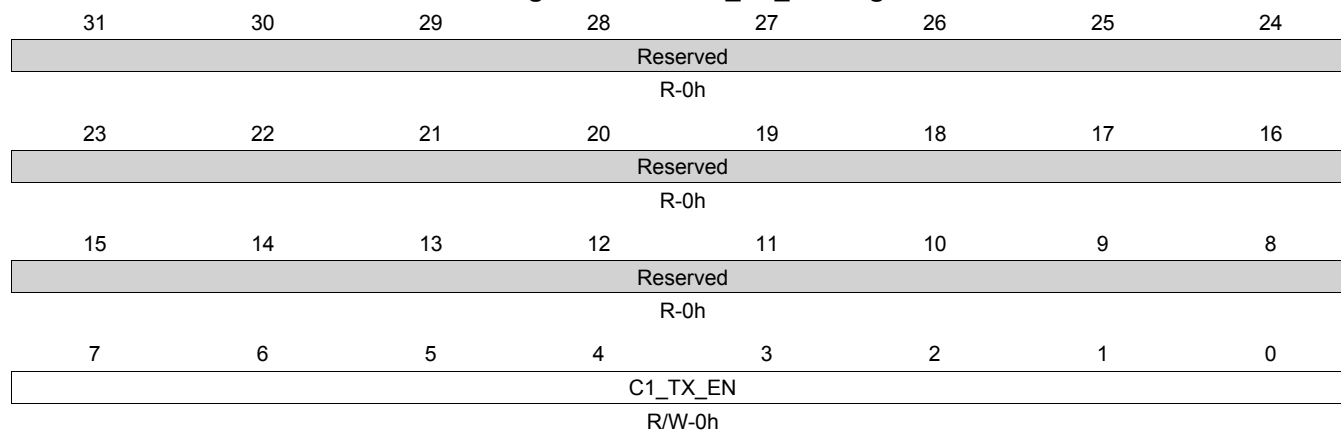
Table 14-223. C1_RX_EN Register Field Descriptions

Bit	Field	Type	Reset	Description
31-8	Reserved	R	0h	
7-0	C1_RX_EN	R/W	0h	Core 1 Receive Enable - Each bit in this register corresponds to the bit in the rx interrupt that is enabled to generate an interrupt on C1_RX_PULSE.

14.5.9.11 C1_TX_EN Register (offset = 28h) [reset = 0h]

 C1_TX_EN is shown in [Figure 14-207](#) and described in [Table 14-224](#).

SUBSYSTEM CORE 1 TRANSMIT INTERRUPT ENABLE REGISTER

Figure 14-207. C1_TX_EN Register


LEGEND: R/W = Read/Write; R = Read only; W1toCl = Write 1 to clear bit; -n = value after reset

Table 14-224. C1_TX_EN Register Field Descriptions

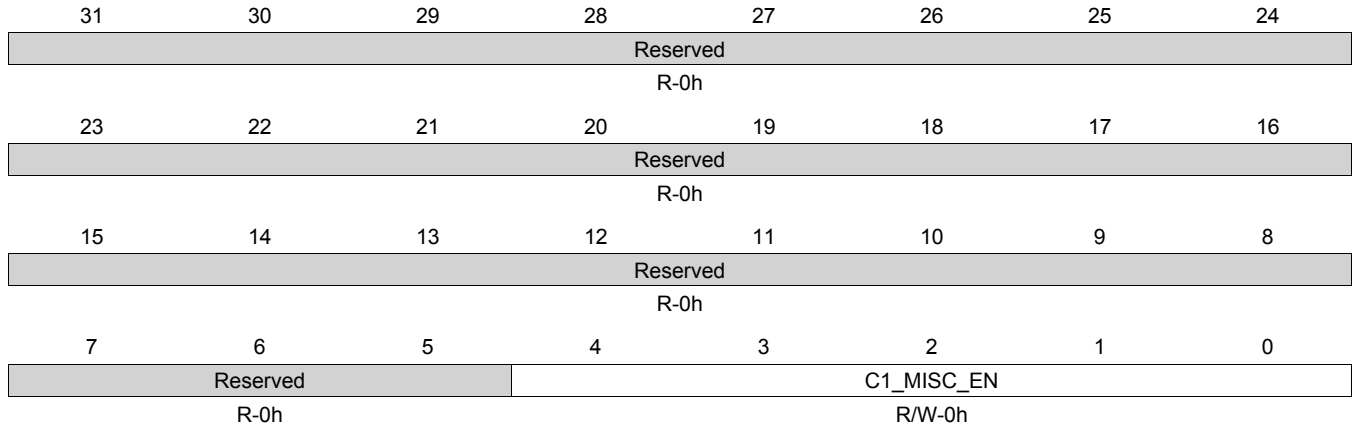
Bit	Field	Type	Reset	Description
31-8	Reserved	R	0h	
7-0	C1_TX_EN	R/W	0h	Core 1 Transmit Enable - Each bit in this register corresponds to the bit in the tx interrupt that is enabled to generate an interrupt on C1_TX_PULSE.

14.5.9.12 C1_MISC_EN Register (offset = 2Ch) [reset = 0h]

C1_MISC_EN is shown in [Figure 14-208](#) and described in [Table 14-225](#).

SUBSYSTEM CORE 1 MISC INTERRUPT ENABLE REGISTER

Figure 14-208. C1_MISC_EN Register



LEGEND: R/W = Read/Write; R = Read only; W1toCl = Write 1 to clear bit; -n = value after reset

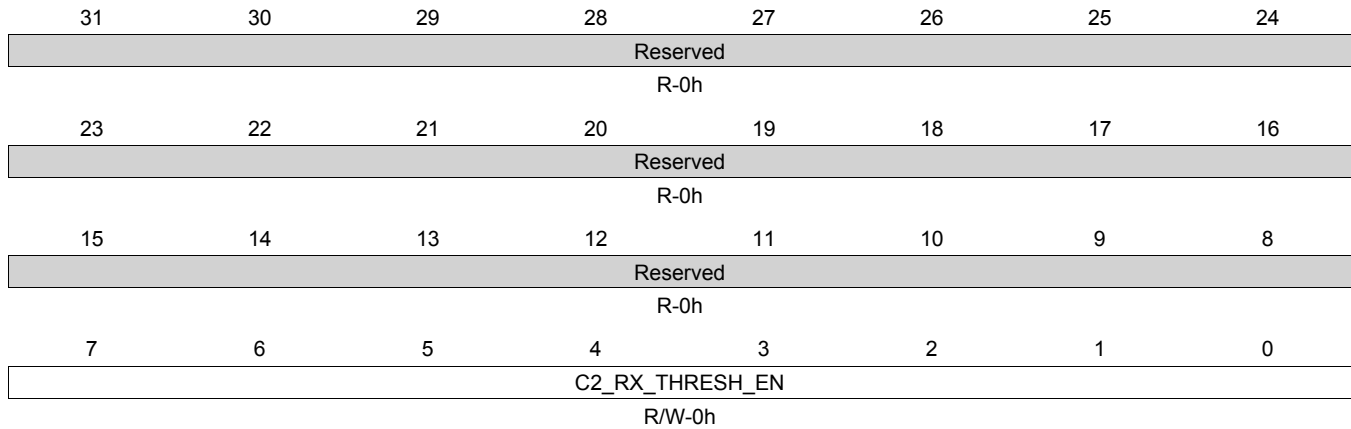
Table 14-225. C1_MISC_EN Register Field Descriptions

Bit	Field	Type	Reset	Description
31-5	Reserved	R	0h	
4-0	C1_MISC_EN	R/W	0h	Core 1 Misc Enable - Each bit in this register corresponds to the miscellaneous interrupt (evnt_pend, stat_pend, host_pend, mdio_linkint, mdio_userint) that is enabled to generate an interrupt on C1_Misc_PULSE. Bit 4 = evnt_pend Bit 3 = stat_pend Bit 2 = host_pend Bit 1 = mdio_linkint Bit 0 = mdio_userint

14.5.9.13 C2_RX_THRESH_EN Register (offset = 30h) [reset = 0h]

 C2_RX_THRESH_EN is shown in [Figure 14-209](#) and described in [Table 14-226](#).

SUBSYSTEM CORE 2 RECEIVE THRESHOLD INT ENABLE REGISTER

Figure 14-209. C2_RX_THRESH_EN Register


LEGEND: R/W = Read/Write; R = Read only; W1toCl = Write 1 to clear bit; -n = value after reset

Table 14-226. C2_RX_THRESH_EN Register Field Descriptions

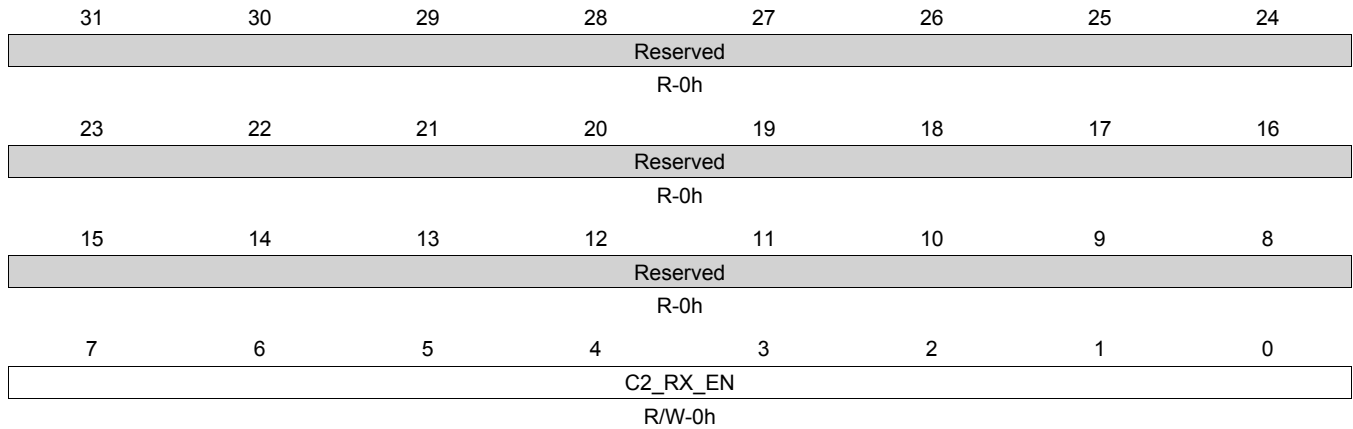
Bit	Field	Type	Reset	Description
31-8	Reserved	R	0h	
7-0	C2_RX_THRESH_EN	R/W	0h	Core 2 Receive Threshold Enable - Each bit in this register corresponds to the bit in the receive threshold interrupt that is enabled to generate an interrupt on C2_RX_THRESH_PULSE.

14.5.9.14 C2_RX_EN Register (offset = 34h) [reset = 0h]

C2_RX_EN is shown in [Figure 14-210](#) and described in [Table 14-227](#).

SUBSYSTEM CORE 2 RECEIVE INTERRUPT ENABLE REGISTER

Figure 14-210. C2_RX_EN Register



LEGEND: R/W = Read/Write; R = Read only; W1toCl = Write 1 to clear bit; -n = value after reset

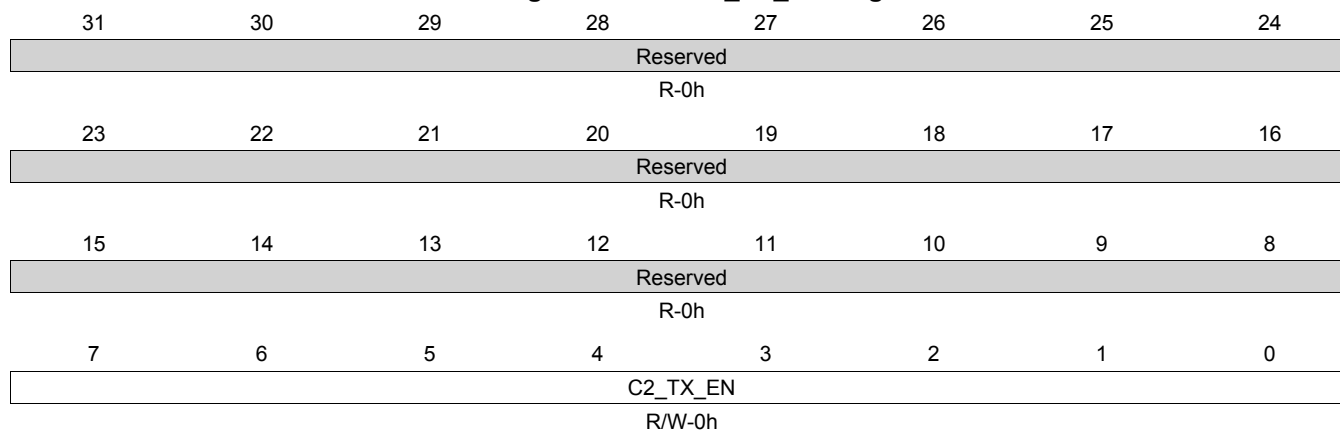
Table 14-227. C2_RX_EN Register Field Descriptions

Bit	Field	Type	Reset	Description
31-8	Reserved	R	0h	
7-0	C2_RX_EN	R/W	0h	Core 2 Receive Enable - Each bit in this register corresponds to the bit in the rx interrupt that is enabled to generate an interrupt on C2_RX_PULSE.

14.5.9.15 C2_TX_EN Register (offset = 38h) [reset = 0h]

 C2_TX_EN is shown in [Figure 14-211](#) and described in [Table 14-228](#).

SUBSYSTEM CORE 2 TRANSMIT INTERRUPT ENABLE REGISTER

Figure 14-211. C2_TX_EN Register


LEGEND: R/W = Read/Write; R = Read only; W1toCl = Write 1 to clear bit; -n = value after reset

Table 14-228. C2_TX_EN Register Field Descriptions

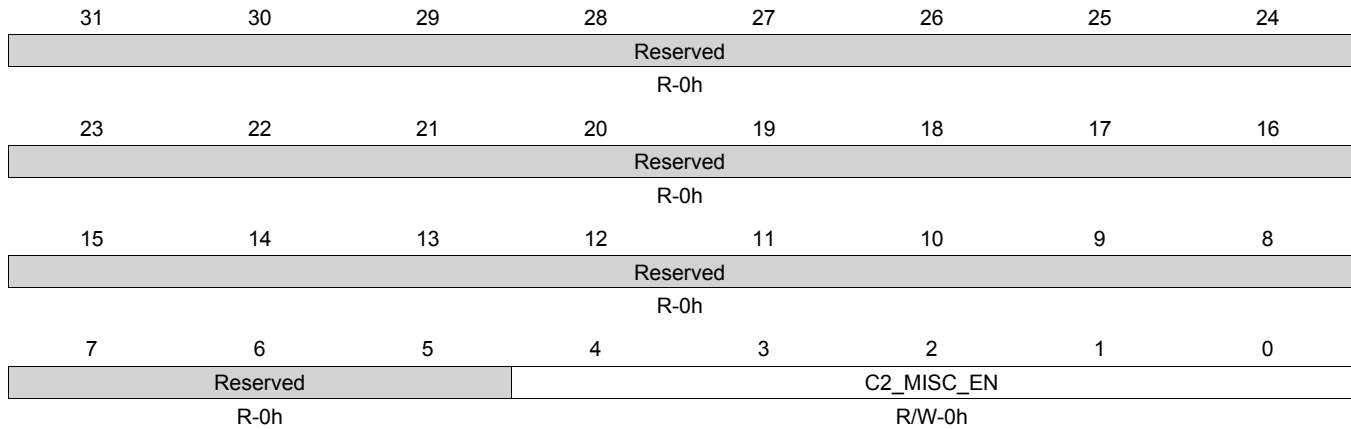
Bit	Field	Type	Reset	Description
31-8	Reserved	R	0h	
7-0	C2_TX_EN	R/W	0h	Core 2 Transmit Enable - Each bit in this register corresponds to the bit in the tx interrupt that is enabled to generate an interrupt on C2_TX_PULSE.

14.5.9.16 C2_MISC_EN Register (offset = 3Ch) [reset = 0h]

C2_MISC_EN is shown in [Figure 14-212](#) and described in [Table 14-229](#).

SUBSYSTEM CORE 2 MISC INTERRUPT ENABLE REGISTER

Figure 14-212. C2_MISC_EN Register



LEGEND: R/W = Read/Write; R = Read only; W1toCl = Write 1 to clear bit; -n = value after reset

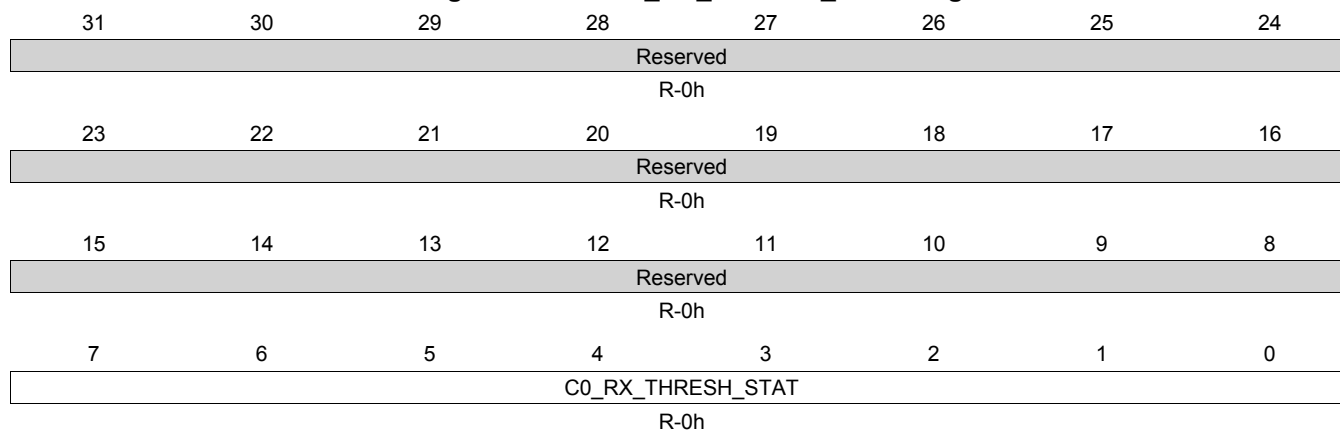
Table 14-229. C2_MISC_EN Register Field Descriptions

Bit	Field	Type	Reset	Description
31-5	Reserved	R	0h	
4-0	C2_MISC_EN	R/W	0h	Core 2 Misc Enable - Each bit in this register corresponds to the miscellaneous interrupt (evnt_pend, stat_pend, host_pend, mdio_linkint, mdio_userint) that is enabled to generate an interrupt on C2_Misc_PULSE. Bit 4 = evnt_pend Bit 3 = stat_pend Bit 2 = host_pend Bit 1 = mdio_linkint Bit 0 = mdio_userint

14.5.9.17 C0_RX_THRESH_STAT Register (offset = 40h) [reset = 0h]

 C0_RX_THRESH_STAT is shown in [Figure 14-213](#) and described in [Table 14-230](#).

SUBSYSTEM CORE 0 RX THRESHOLD MASKED INT STATUS REGISTER

Figure 14-213. C0_RX_THRESH_STAT Register


LEGEND: R/W = Read/Write; R = Read only; W1toCl = Write 1 to clear bit; -n = value after reset

Table 14-230. C0_RX_THRESH_STAT Register Field Descriptions

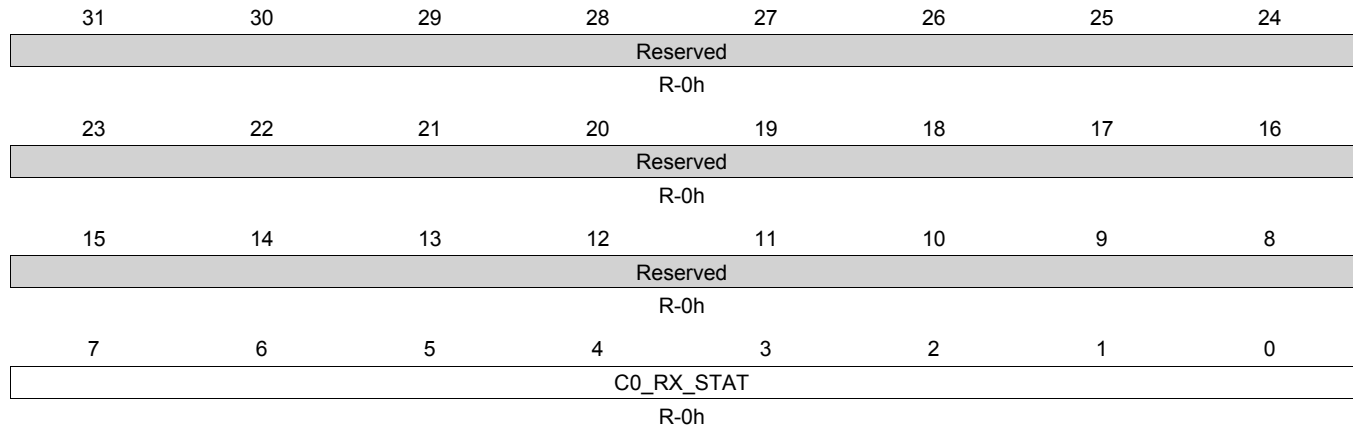
Bit	Field	Type	Reset	Description
31-8	Reserved	R	0h	
7-0	C0_RX_THRESH_STAT	R	0h	Core 0 Receive Threshold Masked Interrupt Status - Each bit in this read only register corresponds to the bit in the receive threshold interrupt that is enabled and generating an interrupt on C0_RX_THRESH_PULSE.

14.5.9.18 C0_RX_STAT Register (offset = 44h) [reset = 0h]

C0_RX_STAT is shown in [Figure 14-214](#) and described in [Table 14-231](#).

SUBSYSTEM CORE 0 RX INTERRUPT MASKED INT STATUS REGISTER

Figure 14-214. C0_RX_STAT Register



LEGEND: R/W = Read/Write; R = Read only; W1toCl = Write 1 to clear bit; -n = value after reset

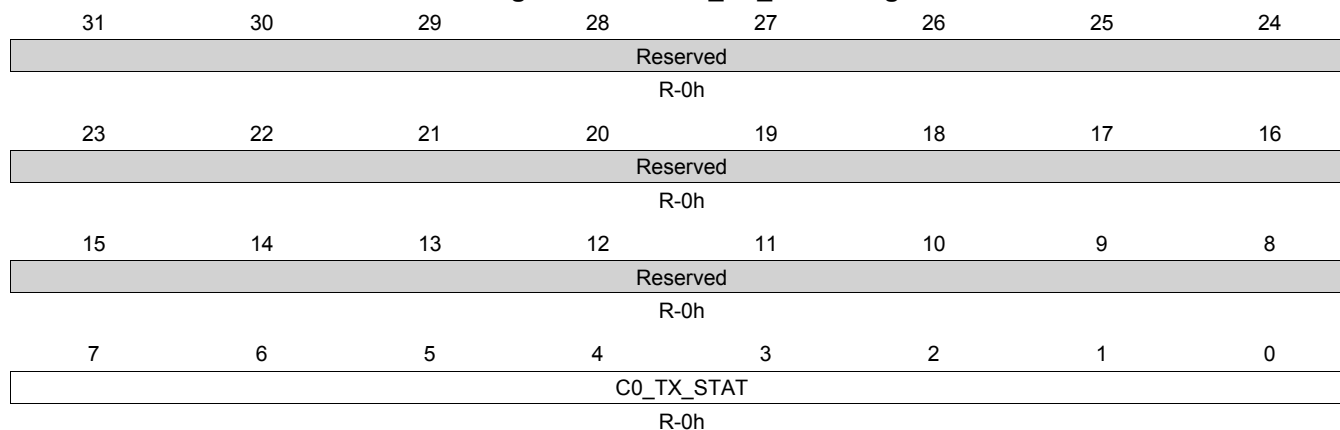
Table 14-231. C0_RX_STAT Register Field Descriptions

Bit	Field	Type	Reset	Description
31-8	Reserved	R	0h	
7-0	C0_RX_STAT	R	0h	Core 0 Receive Masked Interrupt Status - Each bit in this read only register corresponds to the bit in the Rx interrupt that is enabled and generating an interrupt on C0_RX_PULSE.

14.5.9.19 C0_TX_STAT Register (offset = 48h) [reset = 0h]

C0_TX_STAT is shown in [Figure 14-215](#) and described in [Table 14-232](#).

SUBSYSTEM CORE 0 TX INTERRUPT MASKED INT STATUS REGISTER

Figure 14-215. C0_TX_STAT Register


LEGEND: R/W = Read/Write; R = Read only; W1toCl = Write 1 to clear bit; -n = value after reset

Table 14-232. C0_TX_STAT Register Field Descriptions

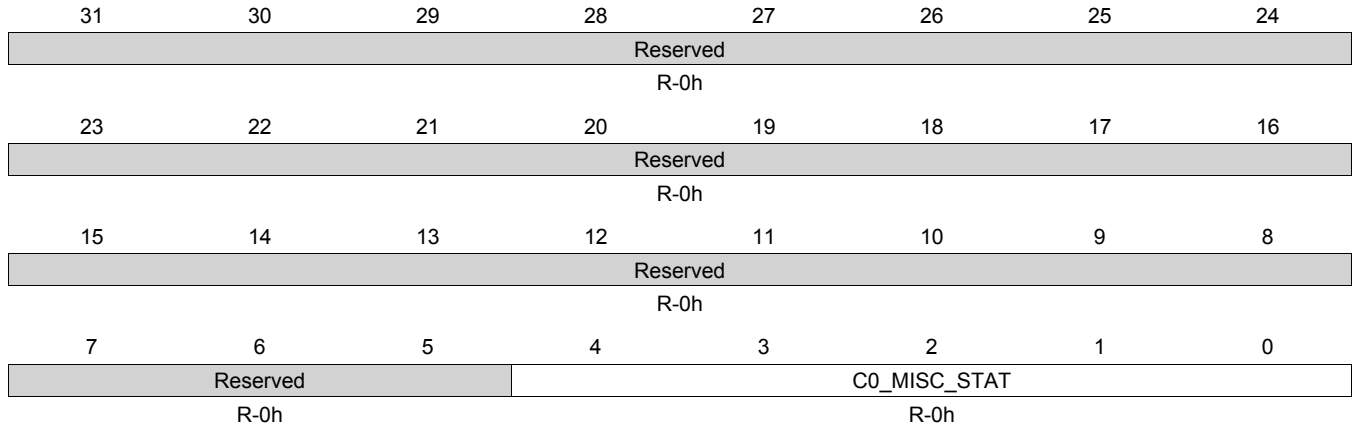
Bit	Field	Type	Reset	Description
31-8	Reserved	R	0h	
7-0	C0_TX_STAT	R	0h	Core 0 Transmit Masked Interrupt Status - Each bit in this read only register corresponds to the bit in the Tx interrupt that is enabled and generating an interrupt on C0_TX_PULSE .

14.5.9.20 C0_MISC_STAT Register (offset = 4Ch) [reset = 0h]

C0_MISC_STAT is shown in [Figure 14-216](#) and described in [Table 14-233](#).

SUBSYSTEM CORE 0 MISC INTERRUPT MASKED INT STATUS REGISTER

Figure 14-216. C0_MISC_STAT Register



LEGEND: R/W = Read/Write; R = Read only; W1toCl = Write 1 to clear bit; -n = value after reset

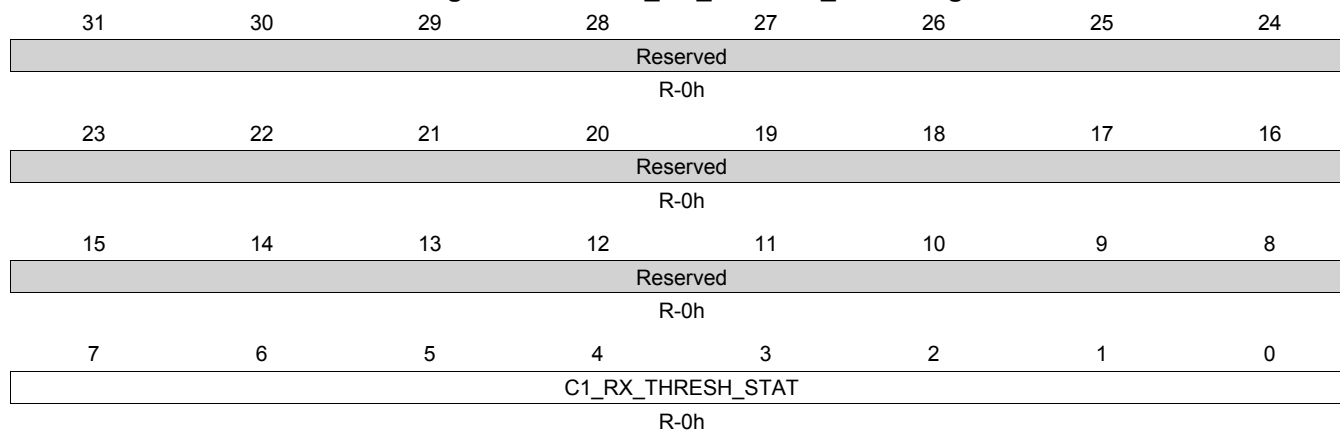
Table 14-233. C0_MISC_STAT Register Field Descriptions

Bit	Field	Type	Reset	Description
31-5	Reserved	R	0h	
4-0	C0_MISC_STAT	R	0h	Core 0 Misc Masked Interrupt Status - Each bit in this register corresponds to the miscellaneous interrupt (evnt_pend, stat_pend, host_pend, mdio_linkint, mdio_userint) that is enabled and generating an interrupt on C0_MISC_PULSE. Bit 4 = evnt_pend Bit 3 = stat_pend Bit 2 = host_pend Bit 1 = mdio_linkint Bit 0 = mdio_userint

14.5.9.21 C1_RX_THRESH_STAT Register (offset = 50h) [reset = 0h]

 C1_RX_THRESH_STAT is shown in [Figure 14-217](#) and described in [Table 14-234](#).

SUBSYSTEM CORE 1 RX THRESHOLD MASKED INT STATUS REGISTER

Figure 14-217. C1_RX_THRESH_STAT Register


LEGEND: R/W = Read/Write; R = Read only; W1toCl = Write 1 to clear bit; -n = value after reset

Table 14-234. C1_RX_THRESH_STAT Register Field Descriptions

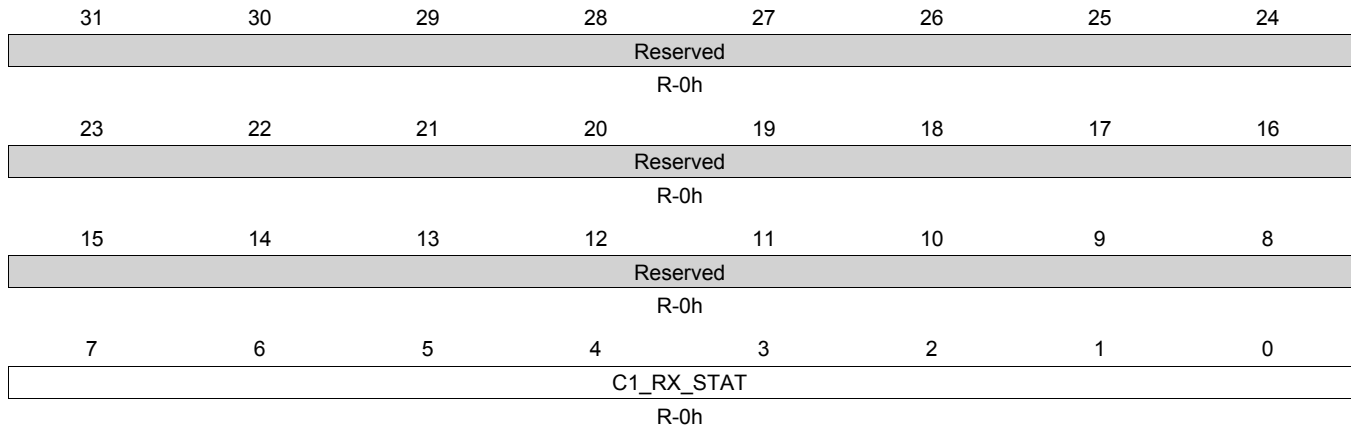
Bit	Field	Type	Reset	Description
31-8	Reserved	R	0h	
7-0	C1_RX_THRESH_STAT	R	0h	Core 1 Receive Threshold Masked Interrupt Status - Each bit in this register corresponds to the bit in the receive threshold interrupt that is enabled and generating an interrupt on C1_RX_THRESH_PULSE.

14.5.9.22 C1_RX_STAT Register (offset = 54h) [reset = 0h]

C1_RX_STAT is shown in [Figure 14-218](#) and described in [Table 14-235](#).

SUBSYSTEM CORE 1 RECEIVE MASKED INTERRUPT STATUS REGISTER

Figure 14-218. C1_RX_STAT Register



LEGEND: R/W = Read/Write; R = Read only; W1toCl = Write 1 to clear bit; -n = value after reset

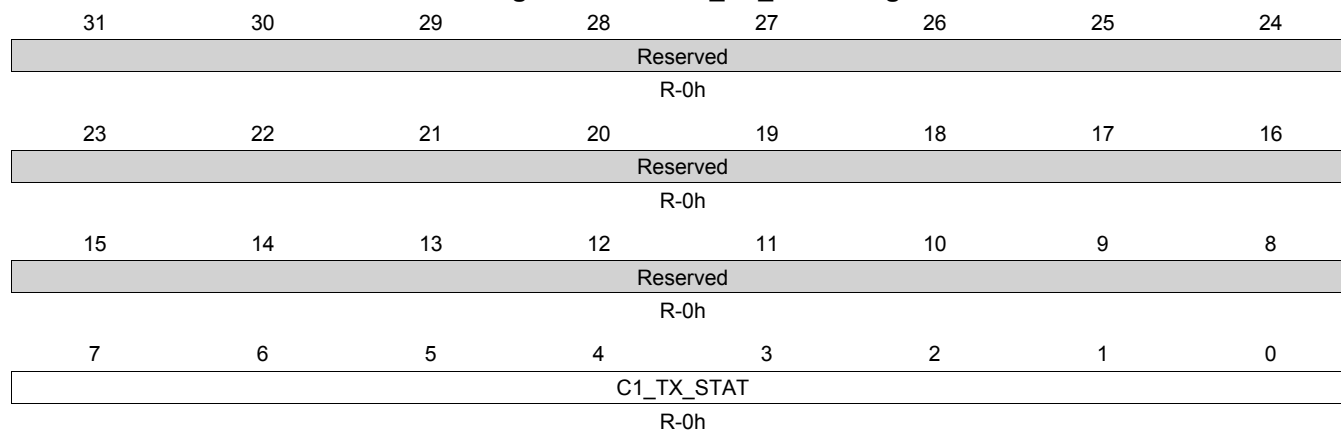
Table 14-235. C1_RX_STAT Register Field Descriptions

Bit	Field	Type	Reset	Description
31-8	Reserved	R	0h	
7-0	C1_RX_STAT	R	0h	Core 1 Receive Masked Interrupt Status - Each bit in this register corresponds to the bit in the Rx interrupt that is enabled and generating an interrupt on C1_RX_PULSE.

14.5.9.23 C1_TX_STAT Register (offset = 58h) [reset = 0h]

C1_TX_STAT is shown in [Figure 14-219](#) and described in [Table 14-236](#).

SUBSYSTEM CORE 1 TRANSMIT MASKED INTERRUPT STATUS REGISTER

Figure 14-219. C1_TX_STAT Register


LEGEND: R/W = Read/Write; R = Read only; W1toCl = Write 1 to clear bit; -n = value after reset

Table 14-236. C1_TX_STAT Register Field Descriptions

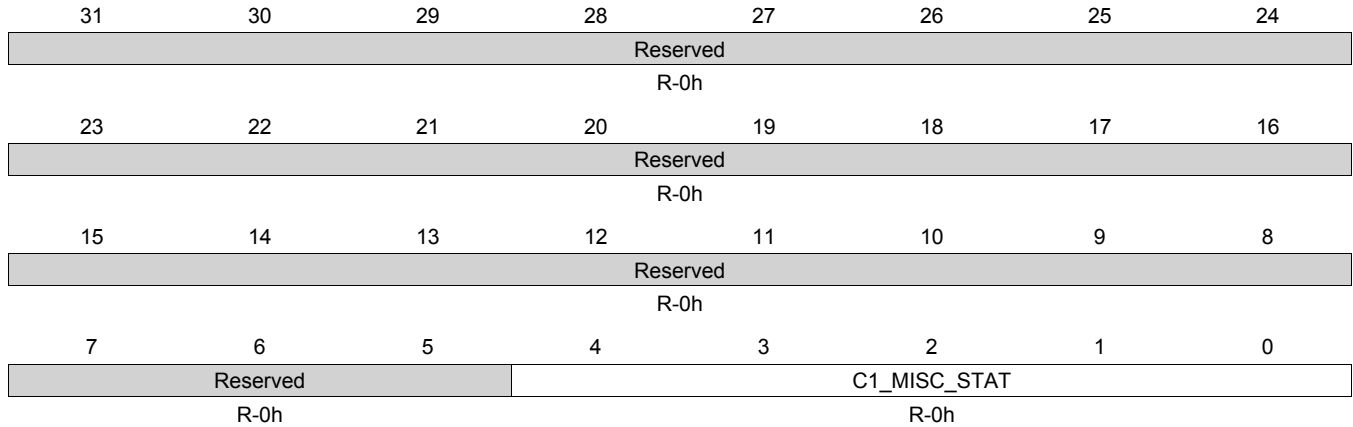
Bit	Field	Type	Reset	Description
31-8	Reserved	R	0h	
7-0	C1_TX_STAT	R	0h	Core 1 Transmit Masked Interrupt Status - Each bit in this register corresponds to the bit in the Tx interrupt that is enabled and generating an interrupt on C1_TX_PULSE.

14.5.9.24 C1_MISC_STAT Register (offset = 5Ch) [reset = 0h]

C1_MISC_STAT is shown in [Figure 14-220](#) and described in [Table 14-237](#).

SUBSYSTEM CORE 1 MISC MASKED INTERRUPT STATUS REGISTER

Figure 14-220. C1_MISC_STAT Register



LEGEND: R/W = Read/Write; R = Read only; W1toCl = Write 1 to clear bit; -n = value after reset

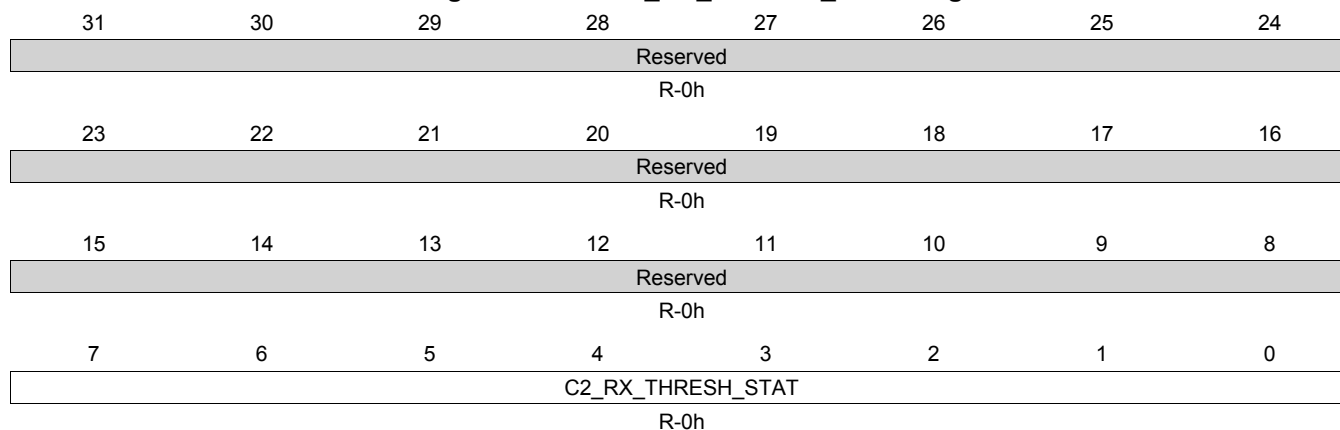
Table 14-237. C1_MISC_STAT Register Field Descriptions

Bit	Field	Type	Reset	Description
31-5	Reserved	R	0h	
4-0	C1_MISC_STAT	R	0h	Core 1 Misc Masked Interrupt Status - Each bit in this register corresponds to the miscellaneous interrupt (evnt_pend, stat_pend, host_pend, mdio_linkint, mdio_userint) that is enabled and generating an interrupt on C1_MISC_PULSE. Bit 4 = evnt_pend Bit 3 = stat_pend Bit 2 = host_pend Bit 1 = mdio_linkint Bit 0 = mdio_userint

14.5.9.25 C2_RX_THRESH_STAT Register (offset = 60h) [reset = 0h]

 C2_RX_THRESH_STAT is shown in [Figure 14-221](#) and described in [Table 14-238](#).

SUBSYSTEM CORE 2 RX THRESHOLD MASKED INT STATUS REGISTER

Figure 14-221. C2_RX_THRESH_STAT Register


LEGEND: R/W = Read/Write; R = Read only; W1toCl = Write 1 to clear bit; -n = value after reset

Table 14-238. C2_RX_THRESH_STAT Register Field Descriptions

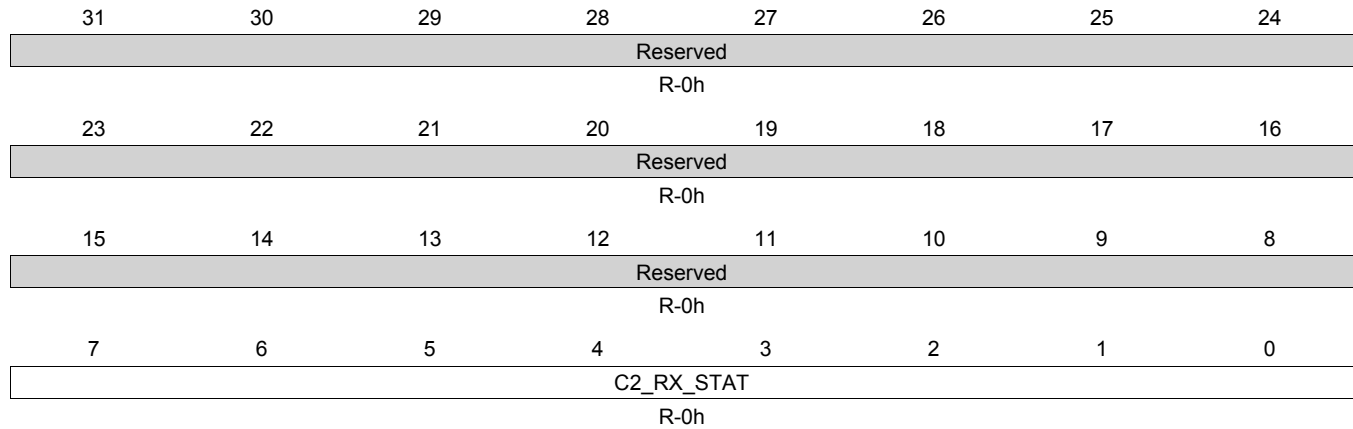
Bit	Field	Type	Reset	Description
31-8	Reserved	R	0h	
7-0	C2_RX_THRESH_STAT	R	0h	Core 2 Receive Threshold Masked Interrupt Status - Each bit in this register corresponds to the bit in the receive threshold interrupt that is enabled and generating an interrupt on C2_RX_THRESH_PULSE.

14.5.9.26 C2_RX_STAT Register (offset = 64h) [reset = 0h]

C2_RX_STAT is shown in [Figure 14-222](#) and described in [Table 14-239](#).

SUBSYSTEM CORE 2 RECEIVE MASKED INTERRUPT STATUS REGISTER

Figure 14-222. C2_RX_STAT Register



LEGEND: R/W = Read/Write; R = Read only; W1toCl = Write 1 to clear bit; -n = value after reset

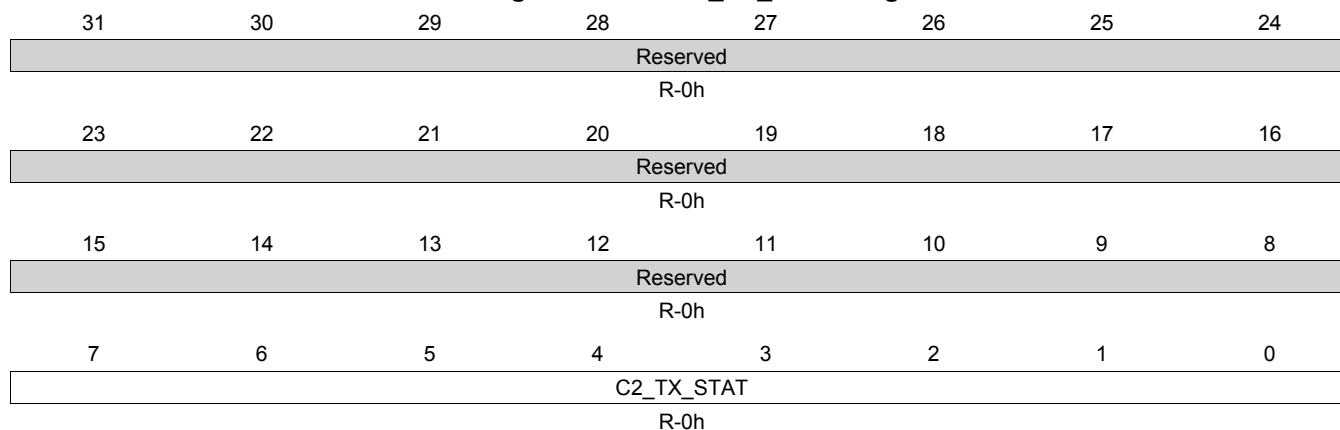
Table 14-239. C2_RX_STAT Register Field Descriptions

Bit	Field	Type	Reset	Description
31-8	Reserved	R	0h	
7-0	C2_RX_STAT	R	0h	Core 2 Receive Masked Interrupt Status - Each bit in this register corresponds to the bit in the Rx interrupt that is enabled and generating an interrupt on C2_RX_PULSE.

14.5.9.27 C2_TX_STAT Register (offset = 68h) [reset = 0h]

 C2_TX_STAT is shown in [Figure 14-223](#) and described in [Table 14-240](#).

SUBSYSTEM CORE 2 TRANSMIT MASKED INTERRUPT STATUS REGISTER

Figure 14-223. C2_TX_STAT Register


LEGEND: R/W = Read/Write; R = Read only; W1toCl = Write 1 to clear bit; -n = value after reset

Table 14-240. C2_TX_STAT Register Field Descriptions

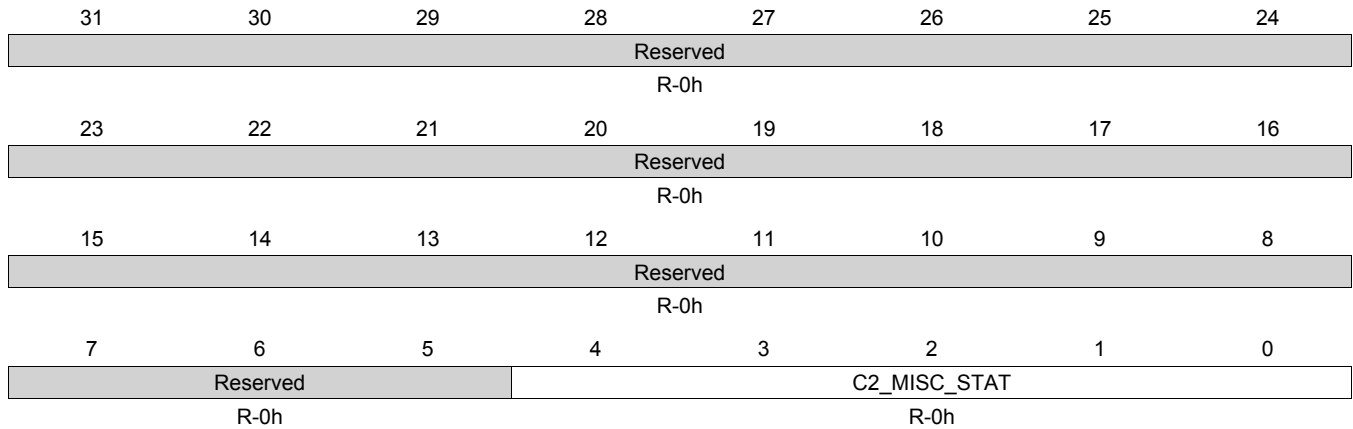
Bit	Field	Type	Reset	Description
31-8	Reserved	R	0h	
7-0	C2_TX_STAT	R	0h	Core 2 Transmit Masked Interrupt Status - Each bit in this register corresponds to the bit in the Tx interrupt that is enabled and generating an interrupt on C2_TX_PULSE.

14.5.9.28 C2_MISC_STAT Register (offset = 6Ch) [reset = 0h]

C2_MISC_STAT is shown in [Figure 14-224](#) and described in [Table 14-241](#).

SUBSYSTEM CORE 2 MISC MASKED INTERRUPT STATUS REGISTER

Figure 14-224. C2_MISC_STAT Register



LEGEND: R/W = Read/Write; R = Read only; W1toCl = Write 1 to clear bit; -n = value after reset

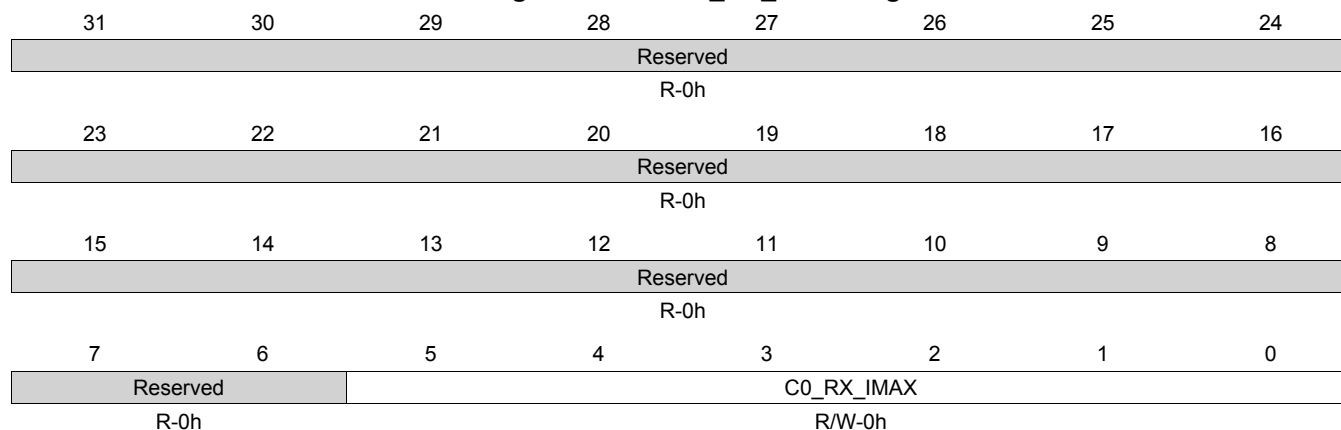
Table 14-241. C2_MISC_STAT Register Field Descriptions

Bit	Field	Type	Reset	Description
31-5	Reserved	R	0h	
4-0	C2_MISC_STAT	R	0h	Core 2 Misc Masked Interrupt Status - Each bit in this register corresponds to the miscellaneous interrupt (evnt_pend, stat_pend, host_pend, mdio_linkint, mdio_userint) that is enabled and generating an interrupt on C2_MISC_PULSE. Bit 4 = evnt_pend Bit 3 = stat_pend Bit 2 = host_pend Bit 1 = mdio_linkint Bit 0 = mdio_userint

14.5.9.29 C0_RX_IMAX Register (offset = 70h) [reset = 0h]

 C0_RX_IMAX is shown in [Figure 14-225](#) and described in [Table 14-242](#).

SUBSYSTEM CORE 0 RECEIVE INTERRUPTS PER MILLISECOND

Figure 14-225. C0_RX_IMAX Register


LEGEND: R/W = Read/Write; R = Read only; W1toCl = Write 1 to clear bit; -n = value after reset

Table 14-242. C0_RX_IMAX Register Field Descriptions

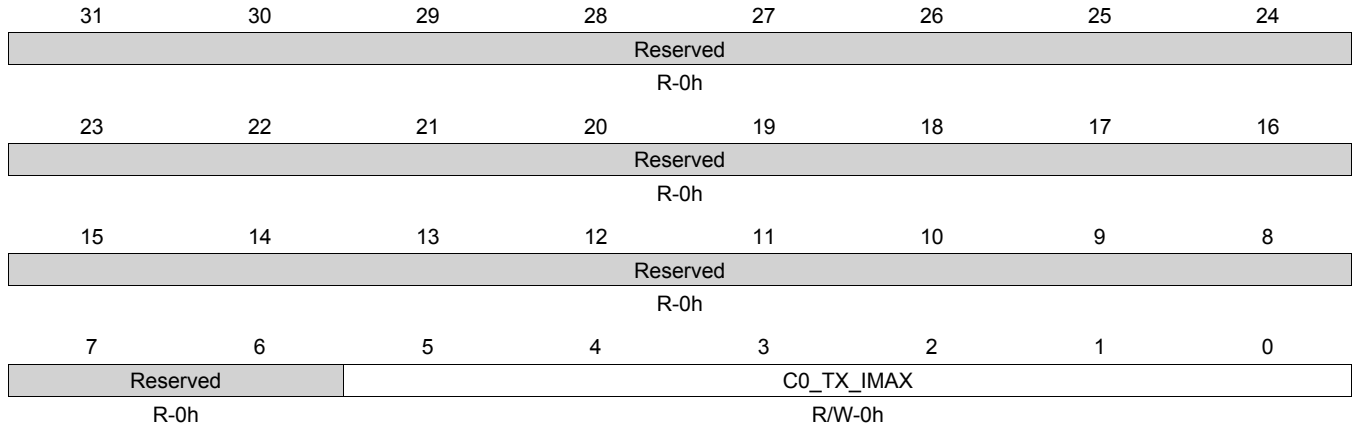
Bit	Field	Type	Reset	Description
31-6	Reserved	R	0h	
5-0	C0_RX_IMAX	R/W	0h	Core 0 Receive Interrupts per Millisecond - The maximum number of interrupts per millisecond generated on C0_RX_PULSE if pacing is enabled for this interrupt.

14.5.9.30 C0_TX_IMAX Register (offset = 74h) [reset = 0h]

C0_TX_IMAX is shown in [Figure 14-226](#) and described in [Table 14-243](#).

SUBSYSTEM CORE 0 TRANSMIT INTERRUPTS PER MILLISECOND

Figure 14-226. C0_TX_IMAX Register



LEGEND: R/W = Read/Write; R = Read only; W1toCl = Write 1 to clear bit; -n = value after reset

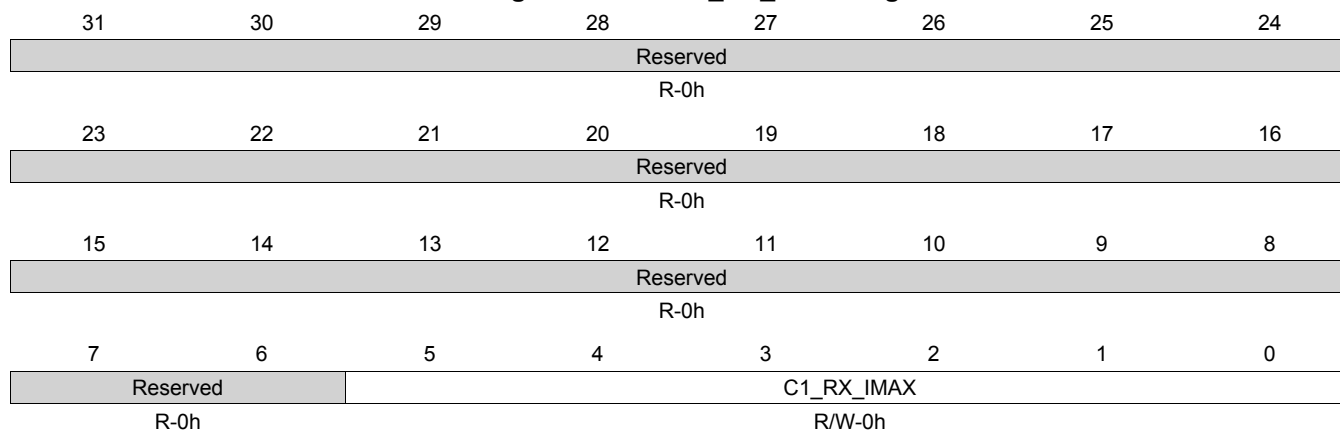
Table 14-243. C0_TX_IMAX Register Field Descriptions

Bit	Field	Type	Reset	Description
31-6	Reserved	R	0h	
5-0	C0_TX_IMAX	R/W	0h	Core 0 Transmit Interrupts per Millisecond - The maximum number of interrupts per millisecond generated on C0_TX_PULSE if pacing is enabled for this interrupt.

14.5.9.31 C1_RX_IMAX Register (offset = 78h) [reset = 0h]

 C1_RX_IMAX is shown in [Figure 14-227](#) and described in [Table 14-244](#).

SUBSYSTEM CORE 1 RECEIVE INTERRUPTS PER MILLISECOND

Figure 14-227. C1_RX_IMAX Register


LEGEND: R/W = Read/Write; R = Read only; W1toCl = Write 1 to clear bit; -n = value after reset

Table 14-244. C1_RX_IMAX Register Field Descriptions

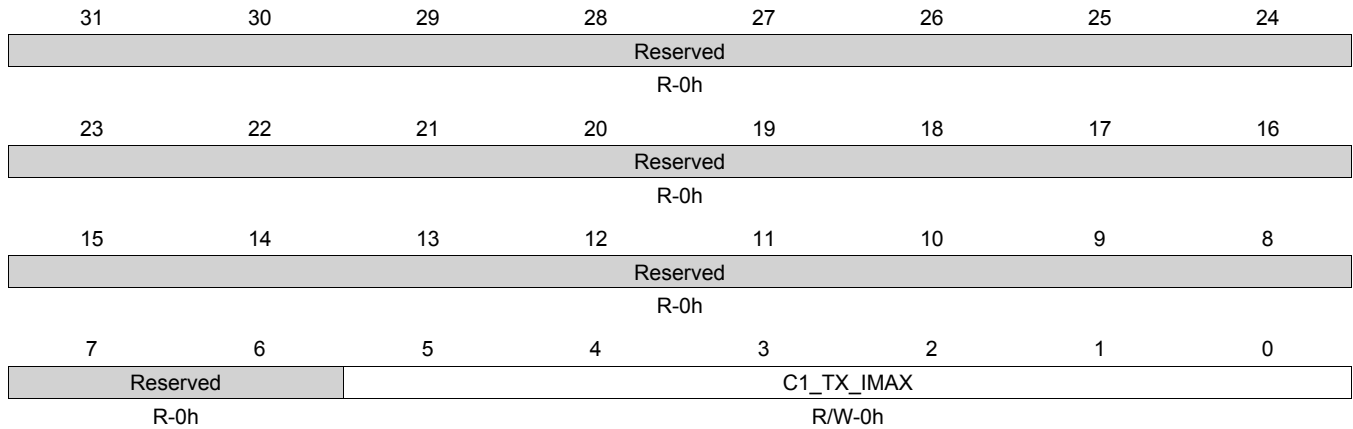
Bit	Field	Type	Reset	Description
31-6	Reserved	R	0h	
5-0	C1_RX_IMAX	R/W	0h	Core 1 Receive Interrupts per Millisecond - The maximum number of interrupts per millisecond generated on C1_RX_PULSE if pacing is enabled for this interrupt.

14.5.9.32 C1_TX_IMAX Register (offset = 7Ch) [reset = 0h]

C1_TX_IMAX is shown in [Figure 14-228](#) and described in [Table 14-245](#).

SUBSYSTEM CORE 1 TRANSMIT INTERRUPTS PER MILLISECOND

Figure 14-228. C1_TX_IMAX Register



LEGEND: R/W = Read/Write; R = Read only; W1toCl = Write 1 to clear bit; -n = value after reset

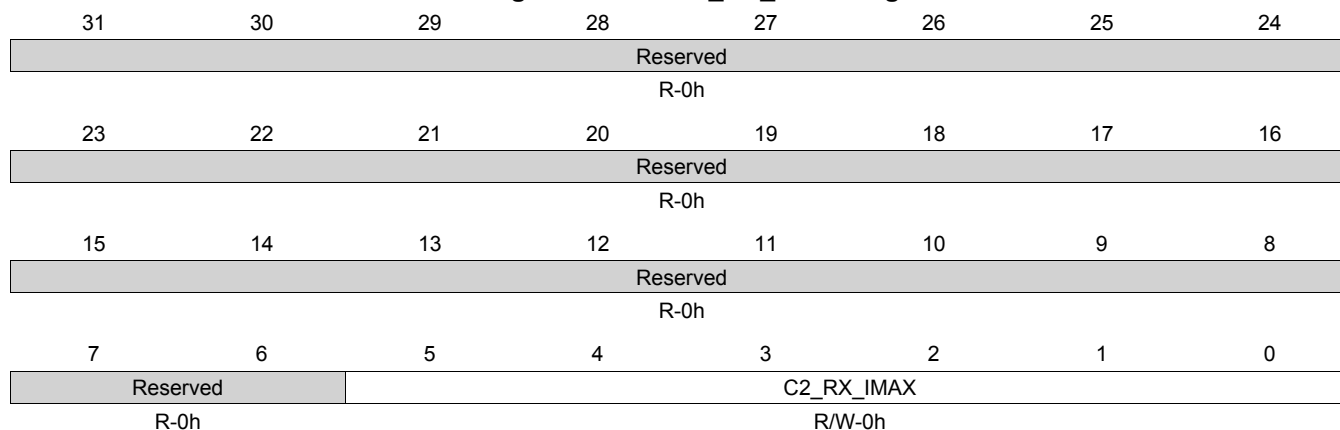
Table 14-245. C1_TX_IMAX Register Field Descriptions

Bit	Field	Type	Reset	Description
31-6	Reserved	R	0h	
5-0	C1_TX_IMAX	R/W	0h	Core 1 Transmit Interrupts per Millisecond - The maximum number of interrupts per millisecond generated on C1_TX_PULSE if pacing is enabled for this interrupt.

14.5.9.33 C2_RX_IMAX Register (offset = 80h) [reset = 0h]

C2_RX_IMAX is shown in [Figure 14-229](#) and described in [Table 14-246](#).

SUBSYSTEM CORE 2 RECEIVE INTERRUPTS PER MILLISECOND

Figure 14-229. C2_RX_IMAX Register


LEGEND: R/W = Read/Write; R = Read only; W1toCl = Write 1 to clear bit; -n = value after reset

Table 14-246. C2_RX_IMAX Register Field Descriptions

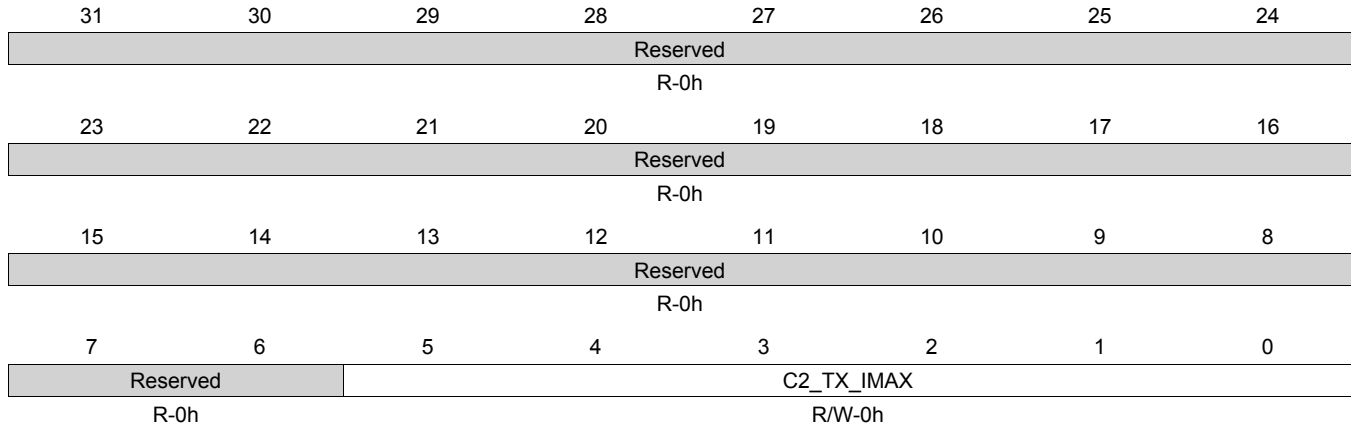
Bit	Field	Type	Reset	Description
31-6	Reserved	R	0h	
5-0	C2_RX_IMAX	R/W	0h	Core 2 Receive Interrupts per Millisecond - The maximum number of interrupts per millisecond generated on C2_RX_PULSE if pacing is enabled for this interrupt.

14.5.9.34 C2_TX_IMAX Register (offset = 84h) [reset = 0h]

C2_TX_IMAX is shown in [Figure 14-230](#) and described in [Table 14-247](#).

SUBSYSTEM CORE 2 TRANSMIT INTERRUPTS PER MILLISECOND

Figure 14-230. C2_TX_IMAX Register



LEGEND: R/W = Read/Write; R = Read only; W1toCl = Write 1 to clear bit; -n = value after reset

Table 14-247. C2_TX_IMAX Register Field Descriptions

Bit	Field	Type	Reset	Description
31-6	Reserved	R	0h	
5-0	C2_TX_IMAX	R/W	0h	Core 2 Transmit Interrupts per Millisecond - The maximum number of interrupts per millisecond generated on C2_TX_PULSE if pacing is enabled for this interrupt.

14.5.9.35 RGMII_CTL Register (offset = 88h) [reset = 0h]

RGMII_CTL is shown in [Figure 14-231](#) and described in [Table 14-248](#).

RGMII CONTROL SIGNAL REGISTER

NOTE: This register only has context in RGMII in-band mode. This register is not updated during forced mode of operation. Note that in-band mode is selected via MACCONTROL.EXT_EN.

Figure 14-231. RGMII_CTL Register

31	30	29	28	27	26	25	24
Reserved							
R-0h							
23	22	21	20	19	18	17	16
Reserved							
R-0h							
15	14	13	12	11	10	9	8
Reserved							
R-0h							
7	6	5	4	3	2	1	0
RGMII2_FULL DUPLEX	RGMII2_SPEED		RGMII2_LINK	RGMII1_FULL DUPLEX	RGMII1_SPEED		RGMII1_LINK
R-0h	R-0h		R-0h	R-0h	R-0h		R-0h

LEGEND: R/W = Read/Write; R = Read only; W1toCl = Write 1 to clear bit; -n = value after reset

Table 14-248. RGMII_CTL Register Field Descriptions

Bit	Field	Type	Reset	Description
31-8	Reserved	R	0h	
7	RGMII2_FULLDUPLEX	R	0h	RGMII 2 Fullduplex - This is the CPRGMII fullduplex output signal. 0 - Half-duplex mode 1 - Fullduplex mode
6-5	RGMII2_SPEED	R	0h	RGMII2 Speed - This is the CPRGMII speed output signal 00 - 10Mbps mode 01 - 100Mbps mode 10 - 1000Mbps (gig) mode 11 - reserved
4	RGMII2_LINK	R	0h	RGMII2 Link Indicator - This is the CPRGMII link output signal 0 - RGMII2 link is down 1 - RGMII2 link is up
3	RGMII1_FULLDUPLEX	R	0h	RGMII1 Fullduplex - This is the CPRGMII fullduplex output signal. 0 - Half-duplex mode 1 - Fullduplex mode
2-1	RGMII1_SPEED	R	0h	RGMII1 Speed - This is the CPRGMII speed output signal 00 - 10Mbps mode 01 - 100Mbps mode 10 - 1000Mbps (gig) mode 11 - reserved
0	RGMII1_LINK	R	0h	RGMII1 Link Indicator - This is the CPRGMII link output signal 0 - RGMII1 link is down

14.5.10 MDIO Registers

This section describes the memory-mapped registers for the Management Data Input/Output (MDIO).

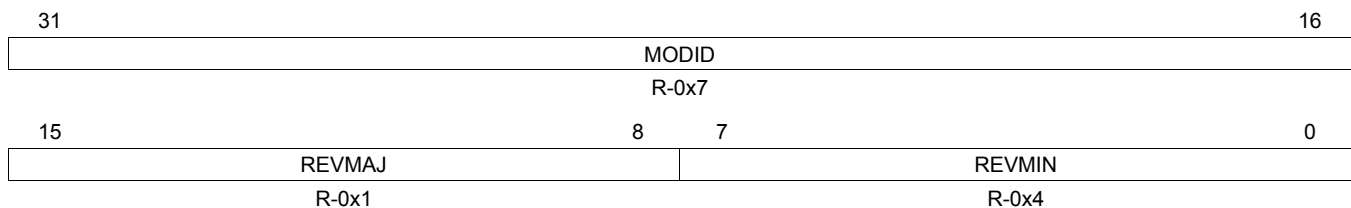
[Table 14-249](#) lists the memory-mapped registers for the Management Data Input/Output (MDIO). See the device-specific data manual for the memory address of these registers.

Table 14-249. MDIO Registers

Offset	Acronym	Register Name	Section
0	MDIOVER	MDIO Version Register	Section 14.5.10.1
4h	MDIOCONTROL	MDIO Control Register	Section 14.5.10.2
8h	MDIOALIVE	PHY Alive Status Register	Section 14.5.10.3
Ch	MDIOLINK	PHY Link Status Register	Section 14.5.10.4
10h	MDIOLINKINTRAW	MDIO Link Status Change Interrupt Register	Section 14.5.10.5
14h	MDIOLINKINTMASKED	MDIO Link Status Change Interrupt Register (Masked Value)	Section 14.5.10.6
20h	MDIOUSERINTRAW	MDIO User Command Complete Interrupt Register (Raw Value)	Section 14.5.10.7
24h	MDIOUSERINTMASKED	MDIO User Command Complete Interrupt Register (Masked Value)	Section 14.5.10.8
28h	MDIOUSERINTMASKSET	MDIO User Command Complete Interrupt Mask Set Register	Section 14.5.10.9
2Ch	MDIOUSERINTMASKCLR	MDIO User Interrupt Mask Clear Register	Section 14.5.10.10
80h	MDIOUSERACCESS0	MDIO User Access Register 0	Section 14.5.10.11
84h	MDIOUSERPHYSEL0	MDIO User PHY Select Register 0	Section 14.5.10.12
88h	MDIOUSERACCESS1	MDIO User Access Register 1	Section 14.5.10.13
8Ch	MDIOUSERPHYSEL1	MDIO User PHY Select Register 1	Section 14.5.10.14

14.5.10.1 MDIOVER Register

The MDIO version register (MDIOVER) is shown in [Figure 14-232](#) and described in [Table 14-250](#).

Figure 14-232. MDIO Version Register (MDIOVER)


LEGEND: R = Read only; -n = value after reset

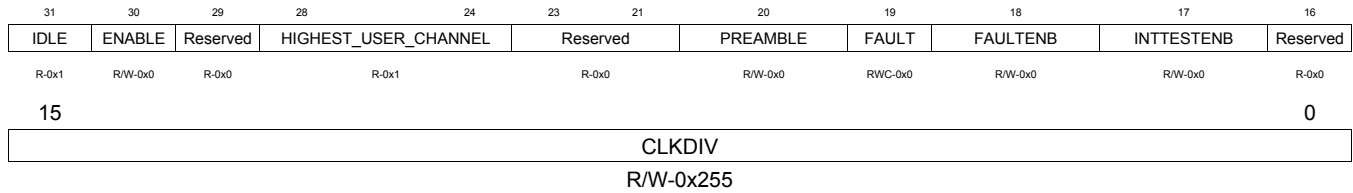
Table 14-250. MDIOVER Register Field Descriptions

Bit	Field	Type	Reset	Description
31-16	MODID	R	7	Identifies type of peripheral.
15-8	REVMAJ	R	1	Management interface module major revision value.
7-0	REVMIN	R	4	Management interface module minor revision value.

14.5.10.2 MDIOCONTROL Register

The MDIO control register (MDIOCONTROL) is shown in [Figure 14-233](#) and described in [Table 14-251](#).

Figure 14-233. MDIO Control Register (MDIOCONTROL)



LEGEND: R/W = Read/Write; RWC = Read/Write/Clear; R = Read only; -n = value after reset

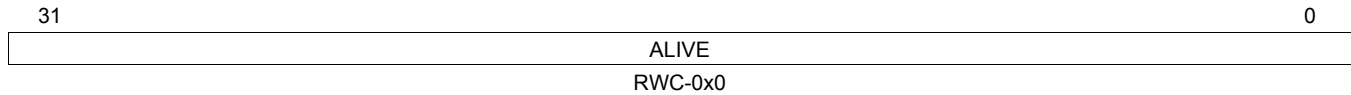
Table 14-251. MDIOCONTROL Register Field Descriptions

Bit	Field	Type	Reset	Description
31	IDLE	R	1	MDIO state machine IDLE. Set to 1 when the state machine is in the idle state. 0 = State machine is not in idle state. 1 = State machine is in idle state.
30	ENABLE	R/W	0	Enable control. If the MDIO state machine is active at the time it is disabled, it will complete the current operation before halting and setting the idle bit. If using byte access, the enable bit has to be the last bit written in this register. 0 = Disables the MDIO state machine. 1 = Enable the MDIO state machine.
29	Reserved	R	0	Reserved.
28-24	HIGHEST_USER_CHANNEL	R	1	Highest user channel. This field specifies the highest user access channel that is available in the module and is currently set to 1. This implies that the MDIOUSERACCESS1 register is the highest available user access channel.
23-21	Reserved	R	0	Reserved.
20	PREAMBLE	R/W	0	Preamble disable. 0 = Standard MDIO preamble is used. 1 = Disables this device from sending MDIO frame preambles.
19	FAULT	RWC	0	Fault indicator. This bit is set to 1 if the MDIO pins fail to read back what the device is driving onto them. This indicates a physical layer fault and the module state machine is reset. Writing a 1 to it clears this bit. 0 = No failure. 1 = Physical layer fault; the MDIO state machine is reset.
18	FAULTENB	R/W	0	Fault detect enable. This bit has to be set to 1 to enable the physical layer fault detection. 0 = Disables the physical layer fault detection. 1 = Enables the physical layer fault detection.
17	INTTESTENB	R/W	0	Interrupt test enable. This bit can be set to 1 to enable the host to set the USERINT and LINKINT bits for test purposes. 0 = Interrupt bits are not set. 1 = Enables the host to set the USERINT and LINKINT bits for test purposes.
16	Reserved	R	0	Reserved.
15-0	CLKDIV	R/W	255	Clock divider. This field specifies the division ratio between CLK and the frequency of MDIO_CLK. MDIO_CLK is disabled when clkdiv is set to 0. MDIO_CLK frequency = clk frequency/(clkdiv+1).

14.5.10.3 MDIOALIVE Register

The PHY acknowledge status register (MDIOALIVE) is shown in [Figure 14-234](#) and described in [Table 14-252](#).

Figure 14-234. PHY Acknowledge Status Register (MDIOALIVE)



LEGEND: RWC = Read/Write/Clear

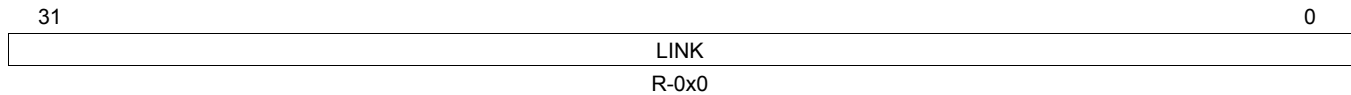
Table 14-252. MDIOALIVE Register Field Descriptions

Bit	Field	Type	Reset	Description
31-0	ALIVE	R/WC	0	MDIO alive. Each of the 32 bits of this register is set if the most recent access to the PHY with address corresponding to the register bit number was acknowledged by the PHY, the bit is reset if the PHY fails to acknowledge the access. Both the user and polling accesses to a PHY will cause the corresponding alive bit to be updated. The alive bits are only meant to be used to give an indication of the presence or not of a PHY with the corresponding address. Writing a 1 to any bit will clear it, writing a 0 has no effect.

14.5.10.4 MDIOLINK Register

The PHY link status register (MDIOLINK) is shown in [Figure 14-235](#) and described in [Table 14-253](#).

Figure 14-235. PHY Link Status Register (MDIOLINK)



LEGEND: R = Read only; -n = value after reset

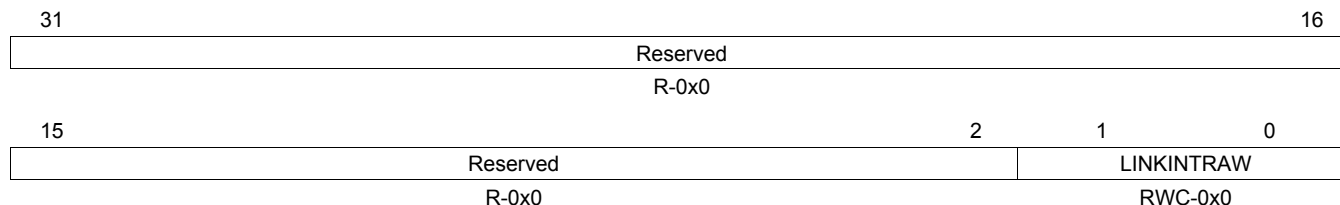
Table 14-253. MDIOLINK Register Field Descriptions

Bit	Field	Type	Reset	Description
31-0	LINK	R	0	MDIO link state. This register is updated after a read of the Generic Status Register of a PHY. The bit is set if the PHY with the corresponding address has link and the PHY acknowledges the read transaction. The bit is reset if the PHY indicates it does not have link or fails to acknowledge the read transaction. Writes to the register have no effect. In addition, the status of the two PHYs specified in the MDIOUSERPHYSEL _n registers can be determined using the MLINK input pins. This is determined by the LINKSEL bit in the MDIOUSERPHYSEL _n register.

14.5.10.5 MDIOLINKINTRAW Register

The MDIO link status change interrupt register (MDIOLINKINTRAW) is shown in [Figure 14-236](#) and described in [Table 14-254](#).

Figure 14-236. MDIO Link Status Change Interrupt Register (MDIOLINKINTRAW)



LEGEND: RWC = Read/Write/Clear; R = Read only; -n = value after reset

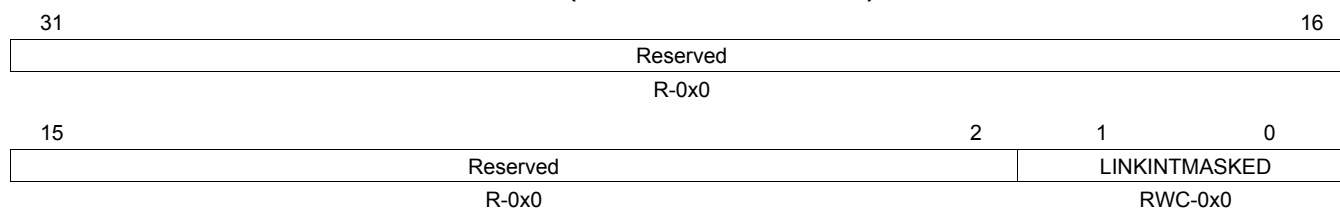
Table 14-254. MDIOLINKINTRAW Register Field Descriptions

Bit	Field	Type	Reset	Description
31-2	Reserved	R	0	Reserved.
1-0	LINKINTRAW	R/WC	0	MDIO link change event, raw value. When asserted 1, a bit indicates that there was an MDIO link change event (i.e. change in the MDIOLINK register) corresponding to the PHY address in the MDIOUSERPHYSEL _n register. LINKINTRAW[0] and LINKINTRAW[1] correspond to MDIOUSERPHYSEL0 and MDIOUSERPHYSEL1, respectively. Writing a 1 will clear the event and writing 0 has no effect. If the INTTESTENB bit in the MDIOCONTROL register is set, the host may set the LINKINTRAW bits to a 1. This mode may be used for test purposes.

14.5.10.6 MDIOLINKINTMASKED Register

The MDIO link status change interrupt register (Masked Value) (MDIOLINKINTMASKED) is shown in [Figure 14-237](#) and described in [Table 14-255](#).

Figure 14-237. MDIO Link Status Change Interrupt Register (Masked Value) (MDIOLINKINTMASKED)



LEGEND: RWC = Read/Write/Clear; R = Read only; -n = value after reset

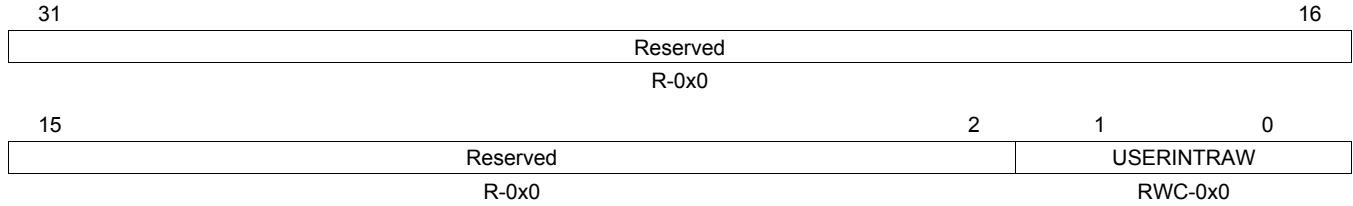
Table 14-255. MDIOLINKINTMASKED Register Field Descriptions

Bit	Field	Type	Reset	Description
31-2	Reserved	R	0	Reserved.
1-0	LINKINTMASKED	R/WC	0	MDIO link change interrupt, masked value. When asserted 1, a bit indicates that there was an MDIO link change event (i.e. change in the MDIO Link register) corresponding to the PHY address in the MDIOUSERPHYSEL _n register and the corresponding LINKINTENB bit was set. LINKINTMASKED[0] and LINKINTMASKED[1] correspond to MDIOUSERPHYSEL0 and MDIOUSERPHYSEL1, respectively. Writing a 1 will clear the interrupt and writing 0 has no effect. If the INTTESTENB bit in the MDIOCONTROL register is set, the host may set the LINKINT bits to a 1. This mode may be used for test purposes.

14.5.10.7 MDIOUSERINTRAW Register

The MDIO user command complete interrupt register (Raw Value) (MDIOUSERINTRAW) is shown in [Figure 14-238](#) and described in [Table 14-256](#).

Figure 14-238. MDIO User Command Complete Interrupt Register (Raw Value) (MDIOUSERINTRAW)



LEGEND: RWC = Read/Write/Clear; R = Read only; -n = value after reset

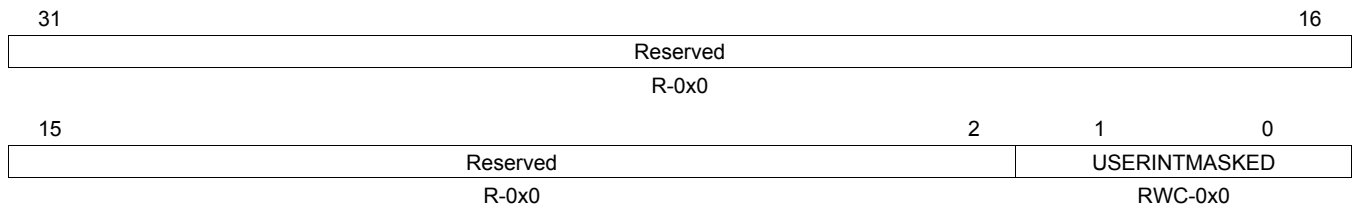
Table 14-256. MDIOUSERINTRAW Register Field Descriptions

Bit	Field	Type	Reset	Description
31-2	Reserved	R	0	Reserved.
1-0	USERINTRAW	R/WC	0	Raw value of MDIO user command complete event for the MDIOUSERACCESS1 register through the MDIOUSERACCESS0 register, respectively. When asserted 1, a bit indicates that the previously scheduled PHY read or write command using that particular MDIOUSERACCESSn register has completed. Writing a 1 will clear the event and writing 0 has no effect. If the INTTESTENB bit in the MDIOCONTROL register is set, the host may set the USERINTRAW bits to a 1. This mode may be used for test purposes.

14.5.10.8 MDIOUSERINTMASKED Register

The MDIO user command complete interrupt register (Masked Value) (MDIOUSERINTMASKED) is shown in [Figure 14-239](#) and described in [Table 14-257](#).

Figure 14-239. MDIO User Command Complete Interrupt Register (Masked Value) (MDIOUSERINTMASKED)



LEGEND: RWC = Read/Write/Clear; R = Read only; -n = value after reset

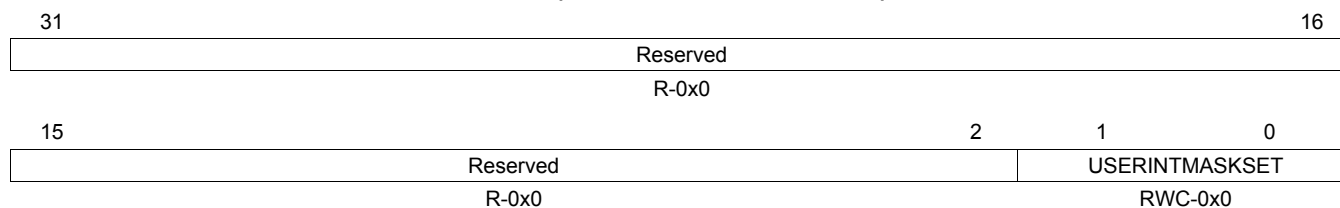
Table 14-257. MDIOUSERINTMASKED Register Field Descriptions

Bit	Field	Type	Reset	Description
31-2	Reserved	R	0	Reserved.
1-0	USERINTMASKED	R/WC	0	Masked value of MDIO user command complete interrupt for the MDIOUSERACCESS1 register through the MDIOUSERACCESS0 register, respectively. When asserted 1, a bit indicates that the previously scheduled PHY read or write command using that particular MDIOUSERACCESSn register has completed and the corresponding USERINTMASKSET bit is set to 1. Writing a 1 will clear the interrupt and writing 0 has no effect. If the INTTESTENB bit in the MDIOCONTROL register is set, the host may set the USERINTMASKED bits to a 1. This mode may be used for test purposes.

14.5.10.9 MDIOUSERINTMASKSET Register

The MDIO user command complete interrupt mask set register (MDIOUSERINTMASKSET) is shown in [Figure 14-240](#) and described in [Table 14-258](#).

Figure 14-240. MDIO User Command Complete Interrupt Mask Set Register (MDIOUSERINTMASKSET)



LEGEND: RWC = Read/Write/Clear; R = Read only; -n = value after reset

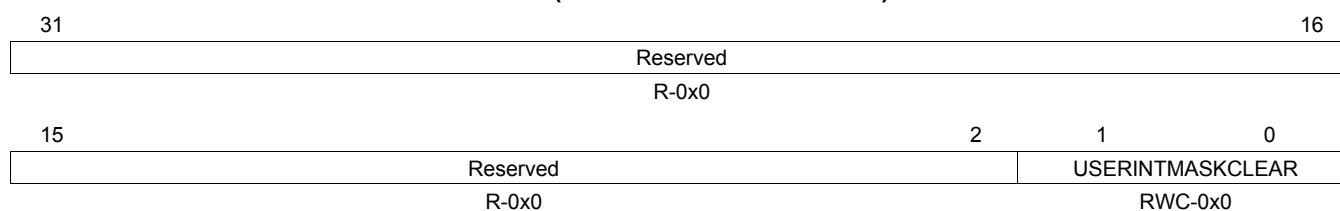
Table 14-258. MDIOUSERINTMASKSET Register Field Descriptions

Bit	Field	Type	Reset	Description
31-2	Reserved	R	0	Reserved.
1-0	USERINTMASKSET	R/WC	0	MDIO user interrupt mask set for USERINTMASKED, respectively. Writing a bit to 1 will enable MDIO user command complete interrupts for that particular MDIOUSERACCESSn register. MDIO user interrupt for a particular MDIOUSERACCESSn register is disabled if the corresponding bit is 0. Writing a 0 to this register has no effect.

14.5.10.10 MDIOUSERINTMASKCLR Register

The MDIO user interrupt mask clear register (MDIOUSERINTMASKCLR) is shown in [Figure 14-241](#) and described in [Table 14-259](#).

Figure 14-241. MDIO User Command Complete Interrupt Mask Clear Register (MDIOUSERINTMASKCLR)



LEGEND: RWC = Read/Write/Clear; R = Read only; -n = value after reset

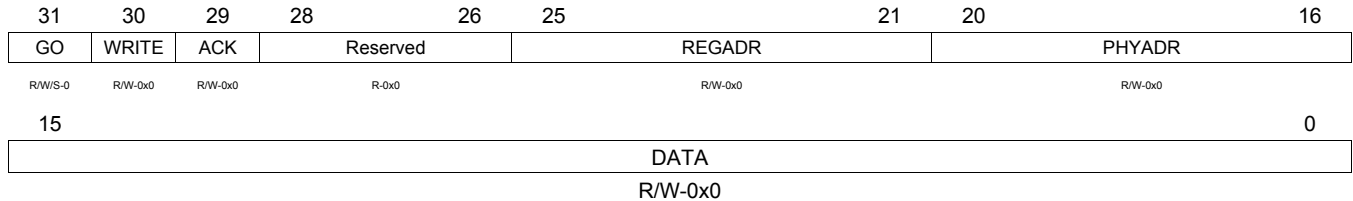
Table 14-259. MDIOUSERINTMASKCLR Register Field Descriptions

Bit	Field	Type	Reset	Description
31-2	Reserved	R	0	Reserved.
1-0	USERINTMASKCLEAR	R/WC	0	MDIO user command complete interrupt mask clear for USERINTMASKED, respectively. Writing a bit to 1 will disable further user command complete interrupts for that particular MDIOUSERACCESSn register. Writing a 0 to this register has no effect.

14.5.10.11 MDIOUSERACCESS0 Register

The MDIO user access register 0 (MDIOUSERACCESS0) is shown in [Figure 14-242](#) and described in [Table 14-260](#).

Figure 14-242. MDIO User Access Register 0 (MDIOUSERACCESS0)



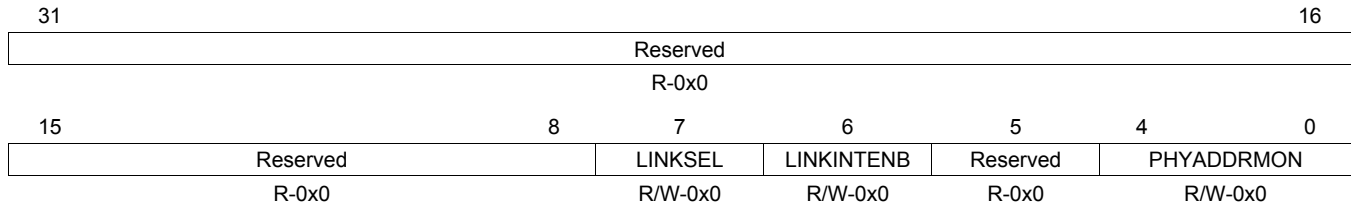
LEGEND: R/W = Read/Write; R = Read only; S = Status; -n = value after reset

Table 14-260. MDIOUSERACCESS0 Register Field Descriptions

Bit	Field	Type	Reset	Description
31	GO	R/W/S	0	Go. Writing a 1 to this bit causes the MDIO state machine to perform an MDIO access when it is convenient for it to do so, this is not an instantaneous process. Writing a 0 to this bit has no effect. This bit is write able only if the MDIO state machine is enabled. This bit will self clear when the requested access has been completed. Any writes to the MDIOUSERACCESS0 register are blocked when the GO bit is 1. If byte access is being used, the GO bit should be written last.
30	WRITE	R/W	0	Write enable. Setting this bit to a 1 causes the MDIO transaction to be a register write, otherwise it is a register read.
29	ACK	R/W	0	Acknowledge. This bit is set if the PHY acknowledged the read transaction.
28-26	Reserved	R	0	Reserved.
25-21	REGADR	R/W	0	Register address. Specifies the PHY register to be accessed for this transaction.
20-16	PHYADR	R/W	0	PHY address. Specifies the PHY to be accesses for this transaction.
15-0	DATA	R/W	0	User data. The data value read from or to be written to the specified PHY register.

14.5.10.12 MDIOUSERPHYSEL0 Register

The MDIO user PHY select register 0 (MDIOUSERPHYSEL0) is shown in [Figure 14-243](#) and described in [Table 14-261](#).

Figure 14-243. MDIO User PHY Select Register 0 (MDIOUSERPHYSEL0)


LEGEND: R/W = Read/Write; R = Read only; -n = value after reset

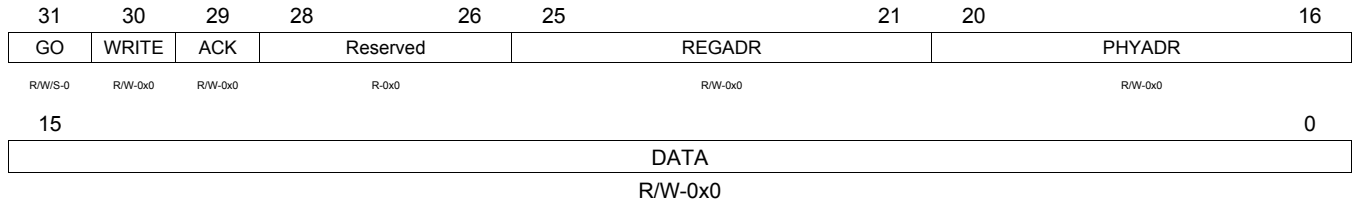
Table 14-261. MDIOUSERPHYSEL0 Register Field Descriptions

Bit	Field	Type	Reset	Description
31-8	Reserved	R	0	Reserved.
7	LINKSEL	R/W	0	Link status determination select. Set to 1 to determine link status using the MLINK pin. Default value is 0 which implies that the link status is determined by the MDIO state machine.
6	LINKINTENB	R/W	0	Link change interrupt enable. Set to 1 to enable link change status interrupts for PHY address specified in PHYADDRMON. Link change interrupts are disabled if this bit is set to 0. 0 = Link change interrupts are disabled. 1 = Link change status interrupts for PHY address specified in PHYADDRMON bits are enabled.
5	Reserved	R	0	Reserved.
4-0	PHYADDRMON	R/W	0	PHY address whose link status is to be monitored.

14.5.10.13 MDIOUSERACCESS1 Register

The MDIO user access register 1 (MDIOUSERACCESS1) is shown in [Figure 14-244](#) and described in [Table 14-262](#).

Figure 14-244. MDIO User Access Register 1 (MDIOUSERACCESS1)



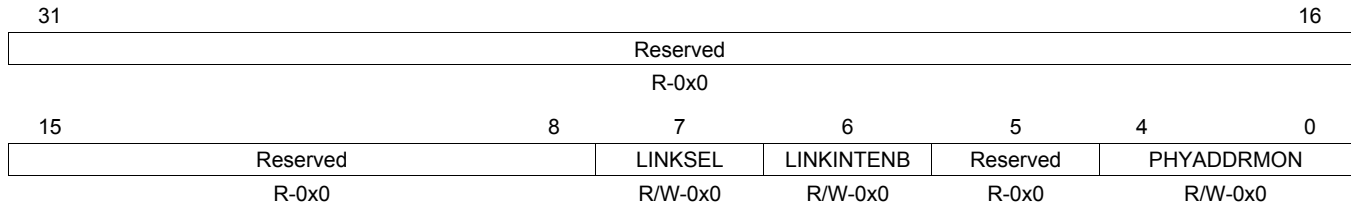
LEGEND: R/W = Read/Write; R = Read only; S = Status; -n = value after reset

Table 14-262. MDIOUSERACCESS1 Register Field Descriptions

Bit	Field	Type	Reset	Description
31	GO	R/W/S	0	Writing a 1 to this bit causes the MDIO state machine to perform an MDIO access when it is convenient for it to do so, this is not an instantaneous process. Writing a 0 to this bit has no effect. This bit is write able only if the MDIO state machine is enabled. This bit will self clear when the requested access has been completed. Any writes to the MDIOUSERACCESS0 register are blocked when the GO bit is 1. If byte access is being used, the GO bit should be written last.
30	WRITE	R/W	0	Write enable. Setting this bit to a 1 causes the MDIO transaction to be a register write, otherwise it is a register read.
29	ACK	R/W	0	Acknowledge. This bit is set if the PHY acknowledged the read transaction.
28-26	Reserved	R	0	Reserved.
25-21	REGADR	R/W	0	Register address; specifies the PHY register to be accessed for this transaction.
20-16	PHYADR	R/W	0	PHY address; specifies the PHY to be accesses for this transaction.
15-0	DATA	R/W	0	User data. The data value read from or to be written to the specified PHY register.

14.5.10.14 MDIOUSERPHYSEL1 Register

The MDIO user PHY select register 1 (MDIOUSERPHYSEL1) is shown in [Figure 14-245](#) and described in [Table 14-263](#).

Figure 14-245. MDIO User PHY Select Register 1 (MDIOUSERPHYSEL1)


LEGEND: R/W = Read/Write; R = Read only; -n = value after reset

Table 14-263. MDIOUSERPHYSEL1 Register Field Descriptions

Bit	Field	Type	Reset	Description
31-8	Reserved	R	0	Reserved.
7	LINKSEL	R/W	0	Link status determination select. Set to 1 to determine link status using the MLINK pin. Default value is 0 which implies that the link status is determined by the MDIO state machine.
6	LINKINTENB	R/W	0	Link change interrupt enable. Set to 1 to enable link change status interrupts for PHY address specified in PHYADDRMON. Link change interrupts are disabled if this bit is cleared to 0. 0 = Link change interrupts are disabled 1 = Link change status interrupts for PHY address specified in PHYADDRMON bits are enabled.
5	Reserved	R	0	Reserved.
4-0	PHYADDRMON	R/W	0	PHY address whose link status is to be monitored.

Pulse-Width Modulation Subsystem (PWMSS)

This chapter describes the PWMSS of the device.

Topic	Page
15.1 Pulse-Width Modulation Subsystem (PWMSS).....	2224
15.2 Enhanced PWM (ePWM) Module	2233
15.3 Enhanced Capture (eCAP) Module	2357
15.4 Enhanced Quadrature Encoder Pulse (eQEP) Module	2399

15.1 Pulse-Width Modulation Subsystem (PWMSS)

Introduction

Features

The general features of the PWMSS are:

eHRPWM

- Dedicated 16 bit time-base with Period / Frequency control
- Can support 2 independent PWM outputs with Single edge operation
- Can support 2 independent PWM outputs with Dual edge symmetric operation
- Can support 1 independent PWM output with Dual edge asymmetric operation
- Supports Dead-band generation with independent Rising and Falling edge delay control
- Provides asynchronous over-ride control of PWM signals during fault conditions
- Supports “trip zone” allocation of both latched and un-latched fault conditions
- Allows events to trigger both CPU interrupts and start of ADC conversions
- Support PWM chopping by high frequency carrier signal, used for pulse transformer gate drives.
- High-resolution module with programmable delay line.
 - Programmable on a per PWM period basis.
 - Can be inserted either on the rising edge or falling edge of the PWM pulse or both or not at all.

eCAP

- Dedicated input Capture pin
- 32 bit Time Base (counter)
- 4 x 32 bit Time-stamp Capture registers (CAP1-CAP4)
- 4 stage sequencer (Mod4 counter) which is synchronized to external events (ECAPx pin edges)
- Independent Edge polarity (Rising / Falling edge) selection for all 4 events
- Input Capture signal pre-scaling (from 1 to 16)
- One-shot compare register (2 bits) to freeze captures after 1 to 4 Time-stamp events
- Control for continuous Time-stamp captures using a 4 deep circular buffer (CAP1-CAP4) scheme
- Interrupt capabilities on any of the 4 capture events

eQEP

- Input Synchronization
- Quadrature Decoder Unit
- Position Counter and Control unit for position measurement
- Quadrature Edge Capture unit for low speed measurement
- Unit Time base for speed/frequency measurement
- Watchdog Timer for detecting stalls

Unsupported Features

The PWMSS module features not supported are shown in [Unsupported Features](#).

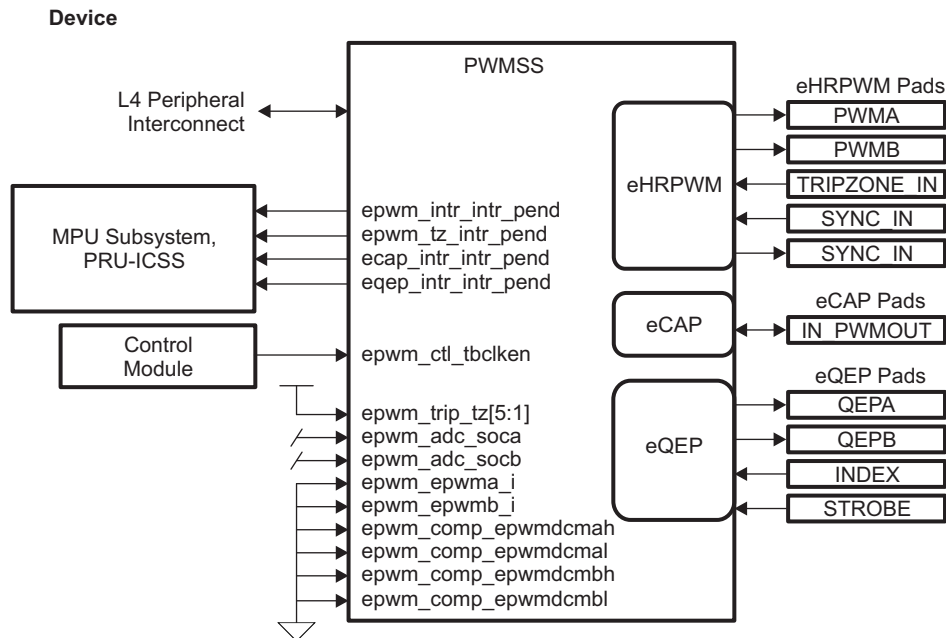
Unsupported Features

Feature	Reason
ePWM inputs	Not pinned out
ePWM tripzone 1-5 inputs	Only Tripzone0 is pinned out
ePWM digital comparators	Inputs not connected
eQEP quadrature outputs	Only input signals are connected
eCAP3-5	Module not used
eQEP3-5	Module not used

15.1.1 Integration

The Pulse Width Modulation Subsystem (PWMSS) includes a single instance of the Enhanced High Resolution Pulse Width Modulator (eHRPWM), Enhanced Capture (eCAP), and Enhanced Quadrature Encoded Pulse (eQEP) modules. This device includes three instantiations of the PWMSS.

Figure 15-1. PWMSS Integration

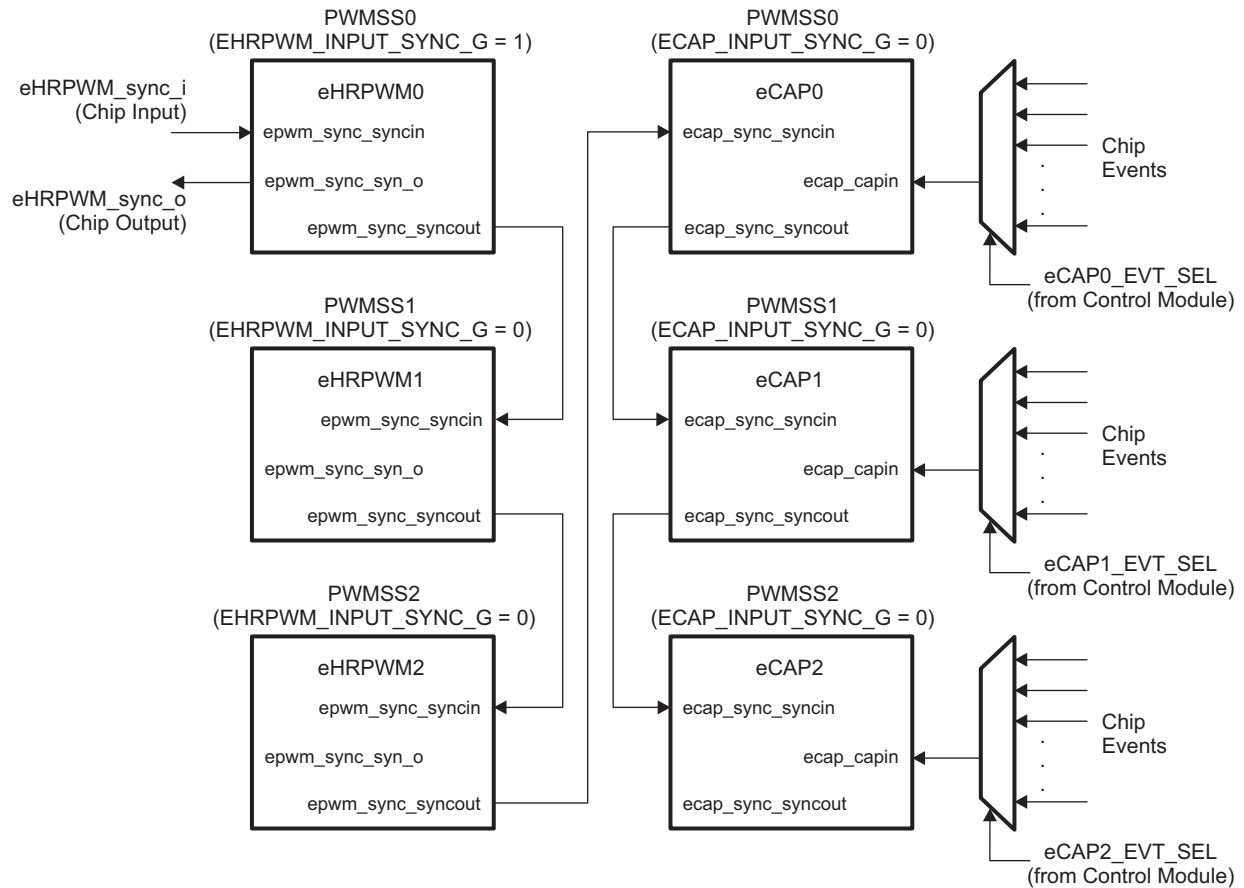


15.1.1.1 PWMSS Synchronization Detail

The PWM (eHRPWM) and capture (eCAP) components of the PWMSS provide synchronization signals to allow them to be synchronized to other modules or events. On this device, these signals are connected in a daisy-chain fashion as shown in [Figure 15-2](#).

The eCAP capture events may be selected from among 31 different pins or internal interrupt signals. The event is selected using the corresponding `ECAPx_EVTCAPT` field of the `ECAP_EVT_CAP` register in the Control Module.

Figure 15-2. PWMSS Synchronization



15.1.1.2 PWMSS Connectivity Attributes

The general connectivity attributes for the PWMSS module are shown in [Table 15-1](#).

Table 15-1. PWMSS Connectivity Attributes

Attributes	Type
Power Domain	Peripheral Domain
Clock Domain	PD_PER_L4LS_GCLK
Reset Signals	PER_DOM_RST_N
Idle/Wakeup Signals	Smart Idle
Interrupt Requests	<p>2 ePWM interrupts per instance</p> <ul style="list-style-type: none"> epwm_intr_intr - Event interrupt, ePWMxINT for ARM subsystem, epwm_intr_intr_pend for PRU-ICSS epwm_tz_intr - Tripzone interrupt, ePWMx_TZINT for ARM subsystem, pwm_trip_zone for PRU-ICSS (only 1 for all 3 instances) <p>1 eCAP interrupt per instance</p> <ul style="list-style-type: none"> ecap_intr - Capture/PWM event interrupt, eCAPxINT for ARM subsystem, ecap_intr_intr_pend for PRU-ICSS <p>1 eQEP Interrupt per instance</p> <ul style="list-style-type: none"> eqep_intr_intr - Event interrupt, eQEPxINT for ARM subsystem, eqep_intr_intr_pend for PRU-ICSS (only for eQEP0)

Table 15-1. PWMSS Connectivity Attributes (continued)

Attributes	Type
DMA Requests	Interrupt requests are redirected as DMA requests: <ul style="list-style-type: none"> • 1 DMA request from ePWM per instance (ePWMEVTx) • 1 DMA request from eCAP per instance (eCAPEVTx) • 1 DMA request from eQEP per instance (eQEPEVTx)
Physical Address	L4 Peripheral slave port

15.1.1.3 PWMSS Clock and Reset Management

The PWMSS controllers have separate bus interface and functional clocks.

Table 15-2. PWMSS Clock Signals

Clock Signal	Max Freq	Reference / Source	Comments
PWMSS_ocp_clk Interface / Functional clock	100 MHz	CORE_CLKOUTM4 / 2	pd_per_l4ls_gclk from PRCM

15.1.1.4 PWMSS Pin list

The external signals for the PWMSS module are shown in the following table.

Table 15-3. PWMSS Pin List

Pin	Type	Description
EPWMxA	O	PWM output A
EPWMxB	O	PWM output B
EPWM_SYNCIN	I	PWM Sync input
EPWM_SYNCOUT	O	PWM Sync output
EPWM_TRIPZONE[5:0]	I	PWM Tripzone inputs
ECAP_CAPIN_APWMOUT	I/O	eCAP Capture input / PWM output
EQEP_A	I/O	eQEP Quadrature input/output
EQEP_B	I/O	eQEP Quadrature input/output
EQEP_INDEX	I/O	eQEP Index input/output
EQEP_STROBE	I/O	eQEP Strobe input/output

15.1.2 PWMSS Registers

Table 15-4 lists the memory-mapped registers for the PWMSS. All register offset addresses not listed in Table 15-4 should be considered as reserved locations and the register contents should not be modified.

Table 15-4. PWMSS Registers

Offset	Acronym	Register Name	Section
0h	IDVER	IP Revision Register	Section 15.1.2.1
4h	SYSCONFIG	System Configuration Register	Section 15.1.2.2
8h	CLKCONFIG	Clock Configuration Register	Section 15.1.2.3
Ch	CLKSTATUS	Clock Status Register	Section 15.1.2.4

15.1.2.1 IDVER Register (offset = 0h) [reset = 4000000h]

IDVER is shown in [Figure 15-3](#) and described in [Table 15-5](#).

The IP revision register is used by software to track features, bugs, and compatibility.

Figure 15-3. IDVER Register

31	30	29	28	27	26	25	24
SCHEME		RESERVED		FUNC			
R-1h		R-0h		R-0h			
23	22	21	20	19	18	17	16
FUNC							
R-0h							
15	14	13	12	11	10	9	8
R_RTL					X_MAJOR		
R-0h					R-0h		
7	6	5	4	3	2	1	0
CUSTOM		Y_MINOR					
R-0h		R-0h					

LEGEND: R/W = Read/Write; R = Read only; W1toCl = Write 1 to clear bit; -n = value after reset

Table 15-5. IDVER Register Field Descriptions

Bit	Field	Type	Reset	Description
31-30	SCHEME	R	1h	Used to distinguish between the old scheme and current.
29-28	RESERVED	R	0h	
27-16	FUNC	R	0h	FUNC
15-11	R_RTL	R	0h	RTL version (R), maintained by IP design owner.
10-8	X_MAJOR	R	0h	Major revision (X)
7-6	CUSTOM	R	0h	CUSTOM
5-0	Y_MINOR	R	0h	Minor revision (Y)

15.1.2.2 SYSCONFIG Register (offset = 4h) [reset = 28h]

SYSCONFIG is shown in [Figure 15-4](#) and described in [Table 15-6](#).

The system configuration register is used for clock management configuration.

Figure 15-4. SYSCONFIG Register

31	30	29	28	27	26	25	24
RESERVED							
R-0h							
23	22	21	20	19	18	17	16
RESERVED							
R-0h							
15	14	13	12	11	10	9	8
RESERVED							
R-0h							
7	6	5	4	3	2	1	0
RESERVED		STANDBYMODE		IDLEMODE		FREEEMU	SOFTRESET
R-0h		R/W-2h		R/W-2h		R/W-0h	R/W-0h

LEGEND: R/W = Read/Write; R = Read only; W1toCl = Write 1 to clear bit; -n = value after reset

Table 15-6. SYSCONFIG Register Field Descriptions

Bit	Field	Type	Reset	Description
31-6	RESERVED	R	0h	
5-4	STANDBYMODE	R/W	2h	Configuration of the local initiator state management mode. By definition, initiator may generate read/write transaction as long as it is out of STANDBY state. 0h = Force-standby mode: local initiator is unconditionally placed in standby state. Backup mode, for debug only. 1h = No-standby mode: local initiator is unconditionally placed out of standby state. Backup mode, for debug only. 2h = Smart-standby mode: local initiator standby status depends on local conditions, i.e., the module's functional requirement from the initiator. IP module should not generate (initiator-related) wakeup events. 3h = Reserved.
3-2	IDLEMODE	R/W	2h	Configuration of the local target state management mode. By definition, target can handle read/write transaction as long as it is out of IDLE state. 0h = Force-idle mode: local target's idle state follows (acknowledges) the system's idle requests unconditionally, i.e. regardless of the IP module's internal requirements. Backup mode, for debug only. 1h = No-idle mode: local target never enters idle state. Backup mode, for debug only. 2h = Smart-idle mode: local target's idle state eventually follows (acknowledges) the system's idle requests, depending on the IP module's internal requirements. IP module shall not generate (IRQ- or DMA-request-related) wakeup events. 3h = Reserved.
1	FREEEMU	R/W	0h	Sensitivity to emulation (debug) suspend event from Debug Subsystem. 0h = IP module is sensitive to emulation suspend. 1h = IP module is not sensitive to emulation suspend event. Debug suspend event is ignored.
0	SOFTRESET	R/W	0h	Software reset (optional)

15.1.2.3 CLKCONFIG Register (offset = 8h) [reset = 111h]

CLKCONFIG is shown in [Figure 15-5](#) and described in [Table 15-7](#).

The clock configuration register is used in the PWMSS submodule for clkstop req and clk_en control.

Figure 15-5. CLKCONFIG Register

31	30	29	28	27	26	25	24
RESERVED							
R-0h							
23	22	21	20	19	18	17	16
RESERVED							
R-0h							
15	14	13	12	11	10	9	8
RESERVED						ePWMCLKSTO P_REQ	ePWMCLK_EN
R-0h						R/W-0h	R/W-1h
7	6	5	4	3	2	1	0
RESERVED		eQEPCLKSTO P_REQ	eQEPCLK_EN	RESERVED		eCAPCLKSTO P_REQ	eCAPCLK_EN
R-0h		R/W-0h	R/W-1h	R-0h		R/W-0h	R/W-1h

LEGEND: R/W = Read/Write; R = Read only; W1toCl = Write 1 to clear bit; -n = value after reset

Table 15-7. CLKCONFIG Register Field Descriptions

Bit	Field	Type	Reset	Description
31-10	RESERVED	R	0h	
9	ePWMCLKSTOP_REQ	R/W	0h	This bit controls the clkstop_req input to the ePWM module.
8	ePWMCLK_EN	R/W	1h	This bit controls the clk_en input to the ePWM module.
7-6	RESERVED	R	0h	
5	eQEPCLKSTOP_REQ	R/W	0h	This bit controls the clkstop_req input to the eQEP module
4	eQEPCLK_EN	R/W	1h	This bit controls the clk_en input to the eQEP module.
3-2	RESERVED	R	0h	
1	eCAPCLKSTOP_REQ	R/W	0h	This bit controls the clkstop_req input to the eCAP module.
0	eCAPCLK_EN	R/W	1h	This bit controls the clk_en input to the eCAP module.

15.1.2.4 CLKSTATUS Register (offset = Ch) [reset = 0h]

CLKSTATUS is shown in [Figure 15-6](#) and described in [Table 15-8](#).

The clock status register is used in the PWMSS submodule for clkstop ack and clk_en ack status.

Figure 15-6. CLKSTATUS Register

31	30	29	28	27	26	25	24
RESERVED							
R-0h							
23	22	21	20	19	18	17	16
RESERVED							
R-0h							
15	14	13	12	11	10	9	8
RESERVED						ePWM_CLKST OP_ACK	ePWM_CLK_E N_ACK
R-0h						R-0h	R-0h
7	6	5	4	3	2	1	0
RESERVED		eQEP_CLKST OP_ACK	eQEP_CLK_EN _ACK	RESERVED		eCAP_CLKST OP_ACK	eCAP_CLK_EN _ACK
R-0h		R-0h	R-0h	R-0h		R-0h	R-0h

LEGEND: R/W = Read/Write; R = Read only; W1toCl = Write 1 to clear bit; -n = value after reset

Table 15-8. CLKSTATUS Register Field Descriptions

Bit	Field	Type	Reset	Description
31-10	RESERVED	R	0h	
9	ePWM_CLKSTOP_ACK	R	0h	This bit is the clkstop_req_ack status output of the ePWM module.
8	ePWM_CLK_EN_ACK	R	0h	This bit is the clk_en status output of the ePWM module.
7-6	RESERVED	R	0h	
5	eQEP_CLKSTOP_ACK	R	0h	This bit is the clkstop_req_ack status output of the eQEP module.
4	eQEP_CLK_EN_ACK	R	0h	This bit is the clk_en status output of the eQEP module.
3-2	RESERVED	R	0h	
1	eCAP_CLKSTOP_ACK	R	0h	This bit is the clkstop_req_ack status output of the eCAP module.
0	eCAP_CLK_EN_ACK	R	0h	This bit is the clk_en status output of the eCAP module.

15.2 Enhanced PWM (ePWM) Module

15.2.1 Introduction

An effective PWM peripheral must be able to generate complex pulse width waveforms with minimal CPU overhead or intervention. It needs to be highly programmable and very flexible while being easy to understand and use. The ePWM unit described here addresses these requirements by allocating all needed timing and control resources on a per PWM channel basis. Cross coupling or sharing of resources has been avoided; instead, the ePWM is built up from smaller single channel modules with separate resources and that can operate together as required to form a system. This modular approach results in an orthogonal architecture and provides a more transparent view of the peripheral structure, helping users to understand its operation quickly.

In this chapter, the letter x within a signal or module name is used to indicate a generic ePWM instance on a device. For example, output signals EPWMxA and EPWMxB refer to the output signals from the ePWMx instance. Thus, EPWM1A and EPWM1B belong to ePWM1 and, likewise, EPWM4A and EPWM4B belong to ePWM4.

15.2.1.1 Submodule Overview

The ePWM module represents one complete PWM channel composed of two PWM outputs: EPWMxA and EPWMxB. Multiple ePWM modules are instanced within a device as shown in [Figure 15-7](#). Each ePWM instance is identical with one exception. Some instances include a hardware extension that allows more precise control of the PWM outputs. This extension is the high-resolution pulse width modulator (HRPWM) and is described in [Section 15.2.2.10](#). See [Section 15.1.1](#) to determine which ePWM instances include this feature. Each ePWM module is indicated by a numerical value starting with 0. For example ePWM0 is the first instance and ePWM2 is the third instance in the system and ePWMx indicates any instance.

The ePWM modules are chained together via a clock synchronization scheme that allows them to operate as a single system when required. Additionally, this synchronization scheme can be extended to the capture peripheral modules (eCAP). The number of modules is device-dependent and based on target application needs. Modules can also operate stand-alone.

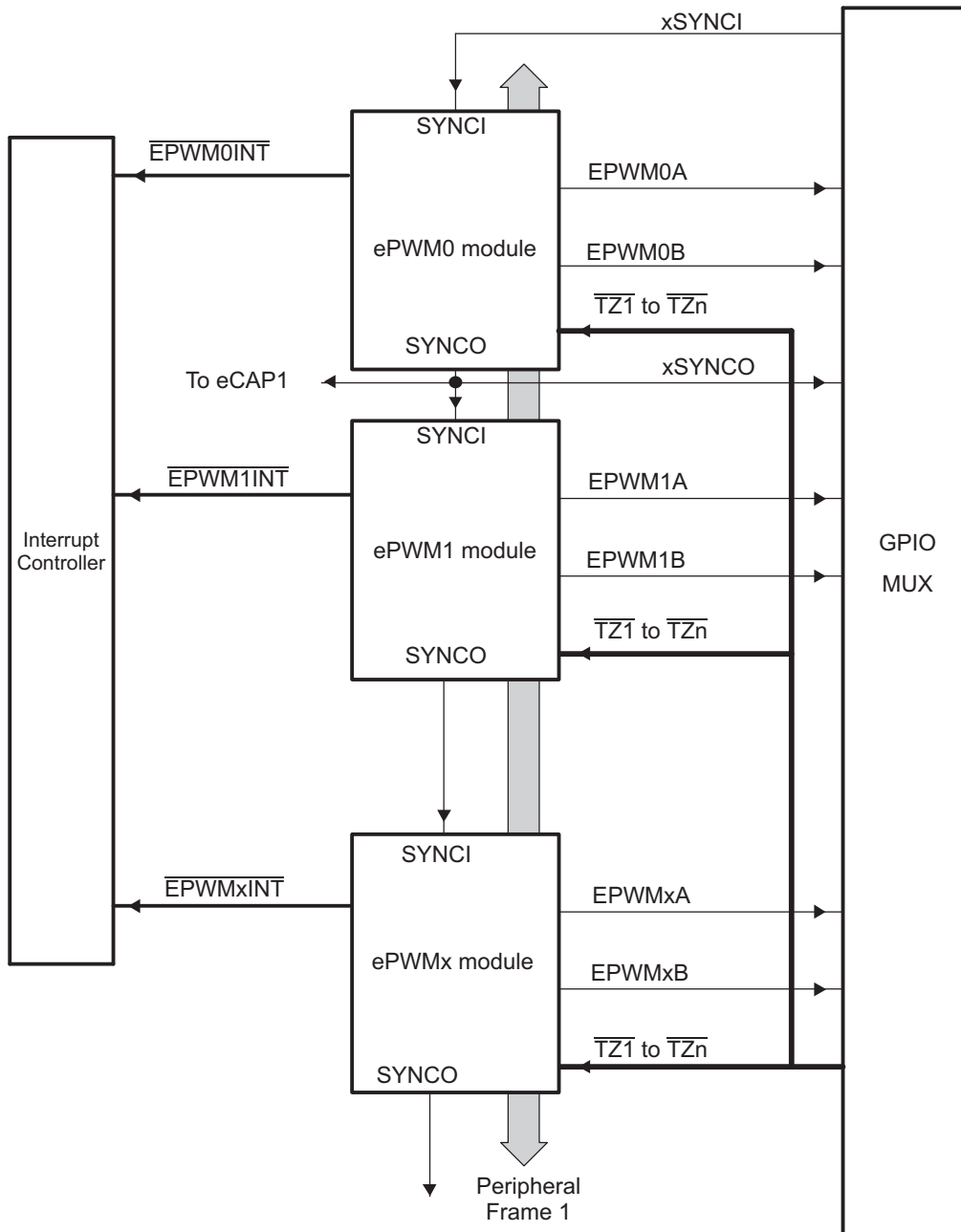
Each ePWM module supports the following features:

- Dedicated 16-bit time-base counter with period and frequency control
- Two PWM outputs (EPWMxA and EPWMxB) that can be used in the following configurations::
 - Two independent PWM outputs with single-edge operation
 - Two independent PWM outputs with dual-edge symmetric operation
 - One independent PWM output with dual-edge asymmetric operation
- Asynchronous override control of PWM signals through software.
- Programmable phase-control support for lag or lead operation relative to other ePWM modules.
- Hardware-locked (synchronized) phase relationship on a cycle-by-cycle basis.
- Dead-band generation with independent rising and falling edge delay control.
- Programmable trip zone allocation of both cycle-by-cycle trip and one-shot trip on fault conditions.
- A trip condition can force either high, low, or high-impedance state logic levels at PWM outputs.
- Programmable event prescaling minimizes CPU overhead on interrupts.
- PWM chopping by high-frequency carrier signal, useful for pulse transformer gate drives.

Each ePWM module is connected to the input/output signals shown in [Figure 15-7](#). The signals are described in detail in subsequent sections.

The order in which the ePWM modules are connected may differ from what is shown in [Figure 15-7](#). See [Section 15.2.2.3.3.2](#) for the synchronization scheme for a particular device. Each ePWM module consists of seven submodules and is connected within a system via the signals shown in [Figure 15-8](#).

Figure 15-7. Multiple ePWM Modules



NOTE: Figure 15-7 is a generic block diagram. For specific implementation, see Section 15.1.1.1, PWMSS Synchronization Detail.

Figure 15-8. Submodules and Signal Connections for an ePWM Module

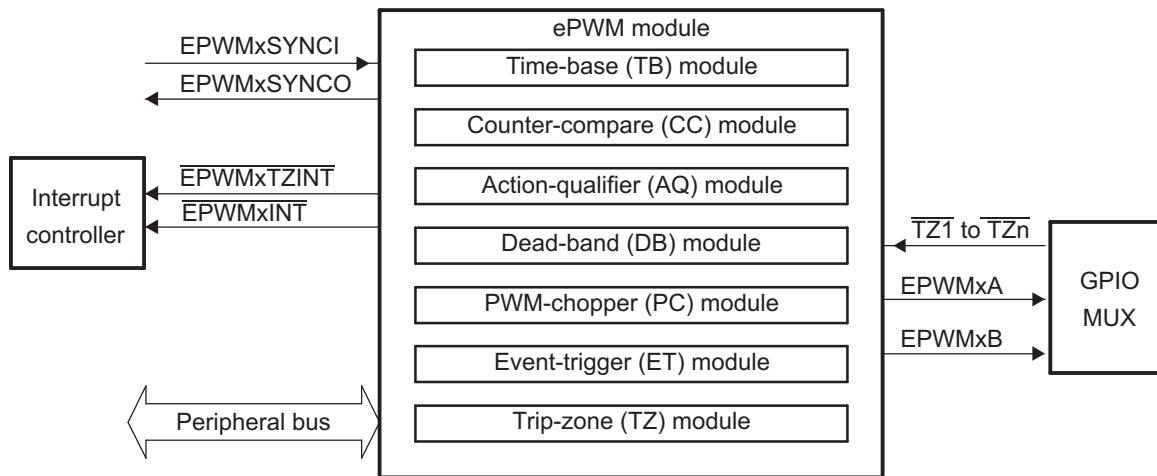
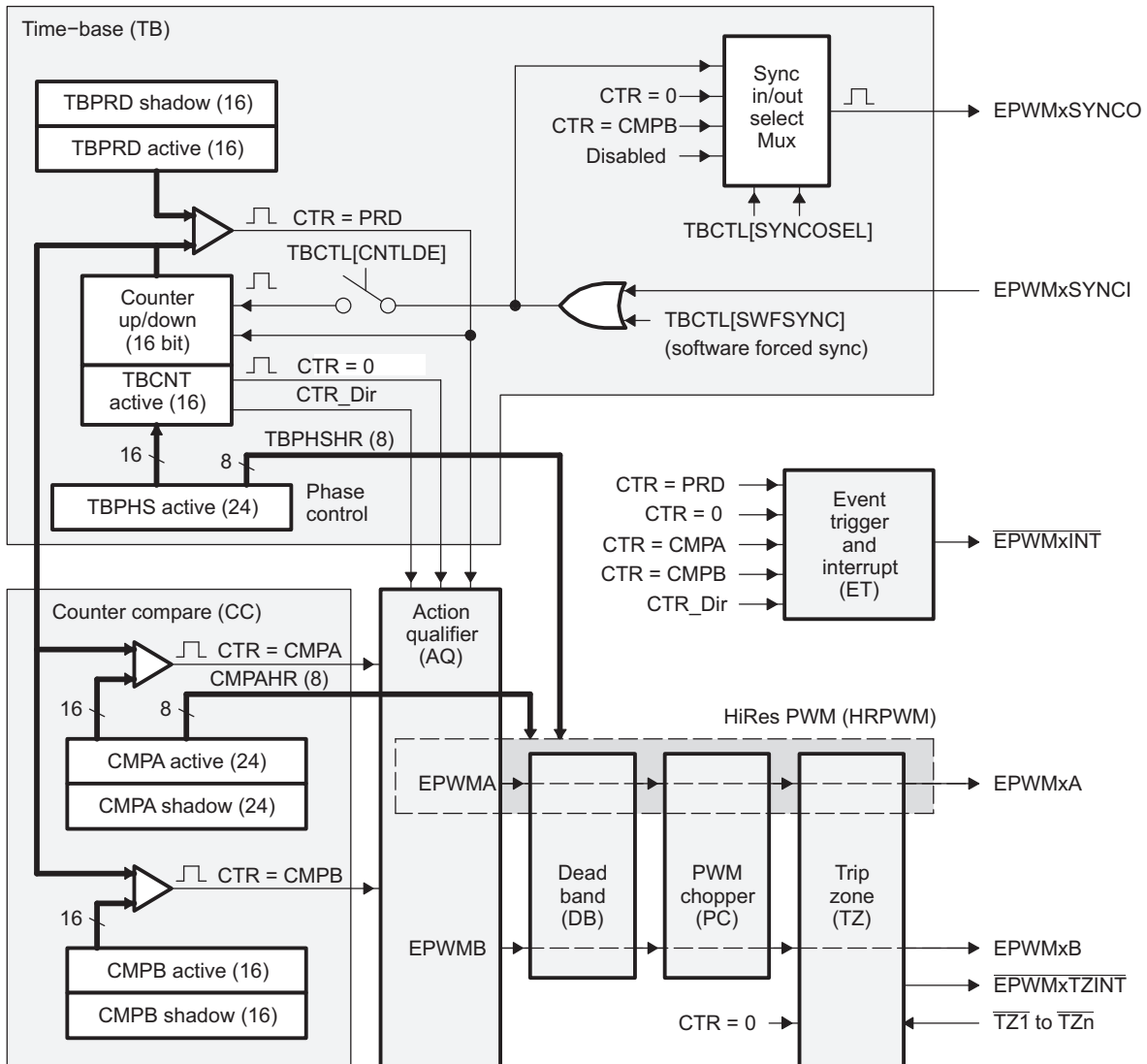


Figure 15-9 shows more internal details of a single ePWM module. The main signals used by the ePWM module are:

- **PWM output signals (EPWMxA and EPWMxB).** The PWM output signals are made available external to the device through the GPIO peripheral described in the system control and interrupts guide for your device.
- **Trip-zone signals ($\overline{TZ1}$ to \overline{TZn}).** These input signals alert the ePWM module of an external fault condition. Each module on a device can be configured to either use or ignore any of the trip-zone signals. The trip-zone signal can be configured as an asynchronous input through the GPIO peripheral. See Section 15.1.1 to determine how many trip-zone pins are available in the device.
- **Time-base synchronization input (EPWMxSYNCl) and output (EPWMxSYNCO) signals.** The synchronization signals daisy chain the ePWM modules together. Each module can be configured to either use or ignore its synchronization input. The clock synchronization input and output signal are brought out to pins only for ePWM0 (ePWM module #0). The synchronization output for ePWM2 (EPWM2SYNCO) is also connected to the SYNCl of the first enhanced capture module (eCAP0).
- **Peripheral Bus.** The peripheral bus is 32-bits wide and allows both 16-bit and 32-bit writes to the ePWM register file.

Figure 15-9 also shows the key internal submodule interconnect signals. Each submodule is described in Section 15.2.2.

Figure 15-9. ePWM Submodules and Critical Internal Signal Interconnects



15.2.2 Functional Description

Seven submodules are included in every ePWM peripheral. There are some instances that include a high-resolution submodule that allows more precise control of the PWM outputs. Each of these submodules performs specific tasks that can be configured by software.

15.2.2.1 Overview

Table 15-9 lists the eight key submodules together with a list of their main configuration parameters. For example, if you need to adjust or control the duty cycle of a PWM waveform, then you should see the counter-compare submodule in Section 15.2.2.4 for relevant details.

Table 15-9. Submodule Configuration Parameters

Submodule	Configuration Parameter or Option
Time-base (TB)	<ul style="list-style-type: none"> • Scale the time-base clock (TBCLK) relative to the system clock (SYSCLKOUT). • Configure the PWM time-base counter (TBCNT) frequency or period. • Set the mode for the time-base counter: <ul style="list-style-type: none"> – count-up mode: used for asymmetric PWM – count-down mode: used for asymmetric PWM – count-up-and-down mode: used for symmetric PWM • Configure the time-base phase relative to another ePWM module. • Synchronize the time-base counter between modules through hardware or software. • Configure the direction (up or down) of the time-base counter after a synchronization event. • Configure how the time-base counter will behave when the device is halted by an emulator. • Specify the source for the synchronization output of the ePWM module: <ul style="list-style-type: none"> – Synchronization input signal – Time-base counter equal to zero – Time-base counter equal to counter-compare B (CMPB) – No output synchronization signal generated.
Counter-compare (CC)	<ul style="list-style-type: none"> • Specify the PWM duty cycle for output EPWMxA and/or output EPWMxB • Specify the time at which switching events occur on the EPWMxA or EPWMxB output
Action-qualifier (AQ)	<ul style="list-style-type: none"> • Specify the type of action taken when a time-base or counter-compare submodule event occurs: <ul style="list-style-type: none"> – No action taken – Output EPWMxA and/or EPWMxB switched high – Output EPWMxA and/or EPWMxB switched low – Output EPWMxA and/or EPWMxB toggled • Force the PWM output state through software control • Configure and control the PWM dead-band through software
Dead-band (DB)	<ul style="list-style-type: none"> • Control of traditional complementary dead-band relationship between upper and lower switches • Specify the output rising-edge-delay value • Specify the output falling-edge delay value • Bypass the dead-band module entirely. In this case the PWM waveform is passed through without modification.
PWM-chopper (PC)	<ul style="list-style-type: none"> • Create a chopping (carrier) frequency. • Pulse width of the first pulse in the chopped pulse train. • Duty cycle of the second and subsequent pulses. • Bypass the PWM-chopper module entirely. In this case the PWM waveform is passed through without modification.

Table 15-9. Submodule Configuration Parameters (continued)

Submodule	Configuration Parameter or Option
Trip-zone (TZ)	<ul style="list-style-type: none"> • Configure the ePWM module to react to one, all, or none of the trip-zone pins. • Specify the tripping action taken when a fault occurs: <ul style="list-style-type: none"> – Force EPWMxA and/or EPWMxB high – Force EPWMxA and/or EPWMxB low – Force EPWMxA and/or EPWMxB to a high-impedance state – Configure EPWMxA and/or EPWMxB to ignore any trip condition. • Configure how often the ePWM will react to each trip-zone pin: <ul style="list-style-type: none"> – One-shot – Cycle-by-cycle • Enable the trip-zone to initiate an interrupt. • Bypass the trip-zone module entirely.
Event-trigger (ET)	<ul style="list-style-type: none"> • Enable the ePWM events that will trigger an interrupt. • Specify the rate at which events cause triggers (every occurrence or every second or third occurrence) • Poll, set, or clear event flags
High-Resolution PWM (HRPWM)	<ul style="list-style-type: none"> • Enable extended time resolution capabilities • Configure finer time granularity control or edge positioning

Code examples are provided in the remainder of this chapter that show how to implement various ePWM module configurations. These examples use the constant definitions shown in [Example 15-1](#).

Example 15-1. Constant Definitions Used in the Code Examples

```

// TBCTL (Time-Base Control)
// =====
// TBCNT MODE bits
#define TB_COUNT_UP          0x0
#define TB_COUNT_DOWN       0x1
#define TB_COUNT_UPDOWN     0x2
#define TB_FREEZE           0x3
// PHSEN bit
#define TB_DISABLE          0x0
#define TB_ENABLE           0x1
// PRDL bit
#define TB_SHADOW           0x0
#define TB_IMMEDIATE        0x1
// SYNCSEL bits
#define TB_SYNC_IN          0x0
#define TB_CTR_ZERO         0x1
#define TB_CTR_CMPB         0x2
#define TB_SYNC_DISABLE     0x3
// HSPCLKDIV and CLKDIV bits
#define TB_DIV1              0x0
#define TB_DIV2              0x1
#define TB_DIV4              0x2
// PHSDIR bit
#define TB_DOWN              0x0
#define TB_UP                0x1

// CMPCTL (Compare Control)
// =====
// LOADAMODE and LOADBMODE bits
#define CC_CTR_ZERO         0x0
#define CC_CTR_PRD          0x1
#define CC_CTR_ZERO_PRD     0x2
#define CC_LD_DISABLE       0x3
// SHDWAMODE and SHDWBMODE bits
    
```


Example 15-1. Constant Definitions Used in the Code Examples (continued)

```

#define          CC_SHADOW          0x0
#define          CC_IMMEDIATE      0x1
// AQCTLA and AQCTLB (Action-qualifier Control)
// = = = = =
// ZRO, PRD, CAU, CAD, CBU, CBD bits
#define          AQ_NO_ACTION      0x0
#define          AQ_CLEAR         0x1
#define          AQ_SET           0x2
#define          AQ_TOGGLE        0x3
// DBCTL (Dead-Band Control)
// = = = = =
// MODE bits
#define          DB_DISABLE       0x0
#define          DBA_ENABLE       0x1
#define          DBB_ENABLE       0x2
#define          DB_FULL_ENABLE   0x3
// POLSEL bits
#define          DB_ACTV_HI       0x0
#define          DB_ACTV_LO      0x1
#define          DB_ACTV_HIC      0x2
#define          DB_ACTV_LO      0x3
// PCCTL (chopper control)
// = = = = =
// CHPEN bit
#define          CHP_ENABLE       0x0
#define          CHP_DISABLE     0x1
// CHPFREQ bits
#define          CHP_DIV1         0x0
#define          CHP_DIV2         0x1
#define          CHP_DIV3         0x2
#define          CHP_DIV4         0x3
#define          CHP_DIV5         0x4
#define          CHP_DIV6         0x5
#define          CHP_DIV7         0x6
#define          CHP_DIV8         0x7
// CHPDUTY bits
#define          CHP1_8TH         0x0
#define          CHP2_8TH         0x1
#define          CHP3_8TH         0x2
#define          CHP4_8TH         0x3
#define          CHP5_8TH         0x4
#define          CHP6_8TH         0x5
#define          CHP7_8TH         0x6
// TZSEL (Trip-zone Select)
// = = = = =
// CBCn and OSHn bits
#define          TZ_ENABLE        0x0
#define          TZ_DISABLE      0x1
// TZCTL (Trip-zone Control)
// = = = = =
// TZA and TZB bits
#define          TZ_HIZ           0x0
#define          TZ_FORCE_HI      0x1
#define          TZ_FORCE_LO      0x2
#define          TZ_DISABLE       0x3
// ETSEL (Event-trigger Select)
// = = = = =
// INTSEL, SOCASEL, SOCBSEL bits
#define          ET_CTR_ZERO      0x1
#define          ET_CTR_PRD       0x2
#define          ET_CTRU_CMPA     0x4
#define          ET_CTRD_CMPA     0x5
#define          ET_CTRU_CMPB     0x6
#define          ET_CTRD_CMPB     0x7

```

Example 15-1. Constant Definitions Used in the Code Examples (continued)

```

// ETPS (Event-trigger Prescale)
// =====
// INTPRD, SOCAPRD, SOCBPRD bits
#define     ET_DISABLE      0x0
#define     ET_1ST         0x1
#define     ET_2ND         0x2
#define     ET_3RD         0x3
    
```

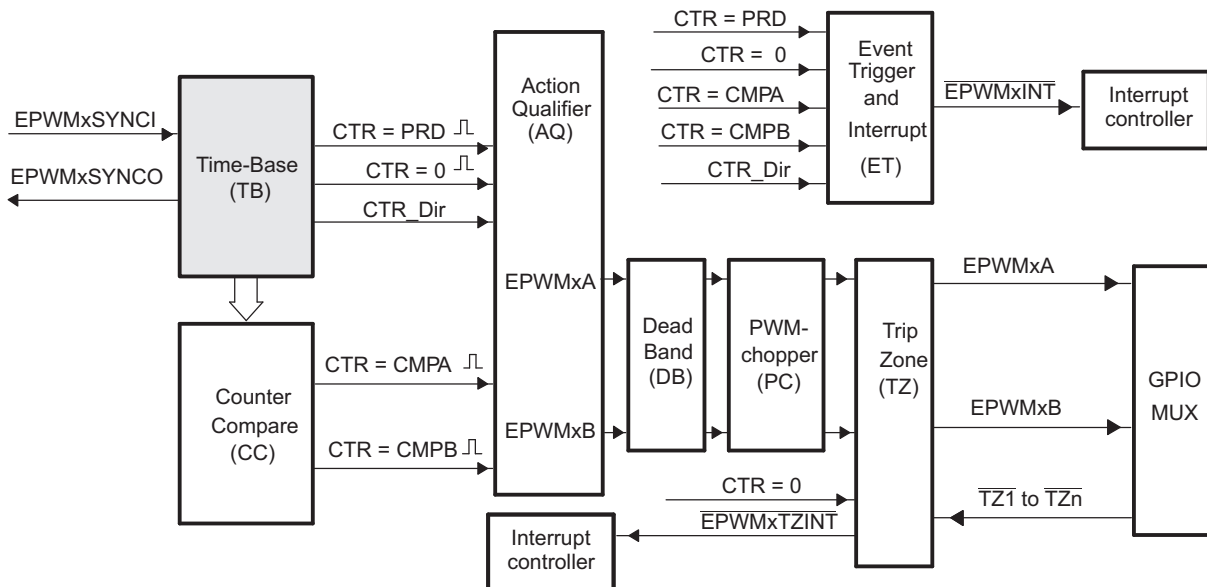
15.2.2.2 Proper Interrupt Initialization Procedure

When the ePWM peripheral clock is enabled it may be possible that interrupt flags may be set due to spurious events due to the ePWM registers not being properly initialized. The proper procedure for initializing the ePWM peripheral is:

1. Disable global interrupts (CPU INTM flag)
2. Disable ePWM interrupts
3. Initialize peripheral registers
4. Clear any spurious ePWM flags
5. Enable ePWM interrupts
6. Enable global interrupts

15.2.2.3 Time-Base (TB) Submodule

Each ePWM module has its own time-base submodule that determines all of the event timing for the ePWM module. Built-in synchronization logic allows the time-base of multiple ePWM modules to work together as a single system. [Figure 15-10](#) illustrates the time-base module's place within the ePWM.

Figure 15-10. Time-Base Submodule Block Diagram


15.2.2.3.1 Purpose of the Time-Base Submodule

You can configure the time-base submodule for the following:

- Specify the ePWM time-base counter (TBCNT) frequency or period to control how often events occur.
- Manage time-base synchronization with other ePWM modules.
- Maintain a phase relationship with other ePWM modules.
- Set the time-base counter to count-up, count-down, or count-up-and-down mode.
- Generate the following events:
 - CTR = PRD: Time-base counter equal to the specified period (TBCNT = TBPRD) .
 - CTR = 0: Time-base counter equal to zero (TBCNT = 0000h).
- Configure the rate of the time-base clock; a prescaled version of the CPU system clock (SYSCLKOUT). This allows the time-base counter to increment/decrement at a slower rate.

15.2.2.3.2 Controlling and Monitoring the Time-Base Submodule

Table 15-10 lists the registers used to control and monitor the time-base submodule.

Table 15-10. Time-Base Submodule Registers

Acronym	Register Description	Address Offset	Shadowed
TBCTL	Time-Base Control Register	0h	No
TBSTS	Time-Base Status Register	2h	No
TBPHSHR	HRPWM extension Phase Register ⁽¹⁾	4h	No
TBPHS	Time-Base Phase Register	6h	No
TBCNT	Time-Base Counter Register	8h	No
TBPRD	Time-Base Period Register	Ah	Yes

⁽¹⁾ This register is available only on ePWM instances that include the high-resolution extension (HRPWM). On ePWM modules that do not include the HRPWM, this location is reserved. See Section 15.1.1 to determine which ePWM instances include this feature.

Figure 15-11 shows the critical signals and registers of the time-base submodule. Table 15-11 provides descriptions of the key signals associated with the time-base submodule.

Figure 15-11. Time-Base Submodule Signals and Registers

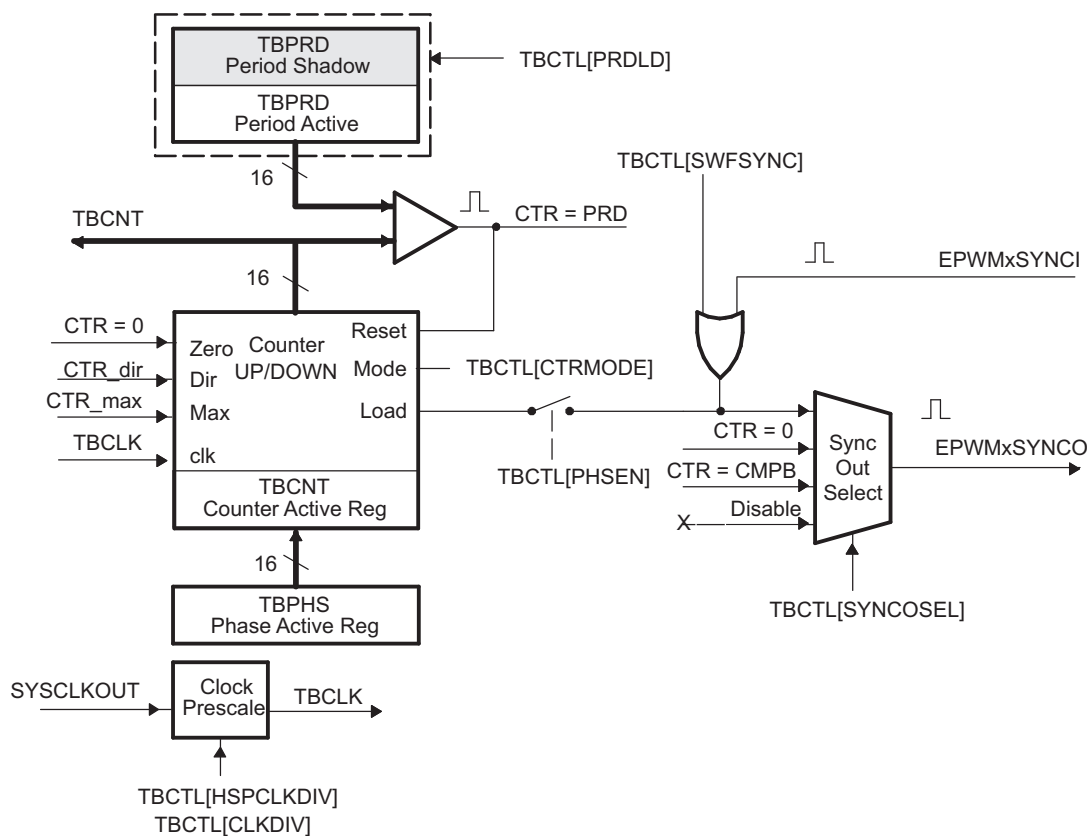


Table 15-11. Key Time-Base Signals

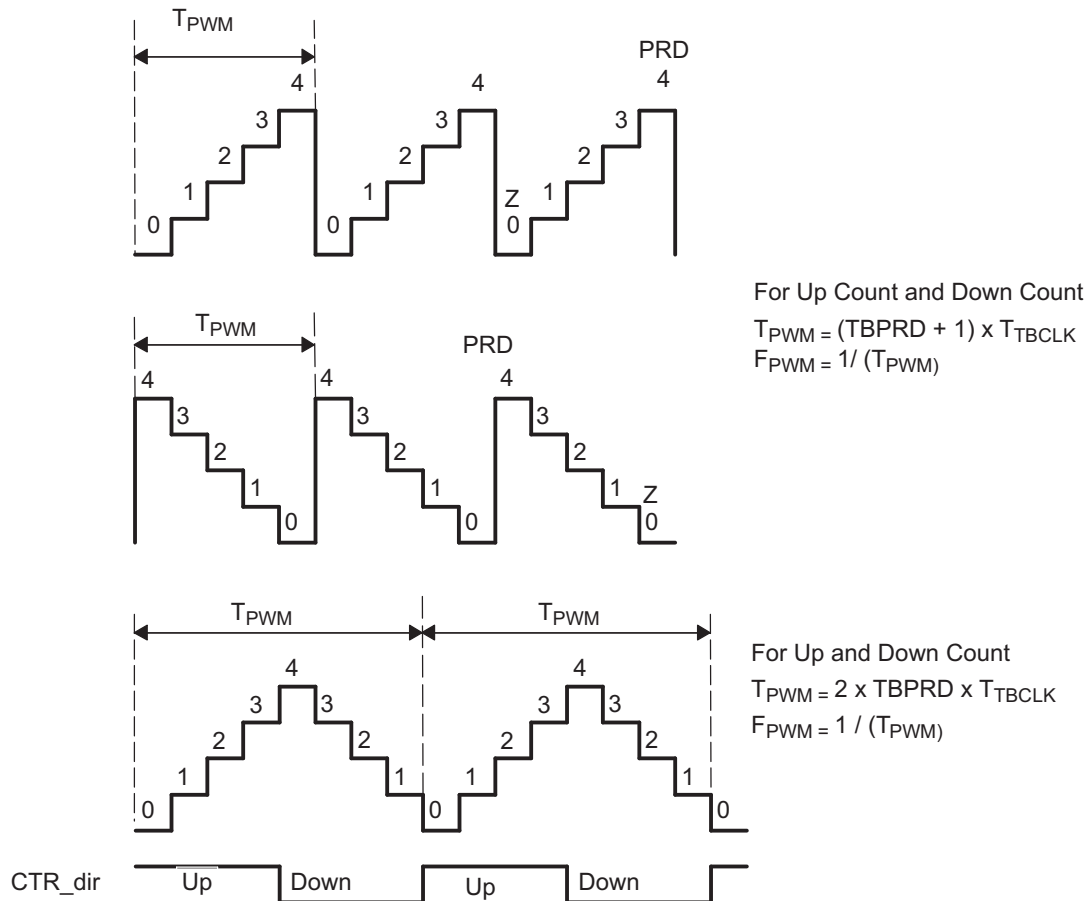
Signal	Description
EPWMxSYNCl	Time-base synchronization input. Input pulse used to synchronize the time-base counter with the counter of ePWM module earlier in the synchronization chain. An ePWM peripheral can be configured to use or ignore this signal. For example, this signal could come from a device pin for the first ePWM module (ePWM0). For subsequent ePWM modules this signal could be passed from another ePWM peripheral, such that EPWM1SYNCl is generated by the ePWM0 peripheral, EPWM2SYNCl is generated by ePWM1, and so forth. See Section 15.1.1 for information on the synchronization order of a particular device.
EPWMxSYNCO	Time-base synchronization output. This output pulse is used to synchronize the counter of an ePWM module later in the synchronization chain. The ePWM module generates this signal from one of three event sources: <ol style="list-style-type: none"> 1. EPWMxSYNCl (Synchronization input pulse) 2. CTR = 0: The time-base counter equal to zero (TBCNT = 0000h). 3. CTR = CMPB: The time-base counter equal to the counter-compare B (TBCNT = CMPB) register.
CTR = PRD	Time-base counter equal to the specified period. This signal is generated whenever the counter value is equal to the active period register value. That is when TBCNT = TBPRD.
CTR = 0	Time-base counter equal to zero. This signal is generated whenever the counter value is zero. That is when TBCNT equals 0000h.
CTR = CMPB	Time-base counter equal to active counter-compare B register (TBCNT = CMPB). This event is generated by the counter-compare submodule and used by the synchronization out logic.
CTR_dir	Time-base counter direction. Indicates the current direction of the ePWM's time-base counter. This signal is high when the counter is increasing and low when it is decreasing.
CTR_max	Time-base counter equal max value. (TBCNT = FFFFh) Generated event when the TBCNT value reaches its maximum value. This signal is only used only as a status bit.
TBCLK	Time-base clock. This is a prescaled version of the system clock (SYSCLKOUT) and is used by all submodules within the ePWM. This clock determines the rate at which time-base counter increments or decrements.

15.2.2.3.3 Calculating PWM Period and Frequency

The frequency of PWM events is controlled by the time-base period (TBPRD) register and the mode of the time-base counter. [Figure 15-12](#) shows the period (T_{pwm}) and frequency (F_{pwm}) relationships for the up-count, down-count, and up-down-count time-base counter modes when the period is set to 4 (TBPRD = 4). The time increment for each step is defined by the time-base clock (TBCLK) which is a prescaled version of the system clock (SYSCLKOUT).

The time-base counter has three modes of operation selected by the time-base control register (TBCTL):

- **Up-Down-Count Mode:** In up-down-count mode, the time-base counter starts from zero and increments until the period (TBPRD) value is reached. When the period value is reached, the time-base counter then decrements until it reaches zero. At this point the counter repeats the pattern and begins to increment.
- **Up-Count Mode:** In this mode, the time-base counter starts from zero and increments until it reaches the value in the period register (TBPRD). When the period value is reached, the time-base counter resets to zero and begins to increment once again.
- **Down-Count Mode:** In down-count mode, the time-base counter starts from the period (TBPRD) value and decrements until it reaches zero. When it reaches zero, the time-base counter is reset to the period value and it begins to decrement once again.

Figure 15-12. Time-Base Frequency and Period


15.2.2.3.3.1 Time-Base Period Shadow Register

The time-base period register (TBPRD) has a shadow register. Shadowing allows the register update to be synchronized with the hardware. The following definitions are used to describe all shadow registers in the ePWM module:

- **Active Register:** The active register controls the hardware and is responsible for actions that the hardware causes or invokes.
- **Shadow Register:** The shadow register buffers or provides a temporary holding location for the active register. It has no direct effect on any control hardware. At a strategic point in time the shadow register's content is transferred to the active register. This prevents corruption or spurious operation due to the register being asynchronously modified by software.

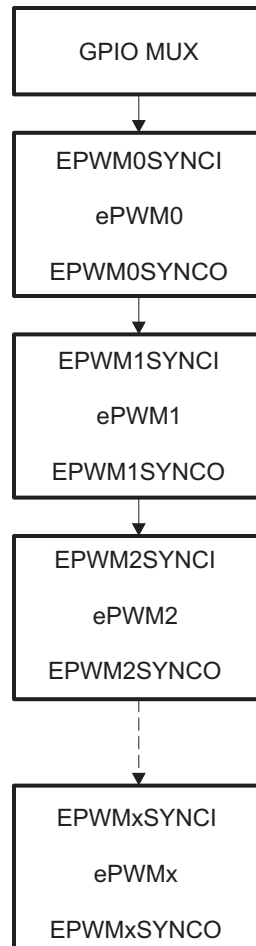
The memory address of the shadow period register is the same as the active register. Which register is written to or read from is determined by the TBCTL[PRDL] bit. This bit enables and disables the TBPRD shadow register as follows:

- **Time-Base Period Shadow Mode:** The TBPRD shadow register is enabled when TBCTL[PRDL] = 0. Reads from and writes to the TBPRD memory address go to the shadow register. The shadow register contents are transferred to the active register (TBPRD (Active) ← TBPRD (shadow)) when the time-base counter equals zero (TBCNT = 0000h). By default the TBPRD shadow register is enabled.
- **Time-Base Period Immediate Load Mode:** If immediate load mode is selected (TBCTL[PRDL] = 1), then a read from or a write to the TBPRD memory address goes directly to the active register.

15.2.2.3.3.2 Time-Base Counter Synchronization

A time-base synchronization scheme connects all of the ePWM modules on a device. Each ePWM module has a synchronization input (EPWMxSYNCl) and a synchronization output (EPWMxSYNCO). The synchronization input can come from an external pin or another ePWM module. An example of synchronization connections for the remaining ePWM modules is shown in [Section 15.1.1](#).

Figure 15-13. Time-Base Counter Synchronization Scheme 1



Each ePWM module can be configured to use or ignore the synchronization input. If the TBCTL[PHSEN] bit is set, then the time-base counter (TBCNT) of the ePWM module will be automatically loaded with the phase register (TBPHS) contents when one of the following conditions occur:

- **EPWMxSYNCl: Synchronization Input Pulse:** The value of the phase register is loaded into the counter register when an input synchronization pulse is detected (TBPHS → TBCNT). This operation occurs on the next valid time-base clock (TBCLK) edge.
- **Software Forced Synchronization Pulse:** Writing a 1 to the TBCTL[SWFSYNC] control bit invokes a software forced synchronization. This pulse is ORed with the synchronization input signal, and therefore has the same effect as a pulse on EPWMxSYNCl.

This feature enables the ePWM module to be automatically synchronized to the time base of another ePWM module. Lead or lag phase control can be added to the waveforms generated by different ePWM modules to synchronize them. In up-down-count mode, the TBCTL[PSHDIR] bit configures the direction of the time-base counter immediately after a synchronization event. The new direction is independent of the direction prior to the synchronization event. The TBPHS bit is ignored in count-up or count-down modes. See [Figure 15-14](#) through [Figure 15-17](#) for examples.

Clearing the TBCTL[PHSEN] bit configures the ePWM to ignore the synchronization input pulse. The synchronization pulse can still be allowed to flow-through to the EPWMxSYNCO and be used to synchronize other ePWM modules. In this way, you can set up a master time-base (for example, ePWM0) and downstream modules (ePWM1 – ePWMx) may elect to run in synchronization with the master.

15.2.2.3.4 Phase Locking the Time-Base Clocks of Multiple ePWM Modules

The TBCLKEN bit in the PWMSS_CTRL register in the Control Module can be used to globally synchronize the time-base clocks of all enabled ePWM modules on a device. The TBCLKEN bit is part of the chip configuration registers and is described in [Chapter 9](#). When TBCLKEN = 0, the time-base clock of all ePWM modules is stopped (default). When TBCLKEN = 1, all ePWM time-base clocks are started with the rising edge of TBCLK aligned. For perfectly synchronized TBCLKs, the prescaler bits in the TBCTL register of each ePWM module must be set identically. The proper procedure for enabling the ePWM clocks is as follows:

1. Enable the ePWM module clocks.
2. Set TBCLKEN = 0. This will stop the time-base clock within any enabled ePWM module.
3. Configure the prescaler values and desired ePWM modes.
4. Set TBCLKEN = 1.

15.2.2.3.5 Time-Base Counter Modes and Timing Waveforms

The time-base counter operates in one of four modes:

- Up-count mode which is asymmetrical.
- Down-count mode which is asymmetrical.
- Up-down-count which is symmetrical.
- Frozen where the time-base counter is held constant at the current value.

To illustrate the operation of the first three modes, [Figure 15-14](#) to [Figure 15-17](#) show when events are generated and how the time-base responds to an EPWMxSYNCl signal.

Figure 15-14. Time-Base Up-Count Mode Waveforms

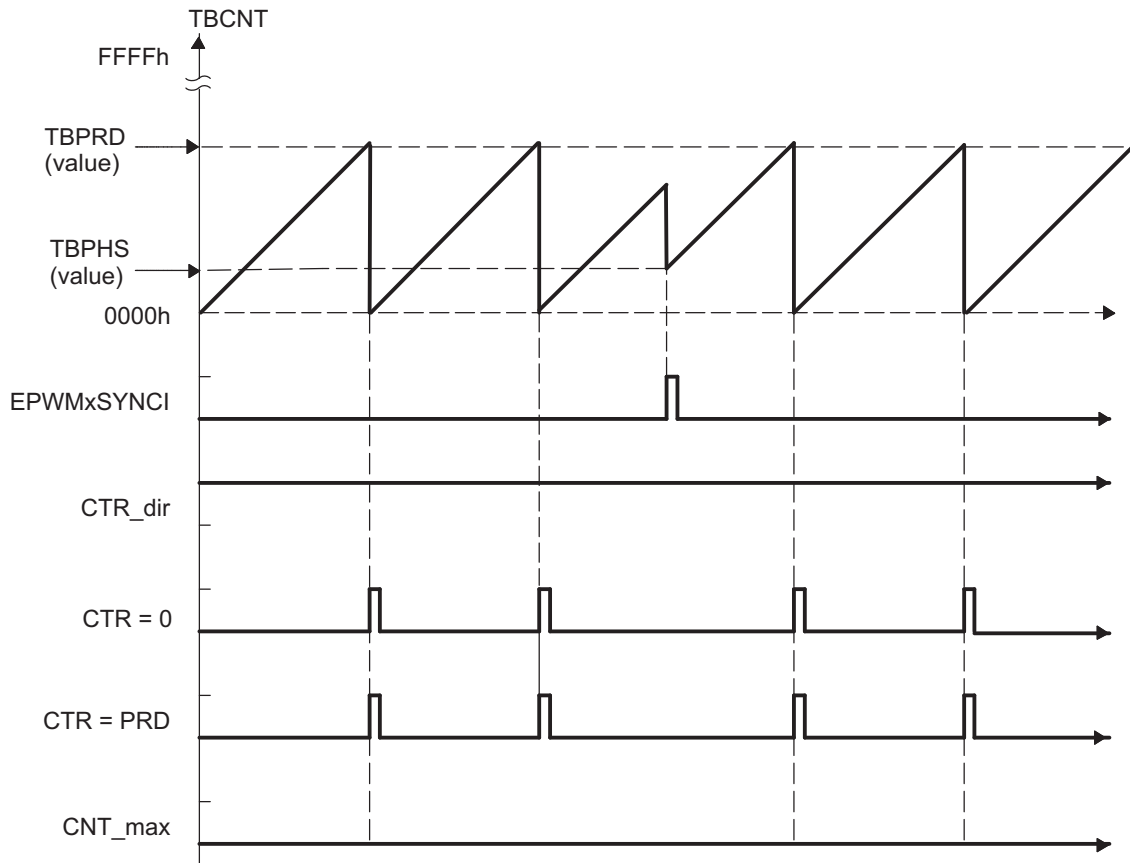


Figure 15-15. Time-Base Down-Count Mode Waveforms

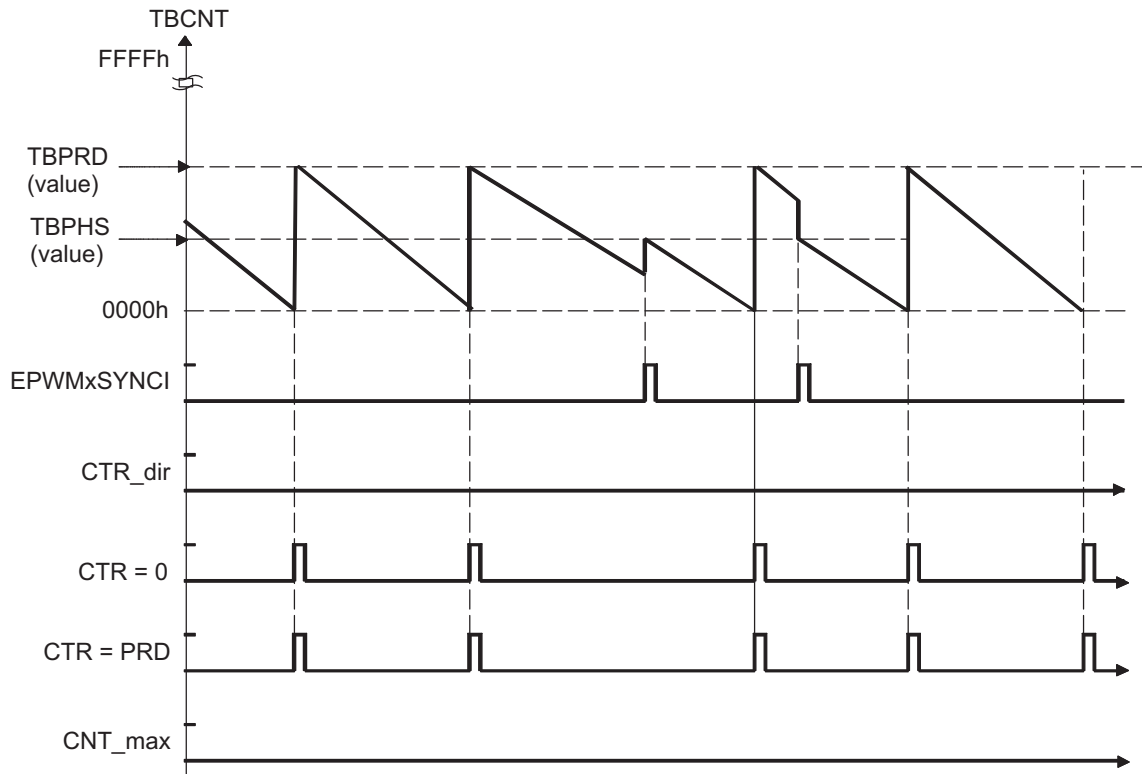


Figure 15-16. Time-Base Up-Down-Count Waveforms, TBCTL[PHSDIR = 0] Count Down on Synchronization Event

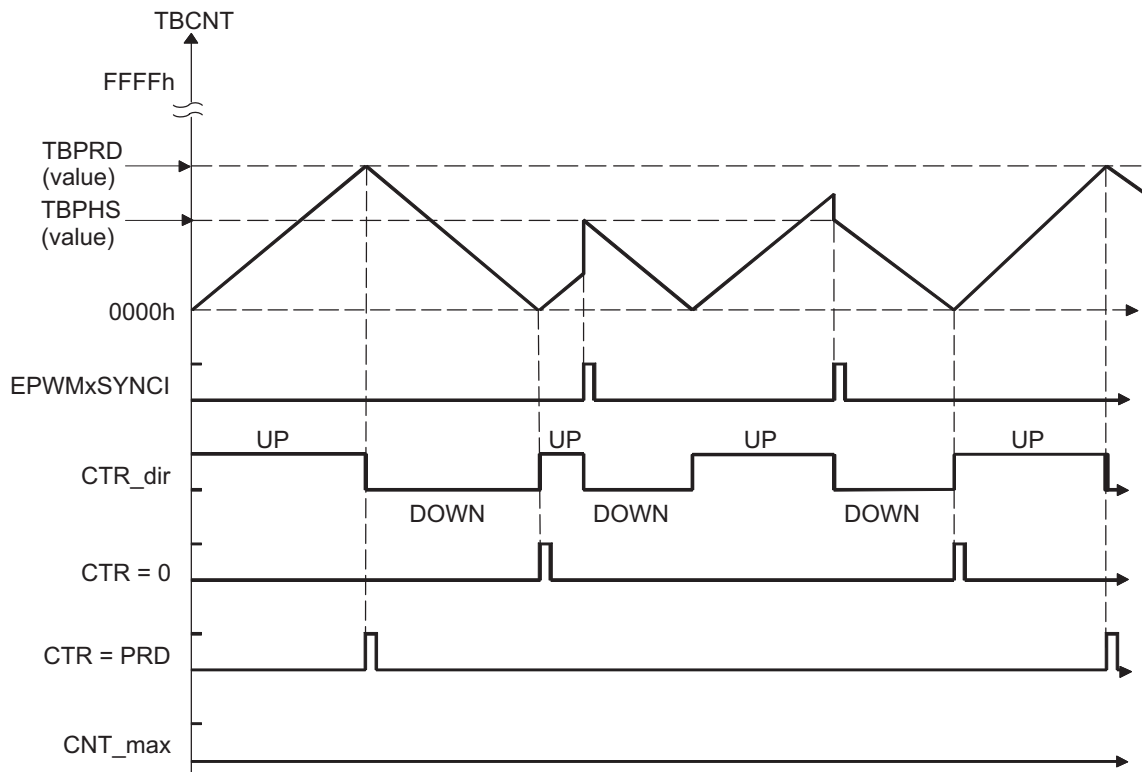
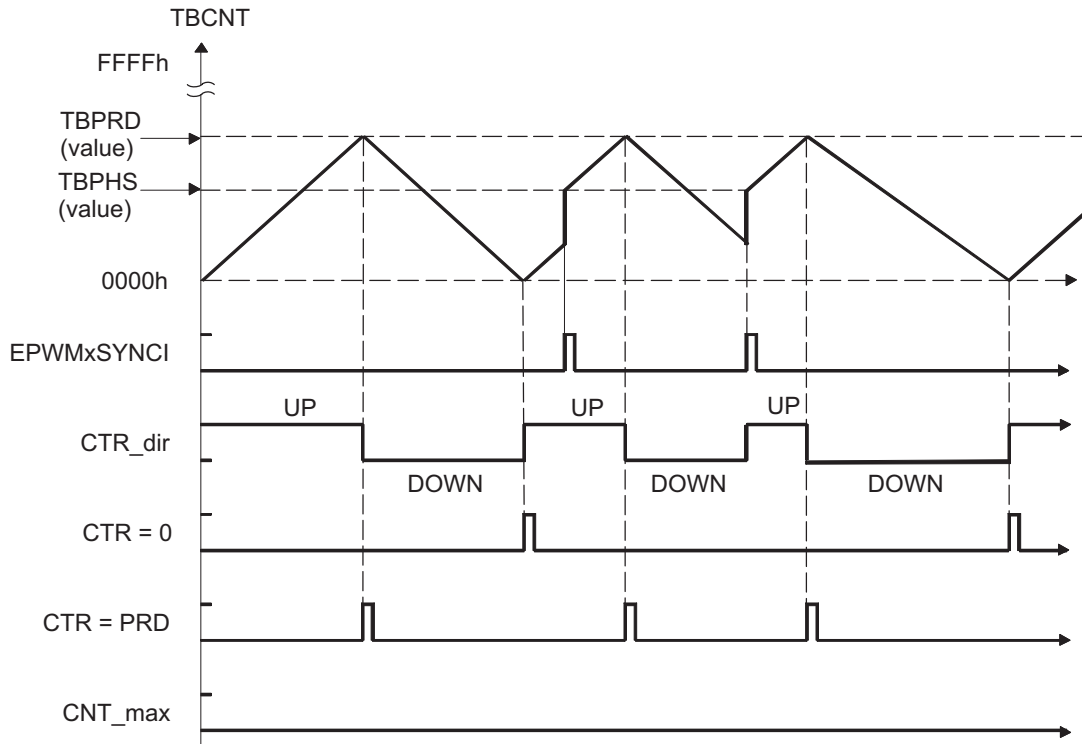


Figure 15-17. Time-Base Up-Down Count Waveforms, TBCTL[PHSDIR = 1] Count Up on Synchronization Event



15.2.2.4 Counter-Compare (CC) Submodule

Figure 15-18 illustrates the counter-compare submodule within the ePWM. Figure 15-19 shows the basic structure of the counter-compare submodule.

Figure 15-18. Counter-Compare Submodule

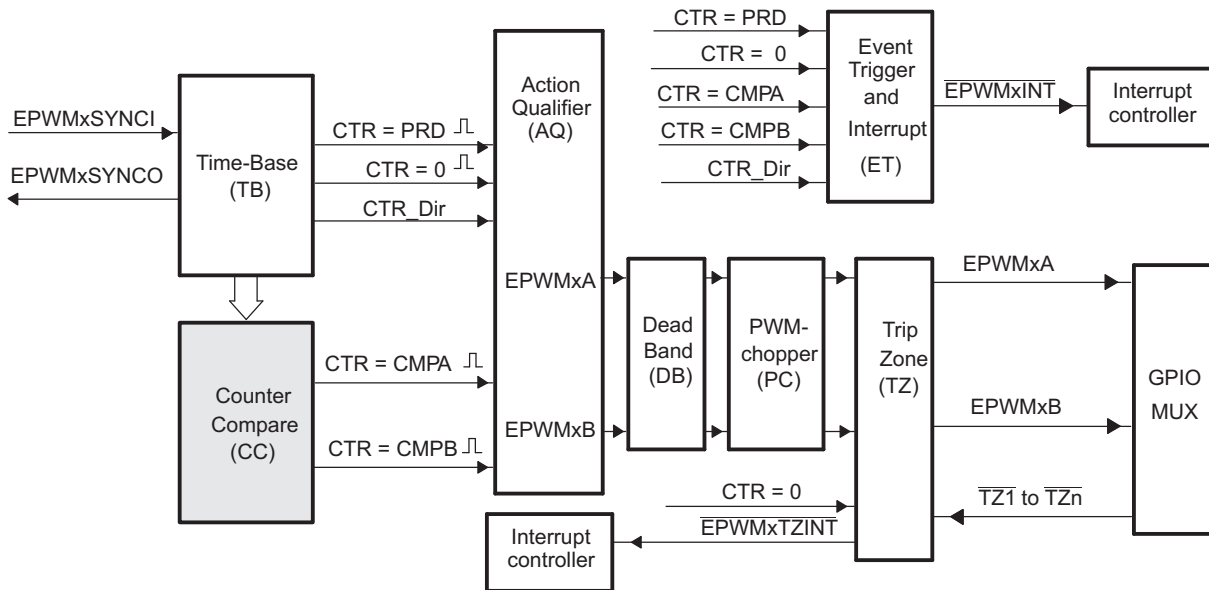
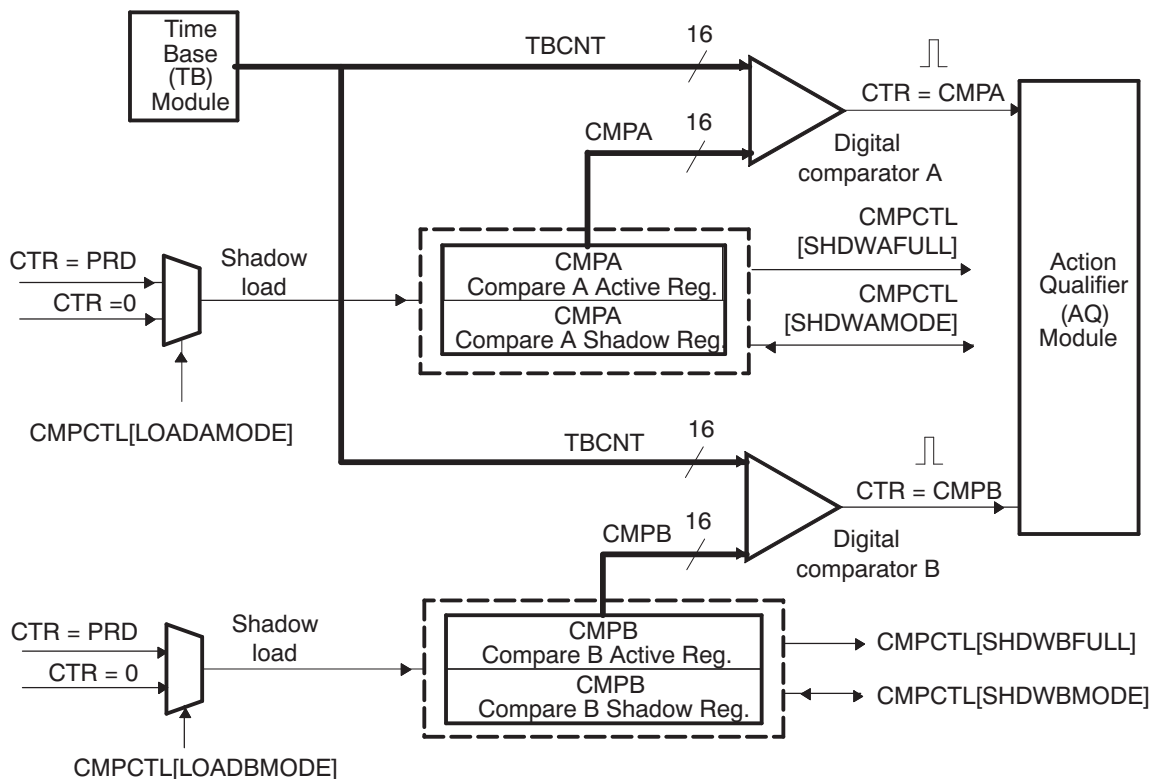


Figure 15-19. Counter-Compare Submodule Signals and Registers



15.2.2.4.1 Purpose of the Counter-Compare Submodule

The counter-compare submodule takes as input the time-base counter value. This value is continuously compared to the counter-compare A (CMPA) and counter-compare B (CMPB) registers. When the time-base counter is equal to one of the compare registers, the counter-compare unit generates an appropriate event.

The counter-compare submodule:

- Generates events based on programmable time stamps using the CMPA and CMPB registers
 - CTR = CMPA: Time-base counter equals counter-compare A register (TBCNT = CMPA).
 - CTR = CMPB: Time-base counter equals counter-compare B register (TBCNT = CMPB)
- Controls the PWM duty cycle if the action-qualifier submodule is configured appropriately
- Shadows new compare values to prevent corruption or glitches during the active PWM cycle

15.2.2.4.2 Controlling and Monitoring the Counter-Compare Submodule

Table 15-12 lists the registers used to control and monitor the counter-compare submodule. Table 15-13 lists the key signals associated with the counter-compare submodule.

Table 15-12. Counter-Compare Submodule Registers

Acronym	Register Description	Address Offset	Shadowed
CMPCTL	Counter-Compare Control Register.	Eh	No
CMPAHR	HRPWM Counter-Compare A Extension Register ⁽¹⁾	10h	Yes
CMPA	Counter-Compare A Register	12h	Yes
CMPB	Counter-Compare B Register	14h	Yes

⁽¹⁾ This register is available only on ePWM modules with the high-resolution extension (HRPWM). On ePWM modules that do not include the HRPWM, this location is reserved. See Section 15.1.1 to determine which ePWM instances include this feature.

Table 15-13. Counter-Compare Submodule Key Signals

Signal	Description of Event	Registers Compared
CTR = CMPA	Time-base counter equal to the active counter-compare A value	TBCNT = CMPA
CTR = CMPB	Time-base counter equal to the active counter-compare B value	TBCNT = CMPB
CTR = PRD	Time-base counter equal to the active period. Used to load active counter-compare A and B registers from the shadow register	TBCNT = TBPRD
CTR = 0	Time-base counter equal to zero. Used to load active counter-compare A and B registers from the shadow register	TBCNT = 0000h

15.2.2.4.3 Operational Highlights for the Counter-Compare Submodule

The counter-compare submodule is responsible for generating two independent compare events based on two compare registers:

1. CTR = CMPA: Time-base counter equal to counter-compare A register (TBCNT = CMPA).
2. CTR = CMPB: Time-base counter equal to counter-compare B register (TBCNT = CMPB).

For up-count or down-count mode, each event occurs only once per cycle. For up-down-count mode each event occurs twice per cycle, if the compare value is between 0000h and TBPRD; and occurs once per cycle, if the compare value is equal to 0000h or equal to TBPRD. These events are fed into the action-qualifier submodule where they are qualified by the counter direction and converted into actions if enabled. Refer to [Section 15.2.2.5.1](#) for more details.

The counter-compare registers CMPA and CMPB each have an associated shadow register. Shadowing provides a way to keep updates to the registers synchronized with the hardware. When shadowing is used, updates to the active registers only occurs at strategic points. This prevents corruption or spurious operation due to the register being asynchronously modified by software. The memory address of the active register and the shadow register is identical. Which register is written to or read from is determined by the CMPCTL[SHDWAMODE] and CMPCTL[SHDWBMODE] bits. These bits enable and disable the CMPA shadow register and CMPB shadow register respectively. The behavior of the two load modes is described below:

- **Shadow Mode:** The shadow mode for the CMPA is enabled by clearing the CMPCTL[SHDWAMODE] bit and the shadow register for CMPB is enabled by clearing the CMPCTL[SHDWBMODE] bit. Shadow mode is enabled by default for both CMPA and CMPB.

If the shadow register is enabled then the content of the shadow register is transferred to the active register on one of the following events:

- CTR = PRD: Time-base counter equal to the period (TBCNT = TBPRD).
- CTR = 0: Time-base counter equal to zero (TBCNT = 0000h)
- Both CTR = PRD and CTR = 0

Which of these three events is specified by the CMPCTL[LOADAMODE] and CMPCTL[LOADBMODE] register bits. Only the active register contents are used by the counter-compare submodule to generate events to be sent to the action-qualifier.

- **Immediate Load Mode:** If immediate load mode is selected (TBCTL[SHADWAMODE] = 1 or TBCTL[SHADWBMODE] = 1), then a read from or a write to the register will go directly to the active register.

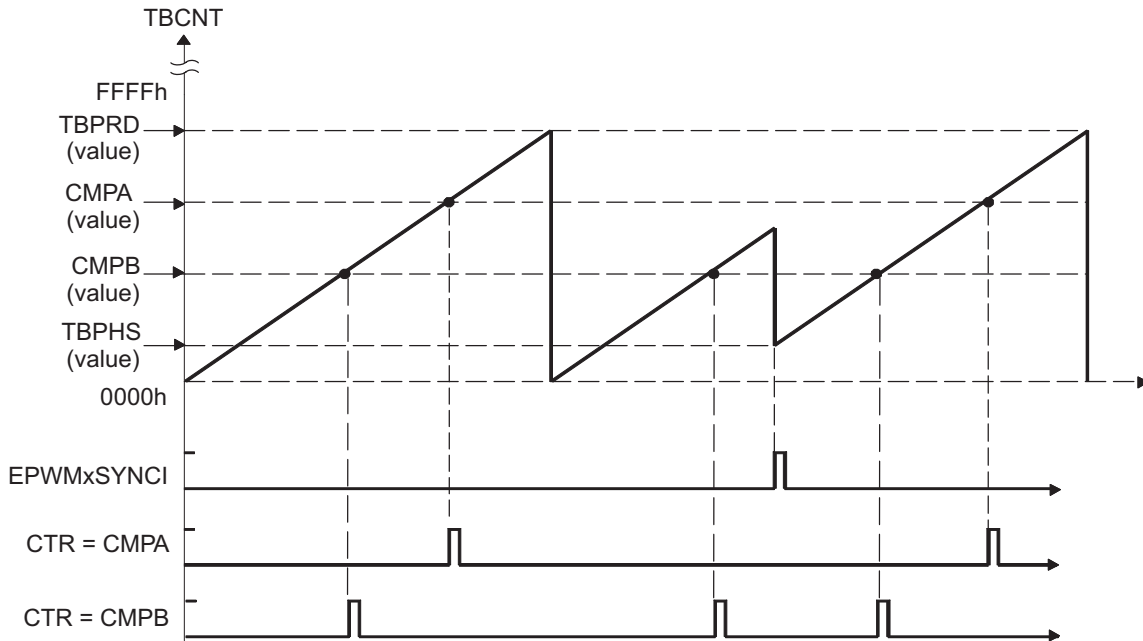
15.2.2.4.4 Count Mode Timing Waveforms

The counter-compare module can generate compare events in all three count modes:

- Up-count mode: used to generate an asymmetrical PWM waveform.
- Down-count mode: used to generate an asymmetrical PWM waveform.
- Up-down-count mode: used to generate a symmetrical PWM waveform.

To best illustrate the operation of the first three modes, the timing diagrams in [Figure 15-20](#) to [Figure 15-23](#) show when events are generated and how the EPWMxSYNCl signal interacts.

Figure 15-20. Counter-Compare Event Waveforms in Up-Count Mode



NOTE: An EPWMxSYNCl external synchronization event can cause a discontinuity in the TBCNT count sequence. This can lead to a compare event being skipped. This skipping is considered normal operation and must be taken into account.

Figure 15-21. Counter-Compare Events in Down-Count Mode

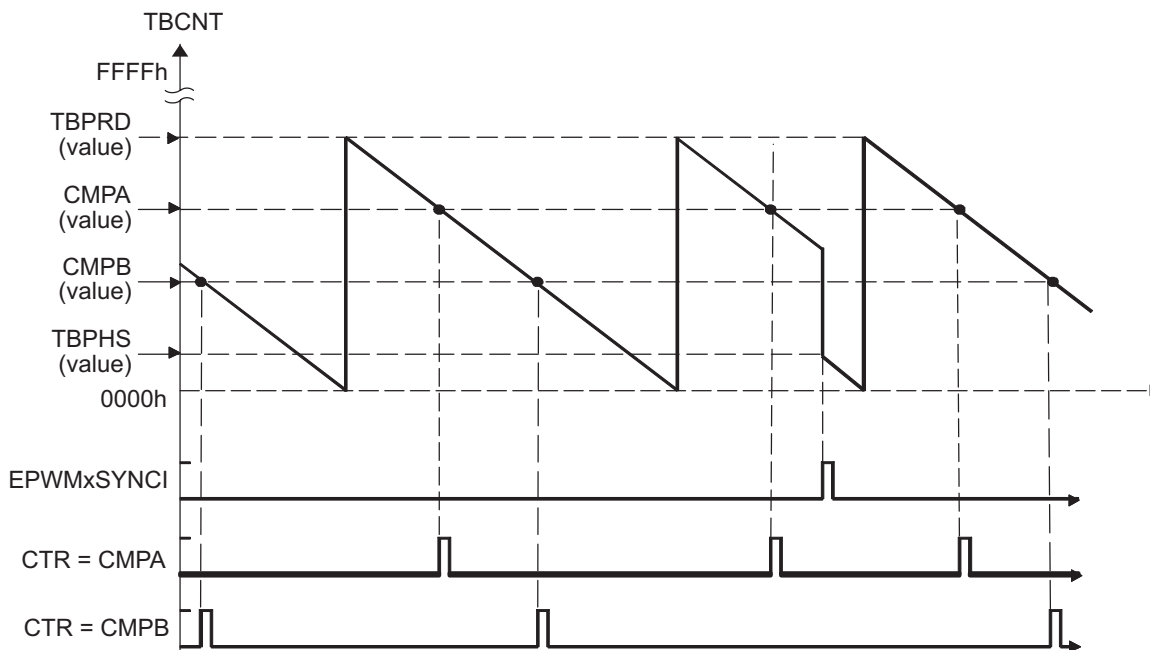


Figure 15-22. Counter-Compare Events in Up-Down-Count Mode, TBCTL[PHSDIR = 0] Count Down on Synchronization Event

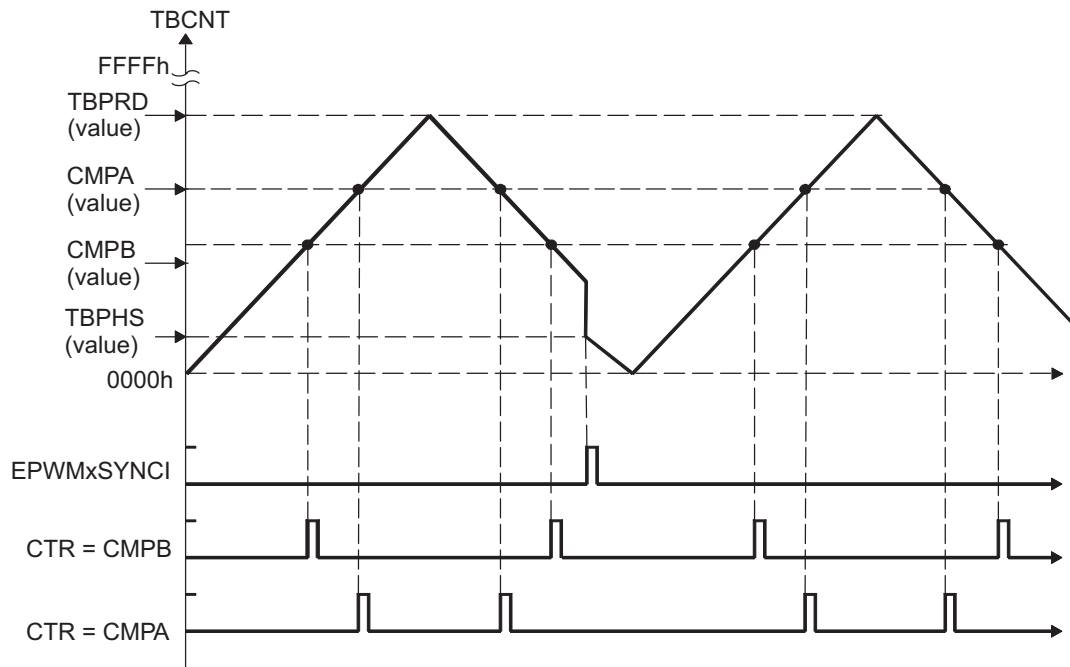
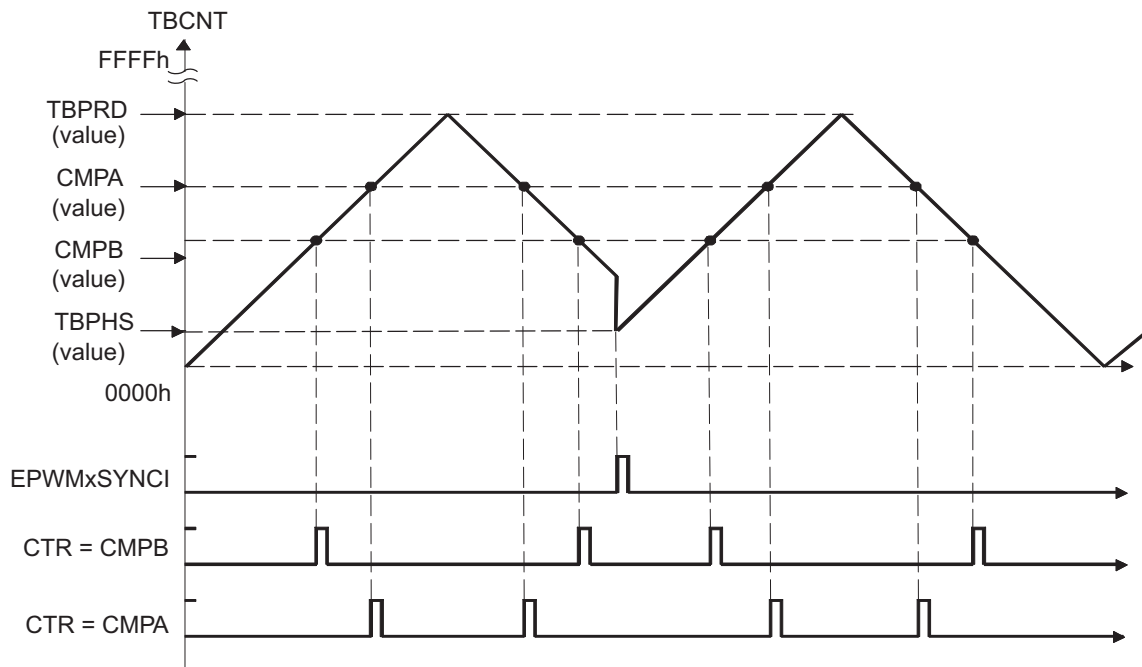


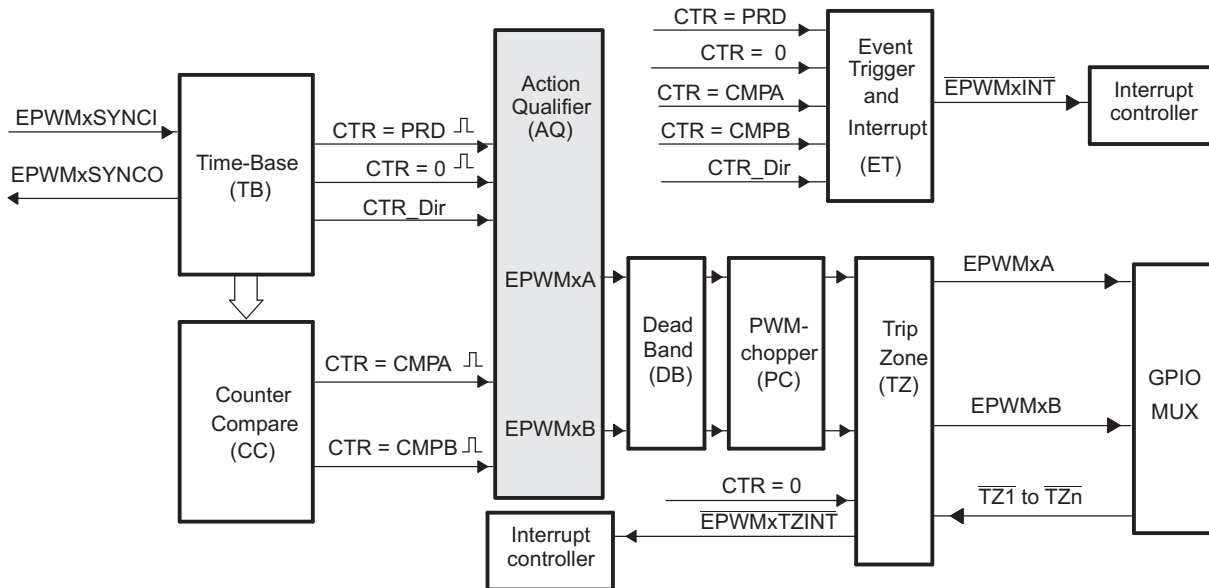
Figure 15-23. Counter-Compare Events in Up-Down-Count Mode, TBCTL[PHSDIR = 1] Count Up on Synchronization Event



15.2.2.5 Action-Qualifier (AQ) Submodule

Figure 15-24 shows the action-qualifier (AQ) submodule (see shaded block) in the ePWM system. The action-qualifier submodule has the most important role in waveform construction and PWM generation. It decides which events are converted into various action types, thereby producing the required switched waveforms at the EPWMxA and EPWMxB outputs.

Figure 15-24. Action-Qualifier Submodule



15.2.2.5.1 Purpose of the Action-Qualifier Submodule

The action-qualifier submodule is responsible for the following:

- Qualifying and generating actions (set, clear, toggle) based on the following events:
 - CTR = PRD: Time-base counter equal to the period (TBCNT = TBPRD)
 - CTR = 0: Time-base counter equal to zero (TBCNT = 0000h)
 - CTR = CMPA: Time-base counter equal to the counter-compare A register (TBCNT = CMPA)
 - CTR = CMPB: Time-base counter equal to the counter-compare B register (TBCNT = CMPB)
- Managing priority when these events occur concurrently
- Providing independent control of events when the time-base counter is increasing and when it is decreasing.

15.2.2.5.2 Controlling and Monitoring the Action-Qualifier Submodule

Table 15-14 lists the registers used to control and monitor the action-qualifier submodule.

Table 15-14. Action-Qualifier Submodule Registers

Acronym	Register Description	Address Offset	Shadowed
AQCTLA	Action-Qualifier Control Register For Output A (EPWMxA)	16h	No
AQCTLB	Action-Qualifier Control Register For Output B (EPWMxB)	18h	No
AQSFRC	Action-Qualifier Software Force Register	1Ah	No
AQCSFRC	Action-Qualifier Continuous Software Force	1Ch	Yes

The action-qualifier submodule is based on event-driven logic. It can be thought of as a programmable cross switch with events at the input and actions at the output, all of which are software controlled via the set of registers shown in [Figure 15-25](#). The possible input events are summarized again in [Table 15-15](#).

Figure 15-25. Action-Qualifier Submodule Inputs and Outputs

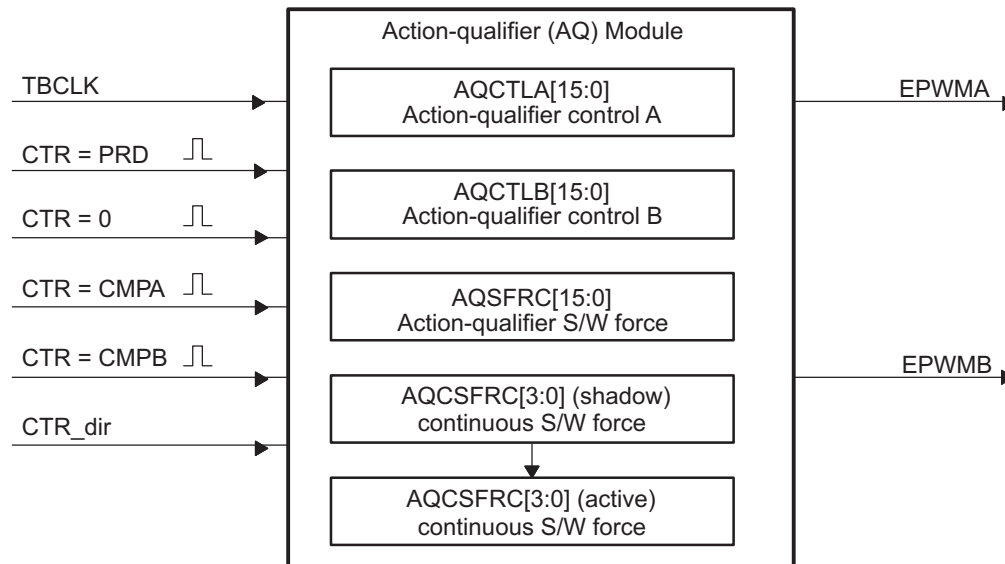


Table 15-15. Action-Qualifier Submodule Possible Input Events

Signal	Description	Registers Compared
CTR = PRD	Time-base counter equal to the period value	TBCNT = TBPRD
CTR = 0	Time-base counter equal to zero	TBCNT = 0000h
CTR = CMPA	Time-base counter equal to the counter-compare A	TBCNT = CMPA
CTR = CMPB	Time-base counter equal to the counter-compare B	TBCNT = CMPB
Software forced event	Asynchronous event initiated by software	

The software forced action is a useful asynchronous event. This control is handled by registers AQSFR and AQCSFRC.

The action-qualifier submodule controls how the two outputs EPWMxA and EPWMxB behave when a particular event occurs. The event inputs to the action-qualifier submodule are further qualified by the counter direction (up or down). This allows for independent action on outputs on both the count-up and count-down phases.

The possible actions imposed on outputs EPWMxA and EPWMxB are:

- **Set High:** Set output EPWMxA or EPWMxB to a high level.
- **Clear Low:** Set output EPWMxA or EPWMxB to a low level.
- **Toggle:** If EPWMxA or EPWMxB is currently pulled high, then pull the output low. If EPWMxA or EPWMxB is currently pulled low, then pull the output high.
- **Do Nothing:** Keep outputs EPWMxA and EPWMxB at same level as currently set. Although the "Do Nothing" option prevents an event from causing an action on the EPWMxA and EPWMxB outputs, this event can still trigger interrupts. See the event-trigger submodule description in [Section 15.2.2.9](#) for details.

Actions are specified independently for either output (EPWMxA or EPWMxB). Any or all events can be configured to generate actions on a given output. For example, both CTR = CMPA and CTR = CMPB can operate on output EPWMxA. All qualifier actions are configured via the control registers found at the end of this section.

For clarity, the drawings in this chapter use a set of symbolic actions. These symbols are summarized in Figure 15-26. Each symbol represents an action as a marker in time. Some actions are fixed in time (zero and period) while the CMPA and CMPB actions are moveable and their time positions are programmed via the counter-compare A and B registers, respectively. To turn off or disable an action, use the "Do Nothing option"; it is the default at reset.

Figure 15-26. Possible Action-Qualifier Actions for EPWMxA and EPWMxB Outputs

S/W force	TB Counter equals:				Actions
	Zero	Comp A	Comp B	Period	
SW X	Z X	CA X	CB X	P X	Do Nothing
SW ↓	Z ↓	CA ↓	CB ↓	P ↓	Clear Low
SW ↑	Z ↑	CA ↑	CB ↑	P ↑	Set High
SW T	Z T	CA T	CB T	P T	Toggle

15.2.2.5.3 Action-Qualifier Event Priority

It is possible for the ePWM action qualifier to receive more than one event at the same time. In this case events are assigned a priority by the hardware. The general rule is events occurring later in time have a higher priority and software forced events always have the highest priority. The event priority levels for up-down-count mode are shown in [Table 15-16](#). A priority level of 1 is the highest priority and level 7 is the lowest. The priority changes slightly depending on the direction of TBCNT.

Table 15-16. Action-Qualifier Event Priority for Up-Down-Count Mode

Priority Level	Event if TBCNT is Incrementing TBCNT = 0 up to TBCNT = TBPRD	Event if TBCNT is Decrementing TBCNT = TBPRD down to TBCNT = 1
1 (Highest)	Software forced event	Software forced event
2	Counter equals CMPB on up-count (CBU)	Counter equals CMPB on down-count (CBD)
3	Counter equals CMPA on up-count (CAU)	Counter equals CMPA on down-count (CAD)
4	Counter equals zero	Counter equals period (TBPRD)
5	Counter equals CMPB on down-count (CBD) ⁽¹⁾	Counter equals CMPB on up-count (CBU) ⁽¹⁾
6 (Lowest)	Counter equals CMPA on down-count (CAD) ⁽¹⁾	Counter equals CMPA on up-count (CBU) ⁽¹⁾

⁽¹⁾ To maintain symmetry for up-down-count mode, both up-events (CAU/CBU) and down-events (CAD/CBD) can be generated for TBPRD. Otherwise, up-events can occur only when the counter is incrementing and down-events can occur only when the counter is decrementing.

[Table 15-17](#) shows the action-qualifier priority for up-count mode. In this case, the counter direction is always defined as up and thus down-count events will never be taken.

Table 15-17. Action-Qualifier Event Priority for Up-Count Mode

Priority Level	Event
1 (Highest)	Software forced event
2	Counter equal to period (TBPRD)
3	Counter equal to CMPB on up-count (CBU)
4	Counter equal to CMPA on up-count (CAU)
5 (Lowest)	Counter equal to Zero

[Table 15-18](#) shows the action-qualifier priority for down-count mode. In this case, the counter direction is always defined as down and thus up-count events will never be taken.

Table 15-18. Action-Qualifier Event Priority for Down-Count Mode

Priority Level	Event
1 (Highest)	Software forced event
2	Counter equal to Zero
3	Counter equal to CMPB on down-count (CBD)
4	Counter equal to CMPA on down-count (CAD)
5 (Lowest)	Counter equal to period (TBPRD)

It is possible to set the compare value greater than the period. In this case the action will take place as shown in [Table 15-19](#).

Table 15-19. Behavior if CMPA/CMPB is Greater than the Period

Counter Mode	Compare on Up-Count Event CAU/CBU	Compare on Down-Count Event CAU/CBU
Up-Count Mode	If $CMPA/CMPB \leq TBPRD$ period, then the event occurs on a compare match ($TBCNT = CMPA$ or $CMPB$). If $CMPA/CMPB > TBPRD$, then the event will not occur.	Never occurs.
Down-Count Mode	Never occurs.	If $CMPA/CMPB < TBPRD$, the event will occur on a compare match ($TBCNT = CMPA$ or $CMPB$). If $CMPA/CMPB \geq TBPRD$, the event will occur on a period match ($TBCNT = TBPRD$).
Up-Down-Count Mode	If $CMPA/CMPB < TBPRD$ and the counter is incrementing, the event occurs on a compare match ($TBCNT = CMPA$ or $CMPB$). If $CMPA/CMPB \geq TBPRD$, the event will occur on a period match ($TBCNT = TBPRD$).	If $CMPA/CMPB < TBPRD$ and the counter is decrementing, the event occurs on a compare match ($TBCNT = CMPA$ or $CMPB$). If $CMPA/CMPB \geq TBPRD$, the event occurs on a period match ($TBCNT = TBPRD$).

15.2.2.5.4 Waveforms for Common Configurations

NOTE: The waveforms in this chapter show the ePWMs behavior for a static compare register value. In a running system, the active compare registers (CMPA and CMPB) are typically updated from their respective shadow registers once every period. The user specifies when the update will take place; either when the time-base counter reaches zero or when the time-base counter reaches period. There are some cases when the action based on the new value can be delayed by one period or the action based on the old value can take effect for an extra period. Some PWM configurations avoid this situation. These include, but are not limited to, the following:

Use up-down-count mode to generate a symmetric PWM:

- If you load CMPA/CMPB on zero, then use CMPA/CMPB values greater than or equal to 1.
- If you load CMPA/CMPB on period, then use CMPA/CMPB values less than or equal to $TBPRD - 1$. This means there will always be a pulse of at least one TBCLK cycle in a PWM period which, when very short, tend to be ignored by the system.

Use up-down-count mode to generate an asymmetric PWM:

- To achieve 50%-0% asymmetric PWM use the following configuration: Load CMPA/CMPB on period and use the period action to clear the PWM and a compare-up action to set the PWM. Modulate the compare value from 0 to TBPRD to achieve 50%-0% PWM duty.

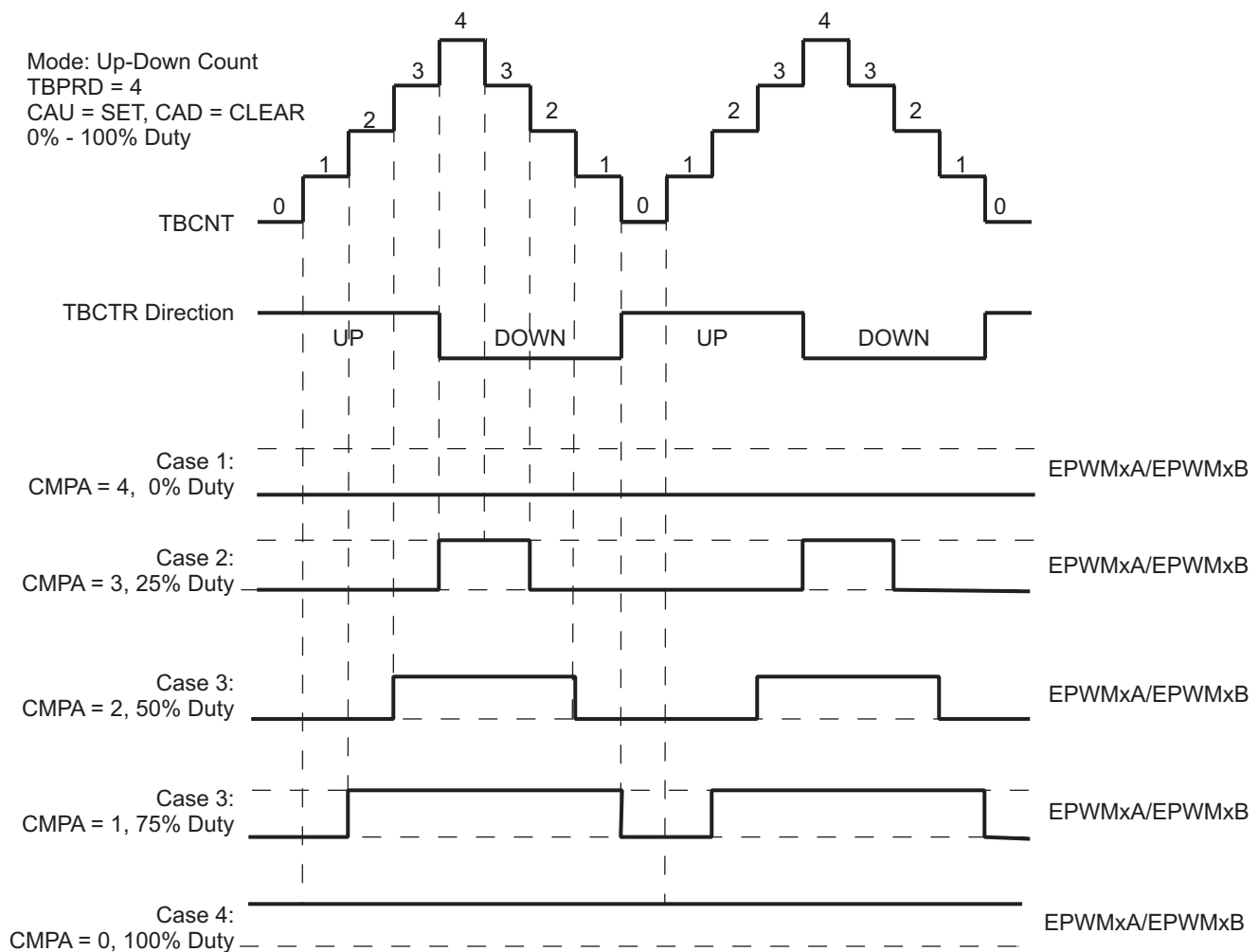
When using up-count mode to generate an asymmetric PWM:

- To achieve 0-100% asymmetric PWM use the following configuration: Load CMPA/CMPB on TBPRD. Use the Zero action to set the PWM and a compare-up action to clear the PWM. Modulate the compare value from 0 to $TBPRD+1$ to achieve 0-100% PWM duty.

Figure 15-27 shows how a symmetric PWM waveform can be generated using the up-down-count mode of the TBCNT. In this mode 0%-100% DC modulation is achieved by using equal compare matches on the up count and down count portions of the waveform. In the example shown, CMPA is used to make the comparison. When the counter is incrementing the CMPA match will pull the PWM output high. Likewise, when the counter is decrementing the compare match will pull the PWM signal low. When $CMPA = 0$, the PWM signal is low for the entire period giving the 0% duty waveform. When $CMPA = TBPRD$, the PWM signal is high achieving 100% duty.

When using this configuration in practice, if you load $CMPA/CMPB$ on zero, then use $CMPA/CMPB$ values greater than or equal to 1. If you load $CMPA/CMPB$ on period, then use $CMPA/CMPB$ values less than or equal to $TBPRD-1$. This means there will always be a pulse of at least one $TBCLK$ cycle in a PWM period which, when very short, tend to be ignored by the system.

Figure 15-27. Up-Down-Count Mode Symmetrical Waveform

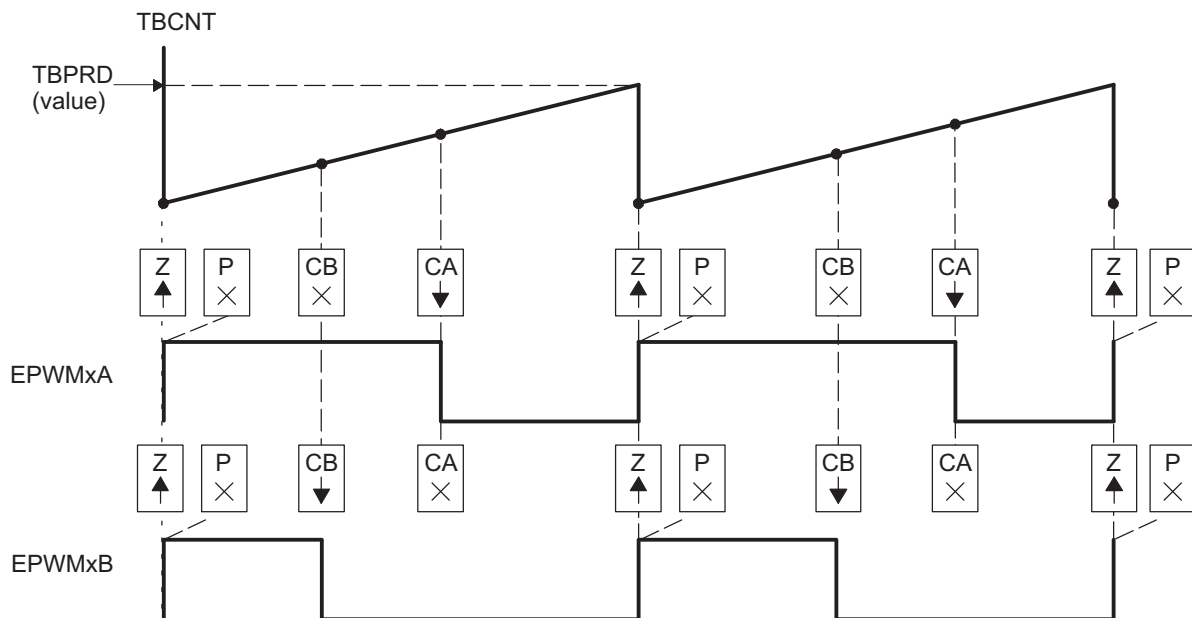


The PWM waveforms in [Figure 15-28](#) through [Figure 15-33](#) show some common action-qualifier configurations. Some conventions used in the figures are as follows:

- TBPRD, CMPA, and CMPB refer to the value written in their respective registers. The active register, not the shadow register, is used by the hardware.
- CMPx, refers to either CMPA or CMPB.
- EPWMxA and EPWMxB refer to the output signals from ePWMx
- Up-Down means Count-up-and-down mode, Up means up-count mode and Dwn means down-count mode
- Sym = Symmetric, Asym = Asymmetric

[Table 15-20](#) and [Table 15-21](#) contains initialization and runtime register configurations for the waveforms in [Figure 15-28](#).

Figure 15-28. Up, Single Edge Asymmetric Waveform, With Independent Modulation on EPWMxA and EPWMxB—Active High



- (1) $PWM\ period = (TBPRD + 1) \times T_{TBCLK}$
- (2) Duty modulation for EPWMxA is set by CMPA, and is active high (that is, high time duty proportional to CMPA).
- (3) Duty modulation for EPWMxB is set by CMPB and is active high (that is, high time duty proportional to CMPB).
- (4) The "Do Nothing" actions (X) are shown for completeness, but will not be shown on subsequent diagrams.
- (5) Actions at zero and period, although appearing to occur concurrently, are actually separated by one TBCLK period. TBCNT wraps from period to 0000h.

Table 15-20. EPWMx Initialization for Figure 15-28

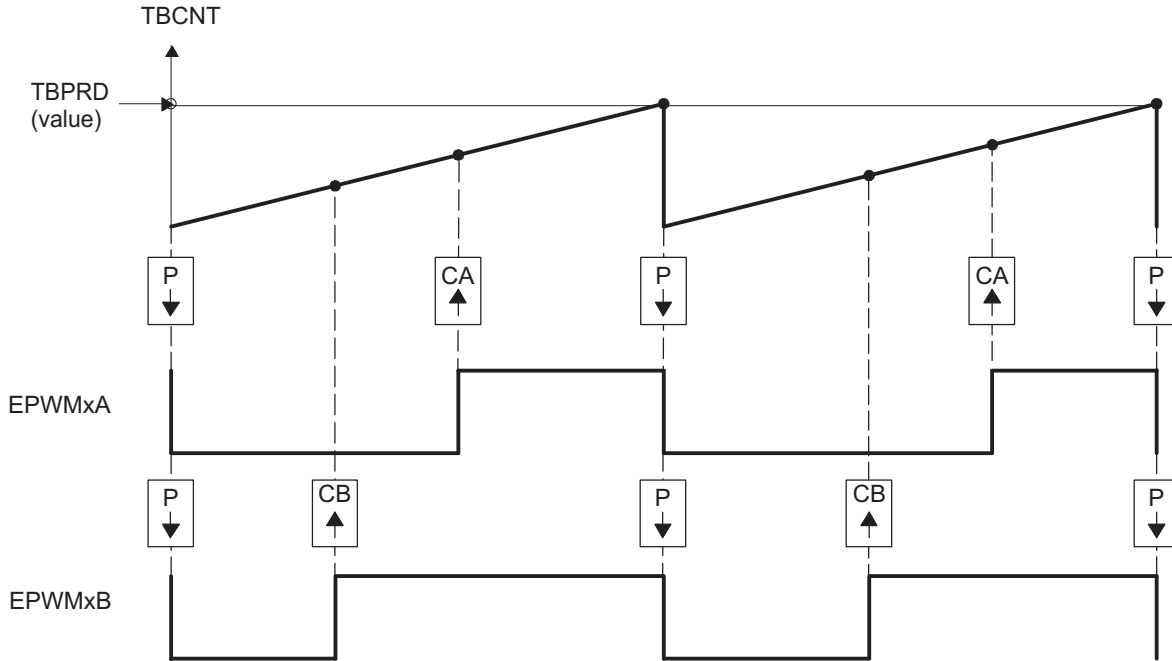
Register	Bit	Value	Comments
TBPRD	TBPRD	600 (258h)	Period = 601 TBCLK counts
TBPHS	TBPHS	0	Clear Phase Register to 0
TBCNT	TBCNT	0	Clear TB counter
TBCTL	CTRMODE	TB_UP	
	PHSEN	TB_DISABLE	Phase loading disabled
	PRDL	TB_SHADOW	
	SYNCOSEL	TB_SYNC_DISABLE	
	HSPCLKDIV	TB_DIV1	TBCLK = SYSCLK
	CLKDIV	TB_DIV1	
CMPA	CMPA	350 (15Eh)	Compare A = 350 TBCLK counts
CMPB	CMPB	200 (C8h)	Compare B = 200 TBCLK counts
CMPCTL	SHDWAMODE	CC_SHADOW	
	SHDWBMODE	CC_SHADOW	
	LOADAMODE	CC_CTR_ZERO	Load on CTR = 0
	LOADBMODE	CC_CTR_ZERO	Load on CTR = 0
AQCTLA	ZRO	AQ_SET	
	CAU	AQ_CLEAR	
AQCTLB	ZRO	AQ_SET	
	CBU	AQ_CLEAR	

Table 15-21. EPWMx Run Time Changes for Figure 15-28

Register	Bit	Value	Comments
CMPA	CMPA	Duty1A	Adjust duty for output EPWM1A
CMPB	CMPB	Duty1B	Adjust duty for output EPWM1B

Table 15-22 and Table 15-23 contains initialization and runtime register configurations for the waveforms in Figure 15-29.

Figure 15-29. Up, Single Edge Asymmetric Waveform With Independent Modulation on EPWMxA and EPWMxB—Active Low



- (1) $PWM\ period = (TBPRD + 1) \times T_{TBCLK}$
- (2) Duty modulation for EPWMxA is set by CMPA, and is active low (that is, the low time duty is proportional to CMPA).
- (3) Duty modulation for EPWMxB is set by CMPB and is active low (that is, the low time duty is proportional to CMPB).
- (4) The Do Nothing actions (X) are shown for completeness here, but will not be shown on subsequent diagrams.
- (5) Actions at zero and period, although appearing to occur concurrently, are actually separated by one TBCLK period. TBCNT wraps from period to 0000h.

Table 15-22. EPWMx Initialization for Figure 15-29

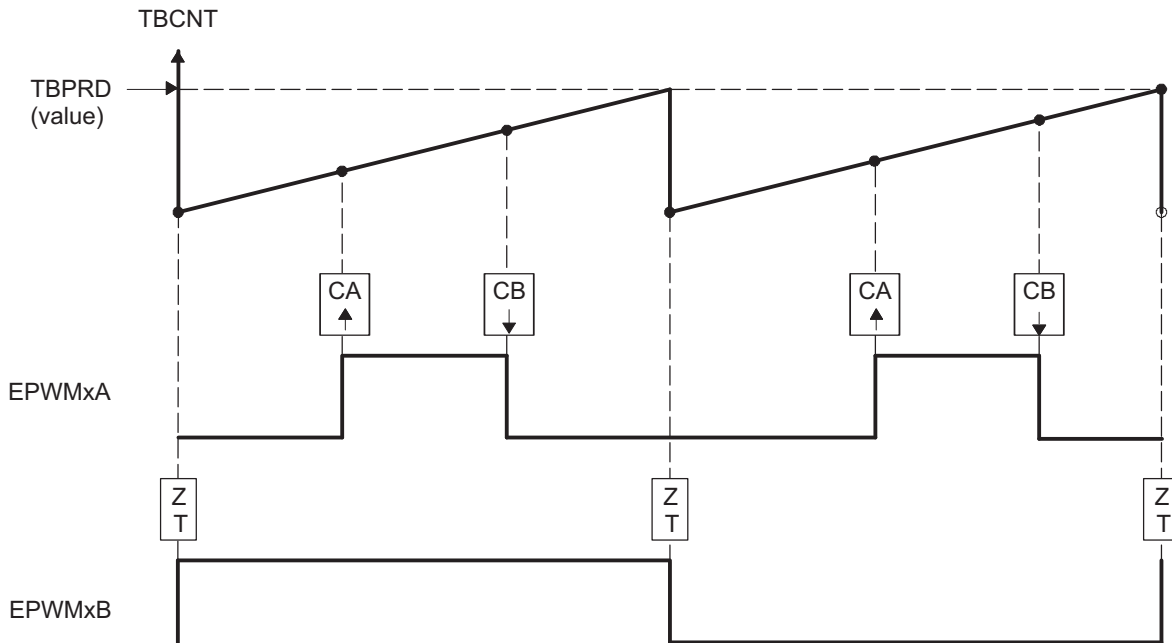
Register	Bit	Value	Comments
TBPRD	TBPRD	600 (258h)	Period = 601 TBCLK counts
TBPHS	TBPHS	0	Clear Phase Register to 0
TBCNT	TBCNT	0	Clear TB counter
TBCTL	CTRMODE	TB_UP	
	PHSEN	TB_DISABLE	Phase loading disabled
	PRDL	TB_SHADOW	
	SYNCOSEL	TB_SYNC_DISABLE	
	HSPCLKDIV	TB_DIV1	TBCLK = SYSCLK
	CLKDIV	TB_DIV1	
CMPA	CMPA	350 (15Eh)	Compare A = 350 TBCLK counts
CMPB	CMPB	200 (C8h)	Compare B = 200 TBCLK counts
CMPCTL	SHDWAMODE	CC_SHADOW	
	SHDWBMODE	CC_SHADOW	
	LOADAMODE	CC_CTR_ZERO	Load on CTR = 0
	LOADBMODE	CC_CTR_ZERO	Load on CTR = 0
AQCTLA	PRD	AQ_CLEAR	
	CAU	AQ_SET	
AQCTLB	PRD	AQ_CLEAR	
	CBU	AQ_SET	

Table 15-23. EPWMx Run Time Changes for Figure 15-29

Register	Bit	Value	Comments
CMPA	CMPA	Duty1A	Adjust duty for output EPWM1A
CMPB	CMPB	Duty1B	Adjust duty for output EPWM1B

Table 15-24 and Table 15-25 contains initialization and runtime register configurations for the waveforms Figure 15-30. Use the code in Example 15-1 to define the headers.

Figure 15-30. Up-Count, Pulse Placement Asymmetric Waveform With Independent Modulation on EPWMxA



- (1) $\text{PWM frequency} = 1 / ((\text{TBPRD} + 1) \times T_{\text{TBCLK}})$
- (2) Pulse can be placed anywhere within the PWM cycle (0000h - TBPRD)
- (3) High time duty proportional to (CMPB - CMPA)
- (4) EPWMxB can be used to generate a 50% duty square wave with frequency = $1/2 \times ((\text{TBPRD} + 1) \times \text{TBCLK})$

Table 15-24. EPWMx Initialization for Figure 15-30

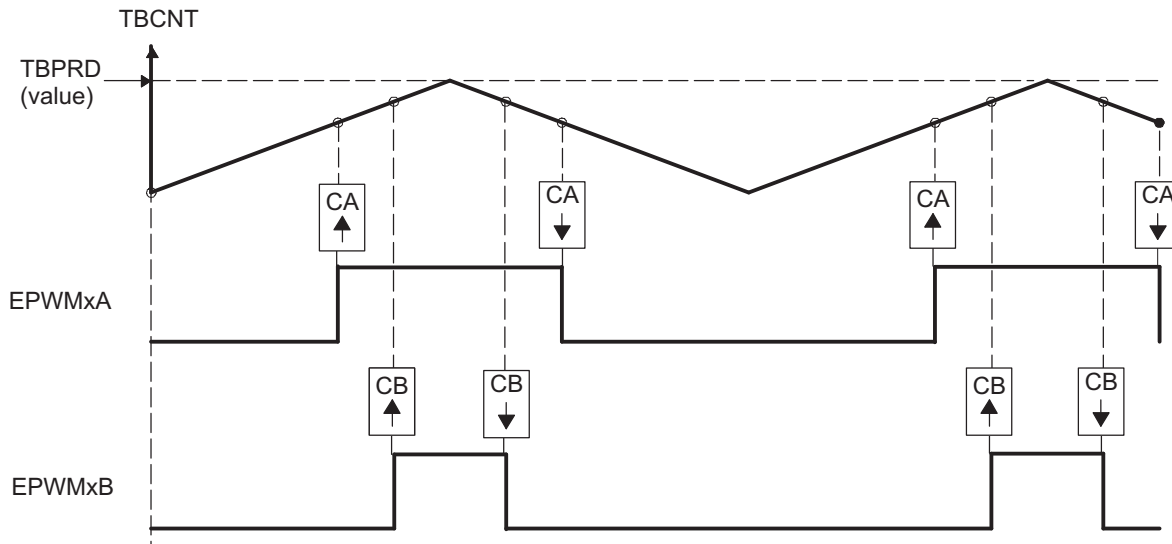
Register	Bit	Value	Comments
TBPRD	TBPRD	600 (258h)	Period = 601 TBCLK counts
TBPHS	TBPHS	0	Clear Phase Register to 0
TBCNT	TBCNT	0	Clear TB counter
TBCTL	CTRMODE	TB_UP	
	PHSEN	TB_DISABLE	Phase loading disabled
	PRDL	TB_SHADOW	
	SYNCOSEL	TB_SYNC_DISABLE	
	HSPCLKDIV	TB_DIV1	TBCLK = SYSCLK
	CLKDIV	TB_DIV1	
CMPA	CMPA	200 (C8h)	Compare A = 200 TBCLK counts
CMPB	CMPB	400 (190h)	Compare B = 400 TBCLK counts
CMPCTL	SHDWAMODE	CC_SHADOW	
	SHDWBMODE	CC_SHADOW	
	LOADAMODE	CC_CTR_ZERO	Load on CTR = 0
	LOADBMODE	CC_CTR_ZERO	Load on CTR = 0
AQCTLA	CAU	AQ_SET	
	CBU	AQ_CLEAR	
AQCTLB	ZRO	AQ_TOGGLE	

Table 15-25. EPWMx Run Time Changes for Figure 15-30

Register	Bit	Value	Comments
CMPA	CMPA	EdgePosA	Adjust duty for output EPWM1A
CMPB	CMPB	EdgePosB	Adjust duty for output EPWM1B

Table 15-26 and Table 15-27 contains initialization and runtime register configurations for the waveforms in Figure 15-31. Use the code in Example 15-1 to define the headers.

Figure 15-31. Up-Down-Count, Dual Edge Symmetric Waveform, With Independent Modulation on EPWMxA and EPWMxB — Active Low



- (1) $\text{PWM period} = 2 \times \text{TBPRD} \times T_{\text{TBCLK}}$
- (2) Duty modulation for EPWMxA is set by CMPA, and is active low (that is, the low time duty is proportional to CMPA).
- (3) Duty modulation for EPWMxB is set by CMPB and is active low (that is, the low time duty is proportional to CMPB).
- (4) Outputs EPWMxA and EPWMxB can drive independent power switches

Table 15-26. EPWMx Initialization for Figure 15-31

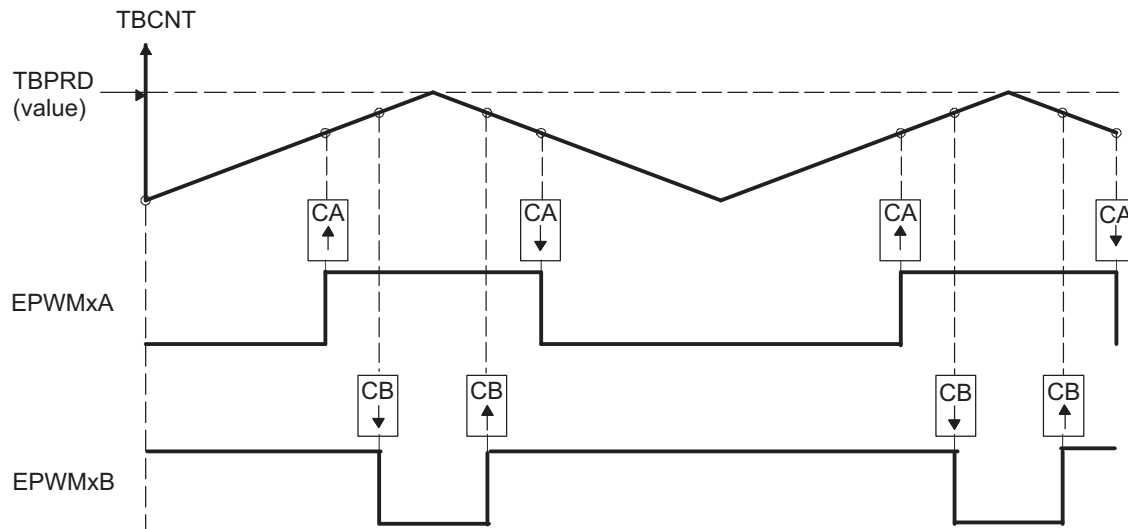
Register	Bit	Value	Comments
TBPRD	TBPRD	600 (258h)	Period = 601 TBCLK counts
TBPHS	TBPHS	0	Clear Phase Register to 0
TBCNT	TBCNT	0	Clear TB counter
TBCTL	CTRMODE	TB_UPDOWN	
	PHSEN	TB_DISABLE	Phase loading disabled
	PRDL	TB_SHADOW	
	SYNCOSEL	TB_SYNC_DISABLE	
	HSPCLKDIV	TB_DIV1	TBCLK = SYSCLK
	CLKDIV	TB_DIV1	
CMPA	CMPA	400 (190h)	Compare A = 400 TBCLK counts
CMPB	CMPB	500 (1F4h)	Compare B = 500 TBCLK counts
CMPCTL	SHDWAMODE	CC_SHADOW	
	SHDWBMODE	CC_SHADOW	
	LOADAMODE	CC_CTR_ZERO	Load on CTR = 0
	LOADBMODE	CC_CTR_ZERO	Load on CTR = 0
AQCTLA	CAU	AQ_SET	
	CAD	AQ_CLEAR	
AQCTLB	CBU	AQ_SET	
	CBD	AQ_CLEAR	

Table 15-27. EPWMx Run Time Changes for Figure 15-31

Register	Bit	Value	Comments
CMPA	CMPA	Duty1A	Adjust duty for output EPWM1A
CMPB	CMPB	Duty1B	Adjust duty for output EPWM1B

Table 15-28 and Table 15-29 contains initialization and runtime register configurations for the waveforms in Figure 15-32. Use the code in Example 15-1 to define the headers.

Figure 15-32. Up-Down-Count, Dual Edge Symmetric Waveform, With Independent Modulation on EPWMxA and EPWMxB — Complementary



- (1) $PWM\ period = 2 \times TBPRD \times T_{TBCLK}$
- (2) Duty modulation for EPWMxA is set by CMPA, and is active low, i.e., low time duty proportional to CMPA
- (3) Duty modulation for EPWMxB is set by CMPB and is active high, i.e., high time duty proportional to CMPB
- (4) Outputs EPWMx can drive upper/lower (complementary) power switches
- (5) Dead-band = $CMPB - CMPA$ (fully programmable edge placement by software). Note the dead-band module is also available if the more classical edge delay method is required.

Table 15-28. EPWMx Initialization for Figure 15-32

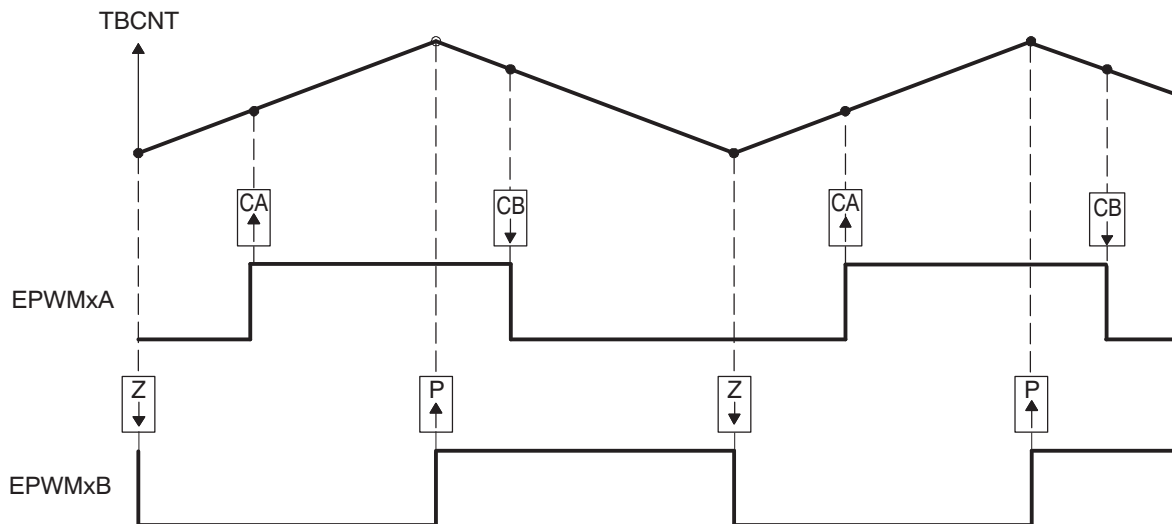
Register	Bit	Value	Comments
TBPRD	TBPRD	600 (258h)	Period = 601 TBCLK counts
TBPHS	TBPHS	0	Clear Phase Register to 0
TBCNT	TBCNT	0	Clear TB counter
TBCTL	CTRMODE	TB_UPDOWN	
	PHSEN	TB_DISABLE	Phase loading disabled
	PRDL	TB_SHADOW	
	SYNCOSEL	TB_SYNC_DISABLE	
	HSPCLKDIV	TB_DIV1	TBCLK = SYSCLK
	CLKDIV	TB_DIV1	
CMPA	CMPA	350 (15Eh)	Compare A = 350 TBCLK counts
CMPB	CMPB	400 (190h)	Compare B = 400 TBCLK counts
CMPCTL	SHDWAMODE	CC_SHADOW	
	SHDWBMODE	CC_SHADOW	
	LOADAMODE	CC_CTR_ZERO	Load on CTR = 0
	LOADBMODE	CC_CTR_ZERO	Load on CTR = 0
AQCTLA	CAU	AQ_SET	
	CAD	AQ_CLEAR	
AQCTLB	CBU	AQ_CLEAR	
	CBD	AQ_SET	

Table 15-29. EPWMx Run Time Changes for Figure 15-32

Register	Bit	Value	Comments
CMPA	CMPA	Duty1A	Adjust duty for output EPWM1A
CMPB	CMPB	Duty1B	Adjust duty for output EPWM1B

Table 15-30 and Table 15-31 contains initialization and runtime register configurations for the waveforms in Figure 15-33. Use the code in Example 15-1 to define the headers.

Figure 15-33. Up-Down-Count, Dual Edge Asymmetric Waveform, With Independent Modulation on EPWMxA—Active Low



- (1) PWM period = $2 \times \text{TBPRD} \times \text{TBCLK}$
- (2) Rising edge and falling edge can be asymmetrically positioned within a PWM cycle. This allows for pulse placement techniques.
- (3) Duty modulation for EPWMxA is set by CMPA and CMPB.
- (4) Low time duty for EPWMxA is proportional to (CMPA + CMPB).
- (5) To change this example to active high, CMPA and CMPB actions need to be inverted (i.e., Set ! Clear and Clear Set).
- (6) Duty modulation for EPWMxB is fixed at 50% (utilizes spare action resources for EPWMxB)

Table 15-30. EPWMx Initialization for Figure 15-33

Register	Bit	Value	Comments
TBPRD	TBPRD	600 (258h)	Period = 601 TBCLK counts
TBPHS	TBPHS	0	Clear Phase Register to 0
TBCNT	TBCNT	0	Clear TB counter
TBCTL	CTRMODE	TB_UPDOWN	
	PHSEN	TB_DISABLE	Phase loading disabled
	PRDL	TB_SHADOW	
	SYNCOSEL	TB_SYNC_DISABLE	
	HSPCLKDIV	TB_DIV1	TBCLK = SYSCLK
	CLKDIV	TB_DIV1	
CMPA	CMPA	250 (FAh)	Compare A = 250 TBCLK counts
CMPB	CMPB	450 (1C2h)	Compare B = 450 TBCLK counts
CMPCTL	SHDWAMODE	CC_SHADOW	
	SHDWBMODE	CC_SHADOW	
	LOADAMODE	CC_CTR_ZERO	Load on CTR = 0
	LOADBMODE	CC_CTR_ZERO	Load on CTR = 0
AQCTLA	CAU	AQ_SET	
	CBD	AQ_CLEAR	
AQCTLB	ZRO	AQ_CLEAR	
	PRD	AQ_SET	

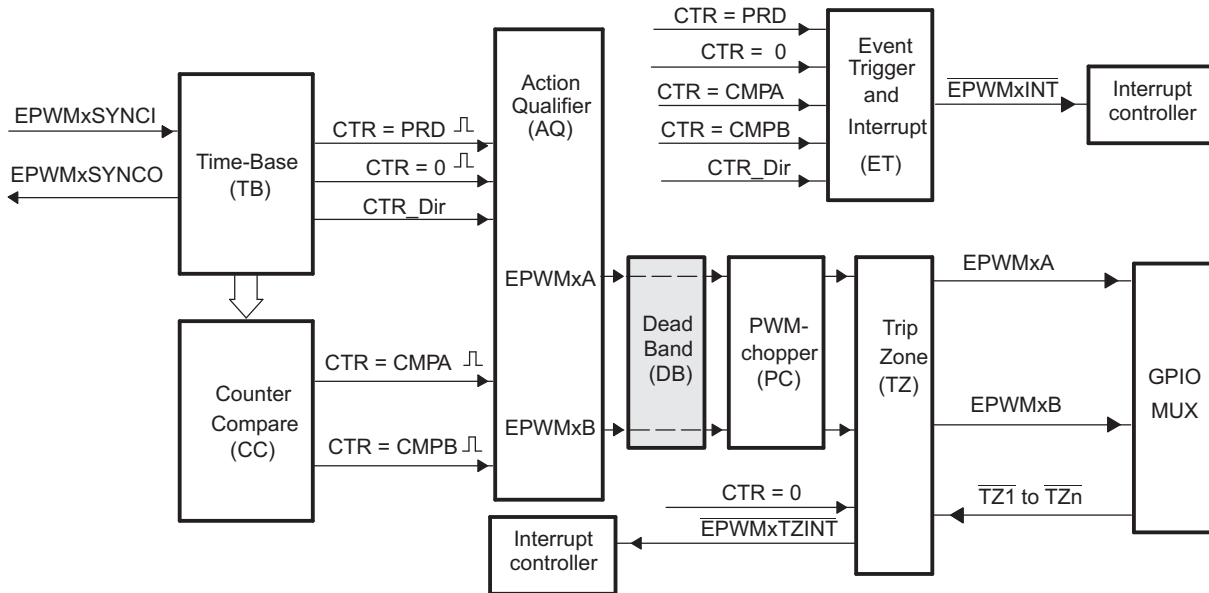
Table 15-31. EPWMx Run Time Changes for Figure 15-33

Register	Bit	Value	Comments
CMPA	CMPA	EdgePosA	Adjust duty for output EPWM1A
CMPB	CMPB	EdgePosB	

15.2.2.6 Dead-Band Generator (DB) Submodule

Figure 15-34 illustrates the dead-band generator submodule within the ePWM module.

Figure 15-34. Dead-Band Generator Submodule



15.2.2.6.1 Purpose of the Dead-Band Submodule

The "Action-qualifier (AQ) Module" section discussed how it is possible to generate the required dead-band by having full control over edge placement using both the CMPA and CMPB resources of the ePWM module. However, if the more classical edge delay-based dead-band with polarity control is required, then the dead-band generator submodule should be used.

The key functions of the dead-band generator submodule are:

- Generating appropriate signal pairs (EPWMxA and EPWMxB) with dead-band relationship from a single EPWMxA input
- Programming signal pairs for:
 - Active high (AH)
 - Active low (AL)
 - Active high complementary (AHC)
 - Active low complementary (ALC)
- Adding programmable delay to rising edges (RED)
- Adding programmable delay to falling edges (FED)
- Can be totally bypassed from the signal path (note dotted lines in diagram)

15.2.2.6.2 Controlling and Monitoring the Dead-Band Submodule

The dead-band generator submodule operation is controlled and monitored via the following registers:

Table 15-32. Dead-Band Generator Submodule Registers

Acronym	Register Description	Address Offset	Shadowed
DBCTL	Dead-Band Control Register	1Eh	No
DBRED	Dead-Band Rising Edge Delay Count Register	20h	No
DBFED	Dead-Band Falling Edge Delay Count Register	22h	No

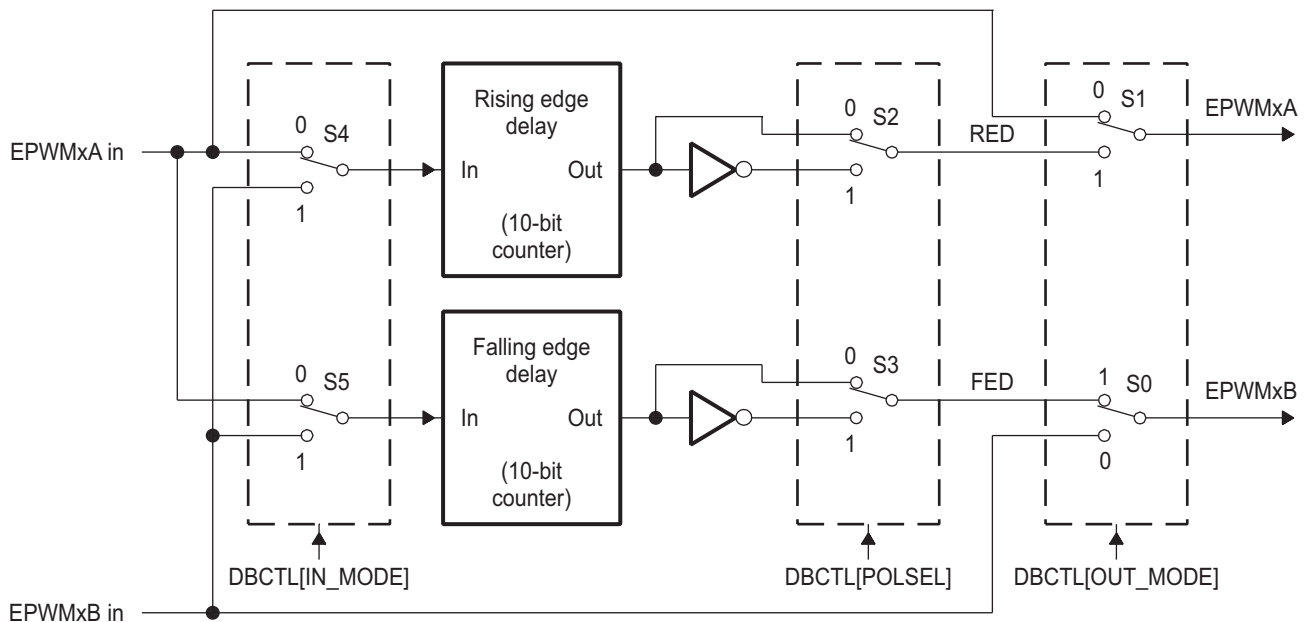
15.2.2.6.3 Operational Highlights for the Dead-Band Generator Submodule

The following sections provide the operational highlights.

The dead-band submodule has two groups of independent selection options as shown in Figure 15-35.

- Input Source Selection:** The input signals to the dead-band module are the EPWMxA and EPWMxB output signals from the action-qualifier. In this section they will be referred to as EPWMxA In and EPWMxB In. Using the DBCTL[IN_MODE] control bits, the signal source for each delay, falling-edge or rising-edge, can be selected:
 - EPWMxA In is the source for both falling-edge and rising-edge delay. This is the default mode.
 - EPWMxA In is the source for falling-edge delay, EPWMxB In is the source for rising-edge delay.
 - EPWMxA In is the source for rising edge delay, EPWMxB In is the source for falling-edge delay.
 - EPWMxB In is the source for both falling-edge and rising-edge delay.
- Output Mode Control:** The output mode is configured by way of the DBCTL[OUT_MODE] bits. These bits determine if the falling-edge delay, rising-edge delay, neither, or both are applied to the input signals.
- Polarity Control:** The polarity control (DBCTL[POLSEL]) allows you to specify whether the rising-edge delayed signal and/or the falling-edge delayed signal is to be inverted before being sent out of the dead-band submodule.

Figure 15-35. Configuration Options for the Dead-Band Generator Submodule



Although all combinations are supported, not all are typical usage modes. [Table 15-33](#) lists some classical dead-band configurations. These modes assume that the DBCTL[IN_MODE] is configured such that EPWMxA In is the source for both falling-edge and rising-edge delay. Enhanced, or non-traditional modes can be achieved by changing the input signal source. The modes shown in [Table 15-33](#) fall into the following categories:

- **Mode 1: Bypass both falling-edge delay (FED) and rising-edge delay (RED)** Allows you to fully disable the dead-band submodule from the PWM signal path.
- **Mode 2-5: Classical Dead-Band Polarity Settings** These represent typical polarity configurations that should address all the active high/low modes required by available industry power switch gate drivers. The waveforms for these typical cases are shown in [Figure 15-36](#). Note that to generate equivalent waveforms to [Figure 15-36](#), configure the action-qualifier submodule to generate the signal as shown for EPWMxA.
- **Mode 6: Bypass rising-edge-delay and Mode 7: Bypass falling-edge-delay** Finally the last two entries in [Table 15-33](#) show combinations where either the falling-edge-delay (FED) or rising-edge-delay (RED) blocks are bypassed.

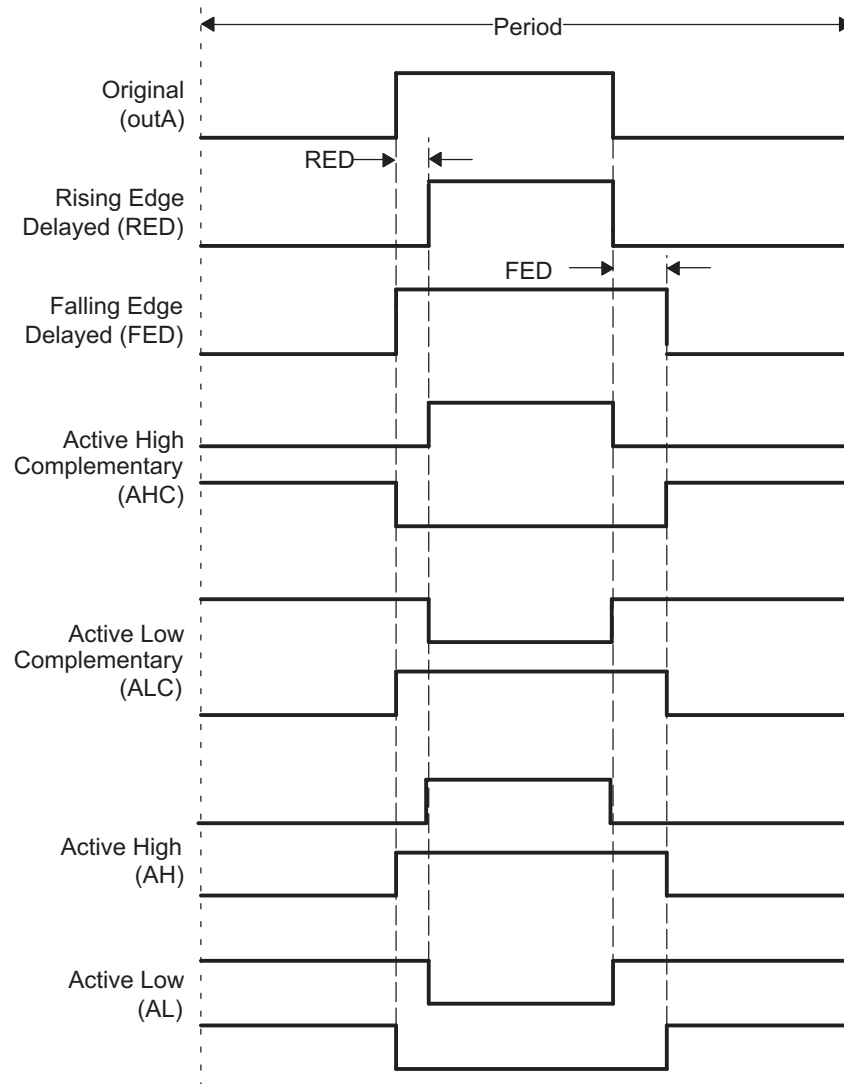
Table 15-33. Classical Dead-Band Operating Modes

Mode	Mode Description ⁽¹⁾	DBCTL[POLSEL]		DBCTL[OUT_MODE]	
		S3	S2	S1	S0
1	EPWMxA and EPWMxB Passed Through (No Delay)	x	x	0	0
2	Active High Complementary (AHC)	1	0	1	1
3	Active Low Complementary (ALC)	0	1	1	1
4	Active High (AH)	0	0	1	1
5	Active Low (AL)	1	1	1	1
6	EPWMxA Out = EPWMxA In (No Delay) EPWMxB Out = EPWMxA In with Falling Edge Delay	0 or 1	0 or 1	0	1
7	EPWMxA Out = EPWMxA In with Rising Edge Delay EPWMxB Out = EPWMxB In with No Delay	0 or 1	0 or 1	1	0

⁽¹⁾ These are classical dead-band modes and assume that DBCTL[IN_MODE] = 0,0. That is, EPWMxA in is the source for both the falling-edge and rising-edge delays. Enhanced, non-traditional modes can be achieved by changing the IN_MODE configuration.

Figure 15-36 shows waveforms for typical cases where $0\% < \text{duty} < 100\%$.

Figure 15-36. Dead-Band Waveforms for Typical Cases ($0\% < \text{Duty} < 100\%$)



The dead-band submodule supports independent values for rising-edge (RED) and falling-edge (FED) delays. The amount of delay is programmed using the DBRED and DBFED registers. These are 10-bit registers and their value represents the number of time-base clock, TBCLK, periods a signal edge is delayed by. For example, the formula to calculate falling-edge-delay and rising-edge-delay are:

$$\text{FED} = \text{DBFED} \times T_{\text{TBCLK}}$$

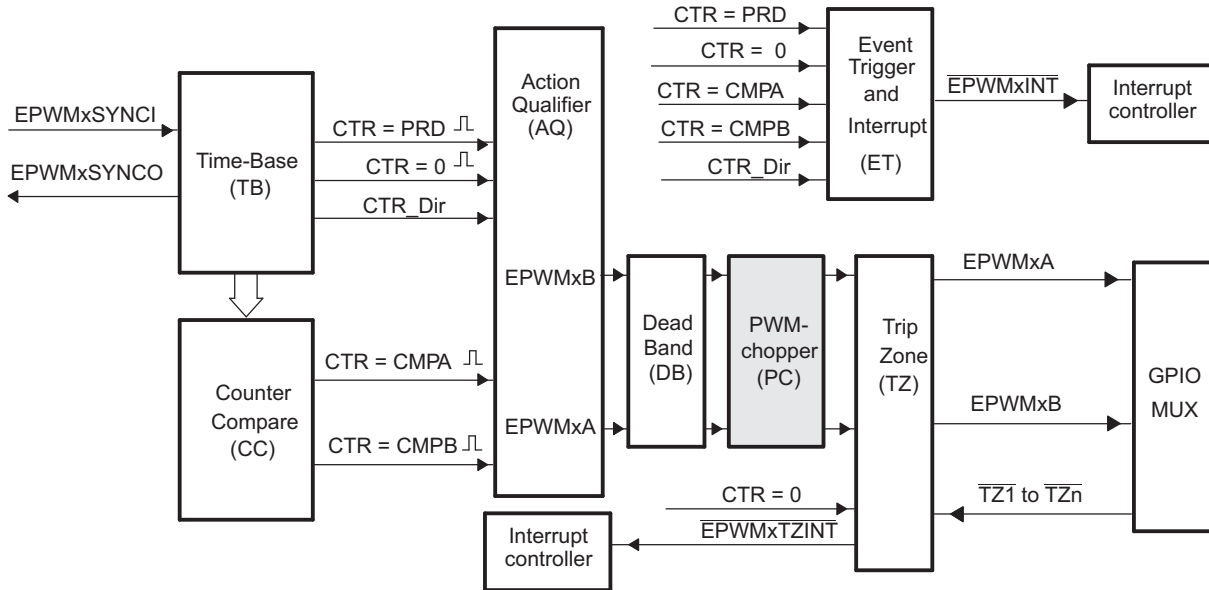
$$\text{RED} = \text{DBRED} \times T_{\text{TBCLK}}$$

Where T_{TBCLK} is the period of TBCLK, the prescaled version of SYSCLKOUT.

15.2.2.7 PWM-Chopper (PC) Submodule

Figure 15-37 illustrates the PWM-chopper (PC) submodule within the ePWM module. The PWM-chopper submodule allows a high-frequency carrier signal to modulate the PWM waveform generated by the action-qualifier and dead-band submodules. This capability is important if you need pulse transformer-based gate drivers to control the power switching elements.

Figure 15-37. PWM-Chopper Submodule



15.2.2.7.1 Purpose of the PWM-Chopper Submodule

The key functions of the PWM-chopper submodule are:

- Programmable chopping (carrier) frequency
- Programmable pulse width of first pulse
- Programmable duty cycle of second and subsequent pulses
- Can be fully bypassed if not required

15.2.2.7.2 Controlling the PWM-Chopper Submodule

The PWM-chopper submodule operation is controlled via the register in Table 15-34.

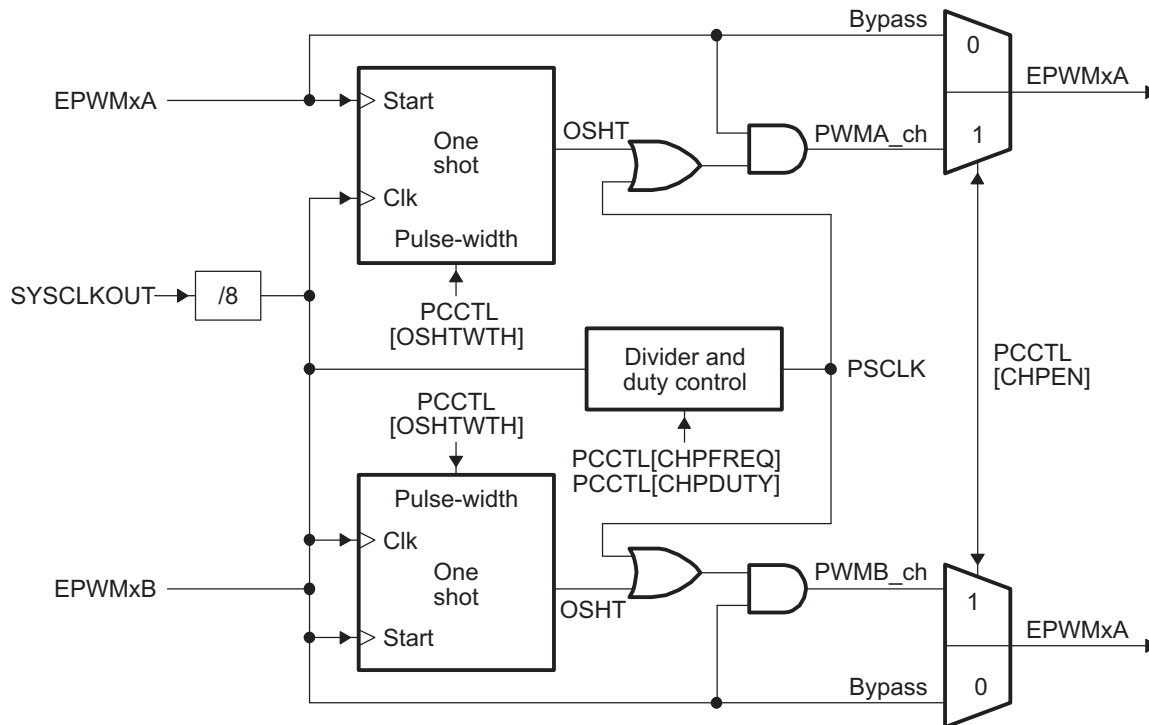
Table 15-34. PWM-Chopper Submodule Registers

Acronym	Register Description	Address Offset	Shadowed
PCCTL	PWM-chopper Control Register	3Ch	No

15.2.2.7.3 Operational Highlights for the PWM-Chopper Submodule

Figure 15-38 shows the operational details of the PWM-chopper submodule. The carrier clock is derived from SYSCLKOUT. Its frequency and duty cycle are controlled via the CHPFREQ and CHPDUTY bits in the PCCTL register. The one-shot block is a feature that provides a high energy first pulse to ensure hard and fast power switch turn on, while the subsequent pulses sustain pulses, ensuring the power switch remains on. The one-shot width is programmed via the OSHTWTH bits. The PWM-chopper submodule can be fully disabled (bypassed) via the CHPEN bit.

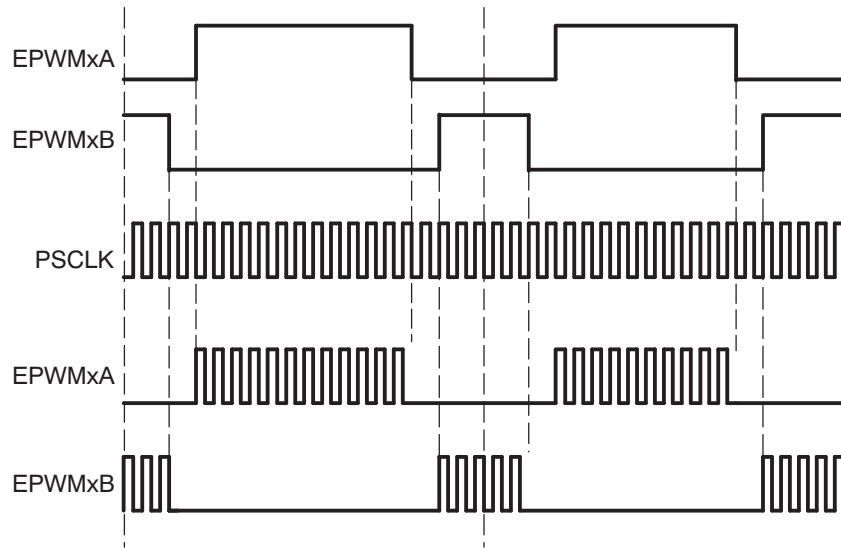
Figure 15-38. PWM-Chopper Submodule Signals and Registers



15.2.2.7.4 Waveforms

Figure 15-39 shows simplified waveforms of the chopping action only; one-shot and duty-cycle control are not shown. Details of the one-shot and duty-cycle control are discussed in the following sections.

Figure 15-39. Simple PWM-Chopper Submodule Waveforms Showing Chopping Action Only



15.2.2.7.4.1 One-Shot Pulse

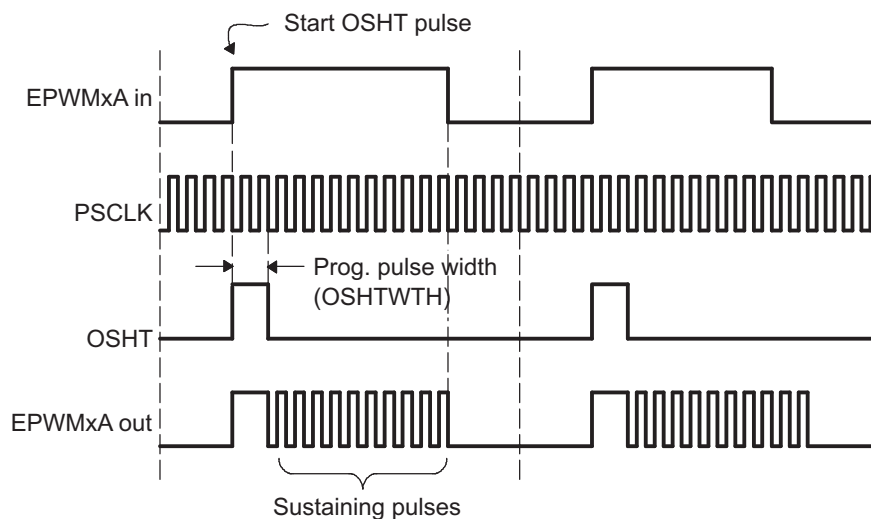
The width of the first pulse can be programmed to any of 16 possible pulse width values. The width or period of the first pulse is given by:

$$T_{1stpulse} = T_{SYSCLKOUT} \times 8 \times OSHTWTH$$

Where $T_{SYSCLKOUT}$ is the period of the system clock (SYSCLKOUT) and OSHTWTH is the four control bits (value from 1 to 16)

Figure 15-40 shows the first and subsequent sustaining pulses.

Figure 15-40. PWM-Chopper Submodule Waveforms Showing the First Pulse and Subsequent Sustaining Pulses

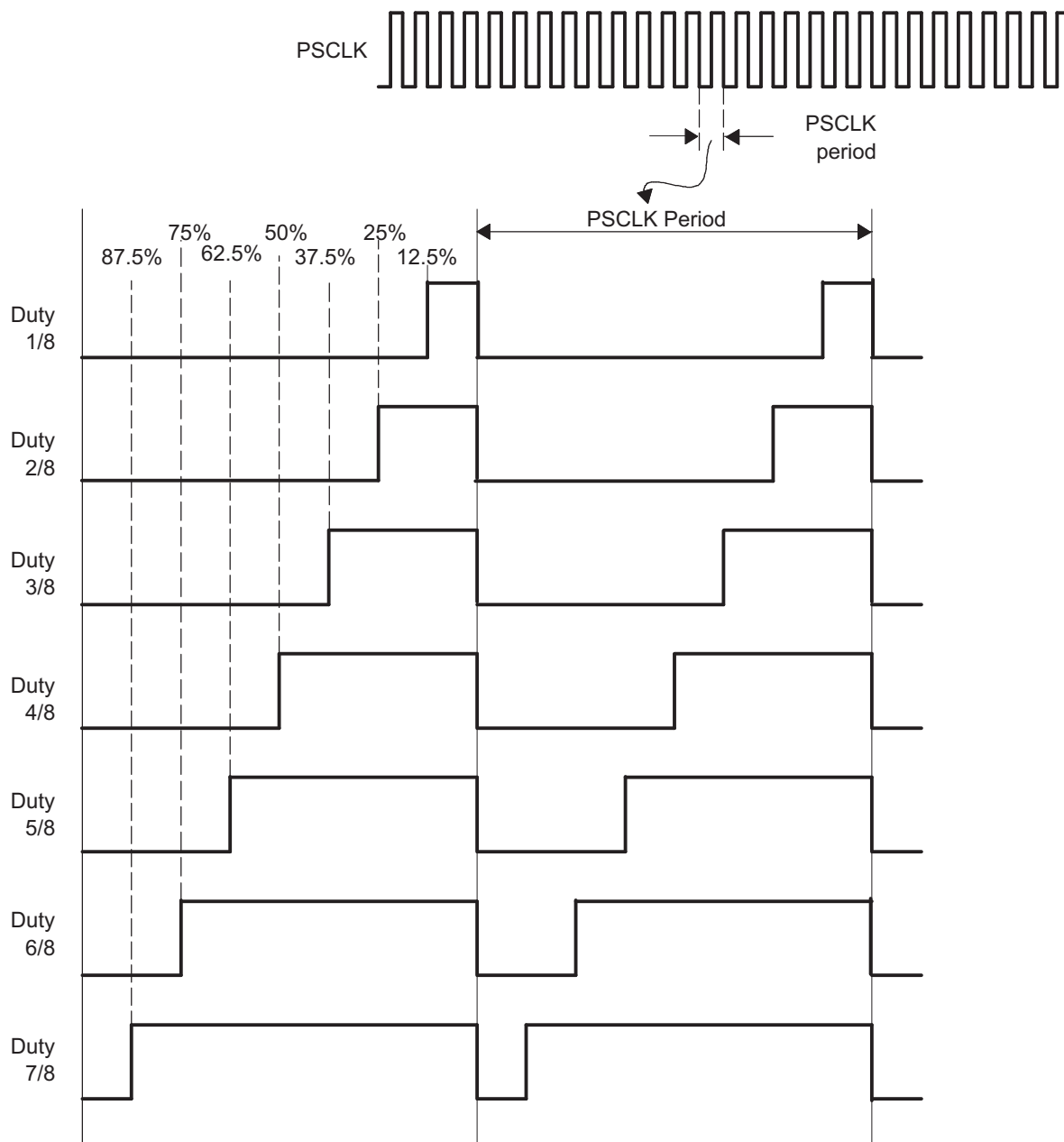


15.2.2.7.4.2 Duty Cycle Control

Pulse transformer-based gate drive designs need to comprehend the magnetic properties or characteristics of the transformer and associated circuitry. Saturation is one such consideration. To assist the gate drive designer, the duty cycles of the second and subsequent pulses have been made programmable. These sustaining pulses ensure the correct drive strength and polarity is maintained on the power switch gate during the on period, and hence a programmable duty cycle allows a design to be tuned or optimized via software control.

Figure 15-41 shows the duty cycle control that is possible by programming the CHPDUTY bits. One of seven possible duty ratios can be selected ranging from 12.5% to 87.5%.

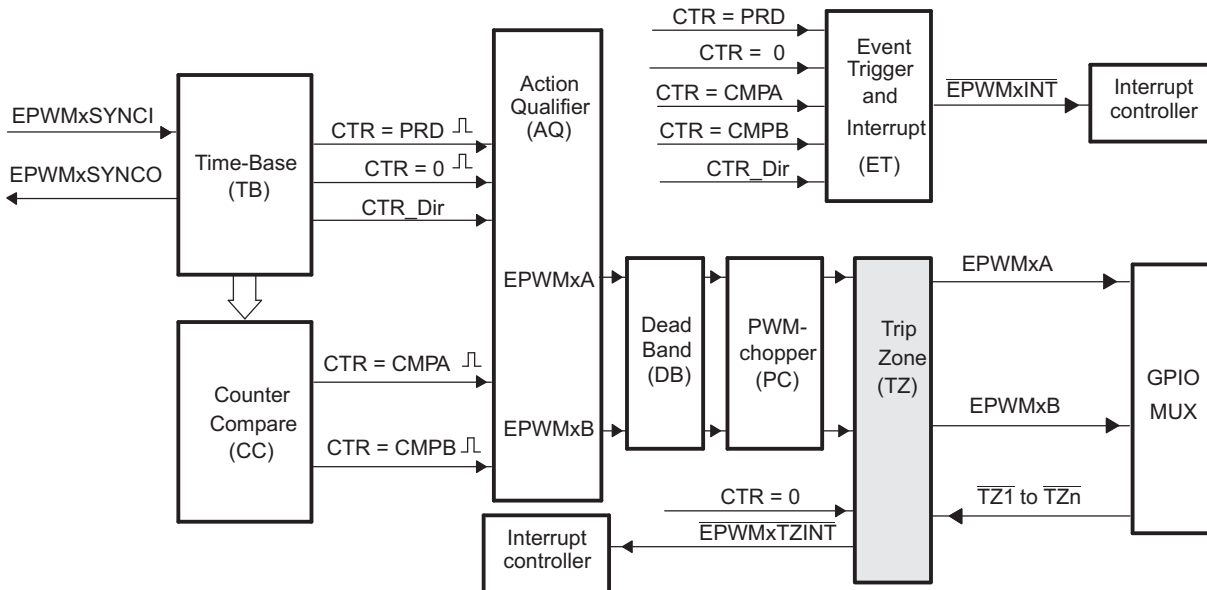
Figure 15-41. PWM-Chopper Submodule Waveforms Showing the Pulse Width (Duty Cycle) Control of Sustaining Pulses



15.2.2.8 Trip-Zone (TZ) Submodule

Figure 15-42 shows how the trip-zone (TZ) submodule fits within the ePWM module. Each ePWM module is connected to every \overline{TZ} signal that are sourced from the GPIO MUX. These signals indicates external fault or trip conditions, and the ePWM outputs can be programmed to respond accordingly when faults occur. See Section 15.1.1 to determine the number of trip-zone pins available for the device.

Figure 15-42. Trip-Zone Submodule



15.2.2.8.1 Purpose of the Trip-Zone Submodule

The key functions of the trip-zone submodule are:

- Trip inputs $\overline{TZ1}$ to \overline{TZn} can be flexibly mapped to any ePWM module.
- Upon a fault condition, outputs $EPWMxA$ and $EPWMxB$ can be forced to one of the following:
 - High
 - Low
 - High-impedance
 - No action taken
- Support for one-shot trip (OSHT) for major short circuits or over-current conditions.
- Support for cycle-by-cycle tripping (CBC) for current limiting operation.
- Each trip-zone input pin can be allocated to either one-shot or cycle-by-cycle operation.
- Interrupt generation is possible on any trip-zone pin.
- Software-forced tripping is also supported.
- The trip-zone submodule can be fully bypassed if it is not required.

15.2.2.8.2 Controlling and Monitoring the Trip-Zone Submodule

The trip-zone submodule operation is controlled and monitored through the following registers:

Table 15-35. Trip-Zone Submodule Registers

Acronym	Register Description	Address Offset	Shadowed
TZSEL	Trip-Zone Select Register	24h	No
TZCTL	Trip-Zone Control Register	28h	No
TZEINT	Trip-Zone Enable Interrupt Register	2Ah	No
TZFLG	Trip-Zone Flag Register	2Ch	No
TZCLR	Trip-Zone Clear Register	2Eh	No
TZFRC	Trip-Zone Force Register	30h	No

15.2.2.8.3 Operational Highlights for the Trip-Zone Submodule

The following sections describe the operational highlights and configuration options for the trip-zone submodule.

The trip-zone signals at pin $\overline{TZ1}$ to \overline{TZn} is an active-low input signal. When the pin goes low, it indicates that a trip event has occurred. Each ePWM module can be individually configured to ignore or use each of the trip-zone pins. Which trip-zone pins are used by a particular ePWM module is determined by the TZSEL register for that specific ePWM module. The trip-zone signal may or may not be synchronized to the system clock (SYSCLKOUT). A minimum of 1 SYSCLKOUT low pulse on the \overline{TZn} inputs is sufficient to trigger a fault condition in the ePWM module. The asynchronous trip makes sure that if clocks are missing for any reason, the outputs can still be tripped by a valid event present on the \overline{TZn} inputs.

The \overline{TZn} input can be individually configured to provide either a cycle-by-cycle or one-shot trip event for a ePWM module. The configuration is determined by the TZSEL[CBCn] and TZSEL[OSHTn] bits (where n corresponds to the trip pin) respectively.

- Cycle-by-Cycle (CBC):** When a cycle-by-cycle trip event occurs, the action specified in the TZCTL register is carried out immediately on the EPWMxA and/or EPWMxB output. [Table 15-36](#) lists the possible actions. In addition, the cycle-by-cycle trip event flag (TZFLG[CBC]) is set and a EPWMxTZINT interrupt is generated if it is enabled in the TZEINT register.

The specified condition on the pins is automatically cleared when the ePWM time-base counter reaches zero (TBCNT = 0000h) if the trip event is no longer present. Therefore, in this mode, the trip event is cleared or reset every PWM cycle. The TZFLG[CBC] flag bit will remain set until it is manually cleared by writing to the TZCLR[CBC] bit. If the cycle-by-cycle trip event is still present when the TZFLG[CBC] bit is cleared, then it will again be immediately set.
- One-Shot (OSHT):** When a one-shot trip event occurs, the action specified in the TZCTL register is carried out immediately on the EPWMxA and/or EPWMxB output. [Table 15-36](#) lists the possible actions. In addition, the one-shot trip event flag (TZFLG[OST]) is set and a EPWMxTZINT interrupt is generated if it is enabled in the TZEINT register. The one-shot trip condition must be cleared manually by writing to the TZCLR[OST] bit.

The action taken when a trip event occurs can be configured individually for each of the ePWM output pins by way of the TZCTL[TZA] and TZCTL[TZB] register bits. One of four possible actions, shown in [Table 15-36](#), can be taken on a trip event.

Table 15-36. Possible Actions On a Trip Event

TZCTL[TZA] and/or TZCTL[TZB]	EPWMxA and/or EPWMxB	Comment
0	High-Impedance	Tripped
1h	Force to High State	Tripped
2h	Force to Low State	Tripped
3h	No Change	Do Nothing. No change is made to the output.

Example 15-2. Trip-Zone Configurations**Scenario A:**

A one-shot trip event on $\overline{TZ1}$ pulls both EPWM1A, EPWM1B low and also forces EPWM2A and EPWM2B high.

- Configure the ePWM1 registers as follows:
 - TZSEL[OSHT1] = 1: enables \overline{TZ} as a one-shot event source for ePWM1
 - TZCTL[TZA] = 2: EPWM1A will be forced low on a trip event.
 - TZCTL[TZB] = 2: EPWM1B will be forced low on a trip event.
- Configure the ePWM2 registers as follows:
 - TZSEL[OSHT1] = 1: enables \overline{TZ} as a one-shot event source for ePWM2
 - TZCTL[TZA] = 1: EPWM2A will be forced high on a trip event.
 - TZCTL[TZB] = 1: EPWM2B will be forced high on a trip event.

Scenario B:

A cycle-by-cycle event on $\overline{TZ5}$ pulls both EPWM1A, EPWM1B low.

A one-shot event on $\overline{TZ1}$ or $\overline{TZ6}$ puts EPWM2A into a high impedance state.

- Configure the ePWM1 registers as follows:
 - TZSEL[CBC5] = 1: enables $\overline{TZ5}$ as a one-shot event source for ePWM1
 - TZCTL[TZA] = 2: EPWM1A will be forced low on a trip event.
 - TZCTL[TZB] = 2: EPWM1B will be forced low on a trip event.
- Configure the ePWM2 registers as follows:
 - TZSEL[OSHT1] = 1: enables $\overline{TZ1}$ as a one-shot event source for ePWM2
 - TZSEL[OSHT6] = 1: enables $\overline{TZ6}$ as a one-shot event source for ePWM1
 - TZCTL[TZA] = 0: EPWM1A will be put into a high-impedance state on a trip event.
 - TZCTL[TZB] = 3: EPWM1B will ignore the trip event.

15.2.2.8.4 Generating Trip Event Interrupts

Figure 15-43 and Figure 15-44 illustrate the trip-zone submodule control and interrupt logic, respectively.

Figure 15-43. Trip-Zone Submodule Mode Control Logic

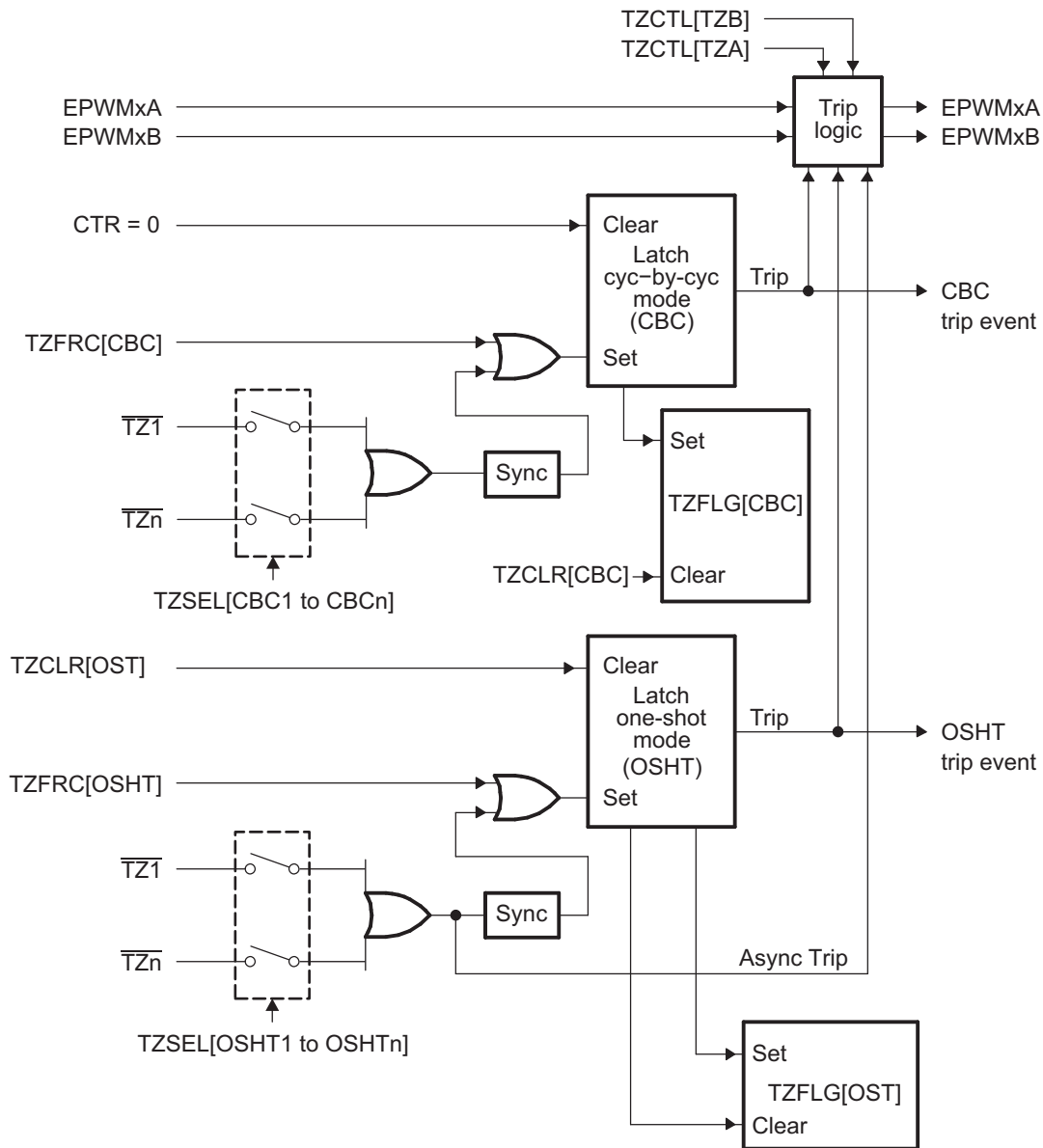
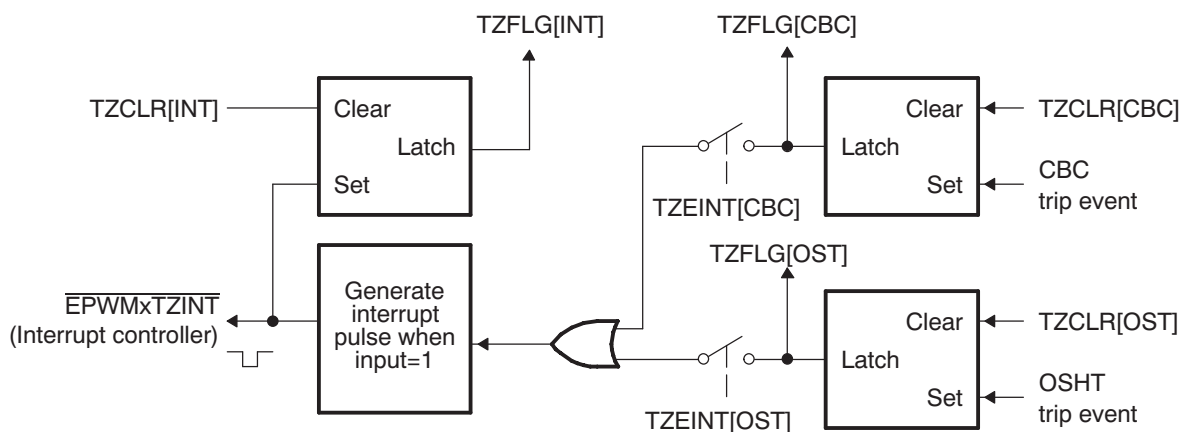


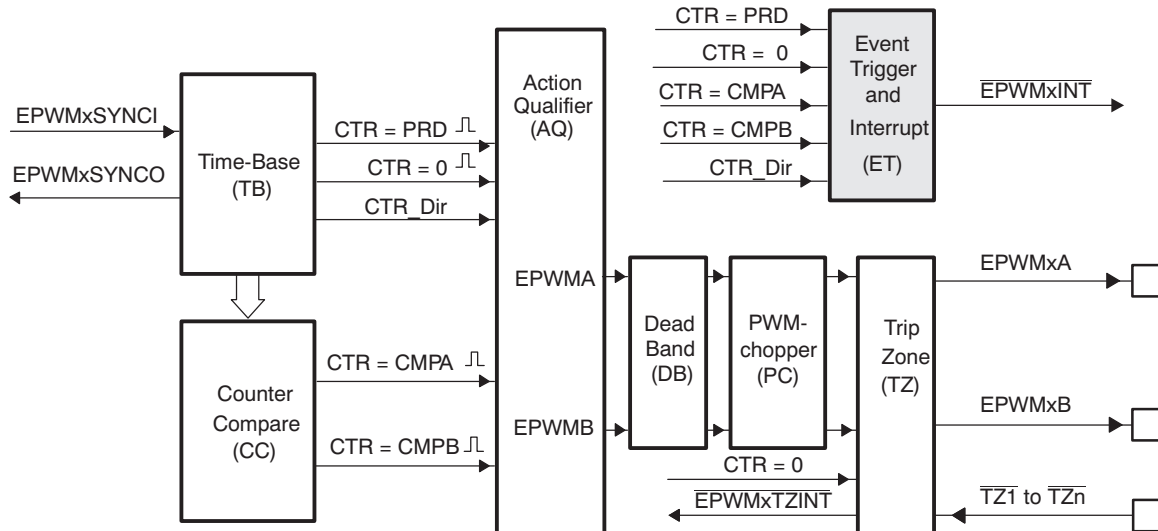
Figure 15-44. Trip-Zone Submodule Interrupt Logic



15.2.2.9 Event-Trigger (ET) Submodule

Figure 15-45 shows the event-trigger (ET) submodule in the ePWM system. The event-trigger submodule manages the events generated by the time-base submodule and the counter-compare submodule to generate an interrupt to the CPU.

Figure 15-45. Event-Trigger Submodule



15.2.2.9.1 Purpose of the Event-Trigger Submodule

The key functions of the event-trigger submodule are:

- Receives event inputs generated by the time-base and counter-compare submodules
- Uses the time-base direction information for up/down event qualification
- Uses prescaling logic to issue interrupt requests at:
 - Every event
 - Every second event
 - Every third event
- Provides full visibility of event generation via event counters and flags

15.2.2.9.2 Controlling and Monitoring the Event-Trigger Submodule

The key registers used to configure the event-trigger submodule are shown in Table 15-37:

Table 15-37. Event-Trigger Submodule Registers

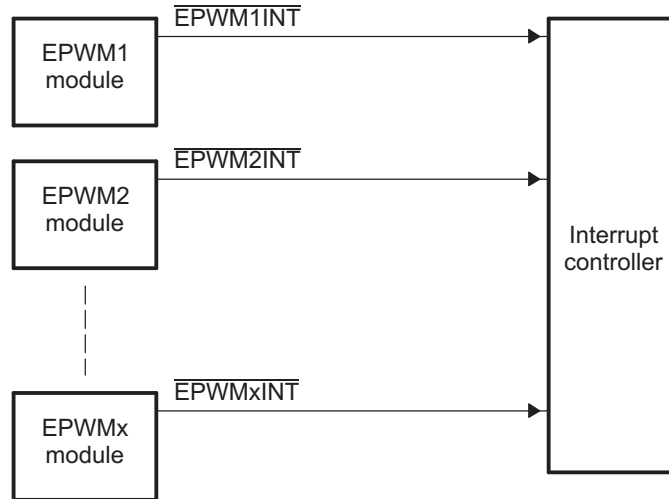
Acronym	Register Description	Address Offset	Shadowed
ETSEL	Event-Trigger Selection Register	32h	No
ETPS	Event-Trigger Prescale Register	34h	No
ETFLG	Event-Trigger Flag Register	36h	No
ETCLR	Event-Trigger Clear Register	38h	No
ETFRC	Event-Trigger Force Register	3Ah	No

15.2.2.9.3 Operational Overview of the Event-Trigger Submodule

The following sections describe the event-trigger submodule's operational highlights.

Each ePWM module has one interrupt request line connected to the interrupt controller as shown in Figure 15-46.

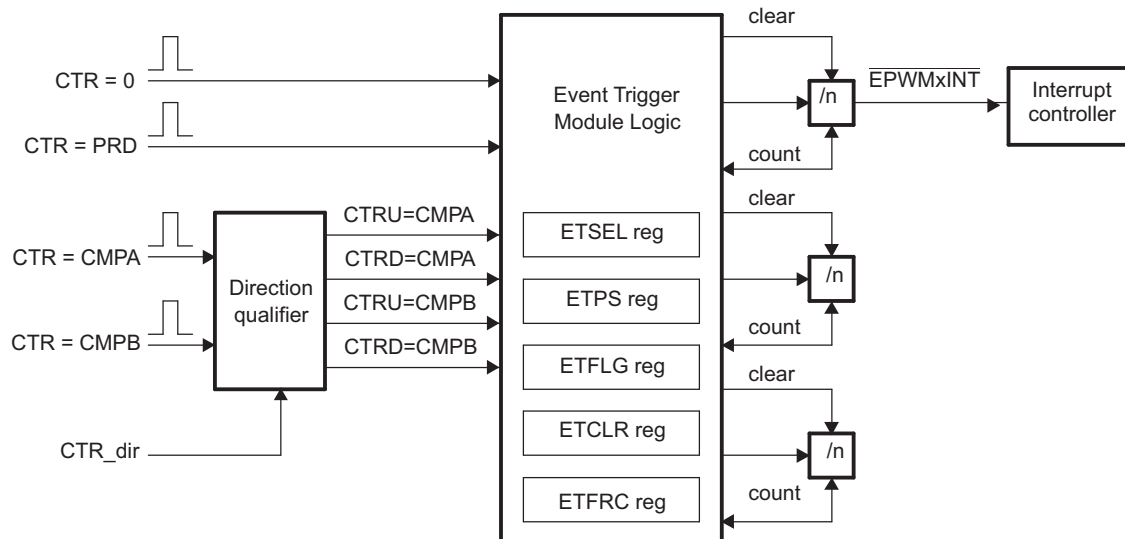
Figure 15-46. Event-Trigger Submodule Inter-Connectivity to Interrupt Controller



The event-trigger submodule monitors various event conditions (the left side inputs to event-trigger submodule shown in Figure 15-47) and can be configured to prescale these events before issuing an Interrupt request. The event-trigger prescaling logic can issue Interrupt requests at:

- Every event
- Every second event
- Every third event

Figure 15-47. Event-Trigger Submodule Showing Event Inputs and Prescaled Outputs



- ETSEL—This selects which of the possible events will trigger an interrupt.
- ETPS—This programs the event prescaling options previously mentioned.
- ETFLG—These are flag bits indicating status of the selected and prescaled events.
- ETCLR—These bits allow you to clear the flag bits in the ETFLG register via software.
- ETFRC—These bits allow software forcing of an event. Useful for debugging or software intervention.

A more detailed look at how the various register bits interact with the Interrupt is shown in [Figure 15-48](#).

[Figure 15-48](#) shows the event-trigger's interrupt generation logic. The interrupt-period (ETPS[INTPRD]) bits specify the number of events required to cause an interrupt pulse to be generated. The choices available are:

- Do not generate an interrupt
- Generate an interrupt on every event
- Generate an interrupt on every second event
- Generate an interrupt on every third event

An interrupt cannot be generated on every fourth or more events.

Which event can cause an interrupt is configured by the interrupt selection (ETSEL[INTSEL]) bits. The event can be one of the following:

- Time-base counter equal to zero (TBCNT = 0000h).
- Time-base counter equal to period (TBCNT = TBPRD).
- Time-base counter equal to the compare A register (CMPA) when the timer is incrementing.
- Time-base counter equal to the compare A register (CMPA) when the timer is decrementing.
- Time-base counter equal to the compare B register (CMPB) when the timer is incrementing.
- Time-base counter equal to the compare B register (CMPB) when the timer is decrementing.

The number of events that have occurred can be read from the interrupt event counter (ETPS[INTCNT]) register bits. That is, when the specified event occurs the ETPS[INTCNT] bits are incremented until they reach the value specified by ETPS[INTPRD]. When ETPS[INTCNT] = ETPS[INTPRD] the counter stops counting and its output is set. The counter is only cleared when an interrupt is sent to the interrupt controller.

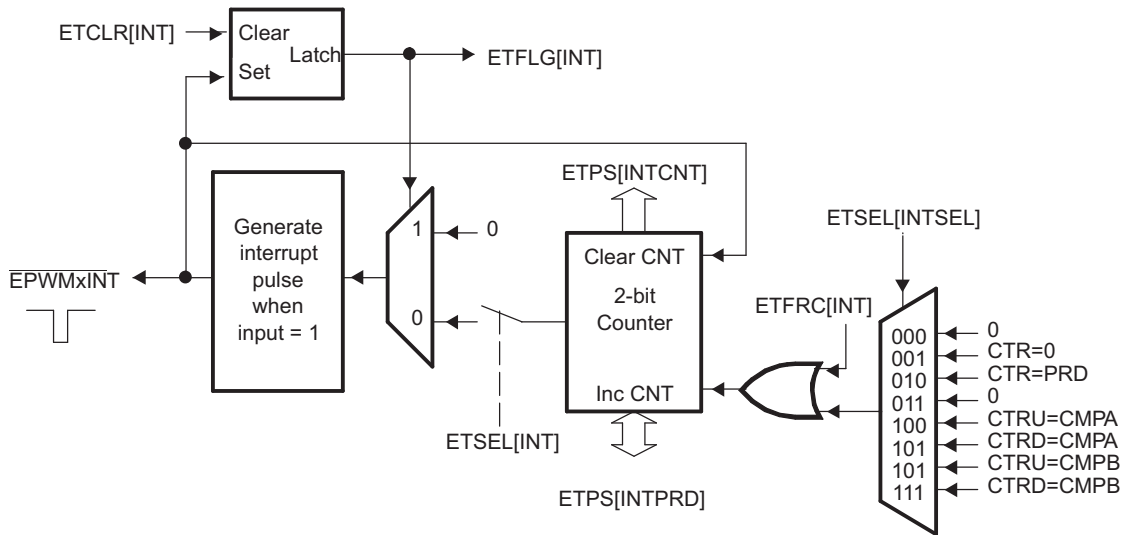
When ETPS[INTCNT] reaches ETPS[INTPRD], one of the following behaviors will occur:

- If interrupts are enabled, ETSEL[INTEN] = 1 and the interrupt flag is clear, ETFLG[INT] = 0, then an interrupt pulse is generated and the interrupt flag is set, ETFLG[INT] = 1, and the event counter is cleared ETPS[INTCNT] = 0. The counter will begin counting events again.
- If interrupts are disabled, ETSEL[INTEN] = 0, or the interrupt flag is set, ETFLG[INT] = 1, the counter stops counting events when it reaches the period value ETPS[INTCNT] = ETPS[INTPRD].
- If interrupts are enabled, but the interrupt flag is already set, then the counter will hold its output high until the ENTFLG[INT] flag is cleared. This allows for one interrupt to be pending while one is serviced.

Writing to the INTPRD bits will automatically clear the counter INTCNT = 0 and the counter output will be reset (so no interrupts are generated). Writing a 1 to the ETFRC[INT] bit will increment the event counter INTCNT. The counter will behave as described above when INTCNT = INTPRD. When INTPRD = 0, the counter is disabled and hence no events will be detected and the ETFRC[INT] bit is also ignored.

Note that the interrupts coming from the ePWM module are also used as DMA events. The interrupt registers should be used to enable and clear the current DMA event in order for the ePWM module to generate subsequent DMA events.

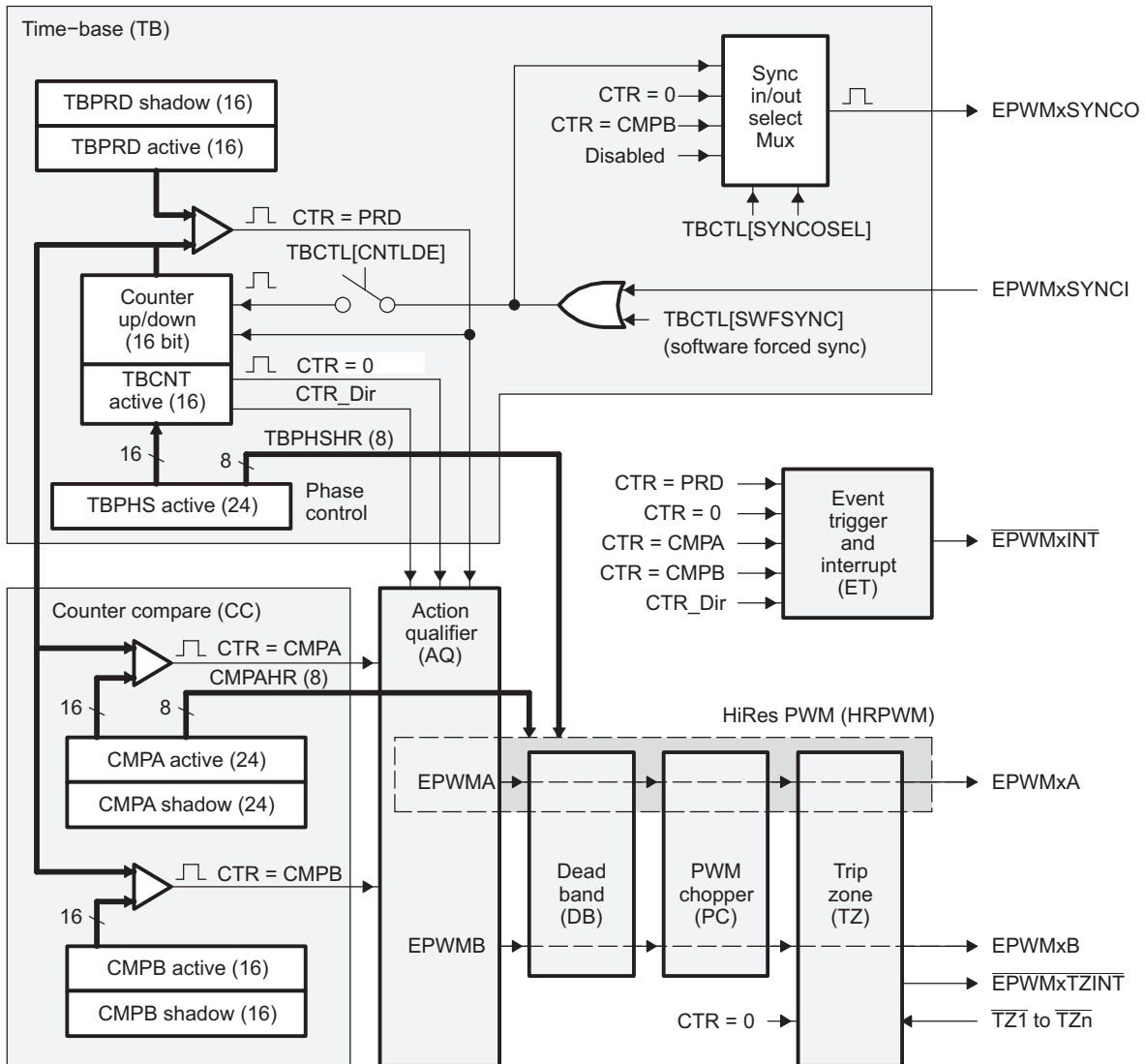
Figure 15-48. Event-Trigger Interrupt Generator



15.2.2.10 High-Resolution PWM (HRPWM) Submodule

Figure 15-49 shows the high-resolution PWM (HRPWM) submodule in the ePWM system. Some devices include the high-resolution PWM submodule, see Section 15.1.1 to determine which ePWM instances include this feature.

Figure 15-49. HRPWM System Interface



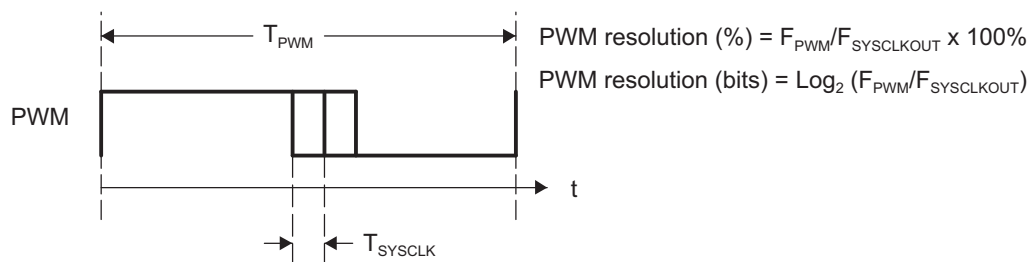
15.2.2.10.1 Purpose of the High-Resolution PWM Submodule

The enhanced high-resolution pulse-width modulator (eHRPWM) extends the time resolution capabilities of the conventionally derived digital pulse-width modulator (PWM). HRPWM is typically used when PWM resolution falls below ~9-10 bits. The key features of HRPWM are:

- Extended time resolution capability
- Used in both duty cycle and phase-shift control methods
- Finer time granularity control or edge positioning using extensions to the Compare A and Phase registers
- Implemented using the A signal path of PWM, that is, on the EPWMxA output. EPWMxB output has conventional PWM capabilities

The ePWM peripheral is used to perform a function that is mathematically equivalent to a digital-to-analog converter (DAC). As shown in Figure 15-50, the effective resolution for conventionally generated PWM is a function of PWM frequency (or period) and system clock frequency.

Figure 15-50. Resolution Calculations for Conventionally Generated PWM



If the required PWM operating frequency does not offer sufficient resolution in PWM mode, you may want to consider HRPWM. As an example of improved performance offered by HRPWM, Table 15-38 shows resolution in bits for various PWM frequencies. Table 15-38 values assume a MEP step size of 180 ps. See your device-specific data manual for typical and maximum performance specifications for the MEP.

Table 15-38. Resolution for PWM and HRPWM

PWM Frequency (kHz)	Regular Resolution (PWM)		High Resolution (HRPWM)	
	Bits	%	Bits	%
20	12.3	0.0	18.1	0.000
50	11.0	0.0	16.8	0.001
100	10.0	0.1	15.8	0.002
150	9.4	0.2	15.2	0.003
200	9.0	0.2	14.8	0.004
250	8.6	0.3	14.4	0.005
500	7.6	0.5	13.8	0.007
1000	6.6	1.0	12.4	0.018
1500	6.1	1.5	11.9	0.027
2000	5.6	2.0	11.4	0.036

Although each application may differ, typical low-frequency PWM operation (below 250 kHz) may not require HRPWM. HRPWM capability is most useful for high-frequency PWM requirements of power conversion topologies such as:

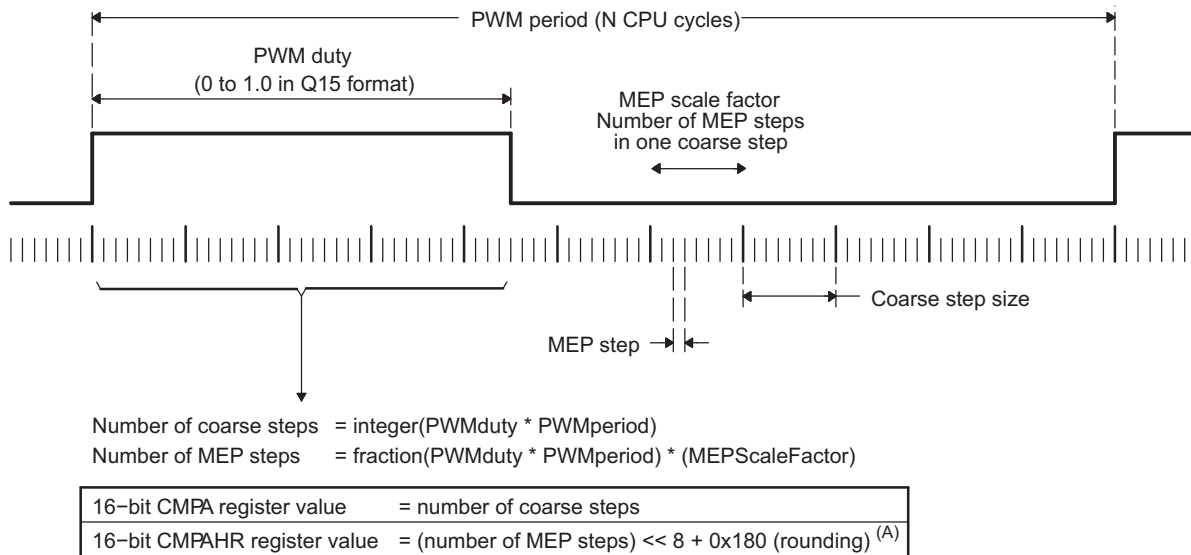
- Single-phase buck, boost, and flyback
- Multi-phase buck, boost, and flyback
- Phase-shifted full bridge
- Direct modulation of D-Class power amplifiers

15.2.2.10.2 Architecture of the High-Resolution PWM Submodule

The HRPWM is based on micro edge positioner (MEP) technology. MEP logic is capable of positioning an edge very finely by sub-dividing one coarse system clock of a conventional PWM generator. The time step accuracy is on the order of 150 ps. The HRPWM also has a self-check software diagnostics mode to check if the MEP logic is running optimally, under all operating conditions.

Figure 15-51 shows the relationship between one coarse system clock and edge position in terms of MEP steps, which are controlled via an 8-bit field in the Compare A extension register (CMPAHR).

Figure 15-51. Operating Logic Using MEP



A For MEP range and rounding adjustment.

To generate an HRPWM waveform, configure the TBM, CCM, and AQM registers as you would to generate a conventional PWM of a given frequency and polarity. The HRPWM works together with the TBM, CCM, and AQM registers to extend edge resolution, and should be configured accordingly. Although many programming combinations are possible, only a few are needed and practical.

15.2.2.10.3 Controlling and Monitoring the High-Resolution PWM Submodule

The MEP of the HRPWM is controlled by two extension registers, each 8-bits wide. These two HRPWM registers are concatenated with the 16-bit TBPHS and CMPA registers used to control PWM operation.

- TBPHSHR - Time-Base Phase High-Resolution Register
- CMPAHR - Counter-Compare A High-Resolution Register

Table 15-39 lists the registers used to control and monitor the high-resolution PWM submodule.

Table 15-39. HRPWM Submodule Registers

Acronym	Register Description	Address Offset	Shadowed
TBPHSHR	Extension Register for HRPWM Phase	4h	No
CMPAHR	Extension Register for HRPWM Duty	10h	Yes
HRCNFG	HRPWM Configuration Register	C0h	No

15.2.2.10.4 Configuring the High-Resolution PWM Submodule

Once the ePWM has been configured to provide conventional PWM of a given frequency and polarity, the HRPWM is configured by programming the HRCNFG register located at offset address C0h. This register provides configuration options for the following key operating modes:

- **Edge Mode:** The MEP can be programmed to provide precise position control on the rising edge (RE), falling edge (FE), or both edges (BE) at the same time. FE and RE are used for power topologies requiring duty cycle control, while BE is used for topologies requiring phase shifting, for example, phase shifted full bridge.
- **Control Mode:** The MEP is programmed to be controlled either from the CMPAHR register (duty cycle control) or the TBPHSHR register (phase control). RE or FE control mode should be used with CMPAHR register. BE control mode should be used with TBPHSHR register.
- **Shadow Mode:** This mode provides the same shadowing (double buffering) option as in regular PWM mode. This option is valid only when operating from the CMPAHR register and should be chosen to be the same as the regular load option for the CMPA register. If TBPHSHR is used, then this option has no effect.

15.2.2.10.5 Operational Highlights for the High-Resolution PWM Submodule

The MEP logic is capable of placing an edge in one of 255 (8 bits) discrete time steps, each of which has a time resolution on the order of 150 ps. The MEP works with the TBM and CCM registers to be certain that time steps are optimally applied and that edge placement accuracy is maintained over a wide range of PWM frequencies, system clock frequencies and other operating conditions. Table 15-40 shows the typical range of operating frequencies supported by the HRPWM.

Table 15-40. Relationship Between MEP Steps, PWM Frequency and Resolution

System (MHz)	MEP Steps Per SYSCLKOUT ^{(1) (2) (3)}	PWM Minimum (Hz) ⁽⁴⁾	PWM Maximum (MHz)	Resolution at Maximum (Bits) ⁽⁵⁾
50.0	111	763	2.50	11.1
60.0	93	916	3.00	10.9
70.0	79	1068	3.50	10.6
80.0	69	1221	4.00	10.4
90.0	62	1373	4.50	10.3
100.0	56	1526	5.00	10.1

⁽¹⁾ System frequency = SYSCLKOUT, that is, CPU clock. TBCLK = SYSCLKOUT

⁽²⁾ Table data based on a MEP time resolution of 180 ps (this is an example value)

⁽³⁾ MEP steps applied = $T_{\text{SYSCLKOUT}}/180 \text{ ps}$ in this example.

⁽⁴⁾ PWM minimum frequency is based on a maximum period value, TBPRD = 65 535. PWM mode is asymmetrical up-count.

⁽⁵⁾ Resolution in bits is given for the maximum PWM frequency stated.

15.2.2.10.5.1 Edge Positioning

In a typical power control loop (switch modes, digital motor control (DMC), uninterruptible power supply (UPS)), a digital controller (PID, 2pole/2zero, lag/lead, etc.) issues a duty command, usually expressed in a per unit or percentage terms.

In the following example, assume that for a particular operating point, the demanded duty cycle is 0.405 or 40.5% on-time and the required converter PWM frequency is 1.25 MHz. In conventional PWM generation with a system clock of 100 MHz, the duty cycle choices are in the vicinity of 40.5%. In [Figure 15-52](#), a compare value of 32 counts (duty = 40%) is the closest to 40.5% that you can attain. This is equivalent to an edge position of 320 ns instead of the desired 324 ns. This data is shown in [Table 15-41](#).

By utilizing the MEP, you can achieve an edge position much closer to the desired point of 324 ns. [Table 15-41](#) shows that in addition to the CMPA value, 22 steps of the MEP (CMPAHR register) will position the edge at 323.96 ns, resulting in almost zero error. In this example, it is assumed that the MEP has a step resolution of 180 ns.

Figure 15-52. Required PWM Waveform for a Requested Duty = 40.5%

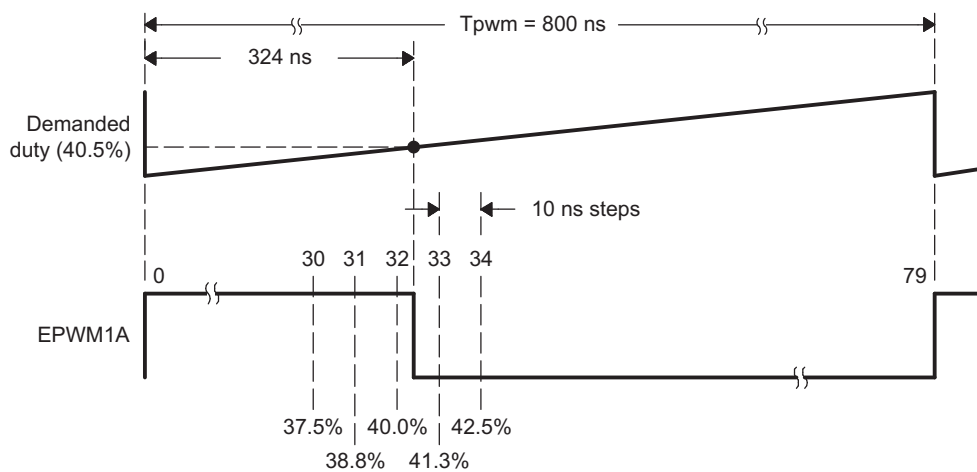


Table 15-41. CMPA vs Duty (left), and [CMPA:CMPAHR] vs Duty (right)

CMPA (count) ^{(1) (2) (3)}	DUTY (%)	High Time (ns)	CMPA (count)	CMPAHR (count)	Duty (%)	High Time (ns)
28	35.0	280	32	18	40.405	323.24
29	36.3	290	32	19	40.428	323.42
30	37.5	300	32	20	40.450	323.60
31	38.8	310	32	21	40.473	323.78
32	40.0	320	32	22	40.495	323.96
33	41.3	330	32	23	40.518	324.14
34	42.5	340	32	24	40.540	324.32
			32	25	40.563	324.50
Required			32	26	40.585	324.68
32.40	40.5	324	32	27	40.608	324.86

⁽¹⁾ System clock, SYSCLKOUT and TBCLK = 100 MHz, 10 ns

⁽²⁾ For a PWM Period register value of 80 counts, PWM Period = 80 × 10 ns = 800 ns, PWM frequency = 1/800 ns = 1.25 MHz

⁽³⁾ Assumed MEP step size for the above example = 180 ps

15.2.2.10.5.2 Scaling Considerations

The mechanics of how to position an edge precisely in time has been demonstrated using the resources of the standard (CMPA) and MEP (CMPAHR) registers. In a practical application, however, it is necessary to seamlessly provide the CPU a mapping function from a per-unit (fractional) duty cycle to a final integer (non-fractional) representation that is written to the [CMPA:CMPAHR] register combination.

To do this, first examine the scaling or mapping steps involved. It is common in control software to express duty cycle in a per-unit or percentage basis. This has the advantage of performing all needed math calculations without concern for the final absolute duty cycle, expressed in clock counts or high time in ns. Furthermore, it makes the code more transportable across multiple converter types running different PWM frequencies.

To implement the mapping scheme, a two-step scaling procedure is required.

Assumptions for this example:

System clock, SYSCLKOUT	= 10 ns (100 MHz)
PWM frequency	= 1.25 MHz (1/800 ns)
Required PWM duty cycle, PWMDuty	= 0.405 (40.5%)
PWM period in terms of coarse steps, PWMperiod (800 ns/10 ns)	= 80
Number of MEP steps per coarse step at 180 ps (10 ns/180 ps), MEP_SF	= 55
Value to keep CMPAHR within the range of 1-255 and fractional rounding constant (default value)	= 180h

Step 1: Percentage Integer Duty value conversion for CMPA register

CMPA register value	= $\text{int}(\text{PWMDuty} \times \text{PWMperiod})$; int means integer part
	= $\text{int}(0.405 \times 80)$
	= $\text{int}(32.4)$
CMPA register value	= 32 (20h)

Step 2: Fractional value conversion for CMPAHR register

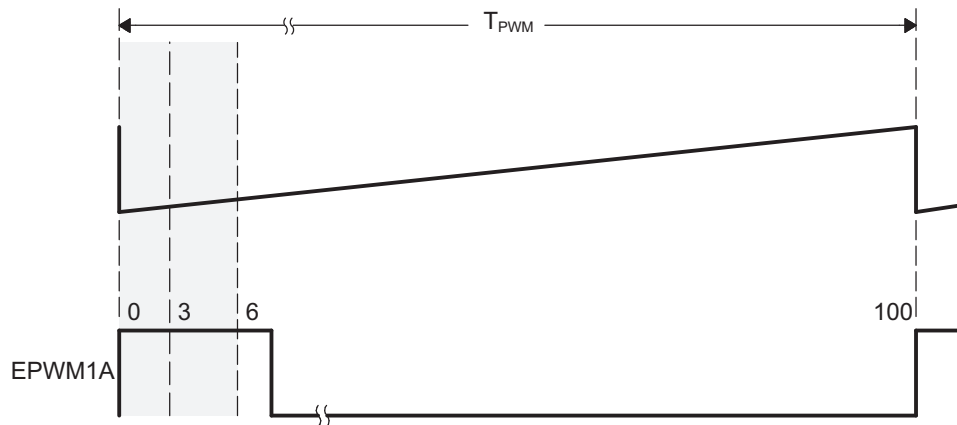
CMPAHR register value	= $(\text{frac}(\text{PWMDuty} \times \text{PWMperiod}) \times \text{MEP_SF}) \ll 8) + 180\text{h}$; frac means fractional part
	= $(\text{frac}(32.4) \times 55 \ll 8) + 180\text{h}$; Shift is to move the value as CMPAHR high byte
	= $((0.4 \times 55) \ll 8) + 180\text{h}$
	= $(22 \ll 8) + 180\text{h}$
	= $22 \times 256 + 180\text{h}$; Shifting left by 8 is the same multiplying by 256.
	= $5632 + 180\text{h}$
	= $1600\text{h} + 180\text{h}$
CMPAHR value	= 1780h; CMPAHR value = 1700h, lower 8 bits will be ignored by hardware.

15.2.2.10.5.3 Duty Cycle Range Limitation

In high resolution mode, the MEP is not active for 100% of the PWM period. It becomes operational 3 SYSCLK cycles after the period starts.

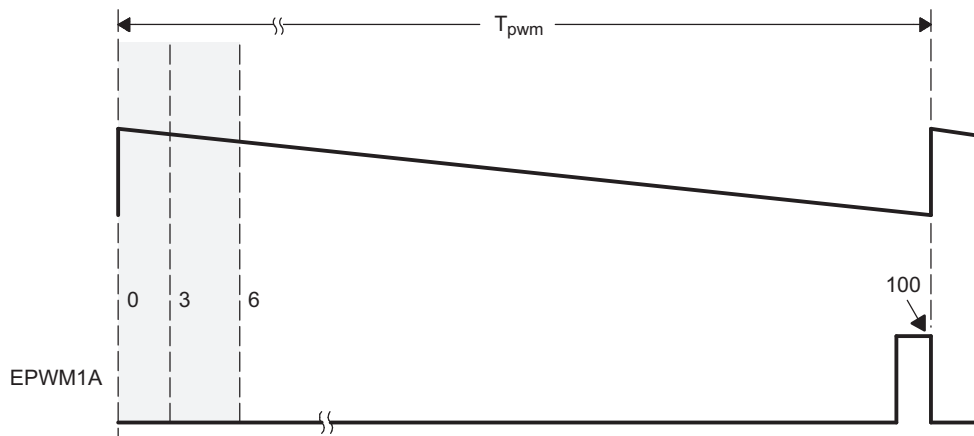
Duty cycle range limitations are illustrated in Figure 15-53. This limitation imposes a lower duty cycle limit on the MEP. For example, precision edge control is not available all the way down to 0% duty cycle. Although for the first 3 or 6 cycles, the HRPWM capabilities are not available, regular PWM duty control is still fully operational down to 0% duty. In most applications this should not be an issue as the controller regulation point is usually not designed to be close to 0% duty cycle.

Figure 15-53. Low % Duty Cycle Range Limitation Example When PWM Frequency = 1 MHz



If the application demands HRPWM operation in the low percent duty cycle region, then the HRPWM can be configured to operate in count-down mode with the rising edge position (REP) controlled by the MEP. This is illustrated in Figure 15-54. In this case low percent duty limitation is no longer an issue.

Figure 15-54. High % Duty Cycle Range Limitation Example when PWM Frequency = 1 MHz



15.2.2.11 ePWM Behavior During Emulation

To configure the ePWM to stop during emulation suspend events (for example, debugger breakpoints), set up the ePWM and the Debug Subsystem:

1. Set TBCTL.FREE_SOFT= 0 or 1 (see register description for more details). This will allow the Suspend_Control signal from the Debug Subsystem ([Chapter 27](#)) to stop and start the ePWM. Note that if FREE_SOFT = 2 or 3, the Suspend_Control signal is ignored and the ePWM is free running regardless of any debug suspend event. This FREE_SOFT bit gives local control from a module perspective to gate the suspend signal coming from the Debug Subsystem.
2. Set the appropriate xxx_Suspend_Control register = 0x9, as described in [Section 27.1.1.1, Debug Suspend Support for Peripherals](#). Choose the register appropriate to the peripheral you want to suspend during a suspend event.

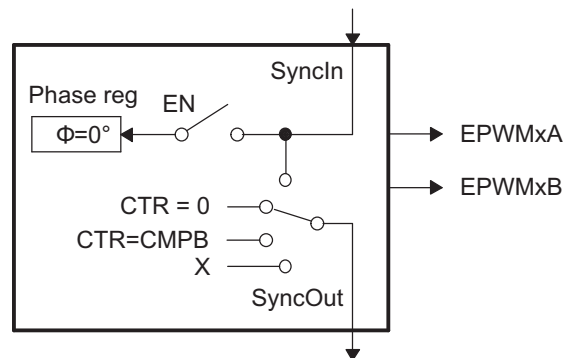
15.2.3 Use Cases

An ePWM module has all the local resources necessary to operate completely as a standalone module or to operate in synchronization with other identical ePWM modules.

15.2.3.1 Overview of Multiple Modules

Previously in this user's guide, all discussions have described the operation of a single module. To facilitate the understanding of multiple modules working together in a system, the ePWM module described in reference is represented by the more simplified block diagram shown in [Figure 15-55](#). This simplified ePWM block shows only the key resources needed to explain how a multiswitch power topology is controlled with multiple ePWM modules working together.

Figure 15-55. Simplified ePWM Module



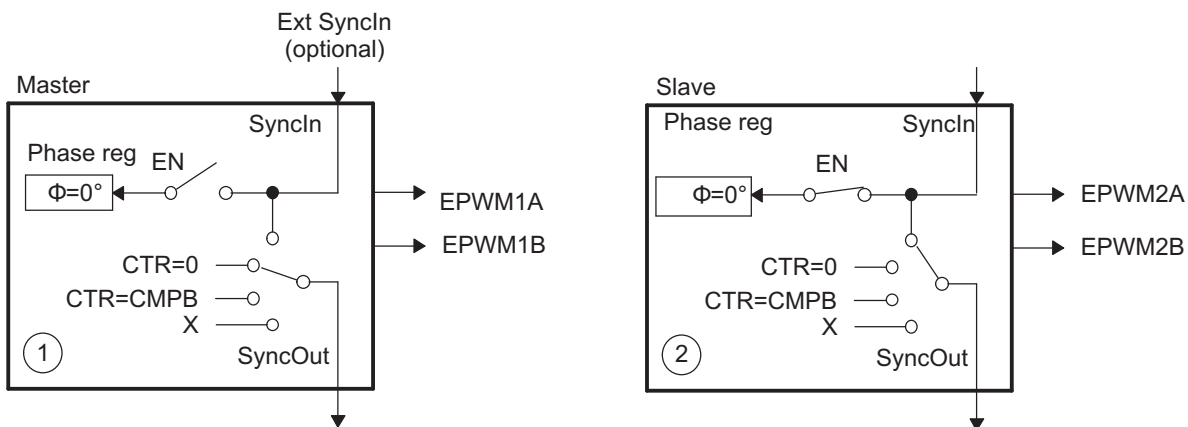
15.2.3.2 Key Configuration Capabilities

The key configuration choices available to each module are as follows:

- Options for SyncIn
 - Load own counter with phase register on an incoming sync strobe—enable (EN) switch closed
 - Do nothing or ignore incoming sync strobe—enable switch open
 - Sync flow-through - SyncOut connected to SyncIn
 - Master mode, provides a sync at PWM boundaries—SyncOut connected to CTR = PRD
 - Master mode, provides a sync at any programmable point in time—SyncOut connected to CTR = CMPB
 - Module is in standalone mode and provides No sync to other modules—SyncOut connected to X (disabled)
- Options for SyncOut
 - Sync flow-through - SyncOut connected to SyncIn
 - Master mode, provides a sync at PWM boundaries—SyncOut connected to CTR = PRD
 - Master mode, provides a sync at any programmable point in time—SyncOut connected to CTR = CMPB
 - Module is in standalone mode and provides No sync to other modules—SyncOut connected to X (disabled)

For each choice of SyncOut, a module may also choose to load its own counter with a new phase value on a SyncIn strobe input or choose to ignore it, i.e., via the enable switch. Although various combinations are possible, the two most common—master module and slave module modes—are shown in [Figure 15-56](#).

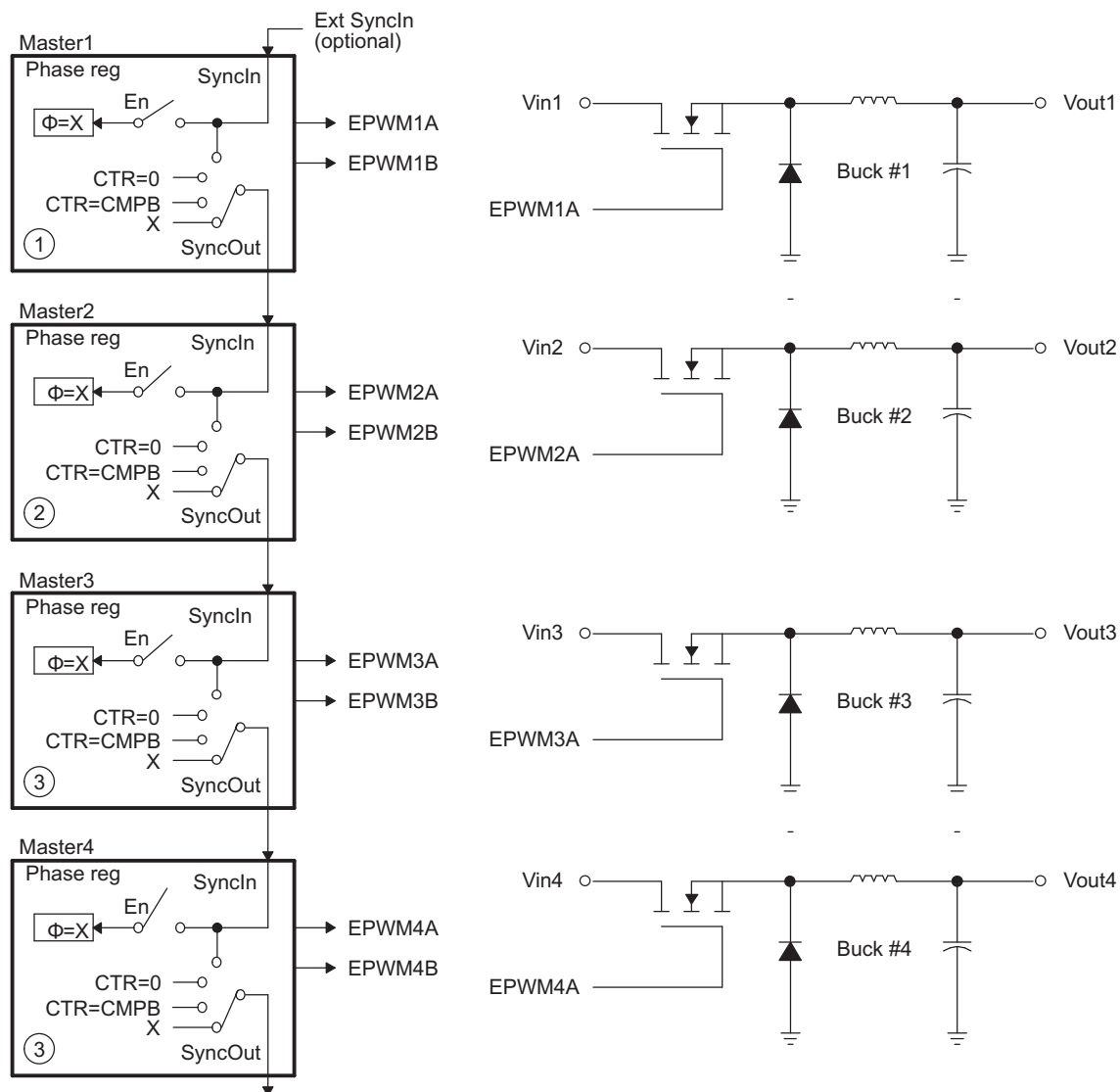
Figure 15-56. EPWM1 Configured as a Typical Master, EPWM2 Configured as a Slave



15.2.3.3 Controlling Multiple Buck Converters With Independent Frequencies

One of the simplest power converter topologies is the buck. A single ePWM module configured as a master can control two buck stages with the same PWM frequency. If independent frequency control is required for each buck converter, then one ePWM module must be allocated for each converter stage. Figure 15-57 shows four buck stages, each running at independent frequencies. In this case, all four ePWM modules are configured as Masters and no synchronization is used. Figure 15-58 shows the waveforms generated by the setup shown in Figure 15-57; note that only three waveforms are shown, although there are four stages.

Figure 15-57. Control of Four Buck Stages. Here $F_{PWM1} \neq F_{PWM2} \neq F_{PWM3} \neq F_{PWM4}$



NOTE: $\Theta = X$ indicates value in phase register is a "don't care"

Figure 15-58. Buck Waveforms for Figure 15-57 (Note: Only three bucks shown here)

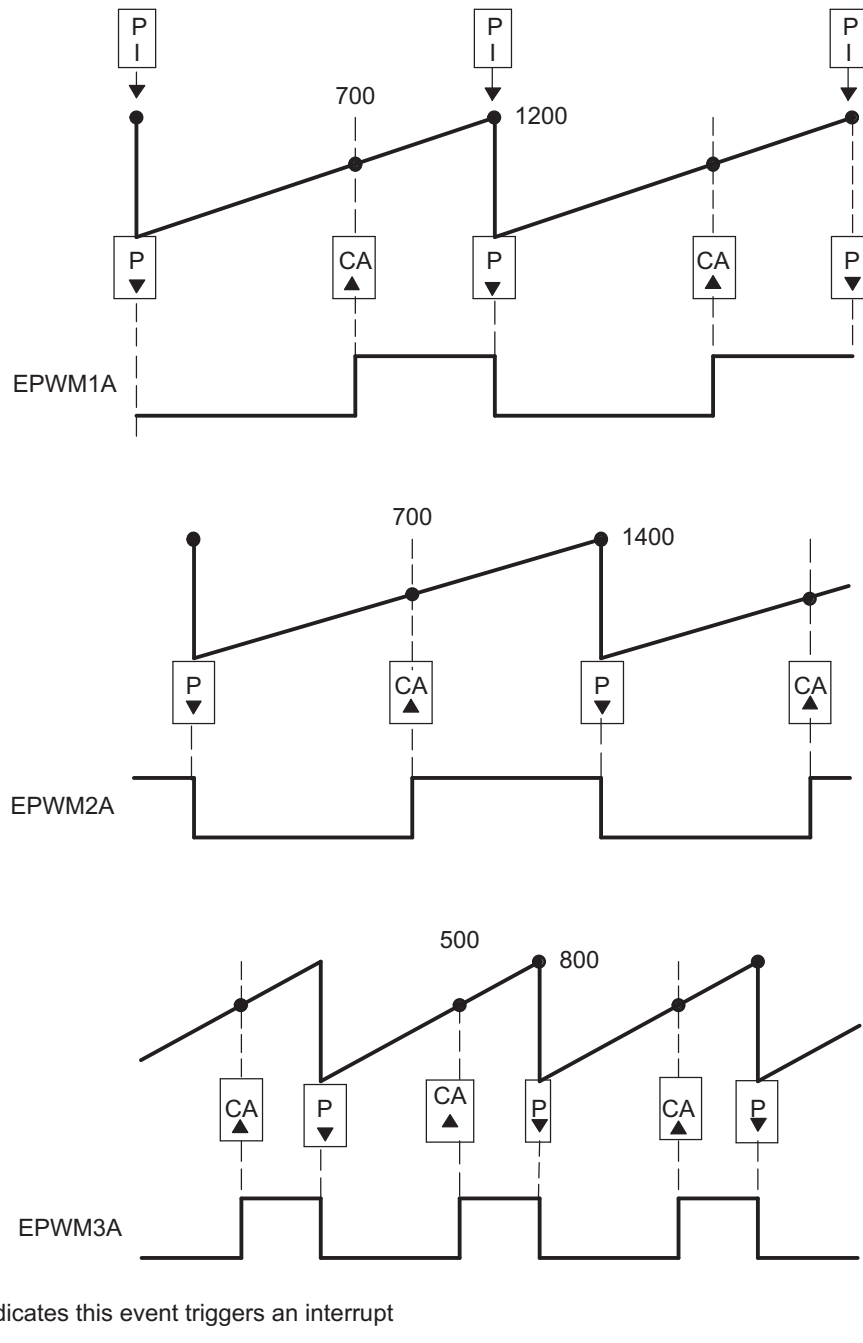


Table 15-42. EPWM1 Initialization for Figure 15-58

Register	Bit	Value	Comments
TBPRD	TBPRD	1200 (4B0h)	Period = 1201 TBCLK counts
TBPHS	TBPHS	0	Clear Phase Register to 0
TBCTL	CTRMODE	TB_UP	
	PHSEN	TB_DISABLE	Phase loading disabled
	PRDL	TB_SHADOW	
	SYNCOSEL	TB_SYNC_DISABLE	
CMPCTL	SHDWAMODE	CC_SHADOW	
	SHDWBMODE	CC_SHADOW	
	LOADAMODE	CC_CTR_ZERO	Load on CTR = 0
	LOADBMODE	CC_CTR_ZERO	Load on CTR = 0
AQCTLA	PRD	AQ_CLEAR	
	CAU	AQ_SET	

Table 15-43. EPWM2 Initialization for Figure 15-58

Register	Bit	Value	Comments
TBPRD	TBPRD	1400 (578h)	Period = 1401 TBCLK counts
TBPHS	TBPHS	0	Clear Phase Register to 0
TBCTL	CTRMODE	TB_UP	
	PHSEN	TB_DISABLE	Phase loading disabled
	PRDL	TB_SHADOW	
	SYNCOSEL	TB_SYNC_DISABLE	
CMPCTL	SHDWAMODE	CC_SHADOW	
	SHDWBMODE	CC_SHADOW	
	LOADAMODE	CC_CTR_ZERO	Load on CTR = 0
	LOADBMODE	CC_CTR_ZERO	Load on CTR = 0
AQCTLA	PRD	AQ_CLEAR	
	CAU	AQ_SET	

Table 15-44. EPWM3 Initialization for Figure 15-58

Register	Bit	Value	Comments
TBPRD	TBPRD	800 (320h)	Period = 801 TBCLK counts
TBPHS	TBPHS	0	Clear Phase Register to 0
TBCTL	CTRMODE	TB_UP	
	PHSEN	TB_DISABLE	Phase loading disabled
	PRDL	TB_SHADOW	
	SYNCOSEL	TB_SYNC_DISABLE	
CMPCTL	SHDWAMODE	CC_SHADOW	
	SHDWBMODE	CC_SHADOW	
	LOADAMODE	CC_CTR_ZERO	Load on CTR = 0
	LOADBMODE	CC_CTR_ZERO	Load on CTR = 0
AQCTLA	PRD	AQ_CLEAR	
	CAU	AQ_SET	

Example 15-3. Configuration for Example in Figure 15-58

```
// Run Time (Note: Example execution of one run-time instance)
//=====
EPwm1Regs.CMPA.half.CMPA = 700;           // adjust duty for output EPWM1A
EPwm2Regs.CMPA.half.CMPA = 700;           // adjust duty for output EPWM2A
EPwm3Regs.CMPA.half.CMPA = 500;           // adjust duty for output EPWM3A
```

15.2.3.4 Controlling Multiple Buck Converters With Same Frequencies

If synchronization is a requirement, ePWM module 2 can be configured as a slave and can operate at integer multiple (N) frequencies of module 1. The sync signal from master to slave ensures these modules remain locked. Figure 15-59 shows such a configuration; Figure 15-60 shows the waveforms generated by the configuration.

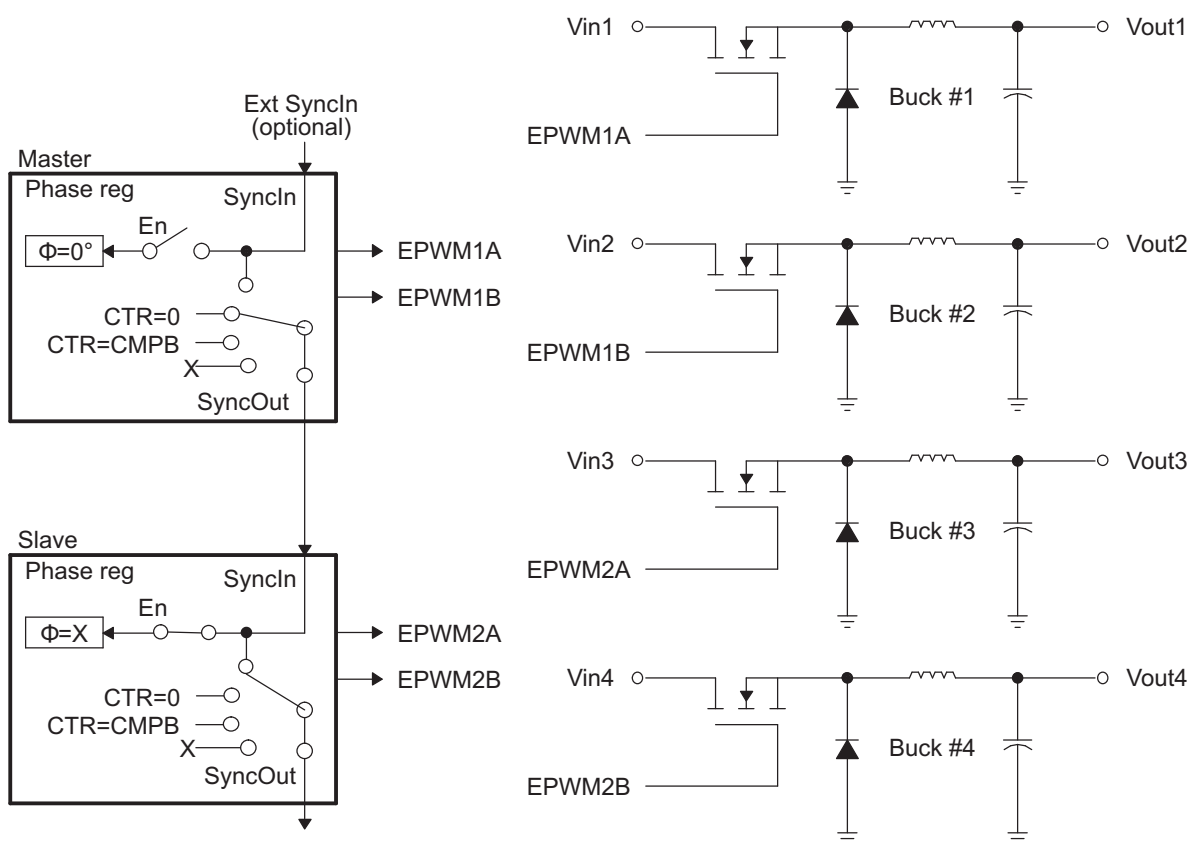
Figure 15-59. Control of Four Buck Stages. (Note: $F_{PWM2} = N \times F_{PWM1}$)


Figure 15-60. Buck Waveforms for Figure 15-59 (Note: $F_{PWM2} = F_{PWM1}$)

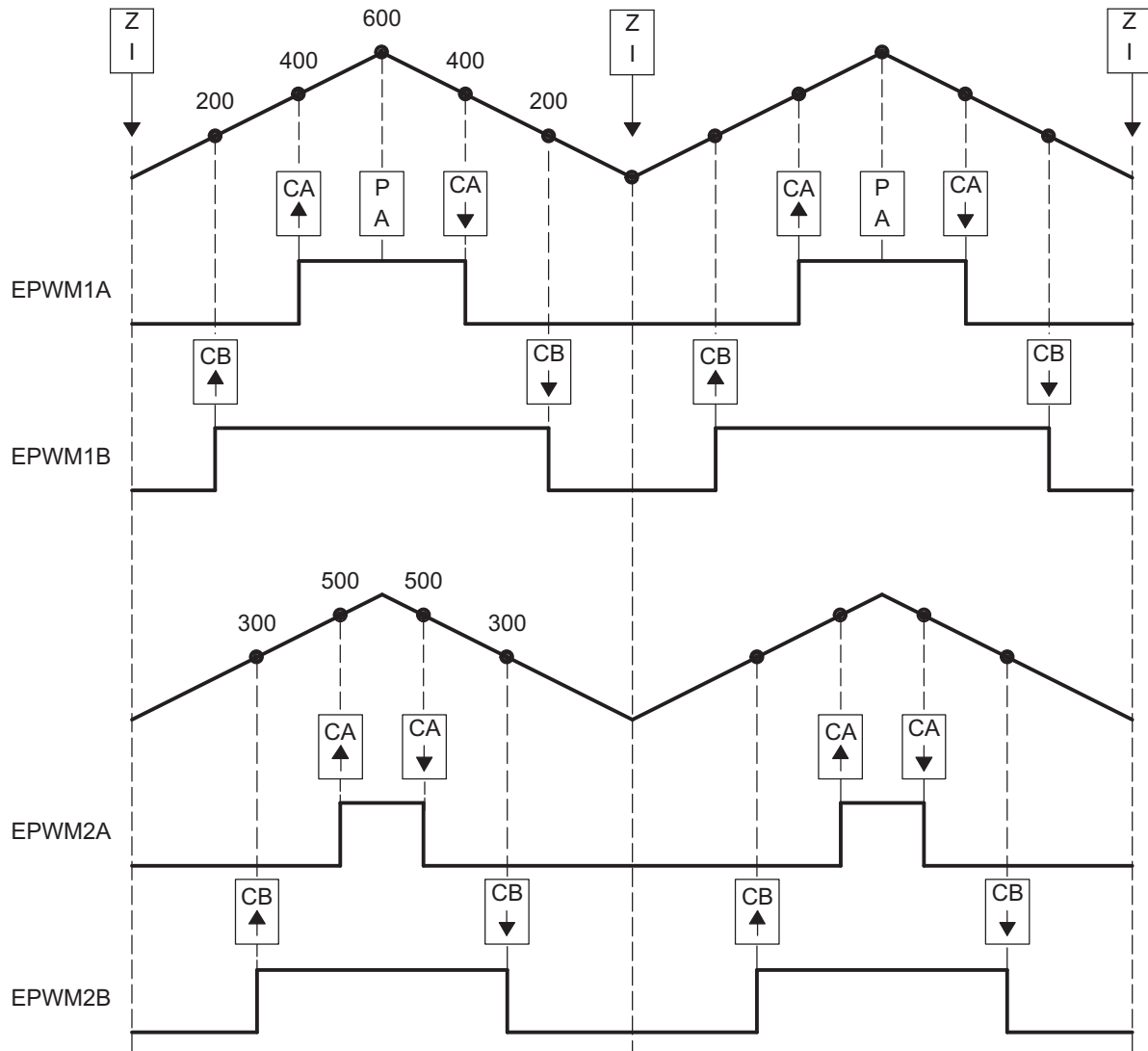


Table 15-45. EPWM1 Initialization for Figure 15-59

Register	Bit	Value	Comments
TBPRD	TBPRD	600 (258h)	Period = 1200 TBCLK counts
TBPHS	TBPHS	0	Clear Phase Register to 0
TBCTL	CTRMODE	TB_UPDOWN	
	PHSEN	TB_DISABLE	Phase loading disabled
	PRDL	TB_SHADOW	
	SYNCOSEL	TB_CTR_ZERO	Sync down-stream module
CMPCTL	SHDWAMODE	CC_SHADOW	
	SHDWBMODE	CC_SHADOW	
	LOADAMODE	CC_CTR_ZERO	Load on CTR = 0
	LOADBMODE	CC_CTR_ZERO	Load on CTR = 0
AQCTLA	CAU	AQ_SET	Set actions for EPWM1A
	CAD	AQ_CLEAR	
AQCTLB	CBU	AQ_SET	Set actions for EPWM1B
	CBD	AQ_CLEAR	

Table 15-46. EPWM2 Initialization for Figure 15-59

Register	Bit	Value	Comments
TBPRD	TBPRD	600 (258h)	Period = 1200 TBCLK counts
TBPHS	TBPHS	0	Clear Phase Register to 0
TBCTL	CTRMODE	TB_UPDOWN	
	PHSEN	TB_ENABLE	Phase loading enabled
	PRDL	TB_SHADOW	
	SYNCOSEL	TB_SYNC_IN	Sync flow-through
CMPCTL	SHDWAMODE	CC_SHADOW	
	SHDWBMODE	CC_SHADOW	
	LOADAMODE	CC_CTR_ZERO	Load on CTR = 0
	LOADBMODE	CC_CTR_ZERO	Load on CTR = 0
AQCTLA	CAU	AQ_SET	Set actions for EPWM2A
	CAD	AQ_CLEAR	
AQCTLB	CBU	AQ_SET	Set actions for EPWM2B
	CBD	AQ_CLEAR	

Example 15-4. Code Snippet for Configuration in Figure 15-59

```

// Run Time (Note: Example execution of one run-time instance)
//=====
EPwm1Regs.CMPA.half.CMPA = 400;      // adjust duty for output EPWM1A
EPwm1Regs.CMPB = 200;                // adjust duty for output EPWM1B
EPwm2Regs.CMPA.half.CMPA = 500;     // adjust duty for output EPWM2A
EPwm2Regs.CMPB = 300;                // adjust duty for output EPWM2B
    
```

15.2.3.5 Controlling Multiple Half H-Bridge (HHB) Converters

Topologies that require control of multiple switching elements can also be addressed with these same ePWM modules. It is possible to control a Half-H bridge stage with a single ePWM module. This control can be extended to multiple stages. Figure 15-61 shows control of two synchronized Half-H bridge stages where stage 2 can operate at integer multiple (N) frequencies of stage 1. Figure 15-62 shows the waveforms generated by the configuration shown in Figure 15-61.

Module 2 (slave) is configured for Sync flow-through; if required, this configuration allows for a third Half-H bridge to be controlled by PWM module 3 and also, most importantly, to remain in synchronization with master module 1.

Figure 15-61. Control of Two Half-H Bridge Stages ($F_{P_{WM2}} = N \times F_{P_{WM1}}$)

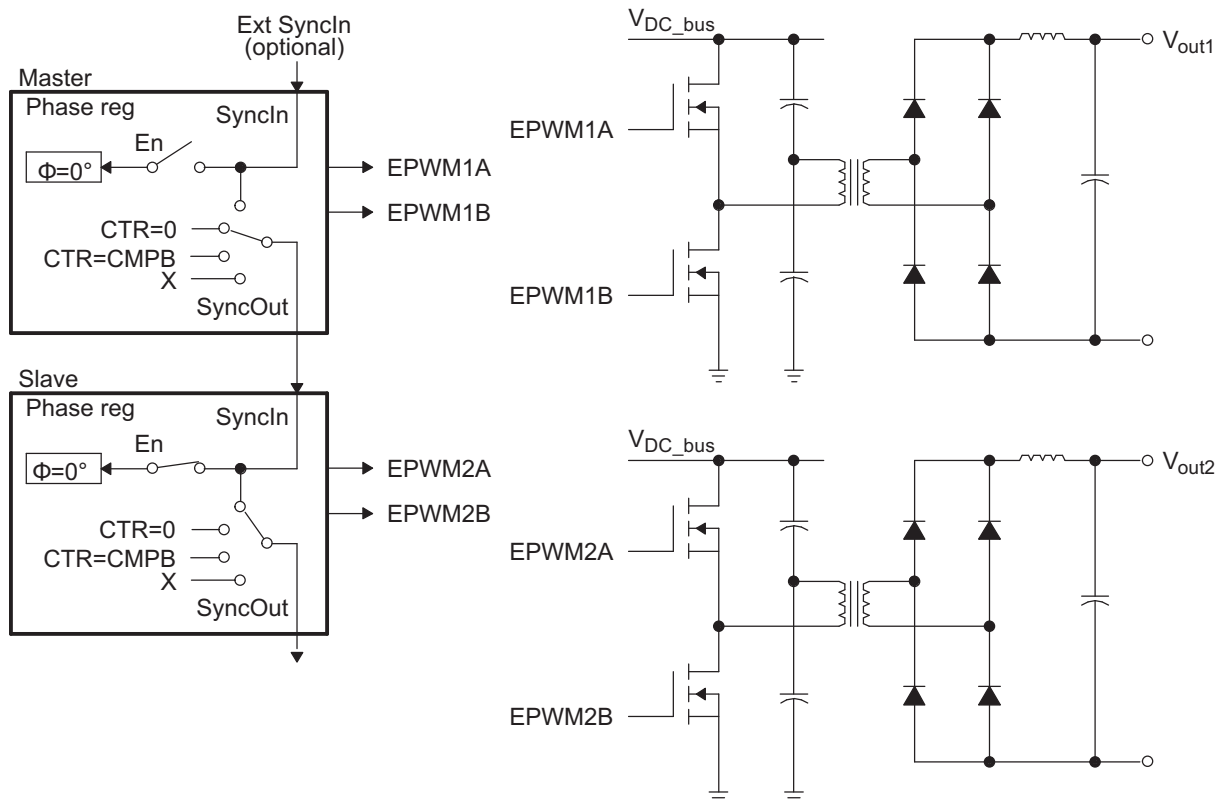


Figure 15-62. Half-H Bridge Waveforms for Figure 15-61 (Note: Here $F_{PWM2} = F_{PWM1}$)

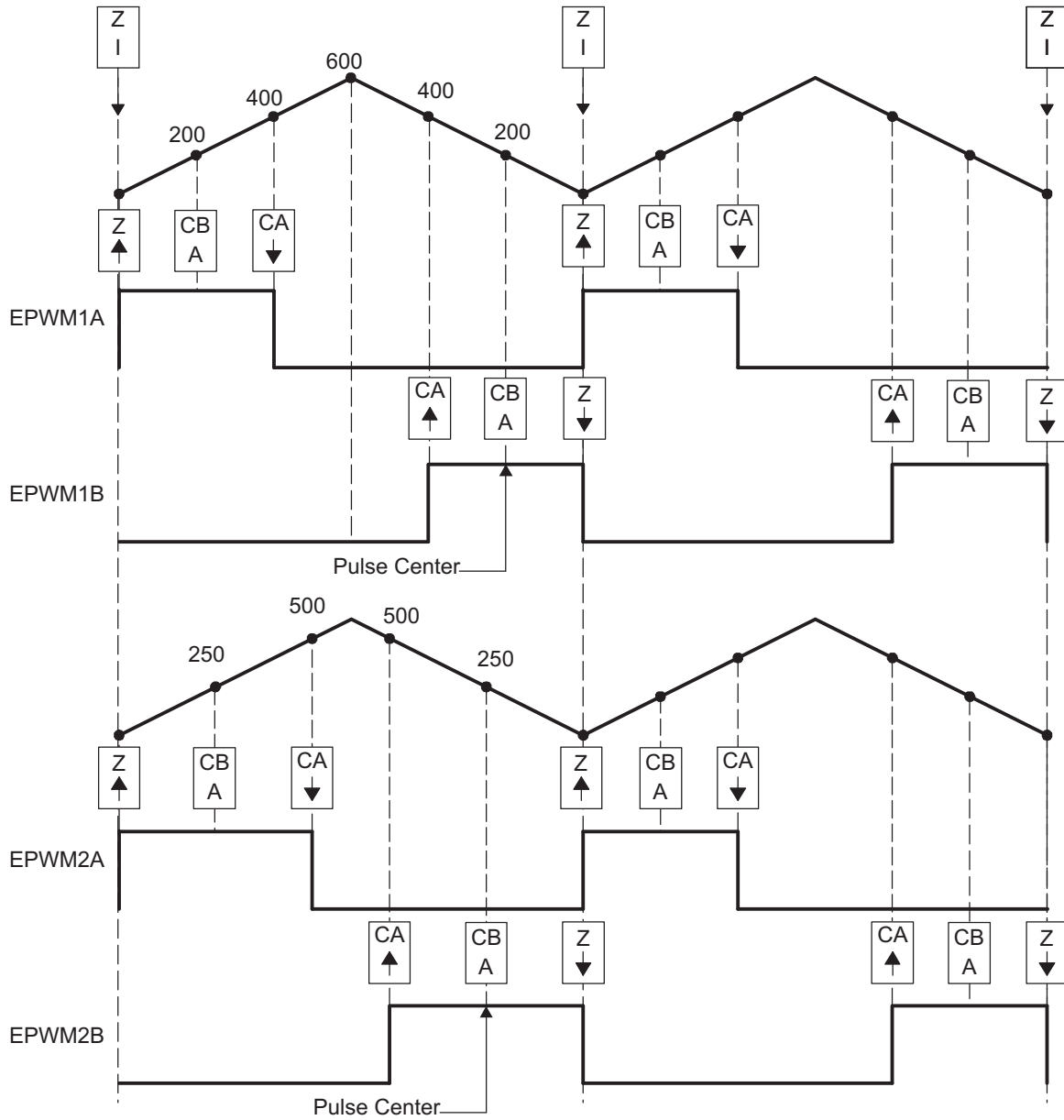


Table 15-47. EPWM1 Initialization for Figure 15-61

Register	Bit	Value	Comments
TBPRD	TBPRD	600 (258h)	Period = 1200 TBCLK counts
TBPHS	TBPHS	0	Clear Phase Register to 0
TBCTL	CTRMODE	TB_UPDOWN	
	PHSEN	TB_DISABLE	Phase loading disabled
	PRDL	TB_SHADOW	
	SYNCOSEL	TB_CTR_ZERO	Sync down-stream module
CMPCTL	SHDWAMODE	CC_SHADOW	
	SHDWBMODE	CC_SHADOW	
	LOADAMODE	CC_CTR_ZERO	Load on CTR = 0
	LOADBMODE	CC_CTR_ZERO	Load on CTR = 0
AQCTLA	ZRO	AQ_SET	Set actions for EPWM1A
	CAU	AQ_CLEAR	
AQCTLB	ZRO	AQ_CLEAR	Set actions for EPWM1B
	CAD	AQ_SET	

Table 15-48. EPWM2 Initialization for Figure 15-61

Register	Bit	Value	Comments
TBPRD	TBPRD	600 (258h)	Period = 1200 TBCLK counts
TBPHS	TBPHS	0	Clear Phase Register to 0
TBCTL	CTRMODE	TB_UPDOWN	
	PHSEN	TB_ENABLE	Phase loading enabled
	PRDL	TB_SHADOW	
	SYNCOSEL	TB_SYNC_IN	Sync flow-through
CMPCTL	SHDWAMODE	CC_SHADOW	
	SHDWBMODE	CC_SHADOW	
	LOADAMODE	CC_CTR_ZERO	Load on CTR = 0
	LOADBMODE	CC_CTR_ZERO	Load on CTR = 0
AQCTLA	ZRO	AQ_SET	Set actions for EPWM2A
	CAU	AQ_CLEAR	
AQCTLB	ZRO	AQ_CLEAR	Set actions for EPWM2B
	CAD	AQ_SET	

Example 15-5. Code Snippet for Configuration in Figure 15-61

```
// Run Time (Note: Example execution of one run-time instance)
//=====
EPwm1Regs.CMPA.half.CMPA = 400; // adjust duty for output EPWM1A
EPwm1Regs.CMPB = 200;          // adjust duty for output EPWM1B
EPwm2Regs.CMPA.half.CMPA = 500; // adjust duty for output EPWM2A
EPwm2Regs.CMPB = 250;          // adjust duty for output EPWM2B
```

15.2.3.6 Controlling Dual 3-Phase Inverters for Motors (ACI and PMSM)

The idea of multiple modules controlling a single power stage can be extended to the 3-phase Inverter case. In such a case, six switching elements can be controlled using three PWM modules, one for each leg of the inverter. Each leg must switch at the same frequency and all legs must be synchronized. A master + two slaves configuration can easily address this requirement. Figure 15-63 shows how six PWM modules can control two independent 3-phase Inverters; each running a motor.

As in the cases shown in the previous sections, we have a choice of running each inverter at a different frequency (module 1 and module 4 are masters as in Figure 15-63), or both inverters can be synchronized by using one master (module 1) and five slaves. In this case, the frequency of modules 4, 5, and 6 (all equal) can be integer multiples of the frequency for modules 1, 2, 3 (also all equal).

Figure 15-63. Control of Dual 3-Phase Inverter Stages as Is Commonly Used in Motor Control

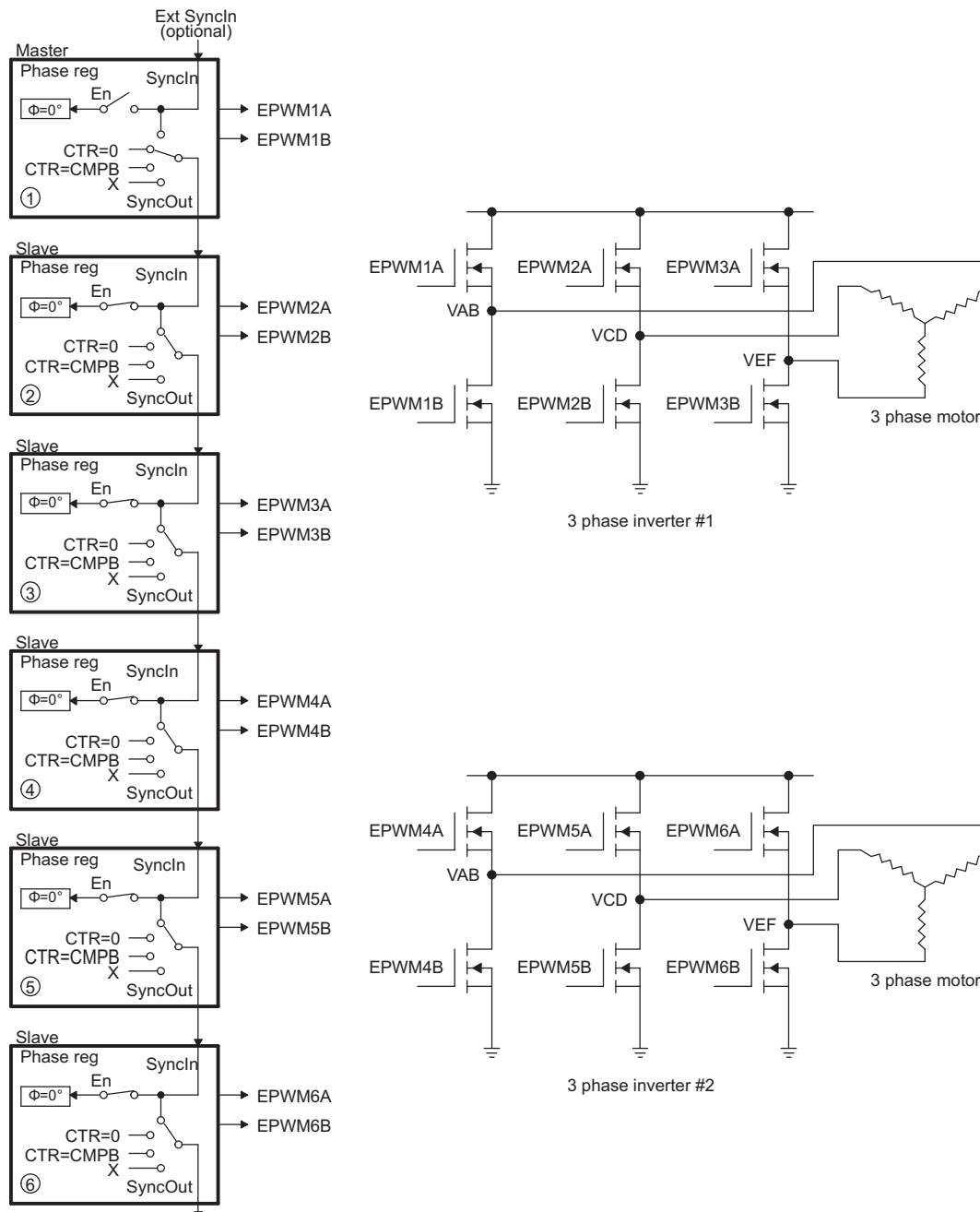


Figure 15-64. 3-Phase Inverter Waveforms for Figure 15-63 (Only One Inverter Shown)

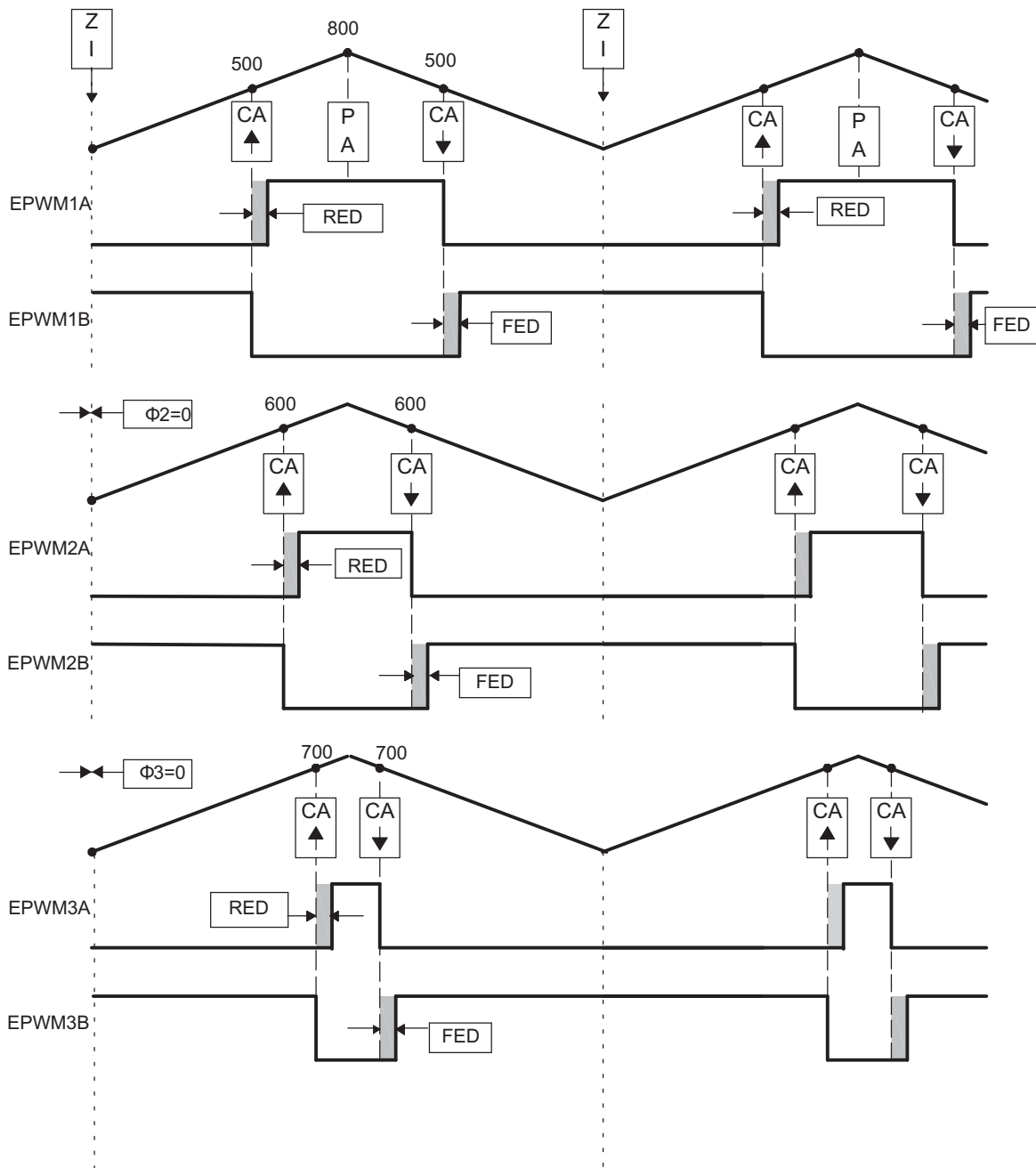


Table 15-49. EPWM1 Initialization for Figure 15-63

Register	Bit	Value	Comments
TBPRD	TBPRD	800 (320h)	Period = 1600 TBCLK counts
TBPHS	TBPHS	0	Clear Phase Register to 0
TBCTL	CTRMODE	TB_UPDOWN	
	PHSEN	TB_DISABLE	Phase loading disabled
	PRDL	TB_SHADOW	
	SYNCOSEL	TB_CTR_ZERO	Sync down-stream module
CMPCTL	SHDWAMODE	CC_SHADOW	
	SHDWBMODE	CC_SHADOW	
	LOADAMODE	CC_CTR_ZERO	Load on CTR = 0
	LOADBMODE	CC_CTR_ZERO	Load on CTR = 0
AQCTLA	CAU	AQ_SET	Set actions for EPWM1A
	CAD	AQ_CLEAR	
DBCTL	MODE	DB_FULL_ENABLE	Enable Dead-band module
	POLSEL	DB_ACTV_HIC	Active Hi complementary
DBFED	DBFED	50	FED = 50 TBCLKs
	DBRED	50	RED = 50 TBCLKs

Table 15-50. EPWM2 Initialization for Figure 15-63

Register	Bit	Value	Comments
TBPRD	TBPRD	800 (320h)	Period = 1600 TBCLK counts
TBPHS	TBPHS	0	Clear Phase Register to 0
TBCTL	CTRMODE	TB_UPDOWN	
	PHSEN	TB_ENABLE	Slave module
	PRDL	TB_SHADOW	
	SYNCOSEL	TB_SYNC_IN	Sync flow-through
CMPCTL	SHDWAMODE	CC_SHADOW	
	SHDWBMODE	CC_SHADOW	
	LOADAMODE	CC_CTR_ZERO	Load on CTR = 0
	LOADBMODE	CC_CTR_ZERO	Load on CTR = 0
AQCTLA	CAU	AQ_SET	Set actions for EPWM2A
	CAD	AQ_CLEAR	
DBCTL	MODE	DB_FULL_ENABLE	Enable Dead-band module
	POLSEL	DB_ACTV_HIC	Active Hi complementary
DBFED	DBFED	50	FED = 50 TBCLKs
	DBRED	50	RED = 50 TBCLKs

Table 15-51. EPWM3 Initialization for Figure 15-63

Register	Bit	Value	Comments
TBPRD	TBPRD	800 (320h)	Period = 1600 TBCLK counts
TBPHS	TBPHS	0	Clear Phase Register to 0
TBCTL	CTRMODE	TB_UPDOWN	
	PHSEN	TB_ENABLE	Slave module
	PRDL	TB_SHADOW	
	SYNCOSEL	TB_SYNC_IN	Sync flow-through
CMPCTL	SHDWAMODE	CC_SHADOW	
	SHDWBMODE	CC_SHADOW	
	LOADAMODE	CC_CTR_ZERO	Load on CTR = 0
	LOADBMODE	CC_CTR_ZERO	Load on CTR = 0
AQCTLA	CAU	AQ_SET	Set actions for EPWM3A
	CAD	AQ_CLEAR	
DBCTL	MODE	DB_FULL_ENABLE	Enable Dead-band module
	POLSEL	DB_ACTV_HIC	Active Hi complementary
DBFED	DBFED	50	FED = 50 TBCLKs
	DBRED	50	RED = 50 TBCLKs

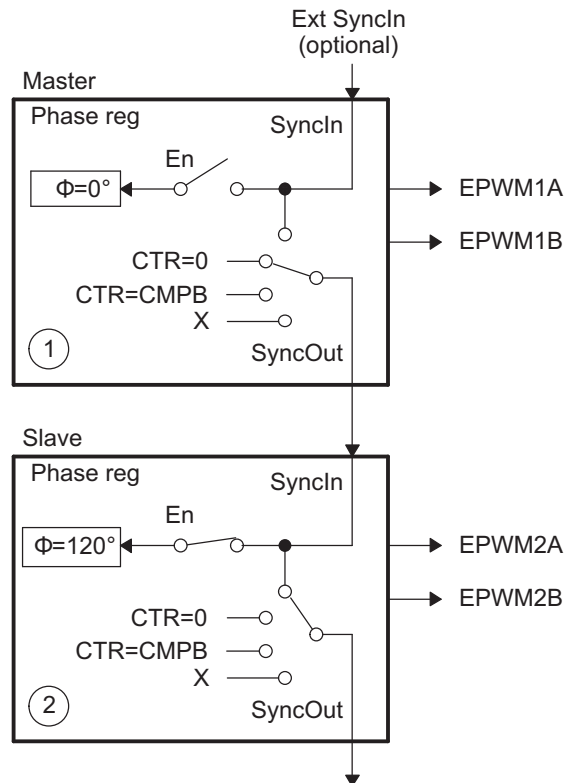
Example 15-6. Code Snippet for Configuration in Figure 15-63

```
// Run Time (Note: Example execution of one run-time instance)
//=====
EPwm1Regs.CMPA.half.CMPA = 500; // adjust duty for output EPWM1A
EPwm2Regs.CMPA.half.CMPA = 600; // adjust duty for output EPWM2A
EPwm3Regs.CMPA.half.CMPA = 700; // adjust duty for output EPWM3A
```

15.2.3.7 Practical Applications Using Phase Control Between PWM Modules

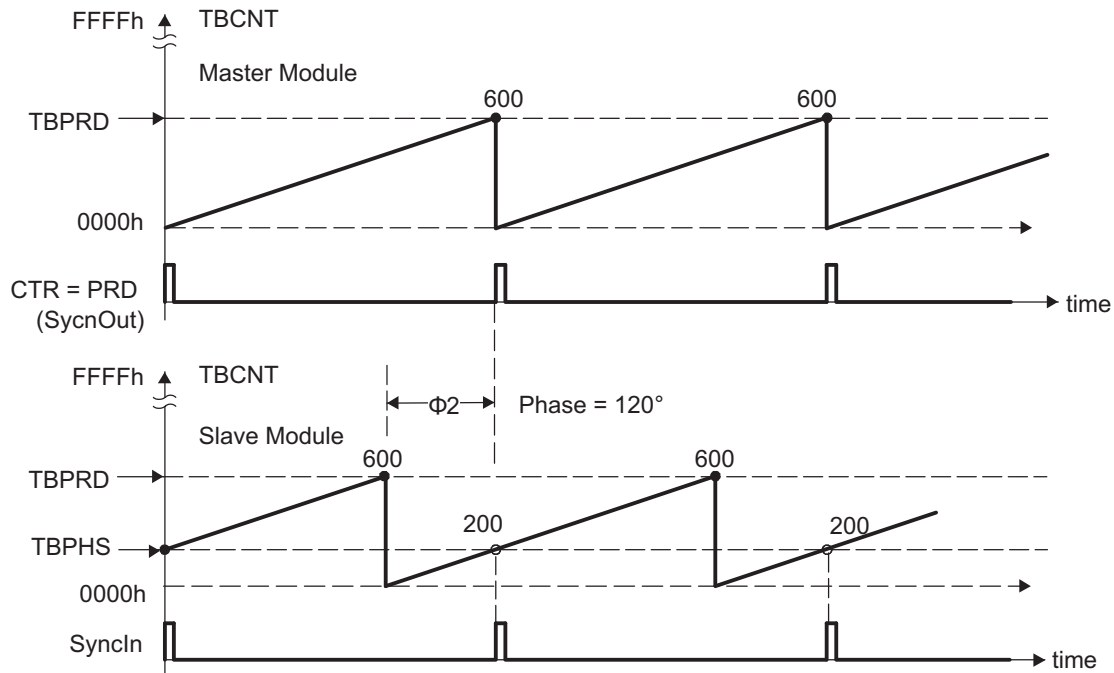
So far, none of the examples have made use of the phase register (TBPHS). It has either been set to zero or its value has been a don't care. However, by programming appropriate values into TBPHS, multiple PWM modules can address another class of power topologies that rely on phase relationship between legs (or stages) for correct operation. As described in the TB module section, a PWM module can be configured to allow a SyncIn pulse to cause the TBPHS register to be loaded into the TBCNT register. To illustrate this concept, [Figure 15-65](#) shows a master and slave module with a phase relationship of 120°, that is, the slave leads the master.

Figure 15-65. Configuring Two PWM Modules for Phase Control



[Figure 15-66](#) shows the associated timing waveforms for this configuration. Here, TBPRD = 600 for both master and slave. For the slave, TBPHS = 200 ($200/600 \times 360^\circ = 120^\circ$). Whenever the master generates a SyncIn pulse (CTR = PRD), the value of TBPHS = 200 is loaded into the slave TBCNT register so the slave time-base is always leading the master's time-base by 120°.

Figure 15-66. Timing Waveforms Associated With Phase Control Between 2 Modules



15.2.3.8 Controlling a 3-Phase Interleaved DC/DC Converter

A popular power topology that makes use of phase-offset between modules is shown in [Figure 15-67](#). This system uses three PWM modules, with module 1 configured as the master. To work, the phase relationship between adjacent modules must be $F = 120^\circ$. This is achieved by setting the slave TBPHS registers 2 and 3 with values of 1/3 and 2/3 of the period value, respectively. For example, if the period register is loaded with a value of 600 counts, then TBPHS (slave 2) = 200 and TBPHS (slave 3) = 400. Both slave modules are synchronized to the master 1 module.

This concept can be extended to four or more phases, by setting the TBPHS values appropriately. The following formula gives the TBPHS values for N phases:

$$TBPHS(N,M) = (TBPRD/N) \times (M - 1)$$

Where:

N = number of phases

M = PWM module number

For example, for the 3-phase case (N = 3), TBPRD = 600,

$$TBPHS(3,2) = (600/3) \times (2 - 1) = 200 \times 1 = 200 \text{ (Phase value for Slave module 2)}$$

$$TBPHS(3,3) = (600/3) \times (3 - 1) = 200 \times 2 = 400 \text{ (Phase value for Slave module 3)}$$

[Figure 15-68](#) shows the waveforms for the configuration in [Figure 15-67](#).

Figure 15-67. Control of a 3-Phase Interleaved DC/DC Converter

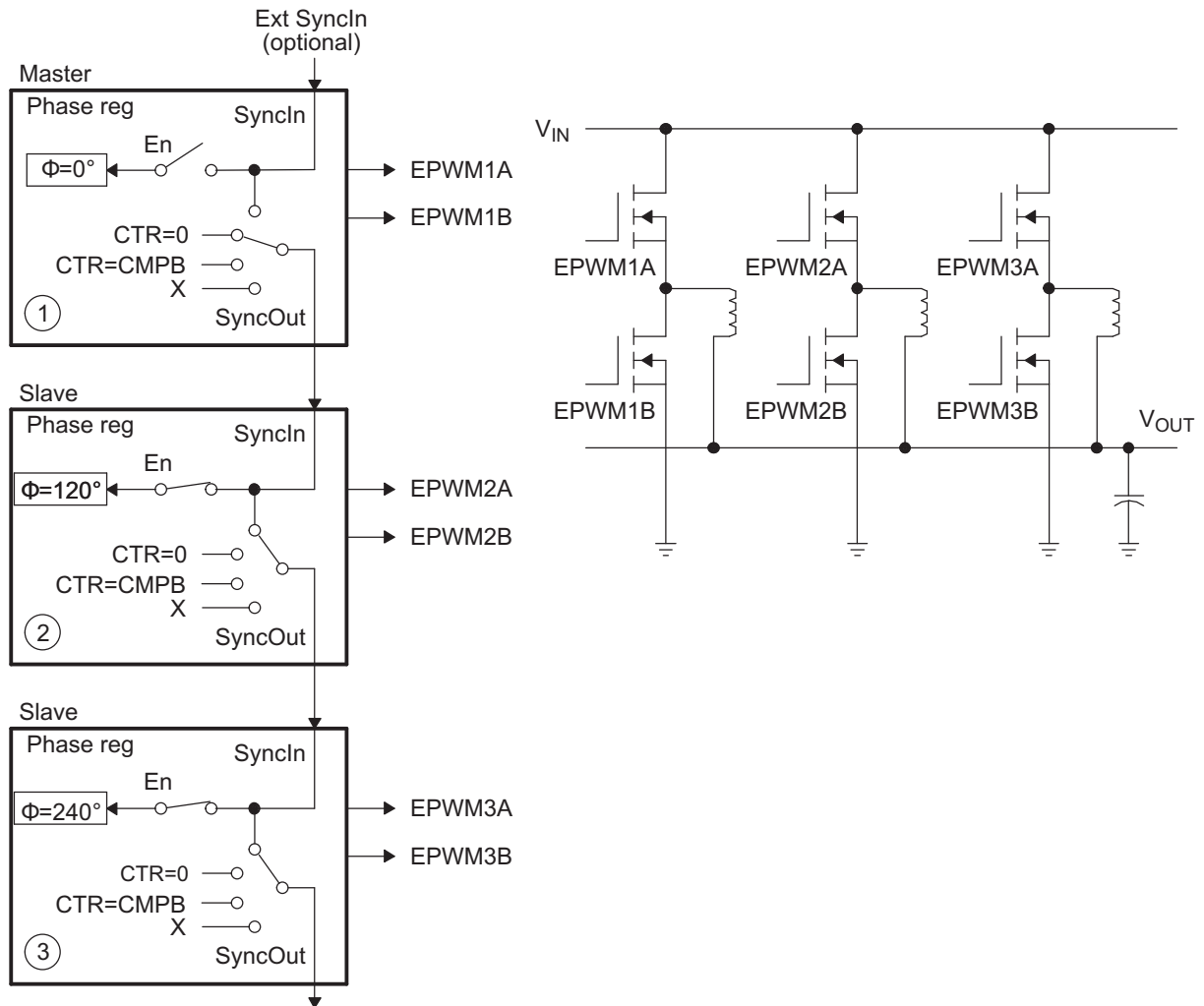


Figure 15-68. 3-Phase Interleaved DC/DC Converter Waveforms for Figure 15-67

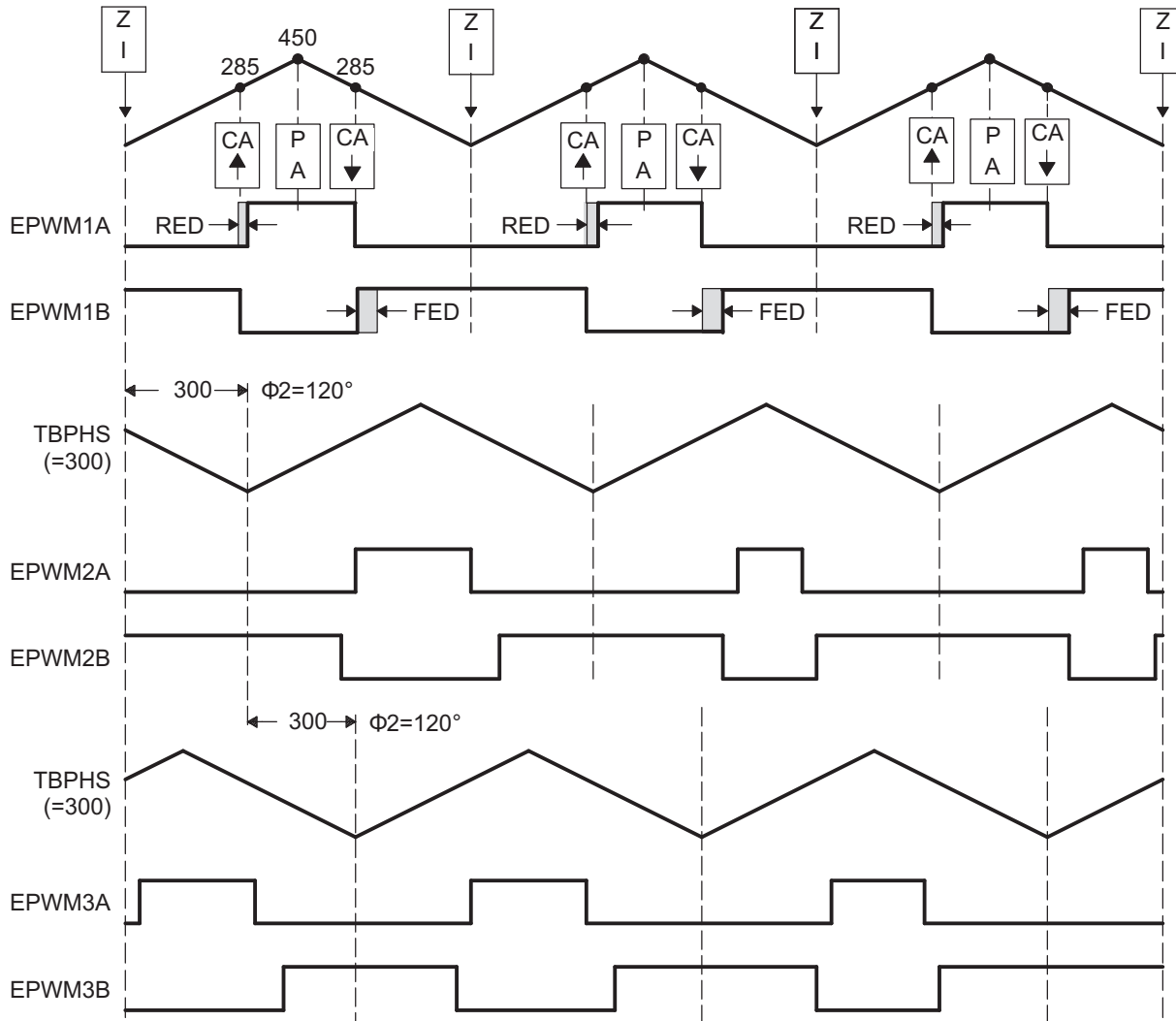


Table 15-52. EPWM1 Initialization for Figure 15-67

Register	Bit	Value	Comments
TBPRD	TBPRD	450 (1C2h)	Period = 900 TBCLK counts
TBPHS	TBPHS	0	Clear Phase Register to 0
TBCTL	CTRMODE	TB_UPDOWN	
	PHSEN	TB_DISABLE	Phase loading disabled
	PRDL	TB_SHADOW	
	SYNCOSEL	TB_CTR_ZERO	Sync down-stream module
CMPCTL	SHDWAMODE	CC_SHADOW	
	SHDWBMODE	CC_SHADOW	
	LOADAMODE	CC_CTR_ZERO	Load on CTR = 0
	LOADBMODE	CC_CTR_ZERO	Load on CTR = 0
AQCTLA	CAU	AQ_SET	Set actions for EPWM1A
	CAD	AQ_CLEAR	
DBCTL	MODE	DB_FULL_ENABLE	Enable Dead-band module
	POLSEL	DB_ACTV_HIC	Active Hi complementary
DBFED	DBFED	20	FED = 20 TBCLKs
	DBRED	20	RED = 20 TBCLKs

Table 15-53. EPWM2 Initialization for Figure 15-67

Register	Bit	Value	Comments
TBPRD	TBPRD	450 (1C2h)	Period = 900 TBCLK counts
TBPHS	TBPHS	300	Phase = $(300/900) \times 360 = 120^\circ$
TBCTL	CTRMODE	TB_UPDOWN	
	PHSEN	TB_ENABLE	Slave module
	PRDL	TB_SHADOW	
	SYNCOSEL	TB_SYNC_IN	Sync flow-through
	PHSDIR	TB_DOWN	Count DOWN on sync
CMPCTL	SHDWAMODE	CC_SHADOW	
	SHDWBMODE	CC_SHADOW	
	LOADAMODE	CC_CTR_ZERO	Load on CTR = 0
	LOADBMODE	CC_CTR_ZERO	Load on CTR = 0
AQCTLA	CAU	AQ_SET	Set actions for EPWM2A
	CAD	AQ_CLEAR	
DBCTL	MODE	DB_FULL_ENABLE	Enable Dead-band module
	POLSEL	DB_ACTV_HIC	Active Hi complementary
DBFED	DBFED	20	FED = 20 TBCLKs
	DBRED	20	RED = 20 TBCLKs

Table 15-54. EPWM3 Initialization for Figure 15-67

Register	Bit	Value	Comments
TBPRD	TBPRD	450 (1C2h)	Period = 900 TBCLK counts
TBPHS	TBPHS	300	Phase = $(300/900) \times 360 = 120^\circ$
TBCTL	CTRMODE	TB_UPDOWN	
	PHSEN	TB_ENABLE	Slave module
	PRDL	TB_SHADOW	
	SYNCOSEL	TB_SYNC_IN	Sync flow-through
	PHSDIR	TB_UP	Count UP on sync
CMPCTL	SHDWAMODE	CC_SHADOW	
	SHDWBMODE	CC_SHADOW	
	LOADAMODE	CC_CTR_ZERO	Load on CTR = 0
	LOADBMODE	CC_CTR_ZERO	Load on CTR = 0
AQCTLA	CAU	AQ_SET	Set actions for EPWM3A
	CAD	AQ_CLEAR	
DBCTL	MODE	DB_FULL_ENABLE	Enable Dead-band module
	POLSEL	DB_ACTV_HIC	Active Hi complementary
DBFED	DBFED	20	FED = 20 TBCLKs
	DBRED	20	RED = 20 TBCLKs

Example 15-7. Code Snippet for Configuration in Figure 15-67

```
// Run Time (Note: Example execution of one run-time instance)
//=====
EPwm1Regs.CMPA.half.CMPA = 285;           // adjust duty for output EPWM1A
EPwm2Regs.CMPA.half.CMPA = 285;           // adjust duty for output EPWM2A
EPwm3Regs.CMPA.half.CMPA = 285;           // adjust duty for output EPWM3A
```

15.2.3.9 Controlling Zero Voltage Switched Full Bridge (ZVSFB) Converter

The example given in [Figure 15-69](#) assumes a static or constant phase relationship between legs (modules). In such a case, control is achieved by modulating the duty cycle. It is also possible to dynamically change the phase value on a cycle-by-cycle basis. This feature lends itself to controlling a class of power topologies known as *phase-shifted full bridge*, or *zero voltage switched full bridge*. Here the controlled parameter is not duty cycle (this is kept constant at approximately 50 percent); instead it is the phase relationship between legs. Such a system can be implemented by allocating the resources of two PWM modules to control a single power stage, which in turn requires control of four switching elements. [Figure 15-70](#) shows a master/slave module combination synchronized together to control a full H-bridge. In this case, both master and slave modules are required to switch at the same PWM frequency. The phase is controlled by using the slave's phase register (TBPHS). The master's phase register is not used and therefore can be initialized to zero.

Figure 15-69. Controlling a Full-H Bridge Stage ($F_{PWM2} = F_{PWM1}$)

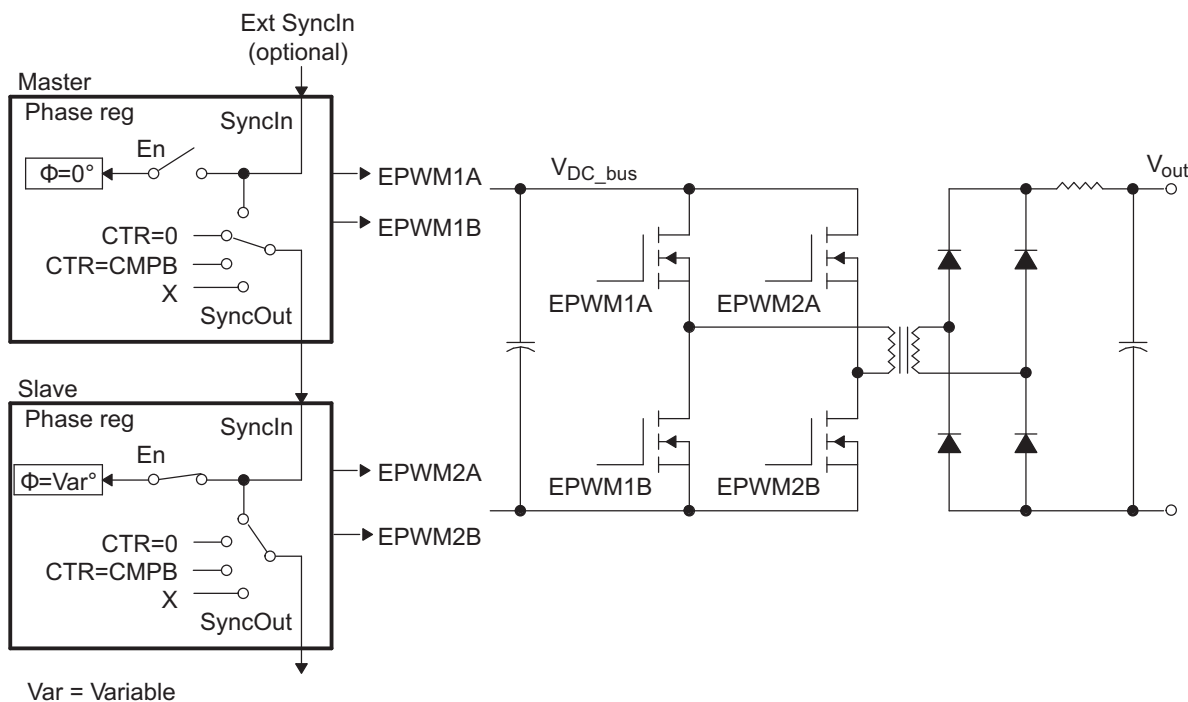


Figure 15-70. ZVS Full-H Bridge Waveforms

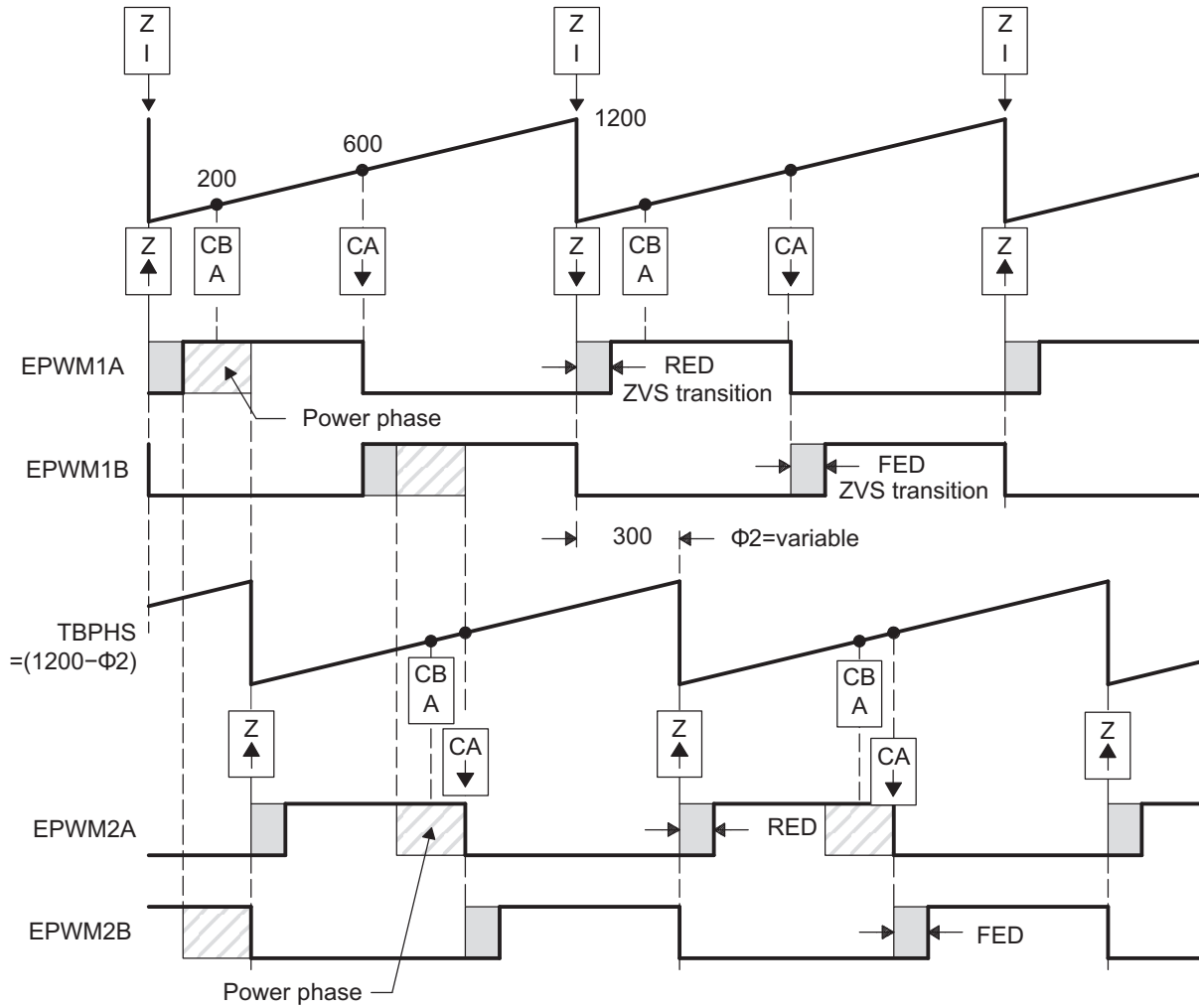


Table 15-55. EPWM1 Initialization for Figure 15-69

Register	Bit	Value	Comments
TBPRD	TBPRD	1200 (4B0h)	Period = 1201 TBCLK counts
TBPHS	TBPHS	0	Clear Phase Register to 0
TBCTL	CTRMODE	TB_UP	
	PHSEN	TB_DISABLE	Phase loading disabled
	PRDL	TB_SHADOW	
	SYNCOSEL	TB_CTR_ZERO	Sync down-stream module
CMPA	CMPA	600 (258h)	Set 50% duty for EPWM1A
CMPCTL	SHDWAMODE	CC_SHADOW	
	SHDWBMODE	CC_SHADOW	
	LOADAMODE	CC_CTR_ZERO	Load on CTR = 0
	LOADBMODE	CC_CTR_ZERO	Load on CTR = 0
AQCTLA	ZRO	AQ_SET	Set actions for EPWM1A
	CAU	AQ_CLEAR	
DBCTL	MODE	DB_FULL_ENABLE	Enable Dead-band module
	POLSEL	DB_ACTV_HIC	Active Hi complementary
DBFED	DBFED	50	FED = 50 TBCLKs
	DBRED	70	RED = 70 TBCLKs

Table 15-56. EPWM2 Initialization for Figure 15-69

Register	Bit	Value	Comments
TBPRD	TBPRD	1200 (4B0h)	Period = 1201 TBCLK counts
TBPHS	TBPHS	0	Clear Phase Register to 0
TBCTL	CTRMODE	TB_UP	
	PHSEN	TB_ENABLE	Slave module
	PRDL	TB_SHADOW	
	SYNCOSEL	TB_SYNC_IN	Sync flow-through
CMPA	CMPA	600 (258h)	Set 50% duty for EPWM2A
CMPCTL	SHDWAMODE	CC_SHADOW	
	SHDWBMODE	CC_SHADOW	
	LOADAMODE	CC_CTR_ZERO	Load on CTR = 0
	LOADBMODE	CC_CTR_ZERO	Load on CTR = 0
AQCTLA	ZRO	AQ_SET	Set actions for EPWM2A
	CAU	AQ_CLEAR	
DBCTL	MODE	DB_FULL_ENABLE	Enable Dead-band module
	POLSEL	DB_ACTV_HIC	Active Hi complementary
DBFED	DBFED	30	FED = 30 TBCLKs
	DBRED	40	RED = 40 TBCLKs

Example 15-8. Code Snippet for Configuration in Figure 15-69

```

// Run Time (Note: Example execution of one run-time instance)
//=====
EPwm2Regs.TBPHS = 1200-300; // Set Phase reg to 300/1200 * 360 = 90 deg
EPwm1Regs.DBFED = FED1_NewValue; // Update ZVS transition interval
EPwm1Regs.DBRED = RED1_NewValue; // Update ZVS transition interval
EPwm2Regs.DBFED = FED2_NewValue; // Update ZVS transition interval
    
```

Example 15-8. Code Snippet for Configuration in Figure 15-69 (continued)

```
EPwm2Regs.DBRED = RED2_NewValue;           // Update ZVS transition interval
```

15.2.4 EPWM Registers

Table 15-57 lists the memory-mapped registers for the EPWM. All register offset addresses not listed in Table 15-57 should be considered as reserved locations and the register contents should not be modified.

Table 15-57. EPWM Registers

Offset	Acronym	Register Name	Section
0h	TBCTL	Time-Base Control Register	Section 15.2.4.1
2h	TBSTS	Time-Base Status Register	Section 15.2.4.2
4h	TBPHSHR	Extension for HRPWM Phase Register	Section 15.2.4.3
6h	TBPHS	Time-Base Phase Register	Section 15.2.4.4
8h	TBCNT	Time-Base Counter Register	Section 15.2.4.5
Ah	TBPRD	Time-Base Period Register	Section 15.2.4.6
Eh	CMPCTL	Counter-Compare Control Register	Section 15.2.4.7
10h	CMPAHR	Extension for HRPWM Counter-Compare A Register	Section 15.2.4.8
12h	CMPA	Counter-Compare A Register	Section 15.2.4.9
14h	CMPB	Counter-Compare B Register	Section 15.2.4.10
16h	AQCTLA	Action-Qualifier Control Register for Output A (EPWMxA)	Section 15.2.4.11
18h	AQCTLB	Action-Qualifier Control Register for Output B (EPWMxB)	Section 15.2.4.12
1Ah	AQSFR	Action-Qualifier Software Force Register	Section 15.2.4.13
1Ch	AQCSFR	Action-Qualifier Continuous S/W Force Register Set	Section 15.2.4.14
1Eh	DBCTL	Dead-Band Generator Control Register	Section 15.2.4.15
20h	DBRED	Dead-Band Generator Rising Edge Delay Count Register	Section 15.2.4.16
22h	DBFED	Dead-Band Generator Falling Edge Delay Count Register	Section 15.2.4.17
24h	TZSEL	Trip-Zone Select Register	Section 15.2.4.18
28h	TZCTL	Trip-Zone Control Register	Section 15.2.4.19
2Ah	TZEINT	Trip-Zone Enable Interrupt Register	Section 15.2.4.20
2Ch	TZFLG	Trip-Zone Flag Register	Section 15.2.4.21
2Eh	TZCLR	Trip-Zone Clear Register	Section 15.2.4.22
30h	TZFRC	Trip-Zone Force Register	Section 15.2.4.23
32h	ETSEL	Event-Trigger Selection Register	Section 15.2.4.24
34h	ETPS	Event-Trigger Pre-Scale Register	Section 15.2.4.25
36h	ETFLG	Event-Trigger Flag Register	Section 15.2.4.26
38h	ETCLR	Event-Trigger Clear Register	Section 15.2.4.27
3Ah	ETFRC	Event-Trigger Force Register	Section 15.2.4.28
3Ch	PCCTL	PWM-Chopper Control Register	Section 15.2.4.29
C0h	HRCNFG	HRPWM configuration register (HRCNFG)	Section 15.2.4.30

15.2.4.1 TBCTL Register (offset = 0h) [reset = 0h]

 TBCTL is shown in [Figure 15-71](#) and described in [Table 15-58](#).

Figure 15-71. TBCTL Register

15	14	13	12	11	10	9	8
FREE_SOFT		PHSDIR	CLKDIV			HSPCLKDIV	
R/W-0h		R/W-0h	R/W-0h			R/W-0h	
7	6	5	4	3	2	1	0
HSPCLKDIV	SWFSYNC	SYNCOSEL		PRDLD	PHSEN	CTRMODE	
R/W-0h	R/W-0h	R/W-0h		R/W-0h	R/W-0h	R/W-0h	

LEGEND: R/W = Read/Write; R = Read only; W1toCl = Write 1 to clear bit; -n = value after reset

Table 15-58. TBCTL Register Field Descriptions

Bit	Field	Type	Reset	Description
15-14	FREE_SOFT	R/W	0h	Emulation Mode Bits. These bits select the behavior of the ePWM time-base counter during emulation suspend events. Emulation debug events can be set up in the Debug Subsystem. 0h (R/W) = Stop after the next time-base counter increment or decrement 1h (R/W) = Stop when counter completes a whole cycle. (a) Up-count mode - stop when the time-base counter = period (TBCNT = TBPRD). (b) Down-count mode - stop when the time-base counter = 0000 (TBCNT = 0000h). (c) Up-down-count mode - stop when the time-base counter = 0000 (TBCNT = 0000h). 2h (R/W) = Free run 3h (R/W) = Free run
13	PHSDIR	R/W	0h	Phase Direction Bit. This bit is only used when the time-base counter is configured in the up-down-count mode. The PHSDIR bit indicates the direction the time-base counter (TBCNT) will count after a synchronization event occurs and a new phase value is loaded from the phase (TBPHS) register. This is irrespective of the direction of the counter before the synchronization event. In the up-count and down-count modes this bit is ignored. 0h (R/W) = Count down after the synchronization event. 1h (R/W) = Count up after the synchronization event.
12-10	CLKDIV	R/W	0h	Time-base Clock Prescale Bits. These bits determine part of the time-base clock prescale value. $TBCLK = SYSCLKOUT / (HSPCLKDIV * CLKDIV)$ 0h (R/W) = /1 (default on reset) 1h (R/W) = /2 2h (R/W) = /4 3h (R/W) = /8 4h (R/W) = /16 5h (R/W) = /32 6h (R/W) = /64 7h (R/W) = /128

Table 15-58. TBCTL Register Field Descriptions (continued)

Bit	Field	Type	Reset	Description
9-7	HSPCLKDIV	R/W	0h	<p>High-Speed Time-base Clock Prescale Bits. These bits determine part of the time-base clock prescale value. $TBCLK = SYSCLKOUT / (HSPCLKDIV * CLKDIV)$. This divisor emulates the HSPCLK in the TMS320x281x system as used on the Event Manager (EV) peripheral.</p> <p>0h (R/W) = /1 1h (R/W) = /2 (default on reset) 2h (R/W) = /4 3h (R/W) = /6 4h (R/W) = /8 5h (R/W) = /10 6h (R/W) = /12 7h (R/W) = /14</p>
6	SWFSYNC	R/W	0h	<p>Software Forced Synchronization Pulse.</p> <p>0h (R/W) = Writing a 0 has no effect and reads always return a 0. 1h (R/W) = Writing a 1 forces a one-time synchronization pulse to be generated. This event is ORed with the EPWMxSYNCl input of the ePWM module. SWFSYNC is valid (operates) only when EPWMxSYNCl is selected by SYNCOSSEL = 00.</p>
5-4	SYNCOSSEL	R/W	0h	<p>Synchronization Output Select. These bits select the source of the EPWMxSYNCO signal.</p> <p>0h (R/W) = EPWMxSYNCO: 1h (R/W) = CTR = 0 - Time-base counter equal to zero (TBCNT = 0000h) 2h (R/W) = CTR = CMPB - Time-base counter equal to counter-compare B (TBCNT = CMPB) 3h (R/W) = Disable EPWMxSYNCO signal</p>
3	PRDL	R/W	0h	<p>Active Period Register Load From Shadow Register Select</p> <p>0h (R/W) = The period register (TBPRD) is loaded from its shadow register when the time-base counter, TBCNT, is equal to zero. A write or read to the TBPRD register accesses the shadow register. 1h (R/W) = Load the TBPRD register immediately without using a shadow register. A write or read to the TBPRD register directly accesses the active register.</p>
2	PHSEN	R/W	0h	<p>Counter Register Load From Phase Register Enable</p> <p>0h (R/W) = Do not load the time-base counter (TBCNT) from the time-base phase register (TBPHS) 1h (R/W) = Load the time-base counter with the phase register when an EPWMxSYNCl input signal occurs or when a software synchronization is forced by the SWFSYNC bit.</p>
1-0	CTRMODE	R/W	0h	<p>Counter Mode. The time-base counter mode is normally configured once and not changed during normal operation. If you change the mode of the counter, the change will take effect at the next TBCLK edge and the current counter value shall increment or decrement from the value before the mode change. These bits set the time-base counter mode of operation as follows:</p> <p>0h (R/W) = Up-count mode 1h (R/W) = Down-count mode 2h (R/W) = Up-down-count mode 3h (R/W) = Stop-freeze counter operation (default on reset)</p>

15.2.4.2 TBSTS Register (offset = 2h) [reset = 0h]

 TBSTS is shown in [Figure 15-72](#) and described in [Table 15-59](#).

Figure 15-72. TBSTS Register

15	14	13	12	11	10	9	8
RESERVED							
R-0h							
7	6	5	4	3	2	1	0
RESERVED					CTRMAX	SYNCI	CTRDIR
R-0h					0h	W1C-0h	R-0h

LEGEND: R/W = Read/Write; R = Read only; W1toCl = Write 1 to clear bit; -n = value after reset

Table 15-59. TBSTS Register Field Descriptions

Bit	Field	Type	Reset	Description
15-3	RESERVED	R	0h	
2	CTRMAX		0h	Time-Base Counter Max Latched Status Bit. 0h (R/W) = Reading a 0 indicates the time-base counter never reached its maximum value. Writing a 0 will have no effect. 1h (R/W) = Reading a 1 on this bit indicates that the time-base counter reached the max value 0xFFFF. Writing a 1 to this bit will clear the latched event.
1	SYNCI	W1C	0h	Input Synchronization Latched Status Bit. 0h (R/W) = Writing a 0 will have no effect. Reading a 0 indicates no external synchronization event has occurred. 1h (R/W) = Reading a 1 on this bit indicates that an external synchronization event has occurred (EPWMxSYNCI). Writing a 1 to this bit will clear the latched event.
0	CTRDIR	R	0h	Time-Base Counter Direction Status Bit. At reset, the counter is frozen, therefore, this bit has no meaning. To make this bit meaningful, you must first set the appropriate mode via TBCTL[CTRMODE]. 0h (R/W) = Time-Base Counter is currently counting down. 1h (R/W) = Time-Base Counter is currently counting up.

15.2.4.3 TBPHSHR Register (offset = 4h) [reset = 0h]

TBPHSHR is shown in [Figure 15-73](#) and described in [Table 15-60](#).

Figure 15-73. TBPHSHR Register

15	14	13	12	11	10	9	8
TBPHSH							
R/W-0h							
7	6	5	4	3	2	1	0
RESERVED							
R-0h							

LEGEND: R/W = Read/Write; R = Read only; W1toCl = Write 1 to clear bit; -n = value after reset

Table 15-60. TBPHSHR Register Field Descriptions

Bit	Field	Type	Reset	Description
15-8	TBPHSH	R/W	0h	Time-base phase high-resolution bits
7-0	RESERVED	R	0h	

15.2.4.4 TBPHS Register (offset = 6h) [reset = 0h]

TBPHS is shown in [Figure 15-74](#) and described in [Table 15-61](#).

This register is only available on ePWM instances that include the high-resolution PWM (HRPWM) extension, otherwise, this location is reserved.

Figure 15-74. TBPHS Register

15	14	13	12	11	10	9	8	7	6	5	4	3	2	1	0
TBPHS															
R/W-0h															

LEGEND: R/W = Read/Write; R = Read only; W1toCl = Write 1 to clear bit; -n = value after reset

Table 15-61. TBPHS Register Field Descriptions

Bit	Field	Type	Reset	Description
15-0	TBPHS	R/W	0h	These bits set time-base counter phase of the selected ePWM relative to the time-base that is supplying the synchronization input signal. (a) If TBCTL[PHSEN] = 0, then the synchronization event is ignored and the time-base counter is not loaded with the phase. (b) If TBCTL[PHSEN] = 1, then the time-base counter (TBCNT) will be loaded with the phase (TBPHS) when a synchronization event occurs. The synchronization event can be initiated by the input synchronization signal (EPWMxSYNCl) or by a software forced synchronization.

15.2.4.5 TBCNT Register (offset = 8h) [reset = 0h]

TBCNT is shown in [Figure 15-75](#) and described in [Table 15-62](#).

Figure 15-75. TBCNT Register

15	14	13	12	11	10	9	8	7	6	5	4	3	2	1	0
TBCNT															
R/W-0h															

LEGEND: R/W = Read/Write; R = Read only; W1toCl = Write 1 to clear bit; -n = value after reset

Table 15-62. TBCNT Register Field Descriptions

Bit	Field	Type	Reset	Description
15-0	TBCNT	R/W	0h	Reading these bits gives the current time-base counter value. Writing to these bits sets the current time-base counter value. The update happens as soon as the write occurs. The write is NOT synchronized to the time-base clock (TBCLK) and the register is not shadowed.

15.2.4.6 TBPRD Register (offset = Ah) [reset = 0h]

TBPRD is shown in [Figure 15-76](#) and described in [Table 15-63](#).

Figure 15-76. TBPRD Register

15	14	13	12	11	10	9	8	7	6	5	4	3	2	1	0
TBPRD															
R/W-0h															

LEGEND: R/W = Read/Write; R = Read only; W1toCl = Write 1 to clear bit; -n = value after reset

Table 15-63. TBPRD Register Field Descriptions

Bit	Field	Type	Reset	Description
15-0	TBPRD	R/W	0h	These bits determine the period of the time-base counter. This sets the PWM frequency. Shadowing of this register is enabled and disabled by the TBCTL[PRDL] bit. By default this register is shadowed. (a) If TBCTL[PRDL] = 0, then the shadow is enabled and any write or read will automatically go to the shadow register. In this case, the active register will be loaded from the shadow register when the time-base counter equals zero. (b) If TBCTL[PRDL] = 1, then the shadow is disabled and any write or read will go directly to the active register, that is the register actively controlling the hardware. (c) The active and shadow registers share the same memory map address.

15.2.4.7 CMPCTL Register (offset = Eh) [reset = 0h]

CMPCTL is shown in [Figure 15-77](#) and described in [Table 15-64](#).

Figure 15-77. CMPCTL Register

15	14	13	12	11	10	9	8
RESERVED						SHDWBFULL	SHDWAFULL
R-0h						R-0h	R-0h
7	6	5	4	3	2	1	0
RESERVED	SHDWBMODE	RESERVED	SHDWAMODE	LOADBMODE		LOADAMODE	
R-0h	R/W-0h	R-0h	R/W-0h	R/W-0h		R/W-0h	

LEGEND: R/W = Read/Write; R = Read only; W1toCl = Write 1 to clear bit; -n = value after reset

Table 15-64. CMPCTL Register Field Descriptions

Bit	Field	Type	Reset	Description
15-10	RESERVED	R	0h	
9	SHDWBFULL	R	0h	Counter-compare B (CMPB) Shadow Register Full Status Flag. This bit self clears once a load-strobe occurs. 0h (R/W) = CMPB shadow FIFO not full yet 1h (R/W) = Indicates the CMPB shadow FIFO is full. A CPU write will overwrite current shadow value.
8	SHDWAFULL	R	0h	Counter-compare A (CMPA) Shadow Register Full Status Flag. The flag bit is set when a 32 bit write to CMPA:CMPAHR register or a 16 bit write to CMPA register is made. A 16 bit write to CMPAHR register will not affect the flag. This bit self clears once a load-strobe occurs. 0h (R/W) = CMPA shadow FIFO not full yet 1h (R/W) = Indicates the CMPA shadow FIFO is full, a CPU write will overwrite the current shadow value.
7	RESERVED	R	0h	
6	SHDWBMODE	R/W	0h	Counter-compare B (CMPB) Register Operating Mode. 0h (R/W) = Shadow mode. Operates as a double buffer. All writes via the CPU access the shadow register. 1h (R/W) = Immediate mode. Only the active compare B register is used. All writes and reads directly access the active register for immediate compare action.
5	RESERVED	R	0h	
4	SHDWAMODE	R/W	0h	Counter-compare A (CMPA) Register Operating Mode. 0h (R/W) = Shadow mode. Operates as a double buffer. All writes via the CPU access the shadow register. 1h (R/W) = Immediate mode. Only the active compare register is used. All writes and reads directly access the active register for immediate compare action
3-2	LOADBMODE	R/W	0h	Active Counter-Compare B (CMPB) Load From Shadow Select Mode. This bit has no effect in immediate mode (CMPCTL[SHDWBMODE] = 1). 0h (R/W) = Load on CTR = 0 - Time-base counter equal to zero (TBCNT = 0000h) 1h (R/W) = Load on CTR = PRD - Time-base counter equal to period (TBCNT = TBPRD) 2h (R/W) = Load on either CTR = 0 or CTR = PRD 3h (R/W) = Freeze (no loads possible)

Table 15-64. CMPCTL Register Field Descriptions (continued)

Bit	Field	Type	Reset	Description
1-0	LOADAMODE	R/W	0h	Active Counter-Compare A (CMPA) Load From Shadow Select Mode. This bit has no effect in immediate mode (CMPCTL[SHDWAMODE] = 1). 0h (R/W) = Load on CTR = 0 - Time-base counter equal to zero (TBCNT = 0000h) 1h (R/W) = Load on CTR = PRD - Time-base counter equal to period (TBCNT = TBPRD) 2h (R/W) = Load on either CTR = 0 or CTR = PRD 3h (R/W) = Freeze (no loads possible)

15.2.4.8 CMPAHR Register (offset = 10h) [reset = 100h]

CMPAHR is shown in [Figure 15-78](#) and described in [Table 15-65](#).

This register is only available on ePWM instances that include the high-resolution PWM (HRPWM) extension; otherwise, this location is reserved.

Figure 15-78. CMPAHR Register

15	14	13	12	11	10	9	8
CMPAHR							
R/W-1h							
7	6	5	4	3	2	1	0
RESERVED							
R-0h							

LEGEND: R/W = Read/Write; R = Read only; W1toCl = Write 1 to clear bit; -n = value after reset

Table 15-65. CMPAHR Register Field Descriptions

Bit	Field	Type	Reset	Description
15-8	CMPAHR	R/W	1h	Compare A High-Resolution register bits for MEP step control. A minimum value of 1h is needed to enable HRPWM capabilities. Valid MEP range of operation 1-255h.
7-0	RESERVED	R	0h	

15.2.4.9 CMPA Register (offset = 12h) [reset = 0h]

 CMPA is shown in [Figure 15-79](#) and described in [Table 15-66](#).

Figure 15-79. CMPA Register

15	14	13	12	11	10	9	8	7	6	5	4	3	2	1	0
CMPA															
R/W-0h															

LEGEND: R/W = Read/Write; R = Read only; W1toCl = Write 1 to clear bit; -n = value after reset

Table 15-66. CMPA Register Field Descriptions

Bit	Field	Type	Reset	Description
15-0	CMPA	R/W	0h	<p>The value in the active CMPA register is continuously compared to the time-base counter (TBCNT). When the values are equal, the counter-compare module generates a "time-base counter equal to counter compare A" event. This event is sent to the action-qualifier where it is qualified and converted it into one or more actions. These actions can be applied to either the EPWMxA or the EPWMxB output depending on the configuration of the AQCTLA and AQCTLB registers. The actions that can be defined in the AQCTLA and AQCTLB registers include the following.</p> <ul style="list-style-type: none"> (a) Do nothing the event is ignored. (b) Clear - Pull the EPWMxA and/or EPWMxB signal low. (c) Set - Pull the EPWMxA and/or EPWMxB signal high. (d) Toggle the EPWMxA and/or EPWMxB signal. <p>Shadowing of this register is enabled and disabled by the CMPCTL[SHDWAMODE] bit. By default this register is shadowed.</p> <ul style="list-style-type: none"> (a) If CMPCTL[SHDWAMODE] = 0, then the shadow is enabled and any write or read will automatically go to the shadow register. In this case, the CMPCTL[LOADAMODE] bit field determines which event will load the active register from the shadow register. (b) Before a write, the CMPCTL[SHDWAFULL] bit can be read to determine if the shadow register is currently full. (c) If CMPCTL[SHDWAMODE] = 1, then the shadow register is disabled and any write or read will go directly to the active register, that is the register actively controlling the hardware. (d) In either mode, the active and shadow registers share the same memory map address.

15.2.4.10 CMPB Register (offset = 14h) [reset = 0h]

 CMPB is shown in [Figure 15-80](#) and described in [Table 15-67](#).

Figure 15-80. CMPB Register

15	14	13	12	11	10	9	8	7	6	5	4	3	2	1	0
CMPB															
R/W-0h															

LEGEND: R/W = Read/Write; R = Read only; W1toCl = Write 1 to clear bit; -n = value after reset

Table 15-67. CMPB Register Field Descriptions

Bit	Field	Type	Reset	Description
15-0	CMPB	R/W	0h	<p>The value in the active CMPB register is continuously compared to the time-base counter (TBCNT). When the values are equal, the counter-compare module generates a "time-base counter equal to counter compare B" event. This event is sent to the action-qualifier where it is qualified and converted it into one or more actions. These actions can be applied to either the EPWMxA or the EPWMxB output depending on the configuration of the AQCTLA and AQCTLB registers. The actions that can be defined in the AQCTLA and AQCTLB registers include the following.</p> <ul style="list-style-type: none"> (a) Do nothing, the event is ignored. (b) Clear - Pull the EPWMxA and/or EPWMxB signal low. (c) Set - Pull the EPWMxA and/or EPWMxB signal high. (d) Toggle the EPWMxA and/or EPWMxB signal. <p>Shadowing of this register is enabled and disabled by the CMPCTL[SHDWBMODE] bit. By default this register is shadowed.</p> <ul style="list-style-type: none"> (a) If CMPCTL[SHDWBMODE] = 0, then the shadow is enabled and any write or read will automatically go to the shadow register. In this case, the CMPCTL[LOADBMODE] bit field determines which event will load the active register from the shadow register: (b) Before a write, the CMPCTL[SHDWBFULL] bit can be read to determine if the shadow register is currently full. (c) If CMPCTL[SHDWBMODE] = 1, then the shadow register is disabled and any write or read will go directly to the active register, that is the register actively controlling the hardware. (d) In either mode, the active and shadow registers share the same memory map address.

15.2.4.11 AQCTLA Register (offset = 16h) [reset = 0h]

 AQCTLA is shown in [Figure 15-81](#) and described in [Table 15-68](#).

Figure 15-81. AQCTLA Register

15	14	13	12	11	10	9	8
RESERVED				CBD		CBU	
R-0h				R/W-0h		R/W-0h	
7	6	5	4	3	2	1	0
CAD		CAU		PRD		ZRO	
R/W-0h		R/W-0h		R/W-0h		R/W-0h	

LEGEND: R/W = Read/Write; R = Read only; W1toCl = Write 1 to clear bit; -n = value after reset

Table 15-68. AQCTLA Register Field Descriptions

Bit	Field	Type	Reset	Description
15-12	RESERVED	R	0h	
11-10	CBD	R/W	0h	Action when the time-base counter equals the active CMPB register and the counter is decrementing. 0h (R/W) = Do nothing (action disabled) 1h (R/W) = Clear - force EPWMxA output low. 2h (R/W) = Set - force EPWMxA output high. 3h (R/W) = Toggle EPWMxA output - low output signal will be forced high, and a high signal will be forced low.
9-8	CBU	R/W	0h	Action when the counter equals the active CMPB register and the counter is incrementing. 0h (R/W) = Do nothing (action disabled) 1h (R/W) = Clear - force EPWMxA output low. 2h (R/W) = Set - force EPWMxA output high. 3h (R/W) = Toggle EPWMxA output - low output signal will be forced high, and a high signal will be forced low.
7-6	CAD	R/W	0h	Action when the counter equals the active CMPA register and the counter is decrementing. 0h (R/W) = Do nothing (action disabled) 1h (R/W) = Clear - force EPWMxA output low. 2h (R/W) = Set - force EPWMxA output high. 3h (R/W) = Toggle EPWMxA output - low output signal will be forced high, and a high signal will be forced low.
5-4	CAU	R/W	0h	Action when the counter equals the active CMPA register and the counter is incrementing. 0h (R/W) = Do nothing (action disabled) 1h (R/W) = Clear - force EPWMxA output low. 2h (R/W) = Set - force EPWMxA output high. 3h (R/W) = Toggle EPWMxA output - low output signal will be forced high, and a high signal will be forced low.
3-2	PRD	R/W	0h	Action when the counter equals the period. Note: By definition, in count up-down mode when the counter equals period the direction is defined as 0 or counting down. 0h (R/W) = Do nothing (action disabled) 1h (R/W) = Clear - force EPWMxA output low. 2h (R/W) = Set - force EPWMxA output high. 3h (R/W) = Toggle EPWMxA output - low output signal will be forced high, and a high signal will be forced low.

Table 15-68. AQCTLA Register Field Descriptions (continued)

Bit	Field	Type	Reset	Description
1-0	ZRO	R/W	0h	Action when counter equals zero. Note: By definition, in count up-down mode when the counter equals 0 the direction is defined as 1 or counting up. 0h (R/W) = Do nothing (action disabled) 1h (R/W) = Clear - force EPWMxA output low. 2h (R/W) = Set - force EPWMxA output high. 3h (R/W) = Toggle EPWMxA output - low output signal will be forced high, and a high signal will be forced low.

15.2.4.12 AQCTLB Register (offset = 18h) [reset = 0h]

 AQCTLB is shown in [Figure 15-82](#) and described in [Table 15-69](#).

Figure 15-82. AQCTLB Register

15	14	13	12	11	10	9	8
RESERVED				CBD		CBU	
R-0h				R/W-0h		R/W-0h	
7	6	5	4	3	2	1	0
CAD		CAU		PRD		ZRO	
R/W-0h		R/W-0h		R/W-0h		R/W-0h	

LEGEND: R/W = Read/Write; R = Read only; W1toCl = Write 1 to clear bit; -n = value after reset

Table 15-69. AQCTLB Register Field Descriptions

Bit	Field	Type	Reset	Description
15-12	RESERVED	R	0h	
11-10	CBD	R/W	0h	Action when the counter equals the active CMPB register and the counter is decrementing. 0h (R/W) = Do nothing (action disabled) 1h (R/W) = Clear - force EPWMxB output low. 2h (R/W) = Set - force EPWMxB output high. 3h (R/W) = Toggle EPWMxB output - low output signal will be forced high, and a high signal will be forced low.
9-8	CBU	R/W	0h	Action when the counter equals the active CMPB register and the counter is incrementing. 0h (R/W) = Do nothing (action disabled) 1h (R/W) = Clear - force EPWMxB output low. 2h (R/W) = Set - force EPWMxB output high. 3h (R/W) = Toggle EPWMxB output - low output signal will be forced high, and a high signal will be forced low.
7-6	CAD	R/W	0h	Action when the counter equals the active CMPA register and the counter is decrementing. 0h (R/W) = Do nothing (action disabled) 1h (R/W) = Clear - force EPWMxB output low. 2h (R/W) = Set - force EPWMxB output high. 3h (R/W) = Toggle EPWMxB output - low output signal will be forced high, and a high signal will be forced low.
5-4	CAU	R/W	0h	Action when the counter equals the active CMPA register and the counter is incrementing. 0h (R/W) = Do nothing (action disabled) 1h (R/W) = Clear - force EPWMxB output low. 2h (R/W) = Set - force EPWMxB output high. 3h (R/W) = Toggle EPWMxB output - low output signal will be forced high, and a high signal will be forced low.
3-2	PRD	R/W	0h	Action when the counter equals the period. Note: By definition, in count up-down mode when the counter equals period the direction is defined as 0 or counting down. 0h (R/W) = Do nothing (action disabled) 1h (R/W) = Clear - force EPWMxB output low. 2h (R/W) = Set - force EPWMxB output high. 3h (R/W) = Toggle EPWMxB output - low output signal will be forced high, and a high signal will be forced low.

Table 15-69. AQCTLB Register Field Descriptions (continued)

Bit	Field	Type	Reset	Description
1-0	ZRO	R/W	0h	<p>Action when counter equals zero.</p> <p>Note: By definition, in count up-down mode when the counter equals 0 the direction is defined as 1 or counting up.</p> <p>0h (R/W) = Do nothing (action disabled)</p> <p>1h (R/W) = Clear - force EPWMxB output low.</p> <p>2h (R/W) = Set - force EPWMxB output high.</p> <p>3h (R/W) = Toggle EPWMxB output - low output signal will be forced high, and a high signal will be forced low.</p>

15.2.4.13 AQSFR Register (offset = 1Ah) [reset = 0h]

 AQSFR is shown in [Figure 15-83](#) and described in [Table 15-70](#).

Figure 15-83. AQSFR Register

15	14	13	12	11	10	9	8
RESERVED							
R-0h							
7	6	5	4	3	2	1	0
RLDCSF		OTSFB	ACTSFB		OTSFA	ACTSFA	
R/W-0h		R/W-0h	R/W-0h		R/W-0h	R/W-0h	

LEGEND: R/W = Read/Write; R = Read only; W1toCl = Write 1 to clear bit; -n = value after reset

Table 15-70. AQSFR Register Field Descriptions

Bit	Field	Type	Reset	Description
15-8	RESERVED	R	0h	
7-6	RLDCSF	R/W	0h	AQCSFRC Active Register Reload From Shadow Options. 0h (R/W) = Load on event counter equals zero 1h (R/W) = Load on event counter equals period 2h (R/W) = Load on event counter equals zero or counter equals period 3h (R/W) = Load immediately (the active register is directly accessed by the CPU and is not loaded from the shadow register).
5	OTSFB	R/W	0h	One-Time Software Forced Event on Output B. 0h (R/W) = Writing a 0 (zero) has no effect. Always reads back a 0. This bit is auto cleared once a write to this register is complete, that is, a forced event is initiated. This is a one-shot forced event. It can be overridden by another subsequent event on output B. 1h (R/W) = Initiates a single s/w forced event
4-3	ACTSFB	R/W	0h	Action when One-Time Software Force B Is Invoked 0h (R/W) = Does nothing (action disabled) 1h (R/W) = Clear (low) 2h (R/W) = Set (high) 3h (R/W) = Toggle (Low -> High, High -> Low). Note: This action is not qualified by counter direction (CNT_dir)
2	OTSFA	R/W	0h	One-Time Software Forced Event on Output A. 0h (R/W) = Writing a 0 (zero) has no effect. Always reads back a 0. This bit is auto cleared once a write to this register is complete (that is, a forced event is initiated). 1h (R/W) = Initiates a single software forced event.
1-0	ACTSFA	R/W	0h	Action When One-Time Software Force A Is Invoked. 0h (R/W) = Does nothing (action disabled). 1h (R/W) = Clear (low). 2h (R/W) = Set (high). 3h (R/W) = Toggle (Low -> High, High -> Low). Note: This action is not qualified by counter direction (CNT_dir)

15.2.4.14 AQCSFRC Register (offset = 1Ch) [reset = 0h]

AQCSFRC is shown in [Figure 15-84](#) and described in [Table 15-71](#).

Figure 15-84. AQCSFRC Register

15	14	13	12	11	10	9	8
RESERVED							
R-0h							
7	6	5	4	3	2	1	0
RESERVED				CSFB		CSFA	
R-0h				R/W-0h		R/W-0h	

LEGEND: R/W = Read/Write; R = Read only; W1toCl = Write 1 to clear bit; -n = value after reset

Table 15-71. AQCSFRC Register Field Descriptions

Bit	Field	Type	Reset	Description
15-4	RESERVED	R	0h	
3-2	CSFB	R/W	0h	Continuous Software Force on Output B. In immediate mode, a continuous force takes effect on the next TBCLK edge. In shadow mode, a continuous force takes effect on the next TBCLK edge after a shadow load into the active register. To configure shadow mode, use AQSFRC[RLDCSF]. 0h (R/W) = Forcing disabled, that is, has no effect 1h (R/W) = Forces a continuous low on output B 2h (R/W) = Forces a continuous high on output B 3h (R/W) = Software forcing is disabled and has no effect
1-0	CSFA	R/W	0h	Continuous Software Force on Output A In immediate mode, a continuous force takes effect on the next TBCLK edge. In shadow mode, a continuous force takes effect on the next TBCLK edge after a shadow load into the active register. 0h (R/W) = Forcing disabled, that is, has no effect 1h (R/W) = Forces a continuous low on output A 2h (R/W) = Forces a continuous high on output A 3h (R/W) = Software forcing is disabled and has no effect

15.2.4.15 DBCTL Register (offset = 1Eh) [reset = 0h]

 DBCTL is shown in [Figure 15-85](#) and described in [Table 15-72](#).

Figure 15-85. DBCTL Register

15	14	13	12	11	10	9	8
RESERVED							
R-0h							
7	6	5	4	3	2	1	0
RESERVED		IN_MODE		POLSEL		OUT_MODE	
R-0h		R/W-0h		R/W-0h		R/W-0h	

LEGEND: R/W = Read/Write; R = Read only; W1toCl = Write 1 to clear bit; -n = value after reset

Table 15-72. DBCTL Register Field Descriptions

Bit	Field	Type	Reset	Description
15-6	RESERVED	R	0h	
5-4	IN_MODE	R/W	0h	Dead Band Input Mode Control. Bit 5 controls the S5 switch and bit 4 controls the S4 switch. This allows you to select the input source to the falling-edge and rising-edge delay. To produce classical dead-band waveforms, the default is EPWMxA In is the source for both falling and rising-edge delays. 0h (R/W) = EPWMxA In (from the action-qualifier) is the source for both falling-edge and rising-edge delay. 1h (R/W) = EPWMxB In (from the action-qualifier) is the source for rising-edge delayed signal. EPWMxA In (from the action-qualifier) is the source for falling-edge delayed signal. 2h (R/W) = EPWMxA In (from the action-qualifier) is the source for rising-edge delayed signal. EPWMxB In (from the action-qualifier) is the source for falling-edge delayed signal. 3h (R/W) = EPWMxB In (from the action-qualifier) is the source for both rising-edge delay and falling-edge delayed signal.
3-2	POLSEL	R/W	0h	Polarity Select Control. Bit 3 controls the S3 switch and bit 2 controls the S2 switch. This allows you to selectively invert one of the delayed signals before it is sent out of the dead-band submodule. The following descriptions correspond to classical upper/lower switch control as found in one leg of a digital motor control inverter. These assume that DBCTL[OUT_MODE] = 1,1 and DBCTL[IN_MODE] = 0,0. Other enhanced modes are also possible, but not regarded as typical usage modes. 0h (R/W) = Active high (AH) mode. Neither EPWMxA nor EPWMxB is inverted (default). 1h (R/W) = Active low complementary (ALC) mode. EPWMxA is inverted. 2h (R/W) = Active high complementary (AHC). EPWMxB is inverted. 3h (R/W) = Active low (AL) mode. Both EPWMxA and EPWMxB are inverted.

Table 15-72. DBCTL Register Field Descriptions (continued)

Bit	Field	Type	Reset	Description
1-0	OUT_MODE	R/W	0h	<p>Dead-band Output Mode Control. Bit 1 controls the S1 switch and bit 0 controls the S0 switch. This allows you to selectively enable or bypass the dead-band generation for the falling-edge and rising-edge delay.</p> <p>0h (R/W) = Dead-band generation is bypassed for both output signals. In this mode, both the EPWMxA and EPWMxB output signals from the action-qualifier are passed directly to the PWM-chopper submodule. In this mode, the POLSEL and IN_MODE bits have no effect.</p> <p>1h (R/W) = Disable rising-edge delay. The EPWMxA signal from the action-qualifier is passed straight through to the EPWMxA input of the PWM-chopper submodule. The falling-edge delayed signal is seen on output EPWMxB. The input signal for the delay is determined by DBCTL[IN_MODE].</p> <p>2h (R/W) = Disable falling-edge delay. The EPWMxB signal from the action-qualifier is passed straight through to the EPWMxB input of the PWM-chopper submodule. The rising-edge delayed signal is seen on output EPWMxA. The input signal for the delay is determined by DBCTL[IN_MODE].</p> <p>3h (R/W) = Dead-band is fully enabled for both rising-edge delay on output EPWMxA and falling-edge delay on output EPWMxB. The input signal for the delay is determined by DBCTL[IN_MODE].</p>

15.2.4.16 DBRED Register (offset = 20h) [reset = 0h]

DBRED is shown in [Figure 15-86](#) and described in [Table 15-73](#).

Figure 15-86. DBRED Register

15	14	13	12	11	10	9	8
RESERVED						DEL	
R-0h						R/W-0h	
7	6	5	4	3	2	1	0
DEL							
R/W-0h							

LEGEND: R/W = Read/Write; R = Read only; W1toCl = Write 1 to clear bit; -n = value after reset

Table 15-73. DBRED Register Field Descriptions

Bit	Field	Type	Reset	Description
15-10	RESERVED	R	0h	
9-0	DEL	R/W	0h	Rising Edge Delay Count. 10 bit counter.

15.2.4.17 DBFED Register (offset = 22h) [reset = 0h]

DBFED is shown in [Figure 15-87](#) and described in [Table 15-74](#).

Figure 15-87. DBFED Register

15	14	13	12	11	10	9	8
RESERVED						DEL	
R-0h						R/W-0h	
7	6	5	4	3	2	1	0
DEL							
R/W-0h							

LEGEND: R/W = Read/Write; R = Read only; W1toCl = Write 1 to clear bit; -n = value after reset

Table 15-74. DBFED Register Field Descriptions

Bit	Field	Type	Reset	Description
15-10	RESERVED	R	0h	
9-0	DEL	R/W	0h	Falling Edge Delay Count. 10 bit counter

15.2.4.18 TZSEL Register (offset = 24h) [reset = 0h]

 TZSEL is shown in [Figure 15-88](#) and described in [Table 15-75](#).

Figure 15-88. TZSEL Register

15	14	13	12	11	10	9	8
OSHTn							
R/W-0h							
7	6	5	4	3	2	1	0
CBCn							
R/W-0h							

LEGEND: R/W = Read/Write; R = Read only; W1toCl = Write 1 to clear bit; -n = value after reset

Table 15-75. TZSEL Register Field Descriptions

Bit	Field	Type	Reset	Description
15-8	OSHTn	R/W	0h	Trip-zone n (TZn) select. One-Shot (OSHT) trip-zone enable/disable. When any of the enabled pins go low, a one-shot trip event occurs for this ePWM module. When the event occurs, the action defined in the TZCTL register is taken on the EPWMxA and EPWMxB outputs. The one-shot trip condition remains latched until you clear the condition via the TZCLR register. 0h (R/W) = Disable TZn as a one-shot trip source for this ePWM module. 1h (R/W) = Enable TZn as a one-shot trip source for this ePWM module.
7-0	CBCn	R/W	0h	Trip-zone n (TZn) select. Cycle-by-Cycle (CBC) trip-zone enable/disable. When any of the enabled pins go low, a cycle-by-cycle trip event occurs for this ePWM module. When the event occurs, the action defined in the TZCTL register is taken on the EPWMxA and EPWMxB outputs. A cycle-by-cycle trip condition is automatically cleared when the time-base counter reaches zero. 0h (R/W) = Disable TZn as a CBC trip source for this ePWM module. 1h (R/W) = Enable TZn as a CBC trip source for this ePWM module.

15.2.4.19 TZCTL Register (offset = 28h) [reset = 0h]

 TZCTL is shown in [Figure 15-89](#) and described in [Table 15-76](#).

Figure 15-89. TZCTL Register

15	14	13	12	11	10	9	8
RESERVED							
R-0h							
7	6	5	4	3	2	1	0
RESERVED				TZB		TZA	
R-0h				R/W-0h		R/W-0h	

LEGEND: R/W = Read/Write; R = Read only; W1toCl = Write 1 to clear bit; -n = value after reset

Table 15-76. TZCTL Register Field Descriptions

Bit	Field	Type	Reset	Description
15-4	RESERVED	R	0h	
3-2	TZB	R/W	0h	When a trip event occurs the following action is taken on output EPWMxB. Which trip-zone pins can cause an event is defined in the TZSEL register. 0h (R/W) = High impedance (EPWMxB = High-impedance state) 1h (R/W) = Force EPWMxB to a high state 2h (R/W) = Force EPWMxB to a low state 3h (R/W) = Do nothing, no action is taken on EPWMxB.
1-0	TZA	R/W	0h	When a trip event occurs the following action is taken on output EPWMxA. Which trip-zone pins can cause an event is defined in the TZSEL register. 0h (R/W) = High impedance (EPWMxA = High-impedance state) 1h (R/W) = Force EPWMxA to a high state 2h (R/W) = Force EPWMxA to a low state 3h (R/W) = Do nothing, no action is taken on EPWMxA.

15.2.4.20 TZEINT Register (offset = 2Ah) [reset = 0h]

TZEINT is shown in [Figure 15-90](#) and described in [Table 15-77](#).

Figure 15-90. TZEINT Register

15	14	13	12	11	10	9	8
RESERVED							
R-0h							
7	6	5	4	3	2	1	0
RESERVED					OST	CBC	RESERVED
R-0h					R/W-0h	R/W-0h	R-0h

LEGEND: R/W = Read/Write; R = Read only; W1toCl = Write 1 to clear bit; -n = value after reset

Table 15-77. TZEINT Register Field Descriptions

Bit	Field	Type	Reset	Description
15-3	RESERVED	R	0h	
2	OST	R/W	0h	Trip-zone One-Shot Interrupt Enable 0h (R/W) = Disable one-shot interrupt generation 1h (R/W) = Enable Interrupt generation; a one-shot trip event will cause a EPWMxTZINT interrupt.
1	CBC	R/W	0h	Trip-zone Cycle-by-Cycle Interrupt Enable 0h (R/W) = Disable cycle-by-cycle interrupt generation. 1h (R/W) = Enable interrupt generation; a cycle-by-cycle trip event will cause an EPWMxTZINT interrupt.
0	RESERVED	R	0h	

15.2.4.21 TZFLG Register (offset = 2Ch) [reset = 0h]

 TZFLG is shown in [Figure 15-91](#) and described in [Table 15-78](#).

Figure 15-91. TZFLG Register

15	14	13	12	11	10	9	8
RESERVED							
R-0h							
7	6	5	4	3	2	1	0
RESERVED					OST	CBC	INT
R-0h					R-0h	R-0h	R-0h

LEGEND: R/W = Read/Write; R = Read only; W1toCl = Write 1 to clear bit; -n = value after reset

Table 15-78. TZFLG Register Field Descriptions

Bit	Field	Type	Reset	Description
15-3	RESERVED	R	0h	
2	OST	R	0h	Latched Status Flag for A One-Shot Trip Event. 0h (R/W) = No one-shot trip event has occurred. 1h (R/W) = Indicates a trip event has occurred on a pin selected as a one-shot trip source. This bit is cleared by writing the appropriate value to the TZCLR register.
1	CBC	R	0h	Latched Status Flag for Cycle-By-Cycle Trip Event 0h (R/W) = No cycle-by-cycle trip event has occurred. 1h (R/W) = Indicates a trip event has occurred on a pin selected as a cycle-by-cycle trip source. The TZFLG[CBC] bit will remain set until it is manually cleared by the user. If the cycle-by-cycle trip event is still present when the CBC bit is cleared, then CBC will be immediately set again. The specified condition on the pins is automatically cleared when the ePWM time-base counter reaches zero (TBCNT = 0000h) if the trip condition is no longer present. The condition on the pins is only cleared when the TBCNT = 0000h no matter where in the cycle the CBC flag is cleared. This bit is cleared by writing the appropriate value to the TZCLR register.
0	INT	R	0h	Latched Trip Interrupt Status Flag 0h (R/W) = Indicates no interrupt has been generated. 1h (R/W) = Indicates an EPWMxTZINT interrupt was generated because of a trip condition. No further EPWMxTZINT interrupts will be generated until this flag is cleared. If the interrupt flag is cleared when either CBC or OST is set, then another interrupt pulse will be generated. Clearing all flag bits will prevent further interrupts. This bit is cleared by writing the appropriate value to the TZCLR register.

15.2.4.22 TZCLR Register (offset = 2Eh) [reset = 0h]

 TZCLR is shown in [Figure 15-92](#) and described in [Table 15-79](#).

Figure 15-92. TZCLR Register

15	14	13	12	11	10	9	8
RESERVED							
R-0h							
7	6	5	4	3	2	1	0
RESERVED					OST	CBC	INT
R-0h					R/W-0h	R/W-0h	R/W-0h

LEGEND: R/W = Read/Write; R = Read only; W1toCl = Write 1 to clear bit; -n = value after reset

Table 15-79. TZCLR Register Field Descriptions

Bit	Field	Type	Reset	Description
15-3	RESERVED	R	0h	
2	OST	R/W	0h	Clear Flag for One-Shot Trip (OST) Latch 0h (R/W) = Has no effect. Always reads back a 0. 1h (R/W) = Clears this Trip (set) condition.
1	CBC	R/W	0h	Clear Flag for Cycle-By-Cycle (CBC) Trip Latch 0h (R/W) = Has no effect. Always reads back a 0. 1h (R/W) = Clears this Trip (set) condition.
0	INT	R/W	0h	Global Interrupt Clear Flag 0h (R/W) = Has no effect. Always reads back a 0. 1h (R/W) = Clears the trip-interrupt flag for this ePWM module (TZFLG[INT]). Note: No further EPWMxTZINT interrupts will be generated until the flag is cleared. If the TZFLG[INT] bit is cleared and any of the other flag bits are set, then another interrupt pulse will be generated. Clearing all flag bits will prevent further interrupts.

15.2.4.23 TZFRC Register (offset = 30h) [reset = 0h]

 TZFRC is shown in [Figure 15-93](#) and described in [Table 15-80](#).

Figure 15-93. TZFRC Register

15	14	13	12	11	10	9	8
RESERVED							
R-0h							
7	6	5	4	3	2	1	0
RESERVED					OST	CBC	RESERVED
R-0h					R/W-0h	R/W-0h	R-0h

LEGEND: R/W = Read/Write; R = Read only; W1toCl = Write 1 to clear bit; -n = value after reset

Table 15-80. TZFRC Register Field Descriptions

Bit	Field	Type	Reset	Description
15-3	RESERVED	R	0h	
2	OST	R/W	0h	Force a One-Shot Trip Event via Software 0h (R/W) = Writing of 0 is ignored. Always reads back a 0. 1h (R/W) = Forces a one-shot trip event and sets the TZFLG[OST] bit.
1	CBC	R/W	0h	Force a Cycle-by-Cycle Trip Event via Software 0h (R/W) = Writing of 0 is ignored. Always reads back a 0. 1h (R/W) = Forces a cycle-by-cycle trip event and sets the TZFLG[CBC] bit.
0	RESERVED	R	0h	

15.2.4.24 ETSEL Register (offset = 32h) [reset = 0h]

 ETSEL is shown in [Figure 15-94](#) and described in [Table 15-81](#).

Figure 15-94. ETSEL Register

15	14	13	12	11	10	9	8
RESERVED							
R-0h							
7	6	5	4	3	2	1	0
RESERVED				INTEN	INTSEL		
R-0h				R/W-0h	R/W-0h		

LEGEND: R/W = Read/Write; R = Read only; W1toCl = Write 1 to clear bit; -n = value after reset

Table 15-81. ETSEL Register Field Descriptions

Bit	Field	Type	Reset	Description
15-4	RESERVED	R	0h	
3	INTEN	R/W	0h	Enable ePWM Interrupt (EPWMx_INT) Generation 0h (R/W) = Disable EPWMx_INT generation 1h (R/W) = Enable EPWMx_INT generation
2-0	INTSEL	R/W	0h	ePWM Interrupt (EPWMx_INT) Selection Options 0h (R/W) = Reserved 1h (R/W) = Enable event time-base counter equal to zero. (TBCNT = 0000h) 2h (R/W) = Enable event time-base counter equal to period (TBCNT = TBPRD) 3h (R/W) = Reserved 4h (R/W) = Enable event time-base counter equal to CMPA when the timer is incrementing. 5h (R/W) = Enable event time-base counter equal to CMPA when the timer is decrementing. 6h (R/W) = Enable event - time-base counter equal to CMPB when the timer is incrementing. 7h (R/W) = Enable event - time-base counter equal to CMPB when the timer is decrementing.

15.2.4.25 ETPS Register (offset = 34h) [reset = 0h]

ETPS is shown in [Figure 15-95](#) and described in [Table 15-82](#).

Figure 15-95. ETPS Register

15	14	13	12	11	10	9	8
RESERVED							
R-0h							
7	6	5	4	3	2	1	0
RESERVED				INTCNT		INTPRD	
R-0h				R-0h		R/W-0h	

LEGEND: R/W = Read/Write; R = Read only; W1toCl = Write 1 to clear bit; -n = value after reset

Table 15-82. ETPS Register Field Descriptions

Bit	Field	Type	Reset	Description
15-4	RESERVED	R	0h	
3-2	INTCNT	R	0h	<p>ePWM Interrupt Event (EPWMx_INT) Counter Register. These bits indicate how many selected ETSEL[INTSEL] events have occurred. These bits are automatically cleared when an interrupt pulse is generated.</p> <p>If interrupts are disabled, ETSEL[INT] = 0 or the interrupt flag is set, ETFLG[INT] = 1, the counter will stop counting events when it reaches the period value ETPS[INTCNT] = ETPS[INTPRD].</p> <p>0h (R/W) = No events have occurred. 1h (R/W) = 1 event has occurred. 2h (R/W) = 2 events have occurred. 3h (R/W) = 3 events have occurred.</p>
1-0	INTPRD	R/W	0h	<p>ePWM Interrupt (EPWMx_INT) Period Select. These bits determine how many selected ETSEL[INTSEL] events need to occur before an interrupt is generated. To be generated, the interrupt must be enabled (ETSEL[INT] = 1). If the interrupt status flag is set from a previous interrupt (ETFLG[INT] = 1) then no interrupt will be generated until the flag is cleared via the ETCLR[INT] bit. This allows for one interrupt to be pending while another is still being serviced. Once the interrupt is generated, the ETPS[INTCNT] bits will automatically be cleared. Writing a INTPRD value that is the same as the current counter value will trigger an interrupt if it is enabled and the status flag is clear. Writing a INTPRD value that is less than the current counter value will result in an undefined state. If a counter event occurs at the same instant as a new zero or non-zero INTPRD value is written, the counter is incremented.</p> <p>0h (R/W) = Disable the interrupt event counter. No interrupt will be generated and ETFRM[INT] is ignored. 1h (R/W) = Generate an interrupt on the first event INTCNT = 01 (first event) 2h (R/W) = Generate interrupt on ETPS[INTCNT] = 1,0 (second event) 3h (R/W) = Generate interrupt on ETPS[INTCNT] = 1,1 (third event)</p>

15.2.4.26 ETFLG Register (offset = 36h) [reset = 0h]

 ETFLG is shown in [Figure 15-96](#) and described in [Table 15-83](#).

Figure 15-96. ETFLG Register

15	14	13	12	11	10	9	8
RESERVED							
R-0h							
7	6	5	4	3	2	1	0
RESERVED							INT
R-0h							R-0h

LEGEND: R/W = Read/Write; R = Read only; W1toCl = Write 1 to clear bit; -n = value after reset

Table 15-83. ETFLG Register Field Descriptions

Bit	Field	Type	Reset	Description
15-1	RESERVED	R	0h	
0	INT	R	0h	Latched ePWM Interrupt (EPWMx_INT) Status Flag 0h (R/W) = Indicates no event occurred 1h (R/W) = Indicates that an ePWMx interrupt (EWPMx_INT) was generated. No further interrupts will be generated until the flag bit is cleared. Up to one interrupt can be pending while the ETFLG[INT] bit is still set. If an interrupt is pending, it will not be generated until after the ETFLG[INT] bit is cleared.

15.2.4.27 ETCLR Register (offset = 38h) [reset = 0h]

ETCLR is shown in [Figure 15-97](#) and described in [Table 15-84](#).

Figure 15-97. ETCLR Register

15	14	13	12	11	10	9	8
RESERVED							
R-0h							
7	6	5	4	3	2	1	0
RESERVED							INT
R-0h							R-0h

LEGEND: R/W = Read/Write; R = Read only; W1toCl = Write 1 to clear bit; -n = value after reset

Table 15-84. ETCLR Register Field Descriptions

Bit	Field	Type	Reset	Description
15-1	RESERVED	R	0h	
0	INT	R	0h	ePWM Interrupt (EPWMx_INT) Flag Clear Bit 0h (R/W) = Writing a 0 has no effect. Always reads back a 0. 1h (R/W) = Clears the ETFLG[INT] flag bit and enable further interrupts pulses to be generated. NOTE: Interrupts can also used as DMA events, and this will also enable further DMA events to be generated

15.2.4.28 ETFRC Register (offset = 3Ah) [reset = 0h]

 ETFRC is shown in [Figure 15-98](#) and described in [Table 15-85](#).

Figure 15-98. ETFRC Register

15	14	13	12	11	10	9	8
RESERVED							
R-0h							
7	6	5	4	3	2	1	0
RESERVED							INT
R-0h							R-0h

LEGEND: R/W = Read/Write; R = Read only; W1toCl = Write 1 to clear bit; -n = value after reset

Table 15-85. ETFRC Register Field Descriptions

Bit	Field	Type	Reset	Description
15-1	RESERVED	R	0h	
0	INT	R	0h	INT Force Bit. The interrupt will only be generated if the event is enabled in the ETSEL register. The INT flag bit will be set regardless. 0h (R/W) = Writing 0 to this bit will be ignored. Always reads back a 0. 1h (R/W) = Generates an interrupt on EPWMxINT and set the INT flag bit. This bit is used for test purposes.

15.2.4.29 PCCTL Register (offset = 3Ch) [reset = 0h]

 PCCTL is shown in [Figure 15-99](#) and described in [Table 15-86](#).

Figure 15-99. PCCTL Register

15	14	13	12	11	10	9	8
RESERVED					CHPDUTY		
R-0h					R/W-0h		
7	6	5	4	3	2	1	0
CHPFREQ			OSHTWTH			CHPEN	
R/W-0h			R/W-0h			R/W-0h	

LEGEND: R/W = Read/Write; R = Read only; W1toCl = Write 1 to clear bit; -n = value after reset

Table 15-86. PCCTL Register Field Descriptions

Bit	Field	Type	Reset	Description
15-11	RESERVED	R	0h	
10-8	CHPDUTY	R/W	0h	Chopping Clock Duty Cycle 0h (R/W) = Duty = 1/8 (12.5%) 1h (R/W) = Duty = 2/8 (25.0%) 2h (R/W) = Duty = 3/8 (37.5%) 3h (R/W) = Duty = 4/8 (50.0%) 4h (R/W) = Duty = 5/8 (62.5%) 5h (R/W) = Duty = 6/8 (75.0%) 6h (R/W) = Duty = 7/8 (87.5%) 7h (R/W) = Reserved.
7-5	CHPFREQ	R/W	0h	Chopping Clock Frequency 0h (R/W) = Divide by 1 (no prescale). 1h (R/W) = Divide by 2. 2h (R/W) = Divide by 3. 3h (R/W) = Divide by 4. 4h (R/W) = Divide by 5. 5h (R/W) = Divide by 6. 6h (R/W) = Divide by 7. 7h (R/W) = Divide by 8.
4-1	OSHTWTH	R/W	0h	One-Shot Pulse Width 0h (R/W) = 1 - SYSCLKOUT/8 wide 1h (R/W) = 2 - SYSCLKOUT/8 wide 2h (R/W) = 3 - SYSCLKOUT/8 wide 3h (R/W) = 4 - SYSCLKOUT/8 wide Fh (R/W) = 16 - SYSCLKOUT/8 wide
0	CHPEN	R/W	0h	PWM-chopping Enable 0h (R/W) = Disable (bypass) PWM chopping function 1h (R/W) = Enable chopping function

15.2.4.30 HRCNFG Register (offset = C0h) [reset = 0h]

HRCNFG is shown in [Figure 15-100](#) and described in [Table 15-87](#).

This register is only available on ePWM instances that include the high-resolution PWM (HRPWM) extension; otherwise, this location is reserved.

Figure 15-100. HRCNFG Register

15	14	13	12	11	10	9	8
RESERVED							
R-0h							
7	6	5	4	3	2	1	0
RESERVED				HRLOAD	CTLMODE	EDGMODE	
R-0h				R/W-0h	R/W-0h	R/W-0h	

LEGEND: R/W = Read/Write; R = Read only; W1toCl = Write 1 to clear bit; -n = value after reset

Table 15-87. HRCNFG Register Field Descriptions

Bit	Field	Type	Reset	Description
15-4	RESERVED	R	0h	
3	HRLOAD	R/W	0h	Shadow mode bit - Selects the time event that loads the CMPAHR shadow value into the active register. Note: Load mode selection is valid only if CTLMODE = 0 has been selected. You should select this event to match the selection of the CMPA load mode (CMPCTL[LOADMODE] bits) in the EPWM module as follows: 0x 0: Load on CTR = 0 Time-base counter equal to zero (TBCNT = 0000h) 0x 1: Load on CTR = PRD Time-base counter equal to period (TBCNT = TBPRD) 0x 2: Load on either CTR = 0 or CTR = PRD (should not be used with HRPWM) 0x 3: Freeze (no loads possible should not be used with HRPWM) 0h (R/W) = CTR = PRD (counter equal period) 1h (R/W) = CTR = 0 (counter equals zero)
2	CTLMODE	R/W	0h	Control Mode Bits - Selects the register (CMP or TBPHS) that controls the MEP. 0h (R/W) = CMPAHR(8) Register controls the edge position (this is duty control mode). (default on reset) 1h (R/W) = TBPHSHR(8) Register controls the edge position (this is phase control mode).
1-0	EDGMODE	R/W	0h	Edge Mode Bits - Selects the edge of the PWM that is controlled by the micro-edge position (MEP) logic. 0h (R/W) = HRPWM capability is disabled (default on reset) 1h (R/W) = MEP control of rising edge 2h (R/W) = MEP control of falling edge 3h (R/W) = MEP control of both edges

15.3 Enhanced Capture (eCAP) Module

15.3.1 Introduction

15.3.1.1 Purpose of the Peripheral

Uses for eCAP include:

- Sample rate measurements of audio inputs
- Speed measurements of rotating machinery (for example, toothed sprockets sensed via Hall sensors)
- Elapsed time measurements between position sensor pulses
- Period and duty cycle measurements of pulse train signals
- Decoding current or voltage amplitude derived from duty cycle encoded current/voltage sensors

15.3.1.2 Features

The eCAP module includes the following features:

- 32-bit time base counter
- 4-event time-stamp registers (each 32 bits)
- Edge polarity selection for up to four sequenced time-stamp capture events
- Interrupt on either of the four events
- Single shot capture of up to four event time-stamps
- Continuous mode capture of time-stamps in a four-deep circular buffer
- Absolute time-stamp capture
- Difference (Delta) mode time-stamp capture
- All above resources dedicated to a single input pin
- When not used in capture mode, the ECAP module can be configured as a single channel PWM output

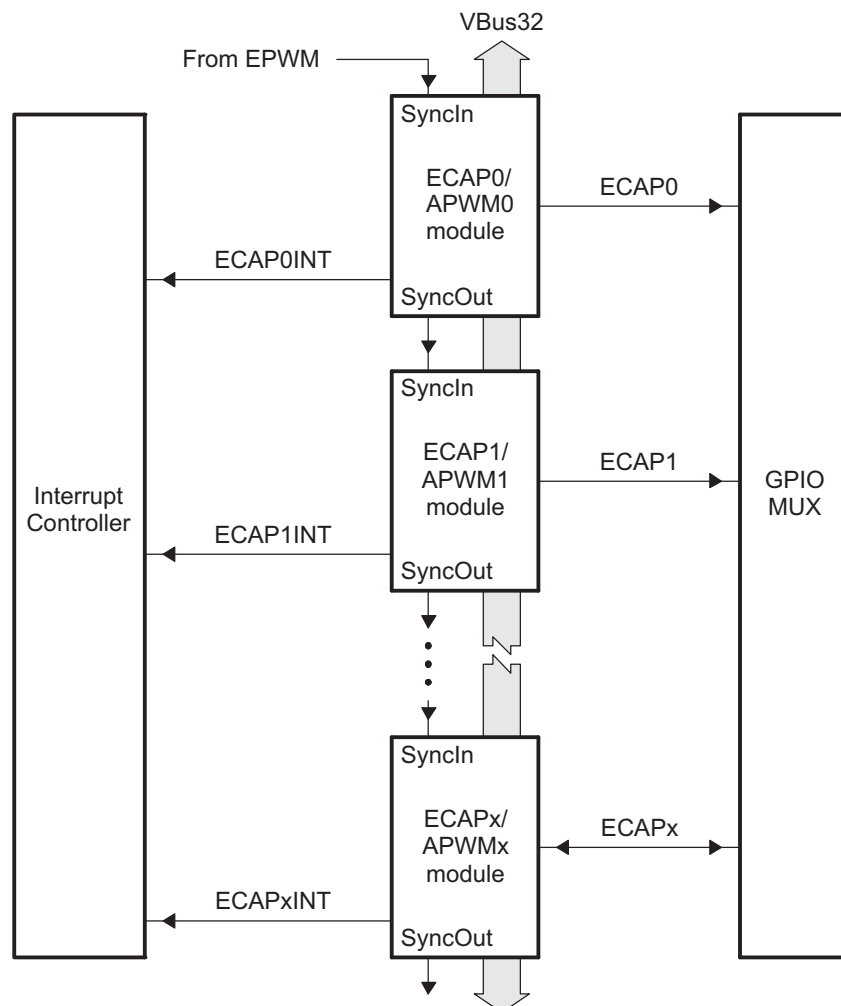
15.3.2 Functional Description

The eCAP module represents one complete capture channel that can be instantiated multiple times depending on the target device. In the context of this guide, one eCAP channel has the following independent key resources:

- Dedicated input capture pin
- 32-bit time base counter
- 4 × 32-bit time-stamp capture registers (CAP1-CAP4)
- 4-stage sequencer (Modulo4 counter) that is synchronized to external events, ECAP pin rising/falling edges.
- Independent edge polarity (rising/falling edge) selection for all 4 events
- Input capture signal prescaling (from 2-62)
- One-shot compare register (2 bits) to freeze captures after 1 to 4 time-stamp events
- Control for continuous time-stamp captures using a 4-deep circular buffer (CAP1-CAP4) scheme
- Interrupt capabilities on any of the 4 capture events

Multiple identical eCAP modules can be contained in a system as shown in [Figure 15-101](#). The number of modules is device-dependent and is based on target application needs. In this chapter, the letter x within a signal or module name is used to indicate a generic eCAP instance on a device.

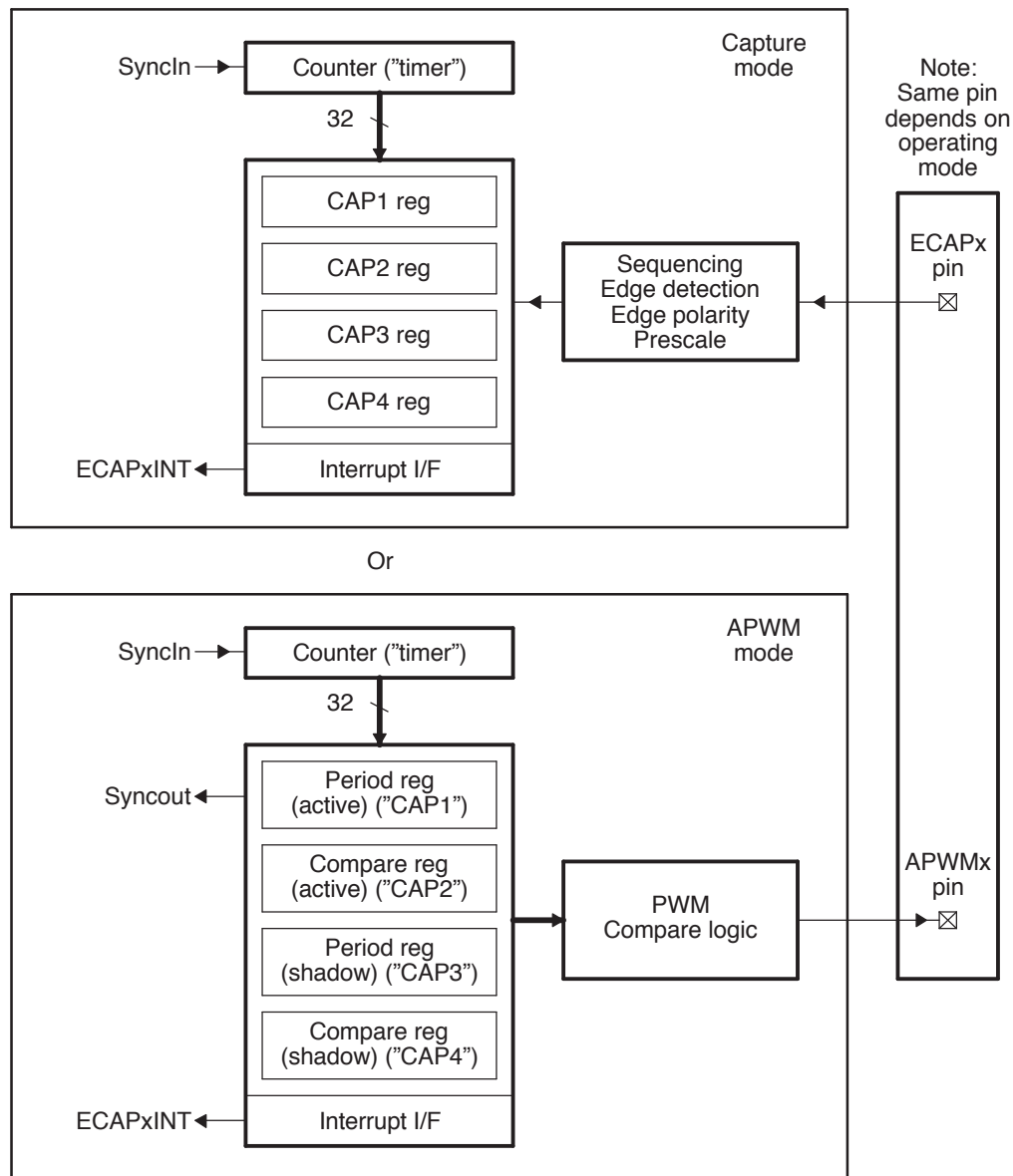
Figure 15-101. Multiple eCAP Modules



15.3.2.1 Capture and APWM Operating Mode

You can use the eCAP module resources to implement a single-channel PWM generator (with 32 bit capabilities) when it is not being used for input captures. The counter operates in count-up mode, providing a time-base for asymmetrical pulse width modulation (PWM) waveforms. The CAP1 and CAP2 registers become the active period and compare registers, respectively, while CAP3 and CAP4 registers become the period and capture shadow registers, respectively. Figure 15-102 is a high-level view of both the capture and auxiliary pulse-width modulator (APWM) modes of operation.

Figure 15-102. Capture and APWM Modes of Operation

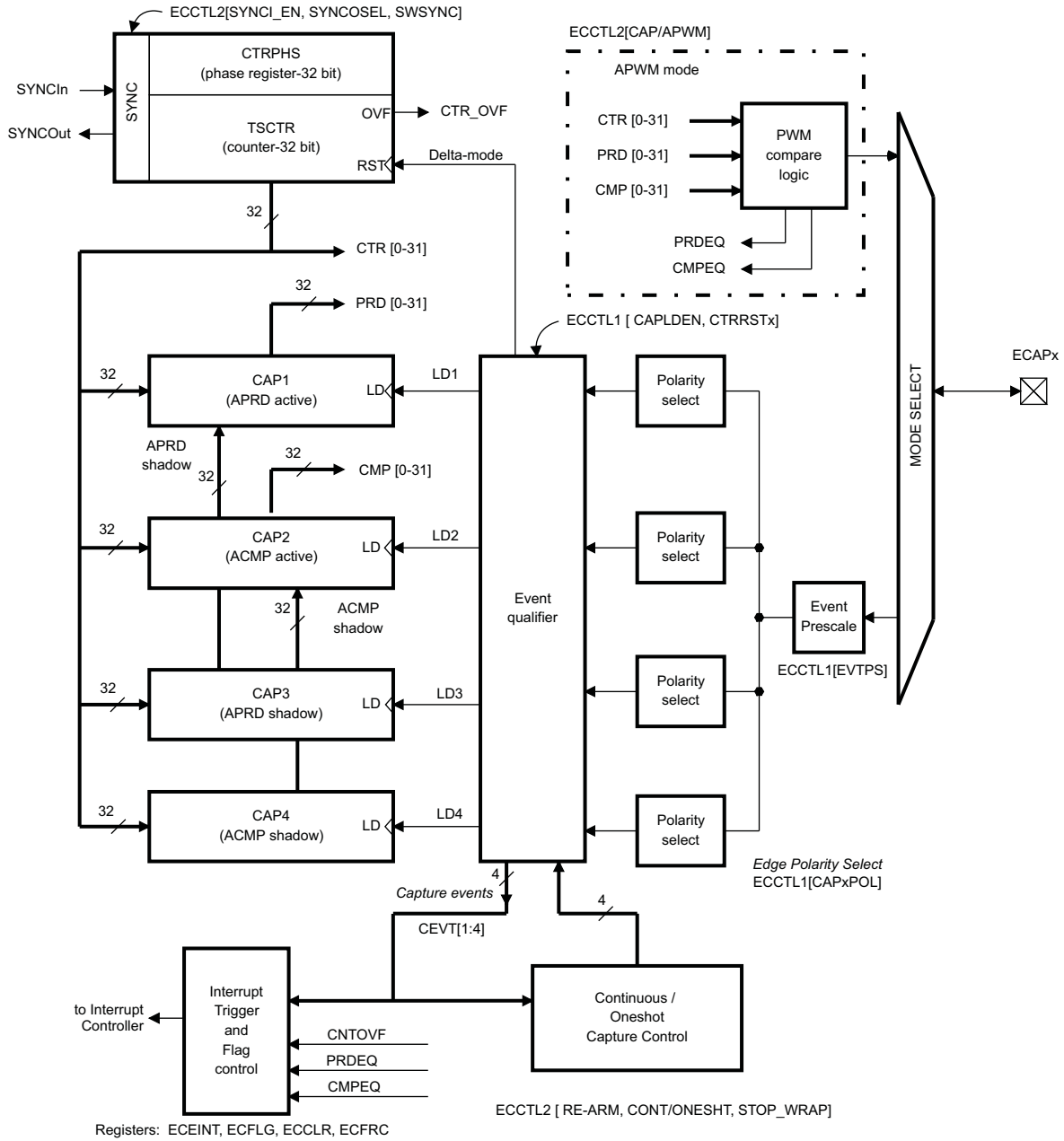


- (1) A single pin is shared between CAP and APWM functions. In capture mode, it is an input; in APWM mode, it is an output.
- (2) In APWM mode, writing any value to CAP1/CAP2 active registers also writes the same value to the corresponding shadow registers CAP3/CAP4. This emulates immediate mode. Writing to the shadow registers CAP3/CAP4 invokes the shadow mode.

15.3.2.2 Capture Mode Description

Figure 15-103 shows the various components that implement the capture function.

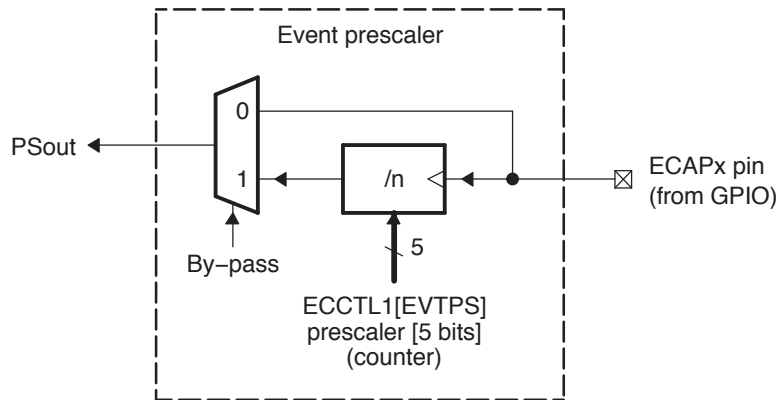
Figure 15-103. Capture Function Diagram



15.3.2.2.1 Event Prescaler

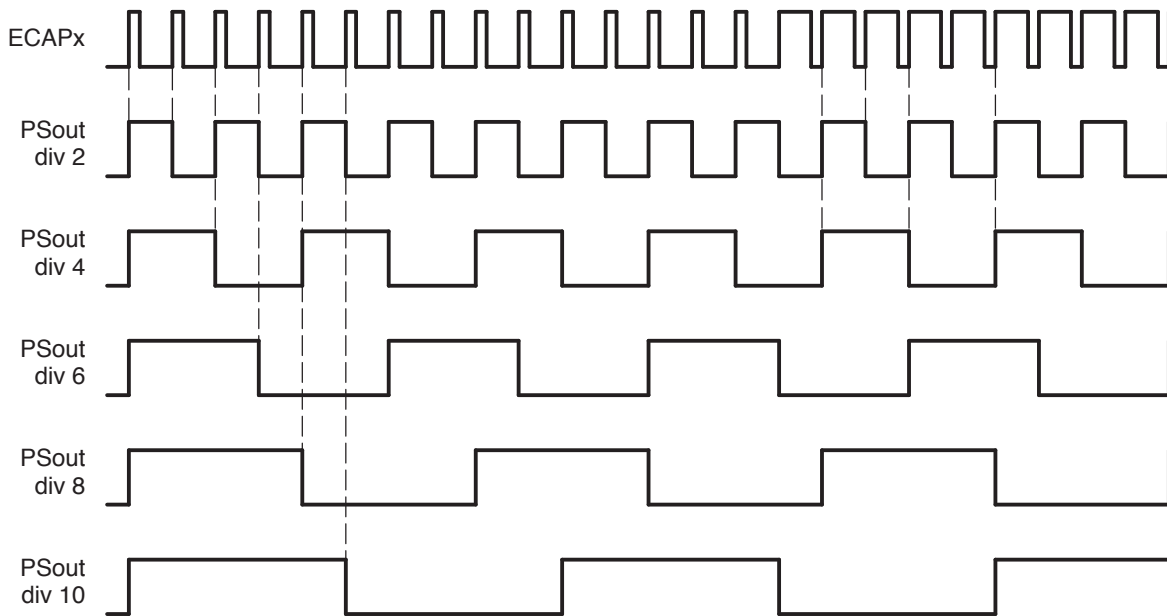
An input capture signal (pulse train) can be prescaled by $N = 2-62$ (in multiples of 2) or can bypass the prescaler. This is useful when very high frequency signals are used as inputs. Figure 15-104 shows a functional diagram and Figure 15-105 shows the operation of the prescale function.

Figure 15-104. Event Prescale Control



- (1) When a prescale value of 1 is chosen (ECCTL1[13:9] = 0000) the input capture signal by-passes the prescale logic completely.

Figure 15-105. Prescale Function Waveforms



15.3.2.2.2 Edge Polarity Select and Qualifier

- Four independent edge polarity (rising edge/falling edge) selection multiplexers are used, one for each capture event.
- Each edge (up to 4) is event qualified by the Modulo4 sequencer.
- The edge event is gated to its respective CAP n register by the Mod4 counter. The CAP n register is loaded on the falling edge.

15.3.2.2.3 Continuous/One-Shot Control

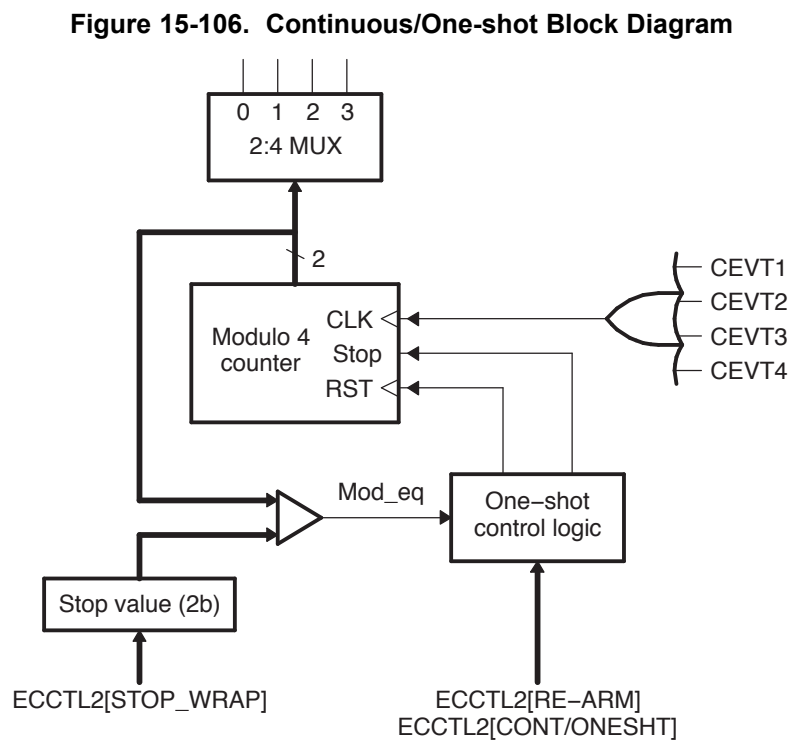
- The Mod4 (2 bit) counter is incremented via edge qualified events (CEVT1-CEVT4).
- The Mod4 counter continues counting (0->1->2->3->0) and wraps around unless stopped.
- A 2-bit stop register is used to compare the Mod4 counter output, and when equal stops the Mod4 counter and inhibits further loads of the CAP1-CAP4 registers. This occurs during one-shot operation.

The continuous/one-shot block (Figure 15-106) controls the start/stop and reset (zero) functions of the Mod4 counter via a mono-shot type of action that can be triggered by the stop-value comparator and re-armed via software control.

Once armed, the eCAP module waits for 1-4 (defined by stop-value) capture events before freezing both the Mod4 counter and contents of CAP1-4 registers (time-stamps).

Re-arming prepares the eCAP module for another capture sequence. Also re-arming clears (to zero) the Mod4 counter and permits loading of CAP1-4 registers again, providing the CAPLDEN bit is set.

In continuous mode, the Mod4 counter continues to run (0->1->2->3->0, the one-shot action is ignored, and capture values continue to be written to CAP1-4 in a circular buffer sequence.



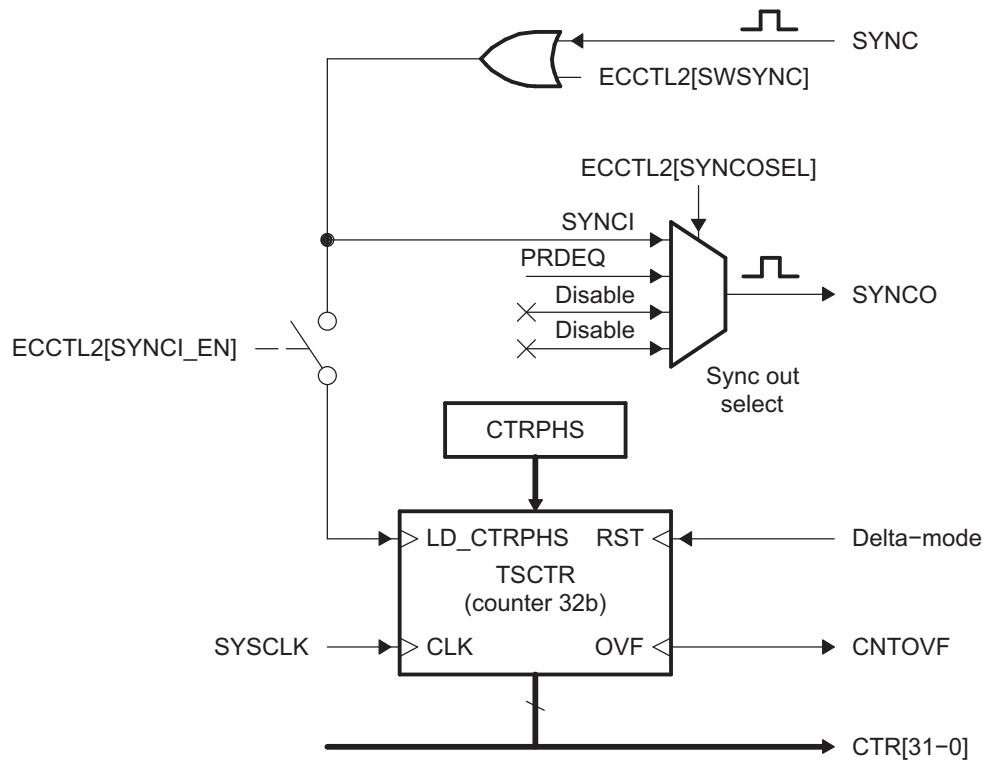
15.3.2.2.4 32-Bit Counter and Phase Control

This counter (Figure 15-107) provides the time-base for event captures, and is clocked via the system clock.

A phase register is provided to achieve synchronization with other counters, via a hardware and software forced sync. This is useful in APWM mode when a phase offset between modules is needed.

On any of the four event loads, an option to reset the 32-bit counter is given. This is useful for time difference capture. The 32-bit counter value is captured first, then it is reset to 0 by any of the LD1-LD4 signals.

Figure 15-107. Counter and Synchronization Block Diagram



15.3.2.2.5 CAP1-CAP4 Registers

These 32-bit registers are fed by the 32-bit counter timer bus, CTR[0-31] and are loaded (capture a time-stamp) when their respective LD inputs are strobed.

Loading of the capture registers can be inhibited via control bit CAPLDEN. During one-shot operation, this bit is cleared (loading is inhibited) automatically when a stop condition occurs, StopValue = Mod4.

CAP1 and CAP2 registers become the active period and compare registers, respectively, in APWM mode.

CAP3 and CAP4 registers become the respective shadow registers (APRD and ACMP) for CAP1 and CAP2 during APWM operation.

15.3.2.2.6 Interrupt Control

An Interrupt can be generated on capture events (CEVT1-CEVT4, CINTOVF) or APWM events (PRDEQ, CMPEQ). See [Figure 15-108](#).

A counter overflow event (FFFF FFFFh->0000 0000h) is also provided as an interrupt source (CINTOVF).

The capture events are edge and sequencer qualified (that is, ordered in time) by the polarity select and Mod4 gating, respectively.

One of these events can be selected as the interrupt source (from the eCAP_n module) going to the interrupt controller.

Seven interrupt events (CEVT1, CEVT2, CEVT3, CEVT4, CINTOVF, PRDEQ, CMPEQ) can be generated. The interrupt enable register (ECEINT) is used to enable/disable individual interrupt event sources. The interrupt flag register (ECFLG) indicates if any interrupt event has been latched and contains the global interrupt flag bit (INT). An interrupt pulse is generated to the interrupt controller only if any of the interrupt events are enabled, the flag bit is 1, and the INT flag bit is 0. The interrupt service routine must clear the global interrupt flag bit and the serviced event via the interrupt clear register (ECCLR) before any other interrupt pulses are generated. You can force an interrupt event via the interrupt force register (ECFRC). This is useful for test purposes.

Note that the interrupts coming from the eCAP module are also used as DMA events. The interrupt registers should be used to enable and clear the current DMA event in order for the eCAP module to generate subsequent DMA events.

15.3.2.2.7 Shadow Load and Lockout Control

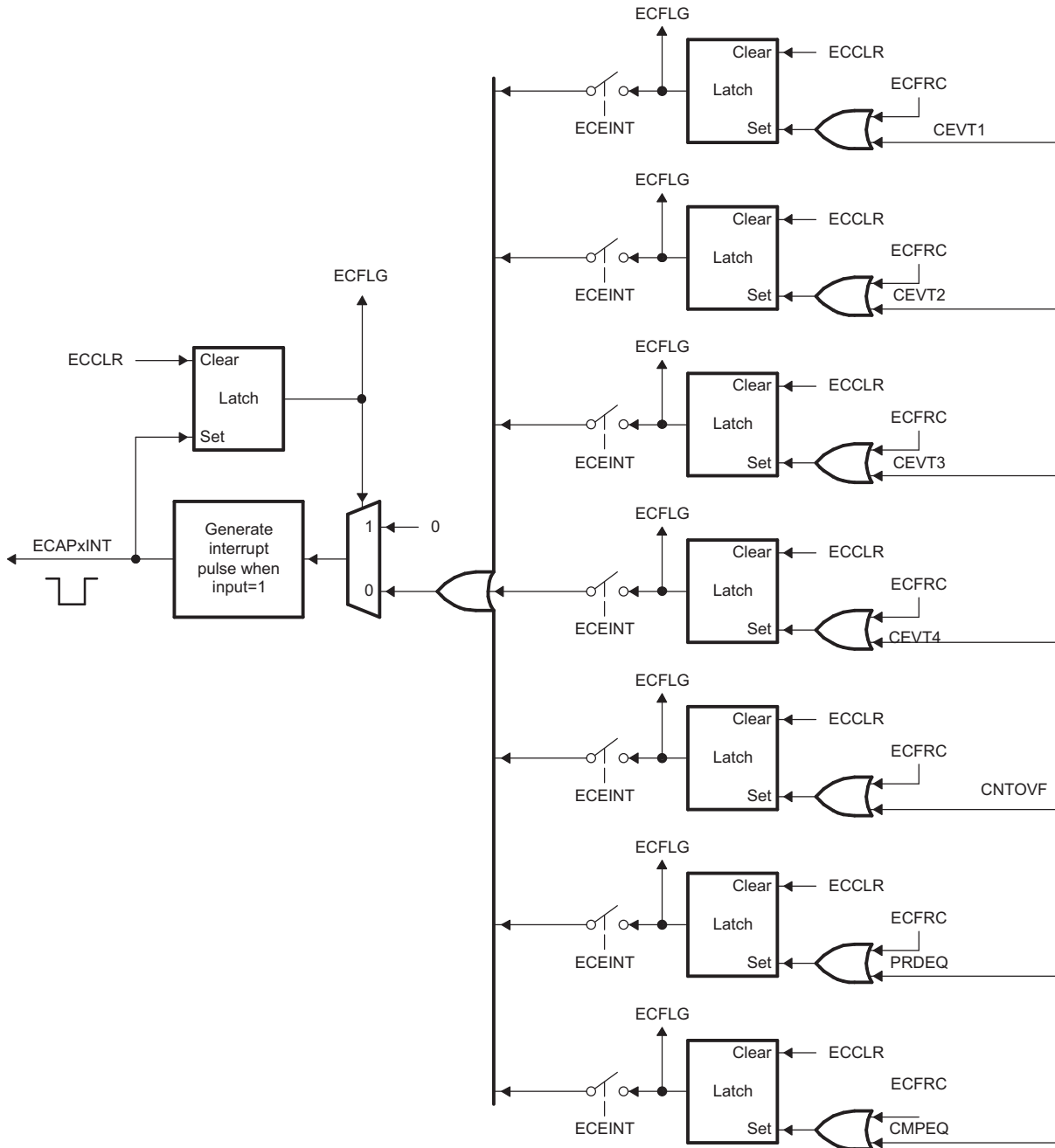
In capture mode, this logic inhibits (locks out) any shadow loading of CAP1 or CAP2 from APRD and ACMP registers, respectively.

In APWM mode, shadow loading is active and two choices are permitted:

- Immediate - APRD or ACMP are transferred to CAP1 or CAP2 immediately upon writing a new value.
- On period equal, CTR[31:0] = PRD[31:0]

NOTE: The CEVT1, CEVT2, CEVT3, CEVT4 flags are only active in capture mode (ECCTL2[CAP/APWM == 0]). The PRDEQ, CMPEQ flags are only valid in APWM mode (ECCTL2[CAP/APWM == 1]). CINTOVF flag is valid in both modes.

Figure 15-108. Interrupts in eCAP Module

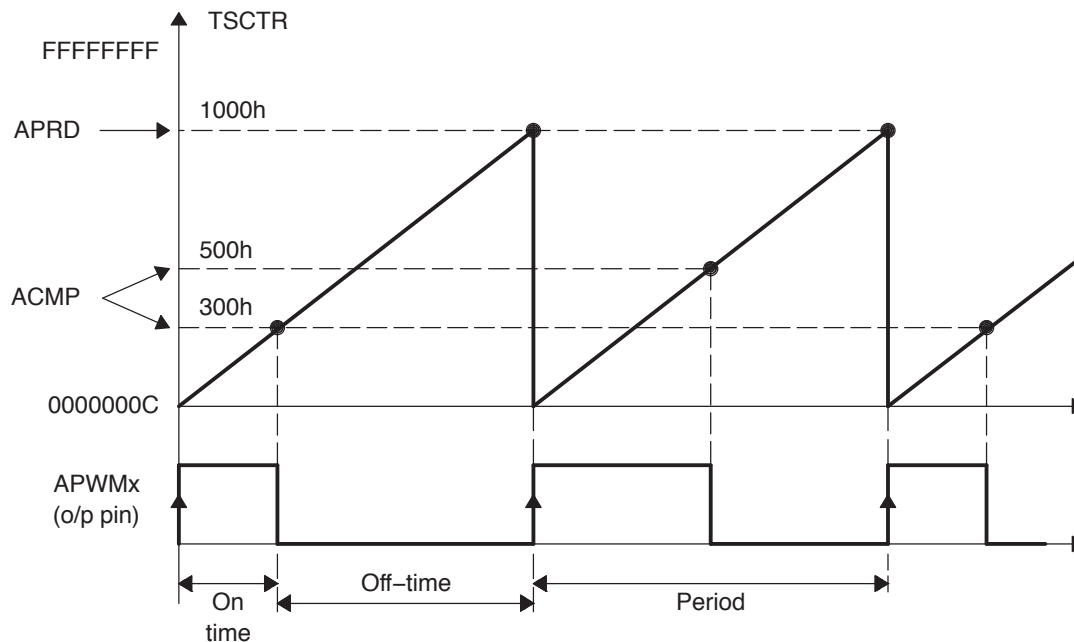


15.3.2.2.8 APWM Mode Operation

Main operating highlights of the APWM section:

- The time-stamp counter bus is made available for comparison via 2 digital (32-bit) comparators.
- When CAP1/2 registers are not used in capture mode, their contents can be used as Period and Compare values in APWM mode.
- Double buffering is achieved via shadow registers APRD and ACMP (CAP3/4). The shadow register contents are transferred over to CAP1/2 registers either immediately upon a write, or on a PRDEQ trigger.
- In APWM mode, writing to CAP1/CAP2 active registers will also write the same value to the corresponding shadow registers CAP3/CAP4. This emulates immediate mode. Writing to the shadow registers CAP3/CAP4 will invoke the shadow mode.
- During initialization, you must write to the active registers for both period and compare. This automatically copies the initial values into the shadow values. For subsequent compare updates, during run-time, you only need to use the shadow registers.

Figure 15-109. PWM Waveform Details Of APWM Mode Operation



The behavior of APWM active-high mode (APWMPOL == 0) is:

CMP = 0x00000000, output low for duration of period (0% duty)

CMP = 0x00000001, output high 1 cycle

CMP = 0x00000002, output high 2 cycles

CMP = PERIOD, output high except for 1 cycle (<100% duty)

CMP = PERIOD+1, output high for complete period (100% duty)

CMP > PERIOD+1, output high for complete period

The behavior of APWM active-low mode (APWMPOL == 1) is:

CMP = 0x00000000, output high for duration of period (0% duty)

CMP = 0x00000001, output low 1 cycle

CMP = 0x00000002, output low 2 cycles

CMP = PERIOD, output low except for 1 cycle (<100% duty)

CMP = PERIOD+1, output low for complete period (100% duty)

CMP > PERIOD+1, output low for complete period

15.3.3 Use Cases

The following sections will provide Applications examples and code snippets to show how to configure and operate the eCAP module. For clarity and ease of use, below are useful #defines which will help in the understanding of the examples.

```
// ECCTL1 ( ECAP Control Reg 1)
//=====
// CAPxPOL bits
#define EC_RISING          0x0
#define EC_FALLING        0x1

// CTRRSTx bits
#define EC_ABS_MODE       0x0
#define EC_DELTA_MODE    0x1

// PRESCALE bits
#define EC_BYPASS         0x0
#define EC_DIV1           0x0
#define EC_DIV2           0x1
#define EC_DIV4           0x2
#define EC_DIV6           0x3
#define EC_DIV8           0x4
#define EC_DIV10          0x5

// ECCTL2 ( ECAP Control Reg 2)
//=====
// CONT/ONESHOT bit
#define EC_CONTINUOUS     0x0
#define EC_ONESHOT       0x1

// STOPVALUE bit
#define EC_EVENT1         0x0
#define EC_EVENT2         0x1
#define EC_EVENT3         0x2
#define EC_EVENT4         0x3

// RE-ARM bit
#define EC_ARM            0x1

// TSCTRSTOP bit
#define EC_FREEZE         0x0
#define EC_RUN            0x1

// SYNCO_SEL bit
#define EC_SYNCIN         0x0
#define EC_CTR_PRD        0x1
#define EC_SYNCO_DIS      0x2

// CAP/APWM mode bit
#define EC_CAP_MODE       0x0
#define EC_APWM_MODE      0x1

// APWMPOL bit
#define EC_ACTV_HI        0x0
#define EC_ACTV_LO        0x1

// Generic
#define EC_DISABLE        0x0
#define EC_ENABLE         0x1
#define EC_FORCE          0x1
```

15.3.3.1 Absolute Time-Stamp Operation Rising Edge Trigger Example

Figure 15-110 shows an example of continuous capture operation (Mod4 counter wraps around). In this figure, TSCTR counts-up without resetting and capture events are qualified on the rising edge only, this gives period (and frequency) information.

On an event, the TSCTR contents (time-stamp) is first captured, then Mod4 counter is incremented to the next state. When the TSCTR reaches FFFF FFFFh (maximum value), it wraps around to 0000 0000h (not shown in Figure 15-110), if this occurs, the CNTOVF (counter overflow) flag is set, and an interrupt (if enabled) occurs, CNTOVF (counter overflow) Flag is set, and an Interrupt (if enabled) occurs. Captured time-stamps are valid at the point indicated by the diagram, after the 4th event, hence event CEVT4 can conveniently be used to trigger an interrupt and the CPU can read data from the CAP_n registers.

Figure 15-110. Capture Sequence for Absolute Time-Stamp, Rising Edge Detect

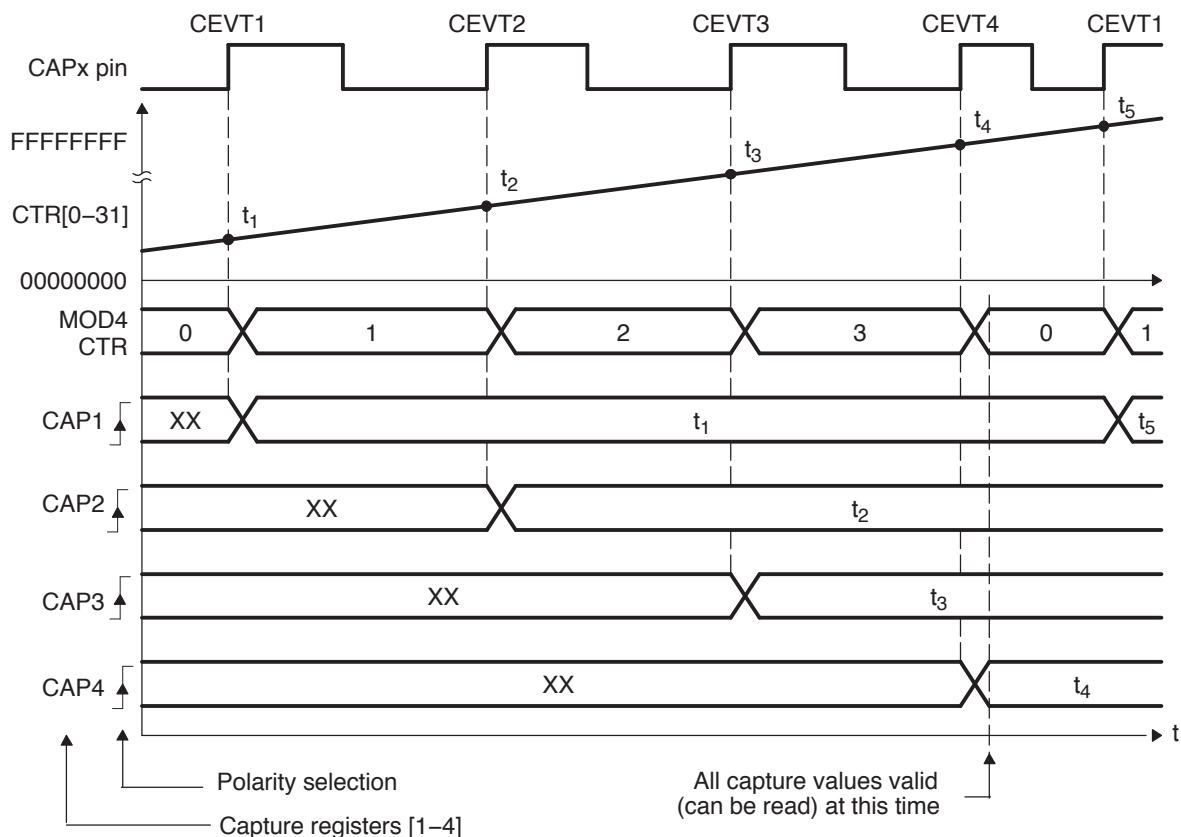


Table 15-88. ECAP Initialization for CAP Mode Absolute Time, Rising Edge Trigger

Register	Bit	Value
ECCTL1	CAP1POL	EC_RISING
ECCTL1	CAP2POL	EC_RISING
ECCTL1	CAP3POL	EC_RISING
ECCTL1	CAP4POL	EC_RISING
ECCTL1	CTRRST1	EC_ABS_MODE
ECCTL1	CTRRST2	EC_ABS_MODE
ECCTL1	CTRRST3	EC_ABS_MODE
ECCTL1	CTRRST4	EC_ABS_MODE
ECCTL1	CAPLDEN	EC_ENABLE
ECCTL1	PRESCALE	EC_DIV1
ECCTL2	CAP_APWM	EC_CAP_MODE
ECCTL2	CONT_ONESHT	EC_CONTINUOUS
ECCTL2	SYNCO_SEL	EC_SYNCO_DIS
ECCTL2	SYNCl_EN	EC_DISABLE
ECCTL2	TSCTRSTOP	EC_RUN

Example 15-9. Code Snippet for CAP Mode Absolute Time, Rising Edge Trigger

```
// Code snippet for CAP mode Absolute Time, Rising edge trigger

// Run Time ( e.g. CEVT4 triggered ISR call)
//=====
TSt1 = ECAPxRegs.CAP1;      // Fetch Time-Stamp captured at t1
TSt2 = ECAPxRegs.CAP2;      // Fetch Time-Stamp captured at t2
TSt3 = ECAPxRegs.CAP3;      // Fetch Time-Stamp captured at t3
TSt4 = ECAPxRegs.CAP4;      // Fetch Time-Stamp captured at t4

Period1 = TSt2-TSt1;        // Calculate 1st period
Period2 = TSt3-TSt2;        // Calculate 2nd period
Period3 = TSt4-TSt3;        // Calculate 3rd period
```

15.3.3.2 Absolute Time-Stamp Operation Rising and Falling Edge Trigger Example

In Figure 15-111 the eCAP operating mode is almost the same as in the previous section except capture events are qualified as either rising or falling edge, this now gives both period and duty cycle information: $\text{Period1} = t_3 - t_1$, $\text{Period2} = t_5 - t_3$, etc. $\text{Duty Cycle1 (on-time \%)} = (t_2 - t_1) / \text{Period1} \times 100\%$, etc. $\text{Duty Cycle1 (off-time \%)} = (t_3 - t_2) / \text{Period1} \times 100\%$, etc.

Figure 15-111. Capture Sequence for Absolute Time-Stamp, Rising and Falling Edge Detect

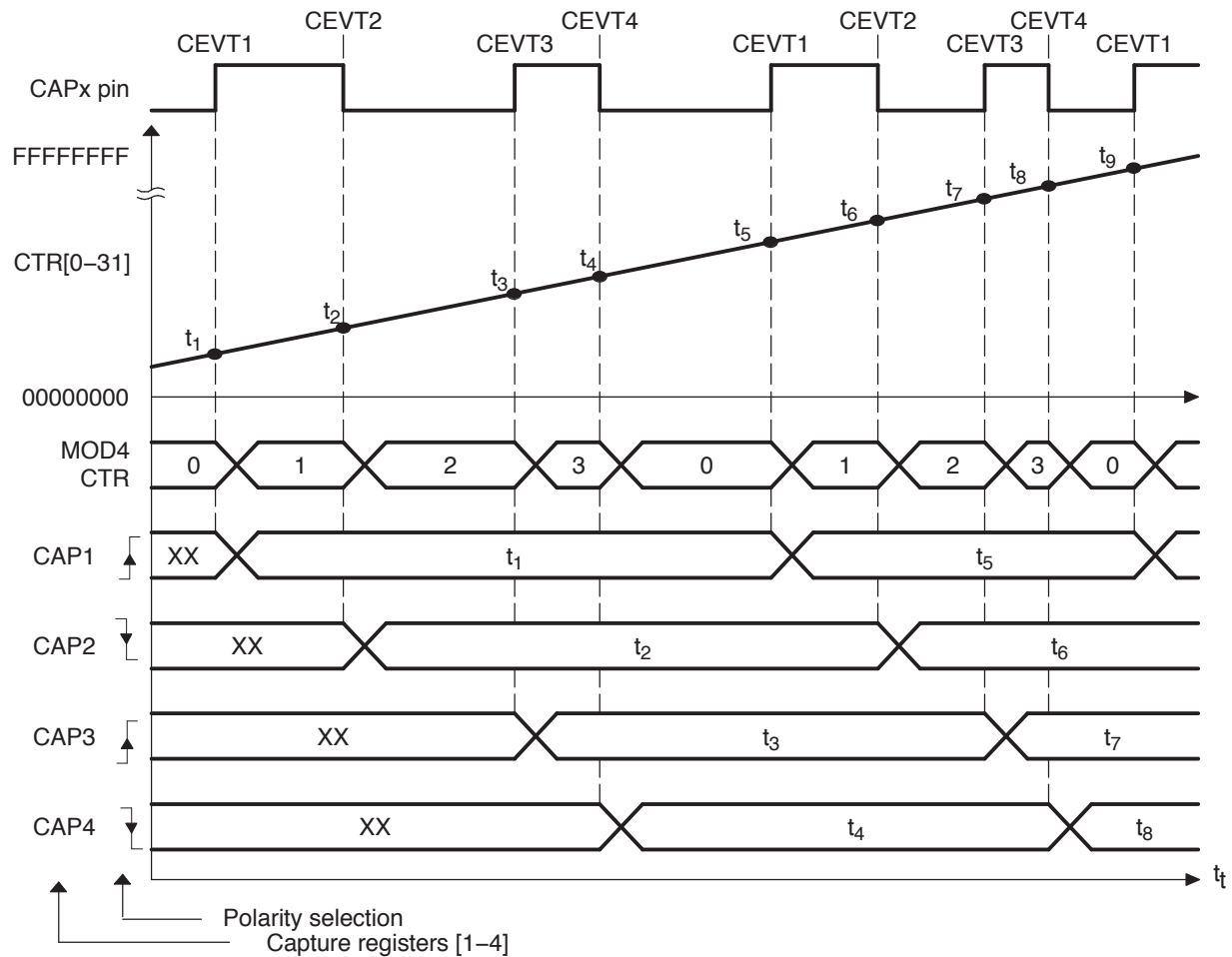


Table 15-89. ECAP Initialization for CAP Mode Absolute Time, Rising and Falling Edge Trigger

Register	Bit	Value
ECCTL1	CAP1POL	EC_RISING
ECCTL1	CAP2POL	EC_FALLING
ECCTL1	CAP3POL	EC_RISING
ECCTL1	CAP4POL	EC_FALLING
ECCTL1	CTRRST1	EC_ABS_MODE
ECCTL1	CTRRST2	EC_ABS_MODE
ECCTL1	CTRRST3	EC_ABS_MODE
ECCTL1	CTRRST4	EC_ABS_MODE
ECCTL1	CAPLDEN	EC_ENABLE
ECCTL1	PRESCALE	EC_DIV1
ECCTL2	CAP_APWM	EC_CAP_MODE
ECCTL2	CONT_ONESHT	EC_CONTINUOUS
ECCTL2	SYNCO_SEL	EC_SYNCO_DIS
ECCTL2	SYNCl_EN	EC_DISABLE
ECCTL2	TSCTRSTOP	EC_RUN

Example 15-10. Code Snippet for CAP Mode Absolute Time, Rising and Falling Edge Trigger

```

// Code snippet for CAP mode Absolute Time, Rising & Falling edge triggers

// Run Time ( e.g. CEVT4 triggered ISR call)
//=====
TSt1 = ECAPxRegs.CAP1;      // Fetch Time-Stamp captured at t1
TSt2 = ECAPxRegs.CAP2;      // Fetch Time-Stamp captured at t2
TSt3 = ECAPxRegs.CAP3;      // Fetch Time-Stamp captured at t3
TSt4 = ECAPxRegs.CAP4;      // Fetch Time-Stamp captured at t4

Period1 = TSt3-TSt1;        // Calculate 1st period
DutyOnTime1 = TSt2-TSt1;    // Calculate On time
DutyOffTime1 = TSt3-TSt2;    // Calculate Off time

```

15.3.3.3 Time Difference (Delta) Operation Rising Edge Trigger Example

Figure 15-112 shows how the eCAP module can be used to collect Delta timing data from pulse train waveforms. Here Continuous Capture mode (TSCTR counts-up without resetting, and Mod4 counter wraps around) is used. In Delta-time mode, TSCTR is Reset back to Zero on every valid event. Here Capture events are qualified as Rising edge only. On an event, TSCTR contents (time-stamp) is captured first, and then TSCTR is reset to Zero. The Mod4 counter then increments to the next state. If TSCTR reaches FFFF FFFFh (maximum value), before the next event, it wraps around to 0000 0000h and continues, a CNTOVF (counter overflow) Flag is set, and an Interrupt (if enabled) occurs. The advantage of Delta-time Mode is that the CAP n contents directly give timing data without the need for CPU calculations: Period1 = T_1 , Period2 = T_2 , etc. As shown in Figure 15-112, the CEVT1 event is a good trigger point to read the timing data, T_1 , T_2 , T_3 , T_4 are all valid here.

Figure 15-112. Capture Sequence for Delta Mode Time-Stamp, Rising Edge Detect

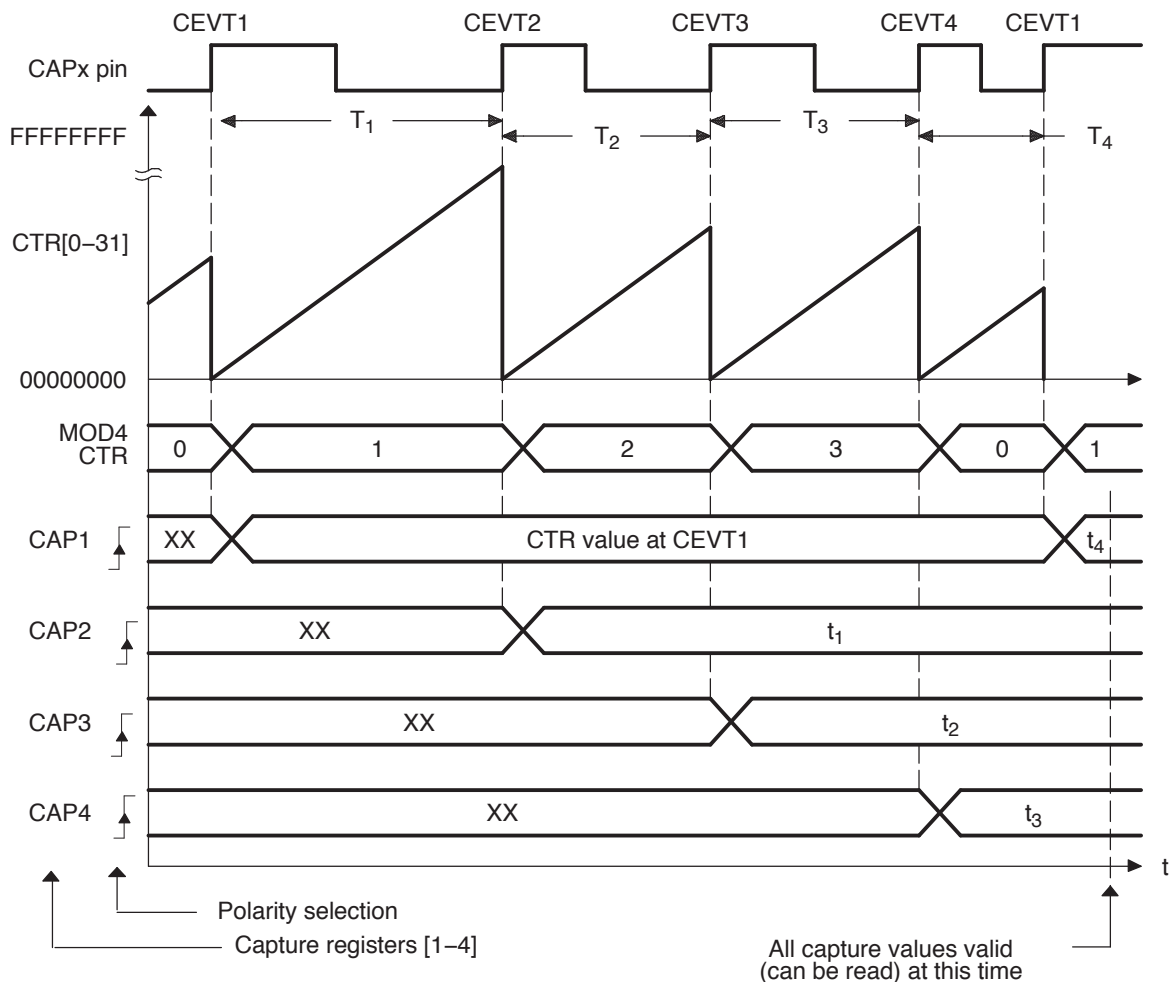


Table 15-90. ECAP Initialization for CAP Mode Delta Time, Rising Edge Trigger

Register	Bit	Value
ECCTL1	CAP1POL	EC_RISING
ECCTL1	CAP2POL	EC_RISING
ECCTL1	CAP3POL	EC_RISING
ECCTL1	CAP4POL	EC_RISING
ECCTL1	CTRRST1	EC_DELTA_MODE
ECCTL1	CTRRST2	EC_DELTA_MODE
ECCTL1	CTRRST3	EC_DELTA_MODE
ECCTL1	CTRRST4	EC_DELTA_MODE
ECCTL1	CAPLDEN	EC_ENABLE
ECCTL1	PRESCALE	EC_DIV1
ECCTL2	CAP_APWM	EC_CAP_MODE
ECCTL2	CONT_ONESHT	EC_CONTINUOUS
ECCTL2	SYNCO_SEL	EC_SYNCO_DIS
ECCTL2	SYNCl_EN	EC_DISABLE
ECCTL2	TSTRSTOP	EC_RUN

Example 15-11. Code Snippet for CAP Mode Delta Time, Rising Edge Trigger

```
// Code snippet for CAP mode Delta Time, Rising edge trigger

// Run Time ( e.g. CEVT1 triggered ISR call)
//=====
// Note: here Time-stamp directly represents the Period value.
Period4 = ECAPxRegs.CAP1;    // Fetch Time-Stamp captured at T1
Period1 = ECAPxRegs.CAP2;    // Fetch Time-Stamp captured at T2
Period2 = ECAPxRegs.CAP3;    // Fetch Time-Stamp captured at T3
Period3 = ECAPxRegs.CAP4;    // Fetch Time-Stamp captured at T4
```

15.3.3.4 Time Difference (Delta) Operation Rising and Falling Edge Trigger Example

In Figure 15-113 the eCAP operating mode is almost the same as in previous section except Capture events are qualified as either Rising or Falling edge, this now gives both Period and Duty cycle information: $\text{Period1} = T_1 + T_2$, $\text{Period2} = T_3 + T_4$, etc $\text{Duty Cycle1 (on-time \%)} = T_1 / \text{Period1} \times 100\%$, etc $\text{Duty Cycle1 (off-time \%)} = T_2 / \text{Period1} \times 100\%$, etc

During initialization, you must write to the active registers for both period and compare. This will then automatically copy the init values into the shadow values. For subsequent compare updates, that is, during run-time, only the shadow registers must be used.

Figure 15-113. Capture Sequence for Delta Mode Time-Stamp, Rising and Falling Edge Detect

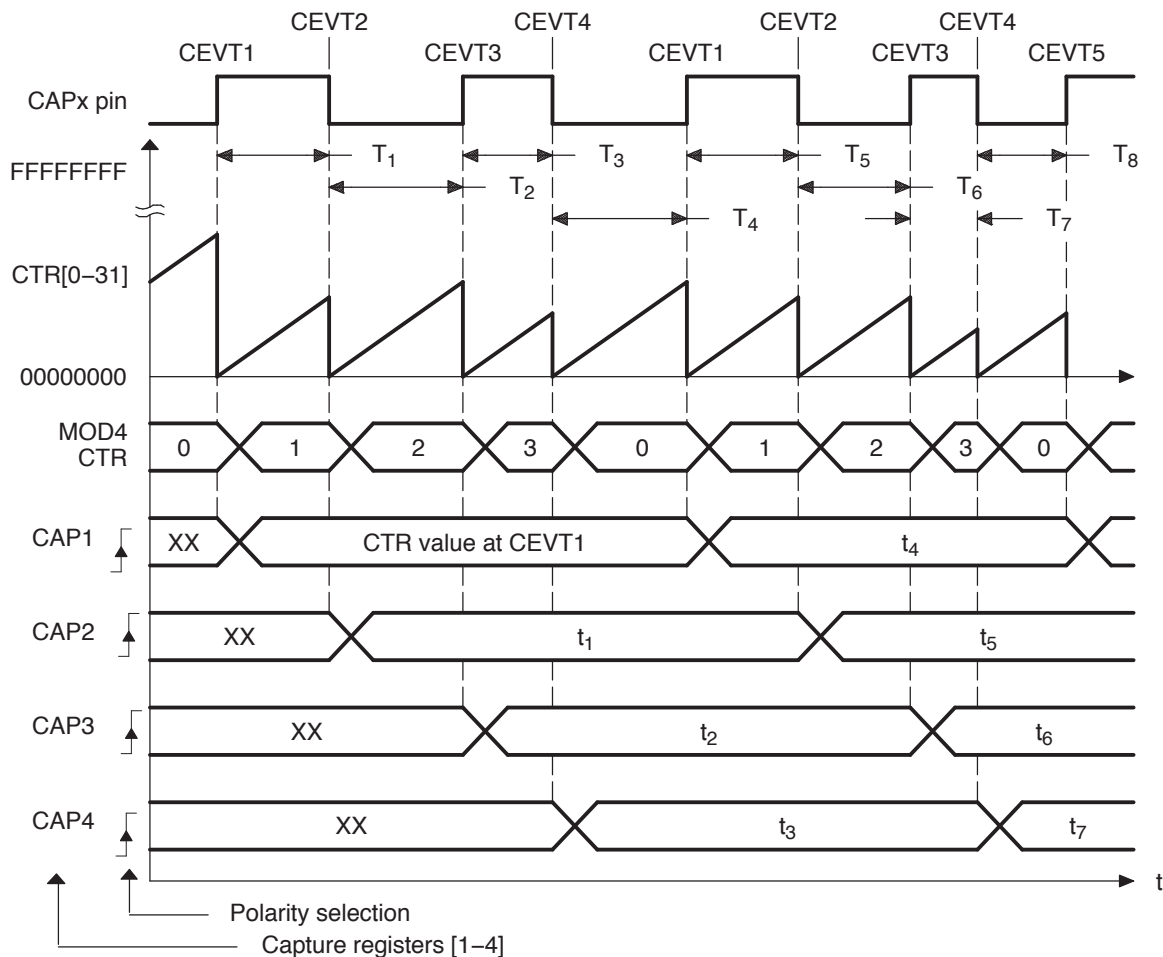


Table 15-91. ECAP Initialization for CAP Mode Delta Time, Rising and Falling Edge Triggers

Register	Bit	Value
ECCTL1	CAP1POL	EC_RISING
ECCTL1	CAP2POL	EC_FALLING
ECCTL1	CAP3POL	EC_RISING
ECCTL1	CAP4POL	EC_FALLING
ECCTL1	CTRRST1	EC_DELTA_MODE
ECCTL1	CTRRST2	EC_DELTA_MODE
ECCTL1	CTRRST3	EC_DELTA_MODE
ECCTL1	CTRRST4	EC_DELTA_MODE
ECCTL1	CAPLDEN	EC_ENABLE
ECCTL1	PRESCALE	EC_DIV1
ECCTL2	CAP_APWM	EC_CAP_MODE
ECCTL2	CONT_ONESHT	EC_CONTINUOUS
ECCTL2	SYNCO_SEL	EC_SYNCO_DIS
ECCTL2	SYNCl_EN	EC_DISABLE
ECCTL2	TSTRSTOP	EC_RUN

Example 15-12. Code Snippet for CAP Mode Delta Time, Rising and Falling Edge Triggers

```
// Code snippet for CAP mode Delta Time, Rising and Falling edge triggers

// Run Time ( e.g. CEVT1 triggered ISR call)
//=====
// Note: here Time-stamp directly represents the Duty cycle values.
DutyOnTime1 = ECAPxRegs.CAP2;    // Fetch Time-Stamp captured at T2
DutyOffTime1 = ECAPxRegs.CAP3;   // Fetch Time-Stamp captured at T3
DutyOnTime2 = ECAPxRegs.CAP4;    // Fetch Time-Stamp captured at T4
DutyOffTime2 = ECAPxRegs.CAP1;   // Fetch Time-Stamp captured at T1

Period1 = DutyOnTime1 + DutyOffTime1;
Period2 = DutyOnTime2 + DutyOffTime2;
```

15.3.3.5 Application of the APWM Mode

15.3.3.5.1 Simple PWM Generation (Independent Channel/s) Example

In this example, the eCAP module is configured to operate as a PWM generator. Here a very simple single channel PWM waveform is generated from output pin APWM n . The PWM polarity is active high, which means that the compare value (CAP2 reg is now a compare register) represents the on-time (high level) of the period. Alternatively, if the APWMPOL bit is configured for active low, then the compare value represents the off-time.

Figure 15-114. PWM Waveform Details of APWM Mode Operation

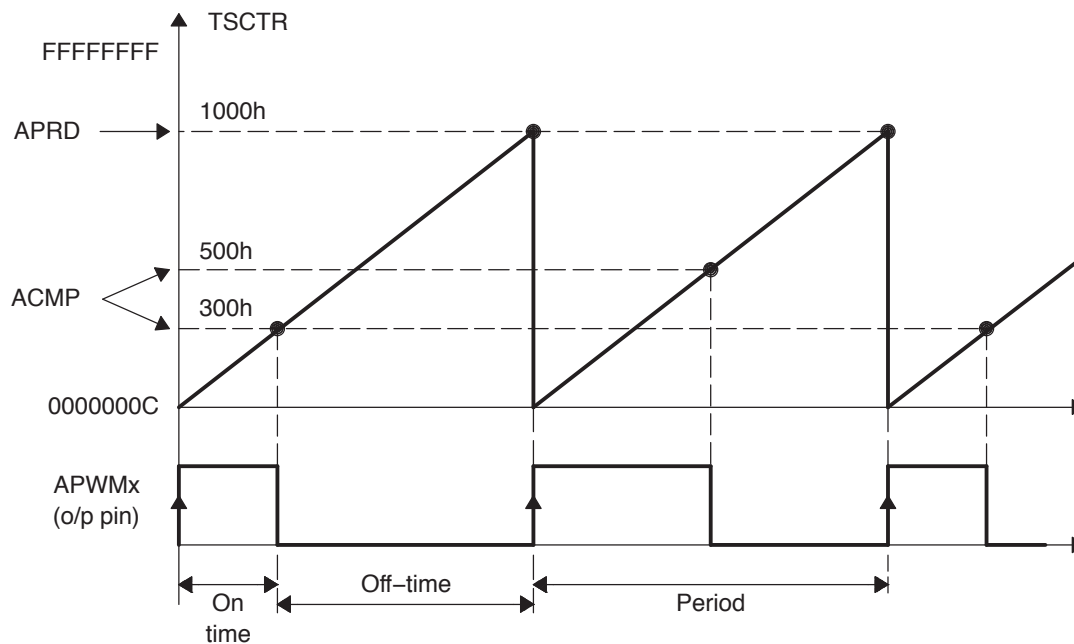


Table 15-92. ECAP Initialization for APWM Mode

Register	Bit	Value
CAP1	CAP1	0x1000
CTRPHS	CTRPHS	0x0
ECCTL2	CAP_APWM	EC_APWM_MODE
ECCTL2	APWMPOL	EC_ACTV_HI
ECCTL2	SYNCl_EN	EC_DISABLE
ECCTL2	SYNCO_SEL	EC_SYNCO_DIS
ECCTL2	TSTRSTOP	EC_RUN

Example 15-13. Code Snippet for APWM Mode

```

// Code snippet for APWM mode Example 1

// Run Time (Instant 1, e.g. ISR call)
//=====
    ECAPxRegs.CAP2 = 0x300;      // Set Duty cycle i.e. compare value

// Run Time (Instant 2, e.g. another ISR call)
//=====
    ECAPxRegs.CAP2 = 0x500;      // Set Duty cycle i.e. compare value

```

15.3.3.5.2 Multichannel PWM Generation with Synchronization Example

Figure 15-115 takes advantage of the synchronization feature between eCAP modules. Here 4 independent PWM channels are required with different frequencies, but at integer multiples of each other to avoid "beat" frequencies. Hence one eCAP module is configured as the Master and the remaining 3 are Slaves all receiving their synch pulse (CTR = PRD) from the master. Note the Master is chosen to have the lower frequency ($F_1 = 1/20,000$) requirement. Here Slave2 Freq = $2 \times F_1$, Slave3 Freq = $4 \times F_1$ and Slave4 Freq = $5 \times F_1$. Note here values are in decimal notation. Also, only the APWM1 output waveform is shown.

Figure 15-115. Multichannel PWM Example Using 4 eCAP Modules

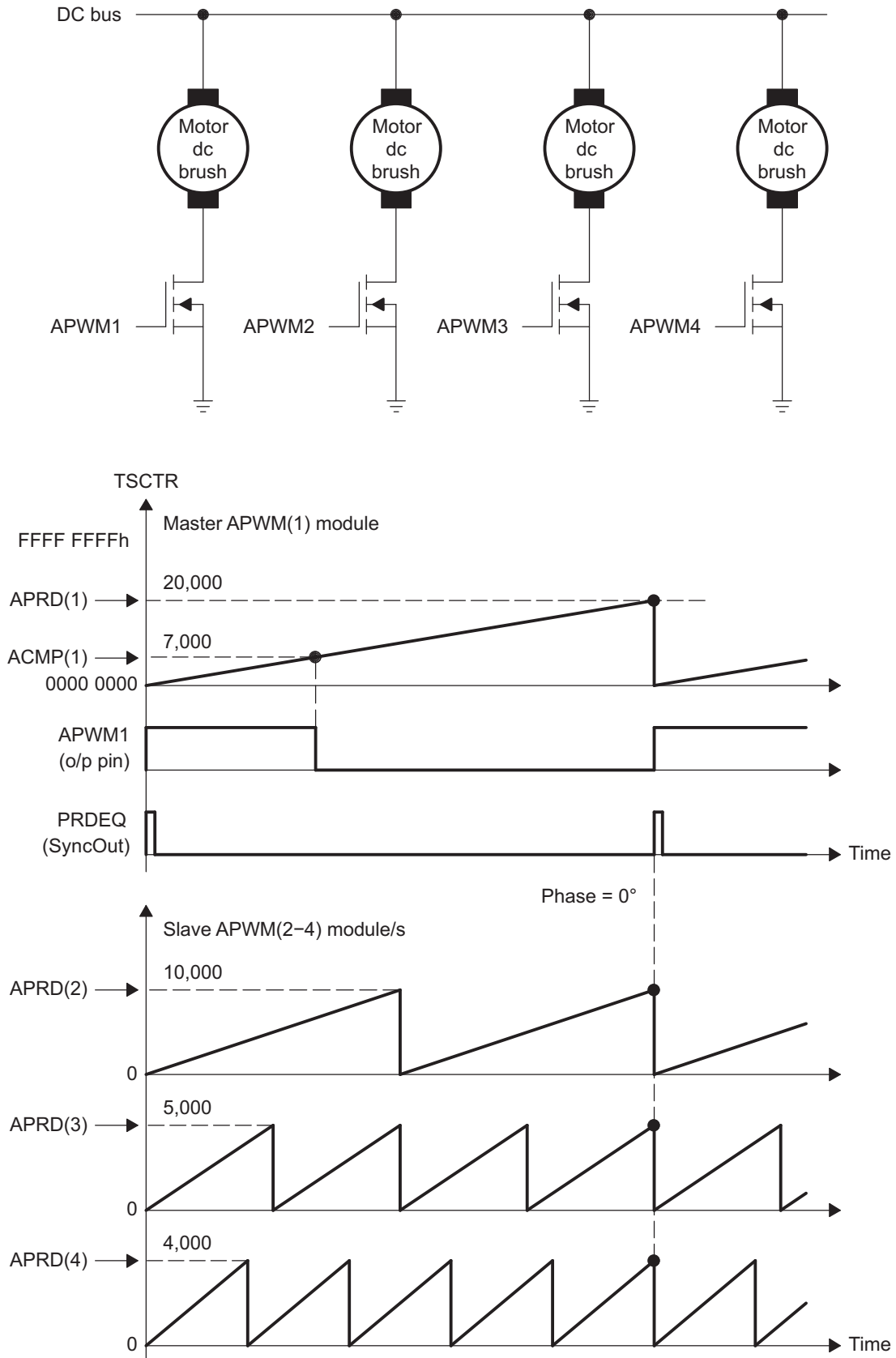


Table 15-93. ECAP1 Initialization for Multichannel PWM Generation with Synchronization

Register	Bit	Value
CAP1	CAP1	20000
CTRPHS	CTRPHS	0
ECCTL2	CAP_APWM	EC_APWM_MODE
ECCTL2	APWMPOL	EC_ACTV_HI
ECCTL2	SYNCl_EN	EC_DISABLE
ECCTL2	SYNCO_SEL	EC_CTR_PRD
ECCTL2	TSCTRSTOP	EC_RUN

Table 15-94. ECAP2 Initialization for Multichannel PWM Generation with Synchronization

Register	Bit	Value
CAP1	CAP1	10000
CTRPHS	CTRPHS	0
ECCTL2	CAP_APWM	EC_APWM_MODE
ECCTL2	APWMPOL	EC_ACTV_HI
ECCTL2	SYNCl_EN	EC_ENABLE
ECCTL2	SYNCO_SEL	EC_SYNCl
ECCTL2	TSCTRSTOP	EC_RUN

Table 15-95. ECAP3 Initialization for Multichannel PWM Generation with Synchronization

Register	Bit	Value
CAP1	CAP1	5000
CTRPHS	CTRPHS	0
ECCTL2	CAP_APWM	EC_APWM_MODE
ECCTL2	APWMPOL	EC_ACTV_HI
ECCTL2	SYNCl_EN	EC_ENABLE
ECCTL2	SYNCO_SEL	EC_SYNCl
ECCTL2	TSCTRSTOP	EC_RUN

Table 15-96. ECAP4 Initialization for Multichannel PWM Generation with Synchronization

Register	Bit	Value
CAP1	CAP1	4000
CTRPHS	CTRPHS	0
ECCTL2	CAP_APWM	EC_APWM_MODE
ECCTL2	APWMPOL	EC_ACTV_HI
ECCTL2	SYNCl_EN	EC_ENABLE
ECCTL2	SYNCO_SEL	EC_SYNCO_DIS
ECCTL2	TSCTRSTOP	EC_RUN

Example 15-14. Code Snippet for Multichannel PWM Generation with Synchronization

```

// Code snippet for APWM mode Example 2

// Run Time (Note: Example execution of one run-time instant)
//=====
ECAP1Regs.CAP2 = 7000;    // Set Duty cycle i.e., compare value = 7000
ECAP2Regs.CAP2 = 2000;    // Set Duty cycle i.e., compare value = 2000
ECAP3Regs.CAP2 = 550;     // Set Duty cycle i.e., compare value = 550
ECAP4Regs.CAP2 = 6500;    // Set Duty cycle i.e., compare value = 6500
    
```

15.3.3.5.3 Multichannel PWM Generation with Phase Control Example

In [Figure 15-116](#), the Phase control feature of the APWM mode is used to control a 3 phase Interleaved DC/DC converter topology. This topology requires each phase to be off-set by 120° from each other. Hence if “Leg” 1 (controlled by APWM1) is the reference Leg (or phase), that is, 0°, then Leg 2 need 120° off-set and Leg 3 needs 240° off-set. The waveforms in [Figure 15-116](#) show the timing relationship between each of the phases (Legs). Note eCAP1 module is the Master and issues a sync out pulse to the slaves (modules 2, 3) whenever TSCTR = Period value.

Figure 15-116. Multiphase (channel) Interleaved PWM Example Using 3 eCAP Modules

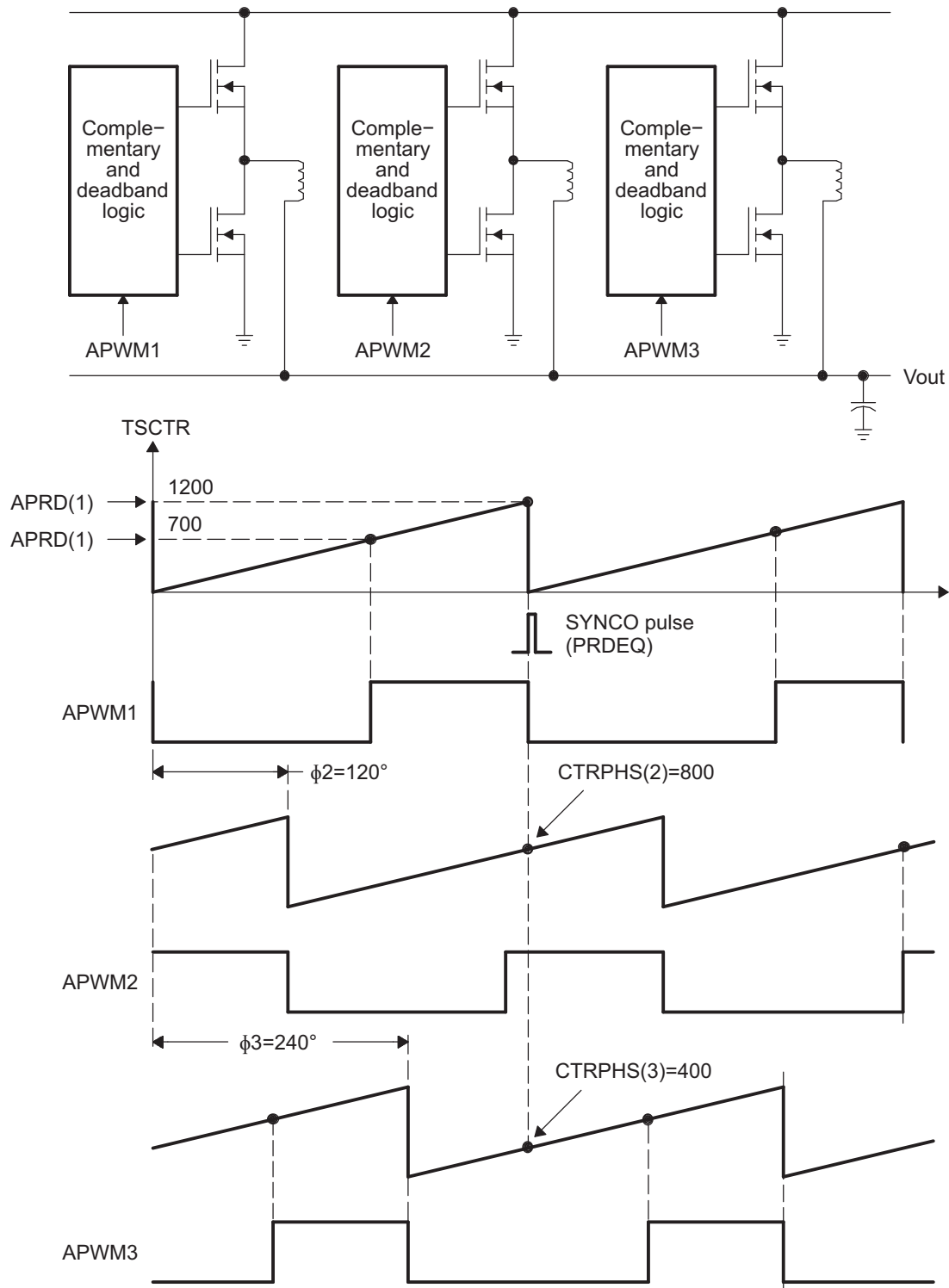


Table 15-97. ECAP1 Initialization for Multichannel PWM Generation with Phase Control

Register	Bit	Value
CAP1	CAP1	1200
CTRPHS	CTRPHS	0
ECCTL2	CAP_APWM	EC_APWM_MODE
ECCTL2	APWMPOL	EC_ACTV_HI
ECCTL2	SYNCl_EN	EC_DISABLE
ECCTL2	SYNCO_SEL	EC_CTR_PRD
ECCTL2	TSCTRSTOP	EC_RUN

Table 15-98. ECAP2 Initialization for Multichannel PWM Generation with Phase Control

Register	Bit	Value
CAP1	CAP1	1200
CTRPHS	CTRPHS	800
ECCTL2	CAP_APWM	EC_APWM_MODE
ECCTL2	APWMPOL	EC_ACTV_HI
ECCTL2	SYNCl_EN	EC_ENABLE
ECCTL2	SYNCO_SEL	EC_SYNCl
ECCTL2	TSCTRSTOP	EC_RUN

Table 15-99. ECAP3 Initialization for Multichannel PWM Generation with Phase Control

Register	Bit	Value
CAP1	CAP1	1200
CTRPHS	CTRPHS	400
ECCTL2	CAP_APWM	EC_APWM_MODE
ECCTL2	APWMPOL	EC_ACTV_HI
ECCTL2	SYNCl_EN	EC_ENABLE
ECCTL2	SYNCO_SEL	EC_SYNCO_DIS
ECCTL2	TSCTRSTOP	EC_RUN

Example 15-15. Code Snippet for Multichannel PWM Generation with Phase Control

```
// Code snippet for APWM mode Example 3

// Run Time (Note: Example execution of one run-time instant)
//=====
// All phases are set to the same duty cycle
ECAP1Regs.CAP2 = 700;    // Set Duty cycle i.e. compare value = 700
ECAP2Regs.CAP2 = 700;    // Set Duty cycle i.e. compare value = 700
ECAP3Regs.CAP2 = 700;    // Set Duty cycle i.e. compare value = 700
```


15.3.4 Registers

All 32-bit registers are aligned on even address boundaries and are organized in little-endian mode. The 16 least-significant bits of a 32-bit register are located on lowest address (even address).

NOTE: In APWM mode, writing to CAP1/CAP2 active registers also writes the same value to the corresponding shadow registers CAP3/CAP4. This emulates immediate mode. Writing to the shadow registers CAP3/CAP4 invokes the shadow mode.

15.3.4.1 ECAP Registers

[Table 15-100](#) lists the memory-mapped registers for the ECAP. All register offset addresses not listed in [Table 15-100](#) should be considered as reserved locations and the register contents should not be modified.

Table 15-100. ECAP Registers

Offset	Acronym	Register Name	Section
0h	TSCTR	Time-Stamp Counter Register	Section 15.3.4.1.1
4h	CTRPHS	Counter Phase Offset Value Register	Section 15.3.4.1.2
8h	CAP1	Capture 1 Register	Section 15.3.4.1.3
Ch	CAP2	Capture 2 Register	Section 15.3.4.1.4
10h	CAP3	Capture 3 Register	Section 15.3.4.1.5
14h	CAP4	Capture 4 Register	Section 15.3.4.1.6
28h	ECCTL1	Capture Control Register 1	Section 15.3.4.1.7
2Ah	ECCTL2	Capture Control Register 2	Section 15.3.4.1.8
2Ch	ECEINT	Capture Interrupt Enable Register	Section 15.3.4.1.9
2Eh	ECFLG	Capture Interrupt Flag Register	Section 15.3.4.1.10
30h	ECCLR	Capture Interrupt Clear Register	Section 15.3.4.1.11
32h	ECFRC	Capture Interrupt Force Register	Section 15.3.4.1.12
5Ch	REVID	Revision ID Register	Section 15.4.3.25

15.3.4.1.1 TSCTR Register (offset = 0h) [reset = 0h]

TSCTR is shown in [Figure 15-117](#) and described in [Table 15-101](#).

Figure 15-117. TSCTR Register

31	30	29	28	27	26	25	24	23	22	21	20	19	18	17	16	15	14	13	12	11	10	9	8	7	6	5	4	3	2	1	0
TSCTR																															
R/W-0h																															

LEGEND: R/W = Read/Write; R = Read only; W1toCl = Write 1 to clear bit; -n = value after reset

Table 15-101. TSCTR Register Field Descriptions

Bit	Field	Type	Reset	Description
31-0	TSCTR	R/W	0h	Active 32 bit counter register that is used as the capture time-base

15.3.4.1.2 CTRPHS Register (offset = 4h) [reset = 0h]

CTRPHS is shown in [Figure 15-118](#) and described in [Table 15-102](#).

Figure 15-118. CTRPHS Register

31	30	29	28	27	26	25	24	23	22	21	20	19	18	17	16	15	14	13	12	11	10	9	8	7	6	5	4	3	2	1	0
CTRPHS																															
R/W-0h																															

LEGEND: R/W = Read/Write; R = Read only; W1toCl = Write 1 to clear bit; -n = value after reset

Table 15-102. CTRPHS Register Field Descriptions

Bit	Field	Type	Reset	Description
31-0	CTRPHS	R/W	0h	Counter phase value register that can be programmed for phase lag/lead. This register shadows TSCTR and is loaded into TSCTR upon either a SYNCI event or S/W force via a control bit. Used to achieve phase control synchronization with respect to other eCAP and EPWM time-bases.

15.3.4.1.3 CAP1 Register (offset = 8h) [reset = 0h]

CAP1 is shown in [Figure 15-119](#) and described in [Table 15-103](#).

Figure 15-119. CAP1 Register

31	30	29	28	27	26	25	24	23	22	21	20	19	18	17	16	15	14	13	12	11	10	9	8	7	6	5	4	3	2	1	0
CAP1																															
R/W-0h																															

LEGEND: R/W = Read/Write; R = Read only; W1toCl = Write 1 to clear bit; -n = value after reset

Table 15-103. CAP1 Register Field Descriptions

Bit	Field	Type	Reset	Description
31-0	CAP1	R/W	0h	This register can be loaded (written) by the following. (a) Time-Stamp (that is, counter value) during a capture event. (b) Software may be useful for test purposes. (c) APRD active register when used in APWM mode.

15.3.4.1.4 CAP2 Register (offset = Ch) [reset = 0h]

CAP2 is shown in [Figure 15-120](#) and described in [Table 15-104](#).

Figure 15-120. CAP2 Register

31	30	29	28	27	26	25	24	23	22	21	20	19	18	17	16	15	14	13	12	11	10	9	8	7	6	5	4	3	2	1	0
CAP2																															
R/W-0h																															

LEGEND: R/W = Read/Write; R = Read only; W1toCl = Write 1 to clear bit; -n = value after reset

Table 15-104. CAP2 Register Field Descriptions

Bit	Field	Type	Reset	Description
31-0	CAP2	R/W	0h	This register can be loaded (written) by the following. (a) Time-Stamp (that is, counter value) during a capture event. (b) Software may be useful for test purposes. (c) APRD active register when used in APWM mode.

15.3.4.1.5 CAP3 Register (offset = 10h) [reset = 0h]

CAP3 is shown in [Figure 15-121](#) and described in [Table 15-105](#).

Figure 15-121. CAP3 Register

31	30	29	28	27	26	25	24	23	22	21	20	19	18	17	16	15	14	13	12	11	10	9	8	7	6	5	4	3	2	1	0
CAP3																															
R/W-0h																															

LEGEND: R/W = Read/Write; R = Read only; W1toCl = Write 1 to clear bit; -n = value after reset

Table 15-105. CAP3 Register Field Descriptions

Bit	Field	Type	Reset	Description
31-0	CAP3	R/W	0h	In CMP mode, this is a time-stamp capture register. In APWM mode, this is the period shadow (APRD) register. You update the PWM period value through this register. In this mode, CAP3 shadows CAP1.

15.3.4.1.6 CAP4 Register (offset = 14h) [reset = 0h]

CAP4 is shown in [Figure 15-122](#) and described in [Table 15-106](#).

Figure 15-122. CAP4 Register

31	30	29	28	27	26	25	24	23	22	21	20	19	18	17	16	15	14	13	12	11	10	9	8	7	6	5	4	3	2	1	0
CAP4																															
R/W-0h																															

LEGEND: R/W = Read/Write; R = Read only; W1toCl = Write 1 to clear bit; -n = value after reset

Table 15-106. CAP4 Register Field Descriptions

Bit	Field	Type	Reset	Description
31-0	CAP4	R/W	0h	In CMP mode, this is a time-stamp capture register. In APWM mode, this is the compare shadow (ACMP) register. You update the PWM compare value through this register. In this mode, CAP4 shadows CAP2.

15.3.4.1.7 ECCTL1 Register (offset = 28h) [reset = 0h]

 ECCTL1 is shown in [Figure 15-123](#) and described in [Table 15-107](#).

Figure 15-123. ECCTL1 Register

15		14		13		12		11		10		9		8	
FREE_SOFT				PRESCALE								CAPLDEN			
R/W-0h				R/W-0h								R/W-0h			
7		6		5		4		3		2		1		0	
CTRRST4		CAP4POL		CTRRST3		CAP3POL		CTRRST2		CAP2POL		CTRRST1		CAP1POL	
R/W-0h		R/W-0h		R/W-0h		R/W-0h		R/W-0h		R/W-0h		R/W-0h		R/W-0h	

LEGEND: R/W = Read/Write; R = Read only; W1toCl = Write 1 to clear bit; -n = value after reset

Table 15-107. ECCTL1 Register Field Descriptions

Bit	Field	Type	Reset	Description
15-14	FREE_SOFT	R/W	0h	Emulation Control 0h = TSCTR counter stops immediately on emulation suspend. 1h = TSCTR counter runs until = 0. 2h = TSCTR counter is unaffected by emulation suspend (Run Free). 3h = TSCTR counter is unaffected by emulation suspend (Run Free).
13-9	PRESCALE	R/W	0h	Event Filter prescale select ... 0h = Divide by 1 (i.e., no prescale, by-pass the prescaler) 1h = Divide by 2 2h = Divide by 4 3h = Divide by 6 4h = Divide by 8 5h = Divide by 10 1Eh = Divide by 60 1Fh = Divide by 62
8	CAPLDEN	R/W	0h	Enable Loading of CAP1 to CAP4 registers on a capture event 0h = Disable CAP1 through 4 register loads at capture event time. 1h = Enable CAP1-4 register loads at capture event time.
7	CTRRST4	R/W	0h	Counter Reset on Capture Event 4 0h = Do not reset counter on Capture Event 4 (absolute time stamp operation) 1h = Reset counter after Capture Event 4 time-stamp has been captured (used in difference mode operation)
6	CAP4POL	R/W	0h	Capture Event 4 Polarity select 0h = Capture Event 4 triggered on a rising edge (RE) 1h = Capture Event 4 triggered on a falling edge (FE)
5	CTRRST3	R/W	0h	Counter Reset on Capture Event 3 0h = Do not reset counter on Capture Event 3 (absolute time stamp) 1h = Reset counter after Event 3 time-stamp has been captured (used in difference mode operation)
4	CAP3POL	R/W	0h	Capture Event 3 Polarity select 0h = Capture Event 3 triggered on a rising edge (RE) 1h = Capture Event 3 triggered on a falling edge (FE)
3	CTRRST2	R/W	0h	Counter Reset on Capture Event 2 0h = Do not reset counter on Capture Event 2 (absolute time stamp) 1h = Reset counter after Event 2 time-stamp has been captured (used in difference mode operation)

Table 15-107. ECCTL1 Register Field Descriptions (continued)

Bit	Field	Type	Reset	Description
2	CAP2POL	R/W	0h	Capture Event 2 Polarity select 0h = Capture Event 2 triggered on a rising edge (RE) 1h = Capture Event 2 triggered on a falling edge (FE)
1	CTRRST1	R/W	0h	Counter Reset on Capture Event 1 0h = Do not reset counter on Capture Event 1 (absolute time stamp) 1h = Reset counter after Event 1 time-stamp has been captured (used in difference mode operation)
0	CAP1POL	R/W	0h	Capture Event 1 Polarity select 0h = Capture Event 1 triggered on a rising edge (RE) 1h = Capture Event 1 triggered on a falling edge (FE)

15.3.4.1.8 ECCTL2 Register (offset = 2Ah) [reset = 6h]

 ECCTL2 is shown in [Figure 15-124](#) and described in [Table 15-108](#).

Figure 15-124. ECCTL2 Register

15	14	13	12	11	10	9	8
RESERVED					APWMPOL	CAP_APWM	SWSYNC
R-0h					R/W-0h	R/W-0h	R/W-0h
7	6	5	4	3	2	1	0
SYNCO_SEL		SYNCI_EN	TSCTRSTOP	RE-ARM	STOP_WRAP		CONT_ONESH T
R/W-0h		R/W-0h	R/W-0h	R/W-0h	R/W-3h		R/W-0h

LEGEND: R/W = Read/Write; R = Read only; W1toCl = Write 1 to clear bit; -n = value after reset

Table 15-108. ECCTL2 Register Field Descriptions

Bit	Field	Type	Reset	Description
15-11	RESERVED	R	0h	
10	APWMPOL	R/W	0h	APWM output polarity select. This is applicable only in APWM operating mode 0h = Output is active high (Compare value defines high time) 1h = Output is active low (Compare value defines low time)
9	CAP_APWM	R/W	0h	CAP/APWM operating mode select 0h = ECAP module operates in capture mode. This mode forces the following configuration. (a) Inhibits TSCTR resets via PRDEQ event. (b) Inhibits shadow loads on CAP1 and 2 registers. (c) Permits user to enable CAP1-4 register load. (d) ECAPn/APWMn pin operates as a capture input. 1h = ECAP module operates in APWM mode. This mode forces the following configuration. (a) Resets TSCTR on PRDEQ event (period boundary). (b) Permits shadow loading on CAP1 and 2 registers. (c) Disables loading of time-stamps into CAP1-4 registers. (d) ECAPn/APWMn pin operates as a APWM output.
8	SWSYNC	R/W	0h	Software-forced Counter (TSCTR) Synchronizing. This provides a convenient software method to synchronize some or all ECAP time bases. In APWM mode, the synchronizing can also be done via the PRDEQ event. Note: Selecting PRDEQ is meaningful only in APWM mode. However, you can choose it in CAP mode if you find doing so useful. 0h = Writing a zero has no effect. Reading always returns a zero 1h = Writing a one forces a TSCTR shadow load of current ECAP module and any ECAP modules down-stream providing the SYNCO_SEL bits are 0,0. After writing a 1, this bit returns to a zero.
7-6	SYNCO_SEL	R/W	0h	Sync-Out Select 0h = Select sync-in event to be the sync-out signal (pass through) 1h = Select PRDEQ event to be the sync-out signal 2h = Disable sync out signal 3h = Disable sync out signal
5	SYNCI_EN	R/W	0h	Counter (TSCTR) Sync-In select mode 0h = Disable sync-in option 1h = Enable counter (TSCTR) to be loaded from CTRPHS register upon either a SYNCI signal or a S/W force event.
4	TSCTRSTOP	R/W	0h	Time Stamp (TSCTR) Counter Stop (freeze) Control 0h = TSCTR stopped 1h = TSCTR free-running

Table 15-108. ECCTL2 Register Field Descriptions (continued)

Bit	Field	Type	Reset	Description
3	RE-ARM	R/W	0h	One-Shot Re-Arming Control, that is, wait for stop trigger. Note: The re-arm function is valid in one shot or continuous mode. 0h = Has no effect (reading always returns a 0) 1h = Arms the one-shot sequence as follows: 1) Resets the Mod4 counter to zero. 2) Unfreezes the Mod4 counter. 3) Enables capture register loads.
2-1	STOP_WRAP	R/W	3h	Stop value for one-shot mode. This is the number (between 1 and 4) of captures allowed to occur before the CAP (1 through 4) registers are frozen, that is, capture sequence is stopped. Wrap value for continuous mode. This is the number (between 1 and 4) of the capture register in which the circular buffer wraps around and starts again. Notes: STOP_WRAP is compared to Mod4 counter and, when equal, the following two actions occur. (1) Mod4 counter is stopped (frozen), and (2) Capture register loads are inhibited. In one-shot mode, further interrupt events are blocked until re-armed. 0h = Stop after Capture Event 1 in one-shot mode. Wrap after Capture Event 1 in continuous mode. 1h = Stop after Capture Event 2 in one-shot mode. Wrap after Capture Event 2 in continuous mode. 2h = Stop after Capture Event 3 in one-shot mode. Wrap after Capture Event 3 in continuous mode. 3h = Stop after Capture Event 4 in one-shot mode. Wrap after Capture Event 4 in continuous mode.
0	CONT_ONESHT	R/W	0h	Continuous or one-shot mode control (applicable only in capture mode) 0h = Operate in continuous mode 1h = Operate in one-shot mode

15.3.4.1.9 ECEINT Register (offset = 2Ch) [reset = 0h]

ECEINT is shown in [Figure 15-125](#) and described in [Table 15-109](#).

The interrupt enable bits (CEVTn) block any of the selected events from generating an interrupt. Events will still be latched into the flag bit (ECFLG register) and can be forced or cleared via the ECFRC and ECCLR registers. The proper procedure for configuring peripheral modes and interrupts is: 1. Disable global interrupts. 2. Stop eCAP counter. 3. Disable eCAP interrupts. 4. Configure peripheral registers. 5. Clear spurious eCAP interrupt flags. 6. Enable eCAP interrupts. 7. Start eCAP counter. 8. Enable global interrupts.

Figure 15-125. ECEINT Register

15		14		13		12		11		10		9		8	
RESERVED															
R-0h															
7		6		5		4		3		2		1		0	
CMPEQ		PRDEQ		CNTOVF		CEVT4		CEVT3		CEVT2		CEVT1		RESERVED	
R/W-0h		R/W-0h		R/W-0h		R/W-0h		R/W-0h		R/W-0h		R/W-0h		R-0h	

LEGEND: R/W = Read/Write; R = Read only; W1toCl = Write 1 to clear bit; -n = value after reset

Table 15-109. ECEINT Register Field Descriptions

Bit	Field	Type	Reset	Description
15-8	RESERVED	R	0h	
7	CMPEQ	R/W	0h	Counter Equal Compare Interrupt Enable. 0h = Disable Compare Equal as an Interrupt source. 1h = Enable Compare Equal as an Interrupt source.
6	PRDEQ	R/W	0h	Counter Equal Period Interrupt Enable. 0h = Disable Period Equal as an Interrupt source. 1h = Enable Period Equal as an Interrupt source.
5	CNTOVF	R/W	0h	Counter Overflow Interrupt Enable. 0h = Disable counter Overflow as an Interrupt source. 1h = Enable counter Overflow as an Interrupt source.
4	CEVT4	R/W	0h	Capture Event 4 Interrupt Enable. 0h = Disable Capture Event 4 as an Interrupt source. 1h = Enable Capture Event 4 as an Interrupt source.
3	CEVT3	R/W	0h	Capture Event 3 Interrupt Enable. 0h = Disable Capture Event 3 as an Interrupt source. 1h = Enable Capture Event 3 as an Interrupt source.
2	CEVT2	R/W	0h	Capture Event 2 Interrupt Enable. 0h = Disable Capture Event 2 as an Interrupt source. 1h = Enable Capture Event 2 as an Interrupt source.
1	CEVT1	R/W	0h	Capture Event 1 Interrupt Enable . 0h = Disable Capture Event 1 as an Interrupt source. 1h = Enable Capture Event 1 as an Interrupt source.
0	RESERVED	R	0h	

15.3.4.1.10 ECFLG Register (offset = 2Eh) [reset = 0h]

 ECFLG is shown in [Figure 15-126](#) and described in [Table 15-110](#).

Figure 15-126. ECFLG Register

15	14	13	12	11	10	9	8
RESERVED							
R-0h							
7	6	5	4	3	2	1	0
CMPEQ	PRDEQ	CNTOVF	CEVT4	CEVT3	CEVT2	CEVT1	INT
R-0h	R-0h	R-0h	R-0h	R-0h	R-0h	R-0h	R-0h

LEGEND: R/W = Read/Write; R = Read only; W1toCl = Write 1 to clear bit; -n = value after reset

Table 15-110. ECFLG Register Field Descriptions

Bit	Field	Type	Reset	Description
15-8	RESERVED	R	0h	
7	CMPEQ	R	0h	Compare Equal Compare Status Flag. This flag is only active in APWM mode. 0h = Indicates no event occurred 1h = Indicates the counter (TSCTR) reached the compare register value (ACMP)
6	PRDEQ	R	0h	Counter Equal Period Status Flag. This flag is only active in APWM mode. 0h = Indicates no event occurred 1h = Indicates the counter (TSCTR) reached the period register value (APRD) and was reset.
5	CNTOVF	R	0h	Counter Overflow Status Flag. This flag is active in CAP and APWM mode. 0h = Indicates no event occurred. 1h = Indicates the counter (TSCTR) has made the transition from 0xFFFFFFFF to 0x00000000
4	CEVT4	R	0h	Capture Event 4 Status Flag This flag is only active in CAP mode. 0h = Indicates no event occurred 1h = Indicates the fourth event occurred at ECAPn pin
3	CEVT3	R	0h	Capture Event 3 Status Flag. This flag is active only in CAP mode. 0h = Indicates no event occurred. 1h = Indicates the third event occurred at ECAPn pin.
2	CEVT2	R	0h	Capture Event 2 Status Flag. This flag is only active in CAP mode. 0h = Indicates no event occurred. 1h = Indicates the second event occurred at ECAPn pin.
1	CEVT1	R	0h	Capture Event 1 Status Flag. This flag is only active in CAP mode. 0h = Indicates no event occurred. 1h = Indicates the first event occurred at ECAPn pin.
0	INT	R	0h	Global Interrupt Status Flag 0h = Indicates no interrupt generated. 1h = Indicates that an interrupt was generated.

15.3.4.1.11 ECCLR Register (offset = 30h) [reset = 0h]

 ECCLR is shown in [Figure 15-127](#) and described in [Table 15-111](#).

Figure 15-127. ECCLR Register

15	14	13	12	11	10	9	8
RESERVED							
R-0h							
7	6	5	4	3	2	1	0
CMPEQ	PRDEQ	CNTOVF	CEVT4	CEVT3	CEVT2	CEVT1	INT
R/W-0h	R/W-0h	R/W-0h	R/W-0h	R/W-0h	R/W-0h	R/W-0h	R/W-0h

LEGEND: R/W = Read/Write; R = Read only; W1toCl = Write 1 to clear bit; -n = value after reset

Table 15-111. ECCLR Register Field Descriptions

Bit	Field	Type	Reset	Description
15-8	RESERVED	R	0h	
7	CMPEQ	R/W	0h	Counter Equal Compare Status Flag 0h = Writing a 0 has no effect. Always reads back a 0 1h = Writing a 1 clears the CMPEQ flag condition
6	PRDEQ	R/W	0h	Counter Equal Period Status Flag 0h = Writing a 0 has no effect. Always reads back a 0 1h = Writing a 1 clears the PRDEQ flag condition
5	CNTOVF	R/W	0h	Counter Overflow Status Flag 0h = Writing a 0 has no effect. Always reads back a 0 1h = Writing a 1 clears the CNTOVF flag condition
4	CEVT4	R/W	0h	Capture Event 4 Status Flag 0h = Writing a 0 has no effect. Always reads back a 0. 1h = Writing a 1 clears the CEVT3 flag condition.
3	CEVT3	R/W	0h	Capture Event 3 Status Flag 0h = Writing a 0 has no effect. Always reads back a 0. 1h = Writing a 1 clears the CEVT3 flag condition.
2	CEVT2	R/W	0h	Capture Event 2 Status Flag 0h = Writing a 0 has no effect. Always reads back a 0. 1h = Writing a 1 clears the CEVT2 flag condition.
1	CEVT1	R/W	0h	Capture Event 1 Status Flag 0h = Writing a 0 has no effect. Always reads back a 0. 1h = Writing a 1 clears the CEVT1 flag condition.
0	INT	R/W	0h	Global Interrupt Clear Flag 0h = Writing a 0 has no effect. Always reads back a 0. 1h = Writing a 1 clears the INT flag and enable further interrupts to be generated if any of the event flags are set to 1.

15.3.4.1.12 ECFRC Register (offset = 32h) [reset = 0h]

ECFRC is shown in [Figure 15-128](#) and described in [Table 15-112](#).

Figure 15-128. ECFRC Register

15		14		13		12		11		10		9		8	
RESERVED															
R-0h															
7		6		5		4		3		2		1		0	
CMPEQ		PRDEQ		CNTOVF		CEVT4		CEVT3		CEVT2		CEVT1		RESERVED	
R/W-0h		R/W-0h		R/W-0h		R/W-0h		R/W-0h		R/W-0h		R/W-0h		R-0h	

LEGEND: R/W = Read/Write; R = Read only; W1toCl = Write 1 to clear bit; -n = value after reset

Table 15-112. ECFRC Register Field Descriptions

Bit	Field	Type	Reset	Description
15-8	RESERVED	R	0h	
7	CMPEQ	R/W	0h	Force Counter Equal Compare Interrupt 0h = No effect. Always reads back a 0. 1h = Writing a 1 sets the CMPEQ flag bit.
6	PRDEQ	R/W	0h	Force Counter Equal Period Interrupt 0h = No effect. Always reads back a 0. 1h = Writing a 1 sets the PRDEQ flag bit.
5	CNTOVF	R/W	0h	Force Counter Overflow 0h = No effect. Always reads back a 0. 1h = Writing a 1 to this bit sets the CNTOVF flag bit.
4	CEVT4	R/W	0h	Force Capture Event 4 0h = No effect. Always reads back a 0. 1h = Writing a 1 sets the CEVT4 flag bit
3	CEVT3	R/W	0h	Force Capture Event 3 0h = No effect. Always reads back a 0. 1h = Writing a 1 sets the CEVT3 flag bit
2	CEVT2	R/W	0h	Force Capture Event 2 0h = No effect. Always reads back a 0. 1h = Writing a 1 sets the CEVT2 flag bit.
1	CEVT1	R/W	0h	Always reads back a 0. Force Capture Event 1 0h = No effect. 1h = Writing a 1 sets the CEVT1 flag bit.
0	RESERVED	R	0h	

15.3.4.1.13 REVID Register (offset = 5Ch) [reset = 44D22100h]

REVID is shown in [Figure 15-174](#) and described in [Table 15-140](#).

Figure 15-129. REVID Register

31	30	29	28	27	26	25	24	23	22	21	20	19	18	17	16	15	14	13	12	11	10	9	8	7	6	5	4	3	2	1	0
REV																															
R-44D22100h																															

LEGEND: R/W = Read/Write; R = Read only; W1toCl = Write 1 to clear bit; -n = value after reset

Table 15-113. REVID Register Field Descriptions

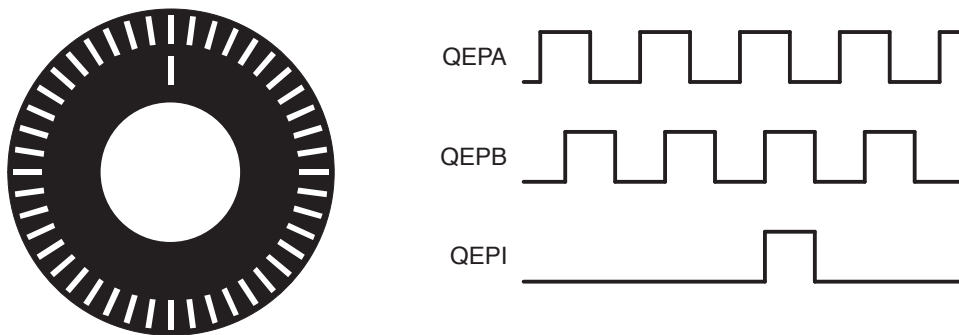
Bit	Field	Type	Reset	Description
31-0	REV	R	44D22100h	Revision ID.

15.4 Enhanced Quadrature Encoder Pulse (eQEP) Module

15.4.1 Introduction

A single track of slots patterns the periphery of an incremental encoder disk, as shown in [Figure 15-130](#). These slots create an alternating pattern of dark and light lines. The disk count is defined as the number of dark/light line pairs that occur per revolution (lines per revolution). As a rule, a second track is added to generate a signal that occurs once per revolution (index signal: QEPI), which can be used to indicate an absolute position. Encoder manufacturers identify the index pulse using different terms such as index, marker, home position, and zero reference.

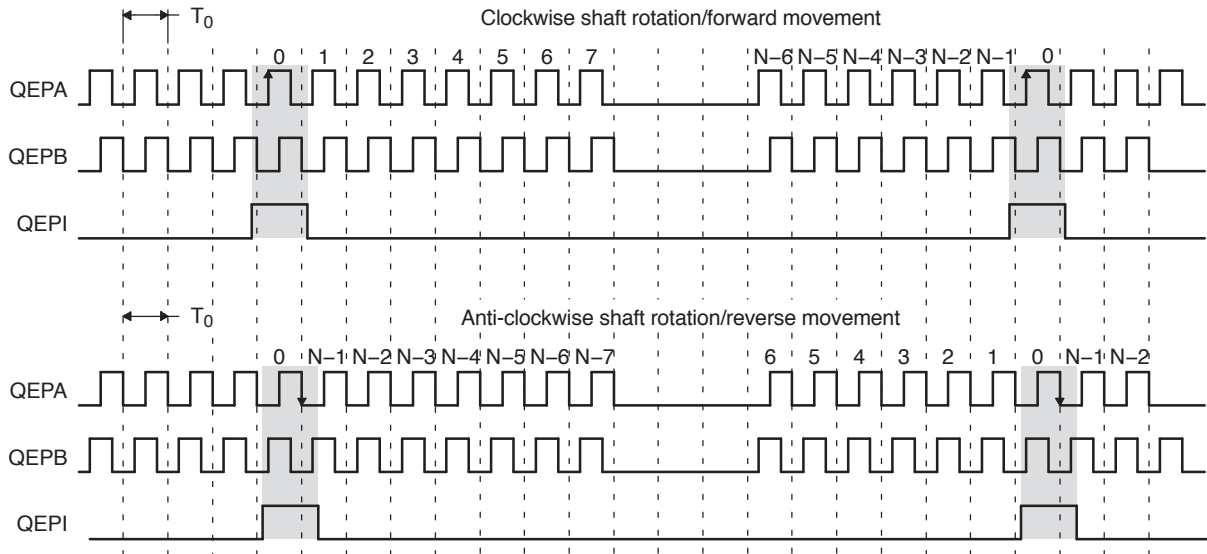
Figure 15-130. Optical Encoder Disk



To derive direction information, the lines on the disk are read out by two different photo-elements that "look" at the disk pattern with a mechanical shift of 1/4 the pitch of a line pair between them. This shift is realized with a reticle or mask that restricts the view of the photo-element to the desired part of the disk lines. As the disk rotates, the two photo-elements generate signals that are shifted 90 degrees out of phase from each other. These are commonly called the quadrature QEPA and QEPB signals. The clockwise direction for most encoders is defined as the QEPA channel going positive before the QEPB channel and vice versa as shown in [Figure 15-131](#).

The encoder wheel typically makes one revolution for every revolution of the motor or the wheel may be at a geared rotation ratio with respect to the motor. Therefore, the frequency of the digital signal coming from the QEPA and QEPB outputs varies proportionally with the velocity of the motor. For example, a 2000-line encoder directly coupled to a motor running at 5000 revolutions per minute (rpm) results in a frequency of 166.6 KHz, so by measuring the frequency of either the QEPA or QEPB output, the processor can determine the velocity of the motor.

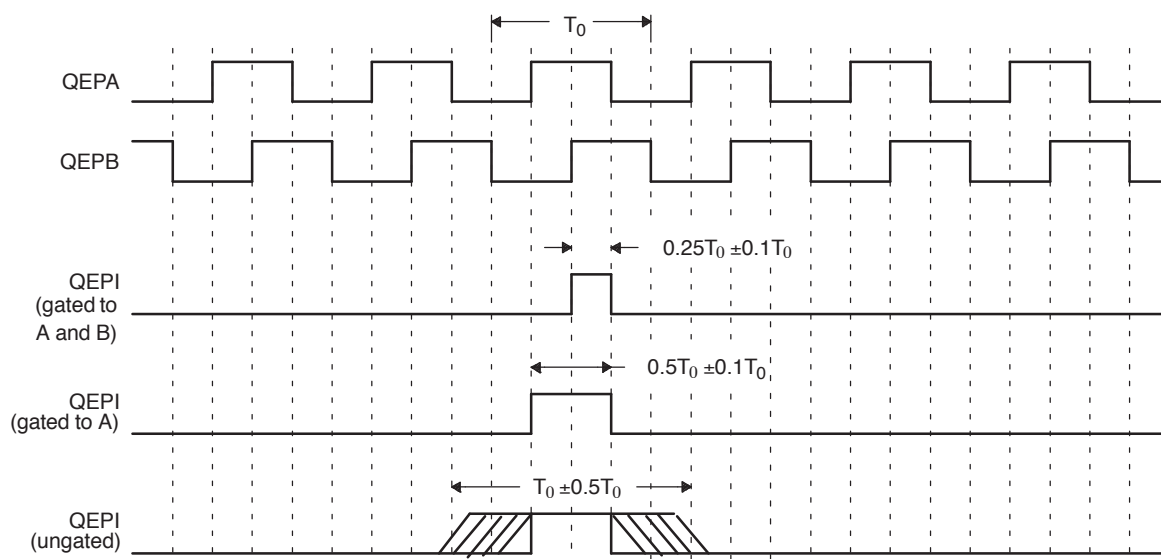
Figure 15-131. QEP Encoder Output Signal for Forward/Reverse Movement



Legend: N = lines per revolution

Quadrature encoders from different manufacturers come with two forms of index pulse (gated index pulse or ungated index pulse) as shown in Figure 15-132. A nonstandard form of index pulse is ungated. In the ungated configuration, the index edges are not necessarily coincident with A and B signals. The gated index pulse is aligned to any of the four quadrature edges and width of the index pulse and can be equal to a quarter, half, or full period of the quadrature signal.

Figure 15-132. Index Pulse Example



Some typical applications of shaft encoders include robotics and even computer input in the form of a mouse. Inside your mouse you can see where the mouse ball spins a pair of axles (a left/right, and an up/down axle). These axles are connected to optical shaft encoders that effectively tell the computer how fast and in what direction the mouse is moving.

General Issues: Estimating velocity from a digital position sensor is a cost-effective strategy in motor control. Two different first order approximations for velocity may be written as:

$$v(k) \approx \frac{x(k) - x(k - 1)}{T} = \frac{\Delta X}{T} \quad (1)$$

$$v(k) \approx \frac{X}{t(k) - t(k - 1)} = \frac{X}{\Delta T} \quad (2)$$

where

$v(k)$: Velocity at time instant k

$x(k)$: Position at time instant k

$x(k-1)$: Position at time instant $k - 1$

T : Fixed unit time or inverse of velocity calculation rate

ΔX : Incremental position movement in unit time

$t(k)$: Time instant " k "

$t(k-1)$: Time instant " $k - 1$ "

X : Fixed unit position

ΔT : Incremental time elapsed for unit position movement.

[Equation 1](#) is the conventional approach to velocity estimation and it requires a time base to provide unit time event for velocity calculation. Unit time is basically the inverse of the velocity calculation rate.

The encoder count (position) is read once during each unit time event. The quantity $[x(k) - x(k-1)]$ is formed by subtracting the previous reading from the current reading. Then the velocity estimate is computed by multiplying by the known constant $1/T$ (where T is the constant time between unit time events and is known in advance).

Estimation based on [Equation 1](#) has an inherent accuracy limit directly related to the resolution of the position sensor and the unit time period T . For example, consider a 500-line per revolution quadrature encoder with a velocity calculation rate of 400 Hz. When used for position the quadrature encoder gives a four-fold increase in resolution, in this case, 2000 counts per revolution. The minimum rotation that can be detected is therefore 0.0005 revolutions, which gives a velocity resolution of 12 rpm when sampled at 400 Hz. While this resolution may be satisfactory at moderate or high speeds, for example, 1% error at 1200 rpm, it would clearly prove inadequate at low speeds. In fact, at speeds below 12 rpm, the speed estimate would erroneously be zero much of the time.

At low speed, [Equation 2](#) provides a more accurate approach. It requires a position sensor that outputs a fixed interval pulse train, such as the aforementioned quadrature encoder. The width of each pulse is defined by motor speed for a given sensor resolution. [Equation 2](#) can be used to calculate motor speed by measuring the elapsed time between successive quadrature pulse edges. However, this method suffers from the opposite limitation, as does [Equation 1](#). A combination of relatively large motor speeds and high sensor resolution makes the time interval ΔT small, and thus more greatly influenced by the timer resolution. This can introduce considerable error into high-speed estimates.

For systems with a large speed range (that is, speed estimation is needed at both low and high speeds), one approach is to use [Equation 2](#) at low speed and have the DSP software switch over to [Equation 1](#) when the motor speed rises above some specified threshold.

15.4.2 Functional Description

This section provides the eQEP inputs and functional description.

NOTE: Multiple identical eQEP modules can be contained in a system. The number of modules is device-dependent and is based on target application needs. In this document, the letter x within a signal or module name is used to indicate a generic eQEP instance on a device.

15.4.2.1 EQEP Inputs

The eQEP inputs include two pins for quadrature-clock mode or direction-count mode, an index (or 0 marker), and a strobe input.

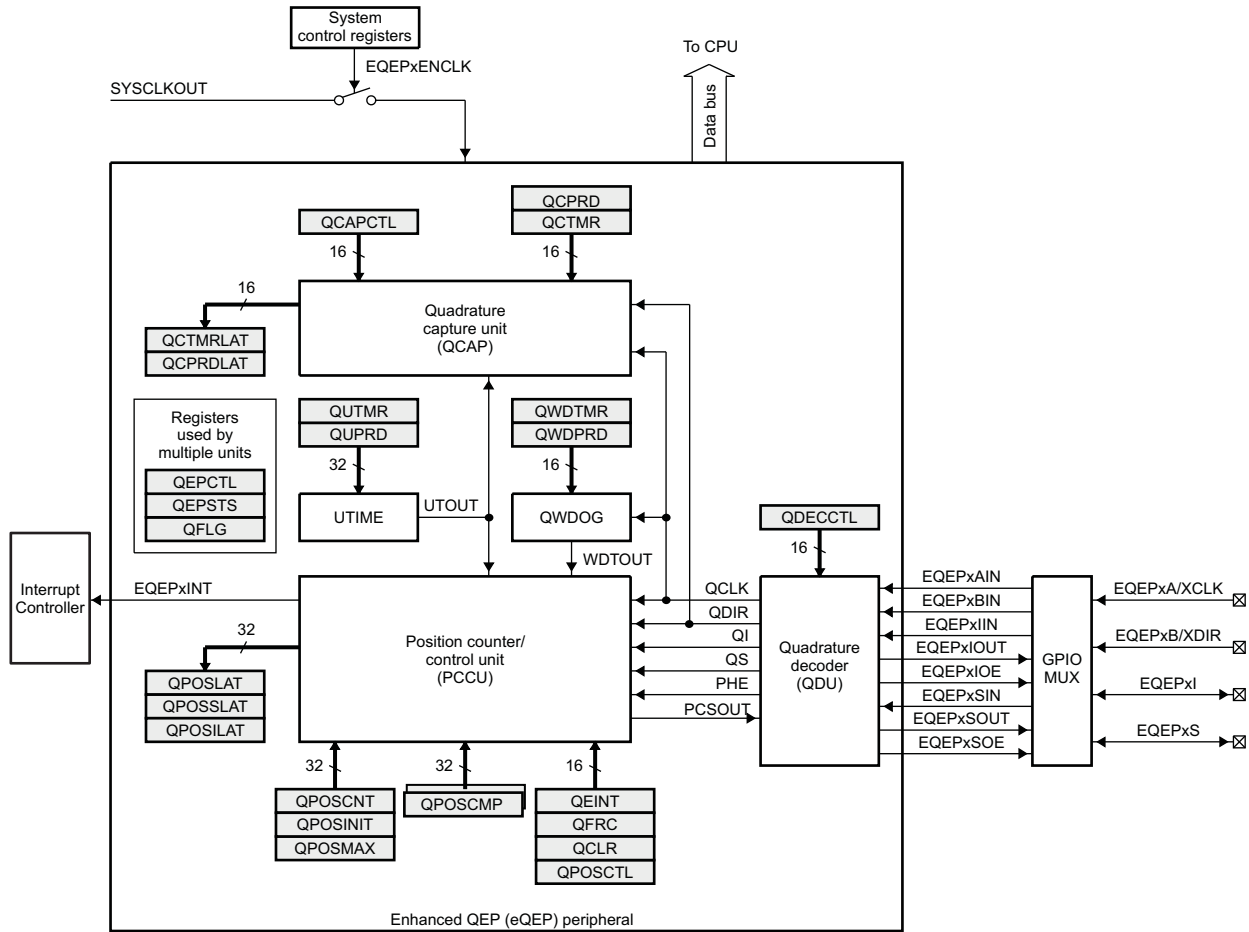
- QEPA/XCLK and QEPB/XDIR: These two pins can be used in quadrature-clock mode or direction-count mode.
 - Quadrature-clock Mode: The eQEP encoders provide two square wave signals (A and B) 90 electrical degrees out of phase whose phase relationship is used to determine the direction of rotation of the input shaft and number of eQEP pulses from the index position to derive the relative position information. For forward or clockwise rotation, QEPA signal leads QEPB signal and vice versa. The quadrature decoder uses these two inputs to generate quadrature-clock and direction signals.
 - Direction-count Mode: In direction-count mode, direction and clock signals are provided directly from the external source. Some position encoders have this type of output instead of quadrature output. The QEPA pin provides the clock input and the QEPB pin provides the direction input.
- QEPI: Index or Zero Marker: The eQEP encoder uses an index signal to assign an absolute start position from which position information is incrementally encoded using quadrature pulses. This pin is connected to the index output of the eQEP encoder to optionally reset the position counter for each revolution. This signal can be used to initialize or latch the position counter on the occurrence of a desired event on the index pin.
- QEPS: Strobe Input: This general-purpose strobe signal can initialize or latch the position counter on the occurrence of a desired event on the strobe pin. This signal is typically connected to a sensor or limit switch to notify that the motor has reached a defined position.

15.4.2.2 Functional Description

The eQEP peripheral contains the following major functional units (as shown in [Figure 15-133](#)):

- Programmable input qualification for each pin (part of the GPIO MUX)
- Quadrature decoder unit (QDU)
- Position counter and control unit for position measurement (PCCU)
- Quadrature edge-capture unit for low-speed measurement (QCAP)
- Unit time base for speed/frequency measurement (UTIME)
- Watchdog timer for detecting stalls (QWDOG)

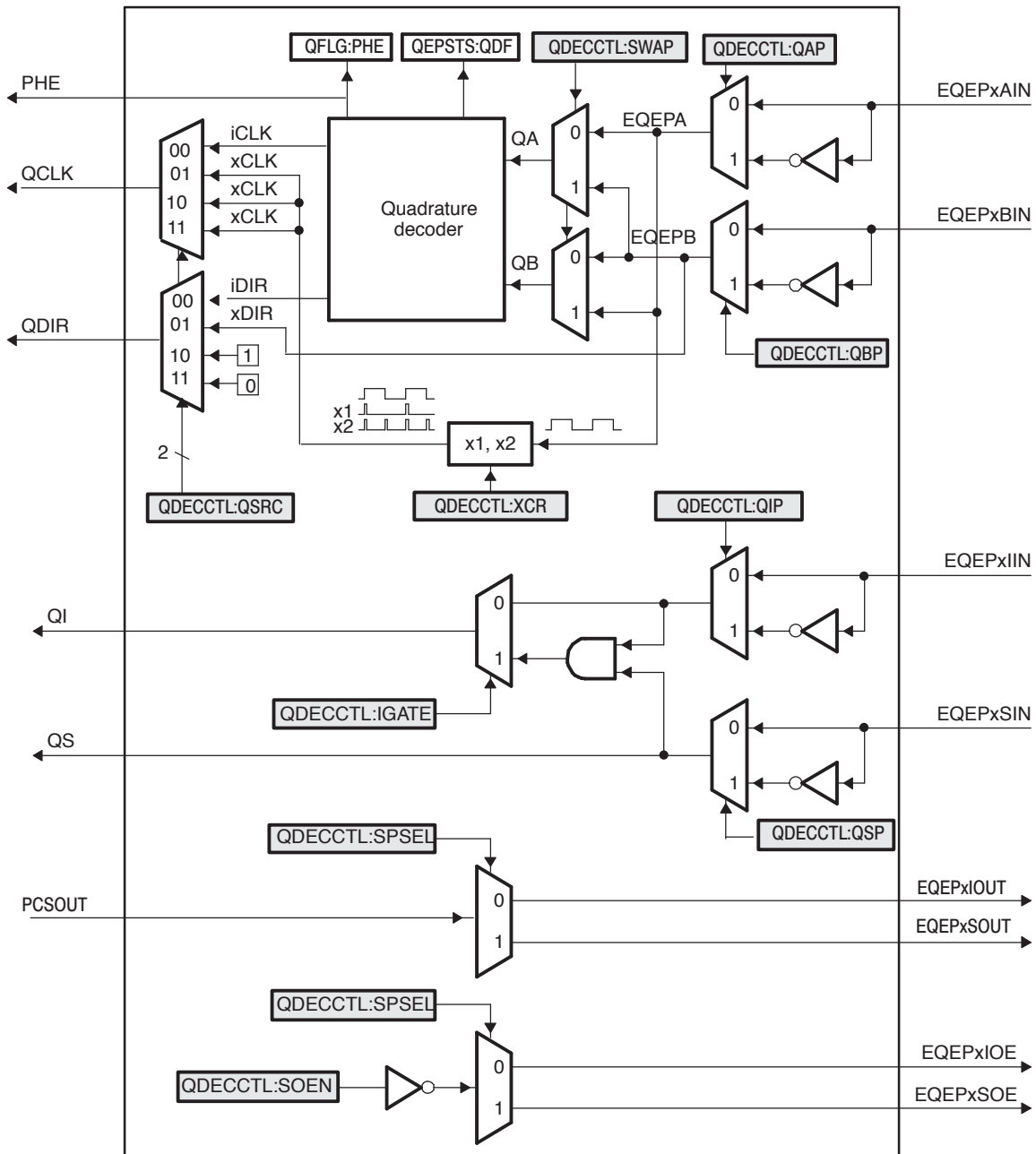
Figure 15-133. Functional Block Diagram of the eQEP Peripheral



15.4.2.3 Quadrature Decoder Unit (QDU)

Figure 15-134 shows a functional block diagram of the QDU.

Figure 15-134. Functional Block Diagram of Decoder Unit



15.4.2.3.1 Position Counter Input Modes

Clock and direction input to position counter is selected using the QSRC bit in the eQEP decoder control register (QDECCTL), based on interface input requirement as follows:

- Quadrature-count mode
- Direction-count mode
- UP-count mode
- DOWN-count mode

15.4.2.3.1.1 Quadrature Count Mode

The quadrature decoder generates the direction and clock to the position counter in quadrature count mode.

Direction Decoding— The direction decoding logic of the eQEP circuit determines which one of the sequences (QEPA, QEPB) is the leading sequence and accordingly updates the direction information in the QDF bit in the eQEP status register (QEPSTS). [Table 15-114](#) and [Figure 15-135](#) show the direction decoding logic in truth table and state machine form. Both edges of the QEPA and QEPB signals are sensed to generate count pulses for the position counter. Therefore, the frequency of the clock generated by the eQEP logic is four times that of each input sequence. [Figure 15-136](#) shows the direction decoding and clock generation from the eQEP input signals.

Phase Error Flag— In normal operating conditions, quadrature inputs QEPA and QEPB will be 90 degrees out of phase. The phase error flag (PHE) is set in the QFLG register when edge transition is detected simultaneously on the QEPA and QEPB signals to optionally generate interrupts. State transitions marked by dashed lines in [Figure 15-135](#) are invalid transitions that generate a phase error.

Count Multiplication— The eQEP position counter provides 4x times the resolution of an input clock by generating a quadrature-clock (QCLK) on the rising/falling edges of both eQEP input clocks (QEPA and QEPB) as shown in [Figure 15-136](#).

Reverse Count— In normal quadrature count operation, QEPA input is fed to the QA input of the quadrature decoder and the QEPB input is fed to the QB input of the quadrature decoder. Reverse counting is enabled by setting the SWAP bit in the eQEP decoder control register (QDECCTL). This will swap the input to the quadrature decoder thereby reversing the counting direction.

Table 15-114. Quadrature Decoder Truth Table

Previous Edge	Present Edge	QDIR	QPOSCNT
QA↑	QB↑	UP	Increment
	QB↓	DOWN	Decrement
	QA↓	TOGGLE	Increment or Decrement
QA↓	QB↓	UP	Increment
	QB↑	DOWN	Decrement
	QA↑	TOGGLE	Increment or Decrement
QB↑	QA↑	DOWN	Increment
	QA↓	UP	Decrement
	QB↓	TOGGLE	Increment or Decrement
QB↓	QA↓	DOWN	Increment
	QA↑	UP	Decrement
	QB↑	TOGGLE	Increment or Decrement

Figure 15-135. Quadrature Decoder State Machine

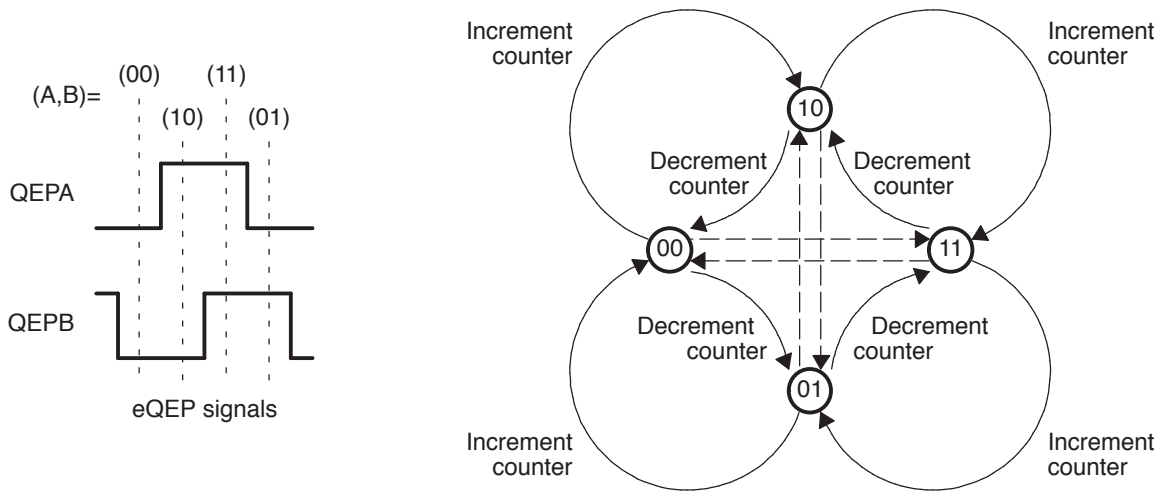
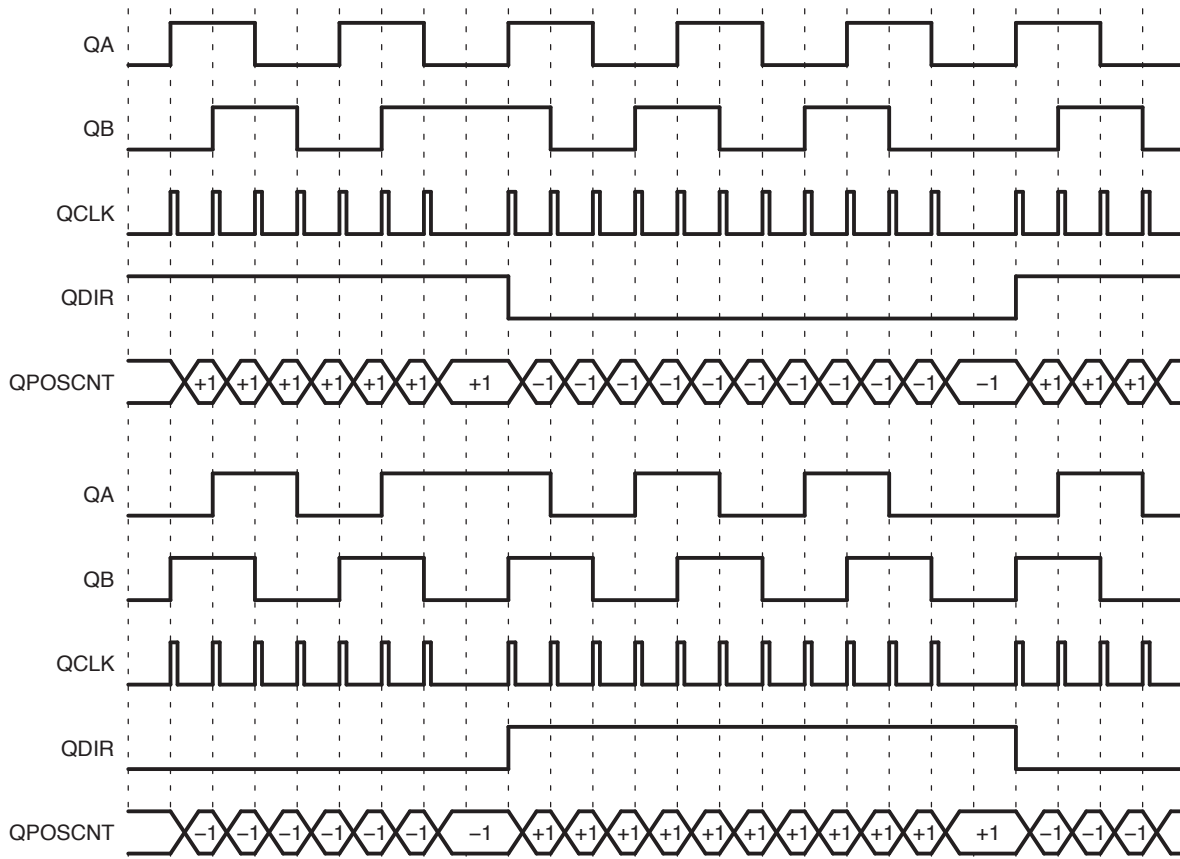


Figure 15-136. Quadrature-clock and Direction Decoding



15.4.2.3.1.2 Direction-count Mode

Some position encoders provide direction and clock outputs, instead of quadrature outputs. In such cases, direction-count mode can be used. QEPA input will provide the clock for position counter and the QEPB input will have the direction information. The position counter is incremented on every rising edge of a QEPA input when the direction input is high and decremented when the direction input is low.

15.4.2.3.1.3 Up-Count Mode

The counter direction signal is hard-wired for up count and the position counter is used to measure the frequency of the QEPA input. Setting of the XCR bit in the eQEP decoder control register (QDECCTL) enables clock generation to the position counter on both edges of the QEPA input, thereby increasing the measurement resolution by 2× factor.

15.4.2.3.1.4 Down-Count Mode

The counter direction signal is hardwired for a down count and the position counter is used to measure the frequency of the QEPA input. Setting of the XCR bit in the eQEP decoder control register (QDECCTL) enables clock generation to the position counter on both edges of a QEPA input, thereby increasing the measurement resolution by 2× factor.

15.4.2.3.2 eQEP Input Polarity Selection

Each eQEP input can be inverted using the in the eQEP decoder control register (QDECCTL[8:5]) control bits. As an example, setting of the QIP bit in QDECCTL inverts the index input.

15.4.2.3.3 Position-Compare Sync Output

The eQEP peripheral includes a position-compare unit that is used to generate the position-compare sync signal on compare match between the position counter register (QPOSCNT) and the position-compare register (QPOSCMP). This sync signal can be output using an index pin or strobe pin of the EQEP peripheral.

Setting the SOEN bit in the eQEP decoder control register (QDECCTL) enables the position-compare sync output and the SPSEL bit in QDECCTL selects either an eQEP index pin or an eQEP strobe pin.

15.4.2.4 Position Counter and Control Unit (PCCU)

The position counter and control unit provides two configuration registers (QEPCTL and QPOSCTL) for setting up position counter operational modes, position counter initialization/latch modes and position-compare logic for sync signal generation.

15.4.2.4.1 Position Counter Operating Modes

Position counter data may be captured in different manners. In some systems, the position counter is accumulated continuously for multiple revolutions and the position counter value provides the position information with respect to the known reference. An example of this is the quadrature encoder mounted on the motor controlling the print head in the printer. Here the position counter is reset by moving the print head to the home position and then position counter provides absolute position information with respect to home position.

In other systems, the position counter is reset on every revolution using index pulse and position counter provides rotor angle with respect to index pulse position.

Position counter can be configured to operate in following four modes

- Position Counter Reset on Index Event
- Position Counter Reset on Maximum Position
- Position Counter Reset on the first Index Event
- Position Counter Reset on Unit Time Out Event (Frequency Measurement)

In all the above operating modes, position counter is reset to 0 on overflow and to QPOS MAX register value on underflow. Overflow occurs when the position counter counts up after QPOS MAX value. Underflow occurs when position counter counts down after "0". Interrupt flag is set to indicate overflow/underflow in QFLG register.

15.4.2.4.1.1 Position Counter Reset on Index Event (QEPCTL[PCRM] = 00)

If the index event occurs during the forward movement, then position counter is reset to 0 on the next eQEP clock. If the index event occurs during the reverse movement, then the position counter is reset to the value in the QPOS MAX register on the next eQEP clock.

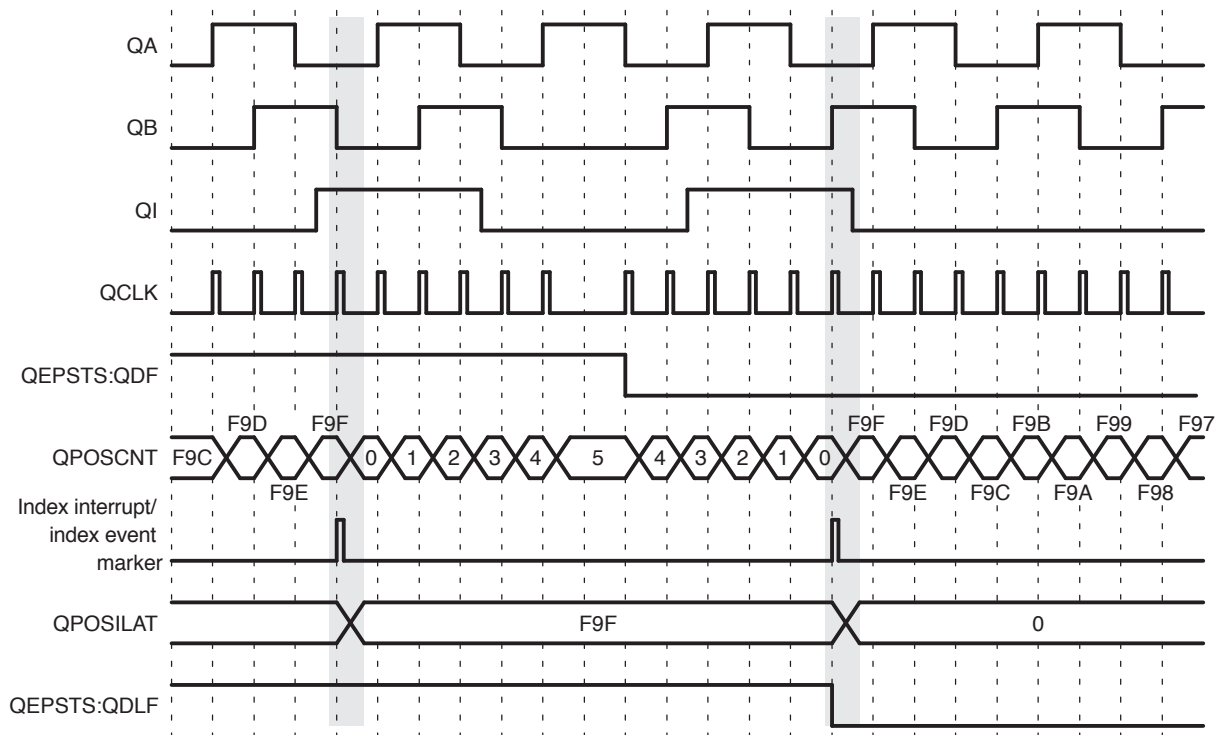
First index marker is defined as the quadrature edge following the first index edge. The eQEP peripheral records the occurrence of the first index marker (QEPSTS[FIMF]) and direction on the first index event marker (QEPSTS[FIDF]) in QEPSTS registers, it also remembers the quadrature edge on the first index marker so that same relative quadrature transition is used for index event reset operation.

For example, if the first reset operation occurs on the falling edge of QEPB during the forward direction, then all the subsequent reset must be aligned with the falling edge of QEPB for the forward rotation and on the rising edge of QEPB for the reverse rotation as shown in [Figure 15-137](#).

The position-counter value is latched to the QPOSILAT register and direction information is recorded in the QEPSTS[QDLF] bit on every index event marker. The position-counter error flag (QEPSTS[PCEF]) and error interrupt flag (QFLG[PCE]) are set if the latched value is not equal to 0 or QPOS MAX. The position-counter error flag (QEPSTS[PCEF]) is updated on every index event marker and an interrupt flag (QFLG[PCE]) will be set on error that can be cleared only through software.

The index event latch configuration QEPCTL[IEL] bits are ignored in this mode and position counter error flag/interrupt flag are generated only in index event reset mode.

Figure 15-137. Position Counter Reset by Index Pulse for 1000 Line Encoder (QPOS MAX = 3999 or F9Fh)

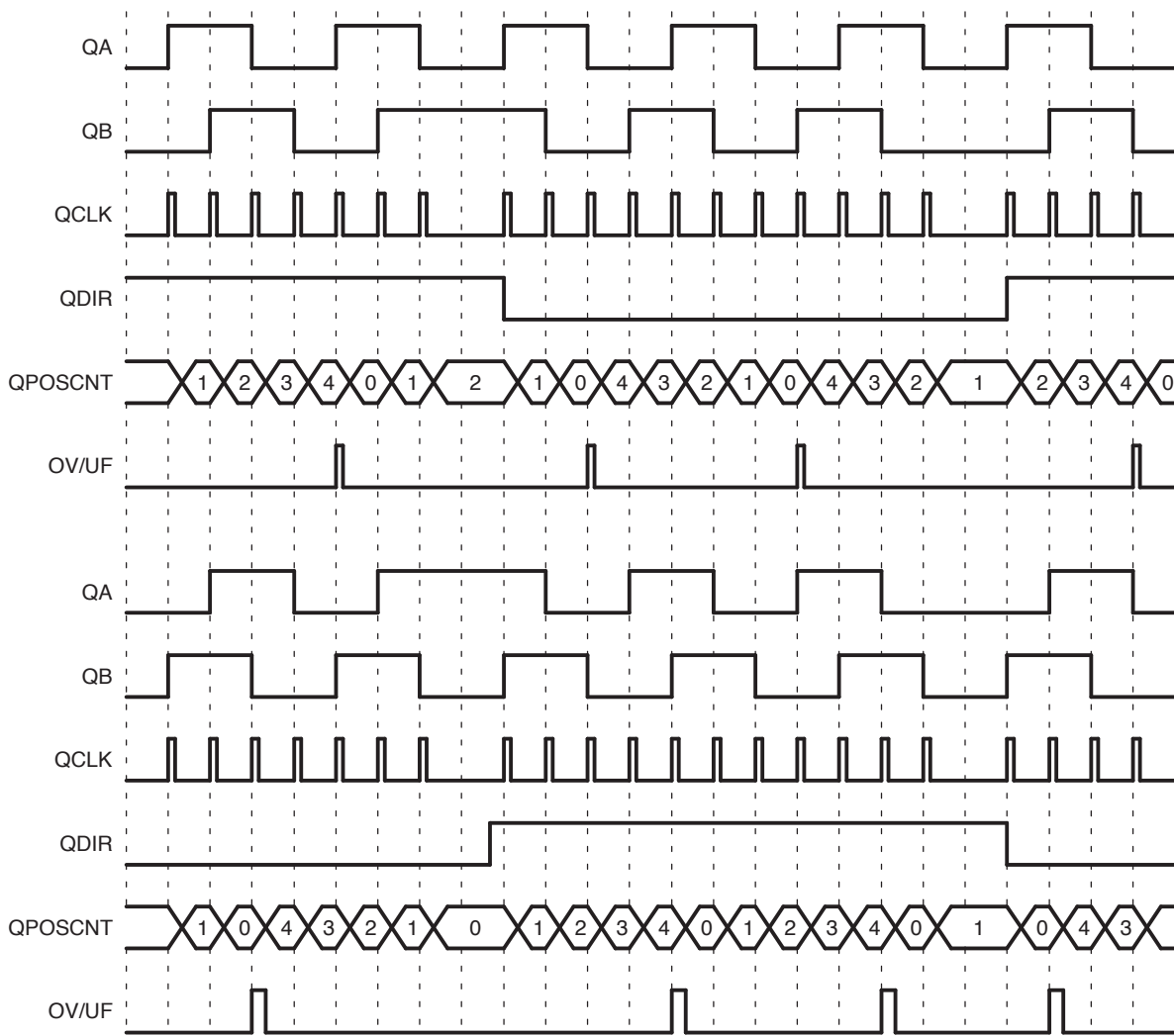


15.4.2.4.1.2 Position Counter Reset on Maximum Position (QEPCTL[PCRM]=01)

If the position counter is equal to QPOSMAX, then the position counter is reset to 0 on the next eQEP clock for forward movement and position counter overflow flag is set. If the position counter is equal to ZERO, then the position counter is reset to QPOSMAX on the next QEP clock for reverse movement and position counter underflow flag is set. Figure 15-138 shows the position counter reset operation in this mode.

First index marker is defined as the quadrature edge following the first index edge. The eQEP peripheral records the occurrence of the first index marker (QEPSTS[FIMF]) and direction on the first index event marker (QEPSTS[FIDF]) in the QEPSTS registers; it also remembers the quadrature edge on the first index marker so that the same relative quadrature transition is used for the software index marker (QEPCTL[IEL]=11).

Figure 15-138. Position Counter Underflow/Overflow (QPOSMAX = 4)



15.4.2.4.1.3 Position Counter Reset on the First Index Event (QEPCTL[PCRM] = 10)

If the index event occurs during forward movement, then the position counter is reset to 0 on the next eQEP clock. If the index event occurs during the reverse movement, then the position counter is reset to the value in the QPOSMAX register on the next eQEP clock. Note that this is done only on the first occurrence and subsequently the position counter value is not reset on an index event; rather, it is reset based on maximum position as described in [Section 15.4.2.4.1.2](#).

First index marker is defined as the quadrature edge following the first index edge. The eQEP peripheral records the occurrence of the first index marker (QEPSTS[FIMF]) and direction on the first index event marker (QEPSTS[FIDF]) in QEPSTS registers. It also remembers the quadrature edge on the first index marker so that same relative quadrature transition is used for software index marker (QEPCTL[IEL]=11).

15.4.2.4.1.4 Position Counter Reset on Unit Time out Event (QEPCTL[PCRM] = 11)

In this mode, the QPOSCNT value is latched to the QPOSLAT register and then the QPOSCNT is reset (to 0 or QPOSMAX, depending on the direction mode selected by QDECCTL[QSRC] bits on a unit time event). This is useful for frequency measurement.

15.4.2.4.2 Position Counter Latch

The eQEP index and strobe input can be configured to latch the position counter (QPOSCNT) into QPOSILAT and QPOSSLAT, respectively, on occurrence of a definite event on these pins.

15.4.2.4.2.1 Index Event Latch

In some applications, it may not be desirable to reset the position counter on every index event and instead it may be required to operate the position counter in full 32-bit mode (QEPCTL[PCRM] = 01 and QEPCTL[PCRM] = 10 modes).

In such cases, the eQEP position counter can be configured to latch on the following events and direction information is recorded in the QEPSTS[QDLF] bit on every index event marker.

- Latch on Rising edge (QEPCTL[IEL] = 01)
- Latch on Falling edge (QEPCTL[IEL] = 10)
- Latch on Index Event Marker (QEPCTL[IEL] = 11)

This is particularly useful as an error checking mechanism to check if the position counter accumulated the correct number of counts between index events. As an example, the 1000-line encoder must count 4000 times when moving in the same direction between the index events.

The index event latch interrupt flag (QFLG[IEL]) is set when the position counter is latched to the QPOSILAT register. The index event latch configuration bits (QEPCTZ[IEL]) are ignored when QEPCTL[PCRM] = 00.

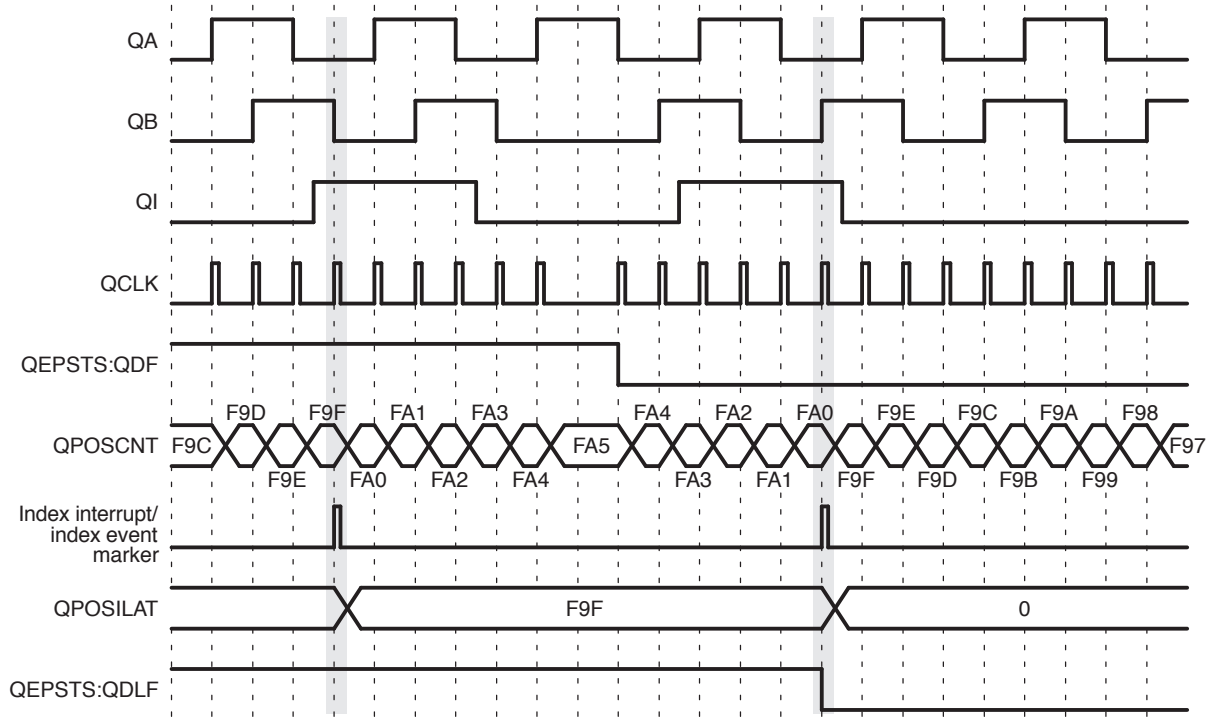
Latch on Rising Edge (QEPCTL[IEL] = 01)— The position counter value (QPOSCNT) is latched to the QPOSILAT register on every rising edge of an index input.

Latch on Falling Edge (QEPCTL[IEL] = 10)— The position counter value (QPOSCNT) is latched to the QPOSILAT register on every falling edge of index input.

Latch on Index Event Marker/Software Index Marker (QEPCTL[IEL] = 11)— The first index marker is defined as the quadrature edge following the first index edge. The eQEP peripheral records the occurrence of the first index marker (QEPSTS[FIMF]) and direction on the first index event marker (QEPSTS[FIDF]) in the QEPSTS registers. It also remembers the quadrature edge on the first index marker so that same relative quadrature transition is used for latching the position counter (QEPCTL[IEL] = 11).

[Figure 15-139](#) shows the position counter latch using an index event marker.

Figure 15-139. Software Index Marker for 1000-line Encoder (QEPCTL[IEL] = 1)



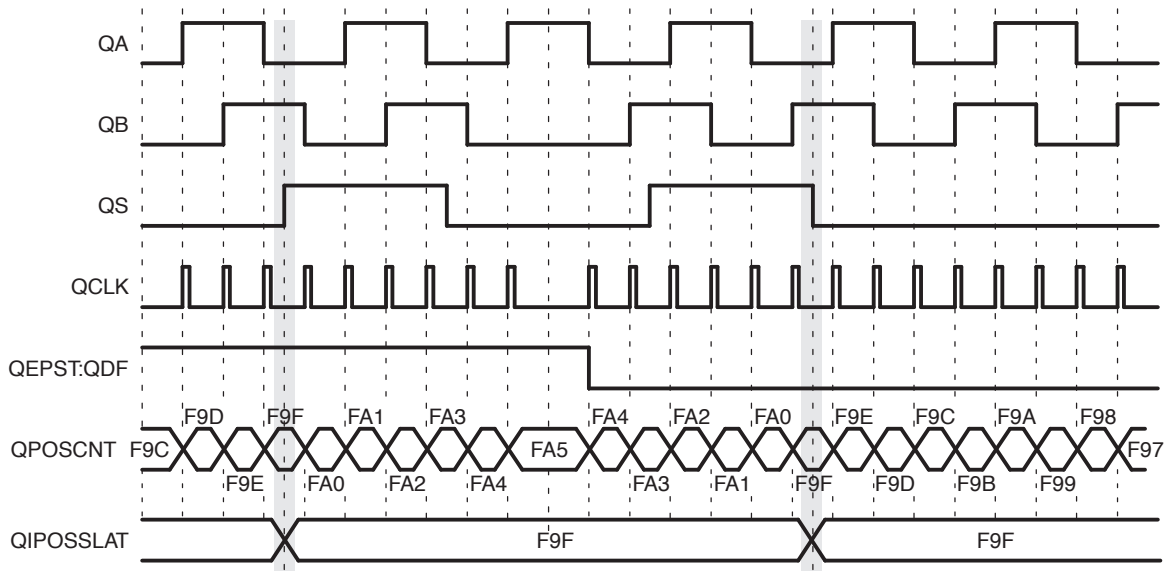
15.4.2.4.2.2 Strobe Event Latch

The position-counter value is latched to the QPOSSLAT register on the rising edge of the strobe input by clearing the QEPCTL[SEL] bit.

If the QEPCTL[SEL] bit is set, then the position counter value is latched to the QPOSSLAT register on the rising edge of the strobe input for forward direction and on the falling edge of the strobe input for reverse direction as shown in Figure 15-140.

The strobe event latch interrupt flag (QFLG[SEL]) is set when the position counter is latched to the QPOSSLAT register.

Figure 15-140. Strobe Event Latch (QEPCTL[SEL] = 1)



15.4.2.4.3 Position Counter Initialization

The position counter can be initialized using following events:

- Index event
- Strobe event
- Software initialization

Index Event Initialization (IEI)— The QEPI index input can be used to trigger the initialization of the position counter at the rising or falling edge of the index input.

If the QEPCTL[IEI] bits are 10, then the position counter (QPOSCNT) is initialized with a value in the QPOSINIT register on the rising edge of strobe input for forward direction and on the falling edge of strobe input for reverse direction.

The index event initialization interrupt flag (QLFG[IEI]) is set when the position counter is initialized with a value in the QPOSINIT register.

Strobe Event Initialization (SEI)— If the QEPCTL[SEI] bits are 10, then the position counter is initialized with a value in the QPOSINIT register on the rising edge of strobe input.

If the QEPCTL[SEL] bits are 11, then the position counter (QPOSCNT) is initialized with a value in the QPOSINIT register on the rising edge of strobe input for forward direction and on the falling edge of strobe input for reverse direction.

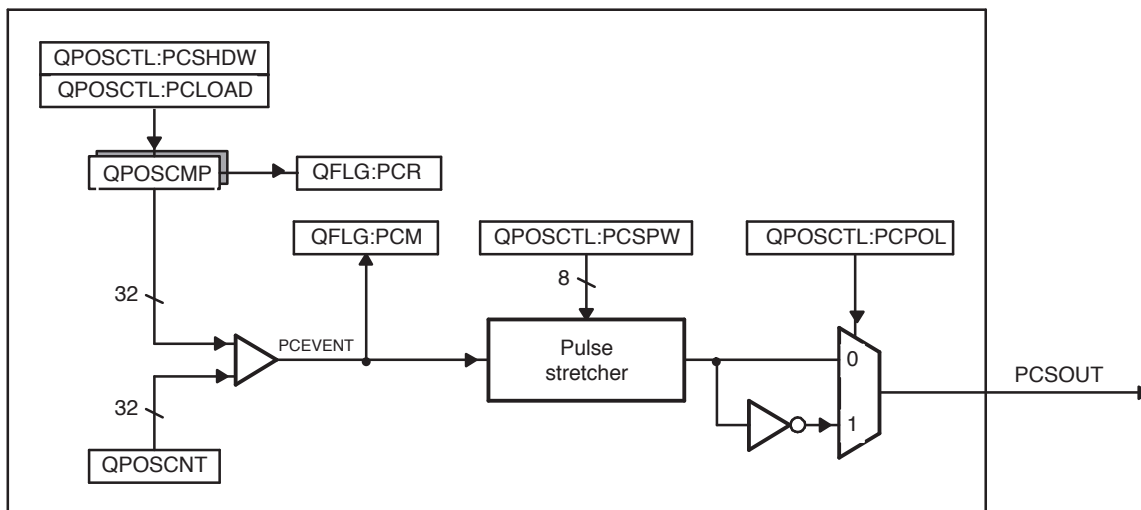
The strobe event initialization interrupt flag (QLFG[SEI]) is set when the position counter is initialized with a value in the QPOSINIT register.

Software Initialization (SWI)— The position counter can be initialized in software by writing a 1 to the QEPCTL[SWI] bit, which will automatically be cleared after initialization.

15.4.2.4.4 eQEP Position-compare Unit

The eQEP peripheral includes a position-compare unit that is used to generate a sync output and/or interrupt on a position-compare match. Figure 15-141 shows a diagram. The position-compare (QPOSCMP) register is shadowed and shadow mode can be enabled or disabled using the QPOSCTL[PSSHDW] bit. If the shadow mode is not enabled, the CPU writes directly to the active position compare register.

Figure 15-141. eQEP Position-compare Unit



In shadow mode, you can configure the position-compare unit (QPOSCTL[PCLOAD]) to load the shadow register value into the active register on the following events and to generate the position-compare ready (QLFG[PCR]) interrupt after loading.

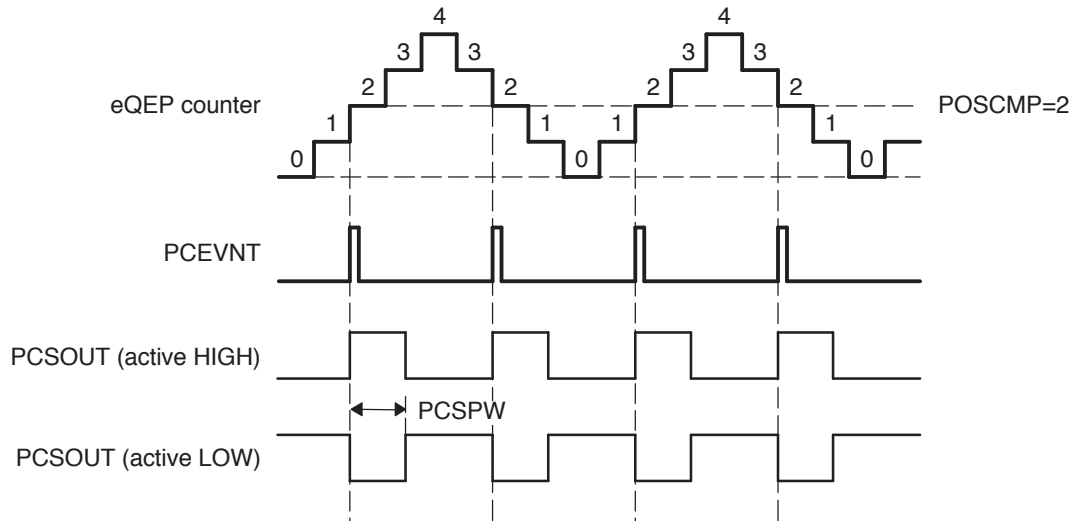
- Load on compare match
- Load on position-counter zero event

The position-compare match (QFLG[PCM]) is set when the position-counter value (QPOSCNT) matches with the active position-compare register (QPOSCMP) and the position-compare sync output of the programmable pulse width is generated on compare match to trigger an external device.

For example, if QPOSCMP = 2, the position-compare unit generates a position-compare event on 1 to 2 transitions of the eQEP position counter for forward counting direction and on 3 to 2 transitions of the eQEP position counter for reverse counting direction (see Figure 15-142).

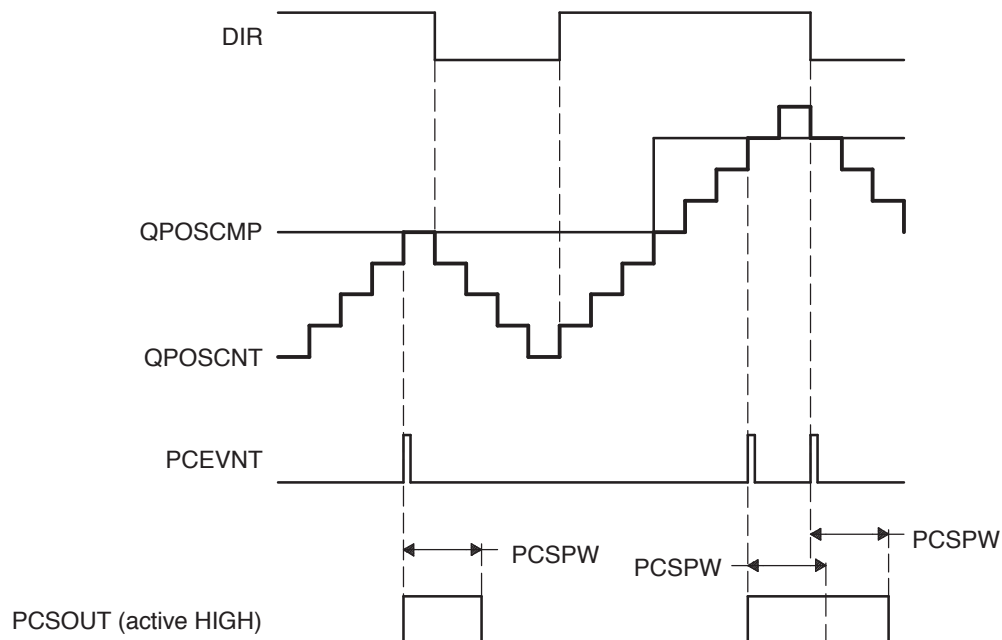
shows the layout of the eQEP Position-Compare Control Register (QPOSCTL) and describes the QPOSCTL bit fields.

Figure 15-142. eQEP Position-compare Event Generation Points



The pulse stretcher logic in the position-compare unit generates a programmable position-compare sync pulse output on the position-compare match. In the event of a new position-compare match while a previous position-compare pulse is still active, then the pulse stretcher generates a pulse of specified duration from the new position-compare event as shown in Figure 15-143.

Figure 15-143. eQEP Position-compare Sync Output Pulse Stretcher



15.4.2.5 eQEP Edge Capture Unit

The eQEP peripheral includes an integrated edge capture unit to measure the elapsed time between the unit position events as shown in [Figure 15-144](#). This feature is typically used for low speed measurement using the following equation:

$$v(k) = \frac{X}{t(k) - t(k - 1)} = \frac{X}{\Delta T} \quad (3)$$

where,

- X - Unit position is defined by integer multiple of quadrature edges (see [Figure 15-145](#))
- ΔT - Elapsed time between unit position events
- v(k) - Velocity at time instant "k"

The eQEP capture timer (QCTMR) runs from prescaled SYSCLKOUT and the prescaler is programmed by the QCAPCTL[CCPS] bits. The capture timer (QCTMR) value is latched into the capture period register (QCPRD) on every unit position event and then the capture timer is reset, a flag is set in QEPSTS[UPEVNT] to indicate that new value is latched into the QCPRD register. Software can check this status flag before reading the period register for low speed measurement and clear the flag by writing 1.

Time measurement (ΔT) between unit position events will be correct if the following conditions are met:

- No more than 65,535 counts have occurred between unit position events.
- No direction change between unit position events.

The capture unit sets the eQEP overflow error flag (QEPSTS[COEF]) in the event of capture timer overflow between unit position events. If a direction change occurs between the unit position events, then an error flag is set in the status register (QEPSTS[CDEF]).

Capture Timer (QCTMR) and Capture period register (QCPRD) can be configured to latch on following events.

- CPU read of QPOSCNT register
- Unit time-out event

If the QEPCTL[QCLM] bit is cleared, then the capture timer and capture period values are latched into the QCTMRLAT and QCPRDLAT registers, respectively, when the CPU reads the position counter (QPOSCNT).

If the QEPCTL[QCLM] bit is set, then the position counter, capture timer, and capture period values are latched into the QPOSLAT, QCTMRLAT and QCPRDLAT registers, respectively, on unit time out.

[Figure 15-146](#) shows the capture unit operation along with the position counter.

NOTE: The QCAPCTL register should not be modified dynamically (such as switching CAPCLK prescaling mode from QCLK/4 to QCLK/8). The capture unit must be disabled before changing the prescaler.

Figure 15-144. eQEP Edge Capture Unit

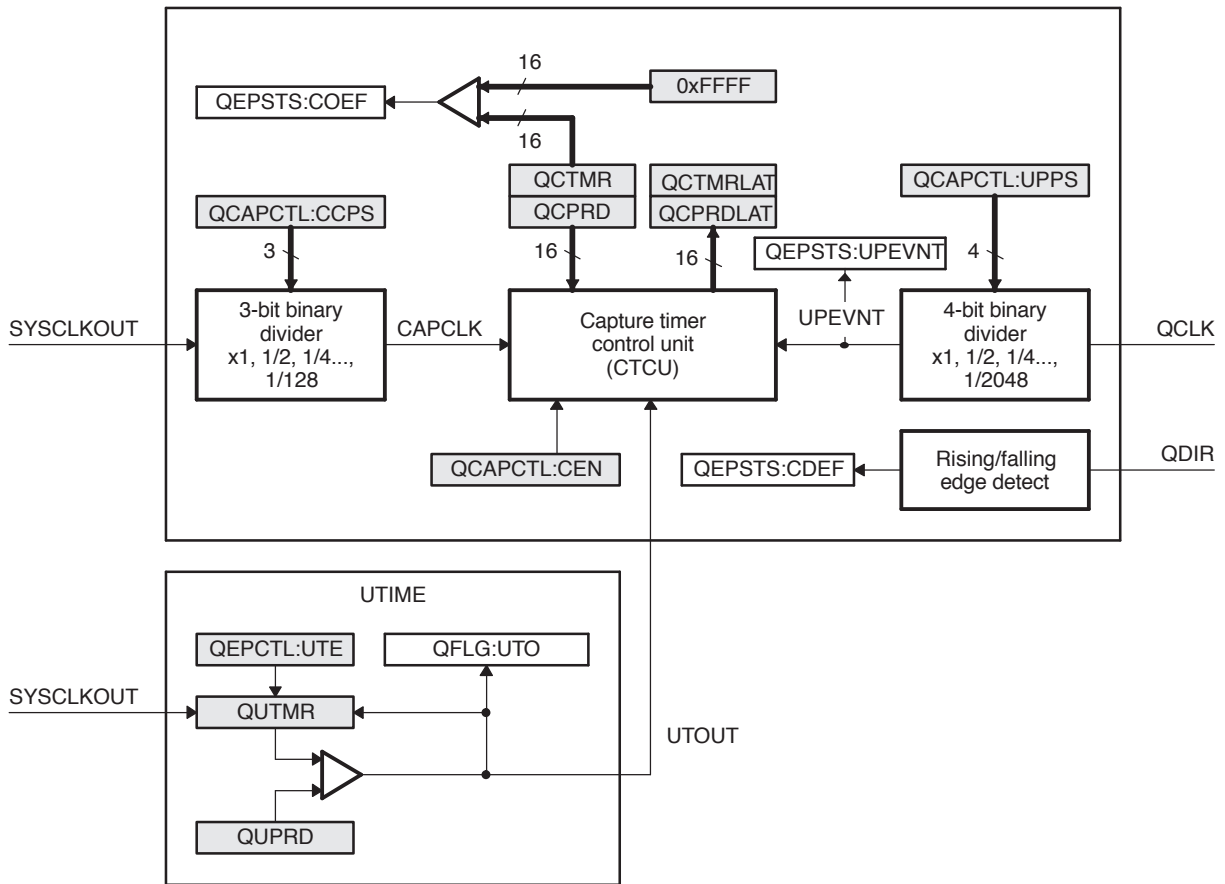


Figure 15-145. Unit Position Event for Low Speed Measurement (QCAPCTL[UPPS] = 0010)

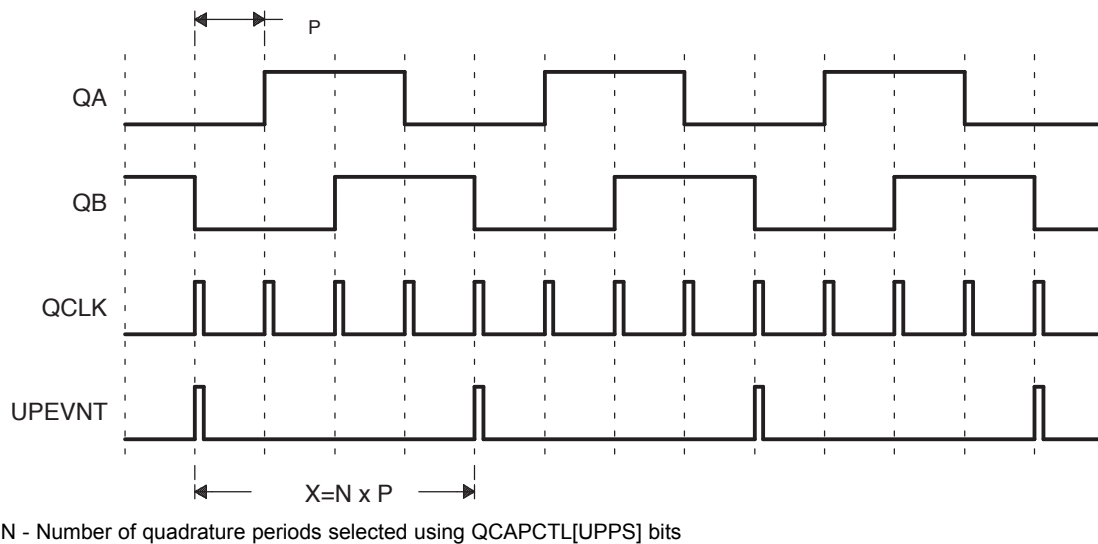
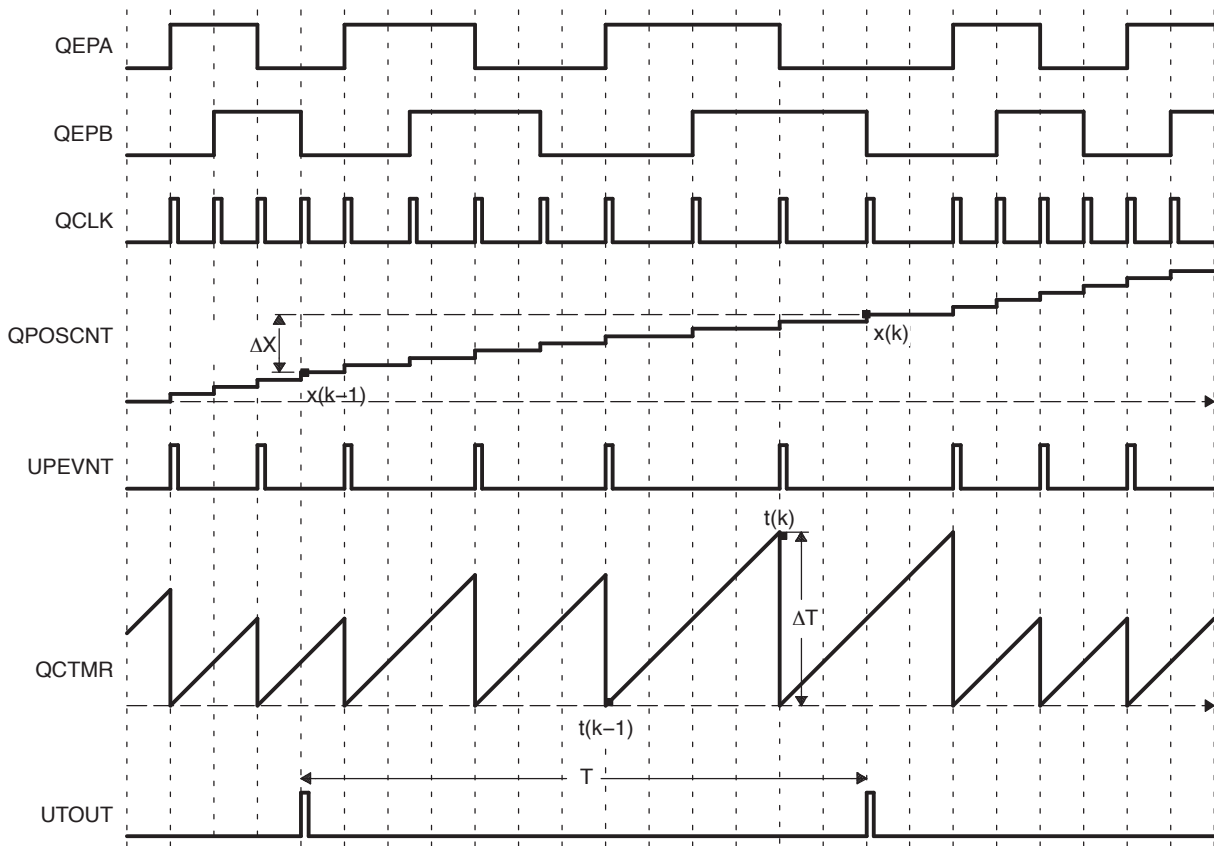


Figure 15-146. eQEP Edge Capture Unit - Timing Details



Velocity Calculation Equations:

$$v(k) = \frac{x(k) - x(k - 1)}{T} = \frac{\Delta X}{T} \quad (4)$$

where

$v(k)$: Velocity at time instant k

$x(k)$: Position at time instant k

$x(k-1)$: Position at time instant $k - 1$

T : Fixed unit time or inverse of velocity calculation rate

ΔX : Incremental position movement in unit time

X : Fixed unit position

ΔT : Incremental time elapsed for unit position movement

$t(k)$: Time instant "k"

$t(k-1)$: Time instant "k - 1"

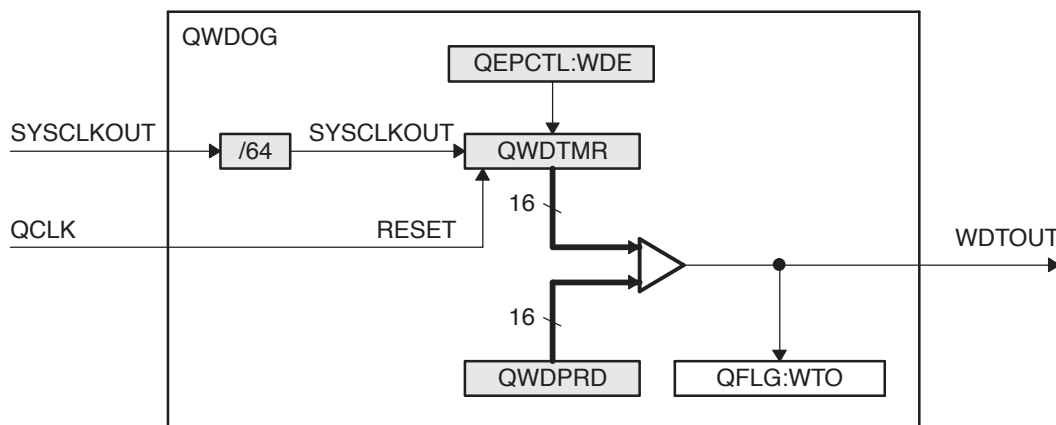
Unit time (T) and unit period (X) are configured using the QUPRD and QCAPCTL[Upps] registers. Incremental position output and incremental time output is available in the QPOSLAT and QCPRDLAT registers.

Parameter	Relevant Register to Configure or Read the Information
T	Unit Period Register (QUPRD)
ΔX	Incremental Position = QOSLAT(k) - QOSLAT(K - 1)
X	Fixed unit position defined by sensor resolution and ZCAPCTL[UPPS] bits
ΔT	Capture Period Latch (QCPRDLAT)

15.4.2.6 eQEP Watchdog

The eQEP peripheral contains a 16-bit watchdog timer that monitors the quadrature-clock to indicate proper operation of the motion-control system. The eQEP watchdog timer is clocked from SYSCLKOUT/64 and the quadrature clock event (pulse) resets the watchdog timer. If no quadrature-clock event is detected until a period match ($QWDPRD = QWDTMR$), then the watchdog timer will time out and the watchdog interrupt flag will be set (QFLG[WTO]). The time-out value is programmable through the watchdog period register (QWDPRD).

Figure 15-147. eQEP Watchdog Timer

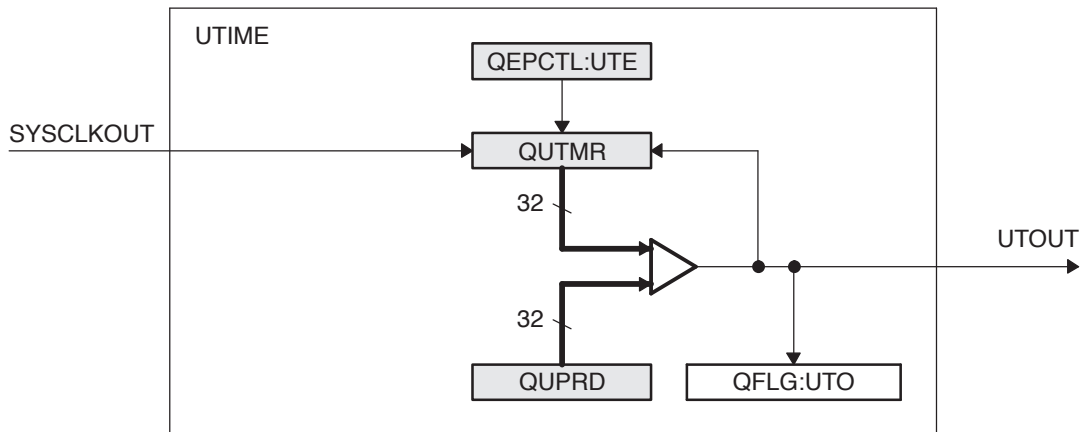


15.4.2.7 Unit Timer Base

The eQEP peripheral includes a 32-bit timer (QUTMR) that is clocked by SYSCLKOUT to generate periodic interrupts for velocity calculations. The unit time out interrupt is set (QFLG[UTO]) when the unit timer (QUTMR) matches the unit period register (QUPRD).

The eQEP peripheral can be configured to latch the position counter, capture timer, and capture period values on a unit time out event so that latched values are used for velocity calculation as described in Section [Section 15.4.2.5](#).

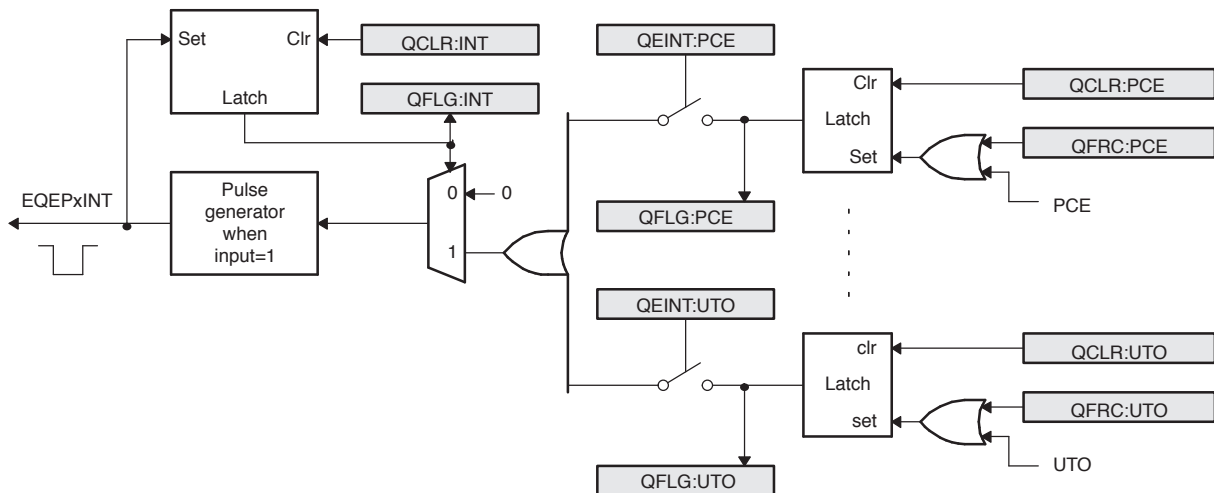
Figure 15-148. eQEP Unit Time Base



15.4.2.8 eQEP Interrupt Structure

Figure 15-149 shows how the interrupt mechanism works in the EQEP module.

Figure 15-149. EQEP Interrupt Generation



Eleven interrupt events (PCE, PHE, QDC, WTO, PCU, PCO, PCR, PCM, SEL, IEL, and UTO) can be generated. The interrupt control register (QEINT) is used to enable/disable individual interrupt event sources. The interrupt flag register (QFLG) indicates if any interrupt event has been latched and contains the global interrupt flag bit (INT). An interrupt pulse is generated only to the interrupt controller if any of the interrupt events is enabled, the flag bit is 1 and the INT flag bit is 0. The interrupt service routine will need to clear the global interrupt flag bit and the serviced event, via the interrupt clear register (QCLR), before any other interrupt pulses are generated. You can force an interrupt event by way of the interrupt force register (QFRC), which is useful for test purposes.

Note that the interrupts coming from the eQEP module are also used as DMA events. The interrupt registers should be used to enable and clear the current DMA event in order for the eQEP module to generate subsequent DMA events.

15.4.3 EQEP Registers

[Table 15-115](#) lists the memory-mapped registers for the EQEP. All register offset addresses not listed in [Table 15-115](#) should be considered as reserved locations and the register contents should not be modified.

Table 15-115. EQEP Registers

Offset	Acronym	Register Name	Section
0h	QPOSCNT	eQEP Position Counter Register	Section 15.4.3.1
4h	QPOSINIT	eQEP Position Counter Initialization Register	Section 15.4.3.2
8h	QPOSMAX	eQEP Maximum Position Count Register	Section 15.4.3.3
Ch	QPOSCMP	eQEP Position-Compare Register	Section 15.4.3.4
10h	QPOSILAT	eQEP Index Position Latch Register	Section 15.4.3.5
14h	QPOSSLAT	eQEP Strobe Position Latch Register	Section 15.4.3.6
18h	QPOSLAT	eQEP Position Counter Latch Register	Section 15.4.3.7
1Ch	QUTMR	eQEP Unit Timer Register	Section 15.4.3.8
20h	QUPRD	eQEP Unit Period Register	Section 15.4.3.9
24h	QWDTMR	eQEP Watchdog Timer Register	Section 15.4.3.10
26h	QWDPRD	eQEP Watchdog Period Register	Section 15.4.3.11
28h	QDECCTL	eQEP Decoder Control Register	Section 15.4.3.12
2Ah	QEPCTL	eQEP Control Register	Section 15.4.3.13
2Ch	QCAPCTL	eQEP Capture Control Register	Section 15.4.3.14
2Eh	QPOSCTL	eQEP Position-Compare Control Register	Section 15.4.3.15
30h	QEINT	eQEP Interrupt Enable Register	Section 15.4.3.16
32h	QFLG	eQEP Interrupt Flag Register	Section 15.4.3.17
34h	QCLR	eQEP Interrupt Clear Register	Section 15.4.3.18
36h	QFRC	eQEP Interrupt Force Register	Section 15.4.3.19
38h	QEPSTS	eQEP Status Register	Section 15.4.3.20
3Ah	QCTMR	eQEP Capture Timer Register	Section 15.4.3.21
3Ch	QCPRD	eQEP Capture Period Register	Section 15.4.3.22
3Eh	QCTMRLAT	eQEP Capture Timer Latch Register	Section 15.4.3.23
40h	QCPRDLAT	eQEP Capture Period Latch Register	Section 15.4.3.24
5Ch	REVID	eQEP Revision ID Register	Section 15.4.3.25

15.4.3.1 QPOSCNT Register (offset = 0h) [reset = 0h]

QPOSCNT is shown in [Figure 15-150](#) and described in [Table 15-116](#).

Figure 15-150. QPOSCNT Register

31	30	29	28	27	26	25	24	23	22	21	20	19	18	17	16	15	14	13	12	11	10	9	8	7	6	5	4	3	2	1	0
QPOSCNT																															
R/W-0h																															

LEGEND: R/W = Read/Write; R = Read only; W1toCl = Write 1 to clear bit; -n = value after reset

Table 15-116. QPOSCNT Register Field Descriptions

Bit	Field	Type	Reset	Description
31-0	QPOSCNT	R/W	0h	This 32 bit position counter register counts up/down on every eQEP pulse based on direction input. This counter acts as a position integrator whose count value is proportional to position from a give reference point.

15.4.3.2 QPOSINIT Register (offset = 4h) [reset = 0h]

QPOSINIT is shown in [Figure 15-151](#) and described in [Table 15-117](#).

Figure 15-151. QPOSINIT Register

31	30	29	28	27	26	25	24	23	22	21	20	19	18	17	16	15	14	13	12	11	10	9	8	7	6	5	4	3	2	1	0
QPOSINIT																															
R/W-0h																															

LEGEND: R/W = Read/Write; R = Read only; W1toCl = Write 1 to clear bit; -n = value after reset

Table 15-117. QPOSINIT Register Field Descriptions

Bit	Field	Type	Reset	Description
31-0	QPOSINIT	R/W	0h	This register contains the position value that is used to initialize the position counter based on external strobe or index event. The position counter can be initialized through software.

15.4.3.3 QPOSMAX Register (offset = 8h) [reset = 0h]

QPOSMAX is shown in [Figure 15-152](#) and described in [Table 15-118](#).

Figure 15-152. QPOSMAX Register

31	30	29	28	27	26	25	24	23	22	21	20	19	18	17	16	15	14	13	12	11	10	9	8	7	6	5	4	3	2	1	0
QPOSMAX																															
R/W-0h																															

LEGEND: R/W = Read/Write; R = Read only; W1toCl = Write 1 to clear bit; -n = value after reset

Table 15-118. QPOSMAX Register Field Descriptions

Bit	Field	Type	Reset	Description
31-0	QPOSMAX	R/W	0h	This register contains the maximum position counter value.

15.4.3.4 QPOSCMP Register (offset = Ch) [reset = 0h]

QPOSCMP is shown in [Figure 15-153](#) and described in [Table 15-119](#).

Figure 15-153. QPOSCMP Register

31	30	29	28	27	26	25	24	23	22	21	20	19	18	17	16	15	14	13	12	11	10	9	8	7	6	5	4	3	2	1	0
QPOSCMP																															
R/W-0h																															

LEGEND: R/W = Read/Write; R = Read only; W1toCl = Write 1 to clear bit; -n = value after reset

Table 15-119. QPOSCMP Register Field Descriptions

Bit	Field	Type	Reset	Description
31-0	QPOSCMP	R/W	0h	The position-compare value in this register is compared with the position counter (QPOSCNT) to generate sync output and/or interrupt on compare match.

15.4.3.5 QPOSILAT Register (offset = 10h) [reset = 0h]

QPOSILAT is shown in [Figure 15-154](#) and described in [Table 15-120](#).

Figure 15-154. QPOSILAT Register

31	30	29	28	27	26	25	24	23	22	21	20	19	18	17	16	15	14	13	12	11	10	9	8	7	6	5	4	3	2	1	0
QPOSILAT																															
R-0h																															

LEGEND: R/W = Read/Write; R = Read only; W1toCl = Write 1 to clear bit; -n = value after reset

Table 15-120. QPOSILAT Register Field Descriptions

Bit	Field	Type	Reset	Description
31-0	QPOSILAT	R	0h	The position-counter value is latched into this register on an index event as defined by the QEPCTL[IEL] bits.

15.4.3.6 QPOSSLAT Register (offset = 14h) [reset = 0h]

QPOSSLAT is shown in [Figure 15-155](#) and described in [Table 15-121](#).

Figure 15-155. QPOSSLAT Register

31	30	29	28	27	26	25	24	23	22	21	20	19	18	17	16	15	14	13	12	11	10	9	8	7	6	5	4	3	2	1	0
QPOSSLAT																															
R-0h																															

LEGEND: R/W = Read/Write; R = Read only; W1toCl = Write 1 to clear bit; -n = value after reset

Table 15-121. QPOSSLAT Register Field Descriptions

Bit	Field	Type	Reset	Description
31-0	QPOSSLAT	R	0h	The position-counter value is latched into this register on strobe event as defined by the QEPCTL[SEL] bits.

15.4.3.7 QPOSLAT Register (offset = 18h) [reset = 0h]

QPOSLAT is shown in [Figure 15-156](#) and described in [Table 15-122](#).

Figure 15-156. QPOSLAT Register

31	30	29	28	27	26	25	24	23	22	21	20	19	18	17	16	15	14	13	12	11	10	9	8	7	6	5	4	3	2	1	0
QPOSLAT																															
R-0h																															

LEGEND: R/W = Read/Write; R = Read only; W1toCl = Write 1 to clear bit; -n = value after reset

Table 15-122. QPOSLAT Register Field Descriptions

Bit	Field	Type	Reset	Description
31-0	QPOSLAT	R	0h	The position-counter value is latched into this register on unit time out event.

15.4.3.8 QUTMR Register (offset = 1Ch) [reset = 0h]

QUTMR is shown in [Figure 15-157](#) and described in [Table 15-123](#).

Figure 15-157. QUTMR Register

31	30	29	28	27	26	25	24	23	22	21	20	19	18	17	16	15	14	13	12	11	10	9	8	7	6	5	4	3	2	1	0
QUTMR																															
R/W-0h																															

LEGEND: R/W = Read/Write; R = Read only; W1toCl = Write 1 to clear bit; -n = value after reset

Table 15-123. QUTMR Register Field Descriptions

Bit	Field	Type	Reset	Description
31-0	QUTMR	R/W	0h	This register acts as time base for unit time event generation. When this timer value matches with unit time period value, unit time event is generated.

15.4.3.9 QUPRD Register (offset = 20h) [reset = 0h]

QUPRD is shown in [Figure 15-158](#) and described in [Table 15-124](#).

Figure 15-158. QUPRD Register

31	30	29	28	27	26	25	24	23	22	21	20	19	18	17	16	15	14	13	12	11	10	9	8	7	6	5	4	3	2	1	0
QUPRD																															
R/W-0h																															

LEGEND: R/W = Read/Write; R = Read only; W1toCl = Write 1 to clear bit; -n = value after reset

Table 15-124. QUPRD Register Field Descriptions

Bit	Field	Type	Reset	Description
31-0	QUPRD	R/W	0h	This register contains the period count for unit timer to generate periodic unit time events to latch the eQEP position information at periodic interval and optionally to generate interrupt.

15.4.3.10 QWDTMR Register (offset = 24h) [reset = 0h]

QWDTMR is shown in [Figure 15-159](#) and described in [Table 15-125](#).

Figure 15-159. QWDTMR Register

15	14	13	12	11	10	9	8	7	6	5	4	3	2	1	0
QWDTMR															
R/W-0h															

LEGEND: R/W = Read/Write; R = Read only; W1toCl = Write 1 to clear bit; -n = value after reset

Table 15-125. QWDTMR Register Field Descriptions

Bit	Field	Type	Reset	Description
15-0	QWDTMR	R/W	0h	This register acts as time base for watch dog to detect motor stalls. When this timer value matches with watch dog period value, watch dog timeout interrupt is generated. This register is reset upon edge transition in quadrature-clock indicating the motion.

15.4.3.11 QWDPRD Register (offset = 26h) [reset = 0h]

QWDPRD is shown in [Figure 15-160](#) and described in [Table 15-126](#).

Figure 15-160. QWDPRD Register

15	14	13	12	11	10	9	8	7	6	5	4	3	2	1	0
QWDPRD															
R/W-0h															

LEGEND: R/W = Read/Write; R = Read only; W1toCl = Write 1 to clear bit; -n = value after reset

Table 15-126. QWDPRD Register Field Descriptions

Bit	Field	Type	Reset	Description
15-0	QWDPRD	R/W	0h	This register contains the time-out count for the eQEP peripheral watch dog timer. When the watchdog timer value matches the watchdog period value, a watchdog timeout interrupt is generated.

15.4.3.12 QDECCTL Register (offset = 28h) [reset = 0h]

 QDECCTL is shown in [Figure 15-161](#) and described in [Table 15-127](#).

Figure 15-161. QDECCTL Register

15		14		13		12		11		10		9		8	
QSRC				SOEN		SPSEL		XCR		SWAP		IGATE		QAP	
R/W-0h				R/W-0h		R/W-0h		R/W-0h		R/W-0h		R/W-0h		R/W-0h	
7		6		5		4		3		2		1		0	
QBP		QIP		QSP		RESERVED									
R/W-0h		R/W-0h		R/W-0h		R-0h									

LEGEND: R/W = Read/Write; R = Read only; W1toCl = Write 1 to clear bit; -n = value after reset

Table 15-127. QDECCTL Register Field Descriptions

Bit	Field	Type	Reset	Description
15-14	QSRC	R/W	0h	Position-counter source selection. 0h = Quadrature count mode (QCLK = iCLK, QDIR = iDIR) 1h = Direction-count mode (QCLK = xCLK, QDIR = xDIR) 2h = UP count mode for frequency measurement (QCLK = xCLK, QDIR = 1) 3h = DOWN count mode for frequency measurement (QCLK = xCLK, QDIR = 0)
13	SOEN	R/W	0h	Sync output-enable 0h = Disable position-compare sync output 1h = Enable position-compare sync output
12	SPSEL	R/W	0h	Sync output pin selection 0h = Index pin is used for sync output 1h = Strobe pin is used for sync output
11	XCR	R/W	0h	External clock rate 0h = 2x resolution: Count the rising/falling edge 1h = 1x resolution: Count the rising edge only
10	SWAP	R/W	0h	Swap quadrature clock inputs. This swaps the input to the quadrature decoder, reversing the counting direction. 0h = Quadrature-clock inputs are not swapped 1h = Quadrature-clock inputs are swapped
9	IGATE	R/W	0h	Index pulse gating option 0h = Disable gating of Index pulse 1h = Gate the index pin with strobe
8	QAP	R/W	0h	QEPA input polarity 0h = No effect 1h = Negates QEPA input
7	QBP	R/W	0h	QEPB input polarity 0h = No effect 1h = Negates QEPB input
6	QIP	R/W	0h	QEPI input polarity 0h = No effect 1h = Negates QEPI input
5	QSP	R/W	0h	QEPS input polarity 0h = No effect 1h = Negates QEPS input
4-0	RESERVED	R	0h	

15.4.3.13 QEPCTL Register (offset = 2Ah) [reset = 0h]

QEPCTL is shown in [Figure 15-162](#) and described in [Table 15-128](#).

Figure 15-162. QEPCTL Register

15	14	13	12	11	10	9	8
FREE_SOFT		PCRM		SEI		IEI	
R/W-0h		R/W-0h		R/W-0h		R/W-0h	
7	6	5	4	3	2	1	0
SWI	SEL	IEL		PHEN	QCLM	UTE	WDE
R/W-0h	R/W-0h	R/W-0h		R/W-0h	R/W-0h	R/W-0h	R/W-0h

LEGEND: R/W = Read/Write; R = Read only; W1toCl = Write 1 to clear bit; -n = value after reset

Table 15-128. QEPCTL Register Field Descriptions

Bit	Field	Type	Reset	Description
15-14	FREE_SOFT	R/W	0h	Emulation Control Bits. In the values 0 through 3 listed below, x is different for the four following behaviors. QPOSCNT behavior, x refers to the Position counter. QWDTMR behavior, x refers to the Watchdog counter. QUTMR behavior, x refers to the Unit timer. QCTMR behavior, x refers to the Capture timer. 0h = x stops immediately. For QPOSCNT behavior, the stop is on emulation suspend. 1h = x continues to count until the rollover. 2h = x is unaffected by emulation suspend. 3h = x is unaffected by emulation suspend.
13-12	PCRM	R/W	0h	Position counter reset mode 0h = Position counter reset on an index event 1h = Position counter reset on the maximum position 2h = Position counter reset on the first index event 3h = Position counter reset on a unit time event
11-10	SEI	R/W	0h	Strobe event initialization of position counter 0h = Does nothing (action disabled) 1h = Does nothing (action disabled) 2h = Initializes the position counter on rising edge of the QEPS signal 3h = Clockwise Direction: Initializes the position counter on the rising edge of QEPS strobe. Counter Clockwise Direction: Initializes the position counter on the falling edge of QEPS strobe
9-8	IEI	R/W	0h	Index event initialization of position counter 0h = Do nothing (action disabled) 1h = Do nothing (action disabled) 2h = Initializes the position counter on the rising edge of the QEPI signal (QPOSCNT = QPOSINIT) 3h = Initializes the position counter on the falling edge of QEPI signal (QPOSCNT = QPOSINIT)
7	SWI	R/W	0h	Software initialization of position counter 0h = Do nothing (action disabled) 1h = Initialize position counter, this bit is cleared automatically
6	SEL	R/W	0h	Strobe event latch of position counter 0h = The position counter is latched on the rising edge of QEPS strobe (QPOSSLAT = POSCCNT). Latching on the falling edge can be done by inverting the strobe input using the QSP bit in the QDECCTL register. 1h = Clockwise Direction: Position counter is latched on rising edge of QEPS strobe. Counter Clockwise Direction: Position counter is latched on falling edge of QEPS strobe.

Table 15-128. QEPCTL Register Field Descriptions (continued)

Bit	Field	Type	Reset	Description
5-4	IEL	R/W	0h	Index event latch of position counter (software index marker) 0h = Reserved 1h = Latches position counter on rising edge of the index signal 2h = Latches position counter on falling edge of the index signal 3h = Software index marker. Latches the position counter and quadrature direction flag on index event marker. The position counter is latched to the QPOSILAT register and the direction flag is latched in the QEPSTS[QDLF] bit. This mode is useful for software index marking.
3	PHEN	R/W	0h	Quadrature position counter enable/software reset 0h = Reset the eQEP peripheral internal operating flags/read-only registers. Control/configuration registers are not disturbed by a software reset. 1h = eQEP position counter is enabled
2	QCLM	R/W	0h	eQEP capture latch mode 0h = Latch on position counter read by CPU. Capture timer and capture period values are latched into QCTMRLAT and QCPRDLAT registers when CPU reads the QPOSCNT register. 1h = Latch on unit time out. Position counter, capture timer and capture period values are latched into QPOSLAT, QCTMRLAT and QCPRDLAT registers on unit time out.
1	UTE	R/W	0h	eQEP unit timer enable 0h = Disable eQEP unit timer 1h = Enable unit timer
0	WDE	R/W	0h	eQEP watchdog enable 0h = Disable the eQEP watchdog timer 1h = Enable the eQEP watchdog timer

15.4.3.14 QCAPCTL Register (offset = 2Ch) [reset = 0h]

 QCAPCTL is shown in [Figure 15-163](#) and described in [Table 15-129](#).

Figure 15-163. QCAPCTL Register

15	14	13	12	11	10	9	8
CEN	RESERVED						
R/W-0h				R-0h			
7	6	5	4	3	2	1	0
RESERVED	CCPS			UPPS			
R-0h		R/W-0h			R/W-0h		

LEGEND: R/W = Read/Write; R = Read only; W1toCl = Write 1 to clear bit; -n = value after reset

Table 15-129. QCAPCTL Register Field Descriptions

Bit	Field	Type	Reset	Description
15	CEN	R/W	0h	Enable eQEP capture 0h = eQEP capture unit is disabled 1h = eQEP capture unit is enabled
14-7	RESERVED	R	0h	
6-4	CCPS	R/W	0h	eQEP capture timer clock prescaler 0h = CAPCLK = SYSCLKOUT/1 1h = CAPCLK = SYSCLKOUT/2 2h = CAPCLK = SYSCLKOUT/4 3h = CAPCLK = SYSCLKOUT/8 4h = CAPCLK = SYSCLKOUT/16 5h = CAPCLK = SYSCLKOUT/32 6h = CAPCLK = SYSCLKOUT/64 7h = CAPCLK = SYSCLKOUT/128
3-0	UPPS	R/W	0h	Unit position event prescaler 0h = UPEVNT = QCLK/1 1h = UPEVNT = QCLK/2 2h = UPEVNT = QCLK/4 3h = UPEVNT = QCLK/8 4h = UPEVNT = QCLK/16 5h = UPEVNT = QCLK/32 6h = UPEVNT = QCLK/64 7h = UPEVNT = QCLK/128 8h = UPEVNT = QCLK/256 9h = UPEVNT = QCLK/512 Ah = UPEVNT = QCLK/1024 Bh = UPEVNT = QCLK/2048 Ch = Reserved Dh = Reserved Eh = Reserved Fh = Reserved

15.4.3.15 QPOSCTL Register (offset = 2Eh) [reset = 0h]

 QPOSCTL is shown in [Figure 15-164](#) and described in [Table 15-130](#).

Figure 15-164. QPOSCTL Register

15	14	13	12	11	10	9	8
PCSHDW	PCLOAD	PCPOL	PCE	PCSPW			
R/W-0h	R/W-0h	R/W-0h	R/W-0h	R/W-0h			
7	6	5	4	3	2	1	0
PCSPW							
R/W-0h							

LEGEND: R/W = Read/Write; R = Read only; W1toCl = Write 1 to clear bit; -n = value after reset

Table 15-130. QPOSCTL Register Field Descriptions

Bit	Field	Type	Reset	Description
15	PCSHDW	R/W	0h	Position-compare shadow enable 0h = Shadow disabled, load Immediate 1h = Shadow enabled
14	PCLOAD	R/W	0h	Position-compare shadow load mode 0h = Load on QPOSCNT = 0 1h = Load when QPOSCNT = QPOSCMP
13	PCPOL	R/W	0h	Polarity of sync output 0h = Active HIGH pulse output 1h = Active LOW pulse output
12	PCE	R/W	0h	Position-compare enable/disable 0h = Disable position compare unit 1h = Enable position compare unit
11-0	PCSPW	R/W	0h	Select-position-compare sync output pulse width ... 0h = 1 x 4 x SYSCLKOUT cycles 1h = 2 x 4 x SYSCLKOUT cycles 2h = 3 x 4 x SYSCLKOUT cycles to 4096 x 4 x SYSCLKOUT cycles FFFh = 3 x 4 x SYSCLKOUT cycles to 4096 x 4 x SYSCLKOUT cycles

15.4.3.16 QEINT Register (offset = 30h) [reset = 0h]

 QEINT is shown in [Figure 15-165](#) and described in [Table 15-131](#).

Figure 15-165. QEINT Register

15	14	13	12	11	10	9	8
RESERVED				UTO	IEL	SEL	PCM
R-0h				R/W-0h	R/W-0h	R/W-0h	R/W-0h
7	6	5	4	3	2	1	0
PCR	PCO	PCU	WTO	QDC	PHE	PCE	RESERVED
R/W-0h	R/W-0h	R/W-0h	R/W-0h	R/W-0h	R/W-0h	R/W-0h	R-0h

LEGEND: R/W = Read/Write; R = Read only; W1toCl = Write 1 to clear bit; -n = value after reset

Table 15-131. QEINT Register Field Descriptions

Bit	Field	Type	Reset	Description
15-12	RESERVED	R	0h	
11	UTO	R/W	0h	Unit time out interrupt enable 0h = Interrupt is disabled 1h = Interrupt is enabled
10	IEL	R/W	0h	Index event latch interrupt enable 0h = Interrupt is disabled 1h = Interrupt is enabled
9	SEL	R/W	0h	Strobe event latch interrupt enable 0h = Interrupt is disabled 1h = Interrupt is enabled
8	PCM	R/W	0h	Position-compare match interrupt enable 0h = Interrupt is disabled 1h = Interrupt is enabled
7	PCR	R/W	0h	Position-compare ready interrupt enable 0h = Interrupt is disabled 1h = Interrupt is enabled
6	PCO	R/W	0h	Position counter overflow interrupt enable 0h = Interrupt is disabled 1h = Interrupt is enabled
5	PCU	R/W	0h	Position counter underflow interrupt enable 0h = Interrupt is disabled 1h = Interrupt is enabled
4	WTO	R/W	0h	Watchdog time out interrupt enable 0h = Interrupt is disabled 1h = Interrupt is enabled
3	QDC	R/W	0h	Quadrature direction change interrupt enable 0h = Interrupt is disabled 1h = Interrupt is enabled
2	PHE	R/W	0h	Quadrature phase error interrupt enable 0h = Interrupt is disabled 1h = Interrupt is enabled
1	PCE	R/W	0h	Position counter error interrupt enable 0h = Interrupt is disabled 1h = Interrupt is enabled
0	RESERVED	R	0h	

15.4.3.17 QFLG Register (offset = 32h) [reset = 0h]

 QFLG is shown in [Figure 15-166](#) and described in [Table 15-132](#).

Figure 15-166. QFLG Register

15	14	13	12	11	10	9	8
RESERVED				UTO	IEL	SEL	PCM
R-0h				R-0h	R-0h	R-0h	R-0h
7	6	5	4	3	2	1	0
PCR	PCO	PCU	WTO	QDC	PHE	PCE	INT
R-0h	R-0h	R-0h	R-0h	R-0h	R-0h	R-0h	R-0h

LEGEND: R/W = Read/Write; R = Read only; W1toCl = Write 1 to clear bit; -n = value after reset

Table 15-132. QFLG Register Field Descriptions

Bit	Field	Type	Reset	Description
15-12	RESERVED	R	0h	
11	UTO	R	0h	Unit time out interrupt flag 0h = No interrupt generated 1h = Set by eQEP unit timer period match
10	IEL	R	0h	Index event latch interrupt flag 0h = No interrupt generated 1h = This bit is set after latching the QPOSCNT to QPOSILAT
9	SEL	R	0h	Strobe event latch interrupt flag 0h = No interrupt generated 1h = This bit is set after latching the QPOSCNT to QPOSSLAT
8	PCM	R	0h	eQEP compare match event interrupt flag 0h = No interrupt generated 1h = This bit is set on position-compare match
7	PCR	R	0h	Position-compare ready interrupt flag 0h = No interrupt generated 1h = This bit is set after transferring the shadow register value to the active position compare register.
6	PCO	R	0h	Position counter overflow interrupt flag 0h = No interrupt generated 1h = This bit is set on position counter overflow.
5	PCU	R	0h	Position counter underflow interrupt flag 0h = No interrupt generated 1h = This bit is set on position counter underflow.
4	WTO	R	0h	Watchdog timeout interrupt flag 0h = No interrupt generated 1h = Set by watch dog timeout
3	QDC	R	0h	Quadrature direction change interrupt flag 0h = No interrupt generated 1h = This bit is set during change of direction
2	PHE	R	0h	Quadrature phase error interrupt flag 0h = No interrupt generated 1h = Set on simultaneous transition of QEPA and QEPB
1	PCE	R	0h	Position counter error interrupt flag 0h = No interrupt generated 1h = Position counter error
0	INT	R	0h	Global interrupt status flag 0h = No interrupt generated 1h = Interrupt was generated

15.4.3.18 QCLR Register (offset = 34h) [reset = 0h]

 QCLR is shown in [Figure 15-167](#) and described in [Table 15-133](#).

Figure 15-167. QCLR Register

15		14		13		12		11		10		9		8	
RESERVED								UTO		IEL		SEL		PCM	
R-0h								R/W-0h		R/W-0h		R/W-0h		R/W-0h	
7		6		5		4		3		2		1		0	
PCR		PCO		PCU		WTO		QDC		PHE		PCE		INT	
R/W-0h		R/W-0h		R/W-0h		R/W-0h		R/W-0h		R/W-0h		R/W-0h		R/W-0h	

LEGEND: R/W = Read/Write; R = Read only; W1toCl = Write 1 to clear bit; -n = value after reset

Table 15-133. QCLR Register Field Descriptions

Bit	Field	Type	Reset	Description
15-12	RESERVED	R	0h	
11	UTO	R/W	0h	Clear unit time out interrupt flag 0h = No effect 1h = Clears the interrupt flag
10	IEL	R/W	0h	Clear index event latch interrupt flag 0h = No effect 1h = Clears the interrupt flag
9	SEL	R/W	0h	Clear strobe event latch interrupt flag 0h = No effect 1h = Clears the interrupt flag
8	PCM	R/W	0h	Clear eQEP compare match event interrupt flag 0h = No effect 1h = Clears the interrupt flag
7	PCR	R/W	0h	Clear position-compare ready interrupt flag 0h = No effect 1h = Clears the interrupt flag
6	PCO	R/W	0h	Clear position counter overflow interrupt flag 0h = No effect 1h = Clears the interrupt flag
5	PCU	R/W	0h	Clear position counter underflow interrupt flag 0h = No effect 1h = Clears the interrupt flag
4	WTO	R/W	0h	Clear watchdog timeout interrupt flag 0h = No effect 1h = Clears the interrupt flag
3	QDC	R/W	0h	Clear quadrature direction change interrupt flag 0h = No effect 1h = Clears the interrupt flag
2	PHE	R/W	0h	Clear quadrature phase error interrupt flag 0h = No effect 1h = Clears the interrupt flag
1	PCE	R/W	0h	Clear position counter error interrupt flag 0h = No effect 1h = Clears the interrupt flag
0	INT	R/W	0h	Global interrupt clear flag 0h = No effect 1h = Clears the interrupt flag and enables further interrupts to be generated if an event flags is set to 1.

15.4.3.19 QFRC Register (offset = 36h) [reset = 0h]

 QFRC is shown in [Figure 15-168](#) and described in [Table 15-134](#).

Figure 15-168. QFRC Register

15	14	13	12	11	10	9	8
RESERVED				UTO	IEL	SEL	PCM
R-0h				R/W-0h	R/W-0h	R/W-0h	R/W-0h
7	6	5	4	3	2	1	0
PCR	PCO	PCU	WTO	QDC	PHE	PCE	RESERVED
R/W-0h	R/W-0h	R/W-0h	R/W-0h	R/W-0h	R/W-0h	R/W-0h	R-0h

LEGEND: R/W = Read/Write; R = Read only; W1toCl = Write 1 to clear bit; -n = value after reset

Table 15-134. QFRC Register Field Descriptions

Bit	Field	Type	Reset	Description
15-12	RESERVED	R	0h	
11	UTO	R/W	0h	Force unit time out interrupt 0h = No effect 1h = Force the interrupt
10	IEL	R/W	0h	Force index event latch interrupt 0h = No effect 1h = Force the interrupt
9	SEL	R/W	0h	Force strobe event latch interrupt 0h = No effect 1h = Force the interrupt
8	PCM	R/W	0h	Force position-compare match interrupt 0h = No effect 1h = Force the interrupt
7	PCR	R/W	0h	Force position-compare ready interrupt 0h = No effect 1h = Force the interrupt
6	PCO	R/W	0h	Force position counter overflow interrupt 0h = No effect 1h = Force the interrupt
5	PCU	R/W	0h	Force position counter underflow interrupt 0h = No effect 1h = Force the interrupt
4	WTO	R/W	0h	Force watchdog time out interrupt 0h = No effect 1h = Force the interrupt
3	QDC	R/W	0h	Force quadrature direction change interrupt 0h = No effect 1h = Force the interrupt
2	PHE	R/W	0h	Force quadrature phase error interrupt 0h = No effect 1h = Force the interrupt
1	PCE	R/W	0h	Force position counter error interrupt 0h = No effect 1h = Force the interrupt
0	RESERVED	R	0h	

15.4.3.20 QEPSTS Register (offset = 38h) [reset = 0h]

 QEPSTS is shown in [Figure 15-169](#) and described in [Table 15-135](#).

Figure 15-169. QEPSTS Register

15	14	13	12	11	10	9	8
RESERVED							
R-0h							
7	6	5	4	3	2	1	0
UPEVNT	FDF	QDF	QDLF	COEF	CDEF	FIMF	PCEF
R-0h	R-0h	R-0h	R-0h	R/W-0h	R/W-0h	R/W-0h	R-0h

LEGEND: R/W = Read/Write; R = Read only; W1toCl = Write 1 to clear bit; -n = value after reset

Table 15-135. QEPSTS Register Field Descriptions

Bit	Field	Type	Reset	Description
15-8	RESERVED	R	0h	
7	UPEVNT	R	0h	Unit position event flag 0h = No unit position event detected 1h = Unit position event detected. Write 1 to clear.
6	FDF	R	0h	Direction on the first index marker. Status of the direction is latched on the first index event marker. 0h = Counter-clockwise rotation (or reverse movement) on the first index event 1h = Clockwise rotation (or forward movement) on the first index event
5	QDF	R	0h	Quadrature direction flag 0h = Counter-clockwise rotation (or reverse movement) 1h = Clockwise rotation (or forward movement)
4	QDLF	R	0h	eQEP direction latch flag. Status of direction is latched on every index event marker. 0h = Counter-clockwise rotation (or reverse movement) on index event marker 1h = Clockwise rotation (or forward movement) on index event marker
3	COEF	R/W	0h	Capture overflow error flag 0h = Sticky bit, cleared by writing 1 1h = Overflow occurred in eQEP Capture timer (QEPCTMR)
2	CDEF	R/W	0h	Capture direction error flag 0h = Sticky bit, cleared by writing 1 1h = Direction change occurred between the capture position event.
1	FIMF	R/W	0h	First index marker flag 0h = Sticky bit, cleared by writing 1 1h = Set by first occurrence of index pulse
0	PCEF	R	0h	Position counter error flag. This bit is not sticky and it is updated for every index event. 0h = No error occurred during the last index transition. 1h = Position counter error

15.4.3.21 QCTMR Register (offset = 3Ah) [reset = 0h]

QCTMR is shown in [Figure 15-170](#) and described in [Table 15-136](#).

Figure 15-170. QCTMR Register

15	14	13	12	11	10	9	8	7	6	5	4	3	2	1	0
QCTMR															
R/W-0h															

LEGEND: R/W = Read/Write; R = Read only; W1toCl = Write 1 to clear bit; -n = value after reset

Table 15-136. QCTMR Register Field Descriptions

Bit	Field	Type	Reset	Description
15-0	QCTMR	R/W	0h	This register provides time base for edge capture unit.

15.4.3.22 QCPRD Register (offset = 3Ch) [reset = 0h]

QCPRD is shown in [Figure 15-171](#) and described in [Table 15-137](#).

Figure 15-171. QCPRD Register

15	14	13	12	11	10	9	8	7	6	5	4	3	2	1	0
QCPRD															
R/W-0h															

LEGEND: R/W = Read/Write; R = Read only; W1toCl = Write 1 to clear bit; -n = value after reset

Table 15-137. QCPRD Register Field Descriptions

Bit	Field	Type	Reset	Description
15-0	QCPRD	R/W	0h	This register holds the period count value between the last successive eQEP position events

15.4.3.23 QCTMRLAT Register (offset = 3Eh) [reset = 0h]

QCTMRLAT is shown in [Figure 15-172](#) and described in [Table 15-138](#).

Figure 15-172. QCTMRLAT Register

15	14	13	12	11	10	9	8	7	6	5	4	3	2	1	0
QCTMRLAT															
R-0h															

LEGEND: R/W = Read/Write; R = Read only; W1toCl = Write 1 to clear bit; -n = value after reset

Table 15-138. QCTMRLAT Register Field Descriptions

Bit	Field	Type	Reset	Description
15-0	QCTMRLAT	R	0h	The eQEP capture timer value can be latched into this register on two events, that is, unit timeout event, reading the eQEP position counter.

15.4.3.24 QCPRDLAT Register (offset = 40h) [reset = 0h]

QCPRDLAT is shown in [Figure 15-173](#) and described in [Table 15-139](#).

Figure 15-173. QCPRDLAT Register

15	14	13	12	11	10	9	8	7	6	5	4	3	2	1	0
QCPRDLAT															
R/W-0h															

LEGEND: R/W = Read/Write; R = Read only; W1toCl = Write 1 to clear bit; -n = value after reset

Table 15-139. QCPRDLAT Register Field Descriptions

Bit	Field	Type	Reset	Description
15-0	QCPRDLAT	R/W	0h	eQEP capture period value can be latched into this register on two events, that is, unit timeout event, reading the eQEP position counter.

15.4.3.25 REVID Register (offset = 5Ch) [reset = 44D31103h]

REVID is shown in [Figure 15-174](#) and described in [Table 15-140](#).

Figure 15-174. REVID Register

31	30	29	28	27	26	25	24	23	22	21	20	19	18	17	16	15	14	13	12	11	10	9	8	7	6	5	4	3	2	1	0
REV																															
R-44D31103h																															

LEGEND: R/W = Read/Write; R = Read only; W1toCl = Write 1 to clear bit; -n = value after reset

Table 15-140. REVID Register Field Descriptions

Bit	Field	Type	Reset	Description
31-0	REV	R	44D31103h	eQEP revision ID

Universal Serial Bus (USB)

This chapter describes the USB of the device.

Topic	Page
16.1 Introduction	2448
16.2 Integration	2451
16.3 Functional Description	2454
16.4 Supported Use Cases	2517
16.5 USB Registers	2518

16.1 Introduction

The USB controller provides a low-cost connectivity solution for numerous consumer portable devices by providing a mechanism for data transfer between USB devices with a line/bus speed up to 480 Mbps. The device USB subsystem has two independent USB 2.0 Modules built around two OTG controllers. The OTG supplement feature, the support for a dynamic role change, is also supported. Each port has the support for a dual-role feature allowing for additional versatility enabling operation capability as a host or peripheral. Both ports have identical capabilities and operate independent of each other.

Each USB controller is built around the Mentor USB OTG controller (musbmhdc) and TI PHY. Each USB controller has user configurable 32K Bytes of Endpoint FIFO and has the support for 15 'Transmit' endpoints and 15 'Receive' endpoints in addition to Endpoint 0. The USB subsystem makes use of the CPPI 4.1 DMA for accelerating data movement via a dedicated DMA hardware.

The two USB modules share the CPPI DMA controller and accompanying Queue Manager, Interrupt Pacer, Power Management module, and PHY/UTMI clock.

Within the descriptions of the USB subsystem that would follow, the term USB controller or USB PHY is used to mean/refer to any of the two USB controllers or PHYs existing within the USB subsystem. The term USB module is used to mean/refer to any of the two USB modules. USB0 is used to refer to one of the USB modules and USB1 is used to refer to the other USB module.

16.1.1 Acronyms, Abbreviations, and Definitions

AHB	Advanced High-performance Bus
CBA	Common Bus Architecture
CDC	Change Data Capture
CPPI	Communications Port Programming Interface
CPU	Central Processing Unit
DFT	Design for Test
DMA	Direct Memory Access
DV	Design Verification
EOI	End of Interrupt
EOP	End of Packet
FIFO	First-In First-Out
FS	Full-Speed USB data rate
HNP	Host Negotiation
HS	High-Speed USB data rate
INTD	Interrupt Distributor
IP	Intellectual Property
ISO	Isochronous transfer type
LS	Low-Speed USB data rate
MHz	Megahertz
MOP	Middle of Packet
OCP	Open Core Protocol
OCP HD	OCP High Performance
OCP MMR	OCP Memory Mapped Registers
OTG	On-The-Go
PDR	Physical Design Requirements
PHY	Physical Layer Device
PPU	Packet Processing Unit
RAM	Random Access Memory
RNDIS	Remote Network Driver Interface Specification

RX	Receive
SCR	Switched Central Resource
SOC	System On a Chip
SOP	Start of Packet
SRP	Session Resume
TX	Transmit
USB	Universal Serial Bus
USB0	One of the two USB 2.0 Compliant USB Module
USB1	One of the two USB2.0 Compliant USB Module
USBSS	USB Subsystem (contains USB0 and USB1)
UTMI	USB 2.0 Transceiver Macrocell Interface
XDMA	Transfer DMA (DMA other than CPPI DMA used within the Controller)

16.1.2 USB Features

The main features of the USB subsystem are:

- Contains 2 usb20otg_f controller modules with the following features:
 - Built around the Mentor USB 2.0 OTG core (musbmhdc)
 - Supports USB 2.0 peripheral at speeds HS (480 Mb/s) and FS (12 Mb/s)
 - Supports USB 2.0 host or OTG at speeds HS (480 Mb/s), FS (12 Mb/s), and LS (1.5 Mb/s)
 - Supports all modes of transfers (control, bulk, interrupt, and isochronous)
 - Supports high bandwidth ISO mode
 - Supports 16 Transmit (TX) and 16 Receive (RX) endpoints including endpoint 0
 - Supports USB OTG extensions for Session Resume (SRP) and Host Negotiation (HNP)
 - Includes a 32K endpoint FIFO RAM, and supports programmable FIFO sizes
 - Includes RNDIS mode for accelerating RNDIS type protocols using short packet termination over USB
 - Includes CDC Linux mode for accelerating CDC type protocols using short packet termination over USB
 - Includes an RNDIS like mode for terminating RNDIS type protocols without using short packet termination for support of MSC applications
- Includes two USB2.0 OTG PHYs
- Interfaces to the CPU via 3 OCP interfaces:
 - Master OCP HP interface for the DMA
 - Master OCP HP interface for the Queue manager
 - Slave OCP MMR interface
- Includes a CPPI 4.1 compliant DMA controller sub-module with 30 RX and 30 TX simultaneous data connections
- Includes a CPPI 4.1 DMA scheduler
- DMA supports CPPI host descriptor formats
- DMA supports stall on buffer starvation
- Supports data buffer sizes up to 4M bytes
- CPPI FIFO interface per TX/RX endpoint
- Provides a CPPI Queue Manager module with 92 queues for queuing/de-queuing packets.
- DMA pacing logic for interrupts
- Loopback MGC test using the UTMI interfaces

16.1.3 Unsupported USB OTG and PHY Features

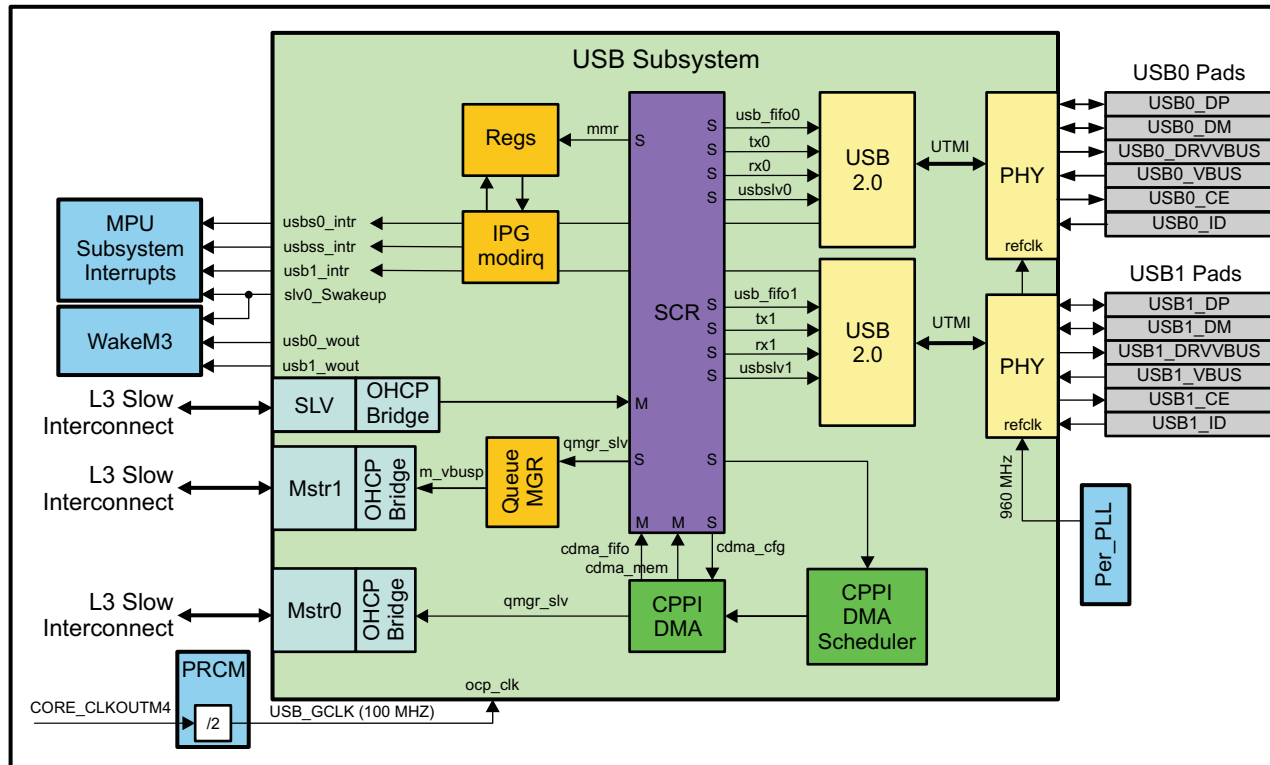
This device supports USBOTG module host, device and OTG features.

16.2 Integration

This device implements the USB2.0 OTG dual port module and PHY for interfacing to USB as a peripheral or host.

Figure 16-1 shows the integration of the USB module on this device.

Figure 16-1. USB Integration



16.2.1 USB Connectivity Attributes

The USB module itself has a very large number of interrupt outputs. For ease of integration, these outputs are all routed to a pair of interrupt aggregators. These aggregator blocks generate a single interrupt on the first occurrence of any interrupt from the USB or DMA logic of the module.

Table 16-1. USB Connectivity Attributes

Attributes	Type
Power domain	Peripheral Domain
Clock domain	PD_PER_L3S_GCLK (OCP) CLKDCOLDO (PHY)
Reset signals	DEF_DOM_RST_N USB_POR_N
Idle/Wakeup signals	Smart idle Wakeup Standby

Table 16-1. USB Connectivity Attributes (continued)

Attributes	Type
Interrupt request	4 interrupts usbss (USBSSINT) to MPU subsystem usb0 (USBINT0) to MPU subsystem usb1 (USBINT1) to MPU subsystem slv0p_Swakeup (USBWAKEUP) to MPU subsystem and WakeM3 2 Wakeup Events to WakeM3 usb0_wuout usb1_wuout
DMA request	None
Physical address	L3 Slow slave port

16.2.2 USB Clock and Reset Management

Each USB controller has a PHY module that generates the UTMI clock. The UTMI clock is fixed in the UTMI specification for an 8-bit interface at 60 MHz (480 Mb/s). The PHYs require a low-jitter 960-MHz source clock.

Table 16-2. USB Clock Signals

Clock Signal	Max Freq	Reference / Source	Comments
ocp_clk OCP / Functional clock	100 MHz	CORE_CLKOUTM4 / 2	pd_per_l3s_gclk From PRCM
phy0_other_refclk960m Phy reference clock	960 MHz	CLKDCOLDO	clkdcoldo_po From Per PLL
phy1_other_refclk960m Phy reference clock	960 MHz	CLKDCOLDO	clkdcoldo_po From Per PLL

16.2.3 USB Pin List

The USB external interface signals are shown in [Table 16-3](#).

Table 16-3. USB Pin List

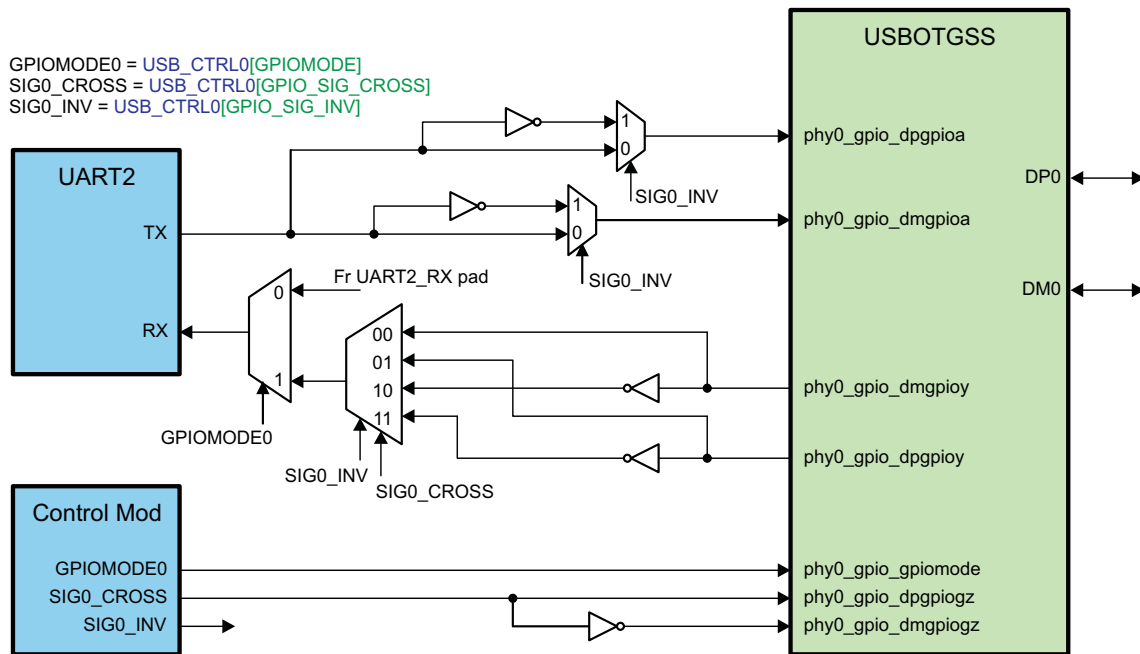
Pin	Type		Description
USBx_DP ⁽¹⁾	USB	Analog I/O	USBx data differential pair
USBx_DM ⁽¹⁾	GPIO	Digital I/O	
USBx_DRVVBUS	Digital output		USBx VBUS supply control
USBx_VBUS	Analog input		USBx VBUS (input only for voltage sensing)
USBx_ID	Analog input		USBx OTG identification
USBx_CE	Digital output		USBx Phy charge enable

⁽¹⁾ Analog in USB mode; CMOS in GPIO mode.

16.2.4 USB GPIO Details

The USB module supports configuration of the DP and DM pins as pass-through GPIOs. In this device, the GPIO mode is used to provide UART over USB interface functionality. Chip level logic allows connection of the UART TX/RX data signals to either DP or DM in either normal or inverted state as shown in [Figure 16-2](#). The diagram shows the UART2 / USB0 port implementation. This logic is also replicated for the UART3 / USB1 ports.

Figure 16-2. USB GPIO Integration



16.2.5 USB Unbonded PHY Pads

The USBOTGSS includes two USB PHY modules. On packages where only 1 PHY is bonded out to pins (e.g. 13x13 package), the following procedures must be followed in order to ensure that the unbonded PHY pads do not cause issues with USBOTGSS operation:

- The USB Controller corresponding to the unbonded PHY must be placed in Host Mode by setting Bit2 of the USB Core DEVCTL register.
- The unbonded PHY must be placed in the SUSPEND state by setting Bits[1:0] of the USB Core POWER register.
- The Control Module USB_CTRLx register corresponding to the unbonded PHY must have the following bits programmed as shown:
 - CHGDET_DIS = 1
 - CM_PWRDN = 1
 - GPIOMODE = 0

16.3 Functional Description

The USB controller within the device supports 15 Transmit endpoints and 15 Receive endpoints in addition to Endpoint 0. (The use of these endpoints for IN and OUT transactions depends on whether the USB controller is being used as a device/peripheral or as a host. When used as a peripheral, IN transactions are processed through TX endpoints and OUT transactions are processed through Rx endpoints. When used as a host, IN transactions is processed through Rx endpoints and OUT transactions is processed through TX endpoints.)

These additional endpoints can be individually configured in software to handle either Bulk transfers (which also allows them to handle Interrupt transfers), Isochronous transfers or Control transfers. Further, the endpoints can also be allocated to different target device functions on the fly – maximizing the number of devices that can be simultaneously supported.

Each endpoint requires a chunk of memory allocated within the FIFO to be associated with it. The USB module has a single block of FIFO RAM (32 Kbytes in size) to be shared by all endpoints. The FIFO for Endpoint 0 is required to be 64 bytes deep and will buffer 1 packet. The first 64 Bytes of the FIFO RAM is reserved by hardware for Endpoint 0 usage and for this reason user software does not need (nor has the capability) to allocate FIFO for Endpoint 0. The rest of the FIFO RAM is user configurable with regard to the other endpoint FIFOs, which may be from 8 to 8192 bytes in size and can buffer either 1 or 2 packets.

Separate FIFOs may be associated with each endpoint: alternatively a TX endpoint and the Rx endpoint with the same Endpoint number can be configured to use the same FIFO, for example to reduce the size of RAM block needed, provided they can never be active at the same time.

The role (host or device) that the USB controller assumes is chosen by user firmware programming the respective USB controller MODE register defined within the USB subsystem space. Note that some USB pins have not been bonded out and the functions of these pins are controlled by user software via dedicated registers.

The user has access to the controller through the OCP slave interface via the CPU. The user can process USB transactions entirely from the CPU or can also use the DMA to perform data transfer. The CPPI DMA can be used to service Endpoints 1 to 15 not Endpoint 0. CPU access method is used to service Endpoint 0 transactions.

16.3.1 VBUS Voltage Sourcing Control

When any of the USB controllers assumes the role of a host, the USB is required to supply a 5V power source to an attached device through its VBUS line. In order to achieve this task, the USB controller requires the use of an external power logic (or charge pump) capable of sourcing 5V power. A USB_DRVVBUS is used as a control signal to enable/disable this external power logic to either source or disable power on the VBUS line. The control on the USB_DRVVBUS is automatic and is handled by the USB controller. The control should be transparent to the user so long as the proper hardware connection and software initialization are in place. The USB controller drives the USB_DRVVBUS signal high when it assumes the role of a host while the controller is in session. When assuming the role of a device, the controller drives the USB_DRVVBUS signal low disabling the external charge pump/power logic; hence, no power is driven on the VBUS line (in this case, power is expected to be sourced by the external host).

Note that both USBs are self-powered and the device does not rely on the voltage on the VBUS line sourced by an external host for controller operation when assuming the role of a device. The power on the VBUS is used to identify the presence of a Host. It is also used to power up the pull-up on the D+ line. The USB PHY would continually monitor the voltage on the VBUS and report the status to USB controller.

16.3.2 Pullup/PullDown Resistors

Since the USB controllers are dual role controllers, capable of assuming a role of a host or device, the necessary required pull-up/pull-down resistors can not exist external to the device. These pull-up/pull-down resistors exist internal to the device, within the PHY to be more specific, and are enabled and disabled based on the role the controller assumes allowing dynamic hardware configuration.

When assuming the role of a host, the data lines are pulled low by the PHY enabling the internal 15KOhms resistors. When assuming the role of a device the required 1.5Kohm pull-up resistor on the D+ line is enabled automatically to signify the USB capability to the external host as a FS device (HS operation is negotiated during reset bus condition).

16.3.3 Role Assuming Method

For an OTG controller, the usual method followed by the controller to assume the role of a host or a device is governed by the state of the ID pin which in turn is controlled by the USB cable connector type. The device has bonded out these ID pins and allows the control to be handled directly from the connector, i.e. the USB controller would assume the role based on the cable end inserted to the mini or micro A/B connector. An alternate method where the ID pin signal is bypassed and the firmware controls the role the controller assumes exists via register access allowing additional control for systems that do not require the use of the USB ID pin. In this case the USBnMODE [Bit7=IDDIG_MUX] needs to be programmed with a value of 1 so that Register programming will be used.

Two registers, USB0 Mode Register at offset 10E8h and USB1 Mode Register at offset 18E8h, are used for a user to select the role the USB controller assumes. The user is required to program the corresponding register prior to the USB controller is in session.

16.3.4 Clock, PLL, and PHY Initialization

Prior to configuring the USB Module Registers, the USB SubSystem and PHY are required to be released from reset, enable interconnects and controllers clocks as well as configure the USB PHY with appropriate setting. Not all registers related for this task are captured within this document. Please refer to the PRCM for clocking and Control Module for PHY configuration registers definitions.

16.3.5 Indexed and Non-Indexed Register Spaces

The USB controller provides two mechanisms for accessing endpoint control and status registers; Indexed and Non-Indexed method.

Indexed Endpoint Control/Status Register Space. This register space can be thought of as a region populated with Proxy Registers. This register space is a memory-mapped region at offset 1410h to 141Fh for USB0 and 1C10h to 1C1Fh for USB1. The endpoint register space mapped at this region is selected by programming the corresponding INDEX register (@ offsets 140Eh and 1C0Eh for USB0 and USB1 respectively) of the controller.

By programming the INDEX register with the corresponding endpoint number, the control and status register corresponding to that particular endpoint is accessible from this Indexed Region. In other words, Index Register region behaves as a proxy to access a selected endpoint registers.

Non-indexed Endpoint Control/Status Register Space. These regions are dedicated endpoint registers memory-mapped residing at offsets 1500h to 16FFh for USB0 and 1D00h to 1EFFh for USB1. Registers at offset 1500h to 150Fh belong to Endpoint 0; registers at offset 1510h to 151Fh belong to Endpoint 1 and lastly registers at offset 16F0h to 16FFh belong to Endpoint 15 for USB0. Similarly registers at offset 1D00h to 1E0Fh belong to Endpoint 0; registers at offset 1D10h to 1D1Fh belong to Endpoint 1 and finally registers at offset 1DF0h to 1DFFh belong to Endpoint 15 for USB1.

This allows the user/firmware to access an endpoint register region directly from its unique space, as specified within a non-indexed region or from a proxy space by programming the corresponding Index register.

Note: The control and status registers/regions apply to both Tx and Rx of a given Endpoint. That is, Endpoint 1 Tx and Endpoint 1 Rx registers occupy the same register space.

For detailed information about the USB controller registers, see [Section 16.5](#).

16.3.6 Dynamic FIFO Sizing

Each USB module supports a total of 32K bytes of FIFO RAM to dynamically allocate FIFO to all endpoints in use. Each endpoint requires a FIFO to be associated with it. There is one set of register per endpoint available for FIFO allocation, excluding endpoint 0. FIFO configuration registers are Indexed registers and cannot be accessed directly; configuration takes place via accessing proxy registers. The INDEX register at addresses 140Eh or 1C0Eh must be set to the appropriate endpoint. In other words, the Endpoint FIFO configuration registers do not have non-indexed regions.

The allocation of FIFO space to the different endpoints requires programming for each Tx and Rx endpoint with the following information:

- The start address of the FIFO within the RAM block
- The maximum size of packet to be supported
- Whether double-buffering is required

(These last two together define the amount of space that needs to be allocated to the FIFO.)

It is the responsibility of the firmware to ensure that all the Tx and Rx endpoints (other than endpoint 0) that are active in the current USB configuration have a block of FIFO RAM allocated for their use. The maximum FIFO size for endpoint 0 required is 64 bytes deep and which is large enough to buffer one packet. For this reason, the first 64 bytes of FIFO memory is reserved for Endpoint 0 usage and this resource allocation is implied to be available at all times and no FIFO allocation is required for Endpoint 0. For endpoints other than endpoint 0, the FIFO RAM interface is configurable and must have a minimum size of 8 bytes and should be capable of buffering either 1 or 2 packets. Separate FIFOs may be associated with each endpoint: alternatively a Tx endpoint and the Rx endpoint with the same Endpoint number can be configured to use the same FIFO, to reduce the size of RAM block needed, provided they can never be active at the same time.

NOTE: The option of dynamically setting FIFO sizes only applies to Endpoints 1-15. Endpoint 0 FIFO has a fixed size (64 bytes) and a fixed location which is the first 64 Bytes of FIFO (FIFO addresses 0-63).

16.3.7 USB Controller Host and Peripheral Modes Operation

The two USB modules can be used in a range of different environments. They can be used as either a high-speed or a full-speed USB peripheral device attached to a conventional USB host (such as a PC) in a point-to-point type of arrangement. As a host, the USB modules can also be used with another peripheral device of any speed (high-,full-, or low-speed) in a point-to-point arrangement or can be used as the host to a range of peripheral devices in a multi-point setup; one-to-many via hub. Note that the role each USB controller is assuming is independent of each other. Two options (h/w or s/w) exist for a USB role assumption/configuration.

For a USB Peripheral configuration the user has the option of using the cable end to select the role by attaching the mini or micro b side of the cable (can consider this as a h/w option) or use the optional method where the firmware is required to program the respective USB Mode Register IDDIG bit field with a value of '1' prior to the USB controller goes into session (can consider this as a s/w option).

Similarly, for a USB host configuration the user has the option of using the cable end to select the role by attaching the mini or micro a side of the cable (can consider this as a h/w option) or use the optional method where the firmware is required to program the respective USB Mode Register IDDIG bit field with a value of '0' value prior to the USB controller going into session (can consider this as a s/w option).

When using the s/w option, the USB ID pin state is ignored/bypassed (this is a similar configuration where an ID pin does not exist) and the USB2.0 controller role adaptation of a host or peripheral (device) is dependent upon the state of the respective USB Mode Register IDDIG field. If the IDDIG field is programmed by the user with a value of '1' prior to the USB going into session, it would assume the role of a peripheral/device. However, if the IDDIG field is programmed with the value of '0', the USB controller will assume the role of a host. What this means is that the USB cable end, connector, will not be able to control the role of the OTG controller and the user needs to be aware of the firmware program setting prior to performing a USB connection.

The procedure for the USB2.0 OTG controller determining its operating modes (usb controller assuming a role of a host or a peripheral) starts when the USB 2.0 controller goes into a session. The USB 2.0 controller is in session when either it senses a voltage ($\geq 4.4V$) on the USBx_VBUSIN pin and the controller sets its DEVCTL[SESSION] bit field or when the firmware sets the DEVCTL[SESSION] bit; assuming that it will operating as a host.

When the DEVCTL[SESSION] bit is set, the controller will start sensing the state of the Iddig signal, which in turn is controlled either by the USBx_ID pin (h/w option) or by the IDDIG bit field of the MODE Register (s/w option). If the state of the iddig signal is found to be low (IDDIG is programmed with '0') then the USB2.0 controller will assume the role of a host and when it finds the iddig signal to be high (IDDIG is programmed with '1') then it will assume the role of a device. Note that iddig is an internal signal that could be driven to high or low via firmware from dedicated registers.

Upon the USB controller determining its role as a host, it will drive the USBx_DRVVBUS pin high to enable the external power logic so that it start sourcing the required 5V power (must be $\geq 4.4V$ but to account for the voltage drop on the cable it is suggested to be in the neighborhood of 4.75V). The USB2.0 controller will then wait to for the voltage of the USBx_VBUSIN to go high. After 100 ms, if it does not see the voltage on the USBX_VBUSIN pin to be within a Vbus Valid range ($\geq 4.4V$), it will generate a Vbus error interrupt. Assuming that the voltage level of the USBX_VBUSIN is found to within the Vbus Valid range, the USB 2.0 host controller will wait for a device to connect; that is for it to see one of its data lines USB0/1_DP/DM be pulled high.

When assuming the role of a peripheral, assuming that the firmware has set the POWER[SOFTCONN] bit, and the USBx_ID pin is floating (h/w option) or USBx Mode Register IDDIG bit field is programmed with '1' (s/w option) and an external host is sourcing power on the USBx_VBUSIN line then the USB2.0 controller will set the DEVCTL[SESSION] bit instructing the controller to go into session. Not that the voltage on the USBx_VBUSIN pin must be within Vbus Valid range (i.e. greater or equal to 4.4V). When the controller goes into session, it will force the USB2.0 Controller to sense the state of the iddig signal. Once it senses iddig signal to be high, it will enable its 1.5Kohm pull-up resistor to signify the external host that it is a Full-Speed device. Note that even when operating as a High-Speed peripheral; the USB controller has to first come up as Full-Speed and then later transition to High-Speed. The USB2.0 controller will then waits for a reset signal from the external host. Then after, if High-Speed option has been selected it will negotiate for a High-Speed operation and if its request has been accepted by the host, it will enable its precision 45ohm termination resistors (to stop signal reflection) on its data lines and disable the 1.5Kohm resistor.

16.3.8 Protocol Description(s)

This section describes the implementation of the USB protocol(s) by the USB modules.

16.3.8.1 USB Controller Peripheral Mode Operation

The USB controller assumes the role of a peripheral when the USB_x_ID pin is floating or USB Mode Register[iddig=bit8] is set to 1 (provided that iddig_mux, which is bit7 of USBnMODE is also set to 1) by the user application prior to the controller goes into session. When the USB controller go into session it will assume the role of a device.

Soft connect –After a POR or USB Module soft reset, the SOFTCONN bit of POWER register (bit 6) is cleared to 0. The controller will therefore appear disconnected until the software has set the SOFTCONN bit to 1. The application software can then choose when to set the PHY into its normal mode. Systems with a lengthy initialization procedure may use this to ensure that initialization is complete and the system is ready to perform enumeration before connecting to the USB. Once the SOFTCONN bit has been set, the software can also simulate a disconnect by clearing this bit to 0.

Entry into suspend mode –When operating as a peripheral device, the controller monitors activity on the bus and when no activity has occurred for 3 ms, it goes into Suspend mode. If the Suspend interrupt has been enabled, an interrupt will be generated at this time.

At this point, the controller can then be left active (and hence able to detect when Resume signaling occurs on the USB), or the application may arrange to disable the controller by stopping its clock. However, the controller will not then be able to detect Resume signaling on the USB if clocks are not running. If such is the case, external hardware will be needed to detect Resume signaling (by monitoring the DM and DP signals), so that the clock to the controller can be restarted.

Resume Signaling –When resume signaling occurs on the bus, first the clock to the controller must be restarted if necessary. Then the controller will automatically exit Suspend mode. If the Resume interrupt is enabled, an interrupt will be generated.

Initiating a remote wakeup –If the software wants to initiate a remote wakeup while the controller is in Suspend mode, it should set the POWER[RESUME] bit to 1. The software should leave then this bit set for approximately 10 ms (minimum of 2 ms, a maximum of 15 ms) before resetting it to 0.

NOTE: No resume interrupt will be generated when the software initiates a remote wakeup.

Reset Signaling –When reset signaling or bus condition occurs on the bus, the controller performs the following actions:

- Clears FADDR register to 0
- Clears INDEX register to 0
- Flushes all endpoint FIFOs
- Clears all controller control/status registers
- Generates a reset interrupt
- Enables all interrupts at the core level.

If the HSENA bit within the POWER register (bit 5) is set, the controller also tries to negotiate for high-speed operation. Whether high-speed operation is selected is indicated by HSMODE bit of POWER register (bit 4). When the application software receives a reset interrupt, it should close any open pipes and wait for bus enumeration to begin.

16.3.8.1.1 Control Transactions:Peripheral Mode

Endpoint 0 is the main control endpoint of the core. The software is required to handle all the standard device requests that may be sent or received via endpoint 0. These are described in Universal Serial Bus Specification, Revision 2.0, Chapter 9. The protocol for these device requests involves different numbers and types of transactions per request/command. To accommodate this, the software needs to take a state machine approach to command decoding and handling.

The Standard Device Requests received by a USB peripheral device can be divided into three categories: Zero Data Requests (in which all the information is included in the command; no additional data is required), Write Requests (in which the command will be followed by additional data), and Read Requests (in which the device is required to send data back to the host).

This section looks at the sequence of actions that the software must perform to process these different types of device request.

NOTE: The Setup packet associated with any standard device request should include an 8-byte command. Any setup packet containing a command field other than 8 bytes will be automatically rejected by the controller.

16.3.8.1.1.1 Zero Data Requests: Peripheral Mode

Zero data requests have all their information included in the 8-byte command and require no additional data to be transferred. Examples of Zero Data standard device requests are:

- SET_FEATURE
- CLEAR_FEATURE
- SET_ADDRESS
- SET_CONFIGURATION
- SET_INTERFACE

The sequence of events will begin, as with all requests, when the software receives an endpoint 0 interrupt. The RXPKTRDY bit of PERI_CSR0 (bit 0) will also have been set. The 8-byte command should then be read from the endpoint 0 FIFO, decoded and the appropriate action taken.

For example, if the command is SET_ADDRESS, the 7-bit address value contained in the command should be written to the FADDR register at the completion of the command. The PERI_CSR0 register should be written by setting the SERV_RXPKTRDY bit (bit 6) (indicating that the command has been read from the FIFO) and also setting the DATAEND bit (bit 3) (indicating that no further data is expected for this request). The interval between setting SERV_RXPKTRDY bit and DATAEND bit should be very small to avoid getting a SETUPEND error condition. It is highly recommended to set both bits at the same time.

When the host moves to the status stage of the request, a second endpoint 0 interrupt will be generated to indicate that the request has completed. No further action is required from the software. The second interrupt is just a confirmation that the request completed successfully. For SET_ADDRESS command, the address should be written to FADDR register at the completion of the command, i.e. when the status stage interrupt is received.

If the command is an unrecognized command, or for some other reason cannot be executed, then when it has been decoded, the PERI_CSR0 register should be written to set the SERV_RXPKTRDY bit (bit 6) and to set the SENDSTALL bit (bit 5). When the host moves to the status stage of the request, the controller will send a STALL packet telling the host that the request was not executed. A second endpoint 0 interrupt will be generated and the SENTSTALL bit (bit 2 of PERI_CSR0) will be set.

If the host sends more data after the DATAEND bit has been set, then the controller will send a STALL packet automatically. An endpoint 0 interrupt will be generated and the SENTSTALL bit (bit 2 of PERI_CSR0) will be set.

NOTE: DMA is not supported for endpoint 0; endpoint 0 is always serviced via CPU.

16.3.8.1.1.2 Write Requests: Peripheral Mode

Write requests involve an additional packet (or packets) of data being sent from the host after the 8-byte command. An example of a Write standard device request is: SET_DESCRIPTOR.

The sequence of events will begin, as with all requests, when the software receives an endpoint 0 interrupt. The RXPKTRDY bit of PERI_CSR0 will also have been set. The 8-byte command should then be read from the Endpoint 0 FIFO and decoded.

As with a zero data request, the PERI_CSR0 register should then be written to set the SERV_RXPKTRDY bit (bit 6) (indicating that the command has been read from the FIFO) but in this case the DATAEND bit (bit 3) should not be set (indicating that more data is expected).

When a second endpoint 0 interrupt is received, the PERI_CSR0 register should be read to check the endpoint status. The RXPKTRDY bit of PERI_CSR0 should be set to indicate that a data packet has been received. The COUNT0 register should then be read to determine the size of this data packet. The data packet can then be read from the endpoint 0 FIFO.

If the length of the data associated with the request (indicated by the wLength field in the command) is greater than the maximum packet size for endpoint 0, further data packets will be sent. In this case, PERI_CSR0 should be written to set the SERV_RXPKTRDY bit, but the DATAEND bit should not be set.

When all the expected data packets have been received, the PERI_CSR0 register should be written to set the SERV_RXPKTRDY bit and to set the DATAEND bit (indicating that no more data is expected).

When the host moves to the status stage of the request, another endpoint 0 interrupt will be generated to indicate that the request has completed. No further action is required from the software, the interrupt is just a confirmation that the request completed successfully.

If the command is an unrecognized command, or for some other reason cannot be executed, then when it has been decoded, the PERI_CSR0 register should be written to set the SERV_RXPKTRDY bit (bit 6) and to set the SENDSTALL bit (bit 5). When the host sends more data, the controller will send a STALL to tell the host that the request was not executed. An endpoint 0 interrupt will be generated and the SENTSTALL bit of PERI_CSR0 (bit 2) will be set.

If the host sends more data after the DATAEND has been set, then the controller will send a STALL. An endpoint 0 interrupt will be generated and the SENTSTALL bit of PERI_CSR0 (bit 2) will be set.

16.3.8.1.1.3 Read Requests: Peripheral Mode

Read requests have a packet (or packets) of data sent from the function to the host after the 8-byte command. Examples of Read Standard Device Requests are:

- GET_CONFIGURATION
- GET_INTERFACE
- GET_DESCRIPTOR
- GET_STATUS
- SYNCH_FRAME

The sequence of events will begin, as with all requests, when the software receives an endpoint 0 interrupt. The RXPKTRDY bit of PERI_CSR0 (bit 0) will also have been set. The 8-byte command should then be read from the endpoint 0 FIFO and decoded. The PERI_CSR0 register should then be written to set the SERV_RXPKTRDY bit (bit 6) (indicating that the command has read from the FIFO).

The data to be sent to the host should then be written to the endpoint 0 FIFO. If the data to be sent is greater than the maximum packet size for endpoint 0, only the maximum packet size should be written to the FIFO. The PERI_CSR0 register should then be written to set the TXPKTRDY bit (bit 1) (indicating that there is a packet in the FIFO to be sent). When the packet has been sent to the host, another endpoint 0 interrupt will be generated and the next data packet can be written to the FIFO.

When the last data packet has been written to the FIFO, the PERI_CSR0 register should be written to set the TXPKTRDY bit and to set the DATAEND bit (bit 3) (indicating that there is no more data after this packet).

When the host moves to the status stage of the request, another endpoint 0 interrupt will be generated to indicate that the request has completed. No further action is required from the software: the interrupt is just a confirmation that the request completed successfully.

If the command is an unrecognized command, or for some other reason cannot be executed, then when it has been decoded, the PERI_CSR0 register should be written to set the SERV_RXPKTRDY bit (bit 6) and to set the SENDSTALL bit (bit 5). When the host requests data, the controller will send a STALL to tell the host that the request was not executed. An endpoint 0 interrupt will be generated and the SENTSTALL bit of PERI_CSR0 (bit 2) will be set.

If the host requests more data after DATAEND (bit 3) has been set, then the controller will send a STALL. An endpoint 0 interrupt will be generated and the SENTSTALL bit of PERI_CSR0 (bit 2) will be set.

16.3.8.1.1.4 Endpoint 0 States: Peripheral Mode

When the USB controller is operating as a peripheral device, the endpoint 0 control needs three modes – IDLE, TX and RX – corresponding to the different phases of the control transfer and the states endpoint 0 enters for the different phases of the transfer (described in later sections).

The default mode on power-up or reset should be IDLE. RXPKT RDY bit of PERI_CSR0 (bit 0) becoming set when endpoint 0 is in IDLE state indicates a new device request. Once the device request is unloaded from the FIFO, the controller decodes the descriptor to find whether there is a data phase and, if so, the direction of the data phase of the control transfer (in order to set the FIFO direction). See [Figure 16-3](#).

Depending on the direction of the data phase, endpoint 0 goes into either TX state or RX state. If there is no Data phase, endpoint 0 remains in IDLE state to accept the next device request

The actions that the CPU needs to take at the different phases of the possible transfers (for example, loading the FIFO, setting TXPKTRDY) are indicated in [Figure 16-4](#).

Figure 16-3. CPU Actions at Transfer Phases

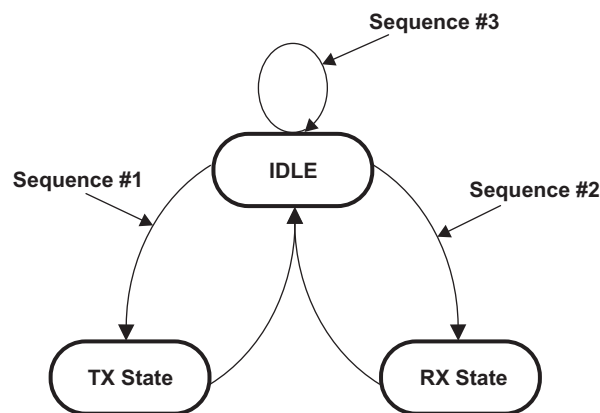
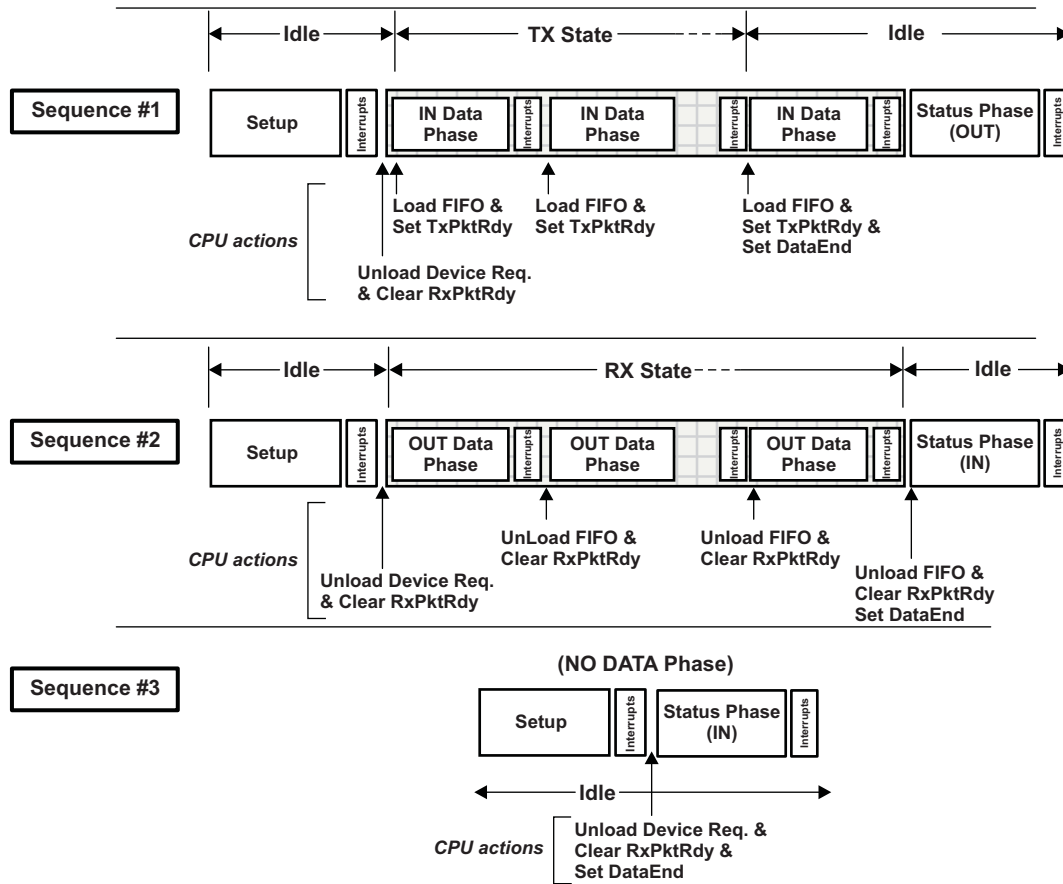


Figure 16-4. Sequence of Transfer



16.3.8.1.1.4.1 Endpoint 0 Interrupt Generating Events: Peripheral Mode

An Endpoint 0 interrupt is generated when any of the below events occur and Interrupt Service handler should determine the right event and launch the proper handler

The following events will cause Endpoint 0 Interrupt to be generated while the controller is operating assuming the role of a device/peripheral:

- The controller sets the RXPKTRDY bit of PERI_CSR0 (bit 0) after a valid token has been received and data has been written to the FIFO (legal status condition).
- The controller clears the TXPKTRDY bit of PERI_CSR0 (bit 1) after the packet of data in the FIFO has been successfully transmitted to the host (legal status condition).
- The controller sets the SENTSTALL bit of PERI_CSR0 (bit 2) after a control transaction is ended due to a protocol violation (illegal status condition).
- The controller sets the SETUPEND bit of PERI_CSR0 (bit 4) because a control transfer has ended before DATAEND (bit 3 of PERI_CSR0) is set (illegal status condition).

In order to determine the cause of the interrupt, the detail below recommends the order of cause determination and execution.

Whenever the endpoint 0 service routine is entered, the software must first check to see if the current control transfer has been ended due to either a STALL condition or a premature end of control transfer. If the control transfer ends due to a STALL condition, the SENTSTALL bit would be set. If the control transfer ends due to a premature end of control transfer, the SETUPEND bit would be set. In either case, the software should abort processing the current control transfer and set the state to IDLE.

Once the software has determined that the interrupt was not generated by an illegal bus state, the next action taken depends on the endpoint state.

If endpoint 0 is in IDLE state, the only valid reason an interrupt can be generated is as a result of the controller receiving data from the bus. The service routine must check for this by testing the RXPKTRDY bit of PERI_CSR0 (bit 0). If this bit is set, then the controller has received a SETUP packet. This must be unloaded from the FIFO and decoded to determine the action the controller must take. Depending on the command contained within the SETUP packet, endpoint 0 will enter one of three states:

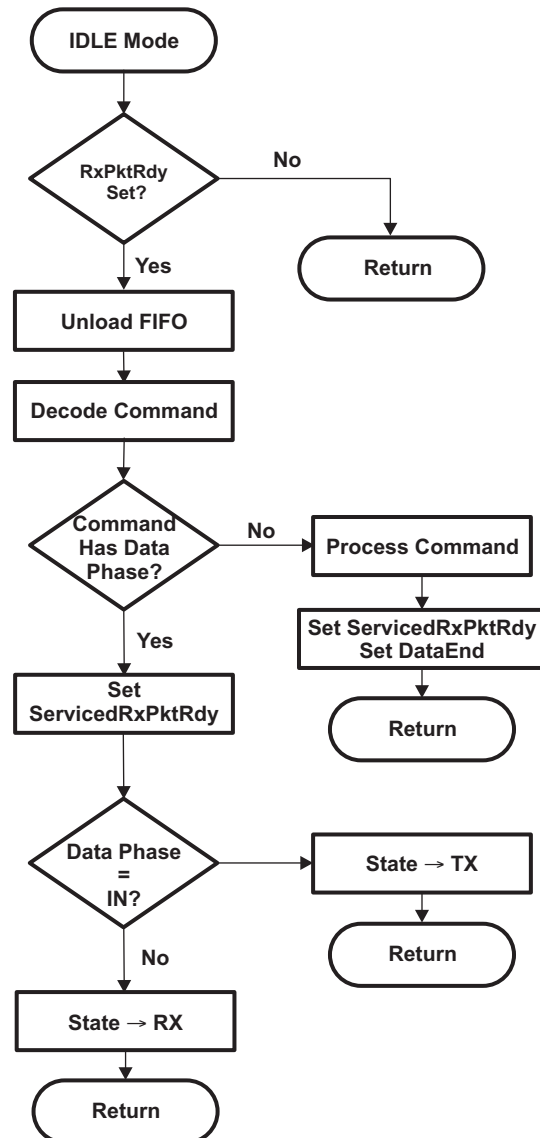
- If the command is a single packet transaction (SET_ADDRESS, SET_INTERFACE etc.) without any data phase, the endpoint will remain in IDLE state.
- If the command has an OUT data phase (SET_DESCRIPTOR etc.), the endpoint will enter RX state.
- If the command has an IN data phase (GET_DESCRIPTOR etc.), the endpoint will enter TX state.
- If the endpoint 0 is in TX state, the interrupt indicates that the core has received an IN token and data from the FIFO has been sent. The software must respond to this either by placing more data in the FIFO if the host is still expecting more data or by setting the DATAEND bit to indicate that the data phase is complete. Once the data phase of the transaction has been completed, endpoint 0 should be returned to IDLE state to await the next control transaction (status stage).
- If the endpoint is in RX state, the interrupt indicates that a data packet has been received. The software must respond by unloading the received data from the FIFO. The software must then determine whether it has received all of the expected data. If it has, the software should set the DATAEND bit and return endpoint 0 to IDLE state. If more data is expected, the firmware should set the SERV_RXPKTRDY bit of PERI_CSR0 (bit 6) to indicate that it has read the data in the FIFO and leave the endpoint in RX state.

16.3.8.1.1.4.2 Idle Mode: Control Transfer of Peripheral Mode

IDLE mode is the mode the Endpoint 0 control needs to select at power-on or reset and is the mode to which the Endpoint 0 control should return when the RX and TX modes are terminated.

It is also the mode in which the SETUP phase of control transfer is handled (as outlined in [Figure 16-5](#)).

Figure 16-5. Flow Chart of Setup Stage of a Control Transfer in Peripheral Mode



16.3.8.1.1.4.3 TX Mode: Control Transfer of Peripheral Mode

When the endpoint is in TX state, all arriving IN tokens need to be treated as part of a data phase until the required amount of data has been sent to the host. If either a SETUP or an OUT token is received while the endpoint is in the TX state, this will cause a SETUPEND condition to occur as the core expects only IN tokens.

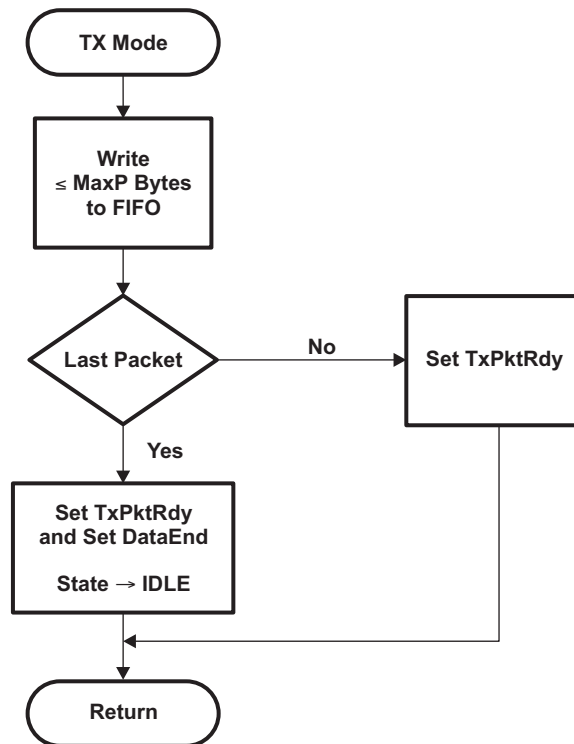
Three events can cause TX mode to be terminated before the expected amount of data has been sent as shown in Figure 16-6:

1. The host sends an invalid token causing a SETUPEND condition (bit 4 of PERI_CSR0 is set).
2. The firmware sends a packet containing less than the maximum packet size for Endpoint 0.
3. The firmware sends an empty data packet.

Until the transaction is terminated, the firmware simply needs to load the FIFO when it receives an interrupt which indicates that a packet has been sent from the FIFO. An interrupt is generated when TXPKTRDY is cleared.

When the firmware forces the termination of a transfer (by sending a short or empty data packet), it should set the DATAEND bit of PERI_CSR0 (bit 3) to indicate to the core that the data phase is complete and that the core should next receive an acknowledge packet.

Figure 16-6. Flow Chart of Transmit Data Stage of a Control Transfer in Peripheral Mode



16.3.8.1.1.4.4 Rx Mode: Control Transfer of Peripheral Mode

In RX mode, all arriving data should be treated as part of a data phase until the expected amount of data has been received. If either a SETUP or an IN token is received while the endpoint is in RX state, a SETUPEND condition will occur as the controller expects only OUT tokens.

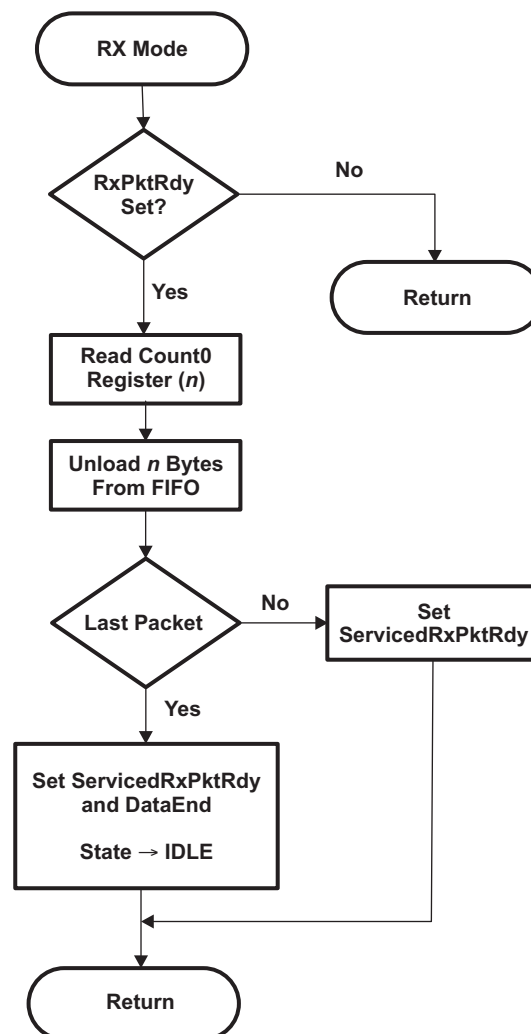
Three events can cause RX mode to be terminated before the expected amount of data has been received as shown in Figure 16-7:

1. The host sends an invalid token causing a SETUPEND condition (setting bit 4 of PERI_CSR0).
2. The host sends a packet which contains less than the maximum packet size for endpoint 0.
3. The host sends an empty data packet.

Until the transaction is terminated, the software unloads the FIFO when it receives an interrupt that indicates new data has arrived (setting RXPkTRDY bit of PERI_CSR0) and to clear RXPkTRDY by setting the SERV_RXPKTRDY bit of PERI_CSR0 (bit 6).

When the software detects the termination of a transfer (by receiving either the expected amount of data or an empty data packet), it should set the DATAEND bit (bit 3 of PERI_CSR0) to indicate to the controller that the data phase is complete and that the core should receive an acknowledge packet next.

Figure 16-7. Flow Chart of Receive Data Stage of a Control Transfer in Peripheral Mode



16.3.8.1.1.4.5 Error Handling: Control Transfer of Peripheral Mode

A control transfer may be aborted due to a protocol error on the USB, the host prematurely ending the transfer, or if the software wishes to abort the transfer (for example, because it cannot process the command).

The controller automatically detects protocol errors and sends a STALL packet to the host under the following conditions:

- The host sends more data during the OUT Data phase of a write request than was specified in the command. This condition is detected when the host sends an OUT token after the DATAEND bit (bit 3 of PERI_CSR0) has been set.
- The host requests more data during the IN Data phase of a read request than was specified in the command. This condition is detected when the host sends an IN token after the DATAEND bit in the PERI_CSR0 register has been set.
- The host sends more than Max Packet Size data bytes in an OUT data packet.
- The host sends a non-zero length DATA1 packet during the STATUS phase of a read request.

When the controller has sent the STALL packet, it sets the SENTSTALL bit (bit 2 of PERI_CSR0) and generates an interrupt. When the software receives an endpoint 0 interrupt with the SENTSTALL bit set, it should abort the current transfer, clear the SENTSTALL bit, and return to the IDLE state.

If the host prematurely ends a transfer by entering the STATUS phase before all the data for the request has been transferred, or by sending a new SETUP packet before completing the current transfer, then the SETUPEND bit (bit 4 of PERI_CSR0) will be set and an endpoint 0 interrupt generated. When the software receives an endpoint 0 interrupt with the SETUPEND bit set, it should abort the current transfer, set the SERV_SETUPEND bit (bit 7 of PERI_CSR0), and return to the IDLE state. If the RXPKTRDY bit (bit 0 of PERI_CSR0) is set this indicates that the host has sent another SETUP packet and the software should then process this command.

If the software wants to abort the current transfer, because it cannot process the command or has some other internal error, then it should set the SENDSTALL bit (bit 5 of PERI_CSR0). The controller will then send a STALL packet to the host, set the SENTSTALL bit (bit 2 of PERI_CSR0) and generate an endpoint 0 interrupt.

16.3.8.1.1.5 Additional Conditions: Control Transfer of Peripheral Mode

When working as a peripheral device, the controller automatically responds to certain conditions on the USB bus or actions by the host. The details are:

- Stall Issued to Control Transfers
 1. The host sends more data during an OUT Data phase of a Control transfer than was specified in the device request during the SETUP phase. This condition is detected by the controller when the host sends an OUT token (instead of an IN token) after the software has unloaded the last OUT packet and set DATAEND.
 2. The host requests more data during an IN data phase of a Control transfer than was specified in the device request during the SETUP phase. This condition is detected by the controller when the host sends an IN token (instead of an OUT token) after the software has cleared TXPKTRDY and set DATAEND in response to the ACK issued by the host to what should have been the last packet.
 3. The host sends more than MaxPktSize data with an OUT data token.
 4. The host sends the wrong PID for the OUT Status phase of a Control transfer.
 5. The host sends more than a zero length data packet for the OUT Status phase.
- Zero Length Out Data Packets In Control Transfer

A zero length OUT data packet is used to indicate the end of a Control transfer. In normal operation, such packets should only be received after the entire length of the device request has been transferred (i.e., after the software has set DataEnd). If, however, the host sends a zero length OUT data packet before the entire length of device request has been transferred, this signals the premature end of the transfer. In this case, the controller will automatically flush any IN token loaded by software ready for the Data phase from the FIFO and set SETUPEND bit (bit 4 of PERI_CSR0).

16.3.8.1.2 Bulk Transfer: Peripheral Mode

Bulk transactions are handled by endpoints other than endpoint 0. It is used to handle non-periodic, large bursty communication typically used for a transfer that use any available bandwidth and can also be delayed until bandwidth is available.

16.3.8.1.2.1 Bulk IN Transactions: Peripheral Mode

A Bulk IN transaction is used to transfer non-periodic data from the USB peripheral device to the host.

The following optional features are available for use with a Tx endpoint used in peripheral mode for Bulk IN transactions:

- Double packet buffering: When enabled, up to two packets can be stored in the FIFO awaiting transmission to the host. Double packet buffering is enabled by setting the DPB bit of TXFIFOSZ register (bit 4).
- DMA: If DMA is enabled for the endpoint, a DMA request will be generated whenever the endpoint is able to accept another packet in its FIFO. This feature allows the DMA controller to load packets into the FIFO without processor intervention

16.3.8.1.2.1.1 Bulk IN Transaction Setup: Peripheral Mode

In configuring a TX endpoint for bulk transactions, the TXMAXP register must be written with the maximum packet size (in bytes) for the endpoint. This value should be the same as the wMaxPacketSize field of the Standard Endpoint Descriptor for the endpoint and the PERI_TXCSR register (DMAEN and DMAMODE bit fields should be set when using DMA. [Table 16-4](#) displays the PERI_TXCSR setting when used for Bulk transfer.

Table 16-4. PERI_TXCSR Register Bit Configuration for Bulk IN Transactions

Bit Field	Bit Name	Description
Bit 15	AUTOSET	Cleared to 0 if using DMA. For CPU Mode use, if AUTOSET bit is set, the TXPKTRDY bit will be automatically set when data of the maximum packet size is loaded into the FIFO.
Bit 14	ISO	Cleared to 0 for bulk mode operation.
Bit 13	MODE	Set to 1 to make sure the FIFO is enabled (only necessary if the FIFO is shared with an RX endpoint)
Bit 12	DMAEN	Set to 1 to enable DMA usage; not needed if CPU is being used to service the Tx Endpoint
Bit 11	FRCDATATOG	Cleared to 0 to allow normal data toggle operations.
Bit 10	DMAMODE	Set to 1 when DMA is used to service Tx FIFO.

When the endpoint is first configured (following a SET_CONFIGURATION or SET_INTERFACE command on Endpoint 0), the lower byte of PERI_TXCSR should be written to set the CLRDATATOG bit (bit 6). This will ensure that the data toggle (which is handled automatically by the controller) starts in the correct state.

Also if there are any data packets in the FIFO, indicated by the FIFONOTEMPTY bit (bit 1 of PERI_TXCSR) being set, they should be flushed by setting the FLUSHFIFO bit (bit 3 of PERI_TXCSR).

NOTE: It may be necessary to set this bit twice in succession if double buffering is enabled.

16.3.8.1.2.1.2 Bulk IN Operation: Peripheral Mode

When data is to be transferred over a Bulk IN pipe, a data packet needs to be loaded into the FIFO and the PERI_TXCSR register written to set the TXPKTRDY bit (bit 0). When the packet has been sent, the TXPKTRDY bit will be cleared by the USB controller and an interrupt generated to signify to the user/application that the next packet can be loaded into the FIFO. If double packet buffering is enabled, then after the first packet has been loaded and the TXPKTRDY bit set, the TXPKTRDY bit will immediately be cleared (will not wait for the loaded first packet to be driven out) by the USB controller and an interrupt generated so that a second packet can be loaded into the FIFO. The software should operate in the same way, loading a packet when it receives an interrupt, regardless of whether double packet buffering is enabled or not.

In the general case, the packet size must not exceed the size specified by the lower 11 bits of the TXMAXP register. This part of the register defines the payload (packet size) for transfers over the USB and is required by the USB Specification to be either 8, 16, 32, 64 (Full-Speed or High-Speed) or 512 bytes (High-Speed only).

The host may determine that all the data for a transfer has been sent by knowing the total amount of data that is expected. Alternatively it may infer that all the data has been sent when it receives a packet which is smaller than the maximum packet size configuration for that particular endpoint (TXMAXP[10-0]). In the latter case, if the total size of the data block is a multiple of this payload, it will be necessary for the function to send a null packet after all the data has been sent. This is done by setting TXPKTRDY when the next interrupt is received, without loading any data into the FIFO.

If large blocks of data are being transferred, then the overhead of calling an interrupt service routine to load each packet can be avoided by using the CPPI DMA. A separate section detailing the use of the DMA is discussed within a latter section. Suffix is to say that the PERI_TXCSR (DMAEN and DMAMODE) bit fields need to be set and the PERI_TXCSR[AUTOSET] bit cleared at the core level when using the DMA with an endpoint configured for any IN transaction/transfer.

16.3.8.1.2.1.3 Error Handling of Bulk IN Transfer: Peripheral Mode

If the software wants to shut down the Bulk IN pipe, it should set the SENDSTALL bit (bit 4 of PERI_TXCSR). When the controller receives the next IN token, it will send a STALL to the host, set the SENTSTALL bit (bit 5 of PERI_TXCSR) and generate an interrupt.

When the software receives an interrupt with the SENTSTALL bit (bit 5 of PERI_TXCSR) set, it should clear the SENTSTALL bit. It should however leave the SENDSTALL bit set until it is ready to re-enable the Bulk IN pipe.

NOTE: If the host failed to receive the STALL packet for some reason, it will send another IN token, so it is advisable to leave the SENDSTALL bit set until the software is ready to re-enable the Bulk IN pipe. When a pipe is re-enabled, the data toggle sequence should be restarted by setting the CLRDATATOG bit in the PERI_TXCSR register (bit 6).

16.3.8.1.2.2 Bulk OUT Transfer: Peripheral Mode

A Bulk OUT transaction is used to transfer non-periodic data from the host to the function controller.

The following optional features are available for use with an Rx endpoint used in peripheral mode for Bulk OUT transactions:

- Double packet buffering: When enabled, up to two packets can be stored in the FIFO on reception from the host. Double packet buffering is enabled by setting the DPB bit of the RXFIFOSZ register (bit 4).
- DMA: If DMA is enabled for the endpoint, a DMA request will be generated whenever the endpoint has a packet in its FIFO. This feature can be used to allow the DMA controller to unload packets from the FIFO without processor intervention.

NOTE: When DMA is enabled, endpoint interrupt will not be generated for completion of packet reception. Endpoint interrupt will be generated only in the error conditions.

16.3.8.1.2.2.1 Bulk OUT Transfer Setup: Peripheral Mode

In configuring an Rx endpoint for Bulk OUT transactions, the RXMAXP register must be written with the maximum packet size (in bytes) for the endpoint. This value should be the same as the wMaxPacketSize field of the Standard Endpoint Descriptor for the endpoint. When using DMA for Rx Endpoints, the PERI_RXCSR needs to have its DMAEN bit set and have its AUTOCLEAR and DMAMODE bits cleared. In addition, the relevant interrupt enable bit in the INTRRXE register should be set (if an interrupt is required for this endpoint) and the PERI_RXCSR register should be set as shown in [Table 16-5](#).

Table 16-5. PERI_RXCSR Register Bit Configuration for Bulk OUT Transactions

Bit Field	Bit Name	Description
Bit 15	AUTOCLEAR	Cleared to 0 if using DMA. In CPU Mode of usage, if the CPU sets AUTOCLEAR bit, the RXPKTRDY bit will be automatically cleared when a packet of RXMAXP bytes has been unloaded from the Receive FIFO.
Bit 14	ISO	Cleared to 0 to enable Bulk protocol.
Bit 13	DMAEN	Set to 1 if a DMA request is required for this Rx endpoint.
Bit 12	DISNYET	Cleared to 0 to allow normal PING flow control. This will affect only high speed transactions.
Bit 11	DMAMODE	Always clear this bit to 0.

When the Rx endpoint is first configured (following a SET_CONFIGURATION or SET_INTERFACE command on Endpoint 0), the lower byte of PERI_RXCSR should be written to set the CLRDATATOG bit (bit 7). This will ensure that the data toggle (which is handled automatically by the USB controller) starts in the correct state.

Also if there are any data packets in the FIFO (indicated by the RXPKTRDY bit (bit 0 of PERI_RXCSR) being set), they should be flushed by setting the FLUSHFIFO bit (bit 4 of PERI_RXCSR).

NOTE: It may be necessary to set this bit twice in succession if double buffering is enabled.

16.3.8.1.2.2.2 Bulk OUT Operation: Peripheral Mode

When a data packet is received by a Bulk Rx endpoint, the RXPKTRDY bit (bit 0 of PERI_RXCSR) is set and an interrupt is generated. The software should read the RXCOUNT register for the endpoint to determine the size of the data packet. The data packet should be read from the FIFO, and then the RXPKTRDY bit should be cleared.

The packets received should not exceed the size specified in the RXMAXP register (as this should be the value set in the wMaxPacketSize field of the endpoint descriptor sent to the host). When a block of data larger than wMaxPacketSize needs to be sent to the function, it will be sent as multiple packets. All the packets will be wMaxPacketSize in size, except the last packet which will contain the residue. The software may use an application specific method of determining the total size of the block and hence when the last packet has been received. Alternatively it may infer that the entire block has been received when it receives a packet which is less than wMaxPacketSize in size. (If the total size of the data block is a multiple of wMaxPacketSize, a null data packet will be sent after the data to signify that the transfer is complete.)

In the general case, the application software will need to read each packet from the FIFO individually. If large blocks of data are being transferred, the overhead of calling an interrupt service routine to unload each packet can be avoided by using DMA.

16.3.8.1.2.2.3 Bulk OUT Error Handling: Peripheral Mode

If the software wants to shut down the Bulk OUT pipe, it should set the SENDSTALL bit (bit 5 of PERI_RXCSR). When the controller receives the next packet it will send a STALL to the host, set the SENTSTALL bit (bit 6 of PERI_RXCSR) and generate an interrupt.

When the software receives an interrupt with the SENTSTALL bit (bit 6 of PERI_RXCSR) set, it should clear this bit. It should however leave the SENDSTALL bit set until it is ready to re-enable the Bulk OUT pipe.

NOTE: If the host failed to receive the STALL packet for some reason, it will send another packet, so it is advisable to leave the SENDSTALL bit set until the software is ready to re-enable the Bulk OUT pipe. When a Bulk OUT pipe is re-enabled, the data toggle sequence should be restarted by setting the CLRDATATOG bit (bit 7) in the PERI_RXCSR register.

16.3.8.1.3 Interrupt Transfer: Peripheral Mode

An Interrupt IN transaction uses the same protocol as a Bulk IN transaction and the configuration and operation mentioned on prior sections apply to Interrupt transfer too with minor changes. Similarly, an Interrupt OUT transaction uses almost the same protocol as a Bulk OUT transaction and can be used the same way.

Tx endpoints in the USB controller have one feature for Interrupt IN transactions that they do not support in Bulk IN transactions. In Interrupt IN transactions, the endpoints support continuous toggle of the data toggle bit.

This feature is enabled by setting the FRCDATATOG bit in the PERI_TXCSR register (bit 11). When this bit is set, the controller will consider the packet as having been successfully sent and toggle the data bit for the endpoint, regardless of whether an ACK was received from the host.

Another difference is that interrupt endpoints do not support PING flow control. This means that the controller should never respond with a NYET handshake, only ACK/NAK/STALL. To ensure this, the DISNYET bit in the PERI_RXCSR register (bit 12) should be set to disable the transmission of NYET handshakes in high-speed mode.

Though DMA can be used with an interrupt OUT endpoint, it generally offers little benefit as interrupt endpoints are usually expected to transfer all their data in a single packet.

16.3.8.1.4 Isochronous Transfer: Peripheral Mode

Isochronous transfers are used when working with isochronous data. Isochronous transfers provide periodic, continuous communication between host and device.

16.3.8.1.4.1 Isochronous IN Transactions: Peripheral Mode

An Isochronous IN transaction is used to transfer periodic data from the function controller to the host.

The following optional features are available for use with a Tx endpoint used in Peripheral mode for Isochronous IN transactions:

- Double packet buffering: When enabled, up to two packets can be stored in the FIFO awaiting transmission to the host. Double packet buffering is enabled by setting the DPB bit of TXFIFOSZ register (bit 4).

NOTE: Double packet buffering is generally advisable for isochronous transactions in order to avoid underrun errors as described in later section.

- DMA: If DMA is enabled for the endpoint, a DMA request will be generated whenever the endpoint is able to accept another packet in its FIFO. This feature allows the DMA controller to load packets into the FIFO without processor intervention.

However, this feature is not particularly useful with Isochronous endpoints because the packets transferred are often not maximum packet size and the PERI_TXCSR register needs to be accessed following every packet to check for Underrun errors.

When DMA is enabled and DMAMODE bit of PERI_TXCSR is set, endpoint interrupt will not be generated for completion of packet transfer. Endpoint interrupt will be generated only in the error conditions.

16.3.8.1.4.1.1 Isochronous IN Transfer Setup: Peripheral Mode

In configuring a Tx endpoint for Isochronous IN transactions, the TXMAXP register must be written with the maximum packet size (in bytes) for the endpoint. This value should be the same as the wMaxPacketSize field of the Standard Endpoint Descriptor for the endpoint. In addition, the relevant interrupt enable bit in the INTRTXE register should be set (if an interrupt is required for this endpoint) and the PERI_TXCSR register should be set as shown in [Table 16-6](#).

Table 16-6. PERI_TXCSR Register Bit Configuration for Isochronous IN Transactions

Bit Field	Bit Name	Description
Bit 14	ISO	Set to 1 to enable Isochronous transfer protocol.
Bit 13	MODE	Set to 1 to ensure the FIFO is enabled (only necessary if the FIFO is shared with an Rx endpoint).
Bit 12	DMAEN	Set to 1 if DMA Requests have to be enabled.
Bit 11	FRCDATATOG	Ignored in Isochronous mode.
Bit 10	DMAMODE	Set to 1 when DMA is enabled.

16.3.8.1.4.1.2 Isochronous IN Transfer Operation: Peripheral Mode

An isochronous endpoint does not support data retries, so if data underrun is to be avoided, the data to be sent to the host must be loaded into the FIFO before the IN token is received. The host will send one IN token per frame (or microframe in High-speed mode), however the timing within the frame (or microframe) can vary. If an IN token is received near the end of one frame and then at the start of the next frame, there will be little time to reload the FIFO. For this reason, double buffering of the endpoint is usually necessary.

An interrupt is generated whenever a packet is sent to the host and the software may use this interrupt to load the next packet into the FIFO and set the TXPKTRDY bit in the PERI_TXCSR register (bit 0) in the same way as for a Bulk Tx endpoint. As the interrupt could occur almost any time within a frame(/microframe), depending on when the host has scheduled the transaction, this may result in irregular timing of FIFO load requests. If the data source for the endpoint is coming from some external hardware, it may be more convenient to wait until the end of each frame(/microframe) before loading the FIFO as this will minimize the requirement for additional buffering. This can be done by using either the SOF interrupt or the external SOF_PULSE signal from the controller to trigger the loading of the next data packet. The SOF_PULSE is generated once per frame(/microframe) when a SOF packet is received. (The controller also maintains an external frame(/microframe) counter so it can still generate a SOF_PULSE when the SOF packet has been lost.) The interrupts may still be used to set the TXPKTRDY bit in PERI_TXCSR (bit 0) and to check for data overruns/underruns.

Starting up a double-buffered Isochronous IN pipe can be a source of problems. Double buffering requires that a data packet is not transmitted until the frame(/microframe) after it is loaded. There is no problem if the function loads the first data packet at least a frame(/microframe) before the host sets up the pipe (and therefore starts sending IN tokens). But if the host has already started sending IN tokens by the time the first packet is loaded, the packet may be transmitted in the same frame(/microframe) as it is loaded, depending on whether it is loaded before, or after, the IN token is received. This potential problem can be avoided by setting the ISOUPDATE bit in the POWER register (bit 7). When this bit is set, any data packet loaded into an Isochronous Tx endpoint FIFO will not be transmitted until after the next SOF packet has been received, thereby ensuring that the data packet is not sent too early.

16.3.8.1.4.1.3 Isochronous IN Error Handling: Peripheral Mode

If the endpoint has no data in its FIFO when an IN token is received, it will send a null data packet to the host and set the UNDERRUN bit in the PERI_TXCSR register (bit 2). This is an indication that the software is not supplying data fast enough for the host. It is up to the application to determine how this error condition is handled.

If the software is loading one packet per frame(/microframe) and it finds that the TXPKTRDY bit in the PERI_TXCSR register (bit 0) is set when it wants to load the next packet, this indicates that a data packet has not been sent (perhaps because an IN token from the host was corrupted). It is up to the application how it handles this condition: it may choose to flush the unsent packet by setting the FLUSHFIFO bit in the PERI_TXCSR register (bit 3), or it may choose to skip the current packet.

16.3.8.1.4.2 Isochronous OUT Transactions: Peripheral Mode

An isochronous OUT transaction is used to transfer periodic data from the host to the function controller.

Following optional features are available for use with an Rx endpoint used in Peripheral mode for Isochronous OUT transactions:

- Double packet buffering: When enabled, up to two packets can be stored in the FIFO on reception from the host. Double packet buffering is enabled by setting the DPB bit of RXFIFOSZ register (bit 4). **NOTE:** Double packet buffering is generally advisable for Isochronous transactions in order to avoid overrun errors.
- DMA: If DMA is enabled for the endpoint, a DMA request will be generated whenever the endpoint has a packet in its FIFO. This feature can be used to allow the DMA controller to unload packets from the FIFO without processor intervention.

However, this feature is not particularly useful with Isochronous endpoints because the packets transferred are often not maximum packet size and the PERI_RXCSR register needs to be accessed following every packet to check for Overrun or CRC errors.

When DMA is enabled, endpoint interrupt will not be generated for completion of packet reception. Endpoint interrupt will be generated only in the error conditions.

16.3.8.1.4.2.1 Isochronous OUT Setup: Peripheral Mode

In configuring an Rx endpoint for Isochronous OUT transactions, the RXMAXP register must be written with the maximum packet size (in bytes) for the endpoint. This value should be the same as the wMaxPacketSize field of the Standard Endpoint Descriptor for the endpoint. In addition, the relevant interrupt enable bit in the INTRRXE register should be set (if an interrupt is required for this endpoint) and the PERI_RXCSR register should be set as shown in [Table 16-7](#).

Table 16-7. PERI_RXCSR Register Bit Configuration for Isochronous OUT Transactions

Bit Field	Bit Name	Description
Bit 15	AUTOCLEAR	Cleared to 0 if using DMA. In CPU Mode of usage, if the CPU sets AUTOCLEAR bit, the RXPKTRDY bit will be automatically cleared when a packet of RXMAXP bytes has been unloaded from the Receive FIFO.
Bit 14	ISO	Set to 1 to configure endpoint usage for Isochronous transfer.
Bit 13	DMAEN	Set to 1 if a DMA request is required for this Rx endpoint.
Bit 12	DISNYET	Ignored in Isochronous Mode.
Bit 11	DMAMODE	Always clear this bit to 0.

16.3.8.1.4.2.2 Isochronous OUT Operation: Peripheral Mode

An Isochronous endpoint does not support data retries so, if a data overrun is to be avoided, there must be space in the FIFO to accept a packet when it is received. The host will send one packet per frame (or microframe in High-speed mode); however, the time within the frame can vary. If a packet is received near the end of one frame(/microframe) and another arrives at the start of the next frame, there will be little time to unload the FIFO. For this reason, double buffering of the endpoint is usually necessary.

An interrupt is generated whenever a packet is received from the host and the software may use this interrupt to unload the packet from the FIFO and clear the RXPKTRDY bit in the PERI_RXCSR register (bit 0) in the same way as for a Bulk Rx endpoint. As the interrupt could occur almost any time within a frame(/microframe), depending on when the host has scheduled the transaction, the timing of FIFO unload requests will probably be irregular. If the data sink for the endpoint is going to some external hardware, it may be better to minimize the requirement for additional buffering by waiting until the end of each frame(/microframe) before unloading the FIFO. This can be done by using either the SOF interrupt or the external SOF_PULSE signal from the controller to trigger the unloading of the data packet. The SOF_PULSE is generated once per frame(/microframe) when a SOF packet is received. (The controller also maintains an external frame(/microframe) counter so it can still generate a SOF_PULSE when the SOF packet has been lost.) The interrupts may still be used to clear the RXPKTRDY bit in PERI_RXCSR and to check for data overruns/underruns.

16.3.8.1.4.2.3 Isochronous OUT Error Handling: Peripheral Mode

If there is no space in the FIFO to store a packet when it is received from the host, the OVERRUN bit in the PERI_RXCSR register (bit 2) will be set. This is an indication that the software is not unloading data fast enough for the host. It is up to the application to determine how this error condition is handled

If the controller finds that a received packet has a CRC error, it will still store the packet in the FIFO and set the RXPKTRDY bit (bit 0 of PERI_RXCSR) and the DATAERROR bit (bit 3 of PERI_RXCSR). It is left up to the application to determine how this error condition is handled.

The number of USB packets sent in any microframe will depend on the amount of data to be transferred, and is indicated through the PIDs used for the individual packets. If the indicated number of packets have not been received by the end of a microframe, the INCOMPRX bit (bit 8) bit in the PERI_RXCSR register will be set to indicate that the data in the FIFO is incomplete. Equally, if a packet of the wrong data type is received, then the PID Error bit in the PERI_RXCSR register will be set. In each case, an interrupt will, however, still be generated to allow the data that has been received to be read from the FIFO.

Note: The circumstances in which a PID Error or INCOMPRX is reported depends on the precise sequence of packets received.

When the core is operating in peripheral mode, the details are in [Table 16-8](#).

Table 16-8. Isochronous OUT Error Handling: Peripheral Mode

No. Packet(s) Expected	Data Packet(s) Received	Response
1	DATA0	OK
	DATA1	PID Error set
	DATA2	PID Error set
	MDATA	PID Error set
2	DATA0	OK
	DATA1	INCOMPRX Set
	DATA2	INCOMPRX Set + PID Error set
	MDATA	INCOMPRX Set
	MDATA DATA0	PID Error Set
	MDATA DATA1	OK
	MDATA DATA2	PID Error Set
3	MDATA MDATA	PID Error Set
	DATA0	OK
	DATA1	INCOMPRX Set

Table 16-8. Isochronous OUT Error Handling: Peripheral Mode (continued)

No. Packet(s) Expected	Data Packet(s) Received	Response
	DATA2	INCOMPRX Set
	MDATA	INCOMPRX Set
	MDATA DATA0	PID Error set
	MDATA DATA1	OK
	MDATA DATA2	INCOMPRX Set
	MDATA MDATA	INCOMPRX Set
	MDATA MDATA DATA0	PID Error set
	MDATA MDATA DATA1	PID Error set
	MDATA MDATA DATA2	OK
	MDATA MDATA MDATA	PID Error set

16.3.8.2 USB Controller Host Mode Operation

The USB controller assumes the role of a host when the USB_x_ID pin state is grounded or USB Mode Register[iddig=bit8] is cleared to 0 (provided that iddig_mux, which is bit7 of USBnMODE is also set to 1) by the user application prior to the controller goes into session. When the USB controller go into session, application/firmware sets the DEVCTL[SESSION] bit to 1, it will assume the role of a host.

- **Entry into Suspend mode.** When operating as a host, the USB controller can be prompted to go into Suspend mode by setting the SUSPENDM bit in the POWER register. When this bit is set, the controller will complete the current transaction then stop the transaction scheduler and frame counter. No further transactions will be started and no SOF packets will be generated. If the ENSUSPM bit (bit 0 of POWER register) is set, the UTMI+ PHY will go into low-power mode when the controller goes into suspend mode.
- **Sending Resume Signaling.** When the application requires the controller to leave suspend mode, it needs to clear the SUSPENDM bit in the POWER register, set the RESUME bit and leave it set for 20ms. While the RESUME bit is high, the controller will generate Resume signaling on the bus. After 20 ms, the CPU should clear the RESUME bit, at which point the frame counter and transaction scheduler will be started.
- **Responding to Remote Wake-up.** If Resume signaling is detected from the target while the controller is in suspend mode, the UTMI+ PHY will be brought out of low-power mode and UTMI clock is restarted. The controller will then exit suspend mode and automatically set the RESUME bit in the POWER register (bit 2) to '1' to take over generating the Resume signaling from the target. If the resume interrupt is enabled, an interrupt will be generated.
- **Reset Signaling.** If the RESET bit in the POWER register (bit 3) is set while the controller is in Host mode, it will generate Reset signaling on the bus. If the HSENAB bit in the POWER register (bit 5) was set, it will also try to negotiate for high-speed operation. The software should keep the RESET bit set for at least 20 ms to ensure correct resetting of the target device. After the software has cleared the bit, the controller will start its frame counter and transaction scheduler. Whether high-speed operation is selected will be indicated by HSMODE bit of POWER register (bit 4).

16.3.8.2.1 Control Transactions: Host Mode

Host control transactions are conducted through Endpoint 0 and the software is required to handle all the Standard Device Requests that may be sent or received via Endpoint 0 (as described in Universal Serial Bus Specification, Revision 2.0). Endpoint 0 can only be serviced via CPU and DMA mode can not be used.

There are three categories of Standard Device Requests to be handled: Zero Data Requests (in which all the information is included in the command); Write Requests (in which the command will be followed by additional data); and Read Requests (in which the device is required to send data back to the host).

1. Zero Data Requests comprise a SETUP command followed by an IN Status Phase.
2. Write Requests comprise a SETUP command, followed by an OUT Data Phase which is in turn followed by an IN Status Phase.
3. Read Requests comprise a SETUP command, followed by an IN Data Phase which is in turn followed by an OUT Status Phase.

A timeout may be set to limit the length of time for which the host controller will retry a transaction which is continually NAKed by the target. This limit can be between 2 and 2 15 frames/microframes and is set through the NAKLIMIT0 register.

The following sections describe the actions that the CPU needs to take in issuing these different types of request through looking at the steps to take in the different phases of a control transaction.

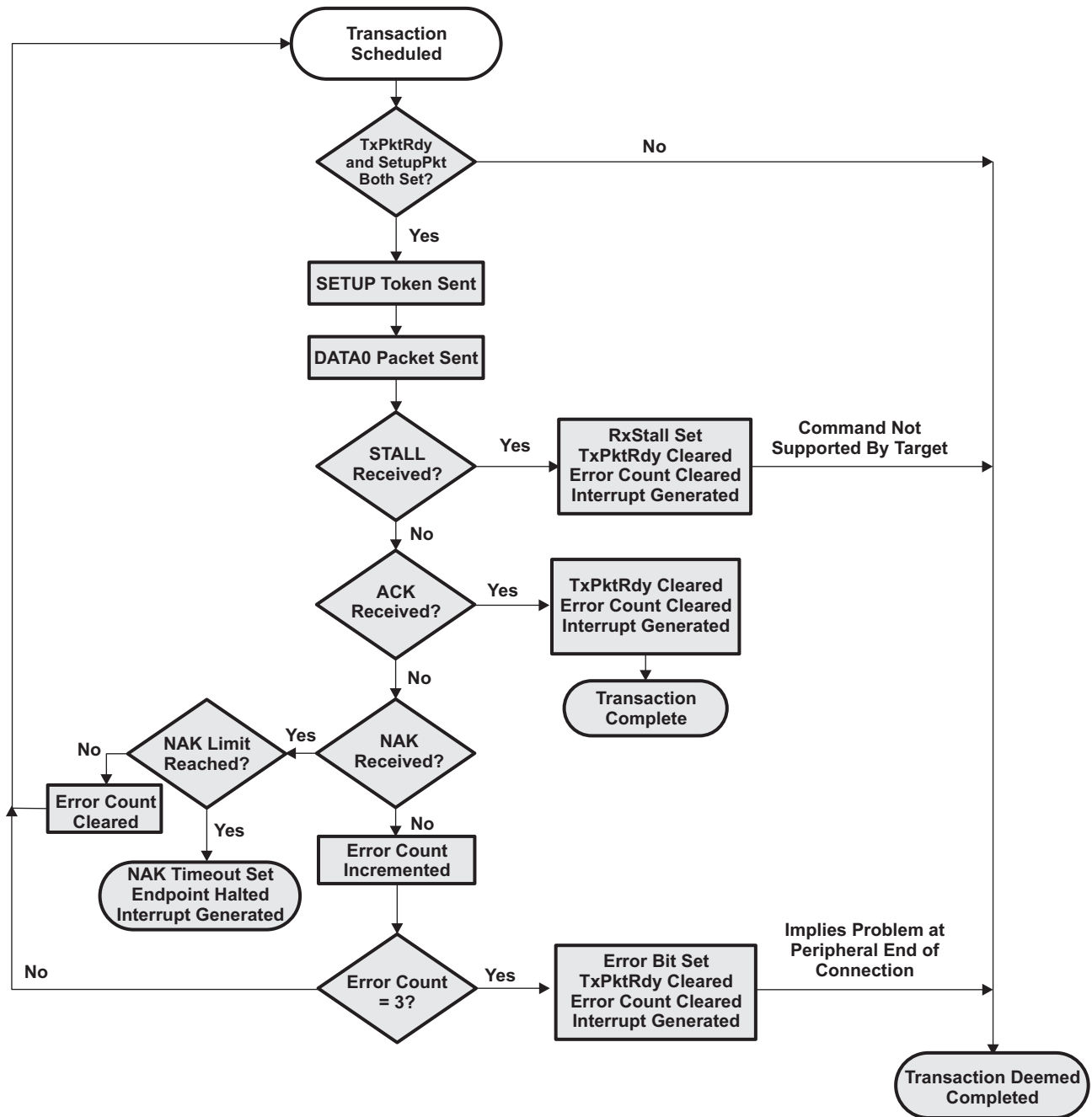
Note: Before initiating any transactions as a Host, the FADDR register needs to be set to address the peripheral device. When the device is first connected, FADDR should be set to zero. After a SET_ADDRESS command is issued, FADDR should be set the target's new address.

16.3.8.2.1.1 Setup Phase of Control Transaction: Host Mode

For the SETUP Phase of a control transaction ([Figure 16-8](#)), the software driving the USB host device needs to:

1. Load the 8 bytes of the required Device request command into the Endpoint 0 FIFO
2. Set SETUPPKT and TXPKTRDY (bits 3 and 1 of HOST_CSR0, respectively).
NOTE: These bits must be set together.
The controller then proceeds to send a SETUP token followed by the 8-byte command/request to Endpoint 0 of the addressed device, retrying as necessary. Note: On errors, the controller retries the transaction three times.
3. At the end of the attempt to send the 8-byte request data, the controller will generate an Endpoint 0 interrupt. The software should then read HOST_CSR0 to establish whether the RXSTALL bit (bit 2), the ERROR bit (bit 4) or the NAK_TIMEOUT bit (bit 7) has been set.
If RXSTALL is set, it indicates that the target did not accept the command (for example, because it is not supported by the target device) and so has issued a STALL response. If ERROR is set, it means that the controller has tried to send the SETUP Packet and the following data packet three times without getting any response.
If NAK_TIMEOUT is set, it means that the controller has received a NAK response to each attempt to send the SETUP packet, for longer than the time set in HOST_NAKLIMIT0. The controller can then be directed either to continue trying this transaction (until it times out again) by clearing the NAK_TIMEOUT bit or to abort the transaction by flushing the FIFO before clearing the NAK_TIMEOUT bit.
4. If none of RXSTALL, ERROR or NAK_TIMEOUT is set, the SETUP Phase has been correctly ACKed and the software should proceed to the following IN Data Phase, OUT Data Phase or IN Status Phase specified for the particular Standard Device Request.

Figure 16-8. Flow Chart of Setup Stage of a Control Transfer in Host Mode



16.3.8.2.1.2 Data Phase (IN Data Phase) of a Control Transaction: Host Mode

For the IN Data Phase of a control transaction (Figure 16-9), the software driving the USB host device needs to

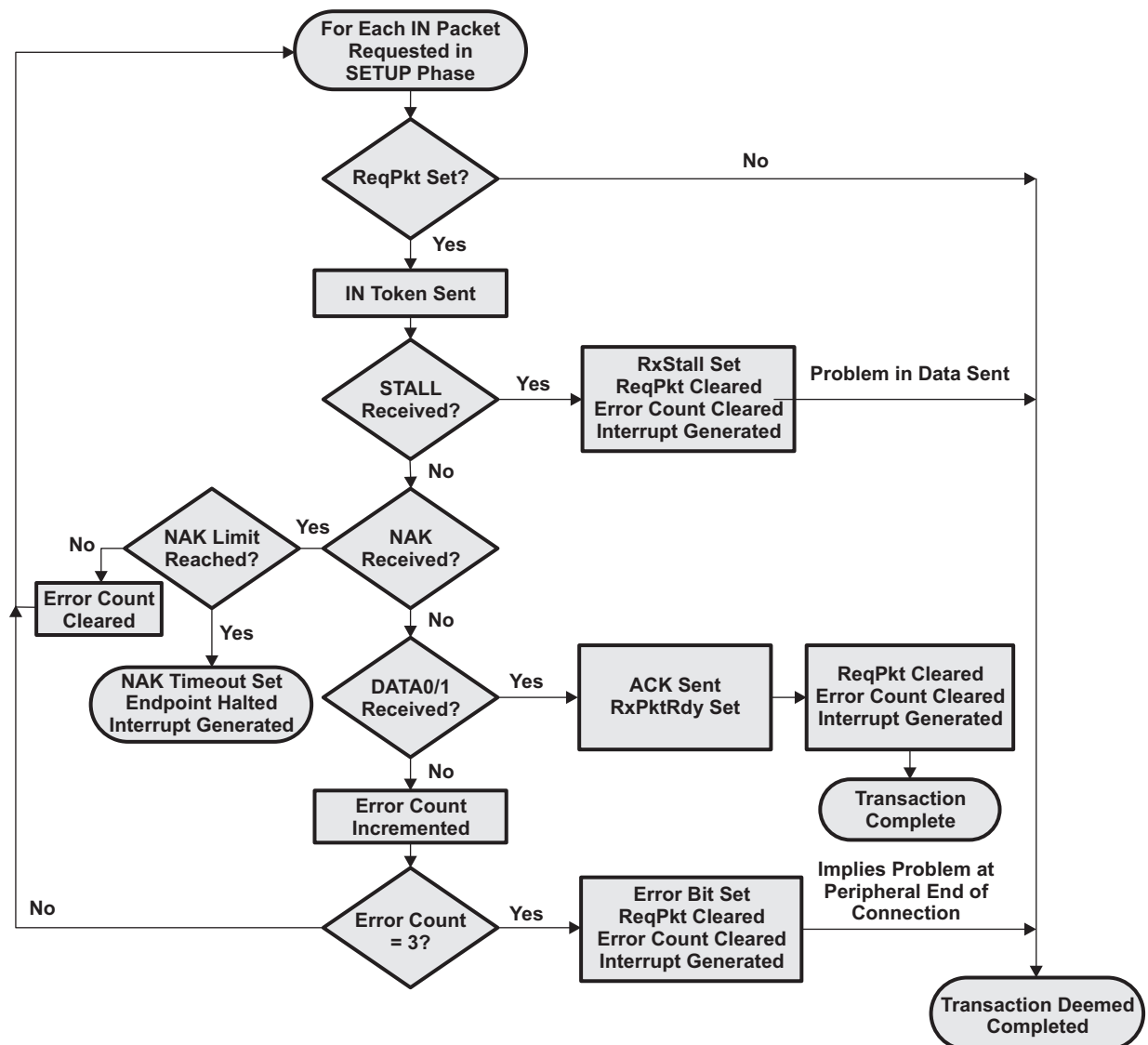
1. Set REQPKT bit of HOST_CSR0 (bit 5)
2. Wait while the controller sends the IN token and receives the required data back.
3. When the controller generates the Endpoint 0 interrupt, read HOST_CSR0 to establish whether the RXSTALL bit (bit 2), the ERROR bit (bit 4), the NAK_TIMEOUT bit (bit 7) or RXPKTTRDY bit (bit 0) has been set.
If RXSTALL is set, it indicates that the target has issued a STALL response.

If ERROR is set, it means that the controller has tried to send the required IN token three times without getting any response. If NAK_TIMEOUT bit is set, it means that the controller has received a NAK response to each attempt to send the IN token, for longer than the time set in HOST_NAKLIMIT0. The controller can then be directed either to continue trying this transaction (until it times out again) by clearing the NAK_TIMEOUT bit or to abort the transaction by clearing REQPKT before clearing the NAK_TIMEOUT bit

4. If RXPKTRDY has been set, the software should read the data from the Endpoint 0 FIFO, then clear RXPKTRDY.
5. If further data is expected, the software should repeat Steps 1-4.

When all the data has been successfully received, the CPU should proceed to the OUT Status Phase of the Control Transaction.

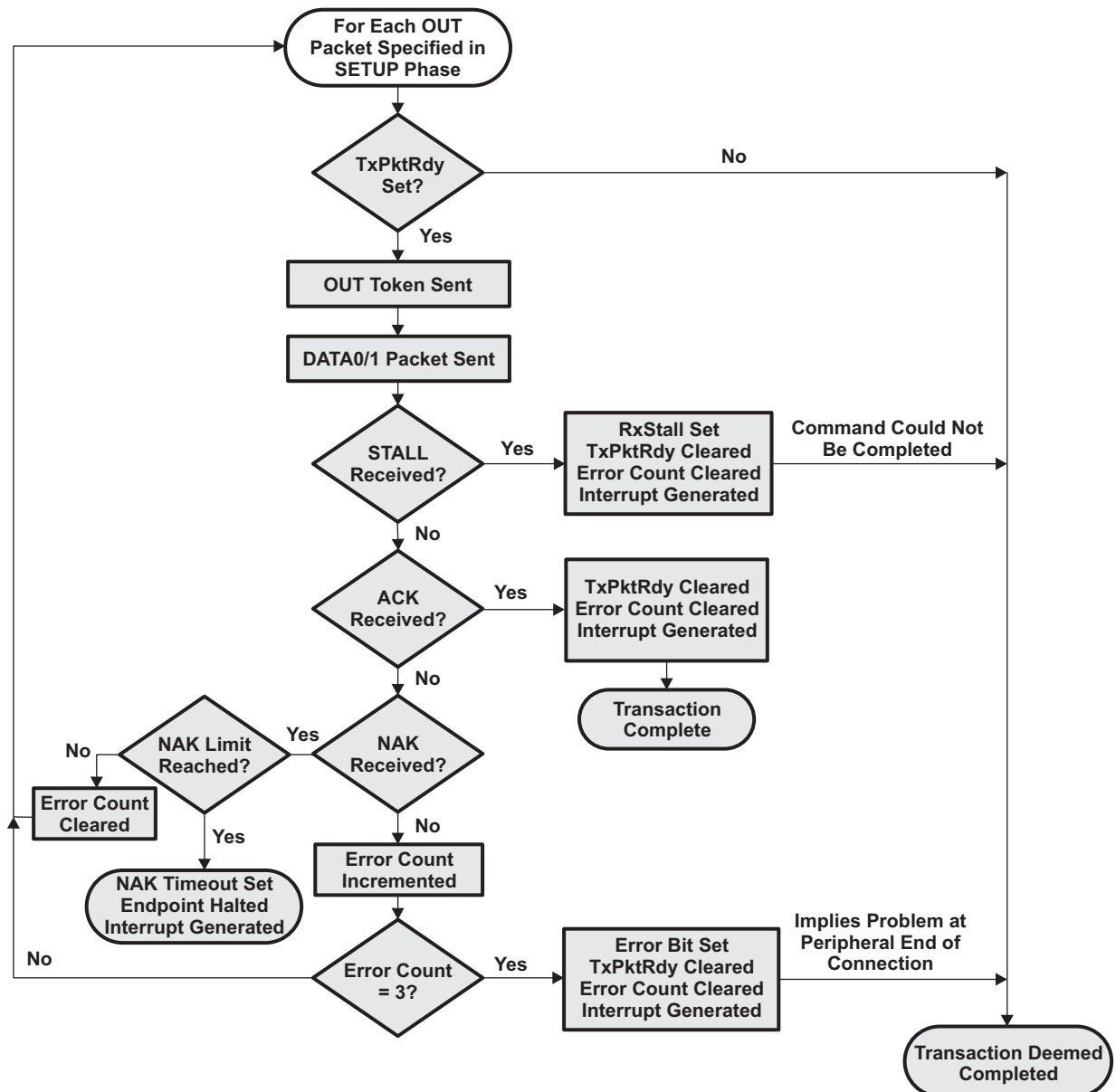
Figure 16-9. Flow Chart of Data Stage (IN Data Phase) of a Control Transfer in Host Mode



16.3.8.2.1.3 Data Phase (OUT Data Phase) of a Control Transaction: Host Mode

For the OUT Data Phase of a control transaction (Figure 16-10), the software driving the USB host device needs to:

1. Load the data to be sent into the endpoint 0 FIFO.
2. Set the TXPKTRDY bit of HOST_CSR0 (bit 1). The controller then proceeds to send an OUT token followed by the data from the FIFO to Endpoint 0 of the addressed device, retrying as necessary.
3. At the end of the attempt to send the data, the controller will generate an Endpoint 0 interrupt. The software should then read HOST_CSR0 to establish whether the RXSTALL bit (bit 2), the ERROR bit (bit 4) or the NAK_TIMEOUT bit (bit 7) has been set.
If RXSTALL bit is set, it indicates that the target has issued a STALL response.
If ERROR bit is set, it means that the controller has tried to send the OUT token and the following data packet three times without getting any response. If NAK_TIMEOUT is set, it means that the controller has received a NAK response to each attempt to send the OUT token, for longer than the time set in the HOST_NAKLIMIT0 register. The controller can then be directed either to continue trying this transaction (until it times out again) by clearing the NAK_TIMEOUT bit or to abort the transaction by flushing the FIFO before clearing the NAK_TIMEOUT bit.
If none of RXSTALL, ERROR or NAKLIMIT is set, the OUT data has been correctly ACKed.
4. If further data needs to be sent, the software should repeat Steps 1-3.
When all the data has been successfully sent, the software should proceed to the IN Status Phase of the Control Transaction.

Figure 16-10. Flow Chart of Data Stage (OUT Data Phase) of a Control Transfer in Host Mode


16.3.8.2.1.4 Status Phase (Status for OUT Data Phase or Setup Phase) of a Control Transaction: Host Mode

IN Status Phase of a control transfer exists for a Zero Data Request or for a Write Request of a control transfer. The IN Status Phase follows the Setup Stage, if no Data Stage of a control transfer exists, or OUT Data Phase of a Data Stage of a control transfer.

For the IN Status Phase of a control transaction (Figure 16-11), the software driving the USB Host device needs to:

1. Set the STATUSPKT and REQPKT bits of HOST_CSR0 (bit 6 and bit 5, respectively).
2. Wait while the controller sends an IN token and receives a response from the USB peripheral device.
3. When the controller generates the Endpoint 0 interrupt, read HOST_CSR0 to establish whether the RXSTALL bit (bit 2), the ERROR bit (bit 4), the NAK_TIMEOUT bit (bit 7) or RXPKTTRDY bit (bit 0) has been set.

If RXSTALL bit is set, it indicates that the target could not complete the command and so has issued a

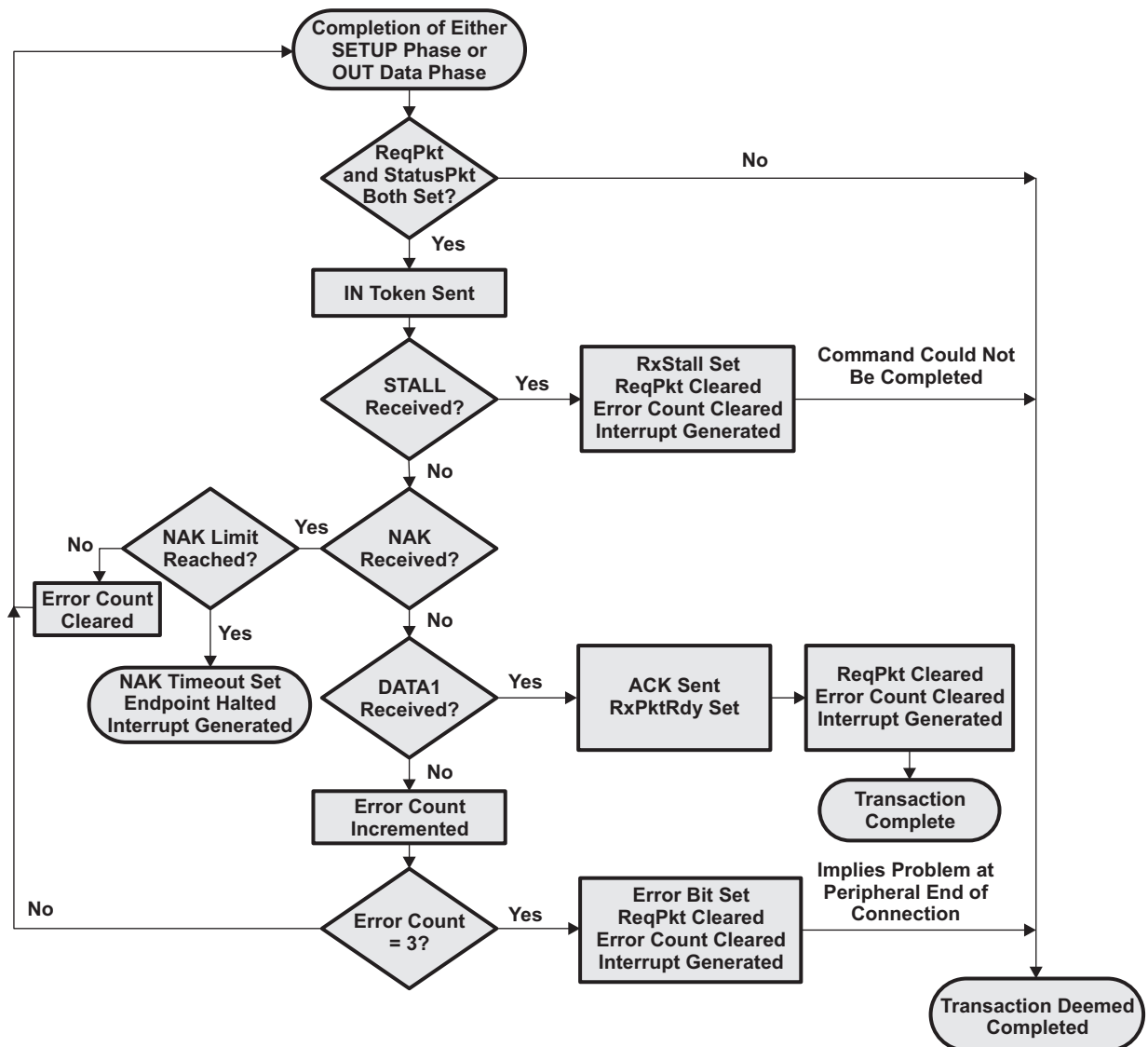
STALL response.

If ERROR bit is set, it means that the controller has tried to send the required IN token three times without getting any response.

If NAK_TIMEOUT bit is set, it means that the controller has received a NAK response to each attempt to send the IN token, for longer than the time set in the HOST_NAKLIMIT0 register. The controller can then be directed either to continue trying this transaction (until it times out again) by clearing the NAK_TIMEOUT bit or to abort the transaction by clearing REQPKT bit and STATUSPKT bit before clearing the NAK_TIMEOUT bit.

4. The CPU should clear the STATUSPPKT bit of HOST_CSR0 together with (i.e., in the same write operation as) RxPktRdy if this has been set.

Figure 16-11. Flow Chart of Status Stage of Zero Data Request or Write Request of a Control Transfer in Host Mode



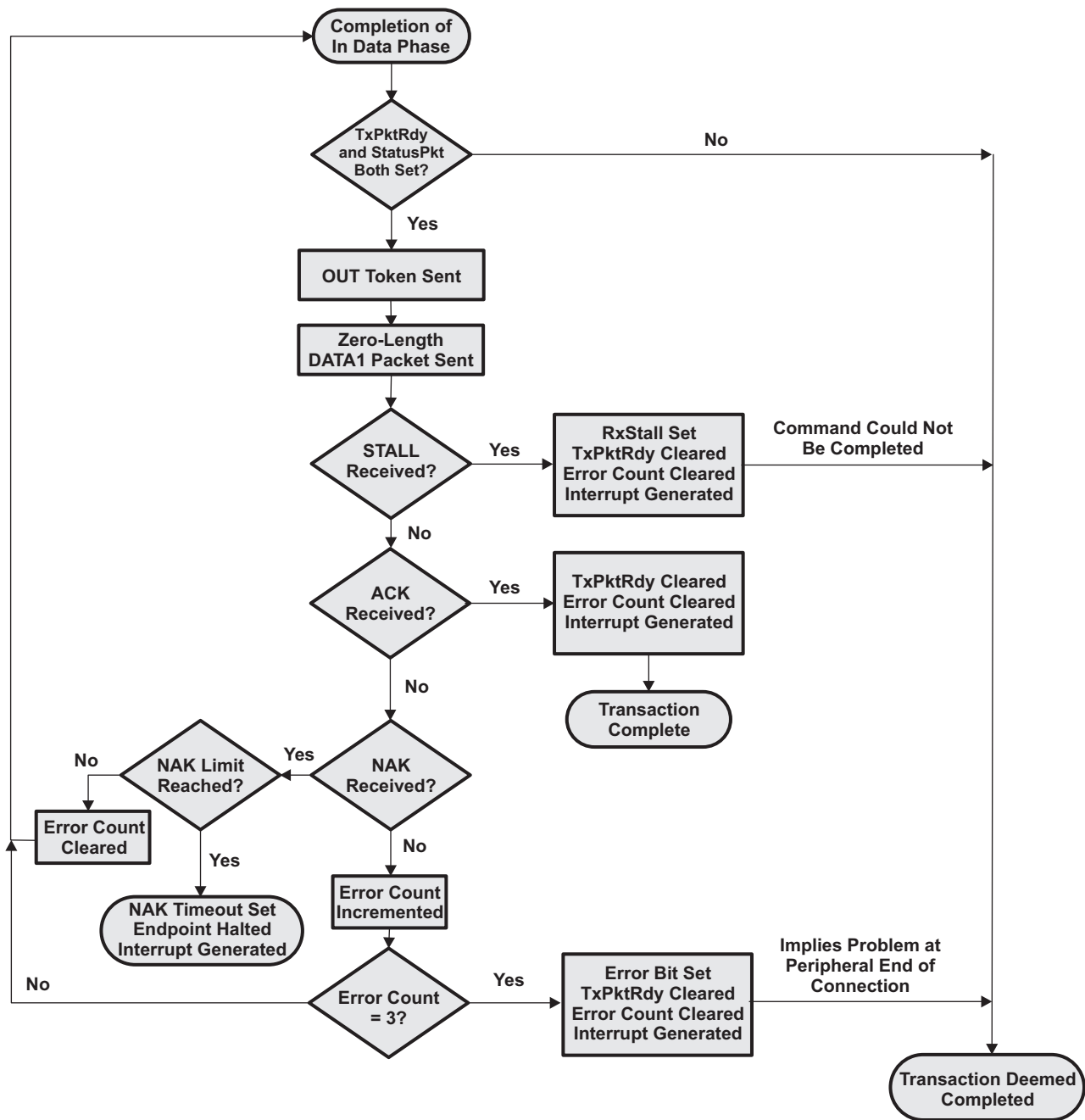
16.3.8.2.1.5 Status Phase for a Read Request of a Control Transaction: Host Mode

OUT Status Phase of a control transfer exist for a Read Request or a control transfer where data was received by the host controller. The OUT Status phase follows the IN Data Stage of a control transfer.

For the OUT Status Phase of a control transaction (Figure 16-12), the CPU driving the host device needs to:

1. Set STATUSPKT and TXPKTRDY bits of HOST_CSR0 (bit 6 and bit 1, respectively).
NOTE: These bits need to be set together
2. Wait while the controller sends the OUT token and a zero-length DATA1 packet.
3. At the end of the attempt to send the data, the controller will generate an Endpoint 0 interrupt. The software should then read HOST_CSR0 to establish whether the RXSTALL bit (bit 2), the ERROR bit (bit 4) or the NAK_TIMEOUT bit (bit 7) has been set.
If RXSTALL bit is set, it indicates that the target could not complete the command and so has issued a STALL response.
If ERROR bit is set, it means that the controller has tried to send the STATUS Packet and the following data packet three times without getting any response.
If NAK_TIMEOUT bit is set, it means that the controller has received a NAK response to each attempt to send the IN token, for longer than the time set in the HOST_NAKLIMIT0 register. The controller can then be directed either to continue trying this transaction (until it times out again) by clearing the NAK_TIMEOUT bit or to abort the transaction by flushing the FIFO before clearing the NAK_TIMEOUT bit.
4. If none of RXSTALL, ERROR or NAK_TIMEOUT bits is set, the STATUS Phase has been correctly ACKed.

Figure 16-12. Chart of Status Stage of a Read Request of a Control Transfer in Host Mode



16.3.8.2.2 Bulk Transfer: Host Mode

Bulk transactions are handled by endpoints other than endpoint 0. It is used to handle non-periodic, large bursty communication typically used for a transfer that use any available bandwidth and can also be delayed until bandwidth is available.

16.3.8.2.2.1 Bulk IN Transactions: Host Mode

A Bulk IN transaction may be used to transfer non-periodic data from the external USB peripheral to the host.

The following optional features are available for use with an Rx endpoint used in host mode to receive the data:

- Double packet buffering: When enabled, up to two packets can be stored in the FIFO on reception from the host. This allows that one packet can be received while another is being read. Double packet buffering is enabled by setting the DPB bit of RXFIFOSZ register (bit 4).
- DMA: If DMA is enabled for the endpoint, a DMA request will be generated whenever the endpoint has a packet in its FIFO. This feature can be used to allow the DMA controller to unload packets from the FIFO without processor intervention.
When DMA is enabled, endpoint interrupt will not be generated for completion of packet reception. Endpoint interrupt will be generated only in the error conditions. For more information see section on CPPI DMA

16.3.8.2.2.1.1 Bulk IN Setup: Host Mode

Before initiating any Bulk IN Transactions in Host mode:

- The HOST_RXTYPE register for the endpoint that is to be used needs to be programmed as:
 - Operating speed in the SPEED bit field (bits 7 and 6).
 - Set 10 (binary value) in the PROT field for bulk transfer.
 - Endpoint Number of the target device in RENDPN field. This is the endpoint number contained in the Rx endpoint descriptor returned by the target device during enumeration.
- The RXMAXP register for the controller endpoint must be written with the maximum packet size (in bytes) for the transfer. This value should be the same as the wMaxPacketSize field of the Standard Endpoint Descriptor for the target endpoint.
- The HOST_RXINTERVAL register needs to be written with the required value for the NAK limit (2-215 frames/microframes), or set to zero if the NAK timeout feature is not required.
- The relevant interrupt enable bit in the INTRRXE register should be set (if an interrupt is required for this endpoint).

Note: Whether interrupt is handled from PDR level or Core level, interrupt is required to be enabled at the core level. See details on Core Interrupt registers, CTRLR register, and sections on Interrupt Handling

- The AUTOREQ bit field should be used only when servicing transfers using CPU mode and must be cleared when using DMA Mode. For DMA Mode, dedicated registers USB0/1 Req Registers exist and the HOST_RXCSR[AUTOREQ] should be cleared.

When DMA is enabled, the following bits of HOST_RXCSR register should be set as:

- Clear AUTOCLEAR.
- Set DMAEN (bit 13) to 1 if a DMA request is required for this endpoint.
- Clear DSINYET (bit 12) to 0 to allow normal PING flow control. This will affect only High Speed transactions.
- Clear DMAMODE (bit 11) to 0.

Note: If DMA is enabled, the USB0/1 Auto Req register can be set for generating IN tokens automatically after receiving the data. Set the bit field RXn_AUTOREQ (where n is the endpoint number) with binary value 01 or 11.

When the endpoint is first configured, the endpoint data toggle should be cleared to 0 either by using the DATATOGWREN and DATATOG bits of HOST_RXCSR (bit 10 and bit 9) to toggle the current setting or by setting the CLRDATATOG bit of HOST_RXCSR (bit 7). This will ensure that the data toggle (which is handled automatically by the controller) starts in the correct state. Also if there are any data packets in the FIFO (indicated by the RXPBKTRDY bit (bit 0 of HOST_RXCSR) being set), they should be flushed by setting the FLUSHFIFO bit of HOST_RXCSR (bit 4).

NOTE: It may be necessary to set this bit twice in succession if double buffering is enabled.

16.3.8.2.2.1.2 Bulk IN Operation: Host Mode

When Bulk data is required from the USB peripheral device, the software should set the REQPKT bit in the corresponding HOST_RXCSR register (bit 5). The controller will then send an IN token to the selected peripheral endpoint and waits for data to be returned.

If data is correctly received, RXPBKTRDY bit of HOST_RXCSR (bit 0) is set. If the USB peripheral device responds with a STALL, RXSTALL bit (bit 6 of HOST_RXCSR) is set. If a NAK is received, the controller tries again and continues to try until either the transaction is successful or the POLINTVL_NAKLIMIT set in the HOST_RXINTERVAL register is reached. If no response at all is received, two further attempts are made before the controller reports an error by setting the ERROR bit of HOST_RXCSR (bit 2).

The controller then generates the appropriate endpoint interrupt, whereupon the software should read the corresponding HOST_RXCSR register to determine whether the RXPBKTRDY, RXSTALL, ERROR or DATAERR_NAKTIMEOUT bit is set and act accordingly. If the DATAERR_NAKTIMEOUT bit is set, the controller can be directed either to continue trying this transaction (until it times out again) by clearing the DATAERR_NAKTIMEOUT bit or to abort the transaction by clearing REQPKT bit before clearing the DATAERR_NAKTIMEOUT bit.

The packets received should not exceed the size specified in the RXMAXP register (as this should be the value set in the wMaxPacketSize field of the endpoint descriptor sent to the host).

In the general case, the application software (if CPU is servicing the endpoint) will need to read each packet from the FIFO individually. If large blocks of data are being transferred, the overhead of calling an interrupt service routine to unload each packet can be avoided by using DMA.

Note: When using DMA, see [Section 16.3.9, Communications Port Programming Interface \(CPPI\) 4.1 DMA](#), for the proper configuration of the core register, HOST_RXCSR.

16.3.8.2.2.1.3 Bulk IN Error Handling: Host Mode

If the target wants to shut down the Bulk IN pipe, it will send a STALL response to the IN token. This will result in the RXSTALL bit of HOST_RXCSR (bit 6) being set.

16.3.8.2.2.2 Bulk OUT Transactions: Host Mode

A Bulk OUT transaction may be used to transfer non-periodic data from the host to the USB peripheral.

Following optional features are available for use with a Tx endpoint used in Host mode to transmit this data:

- Double packet buffering: When enabled, up to two packets can be stored in the FIFO awaiting transmission to the peripheral device. Double packet buffering is enabled by setting the DPB bit of TXFIFOSZ register (bit 4).
- DMA: If DMA is enabled for the endpoint, a DMA request will be generated whenever the endpoint is able to accept another packet in its FIFO. This feature can be used to allow the DMA controller to load packets into the FIFO without processor intervention. For more information on using DMA, consult the section discussing CPPI DMA.
When DMA is enabled and DMAMODE bit in HOST_TXCSR register is set, an endpoint interrupt will not be generated for completion of packet reception. An endpoint interrupt will be generated only in the error conditions.

16.3.8.2.2.1 Bulk OUT Setup: Host Mode

Before initiating any bulk OUT transactions:

- The target function address needs to be set in the TXFUNCADDR register for the selected controller endpoint. (TXFUNCADDR register is available for all endpoints from EP0 to EP15.)
- The HOST_TXTYPE register for the endpoint that is to be used needs to be programmed as:
 - Operating speed in the SPEED bit field (bits 7 and 6).
 - Set PROT field to 10b for bulk transfer.
 - Enter Endpoint Number of the target device in TENDPN field. This is the endpoint number contained in the OUT(Tx) endpoint descriptor returned by the target device during enumeration.
- The TXMAXP register for the controller endpoint must be written with the maximum packet size (in bytes) for the transfer. This value should be the same as the wMaxPacketSize field of the Standard Endpoint Descriptor for the target endpoint.
- The HOST_TXINTERVAL register needs to be written with the required value for the NAK limit (2-215 frames/microframes), or set to zero if the NAK timeout feature is not required.
- The relevant interrupt enable bit in the INTRTXE register should be set (if an interrupt is required for this endpoint).
- The following bits of HOST_TXCSR register should be set as:
 - Set the MODE bit (bit 13) to 1 to ensure the FIFO is enabled (only necessary if the FIFO is shared with an Rx endpoint).
 - Clear the FRCDATATOG bit (bit 11) to 0 to allow normal data toggle operations.
 - Clear/Set AUTOSET bit (bit 15). The setting of this bit depends on the desire of the user/application in automatically setting the TXPKTRDY bit when servicing transactions using CPU.

Note: If DMA is needed to be used in place of the CPU, the following table displays the setting of the core register HOST_TXCSR register in Host mode. For the CPPI DMA registers settings consult the section on CPPI DMA within this document.

Bit Field	Bit Name	Description
Bit 15	AUTOSET	Cleared to 0 if using DMA. For CPU Mode use, if AUTOSET bit is set, the TXPKTRDY bit will be automatically set when data of the maximum packet size is loaded into the FIFO.
Bit 14	ISO	Cleared to 0 for bulk mode operation.
Bit 13	MODE	Set to 1 to make sure the FIFO is enabled (only necessary if the FIFO is shared with an RX endpoint)
Bit 12	DMAEN	Set to 1 to enable DMA usage; not needed if CPU is being used to service the Tx Endpoint
Bit 11	FRCDATATOG	Cleared to 0 to allow normal data toggle operations.
Bit 10	DMAMODE	Set to 1 when DMA is used to service Tx FIFO.

When the endpoint is first configured, the endpoint data toggle should be cleared to 0 either by using the DATATOGWREN bit and DATATOG bit of HOST_TXCSR (bit 9 and bit 8) to toggle the current setting or by setting the CLRDATATOG bit of HOST_TXCSR (bit 6). This will ensure that the data toggle (which is handled automatically by the controller) starts in the correct state. Also, if there are any data packets in the FIFO (indicated by the FIFONOTEMPTY bit of HOST_TXCSR register (bit 1) being set), they should be flushed by setting the FLUSHFIFO bit (bit 3 of HOST_TXCSR).

NOTE: It may be necessary to set this bit twice in succession if double buffering is enabled.

16.3.8.2.2.2 Bulk OUT Operation: Host Mode

When Bulk data is required to be sent to the USB peripheral device, the software should write the first packet of the data to the FIFO (or two packets if double-buffered) and set the TXPKTRDY bit in the corresponding HOST_TXCSR register (bit 0). The controller will then send an OUT token to the selected peripheral endpoint, followed by the first data packet from the FIFO.

If data is correctly received by the peripheral device, an ACK should be received whereupon the controller will clear TXPKTRDY bit of HOST_TXCSR (bit 0). If the USB peripheral device responds with a STALL, the RXSTALL bit (bit 5) of HOST_TXCSR is set. If a NAK is received, the controller tries again and continues to try until either the transaction is successful or the NAK limit set in the HOST_TXINTERVAL register is reached. If no response at all is received, two further attempts are made before the controller reports an error by setting ERROR bit in HOST_TXCSR (bit 2).

The controller then generates the appropriate endpoint interrupt, whereupon the software should read the corresponding HOST_TXCSR register to determine whether the RXSTALL (bit 5), ERROR (bit 2) or NAK_TIMEOUT (bit 7) bit is set and act accordingly. If the NAK_TIMEOUT bit is set, the controller can be directed either to continue trying this transaction (until it times out again) by clearing the NAK_TIMEOUT bit or to abort the transaction by flushing the FIFO before clearing the NAK_TIMEOUT bit.

If large blocks of data are being transferred, then the overhead of calling an interrupt service routine to load each packet can be avoided by using DMA.

16.3.8.2.2.3 Bulk OUT Error Handling: Host Mode

If the target wants to shut down the Bulk OUT pipe, it will send a STALL response. This is indicated by the RXSTALL bit of HOST_TXCSR register (bit 5) being set.

16.3.8.2.3 Interrupt Transfer: Host Mode

When the controller is operating as the host, interactions with an Interrupt endpoint on the USB peripheral device are handled in very much the same way as the equivalent Bulk transactions (described in previous sections).

The principal difference as far as operational steps are concerned is that the PROT field of HOST_RXTYPE and HOST_TXTYPE (bits 5-4) need to be set (binary value) to represent an Interrupt transaction. The required polling interval also needs to be set in the HOST_RXINTERVAL and HOST_TXINTERVAL registers.

16.3.8.2.4 Isochronous Transfer: Host Mode

Isochronous transfers are used when working with isochronous data. Isochronous transfers provide periodic, continuous communication between host and device.

An Isochronous IN transaction is used to transfer periodic data from the USB peripheral to the host.

16.3.8.2.4.1 Isochronous IN Transactions: Host Mode

The following optional features are available for use with an Rx endpoint used in Host mode to receive this data:

- Double packet buffering: When enabled, up to two packets can be stored in the FIFO on reception from the host. This allows that one packet can be received while another is being read. Double packet buffering is enabled by setting the DPB bit of RXFIFOSZ register (bit 4).
- AutoRequest: When the AutoRequest feature is enabled, the REQPKT bit of HOST_RXCSR (bit 5) will be automatically set when the RXPKTRDY bit is cleared. This only applies when the CPU is being used to service the endpoint. When using DMA, this bit field needs to be cleared to Zero. CPPI DMA has its own configuration registers that renders a similar task, USB0/1 Auto Req registers, that needs to be used to have a similar effect. For more information, see [Section 16.3.9, Communications Port Programming Interface \(CPPI\) 4.1 DMA](#).
- DMA: If DMA is enabled for the endpoint, a DMA request will be generated whenever the endpoint has a packet in its FIFO. This feature can be used to allow the DMA controller to unload packets from the FIFO without processor intervention. However, this feature is not particularly useful with isochronous

endpoints because the packets transferred are often not maximum packet size.

- When DMA is enabled, endpoint interrupt will not be generated for completion of packet reception. Endpoint interrupt will be generated only in the error conditions.

16.3.8.2.4.1.1 Isochronous IN Transfer Setup: Host

Before initiating an Isochronous IN Transactions in Host mode:

- The target function address needs to be set in the RXFUNCADDR register for the selected controller endpoint (RXFUNCADDR register is available for all endpoints from EP0 to EP4).
- The HOST_RXTYPE register for the endpoint that is to be used needs to be programmed as:
 - Operating speed in the SPEED bit field (bits 7 and 6).
 - Set 01 (binary value) in the PROT field for isochronous transfer.
 - Endpoint Number of the target device in RENDPN field. This is the endpoint number contained in the Rx endpoint descriptor returned by the target device during enumeration.
- The RXMAXP register for the controller endpoint must be written with the maximum packet size (in bytes) for the transfer. This value should be the same as the wMaxPacketSize field of the Standard Endpoint Descriptor for the target endpoint.
- The HOST_RXINTERVAL register needs to be written with the required transaction interval (usually one transaction per frame/microframe).
- The relevant interrupt enable bit in the INTRRXE register should be set (if an interrupt is required for this endpoint).
- The following bits of HOST_RXCSR register should be set as:
 - Clear AUTOCLEAR
 - Set the DMAEN bit (bit 13) to 1 if a DMA request is required for this endpoint.
 - Clear the DISNYET it (bit 12) to 0 to allow normal PING flow control. This will only affect High Speed transactions.
 - Clear DMAMODE bit (bit 11) to 0.
- If DMA is enabled, AUTOREQ register can be set for generating IN tokens automatically after receiving the data. Set the bit field RXn_AUTOREQ (where n is the endpoint number) with binary value 01 or 11. For detailed information on using CPPI DMA, consult related section within this document.

16.3.8.2.4.1.2 Isochronous IN Operation: Host Mode

The operation starts with the software setting REQPKT bit of HOST_RXCSR (bit 5). This causes the controller to send an IN token to the target.

When a packet is received, an interrupt is generated which the software may use to unload the packet from the FIFO and clear the RXPKTRDY bit in the HOST_RXCSR register (bit 0) in the same way as for a Bulk Rx endpoint. As the interrupt could occur almost any time within a frame(/microframe), the timing of FIFO unload requests will probably be irregular. If the data sink for the endpoint is going to some external hardware, it may be better to minimize the requirement for additional buffering by waiting until the end of each frame before unloading the FIFO. This can be done by using the SOF_PULSE signal from the controller to trigger the unloading of the data packet. The SOF_PULSE is generated once per frame(/microframe). The interrupts may still be used to clear the RXPKTRDY bit in HOST_RXCSR.

16.3.8.2.4.1.3 Isochronous IN Error Handling: Host Mode

If a CRC or bit-stuff error occurs during the reception of a packet, the packet will still be stored in the FIFO but the DATAERR_NAKTIMEOUT bit of HOST_RXCSR (bit 3) is set to indicate that the data may be corrupt.

Note: The number of USB packets sent in any microframe will depend on the amount of data to be transferred, and is indicated through the PIDs used for the individual packets. If the indicated numbers of packets have not been received by the end of a microframe, the INCOMPRX bit in the HOST_RXCSR register will be set to indicate that the data in the FIFO is incomplete. Equally, if a packet of the wrong data type is received, then the PID Error bit in the HOST_RXCSR register will be set. In each case, an interrupt will, however, still be generated to allow the data that has been received to be read from the FIFO.

16.3.8.2.4.2 Isochronous OUT Transactions: Host Mode

An Isochronous OUT transaction may be used to transfer periodic data from the host to the USB peripheral.

Following optional features are available for use with a Tx endpoint used in Host mode to transmit this data:

- Double packet buffering: When enabled, up to two packets can be stored in the FIFO awaiting transmission to the peripheral device. Double packet buffering is enabled by setting the DPB bit of TXFIFOSZ register (bit 4).

DMA: If DMA is enabled for the endpoint, a DMA request will be generated whenever the endpoint is able to accept another packet in its FIFO. This feature can be used to allow the DMA controller to load packets into the FIFO without processor intervention.

However, this feature is not particularly useful with isochronous endpoints because the packets transferred are often not maximum packet size.

When DMA is enabled and endpoint interrupt will not be generated for completion of packet reception. Endpoint interrupt will be generated only in the error conditions.

16.3.8.2.4.2.1 Isochronous OUT Transfer Setup: Host Mode

Before initiating any Isochronous OUT transactions:

- The target function address needs to be set in the TXFUNCADDR register for the selected controller endpoint (TXFUNCADDR register is available for all endpoints from EP0 to EP4).
- The HOST_TXTYPE register for the endpoint that is to be used needs to be programmed as:
 - Operating speed in the SPEED bit field (bits 7 and 6).
 - Set 01 (binary value) in the PROT field for isochronous transfer.
 - Endpoint Number of the target device in TENDPN field. This is the endpoint number contained in the OUT(Tx) endpoint descriptor returned by the target device during enumeration.
- The TXMAXP register for the controller endpoint must be written with the maximum packet size (in bytes) for the transfer. This value should be the same as the wMaxPacketSize field of the Standard Endpoint Descriptor for the target endpoint.
- The HOST_TXINTERVAL register needs to be written with the required transaction interval (usually one transaction per frame/microframe).
- The relevant interrupt enable bit in the INTRTXE register should be set (if an interrupt is required for this endpoint).
- The following bits of HOST_TXCSR register should be set as:
 - Set the MODE bit (bit 13) to 1 to ensure the FIFO is enabled (only necessary if the FIFO is shared with an Rx endpoint).
 - Set the DMAEN bit (bit 12) to 1 if a DMA request is required for this endpoint
 - The FRCDATATOG bit (bit 11) is ignored for isochronous transactions.
 - Set the DMAMODE bit (bit 10) to 1 when DMA is enabled.
 For more details in using DMA, consult CPPI DMA section within this document.

16.3.8.2.4.2.2 Isochronous OUT Transfer Operation: Host Mode

The operation starts when the software writes to the FIFO and sets TXPKTRDY bit of HOST_TXCSR (bit 0). This triggers the controller to send an OUT token followed by the first data packet from the FIFO.

An interrupt is generated whenever a packet is sent and the software may use this interrupt to load the next packet into the FIFO and set the TXPKTRDY bit in the HOST_TXCSR register (bit 0) in the same way as for a Bulk Tx endpoint. As the interrupt could occur almost any time within a frame, depending on when the host has scheduled the transaction, this may result in irregular timing of FIFO load requests. If the data source for the endpoint is coming from some external hardware, it may be more convenient to wait until the end of each frame before loading the FIFO as this will minimize the requirement for additional buffering. This can be done by using the SOF_PULSE signal from the controller to trigger the loading of the next data packet. The SOF_PULSE is generated once per frame(/microframe). The interrupts may still be used to set the TXPKTRDY bit in HOST_TXCSR.

16.3.9 Communications Port Programming Interface (CPPI) 4.1 DMA

The CPPI DMA module supports the transmission and reception of USB packets. The CPPI DMA is designed to facilitate the segmentation and reassembly of CPPI compliant packets to/from smaller data blocks that are natively compatible with the specific requirements of each networking port. Multiple Tx and Rx channels are provided for all endpoints (excluding endpoint 0) within the DMA allowing multiple segmentation or reassembly operations to be effectively performed in parallel (but not actually simultaneously). The DMA controller maintains state information for each of the ports/channels which allows packet segmentation and reassembly operations to be time division multiplexed between channels in order to share the underlying DMA hardware. A DMA scheduler is used to control the ordering and rate at which this multiplexing occurs.

The CPPI (version 4.1) DMA controller sub-module is a common 15 port DMA controller. It supports 15 Tx and 15 Rx channels and each port attaches to the associated endpoint in the controller. Port 1 maps to endpoint 1 and Port 2 maps to endpoint 2 and so on with Port 15 mapped to endpoint 15; endpoint 0 can not utilize the DMA and the firmware is responsible to load or offload the endpoint 0 FIFO via CPU.

16.3.9.1 CPPI Terminology

Host — The host is an intelligent system resource that configures and manages each communications control module. The host is responsible for allocating memory, initializing all data structures, and responding to port interrupts.

Main Memory — The area of data storage managed by the CPU. The CPPI DMA (CDMA) reads and writes CPPI packets from and to main memory. This memory can exist internal or external from the device.

Queue Manager (QM) — The QM is responsible for accelerating management of a variety of Packet Queues and Free Descriptor / Buffer Queues. It provides status indications to the CDMA Scheduler when queues are empty or full.

CPPI DMA (CDMA) — The CDMA is responsible for transferring data between the CPPI FIFO and Main Memory. It acquires free Buffer Descriptor from the QM (Receive Submit Queue) for storage of received data, posts received packets pointers to the Receive Completion Queue, transmits packets stored on the Transmit Submit Queue (Transmit Queue), and posts completed transmit packets to the Transmit Completion Queue.

CDMA Scheduler (CDMAS) — The CDMAS is responsible for scheduling CDMA transmit and receive operations. It uses Queue Indicators from the QM and the CDMA to determine the types of operations to schedule.

CPPI FIFO — The CPPI FIFO provides FIFO interfaces (for each of the 15 transmit and 15 receive endpoints).

Transfer DMA (XDMA) — The XDMA receives DMA requests from the Mentor USB 2.0 Core and initiates DMAs to the CPPI FIFO.

Endpoint FIFOs — The Endpoint FIFOs are the USB packet storage elements used by the Mentor USB 2.0 Core for packet transmission or reception. The XDMA transfers data between the CPPI FIFO and the Endpoint FIFOs for transmit operations and between the Endpoint FIFOs and the CPPI FIFO for receive operations.

Port — A port is the communications module (peripheral hardware) that contains the control logic for Direct Memory Access for a single transmit/receive interface or set of interfaces. Each port may have multiple communication channels that transfer data using homogenous or heterogeneous protocols. A port is usually subdivided into transmit and receive pairs which are independent of each other. Each endpoint, excluding endpoint 0, has its own dedicated port.

Channel — A channel refers to the sub-division of information (flows) that is transported across ports. Each channel has associated state information. Channels are used to segregate information flows based on the protocol used, scheduling requirements (example: CBR, VBR, ABR), or concurrency requirements (that is, blocking avoidance). All fifteen ports per USB Module have dedicated single channels, channel 0, associated for their use in a USB application.

Data Buffer — A data buffer is a single data structure that contains payload information for transmission to or reception from a port. A data buffer is a byte aligned contiguous block of memory used to store packet payload data. A data buffer may hold any portion of a packet and may be linked together (via descriptors) with other buffers to form packets. Data buffers may be allocated anywhere within the 32-bit memory space. The Buffer Length field of the packet descriptor indicates the number of valid data bytes in the buffer. There may be from 1 to 4M-1 valid data bytes in each buffer.

Host Buffer Descriptor (Buffer Descriptor) — A buffer descriptor is a single data structure that contains information about one or more data buffers. This type of descriptor is required when more than one descriptor is needed to define an entire packet, i.e., it either defines the middle of a packet or end of a packet.

Start of Packet (SOP) — Packet along side Buffer Descriptors are used to hold information about Packets. When multiple Descriptors are used to hold a single packet information or a single Descriptor is used to hold a single packet information, the first descriptor is referred to as a Packet Descriptor which is also Start-of-Packet Descriptor.

Host Packet Descriptor (Packet Descriptor) — A packet descriptor is another name for the first buffer descriptor within a packet. Some fields within a data buffer descriptor are only valid when it is a packet descriptor including the tags, packet length, packet type, and flags. This type of descriptor is always used to define a packet since it provides packet level information that is useful to both the ports and the Host in order to properly process the packet. It is the only descriptor used when single descriptor solely defines a packet. When multiple descriptors are needed to define a packet, the packet descriptor is the first descriptor used to define a packet.

Free Descriptor/Buffer Queue — A free descriptor/buffer queue is a hardware managed list of available descriptors with pre-linked empty buffers that are to be used by the receive ports for host type descriptors. Free Descriptor/Buffer Queues are implemented by the Queue Manager.

Teardown Descriptor — Teardown Descriptor is a special structure which is not used to describe either a packet or a buffer but is instead used to describe the completion of a channel halt and teardown event. Channel teardown is an important function because it ensures that when a connection is no longer needed that the hardware can be reliably halted and any remaining packets which had not yet been transmitted can be reclaimed by the Host without the possibility of losing buffer or descriptor references (which results in a memory leak).

Packet Queue — A packet queue is hardware managed list of valid (i.e. populated) packet descriptors that is used for forwarding a packet from one entity to another for any number of purposes.

NOTE: All descriptors (regardless of type) must be allocated at addresses that are naturally aligned to the smallest power of 2 that is equal to or greater than the descriptor size.

16.3.9.2 Data Structures

Two data structures are mainly used to identify data buffers used by packet and buffer descriptors. A third Descriptor, Teardown Descriptor, exists. The purpose of this Descriptor is a channel halt and teardown event. Each of these Descriptor layouts as well as bit fields are shown below.

16.3.9.2.1 Host Packet Descriptor/ Packet Descriptor (SOP Descriptor)

Descriptors are designed to be used when USB like application requires support for true, unlimited fragment count scatter/gather type operations. The Packet Descriptor is the first descriptor on multiple descriptors setup or the only descriptor in a single descriptors setup. The Packet Descriptor contains the following information:

- Indicator which identifies the descriptor as a packet descriptor (always 10h)
- Source and destination tags (reserved)
- Packet type
- Packet length
- Protocol specific region size
- Protocol specific control/statusbits
- Pointer to the first valid byte in the SOP data buffer

- Length of the SOP data buffer
- Pointer to the next buffer descriptor in the

Packet descriptors can vary in size by design of their defined fields from 32 bytes up to 104 bytes. Within this range, packet descriptors always contain 32 bytes of required information and may also contain 8 bytes of software specific tagging information and up to 64 bytes (indicated in 4 byte increments) of protocol specific information. How much protocol specific information (and therefore the allocated size of the descriptors) is application dependent. Port will make use of the first 32 bytes only.

From a general USB use perspective, a 32-byte descriptor size is suffix and the use of this size is expected for a normal USB usage.

The packet descriptor layout is shown in [Figure 16-13](#) and described within [Table 16-9](#) through [Table 16-16](#).

Figure 16-13. Packet Descriptor Layout

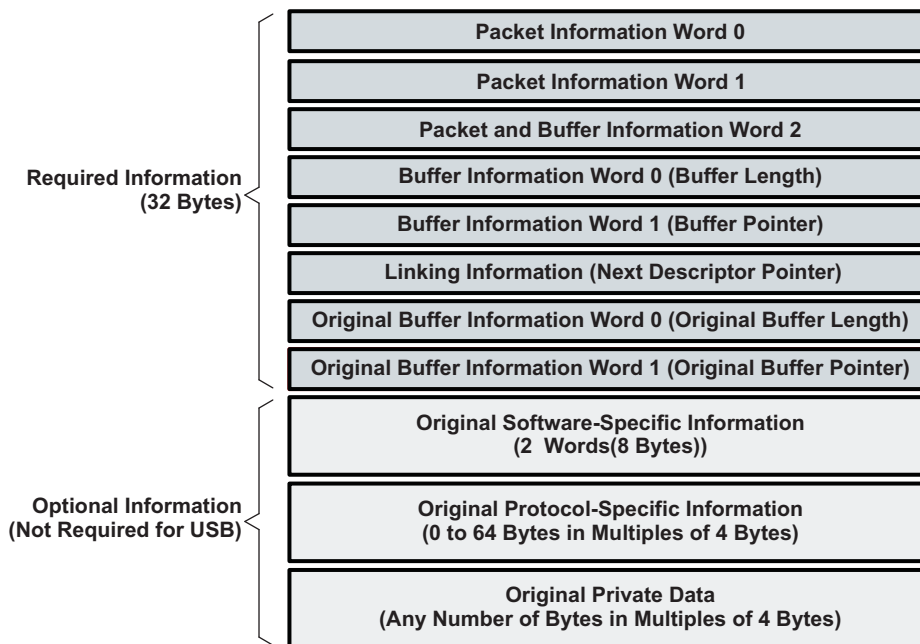


Table 16-9. Packet Descriptor Word 0 (PD0) Bit Field Descriptions

Bits	Field Name	Description
31-27	Descriptor type	The host packet descriptor type is 16 decimal (10h). The CPU initializes this field.
26-22	Protocol-specific valid word count	This field indicates the valid number of 32-bit words in the protocol-specific region. The CPU initializes this field. This is encoded in increments of 4 bytes as: 0 = 0 byte 1 = 4 bytes ... 16 = 64 bytes 17-31 = Reserved
21-0	Packet length	The length of the packet in bytes. If the packet length is less than the sum of the buffer lengths, then the packet data will be truncated. A packet length greater than the sum of the buffers is an error. The valid range for the packet length is 0 to (4M - 1) bytes. The CPU initializes this field for transmitted packets; the DMA overwrites this field on packet reception.

Table 16-10. Packet Descriptor Word 1 (PD1) Bit Field Descriptions

Bits	Field Name	Description
31-27	Source Tag; Port #	This field indicates the port number (0-31) from which the packet originated. The DMA overwrites this field on packet reception. This is the RX Endpoint number from which the packet originated.
26-21	Source Tag; Channel #	This field indicates the channel number within the port from which the packet originated. The DMA overwrites this field on packet reception. This field is always 0-67.
20-16	Source Tag: Sub-channel #	This field indicates the sub-channel number (0-31) within the channel from which the packet originated. The DMA overwrites this field on packet reception. This field is always 0.
15-0	Destination Tag	This field is application-specific. This field is always 0.

Table 16-11. Packet Descriptor Word 2 (PD2) Bit Field Descriptions

Bits	Field Name	Description
31	Packet error	This bit indicates if an error occurred during reception of this packet (0 = no error occurred; 1 = error occurred). The DMA overwrites this field on packet reception. Additional information about different errors may be encoded in the protocol specific fields in the descriptor.
30-26		This field indicates the type of this packet. The CPU initializes this field for transmitted packets; the DMA overwrites this field on packet reception. This field is encoded as: 5 = USB 8-31 = Reserved
25-20	Reserved	Reserved
19	Zero-length packet indicator	If a zero-length USB packet is received, the XDMA will send the CDMA a data block with a byte count of 0 and this bit is set. The CDMA will then perform normal EOP termination of the packet without transferring data. For transmit, if a packet has this bit set, the XDMA will ignore the CPPI packet size and send a zero-length packet to the USB controller.
18-16	Protocol-specific	This field contains protocol-specific flags/information that can be assigned based on the packet type. Not used for USB.
15	Return policy	This field indicates the return policy for this packet. The CPU initializes this field. 0 = Entire packet (still linked together) should be returned to the queue specified in bits 11-0. 1 = Each buffer should be returned to the queue specified in bits 11-0 of Word 2 in their respective descriptors. The Tx DMA will return each buffer in sequence.
14	On-chip	This field indicates whether or not this descriptor is in a region which is in on-chip memory space (1) or in external memory (0).
13-12	Packet return queue mgr #	This field indicates which queue manager in the system the descriptor is to be returned to after transmission is complete. This field is not altered by the DMA during transmission or reception and is initialized by the CPU. There is only one queue manager in the USB HS/FS device controller. This field must always be 0.
11-0	Packet return queue #	This field indicates the queue number within the selected queue manager that the descriptor is to be returned to after transmission is complete. This field is not altered by the DMA during transmission or reception and is initialized by the CPU.

Table 16-12. Packet Descriptor Word 3 (PD3) Bit Field Descriptions

Bits	Field Name	Description
31-22	Reserved	Reserved
21-0	Buffer 0 length	The buffer length field indicates how many valid data bytes are in the buffer. The CPU initializes this field for transmitted packets; the DMA overwrites this field on packet reception.

Table 16-13. Packet Descriptor Word 4 (PD4) Bit Field Descriptions

Bits	Field Name	Description
31-0	Buffer 0 pointer	The buffer pointer is the byte-aligned memory address of the buffer associated with the buffer descriptor. The CPU initializes this field for transmitted packets; the DMA overwrites this field on packet reception.

Table 16-14. Packet Descriptor Word 5 (PD5) Bit Field Descriptions

Bits	Field Name	Description
31-0	Next descriptor pointer	The 32-bit word aligned memory address of the next buffer descriptor in the packet. If the value of this pointer is zero, then the current buffer is the last buffer in the packet. The CPU initializes this field for transmitted packets; the DMA overwrites this field on packet reception.

Table 16-15. Packet Descriptor Word 6 (PD6) Bit Field Descriptions

Bits	Field Name	Description
31-22	Reserved	Reserved
21-0	Original buffer 0 length	The buffer length field indicates the original size of the buffer in bytes. This value is not overwritten during reception. This value is read by the Rx DMA to determine the actual buffer size as allocated by the CPU at initialization. Since the buffer length in Word 3 is overwritten by the Rx port during reception, this field is necessary to permanently store the buffer size information.

Table 16-16. Packet Descriptor Word 7 (PD7) Bit Field Descriptions

Bits	Field Name	Description
31-22	Reserved	Reserved
21-0	Original buffer 0 pointer	The buffer pointer is the byte-aligned memory address of the buffer associated with the buffer descriptor. This value is not overwritten during reception. This value is read by the Rx DMA to determine the actual buffer location as allocated by the CPU at initialization. Since the buffer pointer in Word 4 is overwritten by the Rx port during reception, this field is necessary to permanently store the buffer pointer information.

16.3.9.2.2 Host Buffer Descriptor/Buffer Descriptor (BD)

The buffer descriptor is identical in size and organization to a Packet Descriptor but does not include valid information in the packet level fields and does not include a populated region for protocol specific information. The packet level fields are not needed since the SOP descriptor contains this information and additional copy of this data is not needed/necessary.

Host buffer descriptors are designed to be linked onto a host packet descriptor or another host buffer descriptor to provide support for unlimited scatter / gather type operations. Host buffer descriptors provide information about a single corresponding data buffer. Every host buffer descriptor stores the following information:

- Pointer to the first valid byte in the data
- Length of the data buffer
- Pointer to the next buffer descriptor in the packet

Buffer descriptors always contain 32 bytes of required information. Since it is a requirement that it is possible to convert a descriptor between a Buffer Descriptor and a Packet Descriptor (by filling in the appropriate fields) in practice, Buffer Descriptors will be allocated using the same sizes as Packet Descriptors. In addition, since the 5 LSBs of the Descriptor Pointers are used in CPPI 4.1 for the purpose of indicating the length of the descriptor, the minimum size of a descriptor is always 32 bytes

The buffer descriptor layout is shown in [Figure 16-14](#) and described within [Table 16-17](#) through [Table 16-24](#).

Figure 16-14. Buffer Descriptor (BD) Layout

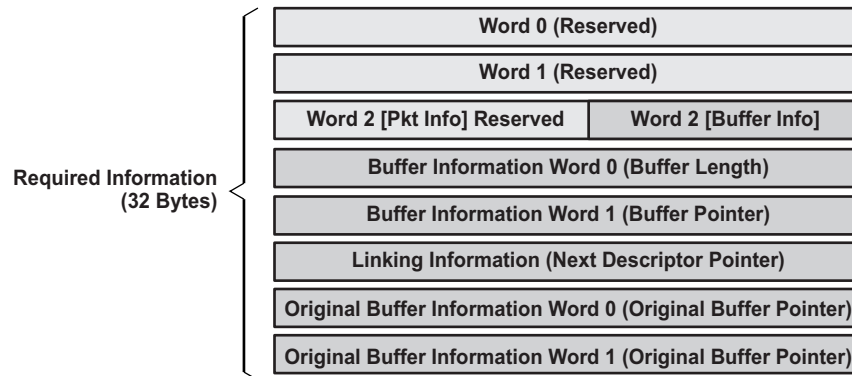


Table 16-17. Buffer Descriptor Word 0 (BD0) Bit Field Descriptions

Bits	Field Name	Description
31-0	Reserved	Reserved

Table 16-18. Buffer Descriptor Word 1 (BD1) Bit Field Descriptions

Bits	Field Name	Description
31-0	Reserved	Reserved

Table 16-19. Buffer Descriptor Word 2 (BD2) Bit Field Descriptions

Bits	Field Name	Description
31-15	Reserved	Reserved
14	On-chip	This field indicates whether or not this descriptor is in a region which is on-chip memory space (1) or in external memory (0).
13-12	Packet return queue mgr #	This field indicates which queue manager in the system the descriptor is to be returned to after transmission is complete. This field is not altered by the DMA during transmission or reception and is initialized by the CPU. There is only 1 queue manager in the USB HS/FS device controller. This field must always be 0.
11-0	Packet return queue #	This field indicates the queue number within the selected queue manager that the descriptor is to be returned to after transmission is complete. This field is not altered by the DMA during transmission or reception and is initialized by the CPU.

Table 16-20. Buffer Descriptor Word 3 (BD3) Bit Field Descriptions

Bits	Field Name	Description
31-22	Reserved	Reserved
21-0	Buffer 0 length	The buffer length field indicates how many valid data bytes are in the buffer. The CPU initializes this field for transmitted packets. The DMA overwrites this field upon packet reception.

Table 16-21. Buffer Descriptor Word 4 (BD4) Bit Field Descriptions

Bits	Field Name	Description
31-0	Buffer 0 pointer	The buffer pointer is the byte-aligned memory address of the buffer associated with the buffer descriptor. The CPU initializes this field for transmitted packets. The DMA overwrites this field upon packet reception.

Table 16-22. Buffer Descriptor Word 5 (BD5) Bit Field Descriptions

Bits	Field Name	Description
31-0	Next description pointer	The 32-bit word aligned memory address of the next buffer descriptor in the packet. If the value of this pointer is zero, then the current descriptor is the last descriptor in the packet. The CPU initializes this field for transmitted packets. The DMA overwrites this field upon packet reception.

Table 16-23. Buffer Descriptor Word 6 (BD6) Bit Field Descriptions

Bits	Field Name	Description
31-22	Reserved	Reserved
21-0	Original buffer 0 length	The buffer length field indicates the original size of the buffer in bytes. This value is not overwritten during reception. This value is read by the Rx DMA to determine the actual buffer size as allocated by the CPU at initialization. Since the buffer length in Word 3 is overwritten by the Rx port during reception, this field is necessary to permanently store the buffer size information.

Table 16-24. Buffer Descriptor Word 7 (BD7) Bit Field Descriptions

Bits	Field Name	Description
31-0	Original buffer 0 pointer	The buffer pointer is the byte-aligned memory address of the buffer associated with the buffer descriptor. This value is not overwritten during reception. This value is read by the Rx DMA to determine the actual buffer location as allocated by the CPU at initialization. Since the buffer pointer in Word 4 is overwritten by the Rx port during reception, this field is necessary to permanently store the buffer pointer information.

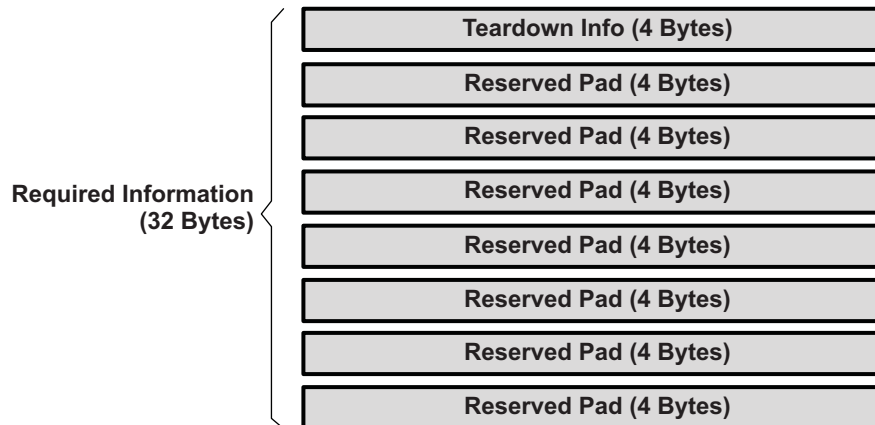
16.3.9.2.3 Teardown Descriptor

The Teardown Descriptor is not like the packet or buffer descriptors since it is not used to describe either a packet or a buffer. The teardown descriptor is always 32 bytes long and is comprised of 4 bytes of actual teardown information and 28 bytes of pad. The teardown descriptor layout and associated bit field descriptions are shown in the Figure below and Tables that follows. Since the 5 LSBs of the descriptor pointers are used in CPPI 4.1 for the purpose of indicating the length of the descriptor, the minimum size of a descriptor is 32 bytes.

The teardown descriptor is used to describe a channel halt and teardown event. Channel teardown ensures that when a connection is no longer needed that the hardware can be reliably halted and any remaining packets which had not yet been transmitted can be reclaimed by the host without the possibility of losing buffer or descriptor references (which results in a memory leak).

The teardown descriptor contains the following information:

- Indicator which identifies the descriptor as a teardown packet descriptor
- DMA controller number where teardown
- Channel number within DMA where teardown occurred
- Indicator of whether this teardown was for the Tx or Rx channel

Figure 16-15. Teardown Descriptor Layout

Table 16-25. Teardown Descriptor Word 0 Bit Field Descriptions

Bits	Field Name	Description
31-27	Descriptor type	The teardown descriptor type is 19 decimal (13h)
26-17	Reserved	Reserved
16	TX_RX	Indicates whether teardown is a TX (0) or RX (1).
15-10	DMA number	Indicates the DMA number for this teardown.
9-6	Reserved	Reserved
5-0	Channel number	Indicates the channel number within the DMA that was torn down.

Table 16-26. Teardown Descriptor Words 1 to 7 Bit Field Descriptions

Bits	Field Name	Description
31-0	Reserved	Reserved

Teardown operation of an endpoint requires three operations. The teardown register in the CPPI DMA must be written, the corresponding endpoint bit in TEARDOWN of the USB module must be set, and the FlushFIFO bit in the Mentor USB controller Tx/RxCSR register must be set.

The following is the Transmit teardown procedure highlighting the steps required to be followed:

1. Set the TX_TEARDOWN bit in the CPPI DMA TX channel n global configuration register (TXGCRn).
2. Set the appropriate TX_TDOWN bit in the USBOTG controller's USB teardown register (TEARDOWN). Write Tx Endpoint Number to teardown to TEARDOWN[TX_TDOWN] field.
3. Check if the teardown descriptor has been received on the teardown queue: The completion queue (see Queue Assignment table) is usually used as the Teardown Completion queue when the Teardown descriptor has been received, the descriptor address will be loaded onto CTRLD[Completion Queue #] register:
 - (a) If not, go to step 2
 - (b) If so, go to step 4
4. Set the appropriate TX_TDOWN bit in the USBOTG controller's USB teardown register (TEARDOWN). Set the bit corresponding to the Channel Number within TEARDOWN[TX_TDOWN] field.
5. Flush the TX FIFO in the Mentor OTG core: Set PERI_TXCSR[FLUSHFIFO] for the corresponding Endpoint.
6. Re-enable the Tx DMA channel.
 - (a) Clear TXGCRn[TX_TEARDOWN and TX_ENABLE] bit.
 - (b) Set TXGCRn[TX_ENABLE] bit.

16.3.9.3 Queue Manager

The queue manager (QM) is a hardware module that is responsible for accelerating management of the queues, i.e. queues are maintained within a queue manager module. Packets are added to a queue by writing the 32-bit descriptor address to a particular memory mapped location in the queue manager module. Packets are de-queued by reading the same location for that particular queue. A single queue manager exists within the device and handles all available 156 queues within the USB subsystem

Descriptors are queued onto a logical queue (pushed) by writing the descriptor pointer to the Queue N Register D. When the Queue N Register D is written, this kicks off the queue manager causing it to add the descriptor to the tail of queue.

The QM keeps track of the order of the descriptors pushed within a queue or the linking status of the descriptors. To accomplish this linking status, QM will first resolve the 32-bit descriptor pointer into a 16-bit index which is used for linking a queue pointer purposes. Once the address to index computation is performed, i.e., the physical index information is determined, the QM will link that descriptor onto the descriptor chain that is maintained for that logical queue by writing the linking information out to a linking RAM which is external to the queue manager. More on linking RAM discussion would follow in latter sections. The QM will also update the queue tail pointers appropriately. Since logical queues within the queue manager are maintained using linked lists, queues cannot become full and no check for fullness is required before queuing a packet descriptor.

16.3.9.3.1 Queue Types

Several types of queues exist (a total of 156 queues) within the CPPI 4.1 DMA. Regardless of the type of queue, queues are used to hold pointers to Packet or Buffer Descriptors while they are being passed between the Host and / or any of the ports in the system. All queues are maintained within the single Queue Manager module.

The following types of Queues exist:

- Free descriptor queue (unassigned to specific endpoint but assigned to specific endpoint type; receive endpoints – can be used as a receive submit queue)
- Transmit submit queue
- Transmit completion (return) queue
- Receive completion (return) queue
- Teardown queue

Dedicated queues exist where one or more queues are assigned for the use of a single endpoint and non-dedicated queues exist where no specific queue assignment to an endpoint is required (but pertains to receive endpoints only). Transmit endpoints are not allowed to use free descriptor queues.

Dedicated queues exist for each specific endpoint use and non-dedicated queues exist that can be used by any/all receive endpoints. Three queues are reserved for each endpoint/port for transmit actions with two of the three queues being transmit submit queues while the remaining queue is used as a completion/return queue. For receive actions, the only dedicated queues are completion/return queues; one queue is assigned/reserved for each receive endpoint. 32 free descriptor queues that do not have dedicated endpoint-queue assignment exist and these queues are used to service any receive endpoint as receive submit queues.

[Table 16-27](#) displays queue-endpoint assignments.

Table 16-27. Queue-Endpoint Assignments

Queue Start Number	Queue Count	Queue-Endpoint Association
0	32	Free Descriptor Queues/Rx Submit Queues (USB0/1 Rx Endpoints)
32	2	USB0 Tx Endpoint 1
34	2	USB0 Tx Endpoint 2
36	2	USB0 Tx Endpoint 3
38	2	USB0 Tx Endpoint 4

Table 16-27. Queue-Endpoint Assignments (continued)

Queue Start Number	Queue Count	Queue-Endpoint Association
40	2	USB0 Tx Endpoint 5
42	2	USB0 Tx Endpoint 6
44	2	USB0 Tx Endpoint 7
46	2	USB0 Tx Endpoint 8
48	2	USB0 Tx Endpoint 9
50	2	USB0 Tx Endpoint 10
52	2	USB0 Tx Endpoint 11
54	2	USB0 Tx Endpoint 12
56	2	USB0 Tx Endpoint 13
58	2	USB0 Tx Endpoint 14
60	2	USB0 Tx Endpoint 15
62	2	USB1 Tx Endpoint 1
64	2	USB1 Tx Endpoint 2
66	2	USB1 Tx Endpoint 3
68	2	USB1 Tx Endpoint 4
70	2	USB1 Tx Endpoint 5
72	2	USB1 Tx Endpoint 6
74	2	USB1 Tx Endpoint 7
76	2	USB1 Tx Endpoint 8
78	2	USB1 Tx Endpoint 9
80	2	USB1 Tx Endpoint 10
82	2	USB1 Tx Endpoint 11
84	2	USB1 Tx Endpoint 12
86	2	USB1 Tx Endpoint 13
88	2	USB1 Tx Endpoint 14
90	2	USB1 Tx Endpoint 15
92	1	Reserved
93	1	USB0 Tx Endpoint 1 completion queue
94	1	USB0 Tx Endpoint 2 completion queue
95	1	USB0 Tx Endpoint 3 completion queue
96	1	USB0 Tx Endpoint 4 completion queue
97	1	USB0 Tx Endpoint 5 completion queue
98	1	USB0 Tx Endpoint 6 completion queue
99	1	USB0 Tx Endpoint 7 completion queue
100	1	USB0 Tx Endpoint 8 completion queue
101	1	USB0 Tx Endpoint 9 completion queue
102	1	USB0 Tx Endpoint 10 completion queue
103	1	USB0 Tx Endpoint 11 completion queue
104	1	USB0 Tx Endpoint 12 completion queue
104	1	USB0 Tx Endpoint 13 completion queue
106	1	USB0 Tx Endpoint 14 completion queue
107	1	USB0 Tx Endpoint 15 completion queue
108	1	Reserved
109	1	USB0 Rx Endpoint 1 completion queue
110	1	USB0 Rx Endpoint 2 completion queue
111	1	USB0 Rx Endpoint 3 completion queue
112	1	USB0 Rx Endpoint 4 completion queue

Table 16-27. Queue-Endpoint Assignments (continued)

Queue Start Number	Queue Count	Queue-Endpoint Association
113	1	USB0 Rx Endpoint 5 completion queue
114	1	USB0 Rx Endpoint 6 completion queue
115	1	USB0 Rx Endpoint 7 completion queue
116	1	USB0 Rx Endpoint 8 completion queue
117	1	USB0 Rx Endpoint 9 completion queue
118	1	USB0 Rx Endpoint 10 completion queue
119	1	USB0 Rx Endpoint 11 completion queue
120	1	USB0 Rx Endpoint 12 completion queue
121	1	USB0 Rx Endpoint 13 completion queue
122	1	USB0 Rx Endpoint 14 completion queue
123	1	USB0 Rx Endpoint 15 completion queue
124	1	Reserved
125	1	USB1 Tx Endpoint 1 completion queue
126	1	USB1 Tx Endpoint 2 completion queue
127	1	USB1 Tx Endpoint 3 completion queue
128	1	USB1 Tx Endpoint 4 completion queue
129	1	USB1 Tx Endpoint 5 completion queue
130	1	USB1 Tx Endpoint 6 completion queue
131	1	USB1 Tx Endpoint 7 completion queue
132	1	USB1 Tx Endpoint 8 completion queue
133	1	USB1 Tx Endpoint 9 completion queue
134	1	USB1 Tx Endpoint 10 completion queue
135	1	USB1 Tx Endpoint 11 completion queue
136	1	USB1 Tx Endpoint 12 completion queue
137	1	USB1 Tx Endpoint 13 completion queue
138	1	USB1 Tx Endpoint 14 completion queue
139	1	USB1 Tx Endpoint 15 completion queue
140	1	Reserved
141	1	USB1 Rx Endpoint 1 completion queue
142	1	USB1 Rx Endpoint 2 completion queue
143	1	USB1 Rx Endpoint 3 completion queue
144	1	USB1 Rx Endpoint 4 completion queue
145	1	USB1 Rx Endpoint 5 completion queue
146	1	USB1 Rx Endpoint 6 completion queue
147	1	USB1 Rx Endpoint 7 completion queue
148	1	USB1 Rx Endpoint 8 completion queue
149	1	USB1 Rx Endpoint 9 completion queue
150	1	USB1 Rx Endpoint 10 completion queue
151	1	USB1 Rx Endpoint 11 completion queue
152	1	USB1 Rx Endpoint 12 completion queue
153	1	USB1 Rx Endpoint 13 completion queue
154	1	USB1 Rx Endpoint 14 completion queue
155	1	USB1 Rx Endpoint 15 completion queue

16.3.9.3.2 Free Descriptor Queue (Receive Submit Queue)

Receive endpoints/channels use queues, referred to as free descriptor queues, or receive submit queues, to forward completed receive packets to the host. The entries on the free descriptor queues have pre-attached empty buffers whose size and location are described in the original buffer information fields in the descriptor. The host is required to allocate both the descriptor and buffer and pre-link them prior to adding (submitting) a descriptor to one of the available free descriptor queue. The first 32 queues (queue 0 up to queue 31) are reserved for all 30 USB0/1 (endpoints 1 to 15 of each USB module) receive endpoints/channels to handle incoming packets to the device.

16.3.9.3.3 Transmit Submit Queue

Transmit ports use packet queues, referred to as transmit submit queues, to store the packets that are waiting to be transmitted. Each transmit endpoint has dedicated queues (2 queues per port) that are reserved exclusively for a use by a single endpoint. Multiple queues per port/channel are allocated to facilitate quality of service (QoS) for applications that require QoS. The first 30 queues, queue 32 up to queue 61, are allocated for USB0 transmit endpoints 1 to 15 with two queues per endpoint. queues 62 up to queue 91, are allocated for transmit USB1 endpoints 1 to 15.

16.3.9.3.4 Transmit Completion (Return) Queue

Transmit ports use packet queues, referred to as "transmit completion queues, to return packet descriptors to the host after packets have been transmitted. A single queue is reserved to be used by a single transmit endpoint. Application s/w needs to insure that the right set of queues is used to return the Descriptors after the completion of a packet transmission based on the endpoint number used. For USB0 transmit endpoints 1 to 15, queues 93–107 are reserved and assigned for use as a completion queue, respectively. Similarly for USB1 transmit endpoints 1 to 15, queues 125–139 are used as completion queues, respectively.

Transmit Completion Queues are also used to return packet Descriptors when performing a Transmit channel teardown operation.

16.3.9.3.5 Receive Completion (Return) Queue

Receive ports use packet queues, referred to as receive completion queues, to return packet descriptors to the port after packets have been received. A single queue is reserved to be used by a single receive endpoint. Application s/w needs to insure that the right set of queues is used to return the descriptors after the completion of a packet reception based on the endpoint number used. For USB0 receive endpoints 1 to 15 queues 122–136 are reserved/assigned for use as a receive completion queue respectively. Similarly for USB1 receive endpoints 1 to 15, queues 137–151 is used as completion queue respectively.

Receive channel teardown is not necessary for receive transactions and no channel teardown information nor resource is available

16.3.9.3.6 Diverting Queue Packets from one Queue to Another

The host can move the entire contents of one queue to another queue by writing the source queue number and the destination queue number to the Queue Diversion register. When diverting packets, the descriptors are pushed onto the tail of the destination queue.

16.3.9.4 Memory Regions and Linking RAM

In addition to allocating buffer for raw data and memory for Descriptors, the host is responsible for allocating additional memory for exclusive use of the CPPI DMA Queue Manager to be used as a scratch PAD RAM. The queue manager uses this memory to manage states of descriptors submitted within the submit queues. In other words, this memory needs not to be managed by the user software and firmware responsibility lies only for allocation/reserving a chunk of memory for the use of the queue manager. The allocated memory can be a single block of memory that is contiguous or two blocks of memory that are not contiguous. These two blocks of memory are referred to as a Linking RAM Regions and should not be confused with memory regions that are used to store descriptors. That is, the use of the term *region* should be used in the context of its use.

To accomplish the linking of submitted descriptors, the queue manager will first resolve the 32-bit descriptor pointer into a 16-bit index which is used for linking and queue pointer purposes. Once the physical index information is determined, the queue manager will link that descriptor onto the descriptor chain that is maintained for that logical queue by writing the linking information out to a linking RAM which is external to the queue manager. The queue manager will also update the queue tail pointer appropriately. Since logical queues within the queue manager are maintained using linked lists, queues cannot become full and no check for fullness is required before queuing a packet descriptor.

The actual physical size of the Linking RAM region(s) to be allocated depends on the total number of descriptors defined within all memory regions. A minimum of four bytes of memory needs to be allocated for each Descriptor defined within all 16 memory regions.

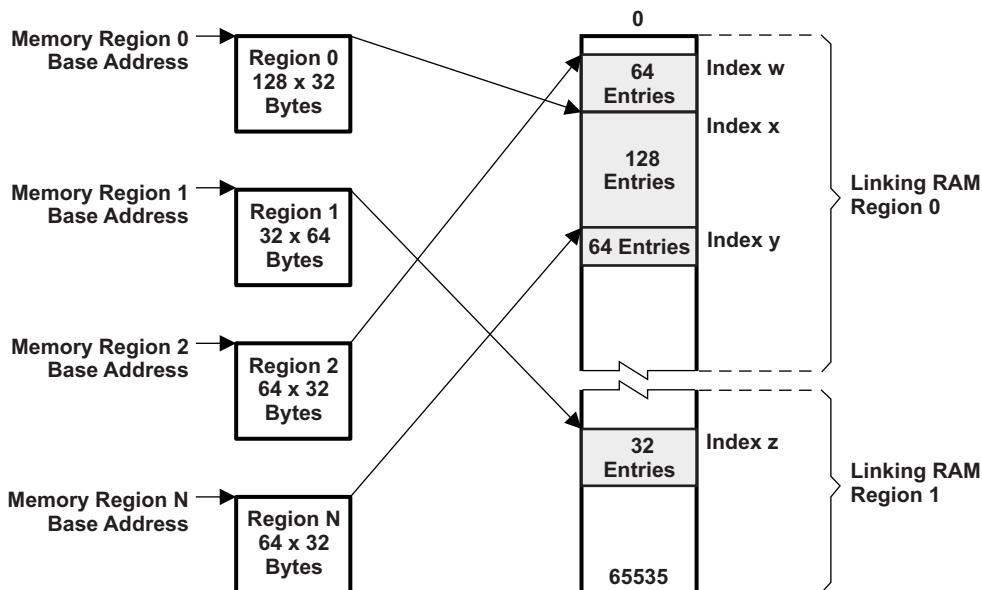
The queue manager has the capability of managing up to 16 memory regions. These memory regions are used to store descriptors of variable sizes. The total number of descriptors that can be managed by the queue manager should not exceed 64K. Each memory region has descriptors of one configurable size, that is, descriptors with different sizes cannot be housed within a single memory region. These 64K descriptors are referenced internally in the queue manager by a 16-bit quantity index.

The information about the Linking RAM regions and the size that are allocated is communicated to the CPPI DMA via three registers dedicated for this purpose. Two of the three registers are used to store the 32-bit aligned start addresses of the Linking RAM regions. The remaining one register is used to store the size of the first Linking RAM. The linking RAM size value stored here is the number of descriptors that is to be managed by the queue manager within that region not the physical size of the buffer, which is four times the number of descriptors.

Note that application is not required to use both linking RAM regions, if the size of the Linking RAM for the first region is large enough to accommodate all descriptors defined. No linking RAM size register for linking RAM region 2 exists. The size of the second linking RAM, when used, is indirectly computed from the total number of descriptors defined less the number of descriptors managed by the first linking RAM

Figure 16-16 displays the relationship between several memory regions and linking RAM.

Figure 16-16. Relationship Between Memory Regions and Linking RAM



16.3.9.5 Zero Length Packets

A special case is the handling of null packets with the CPPI 4.1 compliant DMA controller. Upon receiving a zero length USB packet, the XFER DMA will send a data block to the DMA controller with byte count of zero and the zero byte packet bit of INFO Word 2 set. The DMA controller will then perform normal End of Packet termination of the packet, without transferring data.

If a zero-length USB packet is received, the XDMA will send the CDMA a data block with a byte count of 0 and this bit set. The CDMA will then perform normal EOP termination of the packet without transferring data. For transmit, if a packet has this bit set, the XDMA will ignore the CPPI packet size and send a zero-length packet to the USB controller.

16.3.9.6 CPPI DMA Scheduler

The CPPI DMA scheduler is responsible for controlling the rate and order between the different Tx and Rx threads/transfers that are provided in the CPPI DMA controller. The scheduler table RAM exists within the scheduler.

The DMA controller maintains state information for each of the channels which allows packet segmentation and reassembly operations to be time division multiplexed between channels in order to share the underlying DMA hardware. A DMA scheduler is used to control the ordering and rate at which this multiplexing occurs.

16.3.9.6.1 CPPI DMA Scheduler Operation

Once the scheduler is enabled it will begin processing the entries in the table. When appropriate the scheduler will pass credits to the DMA controller to perform a Tx or Rx operation. The operation of the DMA controller is as follows:

1. After the DMA scheduler is enabled it begins with the table index set to 0.
2. The scheduler reads the entry pointed to by the index and checks to see if the channel in question is currently in a state where a DMA operation can be accepted.
 - (a) The DMA channel must be enabled AND
 - (b) The CPPI FIFO that the channel talks to has free space on TX (FIFO full signal is not asserted) or a valid block on Rx (FIFO empty signal is not asserted)
3. If the DMA channel is capable of processing a credit to transfer a block, the DMA scheduler will issue that credit via the DMA scheduling interface which is a point to point connection between the DMA Scheduler and the DMA Controller.
 - (a) The DMA controller may not be ready to accept the credit immediately and is provided a sched_ready signal which is used to stall the scheduler until it can accept the credit. The DMA controller only asserts the sched_ready signal when it is in the IDLE state.
 - (b) Once a credit has been accepted (indicated by sched_req and sched_ready both asserted), the scheduler will increment the index to the next entry and will start again at step 2.
4. If the channel in question is not currently capable of processing a credit, the scheduler will increment the index in the scheduler table to the next entry and will start at step 2.
5. Note that when the scheduler attempts to increment its index, to the value programmed in the table size register, the index will be reset to 0.

16.3.9.6.1.1 CPPI DMA Scheduler Initialization

Before the scheduler can be used, the host is required to initialize and enable the block. This initialization is performed as follows:

1. The Host initializes entries within an internal memory array in the scheduler. This array contains up to 256 entries (4 entries per table word n where $n=0-63$) and each entry consists of a DMA channel number and a bit indicating if this is a Tx or Rx opportunity. These entries represent both the order and frequency that various Tx and Rx channels will be processed. A table size of 256 entries allows channel bandwidth to be allocated with a maximum precision of 1/256th of the total DMA bandwidth. The more entries that are present for a given channel, the bigger the slice of the bandwidth that channel will be given. Larger tables can be accommodated to allow for more precision. This array can only be written by the Host, it cannot be read.
2. If the application does not need to use the entire 256 entries, firmware can initialize the portion of the 256 entries and indicate the size of the entries used by writing onto an internal register in the scheduler which sets the actual size of the array (it can be less than 256 entries).
3. The host writes an internal register bit to enable the scheduler. The scheduler is not required to be disabled in order to change the scheduler array contents.

16.3.9.6.1.2 CPPI DMA Scheduler Programming Examples

Consider a three endpoints use on a system with the following configurations: EP1-Tx, EP2-Rx, and EP2-Tx. Two assumptions are considered:

Case 1: Assume that you would like to service each enabled endpoints (EP1-Tx, EP2-Rx, and EP2-Tx) with equal priority.

The scheduler handles the rate at which an endpoint is serviced by the number of credits programmed (entries) for that particular endpoint within the scheduler Table Words. The scheduler has up to 256 credits that it can grant and for this example the user can configure the number of entries/credits to be anywhere from 3 to 256 with a set of 3 entries.

However, the optimum and direct programming for this scenario would be programming only the first three entries of the scheduler via scheduler Table WORD[0]. Since this case expects the Scheduler to use only the first three entries, you communicate that by programming DMA_SCHED_CTRL.LAST_ENTRY with 2 (that is, 3 -1). The Enabled Endpoint numbers and the data transfer direction is then communicated by programming the first three entries of WORD[0] (ENTRY0_CHANNEL = 1: ENTRY0_RXTX = 0; ENTRY1_CHANNEL = 2: ENTRY1_RXTX = 1; ENTRY2_CHANNEL = 2: ENTRY2_RXTX = 0). With this programming, the Scheduler will only service the first three entries in a round-robin fashion, checking each credited endpoint for transfer one after the other, and servicing the endpoint that has data to transfer.

Case 2: Enabled endpoint EP1-Tx is serviced at twice the rate as the other enabled endpoints (EP2-Rx and EP2-Tx).

The number of entries/credit that has to be awarded to EP1-Tx has to be twice as much of the others. Four entries/credits would suffice to satisfy our requirement with two credits for EP1-Tx, one credit for EP2-Rx, and one credit for EP2-Tx. This requirement is satisfied by allocating any two of the four entries to EP1-Tx endpoint. Again for this example, scheduler Table WORD[0] would suffice since it can handle the first 4 entries. Even though several scenarios exist to programming the order of service for this case, one scenario would be to allow servicing EP1-Tx to back-to-back followed by the other enabled endpoints. Program DMA_SCHED_CTRL.LAST_ENTRY with 3 (that is, 4 -1). Program WORD[0] (ENTRY0_CHANNEL = 1: ENTRY0_RXTX = 0; ENTRY1_CHANNEL = 1: ENTRY1_RXTX = 0; ENTRY2_CHANNEL = 2: ENTRY2_RXTX = 1; ENTRY3_CHANNEL = 2: ENTRY3_RXTX = 0).

16.3.9.7 CPPI DMA State Registers

The port must store and maintain state information for each transmit and receive port/channel. The state information is referred to as the Tx DMA State and Rx DMA State.

16.3.9.7.1 Transmit DMA State Registers

The Tx DMA State is a combination of control fields and protocol specific port scratchpad space used to manipulate data structures and transmit packets. Each transmit channel has two queues. Each queue has a one head descriptor pointer and one completion pointer. There are thirty Tx DMA State registers; one for each port/channel.

The following information is stored in the Tx DMA State:

- Tx Queue Head Descriptor Pointer(s)
- Tx Completion Pointer(s)
- Protocol specific control/status (port scratchpad)

16.3.9.7.2 Receive DMA State Registers

The Rx DMA State is a combination of control fields and protocol specific port scratchpad space used to manipulate data structures in order to receive packets. Each receive channel has only one queue. Each channel queue has one head descriptor pointer and one completion pointer. There are thirty Rx DMA State registers; one for each port/channel.

The following information is stored in the Rx DMA State:

- Rx Queue Head Descriptor Pointer
- Rx Queue Completion Pointer

- Rx Buffer Offset

16.3.9.8 CPPI DMA Protocols Supported

Four different type of DMA transfers are supported by the CPPI 4.1 DMA; Transparent, RNDIS, Generic RNDIS, and Linux CDC. The following sections will outline the details on these DMA transfer types.

16.3.9.8.1 Transparent DMA Transfer

Transparent Mode DMA operation is the default DMA mode where DMA interrupt is generated whenever a DMA packet is transferred. In the transparent mode, DMA packet size cannot be greater than USB MaxPktSize for the endpoint. This transfer type is ideal for transfer (not packet) sizes that are less than a max packet size.

16.3.9.8.1.1 Transparent DMA Transfer Setup

The following will configure all 30 ports/channels for Transparent DMA Transfer type.

Make sure that RNDIS Mode is disabled globally. This allows the application to configure the CPPI DMA protocol in use to be configured per endpoint need. To disable RNDIS operation, clear RNDIS bit in the USB Control Registers corresponding to the USB Module (default setting), i.e., CTRL0[RNDIS]=0 and CTRL1[RNDIS]=0.

Configure the USB0/1 Tx/Rx DMA Mode Registers (USB0/1 TX(RX)MODE0/1) for the Endpoint field in use is programmed for Transparent Mode, i.e., TXMODE0/1[TXn_MODE] = 00b and RXMODE0/1[RXn_MODE] = 00b.

16.3.9.8.2 RNDIS DMA Transfer

RNDIS mode DMA is used for large transfers (i.e., total data size to be transferred is greater than USB MaxPktSize where the MzxPktSize is a multiple of 64 bytes) that requires multiple USB packets. This is accomplished by breaking the larger packet into smaller packets, where each packet size being USB MaxPktSize except the last packet where its size is less than USB MaxPktSize, including zero bytes. This implies that multiple USB packets of MaxPktSize will be received and transferred together as a single large DMA transfer and the DMA interrupt is generated only at the end of the complete reception of DMA transfer. The protocol defines the end of the complete transfer by receiving a short USB packet (smaller than USB MaxPktSize as mentioned in USB specification 2.0). If the DMA packet size is an exact multiple of USB MaxPktSize, the DMA controller waits for a zero byte packet at the end of complete transfer to signify the completion of the transfer.

NOTE: RNDIS Mode DMA is supported only when USB MaxPktSize is an integral multiple of 64 bytes.

16.3.9.8.2.1 RNDIS DMA Transfer Setup

If all endpoints in use are desired to operate in RNDIS mode, it is only suffix to configure RNDIS DMA operation in RNDIS mode at the global level and application can ignore individual endpoint DMA mode configuration. This is achieved by programming CTRLR0/1[RNDIS] with a '1.'

However if DMA mode is required to be configured at the endpoint level, it is required to disable the use of RNDIS at the global level, this is achieved by clearing RNDIS bit field (CTRLR0/1[RNDIS]=0), since global configuration over-rides endpoint configuration.

To configure RNDIS DMA mode use, configure the field that correspond to the USB module endpoint using the corresponding USB0/1 TX(RX) Mode Register, i.e., TXMODE0/1[TXn_MODE] = 01b and RXMODE0/1[RXn_MODE] = 01b

16.3.9.8.3 Generic RNDIS DMA Transfer

Generic RNDIS DMA transfer mode is identical to the normal RNDIS mode in nearly all respects, except for the exception case where the last packet of the transfer can either be a short packet or the MaxPktSize. When the last packet size is equal to the MaxPktSize then no additional zero-byte packet is sent when using Generic RNDIS transfer. Generic RNDIS transfer makes use of a USB0/1 GENERIC RNDIS EPn Size register (there exists a register for each endpoint) that must be programmed with the

transfer size (in bytes) of the transfer for the USB Module (USB0 or USB1) prior to posting a transfer transaction. If the transfer size is an integer multiple of USB MaxPktSize then no additional zero-byte packet is sent when using Generic RNDIS transfer. However, if the a short packet has been sent prior to programmed size count, the transfer would end in a similar fashion an RDIS transfer would behave. For example, if the USB MaxPktSize (Tx/RxMaxP) is programmed with a value of 64, the Generic RNDIS EP Size register for that endpoint must be programmed with a value that is an integer multiple of 64 (for example, 64, 128, 192, 256, etc.) for it behave differently than RNDIS transfer. In other words, when using Generic RNDIS mode and the DMA is tasked to transfer data transfer size that is less or equal the size value programmed within the USB0/1 GENERIC RNDIS EPn Size register.

This means that Generic RNDIS mode will perform data transfer in the same manner as RNDIS mode, closing the CPPI packet if a USB packet with a size less than the USB MaxPktSize size value is received. Otherwise, the packet will be closed when the value in the Generic RNDIS EP Size register is reached.

Using USB0/1 GENERIC RNDIS EPn Size register, a packet of up to 64K bytes (65536 bytes) can be transferred. This is to allow the host software to program the USB module to transfer data that is an exact multiple of the USB MaxPktSize (Tx/RxMaxP programmed value) without having to send an additional short packet to terminate.

NOTE: As in RNDIS mode, the USB max packet size (Tx/RxMaxp programmed value) of any Generic RNDIS mode enabled endpoints must be a multiple of 64 bytes. Generic RNDIS acceleration should not be enabled for endpoints where the max packet size is not a multiple of 64 bytes. Only transparent mode should be used for such endpoints.

16.3.9.8.3.1 Generic RNDIS DMA Transfer Setup

Disable the use of RNDIS at the global level, this is achieved by clearing RNDIS bit field (CTRLR0/1[RNDIS]=0), since global configuration over-rides endpoint configuration.

Configure the field that correspond to the USB module endpoint using the corresponding USB0/1 TX(RX) Mode Register, i.e., TXMODE0/1[TXn_MODE] = 11b and RXMODE0/1[RXn_MODE] = 11b.

16.3.9.8.4 Linux CDC DMA Transfer

Linux CDC DMA transfer mode acts in the same manner as RNDIS packets, except for the case where the last data matches the max USB packet size requiring additional zero-byte packet transfer in RNDIS mode and this is not the case for Linux CDC. If the last data packet of a transfer is a short packet where the data size is greater than zero and less the USB MaxPktSize, then the behavior of the Linux CDC DMA transfer type is identical with the RNDIS DMA transfer type. The only exception is when the short packet length terminating the transfer is a Null Packet. In this case, instead of transferring the Null Packet, it will transfer a data packet of size 1 byte with the data value of 00h.

In transmit operation, if an endpoint is configured or CDC Linux mode, upon receiving a Null Packet from the CPPI DMA, the XFER DMA will then generate a packet containing 1 byte of data, whose value is 00h, indicating the end of the transfer. During receive operation, the XFER DMA will recognize the one byte zero packet as a termination of the data transfer, and sends a block of data with the EOP indicator set and a byte count of one to the CPPI DMA controller. The CPPI DMA realizing the end of the transfer termination will not update/increase the packet size count of the Host Packet Descriptor.

16.3.9.8.4.1 Linux CDC DMA Transfer Setup

Disable the use of RNDIS at the global level, this is achieved by clearing RNDIS bit field (CTRLR0/1[RNDIS]=0), since global configuration over-rides endpoint configuration.

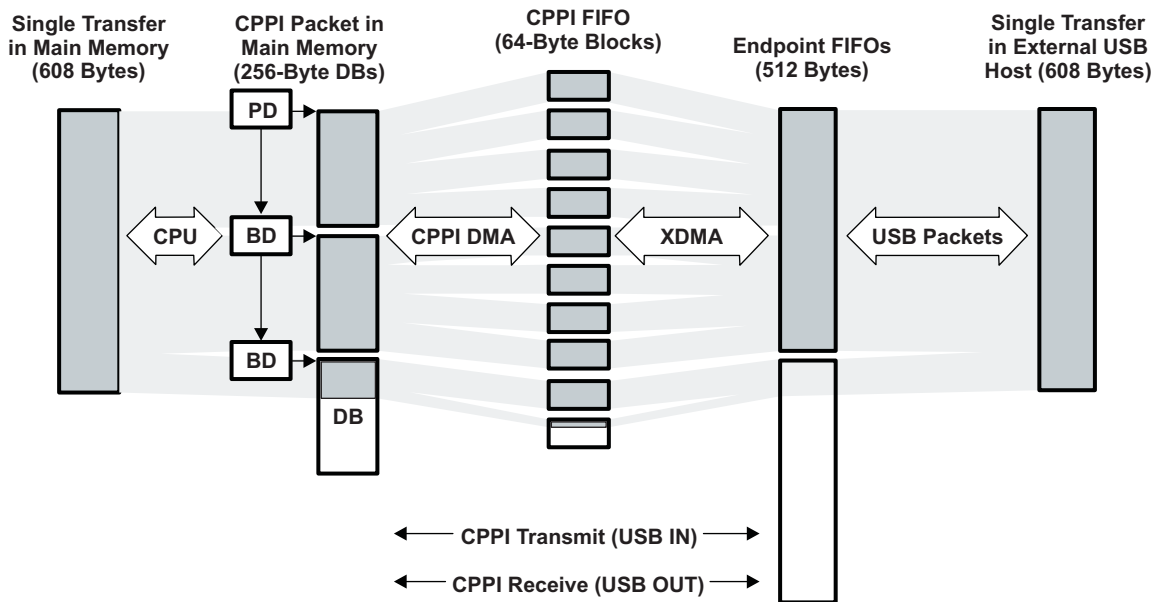
Configure the field that correspond to the USB module endpoint using the corresponding USB0/1 TX(RX) Mode Register, i.e., TXMODE0/1[TXn_MODE] = 10b and RXMODE0/1[RXn_MODE] = 10b.

16.3.9.9 USB Data Flow Using DMA

The necessary steps required to perform a USB data transfer using the CPPI 4.1 DMA is expressed using an example for both transmit and receive cases. Assume USB0 is ready to perform a USB data transfer of size 608 bytes (see [Figure 16-17](#)).

The 608 bytes data to be transferred is described using three descriptors. Since each data buffer defined within a single descriptor has a size of 256 bytes, a 608 bytes data buffer would require three descriptors.

Figure 16-17. High-level Transmit and Receive Data Transfer Example



Example assumptions:

- The CPPI data buffers are 256 bytes in length.
- USB0 module is to be used to perform this transfer. Note that the steps required is similar for USB1 use.
- The USB0 endpoint 1 Tx and Rx endpoint 1 size are programmed to handle max USB packet size of 512 bytes.
- A single transfer length is 608 bytes.
- The SOP offset is 0.

The above translates to the following multi-descriptor setup:

Transmit Case

Transmit setup is as follows:

- One packet descriptor with packet length (this is NOT data buffer length, the term packet used here is to mean a transfer length not USB packet) field of 608 bytes and a Data Buffer of size 256 Bytes linked to the 1st host buffer descriptor.
- Two buffer descriptors with first buffer descriptor (this is the one linked to the packet descriptor) defining the second data buffer size of 256 Bytes which in turn is linked to the next (second) buffer descriptor.
- Second buffer descriptor with a data buffer size of 96 bytes (can be greater, the packet descriptor contain the size of the packet) linked to no other descriptor (NULL).

Receive Case

For this example since each data buffer size is 256 bytes, we would require a minimum of three descriptors that would define data buffer size of 608 bytes. The receive setup is as follows:

- Two buffer descriptors with 256 bytes of data buffer size
- One buffer descriptor with 96 bytes (can be greater) of data buffer size

Within the rest of this section, the following nomenclature is used:

BD — Buffer Descriptor or Host Buffer Descriptor

DB — Data Buffer Size of 256 Bytes

PBD — Pointer to Host Buffer Descriptor

PD — Host Packet Descriptor

PPD — Pointer to Host Packet Descriptor

TXSQ — Transmit Queue or Transmit Submit Queue (for USB0 EP1, use Queues 32 or 33, for USB1 EP1 use Queues 62 or 63)

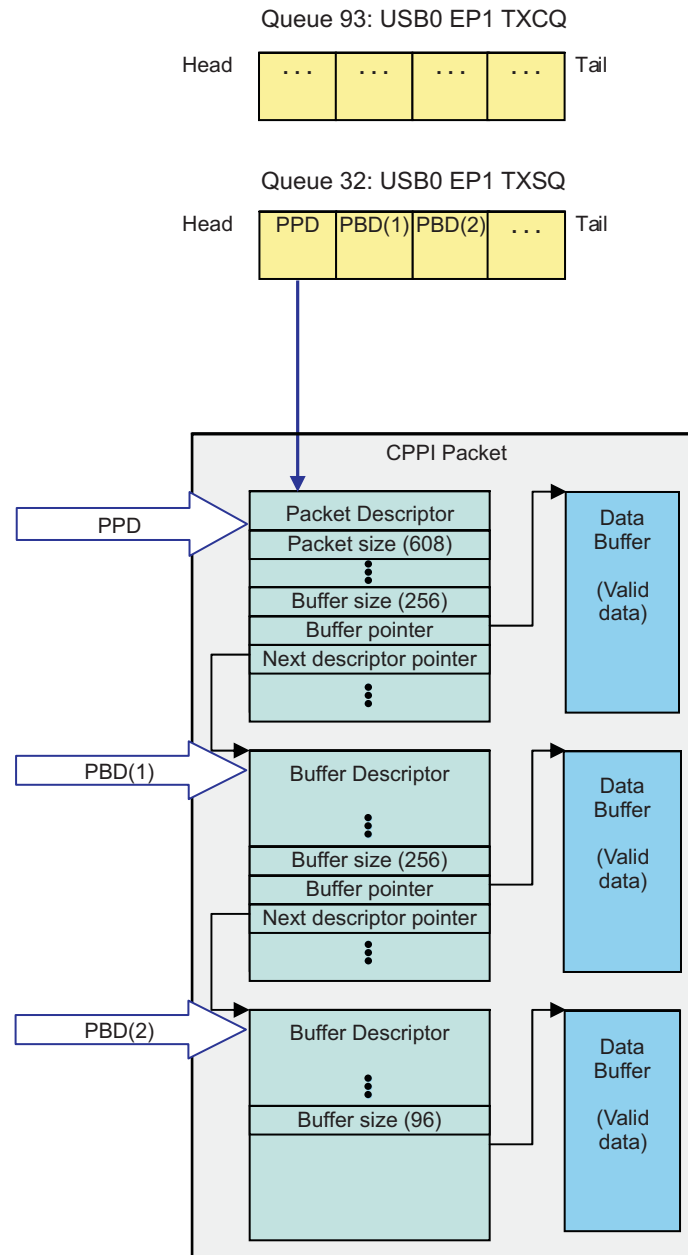
TXCQ — Transmit Completion Queue or Transmit Return Queue (for USB0 Tx EP1, use Queue 93, and for USB1 Tx EP1 use Queue 125)

RXCQ — Receive Completion Queue or Receive Return Queue (for USB0 Rx EP1, use Queue 109, for USB1 Rx EP1 use Queue 141)

RXSQ — Receive Free/Buffer Descriptor Queue or Receive Submit Queue. (For USB0 Rx EP1 Queue 0 is used and for USB1 Rx EP1 Queue 16 should be used)

16.3.9.9.1 Transmit USB Data Flow Using DMA

The transmit descriptors and queue status configuration prior to the transfer taking place is shown in [Figure 16-18](#).

Figure 16-18. Transmit Descriptors and Queue Status Configuration


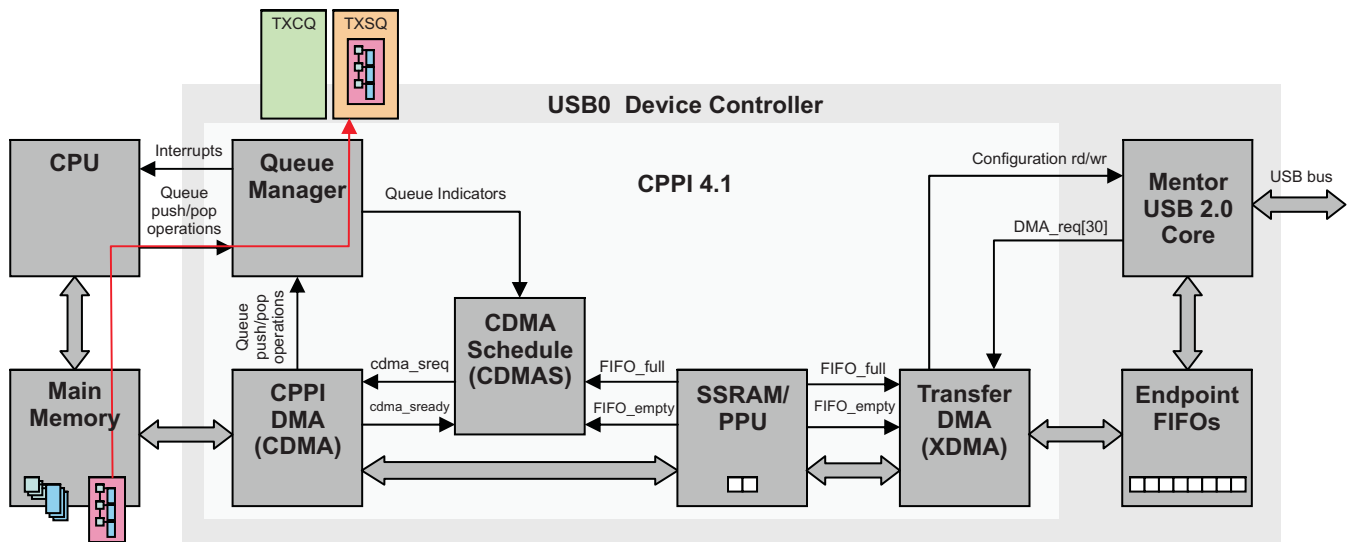
16.3.9.9.1.1 Transmit Initialization (Step 1)

The CPU performs the following steps for transmit initialization:

1. Initializes Memory Region 0 base address and Memory Region 0 size, Link RAM0 Base address, Link RAM0 data size, and Link RAM1 Base address.
2. Creates PD, BDs, and DBs in main memory and link as indicated in [Figure 16-19](#).
3. Initializes and configures the Queue Manager, Channel Setup, DMA Scheduler, and Mentor USB 2.0 Core.
4. Adds (pushes) the PPD and the two PBDs to the TXSQ by writing the Packet Descriptor address to the TXSQ CTRL D Register.

[Figure 16-19](#) captures the BD/DB pair in main memory and later submitted within the TXSQ.

Figure 16-19. Transmit USB Data Flow Example (Initialization)



16.3.9.9.1.2 CDMA and XDMA Transfer Packet Data Into Endpoint FIFO (Step 2)

The steps for CDMA and XDMA to transfer packet data into endpoint FIFO are as follows:

1. The Queue Manager informs the CDMAS that the TXSQ is not empty.
2. CDMAS checks that the CPPI FIFO FIFO_full is not asserted, then issues a credit to the CDMA.
3. CDMA reads the Packet Descriptor pointer (PPD) and descriptor size hint from the queue manager
4. For each 64-byte block of data in the packet data payload (note that packet refers here to CPPI packet which is not the same as USB packet and it means to refer to data transfer size):
 - (a) The CDMA transfers a max burst of 64-byte block (OCP burst) from the data to be transferred in main memory to the CPPI FIFO
 - (b) The XDMA sees FIFO_empty not asserted and transfers 64-byte block from CPPI FIFO to Endpoint FIFO.
 - (c) The CDMA performs the above two steps ('a' and 'b') three more times since the data size of the HPD is 256 bytes.
5. The CDMA reads the first buffer descriptor pointer (PBD).
6. For each 64-byte block of data in the packet data payload:
 - (a) The CDMA transfers a max burst of 64-byte block from the data to be transferred in main memory to the CPPI FIFO.
 - (b) The XDMA sees FIFO_empty not asserted and transfers 64-byte block from CPPI FIFO to Endpoint FIFO.
 - (c) The CDMA performs the above two steps ('a' and 'b') two more times since data size of the HBD is 256 bytes.
7. The CDMA reads the second Buffer Descriptor pointer (PBD)
8. For each 64-byte block of data in the packet data payload:
 - (a) The CDMA transfers a max burst of 64-byte block from the data to be transferred in main memory to the CPPI FIFO.
 - (b) The XDMA sees FIFO_empty not asserted and transfers 64-byte block from CPPI FIFO to Endpoint FIFO.
 - (c) The CDMA transfers the last remaining 32-byte from the data to be transferred in main memory to the CPPI FIFO.
 - (d) The XDMA sees FIFO_empty not asserted and transfers 32-byte block from CPPI FIFO to Endpoint FIFO.

16.3.9.9.1.3 USB 2.0 Core Transmits USB Packets for Tx (Step 3)

1. Once the XDMA has transferred enough 64-byte blocks of burst of data from the CPPI FIFO to fill the Endpoint FIFO (accumulated 512 bytes), it signals the Mentor USB 2.0 Core that a TX packet is ready (sets the endpoint's TxPktRdy bit).
2. The USB 2.0 Core will transmit the packet from the Endpoint FIFO out on the USB BUS when it receives a corresponding IN request from the attached USB Host.
3. After the USB packet is transferred, the USB 2.0 Core issues a TX DMA_req to the XDMA.
4. This process is repeated until (the above steps '1', '2', and '3') the entire packet has been transmitted. The XDMA will also generate the required termination packet depending on the termination mode configured for the endpoint.

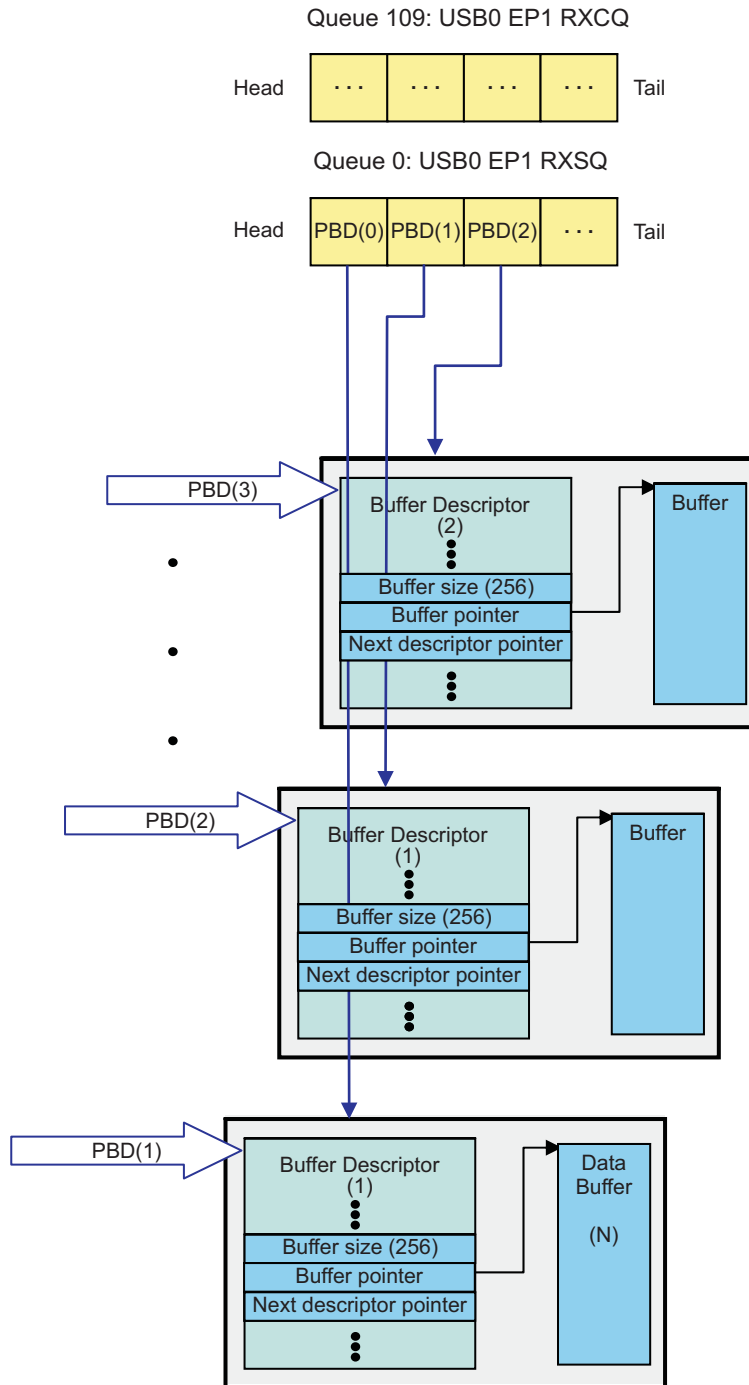
16.3.9.9.1.4 Return Packet to Completion Queue and Interrupt CPU for Tx (Step 4)

1. After all data for the packet has been transmitted (as specified by the packet size field), the CDMA will write the pointer of the Packet Descriptor only to the TX Completion Queue specified in the return queue manager / queue number fields of the packet descriptor.
2. The Queue Manager then indicates the status of the TXSQ (empty) to the CDMA and the TXCQ to the CPU via an interrupt.

16.3.9.9.2 Receive USB Data Flow Using DMA

The receive buffer descriptors and queue status configuration prior to the transfer taking place is shown in [Figure 16-20](#).

Figure 16-20. Receive Buffer Descriptors and Queue Status Configuration



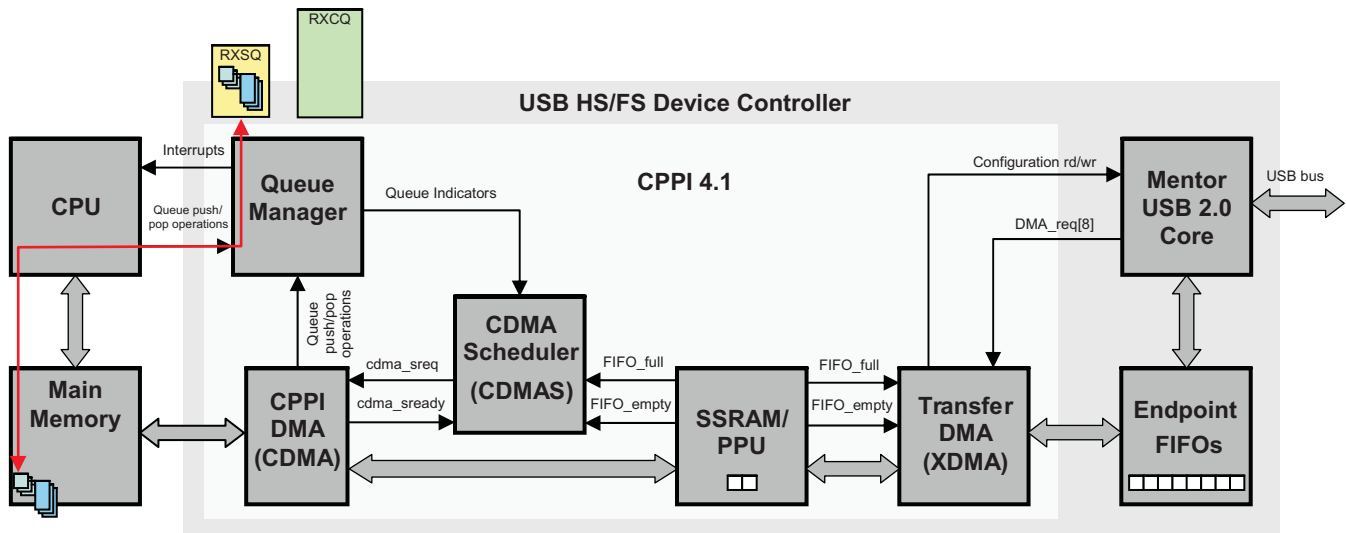
16.3.9.9.2.1 Receive Initialization (Step 1)

1. The CPU initializes Queue Manager with the Memory Region 0 base address and Memory Region 0 size, Link RAM0 Base address, Link RAM0 data size, and Link RAM1 Base address.
2. The CPU creates BDs, and DBs in main memory and link them creating a BD and DB pairs.
3. CPU then initializes the RXCQ queue and configures the Queue Manager, Channel Setup, DMA Scheduler, and USB 2.0 Core.
4. It then adds (pushes) the address of the addresses/pointers of three Buffer Descriptors (PBDs) into the

RXSQ by writing onto CTRL D register.

Figure 16-21 displays receive operation Initialization.

Figure 16-21. Receive USB Data Flow Example (Initialization)



16.3.9.9.2.2 USB 2.0 Core Receives a Packet, XDMA Starts Data Transfer for Receive (Step 2)

1. The USB 2.0 Core receives a USB packet from the USB Host and stores it in the Endpoint FIFO.
2. It then asserts a DMA_req to the XDMA informing it that data is available in the Endpoint FIFO.
3. The XDMA verifies the corresponding CPPI FIFO is not full via the FIFO_full signal, then starts transferring 64-byte data blocks (burst) from the Endpoint FIFO into the CPPI FIFO.

16.3.9.9.2.3 CDMA Transfers Data from SSRAM / PPU to Main Memory for Receive (Step 3)

1. The CDMAS see FIFO_empty de-asserted (there is RX data in the FIFO) and issues a transaction credit to the CDMA.
2. The CDMA begins packet reception by fetching the first PBD from the Queue Manager using the Free Descriptor / Buffer Queue 0 (Rx Submit Queue) index that was initialized in the RX port DMA state for that channel.
3. The CDMA will then begin writing the 64-byte block of packet data into this DB.
4. The CDMA will continue filling the buffer with additional 64-byte blocks of data from the CPPI FIFO and will fetch additional PBD as needed using the Free Descriptor / Buffer Queue 1, 2, and 3 indexes for the 2nd, 3rd, and remaining buffers in the packet. After each buffer is filled, the CDMA writes the buffer descriptor to main memory.

16.3.9.9.2.4 CDMA Completes the Packet Transfer for Receive (Step 4)

1. After the entire packet has been received, the CDMA writes the packet descriptor to main memory.
2. The CDMA then writes the packet descriptor to the RXCQ specified in the Queue Manager / Queue Number fields in the RX Global Configuration Register.
3. The Queue Manager then indicates the status of the RXCQ to the CPU via an interrupt.
4. The CPU can then process the received packet by popping the received packet information from the RXCQ and accessing the packet's data from main memory.

16.3.10 USB 2.0 Test Modes

The USB2.0 controller supports the four USB 2.0 test modes (Test_SE0_NAK, Test_J, Test_K, and Test_Packet) defined for high-speed functions. It also supports an additional “FIFO access” test mode that can be used to test the operation of the CPU interface, the DMA controller and the RAM block.

The test modes are entered by writing to the TESTMODE register. A test mode is usually requested by the host sending a SET_FEATURE request to Endpoint 0. When the software receives the request, it should wait until the Endpoint 0 transfer has completed (when it receives the Endpoint 0 interrupt indicating the status phase has completed) then write to the TESTMODE register.

Note: These test modes have no purpose in normal operation.

16.3.10.1 TEST_SE0_NAK

To enter the Test_SE0_NAK test mode, the software should set the TEST_SE0_NAK bit in the TESTMODE register to 1. The USB controller will then go into a mode in which it responds to any valid IN token with a NAK.

16.3.10.2 TEST_J

To enter the Test_J test mode, the software should set the TEST_J bit in the TESTMODE register to 1. The USB controller will then go into a mode in which it transmits a continuous J on the bus.

16.3.10.3 TEST_K

To enter the Test_K test mode, the software should set the TEST_K bit in the TESTMODE register to 1. The USB controller will then go into a mode in which it transmits a continuous K on the bus.

16.3.10.4 TEST_PACKET

To execute the Test_Packet, the software should:

1. Start a session (if the core is being used in Host mode).
2. Write the standard test packet (shown below) to the Endpoint 0 FIFO.
3. Write 8h to the TESTMODE register (TEST_PACKET = 1) to enter Test_Packet test mode.
4. Set the TxPktRdy bit in the HOST/PERI_CSR0 register (bit 1).

The 53 byte test packet to load is as follows (all bytes in hex). The test packet only has to be loaded once; the USB controller will keep re-sending the test packet without any further intervention from the software.

Table 16-28 displays the 53 Bytes test packet content.

Table 16-28. 53 Bytes Test Packet Content

0	0	0	0	0	0	0	0
0	AA	AA	AA	AA	AA	AA	AA
AA	EE	EE	EE	EE	EE	EE	EE
EE	FE	FF	FF	FF	FF	FF	FF
FF	FF	FF	FF	FF	7F	BF	DF
EF	F7	FB	FD	FC	7E	BF	DF
EF	F7	FB	FD	7E			

This data sequence is defined in Universal Serial Bus Specification Revision 2.0, Section 7.1.20. The USB controller will add the DATA0 PID to the head of the data sequence and the CRC to the end.

16.3.10.5 FIFO_ACCESS

The FIFO Access test mode allows you to test the operation of CPU Interface, the DMA controller (if configured), and the RAM block by loading a packet of up to 64 bytes into the Endpoint 0 FIFO and then reading it back out again. Endpoint 0 is used because it is a bidirectional endpoint that uses the same area of RAM for its Tx and Rx FIFOs.

NOTE: The core does not need to be connected to the USB bus to run this test. If it is connected, then no session should be in progress when the test is run.

The test procedure is as follows:

1. Load a packet of up to 64 bytes into the Endpoint 0 Tx FIFO.
2. Set HOST/PERI_CSR0[TXPKTRDY].
3. Write 40h to the TESTMODE register (FIFO_ACCESS = 1).
4. Unload the packet from the Endpoint Rx FIFO, again.
5. Set HOST/PERI_CSR0[SERVICEDRXPKTRDY].

Writing 40h to the TESTMODE register causes the following sequence of events:

The Endpoint 0 CPU pointer (that records the number of bytes to be transmitted) is copied to the Endpoint 0 USB pointer (that records the number of bytes received).

1. The Endpoint 0 CPU pointer is reset.
2. HOST/PERI_CSR0[TXPKTRDY] is cleared.
3. HOST/PERI_CSR0[RXPKTRDY] is set.
4. An Endpoint 0 interrupt is generated (if enabled).

The effect of these steps is to make the Endpoint 0 controller act as if the packet loaded into the Tx FIFO has flushed and the same packet received over the USB. The data that was loaded in the Tx FIFO can now be read out of the Rx FIFO.

16.3.10.6 FORCE_HOST

The Force Host test mode enables you to instruct the core to operate in Host mode, regardless of whether it is actually connected to any peripheral; that is, the state of the CID input and the LINESTATE and HOSTDISCON signals are ignored. (While in this mode, the state of the HOSTDISCON signal can be read from the BDEVICE bit in the device control register (DEVCTL)).

This mode, which is selected by writing 80h to the TESTMODE register (FORCE_HOST = 1), allows implementation of the USB Test_Force_Enable (USB 2.0 Specification Section 7.1.20). It can also be used for debugging PHY problems in hardware.

While the FORCE_HOST bit remains set, the core enters the Host mode when the SESSION bit in DEVCTL is set to 1 and remains in the Host mode until the SESSION bit is cleared to 0 even if a connected device is disconnected during the session. The operating speed while in this mode is determined by the FORCE_HS and FORCE_FS bits in the TESTMODE register.

16.3.10.7 USB Behavior During Emulation

To configure the USB subsystem to stop during emulation suspend events (for example, debugger breakpoints), set up the USB Subsystem and the Debug Subsystem:

1. Set SYSCONFIG.FREEEMU=0. This will allow the Suspend_Control signal from the Debug Subsystem ([Chapter 27](#)) to stop and start the USBSS. Note that if FREEEMU=1, the Suspend_Control signal is ignored and the USBSS is free running regardless of any debug suspend event. This FREEEMU bit gives local control from a module perspective to gate the suspend signal coming from the Debug Subsystem.
2. Set the appropriate xxx_Suspend_Control register = 0x9, as described in [Section 27.1.1.1, Debug Suspend Support for Peripherals](#). Choose the register appropriate to the peripheral you want to suspend during a suspend event.

16.4 Supported Use Cases

The USB Subsystem supports two independent USB Modules where each USB module can operate as a host or peripheral. When operating as a host, it is capable of interfacing to a single target/peripheral directly or to multiple targets via hub at low-, full-, or high-speed. When operating as a peripheral, it is capable of interfacing to a host at a full- or high-speed.

16.5 USB Registers

16.5.1 USBSS Registers

Table 16-29 lists the memory-mapped registers for the USBSS. All register offset addresses not listed in Table 16-29 should be considered as reserved locations and the register contents should not be modified.

Table 16-29. USBSS Registers

Offset	Acronym	Register Name	Section
0h	REVREG		Section 16.5.1.1
10h	SYSCONFIG		Section 16.5.1.2
24h	IRQSTATRAW		Section 16.5.1.3
28h	IRQSTAT		Section 16.5.1.4
2Ch	IRQENABLER		Section 16.5.1.5
30h	IRQCLEAR		Section 16.5.1.6
100h	IRQDMATHOLDTX00		Section 16.5.1.7
104h	IRQDMATHOLDTX01		Section 16.5.1.8
108h	IRQDMATHOLDTX02		Section 16.5.1.9
10Ch	IRQDMATHOLDTX03		Section 16.5.1.10
110h	IRQDMATHOLDRX00		Section 16.5.1.11
114h	IRQDMATHOLDRX01		Section 16.5.1.12
118h	IRQDMATHOLDRX02		Section 16.5.1.13
11Ch	IRQDMATHOLDRX03		Section 16.5.1.14
120h	IRQDMATHOLDTX10		Section 16.5.1.15
124h	IRQDMATHOLDTX11		Section 16.5.1.16
128h	IRQDMATHOLDTX12		Section 16.5.1.17
12Ch	IRQDMATHOLDTX13		Section 16.5.1.18
130h	IRQDMATHOLDRX10		Section 16.5.1.19
134h	IRQDMATHOLDRX11		Section 16.5.1.20
138h	IRQDMATHOLDRX12		Section 16.5.1.21
13Ch	IRQDMATHOLDRX13		Section 16.5.1.22
140h	IRQDMAENABLE0		Section 16.5.1.23
144h	IRQDMAENABLE1		Section 16.5.1.24
200h	IRQFRAMETHOLDTX00		Section 16.5.1.25
204h	IRQFRAMETHOLDTX01		Section 16.5.1.26
208h	IRQFRAMETHOLDTX02		Section 16.5.1.27
20Ch	IRQFRAMETHOLDTX03		Section 16.5.1.28
210h	IRQFRAMETHOLDRX00		Section 16.5.1.29
214h	IRQFRAMETHOLDRX01		Section 16.5.1.30
218h	IRQFRAMETHOLDRX02		Section 16.5.1.31
21Ch	IRQFRAMETHOLDRX03		Section 16.5.1.32
220h	IRQFRAMETHOLDTX10		Section 16.5.1.33
224h	IRQFRAMETHOLDTX11		Section 16.5.1.34
228h	IRQFRAMETHOLDTX12		Section 16.5.1.35
22Ch	IRQFRAMETHOLDTX13		Section 16.5.1.36
230h	IRQFRAMETHOLDRX10		Section 16.5.1.37
234h	IRQFRAMETHOLDRX11		Section 16.5.1.38
238h	IRQFRAMETHOLDRX12		Section 16.5.1.39
23Ch	IRQFRAMETHOLDRX13		Section 16.5.1.40
240h	IRQFRAMEENABLE0		Section 16.5.1.41
244h	IRQFRAMEENABLE1		Section 16.5.1.42

16.5.1.1 REVREG Register (offset = 0h) [reset = 4EA20800h]

 REVREG is shown in [Figure 16-22](#) and described in [Table 16-30](#).

Figure 16-22. REVREG Register

31	30	29	28	27	26	25	24	23	22	21	20	19	18	17	16
SCHEME		RESERVED			FUNC										
R-1h		R-			R-EA2h										
15	14	13	12	11	10	9	8	7	6	5	4	3	2	1	0
R_RTL				X_MAJOR				CUSTOM			Y_MINOR				
R-1h				R-0h				R-0h			R-0h				

LEGEND: R/W = Read/Write; R = Read only; W1toCl = Write 1 to clear bit; -n = value after reset

Table 16-30. REVREG Register Field Descriptions

Bit	Field	Type	Reset	Description
31-30	SCHEME	R	1h	Used to distinguish between legacy interface scheme and current. 0 = Legacy 1 = Current
29-28	RESERVED	R		
27-16	FUNC	R	EA2h	Function indicates a software compatible module family.
15-11	R_RTL	R	1h	RTL revision. Will vary depending on release.
10-8	X_MAJOR	R	0h	Major revision.
7-6	CUSTOM	R	0h	Custom revision
5-0	Y_MINOR	R	0h	Minor revision. USBSS Revision Register

16.5.1.2 SYSCONFIG Register (offset = 10h) [reset = 28h]

SYSCONFIG is shown in [Figure 16-23](#) and described in [Table 16-31](#).

Figure 16-23. SYSCONFIG Register

31	30	29	28	27	26	25	24
RESERVED							
R/W-0h							
23	22	21	20	19	18	17	16
RESERVED							
R/W-0h							
15	14	13	12	11	10	9	8
RESERVED				USB0_OCP_E N_N	PHY0_UTMI_E N_N	USB1_OCP_E N_N	PHY1_UTMI_E N_N
R/W-0h				R/W-0h	R/W-0h	R/W-0h	R/W-0h
7	6	5	4	3	2	1	0
RESERVED		STANDBY_MODE		IDLEMODE		FREEEMU	SOFT_RESET
R/W-0h		R/W-2h		R/W-2h		R/W-0h	R/W-0h

LEGEND: R/W = Read/Write; R = Read only; W1toCl = Write 1 to clear bit; -n = value after reset

Table 16-31. SYSCONFIG Register Field Descriptions

Bit	Field	Type	Reset	Description
31-12	RESERVED	R/W	0h	
11	USB0_OCP_EN_N	R/W	0h	Active low clock enable for usb0_ocp_clk 0 = enable 1 = disable
10	PHY0_UTMI_EN_N	R/W	0h	Active low clock enable for phy0_utmi_clk 0 = enable 1 = disable
9	USB1_OCP_EN_N	R/W	0h	Active low clock enable for usb1_ocp_clk 0 = enable 1 = disable
8	PHY1_UTMI_EN_N	R/W	0h	Active low clock enable for phy1_utmi_clk 0 = enable 1 = disable
7-6	RESERVED	R/W	0h	
5-4	STANDBY_MODE	R/W	2h	Configuration of the local initiator state management mode. 0 = force-standby mode. 1 = no-standby mode. 2 = smart-standby mode. 3 = Reserved.
3-2	IDLEMODE	R/W	2h	Configuration of the local target state management mode. 0 = force-idle mode. 1 = no-idle mode. 2 = smart-idle mode. 3 = smart-idle with wakeup.
1	FREEEMU	R/W	0h	Sensitivity to emulation (debug) suspend input signal. 0 = sensitive to emulation suspend event from Debug Subsystem. 1 = NOT sensitive to emulation suspend from Debug Subsystem.
0	SOFT_RESET	R/W	0h	Software reset of USBSS, USB0, and USB1 modules Write 0 = No action. Write 1 = Initiate software reset. Read 0 = Reset done, no action. Read 1 = Reset ongoing.

16.5.1.3 IRQSTATRAW Register (offset = 24h) [reset = 0h]

IRQSTATRAW is shown in Figure 16-24 and described in Table 16-32.

Figure 16-24. IRQSTATRAW Register

31	30	29	28	27	26	25	24
RESERVED							
R/W-0h							
23	22	21	20	19	18	17	16
RESERVED							
R/W-0h							
15	14	13	12	11	10	9	8
RESERVED				RX_PKT_CMP_1	TX_PKT_CMP_1	RX_PKT_CMP_0	TX_PKT_CMP_0
R/W-0h				R/W-0h	R/W-0h	R/W-0h	R/W-0h
7	6	5	4	3	2	1	0
RESERVED					PD_CMP_FLAG	RX_MOP_STARVATION	RX_SOP_STARVATION
R/W-0h					R/W-0h	R/W-0h	R/W-0h

LEGEND: R/W = Read/Write; R = Read only; W1toCl = Write 1 to clear bit; -n = value after reset

Table 16-32. IRQSTATRAW Register Field Descriptions

Bit	Field	Type	Reset	Description
31-12	RESERVED	R/W	0h	
11	RX_PKT_CMP_1	R/W	0h	Interrupt status for USB1 Rx CPPI DMA packet completion status
10	TX_PKT_CMP_1	R/W	0h	Interrupt status for USB1 Tx CPPI DMA packet completion status
9	RX_PKT_CMP_0	R/W	0h	Interrupt status for USB0 Rx CPPI DMA packet completion status
8	TX_PKT_CMP_0	R/W	0h	Interrupt status for USB0 Tx CPPI DMA packet completion status
7-3	RESERVED	R/W	0h	
2	PD_CMP_FLAG	R/W	0h	Interrupt status when the packet is completed, the differ bits is set, and the Packet Descriptor is pushed into the queue manager
1	RX_MOP_STARVATION	R/W	0h	Interrupt status when queue manager cannot allocate an Rx buffer in the middle of a packet.
0	RX_SOP_STARVATION	R/W	0h	Interrupt status when queue manager cannot allocate an Rx buffer at the start of a packet. USBSS IRQ_STATUS_RAW Register

16.5.1.4 IRQSTAT Register (offset = 28h) [reset = 0h]

IRQSTAT is shown in [Figure 16-25](#) and described in [Table 16-33](#).

Figure 16-25. IRQSTAT Register

31	30	29	28	27	26	25	24
RESERVED							
R/W-0h							
23	22	21	20	19	18	17	16
RESERVED							
R/W-0h							
15	14	13	12	11	10	9	8
RESERVED				RX_PKT_CMP_1	TX_PKT_CMP_1	RX_PKT_CMP_0	TX_PKT_CMP_0
R/W-0h				R/W-0h	R/W-0h	R/W-0h	R/W-0h
7	6	5	4	3	2	1	0
RESERVED					PD_CMP_FLAG	RX_MOP_STARVATION	RX_SOP_STARVATION
R/W-0h					R/W-0h	R/W-0h	R/W-0h

LEGEND: R/W = Read/Write; R = Read only; W1toCl = Write 1 to clear bit; -n = value after reset

Table 16-33. IRQSTAT Register Field Descriptions

Bit	Field	Type	Reset	Description
31-12	RESERVED	R/W	0h	
11	RX_PKT_CMP_1	R/W	0h	Interrupt status for USB1 Rx CPPI DMA packet completion status
10	TX_PKT_CMP_1	R/W	0h	Interrupt status for USB1 Tx CPPI DMA packet completion status
9	RX_PKT_CMP_0	R/W	0h	Interrupt status for USB0 Rx CPPI DMA packet completion status
8	TX_PKT_CMP_0	R/W	0h	Interrupt status for USB0 Tx CPPI DMA packet completion status
7-3	RESERVED	R/W	0h	
2	PD_CMP_FLAG	R/W	0h	Interrupt status when the packet is completed, the differ bits is set, and the Packet Descriptor is pushed into the queue manager
1	RX_MOP_STARVATION	R/W	0h	Interrupt status when queue manager cannot allocate an Rx buffer in the middle of a packet.
0	RX_SOP_STARVATION	R/W	0h	Interrupt status when queue manager cannot allocate an Rx buffer at the start of a packet. USBSS IRQ_STATUS Register

16.5.1.5 IRQENABLER Register (offset = 2Ch) [reset = 0h]

 IRQENABLER is shown in [Figure 16-26](#) and described in [Table 16-34](#).

Figure 16-26. IRQENABLER Register

31	30	29	28	27	26	25	24
RESERVED							
R/W-0h							
23	22	21	20	19	18	17	16
RESERVED							
R/W-0h							
15	14	13	12	11	10	9	8
RESERVED				RX_PKT_CMP_1	TX_PKT_CMP_1	RX_PKT_CMP_0	TX_PKT_CMP_0
R/W-0h				R/W-0h	R/W-0h	R/W-0h	R/W-0h
7	6	5	4	3	2	1	0
RESERVED					PD_CMP_FLAG	RX_MOP_STARVATION	RX_SOP_STARVATION
R/W-0h					R/W-0h	R/W-0h	R/W-0h

LEGEND: R/W = Read/Write; R = Read only; W1toCl = Write 1 to clear bit; -n = value after reset

Table 16-34. IRQENABLER Register Field Descriptions

Bit	Field	Type	Reset	Description
31-12	RESERVED	R/W	0h	
11	RX_PKT_CMP_1	R/W	0h	Interrupt enable for USB1 Rx CPPI DMA packet completion status
10	TX_PKT_CMP_1	R/W	0h	Interrupt enable for USB1 Tx CPPI DMA packet completion status
9	RX_PKT_CMP_0	R/W	0h	Interrupt enable for USB0 Rx CPPI DMA packet completion status
8	TX_PKT_CMP_0	R/W	0h	Interrupt enable for USB0 Tx CPPI DMA packet completion status
7-3	RESERVED	R/W	0h	
2	PD_CMP_FLAG	R/W	0h	Interrupt enable when the packet is completed, the differ bits is set, and the Packet Descriptor is pushed into the queue manager
1	RX_MOP_STARVATION	R/W	0h	Interrupt enable when queue manager cannot allocate an Rx buffer in the middle of a packet.
0	RX_SOP_STARVATION	R/W	0h	Interrupt enable when queue manager cannot allocate an Rx buffer at the start of a packet. USBSS IRQ_ENABLE_SET Register

16.5.1.6 IRQCLEARR Register (offset = 30h) [reset = 0h]

IRQCLEARR is shown in [Figure 16-27](#) and described in [Table 16-35](#).

Figure 16-27. IRQCLEARR Register

31	30	29	28	27	26	25	24
RESERVED							
R/W-0h							
23	22	21	20	19	18	17	16
RESERVED							
R/W-0h							
15	14	13	12	11	10	9	8
RESERVED				RX_PKT_CMP_1	TX_PKT_CMP_1	RX_PKT_CMP_0	TX_PKT_CMP_0
R/W-0h				R/W-0h	R/W-0h	R/W-0h	R/W-0h
7	6	5	4	3	2	1	0
RESERVED					PD_CMP_FLAG	RX_MOP_STARVATION	RX_SOP_STARVATION
R/W-0h					R/W-0h	R/W-0h	R/W-0h

LEGEND: R/W = Read/Write; R = Read only; W1toCl = Write 1 to clear bit; -n = value after reset

Table 16-35. IRQCLEARR Register Field Descriptions

Bit	Field	Type	Reset	Description
31-12	RESERVED	R/W	0h	
11	RX_PKT_CMP_1	R/W	0h	Interrupt enable for USB1 Rx CPPI DMA packet completion status
10	TX_PKT_CMP_1	R/W	0h	Interrupt enable for USB1 Tx CPPI DMA packet completion status
9	RX_PKT_CMP_0	R/W	0h	Interrupt enable for USB0 Rx CPPI DMA packet completion status
8	TX_PKT_CMP_0	R/W	0h	Interrupt enable for USB0 Tx CPPI DMA packet completion status
7-3	RESERVED	R/W	0h	
2	PD_CMP_FLAG	R/W	0h	Interrupt enable when the packet is completed, the differ bits is set, and the Packet Descriptor is pushed into the queue manager
1	RX_MOP_STARVATION	R/W	0h	Interrupt enable when queue manager cannot allocate an Rx buffer in the middle of a packet.
0	RX_SOP_STARVATION	R/W	0h	Interrupt enable when queue manager cannot allocate an Rx buffer at the start of a packet. USBSS IRQ_ENABLE_CLR Register

16.5.1.7 IRQDMATHOLDTX00 Register (offset = 100h) [reset = 0h]

 IRQDMATHOLDTX00 is shown in [Figure 16-28](#) and described in [Table 16-36](#).

Figure 16-28. IRQDMATHOLDTX00 Register

31	30	29	28	27	26	25	24	23	22	21	20	19	18	17	16
DMA_THRES_TX0_3								DMA_THRES_TX0_2							
R/W-0h								R/W-0h							
15	14	13	12	11	10	9	8	7	6	5	4	3	2	1	0
DMA_THRES_TX0_1								RESERVED							
R/W-0h								R/W-0h							

LEGEND: R/W = Read/Write; R = Read only; W1toCl = Write 1 to clear bit; -n = value after reset

Table 16-36. IRQDMATHOLDTX00 Register Field Descriptions

Bit	Field	Type	Reset	Description
31-24	DMA_THRES_TX0_3	R/W	0h	DMA threshold value for tx_pkt_cmp_0 for USB0 Endpoint 3.
23-16	DMA_THRES_TX0_2	R/W	0h	DMA threshold value for tx_pkt_cmp_0 for USB0 Endpoint 2.
15-8	DMA_THRES_TX0_1	R/W	0h	DMA threshold value for tx_pkt_cmp_0 for USB0 Endpoint 1.
7-0	RESERVED	R/W	0h	

16.5.1.8 IRQDMATHOLDTX01 Register (offset = 104h) [reset = 0h]

IRQDMATHOLDTX01 is shown in [Figure 16-29](#) and described in [Table 16-37](#).

Figure 16-29. IRQDMATHOLDTX01 Register

31	30	29	28	27	26	25	24	23	22	21	20	19	18	17	16
DMA_THRES_TX0_7								DMA_THRES_TX0_6							
R/W-0h								R/W-0h							
15	14	13	12	11	10	9	8	7	6	5	4	3	2	1	0
DMA_THRES_TX0_5								DMA_THRES_TX0_4							
R/W-0h								R/W-0h							

LEGEND: R/W = Read/Write; R = Read only; W1toCl = Write 1 to clear bit; -n = value after reset

Table 16-37. IRQDMATHOLDTX01 Register Field Descriptions

Bit	Field	Type	Reset	Description
31-24	DMA_THRES_TX0_7	R/W	0h	DMA threshold value for tx_pkt_cmp_0 for USB0 Endpoint 7.
23-16	DMA_THRES_TX0_6	R/W	0h	DMA threshold value for tx_pkt_cmp_0 for USB0 Endpoint 6.
15-8	DMA_THRES_TX0_5	R/W	0h	DMA threshold value for tx_pkt_cmp_0 for USB0 Endpoint 5.
7-0	DMA_THRES_TX0_4	R/W	0h	DMA threshold value for tx_pkt_cmp_0 for USB0 Endpoint 4. USBSS IRQ_DMA_THRSHOLD_TX0_1 Register

16.5.1.9 IRQDMATHOLDTX02 Register (offset = 108h) [reset = 0h]

 IRQDMATHOLDTX02 is shown in [Figure 16-30](#) and described in [Table 16-38](#).

Figure 16-30. IRQDMATHOLDTX02 Register

31	30	29	28	27	26	25	24	23	22	21	20	19	18	17	16
DMA_THRES_TX0_11								DMA_THRES_TX0_10							
R/W-0h								R/W-0h							
15	14	13	12	11	10	9	8	7	6	5	4	3	2	1	0
DMA_THRES_TX0_9								DMA_THRES_TX0_8							
R/W-0h								R/W-0h							

LEGEND: R/W = Read/Write; R = Read only; W1toCl = Write 1 to clear bit; -n = value after reset

Table 16-38. IRQDMATHOLDTX02 Register Field Descriptions

Bit	Field	Type	Reset	Description
31-24	DMA_THRES_TX0_11	R/W	0h	DMA threshold value for tx_pkt_cmp_0 for USB0 Endpoint 11.
23-16	DMA_THRES_TX0_10	R/W	0h	DMA threshold value for tx_pkt_cmp_0 for USB0 Endpoint 10.
15-8	DMA_THRES_TX0_9	R/W	0h	DMA threshold value for tx_pkt_cmp_0 for USB0 Endpoint 9.
7-0	DMA_THRES_TX0_8	R/W	0h	DMA threshold value for tx_pkt_cmp_0 for USB0 Endpoint 8. USBSS IRQ_DMA_THRSHOLD_TX0_2 Register

16.5.1.10 IRQDMATHOLDTX03 Register (offset = 10Ch) [reset = 0h]

IRQDMATHOLDTX03 is shown in [Figure 16-31](#) and described in [Table 16-39](#).

Figure 16-31. IRQDMATHOLDTX03 Register

31	30	29	28	27	26	25	24	23	22	21	20	19	18	17	16
DMA_THRES_TX0_15								DMA_THRES_TX0_14							
R/W-0h								R/W-0h							
15	14	13	12	11	10	9	8	7	6	5	4	3	2	1	0
DMA_THRES_TX0_13								DMA_THRES_TX0_12							
R/W-0h								R/W-0h							

LEGEND: R/W = Read/Write; R = Read only; W1toCl = Write 1 to clear bit; -n = value after reset

Table 16-39. IRQDMATHOLDTX03 Register Field Descriptions

Bit	Field	Type	Reset	Description
31-24	DMA_THRES_TX0_15	R/W	0h	DMA threshold value for tx_pkt_cmp_0 for USB0 Endpoint 15.
23-16	DMA_THRES_TX0_14	R/W	0h	DMA threshold value for tx_pkt_cmp_0 for USB0 Endpoint 14.
15-8	DMA_THRES_TX0_13	R/W	0h	DMA threshold value for tx_pkt_cmp_0 for USB0 Endpoint 13.
7-0	DMA_THRES_TX0_12	R/W	0h	DMA threshold value for tx_pkt_cmp_0 for USB0 Endpoint 12. USBSS IRQ_DMA_THRSHOLD_TX0_3 Register

16.5.1.11 IRQDMATHOLDRX00 Register (offset = 110h) [reset = 0h]

 IRQDMATHOLDRX00 is shown in [Figure 16-32](#) and described in [Table 16-40](#).

Figure 16-32. IRQDMATHOLDRX00 Register

31	30	29	28	27	26	25	24	23	22	21	20	19	18	17	16
DMA_THRES_RX0_3								DMA_THRES_RX0_2							
R/W-0h								R/W-0h							
15	14	13	12	11	10	9	8	7	6	5	4	3	2	1	0
DMA_THRES_RX0_1								RESERVED							
R/W-0h								R/W-0h							

LEGEND: R/W = Read/Write; R = Read only; W1toCl = Write 1 to clear bit; -n = value after reset

Table 16-40. IRQDMATHOLDRX00 Register Field Descriptions

Bit	Field	Type	Reset	Description
31-24	DMA_THRES_RX0_3	R/W	0h	DMA threshold value for rx_pkt_cmp_0 for USB0 Endpoint 3.
23-16	DMA_THRES_RX0_2	R/W	0h	DMA threshold value for rx_pkt_cmp_0 for USB0 Endpoint 2.
15-8	DMA_THRES_RX0_1	R/W	0h	DMA threshold value for rx_pkt_cmp_0 for USB0 Endpoint 1.
7-0	RESERVED	R/W	0h	

16.5.1.12 IRQDMATHOLDRX01 Register (offset = 114h) [reset = 0h]

IRQDMATHOLDRX01 is shown in [Figure 16-33](#) and described in [Table 16-41](#).

Figure 16-33. IRQDMATHOLDRX01 Register

31	30	29	28	27	26	25	24	23	22	21	20	19	18	17	16
DMA_THRES_RX0_7								DMA_THRES_RX0_6							
R/W-0h								R/W-0h							
15	14	13	12	11	10	9	8	7	6	5	4	3	2	1	0
DMA_THRES_RX0_5								DMA_THRES_RX0_4							
R/W-0h								R/W-0h							

LEGEND: R/W = Read/Write; R = Read only; W1toCl = Write 1 to clear bit; -n = value after reset

Table 16-41. IRQDMATHOLDRX01 Register Field Descriptions

Bit	Field	Type	Reset	Description
31-24	DMA_THRES_RX0_7	R/W	0h	DMA threshold value for rx_pkt_cmp_0 for USB0 Endpoint 7.
23-16	DMA_THRES_RX0_6	R/W	0h	DMA threshold value for rx_pkt_cmp_0 for USB0 Endpoint 6.
15-8	DMA_THRES_RX0_5	R/W	0h	DMA threshold value for rx_pkt_cmp_0 for USB0 Endpoint 5.
7-0	DMA_THRES_RX0_4	R/W	0h	DMA threshold value for rx_pkt_cmp_0 for USB0 Endpoint 4. USBSS IRQ_DMA_THRSHOLD_RX0_1 Register

16.5.1.13 IRQDMATHOLDRX02 Register (offset = 118h) [reset = 0h]

 IRQDMATHOLDRX02 is shown in [Figure 16-34](#) and described in [Table 16-42](#).

Figure 16-34. IRQDMATHOLDRX02 Register

31	30	29	28	27	26	25	24	23	22	21	20	19	18	17	16
DMA_THRES_RX0_11								DMA_THRES_RX0_10							
R/W-0h								R/W-0h							
15	14	13	12	11	10	9	8	7	6	5	4	3	2	1	0
DMA_THRES_RX0_9								DMA_THRES_RX0_8							
R/W-0h								R/W-0h							

LEGEND: R/W = Read/Write; R = Read only; W1toCl = Write 1 to clear bit; -n = value after reset

Table 16-42. IRQDMATHOLDRX02 Register Field Descriptions

Bit	Field	Type	Reset	Description
31-24	DMA_THRES_RX0_11	R/W	0h	DMA threshold value for rx_pkt_cmp_0 for USB0 Endpoint 11.
23-16	DMA_THRES_RX0_10	R/W	0h	DMA threshold value for rx_pkt_cmp_0 for USB0 Endpoint 10.
15-8	DMA_THRES_RX0_9	R/W	0h	DMA threshold value for rx_pkt_cmp_0 for USB0 Endpoint 9.
7-0	DMA_THRES_RX0_8	R/W	0h	DMA threshold value for rx_pkt_cmp_0 for USB0 Endpoint 8. USBSS IRQ_DMA_THRSHOLD_RX0_2 Register

16.5.1.14 IRQDMATHOLDRX03 Register (offset = 11Ch) [reset = 0h]

IRQDMATHOLDRX03 is shown in [Figure 16-35](#) and described in [Table 16-43](#).

Figure 16-35. IRQDMATHOLDRX03 Register

31	30	29	28	27	26	25	24	23	22	21	20	19	18	17	16
DMA_THRES_RX0_15								DMA_THRES_RX0_14							
R/W-0h								R/W-0h							
15	14	13	12	11	10	9	8	7	6	5	4	3	2	1	0
DMA_THRES_RX0_13								DMA_THRES_RX0_12							
R/W-0h								R/W-0h							

LEGEND: R/W = Read/Write; R = Read only; W1toCl = Write 1 to clear bit; -n = value after reset

Table 16-43. IRQDMATHOLDRX03 Register Field Descriptions

Bit	Field	Type	Reset	Description
31-24	DMA_THRES_RX0_15	R/W	0h	DMA threshold value for rx_pkt_cmp_0 for USB0 Endpoint 15.
23-16	DMA_THRES_RX0_14	R/W	0h	DMA threshold value for rx_pkt_cmp_0 for USB0 Endpoint 14.
15-8	DMA_THRES_RX0_13	R/W	0h	DMA threshold value for rx_pkt_cmp_0 for USB0 Endpoint 13.
7-0	DMA_THRES_RX0_12	R/W	0h	DMA threshold value for rx_pkt_cmp_0 for USB0 Endpoint 12. USBSS IRQ_DMA_THRSHOLD_RX0_3 Register

16.5.1.15 IRQDMATHOLDTX10 Register (offset = 120h) [reset = 0h]

 IRQDMATHOLDTX10 is shown in [Figure 16-36](#) and described in [Table 16-44](#).

Figure 16-36. IRQDMATHOLDTX10 Register

31	30	29	28	27	26	25	24	23	22	21	20	19	18	17	16
DMA_THRES_TX1_3								DMA_THRES_TX1_2							
R/W-0h								R/W-0h							
15	14	13	12	11	10	9	8	7	6	5	4	3	2	1	0
DMA_THRES_TX1_1								RESERVED							
R/W-0h								R/W-0h							

LEGEND: R/W = Read/Write; R = Read only; W1toCl = Write 1 to clear bit; -n = value after reset

Table 16-44. IRQDMATHOLDTX10 Register Field Descriptions

Bit	Field	Type	Reset	Description
31-24	DMA_THRES_TX1_3	R/W	0h	DMA threshold value for tx_pkt_cmp_0 for USB1 Endpoint 3.
23-16	DMA_THRES_TX1_2	R/W	0h	DMA threshold value for tx_pkt_cmp_0 for USB1 Endpoint 2.
15-8	DMA_THRES_TX1_1	R/W	0h	DMA threshold value for tx_pkt_cmp_0 for USB1 Endpoint 1.
7-0	RESERVED	R/W	0h	

16.5.1.16 IRQDMATHOLDTX11 Register (offset = 124h) [reset = 0h]

IRQDMATHOLDTX11 is shown in [Figure 16-37](#) and described in [Table 16-45](#).

Figure 16-37. IRQDMATHOLDTX11 Register

31	30	29	28	27	26	25	24	23	22	21	20	19	18	17	16
DMA_THRES_TX1_7								DMA_THRES_TX1_6							
R/W-0h								R/W-0h							
15	14	13	12	11	10	9	8	7	6	5	4	3	2	1	0
DMA_THRES_TX1_5								DMA_THRES_TX1_4							
R/W-0h								R/W-0h							

LEGEND: R/W = Read/Write; R = Read only; W1toCl = Write 1 to clear bit; -n = value after reset

Table 16-45. IRQDMATHOLDTX11 Register Field Descriptions

Bit	Field	Type	Reset	Description
31-24	DMA_THRES_TX1_7	R/W	0h	DMA threshold value for tx_pkt_cmp_0 for USB1 Endpoint 7.
23-16	DMA_THRES_TX1_6	R/W	0h	DMA threshold value for tx_pkt_cmp_0 for USB1 Endpoint 6.
15-8	DMA_THRES_TX1_5	R/W	0h	DMA threshold value for tx_pkt_cmp_0 for USB1 Endpoint 5.
7-0	DMA_THRES_TX1_4	R/W	0h	DMA threshold value for tx_pkt_cmp_0 for USB1 Endpoint 4. USBSS IRQ_DMA_THRSHOLD_TX1_1 Register

16.5.1.17 IRQDMATHOLDTX12 Register (offset = 128h) [reset = 0h]

 IRQDMATHOLDTX12 is shown in [Figure 16-38](#) and described in [Table 16-46](#).

Figure 16-38. IRQDMATHOLDTX12 Register

31	30	29	28	27	26	25	24	23	22	21	20	19	18	17	16
DMA_THRES_TX1_11								DMA_THRES_TX1_10							
R/W-0h								R/W-0h							
15	14	13	12	11	10	9	8	7	6	5	4	3	2	1	0
DMA_THRES_TX1_9								DMA_THRES_TX1_8							
R/W-0h								R/W-0h							

LEGEND: R/W = Read/Write; R = Read only; W1toCl = Write 1 to clear bit; -n = value after reset

Table 16-46. IRQDMATHOLDTX12 Register Field Descriptions

Bit	Field	Type	Reset	Description
31-24	DMA_THRES_TX1_11	R/W	0h	DMA threshold value for tx_pkt_cmp_0 for USB1 Endpoint 11.
23-16	DMA_THRES_TX1_10	R/W	0h	DMA threshold value for tx_pkt_cmp_0 for USB1 Endpoint 10.
15-8	DMA_THRES_TX1_9	R/W	0h	DMA threshold value for tx_pkt_cmp_0 for USB1 Endpoint 9.
7-0	DMA_THRES_TX1_8	R/W	0h	DMA threshold value for tx_pkt_cmp_0 for USB1 Endpoint 8. USBSS IRQ_DMA_THRSHOLD_TX1_2 Register

16.5.1.18 IRQDMATHOLDTX13 Register (offset = 12Ch) [reset = 0h]

IRQDMATHOLDTX13 is shown in [Figure 16-39](#) and described in [Table 16-47](#).

Figure 16-39. IRQDMATHOLDTX13 Register

31	30	29	28	27	26	25	24	23	22	21	20	19	18	17	16
DMA_THRES_TX1_15								DMA_THRES_TX1_14							
R/W-0h								R/W-0h							
15	14	13	12	11	10	9	8	7	6	5	4	3	2	1	0
DMA_THRES_TX1_13								DMA_THRES_TX1_12							
R/W-0h								R/W-0h							

LEGEND: R/W = Read/Write; R = Read only; W1toCl = Write 1 to clear bit; -n = value after reset

Table 16-47. IRQDMATHOLDTX13 Register Field Descriptions

Bit	Field	Type	Reset	Description
31-24	DMA_THRES_TX1_15	R/W	0h	DMA threshold value for tx_pkt_cmp_0 for USB1 Endpoint 15.
23-16	DMA_THRES_TX1_14	R/W	0h	DMA threshold value for tx_pkt_cmp_0 for USB1 Endpoint 14.
15-8	DMA_THRES_TX1_13	R/W	0h	DMA threshold value for tx_pkt_cmp_0 for USB1 Endpoint 13.
7-0	DMA_THRES_TX1_12	R/W	0h	DMA threshold value for tx_pkt_cmp_0 for USB1 Endpoint 12. USBSS IRQ_DMA_THRSHOLD_TX1_3 Register

16.5.1.19 IRQDMATHOLDRX10 Register (offset = 130h) [reset = 0h]

 IRQDMATHOLDRX10 is shown in [Figure 16-40](#) and described in [Table 16-48](#).

Figure 16-40. IRQDMATHOLDRX10 Register

31	30	29	28	27	26	25	24	23	22	21	20	19	18	17	16
DMA_THRES_RX1_3								DMA_THRES_RX1_2							
R/W-0h								R/W-0h							
15	14	13	12	11	10	9	8	7	6	5	4	3	2	1	0
DMA_THRES_RX1_1								RESERVED							
R/W-0h								R/W-0h							

LEGEND: R/W = Read/Write; R = Read only; W1toCl = Write 1 to clear bit; -n = value after reset

Table 16-48. IRQDMATHOLDRX10 Register Field Descriptions

Bit	Field	Type	Reset	Description
31-24	DMA_THRES_RX1_3	R/W	0h	DMA threshold value for rx_pkt_cmp_0 for USB1 Endpoint 3.
23-16	DMA_THRES_RX1_2	R/W	0h	DMA threshold value for rx_pkt_cmp_0 for USB1 Endpoint 2.
15-8	DMA_THRES_RX1_1	R/W	0h	DMA threshold value for rx_pkt_cmp_0 for USB1 Endpoint 1.
7-0	RESERVED	R/W	0h	

16.5.1.20 IRQDMATHOLDRX11 Register (offset = 134h) [reset = 0h]

IRQDMATHOLDRX11 is shown in [Figure 16-41](#) and described in [Table 16-49](#).

Figure 16-41. IRQDMATHOLDRX11 Register

31	30	29	28	27	26	25	24	23	22	21	20	19	18	17	16
DMA_THRES_RX1_7								DMA_THRES_RX1_6							
R/W-0h								R/W-0h							
15	14	13	12	11	10	9	8	7	6	5	4	3	2	1	0
DMA_THRES_RX1_5								DMA_THRES_RX1_4							
R/W-0h								R/W-0h							

LEGEND: R/W = Read/Write; R = Read only; W1toCl = Write 1 to clear bit; -n = value after reset

Table 16-49. IRQDMATHOLDRX11 Register Field Descriptions

Bit	Field	Type	Reset	Description
31-24	DMA_THRES_RX1_7	R/W	0h	DMA threshold value for rx_pkt_cmp_0 for USB1 Endpoint 7.
23-16	DMA_THRES_RX1_6	R/W	0h	DMA threshold value for rx_pkt_cmp_0 for USB1 Endpoint 6.
15-8	DMA_THRES_RX1_5	R/W	0h	DMA threshold value for rx_pkt_cmp_0 for USB1 Endpoint 5.
7-0	DMA_THRES_RX1_4	R/W	0h	DMA threshold value for rx_pkt_cmp_0 for USB1 Endpoint 4. USBSS IRQ_DMA_THRSHOLD_RX1_1 Register

16.5.1.21 IRQDMATHOLDRX12 Register (offset = 138h) [reset = 0h]

 IRQDMATHOLDRX12 is shown in [Figure 16-42](#) and described in [Table 16-50](#).

Figure 16-42. IRQDMATHOLDRX12 Register

31	30	29	28	27	26	25	24	23	22	21	20	19	18	17	16
DMA_THRES_RX1_11								DMA_THRES_RX1_10							
R/W-0h								R/W-0h							
15	14	13	12	11	10	9	8	7	6	5	4	3	2	1	0
DMA_THRES_RX1_9								DMA_THRES_RX1_8							
R/W-0h								R/W-0h							

LEGEND: R/W = Read/Write; R = Read only; W1toCl = Write 1 to clear bit; -n = value after reset

Table 16-50. IRQDMATHOLDRX12 Register Field Descriptions

Bit	Field	Type	Reset	Description
31-24	DMA_THRES_RX1_11	R/W	0h	DMA threshold value for rx_pkt_cmp_0 for USB1 Endpoint 11.
23-16	DMA_THRES_RX1_10	R/W	0h	DMA threshold value for rx_pkt_cmp_0 for USB1 Endpoint 10.
15-8	DMA_THRES_RX1_9	R/W	0h	DMA threshold value for rx_pkt_cmp_0 for USB1 Endpoint 9.
7-0	DMA_THRES_RX1_8	R/W	0h	DMA threshold value for rx_pkt_cmp_0 for USB1 Endpoint 8. USBSS IRQ_DMA_THRSHOLD_RX1_2 Register

16.5.1.22 IRQDMATHOLDRX13 Register (offset = 13Ch) [reset = 0h]

IRQDMATHOLDRX13 is shown in [Figure 16-43](#) and described in [Table 16-51](#).

Figure 16-43. IRQDMATHOLDRX13 Register

31	30	29	28	27	26	25	24	23	22	21	20	19	18	17	16
DMA_THRES_RX1_15								DMA_THRES_RX1_14							
R/W-0h								R/W-0h							
15	14	13	12	11	10	9	8	7	6	5	4	3	2	1	0
DMA_THRES_RX1_13								DMA_THRES_RX1_12							
R/W-0h								R/W-0h							

LEGEND: R/W = Read/Write; R = Read only; W1toCl = Write 1 to clear bit; -n = value after reset

Table 16-51. IRQDMATHOLDRX13 Register Field Descriptions

Bit	Field	Type	Reset	Description
31-24	DMA_THRES_RX1_15	R/W	0h	DMA threshold value for rx_pkt_cmp_0 for USB1 Endpoint 15.
23-16	DMA_THRES_RX1_14	R/W	0h	DMA threshold value for rx_pkt_cmp_0 for USB1 Endpoint 14.
15-8	DMA_THRES_RX1_13	R/W	0h	DMA threshold value for rx_pkt_cmp_0 for USB1 Endpoint 13.
7-0	DMA_THRES_RX1_12	R/W	0h	DMA threshold value for rx_pkt_cmp_0 for USB1 Endpoint 12. USBSS IRQ_DMA_THRSHOLD_RX1_3 Register

16.5.1.23 IRQDMAENABLE0 Register (offset = 140h) [reset = 0h]

 IRQDMAENABLE0 is shown in [Figure 16-44](#) and described in [Table 16-52](#).

Figure 16-44. IRQDMAENABLE0 Register

31	30	29	28	27	26	25	24
DMA_EN_RX0_15	DMA_EN_RX0_14	DMA_EN_RX0_13	DMA_EN_RX0_12	DMA_EN_RX0_11	DMA_EN_RX0_10	DMA_EN_RX0_9	DMA_EN_RX0_8
R/W-0h	R/W-0h	R/W-0h	R/W-0h	R/W-0h	R/W-0h	R/W-0h	R/W-0h
23	22	21	20	19	18	17	16
DMA_EN_RX0_7	DMA_EN_RX0_6	DMA_EN_RX0_5	DMA_EN_RX0_4	DMA_EN_RX0_3	DMA_EN_RX0_2	DMA_EN_RX0_1	RESERVED
R/W-0h	R/W-0h	R/W-0h	R/W-0h	R/W-0h	R/W-0h	R/W-0h	R/W-0h
15	14	13	12	11	10	9	8
DMA_EN_TX0_15	DMA_EN_TX0_14	DMA_EN_TX0_13	DMA_EN_TX0_12	DMA_EN_TX0_11	DMA_EN_TX0_10	DMA_EN_TX0_9	DMA_EN_TX0_8
R/W-0h	R/W-0h	R/W-0h	R/W-0h	R/W-0h	R/W-0h	R/W-0h	R/W-0h
7	6	5	4	3	2	1	0
DMA_EN_TX0_7	DMA_EN_TX0_6	DMA_EN_TX0_5	DMA_EN_TX0_4	DMA_EN_TX0_3	DMA_EN_TX0_2	DMA_EN_TX0_1	RESERVED
R/W-0h	R/W-0h	R/W-0h	R/W-0h	R/W-0h	R/W-0h	R/W-0h	R/W-0h

LEGEND: R/W = Read/Write; R = Read only; W1toCl = Write 1 to clear bit; -n = value after reset

Table 16-52. IRQDMAENABLE0 Register Field Descriptions

Bit	Field	Type	Reset	Description
31	DMA_EN_RX0_15	R/W	0h	DMA threshold enable value for rx_pkt_cmp_0 for USB0 Endpoint 15.
30	DMA_EN_RX0_14	R/W	0h	DMA threshold enable value for rx_pkt_cmp_0 for USB0 Endpoint 14.
29	DMA_EN_RX0_13	R/W	0h	DMA threshold enable value for rx_pkt_cmp_0 for USB0 Endpoint 13.
28	DMA_EN_RX0_12	R/W	0h	DMA threshold enable value for rx_pkt_cmp_0 for USB0 Endpoint 12.
27	DMA_EN_RX0_11	R/W	0h	DMA threshold enable value for rx_pkt_cmp_0 for USB0 Endpoint 11.
26	DMA_EN_RX0_10	R/W	0h	DMA threshold enable value for rx_pkt_cmp_0 for USB0 Endpoint 10.
25	DMA_EN_RX0_9	R/W	0h	DMA threshold enable value for rx_pkt_cmp_0 for USB0 Endpoint 9.
24	DMA_EN_RX0_8	R/W	0h	DMA threshold enable value for rx_pkt_cmp_0 for USB0 Endpoint 8.
23	DMA_EN_RX0_7	R/W	0h	DMA threshold enable value for rx_pkt_cmp_0 for USB0 Endpoint 7.
22	DMA_EN_RX0_6	R/W	0h	DMA threshold enable value for rx_pkt_cmp_0 for USB0 Endpoint 6.
21	DMA_EN_RX0_5	R/W	0h	DMA threshold enable value for rx_pkt_cmp_0 for USB0 Endpoint 5.
20	DMA_EN_RX0_4	R/W	0h	DMA threshold enable value for rx_pkt_cmp_0 for USB0 Endpoint 4.
19	DMA_EN_RX0_3	R/W	0h	DMA threshold enable value for rx_pkt_cmp_0 for USB0 Endpoint 3.
18	DMA_EN_RX0_2	R/W	0h	DMA threshold enable value for rx_pkt_cmp_0 for USB0 Endpoint 2.
17	DMA_EN_RX0_1	R/W	0h	DMA threshold enable value for rx_pkt_cmp_0 for USB0 Endpoint 1.
16	RESERVED	R/W	0h	
15	DMA_EN_TX0_15	R/W	0h	DMA threshold enable value for tx_pkt_cmp_0 for USB0 Endpoint 15.
14	DMA_EN_TX0_14	R/W	0h	DMA threshold enable value for tx_pkt_cmp_0 for USB0 Endpoint 14.

Table 16-52. IRQDMAENABLE0 Register Field Descriptions (continued)

Bit	Field	Type	Reset	Description
13	DMA_EN_TX0_13	R/W	0h	DMA threshold enable value for tx_pkt_cmp_0 for USB0 Endpoint 13.
12	DMA_EN_TX0_12	R/W	0h	DMA threshold enable value for tx_pkt_cmp_0 for USB0 Endpoint 12.
11	DMA_EN_TX0_11	R/W	0h	DMA threshold enable value for tx_pkt_cmp_0 for USB0 Endpoint 11.
10	DMA_EN_TX0_10	R/W	0h	DMA threshold enable value for tx_pkt_cmp_0 for USB0 Endpoint 10.
9	DMA_EN_TX0_9	R/W	0h	DMA threshold enable value for tx_pkt_cmp_0 for USB0 Endpoint 9.
8	DMA_EN_TX0_8	R/W	0h	DMA threshold enable value for tx_pkt_cmp_0 for USB0 Endpoint 8.
7	DMA_EN_TX0_7	R/W	0h	DMA threshold enable value for tx_pkt_cmp_0 for USB0 Endpoint 7.
6	DMA_EN_TX0_6	R/W	0h	DMA threshold enable value for tx_pkt_cmp_0 for USB0 Endpoint 6.
5	DMA_EN_TX0_5	R/W	0h	DMA threshold enable value for tx_pkt_cmp_0 for USB0 Endpoint 5.
4	DMA_EN_TX0_4	R/W	0h	DMA threshold enable value for tx_pkt_cmp_0 for USB0 Endpoint 4.
3	DMA_EN_TX0_3	R/W	0h	DMA threshold enable value for tx_pkt_cmp_0 for USB0 Endpoint 3.
2	DMA_EN_TX0_2	R/W	0h	DMA threshold enable value for tx_pkt_cmp_0 for USB0 Endpoint 2.
1	DMA_EN_TX0_1	R/W	0h	DMA threshold enable value for tx_pkt_cmp_0 for USB0 Endpoint 1.
0	RESERVED	R/W	0h	

16.5.1.24 IRQDMAENABLE1 Register (offset = 144h) [reset = 0h]

 IRQDMAENABLE1 is shown in [Figure 16-45](#) and described in [Table 16-53](#).

Figure 16-45. IRQDMAENABLE1 Register

31	30	29	28	27	26	25	24
DMA_EN_RX1_15	DMA_EN_RX1_14	DMA_EN_RX1_13	DMA_EN_RX1_12	DMA_EN_RX1_11	DMA_EN_RX1_10	DMA_EN_RX1_9	DMA_EN_RX1_8
R/W-0h	R/W-0h	R/W-0h	R/W-0h	R/W-0h	R/W-0h	R/W-0h	R/W-0h
23	22	21	20	19	18	17	16
DMA_EN_RX1_7	DMA_EN_RX1_6	DMA_EN_RX1_5	DMA_EN_RX1_4	DMA_EN_RX1_3	DMA_EN_RX1_2	DMA_EN_RX1_1	RESERVED
R/W-0h	R/W-0h	R/W-0h	R/W-0h	R/W-0h	R/W-0h	R/W-0h	R/W-0h
15	14	13	12	11	10	9	8
DMA_EN_TX1_15	DMA_EN_TX1_14	DMA_EN_TX1_13	DMA_EN_TX1_12	DMA_EN_TX1_11	DMA_EN_TX1_10	DMA_EN_TX1_9	DMA_EN_TX1_8
R/W-0h	R/W-0h	R/W-0h	R/W-0h	R/W-0h	R/W-0h	R/W-0h	R/W-0h
7	6	5	4	3	2	1	0
DMA_EN_TX1_7	DMA_EN_TX1_6	DMA_EN_TX1_5	DMA_EN_TX1_4	DMA_EN_TX1_3	DMA_EN_TX1_2	DMA_EN_TX1_1	RESERVED
R/W-0h	R/W-0h	R/W-0h	R/W-0h	R/W-0h	R/W-0h	R/W-0h	R/W-0h

LEGEND: R/W = Read/Write; R = Read only; W1toCl = Write 1 to clear bit; -n = value after reset

Table 16-53. IRQDMAENABLE1 Register Field Descriptions

Bit	Field	Type	Reset	Description
31	DMA_EN_RX1_15	R/W	0h	DMA threshold enable value for rx_pkt_cmp_0 for USB0 Endpoint 15.
30	DMA_EN_RX1_14	R/W	0h	DMA threshold enable value for rx_pkt_cmp_0 for USB0 Endpoint 14.
29	DMA_EN_RX1_13	R/W	0h	DMA threshold enable value for rx_pkt_cmp_0 for USB0 Endpoint 13.
28	DMA_EN_RX1_12	R/W	0h	DMA threshold enable value for rx_pkt_cmp_0 for USB0 Endpoint 12.
27	DMA_EN_RX1_11	R/W	0h	DMA threshold enable value for rx_pkt_cmp_0 for USB0 Endpoint 11.
26	DMA_EN_RX1_10	R/W	0h	DMA threshold enable value for rx_pkt_cmp_0 for USB0 Endpoint 10.
25	DMA_EN_RX1_9	R/W	0h	DMA threshold enable value for rx_pkt_cmp_0 for USB0 Endpoint 9.
24	DMA_EN_RX1_8	R/W	0h	DMA threshold enable value for rx_pkt_cmp_0 for USB0 Endpoint 8.
23	DMA_EN_RX1_7	R/W	0h	DMA threshold enable value for rx_pkt_cmp_0 for USB0 Endpoint 7.
22	DMA_EN_RX1_6	R/W	0h	DMA threshold enable value for rx_pkt_cmp_0 for USB0 Endpoint 6.
21	DMA_EN_RX1_5	R/W	0h	DMA threshold enable value for rx_pkt_cmp_0 for USB0 Endpoint 5.
20	DMA_EN_RX1_4	R/W	0h	DMA threshold enable value for rx_pkt_cmp_0 for USB0 Endpoint 4.
19	DMA_EN_RX1_3	R/W	0h	DMA threshold enable value for rx_pkt_cmp_0 for USB0 Endpoint 3.
18	DMA_EN_RX1_2	R/W	0h	DMA threshold enable value for rx_pkt_cmp_0 for USB0 Endpoint 2.
17	DMA_EN_RX1_1	R/W	0h	DMA threshold enable value for rx_pkt_cmp_0 for USB0 Endpoint 1.
16	RESERVED	R/W	0h	
15	DMA_EN_TX1_15	R/W	0h	DMA threshold enable value for tx_pkt_cmp_0 for USB0 Endpoint 15.
14	DMA_EN_TX1_14	R/W	0h	DMA threshold enable value for tx_pkt_cmp_0 for USB0 Endpoint 14.

Table 16-53. IRQDMAENABLE1 Register Field Descriptions (continued)

Bit	Field	Type	Reset	Description
13	DMA_EN_TX1_13	R/W	0h	DMA threshold enable value for tx_pkt_cmp_0 for USB0 Endpoint 13.
12	DMA_EN_TX1_12	R/W	0h	DMA threshold enable value for tx_pkt_cmp_0 for USB0 Endpoint 12.
11	DMA_EN_TX1_11	R/W	0h	DMA threshold enable value for tx_pkt_cmp_0 for USB0 Endpoint 11.
10	DMA_EN_TX1_10	R/W	0h	DMA threshold enable value for tx_pkt_cmp_0 for USB0 Endpoint 10.
9	DMA_EN_TX1_9	R/W	0h	DMA threshold enable value for tx_pkt_cmp_0 for USB0 Endpoint 9.
8	DMA_EN_TX1_8	R/W	0h	DMA threshold enable value for tx_pkt_cmp_0 for USB0 Endpoint 8.
7	DMA_EN_TX1_7	R/W	0h	DMA threshold enable value for tx_pkt_cmp_0 for USB0 Endpoint 7.
6	DMA_EN_TX1_6	R/W	0h	DMA threshold enable value for tx_pkt_cmp_0 for USB0 Endpoint 6.
5	DMA_EN_TX1_5	R/W	0h	DMA threshold enable value for tx_pkt_cmp_0 for USB0 Endpoint 5.
4	DMA_EN_TX1_4	R/W	0h	DMA threshold enable value for tx_pkt_cmp_0 for USB0 Endpoint 4.
3	DMA_EN_TX1_3	R/W	0h	DMA threshold enable value for tx_pkt_cmp_0 for USB0 Endpoint 3.
2	DMA_EN_TX1_2	R/W	0h	DMA threshold enable value for tx_pkt_cmp_0 for USB0 Endpoint 2.
1	DMA_EN_TX1_1	R/W	0h	DMA threshold enable value for tx_pkt_cmp_0 for USB0 Endpoint 1.
0	RESERVED	R/W	0h	

16.5.1.25 IRQFRAMETHOLDTX00 Register (offset = 200h) [reset = 0h]

 IRQFRAMETHOLDTX00 is shown in [Figure 16-46](#) and described in [Table 16-54](#).

Figure 16-46. IRQFRAMETHOLDTX00 Register

31	30	29	28	27	26	25	24	23	22	21	20	19	18	17	16
FRAME_THRES_TX1_3								FRAME_THRES_TX1_2							
R/W-0h								R/W-0h							
15	14	13	12	11	10	9	8	7	6	5	4	3	2	1	0
FRAME_THRES_TX1_1								RESERVED							
R/W-0h								R/W-0h							

LEGEND: R/W = Read/Write; R = Read only; W1toCl = Write 1 to clear bit; -n = value after reset

Table 16-54. IRQFRAMETHOLDTX00 Register Field Descriptions

Bit	Field	Type	Reset	Description
31-24	FRAME_THRES_TX1_3	R/W	0h	FRAME threshold value for tx_pkt_cmp_0 for USB0 Endpoint 3.
23-16	FRAME_THRES_TX1_2	R/W	0h	FRAME threshold value for tx_pkt_cmp_0 for USB0 Endpoint 2.
15-8	FRAME_THRES_TX1_1	R/W	0h	FRAME threshold value for tx_pkt_cmp_0 for USB0 Endpoint 1.
7-0	RESERVED	R/W	0h	

16.5.1.26 IRQFRAMETHOLDTX01 Register (offset = 204h) [reset = 0h]

IRQFRAMETHOLDTX01 is shown in [Figure 16-47](#) and described in [Table 16-55](#).

Figure 16-47. IRQFRAMETHOLDTX01 Register

31	30	29	28	27	26	25	24	23	22	21	20	19	18	17	16
FRAME_THRES_TX1_7								FRAME_THRES_TX1_6							
R/W-0h								R/W-0h							
15	14	13	12	11	10	9	8	7	6	5	4	3	2	1	0
FRAME_THRES_TX1_5								FRAME_THRES_TX1_4							
R/W-0h								R/W-0h							

LEGEND: R/W = Read/Write; R = Read only; W1toCl = Write 1 to clear bit; -n = value after reset

Table 16-55. IRQFRAMETHOLDTX01 Register Field Descriptions

Bit	Field	Type	Reset	Description
31-24	FRAME_THRES_TX1_7	R/W	0h	FRAME threshold value for tx_pkt_cmp_0 for USB0 Endpoint 7.
23-16	FRAME_THRES_TX1_6	R/W	0h	FRAME threshold value for tx_pkt_cmp_0 for USB0 Endpoint 6.
15-8	FRAME_THRES_TX1_5	R/W	0h	FRAME threshold value for tx_pkt_cmp_0 for USB0 Endpoint 5.
7-0	FRAME_THRES_TX1_4	R/W	0h	FRAME threshold value for tx_pkt_cmp_0 for USB0 Endpoint 4. USBSS IRQ_FRAME_THRSHOLD_TX0_1 Register

16.5.1.27 IRQFRAMETHOLDTX02 Register (offset = 208h) [reset = 0h]

 IRQFRAMETHOLDTX02 is shown in [Figure 16-48](#) and described in [Table 16-56](#).

Figure 16-48. IRQFRAMETHOLDTX02 Register

31	30	29	28	27	26	25	24	23	22	21	20	19	18	17	16
FRAME_THRES_TX1_11								FRAME_THRES_TX1_10							
R/W-0h								R/W-0h							
15	14	13	12	11	10	9	8	7	6	5	4	3	2	1	0
FRAME_THRES_TX1_9								FRAME_THRES_TX1_8							
R/W-0h								R/W-0h							

LEGEND: R/W = Read/Write; R = Read only; W1toCl = Write 1 to clear bit; -n = value after reset

Table 16-56. IRQFRAMETHOLDTX02 Register Field Descriptions

Bit	Field	Type	Reset	Description
31-24	FRAME_THRES_TX1_11	R/W	0h	FRAME threshold value for tx_pkt_cmp_0 for USB0 Endpoint 11.
23-16	FRAME_THRES_TX1_10	R/W	0h	FRAME threshold value for tx_pkt_cmp_0 for USB0 Endpoint 10.
15-8	FRAME_THRES_TX1_9	R/W	0h	FRAME threshold value for tx_pkt_cmp_0 for USB0 Endpoint 9.
7-0	FRAME_THRES_TX1_8	R/W	0h	FRAME threshold value for tx_pkt_cmp_0 for USB0 Endpoint 8. USBSS IRQ_FRAME_THRSHOLD_TX0_2 Register

16.5.1.28 IRQFRAMETHOLDTX03 Register (offset = 20Ch) [reset = 0h]

IRQFRAMETHOLDTX03 is shown in [Figure 16-49](#) and described in [Table 16-57](#).

Figure 16-49. IRQFRAMETHOLDTX03 Register

31	30	29	28	27	26	25	24	23	22	21	20	19	18	17	16
FRAME_THRES_TX1_15								FRAME_THRES_TX1_14							
R/W-0h								R/W-0h							
15	14	13	12	11	10	9	8	7	6	5	4	3	2	1	0
FRAME_THRES_TX1_13								FRAME_THRES_TX1_12							
R/W-0h								R/W-0h							

LEGEND: R/W = Read/Write; R = Read only; W1toCl = Write 1 to clear bit; -n = value after reset

Table 16-57. IRQFRAMETHOLDTX03 Register Field Descriptions

Bit	Field	Type	Reset	Description
31-24	FRAME_THRES_TX1_15	R/W	0h	FRAME threshold value for tx_pkt_cmp_0 for USB0 Endpoint 15.
23-16	FRAME_THRES_TX1_14	R/W	0h	FRAME threshold value for tx_pkt_cmp_0 for USB0 Endpoint 14.
15-8	FRAME_THRES_TX1_13	R/W	0h	FRAME threshold value for tx_pkt_cmp_0 for USB0 Endpoint 13.
7-0	FRAME_THRES_TX1_12	R/W	0h	FRAME threshold value for tx_pkt_cmp_0 for USB0 Endpoint 12. USBSS IRQ_FRAME_THRSHOLD_TX0_3 Register

16.5.1.29 IRQFRAMETHOLDRX00 Register (offset = 210h) [reset = 0h]

 IRQFRAMETHOLDRX00 is shown in [Figure 16-50](#) and described in [Table 16-58](#).

Figure 16-50. IRQFRAMETHOLDRX00 Register

31	30	29	28	27	26	25	24	23	22	21	20	19	18	17	16
FRAME_THRES_RX1_3								FRAME_THRES_RX1_2							
R/W-0h								R/W-0h							
15	14	13	12	11	10	9	8	7	6	5	4	3	2	1	0
FRAME_THRES_RX1_1								RESERVED							
R/W-0h								R/W-0h							

LEGEND: R/W = Read/Write; R = Read only; W1toCl = Write 1 to clear bit; -n = value after reset

Table 16-58. IRQFRAMETHOLDRX00 Register Field Descriptions

Bit	Field	Type	Reset	Description
31-24	FRAME_THRES_RX1_3	R/W	0h	FRAME threshold value for rx_pkt_cmp_0 for USB0 Endpoint 3.
23-16	FRAME_THRES_RX1_2	R/W	0h	FRAME threshold value for rx_pkt_cmp_0 for USB0 Endpoint 2.
15-8	FRAME_THRES_RX1_1	R/W	0h	FRAME threshold value for rx_pkt_cmp_0 for USB0 Endpoint 1.
7-0	RESERVED	R/W	0h	

16.5.1.30 IRQFRAMETHOLDRX01 Register (offset = 214h) [reset = 0h]

IRQFRAMETHOLDRX01 is shown in [Figure 16-51](#) and described in [Table 16-59](#).

Figure 16-51. IRQFRAMETHOLDRX01 Register

31	30	29	28	27	26	25	24	23	22	21	20	19	18	17	16
FRAME_THRES_RX1_7								FRAME_THRES_RX1_6							
R/W-0h								R/W-0h							
15	14	13	12	11	10	9	8	7	6	5	4	3	2	1	0
FRAME_THRES_RX1_5								FRAME_THRES_RX1_4							
R/W-0h								R/W-0h							

LEGEND: R/W = Read/Write; R = Read only; W1toCl = Write 1 to clear bit; -n = value after reset

Table 16-59. IRQFRAMETHOLDRX01 Register Field Descriptions

Bit	Field	Type	Reset	Description
31-24	FRAME_THRES_RX1_7	R/W	0h	FRAME threshold value for rx_pkt_cmp_0 for USB0 Endpoint 7.
23-16	FRAME_THRES_RX1_6	R/W	0h	FRAME threshold value for rx_pkt_cmp_0 for USB0 Endpoint 6.
15-8	FRAME_THRES_RX1_5	R/W	0h	FRAME threshold value for rx_pkt_cmp_0 for USB0 Endpoint 5.
7-0	FRAME_THRES_RX1_4	R/W	0h	FRAME threshold value for rx_pkt_cmp_0 for USB0 Endpoint 4. USBSS IRQ_FRAME_THRSHOLD_RX0_1 Register

16.5.1.31 IRQFRAMETHOLDRX02 Register (offset = 218h) [reset = 0h]

 IRQFRAMETHOLDRX02 is shown in [Figure 16-52](#) and described in [Table 16-60](#).

Figure 16-52. IRQFRAMETHOLDRX02 Register

31	30	29	28	27	26	25	24	23	22	21	20	19	18	17	16
FRAME_THRES_RX1_11								FRAME_THRES_RX1_10							
R/W-0h								R/W-0h							
15	14	13	12	11	10	9	8	7	6	5	4	3	2	1	0
FRAME_THRES_RX1_9								FRAME_THRES_RX1_8							
R/W-0h								R/W-0h							

LEGEND: R/W = Read/Write; R = Read only; W1toCl = Write 1 to clear bit; -n = value after reset

Table 16-60. IRQFRAMETHOLDRX02 Register Field Descriptions

Bit	Field	Type	Reset	Description
31-24	FRAME_THRES_RX1_11	R/W	0h	FRAME threshold value for rx_pkt_cmp_0 for USB0 Endpoint 11.
23-16	FRAME_THRES_RX1_10	R/W	0h	FRAME threshold value for rx_pkt_cmp_0 for USB0 Endpoint 10.
15-8	FRAME_THRES_RX1_9	R/W	0h	FRAME threshold value for rx_pkt_cmp_0 for USB0 Endpoint 9.
7-0	FRAME_THRES_RX1_8	R/W	0h	FRAME threshold value for rx_pkt_cmp_0 for USB0 Endpoint 8. USBSS IRQ_FRAME_THRSHOLD_RX0_2 Register

16.5.1.32 IRQFRAMETHOLDRX03 Register (offset = 21Ch) [reset = 0h]

IRQFRAMETHOLDRX03 is shown in [Figure 16-53](#) and described in [Table 16-61](#).

Figure 16-53. IRQFRAMETHOLDRX03 Register

31	30	29	28	27	26	25	24	23	22	21	20	19	18	17	16
FRAME_THRES_RX1_15								FRAME_THRES_RX1_14							
R/W-0h								R/W-0h							
15	14	13	12	11	10	9	8	7	6	5	4	3	2	1	0
FRAME_THRES_RX1_13								FRAME_THRES_RX1_12							
R/W-0h								R/W-0h							

LEGEND: R/W = Read/Write; R = Read only; W1toCl = Write 1 to clear bit; -n = value after reset

Table 16-61. IRQFRAMETHOLDRX03 Register Field Descriptions

Bit	Field	Type	Reset	Description
31-24	FRAME_THRES_RX1_15	R/W	0h	FRAME threshold value for rx_pkt_cmp_0 for USB0 Endpoint 15.
23-16	FRAME_THRES_RX1_14	R/W	0h	FRAME threshold value for rx_pkt_cmp_0 for USB0 Endpoint 14.
15-8	FRAME_THRES_RX1_13	R/W	0h	FRAME threshold value for rx_pkt_cmp_0 for USB0 Endpoint 13.
7-0	FRAME_THRES_RX1_12	R/W	0h	FRAME threshold value for rx_pkt_cmp_0 for USB0 Endpoint 12. USBSS IRQ_FRAME_THRSHOLD_RX0_3 Register

16.5.1.33 IRQFRAMETHOLDTX10 Register (offset = 220h) [reset = 0h]

 IRQFRAMETHOLDTX10 is shown in [Figure 16-54](#) and described in [Table 16-62](#).

Figure 16-54. IRQFRAMETHOLDTX10 Register

31	30	29	28	27	26	25	24	23	22	21	20	19	18	17	16
FRAME_THRES_TX1_3								FRAME_THRES_TX1_2							
R/W-0h								R/W-0h							
15	14	13	12	11	10	9	8	7	6	5	4	3	2	1	0
FRAME_THRES_TX1_1								RESERVED							
R/W-0h								R/W-0h							

LEGEND: R/W = Read/Write; R = Read only; W1toCl = Write 1 to clear bit; -n = value after reset

Table 16-62. IRQFRAMETHOLDTX10 Register Field Descriptions

Bit	Field	Type	Reset	Description
31-24	FRAME_THRES_TX1_3	R/W	0h	FRAME threshold value for tx_pkt_cmp_0 for USB1 Endpoint 3.
23-16	FRAME_THRES_TX1_2	R/W	0h	FRAME threshold value for tx_pkt_cmp_0 for USB1 Endpoint 2.
15-8	FRAME_THRES_TX1_1	R/W	0h	FRAME threshold value for tx_pkt_cmp_0 for USB1 Endpoint 1.
7-0	RESERVED	R/W	0h	

16.5.1.34 IRQFRAMETHOLDTX11 Register (offset = 224h) [reset = 0h]

IRQFRAMETHOLDTX11 is shown in [Figure 16-55](#) and described in [Table 16-63](#).

Figure 16-55. IRQFRAMETHOLDTX11 Register

31	30	29	28	27	26	25	24	23	22	21	20	19	18	17	16
FRAME_THRES_TX1_7								FRAME_THRES_TX1_6							
R/W-0h								R/W-0h							
15	14	13	12	11	10	9	8	7	6	5	4	3	2	1	0
FRAME_THRES_TX1_5								FRAME_THRES_TX1_4							
R/W-0h								R/W-0h							

LEGEND: R/W = Read/Write; R = Read only; W1toCl = Write 1 to clear bit; -n = value after reset

Table 16-63. IRQFRAMETHOLDTX11 Register Field Descriptions

Bit	Field	Type	Reset	Description
31-24	FRAME_THRES_TX1_7	R/W	0h	FRAME threshold value for tx_pkt_cmp_0 for USB1 Endpoint 7.
23-16	FRAME_THRES_TX1_6	R/W	0h	FRAME threshold value for tx_pkt_cmp_0 for USB1 Endpoint 6.
15-8	FRAME_THRES_TX1_5	R/W	0h	FRAME threshold value for tx_pkt_cmp_0 for USB1 Endpoint 5.
7-0	FRAME_THRES_TX1_4	R/W	0h	FRAME threshold value for tx_pkt_cmp_0 for USB1 Endpoint 4. USBSS IRQ_FRAME_THRSHOLD_TX1_1 Register

16.5.1.35 IRQFRAMETHOLDTX12 Register (offset = 228h) [reset = 0h]

 IRQFRAMETHOLDTX12 is shown in [Figure 16-56](#) and described in [Table 16-64](#).

Figure 16-56. IRQFRAMETHOLDTX12 Register

31	30	29	28	27	26	25	24	23	22	21	20	19	18	17	16
FRAME_THRES_TX1_11								FRAME_THRES_TX1_10							
R/W-0h								R/W-0h							
15	14	13	12	11	10	9	8	7	6	5	4	3	2	1	0
FRAME_THRES_TX1_9								FRAME_THRES_TX1_8							
R/W-0h								R/W-0h							

LEGEND: R/W = Read/Write; R = Read only; W1toCl = Write 1 to clear bit; -n = value after reset

Table 16-64. IRQFRAMETHOLDTX12 Register Field Descriptions

Bit	Field	Type	Reset	Description
31-24	FRAME_THRES_TX1_11	R/W	0h	FRAME threshold value for tx_pkt_cmp_0 for USB1 Endpoint 11.
23-16	FRAME_THRES_TX1_10	R/W	0h	FRAME threshold value for tx_pkt_cmp_0 for USB1 Endpoint 10.
15-8	FRAME_THRES_TX1_9	R/W	0h	FRAME threshold value for tx_pkt_cmp_0 for USB1 Endpoint 9.
7-0	FRAME_THRES_TX1_8	R/W	0h	FRAME threshold value for tx_pkt_cmp_0 for USB1 Endpoint 8. USBSS IRQ_FRAME_THRSHOLD_TX1_2 Register

16.5.1.36 IRQFRAMETHOLDTX13 Register (offset = 22Ch) [reset = 0h]

IRQFRAMETHOLDTX13 is shown in [Figure 16-57](#) and described in [Table 16-65](#).

Figure 16-57. IRQFRAMETHOLDTX13 Register

31	30	29	28	27	26	25	24	23	22	21	20	19	18	17	16
FRAME_THRES_TX1_15								FRAME_THRES_TX1_14							
R/W-0h								R/W-0h							
15	14	13	12	11	10	9	8	7	6	5	4	3	2	1	0
FRAME_THRES_TX1_13								FRAME_THRES_TX1_12							
R/W-0h								R/W-0h							

LEGEND: R/W = Read/Write; R = Read only; W1toCl = Write 1 to clear bit; -n = value after reset

Table 16-65. IRQFRAMETHOLDTX13 Register Field Descriptions

Bit	Field	Type	Reset	Description
31-24	FRAME_THRES_TX1_15	R/W	0h	FRAME threshold value for tx_pkt_cmp_0 for USB1 Endpoint 15.
23-16	FRAME_THRES_TX1_14	R/W	0h	FRAME threshold value for tx_pkt_cmp_0 for USB1 Endpoint 14.
15-8	FRAME_THRES_TX1_13	R/W	0h	FRAME threshold value for tx_pkt_cmp_0 for USB1 Endpoint 13.
7-0	FRAME_THRES_TX1_12	R/W	0h	FRAME threshold value for tx_pkt_cmp_0 for USB1 Endpoint 12. USBSS IRQ_FRAME_THRSHOLD_TX1_3 Register

16.5.1.37 IRQFRAMETHOLDRX10 Register (offset = 230h) [reset = 0h]

 IRQFRAMETHOLDRX10 is shown in [Figure 16-58](#) and described in [Table 16-66](#).

Figure 16-58. IRQFRAMETHOLDRX10 Register

31	30	29	28	27	26	25	24	23	22	21	20	19	18	17	16
FRAME_THRES_RX1_3								FRAME_THRES_RX1_2							
R/W-0h								R/W-0h							
15	14	13	12	11	10	9	8	7	6	5	4	3	2	1	0
FRAME_THRES_RX1_1								RESERVED							
R/W-0h								R/W-0h							

LEGEND: R/W = Read/Write; R = Read only; W1toCl = Write 1 to clear bit; -n = value after reset

Table 16-66. IRQFRAMETHOLDRX10 Register Field Descriptions

Bit	Field	Type	Reset	Description
31-24	FRAME_THRES_RX1_3	R/W	0h	FRAME threshold value for rx_pkt_cmp_0 for USB1 Endpoint 3.
23-16	FRAME_THRES_RX1_2	R/W	0h	FRAME threshold value for rx_pkt_cmp_0 for USB1 Endpoint 2.
15-8	FRAME_THRES_RX1_1	R/W	0h	FRAME threshold value for rx_pkt_cmp_0 for USB1 Endpoint 1.
7-0	RESERVED	R/W	0h	

16.5.1.38 IRQFRAMETHOLDRX11 Register (offset = 234h) [reset = 0h]

IRQFRAMETHOLDRX11 is shown in [Figure 16-59](#) and described in [Table 16-67](#).

Figure 16-59. IRQFRAMETHOLDRX11 Register

31	30	29	28	27	26	25	24	23	22	21	20	19	18	17	16
FRAME_THRES_RX1_7								FRAME_THRES_RX1_6							
R/W-0h								R/W-0h							
15	14	13	12	11	10	9	8	7	6	5	4	3	2	1	0
FRAME_THRES_RX1_5								FRAME_THRES_RX1_4							
R/W-0h								R/W-0h							

LEGEND: R/W = Read/Write; R = Read only; W1toCl = Write 1 to clear bit; -n = value after reset

Table 16-67. IRQFRAMETHOLDRX11 Register Field Descriptions

Bit	Field	Type	Reset	Description
31-24	FRAME_THRES_RX1_7	R/W	0h	FRAME threshold value for rx_pkt_cmp_0 for USB1 Endpoint 7.
23-16	FRAME_THRES_RX1_6	R/W	0h	FRAME threshold value for rx_pkt_cmp_0 for USB1 Endpoint 6.
15-8	FRAME_THRES_RX1_5	R/W	0h	FRAME threshold value for rx_pkt_cmp_0 for USB1 Endpoint 5.
7-0	FRAME_THRES_RX1_4	R/W	0h	FRAME threshold value for rx_pkt_cmp_0 for USB1 Endpoint 4. USBSS IRQ_FRAME_THRSHOLD_RX1_1 Register

16.5.1.39 IRQFRAMETHOLDRX12 Register (offset = 238h) [reset = 0h]

 IRQFRAMETHOLDRX12 is shown in [Figure 16-60](#) and described in [Table 16-68](#).

Figure 16-60. IRQFRAMETHOLDRX12 Register

31	30	29	28	27	26	25	24	23	22	21	20	19	18	17	16
FRAME_THRES_RX1_11								FRAME_THRES_RX1_10							
R/W-0h								R/W-0h							
15	14	13	12	11	10	9	8	7	6	5	4	3	2	1	0
FRAME_THRES_RX1_9								FRAME_THRES_RX1_8							
R/W-0h								R/W-0h							

LEGEND: R/W = Read/Write; R = Read only; W1toCl = Write 1 to clear bit; -n = value after reset

Table 16-68. IRQFRAMETHOLDRX12 Register Field Descriptions

Bit	Field	Type	Reset	Description
31-24	FRAME_THRES_RX1_11	R/W	0h	FRAME threshold value for rx_pkt_cmp_0 for USB1 Endpoint 11.
23-16	FRAME_THRES_RX1_10	R/W	0h	FRAME threshold value for rx_pkt_cmp_0 for USB1 Endpoint 10.
15-8	FRAME_THRES_RX1_9	R/W	0h	FRAME threshold value for rx_pkt_cmp_0 for USB1 Endpoint 9.
7-0	FRAME_THRES_RX1_8	R/W	0h	FRAME threshold value for rx_pkt_cmp_0 for USB1 Endpoint 8. USBSS IRQ_FRAME_THRSHOLD_RX1_2 Register

16.5.1.40 IRQFRAMETHOLDRX13 Register (offset = 23Ch) [reset = 0h]

IRQFRAMETHOLDRX13 is shown in [Figure 16-61](#) and described in [Table 16-69](#).

Figure 16-61. IRQFRAMETHOLDRX13 Register

31	30	29	28	27	26	25	24	23	22	21	20	19	18	17	16
FRAME_THRES_RX1_15								FRAME_THRES_RX1_14							
R/W-0h								R/W-0h							
15	14	13	12	11	10	9	8	7	6	5	4	3	2	1	0
FRAME_THRES_RX1_13								FRAME_THRES_RX1_12							
R/W-0h								R/W-0h							

LEGEND: R/W = Read/Write; R = Read only; W1toCl = Write 1 to clear bit; -n = value after reset

Table 16-69. IRQFRAMETHOLDRX13 Register Field Descriptions

Bit	Field	Type	Reset	Description
31-24	FRAME_THRES_RX1_15	R/W	0h	FRAME threshold value for rx_pkt_cmp_0 for USB1 Endpoint 15.
23-16	FRAME_THRES_RX1_14	R/W	0h	FRAME threshold value for rx_pkt_cmp_0 for USB1 Endpoint 14.
15-8	FRAME_THRES_RX1_13	R/W	0h	FRAME threshold value for rx_pkt_cmp_0 for USB1 Endpoint 13.
7-0	FRAME_THRES_RX1_12	R/W	0h	FRAME threshold value for rx_pkt_cmp_0 for USB1 Endpoint 12. USBSS IRQ_FRAME_THRSHOLD_RX1_3 Register

16.5.1.41 IRQFRAMEENABLE0 Register (offset = 240h) [reset = 0h]

 IRQFRAMEENABLE0 is shown in [Figure 16-62](#) and described in [Table 16-70](#).

Figure 16-62. IRQFRAMEENABLE0 Register

31	30	29	28	27	26	25	24
FRAME_EN_RX0_15	RESERVED						
R/W-0h				R/W-0h			
23	22	21	20	19	18	17	16
RESERVED						FRAME_EN_RX0_1	RESERVED
R/W-0h						R/W-0h	R/W-0h
15	14	13	12	11	10	9	8
FRAME_EN_TX0_15	RESERVED						
R/W-0h				R/W-0h			
7	6	5	4	3	2	1	0
RESERVED						FRAME_EN_TX0_1	RESERVED
R/W-0h						R/W-0h	R/W-0h

LEGEND: R/W = Read/Write; R = Read only; W1toCl = Write 1 to clear bit; -n = value after reset

Table 16-70. IRQFRAMEENABLE0 Register Field Descriptions

Bit	Field	Type	Reset	Description
31	FRAME_EN_RX0_15	R/W	0h	FRAME threshold enable value for rx_pkt_cmp_0 for USB0 Endpoint 15.
30-18	RESERVED	R/W	0h	
17	FRAME_EN_RX0_1	R/W	0h	FRAME threshold enable value for rx_pkt_cmp_0 for USB0 Endpoint 1.
16	RESERVED	R/W	0h	
15	FRAME_EN_TX0_15	R/W	0h	FRAME threshold enable value for tx_pkt_cmp_0 for USB0 Endpoint 15.
14-2	RESERVED	R/W	0h	
1	FRAME_EN_TX0_1	R/W	0h	FRAME threshold enable value for tx_pkt_cmp_0 for USB0 Endpoint 1.
0	RESERVED	R/W	0h	

16.5.1.42 IRQFRAMEENABLE1 Register (offset = 244h) [reset = 0h]

IRQFRAMEENABLE1 is shown in [Figure 16-63](#) and described in [Table 16-71](#).

Figure 16-63. IRQFRAMEENABLE1 Register

31	30	29	28	27	26	25	24
FRAME_EN_RX1_15	RESERVED						
R/W-0h				R/W-0h			
23	22	21	20	19	18	17	16
RESERVED						FRAME_EN_RX1_1	RESERVED
R/W-0h						R/W-0h	R/W-0h
15	14	13	12	11	10	9	8
FRAME_EN_TX1_15	RESERVED						
R/W-0h				R/W-0h			
7	6	5	4	3	2	1	0
RESERVED						FRAME_EN_TX1_1	RESERVED
R/W-0h						R/W-0h	R/W-0h

LEGEND: R/W = Read/Write; R = Read only; W1toCl = Write 1 to clear bit; -n = value after reset

Table 16-71. IRQFRAMEENABLE1 Register Field Descriptions

Bit	Field	Type	Reset	Description
31	FRAME_EN_RX1_15	R/W	0h	FRAME threshold enable value for rx_pkt_cmp_1 for USB1 Endpoint 15.
30-18	RESERVED	R/W	0h	
17	FRAME_EN_RX1_1	R/W	0h	FRAME threshold enable value for rx_pkt_cmp_1 for USB1 Endpoint 1.
16	RESERVED	R/W	0h	
15	FRAME_EN_TX1_15	R/W	0h	FRAME threshold enable value for tx_pkt_cmp_1 for USB1 Endpoint 15.
14-2	RESERVED	R/W	0h	
1	FRAME_EN_TX1_1	R/W	0h	FRAME threshold enable value for tx_pkt_cmp_1 for USB1 Endpoint 1.
0	RESERVED	R/W	0h	

16.5.2 USB0_CTRL Registers

[Table 16-72](#) lists the memory-mapped registers for the USB0_CTRL. All register offset addresses not listed in [Table 16-72](#) should be considered as reserved locations and the register contents should not be modified.

Table 16-72. USB0_CTRL Registers

Offset	Acronym	Register Name	Section
1000h	USB0REV		Section 16.5.2.1
1014h	USB0CTRL		Section 16.5.2.2
1018h	USB0STAT		Section 16.5.2.3
1020h	USB0IRQMSTAT		Section 16.5.2.4
1028h	USB0IRQSTATRAW0		Section 16.5.2.5
102Ch	USB0IRQSTATRAW1		Section 16.5.2.6
1030h	USB0IRQSTAT0		Section 16.5.2.7
1034h	USB0IRQSTAT1		Section 16.5.2.8
1038h	USB0IRQENABLESET0		Section 16.5.2.9
103Ch	USB0IRQENABLESET1		Section 16.5.2.10
1040h	USB0IRQENABLECLR0		Section 16.5.2.11
1044h	USB0IRQENABLECLR1		Section 16.5.2.12
1070h	USB0TXMODE		Section 16.5.2.13
1074h	USB0RXMODE		Section 16.5.2.14
1080h	USB0GENRNDISEP1		Section 16.5.2.15
1084h	USB0GENRNDISEP2		Section 16.5.2.16
1088h	USB0GENRNDISEP3		Section 16.5.2.17
108Ch	USB0GENRNDISEP4		Section 16.5.2.18
1090h	USB0GENRNDISEP5		Section 16.5.2.19
1094h	USB0GENRNDISEP6		Section 16.5.2.20
1098h	USB0GENRNDISEP7		Section 16.5.2.21
109Ch	USB0GENRNDISEP8		Section 16.5.2.22
10A0h	USB0GENRNDISEP9		Section 16.5.2.23
10A4h	USB0GENRNDISEP10		Section 16.5.2.24
10A8h	USB0GENRNDISEP11		Section 16.5.2.25
10ACh	USB0GENRNDISEP12		Section 16.5.2.26
10B0h	USB0GENRNDISEP13		Section 16.5.2.27
10B4h	USB0GENRNDISEP14		Section 16.5.2.28
10B8h	USB0GENRNDISEP15		Section 16.5.2.29
10D0h	USB0AUTOREQ		Section 16.5.2.30
10D4h	USB0SRPFXITIME		Section 16.5.2.31
10D8h	USB0_TDOWN		Section 16.5.2.32
10E0h	USB0UTMI		Section 16.5.2.33
10E4h	USB0MGCUTMILB		Section 16.5.2.34
10E8h	USB0MODE		Section 16.5.2.35

16.5.2.1 USB0REV Register (offset = 1000h) [reset = 4EA20800h]

USB0REV is shown in [Figure 16-64](#) and described in [Table 16-73](#).

Figure 16-64. USB0REV Register

31	30	29	28	27	26	25	24	23	22	21	20	19	18	17	16
SCHEME		RESERVED			FUNC										
R-1h		R-0h			R-EA2h										
15	14	13	12	11	10	9	8	7	6	5	4	3	2	1	0
R_RTL				X_MAJOR				CUSTOM			Y_MINOR				
R-1h				R-0h				R-0h			R-0h				

LEGEND: R/W = Read/Write; R = Read only; W1toCl = Write 1 to clear bit; -n = value after reset

Table 16-73. USB0REV Register Field Descriptions

Bit	Field	Type	Reset	Description
31-30	SCHEME	R	1h	Used to distinguish between legacy interface scheme and current. 0 = Legacy 1 = Current
29-28	RESERVED	R	0h	
27-16	FUNC	R	EA2h	Function indicates a software compatible module family.
15-11	R_RTL	R	1h	RTL revision. Will vary depending on release.
10-8	X_MAJOR	R	0h	Major revision.
7-6	CUSTOM	R	0h	Custom revision
5-0	Y_MINOR	R	0h	Minor revision. USB0 Revision Register

16.5.2.2 USB0CTRL Register (offset = 1014h) [reset = 0h]

 USB0CTRL is shown in [Figure 16-65](#) and described in [Table 16-74](#).

Figure 16-65. USB0CTRL Register

31	30	29	28	27	26	25	24
DIS_DEB	DIS_SRP	RESERVED					
R/W-0h	R/W-0h	R/W-0h					
23	22	21	20	19	18	17	16
RESERVED							
R/W-0h							
15	14	13	12	11	10	9	8
RESERVED							
R/W-0h							
7	6	5	4	3	2	1	0
RESERVED		SOFT_RESET_ISOLATION	RNDIS	UINT	RESERVED	CLKFACK	SOFT_RESET
R/W-0h		R/W-0h	R/W-0h	R/W-0h	R/W-0h	R/W-0h	R/W-0h

LEGEND: R/W = Read/Write; R = Read only; W1toCl = Write 1 to clear bit; -n = value after reset

Table 16-74. USB0CTRL Register Field Descriptions

Bit	Field	Type	Reset	Description
31	DIS_DEB	R/W	0h	Disable the VBUS debouncer circuit fix
30	DIS_SRP	R/W	0h	Disable the OTG Session Request Protocol (SRP) AVALID circuit fix. When enabled (=0) this allows additional time for the VBUS signal to be measured against the VBUS thresholds. The time is specified in the USB0 SRP Fix Time Register.
29-6	RESERVED	R/W	0h	
5	SOFT_RESET_ISOLATION	R/W	0h	Soft reset isolation. When high this bit forces all USB0 signals that connect to the USBSS to known values during a soft reset via bit 0 of this register. This bit should be set high prior to setting bit 0 and cleared after bit 0 is cleared.
4	RNDIS	R/W	0h	Global RNDIS mode enable for all endpoints.
3	UINT	R/W	0h	USB interrupt enable 1 = Legacy 0 = Current (recommended setting) If uint is set high, then the mentor controller generic interrupt for USB[9] will be generated (if enabled). This requires S/W to read the mentor controller's registers to determine which interrupt from USB[0] to USB[7] that occurred. If uint is set low, then the usb20otg_f module will automatically read the mentor controller's registers and set the appropriate interrupt from USB[0] to USB[7] (if enabled). The generic interrupt for USB[9] will not be generated.
2	RESERVED	R/W	0h	
1	CLKFACK	R/W	0h	Clock stop fast ack enable.

Table 16-74. USB0CTRL Register Field Descriptions (continued)

Bit	Field	Type	Reset	Description
0	SOFT_RESET	R/W	0h	<p>Software reset of USB0. Write 0 = no action Write 1 = Initiate software reset Read 0 = Reset done, no action Read 1 = Reset ongoing Both the soft_reset and soft_reset_isolation bits should be asserted simultaneously. This will cause the following sequence of actions to occur over multiple cycles:</p> <ul style="list-style-type: none"> - All USB0 output signals will go to a known constant value via multiplexers. <p>This removes the possibility of timing errors due to the asynchronous resets.</p> <ul style="list-style-type: none"> - All USB0 registers will be reset. - The USB0 resets will be de-asserted. - The reset isolation multiplexer inputs will be de-selected. - Both the soft_reset and soft_reset_isolation bits will be automatically cleared. <p>Setting only the soft_reset_isolation bit will cause all USB0 output signals to go to a known constant value via multiplexers. This will prevent future access to USB0. To clear this condition the USBSS must be reset via a hard or soft reset.</p>

16.5.2.3 USB0STAT Register (offset = 1018h) [reset = 0h]

USB0STAT is shown in [Figure 16-66](#) and described in [Table 16-75](#).

Figure 16-66. USB0STAT Register

31	30	29	28	27	26	25	24
RESERVED							
R-0h							
23	22	21	20	19	18	17	16
RESERVED							
R-0h							
15	14	13	12	11	10	9	8
RESERVED							
R-0h							
7	6	5	4	3	2	1	0
RESERVED							DRVVBUS
R-0h							R-0h

LEGEND: R/W = Read/Write; R = Read only; W1toCl = Write 1 to clear bit; -n = value after reset

Table 16-75. USB0STAT Register Field Descriptions

Bit	Field	Type	Reset	Description
31-1	RESERVED	R	0h	
0	DRVVBUS	R	0h	Current DRVVBUS value USB0 Status Register

16.5.2.4 USB0IRQMSTAT Register (offset = 1020h) [reset = 0h]

USB0IRQMSTAT is shown in [Figure 16-67](#) and described in [Table 16-76](#).

Figure 16-67. USB0IRQMSTAT Register

31	30	29	28	27	26	25	24
RESERVED							
R-0h							
23	22	21	20	19	18	17	16
RESERVED							
R-0h							
15	14	13	12	11	10	9	8
RESERVED							
R-0h							
7	6	5	4	3	2	1	0
RESERVED						BANK1	BANK0
R-0h						R-0h	R-0h

LEGEND: R/W = Read/Write; R = Read only; W1toCl = Write 1 to clear bit; -n = value after reset

Table 16-76. USB0IRQMSTAT Register Field Descriptions

Bit	Field	Type	Reset	Description
31-2	RESERVED	R	0h	
1	BANK1	R	0h	0: No events pending from IRQ_STATUS_1 1: At least one event is pending from IRQ_STATUS_1
0	BANK0	R	0h	0: No events pending from IRQ_STATUS_0 1: At least one event is pending from IRQ_STATUS_0 USB0 IRQ_MERGED_STATUS Register

16.5.2.5 USB0IRQSTATRAW0 Register (offset = 1028h) [reset = 0h]

 USB0IRQSTATRAW0 is shown in [Figure 16-68](#) and described in [Table 16-77](#).

Figure 16-68. USB0IRQSTATRAW0 Register

31		30		29		28		27		26		25		24	
RX_EP_15	RX_EP_14	RX_EP_13	RX_EP_12	RX_EP_11	RX_EP_10	RX_EP_9	RX_EP_8	RX_EP_7	RX_EP_6	RX_EP_5	RX_EP_4	RX_EP_3	RX_EP_2	RX_EP_1	RESERVED
R/W-0h		R/W-0h		R/W-0h		R/W-0h		R/W-0h		R/W-0h		R/W-0h		R/W-0h	
23		22		21		20		19		18		17		16	
RX_EP_7	RX_EP_6	RX_EP_5	RX_EP_4	RX_EP_3	RX_EP_2	RX_EP_1	RESERVED	RX_EP_7	RX_EP_6	RX_EP_5	RX_EP_4	RX_EP_3	RX_EP_2	RX_EP_1	RESERVED
R/W-0h		R/W-0h		R/W-0h		R/W-0h		R/W-0h		R/W-0h		R/W-0h		R/W-0h	
15		14		13		12		11		10		9		8	
TX_EP_15	TX_EP_14	TX_EP_13	TX_EP_12	TX_EP_11	TX_EP_10	TX_EP_9	TX_EP_8	TX_EP_15	TX_EP_14	TX_EP_13	TX_EP_12	TX_EP_11	TX_EP_10	TX_EP_9	TX_EP_8
R/W-0h		R/W-0h		R/W-0h		R/W-0h		R/W-0h		R/W-0h		R/W-0h		R/W-0h	
7		6		5		4		3		2		1		0	
TX_EP_7	TX_EP_6	TX_EP_5	TX_EP_4	TX_EP_3	TX_EP_2	TX_EP_1	TX_EP_0	TX_EP_7	TX_EP_6	TX_EP_5	TX_EP_4	TX_EP_3	TX_EP_2	TX_EP_1	TX_EP_0
R/W-0h		R/W-0h		R/W-0h		R/W-0h		R/W-0h		R/W-0h		R/W-0h		R/W-0h	

LEGEND: R/W = Read/Write; R = Read only; W1toCl = Write 1 to clear bit; -n = value after reset

Table 16-77. USB0IRQSTATRAW0 Register Field Descriptions

Bit	Field	Type	Reset	Description
31	RX_EP_15	R/W	0h	Interrupt status for RX endpoint 15
30	RX_EP_14	R/W	0h	Interrupt status for RX endpoint 14
29	RX_EP_13	R/W	0h	Interrupt status for RX endpoint 13
28	RX_EP_12	R/W	0h	Interrupt status for RX endpoint 12
27	RX_EP_11	R/W	0h	Interrupt status for RX endpoint 11
26	RX_EP_10	R/W	0h	Interrupt status for RX endpoint 10
25	RX_EP_9	R/W	0h	Interrupt status for RX endpoint 9
24	RX_EP_8	R/W	0h	Interrupt status for RX endpoint 8
23	RX_EP_7	R/W	0h	Interrupt status for RX endpoint 7
22	RX_EP_6	R/W	0h	Interrupt status for RX endpoint 6
21	RX_EP_5	R/W	0h	Interrupt status for RX endpoint 5
20	RX_EP_4	R/W	0h	Interrupt status for RX endpoint 4
19	RX_EP_3	R/W	0h	Interrupt status for RX endpoint 3
18	RX_EP_2	R/W	0h	Interrupt status for RX endpoint 2
17	RX_EP_1	R/W	0h	Interrupt status for RX endpoint 1
16	RESERVED	R/W	0h	
15	TX_EP_15	R/W	0h	Interrupt status for TX endpoint 15
14	TX_EP_14	R/W	0h	Interrupt status for TX endpoint 14
13	TX_EP_13	R/W	0h	Interrupt status for TX endpoint 13
12	TX_EP_12	R/W	0h	Interrupt status for TX endpoint 12
11	TX_EP_11	R/W	0h	Interrupt status for TX endpoint 11
10	TX_EP_10	R/W	0h	Interrupt status for TX endpoint 10
9	TX_EP_9	R/W	0h	Interrupt status for TX endpoint 9
8	TX_EP_8	R/W	0h	Interrupt status for TX endpoint 8
7	TX_EP_7	R/W	0h	Interrupt status for TX endpoint 7
6	TX_EP_6	R/W	0h	Interrupt status for TX endpoint 6

Table 16-77. USB0IRQSTATRAW0 Register Field Descriptions (continued)

Bit	Field	Type	Reset	Description
5	TX_EP_5	R/W	0h	Interrupt status for TX endpoint 5
4	TX_EP_4	R/W	0h	Interrupt status for TX endpoint 4
3	TX_EP_3	R/W	0h	Interrupt status for TX endpoint 3
2	TX_EP_2	R/W	0h	Interrupt status for TX endpoint 2
1	TX_EP_1	R/W	0h	Interrupt status for TX endpoint 1
0	TX_EP_0	R/W	0h	Interrupt status for TX endpoint 0 USB0_IRQ_STATUS_RAW_0 Register

16.5.2.6 USB0IRQSTATRAW1 Register (offset = 102Ch) [reset = 0h]

 USB0IRQSTATRAW1 is shown in [Figure 16-69](#) and described in [Table 16-78](#).

Figure 16-69. USB0IRQSTATRAW1 Register

31		30		29		28		27		26		25		24	
TX_FIFO_15	TX_FIFO_14	TX_FIFO_13	TX_FIFO_12	TX_FIFO_11	TX_FIFO_10	TX_FIFO_9	TX_FIFO_8								
R/W-0h	R/W-0h	R/W-0h	R/W-0h	R/W-0h	R/W-0h	R/W-0h	R/W-0h								
23		22		21		20		19		18		17		16	
TX_FIFO_7	TX_FIFO_6	TX_FIFO_5	TX_FIFO_4	TX_FIFO_3	TX_FIFO_2	TX_FIFO_1	TX_FIFO_0								
R/W-0h	R/W-0h	R/W-0h	R/W-0h	R/W-0h	R/W-0h	R/W-0h	R/W-0h								
15		14		13		12		11		10		9		8	
RESERVED												USB_9	USB_8		
R/W-0h												R/W-0h	R/W-0h		
7		6		5		4		3		2		1		0	
USB_7	USB_6	USB_5	USB_4	USB_3	USB_2	USB_1	USB_0								
R/W-0h	R/W-0h	R/W-0h	R/W-0h	R/W-0h	R/W-0h	R/W-0h	R/W-0h								

LEGEND: R/W = Read/Write; R = Read only; W1toCl = Write 1 to clear bit; -n = value after reset

Table 16-78. USB0IRQSTATRAW1 Register Field Descriptions

Bit	Field	Type	Reset	Description
31	TX_FIFO_15	R/W	0h	Interrupt status for TX FIFO endpoint 15
30	TX_FIFO_14	R/W	0h	Interrupt status for TX FIFO endpoint 14
29	TX_FIFO_13	R/W	0h	Interrupt status for TX FIFO endpoint 13
28	TX_FIFO_12	R/W	0h	Interrupt status for TX FIFO endpoint 12
27	TX_FIFO_11	R/W	0h	Interrupt status for TX FIFO endpoint 11
26	TX_FIFO_10	R/W	0h	Interrupt status for TX FIFO endpoint 10
25	TX_FIFO_9	R/W	0h	Interrupt status for TX FIFO endpoint 9
24	TX_FIFO_8	R/W	0h	Interrupt status for TX FIFO endpoint 8
23	TX_FIFO_7	R/W	0h	Interrupt status for TX FIFO endpoint 7
22	TX_FIFO_6	R/W	0h	Interrupt status for TX FIFO endpoint 6
21	TX_FIFO_5	R/W	0h	Interrupt status for TX FIFO endpoint 5
20	TX_FIFO_4	R/W	0h	Interrupt status for TX FIFO endpoint 4
19	TX_FIFO_3	R/W	0h	Interrupt status for TX FIFO endpoint 3
18	TX_FIFO_2	R/W	0h	Interrupt status for TX FIFO endpoint 2
17	TX_FIFO_1	R/W	0h	Interrupt status for TX FIFO endpoint 1
16	TX_FIFO_0	R/W	0h	Interrupt status for TX FIFO endpoint 0
15-10	RESERVED	R/W	0h	
9	USB_9	R/W	0h	Interrupt status for Mentor controller USB_INT generic interrupt
8	USB_8	R/W	0h	Interrupt status for DRVVBUS level change
7	USB_7	R/W	0h	Interrupt status for VBUS < VBUS valid threshold
6	USB_6	R/W	0h	Interrupt status for SRP detected
5	USB_5	R/W	0h	Interrupt status for device disconnected (host mode)
4	USB_4	R/W	0h	Interrupt status for device connected (host mode)
3	USB_3	R/W	0h	Interrupt status for SOF started
2	USB_2	R/W	0h	Interrupt status for Reset signaling detected (peripheral mode) Babble detected (host mode)

Table 16-78. USB0IRQSTATRAW1 Register Field Descriptions (continued)

Bit	Field	Type	Reset	Description
1	USB_1	R/W	0h	Interrupt status for Resume signaling detected
0	USB_0	R/W	0h	Interrupt status for Suspend signaling detected USB0 IRQ_STATUS_RAW_1 Register

16.5.2.7 USB0IRQSTAT0 Register (offset = 1030h) [reset = 0h]

 USB0IRQSTAT0 is shown in [Figure 16-70](#) and described in [Table 16-79](#).

Figure 16-70. USB0IRQSTAT0 Register

31		30		29		28		27		26		25		24	
RX_EP_15	RX_EP_14	RX_EP_13	RX_EP_12	RX_EP_11	RX_EP_10	RX_EP_9	RX_EP_8	RX_EP_7	RX_EP_6	RX_EP_5	RX_EP_4	RX_EP_3	RX_EP_2	RX_EP_1	RESERVED
R/W-0h	R/W-0h	R/W-0h	R/W-0h	R/W-0h	R/W-0h	R/W-0h	R/W-0h	R/W-0h	R/W-0h	R/W-0h	R/W-0h	R/W-0h	R/W-0h	R/W-0h	R/W-0h
23		22		21		20		19		18		17		16	
RX_EP_7	RX_EP_6	RX_EP_5	RX_EP_4	RX_EP_3	RX_EP_2	RX_EP_1	RESERVED	RX_EP_7	RX_EP_6	RX_EP_5	RX_EP_4	RX_EP_3	RX_EP_2	RX_EP_1	RESERVED
R/W-0h	R/W-0h	R/W-0h	R/W-0h	R/W-0h	R/W-0h	R/W-0h	R/W-0h	R/W-0h	R/W-0h	R/W-0h	R/W-0h	R/W-0h	R/W-0h	R/W-0h	R/W-0h
15		14		13		12		11		10		9		8	
TX_EP_15	TX_EP_14	TX_EP_13	TX_EP_12	TX_EP_11	TX_EP_10	TX_EP_9	TX_EP_8	TX_EP_7	TX_EP_6	TX_EP_5	TX_EP_4	TX_EP_3	TX_EP_2	TX_EP_1	TX_EP_0
R/W-0h	R/W-0h	R/W-0h	R/W-0h	R/W-0h	R/W-0h	R/W-0h	R/W-0h	R/W-0h	R/W-0h	R/W-0h	R/W-0h	R/W-0h	R/W-0h	R/W-0h	R/W-0h
7		6		5		4		3		2		1		0	
TX_EP_7	TX_EP_6	TX_EP_5	TX_EP_4	TX_EP_3	TX_EP_2	TX_EP_1	TX_EP_0	TX_EP_7	TX_EP_6	TX_EP_5	TX_EP_4	TX_EP_3	TX_EP_2	TX_EP_1	TX_EP_0
R/W-0h	R/W-0h	R/W-0h	R/W-0h	R/W-0h	R/W-0h	R/W-0h	R/W-0h	R/W-0h	R/W-0h	R/W-0h	R/W-0h	R/W-0h	R/W-0h	R/W-0h	R/W-0h

LEGEND: R/W = Read/Write; R = Read only; W1toCl = Write 1 to clear bit; -n = value after reset

Table 16-79. USB0IRQSTAT0 Register Field Descriptions

Bit	Field	Type	Reset	Description
31	RX_EP_15	R/W	0h	Interrupt status for RX endpoint 15
30	RX_EP_14	R/W	0h	Interrupt status for RX endpoint 14
29	RX_EP_13	R/W	0h	Interrupt status for RX endpoint 13
28	RX_EP_12	R/W	0h	Interrupt status for RX endpoint 12
27	RX_EP_11	R/W	0h	Interrupt status for RX endpoint 11
26	RX_EP_10	R/W	0h	Interrupt status for RX endpoint 10
25	RX_EP_9	R/W	0h	Interrupt status for RX endpoint 9
24	RX_EP_8	R/W	0h	Interrupt status for RX endpoint 8
23	RX_EP_7	R/W	0h	Interrupt status for RX endpoint 7
22	RX_EP_6	R/W	0h	Interrupt status for RX endpoint 6
21	RX_EP_5	R/W	0h	Interrupt status for RX endpoint 5
20	RX_EP_4	R/W	0h	Interrupt status for RX endpoint 4
19	RX_EP_3	R/W	0h	Interrupt status for RX endpoint 3
18	RX_EP_2	R/W	0h	Interrupt status for RX endpoint 2
17	RX_EP_1	R/W	0h	Interrupt status for RX endpoint 1
16	RESERVED	R/W	0h	
15	TX_EP_15	R/W	0h	Interrupt status for TX endpoint 15
14	TX_EP_14	R/W	0h	Interrupt status for TX endpoint 14
13	TX_EP_13	R/W	0h	Interrupt status for TX endpoint 13
12	TX_EP_12	R/W	0h	Interrupt status for TX endpoint 12
11	TX_EP_11	R/W	0h	Interrupt status for TX endpoint 11
10	TX_EP_10	R/W	0h	Interrupt status for TX endpoint 10
9	TX_EP_9	R/W	0h	Interrupt status for TX endpoint 9
8	TX_EP_8	R/W	0h	Interrupt status for TX endpoint 8
7	TX_EP_7	R/W	0h	Interrupt status for TX endpoint 7
6	TX_EP_6	R/W	0h	Interrupt status for TX endpoint 6

Table 16-79. USB0IRQSTAT0 Register Field Descriptions (continued)

Bit	Field	Type	Reset	Description
5	TX_EP_5	R/W	0h	Interrupt status for TX endpoint 5
4	TX_EP_4	R/W	0h	Interrupt status for TX endpoint 4
3	TX_EP_3	R/W	0h	Interrupt status for TX endpoint 3
2	TX_EP_2	R/W	0h	Interrupt status for TX endpoint 2
1	TX_EP_1	R/W	0h	Interrupt status for TX endpoint 1
0	TX_EP_0	R/W	0h	Interrupt status for TX endpoint 0 USB0_IRQ_STATUS_0 Register

16.5.2.8 USB0IRQSTAT1 Register (offset = 1034h) [reset = 0h]

 USB0IRQSTAT1 is shown in [Figure 16-71](#) and described in [Table 16-80](#).

Figure 16-71. USB0IRQSTAT1 Register

31		30		29		28		27		26		25		24	
TX_FIFO_15	TX_FIFO_14	TX_FIFO_13	TX_FIFO_12	TX_FIFO_11	TX_FIFO_10	TX_FIFO_9	TX_FIFO_8								
R/W-0h	R/W-0h	R/W-0h	R/W-0h	R/W-0h	R/W-0h	R/W-0h	R/W-0h								
23		22		21		20		19		18		17		16	
TX_FIFO_7	TX_FIFO_6	TX_FIFO_5	TX_FIFO_4	TX_FIFO_3	TX_FIFO_2	TX_FIFO_1	TX_FIFO_0								
R/W-0h	R/W-0h	R/W-0h	R/W-0h	R/W-0h	R/W-0h	R/W-0h	R/W-0h								
15		14		13		12		11		10		9		8	
RESERVED												USB_9	USB_8		
R/W-0h												R/W-0h	R/W-0h		
7		6		5		4		3		2		1		0	
USB_7	USB_6	USB_5	USB_4	USB_3	USB_2	USB_1	USB_0								
R/W-0h	R/W-0h	R/W-0h	R/W-0h	R/W-0h	R/W-0h	R/W-0h	R/W-0h								

LEGEND: R/W = Read/Write; R = Read only; W1toCl = Write 1 to clear bit; -n = value after reset

Table 16-80. USB0IRQSTAT1 Register Field Descriptions

Bit	Field	Type	Reset	Description
31	TX_FIFO_15	R/W	0h	Interrupt status for TX FIFO endpoint 15
30	TX_FIFO_14	R/W	0h	Interrupt status for TX FIFO endpoint 14
29	TX_FIFO_13	R/W	0h	Interrupt status for TX FIFO endpoint 13
28	TX_FIFO_12	R/W	0h	Interrupt status for TX FIFO endpoint 12
27	TX_FIFO_11	R/W	0h	Interrupt status for TX FIFO endpoint 11
26	TX_FIFO_10	R/W	0h	Interrupt status for TX FIFO endpoint 10
25	TX_FIFO_9	R/W	0h	Interrupt status for TX FIFO endpoint 9
24	TX_FIFO_8	R/W	0h	Interrupt status for TX FIFO endpoint 8
23	TX_FIFO_7	R/W	0h	Interrupt status for TX FIFO endpoint 7
22	TX_FIFO_6	R/W	0h	Interrupt status for TX FIFO endpoint 6
21	TX_FIFO_5	R/W	0h	Interrupt status for TX FIFO endpoint 5
20	TX_FIFO_4	R/W	0h	Interrupt status for TX FIFO endpoint 4
19	TX_FIFO_3	R/W	0h	Interrupt status for TX FIFO endpoint 3
18	TX_FIFO_2	R/W	0h	Interrupt status for TX FIFO endpoint 2
17	TX_FIFO_1	R/W	0h	Interrupt status for TX FIFO endpoint 1
16	TX_FIFO_0	R/W	0h	Interrupt status for TX FIFO endpoint 0
15-10	RESERVED	R/W	0h	
9	USB_9	R/W	0h	Interrupt status for Mentor controller USB_INT generic interrupt
8	USB_8	R/W	0h	Interrupt status for DRVVBUS level change
7	USB_7	R/W	0h	Interrupt status for VBUS < VBUS valid threshold
6	USB_6	R/W	0h	Interrupt status for SRP detected
5	USB_5	R/W	0h	Interrupt status for device disconnected (host mode)
4	USB_4	R/W	0h	Interrupt status for device connected (host mode)
3	USB_3	R/W	0h	Interrupt status for SOF started
2	USB_2	R/W	0h	Interrupt status for Reset signaling detected (peripheral mode) Babble detected (host mode)

Table 16-80. USB0IRQSTAT1 Register Field Descriptions (continued)

Bit	Field	Type	Reset	Description
1	USB_1	R/W	0h	Interrupt status for Resume signaling detected
0	USB_0	R/W	0h	Interrupt status for Suspend signaling detected USB0 IRQ_STATUS_1 Register

16.5.2.9 USB0IRQENABLESET0 Register (offset = 1038h) [reset = 0h]

 USB0IRQENABLESET0 is shown in [Figure 16-72](#) and described in [Table 16-81](#).

Figure 16-72. USB0IRQENABLESET0 Register

31		30		29		28		27		26		25		24	
RX_EP_15	RX_EP_14	RX_EP_13	RX_EP_12	RX_EP_11	RX_EP_10	RX_EP_9	RX_EP_8	RX_EP_7	RX_EP_6	RX_EP_5	RX_EP_4	RX_EP_3	RX_EP_2	RX_EP_1	RESERVED
R/W-0h	R/W-0h	R/W-0h	R/W-0h	R/W-0h	R/W-0h	R/W-0h	R/W-0h	R/W-0h	R/W-0h	R/W-0h	R/W-0h	R/W-0h	R/W-0h	R/W-0h	R/W-0h
23		22		21		20		19		18		17		16	
RX_EP_7	RX_EP_6	RX_EP_5	RX_EP_4	RX_EP_3	RX_EP_2	RX_EP_1	RESERVED	RX_EP_7	RX_EP_6	RX_EP_5	RX_EP_4	RX_EP_3	RX_EP_2	RX_EP_1	RESERVED
R/W-0h	R/W-0h	R/W-0h	R/W-0h	R/W-0h	R/W-0h	R/W-0h	R/W-0h	R/W-0h	R/W-0h	R/W-0h	R/W-0h	R/W-0h	R/W-0h	R/W-0h	R/W-0h
15		14		13		12		11		10		9		8	
TX_EP_15	TX_EP_14	TX_EP_13	TX_EP_12	TX_EP_11	TX_EP_10	TX_EP_9	TX_EP_8	TX_EP_7	TX_EP_6	TX_EP_5	TX_EP_4	TX_EP_3	TX_EP_2	TX_EP_1	TX_EP_0
R/W-0h	R/W-0h	R/W-0h	R/W-0h	R/W-0h	R/W-0h	R/W-0h	R/W-0h	R/W-0h	R/W-0h	R/W-0h	R/W-0h	R/W-0h	R/W-0h	R/W-0h	R/W-0h
7		6		5		4		3		2		1		0	
TX_EP_7	TX_EP_6	TX_EP_5	TX_EP_4	TX_EP_3	TX_EP_2	TX_EP_1	TX_EP_0	TX_EP_7	TX_EP_6	TX_EP_5	TX_EP_4	TX_EP_3	TX_EP_2	TX_EP_1	TX_EP_0
R/W-0h	R/W-0h	R/W-0h	R/W-0h	R/W-0h	R/W-0h	R/W-0h	R/W-0h	R/W-0h	R/W-0h	R/W-0h	R/W-0h	R/W-0h	R/W-0h	R/W-0h	R/W-0h

LEGEND: R/W = Read/Write; R = Read only; W1toCl = Write 1 to clear bit; -n = value after reset

Table 16-81. USB0IRQENABLESET0 Register Field Descriptions

Bit	Field	Type	Reset	Description
31	RX_EP_15	R/W	0h	Interrupt enable for RX endpoint 15
30	RX_EP_14	R/W	0h	Interrupt enable for RX endpoint 14
29	RX_EP_13	R/W	0h	Interrupt enable for RX endpoint 13
28	RX_EP_12	R/W	0h	Interrupt enable for RX endpoint 12
27	RX_EP_11	R/W	0h	Interrupt enable for RX endpoint 11
26	RX_EP_10	R/W	0h	Interrupt enable for RX endpoint 10
25	RX_EP_9	R/W	0h	Interrupt enable for RX endpoint 9
24	RX_EP_8	R/W	0h	Interrupt enable for RX endpoint 8
23	RX_EP_7	R/W	0h	Interrupt enable for RX endpoint 7
22	RX_EP_6	R/W	0h	Interrupt enable for RX endpoint 6
21	RX_EP_5	R/W	0h	Interrupt enable for RX endpoint 5
20	RX_EP_4	R/W	0h	Interrupt enable for RX endpoint 4
19	RX_EP_3	R/W	0h	Interrupt enable for RX endpoint 3
18	RX_EP_2	R/W	0h	Interrupt enable for RX endpoint 2
17	RX_EP_1	R/W	0h	Interrupt enable for RX endpoint 1
16	RESERVED	R/W	0h	
15	TX_EP_15	R/W	0h	Interrupt enable for TX endpoint 15
14	TX_EP_14	R/W	0h	Interrupt enable for TX endpoint 14
13	TX_EP_13	R/W	0h	Interrupt enable for TX endpoint 13
12	TX_EP_12	R/W	0h	Interrupt enable for TX endpoint 12
11	TX_EP_11	R/W	0h	Interrupt enable for TX endpoint 11
10	TX_EP_10	R/W	0h	Interrupt enable for TX endpoint 10
9	TX_EP_9	R/W	0h	Interrupt enable for TX endpoint 9
8	TX_EP_8	R/W	0h	Interrupt enable for TX endpoint 8
7	TX_EP_7	R/W	0h	Interrupt enable for TX endpoint 7
6	TX_EP_6	R/W	0h	Interrupt enable for TX endpoint 6

Table 16-81. USB0IRQENABLESET0 Register Field Descriptions (continued)

Bit	Field	Type	Reset	Description
5	TX_EP_5	R/W	0h	Interrupt enable for TX endpoint 5
4	TX_EP_4	R/W	0h	Interrupt enable for TX endpoint 4
3	TX_EP_3	R/W	0h	Interrupt enable for TX endpoint 3
2	TX_EP_2	R/W	0h	Interrupt enable for TX endpoint 2
1	TX_EP_1	R/W	0h	Interrupt enable for TX endpoint 1
0	TX_EP_0	R/W	0h	Interrupt enable for TX endpoint 0 USB0 IRQ_ENABLE_SET_0 Register

16.5.2.10 USB0IRQENABLESET1 Register (offset = 103Ch) [reset = 0h]

 USB0IRQENABLESET1 is shown in [Figure 16-73](#) and described in [Table 16-82](#).

Figure 16-73. USB0IRQENABLESET1 Register

31		30		29		28		27		26		25		24	
TX_FIFO_15	TX_FIFO_14	TX_FIFO_13	TX_FIFO_12	TX_FIFO_11	TX_FIFO_10	TX_FIFO_9	TX_FIFO_8								
R/W-0h	R/W-0h	R/W-0h	R/W-0h	R/W-0h	R/W-0h	R/W-0h	R/W-0h								
23		22		21		20		19		18		17		16	
TX_FIFO_7	TX_FIFO_6	TX_FIFO_5	TX_FIFO_4	TX_FIFO_3	TX_FIFO_2	TX_FIFO_1	TX_FIFO_0								
R/W-0h	R/W-0h	R/W-0h	R/W-0h	R/W-0h	R/W-0h	R/W-0h	R/W-0h								
15		14		13		12		11		10		9		8	
RESERVED												USB_9	USB_8		
R/W-0h												R/W-0h	R/W-0h		
7		6		5		4		3		2		1		0	
USB_7	USB_6	USB_5	USB_4	USB_3	USB_2	USB_1	USB_0								
R/W-0h	R/W-0h	R/W-0h	R/W-0h	R/W-0h	R/W-0h	R/W-0h	R/W-0h								

LEGEND: R/W = Read/Write; R = Read only; W1toCl = Write 1 to clear bit; -n = value after reset

Table 16-82. USB0IRQENABLESET1 Register Field Descriptions

Bit	Field	Type	Reset	Description
31	TX_FIFO_15	R/W	0h	Interrupt enable for TX FIFO endpoint 15
30	TX_FIFO_14	R/W	0h	Interrupt enable for TX FIFO endpoint 14
29	TX_FIFO_13	R/W	0h	Interrupt enable for TX FIFO endpoint 13
28	TX_FIFO_12	R/W	0h	Interrupt enable for TX FIFO endpoint 12
27	TX_FIFO_11	R/W	0h	Interrupt enable for TX FIFO endpoint 11
26	TX_FIFO_10	R/W	0h	Interrupt enable for TX FIFO endpoint 10
25	TX_FIFO_9	R/W	0h	Interrupt enable for TX FIFO endpoint 9
24	TX_FIFO_8	R/W	0h	Interrupt enable for TX FIFO endpoint 8
23	TX_FIFO_7	R/W	0h	Interrupt enable for TX FIFO endpoint 7
22	TX_FIFO_6	R/W	0h	Interrupt enable for TX FIFO endpoint 6
21	TX_FIFO_5	R/W	0h	Interrupt enable for TX FIFO endpoint 5
20	TX_FIFO_4	R/W	0h	Interrupt enable for TX FIFO endpoint 4
19	TX_FIFO_3	R/W	0h	Interrupt enable for TX FIFO endpoint 3
18	TX_FIFO_2	R/W	0h	Interrupt enable for TX FIFO endpoint 2
17	TX_FIFO_1	R/W	0h	Interrupt enable for TX FIFO endpoint 1
16	TX_FIFO_0	R/W	0h	Interrupt enable for TX FIFO endpoint 0
15-10	RESERVED	R/W	0h	
9	USB_9	R/W	0h	Interrupt enable for Mentor controller USB_INT generic interrupt
8	USB_8	R/W	0h	Interrupt enable for DRVVBUS level change
7	USB_7	R/W	0h	Interrupt enable for VBUS < VBUS valid threshold
6	USB_6	R/W	0h	Interrupt enable for SRP detected
5	USB_5	R/W	0h	Interrupt enable for device disconnected (host mode)
4	USB_4	R/W	0h	Interrupt enable for device connected (host mode)
3	USB_3	R/W	0h	Interrupt enable for SOF started
2	USB_2	R/W	0h	Interrupt enable for Reset signaling detected (peripheral mode) Babble detected (host mode)

Table 16-82. USB0IRQENABLESET1 Register Field Descriptions (continued)

Bit	Field	Type	Reset	Description
1	USB_1	R/W	0h	Interrupt enable for Resume signaling detected
0	USB_0	R/W	0h	Interrupt enable for Suspend signaling detected USB0 IRQ_ENABLE_SET_1 Register

16.5.2.11 USB0IRQENABLECLR0 Register (offset = 1040h) [reset = 0h]

 USB0IRQENABLECLR0 is shown in [Figure 16-74](#) and described in [Table 16-83](#).

Figure 16-74. USB0IRQENABLECLR0 Register

31		30		29		28		27		26		25		24	
RX_EP_15	RX_EP_14	RX_EP_13	RX_EP_12	RX_EP_11	RX_EP_10	RX_EP_9	RX_EP_8	RX_EP_7	RX_EP_6	RX_EP_5	RX_EP_4	RX_EP_3	RX_EP_2	RX_EP_1	RESERVED
R/W-0h		R/W-0h		R/W-0h		R/W-0h		R/W-0h		R/W-0h		R/W-0h		R/W-0h	
23		22		21		20		19		18		17		16	
RX_EP_7	RX_EP_6	RX_EP_5	RX_EP_4	RX_EP_3	RX_EP_2	RX_EP_1	RESERVED	RX_EP_7	RX_EP_6	RX_EP_5	RX_EP_4	RX_EP_3	RX_EP_2	RX_EP_1	RESERVED
R/W-0h		R/W-0h		R/W-0h		R/W-0h		R/W-0h		R/W-0h		R/W-0h		R/W-0h	
15		14		13		12		11		10		9		8	
TX_EP_15	TX_EP_14	TX_EP_13	TX_EP_12	TX_EP_11	TX_EP_10	TX_EP_9	TX_EP_8	TX_EP_15	TX_EP_14	TX_EP_13	TX_EP_12	TX_EP_11	TX_EP_10	TX_EP_9	TX_EP_8
R/W-0h		R/W-0h		R/W-0h		R/W-0h		R/W-0h		R/W-0h		R/W-0h		R/W-0h	
7		6		5		4		3		2		1		0	
TX_EP_7	TX_EP_6	TX_EP_5	TX_EP_4	TX_EP_3	TX_EP_2	TX_EP_1	TX_EP_0	TX_EP_7	TX_EP_6	TX_EP_5	TX_EP_4	TX_EP_3	TX_EP_2	TX_EP_1	TX_EP_0
R/W-0h		R/W-0h		R/W-0h		R/W-0h		R/W-0h		R/W-0h		R/W-0h		R/W-0h	

LEGEND: R/W = Read/Write; R = Read only; W1toCl = Write 1 to clear bit; -n = value after reset

Table 16-83. USB0IRQENABLECLR0 Register Field Descriptions

Bit	Field	Type	Reset	Description
31	RX_EP_15	R/W	0h	Interrupt enable for RX endpoint 15
30	RX_EP_14	R/W	0h	Interrupt enable for RX endpoint 14
29	RX_EP_13	R/W	0h	Interrupt enable for RX endpoint 13
28	RX_EP_12	R/W	0h	Interrupt enable for RX endpoint 12
27	RX_EP_11	R/W	0h	Interrupt enable for RX endpoint 11
26	RX_EP_10	R/W	0h	Interrupt enable for RX endpoint 10
25	RX_EP_9	R/W	0h	Interrupt enable for RX endpoint 9
24	RX_EP_8	R/W	0h	Interrupt enable for RX endpoint 8
23	RX_EP_7	R/W	0h	Interrupt enable for RX endpoint 7
22	RX_EP_6	R/W	0h	Interrupt enable for RX endpoint 6
21	RX_EP_5	R/W	0h	Interrupt enable for RX endpoint 5
20	RX_EP_4	R/W	0h	Interrupt enable for RX endpoint 4
19	RX_EP_3	R/W	0h	Interrupt enable for RX endpoint 3
18	RX_EP_2	R/W	0h	Interrupt enable for RX endpoint 2
17	RX_EP_1	R/W	0h	Interrupt enable for RX endpoint 1
16	RESERVED	R/W	0h	
15	TX_EP_15	R/W	0h	Interrupt enable for TX endpoint 15
14	TX_EP_14	R/W	0h	Interrupt enable for TX endpoint 14
13	TX_EP_13	R/W	0h	Interrupt enable for TX endpoint 13
12	TX_EP_12	R/W	0h	Interrupt enable for TX endpoint 12
11	TX_EP_11	R/W	0h	Interrupt enable for TX endpoint 11
10	TX_EP_10	R/W	0h	Interrupt enable for TX endpoint 10
9	TX_EP_9	R/W	0h	Interrupt enable for TX endpoint 9
8	TX_EP_8	R/W	0h	Interrupt enable for TX endpoint 8
7	TX_EP_7	R/W	0h	Interrupt enable for TX endpoint 7
6	TX_EP_6	R/W	0h	Interrupt enable for TX endpoint 6

Table 16-83. USB0IRQENABLECLR0 Register Field Descriptions (continued)

Bit	Field	Type	Reset	Description
5	TX_EP_5	R/W	0h	Interrupt enable for TX endpoint 5
4	TX_EP_4	R/W	0h	Interrupt enable for TX endpoint 4
3	TX_EP_3	R/W	0h	Interrupt enable for TX endpoint 3
2	TX_EP_2	R/W	0h	Interrupt enable for TX endpoint 2
1	TX_EP_1	R/W	0h	Interrupt enable for TX endpoint 1
0	TX_EP_0	R/W	0h	Interrupt enable for TX endpoint 0 USB0_IRQ_ENABLE_CLR_0 Register

16.5.2.12 USB0IRQENABLECLR1 Register (offset = 1044h) [reset = 0h]

 USB0IRQENABLECLR1 is shown in [Figure 16-75](#) and described in [Table 16-84](#).

Figure 16-75. USB0IRQENABLECLR1 Register

31		30		29		28		27		26		25		24	
TX_FIFO_15	TX_FIFO_14	TX_FIFO_13	TX_FIFO_12	TX_FIFO_11	TX_FIFO_10	TX_FIFO_9	TX_FIFO_8								
R/W-0h	R/W-0h	R/W-0h	R/W-0h	R/W-0h	R/W-0h	R/W-0h	R/W-0h								
23		22		21		20		19		18		17		16	
TX_FIFO_7	TX_FIFO_6	TX_FIFO_5	TX_FIFO_4	TX_FIFO_3	TX_FIFO_2	TX_FIFO_1	TX_FIFO_0								
R/W-0h	R/W-0h	R/W-0h	R/W-0h	R/W-0h	R/W-0h	R/W-0h	R/W-0h								
15		14		13		12		11		10		9		8	
RESERVED												USB_9	USB_8		
R/W-0h												R/W-0h	R/W-0h		
7		6		5		4		3		2		1		0	
USB_7	USB_6	USB_5	USB_4	USB_3	USB_2	USB_1	USB_0								
R/W-0h	R/W-0h	R/W-0h	R/W-0h	R/W-0h	R/W-0h	R/W-0h	R/W-0h								

LEGEND: R/W = Read/Write; R = Read only; W1toCl = Write 1 to clear bit; -n = value after reset

Table 16-84. USB0IRQENABLECLR1 Register Field Descriptions

Bit	Field	Type	Reset	Description
31	TX_FIFO_15	R/W	0h	Interrupt enable for TX FIFO endpoint 15
30	TX_FIFO_14	R/W	0h	Interrupt enable for TX FIFO endpoint 14
29	TX_FIFO_13	R/W	0h	Interrupt enable for TX FIFO endpoint 13
28	TX_FIFO_12	R/W	0h	Interrupt enable for TX FIFO endpoint 12
27	TX_FIFO_11	R/W	0h	Interrupt enable for TX FIFO endpoint 11
26	TX_FIFO_10	R/W	0h	Interrupt enable for TX FIFO endpoint 10
25	TX_FIFO_9	R/W	0h	Interrupt enable for TX FIFO endpoint 9
24	TX_FIFO_8	R/W	0h	Interrupt enable for TX FIFO endpoint 8
23	TX_FIFO_7	R/W	0h	Interrupt enable for TX FIFO endpoint 7
22	TX_FIFO_6	R/W	0h	Interrupt enable for TX FIFO endpoint 6
21	TX_FIFO_5	R/W	0h	Interrupt enable for TX FIFO endpoint 5
20	TX_FIFO_4	R/W	0h	Interrupt enable for TX FIFO endpoint 4
19	TX_FIFO_3	R/W	0h	Interrupt enable for TX FIFO endpoint 3
18	TX_FIFO_2	R/W	0h	Interrupt enable for TX FIFO endpoint 2
17	TX_FIFO_1	R/W	0h	Interrupt enable for TX FIFO endpoint 1
16	TX_FIFO_0	R/W	0h	Interrupt enable for TX FIFO endpoint 0
15-10	RESERVED	R/W	0h	
9	USB_9	R/W	0h	Interrupt enable for Mentor controller USB_INT generic interrupt
8	USB_8	R/W	0h	Interrupt enable for DRVVBUS level change
7	USB_7	R/W	0h	Interrupt enable for VBUS < VBUS valid threshold
6	USB_6	R/W	0h	Interrupt enable for SRP detected
5	USB_5	R/W	0h	Interrupt enable for device disconnected (host mode)
4	USB_4	R/W	0h	Interrupt enable for device connected (host mode)
3	USB_3	R/W	0h	Interrupt enable for SOF started
2	USB_2	R/W	0h	Interrupt enable for Reset signaling detected (peripheral mode) Babble detected (host mode)

Table 16-84. USB0IRQENABLECLR1 Register Field Descriptions (continued)

Bit	Field	Type	Reset	Description
1	USB_1	R/W	0h	Interrupt enable for Resume signaling detected
0	USB_0	R/W	0h	Interrupt enable for Suspend signaling detected USB0 IRQ_ENABLE_CLR_1 Register

16.5.2.13 USB0TXMODE Register (offset = 1070h) [reset = 0h]

 USB0TXMODE is shown in [Figure 16-76](#) and described in [Table 16-85](#).

Figure 16-76. USB0TXMODE Register

31	30	29	28	27	26	25	24
RESERVED		TX15_MODE		TX14_MODE		TX13_MODE	
R/W-0h		R/W-0h		R/W-0h		R/W-0h	
23	22	21	20	19	18	17	16
TX12_MODE		TX11_MODE		TX10_MODE		TX9_MODE	
R/W-0h		R/W-0h		R/W-0h		R/W-0h	
15	14	13	12	11	10	9	8
TX8_MODE		TX7_MODE		TX6_MODE		TX5_MODE	
R/W-0h		R/W-0h		R/W-0h		R/W-0h	
7	6	5	4	3	2	1	0
TX4_MODE		TX3_MODE		TX2_MODE		TX1_MODE	
R/W-0h		R/W-0h		R/W-0h		R/W-0h	

LEGEND: R/W = Read/Write; R = Read only; W1toCl = Write 1 to clear bit; -n = value after reset

Table 16-85. USB0TXMODE Register Field Descriptions

Bit	Field	Type	Reset	Description
31-30	RESERVED	R/W	0h	
29-28	TX15_MODE	R/W	0h	00: Transparent Mode on TX endpoint 14 01: RNDIS Mode on TX endpoint 14 10: CDC Mode on TX endpoint 14 11: Generic RNDIS Mode on TX endpoint 14
27-26	TX14_MODE	R/W	0h	00: Transparent Mode on TX endpoint 13 01: RNDIS Mode on TX endpoint 13 10: CDC Mode on TX endpoint 13 11: Generic RNDIS Mode on TX endpoint 13
25-24	TX13_MODE	R/W	0h	00: Transparent Mode on TX endpoint 12 01: RNDIS Mode on TX endpoint 12 10: CDC Mode on TX endpoint 12 11: Generic RNDIS Mode on TX endpoint 12
23-22	TX12_MODE	R/W	0h	00: Transparent Mode on TX endpoint 11 01: RNDIS Mode on TX endpoint 11 10: CDC Mode on TX endpoint 11 11: Generic RNDIS Mode on TX endpoint 11
21-20	TX11_MODE	R/W	0h	00: Transparent Mode on TX endpoint 10 01: RNDIS Mode on TX endpoint 10 10: CDC Mode on TX endpoint 10 11: Generic RNDIS Mode on TX endpoint 10
19-18	TX10_MODE	R/W	0h	00: Transparent Mode on TX endpoint 9 01: RNDIS Mode on TX endpoint 9 10: CDC Mode on TX endpoint 9 11: Generic RNDIS Mode on TX endpoint 9
17-16	TX9_MODE	R/W	0h	00: Transparent Mode on TX endpoint 8 01: RNDIS Mode on TX endpoint 8 10: CDC Mode on TX endpoint 8 11: Generic RNDIS Mode on TX endpoint 8
15-14	TX8_MODE	R/W	0h	00: Transparent Mode on TX endpoint 7 01: RNDIS Mode on TX endpoint 7 10: CDC Mode on TX endpoint 7 11: Generic RNDIS Mode on TX endpoint 7
13-12	TX7_MODE	R/W	0h	00: Transparent Mode on TX endpoint 6 01: RNDIS Mode on TX endpoint 6 10: CDC Mode on TX endpoint 6 11: Generic RNDIS Mode on TX endpoint 6

Table 16-85. USB0TXMODE Register Field Descriptions (continued)

Bit	Field	Type	Reset	Description
11-10	TX6_MODE	R/W	0h	00: Transparent Mode on TX endpoint 5 01: RNDIS Mode on TX endpoint 5 10: CDC Mode on TX endpoint 5 11: Generic RNDIS Mode on TX endpoint 5
9-8	TX5_MODE	R/W	0h	00: Transparent Mode on TX endpoint 4 01: RNDIS Mode on TX endpoint 4 10: CDC Mode on TX endpoint 4 11: Generic RNDIS Mode on TX endpoint 4
7-6	TX4_MODE	R/W	0h	00: Transparent Mode on TX endpoint 3 01: RNDIS Mode on TX endpoint 3 10: CDC Mode on TX endpoint 3 11: Generic RNDIS Mode on TX endpoint 3
5-4	TX3_MODE	R/W	0h	00: Transparent Mode on TX endpoint 2 01: RNDIS Mode on TX endpoint 2 10: CDC Mode on TX endpoint 2 11: Generic RNDIS Mode on TX endpoint 2
3-2	TX2_MODE	R/W	0h	00: Transparent Mode on TX endpoint 1 01: RNDIS Mode on TX endpoint 1 10: CDC Mode on TX endpoint 1 11: Generic RNDIS Mode on TX endpoint 1
1-0	TX1_MODE	R/W	0h	00: Transparent Mode on TX endpoint 0 01: RNDIS Mode on TX endpoint 0 10: CDC Mode on TX endpoint 0 11: Generic RNDIS Mode on TX endpoint 0 USB0 Tx Mode Registers

16.5.2.14 USB0RXMODE Register (offset = 1074h) [reset = 0h]

 USB0RXMODE is shown in [Figure 16-77](#) and described in [Table 16-86](#).

Figure 16-77. USB0RXMODE Register

31	30	29	28	27	26	25	24
RESERVED		RX15_MODE		RX14_MODE		RX13_MODE	
R/W-0h		R/W-0h		R/W-0h		R/W-0h	
23	22	21	20	19	18	17	16
RX12_MODE		RX11_MODE		RX10_MODE		RX9_MODE	
R/W-0h		R/W-0h		R/W-0h		R/W-0h	
15	14	13	12	11	10	9	8
RX8_MODE		RX7_MODE		RX6_MODE		RX5_MODE	
R/W-0h		R/W-0h		R/W-0h		R/W-0h	
7	6	5	4	3	2	1	0
RX4_MODE		RX3_MODE		RX2_MODE		RX1_MODE	
R/W-0h		R/W-0h		R/W-0h		R/W-0h	

LEGEND: R/W = Read/Write; R = Read only; W1toCl = Write 1 to clear bit; -n = value after reset

Table 16-86. USB0RXMODE Register Field Descriptions

Bit	Field	Type	Reset	Description
31-30	RESERVED	R/W	0h	
29-28	RX15_MODE	R/W	0h	00: Transparent Mode on RX endpoint 14 01: RNDIS Mode on RX endpoint 14 10: CDC Mode on RX endpoint 14 11: Generic RNDIS or Infinite Mode on RX endpoint 14
27-26	RX14_MODE	R/W	0h	00: Transparent Mode on RX endpoint 13 01: RNDIS Mode on RX endpoint 13 10: CDC Mode on RX endpoint 13 11: Generic RNDIS or Infinite Mode on RX endpoint 13
25-24	RX13_MODE	R/W	0h	00: Transparent Mode on RX endpoint 12 01: RNDIS Mode on RX endpoint 12 10: CDC Mode on RX endpoint 12 11: Generic RNDIS or Infinite Mode on RX endpoint 12
23-22	RX12_MODE	R/W	0h	00: Transparent Mode on RX endpoint 11 01: RNDIS Mode on RX endpoint 11 10: CDC Mode on RX endpoint 11 11: Generic RNDIS or Infinite Mode on RX endpoint 11
21-20	RX11_MODE	R/W	0h	00: Transparent Mode on RX endpoint 10 01: RNDIS Mode on RX endpoint 10 10: CDC Mode on RX endpoint 10 11: Generic RNDIS or Infinite Mode on RX endpoint 10
19-18	RX10_MODE	R/W	0h	00: Transparent Mode on RX endpoint 9 01: RNDIS Mode on RX endpoint 9 10: CDC Mode on RX endpoint 9 11: Generic RNDIS or Infinite Mode on RX endpoint 9
17-16	RX9_MODE	R/W	0h	00: Transparent Mode on RX endpoint 8 01: RNDIS Mode on RX endpoint 8 10: CDC Mode on RX endpoint 8 11: Generic RNDIS Mode on RX endpoint 8
15-14	RX8_MODE	R/W	0h	00: Transparent Mode on RX endpoint 7 01: RNDIS Mode on RX endpoint 7 10: CDC Mode on RX endpoint 7 11: Generic RNDIS or Infinite Mode on RX endpoint 7
13-12	RX7_MODE	R/W	0h	00: Transparent Mode on RX endpoint 6 01: RNDIS Mode on RX endpoint 6 10: CDC Mode on RX endpoint 6 11: Generic RNDIS or Infinite Mode on RX endpoint 6

Table 16-86. USB0RXMODE Register Field Descriptions (continued)

Bit	Field	Type	Reset	Description
11-10	RX6_MODE	R/W	0h	00: Transparent Mode on RX endpoint 5 01: RNDIS Mode on RX endpoint 5 10: CDC Mode on RX endpoint 5 11: Generic RNDIS or Infinite Mode on RX endpoint 5
9-8	RX5_MODE	R/W	0h	00: Transparent Mode on RX endpoint 4 01: RNDIS Mode on RX endpoint 4 10: CDC Mode on RX endpoint 4 11: Generic RNDIS or Infinite Mode on RX endpoint 4
7-6	RX4_MODE	R/W	0h	00: Transparent Mode on RX endpoint 3 01: RNDIS Mode on RX endpoint 3 10: CDC Mode on RX endpoint 3 11: Generic RNDIS or Infinite Mode on RX endpoint 3
5-4	RX3_MODE	R/W	0h	00: Transparent Mode on RX endpoint 2 01: RNDIS Mode on RX endpoint 2 10: CDC Mode on RX endpoint 2 11: Generic RNDIS or Infinite Mode on RX endpoint 2
3-2	RX2_MODE	R/W	0h	00: Transparent Mode on RX endpoint 1 01: RNDIS Mode on RX endpoint 1 10: CDC Mode on RX endpoint 1 11: Generic RNDIS or Infinite Mode on RX endpoint 1

Table 16-86. USB0RXMODE Register Field Descriptions (continued)

Bit	Field	Type	Reset	Description
1-0	RX1_MODE	R/W	0h	<p>00: Transparent Mode on RX endpoint 0</p> <p>01: RNDIS Mode on RX endpoint 0</p> <p>10: CDC Mode on RX endpoint 0</p> <p>11: Generic RNDIS or Infinite Mode on RX endpoint 0 Each RX endpoint can be configured into 1 of 5 packet termination modes.</p> <p>Transparent mode (b00) * Supports USB endpoint sizes of o FS : 8, 16, 32, 64, and 1023 o HS : 64, 128, 512, and 1024 * Mentor Controller's RXMAXP/TXMAXP must be a valid USB endpoint size.</p> <p>* With autoreq=3 XDMA will always generate a ReqPkt's at the end of the packet.</p> <p>* With autoreq=1 XDMA will never generatate a ReqPkt at the end of the packet.</p> <p>* Each USB packet is equivalent to a single CPPI DMA packet.</p> <p>* Each received CPPI packet will be no larger than the USB max packet size (1023 bytes for FS, 1024 bytes for HS) and will be both a SOP and EOP.</p> <p>* Transmitted CPPI packets can be no larger than the USB max packet size.</p> <p>* Primarily used for interrupt or isochronous endpoints, as CPU will receive an interrupt for every USB packet (if enabled).</p> <p>RNDIS mode (b01) * Supports USB endpoint sizes of o FS : 64 o HS : 64, 128, 512, and 1024 * Mentor controller's RXMAXP/TXMAXP must be an integer multiple of the USB endpoint size.</p> <p>* With autoreq=3 XDMA will always generate a ReqPkt's at the end of the packet.</p> <p>* With autoreq=1 XDMA will continue the generation of ReqPkt's to the Mentor controller until a short packet is received.</p> <p>* Supports transmission of CPPI packets larger than the USB max packet size.</p> <p>* The end of a CPPI packet is defined by a USB short packet (a USB packet less than the USB max packet size).</p> <p>* In the case where the CPPI packet is an exact multiple of the USB max packet size, a zero length terminating packet is used (XDMA recognizes this terminating packet on reception, and generates it on transmission).</p> <p>* Designed for use in an RNDIS compliant networking type of USB device and bulk endpoints Linux CDC mode (b10) * Same as RNDIS mode, except terminating packet has 1-byte of 0 data.</p> <p>* Designed for use with a Linux OS and USB driver stack and bulk endpoints.</p> <p>Generic RNDIS mode (b11 and Generic RNDIS EP N Size register is greater than 0) * Same as RNDIS mode, except the end of a CPPI packet is determined by a USB short packet or when the value in the GENERIC RNDIS EPn SIZE Register is reached (Rx mode only)(i.e. Tx mode does not use this register).</p> <p>The CPU configures this register with a value that is a multiple of the corresponding endpoint size.</p> <p>* No terminating packet is used.</p> <p>* Designed for general bulk endpoint use where specific packet terminations are not required.</p> <p>* Transmit mode transfers only support FS or HS EP sizes through the XDMA and Mentor controller.</p> <p>The CPPI DMA size can be of any legal size as defined by the CPPI 4.1 specification.</p> <p>Infinite mode (b11 and Generic RNDIS EP N Size register equal to 0) * Same as RNDIS mode, except the end of a CPPI packet is determined by a USB short packet or when the CPPI DMA closes up the packet after a defined number of buffers have been filled.</p> <p>This is defined in Rx Channel N Global Configuration Register bits 28:26 rx_max_buffer_cnt.</p> <p>* The CPPI DMA will ignore SOPs generated by the XDMA.</p> <p>* The XDMA packet is assumed to be infinite.</p> <p>* The XDMA starts the packet with a SOP (ignored by the CPPI DMA).</p> <p>* The XDMA ends the packet when a short packet occurs.</p> <p>* Short packets are defined when RXMAXP (0x14) is not equal to RXCOUNT (0x18).</p>

Table 16-86. USB0RXMODE Register Field Descriptions (continued)

Bit	Field	Type	Reset	Description
				RXMAXP and RXCOUNT are both registers within the Mentor controller. * The XDMA will continue to request RX packets from the Mentor controller until a short packet is received. * When the CPPI is configured for chaining mode, the Buffer Descriptor sizes must be integer multiples of the RXMAXP size. * Transmit mode is not supported. * USB0 or USB1 Auto Req register should be set to AUTO REQ ALWAYS.

16.5.2.15 USB0GENRNDISEP1 Register (offset = 1080h) [reset = 0h]

 USB0GENRNDISEP1 is shown in [Figure 16-78](#) and described in [Table 16-87](#).

Figure 16-78. USB0GENRNDISEP1 Register

31	30	29	28	27	26	25	24	23	22	21	20	19	18	17	16	15	14	13	12	11	10	9	8	7	6	5	4	3	2	1	0
RESERVED																EP1_SIZE															
R/W-0h																R/W-0h															

LEGEND: R/W = Read/Write; R = Read only; W1toCl = Write 1 to clear bit; -n = value after reset

Table 16-87. USB0GENRNDISEP1 Register Field Descriptions

Bit	Field	Type	Reset	Description
31-17	RESERVED	R/W	0h	
16-0	EP1_SIZE	R/W	0h	Generic RNDIS packet size. USB0 Generic RNDIS EP N Size Register

16.5.2.16 USB0GENRNDISEP2 Register (offset = 1084h) [reset = 0h]

USB0GENRNDISEP2 is shown in [Figure 16-79](#) and described in [Table 16-88](#).

Figure 16-79. USB0GENRNDISEP2 Register

31	30	29	28	27	26	25	24	23	22	21	20	19	18	17	16	15	14	13	12	11	10	9	8	7	6	5	4	3	2	1	0
RESERVED																EP2_SIZE															
R/W-0h																R/W-0h															

LEGEND: R/W = Read/Write; R = Read only; W1toCl = Write 1 to clear bit; -n = value after reset

Table 16-88. USB0GENRNDISEP2 Register Field Descriptions

Bit	Field	Type	Reset	Description
31-17	RESERVED	R/W	0h	
16-0	EP2_SIZE	R/W	0h	Generic RNDIS packet size. USB0 Generic RNDIS EP N Size Register

16.5.2.17 USB0GENRNDISEP3 Register (offset = 1088h) [reset = 0h]

 USB0GENRNDISEP3 is shown in [Figure 16-80](#) and described in [Table 16-89](#).

Figure 16-80. USB0GENRNDISEP3 Register

31	30	29	28	27	26	25	24	23	22	21	20	19	18	17	16	15	14	13	12	11	10	9	8	7	6	5	4	3	2	1	0
RESERVED															EP3_SIZE																
R/W-0h															R/W-0h																

LEGEND: R/W = Read/Write; R = Read only; W1toCl = Write 1 to clear bit; -n = value after reset

Table 16-89. USB0GENRNDISEP3 Register Field Descriptions

Bit	Field	Type	Reset	Description
31-17	RESERVED	R/W	0h	
16-0	EP3_SIZE	R/W	0h	Generic RNDIS packet size. USB0 Generic RNDIS EP N Size Register

16.5.2.18 USB0GENRNDISEP4 Register (offset = 108Ch) [reset = 0h]

USB0GENRNDISEP4 is shown in [Figure 16-81](#) and described in [Table 16-90](#).

Figure 16-81. USB0GENRNDISEP4 Register

31	30	29	28	27	26	25	24	23	22	21	20	19	18	17	16	15	14	13	12	11	10	9	8	7	6	5	4	3	2	1	0
RESERVED																EP4_SIZE															
R/W-0h																R/W-0h															

LEGEND: R/W = Read/Write; R = Read only; W1toCl = Write 1 to clear bit; -n = value after reset

Table 16-90. USB0GENRNDISEP4 Register Field Descriptions

Bit	Field	Type	Reset	Description
31-17	RESERVED	R/W	0h	
16-0	EP4_SIZE	R/W	0h	Generic RNDIS packet size. USB0 Generic RNDIS EP N Size Register

16.5.2.19 USB0GENRNDISEP5 Register (offset = 1090h) [reset = 0h]

 USB0GENRNDISEP5 is shown in [Figure 16-82](#) and described in [Table 16-91](#).

Figure 16-82. USB0GENRNDISEP5 Register

31	30	29	28	27	26	25	24	23	22	21	20	19	18	17	16	15	14	13	12	11	10	9	8	7	6	5	4	3	2	1	0
RESERVED																EP5_SIZE															
R/W-0h																R/W-0h															

LEGEND: R/W = Read/Write; R = Read only; W1toCl = Write 1 to clear bit; -n = value after reset

Table 16-91. USB0GENRNDISEP5 Register Field Descriptions

Bit	Field	Type	Reset	Description
31-17	RESERVED	R/W	0h	
16-0	EP5_SIZE	R/W	0h	Generic RNDIS packet size. USB0 Generic RNDIS EP N Size Register

16.5.2.20 USB0GENRNDISEP6 Register (offset = 1094h) [reset = 0h]

USB0GENRNDISEP6 is shown in [Figure 16-83](#) and described in [Table 16-92](#).

Figure 16-83. USB0GENRNDISEP6 Register

31	30	29	28	27	26	25	24	23	22	21	20	19	18	17	16	15	14	13	12	11	10	9	8	7	6	5	4	3	2	1	0
RESERVED																EP6_SIZE															
R/W-0h																R/W-0h															

LEGEND: R/W = Read/Write; R = Read only; W1toCl = Write 1 to clear bit; -n = value after reset

Table 16-92. USB0GENRNDISEP6 Register Field Descriptions

Bit	Field	Type	Reset	Description
31-17	RESERVED	R/W	0h	
16-0	EP6_SIZE	R/W	0h	Generic RNDIS packet size. USB0 Generic RNDIS EP N Size Register

16.5.2.21 USB0GENRNDISEP7 Register (offset = 1098h) [reset = 0h]

 USB0GENRNDISEP7 is shown in [Figure 16-84](#) and described in [Table 16-93](#).

Figure 16-84. USB0GENRNDISEP7 Register

31	30	29	28	27	26	25	24	23	22	21	20	19	18	17	16	15	14	13	12	11	10	9	8	7	6	5	4	3	2	1	0
RESERVED																EP7_SIZE															
R/W-0h																R/W-0h															

LEGEND: R/W = Read/Write; R = Read only; W1toCl = Write 1 to clear bit; -n = value after reset

Table 16-93. USB0GENRNDISEP7 Register Field Descriptions

Bit	Field	Type	Reset	Description
31-17	RESERVED	R/W	0h	
16-0	EP7_SIZE	R/W	0h	Generic RNDIS packet size. USB0 Generic RNDIS EP N Size Register

16.5.2.22 USB0GENRNDISEP8 Register (offset = 109Ch) [reset = 0h]

USB0GENRNDISEP8 is shown in [Figure 16-85](#) and described in [Table 16-94](#).

Figure 16-85. USB0GENRNDISEP8 Register

31	30	29	28	27	26	25	24	23	22	21	20	19	18	17	16	15	14	13	12	11	10	9	8	7	6	5	4	3	2	1	0
RESERVED																EP8_SIZE															
R/W-0h																R/W-0h															

LEGEND: R/W = Read/Write; R = Read only; W1toCl = Write 1 to clear bit; -n = value after reset

Table 16-94. USB0GENRNDISEP8 Register Field Descriptions

Bit	Field	Type	Reset	Description
31-17	RESERVED	R/W	0h	
16-0	EP8_SIZE	R/W	0h	Generic RNDIS packet size. USB0 Generic RNDIS EP N Size Register

16.5.2.23 USB0GENRNDISEP9 Register (offset = 10A0h) [reset = 0h]

 USB0GENRNDISEP9 is shown in [Figure 16-86](#) and described in [Table 16-95](#).

Figure 16-86. USB0GENRNDISEP9 Register

31	30	29	28	27	26	25	24	23	22	21	20	19	18	17	16	15	14	13	12	11	10	9	8	7	6	5	4	3	2	1	0
RESERVED																EP9_SIZE															
R/W-0h																R/W-0h															

LEGEND: R/W = Read/Write; R = Read only; W1toCl = Write 1 to clear bit; -n = value after reset

Table 16-95. USB0GENRNDISEP9 Register Field Descriptions

Bit	Field	Type	Reset	Description
31-17	RESERVED	R/W	0h	
16-0	EP9_SIZE	R/W	0h	Generic RNDIS packet size. USB0 Generic RNDIS EP N Size Register

16.5.2.24 USB0GENRNDISEP10 Register (offset = 10A4h) [reset = 0h]

USB0GENRNDISEP10 is shown in [Figure 16-87](#) and described in [Table 16-96](#).

Figure 16-87. USB0GENRNDISEP10 Register

31	30	29	28	27	26	25	24	23	22	21	20	19	18	17	16	15	14	13	12	11	10	9	8	7	6	5	4	3	2	1	0
RESERVED																EP10_SIZE															
R/W-0h																R/W-0h															

LEGEND: R/W = Read/Write; R = Read only; W1toCl = Write 1 to clear bit; -n = value after reset

Table 16-96. USB0GENRNDISEP10 Register Field Descriptions

Bit	Field	Type	Reset	Description
31-17	RESERVED	R/W	0h	
16-0	EP10_SIZE	R/W	0h	Generic RNDIS packet size. USB0 Generic RNDIS EP N Size Register

16.5.2.25 USB0GENRNDISEP11 Register (offset = 10A8h) [reset = 0h]

USB0GENRNDISEP11 is shown in [Figure 16-88](#) and described in [Table 16-97](#).

Figure 16-88. USB0GENRNDISEP11 Register

31	30	29	28	27	26	25	24	23	22	21	20	19	18	17	16	15	14	13	12	11	10	9	8	7	6	5	4	3	2	1	0
RESERVED																EP11_SIZE															
R/W-0h																R/W-0h															

LEGEND: R/W = Read/Write; R = Read only; W1toCl = Write 1 to clear bit; -n = value after reset

Table 16-97. USB0GENRNDISEP11 Register Field Descriptions

Bit	Field	Type	Reset	Description
31-17	RESERVED	R/W	0h	
16-0	EP11_SIZE	R/W	0h	Generic RNDIS packet size. USB0 Generic RNDIS EP N Size Register

16.5.2.26 USB0GENRNDISEP12 Register (offset = 10ACh) [reset = 0h]

USB0GENRNDISEP12 is shown in [Figure 16-89](#) and described in [Table 16-98](#).

Figure 16-89. USB0GENRNDISEP12 Register

31	30	29	28	27	26	25	24	23	22	21	20	19	18	17	16	15	14	13	12	11	10	9	8	7	6	5	4	3	2	1	0
RESERVED																EP12_SIZE															
R/W-0h																R/W-0h															

LEGEND: R/W = Read/Write; R = Read only; W1toCl = Write 1 to clear bit; -n = value after reset

Table 16-98. USB0GENRNDISEP12 Register Field Descriptions

Bit	Field	Type	Reset	Description
31-17	RESERVED	R/W	0h	
16-0	EP12_SIZE	R/W	0h	Generic RNDIS packet size. USB0 Generic RNDIS EP N Size Register

16.5.2.27 USB0GENRNDISEP13 Register (offset = 10B0h) [reset = 0h]

 USB0GENRNDISEP13 is shown in [Figure 16-90](#) and described in [Table 16-99](#).

Figure 16-90. USB0GENRNDISEP13 Register

31	30	29	28	27	26	25	24	23	22	21	20	19	18	17	16	15	14	13	12	11	10	9	8	7	6	5	4	3	2	1	0
RESERVED																EP13_SIZE															
R/W-0h																R/W-0h															

LEGEND: R/W = Read/Write; R = Read only; W1toCl = Write 1 to clear bit; -n = value after reset

Table 16-99. USB0GENRNDISEP13 Register Field Descriptions

Bit	Field	Type	Reset	Description
31-17	RESERVED	R/W	0h	
16-0	EP13_SIZE	R/W	0h	Generic RNDIS packet size. USB0 Generic RNDIS EP N Size Register

16.5.2.28 USB0GENRNDISEP14 Register (offset = 10B4h) [reset = 0h]

USB0GENRNDISEP14 is shown in [Figure 16-91](#) and described in [Table 16-100](#).

Figure 16-91. USB0GENRNDISEP14 Register

31	30	29	28	27	26	25	24	23	22	21	20	19	18	17	16	15	14	13	12	11	10	9	8	7	6	5	4	3	2	1	0
RESERVED															EP14_SIZE																
R/W-0h															R/W-0h																

LEGEND: R/W = Read/Write; R = Read only; W1toCl = Write 1 to clear bit; -n = value after reset

Table 16-100. USB0GENRNDISEP14 Register Field Descriptions

Bit	Field	Type	Reset	Description
31-17	RESERVED	R/W	0h	
16-0	EP14_SIZE	R/W	0h	Generic RNDIS packet size. USB0 Generic RNDIS EP N Size Register

16.5.2.29 USB0GENRNDISEP15 Register (offset = 10B8h) [reset = 0h]

USB0GENRNDISEP15 is shown in [Figure 16-92](#) and described in [Table 16-101](#).

Figure 16-92. USB0GENRNDISEP15 Register

31	30	29	28	27	26	25	24	23	22	21	20	19	18	17	16	15	14	13	12	11	10	9	8	7	6	5	4	3	2	1	0
RESERVED																EP15_SIZE															
R/W-0h																R/W-0h															

LEGEND: R/W = Read/Write; R = Read only; W1toCl = Write 1 to clear bit; -n = value after reset

Table 16-101. USB0GENRNDISEP15 Register Field Descriptions

Bit	Field	Type	Reset	Description
31-17	RESERVED	R/W	0h	
16-0	EP15_SIZE	R/W	0h	Generic RNDIS packet size. USB0 Generic RNDIS EP N Size Register

16.5.2.30 USB0AUTOREQ Register (offset = 10D0h) [reset = 0h]

USB0AUTOREQ is shown in [Figure 16-93](#) and described in [Table 16-102](#).

Figure 16-93. USB0AUTOREQ Register

31	30	29	28	27	26	25	24
RESERVED		RX15_AUTOREQ		RX14_AUTOREQ		RX13_AUTOREQ	
R/W-0h		R/W-0h		R/W-0h		R/W-0h	
23	22	21	20	19	18	17	16
RX12_AUTOREQ		RX11_AUTOREQ		RX10_AUTOREQ		RX9_AUTOREQ	
R/W-0h		R/W-0h		R/W-0h		R/W-0h	
15	14	13	12	11	10	9	8
RX8_AUTOREQ		RX7_AUTOREQ		RX6_AUTOREQ		RX5_AUTOREQ	
R/W-0h		R/W-0h		R/W-0h		R/W-0h	
7	6	5	4	3	2	1	0
RX4_AUTOREQ		RX3_AUTOREQ		RX2_AUTOREQ		RX1_AUTOREQ	
R/W-0h		R/W-0h		R/W-0h		R/W-0h	

LEGEND: R/W = Read/Write; R = Read only; W1toCl = Write 1 to clear bit; -n = value after reset

Table 16-102. USB0AUTOREQ Register Field Descriptions

Bit	Field	Type	Reset	Description
31-30	RESERVED	R/W	0h	
29-28	RX15_AUTOREQ	R/W	0h	RX endpoint 14 Auto Req enable 00 = no auto req 01 = auto req on all but EOP 10 = reserved 11 = auto req always
27-26	RX14_AUTOREQ	R/W	0h	RX endpoint 13 Auto Req enable 00 = no auto req 01 = auto req on all but EOP 10 = reserved 11 = auto req always
25-24	RX13_AUTOREQ	R/W	0h	RX endpoint 12 Auto Req enable 00 = no auto req 01 = auto req on all but EOP 10 = reserved 11 = auto req always
23-22	RX12_AUTOREQ	R/W	0h	RX endpoint 11 Auto Req enable 00 = no auto req 01 = auto req on all but EOP 10 = reserved 11 = auto req always
21-20	RX11_AUTOREQ	R/W	0h	RX endpoint 10 Auto Req enable 00 = no auto req 01 = auto req on all but EOP 10 = reserved 11 = auto req always
19-18	RX10_AUTOREQ	R/W	0h	RX endpoint 9 Auto Req enable 00 = no auto req 01 = auto req on all but EOP 10 = reserved 11 = auto req always
17-16	RX9_AUTOREQ	R/W	0h	RX endpoint 8 Auto Req enable 00 = no auto req 01 = auto req on all but EOP 10 = reserved 11 = auto req always

Table 16-102. USB0AUTOREQ Register Field Descriptions (continued)

Bit	Field	Type	Reset	Description
15-14	RX8_AUTOREQ	R/W	0h	RX endpoint 7 Auto Req enable 00 = no auto req 01 = auto req on all but EOP 10 = reserved 11 = auto req always
13-12	RX7_AUTOREQ	R/W	0h	RX endpoint 6 Auto Req enable 00 = no auto req 01 = auto req on all but EOP 10 = reserved 11 = auto req always
11-10	RX6_AUTOREQ	R/W	0h	RX endpoint 5 Auto Req enable 00 = no auto req 01 = auto req on all but EOP 10 = reserved 11 = auto req always
9-8	RX5_AUTOREQ	R/W	0h	RX endpoint 4 Auto Req enable 00 = no auto req 01 = auto req on all but EOP 10 = reserved 11 = auto req always
7-6	RX4_AUTOREQ	R/W	0h	RX endpoint 3 Auto Req enable 00 = no auto req 01 = auto req on all but EOP 10 = reserved 11 = auto req always
5-4	RX3_AUTOREQ	R/W	0h	RX endpoint 2 Auto Req enable 00 = no auto req 01 = auto req on all but EOP 10 = reserved 11 = auto req always
3-2	RX2_AUTOREQ	R/W	0h	RX endpoint 1 Auto Req enable 00 = no auto req 01 = auto req on all but EOP 10 = reserved 11 = auto req always
1-0	RX1_AUTOREQ	R/W	0h	RX endpoint 0 Auto Req enable 00 = no auto req 01 = auto req on all but EOP 10 = reserved 11 = auto req always USB0 Auto Req Registers

16.5.2.31 USB0SRPFIXTIME Register (offset = 10D4h) [reset = 280DE80h]

USB0SRPFIXTIME is shown in [Figure 16-94](#) and described in [Table 16-103](#).

Figure 16-94. USB0SRPFIXTIME Register

31	30	29	28	27	26	25	24	23	22	21	20	19	18	17	16	15	14	13	12	11	10	9	8	7	6	5	4	3	2	1	0
SRPFIXTIME																															
R/W-280DE80h																															

LEGEND: R/W = Read/Write; R = Read only; W1toCl = Write 1 to clear bit; -n = value after reset

Table 16-103. USB0SRPFIXTIME Register Field Descriptions

Bit	Field	Type	Reset	Description
31-0	SRPFIXTIME	R/W	280DE80h	SRP Fix maximum time in 60 MHz cycles. Default is 700 ms. USB0 SRP Fix Time Register

16.5.2.32 USB0_TDOWN Register (offset = 10D8h) [reset = 0h]

 USB0_TDOWN is shown in [Figure 16-95](#) and described in [Table 16-104](#).

Figure 16-95. USB0_TDOWN Register

31	30	29	28	27	26	25	24	23	22	21	20	19	18	17	16	15	14	13	12	11	10	9	8	7	6	5	4	3	2	1	0
TX_TDOWN															R	RX_TDOWN											R				
															R E S E R V E D												R E S E R V E D				
R/W-0h															R/ W - 0h	R/W-0h											R/ W - 0h				

LEGEND: R/W = Read/Write; R = Read only; W1toCl = Write 1 to clear bit; -n = value after reset

Table 16-104. USB0_TDOWN Register Field Descriptions

Bit	Field	Type	Reset	Description
31-17	TX_TDOWN	R/W	0h	Tx Endpoint Teardown. Write '1' to corresponding bit to set. Read as '0'. Bit 31 = Endpoint 15 ... Bit 17 = Endpoint 1
16	RESERVED	R/W	0h	
15-1	RX_TDOWN	R/W	0h	RX Endpoint Teardown. Write '1' to corresponding bit to set. Read as '0'. Bit 15 = Endpoint 15 ... Bit 1 = Endpoint 1
0	RESERVED	R/W	0h	

16.5.2.33 USB0UTMI Register (offset = 10E0h) [reset = 20002h]

USB0UTMI is shown in [Figure 16-96](#) and described in [Table 16-105](#).

Figure 16-96. USB0UTMI Register

31								30								29								28								27								26								25								24							
RESERVED																																																															
R/W-0h																																																															
23								22								21								20								19								18								17								16							
TXBITSTUFFEN								TXBITSTUFFENH								OTGDISABLE								VBUSVLDEXTSEL								VBUSVLDEXT								TXENABLEN								FSXCVROWNER								TXVALIDH							
R/W-0h								R/W-0h								R/W-1h								R/W-0h								R/W-0h								R/W-0h								R/W-0h								R/W-0h							
15								14								13								12								11								10								9								8							
DATAINH																																																															
R/W-0h																																																															
7								6								5								4								3								2								1								0							
RESERVED																																WORDINTERFACE								FSDATAEXT								FSSE0EXT															
R/W-0h																																R/W-0h								R/W-1h								R/W-0h															

LEGEND: R/W = Read/Write; R = Read only; W1toCl = Write 1 to clear bit; -n = value after reset

Table 16-105. USB0UTMI Register Field Descriptions

Bit	Field	Type	Reset	Description
31-24	RESERVED	R/W	0h	
23	TXBITSTUFFEN	R/W	0h	PHY UTMI input for signal txbitstuffen
22	TXBITSTUFFENH	R/W	0h	PHY UTMI input for signal txbitstuffenh
21	OTGDISABLE	R/W	1h	PHY UTMI input for signal otgdisable
20	VBUSVLDEXTSEL	R/W	0h	PHY UTMI input for signal vbusvldextsel
19	VBUSVLDEXT	R/W	0h	PHY UTMI input for signal vbusvldext
18	TXENABLEN	R/W	0h	PHY UTMI input for signal txenablen
17	FSXCVROWNER	R/W	0h	PHY UTMI input for signal fsxcvrowner
16	TXVALIDH	R/W	0h	PHY UTMI input for signal txvalidh
15-8	DATAINH	R/W	0h	PHY UTMI input for signal datainh
7-3	RESERVED	R/W	0h	
2	WORDINTERFACE	R/W	0h	PHY UTMI input for signal wordinterface
1	FSDATAEXT	R/W	1h	PHY UTMI input for signal fsdataext
0	FSSE0EXT	R/W	0h	PHY UTMI input for signal fsse0ext USB0 PHY UTMI Register

16.5.2.34 USB0MGCUTMILB Register (offset = 10E4h) [reset = 82h]

 USB0MGCUTMILB is shown in [Figure 16-97](#) and described in [Table 16-106](#).

Figure 16-97. USB0MGCUTMILB Register

31	30	29	28	27	26	25	24
RESERVED			SUSPENDM	OPMODE		TXVALID	XCVRSEL
R/W-0h			R-0h	R-0h		R-0h	R-0h
23	22	21	20	19	18	17	16
XCVRSEL	TERMSEL	DRVVBUS	CHRGVBUS	DISCHRGVBU S	DPPULLDOWN	DMPULLDOWN	IDPULLUP
R-0h	R-0h	R-0h	R-0h	R-0h	R-0h	R-0h	R-0h
15	14	13	12	11	10	9	8
RESERVED				IDDIG	HOSTDISCON	SESSEND	AVALID
R/W-0h				R/W-0h	R/W-0h	R/W-0h	R/W-0h
7	6	5	4	3	2	1	0
VBUSVALID	RXERROR	RESERVED		LINESTATE		RESERVED	
R/W-1h	R/W-0h	R/W-0h		R/W-0h		R/W-2h	

LEGEND: R/W = Read/Write; R = Read only; W1toCl = Write 1 to clear bit; -n = value after reset

Table 16-106. USB0MGCUTMILB Register Field Descriptions

Bit	Field	Type	Reset	Description
31-29	RESERVED	R/W	0h	
28	SUSPENDM	R	0h	loopback test observed value for suspendm
27-26	OPMODE	R	0h	loopback test observed value for opmode
25	TXVALID	R	0h	loopback test observed value for txvalid
24-23	XCVRSEL	R	0h	loopback test observed value for xcvsel
22	TERMSEL	R	0h	loopback test observed value for termssel
21	DRVVBUS	R	0h	loopback test observed value for drvdbus
20	CHRGVBUS	R	0h	loopback test observed value for chrgvbus
19	DISCHRGVBUS	R	0h	loopback test observed value for dischrgvbus
18	DPPULLDOWN	R	0h	loopback test observed value for dppulldown
17	DMPULLDOWN	R	0h	loopback test observed value for dmpulldown
16	IDPULLUP	R	0h	loopback test observed value for idpullup
15-12	RESERVED	R/W	0h	
11	IDDIG	R/W	0h	loopback test value for iddig
10	HOSTDISCON	R/W	0h	loopback test value for hostdiscon
9	SESSEND	R/W	0h	loopback test value for sessend
8	AVALID	R/W	0h	loopback test value for avalid
7	VBUSVALID	R/W	1h	loopback test value for vbusvalid
6	RXERROR	R/W	0h	loopback test value for rxerror
5-4	RESERVED	R/W	0h	
3-2	LINESTATE	R/W	0h	loopback test value for linestate
1-0	RESERVED	R/W	2h	

16.5.2.35 USB0MODE Register (offset = 10E8h) [reset = 100h]

USB0MODE is shown in [Figure 16-98](#) and described in [Table 16-107](#).

Figure 16-98. USB0MODE Register

31	30	29	28	27	26	25	24
RESERVED							
R/W-0h							
23	22	21	20	19	18	17	16
RESERVED							
R/W-0h							
15	14	13	12	11	10	9	8
RESERVED							IDDIG
R/W-0h							R/W-1h
7	6	5	4	3	2	1	0
IDDIG_MUX	RESERVED					PHY_TEST	LOOPBACK
R/W-0h	R/W-0h				R/W-0h	R/W-0h	

LEGEND: R/W = Read/Write; R = Read only; W1toCl = Write 1 to clear bit; -n = value after reset

Table 16-107. USB0MODE Register Field Descriptions

Bit	Field	Type	Reset	Description
31-9	RESERVED	R/W	0h	
8	IDDIG	R/W	1h	MGC input value for iddig 0=A type 1=B type
7	IDDIG_MUX	R/W	0h	Multiplexer control for IDDIG signal going to the controller. 0 = IDDIG is from PHY0. 1 = IDDIG is from bit 8 (IDDIG) of this USB0MODE register.
6-2	RESERVED	R/W	0h	
1	PHY_TEST	R/W	0h	PHY test 0 = Normal mode 1 = PHY test mode
0	LOOPBACK	R/W	0h	Loopback test mode 0 = Normal mode 1 = Loopback test mode USB0 Mode Register

16.5.3 USB1_CTRL Registers

[Table 16-108](#) lists the memory-mapped registers for the USB1_CTRL. All register offset addresses not listed in [Table 16-108](#) should be considered as reserved locations and the register contents should not be modified.

Table 16-108. USB1_CTRL Registers

Offset	Acronym	Register Name	Section
1800h	USB1REV		Section 16.5.3.1
1814h	USB1CTRL		Section 16.5.3.2
1818h	USB1STAT		Section 16.5.3.3
1820h	USB1IRQMSTAT		Section 16.5.3.4
1828h	USB1IRQSTATRAW0		Section 16.5.3.5
182Ch	USB1IRQSTATRAW1		Section 16.5.3.6
1830h	USB1IRQSTAT0		Section 16.5.3.7
1834h	USB1IRQSTAT1		Section 16.5.3.8
1838h	USB1IRQENABLESET0		Section 16.5.3.9
183Ch	USB1IRQENABLESET1		Section 16.5.3.10

Table 16-108. USB1_CTRL Registers (continued)

Offset	Acronym	Register Name	Section
1840h	USB1IRQENABLECLR0		Section 16.5.3.11
1844h	USB1IRQENABLECLR1		Section 16.5.3.12
1870h	USB1TXMODE		Section 16.5.3.13
1874h	USB1RXMODE		Section 16.5.3.14
1880h	USB1GENRNDISEP1		Section 16.5.3.15
1884h	USB1GENRNDISEP2		Section 16.5.3.16
1888h	USB1GENRNDISEP3		Section 16.5.3.17
188Ch	USB1GENRNDISEP4		Section 16.5.3.18
1890h	USB1GENRNDISEP5		Section 16.5.3.19
1894h	USB1GENRNDISEP6		Section 16.5.3.20
1898h	USB1GENRNDISEP7		Section 16.5.3.21
189Ch	USB1GENRNDISEP8		Section 16.5.3.22
18A0h	USB1GENRNDISEP9		Section 16.5.3.23
18A4h	USB1GENRNDISEP10		Section 16.5.3.24
18A8h	USB1GENRNDISEP11		Section 16.5.3.25
18ACh	USB1GENRNDISEP12		Section 16.5.3.26
18B0h	USB1GENRNDISEP13		Section 16.5.3.27
18B4h	USB1GENRNDISEP14		Section 16.5.3.28
18B8h	USB1GENRNDISEP15		Section 16.5.3.29
18D0h	USB1AUTOREQ		Section 16.5.3.30
18D4h	USB1SRPFXITIME		Section 16.5.3.31
18D8h	USB1TDOWN		Section 16.5.3.32
18E0h	USB1UTMI		Section 16.5.3.33
18E4h	USB1UTMILB		Section 16.5.3.34
18E8h	USB1MODE		Section 16.5.3.35

16.5.3.1 USB1REV Register (offset = 1800h) [reset = 4EA20800h]

USB1REV is shown in [Figure 16-99](#) and described in [Table 16-109](#).

Figure 16-99. USB1REV Register

31	30	29	28	27	26	25	24	23	22	21	20	19	18	17	16
SCHEME		RESERVED			FUNC										
R-1h		R-0h			R-EA2h										
15	14	13	12	11	10	9	8	7	6	5	4	3	2	1	0
R_RTL				X_MAJOR			CUSTOM			Y_MINOR					
R-1h				R-0h			R-0h			R-0h					

LEGEND: R/W = Read/Write; R = Read only; W1toCl = Write 1 to clear bit; -n = value after reset

Table 16-109. USB1REV Register Field Descriptions

Bit	Field	Type	Reset	Description
31-30	SCHEME	R	1h	Used to distinguish between legacy interface scheme and current. 0 = Legacy 1 = Current
29-28	RESERVED	R	0h	
27-16	FUNC	R	EA2h	Function indicates a software compatible module family.
15-11	R_RTL	R	1h	RTL revision. Will vary depending on release.
10-8	X_MAJOR	R	0h	Major revision.
7-6	CUSTOM	R	0h	Custom revision
5-0	Y_MINOR	R	0h	Minor revision. USB1 Revision Register

16.5.3.2 USB1CTRL Register (offset = 1814h) [reset = 0h]

USB1CTRL is shown in [Figure 16-100](#) and described in [Table 16-110](#).

Figure 16-100. USB1CTRL Register

31	30	29	28	27	26	25	24
DIS_DEB	DIS_SRP	RESERVED					
R/W-0h	R/W-0h	R/W-0h					
23	22	21	20	19	18	17	16
RESERVED							
R/W-0h							
15	14	13	12	11	10	9	8
RESERVED							
R/W-0h							
7	6	5	4	3	2	1	0
RESERVED		SOFT_RESET_ISOLATION	RNDIS	UINT	RESERVED	CLKFACK	SOFT_RESET
R/W-0h		R/W-0h	R/W-0h	R/W-0h	R/W-0h	R/W-0h	R/W-0h

LEGEND: R/W = Read/Write; R = Read only; W1toCl = Write 1 to clear bit; -n = value after reset

Table 16-110. USB1CTRL Register Field Descriptions

Bit	Field	Type	Reset	Description
31	DIS_DEB	R/W	0h	Disable the VBUS debouncer circuit fix
30	DIS_SRP	R/W	0h	Disable the OTG Session Request Protocol (SRP) AVALID circuit fix. When enabled (=0) this allows additional time for the VBUS signal to be measured against the VBUS thresholds. The time is specified in the USB0 SRP Fix Time Register.
29-6	RESERVED	R/W	0h	
5	SOFT_RESET_ISOLATION	R/W	0h	Soft reset isolation. When high this bit forces all USB1 signals that connect to the USBSS to known values during a soft reset via bit 0 of this register. This bit should be set high prior to setting bit 0 and cleared after bit 0 is cleared.
4	RNDIS	R/W	0h	Global RNDIS mode enable for all endpoints.
3	UINT	R/W	0h	USB interrupt enable 1 = Legacy 0 = Current (recommended setting) If uint is set high, then the mentor controller generic interrupt for USB[9] will be generated (if enabled). This requires S/W to read the mentor controller's registers to determine which interrupt from USB[0] to USB[7] that occurred. If uint is set low, then the usb20otg_f module will automatically read the mentor controller's registers and set the appropriate interrupt from USB[0] to USB[7] (if enabled). The generic interrupt for USB[9] will not be generated.
2	RESERVED	R/W	0h	
1	CLKFACK	R/W	0h	Clock stop fast ack enable.

Table 16-110. USB1CTRL Register Field Descriptions (continued)

Bit	Field	Type	Reset	Description
0	SOFT_RESET	R/W	0h	<p>Software reset of USB1. Write 0 = no action Write 1 = Initiate software reset Read 0 = Reset done, no action Read 1 = Reset ongoing Both the soft_reset and soft_reset_isolation bits should be asserted simultaneously. This will cause the following sequence of actions to occur over multiple cycles:</p> <ul style="list-style-type: none"> - All USB0 output signals will go to a known constant value via multiplexers. <p>This removes the possibility of timing errors due to the asynchronous resets.</p> <ul style="list-style-type: none"> - All USB0 registers will be reset. - The USB0 resets will be de-asserted. - The reset isolation multiplexer inputs will be de-selected. - Both the soft_reset and soft_reset_isolation bits will be automatically cleared. <p>Setting only the soft_reset_isolation bit will cause all USB0 output signals to go to a known constant value via multiplexers. This will prevent future access to USB0. To clear this condition the USBSS must be reset via a hard or soft reset.</p>

16.5.3.3 USB1STAT Register (offset = 1818h) [reset = 0h]

USB1STAT is shown in [Figure 16-101](#) and described in [Table 16-111](#).

Figure 16-101. USB1STAT Register

31	30	29	28	27	26	25	24
RESERVED							
R-0h							
23	22	21	20	19	18	17	16
RESERVED							
R-0h							
15	14	13	12	11	10	9	8
RESERVED							
R-0h							
7	6	5	4	3	2	1	0
RESERVED							DRVVBUS
R-0h							R-0h

LEGEND: R/W = Read/Write; R = Read only; W1toCl = Write 1 to clear bit; -n = value after reset

Table 16-111. USB1STAT Register Field Descriptions

Bit	Field	Type	Reset	Description
31-1	RESERVED	R	0h	
0	DRVVBUS	R	0h	Current DRVVBUS value USB1 Status Register

16.5.3.4 USB1IRQMSTAT Register (offset = 1820h) [reset = 0h]

USB1IRQMSTAT is shown in [Figure 16-102](#) and described in [Table 16-112](#).

Figure 16-102. USB1IRQMSTAT Register

31	30	29	28	27	26	25	24
RESERVED							
R-0h							
23	22	21	20	19	18	17	16
RESERVED							
R-0h							
15	14	13	12	11	10	9	8
RESERVED							
R-0h							
7	6	5	4	3	2	1	0
RESERVED						BANK1	BANK0
R-0h						R-0h	R-0h

LEGEND: R/W = Read/Write; R = Read only; W1toCl = Write 1 to clear bit; -n = value after reset

Table 16-112. USB1IRQMSTAT Register Field Descriptions

Bit	Field	Type	Reset	Description
31-2	RESERVED	R	0h	
1	BANK1	R	0h	0: No events pending from IRQ_STATUS_1 1: At least one event is pending from IRQ_STATUS_1
0	BANK0	R	0h	0: No events pending from IRQ_STATUS_0 1: At least one event is pending from IRQ_STATUS_0 USB1 IRQ_MERGED_STATUS Register

16.5.3.5 USB1IRQSTATRAW0 Register (offset = 1828h) [reset = 0h]

USB1IRQSTATRAW0 is shown in [Figure 16-103](#) and described in [Table 16-113](#).

Figure 16-103. USB1IRQSTATRAW0 Register

31		30		29		28		27		26		25		24	
RX_EP_15	RX_EP_14	RX_EP_13	RX_EP_12	RX_EP_11	RX_EP_10	RX_EP_9	RX_EP_8	RX_EP_7	RX_EP_6	RX_EP_5	RX_EP_4	RX_EP_3	RX_EP_2	RX_EP_1	RESERVED
R/W-0h		R/W-0h		R/W-0h		R/W-0h		R/W-0h		R/W-0h		R/W-0h		R/W-0h	
23		22		21		20		19		18		17		16	
RX_EP_7	RX_EP_6	RX_EP_5	RX_EP_4	RX_EP_3	RX_EP_2	RX_EP_1	RESERVED	RX_EP_7	RX_EP_6	RX_EP_5	RX_EP_4	RX_EP_3	RX_EP_2	RX_EP_1	RESERVED
R/W-0h		R/W-0h		R/W-0h		R/W-0h		R/W-0h		R/W-0h		R/W-0h		R/W-0h	
15		14		13		12		11		10		9		8	
TX_EP_15	TX_EP_14	TX_EP_13	TX_EP_12	TX_EP_11	TX_EP_10	TX_EP_9	TX_EP_8	TX_EP_15	TX_EP_14	TX_EP_13	TX_EP_12	TX_EP_11	TX_EP_10	TX_EP_9	TX_EP_8
R/W-0h		R/W-0h		R/W-0h		R/W-0h		R/W-0h		R/W-0h		R/W-0h		R/W-0h	
7		6		5		4		3		2		1		0	
TX_EP_7	TX_EP_6	TX_EP_5	TX_EP_4	TX_EP_3	TX_EP_2	TX_EP_1	TX_EP_0	TX_EP_7	TX_EP_6	TX_EP_5	TX_EP_4	TX_EP_3	TX_EP_2	TX_EP_1	TX_EP_0
R/W-0h		R/W-0h		R/W-0h		R/W-0h		R/W-0h		R/W-0h		R/W-0h		R/W-0h	

LEGEND: R/W = Read/Write; R = Read only; W1toCl = Write 1 to clear bit; -n = value after reset

Table 16-113. USB1IRQSTATRAW0 Register Field Descriptions

Bit	Field	Type	Reset	Description
31	RX_EP_15	R/W	0h	Interrupt status for RX endpoint 15
30	RX_EP_14	R/W	0h	Interrupt status for RX endpoint 14
29	RX_EP_13	R/W	0h	Interrupt status for RX endpoint 13
28	RX_EP_12	R/W	0h	Interrupt status for RX endpoint 12
27	RX_EP_11	R/W	0h	Interrupt status for RX endpoint 11
26	RX_EP_10	R/W	0h	Interrupt status for RX endpoint 10
25	RX_EP_9	R/W	0h	Interrupt status for RX endpoint 9
24	RX_EP_8	R/W	0h	Interrupt status for RX endpoint 8
23	RX_EP_7	R/W	0h	Interrupt status for RX endpoint 7
22	RX_EP_6	R/W	0h	Interrupt status for RX endpoint 6
21	RX_EP_5	R/W	0h	Interrupt status for RX endpoint 5
20	RX_EP_4	R/W	0h	Interrupt status for RX endpoint 4
19	RX_EP_3	R/W	0h	Interrupt status for RX endpoint 3
18	RX_EP_2	R/W	0h	Interrupt status for RX endpoint 2
17	RX_EP_1	R/W	0h	Interrupt status for RX endpoint 1
16	RESERVED	R/W	0h	
15	TX_EP_15	R/W	0h	Interrupt status for TX endpoint 15
14	TX_EP_14	R/W	0h	Interrupt status for TX endpoint 14
13	TX_EP_13	R/W	0h	Interrupt status for TX endpoint 13
12	TX_EP_12	R/W	0h	Interrupt status for TX endpoint 12
11	TX_EP_11	R/W	0h	Interrupt status for TX endpoint 11
10	TX_EP_10	R/W	0h	Interrupt status for TX endpoint 10
9	TX_EP_9	R/W	0h	Interrupt status for TX endpoint 9
8	TX_EP_8	R/W	0h	Interrupt status for TX endpoint 8
7	TX_EP_7	R/W	0h	Interrupt status for TX endpoint 7
6	TX_EP_6	R/W	0h	Interrupt status for TX endpoint 6

Table 16-113. USB1IRQSTATRAW0 Register Field Descriptions (continued)

Bit	Field	Type	Reset	Description
5	TX_EP_5	R/W	0h	Interrupt status for TX endpoint 5
4	TX_EP_4	R/W	0h	Interrupt status for TX endpoint 4
3	TX_EP_3	R/W	0h	Interrupt status for TX endpoint 3
2	TX_EP_2	R/W	0h	Interrupt status for TX endpoint 2
1	TX_EP_1	R/W	0h	Interrupt status for TX endpoint 1
0	TX_EP_0	R/W	0h	Interrupt status for TX endpoint 0 USB1 IRQ_STATUS_RAW_0 Register

16.5.3.6 USB1IRQSTATRAW1 Register (offset = 182Ch) [reset = 0h]

 USB1IRQSTATRAW1 is shown in [Figure 16-104](#) and described in [Table 16-114](#).

Figure 16-104. USB1IRQSTATRAW1 Register

31		30		29		28		27		26		25		24	
TX_FIFO_15	TX_FIFO_14	TX_FIFO_13	TX_FIFO_12	TX_FIFO_11	TX_FIFO_10	TX_FIFO_9	TX_FIFO_8								
R/W-0h	R/W-0h	R/W-0h	R/W-0h	R/W-0h	R/W-0h	R/W-0h	R/W-0h								
23		22		21		20		19		18		17		16	
TX_FIFO_7	TX_FIFO_6	TX_FIFO_5	TX_FIFO_4	TX_FIFO_3	TX_FIFO_2	TX_FIFO_1	RESERVED								
R/W-0h	R/W-0h	R/W-0h	R/W-0h	R/W-0h	R/W-0h	R/W-0h	R/W-0h								
15		14		13		12		11		10		9		8	
RESERVED											USB_9	USB_8			
R/W-0h											R/W-0h	R/W-0h			
7		6		5		4		3		2		1		0	
USB_7	USB_6	USB_5	USB_4	USB_3	USB_2	USB_1	USB_0								
R/W-0h	R/W-0h	R/W-0h	R/W-0h	R/W-0h	R/W-0h	R/W-0h	R/W-0h								

LEGEND: R/W = Read/Write; R = Read only; W1toCl = Write 1 to clear bit; -n = value after reset

Table 16-114. USB1IRQSTATRAW1 Register Field Descriptions

Bit	Field	Type	Reset	Description
31	TX_FIFO_15	R/W	0h	Interrupt status for TX FIFO endpoint 15
30	TX_FIFO_14	R/W	0h	Interrupt status for TX FIFO endpoint 14
29	TX_FIFO_13	R/W	0h	Interrupt status for TX FIFO endpoint 13
28	TX_FIFO_12	R/W	0h	Interrupt status for TX FIFO endpoint 12
27	TX_FIFO_11	R/W	0h	Interrupt status for TX FIFO endpoint 11
26	TX_FIFO_10	R/W	0h	Interrupt status for TX FIFO endpoint 10
25	TX_FIFO_9	R/W	0h	Interrupt status for TX FIFO endpoint 9
24	TX_FIFO_8	R/W	0h	Interrupt status for TX FIFO endpoint 8
23	TX_FIFO_7	R/W	0h	Interrupt status for TX FIFO endpoint 7
22	TX_FIFO_6	R/W	0h	Interrupt status for TX FIFO endpoint 6
21	TX_FIFO_5	R/W	0h	Interrupt status for TX FIFO endpoint 5
20	TX_FIFO_4	R/W	0h	Interrupt status for TX FIFO endpoint 4
19	TX_FIFO_3	R/W	0h	Interrupt status for TX FIFO endpoint 3
18	TX_FIFO_2	R/W	0h	Interrupt status for TX FIFO endpoint 2
17	TX_FIFO_1	R/W	0h	Interrupt status for TX FIFO endpoint 1
16-10	RESERVED	R/W	0h	
9	USB_9	R/W	0h	Interrupt status for Mentor controller USB_INT generic interrupt
8	USB_8	R/W	0h	Interrupt status for DRVVBUS level change
7	USB_7	R/W	0h	Interrupt status for VBUS < VBUS valid threshold
6	USB_6	R/W	0h	Interrupt status for SRP detected
5	USB_5	R/W	0h	Interrupt status for device disconnected (host mode)
4	USB_4	R/W	0h	Interrupt status for device connected (host mode)
3	USB_3	R/W	0h	Interrupt status for SOF started
2	USB_2	R/W	0h	Interrupt status for Reset signaling detected (peripheral mode) Babble detected (host mode)
1	USB_1	R/W	0h	Interrupt status for Resume signaling detected

Table 16-114. USB1IRQSTATRAW1 Register Field Descriptions (continued)

Bit	Field	Type	Reset	Description
0	USB_0	R/W	0h	Interrupt status for Suspend signaling detected USB1 IRQ_STATUS_RAW_1 Register

16.5.3.7 USB1IRQSTAT0 Register (offset = 1830h) [reset = 0h]

USB1IRQSTAT0 is shown in [Figure 16-105](#) and described in [Table 16-115](#).

Figure 16-105. USB1IRQSTAT0 Register

31		30		29		28		27		26		25		24	
RX_EP_15	RX_EP_14	RX_EP_13	RX_EP_12	RX_EP_11	RX_EP_10	RX_EP_9	RX_EP_8	RX_EP_7	RX_EP_6	RX_EP_5	RX_EP_4	RX_EP_3	RX_EP_2	RX_EP_1	RESERVED
R/W-0h	R/W-0h	R/W-0h	R/W-0h	R/W-0h	R/W-0h	R/W-0h	R/W-0h	R/W-0h	R/W-0h	R/W-0h	R/W-0h	R/W-0h	R/W-0h	R/W-0h	R/W-0h
23		22		21		20		19		18		17		16	
RX_EP_7	RX_EP_6	RX_EP_5	RX_EP_4	RX_EP_3	RX_EP_2	RX_EP_1	RESERVED	RX_EP_7	RX_EP_6	RX_EP_5	RX_EP_4	RX_EP_3	RX_EP_2	RX_EP_1	RESERVED
R/W-0h	R/W-0h	R/W-0h	R/W-0h	R/W-0h	R/W-0h	R/W-0h	R/W-0h	R/W-0h	R/W-0h	R/W-0h	R/W-0h	R/W-0h	R/W-0h	R/W-0h	R/W-0h
15		14		13		12		11		10		9		8	
TX_EP_15	TX_EP_14	TX_EP_13	TX_EP_12	TX_EP_11	TX_EP_10	TX_EP_9	TX_EP_8	TX_EP_7	TX_EP_6	TX_EP_5	TX_EP_4	TX_EP_3	TX_EP_2	TX_EP_1	TX_EP_0
R/W-0h	R/W-0h	R/W-0h	R/W-0h	R/W-0h	R/W-0h	R/W-0h	R/W-0h	R/W-0h	R/W-0h	R/W-0h	R/W-0h	R/W-0h	R/W-0h	R/W-0h	R/W-0h
7		6		5		4		3		2		1		0	
TX_EP_7	TX_EP_6	TX_EP_5	TX_EP_4	TX_EP_3	TX_EP_2	TX_EP_1	TX_EP_0	TX_EP_7	TX_EP_6	TX_EP_5	TX_EP_4	TX_EP_3	TX_EP_2	TX_EP_1	TX_EP_0
R/W-0h	R/W-0h	R/W-0h	R/W-0h	R/W-0h	R/W-0h	R/W-0h	R/W-0h	R/W-0h	R/W-0h	R/W-0h	R/W-0h	R/W-0h	R/W-0h	R/W-0h	R/W-0h

LEGEND: R/W = Read/Write; R = Read only; W1toCl = Write 1 to clear bit; -n = value after reset

Table 16-115. USB1IRQSTAT0 Register Field Descriptions

Bit	Field	Type	Reset	Description
31	RX_EP_15	R/W	0h	Interrupt status for RX endpoint 15
30	RX_EP_14	R/W	0h	Interrupt status for RX endpoint 14
29	RX_EP_13	R/W	0h	Interrupt status for RX endpoint 13
28	RX_EP_12	R/W	0h	Interrupt status for RX endpoint 12
27	RX_EP_11	R/W	0h	Interrupt status for RX endpoint 11
26	RX_EP_10	R/W	0h	Interrupt status for RX endpoint 10
25	RX_EP_9	R/W	0h	Interrupt status for RX endpoint 9
24	RX_EP_8	R/W	0h	Interrupt status for RX endpoint 8
23	RX_EP_7	R/W	0h	Interrupt status for RX endpoint 7
22	RX_EP_6	R/W	0h	Interrupt status for RX endpoint 6
21	RX_EP_5	R/W	0h	Interrupt status for RX endpoint 5
20	RX_EP_4	R/W	0h	Interrupt status for RX endpoint 4
19	RX_EP_3	R/W	0h	Interrupt status for RX endpoint 3
18	RX_EP_2	R/W	0h	Interrupt status for RX endpoint 2
17	RX_EP_1	R/W	0h	Interrupt status for RX endpoint 1
16	RESERVED	R/W	0h	
15	TX_EP_15	R/W	0h	Interrupt status for TX endpoint 15
14	TX_EP_14	R/W	0h	Interrupt status for TX endpoint 14
13	TX_EP_13	R/W	0h	Interrupt status for TX endpoint 13
12	TX_EP_12	R/W	0h	Interrupt status for TX endpoint 12
11	TX_EP_11	R/W	0h	Interrupt status for TX endpoint 11
10	TX_EP_10	R/W	0h	Interrupt status for TX endpoint 10
9	TX_EP_9	R/W	0h	Interrupt status for TX endpoint 9
8	TX_EP_8	R/W	0h	Interrupt status for TX endpoint 8
7	TX_EP_7	R/W	0h	Interrupt status for TX endpoint 7
6	TX_EP_6	R/W	0h	Interrupt status for TX endpoint 6

Table 16-115. USB1IRQSTAT0 Register Field Descriptions (continued)

Bit	Field	Type	Reset	Description
5	TX_EP_5	R/W	0h	Interrupt status for TX endpoint 5
4	TX_EP_4	R/W	0h	Interrupt status for TX endpoint 4
3	TX_EP_3	R/W	0h	Interrupt status for TX endpoint 3
2	TX_EP_2	R/W	0h	Interrupt status for TX endpoint 2
1	TX_EP_1	R/W	0h	Interrupt status for TX endpoint 1
0	TX_EP_0	R/W	0h	Interrupt status for TX endpoint 0 USB1 IRQ_STATUS_0 Register

16.5.3.8 USB1IRQSTAT1 Register (offset = 1834h) [reset = 0h]

USB1IRQSTAT1 is shown in [Figure 16-106](#) and described in [Table 16-116](#).

Figure 16-106. USB1IRQSTAT1 Register

31		30		29		28		27		26		25		24	
TX_FIFO_15	TX_FIFO_14	TX_FIFO_13	TX_FIFO_12	TX_FIFO_11	TX_FIFO_10	TX_FIFO_9	TX_FIFO_8								
R/W-0h	R/W-0h	R/W-0h	R/W-0h	R/W-0h	R/W-0h	R/W-0h	R/W-0h								
23		22		21		20		19		18		17		16	
TX_FIFO_7	TX_FIFO_6	TX_FIFO_5	TX_FIFO_4	TX_FIFO_3	TX_FIFO_2	TX_FIFO_1	RESERVED								
R/W-0h	R/W-0h	R/W-0h	R/W-0h	R/W-0h	R/W-0h	R/W-0h	R/W-0h								
15		14		13		12		11		10		9		8	
RESERVED												USB_9	USB_8		
R/W-0h												R/W-0h	R/W-0h		
7		6		5		4		3		2		1		0	
USB_7	USB_6	USB_5	USB_4	USB_3	USB_2	USB_1	USB_0								
R/W-0h	R/W-0h	R/W-0h	R/W-0h	R/W-0h	R/W-0h	R/W-0h	R/W-0h								

LEGEND: R/W = Read/Write; R = Read only; W1toCl = Write 1 to clear bit; -n = value after reset

Table 16-116. USB1IRQSTAT1 Register Field Descriptions

Bit	Field	Type	Reset	Description
31	TX_FIFO_15	R/W	0h	Interrupt status for TX FIFO endpoint 15
30	TX_FIFO_14	R/W	0h	Interrupt status for TX FIFO endpoint 14
29	TX_FIFO_13	R/W	0h	Interrupt status for TX FIFO endpoint 13
28	TX_FIFO_12	R/W	0h	Interrupt status for TX FIFO endpoint 12
27	TX_FIFO_11	R/W	0h	Interrupt status for TX FIFO endpoint 11
26	TX_FIFO_10	R/W	0h	Interrupt status for TX FIFO endpoint 10
25	TX_FIFO_9	R/W	0h	Interrupt status for TX FIFO endpoint 9
24	TX_FIFO_8	R/W	0h	Interrupt status for TX FIFO endpoint 8
23	TX_FIFO_7	R/W	0h	Interrupt status for TX FIFO endpoint 7
22	TX_FIFO_6	R/W	0h	Interrupt status for TX FIFO endpoint 6
21	TX_FIFO_5	R/W	0h	Interrupt status for TX FIFO endpoint 5
20	TX_FIFO_4	R/W	0h	Interrupt status for TX FIFO endpoint 4
19	TX_FIFO_3	R/W	0h	Interrupt status for TX FIFO endpoint 3
18	TX_FIFO_2	R/W	0h	Interrupt status for TX FIFO endpoint 2
17	TX_FIFO_1	R/W	0h	Interrupt status for TX FIFO endpoint 1
16-10	RESERVED	R/W	0h	
9	USB_9	R/W	0h	Interrupt status for Mentor controller USB_INT generic interrupt
8	USB_8	R/W	0h	Interrupt status for DRVVBUS level change
7	USB_7	R/W	0h	Interrupt status for VBUS < VBUS valid threshold
6	USB_6	R/W	0h	Interrupt status for SRP detected
5	USB_5	R/W	0h	Interrupt status for device disconnected (host mode)
4	USB_4	R/W	0h	Interrupt status for device connected (host mode)
3	USB_3	R/W	0h	Interrupt status for SOF started
2	USB_2	R/W	0h	Interrupt status for Reset signaling detected (peripheral mode) Babble detected (host mode)
1	USB_1	R/W	0h	Interrupt status for Resume signaling detected

Table 16-116. USB1IRQSTAT1 Register Field Descriptions (continued)

Bit	Field	Type	Reset	Description
0	USB_0	R/W	0h	Interrupt status for Suspend signaling detected USB1 IRQ_STATUS_1 Register

16.5.3.9 USB1IRQENABLESET0 Register (offset = 1838h) [reset = 0h]

 USB1IRQENABLESET0 is shown in [Figure 16-107](#) and described in [Table 16-117](#).

Figure 16-107. USB1IRQENABLESET0 Register

31		30		29		28		27		26		25		24	
RX_EP_15	RX_EP_14	RX_EP_13	RX_EP_12	RX_EP_11	RX_EP_10	RX_EP_9	RX_EP_8	RX_EP_7	RX_EP_6	RX_EP_5	RX_EP_4	RX_EP_3	RX_EP_2	RX_EP_1	RESERVED
R/W-0h		R/W-0h		R/W-0h		R/W-0h		R/W-0h		R/W-0h		R/W-0h		R/W-0h	
23		22		21		20		19		18		17		16	
RX_EP_7	RX_EP_6	RX_EP_5	RX_EP_4	RX_EP_3	RX_EP_2	RX_EP_1	RESERVED	RX_EP_7	RX_EP_6	RX_EP_5	RX_EP_4	RX_EP_3	RX_EP_2	RX_EP_1	RESERVED
R/W-0h		R/W-0h		R/W-0h		R/W-0h		R/W-0h		R/W-0h		R/W-0h		R/W-0h	
15		14		13		12		11		10		9		8	
TX_EP_15	TX_EP_14	TX_EP_13	TX_EP_12	TX_EP_11	TX_EP_10	TX_EP_9	TX_EP_8	TX_EP_7	TX_EP_6	TX_EP_5	TX_EP_4	TX_EP_3	TX_EP_2	TX_EP_1	TX_EP_0
R/W-0h		R/W-0h		R/W-0h		R/W-0h		R/W-0h		R/W-0h		R/W-0h		R/W-0h	
7		6		5		4		3		2		1		0	
TX_EP_7	TX_EP_6	TX_EP_5	TX_EP_4	TX_EP_3	TX_EP_2	TX_EP_1	TX_EP_0	TX_EP_7	TX_EP_6	TX_EP_5	TX_EP_4	TX_EP_3	TX_EP_2	TX_EP_1	TX_EP_0
R/W-0h		R/W-0h		R/W-0h		R/W-0h		R/W-0h		R/W-0h		R/W-0h		R/W-0h	

LEGEND: R/W = Read/Write; R = Read only; W1toCl = Write 1 to clear bit; -n = value after reset

Table 16-117. USB1IRQENABLESET0 Register Field Descriptions

Bit	Field	Type	Reset	Description
31	RX_EP_15	R/W	0h	Interrupt enable for RX endpoint 15
30	RX_EP_14	R/W	0h	Interrupt enable for RX endpoint 14
29	RX_EP_13	R/W	0h	Interrupt enable for RX endpoint 13
28	RX_EP_12	R/W	0h	Interrupt enable for RX endpoint 12
27	RX_EP_11	R/W	0h	Interrupt enable for RX endpoint 11
26	RX_EP_10	R/W	0h	Interrupt enable for RX endpoint 10
25	RX_EP_9	R/W	0h	Interrupt enable for RX endpoint 9
24	RX_EP_8	R/W	0h	Interrupt enable for RX endpoint 8
23	RX_EP_7	R/W	0h	Interrupt enable for RX endpoint 7
22	RX_EP_6	R/W	0h	Interrupt enable for RX endpoint 6
21	RX_EP_5	R/W	0h	Interrupt enable for RX endpoint 5
20	RX_EP_4	R/W	0h	Interrupt enable for RX endpoint 4
19	RX_EP_3	R/W	0h	Interrupt enable for RX endpoint 3
18	RX_EP_2	R/W	0h	Interrupt enable for RX endpoint 2
17	RX_EP_1	R/W	0h	Interrupt enable for RX endpoint 1
16	RESERVED	R/W	0h	
15	TX_EP_15	R/W	0h	Interrupt enable for TX endpoint 15
14	TX_EP_14	R/W	0h	Interrupt enable for TX endpoint 14
13	TX_EP_13	R/W	0h	Interrupt enable for TX endpoint 13
12	TX_EP_12	R/W	0h	Interrupt enable for TX endpoint 12
11	TX_EP_11	R/W	0h	Interrupt enable for TX endpoint 11
10	TX_EP_10	R/W	0h	Interrupt enable for TX endpoint 10
9	TX_EP_9	R/W	0h	Interrupt enable for TX endpoint 9
8	TX_EP_8	R/W	0h	Interrupt enable for TX endpoint 8
7	TX_EP_7	R/W	0h	Interrupt enable for TX endpoint 7
6	TX_EP_6	R/W	0h	Interrupt enable for TX endpoint 6

Table 16-117. USB1IRQENABLESET0 Register Field Descriptions (continued)

Bit	Field	Type	Reset	Description
5	TX_EP_5	R/W	0h	Interrupt enable for TX endpoint 5
4	TX_EP_4	R/W	0h	Interrupt enable for TX endpoint 4
3	TX_EP_3	R/W	0h	Interrupt enable for TX endpoint 3
2	TX_EP_2	R/W	0h	Interrupt enable for TX endpoint 2
1	TX_EP_1	R/W	0h	Interrupt enable for TX endpoint 1
0	TX_EP_0	R/W	0h	Interrupt enable for TX endpoint 0 USB1 IRQ_ENABLE_SET_0 Register

16.5.3.10 USB1IRQENABLESET1 Register (offset = 183Ch) [reset = 0h]

 USB1IRQENABLESET1 is shown in [Figure 16-108](#) and described in [Table 16-118](#).

Figure 16-108. USB1IRQENABLESET1 Register

31		30		29		28		27		26		25		24	
TX_FIFO_15	TX_FIFO_14	TX_FIFO_13	TX_FIFO_12	TX_FIFO_11	TX_FIFO_10	TX_FIFO_9	TX_FIFO_8								
R/W-0h	R/W-0h	R/W-0h	R/W-0h	R/W-0h	R/W-0h	R/W-0h	R/W-0h								
23		22		21		20		19		18		17		16	
TX_FIFO_7	TX_FIFO_6	TX_FIFO_5	TX_FIFO_4	TX_FIFO_3	TX_FIFO_2	TX_FIFO_1	RESERVED								
R/W-0h	R/W-0h	R/W-0h	R/W-0h	R/W-0h	R/W-0h	R/W-0h	R/W-0h								
15		14		13		12		11		10		9		8	
RESERVED												USB_9	USB_8		
R/W-0h												R/W-0h	R/W-0h		
7		6		5		4		3		2		1		0	
USB_7	USB_6	USB_5	USB_4	USB_3	USB_2	USB_1	USB_0								
R/W-0h	R/W-0h	R/W-0h	R/W-0h	R/W-0h	R/W-0h	R/W-0h	R/W-0h								

LEGEND: R/W = Read/Write; R = Read only; W1toCl = Write 1 to clear bit; -n = value after reset

Table 16-118. USB1IRQENABLESET1 Register Field Descriptions

Bit	Field	Type	Reset	Description
31	TX_FIFO_15	R/W	0h	Interrupt enable for TX FIFO endpoint 15
30	TX_FIFO_14	R/W	0h	Interrupt enable for TX FIFO endpoint 14
29	TX_FIFO_13	R/W	0h	Interrupt enable for TX FIFO endpoint 13
28	TX_FIFO_12	R/W	0h	Interrupt enable for TX FIFO endpoint 12
27	TX_FIFO_11	R/W	0h	Interrupt enable for TX FIFO endpoint 11
26	TX_FIFO_10	R/W	0h	Interrupt enable for TX FIFO endpoint 10
25	TX_FIFO_9	R/W	0h	Interrupt enable for TX FIFO endpoint 9
24	TX_FIFO_8	R/W	0h	Interrupt enable for TX FIFO endpoint 8
23	TX_FIFO_7	R/W	0h	Interrupt enable for TX FIFO endpoint 7
22	TX_FIFO_6	R/W	0h	Interrupt enable for TX FIFO endpoint 6
21	TX_FIFO_5	R/W	0h	Interrupt enable for TX FIFO endpoint 5
20	TX_FIFO_4	R/W	0h	Interrupt enable for TX FIFO endpoint 4
19	TX_FIFO_3	R/W	0h	Interrupt enable for TX FIFO endpoint 3
18	TX_FIFO_2	R/W	0h	Interrupt enable for TX FIFO endpoint 2
17	TX_FIFO_1	R/W	0h	Interrupt enable for TX FIFO endpoint 1
16-10	RESERVED	R/W	0h	
9	USB_9	R/W	0h	Interrupt enable for Mentor controller USB_INT generic interrupt
8	USB_8	R/W	0h	Interrupt enable for DRVVBUS level change
7	USB_7	R/W	0h	Interrupt enable for VBUS < VBUS valid threshold
6	USB_6	R/W	0h	Interrupt enable for SRP detected
5	USB_5	R/W	0h	Interrupt enable for device disconnected (host mode)
4	USB_4	R/W	0h	Interrupt enable for device connected (host mode)
3	USB_3	R/W	0h	Interrupt enable for SOF started
2	USB_2	R/W	0h	Interrupt enable for Reset signaling detected (peripheral mode) Babble detected (host mode)
1	USB_1	R/W	0h	Interrupt enable for Resume signaling detected

Table 16-118. USB1IRQENABLESET1 Register Field Descriptions (continued)

Bit	Field	Type	Reset	Description
0	USB_0	R/W	0h	Interrupt enable for Suspend signaling detected USB1 IRQ_ENABLE_SET_1 Register

16.5.3.11 USB1IRQENABLECLR0 Register (offset = 1840h) [reset = 0h]

 USB1IRQENABLECLR0 is shown in [Figure 16-109](#) and described in [Table 16-119](#).

Figure 16-109. USB1IRQENABLECLR0 Register

31		30		29		28		27		26		25		24	
RX_EP_15	RX_EP_14	RX_EP_13	RX_EP_12	RX_EP_11	RX_EP_10	RX_EP_9	RX_EP_8	RX_EP_7	RX_EP_6	RX_EP_5	RX_EP_4	RX_EP_3	RX_EP_2	RX_EP_1	RESERVED
R/W-0h		R/W-0h		R/W-0h		R/W-0h		R/W-0h		R/W-0h		R/W-0h		R/W-0h	
23		22		21		20		19		18		17		16	
RX_EP_7	RX_EP_6	RX_EP_5	RX_EP_4	RX_EP_3	RX_EP_2	RX_EP_1	RESERVED	RX_EP_7	RX_EP_6	RX_EP_5	RX_EP_4	RX_EP_3	RX_EP_2	RX_EP_1	RESERVED
R/W-0h		R/W-0h		R/W-0h		R/W-0h		R/W-0h		R/W-0h		R/W-0h		R/W-0h	
15		14		13		12		11		10		9		8	
TX_EP_15	TX_EP_14	TX_EP_13	TX_EP_12	TX_EP_11	TX_EP_10	TX_EP_9	TX_EP_8	TX_EP_15	TX_EP_14	TX_EP_13	TX_EP_12	TX_EP_11	TX_EP_10	TX_EP_9	TX_EP_8
R/W-0h		R/W-0h		R/W-0h		R/W-0h		R/W-0h		R/W-0h		R/W-0h		R/W-0h	
7		6		5		4		3		2		1		0	
TX_EP_7	TX_EP_6	TX_EP_5	TX_EP_4	TX_EP_3	TX_EP_2	TX_EP_1	TX_EP_0	TX_EP_7	TX_EP_6	TX_EP_5	TX_EP_4	TX_EP_3	TX_EP_2	TX_EP_1	TX_EP_0
R/W-0h		R/W-0h		R/W-0h		R/W-0h		R/W-0h		R/W-0h		R/W-0h		R/W-0h	

LEGEND: R/W = Read/Write; R = Read only; W1toCl = Write 1 to clear bit; -n = value after reset

Table 16-119. USB1IRQENABLECLR0 Register Field Descriptions

Bit	Field	Type	Reset	Description
31	RX_EP_15	R/W	0h	Interrupt enable for RX endpoint 15
30	RX_EP_14	R/W	0h	Interrupt enable for RX endpoint 14
29	RX_EP_13	R/W	0h	Interrupt enable for RX endpoint 13
28	RX_EP_12	R/W	0h	Interrupt enable for RX endpoint 12
27	RX_EP_11	R/W	0h	Interrupt enable for RX endpoint 11
26	RX_EP_10	R/W	0h	Interrupt enable for RX endpoint 10
25	RX_EP_9	R/W	0h	Interrupt enable for RX endpoint 9
24	RX_EP_8	R/W	0h	Interrupt enable for RX endpoint 8
23	RX_EP_7	R/W	0h	Interrupt enable for RX endpoint 7
22	RX_EP_6	R/W	0h	Interrupt enable for RX endpoint 6
21	RX_EP_5	R/W	0h	Interrupt enable for RX endpoint 5
20	RX_EP_4	R/W	0h	Interrupt enable for RX endpoint 4
19	RX_EP_3	R/W	0h	Interrupt enable for RX endpoint 3
18	RX_EP_2	R/W	0h	Interrupt enable for RX endpoint 2
17	RX_EP_1	R/W	0h	Interrupt enable for RX endpoint 1
16	RESERVED	R/W	0h	
15	TX_EP_15	R/W	0h	Interrupt enable for TX endpoint 15
14	TX_EP_14	R/W	0h	Interrupt enable for TX endpoint 14
13	TX_EP_13	R/W	0h	Interrupt enable for TX endpoint 13
12	TX_EP_12	R/W	0h	Interrupt enable for TX endpoint 12
11	TX_EP_11	R/W	0h	Interrupt enable for TX endpoint 11
10	TX_EP_10	R/W	0h	Interrupt enable for TX endpoint 10
9	TX_EP_9	R/W	0h	Interrupt enable for TX endpoint 9
8	TX_EP_8	R/W	0h	Interrupt enable for TX endpoint 8
7	TX_EP_7	R/W	0h	Interrupt enable for TX endpoint 7
6	TX_EP_6	R/W	0h	Interrupt enable for TX endpoint 6

Table 16-119. USB1IRQENABLECLR0 Register Field Descriptions (continued)

Bit	Field	Type	Reset	Description
5	TX_EP_5	R/W	0h	Interrupt enable for TX endpoint 5
4	TX_EP_4	R/W	0h	Interrupt enable for TX endpoint 4
3	TX_EP_3	R/W	0h	Interrupt enable for TX endpoint 3
2	TX_EP_2	R/W	0h	Interrupt enable for TX endpoint 2
1	TX_EP_1	R/W	0h	Interrupt enable for TX endpoint 1
0	TX_EP_0	R/W	0h	Interrupt enable for TX endpoint 0 USB1 IRQ_ENABLE_CLR_0 Register

16.5.3.12 USB1IRQENABLECLR1 Register (offset = 1844h) [reset = 0h]

 USB1IRQENABLECLR1 is shown in [Figure 16-110](#) and described in [Table 16-120](#).

Figure 16-110. USB1IRQENABLECLR1 Register

31		30		29		28		27		26		25		24	
TX_FIFO_15	TX_FIFO_14	TX_FIFO_13	TX_FIFO_12	TX_FIFO_11	TX_FIFO_10	TX_FIFO_9	TX_FIFO_8								
R/W-0h	R/W-0h	R/W-0h	R/W-0h	R/W-0h	R/W-0h	R/W-0h	R/W-0h								
23		22		21		20		19		18		17		16	
TX_FIFO_7	TX_FIFO_6	TX_FIFO_5	TX_FIFO_4	TX_FIFO_3	TX_FIFO_2	TX_FIFO_1	RESERVED								
R/W-0h	R/W-0h	R/W-0h	R/W-0h	R/W-0h	R/W-0h	R/W-0h	R/W-0h								
15		14		13		12		11		10		9		8	
RESERVED												USB_9	USB_8		
R/W-0h												R/W-0h	R/W-0h		
7		6		5		4		3		2		1		0	
USB_7	USB_6	USB_5	USB_4	USB_3	USB_2	USB_1	USB_0								
R/W-0h	R/W-0h	R/W-0h	R/W-0h	R/W-0h	R/W-0h	R/W-0h	R/W-0h								

LEGEND: R/W = Read/Write; R = Read only; W1toCl = Write 1 to clear bit; -n = value after reset

Table 16-120. USB1IRQENABLECLR1 Register Field Descriptions

Bit	Field	Type	Reset	Description
31	TX_FIFO_15	R/W	0h	Interrupt enable for TX FIFO endpoint 15
30	TX_FIFO_14	R/W	0h	Interrupt enable for TX FIFO endpoint 14
29	TX_FIFO_13	R/W	0h	Interrupt enable for TX FIFO endpoint 13
28	TX_FIFO_12	R/W	0h	Interrupt enable for TX FIFO endpoint 12
27	TX_FIFO_11	R/W	0h	Interrupt enable for TX FIFO endpoint 11
26	TX_FIFO_10	R/W	0h	Interrupt enable for TX FIFO endpoint 10
25	TX_FIFO_9	R/W	0h	Interrupt enable for TX FIFO endpoint 9
24	TX_FIFO_8	R/W	0h	Interrupt enable for TX FIFO endpoint 8
23	TX_FIFO_7	R/W	0h	Interrupt enable for TX FIFO endpoint 7
22	TX_FIFO_6	R/W	0h	Interrupt enable for TX FIFO endpoint 6
21	TX_FIFO_5	R/W	0h	Interrupt enable for TX FIFO endpoint 5
20	TX_FIFO_4	R/W	0h	Interrupt enable for TX FIFO endpoint 4
19	TX_FIFO_3	R/W	0h	Interrupt enable for TX FIFO endpoint 3
18	TX_FIFO_2	R/W	0h	Interrupt enable for TX FIFO endpoint 2
17	TX_FIFO_1	R/W	0h	Interrupt enable for TX FIFO endpoint 1
16-10	RESERVED	R/W	0h	
9	USB_9	R/W	0h	Interrupt enable for Mentor controller USB_INT generic interrupt
8	USB_8	R/W	0h	Interrupt enable for DRVVBUS level change
7	USB_7	R/W	0h	Interrupt enable for VBUS < VBUS valid threshold
6	USB_6	R/W	0h	Interrupt enable for SRP detected
5	USB_5	R/W	0h	Interrupt enable for device disconnected (host mode)
4	USB_4	R/W	0h	Interrupt enable for device connected (host mode)
3	USB_3	R/W	0h	Interrupt enable for SOF started
2	USB_2	R/W	0h	Interrupt enable for Reset signaling detected (peripheral mode) Babble detected (host mode)
1	USB_1	R/W	0h	Interrupt enable for Resume signaling detected

Table 16-120. USB1IRQENABLECLR1 Register Field Descriptions (continued)

Bit	Field	Type	Reset	Description
0	USB_0	R/W	0h	Interrupt enable for Suspend signaling detected USB1 IRQ_ENABLE_CLR_1 Register

16.5.3.13 USB1TXMODE Register (offset = 1870h) [reset = 0h]

 USB1TXMODE is shown in [Figure 16-111](#) and described in [Table 16-121](#).

Figure 16-111. USB1TXMODE Register

31	30	29	28	27	26	25	24
RESERVED		TX15_MODE		TX14_MODE		TX13_MODE	
R/W-0h		R/W-0h		R/W-0h		R/W-0h	
23	22	21	20	19	18	17	16
TX12_MODE		TX11_MODE		TX10_MODE		TX9_MODE	
R/W-0h		R/W-0h		R/W-0h		R/W-0h	
15	14	13	12	11	10	9	8
TX8_MODE		TX7_MODE		TX6_MODE		TX5_MODE	
R/W-0h		R/W-0h		R/W-0h		R/W-0h	
7	6	5	4	3	2	1	0
TX4_MODE		TX3_MODE		TX2_MODE		TX1_MODE	
R/W-0h		R/W-0h		R/W-0h		R/W-0h	

LEGEND: R/W = Read/Write; R = Read only; W1toCl = Write 1 to clear bit; -n = value after reset

Table 16-121. USB1TXMODE Register Field Descriptions

Bit	Field	Type	Reset	Description
31-30	RESERVED	R/W	0h	
29-28	TX15_MODE	R/W	0h	00: Transparent Mode on TX endpoint 14 01: RNDIS Mode on TX endpoint 14 10: CDC Mode on TX endpoint 14 11: Generic RNDIS Mode on TX endpoint 14
27-26	TX14_MODE	R/W	0h	00: Transparent Mode on TX endpoint 13 01: RNDIS Mode on TX endpoint 13 10: CDC Mode on TX endpoint 13 11: Generic RNDIS Mode on TX endpoint 13
25-24	TX13_MODE	R/W	0h	00: Transparent Mode on TX endpoint 12 01: RNDIS Mode on TX endpoint 12 10: CDC Mode on TX endpoint 12 11: Generic RNDIS Mode on TX endpoint 12
23-22	TX12_MODE	R/W	0h	00: Transparent Mode on TX endpoint 11 01: RNDIS Mode on TX endpoint 11 10: CDC Mode on TX endpoint 11 11: Generic RNDIS Mode on TX endpoint 11
21-20	TX11_MODE	R/W	0h	00: Transparent Mode on TX endpoint 10 01: RNDIS Mode on TX endpoint 10 10: CDC Mode on TX endpoint 10 11: Generic RNDIS Mode on TX endpoint 10
19-18	TX10_MODE	R/W	0h	00: Transparent Mode on TX endpoint 9 01: RNDIS Mode on TX endpoint 9 10: CDC Mode on TX endpoint 9 11: Generic RNDIS Mode on TX endpoint 9
17-16	TX9_MODE	R/W	0h	00: Transparent Mode on TX endpoint 8 01: RNDIS Mode on TX endpoint 8 10: CDC Mode on TX endpoint 8 11: Generic RNDIS Mode on TX endpoint 8
15-14	TX8_MODE	R/W	0h	00: Transparent Mode on TX endpoint 7 01: RNDIS Mode on TX endpoint 7 10: CDC Mode on TX endpoint 7 11: Generic RNDIS Mode on TX endpoint 7
13-12	TX7_MODE	R/W	0h	00: Transparent Mode on TX endpoint 6 01: RNDIS Mode on TX endpoint 6 10: CDC Mode on TX endpoint 6 11: Generic RNDIS Mode on TX endpoint 6

Table 16-121. USB1TXMODE Register Field Descriptions (continued)

Bit	Field	Type	Reset	Description
11-10	TX6_MODE	R/W	0h	00: Transparent Mode on TX endpoint 5 01: RNDIS Mode on TX endpoint 5 10: CDC Mode on TX endpoint 5 11: Generic RNDIS Mode on TX endpoint 5
9-8	TX5_MODE	R/W	0h	00: Transparent Mode on TX endpoint 4 01: RNDIS Mode on TX endpoint 4 10: CDC Mode on TX endpoint 4 11: Generic RNDIS Mode on TX endpoint 4
7-6	TX4_MODE	R/W	0h	00: Transparent Mode on TX endpoint 3 01: RNDIS Mode on TX endpoint 3 10: CDC Mode on TX endpoint 3 11: Generic RNDIS Mode on TX endpoint 3
5-4	TX3_MODE	R/W	0h	00: Transparent Mode on TX endpoint 2 01: RNDIS Mode on TX endpoint 2 10: CDC Mode on TX endpoint 2 11: Generic RNDIS Mode on TX endpoint 2
3-2	TX2_MODE	R/W	0h	00: Transparent Mode on TX endpoint 1 01: RNDIS Mode on TX endpoint 1 10: CDC Mode on TX endpoint 1 11: Generic RNDIS Mode on TX endpoint 1
1-0	TX1_MODE	R/W	0h	00: Transparent Mode on TX endpoint 0 01: RNDIS Mode on TX endpoint 0 10: CDC Mode on TX endpoint 0 11: Generic RNDIS Mode on TX endpoint 0 USB1 Tx Mode Registers

16.5.3.14 USB1RXMODE Register (offset = 1874h) [reset = 0h]

 USB1RXMODE is shown in [Figure 16-112](#) and described in [Table 16-122](#).

Figure 16-112. USB1RXMODE Register

31	30	29	28	27	26	25	24
RESERVED		RX15_MODE		RX14_MODE		RX13_MODE	
R/W-0h		R/W-0h		R/W-0h		R/W-0h	
23	22	21	20	19	18	17	16
RX12_MODE		RX11_MODE		RX10_MODE		RX9_MODE	
R/W-0h		R/W-0h		R/W-0h		R/W-0h	
15	14	13	12	11	10	9	8
RX8_MODE		RX7_MODE		RX6_MODE		RX5_MODE	
R/W-0h		R/W-0h		R/W-0h		R/W-0h	
7	6	5	4	3	2	1	0
RX4_MODE		RX3_MODE		RX2_MODE		RX1_MODE	
R/W-0h		R/W-0h		R/W-0h		R/W-0h	

LEGEND: R/W = Read/Write; R = Read only; W1toCl = Write 1 to clear bit; -n = value after reset

Table 16-122. USB1RXMODE Register Field Descriptions

Bit	Field	Type	Reset	Description
31-30	RESERVED	R/W	0h	
29-28	RX15_MODE	R/W	0h	00: Transparent Mode on RX endpoint 14 01: RNDIS Mode on RX endpoint 14 10: CDC Mode on RX endpoint 14 11: Generic RNDIS or Infinite Mode on RX endpoint 14
27-26	RX14_MODE	R/W	0h	00: Transparent Mode on RX endpoint 13 01: RNDIS Mode on RX endpoint 13 10: CDC Mode on RX endpoint 13 11: Generic RNDIS or Infinite Mode on RX endpoint 13
25-24	RX13_MODE	R/W	0h	00: Transparent Mode on RX endpoint 12 01: RNDIS Mode on RX endpoint 12 10: CDC Mode on RX endpoint 12 11: Generic RNDIS or Infinite Mode on RX endpoint 12
23-22	RX12_MODE	R/W	0h	00: Transparent Mode on RX endpoint 11 01: RNDIS Mode on RX endpoint 11 10: CDC Mode on RX endpoint 11 11: Generic RNDIS or Infinite Mode on RX endpoint 11
21-20	RX11_MODE	R/W	0h	00: Transparent Mode on RX endpoint 10 01: RNDIS Mode on RX endpoint 10 10: CDC Mode on RX endpoint 10 11: Generic RNDIS or Infinite Mode on RX endpoint 10
19-18	RX10_MODE	R/W	0h	00: Transparent Mode on RX endpoint 9 01: RNDIS Mode on RX endpoint 9 10: CDC Mode on RX endpoint 9 11: Generic RNDIS or Infinite Mode on RX endpoint 9
17-16	RX9_MODE	R/W	0h	00: Transparent Mode on RX endpoint 8 01: RNDIS Mode on RX endpoint 8 10: CDC Mode on RX endpoint 8 11: Generic RNDIS or Infinite Mode on RX endpoint 8
15-14	RX8_MODE	R/W	0h	00: Transparent Mode on RX endpoint 7 01: RNDIS Mode on RX endpoint 7 10: CDC Mode on RX endpoint 7 11: Generic RNDIS or Infinite Mode on RX endpoint 7
13-12	RX7_MODE	R/W	0h	00: Transparent Mode on RX endpoint 6 01: RNDIS Mode on RX endpoint 6 10: CDC Mode on RX endpoint 6 11: Generic RNDIS or Infinite Mode on RX endpoint 6

Table 16-122. USB1RXMODE Register Field Descriptions (continued)

Bit	Field	Type	Reset	Description
11-10	RX6_MODE	R/W	0h	00: Transparent Mode on RX endpoint 5 01: RNDIS Mode on RX endpoint 5 10: CDC Mode on RX endpoint 5 11: Generic RNDIS or Infinite Mode on RX endpoint 5
9-8	RX5_MODE	R/W	0h	00: Transparent Mode on RX endpoint 4 01: RNDIS Mode on RX endpoint 4 10: CDC Mode on RX endpoint 4 11: Generic RNDIS or Infinite Mode on RX endpoint 4
7-6	RX4_MODE	R/W	0h	00: Transparent Mode on RX endpoint 3 01: RNDIS Mode on RX endpoint 3 10: CDC Mode on RX endpoint 3 11: Generic RNDIS or Infinite Mode on RX endpoint 3
5-4	RX3_MODE	R/W	0h	00: Transparent Mode on RX endpoint 2 01: RNDIS Mode on RX endpoint 2 10: CDC Mode on RX endpoint 2 11: Generic RNDIS or Infinite Mode on RX endpoint 2
3-2	RX2_MODE	R/W	0h	00: Transparent Mode on RX endpoint 1 01: RNDIS Mode on RX endpoint 1 10: CDC Mode on RX endpoint 1 11: Generic RNDIS or Infinite Mode on RX endpoint 1
1-0	RX1_MODE	R/W	0h	00: Transparent Mode on RX endpoint 0 01: RNDIS Mode on RX endpoint 0 10: CDC Mode on RX endpoint 0 11: Generic RNDIS or Infinite Mode on RX endpoint 0 USB1 Rx Mode Registers

16.5.3.15 USB1GENRNDISEP1 Register (offset = 1880h) [reset = 0h]

 USB1GENRNDISEP1 is shown in [Figure 16-113](#) and described in [Table 16-123](#).

Figure 16-113. USB1GENRNDISEP1 Register

31	30	29	28	27	26	25	24	23	22	21	20	19	18	17	16	15	14	13	12	11	10	9	8	7	6	5	4	3	2	1	0
RESERVED																EP1_SIZE															
R/W-0h																R/W-0h															

LEGEND: R/W = Read/Write; R = Read only; W1toCl = Write 1 to clear bit; -n = value after reset

Table 16-123. USB1GENRNDISEP1 Register Field Descriptions

Bit	Field	Type	Reset	Description
31-17	RESERVED	R/W	0h	
16-0	EP1_SIZE	R/W	0h	Generic RNDIS packet size. USB1 Generic RNDIS EP N Size Register

16.5.3.16 USB1GENRNDISEP2 Register (offset = 1884h) [reset = 0h]

USB1GENRNDISEP2 is shown in [Figure 16-114](#) and described in [Table 16-124](#).

Figure 16-114. USB1GENRNDISEP2 Register

31	30	29	28	27	26	25	24	23	22	21	20	19	18	17	16	15	14	13	12	11	10	9	8	7	6	5	4	3	2	1	0
RESERVED																EP2_SIZE															
R/W-0h																R/W-0h															

LEGEND: R/W = Read/Write; R = Read only; W1toCl = Write 1 to clear bit; -n = value after reset

Table 16-124. USB1GENRNDISEP2 Register Field Descriptions

Bit	Field	Type	Reset	Description
31-17	RESERVED	R/W	0h	
16-0	EP2_SIZE	R/W	0h	Generic RNDIS packet size. USB1 Generic RNDIS EP N Size Register

16.5.3.17 USB1GENRNDISEP3 Register (offset = 1888h) [reset = 0h]

 USB1GENRNDISEP3 is shown in [Figure 16-115](#) and described in [Table 16-125](#).

Figure 16-115. USB1GENRNDISEP3 Register

31	30	29	28	27	26	25	24	23	22	21	20	19	18	17	16	15	14	13	12	11	10	9	8	7	6	5	4	3	2	1	0
RESERVED															EP3_SIZE																
R/W-0h															R/W-0h																

LEGEND: R/W = Read/Write; R = Read only; W1toCl = Write 1 to clear bit; -n = value after reset

Table 16-125. USB1GENRNDISEP3 Register Field Descriptions

Bit	Field	Type	Reset	Description
31-17	RESERVED	R/W	0h	
16-0	EP3_SIZE	R/W	0h	Generic RNDIS packet size. USB1 Generic RNDIS EP N Size Register

16.5.3.18 USB1GENRNDISEP4 Register (offset = 188Ch) [reset = 0h]

USB1GENRNDISEP4 is shown in [Figure 16-116](#) and described in [Table 16-126](#).

Figure 16-116. USB1GENRNDISEP4 Register

31	30	29	28	27	26	25	24	23	22	21	20	19	18	17	16	15	14	13	12	11	10	9	8	7	6	5	4	3	2	1	0
RESERVED															EP4_SIZE																
R/W-0h															R/W-0h																

LEGEND: R/W = Read/Write; R = Read only; W1toCl = Write 1 to clear bit; -n = value after reset

Table 16-126. USB1GENRNDISEP4 Register Field Descriptions

Bit	Field	Type	Reset	Description
31-17	RESERVED	R/W	0h	
16-0	EP4_SIZE	R/W	0h	Generic RNDIS packet size. USB1 Generic RNDIS EP N Size Register

16.5.3.19 USB1GENRNDISEP5 Register (offset = 1890h) [reset = 0h]

 USB1GENRNDISEP5 is shown in [Figure 16-117](#) and described in [Table 16-127](#).

Figure 16-117. USB1GENRNDISEP5 Register

31	30	29	28	27	26	25	24	23	22	21	20	19	18	17	16	15	14	13	12	11	10	9	8	7	6	5	4	3	2	1	0
RESERVED																EP5_SIZE															
R/W-0h																R/W-0h															

LEGEND: R/W = Read/Write; R = Read only; W1toCl = Write 1 to clear bit; -n = value after reset

Table 16-127. USB1GENRNDISEP5 Register Field Descriptions

Bit	Field	Type	Reset	Description
31-17	RESERVED	R/W	0h	
16-0	EP5_SIZE	R/W	0h	Generic RNDIS packet size. USB1 Generic RNDIS EP N Size Register

16.5.3.20 USB1GENRNDISEP6 Register (offset = 1894h) [reset = 0h]

USB1GENRNDISEP6 is shown in [Figure 16-118](#) and described in [Table 16-128](#).

Figure 16-118. USB1GENRNDISEP6 Register

31	30	29	28	27	26	25	24	23	22	21	20	19	18	17	16	15	14	13	12	11	10	9	8	7	6	5	4	3	2	1	0
RESERVED															EP6_SIZE																
R/W-0h															R/W-0h																

LEGEND: R/W = Read/Write; R = Read only; W1toCl = Write 1 to clear bit; -n = value after reset

Table 16-128. USB1GENRNDISEP6 Register Field Descriptions

Bit	Field	Type	Reset	Description
31-17	RESERVED	R/W	0h	
16-0	EP6_SIZE	R/W	0h	Generic RNDIS packet size. USB1 Generic RNDIS EP N Size Register

16.5.3.21 USB1GENRNDISEP7 Register (offset = 1898h) [reset = 0h]

 USB1GENRNDISEP7 is shown in [Figure 16-119](#) and described in [Table 16-129](#).

Figure 16-119. USB1GENRNDISEP7 Register

31	30	29	28	27	26	25	24	23	22	21	20	19	18	17	16	15	14	13	12	11	10	9	8	7	6	5	4	3	2	1	0
RESERVED																EP7_SIZE															
R/W-0h																R/W-0h															

LEGEND: R/W = Read/Write; R = Read only; W1toCl = Write 1 to clear bit; -n = value after reset

Table 16-129. USB1GENRNDISEP7 Register Field Descriptions

Bit	Field	Type	Reset	Description
31-17	RESERVED	R/W	0h	
16-0	EP7_SIZE	R/W	0h	Generic RNDIS packet size. USB1 Generic RNDIS EP N Size Register

16.5.3.22 USB1GENRNDISEP8 Register (offset = 189Ch) [reset = 0h]

USB1GENRNDISEP8 is shown in [Figure 16-120](#) and described in [Table 16-130](#).

Figure 16-120. USB1GENRNDISEP8 Register

31	30	29	28	27	26	25	24	23	22	21	20	19	18	17	16	15	14	13	12	11	10	9	8	7	6	5	4	3	2	1	0
RESERVED																EP8_SIZE															
R/W-0h																R/W-0h															

LEGEND: R/W = Read/Write; R = Read only; W1toCl = Write 1 to clear bit; -n = value after reset

Table 16-130. USB1GENRNDISEP8 Register Field Descriptions

Bit	Field	Type	Reset	Description
31-17	RESERVED	R/W	0h	
16-0	EP8_SIZE	R/W	0h	Generic RNDIS packet size. USB1 Generic RNDIS EP N Size Register

16.5.3.23 USB1GENRNDISEP9 Register (offset = 18A0h) [reset = 0h]

USB1GENRNDISEP9 is shown in [Figure 16-121](#) and described in [Table 16-131](#).

Figure 16-121. USB1GENRNDISEP9 Register

31	30	29	28	27	26	25	24	23	22	21	20	19	18	17	16	15	14	13	12	11	10	9	8	7	6	5	4	3	2	1	0
RESERVED																EP9_SIZE															
R/W-0h																R/W-0h															

LEGEND: R/W = Read/Write; R = Read only; W1toCl = Write 1 to clear bit; -n = value after reset

Table 16-131. USB1GENRNDISEP9 Register Field Descriptions

Bit	Field	Type	Reset	Description
31-17	RESERVED	R/W	0h	
16-0	EP9_SIZE	R/W	0h	Generic RNDIS packet size. USB1 Generic RNDIS EP N Size Register

16.5.3.24 USB1GENRNDISEP10 Register (offset = 18A4h) [reset = 0h]

USB1GENRNDISEP10 is shown in [Figure 16-122](#) and described in [Table 16-132](#).

Figure 16-122. USB1GENRNDISEP10 Register

31	30	29	28	27	26	25	24	23	22	21	20	19	18	17	16	15	14	13	12	11	10	9	8	7	6	5	4	3	2	1	0
RESERVED																EP10_SIZE															
R/W-0h																R/W-0h															

LEGEND: R/W = Read/Write; R = Read only; W1toCl = Write 1 to clear bit; -n = value after reset

Table 16-132. USB1GENRNDISEP10 Register Field Descriptions

Bit	Field	Type	Reset	Description
31-17	RESERVED	R/W	0h	
16-0	EP10_SIZE	R/W	0h	Generic RNDIS packet size. USB1 Generic RNDIS EP N Size Register

16.5.3.25 USB1GENRNDISEP11 Register (offset = 18A8h) [reset = 0h]

USB1GENRNDISEP11 is shown in [Figure 16-123](#) and described in [Table 16-133](#).

Figure 16-123. USB1GENRNDISEP11 Register

31	30	29	28	27	26	25	24	23	22	21	20	19	18	17	16	15	14	13	12	11	10	9	8	7	6	5	4	3	2	1	0
RESERVED																EP11_SIZE															
R/W-0h																R/W-0h															

LEGEND: R/W = Read/Write; R = Read only; W1toCl = Write 1 to clear bit; -n = value after reset

Table 16-133. USB1GENRNDISEP11 Register Field Descriptions

Bit	Field	Type	Reset	Description
31-17	RESERVED	R/W	0h	
16-0	EP11_SIZE	R/W	0h	Generic RNDIS packet size. USB1 Generic RNDIS EP N Size Register

16.5.3.26 USB1GENRNDISEP12 Register (offset = 18ACh) [reset = 0h]

USB1GENRNDISEP12 is shown in [Figure 16-124](#) and described in [Table 16-134](#).

Figure 16-124. USB1GENRNDISEP12 Register

31	30	29	28	27	26	25	24	23	22	21	20	19	18	17	16	15	14	13	12	11	10	9	8	7	6	5	4	3	2	1	0
RESERVED															EP12_SIZE																
R/W-0h															R/W-0h																

LEGEND: R/W = Read/Write; R = Read only; W1toCl = Write 1 to clear bit; -n = value after reset

Table 16-134. USB1GENRNDISEP12 Register Field Descriptions

Bit	Field	Type	Reset	Description
31-17	RESERVED	R/W	0h	
16-0	EP12_SIZE	R/W	0h	Generic RNDIS packet size. USB1 Generic RNDIS EP N Size Register

16.5.3.27 USB1GENRNDISEP13 Register (offset = 18B0h) [reset = 0h]

USB1GENRNDISEP13 is shown in [Figure 16-125](#) and described in [Table 16-135](#).

Figure 16-125. USB1GENRNDISEP13 Register

31	30	29	28	27	26	25	24	23	22	21	20	19	18	17	16	15	14	13	12	11	10	9	8	7	6	5	4	3	2	1	0
RESERVED																EP13_SIZE															
R/W-0h																R/W-0h															

LEGEND: R/W = Read/Write; R = Read only; W1toCl = Write 1 to clear bit; -n = value after reset

Table 16-135. USB1GENRNDISEP13 Register Field Descriptions

Bit	Field	Type	Reset	Description
31-17	RESERVED	R/W	0h	
16-0	EP13_SIZE	R/W	0h	Generic RNDIS packet size. USB1 Generic RNDIS EP N Size Register

16.5.3.28 USB1GENRNDISEP14 Register (offset = 18B4h) [reset = 0h]

USB1GENRNDISEP14 is shown in [Figure 16-126](#) and described in [Table 16-136](#).

Figure 16-126. USB1GENRNDISEP14 Register

31	30	29	28	27	26	25	24	23	22	21	20	19	18	17	16	15	14	13	12	11	10	9	8	7	6	5	4	3	2	1	0
RESERVED																EP14_SIZE															
R/W-0h																R/W-0h															

LEGEND: R/W = Read/Write; R = Read only; W1toCl = Write 1 to clear bit; -n = value after reset

Table 16-136. USB1GENRNDISEP14 Register Field Descriptions

Bit	Field	Type	Reset	Description
31-17	RESERVED	R/W	0h	
16-0	EP14_SIZE	R/W	0h	Generic RNDIS packet size. USB1 Generic RNDIS EP N Size Register

16.5.3.29 USB1GENRNDISEP15 Register (offset = 18B8h) [reset = 0h]

USB1GENRNDISEP15 is shown in [Figure 16-127](#) and described in [Table 16-137](#).

Figure 16-127. USB1GENRNDISEP15 Register

31	30	29	28	27	26	25	24	23	22	21	20	19	18	17	16	15	14	13	12	11	10	9	8	7	6	5	4	3	2	1	0
RESERVED																EP15_SIZE															
R/W-0h																R/W-0h															

LEGEND: R/W = Read/Write; R = Read only; W1toCl = Write 1 to clear bit; -n = value after reset

Table 16-137. USB1GENRNDISEP15 Register Field Descriptions

Bit	Field	Type	Reset	Description
31-17	RESERVED	R/W	0h	
16-0	EP15_SIZE	R/W	0h	Generic RNDIS packet size. USB1 Generic RNDIS EP N Size Register

16.5.3.30 USB1AUTOREQ Register (offset = 18D0h) [reset = 0h]

USB1AUTOREQ is shown in [Figure 16-128](#) and described in [Table 16-138](#).

Figure 16-128. USB1AUTOREQ Register

31	30	29	28	27	26	25	24
RESERVED		RX15_AUTOREQ		RX14_AUTOREQ		RX13_AUTOREQ	
R/W-0h		R/W-0h		R/W-0h		R/W-0h	
23	22	21	20	19	18	17	16
RX12_AUTOREQ		RX11_AUTOREQ		RX10_AUTOREQ		RX9_AUTOREQ	
R/W-0h		R/W-0h		R/W-0h		R/W-0h	
15	14	13	12	11	10	9	8
RX8_AUTOREQ		RX7_AUTOREQ		RX6_AUTOREQ		RX5_AUTOREQ	
R/W-0h		R/W-0h		R/W-0h		R/W-0h	
7	6	5	4	3	2	1	0
RX4_AUTOREQ		RX3_AUTOREQ		RX2_AUTOREQ		RX1_AUTOREQ	
R/W-0h		R/W-0h		R/W-0h		R/W-0h	

LEGEND: R/W = Read/Write; R = Read only; W1toCl = Write 1 to clear bit; -n = value after reset

Table 16-138. USB1AUTOREQ Register Field Descriptions

Bit	Field	Type	Reset	Description
31-30	RESERVED	R/W	0h	
29-28	RX15_AUTOREQ	R/W	0h	RX endpoint 14 Auto Req enable 00 = no auto req 01 = auto req on all but EOP 10 = reserved 11 = auto req always
27-26	RX14_AUTOREQ	R/W	0h	RX endpoint 13 Auto Req enable 00 = no auto req 01 = auto req on all but EOP 10 = reserved 11 = auto req always
25-24	RX13_AUTOREQ	R/W	0h	RX endpoint 12 Auto Req enable 00 = no auto req 01 = auto req on all but EOP 10 = reserved 11 = auto req always
23-22	RX12_AUTOREQ	R/W	0h	RX endpoint 11 Auto Req enable 00 = no auto req 01 = auto req on all but EOP 10 = reserved 11 = auto req always
21-20	RX11_AUTOREQ	R/W	0h	RX endpoint 10 Auto Req enable 00 = no auto req 01 = auto req on all but EOP 10 = reserved 11 = auto req always
19-18	RX10_AUTOREQ	R/W	0h	RX endpoint 9 Auto Req enable 00 = no auto req 01 = auto req on all but EOP 10 = reserved 11 = auto req always
17-16	RX9_AUTOREQ	R/W	0h	RX endpoint 8 Auto Req enable 00 = no auto req 01 = auto req on all but EOP 10 = reserved 11 = auto req always

Table 16-138. USB1AUTOREQ Register Field Descriptions (continued)

Bit	Field	Type	Reset	Description
15-14	RX8_AUTOREQ	R/W	0h	RX endpoint 7 Auto Req enable 00 = no auto req 01 = auto req on all but EOP 10 = reserved 11 = auto req always
13-12	RX7_AUTOREQ	R/W	0h	RX endpoint 6 Auto Req enable 00 = no auto req 01 = auto req on all but EOP 10 = reserved 11 = auto req always
11-10	RX6_AUTOREQ	R/W	0h	RX endpoint 5 Auto Req enable 00 = no auto req 01 = auto req on all but EOP 10 = reserved 11 = auto req always
9-8	RX5_AUTOREQ	R/W	0h	RX endpoint 4 Auto Req enable 00 = no auto req 01 = auto req on all but EOP 10 = reserved 11 = auto req always
7-6	RX4_AUTOREQ	R/W	0h	RX endpoint 3 Auto Req enable 00 = no auto req 01 = auto req on all but EOP 10 = reserved 11 = auto req always
5-4	RX3_AUTOREQ	R/W	0h	RX endpoint 2 Auto Req enable 00 = no auto req 01 = auto req on all but EOP 10 = reserved 11 = auto req always
3-2	RX2_AUTOREQ	R/W	0h	RX endpoint 1 Auto Req enable 00 = no auto req 01 = auto req on all but EOP 10 = reserved 11 = auto req always
1-0	RX1_AUTOREQ	R/W	0h	RX endpoint 0 Auto Req enable 00 = no auto req 01 = auto req on all but EOP 10 = reserved 11 = auto req always USB1 Auto Req Registers

16.5.3.31 USB1SRPFIXTIME Register (offset = 18D4h) [reset = 280DE80h]

USB1SRPFIXTIME is shown in [Figure 16-129](#) and described in [Table 16-139](#).

Figure 16-129. USB1SRPFIXTIME Register

31	30	29	28	27	26	25	24	23	22	21	20	19	18	17	16	15	14	13	12	11	10	9	8	7	6	5	4	3	2	1	0
SRPFIXTIME																															
R/W-280DE80h																															

LEGEND: R/W = Read/Write; R = Read only; W1toCl = Write 1 to clear bit; -n = value after reset

Table 16-139. USB1SRPFIXTIME Register Field Descriptions

Bit	Field	Type	Reset	Description
31-0	SRPFIXTIME	R/W	280DE80h	SRP Fix maximum time in 60 MHz cycles. Default is 700 ms. USB1 SRP Fix Time Register

16.5.3.32 USB1TDOWN Register (offset = 18D8h) [reset = 0h]

 USB1TDOWN is shown in [Figure 16-130](#) and described in [Table 16-140](#).

Figure 16-130. USB1TDOWN Register

31	30	29	28	27	26	25	24	23	22	21	20	19	18	17	16	15	14	13	12	11	10	9	8	7	6	5	4	3	2	1	0
TX_TDOWN															R E S E R V E D	RX_TDOWN															R E S E R V E D
R/W-0h															R/ W - 0h	R/W-0h															R/ W - 0h

LEGEND: R/W = Read/Write; R = Read only; W1toCl = Write 1 to clear bit; -n = value after reset

Table 16-140. USB1TDOWN Register Field Descriptions

Bit	Field	Type	Reset	Description
31-17	TX_TDOWN	R/W	0h	Tx Endpoint Teardown. Write '1' to corresponding bit to set. Read as '0'. Bit 31 = Endpoint 15 ... Bit 17 = Endpoint 1
16	RESERVED	R/W	0h	
15-1	RX_TDOWN	R/W	0h	RX Endpoint Teardown. Write '1' to corresponding bit to set. Read as '0'. Bit 15 = Endpoint 15 ... Bit 1 = Endpoint 1
0	RESERVED	R/W	0h	

16.5.3.33 USB1UTMI Register (offset = 18E0h) [reset = 20002h]

USB1UTMI is shown in [Figure 16-131](#) and described in [Table 16-141](#).

Figure 16-131. USB1UTMI Register

31								30								29								28								27								26								25								24							
RESERVED																																																															
R/W-0h																																																															
23								22								21								20								19								18								17								16							
TXBITSTUFFEN								TXBITSTUFFENH								OTGDISABLE								VBUSVLDEXTSEL								VBUSVLDEXT								TXENABLEN								FSXCVROWNER								TXVALIDH							
R/W-0h								R/W-0h								R/W-1h								R/W-0h								R/W-0h								R/W-0h								R/W-0h								R/W-0h							
15								14								13								12								11								10								9								8							
DATAINH																																																															
R/W-0h																																																															
7								6								5								4								3								2								1								0							
RESERVED																																WORDINTERFACE								FSDATAEXT								FSSE0EXT															
R/W-0h																																R/W-0h								R/W-1h								R/W-0h															

LEGEND: R/W = Read/Write; R = Read only; W1toCl = Write 1 to clear bit; -n = value after reset

Table 16-141. USB1UTMI Register Field Descriptions

Bit	Field	Type	Reset	Description
31-24	RESERVED	R/W	0h	
23	TXBITSTUFFEN	R/W	0h	PHY UTMI input for signal txbitstufen
22	TXBITSTUFFENH	R/W	0h	PHY UTMI input for signal txbitstuffenh
21	OTGDISABLE	R/W	1h	PHY UTMI input for signal otgdisable
20	VBUSVLDEXTSEL	R/W	0h	PHY UTMI input for signal vbusvldextsel
19	VBUSVLDEXT	R/W	0h	PHY UTMI input for signal vbusvldext
18	TXENABLEN	R/W	0h	PHY UTMI input for signal txenablen
17	FSXCVROWNER	R/W	0h	PHY UTMI input for signal fsxcvrowner
16	TXVALIDH	R/W	0h	PHY UTMI input for signal txvalidh
15-8	DATAINH	R/W	0h	PHY UTMI input for signal datainh
7-3	RESERVED	R/W	0h	
2	WORDINTERFACE	R/W	0h	PHY UTMI input for signal wordinterface
1	FSDATAEXT	R/W	1h	PHY UTMI input for signal fsdataext
0	FSSE0EXT	R/W	0h	PHY UTMI input for signal fsse0ext USB1 PHY UTMI Register

16.5.3.34 USB1UTMILB Register (offset = 18E4h) [reset = 82h]

 USB1UTMILB is shown in [Figure 16-132](#) and described in [Table 16-142](#).

Figure 16-132. USB1UTMILB Register

31	30	29	28	27	26	25	24
RESERVED			SUSPENDM	OPMODE		TXVALID	XCVRSEL
R/W-0h			R-0h	R-0h		R-0h	R-0h
23	22	21	20	19	18	17	16
XCVRSEL	TERMSEL	DRVVBUS	CHRGVBUS	DISCHRGVBU S	DPPULLDOWN	DMPULLDOWN	IDPULLUP
R-0h	R-0h	R-0h	R-0h	R-0h	R-0h	R-0h	R-0h
15	14	13	12	11	10	9	8
RESERVED				IDDIG	HOSTDISCON	SESSEND	AVALID
R/W-0h				R/W-0h	R/W-0h	R/W-0h	R/W-0h
7	6	5	4	3	2	1	0
VBUSVALID	RXERROR	RESERVED		LINESTATE		RESERVED	
R/W-1h	R/W-0h	R/W-0h		R/W-0h		R/W-2h	

LEGEND: R/W = Read/Write; R = Read only; W1toCl = Write 1 to clear bit; -n = value after reset

Table 16-142. USB1UTMILB Register Field Descriptions

Bit	Field	Type	Reset	Description
31-29	RESERVED	R/W	0h	
28	SUSPENDM	R	0h	loopback test observed value for suspendm
27-26	OPMODE	R	0h	loopback test observed value for opmode
25	TXVALID	R	0h	loopback test observed value for txvalid
24-23	XCVRSEL	R	0h	loopback test observed value for xcvsel
22	TERMSEL	R	0h	loopback test observed value for termssel
21	DRVVBUS	R	0h	loopback test observed value for drvdbus
20	CHRGVBUS	R	0h	loopback test observed value for chrgvbus
19	DISCHRGVBUS	R	0h	loopback test observed value for dischrgvbus
18	DPPULLDOWN	R	0h	loopback test observed value for dppulldown
17	DMPULLDOWN	R	0h	loopback test observed value for dmpulldown
16	IDPULLUP	R	0h	loopback test observed value for idpullup
15-12	RESERVED	R/W	0h	
11	IDDIG	R/W	0h	loopback test value for iddig
10	HOSTDISCON	R/W	0h	loopback test value for hostdiscon
9	SESSEND	R/W	0h	loopback test value for sessend
8	AVALID	R/W	0h	loopback test value for avalid
7	VBUSVALID	R/W	1h	loopback test value for vbusvalid
6	RXERROR	R/W	0h	loopback test value for rxerror
5-4	RESERVED	R/W	0h	
3-2	LINESTATE	R/W	0h	loopback test value for linestate
1-0	RESERVED	R/W	2h	

16.5.3.35 USB1MODE Register (offset = 18E8h) [reset = 100h]

USB1MODE is shown in [Figure 16-133](#) and described in [Table 16-143](#).

Figure 16-133. USB1MODE Register

31	30	29	28	27	26	25	24
RESERVED							
R/W-0h							
23	22	21	20	19	18	17	16
RESERVED							
R/W-0h							
15	14	13	12	11	10	9	8
RESERVED							IDDIG
R/W-0h							R/W-1h
7	6	5	4	3	2	1	0
IDDIG_MUX	RESERVED					PHY_TEST	LOOPBACK
R/W-0h	R/W-0h				R/W-0h	R/W-0h	

LEGEND: R/W = Read/Write; R = Read only; W1toCl = Write 1 to clear bit; -n = value after reset

Table 16-143. USB1MODE Register Field Descriptions

Bit	Field	Type	Reset	Description
31-9	RESERVED	R/W	0h	
8	IDDIG	R/W	1h	MGC input value for iddig 0=A type 1=B type
7	IDDIG_MUX	R/W	0h	Multiplexer control for IDDIG signal going to the controller. 0 = IDDIG is from PHY1. 1 = IDDIG is from bit8 (IDDIG) of this USB1MODE register.
6-2	RESERVED	R/W	0h	
1	PHY_TEST	R/W	0h	PHY test 0 = Normal mode 1 = PHY test mode
0	LOOPBACK	R/W	0h	Loopback test mode 0 = Normal mode 1 = Loopback test mode USB1 Mode Register

16.5.4 USB2PHY Registers

[Table 16-144](#) lists the memory-mapped registers for the USB2PHY. All register offset addresses not listed in [Table 16-144](#) should be considered as reserved locations and the register contents should not be modified.

Table 16-144. USB2PHY Registers

Offset	Acronym	Register Name	Section
0h	Termination_control		Section 16.5.4.1
4h	RX_CALIB		Section 16.5.4.2
8h	DLLHS_2		Section 16.5.4.3
Ch	RX_TEST_2		Section 16.5.4.4
14h	CHRG_DET		Section 16.5.4.5
18h	PWR_CNTL		Section 16.5.4.6
1Ch	UTMI_INTERFACE_CNTL_1		Section 16.5.4.7
20h	UTMI_INTERFACE_CNTL_2		Section 16.5.4.8
24h	BIST		Section 16.5.4.9
28h	BIST_CRC		Section 16.5.4.10

Table 16-144. USB2PHY Registers (continued)

Offset	Acronym	Register Name	Section
2Ch	CDR_BIST2		Section 16.5.4.11
30h	GPIO		Section 16.5.4.12
34h	DLLHS		Section 16.5.4.13
3Ch	USB2PHYCM_CONFIG		Section 16.5.4.14
44h	AD_INTERFACE_REG1		Section 16.5.4.15
48h	AD_INTERFACE_REG2		Section 16.5.4.16
4Ch	AD_INTERFACE_REG3		Section 16.5.4.17
54h	ANA_CONFIG2		Section 16.5.4.18

16.5.4.1 Termination_control Register (offset = 0h) [reset = 1000800h]

Register mask: FFFFFFFFh

Termination_control is shown in [Figure 16-134](#) and described in [Table 16-145](#).

contains bits related to control of terminations in USB2PHY

Figure 16-134. Termination_control Register

31	30	29	28	27	26	25	24
RESERVED		ALWAYS_UPDATE	RTERM_CAL_DONE	FS_CODE_SEL			
R/W-0h		R/W-0h	R-0h	R/W-1h			
23	22	21	20	19	18	17	16
RESERVED		USE_RTERM_RMX_REG	RTERM_RMX				
R/W-0h		R/W-0h	R/W-0h				
15	14	13	12	11	10	9	8
RTERM_RMX		HS_CODE_SEL			RTERM_COMP_OUT	RESTART_RTERM_CAL	DISABLE_TEMP_TRACK
R/W-0h		R/W-1h			R-0h	R/W-0h	R/W-0h
7	6	5	4	3	2	1	0
USE_RTERM_CAL_REG	RTERM_CAL						
R/W-0h				R/W-0h			

LEGEND: R/W = Read/Write; R = Read only; W1toCl = Write 1 to clear bit; -n = value after reset

Table 16-145. Termination_control Register Field Descriptions

Bit	Field	Type	Reset	Description
31-30	RESERVED	R/W	0h	
29	ALWAYS_UPDATE	R/W	0h	When set to 1, the calibration code is updated immediately after a code computation without waiting for idle periods.
28	RTERM_CAL_DONE	R	0h	Rterm calibration is done. 1st time cal is done this bit gets set and gets reset at a restart cal. Read value is valid only if VDDLDO is on.
27-24	FS_CODE_SEL	R/W	1h	FS Code selection control
23-22	RESERVED	R/W	0h	
21	USE_RTERM_RMX_REG	R/W	0h	Override termination resistor trim code with RTERM_RMX from this register
20-14	RTERM_RMX	R/W	0h	When read, this field returns the current Termination resistor trim code. Read value is valid only if VDDLDO is on. The value written to this field is used as Termination resistor trim code if bit 21 is set to 1
13-11	HS_CODE_SEL	R/W	1h	HS Code selection control. Each increment increases the termination impedance by ~1.5%. Valid values are 000b 011b.
10	RTERM_COMP_OUT	R	0h	Master loop comparator output. Read value is valid only if VDDLDO is on.
9	RESTART_RTERM_CAL	R/W	0h	Restart the rterm calibration. The calibration restarts on any toggle 0 to 1 or 1 to 0 on this bit.
8	DISABLE_TEMP_TRACK	R/W	0h	Disables the temperature tracking function of the termination calibration
7	USE_RTERM_CAL_REG	R/W	0h	when '1' the rterm cal code is overridden by values in RTERM_CAL
6-0	RTERM_CAL	R/W	0h	When read this field returns the current rterm calibration code. Read value is valid only if VDDLDO is on. The value written to this field is used as rterm calibration code if the bit USE_RTERM_CAL_REG is 1.

16.5.4.2 RX_CALIB Register (offset = 4h) [reset = 0h]

Register mask: FFFFFFFFh

 RX_CALIB is shown in [Figure 16-135](#) and described in [Table 16-146](#).

Contains bits related to RX calibration

Figure 16-135. RX_CALIB Register

31		30		29		28		27		26		25		24	
RESTART_HS_RX_CAL		USE_HS_OFF_REG		HS_OFF_CODE											
R/W-0h		R/W-0h		R/W-0h											
23		22		21		20		19		18		17		16	
HSRX_COMP_OUT		HSRX_CAL_DONE		USE_SQ_OFF_DAC1		SQ_OFF_CODE_DAC1									
R-0h		R-0h		R/W-0h		R/W-0h									
15		14		13		12		11		10		9		8	
SQ_OFF_CODE_DAC1		USE_SQ_OFF_DAC2		SQ_OFF_CODE_DAC2										USE_SQ_OFF_DAC3	
R/W-0h		R/W-0h		R/W-0h										R/W-0h	
7		6		5		4		3		2		1		0	
SQ_OFF_CODE_DAC3										SQ_COMP_OUT		SQ_CAL_DONE		RESTART_SQ_CAL	
R/W-0h										R-0h		R-0h		R/W-0h	

LEGEND: R/W = Read/Write; R = Read only; W1toCl = Write 1 to clear bit; -n = value after reset

Table 16-146. RX_CALIB Register Field Descriptions

Bit	Field	Type	Reset	Description
31	RESTART_HSRX_CAL	R/W	0h	Restart the HSRX calibration state machine when this bit goes from 0 to 1.
30	USE_HS_OFF_REG	R/W	0h	Override HS offset correction with HS_OFF_CODE when set to '1'
29-24	HS_OFF_CODE	R/W	0h	HS offset code, this code is forced when bit 30 is 1 . Code is updated from calibration logic when bit 30 = 0.
23	HSRX_COMP_OUT	R	0h	The output of the HSRX comparator. Read value is valid only if VDDLDO is on.
22	HSRX_CAL_DONE	R	0h	Signal that indicates that the HSRX calibration is done. This gets reset at every restart. Read value is valid only if VDDLDO is on.
21	USE_SQ_OFF_DAC1	R/W	0h	Override Squelch offset DAC1 code when '1'
20-15	SQ_OFF_CODE_DAC1	R/W	0h	When read returns current Sq offset code for DAC1, if VDDLDO is on. When written this is used as Sq offset code for DAC1 when USE_SQ_OFF_DAC 1 = '1'
14	USE_SQ_OFF_DAC2	R/W	0h	Override Squelch offset DAC2 code when '1'
13-9	SQ_OFF_CODE_DAC2	R/W	0h	When read returns current Sq offset code for DAC2, if VDDLDO is on. When written this is used as Sq offset code for DAC2 when USE_SQ_OFF_DAC 2 = '1'
8	USE_SQ_OFF_DAC3	R/W	0h	Override Squelch offset DAC3 code when '1'
7-3	SQ_OFF_CODE_DAC3	R/W	0h	When read returns current Sq offset code for DAC3, if VDDLDO is on. When written this is used as Sq offset code for DAC3 when USE_SQ_OFF_DAC 3 = '1'

Table 16-146. RX_CALIB Register Field Descriptions (continued)

Bit	Field	Type	Reset	Description
2	SQ_COMP_OUT	R	0h	Sq comp output. Read value is valid only if VDDLDO is on.
1	SQ_CAL_DONE	R	0h	Sq calibration is done when this bit = 1. see RESTART_SQ_CAL for more description. Read value is valid only if VDDLDO is on.
0	RESTART_SQ_CAL	R/W	0h	the squelch calibration continuously goes through restart cycles when this bit is 1 . i.e. restarts waits for done then restarts again etc.

16.5.4.3 DLLHS_2 Register (offset = 8h) [reset = 1Fh]

Register mask: FFFFFFFFh

 DLLHS_2 is shown in [Figure 16-136](#) and described in [Table 16-147](#).

the 2nd DLLHS control register. bits 4:0 are unrelated to the DLLHS and are linestate filter settings

Figure 16-136. DLLHS_2 Register

31	30	29	28	27	26	25	24
DLLHS_CNTRL_LDO							
R/W-0h							
23	22	21	20	19	18	17	16
DLLHS_STATUS_LDO							
R-0h							
15	14	13	12	11	10	9	8
RESERVED							
R/W-0h							
7	6	5	4	3	2	1	0
RESERVED			LINESTATE_D EBOUNCE_EN	LINESTATE_DEBOUNCE_CNTL			
R/W-0h			R/W-1h	R/W-Fh			

LEGEND: R/W = Read/Write; R = Read only; W1toCl = Write 1 to clear bit; -n = value after reset

Table 16-147. DLLHS_2 Register Field Descriptions

Bit	Field	Type	Reset	Description
31-24	DLLHS_CNTRL_LDO	R/W	0h	See DFT spec for details
23-16	DLLHS_STATUS_LDO	R	0h	See DFT spec for details
15-5	RESERVED	R/W	0h	
4	LINESTATE_DEBOUNCE_EN	R/W	1h	Enables the linestate debounce filter
3-0	LINESTATE_DEBOUNCE_CNTL	R/W	Fh	Used for control of the linestate debounce filter when going from synchronous to async linestate.

16.5.4.4 RX_TEST_2 Register (offset = Ch) [reset = 0h]

Register mask: FFFFFFFFh

RX_TEST_2 is shown in [Figure 16-137](#) and described in [Table 16-148](#).

the 2nd receiver test register

Figure 16-137. RX_TEST_2 Register

31	30	29	28	27	26	25	24
HSOSREVERSAL	HSOSBITINVERSION	PHYCLKOUTINVERSION	RXPIDERR	USEINTDATAOUT	INTDATAOUTREG		
R/W-0h	R/W-0h	R/W-0h	R-0h	R/W-0h	R/W-0h		
23	22	21	20	19	18	17	16
INTDATAOUTREG							
R/W-0h							
15	14	13	12	11	10	9	8
INTDATAOUTREG					RESERVED		
R/W-0h					R/W-0h		
7	6	5	4	3	2	1	0
CDR_TESTOUT							
R-0h							

LEGEND: R/W = Read/Write; R = Read only; W1toCl = Write 1 to clear bit; -n = value after reset

Table 16-148. RX_TEST_2 Register Field Descriptions

Bit	Field	Type	Reset	Description
31	HSOSREVERSAL	R/W	0h	Swaps the dataout from HSOS
30	HSOSBITINVERSION	R/W	0h	Inverts the HSOS bits
29	PHYCLKOUTINVERSION	R/W	0h	This inverts the phase for the PHYCLKOUT
28	RXPIDERR	R	0h	Flags if the RX data packet has PID error. NOT IMPLEMENTED YET
27	USEINTDATAOUT	R/W	0h	This will bypass the analog and will send data packet to controller incase of receiver (Faking the receive data). data used will be INTDATAOUTREG
26-11	INTDATAOUTREG	R/W	0h	This register will be loaded through OCP and this data will be given to the controller if USEINTDATAOUT is set to 1
10-8	RESERVED	R/W	0h	
7-0	CDR_TESTOUT	R	0h	CDR debug bits. Read value is valid only if VDDLDO is on. see DFT spec for details

16.5.4.5 CHRГ_DET Register (offset = 14h) [reset = 0h]

Register mask: FFFFFFFFh

CHRГ_DET is shown in [Figure 16-138](#) and described in [Table 16-149](#).

this is the charger detect register. this register is not used in the dead battery case.

Figure 16-138. CHRГ_DET Register

31		30		29		28		27		26		25		24	
RESERVED				USE_CHG_DE T_REG	DIS_CHG_DET	SRC_ON_DM	SINK_ON_DP	CHG_DET_EX T_CTL	RESTART_CH G_DET						
R/W-0h				R/W-0h	R/W-0h	R/W-0h	R/W-0h	R/W-0h	R/W-0h	R/W-0h					
23		22		21		20		19		18		17		16	
CHG_DET_DO NE	CHG_DETECT ED	DATA_DET	RESERVED				CHG_ISINK_E N	CHG_VSRC_E N	COMP_DP						
R-0h	R-0h	R-0h	R/W-0h				R/W-0h	R/W-0h	R-0h						
15		14		13		12		11		10		9		8	
COMP_DM	CHG_DET_OSC_CNTRL			CHG_DET_TIMER											
R-0h	R/W-0h			R/W-0h											
7		6		5		4		3		2		1		0	
CHG_DET_TIM ER	RESERVED			CHG_DET_ICTRL				CHG_DET_VCTRL				FOR_CE			
R/W-0h	R/W-0h			R/W-0h				R/W-0h				R/W-0h			

LEGEND: R/W = Read/Write; R = Read only; W1toCl = Write 1 to clear bit; -n = value after reset

Table 16-149. CHRГ_DET Register Field Descriptions

Bit	Field	Type	Reset	Description
31-30	RESERVED	R/W	0h	
29	USE_CHG_DET_REG	R/W	0h	Use bits 28-24 and 18-17 from this register
28	DIS_CHG_DET	R/W	0h	When read, returns current value of charger detect input. When USE_CHG_DET_REG = 1, the value written to this field overrides the corresponding charger detect input.
27	SRC_ON_DM	R/W	0h	When read, returns current value of charger detect input. When USE_CHG_DET_REG = 1, the value written to this field overrides the corresponding charger detect input.
26	SINK_ON_DP	R/W	0h	When read, returns current value of charger detect input. When USE_CHG_DET_REG = 1, the value written to this field overrides the corresponding charger detect input.
25	CHG_DET_EXT_CTL	R/W	0h	When read, returns current value of charger detect input. When USE_CHG_DET_REG = 1, the value written to this field overrides the corresponding charger detect input.
24	RESTART_CHG_DET	R/W	0h	Restart the charger detection protocol when this goes from 0 to 1
23	CHG_DET_DONE	R	0h	Charger detect protocol has completed
22	CHG_DETECTED	R	0h	Same signal as CE
21	DATA_DET	R	0h	Output of the data det comparator
20-19	RESERVED	R/W	0h	
18	CHG_ISINK_EN	R/W	0h	When read, returns current value of charger detect input. When USE_CHG_DET_REG = 1, the value written to this field overrides the corresponding charger detect input.
17	CHG_VSRC_EN	R/W	0h	When read, returns current value of charger detect input. When USE_CHG_DET_REG = 1, the value written to this field overrides the corresponding charger detect input.
16	COMP_DP	R	0h	Comparator on the DP line value
15	COMP_DM	R	0h	Comparator on the DM line value

Table 16-149. CHRГ_DET Register Field Descriptions (continued)

Bit	Field	Type	Reset	Description
14-13	CHG_DET_OSC_CNTRL	R/W	0h	Charger detect osc control
12-7	CHG_DET_TIMER	R/W	0h	Charger detect timer control. See charger detect section for details
6-5	RESERVED	R/W	0h	
4-3	CHG_DET_ICTRL	R/W	0h	Charger detect current control
2-1	CHG_DET_VCTRL	R/W	0h	Charger detect voltage buffer control
0	FOR_CE	R/W	0h	Force CE = 1 when this bit is set

16.5.4.6 PWR_CNTL Register (offset = 18h) [reset = 400000h]

Register mask: FFFFFFFFh

PWR_CNTL is shown in [Figure 16-139](#) and described in [Table 16-150](#).

has all the power control bits

Figure 16-139. PWR_CNTL Register

31	30	29	28	27	26	25	24
RESETDONET CLK	RESET_DONE_ VMAIN	VMAIN_GLOB AL_RESET_D ONE	RESETDONEM CLK	RESETDONE_ CHGDET	LDOPWRCOUNTER		
R-0h	R-0h	R-0h	R-0h	R-0h	R/W-400h		
23	22	21	20	19	18	17	16
LDOPWRCOUNTER							
R/W-400h							
15	14	13	12	11	10	9	8
LDOPWRCOUNTER				FORCEPLLSL OWCLK	FORCELDOON	FORCEPLLON	RESERVED
R/W-400h				R/W-0h	R/W-0h	R/W-0h	R/W-0h
7	6	5	4	3	2	1	0
RESERVED	PLLLOCK	USEPLLLOCK	USE_DATAPO LARITYN_REG	DATAPOLARIT YN	USE_PD_REG	PD	RESERVED
R/W-0h	R-0h	R/W-0h	R/W-0h	R/W-0h	R/W-0h	R/W-0h	R/W-0h

LEGEND: R/W = Read/Write; R = Read only; W1toCl = Write 1 to clear bit; -n = value after reset

Table 16-150. PWR_CNTL Register Field Descriptions

Bit	Field	Type	Reset	Description
31	RESETDONETCLK	R	0h	Goes high when the RESET is synchronized to TCLK
30	RESET_DONE_VMAIN	R	0h	Goes high when LDO domain is up and PLL LOCK is available and utmi_reset is de-asserted.
29	VMAIN_GLOBAL_RESET_DONE	R	0h	Goes high when LDO domain is up and PLL LOCK is available.
28	RESETDONEMCLK	R	0h	Goes high when the RESET is synchronized to MCLK
27	RESETDONE_CHGDET	R	0h	Goes high when the RESET is synchronized to charger detect oscillator clock domain
26-12	LDOPWRCOUNTER	R/W	400h	This is the value of the counter used for LDO power up. RESET to default.
11	FORCEPLLSLOWCLK	R/W	0h	Forces the PLL to the slow clk mode
10	FORCELDOON	R/W	0h	Forces the LDO to be ON.
9	FORCEPLLON	R/W	0h	Forces the PLL to be ON.
8-7	RESERVED	R/W	0h	
6	PLLLOCK	R	0h	Lock signal from the PLL
5	USEPLLLOCK	R/W	0h	This signal is used to indicate to the Phy, not to do any clock related activity until PLLLOCK = 1. This is not the default option. 0 do not use PLLLOCK. 1 use PLLLOCK as a clock gate.
4	USE_DATAPOLARITYN_REG	R/W	0h	1 -> use bit 3 as override for the DATAPOLARITYN signal.
3	DATAPOLARITYN	R/W	0h	Override value of datapolarityn
2	USE_PD_REG	R/W	0h	Use bit 1 from this register as PD override when set to '1'
1	PD	R/W	0h	Override value for PD
0	RESERVED	R/W	0h	

16.5.4.7 UTMI_INTERFACE_CNTL_1 Register (offset = 1Ch) [reset = 0h]

Register mask: FFFFFFFFh

UTMI_INTERFACE_CNTL_1 is shown in [Figure 16-140](#) and described in [Table 16-151](#).

register to override UTMI interface control pins.

Figure 16-140. UTMI_INTERFACE_CNTL_1 Register

31		30		29		28		27		26		25		24	
USEUTMIDATAREG		UTMIDATAIN													
R/W-0h		R/W-0h													
23		22		21		20		19		18		17		16	
UTMIDATAIN															
R/W-0h															
15		14		13		12		11		10		9		8	
UTMIDATAIN		RESERVED		USEDATABUSREG		DATABUS16OR8		USEOPMODEREG		OPMODE		OVERRIDESUSRESET			
R/W-0h		R/W-0h		R/W-0h		R/W-0h		R/W-0h		R/W-0h		R/W-0h		R/W-0h	
7		6		5		4		3		2		1		0	
SUSPENDM		UTMIRESET		OVERRIDEXCVRSEL		XCVRSEL		USETXVALIDREG		TXVALID		TXVALIDH			
R/W-0h		R/W-0h		R/W-0h		R/W-0h		R/W-0h		R/W-0h		R/W-0h		R/W-0h	

LEGEND: R/W = Read/Write; R = Read only; W1toCl = Write 1 to clear bit; -n = value after reset

Table 16-151. UTMI_INTERFACE_CNTL_1 Register Field Descriptions

Bit	Field	Type	Reset	Description
31	USEUTMIDATAREG	R/W	0h	Use datain from UTMI interface register
30-15	UTMIDATAIN	R/W	0h	Override value for the UTMIDATAIN
14	RESERVED	R/W	0h	
13	USEDATABUSREG	R/W	0h	When set to 1 use bit 12 from register instead of interface
12	DATABUS16OR8	R/W	0h	Override value for UTMI signal DATABUS16OR8
11	USEOPMODEREG	R/W	0h	When set to 1 use bit 10-9 from register instead of interface
10-9	OPMODE	R/W	0h	Override value for UTMI signal OPMODE [1:0]
8	OVERRIDESUSRESET	R/W	0h	Override the suspend and reset values. Use bits 6 and 7
7	SUSPENDM	R/W	0h	Override value for UTMI signal SUSPENDM
6	UTMIRESET	R/W	0h	Override value for UTMI signal UTMIRESET
5	OVERRIDEXCVRSEL	R/W	0h	When set to 1 use bit 4-3 from register instead of interface
4-3	XCVRSEL	R/W	0h	Override value for UTMI signal XCVRSEL [1:0]
2	USETXVALIDREG	R/W	0h	When set to 1 use bit 1-0 from register instead of interface
1	TXVALID	R/W	0h	Override value for UTMI signal TXVALID
0	TXVALIDH	R/W	0h	Override value for UTMI signal TXVALIDH

16.5.4.8 UTMI_INTERFACE_CNTL_2 Register (offset = 20h) [reset = 0h]

Register mask: FFFFFFFFh

 UTMI_INTERFACE_CNTL_2 is shown in [Figure 16-141](#) and described in [Table 16-152](#).

UTMI interface override and observe register 2

Figure 16-141. UTMI_INTERFACE_CNTL_2 Register

31	30	29	28	27	26	25	24	
RXRCV	RXDP	RXDM	HOSTDISCONNECT	LINESTATE		RXVALID	RXVALIDH	
R-0h	R-0h	R-0h	R-0h	R-0h		R-0h	R-0h	
23	22	21	20	19	18	17	16	
RXACTIVE	RXERROR	TXREADY	UTMIRESETDONE	USEBITSTUFFREG	TXBITSTUFFENABLE	TXBITSTUFFENABLEH	USETERMCONTROLREG	
R-0h	R-0h	R-0h	R-0h	R/W-0h	R/W-0h	R/W-0h	R/W-0h	
15	14	13	12	11	10	9	8	
TERMSEL	DPPULLDOWN	DMPULLDOWN	RESERVED			USEREGSERIALMODE	TXSE0	
R/W-0h	R/W-0h	R/W-0h	R/W-0h			R/W-0h	R/W-0h	
7	6	5	4	3	2	1	0	
TXDAT	FSLSSERIALMODE	TXENABLEN	RESERVED				sig_bypass_suspendpulse_incr	
R/W-0h	R/W-0h	R/W-0h	R/W-0h				R/W-0h	

LEGEND: R/W = Read/Write; R = Read only; W1toCl = Write 1 to clear bit; -n = value after reset

Table 16-152. UTMI_INTERFACE_CNTL_2 Register Field Descriptions

Bit	Field	Type	Reset	Description
31	RXRCV	R	0h	Read for UTMI signal. Read value is valid only if VDDLDO is on. Read value is valid only if VDDLDO is on.
30	RXDP	R	0h	Read for UTMI signal. Read value is valid only if VDDLDO is on.
29	RXDM	R	0h	Read for UTMI signal. Read value is valid only if VDDLDO is on.
28	HOSTDISCONNECT	R	0h	Read for UTMI signal. Read value is valid only if VDDLDO is on.
27-26	LINESTATE	R	0h	Read for UTMI signal. Read value is valid only if VDDLDO is on.
25	RXVALID	R	0h	Read for UTMI signal. Read value is valid only if VDDLDO is on.
24	RXVALIDH	R	0h	Read for UTMI signal. Read value is valid only if VDDLDO is on.
23	RXACTIVE	R	0h	Read for UTMI signal. Read value is valid only if VDDLDO is on.
22	RXERROR	R	0h	Read for UTMI signal. Read value is valid only if VDDLDO is on.
21	TXREADY	R	0h	Read for UTMI signal. Read value is valid only if VDDLDO is on.
20	UTMIRESETDONE	R	0h	Read for UTMIRESETDONE signal
19	USEBITSTUFFREG	R/W	0h	When set to 1 use bits 18-17 from register instead of interface
18	TXBITSTUFFENABLE	R/W	0h	Override value for signal TXBITSTUFFENABLE
17	TXBITSTUFFENABLEH	R/W	0h	Override value for pin TXBITSTUFFENABLE
16	USETERMCONTROLREG	R/W	0h	-When set to 1 use bits 15-13 from register instead of interface
15	TERMSEL	R/W	0h	Override value for signal TERMSEL
14	DPPULLDOWN	R/W	0h	Override value for signal DPPULLDOWN
13	DMPULLDOWN	R/W	0h	Override value for signal DMPULLDOWN
12-10	RESERVED	R/W	0h	

Table 16-152. UTMI_INTERFACE_CNTL_2 Register Field Descriptions (continued)

Bit	Field	Type	Reset	Description
9	USEREGSERIALMODE	R/W	0h	When set to 1 use bits 8-5 from register instead of interface
8	TXSE0	R/W	0h	Override value for signal TXSE0
7	TXDAT	R/W	0h	Override value for signal TXDAT
6	FSLSSERIALMODE	R/W	0h	Override value for signal FSLSSERIALMODE
5	TXENABLEN	R/W	0h	Override value for signal TXENABLEN
4-1	RESERVED	R/W	0h	
0	sig_bypass_suspendpulse_incr	R/W	0h	If the suspend signal is asserted for very short-time, it is pulse extended so that all the sampling logic samples it reliably. This pulse extension can be bypassed by writing a '1' to this bit (so that IP's behaviour is similar to previous versions)

16.5.4.9 BIST Register (offset = 24h) [reset = 0h]

Register mask: FFFFFFFFh

 BIST is shown in [Figure 16-142](#) and described in [Table 16-153](#).

Contains bits related to the built in self test of the phy

Figure 16-142. BIST Register

31	30	29	28	27	26	25	24
BIST_START	REDUCED_SWING	BIST_CRC_CALC_EN	BIST_PKT_LENGTH				
R/W-0h	R/W-0h	R/W-0h	R/W-0h				
23	22	21	20	19	18	17	16
BIST_PKT_LENGTH				LOOPBACK_EN	BIST_OP_PHASE_SEL		
R/W-0h				R/W-0h	R/W-0h		
15	14	13	12	11	10	9	8
SWEEP_EN	SWEEP_MODE			BIST_PASS	BIST_BUSY	RESERVED	
R/W-0h	R/W-0h			R-0h	R-0h	R/W-0h	
7	6	5	4	3	2	1	0
RESERVED	OP_CODE		RX_TEST_MODE	RESERVED	INTER_PKT_DELAY_TEST	HS_ALL_ONES_TEST	USE_BIST_TX_PHASES
R/W-0h	R/W-0h		R/W-0h	R/W-0h	R/W-0h	R/W-0h	R/W-0h

LEGEND: R/W = Read/Write; R = Read only; W1toCl = Write 1 to clear bit; -n = value after reset

Table 16-153. BIST Register Field Descriptions

Bit	Field	Type	Reset	Description
31	BIST_START	R/W	0h	When set to 1 the BIST mode is started.
30	REDUCED_SWING	R/W	0h	When 1 the TX swing is reduced in BIST mode
29	BIST_CRC_CALC_EN	R/W	0h	Enables CRC calculation during BIST when set to 1
28-20	BIST_PKT_LENGTH	R/W	0h	Address for which BIST to select
19	LOOPBACK_EN	R/W	0h	Enables the loopback mode
18-16	BIST_OP_PHASE_SEL	R/W	0h	Selects which phase to use for data transmission during BIST
15	SWEEP_EN	R/W	0h	Enables freq sweep on CDR
14-12	SWEEP_MODE	R/W	0h	Selects the freq sweep mode. Details in DFT spec.
11	BIST_PASS	R	0h	Indicates that the BIST has passed. Read value is valid only if VDDLDO is on.
10	BIST_BUSY	R	0h	Indicates that BIST is running. Read value is valid only if VDDLDO is on.
9-7	RESERVED	R/W	0h	
6-5	OP_CODE	R/W	0h	Defined in DFT spec
4	RX_TEST_MODE	R/W	0h	Defined in DFT spec
3	RESERVED	R/W	0h	
2	INTER_PKT_DELAY_TEST	R/W	0h	Defined in DFT spec
1	HS_ALL_ONES_TEST	R/W	0h	Defined in DFT spec
0	USE_BIST_TX_PHASES	R/W	0h	When set to 1 bits 18-16 are activated for choosing the transmitting phase.

16.5.4.10 BIST_CRC Register (offset = 28h) [reset = 0h]

Register mask: FFFFFFFFh

BIST_CRC is shown in [Figure 16-143](#) and described in [Table 16-154](#).

the CRC code for BIST test

Figure 16-143. BIST_CRC Register

31	30	29	28	27	26	25	24	23	22	21	20	19	18	17	16	15	14	13	12	11	10	9	8	7	6	5	4	3	2	1	0
BIST_CRC																															
R/W-0h																															

LEGEND: R/W = Read/Write; R = Read only; W1toCl = Write 1 to clear bit; -n = value after reset

Table 16-154. BIST_CRC Register Field Descriptions

Bit	Field	Type	Reset	Description
31-0	BIST_CRC	R/W	0h	The CRC value from the BIST.

16.5.4.11 CDR_BIST2 Register (offset = 2Ch) [reset = 0h]

Register mask: FFFFFFFFh

 CDR_BIST2 is shown in [Figure 16-144](#) and described in [Table 16-155](#).

clock data recovery register and BIST register 2

Figure 16-144. CDR_BIST2 Register

31	30	29	28	27	26	25	24
CDR_EXE_EN	CDR_EXE_MODE			NUM_DECISIONS			CDR_CHOSEN_PHASE
R/W-0h		R/W-0h			R/W-0h		R-0h
23	22	21	20	19	18	17	16
CDR_CHOSEN_PHASE		FORCE_CDR_PHASE			DISABLE_CDR_FREQ_TRACK	CDR_CONFIGURE	
R-0h		R-0h			R-0h	R-0h	
15	14	13	12	11	10	9	8
CDR_CONFIGURE			FORCE_CDR_PHASE_EN	Bist_start_addr			
R-0h			R-0h	R/W-0h			
7	6	5	4	3	2	1	0
Bist_start_addr		Bist_end_addr					
R/W-0h		R/W-0h					

LEGEND: R/W = Read/Write; R = Read only; W1toCl = Write 1 to clear bit; -n = value after reset

Table 16-155. CDR_BIST2 Register Field Descriptions

Bit	Field	Type	Reset	Description
31	CDR_EXE_EN	R/W	0h	CDR debug bits
30-28	CDR_EXE_MODE	R/W	0h	CDR debug bits
27-25	NUM_DECISIONS	R/W	0h	CDR debug bits
24-22	CDR_CHOSEN_PHASE	R	0h	
21-19	FORCE_CDR_PHASE	R	0h	
18	DISABLE_CDR_FREQ_TRACK	R	0h	
17-13	CDR_CONFIGURE	R	0h	
12	FORCE_CDR_PHASE_EN	R	0h	Use bits 21-19 as the phase to be forced on the CDR.
11-6	Bist_start_addr	R/W	0h	See DFT spec for details
5-0	Bist_end_addr	R/W	0h	See DFT spec for details

16.5.4.12 GPIO Register (offset = 30h) [reset = 0h]

Register mask: FFFFFFFFh

GPIO is shown in [Figure 16-145](#) and described in [Table 16-156](#).

GPIO mode configurations and reads

Figure 16-145. GPIO Register

31	30	29	28	27	26	25	24
USEGPIOMOD EREG	GPIOMODE	DPGPIOGZ	DMGPIOGZ	DPGPIOA	DMGPIOA	DPGPIOY	DMGPIOY
R/W-0h	R/W-0h	R/W-0h	R/W-0h	R/W-0h	R/W-0h	R-0h	R-0h
23	22	21	20	19	18	17	16
GPIO1P8VCO NFIG	GPIOCONFIG			DMGPIOIPD	DPGPIOIPD	RESERVED	
R/W-0h	R/W-0h			R/W-0h	R/W-0h	R/W-0h	
15	14	13	12	11	10	9	8
RESERVED							
R/W-0h							
7	6	5	4	3	2	1	0
RESERVED							
R/W-0h							

LEGEND: R/W = Read/Write; R = Read only; W1toCl = Write 1 to clear bit; -n = value after reset

Table 16-156. GPIO Register Field Descriptions

Bit	Field	Type	Reset	Description
31	USEGPIOMODEREG	R/W	0h	When set to 1 use bits 31 24 from this register instead of primary inputs
30	GPIOMODE	R/W	0h	Overrides the corresponding primary input
29	DPGPIOGZ	R/W	0h	Overrides the corresponding primary input
28	DMGPIOGZ	R/W	0h	Overrides the corresponding primary input
27	DPGPIOA	R/W	0h	Overrides the corresponding primary input
26	DMGPIOA	R/W	0h	Overrides the corresponding primary input
25	DPGPIOY	R	0h	The GPIO Y output is stored here
24	DMGPIOY	R	0h	The GPIO Y output is stored here
23	GPIO1P8VCONFIG	R/W	0h	Overrides the corresponding primary input
22-20	GPIOCONFIG	R/W	0h	Used for configuring the GPIOs. Details to be updated.
19	DMGPIOIPD	R/W	0h	GPIO mode DM pull down enabled. Overrides the corresponding primary input
18	DPGPIOIPD	R/W	0h	GPIO mode DP pull-down enabled. Overrides the corresponding primary input.
17-0	RESERVED	R/W	0h	

16.5.4.13 DLLHS Register (offset = 34h) [reset = 8000h]

Register mask: FFFFFFFFh

 DLLHS is shown in [Figure 16-146](#) and described in [Table 16-157](#).

bits for control and debug of the DLL inside the phy

Figure 16-146. DLLHS Register

31	30	29	28	27	26	25	24
RESERVED			DLLHS_LOCK	DLLHS_GENERATED_CODE			
R/W-0h			R-0h	R-0h			
23	22	21	20	19	18	17	16
DLLHS_GENERATED_CODE		DLL_SEL_COD E_PHS	DLL_LOCKCHK		DLL_SEL_COD		
R-0h		R/W-0h	R/W-0h		R/W-0h		
15	14	13	12	11	10	9	8
DLL_PHS0_8	DLL_FORCED_CODE					FORCE_DLL_CODE	
R/W-1h		R/W-0h				R/W-0h	
7	6	5	4	3	2	1	0
DLL_RATE		DLL_FILT		DLL_CDR_MO DE	DLL_IDLE	DLL_FREEZE	RESERVED
R/W-0h		R/W-0h		R/W-0h	R/W-0h	R/W-0h	R/W-0h

LEGEND: R/W = Read/Write; R = Read only; W1toCl = Write 1 to clear bit; -n = value after reset

Table 16-157. DLLHS Register Field Descriptions

Bit	Field	Type	Reset	Description
31-29	RESERVED	R/W	0h	
28	DLLHS_LOCK	R	0h	Read the AFE output by this name
27-22	DLLHS_GENERATED_CODE	R	0h	Read the AFE output by this name. Read value is valid only if VDDLDO is on.
21	DLL_SEL_CODE_PHS	R/W	0h	Connect to DLLHS_TEST_LDO[0] on AFE interface. see DFT spec for details.
20-19	DLL_LOCKCHK	R/W	0h	Connect to DLLHS_TEST_LDO [2:1] on AFE interface. see DFT spec for details.
18-16	DLL_SEL_COD	R/W	0h	Connect to DLLHS_TEST_LDO [5:3] on AFE interface. see DFT spec for details.
15	DLL_PHS0_8	R/W	1h	Connect to DLLHS_TEST_LDO[6] on AFE interface. see DFT spec for details.
14-9	DLL_FORCED_CODE	R/W	0h	Connect to the pin of this name on AFE interface. see DFT spec for details.
8	FORCE_DLL_CODE	R/W	0h	Connect to DLLHS_TEST_LDO[11] on AFE interface. see DFT spec for details.
7-6	DLL_RATE	R/W	0h	Connect to DLLHS_TEST_LDO [8:7] on AFE interface. see DFT spec for details.
5-4	DLL_FILT	R/W	0h	Connect to DLLHS_TEST_LDO [10:9] on AFE interface. see DFT spec for details.
3	DLL_CDR_MODE	R/W	0h	Connect to the pin of this name on AFE interface. see DFT spec for details.
2	DLL_IDLE	R/W	0h	Connect to DLLHS_TEST_LDO[12] on AFE interface. see DFT spec for details.
1	DLL_FREEZE	R/W	0h	Connect to DLLHS_TEST_LDO[13] on AFE interface. see DFT spec for details.

Table 16-157. DLLHS Register Field Descriptions (continued)

Bit	Field	Type	Reset	Description
0	RESERVED	R/W	0h	

16.5.4.14 USB2PHYCM_CONFIG Register (offset = 3Ch) [reset = 0h]

Register mask: FFFFFFFFh

 USB2PHYCM_CONFIG is shown in [Figure 16-147](#) and described in [Table 16-158](#).

Config and status register for the USB2PHYCM and LDO

Figure 16-147. USB2PHYCM_CONFIG Register

31	30	29	28	27	26	25	24
CONFIGURECM							
R/W-0h							
23	22	21	20	19	18	17	16
CMSTATUS				LDOCONFIG			
R-0h				R/W-0h			
15	14	13	12	11	10	9	8
LDOCONFIG							
R/W-0h							
7	6	5	4	3	2	1	0
LDOCONFIG				LDOSTATUS			
R/W-0h				R-0h			

LEGEND: R/W = Read/Write; R = Read only; W1toCl = Write 1 to clear bit; -n = value after reset

Table 16-158. USB2PHYCM_CONFIG Register Field Descriptions

Bit	Field	Type	Reset	Description
31-24	CONFIGURECM	R/W	0h	Connects to the CONFIGURECM pins. see DFT spec for details.
23-18	CMSTATUS	R	0h	Reads the CMSTATUS bits. see DFT spec for details.
17-2	LDOCONFIG	R/W	0h	The LDOCONFIG bit settings. See DFT spec for details.
1-0	LDOSTATUS	R	0h	Reads the LDOSTATUS bits. see DFT spec for details.

16.5.4.15 AD_INTERFACE_REG1 Register (offset = 44h) [reset = 0h]

Register mask: FFFFFFFFh

AD_INTERFACE_REG1 is shown in [Figure 16-148](#) and described in [Table 16-159](#).

All bits (unless defined) are bypass bits for internal analog to digital interface pins with the same name. All the bits of this register, except the over-ride bits return a '0' on read, if VDDLDO is off.

Figure 16-148. AD_INTERFACE_REG1 Register

31	30	29	28	27	26	25	24
USE_AD_DATA_REG	HS_TX_DATA	FS_TX_DATA	TEST_PRE_EN_CNTRL	SQ_PRE_EN	HS_TX_PRE_EN	HS_RX_PRE_EN	TEST_EN_CNTRL
R/W-0h	R/W-0h	R/W-0h	R/W-0h	R/W-0h	R/W-0h	R/W-0h	R/W-0h
23	22	21	20	19	18	17	16
HS_TX_EN	FS_RX_EN	RESERVED	SQ_EN	HS_RX_EN	TEST_HS_MODE	HS_HV_SW	HS_CHIRP
R/W-0h	R/W-0h	R/W-0h	R/W-0h	R/W-0h	R/W-0h	R/W-0h	R/W-0h
15	14	13	12	11	10	9	8
TEST_FS_MODE	FSTX_GZ	FSTX_PRE_EN	RESERVED	TEST_SQ_CAL_CONTROL	SQ_CAL_EN3	SQ_CAL_EN1	SQ_CAL_EN2
R/W-0h	R/W-0h	R/W-0h	R/W-0h	R/W-0h	R/W-0h	R/W-0h	R/W-0h
7	6	5	4	3	2	1	0
TEST_RTERM_CAL_CONTROL	RTERM_CAL_EN	DLL_RX_DATA	DISCON_DETECT	USE_LSHOST_REG	LSHOSTMODE	LSFS_RX_DATA	SQUELCH
R/W-0h	R/W-0h	R-0h	R-0h	R/W-0h	R/W-0h	R-0h	R-0h

LEGEND: R/W = Read/Write; R = Read only; W1toCl = Write 1 to clear bit; -n = value after reset

Table 16-159. AD_INTERFACE_REG1 Register Field Descriptions

Bit	Field	Type	Reset	Description
31	USE_AD_DATA_REG	R/W	0h	Override for bits 30-29
30	HS_TX_DATA	R/W	0h	
29	FS_TX_DATA	R/W	0h	
28	TEST_PRE_EN_CNTRL	R/W	0h	Override for bits 27-25
27	SQ_PRE_EN	R/W	0h	
26	HS_TX_PRE_EN	R/W	0h	
25	HS_RX_PRE_EN	R/W	0h	
24	TEST_EN_CNTRL	R/W	0h	Override for bits 23-19
23	HS_TX_EN	R/W	0h	
22	FS_RX_EN	R/W	0h	
21	RESERVED	R/W	0h	
20	SQ_EN	R/W	0h	
19	HS_RX_EN	R/W	0h	
18	TEST_HS_MODE	R/W	0h	Override for bits 17-16
17	HS_HV_SW	R/W	0h	
16	HS_CHIRP	R/W	0h	
15	TEST_FS_MODE	R/W	0h	Override for bits 14 12
14	FSTX_GZ	R/W	0h	
13	FSTX_PRE_EN	R/W	0h	
12	RESERVED	R/W	0h	

Table 16-159. AD_INTERFACE_REG1 Register Field Descriptions (continued)

Bit	Field	Type	Reset	Description
11	TEST_SQ_CAL_CONTR OL	R/W	0h	Override for bits 10 8
10	SQ_CAL_EN3	R/W	0h	
9	SQ_CAL_EN1	R/W	0h	
8	SQ_CAL_EN2	R/W	0h	
7	TEST_RTERM_CAL_CO NTROL	R/W	0h	Override for bits 6
6	RTERM_CAL_EN	R/W	0h	
5	DLL_RX_DATA	R	0h	
4	DISCON_DETECT	R	0h	
3	USE_LSHOST_REG	R/W	0h	Use bit 2 for this reg
2	LSHOSTMODE	R/W	0h	
1	LSFS_RX_DATA	R	0h	
0	SQUELCH	R	0h	

16.5.4.16 AD_INTERFACE_REG2 Register (offset = 48h) [reset = 0h]

Register mask: FFFFFFFFh

AD_INTERFACE_REG2 is shown in [Figure 16-149](#) and described in [Table 16-160](#).

All bits (unless defined) are bypass bits for internal analog to digital interface pins with the same name. All the bits of this register, except the over-ride bits return a '0' on read, if VDDLDO is off.

Figure 16-149. AD_INTERFACE_REG2 Register

31	30	29	28	27	26	25	24
USE_SUSP_D RV_REG	SUS_DRV_DP _DATA	SUS_DRV_DP _EN	SUS_DRV_DM _DATA	SUS_DRV_DM _EN	USE_DISCON_ REG	DISCON_EN	DISCON_PRE_ EN
R/W-0h	R/W-0h	R/W-0h	R/W-0h	R/W-0h	R/W-0h	R/W-0h	R/W-0h
23	22	21	20	19	18	17	16
RESERVED	SPARE_OUT_CORE					SERX_DP_CO RE	SERX_DM_CO RE
R/W-0h	R-0h					R-0h	R-0h
15	14	13	12	11	10	9	8
USE_HSRX_C AL_EN_REG	HSRX_CAL_E N	USE_RPU_RP D_REG	RPU_DP_SW1 _EN_CORE	RPU_DP_SW2 _EN_CORE	RPU_DM_SW1 _EN_CORE	RPU_DM_SW2 _EN_CORE	DP_PULLDOW N_EN_CORE
R/W-0h	R/W-0h	R/W-0h	R/W-0h	R/W-0h	R/W-0h	R/W-0h	R/W-0h
7	6	5	4	3	2	1	0
DM_PULLDOW N_EN_CORE	DP_DM_5V_S HORT	SPARE_IN_CORE					PORZ
R/W-0h	R-0h	R/W-0h					R-0h

LEGEND: R/W = Read/Write; R = Read only; W1toCl = Write 1 to clear bit; -n = value after reset

Table 16-160. AD_INTERFACE_REG2 Register Field Descriptions

Bit	Field	Type	Reset	Description
31	USE_SUSP_DRV_REG	R/W	0h	Use bits 27-30 from this register as overrides
30	SUS_DRV_DP_DATA	R/W	0h	
29	SUS_DRV_DP_EN	R/W	0h	
28	SUS_DRV_DM_DATA	R/W	0h	
27	SUS_DRV_DM_EN	R/W	0h	
26	USE_DISCON_REG	R/W	0h	Use bits 24-25 from this register as override
25	DISCON_EN	R/W	0h	
24	DISCON_PRE_EN	R/W	0h	
23	RESERVED	R/W	0h	
22-18	SPARE_OUT_CORE	R	0h	
17	SERX_DP_CORE	R	0h	
16	SERX_DM_CORE	R	0h	
15	USE_HSRX_CAL_EN_REG	R/W	0h	Use bit 14 from this register as override
14	HSRX_CAL_EN	R/W	0h	
13	USE_RPU_RPD_REG	R/W	0h	Use override from bits 7-12
12	RPU_DP_SW1_EN_CORE	R/W	0h	
11	RPU_DP_SW2_EN_CORE	R/W	0h	
10	RPU_DM_SW1_EN_CORE	R/W	0h	

Table 16-160. AD_INTERFACE_REG2 Register Field Descriptions (continued)

Bit	Field	Type	Reset	Description
9	RPU_DM_SW2_EN_COR E	R/W	0h	
8	DP_PULLDOWN_EN_CO RE	R/W	0h	
7	DM_PULLDOWN_EN_CO RE	R/W	0h	
6	DP_DM_5V_SHORT	R	0h	
5-1	SPARE_IN_CORE	R/W	0h	
0	PORZ	R	0h	Read only bit -> the PORZ generated from the digital registered on the A-D interface.

16.5.4.17 AD_INTERFACE_REG3 Register (offset = 4Ch) [reset = 0h]

Register mask: FFFFFFFFh

AD_INTERFACE_REG3 is shown in [Figure 16-150](#) and described in [Table 16-161](#).

All bits (unless defined) are bypass bits for internal analog to digital interface pins with the same name. All the bits of this register, except the over-ride bits return a '0' on read, if VDDLDO is off.

Figure 16-150. AD_INTERFACE_REG3 Register

31	30	29	28	27	26	25	24
USE_HSOS_DATA_REG	HSOS_DATA						
R/W-0h				R/W-0h			
23	22	21	20	19	18	17	16
HSOS_DATA	USE_FS_REG3	FSTX_MODE	FSTX_SE0	USE_HS_TERM_RES_REG	HS_TERM_RES	SPARE_IN_LDO	
R/W-0h	R/W-0h	R/W-0h	R/W-0h	R/W-0h	R/W-0h	R/W-0h	
15	14	13	12	11	10	9	8
SPARE_IN_LDO						SPARE_OUT_LDO	
R/W-0h						R-0h	
7	6	5	4	3	2	1	0
SPARE_OUT_LDO					USE_FARCORE_REG	FARCORE	
R-0h					R/W-0h	R/W-0h	

LEGEND: R/W = Read/Write; R = Read only; W1toCl = Write 1 to clear bit; -n = value after reset

Table 16-161. AD_INTERFACE_REG3 Register Field Descriptions

Bit	Field	Type	Reset	Description
31	USE_HSOS_DATA_REG	R/W	0h	Use bits 30-23 in this register as bypass bits
30-23	HSOS_DATA	R/W	0h	
22	USE_FS_REG3	R/W	0h	Use bits 20-21 as bypass bits
21	FSTX_MODE	R/W	0h	
20	FSTX_SE0	R/W	0h	
19	USE_HS_TERM_RES_REG	R/W	0h	Use bit 18 as override bit
18	HS_TERM_RES	R/W	0h	
17-10	SPARE_IN_LDO	R/W	0h	
9-2	SPARE_OUT_LDO	R	0h	
1	USE_FARCORE_REG	R/W	0h	Use bit 0 from this register as bypass
0	FARCORE	R/W	0h	

16.5.4.18 ANA_CONFIG2 Register (offset = 54h) [reset = 0h]

Register mask: FFFFFFFFh

 ANA_CONFIG2 is shown in [Figure 16-151](#) and described in [Table 16-162](#).

Used to configure and debug the analog blocks.

Figure 16-151. ANA_CONFIG2 Register

31	30	29	28	27	26	25	24
RESERVED					REF_GEN_TEST		
R/W-0h					R/W-0h		
23	22	21	20	19	18	17	16
REF_GEN_TEST				RESERVED		RTERM_TEST	
R/W-0h				R/W-0h		R/W-0h	
15	14	13	12	11	10	9	8
RTERM_TEST	RESERVED						
R/W-0h	R/W-0h						
7	6	5	4	3	2	1	0
RESERVED							
R/W-0h							

LEGEND: R/W = Read/Write; R = Read only; W1toCl = Write 1 to clear bit; -n = value after reset

Table 16-162. ANA_CONFIG2 Register Field Descriptions

Bit	Field	Type	Reset	Description
31-27	RESERVED	R/W	0h	Reserved.
26-20	REF_GEN_TEST	R/W	0h	0000000b - Produces the typical vertical eye diagram amplitude (default). 1100000b - Increases vertical eye diagram amplitude by 15 mV. 1010000b - Decreases vertical eye diagram amplitude by 15 mV. All other values are reserved.
19-18	RESERVED	R/W	0h	Reserved.
17-15	RTERM_TEST	R/W	0h	000b - Typical termination impedance (default). 011b - Decreases the termination impedance by 2 to 3% and can be used to increase the vertical eye diagram amplitude by 1 to 1.5%. All other values reserved.
14-0	RESERVED	R/W	0h	Reserved.

16.5.5 CPPI_DMA Registers

[Table 16-163](#) lists the memory-mapped registers for the CPPI_DMA. All register offset addresses not listed in [Table 16-163](#) should be considered as reserved locations and the register contents should not be modified.

Table 16-163. CPPI_DMA REGISTERS

Offset	Acronym	Register Name	Section
0h	DMAREVID		Section 16.5.5.1
4h	TDFDQ		Section 16.5.5.2
8h	DMAEMU		Section 16.5.5.3
800h	TXGCR0		Section 16.5.5.4
808h	RXGCR0		Section 16.5.5.5
80Ch	RXHPCRA0		Section 16.5.5.6
810h	RXHPCRB0		Section 16.5.5.7
820h	TXGCR1		Section 16.5.5.8
828h	RXGCR1		Section 16.5.5.9

Table 16-163. CPPI_DMA REGISTERS (continued)

Offset	Acronym	Register Name	Section
82Ch	RXHPCRA1		Section 16.5.5.10
830h	RXHPCRB1		Section 16.5.5.11
840h	TXGCR2		Section 16.5.5.12
848h	RXGCR2		Section 16.5.5.13
84Ch	RXHPCRA2		Section 16.5.5.14
850h	RXHPCRB2		Section 16.5.5.15
860h	TXGCR3		Section 16.5.5.16
868h	RXGCR3		Section 16.5.5.17
86Ch	RXHPCRA3		Section 16.5.5.18
870h	RXHPCRB3		Section 16.5.5.19
880h	TXGCR4		Section 16.5.5.20
888h	RXGCR4		Section 16.5.5.21
88Ch	RXHPCRA4		Section 16.5.5.22
890h	RXHPCRB4		Section 16.5.5.23
8A0h	TXGCR5		Section 16.5.5.24
8A8h	RXGCR5		Section 16.5.5.25
8ACh	RXHPCRA5		Section 16.5.5.26
8B0h	RXHPCRB5		Section 16.5.5.27
8C0h	TXGCR6		Section 16.5.5.28
8C8h	RXGCR6		Section 16.5.5.29
8CCh	RXHPCRA6		Section 16.5.5.30
8D0h	RXHPCRB6		Section 16.5.5.31
8E0h	TXGCR7		Section 16.5.5.32
8E8h	RXGCR7		Section 16.5.5.33
8ECh	RXHPCRA7		Section 16.5.5.34
8F0h	RXHPCRB7		Section 16.5.5.35
900h	TXGCR8		Section 16.5.5.36
908h	RXGCR8		Section 16.5.5.37
90Ch	RXHPCRA8		Section 16.5.5.38
910h	RXHPCRB8		Section 16.5.5.39
920h	TXGCR9		Section 16.5.5.40
928h	RXGCR9		Section 16.5.5.41
92Ch	RXHPCRA9		Section 16.5.5.42
930h	RXHPCRB9		Section 16.5.5.43
940h	TXGCR10		Section 16.5.5.44
948h	RXGCR10		Section 16.5.5.45
94Ch	RXHPCRA10		Section 16.5.5.46
950h	RXHPCRB10		Section 16.5.5.47
960h	TXGCR11		Section 16.5.5.48
968h	RXGCR11		Section 16.5.5.49
96Ch	RXHPCRA11		Section 16.5.5.50
970h	RXHPCRB11		Section 16.5.5.51
980h	TXGCR12		Section 16.5.5.52
988h	RXGCR12		Section 16.5.5.53
98Ch	RXHPCRA12		Section 16.5.5.54
990h	RXHPCRB12		Section 16.5.5.55
9A0h	TXGCR13		Section 16.5.5.56

Table 16-163. CPPI_DMA REGISTERS (continued)

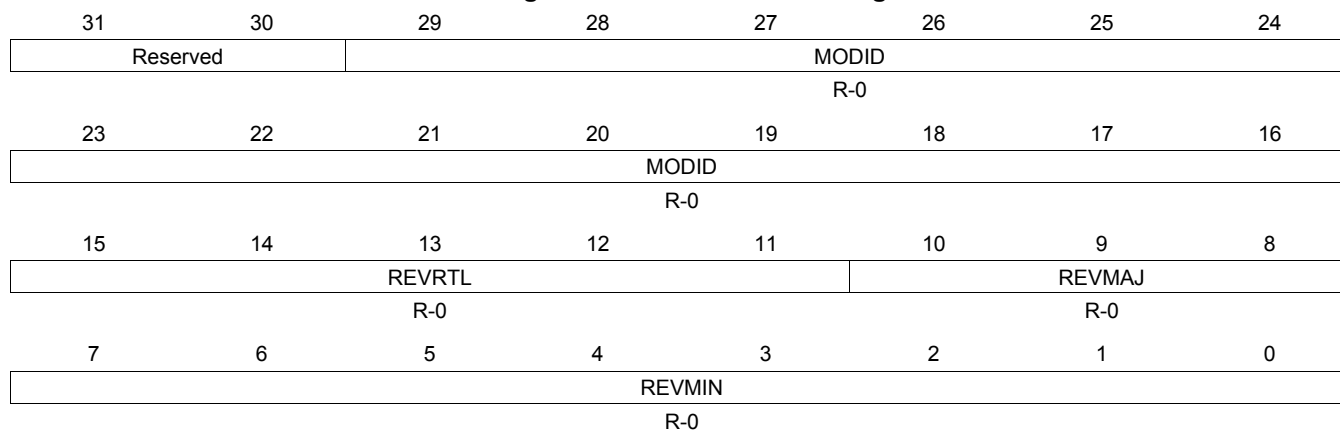
Offset	Acronym	Register Name	Section
9A8h	RXGCR13		Section 16.5.5.57
9ACh	RXHPCRA13		Section 16.5.5.58
9B0h	RXHPCRB13		Section 16.5.5.59
9C0h	TXGCR14		Section 16.5.5.60
9C8h	RXGCR14		Section 16.5.5.61
9CCh	RXHPCRA14		Section 16.5.5.62
9D0h	RXHPCRB14		Section 16.5.5.63
9E0h	TXGCR15		Section 16.5.5.64
9E8h	RXGCR15		Section 16.5.5.65
9ECh	RXHPCRA15		Section 16.5.5.66
9F0h	RXHPCRB15		Section 16.5.5.67
A00h	TXGCR16		Section 16.5.5.68
A08h	RXGCR16		Section 16.5.5.69
A0Ch	RXHPCRA16		Section 16.5.5.70
A10h	RXHPCRB16		Section 16.5.5.71
A20h	TXGCR17		Section 16.5.5.72
A28h	RXGCR17		Section 16.5.5.73
A2Ch	RXHPCRA17		Section 16.5.5.74
A30h	RXHPCRB17		Section 16.5.5.75
A40h	TXGCR18		Section 16.5.5.76
A48h	RXGCR18		Section 16.5.5.77
A4Ch	RXHPCRA18		Section 16.5.5.78
A50h	RXHPCRB18		Section 16.5.5.79
A60h	TXGCR19		Section 16.5.5.80
A68h	RXGCR19		Section 16.5.5.81
A6Ch	RXHPCRA19		Section 16.5.5.82
A70h	RXHPCRB19		Section 16.5.5.83
A80h	TXGCR20		Section 16.5.5.84
A88h	RXGCR20		Section 16.5.5.85
A8Ch	RXHPCRA20		Section 16.5.5.86
A90h	RXHPCRB20		Section 16.5.5.87
AA0h	TXGCR21		Section 16.5.5.88
AA8h	RXGCR21		Section 16.5.5.89
AACH	RXHPCRA21		Section 16.5.5.90
AB0h	RXHPCRB21		Section 16.5.5.91
AC0h	TXGCR22		Section 16.5.5.92
AC8h	RXGCR22		Section 16.5.5.93
ACCh	RXHPCRA22		Section 16.5.5.94
AD0h	RXHPCRB22		Section 16.5.5.95
AE0h	TXGCR23		Section 16.5.5.96
AE8h	RXGCR23		Section 16.5.5.97
AECCh	RXHPCRA23		Section 16.5.5.98
AF0h	RXHPCRB23		Section 16.5.5.99
B00h	TXGCR24		Section 16.5.5.100
B08h	RXGCR24		Section 16.5.5.101
B0Ch	RXHPCRA24		Section 16.5.5.102
B10h	RXHPCRB24		Section 16.5.5.103

Table 16-163. CPPI_DMA REGISTERS (continued)

Offset	Acronym	Register Name	Section
B20h	TXGCR25		Section 16.5.5.104
B28h	RXGCR25		Section 16.5.5.105
B2Ch	RXHPCRA25		Section 16.5.5.106
B30h	RXHPCRB25		Section 16.5.5.107
B40h	TXGCR26		Section 16.5.5.108
B48h	RXGCR26		Section 16.5.5.109
B4Ch	RXHPCRA26		Section 16.5.5.110
B50h	RXHPCRB26		Section 16.5.5.111
B60h	TXGCR27		Section 16.5.5.112
B68h	RXGCR27		Section 16.5.5.113
B6Ch	RXHPCRA27		Section 16.5.5.114
B70h	RXHPCRB27		Section 16.5.5.115
B80h	TXGCR28		Section 16.5.5.116
B88h	RXGCR28		Section 16.5.5.117
B8Ch	RXHPCRA28		Section 16.5.5.118
B90h	RXHPCRB28		Section 16.5.5.119
BA0h	TXGCR29		Section 16.5.5.120
BA8h	RXGCR29		Section 16.5.5.121
BACh	RXHPCRA29		Section 16.5.5.122
BB0h	RXHPCRB29		Section 16.5.5.123

16.5.5.1 DMAREVID Register (offset = 0h) [reset = 530901h]

 DMAREVID is shown in [Figure 16-152](#) and described in [Table 16-164](#).

Figure 16-152. DMAREVID Register


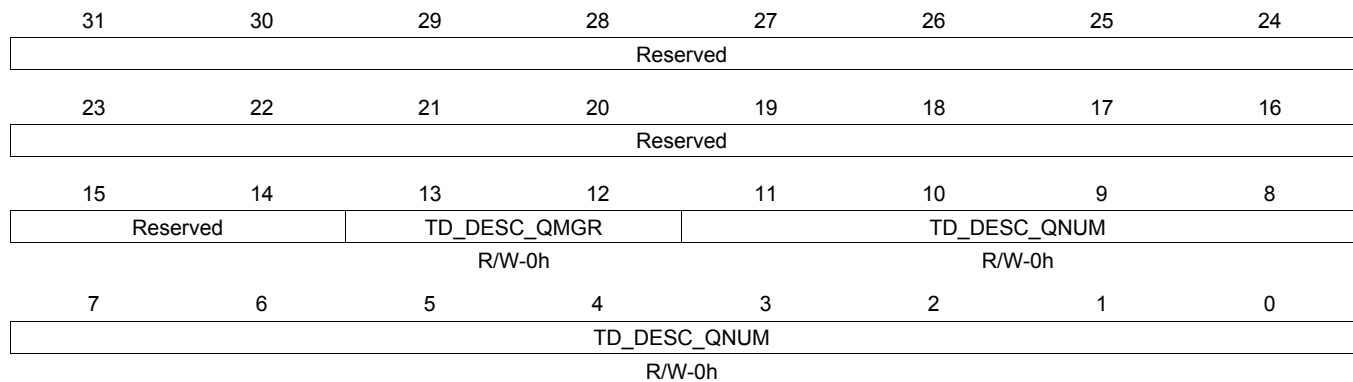
LEGEND: R/W = Read/Write; R = Read only; W1toCl = Write 1 to clear bit; -n = value after reset

Table 16-164. DMAREVID Register Field Descriptions

Bit	Field	Type	Reset	Description
29-16	MODID	R-0	0	Module ID field
15-11	REVRTL	R-0	0	RTL revision. Will vary depending on release.
10-8	REVMAJ	R-0	0	Major revision.
7-0	REVMIN	R-0	0	Minor revision. CPPI DMA Revision Register

16.5.5.2 TDFDQ Register (offset = 4h) [reset = 0h]

TDFDQ is shown in [Figure 16-153](#) and described in [Table 16-165](#).

Figure 16-153. TDFDQ Register


LEGEND: R/W = Read/Write; R = Read only; W1toCl = Write 1 to clear bit; -n = value after reset

Table 16-165. TDFDQ Register Field Descriptions

Bit	Field	Type	Reset	Description
13-12	TD_DESC_QMGR	R/W	0h	This field controls which of the 4 Queue Managers the DMA will access in order to allocate a channel teardown descriptor from the teardown descriptor queue.
11-0	TD_DESC_QNUM	R/W	0h	This field controls which of the 2K queues in the indicated queue manager should be read in order to allocate channel teardown descriptors. CPPI DMA Teardown Free Descriptor Queue Control Register

16.5.5.3 DMAEMU Register (offset = 8h) [reset = 0h]

DMAEMU is shown in [Figure 16-154](#) and described in [Table 16-166](#).

Figure 16-154. DMAEMU Register

31	30	29	28	27	26	25	24
Reserved							
23	22	21	20	19	18	17	16
Reserved							
15	14	13	12	11	10	9	8
Reserved							
7	6	5	4	3	2	1	0
Reserved						SOFT	FREE
						R/W-0h	R/W-0h

LEGEND: R/W = Read/Write; R = Read only; W1toCl = Write 1 to clear bit; -n = value after reset

Table 16-166. DMAEMU Register Field Descriptions

Bit	Field	Type	Reset	Description
1	SOFT	R/W	0h	Control for emulation pause request 1 = Does not force emu_pause_req low 0 = Forces emu_pause_req low
0	FREE	R/W	0h	Enable for emulation suspend CPPI DMA Emulation Control Register

16.5.5.4 TXGCR0 Register (offset = 800h) [reset = 0h]

TXGCR0 is shown in [Figure 16-155](#) and described in [Table 16-167](#).

Figure 16-155. TXGCR0 Register

31	30	29	28	27	26	25	24
TX_ENABLE	TX_TEARDOWN	Reserved					
R/W-0h	R/W-0h						
23	22	21	20	19	18	17	16
Reserved							
15	14	13	12	11	10	9	8
Reserved		TX_DEFAULT_QMGR			TX_DEFAULT_QNUM		
W-0h				W-0h			
7	6	5	4	3	2	1	0
TX_DEFAULT_QNUM							
W-0h							

LEGEND: R/W = Read/Write; R = Read only; W1toCl = Write 1 to clear bit; -n = value after reset

Table 16-167. TXGCR0 Register Field Descriptions

Bit	Field	Type	Reset	Description
31	TX_ENABLE	R/W	0h	This field enables or disables the channel 0 = channel is disabled 1 = channel is enabled This field will be cleared after a channel teardown is complete.
30	TX_TEARDOWN	R/W	0h	Setting this bit will request the channel to be torn down. This field will remain set after a channel teardown is complete.
13-12	TX_DEFAULT_QMGR	W	0h	This field controls the default queue manager number that will be used to queue teardown descriptors back to the host.
11-0	TX_DEFAULT_QNUM	W	0h	This field controls the default queue number within the selected queue manager onto which teardown descriptors will be queued back to the host. Table 98 -Tx Channel N Global Configuration Registers

16.5.5.5 RXGCR0 Register (offset = 808h) [reset = 0h]

 RXGCR0 is shown in [Figure 16-156](#) and described in [Table 16-168](#).

Figure 16-156. RXGCR0 Register

31	30	29	28	27	26	25	24
RX_ENABLE	RX_TEARDOWN	RX_PAUSE	Reserved			RX_ERROR_HANDLING	
R/W-0h	R/W-0h	R/W-0h				W-0h	
23	22	21	20	19	18	17	16
RX_SOP_OFFSET							
W-0h							
15	14	13	12	11	10	9	8
RX_DEFAULT_DESC_TYPE		RX_DEFAULT_RQ_QMGR		RX_DEFAULT_RQ_QNUM			
W-0h		W-0h		W-0h			
7	6	5	4	3	2	1	0
RX_DEFAULT_RQ_QNUM							
W-0h							

LEGEND: R/W = Read/Write; R = Read only; W1toCl = Write 1 to clear bit; -n = value after reset

Table 16-168. RXGCR0 Register Field Descriptions

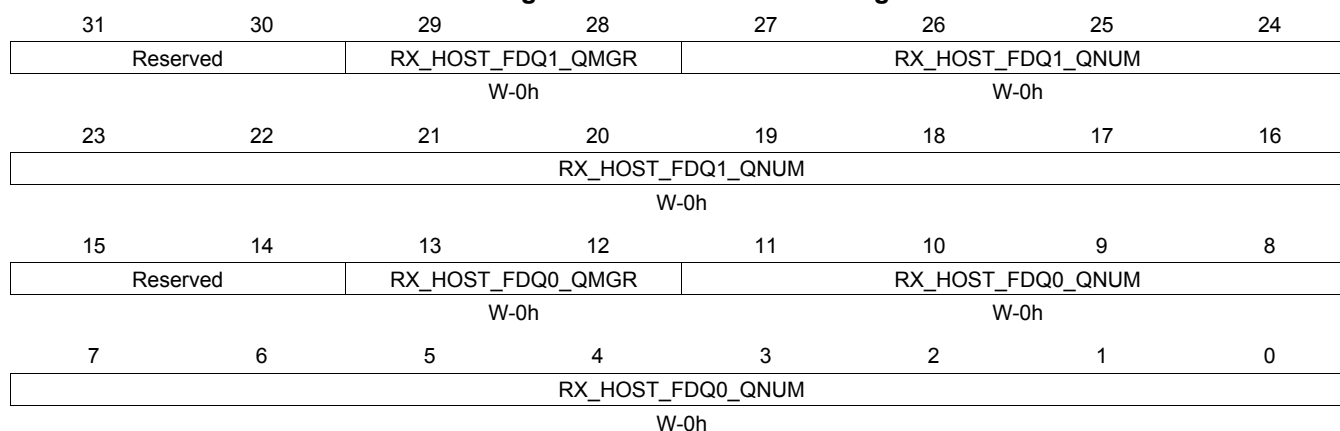
Bit	Field	Type	Reset	Description
31	RX_ENABLE	R/W	0h	This field enables or disables the channel 0 = channel is disabled 1 = channel is enabled This field will be cleared after a channel teardown is complete.
30	RX_TEARDOWN	R/W	0h	This field indicates whether or not an Rx teardown operation is complete. This field should be cleared when a channel is initialized. This field will be set after a channel teardown is complete.
29	RX_PAUSE	R/W	0h	Setting this bit causes the CPPI DMA to be suspended for rx channels. If a pause is being requested and the channel is not in a packet then drop the credit.
24	RX_ERROR_HANDLING	W	0h	This bit controls the error handling mode for the channel and is only used when channel errors (i.e. descriptor or buffer starvation occurs): 0 = Starvation errors result in dropping packet and reclaiming any used descriptor or buffer resources back to the original queues/pools they were allocated to 1 = Starvation errors result in subsequent re-try of the descriptor allocation operation. In this mode, the DMA will return to the IDLE state without saving it's internal operational state back to the internal state RAM and without issuing an advance operation on the FIFO interface. This results in the DMA re-initiating the FIFO block transfer at a later time with the intention that additional free buffers and/or descriptors will have been added. Regardless of the value of this bit, the DMA will assert the <code>cdma_rx_sof_overrun</code> (for SOP) or <code>cdma_rx_mof_overrun</code> (for non-SOP) when
23-16	RX_SOP_OFFSET	W	0h	This field specifies the number of bytes that are to be skipped in the SOP buffer before beginning to write the payload. This value must be less than the minimum size of a buffer in the system. Valid values are 0 - 255 bytes.

Table 16-168. RXGCR0 Register Field Descriptions (continued)

Bit	Field	Type	Reset	Description
15-14	RX_DEFAULT_DESC_TY PE	W	0h	This field indicates the default descriptor type to use: 0 = Reserved 1 = Host 2 = Reserved 3 = Reserved The actual descriptor type that will be used for reception can be overridden by information provided in the CPPI FIFO data block.
13-12	RX_DEFAULT_RQ_QMG R	W	0h	This field indicates the default receive queue manager that this channel should use. The actual receive queue manager index can be overridden by information provided in the CPPI FIFO data block.
11-0	RX_DEFAULT_RQ_QNU M	W	0h	This field indicates the default receive queue that this channel should use. The actual receive queue that will be used for reception can be overridden by information provided in the CPPI FIFO data block. Table 99 -Rx Channel N Global Configuration Registers

16.5.5.6 RXHPCRA0 Register (offset = 80Ch) [reset = 0h]

 RXHPCRA0 is shown in [Figure 16-157](#) and described in [Table 16-169](#).

Figure 16-157. RXHPCRA0 Register


LEGEND: R/W = Read/Write; R = Read only; W1toCl = Write 1 to clear bit; -n = value after reset

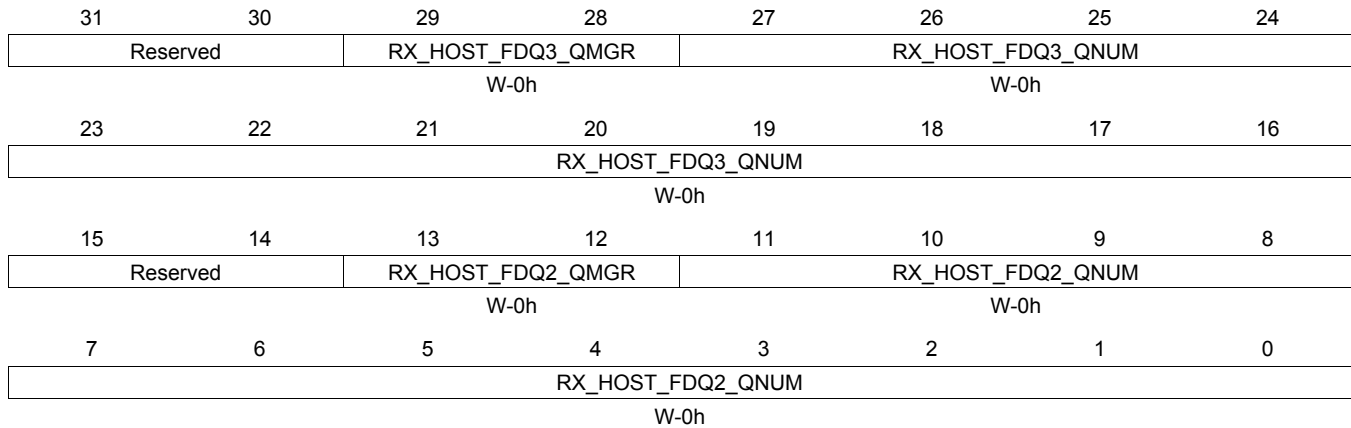
Table 16-169. RXHPCRA0 Register Field Descriptions

Bit	Field	Type	Reset	Description
29-28	RX_HOST_FDQ1_QMGR	W	0h	This field specifies which Buffer Manager should be used for the second Rx buffer in a host type packet.
27-16	RX_HOST_FDQ1_QNUM	W	0h	This field specifies which Free Descriptor / Buffer Pool should be used for the 2nd Rx buffer in a host type packet
13-12	RX_HOST_FDQ0_QMGR	W	0h	This field specifies which Buffer Manager should be used for the second Rx buffer in a host type packet.
11-0	RX_HOST_FDQ0_QNUM	W	0h	This field specifies which Free Descriptor / Buffer Pool should be used for the 1st Rx buffer in a host type packet Table 100 -Rx Channel N Host Packet Configuration Registers A

16.5.5.7 RXHPCR0 Register (offset = 810h) [reset = 0h]

RXHPCR0 is shown in [Figure 16-158](#) and described in [Table 16-170](#).

Figure 16-158. RXHPCR0 Register



LEGEND: R/W = Read/Write; R = Read only; W1toCl = Write 1 to clear bit; -n = value after reset

Table 16-170. RXHPCR0 Register Field Descriptions

Bit	Field	Type	Reset	Description
29-28	RX_HOST_FDQ3_QMGR	W	0h	This field specifies which Manager should be used for the 4th or later Rx buffers in a host type packet
27-16	RX_HOST_FDQ3_QNUM	W	0h	This field specifies which Free Descriptor Queue should be used for the 4th or later Rx buffers in a host type packet
13-12	RX_HOST_FDQ2_QMGR	W	0h	This field specifies which Buffer Manager should be used for the 3rd Rx buffer in a host type packet
11-0	RX_HOST_FDQ2_QNUM	W	0h	This field specifies which Free Descriptor / Buffer Pool should be used for the 3rd Rx buffer in a host type packet Table 101 -Rx Channel N Host Packet Configuration Registers B

16.5.5.8 TXGCR1 Register (offset = 820h) [reset = 0h]

 TXGCR1 is shown in [Figure 16-159](#) and described in [Table 16-171](#).

Figure 16-159. TXGCR1 Register

	31	30	29	28	27	26	25	24
	TX_ENABLE	TX_TEARDOWN	Reserved					
	R/W-0h	R/W-0h						
	23	22	21	20	19	18	17	16
	Reserved							
	15	14	13	12	11	10	9	8
	Reserved		TX_DEFAULT_QMGR			TX_DEFAULT_QNUM		
			W-0h			W-0h		
	7	6	5	4	3	2	1	0
	TX_DEFAULT_QNUM							
	W-0h							

LEGEND: R/W = Read/Write; R = Read only; W1toCl = Write 1 to clear bit; -n = value after reset

Table 16-171. TXGCR1 Register Field Descriptions

Bit	Field	Type	Reset	Description
31	TX_ENABLE	R/W	0h	This field enables or disables the channel 0 = channel is disabled 1 = channel is enabled This field will be cleared after a channel teardown is complete.
30	TX_TEARDOWN	R/W	0h	Setting this bit will request the channel to be torn down. This field will remain set after a channel teardown is complete.
13-12	TX_DEFAULT_QMGR	W	0h	This field controls the default queue manager number that will be used to queue teardown descriptors back to the host.
11-0	TX_DEFAULT_QNUM	W	0h	This field controls the default queue number within the selected queue manager onto which teardown descriptors will be queued back to the host. Table 98 -Tx Channel N Global Configuration Registers

16.5.5.9 RXGCR1 Register (offset = 828h) [reset = 0h]

RXGCR1 is shown in [Figure 16-160](#) and described in [Table 16-172](#).

Figure 16-160. RXGCR1 Register

31	30	29	28	27	26	25	24
RX_ENABLE	RX_TEARDOWN	RX_PAUSE	Reserved			RX_ERROR_HANDLING	
R/W-0h	R/W-0h	R/W-0h				W-0h	
23	22	21	20	19	18	17	16
RX_SOP_OFFSET							
W-0h							
15	14	13	12	11	10	9	8
RX_DEFAULT_DESC_TYPE		RX_DEFAULT_RQ_QMGR		RX_DEFAULT_RQ_QNUM			
W-0h		W-0h		W-0h			
7	6	5	4	3	2	1	0
RX_DEFAULT_RQ_QNUM							
W-0h							

LEGEND: R/W = Read/Write; R = Read only; W1toCl = Write 1 to clear bit; -n = value after reset

Table 16-172. RXGCR1 Register Field Descriptions

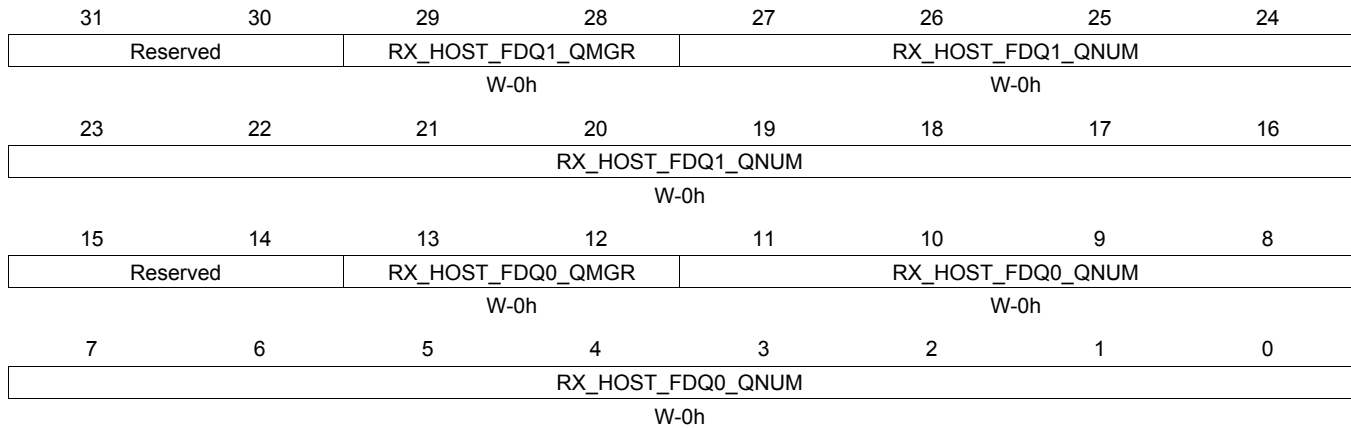
Bit	Field	Type	Reset	Description
31	RX_ENABLE	R/W	0h	This field enables or disables the channel 0 = channel is disabled 1 = channel is enabled This field will be cleared after a channel teardown is complete.
30	RX_TEARDOWN	R/W	0h	This field indicates whether or not an Rx teardown operation is complete. This field should be cleared when a channel is initialized. This field will be set after a channel teardown is complete.
29	RX_PAUSE	R/W	0h	Setting this bit causes the CPPI DMA to be suspended for rx channels. If a pause is being requested and the channel is not in a packet then drop the credit.
24	RX_ERROR_HANDLING	W	0h	This bit controls the error handling mode for the channel and is only used when channel errors (i.e. descriptor or buffer starvation occurs): 0 = Starvation errors result in dropping packet and reclaiming any used descriptor or buffer resources back to the original queues/pools they were allocated to 1 = Starvation errors result in subsequent re-try of the descriptor allocation operation. In this mode, the DMA will return to the IDLE state without saving it's internal operational state back to the internal state RAM and without issuing an advance operation on the FIFO interface. This results in the DMA re-initiating the FIFO block transfer at a later time with the intention that additional free buffers and/or descriptors will have been added. Regardless of the value of this bit, the DMA will assert the <code>cdma_rx_sof_overrun</code> (for SOP) or <code>cdma_rx_mof_overrun</code> (for non-SOP) when
23-16	RX_SOP_OFFSET	W	0h	This field specifies the number of bytes that are to be skipped in the SOP buffer before beginning to write the payload. This value must be less than the minimum size of a buffer in the system. Valid values are 0 - 255 bytes.

Table 16-172. RXGCR1 Register Field Descriptions (continued)

Bit	Field	Type	Reset	Description
15-14	RX_DEFAULT_DESC_TYPE	W	0h	This field indicates the default descriptor type to use: 0 = Reserved 1 = Host 2 = Reserved 3 = Reserved The actual descriptor type that will be used for reception can be overridden by information provided in the CPPI FIFO data block.
13-12	RX_DEFAULT_RQ_QMGR	W	0h	This field indicates the default receive queue manager that this channel should use. The actual receive queue manager index can be overridden by information provided in the CPPI FIFO data block.
11-0	RX_DEFAULT_RQ_QUEUE	W	0h	This field indicates the default receive queue that this channel should use. The actual receive queue that will be used for reception can be overridden by information provided in the CPPI FIFO data block. Table 99 -Rx Channel N Global Configuration Registers

16.5.5.10 RXHPCRA1 Register (offset = 82Ch) [reset = 0h]

RXHPCRA1 is shown in [Figure 16-161](#) and described in [Table 16-173](#).

Figure 16-161. RXHPCRA1 Register


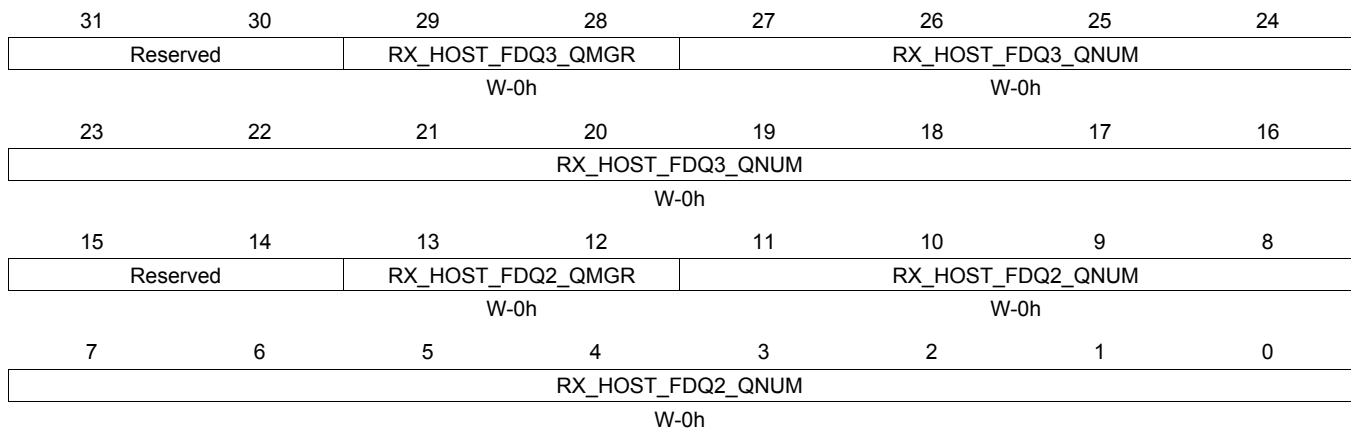
LEGEND: R/W = Read/Write; R = Read only; W1toCl = Write 1 to clear bit; -n = value after reset

Table 16-173. RXHPCRA1 Register Field Descriptions

Bit	Field	Type	Reset	Description
29-28	RX_HOST_FDQ1_QMGR	W	0h	This field specifies which Buffer Manager should be used for the second Rx buffer in a host type packet.
27-16	RX_HOST_FDQ1_QNUM	W	0h	This field specifies which Free Descriptor / Buffer Pool should be used for the 2nd Rx buffer in a host type packet
13-12	RX_HOST_FDQ0_QMGR	W	0h	This field specifies which Buffer Manager should be used for the second Rx buffer in a host type packet.
11-0	RX_HOST_FDQ0_QNUM	W	0h	This field specifies which Free Descriptor / Buffer Pool should be used for the 1st Rx buffer in a host type packet Table 100 -Rx Channel N Host Packet Configuration Registers A

16.5.5.11 RXHPCRB1 Register (offset = 830h) [reset = 0h]

 RXHPCRB1 is shown in [Figure 16-162](#) and described in [Table 16-174](#).

Figure 16-162. RXHPCRB1 Register


LEGEND: R/W = Read/Write; R = Read only; W1toCl = Write 1 to clear bit; -n = value after reset

Table 16-174. RXHPCRB1 Register Field Descriptions

Bit	Field	Type	Reset	Description
29-28	RX_HOST_FDQ3_QMGR	W	0h	This field specifies which Manager should be used for the 4th or later Rx buffers in a host type packet
27-16	RX_HOST_FDQ3_QNUM	W	0h	This field specifies which Free Descriptor Queue should be used for the 4th or later Rx buffers in a host type packet
13-12	RX_HOST_FDQ2_QMGR	W	0h	This field specifies which Buffer Manager should be used for the 3rd Rx buffer in a host type packet
11-0	RX_HOST_FDQ2_QNUM	W	0h	This field specifies which Free Descriptor / Buffer Pool should be used for the 3rd Rx buffer in a host type packet Table 101 -Rx Channel N Host Packet Configuration Registers B

16.5.5.12 TXGCR2 Register (offset = 840h) [reset = 0h]

TXGCR2 is shown in [Figure 16-163](#) and described in [Table 16-175](#).

Figure 16-163. TXGCR2 Register

31	30	29	28	27	26	25	24
TX_ENABLE	TX_TEARDOWN	Reserved					
R/W-0h	R/W-0h						
23	22	21	20	19	18	17	16
Reserved							
15	14	13	12	11	10	9	8
Reserved		TX_DEFAULT_QMGR			TX_DEFAULT_QNUM		
W-0h				W-0h			
7	6	5	4	3	2	1	0
TX_DEFAULT_QNUM							
W-0h							

LEGEND: R/W = Read/Write; R = Read only; W1toCl = Write 1 to clear bit; -n = value after reset

Table 16-175. TXGCR2 Register Field Descriptions

Bit	Field	Type	Reset	Description
31	TX_ENABLE	R/W	0h	This field enables or disables the channel 0 = channel is disabled 1 = channel is enabled This field will be cleared after a channel teardown is complete.
30	TX_TEARDOWN	R/W	0h	Setting this bit will request the channel to be torn down. This field will remain set after a channel teardown is complete.
13-12	TX_DEFAULT_QMGR	W	0h	This field controls the default queue manager number that will be used to queue teardown descriptors back to the host.
11-0	TX_DEFAULT_QNUM	W	0h	This field controls the default queue number within the selected queue manager onto which teardown descriptors will be queued back to the host. Table 98 -Tx Channel N Global Configuration Registers

16.5.5.13 RXGCR2 Register (offset = 848h) [reset = 0h]

 RXGCR2 is shown in [Figure 16-164](#) and described in [Table 16-176](#).

Figure 16-164. RXGCR2 Register

31	30	29	28	27	26	25	24
RX_ENABLE	RX_TEARDOWN	RX_PAUSE	Reserved			RX_ERROR_HANDLING	
R/W-0h	R/W-0h	R/W-0h				W-0h	
23	22	21	20	19	18	17	16
RX_SOP_OFFSET							
W-0h							
15	14	13	12	11	10	9	8
RX_DEFAULT_DESC_TYPE		RX_DEFAULT_RQ_QMGR		RX_DEFAULT_RQ_QNUM			
W-0h		W-0h		W-0h			
7	6	5	4	3	2	1	0
RX_DEFAULT_RQ_QNUM							
W-0h							

LEGEND: R/W = Read/Write; R = Read only; W1toCl = Write 1 to clear bit; -n = value after reset

Table 16-176. RXGCR2 Register Field Descriptions

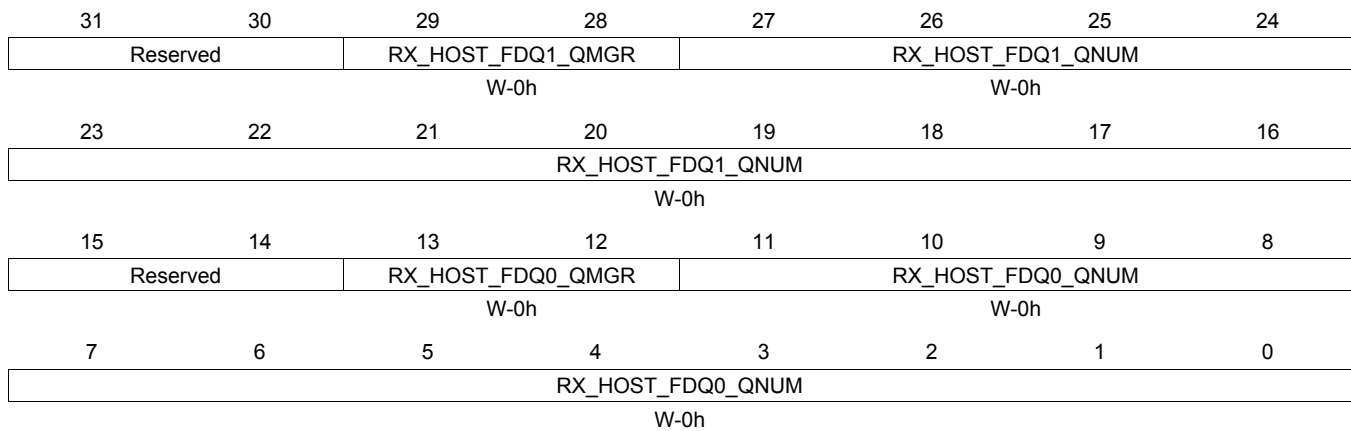
Bit	Field	Type	Reset	Description
31	RX_ENABLE	R/W	0h	This field enables or disables the channel 0 = channel is disabled 1 = channel is enabled This field will be cleared after a channel teardown is complete.
30	RX_TEARDOWN	R/W	0h	This field indicates whether or not an Rx teardown operation is complete. This field should be cleared when a channel is initialized. This field will be set after a channel teardown is complete.
29	RX_PAUSE	R/W	0h	Setting this bit causes the CPPI DMA to be suspended for rx channels. If a pause is being requested and the channel is not in a packet then drop the credit.
24	RX_ERROR_HANDLING	W	0h	This bit controls the error handling mode for the channel and is only used when channel errors (i.e. descriptor or buffer starvation occurs): 0 = Starvation errors result in dropping packet and reclaiming any used descriptor or buffer resources back to the original queues/pools they were allocated to 1 = Starvation errors result in subsequent re-try of the descriptor allocation operation. In this mode, the DMA will return to the IDLE state without saving it's internal operational state back to the internal state RAM and without issuing an advance operation on the FIFO interface. This results in the DMA re-initiating the FIFO block transfer at a later time with the intention that additional free buffers and/or descriptors will have been added. Regardless of the value of this bit, the DMA will assert the <code>cdma_rx_sof_overrun</code> (for SOP) or <code>cdma_rx_mof_overrun</code> (for non-SOP) when
23-16	RX_SOP_OFFSET	W	0h	This field specifies the number of bytes that are to be skipped in the SOP buffer before beginning to write the payload. This value must be less than the minimum size of a buffer in the system. Valid values are 0 - 255 bytes.

Table 16-176. RXGCR2 Register Field Descriptions (continued)

Bit	Field	Type	Reset	Description
15-14	RX_DEFAULT_DESC_TY PE	W	0h	This field indicates the default descriptor type to use: 0 = Reserved 1 = Host 2 = Reserved 3 = Reserved The actual descriptor type that will be used for reception can be overridden by information provided in the CPPI FIFO data block.
13-12	RX_DEFAULT_RQ_QMG R	W	0h	This field indicates the default receive queue manager that this channel should use. The actual receive queue manager index can be overridden by information provided in the CPPI FIFO data block.
11-0	RX_DEFAULT_RQ_QNU M	W	0h	This field indicates the default receive queue that this channel should use. The actual receive queue that will be used for reception can be overridden by information provided in the CPPI FIFO data block. Table 99 -Rx Channel N Global Configuration Registers

16.5.5.14 RXHPCRA2 Register (offset = 84Ch) [reset = 0h]

 RXHPCRA2 is shown in [Figure 16-165](#) and described in [Table 16-177](#).

Figure 16-165. RXHPCRA2 Register


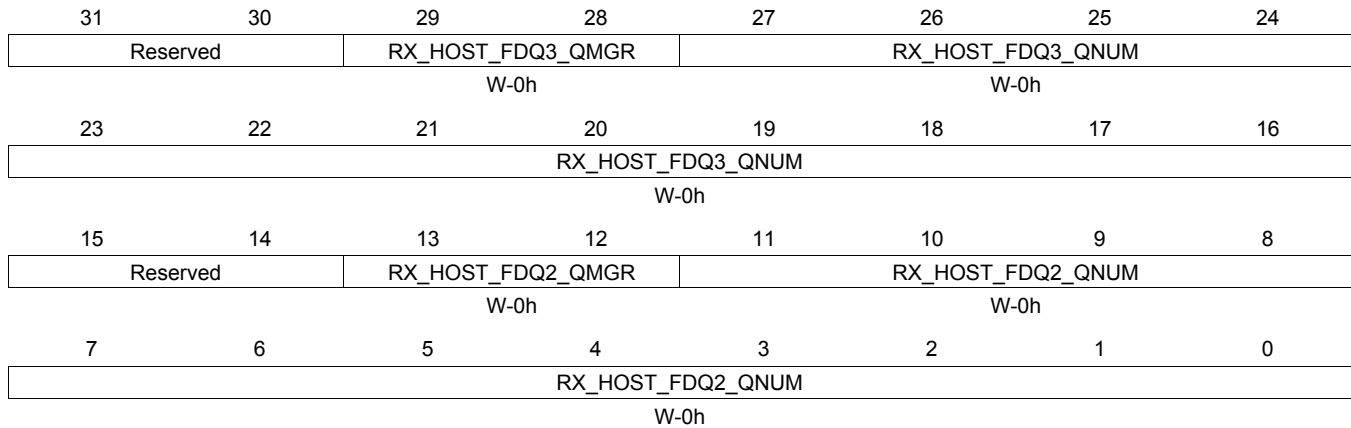
LEGEND: R/W = Read/Write; R = Read only; W1toCl = Write 1 to clear bit; -n = value after reset

Table 16-177. RXHPCRA2 Register Field Descriptions

Bit	Field	Type	Reset	Description
29-28	RX_HOST_FDQ1_QMGR	W	0h	This field specifies which Buffer Manager should be used for the second Rx buffer in a host type packet.
27-16	RX_HOST_FDQ1_QNUM	W	0h	This field specifies which Free Descriptor / Buffer Pool should be used for the 2nd Rx buffer in a host type packet
13-12	RX_HOST_FDQ0_QMGR	W	0h	This field specifies which Buffer Manager should be used for the second Rx buffer in a host type packet.
11-0	RX_HOST_FDQ0_QNUM	W	0h	This field specifies which Free Descriptor / Buffer Pool should be used for the 1st Rx buffer in a host type packet Table 100 -Rx Channel N Host Packet Configuration Registers A

16.5.5.15 RXHPCRB2 Register (offset = 850h) [reset = 0h]

 RXHPCRB2 is shown in [Figure 16-166](#) and described in [Table 16-178](#).

Figure 16-166. RXHPCRB2 Register


LEGEND: R/W = Read/Write; R = Read only; W1toCl = Write 1 to clear bit; -n = value after reset

Table 16-178. RXHPCRB2 Register Field Descriptions

Bit	Field	Type	Reset	Description
29-28	RX_HOST_FDQ3_QMGR	W	0h	This field specifies which Manager should be used for the 4th or later Rx buffers in a host type packet
27-16	RX_HOST_FDQ3_QNUM	W	0h	This field specifies which Free Descriptor Queue should be used for the 4th or later Rx buffers in a host type packet
13-12	RX_HOST_FDQ2_QMGR	W	0h	This field specifies which Buffer Manager should be used for the 3rd Rx buffer in a host type packet
11-0	RX_HOST_FDQ2_QNUM	W	0h	This field specifies which Free Descriptor / Buffer Pool should be used for the 3rd Rx buffer in a host type packet Table 101 -Rx Channel N Host Packet Configuration Registers B

16.5.5.16 TXGCR3 Register (offset = 860h) [reset = 0h]

 TXGCR3 is shown in [Figure 16-167](#) and described in [Table 16-179](#).

Figure 16-167. TXGCR3 Register

31	30	29	28	27	26	25	24
TX_ENABLE	TX_TEARDOWN	Reserved					
R/W-0h	R/W-0h						
23	22	21	20	19	18	17	16
Reserved							
15	14	13	12	11	10	9	8
Reserved		TX_DEFAULT_QMGR			TX_DEFAULT_QNUM		
W-0h				W-0h			
7	6	5	4	3	2	1	0
TX_DEFAULT_QNUM							
W-0h							

LEGEND: R/W = Read/Write; R = Read only; W1toCl = Write 1 to clear bit; -n = value after reset

Table 16-179. TXGCR3 Register Field Descriptions

Bit	Field	Type	Reset	Description
31	TX_ENABLE	R/W	0h	This field enables or disables the channel 0 = channel is disabled 1 = channel is enabled This field will be cleared after a channel teardown is complete.
30	TX_TEARDOWN	R/W	0h	Setting this bit will request the channel to be torn down. This field will remain set after a channel teardown is complete.
13-12	TX_DEFAULT_QMGR	W	0h	This field controls the default queue manager number that will be used to queue teardown descriptors back to the host.
11-0	TX_DEFAULT_QNUM	W	0h	This field controls the default queue number within the selected queue manager onto which teardown descriptors will be queued back to the host. Table 98 -Tx Channel N Global Configuration Registers

16.5.5.17 RXGCR3 Register (offset = 868h) [reset = 0h]

RXGCR3 is shown in [Figure 16-168](#) and described in [Table 16-180](#).

Figure 16-168. RXGCR3 Register

31	30	29	28	27	26	25	24
RX_ENABLE	RX_TEARDOWN	RX_PAUSE	Reserved			RX_ERROR_HANDLING	
R/W-0h	R/W-0h	R/W-0h				W-0h	
23	22	21	20	19	18	17	16
RX_SOP_OFFSET							
W-0h							
15	14	13	12	11	10	9	8
RX_DEFAULT_DESC_TYPE		RX_DEFAULT_RQ_QMGR		RX_DEFAULT_RQ_QNUM			
W-0h		W-0h		W-0h			
7	6	5	4	3	2	1	0
RX_DEFAULT_RQ_QNUM							
W-0h							

LEGEND: R/W = Read/Write; R = Read only; W1toCl = Write 1 to clear bit; -n = value after reset

Table 16-180. RXGCR3 Register Field Descriptions

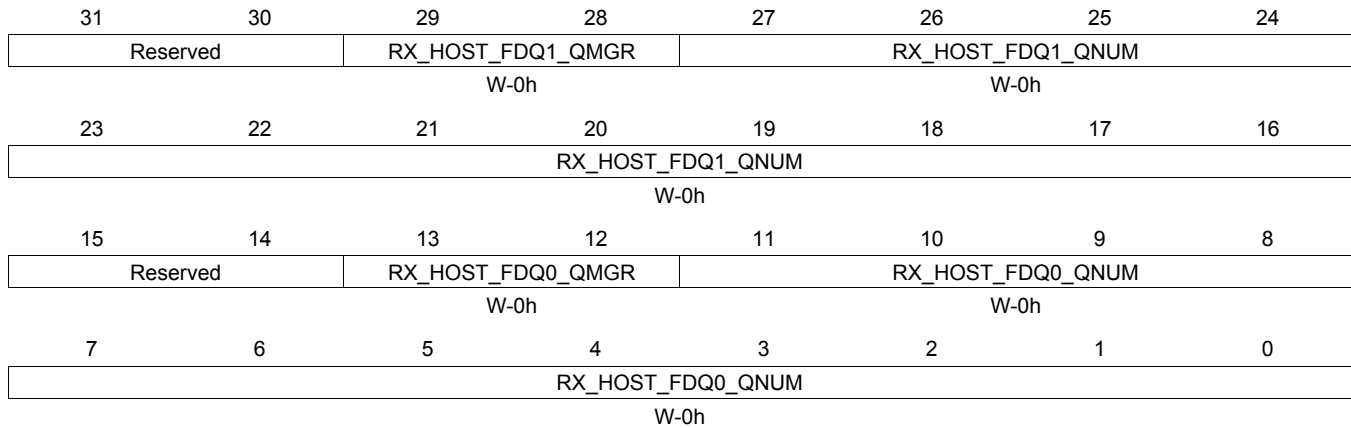
Bit	Field	Type	Reset	Description
31	RX_ENABLE	R/W	0h	This field enables or disables the channel 0 = channel is disabled 1 = channel is enabled This field will be cleared after a channel teardown is complete.
30	RX_TEARDOWN	R/W	0h	This field indicates whether or not an Rx teardown operation is complete. This field should be cleared when a channel is initialized. This field will be set after a channel teardown is complete.
29	RX_PAUSE	R/W	0h	Setting this bit causes the CPPI DMA to be suspended for rx channels. If a pause is being requested and the channel is not in a packet then drop the credit.
24	RX_ERROR_HANDLING	W	0h	This bit controls the error handling mode for the channel and is only used when channel errors (i.e. descriptor or buffer starvation occurs): 0 = Starvation errors result in dropping packet and reclaiming any used descriptor or buffer resources back to the original queues/pools they were allocated to 1 = Starvation errors result in subsequent re-try of the descriptor allocation operation. In this mode, the DMA will return to the IDLE state without saving it's internal operational state back to the internal state RAM and without issuing an advance operation on the FIFO interface. This results in the DMA re-initiating the FIFO block transfer at a later time with the intention that additional free buffers and/or descriptors will have been added. Regardless of the value of this bit, the DMA will assert the <code>cdma_rx_sof_overrun</code> (for SOP) or <code>cdma_rx_mof_overrun</code> (for non-SOP) when
23-16	RX_SOP_OFFSET	W	0h	This field specifies the number of bytes that are to be skipped in the SOP buffer before beginning to write the payload. This value must be less than the minimum size of a buffer in the system. Valid values are 0 - 255 bytes.

Table 16-180. RXGCR3 Register Field Descriptions (continued)

Bit	Field	Type	Reset	Description
15-14	RX_DEFAULT_DESC_TYPE	W	0h	This field indicates the default descriptor type to use: 0 = Reserved 1 = Host 2 = Reserved 3 = Reserved The actual descriptor type that will be used for reception can be overridden by information provided in the CPPI FIFO data block.
13-12	RX_DEFAULT_RQ_QMGR	W	0h	This field indicates the default receive queue manager that this channel should use. The actual receive queue manager index can be overridden by information provided in the CPPI FIFO data block.
11-0	RX_DEFAULT_RQ_QUEUE	W	0h	This field indicates the default receive queue that this channel should use. The actual receive queue that will be used for reception can be overridden by information provided in the CPPI FIFO data block. Table 99 -Rx Channel N Global Configuration Registers

16.5.5.18 RXHPCRA3 Register (offset = 86Ch) [reset = 0h]

RXHPCRA3 is shown in [Figure 16-169](#) and described in [Table 16-181](#).

Figure 16-169. RXHPCRA3 Register


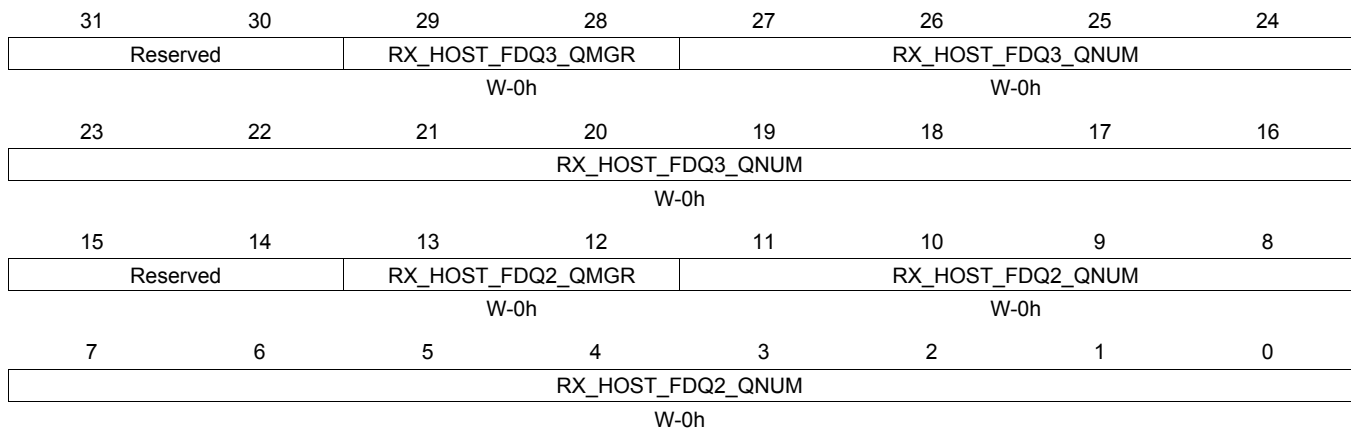
LEGEND: R/W = Read/Write; R = Read only; W1toCl = Write 1 to clear bit; -n = value after reset

Table 16-181. RXHPCRA3 Register Field Descriptions

Bit	Field	Type	Reset	Description
29-28	RX_HOST_FDQ1_QMGR	W	0h	This field specifies which Buffer Manager should be used for the second Rx buffer in a host type packet.
27-16	RX_HOST_FDQ1_QNUM	W	0h	This field specifies which Free Descriptor / Buffer Pool should be used for the 2nd Rx buffer in a host type packet
13-12	RX_HOST_FDQ0_QMGR	W	0h	This field specifies which Buffer Manager should be used for the second Rx buffer in a host type packet.
11-0	RX_HOST_FDQ0_QNUM	W	0h	This field specifies which Free Descriptor / Buffer Pool should be used for the 1st Rx buffer in a host type packet Table 100 -Rx Channel N Host Packet Configuration Registers A

16.5.5.19 RXHPCRB3 Register (offset = 870h) [reset = 0h]

 RXHPCRB3 is shown in [Figure 16-170](#) and described in [Table 16-182](#).

Figure 16-170. RXHPCRB3 Register


LEGEND: R/W = Read/Write; R = Read only; W1toCl = Write 1 to clear bit; -n = value after reset

Table 16-182. RXHPCRB3 Register Field Descriptions

Bit	Field	Type	Reset	Description
29-28	RX_HOST_FDQ3_QMGR	W	0h	This field specifies which Manager should be used for the 4th or later Rx buffers in a host type packet
27-16	RX_HOST_FDQ3_QNUM	W	0h	This field specifies which Free Descriptor Queue should be used for the 4th or later Rx buffers in a host type packet
13-12	RX_HOST_FDQ2_QMGR	W	0h	This field specifies which Buffer Manager should be used for the 3rd Rx buffer in a host type packet
11-0	RX_HOST_FDQ2_QNUM	W	0h	This field specifies which Free Descriptor / Buffer Pool should be used for the 3rd Rx buffer in a host type packet Table 101 -Rx Channel N Host Packet Configuration Registers B

16.5.5.20 TXGCR4 Register (offset = 880h) [reset = 0h]

TXGCR4 is shown in [Figure 16-171](#) and described in [Table 16-183](#).

Figure 16-171. TXGCR4 Register

31	30	29	28	27	26	25	24
TX_ENABLE	TX_TEARDOWN	Reserved					
R/W-0h	R/W-0h						
23	22	21	20	19	18	17	16
Reserved							
15	14	13	12	11	10	9	8
Reserved		TX_DEFAULT_QMGR			TX_DEFAULT_QNUM		
W-0h				W-0h			
7	6	5	4	3	2	1	0
TX_DEFAULT_QNUM							
W-0h							

LEGEND: R/W = Read/Write; R = Read only; W1toCl = Write 1 to clear bit; -n = value after reset

Table 16-183. TXGCR4 Register Field Descriptions

Bit	Field	Type	Reset	Description
31	TX_ENABLE	R/W	0h	This field enables or disables the channel 0 = channel is disabled 1 = channel is enabled This field will be cleared after a channel teardown is complete.
30	TX_TEARDOWN	R/W	0h	Setting this bit will request the channel to be torn down. This field will remain set after a channel teardown is complete.
13-12	TX_DEFAULT_QMGR	W	0h	This field controls the default queue manager number that will be used to queue teardown descriptors back to the host.
11-0	TX_DEFAULT_QNUM	W	0h	This field controls the default queue number within the selected queue manager onto which teardown descriptors will be queued back to the host. Table 98 -Tx Channel N Global Configuration Registers

16.5.5.21 RXGCR4 Register (offset = 888h) [reset = 0h]

 RXGCR4 is shown in [Figure 16-172](#) and described in [Table 16-184](#).

Figure 16-172. RXGCR4 Register

31	30	29	28	27	26	25	24
RX_ENABLE	RX_TEARDOWN	RX_PAUSE	Reserved			RX_ERROR_HANDLING	
R/W-0h	R/W-0h	R/W-0h				W-0h	
23	22	21	20	19	18	17	16
RX_SOP_OFFSET							
W-0h							
15	14	13	12	11	10	9	8
RX_DEFAULT_DESC_TYPE		RX_DEFAULT_RQ_QMGR		RX_DEFAULT_RQ_QNUM			
W-0h		W-0h		W-0h			
7	6	5	4	3	2	1	0
RX_DEFAULT_RQ_QNUM							
W-0h							

LEGEND: R/W = Read/Write; R = Read only; W1toCl = Write 1 to clear bit; -n = value after reset

Table 16-184. RXGCR4 Register Field Descriptions

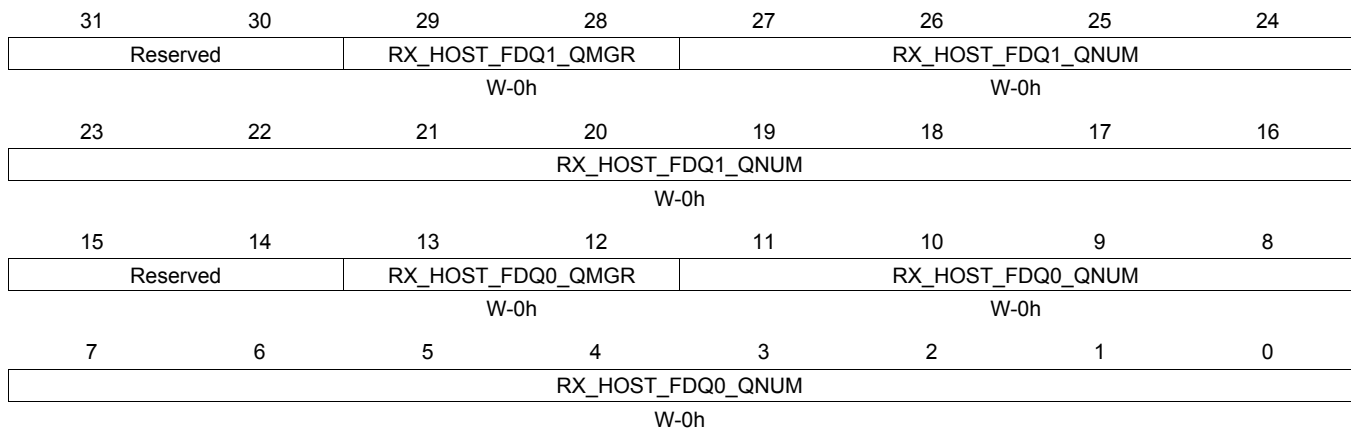
Bit	Field	Type	Reset	Description
31	RX_ENABLE	R/W	0h	This field enables or disables the channel 0 = channel is disabled 1 = channel is enabled This field will be cleared after a channel teardown is complete.
30	RX_TEARDOWN	R/W	0h	This field indicates whether or not an Rx teardown operation is complete. This field should be cleared when a channel is initialized. This field will be set after a channel teardown is complete.
29	RX_PAUSE	R/W	0h	Setting this bit causes the CPPI DMA to be suspended for rx channels. If a pause is being requested and the channel is not in a packet then drop the credit.
24	RX_ERROR_HANDLING	W	0h	This bit controls the error handling mode for the channel and is only used when channel errors (i.e. descriptor or buffer starvation occurs): 0 = Starvation errors result in dropping packet and reclaiming any used descriptor or buffer resources back to the original queues/pools they were allocated to 1 = Starvation errors result in subsequent re-try of the descriptor allocation operation. In this mode, the DMA will return to the IDLE state without saving it's internal operational state back to the internal state RAM and without issuing an advance operation on the FIFO interface. This results in the DMA re-initiating the FIFO block transfer at a later time with the intention that additional free buffers and/or descriptors will have been added. Regardless of the value of this bit, the DMA will assert the <code>cdma_rx_sof_overrun</code> (for SOP) or <code>cdma_rx_mof_overrun</code> (for non-SOP) when
23-16	RX_SOP_OFFSET	W	0h	This field specifies the number of bytes that are to be skipped in the SOP buffer before beginning to write the payload. This value must be less than the minimum size of a buffer in the system. Valid values are 0 - 255 bytes.

Table 16-184. RXGCR4 Register Field Descriptions (continued)

Bit	Field	Type	Reset	Description
15-14	RX_DEFAULT_DESC_TY PE	W	0h	This field indicates the default descriptor type to use: 0 = Reserved 1 = Host 2 = Reserved 3 = Reserved The actual descriptor type that will be used for reception can be overridden by information provided in the CPPI FIFO data block.
13-12	RX_DEFAULT_RQ_QMG R	W	0h	This field indicates the default receive queue manager that this channel should use. The actual receive queue manager index can be overridden by information provided in the CPPI FIFO data block.
11-0	RX_DEFAULT_RQ_QNU M	W	0h	This field indicates the default receive queue that this channel should use. The actual receive queue that will be used for reception can be overridden by information provided in the CPPI FIFO data block. Table 99 -Rx Channel N Global Configuration Registers

16.5.5.22 RXHPCRA4 Register (offset = 88Ch) [reset = 0h]

 RXHPCRA4 is shown in [Figure 16-173](#) and described in [Table 16-185](#).

Figure 16-173. RXHPCRA4 Register


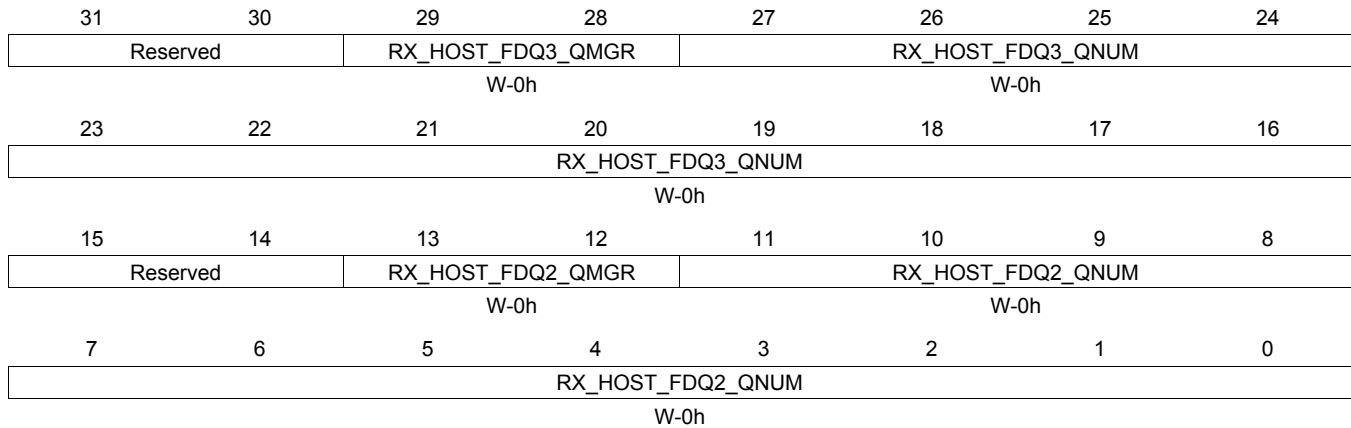
LEGEND: R/W = Read/Write; R = Read only; W1toCl = Write 1 to clear bit; -n = value after reset

Table 16-185. RXHPCRA4 Register Field Descriptions

Bit	Field	Type	Reset	Description
29-28	RX_HOST_FDQ1_QMGR	W	0h	This field specifies which Buffer Manager should be used for the second Rx buffer in a host type packet.
27-16	RX_HOST_FDQ1_QNUM	W	0h	This field specifies which Free Descriptor / Buffer Pool should be used for the 2nd Rx buffer in a host type packet
13-12	RX_HOST_FDQ0_QMGR	W	0h	This field specifies which Buffer Manager should be used for the second Rx buffer in a host type packet.
11-0	RX_HOST_FDQ0_QNUM	W	0h	This field specifies which Free Descriptor / Buffer Pool should be used for the 1st Rx buffer in a host type packet Table 100 -Rx Channel N Host Packet Configuration Registers A

16.5.5.23 RXHPCRB4 Register (offset = 890h) [reset = 0h]

RXHPCRB4 is shown in [Figure 16-174](#) and described in [Table 16-186](#).

Figure 16-174. RXHPCRB4 Register


LEGEND: R/W = Read/Write; R = Read only; W1toCl = Write 1 to clear bit; -n = value after reset

Table 16-186. RXHPCRB4 Register Field Descriptions

Bit	Field	Type	Reset	Description
29-28	RX_HOST_FDQ3_QMGR	W	0h	This field specifies which Manager should be used for the 4th or later Rx buffers in a host type packet
27-16	RX_HOST_FDQ3_QNUM	W	0h	This field specifies which Free Descriptor Queue should be used for the 4th or later Rx buffers in a host type packet
13-12	RX_HOST_FDQ2_QMGR	W	0h	This field specifies which Buffer Manager should be used for the 3rd Rx buffer in a host type packet
11-0	RX_HOST_FDQ2_QNUM	W	0h	This field specifies which Free Descriptor / Buffer Pool should be used for the 3rd Rx buffer in a host type packet Table 101 -Rx Channel N Host Packet Configuration Registers B

16.5.5.24 TXGCR5 Register (offset = 8A0h) [reset = 0h]

 TXGCR5 is shown in [Figure 16-175](#) and described in [Table 16-187](#).

Figure 16-175. TXGCR5 Register

31	30	29	28	27	26	25	24
TX_ENABLE		TX_TEARDOWN		Reserved			
R/W-0h		R/W-0h					
23	22	21	20	19	18	17	16
Reserved							
15	14	13	12	11	10	9	8
Reserved		TX_DEFAULT_QMGR			TX_DEFAULT_QNUM		
W-0h				W-0h			
7	6	5	4	3	2	1	0
TX_DEFAULT_QNUM							
W-0h							

LEGEND: R/W = Read/Write; R = Read only; W1toCl = Write 1 to clear bit; -n = value after reset

Table 16-187. TXGCR5 Register Field Descriptions

Bit	Field	Type	Reset	Description
31	TX_ENABLE	R/W	0h	This field enables or disables the channel 0 = channel is disabled 1 = channel is enabled This field will be cleared after a channel teardown is complete.
30	TX_TEARDOWN	R/W	0h	Setting this bit will request the channel to be torn down. This field will remain set after a channel teardown is complete.
13-12	TX_DEFAULT_QMGR	W	0h	This field controls the default queue manager number that will be used to queue teardown descriptors back to the host.
11-0	TX_DEFAULT_QNUM	W	0h	This field controls the default queue number within the selected queue manager onto which teardown descriptors will be queued back to the host. Table 98 -Tx Channel N Global Configuration Registers

16.5.5.25 RXGCR5 Register (offset = 8A8h) [reset = 0h]

RXGCR5 is shown in [Figure 16-176](#) and described in [Table 16-188](#).

Figure 16-176. RXGCR5 Register

31	30	29	28	27	26	25	24
RX_ENABLE	RX_TEARDOWN N	RX_PAUSE	Reserved			RX_ERROR_H ANDLING	
R/W-0h	R/W-0h	R/W-0h				W-0h	
23	22	21	20	19	18	17	16
RX_SOP_OFFSET							
W-0h							
15	14	13	12	11	10	9	8
RX_DEFAULT_DESC_TYPE		RX_DEFAULT_RQ_QMGR		RX_DEFAULT_RQ_QNUM			
W-0h		W-0h		W-0h			
7	6	5	4	3	2	1	0
RX_DEFAULT_RQ_QNUM							
W-0h							

LEGEND: R/W = Read/Write; R = Read only; W1toCl = Write 1 to clear bit; -n = value after reset

Table 16-188. RXGCR5 Register Field Descriptions

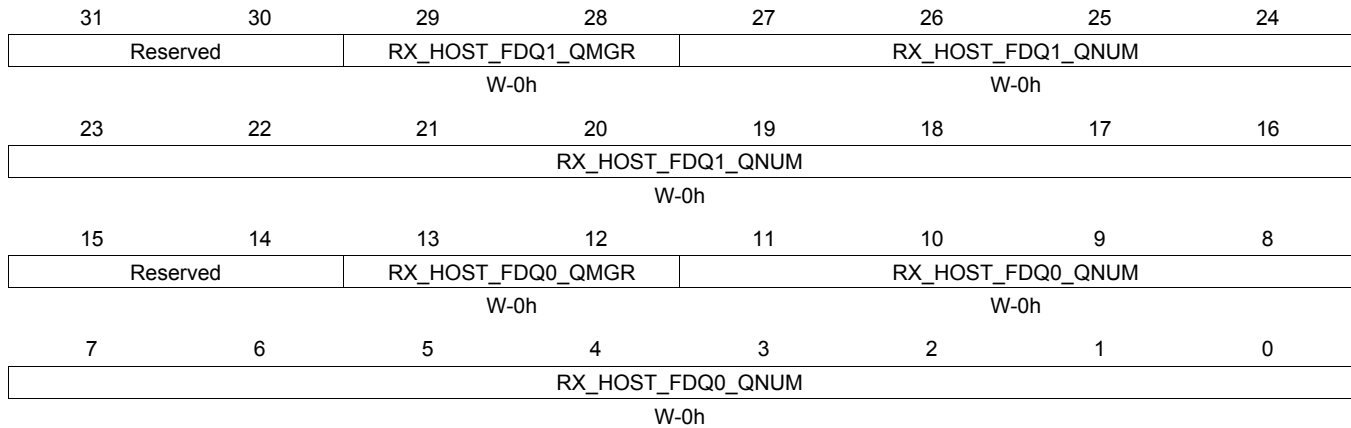
Bit	Field	Type	Reset	Description
31	RX_ENABLE	R/W	0h	This field enables or disables the channel 0 = channel is disabled 1 = channel is enabled This field will be cleared after a channel teardown is complete.
30	RX_TEARDOWN	R/W	0h	This field indicates whether or not an Rx teardown operation is complete. This field should be cleared when a channel is initialized. This field will be set after a channel teardown is complete.
29	RX_PAUSE	R/W	0h	Setting this bit causes the CPPI DMA to be suspended for rx channels. If a pause is being requested and the channel is not in a packet then drop the credit.
24	RX_ERROR_HANDLING	W	0h	This bit controls the error handling mode for the channel and is only used when channel errors (i.e. descriptor or buffer starvation occurs): 0 = Starvation errors result in dropping packet and reclaiming any used descriptor or buffer resources back to the original queues/pools they were allocated to 1 = Starvation errors result in subsequent re-try of the descriptor allocation operation. In this mode, the DMA will return to the IDLE state without saving it's internal operational state back to the internal state RAM and without issuing an advance operation on the FIFO interface. This results in the DMA re-initiating the FIFO block transfer at a later time with the intention that additional free buffers and/or descriptors will have been added. Regardless of the value of this bit, the DMA will assert the <code>cdma_rx_sof_overrun</code> (for SOP) or <code>cdma_rx_mof_overrun</code> (for non-SOP) when
23-16	RX_SOP_OFFSET	W	0h	This field specifies the number of bytes that are to be skipped in the SOP buffer before beginning to write the payload. This value must be less than the minimum size of a buffer in the system. Valid values are 0 - 255 bytes.

Table 16-188. RXGCR5 Register Field Descriptions (continued)

Bit	Field	Type	Reset	Description
15-14	RX_DEFAULT_DESC_TYPE	W	0h	This field indicates the default descriptor type to use: 0 = Reserved 1 = Host 2 = Reserved 3 = Reserved The actual descriptor type that will be used for reception can be overridden by information provided in the CPPI FIFO data block.
13-12	RX_DEFAULT_RQ_QMGR	W	0h	This field indicates the default receive queue manager that this channel should use. The actual receive queue manager index can be overridden by information provided in the CPPI FIFO data block.
11-0	RX_DEFAULT_RQ_QUEUE	W	0h	This field indicates the default receive queue that this channel should use. The actual receive queue that will be used for reception can be overridden by information provided in the CPPI FIFO data block. Table 99 -Rx Channel N Global Configuration Registers

16.5.5.26 RXHPCRA5 Register (offset = 8ACh) [reset = 0h]

RXHPCRA5 is shown in [Figure 16-177](#) and described in [Table 16-189](#).

Figure 16-177. RXHPCRA5 Register


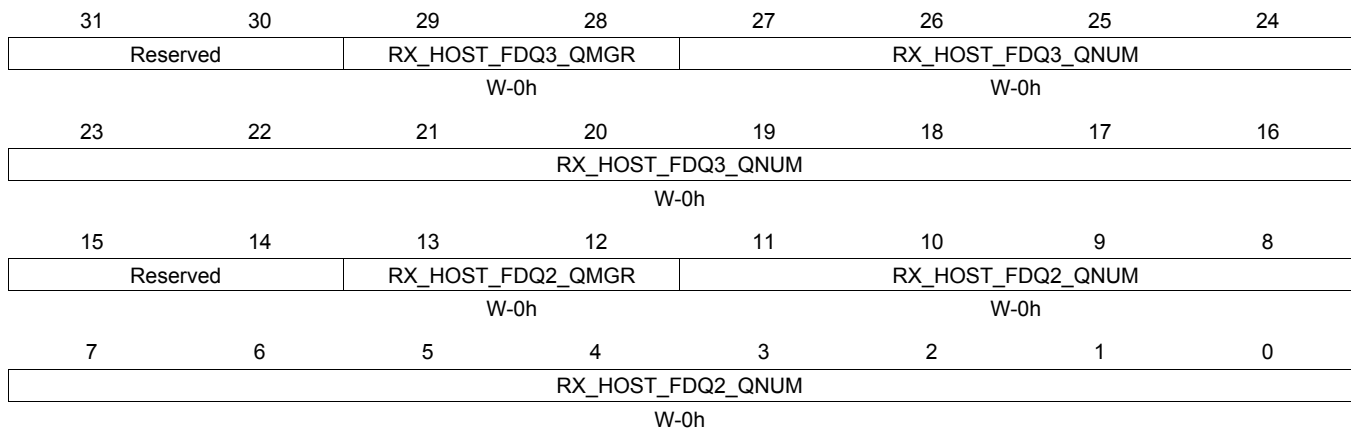
LEGEND: R/W = Read/Write; R = Read only; W1toCl = Write 1 to clear bit; -n = value after reset

Table 16-189. RXHPCRA5 Register Field Descriptions

Bit	Field	Type	Reset	Description
29-28	RX_HOST_FDQ1_QMGR	W	0h	This field specifies which Buffer Manager should be used for the second Rx buffer in a host type packet.
27-16	RX_HOST_FDQ1_QNUM	W	0h	This field specifies which Free Descriptor / Buffer Pool should be used for the 2nd Rx buffer in a host type packet
13-12	RX_HOST_FDQ0_QMGR	W	0h	This field specifies which Buffer Manager should be used for the second Rx buffer in a host type packet.
11-0	RX_HOST_FDQ0_QNUM	W	0h	This field specifies which Free Descriptor / Buffer Pool should be used for the 1st Rx buffer in a host type packet Table 100 -Rx Channel N Host Packet Configuration Registers A

16.5.5.27 RXHPCRB5 Register (offset = 8B0h) [reset = 0h]

 RXHPCRB5 is shown in [Figure 16-178](#) and described in [Table 16-190](#).

Figure 16-178. RXHPCRB5 Register


LEGEND: R/W = Read/Write; R = Read only; W1toCl = Write 1 to clear bit; -n = value after reset

Table 16-190. RXHPCRB5 Register Field Descriptions

Bit	Field	Type	Reset	Description
29-28	RX_HOST_FDQ3_QMGR	W	0h	This field specifies which Manager should be used for the 4th or later Rx buffers in a host type packet
27-16	RX_HOST_FDQ3_QNUM	W	0h	This field specifies which Free Descriptor Queue should be used for the 4th or later Rx buffers in a host type packet
13-12	RX_HOST_FDQ2_QMGR	W	0h	This field specifies which Buffer Manager should be used for the 3rd Rx buffer in a host type packet
11-0	RX_HOST_FDQ2_QNUM	W	0h	This field specifies which Free Descriptor / Buffer Pool should be used for the 3rd Rx buffer in a host type packet Table 101 -Rx Channel N Host Packet Configuration Registers B

16.5.5.28 TXGCR6 Register (offset = 8C0h) [reset = 0h]

TXGCR6 is shown in [Figure 16-179](#) and described in [Table 16-191](#).

Figure 16-179. TXGCR6 Register

31	30	29	28	27	26	25	24
TX_ENABLE	TX_TEARDOWN	Reserved					
R/W-0h	R/W-0h						
23	22	21	20	19	18	17	16
Reserved							
15	14	13	12	11	10	9	8
Reserved		TX_DEFAULT_QMGR			TX_DEFAULT_QNUM		
W-0h				W-0h			
7	6	5	4	3	2	1	0
TX_DEFAULT_QNUM							
W-0h							

LEGEND: R/W = Read/Write; R = Read only; W1toCl = Write 1 to clear bit; -n = value after reset

Table 16-191. TXGCR6 Register Field Descriptions

Bit	Field	Type	Reset	Description
31	TX_ENABLE	R/W	0h	This field enables or disables the channel 0 = channel is disabled 1 = channel is enabled This field will be cleared after a channel teardown is complete.
30	TX_TEARDOWN	R/W	0h	Setting this bit will request the channel to be torn down. This field will remain set after a channel teardown is complete.
13-12	TX_DEFAULT_QMGR	W	0h	This field controls the default queue manager number that will be used to queue teardown descriptors back to the host.
11-0	TX_DEFAULT_QNUM	W	0h	This field controls the default queue number within the selected queue manager onto which teardown descriptors will be queued back to the host. Table 98 -Tx Channel N Global Configuration Registers

16.5.5.29 RXGCR6 Register (offset = 8C8h) [reset = 0h]

 RXGCR6 is shown in [Figure 16-180](#) and described in [Table 16-192](#).

Figure 16-180. RXGCR6 Register

31	30	29	28	27	26	25	24
RX_ENABLE	RX_TEARDOWN	RX_PAUSE	Reserved			RX_ERROR_HANDLING	
R/W-0h	R/W-0h	R/W-0h				W-0h	
23	22	21	20	19	18	17	16
RX_SOP_OFFSET							
W-0h							
15	14	13	12	11	10	9	8
RX_DEFAULT_DESC_TYPE		RX_DEFAULT_RQ_QMGR		RX_DEFAULT_RQ_QNUM			
W-0h		W-0h		W-0h			
7	6	5	4	3	2	1	0
RX_DEFAULT_RQ_QNUM							
W-0h							

LEGEND: R/W = Read/Write; R = Read only; W1toCl = Write 1 to clear bit; -n = value after reset

Table 16-192. RXGCR6 Register Field Descriptions

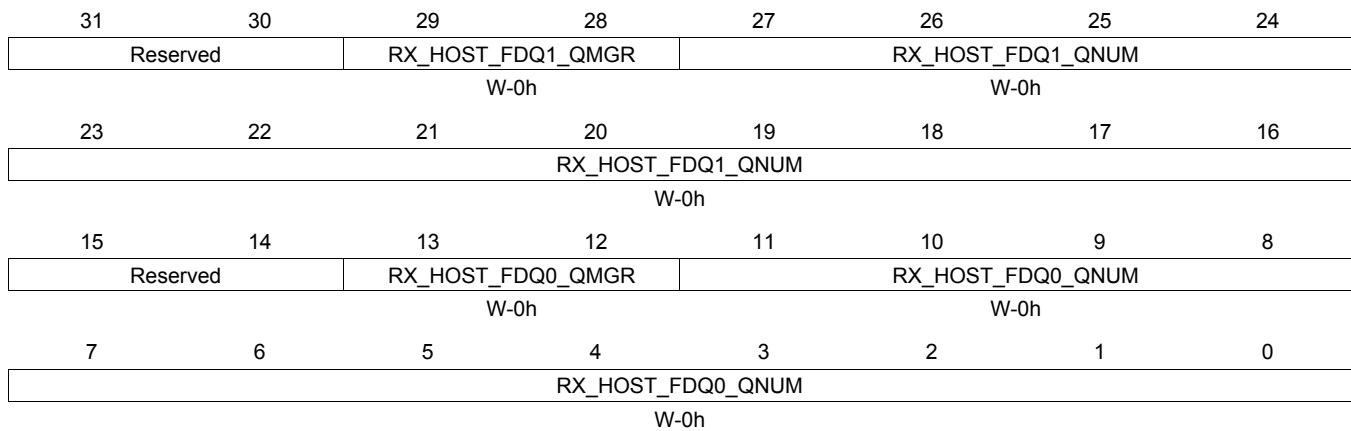
Bit	Field	Type	Reset	Description
31	RX_ENABLE	R/W	0h	This field enables or disables the channel 0 = channel is disabled 1 = channel is enabled This field will be cleared after a channel teardown is complete.
30	RX_TEARDOWN	R/W	0h	This field indicates whether or not an Rx teardown operation is complete. This field should be cleared when a channel is initialized. This field will be set after a channel teardown is complete.
29	RX_PAUSE	R/W	0h	Setting this bit causes the CPPI DMA to be suspended for rx channels. If a pause is being requested and the channel is not in a packet then drop the credit.
24	RX_ERROR_HANDLING	W	0h	This bit controls the error handling mode for the channel and is only used when channel errors (i.e. descriptor or buffer starvation occurs): 0 = Starvation errors result in dropping packet and reclaiming any used descriptor or buffer resources back to the original queues/pools they were allocated to 1 = Starvation errors result in subsequent re-try of the descriptor allocation operation. In this mode, the DMA will return to the IDLE state without saving it's internal operational state back to the internal state RAM and without issuing an advance operation on the FIFO interface. This results in the DMA re-initiating the FIFO block transfer at a later time with the intention that additional free buffers and/or descriptors will have been added. Regardless of the value of this bit, the DMA will assert the cdma_rx_sof_overrun (for SOP) or cdma_rx_mof_overrun (for non-SOP) when
23-16	RX_SOP_OFFSET	W	0h	This field specifies the number of bytes that are to be skipped in the SOP buffer before beginning to write the payload. This value must be less than the minimum size of a buffer in the system. Valid values are 0 - 255 bytes.

Table 16-192. RXGCR6 Register Field Descriptions (continued)

Bit	Field	Type	Reset	Description
15-14	RX_DEFAULT_DESC_TY PE	W	0h	This field indicates the default descriptor type to use: 0 = Reserved 1 = Host 2 = Reserved 3 = Reserved The actual descriptor type that will be used for reception can be overridden by information provided in the CPPI FIFO data block.
13-12	RX_DEFAULT_RQ_QMG R	W	0h	This field indicates the default receive queue manager that this channel should use. The actual receive queue manager index can be overridden by information provided in the CPPI FIFO data block.
11-0	RX_DEFAULT_RQ_QNU M	W	0h	This field indicates the default receive queue that this channel should use. The actual receive queue that will be used for reception can be overridden by information provided in the CPPI FIFO data block. Table 99 -Rx Channel N Global Configuration Registers

16.5.5.30 RXHPCRA6 Register (offset = 8CCh) [reset = 0h]

 RXHPCRA6 is shown in [Figure 16-181](#) and described in [Table 16-193](#).

Figure 16-181. RXHPCRA6 Register


LEGEND: R/W = Read/Write; R = Read only; W1toCl = Write 1 to clear bit; -n = value after reset

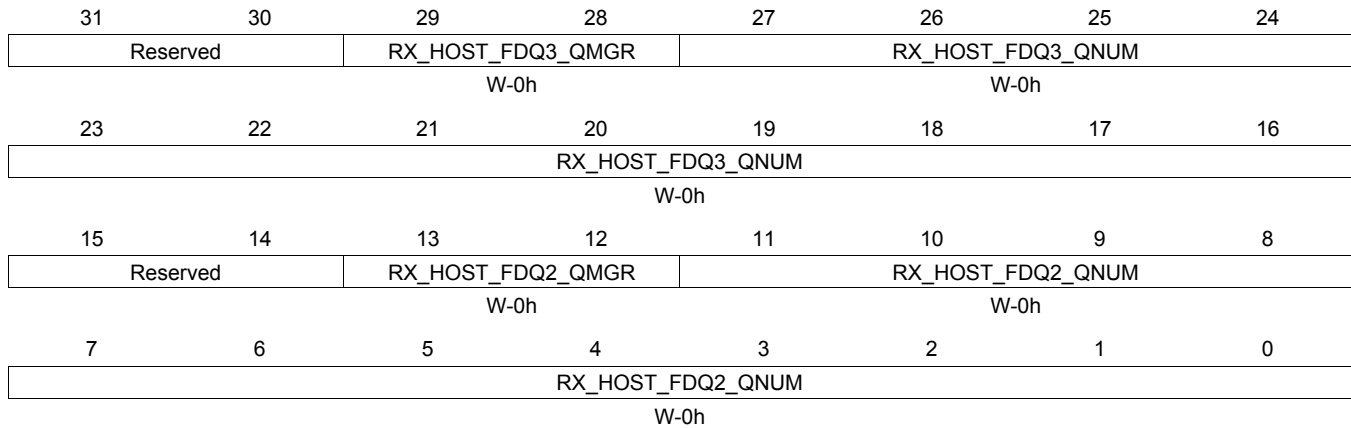
Table 16-193. RXHPCRA6 Register Field Descriptions

Bit	Field	Type	Reset	Description
29-28	RX_HOST_FDQ1_QMGR	W	0h	This field specifies which Buffer Manager should be used for the second Rx buffer in a host type packet.
27-16	RX_HOST_FDQ1_QNUM	W	0h	This field specifies which Free Descriptor / Buffer Pool should be used for the 2nd Rx buffer in a host type packet
13-12	RX_HOST_FDQ0_QMGR	W	0h	This field specifies which Buffer Manager should be used for the second Rx buffer in a host type packet.
11-0	RX_HOST_FDQ0_QNUM	W	0h	This field specifies which Free Descriptor / Buffer Pool should be used for the 1st Rx buffer in a host type packet Table 100 -Rx Channel N Host Packet Configuration Registers A

16.5.5.31 RXHPCRB6 Register (offset = 8D0h) [reset = 0h]

RXHPCRB6 is shown in [Figure 16-182](#) and described in [Table 16-194](#).

Figure 16-182. RXHPCRB6 Register



LEGEND: R/W = Read/Write; R = Read only; W1toCl = Write 1 to clear bit; -n = value after reset

Table 16-194. RXHPCRB6 Register Field Descriptions

Bit	Field	Type	Reset	Description
29-28	RX_HOST_FDQ3_QMGR	W	0h	This field specifies which Manager should be used for the 4th or later Rx buffers in a host type packet
27-16	RX_HOST_FDQ3_QNUM	W	0h	This field specifies which Free Descriptor Queue should be used for the 4th or later Rx buffers in a host type packet
13-12	RX_HOST_FDQ2_QMGR	W	0h	This field specifies which Buffer Manager should be used for the 3rd Rx buffer in a host type packet
11-0	RX_HOST_FDQ2_QNUM	W	0h	This field specifies which Free Descriptor / Buffer Pool should be used for the 3rd Rx buffer in a host type packet Table 101 -Rx Channel N Host Packet Configuration Registers B

16.5.5.32 TXGCR7 Register (offset = 8E0h) [reset = 0h]

 TXGCR7 is shown in [Figure 16-183](#) and described in [Table 16-195](#).

Figure 16-183. TXGCR7 Register

31	30	29	28	27	26	25	24
TX_ENABLE	TX_TEARDOWN N	Reserved					
R/W-0h	R/W-0h						
23	22	21	20	19	18	17	16
Reserved							
15	14	13	12	11	10	9	8
Reserved		TX_DEFAULT_QMGR			TX_DEFAULT_QNUM		
		W-0h			W-0h		
7	6	5	4	3	2	1	0
TX_DEFAULT_QNUM							
W-0h							

LEGEND: R/W = Read/Write; R = Read only; W1toCl = Write 1 to clear bit; -n = value after reset

Table 16-195. TXGCR7 Register Field Descriptions

Bit	Field	Type	Reset	Description
31	TX_ENABLE	R/W	0h	This field enables or disables the channel 0 = channel is disabled 1 = channel is enabled This field will be cleared after a channel teardown is complete.
30	TX_TEARDOWN	R/W	0h	Setting this bit will request the channel to be torn down. This field will remain set after a channel teardown is complete.
13-12	TX_DEFAULT_QMGR	W	0h	This field controls the default queue manager number that will be used to queue teardown descriptors back to the host.
11-0	TX_DEFAULT_QNUM	W	0h	This field controls the default queue number within the selected queue manager onto which teardown descriptors will be queued back to the host. Table 98 -Tx Channel N Global Configuration Registers

16.5.5.33 RXGCR7 Register (offset = 8E8h) [reset = 0h]

RXGCR7 is shown in [Figure 16-184](#) and described in [Table 16-196](#).

Figure 16-184. RXGCR7 Register

31	30	29	28	27	26	25	24
RX_ENABLE	RX_TEARDOWN	RX_PAUSE	Reserved			RX_ERROR_HANDLING	
R/W-0h	R/W-0h	R/W-0h				W-0h	
23	22	21	20	19	18	17	16
RX_SOP_OFFSET							
W-0h							
15	14	13	12	11	10	9	8
RX_DEFAULT_DESC_TYPE		RX_DEFAULT_RQ_QMGR		RX_DEFAULT_RQ_QNUM			
W-0h		W-0h		W-0h			
7	6	5	4	3	2	1	0
RX_DEFAULT_RQ_QNUM							
W-0h							

LEGEND: R/W = Read/Write; R = Read only; W1toCl = Write 1 to clear bit; -n = value after reset

Table 16-196. RXGCR7 Register Field Descriptions

Bit	Field	Type	Reset	Description
31	RX_ENABLE	R/W	0h	This field enables or disables the channel 0 = channel is disabled 1 = channel is enabled This field will be cleared after a channel teardown is complete.
30	RX_TEARDOWN	R/W	0h	This field indicates whether or not an Rx teardown operation is complete. This field should be cleared when a channel is initialized. This field will be set after a channel teardown is complete.
29	RX_PAUSE	R/W	0h	Setting this bit causes the CPPI DMA to be suspended for rx channels. If a pause is being requested and the channel is not in a packet then drop the credit.
24	RX_ERROR_HANDLING	W	0h	This bit controls the error handling mode for the channel and is only used when channel errors (i.e. descriptor or buffer starvation occurs): 0 = Starvation errors result in dropping packet and reclaiming any used descriptor or buffer resources back to the original queues/pools they were allocated to 1 = Starvation errors result in subsequent re-try of the descriptor allocation operation. In this mode, the DMA will return to the IDLE state without saving it's internal operational state back to the internal state RAM and without issuing an advance operation on the FIFO interface. This results in the DMA re-initiating the FIFO block transfer at a later time with the intention that additional free buffers and/or descriptors will have been added. Regardless of the value of this bit, the DMA will assert the <code>cdma_rx_sof_overrun</code> (for SOP) or <code>cdma_rx_mof_overrun</code> (for non-SOP) when
23-16	RX_SOP_OFFSET	W	0h	This field specifies the number of bytes that are to be skipped in the SOP buffer before beginning to write the payload. This value must be less than the minimum size of a buffer in the system. Valid values are 0 - 255 bytes.

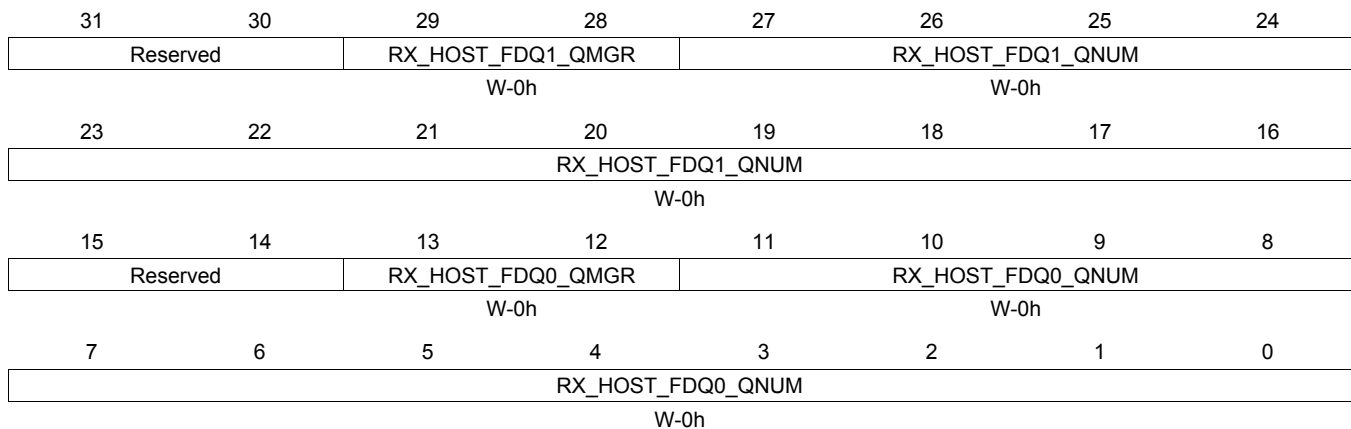
Table 16-196. RXGCR7 Register Field Descriptions (continued)

Bit	Field	Type	Reset	Description
15-14	RX_DEFAULT_DESC_TYPE	W	0h	This field indicates the default descriptor type to use: 0 = Reserved 1 = Host 2 = Reserved 3 = Reserved The actual descriptor type that will be used for reception can be overridden by information provided in the CPPI FIFO data block.
13-12	RX_DEFAULT_RQ_QMGR	W	0h	This field indicates the default receive queue manager that this channel should use. The actual receive queue manager index can be overridden by information provided in the CPPI FIFO data block.
11-0	RX_DEFAULT_RQ_QUEUE	W	0h	This field indicates the default receive queue that this channel should use. The actual receive queue that will be used for reception can be overridden by information provided in the CPPI FIFO data block. Table 99 -Rx Channel N Global Configuration Registers

16.5.5.34 RXHPCRA7 Register (offset = 8ECh) [reset = 0h]

RXHPCRA7 is shown in [Figure 16-185](#) and described in [Table 16-197](#).

Figure 16-185. RXHPCRA7 Register



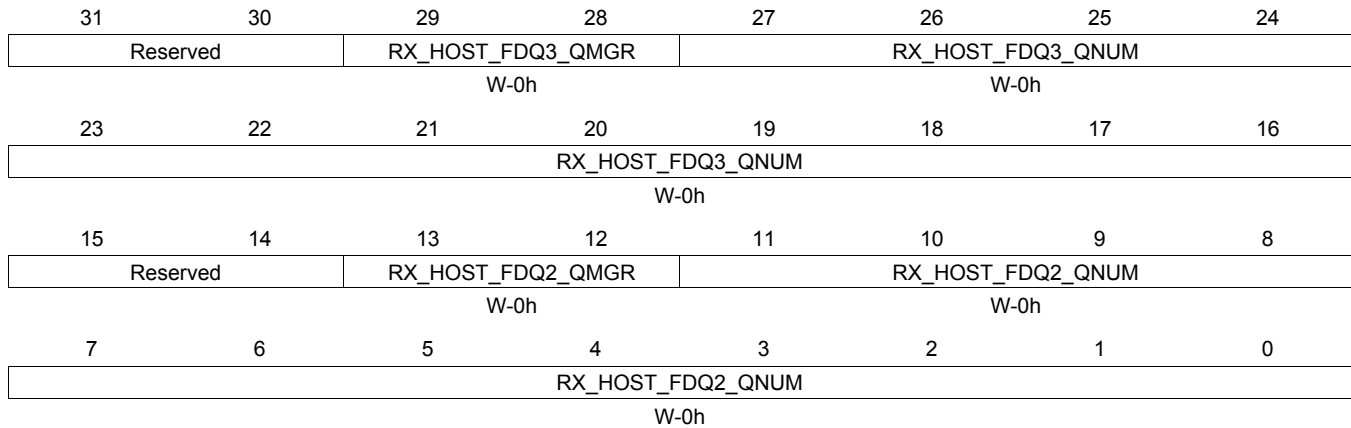
LEGEND: R/W = Read/Write; R = Read only; W1toCl = Write 1 to clear bit; -n = value after reset

Table 16-197. RXHPCRA7 Register Field Descriptions

Bit	Field	Type	Reset	Description
29-28	RX_HOST_FDQ1_QMGR	W	0h	This field specifies which Buffer Manager should be used for the second Rx buffer in a host type packet.
27-16	RX_HOST_FDQ1_QNUM	W	0h	This field specifies which Free Descriptor / Buffer Pool should be used for the 2nd Rx buffer in a host type packet
13-12	RX_HOST_FDQ0_QMGR	W	0h	This field specifies which Buffer Manager should be used for the second Rx buffer in a host type packet.
11-0	RX_HOST_FDQ0_QNUM	W	0h	This field specifies which Free Descriptor / Buffer Pool should be used for the 1st Rx buffer in a host type packet Table 100 -Rx Channel N Host Packet Configuration Registers A

16.5.5.35 RXHPCRB7 Register (offset = 8F0h) [reset = 0h]

 RXHPCRB7 is shown in [Figure 16-186](#) and described in [Table 16-198](#).

Figure 16-186. RXHPCRB7 Register


LEGEND: R/W = Read/Write; R = Read only; W1toCl = Write 1 to clear bit; -n = value after reset

Table 16-198. RXHPCRB7 Register Field Descriptions

Bit	Field	Type	Reset	Description
29-28	RX_HOST_FDQ3_QMGR	W	0h	This field specifies which Manager should be used for the 4th or later Rx buffers in a host type packet
27-16	RX_HOST_FDQ3_QNUM	W	0h	This field specifies which Free Descriptor Queue should be used for the 4th or later Rx buffers in a host type packet
13-12	RX_HOST_FDQ2_QMGR	W	0h	This field specifies which Buffer Manager should be used for the 3rd Rx buffer in a host type packet
11-0	RX_HOST_FDQ2_QNUM	W	0h	This field specifies which Free Descriptor / Buffer Pool should be used for the 3rd Rx buffer in a host type packet Table 101 -Rx Channel N Host Packet Configuration Registers B

16.5.5.36 TXGCR8 Register (offset = 900h) [reset = 0h]

TXGCR8 is shown in [Figure 16-187](#) and described in [Table 16-199](#).

Figure 16-187. TXGCR8 Register

31	30	29	28	27	26	25	24
TX_ENABLE	TX_TEARDOWN	Reserved					
R/W-0h	R/W-0h						
23	22	21	20	19	18	17	16
Reserved							
15	14	13	12	11	10	9	8
Reserved		TX_DEFAULT_QMGR			TX_DEFAULT_QNUM		
W-0h				W-0h			
7	6	5	4	3	2	1	0
TX_DEFAULT_QNUM							
W-0h							

LEGEND: R/W = Read/Write; R = Read only; W1toCl = Write 1 to clear bit; -n = value after reset

Table 16-199. TXGCR8 Register Field Descriptions

Bit	Field	Type	Reset	Description
31	TX_ENABLE	R/W	0h	This field enables or disables the channel 0 = channel is disabled 1 = channel is enabled This field will be cleared after a channel teardown is complete.
30	TX_TEARDOWN	R/W	0h	Setting this bit will request the channel to be torn down. This field will remain set after a channel teardown is complete.
13-12	TX_DEFAULT_QMGR	W	0h	This field controls the default queue manager number that will be used to queue teardown descriptors back to the host.
11-0	TX_DEFAULT_QNUM	W	0h	This field controls the default queue number within the selected queue manager onto which teardown descriptors will be queued back to the host. Table 98 -Tx Channel N Global Configuration Registers

16.5.5.37 RXGCR8 Register (offset = 908h) [reset = 0h]

 RXGCR8 is shown in [Figure 16-188](#) and described in [Table 16-200](#).

Figure 16-188. RXGCR8 Register

31	30	29	28	27	26	25	24
RX_ENABLE	RX_TEARDOWN	RX_PAUSE	Reserved			RX_ERROR_HANDLING	
R/W-0h	R/W-0h	R/W-0h				W-0h	
23	22	21	20	19	18	17	16
RX_SOP_OFFSET							
W-0h							
15	14	13	12	11	10	9	8
RX_DEFAULT_DESC_TYPE		RX_DEFAULT_RQ_QMGR		RX_DEFAULT_RQ_QNUM			
W-0h		W-0h		W-0h			
7	6	5	4	3	2	1	0
RX_DEFAULT_RQ_QNUM							
W-0h							

LEGEND: R/W = Read/Write; R = Read only; W1toCl = Write 1 to clear bit; -n = value after reset

Table 16-200. RXGCR8 Register Field Descriptions

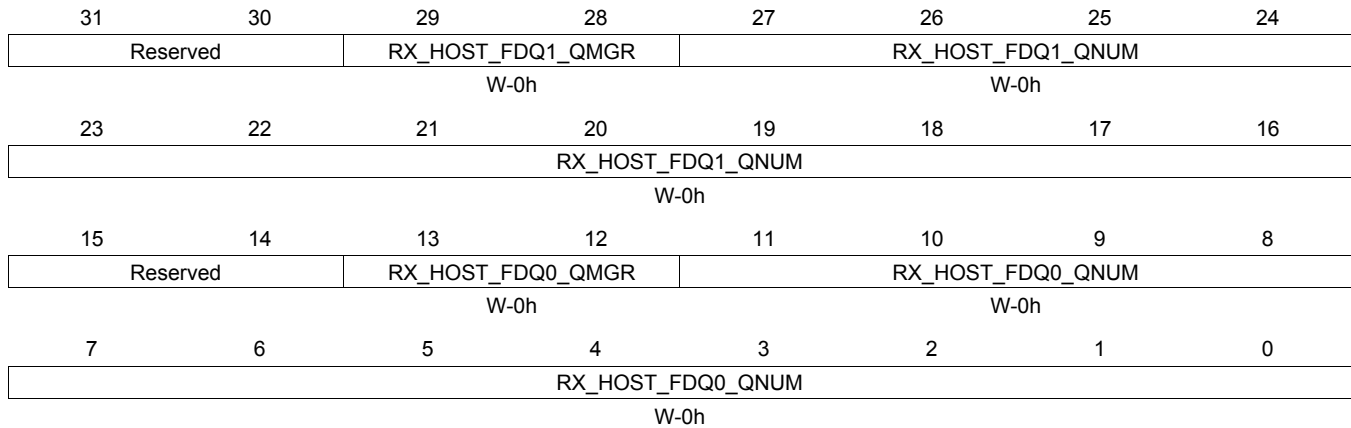
Bit	Field	Type	Reset	Description
31	RX_ENABLE	R/W	0h	This field enables or disables the channel 0 = channel is disabled 1 = channel is enabled This field will be cleared after a channel teardown is complete.
30	RX_TEARDOWN	R/W	0h	This field indicates whether or not an Rx teardown operation is complete. This field should be cleared when a channel is initialized. This field will be set after a channel teardown is complete.
29	RX_PAUSE	R/W	0h	Setting this bit causes the CPPI DMA to be suspended for rx channels. If a pause is being requested and the channel is not in a packet then drop the credit.
24	RX_ERROR_HANDLING	W	0h	This bit controls the error handling mode for the channel and is only used when channel errors (i.e. descriptor or buffer starvation occurs): 0 = Starvation errors result in dropping packet and reclaiming any used descriptor or buffer resources back to the original queues/pools they were allocated to 1 = Starvation errors result in subsequent re-try of the descriptor allocation operation. In this mode, the DMA will return to the IDLE state without saving it's internal operational state back to the internal state RAM and without issuing an advance operation on the FIFO interface. This results in the DMA re-initiating the FIFO block transfer at a later time with the intention that additional free buffers and/or descriptors will have been added. Regardless of the value of this bit, the DMA will assert the <code>cdma_rx_sof_overrun</code> (for SOP) or <code>cdma_rx_mof_overrun</code> (for non-SOP) when
23-16	RX_SOP_OFFSET	W	0h	This field specifies the number of bytes that are to be skipped in the SOP buffer before beginning to write the payload. This value must be less than the minimum size of a buffer in the system. Valid values are 0 - 255 bytes.

Table 16-200. RXGCR8 Register Field Descriptions (continued)

Bit	Field	Type	Reset	Description
15-14	RX_DEFAULT_DESC_TY PE	W	0h	This field indicates the default descriptor type to use: 0 = Reserved 1 = Host 2 = Reserved 3 = Reserved The actual descriptor type that will be used for reception can be overridden by information provided in the CPPI FIFO data block.
13-12	RX_DEFAULT_RQ_QMG R	W	0h	This field indicates the default receive queue manager that this channel should use. The actual receive queue manager index can be overridden by information provided in the CPPI FIFO data block.
11-0	RX_DEFAULT_RQ_QNU M	W	0h	This field indicates the default receive queue that this channel should use. The actual receive queue that will be used for reception can be overridden by information provided in the CPPI FIFO data block. Table 99 -Rx Channel N Global Configuration Registers

16.5.5.38 RXHPCRA8 Register (offset = 90Ch) [reset = 0h]

 RXHPCRA8 is shown in [Figure 16-189](#) and described in [Table 16-201](#).

Figure 16-189. RXHPCRA8 Register


LEGEND: R/W = Read/Write; R = Read only; W1toCl = Write 1 to clear bit; -n = value after reset

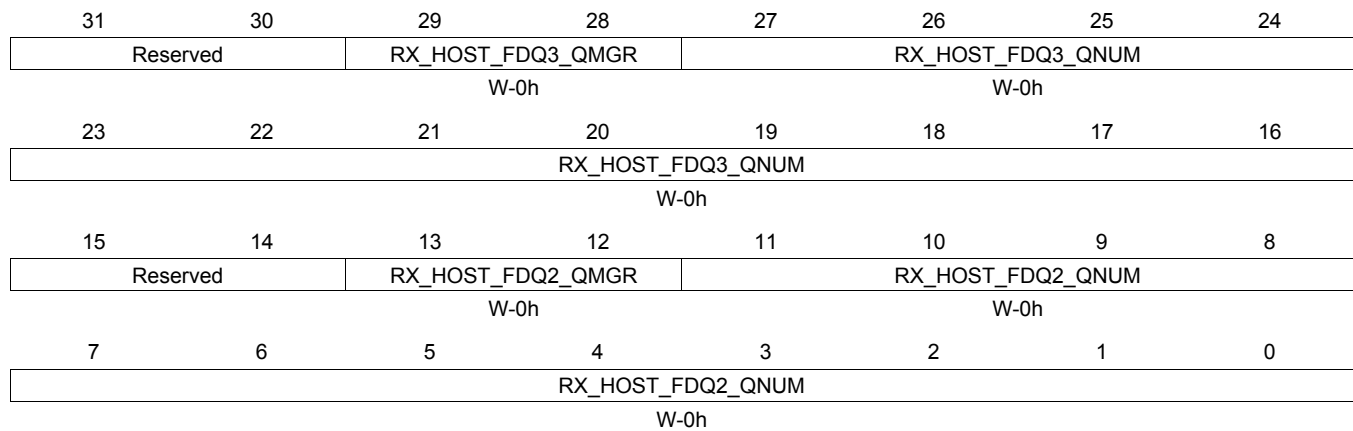
Table 16-201. RXHPCRA8 Register Field Descriptions

Bit	Field	Type	Reset	Description
29-28	RX_HOST_FDQ1_QMGR	W	0h	This field specifies which Buffer Manager should be used for the second Rx buffer in a host type packet.
27-16	RX_HOST_FDQ1_QNUM	W	0h	This field specifies which Free Descriptor / Buffer Pool should be used for the 2nd Rx buffer in a host type packet
13-12	RX_HOST_FDQ0_QMGR	W	0h	This field specifies which Buffer Manager should be used for the second Rx buffer in a host type packet.
11-0	RX_HOST_FDQ0_QNUM	W	0h	This field specifies which Free Descriptor / Buffer Pool should be used for the 1st Rx buffer in a host type packet Table 100 -Rx Channel N Host Packet Configuration Registers A

16.5.5.39 RXHPCRB8 Register (offset = 910h) [reset = 0h]

RXHPCRB8 is shown in [Figure 16-190](#) and described in [Table 16-202](#).

Figure 16-190. RXHPCRB8 Register



LEGEND: R/W = Read/Write; R = Read only; W1toCl = Write 1 to clear bit; -n = value after reset

Table 16-202. RXHPCRB8 Register Field Descriptions

Bit	Field	Type	Reset	Description
29-28	RX_HOST_FDQ3_QMGR	W	0h	This field specifies which Manager should be used for the 4th or later Rx buffers in a host type packet
27-16	RX_HOST_FDQ3_QNUM	W	0h	This field specifies which Free Descriptor Queue should be used for the 4th or later Rx buffers in a host type packet
13-12	RX_HOST_FDQ2_QMGR	W	0h	This field specifies which Buffer Manager should be used for the 3rd Rx buffer in a host type packet
11-0	RX_HOST_FDQ2_QNUM	W	0h	This field specifies which Free Descriptor / Buffer Pool should be used for the 3rd Rx buffer in a host type packet Table 101 -Rx Channel N Host Packet Configuration Registers B

16.5.5.40 TXGCR9 Register (offset = 920h) [reset = 0h]

 TXGCR9 is shown in [Figure 16-191](#) and described in [Table 16-203](#).

Figure 16-191. TXGCR9 Register

	31	30	29	28	27	26	25	24
	TX_ENABLE	TX_TEARDOWN	Reserved					
	R/W-0h	R/W-0h						
	23	22	21	20	19	18	17	16
	Reserved							
	15	14	13	12	11	10	9	8
	Reserved		TX_DEFAULT_QMGR			TX_DEFAULT_QNUM		
			W-0h			W-0h		
	7	6	5	4	3	2	1	0
	TX_DEFAULT_QNUM							
	W-0h							

LEGEND: R/W = Read/Write; R = Read only; W1toCl = Write 1 to clear bit; -n = value after reset

Table 16-203. TXGCR9 Register Field Descriptions

Bit	Field	Type	Reset	Description
31	TX_ENABLE	R/W	0h	This field enables or disables the channel 0 = channel is disabled 1 = channel is enabled This field will be cleared after a channel teardown is complete.
30	TX_TEARDOWN	R/W	0h	Setting this bit will request the channel to be torn down. This field will remain set after a channel teardown is complete.
13-12	TX_DEFAULT_QMGR	W	0h	This field controls the default queue manager number that will be used to queue teardown descriptors back to the host.
11-0	TX_DEFAULT_QNUM	W	0h	This field controls the default queue number within the selected queue manager onto which teardown descriptors will be queued back to the host. Table 98 -Tx Channel N Global Configuration Registers

16.5.5.41 RXGCR9 Register (offset = 928h) [reset = 0h]

RXGCR9 is shown in [Figure 16-192](#) and described in [Table 16-204](#).

Figure 16-192. RXGCR9 Register

31	30	29	28	27	26	25	24
RX_ENABLE	RX_TEARDOWN	RX_PAUSE	Reserved			RX_ERROR_HANDLING	
R/W-0h	R/W-0h	R/W-0h				W-0h	
23	22	21	20	19	18	17	16
RX_SOP_OFFSET							
W-0h							
15	14	13	12	11	10	9	8
RX_DEFAULT_DESC_TYPE		RX_DEFAULT_RQ_QMGR		RX_DEFAULT_RQ_QNUM			
W-0h		W-0h		W-0h			
7	6	5	4	3	2	1	0
RX_DEFAULT_RQ_QNUM							
W-0h							

LEGEND: R/W = Read/Write; R = Read only; W1toCl = Write 1 to clear bit; -n = value after reset

Table 16-204. RXGCR9 Register Field Descriptions

Bit	Field	Type	Reset	Description
31	RX_ENABLE	R/W	0h	This field enables or disables the channel 0 = channel is disabled 1 = channel is enabled This field will be cleared after a channel teardown is complete.
30	RX_TEARDOWN	R/W	0h	This field indicates whether or not an Rx teardown operation is complete. This field should be cleared when a channel is initialized. This field will be set after a channel teardown is complete.
29	RX_PAUSE	R/W	0h	Setting this bit causes the CPPI DMA to be suspended for rx channels. If a pause is being requested and the channel is not in a packet then drop the credit.
24	RX_ERROR_HANDLING	W	0h	This bit controls the error handling mode for the channel and is only used when channel errors (i.e. descriptor or buffer starvation occurs): 0 = Starvation errors result in dropping packet and reclaiming any used descriptor or buffer resources back to the original queues/pools they were allocated to 1 = Starvation errors result in subsequent re-try of the descriptor allocation operation. In this mode, the DMA will return to the IDLE state without saving it's internal operational state back to the internal state RAM and without issuing an advance operation on the FIFO interface. This results in the DMA re-initiating the FIFO block transfer at a later time with the intention that additional free buffers and/or descriptors will have been added. Regardless of the value of this bit, the DMA will assert the <code>cdma_rx_sof_overrun</code> (for SOP) or <code>cdma_rx_mof_overrun</code> (for non-SOP) when
23-16	RX_SOP_OFFSET	W	0h	This field specifies the number of bytes that are to be skipped in the SOP buffer before beginning to write the payload. This value must be less than the minimum size of a buffer in the system. Valid values are 0 - 255 bytes.

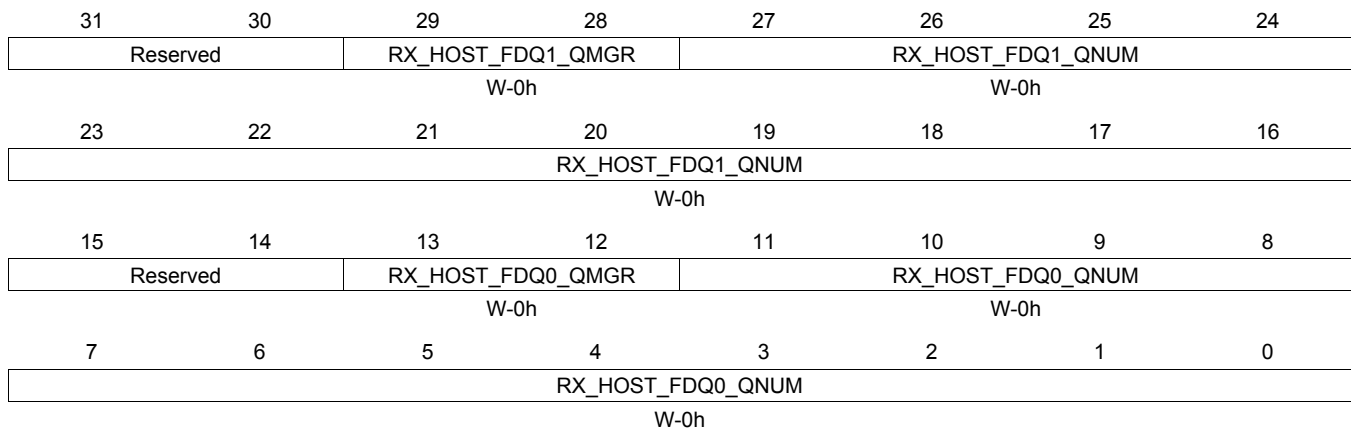
Table 16-204. RXGCR9 Register Field Descriptions (continued)

Bit	Field	Type	Reset	Description
15-14	RX_DEFAULT_DESC_TYPE	W	0h	This field indicates the default descriptor type to use: 0 = Reserved 1 = Host 2 = Reserved 3 = Reserved The actual descriptor type that will be used for reception can be overridden by information provided in the CPPI FIFO data block.
13-12	RX_DEFAULT_RQ_QMGR	W	0h	This field indicates the default receive queue manager that this channel should use. The actual receive queue manager index can be overridden by information provided in the CPPI FIFO data block.
11-0	RX_DEFAULT_RQ_QUEUE	W	0h	This field indicates the default receive queue that this channel should use. The actual receive queue that will be used for reception can be overridden by information provided in the CPPI FIFO data block. Table 99 -Rx Channel N Global Configuration Registers

16.5.5.42 RXHPCRA9 Register (offset = 92Ch) [reset = 0h]

RXHPCRA9 is shown in [Figure 16-193](#) and described in [Table 16-205](#).

Figure 16-193. RXHPCRA9 Register



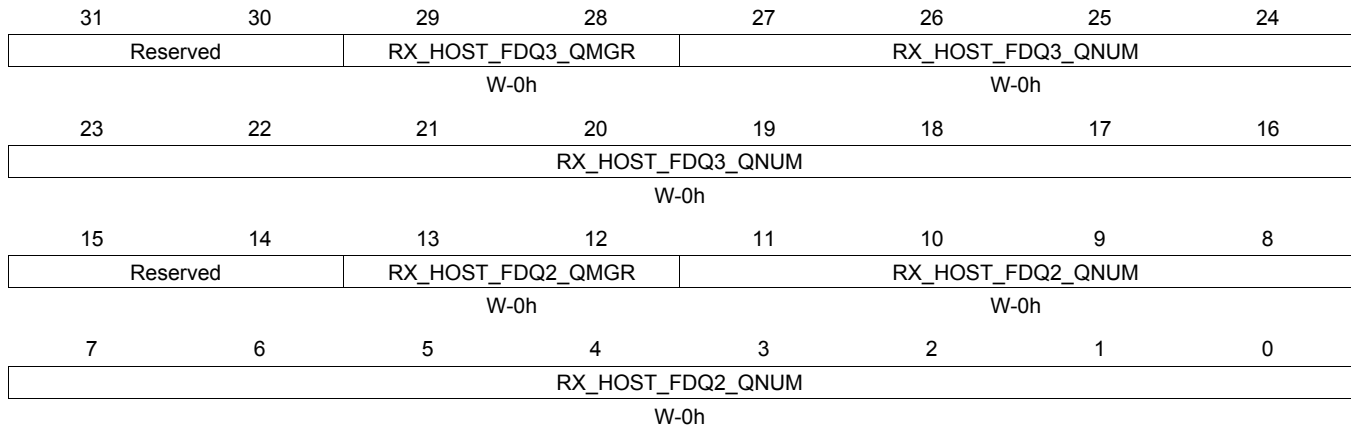
LEGEND: R/W = Read/Write; R = Read only; W1toCl = Write 1 to clear bit; -n = value after reset

Table 16-205. RXHPCRA9 Register Field Descriptions

Bit	Field	Type	Reset	Description
29-28	RX_HOST_FDQ1_QMGR	W	0h	This field specifies which Buffer Manager should be used for the second Rx buffer in a host type packet.
27-16	RX_HOST_FDQ1_QNUM	W	0h	This field specifies which Free Descriptor / Buffer Pool should be used for the 2nd Rx buffer in a host type packet
13-12	RX_HOST_FDQ0_QMGR	W	0h	This field specifies which Buffer Manager should be used for the second Rx buffer in a host type packet.
11-0	RX_HOST_FDQ0_QNUM	W	0h	This field specifies which Free Descriptor / Buffer Pool should be used for the 1st Rx buffer in a host type packet Table 100 -Rx Channel N Host Packet Configuration Registers A

16.5.5.43 RXHPCRB9 Register (offset = 930h) [reset = 0h]

 RXHPCRB9 is shown in [Figure 16-194](#) and described in [Table 16-206](#).

Figure 16-194. RXHPCRB9 Register


LEGEND: R/W = Read/Write; R = Read only; W1toCl = Write 1 to clear bit; -n = value after reset

Table 16-206. RXHPCRB9 Register Field Descriptions

Bit	Field	Type	Reset	Description
29-28	RX_HOST_FDQ3_QMGR	W	0h	This field specifies which Manager should be used for the 4th or later Rx buffers in a host type packet
27-16	RX_HOST_FDQ3_QNUM	W	0h	This field specifies which Free Descriptor Queue should be used for the 4th or later Rx buffers in a host type packet
13-12	RX_HOST_FDQ2_QMGR	W	0h	This field specifies which Buffer Manager should be used for the 3rd Rx buffer in a host type packet
11-0	RX_HOST_FDQ2_QNUM	W	0h	This field specifies which Free Descriptor / Buffer Pool should be used for the 3rd Rx buffer in a host type packet Table 101 -Rx Channel N Host Packet Configuration Registers B

16.5.5.44 TXGCR10 Register (offset = 940h) [reset = 0h]

TXGCR10 is shown in [Figure 16-195](#) and described in [Table 16-207](#).

Figure 16-195. TXGCR10 Register

31	30	29	28	27	26	25	24
TX_ENABLE	TX_TEARDOWN	Reserved					
R/W-0h	R/W-0h						
23	22	21	20	19	18	17	16
Reserved							
15	14	13	12	11	10	9	8
Reserved		TX_DEFAULT_QMGR			TX_DEFAULT_QNUM		
W-0h				W-0h			
7	6	5	4	3	2	1	0
TX_DEFAULT_QNUM							
W-0h							

LEGEND: R/W = Read/Write; R = Read only; W1toCl = Write 1 to clear bit; -n = value after reset

Table 16-207. TXGCR10 Register Field Descriptions

Bit	Field	Type	Reset	Description
31	TX_ENABLE	R/W	0h	This field enables or disables the channel 0 = channel is disabled 1 = channel is enabled This field will be cleared after a channel teardown is complete.
30	TX_TEARDOWN	R/W	0h	Setting this bit will request the channel to be torn down. This field will remain set after a channel teardown is complete.
13-12	TX_DEFAULT_QMGR	W	0h	This field controls the default queue manager number that will be used to queue teardown descriptors back to the host.
11-0	TX_DEFAULT_QNUM	W	0h	This field controls the default queue number within the selected queue manager onto which teardown descriptors will be queued back to the host. Table 98 -Tx Channel N Global Configuration Registers

16.5.5.45 RXGCR10 Register (offset = 948h) [reset = 0h]

 RXGCR10 is shown in [Figure 16-196](#) and described in [Table 16-208](#).

Figure 16-196. RXGCR10 Register

31	30	29	28	27	26	25	24
RX_ENABLE	RX_TEARDOWN	RX_PAUSE	Reserved			RX_ERROR_HANDLING	
R/W-0h	R/W-0h	R/W-0h				W-0h	
23	22	21	20	19	18	17	16
RX_SOP_OFFSET							
W-0h							
15	14	13	12	11	10	9	8
RX_DEFAULT_DESC_TYPE		RX_DEFAULT_RQ_QMGR		RX_DEFAULT_RQ_QNUM			
W-0h		W-0h		W-0h			
7	6	5	4	3	2	1	0
RX_DEFAULT_RQ_QNUM							
W-0h							

LEGEND: R/W = Read/Write; R = Read only; W1toCl = Write 1 to clear bit; -n = value after reset

Table 16-208. RXGCR10 Register Field Descriptions

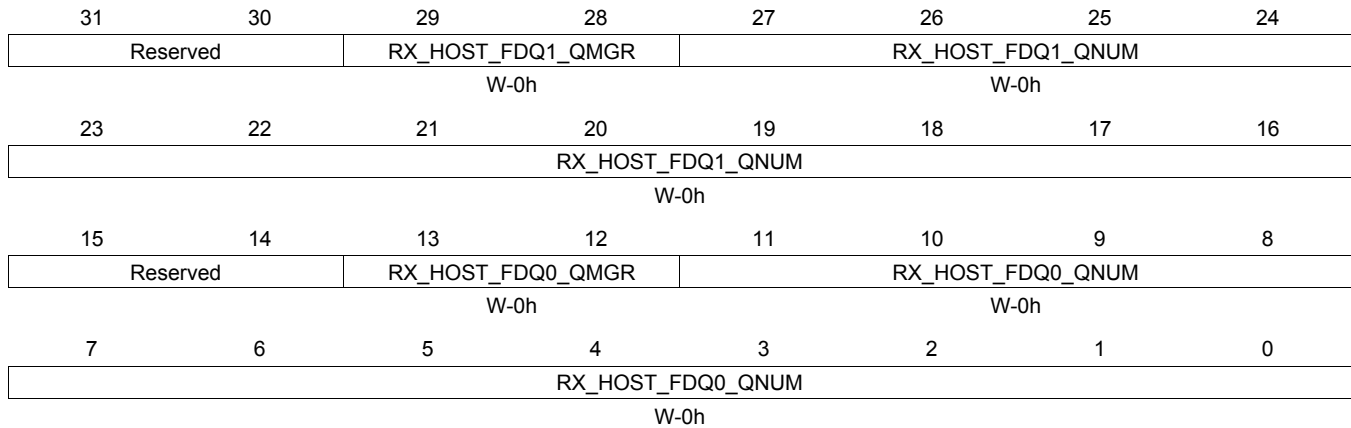
Bit	Field	Type	Reset	Description
31	RX_ENABLE	R/W	0h	This field enables or disables the channel 0 = channel is disabled 1 = channel is enabled This field will be cleared after a channel teardown is complete.
30	RX_TEARDOWN	R/W	0h	This field indicates whether or not an Rx teardown operation is complete. This field should be cleared when a channel is initialized. This field will be set after a channel teardown is complete.
29	RX_PAUSE	R/W	0h	Setting this bit causes the CPPI DMA to be suspended for rx channels. If a pause is being requested and the channel is not in a packet then drop the credit.
24	RX_ERROR_HANDLING	W	0h	This bit controls the error handling mode for the channel and is only used when channel errors (i.e. descriptor or buffer starvation occurs): 0 = Starvation errors result in dropping packet and reclaiming any used descriptor or buffer resources back to the original queues/pools they were allocated to 1 = Starvation errors result in subsequent re-try of the descriptor allocation operation. In this mode, the DMA will return to the IDLE state without saving it's internal operational state back to the internal state RAM and without issuing an advance operation on the FIFO interface. This results in the DMA re-initiating the FIFO block transfer at a later time with the intention that additional free buffers and/or descriptors will have been added. Regardless of the value of this bit, the DMA will assert the <code>cdma_rx_sof_overrun</code> (for SOP) or <code>cdma_rx_mof_overrun</code> (for non-SOP) when
23-16	RX_SOP_OFFSET	W	0h	This field specifies the number of bytes that are to be skipped in the SOP buffer before beginning to write the payload. This value must be less than the minimum size of a buffer in the system. Valid values are 0 - 255 bytes.

Table 16-208. RXGCR10 Register Field Descriptions (continued)

Bit	Field	Type	Reset	Description
15-14	RX_DEFAULT_DESC_TY PE	W	0h	This field indicates the default descriptor type to use: 0 = Reserved 1 = Host 2 = Reserved 3 = Reserved The actual descriptor type that will be used for reception can be overridden by information provided in the CPPI FIFO data block.
13-12	RX_DEFAULT_RQ_QMG R	W	0h	This field indicates the default receive queue manager that this channel should use. The actual receive queue manager index can be overridden by information provided in the CPPI FIFO data block.
11-0	RX_DEFAULT_RQ_QNU M	W	0h	This field indicates the default receive queue that this channel should use. The actual receive queue that will be used for reception can be overridden by information provided in the CPPI FIFO data block. Table 99 -Rx Channel N Global Configuration Registers

16.5.5.46 RXHPCRA10 Register (offset = 94Ch) [reset = 0h]

 RXHPCRA10 is shown in [Figure 16-197](#) and described in [Table 16-209](#).

Figure 16-197. RXHPCRA10 Register


LEGEND: R/W = Read/Write; R = Read only; W1toCl = Write 1 to clear bit; -n = value after reset

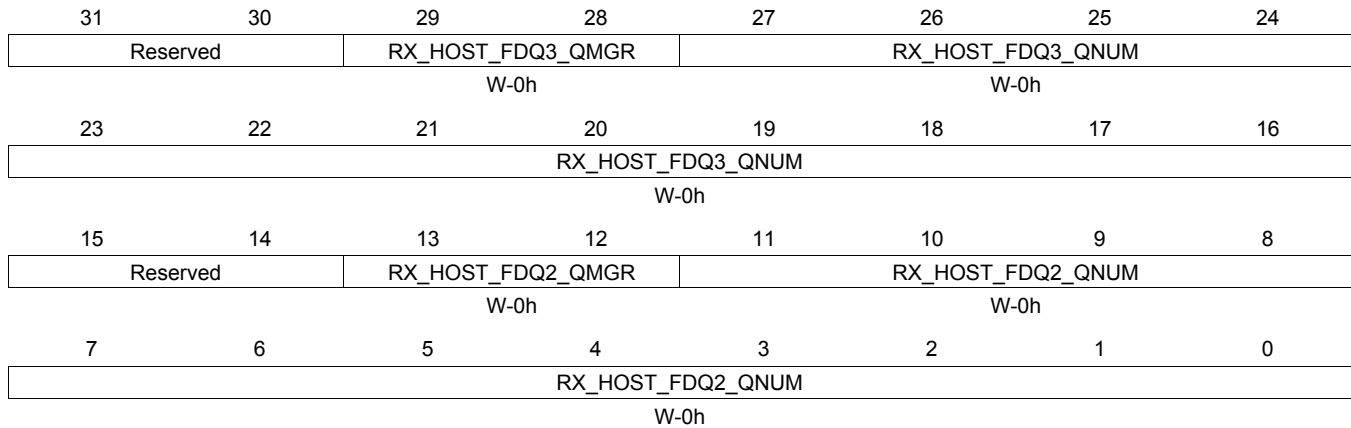
Table 16-209. RXHPCRA10 Register Field Descriptions

Bit	Field	Type	Reset	Description
29-28	RX_HOST_FDQ1_QMGR	W	0h	This field specifies which Buffer Manager should be used for the second Rx buffer in a host type packet.
27-16	RX_HOST_FDQ1_QNUM	W	0h	This field specifies which Free Descriptor / Buffer Pool should be used for the 2nd Rx buffer in a host type packet
13-12	RX_HOST_FDQ0_QMGR	W	0h	This field specifies which Buffer Manager should be used for the second Rx buffer in a host type packet.
11-0	RX_HOST_FDQ0_QNUM	W	0h	This field specifies which Free Descriptor / Buffer Pool should be used for the 1st Rx buffer in a host type packet Table 100 -Rx Channel N Host Packet Configuration Registers A

16.5.5.47 RXHPCRB10 Register (offset = 950h) [reset = 0h]

RXHPCRB10 is shown in [Figure 16-198](#) and described in [Table 16-210](#).

Figure 16-198. RXHPCRB10 Register



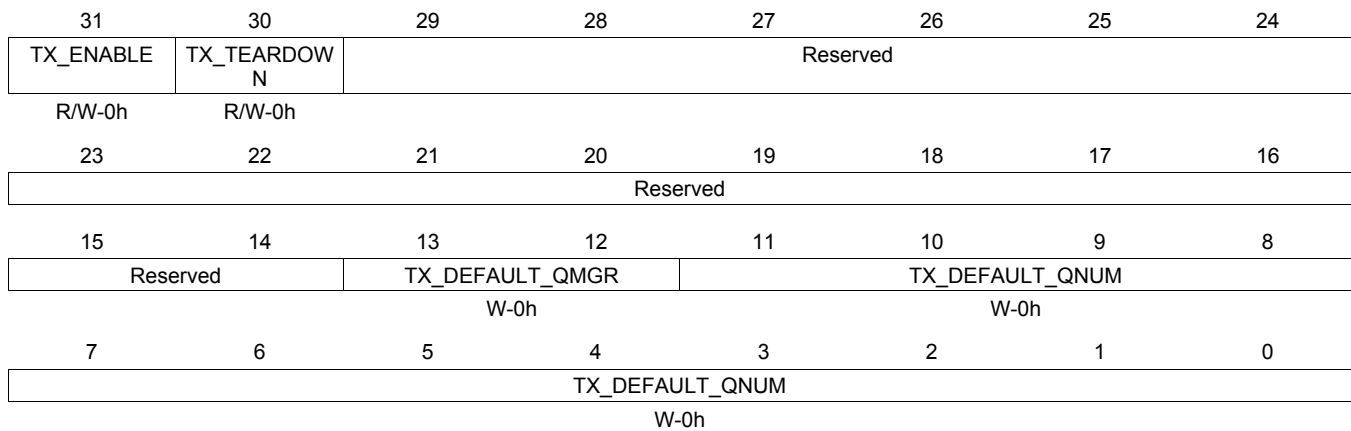
LEGEND: R/W = Read/Write; R = Read only; W1toCl = Write 1 to clear bit; -n = value after reset

Table 16-210. RXHPCRB10 Register Field Descriptions

Bit	Field	Type	Reset	Description
29-28	RX_HOST_FDQ3_QMGR	W	0h	This field specifies which Manager should be used for the 4th or later Rx buffers in a host type packet
27-16	RX_HOST_FDQ3_QNUM	W	0h	This field specifies which Free Descriptor Queue should be used for the 4th or later Rx buffers in a host type packet
13-12	RX_HOST_FDQ2_QMGR	W	0h	This field specifies which Buffer Manager should be used for the 3rd Rx buffer in a host type packet
11-0	RX_HOST_FDQ2_QNUM	W	0h	This field specifies which Free Descriptor / Buffer Pool should be used for the 3rd Rx buffer in a host type packet Table 101 -Rx Channel N Host Packet Configuration Registers B

16.5.5.48 TXGCR11 Register (offset = 960h) [reset = 0h]

 TXGCR11 is shown in [Figure 16-199](#) and described in [Table 16-211](#).

Figure 16-199. TXGCR11 Register


LEGEND: R/W = Read/Write; R = Read only; W1toCl = Write 1 to clear bit; -n = value after reset

Table 16-211. TXGCR11 Register Field Descriptions

Bit	Field	Type	Reset	Description
31	TX_ENABLE	R/W	0h	This field enables or disables the channel 0 = channel is disabled 1 = channel is enabled This field will be cleared after a channel teardown is complete.
30	TX_TEARDOWN	R/W	0h	Setting this bit will request the channel to be torn down. This field will remain set after a channel teardown is complete.
13-12	TX_DEFAULT_QMGR	W	0h	This field controls the default queue manager number that will be used to queue teardown descriptors back to the host.
11-0	TX_DEFAULT_QNUM	W	0h	This field controls the default queue number within the selected queue manager onto which teardown descriptors will be queued back to the host. Table 98 -Tx Channel N Global Configuration Registers

16.5.5.49 RXGCR11 Register (offset = 968h) [reset = 0h]

RXGCR11 is shown in [Figure 16-200](#) and described in [Table 16-212](#).

Figure 16-200. RXGCR11 Register

31	30	29	28	27	26	25	24
RX_ENABLE	RX_TEARDOWN	RX_PAUSE	Reserved			RX_ERROR_HANDLING	
R/W-0h	R/W-0h	R/W-0h				W-0h	
23	22	21	20	19	18	17	16
RX_SOP_OFFSET							
W-0h							
15	14	13	12	11	10	9	8
RX_DEFAULT_DESC_TYPE		RX_DEFAULT_RQ_QMGR		RX_DEFAULT_RQ_QNUM			
W-0h		W-0h		W-0h			
7	6	5	4	3	2	1	0
RX_DEFAULT_RQ_QNUM							
W-0h							

LEGEND: R/W = Read/Write; R = Read only; W1toCl = Write 1 to clear bit; -n = value after reset

Table 16-212. RXGCR11 Register Field Descriptions

Bit	Field	Type	Reset	Description
31	RX_ENABLE	R/W	0h	This field enables or disables the channel 0 = channel is disabled 1 = channel is enabled This field will be cleared after a channel teardown is complete.
30	RX_TEARDOWN	R/W	0h	This field indicates whether or not an Rx teardown operation is complete. This field should be cleared when a channel is initialized. This field will be set after a channel teardown is complete.
29	RX_PAUSE	R/W	0h	Setting this bit causes the CPPI DMA to be suspended for rx channels. If a pause is being requested and the channel is not in a packet then drop the credit.
24	RX_ERROR_HANDLING	W	0h	This bit controls the error handling mode for the channel and is only used when channel errors (i.e. descriptor or buffer starvation occurs): 0 = Starvation errors result in dropping packet and reclaiming any used descriptor or buffer resources back to the original queues/pools they were allocated to 1 = Starvation errors result in subsequent re-try of the descriptor allocation operation. In this mode, the DMA will return to the IDLE state without saving it's internal operational state back to the internal state RAM and without issuing an advance operation on the FIFO interface. This results in the DMA re-initiating the FIFO block transfer at a later time with the intention that additional free buffers and/or descriptors will have been added. Regardless of the value of this bit, the DMA will assert the <code>cdma_rx_sof_overrun</code> (for SOP) or <code>cdma_rx_mof_overrun</code> (for non-SOP) when
23-16	RX_SOP_OFFSET	W	0h	This field specifies the number of bytes that are to be skipped in the SOP buffer before beginning to write the payload. This value must be less than the minimum size of a buffer in the system. Valid values are 0 - 255 bytes.

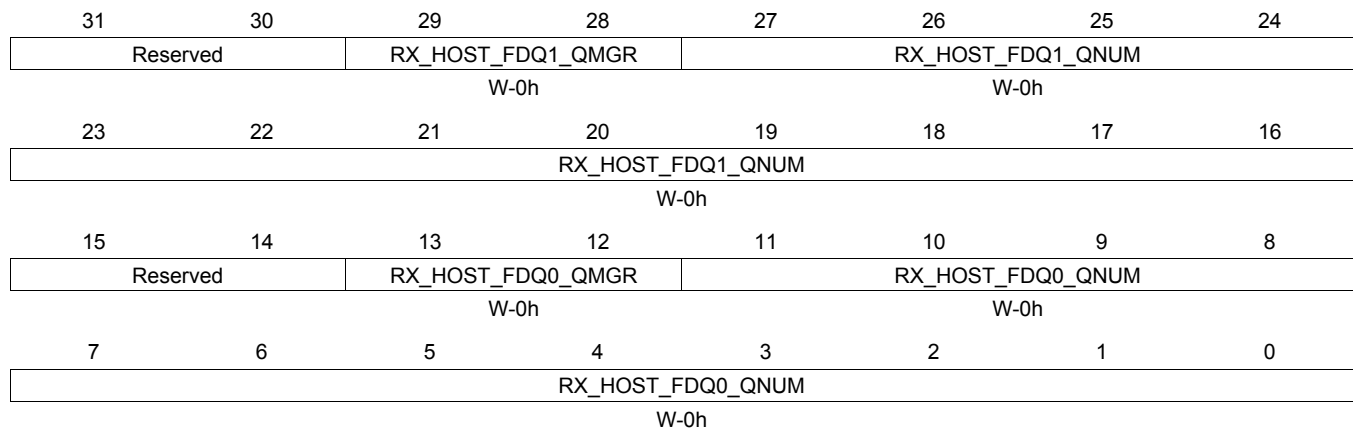
Table 16-212. RXGCR11 Register Field Descriptions (continued)

Bit	Field	Type	Reset	Description
15-14	RX_DEFAULT_DESC_TYPE	W	0h	This field indicates the default descriptor type to use: 0 = Reserved 1 = Host 2 = Reserved 3 = Reserved The actual descriptor type that will be used for reception can be overridden by information provided in the CPPI FIFO data block.
13-12	RX_DEFAULT_RQ_QMGR	W	0h	This field indicates the default receive queue manager that this channel should use. The actual receive queue manager index can be overridden by information provided in the CPPI FIFO data block.
11-0	RX_DEFAULT_RQ_QUEUE	W	0h	This field indicates the default receive queue that this channel should use. The actual receive queue that will be used for reception can be overridden by information provided in the CPPI FIFO data block. Table 99 -Rx Channel N Global Configuration Registers

16.5.5.50 RXHPCRA11 Register (offset = 96Ch) [reset = 0h]

RXHPCRA11 is shown in [Figure 16-201](#) and described in [Table 16-213](#).

Figure 16-201. RXHPCRA11 Register



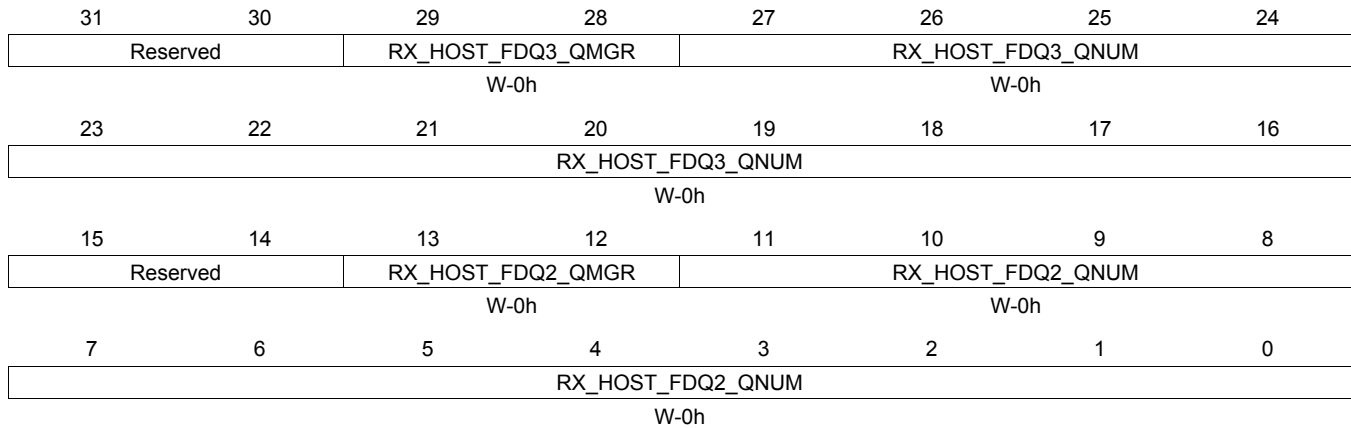
LEGEND: R/W = Read/Write; R = Read only; W1toCl = Write 1 to clear bit; -n = value after reset

Table 16-213. RXHPCRA11 Register Field Descriptions

Bit	Field	Type	Reset	Description
29-28	RX_HOST_FDQ1_QMGR	W	0h	This field specifies which Buffer Manager should be used for the second Rx buffer in a host type packet.
27-16	RX_HOST_FDQ1_QNUM	W	0h	This field specifies which Free Descriptor / Buffer Pool should be used for the 2nd Rx buffer in a host type packet
13-12	RX_HOST_FDQ0_QMGR	W	0h	This field specifies which Buffer Manager should be used for the second Rx buffer in a host type packet.
11-0	RX_HOST_FDQ0_QNUM	W	0h	This field specifies which Free Descriptor / Buffer Pool should be used for the 1st Rx buffer in a host type packet Table 100 -Rx Channel N Host Packet Configuration Registers A

16.5.5.51 RXHPCRB11 Register (offset = 970h) [reset = 0h]

 RXHPCRB11 is shown in [Figure 16-202](#) and described in [Table 16-214](#).

Figure 16-202. RXHPCRB11 Register


LEGEND: R/W = Read/Write; R = Read only; W1toCl = Write 1 to clear bit; -n = value after reset

Table 16-214. RXHPCRB11 Register Field Descriptions

Bit	Field	Type	Reset	Description
29-28	RX_HOST_FDQ3_QMGR	W	0h	This field specifies which Manager should be used for the 4th or later Rx buffers in a host type packet
27-16	RX_HOST_FDQ3_QNUM	W	0h	This field specifies which Free Descriptor Queue should be used for the 4th or later Rx buffers in a host type packet
13-12	RX_HOST_FDQ2_QMGR	W	0h	This field specifies which Buffer Manager should be used for the 3rd Rx buffer in a host type packet
11-0	RX_HOST_FDQ2_QNUM	W	0h	This field specifies which Free Descriptor / Buffer Pool should be used for the 3rd Rx buffer in a host type packet Table 101 -Rx Channel N Host Packet Configuration Registers B

16.5.5.52 TXGCR12 Register (offset = 980h) [reset = 0h]

TXGCR12 is shown in [Figure 16-203](#) and described in [Table 16-215](#).

Figure 16-203. TXGCR12 Register

31	30	29	28	27	26	25	24
TX_ENABLE	TX_TEARDOWN	Reserved					
R/W-0h	R/W-0h						
23	22	21	20	19	18	17	16
Reserved							
15	14	13	12	11	10	9	8
Reserved		TX_DEFAULT_QMGR			TX_DEFAULT_QNUM		
W-0h				W-0h			
7	6	5	4	3	2	1	0
TX_DEFAULT_QNUM							
W-0h							

LEGEND: R/W = Read/Write; R = Read only; W1toCl = Write 1 to clear bit; -n = value after reset

Table 16-215. TXGCR12 Register Field Descriptions

Bit	Field	Type	Reset	Description
31	TX_ENABLE	R/W	0h	This field enables or disables the channel 0 = channel is disabled 1 = channel is enabled This field will be cleared after a channel teardown is complete.
30	TX_TEARDOWN	R/W	0h	Setting this bit will request the channel to be torn down. This field will remain set after a channel teardown is complete.
13-12	TX_DEFAULT_QMGR	W	0h	This field controls the default queue manager number that will be used to queue teardown descriptors back to the host.
11-0	TX_DEFAULT_QNUM	W	0h	This field controls the default queue number within the selected queue manager onto which teardown descriptors will be queued back to the host. Table 98 -Tx Channel N Global Configuration Registers

16.5.5.53 RXGCR12 Register (offset = 988h) [reset = 0h]

 RXGCR12 is shown in [Figure 16-204](#) and described in [Table 16-216](#).

Figure 16-204. RXGCR12 Register

31	30	29	28	27	26	25	24
RX_ENABLE	RX_TEARDOWN N	RX_PAUSE	Reserved			RX_ERROR_H ANDLING	
R/W-0h	R/W-0h	R/W-0h				W-0h	
23	22	21	20	19	18	17	16
RX_SOP_OFFSET							
W-0h							
15	14	13	12	11	10	9	8
RX_DEFAULT_DESC_TYPE		RX_DEFAULT_RQ_QMGR		RX_DEFAULT_RQ_QNUM			
W-0h		W-0h		W-0h			
7	6	5	4	3	2	1	0
RX_DEFAULT_RQ_QNUM							
W-0h							

LEGEND: R/W = Read/Write; R = Read only; W1toCl = Write 1 to clear bit; -n = value after reset

Table 16-216. RXGCR12 Register Field Descriptions

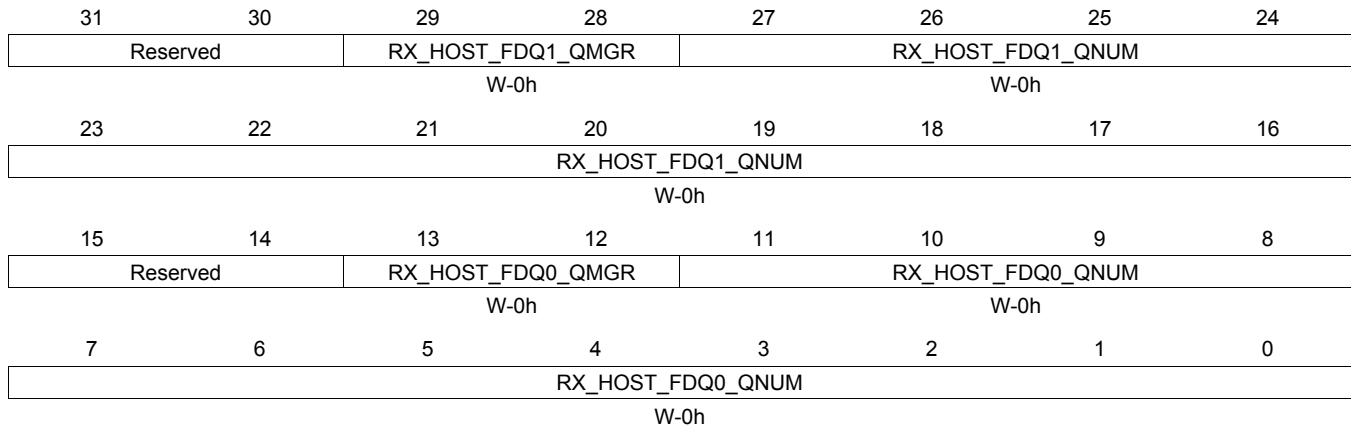
Bit	Field	Type	Reset	Description
31	RX_ENABLE	R/W	0h	This field enables or disables the channel 0 = channel is disabled 1 = channel is enabled This field will be cleared after a channel teardown is complete.
30	RX_TEARDOWN	R/W	0h	This field indicates whether or not an Rx teardown operation is complete. This field should be cleared when a channel is initialized. This field will be set after a channel teardown is complete.
29	RX_PAUSE	R/W	0h	Setting this bit causes the CPPI DMA to be suspended for rx channels. If a pause is being requested and the channel is not in a packet then drop the credit.
24	RX_ERROR_HANDLING	W	0h	This bit controls the error handling mode for the channel and is only used when channel errors (i.e. descriptor or buffer starvation occurs): 0 = Starvation errors result in dropping packet and reclaiming any used descriptor or buffer resources back to the original queues/pools they were allocated to 1 = Starvation errors result in subsequent re-try of the descriptor allocation operation. In this mode, the DMA will return to the IDLE state without saving it's internal operational state back to the internal state RAM and without issuing an advance operation on the FIFO interface. This results in the DMA re-initiating the FIFO block transfer at a later time with the intention that additional free buffers and/or descriptors will have been added. Regardless of the value of this bit, the DMA will assert the <code>cdma_rx_sof_overrun</code> (for SOP) or <code>cdma_rx_mof_overrun</code> (for non-SOP) when
23-16	RX_SOP_OFFSET	W	0h	This field specifies the number of bytes that are to be skipped in the SOP buffer before beginning to write the payload. This value must be less than the minimum size of a buffer in the system. Valid values are 0 - 255 bytes.

Table 16-216. RXGCR12 Register Field Descriptions (continued)

Bit	Field	Type	Reset	Description
15-14	RX_DEFAULT_DESC_TY PE	W	0h	This field indicates the default descriptor type to use: 0 = Reserved 1 = Host 2 = Reserved 3 = Reserved The actual descriptor type that will be used for reception can be overridden by information provided in the CPPI FIFO data block.
13-12	RX_DEFAULT_RQ_QMG R	W	0h	This field indicates the default receive queue manager that this channel should use. The actual receive queue manager index can be overridden by information provided in the CPPI FIFO data block.
11-0	RX_DEFAULT_RQ_QNU M	W	0h	This field indicates the default receive queue that this channel should use. The actual receive queue that will be used for reception can be overridden by information provided in the CPPI FIFO data block. Table 99 -Rx Channel N Global Configuration Registers

16.5.5.54 RXHPCRA12 Register (offset = 98Ch) [reset = 0h]

 RXHPCRA12 is shown in [Figure 16-205](#) and described in [Table 16-217](#).

Figure 16-205. RXHPCRA12 Register


LEGEND: R/W = Read/Write; R = Read only; W1toCl = Write 1 to clear bit; -n = value after reset

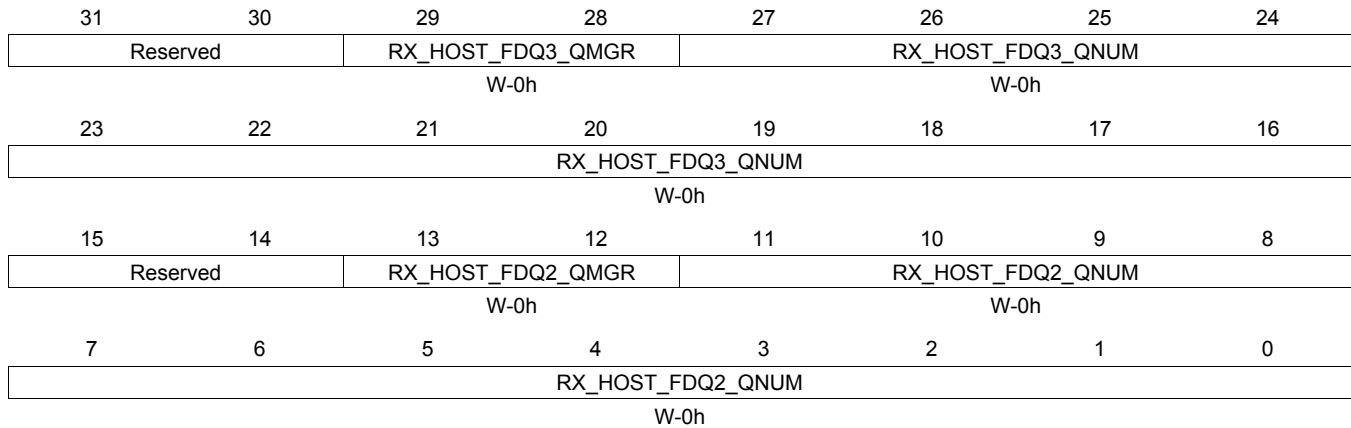
Table 16-217. RXHPCRA12 Register Field Descriptions

Bit	Field	Type	Reset	Description
29-28	RX_HOST_FDQ1_QMGR	W	0h	This field specifies which Buffer Manager should be used for the second Rx buffer in a host type packet.
27-16	RX_HOST_FDQ1_QNUM	W	0h	This field specifies which Free Descriptor / Buffer Pool should be used for the 2nd Rx buffer in a host type packet
13-12	RX_HOST_FDQ0_QMGR	W	0h	This field specifies which Buffer Manager should be used for the second Rx buffer in a host type packet.
11-0	RX_HOST_FDQ0_QNUM	W	0h	This field specifies which Free Descriptor / Buffer Pool should be used for the 1st Rx buffer in a host type packet Table 100 -Rx Channel N Host Packet Configuration Registers A

16.5.5.55 RXHPCRB12 Register (offset = 990h) [reset = 0h]

RXHPCRB12 is shown in [Figure 16-206](#) and described in [Table 16-218](#).

Figure 16-206. RXHPCRB12 Register



LEGEND: R/W = Read/Write; R = Read only; W1toCl = Write 1 to clear bit; -n = value after reset

Table 16-218. RXHPCRB12 Register Field Descriptions

Bit	Field	Type	Reset	Description
29-28	RX_HOST_FDQ3_QMGR	W	0h	This field specifies which Manager should be used for the 4th or later Rx buffers in a host type packet
27-16	RX_HOST_FDQ3_QNUM	W	0h	This field specifies which Free Descriptor Queue should be used for the 4th or later Rx buffers in a host type packet
13-12	RX_HOST_FDQ2_QMGR	W	0h	This field specifies which Buffer Manager should be used for the 3rd Rx buffer in a host type packet
11-0	RX_HOST_FDQ2_QNUM	W	0h	This field specifies which Free Descriptor / Buffer Pool should be used for the 3rd Rx buffer in a host type packet Table 101 -Rx Channel N Host Packet Configuration Registers B

16.5.5.56 TXGCR13 Register (offset = 9A0h) [reset = 0h]

 TXGCR13 is shown in [Figure 16-207](#) and described in [Table 16-219](#).

Figure 16-207. TXGCR13 Register

31	30	29	28	27	26	25	24
TX_ENABLE		TX_TEARDOWN		Reserved			
R/W-0h		R/W-0h					
23	22	21	20	19	18	17	16
Reserved							
15	14	13	12	11	10	9	8
Reserved		TX_DEFAULT_QMGR			TX_DEFAULT_QNUM		
W-0h				W-0h			
7	6	5	4	3	2	1	0
TX_DEFAULT_QNUM							
W-0h							

LEGEND: R/W = Read/Write; R = Read only; W1toCl = Write 1 to clear bit; -n = value after reset

Table 16-219. TXGCR13 Register Field Descriptions

Bit	Field	Type	Reset	Description
31	TX_ENABLE	R/W	0h	This field enables or disables the channel 0 = channel is disabled 1 = channel is enabled This field will be cleared after a channel teardown is complete.
30	TX_TEARDOWN	R/W	0h	Setting this bit will request the channel to be torn down. This field will remain set after a channel teardown is complete.
13-12	TX_DEFAULT_QMGR	W	0h	This field controls the default queue manager number that will be used to queue teardown descriptors back to the host.
11-0	TX_DEFAULT_QNUM	W	0h	This field controls the default queue number within the selected queue manager onto which teardown descriptors will be queued back to the host. Table 98 -Tx Channel N Global Configuration Registers

16.5.5.57 RXGCR13 Register (offset = 9A8h) [reset = 0h]

RXGCR13 is shown in [Figure 16-208](#) and described in [Table 16-220](#).

Figure 16-208. RXGCR13 Register

31	30	29	28	27	26	25	24
RX_ENABLE	RX_TEARDOWN	RX_PAUSE	Reserved			RX_ERROR_HANDLING	
R/W-0h	R/W-0h	R/W-0h				W-0h	
23	22	21	20	19	18	17	16
RX_SOP_OFFSET							
W-0h							
15	14	13	12	11	10	9	8
RX_DEFAULT_DESC_TYPE		RX_DEFAULT_RQ_QMGR		RX_DEFAULT_RQ_QNUM			
W-0h		W-0h		W-0h			
7	6	5	4	3	2	1	0
RX_DEFAULT_RQ_QNUM							
W-0h							

LEGEND: R/W = Read/Write; R = Read only; W1toCl = Write 1 to clear bit; -n = value after reset

Table 16-220. RXGCR13 Register Field Descriptions

Bit	Field	Type	Reset	Description
31	RX_ENABLE	R/W	0h	This field enables or disables the channel 0 = channel is disabled 1 = channel is enabled This field will be cleared after a channel teardown is complete.
30	RX_TEARDOWN	R/W	0h	This field indicates whether or not an Rx teardown operation is complete. This field should be cleared when a channel is initialized. This field will be set after a channel teardown is complete.
29	RX_PAUSE	R/W	0h	Setting this bit causes the CPPI DMA to be suspended for rx channels. If a pause is being requested and the channel is not in a packet then drop the credit.
24	RX_ERROR_HANDLING	W	0h	This bit controls the error handling mode for the channel and is only used when channel errors (i.e. descriptor or buffer starvation occurs): 0 = Starvation errors result in dropping packet and reclaiming any used descriptor or buffer resources back to the original queues/pools they were allocated to 1 = Starvation errors result in subsequent re-try of the descriptor allocation operation. In this mode, the DMA will return to the IDLE state without saving it's internal operational state back to the internal state RAM and without issuing an advance operation on the FIFO interface. This results in the DMA re-initiating the FIFO block transfer at a later time with the intention that additional free buffers and/or descriptors will have been added. Regardless of the value of this bit, the DMA will assert the <code>cdma_rx_sof_overrun</code> (for SOP) or <code>cdma_rx_mof_overrun</code> (for non-SOP) when
23-16	RX_SOP_OFFSET	W	0h	This field specifies the number of bytes that are to be skipped in the SOP buffer before beginning to write the payload. This value must be less than the minimum size of a buffer in the system. Valid values are 0 - 255 bytes.

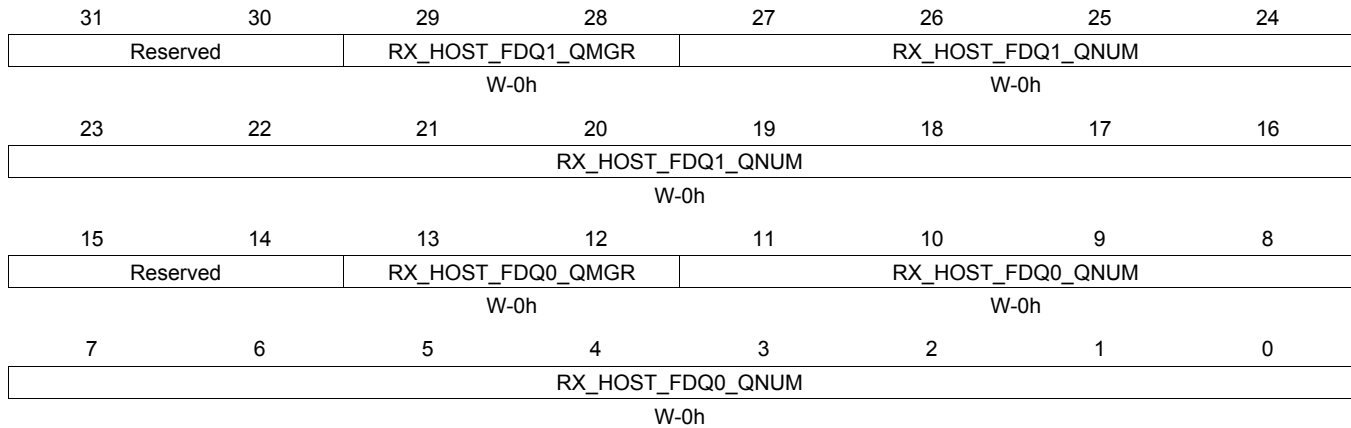
Table 16-220. RXGCR13 Register Field Descriptions (continued)

Bit	Field	Type	Reset	Description
15-14	RX_DEFAULT_DESC_TYPE	W	0h	This field indicates the default descriptor type to use: 0 = Reserved 1 = Host 2 = Reserved 3 = Reserved The actual descriptor type that will be used for reception can be overridden by information provided in the CPPI FIFO data block.
13-12	RX_DEFAULT_RQ_QMGR	W	0h	This field indicates the default receive queue manager that this channel should use. The actual receive queue manager index can be overridden by information provided in the CPPI FIFO data block.
11-0	RX_DEFAULT_RQ_QUEUE	W	0h	This field indicates the default receive queue that this channel should use. The actual receive queue that will be used for reception can be overridden by information provided in the CPPI FIFO data block. Table 99 -Rx Channel N Global Configuration Registers

16.5.5.58 RXHPCRA13 Register (offset = 9ACh) [reset = 0h]

RXHPCRA13 is shown in [Figure 16-209](#) and described in [Table 16-221](#).

Figure 16-209. RXHPCRA13 Register



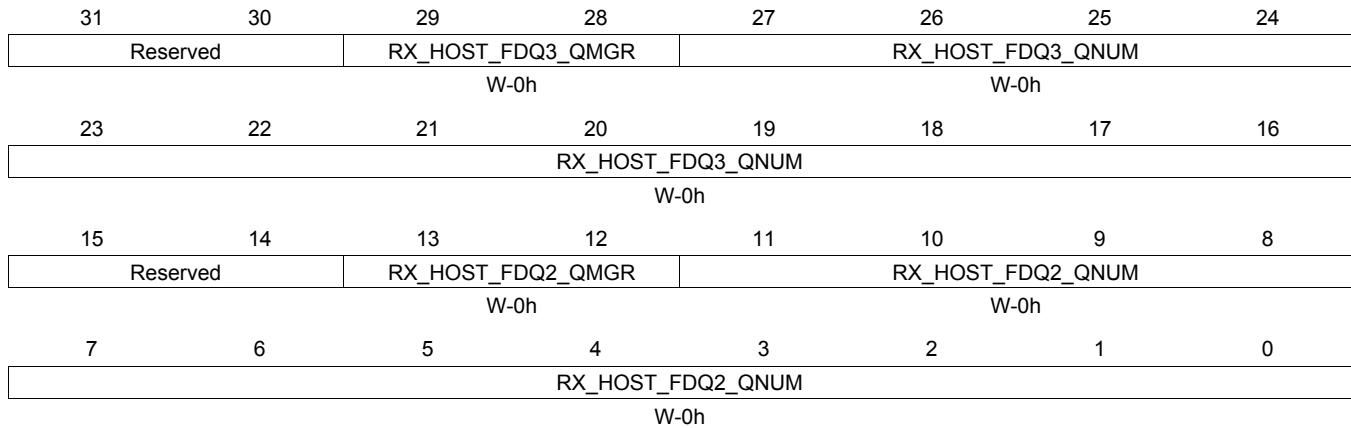
LEGEND: R/W = Read/Write; R = Read only; W1toCl = Write 1 to clear bit; -n = value after reset

Table 16-221. RXHPCRA13 Register Field Descriptions

Bit	Field	Type	Reset	Description
29-28	RX_HOST_FDQ1_QMGR	W	0h	This field specifies which Buffer Manager should be used for the second Rx buffer in a host type packet.
27-16	RX_HOST_FDQ1_QNUM	W	0h	This field specifies which Free Descriptor / Buffer Pool should be used for the 2nd Rx buffer in a host type packet
13-12	RX_HOST_FDQ0_QMGR	W	0h	This field specifies which Buffer Manager should be used for the second Rx buffer in a host type packet.
11-0	RX_HOST_FDQ0_QNUM	W	0h	This field specifies which Free Descriptor / Buffer Pool should be used for the 1st Rx buffer in a host type packet Table 100 -Rx Channel N Host Packet Configuration Registers A

16.5.5.59 RXHPCRB13 Register (offset = 9B0h) [reset = 0h]

 RXHPCRB13 is shown in [Figure 16-210](#) and described in [Table 16-222](#).

Figure 16-210. RXHPCRB13 Register


LEGEND: R/W = Read/Write; R = Read only; W1toCl = Write 1 to clear bit; -n = value after reset

Table 16-222. RXHPCRB13 Register Field Descriptions

Bit	Field	Type	Reset	Description
29-28	RX_HOST_FDQ3_QMGR	W	0h	This field specifies which Manager should be used for the 4th or later Rx buffers in a host type packet
27-16	RX_HOST_FDQ3_QNUM	W	0h	This field specifies which Free Descriptor Queue should be used for the 4th or later Rx buffers in a host type packet
13-12	RX_HOST_FDQ2_QMGR	W	0h	This field specifies which Buffer Manager should be used for the 3rd Rx buffer in a host type packet
11-0	RX_HOST_FDQ2_QNUM	W	0h	This field specifies which Free Descriptor / Buffer Pool should be used for the 3rd Rx buffer in a host type packet Table 101 -Rx Channel N Host Packet Configuration Registers B

16.5.5.60 TXGCR14 Register (offset = 9C0h) [reset = 0h]

TXGCR14 is shown in [Figure 16-211](#) and described in [Table 16-223](#).

Figure 16-211. TXGCR14 Register

31	30	29	28	27	26	25	24
TX_ENABLE	TX_TEARDOWN	Reserved					
R/W-0h	R/W-0h						
23	22	21	20	19	18	17	16
Reserved							
15	14	13	12	11	10	9	8
Reserved		TX_DEFAULT_QMGR			TX_DEFAULT_QNUM		
W-0h				W-0h			
7	6	5	4	3	2	1	0
TX_DEFAULT_QNUM							
W-0h							

LEGEND: R/W = Read/Write; R = Read only; W1toCl = Write 1 to clear bit; -n = value after reset

Table 16-223. TXGCR14 Register Field Descriptions

Bit	Field	Type	Reset	Description
31	TX_ENABLE	R/W	0h	This field enables or disables the channel 0 = channel is disabled 1 = channel is enabled This field will be cleared after a channel teardown is complete.
30	TX_TEARDOWN	R/W	0h	Setting this bit will request the channel to be torn down. This field will remain set after a channel teardown is complete.
13-12	TX_DEFAULT_QMGR	W	0h	This field controls the default queue manager number that will be used to queue teardown descriptors back to the host.
11-0	TX_DEFAULT_QNUM	W	0h	This field controls the default queue number within the selected queue manager onto which teardown descriptors will be queued back to the host. Table 98 -Tx Channel N Global Configuration Registers

16.5.5.61 RXGCR14 Register (offset = 9C8h) [reset = 0h]

 RXGCR14 is shown in [Figure 16-212](#) and described in [Table 16-224](#).

Figure 16-212. RXGCR14 Register

31	30	29	28	27	26	25	24
RX_ENABLE	RX_TEARDOWN	RX_PAUSE	Reserved			RX_ERROR_HANDLING	
R/W-0h	R/W-0h	R/W-0h				W-0h	
23	22	21	20	19	18	17	16
RX_SOP_OFFSET							
W-0h							
15	14	13	12	11	10	9	8
RX_DEFAULT_DESC_TYPE		RX_DEFAULT_RQ_QMGR		RX_DEFAULT_RQ_QNUM			
W-0h		W-0h		W-0h			
7	6	5	4	3	2	1	0
RX_DEFAULT_RQ_QNUM							
W-0h							

LEGEND: R/W = Read/Write; R = Read only; W1toCl = Write 1 to clear bit; -n = value after reset

Table 16-224. RXGCR14 Register Field Descriptions

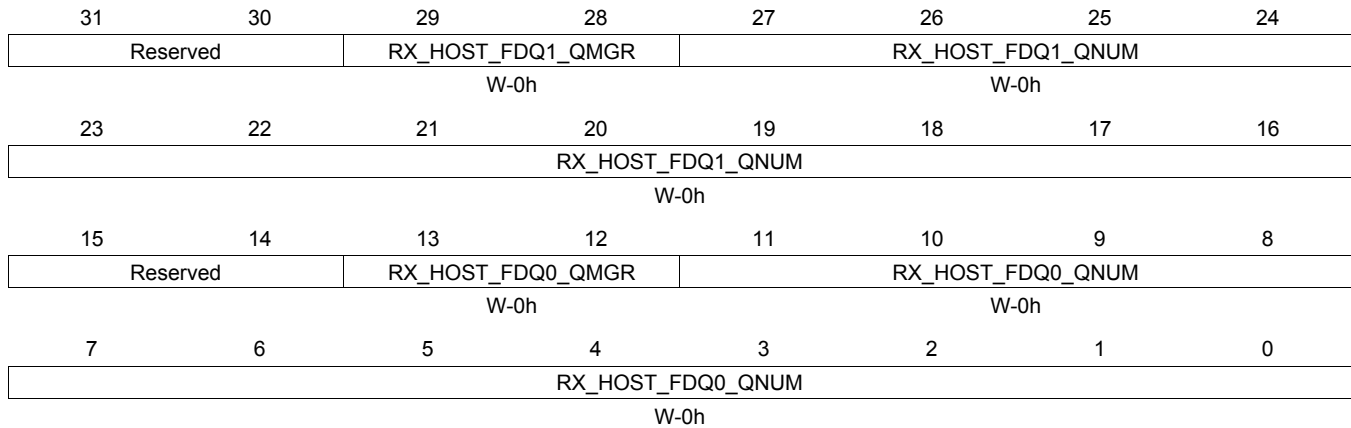
Bit	Field	Type	Reset	Description
31	RX_ENABLE	R/W	0h	This field enables or disables the channel 0 = channel is disabled 1 = channel is enabled This field will be cleared after a channel teardown is complete.
30	RX_TEARDOWN	R/W	0h	This field indicates whether or not an Rx teardown operation is complete. This field should be cleared when a channel is initialized. This field will be set after a channel teardown is complete.
29	RX_PAUSE	R/W	0h	Setting this bit causes the CPPI DMA to be suspended for rx channels. If a pause is being requested and the channel is not in a packet then drop the credit.
24	RX_ERROR_HANDLING	W	0h	This bit controls the error handling mode for the channel and is only used when channel errors (i.e. descriptor or buffer starvation occurs): 0 = Starvation errors result in dropping packet and reclaiming any used descriptor or buffer resources back to the original queues/pools they were allocated to 1 = Starvation errors result in subsequent re-try of the descriptor allocation operation. In this mode, the DMA will return to the IDLE state without saving it's internal operational state back to the internal state RAM and without issuing an advance operation on the FIFO interface. This results in the DMA re-initiating the FIFO block transfer at a later time with the intention that additional free buffers and/or descriptors will have been added. Regardless of the value of this bit, the DMA will assert the <code>cdma_rx_sof_overrun</code> (for SOP) or <code>cdma_rx_mof_overrun</code> (for non-SOP) when
23-16	RX_SOP_OFFSET	W	0h	This field specifies the number of bytes that are to be skipped in the SOP buffer before beginning to write the payload. This value must be less than the minimum size of a buffer in the system. Valid values are 0 - 255 bytes.

Table 16-224. RXGCR14 Register Field Descriptions (continued)

Bit	Field	Type	Reset	Description
15-14	RX_DEFAULT_DESC_TY PE	W	0h	This field indicates the default descriptor type to use: 0 = Reserved 1 = Host 2 = Reserved 3 = Reserved The actual descriptor type that will be used for reception can be overridden by information provided in the CPPI FIFO data block.
13-12	RX_DEFAULT_RQ_QMG R	W	0h	This field indicates the default receive queue manager that this channel should use. The actual receive queue manager index can be overridden by information provided in the CPPI FIFO data block.
11-0	RX_DEFAULT_RQ_QNU M	W	0h	This field indicates the default receive queue that this channel should use. The actual receive queue that will be used for reception can be overridden by information provided in the CPPI FIFO data block. Table 99 -Rx Channel N Global Configuration Registers

16.5.5.62 RXHPCRA14 Register (offset = 9CCh) [reset = 0h]

 RXHPCRA14 is shown in [Figure 16-213](#) and described in [Table 16-225](#).

Figure 16-213. RXHPCRA14 Register


LEGEND: R/W = Read/Write; R = Read only; W1toCl = Write 1 to clear bit; -n = value after reset

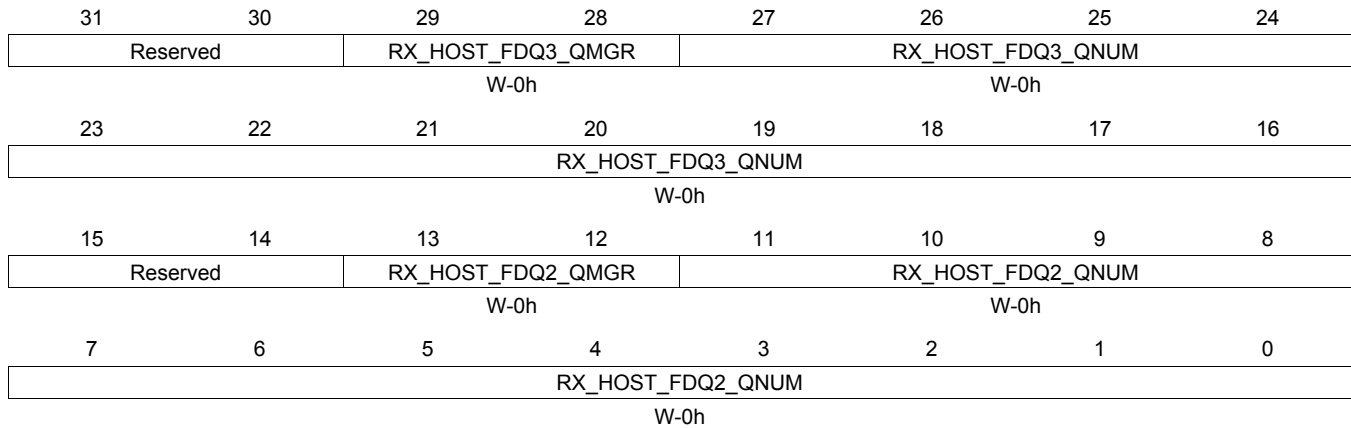
Table 16-225. RXHPCRA14 Register Field Descriptions

Bit	Field	Type	Reset	Description
29-28	RX_HOST_FDQ1_QMGR	W	0h	This field specifies which Buffer Manager should be used for the second Rx buffer in a host type packet.
27-16	RX_HOST_FDQ1_QNUM	W	0h	This field specifies which Free Descriptor / Buffer Pool should be used for the 2nd Rx buffer in a host type packet
13-12	RX_HOST_FDQ0_QMGR	W	0h	This field specifies which Buffer Manager should be used for the second Rx buffer in a host type packet.
11-0	RX_HOST_FDQ0_QNUM	W	0h	This field specifies which Free Descriptor / Buffer Pool should be used for the 1st Rx buffer in a host type packet Table 100 -Rx Channel N Host Packet Configuration Registers A

16.5.5.63 RXHPCRB14 Register (offset = 9D0h) [reset = 0h]

RXHPCRB14 is shown in [Figure 16-214](#) and described in [Table 16-226](#).

Figure 16-214. RXHPCRB14 Register



LEGEND: R/W = Read/Write; R = Read only; W1toCl = Write 1 to clear bit; -n = value after reset

Table 16-226. RXHPCRB14 Register Field Descriptions

Bit	Field	Type	Reset	Description
29-28	RX_HOST_FDQ3_QMGR	W	0h	This field specifies which Manager should be used for the 4th or later Rx buffers in a host type packet
27-16	RX_HOST_FDQ3_QNUM	W	0h	This field specifies which Free Descriptor Queue should be used for the 4th or later Rx buffers in a host type packet
13-12	RX_HOST_FDQ2_QMGR	W	0h	This field specifies which Buffer Manager should be used for the 3rd Rx buffer in a host type packet
11-0	RX_HOST_FDQ2_QNUM	W	0h	This field specifies which Free Descriptor / Buffer Pool should be used for the 3rd Rx buffer in a host type packet Table 101 -Rx Channel N Host Packet Configuration Registers B

16.5.5.64 TXGCR15 Register (offset = 9E0h) [reset = 0h]

 TXGCR15 is shown in [Figure 16-215](#) and described in [Table 16-227](#).

Figure 16-215. TXGCR15 Register

	31	30	29	28	27	26	25	24
	TX_ENABLE	TX_TEARDOWN	Reserved					
	R/W-0h	R/W-0h						
	23	22	21	20	19	18	17	16
	Reserved							
	15	14	13	12	11	10	9	8
	Reserved		TX_DEFAULT_QMGR			TX_DEFAULT_QNUM		
			W-0h			W-0h		
	7	6	5	4	3	2	1	0
	TX_DEFAULT_QNUM							
	W-0h							

LEGEND: R/W = Read/Write; R = Read only; W1toCl = Write 1 to clear bit; -n = value after reset

Table 16-227. TXGCR15 Register Field Descriptions

Bit	Field	Type	Reset	Description
31	TX_ENABLE	R/W	0h	This field enables or disables the channel 0 = channel is disabled 1 = channel is enabled This field will be cleared after a channel teardown is complete.
30	TX_TEARDOWN	R/W	0h	Setting this bit will request the channel to be torn down. This field will remain set after a channel teardown is complete.
13-12	TX_DEFAULT_QMGR	W	0h	This field controls the default queue manager number that will be used to queue teardown descriptors back to the host.
11-0	TX_DEFAULT_QNUM	W	0h	This field controls the default queue number within the selected queue manager onto which teardown descriptors will be queued back to the host. Table 98 -Tx Channel N Global Configuration Registers

16.5.5.65 RXGCR15 Register (offset = 9E8h) [reset = 0h]

RXGCR15 is shown in [Figure 16-216](#) and described in [Table 16-228](#).

Figure 16-216. RXGCR15 Register

31	30	29	28	27	26	25	24
RX_ENABLE	RX_TEARDOWN	RX_PAUSE	Reserved			RX_ERROR_HANDLING	
R/W-0h	R/W-0h	R/W-0h				W-0h	
23	22	21	20	19	18	17	16
RX_SOP_OFFSET							
W-0h							
15	14	13	12	11	10	9	8
RX_DEFAULT_DESC_TYPE		RX_DEFAULT_RQ_QMGR		RX_DEFAULT_RQ_QNUM			
W-0h		W-0h		W-0h			
7	6	5	4	3	2	1	0
RX_DEFAULT_RQ_QNUM							
W-0h							

LEGEND: R/W = Read/Write; R = Read only; W1toCl = Write 1 to clear bit; -n = value after reset

Table 16-228. RXGCR15 Register Field Descriptions

Bit	Field	Type	Reset	Description
31	RX_ENABLE	R/W	0h	This field enables or disables the channel 0 = channel is disabled 1 = channel is enabled This field will be cleared after a channel teardown is complete.
30	RX_TEARDOWN	R/W	0h	This field indicates whether or not an Rx teardown operation is complete. This field should be cleared when a channel is initialized. This field will be set after a channel teardown is complete.
29	RX_PAUSE	R/W	0h	Setting this bit causes the CPPI DMA to be suspended for rx channels. If a pause is being requested and the channel is not in a packet then drop the credit.
24	RX_ERROR_HANDLING	W	0h	This bit controls the error handling mode for the channel and is only used when channel errors (i.e. descriptor or buffer starvation occurs): 0 = Starvation errors result in dropping packet and reclaiming any used descriptor or buffer resources back to the original queues/pools they were allocated to 1 = Starvation errors result in subsequent re-try of the descriptor allocation operation. In this mode, the DMA will return to the IDLE state without saving it's internal operational state back to the internal state RAM and without issuing an advance operation on the FIFO interface. This results in the DMA re-initiating the FIFO block transfer at a later time with the intention that additional free buffers and/or descriptors will have been added. Regardless of the value of this bit, the DMA will assert the <code>cdma_rx_sof_overrun</code> (for SOP) or <code>cdma_rx_mof_overrun</code> (for non-SOP) when
23-16	RX_SOP_OFFSET	W	0h	This field specifies the number of bytes that are to be skipped in the SOP buffer before beginning to write the payload. This value must be less than the minimum size of a buffer in the system. Valid values are 0 - 255 bytes.

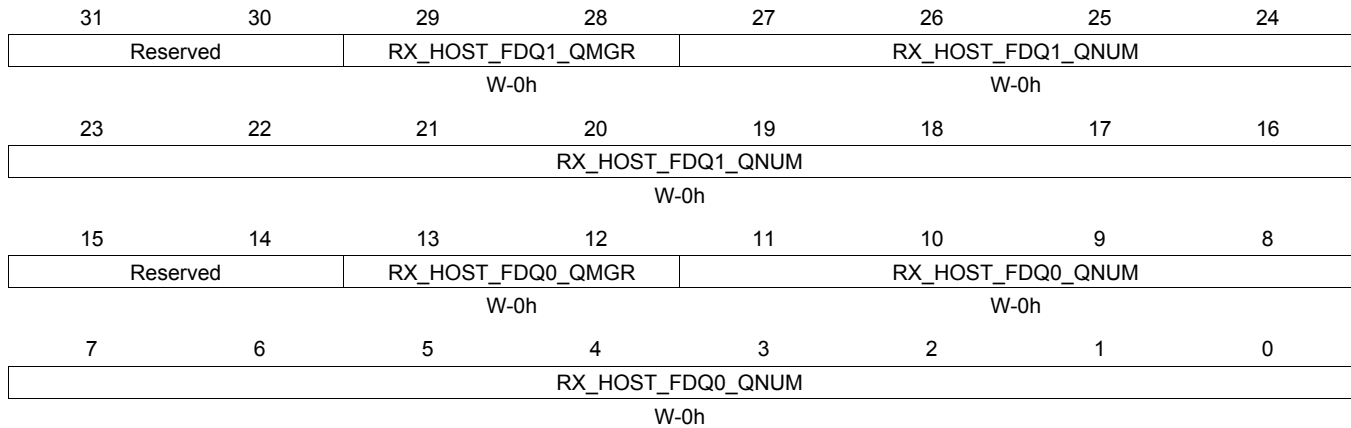
Table 16-228. RXGCR15 Register Field Descriptions (continued)

Bit	Field	Type	Reset	Description
15-14	RX_DEFAULT_DESC_TYPE	W	0h	This field indicates the default descriptor type to use: 0 = Reserved 1 = Host 2 = Reserved 3 = Reserved The actual descriptor type that will be used for reception can be overridden by information provided in the CPPI FIFO data block.
13-12	RX_DEFAULT_RQ_QMGR	W	0h	This field indicates the default receive queue manager that this channel should use. The actual receive queue manager index can be overridden by information provided in the CPPI FIFO data block.
11-0	RX_DEFAULT_RQ_QUEUE	W	0h	This field indicates the default receive queue that this channel should use. The actual receive queue that will be used for reception can be overridden by information provided in the CPPI FIFO data block. Table 99 -Rx Channel N Global Configuration Registers

16.5.5.66 RXHPCRA15 Register (offset = 9ECh) [reset = 0h]

RXHPCRA15 is shown in [Figure 16-217](#) and described in [Table 16-229](#).

Figure 16-217. RXHPCRA15 Register



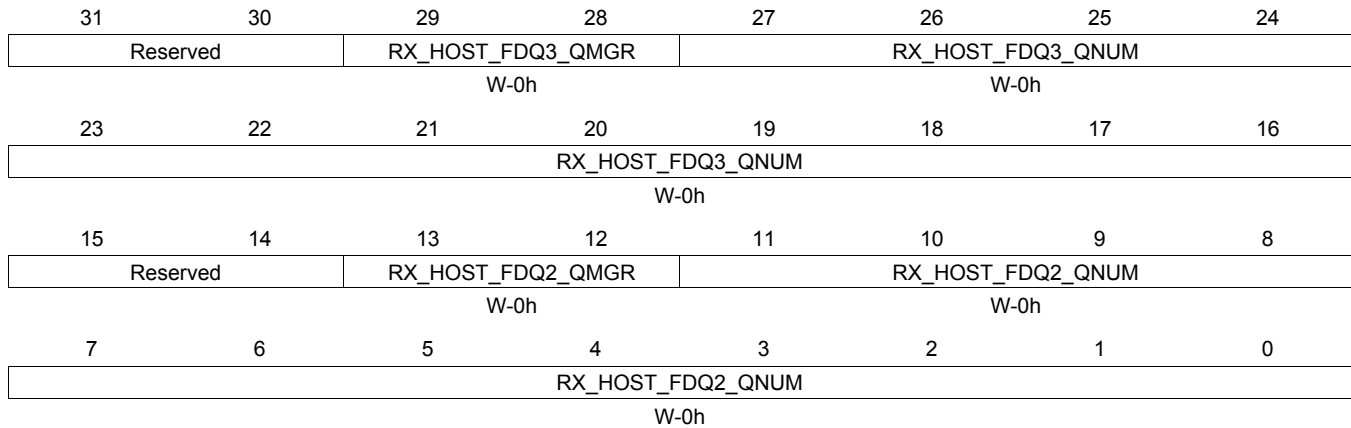
LEGEND: R/W = Read/Write; R = Read only; W1toCl = Write 1 to clear bit; -n = value after reset

Table 16-229. RXHPCRA15 Register Field Descriptions

Bit	Field	Type	Reset	Description
29-28	RX_HOST_FDQ1_QMGR	W	0h	This field specifies which Buffer Manager should be used for the second Rx buffer in a host type packet.
27-16	RX_HOST_FDQ1_QNUM	W	0h	This field specifies which Free Descriptor / Buffer Pool should be used for the 2nd Rx buffer in a host type packet
13-12	RX_HOST_FDQ0_QMGR	W	0h	This field specifies which Buffer Manager should be used for the second Rx buffer in a host type packet.
11-0	RX_HOST_FDQ0_QNUM	W	0h	This field specifies which Free Descriptor / Buffer Pool should be used for the 1st Rx buffer in a host type packet Table 100 -Rx Channel N Host Packet Configuration Registers A

16.5.5.67 RXHPCRB15 Register (offset = 9F0h) [reset = 0h]

 RXHPCRB15 is shown in [Figure 16-218](#) and described in [Table 16-230](#).

Figure 16-218. RXHPCRB15 Register


LEGEND: R/W = Read/Write; R = Read only; W1toCl = Write 1 to clear bit; -n = value after reset

Table 16-230. RXHPCRB15 Register Field Descriptions

Bit	Field	Type	Reset	Description
29-28	RX_HOST_FDQ3_QMGR	W	0h	This field specifies which Manager should be used for the 4th or later Rx buffers in a host type packet
27-16	RX_HOST_FDQ3_QNUM	W	0h	This field specifies which Free Descriptor Queue should be used for the 4th or later Rx buffers in a host type packet
13-12	RX_HOST_FDQ2_QMGR	W	0h	This field specifies which Buffer Manager should be used for the 3rd Rx buffer in a host type packet
11-0	RX_HOST_FDQ2_QNUM	W	0h	This field specifies which Free Descriptor / Buffer Pool should be used for the 3rd Rx buffer in a host type packet Table 101 -Rx Channel N Host Packet Configuration Registers B

16.5.5.68 TXGCR16 Register (offset = A00h) [reset = 0h]

TXGCR16 is shown in [Figure 16-219](#) and described in [Table 16-231](#).

Figure 16-219. TXGCR16 Register

31	30	29	28	27	26	25	24
TX_ENABLE	TX_TEARDOWN	Reserved					
R/W-0h	R/W-0h						
23	22	21	20	19	18	17	16
Reserved							
15	14	13	12	11	10	9	8
Reserved		TX_DEFAULT_QMGR			TX_DEFAULT_QNUM		
W-0h				W-0h			
7	6	5	4	3	2	1	0
TX_DEFAULT_QNUM							
W-0h							

LEGEND: R/W = Read/Write; R = Read only; W1toCl = Write 1 to clear bit; -n = value after reset

Table 16-231. TXGCR16 Register Field Descriptions

Bit	Field	Type	Reset	Description
31	TX_ENABLE	R/W	0h	This field enables or disables the channel 0 = channel is disabled 1 = channel is enabled This field will be cleared after a channel teardown is complete.
30	TX_TEARDOWN	R/W	0h	Setting this bit will request the channel to be torn down. This field will remain set after a channel teardown is complete.
13-12	TX_DEFAULT_QMGR	W	0h	This field controls the default queue manager number that will be used to queue teardown descriptors back to the host.
11-0	TX_DEFAULT_QNUM	W	0h	This field controls the default queue number within the selected queue manager onto which teardown descriptors will be queued back to the host. Table 98 -Tx Channel N Global Configuration Registers

16.5.5.69 RXGCR16 Register (offset = A08h) [reset = 0h]

 RXGCR16 is shown in [Figure 16-220](#) and described in [Table 16-232](#).

Figure 16-220. RXGCR16 Register

31	30	29	28	27	26	25	24
RX_ENABLE	RX_TEARDOWN	RX_PAUSE	Reserved			RX_ERROR_HANDLING	
R/W-0h	R/W-0h	R/W-0h				W-0h	
23	22	21	20	19	18	17	16
RX_SOP_OFFSET							
W-0h							
15	14	13	12	11	10	9	8
RX_DEFAULT_DESC_TYPE		RX_DEFAULT_RQ_QMGR		RX_DEFAULT_RQ_QNUM			
W-0h		W-0h		W-0h			
7	6	5	4	3	2	1	0
RX_DEFAULT_RQ_QNUM							
W-0h							

LEGEND: R/W = Read/Write; R = Read only; W1toCl = Write 1 to clear bit; -n = value after reset

Table 16-232. RXGCR16 Register Field Descriptions

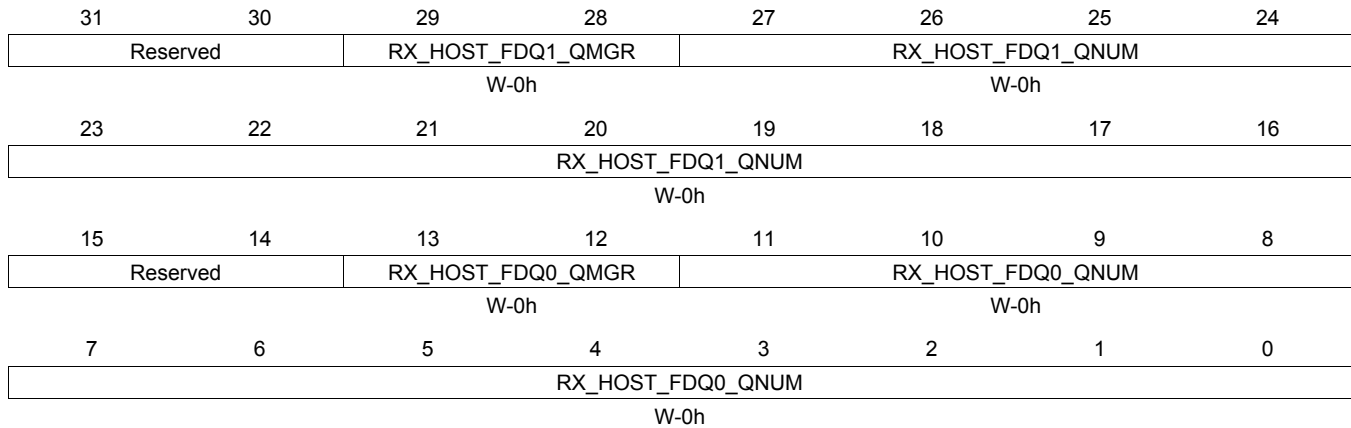
Bit	Field	Type	Reset	Description
31	RX_ENABLE	R/W	0h	This field enables or disables the channel 0 = channel is disabled 1 = channel is enabled This field will be cleared after a channel teardown is complete.
30	RX_TEARDOWN	R/W	0h	This field indicates whether or not an Rx teardown operation is complete. This field should be cleared when a channel is initialized. This field will be set after a channel teardown is complete.
29	RX_PAUSE	R/W	0h	Setting this bit causes the CPPI DMA to be suspended for rx channels. If a pause is being requested and the channel is not in a packet then drop the credit.
24	RX_ERROR_HANDLING	W	0h	This bit controls the error handling mode for the channel and is only used when channel errors (i.e. descriptor or buffer starvation occurs): 0 = Starvation errors result in dropping packet and reclaiming any used descriptor or buffer resources back to the original queues/pools they were allocated to 1 = Starvation errors result in subsequent re-try of the descriptor allocation operation. In this mode, the DMA will return to the IDLE state without saving it's internal operational state back to the internal state RAM and without issuing an advance operation on the FIFO interface. This results in the DMA re-initiating the FIFO block transfer at a later time with the intention that additional free buffers and/or descriptors will have been added. Regardless of the value of this bit, the DMA will assert the <code>cdma_rx_sof_overrun</code> (for SOP) or <code>cdma_rx_mof_overrun</code> (for non-SOP) when
23-16	RX_SOP_OFFSET	W	0h	This field specifies the number of bytes that are to be skipped in the SOP buffer before beginning to write the payload. This value must be less than the minimum size of a buffer in the system. Valid values are 0 - 255 bytes.

Table 16-232. RXGCR16 Register Field Descriptions (continued)

Bit	Field	Type	Reset	Description
15-14	RX_DEFAULT_DESC_TY PE	W	0h	This field indicates the default descriptor type to use: 0 = Reserved 1 = Host 2 = Reserved 3 = Reserved The actual descriptor type that will be used for reception can be overridden by information provided in the CPPI FIFO data block.
13-12	RX_DEFAULT_RQ_QMG R	W	0h	This field indicates the default receive queue manager that this channel should use. The actual receive queue manager index can be overridden by information provided in the CPPI FIFO data block.
11-0	RX_DEFAULT_RQ_QNU M	W	0h	This field indicates the default receive queue that this channel should use. The actual receive queue that will be used for reception can be overridden by information provided in the CPPI FIFO data block. Table 99 -Rx Channel N Global Configuration Registers

16.5.5.70 RXHPCRA16 Register (offset = A0Ch) [reset = 0h]

 RXHPCRA16 is shown in [Figure 16-221](#) and described in [Table 16-233](#).

Figure 16-221. RXHPCRA16 Register


LEGEND: R/W = Read/Write; R = Read only; W1toCl = Write 1 to clear bit; -n = value after reset

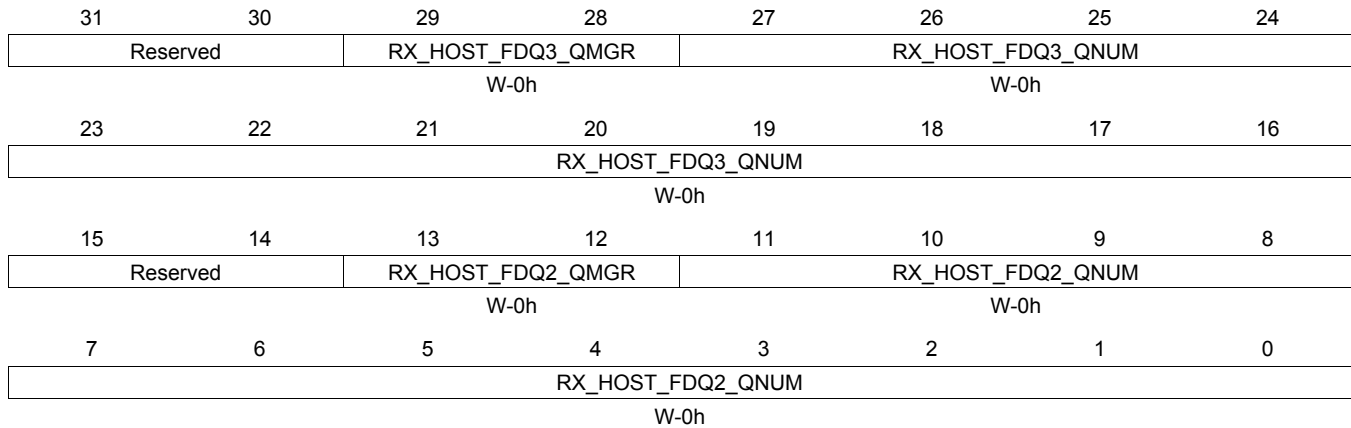
Table 16-233. RXHPCRA16 Register Field Descriptions

Bit	Field	Type	Reset	Description
29-28	RX_HOST_FDQ1_QMGR	W	0h	This field specifies which Buffer Manager should be used for the second Rx buffer in a host type packet.
27-16	RX_HOST_FDQ1_QNUM	W	0h	This field specifies which Free Descriptor / Buffer Pool should be used for the 2nd Rx buffer in a host type packet
13-12	RX_HOST_FDQ0_QMGR	W	0h	This field specifies which Buffer Manager should be used for the second Rx buffer in a host type packet.
11-0	RX_HOST_FDQ0_QNUM	W	0h	This field specifies which Free Descriptor / Buffer Pool should be used for the 1st Rx buffer in a host type packet Table 100 -Rx Channel N Host Packet Configuration Registers A

16.5.5.71 RXHPCRB16 Register (offset = A10h) [reset = 0h]

RXHPCRB16 is shown in [Figure 16-222](#) and described in [Table 16-234](#).

Figure 16-222. RXHPCRB16 Register



LEGEND: R/W = Read/Write; R = Read only; W1toCl = Write 1 to clear bit; -n = value after reset

Table 16-234. RXHPCRB16 Register Field Descriptions

Bit	Field	Type	Reset	Description
29-28	RX_HOST_FDQ3_QMGR	W	0h	This field specifies which Manager should be used for the 4th or later Rx buffers in a host type packet
27-16	RX_HOST_FDQ3_QNUM	W	0h	This field specifies which Free Descriptor Queue should be used for the 4th or later Rx buffers in a host type packet
13-12	RX_HOST_FDQ2_QMGR	W	0h	This field specifies which Buffer Manager should be used for the 3rd Rx buffer in a host type packet
11-0	RX_HOST_FDQ2_QNUM	W	0h	This field specifies which Free Descriptor / Buffer Pool should be used for the 3rd Rx buffer in a host type packet Table 101 -Rx Channel N Host Packet Configuration Registers B

16.5.5.72 TXGCR17 Register (offset = A20h) [reset = 0h]

 TXGCR17 is shown in [Figure 16-223](#) and described in [Table 16-235](#).

Figure 16-223. TXGCR17 Register

31	30	29	28	27	26	25	24
TX_ENABLE	TX_TEARDOWN	Reserved					
R/W-0h	R/W-0h						
23	22	21	20	19	18	17	16
Reserved							
15	14	13	12	11	10	9	8
Reserved		TX_DEFAULT_QMGR			TX_DEFAULT_QNUM		
W-0h				W-0h			
7	6	5	4	3	2	1	0
TX_DEFAULT_QNUM							
W-0h							

LEGEND: R/W = Read/Write; R = Read only; W1toCl = Write 1 to clear bit; -n = value after reset

Table 16-235. TXGCR17 Register Field Descriptions

Bit	Field	Type	Reset	Description
31	TX_ENABLE	R/W	0h	This field enables or disables the channel 0 = channel is disabled 1 = channel is enabled This field will be cleared after a channel teardown is complete.
30	TX_TEARDOWN	R/W	0h	Setting this bit will request the channel to be torn down. This field will remain set after a channel teardown is complete.
13-12	TX_DEFAULT_QMGR	W	0h	This field controls the default queue manager number that will be used to queue teardown descriptors back to the host.
11-0	TX_DEFAULT_QNUM	W	0h	This field controls the default queue number within the selected queue manager onto which teardown descriptors will be queued back to the host. Table 98 -Tx Channel N Global Configuration Registers

16.5.5.73 RXGCR17 Register (offset = A28h) [reset = 0h]

RXGCR17 is shown in [Figure 16-224](#) and described in [Table 16-236](#).

Figure 16-224. RXGCR17 Register

31	30	29	28	27	26	25	24
RX_ENABLE	RX_TEARDOWN	RX_PAUSE	Reserved			RX_ERROR_HANDLING	
R/W-0h	R/W-0h	R/W-0h				W-0h	
23	22	21	20	19	18	17	16
RX_SOP_OFFSET							
W-0h							
15	14	13	12	11	10	9	8
RX_DEFAULT_DESC_TYPE		RX_DEFAULT_RQ_QMGR		RX_DEFAULT_RQ_QNUM			
W-0h		W-0h		W-0h			
7	6	5	4	3	2	1	0
RX_DEFAULT_RQ_QNUM							
W-0h							

LEGEND: R/W = Read/Write; R = Read only; W1toCl = Write 1 to clear bit; -n = value after reset

Table 16-236. RXGCR17 Register Field Descriptions

Bit	Field	Type	Reset	Description
31	RX_ENABLE	R/W	0h	This field enables or disables the channel 0 = channel is disabled 1 = channel is enabled This field will be cleared after a channel teardown is complete.
30	RX_TEARDOWN	R/W	0h	This field indicates whether or not an Rx teardown operation is complete. This field should be cleared when a channel is initialized. This field will be set after a channel teardown is complete.
29	RX_PAUSE	R/W	0h	Setting this bit causes the CPPI DMA to be suspended for rx channels. If a pause is being requested and the channel is not in a packet then drop the credit.
24	RX_ERROR_HANDLING	W	0h	This bit controls the error handling mode for the channel and is only used when channel errors (i.e. descriptor or buffer starvation occurs): 0 = Starvation errors result in dropping packet and reclaiming any used descriptor or buffer resources back to the original queues/pools they were allocated to 1 = Starvation errors result in subsequent re-try of the descriptor allocation operation. In this mode, the DMA will return to the IDLE state without saving it's internal operational state back to the internal state RAM and without issuing an advance operation on the FIFO interface. This results in the DMA re-initiating the FIFO block transfer at a later time with the intention that additional free buffers and/or descriptors will have been added. Regardless of the value of this bit, the DMA will assert the <code>cdma_rx_sof_overrun</code> (for SOP) or <code>cdma_rx_mof_overrun</code> (for non-SOP) when
23-16	RX_SOP_OFFSET	W	0h	This field specifies the number of bytes that are to be skipped in the SOP buffer before beginning to write the payload. This value must be less than the minimum size of a buffer in the system. Valid values are 0 - 255 bytes.

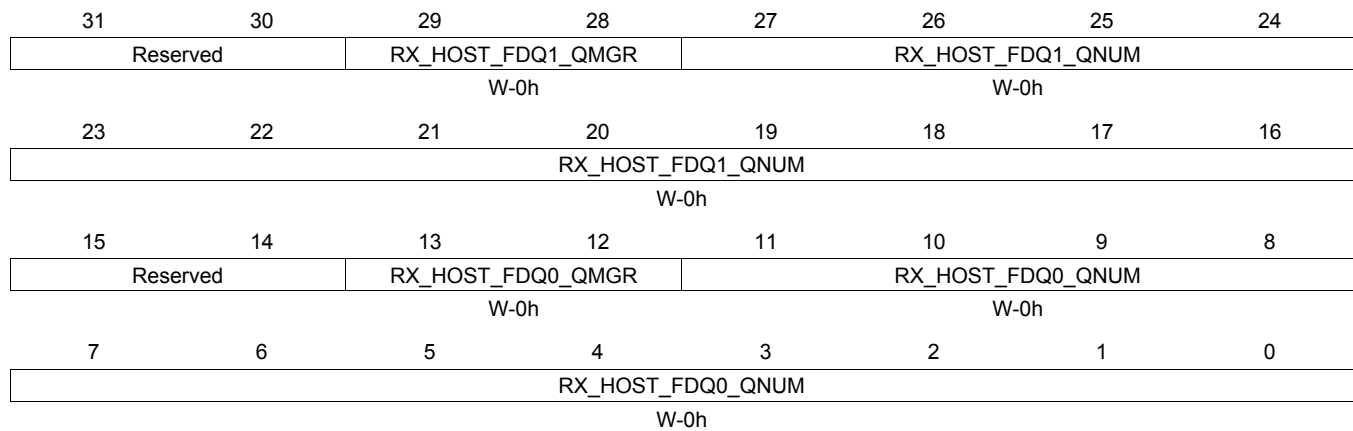
Table 16-236. RXGCR17 Register Field Descriptions (continued)

Bit	Field	Type	Reset	Description
15-14	RX_DEFAULT_DESC_TYPE	W	0h	This field indicates the default descriptor type to use: 0 = Reserved 1 = Host 2 = Reserved 3 = Reserved The actual descriptor type that will be used for reception can be overridden by information provided in the CPPI FIFO data block.
13-12	RX_DEFAULT_RQ_QMGR	W	0h	This field indicates the default receive queue manager that this channel should use. The actual receive queue manager index can be overridden by information provided in the CPPI FIFO data block.
11-0	RX_DEFAULT_RQ_QUEUE	W	0h	This field indicates the default receive queue that this channel should use. The actual receive queue that will be used for reception can be overridden by information provided in the CPPI FIFO data block. Table 99 -Rx Channel N Global Configuration Registers

16.5.5.74 RXHPCRA17 Register (offset = A2Ch) [reset = 0h]

RXHPCRA17 is shown in [Figure 16-225](#) and described in [Table 16-237](#).

Figure 16-225. RXHPCRA17 Register



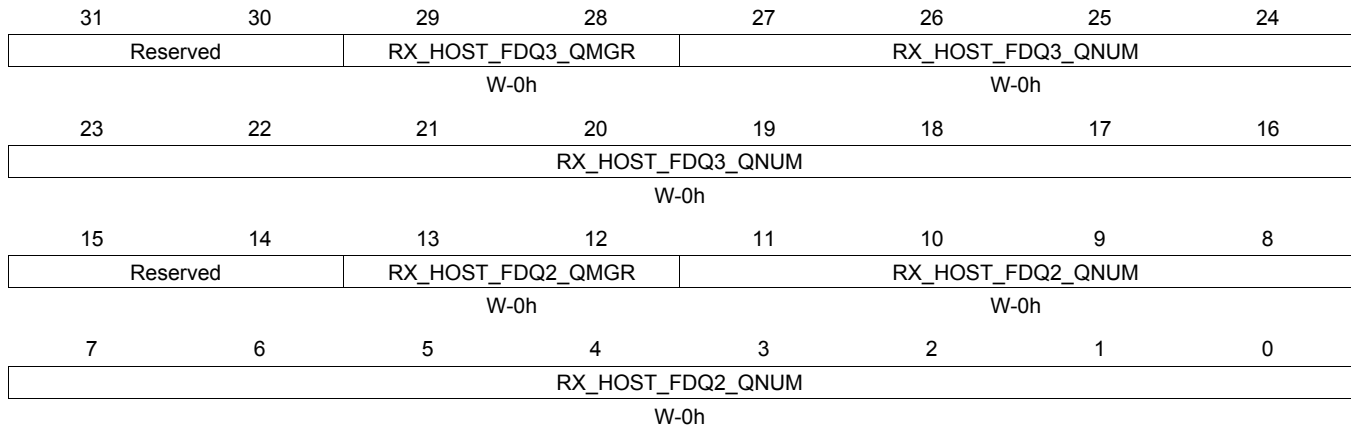
LEGEND: R/W = Read/Write; R = Read only; W1toCl = Write 1 to clear bit; -n = value after reset

Table 16-237. RXHPCRA17 Register Field Descriptions

Bit	Field	Type	Reset	Description
29-28	RX_HOST_FDQ1_QMGR	W	0h	This field specifies which Buffer Manager should be used for the second Rx buffer in a host type packet.
27-16	RX_HOST_FDQ1_QNUM	W	0h	This field specifies which Free Descriptor / Buffer Pool should be used for the 2nd Rx buffer in a host type packet
13-12	RX_HOST_FDQ0_QMGR	W	0h	This field specifies which Buffer Manager should be used for the second Rx buffer in a host type packet.
11-0	RX_HOST_FDQ0_QNUM	W	0h	This field specifies which Free Descriptor / Buffer Pool should be used for the 1st Rx buffer in a host type packet Table 100 -Rx Channel N Host Packet Configuration Registers A

16.5.5.75 RXHPCRB17 Register (offset = A30h) [reset = 0h]

 RXHPCRB17 is shown in [Figure 16-226](#) and described in [Table 16-238](#).

Figure 16-226. RXHPCRB17 Register


LEGEND: R/W = Read/Write; R = Read only; W1toCl = Write 1 to clear bit; -n = value after reset

Table 16-238. RXHPCRB17 Register Field Descriptions

Bit	Field	Type	Reset	Description
29-28	RX_HOST_FDQ3_QMGR	W	0h	This field specifies which Manager should be used for the 4th or later Rx buffers in a host type packet
27-16	RX_HOST_FDQ3_QNUM	W	0h	This field specifies which Free Descriptor Queue should be used for the 4th or later Rx buffers in a host type packet
13-12	RX_HOST_FDQ2_QMGR	W	0h	This field specifies which Buffer Manager should be used for the 3rd Rx buffer in a host type packet
11-0	RX_HOST_FDQ2_QNUM	W	0h	This field specifies which Free Descriptor / Buffer Pool should be used for the 3rd Rx buffer in a host type packet Table 101 -Rx Channel N Host Packet Configuration Registers B

16.5.5.76 TXGCR18 Register (offset = A40h) [reset = 0h]

TXGCR18 is shown in [Figure 16-227](#) and described in [Table 16-239](#).

Figure 16-227. TXGCR18 Register

31	30	29	28	27	26	25	24
TX_ENABLE	TX_TEARDOWN	Reserved					
R/W-0h	R/W-0h						
23	22	21	20	19	18	17	16
Reserved							
15	14	13	12	11	10	9	8
Reserved		TX_DEFAULT_QMGR			TX_DEFAULT_QNUM		
W-0h				W-0h			
7	6	5	4	3	2	1	0
TX_DEFAULT_QNUM							
W-0h							

LEGEND: R/W = Read/Write; R = Read only; W1toCl = Write 1 to clear bit; -n = value after reset

Table 16-239. TXGCR18 Register Field Descriptions

Bit	Field	Type	Reset	Description
31	TX_ENABLE	R/W	0h	This field enables or disables the channel 0 = channel is disabled 1 = channel is enabled This field will be cleared after a channel teardown is complete.
30	TX_TEARDOWN	R/W	0h	Setting this bit will request the channel to be torn down. This field will remain set after a channel teardown is complete.
13-12	TX_DEFAULT_QMGR	W	0h	This field controls the default queue manager number that will be used to queue teardown descriptors back to the host.
11-0	TX_DEFAULT_QNUM	W	0h	This field controls the default queue number within the selected queue manager onto which teardown descriptors will be queued back to the host. Table 98 -Tx Channel N Global Configuration Registers

16.5.5.77 RXGCR18 Register (offset = A48h) [reset = 0h]

 RXGCR18 is shown in [Figure 16-228](#) and described in [Table 16-240](#).

Figure 16-228. RXGCR18 Register

31	30	29	28	27	26	25	24
RX_ENABLE	RX_TEARDOWN	RX_PAUSE	Reserved			RX_ERROR_HANDLING	
R/W-0h	R/W-0h	R/W-0h				W-0h	
23	22	21	20	19	18	17	16
RX_SOP_OFFSET							
W-0h							
15	14	13	12	11	10	9	8
RX_DEFAULT_DESC_TYPE		RX_DEFAULT_RQ_QMGR		RX_DEFAULT_RQ_QNUM			
W-0h		W-0h		W-0h			
7	6	5	4	3	2	1	0
RX_DEFAULT_RQ_QNUM							
W-0h							

LEGEND: R/W = Read/Write; R = Read only; W1toCl = Write 1 to clear bit; -n = value after reset

Table 16-240. RXGCR18 Register Field Descriptions

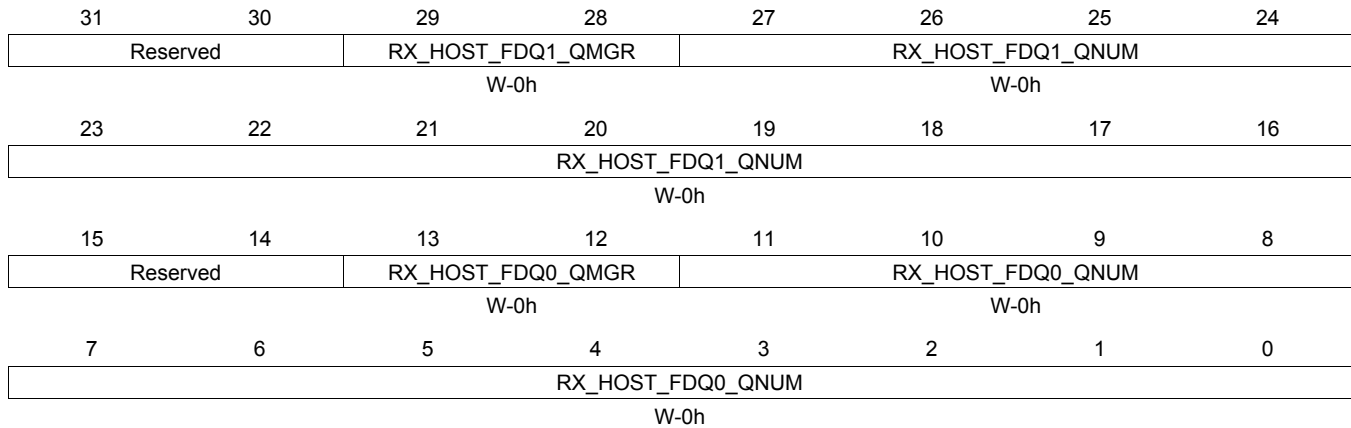
Bit	Field	Type	Reset	Description
31	RX_ENABLE	R/W	0h	This field enables or disables the channel 0 = channel is disabled 1 = channel is enabled This field will be cleared after a channel teardown is complete.
30	RX_TEARDOWN	R/W	0h	This field indicates whether or not an Rx teardown operation is complete. This field should be cleared when a channel is initialized. This field will be set after a channel teardown is complete.
29	RX_PAUSE	R/W	0h	Setting this bit causes the CPPI DMA to be suspended for rx channels. If a pause is being requested and the channel is not in a packet then drop the credit.
24	RX_ERROR_HANDLING	W	0h	This bit controls the error handling mode for the channel and is only used when channel errors (i.e. descriptor or buffer starvation occurs): 0 = Starvation errors result in dropping packet and reclaiming any used descriptor or buffer resources back to the original queues/pools they were allocated to 1 = Starvation errors result in subsequent re-try of the descriptor allocation operation. In this mode, the DMA will return to the IDLE state without saving it's internal operational state back to the internal state RAM and without issuing an advance operation on the FIFO interface. This results in the DMA re-initiating the FIFO block transfer at a later time with the intention that additional free buffers and/or descriptors will have been added. Regardless of the value of this bit, the DMA will assert the <code>cdma_rx_sof_overrun</code> (for SOP) or <code>cdma_rx_mof_overrun</code> (for non-SOP) when
23-16	RX_SOP_OFFSET	W	0h	This field specifies the number of bytes that are to be skipped in the SOP buffer before beginning to write the payload. This value must be less than the minimum size of a buffer in the system. Valid values are 0 - 255 bytes.

Table 16-240. RXGCR18 Register Field Descriptions (continued)

Bit	Field	Type	Reset	Description
15-14	RX_DEFAULT_DESC_TY PE	W	0h	This field indicates the default descriptor type to use: 0 = Reserved 1 = Host 2 = Reserved 3 = Reserved The actual descriptor type that will be used for reception can be overridden by information provided in the CPPI FIFO data block.
13-12	RX_DEFAULT_RQ_QMG R	W	0h	This field indicates the default receive queue manager that this channel should use. The actual receive queue manager index can be overridden by information provided in the CPPI FIFO data block.
11-0	RX_DEFAULT_RQ_QNU M	W	0h	This field indicates the default receive queue that this channel should use. The actual receive queue that will be used for reception can be overridden by information provided in the CPPI FIFO data block. Table 99 -Rx Channel N Global Configuration Registers

16.5.5.78 RXHPCRA18 Register (offset = A4Ch) [reset = 0h]

 RXHPCRA18 is shown in [Figure 16-229](#) and described in [Table 16-241](#).

Figure 16-229. RXHPCRA18 Register


LEGEND: R/W = Read/Write; R = Read only; W1toCl = Write 1 to clear bit; -n = value after reset

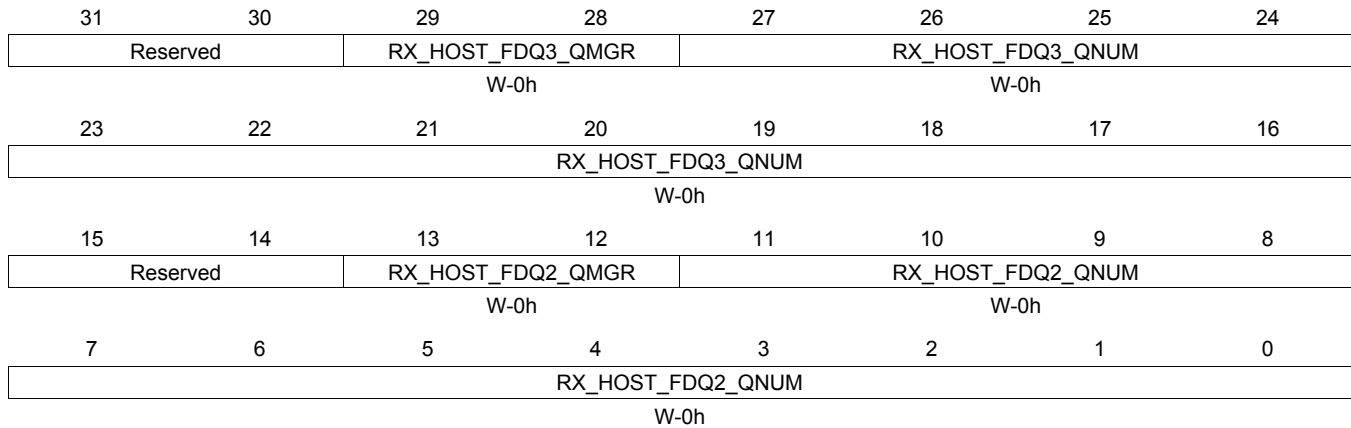
Table 16-241. RXHPCRA18 Register Field Descriptions

Bit	Field	Type	Reset	Description
29-28	RX_HOST_FDQ1_QMGR	W	0h	This field specifies which Buffer Manager should be used for the second Rx buffer in a host type packet.
27-16	RX_HOST_FDQ1_QNUM	W	0h	This field specifies which Free Descriptor / Buffer Pool should be used for the 2nd Rx buffer in a host type packet
13-12	RX_HOST_FDQ0_QMGR	W	0h	This field specifies which Buffer Manager should be used for the second Rx buffer in a host type packet.
11-0	RX_HOST_FDQ0_QNUM	W	0h	This field specifies which Free Descriptor / Buffer Pool should be used for the 1st Rx buffer in a host type packet Table 100 -Rx Channel N Host Packet Configuration Registers A

16.5.5.79 RXHPCRB18 Register (offset = A50h) [reset = 0h]

RXHPCRB18 is shown in [Figure 16-230](#) and described in [Table 16-242](#).

Figure 16-230. RXHPCRB18 Register



LEGEND: R/W = Read/Write; R = Read only; W1toCl = Write 1 to clear bit; -n = value after reset

Table 16-242. RXHPCRB18 Register Field Descriptions

Bit	Field	Type	Reset	Description
29-28	RX_HOST_FDQ3_QMGR	W	0h	This field specifies which Manager should be used for the 4th or later Rx buffers in a host type packet
27-16	RX_HOST_FDQ3_QNUM	W	0h	This field specifies which Free Descriptor Queue should be used for the 4th or later Rx buffers in a host type packet
13-12	RX_HOST_FDQ2_QMGR	W	0h	This field specifies which Buffer Manager should be used for the 3rd Rx buffer in a host type packet
11-0	RX_HOST_FDQ2_QNUM	W	0h	This field specifies which Free Descriptor / Buffer Pool should be used for the 3rd Rx buffer in a host type packet Table 101 -Rx Channel N Host Packet Configuration Registers B

16.5.5.80 TXGCR19 Register (offset = A60h) [reset = 0h]

 TXGCR19 is shown in [Figure 16-231](#) and described in [Table 16-243](#).

Figure 16-231. TXGCR19 Register

	31	30	29	28	27	26	25	24
	TX_ENABLE	TX_TEARDOWN	Reserved					
	R/W-0h	R/W-0h						
	23	22	21	20	19	18	17	16
	Reserved							
	15	14	13	12	11	10	9	8
	Reserved		TX_DEFAULT_QMGR			TX_DEFAULT_QNUM		
			W-0h			W-0h		
	7	6	5	4	3	2	1	0
	TX_DEFAULT_QNUM							
	W-0h							

LEGEND: R/W = Read/Write; R = Read only; W1toCl = Write 1 to clear bit; -n = value after reset

Table 16-243. TXGCR19 Register Field Descriptions

Bit	Field	Type	Reset	Description
31	TX_ENABLE	R/W	0h	This field enables or disables the channel 0 = channel is disabled 1 = channel is enabled This field will be cleared after a channel teardown is complete.
30	TX_TEARDOWN	R/W	0h	Setting this bit will request the channel to be torn down. This field will remain set after a channel teardown is complete.
13-12	TX_DEFAULT_QMGR	W	0h	This field controls the default queue manager number that will be used to queue teardown descriptors back to the host.
11-0	TX_DEFAULT_QNUM	W	0h	This field controls the default queue number within the selected queue manager onto which teardown descriptors will be queued back to the host. Table 98 -Tx Channel N Global Configuration Registers

16.5.5.81 RXGCR19 Register (offset = A68h) [reset = 0h]

RXGCR19 is shown in [Figure 16-232](#) and described in [Table 16-244](#).

Figure 16-232. RXGCR19 Register

31	30	29	28	27	26	25	24
RX_ENABLE	RX_TEARDOWN	RX_PAUSE	Reserved			RX_ERROR_HANDLING	
R/W-0h	R/W-0h	R/W-0h				W-0h	
23	22	21	20	19	18	17	16
RX_SOP_OFFSET							
W-0h							
15	14	13	12	11	10	9	8
RX_DEFAULT_DESC_TYPE		RX_DEFAULT_RQ_QMGR		RX_DEFAULT_RQ_QNUM			
W-0h		W-0h		W-0h			
7	6	5	4	3	2	1	0
RX_DEFAULT_RQ_QNUM							
W-0h							

LEGEND: R/W = Read/Write; R = Read only; W1toCl = Write 1 to clear bit; -n = value after reset

Table 16-244. RXGCR19 Register Field Descriptions

Bit	Field	Type	Reset	Description
31	RX_ENABLE	R/W	0h	This field enables or disables the channel 0 = channel is disabled 1 = channel is enabled This field will be cleared after a channel teardown is complete.
30	RX_TEARDOWN	R/W	0h	This field indicates whether or not an Rx teardown operation is complete. This field should be cleared when a channel is initialized. This field will be set after a channel teardown is complete.
29	RX_PAUSE	R/W	0h	Setting this bit causes the CPPI DMA to be suspended for rx channels. If a pause is being requested and the channel is not in a packet then drop the credit.
24	RX_ERROR_HANDLING	W	0h	This bit controls the error handling mode for the channel and is only used when channel errors (i.e. descriptor or buffer starvation occurs): 0 = Starvation errors result in dropping packet and reclaiming any used descriptor or buffer resources back to the original queues/pools they were allocated to 1 = Starvation errors result in subsequent re-try of the descriptor allocation operation. In this mode, the DMA will return to the IDLE state without saving it's internal operational state back to the internal state RAM and without issuing an advance operation on the FIFO interface. This results in the DMA re-initiating the FIFO block transfer at a later time with the intention that additional free buffers and/or descriptors will have been added. Regardless of the value of this bit, the DMA will assert the <code>cdma_rx_sof_overrun</code> (for SOP) or <code>cdma_rx_mof_overrun</code> (for non-SOP) when
23-16	RX_SOP_OFFSET	W	0h	This field specifies the number of bytes that are to be skipped in the SOP buffer before beginning to write the payload. This value must be less than the minimum size of a buffer in the system. Valid values are 0 - 255 bytes.

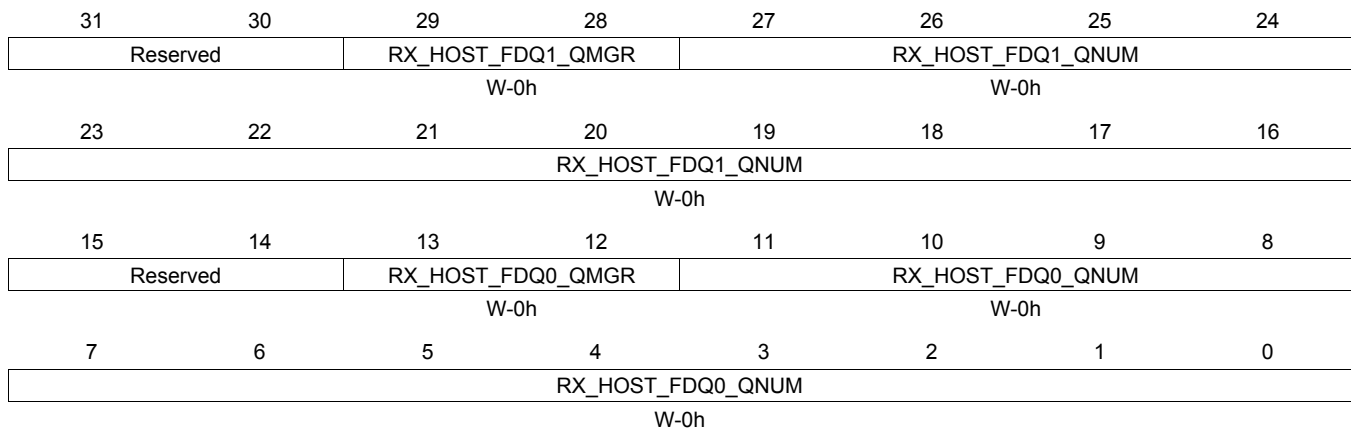
Table 16-244. RXGCR19 Register Field Descriptions (continued)

Bit	Field	Type	Reset	Description
15-14	RX_DEFAULT_DESC_TYPE	W	0h	This field indicates the default descriptor type to use: 0 = Reserved 1 = Host 2 = Reserved 3 = Reserved The actual descriptor type that will be used for reception can be overridden by information provided in the CPPI FIFO data block.
13-12	RX_DEFAULT_RQ_QMGR	W	0h	This field indicates the default receive queue manager that this channel should use. The actual receive queue manager index can be overridden by information provided in the CPPI FIFO data block.
11-0	RX_DEFAULT_RQ_QUEUE	W	0h	This field indicates the default receive queue that this channel should use. The actual receive queue that will be used for reception can be overridden by information provided in the CPPI FIFO data block. Table 99 -Rx Channel N Global Configuration Registers

16.5.5.82 RXHPCRA19 Register (offset = A6Ch) [reset = 0h]

RXHPCRA19 is shown in [Figure 16-233](#) and described in [Table 16-245](#).

Figure 16-233. RXHPCRA19 Register



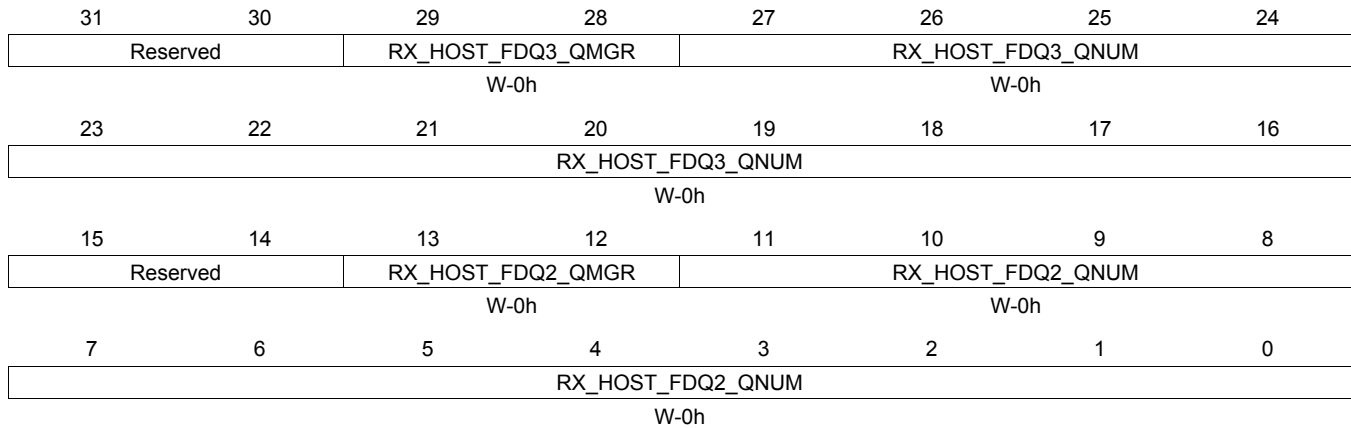
LEGEND: R/W = Read/Write; R = Read only; W1toCl = Write 1 to clear bit; -n = value after reset

Table 16-245. RXHPCRA19 Register Field Descriptions

Bit	Field	Type	Reset	Description
29-28	RX_HOST_FDQ1_QMGR	W	0h	This field specifies which Buffer Manager should be used for the second Rx buffer in a host type packet.
27-16	RX_HOST_FDQ1_QNUM	W	0h	This field specifies which Free Descriptor / Buffer Pool should be used for the 2nd Rx buffer in a host type packet
13-12	RX_HOST_FDQ0_QMGR	W	0h	This field specifies which Buffer Manager should be used for the second Rx buffer in a host type packet.
11-0	RX_HOST_FDQ0_QNUM	W	0h	This field specifies which Free Descriptor / Buffer Pool should be used for the 1st Rx buffer in a host type packet Table 100 -Rx Channel N Host Packet Configuration Registers A

16.5.5.83 RXHPCRB19 Register (offset = A70h) [reset = 0h]

 RXHPCRB19 is shown in [Figure 16-234](#) and described in [Table 16-246](#).

Figure 16-234. RXHPCRB19 Register


LEGEND: R/W = Read/Write; R = Read only; W1toCl = Write 1 to clear bit; -n = value after reset

Table 16-246. RXHPCRB19 Register Field Descriptions

Bit	Field	Type	Reset	Description
29-28	RX_HOST_FDQ3_QMGR	W	0h	This field specifies which Manager should be used for the 4th or later Rx buffers in a host type packet
27-16	RX_HOST_FDQ3_QNUM	W	0h	This field specifies which Free Descriptor Queue should be used for the 4th or later Rx buffers in a host type packet
13-12	RX_HOST_FDQ2_QMGR	W	0h	This field specifies which Buffer Manager should be used for the 3rd Rx buffer in a host type packet
11-0	RX_HOST_FDQ2_QNUM	W	0h	This field specifies which Free Descriptor / Buffer Pool should be used for the 3rd Rx buffer in a host type packet Table 101 -Rx Channel N Host Packet Configuration Registers B

16.5.5.84 TXGCR20 Register (offset = A80h) [reset = 0h]

TXGCR20 is shown in [Figure 16-235](#) and described in [Table 16-247](#).

Figure 16-235. TXGCR20 Register

31	30	29	28	27	26	25	24
TX_ENABLE	TX_TEARDOWN	Reserved					
R/W-0h	R/W-0h						
23	22	21	20	19	18	17	16
Reserved							
15	14	13	12	11	10	9	8
Reserved		TX_DEFAULT_QMGR			TX_DEFAULT_QNUM		
W-0h				W-0h			
7	6	5	4	3	2	1	0
TX_DEFAULT_QNUM							
W-0h							

LEGEND: R/W = Read/Write; R = Read only; W1toCl = Write 1 to clear bit; -n = value after reset

Table 16-247. TXGCR20 Register Field Descriptions

Bit	Field	Type	Reset	Description
31	TX_ENABLE	R/W	0h	This field enables or disables the channel 0 = channel is disabled 1 = channel is enabled This field will be cleared after a channel teardown is complete.
30	TX_TEARDOWN	R/W	0h	Setting this bit will request the channel to be torn down. This field will remain set after a channel teardown is complete.
13-12	TX_DEFAULT_QMGR	W	0h	This field controls the default queue manager number that will be used to queue teardown descriptors back to the host.
11-0	TX_DEFAULT_QNUM	W	0h	This field controls the default queue number within the selected queue manager onto which teardown descriptors will be queued back to the host. Table 98 -Tx Channel N Global Configuration Registers

16.5.5.85 RXGCR20 Register (offset = A88h) [reset = 0h]

 RXGCR20 is shown in [Figure 16-236](#) and described in [Table 16-248](#).

Figure 16-236. RXGCR20 Register

31	30	29	28	27	26	25	24
RX_ENABLE	RX_TEARDOWN	RX_PAUSE	Reserved			RX_ERROR_HANDLING	
R/W-0h	R/W-0h	R/W-0h				W-0h	
23	22	21	20	19	18	17	16
RX_SOP_OFFSET							
W-0h							
15	14	13	12	11	10	9	8
RX_DEFAULT_DESC_TYPE		RX_DEFAULT_RQ_QMGR		RX_DEFAULT_RQ_QNUM			
W-0h		W-0h		W-0h			
7	6	5	4	3	2	1	0
RX_DEFAULT_RQ_QNUM							
W-0h							

LEGEND: R/W = Read/Write; R = Read only; W1toCl = Write 1 to clear bit; -n = value after reset

Table 16-248. RXGCR20 Register Field Descriptions

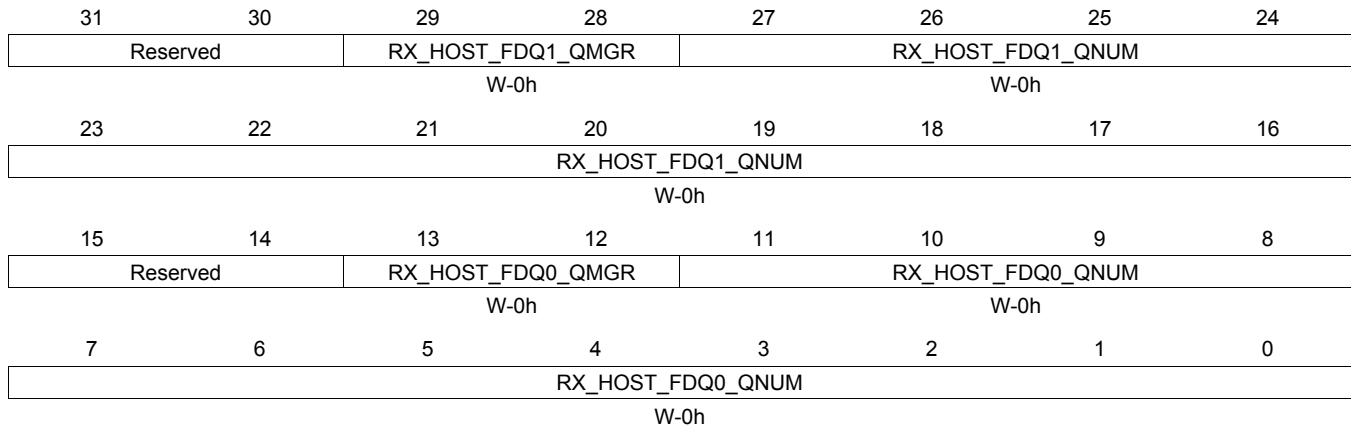
Bit	Field	Type	Reset	Description
31	RX_ENABLE	R/W	0h	This field enables or disables the channel 0 = channel is disabled 1 = channel is enabled This field will be cleared after a channel teardown is complete.
30	RX_TEARDOWN	R/W	0h	This field indicates whether or not an Rx teardown operation is complete. This field should be cleared when a channel is initialized. This field will be set after a channel teardown is complete.
29	RX_PAUSE	R/W	0h	Setting this bit causes the CPPI DMA to be suspended for rx channels. If a pause is being requested and the channel is not in a packet then drop the credit.
24	RX_ERROR_HANDLING	W	0h	This bit controls the error handling mode for the channel and is only used when channel errors (i.e. descriptor or buffer starvation occurs): 0 = Starvation errors result in dropping packet and reclaiming any used descriptor or buffer resources back to the original queues/pools they were allocated to 1 = Starvation errors result in subsequent re-try of the descriptor allocation operation. In this mode, the DMA will return to the IDLE state without saving it's internal operational state back to the internal state RAM and without issuing an advance operation on the FIFO interface. This results in the DMA re-initiating the FIFO block transfer at a later time with the intention that additional free buffers and/or descriptors will have been added. Regardless of the value of this bit, the DMA will assert the <code>cdma_rx_sof_overrun</code> (for SOP) or <code>cdma_rx_mof_overrun</code> (for non-SOP) when
23-16	RX_SOP_OFFSET	W	0h	This field specifies the number of bytes that are to be skipped in the SOP buffer before beginning to write the payload. This value must be less than the minimum size of a buffer in the system. Valid values are 0 - 255 bytes.

Table 16-248. RXGCR20 Register Field Descriptions (continued)

Bit	Field	Type	Reset	Description
15-14	RX_DEFAULT_DESC_TY PE	W	0h	This field indicates the default descriptor type to use: 0 = Reserved 1 = Host 2 = Reserved 3 = Reserved The actual descriptor type that will be used for reception can be overridden by information provided in the CPPI FIFO data block.
13-12	RX_DEFAULT_RQ_QMG R	W	0h	This field indicates the default receive queue manager that this channel should use. The actual receive queue manager index can be overridden by information provided in the CPPI FIFO data block.
11-0	RX_DEFAULT_RQ_QNU M	W	0h	This field indicates the default receive queue that this channel should use. The actual receive queue that will be used for reception can be overridden by information provided in the CPPI FIFO data block. Table 99 -Rx Channel N Global Configuration Registers

16.5.5.86 RXHPCRA20 Register (offset = A8Ch) [reset = 0h]

 RXHPCRA20 is shown in [Figure 16-237](#) and described in [Table 16-249](#).

Figure 16-237. RXHPCRA20 Register


LEGEND: R/W = Read/Write; R = Read only; W1toCl = Write 1 to clear bit; -n = value after reset

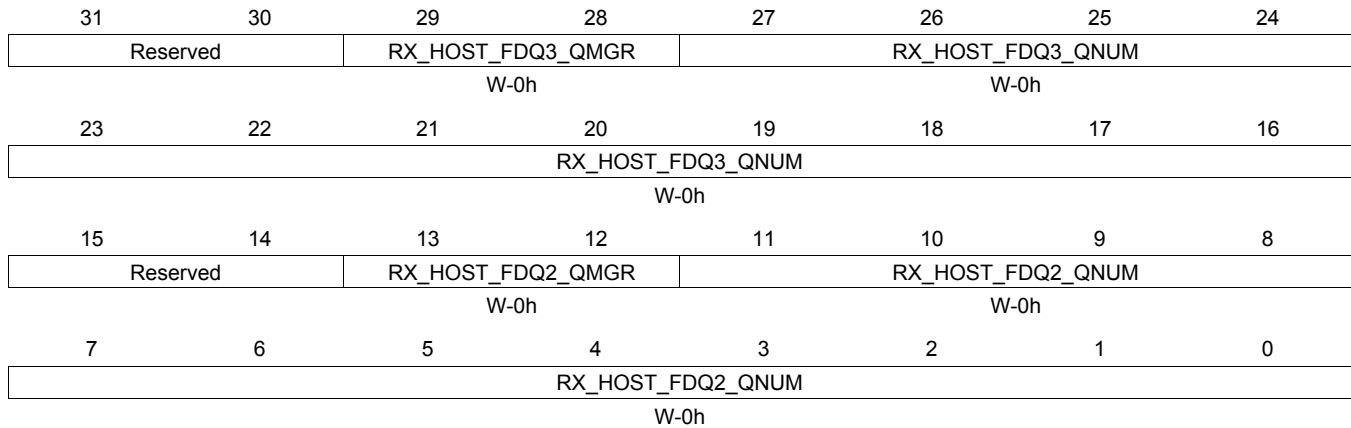
Table 16-249. RXHPCRA20 Register Field Descriptions

Bit	Field	Type	Reset	Description
29-28	RX_HOST_FDQ1_QMGR	W	0h	This field specifies which Buffer Manager should be used for the second Rx buffer in a host type packet.
27-16	RX_HOST_FDQ1_QNUM	W	0h	This field specifies which Free Descriptor / Buffer Pool should be used for the 2nd Rx buffer in a host type packet
13-12	RX_HOST_FDQ0_QMGR	W	0h	This field specifies which Buffer Manager should be used for the second Rx buffer in a host type packet.
11-0	RX_HOST_FDQ0_QNUM	W	0h	This field specifies which Free Descriptor / Buffer Pool should be used for the 1st Rx buffer in a host type packet Table 100 -Rx Channel N Host Packet Configuration Registers A

16.5.5.87 RXHPCRB20 Register (offset = A90h) [reset = 0h]

RXHPCRB20 is shown in [Figure 16-238](#) and described in [Table 16-250](#).

Figure 16-238. RXHPCRB20 Register



LEGEND: R/W = Read/Write; R = Read only; W1toCl = Write 1 to clear bit; -n = value after reset

Table 16-250. RXHPCRB20 Register Field Descriptions

Bit	Field	Type	Reset	Description
29-28	RX_HOST_FDQ3_QMGR	W	0h	This field specifies which Manager should be used for the 4th or later Rx buffers in a host type packet
27-16	RX_HOST_FDQ3_QNUM	W	0h	This field specifies which Free Descriptor Queue should be used for the 4th or later Rx buffers in a host type packet
13-12	RX_HOST_FDQ2_QMGR	W	0h	This field specifies which Buffer Manager should be used for the 3rd Rx buffer in a host type packet
11-0	RX_HOST_FDQ2_QNUM	W	0h	This field specifies which Free Descriptor / Buffer Pool should be used for the 3rd Rx buffer in a host type packet Table 101 -Rx Channel N Host Packet Configuration Registers B

16.5.5.88 TXGCR21 Register (offset = AA0h) [reset = 0h]

 TXGCR21 is shown in [Figure 16-239](#) and described in [Table 16-251](#).

Figure 16-239. TXGCR21 Register

31	30	29	28	27	26	25	24
TX_ENABLE	TX_TEARDOWN	Reserved					
R/W-0h	R/W-0h						
23	22	21	20	19	18	17	16
Reserved							
15	14	13	12	11	10	9	8
Reserved		TX_DEFAULT_QMGR			TX_DEFAULT_QNUM		
W-0h				W-0h			
7	6	5	4	3	2	1	0
TX_DEFAULT_QNUM							
W-0h							

LEGEND: R/W = Read/Write; R = Read only; W1toCl = Write 1 to clear bit; -n = value after reset

Table 16-251. TXGCR21 Register Field Descriptions

Bit	Field	Type	Reset	Description
31	TX_ENABLE	R/W	0h	This field enables or disables the channel 0 = channel is disabled 1 = channel is enabled This field will be cleared after a channel teardown is complete.
30	TX_TEARDOWN	R/W	0h	Setting this bit will request the channel to be torn down. This field will remain set after a channel teardown is complete.
13-12	TX_DEFAULT_QMGR	W	0h	This field controls the default queue manager number that will be used to queue teardown descriptors back to the host.
11-0	TX_DEFAULT_QNUM	W	0h	This field controls the default queue number within the selected queue manager onto which teardown descriptors will be queued back to the host. Table 98 -Tx Channel N Global Configuration Registers

16.5.5.89 RXGCR21 Register (offset = AA8h) [reset = 0h]

RXGCR21 is shown in [Figure 16-240](#) and described in [Table 16-252](#).

Figure 16-240. RXGCR21 Register

31	30	29	28	27	26	25	24
RX_ENABLE	RX_TEARDOWN	RX_PAUSE	Reserved			RX_ERROR_HANDLING	
R/W-0h	R/W-0h	R/W-0h				W-0h	
23	22	21	20	19	18	17	16
RX_SOP_OFFSET							
W-0h							
15	14	13	12	11	10	9	8
RX_DEFAULT_DESC_TYPE		RX_DEFAULT_RQ_QMGR		RX_DEFAULT_RQ_QNUM			
W-0h		W-0h		W-0h			
7	6	5	4	3	2	1	0
RX_DEFAULT_RQ_QNUM							
W-0h							

LEGEND: R/W = Read/Write; R = Read only; W1toCl = Write 1 to clear bit; -n = value after reset

Table 16-252. RXGCR21 Register Field Descriptions

Bit	Field	Type	Reset	Description
31	RX_ENABLE	R/W	0h	This field enables or disables the channel 0 = channel is disabled 1 = channel is enabled This field will be cleared after a channel teardown is complete.
30	RX_TEARDOWN	R/W	0h	This field indicates whether or not an Rx teardown operation is complete. This field should be cleared when a channel is initialized. This field will be set after a channel teardown is complete.
29	RX_PAUSE	R/W	0h	Setting this bit causes the CPPI DMA to be suspended for rx channels. If a pause is being requested and the channel is not in a packet then drop the credit.
24	RX_ERROR_HANDLING	W	0h	This bit controls the error handling mode for the channel and is only used when channel errors (i.e. descriptor or buffer starvation occurs): 0 = Starvation errors result in dropping packet and reclaiming any used descriptor or buffer resources back to the original queues/pools they were allocated to 1 = Starvation errors result in subsequent re-try of the descriptor allocation operation. In this mode, the DMA will return to the IDLE state without saving it's internal operational state back to the internal state RAM and without issuing an advance operation on the FIFO interface. This results in the DMA re-initiating the FIFO block transfer at a later time with the intention that additional free buffers and/or descriptors will have been added. Regardless of the value of this bit, the DMA will assert the <code>cdma_rx_sof_overrun</code> (for SOP) or <code>cdma_rx_mof_overrun</code> (for non-SOP) when
23-16	RX_SOP_OFFSET	W	0h	This field specifies the number of bytes that are to be skipped in the SOP buffer before beginning to write the payload. This value must be less than the minimum size of a buffer in the system. Valid values are 0 - 255 bytes.

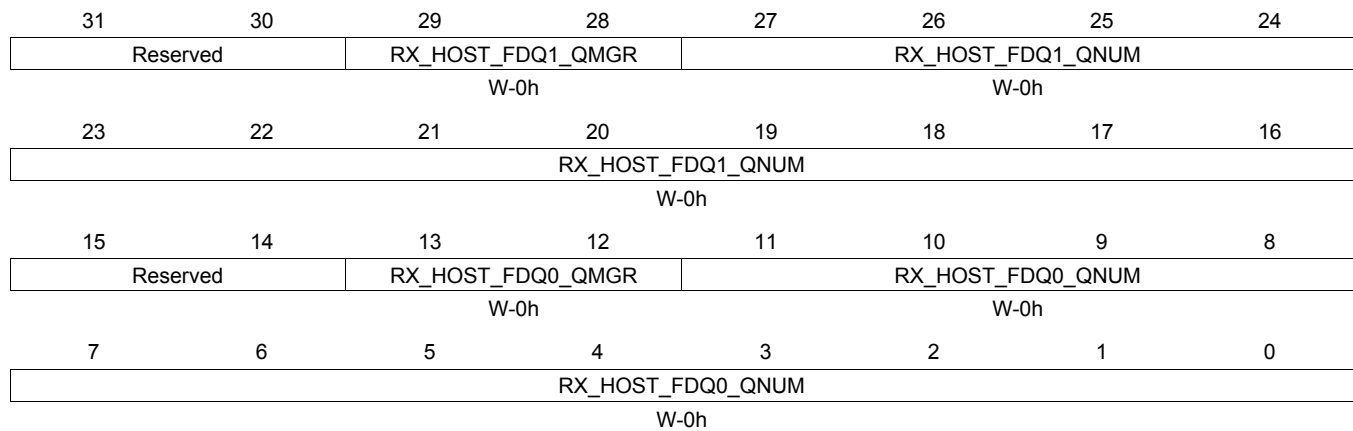
Table 16-252. RXGCR21 Register Field Descriptions (continued)

Bit	Field	Type	Reset	Description
15-14	RX_DEFAULT_DESC_TYPE	W	0h	This field indicates the default descriptor type to use: 0 = Reserved 1 = Host 2 = Reserved 3 = Reserved The actual descriptor type that will be used for reception can be overridden by information provided in the CPPI FIFO data block.
13-12	RX_DEFAULT_RQ_QMGR	W	0h	This field indicates the default receive queue manager that this channel should use. The actual receive queue manager index can be overridden by information provided in the CPPI FIFO data block.
11-0	RX_DEFAULT_RQ_QUEUE	W	0h	This field indicates the default receive queue that this channel should use. The actual receive queue that will be used for reception can be overridden by information provided in the CPPI FIFO data block. Table 99 -Rx Channel N Global Configuration Registers

16.5.5.90 RXHPCRA21 Register (offset = AACH) [reset = 0h]

RXHPCRA21 is shown in [Figure 16-241](#) and described in [Table 16-253](#).

Figure 16-241. RXHPCRA21 Register



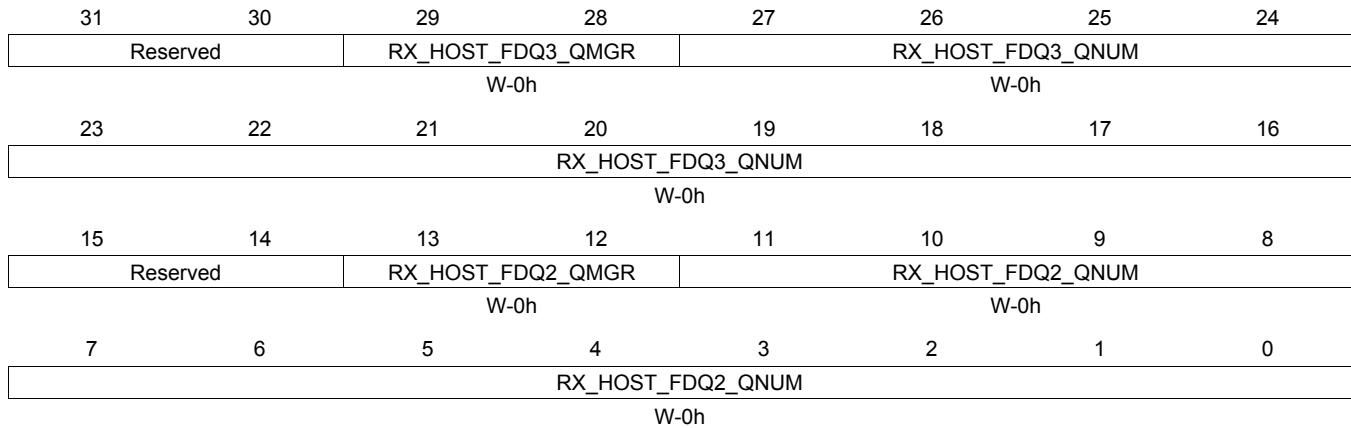
LEGEND: R/W = Read/Write; R = Read only; W1toCl = Write 1 to clear bit; -n = value after reset

Table 16-253. RXHPCRA21 Register Field Descriptions

Bit	Field	Type	Reset	Description
29-28	RX_HOST_FDQ1_QMGR	W	0h	This field specifies which Buffer Manager should be used for the second Rx buffer in a host type packet.
27-16	RX_HOST_FDQ1_QNUM	W	0h	This field specifies which Free Descriptor / Buffer Pool should be used for the 2nd Rx buffer in a host type packet
13-12	RX_HOST_FDQ0_QMGR	W	0h	This field specifies which Buffer Manager should be used for the second Rx buffer in a host type packet.
11-0	RX_HOST_FDQ0_QNUM	W	0h	This field specifies which Free Descriptor / Buffer Pool should be used for the 1st Rx buffer in a host type packet Table 100 -Rx Channel N Host Packet Configuration Registers A

16.5.5.91 RXHPCRB21 Register (offset = AB0h) [reset = 0h]

 RXHPCRB21 is shown in [Figure 16-242](#) and described in [Table 16-254](#).

Figure 16-242. RXHPCRB21 Register


LEGEND: R/W = Read/Write; R = Read only; W1toCl = Write 1 to clear bit; -n = value after reset

Table 16-254. RXHPCRB21 Register Field Descriptions

Bit	Field	Type	Reset	Description
29-28	RX_HOST_FDQ3_QMGR	W	0h	This field specifies which Manager should be used for the 4th or later Rx buffers in a host type packet
27-16	RX_HOST_FDQ3_QNUM	W	0h	This field specifies which Free Descriptor Queue should be used for the 4th or later Rx buffers in a host type packet
13-12	RX_HOST_FDQ2_QMGR	W	0h	This field specifies which Buffer Manager should be used for the 3rd Rx buffer in a host type packet
11-0	RX_HOST_FDQ2_QNUM	W	0h	This field specifies which Free Descriptor / Buffer Pool should be used for the 3rd Rx buffer in a host type packet Table 101 -Rx Channel N Host Packet Configuration Registers B

16.5.5.92 TXGCR22 Register (offset = AC0h) [reset = 0h]

TXGCR22 is shown in [Figure 16-243](#) and described in [Table 16-255](#).

Figure 16-243. TXGCR22 Register

31	30	29	28	27	26	25	24
TX_ENABLE	TX_TEARDOWN	Reserved					
R/W-0h	R/W-0h						
23	22	21	20	19	18	17	16
Reserved							
15	14	13	12	11	10	9	8
Reserved		TX_DEFAULT_QMGR			TX_DEFAULT_QNUM		
W-0h				W-0h			
7	6	5	4	3	2	1	0
TX_DEFAULT_QNUM							
W-0h							

LEGEND: R/W = Read/Write; R = Read only; W1toCl = Write 1 to clear bit; -n = value after reset

Table 16-255. TXGCR22 Register Field Descriptions

Bit	Field	Type	Reset	Description
31	TX_ENABLE	R/W	0h	This field enables or disables the channel 0 = channel is disabled 1 = channel is enabled This field will be cleared after a channel teardown is complete.
30	TX_TEARDOWN	R/W	0h	Setting this bit will request the channel to be torn down. This field will remain set after a channel teardown is complete.
13-12	TX_DEFAULT_QMGR	W	0h	This field controls the default queue manager number that will be used to queue teardown descriptors back to the host.
11-0	TX_DEFAULT_QNUM	W	0h	This field controls the default queue number within the selected queue manager onto which teardown descriptors will be queued back to the host. Table 98 -Tx Channel N Global Configuration Registers

16.5.5.93 RXGCR22 Register (offset = AC8h) [reset = 0h]

 RXGCR22 is shown in [Figure 16-244](#) and described in [Table 16-256](#).

Figure 16-244. RXGCR22 Register

31	30	29	28	27	26	25	24
RX_ENABLE	RX_TEARDOWN	RX_PAUSE	Reserved			RX_ERROR_HANDLING	
R/W-0h	R/W-0h	R/W-0h				W-0h	
23	22	21	20	19	18	17	16
RX_SOP_OFFSET							
W-0h							
15	14	13	12	11	10	9	8
RX_DEFAULT_DESC_TYPE		RX_DEFAULT_RQ_QMGR		RX_DEFAULT_RQ_QNUM			
W-0h		W-0h		W-0h			
7	6	5	4	3	2	1	0
RX_DEFAULT_RQ_QNUM							
W-0h							

LEGEND: R/W = Read/Write; R = Read only; W1toCl = Write 1 to clear bit; -n = value after reset

Table 16-256. RXGCR22 Register Field Descriptions

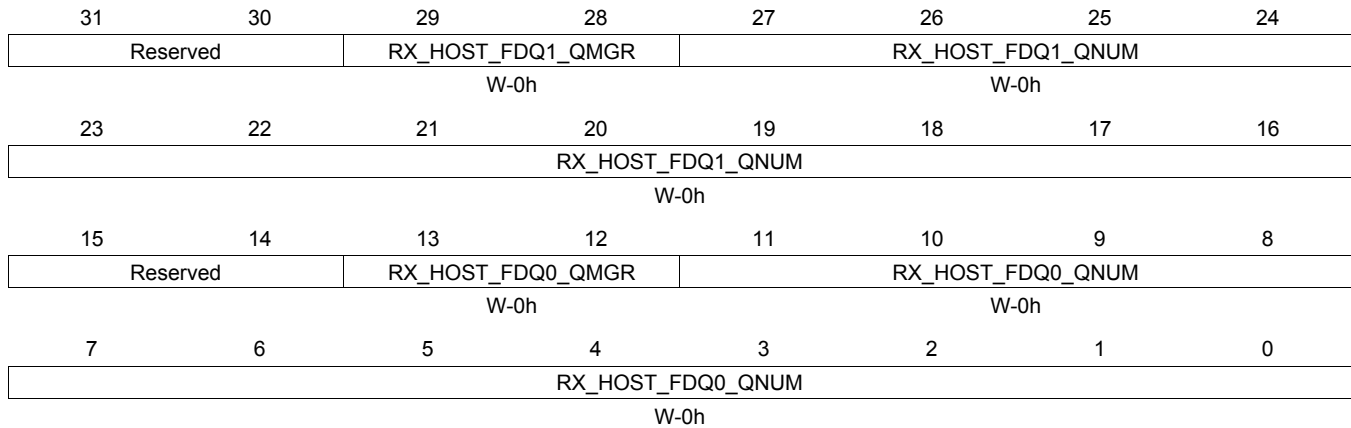
Bit	Field	Type	Reset	Description
31	RX_ENABLE	R/W	0h	This field enables or disables the channel 0 = channel is disabled 1 = channel is enabled This field will be cleared after a channel teardown is complete.
30	RX_TEARDOWN	R/W	0h	This field indicates whether or not an Rx teardown operation is complete. This field should be cleared when a channel is initialized. This field will be set after a channel teardown is complete.
29	RX_PAUSE	R/W	0h	Setting this bit causes the CPPI DMA to be suspended for rx channels. If a pause is being requested and the channel is not in a packet then drop the credit.
24	RX_ERROR_HANDLING	W	0h	This bit controls the error handling mode for the channel and is only used when channel errors (i.e. descriptor or buffer starvation occurs): 0 = Starvation errors result in dropping packet and reclaiming any used descriptor or buffer resources back to the original queues/pools they were allocated to 1 = Starvation errors result in subsequent re-try of the descriptor allocation operation. In this mode, the DMA will return to the IDLE state without saving it's internal operational state back to the internal state RAM and without issuing an advance operation on the FIFO interface. This results in the DMA re-initiating the FIFO block transfer at a later time with the intention that additional free buffers and/or descriptors will have been added. Regardless of the value of this bit, the DMA will assert the <code>cdma_rx_sof_overrun</code> (for SOP) or <code>cdma_rx_mof_overrun</code> (for non-SOP) when
23-16	RX_SOP_OFFSET	W	0h	This field specifies the number of bytes that are to be skipped in the SOP buffer before beginning to write the payload. This value must be less than the minimum size of a buffer in the system. Valid values are 0 - 255 bytes.

Table 16-256. RXGCR22 Register Field Descriptions (continued)

Bit	Field	Type	Reset	Description
15-14	RX_DEFAULT_DESC_TY PE	W	0h	This field indicates the default descriptor type to use: 0 = Reserved 1 = Host 2 = Reserved 3 = Reserved The actual descriptor type that will be used for reception can be overridden by information provided in the CPPI FIFO data block.
13-12	RX_DEFAULT_RQ_QMG R	W	0h	This field indicates the default receive queue manager that this channel should use. The actual receive queue manager index can be overridden by information provided in the CPPI FIFO data block.
11-0	RX_DEFAULT_RQ_QNU M	W	0h	This field indicates the default receive queue that this channel should use. The actual receive queue that will be used for reception can be overridden by information provided in the CPPI FIFO data block. Table 99 -Rx Channel N Global Configuration Registers

16.5.5.94 RXHPCRA22 Register (offset = ACCh) [reset = 0h]

 RXHPCRA22 is shown in [Figure 16-245](#) and described in [Table 16-257](#).

Figure 16-245. RXHPCRA22 Register


LEGEND: R/W = Read/Write; R = Read only; W1toCl = Write 1 to clear bit; -n = value after reset

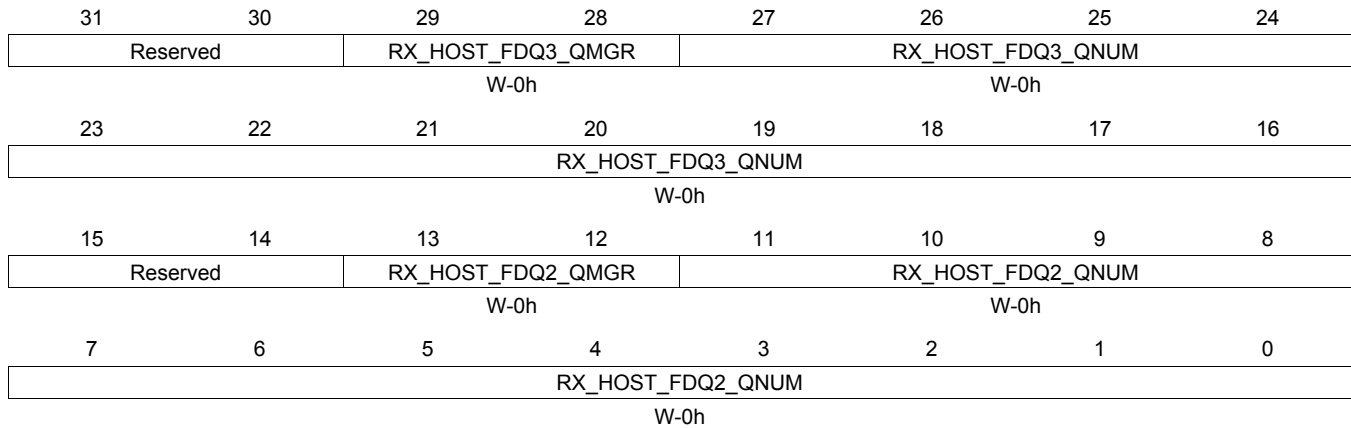
Table 16-257. RXHPCRA22 Register Field Descriptions

Bit	Field	Type	Reset	Description
29-28	RX_HOST_FDQ1_QMGR	W	0h	This field specifies which Buffer Manager should be used for the second Rx buffer in a host type packet.
27-16	RX_HOST_FDQ1_QNUM	W	0h	This field specifies which Free Descriptor / Buffer Pool should be used for the 2nd Rx buffer in a host type packet
13-12	RX_HOST_FDQ0_QMGR	W	0h	This field specifies which Buffer Manager should be used for the second Rx buffer in a host type packet.
11-0	RX_HOST_FDQ0_QNUM	W	0h	This field specifies which Free Descriptor / Buffer Pool should be used for the 1st Rx buffer in a host type packet Table 100 -Rx Channel N Host Packet Configuration Registers A

16.5.5.95 RXHPCRB22 Register (offset = AD0h) [reset = 0h]

RXHPCRB22 is shown in [Figure 16-246](#) and described in [Table 16-258](#).

Figure 16-246. RXHPCRB22 Register



LEGEND: R/W = Read/Write; R = Read only; W1toCl = Write 1 to clear bit; -n = value after reset

Table 16-258. RXHPCRB22 Register Field Descriptions

Bit	Field	Type	Reset	Description
29-28	RX_HOST_FDQ3_QMGR	W	0h	This field specifies which Manager should be used for the 4th or later Rx buffers in a host type packet
27-16	RX_HOST_FDQ3_QNUM	W	0h	This field specifies which Free Descriptor Queue should be used for the 4th or later Rx buffers in a host type packet
13-12	RX_HOST_FDQ2_QMGR	W	0h	This field specifies which Buffer Manager should be used for the 3rd Rx buffer in a host type packet
11-0	RX_HOST_FDQ2_QNUM	W	0h	This field specifies which Free Descriptor / Buffer Pool should be used for the 3rd Rx buffer in a host type packet Table 101 -Rx Channel N Host Packet Configuration Registers B

16.5.5.96 TXGCR23 Register (offset = AE0h) [reset = 0h]

 TXGCR23 is shown in [Figure 16-247](#) and described in [Table 16-259](#).

Figure 16-247. TXGCR23 Register

	31	30	29	28	27	26	25	24
	TX_ENABLE	TX_TEARDOWN	Reserved					
	R/W-0h	R/W-0h						
	23	22	21	20	19	18	17	16
	Reserved							
	15	14	13	12	11	10	9	8
	Reserved		TX_DEFAULT_QMGR			TX_DEFAULT_QNUM		
	W-0h			W-0h				
	7	6	5	4	3	2	1	0
	TX_DEFAULT_QNUM							
	W-0h							

LEGEND: R/W = Read/Write; R = Read only; W1toCl = Write 1 to clear bit; -n = value after reset

Table 16-259. TXGCR23 Register Field Descriptions

Bit	Field	Type	Reset	Description
31	TX_ENABLE	R/W	0h	This field enables or disables the channel 0 = channel is disabled 1 = channel is enabled This field will be cleared after a channel teardown is complete.
30	TX_TEARDOWN	R/W	0h	Setting this bit will request the channel to be torn down. This field will remain set after a channel teardown is complete.
13-12	TX_DEFAULT_QMGR	W	0h	This field controls the default queue manager number that will be used to queue teardown descriptors back to the host.
11-0	TX_DEFAULT_QNUM	W	0h	This field controls the default queue number within the selected queue manager onto which teardown descriptors will be queued back to the host. Table 98 -Tx Channel N Global Configuration Registers

16.5.5.97 RXGCR23 Register (offset = AE8h) [reset = 0h]

RXGCR23 is shown in [Figure 16-248](#) and described in [Table 16-260](#).

Figure 16-248. RXGCR23 Register

31	30	29	28	27	26	25	24
RX_ENABLE	RX_TEARDOWN	RX_PAUSE	Reserved			RX_ERROR_HANDLING	
R/W-0h	R/W-0h	R/W-0h				W-0h	
23	22	21	20	19	18	17	16
RX_SOP_OFFSET							
W-0h							
15	14	13	12	11	10	9	8
RX_DEFAULT_DESC_TYPE		RX_DEFAULT_RQ_QMGR		RX_DEFAULT_RQ_QNUM			
W-0h		W-0h		W-0h			
7	6	5	4	3	2	1	0
RX_DEFAULT_RQ_QNUM							
W-0h							

LEGEND: R/W = Read/Write; R = Read only; W1toCl = Write 1 to clear bit; -n = value after reset

Table 16-260. RXGCR23 Register Field Descriptions

Bit	Field	Type	Reset	Description
31	RX_ENABLE	R/W	0h	This field enables or disables the channel 0 = channel is disabled 1 = channel is enabled This field will be cleared after a channel teardown is complete.
30	RX_TEARDOWN	R/W	0h	This field indicates whether or not an Rx teardown operation is complete. This field should be cleared when a channel is initialized. This field will be set after a channel teardown is complete.
29	RX_PAUSE	R/W	0h	Setting this bit causes the CPPI DMA to be suspended for rx channels. If a pause is being requested and the channel is not in a packet then drop the credit.
24	RX_ERROR_HANDLING	W	0h	This bit controls the error handling mode for the channel and is only used when channel errors (i.e. descriptor or buffer starvation occurs): 0 = Starvation errors result in dropping packet and reclaiming any used descriptor or buffer resources back to the original queues/pools they were allocated to 1 = Starvation errors result in subsequent re-try of the descriptor allocation operation. In this mode, the DMA will return to the IDLE state without saving it's internal operational state back to the internal state RAM and without issuing an advance operation on the FIFO interface. This results in the DMA re-initiating the FIFO block transfer at a later time with the intention that additional free buffers and/or descriptors will have been added. Regardless of the value of this bit, the DMA will assert the <code>cdma_rx_sof_overrun</code> (for SOP) or <code>cdma_rx_mof_overrun</code> (for non-SOP) when
23-16	RX_SOP_OFFSET	W	0h	This field specifies the number of bytes that are to be skipped in the SOP buffer before beginning to write the payload. This value must be less than the minimum size of a buffer in the system. Valid values are 0 - 255 bytes.

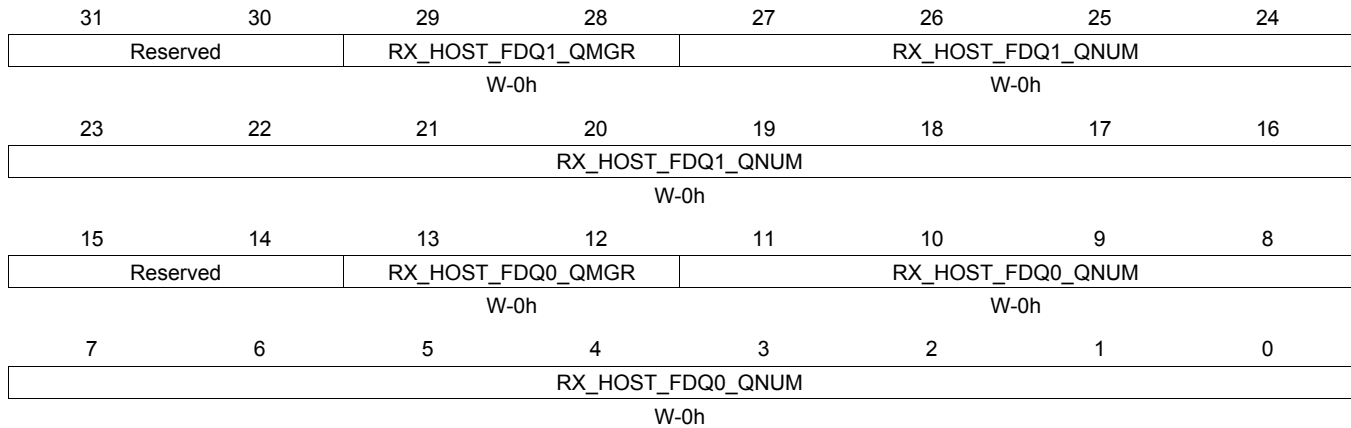
Table 16-260. RXGCR23 Register Field Descriptions (continued)

Bit	Field	Type	Reset	Description
15-14	RX_DEFAULT_DESC_TYPE	W	0h	This field indicates the default descriptor type to use: 0 = Reserved 1 = Host 2 = Reserved 3 = Reserved The actual descriptor type that will be used for reception can be overridden by information provided in the CPPI FIFO data block.
13-12	RX_DEFAULT_RQ_QMGR	W	0h	This field indicates the default receive queue manager that this channel should use. The actual receive queue manager index can be overridden by information provided in the CPPI FIFO data block.
11-0	RX_DEFAULT_RQ_QUEUE	W	0h	This field indicates the default receive queue that this channel should use. The actual receive queue that will be used for reception can be overridden by information provided in the CPPI FIFO data block. Table 99 -Rx Channel N Global Configuration Registers

16.5.5.98 RXHPCRA23 Register (offset = AECh) [reset = 0h]

RXHPCRA23 is shown in [Figure 16-249](#) and described in [Table 16-261](#).

Figure 16-249. RXHPCRA23 Register



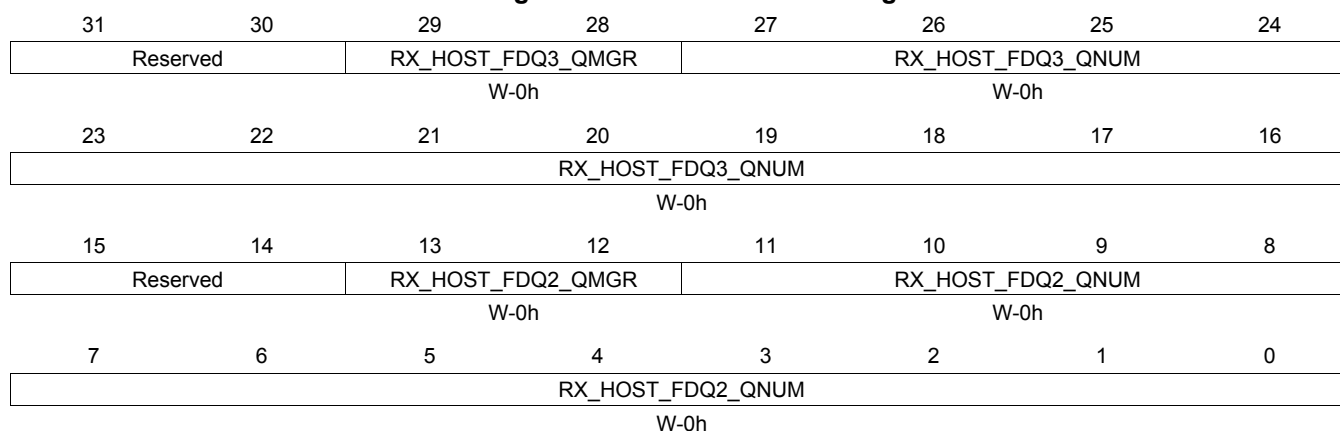
LEGEND: R/W = Read/Write; R = Read only; W1toCl = Write 1 to clear bit; -n = value after reset

Table 16-261. RXHPCRA23 Register Field Descriptions

Bit	Field	Type	Reset	Description
29-28	RX_HOST_FDQ1_QMGR	W	0h	This field specifies which Buffer Manager should be used for the second Rx buffer in a host type packet.
27-16	RX_HOST_FDQ1_QNUM	W	0h	This field specifies which Free Descriptor / Buffer Pool should be used for the 2nd Rx buffer in a host type packet
13-12	RX_HOST_FDQ0_QMGR	W	0h	This field specifies which Buffer Manager should be used for the second Rx buffer in a host type packet.
11-0	RX_HOST_FDQ0_QNUM	W	0h	This field specifies which Free Descriptor / Buffer Pool should be used for the 1st Rx buffer in a host type packet Table 100 -Rx Channel N Host Packet Configuration Registers A

16.5.5.99 RXHPCRB23 Register (offset = AF0h) [reset = 0h]

 RXHPCRB23 is shown in [Figure 16-250](#) and described in [Table 16-262](#).

Figure 16-250. RXHPCRB23 Register


LEGEND: R/W = Read/Write; R = Read only; W1toCl = Write 1 to clear bit; -n = value after reset

Table 16-262. RXHPCRB23 Register Field Descriptions

Bit	Field	Type	Reset	Description
29-28	RX_HOST_FDQ3_QMGR	W	0h	This field specifies which Manager should be used for the 4th or later Rx buffers in a host type packet
27-16	RX_HOST_FDQ3_QNUM	W	0h	This field specifies which Free Descriptor Queue should be used for the 4th or later Rx buffers in a host type packet
13-12	RX_HOST_FDQ2_QMGR	W	0h	This field specifies which Buffer Manager should be used for the 3rd Rx buffer in a host type packet
11-0	RX_HOST_FDQ2_QNUM	W	0h	This field specifies which Free Descriptor / Buffer Pool should be used for the 3rd Rx buffer in a host type packet Table 101 -Rx Channel N Host Packet Configuration Registers B

16.5.5.100 TXGCR24 Register (offset = B00h) [reset = 0h]

TXGCR24 is shown in [Figure 16-251](#) and described in [Table 16-263](#).

Figure 16-251. TXGCR24 Register

31	30	29	28	27	26	25	24
TX_ENABLE	TX_TEARDOWN	Reserved					
R/W-0h	R/W-0h						
23	22	21	20	19	18	17	16
Reserved							
15	14	13	12	11	10	9	8
Reserved		TX_DEFAULT_QMGR			TX_DEFAULT_QNUM		
W-0h				W-0h			
7	6	5	4	3	2	1	0
TX_DEFAULT_QNUM							
W-0h							

LEGEND: R/W = Read/Write; R = Read only; W1toCl = Write 1 to clear bit; -n = value after reset

Table 16-263. TXGCR24 Register Field Descriptions

Bit	Field	Type	Reset	Description
31	TX_ENABLE	R/W	0h	This field enables or disables the channel 0 = channel is disabled 1 = channel is enabled This field will be cleared after a channel teardown is complete.
30	TX_TEARDOWN	R/W	0h	Setting this bit will request the channel to be torn down. This field will remain set after a channel teardown is complete.
13-12	TX_DEFAULT_QMGR	W	0h	This field controls the default queue manager number that will be used to queue teardown descriptors back to the host.
11-0	TX_DEFAULT_QNUM	W	0h	This field controls the default queue number within the selected queue manager onto which teardown descriptors will be queued back to the host. Table 98 -Tx Channel N Global Configuration Registers

16.5.5.101 RXGCR24 Register (offset = B08h) [reset = 0h]

 RXGCR24 is shown in [Figure 16-252](#) and described in [Table 16-264](#).

Figure 16-252. RXGCR24 Register

31	30	29	28	27	26	25	24
RX_ENABLE	RX_TEARDOWN	RX_PAUSE	Reserved			RX_ERROR_HANDLING	
R/W-0h	R/W-0h	R/W-0h				W-0h	
23	22	21	20	19	18	17	16
RX_SOP_OFFSET							
W-0h							
15	14	13	12	11	10	9	8
RX_DEFAULT_DESC_TYPE		RX_DEFAULT_RQ_QMGR		RX_DEFAULT_RQ_QNUM			
W-0h		W-0h		W-0h			
7	6	5	4	3	2	1	0
RX_DEFAULT_RQ_QNUM							
W-0h							

LEGEND: R/W = Read/Write; R = Read only; W1toCl = Write 1 to clear bit; -n = value after reset

Table 16-264. RXGCR24 Register Field Descriptions

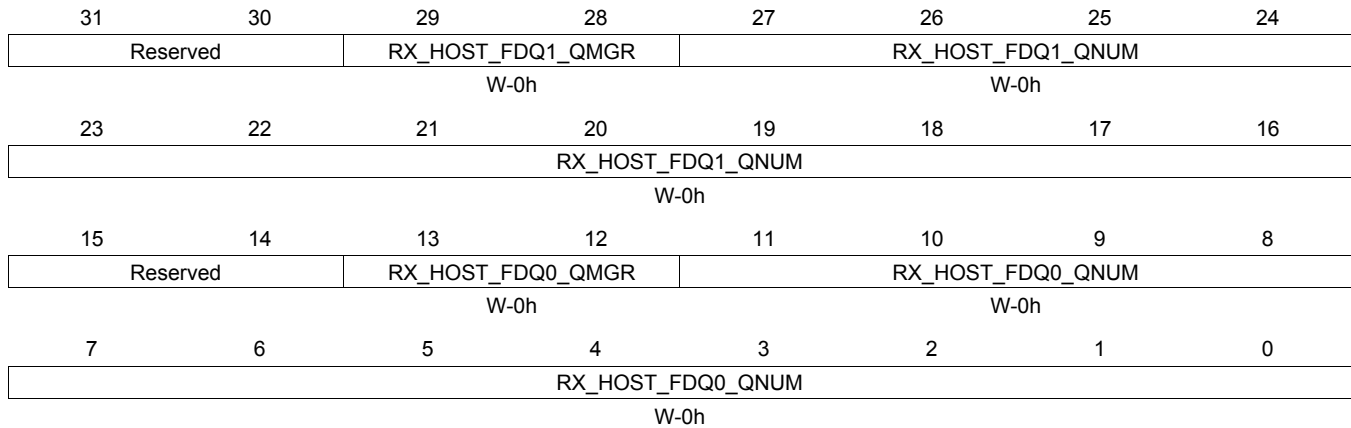
Bit	Field	Type	Reset	Description
31	RX_ENABLE	R/W	0h	This field enables or disables the channel 0 = channel is disabled 1 = channel is enabled This field will be cleared after a channel teardown is complete.
30	RX_TEARDOWN	R/W	0h	This field indicates whether or not an Rx teardown operation is complete. This field should be cleared when a channel is initialized. This field will be set after a channel teardown is complete.
29	RX_PAUSE	R/W	0h	Setting this bit causes the CPPI DMA to be suspended for rx channels. If a pause is being requested and the channel is not in a packet then drop the credit.
24	RX_ERROR_HANDLING	W	0h	This bit controls the error handling mode for the channel and is only used when channel errors (i.e. descriptor or buffer starvation occurs): 0 = Starvation errors result in dropping packet and reclaiming any used descriptor or buffer resources back to the original queues/pools they were allocated to 1 = Starvation errors result in subsequent re-try of the descriptor allocation operation. In this mode, the DMA will return to the IDLE state without saving it's internal operational state back to the internal state RAM and without issuing an advance operation on the FIFO interface. This results in the DMA re-initiating the FIFO block transfer at a later time with the intention that additional free buffers and/or descriptors will have been added. Regardless of the value of this bit, the DMA will assert the <code>cdma_rx_sof_overrun</code> (for SOP) or <code>cdma_rx_mof_overrun</code> (for non-SOP) when
23-16	RX_SOP_OFFSET	W	0h	This field specifies the number of bytes that are to be skipped in the SOP buffer before beginning to write the payload. This value must be less than the minimum size of a buffer in the system. Valid values are 0 - 255 bytes.

Table 16-264. RXGCR24 Register Field Descriptions (continued)

Bit	Field	Type	Reset	Description
15-14	RX_DEFAULT_DESC_TY PE	W	0h	This field indicates the default descriptor type to use: 0 = Reserved 1 = Host 2 = Reserved 3 = Reserved The actual descriptor type that will be used for reception can be overridden by information provided in the CPPI FIFO data block.
13-12	RX_DEFAULT_RQ_QMG R	W	0h	This field indicates the default receive queue manager that this channel should use. The actual receive queue manager index can be overridden by information provided in the CPPI FIFO data block.
11-0	RX_DEFAULT_RQ_QNU M	W	0h	This field indicates the default receive queue that this channel should use. The actual receive queue that will be used for reception can be overridden by information provided in the CPPI FIFO data block. Table 99 -Rx Channel N Global Configuration Registers

16.5.5.102 RXHPCRA24 Register (offset = B0Ch) [reset = 0h]

 RXHPCRA24 is shown in [Figure 16-253](#) and described in [Table 16-265](#).

Figure 16-253. RXHPCRA24 Register


LEGEND: R/W = Read/Write; R = Read only; W1toCl = Write 1 to clear bit; -n = value after reset

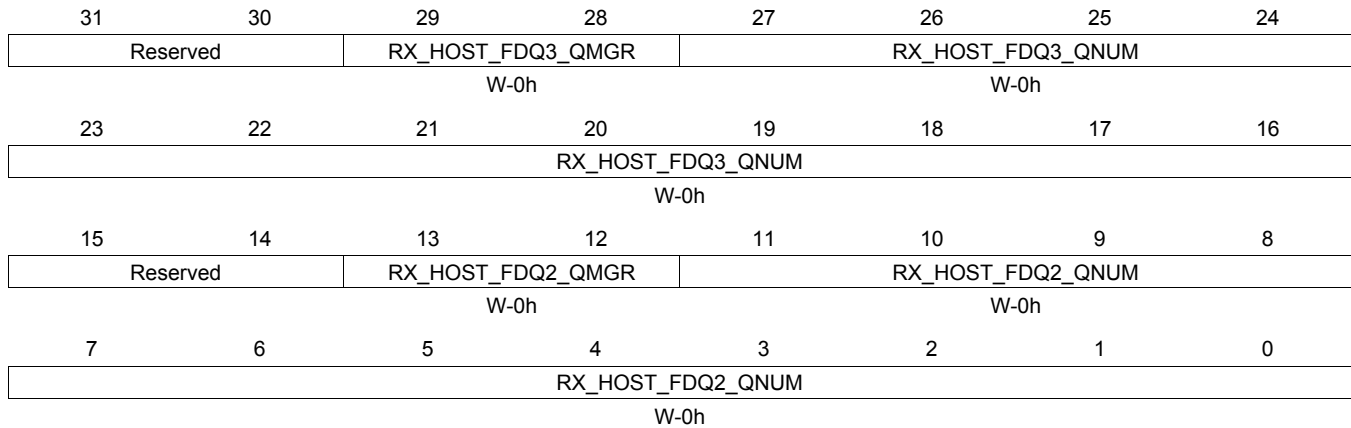
Table 16-265. RXHPCRA24 Register Field Descriptions

Bit	Field	Type	Reset	Description
29-28	RX_HOST_FDQ1_QMGR	W	0h	This field specifies which Buffer Manager should be used for the second Rx buffer in a host type packet.
27-16	RX_HOST_FDQ1_QNUM	W	0h	This field specifies which Free Descriptor / Buffer Pool should be used for the 2nd Rx buffer in a host type packet
13-12	RX_HOST_FDQ0_QMGR	W	0h	This field specifies which Buffer Manager should be used for the second Rx buffer in a host type packet.
11-0	RX_HOST_FDQ0_QNUM	W	0h	This field specifies which Free Descriptor / Buffer Pool should be used for the 1st Rx buffer in a host type packet Table 100 -Rx Channel N Host Packet Configuration Registers A

16.5.5.103 RXHPCRB24 Register (offset = B10h) [reset = 0h]

RXHPCRB24 is shown in [Figure 16-254](#) and described in [Table 16-266](#).

Figure 16-254. RXHPCRB24 Register



LEGEND: R/W = Read/Write; R = Read only; W1toCl = Write 1 to clear bit; -n = value after reset

Table 16-266. RXHPCRB24 Register Field Descriptions

Bit	Field	Type	Reset	Description
29-28	RX_HOST_FDQ3_QMGR	W	0h	This field specifies which Manager should be used for the 4th or later Rx buffers in a host type packet
27-16	RX_HOST_FDQ3_QNUM	W	0h	This field specifies which Free Descriptor Queue should be used for the 4th or later Rx buffers in a host type packet
13-12	RX_HOST_FDQ2_QMGR	W	0h	This field specifies which Buffer Manager should be used for the 3rd Rx buffer in a host type packet
11-0	RX_HOST_FDQ2_QNUM	W	0h	This field specifies which Free Descriptor / Buffer Pool should be used for the 3rd Rx buffer in a host type packet Table 101 -Rx Channel N Host Packet Configuration Registers B

16.5.5.104 TXGCR25 Register (offset = B20h) [reset = 0h]

 TXGCR25 is shown in [Figure 16-255](#) and described in [Table 16-267](#).

Figure 16-255. TXGCR25 Register

31	30	29	28	27	26	25	24
TX_ENABLE		TX_TEARDOWN		Reserved			
R/W-0h		R/W-0h					
23	22	21	20	19	18	17	16
Reserved							
15	14	13	12	11	10	9	8
Reserved		TX_DEFAULT_QMGR			TX_DEFAULT_QNUM		
W-0h				W-0h			
7	6	5	4	3	2	1	0
TX_DEFAULT_QNUM							
W-0h							

LEGEND: R/W = Read/Write; R = Read only; W1toCl = Write 1 to clear bit; -n = value after reset

Table 16-267. TXGCR25 Register Field Descriptions

Bit	Field	Type	Reset	Description
31	TX_ENABLE	R/W	0h	This field enables or disables the channel 0 = channel is disabled 1 = channel is enabled This field will be cleared after a channel teardown is complete.
30	TX_TEARDOWN	R/W	0h	Setting this bit will request the channel to be torn down. This field will remain set after a channel teardown is complete.
13-12	TX_DEFAULT_QMGR	W	0h	This field controls the default queue manager number that will be used to queue teardown descriptors back to the host.
11-0	TX_DEFAULT_QNUM	W	0h	This field controls the default queue number within the selected queue manager onto which teardown descriptors will be queued back to the host. Table 98 -Tx Channel N Global Configuration Registers

16.5.5.105 RXGCR25 Register (offset = B28h) [reset = 0h]

RXGCR25 is shown in [Figure 16-256](#) and described in [Table 16-268](#).

Figure 16-256. RXGCR25 Register

31	30	29	28	27	26	25	24
RX_ENABLE	RX_TEARDOWN	RX_PAUSE	Reserved			RX_ERROR_HANDLING	
R/W-0h	R/W-0h	R/W-0h				W-0h	
23	22	21	20	19	18	17	16
RX_SOP_OFFSET							
W-0h							
15	14	13	12	11	10	9	8
RX_DEFAULT_DESC_TYPE		RX_DEFAULT_RQ_QMGR		RX_DEFAULT_RQ_QNUM			
W-0h		W-0h		W-0h			
7	6	5	4	3	2	1	0
RX_DEFAULT_RQ_QNUM							
W-0h							

LEGEND: R/W = Read/Write; R = Read only; W1toCl = Write 1 to clear bit; -n = value after reset

Table 16-268. RXGCR25 Register Field Descriptions

Bit	Field	Type	Reset	Description
31	RX_ENABLE	R/W	0h	This field enables or disables the channel 0 = channel is disabled 1 = channel is enabled This field will be cleared after a channel teardown is complete.
30	RX_TEARDOWN	R/W	0h	This field indicates whether or not an Rx teardown operation is complete. This field should be cleared when a channel is initialized. This field will be set after a channel teardown is complete.
29	RX_PAUSE	R/W	0h	Setting this bit causes the CPPI DMA to be suspended for rx channels. If a pause is being requested and the channel is not in a packet then drop the credit.
24	RX_ERROR_HANDLING	W	0h	This bit controls the error handling mode for the channel and is only used when channel errors (i.e. descriptor or buffer starvation occurs): 0 = Starvation errors result in dropping packet and reclaiming any used descriptor or buffer resources back to the original queues/pools they were allocated to 1 = Starvation errors result in subsequent re-try of the descriptor allocation operation. In this mode, the DMA will return to the IDLE state without saving it's internal operational state back to the internal state RAM and without issuing an advance operation on the FIFO interface. This results in the DMA re-initiating the FIFO block transfer at a later time with the intention that additional free buffers and/or descriptors will have been added. Regardless of the value of this bit, the DMA will assert the <code>cdma_rx_sof_overrun</code> (for SOP) or <code>cdma_rx_mof_overrun</code> (for non-SOP) when
23-16	RX_SOP_OFFSET	W	0h	This field specifies the number of bytes that are to be skipped in the SOP buffer before beginning to write the payload. This value must be less than the minimum size of a buffer in the system. Valid values are 0 - 255 bytes.

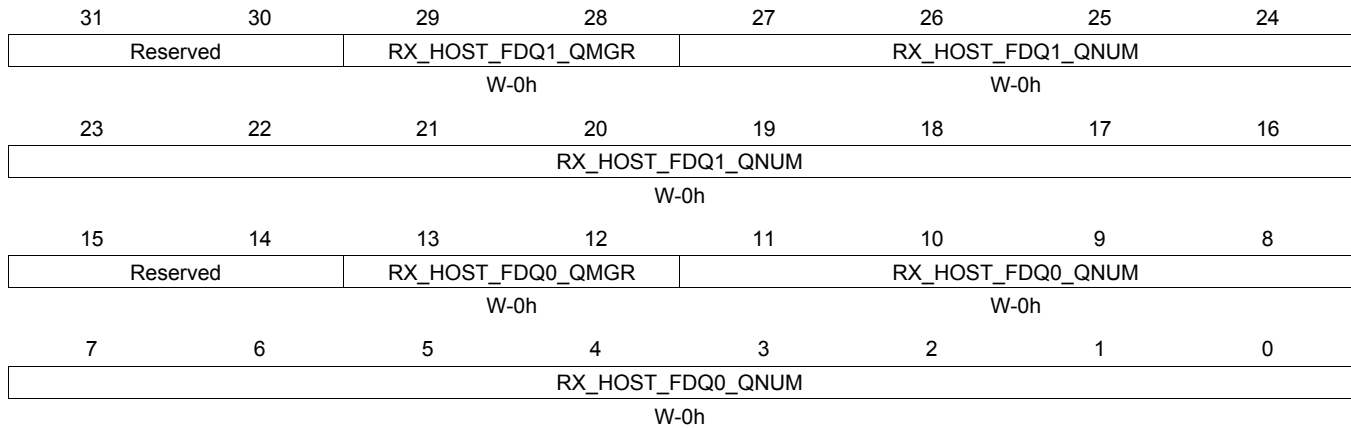
Table 16-268. RXGCR25 Register Field Descriptions (continued)

Bit	Field	Type	Reset	Description
15-14	RX_DEFAULT_DESC_TYPE	W	0h	This field indicates the default descriptor type to use: 0 = Reserved 1 = Host 2 = Reserved 3 = Reserved The actual descriptor type that will be used for reception can be overridden by information provided in the CPPI FIFO data block.
13-12	RX_DEFAULT_RQ_QMGR	W	0h	This field indicates the default receive queue manager that this channel should use. The actual receive queue manager index can be overridden by information provided in the CPPI FIFO data block.
11-0	RX_DEFAULT_RQ_QUEUE	W	0h	This field indicates the default receive queue that this channel should use. The actual receive queue that will be used for reception can be overridden by information provided in the CPPI FIFO data block. Table 99 -Rx Channel N Global Configuration Registers

16.5.5.106 RXHPCRA25 Register (offset = B2Ch) [reset = 0h]

RXHPCRA25 is shown in [Figure 16-257](#) and described in [Table 16-269](#).

Figure 16-257. RXHPCRA25 Register



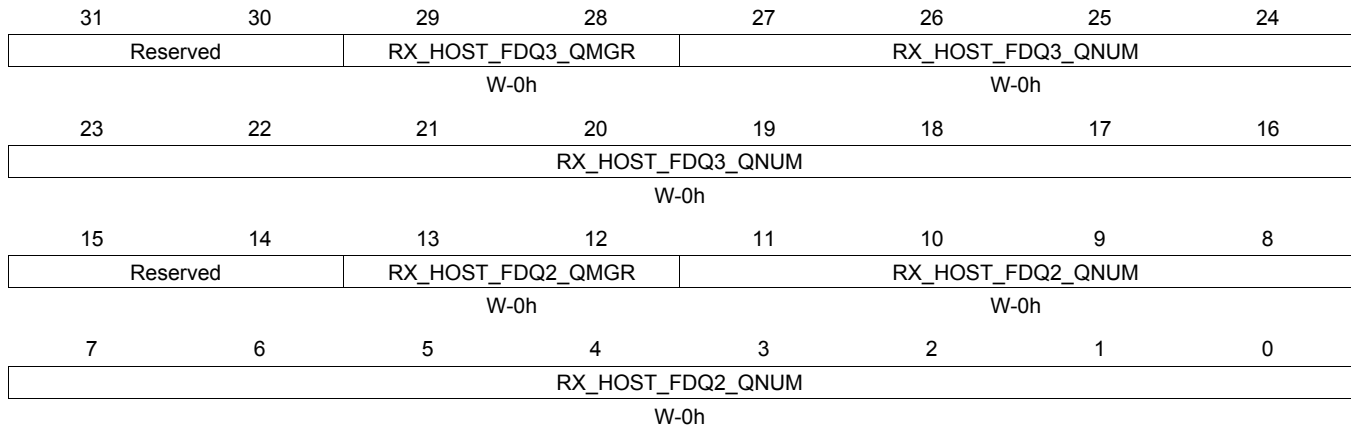
LEGEND: R/W = Read/Write; R = Read only; W1toCl = Write 1 to clear bit; -n = value after reset

Table 16-269. RXHPCRA25 Register Field Descriptions

Bit	Field	Type	Reset	Description
29-28	RX_HOST_FDQ1_QMGR	W	0h	This field specifies which Buffer Manager should be used for the second Rx buffer in a host type packet.
27-16	RX_HOST_FDQ1_QNUM	W	0h	This field specifies which Free Descriptor / Buffer Pool should be used for the 2nd Rx buffer in a host type packet
13-12	RX_HOST_FDQ0_QMGR	W	0h	This field specifies which Buffer Manager should be used for the second Rx buffer in a host type packet.
11-0	RX_HOST_FDQ0_QNUM	W	0h	This field specifies which Free Descriptor / Buffer Pool should be used for the 1st Rx buffer in a host type packet Table 100 -Rx Channel N Host Packet Configuration Registers A

16.5.5.107 RXHPCRB25 Register (offset = B30h) [reset = 0h]

 RXHPCRB25 is shown in [Figure 16-258](#) and described in [Table 16-270](#).

Figure 16-258. RXHPCRB25 Register


LEGEND: R/W = Read/Write; R = Read only; W1toCl = Write 1 to clear bit; -n = value after reset

Table 16-270. RXHPCRB25 Register Field Descriptions

Bit	Field	Type	Reset	Description
29-28	RX_HOST_FDQ3_QMGR	W	0h	This field specifies which Manager should be used for the 4th or later Rx buffers in a host type packet
27-16	RX_HOST_FDQ3_QNUM	W	0h	This field specifies which Free Descriptor Queue should be used for the 4th or later Rx buffers in a host type packet
13-12	RX_HOST_FDQ2_QMGR	W	0h	This field specifies which Buffer Manager should be used for the 3rd Rx buffer in a host type packet
11-0	RX_HOST_FDQ2_QNUM	W	0h	This field specifies which Free Descriptor / Buffer Pool should be used for the 3rd Rx buffer in a host type packet Table 101 -Rx Channel N Host Packet Configuration Registers B

16.5.5.108 TXGCR26 Register (offset = B40h) [reset = 0h]

TXGCR26 is shown in [Figure 16-259](#) and described in [Table 16-271](#).

Figure 16-259. TXGCR26 Register

31	30	29	28	27	26	25	24
TX_ENABLE	TX_TEARDOWN	Reserved					
R/W-0h	R/W-0h						
23	22	21	20	19	18	17	16
Reserved							
15	14	13	12	11	10	9	8
Reserved		TX_DEFAULT_QMGR			TX_DEFAULT_QNUM		
W-0h				W-0h			
7	6	5	4	3	2	1	0
TX_DEFAULT_QNUM							
W-0h							

LEGEND: R/W = Read/Write; R = Read only; W1toCl = Write 1 to clear bit; -n = value after reset

Table 16-271. TXGCR26 Register Field Descriptions

Bit	Field	Type	Reset	Description
31	TX_ENABLE	R/W	0h	This field enables or disables the channel 0 = channel is disabled 1 = channel is enabled This field will be cleared after a channel teardown is complete.
30	TX_TEARDOWN	R/W	0h	Setting this bit will request the channel to be torn down. This field will remain set after a channel teardown is complete.
13-12	TX_DEFAULT_QMGR	W	0h	This field controls the default queue manager number that will be used to queue teardown descriptors back to the host.
11-0	TX_DEFAULT_QNUM	W	0h	This field controls the default queue number within the selected queue manager onto which teardown descriptors will be queued back to the host. Table 98 -Tx Channel N Global Configuration Registers

16.5.5.109 RXGCR26 Register (offset = B48h) [reset = 0h]

 RXGCR26 is shown in [Figure 16-260](#) and described in [Table 16-272](#).

Figure 16-260. RXGCR26 Register

31	30	29	28	27	26	25	24
RX_ENABLE	RX_TEARDOWN	RX_PAUSE	Reserved			RX_ERROR_HANDLING	
R/W-0h	R/W-0h	R/W-0h				W-0h	
23	22	21	20	19	18	17	16
RX_SOP_OFFSET							
W-0h							
15	14	13	12	11	10	9	8
RX_DEFAULT_DESC_TYPE		RX_DEFAULT_RQ_QMGR		RX_DEFAULT_RQ_QNUM			
W-0h		W-0h		W-0h			
7	6	5	4	3	2	1	0
RX_DEFAULT_RQ_QNUM							
W-0h							

LEGEND: R/W = Read/Write; R = Read only; W1toCl = Write 1 to clear bit; -n = value after reset

Table 16-272. RXGCR26 Register Field Descriptions

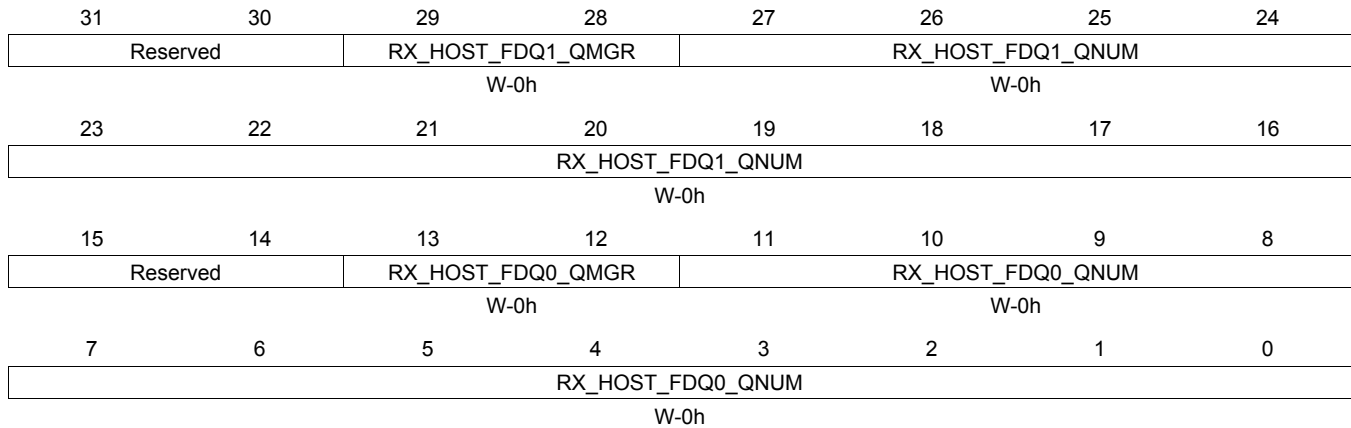
Bit	Field	Type	Reset	Description
31	RX_ENABLE	R/W	0h	This field enables or disables the channel 0 = channel is disabled 1 = channel is enabled This field will be cleared after a channel teardown is complete.
30	RX_TEARDOWN	R/W	0h	This field indicates whether or not an Rx teardown operation is complete. This field should be cleared when a channel is initialized. This field will be set after a channel teardown is complete.
29	RX_PAUSE	R/W	0h	Setting this bit causes the CPPI DMA to be suspended for rx channels. If a pause is being requested and the channel is not in a packet then drop the credit.
24	RX_ERROR_HANDLING	W	0h	This bit controls the error handling mode for the channel and is only used when channel errors (i.e. descriptor or buffer starvation occurs): 0 = Starvation errors result in dropping packet and reclaiming any used descriptor or buffer resources back to the original queues/pools they were allocated to 1 = Starvation errors result in subsequent re-try of the descriptor allocation operation. In this mode, the DMA will return to the IDLE state without saving it's internal operational state back to the internal state RAM and without issuing an advance operation on the FIFO interface. This results in the DMA re-initiating the FIFO block transfer at a later time with the intention that additional free buffers and/or descriptors will have been added. Regardless of the value of this bit, the DMA will assert the <code>cdma_rx_sof_overrun</code> (for SOP) or <code>cdma_rx_mof_overrun</code> (for non-SOP) when
23-16	RX_SOP_OFFSET	W	0h	This field specifies the number of bytes that are to be skipped in the SOP buffer before beginning to write the payload. This value must be less than the minimum size of a buffer in the system. Valid values are 0 - 255 bytes.

Table 16-272. RXGCR26 Register Field Descriptions (continued)

Bit	Field	Type	Reset	Description
15-14	RX_DEFAULT_DESC_TY PE	W	0h	This field indicates the default descriptor type to use: 0 = Reserved 1 = Host 2 = Reserved 3 = Reserved The actual descriptor type that will be used for reception can be overridden by information provided in the CPPI FIFO data block.
13-12	RX_DEFAULT_RQ_QMG R	W	0h	This field indicates the default receive queue manager that this channel should use. The actual receive queue manager index can be overridden by information provided in the CPPI FIFO data block.
11-0	RX_DEFAULT_RQ_QNU M	W	0h	This field indicates the default receive queue that this channel should use. The actual receive queue that will be used for reception can be overridden by information provided in the CPPI FIFO data block. Table 99 -Rx Channel N Global Configuration Registers

16.5.5.110 RXHPCRA26 Register (offset = B4Ch) [reset = 0h]

 RXHPCRA26 is shown in [Figure 16-261](#) and described in [Table 16-273](#).

Figure 16-261. RXHPCRA26 Register


LEGEND: R/W = Read/Write; R = Read only; W1toCl = Write 1 to clear bit; -n = value after reset

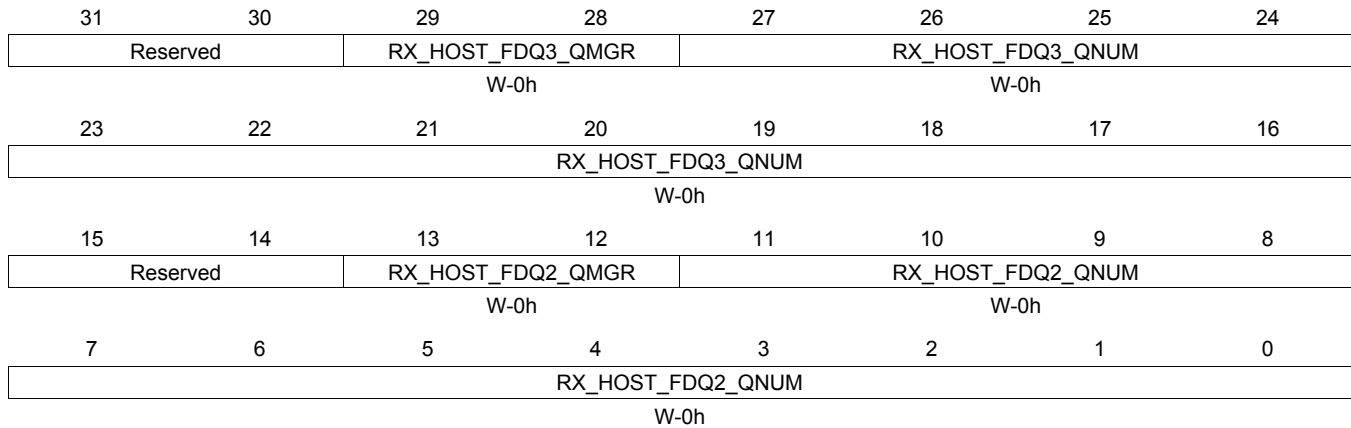
Table 16-273. RXHPCRA26 Register Field Descriptions

Bit	Field	Type	Reset	Description
29-28	RX_HOST_FDQ1_QMGR	W	0h	This field specifies which Buffer Manager should be used for the second Rx buffer in a host type packet.
27-16	RX_HOST_FDQ1_QNUM	W	0h	This field specifies which Free Descriptor / Buffer Pool should be used for the 2nd Rx buffer in a host type packet
13-12	RX_HOST_FDQ0_QMGR	W	0h	This field specifies which Buffer Manager should be used for the second Rx buffer in a host type packet.
11-0	RX_HOST_FDQ0_QNUM	W	0h	This field specifies which Free Descriptor / Buffer Pool should be used for the 1st Rx buffer in a host type packet Table 100 -Rx Channel N Host Packet Configuration Registers A

16.5.5.111 RXHPCRB26 Register (offset = B50h) [reset = 0h]

RXHPCRB26 is shown in [Figure 16-262](#) and described in [Table 16-274](#).

Figure 16-262. RXHPCRB26 Register



LEGEND: R/W = Read/Write; R = Read only; W1toCl = Write 1 to clear bit; -n = value after reset

Table 16-274. RXHPCRB26 Register Field Descriptions

Bit	Field	Type	Reset	Description
29-28	RX_HOST_FDQ3_QMGR	W	0h	This field specifies which Manager should be used for the 4th or later Rx buffers in a host type packet
27-16	RX_HOST_FDQ3_QNUM	W	0h	This field specifies which Free Descriptor Queue should be used for the 4th or later Rx buffers in a host type packet
13-12	RX_HOST_FDQ2_QMGR	W	0h	This field specifies which Buffer Manager should be used for the 3rd Rx buffer in a host type packet
11-0	RX_HOST_FDQ2_QNUM	W	0h	This field specifies which Free Descriptor / Buffer Pool should be used for the 3rd Rx buffer in a host type packet Table 101 -Rx Channel N Host Packet Configuration Registers B

16.5.5.112 TXGCR27 Register (offset = B60h) [reset = 0h]

 TXGCR27 is shown in [Figure 16-263](#) and described in [Table 16-275](#).

Figure 16-263. TXGCR27 Register

	31	30	29	28	27	26	25	24
	TX_ENABLE	TX_TEARDOWN	Reserved					
	R/W-0h	R/W-0h						
	23	22	21	20	19	18	17	16
	Reserved							
	15	14	13	12	11	10	9	8
	Reserved		TX_DEFAULT_QMGR			TX_DEFAULT_QNUM		
	W-0h			W-0h				
	7	6	5	4	3	2	1	0
	TX_DEFAULT_QNUM							
	W-0h							

LEGEND: R/W = Read/Write; R = Read only; W1toCl = Write 1 to clear bit; -n = value after reset

Table 16-275. TXGCR27 Register Field Descriptions

Bit	Field	Type	Reset	Description
31	TX_ENABLE	R/W	0h	This field enables or disables the channel 0 = channel is disabled 1 = channel is enabled This field will be cleared after a channel teardown is complete.
30	TX_TEARDOWN	R/W	0h	Setting this bit will request the channel to be torn down. This field will remain set after a channel teardown is complete.
13-12	TX_DEFAULT_QMGR	W	0h	This field controls the default queue manager number that will be used to queue teardown descriptors back to the host.
11-0	TX_DEFAULT_QNUM	W	0h	This field controls the default queue number within the selected queue manager onto which teardown descriptors will be queued back to the host. Table 98 -Tx Channel N Global Configuration Registers

16.5.5.113 RXGCR27 Register (offset = B68h) [reset = 0h]

RXGCR27 is shown in [Figure 16-264](#) and described in [Table 16-276](#).

Figure 16-264. RXGCR27 Register

31	30	29	28	27	26	25	24
RX_ENABLE	RX_TEARDOWN	RX_PAUSE	Reserved			RX_ERROR_HANDLING	
R/W-0h	R/W-0h	R/W-0h				W-0h	
23	22	21	20	19	18	17	16
RX_SOP_OFFSET							
W-0h							
15	14	13	12	11	10	9	8
RX_DEFAULT_DESC_TYPE		RX_DEFAULT_RQ_QMGR		RX_DEFAULT_RQ_QNUM			
W-0h		W-0h		W-0h			
7	6	5	4	3	2	1	0
RX_DEFAULT_RQ_QNUM							
W-0h							

LEGEND: R/W = Read/Write; R = Read only; W1toCl = Write 1 to clear bit; -n = value after reset

Table 16-276. RXGCR27 Register Field Descriptions

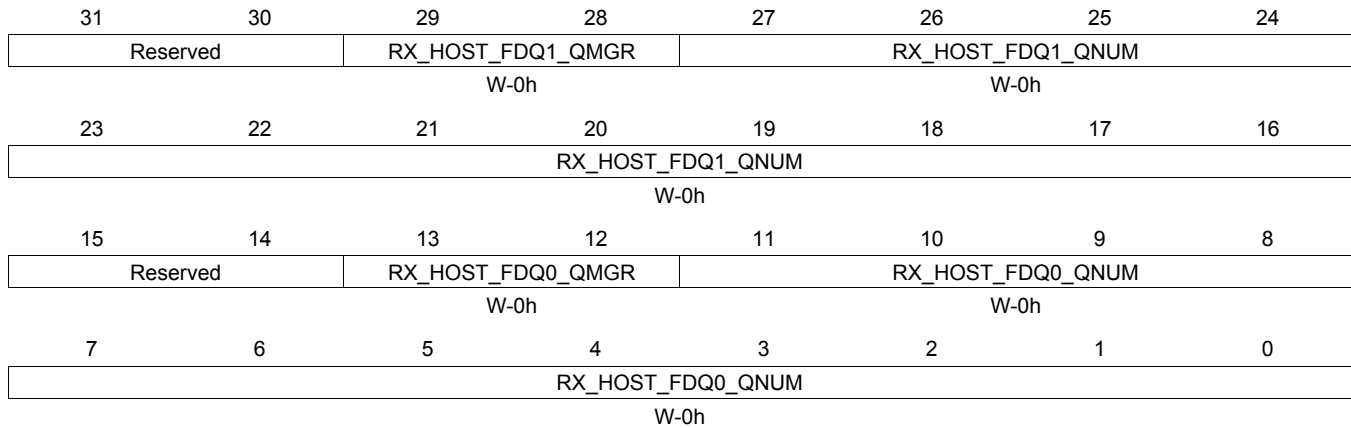
Bit	Field	Type	Reset	Description
31	RX_ENABLE	R/W	0h	This field enables or disables the channel 0 = channel is disabled 1 = channel is enabled This field will be cleared after a channel teardown is complete.
30	RX_TEARDOWN	R/W	0h	This field indicates whether or not an Rx teardown operation is complete. This field should be cleared when a channel is initialized. This field will be set after a channel teardown is complete.
29	RX_PAUSE	R/W	0h	Setting this bit causes the CPPI DMA to be suspended for rx channels. If a pause is being requested and the channel is not in a packet then drop the credit.
24	RX_ERROR_HANDLING	W	0h	This bit controls the error handling mode for the channel and is only used when channel errors (i.e. descriptor or buffer starvation occurs): 0 = Starvation errors result in dropping packet and reclaiming any used descriptor or buffer resources back to the original queues/pools they were allocated to 1 = Starvation errors result in subsequent re-try of the descriptor allocation operation. In this mode, the DMA will return to the IDLE state without saving it's internal operational state back to the internal state RAM and without issuing an advance operation on the FIFO interface. This results in the DMA re-initiating the FIFO block transfer at a later time with the intention that additional free buffers and/or descriptors will have been added. Regardless of the value of this bit, the DMA will assert the <code>cdma_rx_sof_overrun</code> (for SOP) or <code>cdma_rx_mof_overrun</code> (for non-SOP) when
23-16	RX_SOP_OFFSET	W	0h	This field specifies the number of bytes that are to be skipped in the SOP buffer before beginning to write the payload. This value must be less than the minimum size of a buffer in the system. Valid values are 0 - 255 bytes.

Table 16-276. RXGCR27 Register Field Descriptions (continued)

Bit	Field	Type	Reset	Description
15-14	RX_DEFAULT_DESC_TY PE	W	0h	This field indicates the default descriptor type to use: 0 = Reserved 1 = Host 2 = Reserved 3 = Reserved The actual descriptor type that will be used for reception can be overridden by information provided in the CPPI FIFO data block.
13-12	RX_DEFAULT_RQ_QMG R	W	0h	This field indicates the default receive queue manager that this channel should use. The actual receive queue manager index can be overridden by information provided in the CPPI FIFO data block.
11-0	RX_DEFAULT_RQ_QNU M	W	0h	This field indicates the default receive queue that this channel should use. The actual receive queue that will be used for reception can be overridden by information provided in the CPPI FIFO data block. Table 99 -Rx Channel N Global Configuration Registers

16.5.5.114 RXHPCRA27 Register (offset = B6Ch) [reset = 0h]

RXHPCRA27 is shown in [Figure 16-265](#) and described in [Table 16-277](#).

Figure 16-265. RXHPCRA27 Register


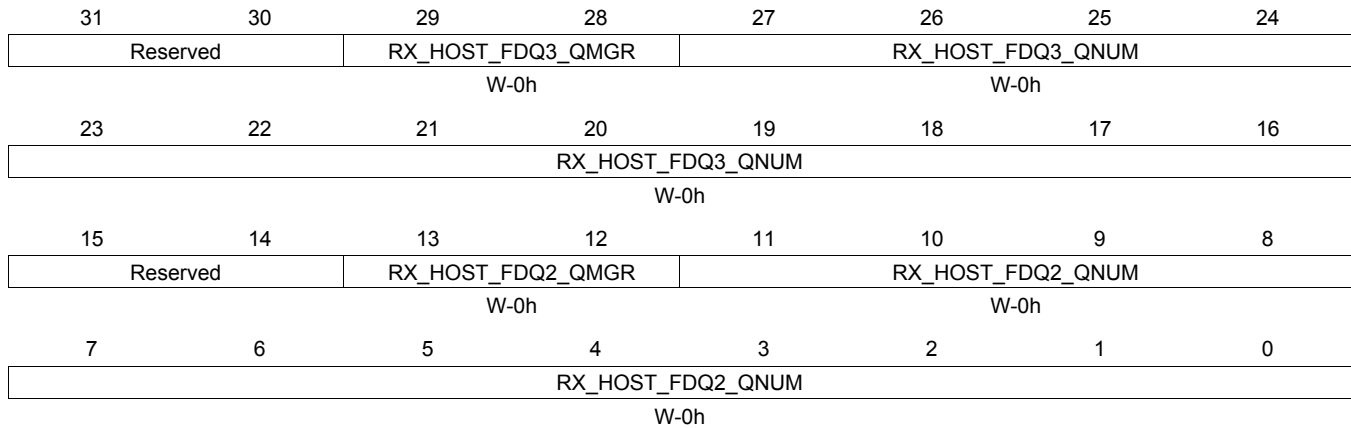
LEGEND: R/W = Read/Write; R = Read only; W1toCl = Write 1 to clear bit; -n = value after reset

Table 16-277. RXHPCRA27 Register Field Descriptions

Bit	Field	Type	Reset	Description
29-28	RX_HOST_FDQ1_QMGR	W	0h	This field specifies which Buffer Manager should be used for the second Rx buffer in a host type packet.
27-16	RX_HOST_FDQ1_QNUM	W	0h	This field specifies which Free Descriptor / Buffer Pool should be used for the 2nd Rx buffer in a host type packet
13-12	RX_HOST_FDQ0_QMGR	W	0h	This field specifies which Buffer Manager should be used for the second Rx buffer in a host type packet.
11-0	RX_HOST_FDQ0_QNUM	W	0h	This field specifies which Free Descriptor / Buffer Pool should be used for the 1st Rx buffer in a host type packet Table 100 -Rx Channel N Host Packet Configuration Registers A

16.5.5.115 RXHPCRB27 Register (offset = B70h) [reset = 0h]

 RXHPCRB27 is shown in [Figure 16-266](#) and described in [Table 16-278](#).

Figure 16-266. RXHPCRB27 Register


LEGEND: R/W = Read/Write; R = Read only; W1toCl = Write 1 to clear bit; -n = value after reset

Table 16-278. RXHPCRB27 Register Field Descriptions

Bit	Field	Type	Reset	Description
29-28	RX_HOST_FDQ3_QMGR	W	0h	This field specifies which Manager should be used for the 4th or later Rx buffers in a host type packet
27-16	RX_HOST_FDQ3_QNUM	W	0h	This field specifies which Free Descriptor Queue should be used for the 4th or later Rx buffers in a host type packet
13-12	RX_HOST_FDQ2_QMGR	W	0h	This field specifies which Buffer Manager should be used for the 3rd Rx buffer in a host type packet
11-0	RX_HOST_FDQ2_QNUM	W	0h	This field specifies which Free Descriptor / Buffer Pool should be used for the 3rd Rx buffer in a host type packet Table 101 -Rx Channel N Host Packet Configuration Registers B

16.5.5.116 TXGCR28 Register (offset = B80h) [reset = 0h]

TXGCR28 is shown in [Figure 16-267](#) and described in [Table 16-279](#).

Figure 16-267. TXGCR28 Register

31	30	29	28	27	26	25	24
TX_ENABLE	TX_TEARDOWN	Reserved					
R/W-0h	R/W-0h						
23	22	21	20	19	18	17	16
Reserved							
15	14	13	12	11	10	9	8
Reserved		TX_DEFAULT_QMGR			TX_DEFAULT_QNUM		
W-0h				W-0h			
7	6	5	4	3	2	1	0
TX_DEFAULT_QNUM							
W-0h							

LEGEND: R/W = Read/Write; R = Read only; W1toCl = Write 1 to clear bit; -n = value after reset

Table 16-279. TXGCR28 Register Field Descriptions

Bit	Field	Type	Reset	Description
31	TX_ENABLE	R/W	0h	This field enables or disables the channel 0 = channel is disabled 1 = channel is enabled This field will be cleared after a channel teardown is complete.
30	TX_TEARDOWN	R/W	0h	Setting this bit will request the channel to be torn down. This field will remain set after a channel teardown is complete.
13-12	TX_DEFAULT_QMGR	W	0h	This field controls the default queue manager number that will be used to queue teardown descriptors back to the host.
11-0	TX_DEFAULT_QNUM	W	0h	This field controls the default queue number within the selected queue manager onto which teardown descriptors will be queued back to the host. Table 98 -Tx Channel N Global Configuration Registers

16.5.5.117 RXGCR28 Register (offset = B88h) [reset = 0h]

 RXGCR28 is shown in [Figure 16-268](#) and described in [Table 16-280](#).

Figure 16-268. RXGCR28 Register

31	30	29	28	27	26	25	24
RX_ENABLE	RX_TEARDOWN	RX_PAUSE	Reserved			RX_ERROR_HANDLING	
R/W-0h	R/W-0h	R/W-0h				W-0h	
23	22	21	20	19	18	17	16
RX_SOP_OFFSET							
W-0h							
15	14	13	12	11	10	9	8
RX_DEFAULT_DESC_TYPE		RX_DEFAULT_RQ_QMGR		RX_DEFAULT_RQ_QNUM			
W-0h		W-0h		W-0h			
7	6	5	4	3	2	1	0
RX_DEFAULT_RQ_QNUM							
W-0h							

LEGEND: R/W = Read/Write; R = Read only; W1toCl = Write 1 to clear bit; -n = value after reset

Table 16-280. RXGCR28 Register Field Descriptions

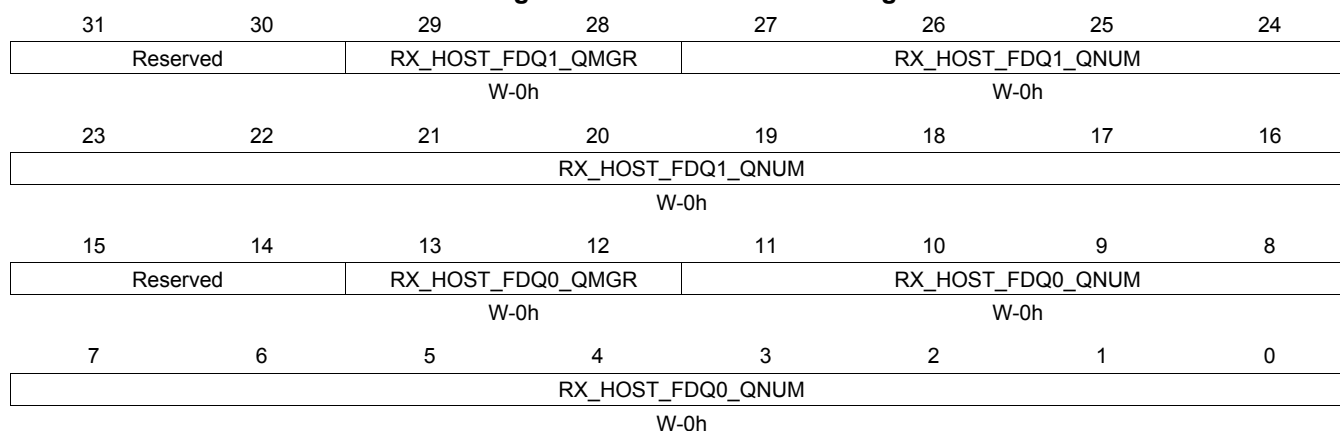
Bit	Field	Type	Reset	Description
31	RX_ENABLE	R/W	0h	This field enables or disables the channel 0 = channel is disabled 1 = channel is enabled This field will be cleared after a channel teardown is complete.
30	RX_TEARDOWN	R/W	0h	This field indicates whether or not an Rx teardown operation is complete. This field should be cleared when a channel is initialized. This field will be set after a channel teardown is complete.
29	RX_PAUSE	R/W	0h	Setting this bit causes the CPPI DMA to be suspended for rx channels. If a pause is being requested and the channel is not in a packet then drop the credit.
24	RX_ERROR_HANDLING	W	0h	This bit controls the error handling mode for the channel and is only used when channel errors (i.e. descriptor or buffer starvation occurs): 0 = Starvation errors result in dropping packet and reclaiming any used descriptor or buffer resources back to the original queues/pools they were allocated to 1 = Starvation errors result in subsequent re-try of the descriptor allocation operation. In this mode, the DMA will return to the IDLE state without saving it's internal operational state back to the internal state RAM and without issuing an advance operation on the FIFO interface. This results in the DMA re-initiating the FIFO block transfer at a later time with the intention that additional free buffers and/or descriptors will have been added. Regardless of the value of this bit, the DMA will assert the <code>cdma_rx_sof_overrun</code> (for SOP) or <code>cdma_rx_mof_overrun</code> (for non-SOP) when
23-16	RX_SOP_OFFSET	W	0h	This field specifies the number of bytes that are to be skipped in the SOP buffer before beginning to write the payload. This value must be less than the minimum size of a buffer in the system. Valid values are 0 - 255 bytes.

Table 16-280. RXGCR28 Register Field Descriptions (continued)

Bit	Field	Type	Reset	Description
15-14	RX_DEFAULT_DESC_TY PE	W	0h	This field indicates the default descriptor type to use: 0 = Reserved 1 = Host 2 = Reserved 3 = Reserved The actual descriptor type that will be used for reception can be overridden by information provided in the CPPI FIFO data block.
13-12	RX_DEFAULT_RQ_QMG R	W	0h	This field indicates the default receive queue manager that this channel should use. The actual receive queue manager index can be overridden by information provided in the CPPI FIFO data block.
11-0	RX_DEFAULT_RQ_QNU M	W	0h	This field indicates the default receive queue that this channel should use. The actual receive queue that will be used for reception can be overridden by information provided in the CPPI FIFO data block. Table 99 -Rx Channel N Global Configuration Registers

16.5.5.118 RXHPCRA28 Register (offset = B8Ch) [reset = 0h]

 RXHPCRA28 is shown in [Figure 16-269](#) and described in [Table 16-281](#).

Figure 16-269. RXHPCRA28 Register


LEGEND: R/W = Read/Write; R = Read only; W1toCl = Write 1 to clear bit; -n = value after reset

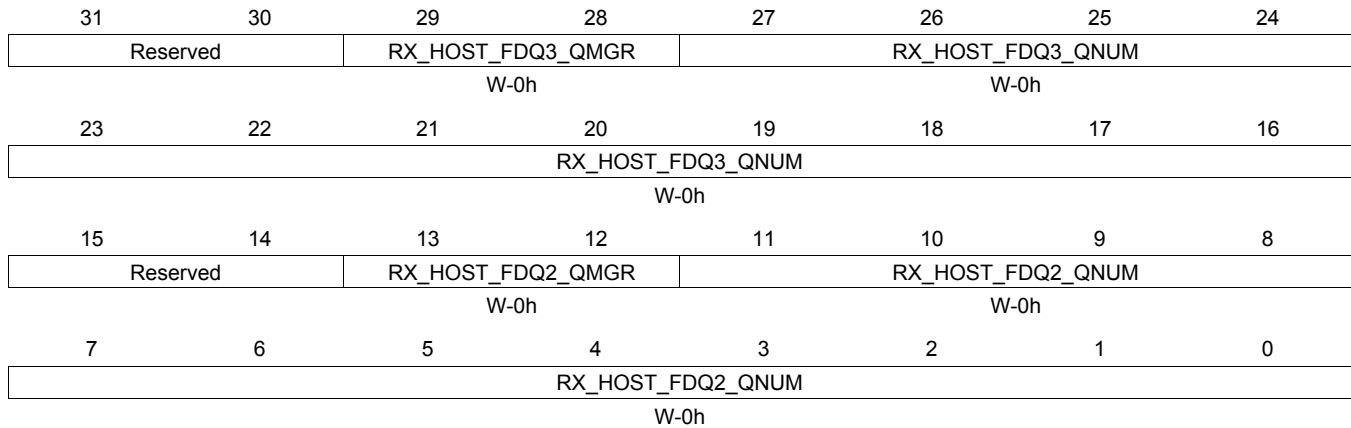
Table 16-281. RXHPCRA28 Register Field Descriptions

Bit	Field	Type	Reset	Description
29-28	RX_HOST_FDQ1_QMGR	W	0h	This field specifies which Buffer Manager should be used for the second Rx buffer in a host type packet.
27-16	RX_HOST_FDQ1_QNUM	W	0h	This field specifies which Free Descriptor / Buffer Pool should be used for the 2nd Rx buffer in a host type packet
13-12	RX_HOST_FDQ0_QMGR	W	0h	This field specifies which Buffer Manager should be used for the second Rx buffer in a host type packet.
11-0	RX_HOST_FDQ0_QNUM	W	0h	This field specifies which Free Descriptor / Buffer Pool should be used for the 1st Rx buffer in a host type packet Table 100 -Rx Channel N Host Packet Configuration Registers A

16.5.5.119 RXHPCRB28 Register (offset = B90h) [reset = 0h]

RXHPCRB28 is shown in [Figure 16-270](#) and described in [Table 16-282](#).

Figure 16-270. RXHPCRB28 Register



LEGEND: R/W = Read/Write; R = Read only; W1toCl = Write 1 to clear bit; -n = value after reset

Table 16-282. RXHPCRB28 Register Field Descriptions

Bit	Field	Type	Reset	Description
29-28	RX_HOST_FDQ3_QMGR	W	0h	This field specifies which Manager should be used for the 4th or later Rx buffers in a host type packet
27-16	RX_HOST_FDQ3_QNUM	W	0h	This field specifies which Free Descriptor Queue should be used for the 4th or later Rx buffers in a host type packet
13-12	RX_HOST_FDQ2_QMGR	W	0h	This field specifies which Buffer Manager should be used for the 3rd Rx buffer in a host type packet
11-0	RX_HOST_FDQ2_QNUM	W	0h	This field specifies which Free Descriptor / Buffer Pool should be used for the 3rd Rx buffer in a host type packet Table 101 -Rx Channel N Host Packet Configuration Registers B

16.5.5.120 TXGCR29 Register (offset = BA0h) [reset = 0h]

 TXGCR29 is shown in [Figure 16-271](#) and described in [Table 16-283](#).

Figure 16-271. TXGCR29 Register

31	30	29	28	27	26	25	24
TX_ENABLE		TX_TEARDOWN		Reserved			
R/W-0h		R/W-0h					
23	22	21	20	19	18	17	16
Reserved							
15	14	13	12	11	10	9	8
Reserved		TX_DEFAULT_QMGR			TX_DEFAULT_QNUM		
W-0h				W-0h			
7	6	5	4	3	2	1	0
TX_DEFAULT_QNUM							
W-0h							

LEGEND: R/W = Read/Write; R = Read only; W1toCl = Write 1 to clear bit; -n = value after reset

Table 16-283. TXGCR29 Register Field Descriptions

Bit	Field	Type	Reset	Description
31	TX_ENABLE	R/W	0h	This field enables or disables the channel 0 = channel is disabled 1 = channel is enabled This field will be cleared after a channel teardown is complete.
30	TX_TEARDOWN	R/W	0h	Setting this bit will request the channel to be torn down. This field will remain set after a channel teardown is complete.
13-12	TX_DEFAULT_QMGR	W	0h	This field controls the default queue manager number that will be used to queue teardown descriptors back to the host.
11-0	TX_DEFAULT_QNUM	W	0h	This field controls the default queue number within the selected queue manager onto which teardown descriptors will be queued back to the host. Table 98 -Tx Channel N Global Configuration Registers

16.5.5.121 RXGCR29 Register (offset = BA8h) [reset = 0h]

RXGCR29 is shown in [Figure 16-272](#) and described in [Table 16-284](#).

Figure 16-272. RXGCR29 Register

31	30	29	28	27	26	25	24
RX_ENABLE	RX_TEARDOWN	RX_PAUSE	Reserved			RX_ERROR_HANDLING	
R/W-0h	R/W-0h	R/W-0h				W-0h	
23	22	21	20	19	18	17	16
RX_SOP_OFFSET							
W-0h							
15	14	13	12	11	10	9	8
RX_DEFAULT_DESC_TYPE		RX_DEFAULT_RQ_QMGR		RX_DEFAULT_RQ_QNUM			
W-0h		W-0h		W-0h			
7	6	5	4	3	2	1	0
RX_DEFAULT_RQ_QNUM							
W-0h							

LEGEND: R/W = Read/Write; R = Read only; W1toCl = Write 1 to clear bit; -n = value after reset

Table 16-284. RXGCR29 Register Field Descriptions

Bit	Field	Type	Reset	Description
31	RX_ENABLE	R/W	0h	This field enables or disables the channel 0 = channel is disabled 1 = channel is enabled This field will be cleared after a channel teardown is complete.
30	RX_TEARDOWN	R/W	0h	This field indicates whether or not an Rx teardown operation is complete. This field should be cleared when a channel is initialized. This field will be set after a channel teardown is complete.
29	RX_PAUSE	R/W	0h	Setting this bit causes the CPPI DMA to be suspended for rx channels. If a pause is being requested and the channel is not in a packet then drop the credit.
24	RX_ERROR_HANDLING	W	0h	This bit controls the error handling mode for the channel and is only used when channel errors (i.e. descriptor or buffer starvation occurs): 0 = Starvation errors result in dropping packet and reclaiming any used descriptor or buffer resources back to the original queues/pools they were allocated to 1 = Starvation errors result in subsequent re-try of the descriptor allocation operation. In this mode, the DMA will return to the IDLE state without saving it's internal operational state back to the internal state RAM and without issuing an advance operation on the FIFO interface. This results in the DMA re-initiating the FIFO block transfer at a later time with the intention that additional free buffers and/or descriptors will have been added. Regardless of the value of this bit, the DMA will assert the <code>cdma_rx_sof_overrun</code> (for SOP) or <code>cdma_rx_mof_overrun</code> (for non-SOP) when
23-16	RX_SOP_OFFSET	W	0h	This field specifies the number of bytes that are to be skipped in the SOP buffer before beginning to write the payload. This value must be less than the minimum size of a buffer in the system. Valid values are 0 - 255 bytes.

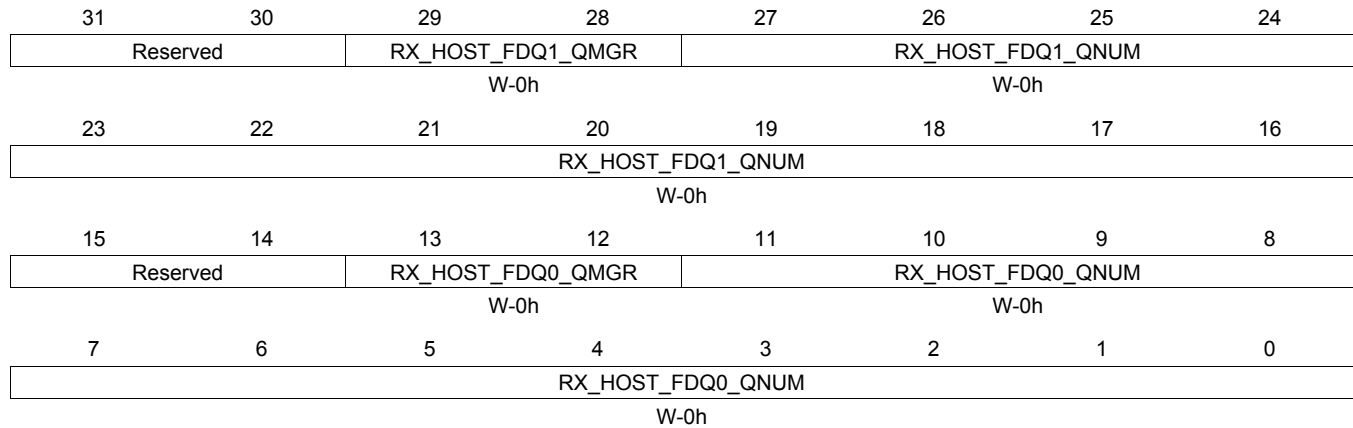
Table 16-284. RXGCR29 Register Field Descriptions (continued)

Bit	Field	Type	Reset	Description
15-14	RX_DEFAULT_DESC_TYPE	W	0h	This field indicates the default descriptor type to use: 0 = Reserved 1 = Host 2 = Reserved 3 = Reserved The actual descriptor type that will be used for reception can be overridden by information provided in the CPPI FIFO data block.
13-12	RX_DEFAULT_RQ_QMGR	W	0h	This field indicates the default receive queue manager that this channel should use. The actual receive queue manager index can be overridden by information provided in the CPPI FIFO data block.
11-0	RX_DEFAULT_RQ_QUEUE	W	0h	This field indicates the default receive queue that this channel should use. The actual receive queue that will be used for reception can be overridden by information provided in the CPPI FIFO data block. Table 99 -Rx Channel N Global Configuration Registers

16.5.5.122 RXHPCRA29 Register (offset = BACH) [reset = 0h]

RXHPCRA29 is shown in [Figure 16-273](#) and described in [Table 16-285](#).

Figure 16-273. RXHPCRA29 Register



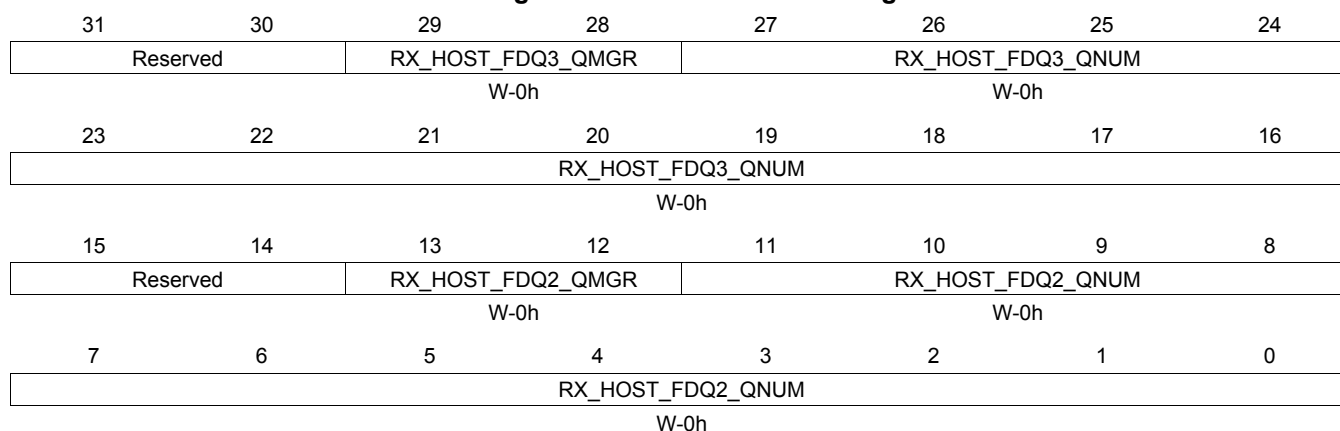
LEGEND: R/W = Read/Write; R = Read only; W1toCl = Write 1 to clear bit; -n = value after reset

Table 16-285. RXHPCRA29 Register Field Descriptions

Bit	Field	Type	Reset	Description
29-28	RX_HOST_FDQ1_QMGR	W	0h	This field specifies which Buffer Manager should be used for the second Rx buffer in a host type packet.
27-16	RX_HOST_FDQ1_QNUM	W	0h	This field specifies which Free Descriptor / Buffer Pool should be used for the 2nd Rx buffer in a host type packet
13-12	RX_HOST_FDQ0_QMGR	W	0h	This field specifies which Buffer Manager should be used for the second Rx buffer in a host type packet.
11-0	RX_HOST_FDQ0_QNUM	W	0h	This field specifies which Free Descriptor / Buffer Pool should be used for the 1st Rx buffer in a host type packet Table 100 -Rx Channel N Host Packet Configuration Registers A

16.5.5.123 RXHPCRB29 Register (offset = BB0h) [reset = 0h]

 RXHPCRB29 is shown in [Figure 16-274](#) and described in [Table 16-286](#).

Figure 16-274. RXHPCRB29 Register


LEGEND: R/W = Read/Write; R = Read only; W1toCl = Write 1 to clear bit; -n = value after reset

Table 16-286. RXHPCRB29 Register Field Descriptions

Bit	Field	Type	Reset	Description
29-28	RX_HOST_FDQ3_QMGR	W	0h	This field specifies which Manager should be used for the 4th or later Rx buffers in a host type packet
27-16	RX_HOST_FDQ3_QNUM	W	0h	This field specifies which Free Descriptor Queue should be used for the 4th or later Rx buffers in a host type packet
13-12	RX_HOST_FDQ2_QMGR	W	0h	This field specifies which Buffer Manager should be used for the 3rd Rx buffer in a host type packet
11-0	RX_HOST_FDQ2_QNUM	W	0h	This field specifies which Free Descriptor / Buffer Pool should be used for the 3rd Rx buffer in a host type packet Table 101 -Rx Channel N Host Packet Configuration Registers B

16.5.6 CPPI_DMA_SCHEDULER Registers

[Table 16-287](#) lists the memory-mapped registers for the CPPI_DMA_SCHEDULER. All register offset addresses not listed in [Table 16-287](#) should be considered as reserved locations and the register contents should not be modified.

Table 16-287. CPPI_DMA_SCHEDULER Registers

Offset	Acronym	Register Name	Section
3000h	DMA_SCHED_CTRL		Section 16.5.6.1
3800h to 38FCh	WORD_0 to WORD_63		Section 16.5.6.2

16.5.6.1 DMA_SCHED_CTRL Register (offset = 3000h) [reset = 0h]

DMA_SCHED_CTRL is shown in [Figure 16-275](#) and described in [Table 16-288](#).

Figure 16-275. DMA_SCHED_CTRL Register

31	30	29	28	27	26	25	24
ENABLE	RESERVED						
R/W-0h				R/W-0h			
23	22	21	20	19	18	17	16
RESERVED							
R/W-0h							
15	14	13	12	11	10	9	8
RESERVED							
R/W-0h							
7	6	5	4	3	2	1	0
LAST_ENTRY							
R/W-0h							

LEGEND: R/W = Read/Write; R = Read only; W1toCl = Write 1 to clear bit; -n = value after reset

Table 16-288. DMA_SCHED_CTRL Register Field Descriptions

Bit	Field	Type	Reset	Description
31	ENABLE	R/W	0h	This is the enable bit for the scheduler and is encoded as follows: 0 = scheduler is disabled and will no longer fetch entries from the scheduler table or pass credits to the DMA controller 1 = scheduler is enabled This bit should only be set after the table has been initialized.
30-8	RESERVED	R/W	0h	
7-0	LAST_ENTRY	R/W	0h	This field indicates the last valid entry in the scheduler table. There are 64 words in the table and there are 4 entries in each word. The table can be programmed with any integer number of entries from 1 to 256. The corresponding encoding for this field is as follows: 0 = 1 entry 1 = 2 entries ... 254 = 255 entries 255 = 256 entries CPPI DMA Scheduler Control Registers

16.5.6.2 WORD_0 to WORD_63 Register (offset = 3800h to 38FCh) [reset = 0h]

 WORD_0 to WORD_63 is shown in [Figure 16-276](#) and described in [Table 16-289](#).

Figure 16-276. WORD_0 to WORD_63 Register

31	30	29	28	27	26	25	24
ENTRY3_RXT X	RESERVED			ENTRY3_CHANNEL			
W-0h	W-			R/W-			
23	22	21	20	19	18	17	16
ENTRY2_RXT X	RESERVED			ENTRY2_CHANNEL			
W-0h	W-			R/W-			
15	14	13	12	11	10	9	8
ENTRY1_RXT X	RESERVED			ENTRY1_CHANNEL			
W-0h	W-			R/W-			
7	6	5	4	3	2	1	0
ENTRY0_RXT X	RESERVED			ENTRY0_CHANNEL			
W-0h	W-			R/W-			

LEGEND: R/W = Read/Write; R = Read only; W1toCl = Write 1 to clear bit; -n = value after reset

Table 16-289. WORD_0 to WORD_63 Register Field Descriptions

Bit	Field	Type	Reset	Description
31	ENTRY3_RXTX	W	0h	This bit indicates if this entry is for a Tx or an Rx channel and is encoded as follows: 0 = Tx Channel 1 = Rx Channel
30-29	RESERVED	W		
28-24	ENTRY3_CHANNEL	R/W		This field indicates the channel number that is to be given an opportunity to transfer data. If this is a Tx entry, the DMA will be presented with a scheduling credit for that exact Tx channel. If this is an Rx entry, the DMA will be presented with a scheduling credit for the Rx FIFO that is associated with this channel. For Rx FIFOs which carry traffic for more than 1 Rx DMA channel, the exact channel number that is given in the Rx credit will actually be the channel number which is currently on the head element of that Rx FIFO, which is not necessarily the channel number given in the scheduler table entry.
23	ENTRY2_RXTX	W	0h	This bit indicates if this entry is for a Tx or an Rx channel and is encoded as follows: 0 = Tx Channel 1 = Rx Channel
22-21	RESERVED	W		
20-16	ENTRY2_CHANNEL	R/W		This field indicates the channel number that is to be given an opportunity to transfer data. If this is a Tx entry, the DMA will be presented with a scheduling credit for that exact Tx channel. If this is an Rx entry, the DMA will be presented with a scheduling credit for the Rx FIFO that is associated with this channel. For Rx FIFOs which carry traffic for more than 1 Rx DMA channel, the exact channel number that is given in the Rx credit will actually be the channel number which is currently on the head element of that Rx FIFO, which is not necessarily the channel number given in the scheduler table entry.
15	ENTRY1_RXTX	W	0h	This bit indicates if this entry is for a Tx or an Rx channel and is encoded as follows: 0 = Tx Channel 1 = Rx Channel

Table 16-289. WORD_0 to WORD_63 Register Field Descriptions (continued)

Bit	Field	Type	Reset	Description
14-13	RESERVED	W		
12-8	ENTRY1_CHANNEL	R/W		This field indicates the channel number that is to be given an opportunity to transfer data. If this is a Tx entry, the DMA will be presented with a scheduling credit for that exact Tx channel. If this is an Rx entry, the DMA will be presented with a scheduling credit for the Rx FIFO that is associated with this channel. For Rx FIFOs which carry traffic for more than 1 Rx DMA channel, the exact channel number that is given in the Rx credit will actually be the channel number which is currently on the head element of that Rx FIFO, which is not necessarily the channel number given in the scheduler table entry.
7	ENTRY0_RXTX	W	0h	This bit indicates if this entry is for a Tx or an Rx channel and is encoded as follows: 0 = Tx Channel 1 = Rx Channel
6-5	RESERVED	W		
4-0	ENTRY0_CHANNEL	R/W		This field indicates the channel number that is to be given an opportunity to transfer data. If this is a Tx entry, the DMA will be presented with a scheduling credit for that exact Tx channel. If this is an Rx entry, the DMA will be presented with a scheduling credit for the Rx FIFO that is associated with this channel. For Rx FIFOs which carry traffic for more than 1 Rx DMA channel, the exact channel number that is given in the Rx credit will actually be the channel number which is currently on the head element of that Rx FIFO, which is not necessarily the channel number given in the scheduler table entry.

16.5.7 QUEUE_MGR Registers

Table 16-290 lists the memory-mapped registers for the QUEUE_MGR. All register offset addresses not listed in Table 16-290 should be considered as reserved locations and the register contents should not be modified.

Table 16-290. QUEUE_MGR REGISTERS

Offset	Acronym	Register Name	Section
0h	QMGRREVID		Section 16.5.7.1
8h	QMGRRST		Section 16.5.7.2
20h	FDBSC0		Section 16.5.7.3
24h	FDBSC1		Section 16.5.7.4
28h	FDBSC2		Section 16.5.7.5
2Ch	FDBSC3		Section 16.5.7.6
30h	FDBSC4		Section 16.5.7.7
34h	FDBSC5		Section 16.5.7.8
38h	FDBSC6		Section 16.5.7.9
3Ch	FDBSC7		Section 16.5.7.10
80h	LRAM0BASE		Section 16.5.7.11
84h	LRAM0SIZE		Section 16.5.7.12
88h	LRAM1BASE		Section 16.5.7.13
90h	PEND0		Section 16.5.7.14
94h	PEND1		Section 16.5.7.15
98h	PEND2		Section 16.5.7.16
9Ch	PEND3		Section 16.5.7.17
A0h	PEND4		Section 16.5.7.18

Table 16-290. QUEUE_MGR REGISTERS (continued)

Offset	Acronym	Register Name	Section
1000h	QMEMRBASE0		Section 16.5.7.19
1004h	QMEMCTRL0		Section 16.5.7.20
1010h	QMEMRBASE1		Section 16.5.7.21
1014h	QMEMCTRL1		Section 16.5.7.22
1020h	QMEMRBASE2		Section 16.5.7.23
1024h	QMEMCTRL2		Section 16.5.7.24
1030h	QMEMRBASE3		Section 16.5.7.25
1034h	QMEMCTRL3		Section 16.5.7.26
1040h	QMEMRBASE4		Section 16.5.7.27
1044h	QMEMCTRL4		Section 16.5.7.28
1050h	QMEMRBASE5		Section 16.5.7.29
1054h	QMEMCTRL5		Section 16.5.7.30
1060h	QMEMRBASE6		Section 16.5.7.31
1064h	QMEMCTRL6		Section 16.5.7.32
1070h	QMEMRBASE7		Section 16.5.7.33
1074h	QMEMCTRL7		Section 16.5.7.34
2000h	QUEUE_0_A		Section 16.5.7.35
2004h	QUEUE_0_B		Section 16.5.7.36
2008h	QUEUE_0_C		Section 16.5.7.37
200Ch	QUEUE_0_D		Section 16.5.7.38
2010h	QUEUE_1_A		Section 16.5.7.39
2014h	QUEUE_1_B		Section 16.5.7.40
2018h	QUEUE_1_C		Section 16.5.7.41
201Ch	QUEUE_1_D		Section 16.5.7.42
2020h	QUEUE_2_A		Section 16.5.7.43
2024h	QUEUE_2_B		Section 16.5.7.44
2028h	QUEUE_2_C		Section 16.5.7.45
202Ch	QUEUE_2_D		Section 16.5.7.46
2030h	QUEUE_3_A		Section 16.5.7.47
2034h	QUEUE_3_B		Section 16.5.7.48
2038h	QUEUE_3_C		Section 16.5.7.49
203Ch	QUEUE_3_D		Section 16.5.7.50
2040h	QUEUE_4_A		Section 16.5.7.51
2044h	QUEUE_4_B		Section 16.5.7.52
2048h	QUEUE_4_C		Section 16.5.7.53
204Ch	QUEUE_4_D		Section 16.5.7.54
2050h	QUEUE_5_A		Section 16.5.7.55
2054h	QUEUE_5_B		Section 16.5.7.56
2058h	QUEUE_5_C		Section 16.5.7.57
205Ch	QUEUE_5_D		Section 16.5.7.58
2060h	QUEUE_6_A		Section 16.5.7.59
2064h	QUEUE_6_B		Section 16.5.7.60
2068h	QUEUE_6_C		Section 16.5.7.61
206Ch	QUEUE_6_D		Section 16.5.7.62
2070h	QUEUE_7_A		Section 16.5.7.63
2074h	QUEUE_7_B		Section 16.5.7.64
2078h	QUEUE_7_C		Section 16.5.7.65

Table 16-290. QUEUE_MGR REGISTERS (continued)

Offset	Acronym	Register Name	Section
207Ch	QUEUE_7_D		Section 16.5.7.66
2080h	QUEUE_8_A		Section 16.5.7.67
2084h	QUEUE_8_B		Section 16.5.7.68
2088h	QUEUE_8_C		Section 16.5.7.69
208Ch	QUEUE_8_D		Section 16.5.7.70
2090h	QUEUE_9_A		Section 16.5.7.71
2094h	QUEUE_9_B		Section 16.5.7.72
2098h	QUEUE_9_C		Section 16.5.7.73
209Ch	QUEUE_9_D		Section 16.5.7.74
20A0h	QUEUE_10_A		Section 16.5.7.75
20A4h	QUEUE_10_B		Section 16.5.7.76
20A8h	QUEUE_10_C		Section 16.5.7.77
20ACh	QUEUE_10_D		Section 16.5.7.78
20B0h	QUEUE_11_A		Section 16.5.7.79
20B4h	QUEUE_11_B		Section 16.5.7.80
20B8h	QUEUE_11_C		Section 16.5.7.81
20BCh	QUEUE_11_D		Section 16.5.7.82
20C0h	QUEUE_12_A		Section 16.5.7.83
20C4h	QUEUE_12_B		Section 16.5.7.84
20C8h	QUEUE_12_C		Section 16.5.7.85
20CCh	QUEUE_12_D		Section 16.5.7.86
20D0h	QUEUE_13_A		Section 16.5.7.87
20D4h	QUEUE_13_B		Section 16.5.7.88
20D8h	QUEUE_13_C		Section 16.5.7.89
20DCh	QUEUE_13_D		Section 16.5.7.90
20E0h	QUEUE_14_A		Section 16.5.7.91
20E4h	QUEUE_14_B		Section 16.5.7.92
20E8h	QUEUE_14_C		Section 16.5.7.93
20ECh	QUEUE_14_D		Section 16.5.7.94
20F0h	QUEUE_15_A		Section 16.5.7.95
20F4h	QUEUE_15_B		Section 16.5.7.96
20F8h	QUEUE_15_C		Section 16.5.7.97
20FCh	QUEUE_15_D		Section 16.5.7.98
2100h	QUEUE_16_A		Section 16.5.7.99
2104h	QUEUE_16_B		Section 16.5.7.100
2108h	QUEUE_16_C		Section 16.5.7.101
210Ch	QUEUE_16_D		Section 16.5.7.102
2110h	QUEUE_17_A		Section 16.5.7.103
2114h	QUEUE_17_B		Section 16.5.7.104
2118h	QUEUE_17_C		Section 16.5.7.105
211Ch	QUEUE_17_D		Section 16.5.7.106
2120h	QUEUE_18_A		Section 16.5.7.107
2124h	QUEUE_18_B		Section 16.5.7.108
2128h	QUEUE_18_C		Section 16.5.7.109
212Ch	QUEUE_18_D		Section 16.5.7.110
2130h	QUEUE_19_A		Section 16.5.7.111
2134h	QUEUE_19_B		Section 16.5.7.112

Table 16-290. QUEUE_MGR REGISTERS (continued)

Offset	Acronym	Register Name	Section
2138h	QUEUE_19_C		Section 16.5.7.113
213Ch	QUEUE_19_D		Section 16.5.7.114
2140h	QUEUE_20_A		Section 16.5.7.115
2144h	QUEUE_20_B		Section 16.5.7.116
2148h	QUEUE_20_C		Section 16.5.7.117
214Ch	QUEUE_20_D		Section 16.5.7.118
2150h	QUEUE_21_A		Section 16.5.7.119
2154h	QUEUE_21_B		Section 16.5.7.120
2158h	QUEUE_21_C		Section 16.5.7.121
215Ch	QUEUE_21_D		Section 16.5.7.122
2160h	QUEUE_22_A		Section 16.5.7.123
2164h	QUEUE_22_B		Section 16.5.7.124
2168h	QUEUE_22_C		Section 16.5.7.125
216Ch	QUEUE_22_D		Section 16.5.7.126
2170h	QUEUE_23_A		Section 16.5.7.127
2174h	QUEUE_23_B		Section 16.5.7.128
2178h	QUEUE_23_C		Section 16.5.7.129
217Ch	QUEUE_23_D		Section 16.5.7.130
2180h	QUEUE_24_A		Section 16.5.7.131
2184h	QUEUE_24_B		Section 16.5.7.132
2188h	QUEUE_24_C		Section 16.5.7.133
218Ch	QUEUE_24_D		Section 16.5.7.134
2190h	QUEUE_25_A		Section 16.5.7.135
2194h	QUEUE_25_B		Section 16.5.7.136
2198h	QUEUE_25_C		Section 16.5.7.137
219Ch	QUEUE_25_D		Section 16.5.7.138
21A0h	QUEUE_26_A		Section 16.5.7.139
21A4h	QUEUE_26_B		Section 16.5.7.140
21A8h	QUEUE_26_C		Section 16.5.7.141
21ACh	QUEUE_26_D		Section 16.5.7.142
21B0h	QUEUE_27_A		Section 16.5.7.143
21B4h	QUEUE_27_B		Section 16.5.7.144
21B8h	QUEUE_27_C		Section 16.5.7.145
21BCh	QUEUE_27_D		Section 16.5.7.146
21C0h	QUEUE_28_A		Section 16.5.7.147
21C4h	QUEUE_28_B		Section 16.5.7.148
21C8h	QUEUE_28_C		Section 16.5.7.149
21CCh	QUEUE_28_D		Section 16.5.7.150
21D0h	QUEUE_29_A		Section 16.5.7.151
21D4h	QUEUE_29_B		Section 16.5.7.152
21D8h	QUEUE_29_C		Section 16.5.7.153
21DCh	QUEUE_29_D		Section 16.5.7.154
21E0h	QUEUE_30_A		Section 16.5.7.155
21E4h	QUEUE_30_B		Section 16.5.7.156
21E8h	QUEUE_30_C		Section 16.5.7.157
21ECh	QUEUE_30_D		Section 16.5.7.158
21F0h	QUEUE_31_A		Section 16.5.7.159

Table 16-290. QUEUE_MGR REGISTERS (continued)

Offset	Acronym	Register Name	Section
21F4h	QUEUE_31_B		Section 16.5.7.160
21F8h	QUEUE_31_C		Section 16.5.7.161
21FCh	QUEUE_31_D		Section 16.5.7.162
2200h	QUEUE_32_A		Section 16.5.7.163
2204h	QUEUE_32_B		Section 16.5.7.164
2208h	QUEUE_32_C		Section 16.5.7.165
220Ch	QUEUE_32_D		Section 16.5.7.166
2210h	QUEUE_33_A		Section 16.5.7.167
2214h	QUEUE_33_B		Section 16.5.7.168
2218h	QUEUE_33_C		Section 16.5.7.169
221Ch	QUEUE_33_D		Section 16.5.7.170
2220h	QUEUE_34_A		Section 16.5.7.171
2224h	QUEUE_34_B		Section 16.5.7.172
2228h	QUEUE_34_C		Section 16.5.7.173
222Ch	QUEUE_34_D		Section 16.5.7.174
2230h	QUEUE_35_A		Section 16.5.7.175
2234h	QUEUE_35_B		Section 16.5.7.176
2238h	QUEUE_35_C		Section 16.5.7.177
223Ch	QUEUE_35_D		Section 16.5.7.178
2240h	QUEUE_36_A		Section 16.5.7.179
2244h	QUEUE_36_B		Section 16.5.7.180
2248h	QUEUE_36_C		Section 16.5.7.181
224Ch	QUEUE_36_D		Section 16.5.7.182
2250h	QUEUE_37_A		Section 16.5.7.183
2254h	QUEUE_37_B		Section 16.5.7.184
2258h	QUEUE_37_C		Section 16.5.7.185
225Ch	QUEUE_37_D		Section 16.5.7.186
2260h	QUEUE_38_A		Section 16.5.7.187
2264h	QUEUE_38_B		Section 16.5.7.188
2268h	QUEUE_38_C		Section 16.5.7.189
226Ch	QUEUE_38_D		Section 16.5.7.190
2270h	QUEUE_39_A		Section 16.5.7.191
2274h	QUEUE_39_B		Section 16.5.7.192
2278h	QUEUE_39_C		Section 16.5.7.193
227Ch	QUEUE_39_D		Section 16.5.7.194
2280h	QUEUE_40_A		Section 16.5.7.195
2284h	QUEUE_40_B		Section 16.5.7.196
2288h	QUEUE_40_C		Section 16.5.7.197
228Ch	QUEUE_40_D		Section 16.5.7.198
2290h	QUEUE_41_A		Section 16.5.7.199
2294h	QUEUE_41_B		Section 16.5.7.200
2298h	QUEUE_41_C		Section 16.5.7.201
229Ch	QUEUE_41_D		Section 16.5.7.202
22A0h	QUEUE_42_A		Section 16.5.7.203
22A4h	QUEUE_42_B		Section 16.5.7.204
22A8h	QUEUE_42_C		Section 16.5.7.205
22ACh	QUEUE_42_D		Section 16.5.7.206

Table 16-290. QUEUE_MGR REGISTERS (continued)

Offset	Acronym	Register Name	Section
22B0h	QUEUE_43_A		Section 16.5.7.207
22B4h	QUEUE_43_B		Section 16.5.7.208
22B8h	QUEUE_43_C		Section 16.5.7.209
22BCh	QUEUE_43_D		Section 16.5.7.210
22C0h	QUEUE_44_A		Section 16.5.7.211
22C4h	QUEUE_44_B		Section 16.5.7.212
22C8h	QUEUE_44_C		Section 16.5.7.213
22CCh	QUEUE_44_D		Section 16.5.7.214
22D0h	QUEUE_45_A		Section 16.5.7.215
22D4h	QUEUE_45_B		Section 16.5.7.216
22D8h	QUEUE_45_C		Section 16.5.7.217
22DCh	QUEUE_45_D		Section 16.5.7.218
22E0h	QUEUE_46_A		Section 16.5.7.219
22E4h	QUEUE_46_B		Section 16.5.7.220
22E8h	QUEUE_46_C		Section 16.5.7.221
22ECh	QUEUE_46_D		Section 16.5.7.222
22F0h	QUEUE_47_A		Section 16.5.7.223
22F4h	QUEUE_47_B		Section 16.5.7.224
22F8h	QUEUE_47_C		Section 16.5.7.225
22FCh	QUEUE_47_D		Section 16.5.7.226
2300h	QUEUE_48_A		Section 16.5.7.227
2304h	QUEUE_48_B		Section 16.5.7.228
2308h	QUEUE_48_C		Section 16.5.7.229
230Ch	QUEUE_48_D		Section 16.5.7.230
2310h	QUEUE_49_A		Section 16.5.7.231
2314h	QUEUE_49_B		Section 16.5.7.232
2318h	QUEUE_49_C		Section 16.5.7.233
231Ch	QUEUE_49_D		Section 16.5.7.234
2320h	QUEUE_50_A		Section 16.5.7.235
2324h	QUEUE_50_B		Section 16.5.7.236
2328h	QUEUE_50_C		Section 16.5.7.237
232Ch	QUEUE_50_D		Section 16.5.7.238
2330h	QUEUE_51_A		Section 16.5.7.239
2334h	QUEUE_51_B		Section 16.5.7.240
2338h	QUEUE_51_C		Section 16.5.7.241
233Ch	QUEUE_51_D		Section 16.5.7.242
2340h	QUEUE_52_A		Section 16.5.7.243
2344h	QUEUE_52_B		Section 16.5.7.244
2348h	QUEUE_52_C		Section 16.5.7.245
234Ch	QUEUE_52_D		Section 16.5.7.246
2350h	QUEUE_53_A		Section 16.5.7.247
2354h	QUEUE_53_B		Section 16.5.7.248
2358h	QUEUE_53_C		Section 16.5.7.249
235Ch	QUEUE_53_D		Section 16.5.7.250
2360h	QUEUE_54_A		Section 16.5.7.251
2364h	QUEUE_54_B		Section 16.5.7.252
2368h	QUEUE_54_C		Section 16.5.7.253

Table 16-290. QUEUE_MGR REGISTERS (continued)

Offset	Acronym	Register Name	Section
236Ch	QUEUE_54_D		Section 16.5.7.254
2370h	QUEUE_55_A		Section 16.5.7.255
2374h	QUEUE_55_B		Section 16.5.7.256
2378h	QUEUE_55_C		Section 16.5.7.257
237Ch	QUEUE_55_D		Section 16.5.7.258
2380h	QUEUE_56_A		Section 16.5.7.259
2384h	QUEUE_56_B		Section 16.5.7.260
2388h	QUEUE_56_C		Section 16.5.7.261
238Ch	QUEUE_56_D		Section 16.5.7.262
2390h	QUEUE_57_A		Section 16.5.7.263
2394h	QUEUE_57_B		Section 16.5.7.264
2398h	QUEUE_57_C		Section 16.5.7.265
239Ch	QUEUE_57_D		Section 16.5.7.266
23A0h	QUEUE_58_A		Section 16.5.7.267
23A4h	QUEUE_58_B		Section 16.5.7.268
23A8h	QUEUE_58_C		Section 16.5.7.269
23ACh	QUEUE_58_D		Section 16.5.7.270
23B0h	QUEUE_59_A		Section 16.5.7.271
23B4h	QUEUE_59_B		Section 16.5.7.272
23B8h	QUEUE_59_C		Section 16.5.7.273
23BCh	QUEUE_59_D		Section 16.5.7.274
23C0h	QUEUE_60_A		Section 16.5.7.275
23C4h	QUEUE_60_B		Section 16.5.7.276
23C8h	QUEUE_60_C		Section 16.5.7.277
23CCh	QUEUE_60_D		Section 16.5.7.278
23D0h	QUEUE_61_A		Section 16.5.7.279
23D4h	QUEUE_61_B		Section 16.5.7.280
23D8h	QUEUE_61_C		Section 16.5.7.281
23DCh	QUEUE_61_D		Section 16.5.7.282
23E0h	QUEUE_62_A		Section 16.5.7.283
23E4h	QUEUE_62_B		Section 16.5.7.284
23E8h	QUEUE_62_C		Section 16.5.7.285
23ECh	QUEUE_62_D		Section 16.5.7.286
23F0h	QUEUE_63_A		Section 16.5.7.287
23F4h	QUEUE_63_B		Section 16.5.7.288
23F8h	QUEUE_63_C		Section 16.5.7.289
23FCh	QUEUE_63_D		Section 16.5.7.290
2400h	QUEUE_64_A		Section 16.5.7.291
2404h	QUEUE_64_B		Section 16.5.7.292
2408h	QUEUE_64_C		Section 16.5.7.293
240Ch	QUEUE_64_D		Section 16.5.7.294
2410h	QUEUE_65_A		Section 16.5.7.295
2414h	QUEUE_65_B		Section 16.5.7.296
2418h	QUEUE_65_C		Section 16.5.7.297
241Ch	QUEUE_65_D		Section 16.5.7.298
2420h	QUEUE_66_A		Section 16.5.7.299
2424h	QUEUE_66_B		Section 16.5.7.300

Table 16-290. QUEUE_MGR REGISTERS (continued)

Offset	Acronym	Register Name	Section
2428h	QUEUE_66_C		Section 16.5.7.301
242Ch	QUEUE_66_D		Section 16.5.7.302
2430h	QUEUE_67_A		Section 16.5.7.303
2434h	QUEUE_67_B		Section 16.5.7.304
2438h	QUEUE_67_C		Section 16.5.7.305
243Ch	QUEUE_67_D		Section 16.5.7.306
2440h	QUEUE_68_A		Section 16.5.7.307
2444h	QUEUE_68_B		Section 16.5.7.308
2448h	QUEUE_68_C		Section 16.5.7.309
244Ch	QUEUE_68_D		Section 16.5.7.310
2450h	QUEUE_69_A		Section 16.5.7.311
2454h	QUEUE_69_B		Section 16.5.7.312
2458h	QUEUE_69_C		Section 16.5.7.313
245Ch	QUEUE_69_D		Section 16.5.7.314
2460h	QUEUE_70_A		Section 16.5.7.315
2464h	QUEUE_70_B		Section 16.5.7.316
2468h	QUEUE_70_C		Section 16.5.7.317
246Ch	QUEUE_70_D		Section 16.5.7.318
2470h	QUEUE_71_A		Section 16.5.7.319
2474h	QUEUE_71_B		Section 16.5.7.320
2478h	QUEUE_71_C		Section 16.5.7.321
247Ch	QUEUE_71_D		Section 16.5.7.322
2480h	QUEUE_72_A		Section 16.5.7.323
2484h	QUEUE_72_B		Section 16.5.7.324
2488h	QUEUE_72_C		Section 16.5.7.325
248Ch	QUEUE_72_D		Section 16.5.7.326
2490h	QUEUE_73_A		Section 16.5.7.327
2494h	QUEUE_73_B		Section 16.5.7.328
2498h	QUEUE_73_C		Section 16.5.7.329
249Ch	QUEUE_73_D		Section 16.5.7.330
24A0h	QUEUE_74_A		Section 16.5.7.331
24A4h	QUEUE_74_B		Section 16.5.7.332
24A8h	QUEUE_74_C		Section 16.5.7.333
24ACh	QUEUE_74_D		Section 16.5.7.334
24B0h	QUEUE_75_A		Section 16.5.7.335
24B4h	QUEUE_75_B		Section 16.5.7.336
24B8h	QUEUE_75_C		Section 16.5.7.337
24BCh	QUEUE_75_D		Section 16.5.7.338
24C0h	QUEUE_76_A		Section 16.5.7.339
24C4h	QUEUE_76_B		Section 16.5.7.340
24C8h	QUEUE_76_C		Section 16.5.7.341
24CCh	QUEUE_76_D		Section 16.5.7.342
24D0h	QUEUE_77_A		Section 16.5.7.343
24D4h	QUEUE_77_B		Section 16.5.7.344
24D8h	QUEUE_77_C		Section 16.5.7.345
24DCh	QUEUE_77_D		Section 16.5.7.346
24E0h	QUEUE_78_A		Section 16.5.7.347

Table 16-290. QUEUE_MGR REGISTERS (continued)

Offset	Acronym	Register Name	Section
24E4h	QUEUE_78_B		Section 16.5.7.348
24E8h	QUEUE_78_C		Section 16.5.7.349
24ECh	QUEUE_78_D		Section 16.5.7.350
24F0h	QUEUE_79_A		Section 16.5.7.351
24F4h	QUEUE_79_B		Section 16.5.7.352
24F8h	QUEUE_79_C		Section 16.5.7.353
24FCh	QUEUE_79_D		Section 16.5.7.354
2500h	QUEUE_80_A		Section 16.5.7.355
2504h	QUEUE_80_B		Section 16.5.7.356
2508h	QUEUE_80_C		Section 16.5.7.357
250Ch	QUEUE_80_D		Section 16.5.7.358
2510h	QUEUE_81_A		Section 16.5.7.359
2514h	QUEUE_81_B		Section 16.5.7.360
2518h	QUEUE_81_C		Section 16.5.7.361
251Ch	QUEUE_81_D		Section 16.5.7.362
2520h	QUEUE_82_A		Section 16.5.7.363
2524h	QUEUE_82_B		Section 16.5.7.364
2528h	QUEUE_82_C		Section 16.5.7.365
252Ch	QUEUE_82_D		Section 16.5.7.366
2530h	QUEUE_83_A		Section 16.5.7.367
2534h	QUEUE_83_B		Section 16.5.7.368
2538h	QUEUE_83_C		Section 16.5.7.369
253Ch	QUEUE_83_D		Section 16.5.7.370
2540h	QUEUE_84_A		Section 16.5.7.371
2544h	QUEUE_84_B		Section 16.5.7.372
2548h	QUEUE_84_C		Section 16.5.7.373
254Ch	QUEUE_84_D		Section 16.5.7.374
2550h	QUEUE_85_A		Section 16.5.7.375
2554h	QUEUE_85_B		Section 16.5.7.376
2558h	QUEUE_85_C		Section 16.5.7.377
255Ch	QUEUE_85_D		Section 16.5.7.378
2560h	QUEUE_86_A		Section 16.5.7.379
2564h	QUEUE_86_B		Section 16.5.7.380
2568h	QUEUE_86_C		Section 16.5.7.381
256Ch	QUEUE_86_D		Section 16.5.7.382
2570h	QUEUE_87_A		Section 16.5.7.383
2574h	QUEUE_87_B		Section 16.5.7.384
2578h	QUEUE_87_C		Section 16.5.7.385
257Ch	QUEUE_87_D		Section 16.5.7.386
2580h	QUEUE_88_A		Section 16.5.7.387
2584h	QUEUE_88_B		Section 16.5.7.388
2588h	QUEUE_88_C		Section 16.5.7.389
258Ch	QUEUE_88_D		Section 16.5.7.390
2590h	QUEUE_89_A		Section 16.5.7.391
2594h	QUEUE_89_B		Section 16.5.7.392
2598h	QUEUE_89_C		Section 16.5.7.393
259Ch	QUEUE_89_D		Section 16.5.7.394

Table 16-290. QUEUE_MGR REGISTERS (continued)

Offset	Acronym	Register Name	Section
25A0h	QUEUE_90_A		Section 16.5.7.395
25A4h	QUEUE_90_B		Section 16.5.7.396
25A8h	QUEUE_90_C		Section 16.5.7.397
25ACh	QUEUE_90_D		Section 16.5.7.398
25B0h	QUEUE_91_A		Section 16.5.7.399
25B4h	QUEUE_91_B		Section 16.5.7.400
25B8h	QUEUE_91_C		Section 16.5.7.401
25BCh	QUEUE_91_D		Section 16.5.7.402
25C0h	QUEUE_92_A		Section 16.5.7.403
25C4h	QUEUE_92_B		Section 16.5.7.404
25C8h	QUEUE_92_C		Section 16.5.7.405
25CCh	QUEUE_92_D		Section 16.5.7.406
25D0h	QUEUE_93_A		Section 16.5.7.407
25D4h	QUEUE_93_B		Section 16.5.7.408
25D8h	QUEUE_93_C		Section 16.5.7.409
25DCh	QUEUE_93_D		Section 16.5.7.410
25E0h	QUEUE_94_A		Section 16.5.7.411
25E4h	QUEUE_94_B		Section 16.5.7.412
25E8h	QUEUE_94_C		Section 16.5.7.413
25ECh	QUEUE_94_D		Section 16.5.7.414
25F0h	QUEUE_95_A		Section 16.5.7.415
25F4h	QUEUE_95_B		Section 16.5.7.416
25F8h	QUEUE_95_C		Section 16.5.7.417
25FCh	QUEUE_95_D		Section 16.5.7.418
2600h	QUEUE_96_A		Section 16.5.7.419
2604h	QUEUE_96_B		Section 16.5.7.420
2608h	QUEUE_96_C		Section 16.5.7.421
260Ch	QUEUE_96_D		Section 16.5.7.422
2610h	QUEUE_97_A		Section 16.5.7.423
2614h	QUEUE_97_B		Section 16.5.7.424
2618h	QUEUE_97_C		Section 16.5.7.425
261Ch	QUEUE_97_D		Section 16.5.7.426
2620h	QUEUE_98_A		Section 16.5.7.427
2624h	QUEUE_98_B		Section 16.5.7.428
2628h	QUEUE_98_C		Section 16.5.7.429
262Ch	QUEUE_98_D		Section 16.5.7.430
2630h	QUEUE_99_A		Section 16.5.7.431
2634h	QUEUE_99_B		Section 16.5.7.432
2638h	QUEUE_99_C		Section 16.5.7.433
263Ch	QUEUE_99_D		Section 16.5.7.434
2640h	QUEUE_100_A		Section 16.5.7.435
2644h	QUEUE_100_B		Section 16.5.7.436
2648h	QUEUE_100_C		Section 16.5.7.437
264Ch	QUEUE_100_D		Section 16.5.7.438
2650h	QUEUE_101_A		Section 16.5.7.439
2654h	QUEUE_101_B		Section 16.5.7.440
2658h	QUEUE_101_C		Section 16.5.7.441

Table 16-290. QUEUE_MGR REGISTERS (continued)

Offset	Acronym	Register Name	Section
265Ch	QUEUE_101_D		Section 16.5.7.442
2660h	QUEUE_102_A		Section 16.5.7.443
2664h	QUEUE_102_B		Section 16.5.7.444
2668h	QUEUE_102_C		Section 16.5.7.445
266Ch	QUEUE_102_D		Section 16.5.7.446
2670h	QUEUE_103_A		Section 16.5.7.447
2674h	QUEUE_103_B		Section 16.5.7.448
2678h	QUEUE_103_C		Section 16.5.7.449
267Ch	QUEUE_103_D		Section 16.5.7.450
2680h	QUEUE_104_A		Section 16.5.7.451
2684h	QUEUE_104_B		Section 16.5.7.452
2688h	QUEUE_104_C		Section 16.5.7.453
268Ch	QUEUE_104_D		Section 16.5.7.454
2690h	QUEUE_105_A		Section 16.5.7.455
2694h	QUEUE_105_B		Section 16.5.7.456
2698h	QUEUE_105_C		Section 16.5.7.457
269Ch	QUEUE_105_D		Section 16.5.7.458
26A0h	QUEUE_106_A		Section 16.5.7.459
26A4h	QUEUE_106_B		Section 16.5.7.460
26A8h	QUEUE_106_C		Section 16.5.7.461
26ACh	QUEUE_106_D		Section 16.5.7.462
26B0h	QUEUE_107_A		Section 16.5.7.463
26B4h	QUEUE_107_B		Section 16.5.7.464
26B8h	QUEUE_107_C		Section 16.5.7.465
26BCh	QUEUE_107_D		Section 16.5.7.466
26C0h	QUEUE_108_A		Section 16.5.7.467
26C4h	QUEUE_108_B		Section 16.5.7.468
26C8h	QUEUE_108_C		Section 16.5.7.469
26CCh	QUEUE_108_D		Section 16.5.7.470
26D0h	QUEUE_109_A		Section 16.5.7.471
26D4h	QUEUE_109_B		Section 16.5.7.472
26D8h	QUEUE_109_C		Section 16.5.7.473
26DCh	QUEUE_109_D		Section 16.5.7.474
26E0h	QUEUE_110_A		Section 16.5.7.475
26E4h	QUEUE_110_B		Section 16.5.7.476
26E8h	QUEUE_110_C		Section 16.5.7.477
26ECh	QUEUE_110_D		Section 16.5.7.478
26F0h	QUEUE_111_A		Section 16.5.7.479
26F4h	QUEUE_111_B		Section 16.5.7.480
26F8h	QUEUE_111_C		Section 16.5.7.481
26FCh	QUEUE_111_D		Section 16.5.7.482
2700h	QUEUE_112_A		Section 16.5.7.483
2704h	QUEUE_112_B		Section 16.5.7.484
2708h	QUEUE_112_C		Section 16.5.7.485
270Ch	QUEUE_112_D		Section 16.5.7.486
2710h	QUEUE_113_A		Section 16.5.7.487
2714h	QUEUE_113_B		Section 16.5.7.488

Table 16-290. QUEUE_MGR REGISTERS (continued)

Offset	Acronym	Register Name	Section
2718h	QUEUE_113_C		Section 16.5.7.489
271Ch	QUEUE_113_D		Section 16.5.7.490
2720h	QUEUE_114_A		Section 16.5.7.491
2724h	QUEUE_114_B		Section 16.5.7.492
2728h	QUEUE_114_C		Section 16.5.7.493
272Ch	QUEUE_114_D		Section 16.5.7.494
2730h	QUEUE_115_A		Section 16.5.7.495
2734h	QUEUE_115_B		Section 16.5.7.496
2738h	QUEUE_115_C		Section 16.5.7.497
273Ch	QUEUE_115_D		Section 16.5.7.498
2740h	QUEUE_116_A		Section 16.5.7.499
2744h	QUEUE_116_B		Section 16.5.7.500
2748h	QUEUE_116_C		Section 16.5.7.501
274Ch	QUEUE_116_D		Section 16.5.7.502
2750h	QUEUE_117_A		Section 16.5.7.503
2754h	QUEUE_117_B		Section 16.5.7.504
2758h	QUEUE_117_C		Section 16.5.7.505
275Ch	QUEUE_117_D		Section 16.5.7.506
2760h	QUEUE_118_A		Section 16.5.7.507
2764h	QUEUE_118_B		Section 16.5.7.508
2768h	QUEUE_118_C		Section 16.5.7.509
276Ch	QUEUE_118_D		Section 16.5.7.510
2770h	QUEUE_119_A		Section 16.5.7.511
2774h	QUEUE_119_B		Section 16.5.7.512
2778h	QUEUE_119_C		Section 16.5.7.513
277Ch	QUEUE_119_D		Section 16.5.7.514
2780h	QUEUE_120_A		Section 16.5.7.515
2784h	QUEUE_120_B		Section 16.5.7.516
2788h	QUEUE_120_C		Section 16.5.7.517
278Ch	QUEUE_120_D		Section 16.5.7.518
2790h	QUEUE_121_A		Section 16.5.7.519
2794h	QUEUE_121_B		Section 16.5.7.520
2798h	QUEUE_121_C		Section 16.5.7.521
279Ch	QUEUE_121_D		Section 16.5.7.522
27A0h	QUEUE_122_A		Section 16.5.7.523
27A4h	QUEUE_122_B		Section 16.5.7.524
27A8h	QUEUE_122_C		Section 16.5.7.525
27ACh	QUEUE_122_D		Section 16.5.7.526
27B0h	QUEUE_123_A		Section 16.5.7.527
27B4h	QUEUE_123_B		Section 16.5.7.528
27B8h	QUEUE_123_C		Section 16.5.7.529
27BCh	QUEUE_123_D		Section 16.5.7.530
27C0h	QUEUE_124_A		Section 16.5.7.531
27C4h	QUEUE_124_B		Section 16.5.7.532
27C8h	QUEUE_124_C		Section 16.5.7.533
27CCh	QUEUE_124_D		Section 16.5.7.534
27D0h	QUEUE_125_A		Section 16.5.7.535

Table 16-290. QUEUE_MGR REGISTERS (continued)

Offset	Acronym	Register Name	Section
27D4h	QUEUE_125_B		Section 16.5.7.536
27D8h	QUEUE_125_C		Section 16.5.7.537
27DCh	QUEUE_125_D		Section 16.5.7.538
27E0h	QUEUE_126_A		Section 16.5.7.539
27E4h	QUEUE_126_B		Section 16.5.7.540
27E8h	QUEUE_126_C		Section 16.5.7.541
27ECh	QUEUE_126_D		Section 16.5.7.542
27F0h	QUEUE_127_A		Section 16.5.7.543
27F4h	QUEUE_127_B		Section 16.5.7.544
27F8h	QUEUE_127_C		Section 16.5.7.545
27FCh	QUEUE_127_D		Section 16.5.7.546
2800h	QUEUE_128_A		Section 16.5.7.547
2804h	QUEUE_128_B		Section 16.5.7.548
2808h	QUEUE_128_C		Section 16.5.7.549
280Ch	QUEUE_128_D		Section 16.5.7.550
2810h	QUEUE_129_A		Section 16.5.7.551
2814h	QUEUE_129_B		Section 16.5.7.552
2818h	QUEUE_129_C		Section 16.5.7.553
281Ch	QUEUE_129_D		Section 16.5.7.554
2820h	QUEUE_130_A		Section 16.5.7.555
2824h	QUEUE_130_B		Section 16.5.7.556
2828h	QUEUE_130_C		Section 16.5.7.557
282Ch	QUEUE_130_D		Section 16.5.7.558
2830h	QUEUE_131_A		Section 16.5.7.559
2834h	QUEUE_131_B		Section 16.5.7.560
2838h	QUEUE_131_C		Section 16.5.7.561
283Ch	QUEUE_131_D		Section 16.5.7.562
2840h	QUEUE_132_A		Section 16.5.7.563
2844h	QUEUE_132_B		Section 16.5.7.564
2848h	QUEUE_132_C		Section 16.5.7.565
284Ch	QUEUE_132_D		Section 16.5.7.566
2850h	QUEUE_133_A		Section 16.5.7.567
2854h	QUEUE_133_B		Section 16.5.7.568
2858h	QUEUE_133_C		Section 16.5.7.569
285Ch	QUEUE_133_D		Section 16.5.7.570
2860h	QUEUE_134_A		Section 16.5.7.571
2864h	QUEUE_134_B		Section 16.5.7.572
2868h	QUEUE_134_C		Section 16.5.7.573
286Ch	QUEUE_134_D		Section 16.5.7.574
2870h	QUEUE_135_A		Section 16.5.7.575
2874h	QUEUE_135_B		Section 16.5.7.576
2878h	QUEUE_135_C		Section 16.5.7.577
287Ch	QUEUE_135_D		Section 16.5.7.578
2880h	QUEUE_136_A		Section 16.5.7.579
2884h	QUEUE_136_B		Section 16.5.7.580
2888h	QUEUE_136_C		Section 16.5.7.581
288Ch	QUEUE_136_D		Section 16.5.7.582

Table 16-290. QUEUE_MGR REGISTERS (continued)

Offset	Acronym	Register Name	Section
2890h	QUEUE_137_A		Section 16.5.7.583
2894h	QUEUE_137_B		Section 16.5.7.584
2898h	QUEUE_137_C		Section 16.5.7.585
289Ch	QUEUE_137_D		Section 16.5.7.586
28A0h	QUEUE_138_A		Section 16.5.7.587
28A4h	QUEUE_138_B		Section 16.5.7.588
28A8h	QUEUE_138_C		Section 16.5.7.589
28ACh	QUEUE_138_D		Section 16.5.7.590
28B0h	QUEUE_139_A		Section 16.5.7.591
28B4h	QUEUE_139_B		Section 16.5.7.592
28B8h	QUEUE_139_C		Section 16.5.7.593
28BCh	QUEUE_139_D		Section 16.5.7.594
28C0h	QUEUE_140_A		Section 16.5.7.595
28C4h	QUEUE_140_B		Section 16.5.7.596
28C8h	QUEUE_140_C		Section 16.5.7.597
28CCh	QUEUE_140_D		Section 16.5.7.598
28D0h	QUEUE_141_A		Section 16.5.7.599
28D4h	QUEUE_141_B		Section 16.5.7.600
28D8h	QUEUE_141_C		Section 16.5.7.601
28DCh	QUEUE_141_D		Section 16.5.7.602
28E0h	QUEUE_142_A		Section 16.5.7.603
28E4h	QUEUE_142_B		Section 16.5.7.604
28E8h	QUEUE_142_C		Section 16.5.7.605
28ECh	QUEUE_142_D		Section 16.5.7.606
28F0h	QUEUE_143_A		Section 16.5.7.607
28F4h	QUEUE_143_B		Section 16.5.7.608
28F8h	QUEUE_143_C		Section 16.5.7.609
28FCh	QUEUE_143_D		Section 16.5.7.610
2900h	QUEUE_144_A		Section 16.5.7.611
2904h	QUEUE_144_B		Section 16.5.7.612
2908h	QUEUE_144_C		Section 16.5.7.613
290Ch	QUEUE_144_D		Section 16.5.7.614
2910h	QUEUE_145_A		Section 16.5.7.615
2914h	QUEUE_145_B		Section 16.5.7.616
2918h	QUEUE_145_C		Section 16.5.7.617
291Ch	QUEUE_145_D		Section 16.5.7.618
2920h	QUEUE_146_A		Section 16.5.7.619
2924h	QUEUE_146_B		Section 16.5.7.620
2928h	QUEUE_146_C		Section 16.5.7.621
292Ch	QUEUE_146_D		Section 16.5.7.622
2930h	QUEUE_147_A		Section 16.5.7.623
2934h	QUEUE_147_B		Section 16.5.7.624
2938h	QUEUE_147_C		Section 16.5.7.625
293Ch	QUEUE_147_D		Section 16.5.7.626
2940h	QUEUE_148_A		Section 16.5.7.627
2944h	QUEUE_148_B		Section 16.5.7.628
2948h	QUEUE_148_C		Section 16.5.7.629

Table 16-290. QUEUE_MGR REGISTERS (continued)

Offset	Acronym	Register Name	Section
294Ch	QUEUE_148_D		Section 16.5.7.630
2950h	QUEUE_149_A		Section 16.5.7.631
2954h	QUEUE_149_B		Section 16.5.7.632
2958h	QUEUE_149_C		Section 16.5.7.633
295Ch	QUEUE_149_D		Section 16.5.7.634
2960h	QUEUE_150_A		Section 16.5.7.635
2964h	QUEUE_150_B		Section 16.5.7.636
2968h	QUEUE_150_C		Section 16.5.7.637
296Ch	QUEUE_150_D		Section 16.5.7.638
2970h	QUEUE_151_A		Section 16.5.7.639
2974h	QUEUE_151_B		Section 16.5.7.640
2978h	QUEUE_151_C		Section 16.5.7.641
297Ch	QUEUE_151_D		Section 16.5.7.642
2980h	QUEUE_152_A		Section 16.5.7.643
2984h	QUEUE_152_B		Section 16.5.7.644
2988h	QUEUE_152_C		Section 16.5.7.645
298Ch	QUEUE_152_D		Section 16.5.7.646
2990h	QUEUE_153_A		Section 16.5.7.647
2994h	QUEUE_153_B		Section 16.5.7.648
2998h	QUEUE_153_C		Section 16.5.7.649
299Ch	QUEUE_153_D		Section 16.5.7.650
29A0h	QUEUE_154_A		Section 16.5.7.651
29A4h	QUEUE_154_B		Section 16.5.7.652
29A8h	QUEUE_154_C		Section 16.5.7.653
29ACh	QUEUE_154_D		Section 16.5.7.654
29B0h	QUEUE_155_A		Section 16.5.7.655
29B4h	QUEUE_155_B		Section 16.5.7.656
29B8h	QUEUE_155_C		Section 16.5.7.657
29BCh	QUEUE_155_D		Section 16.5.7.658
3000h	QUEUE_0_STATUS_A		Section 16.5.7.659
3004h	QUEUE_0_STATUS_B		Section 16.5.7.660
3008h	QUEUE_0_STATUS_C		Section 16.5.7.661
3010h	QUEUE_1_STATUS_A		Section 16.5.7.662
3014h	QUEUE_1_STATUS_B		Section 16.5.7.663
3018h	QUEUE_1_STATUS_C		Section 16.5.7.664
3020h	QUEUE_2_STATUS_A		Section 16.5.7.665
3024h	QUEUE_2_STATUS_B		Section 16.5.7.666
3028h	QUEUE_2_STATUS_C		Section 16.5.7.667
3030h	QUEUE_3_STATUS_A		Section 16.5.7.668
3034h	QUEUE_3_STATUS_B		Section 16.5.7.669
3038h	QUEUE_3_STATUS_C		Section 16.5.7.670
3040h	QUEUE_4_STATUS_A		Section 16.5.7.671
3044h	QUEUE_4_STATUS_B		Section 16.5.7.672
3048h	QUEUE_4_STATUS_C		Section 16.5.7.673
3050h	QUEUE_5_STATUS_A		Section 16.5.7.674
3054h	QUEUE_5_STATUS_B		Section 16.5.7.675
3058h	QUEUE_5_STATUS_C		Section 16.5.7.676

Table 16-290. QUEUE_MGR REGISTERS (continued)

Offset	Acronym	Register Name	Section
3060h	QUEUE_6_STATUS_A		Section 16.5.7.677
3064h	QUEUE_6_STATUS_B		Section 16.5.7.678
3068h	QUEUE_6_STATUS_C		Section 16.5.7.679
3070h	QUEUE_7_STATUS_A		Section 16.5.7.680
3074h	QUEUE_7_STATUS_B		Section 16.5.7.681
3078h	QUEUE_7_STATUS_C		Section 16.5.7.682
3080h	QUEUE_8_STATUS_A		Section 16.5.7.683
3084h	QUEUE_8_STATUS_B		Section 16.5.7.684
3088h	QUEUE_8_STATUS_C		Section 16.5.7.685
3090h	QUEUE_9_STATUS_A		Section 16.5.7.686
3094h	QUEUE_9_STATUS_B		Section 16.5.7.687
3098h	QUEUE_9_STATUS_C		Section 16.5.7.688
30A0h	QUEUE_10_STATUS_A		Section 16.5.7.689
30A4h	QUEUE_10_STATUS_B		Section 16.5.7.690
30A8h	QUEUE_10_STATUS_C		Section 16.5.7.691
30B0h	QUEUE_11_STATUS_A		Section 16.5.7.692
30B4h	QUEUE_11_STATUS_B		Section 16.5.7.693
30B8h	QUEUE_11_STATUS_C		Section 16.5.7.694
30C0h	QUEUE_12_STATUS_A		Section 16.5.7.695
30C4h	QUEUE_12_STATUS_B		Section 16.5.7.696
30C8h	QUEUE_12_STATUS_C		Section 16.5.7.697
30D0h	QUEUE_13_STATUS_A		Section 16.5.7.698
30D4h	QUEUE_13_STATUS_B		Section 16.5.7.699
30D8h	QUEUE_13_STATUS_C		Section 16.5.7.700
30E0h	QUEUE_14_STATUS_A		Section 16.5.7.701
30E4h	QUEUE_14_STATUS_B		Section 16.5.7.702
30E8h	QUEUE_14_STATUS_C		Section 16.5.7.703
30F0h	QUEUE_15_STATUS_A		Section 16.5.7.704
30F4h	QUEUE_15_STATUS_B		Section 16.5.7.705
30F8h	QUEUE_15_STATUS_C		Section 16.5.7.706
3100h	QUEUE_16_STATUS_A		Section 16.5.7.707
3104h	QUEUE_16_STATUS_B		Section 16.5.7.708
3108h	QUEUE_16_STATUS_C		Section 16.5.7.709
3110h	QUEUE_17_STATUS_A		Section 16.5.7.710
3114h	QUEUE_17_STATUS_B		Section 16.5.7.711
3118h	QUEUE_17_STATUS_C		Section 16.5.7.712
3120h	QUEUE_18_STATUS_A		Section 16.5.7.713
3124h	QUEUE_18_STATUS_B		Section 16.5.7.714
3128h	QUEUE_18_STATUS_C		Section 16.5.7.715
3130h	QUEUE_19_STATUS_A		Section 16.5.7.716
3134h	QUEUE_19_STATUS_B		Section 16.5.7.717
3138h	QUEUE_19_STATUS_C		Section 16.5.7.718
3140h	QUEUE_20_STATUS_A		Section 16.5.7.719
3144h	QUEUE_20_STATUS_B		Section 16.5.7.720
3148h	QUEUE_20_STATUS_C		Section 16.5.7.721
3150h	QUEUE_21_STATUS_A		Section 16.5.7.722
3154h	QUEUE_21_STATUS_B		Section 16.5.7.723

Table 16-290. QUEUE_MGR REGISTERS (continued)

Offset	Acronym	Register Name	Section
3158h	QUEUE_21_STATUS_C		Section 16.5.7.724
3160h	QUEUE_22_STATUS_A		Section 16.5.7.725
3164h	QUEUE_22_STATUS_B		Section 16.5.7.726
3168h	QUEUE_22_STATUS_C		Section 16.5.7.727
3170h	QUEUE_23_STATUS_A		Section 16.5.7.728
3174h	QUEUE_23_STATUS_B		Section 16.5.7.729
3178h	QUEUE_23_STATUS_C		Section 16.5.7.730
3180h	QUEUE_24_STATUS_A		Section 16.5.7.731
3184h	QUEUE_24_STATUS_B		Section 16.5.7.732
3188h	QUEUE_24_STATUS_C		Section 16.5.7.733
3190h	QUEUE_25_STATUS_A		Section 16.5.7.734
3194h	QUEUE_25_STATUS_B		Section 16.5.7.735
3198h	QUEUE_25_STATUS_C		Section 16.5.7.736
31A0h	QUEUE_26_STATUS_A		Section 16.5.7.737
31A4h	QUEUE_26_STATUS_B		Section 16.5.7.738
31A8h	QUEUE_26_STATUS_C		Section 16.5.7.739
31B0h	QUEUE_27_STATUS_A		Section 16.5.7.740
31B4h	QUEUE_27_STATUS_B		Section 16.5.7.741
31B8h	QUEUE_27_STATUS_C		Section 16.5.7.742
31C0h	QUEUE_28_STATUS_A		Section 16.5.7.743
31C4h	QUEUE_28_STATUS_B		Section 16.5.7.744
31C8h	QUEUE_28_STATUS_C		Section 16.5.7.745
31D0h	QUEUE_29_STATUS_A		Section 16.5.7.746
31D4h	QUEUE_29_STATUS_B		Section 16.5.7.747
31D8h	QUEUE_29_STATUS_C		Section 16.5.7.748
31E0h	QUEUE_30_STATUS_A		Section 16.5.7.749
31E4h	QUEUE_30_STATUS_B		Section 16.5.7.750
31E8h	QUEUE_30_STATUS_C		Section 16.5.7.751
31F0h	QUEUE_31_STATUS_A		Section 16.5.7.752
31F4h	QUEUE_31_STATUS_B		Section 16.5.7.753
31F8h	QUEUE_31_STATUS_C		Section 16.5.7.754
3200h	QUEUE_32_STATUS_A		Section 16.5.7.755
3204h	QUEUE_32_STATUS_B		Section 16.5.7.756
3208h	QUEUE_32_STATUS_C		Section 16.5.7.757
3210h	QUEUE_33_STATUS_A		Section 16.5.7.758
3214h	QUEUE_33_STATUS_B		Section 16.5.7.759
3218h	QUEUE_33_STATUS_C		Section 16.5.7.760
3220h	QUEUE_34_STATUS_A		Section 16.5.7.761
3224h	QUEUE_34_STATUS_B		Section 16.5.7.762
3228h	QUEUE_34_STATUS_C		Section 16.5.7.763
3230h	QUEUE_35_STATUS_A		Section 16.5.7.764
3234h	QUEUE_35_STATUS_B		Section 16.5.7.765
3238h	QUEUE_35_STATUS_C		Section 16.5.7.766
3240h	QUEUE_36_STATUS_A		Section 16.5.7.767
3244h	QUEUE_36_STATUS_B		Section 16.5.7.768
3248h	QUEUE_36_STATUS_C		Section 16.5.7.769
3250h	QUEUE_37_STATUS_A		Section 16.5.7.770

Table 16-290. QUEUE_MGR REGISTERS (continued)

Offset	Acronym	Register Name	Section
3254h	QUEUE_37_STATUS_B		Section 16.5.7.771
3258h	QUEUE_37_STATUS_C		Section 16.5.7.772
3260h	QUEUE_38_STATUS_A		Section 16.5.7.773
3264h	QUEUE_38_STATUS_B		Section 16.5.7.774
3268h	QUEUE_38_STATUS_C		Section 16.5.7.775
3270h	QUEUE_39_STATUS_A		Section 16.5.7.776
3274h	QUEUE_39_STATUS_B		Section 16.5.7.777
3278h	QUEUE_39_STATUS_C		Section 16.5.7.778
3280h	QUEUE_40_STATUS_A		Section 16.5.7.779
3284h	QUEUE_40_STATUS_B		Section 16.5.7.780
3288h	QUEUE_40_STATUS_C		Section 16.5.7.781
3290h	QUEUE_41_STATUS_A		Section 16.5.7.782
3294h	QUEUE_41_STATUS_B		Section 16.5.7.783
3298h	QUEUE_41_STATUS_C		Section 16.5.7.784
32A0h	QUEUE_42_STATUS_A		Section 16.5.7.785
32A4h	QUEUE_42_STATUS_B		Section 16.5.7.786
32A8h	QUEUE_42_STATUS_C		Section 16.5.7.787
32B0h	QUEUE_43_STATUS_A		Section 16.5.7.788
32B4h	QUEUE_43_STATUS_B		Section 16.5.7.789
32B8h	QUEUE_43_STATUS_C		Section 16.5.7.790
32C0h	QUEUE_44_STATUS_A		Section 16.5.7.791
32C4h	QUEUE_44_STATUS_B		Section 16.5.7.792
32C8h	QUEUE_44_STATUS_C		Section 16.5.7.793
32D0h	QUEUE_45_STATUS_A		Section 16.5.7.794
32D4h	QUEUE_45_STATUS_B		Section 16.5.7.795
32D8h	QUEUE_45_STATUS_C		Section 16.5.7.796
32E0h	QUEUE_46_STATUS_A		Section 16.5.7.797
32E4h	QUEUE_46_STATUS_B		Section 16.5.7.798
32E8h	QUEUE_46_STATUS_C		Section 16.5.7.799
32F0h	QUEUE_47_STATUS_A		Section 16.5.7.800
32F4h	QUEUE_47_STATUS_B		Section 16.5.7.801
32F8h	QUEUE_47_STATUS_C		Section 16.5.7.802
3300h	QUEUE_48_STATUS_A		Section 16.5.7.803
3304h	QUEUE_48_STATUS_B		Section 16.5.7.804
3308h	QUEUE_48_STATUS_C		Section 16.5.7.805
3310h	QUEUE_49_STATUS_A		Section 16.5.7.806
3314h	QUEUE_49_STATUS_B		Section 16.5.7.807
3318h	QUEUE_49_STATUS_C		Section 16.5.7.808
3320h	QUEUE_50_STATUS_A		Section 16.5.7.809
3324h	QUEUE_50_STATUS_B		Section 16.5.7.810
3328h	QUEUE_50_STATUS_C		Section 16.5.7.811
3330h	QUEUE_51_STATUS_A		Section 16.5.7.812
3334h	QUEUE_51_STATUS_B		Section 16.5.7.813
3338h	QUEUE_51_STATUS_C		Section 16.5.7.814
3340h	QUEUE_52_STATUS_A		Section 16.5.7.815
3344h	QUEUE_52_STATUS_B		Section 16.5.7.816
3348h	QUEUE_52_STATUS_C		Section 16.5.7.817

Table 16-290. QUEUE_MGR REGISTERS (continued)

Offset	Acronym	Register Name	Section
3350h	QUEUE_53_STATUS_A		Section 16.5.7.818
3354h	QUEUE_53_STATUS_B		Section 16.5.7.819
3358h	QUEUE_53_STATUS_C		Section 16.5.7.820
3360h	QUEUE_54_STATUS_A		Section 16.5.7.821
3364h	QUEUE_54_STATUS_B		Section 16.5.7.822
3368h	QUEUE_54_STATUS_C		Section 16.5.7.823
3370h	QUEUE_55_STATUS_A		Section 16.5.7.824
3374h	QUEUE_55_STATUS_B		Section 16.5.7.825
3378h	QUEUE_55_STATUS_C		Section 16.5.7.826
3380h	QUEUE_56_STATUS_A		Section 16.5.7.827
3384h	QUEUE_56_STATUS_B		Section 16.5.7.828
3388h	QUEUE_56_STATUS_C		Section 16.5.7.829
3390h	QUEUE_57_STATUS_A		Section 16.5.7.830
3394h	QUEUE_57_STATUS_B		Section 16.5.7.831
3398h	QUEUE_57_STATUS_C		Section 16.5.7.832
33A0h	QUEUE_58_STATUS_A		Section 16.5.7.833
33A4h	QUEUE_58_STATUS_B		Section 16.5.7.834
33A8h	QUEUE_58_STATUS_C		Section 16.5.7.835
33B0h	QUEUE_59_STATUS_A		Section 16.5.7.836
33B4h	QUEUE_59_STATUS_B		Section 16.5.7.837
33B8h	QUEUE_59_STATUS_C		Section 16.5.7.838
33C0h	QUEUE_60_STATUS_A		Section 16.5.7.839
33C4h	QUEUE_60_STATUS_B		Section 16.5.7.840
33C8h	QUEUE_60_STATUS_C		Section 16.5.7.841
33D0h	QUEUE_61_STATUS_A		Section 16.5.7.842
33D4h	QUEUE_61_STATUS_B		Section 16.5.7.843
33D8h	QUEUE_61_STATUS_C		Section 16.5.7.844
33E0h	QUEUE_62_STATUS_A		Section 16.5.7.845
33E4h	QUEUE_62_STATUS_B		Section 16.5.7.846
33E8h	QUEUE_62_STATUS_C		Section 16.5.7.847
33F0h	QUEUE_63_STATUS_A		Section 16.5.7.848
33F4h	QUEUE_63_STATUS_B		Section 16.5.7.849
33F8h	QUEUE_63_STATUS_C		Section 16.5.7.850
3400h	QUEUE_64_STATUS_A		Section 16.5.7.851
3404h	QUEUE_64_STATUS_B		Section 16.5.7.852
3408h	QUEUE_64_STATUS_C		Section 16.5.7.853
3410h	QUEUE_65_STATUS_A		Section 16.5.7.854
3414h	QUEUE_65_STATUS_B		Section 16.5.7.855
3418h	QUEUE_65_STATUS_C		Section 16.5.7.856
3420h	QUEUE_66_STATUS_A		Section 16.5.7.857
3424h	QUEUE_66_STATUS_B		Section 16.5.7.858
3428h	QUEUE_66_STATUS_C		Section 16.5.7.859
3430h	QUEUE_67_STATUS_A		Section 16.5.7.860
3434h	QUEUE_67_STATUS_B		Section 16.5.7.861
3438h	QUEUE_67_STATUS_C		Section 16.5.7.862
3440h	QUEUE_68_STATUS_A		Section 16.5.7.863
3444h	QUEUE_68_STATUS_B		Section 16.5.7.864

Table 16-290. QUEUE_MGR REGISTERS (continued)

Offset	Acronym	Register Name	Section
3448h	QUEUE_68_STATUS_C		Section 16.5.7.865
3450h	QUEUE_69_STATUS_A		Section 16.5.7.866
3454h	QUEUE_69_STATUS_B		Section 16.5.7.867
3458h	QUEUE_69_STATUS_C		Section 16.5.7.868
3460h	QUEUE_70_STATUS_A		Section 16.5.7.869
3464h	QUEUE_70_STATUS_B		Section 16.5.7.870
3468h	QUEUE_70_STATUS_C		Section 16.5.7.871
3470h	QUEUE_71_STATUS_A		Section 16.5.7.872
3474h	QUEUE_71_STATUS_B		Section 16.5.7.873
3478h	QUEUE_71_STATUS_C		Section 16.5.7.874
3480h	QUEUE_72_STATUS_A		Section 16.5.7.875
3484h	QUEUE_72_STATUS_B		Section 16.5.7.876
3488h	QUEUE_72_STATUS_C		Section 16.5.7.877
3490h	QUEUE_73_STATUS_A		Section 16.5.7.878
3494h	QUEUE_73_STATUS_B		Section 16.5.7.879
3498h	QUEUE_73_STATUS_C		Section 16.5.7.880
34A0h	QUEUE_74_STATUS_A		Section 16.5.7.881
34A4h	QUEUE_74_STATUS_B		Section 16.5.7.882
34A8h	QUEUE_74_STATUS_C		Section 16.5.7.883
34B0h	QUEUE_75_STATUS_A		Section 16.5.7.884
34B4h	QUEUE_75_STATUS_B		Section 16.5.7.885
34B8h	QUEUE_75_STATUS_C		Section 16.5.7.886
34C0h	QUEUE_76_STATUS_A		Section 16.5.7.887
34C4h	QUEUE_76_STATUS_B		Section 16.5.7.888
34C8h	QUEUE_76_STATUS_C		Section 16.5.7.889
34D0h	QUEUE_77_STATUS_A		Section 16.5.7.890
34D4h	QUEUE_77_STATUS_B		Section 16.5.7.891
34D8h	QUEUE_77_STATUS_C		Section 16.5.7.892
34E0h	QUEUE_78_STATUS_A		Section 16.5.7.893
34E4h	QUEUE_78_STATUS_B		Section 16.5.7.894
34E8h	QUEUE_78_STATUS_C		Section 16.5.7.895
34F0h	QUEUE_79_STATUS_A		Section 16.5.7.896
34F4h	QUEUE_79_STATUS_B		Section 16.5.7.897
34F8h	QUEUE_79_STATUS_C		Section 16.5.7.898
3500h	QUEUE_80_STATUS_A		Section 16.5.7.899
3504h	QUEUE_80_STATUS_B		Section 16.5.7.900
3508h	QUEUE_80_STATUS_C		Section 16.5.7.901
3510h	QUEUE_81_STATUS_A		Section 16.5.7.902
3514h	QUEUE_81_STATUS_B		Section 16.5.7.903
3518h	QUEUE_81_STATUS_C		Section 16.5.7.904
3520h	QUEUE_82_STATUS_A		Section 16.5.7.905
3524h	QUEUE_82_STATUS_B		Section 16.5.7.906
3528h	QUEUE_82_STATUS_C		Section 16.5.7.907
3530h	QUEUE_83_STATUS_A		Section 16.5.7.908
3534h	QUEUE_83_STATUS_B		Section 16.5.7.909
3538h	QUEUE_83_STATUS_C		Section 16.5.7.910
3540h	QUEUE_84_STATUS_A		Section 16.5.7.911

Table 16-290. QUEUE_MGR REGISTERS (continued)

Offset	Acronym	Register Name	Section
3544h	QUEUE_84_STATUS_B		Section 16.5.7.912
3548h	QUEUE_84_STATUS_C		Section 16.5.7.913
3550h	QUEUE_85_STATUS_A		Section 16.5.7.914
3554h	QUEUE_85_STATUS_B		Section 16.5.7.915
3558h	QUEUE_85_STATUS_C		Section 16.5.7.916
3560h	QUEUE_86_STATUS_A		Section 16.5.7.917
3564h	QUEUE_86_STATUS_B		Section 16.5.7.918
3568h	QUEUE_86_STATUS_C		Section 16.5.7.919
3570h	QUEUE_87_STATUS_A		Section 16.5.7.920
3574h	QUEUE_87_STATUS_B		Section 16.5.7.921
3578h	QUEUE_87_STATUS_C		Section 16.5.7.922
3580h	QUEUE_88_STATUS_A		Section 16.5.7.923
3584h	QUEUE_88_STATUS_B		Section 16.5.7.924
3588h	QUEUE_88_STATUS_C		Section 16.5.7.925
3590h	QUEUE_89_STATUS_A		Section 16.5.7.926
3594h	QUEUE_89_STATUS_B		Section 16.5.7.927
3598h	QUEUE_89_STATUS_C		Section 16.5.7.928
35A0h	QUEUE_90_STATUS_A		Section 16.5.7.929
35A4h	QUEUE_90_STATUS_B		Section 16.5.7.930
35A8h	QUEUE_90_STATUS_C		Section 16.5.7.931
35B0h	QUEUE_91_STATUS_A		Section 16.5.7.932
35B4h	QUEUE_91_STATUS_B		Section 16.5.7.933
35B8h	QUEUE_91_STATUS_C		Section 16.5.7.934
35C0h	QUEUE_92_STATUS_A		Section 16.5.7.935
35C4h	QUEUE_92_STATUS_B		Section 16.5.7.936
35C8h	QUEUE_92_STATUS_C		Section 16.5.7.937
35D0h	QUEUE_93_STATUS_A		Section 16.5.7.938
35D4h	QUEUE_93_STATUS_B		Section 16.5.7.939
35D8h	QUEUE_93_STATUS_C		Section 16.5.7.940
35E0h	QUEUE_94_STATUS_A		Section 16.5.7.941
35E4h	QUEUE_94_STATUS_B		Section 16.5.7.942
35E8h	QUEUE_94_STATUS_C		Section 16.5.7.943
35F0h	QUEUE_95_STATUS_A		Section 16.5.7.944
35F4h	QUEUE_95_STATUS_B		Section 16.5.7.945
35F8h	QUEUE_95_STATUS_C		Section 16.5.7.946
3600h	QUEUE_96_STATUS_A		Section 16.5.7.947
3604h	QUEUE_96_STATUS_B		Section 16.5.7.948
3608h	QUEUE_96_STATUS_C		Section 16.5.7.949
3610h	QUEUE_97_STATUS_A		Section 16.5.7.950
3614h	QUEUE_97_STATUS_B		Section 16.5.7.951
3618h	QUEUE_97_STATUS_C		Section 16.5.7.952
3620h	QUEUE_98_STATUS_A		Section 16.5.7.953
3624h	QUEUE_98_STATUS_B		Section 16.5.7.954
3628h	QUEUE_98_STATUS_C		Section 16.5.7.955
3630h	QUEUE_99_STATUS_A		Section 16.5.7.956
3634h	QUEUE_99_STATUS_B		Section 16.5.7.957
3638h	QUEUE_99_STATUS_C		Section 16.5.7.958

Table 16-290. QUEUE_MGR REGISTERS (continued)

Offset	Acronym	Register Name	Section
3640h	QUEUE_100_STATUS_A		Section 16.5.7.959
3644h	QUEUE_100_STATUS_B		Section 16.5.7.960
3648h	QUEUE_100_STATUS_C		Section 16.5.7.961
3650h	QUEUE_101_STATUS_A		Section 16.5.7.962
3654h	QUEUE_101_STATUS_B		Section 16.5.7.963
3658h	QUEUE_101_STATUS_C		Section 16.5.7.964
3660h	QUEUE_102_STATUS_A		Section 16.5.7.965
3664h	QUEUE_102_STATUS_B		Section 16.5.7.966
3668h	QUEUE_102_STATUS_C		Section 16.5.7.967
3670h	QUEUE_103_STATUS_A		Section 16.5.7.968
3674h	QUEUE_103_STATUS_B		Section 16.5.7.969
3678h	QUEUE_103_STATUS_C		Section 16.5.7.970
3680h	QUEUE_104_STATUS_A		Section 16.5.7.971
3684h	QUEUE_104_STATUS_B		Section 16.5.7.972
3688h	QUEUE_104_STATUS_C		Section 16.5.7.973
3690h	QUEUE_105_STATUS_A		Section 16.5.7.974
3694h	QUEUE_105_STATUS_B		Section 16.5.7.975
3698h	QUEUE_105_STATUS_C		Section 16.5.7.976
36A0h	QUEUE_106_STATUS_A		Section 16.5.7.977
36A4h	QUEUE_106_STATUS_B		Section 16.5.7.978
36A8h	QUEUE_106_STATUS_C		Section 16.5.7.979
36B0h	QUEUE_107_STATUS_A		Section 16.5.7.980
36B4h	QUEUE_107_STATUS_B		Section 16.5.7.981
36B8h	QUEUE_107_STATUS_C		Section 16.5.7.982
36C0h	QUEUE_108_STATUS_A		Section 16.5.7.983
36C4h	QUEUE_108_STATUS_B		Section 16.5.7.984
36C8h	QUEUE_108_STATUS_C		Section 16.5.7.985
36D0h	QUEUE_109_STATUS_A		Section 16.5.7.986
36D4h	QUEUE_109_STATUS_B		Section 16.5.7.987
36D8h	QUEUE_109_STATUS_C		Section 16.5.7.988
36E0h	QUEUE_110_STATUS_A		Section 16.5.7.989
36E4h	QUEUE_110_STATUS_B		Section 16.5.7.990
36E8h	QUEUE_110_STATUS_C		Section 16.5.7.991
36F0h	QUEUE_111_STATUS_A		Section 16.5.7.992
36F4h	QUEUE_111_STATUS_B		Section 16.5.7.993
36F8h	QUEUE_111_STATUS_C		Section 16.5.7.994
3700h	QUEUE_112_STATUS_A		Section 16.5.7.995
3704h	QUEUE_112_STATUS_B		Section 16.5.7.996
3708h	QUEUE_112_STATUS_C		Section 16.5.7.997
3710h	QUEUE_113_STATUS_A		Section 16.5.7.998
3714h	QUEUE_113_STATUS_B		Section 16.5.7.999
3718h	QUEUE_113_STATUS_C		Section 16.5.7.1000
3720h	QUEUE_114_STATUS_A		Section 16.5.7.1001
3724h	QUEUE_114_STATUS_B		Section 16.5.7.1002
3728h	QUEUE_114_STATUS_C		Section 16.5.7.1003
3730h	QUEUE_115_STATUS_A		Section 16.5.7.1004
3734h	QUEUE_115_STATUS_B		Section 16.5.7.1005

Table 16-290. QUEUE_MGR REGISTERS (continued)

Offset	Acronym	Register Name	Section
3738h	QUEUE_115_STATUS_C		Section 16.5.7.1006
3740h	QUEUE_116_STATUS_A		Section 16.5.7.1007
3744h	QUEUE_116_STATUS_B		Section 16.5.7.1008
3748h	QUEUE_116_STATUS_C		Section 16.5.7.1009
3750h	QUEUE_117_STATUS_A		Section 16.5.7.1010
3754h	QUEUE_117_STATUS_B		Section 16.5.7.1011
3758h	QUEUE_117_STATUS_C		Section 16.5.7.1012
3760h	QUEUE_118_STATUS_A		Section 16.5.7.1013
3764h	QUEUE_118_STATUS_B		Section 16.5.7.1014
3768h	QUEUE_118_STATUS_C		Section 16.5.7.1015
3770h	QUEUE_119_STATUS_A		Section 16.5.7.1016
3774h	QUEUE_119_STATUS_B		Section 16.5.7.1017
3778h	QUEUE_119_STATUS_C		Section 16.5.7.1018
3780h	QUEUE_120_STATUS_A		Section 16.5.7.1019
3784h	QUEUE_120_STATUS_B		Section 16.5.7.1020
3788h	QUEUE_120_STATUS_C		Section 16.5.7.1021
3790h	QUEUE_121_STATUS_A		Section 16.5.7.1022
3794h	QUEUE_121_STATUS_B		Section 16.5.7.1023
3798h	QUEUE_121_STATUS_C		Section 16.5.7.1024
37A0h	QUEUE_122_STATUS_A		Section 16.5.7.1025
37A4h	QUEUE_122_STATUS_B		Section 16.5.7.1026
37A8h	QUEUE_122_STATUS_C		Section 16.5.7.1027
37B0h	QUEUE_123_STATUS_A		Section 16.5.7.1028
37B4h	QUEUE_123_STATUS_B		Section 16.5.7.1029
37B8h	QUEUE_123_STATUS_C		Section 16.5.7.1030
37C0h	QUEUE_124_STATUS_A		Section 16.5.7.1031
37C4h	QUEUE_124_STATUS_B		Section 16.5.7.1032
37C8h	QUEUE_124_STATUS_C		Section 16.5.7.1033
37D0h	QUEUE_125_STATUS_A		Section 16.5.7.1034
37D4h	QUEUE_125_STATUS_B		Section 16.5.7.1035
37D8h	QUEUE_125_STATUS_C		Section 16.5.7.1036
37E0h	QUEUE_126_STATUS_A		Section 16.5.7.1037
37E4h	QUEUE_126_STATUS_B		Section 16.5.7.1038
37E8h	QUEUE_126_STATUS_C		Section 16.5.7.1039
37F0h	QUEUE_127_STATUS_A		Section 16.5.7.1040
37F4h	QUEUE_127_STATUS_B		Section 16.5.7.1041
37F8h	QUEUE_127_STATUS_C		Section 16.5.7.1042
3800h	QUEUE_128_STATUS_A		Section 16.5.7.1043
3804h	QUEUE_128_STATUS_B		Section 16.5.7.1044
3808h	QUEUE_128_STATUS_C		Section 16.5.7.1045
3810h	QUEUE_129_STATUS_A		Section 16.5.7.1046
3814h	QUEUE_129_STATUS_B		Section 16.5.7.1047
3818h	QUEUE_129_STATUS_C		Section 16.5.7.1048
3820h	QUEUE_130_STATUS_A		Section 16.5.7.1049
3824h	QUEUE_130_STATUS_B		Section 16.5.7.1050
3828h	QUEUE_130_STATUS_C		Section 16.5.7.1051
3830h	QUEUE_131_STATUS_A		Section 16.5.7.1052

Table 16-290. QUEUE_MGR REGISTERS (continued)

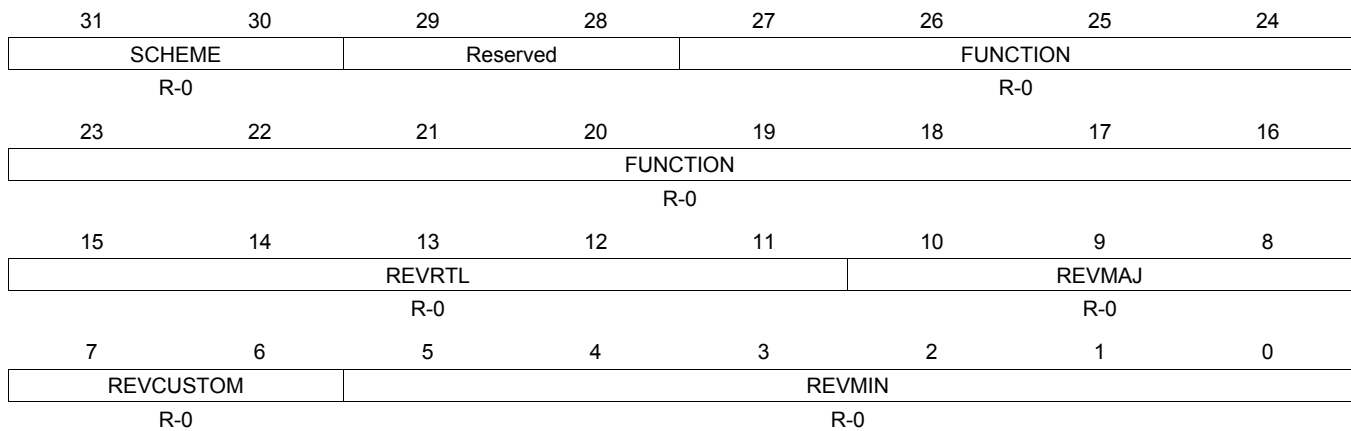
Offset	Acronym	Register Name	Section
3834h	QUEUE_131_STATUS_B		Section 16.5.7.1053
3838h	QUEUE_131_STATUS_C		Section 16.5.7.1054
3840h	QUEUE_132_STATUS_A		Section 16.5.7.1055
3844h	QUEUE_132_STATUS_B		Section 16.5.7.1056
3848h	QUEUE_132_STATUS_C		Section 16.5.7.1057
3850h	QUEUE_133_STATUS_A		Section 16.5.7.1058
3854h	QUEUE_133_STATUS_B		Section 16.5.7.1059
3858h	QUEUE_133_STATUS_C		Section 16.5.7.1060
3860h	QUEUE_134_STATUS_A		Section 16.5.7.1061
3864h	QUEUE_134_STATUS_B		Section 16.5.7.1062
3868h	QUEUE_134_STATUS_C		Section 16.5.7.1063
3870h	QUEUE_135_STATUS_A		Section 16.5.7.1064
3874h	QUEUE_135_STATUS_B		Section 16.5.7.1065
3878h	QUEUE_135_STATUS_C		Section 16.5.7.1066
3880h	QUEUE_136_STATUS_A		Section 16.5.7.1067
3884h	QUEUE_136_STATUS_B		Section 16.5.7.1068
3888h	QUEUE_136_STATUS_C		Section 16.5.7.1069
3890h	QUEUE_137_STATUS_A		Section 16.5.7.1070
3894h	QUEUE_137_STATUS_B		Section 16.5.7.1071
3898h	QUEUE_137_STATUS_C		Section 16.5.7.1072
38A0h	QUEUE_138_STATUS_A		Section 16.5.7.1073
38A4h	QUEUE_138_STATUS_B		Section 16.5.7.1074
38A8h	QUEUE_138_STATUS_C		Section 16.5.7.1075
38B0h	QUEUE_139_STATUS_A		Section 16.5.7.1076
38B4h	QUEUE_139_STATUS_B		Section 16.5.7.1077
38B8h	QUEUE_139_STATUS_C		Section 16.5.7.1078
38C0h	QUEUE_140_STATUS_A		Section 16.5.7.1079
38C4h	QUEUE_140_STATUS_B		Section 16.5.7.1080
38C8h	QUEUE_140_STATUS_C		Section 16.5.7.1081
38D0h	QUEUE_141_STATUS_A		Section 16.5.7.1082
38D4h	QUEUE_141_STATUS_B		Section 16.5.7.1083
38D8h	QUEUE_141_STATUS_C		Section 16.5.7.1084
38E0h	QUEUE_142_STATUS_A		Section 16.5.7.1085
38E4h	QUEUE_142_STATUS_B		Section 16.5.7.1086
38E8h	QUEUE_142_STATUS_C		Section 16.5.7.1087
38F0h	QUEUE_143_STATUS_A		Section 16.5.7.1088
38F4h	QUEUE_143_STATUS_B		Section 16.5.7.1089
38F8h	QUEUE_143_STATUS_C		Section 16.5.7.1090
3900h	QUEUE_144_STATUS_A		Section 16.5.7.1091
3904h	QUEUE_144_STATUS_B		Section 16.5.7.1092
3908h	QUEUE_144_STATUS_C		Section 16.5.7.1093
3910h	QUEUE_145_STATUS_A		Section 16.5.7.1094
3914h	QUEUE_145_STATUS_B		Section 16.5.7.1095
3918h	QUEUE_145_STATUS_C		Section 16.5.7.1096
3920h	QUEUE_146_STATUS_A		Section 16.5.7.1097
3924h	QUEUE_146_STATUS_B		Section 16.5.7.1098
3928h	QUEUE_146_STATUS_C		Section 16.5.7.1099

Table 16-290. QUEUE_MGR REGISTERS (continued)

Offset	Acronym	Register Name	Section
3930h	QUEUE_147_STATUS_A		Section 16.5.7.1100
3934h	QUEUE_147_STATUS_B		Section 16.5.7.1101
3938h	QUEUE_147_STATUS_C		Section 16.5.7.1102
3940h	QUEUE_148_STATUS_A		Section 16.5.7.1103
3944h	QUEUE_148_STATUS_B		Section 16.5.7.1104
3948h	QUEUE_148_STATUS_C		Section 16.5.7.1105
3950h	QUEUE_149_STATUS_A		Section 16.5.7.1106
3954h	QUEUE_149_STATUS_B		Section 16.5.7.1107
3958h	QUEUE_149_STATUS_C		Section 16.5.7.1108
3960h	QUEUE_150_STATUS_A		Section 16.5.7.1109
3964h	QUEUE_150_STATUS_B		Section 16.5.7.1110
3968h	QUEUE_150_STATUS_C		Section 16.5.7.1111
3970h	QUEUE_151_STATUS_A		Section 16.5.7.1112
3974h	QUEUE_151_STATUS_B		Section 16.5.7.1113
3978h	QUEUE_151_STATUS_C		Section 16.5.7.1114
3980h	QUEUE_152_STATUS_A		Section 16.5.7.1115
3984h	QUEUE_152_STATUS_B		Section 16.5.7.1116
3988h	QUEUE_152_STATUS_C		Section 16.5.7.1117
3990h	QUEUE_153_STATUS_A		Section 16.5.7.1118
3994h	QUEUE_153_STATUS_B		Section 16.5.7.1119
3998h	QUEUE_153_STATUS_C		Section 16.5.7.1120
39A0h	QUEUE_154_STATUS_A		Section 16.5.7.1121
39A4h	QUEUE_154_STATUS_B		Section 16.5.7.1122
39A8h	QUEUE_154_STATUS_C		Section 16.5.7.1123
39B0h	QUEUE_155_STATUS_A		Section 16.5.7.1124
39B4h	QUEUE_155_STATUS_B		Section 16.5.7.1125
39B8h	QUEUE_155_STATUS_C		Section 16.5.7.1126

16.5.7.1 QMGRREVID Register (offset = 0h) [reset = 4E530800h]

 QMGRREVID is shown in [Figure 16-277](#) and described in [Table 16-291](#).

Figure 16-277. QMGRREVID Register


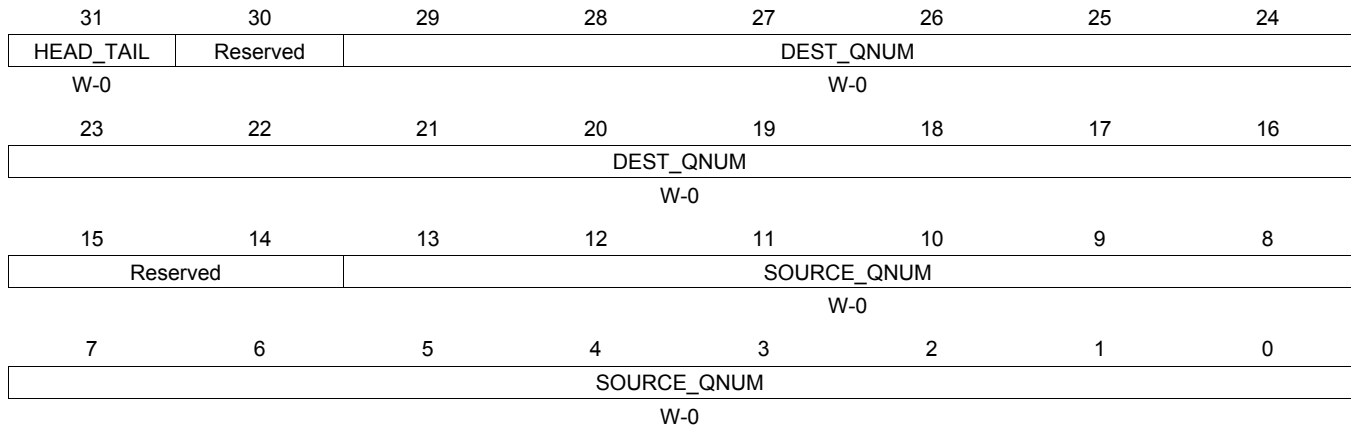
LEGEND: R/W = Read/Write; R = Read only; W1toCl = Write 1 to clear bit; -n = value after reset

Table 16-291. QMGRREVID Register Field Descriptions

Bit	Field	Type	Reset	Description
31-30	SCHEME	R-0	0	Scheme that this register is compliant with
27-16	FUNCTION	R-0	0	Function
15-11	REVRTL	R-0	0	RTL revision
10-8	REVMAJ	R-0	0	Major revision
7-6	REVCUSTOM	R-0	0	Custom revision
5-0	REVMIN	R-0	0	Minor revision Queue Manager Revision Register

16.5.7.2 QMGRST Register (offset = 8h) [reset = 0h]

 QMGRST is shown in [Figure 16-278](#) and described in [Table 16-292](#).

Figure 16-278. QMGRST Register


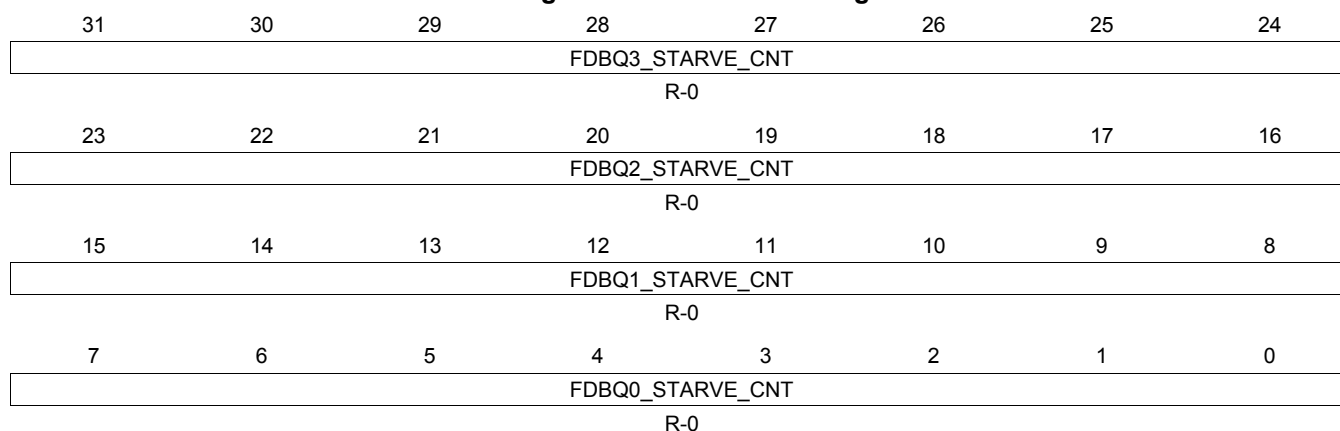
LEGEND: R/W = Read/Write; R = Read only; W1toCl = Write 1 to clear bit; -n = value after reset

Table 16-292. QMGRST Register Field Descriptions

Bit	Field	Type	Reset	Description
31	HEAD_TAIL	W-0	0	Indicates whether queue contents should be merged on to head or tail of destination queue. Clear this field for head and set for tail.
29-16	DEST_QNUM	W-0	0	Destination Queue Number
13-0	SOURCE_QNUM	W-0	0	Source Queue Number Queue Manager Queue Diversion Register Note : CBA write transactions to this register cause the QMGR to start processing an internal state machine. This disables CBA read transactions.while it is busy processing the state machine. Once the state machine is back in the idle state CBA read transactions are available again.

16.5.7.3 FDBSC0 Register (offset = 20h) [reset = 0h]

 FDBSC0 is shown in [Figure 16-279](#) and described in [Table 16-293](#).

Figure 16-279. FDBSC0 Register


LEGEND: R/W = Read/Write; R = Read only; W1toCl = Write 1 to clear bit; -n = value after reset

Table 16-293. FDBSC0 Register Field Descriptions

Bit	Field	Type	Reset	Description
31-24	FDBQ3_STARVE_CNT	R-0	0	This field increments each time the Free Descriptor/Buffer Queue 3 is read while it is empty via the CPPI DMA. This field is cleared when read via the cpu.
23-16	FDBQ2_STARVE_CNT	R-0	0	This field increments each time the Free Descriptor/Buffer Queue 2 is read while it is empty via the CPPI DMA. This field is cleared when read via the cpu.
15-8	FDBQ1_STARVE_CNT	R-0	0	This field increments each time the Free Descriptor/Buffer Queue 1 is read while it is empty via the CPPI DMA. This field is cleared when read via the cpu.
7-0	FDBQ0_STARVE_CNT	R-0	0	This field increments each time the Free Descriptor/Buffer Queue 0 is read while it is empty via the CPPI DMA. This field is cleared when read via the cpu. Queue_Manager_Free_Descriptor_Buffer_Starvation_Count Register 0

16.5.7.4 FDBSC1 Register (offset = 24h) [reset = 0h]

FDBSC1 is shown in [Figure 16-280](#) and described in [Table 16-294](#).

Figure 16-280. FDBSC1 Register

31	30	29	28	27	26	25	24
FDBQ7_STARVE_CNT							
R-0							
23	22	21	20	19	18	17	16
FDBQ6_STARVE_CNT							
R-0							
15	14	13	12	11	10	9	8
FDBQ5_STARVE_CNT							
R-0							
7	6	5	4	3	2	1	0
FDBQ4_STARVE_CNT							
R-0							

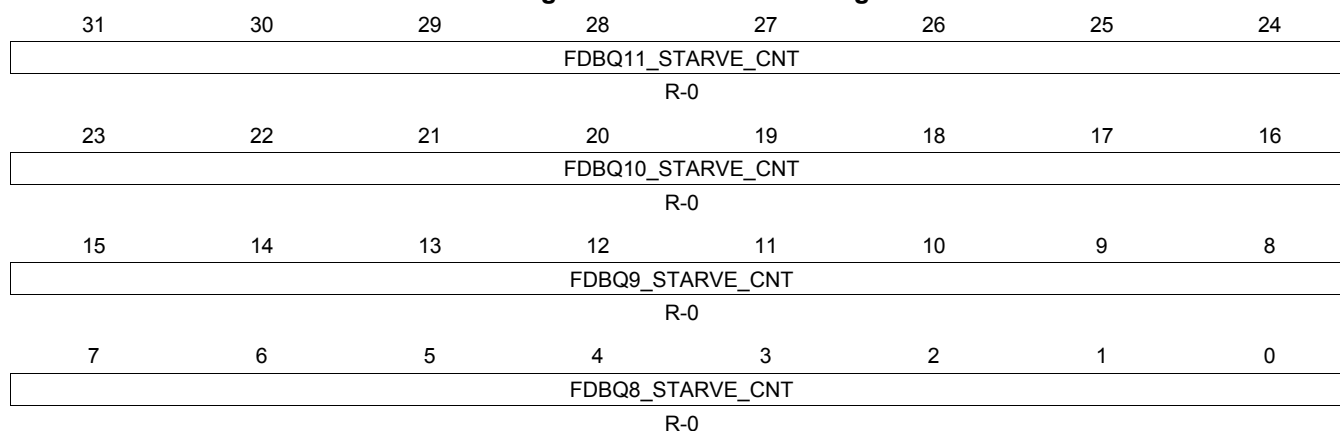
LEGEND: R/W = Read/Write; R = Read only; W1toCl = Write 1 to clear bit; -n = value after reset

Table 16-294. FDBSC1 Register Field Descriptions

Bit	Field	Type	Reset	Description
31-24	FDBQ7_STARVE_CNT	R-0	0	This field increments each time the Free Descriptor/Buffer Queue 7 is read while it is empty via the CPPI DMA. This field is cleared when read via the cpu.
23-16	FDBQ6_STARVE_CNT	R-0	0	This field increments each time the Free Descriptor/Buffer Queue 6 is read while it is empty via the CPPI DMA. This field is cleared when read via the cpu.
15-8	FDBQ5_STARVE_CNT	R-0	0	This field increments each time the Free Descriptor/Buffer Queue 5 is read while it is empty via the CPPI DMA. This field is cleared when read via the cpu.
7-0	FDBQ4_STARVE_CNT	R-0	0	This field increments each time the Free Descriptor/Buffer Queue 4 is read while it is empty via the CPPI DMA. This field is cleared when read via the cpu. Queue_Manager_Free_Descriptor_Buffer_Starvation_Count Register 1

16.5.7.5 FDBSC2 Register (offset = 28h) [reset = 0h]

 FDBSC2 is shown in [Figure 16-281](#) and described in [Table 16-295](#).

Figure 16-281. FDBSC2 Register


LEGEND: R/W = Read/Write; R = Read only; W1toCl = Write 1 to clear bit; -n = value after reset

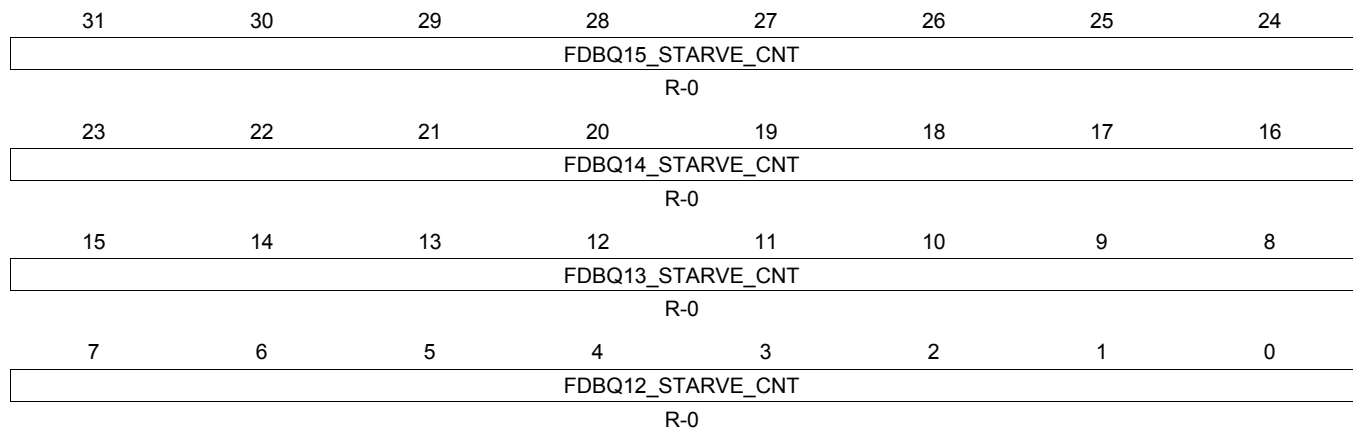
Table 16-295. FDBSC2 Register Field Descriptions

Bit	Field	Type	Reset	Description
31-24	FDBQ11_STARVE_CNT	R-0	0	This field increments each time the Free Descriptor/Buffer Queue 11 is read while it is empty via the CPPI DMA. This field is cleared when read via the cpu.
23-16	FDBQ10_STARVE_CNT	R-0	0	This field increments each time the Free Descriptor/Buffer Queue 10 is read while it is empty via the CPPI DMA. This field is cleared when read via the cpu.
15-8	FDBQ9_STARVE_CNT	R-0	0	This field increments each time the Free Descriptor/Buffer Queue 9 is read while it is empty via the CPPI DMA. This field is cleared when read via the cpu.
7-0	FDBQ8_STARVE_CNT	R-0	0	This field increments each time the Free Descriptor/Buffer Queue 8 is read while it is empty via the CPPI DMA. This field is cleared when read via the cpu. Queue_Manager_Free_Descriptor_Buffer_Starvation_Count Register 2

16.5.7.6 FDBSC3 Register (offset = 2Ch) [reset = 0h]

FDBSC3 is shown in [Figure 16-282](#) and described in [Table 16-296](#).

Figure 16-282. FDBSC3 Register



LEGEND: R/W = Read/Write; R = Read only; W1toCl = Write 1 to clear bit; -n = value after reset

Table 16-296. FDBSC3 Register Field Descriptions

Bit	Field	Type	Reset	Description
31-24	FDBQ15_STARVE_CNT	R-0	0	This field increments each time the Free Descriptor/Buffer Queue 15 is read while it is empty via the CPPI DMA. This field is cleared when read via the cpu.
23-16	FDBQ14_STARVE_CNT	R-0	0	This field increments each time the Free Descriptor/Buffer Queue 14 is read while it is empty via the CPPI DMA. This field is cleared when read via the cpu.
15-8	FDBQ13_STARVE_CNT	R-0	0	This field increments each time the Free Descriptor/Buffer Queue 13 is read while it is empty via the CPPI DMA. This field is cleared when read via the cpu.
7-0	FDBQ12_STARVE_CNT	R-0	0	This field increments each time the Free Descriptor/Buffer Queue 12 is read while it is empty via the CPPI DMA. This field is cleared when read via the cpu. Table 109 - QMGR_Free_Descriptor_Buffer_Starvation_Count Register 3

16.5.7.7 FDBSC4 Register (offset = 30h) [reset = 0h]

 FDBSC4 is shown in [Figure 16-283](#) and described in [Table 16-297](#).

Figure 16-283. FDBSC4 Register

31	30	29	28	27	26	25	24
FDBQ19_STARVE_CNT							
R-0							
23	22	21	20	19	18	17	16
FDBQ18_STARVE_CNT							
R-0							
15	14	13	12	11	10	9	8
FDBQ17_STARVE_CNT							
R-0							
7	6	5	4	3	2	1	0
FDBQ16_STARVE_CNT							
R-0							

LEGEND: R/W = Read/Write; R = Read only; W1toCl = Write 1 to clear bit; -n = value after reset

Table 16-297. FDBSC4 Register Field Descriptions

Bit	Field	Type	Reset	Description
31-24	FDBQ19_STARVE_CNT	R-0	0	This field increments each time the Free Descriptor/Buffer Queue 19 is read while it is empty via the CPPI DMA. This field is cleared when read via the cpu.
23-16	FDBQ18_STARVE_CNT	R-0	0	This field increments each time the Free Descriptor/Buffer Queue 18 is read while it is empty via the CPPI DMA. This field is cleared when read via the cpu.
15-8	FDBQ17_STARVE_CNT	R-0	0	This field increments each time the Free Descriptor/Buffer Queue 17 is read while it is empty via the CPPI DMA. This field is cleared when read via the cpu.
7-0	FDBQ16_STARVE_CNT	R-0	0	This field increments each time the Free Descriptor/Buffer Queue 16 is read while it is empty via the CPPI DMA. This field is cleared when read via the cpu. Queue_Manager_Free_Descriptor_Buffer_Starvation_Count Register 4

16.5.7.8 FDBSC5 Register (offset = 34h) [reset = 0h]

FDBSC5 is shown in [Figure 16-284](#) and described in [Table 16-298](#).

Figure 16-284. FDBSC5 Register

31	30	29	28	27	26	25	24
FDBQ23_STARVE_CNT							
R-0							
23	22	21	20	19	18	17	16
FDBQ22_STARVE_CNT							
R-0							
15	14	13	12	11	10	9	8
FDBQ21_STARVE_CNT							
R-0							
7	6	5	4	3	2	1	0
FDBQ20_STARVE_CNT							
R-0							

LEGEND: R/W = Read/Write; R = Read only; W1toCl = Write 1 to clear bit; -n = value after reset

Table 16-298. FDBSC5 Register Field Descriptions

Bit	Field	Type	Reset	Description
31-24	FDBQ23_STARVE_CNT	R-0	0	This field increments each time the Free Descriptor/Buffer Queue 23 is read while it is empty via the CPPI DMA. This field is cleared when read via the cpu.
23-16	FDBQ22_STARVE_CNT	R-0	0	This field increments each time the Free Descriptor/Buffer Queue 22 is read while it is empty via the CPPI DMA. This field is cleared when read via the cpu.
15-8	FDBQ21_STARVE_CNT	R-0	0	This field increments each time the Free Descriptor/Buffer Queue 21 is read while it is empty via the CPPI DMA. This field is cleared when read via the cpu.
7-0	FDBQ20_STARVE_CNT	R-0	0	This field increments each time the Free Descriptor/Buffer Queue 20 is read while it is empty via the CPPI DMA. This field is cleared when read via the cpu. Queue_Manager_Free_Descriptor_Buffer_Starvation_Count Register 5

16.5.7.9 FDBSC6 Register (offset = 38h) [reset = 0h]

 FDBSC6 is shown in [Figure 16-285](#) and described in [Table 16-299](#).

Figure 16-285. FDBSC6 Register

31	30	29	28	27	26	25	24
FDBQ27_STARVE_CNT							
R-0							
23	22	21	20	19	18	17	16
FDBQ26_STARVE_CNT							
R-0							
15	14	13	12	11	10	9	8
FDBQ25_STARVE_CNT							
R-0							
7	6	5	4	3	2	1	0
FDBQ24_STARVE_CNT							
R-0							

LEGEND: R/W = Read/Write; R = Read only; W1toCl = Write 1 to clear bit; -n = value after reset

Table 16-299. FDBSC6 Register Field Descriptions

Bit	Field	Type	Reset	Description
31-24	FDBQ27_STARVE_CNT	R-0	0	This field increments each time the Free Descriptor/Buffer Queue 27 is read while it is empty via the CPPI DMA. This field is cleared when read via the cpu.
23-16	FDBQ26_STARVE_CNT	R-0	0	This field increments each time the Free Descriptor/Buffer Queue 26 is read while it is empty via the CPPI DMA. This field is cleared when read via the cpu.
15-8	FDBQ25_STARVE_CNT	R-0	0	This field increments each time the Free Descriptor/Buffer Queue 25 is read while it is empty via the CPPI DMA. This field is cleared when read via the cpu.
7-0	FDBQ24_STARVE_CNT	R-0	0	This field increments each time the Free Descriptor/Buffer Queue 24 is read while it is empty via the CPPI DMA. This field is cleared when read via the cpu. Queue_Manager_Free_Descriptor_Buffer_Starvation_Count Register 6

16.5.7.10 FDBSC7 Register (offset = 3Ch) [reset = 0h]

FDBSC7 is shown in [Figure 16-286](#) and described in [Table 16-300](#).

Figure 16-286. FDBSC7 Register

31	30	29	28	27	26	25	24
FDBQ31_STARVE_CNT							
R-0							
23	22	21	20	19	18	17	16
FDBQ30_STARVE_CNT							
R-0							
15	14	13	12	11	10	9	8
FDBQ29_STARVE_CNT							
R-0							
7	6	5	4	3	2	1	0
FDBQ28_STARVE_CNT							
R-0							

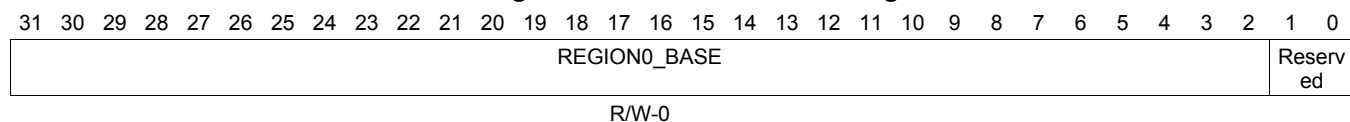
LEGEND: R/W = Read/Write; R = Read only; W1toCl = Write 1 to clear bit; -n = value after reset

Table 16-300. FDBSC7 Register Field Descriptions

Bit	Field	Type	Reset	Description
31-24	FDBQ31_STARVE_CNT	R-0	0	This field increments each time the Free Descriptor/Buffer Queue 31 is read while it is empty via the CPPI DMA. This field is cleared when read via the cpu.
23-16	FDBQ30_STARVE_CNT	R-0	0	This field increments each time the Free Descriptor/Buffer Queue 30 is read while it is empty via the CPPI DMA. This field is cleared when read via the cpu.
15-8	FDBQ29_STARVE_CNT	R-0	0	This field increments each time the Free Descriptor/Buffer Queue 29 is read while it is empty via the CPPI DMA. This field is cleared when read via the cpu.
7-0	FDBQ28_STARVE_CNT	R-0	0	This field increments each time the Free Descriptor/Buffer Queue 28 is read while it is empty via the CPPI DMA. This field is cleared when read via the cpu. Queue_Manager_Free_Descriptor_Buffer_Starvation_Count Register 7

16.5.7.11 LRAM0BASE Register (offset = 80h) [reset = 0h]

LRAM0BASE is shown in [Figure 16-287](#) and described in [Table 16-301](#).

Figure 16-287. LRAM0BASE Register


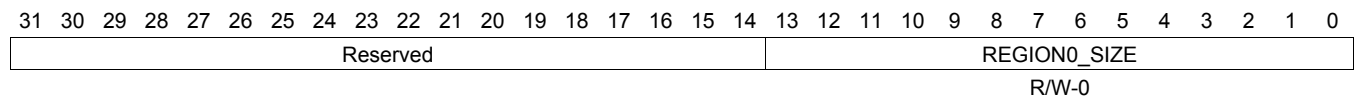
LEGEND: R/W = Read/Write; R = Read only; W1toCl = Write 1 to clear bit; -n = value after reset

Table 16-301. LRAM0BASE Register Field Descriptions

Bit	Field	Type	Reset	Description
31-2	REGION0_BASE	R/W-0	0	This field stores the base address for the first region of the linking RAM. This may be anywhere in 32-bit address space but would be typically located in on-chip memory.

16.5.7.12 LRAM0SIZE Register (offset = 84h) [reset = 0h]

 LRAM0SIZE is shown in [Figure 16-288](#) and described in [Table 16-302](#).

Figure 16-288. LRAM0SIZE Register


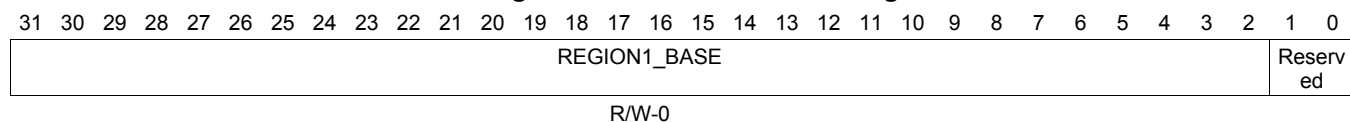
LEGEND: R/W = Read/Write; R = Read only; W1toCl = Write 1 to clear bit; -n = value after reset

Table 16-302. LRAM0SIZE Register Field Descriptions

Bit	Field	Type	Reset	Description
13-0	REGION0_SIZE	R/W-0	0	This field indicates the number of entries that are contained in the linking RAM region 0. A descriptor with index less than region0_size value has its linking location in region 0. A descriptor with index greater than region0_size has its linking location in region 1. The queue manager will add the index (left shifted by 2 bits) to the appropriate regionX_base_addr to get the absolute 32-bit address to the linking location for a descriptor. Queue Manager Linking Ram Region 0 Size Register

16.5.7.13 LRAM1BASE Register (offset = 88h) [reset = 0h]

LRAM1BASE is shown in [Figure 16-289](#) and described in [Table 16-303](#).

Figure 16-289. LRAM1BASE Register


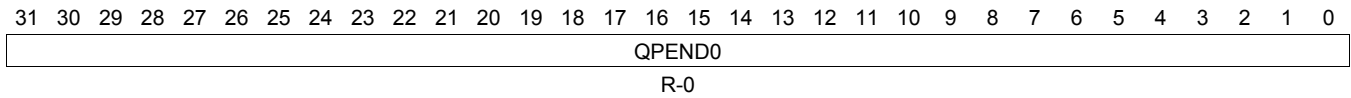
LEGEND: R/W = Read/Write; R = Read only; W1toCl = Write 1 to clear bit; -n = value after reset

Table 16-303. LRAM1BASE Register Field Descriptions

Bit	Field	Type	Reset	Description
31-2	REGION1_BASE	R/W-0	0	This field stores the base address for the second region of the linking RAM. This may be anywhere in 32-bit address space but would be typically located in off-chip memory.

16.5.7.14 PEND0 Register (offset = 90h) [reset = 0h]

PEND0 is shown in [Figure 16-290](#) and described in [Table 16-304](#).

Figure 16-290. PEND0 Register


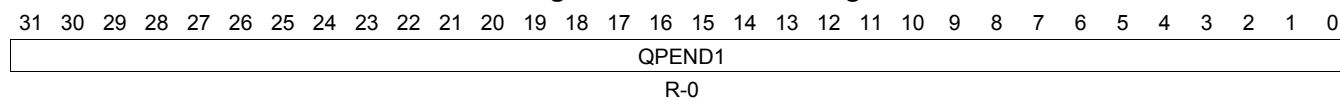
LEGEND: R/W = Read/Write; R = Read only; W1toCl = Write 1 to clear bit; -n = value after reset

Table 16-304. PEND0 Register Field Descriptions

Bit	Field	Type	Reset	Description
31-0	QPEND0	R-0	0	This field indicates the queue pending status for queues[31:0].

16.5.7.15 PEND1 Register (offset = 94h) [reset = 0h]

PEND1 is shown in [Figure 16-291](#) and described in [Table 16-305](#).

Figure 16-291. PEND1 Register


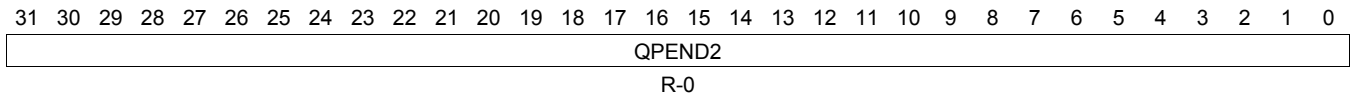
LEGEND: R/W = Read/Write; R = Read only; W1toCl = Write 1 to clear bit; -n = value after reset

Table 16-305. PEND1 Register Field Descriptions

Bit	Field	Type	Reset	Description
31-0	QPEND1	R-0	0	This field indicates the queue pending status for queues[63:32]. Table 118 - QMGR_Queue_Pending_1 Register 1

16.5.7.16 PEND2 Register (offset = 98h) [reset = 0h]

PEND2 is shown in [Figure 16-292](#) and described in [Table 16-306](#).

Figure 16-292. PEND2 Register


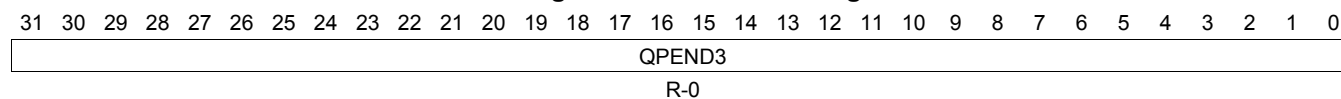
LEGEND: R/W = Read/Write; R = Read only; W1toCl = Write 1 to clear bit; -n = value after reset

Table 16-306. PEND2 Register Field Descriptions

Bit	Field	Type	Reset	Description
31-0	QPEND2	R-0	0	This field indicates the queue pending status for queues[95:64]. Queue_Manager_Queue_Pending_2 Register 2

16.5.7.17 PEND3 Register (offset = 9Ch) [reset = 0h]

PEND3 is shown in [Figure 16-293](#) and described in [Table 16-307](#).

Figure 16-293. PEND3 Register


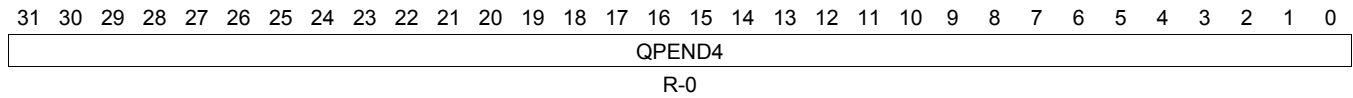
LEGEND: R/W = Read/Write; R = Read only; W1toCl = Write 1 to clear bit; -n = value after reset

Table 16-307. PEND3 Register Field Descriptions

Bit	Field	Type	Reset	Description
31-0	QPEND3	R-0	0	This field indicates the queue pending status for queues[127:96]. Queue_Manager_Queue_Pending_3 Register 3

16.5.7.18 PEND4 Register (offset = A0h) [reset = 0h]

PEND4 is shown in [Figure 16-294](#) and described in [Table 16-308](#).

Figure 16-294. PEND4 Register


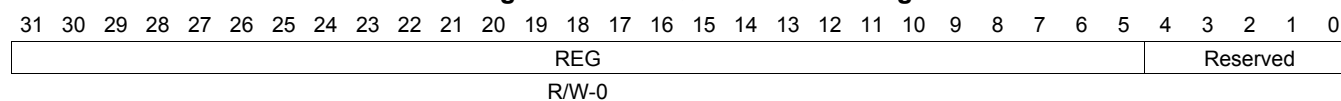
LEGEND: R/W = Read/Write; R = Read only; W1toCl = Write 1 to clear bit; -n = value after reset

Table 16-308. PEND4 Register Field Descriptions

Bit	Field	Type	Reset	Description
31-0	QPEND4	R-0	0	This field indicates the queue pending status for queues[159:128]. Queue_Manager_Queue_Pending_4 Register 4

16.5.7.19 QMEMRBASE0 Register (offset = 1000h) [reset = 0h]

QMEMRBASE0 is shown in [Figure 16-295](#) and described in [Table 16-309](#).

Figure 16-295. QMEMRBASE0 Register


LEGEND: R/W = Read/Write; R = Read only; W1toCl = Write 1 to clear bit; -n = value after reset

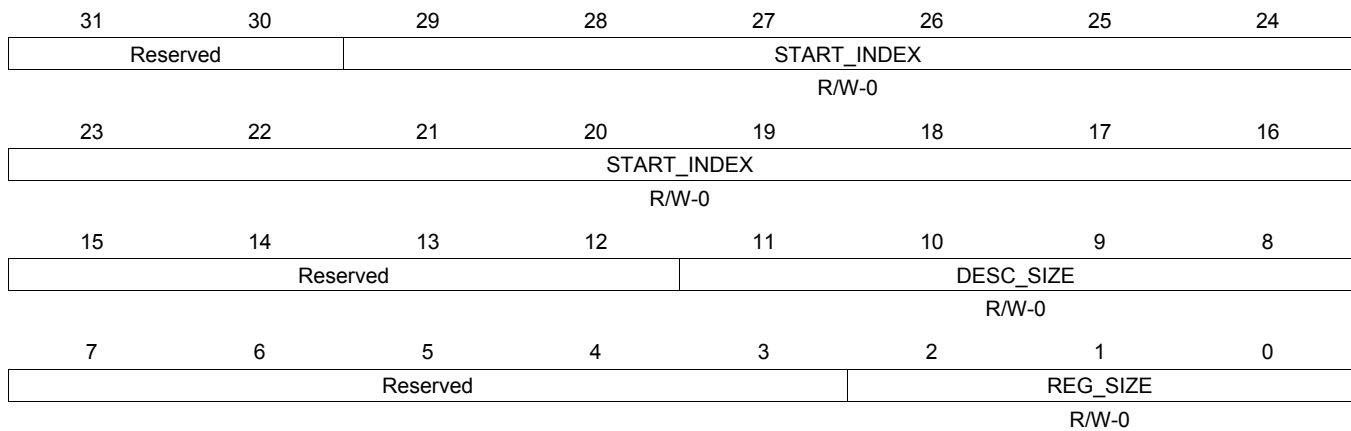
Table 16-309. QMEMRBASE0 Register Field Descriptions

Bit	Field	Type	Reset	Description
31-5	REG	R/W-0	0	This field contains the base address of the memory region R.

16.5.7.20 QMEMCTRL0 Register (offset = 1004h) [reset = 0h]

QMEMCTRL0 is shown in [Figure 16-296](#) and described in [Table 16-310](#).

Figure 16-296. QMEMCTRL0 Register



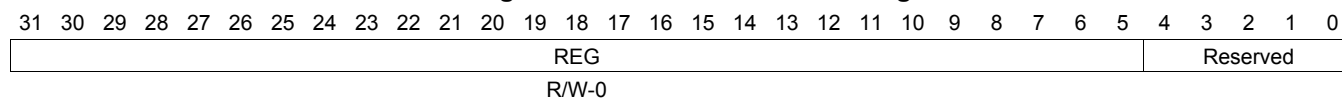
LEGEND: R/W = Read/Write; R = Read only; W1toCl = Write 1 to clear bit; -n = value after reset

Table 16-310. QMEMCTRL0 Register Field Descriptions

Bit	Field	Type	Reset	Description
29-16	START_INDEX	R/W-0	0	This field indicates where in linking RAM does the descriptor linking information corresponding to memory region R starts.
11-8	DESC_SIZE	R/W-0	0	This field indicates the size of each descriptor in this memory region. It is an encoded value that specifies descriptor size as $2^{(5+desc_size)}$ number of bytes. The settings of desc_size from 9-15 are reserved.
2-0	REG_SIZE	R/W-0	0	This field indicates the size of the memory region (in terms of number of descriptors). It is an encoded value that specifies region size as $2^{(5+reg_size)}$ number of descriptors. Queue Manager Memory Region R Control Registers The following sections describe each of the four register locations that may be present for each queue in the queues region. For reasons of implementation and area efficiency, these registers are not actually implemented as a huge array of flip flops but are instead implemented as a single set of mailbox registers which use the LSBs of the provided address as a queue index. Due to this implementation all accesses to these registers need to be performed as a single burst write for each packet push operation or a single burst read for each packet pop operation. The length of a burst to push or pop a packet will vary depending on the optional features that the queue supports which may be 4, 8, 12 or 16 bytes. Queue N Register D must always be written / read in the burst but the preceding words are optional depending on the required queue functionality.

16.5.7.21 QMEMRBASE1 Register (offset = 1010h) [reset = 0h]

QMEMRBASE1 is shown in [Figure 16-297](#) and described in [Table 16-311](#).

Figure 16-297. QMEMRBASE1 Register


LEGEND: R/W = Read/Write; R = Read only; W1toCl = Write 1 to clear bit; -n = value after reset

Table 16-311. QMEMRBASE1 Register Field Descriptions

Bit	Field	Type	Reset	Description
31-5	REG	R/W-0	0	This field contains the base address of the memory region R.

16.5.7.22 QMEMCTRL1 Register (offset = 1014h) [reset = 0h]

QMEMCTRL1 is shown in [Figure 16-298](#) and described in [Table 16-312](#).

Figure 16-298. QMEMCTRL1 Register

31	30	29	28	27	26	25	24
Reserved			START_INDEX				
R/W-0							
23	22	21	20	19	18	17	16
START_INDEX							
R/W-0							
15	14	13	12	11	10	9	8
Reserved				DESC_SIZE			
R/W-0							
7	6	5	4	3	2	1	0
Reserved					REG_SIZE		
R/W-0							

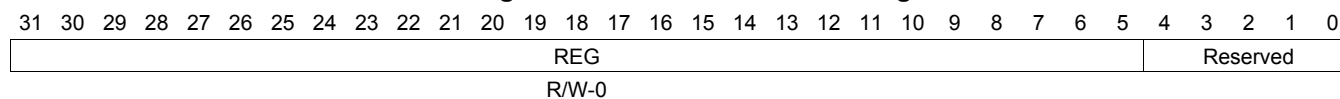
LEGEND: R/W = Read/Write; R = Read only; W1toCl = Write 1 to clear bit; -n = value after reset

Table 16-312. QMEMCTRL1 Register Field Descriptions

Bit	Field	Type	Reset	Description
29-16	START_INDEX	R/W-0	0	This field indicates where in linking RAM does the descriptor linking information corresponding to memory region R starts.
11-8	DESC_SIZE	R/W-0	0	This field indicates the size of each descriptor in this memory region. It is an encoded value that specifies descriptor size as $2^{(5+desc_size)}$ number of bytes. The settings of desc_size from 9-15 are reserved.
2-0	REG_SIZE	R/W-0	0	This field indicates the size of the memory region (in terms of number of descriptors). It is an encoded value that specifies region size as $2^{(5+reg_size)}$ number of descriptors. Queue Manager Memory Region R Control Registers The following sections describe each of the four register locations that may be present for each queue in the queues region. For reasons of implementation and area efficiency, these registers are not actually implemented as a huge array of flip flops but are instead implemented as a single set of mailbox registers which use the LSBs of the provided address as a queue index. Due to this implementation all accesses to these registers need to be performed as a single burst write for each packet push operation or a single burst read for each packet pop operation. The length of a burst to push or pop a packet will vary depending on the optional features that the queue supports which may be 4, 8, 12 or 16 bytes. Queue N Register D must always be written / read in the burst but the preceding words are optional depending on the required queue functionality.

16.5.7.23 QMEMRBASE2 Register (offset = 1020h) [reset = 0h]

QMEMRBASE2 is shown in [Figure 16-299](#) and described in [Table 16-313](#).

Figure 16-299. QMEMRBASE2 Register


LEGEND: R/W = Read/Write; R = Read only; W1toCl = Write 1 to clear bit; -n = value after reset

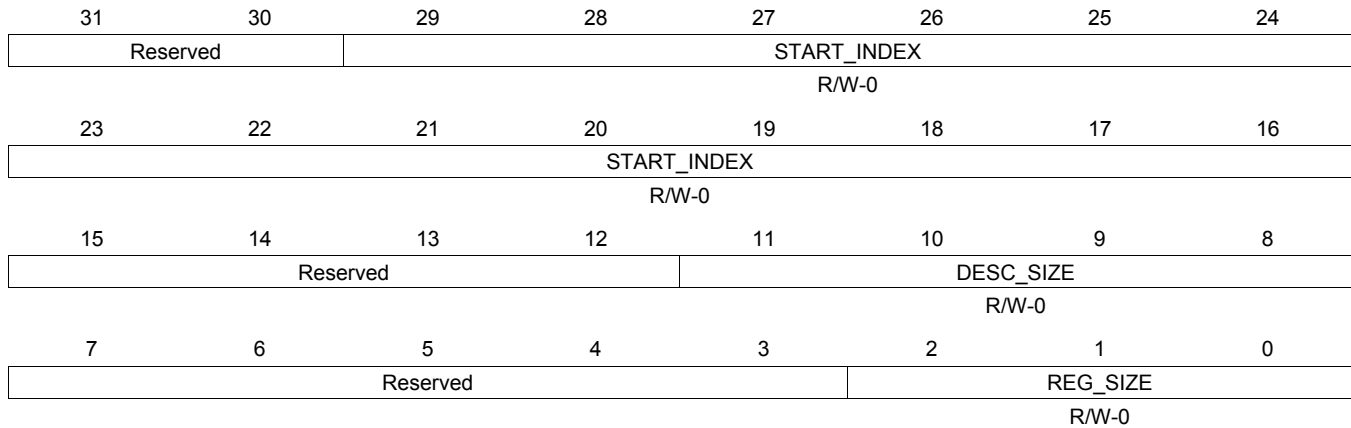
Table 16-313. QMEMRBASE2 Register Field Descriptions

Bit	Field	Type	Reset	Description
31-5	REG	R/W-0	0	This field contains the base address of the memory region R.

16.5.7.24 QMEMCTRL2 Register (offset = 1024h) [reset = 0h]

QMEMCTRL2 is shown in [Figure 16-300](#) and described in [Table 16-314](#).

Figure 16-300. QMEMCTRL2 Register



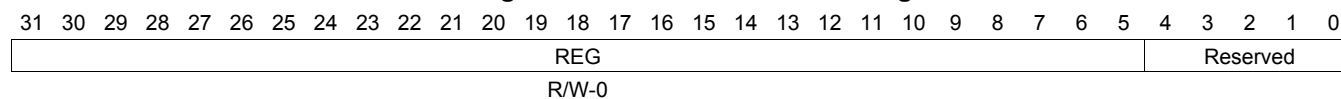
LEGEND: R/W = Read/Write; R = Read only; W1toCl = Write 1 to clear bit; -n = value after reset

Table 16-314. QMEMCTRL2 Register Field Descriptions

Bit	Field	Type	Reset	Description
29-16	START_INDEX	R/W-0	0	This field indicates where in linking RAM does the descriptor linking information corresponding to memory region R starts.
11-8	DESC_SIZE	R/W-0	0	This field indicates the size of each descriptor in this memory region. It is an encoded value that specifies descriptor size as $2^{(5+desc_size)}$ number of bytes. The settings of desc_size from 9-15 are reserved.
2-0	REG_SIZE	R/W-0	0	This field indicates the size of the memory region (in terms of number of descriptors). It is an encoded value that specifies region size as $2^{(5+reg_size)}$ number of descriptors. Queue Manager Memory Region R Control Registers The following sections describe each of the four register locations that may be present for each queue in the queues region. For reasons of implementation and area efficiency, these registers are not actually implemented as a huge array of flip flops but are instead implemented as a single set of mailbox registers which use the LSBs of the provided address as a queue index. Due to this implementation all accesses to these registers need to be performed as a single burst write for each packet push operation or a single burst read for each packet pop operation. The length of a burst to push or pop a packet will vary depending on the optional features that the queue supports which may be 4, 8, 12 or 16 bytes. Queue N Register D must always be written / read in the burst but the preceding words are optional depending on the required queue functionality.

16.5.7.25 QMEMRBASE3 Register (offset = 1030h) [reset = 0h]

QMEMRBASE3 is shown in [Figure 16-301](#) and described in [Table 16-315](#).

Figure 16-301. QMEMRBASE3 Register


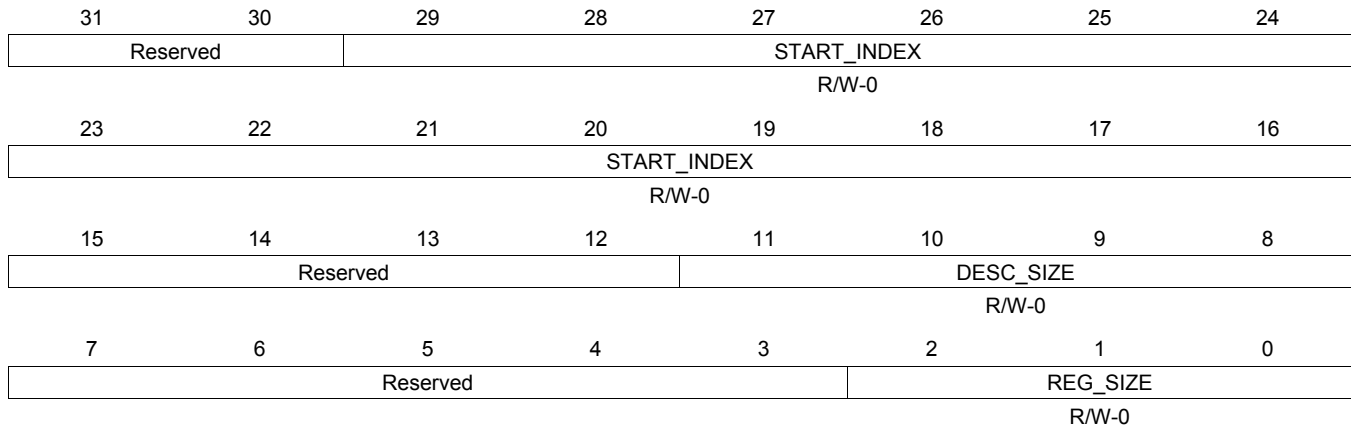
LEGEND: R/W = Read/Write; R = Read only; W1toCl = Write 1 to clear bit; -n = value after reset

Table 16-315. QMEMRBASE3 Register Field Descriptions

Bit	Field	Type	Reset	Description
31-5	REG	R/W-0	0	This field contains the base address of the memory region R.

16.5.7.26 QMEMCTRL3 Register (offset = 1034h) [reset = 0h]

QMEMCTRL3 is shown in [Figure 16-302](#) and described in [Table 16-316](#).

Figure 16-302. QMEMCTRL3 Register


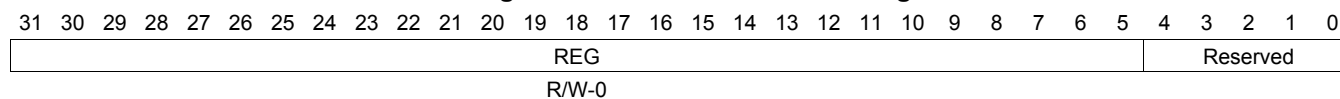
LEGEND: R/W = Read/Write; R = Read only; W1toCl = Write 1 to clear bit; -n = value after reset

Table 16-316. QMEMCTRL3 Register Field Descriptions

Bit	Field	Type	Reset	Description
29-16	START_INDEX	R/W-0	0	This field indicates where in linking RAM does the descriptor linking information corresponding to memory region R starts.
11-8	DESC_SIZE	R/W-0	0	This field indicates the size of each descriptor in this memory region. It is an encoded value that specifies descriptor size as $2^{(5+desc_size)}$ number of bytes. The settings of desc_size from 9-15 are reserved.
2-0	REG_SIZE	R/W-0	0	This field indicates the size of the memory region (in terms of number of descriptors). It is an encoded value that specifies region size as $2^{(5+reg_size)}$ number of descriptors. Queue Manager Memory Region R Control Registers The following sections describe each of the four register locations that may be present for each queue in the queues region. For reasons of implementation and area efficiency, these registers are not actually implemented as a huge array of flip flops but are instead implemented as a single set of mailbox registers which use the LSBs of the provided address as a queue index. Due to this implementation all accesses to these registers need to be performed as a single burst write for each packet push operation or a single burst read for each packet pop operation. The length of a burst to push or pop a packet will vary depending on the optional features that the queue supports which may be 4, 8, 12 or 16 bytes. Queue N Register D must always be written / read in the burst but the preceding words are optional depending on the required queue functionality.

16.5.7.27 QMEMRBASE4 Register (offset = 1040h) [reset = 0h]

QMEMRBASE4 is shown in [Figure 16-303](#) and described in [Table 16-317](#).

Figure 16-303. QMEMRBASE4 Register


LEGEND: R/W = Read/Write; R = Read only; W1toCl = Write 1 to clear bit; -n = value after reset

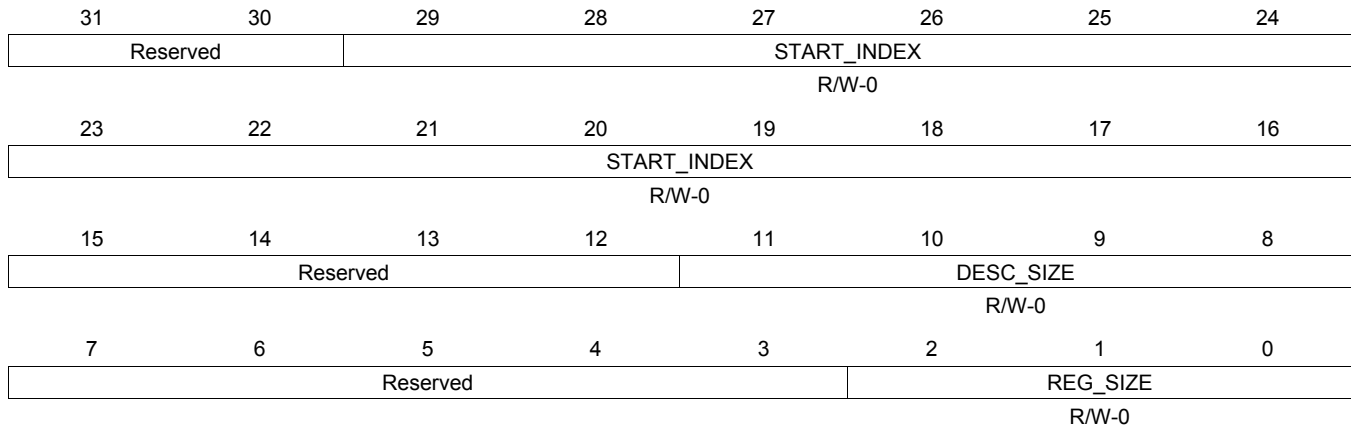
Table 16-317. QMEMRBASE4 Register Field Descriptions

Bit	Field	Type	Reset	Description
31-5	REG	R/W-0	0	This field contains the base address of the memory region R.

16.5.7.28 QMEMCTRL4 Register (offset = 1044h) [reset = 0h]

QMEMCTRL4 is shown in [Figure 16-304](#) and described in [Table 16-318](#).

Figure 16-304. QMEMCTRL4 Register



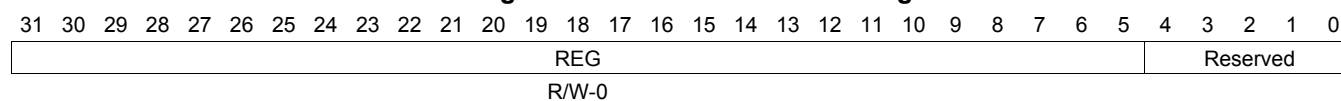
LEGEND: R/W = Read/Write; R = Read only; W1toCl = Write 1 to clear bit; -n = value after reset

Table 16-318. QMEMCTRL4 Register Field Descriptions

Bit	Field	Type	Reset	Description
29-16	START_INDEX	R/W-0	0	This field indicates where in linking RAM does the descriptor linking information corresponding to memory region R starts.
11-8	DESC_SIZE	R/W-0	0	This field indicates the size of each descriptor in this memory region. It is an encoded value that specifies descriptor size as $2^{(5+desc_size)}$ number of bytes. The settings of desc_size from 9-15 are reserved.
2-0	REG_SIZE	R/W-0	0	This field indicates the size of the memory region (in terms of number of descriptors). It is an encoded value that specifies region size as $2^{(5+reg_size)}$ number of descriptors. Queue Manager Memory Region R Control Registers The following sections describe each of the four register locations that may be present for each queue in the queues region. For reasons of implementation and area efficiency, these registers are not actually implemented as a huge array of flip flops but are instead implemented as a single set of mailbox registers which use the LSBs of the provided address as a queue index. Due to this implementation all accesses to these registers need to be performed as a single burst write for each packet push operation or a single burst read for each packet pop operation. The length of a burst to push or pop a packet will vary depending on the optional features that the queue supports which may be 4, 8, 12 or 16 bytes. Queue N Register D must always be written / read in the burst but the preceding words are optional depending on the required queue functionality.

16.5.7.29 QMEMRBASE5 Register (offset = 1050h) [reset = 0h]

QMEMRBASE5 is shown in [Figure 16-305](#) and described in [Table 16-319](#).

Figure 16-305. QMEMRBASE5 Register


LEGEND: R/W = Read/Write; R = Read only; W1toCl = Write 1 to clear bit; -n = value after reset

Table 16-319. QMEMRBASE5 Register Field Descriptions

Bit	Field	Type	Reset	Description
31-5	REG	R/W-0	0	This field contains the base address of the memory region R.

16.5.7.30 QMEMCTRL5 Register (offset = 1054h) [reset = 0h]

QMEMCTRL5 is shown in [Figure 16-306](#) and described in [Table 16-320](#).

Figure 16-306. QMEMCTRL5 Register

31	30	29	28	27	26	25	24
Reserved		START_INDEX					
R/W-0							
23	22	21	20	19	18	17	16
START_INDEX							
R/W-0							
15	14	13	12	11	10	9	8
Reserved				DESC_SIZE			
R/W-0							
7	6	5	4	3	2	1	0
Reserved				REG_SIZE			
R/W-0							

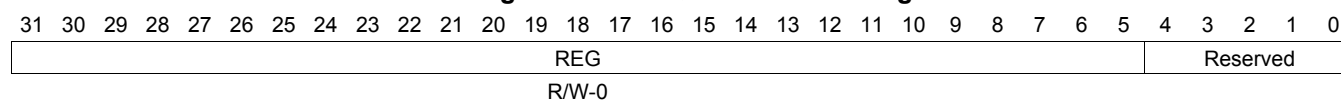
LEGEND: R/W = Read/Write; R = Read only; W1toCl = Write 1 to clear bit; -n = value after reset

Table 16-320. QMEMCTRL5 Register Field Descriptions

Bit	Field	Type	Reset	Description
29-16	START_INDEX	R/W-0	0	This field indicates where in linking RAM does the descriptor linking information corresponding to memory region R starts.
11-8	DESC_SIZE	R/W-0	0	This field indicates the size of each descriptor in this memory region. It is an encoded value that specifies descriptor size as $2^{(5+desc_size)}$ number of bytes. The settings of desc_size from 9-15 are reserved.
2-0	REG_SIZE	R/W-0	0	This field indicates the size of the memory region (in terms of number of descriptors). It is an encoded value that specifies region size as $2^{(5+reg_size)}$ number of descriptors. Queue Manager Memory Region R Control Registers The following sections describe each of the four register locations that may be present for each queue in the queues region. For reasons of implementation and area efficiency, these registers are not actually implemented as a huge array of flip flops but are instead implemented as a single set of mailbox registers which use the LSBs of the provided address as a queue index. Due to this implementation all accesses to these registers need to be performed as a single burst write for each packet push operation or a single burst read for each packet pop operation. The length of a burst to push or pop a packet will vary depending on the optional features that the queue supports which may be 4, 8, 12 or 16 bytes. Queue N Register D must always be written / read in the burst but the preceding words are optional depending on the required queue functionality.

16.5.7.31 QMEMRBASE6 Register (offset = 1060h) [reset = 0h]

QMEMRBASE6 is shown in [Figure 16-307](#) and described in [Table 16-321](#).

Figure 16-307. QMEMRBASE6 Register


LEGEND: R/W = Read/Write; R = Read only; W1toCl = Write 1 to clear bit; -n = value after reset

Table 16-321. QMEMRBASE6 Register Field Descriptions

Bit	Field	Type	Reset	Description
31-5	REG	R/W-0	0	This field contains the base address of the memory region R.

16.5.7.32 QMEMCTRL6 Register (offset = 1064h) [reset = 0h]

QMEMCTRL6 is shown in [Figure 16-308](#) and described in [Table 16-322](#).

Figure 16-308. QMEMCTRL6 Register

31	30	29	28	27	26	25	24
Reserved			START_INDEX				
R/W-0							
23	22	21	20	19	18	17	16
START_INDEX							
R/W-0							
15	14	13	12	11	10	9	8
Reserved				DESC_SIZE			
R/W-0							
7	6	5	4	3	2	1	0
Reserved					REG_SIZE		
R/W-0							

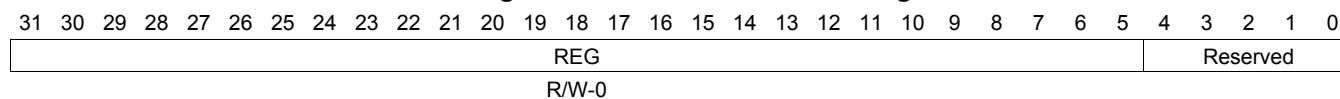
LEGEND: R/W = Read/Write; R = Read only; W1toCl = Write 1 to clear bit; -n = value after reset

Table 16-322. QMEMCTRL6 Register Field Descriptions

Bit	Field	Type	Reset	Description
29-16	START_INDEX	R/W-0	0	This field indicates where in linking RAM does the descriptor linking information corresponding to memory region R starts.
11-8	DESC_SIZE	R/W-0	0	This field indicates the size of each descriptor in this memory region. It is an encoded value that specifies descriptor size as $2^{(5+desc_size)}$ number of bytes. The settings of desc_size from 9-15 are reserved.
2-0	REG_SIZE	R/W-0	0	This field indicates the size of the memory region (in terms of number of descriptors). It is an encoded value that specifies region size as $2^{(5+reg_size)}$ number of descriptors. Queue Manager Memory Region R Control Registers The following sections describe each of the four register locations that may be present for each queue in the queues region. For reasons of implementation and area efficiency, these registers are not actually implemented as a huge array of flip flops but are instead implemented as a single set of mailbox registers which use the LSBs of the provided address as a queue index. Due to this implementation all accesses to these registers need to be performed as a single burst write for each packet push operation or a single burst read for each packet pop operation. The length of a burst to push or pop a packet will vary depending on the optional features that the queue supports which may be 4, 8, 12 or 16 bytes. Queue N Register D must always be written / read in the burst but the preceding words are optional depending on the required queue functionality.

16.5.7.33 QMEMRBASE7 Register (offset = 1070h) [reset = 0h]

QMEMRBASE7 is shown in [Figure 16-309](#) and described in [Table 16-323](#).

Figure 16-309. QMEMRBASE7 Register


LEGEND: R/W = Read/Write; R = Read only; W1toCl = Write 1 to clear bit; -n = value after reset

Table 16-323. QMEMRBASE7 Register Field Descriptions

Bit	Field	Type	Reset	Description
31-5	REG	R/W-0	0	This field contains the base address of the memory region R.

16.5.7.34 QMEMCTRL7 Register (offset = 1074h) [reset = 0h]

QMEMCTRL7 is shown in [Figure 16-310](#) and described in [Table 16-324](#).

Figure 16-310. QMEMCTRL7 Register

31	30	29	28	27	26	25	24
Reserved			START_INDEX				
R/W-0							
23	22	21	20	19	18	17	16
START_INDEX							
R/W-0							
15	14	13	12	11	10	9	8
Reserved				DESC_SIZE			
R/W-0							
7	6	5	4	3	2	1	0
Reserved					REG_SIZE		
R/W-0							

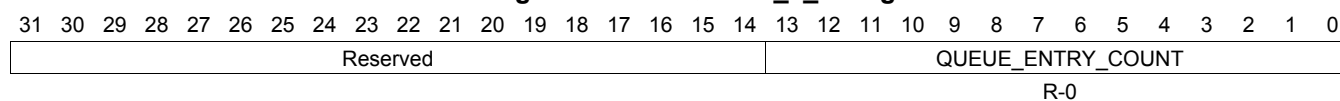
LEGEND: R/W = Read/Write; R = Read only; W1toCl = Write 1 to clear bit; -n = value after reset

Table 16-324. QMEMCTRL7 Register Field Descriptions

Bit	Field	Type	Reset	Description
29-16	START_INDEX	R/W-0	0	This field indicates where in linking RAM does the descriptor linking information corresponding to memory region R starts.
11-8	DESC_SIZE	R/W-0	0	This field indicates the size of each descriptor in this memory region. It is an encoded value that specifies descriptor size as $2^{(5+desc_size)}$ number of bytes. The settings of desc_size from 9-15 are reserved.
2-0	REG_SIZE	R/W-0	0	This field indicates the size of the memory region (in terms of number of descriptors). It is an encoded value that specifies region size as $2^{(5+reg_size)}$ number of descriptors. Queue Manager Memory Region R Control Registers The following sections describe each of the four register locations that may be present for each queue in the queues region. For reasons of implementation and area efficiency, these registers are not actually implemented as a huge array of flip flops but are instead implemented as a single set of mailbox registers which use the LSBs of the provided address as a queue index. Due to this implementation all accesses to these registers need to be performed as a single burst write for each packet push operation or a single burst read for each packet pop operation. The length of a burst to push or pop a packet will vary depending on the optional features that the queue supports which may be 4, 8, 12 or 16 bytes. Queue N Register D must always be written / read in the burst but the preceding words are optional depending on the required queue functionality.

16.5.7.35 QUEUE_0_A Register (offset = 2000h) [reset = 0h]

QUEUE_0_A is shown in [Figure 16-311](#) and described in [Table 16-325](#).

Figure 16-311. QUEUE_0_A Register


LEGEND: R/W = Read/Write; R = Read only; W1toCl = Write 1 to clear bit; -n = value after reset

Table 16-325. QUEUE_0_A Register Field Descriptions

Bit	Field	Type	Reset	Description
13-0	QUEUE_ENTRY_COUNT	R-0	0	This field indicates how many packets are currently queued on the queue. This count is incremented by 1 whenever a packet is added to the queue. This count is decremented by 1 whenever a packet is popped from the queue.

16.5.7.36 QUEUE_0_B Register (offset = 2004h) [reset = 0h]

QUEUE_0_B is shown in [Figure 16-312](#) and described in [Table 16-326](#).

Figure 16-312. QUEUE_0_B Register

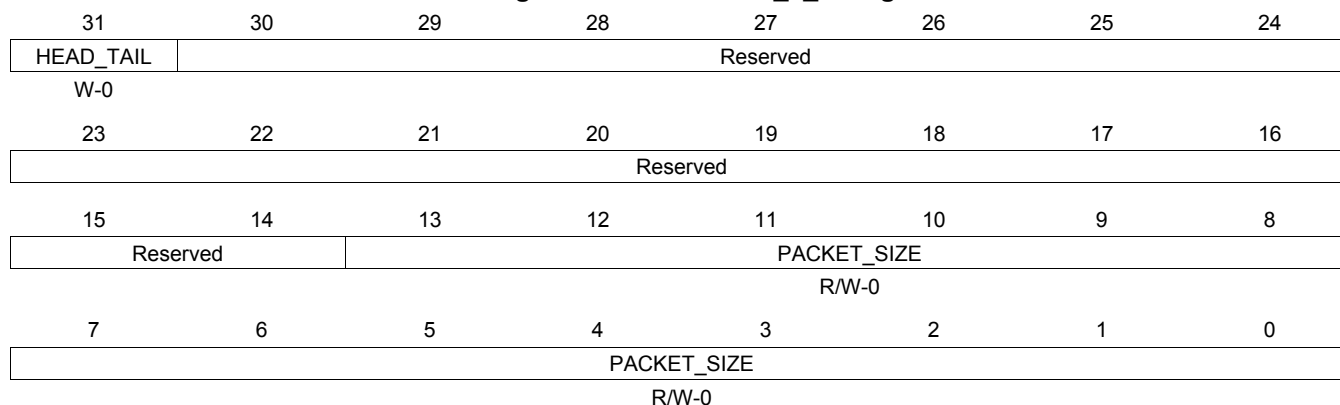

LEGEND: R/W = Read/Write; R = Read only; W1toCl = Write 1 to clear bit; -n = value after reset

Table 16-326. QUEUE_0_B Register Field Descriptions

Bit	Field	Type	Reset	Description
27-0	QUEUE_BYTE_COUNT	R-0	0	This field indicates how many bytes total are contained in all of the packets which are currently queued on this queue.

16.5.7.37 QUEUE_0_C Register (offset = 2008h) [reset = 0h]

 QUEUE_0_C is shown in [Figure 16-313](#) and described in [Table 16-327](#).

Figure 16-313. QUEUE_0_C Register


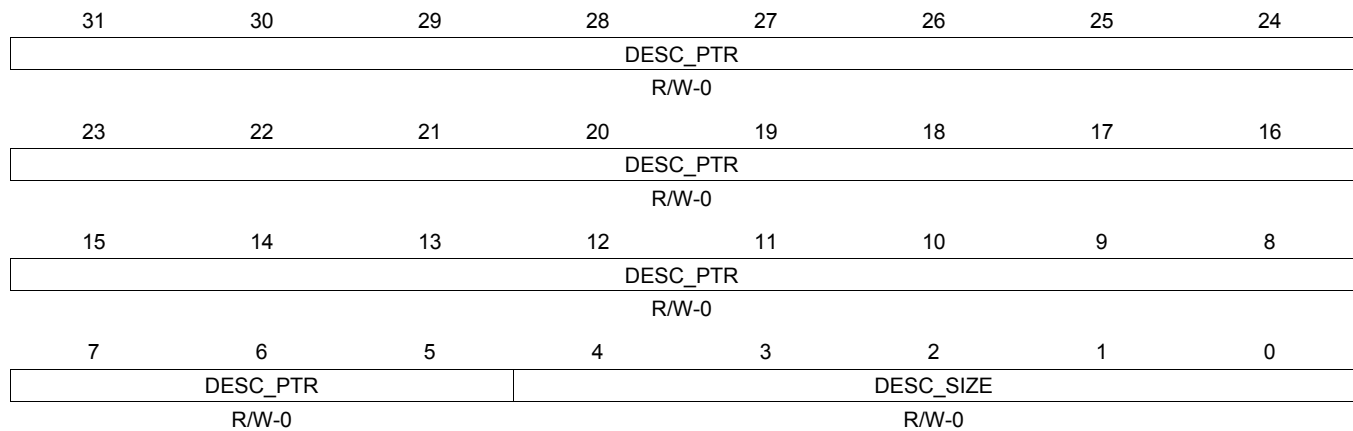
LEGEND: R/W = Read/Write; R = Read only; W1toCl = Write 1 to clear bit; -n = value after reset

Table 16-327. QUEUE_0_C Register Field Descriptions

Bit	Field	Type	Reset	Description
31	HEAD_TAIL	W-0	0	Head/Tail Push Control. Set to zero in order to push packet onto tail of queue and set to one in order to push packet onto head of queue.
13-0	PACKET_SIZE	R/W-0	0	packet_size This field indicates packet size and is assumed to be zero on each packet add unless the value is explicitly overwritten. This field indicates packet size for packet pop operation.

16.5.7.38 QUEUE_0_D Register (offset = 200Ch) [reset = 0h]

QUEUE_0_D is shown in [Figure 16-314](#) and described in [Table 16-328](#).

Figure 16-314. QUEUE_0_D Register


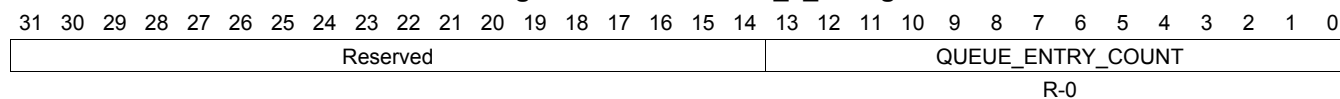
LEGEND: R/W = Read/Write; R = Read only; W1toCl = Write 1 to clear bit; -n = value after reset

Table 16-328. QUEUE_0_D Register Field Descriptions

Bit	Field	Type	Reset	Description
31-5	DESC_PTR	R/W-0	0	Descriptor pointer. It will be read as zero if the queue is empty. It will indicate a 32-bit aligned address that points to a descriptor when the queue is not empty.
4-0	DESC_SIZE	R/W-0	0	Descriptor Size. It is encoded in 4-byte increments with values 0 to 31 representing 24 and so on to 148 bytes. This field will return a 0x0 when an empty queue is read. Queue Manager Queue N Registers D To save hardware resources, the queue manager internally stores descriptor size (desc_size) information in four bits. However, register D has five LSBs that specify descriptor size. As a consequence, the value of desc_size that is pushed may not be same as that is read during a pop. The value that is read back is equal to always rounded to an odd number. So, for even values, the value read back is one more than what was written. For odd values, the value read back is same as the value that was written. Note that this 5-bit field (desc_size) is unrelated to the code for size of descriptors in a descriptor region. It is just a place holder for a 5-bit value that is maintained across the push and pop operations for every descriptor managed by the queue manager.

16.5.7.39 QUEUE_1_A Register (offset = 2010h) [reset = 0h]

QUEUE_1_A is shown in [Figure 16-315](#) and described in [Table 16-329](#).

Figure 16-315. QUEUE_1_A Register


LEGEND: R/W = Read/Write; R = Read only; W1toCl = Write 1 to clear bit; -n = value after reset

Table 16-329. QUEUE_1_A Register Field Descriptions

Bit	Field	Type	Reset	Description
13-0	QUEUE_ENTRY_COUNT	R-0	0	This field indicates how many packets are currently queued on the queue. This count is incremented by 1 whenever a packet is added to the queue. This count is decremented by 1 whenever a packet is popped from the queue.

16.5.7.40 QUEUE_1_B Register (offset = 2014h) [reset = 0h]

QUEUE_1_B is shown in [Figure 16-316](#) and described in [Table 16-330](#).

Figure 16-316. QUEUE_1_B Register

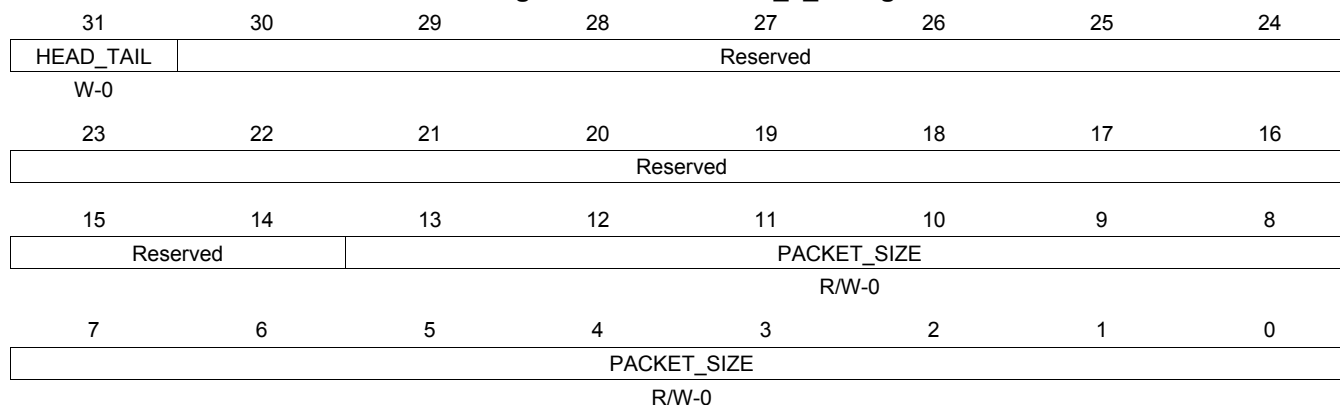

LEGEND: R/W = Read/Write; R = Read only; W1toCl = Write 1 to clear bit; -n = value after reset

Table 16-330. QUEUE_1_B Register Field Descriptions

Bit	Field	Type	Reset	Description
27-0	QUEUE_BYTE_COUNT	R-0	0	This field indicates how many bytes total are contained in all of the packets which are currently queued on this queue.

16.5.7.41 QUEUE_1_C Register (offset = 2018h) [reset = 0h]

 QUEUE_1_C is shown in [Figure 16-317](#) and described in [Table 16-331](#).

Figure 16-317. QUEUE_1_C Register


LEGEND: R/W = Read/Write; R = Read only; W1toCl = Write 1 to clear bit; -n = value after reset

Table 16-331. QUEUE_1_C Register Field Descriptions

Bit	Field	Type	Reset	Description
31	HEAD_TAIL	W-0	0	Head/Tail Push Control. Set to zero in order to push packet onto tail of queue and set to one in order to push packet onto head of queue.
13-0	PACKET_SIZE	R/W-0	0	packet_size This field indicates packet size and is assumed to be zero on each packet add unless the value is explicitly overwritten. This field indicates packet size for packet pop operation.

16.5.7.42 QUEUE_1_D Register (offset = 201Ch) [reset = 0h]

QUEUE_1_D is shown in [Figure 16-318](#) and described in [Table 16-332](#).

Figure 16-318. QUEUE_1_D Register



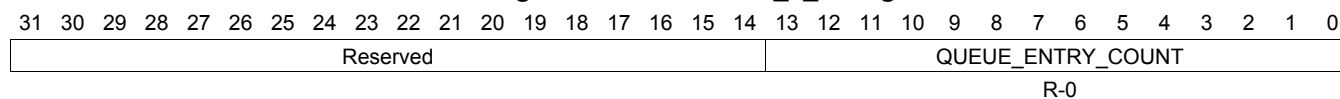
LEGEND: R/W = Read/Write; R = Read only; W1toCl = Write 1 to clear bit; -n = value after reset

Table 16-332. QUEUE_1_D Register Field Descriptions

Bit	Field	Type	Reset	Description
31-5	DESC_PTR	R/W-0	0	Descriptor pointer. It will be read as zero if the queue is empty. It will indicate a 32-bit aligned address that points to a descriptor when the queue is not empty.
4-0	DESC_SIZE	R/W-0	0	Descriptor Size. It is encoded in 4-byte increments with values 0 to 31 representing 24 and so on to 148 bytes. This field will return a 0x0 when an empty queue is read. Queue Manager Queue N Registers D To save hardware resources, the queue manager internally stores descriptor size (desc_size) information in four bits. However, register D has five LSBs that specify descriptor size. As a consequence, the value of desc_size that is pushed may not be same as that is read during a pop. The value that is read back is equal to always rounded to an odd number. So, for even values, the value read back is one more than what was written. For odd values, the value read back is same as the value that was written. Note that this 5-bit field (desc_size) is unrelated to the code for size of descriptors in a descriptor region. It is just a place holder for a 5-bit value that is maintained across the push and pop operations for every descriptor managed by the queue manager.

16.5.7.43 QUEUE_2_A Register (offset = 2020h) [reset = 0h]

QUEUE_2_A is shown in [Figure 16-319](#) and described in [Table 16-333](#).

Figure 16-319. QUEUE_2_A Register


LEGEND: R/W = Read/Write; R = Read only; W1toCl = Write 1 to clear bit; -n = value after reset

Table 16-333. QUEUE_2_A Register Field Descriptions

Bit	Field	Type	Reset	Description
13-0	QUEUE_ENTRY_COUNT	R-0	0	This field indicates how many packets are currently queued on the queue. This count is incremented by 1 whenever a packet is added to the queue. This count is decremented by 1 whenever a packet is popped from the queue.

16.5.7.44 QUEUE_2_B Register (offset = 2024h) [reset = 0h]

QUEUE_2_B is shown in [Figure 16-320](#) and described in [Table 16-334](#).

Figure 16-320. QUEUE_2_B Register

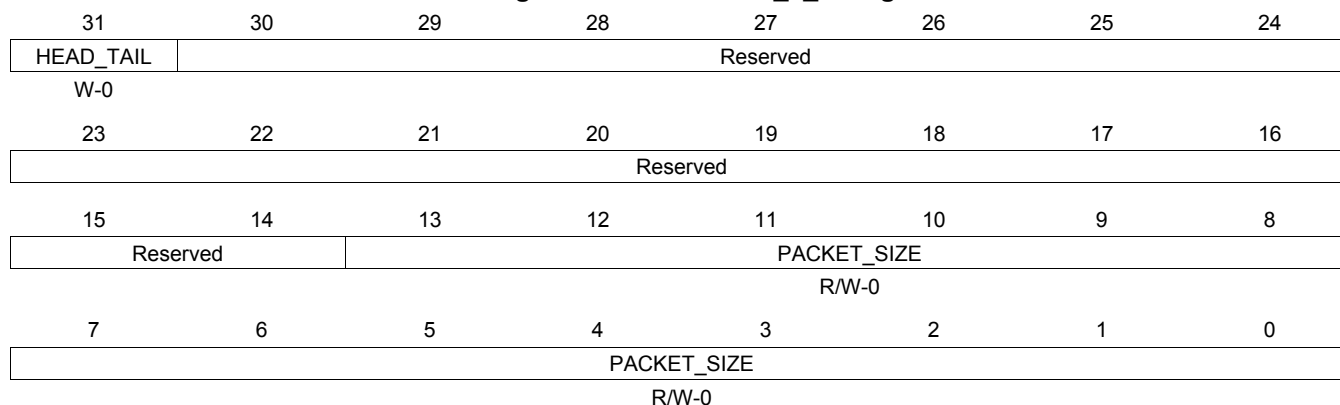

LEGEND: R/W = Read/Write; R = Read only; W1toCl = Write 1 to clear bit; -n = value after reset

Table 16-334. QUEUE_2_B Register Field Descriptions

Bit	Field	Type	Reset	Description
27-0	QUEUE_BYTE_COUNT	R-0	0	This field indicates how many bytes total are contained in all of the packets which are currently queued on this queue.

16.5.7.45 QUEUE_2_C Register (offset = 2028h) [reset = 0h]

 QUEUE_2_C is shown in [Figure 16-321](#) and described in [Table 16-335](#).

Figure 16-321. QUEUE_2_C Register


LEGEND: R/W = Read/Write; R = Read only; W1toCl = Write 1 to clear bit; -n = value after reset

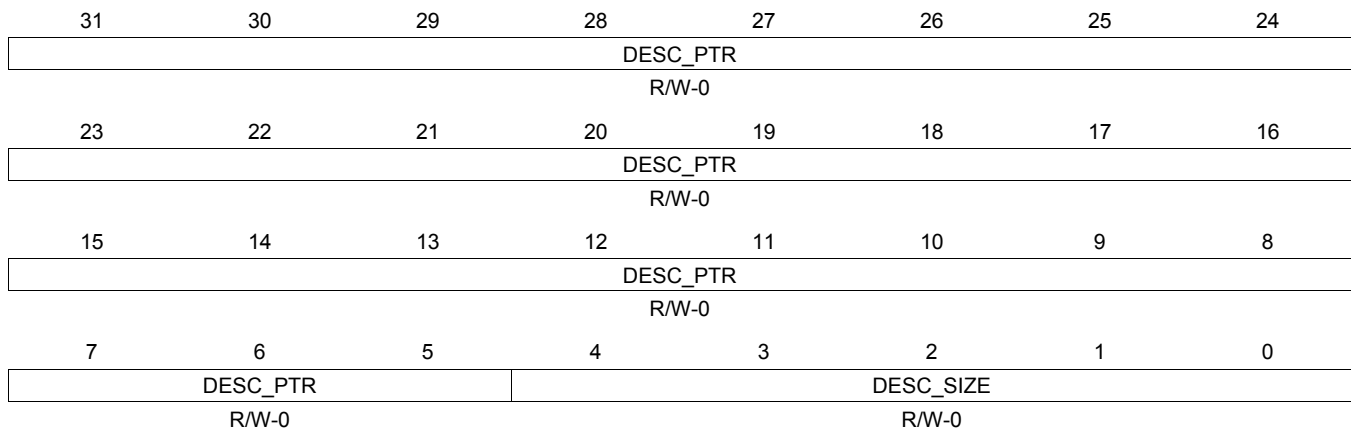
Table 16-335. QUEUE_2_C Register Field Descriptions

Bit	Field	Type	Reset	Description
31	HEAD_TAIL	W-0	0	Head/Tail Push Control. Set to zero in order to push packet onto tail of queue and set to one in order to push packet onto head of queue.
13-0	PACKET_SIZE	R/W-0	0	packet_size This field indicates packet size and is assumed to be zero on each packet add unless the value is explicitly overwritten. This field indicates packet size for packet pop operation.

16.5.7.46 QUEUE_2_D Register (offset = 202Ch) [reset = 0h]

QUEUE_2_D is shown in [Figure 16-322](#) and described in [Table 16-336](#).

Figure 16-322. QUEUE_2_D Register



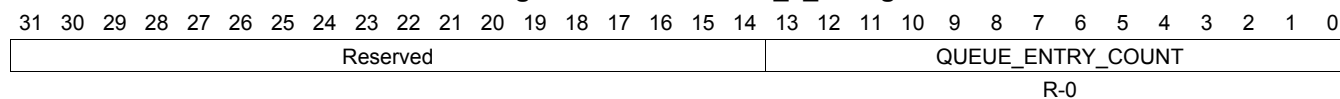
LEGEND: R/W = Read/Write; R = Read only; W1toCl = Write 1 to clear bit; -n = value after reset

Table 16-336. QUEUE_2_D Register Field Descriptions

Bit	Field	Type	Reset	Description
31-5	DESC_PTR	R/W-0	0	Descriptor pointer. It will be read as zero if the queue is empty. It will indicate a 32-bit aligned address that points to a descriptor when the queue is not empty.
4-0	DESC_SIZE	R/W-0	0	Descriptor Size. It is encoded in 4-byte increments with values 0 to 31 representing 24 and so on to 148 bytes. This field will return a 0x0 when an empty queue is read. Queue Manager Queue N Registers D To save hardware resources, the queue manager internally stores descriptor size (desc_size) information in four bits. However, register D has five LSBs that specify descriptor size. As a consequence, the value of desc_size that is pushed may not be same as that is read during a pop. The value that is read back is equal to always rounded to an odd number. So, for even values, the value read back is one more than what was written. For odd values, the value read back is same as the value that was written. Note that this 5-bit field (desc_size) is unrelated to the code for size of descriptors in a descriptor region. It is just a place holder for a 5-bit value that is maintained across the push and pop operations for every descriptor managed by the queue manager.

16.5.7.47 QUEUE_3_A Register (offset = 2030h) [reset = 0h]

QUEUE_3_A is shown in [Figure 16-323](#) and described in [Table 16-337](#).

Figure 16-323. QUEUE_3_A Register


LEGEND: R/W = Read/Write; R = Read only; W1toCl = Write 1 to clear bit; -n = value after reset

Table 16-337. QUEUE_3_A Register Field Descriptions

Bit	Field	Type	Reset	Description
13-0	QUEUE_ENTRY_COUNT	R-0	0	This field indicates how many packets are currently queued on the queue. This count is incremented by 1 whenever a packet is added to the queue. This count is decremented by 1 whenever a packet is popped from the queue.

16.5.7.48 QUEUE_3_B Register (offset = 2034h) [reset = 0h]

QUEUE_3_B is shown in [Figure 16-324](#) and described in [Table 16-338](#).

Figure 16-324. QUEUE_3_B Register

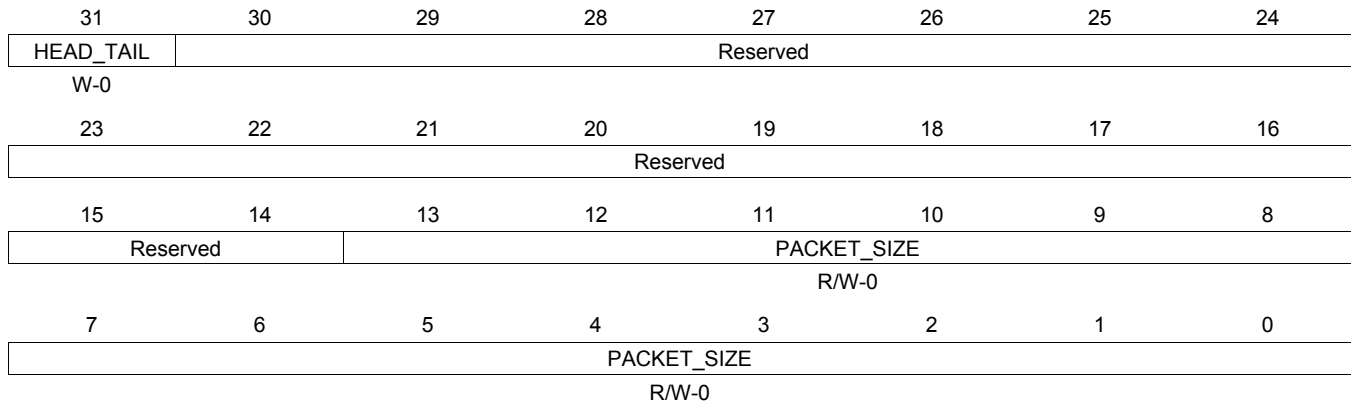

LEGEND: R/W = Read/Write; R = Read only; W1toCl = Write 1 to clear bit; -n = value after reset

Table 16-338. QUEUE_3_B Register Field Descriptions

Bit	Field	Type	Reset	Description
27-0	QUEUE_BYTE_COUNT	R-0	0	This field indicates how many bytes total are contained in all of the packets which are currently queued on this queue.

16.5.7.49 QUEUE_3_C Register (offset = 2038h) [reset = 0h]

 QUEUE_3_C is shown in [Figure 16-325](#) and described in [Table 16-339](#).

Figure 16-325. QUEUE_3_C Register


LEGEND: R/W = Read/Write; R = Read only; W1toCl = Write 1 to clear bit; -n = value after reset

Table 16-339. QUEUE_3_C Register Field Descriptions

Bit	Field	Type	Reset	Description
31	HEAD_TAIL	W-0	0	Head/Tail Push Control. Set to zero in order to push packet onto tail of queue and set to one in order to push packet onto head of queue.
13-0	PACKET_SIZE	R/W-0	0	packet_size This field indicates packet size and is assumed to be zero on each packet add unless the value is explicitly overwritten. This field indicates packet size for packet pop operation.

16.5.7.50 QUEUE_3_D Register (offset = 203Ch) [reset = 0h]

QUEUE_3_D is shown in [Figure 16-326](#) and described in [Table 16-340](#).

Figure 16-326. QUEUE_3_D Register



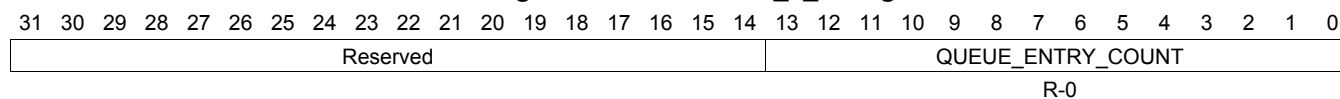
LEGEND: R/W = Read/Write; R = Read only; W1toCl = Write 1 to clear bit; -n = value after reset

Table 16-340. QUEUE_3_D Register Field Descriptions

Bit	Field	Type	Reset	Description
31-5	DESC_PTR	R/W-0	0	Descriptor pointer. It will be read as zero if the queue is empty. It will indicate a 32-bit aligned address that points to a descriptor when the queue is not empty.
4-0	DESC_SIZE	R/W-0	0	Descriptor Size. It is encoded in 4-byte increments with values 0 to 31 representing 24 and so on to 148 bytes. This field will return a 0x0 when an empty queue is read. Queue Manager Queue N Registers D To save hardware resources, the queue manager internally stores descriptor size (desc_size) information in four bits. However, register D has five LSBs that specify descriptor size. As a consequence, the value of desc_size that is pushed may not be same as that is read during a pop. The value that is read back is equal to always rounded to an odd number. So, for even values, the value read back is one more than what was written. For odd values, the value read back is same as the value that was written. Note that this 5-bit field (desc_size) is unrelated to the code for size of descriptors in a descriptor region. It is just a place holder for a 5-bit value that is maintained across the push and pop operations for every descriptor managed by the queue manager.

16.5.7.51 QUEUE_4_A Register (offset = 2040h) [reset = 0h]

QUEUE_4_A is shown in [Figure 16-327](#) and described in [Table 16-341](#).

Figure 16-327. QUEUE_4_A Register


LEGEND: R/W = Read/Write; R = Read only; W1toCl = Write 1 to clear bit; -n = value after reset

Table 16-341. QUEUE_4_A Register Field Descriptions

Bit	Field	Type	Reset	Description
13-0	QUEUE_ENTRY_COUNT	R-0	0	This field indicates how many packets are currently queued on the queue. This count is incremented by 1 whenever a packet is added to the queue. This count is decremented by 1 whenever a packet is popped from the queue.

16.5.7.52 QUEUE_4_B Register (offset = 2044h) [reset = 0h]

QUEUE_4_B is shown in [Figure 16-328](#) and described in [Table 16-342](#).

Figure 16-328. QUEUE_4_B Register

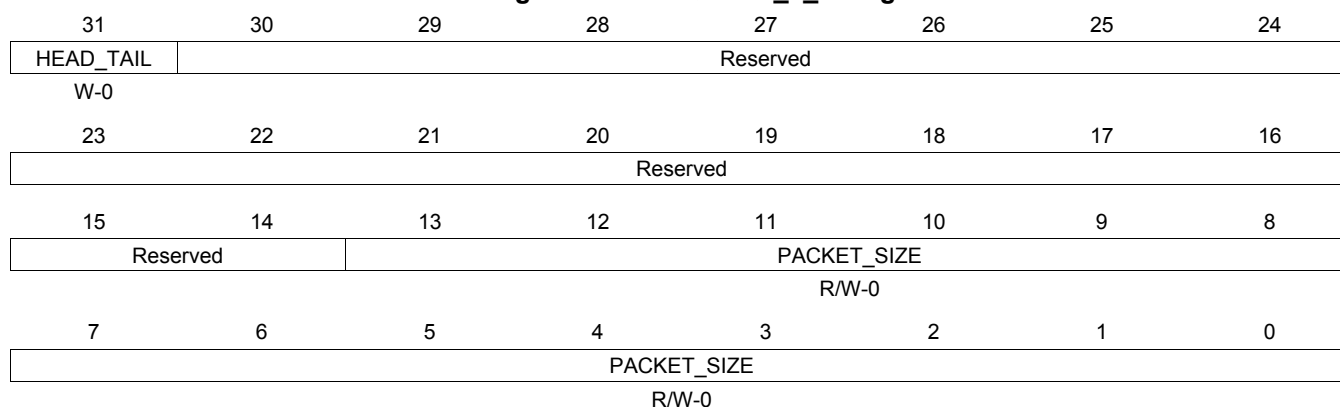

LEGEND: R/W = Read/Write; R = Read only; W1toCl = Write 1 to clear bit; -n = value after reset

Table 16-342. QUEUE_4_B Register Field Descriptions

Bit	Field	Type	Reset	Description
27-0	QUEUE_BYTE_COUNT	R-0	0	This field indicates how many bytes total are contained in all of the packets which are currently queued on this queue.

16.5.7.53 QUEUE_4_C Register (offset = 2048h) [reset = 0h]

 QUEUE_4_C is shown in [Figure 16-329](#) and described in [Table 16-343](#).

Figure 16-329. QUEUE_4_C Register


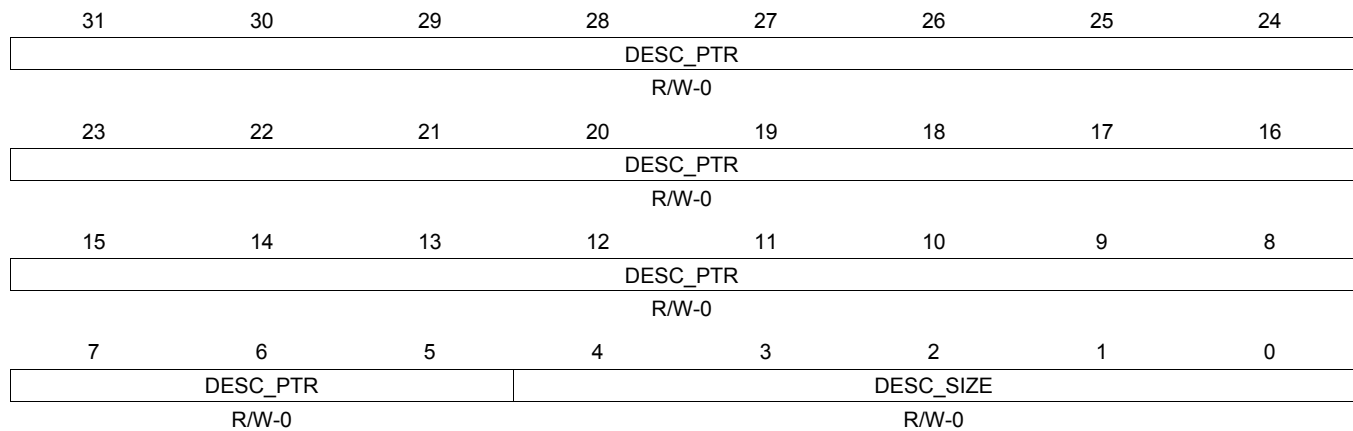
LEGEND: R/W = Read/Write; R = Read only; W1toCl = Write 1 to clear bit; -n = value after reset

Table 16-343. QUEUE_4_C Register Field Descriptions

Bit	Field	Type	Reset	Description
31	HEAD_TAIL	W-0	0	Head/Tail Push Control. Set to zero in order to push packet onto tail of queue and set to one in order to push packet onto head of queue.
13-0	PACKET_SIZE	R/W-0	0	packet_size This field indicates packet size and is assumed to be zero on each packet add unless the value is explicitly overwritten. This field indicates packet size for packet pop operation.

16.5.7.54 QUEUE_4_D Register (offset = 204Ch) [reset = 0h]

 QUEUE_4_D is shown in [Figure 16-330](#) and described in [Table 16-344](#).

Figure 16-330. QUEUE_4_D Register


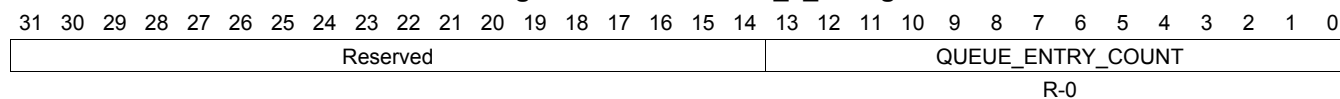
LEGEND: R/W = Read/Write; R = Read only; W1toCl = Write 1 to clear bit; -n = value after reset

Table 16-344. QUEUE_4_D Register Field Descriptions

Bit	Field	Type	Reset	Description
31-5	DESC_PTR	R/W-0	0	Descriptor pointer. It will be read as zero if the queue is empty. It will indicate a 32-bit aligned address that points to a descriptor when the queue is not empty.
4-0	DESC_SIZE	R/W-0	0	Descriptor Size. It is encoded in 4-byte increments with values 0 to 31 representing 24 and so on to 148 bytes. This field will return a 0x0 when an empty queue is read. Queue Manager Queue N Registers D To save hardware resources, the queue manager internally stores descriptor size (desc_size) information in four bits. However, register D has five LSBs that specify descriptor size. As a consequence, the value of desc_size that is pushed may not be same as that is read during a pop. The value that is read back is equal to always rounded to an odd number. So, for even values, the value read back is one more than what was written. For odd values, the value read back is same as the value that was written. Note that this 5-bit field (desc_size) is unrelated to the code for size of descriptors in a descriptor region. It is just a place holder for a 5-bit value that is maintained across the push and pop operations for every descriptor managed by the queue manager.

16.5.7.55 QUEUE_5_A Register (offset = 2050h) [reset = 0h]

QUEUE_5_A is shown in [Figure 16-331](#) and described in [Table 16-345](#).

Figure 16-331. QUEUE_5_A Register


LEGEND: R/W = Read/Write; R = Read only; W1toCl = Write 1 to clear bit; -n = value after reset

Table 16-345. QUEUE_5_A Register Field Descriptions

Bit	Field	Type	Reset	Description
13-0	QUEUE_ENTRY_COUNT	R-0	0	This field indicates how many packets are currently queued on the queue. This count is incremented by 1 whenever a packet is added to the queue. This count is decremented by 1 whenever a packet is popped from the queue.

16.5.7.56 QUEUE_5_B Register (offset = 2054h) [reset = 0h]

QUEUE_5_B is shown in [Figure 16-332](#) and described in [Table 16-346](#).

Figure 16-332. QUEUE_5_B Register

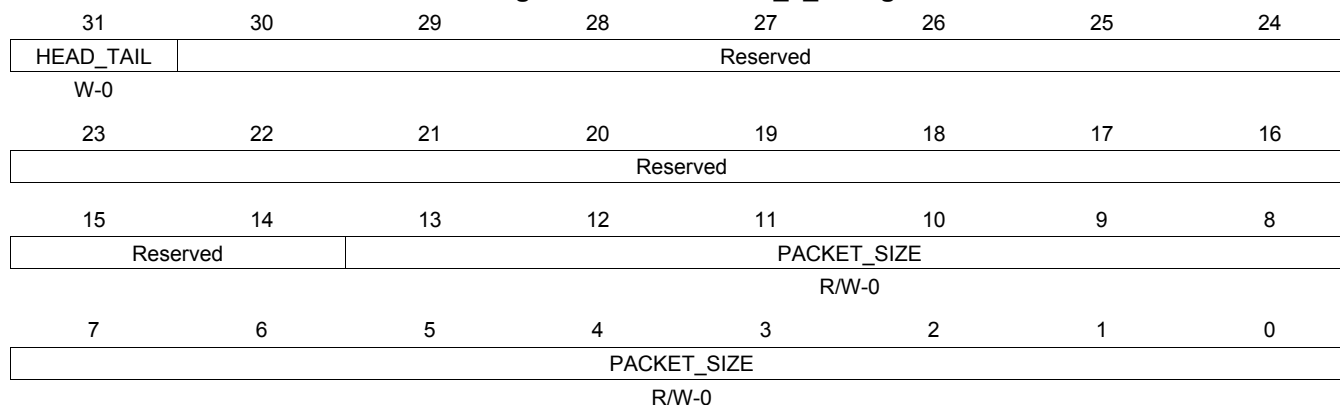

LEGEND: R/W = Read/Write; R = Read only; W1toCl = Write 1 to clear bit; -n = value after reset

Table 16-346. QUEUE_5_B Register Field Descriptions

Bit	Field	Type	Reset	Description
27-0	QUEUE_BYTE_COUNT	R-0	0	This field indicates how many bytes total are contained in all of the packets which are currently queued on this queue.

16.5.7.57 QUEUE_5_C Register (offset = 2058h) [reset = 0h]

 QUEUE_5_C is shown in [Figure 16-333](#) and described in [Table 16-347](#).

Figure 16-333. QUEUE_5_C Register


LEGEND: R/W = Read/Write; R = Read only; W1toCl = Write 1 to clear bit; -n = value after reset

Table 16-347. QUEUE_5_C Register Field Descriptions

Bit	Field	Type	Reset	Description
31	HEAD_TAIL	W-0	0	Head/Tail Push Control. Set to zero in order to push packet onto tail of queue and set to one in order to push packet onto head of queue.
13-0	PACKET_SIZE	R/W-0	0	packet_size This field indicates packet size and is assumed to be zero on each packet add unless the value is explicitly overwritten. This field indicates packet size for packet pop operation.

16.5.7.58 QUEUE_5_D Register (offset = 205Ch) [reset = 0h]

 QUEUE_5_D is shown in [Figure 16-334](#) and described in [Table 16-348](#).

Figure 16-334. QUEUE_5_D Register

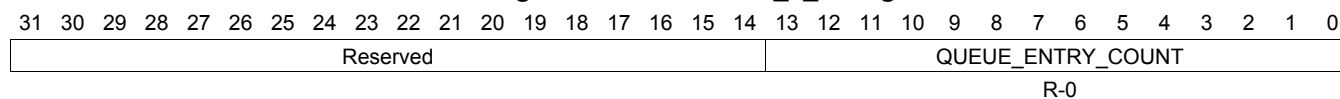

LEGEND: R/W = Read/Write; R = Read only; W1toCl = Write 1 to clear bit; -n = value after reset

Table 16-348. QUEUE_5_D Register Field Descriptions

Bit	Field	Type	Reset	Description
31-5	DESC_PTR	R/W-0	0	Descriptor pointer. It will be read as zero if the queue is empty. It will indicate a 32-bit aligned address that points to a descriptor when the queue is not empty.
4-0	DESC_SIZE	R/W-0	0	Descriptor Size. It is encoded in 4-byte increments with values 0 to 31 representing 24 and so on to 148 bytes. This field will return a 0x0 when an empty queue is read. Queue Manager Queue N Registers D To save hardware resources, the queue manager internally stores descriptor size (desc_size) information in four bits. However, register D has five LSBs that specify descriptor size. As a consequence, the value of desc_size that is pushed may not be same as that is read during a pop. The value that is read back is equal to always rounded to an odd number. So, for even values, the value read back is one more than what was written. For odd values, the value read back is same as the value that was written. Note that this 5-bit field (desc_size) is unrelated to the code for size of descriptors in a descriptor region. It is just a place holder for a 5-bit value that is maintained across the push and pop operations for every descriptor managed by the queue manager.

16.5.7.59 QUEUE_6_A Register (offset = 2060h) [reset = 0h]

QUEUE_6_A is shown in [Figure 16-335](#) and described in [Table 16-349](#).

Figure 16-335. QUEUE_6_A Register


LEGEND: R/W = Read/Write; R = Read only; W1toCl = Write 1 to clear bit; -n = value after reset

Table 16-349. QUEUE_6_A Register Field Descriptions

Bit	Field	Type	Reset	Description
13-0	QUEUE_ENTRY_COUNT	R-0	0	This field indicates how many packets are currently queued on the queue. This count is incremented by 1 whenever a packet is added to the queue. This count is decremented by 1 whenever a packet is popped from the queue.

16.5.7.60 QUEUE_6_B Register (offset = 2064h) [reset = 0h]

QUEUE_6_B is shown in [Figure 16-336](#) and described in [Table 16-350](#).

Figure 16-336. QUEUE_6_B Register


LEGEND: R/W = Read/Write; R = Read only; W1toCl = Write 1 to clear bit; -n = value after reset

Table 16-350. QUEUE_6_B Register Field Descriptions

Bit	Field	Type	Reset	Description
27-0	QUEUE_BYTE_COUNT	R-0	0	This field indicates how many bytes total are contained in all of the packets which are currently queued on this queue.

16.5.7.61 QUEUE_6_C Register (offset = 2068h) [reset = 0h]

 QUEUE_6_C is shown in [Figure 16-337](#) and described in [Table 16-351](#).

Figure 16-337. QUEUE_6_C Register


LEGEND: R/W = Read/Write; R = Read only; W1toCl = Write 1 to clear bit; -n = value after reset

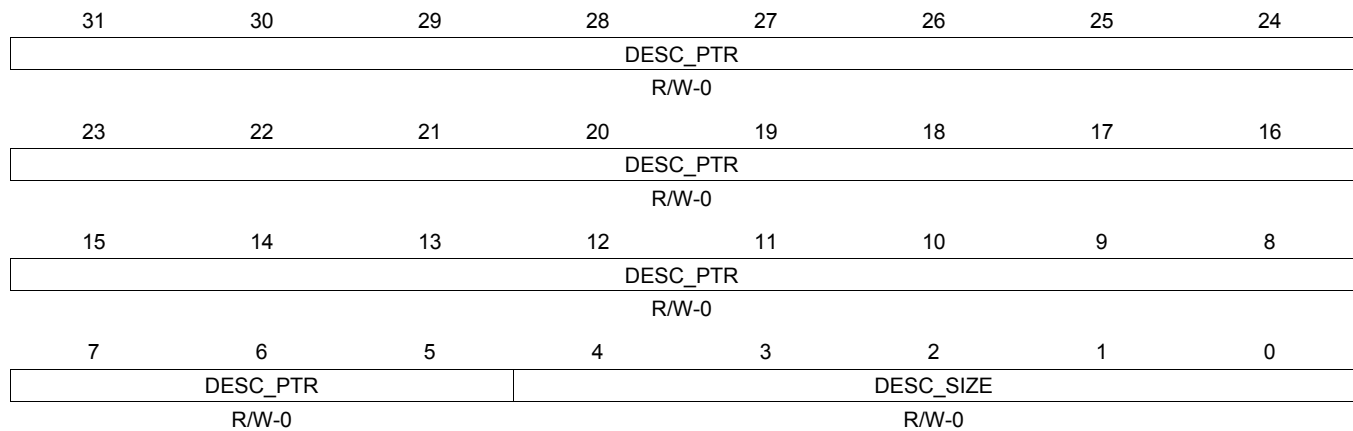
Table 16-351. QUEUE_6_C Register Field Descriptions

Bit	Field	Type	Reset	Description
31	HEAD_TAIL	W-0	0	Head/Tail Push Control. Set to zero in order to push packet onto tail of queue and set to one in order to push packet onto head of queue.
13-0	PACKET_SIZE	R/W-0	0	packet_size This field indicates packet size and is assumed to be zero on each packet add unless the value is explicitly overwritten. This field indicates packet size for packet pop operation.

16.5.7.62 QUEUE_6_D Register (offset = 206Ch) [reset = 0h]

QUEUE_6_D is shown in [Figure 16-338](#) and described in [Table 16-352](#).

Figure 16-338. QUEUE_6_D Register



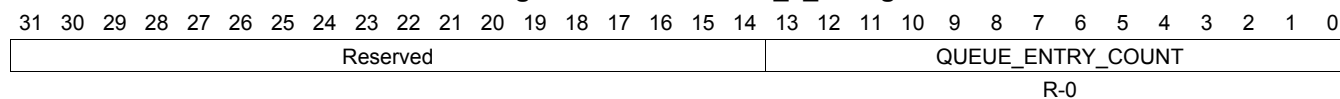
LEGEND: R/W = Read/Write; R = Read only; W1toCl = Write 1 to clear bit; -n = value after reset

Table 16-352. QUEUE_6_D Register Field Descriptions

Bit	Field	Type	Reset	Description
31-5	DESC_PTR	R/W-0	0	Descriptor pointer. It will be read as zero if the queue is empty. It will indicate a 32-bit aligned address that points to a descriptor when the queue is not empty.
4-0	DESC_SIZE	R/W-0	0	Descriptor Size. It is encoded in 4-byte increments with values 0 to 31 representing 24 and so on to 148 bytes. This field will return a 0x0 when an empty queue is read. Queue Manager Queue N Registers D To save hardware resources, the queue manager internally stores descriptor size (desc_size) information in four bits. However, register D has five LSBs that specify descriptor size. As a consequence, the value of desc_size that is pushed may not be same as that is read during a pop. The value that is read back is equal to always rounded to an odd number. So, for even values, the value read back is one more than what was written. For odd values, the value read back is same as the value that was written. Note that this 5-bit field (desc_size) is unrelated to the code for size of descriptors in a descriptor region. It is just a place holder for a 5-bit value that is maintained across the push and pop operations for every descriptor managed by the queue manager.

16.5.7.63 QUEUE_7_A Register (offset = 2070h) [reset = 0h]

QUEUE_7_A is shown in [Figure 16-339](#) and described in [Table 16-353](#).

Figure 16-339. QUEUE_7_A Register


LEGEND: R/W = Read/Write; R = Read only; W1toCl = Write 1 to clear bit; -n = value after reset

Table 16-353. QUEUE_7_A Register Field Descriptions

Bit	Field	Type	Reset	Description
13-0	QUEUE_ENTRY_COUNT	R-0	0	This field indicates how many packets are currently queued on the queue. This count is incremented by 1 whenever a packet is added to the queue. This count is decremented by 1 whenever a packet is popped from the queue.

16.5.7.64 QUEUE_7_B Register (offset = 2074h) [reset = 0h]

QUEUE_7_B is shown in [Figure 16-340](#) and described in [Table 16-354](#).

Figure 16-340. QUEUE_7_B Register


LEGEND: R/W = Read/Write; R = Read only; W1toCl = Write 1 to clear bit; -n = value after reset

Table 16-354. QUEUE_7_B Register Field Descriptions

Bit	Field	Type	Reset	Description
27-0	QUEUE_BYTE_COUNT	R-0	0	This field indicates how many bytes total are contained in all of the packets which are currently queued on this queue.

16.5.7.65 QUEUE_7_C Register (offset = 2078h) [reset = 0h]

 QUEUE_7_C is shown in [Figure 16-341](#) and described in [Table 16-355](#).

Figure 16-341. QUEUE_7_C Register


LEGEND: R/W = Read/Write; R = Read only; W1toCl = Write 1 to clear bit; -n = value after reset

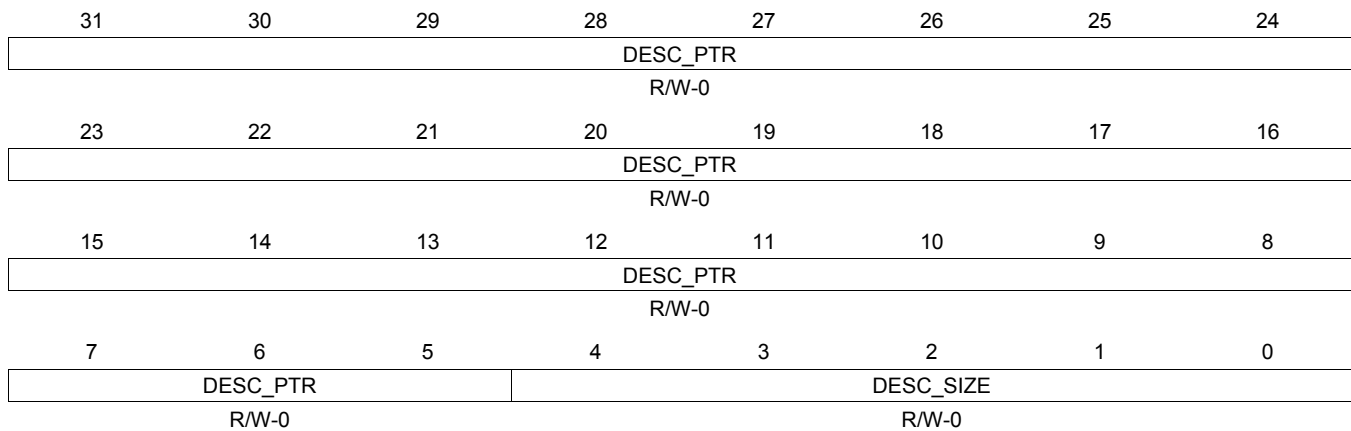
Table 16-355. QUEUE_7_C Register Field Descriptions

Bit	Field	Type	Reset	Description
31	HEAD_TAIL	W-0	0	Head/Tail Push Control. Set to zero in order to push packet onto tail of queue and set to one in order to push packet onto head of queue.
13-0	PACKET_SIZE	R/W-0	0	packet_size This field indicates packet size and is assumed to be zero on each packet add unless the value is explicitly overwritten. This field indicates packet size for packet pop operation.

16.5.7.66 QUEUE_7_D Register (offset = 207Ch) [reset = 0h]

QUEUE_7_D is shown in [Figure 16-342](#) and described in [Table 16-356](#).

Figure 16-342. QUEUE_7_D Register



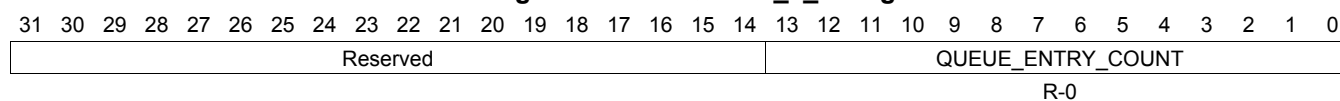
LEGEND: R/W = Read/Write; R = Read only; W1toCl = Write 1 to clear bit; -n = value after reset

Table 16-356. QUEUE_7_D Register Field Descriptions

Bit	Field	Type	Reset	Description
31-5	DESC_PTR	R/W-0	0	Descriptor pointer. It will be read as zero if the queue is empty. It will indicate a 32-bit aligned address that points to a descriptor when the queue is not empty.
4-0	DESC_SIZE	R/W-0	0	Descriptor Size. It is encoded in 4-byte increments with values 0 to 31 representing 24 and so on to 148 bytes. This field will return a 0x0 when an empty queue is read. Queue Manager Queue N Registers D To save hardware resources, the queue manager internally stores descriptor size (desc_size) information in four bits. However, register D has five LSBs that specify descriptor size. As a consequence, the value of desc_size that is pushed may not be same as that is read during a pop. The value that is read back is equal to always rounded to an odd number. So, for even values, the value read back is one more than what was written. For odd values, the value read back is same as the value that was written. Note that this 5-bit field (desc_size) is unrelated to the code for size of descriptors in a descriptor region. It is just a place holder for a 5-bit value that is maintained across the push and pop operations for every descriptor managed by the queue manager.

16.5.7.67 QUEUE_8_A Register (offset = 2080h) [reset = 0h]

QUEUE_8_A is shown in [Figure 16-343](#) and described in [Table 16-357](#).

Figure 16-343. QUEUE_8_A Register


LEGEND: R/W = Read/Write; R = Read only; W1toCl = Write 1 to clear bit; -n = value after reset

Table 16-357. QUEUE_8_A Register Field Descriptions

Bit	Field	Type	Reset	Description
13-0	QUEUE_ENTRY_COUNT	R-0	0	This field indicates how many packets are currently queued on the queue. This count is incremented by 1 whenever a packet is added to the queue. This count is decremented by 1 whenever a packet is popped from the queue.

16.5.7.68 QUEUE_8_B Register (offset = 2084h) [reset = 0h]

QUEUE_8_B is shown in [Figure 16-344](#) and described in [Table 16-358](#).

Figure 16-344. QUEUE_8_B Register


LEGEND: R/W = Read/Write; R = Read only; W1toCl = Write 1 to clear bit; -n = value after reset

Table 16-358. QUEUE_8_B Register Field Descriptions

Bit	Field	Type	Reset	Description
27-0	QUEUE_BYTE_COUNT	R-0	0	This field indicates how many bytes total are contained in all of the packets which are currently queued on this queue.

16.5.7.69 QUEUE_8_C Register (offset = 2088h) [reset = 0h]

 QUEUE_8_C is shown in [Figure 16-345](#) and described in [Table 16-359](#).

Figure 16-345. QUEUE_8_C Register

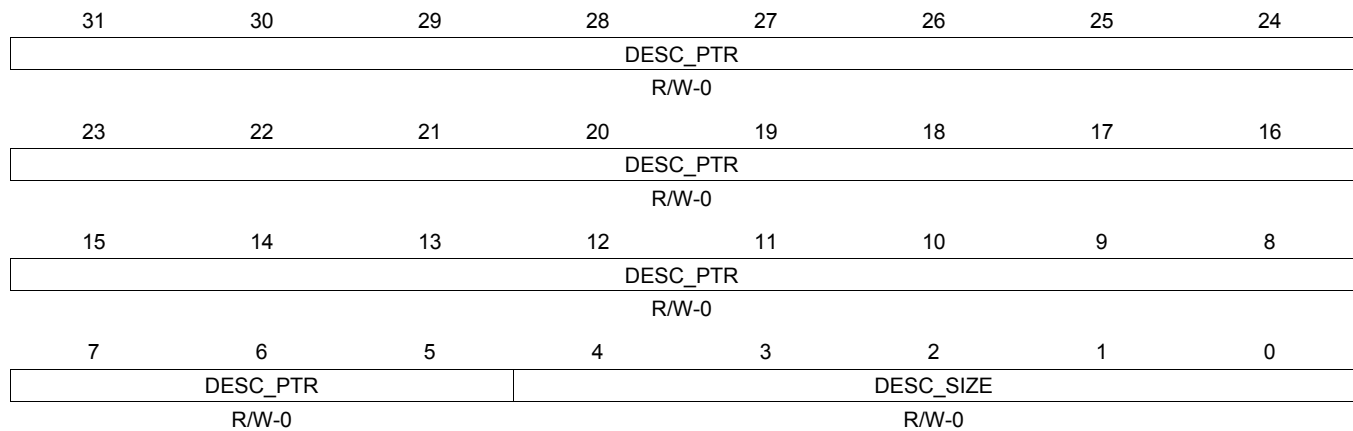

LEGEND: R/W = Read/Write; R = Read only; W1toCl = Write 1 to clear bit; -n = value after reset

Table 16-359. QUEUE_8_C Register Field Descriptions

Bit	Field	Type	Reset	Description
31	HEAD_TAIL	W-0	0	Head/Tail Push Control. Set to zero in order to push packet onto tail of queue and set to one in order to push packet onto head of queue.
13-0	PACKET_SIZE	R/W-0	0	packet_size This field indicates packet size and is assumed to be zero on each packet add unless the value is explicitly overwritten. This field indicates packet size for packet pop operation.

16.5.7.70 QUEUE_8_D Register (offset = 208Ch) [reset = 0h]

 QUEUE_8_D is shown in [Figure 16-346](#) and described in [Table 16-360](#).

Figure 16-346. QUEUE_8_D Register


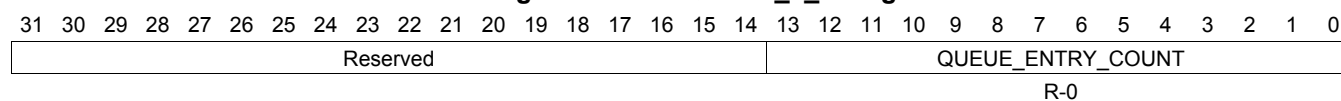
LEGEND: R/W = Read/Write; R = Read only; W1toCl = Write 1 to clear bit; -n = value after reset

Table 16-360. QUEUE_8_D Register Field Descriptions

Bit	Field	Type	Reset	Description
31-5	DESC_PTR	R/W-0	0	Descriptor pointer. It will be read as zero if the queue is empty. It will indicate a 32-bit aligned address that points to a descriptor when the queue is not empty.
4-0	DESC_SIZE	R/W-0	0	Descriptor Size. It is encoded in 4-byte increments with values 0 to 31 representing 24 and so on to 148 bytes. This field will return a 0x0 when an empty queue is read. Queue Manager Queue N Registers D To save hardware resources, the queue manager internally stores descriptor size (desc_size) information in four bits. However, register D has five LSBs that specify descriptor size. As a consequence, the value of desc_size that is pushed may not be same as that is read during a pop. The value that is read back is equal to always rounded to an odd number. So, for even values, the value read back is one more than what was written. For odd values, the value read back is same as the value that was written. Note that this 5-bit field (desc_size) is unrelated to the code for size of descriptors in a descriptor region. It is just a place holder for a 5-bit value that is maintained across the push and pop operations for every descriptor managed by the queue manager.

16.5.7.71 QUEUE_9_A Register (offset = 2090h) [reset = 0h]

QUEUE_9_A is shown in [Figure 16-347](#) and described in [Table 16-361](#).

Figure 16-347. QUEUE_9_A Register


LEGEND: R/W = Read/Write; R = Read only; W1toCl = Write 1 to clear bit; -n = value after reset

Table 16-361. QUEUE_9_A Register Field Descriptions

Bit	Field	Type	Reset	Description
13-0	QUEUE_ENTRY_COUNT	R-0	0	This field indicates how many packets are currently queued on the queue. This count is incremented by 1 whenever a packet is added to the queue. This count is decremented by 1 whenever a packet is popped from the queue.

16.5.7.72 QUEUE_9_B Register (offset = 2094h) [reset = 0h]

QUEUE_9_B is shown in [Figure 16-348](#) and described in [Table 16-362](#).

Figure 16-348. QUEUE_9_B Register


LEGEND: R/W = Read/Write; R = Read only; W1toCl = Write 1 to clear bit; -n = value after reset

Table 16-362. QUEUE_9_B Register Field Descriptions

Bit	Field	Type	Reset	Description
27-0	QUEUE_BYTE_COUNT	R-0	0	This field indicates how many bytes total are contained in all of the packets which are currently queued on this queue.

16.5.7.73 QUEUE_9_C Register (offset = 2098h) [reset = 0h]

 QUEUE_9_C is shown in [Figure 16-349](#) and described in [Table 16-363](#).

Figure 16-349. QUEUE_9_C Register


LEGEND: R/W = Read/Write; R = Read only; W1toCl = Write 1 to clear bit; -n = value after reset

Table 16-363. QUEUE_9_C Register Field Descriptions

Bit	Field	Type	Reset	Description
31	HEAD_TAIL	W-0	0	Head/Tail Push Control. Set to zero in order to push packet onto tail of queue and set to one in order to push packet onto head of queue.
13-0	PACKET_SIZE	R/W-0	0	packet_size This field indicates packet size and is assumed to be zero on each packet add unless the value is explicitly overwritten. This field indicates packet size for packet pop operation.

16.5.7.74 QUEUE_9_D Register (offset = 209Ch) [reset = 0h]

QUEUE_9_D is shown in [Figure 16-350](#) and described in [Table 16-364](#).

Figure 16-350. QUEUE_9_D Register



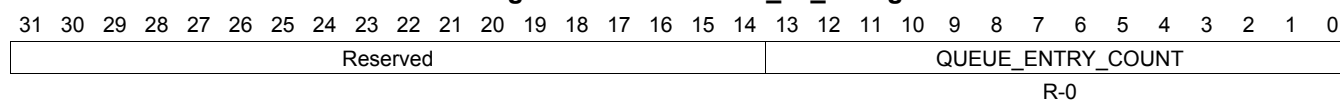
LEGEND: R/W = Read/Write; R = Read only; W1toCl = Write 1 to clear bit; -n = value after reset

Table 16-364. QUEUE_9_D Register Field Descriptions

Bit	Field	Type	Reset	Description
31-5	DESC_PTR	R/W-0	0	Descriptor pointer. It will be read as zero if the queue is empty. It will indicate a 32-bit aligned address that points to a descriptor when the queue is not empty.
4-0	DESC_SIZE	R/W-0	0	Descriptor Size. It is encoded in 4-byte increments with values 0 to 31 representing 24 and so on to 148 bytes. This field will return a 0x0 when an empty queue is read. Queue Manager Queue N Registers D To save hardware resources, the queue manager internally stores descriptor size (desc_size) information in four bits. However, register D has five LSBs that specify descriptor size. As a consequence, the value of desc_size that is pushed may not be same as that is read during a pop. The value that is read back is equal to always rounded to an odd number. So, for even values, the value read back is one more than what was written. For odd values, the value read back is same as the value that was written. Note that this 5-bit field (desc_size) is unrelated to the code for size of descriptors in a descriptor region. It is just a place holder for a 5-bit value that is maintained across the push and pop operations for every descriptor managed by the queue manager.

16.5.7.75 QUEUE_10_A Register (offset = 20A0h) [reset = 0h]

QUEUE_10_A is shown in [Figure 16-351](#) and described in [Table 16-365](#).

Figure 16-351. QUEUE_10_A Register


LEGEND: R/W = Read/Write; R = Read only; W1toCl = Write 1 to clear bit; -n = value after reset

Table 16-365. QUEUE_10_A Register Field Descriptions

Bit	Field	Type	Reset	Description
13-0	QUEUE_ENTRY_COUNT	R-0	0	This field indicates how many packets are currently queued on the queue. This count is incremented by 1 whenever a packet is added to the queue. This count is decremented by 1 whenever a packet is popped from the queue.

16.5.7.76 QUEUE_10_B Register (offset = 20A4h) [reset = 0h]

 QUEUE_10_B is shown in [Figure 16-352](#) and described in [Table 16-366](#).

Figure 16-352. QUEUE_10_B Register

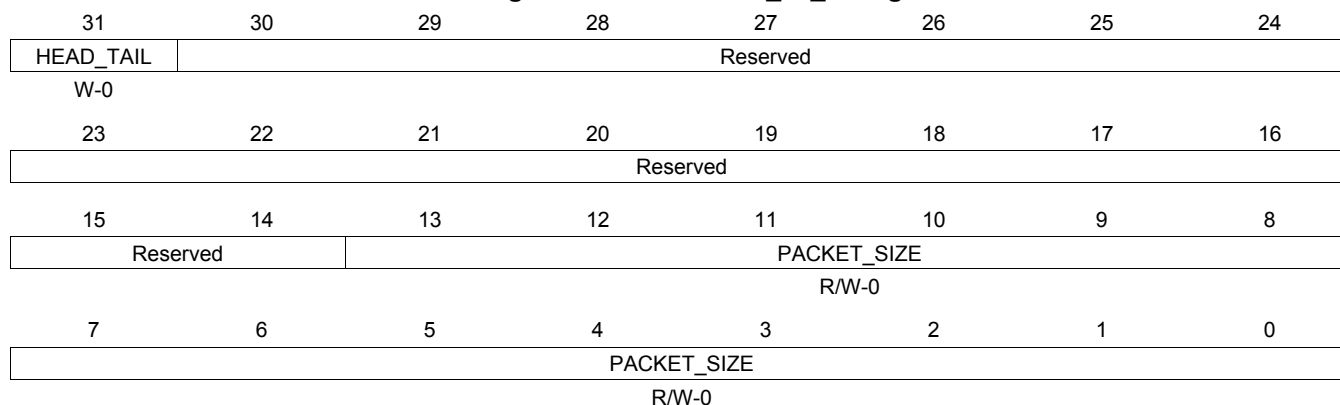

LEGEND: R/W = Read/Write; R = Read only; W1toCl = Write 1 to clear bit; -n = value after reset

Table 16-366. QUEUE_10_B Register Field Descriptions

Bit	Field	Type	Reset	Description
27-0	QUEUE_BYTE_COUNT	R-0	0	This field indicates how many bytes total are contained in all of the packets which are currently queued on this queue.

16.5.7.77 QUEUE_10_C Register (offset = 20A8h) [reset = 0h]

 QUEUE_10_C is shown in [Figure 16-353](#) and described in [Table 16-367](#).

Figure 16-353. QUEUE_10_C Register


LEGEND: R/W = Read/Write; R = Read only; W1toCl = Write 1 to clear bit; -n = value after reset

Table 16-367. QUEUE_10_C Register Field Descriptions

Bit	Field	Type	Reset	Description
31	HEAD_TAIL	W-0	0	Head/Tail Push Control. Set to zero in order to push packet onto tail of queue and set to one in order to push packet onto head of queue.
13-0	PACKET_SIZE	R/W-0	0	packet_size This field indicates packet size and is assumed to be zero on each packet add unless the value is explicitly overwritten. This field indicates packet size for packet pop operation.

16.5.7.78 QUEUE_10_D Register (offset = 20ACh) [reset = 0h]

QUEUE_10_D is shown in [Figure 16-354](#) and described in [Table 16-368](#).

Figure 16-354. QUEUE_10_D Register


LEGEND: R/W = Read/Write; R = Read only; W1toCl = Write 1 to clear bit; -n = value after reset

Table 16-368. QUEUE_10_D Register Field Descriptions

Bit	Field	Type	Reset	Description
31-5	DESC_PTR	R/W-0	0	Descriptor pointer. It will be read as zero if the queue is empty. It will indicate a 32-bit aligned address that points to a descriptor when the queue is not empty.
4-0	DESC_SIZE	R/W-0	0	Descriptor Size. It is encoded in 4-byte increments with values 0 to 31 representing 24 and so on to 148 bytes. This field will return a 0x0 when an empty queue is read. Queue Manager Queue N Registers D To save hardware resources, the queue manager internally stores descriptor size (desc_size) information in four bits. However, register D has five LSBs that specify descriptor size. As a consequence, the value of desc_size that is pushed may not be same as that is read during a pop. The value that is read back is equal to always rounded to an odd number. So, for even values, the value read back is one more than what was written. For odd values, the value read back is same as the value that was written. Note that this 5-bit field (desc_size) is unrelated to the code for size of descriptors in a descriptor region. It is just a place holder for a 5-bit value that is maintained across the push and pop operations for every descriptor managed by the queue manager.

16.5.7.79 QUEUE_11_A Register (offset = 20B0h) [reset = 0h]

QUEUE_11_A is shown in [Figure 16-355](#) and described in [Table 16-369](#).

Figure 16-355. QUEUE_11_A Register


LEGEND: R/W = Read/Write; R = Read only; W1toCl = Write 1 to clear bit; -n = value after reset

Table 16-369. QUEUE_11_A Register Field Descriptions

Bit	Field	Type	Reset	Description
13-0	QUEUE_ENTRY_COUNT	R-0	0	This field indicates how many packets are currently queued on the queue. This count is incremented by 1 whenever a packet is added to the queue. This count is decremented by 1 whenever a packet is popped from the queue.

16.5.7.80 QUEUE_11_B Register (offset = 20B4h) [reset = 0h]

QUEUE_11_B is shown in [Figure 16-356](#) and described in [Table 16-370](#).

Figure 16-356. QUEUE_11_B Register


LEGEND: R/W = Read/Write; R = Read only; W1toCl = Write 1 to clear bit; -n = value after reset

Table 16-370. QUEUE_11_B Register Field Descriptions

Bit	Field	Type	Reset	Description
27-0	QUEUE_BYTE_COUNT	R-0	0	This field indicates how many bytes total are contained in all of the packets which are currently queued on this queue.

16.5.7.81 QUEUE_11_C Register (offset = 20B8h) [reset = 0h]

 QUEUE_11_C is shown in [Figure 16-357](#) and described in [Table 16-371](#).

Figure 16-357. QUEUE_11_C Register

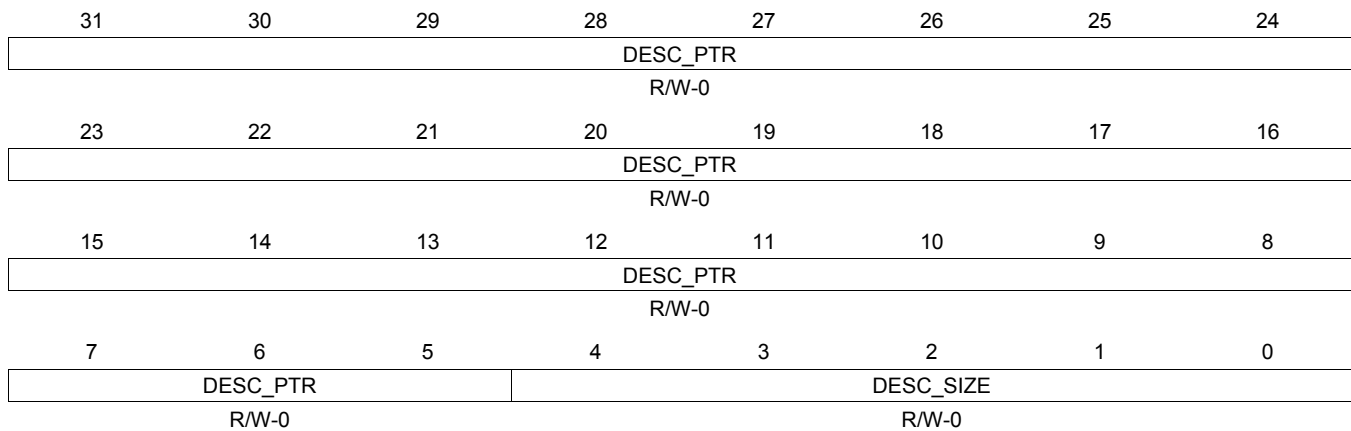

LEGEND: R/W = Read/Write; R = Read only; W1toCl = Write 1 to clear bit; -n = value after reset

Table 16-371. QUEUE_11_C Register Field Descriptions

Bit	Field	Type	Reset	Description
31	HEAD_TAIL	W-0	0	Head/Tail Push Control. Set to zero in order to push packet onto tail of queue and set to one in order to push packet onto head of queue.
13-0	PACKET_SIZE	R/W-0	0	packet_size This field indicates packet size and is assumed to be zero on each packet add unless the value is explicitly overwritten. This field indicates packet size for packet pop operation.

16.5.7.82 QUEUE_11_D Register (offset = 20BCh) [reset = 0h]

 QUEUE_11_D is shown in [Figure 16-358](#) and described in [Table 16-372](#).

Figure 16-358. QUEUE_11_D Register


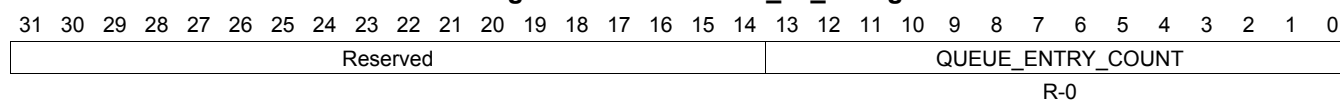
LEGEND: R/W = Read/Write; R = Read only; W1toCl = Write 1 to clear bit; -n = value after reset

Table 16-372. QUEUE_11_D Register Field Descriptions

Bit	Field	Type	Reset	Description
31-5	DESC_PTR	R/W-0	0	Descriptor pointer. It will be read as zero if the queue is empty. It will indicate a 32-bit aligned address that points to a descriptor when the queue is not empty.
4-0	DESC_SIZE	R/W-0	0	Descriptor Size. It is encoded in 4-byte increments with values 0 to 31 representing 24 and so on to 148 bytes. This field will return a 0x0 when an empty queue is read. Queue Manager Queue N Registers D To save hardware resources, the queue manager internally stores descriptor size (desc_size) information in four bits. However, register D has five LSBs that specify descriptor size. As a consequence, the value of desc_size that is pushed may not be same as that is read during a pop. The value that is read back is equal to always rounded to an odd number. So, for even values, the value read back is one more than what was written. For odd values, the value read back is same as the value that was written. Note that this 5-bit field (desc_size) is unrelated to the code for size of descriptors in a descriptor region. It is just a place holder for a 5-bit value that is maintained across the push and pop operations for every descriptor managed by the queue manager.

16.5.7.83 QUEUE_12_A Register (offset = 20C0h) [reset = 0h]

QUEUE_12_A is shown in [Figure 16-359](#) and described in [Table 16-373](#).

Figure 16-359. QUEUE_12_A Register


LEGEND: R/W = Read/Write; R = Read only; W1toCl = Write 1 to clear bit; -n = value after reset

Table 16-373. QUEUE_12_A Register Field Descriptions

Bit	Field	Type	Reset	Description
13-0	QUEUE_ENTRY_COUNT	R-0	0	This field indicates how many packets are currently queued on the queue. This count is incremented by 1 whenever a packet is added to the queue. This count is decremented by 1 whenever a packet is popped from the queue.

16.5.7.84 QUEUE_12_B Register (offset = 20C4h) [reset = 0h]

QUEUE_12_B is shown in [Figure 16-360](#) and described in [Table 16-374](#).

Figure 16-360. QUEUE_12_B Register


LEGEND: R/W = Read/Write; R = Read only; W1toCl = Write 1 to clear bit; -n = value after reset

Table 16-374. QUEUE_12_B Register Field Descriptions

Bit	Field	Type	Reset	Description
27-0	QUEUE_BYTE_COUNT	R-0	0	This field indicates how many bytes total are contained in all of the packets which are currently queued on this queue.

16.5.7.85 QUEUE_12_C Register (offset = 20C8h) [reset = 0h]

 QUEUE_12_C is shown in [Figure 16-361](#) and described in [Table 16-375](#).

Figure 16-361. QUEUE_12_C Register


LEGEND: R/W = Read/Write; R = Read only; W1toCl = Write 1 to clear bit; -n = value after reset

Table 16-375. QUEUE_12_C Register Field Descriptions

Bit	Field	Type	Reset	Description
31	HEAD_TAIL	W-0	0	Head/Tail Push Control. Set to zero in order to push packet onto tail of queue and set to one in order to push packet onto head of queue.
13-0	PACKET_SIZE	R/W-0	0	packet_size This field indicates packet size and is assumed to be zero on each packet add unless the value is explicitly overwritten. This field indicates packet size for packet pop operation.

16.5.7.86 QUEUE_12_D Register (offset = 20CCh) [reset = 0h]

 QUEUE_12_D is shown in [Figure 16-362](#) and described in [Table 16-376](#).

Figure 16-362. QUEUE_12_D Register


LEGEND: R/W = Read/Write; R = Read only; W1toCl = Write 1 to clear bit; -n = value after reset

Table 16-376. QUEUE_12_D Register Field Descriptions

Bit	Field	Type	Reset	Description
31-5	DESC_PTR	R/W-0	0	Descriptor pointer. It will be read as zero if the queue is empty. It will indicate a 32-bit aligned address that points to a descriptor when the queue is not empty.
4-0	DESC_SIZE	R/W-0	0	Descriptor Size. It is encoded in 4-byte increments with values 0 to 31 representing 24 and so on to 148 bytes. This field will return a 0x0 when an empty queue is read. Queue Manager Queue N Registers D To save hardware resources, the queue manager internally stores descriptor size (desc_size) information in four bits. However, register D has five LSBs that specify descriptor size. As a consequence, the value of desc_size that is pushed may not be same as that is read during a pop. The value that is read back is equal to always rounded to an odd number. So, for even values, the value read back is one more than what was written. For odd values, the value read back is same as the value that was written. Note that this 5-bit field (desc_size) is unrelated to the code for size of descriptors in a descriptor region. It is just a place holder for a 5-bit value that is maintained across the push and pop operations for every descriptor managed by the queue manager.

16.5.7.87 QUEUE_13_A Register (offset = 20D0h) [reset = 0h]

QUEUE_13_A is shown in [Figure 16-363](#) and described in [Table 16-377](#).

Figure 16-363. QUEUE_13_A Register


LEGEND: R/W = Read/Write; R = Read only; W1toCl = Write 1 to clear bit; -n = value after reset

Table 16-377. QUEUE_13_A Register Field Descriptions

Bit	Field	Type	Reset	Description
13-0	QUEUE_ENTRY_COUNT	R-0	0	This field indicates how many packets are currently queued on the queue. This count is incremented by 1 whenever a packet is added to the queue. This count is decremented by 1 whenever a packet is popped from the queue.

16.5.7.88 QUEUE_13_B Register (offset = 20D4h) [reset = 0h]

QUEUE_13_B is shown in [Figure 16-364](#) and described in [Table 16-378](#).

Figure 16-364. QUEUE_13_B Register


LEGEND: R/W = Read/Write; R = Read only; W1toCl = Write 1 to clear bit; -n = value after reset

Table 16-378. QUEUE_13_B Register Field Descriptions

Bit	Field	Type	Reset	Description
27-0	QUEUE_BYTE_COUNT	R-0	0	This field indicates how many bytes total are contained in all of the packets which are currently queued on this queue.

16.5.7.89 QUEUE_13_C Register (offset = 20D8h) [reset = 0h]

 QUEUE_13_C is shown in [Figure 16-365](#) and described in [Table 16-379](#).

Figure 16-365. QUEUE_13_C Register


LEGEND: R/W = Read/Write; R = Read only; W1toCl = Write 1 to clear bit; -n = value after reset

Table 16-379. QUEUE_13_C Register Field Descriptions

Bit	Field	Type	Reset	Description
31	HEAD_TAIL	W-0	0	Head/Tail Push Control. Set to zero in order to push packet onto tail of queue and set to one in order to push packet onto head of queue.
13-0	PACKET_SIZE	R/W-0	0	packet_size This field indicates packet size and is assumed to be zero on each packet add unless the value is explicitly overwritten. This field indicates packet size for packet pop operation.

16.5.7.90 QUEUE_13_D Register (offset = 20DCh) [reset = 0h]

 QUEUE_13_D is shown in [Figure 16-366](#) and described in [Table 16-380](#).

Figure 16-366. QUEUE_13_D Register


LEGEND: R/W = Read/Write; R = Read only; W1toCl = Write 1 to clear bit; -n = value after reset

Table 16-380. QUEUE_13_D Register Field Descriptions

Bit	Field	Type	Reset	Description
31-5	DESC_PTR	R/W-0	0	Descriptor pointer. It will be read as zero if the queue is empty. It will indicate a 32-bit aligned address that points to a descriptor when the queue is not empty.
4-0	DESC_SIZE	R/W-0	0	Descriptor Size. It is encoded in 4-byte increments with values 0 to 31 representing 24 and so on to 148 bytes. This field will return a 0x0 when an empty queue is read. Queue Manager Queue N Registers D To save hardware resources, the queue manager internally stores descriptor size (desc_size) information in four bits. However, register D has five LSBs that specify descriptor size. As a consequence, the value of desc_size that is pushed may not be same as that is read during a pop. The value that is read back is equal to always rounded to an odd number. So, for even values, the value read back is one more than what was written. For odd values, the value read back is same as the value that was written. Note that this 5-bit field (desc_size) is unrelated to the code for size of descriptors in a descriptor region. It is just a place holder for a 5-bit value that is maintained across the push and pop operations for every descriptor managed by the queue manager.

16.5.7.91 QUEUE_14_A Register (offset = 20E0h) [reset = 0h]

QUEUE_14_A is shown in [Figure 16-367](#) and described in [Table 16-381](#).

Figure 16-367. QUEUE_14_A Register


LEGEND: R/W = Read/Write; R = Read only; W1toCl = Write 1 to clear bit; -n = value after reset

Table 16-381. QUEUE_14_A Register Field Descriptions

Bit	Field	Type	Reset	Description
13-0	QUEUE_ENTRY_COUNT	R-0	0	This field indicates how many packets are currently queued on the queue. This count is incremented by 1 whenever a packet is added to the queue. This count is decremented by 1 whenever a packet is popped from the queue.

16.5.7.92 QUEUE_14_B Register (offset = 20E4h) [reset = 0h]

 QUEUE_14_B is shown in [Figure 16-368](#) and described in [Table 16-382](#).

Figure 16-368. QUEUE_14_B Register

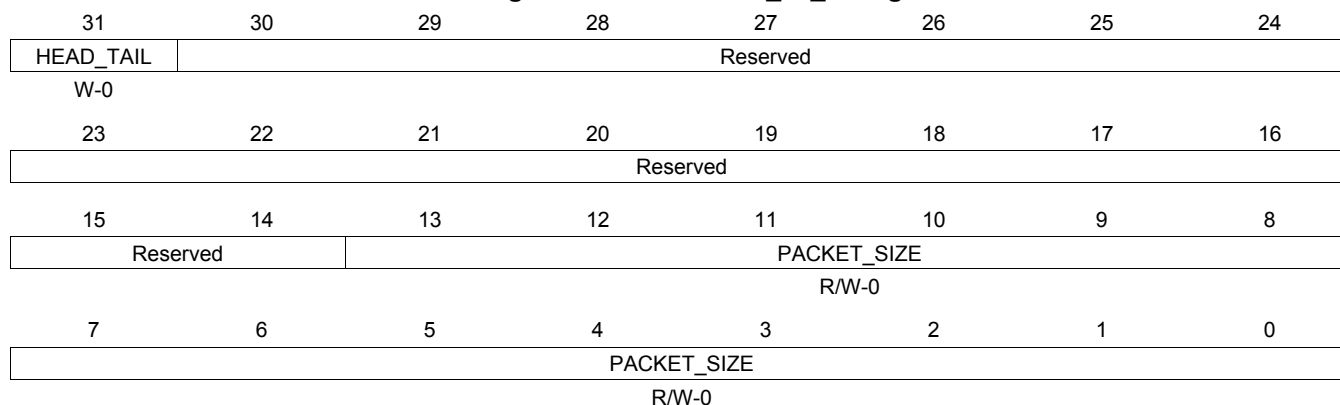

LEGEND: R/W = Read/Write; R = Read only; W1toCl = Write 1 to clear bit; -n = value after reset

Table 16-382. QUEUE_14_B Register Field Descriptions

Bit	Field	Type	Reset	Description
27-0	QUEUE_BYTE_COUNT	R-0	0	This field indicates how many bytes total are contained in all of the packets which are currently queued on this queue.

16.5.7.93 QUEUE_14_C Register (offset = 20E8h) [reset = 0h]

 QUEUE_14_C is shown in [Figure 16-369](#) and described in [Table 16-383](#).

Figure 16-369. QUEUE_14_C Register


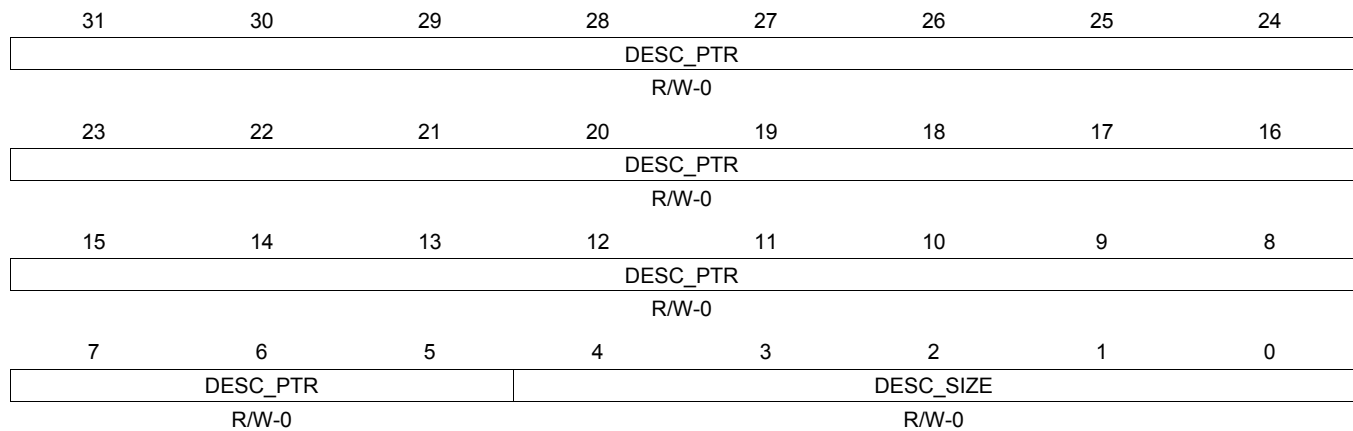
LEGEND: R/W = Read/Write; R = Read only; W1toCl = Write 1 to clear bit; -n = value after reset

Table 16-383. QUEUE_14_C Register Field Descriptions

Bit	Field	Type	Reset	Description
31	HEAD_TAIL	W-0	0	Head/Tail Push Control. Set to zero in order to push packet onto tail of queue and set to one in order to push packet onto head of queue.
13-0	PACKET_SIZE	R/W-0	0	packet_size This field indicates packet size and is assumed to be zero on each packet add unless the value is explicitly overwritten. This field indicates packet size for packet pop operation.

16.5.7.94 QUEUE_14_D Register (offset = 20ECh) [reset = 0h]

 QUEUE_14_D is shown in [Figure 16-370](#) and described in [Table 16-384](#).

Figure 16-370. QUEUE_14_D Register


LEGEND: R/W = Read/Write; R = Read only; W1toCl = Write 1 to clear bit; -n = value after reset

Table 16-384. QUEUE_14_D Register Field Descriptions

Bit	Field	Type	Reset	Description
31-5	DESC_PTR	R/W-0	0	Descriptor pointer. It will be read as zero if the queue is empty. It will indicate a 32-bit aligned address that points to a descriptor when the queue is not empty.
4-0	DESC_SIZE	R/W-0	0	Descriptor Size. It is encoded in 4-byte increments with values 0 to 31 representing 24 and so on to 148 bytes. This field will return a 0x0 when an empty queue is read. Queue Manager Queue N Registers D To save hardware resources, the queue manager internally stores descriptor size (desc_size) information in four bits. However, register D has five LSBs that specify descriptor size. As a consequence, the value of desc_size that is pushed may not be same as that is read during a pop. The value that is read back is equal to always rounded to an odd number. So, for even values, the value read back is one more than what was written. For odd values, the value read back is same as the value that was written. Note that this 5-bit field (desc_size) is unrelated to the code for size of descriptors in a descriptor region. It is just a place holder for a 5-bit value that is maintained across the push and pop operations for every descriptor managed by the queue manager.

16.5.7.95 QUEUE_15_A Register (offset = 20F0h) [reset = 0h]

QUEUE_15_A is shown in [Figure 16-371](#) and described in [Table 16-385](#).

Figure 16-371. QUEUE_15_A Register


LEGEND: R/W = Read/Write; R = Read only; W1toCl = Write 1 to clear bit; -n = value after reset

Table 16-385. QUEUE_15_A Register Field Descriptions

Bit	Field	Type	Reset	Description
13-0	QUEUE_ENTRY_COUNT	R-0	0	This field indicates how many packets are currently queued on the queue. This count is incremented by 1 whenever a packet is added to the queue. This count is decremented by 1 whenever a packet is popped from the queue.

16.5.7.96 QUEUE_15_B Register (offset = 20F4h) [reset = 0h]

 QUEUE_15_B is shown in [Figure 16-372](#) and described in [Table 16-386](#).

Figure 16-372. QUEUE_15_B Register

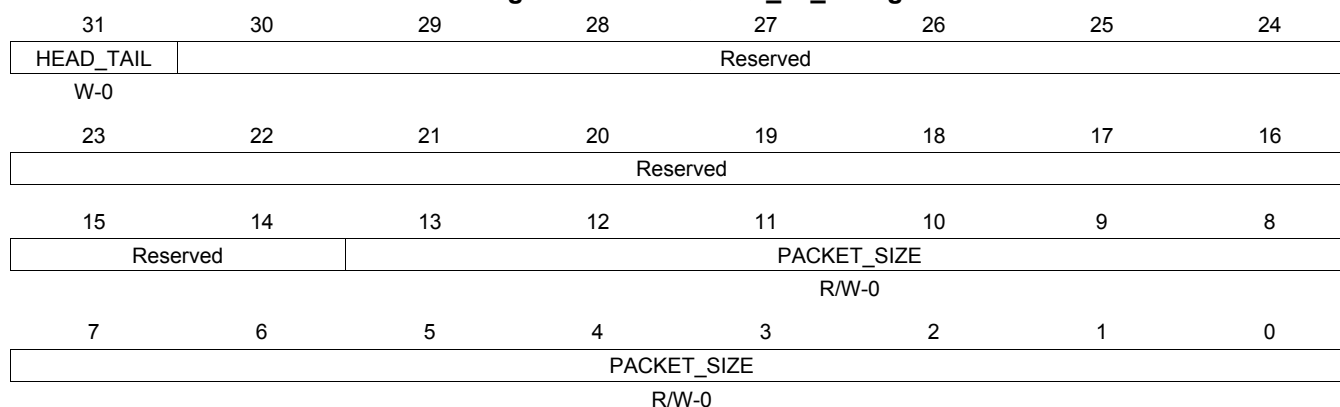

LEGEND: R/W = Read/Write; R = Read only; W1toCl = Write 1 to clear bit; -n = value after reset

Table 16-386. QUEUE_15_B Register Field Descriptions

Bit	Field	Type	Reset	Description
27-0	QUEUE_BYTE_COUNT	R-0	0	This field indicates how many bytes total are contained in all of the packets which are currently queued on this queue.

16.5.7.97 QUEUE_15_C Register (offset = 20F8h) [reset = 0h]

 QUEUE_15_C is shown in [Figure 16-373](#) and described in [Table 16-387](#).

Figure 16-373. QUEUE_15_C Register


LEGEND: R/W = Read/Write; R = Read only; W1toCl = Write 1 to clear bit; -n = value after reset

Table 16-387. QUEUE_15_C Register Field Descriptions

Bit	Field	Type	Reset	Description
31	HEAD_TAIL	W-0	0	Head/Tail Push Control. Set to zero in order to push packet onto tail of queue and set to one in order to push packet onto head of queue.
13-0	PACKET_SIZE	R/W-0	0	packet_size This field indicates packet size and is assumed to be zero on each packet add unless the value is explicitly overwritten. This field indicates packet size for packet pop operation.

16.5.7.98 QUEUE_15_D Register (offset = 20FCh) [reset = 0h]

QUEUE_15_D is shown in [Figure 16-374](#) and described in [Table 16-388](#).

Figure 16-374. QUEUE_15_D Register



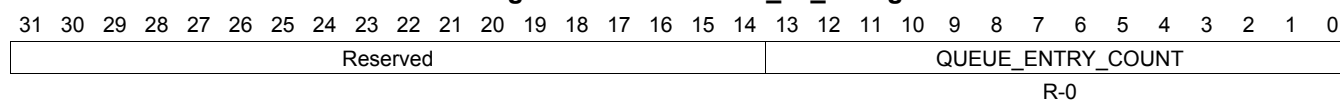
LEGEND: R/W = Read/Write; R = Read only; W1toCl = Write 1 to clear bit; -n = value after reset

Table 16-388. QUEUE_15_D Register Field Descriptions

Bit	Field	Type	Reset	Description
31-5	DESC_PTR	R/W-0	0	Descriptor pointer. It will be read as zero if the queue is empty. It will indicate a 32-bit aligned address that points to a descriptor when the queue is not empty.
4-0	DESC_SIZE	R/W-0	0	Descriptor Size. It is encoded in 4-byte increments with values 0 to 31 representing 24 and so on to 148 bytes. This field will return a 0x0 when an empty queue is read. Queue Manager Queue N Registers D To save hardware resources, the queue manager internally stores descriptor size (desc_size) information in four bits. However, register D has five LSBs that specify descriptor size. As a consequence, the value of desc_size that is pushed may not be same as that is read during a pop. The value that is read back is equal to always rounded to an odd number. So, for even values, the value read back is one more than what was written. For odd values, the value read back is same as the value that was written. Note that this 5-bit field (desc_size) is unrelated to the code for size of descriptors in a descriptor region. It is just a place holder for a 5-bit value that is maintained across the push and pop operations for every descriptor managed by the queue manager.

16.5.7.99 QUEUE_16_A Register (offset = 2100h) [reset = 0h]

QUEUE_16_A is shown in [Figure 16-375](#) and described in [Table 16-389](#).

Figure 16-375. QUEUE_16_A Register


LEGEND: R/W = Read/Write; R = Read only; W1toCl = Write 1 to clear bit; -n = value after reset

Table 16-389. QUEUE_16_A Register Field Descriptions

Bit	Field	Type	Reset	Description
13-0	QUEUE_ENTRY_COUNT	R-0	0	This field indicates how many packets are currently queued on the queue. This count is incremented by 1 whenever a packet is added to the queue. This count is decremented by 1 whenever a packet is popped from the queue.

16.5.7.100 QUEUE_16_B Register (offset = 2104h) [reset = 0h]

QUEUE_16_B is shown in [Figure 16-376](#) and described in [Table 16-390](#).

Figure 16-376. QUEUE_16_B Register


LEGEND: R/W = Read/Write; R = Read only; W1toCl = Write 1 to clear bit; -n = value after reset

Table 16-390. QUEUE_16_B Register Field Descriptions

Bit	Field	Type	Reset	Description
27-0	QUEUE_BYTE_COUNT	R-0	0	This field indicates how many bytes total are contained in all of the packets which are currently queued on this queue.

16.5.7.101 QUEUE_16_C Register (offset = 2108h) [reset = 0h]

 QUEUE_16_C is shown in [Figure 16-377](#) and described in [Table 16-391](#).

Figure 16-377. QUEUE_16_C Register


LEGEND: R/W = Read/Write; R = Read only; W1toCl = Write 1 to clear bit; -n = value after reset

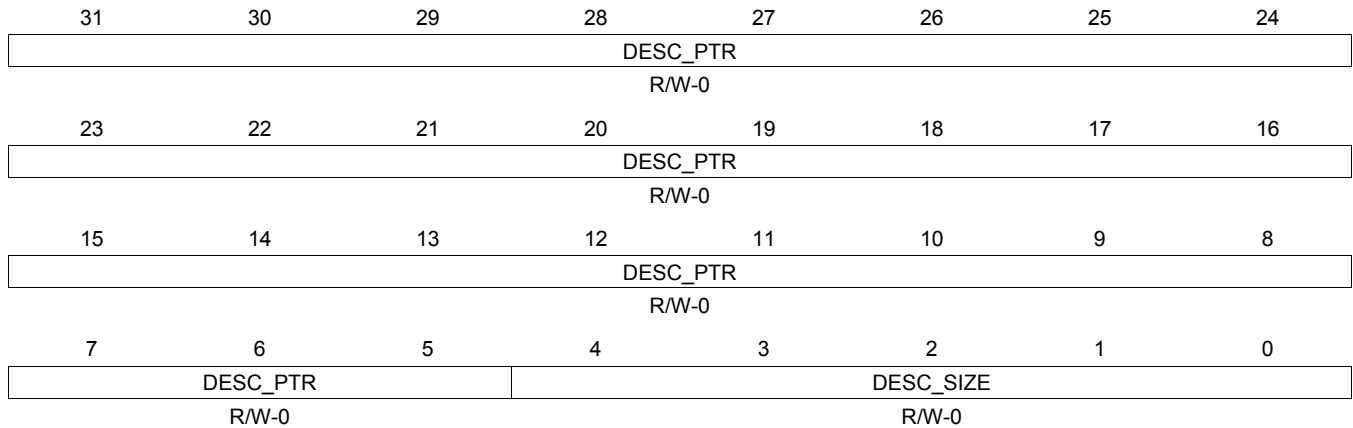
Table 16-391. QUEUE_16_C Register Field Descriptions

Bit	Field	Type	Reset	Description
31	HEAD_TAIL	W-0	0	Head/Tail Push Control. Set to zero in order to push packet onto tail of queue and set to one in order to push packet onto head of queue.
13-0	PACKET_SIZE	R/W-0	0	packet_size This field indicates packet size and is assumed to be zero on each packet add unless the value is explicitly overwritten. This field indicates packet size for packet pop operation.

16.5.7.102 QUEUE_16_D Register (offset = 210Ch) [reset = 0h]

QUEUE_16_D is shown in [Figure 16-378](#) and described in [Table 16-392](#).

Figure 16-378. QUEUE_16_D Register



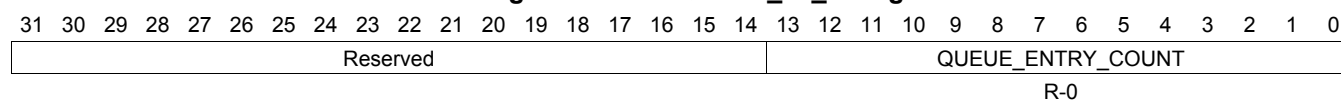
LEGEND: R/W = Read/Write; R = Read only; W1toCl = Write 1 to clear bit; -n = value after reset

Table 16-392. QUEUE_16_D Register Field Descriptions

Bit	Field	Type	Reset	Description
31-5	DESC_PTR	R/W-0	0	Descriptor pointer. It will be read as zero if the queue is empty. It will indicate a 32-bit aligned address that points to a descriptor when the queue is not empty.
4-0	DESC_SIZE	R/W-0	0	Descriptor Size. It is encoded in 4-byte increments with values 0 to 31 representing 24 and so on to 148 bytes. This field will return a 0x0 when an empty queue is read. Queue Manager Queue N Registers D To save hardware resources, the queue manager internally stores descriptor size (desc_size) information in four bits. However, register D has five LSBs that specify descriptor size. As a consequence, the value of desc_size that is pushed may not be same as that is read during a pop. The value that is read back is equal to always rounded to an odd number. So, for even values, the value read back is one more than what was written. For odd values, the value read back is same as the value that was written. Note that this 5-bit field (desc_size) is unrelated to the code for size of descriptors in a descriptor region. It is just a place holder for a 5-bit value that is maintained across the push and pop operations for every descriptor managed by the queue manager.

16.5.7.103 QUEUE_17_A Register (offset = 2110h) [reset = 0h]

QUEUE_17_A is shown in [Figure 16-379](#) and described in [Table 16-393](#).

Figure 16-379. QUEUE_17_A Register


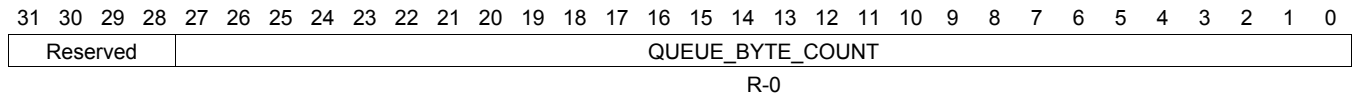
LEGEND: R/W = Read/Write; R = Read only; W1toCl = Write 1 to clear bit; -n = value after reset

Table 16-393. QUEUE_17_A Register Field Descriptions

Bit	Field	Type	Reset	Description
13-0	QUEUE_ENTRY_COUNT	R-0	0	This field indicates how many packets are currently queued on the queue. This count is incremented by 1 whenever a packet is added to the queue. This count is decremented by 1 whenever a packet is popped from the queue.

16.5.7.104 QUEUE_17_B Register (offset = 2114h) [reset = 0h]

QUEUE_17_B is shown in [Figure 16-380](#) and described in [Table 16-394](#).

Figure 16-380. QUEUE_17_B Register


LEGEND: R/W = Read/Write; R = Read only; W1toCl = Write 1 to clear bit; -n = value after reset

Table 16-394. QUEUE_17_B Register Field Descriptions

Bit	Field	Type	Reset	Description
27-0	QUEUE_BYTE_COUNT	R-0	0	This field indicates how many bytes total are contained in all of the packets which are currently queued on this queue.

16.5.7.105 QUEUE_17_C Register (offset = 2118h) [reset = 0h]

 QUEUE_17_C is shown in [Figure 16-381](#) and described in [Table 16-395](#).

Figure 16-381. QUEUE_17_C Register


LEGEND: R/W = Read/Write; R = Read only; W1toCl = Write 1 to clear bit; -n = value after reset

Table 16-395. QUEUE_17_C Register Field Descriptions

Bit	Field	Type	Reset	Description
31	HEAD_TAIL	W-0	0	Head/Tail Push Control. Set to zero in order to push packet onto tail of queue and set to one in order to push packet onto head of queue.
13-0	PACKET_SIZE	R/W-0	0	packet_size This field indicates packet size and is assumed to be zero on each packet add unless the value is explicitly overwritten. This field indicates packet size for packet pop operation.

16.5.7.106 QUEUE_17_D Register (offset = 211Ch) [reset = 0h]

QUEUE_17_D is shown in [Figure 16-382](#) and described in [Table 16-396](#).

Figure 16-382. QUEUE_17_D Register



LEGEND: R/W = Read/Write; R = Read only; W1toCl = Write 1 to clear bit; -n = value after reset

Table 16-396. QUEUE_17_D Register Field Descriptions

Bit	Field	Type	Reset	Description
31-5	DESC_PTR	R/W-0	0	Descriptor pointer. It will be read as zero if the queue is empty. It will indicate a 32-bit aligned address that points to a descriptor when the queue is not empty.
4-0	DESC_SIZE	R/W-0	0	Descriptor Size. It is encoded in 4-byte increments with values 0 to 31 representing 24 and so on to 148 bytes. This field will return a 0x0 when an empty queue is read. Queue Manager Queue N Registers D To save hardware resources, the queue manager internally stores descriptor size (desc_size) information in four bits. However, register D has five LSBs that specify descriptor size. As a consequence, the value of desc_size that is pushed may not be same as that is read during a pop. The value that is read back is equal to always rounded to an odd number. So, for even values, the value read back is one more than what was written. For odd values, the value read back is same as the value that was written. Note that this 5-bit field (desc_size) is unrelated to the code for size of descriptors in a descriptor region. It is just a place holder for a 5-bit value that is maintained across the push and pop operations for every descriptor managed by the queue manager.

16.5.7.107 QUEUE_18_A Register (offset = 2120h) [reset = 0h]

QUEUE_18_A is shown in [Figure 16-383](#) and described in [Table 16-397](#).

Figure 16-383. QUEUE_18_A Register


LEGEND: R/W = Read/Write; R = Read only; W1toCl = Write 1 to clear bit; -n = value after reset

Table 16-397. QUEUE_18_A Register Field Descriptions

Bit	Field	Type	Reset	Description
13-0	QUEUE_ENTRY_COUNT	R-0	0	This field indicates how many packets are currently queued on the queue. This count is incremented by 1 whenever a packet is added to the queue. This count is decremented by 1 whenever a packet is popped from the queue.

16.5.7.108 QUEUE_18_B Register (offset = 2124h) [reset = 0h]

QUEUE_18_B is shown in [Figure 16-384](#) and described in [Table 16-398](#).

Figure 16-384. QUEUE_18_B Register


LEGEND: R/W = Read/Write; R = Read only; W1toCl = Write 1 to clear bit; -n = value after reset

Table 16-398. QUEUE_18_B Register Field Descriptions

Bit	Field	Type	Reset	Description
27-0	QUEUE_BYTE_COUNT	R-0	0	This field indicates how many bytes total are contained in all of the packets which are currently queued on this queue.

16.5.7.109 QUEUE_18_C Register (offset = 2128h) [reset = 0h]

 QUEUE_18_C is shown in [Figure 16-385](#) and described in [Table 16-399](#).

Figure 16-385. QUEUE_18_C Register

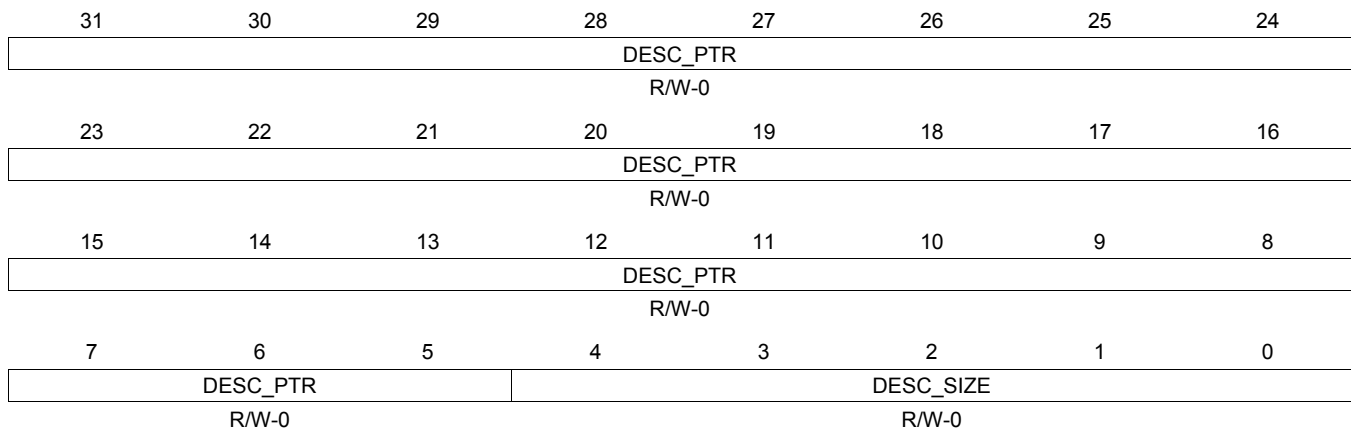

LEGEND: R/W = Read/Write; R = Read only; W1toCl = Write 1 to clear bit; -n = value after reset

Table 16-399. QUEUE_18_C Register Field Descriptions

Bit	Field	Type	Reset	Description
31	HEAD_TAIL	W-0	0	Head/Tail Push Control. Set to zero in order to push packet onto tail of queue and set to one in order to push packet onto head of queue.
13-0	PACKET_SIZE	R/W-0	0	packet_size This field indicates packet size and is assumed to be zero on each packet add unless the value is explicitly overwritten. This field indicates packet size for packet pop operation.

16.5.7.110 QUEUE_18_D Register (offset = 212Ch) [reset = 0h]

QUEUE_18_D is shown in [Figure 16-386](#) and described in [Table 16-400](#).

Figure 16-386. QUEUE_18_D Register


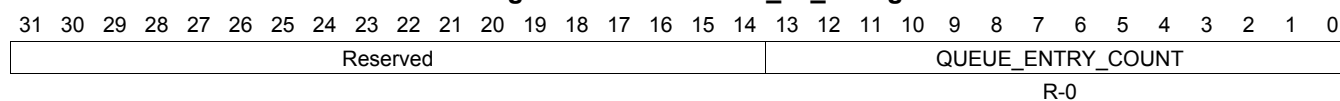
LEGEND: R/W = Read/Write; R = Read only; W1toCl = Write 1 to clear bit; -n = value after reset

Table 16-400. QUEUE_18_D Register Field Descriptions

Bit	Field	Type	Reset	Description
31-5	DESC_PTR	R/W-0	0	Descriptor pointer. It will be read as zero if the queue is empty. It will indicate a 32-bit aligned address that points to a descriptor when the queue is not empty.
4-0	DESC_SIZE	R/W-0	0	Descriptor Size. It is encoded in 4-byte increments with values 0 to 31 representing 24 and so on to 148 bytes. This field will return a 0x0 when an empty queue is read. Queue Manager Queue N Registers D To save hardware resources, the queue manager internally stores descriptor size (desc_size) information in four bits. However, register D has five LSBs that specify descriptor size. As a consequence, the value of desc_size that is pushed may not be same as that is read during a pop. The value that is read back is equal to always rounded to an odd number. So, for even values, the value read back is one more than what was written. For odd values, the value read back is same as the value that was written. Note that this 5-bit field (desc_size) is unrelated to the code for size of descriptors in a descriptor region. It is just a place holder for a 5-bit value that is maintained across the push and pop operations for every descriptor managed by the queue manager.

16.5.7.111 QUEUE_19_A Register (offset = 2130h) [reset = 0h]

QUEUE_19_A is shown in [Figure 16-387](#) and described in [Table 16-401](#).

Figure 16-387. QUEUE_19_A Register


LEGEND: R/W = Read/Write; R = Read only; W1toCl = Write 1 to clear bit; -n = value after reset

Table 16-401. QUEUE_19_A Register Field Descriptions

Bit	Field	Type	Reset	Description
13-0	QUEUE_ENTRY_COUNT	R-0	0	This field indicates how many packets are currently queued on the queue. This count is incremented by 1 whenever a packet is added to the queue. This count is decremented by 1 whenever a packet is popped from the queue.

16.5.7.112 QUEUE_19_B Register (offset = 2134h) [reset = 0h]

 QUEUE_19_B is shown in [Figure 16-388](#) and described in [Table 16-402](#).

Figure 16-388. QUEUE_19_B Register

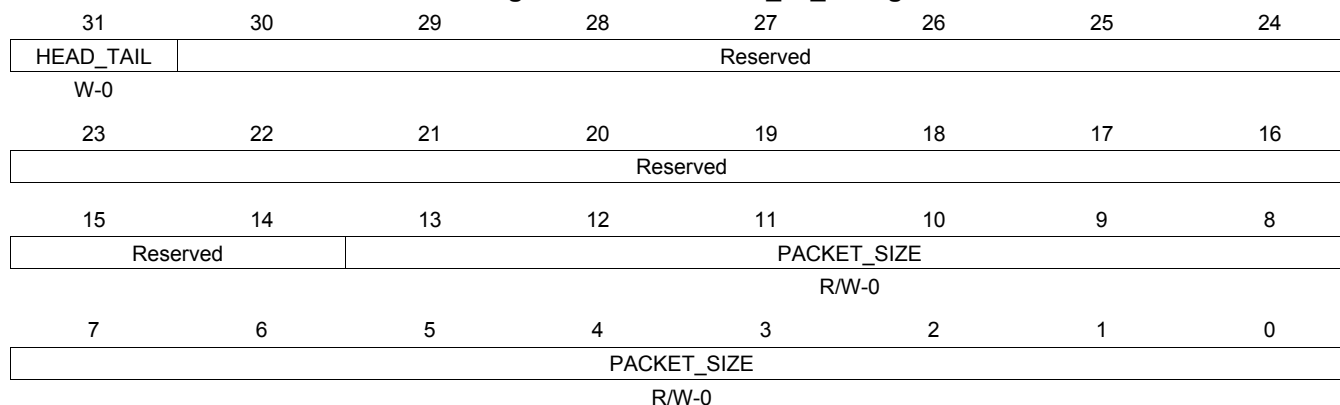

LEGEND: R/W = Read/Write; R = Read only; W1toCl = Write 1 to clear bit; -n = value after reset

Table 16-402. QUEUE_19_B Register Field Descriptions

Bit	Field	Type	Reset	Description
27-0	QUEUE_BYTE_COUNT	R-0	0	This field indicates how many bytes total are contained in all of the packets which are currently queued on this queue.

16.5.7.113 QUEUE_19_C Register (offset = 2138h) [reset = 0h]

 QUEUE_19_C is shown in [Figure 16-389](#) and described in [Table 16-403](#).

Figure 16-389. QUEUE_19_C Register


LEGEND: R/W = Read/Write; R = Read only; W1toCl = Write 1 to clear bit; -n = value after reset

Table 16-403. QUEUE_19_C Register Field Descriptions

Bit	Field	Type	Reset	Description
31	HEAD_TAIL	W-0	0	Head/Tail Push Control. Set to zero in order to push packet onto tail of queue and set to one in order to push packet onto head of queue.
13-0	PACKET_SIZE	R/W-0	0	packet_size This field indicates packet size and is assumed to be zero on each packet add unless the value is explicitly overwritten. This field indicates packet size for packet pop operation.

16.5.7.114 QUEUE_19_D Register (offset = 213Ch) [reset = 0h]

 QUEUE_19_D is shown in [Figure 16-390](#) and described in [Table 16-404](#).

Figure 16-390. QUEUE_19_D Register


LEGEND: R/W = Read/Write; R = Read only; W1toCl = Write 1 to clear bit; -n = value after reset

Table 16-404. QUEUE_19_D Register Field Descriptions

Bit	Field	Type	Reset	Description
31-5	DESC_PTR	R/W-0	0	Descriptor pointer. It will be read as zero if the queue is empty. It will indicate a 32-bit aligned address that points to a descriptor when the queue is not empty.
4-0	DESC_SIZE	R/W-0	0	Descriptor Size. It is encoded in 4-byte increments with values 0 to 31 representing 24 and so on to 148 bytes. This field will return a 0x0 when an empty queue is read. Queue Manager Queue N Registers D To save hardware resources, the queue manager internally stores descriptor size (desc_size) information in four bits. However, register D has five LSBs that specify descriptor size. As a consequence, the value of desc_size that is pushed may not be same as that is read during a pop. The value that is read back is equal to always rounded to an odd number. So, for even values, the value read back is one more than what was written. For odd values, the value read back is same as the value that was written. Note that this 5-bit field (desc_size) is unrelated to the code for size of descriptors in a descriptor region. It is just a place holder for a 5-bit value that is maintained across the push and pop operations for every descriptor managed by the queue manager.

16.5.7.115 QUEUE_20_A Register (offset = 2140h) [reset = 0h]

QUEUE_20_A is shown in [Figure 16-391](#) and described in [Table 16-405](#).

Figure 16-391. QUEUE_20_A Register

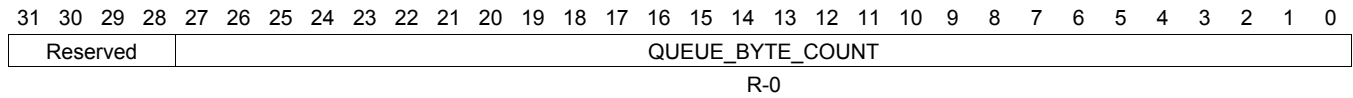

LEGEND: R/W = Read/Write; R = Read only; W1toCl = Write 1 to clear bit; -n = value after reset

Table 16-405. QUEUE_20_A Register Field Descriptions

Bit	Field	Type	Reset	Description
13-0	QUEUE_ENTRY_COUNT	R-0	0	This field indicates how many packets are currently queued on the queue. This count is incremented by 1 whenever a packet is added to the queue. This count is decremented by 1 whenever a packet is popped from the queue.

16.5.7.116 QUEUE_20_B Register (offset = 2144h) [reset = 0h]

QUEUE_20_B is shown in [Figure 16-392](#) and described in [Table 16-406](#).

Figure 16-392. QUEUE_20_B Register


LEGEND: R/W = Read/Write; R = Read only; W1toCl = Write 1 to clear bit; -n = value after reset

Table 16-406. QUEUE_20_B Register Field Descriptions

Bit	Field	Type	Reset	Description
27-0	QUEUE_BYTE_COUNT	R-0	0	This field indicates how many bytes total are contained in all of the packets which are currently queued on this queue.

16.5.7.117 QUEUE_20_C Register (offset = 2148h) [reset = 0h]

 QUEUE_20_C is shown in [Figure 16-393](#) and described in [Table 16-407](#).

Figure 16-393. QUEUE_20_C Register


LEGEND: R/W = Read/Write; R = Read only; W1toCl = Write 1 to clear bit; -n = value after reset

Table 16-407. QUEUE_20_C Register Field Descriptions

Bit	Field	Type	Reset	Description
31	HEAD_TAIL	W-0	0	Head/Tail Push Control. Set to zero in order to push packet onto tail of queue and set to one in order to push packet onto head of queue.
13-0	PACKET_SIZE	R/W-0	0	packet_size This field indicates packet size and is assumed to be zero on each packet add unless the value is explicitly overwritten. This field indicates packet size for packet pop operation.

16.5.7.118 QUEUE_20_D Register (offset = 214Ch) [reset = 0h]

 QUEUE_20_D is shown in [Figure 16-394](#) and described in [Table 16-408](#).

Figure 16-394. QUEUE_20_D Register


LEGEND: R/W = Read/Write; R = Read only; W1toCl = Write 1 to clear bit; -n = value after reset

Table 16-408. QUEUE_20_D Register Field Descriptions

Bit	Field	Type	Reset	Description
31-5	DESC_PTR	R/W-0	0	Descriptor pointer. It will be read as zero if the queue is empty. It will indicate a 32-bit aligned address that points to a descriptor when the queue is not empty.
4-0	DESC_SIZE	R/W-0	0	Descriptor Size. It is encoded in 4-byte increments with values 0 to 31 representing 24 and so on to 148 bytes. This field will return a 0x0 when an empty queue is read. Queue Manager Queue N Registers D To save hardware resources, the queue manager internally stores descriptor size (desc_size) information in four bits. However, register D has five LSBs that specify descriptor size. As a consequence, the value of desc_size that is pushed may not be same as that is read during a pop. The value that is read back is equal to always rounded to an odd number. So, for even values, the value read back is one more than what was written. For odd values, the value read back is same as the value that was written. Note that this 5-bit field (desc_size) is unrelated to the code for size of descriptors in a descriptor region. It is just a place holder for a 5-bit value that is maintained across the push and pop operations for every descriptor managed by the queue manager.

16.5.7.119 QUEUE_21_A Register (offset = 2150h) [reset = 0h]

QUEUE_21_A is shown in [Figure 16-395](#) and described in [Table 16-409](#).

Figure 16-395. QUEUE_21_A Register

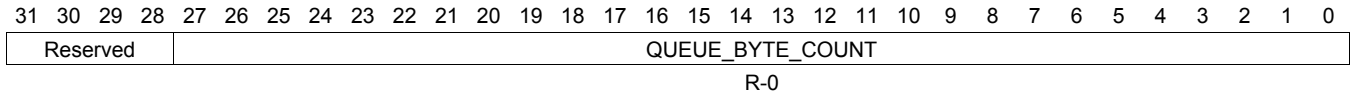

LEGEND: R/W = Read/Write; R = Read only; W1toCl = Write 1 to clear bit; -n = value after reset

Table 16-409. QUEUE_21_A Register Field Descriptions

Bit	Field	Type	Reset	Description
13-0	QUEUE_ENTRY_COUNT	R-0	0	This field indicates how many packets are currently queued on the queue. This count is incremented by 1 whenever a packet is added to the queue. This count is decremented by 1 whenever a packet is popped from the queue.

16.5.7.120 QUEUE_21_B Register (offset = 2154h) [reset = 0h]

 QUEUE_21_B is shown in [Figure 16-396](#) and described in [Table 16-410](#).

Figure 16-396. QUEUE_21_B Register


LEGEND: R/W = Read/Write; R = Read only; W1toCl = Write 1 to clear bit; -n = value after reset

Table 16-410. QUEUE_21_B Register Field Descriptions

Bit	Field	Type	Reset	Description
27-0	QUEUE_BYTE_COUNT	R-0	0	This field indicates how many bytes total are contained in all of the packets which are currently queued on this queue.

16.5.7.121 QUEUE_21_C Register (offset = 2158h) [reset = 0h]

 QUEUE_21_C is shown in [Figure 16-397](#) and described in [Table 16-411](#).

Figure 16-397. QUEUE_21_C Register


LEGEND: R/W = Read/Write; R = Read only; W1toCl = Write 1 to clear bit; -n = value after reset

Table 16-411. QUEUE_21_C Register Field Descriptions

Bit	Field	Type	Reset	Description
31	HEAD_TAIL	W-0	0	Head/Tail Push Control. Set to zero in order to push packet onto tail of queue and set to one in order to push packet onto head of queue.
13-0	PACKET_SIZE	R/W-0	0	packet_size This field indicates packet size and is assumed to be zero on each packet add unless the value is explicitly overwritten. This field indicates packet size for packet pop operation.

16.5.7.122 QUEUE_21_D Register (offset = 215Ch) [reset = 0h]

 QUEUE_21_D is shown in [Figure 16-398](#) and described in [Table 16-412](#).

Figure 16-398. QUEUE_21_D Register


LEGEND: R/W = Read/Write; R = Read only; W1toCl = Write 1 to clear bit; -n = value after reset

Table 16-412. QUEUE_21_D Register Field Descriptions

Bit	Field	Type	Reset	Description
31-5	DESC_PTR	R/W-0	0	Descriptor pointer. It will be read as zero if the queue is empty. It will indicate a 32-bit aligned address that points to a descriptor when the queue is not empty.
4-0	DESC_SIZE	R/W-0	0	Descriptor Size. It is encoded in 4-byte increments with values 0 to 31 representing 24 and so on to 148 bytes. This field will return a 0x0 when an empty queue is read. Queue Manager Queue N Registers D To save hardware resources, the queue manager internally stores descriptor size (desc_size) information in four bits. However, register D has five LSBs that specify descriptor size. As a consequence, the value of desc_size that is pushed may not be same as that is read during a pop. The value that is read back is equal to always rounded to an odd number. So, for even values, the value read back is one more than what was written. For odd values, the value read back is same as the value that was written. Note that this 5-bit field (desc_size) is unrelated to the code for size of descriptors in a descriptor region. It is just a place holder for a 5-bit value that is maintained across the push and pop operations for every descriptor managed by the queue manager.

16.5.7.123 QUEUE_22_A Register (offset = 2160h) [reset = 0h]

QUEUE_22_A is shown in [Figure 16-399](#) and described in [Table 16-413](#).

Figure 16-399. QUEUE_22_A Register

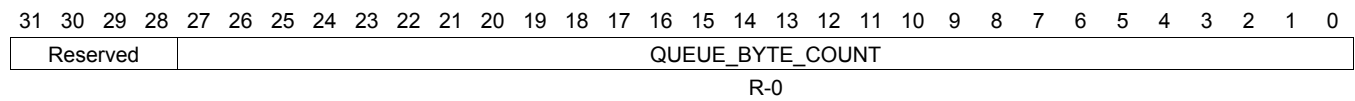

LEGEND: R/W = Read/Write; R = Read only; W1toCl = Write 1 to clear bit; -n = value after reset

Table 16-413. QUEUE_22_A Register Field Descriptions

Bit	Field	Type	Reset	Description
13-0	QUEUE_ENTRY_COUNT	R-0	0	This field indicates how many packets are currently queued on the queue. This count is incremented by 1 whenever a packet is added to the queue. This count is decremented by 1 whenever a packet is popped from the queue.

16.5.7.124 QUEUE_22_B Register (offset = 2164h) [reset = 0h]

QUEUE_22_B is shown in [Figure 16-400](#) and described in [Table 16-414](#).

Figure 16-400. QUEUE_22_B Register


LEGEND: R/W = Read/Write; R = Read only; W1toCl = Write 1 to clear bit; -n = value after reset

Table 16-414. QUEUE_22_B Register Field Descriptions

Bit	Field	Type	Reset	Description
27-0	QUEUE_BYTE_COUNT	R-0	0	This field indicates how many bytes total are contained in all of the packets which are currently queued on this queue.

16.5.7.125 QUEUE_22_C Register (offset = 2168h) [reset = 0h]

 QUEUE_22_C is shown in [Figure 16-401](#) and described in [Table 16-415](#).

Figure 16-401. QUEUE_22_C Register

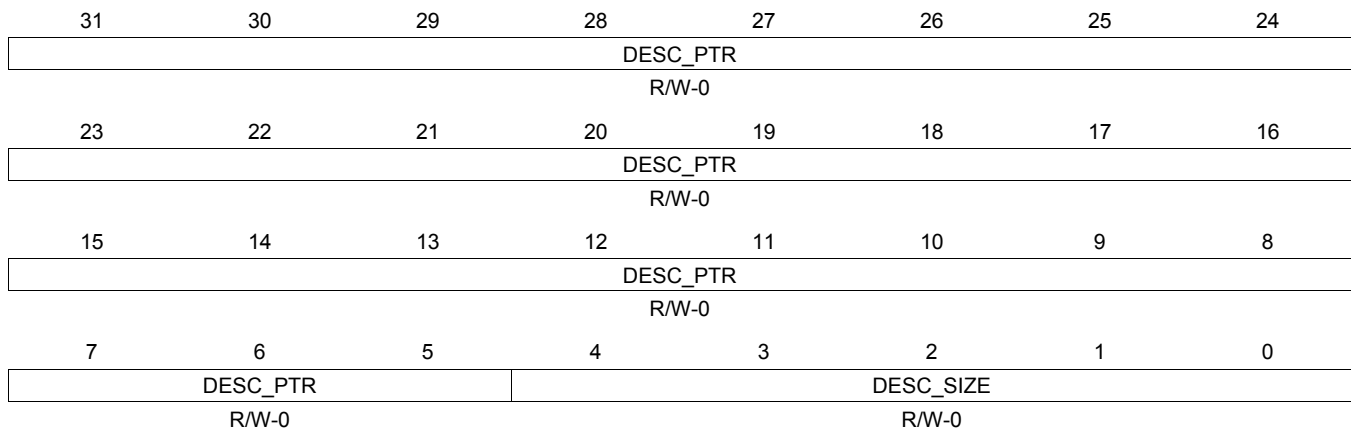

LEGEND: R/W = Read/Write; R = Read only; W1toCl = Write 1 to clear bit; -n = value after reset

Table 16-415. QUEUE_22_C Register Field Descriptions

Bit	Field	Type	Reset	Description
31	HEAD_TAIL	W-0	0	Head/Tail Push Control. Set to zero in order to push packet onto tail of queue and set to one in order to push packet onto head of queue.
13-0	PACKET_SIZE	R/W-0	0	packet_size This field indicates packet size and is assumed to be zero on each packet add unless the value is explicitly overwritten. This field indicates packet size for packet pop operation.

16.5.7.126 QUEUE_22_D Register (offset = 216Ch) [reset = 0h]

QUEUE_22_D is shown in [Figure 16-402](#) and described in [Table 16-416](#).

Figure 16-402. QUEUE_22_D Register


LEGEND: R/W = Read/Write; R = Read only; W1toCl = Write 1 to clear bit; -n = value after reset

Table 16-416. QUEUE_22_D Register Field Descriptions

Bit	Field	Type	Reset	Description
31-5	DESC_PTR	R/W-0	0	Descriptor pointer. It will be read as zero if the queue is empty. It will indicate a 32-bit aligned address that points to a descriptor when the queue is not empty.
4-0	DESC_SIZE	R/W-0	0	Descriptor Size. It is encoded in 4-byte increments with values 0 to 31 representing 24 and so on to 148 bytes. This field will return a 0x0 when an empty queue is read. Queue Manager Queue N Registers D To save hardware resources, the queue manager internally stores descriptor size (desc_size) information in four bits. However, register D has five LSBs that specify descriptor size. As a consequence, the value of desc_size that is pushed may not be same as that is read during a pop. The value that is read back is equal to always rounded to an odd number. So, for even values, the value read back is one more than what was written. For odd values, the value read back is same as the value that was written. Note that this 5-bit field (desc_size) is unrelated to the code for size of descriptors in a descriptor region. It is just a place holder for a 5-bit value that is maintained across the push and pop operations for every descriptor managed by the queue manager.

16.5.7.127 QUEUE_23_A Register (offset = 2170h) [reset = 0h]

QUEUE_23_A is shown in [Figure 16-403](#) and described in [Table 16-417](#).

Figure 16-403. QUEUE_23_A Register


LEGEND: R/W = Read/Write; R = Read only; W1toCl = Write 1 to clear bit; -n = value after reset

Table 16-417. QUEUE_23_A Register Field Descriptions

Bit	Field	Type	Reset	Description
13-0	QUEUE_ENTRY_COUNT	R-0	0	This field indicates how many packets are currently queued on the queue. This count is incremented by 1 whenever a packet is added to the queue. This count is decremented by 1 whenever a packet is popped from the queue.

16.5.7.128 QUEUE_23_B Register (offset = 2174h) [reset = 0h]

QUEUE_23_B is shown in [Figure 16-404](#) and described in [Table 16-418](#).

Figure 16-404. QUEUE_23_B Register


LEGEND: R/W = Read/Write; R = Read only; W1toCl = Write 1 to clear bit; -n = value after reset

Table 16-418. QUEUE_23_B Register Field Descriptions

Bit	Field	Type	Reset	Description
27-0	QUEUE_BYTE_COUNT	R-0	0	This field indicates how many bytes total are contained in all of the packets which are currently queued on this queue.

16.5.7.129 QUEUE_23_C Register (offset = 2178h) [reset = 0h]

 QUEUE_23_C is shown in [Figure 16-405](#) and described in [Table 16-419](#).

Figure 16-405. QUEUE_23_C Register

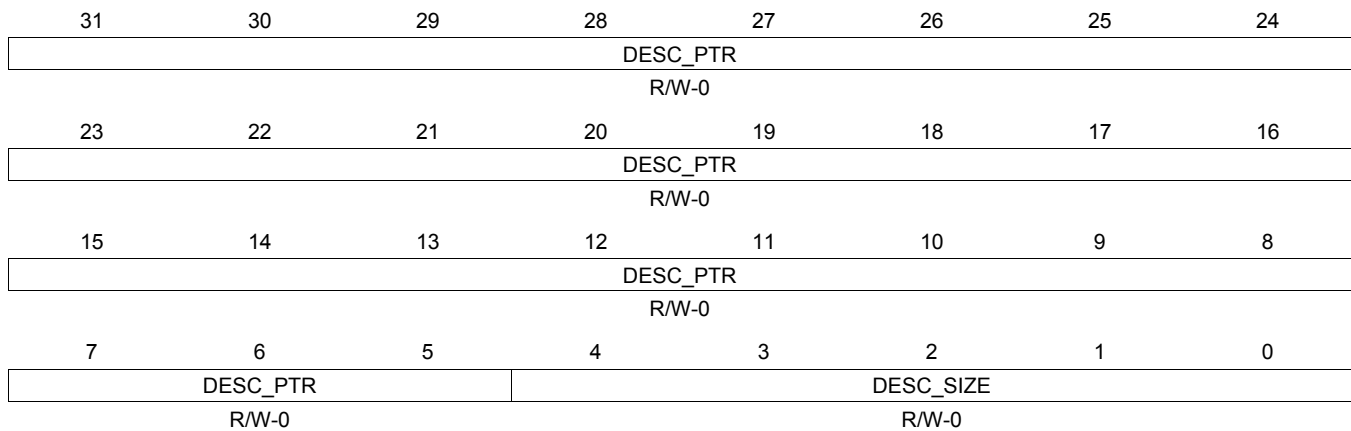

LEGEND: R/W = Read/Write; R = Read only; W1toCl = Write 1 to clear bit; -n = value after reset

Table 16-419. QUEUE_23_C Register Field Descriptions

Bit	Field	Type	Reset	Description
31	HEAD_TAIL	W-0	0	Head/Tail Push Control. Set to zero in order to push packet onto tail of queue and set to one in order to push packet onto head of queue.
13-0	PACKET_SIZE	R/W-0	0	packet_size This field indicates packet size and is assumed to be zero on each packet add unless the value is explicitly overwritten. This field indicates packet size for packet pop operation.

16.5.7.130 QUEUE_23_D Register (offset = 217Ch) [reset = 0h]

QUEUE_23_D is shown in [Figure 16-406](#) and described in [Table 16-420](#).

Figure 16-406. QUEUE_23_D Register


LEGEND: R/W = Read/Write; R = Read only; W1toCl = Write 1 to clear bit; -n = value after reset

Table 16-420. QUEUE_23_D Register Field Descriptions

Bit	Field	Type	Reset	Description
31-5	DESC_PTR	R/W-0	0	Descriptor pointer. It will be read as zero if the queue is empty. It will indicate a 32-bit aligned address that points to a descriptor when the queue is not empty.
4-0	DESC_SIZE	R/W-0	0	Descriptor Size. It is encoded in 4-byte increments with values 0 to 31 representing 24 and so on to 148 bytes. This field will return a 0x0 when an empty queue is read. Queue Manager Queue N Registers D To save hardware resources, the queue manager internally stores descriptor size (desc_size) information in four bits. However, register D has five LSBs that specify descriptor size. As a consequence, the value of desc_size that is pushed may not be same as that is read during a pop. The value that is read back is equal to always rounded to an odd number. So, for even values, the value read back is one more than what was written. For odd values, the value read back is same as the value that was written. Note that this 5-bit field (desc_size) is unrelated to the code for size of descriptors in a descriptor region. It is just a place holder for a 5-bit value that is maintained across the push and pop operations for every descriptor managed by the queue manager.

16.5.7.131 QUEUE_24_A Register (offset = 2180h) [reset = 0h]

QUEUE_24_A is shown in [Figure 16-407](#) and described in [Table 16-421](#).

Figure 16-407. QUEUE_24_A Register

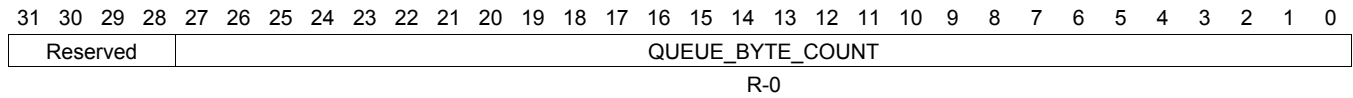

LEGEND: R/W = Read/Write; R = Read only; W1toCl = Write 1 to clear bit; -n = value after reset

Table 16-421. QUEUE_24_A Register Field Descriptions

Bit	Field	Type	Reset	Description
13-0	QUEUE_ENTRY_COUNT	R-0	0	This field indicates how many packets are currently queued on the queue. This count is incremented by 1 whenever a packet is added to the queue. This count is decremented by 1 whenever a packet is popped from the queue.

16.5.7.132 QUEUE_24_B Register (offset = 2184h) [reset = 0h]

QUEUE_24_B is shown in [Figure 16-408](#) and described in [Table 16-422](#).

Figure 16-408. QUEUE_24_B Register


LEGEND: R/W = Read/Write; R = Read only; W1toCl = Write 1 to clear bit; -n = value after reset

Table 16-422. QUEUE_24_B Register Field Descriptions

Bit	Field	Type	Reset	Description
27-0	QUEUE_BYTE_COUNT	R-0	0	This field indicates how many bytes total are contained in all of the packets which are currently queued on this queue.

16.5.7.133 QUEUE_24_C Register (offset = 2188h) [reset = 0h]

 QUEUE_24_C is shown in [Figure 16-409](#) and described in [Table 16-423](#).

Figure 16-409. QUEUE_24_C Register


LEGEND: R/W = Read/Write; R = Read only; W1toCl = Write 1 to clear bit; -n = value after reset

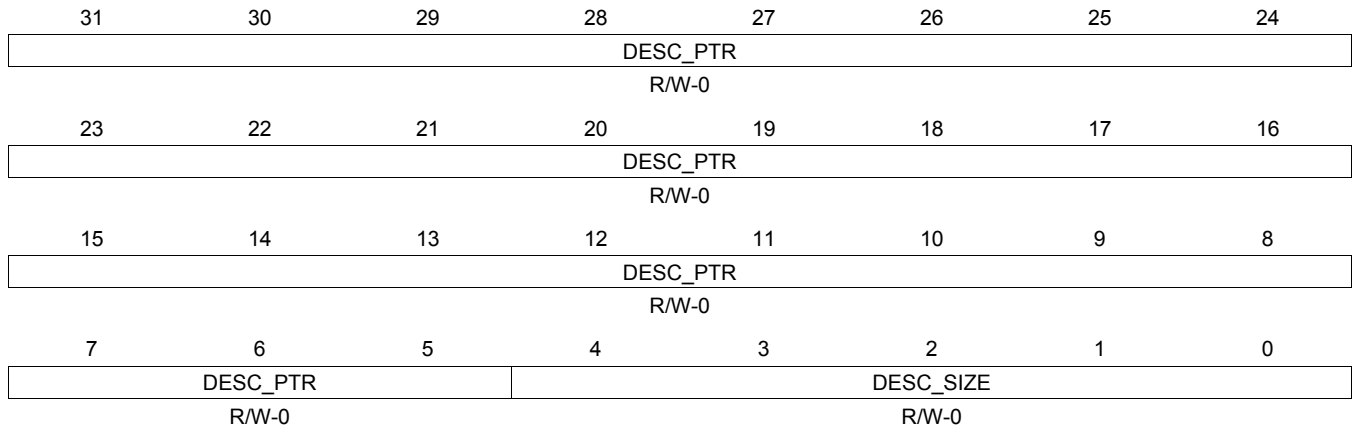
Table 16-423. QUEUE_24_C Register Field Descriptions

Bit	Field	Type	Reset	Description
31	HEAD_TAIL	W-0	0	Head/Tail Push Control. Set to zero in order to push packet onto tail of queue and set to one in order to push packet onto head of queue.
13-0	PACKET_SIZE	R/W-0	0	packet_size This field indicates packet size and is assumed to be zero on each packet add unless the value is explicitly overwritten. This field indicates packet size for packet pop operation.

16.5.7.134 QUEUE_24_D Register (offset = 218Ch) [reset = 0h]

QUEUE_24_D is shown in [Figure 16-410](#) and described in [Table 16-424](#).

Figure 16-410. QUEUE_24_D Register



LEGEND: R/W = Read/Write; R = Read only; W1toCl = Write 1 to clear bit; -n = value after reset

Table 16-424. QUEUE_24_D Register Field Descriptions

Bit	Field	Type	Reset	Description
31-5	DESC_PTR	R/W-0	0	Descriptor pointer. It will be read as zero if the queue is empty. It will indicate a 32-bit aligned address that points to a descriptor when the queue is not empty.
4-0	DESC_SIZE	R/W-0	0	Descriptor Size. It is encoded in 4-byte increments with values 0 to 31 representing 24 and so on to 148 bytes. This field will return a 0x0 when an empty queue is read. Queue Manager Queue N Registers D To save hardware resources, the queue manager internally stores descriptor size (desc_size) information in four bits. However, register D has five LSBs that specify descriptor size. As a consequence, the value of desc_size that is pushed may not be same as that is read during a pop. The value that is read back is equal to always rounded to an odd number. So, for even values, the value read back is one more than what was written. For odd values, the value read back is same as the value that was written. Note that this 5-bit field (desc_size) is unrelated to the code for size of descriptors in a descriptor region. It is just a place holder for a 5-bit value that is maintained across the push and pop operations for every descriptor managed by the queue manager.

16.5.7.135 QUEUE_25_A Register (offset = 2190h) [reset = 0h]

QUEUE_25_A is shown in [Figure 16-411](#) and described in [Table 16-425](#).

Figure 16-411. QUEUE_25_A Register


LEGEND: R/W = Read/Write; R = Read only; W1toCl = Write 1 to clear bit; -n = value after reset

Table 16-425. QUEUE_25_A Register Field Descriptions

Bit	Field	Type	Reset	Description
13-0	QUEUE_ENTRY_COUNT	R-0	0	This field indicates how many packets are currently queued on the queue. This count is incremented by 1 whenever a packet is added to the queue. This count is decremented by 1 whenever a packet is popped from the queue.

16.5.7.136 QUEUE_25_B Register (offset = 2194h) [reset = 0h]

 QUEUE_25_B is shown in [Figure 16-412](#) and described in [Table 16-426](#).

Figure 16-412. QUEUE_25_B Register

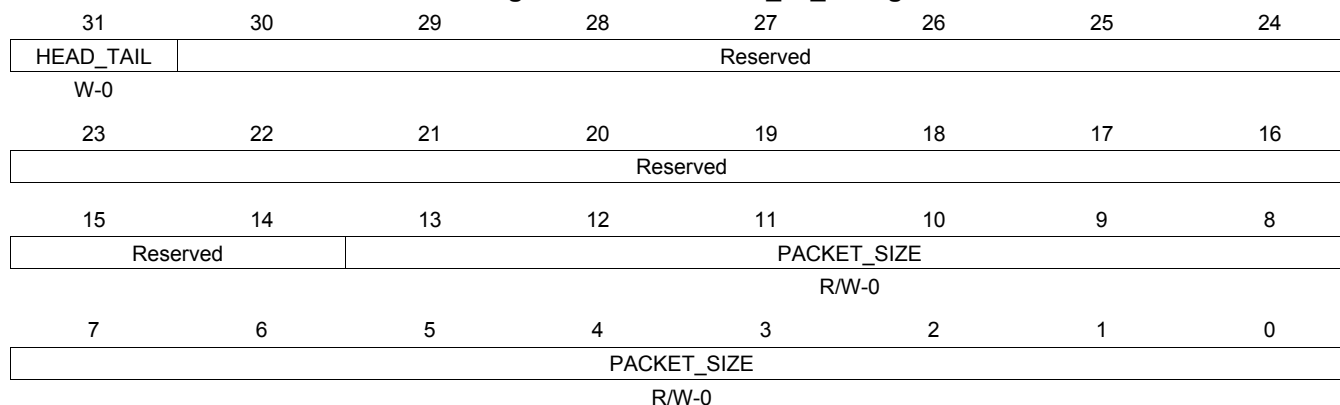

LEGEND: R/W = Read/Write; R = Read only; W1toCl = Write 1 to clear bit; -n = value after reset

Table 16-426. QUEUE_25_B Register Field Descriptions

Bit	Field	Type	Reset	Description
27-0	QUEUE_BYTE_COUNT	R-0	0	This field indicates how many bytes total are contained in all of the packets which are currently queued on this queue.

16.5.7.137 QUEUE_25_C Register (offset = 2198h) [reset = 0h]

 QUEUE_25_C is shown in [Figure 16-413](#) and described in [Table 16-427](#).

Figure 16-413. QUEUE_25_C Register


LEGEND: R/W = Read/Write; R = Read only; W1toCl = Write 1 to clear bit; -n = value after reset

Table 16-427. QUEUE_25_C Register Field Descriptions

Bit	Field	Type	Reset	Description
31	HEAD_TAIL	W-0	0	Head/Tail Push Control. Set to zero in order to push packet onto tail of queue and set to one in order to push packet onto head of queue.
13-0	PACKET_SIZE	R/W-0	0	packet_size This field indicates packet size and is assumed to be zero on each packet add unless the value is explicitly overwritten. This field indicates packet size for packet pop operation.

16.5.7.138 QUEUE_25_D Register (offset = 219Ch) [reset = 0h]

QUEUE_25_D is shown in [Figure 16-414](#) and described in [Table 16-428](#).

Figure 16-414. QUEUE_25_D Register



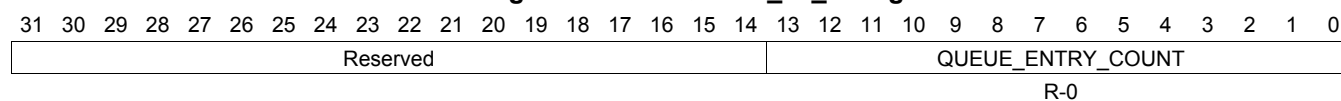
LEGEND: R/W = Read/Write; R = Read only; W1toCl = Write 1 to clear bit; -n = value after reset

Table 16-428. QUEUE_25_D Register Field Descriptions

Bit	Field	Type	Reset	Description
31-5	DESC_PTR	R/W-0	0	Descriptor pointer. It will be read as zero if the queue is empty. It will indicate a 32-bit aligned address that points to a descriptor when the queue is not empty.
4-0	DESC_SIZE	R/W-0	0	Descriptor Size. It is encoded in 4-byte increments with values 0 to 31 representing 24 and so on to 148 bytes. This field will return a 0x0 when an empty queue is read. Queue Manager Queue N Registers D To save hardware resources, the queue manager internally stores descriptor size (desc_size) information in four bits. However, register D has five LSBs that specify descriptor size. As a consequence, the value of desc_size that is pushed may not be same as that is read during a pop. The value that is read back is equal to always rounded to an odd number. So, for even values, the value read back is one more than what was written. For odd values, the value read back is same as the value that was written. Note that this 5-bit field (desc_size) is unrelated to the code for size of descriptors in a descriptor region. It is just a place holder for a 5-bit value that is maintained across the push and pop operations for every descriptor managed by the queue manager.

16.5.7.139 QUEUE_26_A Register (offset = 21A0h) [reset = 0h]

QUEUE_26_A is shown in [Figure 16-415](#) and described in [Table 16-429](#).

Figure 16-415. QUEUE_26_A Register


LEGEND: R/W = Read/Write; R = Read only; W1toCl = Write 1 to clear bit; -n = value after reset

Table 16-429. QUEUE_26_A Register Field Descriptions

Bit	Field	Type	Reset	Description
13-0	QUEUE_ENTRY_COUNT	R-0	0	This field indicates how many packets are currently queued on the queue. This count is incremented by 1 whenever a packet is added to the queue. This count is decremented by 1 whenever a packet is popped from the queue.

16.5.7.140 QUEUE_26_B Register (offset = 21A4h) [reset = 0h]

 QUEUE_26_B is shown in [Figure 16-416](#) and described in [Table 16-430](#).

Figure 16-416. QUEUE_26_B Register

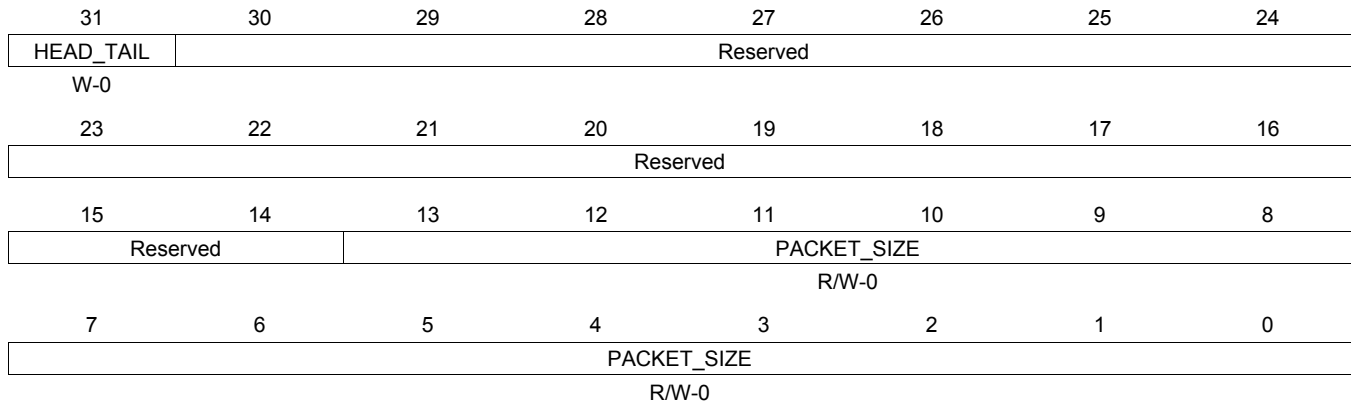

LEGEND: R/W = Read/Write; R = Read only; W1toCl = Write 1 to clear bit; -n = value after reset

Table 16-430. QUEUE_26_B Register Field Descriptions

Bit	Field	Type	Reset	Description
27-0	QUEUE_BYTE_COUNT	R-0	0	This field indicates how many bytes total are contained in all of the packets which are currently queued on this queue.

16.5.7.141 QUEUE_26_C Register (offset = 21A8h) [reset = 0h]

 QUEUE_26_C is shown in [Figure 16-417](#) and described in [Table 16-431](#).

Figure 16-417. QUEUE_26_C Register


LEGEND: R/W = Read/Write; R = Read only; W1toCl = Write 1 to clear bit; -n = value after reset

Table 16-431. QUEUE_26_C Register Field Descriptions

Bit	Field	Type	Reset	Description
31	HEAD_TAIL	W-0	0	Head/Tail Push Control. Set to zero in order to push packet onto tail of queue and set to one in order to push packet onto head of queue.
13-0	PACKET_SIZE	R/W-0	0	packet_size This field indicates packet size and is assumed to be zero on each packet add unless the value is explicitly overwritten. This field indicates packet size for packet pop operation.

16.5.7.142 QUEUE_26_D Register (offset = 21ACh) [reset = 0h]

QUEUE_26_D is shown in [Figure 16-418](#) and described in [Table 16-432](#).

Figure 16-418. QUEUE_26_D Register

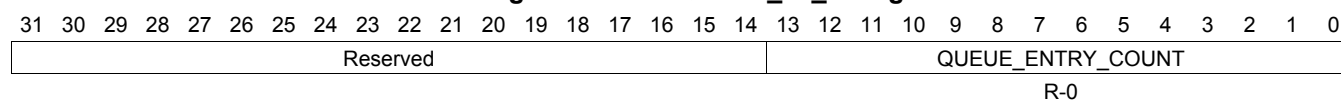

LEGEND: R/W = Read/Write; R = Read only; W1toCl = Write 1 to clear bit; -n = value after reset

Table 16-432. QUEUE_26_D Register Field Descriptions

Bit	Field	Type	Reset	Description
31-5	DESC_PTR	R/W-0	0	Descriptor pointer. It will be read as zero if the queue is empty. It will indicate a 32-bit aligned address that points to a descriptor when the queue is not empty.
4-0	DESC_SIZE	R/W-0	0	Descriptor Size. It is encoded in 4-byte increments with values 0 to 31 representing 24 and so on to 148 bytes. This field will return a 0x0 when an empty queue is read. Queue Manager Queue N Registers D To save hardware resources, the queue manager internally stores descriptor size (desc_size) information in four bits. However, register D has five LSBs that specify descriptor size. As a consequence, the value of desc_size that is pushed may not be same as that is read during a pop. The value that is read back is equal to always rounded to an odd number. So, for even values, the value read back is one more than what was written. For odd values, the value read back is same as the value that was written. Note that this 5-bit field (desc_size) is unrelated to the code for size of descriptors in a descriptor region. It is just a place holder for a 5-bit value that is maintained across the push and pop operations for every descriptor managed by the queue manager.

16.5.7.143 QUEUE_27_A Register (offset = 21B0h) [reset = 0h]

QUEUE_27_A is shown in [Figure 16-419](#) and described in [Table 16-433](#).

Figure 16-419. QUEUE_27_A Register


LEGEND: R/W = Read/Write; R = Read only; W1toCl = Write 1 to clear bit; -n = value after reset

Table 16-433. QUEUE_27_A Register Field Descriptions

Bit	Field	Type	Reset	Description
13-0	QUEUE_ENTRY_COUNT	R-0	0	This field indicates how many packets are currently queued on the queue. This count is incremented by 1 whenever a packet is added to the queue. This count is decremented by 1 whenever a packet is popped from the queue.

16.5.7.144 QUEUE_27_B Register (offset = 21B4h) [reset = 0h]

QUEUE_27_B is shown in [Figure 16-420](#) and described in [Table 16-434](#).

Figure 16-420. QUEUE_27_B Register


LEGEND: R/W = Read/Write; R = Read only; W1toCl = Write 1 to clear bit; -n = value after reset

Table 16-434. QUEUE_27_B Register Field Descriptions

Bit	Field	Type	Reset	Description
27-0	QUEUE_BYTE_COUNT	R-0	0	This field indicates how many bytes total are contained in all of the packets which are currently queued on this queue.

16.5.7.145 QUEUE_27_C Register (offset = 21B8h) [reset = 0h]

 QUEUE_27_C is shown in [Figure 16-421](#) and described in [Table 16-435](#).

Figure 16-421. QUEUE_27_C Register


LEGEND: R/W = Read/Write; R = Read only; W1toCl = Write 1 to clear bit; -n = value after reset

Table 16-435. QUEUE_27_C Register Field Descriptions

Bit	Field	Type	Reset	Description
31	HEAD_TAIL	W-0	0	Head/Tail Push Control. Set to zero in order to push packet onto tail of queue and set to one in order to push packet onto head of queue.
13-0	PACKET_SIZE	R/W-0	0	packet_size This field indicates packet size and is assumed to be zero on each packet add unless the value is explicitly overwritten. This field indicates packet size for packet pop operation.

16.5.7.146 QUEUE_27_D Register (offset = 21BCh) [reset = 0h]

QUEUE_27_D is shown in [Figure 16-422](#) and described in [Table 16-436](#).

Figure 16-422. QUEUE_27_D Register



LEGEND: R/W = Read/Write; R = Read only; W1toCl = Write 1 to clear bit; -n = value after reset

Table 16-436. QUEUE_27_D Register Field Descriptions

Bit	Field	Type	Reset	Description
31-5	DESC_PTR	R/W-0	0	Descriptor pointer. It will be read as zero if the queue is empty. It will indicate a 32-bit aligned address that points to a descriptor when the queue is not empty.
4-0	DESC_SIZE	R/W-0	0	Descriptor Size. It is encoded in 4-byte increments with values 0 to 31 representing 24 and so on to 148 bytes. This field will return a 0x0 when an empty queue is read. Queue Manager Queue N Registers D To save hardware resources, the queue manager internally stores descriptor size (desc_size) information in four bits. However, register D has five LSBs that specify descriptor size. As a consequence, the value of desc_size that is pushed may not be same as that is read during a pop. The value that is read back is equal to always rounded to an odd number. So, for even values, the value read back is one more than what was written. For odd values, the value read back is same as the value that was written. Note that this 5-bit field (desc_size) is unrelated to the code for size of descriptors in a descriptor region. It is just a place holder for a 5-bit value that is maintained across the push and pop operations for every descriptor managed by the queue manager.

16.5.7.147 QUEUE_28_A Register (offset = 21C0h) [reset = 0h]

QUEUE_28_A is shown in [Figure 16-423](#) and described in [Table 16-437](#).

Figure 16-423. QUEUE_28_A Register


LEGEND: R/W = Read/Write; R = Read only; W1toCl = Write 1 to clear bit; -n = value after reset

Table 16-437. QUEUE_28_A Register Field Descriptions

Bit	Field	Type	Reset	Description
13-0	QUEUE_ENTRY_COUNT	R-0	0	This field indicates how many packets are currently queued on the queue. This count is incremented by 1 whenever a packet is added to the queue. This count is decremented by 1 whenever a packet is popped from the queue.

16.5.7.148 QUEUE_28_B Register (offset = 21C4h) [reset = 0h]

 QUEUE_28_B is shown in [Figure 16-424](#) and described in [Table 16-438](#).

Figure 16-424. QUEUE_28_B Register


LEGEND: R/W = Read/Write; R = Read only; W1toCl = Write 1 to clear bit; -n = value after reset

Table 16-438. QUEUE_28_B Register Field Descriptions

Bit	Field	Type	Reset	Description
27-0	QUEUE_BYTE_COUNT	R-0	0	This field indicates how many bytes total are contained in all of the packets which are currently queued on this queue.

16.5.7.149 QUEUE_28_C Register (offset = 21C8h) [reset = 0h]

 QUEUE_28_C is shown in [Figure 16-425](#) and described in [Table 16-439](#).

Figure 16-425. QUEUE_28_C Register


LEGEND: R/W = Read/Write; R = Read only; W1toCl = Write 1 to clear bit; -n = value after reset

Table 16-439. QUEUE_28_C Register Field Descriptions

Bit	Field	Type	Reset	Description
31	HEAD_TAIL	W-0	0	Head/Tail Push Control. Set to zero in order to push packet onto tail of queue and set to one in order to push packet onto head of queue.
13-0	PACKET_SIZE	R/W-0	0	packet_size This field indicates packet size and is assumed to be zero on each packet add unless the value is explicitly overwritten. This field indicates packet size for packet pop operation.

16.5.7.150 QUEUE_28_D Register (offset = 21CCh) [reset = 0h]

QUEUE_28_D is shown in [Figure 16-426](#) and described in [Table 16-440](#).

Figure 16-426. QUEUE_28_D Register


LEGEND: R/W = Read/Write; R = Read only; W1toCl = Write 1 to clear bit; -n = value after reset

Table 16-440. QUEUE_28_D Register Field Descriptions

Bit	Field	Type	Reset	Description
31-5	DESC_PTR	R/W-0	0	Descriptor pointer. It will be read as zero if the queue is empty. It will indicate a 32-bit aligned address that points to a descriptor when the queue is not empty.
4-0	DESC_SIZE	R/W-0	0	Descriptor Size. It is encoded in 4-byte increments with values 0 to 31 representing 24 and so on to 148 bytes. This field will return a 0x0 when an empty queue is read. Queue Manager Queue N Registers D To save hardware resources, the queue manager internally stores descriptor size (desc_size) information in four bits. However, register D has five LSBs that specify descriptor size. As a consequence, the value of desc_size that is pushed may not be same as that is read during a pop. The value that is read back is equal to always rounded to an odd number. So, for even values, the value read back is one more than what was written. For odd values, the value read back is same as the value that was written. Note that this 5-bit field (desc_size) is unrelated to the code for size of descriptors in a descriptor region. It is just a place holder for a 5-bit value that is maintained across the push and pop operations for every descriptor managed by the queue manager.

16.5.7.151 QUEUE_29_A Register (offset = 21D0h) [reset = 0h]

QUEUE_29_A is shown in [Figure 16-427](#) and described in [Table 16-441](#).

Figure 16-427. QUEUE_29_A Register


LEGEND: R/W = Read/Write; R = Read only; W1toCl = Write 1 to clear bit; -n = value after reset

Table 16-441. QUEUE_29_A Register Field Descriptions

Bit	Field	Type	Reset	Description
13-0	QUEUE_ENTRY_COUNT	R-0	0	This field indicates how many packets are currently queued on the queue. This count is incremented by 1 whenever a packet is added to the queue. This count is decremented by 1 whenever a packet is popped from the queue.

16.5.7.152 QUEUE_29_B Register (offset = 21D4h) [reset = 0h]

QUEUE_29_B is shown in [Figure 16-428](#) and described in [Table 16-442](#).

Figure 16-428. QUEUE_29_B Register

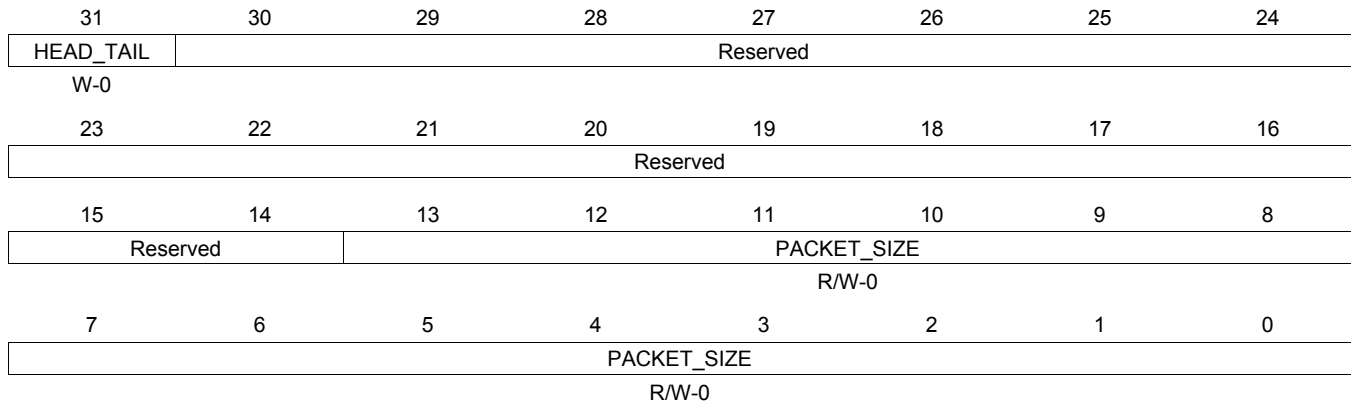

LEGEND: R/W = Read/Write; R = Read only; W1toCl = Write 1 to clear bit; -n = value after reset

Table 16-442. QUEUE_29_B Register Field Descriptions

Bit	Field	Type	Reset	Description
27-0	QUEUE_BYTE_COUNT	R-0	0	This field indicates how many bytes total are contained in all of the packets which are currently queued on this queue.

16.5.7.153 QUEUE_29_C Register (offset = 21D8h) [reset = 0h]

 QUEUE_29_C is shown in [Figure 16-429](#) and described in [Table 16-443](#).

Figure 16-429. QUEUE_29_C Register


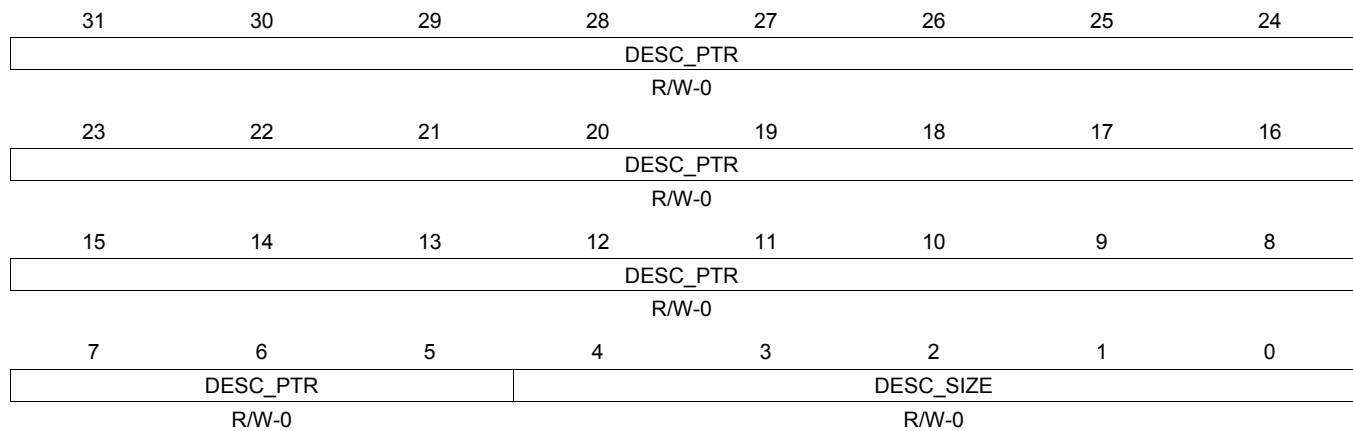
LEGEND: R/W = Read/Write; R = Read only; W1toCl = Write 1 to clear bit; -n = value after reset

Table 16-443. QUEUE_29_C Register Field Descriptions

Bit	Field	Type	Reset	Description
31	HEAD_TAIL	W-0	0	Head/Tail Push Control. Set to zero in order to push packet onto tail of queue and set to one in order to push packet onto head of queue.
13-0	PACKET_SIZE	R/W-0	0	packet_size This field indicates packet size and is assumed to be zero on each packet add unless the value is explicitly overwritten. This field indicates packet size for packet pop operation.

16.5.7.154 QUEUE_29_D Register (offset = 21DCh) [reset = 0h]

QUEUE_29_D is shown in [Figure 16-430](#) and described in [Table 16-444](#).

Figure 16-430. QUEUE_29_D Register


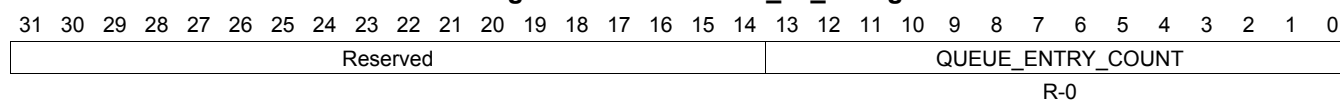
LEGEND: R/W = Read/Write; R = Read only; W1toCl = Write 1 to clear bit; -n = value after reset

Table 16-444. QUEUE_29_D Register Field Descriptions

Bit	Field	Type	Reset	Description
31-5	DESC_PTR	R/W-0	0	Descriptor pointer. It will be read as zero if the queue is empty. It will indicate a 32-bit aligned address that points to a descriptor when the queue is not empty.
4-0	DESC_SIZE	R/W-0	0	Descriptor Size. It is encoded in 4-byte increments with values 0 to 31 representing 24 and so on to 148 bytes. This field will return a 0x0 when an empty queue is read. Queue Manager Queue N Registers D To save hardware resources, the queue manager internally stores descriptor size (desc_size) information in four bits. However, register D has five LSBs that specify descriptor size. As a consequence, the value of desc_size that is pushed may not be same as that is read during a pop. The value that is read back is equal to always rounded to an odd number. So, for even values, the value read back is one more than what was written. For odd values, the value read back is same as the value that was written. Note that this 5-bit field (desc_size) is unrelated to the code for size of descriptors in a descriptor region. It is just a place holder for a 5-bit value that is maintained across the push and pop operations for every descriptor managed by the queue manager.

16.5.7.155 QUEUE_30_A Register (offset = 21E0h) [reset = 0h]

QUEUE_30_A is shown in [Figure 16-431](#) and described in [Table 16-445](#).

Figure 16-431. QUEUE_30_A Register


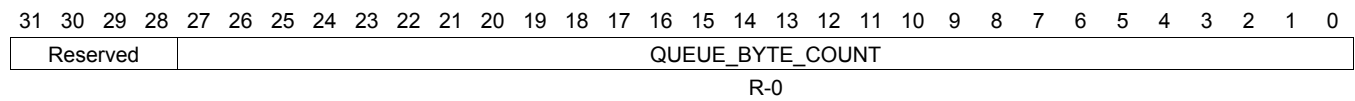
LEGEND: R/W = Read/Write; R = Read only; W1toCl = Write 1 to clear bit; -n = value after reset

Table 16-445. QUEUE_30_A Register Field Descriptions

Bit	Field	Type	Reset	Description
13-0	QUEUE_ENTRY_COUNT	R-0	0	This field indicates how many packets are currently queued on the queue. This count is incremented by 1 whenever a packet is added to the queue. This count is decremented by 1 whenever a packet is popped from the queue.

16.5.7.156 QUEUE_30_B Register (offset = 21E4h) [reset = 0h]

 QUEUE_30_B is shown in [Figure 16-432](#) and described in [Table 16-446](#).

Figure 16-432. QUEUE_30_B Register


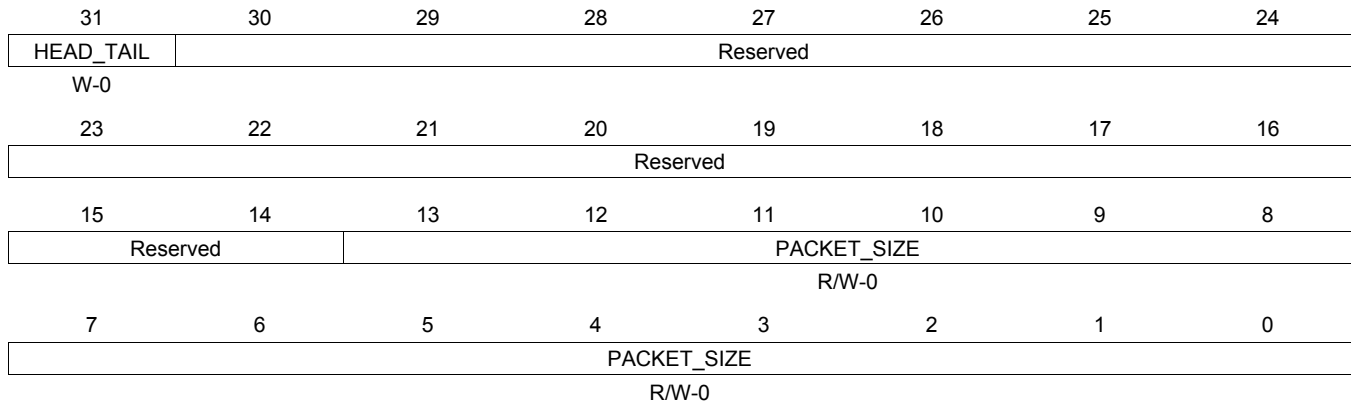
LEGEND: R/W = Read/Write; R = Read only; W1toCl = Write 1 to clear bit; -n = value after reset

Table 16-446. QUEUE_30_B Register Field Descriptions

Bit	Field	Type	Reset	Description
27-0	QUEUE_BYTE_COUNT	R-0	0	This field indicates how many bytes total are contained in all of the packets which are currently queued on this queue.

16.5.7.157 QUEUE_30_C Register (offset = 21E8h) [reset = 0h]

 QUEUE_30_C is shown in [Figure 16-433](#) and described in [Table 16-447](#).

Figure 16-433. QUEUE_30_C Register


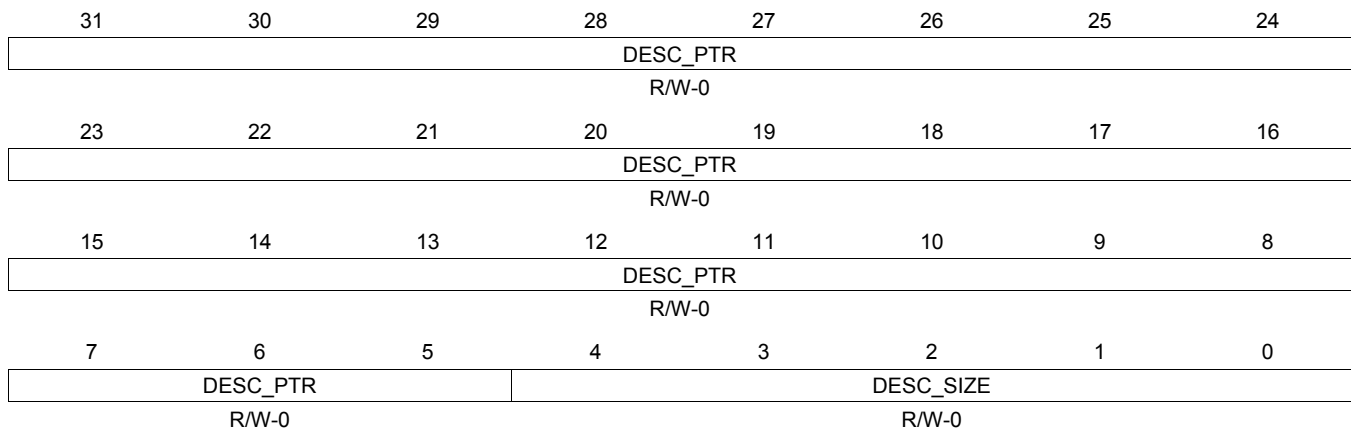
LEGEND: R/W = Read/Write; R = Read only; W1toCl = Write 1 to clear bit; -n = value after reset

Table 16-447. QUEUE_30_C Register Field Descriptions

Bit	Field	Type	Reset	Description
31	HEAD_TAIL	W-0	0	Head/Tail Push Control. Set to zero in order to push packet onto tail of queue and set to one in order to push packet onto head of queue.
13-0	PACKET_SIZE	R/W-0	0	packet_size This field indicates packet size and is assumed to be zero on each packet add unless the value is explicitly overwritten. This field indicates packet size for packet pop operation.

16.5.7.158 QUEUE_30_D Register (offset = 21ECh) [reset = 0h]

QUEUE_30_D is shown in [Figure 16-434](#) and described in [Table 16-448](#).

Figure 16-434. QUEUE_30_D Register


LEGEND: R/W = Read/Write; R = Read only; W1toCl = Write 1 to clear bit; -n = value after reset

Table 16-448. QUEUE_30_D Register Field Descriptions

Bit	Field	Type	Reset	Description
31-5	DESC_PTR	R/W-0	0	Descriptor pointer. It will be read as zero if the queue is empty. It will indicate a 32-bit aligned address that points to a descriptor when the queue is not empty.
4-0	DESC_SIZE	R/W-0	0	Descriptor Size. It is encoded in 4-byte increments with values 0 to 31 representing 24 and so on to 148 bytes. This field will return a 0x0 when an empty queue is read. Queue Manager Queue N Registers D To save hardware resources, the queue manager internally stores descriptor size (desc_size) information in four bits. However, register D has five LSBs that specify descriptor size. As a consequence, the value of desc_size that is pushed may not be same as that is read during a pop. The value that is read back is equal to always rounded to an odd number. So, for even values, the value read back is one more than what was written. For odd values, the value read back is same as the value that was written. Note that this 5-bit field (desc_size) is unrelated to the code for size of descriptors in a descriptor region. It is just a place holder for a 5-bit value that is maintained across the push and pop operations for every descriptor managed by the queue manager.

16.5.7.159 QUEUE_31_A Register (offset = 21F0h) [reset = 0h]

QUEUE_31_A is shown in [Figure 16-435](#) and described in [Table 16-449](#).

Figure 16-435. QUEUE_31_A Register


LEGEND: R/W = Read/Write; R = Read only; W1toCl = Write 1 to clear bit; -n = value after reset

Table 16-449. QUEUE_31_A Register Field Descriptions

Bit	Field	Type	Reset	Description
13-0	QUEUE_ENTRY_COUNT	R-0	0	This field indicates how many packets are currently queued on the queue. This count is incremented by 1 whenever a packet is added to the queue. This count is decremented by 1 whenever a packet is popped from the queue.

16.5.7.160 QUEUE_31_B Register (offset = 21F4h) [reset = 0h]

 QUEUE_31_B is shown in [Figure 16-436](#) and described in [Table 16-450](#).

Figure 16-436. QUEUE_31_B Register


LEGEND: R/W = Read/Write; R = Read only; W1toCl = Write 1 to clear bit; -n = value after reset

Table 16-450. QUEUE_31_B Register Field Descriptions

Bit	Field	Type	Reset	Description
27-0	QUEUE_BYTE_COUNT	R-0	0	This field indicates how many bytes total are contained in all of the packets which are currently queued on this queue.

16.5.7.161 QUEUE_31_C Register (offset = 21F8h) [reset = 0h]

 QUEUE_31_C is shown in [Figure 16-437](#) and described in [Table 16-451](#).

Figure 16-437. QUEUE_31_C Register


LEGEND: R/W = Read/Write; R = Read only; W1toCl = Write 1 to clear bit; -n = value after reset

Table 16-451. QUEUE_31_C Register Field Descriptions

Bit	Field	Type	Reset	Description
31	HEAD_TAIL	W-0	0	Head/Tail Push Control. Set to zero in order to push packet onto tail of queue and set to one in order to push packet onto head of queue.
13-0	PACKET_SIZE	R/W-0	0	packet_size This field indicates packet size and is assumed to be zero on each packet add unless the value is explicitly overwritten. This field indicates packet size for packet pop operation.

16.5.7.162 QUEUE_31_D Register (offset = 21FCh) [reset = 0h]

 QUEUE_31_D is shown in [Figure 16-438](#) and described in [Table 16-452](#).

Figure 16-438. QUEUE_31_D Register


LEGEND: R/W = Read/Write; R = Read only; W1toCl = Write 1 to clear bit; -n = value after reset

Table 16-452. QUEUE_31_D Register Field Descriptions

Bit	Field	Type	Reset	Description
31-5	DESC_PTR	R/W-0	0	Descriptor pointer. It will be read as zero if the queue is empty. It will indicate a 32-bit aligned address that points to a descriptor when the queue is not empty.
4-0	DESC_SIZE	R/W-0	0	Descriptor Size. It is encoded in 4-byte increments with values 0 to 31 representing 24 and so on to 148 bytes. This field will return a 0x0 when an empty queue is read. Queue Manager Queue N Registers D To save hardware resources, the queue manager internally stores descriptor size (desc_size) information in four bits. However, register D has five LSBs that specify descriptor size. As a consequence, the value of desc_size that is pushed may not be same as that is read during a pop. The value that is read back is equal to always rounded to an odd number. So, for even values, the value read back is one more than what was written. For odd values, the value read back is same as the value that was written. Note that this 5-bit field (desc_size) is unrelated to the code for size of descriptors in a descriptor region. It is just a place holder for a 5-bit value that is maintained across the push and pop operations for every descriptor managed by the queue manager.

16.5.7.163 QUEUE_32_A Register (offset = 2200h) [reset = 0h]

QUEUE_32_A is shown in [Figure 16-439](#) and described in [Table 16-453](#).

Figure 16-439. QUEUE_32_A Register


LEGEND: R/W = Read/Write; R = Read only; W1toCl = Write 1 to clear bit; -n = value after reset

Table 16-453. QUEUE_32_A Register Field Descriptions

Bit	Field	Type	Reset	Description
13-0	QUEUE_ENTRY_COUNT	R-0	0	This field indicates how many packets are currently queued on the queue. This count is incremented by 1 whenever a packet is added to the queue. This count is decremented by 1 whenever a packet is popped from the queue.

16.5.7.164 QUEUE_32_B Register (offset = 2204h) [reset = 0h]

 QUEUE_32_B is shown in [Figure 16-440](#) and described in [Table 16-454](#).

Figure 16-440. QUEUE_32_B Register

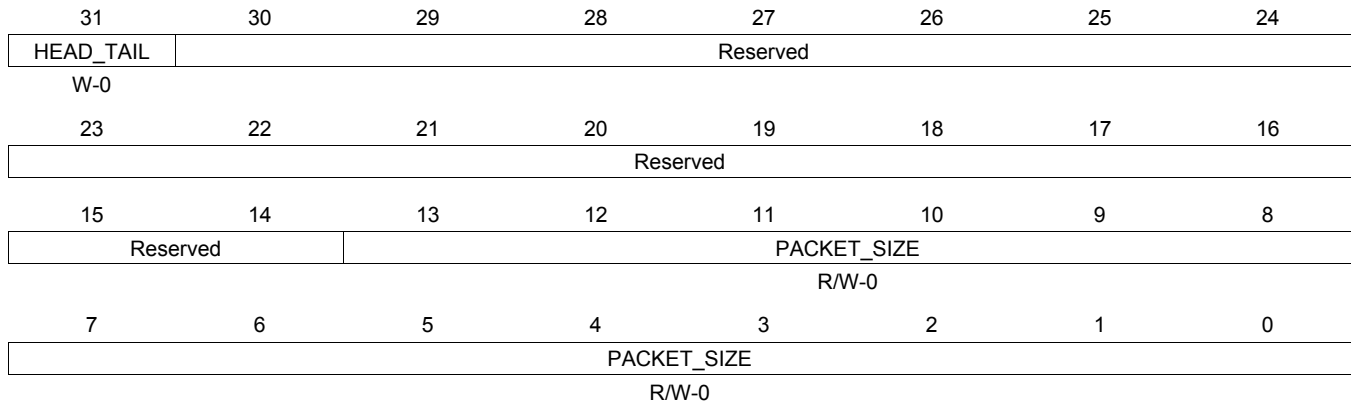

LEGEND: R/W = Read/Write; R = Read only; W1toCl = Write 1 to clear bit; -n = value after reset

Table 16-454. QUEUE_32_B Register Field Descriptions

Bit	Field	Type	Reset	Description
27-0	QUEUE_BYTE_COUNT	R-0	0	This field indicates how many bytes total are contained in all of the packets which are currently queued on this queue.

16.5.7.165 QUEUE_32_C Register (offset = 2208h) [reset = 0h]

 QUEUE_32_C is shown in [Figure 16-441](#) and described in [Table 16-455](#).

Figure 16-441. QUEUE_32_C Register


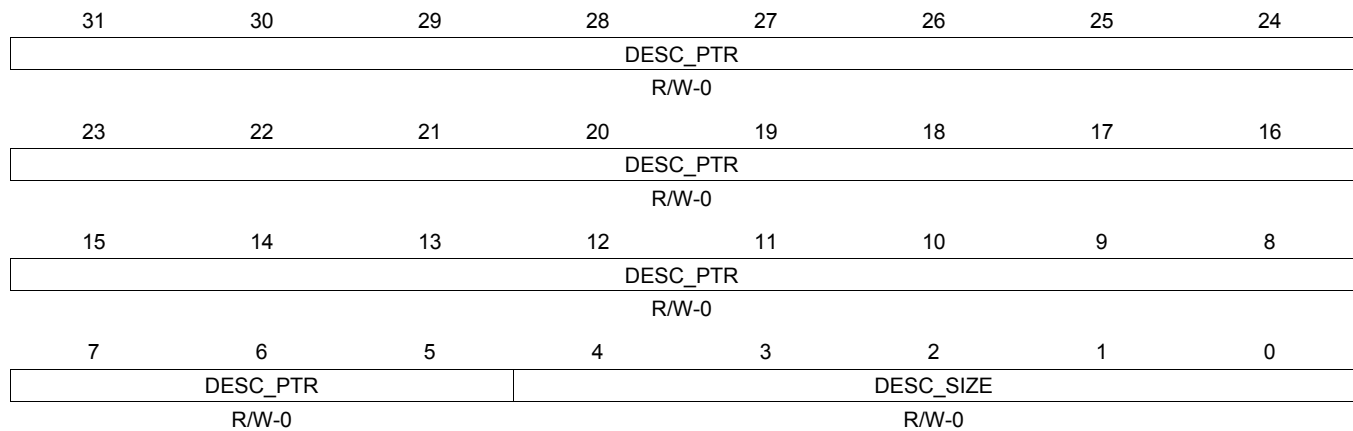
LEGEND: R/W = Read/Write; R = Read only; W1toCl = Write 1 to clear bit; -n = value after reset

Table 16-455. QUEUE_32_C Register Field Descriptions

Bit	Field	Type	Reset	Description
31	HEAD_TAIL	W-0	0	Head/Tail Push Control. Set to zero in order to push packet onto tail of queue and set to one in order to push packet onto head of queue.
13-0	PACKET_SIZE	R/W-0	0	packet_size This field indicates packet size and is assumed to be zero on each packet add unless the value is explicitly overwritten. This field indicates packet size for packet pop operation.

16.5.7.166 QUEUE_32_D Register (offset = 220Ch) [reset = 0h]

 QUEUE_32_D is shown in [Figure 16-442](#) and described in [Table 16-456](#).

Figure 16-442. QUEUE_32_D Register


LEGEND: R/W = Read/Write; R = Read only; W1toCl = Write 1 to clear bit; -n = value after reset

Table 16-456. QUEUE_32_D Register Field Descriptions

Bit	Field	Type	Reset	Description
31-5	DESC_PTR	R/W-0	0	Descriptor pointer. It will be read as zero if the queue is empty. It will indicate a 32-bit aligned address that points to a descriptor when the queue is not empty.
4-0	DESC_SIZE	R/W-0	0	Descriptor Size. It is encoded in 4-byte increments with values 0 to 31 representing 24 and so on to 148 bytes. This field will return a 0x0 when an empty queue is read. Queue Manager Queue N Registers D To save hardware resources, the queue manager internally stores descriptor size (desc_size) information in four bits. However, register D has five LSBs that specify descriptor size. As a consequence, the value of desc_size that is pushed may not be same as that is read during a pop. The value that is read back is equal to always rounded to an odd number. So, for even values, the value read back is one more than what was written. For odd values, the value read back is same as the value that was written. Note that this 5-bit field (desc_size) is unrelated to the code for size of descriptors in a descriptor region. It is just a place holder for a 5-bit value that is maintained across the push and pop operations for every descriptor managed by the queue manager.

16.5.7.167 QUEUE_33_A Register (offset = 2210h) [reset = 0h]

QUEUE_33_A is shown in [Figure 16-443](#) and described in [Table 16-457](#).

Figure 16-443. QUEUE_33_A Register


LEGEND: R/W = Read/Write; R = Read only; W1toCl = Write 1 to clear bit; -n = value after reset

Table 16-457. QUEUE_33_A Register Field Descriptions

Bit	Field	Type	Reset	Description
13-0	QUEUE_ENTRY_COUNT	R-0	0	This field indicates how many packets are currently queued on the queue. This count is incremented by 1 whenever a packet is added to the queue. This count is decremented by 1 whenever a packet is popped from the queue.

16.5.7.168 QUEUE_33_B Register (offset = 2214h) [reset = 0h]

 QUEUE_33_B is shown in [Figure 16-444](#) and described in [Table 16-458](#).

Figure 16-444. QUEUE_33_B Register

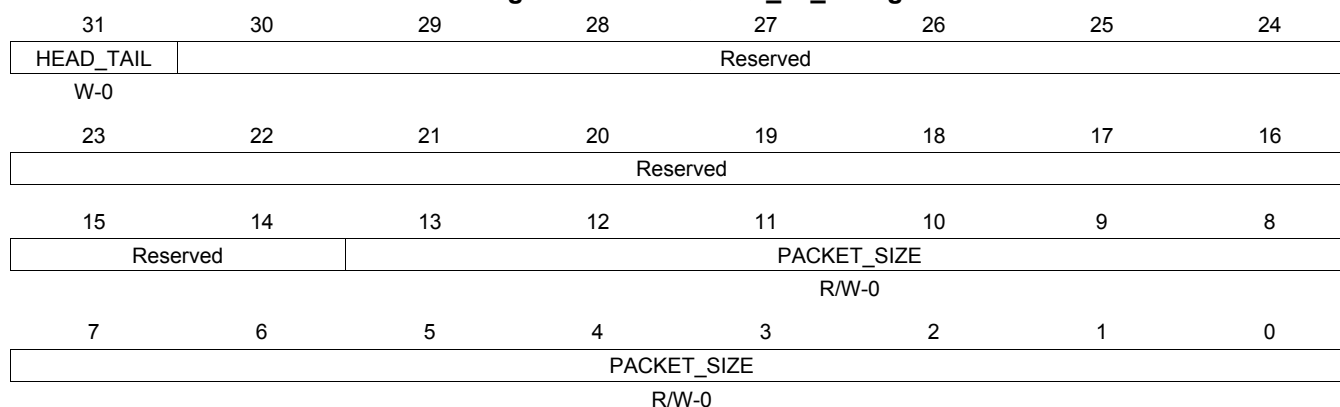

LEGEND: R/W = Read/Write; R = Read only; W1toCl = Write 1 to clear bit; -n = value after reset

Table 16-458. QUEUE_33_B Register Field Descriptions

Bit	Field	Type	Reset	Description
27-0	QUEUE_BYTE_COUNT	R-0	0	This field indicates how many bytes total are contained in all of the packets which are currently queued on this queue.

16.5.7.169 QUEUE_33_C Register (offset = 2218h) [reset = 0h]

 QUEUE_33_C is shown in [Figure 16-445](#) and described in [Table 16-459](#).

Figure 16-445. QUEUE_33_C Register


LEGEND: R/W = Read/Write; R = Read only; W1toCl = Write 1 to clear bit; -n = value after reset

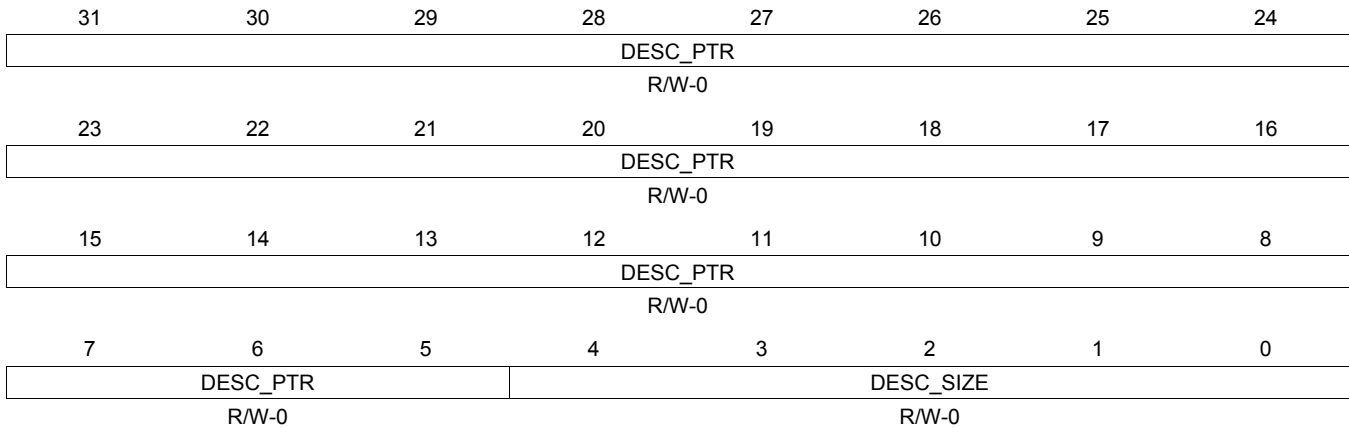
Table 16-459. QUEUE_33_C Register Field Descriptions

Bit	Field	Type	Reset	Description
31	HEAD_TAIL	W-0	0	Head/Tail Push Control. Set to zero in order to push packet onto tail of queue and set to one in order to push packet onto head of queue.
13-0	PACKET_SIZE	R/W-0	0	packet_size This field indicates packet size and is assumed to be zero on each packet add unless the value is explicitly overwritten. This field indicates packet size for packet pop operation.

16.5.7.170 QUEUE_33_D Register (offset = 221Ch) [reset = 0h]

QUEUE_33_D is shown in [Figure 16-446](#) and described in [Table 16-460](#).

Figure 16-446. QUEUE_33_D Register



LEGEND: R/W = Read/Write; R = Read only; W1toCl = Write 1 to clear bit; -n = value after reset

Table 16-460. QUEUE_33_D Register Field Descriptions

Bit	Field	Type	Reset	Description
31-5	DESC_PTR	R/W-0	0	Descriptor pointer. It will be read as zero if the queue is empty. It will indicate a 32-bit aligned address that points to a descriptor when the queue is not empty.
4-0	DESC_SIZE	R/W-0	0	Descriptor Size. It is encoded in 4-byte increments with values 0 to 31 representing 24 and so on to 148 bytes. This field will return a 0x0 when an empty queue is read. Queue Manager Queue N Registers D To save hardware resources, the queue manager internally stores descriptor size (desc_size) information in four bits. However, register D has five LSBs that specify descriptor size. As a consequence, the value of desc_size that is pushed may not be same as that is read during a pop. The value that is read back is equal to always rounded to an odd number. So, for even values, the value read back is one more than what was written. For odd values, the value read back is same as the value that was written. Note that this 5-bit field (desc_size) is unrelated to the code for size of descriptors in a descriptor region. It is just a place holder for a 5-bit value that is maintained across the push and pop operations for every descriptor managed by the queue manager.

16.5.7.171 QUEUE_34_A Register (offset = 2220h) [reset = 0h]

QUEUE_34_A is shown in [Figure 16-447](#) and described in [Table 16-461](#).

Figure 16-447. QUEUE_34_A Register

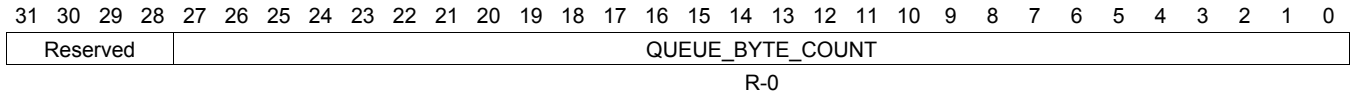

LEGEND: R/W = Read/Write; R = Read only; W1toCl = Write 1 to clear bit; -n = value after reset

Table 16-461. QUEUE_34_A Register Field Descriptions

Bit	Field	Type	Reset	Description
13-0	QUEUE_ENTRY_COUNT	R-0	0	This field indicates how many packets are currently queued on the queue. This count is incremented by 1 whenever a packet is added to the queue. This count is decremented by 1 whenever a packet is popped from the queue.

16.5.7.172 QUEUE_34_B Register (offset = 2224h) [reset = 0h]

 QUEUE_34_B is shown in [Figure 16-448](#) and described in [Table 16-462](#).

Figure 16-448. QUEUE_34_B Register


LEGEND: R/W = Read/Write; R = Read only; W1toCl = Write 1 to clear bit; -n = value after reset

Table 16-462. QUEUE_34_B Register Field Descriptions

Bit	Field	Type	Reset	Description
27-0	QUEUE_BYTE_COUNT	R-0	0	This field indicates how many bytes total are contained in all of the packets which are currently queued on this queue.

16.5.7.173 QUEUE_34_C Register (offset = 2228h) [reset = 0h]

 QUEUE_34_C is shown in [Figure 16-449](#) and described in [Table 16-463](#).

Figure 16-449. QUEUE_34_C Register

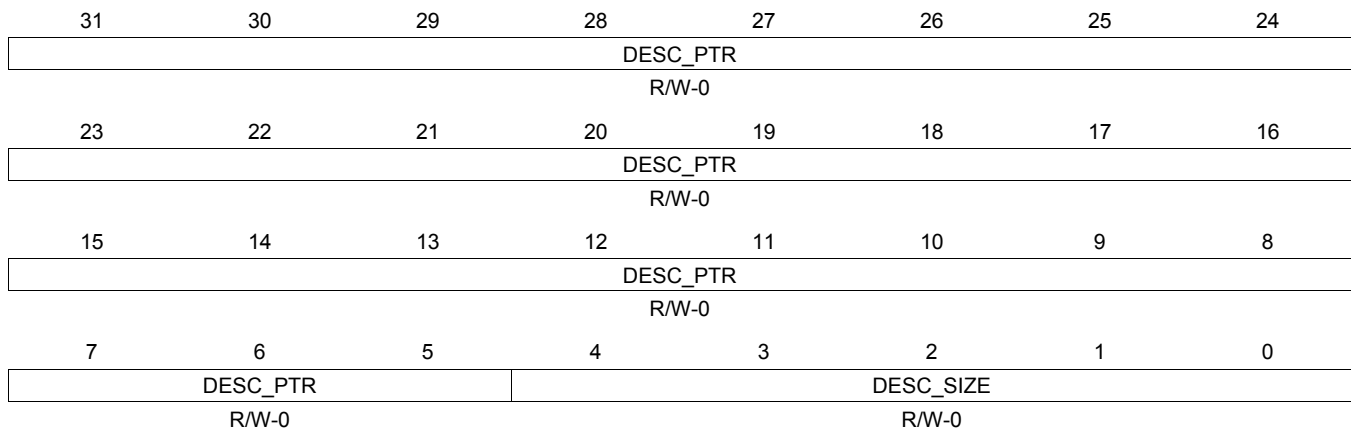

LEGEND: R/W = Read/Write; R = Read only; W1toCl = Write 1 to clear bit; -n = value after reset

Table 16-463. QUEUE_34_C Register Field Descriptions

Bit	Field	Type	Reset	Description
31	HEAD_TAIL	W-0	0	Head/Tail Push Control. Set to zero in order to push packet onto tail of queue and set to one in order to push packet onto head of queue.
13-0	PACKET_SIZE	R/W-0	0	packet_size This field indicates packet size and is assumed to be zero on each packet add unless the value is explicitly overwritten. This field indicates packet size for packet pop operation.

16.5.7.174 QUEUE_34_D Register (offset = 222Ch) [reset = 0h]

QUEUE_34_D is shown in [Figure 16-450](#) and described in [Table 16-464](#).

Figure 16-450. QUEUE_34_D Register


LEGEND: R/W = Read/Write; R = Read only; W1toCl = Write 1 to clear bit; -n = value after reset

Table 16-464. QUEUE_34_D Register Field Descriptions

Bit	Field	Type	Reset	Description
31-5	DESC_PTR	R/W-0	0	Descriptor pointer. It will be read as zero if the queue is empty. It will indicate a 32-bit aligned address that points to a descriptor when the queue is not empty.
4-0	DESC_SIZE	R/W-0	0	Descriptor Size. It is encoded in 4-byte increments with values 0 to 31 representing 24 and so on to 148 bytes. This field will return a 0x0 when an empty queue is read. Queue Manager Queue N Registers D To save hardware resources, the queue manager internally stores descriptor size (desc_size) information in four bits. However, register D has five LSBs that specify descriptor size. As a consequence, the value of desc_size that is pushed may not be same as that is read during a pop. The value that is read back is equal to always rounded to an odd number. So, for even values, the value read back is one more than what was written. For odd values, the value read back is same as the value that was written. Note that this 5-bit field (desc_size) is unrelated to the code for size of descriptors in a descriptor region. It is just a place holder for a 5-bit value that is maintained across the push and pop operations for every descriptor managed by the queue manager.

16.5.7.175 QUEUE_35_A Register (offset = 2230h) [reset = 0h]

QUEUE_35_A is shown in [Figure 16-451](#) and described in [Table 16-465](#).

Figure 16-451. QUEUE_35_A Register


LEGEND: R/W = Read/Write; R = Read only; W1toCl = Write 1 to clear bit; -n = value after reset

Table 16-465. QUEUE_35_A Register Field Descriptions

Bit	Field	Type	Reset	Description
13-0	QUEUE_ENTRY_COUNT	R-0	0	This field indicates how many packets are currently queued on the queue. This count is incremented by 1 whenever a packet is added to the queue. This count is decremented by 1 whenever a packet is popped from the queue.

16.5.7.176 QUEUE_35_B Register (offset = 2234h) [reset = 0h]

QUEUE_35_B is shown in [Figure 16-452](#) and described in [Table 16-466](#).

Figure 16-452. QUEUE_35_B Register


LEGEND: R/W = Read/Write; R = Read only; W1toCl = Write 1 to clear bit; -n = value after reset

Table 16-466. QUEUE_35_B Register Field Descriptions

Bit	Field	Type	Reset	Description
27-0	QUEUE_BYTE_COUNT	R-0	0	This field indicates how many bytes total are contained in all of the packets which are currently queued on this queue.

16.5.7.177 QUEUE_35_C Register (offset = 2238h) [reset = 0h]

 QUEUE_35_C is shown in [Figure 16-453](#) and described in [Table 16-467](#).

Figure 16-453. QUEUE_35_C Register


LEGEND: R/W = Read/Write; R = Read only; W1toCl = Write 1 to clear bit; -n = value after reset

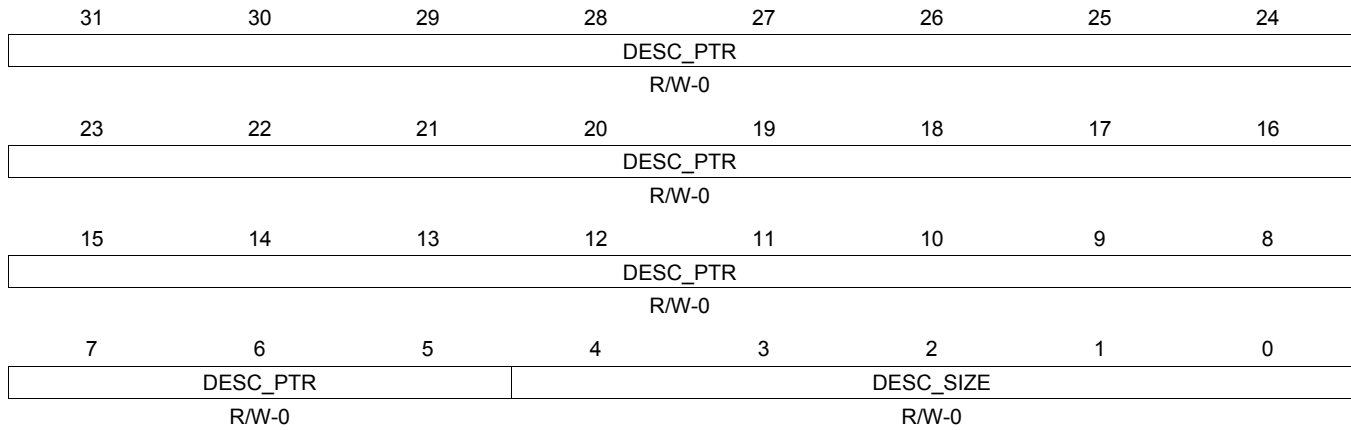
Table 16-467. QUEUE_35_C Register Field Descriptions

Bit	Field	Type	Reset	Description
31	HEAD_TAIL	W-0	0	Head/Tail Push Control. Set to zero in order to push packet onto tail of queue and set to one in order to push packet onto head of queue.
13-0	PACKET_SIZE	R/W-0	0	packet_size This field indicates packet size and is assumed to be zero on each packet add unless the value is explicitly overwritten. This field indicates packet size for packet pop operation.

16.5.7.178 QUEUE_35_D Register (offset = 223Ch) [reset = 0h]

QUEUE_35_D is shown in [Figure 16-454](#) and described in [Table 16-468](#).

Figure 16-454. QUEUE_35_D Register



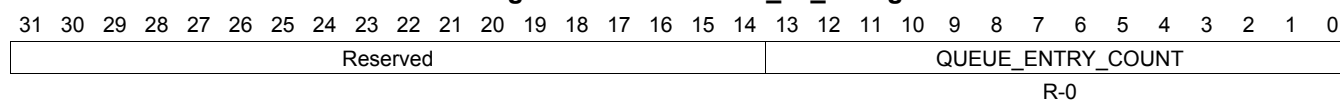
LEGEND: R/W = Read/Write; R = Read only; W1toCl = Write 1 to clear bit; -n = value after reset

Table 16-468. QUEUE_35_D Register Field Descriptions

Bit	Field	Type	Reset	Description
31-5	DESC_PTR	R/W-0	0	Descriptor pointer. It will be read as zero if the queue is empty. It will indicate a 32-bit aligned address that points to a descriptor when the queue is not empty.
4-0	DESC_SIZE	R/W-0	0	Descriptor Size. It is encoded in 4-byte increments with values 0 to 31 representing 24 and so on to 148 bytes. This field will return a 0x0 when an empty queue is read. Queue Manager Queue N Registers D To save hardware resources, the queue manager internally stores descriptor size (desc_size) information in four bits. However, register D has five LSBs that specify descriptor size. As a consequence, the value of desc_size that is pushed may not be same as that is read during a pop. The value that is read back is equal to always rounded to an odd number. So, for even values, the value read back is one more than what was written. For odd values, the value read back is same as the value that was written. Note that this 5-bit field (desc_size) is unrelated to the code for size of descriptors in a descriptor region. It is just a place holder for a 5-bit value that is maintained across the push and pop operations for every descriptor managed by the queue manager.

16.5.7.179 QUEUE_36_A Register (offset = 2240h) [reset = 0h]

QUEUE_36_A is shown in [Figure 16-455](#) and described in [Table 16-469](#).

Figure 16-455. QUEUE_36_A Register


LEGEND: R/W = Read/Write; R = Read only; W1toCl = Write 1 to clear bit; -n = value after reset

Table 16-469. QUEUE_36_A Register Field Descriptions

Bit	Field	Type	Reset	Description
13-0	QUEUE_ENTRY_COUNT	R-0	0	This field indicates how many packets are currently queued on the queue. This count is incremented by 1 whenever a packet is added to the queue. This count is decremented by 1 whenever a packet is popped from the queue.

16.5.7.180 QUEUE_36_B Register (offset = 2244h) [reset = 0h]

QUEUE_36_B is shown in [Figure 16-456](#) and described in [Table 16-470](#).

Figure 16-456. QUEUE_36_B Register


LEGEND: R/W = Read/Write; R = Read only; W1toCl = Write 1 to clear bit; -n = value after reset

Table 16-470. QUEUE_36_B Register Field Descriptions

Bit	Field	Type	Reset	Description
27-0	QUEUE_BYTE_COUNT	R-0	0	This field indicates how many bytes total are contained in all of the packets which are currently queued on this queue.

16.5.7.181 QUEUE_36_C Register (offset = 2248h) [reset = 0h]

 QUEUE_36_C is shown in [Figure 16-457](#) and described in [Table 16-471](#).

Figure 16-457. QUEUE_36_C Register


LEGEND: R/W = Read/Write; R = Read only; W1toCl = Write 1 to clear bit; -n = value after reset

Table 16-471. QUEUE_36_C Register Field Descriptions

Bit	Field	Type	Reset	Description
31	HEAD_TAIL	W-0	0	Head/Tail Push Control. Set to zero in order to push packet onto tail of queue and set to one in order to push packet onto head of queue.
13-0	PACKET_SIZE	R/W-0	0	packet_size This field indicates packet size and is assumed to be zero on each packet add unless the value is explicitly overwritten. This field indicates packet size for packet pop operation.

16.5.7.182 QUEUE_36_D Register (offset = 224Ch) [reset = 0h]

QUEUE_36_D is shown in [Figure 16-458](#) and described in [Table 16-472](#).

Figure 16-458. QUEUE_36_D Register


LEGEND: R/W = Read/Write; R = Read only; W1toCl = Write 1 to clear bit; -n = value after reset

Table 16-472. QUEUE_36_D Register Field Descriptions

Bit	Field	Type	Reset	Description
31-5	DESC_PTR	R/W-0	0	Descriptor pointer. It will be read as zero if the queue is empty. It will indicate a 32-bit aligned address that points to a descriptor when the queue is not empty.
4-0	DESC_SIZE	R/W-0	0	Descriptor Size. It is encoded in 4-byte increments with values 0 to 31 representing 24 and so on to 148 bytes. This field will return a 0x0 when an empty queue is read. Queue Manager Queue N Registers D To save hardware resources, the queue manager internally stores descriptor size (desc_size) information in four bits. However, register D has five LSBs that specify descriptor size. As a consequence, the value of desc_size that is pushed may not be same as that is read during a pop. The value that is read back is equal to always rounded to an odd number. So, for even values, the value read back is one more than what was written. For odd values, the value read back is same as the value that was written. Note that this 5-bit field (desc_size) is unrelated to the code for size of descriptors in a descriptor region. It is just a place holder for a 5-bit value that is maintained across the push and pop operations for every descriptor managed by the queue manager.

16.5.7.183 QUEUE_37_A Register (offset = 2250h) [reset = 0h]

QUEUE_37_A is shown in [Figure 16-459](#) and described in [Table 16-473](#).

Figure 16-459. QUEUE_37_A Register


LEGEND: R/W = Read/Write; R = Read only; W1toCl = Write 1 to clear bit; -n = value after reset

Table 16-473. QUEUE_37_A Register Field Descriptions

Bit	Field	Type	Reset	Description
13-0	QUEUE_ENTRY_COUNT	R-0	0	This field indicates how many packets are currently queued on the queue. This count is incremented by 1 whenever a packet is added to the queue. This count is decremented by 1 whenever a packet is popped from the queue.

16.5.7.184 QUEUE_37_B Register (offset = 2254h) [reset = 0h]

QUEUE_37_B is shown in [Figure 16-460](#) and described in [Table 16-474](#).

Figure 16-460. QUEUE_37_B Register


LEGEND: R/W = Read/Write; R = Read only; W1toCl = Write 1 to clear bit; -n = value after reset

Table 16-474. QUEUE_37_B Register Field Descriptions

Bit	Field	Type	Reset	Description
27-0	QUEUE_BYTE_COUNT	R-0	0	This field indicates how many bytes total are contained in all of the packets which are currently queued on this queue.

16.5.7.185 QUEUE_37_C Register (offset = 2258h) [reset = 0h]

 QUEUE_37_C is shown in [Figure 16-461](#) and described in [Table 16-475](#).

Figure 16-461. QUEUE_37_C Register


LEGEND: R/W = Read/Write; R = Read only; W1toCl = Write 1 to clear bit; -n = value after reset

Table 16-475. QUEUE_37_C Register Field Descriptions

Bit	Field	Type	Reset	Description
31	HEAD_TAIL	W-0	0	Head/Tail Push Control. Set to zero in order to push packet onto tail of queue and set to one in order to push packet onto head of queue.
13-0	PACKET_SIZE	R/W-0	0	packet_size This field indicates packet size and is assumed to be zero on each packet add unless the value is explicitly overwritten. This field indicates packet size for packet pop operation.

16.5.7.186 QUEUE_37_D Register (offset = 225Ch) [reset = 0h]

 QUEUE_37_D is shown in [Figure 16-462](#) and described in [Table 16-476](#).

Figure 16-462. QUEUE_37_D Register

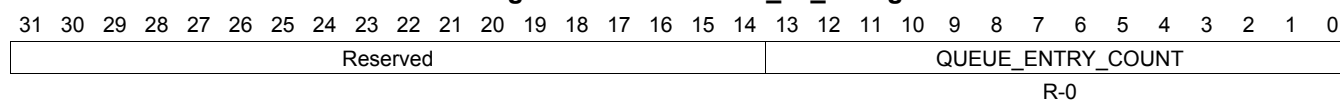

LEGEND: R/W = Read/Write; R = Read only; W1toCl = Write 1 to clear bit; -n = value after reset

Table 16-476. QUEUE_37_D Register Field Descriptions

Bit	Field	Type	Reset	Description
31-5	DESC_PTR	R/W-0	0	Descriptor pointer. It will be read as zero if the queue is empty. It will indicate a 32-bit aligned address that points to a descriptor when the queue is not empty.
4-0	DESC_SIZE	R/W-0	0	Descriptor Size. It is encoded in 4-byte increments with values 0 to 31 representing 24 and so on to 148 bytes. This field will return a 0x0 when an empty queue is read. Queue Manager Queue N Registers D To save hardware resources, the queue manager internally stores descriptor size (desc_size) information in four bits. However, register D has five LSBs that specify descriptor size. As a consequence, the value of desc_size that is pushed may not be same as that is read during a pop. The value that is read back is equal to always rounded to an odd number. So, for even values, the value read back is one more than what was written. For odd values, the value read back is same as the value that was written. Note that this 5-bit field (desc_size) is unrelated to the code for size of descriptors in a descriptor region. It is just a place holder for a 5-bit value that is maintained across the push and pop operations for every descriptor managed by the queue manager.

16.5.7.187 QUEUE_38_A Register (offset = 2260h) [reset = 0h]

QUEUE_38_A is shown in [Figure 16-463](#) and described in [Table 16-477](#).

Figure 16-463. QUEUE_38_A Register


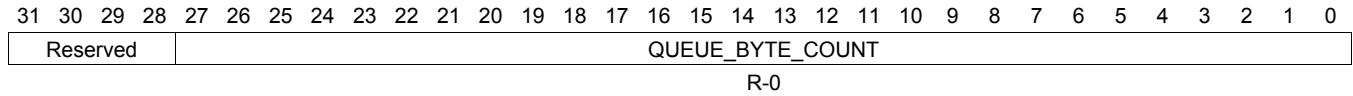
LEGEND: R/W = Read/Write; R = Read only; W1toCl = Write 1 to clear bit; -n = value after reset

Table 16-477. QUEUE_38_A Register Field Descriptions

Bit	Field	Type	Reset	Description
13-0	QUEUE_ENTRY_COUNT	R-0	0	This field indicates how many packets are currently queued on the queue. This count is incremented by 1 whenever a packet is added to the queue. This count is decremented by 1 whenever a packet is popped from the queue.

16.5.7.188 QUEUE_38_B Register (offset = 2264h) [reset = 0h]

QUEUE_38_B is shown in [Figure 16-464](#) and described in [Table 16-478](#).

Figure 16-464. QUEUE_38_B Register


LEGEND: R/W = Read/Write; R = Read only; W1toCl = Write 1 to clear bit; -n = value after reset

Table 16-478. QUEUE_38_B Register Field Descriptions

Bit	Field	Type	Reset	Description
27-0	QUEUE_BYTE_COUNT	R-0	0	This field indicates how many bytes total are contained in all of the packets which are currently queued on this queue.

16.5.7.189 QUEUE_38_C Register (offset = 2268h) [reset = 0h]

 QUEUE_38_C is shown in [Figure 16-465](#) and described in [Table 16-479](#).

Figure 16-465. QUEUE_38_C Register


LEGEND: R/W = Read/Write; R = Read only; W1toCl = Write 1 to clear bit; -n = value after reset

Table 16-479. QUEUE_38_C Register Field Descriptions

Bit	Field	Type	Reset	Description
31	HEAD_TAIL	W-0	0	Head/Tail Push Control. Set to zero in order to push packet onto tail of queue and set to one in order to push packet onto head of queue.
13-0	PACKET_SIZE	R/W-0	0	packet_size This field indicates packet size and is assumed to be zero on each packet add unless the value is explicitly overwritten. This field indicates packet size for packet pop operation.

16.5.7.190 QUEUE_38_D Register (offset = 226Ch) [reset = 0h]

QUEUE_38_D is shown in [Figure 16-466](#) and described in [Table 16-480](#).

Figure 16-466. QUEUE_38_D Register

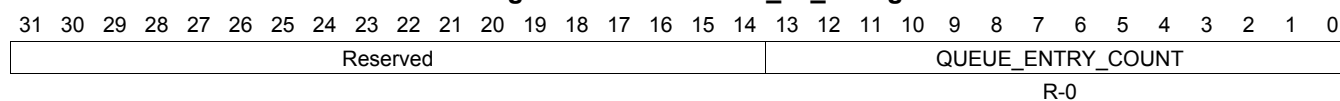

LEGEND: R/W = Read/Write; R = Read only; W1toCl = Write 1 to clear bit; -n = value after reset

Table 16-480. QUEUE_38_D Register Field Descriptions

Bit	Field	Type	Reset	Description
31-5	DESC_PTR	R/W-0	0	Descriptor pointer. It will be read as zero if the queue is empty. It will indicate a 32-bit aligned address that points to a descriptor when the queue is not empty.
4-0	DESC_SIZE	R/W-0	0	Descriptor Size. It is encoded in 4-byte increments with values 0 to 31 representing 24 and so on to 148 bytes. This field will return a 0x0 when an empty queue is read. Queue Manager Queue N Registers D To save hardware resources, the queue manager internally stores descriptor size (desc_size) information in four bits. However, register D has five LSBs that specify descriptor size. As a consequence, the value of desc_size that is pushed may not be same as that is read during a pop. The value that is read back is equal to always rounded to an odd number. So, for even values, the value read back is one more than what was written. For odd values, the value read back is same as the value that was written. Note that this 5-bit field (desc_size) is unrelated to the code for size of descriptors in a descriptor region. It is just a place holder for a 5-bit value that is maintained across the push and pop operations for every descriptor managed by the queue manager.

16.5.7.191 QUEUE_39_A Register (offset = 2270h) [reset = 0h]

QUEUE_39_A is shown in [Figure 16-467](#) and described in [Table 16-481](#).

Figure 16-467. QUEUE_39_A Register


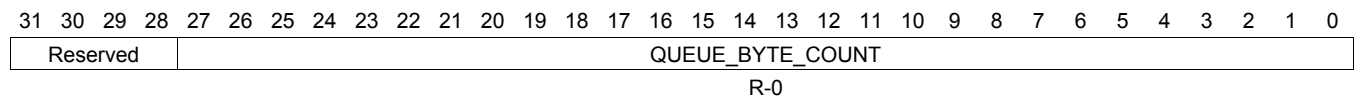
LEGEND: R/W = Read/Write; R = Read only; W1toCl = Write 1 to clear bit; -n = value after reset

Table 16-481. QUEUE_39_A Register Field Descriptions

Bit	Field	Type	Reset	Description
13-0	QUEUE_ENTRY_COUNT	R-0	0	This field indicates how many packets are currently queued on the queue. This count is incremented by 1 whenever a packet is added to the queue. This count is decremented by 1 whenever a packet is popped from the queue.

16.5.7.192 QUEUE_39_B Register (offset = 2274h) [reset = 0h]

 QUEUE_39_B is shown in [Figure 16-468](#) and described in [Table 16-482](#).

Figure 16-468. QUEUE_39_B Register


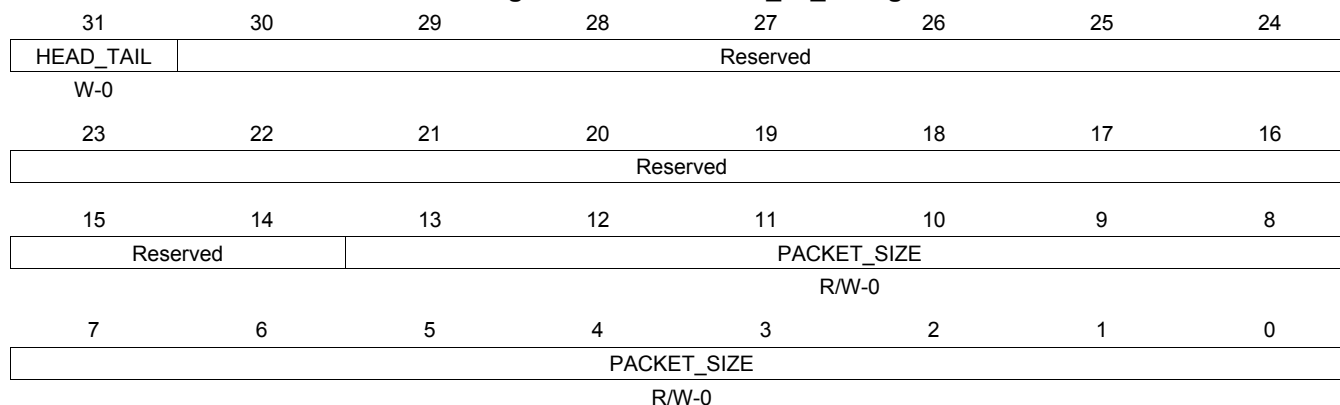
LEGEND: R/W = Read/Write; R = Read only; W1toCl = Write 1 to clear bit; -n = value after reset

Table 16-482. QUEUE_39_B Register Field Descriptions

Bit	Field	Type	Reset	Description
27-0	QUEUE_BYTE_COUNT	R-0	0	This field indicates how many bytes total are contained in all of the packets which are currently queued on this queue.

16.5.7.193 QUEUE_39_C Register (offset = 2278h) [reset = 0h]

 QUEUE_39_C is shown in [Figure 16-469](#) and described in [Table 16-483](#).

Figure 16-469. QUEUE_39_C Register


LEGEND: R/W = Read/Write; R = Read only; W1toCl = Write 1 to clear bit; -n = value after reset

Table 16-483. QUEUE_39_C Register Field Descriptions

Bit	Field	Type	Reset	Description
31	HEAD_TAIL	W-0	0	Head/Tail Push Control. Set to zero in order to push packet onto tail of queue and set to one in order to push packet onto head of queue.
13-0	PACKET_SIZE	R/W-0	0	packet_size This field indicates packet size and is assumed to be zero on each packet add unless the value is explicitly overwritten. This field indicates packet size for packet pop operation.

16.5.7.194 QUEUE_39_D Register (offset = 227Ch) [reset = 0h]

QUEUE_39_D is shown in [Figure 16-470](#) and described in [Table 16-484](#).

Figure 16-470. QUEUE_39_D Register



LEGEND: R/W = Read/Write; R = Read only; W1toCl = Write 1 to clear bit; -n = value after reset

Table 16-484. QUEUE_39_D Register Field Descriptions

Bit	Field	Type	Reset	Description
31-5	DESC_PTR	R/W-0	0	Descriptor pointer. It will be read as zero if the queue is empty. It will indicate a 32-bit aligned address that points to a descriptor when the queue is not empty.
4-0	DESC_SIZE	R/W-0	0	Descriptor Size. It is encoded in 4-byte increments with values 0 to 31 representing 24 and so on to 148 bytes. This field will return a 0x0 when an empty queue is read. Queue Manager Queue N Registers D To save hardware resources, the queue manager internally stores descriptor size (desc_size) information in four bits. However, register D has five LSBs that specify descriptor size. As a consequence, the value of desc_size that is pushed may not be same as that is read during a pop. The value that is read back is equal to always rounded to an odd number. So, for even values, the value read back is one more than what was written. For odd values, the value read back is same as the value that was written. Note that this 5-bit field (desc_size) is unrelated to the code for size of descriptors in a descriptor region. It is just a place holder for a 5-bit value that is maintained across the push and pop operations for every descriptor managed by the queue manager.

16.5.7.195 QUEUE_40_A Register (offset = 2280h) [reset = 0h]

 QUEUE_40_A is shown in [Figure 16-471](#) and described in [Table 16-485](#).

Figure 16-471. QUEUE_40_A Register


LEGEND: R/W = Read/Write; R = Read only; W1toCl = Write 1 to clear bit; -n = value after reset

Table 16-485. QUEUE_40_A Register Field Descriptions

Bit	Field	Type	Reset	Description
13-0	QUEUE_ENTRY_COUNT	R-0	0	This field indicates how many packets are currently queued on the queue. This count is incremented by 1 whenever a packet is added to the queue. This count is decremented by 1 whenever a packet is popped from the queue.

16.5.7.196 QUEUE_40_B Register (offset = 2284h) [reset = 0h]

QUEUE_40_B is shown in [Figure 16-472](#) and described in [Table 16-486](#).

Figure 16-472. QUEUE_40_B Register

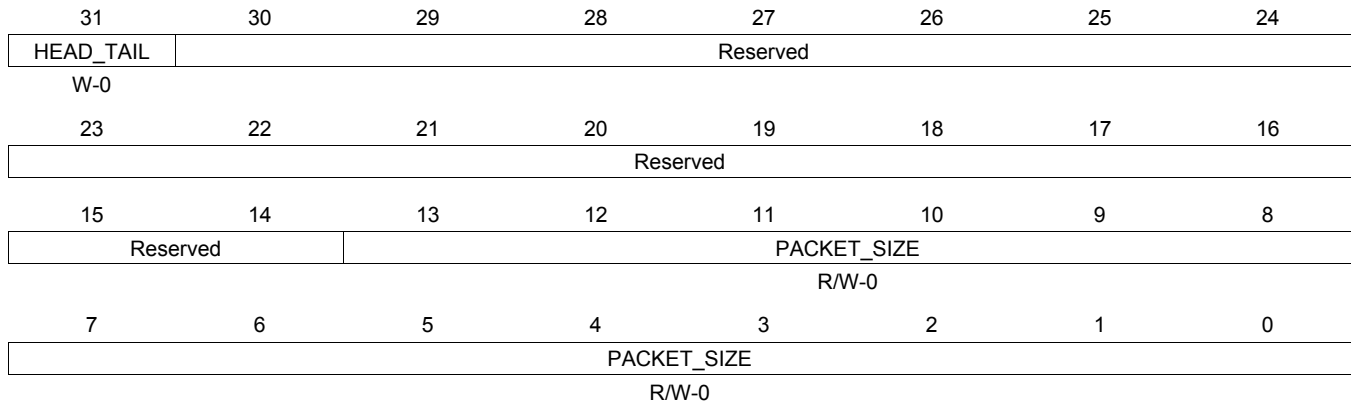

LEGEND: R/W = Read/Write; R = Read only; W1toCl = Write 1 to clear bit; -n = value after reset

Table 16-486. QUEUE_40_B Register Field Descriptions

Bit	Field	Type	Reset	Description
27-0	QUEUE_BYTE_COUNT	R-0	0	This field indicates how many bytes total are contained in all of the packets which are currently queued on this queue.

16.5.7.197 QUEUE_40_C Register (offset = 2288h) [reset = 0h]

 QUEUE_40_C is shown in [Figure 16-473](#) and described in [Table 16-487](#).

Figure 16-473. QUEUE_40_C Register


LEGEND: R/W = Read/Write; R = Read only; W1toCl = Write 1 to clear bit; -n = value after reset

Table 16-487. QUEUE_40_C Register Field Descriptions

Bit	Field	Type	Reset	Description
31	HEAD_TAIL	W-0	0	Head/Tail Push Control. Set to zero in order to push packet onto tail of queue and set to one in order to push packet onto head of queue.
13-0	PACKET_SIZE	R/W-0	0	packet_size This field indicates packet size and is assumed to be zero on each packet add unless the value is explicitly overwritten. This field indicates packet size for packet pop operation.

16.5.7.198 QUEUE_40_D Register (offset = 228Ch) [reset = 0h]

 QUEUE_40_D is shown in [Figure 16-474](#) and described in [Table 16-488](#).

Figure 16-474. QUEUE_40_D Register

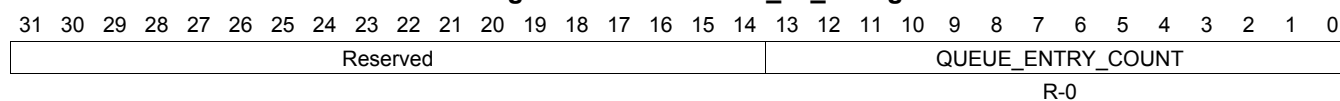

LEGEND: R/W = Read/Write; R = Read only; W1toCl = Write 1 to clear bit; -n = value after reset

Table 16-488. QUEUE_40_D Register Field Descriptions

Bit	Field	Type	Reset	Description
31-5	DESC_PTR	R/W-0	0	Descriptor pointer. It will be read as zero if the queue is empty. It will indicate a 32-bit aligned address that points to a descriptor when the queue is not empty.
4-0	DESC_SIZE	R/W-0	0	Descriptor Size. It is encoded in 4-byte increments with values 0 to 31 representing 24 and so on to 148 bytes. This field will return a 0x0 when an empty queue is read. Queue Manager Queue N Registers D To save hardware resources, the queue manager internally stores descriptor size (desc_size) information in four bits. However, register D has five LSBs that specify descriptor size. As a consequence, the value of desc_size that is pushed may not be same as that is read during a pop. The value that is read back is equal to always rounded to an odd number. So, for even values, the value read back is one more than what was written. For odd values, the value read back is same as the value that was written. Note that this 5-bit field (desc_size) is unrelated to the code for size of descriptors in a descriptor region. It is just a place holder for a 5-bit value that is maintained across the push and pop operations for every descriptor managed by the queue manager.

16.5.7.199 QUEUE_41_A Register (offset = 2290h) [reset = 0h]

QUEUE_41_A is shown in [Figure 16-475](#) and described in [Table 16-489](#).

Figure 16-475. QUEUE_41_A Register


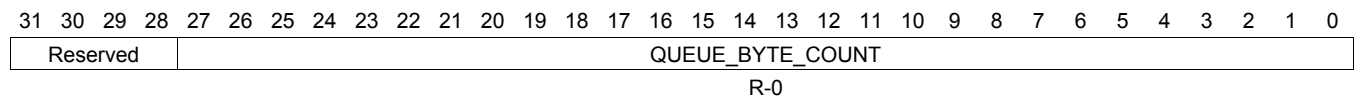
LEGEND: R/W = Read/Write; R = Read only; W1toCl = Write 1 to clear bit; -n = value after reset

Table 16-489. QUEUE_41_A Register Field Descriptions

Bit	Field	Type	Reset	Description
13-0	QUEUE_ENTRY_COUNT	R-0	0	This field indicates how many packets are currently queued on the queue. This count is incremented by 1 whenever a packet is added to the queue. This count is decremented by 1 whenever a packet is popped from the queue.

16.5.7.200 QUEUE_41_B Register (offset = 2294h) [reset = 0h]

QUEUE_41_B is shown in [Figure 16-476](#) and described in [Table 16-490](#).

Figure 16-476. QUEUE_41_B Register


LEGEND: R/W = Read/Write; R = Read only; W1toCl = Write 1 to clear bit; -n = value after reset

Table 16-490. QUEUE_41_B Register Field Descriptions

Bit	Field	Type	Reset	Description
27-0	QUEUE_BYTE_COUNT	R-0	0	This field indicates how many bytes total are contained in all of the packets which are currently queued on this queue.

16.5.7.201 QUEUE_41_C Register (offset = 2298h) [reset = 0h]

 QUEUE_41_C is shown in [Figure 16-477](#) and described in [Table 16-491](#).

Figure 16-477. QUEUE_41_C Register


LEGEND: R/W = Read/Write; R = Read only; W1toCl = Write 1 to clear bit; -n = value after reset

Table 16-491. QUEUE_41_C Register Field Descriptions

Bit	Field	Type	Reset	Description
31	HEAD_TAIL	W-0	0	Head/Tail Push Control. Set to zero in order to push packet onto tail of queue and set to one in order to push packet onto head of queue.
13-0	PACKET_SIZE	R/W-0	0	packet_size This field indicates packet size and is assumed to be zero on each packet add unless the value is explicitly overwritten. This field indicates packet size for packet pop operation.

16.5.7.202 QUEUE_41_D Register (offset = 229Ch) [reset = 0h]

QUEUE_41_D is shown in [Figure 16-478](#) and described in [Table 16-492](#).

Figure 16-478. QUEUE_41_D Register


LEGEND: R/W = Read/Write; R = Read only; W1toCl = Write 1 to clear bit; -n = value after reset

Table 16-492. QUEUE_41_D Register Field Descriptions

Bit	Field	Type	Reset	Description
31-5	DESC_PTR	R/W-0	0	Descriptor pointer. It will be read as zero if the queue is empty. It will indicate a 32-bit aligned address that points to a descriptor when the queue is not empty.
4-0	DESC_SIZE	R/W-0	0	Descriptor Size. It is encoded in 4-byte increments with values 0 to 31 representing 24 and so on to 148 bytes. This field will return a 0x0 when an empty queue is read. Queue Manager Queue N Registers D To save hardware resources, the queue manager internally stores descriptor size (desc_size) information in four bits. However, register D has five LSBs that specify descriptor size. As a consequence, the value of desc_size that is pushed may not be same as that is read during a pop. The value that is read back is equal to always rounded to an odd number. So, for even values, the value read back is one more than what was written. For odd values, the value read back is same as the value that was written. Note that this 5-bit field (desc_size) is unrelated to the code for size of descriptors in a descriptor region. It is just a place holder for a 5-bit value that is maintained across the push and pop operations for every descriptor managed by the queue manager.

16.5.7.203 QUEUE_42_A Register (offset = 22A0h) [reset = 0h]

QUEUE_42_A is shown in [Figure 16-479](#) and described in [Table 16-493](#).

Figure 16-479. QUEUE_42_A Register

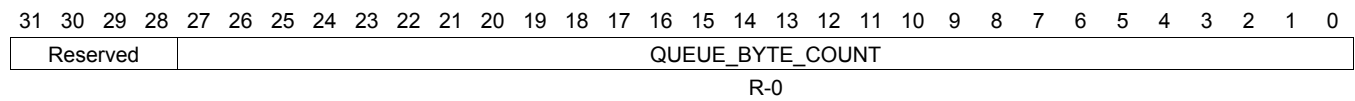

LEGEND: R/W = Read/Write; R = Read only; W1toCl = Write 1 to clear bit; -n = value after reset

Table 16-493. QUEUE_42_A Register Field Descriptions

Bit	Field	Type	Reset	Description
13-0	QUEUE_ENTRY_COUNT	R-0	0	This field indicates how many packets are currently queued on the queue. This count is incremented by 1 whenever a packet is added to the queue. This count is decremented by 1 whenever a packet is popped from the queue.

16.5.7.204 QUEUE_42_B Register (offset = 22A4h) [reset = 0h]

 QUEUE_42_B is shown in [Figure 16-480](#) and described in [Table 16-494](#).

Figure 16-480. QUEUE_42_B Register


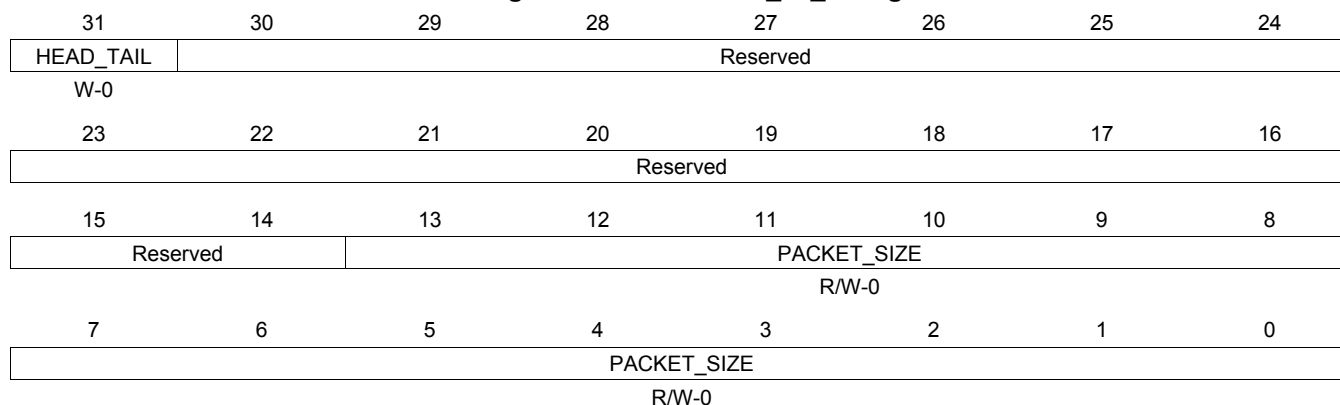
LEGEND: R/W = Read/Write; R = Read only; W1toCl = Write 1 to clear bit; -n = value after reset

Table 16-494. QUEUE_42_B Register Field Descriptions

Bit	Field	Type	Reset	Description
27-0	QUEUE_BYTE_COUNT	R-0	0	This field indicates how many bytes total are contained in all of the packets which are currently queued on this queue.

16.5.7.205 QUEUE_42_C Register (offset = 22A8h) [reset = 0h]

 QUEUE_42_C is shown in [Figure 16-481](#) and described in [Table 16-495](#).

Figure 16-481. QUEUE_42_C Register


LEGEND: R/W = Read/Write; R = Read only; W1toCl = Write 1 to clear bit; -n = value after reset

Table 16-495. QUEUE_42_C Register Field Descriptions

Bit	Field	Type	Reset	Description
31	HEAD_TAIL	W-0	0	Head/Tail Push Control. Set to zero in order to push packet onto tail of queue and set to one in order to push packet onto head of queue.
13-0	PACKET_SIZE	R/W-0	0	packet_size This field indicates packet size and is assumed to be zero on each packet add unless the value is explicitly overwritten. This field indicates packet size for packet pop operation.

16.5.7.206 QUEUE_42_D Register (offset = 22ACh) [reset = 0h]

QUEUE_42_D is shown in [Figure 16-482](#) and described in [Table 16-496](#).

Figure 16-482. QUEUE_42_D Register

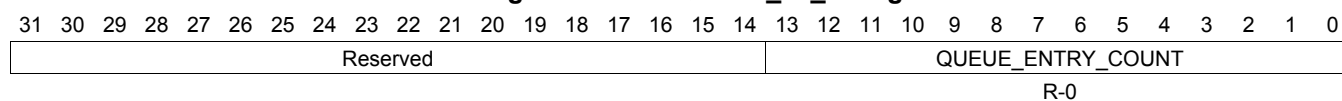

LEGEND: R/W = Read/Write; R = Read only; W1toCl = Write 1 to clear bit; -n = value after reset

Table 16-496. QUEUE_42_D Register Field Descriptions

Bit	Field	Type	Reset	Description
31-5	DESC_PTR	R/W-0	0	Descriptor pointer. It will be read as zero if the queue is empty. It will indicate a 32-bit aligned address that points to a descriptor when the queue is not empty.
4-0	DESC_SIZE	R/W-0	0	Descriptor Size. It is encoded in 4-byte increments with values 0 to 31 representing 24 and so on to 148 bytes. This field will return a 0x0 when an empty queue is read. Queue Manager Queue N Registers D To save hardware resources, the queue manager internally stores descriptor size (desc_size) information in four bits. However, register D has five LSBs that specify descriptor size. As a consequence, the value of desc_size that is pushed may not be same as that is read during a pop. The value that is read back is equal to always rounded to an odd number. So, for even values, the value read back is one more than what was written. For odd values, the value read back is same as the value that was written. Note that this 5-bit field (desc_size) is unrelated to the code for size of descriptors in a descriptor region. It is just a place holder for a 5-bit value that is maintained across the push and pop operations for every descriptor managed by the queue manager.

16.5.7.207 QUEUE_43_A Register (offset = 22B0h) [reset = 0h]

QUEUE_43_A is shown in [Figure 16-483](#) and described in [Table 16-497](#).

Figure 16-483. QUEUE_43_A Register


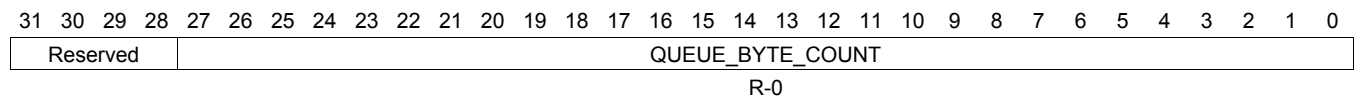
LEGEND: R/W = Read/Write; R = Read only; W1toCl = Write 1 to clear bit; -n = value after reset

Table 16-497. QUEUE_43_A Register Field Descriptions

Bit	Field	Type	Reset	Description
13-0	QUEUE_ENTRY_COUNT	R-0	0	This field indicates how many packets are currently queued on the queue. This count is incremented by 1 whenever a packet is added to the queue. This count is decremented by 1 whenever a packet is popped from the queue.

16.5.7.208 QUEUE_43_B Register (offset = 22B4h) [reset = 0h]

 QUEUE_43_B is shown in [Figure 16-484](#) and described in [Table 16-498](#).

Figure 16-484. QUEUE_43_B Register


LEGEND: R/W = Read/Write; R = Read only; W1toCl = Write 1 to clear bit; -n = value after reset

Table 16-498. QUEUE_43_B Register Field Descriptions

Bit	Field	Type	Reset	Description
27-0	QUEUE_BYTE_COUNT	R-0	0	This field indicates how many bytes total are contained in all of the packets which are currently queued on this queue.

16.5.7.209 QUEUE_43_C Register (offset = 22B8h) [reset = 0h]

 QUEUE_43_C is shown in [Figure 16-485](#) and described in [Table 16-499](#).

Figure 16-485. QUEUE_43_C Register


LEGEND: R/W = Read/Write; R = Read only; W1toCl = Write 1 to clear bit; -n = value after reset

Table 16-499. QUEUE_43_C Register Field Descriptions

Bit	Field	Type	Reset	Description
31	HEAD_TAIL	W-0	0	Head/Tail Push Control. Set to zero in order to push packet onto tail of queue and set to one in order to push packet onto head of queue.
13-0	PACKET_SIZE	R/W-0	0	packet_size This field indicates packet size and is assumed to be zero on each packet add unless the value is explicitly overwritten. This field indicates packet size for packet pop operation.

16.5.7.210 QUEUE_43_D Register (offset = 22BCh) [reset = 0h]

QUEUE_43_D is shown in [Figure 16-486](#) and described in [Table 16-500](#).

Figure 16-486. QUEUE_43_D Register


LEGEND: R/W = Read/Write; R = Read only; W1toCl = Write 1 to clear bit; -n = value after reset

Table 16-500. QUEUE_43_D Register Field Descriptions

Bit	Field	Type	Reset	Description
31-5	DESC_PTR	R/W-0	0	Descriptor pointer. It will be read as zero if the queue is empty. It will indicate a 32-bit aligned address that points to a descriptor when the queue is not empty.
4-0	DESC_SIZE	R/W-0	0	Descriptor Size. It is encoded in 4-byte increments with values 0 to 31 representing 24 and so on to 148 bytes. This field will return a 0x0 when an empty queue is read. Queue Manager Queue N Registers D To save hardware resources, the queue manager internally stores descriptor size (desc_size) information in four bits. However, register D has five LSBs that specify descriptor size. As a consequence, the value of desc_size that is pushed may not be same as that is read during a pop. The value that is read back is equal to always rounded to an odd number. So, for even values, the value read back is one more than what was written. For odd values, the value read back is same as the value that was written. Note that this 5-bit field (desc_size) is unrelated to the code for size of descriptors in a descriptor region. It is just a place holder for a 5-bit value that is maintained across the push and pop operations for every descriptor managed by the queue manager.

16.5.7.211 QUEUE_44_A Register (offset = 22C0h) [reset = 0h]

QUEUE_44_A is shown in [Figure 16-487](#) and described in [Table 16-501](#).

Figure 16-487. QUEUE_44_A Register


LEGEND: R/W = Read/Write; R = Read only; W1toCl = Write 1 to clear bit; -n = value after reset

Table 16-501. QUEUE_44_A Register Field Descriptions

Bit	Field	Type	Reset	Description
13-0	QUEUE_ENTRY_COUNT	R-0	0	This field indicates how many packets are currently queued on the queue. This count is incremented by 1 whenever a packet is added to the queue. This count is decremented by 1 whenever a packet is popped from the queue.

16.5.7.212 QUEUE_44_B Register (offset = 22C4h) [reset = 0h]

 QUEUE_44_B is shown in [Figure 16-488](#) and described in [Table 16-502](#).

Figure 16-488. QUEUE_44_B Register


LEGEND: R/W = Read/Write; R = Read only; W1toCl = Write 1 to clear bit; -n = value after reset

Table 16-502. QUEUE_44_B Register Field Descriptions

Bit	Field	Type	Reset	Description
27-0	QUEUE_BYTE_COUNT	R-0	0	This field indicates how many bytes total are contained in all of the packets which are currently queued on this queue.

16.5.7.213 QUEUE_44_C Register (offset = 22C8h) [reset = 0h]

 QUEUE_44_C is shown in [Figure 16-489](#) and described in [Table 16-503](#).

Figure 16-489. QUEUE_44_C Register


LEGEND: R/W = Read/Write; R = Read only; W1toCl = Write 1 to clear bit; -n = value after reset

Table 16-503. QUEUE_44_C Register Field Descriptions

Bit	Field	Type	Reset	Description
31	HEAD_TAIL	W-0	0	Head/Tail Push Control. Set to zero in order to push packet onto tail of queue and set to one in order to push packet onto head of queue.
13-0	PACKET_SIZE	R/W-0	0	packet_size This field indicates packet size and is assumed to be zero on each packet add unless the value is explicitly overwritten. This field indicates packet size for packet pop operation.

16.5.7.214 QUEUE_44_D Register (offset = 22CCh) [reset = 0h]

QUEUE_44_D is shown in [Figure 16-490](#) and described in [Table 16-504](#).

Figure 16-490. QUEUE_44_D Register


LEGEND: R/W = Read/Write; R = Read only; W1toCl = Write 1 to clear bit; -n = value after reset

Table 16-504. QUEUE_44_D Register Field Descriptions

Bit	Field	Type	Reset	Description
31-5	DESC_PTR	R/W-0	0	Descriptor pointer. It will be read as zero if the queue is empty. It will indicate a 32-bit aligned address that points to a descriptor when the queue is not empty.
4-0	DESC_SIZE	R/W-0	0	Descriptor Size. It is encoded in 4-byte increments with values 0 to 31 representing 24 and so on to 148 bytes. This field will return a 0x0 when an empty queue is read. Queue Manager Queue N Registers D To save hardware resources, the queue manager internally stores descriptor size (desc_size) information in four bits. However, register D has five LSBs that specify descriptor size. As a consequence, the value of desc_size that is pushed may not be same as that is read during a pop. The value that is read back is equal to always rounded to an odd number. So, for even values, the value read back is one more than what was written. For odd values, the value read back is same as the value that was written. Note that this 5-bit field (desc_size) is unrelated to the code for size of descriptors in a descriptor region. It is just a place holder for a 5-bit value that is maintained across the push and pop operations for every descriptor managed by the queue manager.

16.5.7.215 QUEUE_45_A Register (offset = 22D0h) [reset = 0h]

QUEUE_45_A is shown in [Figure 16-491](#) and described in [Table 16-505](#).

Figure 16-491. QUEUE_45_A Register

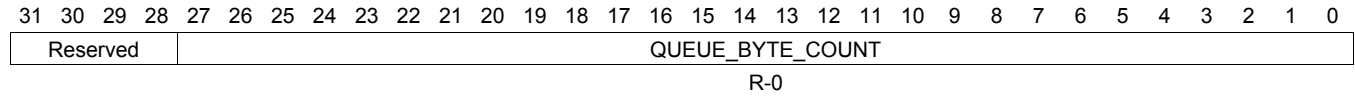

LEGEND: R/W = Read/Write; R = Read only; W1toCl = Write 1 to clear bit; -n = value after reset

Table 16-505. QUEUE_45_A Register Field Descriptions

Bit	Field	Type	Reset	Description
13-0	QUEUE_ENTRY_COUNT	R-0	0	This field indicates how many packets are currently queued on the queue. This count is incremented by 1 whenever a packet is added to the queue. This count is decremented by 1 whenever a packet is popped from the queue.

16.5.7.216 QUEUE_45_B Register (offset = 22D4h) [reset = 0h]

 QUEUE_45_B is shown in [Figure 16-492](#) and described in [Table 16-506](#).

Figure 16-492. QUEUE_45_B Register


LEGEND: R/W = Read/Write; R = Read only; W1toCl = Write 1 to clear bit; -n = value after reset

Table 16-506. QUEUE_45_B Register Field Descriptions

Bit	Field	Type	Reset	Description
27-0	QUEUE_BYTE_COUNT	R-0	0	This field indicates how many bytes total are contained in all of the packets which are currently queued on this queue.

16.5.7.217 QUEUE_45_C Register (offset = 22D8h) [reset = 0h]

 QUEUE_45_C is shown in [Figure 16-493](#) and described in [Table 16-507](#).

Figure 16-493. QUEUE_45_C Register


LEGEND: R/W = Read/Write; R = Read only; W1toCl = Write 1 to clear bit; -n = value after reset

Table 16-507. QUEUE_45_C Register Field Descriptions

Bit	Field	Type	Reset	Description
31	HEAD_TAIL	W-0	0	Head/Tail Push Control. Set to zero in order to push packet onto tail of queue and set to one in order to push packet onto head of queue.
13-0	PACKET_SIZE	R/W-0	0	packet_size This field indicates packet size and is assumed to be zero on each packet add unless the value is explicitly overwritten. This field indicates packet size for packet pop operation.

16.5.7.218 QUEUE_45_D Register (offset = 22DCh) [reset = 0h]

QUEUE_45_D is shown in [Figure 16-494](#) and described in [Table 16-508](#).

Figure 16-494. QUEUE_45_D Register


LEGEND: R/W = Read/Write; R = Read only; W1toCl = Write 1 to clear bit; -n = value after reset

Table 16-508. QUEUE_45_D Register Field Descriptions

Bit	Field	Type	Reset	Description
31-5	DESC_PTR	R/W-0	0	Descriptor pointer. It will be read as zero if the queue is empty. It will indicate a 32-bit aligned address that points to a descriptor when the queue is not empty.
4-0	DESC_SIZE	R/W-0	0	Descriptor Size. It is encoded in 4-byte increments with values 0 to 31 representing 24 and so on to 148 bytes. This field will return a 0x0 when an empty queue is read. Queue Manager Queue N Registers D To save hardware resources, the queue manager internally stores descriptor size (desc_size) information in four bits. However, register D has five LSBs that specify descriptor size. As a consequence, the value of desc_size that is pushed may not be same as that is read during a pop. The value that is read back is equal to always rounded to an odd number. So, for even values, the value read back is one more than what was written. For odd values, the value read back is same as the value that was written. Note that this 5-bit field (desc_size) is unrelated to the code for size of descriptors in a descriptor region. It is just a place holder for a 5-bit value that is maintained across the push and pop operations for every descriptor managed by the queue manager.

16.5.7.219 QUEUE_46_A Register (offset = 22E0h) [reset = 0h]

QUEUE_46_A is shown in [Figure 16-495](#) and described in [Table 16-509](#).

Figure 16-495. QUEUE_46_A Register


LEGEND: R/W = Read/Write; R = Read only; W1toCl = Write 1 to clear bit; -n = value after reset

Table 16-509. QUEUE_46_A Register Field Descriptions

Bit	Field	Type	Reset	Description
13-0	QUEUE_ENTRY_COUNT	R-0	0	This field indicates how many packets are currently queued on the queue. This count is incremented by 1 whenever a packet is added to the queue. This count is decremented by 1 whenever a packet is popped from the queue.

16.5.7.220 QUEUE_46_B Register (offset = 22E4h) [reset = 0h]

QUEUE_46_B is shown in [Figure 16-496](#) and described in [Table 16-510](#).

Figure 16-496. QUEUE_46_B Register


LEGEND: R/W = Read/Write; R = Read only; W1toCl = Write 1 to clear bit; -n = value after reset

Table 16-510. QUEUE_46_B Register Field Descriptions

Bit	Field	Type	Reset	Description
27-0	QUEUE_BYTE_COUNT	R-0	0	This field indicates how many bytes total are contained in all of the packets which are currently queued on this queue.

16.5.7.221 QUEUE_46_C Register (offset = 22E8h) [reset = 0h]

 QUEUE_46_C is shown in [Figure 16-497](#) and described in [Table 16-511](#).

Figure 16-497. QUEUE_46_C Register

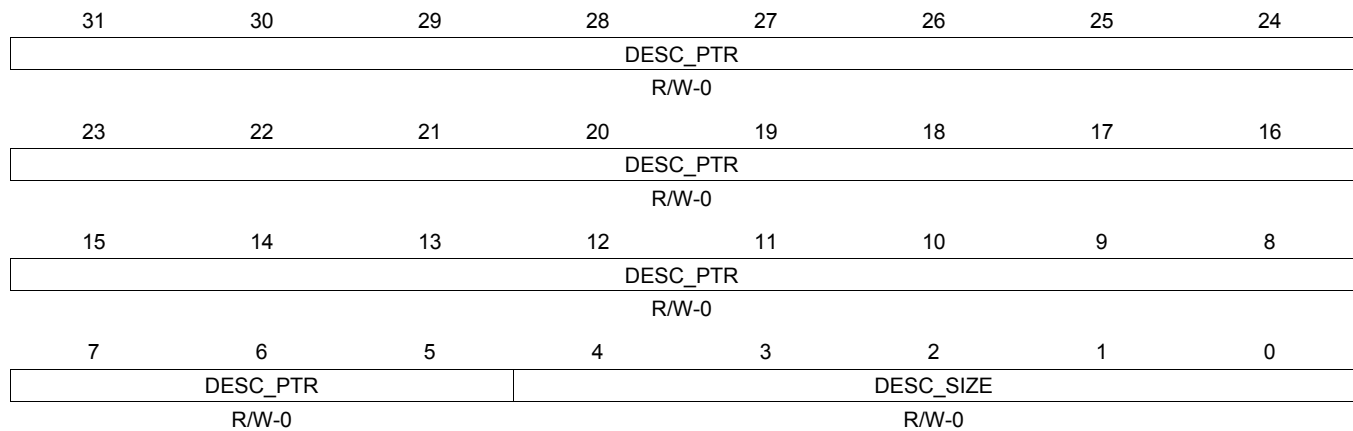

LEGEND: R/W = Read/Write; R = Read only; W1toCl = Write 1 to clear bit; -n = value after reset

Table 16-511. QUEUE_46_C Register Field Descriptions

Bit	Field	Type	Reset	Description
31	HEAD_TAIL	W-0	0	Head/Tail Push Control. Set to zero in order to push packet onto tail of queue and set to one in order to push packet onto head of queue.
13-0	PACKET_SIZE	R/W-0	0	packet_size This field indicates packet size and is assumed to be zero on each packet add unless the value is explicitly overwritten. This field indicates packet size for packet pop operation.

16.5.7.222 QUEUE_46_D Register (offset = 22ECh) [reset = 0h]

 QUEUE_46_D is shown in [Figure 16-498](#) and described in [Table 16-512](#).

Figure 16-498. QUEUE_46_D Register


LEGEND: R/W = Read/Write; R = Read only; W1toCl = Write 1 to clear bit; -n = value after reset

Table 16-512. QUEUE_46_D Register Field Descriptions

Bit	Field	Type	Reset	Description
31-5	DESC_PTR	R/W-0	0	Descriptor pointer. It will be read as zero if the queue is empty. It will indicate a 32-bit aligned address that points to a descriptor when the queue is not empty.
4-0	DESC_SIZE	R/W-0	0	Descriptor Size. It is encoded in 4-byte increments with values 0 to 31 representing 24 and so on to 148 bytes. This field will return a 0x0 when an empty queue is read. Queue Manager Queue N Registers D To save hardware resources, the queue manager internally stores descriptor size (desc_size) information in four bits. However, register D has five LSBs that specify descriptor size. As a consequence, the value of desc_size that is pushed may not be same as that is read during a pop. The value that is read back is equal to always rounded to an odd number. So, for even values, the value read back is one more than what was written. For odd values, the value read back is same as the value that was written. Note that this 5-bit field (desc_size) is unrelated to the code for size of descriptors in a descriptor region. It is just a place holder for a 5-bit value that is maintained across the push and pop operations for every descriptor managed by the queue manager.

16.5.7.223 QUEUE_47_A Register (offset = 22F0h) [reset = 0h]

QUEUE_47_A is shown in [Figure 16-499](#) and described in [Table 16-513](#).

Figure 16-499. QUEUE_47_A Register


LEGEND: R/W = Read/Write; R = Read only; W1toCl = Write 1 to clear bit; -n = value after reset

Table 16-513. QUEUE_47_A Register Field Descriptions

Bit	Field	Type	Reset	Description
13-0	QUEUE_ENTRY_COUNT	R-0	0	This field indicates how many packets are currently queued on the queue. This count is incremented by 1 whenever a packet is added to the queue. This count is decremented by 1 whenever a packet is popped from the queue.

16.5.7.224 QUEUE_47_B Register (offset = 22F4h) [reset = 0h]

QUEUE_47_B is shown in [Figure 16-500](#) and described in [Table 16-514](#).

Figure 16-500. QUEUE_47_B Register

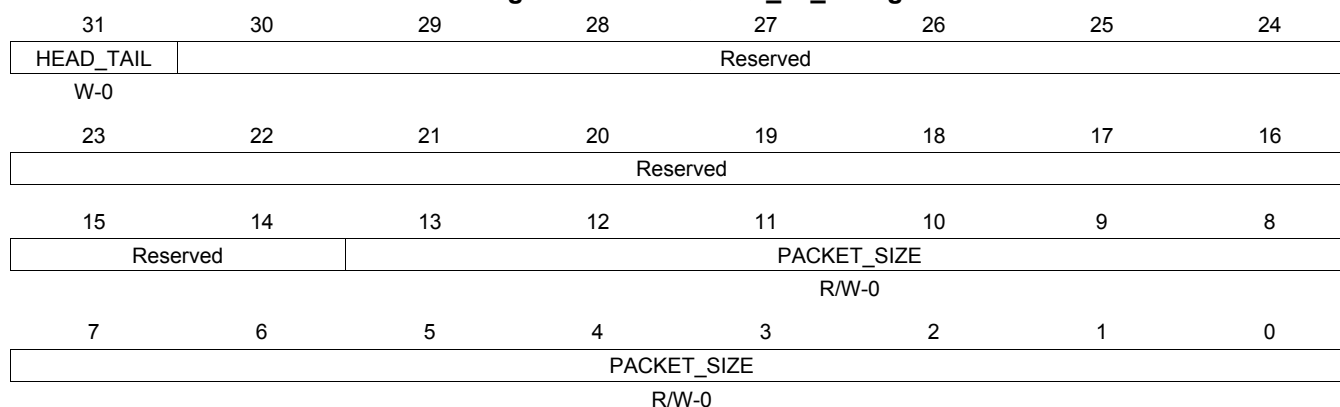

LEGEND: R/W = Read/Write; R = Read only; W1toCl = Write 1 to clear bit; -n = value after reset

Table 16-514. QUEUE_47_B Register Field Descriptions

Bit	Field	Type	Reset	Description
27-0	QUEUE_BYTE_COUNT	R-0	0	This field indicates how many bytes total are contained in all of the packets which are currently queued on this queue.

16.5.7.225 QUEUE_47_C Register (offset = 22F8h) [reset = 0h]

 QUEUE_47_C is shown in [Figure 16-501](#) and described in [Table 16-515](#).

Figure 16-501. QUEUE_47_C Register


LEGEND: R/W = Read/Write; R = Read only; W1toCl = Write 1 to clear bit; -n = value after reset

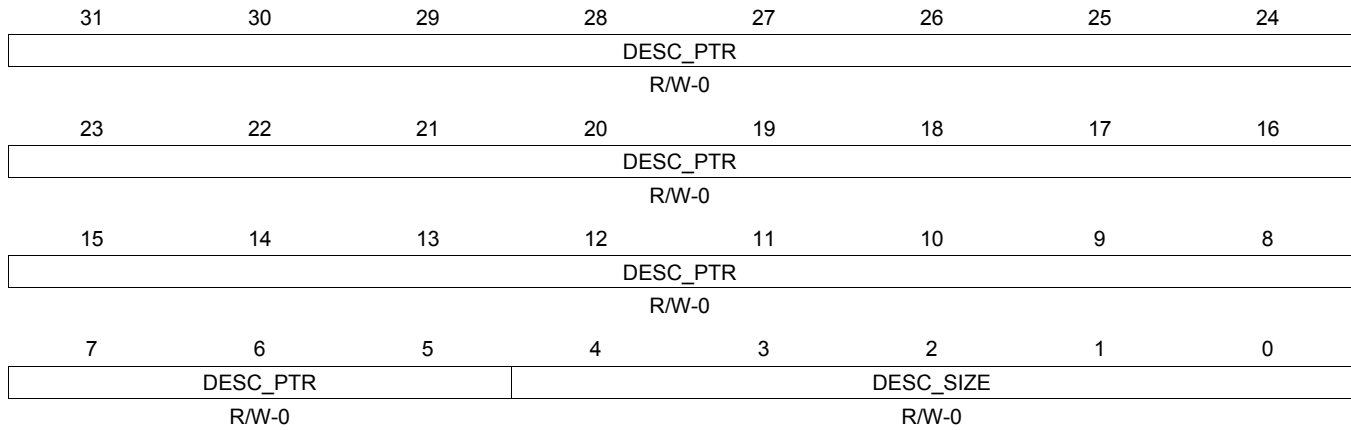
Table 16-515. QUEUE_47_C Register Field Descriptions

Bit	Field	Type	Reset	Description
31	HEAD_TAIL	W-0	0	Head/Tail Push Control. Set to zero in order to push packet onto tail of queue and set to one in order to push packet onto head of queue.
13-0	PACKET_SIZE	R/W-0	0	packet_size This field indicates packet size and is assumed to be zero on each packet add unless the value is explicitly overwritten. This field indicates packet size for packet pop operation.

16.5.7.226 QUEUE_47_D Register (offset = 22FCh) [reset = 0h]

QUEUE_47_D is shown in [Figure 16-502](#) and described in [Table 16-516](#).

Figure 16-502. QUEUE_47_D Register



LEGEND: R/W = Read/Write; R = Read only; W1toCl = Write 1 to clear bit; -n = value after reset

Table 16-516. QUEUE_47_D Register Field Descriptions

Bit	Field	Type	Reset	Description
31-5	DESC_PTR	R/W-0	0	Descriptor pointer. It will be read as zero if the queue is empty. It will indicate a 32-bit aligned address that points to a descriptor when the queue is not empty.
4-0	DESC_SIZE	R/W-0	0	Descriptor Size. It is encoded in 4-byte increments with values 0 to 31 representing 24 and so on to 148 bytes. This field will return a 0x0 when an empty queue is read. Queue Manager Queue N Registers D To save hardware resources, the queue manager internally stores descriptor size (desc_size) information in four bits. However, register D has five LSBs that specify descriptor size. As a consequence, the value of desc_size that is pushed may not be same as that is read during a pop. The value that is read back is equal to always rounded to an odd number. So, for even values, the value read back is one more than what was written. For odd values, the value read back is same as the value that was written. Note that this 5-bit field (desc_size) is unrelated to the code for size of descriptors in a descriptor region. It is just a place holder for a 5-bit value that is maintained across the push and pop operations for every descriptor managed by the queue manager.

16.5.7.227 QUEUE_48_A Register (offset = 2300h) [reset = 0h]

QUEUE_48_A is shown in [Figure 16-503](#) and described in [Table 16-517](#).

Figure 16-503. QUEUE_48_A Register

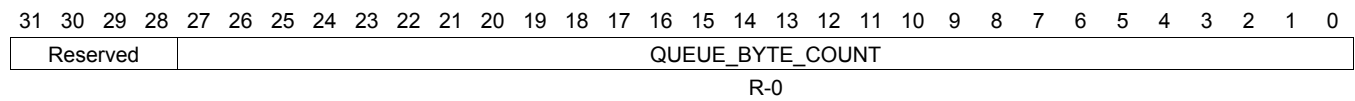

LEGEND: R/W = Read/Write; R = Read only; W1toCl = Write 1 to clear bit; -n = value after reset

Table 16-517. QUEUE_48_A Register Field Descriptions

Bit	Field	Type	Reset	Description
13-0	QUEUE_ENTRY_COUNT	R-0	0	This field indicates how many packets are currently queued on the queue. This count is incremented by 1 whenever a packet is added to the queue. This count is decremented by 1 whenever a packet is popped from the queue.

16.5.7.228 QUEUE_48_B Register (offset = 2304h) [reset = 0h]

 QUEUE_48_B is shown in [Figure 16-504](#) and described in [Table 16-518](#).

Figure 16-504. QUEUE_48_B Register


LEGEND: R/W = Read/Write; R = Read only; W1toCl = Write 1 to clear bit; -n = value after reset

Table 16-518. QUEUE_48_B Register Field Descriptions

Bit	Field	Type	Reset	Description
27-0	QUEUE_BYTE_COUNT	R-0	0	This field indicates how many bytes total are contained in all of the packets which are currently queued on this queue.

16.5.7.229 QUEUE_48_C Register (offset = 2308h) [reset = 0h]

 QUEUE_48_C is shown in [Figure 16-505](#) and described in [Table 16-519](#).

Figure 16-505. QUEUE_48_C Register


LEGEND: R/W = Read/Write; R = Read only; W1toCl = Write 1 to clear bit; -n = value after reset

Table 16-519. QUEUE_48_C Register Field Descriptions

Bit	Field	Type	Reset	Description
31	HEAD_TAIL	W-0	0	Head/Tail Push Control. Set to zero in order to push packet onto tail of queue and set to one in order to push packet onto head of queue.
13-0	PACKET_SIZE	R/W-0	0	packet_size This field indicates packet size and is assumed to be zero on each packet add unless the value is explicitly overwritten. This field indicates packet size for packet pop operation.

16.5.7.230 QUEUE_48_D Register (offset = 230Ch) [reset = 0h]

 QUEUE_48_D is shown in [Figure 16-506](#) and described in [Table 16-520](#).

Figure 16-506. QUEUE_48_D Register


LEGEND: R/W = Read/Write; R = Read only; W1toCl = Write 1 to clear bit; -n = value after reset

Table 16-520. QUEUE_48_D Register Field Descriptions

Bit	Field	Type	Reset	Description
31-5	DESC_PTR	R/W-0	0	Descriptor pointer. It will be read as zero if the queue is empty. It will indicate a 32-bit aligned address that points to a descriptor when the queue is not empty.
4-0	DESC_SIZE	R/W-0	0	Descriptor Size. It is encoded in 4-byte increments with values 0 to 31 representing 24 and so on to 148 bytes. This field will return a 0x0 when an empty queue is read. Queue Manager Queue N Registers D To save hardware resources, the queue manager internally stores descriptor size (desc_size) information in four bits. However, register D has five LSBs that specify descriptor size. As a consequence, the value of desc_size that is pushed may not be same as that is read during a pop. The value that is read back is equal to always rounded to an odd number. So, for even values, the value read back is one more than what was written. For odd values, the value read back is same as the value that was written. Note that this 5-bit field (desc_size) is unrelated to the code for size of descriptors in a descriptor region. It is just a place holder for a 5-bit value that is maintained across the push and pop operations for every descriptor managed by the queue manager.

16.5.7.231 QUEUE_49_A Register (offset = 2310h) [reset = 0h]

QUEUE_49_A is shown in [Figure 16-507](#) and described in [Table 16-521](#).

Figure 16-507. QUEUE_49_A Register

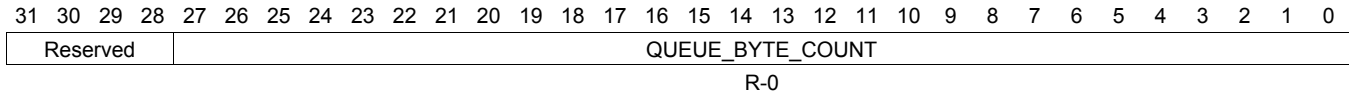

LEGEND: R/W = Read/Write; R = Read only; W1toCl = Write 1 to clear bit; -n = value after reset

Table 16-521. QUEUE_49_A Register Field Descriptions

Bit	Field	Type	Reset	Description
13-0	QUEUE_ENTRY_COUNT	R-0	0	This field indicates how many packets are currently queued on the queue. This count is incremented by 1 whenever a packet is added to the queue. This count is decremented by 1 whenever a packet is popped from the queue.

16.5.7.232 QUEUE_49_B Register (offset = 2314h) [reset = 0h]

 QUEUE_49_B is shown in [Figure 16-508](#) and described in [Table 16-522](#).

Figure 16-508. QUEUE_49_B Register


LEGEND: R/W = Read/Write; R = Read only; W1toCl = Write 1 to clear bit; -n = value after reset

Table 16-522. QUEUE_49_B Register Field Descriptions

Bit	Field	Type	Reset	Description
27-0	QUEUE_BYTE_COUNT	R-0	0	This field indicates how many bytes total are contained in all of the packets which are currently queued on this queue.

16.5.7.233 QUEUE_49_C Register (offset = 2318h) [reset = 0h]

 QUEUE_49_C is shown in [Figure 16-509](#) and described in [Table 16-523](#).

Figure 16-509. QUEUE_49_C Register


LEGEND: R/W = Read/Write; R = Read only; W1toCl = Write 1 to clear bit; -n = value after reset

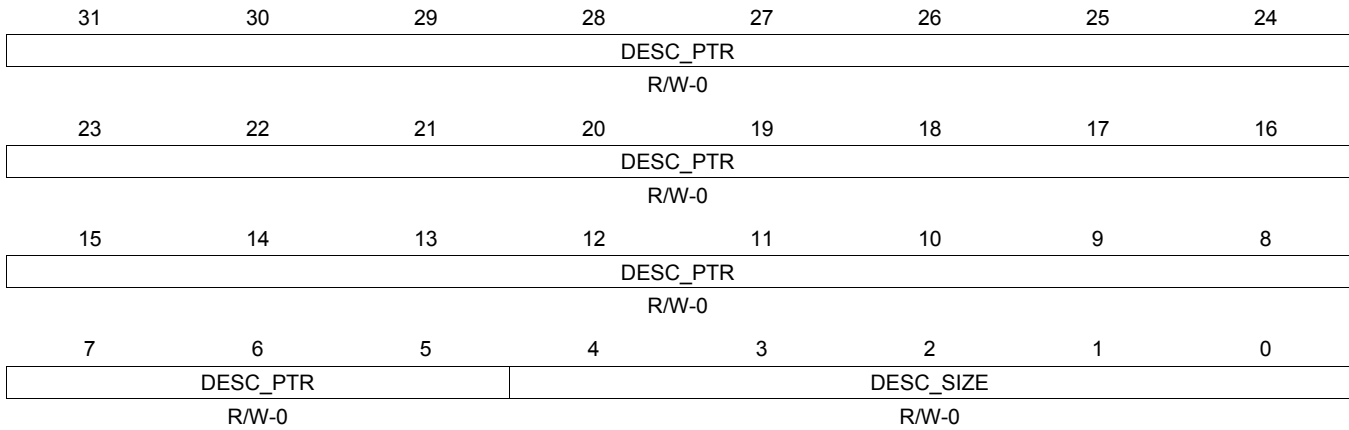
Table 16-523. QUEUE_49_C Register Field Descriptions

Bit	Field	Type	Reset	Description
31	HEAD_TAIL	W-0	0	Head/Tail Push Control. Set to zero in order to push packet onto tail of queue and set to one in order to push packet onto head of queue.
13-0	PACKET_SIZE	R/W-0	0	packet_size This field indicates packet size and is assumed to be zero on each packet add unless the value is explicitly overwritten. This field indicates packet size for packet pop operation.

16.5.7.234 QUEUE_49_D Register (offset = 231Ch) [reset = 0h]

QUEUE_49_D is shown in [Figure 16-510](#) and described in [Table 16-524](#).

Figure 16-510. QUEUE_49_D Register



LEGEND: R/W = Read/Write; R = Read only; W1toCl = Write 1 to clear bit; -n = value after reset

Table 16-524. QUEUE_49_D Register Field Descriptions

Bit	Field	Type	Reset	Description
31-5	DESC_PTR	R/W-0	0	Descriptor pointer. It will be read as zero if the queue is empty. It will indicate a 32-bit aligned address that points to a descriptor when the queue is not empty.
4-0	DESC_SIZE	R/W-0	0	Descriptor Size. It is encoded in 4-byte increments with values 0 to 31 representing 24 and so on to 148 bytes. This field will return a 0x0 when an empty queue is read. Queue Manager Queue N Registers D To save hardware resources, the queue manager internally stores descriptor size (desc_size) information in four bits. However, register D has five LSBs that specify descriptor size. As a consequence, the value of desc_size that is pushed may not be same as that is read during a pop. The value that is read back is equal to always rounded to an odd number. So, for even values, the value read back is one more than what was written. For odd values, the value read back is same as the value that was written. Note that this 5-bit field (desc_size) is unrelated to the code for size of descriptors in a descriptor region. It is just a place holder for a 5-bit value that is maintained across the push and pop operations for every descriptor managed by the queue manager.

16.5.7.235 QUEUE_50_A Register (offset = 2320h) [reset = 0h]

QUEUE_50_A is shown in [Figure 16-511](#) and described in [Table 16-525](#).

Figure 16-511. QUEUE_50_A Register


LEGEND: R/W = Read/Write; R = Read only; W1toCl = Write 1 to clear bit; -n = value after reset

Table 16-525. QUEUE_50_A Register Field Descriptions

Bit	Field	Type	Reset	Description
13-0	QUEUE_ENTRY_COUNT	R-0	0	This field indicates how many packets are currently queued on the queue. This count is incremented by 1 whenever a packet is added to the queue. This count is decremented by 1 whenever a packet is popped from the queue.

16.5.7.236 QUEUE_50_B Register (offset = 2324h) [reset = 0h]

QUEUE_50_B is shown in [Figure 16-512](#) and described in [Table 16-526](#).

Figure 16-512. QUEUE_50_B Register

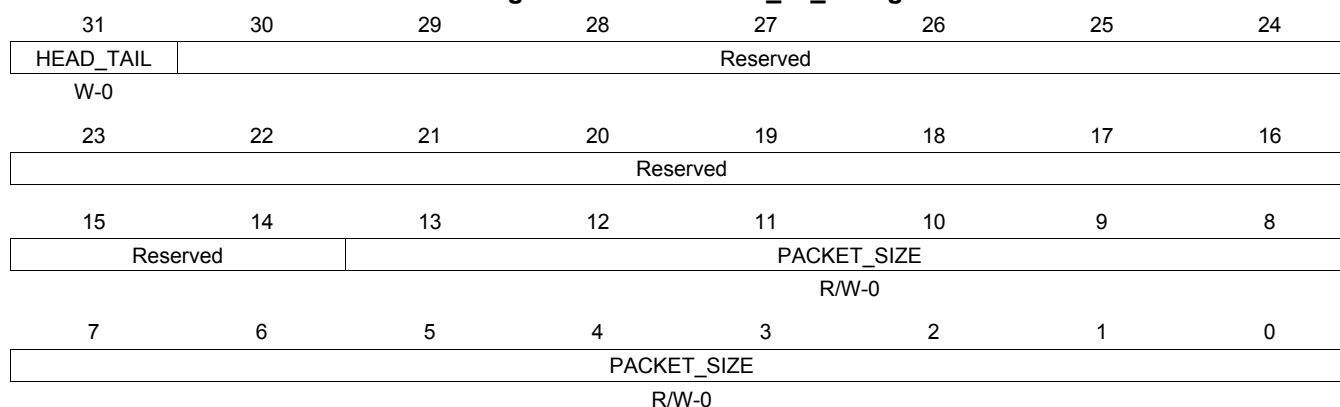

LEGEND: R/W = Read/Write; R = Read only; W1toCl = Write 1 to clear bit; -n = value after reset

Table 16-526. QUEUE_50_B Register Field Descriptions

Bit	Field	Type	Reset	Description
27-0	QUEUE_BYTE_COUNT	R-0	0	This field indicates how many bytes total are contained in all of the packets which are currently queued on this queue.

16.5.7.237 QUEUE_50_C Register (offset = 2328h) [reset = 0h]

 QUEUE_50_C is shown in [Figure 16-513](#) and described in [Table 16-527](#).

Figure 16-513. QUEUE_50_C Register


LEGEND: R/W = Read/Write; R = Read only; W1toCl = Write 1 to clear bit; -n = value after reset

Table 16-527. QUEUE_50_C Register Field Descriptions

Bit	Field	Type	Reset	Description
31	HEAD_TAIL	W-0	0	Head/Tail Push Control. Set to zero in order to push packet onto tail of queue and set to one in order to push packet onto head of queue.
13-0	PACKET_SIZE	R/W-0	0	packet_size This field indicates packet size and is assumed to be zero on each packet add unless the value is explicitly overwritten. This field indicates packet size for packet pop operation.

16.5.7.238 QUEUE_50_D Register (offset = 232Ch) [reset = 0h]

QUEUE_50_D is shown in [Figure 16-514](#) and described in [Table 16-528](#).

Figure 16-514. QUEUE_50_D Register

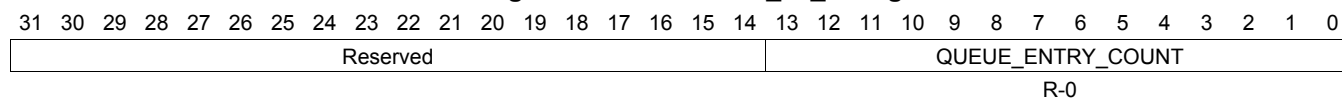

LEGEND: R/W = Read/Write; R = Read only; W1toCl = Write 1 to clear bit; -n = value after reset

Table 16-528. QUEUE_50_D Register Field Descriptions

Bit	Field	Type	Reset	Description
31-5	DESC_PTR	R/W-0	0	Descriptor pointer. It will be read as zero if the queue is empty. It will indicate a 32-bit aligned address that points to a descriptor when the queue is not empty.
4-0	DESC_SIZE	R/W-0	0	Descriptor Size. It is encoded in 4-byte increments with values 0 to 31 representing 24 and so on to 148 bytes. This field will return a 0x0 when an empty queue is read. Queue Manager Queue N Registers D To save hardware resources, the queue manager internally stores descriptor size (desc_size) information in four bits. However, register D has five LSBs that specify descriptor size. As a consequence, the value of desc_size that is pushed may not be same as that is read during a pop. The value that is read back is equal to always rounded to an odd number. So, for even values, the value read back is one more than what was written. For odd values, the value read back is same as the value that was written. Note that this 5-bit field (desc_size) is unrelated to the code for size of descriptors in a descriptor region. It is just a place holder for a 5-bit value that is maintained across the push and pop operations for every descriptor managed by the queue manager.

16.5.7.239 QUEUE_51_A Register (offset = 2330h) [reset = 0h]

QUEUE_51_A is shown in [Figure 16-515](#) and described in [Table 16-529](#).

Figure 16-515. QUEUE_51_A Register


LEGEND: R/W = Read/Write; R = Read only; W1toCl = Write 1 to clear bit; -n = value after reset

Table 16-529. QUEUE_51_A Register Field Descriptions

Bit	Field	Type	Reset	Description
13-0	QUEUE_ENTRY_COUNT	R-0	0	This field indicates how many packets are currently queued on the queue. This count is incremented by 1 whenever a packet is added to the queue. This count is decremented by 1 whenever a packet is popped from the queue.

16.5.7.240 QUEUE_51_B Register (offset = 2334h) [reset = 0h]

 QUEUE_51_B is shown in [Figure 16-516](#) and described in [Table 16-530](#).

Figure 16-516. QUEUE_51_B Register


LEGEND: R/W = Read/Write; R = Read only; W1toCl = Write 1 to clear bit; -n = value after reset

Table 16-530. QUEUE_51_B Register Field Descriptions

Bit	Field	Type	Reset	Description
27-0	QUEUE_BYTE_COUNT	R-0	0	This field indicates how many bytes total are contained in all of the packets which are currently queued on this queue.

16.5.7.241 QUEUE_51_C Register (offset = 2338h) [reset = 0h]

 QUEUE_51_C is shown in [Figure 16-517](#) and described in [Table 16-531](#).

Figure 16-517. QUEUE_51_C Register

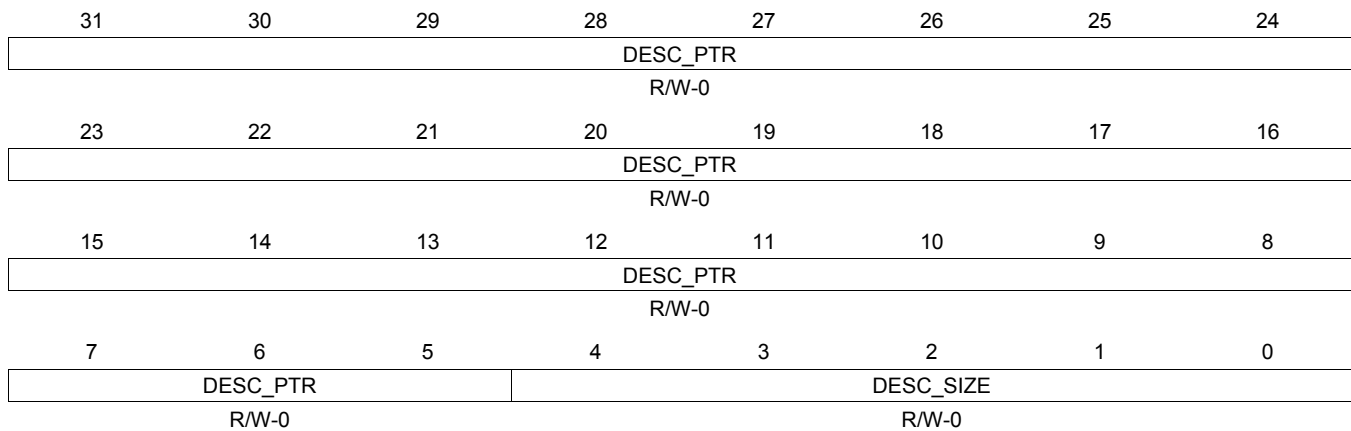

LEGEND: R/W = Read/Write; R = Read only; W1toCl = Write 1 to clear bit; -n = value after reset

Table 16-531. QUEUE_51_C Register Field Descriptions

Bit	Field	Type	Reset	Description
31	HEAD_TAIL	W-0	0	Head/Tail Push Control. Set to zero in order to push packet onto tail of queue and set to one in order to push packet onto head of queue.
13-0	PACKET_SIZE	R/W-0	0	packet_size This field indicates packet size and is assumed to be zero on each packet add unless the value is explicitly overwritten. This field indicates packet size for packet pop operation.

16.5.7.242 QUEUE_51_D Register (offset = 233Ch) [reset = 0h]

 QUEUE_51_D is shown in [Figure 16-518](#) and described in [Table 16-532](#).

Figure 16-518. QUEUE_51_D Register


LEGEND: R/W = Read/Write; R = Read only; W1toCl = Write 1 to clear bit; -n = value after reset

Table 16-532. QUEUE_51_D Register Field Descriptions

Bit	Field	Type	Reset	Description
31-5	DESC_PTR	R/W-0	0	Descriptor pointer. It will be read as zero if the queue is empty. It will indicate a 32-bit aligned address that points to a descriptor when the queue is not empty.
4-0	DESC_SIZE	R/W-0	0	Descriptor Size. It is encoded in 4-byte increments with values 0 to 31 representing 24 and so on to 148 bytes. This field will return a 0x0 when an empty queue is read. Queue Manager Queue N Registers D To save hardware resources, the queue manager internally stores descriptor size (desc_size) information in four bits. However, register D has five LSBs that specify descriptor size. As a consequence, the value of desc_size that is pushed may not be same as that is read during a pop. The value that is read back is equal to always rounded to an odd number. So, for even values, the value read back is one more than what was written. For odd values, the value read back is same as the value that was written. Note that this 5-bit field (desc_size) is unrelated to the code for size of descriptors in a descriptor region. It is just a place holder for a 5-bit value that is maintained across the push and pop operations for every descriptor managed by the queue manager.

16.5.7.243 QUEUE_52_A Register (offset = 2340h) [reset = 0h]

QUEUE_52_A is shown in [Figure 16-519](#) and described in [Table 16-533](#).

Figure 16-519. QUEUE_52_A Register


LEGEND: R/W = Read/Write; R = Read only; W1toCl = Write 1 to clear bit; -n = value after reset

Table 16-533. QUEUE_52_A Register Field Descriptions

Bit	Field	Type	Reset	Description
13-0	QUEUE_ENTRY_COUNT	R-0	0	This field indicates how many packets are currently queued on the queue. This count is incremented by 1 whenever a packet is added to the queue. This count is decremented by 1 whenever a packet is popped from the queue.

16.5.7.244 QUEUE_52_B Register (offset = 2344h) [reset = 0h]

QUEUE_52_B is shown in [Figure 16-520](#) and described in [Table 16-534](#).

Figure 16-520. QUEUE_52_B Register


LEGEND: R/W = Read/Write; R = Read only; W1toCl = Write 1 to clear bit; -n = value after reset

Table 16-534. QUEUE_52_B Register Field Descriptions

Bit	Field	Type	Reset	Description
27-0	QUEUE_BYTE_COUNT	R-0	0	This field indicates how many bytes total are contained in all of the packets which are currently queued on this queue.

16.5.7.245 QUEUE_52_C Register (offset = 2348h) [reset = 0h]

 QUEUE_52_C is shown in [Figure 16-521](#) and described in [Table 16-535](#).

Figure 16-521. QUEUE_52_C Register


LEGEND: R/W = Read/Write; R = Read only; W1toCl = Write 1 to clear bit; -n = value after reset

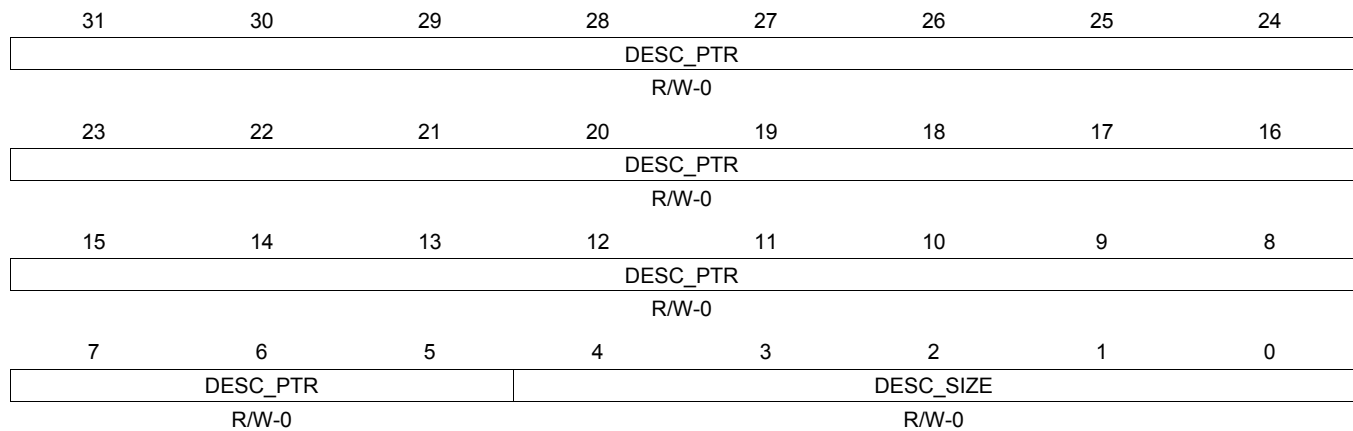
Table 16-535. QUEUE_52_C Register Field Descriptions

Bit	Field	Type	Reset	Description
31	HEAD_TAIL	W-0	0	Head/Tail Push Control. Set to zero in order to push packet onto tail of queue and set to one in order to push packet onto head of queue.
13-0	PACKET_SIZE	R/W-0	0	packet_size This field indicates packet size and is assumed to be zero on each packet add unless the value is explicitly overwritten. This field indicates packet size for packet pop operation.

16.5.7.246 QUEUE_52_D Register (offset = 234Ch) [reset = 0h]

QUEUE_52_D is shown in [Figure 16-522](#) and described in [Table 16-536](#).

Figure 16-522. QUEUE_52_D Register



LEGEND: R/W = Read/Write; R = Read only; W1toCl = Write 1 to clear bit; -n = value after reset

Table 16-536. QUEUE_52_D Register Field Descriptions

Bit	Field	Type	Reset	Description
31-5	DESC_PTR	R/W-0	0	Descriptor pointer. It will be read as zero if the queue is empty. It will indicate a 32-bit aligned address that points to a descriptor when the queue is not empty.
4-0	DESC_SIZE	R/W-0	0	Descriptor Size. It is encoded in 4-byte increments with values 0 to 31 representing 24 and so on to 148 bytes. This field will return a 0x0 when an empty queue is read. Queue Manager Queue N Registers D To save hardware resources, the queue manager internally stores descriptor size (desc_size) information in four bits. However, register D has five LSBs that specify descriptor size. As a consequence, the value of desc_size that is pushed may not be same as that is read during a pop. The value that is read back is equal to always rounded to an odd number. So, for even values, the value read back is one more than what was written. For odd values, the value read back is same as the value that was written. Note that this 5-bit field (desc_size) is unrelated to the code for size of descriptors in a descriptor region. It is just a place holder for a 5-bit value that is maintained across the push and pop operations for every descriptor managed by the queue manager.

16.5.7.247 QUEUE_53_A Register (offset = 2350h) [reset = 0h]

QUEUE_53_A is shown in [Figure 16-523](#) and described in [Table 16-537](#).

Figure 16-523. QUEUE_53_A Register


LEGEND: R/W = Read/Write; R = Read only; W1toCl = Write 1 to clear bit; -n = value after reset

Table 16-537. QUEUE_53_A Register Field Descriptions

Bit	Field	Type	Reset	Description
13-0	QUEUE_ENTRY_COUNT	R-0	0	This field indicates how many packets are currently queued on the queue. This count is incremented by 1 whenever a packet is added to the queue. This count is decremented by 1 whenever a packet is popped from the queue.

16.5.7.248 QUEUE_53_B Register (offset = 2354h) [reset = 0h]

QUEUE_53_B is shown in [Figure 16-524](#) and described in [Table 16-538](#).

Figure 16-524. QUEUE_53_B Register

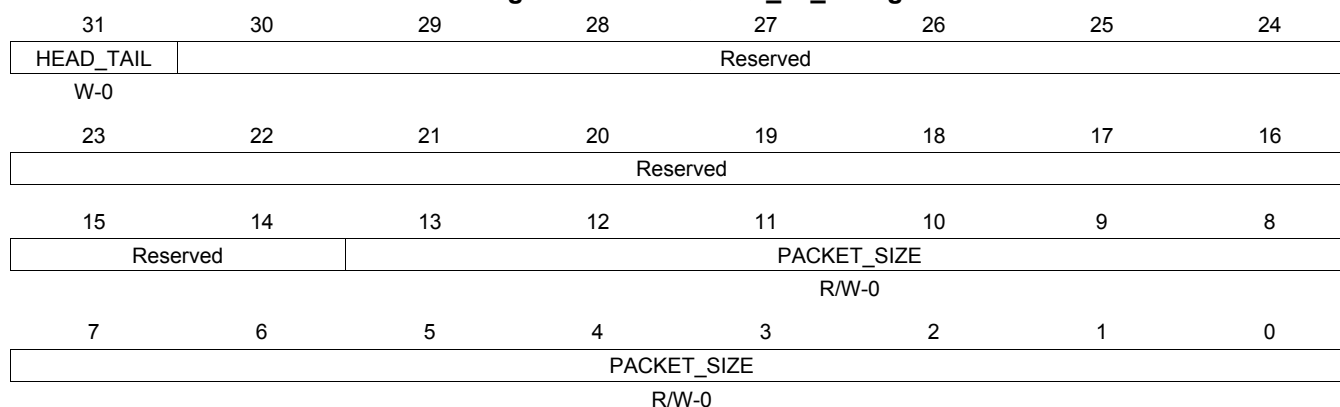

LEGEND: R/W = Read/Write; R = Read only; W1toCl = Write 1 to clear bit; -n = value after reset

Table 16-538. QUEUE_53_B Register Field Descriptions

Bit	Field	Type	Reset	Description
27-0	QUEUE_BYTE_COUNT	R-0	0	This field indicates how many bytes total are contained in all of the packets which are currently queued on this queue.

16.5.7.249 QUEUE_53_C Register (offset = 2358h) [reset = 0h]

 QUEUE_53_C is shown in [Figure 16-525](#) and described in [Table 16-539](#).

Figure 16-525. QUEUE_53_C Register


LEGEND: R/W = Read/Write; R = Read only; W1toCl = Write 1 to clear bit; -n = value after reset

Table 16-539. QUEUE_53_C Register Field Descriptions

Bit	Field	Type	Reset	Description
31	HEAD_TAIL	W-0	0	Head/Tail Push Control. Set to zero in order to push packet onto tail of queue and set to one in order to push packet onto head of queue.
13-0	PACKET_SIZE	R/W-0	0	packet_size This field indicates packet size and is assumed to be zero on each packet add unless the value is explicitly overwritten. This field indicates packet size for packet pop operation.

16.5.7.250 QUEUE_53_D Register (offset = 235Ch) [reset = 0h]

 QUEUE_53_D is shown in [Figure 16-526](#) and described in [Table 16-540](#).

Figure 16-526. QUEUE_53_D Register


LEGEND: R/W = Read/Write; R = Read only; W1toCl = Write 1 to clear bit; -n = value after reset

Table 16-540. QUEUE_53_D Register Field Descriptions

Bit	Field	Type	Reset	Description
31-5	DESC_PTR	R/W-0	0	Descriptor pointer. It will be read as zero if the queue is empty. It will indicate a 32-bit aligned address that points to a descriptor when the queue is not empty.
4-0	DESC_SIZE	R/W-0	0	Descriptor Size. It is encoded in 4-byte increments with values 0 to 31 representing 24 and so on to 148 bytes. This field will return a 0x0 when an empty queue is read. Queue Manager Queue N Registers D To save hardware resources, the queue manager internally stores descriptor size (desc_size) information in four bits. However, register D has five LSBs that specify descriptor size. As a consequence, the value of desc_size that is pushed may not be same as that is read during a pop. The value that is read back is equal to always rounded to an odd number. So, for even values, the value read back is one more than what was written. For odd values, the value read back is same as the value that was written. Note that this 5-bit field (desc_size) is unrelated to the code for size of descriptors in a descriptor region. It is just a place holder for a 5-bit value that is maintained across the push and pop operations for every descriptor managed by the queue manager.

16.5.7.251 QUEUE_54_A Register (offset = 2360h) [reset = 0h]

QUEUE_54_A is shown in [Figure 16-527](#) and described in [Table 16-541](#).

Figure 16-527. QUEUE_54_A Register

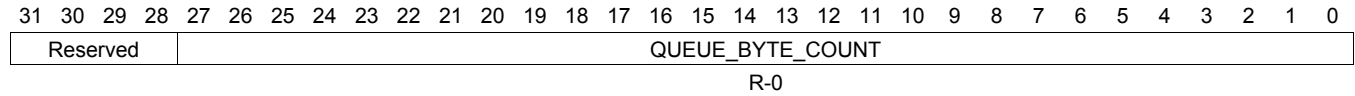

LEGEND: R/W = Read/Write; R = Read only; W1toCl = Write 1 to clear bit; -n = value after reset

Table 16-541. QUEUE_54_A Register Field Descriptions

Bit	Field	Type	Reset	Description
13-0	QUEUE_ENTRY_COUNT	R-0	0	This field indicates how many packets are currently queued on the queue. This count is incremented by 1 whenever a packet is added to the queue. This count is decremented by 1 whenever a packet is popped from the queue.

16.5.7.252 QUEUE_54_B Register (offset = 2364h) [reset = 0h]

 QUEUE_54_B is shown in [Figure 16-528](#) and described in [Table 16-542](#).

Figure 16-528. QUEUE_54_B Register


LEGEND: R/W = Read/Write; R = Read only; W1toCl = Write 1 to clear bit; -n = value after reset

Table 16-542. QUEUE_54_B Register Field Descriptions

Bit	Field	Type	Reset	Description
27-0	QUEUE_BYTE_COUNT	R-0	0	This field indicates how many bytes total are contained in all of the packets which are currently queued on this queue.

16.5.7.253 QUEUE_54_C Register (offset = 2368h) [reset = 0h]

 QUEUE_54_C is shown in [Figure 16-529](#) and described in [Table 16-543](#).

Figure 16-529. QUEUE_54_C Register

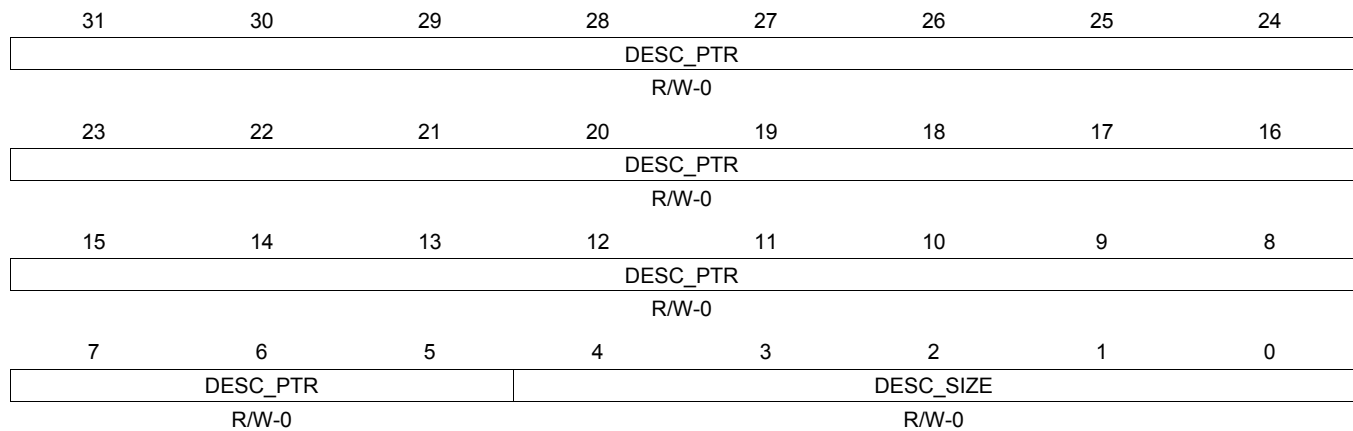

LEGEND: R/W = Read/Write; R = Read only; W1toCl = Write 1 to clear bit; -n = value after reset

Table 16-543. QUEUE_54_C Register Field Descriptions

Bit	Field	Type	Reset	Description
31	HEAD_TAIL	W-0	0	Head/Tail Push Control. Set to zero in order to push packet onto tail of queue and set to one in order to push packet onto head of queue.
13-0	PACKET_SIZE	R/W-0	0	packet_size This field indicates packet size and is assumed to be zero on each packet add unless the value is explicitly overwritten. This field indicates packet size for packet pop operation.

16.5.7.254 QUEUE_54_D Register (offset = 236Ch) [reset = 0h]

QUEUE_54_D is shown in [Figure 16-530](#) and described in [Table 16-544](#).

Figure 16-530. QUEUE_54_D Register


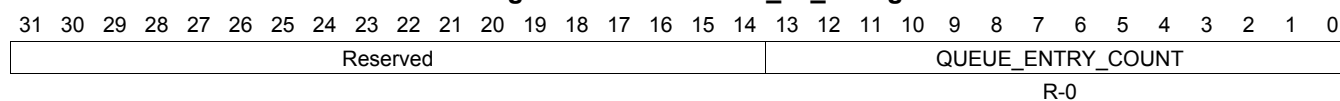
LEGEND: R/W = Read/Write; R = Read only; W1toCl = Write 1 to clear bit; -n = value after reset

Table 16-544. QUEUE_54_D Register Field Descriptions

Bit	Field	Type	Reset	Description
31-5	DESC_PTR	R/W-0	0	Descriptor pointer. It will be read as zero if the queue is empty. It will indicate a 32-bit aligned address that points to a descriptor when the queue is not empty.
4-0	DESC_SIZE	R/W-0	0	Descriptor Size. It is encoded in 4-byte increments with values 0 to 31 representing 24 and so on to 148 bytes. This field will return a 0x0 when an empty queue is read. Queue Manager Queue N Registers D To save hardware resources, the queue manager internally stores descriptor size (desc_size) information in four bits. However, register D has five LSBs that specify descriptor size. As a consequence, the value of desc_size that is pushed may not be same as that is read during a pop. The value that is read back is equal to always rounded to an odd number. So, for even values, the value read back is one more than what was written. For odd values, the value read back is same as the value that was written. Note that this 5-bit field (desc_size) is unrelated to the code for size of descriptors in a descriptor region. It is just a place holder for a 5-bit value that is maintained across the push and pop operations for every descriptor managed by the queue manager.

16.5.7.255 QUEUE_55_A Register (offset = 2370h) [reset = 0h]

QUEUE_55_A is shown in [Figure 16-531](#) and described in [Table 16-545](#).

Figure 16-531. QUEUE_55_A Register


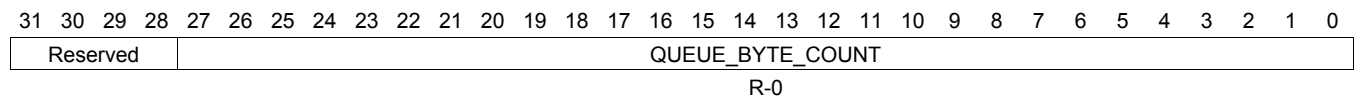
LEGEND: R/W = Read/Write; R = Read only; W1toCl = Write 1 to clear bit; -n = value after reset

Table 16-545. QUEUE_55_A Register Field Descriptions

Bit	Field	Type	Reset	Description
13-0	QUEUE_ENTRY_COUNT	R-0	0	This field indicates how many packets are currently queued on the queue. This count is incremented by 1 whenever a packet is added to the queue. This count is decremented by 1 whenever a packet is popped from the queue.

16.5.7.256 QUEUE_55_B Register (offset = 2374h) [reset = 0h]

QUEUE_55_B is shown in [Figure 16-532](#) and described in [Table 16-546](#).

Figure 16-532. QUEUE_55_B Register


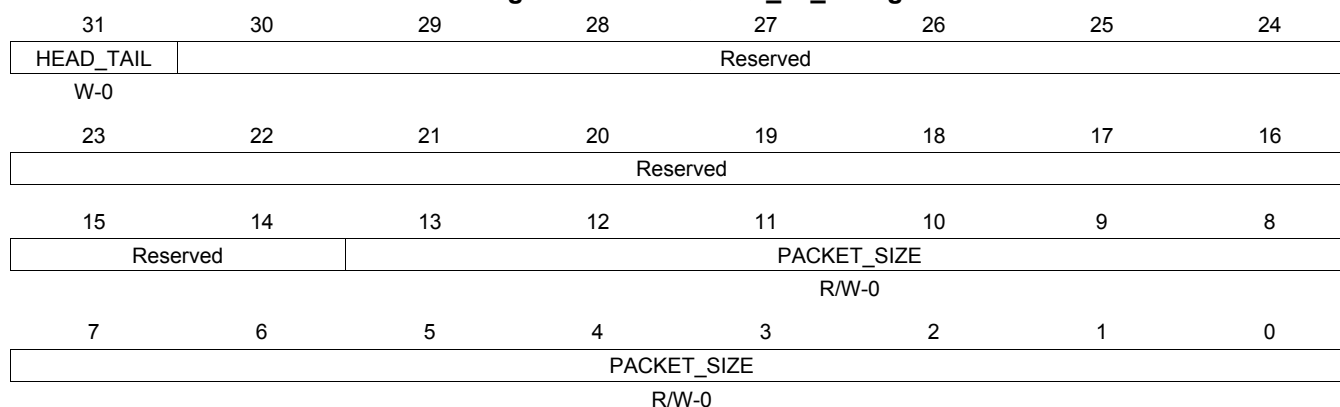
LEGEND: R/W = Read/Write; R = Read only; W1toCl = Write 1 to clear bit; -n = value after reset

Table 16-546. QUEUE_55_B Register Field Descriptions

Bit	Field	Type	Reset	Description
27-0	QUEUE_BYTE_COUNT	R-0	0	This field indicates how many bytes total are contained in all of the packets which are currently queued on this queue.

16.5.7.257 QUEUE_55_C Register (offset = 2378h) [reset = 0h]

 QUEUE_55_C is shown in [Figure 16-533](#) and described in [Table 16-547](#).

Figure 16-533. QUEUE_55_C Register


LEGEND: R/W = Read/Write; R = Read only; W1toCl = Write 1 to clear bit; -n = value after reset

Table 16-547. QUEUE_55_C Register Field Descriptions

Bit	Field	Type	Reset	Description
31	HEAD_TAIL	W-0	0	Head/Tail Push Control. Set to zero in order to push packet onto tail of queue and set to one in order to push packet onto head of queue.
13-0	PACKET_SIZE	R/W-0	0	packet_size This field indicates packet size and is assumed to be zero on each packet add unless the value is explicitly overwritten. This field indicates packet size for packet pop operation.

16.5.7.258 QUEUE_55_D Register (offset = 237Ch) [reset = 0h]

 QUEUE_55_D is shown in [Figure 16-534](#) and described in [Table 16-548](#).

Figure 16-534. QUEUE_55_D Register

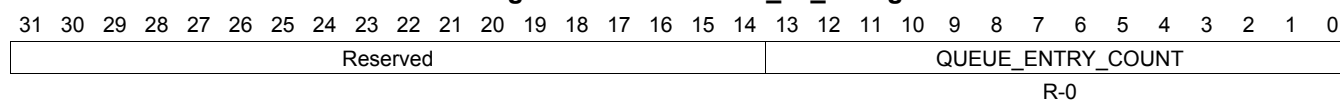

LEGEND: R/W = Read/Write; R = Read only; W1toCl = Write 1 to clear bit; -n = value after reset

Table 16-548. QUEUE_55_D Register Field Descriptions

Bit	Field	Type	Reset	Description
31-5	DESC_PTR	R/W-0	0	Descriptor pointer. It will be read as zero if the queue is empty. It will indicate a 32-bit aligned address that points to a descriptor when the queue is not empty.
4-0	DESC_SIZE	R/W-0	0	Descriptor Size. It is encoded in 4-byte increments with values 0 to 31 representing 24 and so on to 148 bytes. This field will return a 0x0 when an empty queue is read. Queue Manager Queue N Registers D To save hardware resources, the queue manager internally stores descriptor size (desc_size) information in four bits. However, register D has five LSBs that specify descriptor size. As a consequence, the value of desc_size that is pushed may not be same as that is read during a pop. The value that is read back is equal to always rounded to an odd number. So, for even values, the value read back is one more than what was written. For odd values, the value read back is same as the value that was written. Note that this 5-bit field (desc_size) is unrelated to the code for size of descriptors in a descriptor region. It is just a place holder for a 5-bit value that is maintained across the push and pop operations for every descriptor managed by the queue manager.

16.5.7.259 QUEUE_56_A Register (offset = 2380h) [reset = 0h]

QUEUE_56_A is shown in [Figure 16-535](#) and described in [Table 16-549](#).

Figure 16-535. QUEUE_56_A Register


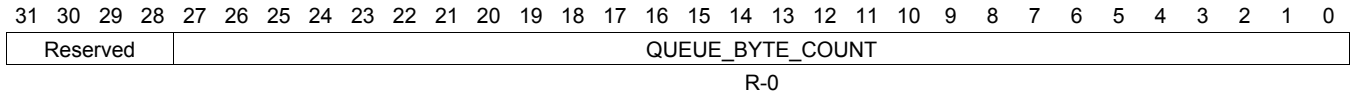
LEGEND: R/W = Read/Write; R = Read only; W1toCl = Write 1 to clear bit; -n = value after reset

Table 16-549. QUEUE_56_A Register Field Descriptions

Bit	Field	Type	Reset	Description
13-0	QUEUE_ENTRY_COUNT	R-0	0	This field indicates how many packets are currently queued on the queue. This count is incremented by 1 whenever a packet is added to the queue. This count is decremented by 1 whenever a packet is popped from the queue.

16.5.7.260 QUEUE_56_B Register (offset = 2384h) [reset = 0h]

 QUEUE_56_B is shown in [Figure 16-536](#) and described in [Table 16-550](#).

Figure 16-536. QUEUE_56_B Register


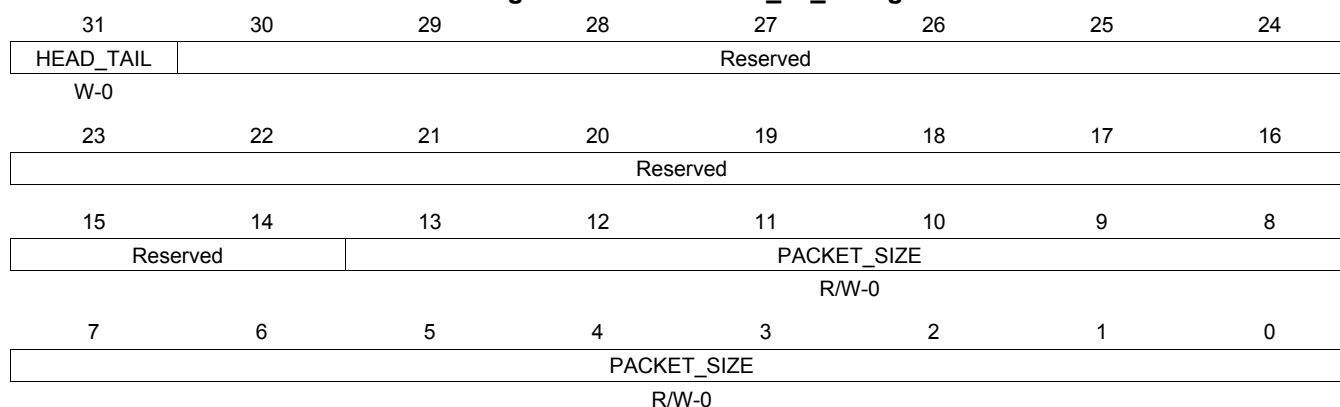
LEGEND: R/W = Read/Write; R = Read only; W1toCl = Write 1 to clear bit; -n = value after reset

Table 16-550. QUEUE_56_B Register Field Descriptions

Bit	Field	Type	Reset	Description
27-0	QUEUE_BYTE_COUNT	R-0	0	This field indicates how many bytes total are contained in all of the packets which are currently queued on this queue.

16.5.7.261 QUEUE_56_C Register (offset = 2388h) [reset = 0h]

 QUEUE_56_C is shown in [Figure 16-537](#) and described in [Table 16-551](#).

Figure 16-537. QUEUE_56_C Register


LEGEND: R/W = Read/Write; R = Read only; W1toCl = Write 1 to clear bit; -n = value after reset

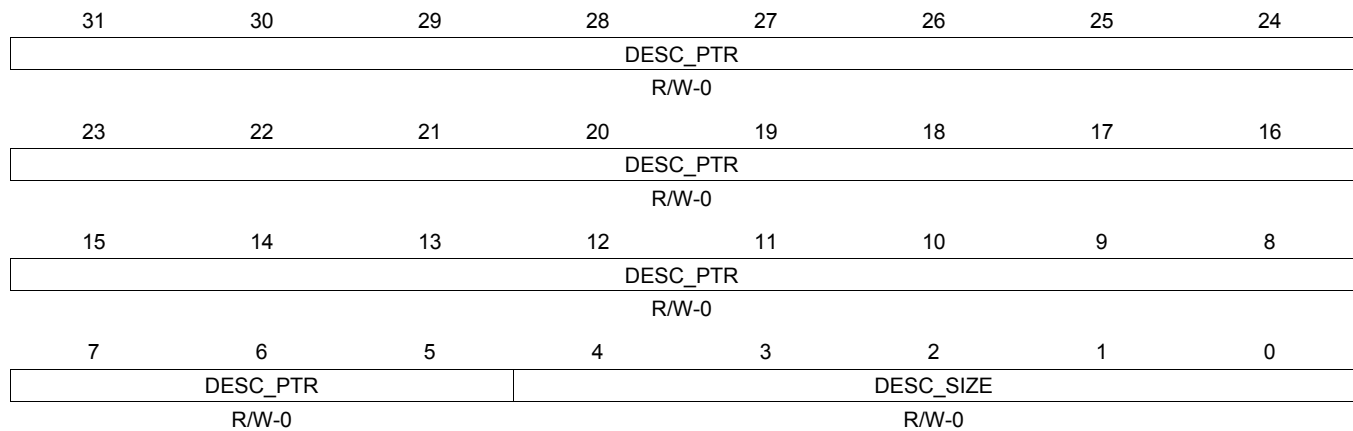
Table 16-551. QUEUE_56_C Register Field Descriptions

Bit	Field	Type	Reset	Description
31	HEAD_TAIL	W-0	0	Head/Tail Push Control. Set to zero in order to push packet onto tail of queue and set to one in order to push packet onto head of queue.
13-0	PACKET_SIZE	R/W-0	0	packet_size This field indicates packet size and is assumed to be zero on each packet add unless the value is explicitly overwritten. This field indicates packet size for packet pop operation.

16.5.7.262 QUEUE_56_D Register (offset = 238Ch) [reset = 0h]

QUEUE_56_D is shown in [Figure 16-538](#) and described in [Table 16-552](#).

Figure 16-538. QUEUE_56_D Register



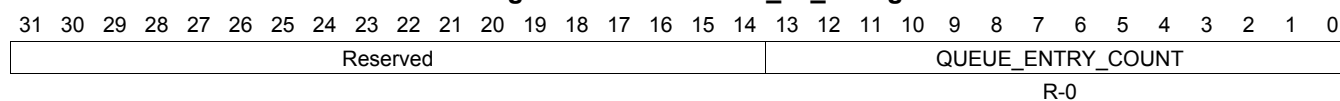
LEGEND: R/W = Read/Write; R = Read only; W1toCl = Write 1 to clear bit; -n = value after reset

Table 16-552. QUEUE_56_D Register Field Descriptions

Bit	Field	Type	Reset	Description
31-5	DESC_PTR	R/W-0	0	Descriptor pointer. It will be read as zero if the queue is empty. It will indicate a 32-bit aligned address that points to a descriptor when the queue is not empty.
4-0	DESC_SIZE	R/W-0	0	Descriptor Size. It is encoded in 4-byte increments with values 0 to 31 representing 24 and so on to 148 bytes. This field will return a 0x0 when an empty queue is read. Queue Manager Queue N Registers D To save hardware resources, the queue manager internally stores descriptor size (desc_size) information in four bits. However, register D has five LSBs that specify descriptor size. As a consequence, the value of desc_size that is pushed may not be same as that is read during a pop. The value that is read back is equal to always rounded to an odd number. So, for even values, the value read back is one more than what was written. For odd values, the value read back is same as the value that was written. Note that this 5-bit field (desc_size) is unrelated to the code for size of descriptors in a descriptor region. It is just a place holder for a 5-bit value that is maintained across the push and pop operations for every descriptor managed by the queue manager.

16.5.7.263 QUEUE_57_A Register (offset = 2390h) [reset = 0h]

QUEUE_57_A is shown in [Figure 16-539](#) and described in [Table 16-553](#).

Figure 16-539. QUEUE_57_A Register


LEGEND: R/W = Read/Write; R = Read only; W1toCl = Write 1 to clear bit; -n = value after reset

Table 16-553. QUEUE_57_A Register Field Descriptions

Bit	Field	Type	Reset	Description
13-0	QUEUE_ENTRY_COUNT	R-0	0	This field indicates how many packets are currently queued on the queue. This count is incremented by 1 whenever a packet is added to the queue. This count is decremented by 1 whenever a packet is popped from the queue.

16.5.7.264 QUEUE_57_B Register (offset = 2394h) [reset = 0h]

 QUEUE_57_B is shown in [Figure 16-540](#) and described in [Table 16-554](#).

Figure 16-540. QUEUE_57_B Register


LEGEND: R/W = Read/Write; R = Read only; W1toCl = Write 1 to clear bit; -n = value after reset

Table 16-554. QUEUE_57_B Register Field Descriptions

Bit	Field	Type	Reset	Description
27-0	QUEUE_BYTE_COUNT	R-0	0	This field indicates how many bytes total are contained in all of the packets which are currently queued on this queue.

16.5.7.265 QUEUE_57_C Register (offset = 2398h) [reset = 0h]

 QUEUE_57_C is shown in [Figure 16-541](#) and described in [Table 16-555](#).

Figure 16-541. QUEUE_57_C Register


LEGEND: R/W = Read/Write; R = Read only; W1toCl = Write 1 to clear bit; -n = value after reset

Table 16-555. QUEUE_57_C Register Field Descriptions

Bit	Field	Type	Reset	Description
31	HEAD_TAIL	W-0	0	Head/Tail Push Control. Set to zero in order to push packet onto tail of queue and set to one in order to push packet onto head of queue.
13-0	PACKET_SIZE	R/W-0	0	packet_size This field indicates packet size and is assumed to be zero on each packet add unless the value is explicitly overwritten. This field indicates packet size for packet pop operation.

16.5.7.266 QUEUE_57_D Register (offset = 239Ch) [reset = 0h]

 QUEUE_57_D is shown in [Figure 16-542](#) and described in [Table 16-556](#).

Figure 16-542. QUEUE_57_D Register

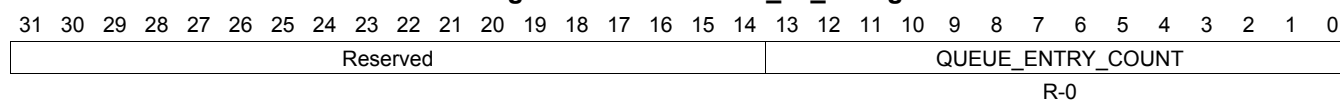

LEGEND: R/W = Read/Write; R = Read only; W1toCl = Write 1 to clear bit; -n = value after reset

Table 16-556. QUEUE_57_D Register Field Descriptions

Bit	Field	Type	Reset	Description
31-5	DESC_PTR	R/W-0	0	Descriptor pointer. It will be read as zero if the queue is empty. It will indicate a 32-bit aligned address that points to a descriptor when the queue is not empty.
4-0	DESC_SIZE	R/W-0	0	Descriptor Size. It is encoded in 4-byte increments with values 0 to 31 representing 24 and so on to 148 bytes. This field will return a 0x0 when an empty queue is read. Queue Manager Queue N Registers D To save hardware resources, the queue manager internally stores descriptor size (desc_size) information in four bits. However, register D has five LSBs that specify descriptor size. As a consequence, the value of desc_size that is pushed may not be same as that is read during a pop. The value that is read back is equal to always rounded to an odd number. So, for even values, the value read back is one more than what was written. For odd values, the value read back is same as the value that was written. Note that this 5-bit field (desc_size) is unrelated to the code for size of descriptors in a descriptor region. It is just a place holder for a 5-bit value that is maintained across the push and pop operations for every descriptor managed by the queue manager.

16.5.7.267 QUEUE_58_A Register (offset = 23A0h) [reset = 0h]

QUEUE_58_A is shown in [Figure 16-543](#) and described in [Table 16-557](#).

Figure 16-543. QUEUE_58_A Register


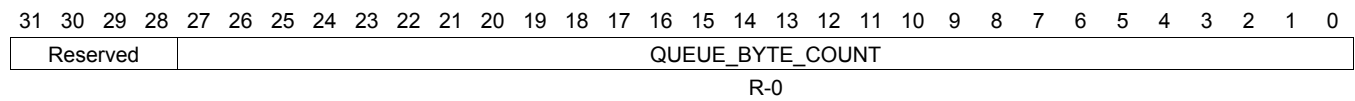
LEGEND: R/W = Read/Write; R = Read only; W1toCl = Write 1 to clear bit; -n = value after reset

Table 16-557. QUEUE_58_A Register Field Descriptions

Bit	Field	Type	Reset	Description
13-0	QUEUE_ENTRY_COUNT	R-0	0	This field indicates how many packets are currently queued on the queue. This count is incremented by 1 whenever a packet is added to the queue. This count is decremented by 1 whenever a packet is popped from the queue.

16.5.7.268 QUEUE_58_B Register (offset = 23A4h) [reset = 0h]

 QUEUE_58_B is shown in [Figure 16-544](#) and described in [Table 16-558](#).

Figure 16-544. QUEUE_58_B Register


LEGEND: R/W = Read/Write; R = Read only; W1toCl = Write 1 to clear bit; -n = value after reset

Table 16-558. QUEUE_58_B Register Field Descriptions

Bit	Field	Type	Reset	Description
27-0	QUEUE_BYTE_COUNT	R-0	0	This field indicates how many bytes total are contained in all of the packets which are currently queued on this queue.

16.5.7.269 QUEUE_58_C Register (offset = 23A8h) [reset = 0h]

 QUEUE_58_C is shown in [Figure 16-545](#) and described in [Table 16-559](#).

Figure 16-545. QUEUE_58_C Register


LEGEND: R/W = Read/Write; R = Read only; W1toCl = Write 1 to clear bit; -n = value after reset

Table 16-559. QUEUE_58_C Register Field Descriptions

Bit	Field	Type	Reset	Description
31	HEAD_TAIL	W-0	0	Head/Tail Push Control. Set to zero in order to push packet onto tail of queue and set to one in order to push packet onto head of queue.
13-0	PACKET_SIZE	R/W-0	0	packet_size This field indicates packet size and is assumed to be zero on each packet add unless the value is explicitly overwritten. This field indicates packet size for packet pop operation.

16.5.7.270 QUEUE_58_D Register (offset = 23ACh) [reset = 0h]

 QUEUE_58_D is shown in [Figure 16-546](#) and described in [Table 16-560](#).

Figure 16-546. QUEUE_58_D Register

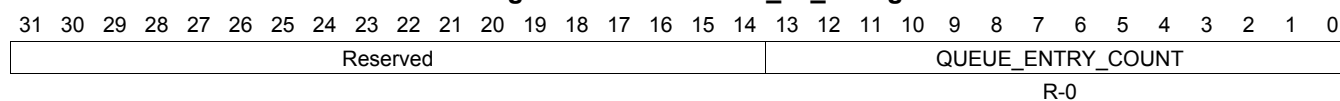

LEGEND: R/W = Read/Write; R = Read only; W1toCl = Write 1 to clear bit; -n = value after reset

Table 16-560. QUEUE_58_D Register Field Descriptions

Bit	Field	Type	Reset	Description
31-5	DESC_PTR	R/W-0	0	Descriptor pointer. It will be read as zero if the queue is empty. It will indicate a 32-bit aligned address that points to a descriptor when the queue is not empty.
4-0	DESC_SIZE	R/W-0	0	Descriptor Size. It is encoded in 4-byte increments with values 0 to 31 representing 24 and so on to 148 bytes. This field will return a 0x0 when an empty queue is read. Queue Manager Queue N Registers D To save hardware resources, the queue manager internally stores descriptor size (desc_size) information in four bits. However, register D has five LSBs that specify descriptor size. As a consequence, the value of desc_size that is pushed may not be same as that is read during a pop. The value that is read back is equal to always rounded to an odd number. So, for even values, the value read back is one more than what was written. For odd values, the value read back is same as the value that was written. Note that this 5-bit field (desc_size) is unrelated to the code for size of descriptors in a descriptor region. It is just a place holder for a 5-bit value that is maintained across the push and pop operations for every descriptor managed by the queue manager.

16.5.7.271 QUEUE_59_A Register (offset = 23B0h) [reset = 0h]

QUEUE_59_A is shown in [Figure 16-547](#) and described in [Table 16-561](#).

Figure 16-547. QUEUE_59_A Register


LEGEND: R/W = Read/Write; R = Read only; W1toCl = Write 1 to clear bit; -n = value after reset

Table 16-561. QUEUE_59_A Register Field Descriptions

Bit	Field	Type	Reset	Description
13-0	QUEUE_ENTRY_COUNT	R-0	0	This field indicates how many packets are currently queued on the queue. This count is incremented by 1 whenever a packet is added to the queue. This count is decremented by 1 whenever a packet is popped from the queue.

16.5.7.272 QUEUE_59_B Register (offset = 23B4h) [reset = 0h]

 QUEUE_59_B is shown in [Figure 16-548](#) and described in [Table 16-562](#).

Figure 16-548. QUEUE_59_B Register

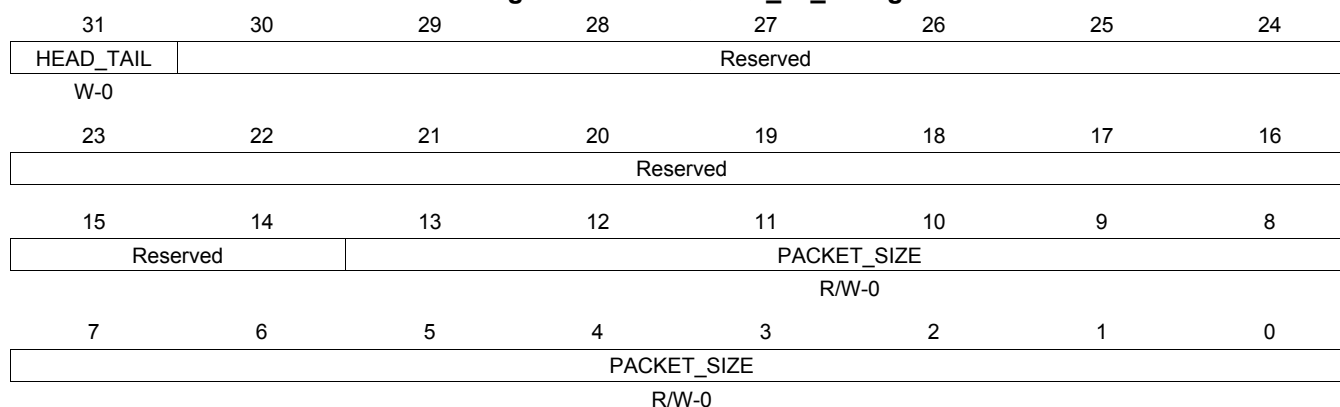

LEGEND: R/W = Read/Write; R = Read only; W1toCl = Write 1 to clear bit; -n = value after reset

Table 16-562. QUEUE_59_B Register Field Descriptions

Bit	Field	Type	Reset	Description
27-0	QUEUE_BYTE_COUNT	R-0	0	This field indicates how many bytes total are contained in all of the packets which are currently queued on this queue.

16.5.7.273 QUEUE_59_C Register (offset = 23B8h) [reset = 0h]

 QUEUE_59_C is shown in [Figure 16-549](#) and described in [Table 16-563](#).

Figure 16-549. QUEUE_59_C Register


LEGEND: R/W = Read/Write; R = Read only; W1toCl = Write 1 to clear bit; -n = value after reset

Table 16-563. QUEUE_59_C Register Field Descriptions

Bit	Field	Type	Reset	Description
31	HEAD_TAIL	W-0	0	Head/Tail Push Control. Set to zero in order to push packet onto tail of queue and set to one in order to push packet onto head of queue.
13-0	PACKET_SIZE	R/W-0	0	packet_size This field indicates packet size and is assumed to be zero on each packet add unless the value is explicitly overwritten. This field indicates packet size for packet pop operation.

16.5.7.274 QUEUE_59_D Register (offset = 23BCh) [reset = 0h]

QUEUE_59_D is shown in [Figure 16-550](#) and described in [Table 16-564](#).

Figure 16-550. QUEUE_59_D Register



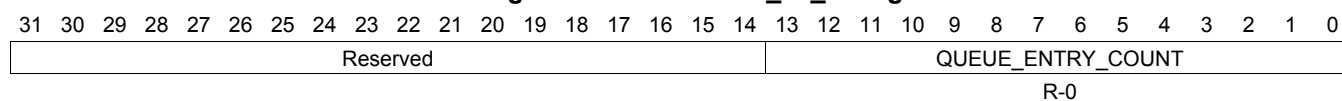
LEGEND: R/W = Read/Write; R = Read only; W1toCl = Write 1 to clear bit; -n = value after reset

Table 16-564. QUEUE_59_D Register Field Descriptions

Bit	Field	Type	Reset	Description
31-5	DESC_PTR	R/W-0	0	Descriptor pointer. It will be read as zero if the queue is empty. It will indicate a 32-bit aligned address that points to a descriptor when the queue is not empty.
4-0	DESC_SIZE	R/W-0	0	Descriptor Size. It is encoded in 4-byte increments with values 0 to 31 representing 24 and so on to 148 bytes. This field will return a 0x0 when an empty queue is read. Queue Manager Queue N Registers D To save hardware resources, the queue manager internally stores descriptor size (desc_size) information in four bits. However, register D has five LSBs that specify descriptor size. As a consequence, the value of desc_size that is pushed may not be same as that is read during a pop. The value that is read back is equal to always rounded to an odd number. So, for even values, the value read back is one more than what was written. For odd values, the value read back is same as the value that was written. Note that this 5-bit field (desc_size) is unrelated to the code for size of descriptors in a descriptor region. It is just a place holder for a 5-bit value that is maintained across the push and pop operations for every descriptor managed by the queue manager.

16.5.7.275 QUEUE_60_A Register (offset = 23C0h) [reset = 0h]

QUEUE_60_A is shown in [Figure 16-551](#) and described in [Table 16-565](#).

Figure 16-551. QUEUE_60_A Register


LEGEND: R/W = Read/Write; R = Read only; W1toCl = Write 1 to clear bit; -n = value after reset

Table 16-565. QUEUE_60_A Register Field Descriptions

Bit	Field	Type	Reset	Description
13-0	QUEUE_ENTRY_COUNT	R-0	0	This field indicates how many packets are currently queued on the queue. This count is incremented by 1 whenever a packet is added to the queue. This count is decremented by 1 whenever a packet is popped from the queue.

16.5.7.276 QUEUE_60_B Register (offset = 23C4h) [reset = 0h]

 QUEUE_60_B is shown in [Figure 16-552](#) and described in [Table 16-566](#).

Figure 16-552. QUEUE_60_B Register

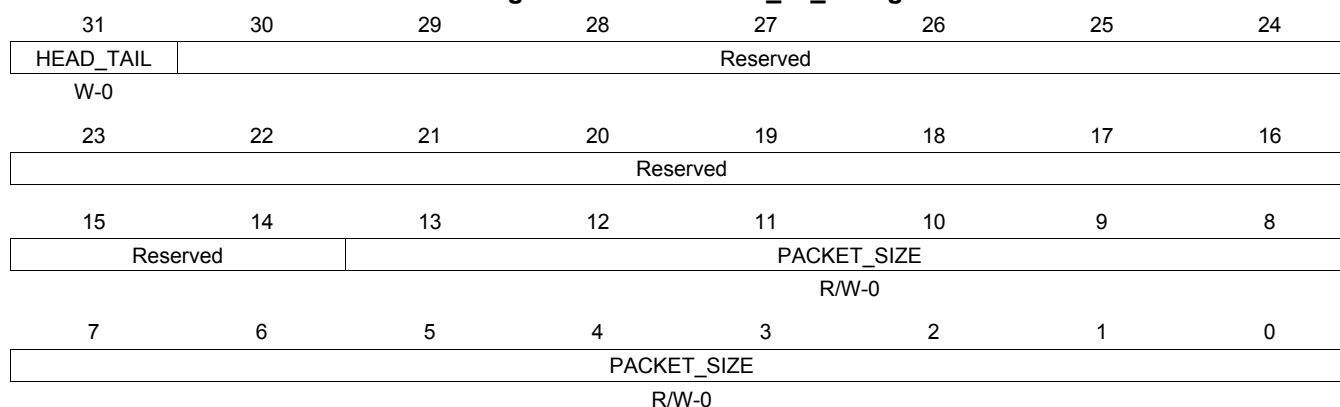

LEGEND: R/W = Read/Write; R = Read only; W1toCl = Write 1 to clear bit; -n = value after reset

Table 16-566. QUEUE_60_B Register Field Descriptions

Bit	Field	Type	Reset	Description
27-0	QUEUE_BYTE_COUNT	R-0	0	This field indicates how many bytes total are contained in all of the packets which are currently queued on this queue.

16.5.7.277 QUEUE_60_C Register (offset = 23C8h) [reset = 0h]

 QUEUE_60_C is shown in [Figure 16-553](#) and described in [Table 16-567](#).

Figure 16-553. QUEUE_60_C Register


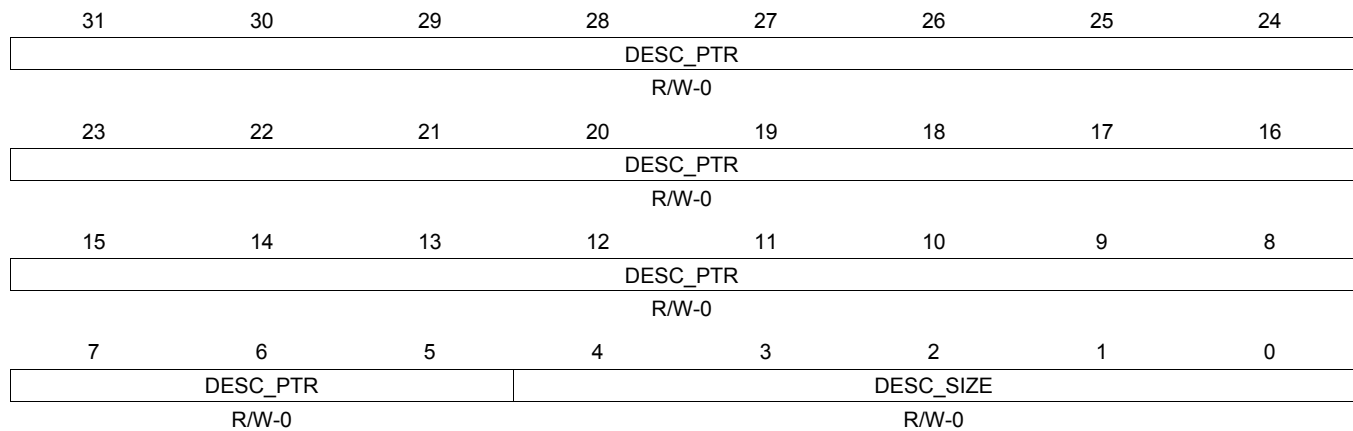
LEGEND: R/W = Read/Write; R = Read only; W1toCl = Write 1 to clear bit; -n = value after reset

Table 16-567. QUEUE_60_C Register Field Descriptions

Bit	Field	Type	Reset	Description
31	HEAD_TAIL	W-0	0	Head/Tail Push Control. Set to zero in order to push packet onto tail of queue and set to one in order to push packet onto head of queue.
13-0	PACKET_SIZE	R/W-0	0	packet_size This field indicates packet size and is assumed to be zero on each packet add unless the value is explicitly overwritten. This field indicates packet size for packet pop operation.

16.5.7.278 QUEUE_60_D Register (offset = 23CCh) [reset = 0h]

QUEUE_60_D is shown in [Figure 16-554](#) and described in [Table 16-568](#).

Figure 16-554. QUEUE_60_D Register


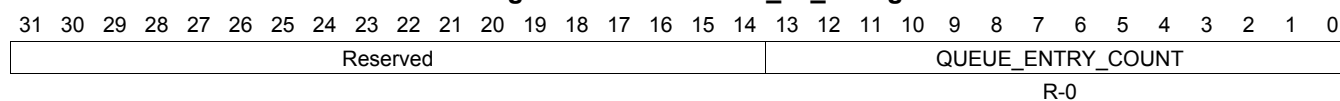
LEGEND: R/W = Read/Write; R = Read only; W1toCl = Write 1 to clear bit; -n = value after reset

Table 16-568. QUEUE_60_D Register Field Descriptions

Bit	Field	Type	Reset	Description
31-5	DESC_PTR	R/W-0	0	Descriptor pointer. It will be read as zero if the queue is empty. It will indicate a 32-bit aligned address that points to a descriptor when the queue is not empty.
4-0	DESC_SIZE	R/W-0	0	Descriptor Size. It is encoded in 4-byte increments with values 0 to 31 representing 24 and so on to 148 bytes. This field will return a 0x0 when an empty queue is read. Queue Manager Queue N Registers D To save hardware resources, the queue manager internally stores descriptor size (desc_size) information in four bits. However, register D has five LSBs that specify descriptor size. As a consequence, the value of desc_size that is pushed may not be same as that is read during a pop. The value that is read back is equal to always rounded to an odd number. So, for even values, the value read back is one more than what was written. For odd values, the value read back is same as the value that was written. Note that this 5-bit field (desc_size) is unrelated to the code for size of descriptors in a descriptor region. It is just a place holder for a 5-bit value that is maintained across the push and pop operations for every descriptor managed by the queue manager.

16.5.7.279 QUEUE_61_A Register (offset = 23D0h) [reset = 0h]

QUEUE_61_A is shown in [Figure 16-555](#) and described in [Table 16-569](#).

Figure 16-555. QUEUE_61_A Register


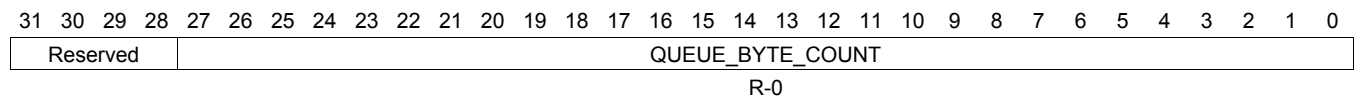
LEGEND: R/W = Read/Write; R = Read only; W1toCl = Write 1 to clear bit; -n = value after reset

Table 16-569. QUEUE_61_A Register Field Descriptions

Bit	Field	Type	Reset	Description
13-0	QUEUE_ENTRY_COUNT	R-0	0	This field indicates how many packets are currently queued on the queue. This count is incremented by 1 whenever a packet is added to the queue. This count is decremented by 1 whenever a packet is popped from the queue.

16.5.7.280 QUEUE_61_B Register (offset = 23D4h) [reset = 0h]

 QUEUE_61_B is shown in [Figure 16-556](#) and described in [Table 16-570](#).

Figure 16-556. QUEUE_61_B Register


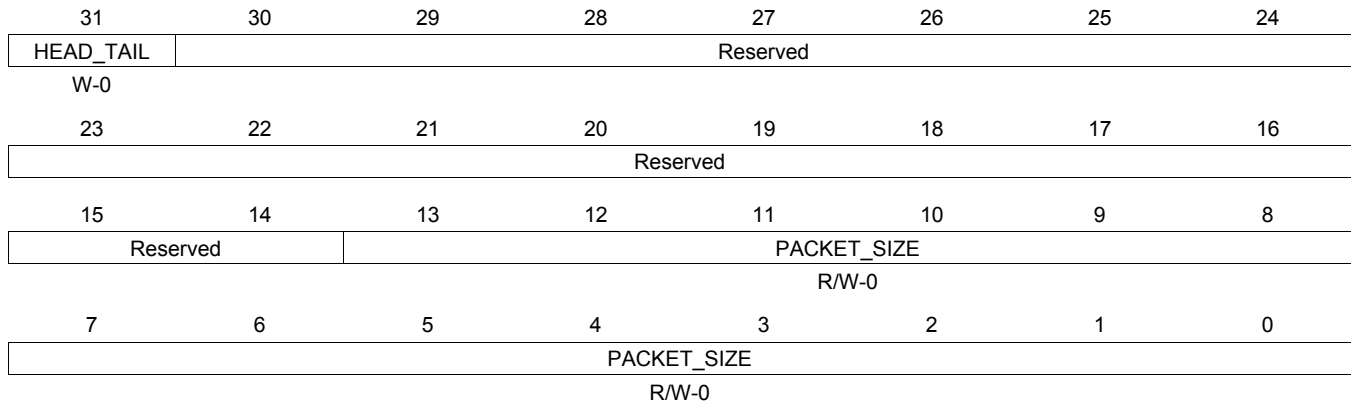
LEGEND: R/W = Read/Write; R = Read only; W1toCl = Write 1 to clear bit; -n = value after reset

Table 16-570. QUEUE_61_B Register Field Descriptions

Bit	Field	Type	Reset	Description
27-0	QUEUE_BYTE_COUNT	R-0	0	This field indicates how many bytes total are contained in all of the packets which are currently queued on this queue.

16.5.7.281 QUEUE_61_C Register (offset = 23D8h) [reset = 0h]

 QUEUE_61_C is shown in [Figure 16-557](#) and described in [Table 16-571](#).

Figure 16-557. QUEUE_61_C Register


LEGEND: R/W = Read/Write; R = Read only; W1toCl = Write 1 to clear bit; -n = value after reset

Table 16-571. QUEUE_61_C Register Field Descriptions

Bit	Field	Type	Reset	Description
31	HEAD_TAIL	W-0	0	Head/Tail Push Control. Set to zero in order to push packet onto tail of queue and set to one in order to push packet onto head of queue.
13-0	PACKET_SIZE	R/W-0	0	packet_size This field indicates packet size and is assumed to be zero on each packet add unless the value is explicitly overwritten. This field indicates packet size for packet pop operation.

16.5.7.282 QUEUE_61_D Register (offset = 23DCh) [reset = 0h]

 QUEUE_61_D is shown in [Figure 16-558](#) and described in [Table 16-572](#).

Figure 16-558. QUEUE_61_D Register


LEGEND: R/W = Read/Write; R = Read only; W1toCl = Write 1 to clear bit; -n = value after reset

Table 16-572. QUEUE_61_D Register Field Descriptions

Bit	Field	Type	Reset	Description
31-5	DESC_PTR	R/W-0	0	Descriptor pointer. It will be read as zero if the queue is empty. It will indicate a 32-bit aligned address that points to a descriptor when the queue is not empty.
4-0	DESC_SIZE	R/W-0	0	Descriptor Size. It is encoded in 4-byte increments with values 0 to 31 representing 24 and so on to 148 bytes. This field will return a 0x0 when an empty queue is read. Queue Manager Queue N Registers D To save hardware resources, the queue manager internally stores descriptor size (desc_size) information in four bits. However, register D has five LSBs that specify descriptor size. As a consequence, the value of desc_size that is pushed may not be same as that is read during a pop. The value that is read back is equal to always rounded to an odd number. So, for even values, the value read back is one more than what was written. For odd values, the value read back is same as the value that was written. Note that this 5-bit field (desc_size) is unrelated to the code for size of descriptors in a descriptor region. It is just a place holder for a 5-bit value that is maintained across the push and pop operations for every descriptor managed by the queue manager.

16.5.7.283 QUEUE_62_A Register (offset = 23E0h) [reset = 0h]

QUEUE_62_A is shown in [Figure 16-559](#) and described in [Table 16-573](#).

Figure 16-559. QUEUE_62_A Register


LEGEND: R/W = Read/Write; R = Read only; W1toCl = Write 1 to clear bit; -n = value after reset

Table 16-573. QUEUE_62_A Register Field Descriptions

Bit	Field	Type	Reset	Description
13-0	QUEUE_ENTRY_COUNT	R-0	0	This field indicates how many packets are currently queued on the queue. This count is incremented by 1 whenever a packet is added to the queue. This count is decremented by 1 whenever a packet is popped from the queue.

16.5.7.284 QUEUE_62_B Register (offset = 23E4h) [reset = 0h]

QUEUE_62_B is shown in [Figure 16-560](#) and described in [Table 16-574](#).

Figure 16-560. QUEUE_62_B Register

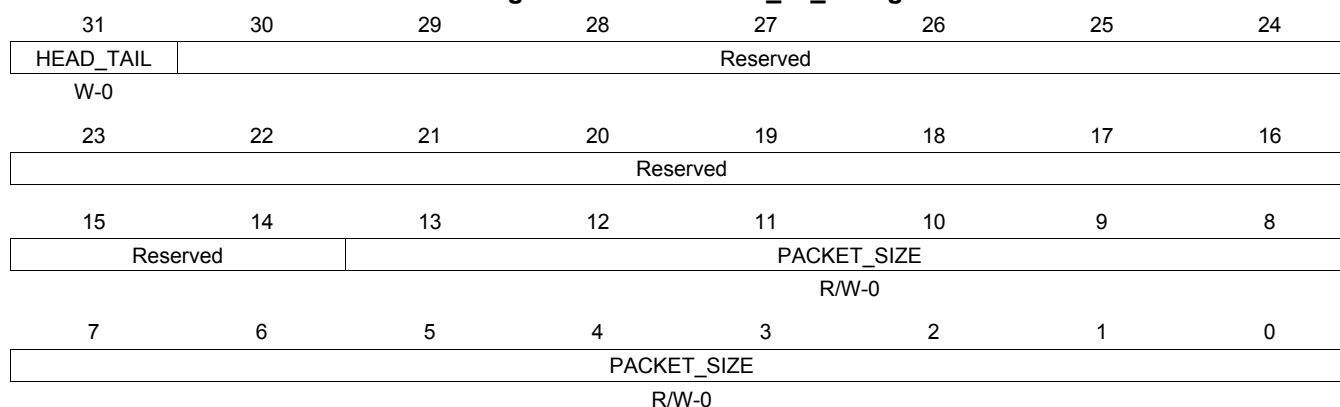

LEGEND: R/W = Read/Write; R = Read only; W1toCl = Write 1 to clear bit; -n = value after reset

Table 16-574. QUEUE_62_B Register Field Descriptions

Bit	Field	Type	Reset	Description
27-0	QUEUE_BYTE_COUNT	R-0	0	This field indicates how many bytes total are contained in all of the packets which are currently queued on this queue.

16.5.7.285 QUEUE_62_C Register (offset = 23E8h) [reset = 0h]

 QUEUE_62_C is shown in [Figure 16-561](#) and described in [Table 16-575](#).

Figure 16-561. QUEUE_62_C Register


LEGEND: R/W = Read/Write; R = Read only; W1toCl = Write 1 to clear bit; -n = value after reset

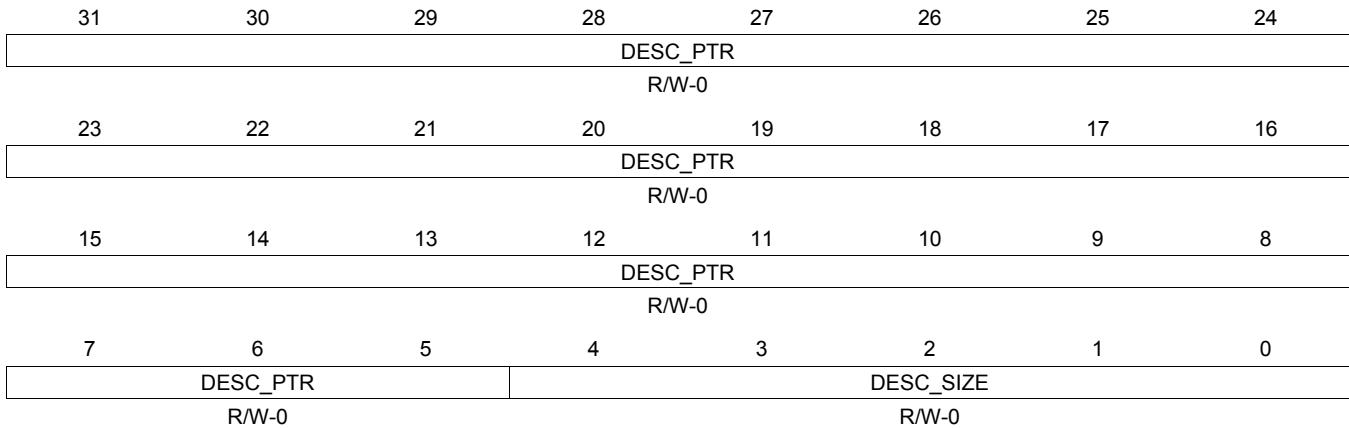
Table 16-575. QUEUE_62_C Register Field Descriptions

Bit	Field	Type	Reset	Description
31	HEAD_TAIL	W-0	0	Head/Tail Push Control. Set to zero in order to push packet onto tail of queue and set to one in order to push packet onto head of queue.
13-0	PACKET_SIZE	R/W-0	0	packet_size This field indicates packet size and is assumed to be zero on each packet add unless the value is explicitly overwritten. This field indicates packet size for packet pop operation.

16.5.7.286 QUEUE_62_D Register (offset = 23ECh) [reset = 0h]

QUEUE_62_D is shown in [Figure 16-562](#) and described in [Table 16-576](#).

Figure 16-562. QUEUE_62_D Register



LEGEND: R/W = Read/Write; R = Read only; W1toCl = Write 1 to clear bit; -n = value after reset

Table 16-576. QUEUE_62_D Register Field Descriptions

Bit	Field	Type	Reset	Description
31-5	DESC_PTR	R/W-0	0	Descriptor pointer. It will be read as zero if the queue is empty. It will indicate a 32-bit aligned address that points to a descriptor when the queue is not empty.
4-0	DESC_SIZE	R/W-0	0	Descriptor Size. It is encoded in 4-byte increments with values 0 to 31 representing 24 and so on to 148 bytes. This field will return a 0x0 when an empty queue is read. Queue Manager Queue N Registers D To save hardware resources, the queue manager internally stores descriptor size (desc_size) information in four bits. However, register D has five LSBs that specify descriptor size. As a consequence, the value of desc_size that is pushed may not be same as that is read during a pop. The value that is read back is equal to always rounded to an odd number. So, for even values, the value read back is one more than what was written. For odd values, the value read back is same as the value that was written. Note that this 5-bit field (desc_size) is unrelated to the code for size of descriptors in a descriptor region. It is just a place holder for a 5-bit value that is maintained across the push and pop operations for every descriptor managed by the queue manager.

16.5.7.287 QUEUE_63_A Register (offset = 23F0h) [reset = 0h]

QUEUE_63_A is shown in [Figure 16-563](#) and described in [Table 16-577](#).

Figure 16-563. QUEUE_63_A Register

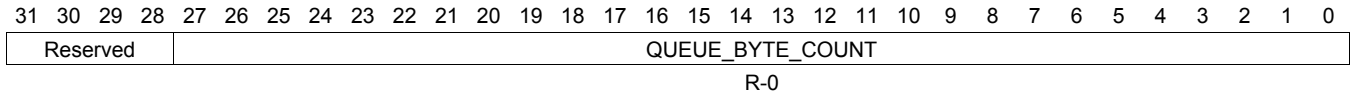

LEGEND: R/W = Read/Write; R = Read only; W1toCl = Write 1 to clear bit; -n = value after reset

Table 16-577. QUEUE_63_A Register Field Descriptions

Bit	Field	Type	Reset	Description
13-0	QUEUE_ENTRY_COUNT	R-0	0	This field indicates how many packets are currently queued on the queue. This count is incremented by 1 whenever a packet is added to the queue. This count is decremented by 1 whenever a packet is popped from the queue.

16.5.7.288 QUEUE_63_B Register (offset = 23F4h) [reset = 0h]

 QUEUE_63_B is shown in [Figure 16-564](#) and described in [Table 16-578](#).

Figure 16-564. QUEUE_63_B Register


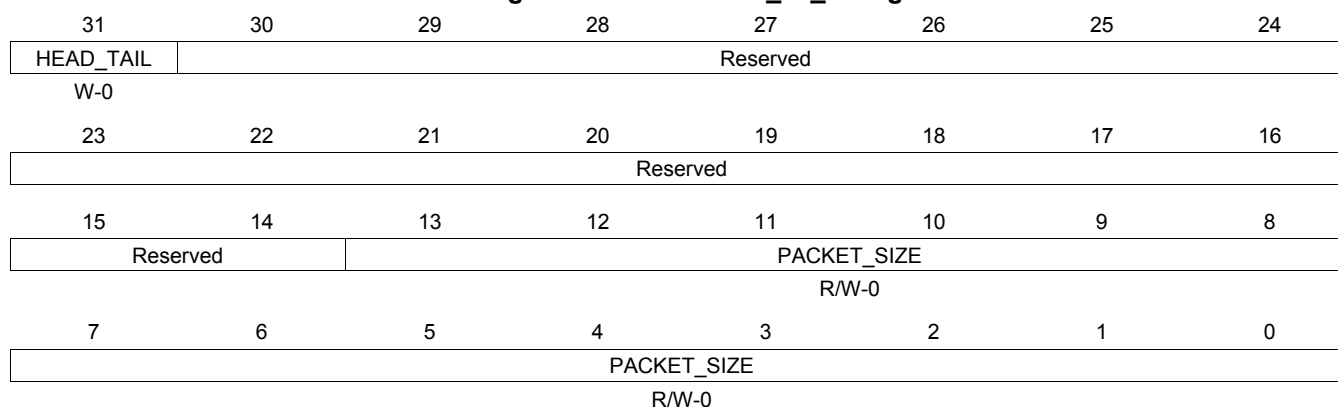
LEGEND: R/W = Read/Write; R = Read only; W1toCl = Write 1 to clear bit; -n = value after reset

Table 16-578. QUEUE_63_B Register Field Descriptions

Bit	Field	Type	Reset	Description
27-0	QUEUE_BYTE_COUNT	R-0	0	This field indicates how many bytes total are contained in all of the packets which are currently queued on this queue.

16.5.7.289 QUEUE_63_C Register (offset = 23F8h) [reset = 0h]

 QUEUE_63_C is shown in [Figure 16-565](#) and described in [Table 16-579](#).

Figure 16-565. QUEUE_63_C Register


LEGEND: R/W = Read/Write; R = Read only; W1toCl = Write 1 to clear bit; -n = value after reset

Table 16-579. QUEUE_63_C Register Field Descriptions

Bit	Field	Type	Reset	Description
31	HEAD_TAIL	W-0	0	Head/Tail Push Control. Set to zero in order to push packet onto tail of queue and set to one in order to push packet onto head of queue.
13-0	PACKET_SIZE	R/W-0	0	packet_size This field indicates packet size and is assumed to be zero on each packet add unless the value is explicitly overwritten. This field indicates packet size for packet pop operation.

16.5.7.290 QUEUE_63_D Register (offset = 23FCh) [reset = 0h]

QUEUE_63_D is shown in [Figure 16-566](#) and described in [Table 16-580](#).

Figure 16-566. QUEUE_63_D Register



LEGEND: R/W = Read/Write; R = Read only; W1toCl = Write 1 to clear bit; -n = value after reset

Table 16-580. QUEUE_63_D Register Field Descriptions

Bit	Field	Type	Reset	Description
31-5	DESC_PTR	R/W-0	0	Descriptor pointer. It will be read as zero if the queue is empty. It will indicate a 32-bit aligned address that points to a descriptor when the queue is not empty.
4-0	DESC_SIZE	R/W-0	0	Descriptor Size. It is encoded in 4-byte increments with values 0 to 31 representing 24 and so on to 148 bytes. This field will return a 0x0 when an empty queue is read. Queue Manager Queue N Registers D To save hardware resources, the queue manager internally stores descriptor size (desc_size) information in four bits. However, register D has five LSBs that specify descriptor size. As a consequence, the value of desc_size that is pushed may not be same as that is read during a pop. The value that is read back is equal to always rounded to an odd number. So, for even values, the value read back is one more than what was written. For odd values, the value read back is same as the value that was written. Note that this 5-bit field (desc_size) is unrelated to the code for size of descriptors in a descriptor region. It is just a place holder for a 5-bit value that is maintained across the push and pop operations for every descriptor managed by the queue manager.

16.5.7.291 QUEUE_64_A Register (offset = 2400h) [reset = 0h]

QUEUE_64_A is shown in [Figure 16-567](#) and described in [Table 16-581](#).

Figure 16-567. QUEUE_64_A Register

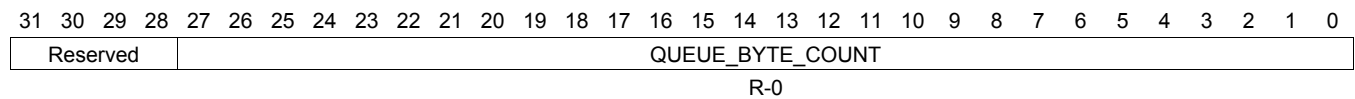

LEGEND: R/W = Read/Write; R = Read only; W1toCl = Write 1 to clear bit; -n = value after reset

Table 16-581. QUEUE_64_A Register Field Descriptions

Bit	Field	Type	Reset	Description
13-0	QUEUE_ENTRY_COUNT	R-0	0	This field indicates how many packets are currently queued on the queue. This count is incremented by 1 whenever a packet is added to the queue. This count is decremented by 1 whenever a packet is popped from the queue.

16.5.7.292 QUEUE_64_B Register (offset = 2404h) [reset = 0h]

 QUEUE_64_B is shown in [Figure 16-568](#) and described in [Table 16-582](#).

Figure 16-568. QUEUE_64_B Register


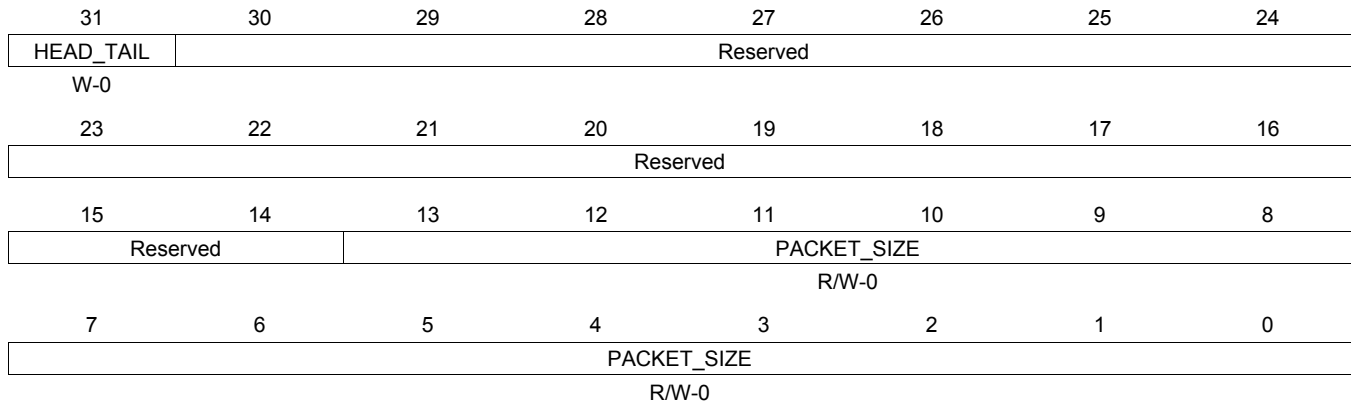
LEGEND: R/W = Read/Write; R = Read only; W1toCl = Write 1 to clear bit; -n = value after reset

Table 16-582. QUEUE_64_B Register Field Descriptions

Bit	Field	Type	Reset	Description
27-0	QUEUE_BYTE_COUNT	R-0	0	This field indicates how many bytes total are contained in all of the packets which are currently queued on this queue.

16.5.7.293 QUEUE_64_C Register (offset = 2408h) [reset = 0h]

 QUEUE_64_C is shown in [Figure 16-569](#) and described in [Table 16-583](#).

Figure 16-569. QUEUE_64_C Register


LEGEND: R/W = Read/Write; R = Read only; W1toCl = Write 1 to clear bit; -n = value after reset

Table 16-583. QUEUE_64_C Register Field Descriptions

Bit	Field	Type	Reset	Description
31	HEAD_TAIL	W-0	0	Head/Tail Push Control. Set to zero in order to push packet onto tail of queue and set to one in order to push packet onto head of queue.
13-0	PACKET_SIZE	R/W-0	0	packet_size This field indicates packet size and is assumed to be zero on each packet add unless the value is explicitly overwritten. This field indicates packet size for packet pop operation.

16.5.7.294 QUEUE_64_D Register (offset = 240Ch) [reset = 0h]

QUEUE_64_D is shown in [Figure 16-570](#) and described in [Table 16-584](#).

Figure 16-570. QUEUE_64_D Register



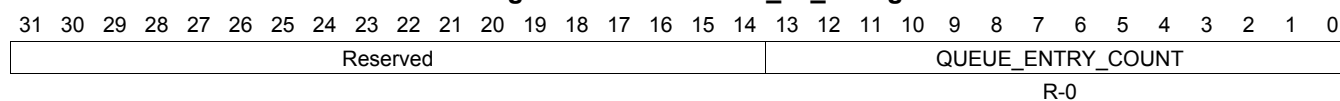
LEGEND: R/W = Read/Write; R = Read only; W1toCl = Write 1 to clear bit; -n = value after reset

Table 16-584. QUEUE_64_D Register Field Descriptions

Bit	Field	Type	Reset	Description
31-5	DESC_PTR	R/W-0	0	Descriptor pointer. It will be read as zero if the queue is empty. It will indicate a 32-bit aligned address that points to a descriptor when the queue is not empty.
4-0	DESC_SIZE	R/W-0	0	Descriptor Size. It is encoded in 4-byte increments with values 0 to 31 representing 24 and so on to 148 bytes. This field will return a 0x0 when an empty queue is read. Queue Manager Queue N Registers D To save hardware resources, the queue manager internally stores descriptor size (desc_size) information in four bits. However, register D has five LSBs that specify descriptor size. As a consequence, the value of desc_size that is pushed may not be same as that is read during a pop. The value that is read back is equal to always rounded to an odd number. So, for even values, the value read back is one more than what was written. For odd values, the value read back is same as the value that was written. Note that this 5-bit field (desc_size) is unrelated to the code for size of descriptors in a descriptor region. It is just a place holder for a 5-bit value that is maintained across the push and pop operations for every descriptor managed by the queue manager.

16.5.7.295 QUEUE_65_A Register (offset = 2410h) [reset = 0h]

QUEUE_65_A is shown in [Figure 16-571](#) and described in [Table 16-585](#).

Figure 16-571. QUEUE_65_A Register


LEGEND: R/W = Read/Write; R = Read only; W1toCl = Write 1 to clear bit; -n = value after reset

Table 16-585. QUEUE_65_A Register Field Descriptions

Bit	Field	Type	Reset	Description
13-0	QUEUE_ENTRY_COUNT	R-0	0	This field indicates how many packets are currently queued on the queue. This count is incremented by 1 whenever a packet is added to the queue. This count is decremented by 1 whenever a packet is popped from the queue.

16.5.7.296 QUEUE_65_B Register (offset = 2414h) [reset = 0h]

 QUEUE_65_B is shown in [Figure 16-572](#) and described in [Table 16-586](#).

Figure 16-572. QUEUE_65_B Register

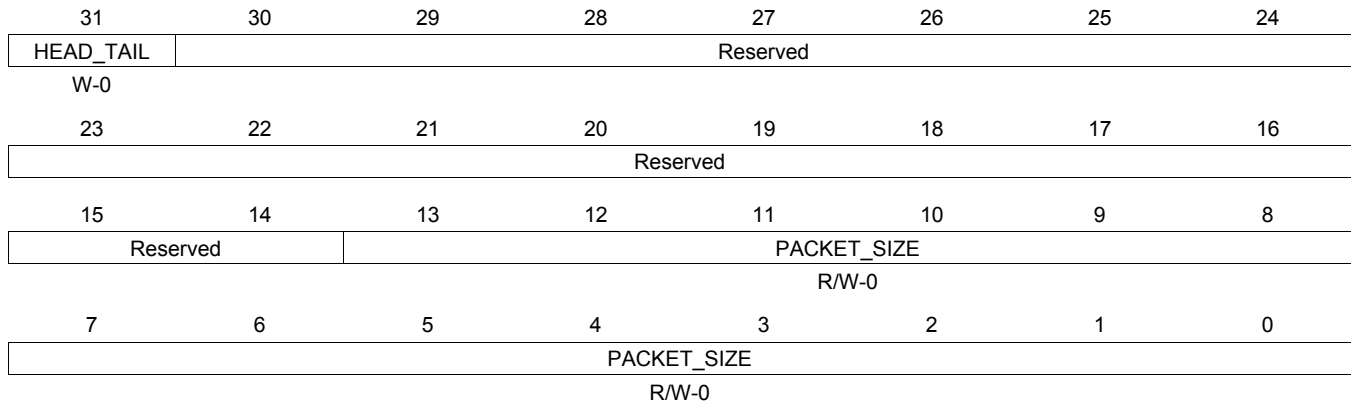

LEGEND: R/W = Read/Write; R = Read only; W1toCl = Write 1 to clear bit; -n = value after reset

Table 16-586. QUEUE_65_B Register Field Descriptions

Bit	Field	Type	Reset	Description
27-0	QUEUE_BYTE_COUNT	R-0	0	This field indicates how many bytes total are contained in all of the packets which are currently queued on this queue.

16.5.7.297 QUEUE_65_C Register (offset = 2418h) [reset = 0h]

 QUEUE_65_C is shown in [Figure 16-573](#) and described in [Table 16-587](#).

Figure 16-573. QUEUE_65_C Register


LEGEND: R/W = Read/Write; R = Read only; W1toCl = Write 1 to clear bit; -n = value after reset

Table 16-587. QUEUE_65_C Register Field Descriptions

Bit	Field	Type	Reset	Description
31	HEAD_TAIL	W-0	0	Head/Tail Push Control. Set to zero in order to push packet onto tail of queue and set to one in order to push packet onto head of queue.
13-0	PACKET_SIZE	R/W-0	0	packet_size This field indicates packet size and is assumed to be zero on each packet add unless the value is explicitly overwritten. This field indicates packet size for packet pop operation.

16.5.7.298 QUEUE_65_D Register (offset = 241Ch) [reset = 0h]

 QUEUE_65_D is shown in [Figure 16-574](#) and described in [Table 16-588](#).

Figure 16-574. QUEUE_65_D Register


LEGEND: R/W = Read/Write; R = Read only; W1toCl = Write 1 to clear bit; -n = value after reset

Table 16-588. QUEUE_65_D Register Field Descriptions

Bit	Field	Type	Reset	Description
31-5	DESC_PTR	R/W-0	0	Descriptor pointer. It will be read as zero if the queue is empty. It will indicate a 32-bit aligned address that points to a descriptor when the queue is not empty.
4-0	DESC_SIZE	R/W-0	0	Descriptor Size. It is encoded in 4-byte increments with values 0 to 31 representing 24 and so on to 148 bytes. This field will return a 0x0 when an empty queue is read. Queue Manager Queue N Registers D To save hardware resources, the queue manager internally stores descriptor size (desc_size) information in four bits. However, register D has five LSBs that specify descriptor size. As a consequence, the value of desc_size that is pushed may not be same as that is read during a pop. The value that is read back is equal to always rounded to an odd number. So, for even values, the value read back is one more than what was written. For odd values, the value read back is same as the value that was written. Note that this 5-bit field (desc_size) is unrelated to the code for size of descriptors in a descriptor region. It is just a place holder for a 5-bit value that is maintained across the push and pop operations for every descriptor managed by the queue manager.

16.5.7.299 QUEUE_66_A Register (offset = 2420h) [reset = 0h]

QUEUE_66_A is shown in [Figure 16-575](#) and described in [Table 16-589](#).

Figure 16-575. QUEUE_66_A Register

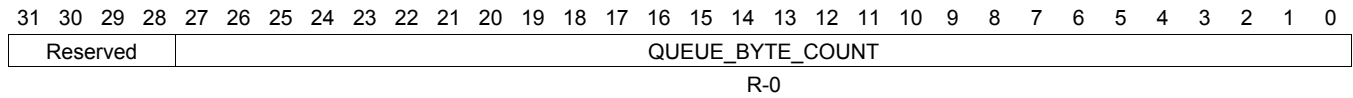

LEGEND: R/W = Read/Write; R = Read only; W1toCl = Write 1 to clear bit; -n = value after reset

Table 16-589. QUEUE_66_A Register Field Descriptions

Bit	Field	Type	Reset	Description
13-0	QUEUE_ENTRY_COUNT	R-0	0	This field indicates how many packets are currently queued on the queue. This count is incremented by 1 whenever a packet is added to the queue. This count is decremented by 1 whenever a packet is popped from the queue.

16.5.7.300 QUEUE_66_B Register (offset = 2424h) [reset = 0h]

QUEUE_66_B is shown in [Figure 16-576](#) and described in [Table 16-590](#).

Figure 16-576. QUEUE_66_B Register


LEGEND: R/W = Read/Write; R = Read only; W1toCl = Write 1 to clear bit; -n = value after reset

Table 16-590. QUEUE_66_B Register Field Descriptions

Bit	Field	Type	Reset	Description
27-0	QUEUE_BYTE_COUNT	R-0	0	This field indicates how many bytes total are contained in all of the packets which are currently queued on this queue.

16.5.7.301 QUEUE_66_C Register (offset = 2428h) [reset = 0h]

 QUEUE_66_C is shown in [Figure 16-577](#) and described in [Table 16-591](#).

Figure 16-577. QUEUE_66_C Register


LEGEND: R/W = Read/Write; R = Read only; W1toCl = Write 1 to clear bit; -n = value after reset

Table 16-591. QUEUE_66_C Register Field Descriptions

Bit	Field	Type	Reset	Description
31	HEAD_TAIL	W-0	0	Head/Tail Push Control. Set to zero in order to push packet onto tail of queue and set to one in order to push packet onto head of queue.
13-0	PACKET_SIZE	R/W-0	0	packet_size This field indicates packet size and is assumed to be zero on each packet add unless the value is explicitly overwritten. This field indicates packet size for packet pop operation.

16.5.7.302 QUEUE_66_D Register (offset = 242Ch) [reset = 0h]

 QUEUE_66_D is shown in [Figure 16-578](#) and described in [Table 16-592](#).

Figure 16-578. QUEUE_66_D Register


LEGEND: R/W = Read/Write; R = Read only; W1toCl = Write 1 to clear bit; -n = value after reset

Table 16-592. QUEUE_66_D Register Field Descriptions

Bit	Field	Type	Reset	Description
31-5	DESC_PTR	R/W-0	0	Descriptor pointer. It will be read as zero if the queue is empty. It will indicate a 32-bit aligned address that points to a descriptor when the queue is not empty.
4-0	DESC_SIZE	R/W-0	0	Descriptor Size. It is encoded in 4-byte increments with values 0 to 31 representing 24 and so on to 148 bytes. This field will return a 0x0 when an empty queue is read. Queue Manager Queue N Registers D To save hardware resources, the queue manager internally stores descriptor size (desc_size) information in four bits. However, register D has five LSBs that specify descriptor size. As a consequence, the value of desc_size that is pushed may not be same as that is read during a pop. The value that is read back is equal to always rounded to an odd number. So, for even values, the value read back is one more than what was written. For odd values, the value read back is same as the value that was written. Note that this 5-bit field (desc_size) is unrelated to the code for size of descriptors in a descriptor region. It is just a place holder for a 5-bit value that is maintained across the push and pop operations for every descriptor managed by the queue manager.

16.5.7.303 QUEUE_67_A Register (offset = 2430h) [reset = 0h]

QUEUE_67_A is shown in [Figure 16-579](#) and described in [Table 16-593](#).

Figure 16-579. QUEUE_67_A Register

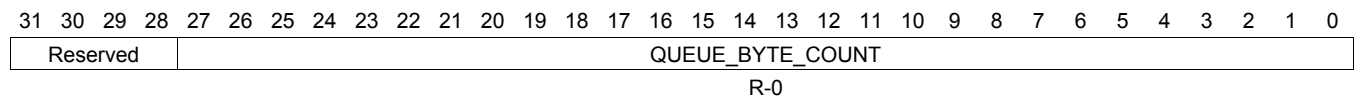

LEGEND: R/W = Read/Write; R = Read only; W1toCl = Write 1 to clear bit; -n = value after reset

Table 16-593. QUEUE_67_A Register Field Descriptions

Bit	Field	Type	Reset	Description
13-0	QUEUE_ENTRY_COUNT	R-0	0	This field indicates how many packets are currently queued on the queue. This count is incremented by 1 whenever a packet is added to the queue. This count is decremented by 1 whenever a packet is popped from the queue.

16.5.7.304 QUEUE_67_B Register (offset = 2434h) [reset = 0h]

QUEUE_67_B is shown in [Figure 16-580](#) and described in [Table 16-594](#).

Figure 16-580. QUEUE_67_B Register


LEGEND: R/W = Read/Write; R = Read only; W1toCl = Write 1 to clear bit; -n = value after reset

Table 16-594. QUEUE_67_B Register Field Descriptions

Bit	Field	Type	Reset	Description
27-0	QUEUE_BYTE_COUNT	R-0	0	This field indicates how many bytes total are contained in all of the packets which are currently queued on this queue.

16.5.7.305 QUEUE_67_C Register (offset = 2438h) [reset = 0h]

 QUEUE_67_C is shown in [Figure 16-581](#) and described in [Table 16-595](#).

Figure 16-581. QUEUE_67_C Register


LEGEND: R/W = Read/Write; R = Read only; W1toCl = Write 1 to clear bit; -n = value after reset

Table 16-595. QUEUE_67_C Register Field Descriptions

Bit	Field	Type	Reset	Description
31	HEAD_TAIL	W-0	0	Head/Tail Push Control. Set to zero in order to push packet onto tail of queue and set to one in order to push packet onto head of queue.
13-0	PACKET_SIZE	R/W-0	0	packet_size This field indicates packet size and is assumed to be zero on each packet add unless the value is explicitly overwritten. This field indicates packet size for packet pop operation.

16.5.7.306 QUEUE_67_D Register (offset = 243Ch) [reset = 0h]

 QUEUE_67_D is shown in [Figure 16-582](#) and described in [Table 16-596](#).

Figure 16-582. QUEUE_67_D Register

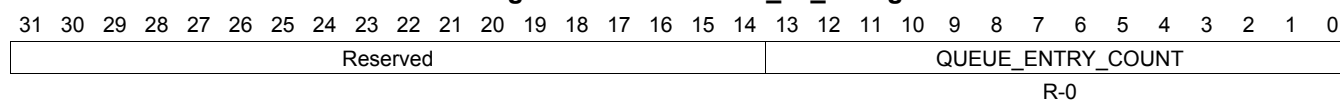

LEGEND: R/W = Read/Write; R = Read only; W1toCl = Write 1 to clear bit; -n = value after reset

Table 16-596. QUEUE_67_D Register Field Descriptions

Bit	Field	Type	Reset	Description
31-5	DESC_PTR	R/W-0	0	Descriptor pointer. It will be read as zero if the queue is empty. It will indicate a 32-bit aligned address that points to a descriptor when the queue is not empty.
4-0	DESC_SIZE	R/W-0	0	Descriptor Size. It is encoded in 4-byte increments with values 0 to 31 representing 24 and so on to 148 bytes. This field will return a 0x0 when an empty queue is read. Queue Manager Queue N Registers D To save hardware resources, the queue manager internally stores descriptor size (desc_size) information in four bits. However, register D has five LSBs that specify descriptor size. As a consequence, the value of desc_size that is pushed may not be same as that is read during a pop. The value that is read back is equal to always rounded to an odd number. So, for even values, the value read back is one more than what was written. For odd values, the value read back is same as the value that was written. Note that this 5-bit field (desc_size) is unrelated to the code for size of descriptors in a descriptor region. It is just a place holder for a 5-bit value that is maintained across the push and pop operations for every descriptor managed by the queue manager.

16.5.7.307 QUEUE_68_A Register (offset = 2440h) [reset = 0h]

QUEUE_68_A is shown in [Figure 16-583](#) and described in [Table 16-597](#).

Figure 16-583. QUEUE_68_A Register


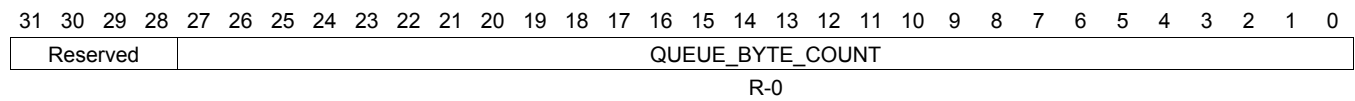
LEGEND: R/W = Read/Write; R = Read only; W1toCl = Write 1 to clear bit; -n = value after reset

Table 16-597. QUEUE_68_A Register Field Descriptions

Bit	Field	Type	Reset	Description
13-0	QUEUE_ENTRY_COUNT	R-0	0	This field indicates how many packets are currently queued on the queue. This count is incremented by 1 whenever a packet is added to the queue. This count is decremented by 1 whenever a packet is popped from the queue.

16.5.7.308 QUEUE_68_B Register (offset = 2444h) [reset = 0h]

 QUEUE_68_B is shown in [Figure 16-584](#) and described in [Table 16-598](#).

Figure 16-584. QUEUE_68_B Register


LEGEND: R/W = Read/Write; R = Read only; W1toCl = Write 1 to clear bit; -n = value after reset

Table 16-598. QUEUE_68_B Register Field Descriptions

Bit	Field	Type	Reset	Description
27-0	QUEUE_BYTE_COUNT	R-0	0	This field indicates how many bytes total are contained in all of the packets which are currently queued on this queue.

16.5.7.309 QUEUE_68_C Register (offset = 2448h) [reset = 0h]

 QUEUE_68_C is shown in [Figure 16-585](#) and described in [Table 16-599](#).

Figure 16-585. QUEUE_68_C Register


LEGEND: R/W = Read/Write; R = Read only; W1toCl = Write 1 to clear bit; -n = value after reset

Table 16-599. QUEUE_68_C Register Field Descriptions

Bit	Field	Type	Reset	Description
31	HEAD_TAIL	W-0	0	Head/Tail Push Control. Set to zero in order to push packet onto tail of queue and set to one in order to push packet onto head of queue.
13-0	PACKET_SIZE	R/W-0	0	packet_size This field indicates packet size and is assumed to be zero on each packet add unless the value is explicitly overwritten. This field indicates packet size for packet pop operation.

16.5.7.310 QUEUE_68_D Register (offset = 244Ch) [reset = 0h]

QUEUE_68_D is shown in [Figure 16-586](#) and described in [Table 16-600](#).

Figure 16-586. QUEUE_68_D Register



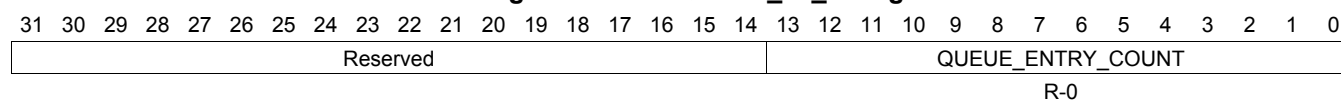
LEGEND: R/W = Read/Write; R = Read only; W1toCl = Write 1 to clear bit; -n = value after reset

Table 16-600. QUEUE_68_D Register Field Descriptions

Bit	Field	Type	Reset	Description
31-5	DESC_PTR	R/W-0	0	Descriptor pointer. It will be read as zero if the queue is empty. It will indicate a 32-bit aligned address that points to a descriptor when the queue is not empty.
4-0	DESC_SIZE	R/W-0	0	Descriptor Size. It is encoded in 4-byte increments with values 0 to 31 representing 24 and so on to 148 bytes. This field will return a 0x0 when an empty queue is read. Queue Manager Queue N Registers D To save hardware resources, the queue manager internally stores descriptor size (desc_size) information in four bits. However, register D has five LSBs that specify descriptor size. As a consequence, the value of desc_size that is pushed may not be same as that is read during a pop. The value that is read back is equal to always rounded to an odd number. So, for even values, the value read back is one more than what was written. For odd values, the value read back is same as the value that was written. Note that this 5-bit field (desc_size) is unrelated to the code for size of descriptors in a descriptor region. It is just a place holder for a 5-bit value that is maintained across the push and pop operations for every descriptor managed by the queue manager.

16.5.7.311 QUEUE_69_A Register (offset = 2450h) [reset = 0h]

QUEUE_69_A is shown in [Figure 16-587](#) and described in [Table 16-601](#).

Figure 16-587. QUEUE_69_A Register


LEGEND: R/W = Read/Write; R = Read only; W1toCl = Write 1 to clear bit; -n = value after reset

Table 16-601. QUEUE_69_A Register Field Descriptions

Bit	Field	Type	Reset	Description
13-0	QUEUE_ENTRY_COUNT	R-0	0	This field indicates how many packets are currently queued on the queue. This count is incremented by 1 whenever a packet is added to the queue. This count is decremented by 1 whenever a packet is popped from the queue.

16.5.7.312 QUEUE_69_B Register (offset = 2454h) [reset = 0h]

 QUEUE_69_B is shown in [Figure 16-588](#) and described in [Table 16-602](#).

Figure 16-588. QUEUE_69_B Register


LEGEND: R/W = Read/Write; R = Read only; W1toCl = Write 1 to clear bit; -n = value after reset

Table 16-602. QUEUE_69_B Register Field Descriptions

Bit	Field	Type	Reset	Description
27-0	QUEUE_BYTE_COUNT	R-0	0	This field indicates how many bytes total are contained in all of the packets which are currently queued on this queue.

16.5.7.313 QUEUE_69_C Register (offset = 2458h) [reset = 0h]

 QUEUE_69_C is shown in [Figure 16-589](#) and described in [Table 16-603](#).

Figure 16-589. QUEUE_69_C Register


LEGEND: R/W = Read/Write; R = Read only; W1toCl = Write 1 to clear bit; -n = value after reset

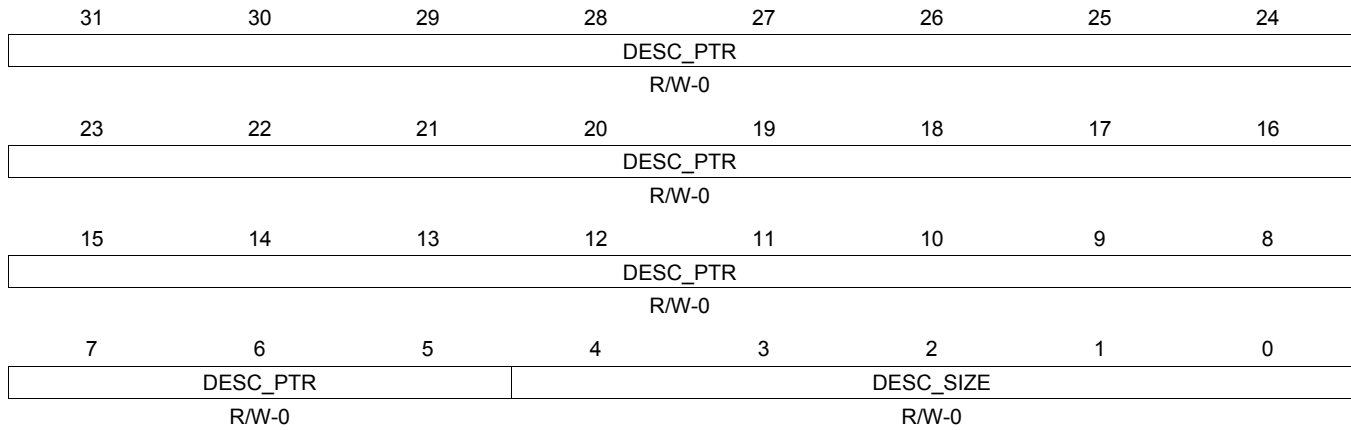
Table 16-603. QUEUE_69_C Register Field Descriptions

Bit	Field	Type	Reset	Description
31	HEAD_TAIL	W-0	0	Head/Tail Push Control. Set to zero in order to push packet onto tail of queue and set to one in order to push packet onto head of queue.
13-0	PACKET_SIZE	R/W-0	0	packet_size This field indicates packet size and is assumed to be zero on each packet add unless the value is explicitly overwritten. This field indicates packet size for packet pop operation.

16.5.7.314 QUEUE_69_D Register (offset = 245Ch) [reset = 0h]

QUEUE_69_D is shown in [Figure 16-590](#) and described in [Table 16-604](#).

Figure 16-590. QUEUE_69_D Register



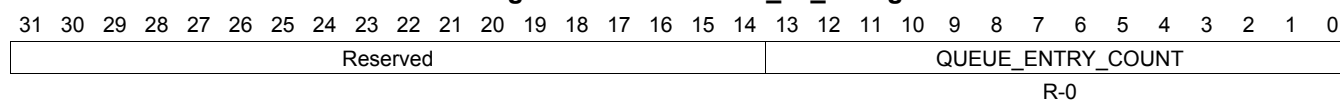
LEGEND: R/W = Read/Write; R = Read only; W1toCl = Write 1 to clear bit; -n = value after reset

Table 16-604. QUEUE_69_D Register Field Descriptions

Bit	Field	Type	Reset	Description
31-5	DESC_PTR	R/W-0	0	Descriptor pointer. It will be read as zero if the queue is empty. It will indicate a 32-bit aligned address that points to a descriptor when the queue is not empty.
4-0	DESC_SIZE	R/W-0	0	Descriptor Size. It is encoded in 4-byte increments with values 0 to 31 representing 24 and so on to 148 bytes. This field will return a 0x0 when an empty queue is read. Queue Manager Queue N Registers D To save hardware resources, the queue manager internally stores descriptor size (desc_size) information in four bits. However, register D has five LSBs that specify descriptor size. As a consequence, the value of desc_size that is pushed may not be same as that is read during a pop. The value that is read back is equal to always rounded to an odd number. So, for even values, the value read back is one more than what was written. For odd values, the value read back is same as the value that was written. Note that this 5-bit field (desc_size) is unrelated to the code for size of descriptors in a descriptor region. It is just a place holder for a 5-bit value that is maintained across the push and pop operations for every descriptor managed by the queue manager.

16.5.7.315 QUEUE_70_A Register (offset = 2460h) [reset = 0h]

QUEUE_70_A is shown in [Figure 16-591](#) and described in [Table 16-605](#).

Figure 16-591. QUEUE_70_A Register


LEGEND: R/W = Read/Write; R = Read only; W1toCl = Write 1 to clear bit; -n = value after reset

Table 16-605. QUEUE_70_A Register Field Descriptions

Bit	Field	Type	Reset	Description
13-0	QUEUE_ENTRY_COUNT	R-0	0	This field indicates how many packets are currently queued on the queue. This count is incremented by 1 whenever a packet is added to the queue. This count is decremented by 1 whenever a packet is popped from the queue.

16.5.7.316 QUEUE_70_B Register (offset = 2464h) [reset = 0h]

QUEUE_70_B is shown in [Figure 16-592](#) and described in [Table 16-606](#).

Figure 16-592. QUEUE_70_B Register

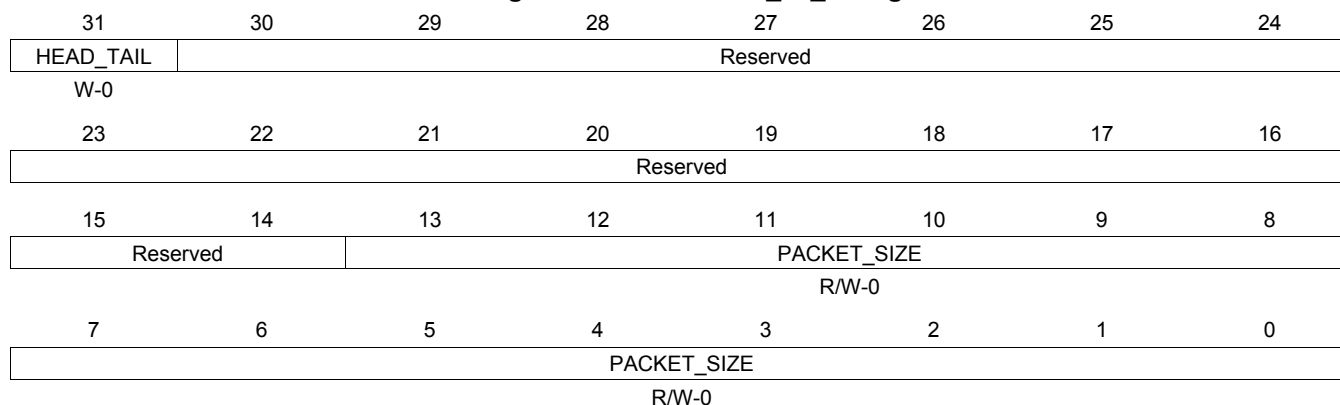

LEGEND: R/W = Read/Write; R = Read only; W1toCl = Write 1 to clear bit; -n = value after reset

Table 16-606. QUEUE_70_B Register Field Descriptions

Bit	Field	Type	Reset	Description
27-0	QUEUE_BYTE_COUNT	R-0	0	This field indicates how many bytes total are contained in all of the packets which are currently queued on this queue.

16.5.7.317 QUEUE_70_C Register (offset = 2468h) [reset = 0h]

 QUEUE_70_C is shown in [Figure 16-593](#) and described in [Table 16-607](#).

Figure 16-593. QUEUE_70_C Register


LEGEND: R/W = Read/Write; R = Read only; W1toCl = Write 1 to clear bit; -n = value after reset

Table 16-607. QUEUE_70_C Register Field Descriptions

Bit	Field	Type	Reset	Description
31	HEAD_TAIL	W-0	0	Head/Tail Push Control. Set to zero in order to push packet onto tail of queue and set to one in order to push packet onto head of queue.
13-0	PACKET_SIZE	R/W-0	0	packet_size This field indicates packet size and is assumed to be zero on each packet add unless the value is explicitly overwritten. This field indicates packet size for packet pop operation.

16.5.7.318 QUEUE_70_D Register (offset = 246Ch) [reset = 0h]

 QUEUE_70_D is shown in [Figure 16-594](#) and described in [Table 16-608](#).

Figure 16-594. QUEUE_70_D Register


LEGEND: R/W = Read/Write; R = Read only; W1toCl = Write 1 to clear bit; -n = value after reset

Table 16-608. QUEUE_70_D Register Field Descriptions

Bit	Field	Type	Reset	Description
31-5	DESC_PTR	R/W-0	0	Descriptor pointer. It will be read as zero if the queue is empty. It will indicate a 32-bit aligned address that points to a descriptor when the queue is not empty.
4-0	DESC_SIZE	R/W-0	0	Descriptor Size. It is encoded in 4-byte increments with values 0 to 31 representing 24 and so on to 148 bytes. This field will return a 0x0 when an empty queue is read. Queue Manager Queue N Registers D To save hardware resources, the queue manager internally stores descriptor size (desc_size) information in four bits. However, register D has five LSBs that specify descriptor size. As a consequence, the value of desc_size that is pushed may not be same as that is read during a pop. The value that is read back is equal to always rounded to an odd number. So, for even values, the value read back is one more than what was written. For odd values, the value read back is same as the value that was written. Note that this 5-bit field (desc_size) is unrelated to the code for size of descriptors in a descriptor region. It is just a place holder for a 5-bit value that is maintained across the push and pop operations for every descriptor managed by the queue manager.

16.5.7.319 QUEUE_71_A Register (offset = 2470h) [reset = 0h]

QUEUE_71_A is shown in [Figure 16-595](#) and described in [Table 16-609](#).

Figure 16-595. QUEUE_71_A Register

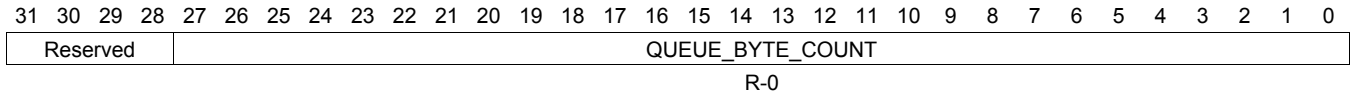

LEGEND: R/W = Read/Write; R = Read only; W1toCl = Write 1 to clear bit; -n = value after reset

Table 16-609. QUEUE_71_A Register Field Descriptions

Bit	Field	Type	Reset	Description
13-0	QUEUE_ENTRY_COUNT	R-0	0	This field indicates how many packets are currently queued on the queue. This count is incremented by 1 whenever a packet is added to the queue. This count is decremented by 1 whenever a packet is popped from the queue.

16.5.7.320 QUEUE_71_B Register (offset = 2474h) [reset = 0h]

 QUEUE_71_B is shown in [Figure 16-596](#) and described in [Table 16-610](#).

Figure 16-596. QUEUE_71_B Register


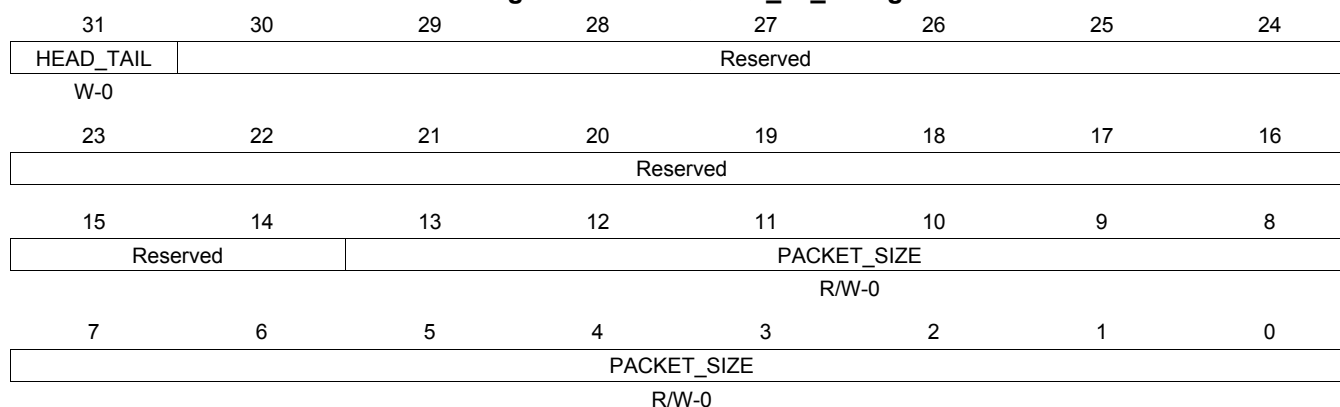
LEGEND: R/W = Read/Write; R = Read only; W1toCl = Write 1 to clear bit; -n = value after reset

Table 16-610. QUEUE_71_B Register Field Descriptions

Bit	Field	Type	Reset	Description
27-0	QUEUE_BYTE_COUNT	R-0	0	This field indicates how many bytes total are contained in all of the packets which are currently queued on this queue.

16.5.7.321 QUEUE_71_C Register (offset = 2478h) [reset = 0h]

 QUEUE_71_C is shown in [Figure 16-597](#) and described in [Table 16-611](#).

Figure 16-597. QUEUE_71_C Register


LEGEND: R/W = Read/Write; R = Read only; W1toCl = Write 1 to clear bit; -n = value after reset

Table 16-611. QUEUE_71_C Register Field Descriptions

Bit	Field	Type	Reset	Description
31	HEAD_TAIL	W-0	0	Head/Tail Push Control. Set to zero in order to push packet onto tail of queue and set to one in order to push packet onto head of queue.
13-0	PACKET_SIZE	R/W-0	0	packet_size This field indicates packet size and is assumed to be zero on each packet add unless the value is explicitly overwritten. This field indicates packet size for packet pop operation.

16.5.7.322 QUEUE_71_D Register (offset = 247Ch) [reset = 0h]

 QUEUE_71_D is shown in [Figure 16-598](#) and described in [Table 16-612](#).

Figure 16-598. QUEUE_71_D Register


LEGEND: R/W = Read/Write; R = Read only; W1toCl = Write 1 to clear bit; -n = value after reset

Table 16-612. QUEUE_71_D Register Field Descriptions

Bit	Field	Type	Reset	Description
31-5	DESC_PTR	R/W-0	0	Descriptor pointer. It will be read as zero if the queue is empty. It will indicate a 32-bit aligned address that points to a descriptor when the queue is not empty.
4-0	DESC_SIZE	R/W-0	0	Descriptor Size. It is encoded in 4-byte increments with values 0 to 31 representing 24 and so on to 148 bytes. This field will return a 0x0 when an empty queue is read. Queue Manager Queue N Registers D To save hardware resources, the queue manager internally stores descriptor size (desc_size) information in four bits. However, register D has five LSBs that specify descriptor size. As a consequence, the value of desc_size that is pushed may not be same as that is read during a pop. The value that is read back is equal to always rounded to an odd number. So, for even values, the value read back is one more than what was written. For odd values, the value read back is same as the value that was written. Note that this 5-bit field (desc_size) is unrelated to the code for size of descriptors in a descriptor region. It is just a place holder for a 5-bit value that is maintained across the push and pop operations for every descriptor managed by the queue manager.

16.5.7.323 QUEUE_72_A Register (offset = 2480h) [reset = 0h]

QUEUE_72_A is shown in [Figure 16-599](#) and described in [Table 16-613](#).

Figure 16-599. QUEUE_72_A Register


LEGEND: R/W = Read/Write; R = Read only; W1toCl = Write 1 to clear bit; -n = value after reset

Table 16-613. QUEUE_72_A Register Field Descriptions

Bit	Field	Type	Reset	Description
13-0	QUEUE_ENTRY_COUNT	R-0	0	This field indicates how many packets are currently queued on the queue. This count is incremented by 1 whenever a packet is added to the queue. This count is decremented by 1 whenever a packet is popped from the queue.

16.5.7.324 QUEUE_72_B Register (offset = 2484h) [reset = 0h]

QUEUE_72_B is shown in [Figure 16-600](#) and described in [Table 16-614](#).

Figure 16-600. QUEUE_72_B Register


LEGEND: R/W = Read/Write; R = Read only; W1toCl = Write 1 to clear bit; -n = value after reset

Table 16-614. QUEUE_72_B Register Field Descriptions

Bit	Field	Type	Reset	Description
27-0	QUEUE_BYTE_COUNT	R-0	0	This field indicates how many bytes total are contained in all of the packets which are currently queued on this queue.

16.5.7.325 QUEUE_72_C Register (offset = 2488h) [reset = 0h]

 QUEUE_72_C is shown in [Figure 16-601](#) and described in [Table 16-615](#).

Figure 16-601. QUEUE_72_C Register


LEGEND: R/W = Read/Write; R = Read only; W1toCl = Write 1 to clear bit; -n = value after reset

Table 16-615. QUEUE_72_C Register Field Descriptions

Bit	Field	Type	Reset	Description
31	HEAD_TAIL	W-0	0	Head/Tail Push Control. Set to zero in order to push packet onto tail of queue and set to one in order to push packet onto head of queue.
13-0	PACKET_SIZE	R/W-0	0	packet_size This field indicates packet size and is assumed to be zero on each packet add unless the value is explicitly overwritten. This field indicates packet size for packet pop operation.

16.5.7.326 QUEUE_72_D Register (offset = 248Ch) [reset = 0h]

QUEUE_72_D is shown in [Figure 16-602](#) and described in [Table 16-616](#).

Figure 16-602. QUEUE_72_D Register



LEGEND: R/W = Read/Write; R = Read only; W1toCl = Write 1 to clear bit; -n = value after reset

Table 16-616. QUEUE_72_D Register Field Descriptions

Bit	Field	Type	Reset	Description
31-5	DESC_PTR	R/W-0	0	Descriptor pointer. It will be read as zero if the queue is empty. It will indicate a 32-bit aligned address that points to a descriptor when the queue is not empty.
4-0	DESC_SIZE	R/W-0	0	Descriptor Size. It is encoded in 4-byte increments with values 0 to 31 representing 24 and so on to 148 bytes. This field will return a 0x0 when an empty queue is read. Queue Manager Queue N Registers D To save hardware resources, the queue manager internally stores descriptor size (desc_size) information in four bits. However, register D has five LSBs that specify descriptor size. As a consequence, the value of desc_size that is pushed may not be same as that is read during a pop. The value that is read back is equal to always rounded to an odd number. So, for even values, the value read back is one more than what was written. For odd values, the value read back is same as the value that was written. Note that this 5-bit field (desc_size) is unrelated to the code for size of descriptors in a descriptor region. It is just a place holder for a 5-bit value that is maintained across the push and pop operations for every descriptor managed by the queue manager.

16.5.7.327 QUEUE_73_A Register (offset = 2490h) [reset = 0h]

QUEUE_73_A is shown in [Figure 16-603](#) and described in [Table 16-617](#).

Figure 16-603. QUEUE_73_A Register

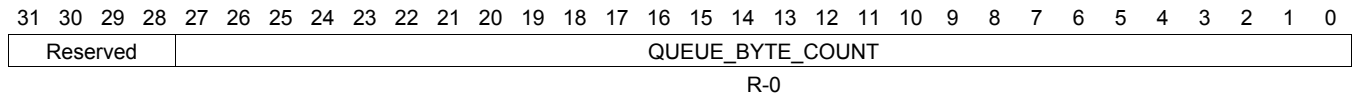

LEGEND: R/W = Read/Write; R = Read only; W1toCl = Write 1 to clear bit; -n = value after reset

Table 16-617. QUEUE_73_A Register Field Descriptions

Bit	Field	Type	Reset	Description
13-0	QUEUE_ENTRY_COUNT	R-0	0	This field indicates how many packets are currently queued on the queue. This count is incremented by 1 whenever a packet is added to the queue. This count is decremented by 1 whenever a packet is popped from the queue.

16.5.7.328 QUEUE_73_B Register (offset = 2494h) [reset = 0h]

 QUEUE_73_B is shown in [Figure 16-604](#) and described in [Table 16-618](#).

Figure 16-604. QUEUE_73_B Register


LEGEND: R/W = Read/Write; R = Read only; W1toCl = Write 1 to clear bit; -n = value after reset

Table 16-618. QUEUE_73_B Register Field Descriptions

Bit	Field	Type	Reset	Description
27-0	QUEUE_BYTE_COUNT	R-0	0	This field indicates how many bytes total are contained in all of the packets which are currently queued on this queue.

16.5.7.329 QUEUE_73_C Register (offset = 2498h) [reset = 0h]

 QUEUE_73_C is shown in [Figure 16-605](#) and described in [Table 16-619](#).

Figure 16-605. QUEUE_73_C Register


LEGEND: R/W = Read/Write; R = Read only; W1toCl = Write 1 to clear bit; -n = value after reset

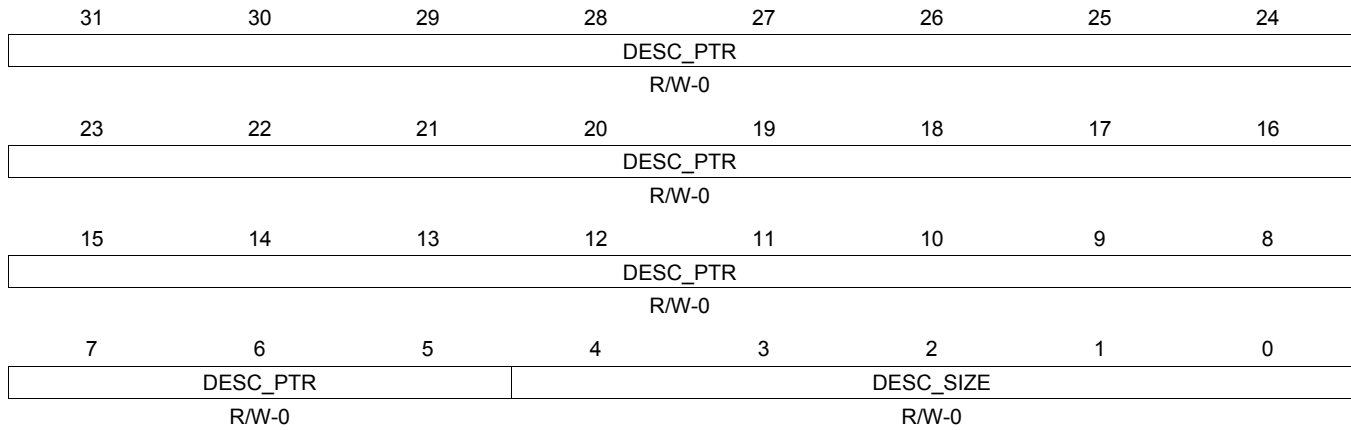
Table 16-619. QUEUE_73_C Register Field Descriptions

Bit	Field	Type	Reset	Description
31	HEAD_TAIL	W-0	0	Head/Tail Push Control. Set to zero in order to push packet onto tail of queue and set to one in order to push packet onto head of queue.
13-0	PACKET_SIZE	R/W-0	0	packet_size This field indicates packet size and is assumed to be zero on each packet add unless the value is explicitly overwritten. This field indicates packet size for packet pop operation.

16.5.7.330 QUEUE_73_D Register (offset = 249Ch) [reset = 0h]

QUEUE_73_D is shown in [Figure 16-606](#) and described in [Table 16-620](#).

Figure 16-606. QUEUE_73_D Register



LEGEND: R/W = Read/Write; R = Read only; W1toCl = Write 1 to clear bit; -n = value after reset

Table 16-620. QUEUE_73_D Register Field Descriptions

Bit	Field	Type	Reset	Description
31-5	DESC_PTR	R/W-0	0	Descriptor pointer. It will be read as zero if the queue is empty. It will indicate a 32-bit aligned address that points to a descriptor when the queue is not empty.
4-0	DESC_SIZE	R/W-0	0	Descriptor Size. It is encoded in 4-byte increments with values 0 to 31 representing 24 and so on to 148 bytes. This field will return a 0x0 when an empty queue is read. Queue Manager Queue N Registers D To save hardware resources, the queue manager internally stores descriptor size (desc_size) information in four bits. However, register D has five LSBs that specify descriptor size. As a consequence, the value of desc_size that is pushed may not be same as that is read during a pop. The value that is read back is equal to always rounded to an odd number. So, for even values, the value read back is one more than what was written. For odd values, the value read back is same as the value that was written. Note that this 5-bit field (desc_size) is unrelated to the code for size of descriptors in a descriptor region. It is just a place holder for a 5-bit value that is maintained across the push and pop operations for every descriptor managed by the queue manager.

16.5.7.331 QUEUE_74_A Register (offset = 24A0h) [reset = 0h]

QUEUE_74_A is shown in [Figure 16-607](#) and described in [Table 16-621](#).

Figure 16-607. QUEUE_74_A Register

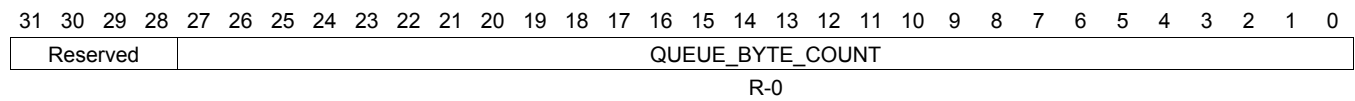

LEGEND: R/W = Read/Write; R = Read only; W1toCl = Write 1 to clear bit; -n = value after reset

Table 16-621. QUEUE_74_A Register Field Descriptions

Bit	Field	Type	Reset	Description
13-0	QUEUE_ENTRY_COUNT	R-0	0	This field indicates how many packets are currently queued on the queue. This count is incremented by 1 whenever a packet is added to the queue. This count is decremented by 1 whenever a packet is popped from the queue.

16.5.7.332 QUEUE_74_B Register (offset = 24A4h) [reset = 0h]

 QUEUE_74_B is shown in [Figure 16-608](#) and described in [Table 16-622](#).

Figure 16-608. QUEUE_74_B Register


LEGEND: R/W = Read/Write; R = Read only; W1toCl = Write 1 to clear bit; -n = value after reset

Table 16-622. QUEUE_74_B Register Field Descriptions

Bit	Field	Type	Reset	Description
27-0	QUEUE_BYTE_COUNT	R-0	0	This field indicates how many bytes total are contained in all of the packets which are currently queued on this queue.

16.5.7.333 QUEUE_74_C Register (offset = 24A8h) [reset = 0h]

 QUEUE_74_C is shown in [Figure 16-609](#) and described in [Table 16-623](#).

Figure 16-609. QUEUE_74_C Register


LEGEND: R/W = Read/Write; R = Read only; W1toCl = Write 1 to clear bit; -n = value after reset

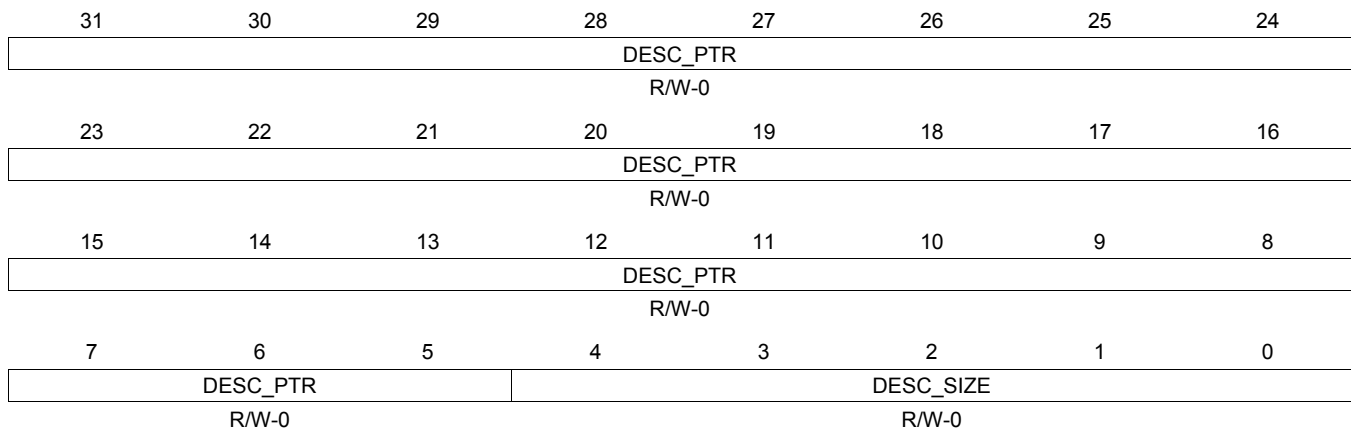
Table 16-623. QUEUE_74_C Register Field Descriptions

Bit	Field	Type	Reset	Description
31	HEAD_TAIL	W-0	0	Head/Tail Push Control. Set to zero in order to push packet onto tail of queue and set to one in order to push packet onto head of queue.
13-0	PACKET_SIZE	R/W-0	0	packet_size This field indicates packet size and is assumed to be zero on each packet add unless the value is explicitly overwritten. This field indicates packet size for packet pop operation.

16.5.7.334 QUEUE_74_D Register (offset = 24ACh) [reset = 0h]

QUEUE_74_D is shown in [Figure 16-610](#) and described in [Table 16-624](#).

Figure 16-610. QUEUE_74_D Register



LEGEND: R/W = Read/Write; R = Read only; W1toCl = Write 1 to clear bit; -n = value after reset

Table 16-624. QUEUE_74_D Register Field Descriptions

Bit	Field	Type	Reset	Description
31-5	DESC_PTR	R/W-0	0	Descriptor pointer. It will be read as zero if the queue is empty. It will indicate a 32-bit aligned address that points to a descriptor when the queue is not empty.
4-0	DESC_SIZE	R/W-0	0	Descriptor Size. It is encoded in 4-byte increments with values 0 to 31 representing 24 and so on to 148 bytes. This field will return a 0x0 when an empty queue is read. Queue Manager Queue N Registers D To save hardware resources, the queue manager internally stores descriptor size (desc_size) information in four bits. However, register D has five LSBs that specify descriptor size. As a consequence, the value of desc_size that is pushed may not be same as that is read during a pop. The value that is read back is equal to always rounded to an odd number. So, for even values, the value read back is one more than what was written. For odd values, the value read back is same as the value that was written. Note that this 5-bit field (desc_size) is unrelated to the code for size of descriptors in a descriptor region. It is just a place holder for a 5-bit value that is maintained across the push and pop operations for every descriptor managed by the queue manager.

16.5.7.335 QUEUE_75_A Register (offset = 24B0h) [reset = 0h]

QUEUE_75_A is shown in [Figure 16-611](#) and described in [Table 16-625](#).

Figure 16-611. QUEUE_75_A Register


LEGEND: R/W = Read/Write; R = Read only; W1toCl = Write 1 to clear bit; -n = value after reset

Table 16-625. QUEUE_75_A Register Field Descriptions

Bit	Field	Type	Reset	Description
13-0	QUEUE_ENTRY_COUNT	R-0	0	This field indicates how many packets are currently queued on the queue. This count is incremented by 1 whenever a packet is added to the queue. This count is decremented by 1 whenever a packet is popped from the queue.

16.5.7.336 QUEUE_75_B Register (offset = 24B4h) [reset = 0h]

 QUEUE_75_B is shown in [Figure 16-612](#) and described in [Table 16-626](#).

Figure 16-612. QUEUE_75_B Register

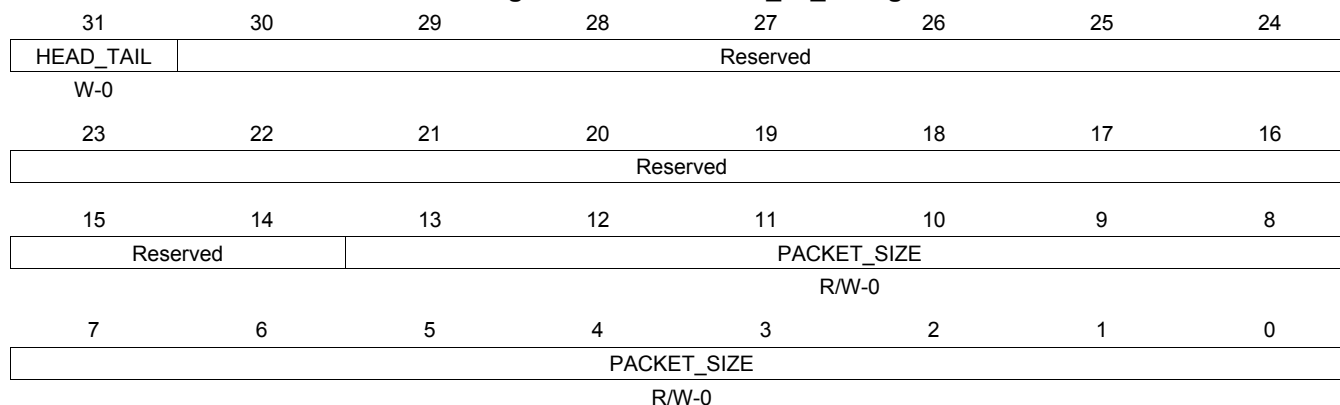

LEGEND: R/W = Read/Write; R = Read only; W1toCl = Write 1 to clear bit; -n = value after reset

Table 16-626. QUEUE_75_B Register Field Descriptions

Bit	Field	Type	Reset	Description
27-0	QUEUE_BYTE_COUNT	R-0	0	This field indicates how many bytes total are contained in all of the packets which are currently queued on this queue.

16.5.7.337 QUEUE_75_C Register (offset = 24B8h) [reset = 0h]

 QUEUE_75_C is shown in [Figure 16-613](#) and described in [Table 16-627](#).

Figure 16-613. QUEUE_75_C Register


LEGEND: R/W = Read/Write; R = Read only; W1toCl = Write 1 to clear bit; -n = value after reset

Table 16-627. QUEUE_75_C Register Field Descriptions

Bit	Field	Type	Reset	Description
31	HEAD_TAIL	W-0	0	Head/Tail Push Control. Set to zero in order to push packet onto tail of queue and set to one in order to push packet onto head of queue.
13-0	PACKET_SIZE	R/W-0	0	packet_size This field indicates packet size and is assumed to be zero on each packet add unless the value is explicitly overwritten. This field indicates packet size for packet pop operation.

16.5.7.338 QUEUE_75_D Register (offset = 24BCh) [reset = 0h]

QUEUE_75_D is shown in [Figure 16-614](#) and described in [Table 16-628](#).

Figure 16-614. QUEUE_75_D Register

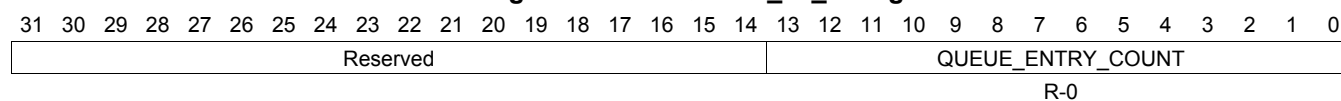

LEGEND: R/W = Read/Write; R = Read only; W1toCl = Write 1 to clear bit; -n = value after reset

Table 16-628. QUEUE_75_D Register Field Descriptions

Bit	Field	Type	Reset	Description
31-5	DESC_PTR	R/W-0	0	Descriptor pointer. It will be read as zero if the queue is empty. It will indicate a 32-bit aligned address that points to a descriptor when the queue is not empty.
4-0	DESC_SIZE	R/W-0	0	Descriptor Size. It is encoded in 4-byte increments with values 0 to 31 representing 24 and so on to 148 bytes. This field will return a 0x0 when an empty queue is read. Queue Manager Queue N Registers D To save hardware resources, the queue manager internally stores descriptor size (desc_size) information in four bits. However, register D has five LSBs that specify descriptor size. As a consequence, the value of desc_size that is pushed may not be same as that is read during a pop. The value that is read back is equal to always rounded to an odd number. So, for even values, the value read back is one more than what was written. For odd values, the value read back is same as the value that was written. Note that this 5-bit field (desc_size) is unrelated to the code for size of descriptors in a descriptor region. It is just a place holder for a 5-bit value that is maintained across the push and pop operations for every descriptor managed by the queue manager.

16.5.7.339 QUEUE_76_A Register (offset = 24C0h) [reset = 0h]

QUEUE_76_A is shown in [Figure 16-615](#) and described in [Table 16-629](#).

Figure 16-615. QUEUE_76_A Register


LEGEND: R/W = Read/Write; R = Read only; W1toCl = Write 1 to clear bit; -n = value after reset

Table 16-629. QUEUE_76_A Register Field Descriptions

Bit	Field	Type	Reset	Description
13-0	QUEUE_ENTRY_COUNT	R-0	0	This field indicates how many packets are currently queued on the queue. This count is incremented by 1 whenever a packet is added to the queue. This count is decremented by 1 whenever a packet is popped from the queue.

16.5.7.340 QUEUE_76_B Register (offset = 24C4h) [reset = 0h]

QUEUE_76_B is shown in [Figure 16-616](#) and described in [Table 16-630](#).

Figure 16-616. QUEUE_76_B Register

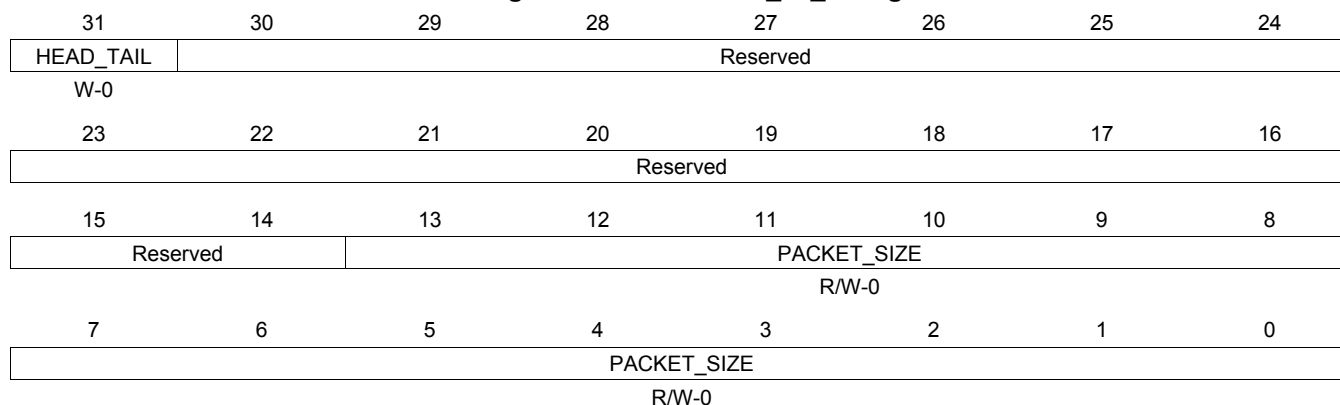

LEGEND: R/W = Read/Write; R = Read only; W1toCl = Write 1 to clear bit; -n = value after reset

Table 16-630. QUEUE_76_B Register Field Descriptions

Bit	Field	Type	Reset	Description
27-0	QUEUE_BYTE_COUNT	R-0	0	This field indicates how many bytes total are contained in all of the packets which are currently queued on this queue.

16.5.7.341 QUEUE_76_C Register (offset = 24C8h) [reset = 0h]

 QUEUE_76_C is shown in [Figure 16-617](#) and described in [Table 16-631](#).

Figure 16-617. QUEUE_76_C Register


LEGEND: R/W = Read/Write; R = Read only; W1toCl = Write 1 to clear bit; -n = value after reset

Table 16-631. QUEUE_76_C Register Field Descriptions

Bit	Field	Type	Reset	Description
31	HEAD_TAIL	W-0	0	Head/Tail Push Control. Set to zero in order to push packet onto tail of queue and set to one in order to push packet onto head of queue.
13-0	PACKET_SIZE	R/W-0	0	packet_size This field indicates packet size and is assumed to be zero on each packet add unless the value is explicitly overwritten. This field indicates packet size for packet pop operation.

16.5.7.342 QUEUE_76_D Register (offset = 24CCh) [reset = 0h]

 QUEUE_76_D is shown in [Figure 16-618](#) and described in [Table 16-632](#).

Figure 16-618. QUEUE_76_D Register

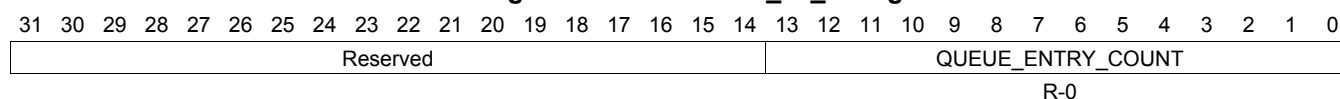

LEGEND: R/W = Read/Write; R = Read only; W1toCl = Write 1 to clear bit; -n = value after reset

Table 16-632. QUEUE_76_D Register Field Descriptions

Bit	Field	Type	Reset	Description
31-5	DESC_PTR	R/W-0	0	Descriptor pointer. It will be read as zero if the queue is empty. It will indicate a 32-bit aligned address that points to a descriptor when the queue is not empty.
4-0	DESC_SIZE	R/W-0	0	Descriptor Size. It is encoded in 4-byte increments with values 0 to 31 representing 24 and so on to 148 bytes. This field will return a 0x0 when an empty queue is read. Queue Manager Queue N Registers D To save hardware resources, the queue manager internally stores descriptor size (desc_size) information in four bits. However, register D has five LSBs that specify descriptor size. As a consequence, the value of desc_size that is pushed may not be same as that is read during a pop. The value that is read back is equal to always rounded to an odd number. So, for even values, the value read back is one more than what was written. For odd values, the value read back is same as the value that was written. Note that this 5-bit field (desc_size) is unrelated to the code for size of descriptors in a descriptor region. It is just a place holder for a 5-bit value that is maintained across the push and pop operations for every descriptor managed by the queue manager.

16.5.7.343 QUEUE_77_A Register (offset = 24D0h) [reset = 0h]

QUEUE_77_A is shown in [Figure 16-619](#) and described in [Table 16-633](#).

Figure 16-619. QUEUE_77_A Register


LEGEND: R/W = Read/Write; R = Read only; W1toCl = Write 1 to clear bit; -n = value after reset

Table 16-633. QUEUE_77_A Register Field Descriptions

Bit	Field	Type	Reset	Description
13-0	QUEUE_ENTRY_COUNT	R-0	0	This field indicates how many packets are currently queued on the queue. This count is incremented by 1 whenever a packet is added to the queue. This count is decremented by 1 whenever a packet is popped from the queue.

16.5.7.344 QUEUE_77_B Register (offset = 24D4h) [reset = 0h]

 QUEUE_77_B is shown in [Figure 16-620](#) and described in [Table 16-634](#).

Figure 16-620. QUEUE_77_B Register

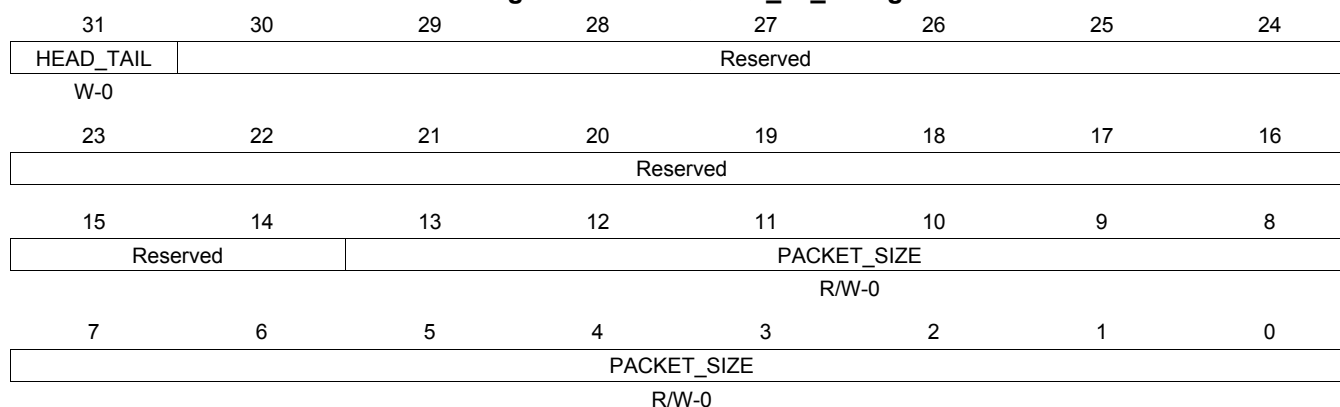

LEGEND: R/W = Read/Write; R = Read only; W1toCl = Write 1 to clear bit; -n = value after reset

Table 16-634. QUEUE_77_B Register Field Descriptions

Bit	Field	Type	Reset	Description
27-0	QUEUE_BYTE_COUNT	R-0	0	This field indicates how many bytes total are contained in all of the packets which are currently queued on this queue.

16.5.7.345 QUEUE_77_C Register (offset = 24D8h) [reset = 0h]

 QUEUE_77_C is shown in [Figure 16-621](#) and described in [Table 16-635](#).

Figure 16-621. QUEUE_77_C Register


LEGEND: R/W = Read/Write; R = Read only; W1toCl = Write 1 to clear bit; -n = value after reset

Table 16-635. QUEUE_77_C Register Field Descriptions

Bit	Field	Type	Reset	Description
31	HEAD_TAIL	W-0	0	Head/Tail Push Control. Set to zero in order to push packet onto tail of queue and set to one in order to push packet onto head of queue.
13-0	PACKET_SIZE	R/W-0	0	packet_size This field indicates packet size and is assumed to be zero on each packet add unless the value is explicitly overwritten. This field indicates packet size for packet pop operation.

16.5.7.346 QUEUE_77_D Register (offset = 24DCh) [reset = 0h]

QUEUE_77_D is shown in [Figure 16-622](#) and described in [Table 16-636](#).

Figure 16-622. QUEUE_77_D Register



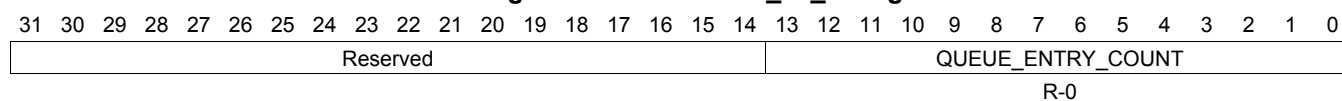
LEGEND: R/W = Read/Write; R = Read only; W1toCl = Write 1 to clear bit; -n = value after reset

Table 16-636. QUEUE_77_D Register Field Descriptions

Bit	Field	Type	Reset	Description
31-5	DESC_PTR	R/W-0	0	Descriptor pointer. It will be read as zero if the queue is empty. It will indicate a 32-bit aligned address that points to a descriptor when the queue is not empty.
4-0	DESC_SIZE	R/W-0	0	Descriptor Size. It is encoded in 4-byte increments with values 0 to 31 representing 24 and so on to 148 bytes. This field will return a 0x0 when an empty queue is read. Queue Manager Queue N Registers D To save hardware resources, the queue manager internally stores descriptor size (desc_size) information in four bits. However, register D has five LSBs that specify descriptor size. As a consequence, the value of desc_size that is pushed may not be same as that is read during a pop. The value that is read back is equal to always rounded to an odd number. So, for even values, the value read back is one more than what was written. For odd values, the value read back is same as the value that was written. Note that this 5-bit field (desc_size) is unrelated to the code for size of descriptors in a descriptor region. It is just a place holder for a 5-bit value that is maintained across the push and pop operations for every descriptor managed by the queue manager.

16.5.7.347 QUEUE_78_A Register (offset = 24E0h) [reset = 0h]

QUEUE_78_A is shown in [Figure 16-623](#) and described in [Table 16-637](#).

Figure 16-623. QUEUE_78_A Register


LEGEND: R/W = Read/Write; R = Read only; W1toCl = Write 1 to clear bit; -n = value after reset

Table 16-637. QUEUE_78_A Register Field Descriptions

Bit	Field	Type	Reset	Description
13-0	QUEUE_ENTRY_COUNT	R-0	0	This field indicates how many packets are currently queued on the queue. This count is incremented by 1 whenever a packet is added to the queue. This count is decremented by 1 whenever a packet is popped from the queue.

16.5.7.348 QUEUE_78_B Register (offset = 24E4h) [reset = 0h]

 QUEUE_78_B is shown in [Figure 16-624](#) and described in [Table 16-638](#).

Figure 16-624. QUEUE_78_B Register

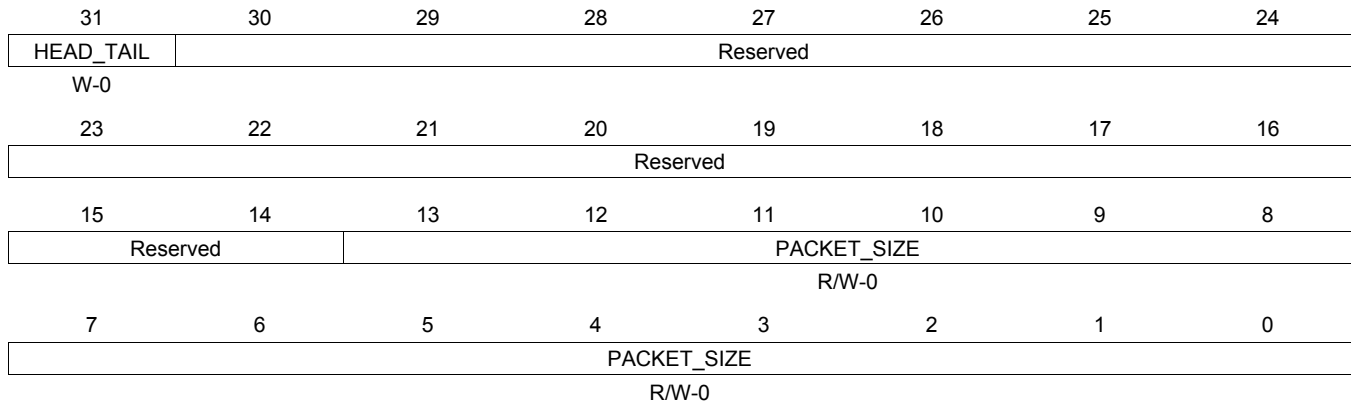

LEGEND: R/W = Read/Write; R = Read only; W1toCl = Write 1 to clear bit; -n = value after reset

Table 16-638. QUEUE_78_B Register Field Descriptions

Bit	Field	Type	Reset	Description
27-0	QUEUE_BYTE_COUNT	R-0	0	This field indicates how many bytes total are contained in all of the packets which are currently queued on this queue.

16.5.7.349 QUEUE_78_C Register (offset = 24E8h) [reset = 0h]

 QUEUE_78_C is shown in [Figure 16-625](#) and described in [Table 16-639](#).

Figure 16-625. QUEUE_78_C Register


LEGEND: R/W = Read/Write; R = Read only; W1toCl = Write 1 to clear bit; -n = value after reset

Table 16-639. QUEUE_78_C Register Field Descriptions

Bit	Field	Type	Reset	Description
31	HEAD_TAIL	W-0	0	Head/Tail Push Control. Set to zero in order to push packet onto tail of queue and set to one in order to push packet onto head of queue.
13-0	PACKET_SIZE	R/W-0	0	packet_size This field indicates packet size and is assumed to be zero on each packet add unless the value is explicitly overwritten. This field indicates packet size for packet pop operation.

16.5.7.350 QUEUE_78_D Register (offset = 24ECh) [reset = 0h]

QUEUE_78_D is shown in [Figure 16-626](#) and described in [Table 16-640](#).

Figure 16-626. QUEUE_78_D Register



LEGEND: R/W = Read/Write; R = Read only; W1toCl = Write 1 to clear bit; -n = value after reset

Table 16-640. QUEUE_78_D Register Field Descriptions

Bit	Field	Type	Reset	Description
31-5	DESC_PTR	R/W-0	0	Descriptor pointer. It will be read as zero if the queue is empty. It will indicate a 32-bit aligned address that points to a descriptor when the queue is not empty.
4-0	DESC_SIZE	R/W-0	0	Descriptor Size. It is encoded in 4-byte increments with values 0 to 31 representing 24 and so on to 148 bytes. This field will return a 0x0 when an empty queue is read. Queue Manager Queue N Registers D To save hardware resources, the queue manager internally stores descriptor size (desc_size) information in four bits. However, register D has five LSBs that specify descriptor size. As a consequence, the value of desc_size that is pushed may not be same as that is read during a pop. The value that is read back is equal to always rounded to an odd number. So, for even values, the value read back is one more than what was written. For odd values, the value read back is same as the value that was written. Note that this 5-bit field (desc_size) is unrelated to the code for size of descriptors in a descriptor region. It is just a place holder for a 5-bit value that is maintained across the push and pop operations for every descriptor managed by the queue manager.

16.5.7.351 QUEUE_79_A Register (offset = 24F0h) [reset = 0h]

QUEUE_79_A is shown in [Figure 16-627](#) and described in [Table 16-641](#).

Figure 16-627. QUEUE_79_A Register


LEGEND: R/W = Read/Write; R = Read only; W1toCl = Write 1 to clear bit; -n = value after reset

Table 16-641. QUEUE_79_A Register Field Descriptions

Bit	Field	Type	Reset	Description
13-0	QUEUE_ENTRY_COUNT	R-0	0	This field indicates how many packets are currently queued on the queue. This count is incremented by 1 whenever a packet is added to the queue. This count is decremented by 1 whenever a packet is popped from the queue.

16.5.7.352 QUEUE_79_B Register (offset = 24F4h) [reset = 0h]

 QUEUE_79_B is shown in [Figure 16-628](#) and described in [Table 16-642](#).

Figure 16-628. QUEUE_79_B Register

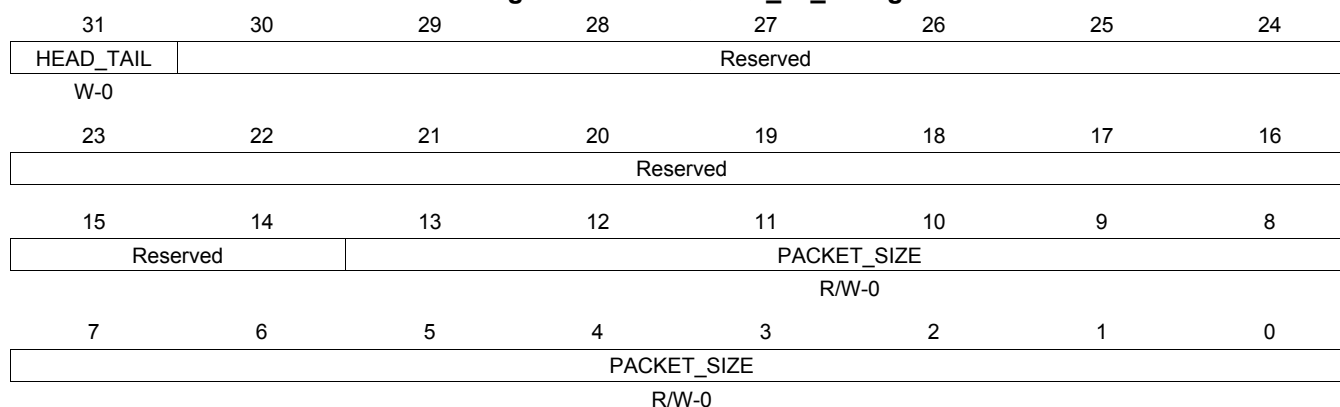

LEGEND: R/W = Read/Write; R = Read only; W1toCl = Write 1 to clear bit; -n = value after reset

Table 16-642. QUEUE_79_B Register Field Descriptions

Bit	Field	Type	Reset	Description
27-0	QUEUE_BYTE_COUNT	R-0	0	This field indicates how many bytes total are contained in all of the packets which are currently queued on this queue.

16.5.7.353 QUEUE_79_C Register (offset = 24F8h) [reset = 0h]

 QUEUE_79_C is shown in [Figure 16-629](#) and described in [Table 16-643](#).

Figure 16-629. QUEUE_79_C Register


LEGEND: R/W = Read/Write; R = Read only; W1toCl = Write 1 to clear bit; -n = value after reset

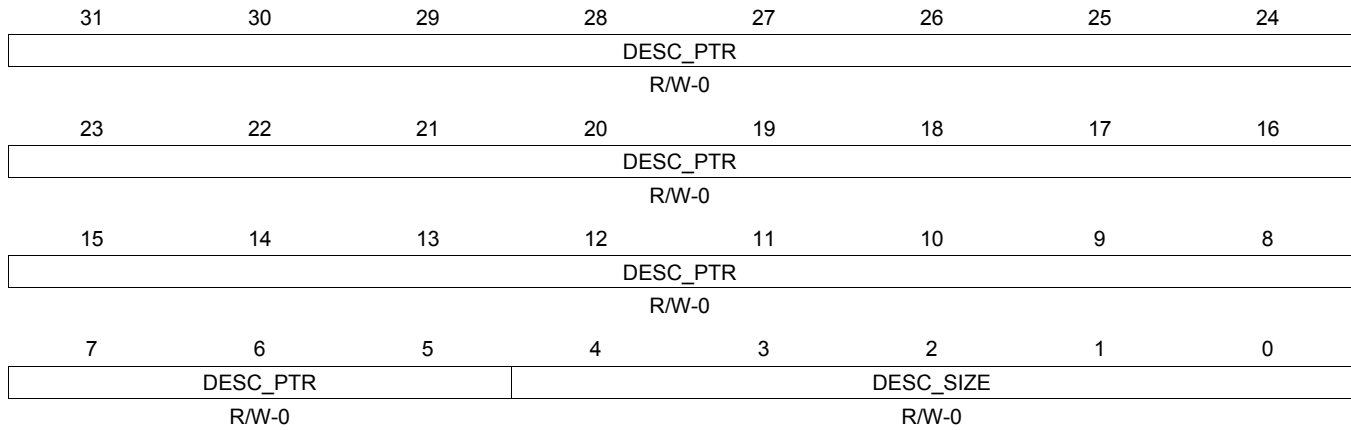
Table 16-643. QUEUE_79_C Register Field Descriptions

Bit	Field	Type	Reset	Description
31	HEAD_TAIL	W-0	0	Head/Tail Push Control. Set to zero in order to push packet onto tail of queue and set to one in order to push packet onto head of queue.
13-0	PACKET_SIZE	R/W-0	0	packet_size This field indicates packet size and is assumed to be zero on each packet add unless the value is explicitly overwritten. This field indicates packet size for packet pop operation.

16.5.7.354 QUEUE_79_D Register (offset = 24FCh) [reset = 0h]

QUEUE_79_D is shown in [Figure 16-630](#) and described in [Table 16-644](#).

Figure 16-630. QUEUE_79_D Register



LEGEND: R/W = Read/Write; R = Read only; W1toCl = Write 1 to clear bit; -n = value after reset

Table 16-644. QUEUE_79_D Register Field Descriptions

Bit	Field	Type	Reset	Description
31-5	DESC_PTR	R/W-0	0	Descriptor pointer. It will be read as zero if the queue is empty. It will indicate a 32-bit aligned address that points to a descriptor when the queue is not empty.
4-0	DESC_SIZE	R/W-0	0	Descriptor Size. It is encoded in 4-byte increments with values 0 to 31 representing 24 and so on to 148 bytes. This field will return a 0x0 when an empty queue is read. Queue Manager Queue N Registers D To save hardware resources, the queue manager internally stores descriptor size (desc_size) information in four bits. However, register D has five LSBs that specify descriptor size. As a consequence, the value of desc_size that is pushed may not be same as that is read during a pop. The value that is read back is equal to always rounded to an odd number. So, for even values, the value read back is one more than what was written. For odd values, the value read back is same as the value that was written. Note that this 5-bit field (desc_size) is unrelated to the code for size of descriptors in a descriptor region. It is just a place holder for a 5-bit value that is maintained across the push and pop operations for every descriptor managed by the queue manager.

16.5.7.355 QUEUE_80_A Register (offset = 2500h) [reset = 0h]

QUEUE_80_A is shown in [Figure 16-631](#) and described in [Table 16-645](#).

Figure 16-631. QUEUE_80_A Register


LEGEND: R/W = Read/Write; R = Read only; W1toCl = Write 1 to clear bit; -n = value after reset

Table 16-645. QUEUE_80_A Register Field Descriptions

Bit	Field	Type	Reset	Description
13-0	QUEUE_ENTRY_COUNT	R-0	0	This field indicates how many packets are currently queued on the queue. This count is incremented by 1 whenever a packet is added to the queue. This count is decremented by 1 whenever a packet is popped from the queue.

16.5.7.356 QUEUE_80_B Register (offset = 2504h) [reset = 0h]

 QUEUE_80_B is shown in [Figure 16-632](#) and described in [Table 16-646](#).

Figure 16-632. QUEUE_80_B Register

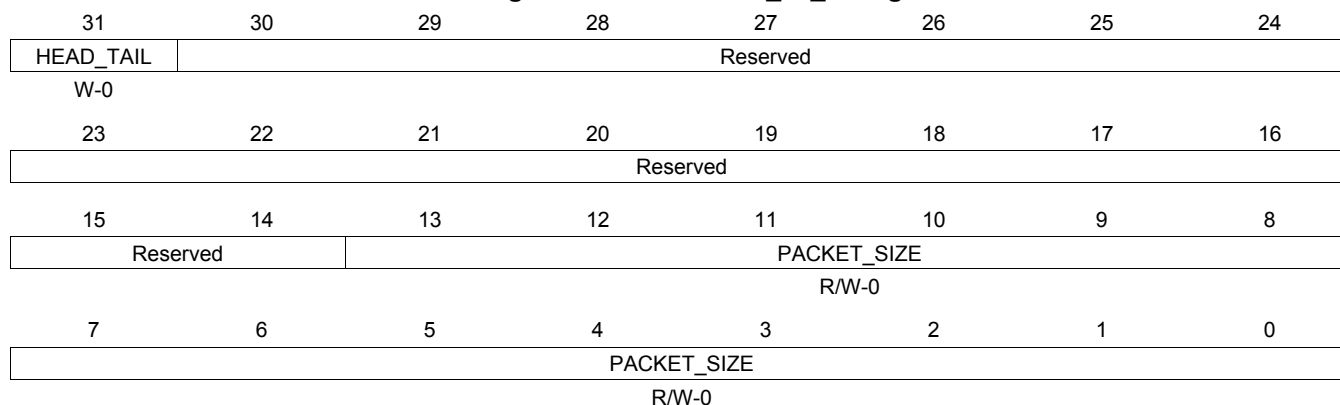

LEGEND: R/W = Read/Write; R = Read only; W1toCl = Write 1 to clear bit; -n = value after reset

Table 16-646. QUEUE_80_B Register Field Descriptions

Bit	Field	Type	Reset	Description
27-0	QUEUE_BYTE_COUNT	R-0	0	This field indicates how many bytes total are contained in all of the packets which are currently queued on this queue.

16.5.7.357 QUEUE_80_C Register (offset = 2508h) [reset = 0h]

 QUEUE_80_C is shown in [Figure 16-633](#) and described in [Table 16-647](#).

Figure 16-633. QUEUE_80_C Register


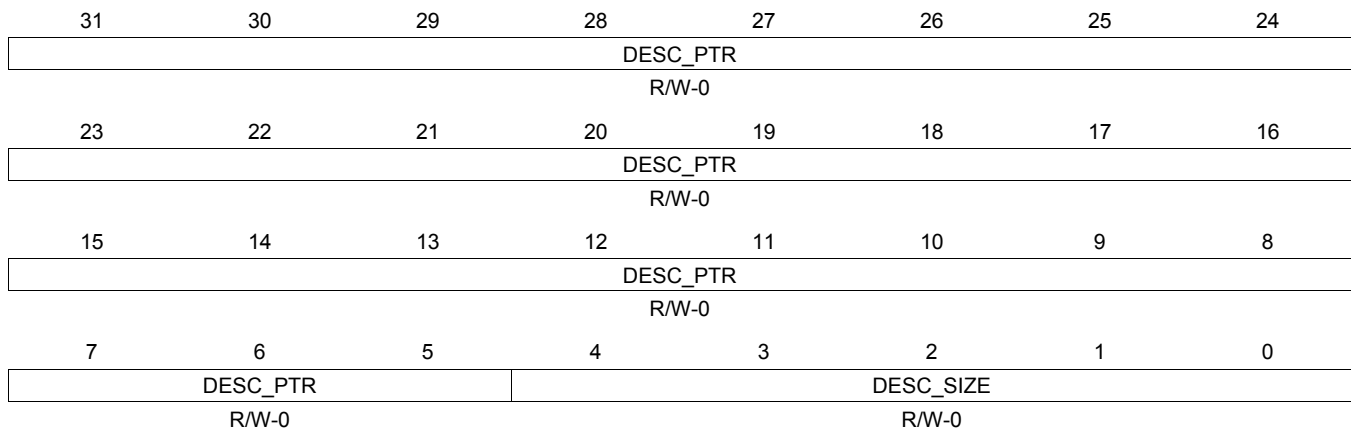
LEGEND: R/W = Read/Write; R = Read only; W1toCl = Write 1 to clear bit; -n = value after reset

Table 16-647. QUEUE_80_C Register Field Descriptions

Bit	Field	Type	Reset	Description
31	HEAD_TAIL	W-0	0	Head/Tail Push Control. Set to zero in order to push packet onto tail of queue and set to one in order to push packet onto head of queue.
13-0	PACKET_SIZE	R/W-0	0	packet_size This field indicates packet size and is assumed to be zero on each packet add unless the value is explicitly overwritten. This field indicates packet size for packet pop operation.

16.5.7.358 QUEUE_80_D Register (offset = 250Ch) [reset = 0h]

QUEUE_80_D is shown in [Figure 16-634](#) and described in [Table 16-648](#).

Figure 16-634. QUEUE_80_D Register


LEGEND: R/W = Read/Write; R = Read only; W1toCl = Write 1 to clear bit; -n = value after reset

Table 16-648. QUEUE_80_D Register Field Descriptions

Bit	Field	Type	Reset	Description
31-5	DESC_PTR	R/W-0	0	Descriptor pointer. It will be read as zero if the queue is empty. It will indicate a 32-bit aligned address that points to a descriptor when the queue is not empty.
4-0	DESC_SIZE	R/W-0	0	Descriptor Size. It is encoded in 4-byte increments with values 0 to 31 representing 24 and so on to 148 bytes. This field will return a 0x0 when an empty queue is read. Queue Manager Queue N Registers D To save hardware resources, the queue manager internally stores descriptor size (desc_size) information in four bits. However, register D has five LSBs that specify descriptor size. As a consequence, the value of desc_size that is pushed may not be same as that is read during a pop. The value that is read back is equal to always rounded to an odd number. So, for even values, the value read back is one more than what was written. For odd values, the value read back is same as the value that was written. Note that this 5-bit field (desc_size) is unrelated to the code for size of descriptors in a descriptor region. It is just a place holder for a 5-bit value that is maintained across the push and pop operations for every descriptor managed by the queue manager.

16.5.7.359 QUEUE_81_A Register (offset = 2510h) [reset = 0h]

QUEUE_81_A is shown in [Figure 16-635](#) and described in [Table 16-649](#).

Figure 16-635. QUEUE_81_A Register


LEGEND: R/W = Read/Write; R = Read only; W1toCl = Write 1 to clear bit; -n = value after reset

Table 16-649. QUEUE_81_A Register Field Descriptions

Bit	Field	Type	Reset	Description
13-0	QUEUE_ENTRY_COUNT	R-0	0	This field indicates how many packets are currently queued on the queue. This count is incremented by 1 whenever a packet is added to the queue. This count is decremented by 1 whenever a packet is popped from the queue.

16.5.7.360 QUEUE_81_B Register (offset = 2514h) [reset = 0h]

QUEUE_81_B is shown in [Figure 16-636](#) and described in [Table 16-650](#).

Figure 16-636. QUEUE_81_B Register


LEGEND: R/W = Read/Write; R = Read only; W1toCl = Write 1 to clear bit; -n = value after reset

Table 16-650. QUEUE_81_B Register Field Descriptions

Bit	Field	Type	Reset	Description
27-0	QUEUE_BYTE_COUNT	R-0	0	This field indicates how many bytes total are contained in all of the packets which are currently queued on this queue.

16.5.7.361 QUEUE_81_C Register (offset = 2518h) [reset = 0h]

 QUEUE_81_C is shown in [Figure 16-637](#) and described in [Table 16-651](#).

Figure 16-637. QUEUE_81_C Register

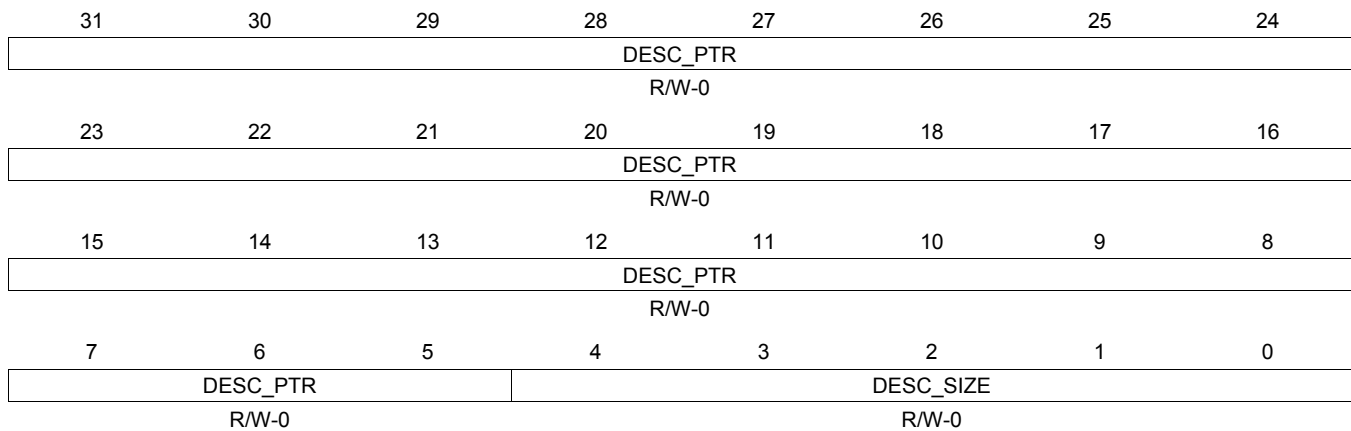

LEGEND: R/W = Read/Write; R = Read only; W1toCl = Write 1 to clear bit; -n = value after reset

Table 16-651. QUEUE_81_C Register Field Descriptions

Bit	Field	Type	Reset	Description
31	HEAD_TAIL	W-0	0	Head/Tail Push Control. Set to zero in order to push packet onto tail of queue and set to one in order to push packet onto head of queue.
13-0	PACKET_SIZE	R/W-0	0	packet_size This field indicates packet size and is assumed to be zero on each packet add unless the value is explicitly overwritten. This field indicates packet size for packet pop operation.

16.5.7.362 QUEUE_81_D Register (offset = 251Ch) [reset = 0h]

QUEUE_81_D is shown in [Figure 16-638](#) and described in [Table 16-652](#).

Figure 16-638. QUEUE_81_D Register


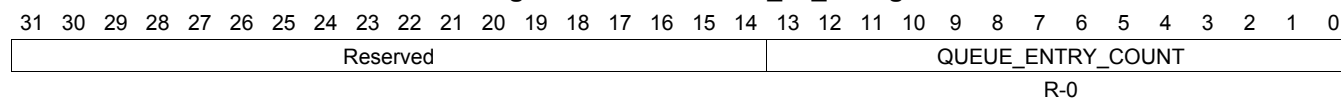
LEGEND: R/W = Read/Write; R = Read only; W1toCl = Write 1 to clear bit; -n = value after reset

Table 16-652. QUEUE_81_D Register Field Descriptions

Bit	Field	Type	Reset	Description
31-5	DESC_PTR	R/W-0	0	Descriptor pointer. It will be read as zero if the queue is empty. It will indicate a 32-bit aligned address that points to a descriptor when the queue is not empty.
4-0	DESC_SIZE	R/W-0	0	Descriptor Size. It is encoded in 4-byte increments with values 0 to 31 representing 24 and so on to 148 bytes. This field will return a 0x0 when an empty queue is read. Queue Manager Queue N Registers D To save hardware resources, the queue manager internally stores descriptor size (desc_size) information in four bits. However, register D has five LSBs that specify descriptor size. As a consequence, the value of desc_size that is pushed may not be same as that is read during a pop. The value that is read back is equal to always rounded to an odd number. So, for even values, the value read back is one more than what was written. For odd values, the value read back is same as the value that was written. Note that this 5-bit field (desc_size) is unrelated to the code for size of descriptors in a descriptor region. It is just a place holder for a 5-bit value that is maintained across the push and pop operations for every descriptor managed by the queue manager.

16.5.7.363 QUEUE_82_A Register (offset = 2520h) [reset = 0h]

QUEUE_82_A is shown in [Figure 16-639](#) and described in [Table 16-653](#).

Figure 16-639. QUEUE_82_A Register


LEGEND: R/W = Read/Write; R = Read only; W1toCl = Write 1 to clear bit; -n = value after reset

Table 16-653. QUEUE_82_A Register Field Descriptions

Bit	Field	Type	Reset	Description
13-0	QUEUE_ENTRY_COUNT	R-0	0	This field indicates how many packets are currently queued on the queue. This count is incremented by 1 whenever a packet is added to the queue. This count is decremented by 1 whenever a packet is popped from the queue.

16.5.7.364 QUEUE_82_B Register (offset = 2524h) [reset = 0h]

 QUEUE_82_B is shown in [Figure 16-640](#) and described in [Table 16-654](#).

Figure 16-640. QUEUE_82_B Register


LEGEND: R/W = Read/Write; R = Read only; W1toCl = Write 1 to clear bit; -n = value after reset

Table 16-654. QUEUE_82_B Register Field Descriptions

Bit	Field	Type	Reset	Description
27-0	QUEUE_BYTE_COUNT	R-0	0	This field indicates how many bytes total are contained in all of the packets which are currently queued on this queue.

16.5.7.365 QUEUE_82_C Register (offset = 2528h) [reset = 0h]

 QUEUE_82_C is shown in [Figure 16-641](#) and described in [Table 16-655](#).

Figure 16-641. QUEUE_82_C Register

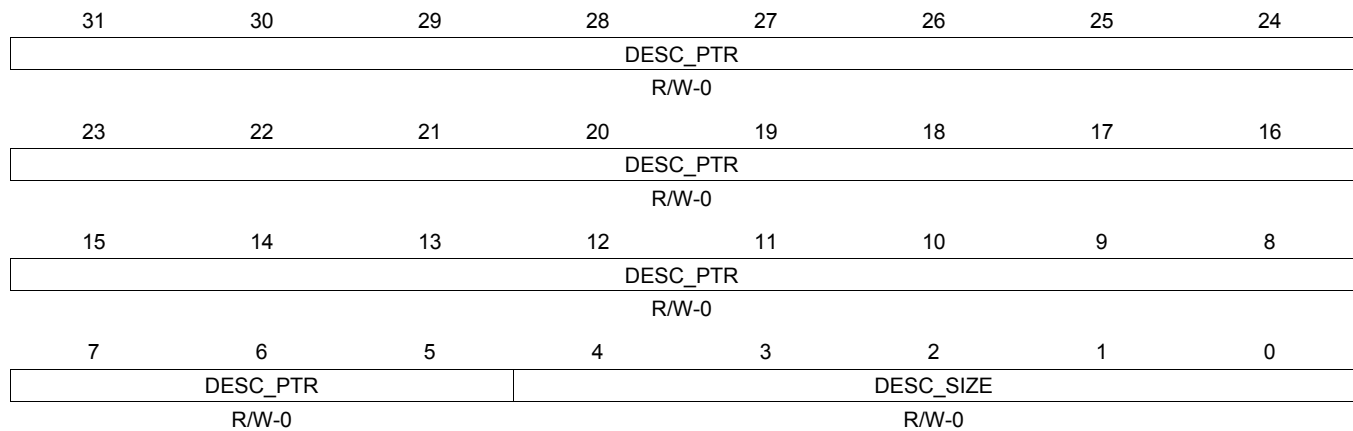

LEGEND: R/W = Read/Write; R = Read only; W1toCl = Write 1 to clear bit; -n = value after reset

Table 16-655. QUEUE_82_C Register Field Descriptions

Bit	Field	Type	Reset	Description
31	HEAD_TAIL	W-0	0	Head/Tail Push Control. Set to zero in order to push packet onto tail of queue and set to one in order to push packet onto head of queue.
13-0	PACKET_SIZE	R/W-0	0	packet_size This field indicates packet size and is assumed to be zero on each packet add unless the value is explicitly overwritten. This field indicates packet size for packet pop operation.

16.5.7.366 QUEUE_82_D Register (offset = 252Ch) [reset = 0h]

QUEUE_82_D is shown in [Figure 16-642](#) and described in [Table 16-656](#).

Figure 16-642. QUEUE_82_D Register


LEGEND: R/W = Read/Write; R = Read only; W1toCl = Write 1 to clear bit; -n = value after reset

Table 16-656. QUEUE_82_D Register Field Descriptions

Bit	Field	Type	Reset	Description
31-5	DESC_PTR	R/W-0	0	Descriptor pointer. It will be read as zero if the queue is empty. It will indicate a 32-bit aligned address that points to a descriptor when the queue is not empty.
4-0	DESC_SIZE	R/W-0	0	Descriptor Size. It is encoded in 4-byte increments with values 0 to 31 representing 24 and so on to 148 bytes. This field will return a 0x0 when an empty queue is read. Queue Manager Queue N Registers D To save hardware resources, the queue manager internally stores descriptor size (desc_size) information in four bits. However, register D has five LSBs that specify descriptor size. As a consequence, the value of desc_size that is pushed may not be same as that is read during a pop. The value that is read back is equal to always rounded to an odd number. So, for even values, the value read back is one more than what was written. For odd values, the value read back is same as the value that was written. Note that this 5-bit field (desc_size) is unrelated to the code for size of descriptors in a descriptor region. It is just a place holder for a 5-bit value that is maintained across the push and pop operations for every descriptor managed by the queue manager.

16.5.7.367 QUEUE_83_A Register (offset = 2530h) [reset = 0h]

QUEUE_83_A is shown in [Figure 16-643](#) and described in [Table 16-657](#).

Figure 16-643. QUEUE_83_A Register

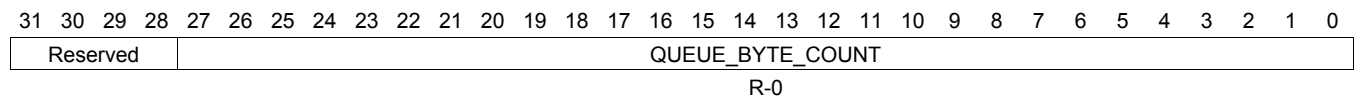

LEGEND: R/W = Read/Write; R = Read only; W1toCl = Write 1 to clear bit; -n = value after reset

Table 16-657. QUEUE_83_A Register Field Descriptions

Bit	Field	Type	Reset	Description
13-0	QUEUE_ENTRY_COUNT	R-0	0	This field indicates how many packets are currently queued on the queue. This count is incremented by 1 whenever a packet is added to the queue. This count is decremented by 1 whenever a packet is popped from the queue.

16.5.7.368 QUEUE_83_B Register (offset = 2534h) [reset = 0h]

 QUEUE_83_B is shown in [Figure 16-644](#) and described in [Table 16-658](#).

Figure 16-644. QUEUE_83_B Register


LEGEND: R/W = Read/Write; R = Read only; W1toCl = Write 1 to clear bit; -n = value after reset

Table 16-658. QUEUE_83_B Register Field Descriptions

Bit	Field	Type	Reset	Description
27-0	QUEUE_BYTE_COUNT	R-0	0	This field indicates how many bytes total are contained in all of the packets which are currently queued on this queue.

16.5.7.369 QUEUE_83_C Register (offset = 2538h) [reset = 0h]

 QUEUE_83_C is shown in [Figure 16-645](#) and described in [Table 16-659](#).

Figure 16-645. QUEUE_83_C Register

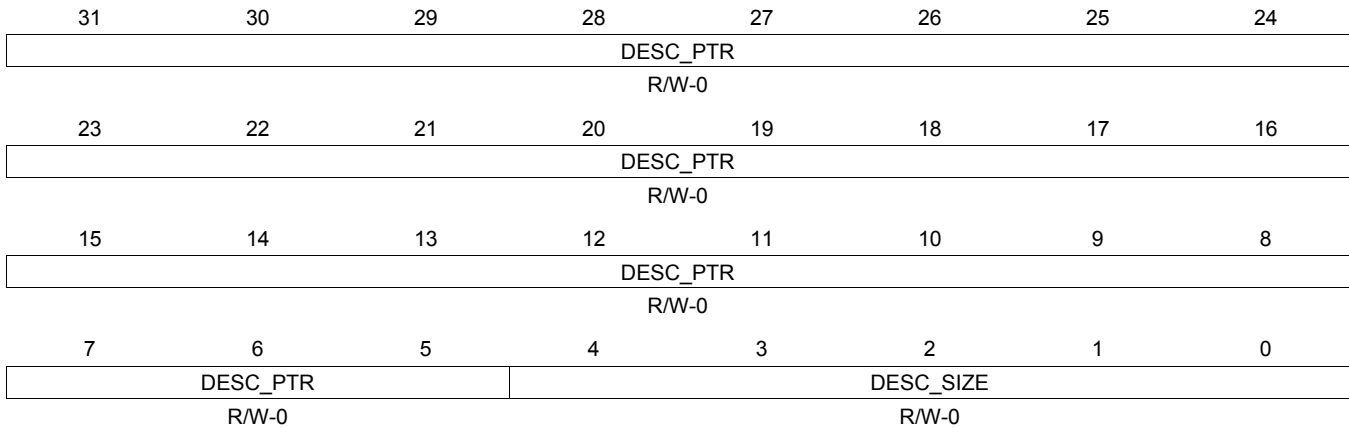

LEGEND: R/W = Read/Write; R = Read only; W1toCl = Write 1 to clear bit; -n = value after reset

Table 16-659. QUEUE_83_C Register Field Descriptions

Bit	Field	Type	Reset	Description
31	HEAD_TAIL	W-0	0	Head/Tail Push Control. Set to zero in order to push packet onto tail of queue and set to one in order to push packet onto head of queue.
13-0	PACKET_SIZE	R/W-0	0	packet_size This field indicates packet size and is assumed to be zero on each packet add unless the value is explicitly overwritten. This field indicates packet size for packet pop operation.

16.5.7.370 QUEUE_83_D Register (offset = 253Ch) [reset = 0h]

QUEUE_83_D is shown in [Figure 16-646](#) and described in [Table 16-660](#).

Figure 16-646. QUEUE_83_D Register


LEGEND: R/W = Read/Write; R = Read only; W1toCl = Write 1 to clear bit; -n = value after reset

Table 16-660. QUEUE_83_D Register Field Descriptions

Bit	Field	Type	Reset	Description
31-5	DESC_PTR	R/W-0	0	Descriptor pointer. It will be read as zero if the queue is empty. It will indicate a 32-bit aligned address that points to a descriptor when the queue is not empty.
4-0	DESC_SIZE	R/W-0	0	Descriptor Size. It is encoded in 4-byte increments with values 0 to 31 representing 24 and so on to 148 bytes. This field will return a 0x0 when an empty queue is read. Queue Manager Queue N Registers D To save hardware resources, the queue manager internally stores descriptor size (desc_size) information in four bits. However, register D has five LSBs that specify descriptor size. As a consequence, the value of desc_size that is pushed may not be same as that is read during a pop. The value that is read back is equal to always rounded to an odd number. So, for even values, the value read back is one more than what was written. For odd values, the value read back is same as the value that was written. Note that this 5-bit field (desc_size) is unrelated to the code for size of descriptors in a descriptor region. It is just a place holder for a 5-bit value that is maintained across the push and pop operations for every descriptor managed by the queue manager.

16.5.7.371 QUEUE_84_A Register (offset = 2540h) [reset = 0h]

QUEUE_84_A is shown in [Figure 16-647](#) and described in [Table 16-661](#).

Figure 16-647. QUEUE_84_A Register


LEGEND: R/W = Read/Write; R = Read only; W1toCl = Write 1 to clear bit; -n = value after reset

Table 16-661. QUEUE_84_A Register Field Descriptions

Bit	Field	Type	Reset	Description
13-0	QUEUE_ENTRY_COUNT	R-0	0	This field indicates how many packets are currently queued on the queue. This count is incremented by 1 whenever a packet is added to the queue. This count is decremented by 1 whenever a packet is popped from the queue.

16.5.7.372 QUEUE_84_B Register (offset = 2544h) [reset = 0h]

QUEUE_84_B is shown in [Figure 16-648](#) and described in [Table 16-662](#).

Figure 16-648. QUEUE_84_B Register

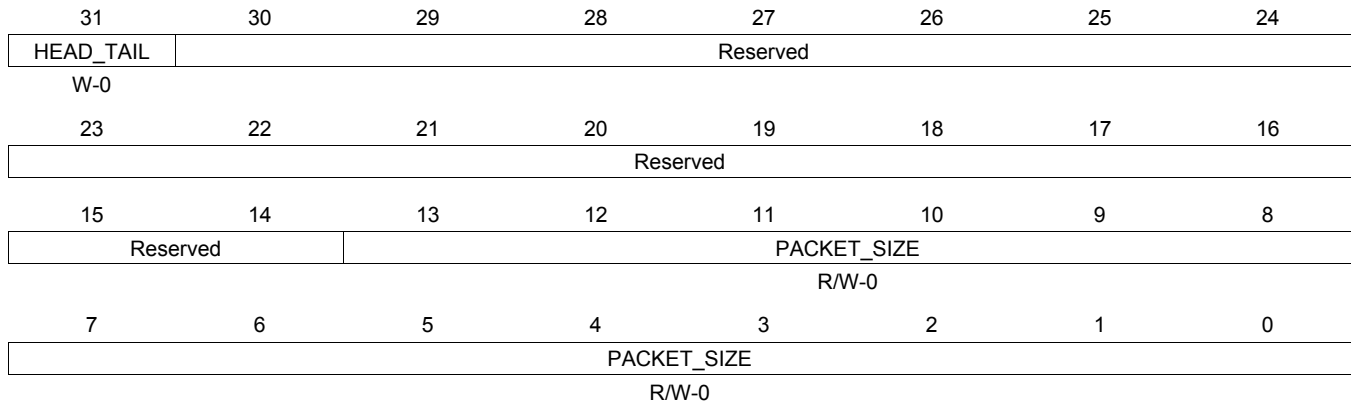

LEGEND: R/W = Read/Write; R = Read only; W1toCl = Write 1 to clear bit; -n = value after reset

Table 16-662. QUEUE_84_B Register Field Descriptions

Bit	Field	Type	Reset	Description
27-0	QUEUE_BYTE_COUNT	R-0	0	This field indicates how many bytes total are contained in all of the packets which are currently queued on this queue.

16.5.7.373 QUEUE_84_C Register (offset = 2548h) [reset = 0h]

 QUEUE_84_C is shown in [Figure 16-649](#) and described in [Table 16-663](#).

Figure 16-649. QUEUE_84_C Register


LEGEND: R/W = Read/Write; R = Read only; W1toCl = Write 1 to clear bit; -n = value after reset

Table 16-663. QUEUE_84_C Register Field Descriptions

Bit	Field	Type	Reset	Description
31	HEAD_TAIL	W-0	0	Head/Tail Push Control. Set to zero in order to push packet onto tail of queue and set to one in order to push packet onto head of queue.
13-0	PACKET_SIZE	R/W-0	0	packet_size This field indicates packet size and is assumed to be zero on each packet add unless the value is explicitly overwritten. This field indicates packet size for packet pop operation.

16.5.7.374 QUEUE_84_D Register (offset = 254Ch) [reset = 0h]

 QUEUE_84_D is shown in [Figure 16-650](#) and described in [Table 16-664](#).

Figure 16-650. QUEUE_84_D Register


LEGEND: R/W = Read/Write; R = Read only; W1toCl = Write 1 to clear bit; -n = value after reset

Table 16-664. QUEUE_84_D Register Field Descriptions

Bit	Field	Type	Reset	Description
31-5	DESC_PTR	R/W-0	0	Descriptor pointer. It will be read as zero if the queue is empty. It will indicate a 32-bit aligned address that points to a descriptor when the queue is not empty.
4-0	DESC_SIZE	R/W-0	0	Descriptor Size. It is encoded in 4-byte increments with values 0 to 31 representing 24 and so on to 148 bytes. This field will return a 0x0 when an empty queue is read. Queue Manager Queue N Registers D To save hardware resources, the queue manager internally stores descriptor size (desc_size) information in four bits. However, register D has five LSBs that specify descriptor size. As a consequence, the value of desc_size that is pushed may not be same as that is read during a pop. The value that is read back is equal to always rounded to an odd number. So, for even values, the value read back is one more than what was written. For odd values, the value read back is same as the value that was written. Note that this 5-bit field (desc_size) is unrelated to the code for size of descriptors in a descriptor region. It is just a place holder for a 5-bit value that is maintained across the push and pop operations for every descriptor managed by the queue manager.

16.5.7.375 QUEUE_85_A Register (offset = 2550h) [reset = 0h]

QUEUE_85_A is shown in [Figure 16-651](#) and described in [Table 16-665](#).

Figure 16-651. QUEUE_85_A Register

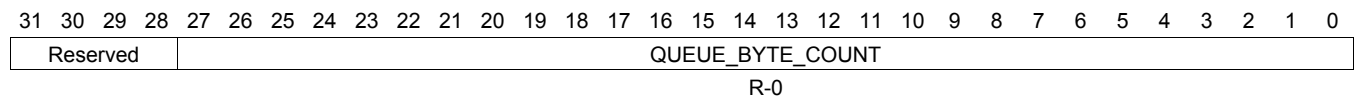

LEGEND: R/W = Read/Write; R = Read only; W1toCl = Write 1 to clear bit; -n = value after reset

Table 16-665. QUEUE_85_A Register Field Descriptions

Bit	Field	Type	Reset	Description
13-0	QUEUE_ENTRY_COUNT	R-0	0	This field indicates how many packets are currently queued on the queue. This count is incremented by 1 whenever a packet is added to the queue. This count is decremented by 1 whenever a packet is popped from the queue.

16.5.7.376 QUEUE_85_B Register (offset = 2554h) [reset = 0h]

QUEUE_85_B is shown in [Figure 16-652](#) and described in [Table 16-666](#).

Figure 16-652. QUEUE_85_B Register


LEGEND: R/W = Read/Write; R = Read only; W1toCl = Write 1 to clear bit; -n = value after reset

Table 16-666. QUEUE_85_B Register Field Descriptions

Bit	Field	Type	Reset	Description
27-0	QUEUE_BYTE_COUNT	R-0	0	This field indicates how many bytes total are contained in all of the packets which are currently queued on this queue.

16.5.7.377 QUEUE_85_C Register (offset = 2558h) [reset = 0h]

 QUEUE_85_C is shown in [Figure 16-653](#) and described in [Table 16-667](#).

Figure 16-653. QUEUE_85_C Register


LEGEND: R/W = Read/Write; R = Read only; W1toCl = Write 1 to clear bit; -n = value after reset

Table 16-667. QUEUE_85_C Register Field Descriptions

Bit	Field	Type	Reset	Description
31	HEAD_TAIL	W-0	0	Head/Tail Push Control. Set to zero in order to push packet onto tail of queue and set to one in order to push packet onto head of queue.
13-0	PACKET_SIZE	R/W-0	0	packet_size This field indicates packet size and is assumed to be zero on each packet add unless the value is explicitly overwritten. This field indicates packet size for packet pop operation.

16.5.7.378 QUEUE_85_D Register (offset = 255Ch) [reset = 0h]

 QUEUE_85_D is shown in [Figure 16-654](#) and described in [Table 16-668](#).

Figure 16-654. QUEUE_85_D Register


LEGEND: R/W = Read/Write; R = Read only; W1toCl = Write 1 to clear bit; -n = value after reset

Table 16-668. QUEUE_85_D Register Field Descriptions

Bit	Field	Type	Reset	Description
31-5	DESC_PTR	R/W-0	0	Descriptor pointer. It will be read as zero if the queue is empty. It will indicate a 32-bit aligned address that points to a descriptor when the queue is not empty.
4-0	DESC_SIZE	R/W-0	0	Descriptor Size. It is encoded in 4-byte increments with values 0 to 31 representing 24 and so on to 148 bytes. This field will return a 0x0 when an empty queue is read. Queue Manager Queue N Registers D To save hardware resources, the queue manager internally stores descriptor size (desc_size) information in four bits. However, register D has five LSBs that specify descriptor size. As a consequence, the value of desc_size that is pushed may not be same as that is read during a pop. The value that is read back is equal to always rounded to an odd number. So, for even values, the value read back is one more than what was written. For odd values, the value read back is same as the value that was written. Note that this 5-bit field (desc_size) is unrelated to the code for size of descriptors in a descriptor region. It is just a place holder for a 5-bit value that is maintained across the push and pop operations for every descriptor managed by the queue manager.

16.5.7.379 QUEUE_86_A Register (offset = 2560h) [reset = 0h]

QUEUE_86_A is shown in [Figure 16-655](#) and described in [Table 16-669](#).

Figure 16-655. QUEUE_86_A Register


LEGEND: R/W = Read/Write; R = Read only; W1toCl = Write 1 to clear bit; -n = value after reset

Table 16-669. QUEUE_86_A Register Field Descriptions

Bit	Field	Type	Reset	Description
13-0	QUEUE_ENTRY_COUNT	R-0	0	This field indicates how many packets are currently queued on the queue. This count is incremented by 1 whenever a packet is added to the queue. This count is decremented by 1 whenever a packet is popped from the queue.

16.5.7.380 QUEUE_86_B Register (offset = 2564h) [reset = 0h]

 QUEUE_86_B is shown in [Figure 16-656](#) and described in [Table 16-670](#).

Figure 16-656. QUEUE_86_B Register

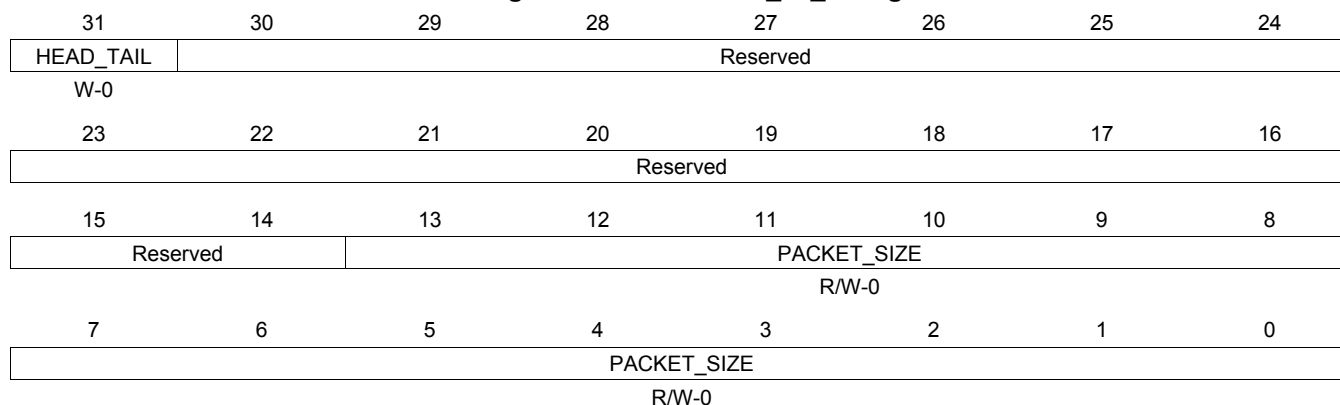

LEGEND: R/W = Read/Write; R = Read only; W1toCl = Write 1 to clear bit; -n = value after reset

Table 16-670. QUEUE_86_B Register Field Descriptions

Bit	Field	Type	Reset	Description
27-0	QUEUE_BYTE_COUNT	R-0	0	This field indicates how many bytes total are contained in all of the packets which are currently queued on this queue.

16.5.7.381 QUEUE_86_C Register (offset = 2568h) [reset = 0h]

 QUEUE_86_C is shown in [Figure 16-657](#) and described in [Table 16-671](#).

Figure 16-657. QUEUE_86_C Register


LEGEND: R/W = Read/Write; R = Read only; W1toCl = Write 1 to clear bit; -n = value after reset

Table 16-671. QUEUE_86_C Register Field Descriptions

Bit	Field	Type	Reset	Description
31	HEAD_TAIL	W-0	0	Head/Tail Push Control. Set to zero in order to push packet onto tail of queue and set to one in order to push packet onto head of queue.
13-0	PACKET_SIZE	R/W-0	0	packet_size This field indicates packet size and is assumed to be zero on each packet add unless the value is explicitly overwritten. This field indicates packet size for packet pop operation.

16.5.7.382 QUEUE_86_D Register (offset = 256Ch) [reset = 0h]

 QUEUE_86_D is shown in [Figure 16-658](#) and described in [Table 16-672](#).

Figure 16-658. QUEUE_86_D Register


LEGEND: R/W = Read/Write; R = Read only; W1toCl = Write 1 to clear bit; -n = value after reset

Table 16-672. QUEUE_86_D Register Field Descriptions

Bit	Field	Type	Reset	Description
31-5	DESC_PTR	R/W-0	0	Descriptor pointer. It will be read as zero if the queue is empty. It will indicate a 32-bit aligned address that points to a descriptor when the queue is not empty.
4-0	DESC_SIZE	R/W-0	0	Descriptor Size. It is encoded in 4-byte increments with values 0 to 31 representing 24 and so on to 148 bytes. This field will return a 0x0 when an empty queue is read. Queue Manager Queue N Registers D To save hardware resources, the queue manager internally stores descriptor size (desc_size) information in four bits. However, register D has five LSBs that specify descriptor size. As a consequence, the value of desc_size that is pushed may not be same as that is read during a pop. The value that is read back is equal to always rounded to an odd number. So, for even values, the value read back is one more than what was written. For odd values, the value read back is same as the value that was written. Note that this 5-bit field (desc_size) is unrelated to the code for size of descriptors in a descriptor region. It is just a place holder for a 5-bit value that is maintained across the push and pop operations for every descriptor managed by the queue manager.

16.5.7.383 QUEUE_87_A Register (offset = 2570h) [reset = 0h]

QUEUE_87_A is shown in [Figure 16-659](#) and described in [Table 16-673](#).

Figure 16-659. QUEUE_87_A Register

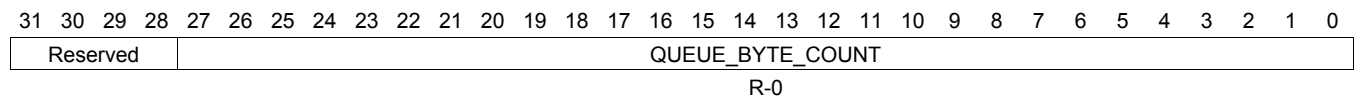

LEGEND: R/W = Read/Write; R = Read only; W1toCl = Write 1 to clear bit; -n = value after reset

Table 16-673. QUEUE_87_A Register Field Descriptions

Bit	Field	Type	Reset	Description
13-0	QUEUE_ENTRY_COUNT	R-0	0	This field indicates how many packets are currently queued on the queue. This count is incremented by 1 whenever a packet is added to the queue. This count is decremented by 1 whenever a packet is popped from the queue.

16.5.7.384 QUEUE_87_B Register (offset = 2574h) [reset = 0h]

 QUEUE_87_B is shown in [Figure 16-660](#) and described in [Table 16-674](#).

Figure 16-660. QUEUE_87_B Register


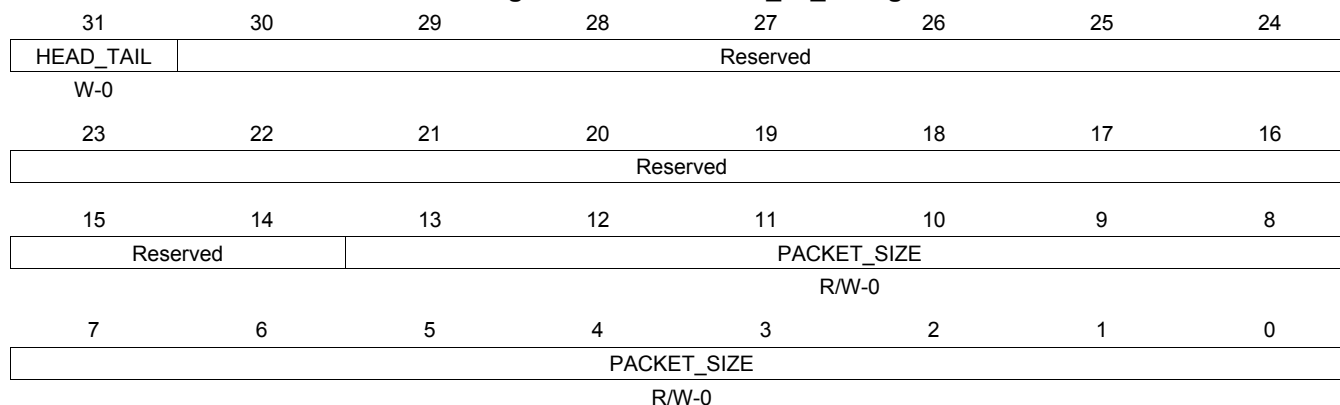
LEGEND: R/W = Read/Write; R = Read only; W1toCl = Write 1 to clear bit; -n = value after reset

Table 16-674. QUEUE_87_B Register Field Descriptions

Bit	Field	Type	Reset	Description
27-0	QUEUE_BYTE_COUNT	R-0	0	This field indicates how many bytes total are contained in all of the packets which are currently queued on this queue.

16.5.7.385 QUEUE_87_C Register (offset = 2578h) [reset = 0h]

 QUEUE_87_C is shown in [Figure 16-661](#) and described in [Table 16-675](#).

Figure 16-661. QUEUE_87_C Register


LEGEND: R/W = Read/Write; R = Read only; W1toCl = Write 1 to clear bit; -n = value after reset

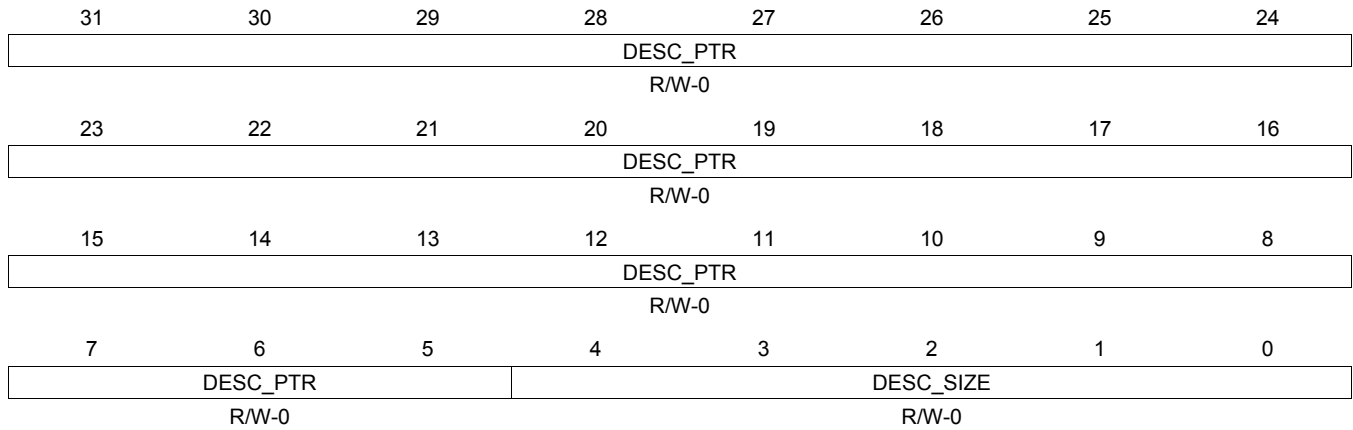
Table 16-675. QUEUE_87_C Register Field Descriptions

Bit	Field	Type	Reset	Description
31	HEAD_TAIL	W-0	0	Head/Tail Push Control. Set to zero in order to push packet onto tail of queue and set to one in order to push packet onto head of queue.
13-0	PACKET_SIZE	R/W-0	0	packet_size This field indicates packet size and is assumed to be zero on each packet add unless the value is explicitly overwritten. This field indicates packet size for packet pop operation.

16.5.7.386 QUEUE_87_D Register (offset = 257Ch) [reset = 0h]

QUEUE_87_D is shown in [Figure 16-662](#) and described in [Table 16-676](#).

Figure 16-662. QUEUE_87_D Register



LEGEND: R/W = Read/Write; R = Read only; W1toCl = Write 1 to clear bit; -n = value after reset

Table 16-676. QUEUE_87_D Register Field Descriptions

Bit	Field	Type	Reset	Description
31-5	DESC_PTR	R/W-0	0	Descriptor pointer. It will be read as zero if the queue is empty. It will indicate a 32-bit aligned address that points to a descriptor when the queue is not empty.
4-0	DESC_SIZE	R/W-0	0	Descriptor Size. It is encoded in 4-byte increments with values 0 to 31 representing 24 and so on to 148 bytes. This field will return a 0x0 when an empty queue is read. Queue Manager Queue N Registers D To save hardware resources, the queue manager internally stores descriptor size (desc_size) information in four bits. However, register D has five LSBs that specify descriptor size. As a consequence, the value of desc_size that is pushed may not be same as that is read during a pop. The value that is read back is equal to always rounded to an odd number. So, for even values, the value read back is one more than what was written. For odd values, the value read back is same as the value that was written. Note that this 5-bit field (desc_size) is unrelated to the code for size of descriptors in a descriptor region. It is just a place holder for a 5-bit value that is maintained across the push and pop operations for every descriptor managed by the queue manager.

16.5.7.387 QUEUE_88_A Register (offset = 2580h) [reset = 0h]

QUEUE_88_A is shown in [Figure 16-663](#) and described in [Table 16-677](#).

Figure 16-663. QUEUE_88_A Register

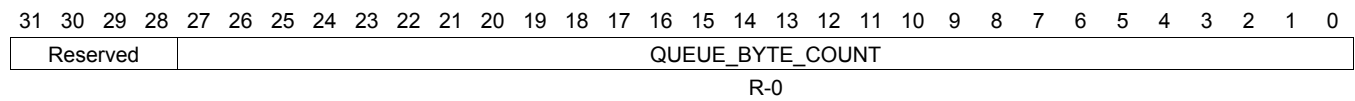

LEGEND: R/W = Read/Write; R = Read only; W1toCl = Write 1 to clear bit; -n = value after reset

Table 16-677. QUEUE_88_A Register Field Descriptions

Bit	Field	Type	Reset	Description
13-0	QUEUE_ENTRY_COUNT	R-0	0	This field indicates how many packets are currently queued on the queue. This count is incremented by 1 whenever a packet is added to the queue. This count is decremented by 1 whenever a packet is popped from the queue.

16.5.7.388 QUEUE_88_B Register (offset = 2584h) [reset = 0h]

 QUEUE_88_B is shown in [Figure 16-664](#) and described in [Table 16-678](#).

Figure 16-664. QUEUE_88_B Register


LEGEND: R/W = Read/Write; R = Read only; W1toCl = Write 1 to clear bit; -n = value after reset

Table 16-678. QUEUE_88_B Register Field Descriptions

Bit	Field	Type	Reset	Description
27-0	QUEUE_BYTE_COUNT	R-0	0	This field indicates how many bytes total are contained in all of the packets which are currently queued on this queue.

16.5.7.389 QUEUE_88_C Register (offset = 2588h) [reset = 0h]

 QUEUE_88_C is shown in [Figure 16-665](#) and described in [Table 16-679](#).

Figure 16-665. QUEUE_88_C Register


LEGEND: R/W = Read/Write; R = Read only; W1toCl = Write 1 to clear bit; -n = value after reset

Table 16-679. QUEUE_88_C Register Field Descriptions

Bit	Field	Type	Reset	Description
31	HEAD_TAIL	W-0	0	Head/Tail Push Control. Set to zero in order to push packet onto tail of queue and set to one in order to push packet onto head of queue.
13-0	PACKET_SIZE	R/W-0	0	packet_size This field indicates packet size and is assumed to be zero on each packet add unless the value is explicitly overwritten. This field indicates packet size for packet pop operation.

16.5.7.390 QUEUE_88_D Register (offset = 258Ch) [reset = 0h]

QUEUE_88_D is shown in [Figure 16-666](#) and described in [Table 16-680](#).

Figure 16-666. QUEUE_88_D Register


LEGEND: R/W = Read/Write; R = Read only; W1toCl = Write 1 to clear bit; -n = value after reset

Table 16-680. QUEUE_88_D Register Field Descriptions

Bit	Field	Type	Reset	Description
31-5	DESC_PTR	R/W-0	0	Descriptor pointer. It will be read as zero if the queue is empty. It will indicate a 32-bit aligned address that points to a descriptor when the queue is not empty.
4-0	DESC_SIZE	R/W-0	0	Descriptor Size. It is encoded in 4-byte increments with values 0 to 31 representing 24 and so on to 148 bytes. This field will return a 0x0 when an empty queue is read. Queue Manager Queue N Registers D To save hardware resources, the queue manager internally stores descriptor size (desc_size) information in four bits. However, register D has five LSBs that specify descriptor size. As a consequence, the value of desc_size that is pushed may not be same as that is read during a pop. The value that is read back is equal to always rounded to an odd number. So, for even values, the value read back is one more than what was written. For odd values, the value read back is same as the value that was written. Note that this 5-bit field (desc_size) is unrelated to the code for size of descriptors in a descriptor region. It is just a place holder for a 5-bit value that is maintained across the push and pop operations for every descriptor managed by the queue manager.

16.5.7.391 QUEUE_89_A Register (offset = 2590h) [reset = 0h]

QUEUE_89_A is shown in [Figure 16-667](#) and described in [Table 16-681](#).

Figure 16-667. QUEUE_89_A Register

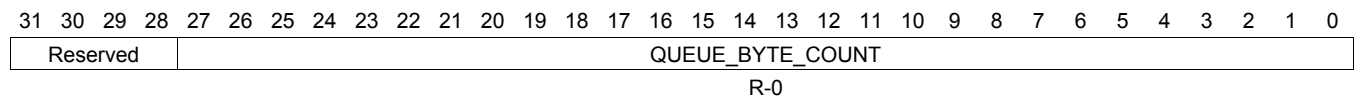

LEGEND: R/W = Read/Write; R = Read only; W1toCl = Write 1 to clear bit; -n = value after reset

Table 16-681. QUEUE_89_A Register Field Descriptions

Bit	Field	Type	Reset	Description
13-0	QUEUE_ENTRY_COUNT	R-0	0	This field indicates how many packets are currently queued on the queue. This count is incremented by 1 whenever a packet is added to the queue. This count is decremented by 1 whenever a packet is popped from the queue.

16.5.7.392 QUEUE_89_B Register (offset = 2594h) [reset = 0h]

 QUEUE_89_B is shown in [Figure 16-668](#) and described in [Table 16-682](#).

Figure 16-668. QUEUE_89_B Register


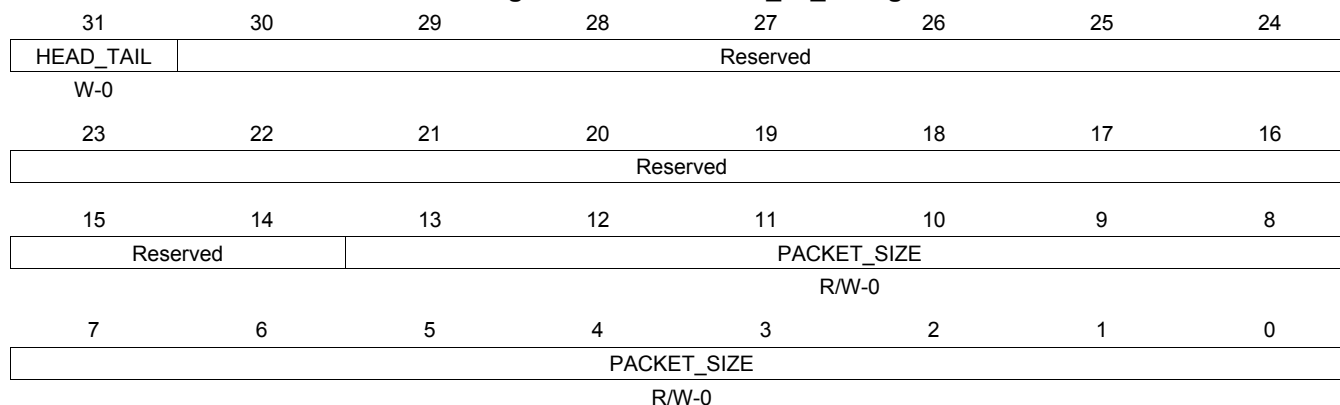
LEGEND: R/W = Read/Write; R = Read only; W1toCl = Write 1 to clear bit; -n = value after reset

Table 16-682. QUEUE_89_B Register Field Descriptions

Bit	Field	Type	Reset	Description
27-0	QUEUE_BYTE_COUNT	R-0	0	This field indicates how many bytes total are contained in all of the packets which are currently queued on this queue.

16.5.7.393 QUEUE_89_C Register (offset = 2598h) [reset = 0h]

 QUEUE_89_C is shown in [Figure 16-669](#) and described in [Table 16-683](#).

Figure 16-669. QUEUE_89_C Register


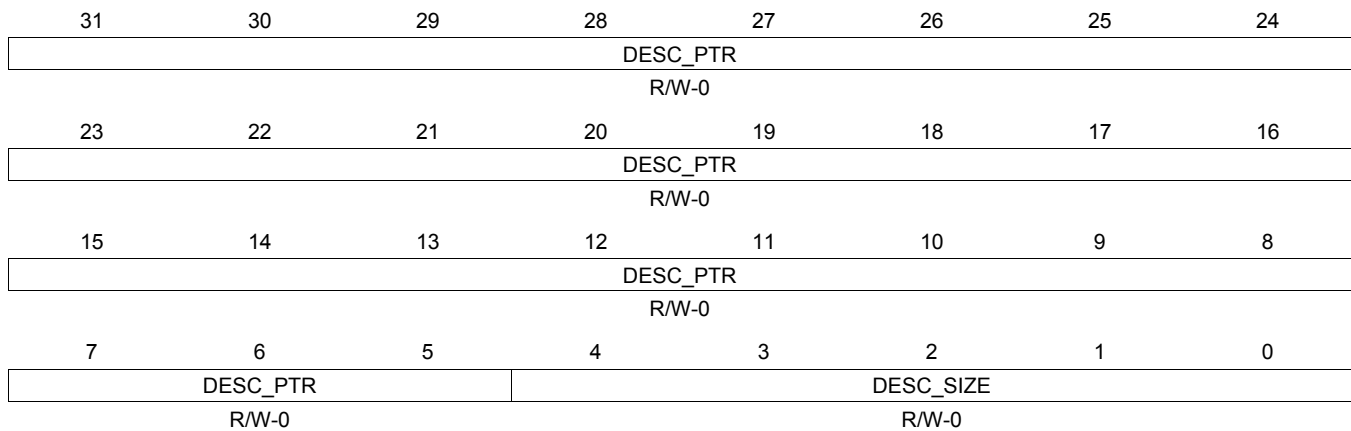
LEGEND: R/W = Read/Write; R = Read only; W1toCl = Write 1 to clear bit; -n = value after reset

Table 16-683. QUEUE_89_C Register Field Descriptions

Bit	Field	Type	Reset	Description
31	HEAD_TAIL	W-0	0	Head/Tail Push Control. Set to zero in order to push packet onto tail of queue and set to one in order to push packet onto head of queue.
13-0	PACKET_SIZE	R/W-0	0	packet_size This field indicates packet size and is assumed to be zero on each packet add unless the value is explicitly overwritten. This field indicates packet size for packet pop operation.

16.5.7.394 QUEUE_89_D Register (offset = 259Ch) [reset = 0h]

QUEUE_89_D is shown in [Figure 16-670](#) and described in [Table 16-684](#).

Figure 16-670. QUEUE_89_D Register


LEGEND: R/W = Read/Write; R = Read only; W1toCl = Write 1 to clear bit; -n = value after reset

Table 16-684. QUEUE_89_D Register Field Descriptions

Bit	Field	Type	Reset	Description
31-5	DESC_PTR	R/W-0	0	Descriptor pointer. It will be read as zero if the queue is empty. It will indicate a 32-bit aligned address that points to a descriptor when the queue is not empty.
4-0	DESC_SIZE	R/W-0	0	Descriptor Size. It is encoded in 4-byte increments with values 0 to 31 representing 24 and so on to 148 bytes. This field will return a 0x0 when an empty queue is read. Queue Manager Queue N Registers D To save hardware resources, the queue manager internally stores descriptor size (desc_size) information in four bits. However, register D has five LSBs that specify descriptor size. As a consequence, the value of desc_size that is pushed may not be same as that is read during a pop. The value that is read back is equal to always rounded to an odd number. So, for even values, the value read back is one more than what was written. For odd values, the value read back is same as the value that was written. Note that this 5-bit field (desc_size) is unrelated to the code for size of descriptors in a descriptor region. It is just a place holder for a 5-bit value that is maintained across the push and pop operations for every descriptor managed by the queue manager.

16.5.7.395 QUEUE_90_A Register (offset = 25A0h) [reset = 0h]

QUEUE_90_A is shown in [Figure 16-671](#) and described in [Table 16-685](#).

Figure 16-671. QUEUE_90_A Register


LEGEND: R/W = Read/Write; R = Read only; W1toCl = Write 1 to clear bit; -n = value after reset

Table 16-685. QUEUE_90_A Register Field Descriptions

Bit	Field	Type	Reset	Description
13-0	QUEUE_ENTRY_COUNT	R-0	0	This field indicates how many packets are currently queued on the queue. This count is incremented by 1 whenever a packet is added to the queue. This count is decremented by 1 whenever a packet is popped from the queue.

16.5.7.396 QUEUE_90_B Register (offset = 25A4h) [reset = 0h]

QUEUE_90_B is shown in [Figure 16-672](#) and described in [Table 16-686](#).

Figure 16-672. QUEUE_90_B Register

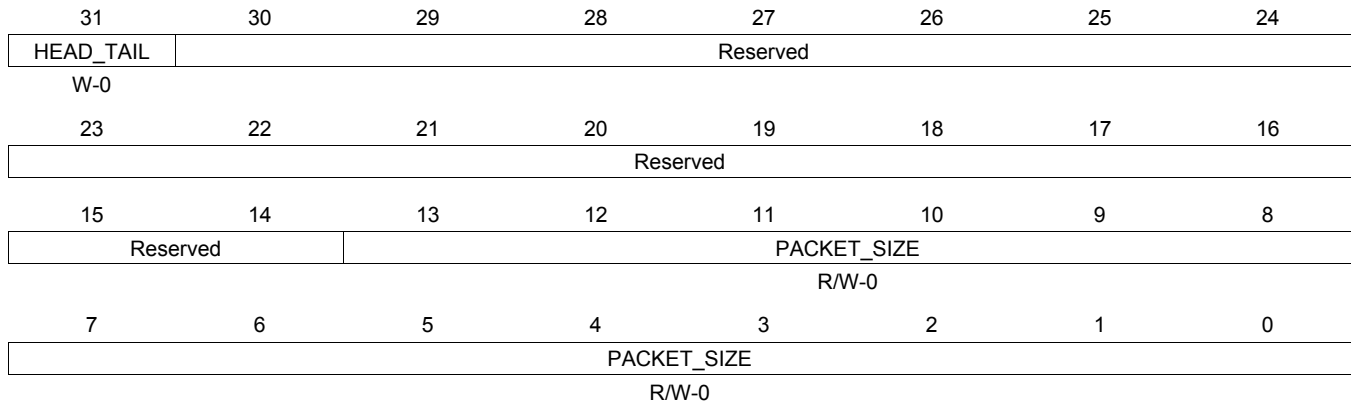

LEGEND: R/W = Read/Write; R = Read only; W1toCl = Write 1 to clear bit; -n = value after reset

Table 16-686. QUEUE_90_B Register Field Descriptions

Bit	Field	Type	Reset	Description
27-0	QUEUE_BYTE_COUNT	R-0	0	This field indicates how many bytes total are contained in all of the packets which are currently queued on this queue.

16.5.7.397 QUEUE_90_C Register (offset = 25A8h) [reset = 0h]

 QUEUE_90_C is shown in [Figure 16-673](#) and described in [Table 16-687](#).

Figure 16-673. QUEUE_90_C Register


LEGEND: R/W = Read/Write; R = Read only; W1toCl = Write 1 to clear bit; -n = value after reset

Table 16-687. QUEUE_90_C Register Field Descriptions

Bit	Field	Type	Reset	Description
31	HEAD_TAIL	W-0	0	Head/Tail Push Control. Set to zero in order to push packet onto tail of queue and set to one in order to push packet onto head of queue.
13-0	PACKET_SIZE	R/W-0	0	packet_size This field indicates packet size and is assumed to be zero on each packet add unless the value is explicitly overwritten. This field indicates packet size for packet pop operation.

16.5.7.398 QUEUE_90_D Register (offset = 25ACh) [reset = 0h]

 QUEUE_90_D is shown in [Figure 16-674](#) and described in [Table 16-688](#).

Figure 16-674. QUEUE_90_D Register

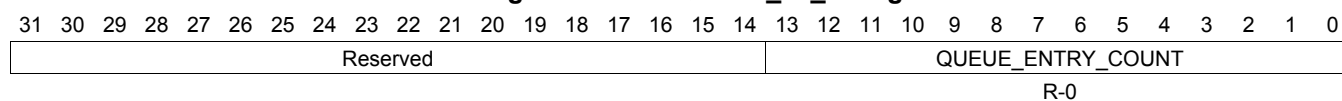

LEGEND: R/W = Read/Write; R = Read only; W1toCl = Write 1 to clear bit; -n = value after reset

Table 16-688. QUEUE_90_D Register Field Descriptions

Bit	Field	Type	Reset	Description
31-5	DESC_PTR	R/W-0	0	Descriptor pointer. It will be read as zero if the queue is empty. It will indicate a 32-bit aligned address that points to a descriptor when the queue is not empty.
4-0	DESC_SIZE	R/W-0	0	Descriptor Size. It is encoded in 4-byte increments with values 0 to 31 representing 24 and so on to 148 bytes. This field will return a 0x0 when an empty queue is read. Queue Manager Queue N Registers D To save hardware resources, the queue manager internally stores descriptor size (desc_size) information in four bits. However, register D has five LSBs that specify descriptor size. As a consequence, the value of desc_size that is pushed may not be same as that is read during a pop. The value that is read back is equal to always rounded to an odd number. So, for even values, the value read back is one more than what was written. For odd values, the value read back is same as the value that was written. Note that this 5-bit field (desc_size) is unrelated to the code for size of descriptors in a descriptor region. It is just a place holder for a 5-bit value that is maintained across the push and pop operations for every descriptor managed by the queue manager.

16.5.7.399 QUEUE_91_A Register (offset = 25B0h) [reset = 0h]

QUEUE_91_A is shown in [Figure 16-675](#) and described in [Table 16-689](#).

Figure 16-675. QUEUE_91_A Register


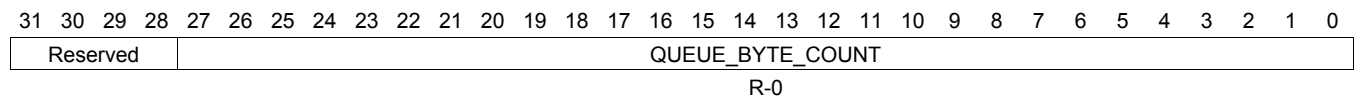
LEGEND: R/W = Read/Write; R = Read only; W1toCl = Write 1 to clear bit; -n = value after reset

Table 16-689. QUEUE_91_A Register Field Descriptions

Bit	Field	Type	Reset	Description
13-0	QUEUE_ENTRY_COUNT	R-0	0	This field indicates how many packets are currently queued on the queue. This count is incremented by 1 whenever a packet is added to the queue. This count is decremented by 1 whenever a packet is popped from the queue.

16.5.7.400 QUEUE_91_B Register (offset = 25B4h) [reset = 0h]

 QUEUE_91_B is shown in [Figure 16-676](#) and described in [Table 16-690](#).

Figure 16-676. QUEUE_91_B Register


LEGEND: R/W = Read/Write; R = Read only; W1toCl = Write 1 to clear bit; -n = value after reset

Table 16-690. QUEUE_91_B Register Field Descriptions

Bit	Field	Type	Reset	Description
27-0	QUEUE_BYTE_COUNT	R-0	0	This field indicates how many bytes total are contained in all of the packets which are currently queued on this queue.

16.5.7.401 QUEUE_91_C Register (offset = 25B8h) [reset = 0h]

 QUEUE_91_C is shown in [Figure 16-677](#) and described in [Table 16-691](#).

Figure 16-677. QUEUE_91_C Register

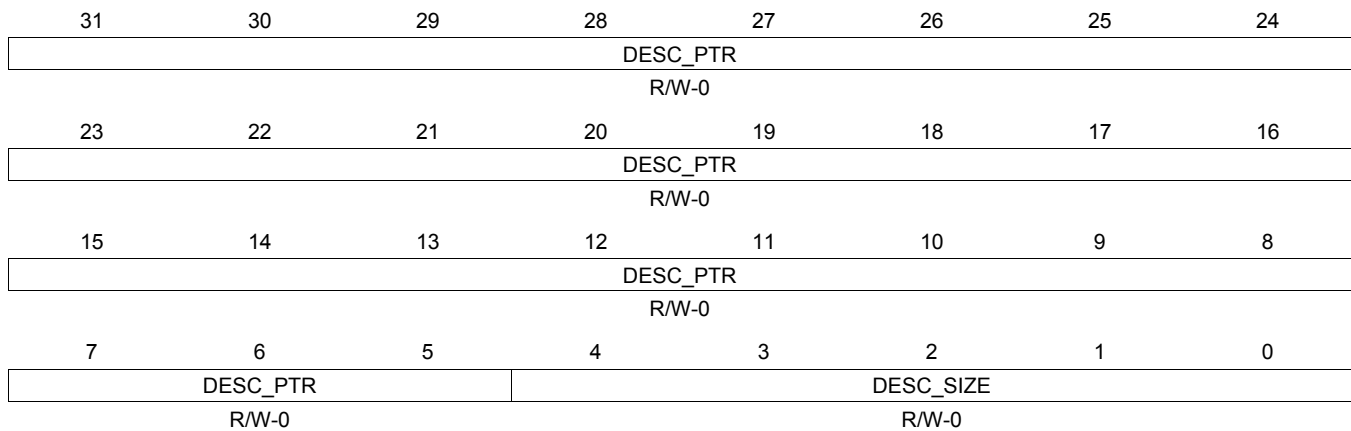

LEGEND: R/W = Read/Write; R = Read only; W1toCl = Write 1 to clear bit; -n = value after reset

Table 16-691. QUEUE_91_C Register Field Descriptions

Bit	Field	Type	Reset	Description
31	HEAD_TAIL	W-0	0	Head/Tail Push Control. Set to zero in order to push packet onto tail of queue and set to one in order to push packet onto head of queue.
13-0	PACKET_SIZE	R/W-0	0	packet_size This field indicates packet size and is assumed to be zero on each packet add unless the value is explicitly overwritten. This field indicates packet size for packet pop operation.

16.5.7.402 QUEUE_91_D Register (offset = 25BCh) [reset = 0h]

 QUEUE_91_D is shown in [Figure 16-678](#) and described in [Table 16-692](#).

Figure 16-678. QUEUE_91_D Register


LEGEND: R/W = Read/Write; R = Read only; W1toCl = Write 1 to clear bit; -n = value after reset

Table 16-692. QUEUE_91_D Register Field Descriptions

Bit	Field	Type	Reset	Description
31-5	DESC_PTR	R/W-0	0	Descriptor pointer. It will be read as zero if the queue is empty. It will indicate a 32-bit aligned address that points to a descriptor when the queue is not empty.
4-0	DESC_SIZE	R/W-0	0	Descriptor Size. It is encoded in 4-byte increments with values 0 to 31 representing 24 and so on to 148 bytes. This field will return a 0x0 when an empty queue is read. Queue Manager Queue N Registers D To save hardware resources, the queue manager internally stores descriptor size (desc_size) information in four bits. However, register D has five LSBs that specify descriptor size. As a consequence, the value of desc_size that is pushed may not be same as that is read during a pop. The value that is read back is equal to always rounded to an odd number. So, for even values, the value read back is one more than what was written. For odd values, the value read back is same as the value that was written. Note that this 5-bit field (desc_size) is unrelated to the code for size of descriptors in a descriptor region. It is just a place holder for a 5-bit value that is maintained across the push and pop operations for every descriptor managed by the queue manager.

16.5.7.403 QUEUE_92_A Register (offset = 25C0h) [reset = 0h]

QUEUE_92_A is shown in [Figure 16-679](#) and described in [Table 16-693](#).

Figure 16-679. QUEUE_92_A Register


LEGEND: R/W = Read/Write; R = Read only; W1toCl = Write 1 to clear bit; -n = value after reset

Table 16-693. QUEUE_92_A Register Field Descriptions

Bit	Field	Type	Reset	Description
13-0	QUEUE_ENTRY_COUNT	R-0	0	This field indicates how many packets are currently queued on the queue. This count is incremented by 1 whenever a packet is added to the queue. This count is decremented by 1 whenever a packet is popped from the queue.

16.5.7.404 QUEUE_92_B Register (offset = 25C4h) [reset = 0h]

 QUEUE_92_B is shown in [Figure 16-680](#) and described in [Table 16-694](#).

Figure 16-680. QUEUE_92_B Register

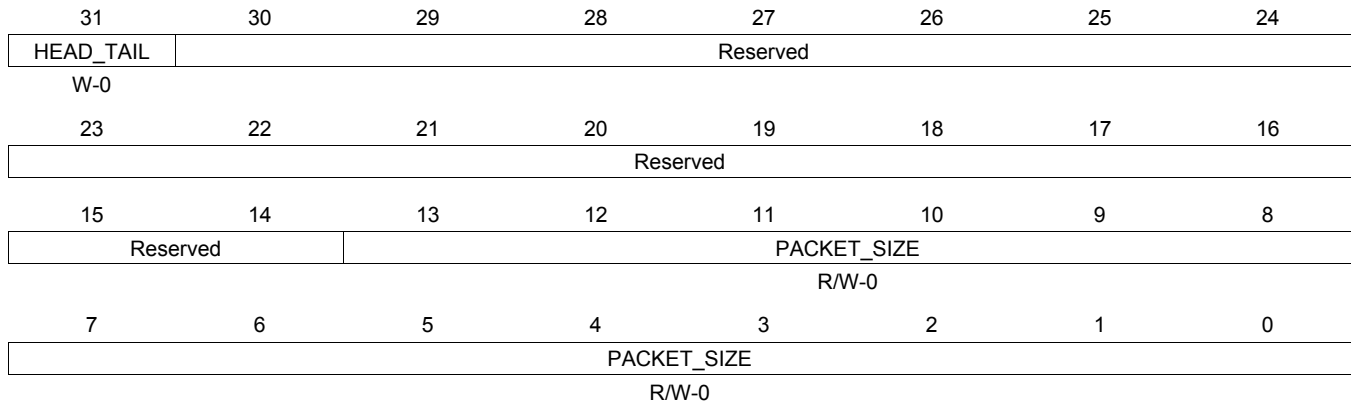

LEGEND: R/W = Read/Write; R = Read only; W1toCl = Write 1 to clear bit; -n = value after reset

Table 16-694. QUEUE_92_B Register Field Descriptions

Bit	Field	Type	Reset	Description
27-0	QUEUE_BYTE_COUNT	R-0	0	This field indicates how many bytes total are contained in all of the packets which are currently queued on this queue.

16.5.7.405 QUEUE_92_C Register (offset = 25C8h) [reset = 0h]

 QUEUE_92_C is shown in [Figure 16-681](#) and described in [Table 16-695](#).

Figure 16-681. QUEUE_92_C Register


LEGEND: R/W = Read/Write; R = Read only; W1toCl = Write 1 to clear bit; -n = value after reset

Table 16-695. QUEUE_92_C Register Field Descriptions

Bit	Field	Type	Reset	Description
31	HEAD_TAIL	W-0	0	Head/Tail Push Control. Set to zero in order to push packet onto tail of queue and set to one in order to push packet onto head of queue.
13-0	PACKET_SIZE	R/W-0	0	packet_size This field indicates packet size and is assumed to be zero on each packet add unless the value is explicitly overwritten. This field indicates packet size for packet pop operation.

16.5.7.406 QUEUE_92_D Register (offset = 25CCh) [reset = 0h]

 QUEUE_92_D is shown in [Figure 16-682](#) and described in [Table 16-696](#).

Figure 16-682. QUEUE_92_D Register

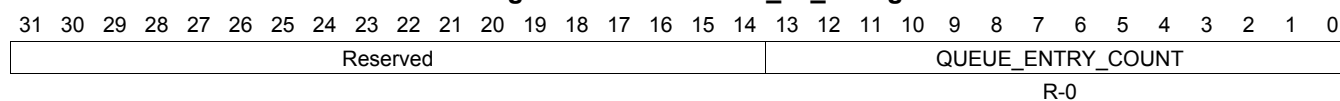

LEGEND: R/W = Read/Write; R = Read only; W1toCl = Write 1 to clear bit; -n = value after reset

Table 16-696. QUEUE_92_D Register Field Descriptions

Bit	Field	Type	Reset	Description
31-5	DESC_PTR	R/W-0	0	Descriptor pointer. It will be read as zero if the queue is empty. It will indicate a 32-bit aligned address that points to a descriptor when the queue is not empty.
4-0	DESC_SIZE	R/W-0	0	Descriptor Size. It is encoded in 4-byte increments with values 0 to 31 representing 24 and so on to 148 bytes. This field will return a 0x0 when an empty queue is read. Queue Manager Queue N Registers D To save hardware resources, the queue manager internally stores descriptor size (desc_size) information in four bits. However, register D has five LSBs that specify descriptor size. As a consequence, the value of desc_size that is pushed may not be same as that is read during a pop. The value that is read back is equal to always rounded to an odd number. So, for even values, the value read back is one more than what was written. For odd values, the value read back is same as the value that was written. Note that this 5-bit field (desc_size) is unrelated to the code for size of descriptors in a descriptor region. It is just a place holder for a 5-bit value that is maintained across the push and pop operations for every descriptor managed by the queue manager.

16.5.7.407 QUEUE_93_A Register (offset = 25D0h) [reset = 0h]

QUEUE_93_A is shown in [Figure 16-683](#) and described in [Table 16-697](#).

Figure 16-683. QUEUE_93_A Register


LEGEND: R/W = Read/Write; R = Read only; W1toCl = Write 1 to clear bit; -n = value after reset

Table 16-697. QUEUE_93_A Register Field Descriptions

Bit	Field	Type	Reset	Description
13-0	QUEUE_ENTRY_COUNT	R-0	0	This field indicates how many packets are currently queued on the queue. This count is incremented by 1 whenever a packet is added to the queue. This count is decremented by 1 whenever a packet is popped from the queue.

16.5.7.408 QUEUE_93_B Register (offset = 25D4h) [reset = 0h]

 QUEUE_93_B is shown in [Figure 16-684](#) and described in [Table 16-698](#).

Figure 16-684. QUEUE_93_B Register


LEGEND: R/W = Read/Write; R = Read only; W1toCl = Write 1 to clear bit; -n = value after reset

Table 16-698. QUEUE_93_B Register Field Descriptions

Bit	Field	Type	Reset	Description
27-0	QUEUE_BYTE_COUNT	R-0	0	This field indicates how many bytes total are contained in all of the packets which are currently queued on this queue.

16.5.7.409 QUEUE_93_C Register (offset = 25D8h) [reset = 0h]

 QUEUE_93_C is shown in [Figure 16-685](#) and described in [Table 16-699](#).

Figure 16-685. QUEUE_93_C Register


LEGEND: R/W = Read/Write; R = Read only; W1toCl = Write 1 to clear bit; -n = value after reset

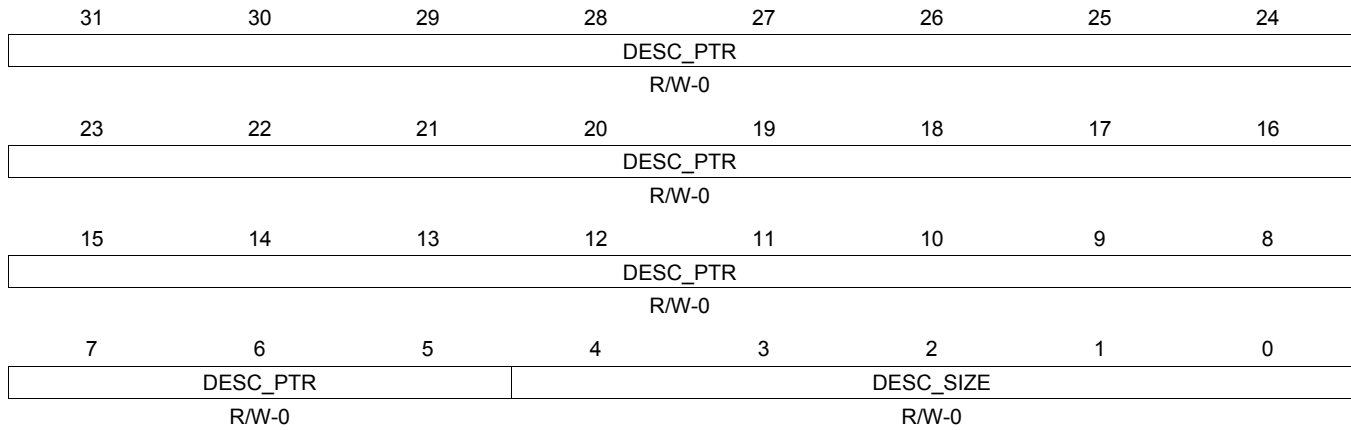
Table 16-699. QUEUE_93_C Register Field Descriptions

Bit	Field	Type	Reset	Description
31	HEAD_TAIL	W-0	0	Head/Tail Push Control. Set to zero in order to push packet onto tail of queue and set to one in order to push packet onto head of queue.
13-0	PACKET_SIZE	R/W-0	0	packet_size This field indicates packet size and is assumed to be zero on each packet add unless the value is explicitly overwritten. This field indicates packet size for packet pop operation.

16.5.7.410 QUEUE_93_D Register (offset = 25DCh) [reset = 0h]

QUEUE_93_D is shown in [Figure 16-686](#) and described in [Table 16-700](#).

Figure 16-686. QUEUE_93_D Register



LEGEND: R/W = Read/Write; R = Read only; W1toCl = Write 1 to clear bit; -n = value after reset

Table 16-700. QUEUE_93_D Register Field Descriptions

Bit	Field	Type	Reset	Description
31-5	DESC_PTR	R/W-0	0	Descriptor pointer. It will be read as zero if the queue is empty. It will indicate a 32-bit aligned address that points to a descriptor when the queue is not empty.
4-0	DESC_SIZE	R/W-0	0	Descriptor Size. It is encoded in 4-byte increments with values 0 to 31 representing 24 and so on to 148 bytes. This field will return a 0x0 when an empty queue is read. Queue Manager Queue N Registers D To save hardware resources, the queue manager internally stores descriptor size (desc_size) information in four bits. However, register D has five LSBs that specify descriptor size. As a consequence, the value of desc_size that is pushed may not be same as that is read during a pop. The value that is read back is equal to always rounded to an odd number. So, for even values, the value read back is one more than what was written. For odd values, the value read back is same as the value that was written. Note that this 5-bit field (desc_size) is unrelated to the code for size of descriptors in a descriptor region. It is just a place holder for a 5-bit value that is maintained across the push and pop operations for every descriptor managed by the queue manager.

16.5.7.411 QUEUE_94_A Register (offset = 25E0h) [reset = 0h]

QUEUE_94_A is shown in [Figure 16-687](#) and described in [Table 16-701](#).

Figure 16-687. QUEUE_94_A Register


LEGEND: R/W = Read/Write; R = Read only; W1toCl = Write 1 to clear bit; -n = value after reset

Table 16-701. QUEUE_94_A Register Field Descriptions

Bit	Field	Type	Reset	Description
13-0	QUEUE_ENTRY_COUNT	R-0	0	This field indicates how many packets are currently queued on the queue. This count is incremented by 1 whenever a packet is added to the queue. This count is decremented by 1 whenever a packet is popped from the queue.

16.5.7.412 QUEUE_94_B Register (offset = 25E4h) [reset = 0h]

QUEUE_94_B is shown in [Figure 16-688](#) and described in [Table 16-702](#).

Figure 16-688. QUEUE_94_B Register


LEGEND: R/W = Read/Write; R = Read only; W1toCl = Write 1 to clear bit; -n = value after reset

Table 16-702. QUEUE_94_B Register Field Descriptions

Bit	Field	Type	Reset	Description
27-0	QUEUE_BYTE_COUNT	R-0	0	This field indicates how many bytes total are contained in all of the packets which are currently queued on this queue.

16.5.7.413 QUEUE_94_C Register (offset = 25E8h) [reset = 0h]

 QUEUE_94_C is shown in [Figure 16-689](#) and described in [Table 16-703](#).

Figure 16-689. QUEUE_94_C Register


LEGEND: R/W = Read/Write; R = Read only; W1toCl = Write 1 to clear bit; -n = value after reset

Table 16-703. QUEUE_94_C Register Field Descriptions

Bit	Field	Type	Reset	Description
31	HEAD_TAIL	W-0	0	Head/Tail Push Control. Set to zero in order to push packet onto tail of queue and set to one in order to push packet onto head of queue.
13-0	PACKET_SIZE	R/W-0	0	packet_size This field indicates packet size and is assumed to be zero on each packet add unless the value is explicitly overwritten. This field indicates packet size for packet pop operation.

16.5.7.414 QUEUE_94_D Register (offset = 25ECh) [reset = 0h]

QUEUE_94_D is shown in [Figure 16-690](#) and described in [Table 16-704](#).

Figure 16-690. QUEUE_94_D Register

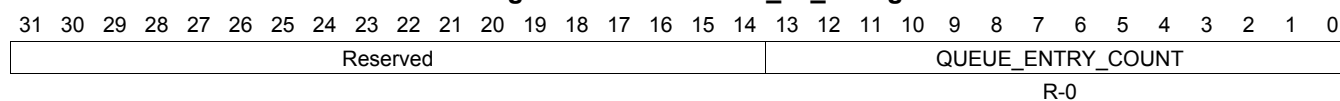

LEGEND: R/W = Read/Write; R = Read only; W1toCl = Write 1 to clear bit; -n = value after reset

Table 16-704. QUEUE_94_D Register Field Descriptions

Bit	Field	Type	Reset	Description
31-5	DESC_PTR	R/W-0	0	Descriptor pointer. It will be read as zero if the queue is empty. It will indicate a 32-bit aligned address that points to a descriptor when the queue is not empty.
4-0	DESC_SIZE	R/W-0	0	Descriptor Size. It is encoded in 4-byte increments with values 0 to 31 representing 24 and so on to 148 bytes. This field will return a 0x0 when an empty queue is read. Queue Manager Queue N Registers D To save hardware resources, the queue manager internally stores descriptor size (desc_size) information in four bits. However, register D has five LSBs that specify descriptor size. As a consequence, the value of desc_size that is pushed may not be same as that is read during a pop. The value that is read back is equal to always rounded to an odd number. So, for even values, the value read back is one more than what was written. For odd values, the value read back is same as the value that was written. Note that this 5-bit field (desc_size) is unrelated to the code for size of descriptors in a descriptor region. It is just a place holder for a 5-bit value that is maintained across the push and pop operations for every descriptor managed by the queue manager.

16.5.7.415 QUEUE_95_A Register (offset = 25F0h) [reset = 0h]

QUEUE_95_A is shown in [Figure 16-691](#) and described in [Table 16-705](#).

Figure 16-691. QUEUE_95_A Register


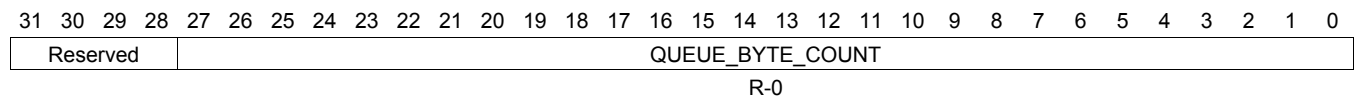
LEGEND: R/W = Read/Write; R = Read only; W1toCl = Write 1 to clear bit; -n = value after reset

Table 16-705. QUEUE_95_A Register Field Descriptions

Bit	Field	Type	Reset	Description
13-0	QUEUE_ENTRY_COUNT	R-0	0	This field indicates how many packets are currently queued on the queue. This count is incremented by 1 whenever a packet is added to the queue. This count is decremented by 1 whenever a packet is popped from the queue.

16.5.7.416 QUEUE_95_B Register (offset = 25F4h) [reset = 0h]

QUEUE_95_B is shown in [Figure 16-692](#) and described in [Table 16-706](#).

Figure 16-692. QUEUE_95_B Register


LEGEND: R/W = Read/Write; R = Read only; W1toCl = Write 1 to clear bit; -n = value after reset

Table 16-706. QUEUE_95_B Register Field Descriptions

Bit	Field	Type	Reset	Description
27-0	QUEUE_BYTE_COUNT	R-0	0	This field indicates how many bytes total are contained in all of the packets which are currently queued on this queue.

16.5.7.417 QUEUE_95_C Register (offset = 25F8h) [reset = 0h]

 QUEUE_95_C is shown in [Figure 16-693](#) and described in [Table 16-707](#).

Figure 16-693. QUEUE_95_C Register


LEGEND: R/W = Read/Write; R = Read only; W1toCl = Write 1 to clear bit; -n = value after reset

Table 16-707. QUEUE_95_C Register Field Descriptions

Bit	Field	Type	Reset	Description
31	HEAD_TAIL	W-0	0	Head/Tail Push Control. Set to zero in order to push packet onto tail of queue and set to one in order to push packet onto head of queue.
13-0	PACKET_SIZE	R/W-0	0	packet_size This field indicates packet size and is assumed to be zero on each packet add unless the value is explicitly overwritten. This field indicates packet size for packet pop operation.

16.5.7.418 QUEUE_95_D Register (offset = 25FCh) [reset = 0h]

QUEUE_95_D is shown in [Figure 16-694](#) and described in [Table 16-708](#).

Figure 16-694. QUEUE_95_D Register

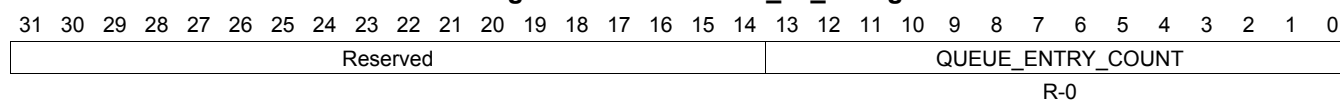

LEGEND: R/W = Read/Write; R = Read only; W1toCl = Write 1 to clear bit; -n = value after reset

Table 16-708. QUEUE_95_D Register Field Descriptions

Bit	Field	Type	Reset	Description
31-5	DESC_PTR	R/W-0	0	Descriptor pointer. It will be read as zero if the queue is empty. It will indicate a 32-bit aligned address that points to a descriptor when the queue is not empty.
4-0	DESC_SIZE	R/W-0	0	Descriptor Size. It is encoded in 4-byte increments with values 0 to 31 representing 24 and so on to 148 bytes. This field will return a 0x0 when an empty queue is read. Queue Manager Queue N Registers D To save hardware resources, the queue manager internally stores descriptor size (desc_size) information in four bits. However, register D has five LSBs that specify descriptor size. As a consequence, the value of desc_size that is pushed may not be same as that is read during a pop. The value that is read back is equal to always rounded to an odd number. So, for even values, the value read back is one more than what was written. For odd values, the value read back is same as the value that was written. Note that this 5-bit field (desc_size) is unrelated to the code for size of descriptors in a descriptor region. It is just a place holder for a 5-bit value that is maintained across the push and pop operations for every descriptor managed by the queue manager.

16.5.7.419 QUEUE_96_A Register (offset = 2600h) [reset = 0h]

QUEUE_96_A is shown in [Figure 16-695](#) and described in [Table 16-709](#).

Figure 16-695. QUEUE_96_A Register


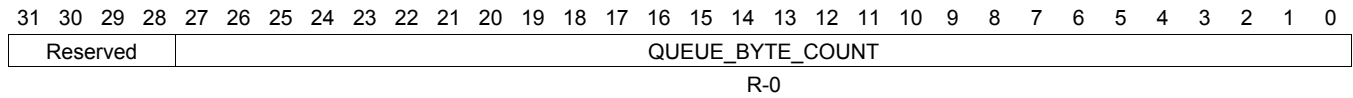
LEGEND: R/W = Read/Write; R = Read only; W1toCl = Write 1 to clear bit; -n = value after reset

Table 16-709. QUEUE_96_A Register Field Descriptions

Bit	Field	Type	Reset	Description
13-0	QUEUE_ENTRY_COUNT	R-0	0	This field indicates how many packets are currently queued on the queue. This count is incremented by 1 whenever a packet is added to the queue. This count is decremented by 1 whenever a packet is popped from the queue.

16.5.7.420 QUEUE_96_B Register (offset = 2604h) [reset = 0h]

 QUEUE_96_B is shown in [Figure 16-696](#) and described in [Table 16-710](#).

Figure 16-696. QUEUE_96_B Register


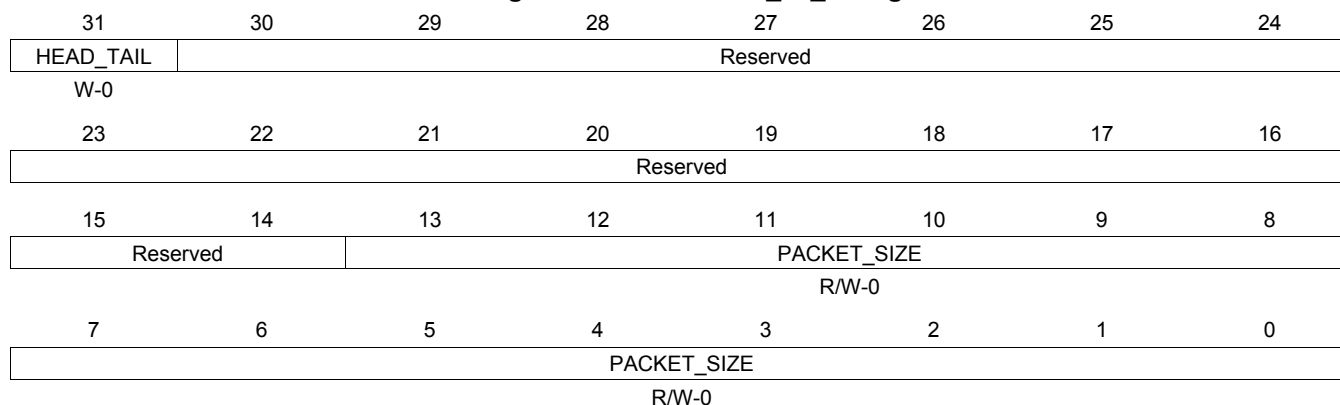
LEGEND: R/W = Read/Write; R = Read only; W1toCl = Write 1 to clear bit; -n = value after reset

Table 16-710. QUEUE_96_B Register Field Descriptions

Bit	Field	Type	Reset	Description
27-0	QUEUE_BYTE_COUNT	R-0	0	This field indicates how many bytes total are contained in all of the packets which are currently queued on this queue.

16.5.7.421 QUEUE_96_C Register (offset = 2608h) [reset = 0h]

 QUEUE_96_C is shown in [Figure 16-697](#) and described in [Table 16-711](#).

Figure 16-697. QUEUE_96_C Register


LEGEND: R/W = Read/Write; R = Read only; W1toCl = Write 1 to clear bit; -n = value after reset

Table 16-711. QUEUE_96_C Register Field Descriptions

Bit	Field	Type	Reset	Description
31	HEAD_TAIL	W-0	0	Head/Tail Push Control. Set to zero in order to push packet onto tail of queue and set to one in order to push packet onto head of queue.
13-0	PACKET_SIZE	R/W-0	0	packet_size This field indicates packet size and is assumed to be zero on each packet add unless the value is explicitly overwritten. This field indicates packet size for packet pop operation.

16.5.7.422 QUEUE_96_D Register (offset = 260Ch) [reset = 0h]

 QUEUE_96_D is shown in [Figure 16-698](#) and described in [Table 16-712](#).

Figure 16-698. QUEUE_96_D Register

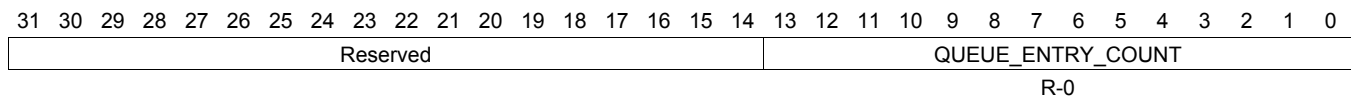

LEGEND: R/W = Read/Write; R = Read only; W1toCl = Write 1 to clear bit; -n = value after reset

Table 16-712. QUEUE_96_D Register Field Descriptions

Bit	Field	Type	Reset	Description
31-5	DESC_PTR	R/W-0	0	Descriptor pointer. It will be read as zero if the queue is empty. It will indicate a 32-bit aligned address that points to a descriptor when the queue is not empty.
4-0	DESC_SIZE	R/W-0	0	Descriptor Size. It is encoded in 4-byte increments with values 0 to 31 representing 24 and so on to 148 bytes. This field will return a 0x0 when an empty queue is read. Queue Manager Queue N Registers D To save hardware resources, the queue manager internally stores descriptor size (desc_size) information in four bits. However, register D has five LSBs that specify descriptor size. As a consequence, the value of desc_size that is pushed may not be same as that is read during a pop. The value that is read back is equal to always rounded to an odd number. So, for even values, the value read back is one more than what was written. For odd values, the value read back is same as the value that was written. Note that this 5-bit field (desc_size) is unrelated to the code for size of descriptors in a descriptor region. It is just a place holder for a 5-bit value that is maintained across the push and pop operations for every descriptor managed by the queue manager.

16.5.7.423 QUEUE_97_A Register (offset = 2610h) [reset = 0h]

QUEUE_97_A is shown in [Figure 16-699](#) and described in [Table 16-713](#).

Figure 16-699. QUEUE_97_A Register


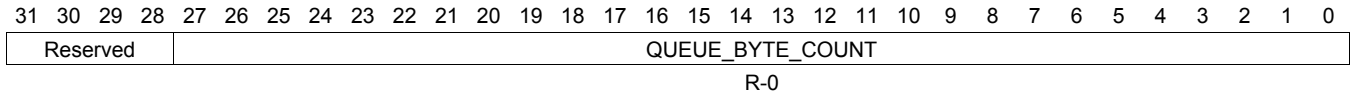
LEGEND: R/W = Read/Write; R = Read only; W1toCl = Write 1 to clear bit; -n = value after reset

Table 16-713. QUEUE_97_A Register Field Descriptions

Bit	Field	Type	Reset	Description
13-0	QUEUE_ENTRY_COUNT	R-0	0	This field indicates how many packets are currently queued on the queue. This count is incremented by 1 whenever a packet is added to the queue. This count is decremented by 1 whenever a packet is popped from the queue.

16.5.7.424 QUEUE_97_B Register (offset = 2614h) [reset = 0h]

QUEUE_97_B is shown in [Figure 16-700](#) and described in [Table 16-714](#).

Figure 16-700. QUEUE_97_B Register


LEGEND: R/W = Read/Write; R = Read only; W1toCl = Write 1 to clear bit; -n = value after reset

Table 16-714. QUEUE_97_B Register Field Descriptions

Bit	Field	Type	Reset	Description
27-0	QUEUE_BYTE_COUNT	R-0	0	This field indicates how many bytes total are contained in all of the packets which are currently queued on this queue.

16.5.7.425 QUEUE_97_C Register (offset = 2618h) [reset = 0h]

 QUEUE_97_C is shown in [Figure 16-701](#) and described in [Table 16-715](#).

Figure 16-701. QUEUE_97_C Register

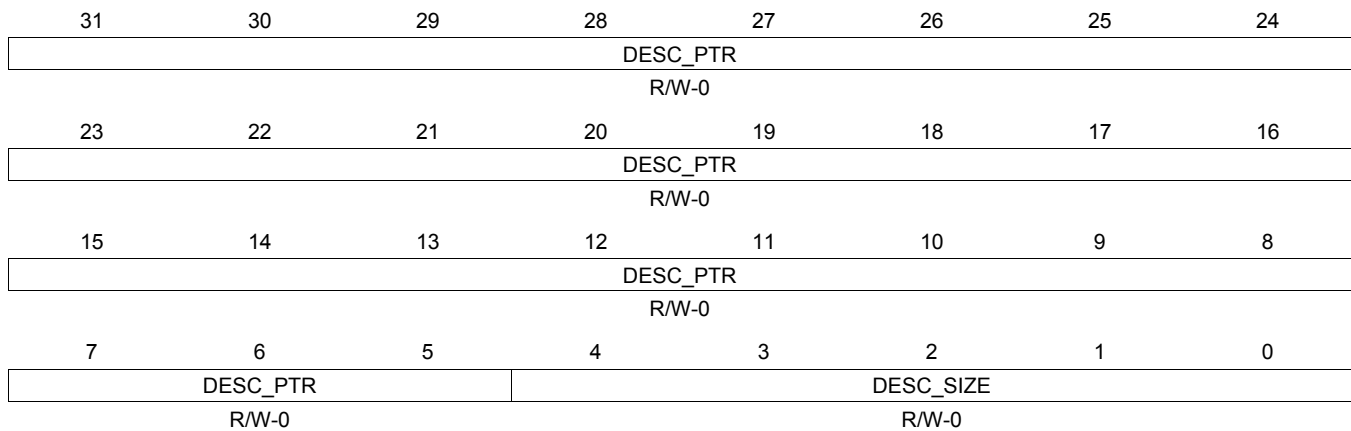

LEGEND: R/W = Read/Write; R = Read only; W1toCl = Write 1 to clear bit; -n = value after reset

Table 16-715. QUEUE_97_C Register Field Descriptions

Bit	Field	Type	Reset	Description
31	HEAD_TAIL	W-0	0	Head/Tail Push Control. Set to zero in order to push packet onto tail of queue and set to one in order to push packet onto head of queue.
13-0	PACKET_SIZE	R/W-0	0	packet_size This field indicates packet size and is assumed to be zero on each packet add unless the value is explicitly overwritten. This field indicates packet size for packet pop operation.

16.5.7.426 QUEUE_97_D Register (offset = 261Ch) [reset = 0h]

QUEUE_97_D is shown in [Figure 16-702](#) and described in [Table 16-716](#).

Figure 16-702. QUEUE_97_D Register


LEGEND: R/W = Read/Write; R = Read only; W1toCl = Write 1 to clear bit; -n = value after reset

Table 16-716. QUEUE_97_D Register Field Descriptions

Bit	Field	Type	Reset	Description
31-5	DESC_PTR	R/W-0	0	Descriptor pointer. It will be read as zero if the queue is empty. It will indicate a 32-bit aligned address that points to a descriptor when the queue is not empty.
4-0	DESC_SIZE	R/W-0	0	Descriptor Size. It is encoded in 4-byte increments with values 0 to 31 representing 24 and so on to 148 bytes. This field will return a 0x0 when an empty queue is read. Queue Manager Queue N Registers D To save hardware resources, the queue manager internally stores descriptor size (desc_size) information in four bits. However, register D has five LSBs that specify descriptor size. As a consequence, the value of desc_size that is pushed may not be same as that is read during a pop. The value that is read back is equal to always rounded to an odd number. So, for even values, the value read back is one more than what was written. For odd values, the value read back is same as the value that was written. Note that this 5-bit field (desc_size) is unrelated to the code for size of descriptors in a descriptor region. It is just a place holder for a 5-bit value that is maintained across the push and pop operations for every descriptor managed by the queue manager.

16.5.7.427 QUEUE_98_A Register (offset = 2620h) [reset = 0h]

QUEUE_98_A is shown in [Figure 16-703](#) and described in [Table 16-717](#).

Figure 16-703. QUEUE_98_A Register

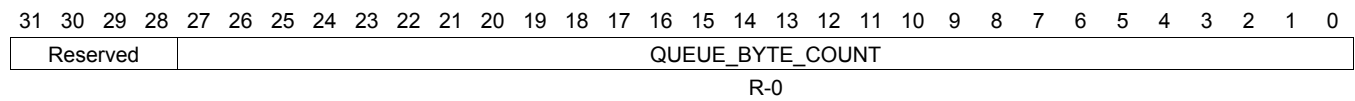

LEGEND: R/W = Read/Write; R = Read only; W1toCl = Write 1 to clear bit; -n = value after reset

Table 16-717. QUEUE_98_A Register Field Descriptions

Bit	Field	Type	Reset	Description
13-0	QUEUE_ENTRY_COUNT	R-0	0	This field indicates how many packets are currently queued on the queue. This count is incremented by 1 whenever a packet is added to the queue. This count is decremented by 1 whenever a packet is popped from the queue.

16.5.7.428 QUEUE_98_B Register (offset = 2624h) [reset = 0h]

 QUEUE_98_B is shown in [Figure 16-704](#) and described in [Table 16-718](#).

Figure 16-704. QUEUE_98_B Register


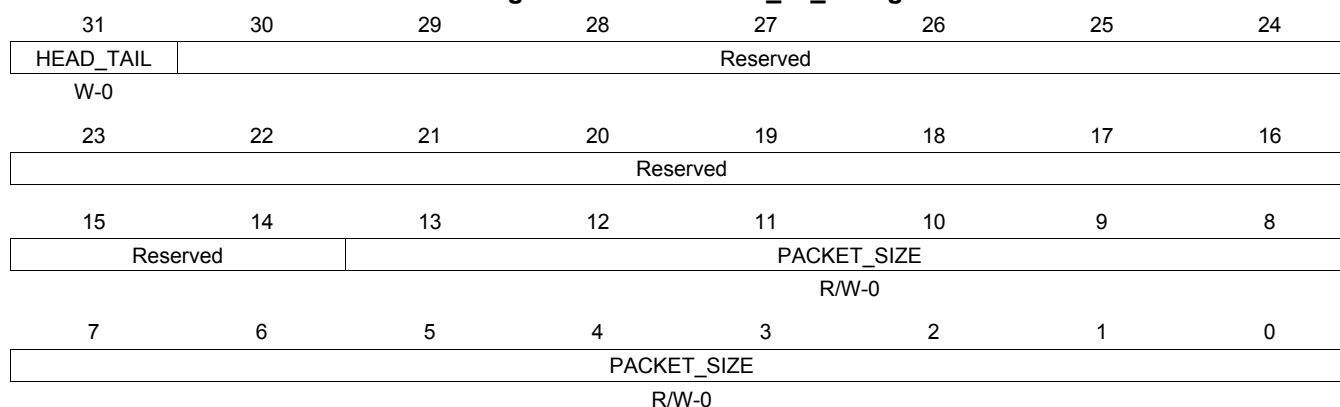
LEGEND: R/W = Read/Write; R = Read only; W1toCl = Write 1 to clear bit; -n = value after reset

Table 16-718. QUEUE_98_B Register Field Descriptions

Bit	Field	Type	Reset	Description
27-0	QUEUE_BYTE_COUNT	R-0	0	This field indicates how many bytes total are contained in all of the packets which are currently queued on this queue.

16.5.7.429 QUEUE_98_C Register (offset = 2628h) [reset = 0h]

 QUEUE_98_C is shown in [Figure 16-705](#) and described in [Table 16-719](#).

Figure 16-705. QUEUE_98_C Register


LEGEND: R/W = Read/Write; R = Read only; W1toCl = Write 1 to clear bit; -n = value after reset

Table 16-719. QUEUE_98_C Register Field Descriptions

Bit	Field	Type	Reset	Description
31	HEAD_TAIL	W-0	0	Head/Tail Push Control. Set to zero in order to push packet onto tail of queue and set to one in order to push packet onto head of queue.
13-0	PACKET_SIZE	R/W-0	0	packet_size This field indicates packet size and is assumed to be zero on each packet add unless the value is explicitly overwritten. This field indicates packet size for packet pop operation.

16.5.7.430 QUEUE_98_D Register (offset = 262Ch) [reset = 0h]

 QUEUE_98_D is shown in [Figure 16-706](#) and described in [Table 16-720](#).

Figure 16-706. QUEUE_98_D Register

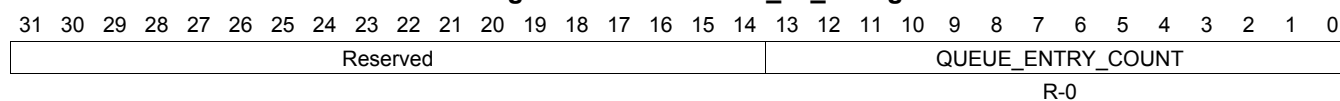

LEGEND: R/W = Read/Write; R = Read only; W1toCl = Write 1 to clear bit; -n = value after reset

Table 16-720. QUEUE_98_D Register Field Descriptions

Bit	Field	Type	Reset	Description
31-5	DESC_PTR	R/W-0	0	Descriptor pointer. It will be read as zero if the queue is empty. It will indicate a 32-bit aligned address that points to a descriptor when the queue is not empty.
4-0	DESC_SIZE	R/W-0	0	Descriptor Size. It is encoded in 4-byte increments with values 0 to 31 representing 24 and so on to 148 bytes. This field will return a 0x0 when an empty queue is read. Queue Manager Queue N Registers D To save hardware resources, the queue manager internally stores descriptor size (desc_size) information in four bits. However, register D has five LSBs that specify descriptor size. As a consequence, the value of desc_size that is pushed may not be same as that is read during a pop. The value that is read back is equal to always rounded to an odd number. So, for even values, the value read back is one more than what was written. For odd values, the value read back is same as the value that was written. Note that this 5-bit field (desc_size) is unrelated to the code for size of descriptors in a descriptor region. It is just a place holder for a 5-bit value that is maintained across the push and pop operations for every descriptor managed by the queue manager.

16.5.7.431 QUEUE_99_A Register (offset = 2630h) [reset = 0h]

QUEUE_99_A is shown in [Figure 16-707](#) and described in [Table 16-721](#).

Figure 16-707. QUEUE_99_A Register


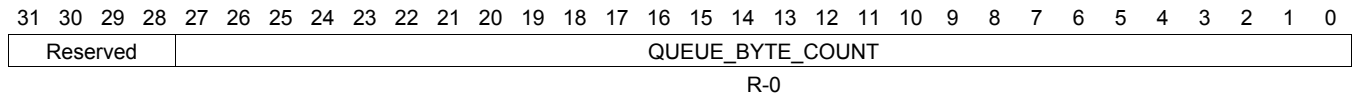
LEGEND: R/W = Read/Write; R = Read only; W1toCl = Write 1 to clear bit; -n = value after reset

Table 16-721. QUEUE_99_A Register Field Descriptions

Bit	Field	Type	Reset	Description
13-0	QUEUE_ENTRY_COUNT	R-0	0	This field indicates how many packets are currently queued on the queue. This count is incremented by 1 whenever a packet is added to the queue. This count is decremented by 1 whenever a packet is popped from the queue.

16.5.7.432 QUEUE_99_B Register (offset = 2634h) [reset = 0h]

 QUEUE_99_B is shown in [Figure 16-708](#) and described in [Table 16-722](#).

Figure 16-708. QUEUE_99_B Register


LEGEND: R/W = Read/Write; R = Read only; W1toCl = Write 1 to clear bit; -n = value after reset

Table 16-722. QUEUE_99_B Register Field Descriptions

Bit	Field	Type	Reset	Description
27-0	QUEUE_BYTE_COUNT	R-0	0	This field indicates how many bytes total are contained in all of the packets which are currently queued on this queue.

16.5.7.433 QUEUE_99_C Register (offset = 2638h) [reset = 0h]

 QUEUE_99_C is shown in [Figure 16-709](#) and described in [Table 16-723](#).

Figure 16-709. QUEUE_99_C Register


LEGEND: R/W = Read/Write; R = Read only; W1toCl = Write 1 to clear bit; -n = value after reset

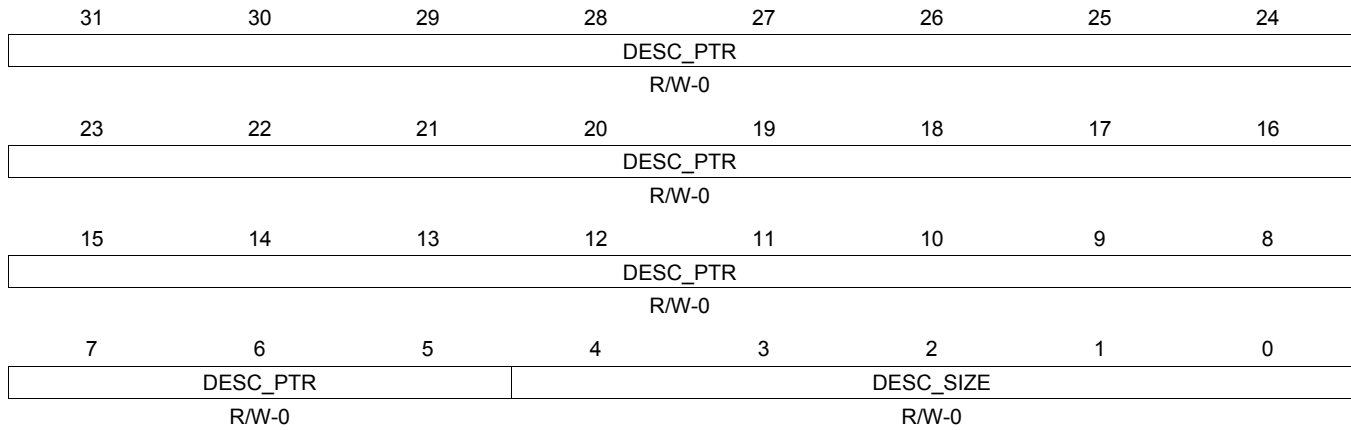
Table 16-723. QUEUE_99_C Register Field Descriptions

Bit	Field	Type	Reset	Description
31	HEAD_TAIL	W-0	0	Head/Tail Push Control. Set to zero in order to push packet onto tail of queue and set to one in order to push packet onto head of queue.
13-0	PACKET_SIZE	R/W-0	0	packet_size This field indicates packet size and is assumed to be zero on each packet add unless the value is explicitly overwritten. This field indicates packet size for packet pop operation.

16.5.7.434 QUEUE_99_D Register (offset = 263Ch) [reset = 0h]

QUEUE_99_D is shown in [Figure 16-710](#) and described in [Table 16-724](#).

Figure 16-710. QUEUE_99_D Register



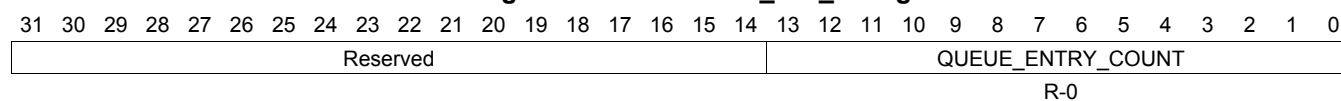
LEGEND: R/W = Read/Write; R = Read only; W1toCl = Write 1 to clear bit; -n = value after reset

Table 16-724. QUEUE_99_D Register Field Descriptions

Bit	Field	Type	Reset	Description
31-5	DESC_PTR	R/W-0	0	Descriptor pointer. It will be read as zero if the queue is empty. It will indicate a 32-bit aligned address that points to a descriptor when the queue is not empty.
4-0	DESC_SIZE	R/W-0	0	Descriptor Size. It is encoded in 4-byte increments with values 0 to 31 representing 24 and so on to 148 bytes. This field will return a 0x0 when an empty queue is read. Queue Manager Queue N Registers D To save hardware resources, the queue manager internally stores descriptor size (desc_size) information in four bits. However, register D has five LSBs that specify descriptor size. As a consequence, the value of desc_size that is pushed may not be same as that is read during a pop. The value that is read back is equal to always rounded to an odd number. So, for even values, the value read back is one more than what was written. For odd values, the value read back is same as the value that was written. Note that this 5-bit field (desc_size) is unrelated to the code for size of descriptors in a descriptor region. It is just a place holder for a 5-bit value that is maintained across the push and pop operations for every descriptor managed by the queue manager.

16.5.7.435 QUEUE_100_A Register (offset = 2640h) [reset = 0h]

QUEUE_100_A is shown in [Figure 16-711](#) and described in [Table 16-725](#).

Figure 16-711. QUEUE_100_A Register


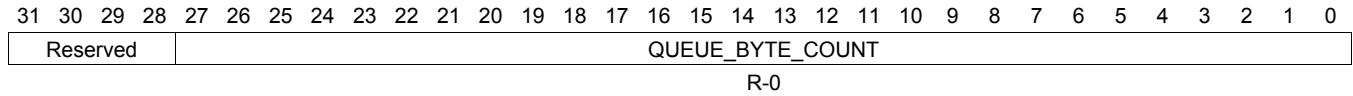
LEGEND: R/W = Read/Write; R = Read only; W1toCl = Write 1 to clear bit; -n = value after reset

Table 16-725. QUEUE_100_A Register Field Descriptions

Bit	Field	Type	Reset	Description
13-0	QUEUE_ENTRY_COUNT	R-0	0	This field indicates how many packets are currently queued on the queue. This count is incremented by 1 whenever a packet is added to the queue. This count is decremented by 1 whenever a packet is popped from the queue.

16.5.7.436 QUEUE_100_B Register (offset = 2644h) [reset = 0h]

QUEUE_100_B is shown in [Figure 16-712](#) and described in [Table 16-726](#).

Figure 16-712. QUEUE_100_B Register


LEGEND: R/W = Read/Write; R = Read only; W1toCl = Write 1 to clear bit; -n = value after reset

Table 16-726. QUEUE_100_B Register Field Descriptions

Bit	Field	Type	Reset	Description
27-0	QUEUE_BYTE_COUNT	R-0	0	This field indicates how many bytes total are contained in all of the packets which are currently queued on this queue.

16.5.7.437 QUEUE_100_C Register (offset = 2648h) [reset = 0h]

 QUEUE_100_C is shown in [Figure 16-713](#) and described in [Table 16-727](#).

Figure 16-713. QUEUE_100_C Register


LEGEND: R/W = Read/Write; R = Read only; W1toCl = Write 1 to clear bit; -n = value after reset

Table 16-727. QUEUE_100_C Register Field Descriptions

Bit	Field	Type	Reset	Description
31	HEAD_TAIL	W-0	0	Head/Tail Push Control. Set to zero in order to push packet onto tail of queue and set to one in order to push packet onto head of queue.
13-0	PACKET_SIZE	R/W-0	0	packet_size This field indicates packet size and is assumed to be zero on each packet add unless the value is explicitly overwritten. This field indicates packet size for packet pop operation.

16.5.7.438 QUEUE_100_D Register (offset = 264Ch) [reset = 0h]

QUEUE_100_D is shown in [Figure 16-714](#) and described in [Table 16-728](#).

Figure 16-714. QUEUE_100_D Register



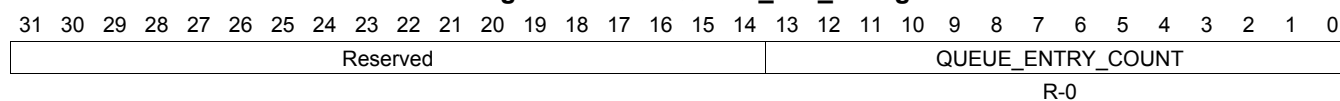
LEGEND: R/W = Read/Write; R = Read only; W1toCl = Write 1 to clear bit; -n = value after reset

Table 16-728. QUEUE_100_D Register Field Descriptions

Bit	Field	Type	Reset	Description
31-5	DESC_PTR	R/W-0	0	Descriptor pointer. It will be read as zero if the queue is empty. It will indicate a 32-bit aligned address that points to a descriptor when the queue is not empty.
4-0	DESC_SIZE	R/W-0	0	Descriptor Size. It is encoded in 4-byte increments with values 0 to 31 representing 24 and so on to 148 bytes. This field will return a 0x0 when an empty queue is read. Queue Manager Queue N Registers D To save hardware resources, the queue manager internally stores descriptor size (desc_size) information in four bits. However, register D has five LSBs that specify descriptor size. As a consequence, the value of desc_size that is pushed may not be same as that is read during a pop. The value that is read back is equal to always rounded to an odd number. So, for even values, the value read back is one more than what was written. For odd values, the value read back is same as the value that was written. Note that this 5-bit field (desc_size) is unrelated to the code for size of descriptors in a descriptor region. It is just a place holder for a 5-bit value that is maintained across the push and pop operations for every descriptor managed by the queue manager.

16.5.7.439 QUEUE_101_A Register (offset = 2650h) [reset = 0h]

QUEUE_101_A is shown in [Figure 16-715](#) and described in [Table 16-729](#).

Figure 16-715. QUEUE_101_A Register


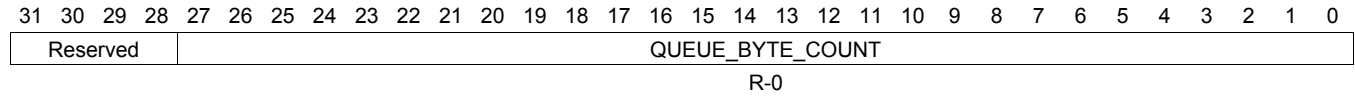
LEGEND: R/W = Read/Write; R = Read only; W1toCl = Write 1 to clear bit; -n = value after reset

Table 16-729. QUEUE_101_A Register Field Descriptions

Bit	Field	Type	Reset	Description
13-0	QUEUE_ENTRY_COUNT	R-0	0	This field indicates how many packets are currently queued on the queue. This count is incremented by 1 whenever a packet is added to the queue. This count is decremented by 1 whenever a packet is popped from the queue.

16.5.7.440 QUEUE_101_B Register (offset = 2654h) [reset = 0h]

 QUEUE_101_B is shown in [Figure 16-716](#) and described in [Table 16-730](#).

Figure 16-716. QUEUE_101_B Register


LEGEND: R/W = Read/Write; R = Read only; W1toCl = Write 1 to clear bit; -n = value after reset

Table 16-730. QUEUE_101_B Register Field Descriptions

Bit	Field	Type	Reset	Description
27-0	QUEUE_BYTE_COUNT	R-0	0	This field indicates how many bytes total are contained in all of the packets which are currently queued on this queue.

16.5.7.441 QUEUE_101_C Register (offset = 2658h) [reset = 0h]

 QUEUE_101_C is shown in [Figure 16-717](#) and described in [Table 16-731](#).

Figure 16-717. QUEUE_101_C Register


LEGEND: R/W = Read/Write; R = Read only; W1toCl = Write 1 to clear bit; -n = value after reset

Table 16-731. QUEUE_101_C Register Field Descriptions

Bit	Field	Type	Reset	Description
31	HEAD_TAIL	W-0	0	Head/Tail Push Control. Set to zero in order to push packet onto tail of queue and set to one in order to push packet onto head of queue.
13-0	PACKET_SIZE	R/W-0	0	packet_size This field indicates packet size and is assumed to be zero on each packet add unless the value is explicitly overwritten. This field indicates packet size for packet pop operation.

16.5.7.442 QUEUE_101_D Register (offset = 265Ch) [reset = 0h]

QUEUE_101_D is shown in [Figure 16-718](#) and described in [Table 16-732](#).

Figure 16-718. QUEUE_101_D Register



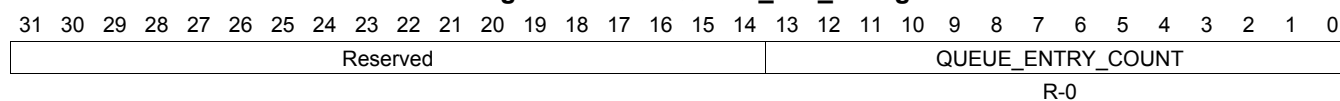
LEGEND: R/W = Read/Write; R = Read only; W1toCl = Write 1 to clear bit; -n = value after reset

Table 16-732. QUEUE_101_D Register Field Descriptions

Bit	Field	Type	Reset	Description
31-5	DESC_PTR	R/W-0	0	Descriptor pointer. It will be read as zero if the queue is empty. It will indicate a 32-bit aligned address that points to a descriptor when the queue is not empty.
4-0	DESC_SIZE	R/W-0	0	Descriptor Size. It is encoded in 4-byte increments with values 0 to 31 representing 24 and so on to 148 bytes. This field will return a 0x0 when an empty queue is read. Queue Manager Queue N Registers D To save hardware resources, the queue manager internally stores descriptor size (desc_size) information in four bits. However, register D has five LSBs that specify descriptor size. As a consequence, the value of desc_size that is pushed may not be same as that is read during a pop. The value that is read back is equal to always rounded to an odd number. So, for even values, the value read back is one more than what was written. For odd values, the value read back is same as the value that was written. Note that this 5-bit field (desc_size) is unrelated to the code for size of descriptors in a descriptor region. It is just a place holder for a 5-bit value that is maintained across the push and pop operations for every descriptor managed by the queue manager.

16.5.7.443 QUEUE_102_A Register (offset = 2660h) [reset = 0h]

QUEUE_102_A is shown in [Figure 16-719](#) and described in [Table 16-733](#).

Figure 16-719. QUEUE_102_A Register


LEGEND: R/W = Read/Write; R = Read only; W1toCl = Write 1 to clear bit; -n = value after reset

Table 16-733. QUEUE_102_A Register Field Descriptions

Bit	Field	Type	Reset	Description
13-0	QUEUE_ENTRY_COUNT	R-0	0	This field indicates how many packets are currently queued on the queue. This count is incremented by 1 whenever a packet is added to the queue. This count is decremented by 1 whenever a packet is popped from the queue.

16.5.7.444 QUEUE_102_B Register (offset = 2664h) [reset = 0h]

QUEUE_102_B is shown in [Figure 16-720](#) and described in [Table 16-734](#).

Figure 16-720. QUEUE_102_B Register

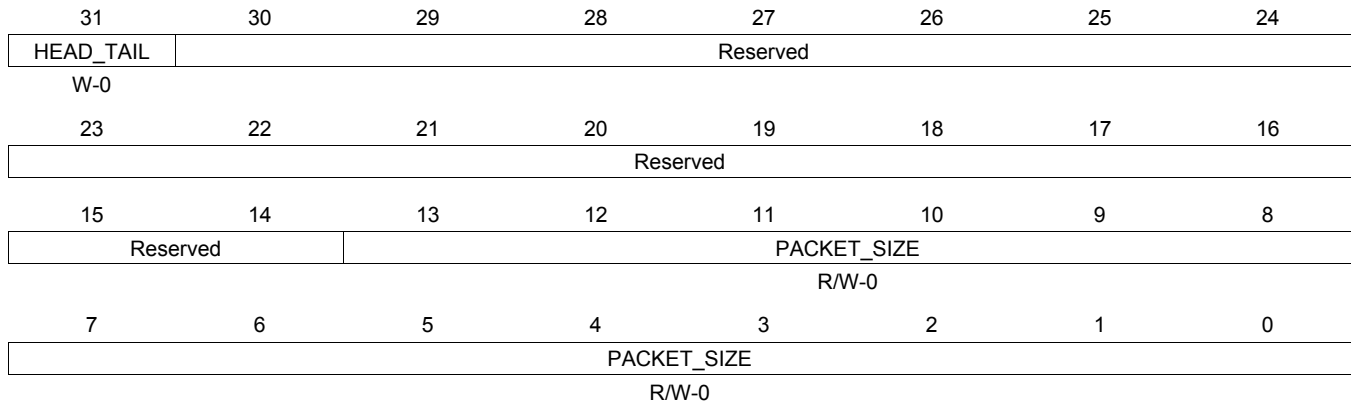

LEGEND: R/W = Read/Write; R = Read only; W1toCl = Write 1 to clear bit; -n = value after reset

Table 16-734. QUEUE_102_B Register Field Descriptions

Bit	Field	Type	Reset	Description
27-0	QUEUE_BYTE_COUNT	R-0	0	This field indicates how many bytes total are contained in all of the packets which are currently queued on this queue.

16.5.7.445 QUEUE_102_C Register (offset = 2668h) [reset = 0h]

 QUEUE_102_C is shown in [Figure 16-721](#) and described in [Table 16-735](#).

Figure 16-721. QUEUE_102_C Register


LEGEND: R/W = Read/Write; R = Read only; W1toCl = Write 1 to clear bit; -n = value after reset

Table 16-735. QUEUE_102_C Register Field Descriptions

Bit	Field	Type	Reset	Description
31	HEAD_TAIL	W-0	0	Head/Tail Push Control. Set to zero in order to push packet onto tail of queue and set to one in order to push packet onto head of queue.
13-0	PACKET_SIZE	R/W-0	0	packet_size This field indicates packet size and is assumed to be zero on each packet add unless the value is explicitly overwritten. This field indicates packet size for packet pop operation.

16.5.7.446 QUEUE_102_D Register (offset = 266Ch) [reset = 0h]

QUEUE_102_D is shown in [Figure 16-722](#) and described in [Table 16-736](#).

Figure 16-722. QUEUE_102_D Register



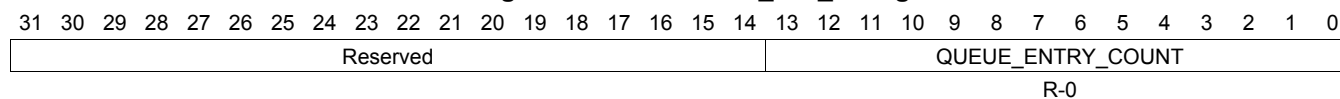
LEGEND: R/W = Read/Write; R = Read only; W1toCl = Write 1 to clear bit; -n = value after reset

Table 16-736. QUEUE_102_D Register Field Descriptions

Bit	Field	Type	Reset	Description
31-5	DESC_PTR	R/W-0	0	Descriptor pointer. It will be read as zero if the queue is empty. It will indicate a 32-bit aligned address that points to a descriptor when the queue is not empty.
4-0	DESC_SIZE	R/W-0	0	Descriptor Size. It is encoded in 4-byte increments with values 0 to 31 representing 24 and so on to 148 bytes. This field will return a 0x0 when an empty queue is read. Queue Manager Queue N Registers D To save hardware resources, the queue manager internally stores descriptor size (desc_size) information in four bits. However, register D has five LSBs that specify descriptor size. As a consequence, the value of desc_size that is pushed may not be same as that is read during a pop. The value that is read back is equal to always rounded to an odd number. So, for even values, the value read back is one more than what was written. For odd values, the value read back is same as the value that was written. Note that this 5-bit field (desc_size) is unrelated to the code for size of descriptors in a descriptor region. It is just a place holder for a 5-bit value that is maintained across the push and pop operations for every descriptor managed by the queue manager.

16.5.7.447 QUEUE_103_A Register (offset = 2670h) [reset = 0h]

QUEUE_103_A is shown in [Figure 16-723](#) and described in [Table 16-737](#).

Figure 16-723. QUEUE_103_A Register


LEGEND: R/W = Read/Write; R = Read only; W1toCl = Write 1 to clear bit; -n = value after reset

Table 16-737. QUEUE_103_A Register Field Descriptions

Bit	Field	Type	Reset	Description
13-0	QUEUE_ENTRY_COUNT	R-0	0	This field indicates how many packets are currently queued on the queue. This count is incremented by 1 whenever a packet is added to the queue. This count is decremented by 1 whenever a packet is popped from the queue.

16.5.7.448 QUEUE_103_B Register (offset = 2674h) [reset = 0h]

QUEUE_103_B is shown in [Figure 16-724](#) and described in [Table 16-738](#).

Figure 16-724. QUEUE_103_B Register

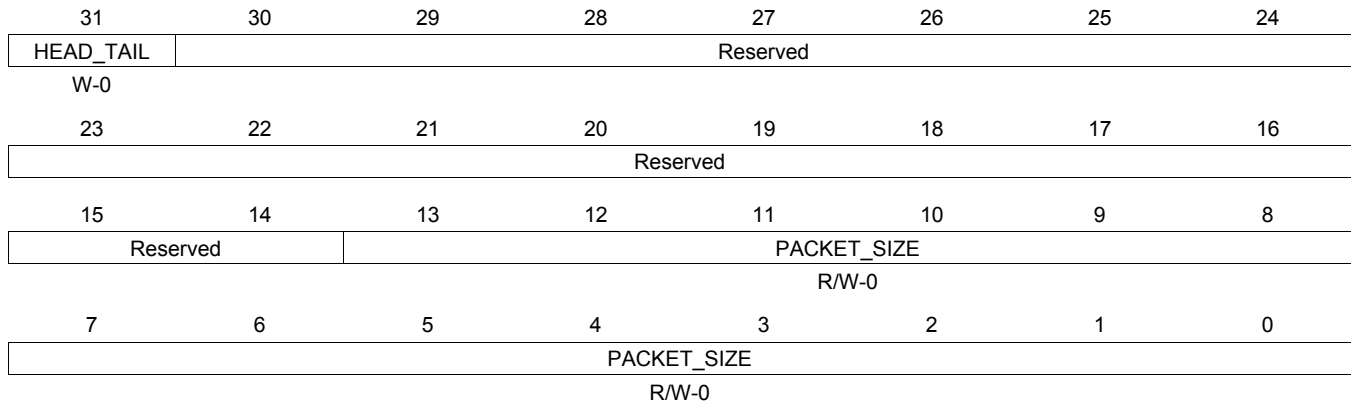

LEGEND: R/W = Read/Write; R = Read only; W1toCl = Write 1 to clear bit; -n = value after reset

Table 16-738. QUEUE_103_B Register Field Descriptions

Bit	Field	Type	Reset	Description
27-0	QUEUE_BYTE_COUNT	R-0	0	This field indicates how many bytes total are contained in all of the packets which are currently queued on this queue.

16.5.7.449 QUEUE_103_C Register (offset = 2678h) [reset = 0h]

 QUEUE_103_C is shown in [Figure 16-725](#) and described in [Table 16-739](#).

Figure 16-725. QUEUE_103_C Register


LEGEND: R/W = Read/Write; R = Read only; W1toCl = Write 1 to clear bit; -n = value after reset

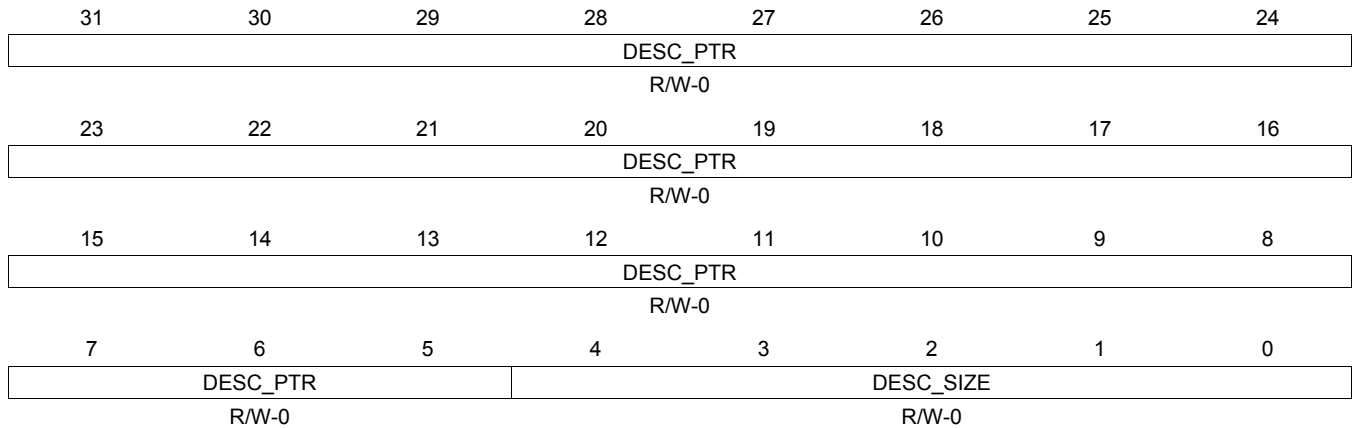
Table 16-739. QUEUE_103_C Register Field Descriptions

Bit	Field	Type	Reset	Description
31	HEAD_TAIL	W-0	0	Head/Tail Push Control. Set to zero in order to push packet onto tail of queue and set to one in order to push packet onto head of queue.
13-0	PACKET_SIZE	R/W-0	0	packet_size This field indicates packet size and is assumed to be zero on each packet add unless the value is explicitly overwritten. This field indicates packet size for packet pop operation.

16.5.7.450 QUEUE_103_D Register (offset = 267Ch) [reset = 0h]

QUEUE_103_D is shown in [Figure 16-726](#) and described in [Table 16-740](#).

Figure 16-726. QUEUE_103_D Register



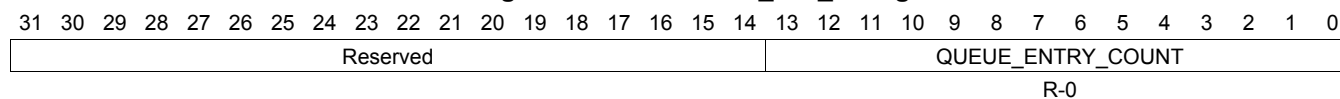
LEGEND: R/W = Read/Write; R = Read only; W1toCl = Write 1 to clear bit; -n = value after reset

Table 16-740. QUEUE_103_D Register Field Descriptions

Bit	Field	Type	Reset	Description
31-5	DESC_PTR	R/W-0	0	Descriptor pointer. It will be read as zero if the queue is empty. It will indicate a 32-bit aligned address that points to a descriptor when the queue is not empty.
4-0	DESC_SIZE	R/W-0	0	Descriptor Size. It is encoded in 4-byte increments with values 0 to 31 representing 24 and so on to 148 bytes. This field will return a 0x0 when an empty queue is read. Queue Manager Queue N Registers D To save hardware resources, the queue manager internally stores descriptor size (desc_size) information in four bits. However, register D has five LSBs that specify descriptor size. As a consequence, the value of desc_size that is pushed may not be same as that is read during a pop. The value that is read back is equal to always rounded to an odd number. So, for even values, the value read back is one more than what was written. For odd values, the value read back is same as the value that was written. Note that this 5-bit field (desc_size) is unrelated to the code for size of descriptors in a descriptor region. It is just a place holder for a 5-bit value that is maintained across the push and pop operations for every descriptor managed by the queue manager.

16.5.7.451 QUEUE_104_A Register (offset = 2680h) [reset = 0h]

QUEUE_104_A is shown in [Figure 16-727](#) and described in [Table 16-741](#).

Figure 16-727. QUEUE_104_A Register


LEGEND: R/W = Read/Write; R = Read only; W1toCl = Write 1 to clear bit; -n = value after reset

Table 16-741. QUEUE_104_A Register Field Descriptions

Bit	Field	Type	Reset	Description
13-0	QUEUE_ENTRY_COUNT	R-0	0	This field indicates how many packets are currently queued on the queue. This count is incremented by 1 whenever a packet is added to the queue. This count is decremented by 1 whenever a packet is popped from the queue.

16.5.7.452 QUEUE_104_B Register (offset = 2684h) [reset = 0h]

QUEUE_104_B is shown in [Figure 16-728](#) and described in [Table 16-742](#).

Figure 16-728. QUEUE_104_B Register


LEGEND: R/W = Read/Write; R = Read only; W1toCl = Write 1 to clear bit; -n = value after reset

Table 16-742. QUEUE_104_B Register Field Descriptions

Bit	Field	Type	Reset	Description
27-0	QUEUE_BYTE_COUNT	R-0	0	This field indicates how many bytes total are contained in all of the packets which are currently queued on this queue.

16.5.7.453 QUEUE_104_C Register (offset = 2688h) [reset = 0h]

 QUEUE_104_C is shown in [Figure 16-729](#) and described in [Table 16-743](#).

Figure 16-729. QUEUE_104_C Register


LEGEND: R/W = Read/Write; R = Read only; W1toCl = Write 1 to clear bit; -n = value after reset

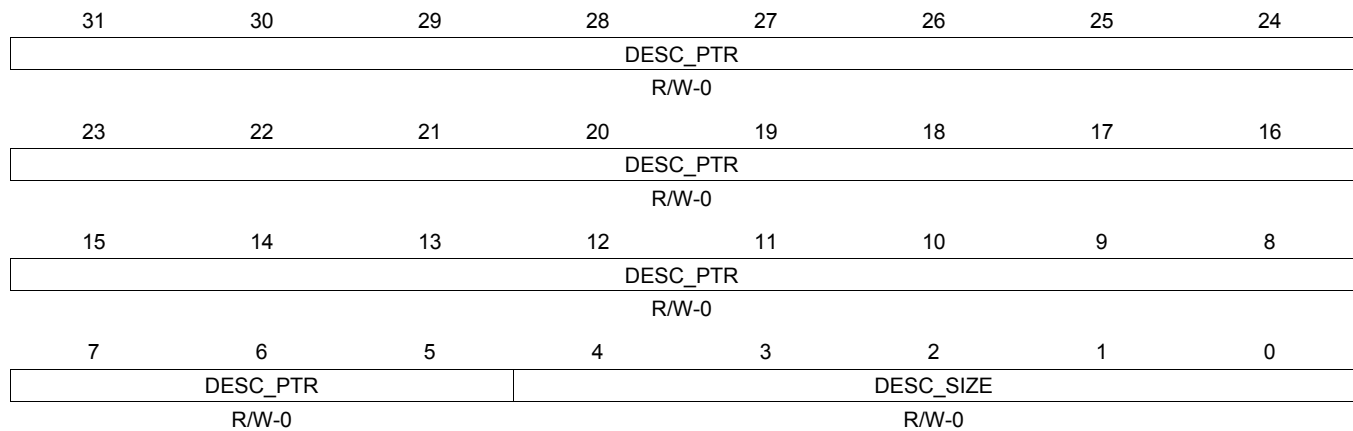
Table 16-743. QUEUE_104_C Register Field Descriptions

Bit	Field	Type	Reset	Description
31	HEAD_TAIL	W-0	0	Head/Tail Push Control. Set to zero in order to push packet onto tail of queue and set to one in order to push packet onto head of queue.
13-0	PACKET_SIZE	R/W-0	0	packet_size This field indicates packet size and is assumed to be zero on each packet add unless the value is explicitly overwritten. This field indicates packet size for packet pop operation.

16.5.7.454 QUEUE_104_D Register (offset = 268Ch) [reset = 0h]

QUEUE_104_D is shown in [Figure 16-730](#) and described in [Table 16-744](#).

Figure 16-730. QUEUE_104_D Register



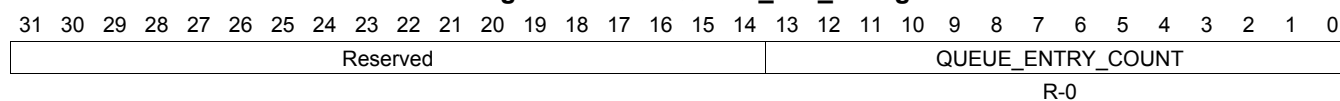
LEGEND: R/W = Read/Write; R = Read only; W1toCl = Write 1 to clear bit; -n = value after reset

Table 16-744. QUEUE_104_D Register Field Descriptions

Bit	Field	Type	Reset	Description
31-5	DESC_PTR	R/W-0	0	Descriptor pointer. It will be read as zero if the queue is empty. It will indicate a 32-bit aligned address that points to a descriptor when the queue is not empty.
4-0	DESC_SIZE	R/W-0	0	Descriptor Size. It is encoded in 4-byte increments with values 0 to 31 representing 24 and so on to 148 bytes. This field will return a 0x0 when an empty queue is read. Queue Manager Queue N Registers D To save hardware resources, the queue manager internally stores descriptor size (desc_size) information in four bits. However, register D has five LSBs that specify descriptor size. As a consequence, the value of desc_size that is pushed may not be same as that is read during a pop. The value that is read back is equal to always rounded to an odd number. So, for even values, the value read back is one more than what was written. For odd values, the value read back is same as the value that was written. Note that this 5-bit field (desc_size) is unrelated to the code for size of descriptors in a descriptor region. It is just a place holder for a 5-bit value that is maintained across the push and pop operations for every descriptor managed by the queue manager.

16.5.7.455 QUEUE_105_A Register (offset = 2690h) [reset = 0h]

QUEUE_105_A is shown in [Figure 16-731](#) and described in [Table 16-745](#).

Figure 16-731. QUEUE_105_A Register


LEGEND: R/W = Read/Write; R = Read only; W1toCl = Write 1 to clear bit; -n = value after reset

Table 16-745. QUEUE_105_A Register Field Descriptions

Bit	Field	Type	Reset	Description
13-0	QUEUE_ENTRY_COUNT	R-0	0	This field indicates how many packets are currently queued on the queue. This count is incremented by 1 whenever a packet is added to the queue. This count is decremented by 1 whenever a packet is popped from the queue.

16.5.7.456 QUEUE_105_B Register (offset = 2694h) [reset = 0h]

QUEUE_105_B is shown in [Figure 16-732](#) and described in [Table 16-746](#).

Figure 16-732. QUEUE_105_B Register


LEGEND: R/W = Read/Write; R = Read only; W1toCl = Write 1 to clear bit; -n = value after reset

Table 16-746. QUEUE_105_B Register Field Descriptions

Bit	Field	Type	Reset	Description
27-0	QUEUE_BYTE_COUNT	R-0	0	This field indicates how many bytes total are contained in all of the packets which are currently queued on this queue.

16.5.7.457 QUEUE_105_C Register (offset = 2698h) [reset = 0h]

 QUEUE_105_C is shown in [Figure 16-733](#) and described in [Table 16-747](#).

Figure 16-733. QUEUE_105_C Register


LEGEND: R/W = Read/Write; R = Read only; W1toCl = Write 1 to clear bit; -n = value after reset

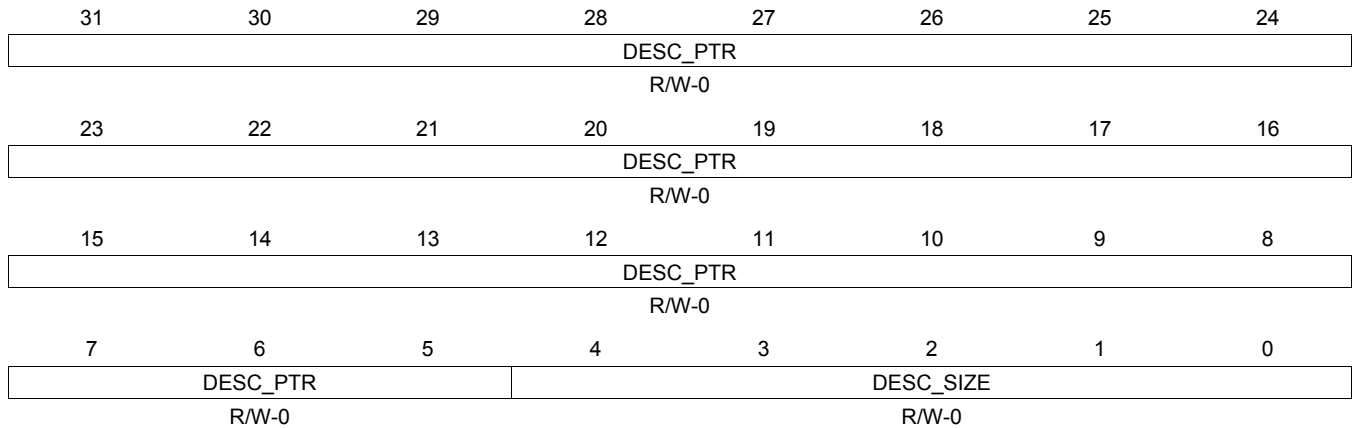
Table 16-747. QUEUE_105_C Register Field Descriptions

Bit	Field	Type	Reset	Description
31	HEAD_TAIL	W-0	0	Head/Tail Push Control. Set to zero in order to push packet onto tail of queue and set to one in order to push packet onto head of queue.
13-0	PACKET_SIZE	R/W-0	0	packet_size This field indicates packet size and is assumed to be zero on each packet add unless the value is explicitly overwritten. This field indicates packet size for packet pop operation.

16.5.7.458 QUEUE_105_D Register (offset = 269Ch) [reset = 0h]

QUEUE_105_D is shown in [Figure 16-734](#) and described in [Table 16-748](#).

Figure 16-734. QUEUE_105_D Register



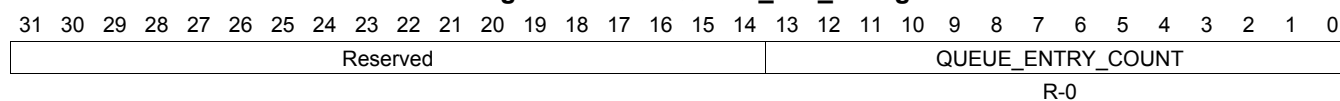
LEGEND: R/W = Read/Write; R = Read only; W1toCl = Write 1 to clear bit; -n = value after reset

Table 16-748. QUEUE_105_D Register Field Descriptions

Bit	Field	Type	Reset	Description
31-5	DESC_PTR	R/W-0	0	Descriptor pointer. It will be read as zero if the queue is empty. It will indicate a 32-bit aligned address that points to a descriptor when the queue is not empty.
4-0	DESC_SIZE	R/W-0	0	Descriptor Size. It is encoded in 4-byte increments with values 0 to 31 representing 24 and so on to 148 bytes. This field will return a 0x0 when an empty queue is read. Queue Manager Queue N Registers D To save hardware resources, the queue manager internally stores descriptor size (desc_size) information in four bits. However, register D has five LSBs that specify descriptor size. As a consequence, the value of desc_size that is pushed may not be same as that is read during a pop. The value that is read back is equal to always rounded to an odd number. So, for even values, the value read back is one more than what was written. For odd values, the value read back is same as the value that was written. Note that this 5-bit field (desc_size) is unrelated to the code for size of descriptors in a descriptor region. It is just a place holder for a 5-bit value that is maintained across the push and pop operations for every descriptor managed by the queue manager.

16.5.7.459 QUEUE_106_A Register (offset = 26A0h) [reset = 0h]

QUEUE_106_A is shown in [Figure 16-735](#) and described in [Table 16-749](#).

Figure 16-735. QUEUE_106_A Register


LEGEND: R/W = Read/Write; R = Read only; W1toCl = Write 1 to clear bit; -n = value after reset

Table 16-749. QUEUE_106_A Register Field Descriptions

Bit	Field	Type	Reset	Description
13-0	QUEUE_ENTRY_COUNT	R-0	0	This field indicates how many packets are currently queued on the queue. This count is incremented by 1 whenever a packet is added to the queue. This count is decremented by 1 whenever a packet is popped from the queue.

16.5.7.460 QUEUE_106_B Register (offset = 26A4h) [reset = 0h]

QUEUE_106_B is shown in [Figure 16-736](#) and described in [Table 16-750](#).

Figure 16-736. QUEUE_106_B Register


LEGEND: R/W = Read/Write; R = Read only; W1toCl = Write 1 to clear bit; -n = value after reset

Table 16-750. QUEUE_106_B Register Field Descriptions

Bit	Field	Type	Reset	Description
27-0	QUEUE_BYTE_COUNT	R-0	0	This field indicates how many bytes total are contained in all of the packets which are currently queued on this queue.

16.5.7.461 QUEUE_106_C Register (offset = 26A8h) [reset = 0h]

 QUEUE_106_C is shown in [Figure 16-737](#) and described in [Table 16-751](#).

Figure 16-737. QUEUE_106_C Register


LEGEND: R/W = Read/Write; R = Read only; W1toCl = Write 1 to clear bit; -n = value after reset

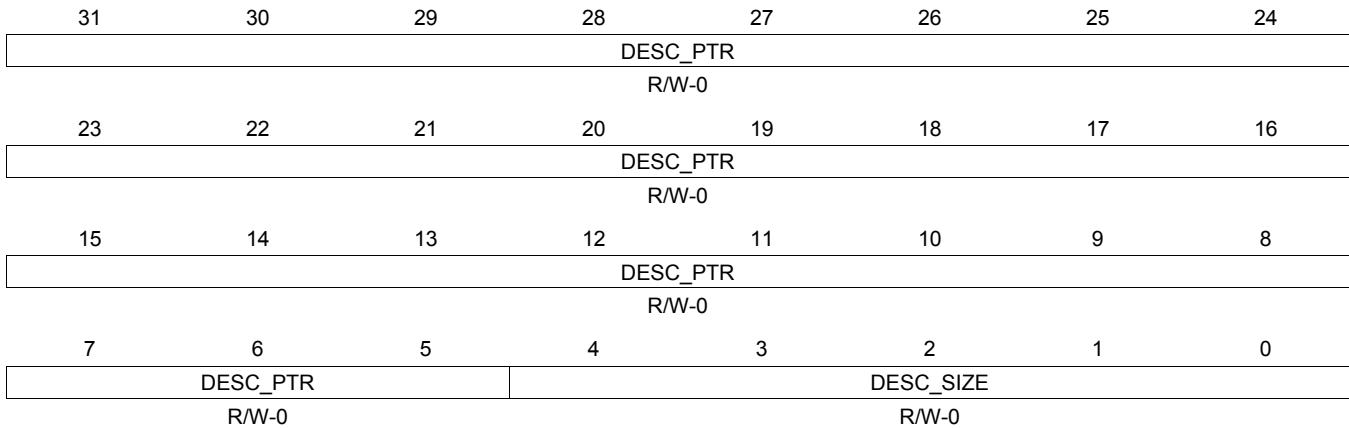
Table 16-751. QUEUE_106_C Register Field Descriptions

Bit	Field	Type	Reset	Description
31	HEAD_TAIL	W-0	0	Head/Tail Push Control. Set to zero in order to push packet onto tail of queue and set to one in order to push packet onto head of queue.
13-0	PACKET_SIZE	R/W-0	0	packet_size This field indicates packet size and is assumed to be zero on each packet add unless the value is explicitly overwritten. This field indicates packet size for packet pop operation.

16.5.7.462 QUEUE_106_D Register (offset = 26ACh) [reset = 0h]

QUEUE_106_D is shown in [Figure 16-738](#) and described in [Table 16-752](#).

Figure 16-738. QUEUE_106_D Register



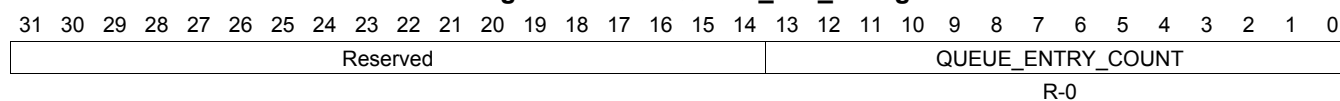
LEGEND: R/W = Read/Write; R = Read only; W1toCl = Write 1 to clear bit; -n = value after reset

Table 16-752. QUEUE_106_D Register Field Descriptions

Bit	Field	Type	Reset	Description
31-5	DESC_PTR	R/W-0	0	Descriptor pointer. It will be read as zero if the queue is empty. It will indicate a 32-bit aligned address that points to a descriptor when the queue is not empty.
4-0	DESC_SIZE	R/W-0	0	Descriptor Size. It is encoded in 4-byte increments with values 0 to 31 representing 24 and so on to 148 bytes. This field will return a 0x0 when an empty queue is read. Queue Manager Queue N Registers D To save hardware resources, the queue manager internally stores descriptor size (desc_size) information in four bits. However, register D has five LSBs that specify descriptor size. As a consequence, the value of desc_size that is pushed may not be same as that is read during a pop. The value that is read back is equal to always rounded to an odd number. So, for even values, the value read back is one more than what was written. For odd values, the value read back is same as the value that was written. Note that this 5-bit field (desc_size) is unrelated to the code for size of descriptors in a descriptor region. It is just a place holder for a 5-bit value that is maintained across the push and pop operations for every descriptor managed by the queue manager.

16.5.7.463 QUEUE_107_A Register (offset = 26B0h) [reset = 0h]

QUEUE_107_A is shown in [Figure 16-739](#) and described in [Table 16-753](#).

Figure 16-739. QUEUE_107_A Register


LEGEND: R/W = Read/Write; R = Read only; W1toCl = Write 1 to clear bit; -n = value after reset

Table 16-753. QUEUE_107_A Register Field Descriptions

Bit	Field	Type	Reset	Description
13-0	QUEUE_ENTRY_COUNT	R-0	0	This field indicates how many packets are currently queued on the queue. This count is incremented by 1 whenever a packet is added to the queue. This count is decremented by 1 whenever a packet is popped from the queue.

16.5.7.464 QUEUE_107_B Register (offset = 26B4h) [reset = 0h]

QUEUE_107_B is shown in [Figure 16-740](#) and described in [Table 16-754](#).

Figure 16-740. QUEUE_107_B Register

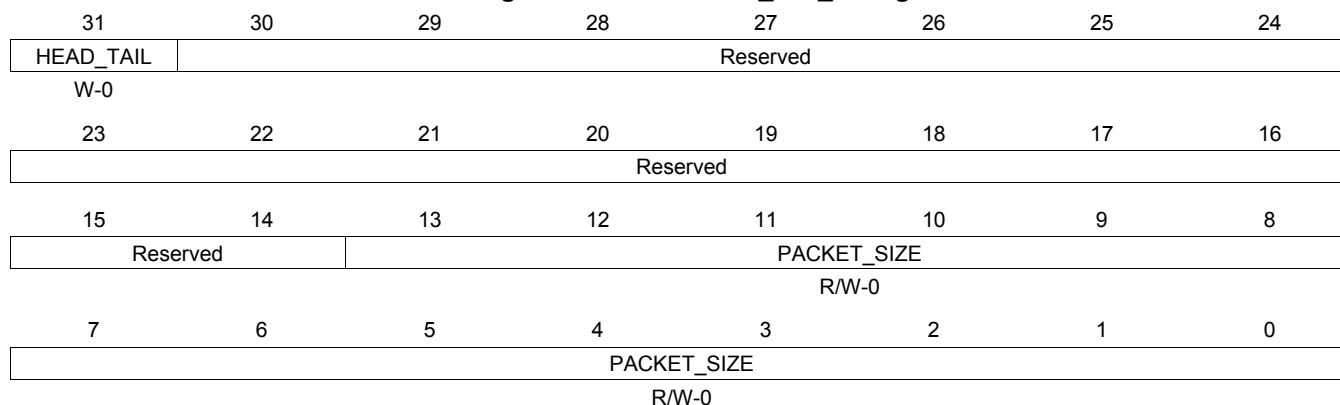

LEGEND: R/W = Read/Write; R = Read only; W1toCl = Write 1 to clear bit; -n = value after reset

Table 16-754. QUEUE_107_B Register Field Descriptions

Bit	Field	Type	Reset	Description
27-0	QUEUE_BYTE_COUNT	R-0	0	This field indicates how many bytes total are contained in all of the packets which are currently queued on this queue.

16.5.7.465 QUEUE_107_C Register (offset = 26B8h) [reset = 0h]

 QUEUE_107_C is shown in [Figure 16-741](#) and described in [Table 16-755](#).

Figure 16-741. QUEUE_107_C Register


LEGEND: R/W = Read/Write; R = Read only; W1toCl = Write 1 to clear bit; -n = value after reset

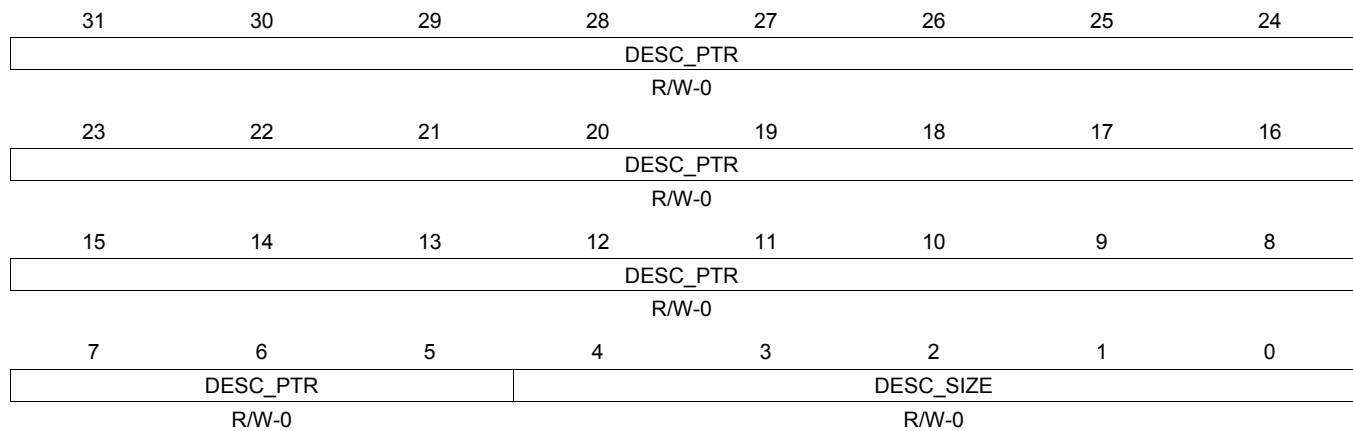
Table 16-755. QUEUE_107_C Register Field Descriptions

Bit	Field	Type	Reset	Description
31	HEAD_TAIL	W-0	0	Head/Tail Push Control. Set to zero in order to push packet onto tail of queue and set to one in order to push packet onto head of queue.
13-0	PACKET_SIZE	R/W-0	0	packet_size This field indicates packet size and is assumed to be zero on each packet add unless the value is explicitly overwritten. This field indicates packet size for packet pop operation.

16.5.7.466 QUEUE_107_D Register (offset = 26BCh) [reset = 0h]

QUEUE_107_D is shown in [Figure 16-742](#) and described in [Table 16-756](#).

Figure 16-742. QUEUE_107_D Register



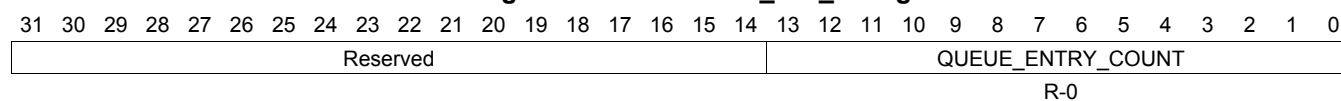
LEGEND: R/W = Read/Write; R = Read only; W1toCl = Write 1 to clear bit; -n = value after reset

Table 16-756. QUEUE_107_D Register Field Descriptions

Bit	Field	Type	Reset	Description
31-5	DESC_PTR	R/W-0	0	Descriptor pointer. It will be read as zero if the queue is empty. It will indicate a 32-bit aligned address that points to a descriptor when the queue is not empty.
4-0	DESC_SIZE	R/W-0	0	Descriptor Size. It is encoded in 4-byte increments with values 0 to 31 representing 24 and so on to 148 bytes. This field will return a 0x0 when an empty queue is read. Queue Manager Queue N Registers D To save hardware resources, the queue manager internally stores descriptor size (desc_size) information in four bits. However, register D has five LSBs that specify descriptor size. As a consequence, the value of desc_size that is pushed may not be same as that is read during a pop. The value that is read back is equal to always rounded to an odd number. So, for even values, the value read back is one more than what was written. For odd values, the value read back is same as the value that was written. Note that this 5-bit field (desc_size) is unrelated to the code for size of descriptors in a descriptor region. It is just a place holder for a 5-bit value that is maintained across the push and pop operations for every descriptor managed by the queue manager.

16.5.7.467 QUEUE_108_A Register (offset = 26C0h) [reset = 0h]

QUEUE_108_A is shown in [Figure 16-743](#) and described in [Table 16-757](#).

Figure 16-743. QUEUE_108_A Register


LEGEND: R/W = Read/Write; R = Read only; W1toCl = Write 1 to clear bit; -n = value after reset

Table 16-757. QUEUE_108_A Register Field Descriptions

Bit	Field	Type	Reset	Description
13-0	QUEUE_ENTRY_COUNT	R-0	0	This field indicates how many packets are currently queued on the queue. This count is incremented by 1 whenever a packet is added to the queue. This count is decremented by 1 whenever a packet is popped from the queue.

16.5.7.468 QUEUE_108_B Register (offset = 26C4h) [reset = 0h]

QUEUE_108_B is shown in [Figure 16-744](#) and described in [Table 16-758](#).

Figure 16-744. QUEUE_108_B Register


LEGEND: R/W = Read/Write; R = Read only; W1toCl = Write 1 to clear bit; -n = value after reset

Table 16-758. QUEUE_108_B Register Field Descriptions

Bit	Field	Type	Reset	Description
27-0	QUEUE_BYTE_COUNT	R-0	0	This field indicates how many bytes total are contained in all of the packets which are currently queued on this queue.

16.5.7.469 QUEUE_108_C Register (offset = 26C8h) [reset = 0h]

 QUEUE_108_C is shown in [Figure 16-745](#) and described in [Table 16-759](#).

Figure 16-745. QUEUE_108_C Register


LEGEND: R/W = Read/Write; R = Read only; W1toCl = Write 1 to clear bit; -n = value after reset

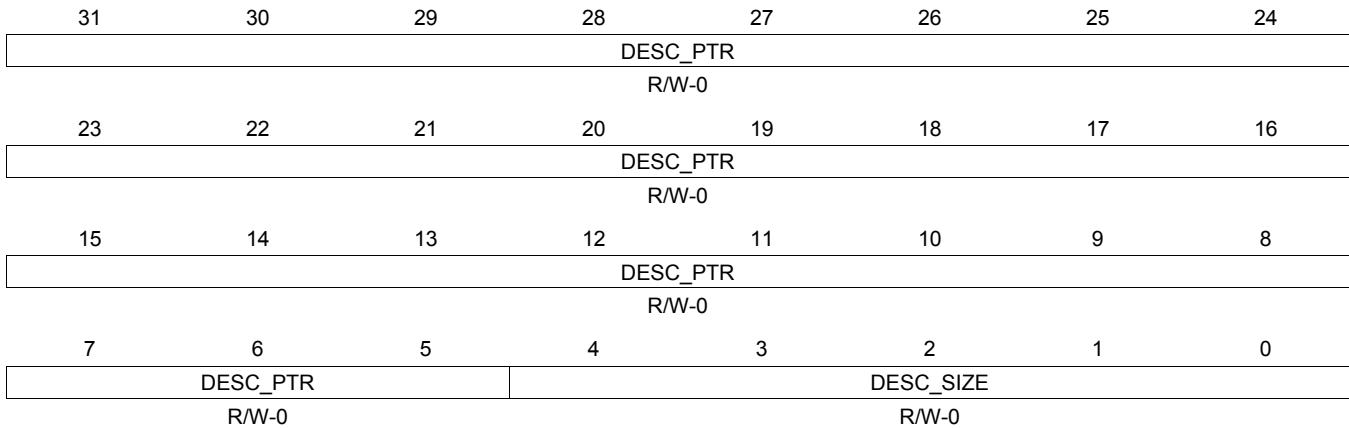
Table 16-759. QUEUE_108_C Register Field Descriptions

Bit	Field	Type	Reset	Description
31	HEAD_TAIL	W-0	0	Head/Tail Push Control. Set to zero in order to push packet onto tail of queue and set to one in order to push packet onto head of queue.
13-0	PACKET_SIZE	R/W-0	0	packet_size This field indicates packet size and is assumed to be zero on each packet add unless the value is explicitly overwritten. This field indicates packet size for packet pop operation.

16.5.7.470 QUEUE_108_D Register (offset = 26CCh) [reset = 0h]

QUEUE_108_D is shown in [Figure 16-746](#) and described in [Table 16-760](#).

Figure 16-746. QUEUE_108_D Register



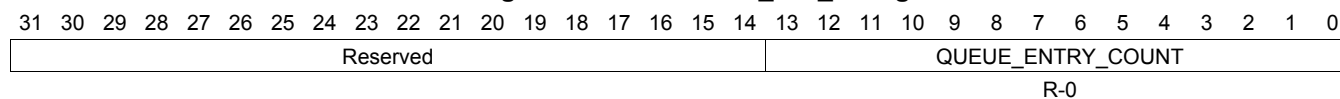
LEGEND: R/W = Read/Write; R = Read only; W1toCl = Write 1 to clear bit; -n = value after reset

Table 16-760. QUEUE_108_D Register Field Descriptions

Bit	Field	Type	Reset	Description
31-5	DESC_PTR	R/W-0	0	Descriptor pointer. It will be read as zero if the queue is empty. It will indicate a 32-bit aligned address that points to a descriptor when the queue is not empty.
4-0	DESC_SIZE	R/W-0	0	Descriptor Size. It is encoded in 4-byte increments with values 0 to 31 representing 24 and so on to 148 bytes. This field will return a 0x0 when an empty queue is read. Queue Manager Queue N Registers D To save hardware resources, the queue manager internally stores descriptor size (desc_size) information in four bits. However, register D has five LSBs that specify descriptor size. As a consequence, the value of desc_size that is pushed may not be same as that is read during a pop. The value that is read back is equal to always rounded to an odd number. So, for even values, the value read back is one more than what was written. For odd values, the value read back is same as the value that was written. Note that this 5-bit field (desc_size) is unrelated to the code for size of descriptors in a descriptor region. It is just a place holder for a 5-bit value that is maintained across the push and pop operations for every descriptor managed by the queue manager.

16.5.7.471 QUEUE_109_A Register (offset = 26D0h) [reset = 0h]

QUEUE_109_A is shown in [Figure 16-747](#) and described in [Table 16-761](#).

Figure 16-747. QUEUE_109_A Register


LEGEND: R/W = Read/Write; R = Read only; W1toCl = Write 1 to clear bit; -n = value after reset

Table 16-761. QUEUE_109_A Register Field Descriptions

Bit	Field	Type	Reset	Description
13-0	QUEUE_ENTRY_COUNT	R-0	0	This field indicates how many packets are currently queued on the queue. This count is incremented by 1 whenever a packet is added to the queue. This count is decremented by 1 whenever a packet is popped from the queue.

16.5.7.472 QUEUE_109_B Register (offset = 26D4h) [reset = 0h]

QUEUE_109_B is shown in [Figure 16-748](#) and described in [Table 16-762](#).

Figure 16-748. QUEUE_109_B Register


LEGEND: R/W = Read/Write; R = Read only; W1toCl = Write 1 to clear bit; -n = value after reset

Table 16-762. QUEUE_109_B Register Field Descriptions

Bit	Field	Type	Reset	Description
27-0	QUEUE_BYTE_COUNT	R-0	0	This field indicates how many bytes total are contained in all of the packets which are currently queued on this queue.

16.5.7.473 QUEUE_109_C Register (offset = 26D8h) [reset = 0h]

 QUEUE_109_C is shown in [Figure 16-749](#) and described in [Table 16-763](#).

Figure 16-749. QUEUE_109_C Register

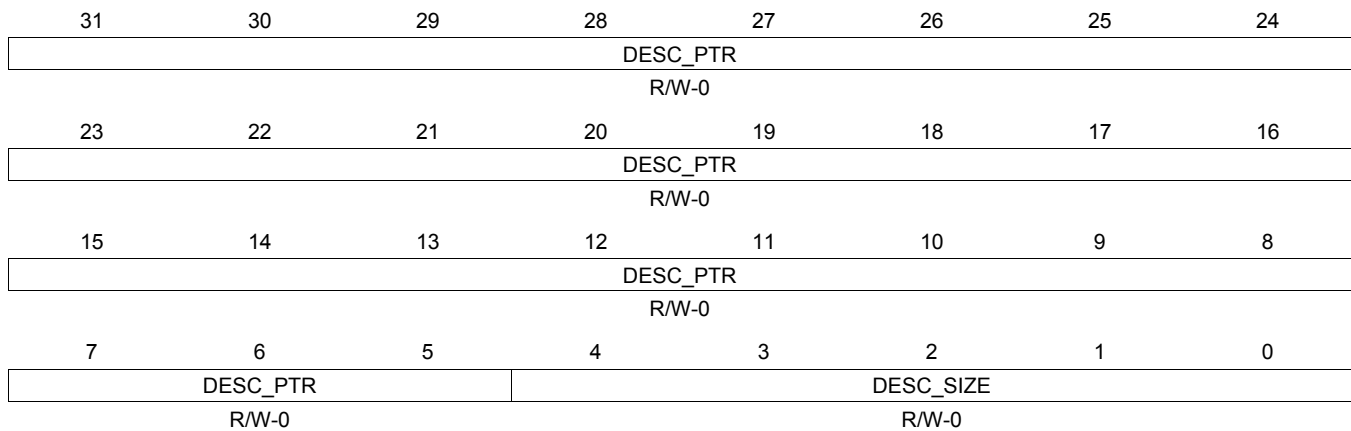

LEGEND: R/W = Read/Write; R = Read only; W1toCl = Write 1 to clear bit; -n = value after reset

Table 16-763. QUEUE_109_C Register Field Descriptions

Bit	Field	Type	Reset	Description
31	HEAD_TAIL	W-0	0	Head/Tail Push Control. Set to zero in order to push packet onto tail of queue and set to one in order to push packet onto head of queue.
13-0	PACKET_SIZE	R/W-0	0	packet_size This field indicates packet size and is assumed to be zero on each packet add unless the value is explicitly overwritten. This field indicates packet size for packet pop operation.

16.5.7.474 QUEUE_109_D Register (offset = 26DCh) [reset = 0h]

QUEUE_109_D is shown in [Figure 16-750](#) and described in [Table 16-764](#).

Figure 16-750. QUEUE_109_D Register


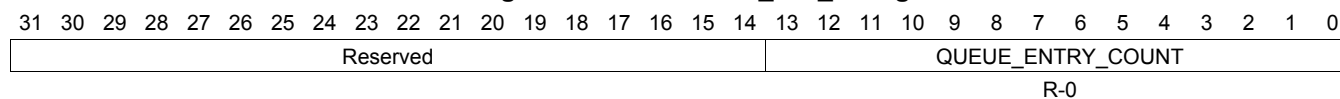
LEGEND: R/W = Read/Write; R = Read only; W1toCl = Write 1 to clear bit; -n = value after reset

Table 16-764. QUEUE_109_D Register Field Descriptions

Bit	Field	Type	Reset	Description
31-5	DESC_PTR	R/W-0	0	Descriptor pointer. It will be read as zero if the queue is empty. It will indicate a 32-bit aligned address that points to a descriptor when the queue is not empty.
4-0	DESC_SIZE	R/W-0	0	Descriptor Size. It is encoded in 4-byte increments with values 0 to 31 representing 24 and so on to 148 bytes. This field will return a 0x0 when an empty queue is read. Queue Manager Queue N Registers D To save hardware resources, the queue manager internally stores descriptor size (desc_size) information in four bits. However, register D has five LSBs that specify descriptor size. As a consequence, the value of desc_size that is pushed may not be same as that is read during a pop. The value that is read back is equal to always rounded to an odd number. So, for even values, the value read back is one more than what was written. For odd values, the value read back is same as the value that was written. Note that this 5-bit field (desc_size) is unrelated to the code for size of descriptors in a descriptor region. It is just a place holder for a 5-bit value that is maintained across the push and pop operations for every descriptor managed by the queue manager.

16.5.7.475 QUEUE_110_A Register (offset = 26E0h) [reset = 0h]

QUEUE_110_A is shown in [Figure 16-751](#) and described in [Table 16-765](#).

Figure 16-751. QUEUE_110_A Register


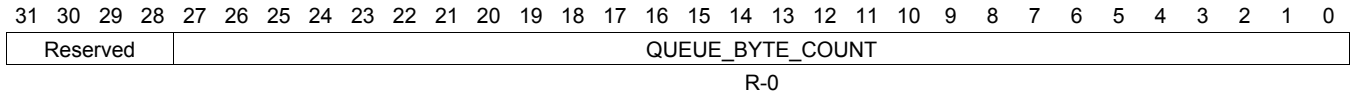
LEGEND: R/W = Read/Write; R = Read only; W1toCl = Write 1 to clear bit; -n = value after reset

Table 16-765. QUEUE_110_A Register Field Descriptions

Bit	Field	Type	Reset	Description
13-0	QUEUE_ENTRY_COUNT	R-0	0	This field indicates how many packets are currently queued on the queue. This count is incremented by 1 whenever a packet is added to the queue. This count is decremented by 1 whenever a packet is popped from the queue.

16.5.7.476 QUEUE_110_B Register (offset = 26E4h) [reset = 0h]

QUEUE_110_B is shown in [Figure 16-752](#) and described in [Table 16-766](#).

Figure 16-752. QUEUE_110_B Register


LEGEND: R/W = Read/Write; R = Read only; W1toCl = Write 1 to clear bit; -n = value after reset

Table 16-766. QUEUE_110_B Register Field Descriptions

Bit	Field	Type	Reset	Description
27-0	QUEUE_BYTE_COUNT	R-0	0	This field indicates how many bytes total are contained in all of the packets which are currently queued on this queue.

16.5.7.477 QUEUE_110_C Register (offset = 26E8h) [reset = 0h]

 QUEUE_110_C is shown in [Figure 16-753](#) and described in [Table 16-767](#).

Figure 16-753. QUEUE_110_C Register


LEGEND: R/W = Read/Write; R = Read only; W1toCl = Write 1 to clear bit; -n = value after reset

Table 16-767. QUEUE_110_C Register Field Descriptions

Bit	Field	Type	Reset	Description
31	HEAD_TAIL	W-0	0	Head/Tail Push Control. Set to zero in order to push packet onto tail of queue and set to one in order to push packet onto head of queue.
13-0	PACKET_SIZE	R/W-0	0	packet_size This field indicates packet size and is assumed to be zero on each packet add unless the value is explicitly overwritten. This field indicates packet size for packet pop operation.

16.5.7.478 QUEUE_110_D Register (offset = 26ECh) [reset = 0h]

QUEUE_110_D is shown in [Figure 16-754](#) and described in [Table 16-768](#).

Figure 16-754. QUEUE_110_D Register



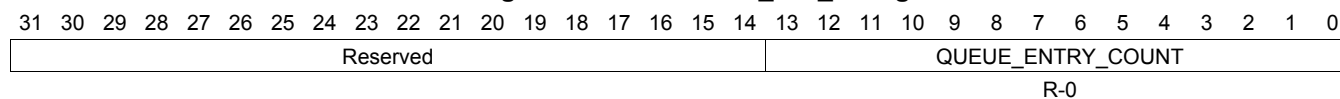
LEGEND: R/W = Read/Write; R = Read only; W1toCl = Write 1 to clear bit; -n = value after reset

Table 16-768. QUEUE_110_D Register Field Descriptions

Bit	Field	Type	Reset	Description
31-5	DESC_PTR	R/W-0	0	Descriptor pointer. It will be read as zero if the queue is empty. It will indicate a 32-bit aligned address that points to a descriptor when the queue is not empty.
4-0	DESC_SIZE	R/W-0	0	Descriptor Size. It is encoded in 4-byte increments with values 0 to 31 representing 24 and so on to 148 bytes. This field will return a 0x0 when an empty queue is read. Queue Manager Queue N Registers D To save hardware resources, the queue manager internally stores descriptor size (desc_size) information in four bits. However, register D has five LSBs that specify descriptor size. As a consequence, the value of desc_size that is pushed may not be same as that is read during a pop. The value that is read back is equal to always rounded to an odd number. So, for even values, the value read back is one more than what was written. For odd values, the value read back is same as the value that was written. Note that this 5-bit field (desc_size) is unrelated to the code for size of descriptors in a descriptor region. It is just a place holder for a 5-bit value that is maintained across the push and pop operations for every descriptor managed by the queue manager.

16.5.7.479 QUEUE_111_A Register (offset = 26F0h) [reset = 0h]

QUEUE_111_A is shown in [Figure 16-755](#) and described in [Table 16-769](#).

Figure 16-755. QUEUE_111_A Register


LEGEND: R/W = Read/Write; R = Read only; W1toCl = Write 1 to clear bit; -n = value after reset

Table 16-769. QUEUE_111_A Register Field Descriptions

Bit	Field	Type	Reset	Description
13-0	QUEUE_ENTRY_COUNT	R-0	0	This field indicates how many packets are currently queued on the queue. This count is incremented by 1 whenever a packet is added to the queue. This count is decremented by 1 whenever a packet is popped from the queue.

16.5.7.480 QUEUE_111_B Register (offset = 26F4h) [reset = 0h]

QUEUE_111_B is shown in [Figure 16-756](#) and described in [Table 16-770](#).

Figure 16-756. QUEUE_111_B Register


LEGEND: R/W = Read/Write; R = Read only; W1toCl = Write 1 to clear bit; -n = value after reset

Table 16-770. QUEUE_111_B Register Field Descriptions

Bit	Field	Type	Reset	Description
27-0	QUEUE_BYTE_COUNT	R-0	0	This field indicates how many bytes total are contained in all of the packets which are currently queued on this queue.

16.5.7.481 QUEUE_111_C Register (offset = 26F8h) [reset = 0h]

 QUEUE_111_C is shown in [Figure 16-757](#) and described in [Table 16-771](#).

Figure 16-757. QUEUE_111_C Register


LEGEND: R/W = Read/Write; R = Read only; W1toCl = Write 1 to clear bit; -n = value after reset

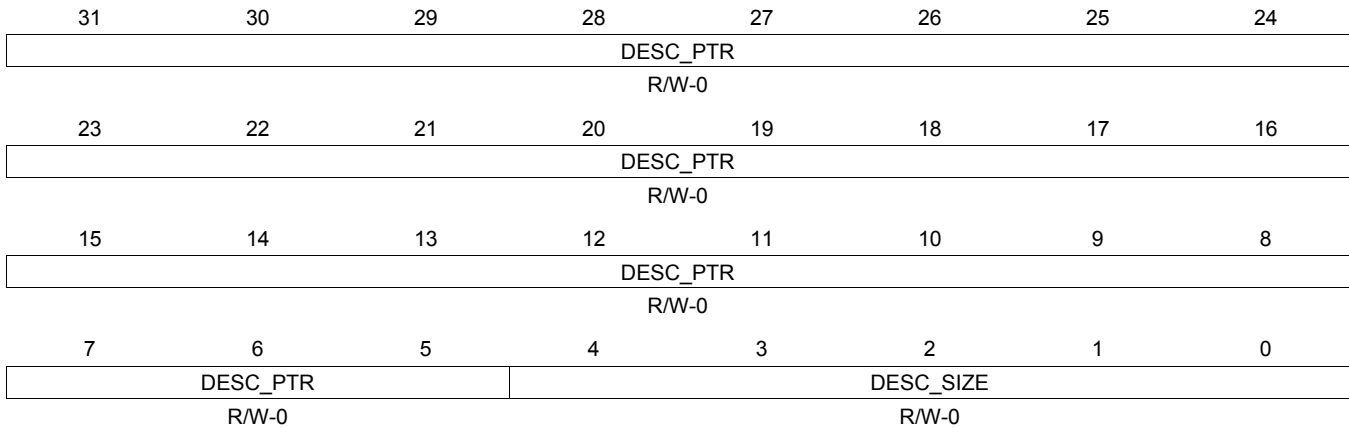
Table 16-771. QUEUE_111_C Register Field Descriptions

Bit	Field	Type	Reset	Description
31	HEAD_TAIL	W-0	0	Head/Tail Push Control. Set to zero in order to push packet onto tail of queue and set to one in order to push packet onto head of queue.
13-0	PACKET_SIZE	R/W-0	0	packet_size This field indicates packet size and is assumed to be zero on each packet add unless the value is explicitly overwritten. This field indicates packet size for packet pop operation.

16.5.7.482 QUEUE_111_D Register (offset = 26FCh) [reset = 0h]

QUEUE_111_D is shown in [Figure 16-758](#) and described in [Table 16-772](#).

Figure 16-758. QUEUE_111_D Register



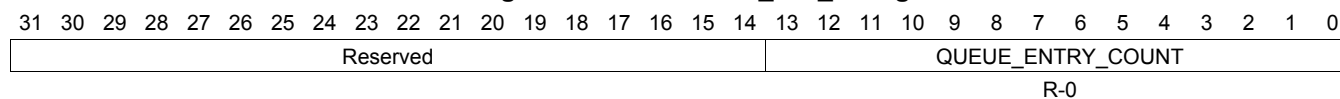
LEGEND: R/W = Read/Write; R = Read only; W1toCl = Write 1 to clear bit; -n = value after reset

Table 16-772. QUEUE_111_D Register Field Descriptions

Bit	Field	Type	Reset	Description
31-5	DESC_PTR	R/W-0	0	Descriptor pointer. It will be read as zero if the queue is empty. It will indicate a 32-bit aligned address that points to a descriptor when the queue is not empty.
4-0	DESC_SIZE	R/W-0	0	Descriptor Size. It is encoded in 4-byte increments with values 0 to 31 representing 24 and so on to 148 bytes. This field will return a 0x0 when an empty queue is read. Queue Manager Queue N Registers D To save hardware resources, the queue manager internally stores descriptor size (desc_size) information in four bits. However, register D has five LSBs that specify descriptor size. As a consequence, the value of desc_size that is pushed may not be same as that is read during a pop. The value that is read back is equal to always rounded to an odd number. So, for even values, the value read back is one more than what was written. For odd values, the value read back is same as the value that was written. Note that this 5-bit field (desc_size) is unrelated to the code for size of descriptors in a descriptor region. It is just a place holder for a 5-bit value that is maintained across the push and pop operations for every descriptor managed by the queue manager.

16.5.7.483 QUEUE_112_A Register (offset = 2700h) [reset = 0h]

QUEUE_112_A is shown in [Figure 16-759](#) and described in [Table 16-773](#).

Figure 16-759. QUEUE_112_A Register


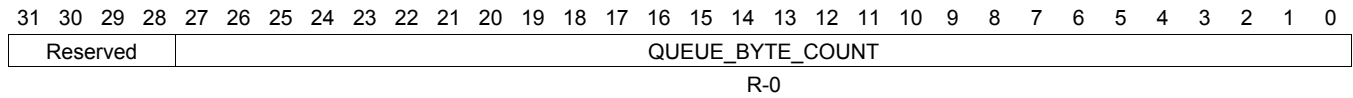
LEGEND: R/W = Read/Write; R = Read only; W1toCl = Write 1 to clear bit; -n = value after reset

Table 16-773. QUEUE_112_A Register Field Descriptions

Bit	Field	Type	Reset	Description
13-0	QUEUE_ENTRY_COUNT	R-0	0	This field indicates how many packets are currently queued on the queue. This count is incremented by 1 whenever a packet is added to the queue. This count is decremented by 1 whenever a packet is popped from the queue.

16.5.7.484 QUEUE_112_B Register (offset = 2704h) [reset = 0h]

QUEUE_112_B is shown in [Figure 16-760](#) and described in [Table 16-774](#).

Figure 16-760. QUEUE_112_B Register


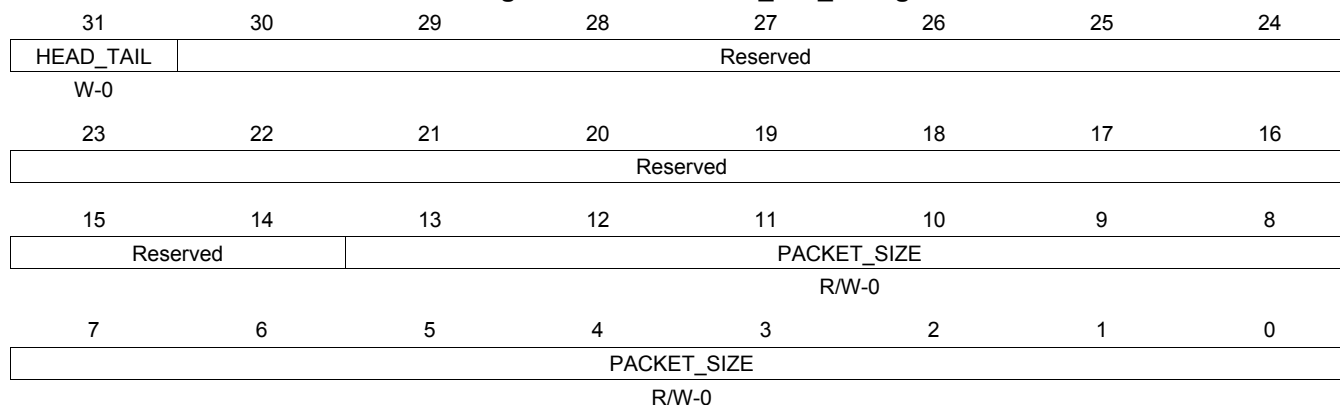
LEGEND: R/W = Read/Write; R = Read only; W1toCl = Write 1 to clear bit; -n = value after reset

Table 16-774. QUEUE_112_B Register Field Descriptions

Bit	Field	Type	Reset	Description
27-0	QUEUE_BYTE_COUNT	R-0	0	This field indicates how many bytes total are contained in all of the packets which are currently queued on this queue.

16.5.7.485 QUEUE_112_C Register (offset = 2708h) [reset = 0h]

 QUEUE_112_C is shown in [Figure 16-761](#) and described in [Table 16-775](#).

Figure 16-761. QUEUE_112_C Register


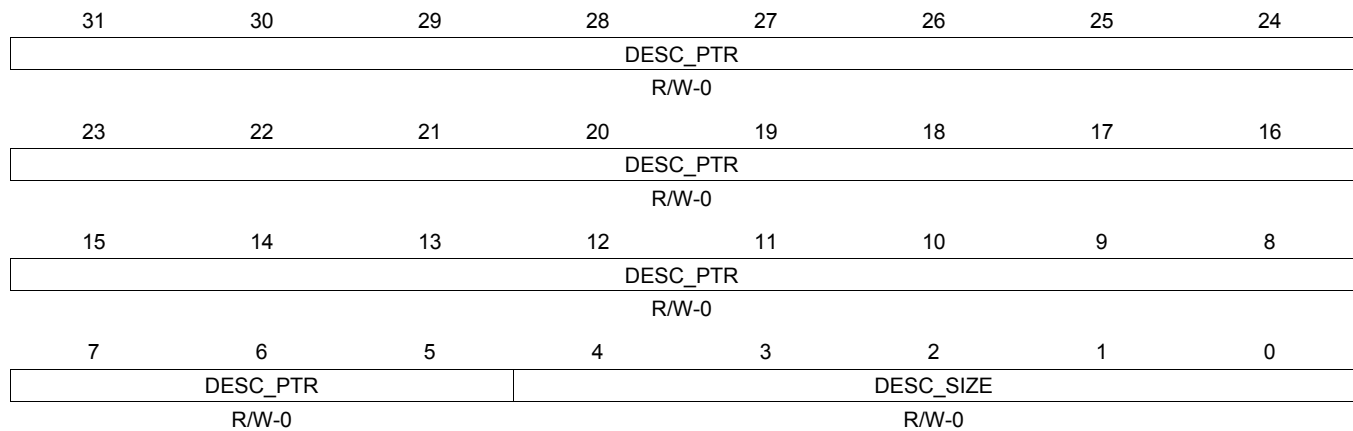
LEGEND: R/W = Read/Write; R = Read only; W1toCl = Write 1 to clear bit; -n = value after reset

Table 16-775. QUEUE_112_C Register Field Descriptions

Bit	Field	Type	Reset	Description
31	HEAD_TAIL	W-0	0	Head/Tail Push Control. Set to zero in order to push packet onto tail of queue and set to one in order to push packet onto head of queue.
13-0	PACKET_SIZE	R/W-0	0	packet_size This field indicates packet size and is assumed to be zero on each packet add unless the value is explicitly overwritten. This field indicates packet size for packet pop operation.

16.5.7.486 QUEUE_112_D Register (offset = 270Ch) [reset = 0h]

QUEUE_112_D is shown in [Figure 16-762](#) and described in [Table 16-776](#).

Figure 16-762. QUEUE_112_D Register


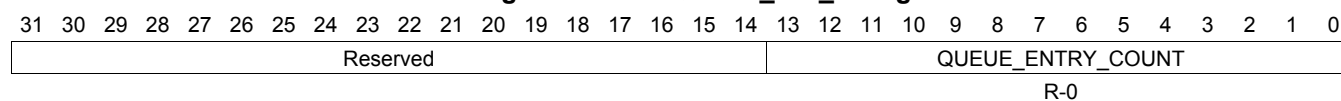
LEGEND: R/W = Read/Write; R = Read only; W1toCl = Write 1 to clear bit; -n = value after reset

Table 16-776. QUEUE_112_D Register Field Descriptions

Bit	Field	Type	Reset	Description
31-5	DESC_PTR	R/W-0	0	Descriptor pointer. It will be read as zero if the queue is empty. It will indicate a 32-bit aligned address that points to a descriptor when the queue is not empty.
4-0	DESC_SIZE	R/W-0	0	Descriptor Size. It is encoded in 4-byte increments with values 0 to 31 representing 24 and so on to 148 bytes. This field will return a 0x0 when an empty queue is read. Queue Manager Queue N Registers D To save hardware resources, the queue manager internally stores descriptor size (desc_size) information in four bits. However, register D has five LSBs that specify descriptor size. As a consequence, the value of desc_size that is pushed may not be same as that is read during a pop. The value that is read back is equal to always rounded to an odd number. So, for even values, the value read back is one more than what was written. For odd values, the value read back is same as the value that was written. Note that this 5-bit field (desc_size) is unrelated to the code for size of descriptors in a descriptor region. It is just a place holder for a 5-bit value that is maintained across the push and pop operations for every descriptor managed by the queue manager.

16.5.7.487 QUEUE_113_A Register (offset = 2710h) [reset = 0h]

QUEUE_113_A is shown in [Figure 16-763](#) and described in [Table 16-777](#).

Figure 16-763. QUEUE_113_A Register


LEGEND: R/W = Read/Write; R = Read only; W1toCl = Write 1 to clear bit; -n = value after reset

Table 16-777. QUEUE_113_A Register Field Descriptions

Bit	Field	Type	Reset	Description
13-0	QUEUE_ENTRY_COUNT	R-0	0	This field indicates how many packets are currently queued on the queue. This count is incremented by 1 whenever a packet is added to the queue. This count is decremented by 1 whenever a packet is popped from the queue.

16.5.7.488 QUEUE_113_B Register (offset = 2714h) [reset = 0h]

QUEUE_113_B is shown in [Figure 16-764](#) and described in [Table 16-778](#).

Figure 16-764. QUEUE_113_B Register


LEGEND: R/W = Read/Write; R = Read only; W1toCl = Write 1 to clear bit; -n = value after reset

Table 16-778. QUEUE_113_B Register Field Descriptions

Bit	Field	Type	Reset	Description
27-0	QUEUE_BYTE_COUNT	R-0	0	This field indicates how many bytes total are contained in all of the packets which are currently queued on this queue.

16.5.7.489 QUEUE_113_C Register (offset = 2718h) [reset = 0h]

 QUEUE_113_C is shown in [Figure 16-765](#) and described in [Table 16-779](#).

Figure 16-765. QUEUE_113_C Register


LEGEND: R/W = Read/Write; R = Read only; W1toCl = Write 1 to clear bit; -n = value after reset

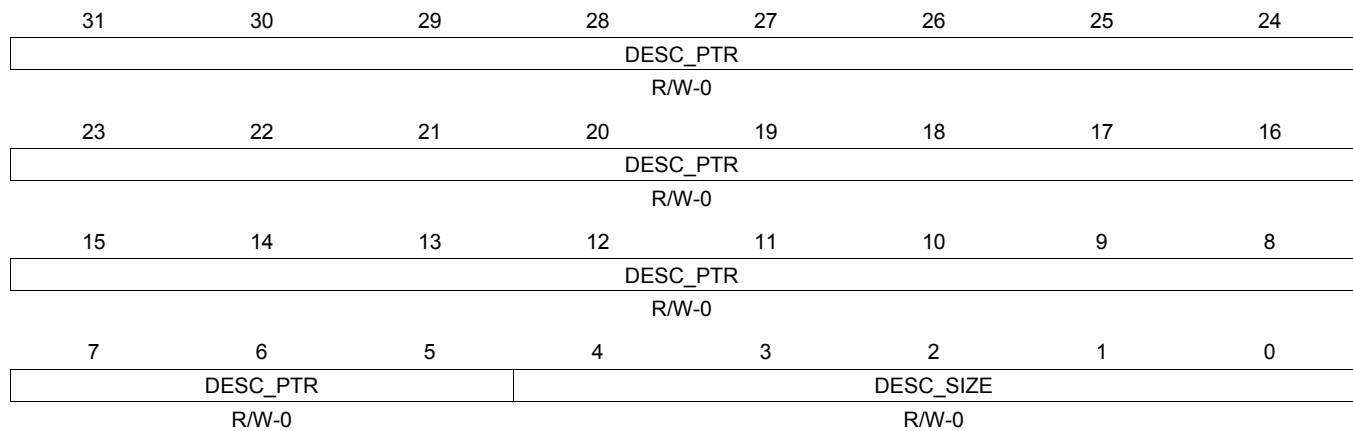
Table 16-779. QUEUE_113_C Register Field Descriptions

Bit	Field	Type	Reset	Description
31	HEAD_TAIL	W-0	0	Head/Tail Push Control. Set to zero in order to push packet onto tail of queue and set to one in order to push packet onto head of queue.
13-0	PACKET_SIZE	R/W-0	0	packet_size This field indicates packet size and is assumed to be zero on each packet add unless the value is explicitly overwritten. This field indicates packet size for packet pop operation.

16.5.7.490 QUEUE_113_D Register (offset = 271Ch) [reset = 0h]

QUEUE_113_D is shown in [Figure 16-766](#) and described in [Table 16-780](#).

Figure 16-766. QUEUE_113_D Register



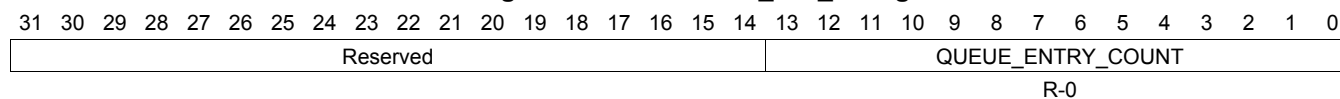
LEGEND: R/W = Read/Write; R = Read only; W1toCl = Write 1 to clear bit; -n = value after reset

Table 16-780. QUEUE_113_D Register Field Descriptions

Bit	Field	Type	Reset	Description
31-5	DESC_PTR	R/W-0	0	Descriptor pointer. It will be read as zero if the queue is empty. It will indicate a 32-bit aligned address that points to a descriptor when the queue is not empty.
4-0	DESC_SIZE	R/W-0	0	Descriptor Size. It is encoded in 4-byte increments with values 0 to 31 representing 24 and so on to 148 bytes. This field will return a 0x0 when an empty queue is read. Queue Manager Queue N Registers D To save hardware resources, the queue manager internally stores descriptor size (desc_size) information in four bits. However, register D has five LSBs that specify descriptor size. As a consequence, the value of desc_size that is pushed may not be same as that is read during a pop. The value that is read back is equal to always rounded to an odd number. So, for even values, the value read back is one more than what was written. For odd values, the value read back is same as the value that was written. Note that this 5-bit field (desc_size) is unrelated to the code for size of descriptors in a descriptor region. It is just a place holder for a 5-bit value that is maintained across the push and pop operations for every descriptor managed by the queue manager.

16.5.7.491 QUEUE_114_A Register (offset = 2720h) [reset = 0h]

QUEUE_114_A is shown in [Figure 16-767](#) and described in [Table 16-781](#).

Figure 16-767. QUEUE_114_A Register


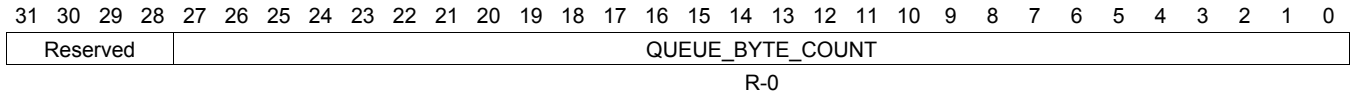
LEGEND: R/W = Read/Write; R = Read only; W1toCl = Write 1 to clear bit; -n = value after reset

Table 16-781. QUEUE_114_A Register Field Descriptions

Bit	Field	Type	Reset	Description
13-0	QUEUE_ENTRY_COUNT	R-0	0	This field indicates how many packets are currently queued on the queue. This count is incremented by 1 whenever a packet is added to the queue. This count is decremented by 1 whenever a packet is popped from the queue.

16.5.7.492 QUEUE_114_B Register (offset = 2724h) [reset = 0h]

QUEUE_114_B is shown in [Figure 16-768](#) and described in [Table 16-782](#).

Figure 16-768. QUEUE_114_B Register


LEGEND: R/W = Read/Write; R = Read only; W1toCl = Write 1 to clear bit; -n = value after reset

Table 16-782. QUEUE_114_B Register Field Descriptions

Bit	Field	Type	Reset	Description
27-0	QUEUE_BYTE_COUNT	R-0	0	This field indicates how many bytes total are contained in all of the packets which are currently queued on this queue.

16.5.7.493 QUEUE_114_C Register (offset = 2728h) [reset = 0h]

 QUEUE_114_C is shown in [Figure 16-769](#) and described in [Table 16-783](#).

Figure 16-769. QUEUE_114_C Register


LEGEND: R/W = Read/Write; R = Read only; W1toCl = Write 1 to clear bit; -n = value after reset

Table 16-783. QUEUE_114_C Register Field Descriptions

Bit	Field	Type	Reset	Description
31	HEAD_TAIL	W-0	0	Head/Tail Push Control. Set to zero in order to push packet onto tail of queue and set to one in order to push packet onto head of queue.
13-0	PACKET_SIZE	R/W-0	0	packet_size This field indicates packet size and is assumed to be zero on each packet add unless the value is explicitly overwritten. This field indicates packet size for packet pop operation.

16.5.7.494 QUEUE_114_D Register (offset = 272Ch) [reset = 0h]

 QUEUE_114_D is shown in [Figure 16-770](#) and described in [Table 16-784](#).

Figure 16-770. QUEUE_114_D Register

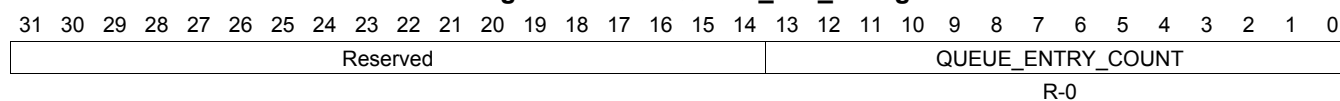

LEGEND: R/W = Read/Write; R = Read only; W1toCl = Write 1 to clear bit; -n = value after reset

Table 16-784. QUEUE_114_D Register Field Descriptions

Bit	Field	Type	Reset	Description
31-5	DESC_PTR	R/W-0	0	Descriptor pointer. It will be read as zero if the queue is empty. It will indicate a 32-bit aligned address that points to a descriptor when the queue is not empty.
4-0	DESC_SIZE	R/W-0	0	Descriptor Size. It is encoded in 4-byte increments with values 0 to 31 representing 24 and so on to 148 bytes. This field will return a 0x0 when an empty queue is read. Queue Manager Queue N Registers D To save hardware resources, the queue manager internally stores descriptor size (desc_size) information in four bits. However, register D has five LSBs that specify descriptor size. As a consequence, the value of desc_size that is pushed may not be same as that is read during a pop. The value that is read back is equal to always rounded to an odd number. So, for even values, the value read back is one more than what was written. For odd values, the value read back is same as the value that was written. Note that this 5-bit field (desc_size) is unrelated to the code for size of descriptors in a descriptor region. It is just a place holder for a 5-bit value that is maintained across the push and pop operations for every descriptor managed by the queue manager.

16.5.7.495 QUEUE_115_A Register (offset = 2730h) [reset = 0h]

QUEUE_115_A is shown in [Figure 16-771](#) and described in [Table 16-785](#).

Figure 16-771. QUEUE_115_A Register


LEGEND: R/W = Read/Write; R = Read only; W1toCl = Write 1 to clear bit; -n = value after reset

Table 16-785. QUEUE_115_A Register Field Descriptions

Bit	Field	Type	Reset	Description
13-0	QUEUE_ENTRY_COUNT	R-0	0	This field indicates how many packets are currently queued on the queue. This count is incremented by 1 whenever a packet is added to the queue. This count is decremented by 1 whenever a packet is popped from the queue.

16.5.7.496 QUEUE_115_B Register (offset = 2734h) [reset = 0h]

QUEUE_115_B is shown in [Figure 16-772](#) and described in [Table 16-786](#).

Figure 16-772. QUEUE_115_B Register


LEGEND: R/W = Read/Write; R = Read only; W1toCl = Write 1 to clear bit; -n = value after reset

Table 16-786. QUEUE_115_B Register Field Descriptions

Bit	Field	Type	Reset	Description
27-0	QUEUE_BYTE_COUNT	R-0	0	This field indicates how many bytes total are contained in all of the packets which are currently queued on this queue.

16.5.7.497 QUEUE_115_C Register (offset = 2738h) [reset = 0h]

 QUEUE_115_C is shown in [Figure 16-773](#) and described in [Table 16-787](#).

Figure 16-773. QUEUE_115_C Register


LEGEND: R/W = Read/Write; R = Read only; W1toCl = Write 1 to clear bit; -n = value after reset

Table 16-787. QUEUE_115_C Register Field Descriptions

Bit	Field	Type	Reset	Description
31	HEAD_TAIL	W-0	0	Head/Tail Push Control. Set to zero in order to push packet onto tail of queue and set to one in order to push packet onto head of queue.
13-0	PACKET_SIZE	R/W-0	0	packet_size This field indicates packet size and is assumed to be zero on each packet add unless the value is explicitly overwritten. This field indicates packet size for packet pop operation.

16.5.7.498 QUEUE_115_D Register (offset = 273Ch) [reset = 0h]

QUEUE_115_D is shown in [Figure 16-774](#) and described in [Table 16-788](#).

Figure 16-774. QUEUE_115_D Register

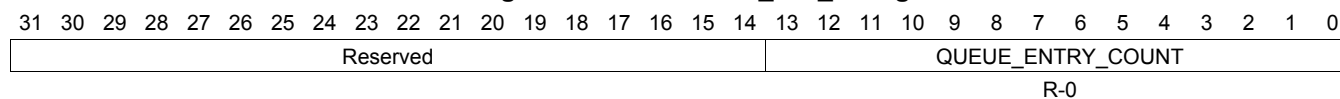

LEGEND: R/W = Read/Write; R = Read only; W1toCl = Write 1 to clear bit; -n = value after reset

Table 16-788. QUEUE_115_D Register Field Descriptions

Bit	Field	Type	Reset	Description
31-5	DESC_PTR	R/W-0	0	Descriptor pointer. It will be read as zero if the queue is empty. It will indicate a 32-bit aligned address that points to a descriptor when the queue is not empty.
4-0	DESC_SIZE	R/W-0	0	Descriptor Size. It is encoded in 4-byte increments with values 0 to 31 representing 24 and so on to 148 bytes. This field will return a 0x0 when an empty queue is read. Queue Manager Queue N Registers D To save hardware resources, the queue manager internally stores descriptor size (desc_size) information in four bits. However, register D has five LSBs that specify descriptor size. As a consequence, the value of desc_size that is pushed may not be same as that is read during a pop. The value that is read back is equal to always rounded to an odd number. So, for even values, the value read back is one more than what was written. For odd values, the value read back is same as the value that was written. Note that this 5-bit field (desc_size) is unrelated to the code for size of descriptors in a descriptor region. It is just a place holder for a 5-bit value that is maintained across the push and pop operations for every descriptor managed by the queue manager.

16.5.7.499 QUEUE_116_A Register (offset = 2740h) [reset = 0h]

QUEUE_116_A is shown in [Figure 16-775](#) and described in [Table 16-789](#).

Figure 16-775. QUEUE_116_A Register


LEGEND: R/W = Read/Write; R = Read only; W1toCl = Write 1 to clear bit; -n = value after reset

Table 16-789. QUEUE_116_A Register Field Descriptions

Bit	Field	Type	Reset	Description
13-0	QUEUE_ENTRY_COUNT	R-0	0	This field indicates how many packets are currently queued on the queue. This count is incremented by 1 whenever a packet is added to the queue. This count is decremented by 1 whenever a packet is popped from the queue.

16.5.7.500 QUEUE_116_B Register (offset = 2744h) [reset = 0h]

QUEUE_116_B is shown in [Figure 16-776](#) and described in [Table 16-790](#).

Figure 16-776. QUEUE_116_B Register

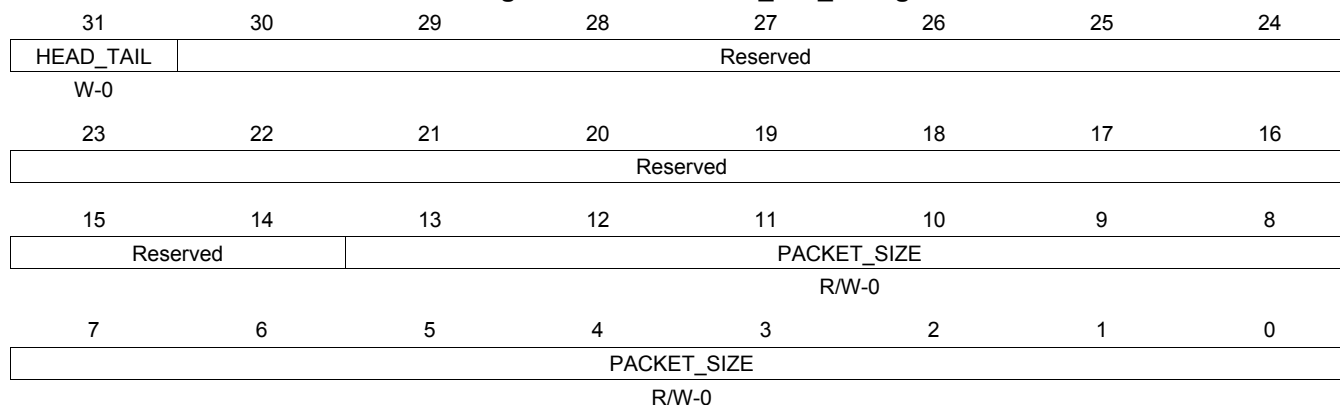

LEGEND: R/W = Read/Write; R = Read only; W1toCl = Write 1 to clear bit; -n = value after reset

Table 16-790. QUEUE_116_B Register Field Descriptions

Bit	Field	Type	Reset	Description
27-0	QUEUE_BYTE_COUNT	R-0	0	This field indicates how many bytes total are contained in all of the packets which are currently queued on this queue.

16.5.7.501 QUEUE_116_C Register (offset = 2748h) [reset = 0h]

 QUEUE_116_C is shown in [Figure 16-777](#) and described in [Table 16-791](#).

Figure 16-777. QUEUE_116_C Register


LEGEND: R/W = Read/Write; R = Read only; W1toCl = Write 1 to clear bit; -n = value after reset

Table 16-791. QUEUE_116_C Register Field Descriptions

Bit	Field	Type	Reset	Description
31	HEAD_TAIL	W-0	0	Head/Tail Push Control. Set to zero in order to push packet onto tail of queue and set to one in order to push packet onto head of queue.
13-0	PACKET_SIZE	R/W-0	0	packet_size This field indicates packet size and is assumed to be zero on each packet add unless the value is explicitly overwritten. This field indicates packet size for packet pop operation.

16.5.7.502 QUEUE_116_D Register (offset = 274Ch) [reset = 0h]

QUEUE_116_D is shown in [Figure 16-778](#) and described in [Table 16-792](#).

Figure 16-778. QUEUE_116_D Register



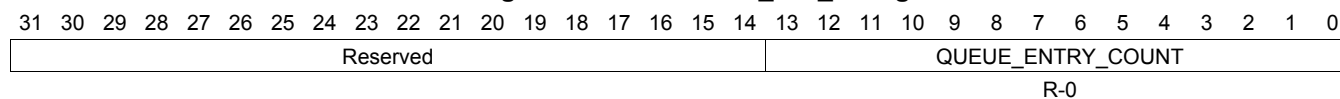
LEGEND: R/W = Read/Write; R = Read only; W1toCl = Write 1 to clear bit; -n = value after reset

Table 16-792. QUEUE_116_D Register Field Descriptions

Bit	Field	Type	Reset	Description
31-5	DESC_PTR	R/W-0	0	Descriptor pointer. It will be read as zero if the queue is empty. It will indicate a 32-bit aligned address that points to a descriptor when the queue is not empty.
4-0	DESC_SIZE	R/W-0	0	Descriptor Size. It is encoded in 4-byte increments with values 0 to 31 representing 24 and so on to 148 bytes. This field will return a 0x0 when an empty queue is read. Queue Manager Queue N Registers D To save hardware resources, the queue manager internally stores descriptor size (desc_size) information in four bits. However, register D has five LSBs that specify descriptor size. As a consequence, the value of desc_size that is pushed may not be same as that is read during a pop. The value that is read back is equal to always rounded to an odd number. So, for even values, the value read back is one more than what was written. For odd values, the value read back is same as the value that was written. Note that this 5-bit field (desc_size) is unrelated to the code for size of descriptors in a descriptor region. It is just a place holder for a 5-bit value that is maintained across the push and pop operations for every descriptor managed by the queue manager.

16.5.7.503 QUEUE_117_A Register (offset = 2750h) [reset = 0h]

QUEUE_117_A is shown in [Figure 16-779](#) and described in [Table 16-793](#).

Figure 16-779. QUEUE_117_A Register


LEGEND: R/W = Read/Write; R = Read only; W1toCl = Write 1 to clear bit; -n = value after reset

Table 16-793. QUEUE_117_A Register Field Descriptions

Bit	Field	Type	Reset	Description
13-0	QUEUE_ENTRY_COUNT	R-0	0	This field indicates how many packets are currently queued on the queue. This count is incremented by 1 whenever a packet is added to the queue. This count is decremented by 1 whenever a packet is popped from the queue.

16.5.7.504 QUEUE_117_B Register (offset = 2754h) [reset = 0h]

QUEUE_117_B is shown in [Figure 16-780](#) and described in [Table 16-794](#).

Figure 16-780. QUEUE_117_B Register

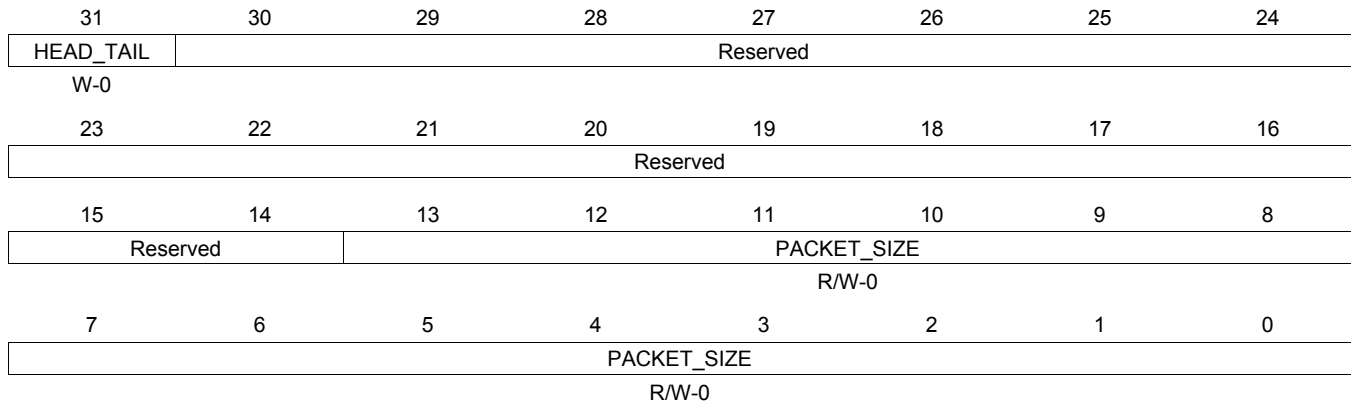

LEGEND: R/W = Read/Write; R = Read only; W1toCl = Write 1 to clear bit; -n = value after reset

Table 16-794. QUEUE_117_B Register Field Descriptions

Bit	Field	Type	Reset	Description
27-0	QUEUE_BYTE_COUNT	R-0	0	This field indicates how many bytes total are contained in all of the packets which are currently queued on this queue.

16.5.7.505 QUEUE_117_C Register (offset = 2758h) [reset = 0h]

 QUEUE_117_C is shown in [Figure 16-781](#) and described in [Table 16-795](#).

Figure 16-781. QUEUE_117_C Register


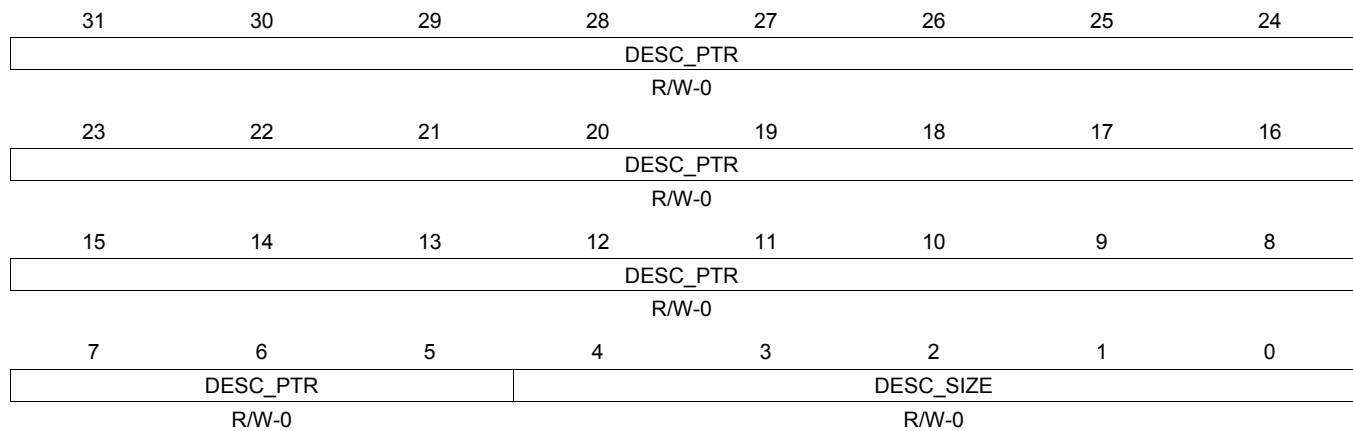
LEGEND: R/W = Read/Write; R = Read only; W1toCl = Write 1 to clear bit; -n = value after reset

Table 16-795. QUEUE_117_C Register Field Descriptions

Bit	Field	Type	Reset	Description
31	HEAD_TAIL	W-0	0	Head/Tail Push Control. Set to zero in order to push packet onto tail of queue and set to one in order to push packet onto head of queue.
13-0	PACKET_SIZE	R/W-0	0	packet_size This field indicates packet size and is assumed to be zero on each packet add unless the value is explicitly overwritten. This field indicates packet size for packet pop operation.

16.5.7.506 QUEUE_117_D Register (offset = 275Ch) [reset = 0h]

QUEUE_117_D is shown in [Figure 16-782](#) and described in [Table 16-796](#).

Figure 16-782. QUEUE_117_D Register


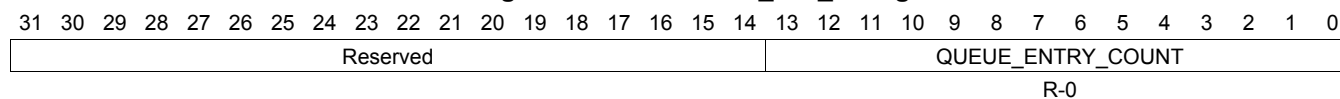
LEGEND: R/W = Read/Write; R = Read only; W1toCl = Write 1 to clear bit; -n = value after reset

Table 16-796. QUEUE_117_D Register Field Descriptions

Bit	Field	Type	Reset	Description
31-5	DESC_PTR	R/W-0	0	Descriptor pointer. It will be read as zero if the queue is empty. It will indicate a 32-bit aligned address that points to a descriptor when the queue is not empty.
4-0	DESC_SIZE	R/W-0	0	Descriptor Size. It is encoded in 4-byte increments with values 0 to 31 representing 24 and so on to 148 bytes. This field will return a 0x0 when an empty queue is read. Queue Manager Queue N Registers D To save hardware resources, the queue manager internally stores descriptor size (desc_size) information in four bits. However, register D has five LSBs that specify descriptor size. As a consequence, the value of desc_size that is pushed may not be same as that is read during a pop. The value that is read back is equal to always rounded to an odd number. So, for even values, the value read back is one more than what was written. For odd values, the value read back is same as the value that was written. Note that this 5-bit field (desc_size) is unrelated to the code for size of descriptors in a descriptor region. It is just a place holder for a 5-bit value that is maintained across the push and pop operations for every descriptor managed by the queue manager.

16.5.7.507 QUEUE_118_A Register (offset = 2760h) [reset = 0h]

QUEUE_118_A is shown in [Figure 16-783](#) and described in [Table 16-797](#).

Figure 16-783. QUEUE_118_A Register


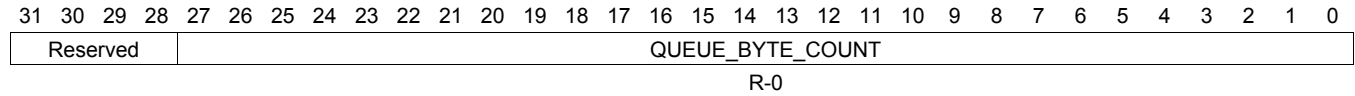
LEGEND: R/W = Read/Write; R = Read only; W1toCl = Write 1 to clear bit; -n = value after reset

Table 16-797. QUEUE_118_A Register Field Descriptions

Bit	Field	Type	Reset	Description
13-0	QUEUE_ENTRY_COUNT	R-0	0	This field indicates how many packets are currently queued on the queue. This count is incremented by 1 whenever a packet is added to the queue. This count is decremented by 1 whenever a packet is popped from the queue.

16.5.7.508 QUEUE_118_B Register (offset = 2764h) [reset = 0h]

QUEUE_118_B is shown in [Figure 16-784](#) and described in [Table 16-798](#).

Figure 16-784. QUEUE_118_B Register


LEGEND: R/W = Read/Write; R = Read only; W1toCl = Write 1 to clear bit; -n = value after reset

Table 16-798. QUEUE_118_B Register Field Descriptions

Bit	Field	Type	Reset	Description
27-0	QUEUE_BYTE_COUNT	R-0	0	This field indicates how many bytes total are contained in all of the packets which are currently queued on this queue.

16.5.7.509 QUEUE_118_C Register (offset = 2768h) [reset = 0h]

 QUEUE_118_C is shown in [Figure 16-785](#) and described in [Table 16-799](#).

Figure 16-785. QUEUE_118_C Register


LEGEND: R/W = Read/Write; R = Read only; W1toCl = Write 1 to clear bit; -n = value after reset

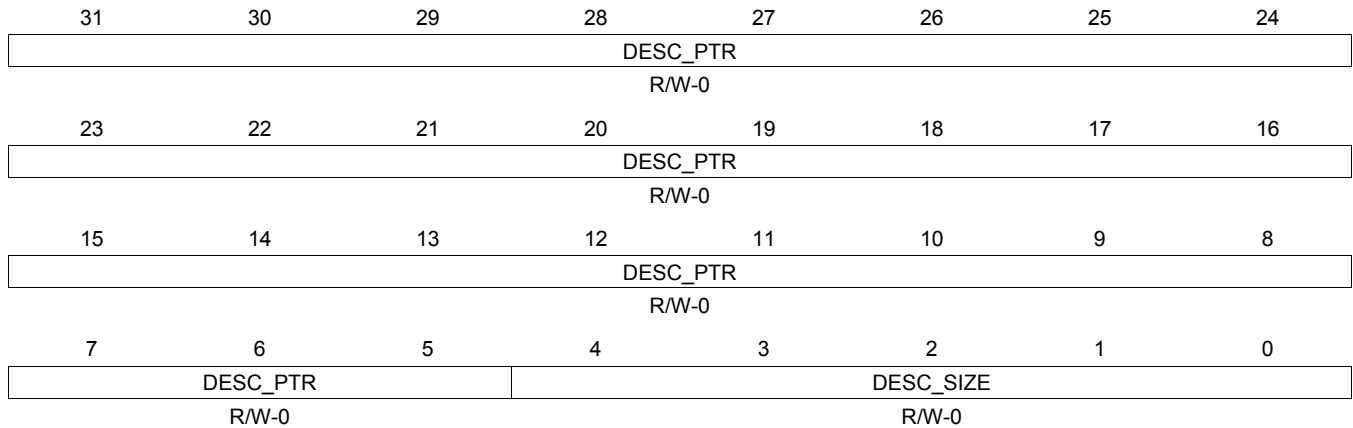
Table 16-799. QUEUE_118_C Register Field Descriptions

Bit	Field	Type	Reset	Description
31	HEAD_TAIL	W-0	0	Head/Tail Push Control. Set to zero in order to push packet onto tail of queue and set to one in order to push packet onto head of queue.
13-0	PACKET_SIZE	R/W-0	0	packet_size This field indicates packet size and is assumed to be zero on each packet add unless the value is explicitly overwritten. This field indicates packet size for packet pop operation.

16.5.7.510 QUEUE_118_D Register (offset = 276Ch) [reset = 0h]

QUEUE_118_D is shown in [Figure 16-786](#) and described in [Table 16-800](#).

Figure 16-786. QUEUE_118_D Register



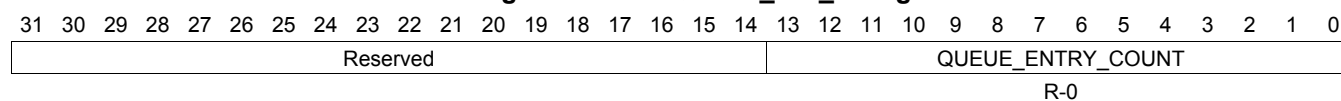
LEGEND: R/W = Read/Write; R = Read only; W1toCl = Write 1 to clear bit; -n = value after reset

Table 16-800. QUEUE_118_D Register Field Descriptions

Bit	Field	Type	Reset	Description
31-5	DESC_PTR	R/W-0	0	Descriptor pointer. It will be read as zero if the queue is empty. It will indicate a 32-bit aligned address that points to a descriptor when the queue is not empty.
4-0	DESC_SIZE	R/W-0	0	Descriptor Size. It is encoded in 4-byte increments with values 0 to 31 representing 24 and so on to 148 bytes. This field will return a 0x0 when an empty queue is read. Queue Manager Queue N Registers D To save hardware resources, the queue manager internally stores descriptor size (desc_size) information in four bits. However, register D has five LSBs that specify descriptor size. As a consequence, the value of desc_size that is pushed may not be same as that is read during a pop. The value that is read back is equal to always rounded to an odd number. So, for even values, the value read back is one more than what was written. For odd values, the value read back is same as the value that was written. Note that this 5-bit field (desc_size) is unrelated to the code for size of descriptors in a descriptor region. It is just a place holder for a 5-bit value that is maintained across the push and pop operations for every descriptor managed by the queue manager.

16.5.7.511 QUEUE_119_A Register (offset = 2770h) [reset = 0h]

QUEUE_119_A is shown in [Figure 16-787](#) and described in [Table 16-801](#).

Figure 16-787. QUEUE_119_A Register


LEGEND: R/W = Read/Write; R = Read only; W1toCl = Write 1 to clear bit; -n = value after reset

Table 16-801. QUEUE_119_A Register Field Descriptions

Bit	Field	Type	Reset	Description
13-0	QUEUE_ENTRY_COUNT	R-0	0	This field indicates how many packets are currently queued on the queue. This count is incremented by 1 whenever a packet is added to the queue. This count is decremented by 1 whenever a packet is popped from the queue.

16.5.7.512 QUEUE_119_B Register (offset = 2774h) [reset = 0h]

QUEUE_119_B is shown in [Figure 16-788](#) and described in [Table 16-802](#).

Figure 16-788. QUEUE_119_B Register


LEGEND: R/W = Read/Write; R = Read only; W1toCl = Write 1 to clear bit; -n = value after reset

Table 16-802. QUEUE_119_B Register Field Descriptions

Bit	Field	Type	Reset	Description
27-0	QUEUE_BYTE_COUNT	R-0	0	This field indicates how many bytes total are contained in all of the packets which are currently queued on this queue.

16.5.7.513 QUEUE_119_C Register (offset = 2778h) [reset = 0h]

 QUEUE_119_C is shown in [Figure 16-789](#) and described in [Table 16-803](#).

Figure 16-789. QUEUE_119_C Register

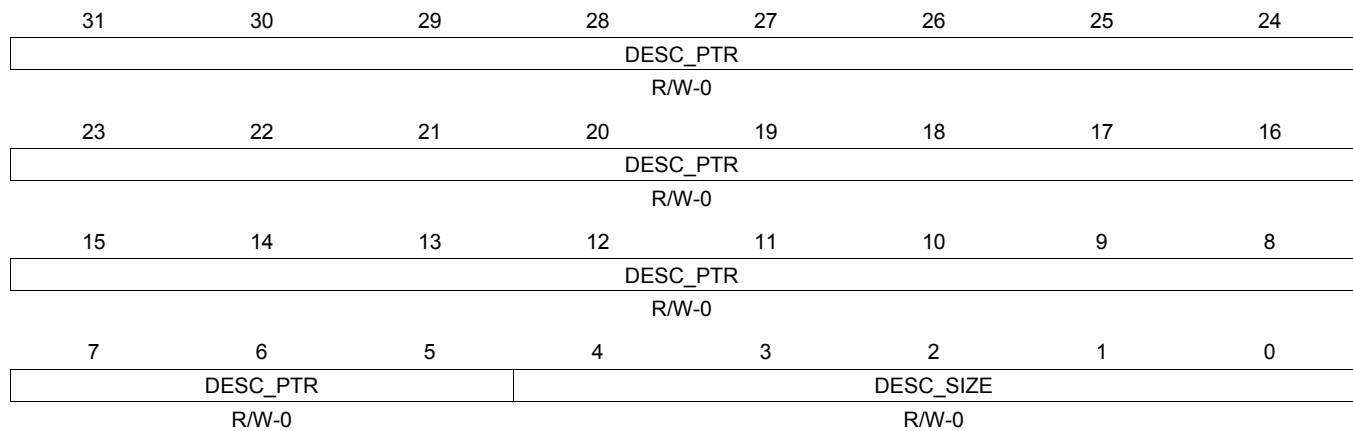

LEGEND: R/W = Read/Write; R = Read only; W1toCl = Write 1 to clear bit; -n = value after reset

Table 16-803. QUEUE_119_C Register Field Descriptions

Bit	Field	Type	Reset	Description
31	HEAD_TAIL	W-0	0	Head/Tail Push Control. Set to zero in order to push packet onto tail of queue and set to one in order to push packet onto head of queue.
13-0	PACKET_SIZE	R/W-0	0	packet_size This field indicates packet size and is assumed to be zero on each packet add unless the value is explicitly overwritten. This field indicates packet size for packet pop operation.

16.5.7.514 QUEUE_119_D Register (offset = 277Ch) [reset = 0h]

QUEUE_119_D is shown in [Figure 16-790](#) and described in [Table 16-804](#).

Figure 16-790. QUEUE_119_D Register


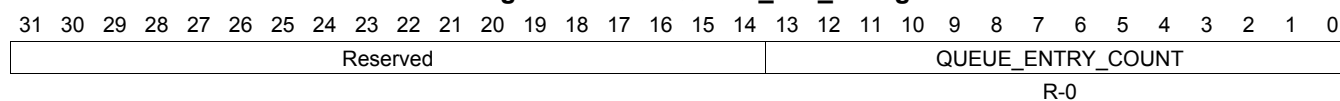
LEGEND: R/W = Read/Write; R = Read only; W1toCl = Write 1 to clear bit; -n = value after reset

Table 16-804. QUEUE_119_D Register Field Descriptions

Bit	Field	Type	Reset	Description
31-5	DESC_PTR	R/W-0	0	Descriptor pointer. It will be read as zero if the queue is empty. It will indicate a 32-bit aligned address that points to a descriptor when the queue is not empty.
4-0	DESC_SIZE	R/W-0	0	Descriptor Size. It is encoded in 4-byte increments with values 0 to 31 representing 24 and so on to 148 bytes. This field will return a 0x0 when an empty queue is read. Queue Manager Queue N Registers D To save hardware resources, the queue manager internally stores descriptor size (desc_size) information in four bits. However, register D has five LSBs that specify descriptor size. As a consequence, the value of desc_size that is pushed may not be same as that is read during a pop. The value that is read back is equal to always rounded to an odd number. So, for even values, the value read back is one more than what was written. For odd values, the value read back is same as the value that was written. Note that this 5-bit field (desc_size) is unrelated to the code for size of descriptors in a descriptor region. It is just a place holder for a 5-bit value that is maintained across the push and pop operations for every descriptor managed by the queue manager.

16.5.7.515 QUEUE_120_A Register (offset = 2780h) [reset = 0h]

QUEUE_120_A is shown in [Figure 16-791](#) and described in [Table 16-805](#).

Figure 16-791. QUEUE_120_A Register


LEGEND: R/W = Read/Write; R = Read only; W1toCl = Write 1 to clear bit; -n = value after reset

Table 16-805. QUEUE_120_A Register Field Descriptions

Bit	Field	Type	Reset	Description
13-0	QUEUE_ENTRY_COUNT	R-0	0	This field indicates how many packets are currently queued on the queue. This count is incremented by 1 whenever a packet is added to the queue. This count is decremented by 1 whenever a packet is popped from the queue.

16.5.7.516 QUEUE_120_B Register (offset = 2784h) [reset = 0h]

QUEUE_120_B is shown in [Figure 16-792](#) and described in [Table 16-806](#).

Figure 16-792. QUEUE_120_B Register

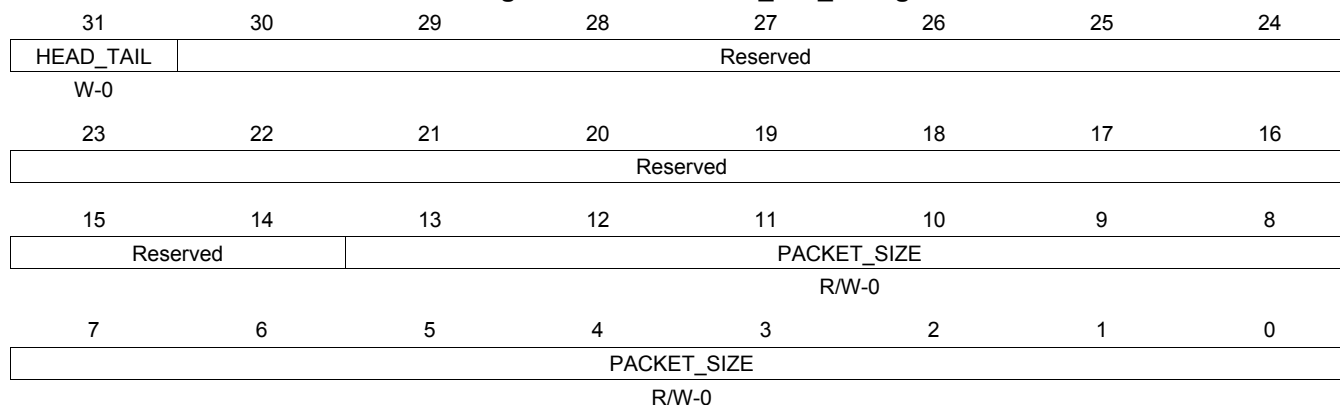

LEGEND: R/W = Read/Write; R = Read only; W1toCl = Write 1 to clear bit; -n = value after reset

Table 16-806. QUEUE_120_B Register Field Descriptions

Bit	Field	Type	Reset	Description
27-0	QUEUE_BYTE_COUNT	R-0	0	This field indicates how many bytes total are contained in all of the packets which are currently queued on this queue.

16.5.7.517 QUEUE_120_C Register (offset = 2788h) [reset = 0h]

 QUEUE_120_C is shown in [Figure 16-793](#) and described in [Table 16-807](#).

Figure 16-793. QUEUE_120_C Register


LEGEND: R/W = Read/Write; R = Read only; W1toCl = Write 1 to clear bit; -n = value after reset

Table 16-807. QUEUE_120_C Register Field Descriptions

Bit	Field	Type	Reset	Description
31	HEAD_TAIL	W-0	0	Head/Tail Push Control. Set to zero in order to push packet onto tail of queue and set to one in order to push packet onto head of queue.
13-0	PACKET_SIZE	R/W-0	0	packet_size This field indicates packet size and is assumed to be zero on each packet add unless the value is explicitly overwritten. This field indicates packet size for packet pop operation.

16.5.7.518 QUEUE_120_D Register (offset = 278Ch) [reset = 0h]

QUEUE_120_D is shown in [Figure 16-794](#) and described in [Table 16-808](#).

Figure 16-794. QUEUE_120_D Register



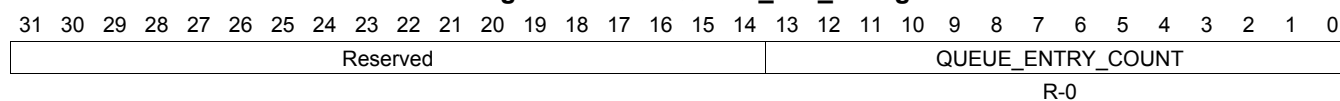
LEGEND: R/W = Read/Write; R = Read only; W1toCl = Write 1 to clear bit; -n = value after reset

Table 16-808. QUEUE_120_D Register Field Descriptions

Bit	Field	Type	Reset	Description
31-5	DESC_PTR	R/W-0	0	Descriptor pointer. It will be read as zero if the queue is empty. It will indicate a 32-bit aligned address that points to a descriptor when the queue is not empty.
4-0	DESC_SIZE	R/W-0	0	Descriptor Size. It is encoded in 4-byte increments with values 0 to 31 representing 24 and so on to 148 bytes. This field will return a 0x0 when an empty queue is read. Queue Manager Queue N Registers D To save hardware resources, the queue manager internally stores descriptor size (desc_size) information in four bits. However, register D has five LSBs that specify descriptor size. As a consequence, the value of desc_size that is pushed may not be same as that is read during a pop. The value that is read back is equal to always rounded to an odd number. So, for even values, the value read back is one more than what was written. For odd values, the value read back is same as the value that was written. Note that this 5-bit field (desc_size) is unrelated to the code for size of descriptors in a descriptor region. It is just a place holder for a 5-bit value that is maintained across the push and pop operations for every descriptor managed by the queue manager.

16.5.7.519 QUEUE_121_A Register (offset = 2790h) [reset = 0h]

QUEUE_121_A is shown in [Figure 16-795](#) and described in [Table 16-809](#).

Figure 16-795. QUEUE_121_A Register


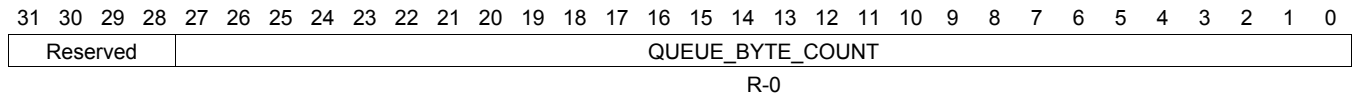
LEGEND: R/W = Read/Write; R = Read only; W1toCl = Write 1 to clear bit; -n = value after reset

Table 16-809. QUEUE_121_A Register Field Descriptions

Bit	Field	Type	Reset	Description
13-0	QUEUE_ENTRY_COUNT	R-0	0	This field indicates how many packets are currently queued on the queue. This count is incremented by 1 whenever a packet is added to the queue. This count is decremented by 1 whenever a packet is popped from the queue.

16.5.7.520 QUEUE_121_B Register (offset = 2794h) [reset = 0h]

QUEUE_121_B is shown in [Figure 16-796](#) and described in [Table 16-810](#).

Figure 16-796. QUEUE_121_B Register


LEGEND: R/W = Read/Write; R = Read only; W1toCl = Write 1 to clear bit; -n = value after reset

Table 16-810. QUEUE_121_B Register Field Descriptions

Bit	Field	Type	Reset	Description
27-0	QUEUE_BYTE_COUNT	R-0	0	This field indicates how many bytes total are contained in all of the packets which are currently queued on this queue.

16.5.7.521 QUEUE_121_C Register (offset = 2798h) [reset = 0h]

 QUEUE_121_C is shown in [Figure 16-797](#) and described in [Table 16-811](#).

Figure 16-797. QUEUE_121_C Register

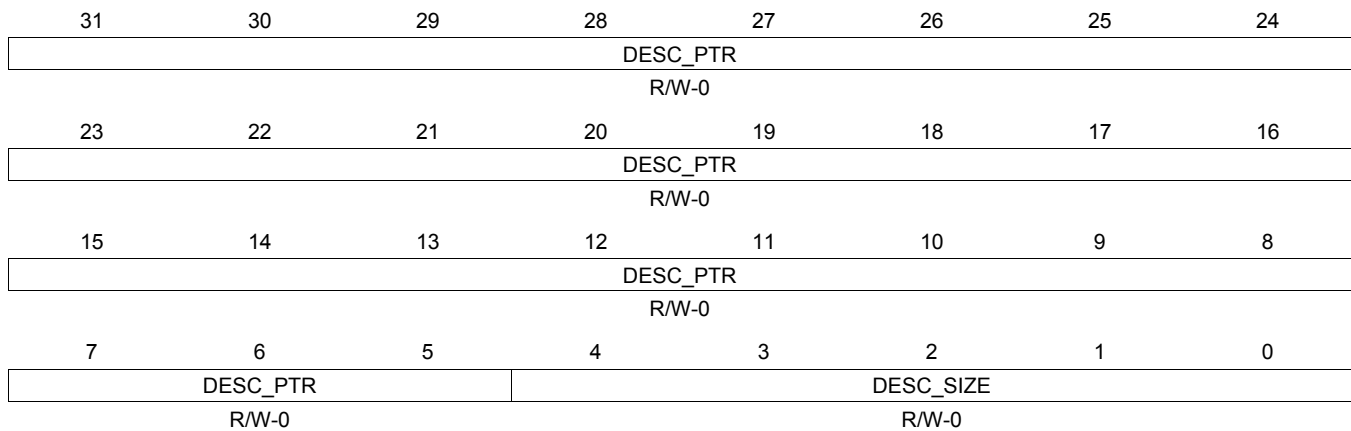

LEGEND: R/W = Read/Write; R = Read only; W1toCl = Write 1 to clear bit; -n = value after reset

Table 16-811. QUEUE_121_C Register Field Descriptions

Bit	Field	Type	Reset	Description
31	HEAD_TAIL	W-0	0	Head/Tail Push Control. Set to zero in order to push packet onto tail of queue and set to one in order to push packet onto head of queue.
13-0	PACKET_SIZE	R/W-0	0	packet_size This field indicates packet size and is assumed to be zero on each packet add unless the value is explicitly overwritten. This field indicates packet size for packet pop operation.

16.5.7.522 QUEUE_121_D Register (offset = 279Ch) [reset = 0h]

QUEUE_121_D is shown in [Figure 16-798](#) and described in [Table 16-812](#).

Figure 16-798. QUEUE_121_D Register


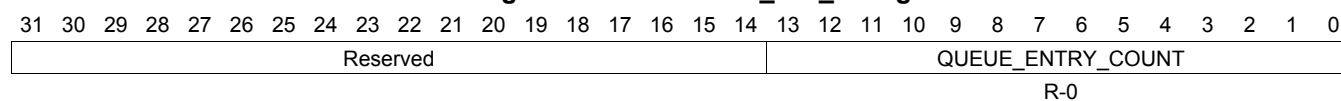
LEGEND: R/W = Read/Write; R = Read only; W1toCl = Write 1 to clear bit; -n = value after reset

Table 16-812. QUEUE_121_D Register Field Descriptions

Bit	Field	Type	Reset	Description
31-5	DESC_PTR	R/W-0	0	Descriptor pointer. It will be read as zero if the queue is empty. It will indicate a 32-bit aligned address that points to a descriptor when the queue is not empty.
4-0	DESC_SIZE	R/W-0	0	Descriptor Size. It is encoded in 4-byte increments with values 0 to 31 representing 24 and so on to 148 bytes. This field will return a 0x0 when an empty queue is read. Queue Manager Queue N Registers D To save hardware resources, the queue manager internally stores descriptor size (desc_size) information in four bits. However, register D has five LSBs that specify descriptor size. As a consequence, the value of desc_size that is pushed may not be same as that is read during a pop. The value that is read back is equal to always rounded to an odd number. So, for even values, the value read back is one more than what was written. For odd values, the value read back is same as the value that was written. Note that this 5-bit field (desc_size) is unrelated to the code for size of descriptors in a descriptor region. It is just a place holder for a 5-bit value that is maintained across the push and pop operations for every descriptor managed by the queue manager.

16.5.7.523 QUEUE_122_A Register (offset = 27A0h) [reset = 0h]

QUEUE_122_A is shown in [Figure 16-799](#) and described in [Table 16-813](#).

Figure 16-799. QUEUE_122_A Register


LEGEND: R/W = Read/Write; R = Read only; W1toCl = Write 1 to clear bit; -n = value after reset

Table 16-813. QUEUE_122_A Register Field Descriptions

Bit	Field	Type	Reset	Description
13-0	QUEUE_ENTRY_COUNT	R-0	0	This field indicates how many packets are currently queued on the queue. This count is incremented by 1 whenever a packet is added to the queue. This count is decremented by 1 whenever a packet is popped from the queue.

16.5.7.524 QUEUE_122_B Register (offset = 27A4h) [reset = 0h]

QUEUE_122_B is shown in [Figure 16-800](#) and described in [Table 16-814](#).

Figure 16-800. QUEUE_122_B Register


LEGEND: R/W = Read/Write; R = Read only; W1toCl = Write 1 to clear bit; -n = value after reset

Table 16-814. QUEUE_122_B Register Field Descriptions

Bit	Field	Type	Reset	Description
27-0	QUEUE_BYTE_COUNT	R-0	0	This field indicates how many bytes total are contained in all of the packets which are currently queued on this queue.

16.5.7.525 QUEUE_122_C Register (offset = 27A8h) [reset = 0h]

 QUEUE_122_C is shown in [Figure 16-801](#) and described in [Table 16-815](#).

Figure 16-801. QUEUE_122_C Register

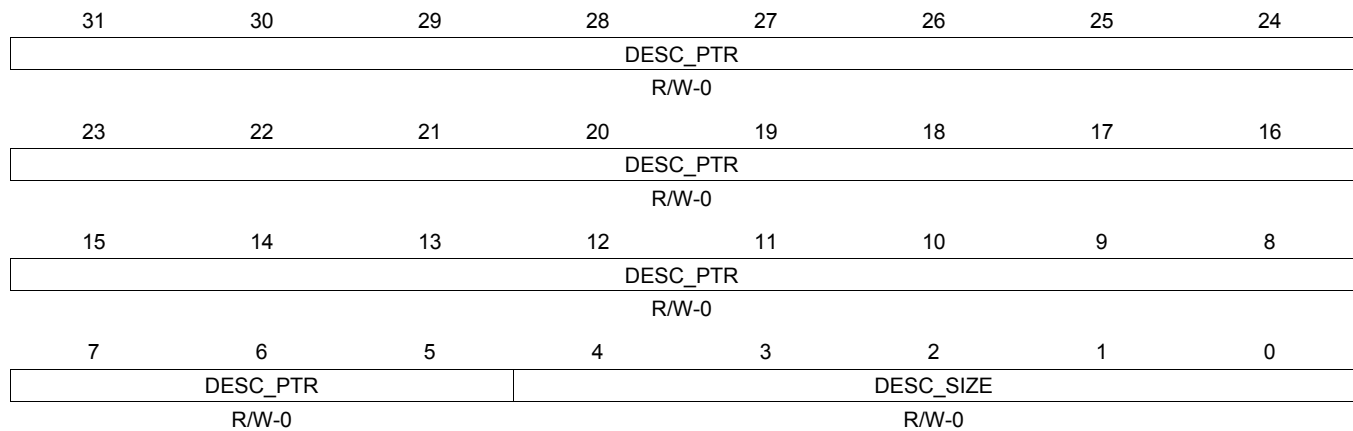

LEGEND: R/W = Read/Write; R = Read only; W1toCl = Write 1 to clear bit; -n = value after reset

Table 16-815. QUEUE_122_C Register Field Descriptions

Bit	Field	Type	Reset	Description
31	HEAD_TAIL	W-0	0	Head/Tail Push Control. Set to zero in order to push packet onto tail of queue and set to one in order to push packet onto head of queue.
13-0	PACKET_SIZE	R/W-0	0	packet_size This field indicates packet size and is assumed to be zero on each packet add unless the value is explicitly overwritten. This field indicates packet size for packet pop operation.

16.5.7.526 QUEUE_122_D Register (offset = 27ACh) [reset = 0h]

QUEUE_122_D is shown in [Figure 16-802](#) and described in [Table 16-816](#).

Figure 16-802. QUEUE_122_D Register


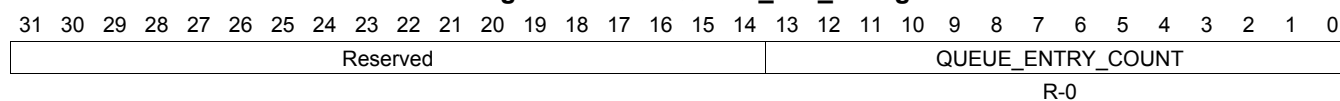
LEGEND: R/W = Read/Write; R = Read only; W1toCl = Write 1 to clear bit; -n = value after reset

Table 16-816. QUEUE_122_D Register Field Descriptions

Bit	Field	Type	Reset	Description
31-5	DESC_PTR	R/W-0	0	Descriptor pointer. It will be read as zero if the queue is empty. It will indicate a 32-bit aligned address that points to a descriptor when the queue is not empty.
4-0	DESC_SIZE	R/W-0	0	Descriptor Size. It is encoded in 4-byte increments with values 0 to 31 representing 24 and so on to 148 bytes. This field will return a 0x0 when an empty queue is read. Queue Manager Queue N Registers D To save hardware resources, the queue manager internally stores descriptor size (desc_size) information in four bits. However, register D has five LSBs that specify descriptor size. As a consequence, the value of desc_size that is pushed may not be same as that is read during a pop. The value that is read back is equal to always rounded to an odd number. So, for even values, the value read back is one more than what was written. For odd values, the value read back is same as the value that was written. Note that this 5-bit field (desc_size) is unrelated to the code for size of descriptors in a descriptor region. It is just a place holder for a 5-bit value that is maintained across the push and pop operations for every descriptor managed by the queue manager.

16.5.7.527 QUEUE_123_A Register (offset = 27B0h) [reset = 0h]

QUEUE_123_A is shown in [Figure 16-803](#) and described in [Table 16-817](#).

Figure 16-803. QUEUE_123_A Register


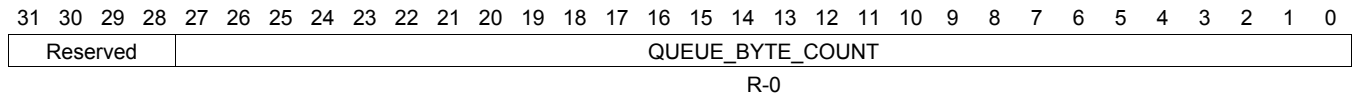
LEGEND: R/W = Read/Write; R = Read only; W1toCl = Write 1 to clear bit; -n = value after reset

Table 16-817. QUEUE_123_A Register Field Descriptions

Bit	Field	Type	Reset	Description
13-0	QUEUE_ENTRY_COUNT	R-0	0	This field indicates how many packets are currently queued on the queue. This count is incremented by 1 whenever a packet is added to the queue. This count is decremented by 1 whenever a packet is popped from the queue.

16.5.7.528 QUEUE_123_B Register (offset = 27B4h) [reset = 0h]

QUEUE_123_B is shown in [Figure 16-804](#) and described in [Table 16-818](#).

Figure 16-804. QUEUE_123_B Register


LEGEND: R/W = Read/Write; R = Read only; W1toCl = Write 1 to clear bit; -n = value after reset

Table 16-818. QUEUE_123_B Register Field Descriptions

Bit	Field	Type	Reset	Description
27-0	QUEUE_BYTE_COUNT	R-0	0	This field indicates how many bytes total are contained in all of the packets which are currently queued on this queue.

16.5.7.529 QUEUE_123_C Register (offset = 27B8h) [reset = 0h]

 QUEUE_123_C is shown in [Figure 16-805](#) and described in [Table 16-819](#).

Figure 16-805. QUEUE_123_C Register


LEGEND: R/W = Read/Write; R = Read only; W1toCl = Write 1 to clear bit; -n = value after reset

Table 16-819. QUEUE_123_C Register Field Descriptions

Bit	Field	Type	Reset	Description
31	HEAD_TAIL	W-0	0	Head/Tail Push Control. Set to zero in order to push packet onto tail of queue and set to one in order to push packet onto head of queue.
13-0	PACKET_SIZE	R/W-0	0	packet_size This field indicates packet size and is assumed to be zero on each packet add unless the value is explicitly overwritten. This field indicates packet size for packet pop operation.

16.5.7.530 QUEUE_123_D Register (offset = 27BCh) [reset = 0h]

QUEUE_123_D is shown in [Figure 16-806](#) and described in [Table 16-820](#).

Figure 16-806. QUEUE_123_D Register



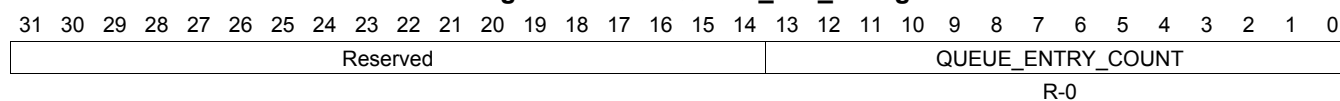
LEGEND: R/W = Read/Write; R = Read only; W1toCl = Write 1 to clear bit; -n = value after reset

Table 16-820. QUEUE_123_D Register Field Descriptions

Bit	Field	Type	Reset	Description
31-5	DESC_PTR	R/W-0	0	Descriptor pointer. It will be read as zero if the queue is empty. It will indicate a 32-bit aligned address that points to a descriptor when the queue is not empty.
4-0	DESC_SIZE	R/W-0	0	Descriptor Size. It is encoded in 4-byte increments with values 0 to 31 representing 24 and so on to 148 bytes. This field will return a 0x0 when an empty queue is read. Queue Manager Queue N Registers D To save hardware resources, the queue manager internally stores descriptor size (desc_size) information in four bits. However, register D has five LSBs that specify descriptor size. As a consequence, the value of desc_size that is pushed may not be same as that is read during a pop. The value that is read back is equal to always rounded to an odd number. So, for even values, the value read back is one more than what was written. For odd values, the value read back is same as the value that was written. Note that this 5-bit field (desc_size) is unrelated to the code for size of descriptors in a descriptor region. It is just a place holder for a 5-bit value that is maintained across the push and pop operations for every descriptor managed by the queue manager.

16.5.7.531 QUEUE_124_A Register (offset = 27C0h) [reset = 0h]

QUEUE_124_A is shown in [Figure 16-807](#) and described in [Table 16-821](#).

Figure 16-807. QUEUE_124_A Register


LEGEND: R/W = Read/Write; R = Read only; W1toCl = Write 1 to clear bit; -n = value after reset

Table 16-821. QUEUE_124_A Register Field Descriptions

Bit	Field	Type	Reset	Description
13-0	QUEUE_ENTRY_COUNT	R-0	0	This field indicates how many packets are currently queued on the queue. This count is incremented by 1 whenever a packet is added to the queue. This count is decremented by 1 whenever a packet is popped from the queue.

16.5.7.532 QUEUE_124_B Register (offset = 27C4h) [reset = 0h]

QUEUE_124_B is shown in [Figure 16-808](#) and described in [Table 16-822](#).

Figure 16-808. QUEUE_124_B Register


LEGEND: R/W = Read/Write; R = Read only; W1toCl = Write 1 to clear bit; -n = value after reset

Table 16-822. QUEUE_124_B Register Field Descriptions

Bit	Field	Type	Reset	Description
27-0	QUEUE_BYTE_COUNT	R-0	0	This field indicates how many bytes total are contained in all of the packets which are currently queued on this queue.

16.5.7.533 QUEUE_124_C Register (offset = 27C8h) [reset = 0h]

 QUEUE_124_C is shown in [Figure 16-809](#) and described in [Table 16-823](#).

Figure 16-809. QUEUE_124_C Register

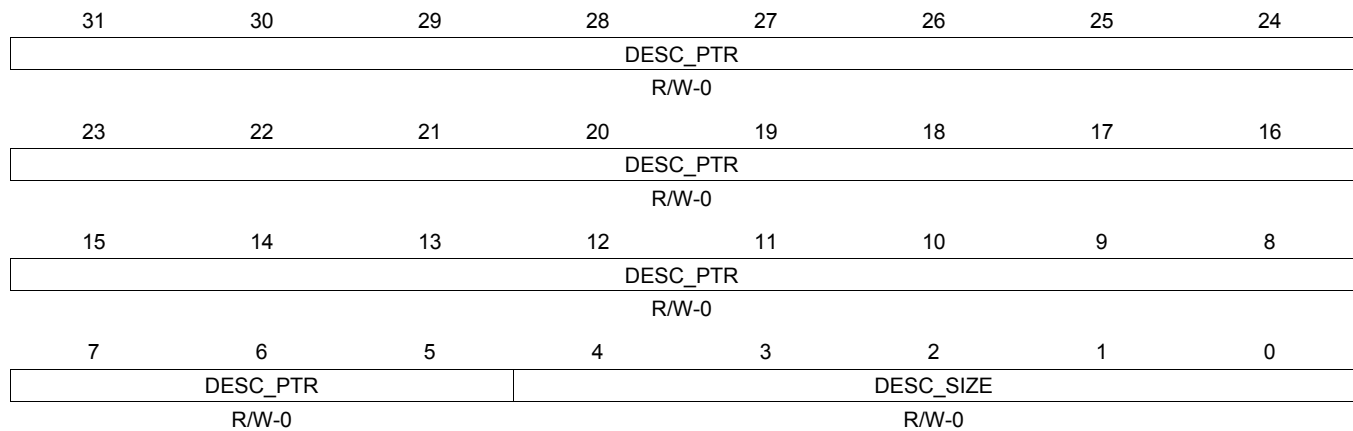

LEGEND: R/W = Read/Write; R = Read only; W1toCl = Write 1 to clear bit; -n = value after reset

Table 16-823. QUEUE_124_C Register Field Descriptions

Bit	Field	Type	Reset	Description
31	HEAD_TAIL	W-0	0	Head/Tail Push Control. Set to zero in order to push packet onto tail of queue and set to one in order to push packet onto head of queue.
13-0	PACKET_SIZE	R/W-0	0	packet_size This field indicates packet size and is assumed to be zero on each packet add unless the value is explicitly overwritten. This field indicates packet size for packet pop operation.

16.5.7.534 QUEUE_124_D Register (offset = 27CCh) [reset = 0h]

QUEUE_124_D is shown in [Figure 16-810](#) and described in [Table 16-824](#).

Figure 16-810. QUEUE_124_D Register


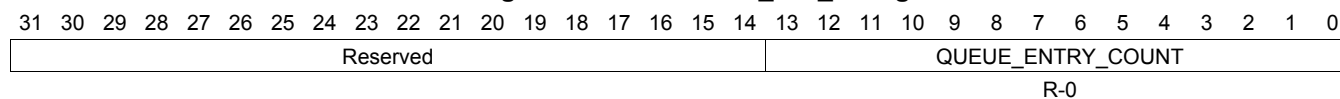
LEGEND: R/W = Read/Write; R = Read only; W1toCl = Write 1 to clear bit; -n = value after reset

Table 16-824. QUEUE_124_D Register Field Descriptions

Bit	Field	Type	Reset	Description
31-5	DESC_PTR	R/W-0	0	Descriptor pointer. It will be read as zero if the queue is empty. It will indicate a 32-bit aligned address that points to a descriptor when the queue is not empty.
4-0	DESC_SIZE	R/W-0	0	Descriptor Size. It is encoded in 4-byte increments with values 0 to 31 representing 24 and so on to 148 bytes. This field will return a 0x0 when an empty queue is read. Queue Manager Queue N Registers D To save hardware resources, the queue manager internally stores descriptor size (desc_size) information in four bits. However, register D has five LSBs that specify descriptor size. As a consequence, the value of desc_size that is pushed may not be same as that is read during a pop. The value that is read back is equal to always rounded to an odd number. So, for even values, the value read back is one more than what was written. For odd values, the value read back is same as the value that was written. Note that this 5-bit field (desc_size) is unrelated to the code for size of descriptors in a descriptor region. It is just a place holder for a 5-bit value that is maintained across the push and pop operations for every descriptor managed by the queue manager.

16.5.7.535 QUEUE_125_A Register (offset = 27D0h) [reset = 0h]

QUEUE_125_A is shown in [Figure 16-811](#) and described in [Table 16-825](#).

Figure 16-811. QUEUE_125_A Register


LEGEND: R/W = Read/Write; R = Read only; W1toCl = Write 1 to clear bit; -n = value after reset

Table 16-825. QUEUE_125_A Register Field Descriptions

Bit	Field	Type	Reset	Description
13-0	QUEUE_ENTRY_COUNT	R-0	0	This field indicates how many packets are currently queued on the queue. This count is incremented by 1 whenever a packet is added to the queue. This count is decremented by 1 whenever a packet is popped from the queue.

16.5.7.536 QUEUE_125_B Register (offset = 27D4h) [reset = 0h]

QUEUE_125_B is shown in [Figure 16-812](#) and described in [Table 16-826](#).

Figure 16-812. QUEUE_125_B Register


LEGEND: R/W = Read/Write; R = Read only; W1toCl = Write 1 to clear bit; -n = value after reset

Table 16-826. QUEUE_125_B Register Field Descriptions

Bit	Field	Type	Reset	Description
27-0	QUEUE_BYTE_COUNT	R-0	0	This field indicates how many bytes total are contained in all of the packets which are currently queued on this queue.

16.5.7.537 QUEUE_125_C Register (offset = 27D8h) [reset = 0h]

 QUEUE_125_C is shown in [Figure 16-813](#) and described in [Table 16-827](#).

Figure 16-813. QUEUE_125_C Register


LEGEND: R/W = Read/Write; R = Read only; W1toCl = Write 1 to clear bit; -n = value after reset

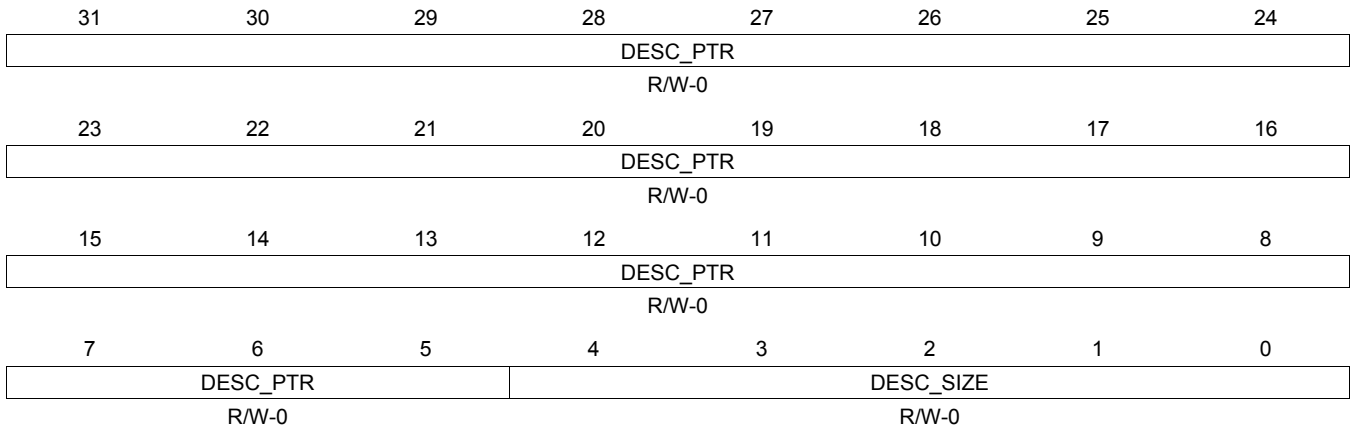
Table 16-827. QUEUE_125_C Register Field Descriptions

Bit	Field	Type	Reset	Description
31	HEAD_TAIL	W-0	0	Head/Tail Push Control. Set to zero in order to push packet onto tail of queue and set to one in order to push packet onto head of queue.
13-0	PACKET_SIZE	R/W-0	0	packet_size This field indicates packet size and is assumed to be zero on each packet add unless the value is explicitly overwritten. This field indicates packet size for packet pop operation.

16.5.7.538 QUEUE_125_D Register (offset = 27DCh) [reset = 0h]

QUEUE_125_D is shown in [Figure 16-814](#) and described in [Table 16-828](#).

Figure 16-814. QUEUE_125_D Register



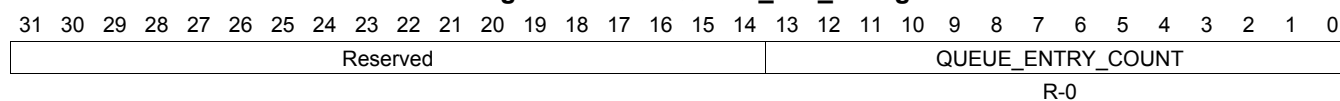
LEGEND: R/W = Read/Write; R = Read only; W1toCl = Write 1 to clear bit; -n = value after reset

Table 16-828. QUEUE_125_D Register Field Descriptions

Bit	Field	Type	Reset	Description
31-5	DESC_PTR	R/W-0	0	Descriptor pointer. It will be read as zero if the queue is empty. It will indicate a 32-bit aligned address that points to a descriptor when the queue is not empty.
4-0	DESC_SIZE	R/W-0	0	Descriptor Size. It is encoded in 4-byte increments with values 0 to 31 representing 24 and so on to 148 bytes. This field will return a 0x0 when an empty queue is read. Queue Manager Queue N Registers D To save hardware resources, the queue manager internally stores descriptor size (desc_size) information in four bits. However, register D has five LSBs that specify descriptor size. As a consequence, the value of desc_size that is pushed may not be same as that is read during a pop. The value that is read back is equal to always rounded to an odd number. So, for even values, the value read back is one more than what was written. For odd values, the value read back is same as the value that was written. Note that this 5-bit field (desc_size) is unrelated to the code for size of descriptors in a descriptor region. It is just a place holder for a 5-bit value that is maintained across the push and pop operations for every descriptor managed by the queue manager.

16.5.7.539 QUEUE_126_A Register (offset = 27E0h) [reset = 0h]

QUEUE_126_A is shown in [Figure 16-815](#) and described in [Table 16-829](#).

Figure 16-815. QUEUE_126_A Register


LEGEND: R/W = Read/Write; R = Read only; W1toCl = Write 1 to clear bit; -n = value after reset

Table 16-829. QUEUE_126_A Register Field Descriptions

Bit	Field	Type	Reset	Description
13-0	QUEUE_ENTRY_COUNT	R-0	0	This field indicates how many packets are currently queued on the queue. This count is incremented by 1 whenever a packet is added to the queue. This count is decremented by 1 whenever a packet is popped from the queue.

16.5.7.540 QUEUE_126_B Register (offset = 27E4h) [reset = 0h]

QUEUE_126_B is shown in [Figure 16-816](#) and described in [Table 16-830](#).

Figure 16-816. QUEUE_126_B Register

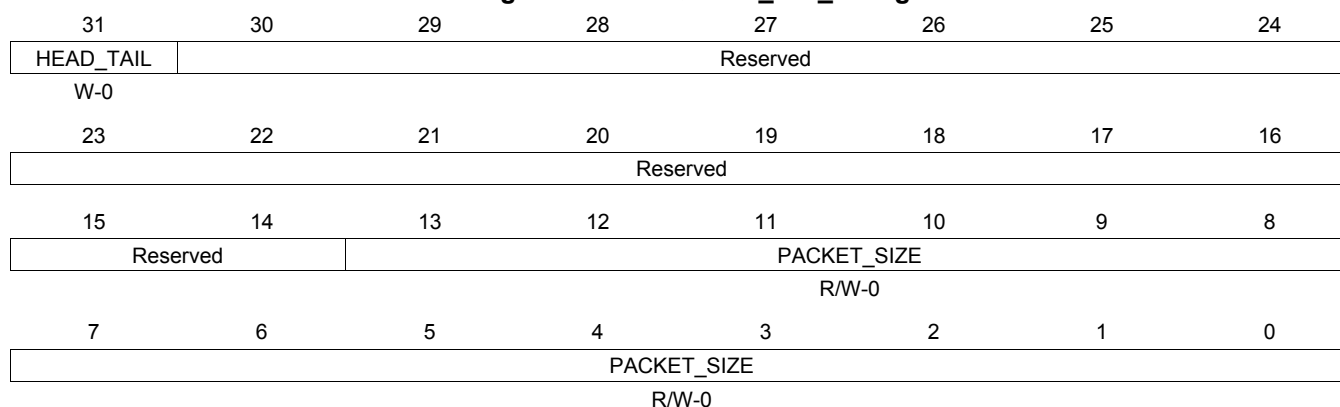

LEGEND: R/W = Read/Write; R = Read only; W1toCl = Write 1 to clear bit; -n = value after reset

Table 16-830. QUEUE_126_B Register Field Descriptions

Bit	Field	Type	Reset	Description
27-0	QUEUE_BYTE_COUNT	R-0	0	This field indicates how many bytes total are contained in all of the packets which are currently queued on this queue.

16.5.7.541 QUEUE_126_C Register (offset = 27E8h) [reset = 0h]

 QUEUE_126_C is shown in [Figure 16-817](#) and described in [Table 16-831](#).

Figure 16-817. QUEUE_126_C Register


LEGEND: R/W = Read/Write; R = Read only; W1toCl = Write 1 to clear bit; -n = value after reset

Table 16-831. QUEUE_126_C Register Field Descriptions

Bit	Field	Type	Reset	Description
31	HEAD_TAIL	W-0	0	Head/Tail Push Control. Set to zero in order to push packet onto tail of queue and set to one in order to push packet onto head of queue.
13-0	PACKET_SIZE	R/W-0	0	packet_size This field indicates packet size and is assumed to be zero on each packet add unless the value is explicitly overwritten. This field indicates packet size for packet pop operation.

16.5.7.542 QUEUE_126_D Register (offset = 27ECh) [reset = 0h]

QUEUE_126_D is shown in [Figure 16-818](#) and described in [Table 16-832](#).

Figure 16-818. QUEUE_126_D Register

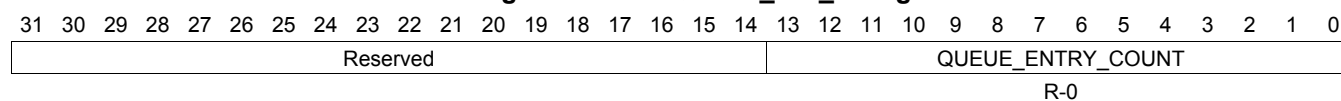

LEGEND: R/W = Read/Write; R = Read only; W1toCl = Write 1 to clear bit; -n = value after reset

Table 16-832. QUEUE_126_D Register Field Descriptions

Bit	Field	Type	Reset	Description
31-5	DESC_PTR	R/W-0	0	Descriptor pointer. It will be read as zero if the queue is empty. It will indicate a 32-bit aligned address that points to a descriptor when the queue is not empty.
4-0	DESC_SIZE	R/W-0	0	Descriptor Size. It is encoded in 4-byte increments with values 0 to 31 representing 24 and so on to 148 bytes. This field will return a 0x0 when an empty queue is read. Queue Manager Queue N Registers D To save hardware resources, the queue manager internally stores descriptor size (desc_size) information in four bits. However, register D has five LSBs that specify descriptor size. As a consequence, the value of desc_size that is pushed may not be same as that is read during a pop. The value that is read back is equal to always rounded to an odd number. So, for even values, the value read back is one more than what was written. For odd values, the value read back is same as the value that was written. Note that this 5-bit field (desc_size) is unrelated to the code for size of descriptors in a descriptor region. It is just a place holder for a 5-bit value that is maintained across the push and pop operations for every descriptor managed by the queue manager.

16.5.7.543 QUEUE_127_A Register (offset = 27F0h) [reset = 0h]

QUEUE_127_A is shown in [Figure 16-819](#) and described in [Table 16-833](#).

Figure 16-819. QUEUE_127_A Register


LEGEND: R/W = Read/Write; R = Read only; W1toCl = Write 1 to clear bit; -n = value after reset

Table 16-833. QUEUE_127_A Register Field Descriptions

Bit	Field	Type	Reset	Description
13-0	QUEUE_ENTRY_COUNT	R-0	0	This field indicates how many packets are currently queued on the queue. This count is incremented by 1 whenever a packet is added to the queue. This count is decremented by 1 whenever a packet is popped from the queue.

16.5.7.544 QUEUE_127_B Register (offset = 27F4h) [reset = 0h]

QUEUE_127_B is shown in [Figure 16-820](#) and described in [Table 16-834](#).

Figure 16-820. QUEUE_127_B Register


LEGEND: R/W = Read/Write; R = Read only; W1toCl = Write 1 to clear bit; -n = value after reset

Table 16-834. QUEUE_127_B Register Field Descriptions

Bit	Field	Type	Reset	Description
27-0	QUEUE_BYTE_COUNT	R-0	0	This field indicates how many bytes total are contained in all of the packets which are currently queued on this queue.

16.5.7.545 QUEUE_127_C Register (offset = 27F8h) [reset = 0h]

 QUEUE_127_C is shown in [Figure 16-821](#) and described in [Table 16-835](#).

Figure 16-821. QUEUE_127_C Register


LEGEND: R/W = Read/Write; R = Read only; W1toCl = Write 1 to clear bit; -n = value after reset

Table 16-835. QUEUE_127_C Register Field Descriptions

Bit	Field	Type	Reset	Description
31	HEAD_TAIL	W-0	0	Head/Tail Push Control. Set to zero in order to push packet onto tail of queue and set to one in order to push packet onto head of queue.
13-0	PACKET_SIZE	R/W-0	0	packet_size This field indicates packet size and is assumed to be zero on each packet add unless the value is explicitly overwritten. This field indicates packet size for packet pop operation.

16.5.7.546 QUEUE_127_D Register (offset = 27FCh) [reset = 0h]

QUEUE_127_D is shown in [Figure 16-822](#) and described in [Table 16-836](#).

Figure 16-822. QUEUE_127_D Register



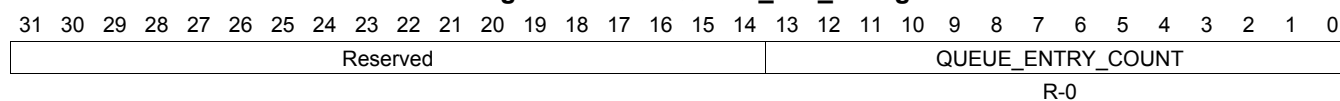
LEGEND: R/W = Read/Write; R = Read only; W1toCl = Write 1 to clear bit; -n = value after reset

Table 16-836. QUEUE_127_D Register Field Descriptions

Bit	Field	Type	Reset	Description
31-5	DESC_PTR	R/W-0	0	Descriptor pointer. It will be read as zero if the queue is empty. It will indicate a 32-bit aligned address that points to a descriptor when the queue is not empty.
4-0	DESC_SIZE	R/W-0	0	Descriptor Size. It is encoded in 4-byte increments with values 0 to 31 representing 24 and so on to 148 bytes. This field will return a 0x0 when an empty queue is read. Queue Manager Queue N Registers D To save hardware resources, the queue manager internally stores descriptor size (desc_size) information in four bits. However, register D has five LSBs that specify descriptor size. As a consequence, the value of desc_size that is pushed may not be same as that is read during a pop. The value that is read back is equal to always rounded to an odd number. So, for even values, the value read back is one more than what was written. For odd values, the value read back is same as the value that was written. Note that this 5-bit field (desc_size) is unrelated to the code for size of descriptors in a descriptor region. It is just a place holder for a 5-bit value that is maintained across the push and pop operations for every descriptor managed by the queue manager.

16.5.7.547 QUEUE_128_A Register (offset = 2800h) [reset = 0h]

QUEUE_128_A is shown in [Figure 16-823](#) and described in [Table 16-837](#).

Figure 16-823. QUEUE_128_A Register


LEGEND: R/W = Read/Write; R = Read only; W1toCl = Write 1 to clear bit; -n = value after reset

Table 16-837. QUEUE_128_A Register Field Descriptions

Bit	Field	Type	Reset	Description
13-0	QUEUE_ENTRY_COUNT	R-0	0	This field indicates how many packets are currently queued on the queue. This count is incremented by 1 whenever a packet is added to the queue. This count is decremented by 1 whenever a packet is popped from the queue.

16.5.7.548 QUEUE_128_B Register (offset = 2804h) [reset = 0h]

QUEUE_128_B is shown in [Figure 16-824](#) and described in [Table 16-838](#).

Figure 16-824. QUEUE_128_B Register


LEGEND: R/W = Read/Write; R = Read only; W1toCl = Write 1 to clear bit; -n = value after reset

Table 16-838. QUEUE_128_B Register Field Descriptions

Bit	Field	Type	Reset	Description
27-0	QUEUE_BYTE_COUNT	R-0	0	This field indicates how many bytes total are contained in all of the packets which are currently queued on this queue.

16.5.7.549 QUEUE_128_C Register (offset = 2808h) [reset = 0h]

 QUEUE_128_C is shown in [Figure 16-825](#) and described in [Table 16-839](#).

Figure 16-825. QUEUE_128_C Register


LEGEND: R/W = Read/Write; R = Read only; W1toCl = Write 1 to clear bit; -n = value after reset

Table 16-839. QUEUE_128_C Register Field Descriptions

Bit	Field	Type	Reset	Description
31	HEAD_TAIL	W-0	0	Head/Tail Push Control. Set to zero in order to push packet onto tail of queue and set to one in order to push packet onto head of queue.
13-0	PACKET_SIZE	R/W-0	0	packet_size This field indicates packet size and is assumed to be zero on each packet add unless the value is explicitly overwritten. This field indicates packet size for packet pop operation.

16.5.7.550 QUEUE_128_D Register (offset = 280Ch) [reset = 0h]

QUEUE_128_D is shown in [Figure 16-826](#) and described in [Table 16-840](#).

Figure 16-826. QUEUE_128_D Register



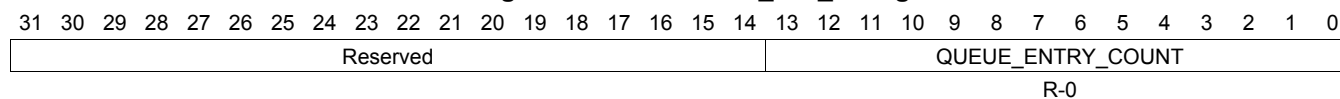
LEGEND: R/W = Read/Write; R = Read only; W1toCl = Write 1 to clear bit; -n = value after reset

Table 16-840. QUEUE_128_D Register Field Descriptions

Bit	Field	Type	Reset	Description
31-5	DESC_PTR	R/W-0	0	Descriptor pointer. It will be read as zero if the queue is empty. It will indicate a 32-bit aligned address that points to a descriptor when the queue is not empty.
4-0	DESC_SIZE	R/W-0	0	Descriptor Size. It is encoded in 4-byte increments with values 0 to 31 representing 24 and so on to 148 bytes. This field will return a 0x0 when an empty queue is read. Queue Manager Queue N Registers D To save hardware resources, the queue manager internally stores descriptor size (desc_size) information in four bits. However, register D has five LSBs that specify descriptor size. As a consequence, the value of desc_size that is pushed may not be same as that is read during a pop. The value that is read back is equal to always rounded to an odd number. So, for even values, the value read back is one more than what was written. For odd values, the value read back is same as the value that was written. Note that this 5-bit field (desc_size) is unrelated to the code for size of descriptors in a descriptor region. It is just a place holder for a 5-bit value that is maintained across the push and pop operations for every descriptor managed by the queue manager.

16.5.7.551 QUEUE_129_A Register (offset = 2810h) [reset = 0h]

QUEUE_129_A is shown in [Figure 16-827](#) and described in [Table 16-841](#).

Figure 16-827. QUEUE_129_A Register


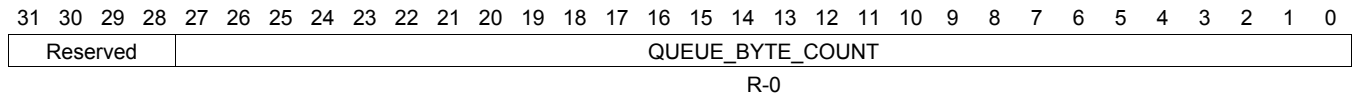
LEGEND: R/W = Read/Write; R = Read only; W1toCl = Write 1 to clear bit; -n = value after reset

Table 16-841. QUEUE_129_A Register Field Descriptions

Bit	Field	Type	Reset	Description
13-0	QUEUE_ENTRY_COUNT	R-0	0	This field indicates how many packets are currently queued on the queue. This count is incremented by 1 whenever a packet is added to the queue. This count is decremented by 1 whenever a packet is popped from the queue.

16.5.7.552 QUEUE_129_B Register (offset = 2814h) [reset = 0h]

QUEUE_129_B is shown in [Figure 16-828](#) and described in [Table 16-842](#).

Figure 16-828. QUEUE_129_B Register


LEGEND: R/W = Read/Write; R = Read only; W1toCl = Write 1 to clear bit; -n = value after reset

Table 16-842. QUEUE_129_B Register Field Descriptions

Bit	Field	Type	Reset	Description
27-0	QUEUE_BYTE_COUNT	R-0	0	This field indicates how many bytes total are contained in all of the packets which are currently queued on this queue.

16.5.7.553 QUEUE_129_C Register (offset = 2818h) [reset = 0h]

 QUEUE_129_C is shown in [Figure 16-829](#) and described in [Table 16-843](#).

Figure 16-829. QUEUE_129_C Register

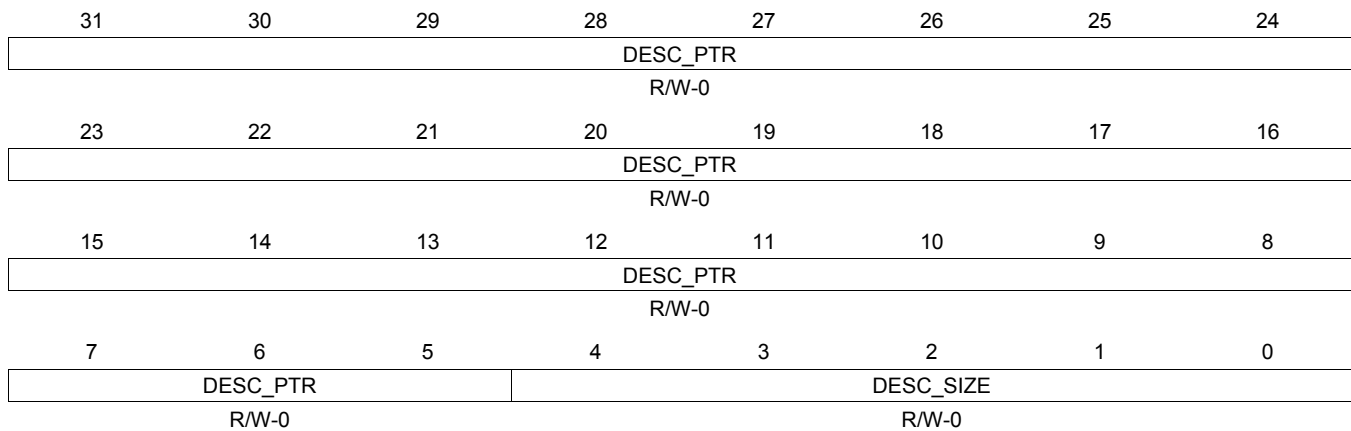

LEGEND: R/W = Read/Write; R = Read only; W1toCl = Write 1 to clear bit; -n = value after reset

Table 16-843. QUEUE_129_C Register Field Descriptions

Bit	Field	Type	Reset	Description
31	HEAD_TAIL	W-0	0	Head/Tail Push Control. Set to zero in order to push packet onto tail of queue and set to one in order to push packet onto head of queue.
13-0	PACKET_SIZE	R/W-0	0	packet_size This field indicates packet size and is assumed to be zero on each packet add unless the value is explicitly overwritten. This field indicates packet size for packet pop operation.

16.5.7.554 QUEUE_129_D Register (offset = 281Ch) [reset = 0h]

QUEUE_129_D is shown in [Figure 16-830](#) and described in [Table 16-844](#).

Figure 16-830. QUEUE_129_D Register


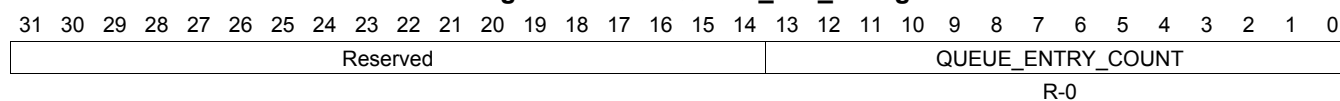
LEGEND: R/W = Read/Write; R = Read only; W1toCl = Write 1 to clear bit; -n = value after reset

Table 16-844. QUEUE_129_D Register Field Descriptions

Bit	Field	Type	Reset	Description
31-5	DESC_PTR	R/W-0	0	Descriptor pointer. It will be read as zero if the queue is empty. It will indicate a 32-bit aligned address that points to a descriptor when the queue is not empty.
4-0	DESC_SIZE	R/W-0	0	Descriptor Size. It is encoded in 4-byte increments with values 0 to 31 representing 24 and so on to 148 bytes. This field will return a 0x0 when an empty queue is read. Queue Manager Queue N Registers D To save hardware resources, the queue manager internally stores descriptor size (desc_size) information in four bits. However, register D has five LSBs that specify descriptor size. As a consequence, the value of desc_size that is pushed may not be same as that is read during a pop. The value that is read back is equal to always rounded to an odd number. So, for even values, the value read back is one more than what was written. For odd values, the value read back is same as the value that was written. Note that this 5-bit field (desc_size) is unrelated to the code for size of descriptors in a descriptor region. It is just a place holder for a 5-bit value that is maintained across the push and pop operations for every descriptor managed by the queue manager.

16.5.7.555 QUEUE_130_A Register (offset = 2820h) [reset = 0h]

QUEUE_130_A is shown in [Figure 16-831](#) and described in [Table 16-845](#).

Figure 16-831. QUEUE_130_A Register


LEGEND: R/W = Read/Write; R = Read only; W1toCl = Write 1 to clear bit; -n = value after reset

Table 16-845. QUEUE_130_A Register Field Descriptions

Bit	Field	Type	Reset	Description
13-0	QUEUE_ENTRY_COUNT	R-0	0	This field indicates how many packets are currently queued on the queue. This count is incremented by 1 whenever a packet is added to the queue. This count is decremented by 1 whenever a packet is popped from the queue.

16.5.7.556 QUEUE_130_B Register (offset = 2824h) [reset = 0h]

QUEUE_130_B is shown in [Figure 16-832](#) and described in [Table 16-846](#).

Figure 16-832. QUEUE_130_B Register


LEGEND: R/W = Read/Write; R = Read only; W1toCl = Write 1 to clear bit; -n = value after reset

Table 16-846. QUEUE_130_B Register Field Descriptions

Bit	Field	Type	Reset	Description
27-0	QUEUE_BYTE_COUNT	R-0	0	This field indicates how many bytes total are contained in all of the packets which are currently queued on this queue.

16.5.7.557 QUEUE_130_C Register (offset = 2828h) [reset = 0h]

 QUEUE_130_C is shown in [Figure 16-833](#) and described in [Table 16-847](#).

Figure 16-833. QUEUE_130_C Register


LEGEND: R/W = Read/Write; R = Read only; W1toCl = Write 1 to clear bit; -n = value after reset

Table 16-847. QUEUE_130_C Register Field Descriptions

Bit	Field	Type	Reset	Description
31	HEAD_TAIL	W-0	0	Head/Tail Push Control. Set to zero in order to push packet onto tail of queue and set to one in order to push packet onto head of queue.
13-0	PACKET_SIZE	R/W-0	0	packet_size This field indicates packet size and is assumed to be zero on each packet add unless the value is explicitly overwritten. This field indicates packet size for packet pop operation.

16.5.7.558 QUEUE_130_D Register (offset = 282Ch) [reset = 0h]

QUEUE_130_D is shown in [Figure 16-834](#) and described in [Table 16-848](#).

Figure 16-834. QUEUE_130_D Register



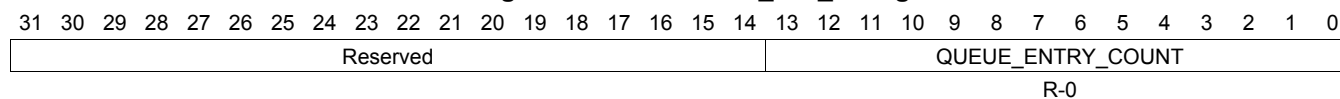
LEGEND: R/W = Read/Write; R = Read only; W1toCl = Write 1 to clear bit; -n = value after reset

Table 16-848. QUEUE_130_D Register Field Descriptions

Bit	Field	Type	Reset	Description
31-5	DESC_PTR	R/W-0	0	Descriptor pointer. It will be read as zero if the queue is empty. It will indicate a 32-bit aligned address that points to a descriptor when the queue is not empty.
4-0	DESC_SIZE	R/W-0	0	Descriptor Size. It is encoded in 4-byte increments with values 0 to 31 representing 24 and so on to 148 bytes. This field will return a 0x0 when an empty queue is read. Queue Manager Queue N Registers D To save hardware resources, the queue manager internally stores descriptor size (desc_size) information in four bits. However, register D has five LSBs that specify descriptor size. As a consequence, the value of desc_size that is pushed may not be same as that is read during a pop. The value that is read back is equal to always rounded to an odd number. So, for even values, the value read back is one more than what was written. For odd values, the value read back is same as the value that was written. Note that this 5-bit field (desc_size) is unrelated to the code for size of descriptors in a descriptor region. It is just a place holder for a 5-bit value that is maintained across the push and pop operations for every descriptor managed by the queue manager.

16.5.7.559 QUEUE_131_A Register (offset = 2830h) [reset = 0h]

QUEUE_131_A is shown in [Figure 16-835](#) and described in [Table 16-849](#).

Figure 16-835. QUEUE_131_A Register


LEGEND: R/W = Read/Write; R = Read only; W1toCl = Write 1 to clear bit; -n = value after reset

Table 16-849. QUEUE_131_A Register Field Descriptions

Bit	Field	Type	Reset	Description
13-0	QUEUE_ENTRY_COUNT	R-0	0	This field indicates how many packets are currently queued on the queue. This count is incremented by 1 whenever a packet is added to the queue. This count is decremented by 1 whenever a packet is popped from the queue.

16.5.7.560 QUEUE_131_B Register (offset = 2834h) [reset = 0h]

QUEUE_131_B is shown in [Figure 16-836](#) and described in [Table 16-850](#).

Figure 16-836. QUEUE_131_B Register

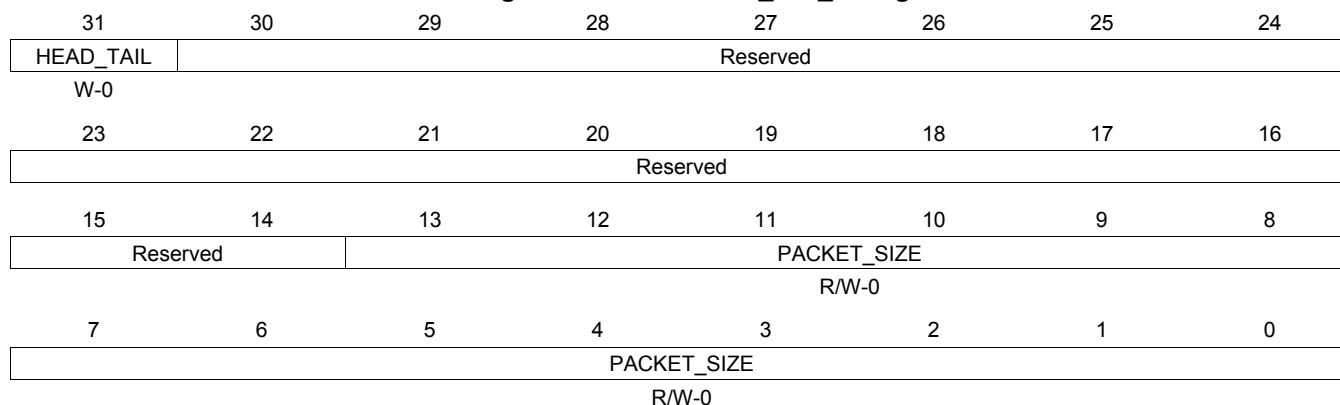

LEGEND: R/W = Read/Write; R = Read only; W1toCl = Write 1 to clear bit; -n = value after reset

Table 16-850. QUEUE_131_B Register Field Descriptions

Bit	Field	Type	Reset	Description
27-0	QUEUE_BYTE_COUNT	R-0	0	This field indicates how many bytes total are contained in all of the packets which are currently queued on this queue.

16.5.7.561 QUEUE_131_C Register (offset = 2838h) [reset = 0h]

 QUEUE_131_C is shown in [Figure 16-837](#) and described in [Table 16-851](#).

Figure 16-837. QUEUE_131_C Register


LEGEND: R/W = Read/Write; R = Read only; W1toCl = Write 1 to clear bit; -n = value after reset

Table 16-851. QUEUE_131_C Register Field Descriptions

Bit	Field	Type	Reset	Description
31	HEAD_TAIL	W-0	0	Head/Tail Push Control. Set to zero in order to push packet onto tail of queue and set to one in order to push packet onto head of queue.
13-0	PACKET_SIZE	R/W-0	0	packet_size This field indicates packet size and is assumed to be zero on each packet add unless the value is explicitly overwritten. This field indicates packet size for packet pop operation.

16.5.7.562 QUEUE_131_D Register (offset = 283Ch) [reset = 0h]

QUEUE_131_D is shown in [Figure 16-838](#) and described in [Table 16-852](#).

Figure 16-838. QUEUE_131_D Register



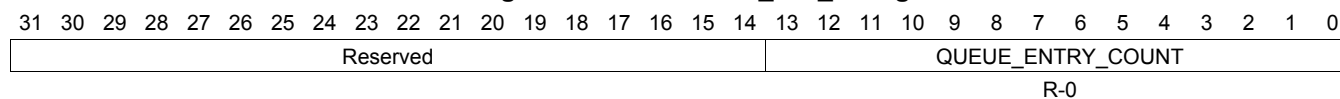
LEGEND: R/W = Read/Write; R = Read only; W1toCl = Write 1 to clear bit; -n = value after reset

Table 16-852. QUEUE_131_D Register Field Descriptions

Bit	Field	Type	Reset	Description
31-5	DESC_PTR	R/W-0	0	Descriptor pointer. It will be read as zero if the queue is empty. It will indicate a 32-bit aligned address that points to a descriptor when the queue is not empty.
4-0	DESC_SIZE	R/W-0	0	Descriptor Size. It is encoded in 4-byte increments with values 0 to 31 representing 24 and so on to 148 bytes. This field will return a 0x0 when an empty queue is read. Queue Manager Queue N Registers D To save hardware resources, the queue manager internally stores descriptor size (desc_size) information in four bits. However, register D has five LSBs that specify descriptor size. As a consequence, the value of desc_size that is pushed may not be same as that is read during a pop. The value that is read back is equal to always rounded to an odd number. So, for even values, the value read back is one more than what was written. For odd values, the value read back is same as the value that was written. Note that this 5-bit field (desc_size) is unrelated to the code for size of descriptors in a descriptor region. It is just a place holder for a 5-bit value that is maintained across the push and pop operations for every descriptor managed by the queue manager.

16.5.7.563 QUEUE_132_A Register (offset = 2840h) [reset = 0h]

QUEUE_132_A is shown in [Figure 16-839](#) and described in [Table 16-853](#).

Figure 16-839. QUEUE_132_A Register


LEGEND: R/W = Read/Write; R = Read only; W1toCl = Write 1 to clear bit; -n = value after reset

Table 16-853. QUEUE_132_A Register Field Descriptions

Bit	Field	Type	Reset	Description
13-0	QUEUE_ENTRY_COUNT	R-0	0	This field indicates how many packets are currently queued on the queue. This count is incremented by 1 whenever a packet is added to the queue. This count is decremented by 1 whenever a packet is popped from the queue.

16.5.7.564 QUEUE_132_B Register (offset = 2844h) [reset = 0h]

QUEUE_132_B is shown in [Figure 16-840](#) and described in [Table 16-854](#).

Figure 16-840. QUEUE_132_B Register


LEGEND: R/W = Read/Write; R = Read only; W1toCl = Write 1 to clear bit; -n = value after reset

Table 16-854. QUEUE_132_B Register Field Descriptions

Bit	Field	Type	Reset	Description
27-0	QUEUE_BYTE_COUNT	R-0	0	This field indicates how many bytes total are contained in all of the packets which are currently queued on this queue.

16.5.7.565 QUEUE_132_C Register (offset = 2848h) [reset = 0h]

 QUEUE_132_C is shown in [Figure 16-841](#) and described in [Table 16-855](#).

Figure 16-841. QUEUE_132_C Register


LEGEND: R/W = Read/Write; R = Read only; W1toCl = Write 1 to clear bit; -n = value after reset

Table 16-855. QUEUE_132_C Register Field Descriptions

Bit	Field	Type	Reset	Description
31	HEAD_TAIL	W-0	0	Head/Tail Push Control. Set to zero in order to push packet onto tail of queue and set to one in order to push packet onto head of queue.
13-0	PACKET_SIZE	R/W-0	0	packet_size This field indicates packet size and is assumed to be zero on each packet add unless the value is explicitly overwritten. This field indicates packet size for packet pop operation.

16.5.7.566 QUEUE_132_D Register (offset = 284Ch) [reset = 0h]

QUEUE_132_D is shown in [Figure 16-842](#) and described in [Table 16-856](#).

Figure 16-842. QUEUE_132_D Register

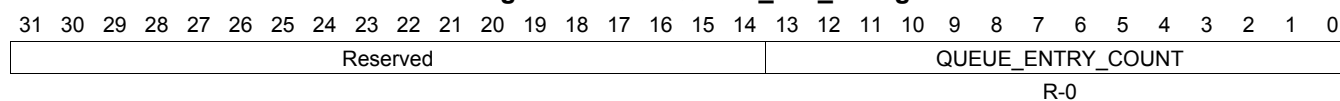

LEGEND: R/W = Read/Write; R = Read only; W1toCl = Write 1 to clear bit; -n = value after reset

Table 16-856. QUEUE_132_D Register Field Descriptions

Bit	Field	Type	Reset	Description
31-5	DESC_PTR	R/W-0	0	Descriptor pointer. It will be read as zero if the queue is empty. It will indicate a 32-bit aligned address that points to a descriptor when the queue is not empty.
4-0	DESC_SIZE	R/W-0	0	Descriptor Size. It is encoded in 4-byte increments with values 0 to 31 representing 24 and so on to 148 bytes. This field will return a 0x0 when an empty queue is read. Queue Manager Queue N Registers D To save hardware resources, the queue manager internally stores descriptor size (desc_size) information in four bits. However, register D has five LSBs that specify descriptor size. As a consequence, the value of desc_size that is pushed may not be same as that is read during a pop. The value that is read back is equal to always rounded to an odd number. So, for even values, the value read back is one more than what was written. For odd values, the value read back is same as the value that was written. Note that this 5-bit field (desc_size) is unrelated to the code for size of descriptors in a descriptor region. It is just a place holder for a 5-bit value that is maintained across the push and pop operations for every descriptor managed by the queue manager.

16.5.7.567 QUEUE_133_A Register (offset = 2850h) [reset = 0h]

 QUEUE_133_A is shown in [Figure 16-843](#) and described in [Table 16-857](#).

Figure 16-843. QUEUE_133_A Register


LEGEND: R/W = Read/Write; R = Read only; W1toCl = Write 1 to clear bit; -n = value after reset

Table 16-857. QUEUE_133_A Register Field Descriptions

Bit	Field	Type	Reset	Description
13-0	QUEUE_ENTRY_COUNT	R-0	0	This field indicates how many packets are currently queued on the queue. This count is incremented by 1 whenever a packet is added to the queue. This count is decremented by 1 whenever a packet is popped from the queue.

16.5.7.568 QUEUE_133_B Register (offset = 2854h) [reset = 0h]

QUEUE_133_B is shown in [Figure 16-844](#) and described in [Table 16-858](#).

Figure 16-844. QUEUE_133_B Register


LEGEND: R/W = Read/Write; R = Read only; W1toCl = Write 1 to clear bit; -n = value after reset

Table 16-858. QUEUE_133_B Register Field Descriptions

Bit	Field	Type	Reset	Description
27-0	QUEUE_BYTE_COUNT	R-0	0	This field indicates how many bytes total are contained in all of the packets which are currently queued on this queue.

16.5.7.569 QUEUE_133_C Register (offset = 2858h) [reset = 0h]

 QUEUE_133_C is shown in [Figure 16-845](#) and described in [Table 16-859](#).

Figure 16-845. QUEUE_133_C Register

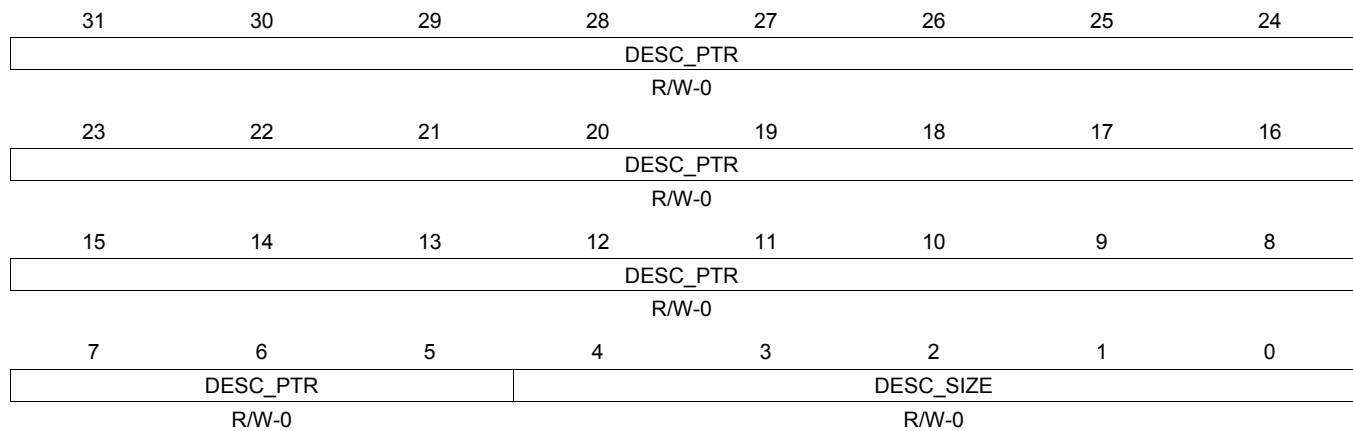

LEGEND: R/W = Read/Write; R = Read only; W1toCl = Write 1 to clear bit; -n = value after reset

Table 16-859. QUEUE_133_C Register Field Descriptions

Bit	Field	Type	Reset	Description
31	HEAD_TAIL	W-0	0	Head/Tail Push Control. Set to zero in order to push packet onto tail of queue and set to one in order to push packet onto head of queue.
13-0	PACKET_SIZE	R/W-0	0	packet_size This field indicates packet size and is assumed to be zero on each packet add unless the value is explicitly overwritten. This field indicates packet size for packet pop operation.

16.5.7.570 QUEUE_133_D Register (offset = 285Ch) [reset = 0h]

QUEUE_133_D is shown in [Figure 16-846](#) and described in [Table 16-860](#).

Figure 16-846. QUEUE_133_D Register


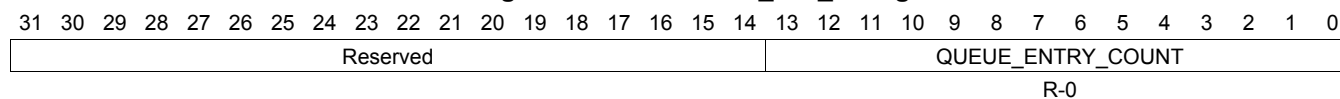
LEGEND: R/W = Read/Write; R = Read only; W1toCl = Write 1 to clear bit; -n = value after reset

Table 16-860. QUEUE_133_D Register Field Descriptions

Bit	Field	Type	Reset	Description
31-5	DESC_PTR	R/W-0	0	Descriptor pointer. It will be read as zero if the queue is empty. It will indicate a 32-bit aligned address that points to a descriptor when the queue is not empty.
4-0	DESC_SIZE	R/W-0	0	Descriptor Size. It is encoded in 4-byte increments with values 0 to 31 representing 24 and so on to 148 bytes. This field will return a 0x0 when an empty queue is read. Queue Manager Queue N Registers D To save hardware resources, the queue manager internally stores descriptor size (desc_size) information in four bits. However, register D has five LSBs that specify descriptor size. As a consequence, the value of desc_size that is pushed may not be same as that is read during a pop. The value that is read back is equal to always rounded to an odd number. So, for even values, the value read back is one more than what was written. For odd values, the value read back is same as the value that was written. Note that this 5-bit field (desc_size) is unrelated to the code for size of descriptors in a descriptor region. It is just a place holder for a 5-bit value that is maintained across the push and pop operations for every descriptor managed by the queue manager.

16.5.7.571 QUEUE_134_A Register (offset = 2860h) [reset = 0h]

QUEUE_134_A is shown in [Figure 16-847](#) and described in [Table 16-861](#).

Figure 16-847. QUEUE_134_A Register


LEGEND: R/W = Read/Write; R = Read only; W1toCl = Write 1 to clear bit; -n = value after reset

Table 16-861. QUEUE_134_A Register Field Descriptions

Bit	Field	Type	Reset	Description
13-0	QUEUE_ENTRY_COUNT	R-0	0	This field indicates how many packets are currently queued on the queue. This count is incremented by 1 whenever a packet is added to the queue. This count is decremented by 1 whenever a packet is popped from the queue.

16.5.7.572 QUEUE_134_B Register (offset = 2864h) [reset = 0h]

QUEUE_134_B is shown in [Figure 16-848](#) and described in [Table 16-862](#).

Figure 16-848. QUEUE_134_B Register

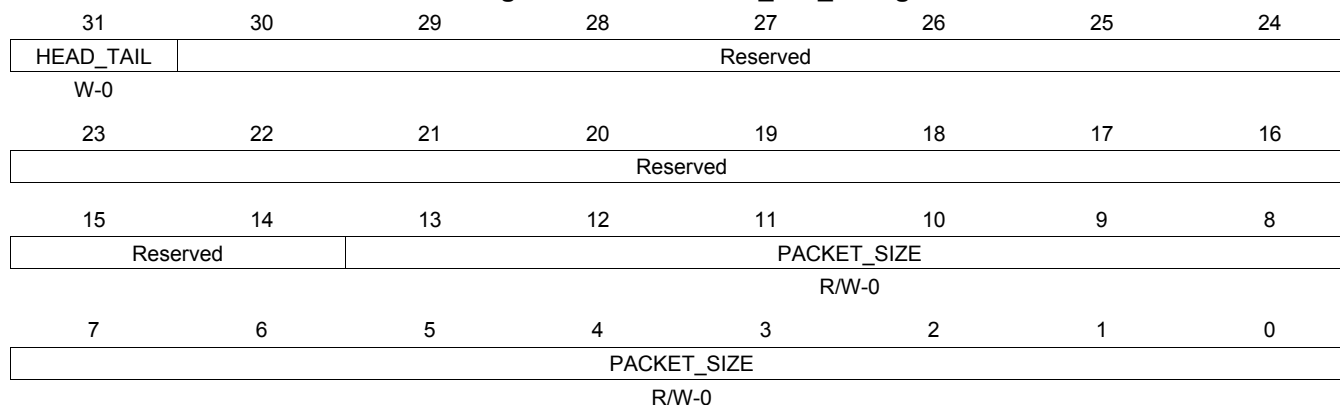

LEGEND: R/W = Read/Write; R = Read only; W1toCl = Write 1 to clear bit; -n = value after reset

Table 16-862. QUEUE_134_B Register Field Descriptions

Bit	Field	Type	Reset	Description
27-0	QUEUE_BYTE_COUNT	R-0	0	This field indicates how many bytes total are contained in all of the packets which are currently queued on this queue.

16.5.7.573 QUEUE_134_C Register (offset = 2868h) [reset = 0h]

 QUEUE_134_C is shown in [Figure 16-849](#) and described in [Table 16-863](#).

Figure 16-849. QUEUE_134_C Register


LEGEND: R/W = Read/Write; R = Read only; W1toCl = Write 1 to clear bit; -n = value after reset

Table 16-863. QUEUE_134_C Register Field Descriptions

Bit	Field	Type	Reset	Description
31	HEAD_TAIL	W-0	0	Head/Tail Push Control. Set to zero in order to push packet onto tail of queue and set to one in order to push packet onto head of queue.
13-0	PACKET_SIZE	R/W-0	0	packet_size This field indicates packet size and is assumed to be zero on each packet add unless the value is explicitly overwritten. This field indicates packet size for packet pop operation.

16.5.7.574 QUEUE_134_D Register (offset = 286Ch) [reset = 0h]

 QUEUE_134_D is shown in [Figure 16-850](#) and described in [Table 16-864](#).

Figure 16-850. QUEUE_134_D Register

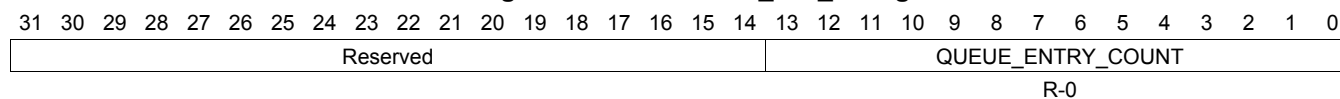

LEGEND: R/W = Read/Write; R = Read only; W1toCl = Write 1 to clear bit; -n = value after reset

Table 16-864. QUEUE_134_D Register Field Descriptions

Bit	Field	Type	Reset	Description
31-5	DESC_PTR	R/W-0	0	Descriptor pointer. It will be read as zero if the queue is empty. It will indicate a 32-bit aligned address that points to a descriptor when the queue is not empty.
4-0	DESC_SIZE	R/W-0	0	Descriptor Size. It is encoded in 4-byte increments with values 0 to 31 representing 24 and so on to 148 bytes. This field will return a 0x0 when an empty queue is read. Queue Manager Queue N Registers D To save hardware resources, the queue manager internally stores descriptor size (desc_size) information in four bits. However, register D has five LSBs that specify descriptor size. As a consequence, the value of desc_size that is pushed may not be same as that is read during a pop. The value that is read back is equal to always rounded to an odd number. So, for even values, the value read back is one more than what was written. For odd values, the value read back is same as the value that was written. Note that this 5-bit field (desc_size) is unrelated to the code for size of descriptors in a descriptor region. It is just a place holder for a 5-bit value that is maintained across the push and pop operations for every descriptor managed by the queue manager.

16.5.7.575 QUEUE_135_A Register (offset = 2870h) [reset = 0h]

QUEUE_135_A is shown in [Figure 16-851](#) and described in [Table 16-865](#).

Figure 16-851. QUEUE_135_A Register


LEGEND: R/W = Read/Write; R = Read only; W1toCl = Write 1 to clear bit; -n = value after reset

Table 16-865. QUEUE_135_A Register Field Descriptions

Bit	Field	Type	Reset	Description
13-0	QUEUE_ENTRY_COUNT	R-0	0	This field indicates how many packets are currently queued on the queue. This count is incremented by 1 whenever a packet is added to the queue. This count is decremented by 1 whenever a packet is popped from the queue.

16.5.7.576 QUEUE_135_B Register (offset = 2874h) [reset = 0h]

QUEUE_135_B is shown in [Figure 16-852](#) and described in [Table 16-866](#).

Figure 16-852. QUEUE_135_B Register


LEGEND: R/W = Read/Write; R = Read only; W1toCl = Write 1 to clear bit; -n = value after reset

Table 16-866. QUEUE_135_B Register Field Descriptions

Bit	Field	Type	Reset	Description
27-0	QUEUE_BYTE_COUNT	R-0	0	This field indicates how many bytes total are contained in all of the packets which are currently queued on this queue.

16.5.7.577 QUEUE_135_C Register (offset = 2878h) [reset = 0h]

 QUEUE_135_C is shown in [Figure 16-853](#) and described in [Table 16-867](#).

Figure 16-853. QUEUE_135_C Register


LEGEND: R/W = Read/Write; R = Read only; W1toCl = Write 1 to clear bit; -n = value after reset

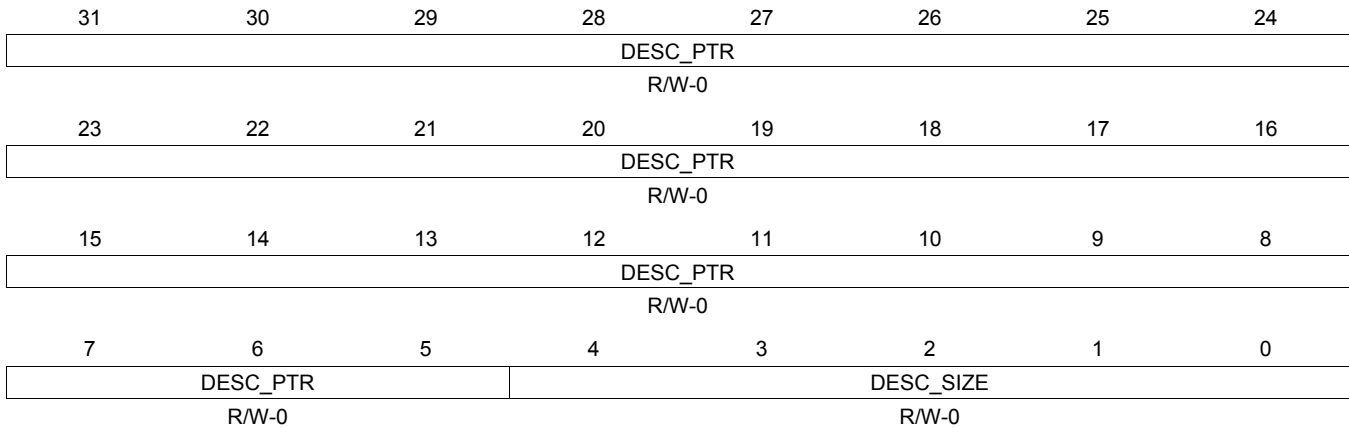
Table 16-867. QUEUE_135_C Register Field Descriptions

Bit	Field	Type	Reset	Description
31	HEAD_TAIL	W-0	0	Head/Tail Push Control. Set to zero in order to push packet onto tail of queue and set to one in order to push packet onto head of queue.
13-0	PACKET_SIZE	R/W-0	0	packet_size This field indicates packet size and is assumed to be zero on each packet add unless the value is explicitly overwritten. This field indicates packet size for packet pop operation.

16.5.7.578 QUEUE_135_D Register (offset = 287Ch) [reset = 0h]

QUEUE_135_D is shown in [Figure 16-854](#) and described in [Table 16-868](#).

Figure 16-854. QUEUE_135_D Register



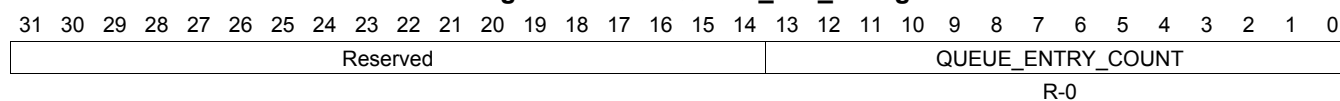
LEGEND: R/W = Read/Write; R = Read only; W1toCl = Write 1 to clear bit; -n = value after reset

Table 16-868. QUEUE_135_D Register Field Descriptions

Bit	Field	Type	Reset	Description
31-5	DESC_PTR	R/W-0	0	Descriptor pointer. It will be read as zero if the queue is empty. It will indicate a 32-bit aligned address that points to a descriptor when the queue is not empty.
4-0	DESC_SIZE	R/W-0	0	Descriptor Size. It is encoded in 4-byte increments with values 0 to 31 representing 24 and so on to 148 bytes. This field will return a 0x0 when an empty queue is read. Queue Manager Queue N Registers D To save hardware resources, the queue manager internally stores descriptor size (desc_size) information in four bits. However, register D has five LSBs that specify descriptor size. As a consequence, the value of desc_size that is pushed may not be same as that is read during a pop. The value that is read back is equal to always rounded to an odd number. So, for even values, the value read back is one more than what was written. For odd values, the value read back is same as the value that was written. Note that this 5-bit field (desc_size) is unrelated to the code for size of descriptors in a descriptor region. It is just a place holder for a 5-bit value that is maintained across the push and pop operations for every descriptor managed by the queue manager.

16.5.7.579 QUEUE_136_A Register (offset = 2880h) [reset = 0h]

QUEUE_136_A is shown in [Figure 16-855](#) and described in [Table 16-869](#).

Figure 16-855. QUEUE_136_A Register


LEGEND: R/W = Read/Write; R = Read only; W1toCl = Write 1 to clear bit; -n = value after reset

Table 16-869. QUEUE_136_A Register Field Descriptions

Bit	Field	Type	Reset	Description
13-0	QUEUE_ENTRY_COUNT	R-0	0	This field indicates how many packets are currently queued on the queue. This count is incremented by 1 whenever a packet is added to the queue. This count is decremented by 1 whenever a packet is popped from the queue.

16.5.7.580 QUEUE_136_B Register (offset = 2884h) [reset = 0h]

QUEUE_136_B is shown in [Figure 16-856](#) and described in [Table 16-870](#).

Figure 16-856. QUEUE_136_B Register

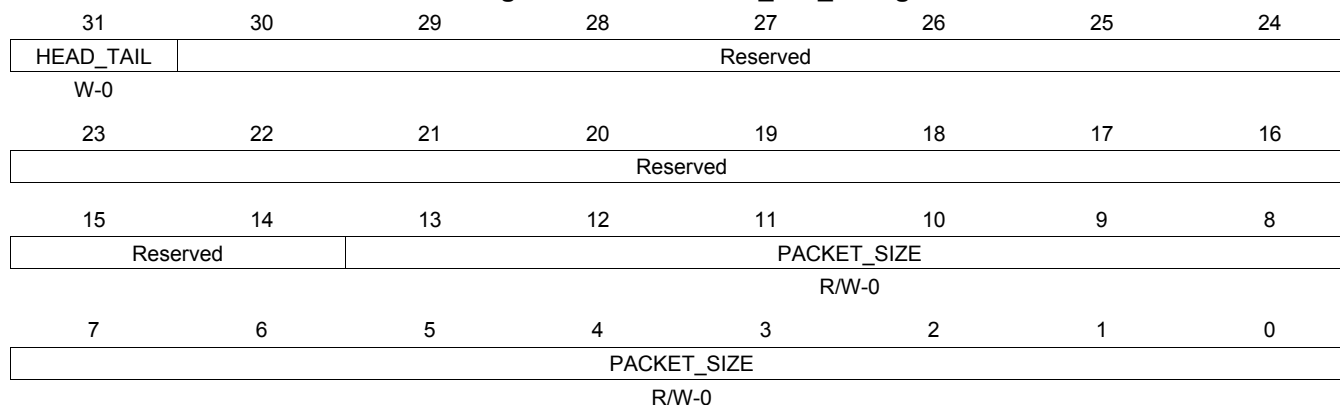

LEGEND: R/W = Read/Write; R = Read only; W1toCl = Write 1 to clear bit; -n = value after reset

Table 16-870. QUEUE_136_B Register Field Descriptions

Bit	Field	Type	Reset	Description
27-0	QUEUE_BYTE_COUNT	R-0	0	This field indicates how many bytes total are contained in all of the packets which are currently queued on this queue.

16.5.7.581 QUEUE_136_C Register (offset = 2888h) [reset = 0h]

 QUEUE_136_C is shown in [Figure 16-857](#) and described in [Table 16-871](#).

Figure 16-857. QUEUE_136_C Register


LEGEND: R/W = Read/Write; R = Read only; W1toCl = Write 1 to clear bit; -n = value after reset

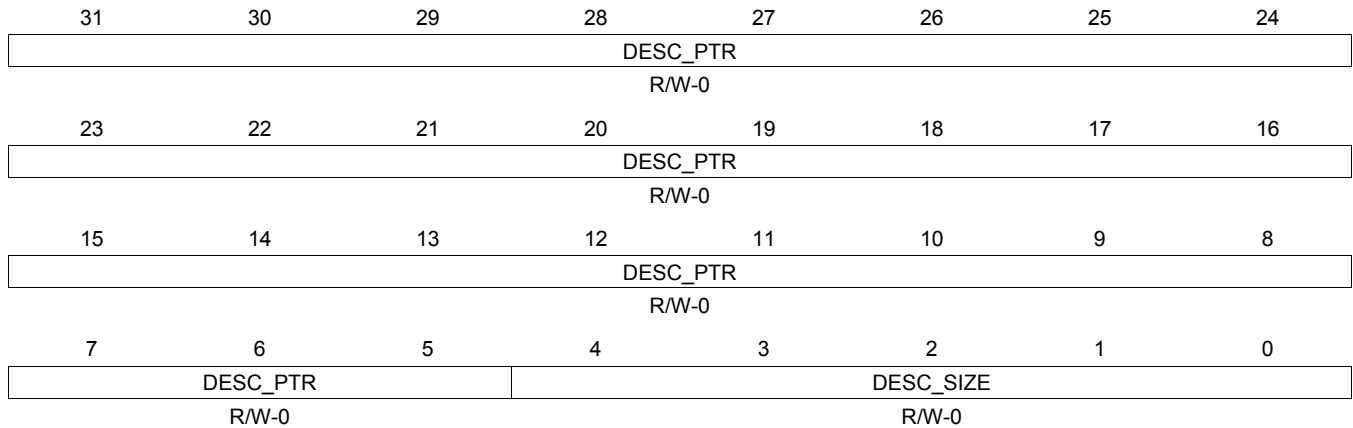
Table 16-871. QUEUE_136_C Register Field Descriptions

Bit	Field	Type	Reset	Description
31	HEAD_TAIL	W-0	0	Head/Tail Push Control. Set to zero in order to push packet onto tail of queue and set to one in order to push packet onto head of queue.
13-0	PACKET_SIZE	R/W-0	0	packet_size This field indicates packet size and is assumed to be zero on each packet add unless the value is explicitly overwritten. This field indicates packet size for packet pop operation.

16.5.7.582 QUEUE_136_D Register (offset = 288Ch) [reset = 0h]

QUEUE_136_D is shown in [Figure 16-858](#) and described in [Table 16-872](#).

Figure 16-858. QUEUE_136_D Register



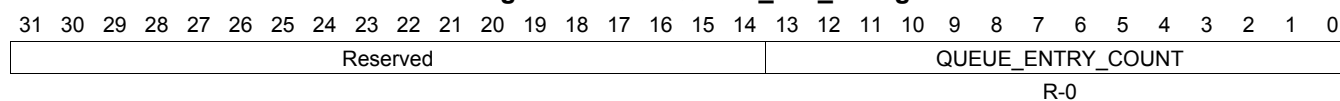
LEGEND: R/W = Read/Write; R = Read only; W1toCl = Write 1 to clear bit; -n = value after reset

Table 16-872. QUEUE_136_D Register Field Descriptions

Bit	Field	Type	Reset	Description
31-5	DESC_PTR	R/W-0	0	Descriptor pointer. It will be read as zero if the queue is empty. It will indicate a 32-bit aligned address that points to a descriptor when the queue is not empty.
4-0	DESC_SIZE	R/W-0	0	Descriptor Size. It is encoded in 4-byte increments with values 0 to 31 representing 24 and so on to 148 bytes. This field will return a 0x0 when an empty queue is read. Queue Manager Queue N Registers D To save hardware resources, the queue manager internally stores descriptor size (desc_size) information in four bits. However, register D has five LSBs that specify descriptor size. As a consequence, the value of desc_size that is pushed may not be same as that is read during a pop. The value that is read back is equal to always rounded to an odd number. So, for even values, the value read back is one more than what was written. For odd values, the value read back is same as the value that was written. Note that this 5-bit field (desc_size) is unrelated to the code for size of descriptors in a descriptor region. It is just a place holder for a 5-bit value that is maintained across the push and pop operations for every descriptor managed by the queue manager.

16.5.7.583 QUEUE_137_A Register (offset = 2890h) [reset = 0h]

QUEUE_137_A is shown in [Figure 16-859](#) and described in [Table 16-873](#).

Figure 16-859. QUEUE_137_A Register


LEGEND: R/W = Read/Write; R = Read only; W1toCl = Write 1 to clear bit; -n = value after reset

Table 16-873. QUEUE_137_A Register Field Descriptions

Bit	Field	Type	Reset	Description
13-0	QUEUE_ENTRY_COUNT	R-0	0	This field indicates how many packets are currently queued on the queue. This count is incremented by 1 whenever a packet is added to the queue. This count is decremented by 1 whenever a packet is popped from the queue.

16.5.7.584 QUEUE_137_B Register (offset = 2894h) [reset = 0h]

QUEUE_137_B is shown in [Figure 16-860](#) and described in [Table 16-874](#).

Figure 16-860. QUEUE_137_B Register

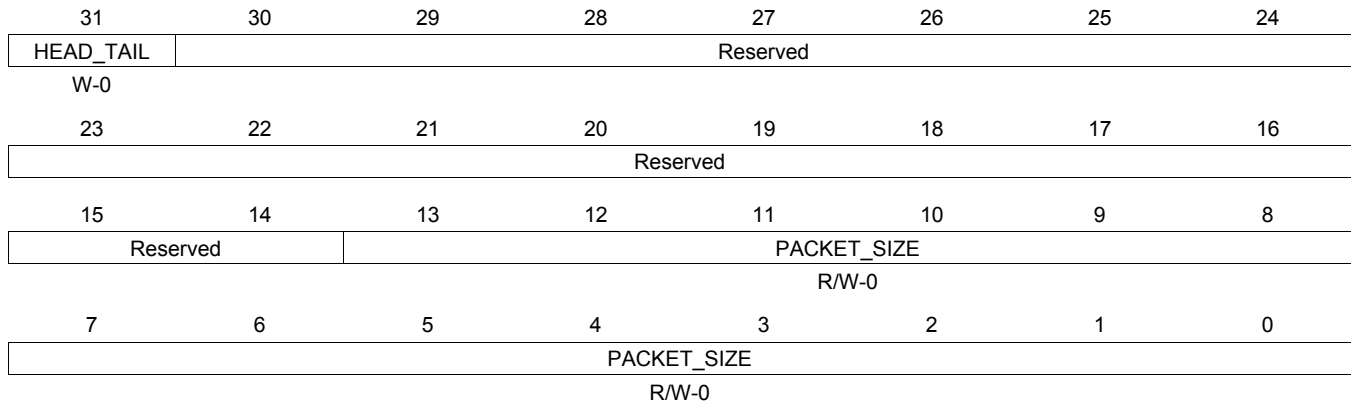

LEGEND: R/W = Read/Write; R = Read only; W1toCl = Write 1 to clear bit; -n = value after reset

Table 16-874. QUEUE_137_B Register Field Descriptions

Bit	Field	Type	Reset	Description
27-0	QUEUE_BYTE_COUNT	R-0	0	This field indicates how many bytes total are contained in all of the packets which are currently queued on this queue.

16.5.7.585 QUEUE_137_C Register (offset = 2898h) [reset = 0h]

 QUEUE_137_C is shown in [Figure 16-861](#) and described in [Table 16-875](#).

Figure 16-861. QUEUE_137_C Register


LEGEND: R/W = Read/Write; R = Read only; W1toCl = Write 1 to clear bit; -n = value after reset

Table 16-875. QUEUE_137_C Register Field Descriptions

Bit	Field	Type	Reset	Description
31	HEAD_TAIL	W-0	0	Head/Tail Push Control. Set to zero in order to push packet onto tail of queue and set to one in order to push packet onto head of queue.
13-0	PACKET_SIZE	R/W-0	0	packet_size This field indicates packet size and is assumed to be zero on each packet add unless the value is explicitly overwritten. This field indicates packet size for packet pop operation.

16.5.7.586 QUEUE_137_D Register (offset = 289Ch) [reset = 0h]

 QUEUE_137_D is shown in [Figure 16-862](#) and described in [Table 16-876](#).

Figure 16-862. QUEUE_137_D Register

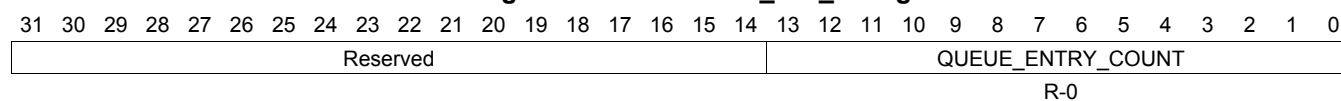

LEGEND: R/W = Read/Write; R = Read only; W1toCl = Write 1 to clear bit; -n = value after reset

Table 16-876. QUEUE_137_D Register Field Descriptions

Bit	Field	Type	Reset	Description
31-5	DESC_PTR	R/W-0	0	Descriptor pointer. It will be read as zero if the queue is empty. It will indicate a 32-bit aligned address that points to a descriptor when the queue is not empty.
4-0	DESC_SIZE	R/W-0	0	Descriptor Size. It is encoded in 4-byte increments with values 0 to 31 representing 24 and so on to 148 bytes. This field will return a 0x0 when an empty queue is read. Queue Manager Queue N Registers D To save hardware resources, the queue manager internally stores descriptor size (desc_size) information in four bits. However, register D has five LSBs that specify descriptor size. As a consequence, the value of desc_size that is pushed may not be same as that is read during a pop. The value that is read back is equal to always rounded to an odd number. So, for even values, the value read back is one more than what was written. For odd values, the value read back is same as the value that was written. Note that this 5-bit field (desc_size) is unrelated to the code for size of descriptors in a descriptor region. It is just a place holder for a 5-bit value that is maintained across the push and pop operations for every descriptor managed by the queue manager.

16.5.7.587 QUEUE_138_A Register (offset = 28A0h) [reset = 0h]

QUEUE_138_A is shown in [Figure 16-863](#) and described in [Table 16-877](#).

Figure 16-863. QUEUE_138_A Register


LEGEND: R/W = Read/Write; R = Read only; W1toCl = Write 1 to clear bit; -n = value after reset

Table 16-877. QUEUE_138_A Register Field Descriptions

Bit	Field	Type	Reset	Description
13-0	QUEUE_ENTRY_COUNT	R-0	0	This field indicates how many packets are currently queued on the queue. This count is incremented by 1 whenever a packet is added to the queue. This count is decremented by 1 whenever a packet is popped from the queue.

16.5.7.588 QUEUE_138_B Register (offset = 28A4h) [reset = 0h]

QUEUE_138_B is shown in [Figure 16-864](#) and described in [Table 16-878](#).

Figure 16-864. QUEUE_138_B Register

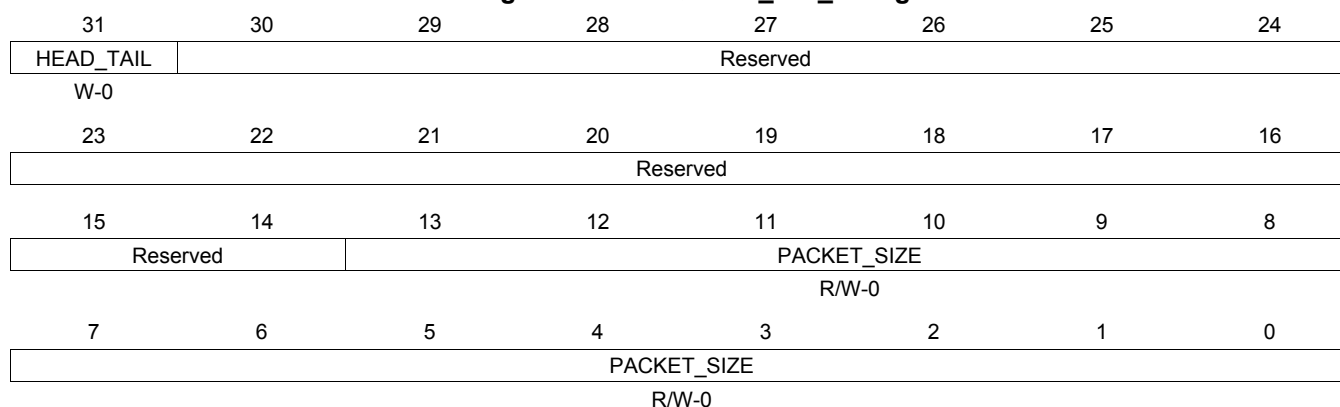

LEGEND: R/W = Read/Write; R = Read only; W1toCl = Write 1 to clear bit; -n = value after reset

Table 16-878. QUEUE_138_B Register Field Descriptions

Bit	Field	Type	Reset	Description
27-0	QUEUE_BYTE_COUNT	R-0	0	This field indicates how many bytes total are contained in all of the packets which are currently queued on this queue.

16.5.7.589 QUEUE_138_C Register (offset = 28A8h) [reset = 0h]

 QUEUE_138_C is shown in [Figure 16-865](#) and described in [Table 16-879](#).

Figure 16-865. QUEUE_138_C Register


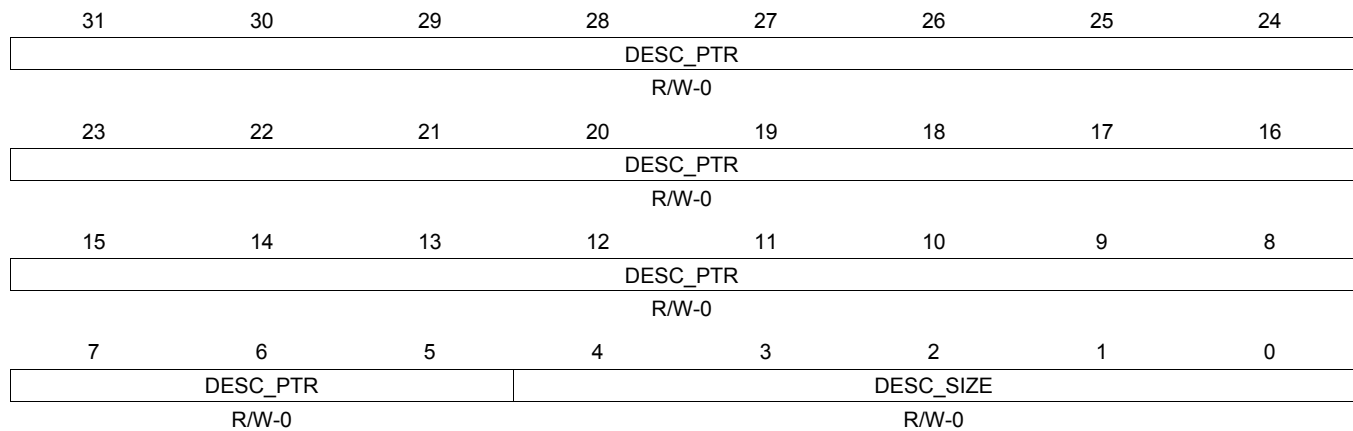
LEGEND: R/W = Read/Write; R = Read only; W1toCl = Write 1 to clear bit; -n = value after reset

Table 16-879. QUEUE_138_C Register Field Descriptions

Bit	Field	Type	Reset	Description
31	HEAD_TAIL	W-0	0	Head/Tail Push Control. Set to zero in order to push packet onto tail of queue and set to one in order to push packet onto head of queue.
13-0	PACKET_SIZE	R/W-0	0	packet_size This field indicates packet size and is assumed to be zero on each packet add unless the value is explicitly overwritten. This field indicates packet size for packet pop operation.

16.5.7.590 QUEUE_138_D Register (offset = 28ACh) [reset = 0h]

QUEUE_138_D is shown in [Figure 16-866](#) and described in [Table 16-880](#).

Figure 16-866. QUEUE_138_D Register


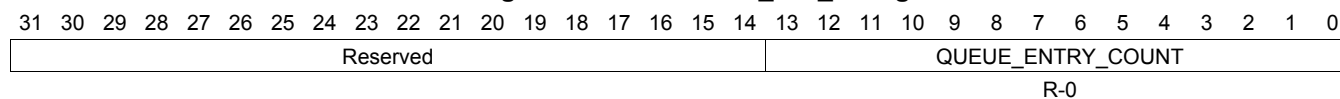
LEGEND: R/W = Read/Write; R = Read only; W1toCl = Write 1 to clear bit; -n = value after reset

Table 16-880. QUEUE_138_D Register Field Descriptions

Bit	Field	Type	Reset	Description
31-5	DESC_PTR	R/W-0	0	Descriptor pointer. It will be read as zero if the queue is empty. It will indicate a 32-bit aligned address that points to a descriptor when the queue is not empty.
4-0	DESC_SIZE	R/W-0	0	Descriptor Size. It is encoded in 4-byte increments with values 0 to 31 representing 24 and so on to 148 bytes. This field will return a 0x0 when an empty queue is read. Queue Manager Queue N Registers D To save hardware resources, the queue manager internally stores descriptor size (desc_size) information in four bits. However, register D has five LSBs that specify descriptor size. As a consequence, the value of desc_size that is pushed may not be same as that is read during a pop. The value that is read back is equal to always rounded to an odd number. So, for even values, the value read back is one more than what was written. For odd values, the value read back is same as the value that was written. Note that this 5-bit field (desc_size) is unrelated to the code for size of descriptors in a descriptor region. It is just a place holder for a 5-bit value that is maintained across the push and pop operations for every descriptor managed by the queue manager.

16.5.7.591 QUEUE_139_A Register (offset = 28B0h) [reset = 0h]

QUEUE_139_A is shown in [Figure 16-867](#) and described in [Table 16-881](#).

Figure 16-867. QUEUE_139_A Register


LEGEND: R/W = Read/Write; R = Read only; W1toCl = Write 1 to clear bit; -n = value after reset

Table 16-881. QUEUE_139_A Register Field Descriptions

Bit	Field	Type	Reset	Description
13-0	QUEUE_ENTRY_COUNT	R-0	0	This field indicates how many packets are currently queued on the queue. This count is incremented by 1 whenever a packet is added to the queue. This count is decremented by 1 whenever a packet is popped from the queue.

16.5.7.592 QUEUE_139_B Register (offset = 28B4h) [reset = 0h]

 QUEUE_139_B is shown in [Figure 16-868](#) and described in [Table 16-882](#).

Figure 16-868. QUEUE_139_B Register


LEGEND: R/W = Read/Write; R = Read only; W1toCl = Write 1 to clear bit; -n = value after reset

Table 16-882. QUEUE_139_B Register Field Descriptions

Bit	Field	Type	Reset	Description
27-0	QUEUE_BYTE_COUNT	R-0	0	This field indicates how many bytes total are contained in all of the packets which are currently queued on this queue.

16.5.7.593 QUEUE_139_C Register (offset = 28B8h) [reset = 0h]

 QUEUE_139_C is shown in [Figure 16-869](#) and described in [Table 16-883](#).

Figure 16-869. QUEUE_139_C Register


LEGEND: R/W = Read/Write; R = Read only; W1toCl = Write 1 to clear bit; -n = value after reset

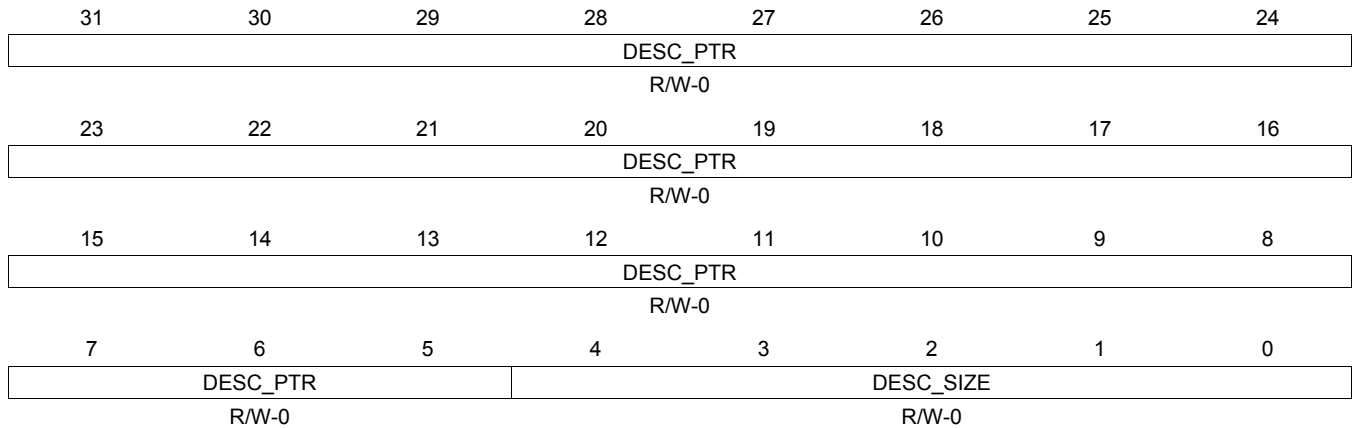
Table 16-883. QUEUE_139_C Register Field Descriptions

Bit	Field	Type	Reset	Description
31	HEAD_TAIL	W-0	0	Head/Tail Push Control. Set to zero in order to push packet onto tail of queue and set to one in order to push packet onto head of queue.
13-0	PACKET_SIZE	R/W-0	0	packet_size This field indicates packet size and is assumed to be zero on each packet add unless the value is explicitly overwritten. This field indicates packet size for packet pop operation.

16.5.7.594 QUEUE_139_D Register (offset = 28BCh) [reset = 0h]

QUEUE_139_D is shown in [Figure 16-870](#) and described in [Table 16-884](#).

Figure 16-870. QUEUE_139_D Register



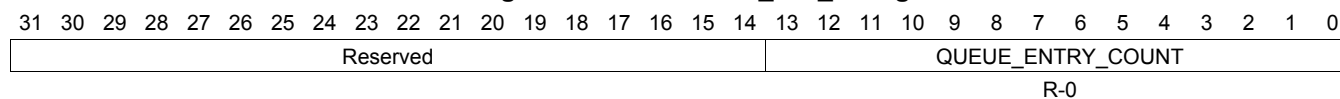
LEGEND: R/W = Read/Write; R = Read only; W1toCl = Write 1 to clear bit; -n = value after reset

Table 16-884. QUEUE_139_D Register Field Descriptions

Bit	Field	Type	Reset	Description
31-5	DESC_PTR	R/W-0	0	Descriptor pointer. It will be read as zero if the queue is empty. It will indicate a 32-bit aligned address that points to a descriptor when the queue is not empty.
4-0	DESC_SIZE	R/W-0	0	Descriptor Size. It is encoded in 4-byte increments with values 0 to 31 representing 24 and so on to 148 bytes. This field will return a 0x0 when an empty queue is read. Queue Manager Queue N Registers D To save hardware resources, the queue manager internally stores descriptor size (desc_size) information in four bits. However, register D has five LSBs that specify descriptor size. As a consequence, the value of desc_size that is pushed may not be same as that is read during a pop. The value that is read back is equal to always rounded to an odd number. So, for even values, the value read back is one more than what was written. For odd values, the value read back is same as the value that was written. Note that this 5-bit field (desc_size) is unrelated to the code for size of descriptors in a descriptor region. It is just a place holder for a 5-bit value that is maintained across the push and pop operations for every descriptor managed by the queue manager.

16.5.7.595 QUEUE_140_A Register (offset = 28C0h) [reset = 0h]

QUEUE_140_A is shown in [Figure 16-871](#) and described in [Table 16-885](#).

Figure 16-871. QUEUE_140_A Register


LEGEND: R/W = Read/Write; R = Read only; W1toCl = Write 1 to clear bit; -n = value after reset

Table 16-885. QUEUE_140_A Register Field Descriptions

Bit	Field	Type	Reset	Description
13-0	QUEUE_ENTRY_COUNT	R-0	0	This field indicates how many packets are currently queued on the queue. This count is incremented by 1 whenever a packet is added to the queue. This count is decremented by 1 whenever a packet is popped from the queue.

16.5.7.596 QUEUE_140_B Register (offset = 28C4h) [reset = 0h]

QUEUE_140_B is shown in [Figure 16-872](#) and described in [Table 16-886](#).

Figure 16-872. QUEUE_140_B Register


LEGEND: R/W = Read/Write; R = Read only; W1toCl = Write 1 to clear bit; -n = value after reset

Table 16-886. QUEUE_140_B Register Field Descriptions

Bit	Field	Type	Reset	Description
27-0	QUEUE_BYTE_COUNT	R-0	0	This field indicates how many bytes total are contained in all of the packets which are currently queued on this queue.

16.5.7.597 QUEUE_140_C Register (offset = 28C8h) [reset = 0h]

 QUEUE_140_C is shown in [Figure 16-873](#) and described in [Table 16-887](#).

Figure 16-873. QUEUE_140_C Register


LEGEND: R/W = Read/Write; R = Read only; W1toCl = Write 1 to clear bit; -n = value after reset

Table 16-887. QUEUE_140_C Register Field Descriptions

Bit	Field	Type	Reset	Description
31	HEAD_TAIL	W-0	0	Head/Tail Push Control. Set to zero in order to push packet onto tail of queue and set to one in order to push packet onto head of queue.
13-0	PACKET_SIZE	R/W-0	0	packet_size This field indicates packet size and is assumed to be zero on each packet add unless the value is explicitly overwritten. This field indicates packet size for packet pop operation.

16.5.7.598 QUEUE_140_D Register (offset = 28CCh) [reset = 0h]

QUEUE_140_D is shown in [Figure 16-874](#) and described in [Table 16-888](#).

Figure 16-874. QUEUE_140_D Register



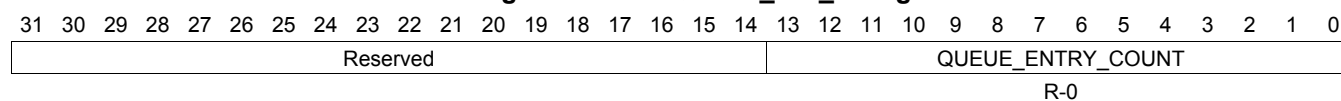
LEGEND: R/W = Read/Write; R = Read only; W1toCl = Write 1 to clear bit; -n = value after reset

Table 16-888. QUEUE_140_D Register Field Descriptions

Bit	Field	Type	Reset	Description
31-5	DESC_PTR	R/W-0	0	Descriptor pointer. It will be read as zero if the queue is empty. It will indicate a 32-bit aligned address that points to a descriptor when the queue is not empty.
4-0	DESC_SIZE	R/W-0	0	Descriptor Size. It is encoded in 4-byte increments with values 0 to 31 representing 24 and so on to 148 bytes. This field will return a 0x0 when an empty queue is read. Queue Manager Queue N Registers D To save hardware resources, the queue manager internally stores descriptor size (desc_size) information in four bits. However, register D has five LSBs that specify descriptor size. As a consequence, the value of desc_size that is pushed may not be same as that is read during a pop. The value that is read back is equal to always rounded to an odd number. So, for even values, the value read back is one more than what was written. For odd values, the value read back is same as the value that was written. Note that this 5-bit field (desc_size) is unrelated to the code for size of descriptors in a descriptor region. It is just a place holder for a 5-bit value that is maintained across the push and pop operations for every descriptor managed by the queue manager.

16.5.7.599 QUEUE_141_A Register (offset = 28D0h) [reset = 0h]

 QUEUE_141_A is shown in [Figure 16-875](#) and described in [Table 16-889](#).

Figure 16-875. QUEUE_141_A Register


LEGEND: R/W = Read/Write; R = Read only; W1toCl = Write 1 to clear bit; -n = value after reset

Table 16-889. QUEUE_141_A Register Field Descriptions

Bit	Field	Type	Reset	Description
13-0	QUEUE_ENTRY_COUNT	R-0	0	This field indicates how many packets are currently queued on the queue. This count is incremented by 1 whenever a packet is added to the queue. This count is decremented by 1 whenever a packet is popped from the queue.

16.5.7.600 QUEUE_141_B Register (offset = 28D4h) [reset = 0h]

QUEUE_141_B is shown in [Figure 16-876](#) and described in [Table 16-890](#).

Figure 16-876. QUEUE_141_B Register

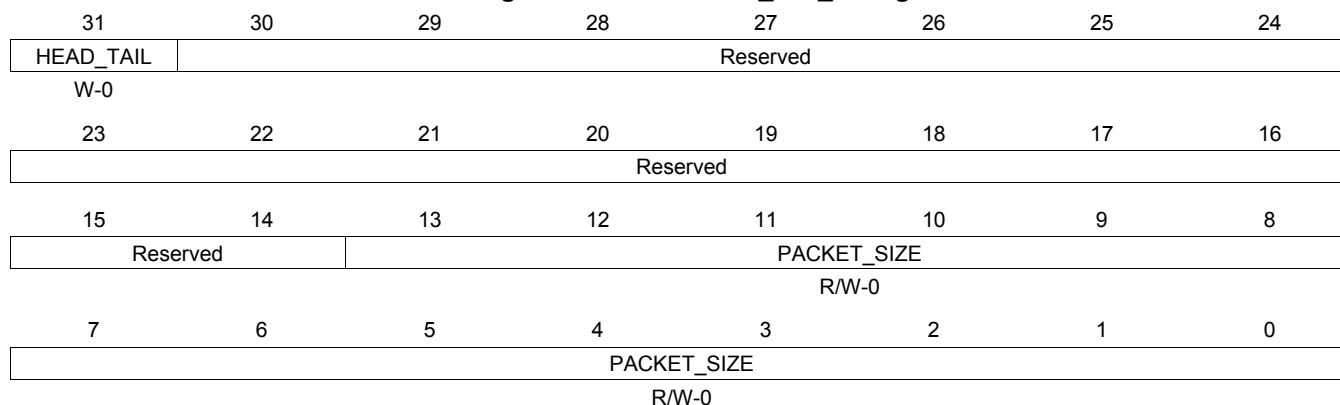

LEGEND: R/W = Read/Write; R = Read only; W1toCl = Write 1 to clear bit; -n = value after reset

Table 16-890. QUEUE_141_B Register Field Descriptions

Bit	Field	Type	Reset	Description
27-0	QUEUE_BYTE_COUNT	R-0	0	This field indicates how many bytes total are contained in all of the packets which are currently queued on this queue.

16.5.7.601 QUEUE_141_C Register (offset = 28D8h) [reset = 0h]

 QUEUE_141_C is shown in [Figure 16-877](#) and described in [Table 16-891](#).

Figure 16-877. QUEUE_141_C Register


LEGEND: R/W = Read/Write; R = Read only; W1toCl = Write 1 to clear bit; -n = value after reset

Table 16-891. QUEUE_141_C Register Field Descriptions

Bit	Field	Type	Reset	Description
31	HEAD_TAIL	W-0	0	Head/Tail Push Control. Set to zero in order to push packet onto tail of queue and set to one in order to push packet onto head of queue.
13-0	PACKET_SIZE	R/W-0	0	packet_size This field indicates packet size and is assumed to be zero on each packet add unless the value is explicitly overwritten. This field indicates packet size for packet pop operation.

16.5.7.602 QUEUE_141_D Register (offset = 28DCh) [reset = 0h]

QUEUE_141_D is shown in [Figure 16-878](#) and described in [Table 16-892](#).

Figure 16-878. QUEUE_141_D Register

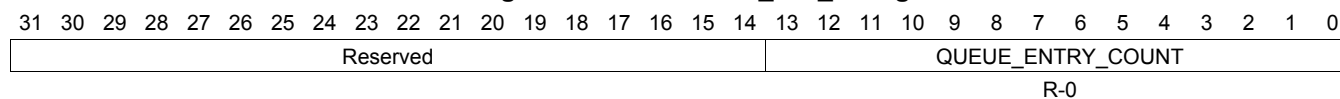

LEGEND: R/W = Read/Write; R = Read only; W1toCl = Write 1 to clear bit; -n = value after reset

Table 16-892. QUEUE_141_D Register Field Descriptions

Bit	Field	Type	Reset	Description
31-5	DESC_PTR	R/W-0	0	Descriptor pointer. It will be read as zero if the queue is empty. It will indicate a 32-bit aligned address that points to a descriptor when the queue is not empty.
4-0	DESC_SIZE	R/W-0	0	Descriptor Size. It is encoded in 4-byte increments with values 0 to 31 representing 24 and so on to 148 bytes. This field will return a 0x0 when an empty queue is read. Queue Manager Queue N Registers D To save hardware resources, the queue manager internally stores descriptor size (desc_size) information in four bits. However, register D has five LSBs that specify descriptor size. As a consequence, the value of desc_size that is pushed may not be same as that is read during a pop. The value that is read back is equal to always rounded to an odd number. So, for even values, the value read back is one more than what was written. For odd values, the value read back is same as the value that was written. Note that this 5-bit field (desc_size) is unrelated to the code for size of descriptors in a descriptor region. It is just a place holder for a 5-bit value that is maintained across the push and pop operations for every descriptor managed by the queue manager.

16.5.7.603 QUEUE_142_A Register (offset = 28E0h) [reset = 0h]

QUEUE_142_A is shown in [Figure 16-879](#) and described in [Table 16-893](#).

Figure 16-879. QUEUE_142_A Register


LEGEND: R/W = Read/Write; R = Read only; W1toCl = Write 1 to clear bit; -n = value after reset

Table 16-893. QUEUE_142_A Register Field Descriptions

Bit	Field	Type	Reset	Description
13-0	QUEUE_ENTRY_COUNT	R-0	0	This field indicates how many packets are currently queued on the queue. This count is incremented by 1 whenever a packet is added to the queue. This count is decremented by 1 whenever a packet is popped from the queue.

16.5.7.604 QUEUE_142_B Register (offset = 28E4h) [reset = 0h]

QUEUE_142_B is shown in [Figure 16-880](#) and described in [Table 16-894](#).

Figure 16-880. QUEUE_142_B Register


LEGEND: R/W = Read/Write; R = Read only; W1toCl = Write 1 to clear bit; -n = value after reset

Table 16-894. QUEUE_142_B Register Field Descriptions

Bit	Field	Type	Reset	Description
27-0	QUEUE_BYTE_COUNT	R-0	0	This field indicates how many bytes total are contained in all of the packets which are currently queued on this queue.

16.5.7.605 QUEUE_142_C Register (offset = 28E8h) [reset = 0h]

 QUEUE_142_C is shown in [Figure 16-881](#) and described in [Table 16-895](#).

Figure 16-881. QUEUE_142_C Register


LEGEND: R/W = Read/Write; R = Read only; W1toCl = Write 1 to clear bit; -n = value after reset

Table 16-895. QUEUE_142_C Register Field Descriptions

Bit	Field	Type	Reset	Description
31	HEAD_TAIL	W-0	0	Head/Tail Push Control. Set to zero in order to push packet onto tail of queue and set to one in order to push packet onto head of queue.
13-0	PACKET_SIZE	R/W-0	0	packet_size This field indicates packet size and is assumed to be zero on each packet add unless the value is explicitly overwritten. This field indicates packet size for packet pop operation.

16.5.7.606 QUEUE_142_D Register (offset = 28ECh) [reset = 0h]

QUEUE_142_D is shown in [Figure 16-882](#) and described in [Table 16-896](#).

Figure 16-882. QUEUE_142_D Register

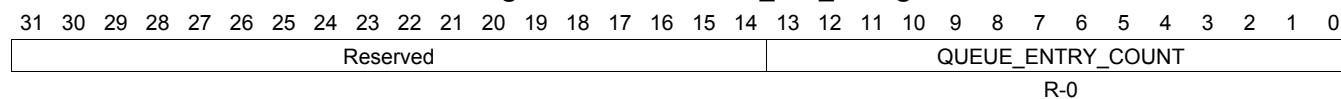

LEGEND: R/W = Read/Write; R = Read only; W1toCl = Write 1 to clear bit; -n = value after reset

Table 16-896. QUEUE_142_D Register Field Descriptions

Bit	Field	Type	Reset	Description
31-5	DESC_PTR	R/W-0	0	Descriptor pointer. It will be read as zero if the queue is empty. It will indicate a 32-bit aligned address that points to a descriptor when the queue is not empty.
4-0	DESC_SIZE	R/W-0	0	Descriptor Size. It is encoded in 4-byte increments with values 0 to 31 representing 24 and so on to 148 bytes. This field will return a 0x0 when an empty queue is read. Queue Manager Queue N Registers D To save hardware resources, the queue manager internally stores descriptor size (desc_size) information in four bits. However, register D has five LSBs that specify descriptor size. As a consequence, the value of desc_size that is pushed may not be same as that is read during a pop. The value that is read back is equal to always rounded to an odd number. So, for even values, the value read back is one more than what was written. For odd values, the value read back is same as the value that was written. Note that this 5-bit field (desc_size) is unrelated to the code for size of descriptors in a descriptor region. It is just a place holder for a 5-bit value that is maintained across the push and pop operations for every descriptor managed by the queue manager.

16.5.7.607 QUEUE_143_A Register (offset = 28F0h) [reset = 0h]

QUEUE_143_A is shown in [Figure 16-883](#) and described in [Table 16-897](#).

Figure 16-883. QUEUE_143_A Register


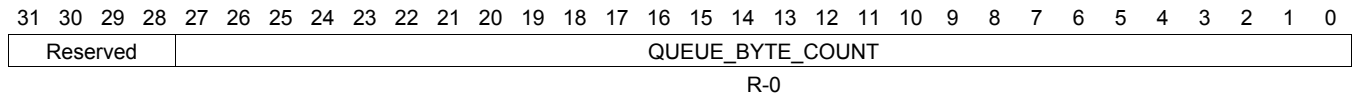
LEGEND: R/W = Read/Write; R = Read only; W1toCl = Write 1 to clear bit; -n = value after reset

Table 16-897. QUEUE_143_A Register Field Descriptions

Bit	Field	Type	Reset	Description
13-0	QUEUE_ENTRY_COUNT	R-0	0	This field indicates how many packets are currently queued on the queue. This count is incremented by 1 whenever a packet is added to the queue. This count is decremented by 1 whenever a packet is popped from the queue.

16.5.7.608 QUEUE_143_B Register (offset = 28F4h) [reset = 0h]

QUEUE_143_B is shown in [Figure 16-884](#) and described in [Table 16-898](#).

Figure 16-884. QUEUE_143_B Register


LEGEND: R/W = Read/Write; R = Read only; W1toCl = Write 1 to clear bit; -n = value after reset

Table 16-898. QUEUE_143_B Register Field Descriptions

Bit	Field	Type	Reset	Description
27-0	QUEUE_BYTE_COUNT	R-0	0	This field indicates how many bytes total are contained in all of the packets which are currently queued on this queue.

16.5.7.609 QUEUE_143_C Register (offset = 28F8h) [reset = 0h]

 QUEUE_143_C is shown in [Figure 16-885](#) and described in [Table 16-899](#).

Figure 16-885. QUEUE_143_C Register


LEGEND: R/W = Read/Write; R = Read only; W1toCl = Write 1 to clear bit; -n = value after reset

Table 16-899. QUEUE_143_C Register Field Descriptions

Bit	Field	Type	Reset	Description
31	HEAD_TAIL	W-0	0	Head/Tail Push Control. Set to zero in order to push packet onto tail of queue and set to one in order to push packet onto head of queue.
13-0	PACKET_SIZE	R/W-0	0	packet_size This field indicates packet size and is assumed to be zero on each packet add unless the value is explicitly overwritten. This field indicates packet size for packet pop operation.

16.5.7.610 QUEUE_143_D Register (offset = 28FCh) [reset = 0h]

QUEUE_143_D is shown in [Figure 16-886](#) and described in [Table 16-900](#).

Figure 16-886. QUEUE_143_D Register



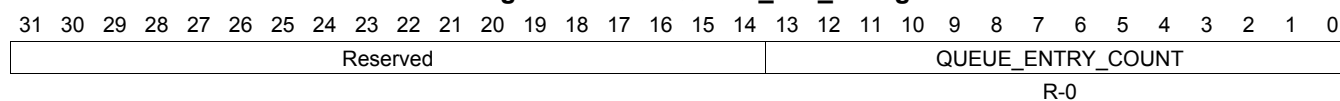
LEGEND: R/W = Read/Write; R = Read only; W1toCl = Write 1 to clear bit; -n = value after reset

Table 16-900. QUEUE_143_D Register Field Descriptions

Bit	Field	Type	Reset	Description
31-5	DESC_PTR	R/W-0	0	Descriptor pointer. It will be read as zero if the queue is empty. It will indicate a 32-bit aligned address that points to a descriptor when the queue is not empty.
4-0	DESC_SIZE	R/W-0	0	Descriptor Size. It is encoded in 4-byte increments with values 0 to 31 representing 24 and so on to 148 bytes. This field will return a 0x0 when an empty queue is read. Queue Manager Queue N Registers D To save hardware resources, the queue manager internally stores descriptor size (desc_size) information in four bits. However, register D has five LSBs that specify descriptor size. As a consequence, the value of desc_size that is pushed may not be same as that is read during a pop. The value that is read back is equal to always rounded to an odd number. So, for even values, the value read back is one more than what was written. For odd values, the value read back is same as the value that was written. Note that this 5-bit field (desc_size) is unrelated to the code for size of descriptors in a descriptor region. It is just a place holder for a 5-bit value that is maintained across the push and pop operations for every descriptor managed by the queue manager.

16.5.7.611 QUEUE_144_A Register (offset = 2900h) [reset = 0h]

QUEUE_144_A is shown in [Figure 16-887](#) and described in [Table 16-901](#).

Figure 16-887. QUEUE_144_A Register


LEGEND: R/W = Read/Write; R = Read only; W1toCl = Write 1 to clear bit; -n = value after reset

Table 16-901. QUEUE_144_A Register Field Descriptions

Bit	Field	Type	Reset	Description
13-0	QUEUE_ENTRY_COUNT	R-0	0	This field indicates how many packets are currently queued on the queue. This count is incremented by 1 whenever a packet is added to the queue. This count is decremented by 1 whenever a packet is popped from the queue.

16.5.7.612 QUEUE_144_B Register (offset = 2904h) [reset = 0h]

QUEUE_144_B is shown in [Figure 16-888](#) and described in [Table 16-902](#).

Figure 16-888. QUEUE_144_B Register


LEGEND: R/W = Read/Write; R = Read only; W1toCl = Write 1 to clear bit; -n = value after reset

Table 16-902. QUEUE_144_B Register Field Descriptions

Bit	Field	Type	Reset	Description
27-0	QUEUE_BYTE_COUNT	R-0	0	This field indicates how many bytes total are contained in all of the packets which are currently queued on this queue.

16.5.7.613 QUEUE_144_C Register (offset = 2908h) [reset = 0h]

 QUEUE_144_C is shown in [Figure 16-889](#) and described in [Table 16-903](#).

Figure 16-889. QUEUE_144_C Register

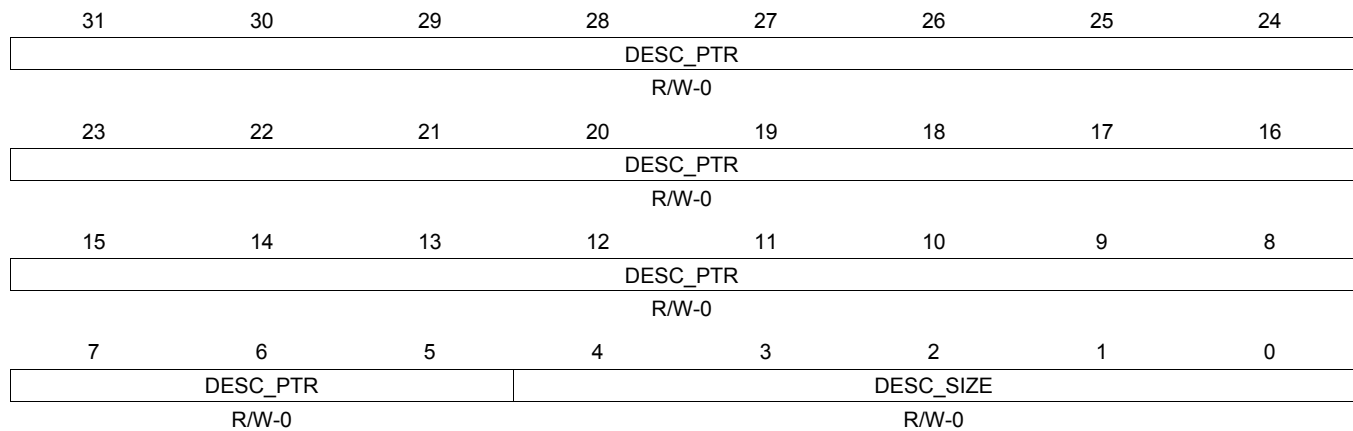

LEGEND: R/W = Read/Write; R = Read only; W1toCl = Write 1 to clear bit; -n = value after reset

Table 16-903. QUEUE_144_C Register Field Descriptions

Bit	Field	Type	Reset	Description
31	HEAD_TAIL	W-0	0	Head/Tail Push Control. Set to zero in order to push packet onto tail of queue and set to one in order to push packet onto head of queue.
13-0	PACKET_SIZE	R/W-0	0	packet_size This field indicates packet size and is assumed to be zero on each packet add unless the value is explicitly overwritten. This field indicates packet size for packet pop operation.

16.5.7.614 QUEUE_144_D Register (offset = 290Ch) [reset = 0h]

QUEUE_144_D is shown in [Figure 16-890](#) and described in [Table 16-904](#).

Figure 16-890. QUEUE_144_D Register


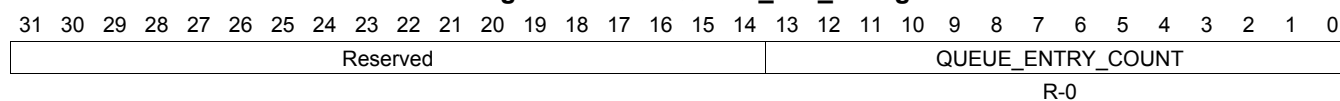
LEGEND: R/W = Read/Write; R = Read only; W1toCl = Write 1 to clear bit; -n = value after reset

Table 16-904. QUEUE_144_D Register Field Descriptions

Bit	Field	Type	Reset	Description
31-5	DESC_PTR	R/W-0	0	Descriptor pointer. It will be read as zero if the queue is empty. It will indicate a 32-bit aligned address that points to a descriptor when the queue is not empty.
4-0	DESC_SIZE	R/W-0	0	Descriptor Size. It is encoded in 4-byte increments with values 0 to 31 representing 24 and so on to 148 bytes. This field will return a 0x0 when an empty queue is read. Queue Manager Queue N Registers D To save hardware resources, the queue manager internally stores descriptor size (desc_size) information in four bits. However, register D has five LSBs that specify descriptor size. As a consequence, the value of desc_size that is pushed may not be same as that is read during a pop. The value that is read back is equal to always rounded to an odd number. So, for even values, the value read back is one more than what was written. For odd values, the value read back is same as the value that was written. Note that this 5-bit field (desc_size) is unrelated to the code for size of descriptors in a descriptor region. It is just a place holder for a 5-bit value that is maintained across the push and pop operations for every descriptor managed by the queue manager.

16.5.7.615 QUEUE_145_A Register (offset = 2910h) [reset = 0h]

QUEUE_145_A is shown in [Figure 16-891](#) and described in [Table 16-905](#).

Figure 16-891. QUEUE_145_A Register


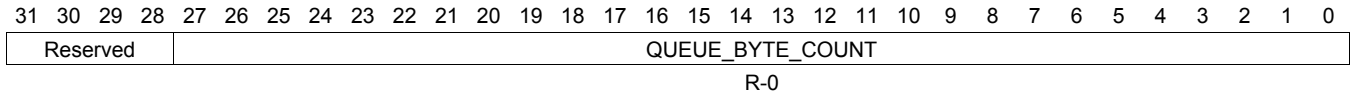
LEGEND: R/W = Read/Write; R = Read only; W1toCl = Write 1 to clear bit; -n = value after reset

Table 16-905. QUEUE_145_A Register Field Descriptions

Bit	Field	Type	Reset	Description
13-0	QUEUE_ENTRY_COUNT	R-0	0	This field indicates how many packets are currently queued on the queue. This count is incremented by 1 whenever a packet is added to the queue. This count is decremented by 1 whenever a packet is popped from the queue.

16.5.7.616 QUEUE_145_B Register (offset = 2914h) [reset = 0h]

QUEUE_145_B is shown in [Figure 16-892](#) and described in [Table 16-906](#).

Figure 16-892. QUEUE_145_B Register


LEGEND: R/W = Read/Write; R = Read only; W1toCl = Write 1 to clear bit; -n = value after reset

Table 16-906. QUEUE_145_B Register Field Descriptions

Bit	Field	Type	Reset	Description
27-0	QUEUE_BYTE_COUNT	R-0	0	This field indicates how many bytes total are contained in all of the packets which are currently queued on this queue.

16.5.7.617 QUEUE_145_C Register (offset = 2918h) [reset = 0h]

 QUEUE_145_C is shown in [Figure 16-893](#) and described in [Table 16-907](#).

Figure 16-893. QUEUE_145_C Register

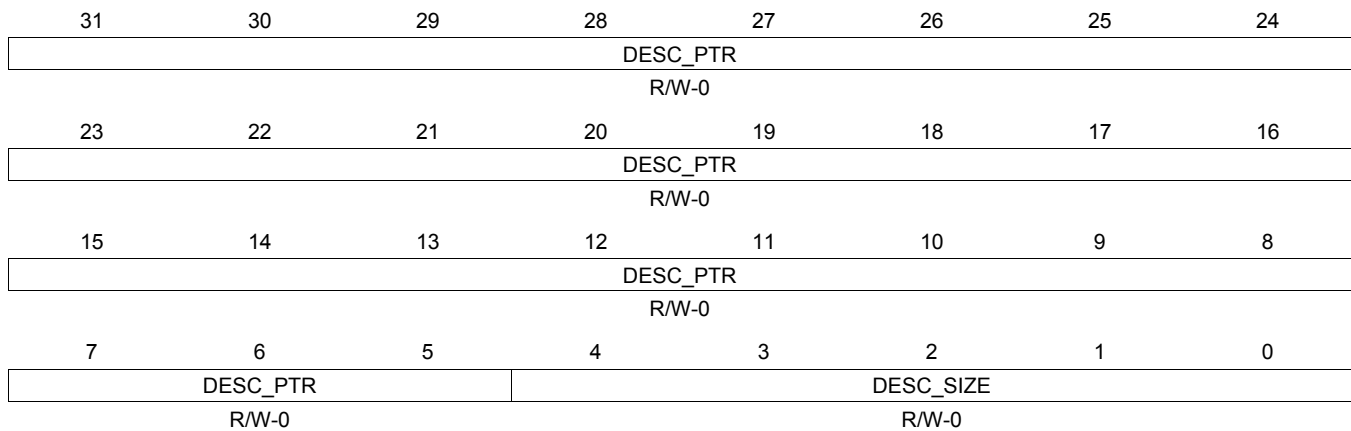

LEGEND: R/W = Read/Write; R = Read only; W1toCl = Write 1 to clear bit; -n = value after reset

Table 16-907. QUEUE_145_C Register Field Descriptions

Bit	Field	Type	Reset	Description
31	HEAD_TAIL	W-0	0	Head/Tail Push Control. Set to zero in order to push packet onto tail of queue and set to one in order to push packet onto head of queue.
13-0	PACKET_SIZE	R/W-0	0	packet_size This field indicates packet size and is assumed to be zero on each packet add unless the value is explicitly overwritten. This field indicates packet size for packet pop operation.

16.5.7.618 QUEUE_145_D Register (offset = 291Ch) [reset = 0h]

QUEUE_145_D is shown in [Figure 16-894](#) and described in [Table 16-908](#).

Figure 16-894. QUEUE_145_D Register


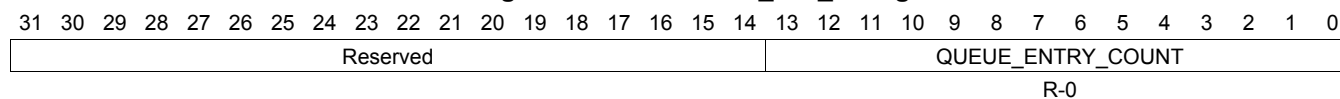
LEGEND: R/W = Read/Write; R = Read only; W1toCl = Write 1 to clear bit; -n = value after reset

Table 16-908. QUEUE_145_D Register Field Descriptions

Bit	Field	Type	Reset	Description
31-5	DESC_PTR	R/W-0	0	Descriptor pointer. It will be read as zero if the queue is empty. It will indicate a 32-bit aligned address that points to a descriptor when the queue is not empty.
4-0	DESC_SIZE	R/W-0	0	Descriptor Size. It is encoded in 4-byte increments with values 0 to 31 representing 24 and so on to 148 bytes. This field will return a 0x0 when an empty queue is read. Queue Manager Queue N Registers D To save hardware resources, the queue manager internally stores descriptor size (desc_size) information in four bits. However, register D has five LSBs that specify descriptor size. As a consequence, the value of desc_size that is pushed may not be same as that is read during a pop. The value that is read back is equal to always rounded to an odd number. So, for even values, the value read back is one more than what was written. For odd values, the value read back is same as the value that was written. Note that this 5-bit field (desc_size) is unrelated to the code for size of descriptors in a descriptor region. It is just a place holder for a 5-bit value that is maintained across the push and pop operations for every descriptor managed by the queue manager.

16.5.7.619 QUEUE_146_A Register (offset = 2920h) [reset = 0h]

QUEUE_146_A is shown in [Figure 16-895](#) and described in [Table 16-909](#).

Figure 16-895. QUEUE_146_A Register


LEGEND: R/W = Read/Write; R = Read only; W1toCl = Write 1 to clear bit; -n = value after reset

Table 16-909. QUEUE_146_A Register Field Descriptions

Bit	Field	Type	Reset	Description
13-0	QUEUE_ENTRY_COUNT	R-0	0	This field indicates how many packets are currently queued on the queue. This count is incremented by 1 whenever a packet is added to the queue. This count is decremented by 1 whenever a packet is popped from the queue.

16.5.7.620 QUEUE_146_B Register (offset = 2924h) [reset = 0h]

QUEUE_146_B is shown in [Figure 16-896](#) and described in [Table 16-910](#).

Figure 16-896. QUEUE_146_B Register


LEGEND: R/W = Read/Write; R = Read only; W1toCl = Write 1 to clear bit; -n = value after reset

Table 16-910. QUEUE_146_B Register Field Descriptions

Bit	Field	Type	Reset	Description
27-0	QUEUE_BYTE_COUNT	R-0	0	This field indicates how many bytes total are contained in all of the packets which are currently queued on this queue.

16.5.7.621 QUEUE_146_C Register (offset = 2928h) [reset = 0h]

 QUEUE_146_C is shown in [Figure 16-897](#) and described in [Table 16-911](#).

Figure 16-897. QUEUE_146_C Register

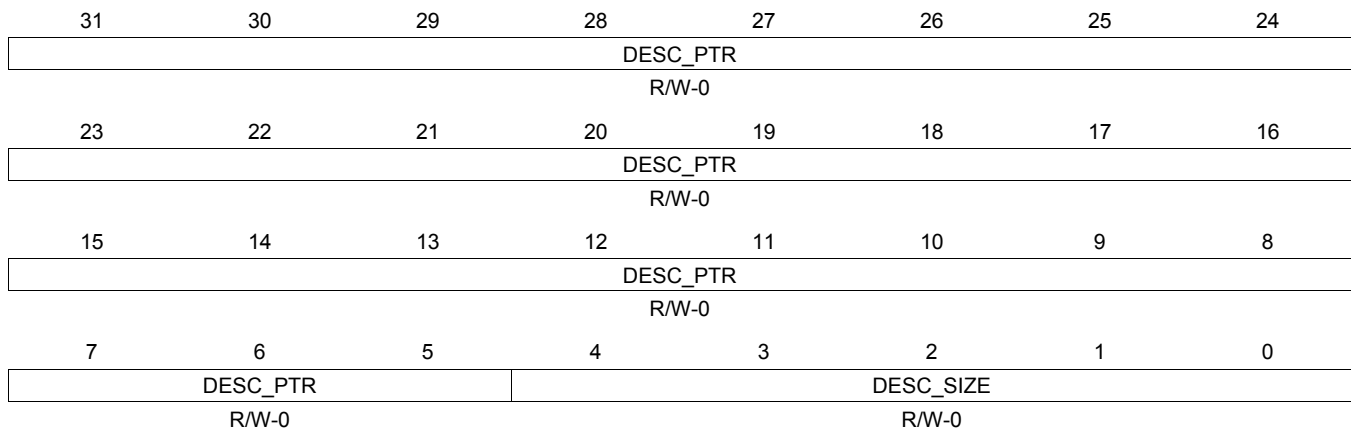

LEGEND: R/W = Read/Write; R = Read only; W1toCl = Write 1 to clear bit; -n = value after reset

Table 16-911. QUEUE_146_C Register Field Descriptions

Bit	Field	Type	Reset	Description
31	HEAD_TAIL	W-0	0	Head/Tail Push Control. Set to zero in order to push packet onto tail of queue and set to one in order to push packet onto head of queue.
13-0	PACKET_SIZE	R/W-0	0	packet_size This field indicates packet size and is assumed to be zero on each packet add unless the value is explicitly overwritten. This field indicates packet size for packet pop operation.

16.5.7.622 QUEUE_146_D Register (offset = 292Ch) [reset = 0h]

QUEUE_146_D is shown in [Figure 16-898](#) and described in [Table 16-912](#).

Figure 16-898. QUEUE_146_D Register


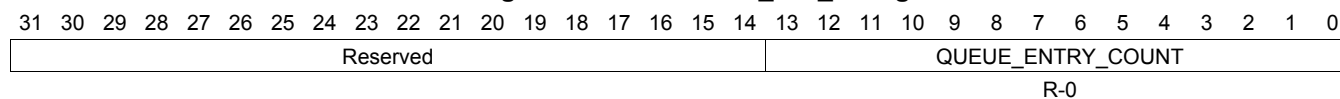
LEGEND: R/W = Read/Write; R = Read only; W1toCl = Write 1 to clear bit; -n = value after reset

Table 16-912. QUEUE_146_D Register Field Descriptions

Bit	Field	Type	Reset	Description
31-5	DESC_PTR	R/W-0	0	Descriptor pointer. It will be read as zero if the queue is empty. It will indicate a 32-bit aligned address that points to a descriptor when the queue is not empty.
4-0	DESC_SIZE	R/W-0	0	Descriptor Size. It is encoded in 4-byte increments with values 0 to 31 representing 24 and so on to 148 bytes. This field will return a 0x0 when an empty queue is read. Queue Manager Queue N Registers D To save hardware resources, the queue manager internally stores descriptor size (desc_size) information in four bits. However, register D has five LSBs that specify descriptor size. As a consequence, the value of desc_size that is pushed may not be same as that is read during a pop. The value that is read back is equal to always rounded to an odd number. So, for even values, the value read back is one more than what was written. For odd values, the value read back is same as the value that was written. Note that this 5-bit field (desc_size) is unrelated to the code for size of descriptors in a descriptor region. It is just a place holder for a 5-bit value that is maintained across the push and pop operations for every descriptor managed by the queue manager.

16.5.7.623 QUEUE_147_A Register (offset = 2930h) [reset = 0h]

QUEUE_147_A is shown in [Figure 16-899](#) and described in [Table 16-913](#).

Figure 16-899. QUEUE_147_A Register


LEGEND: R/W = Read/Write; R = Read only; W1toCl = Write 1 to clear bit; -n = value after reset

Table 16-913. QUEUE_147_A Register Field Descriptions

Bit	Field	Type	Reset	Description
13-0	QUEUE_ENTRY_COUNT	R-0	0	This field indicates how many packets are currently queued on the queue. This count is incremented by 1 whenever a packet is added to the queue. This count is decremented by 1 whenever a packet is popped from the queue.

16.5.7.624 QUEUE_147_B Register (offset = 2934h) [reset = 0h]

QUEUE_147_B is shown in [Figure 16-900](#) and described in [Table 16-914](#).

Figure 16-900. QUEUE_147_B Register


LEGEND: R/W = Read/Write; R = Read only; W1toCl = Write 1 to clear bit; -n = value after reset

Table 16-914. QUEUE_147_B Register Field Descriptions

Bit	Field	Type	Reset	Description
27-0	QUEUE_BYTE_COUNT	R-0	0	This field indicates how many bytes total are contained in all of the packets which are currently queued on this queue.

16.5.7.625 QUEUE_147_C Register (offset = 2938h) [reset = 0h]

 QUEUE_147_C is shown in [Figure 16-901](#) and described in [Table 16-915](#).

Figure 16-901. QUEUE_147_C Register


LEGEND: R/W = Read/Write; R = Read only; W1toCl = Write 1 to clear bit; -n = value after reset

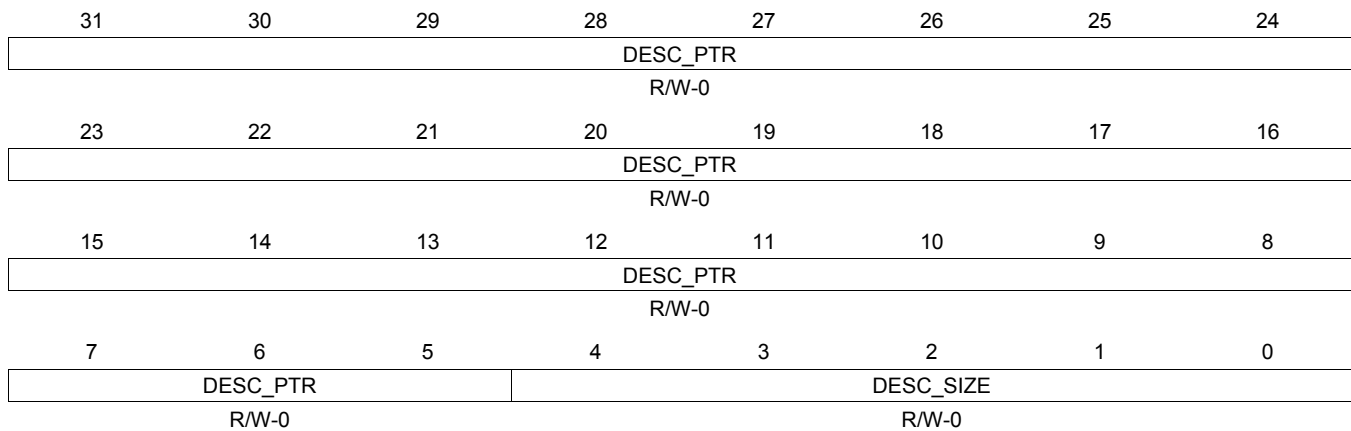
Table 16-915. QUEUE_147_C Register Field Descriptions

Bit	Field	Type	Reset	Description
31	HEAD_TAIL	W-0	0	Head/Tail Push Control. Set to zero in order to push packet onto tail of queue and set to one in order to push packet onto head of queue.
13-0	PACKET_SIZE	R/W-0	0	packet_size This field indicates packet size and is assumed to be zero on each packet add unless the value is explicitly overwritten. This field indicates packet size for packet pop operation.

16.5.7.626 QUEUE_147_D Register (offset = 293Ch) [reset = 0h]

QUEUE_147_D is shown in [Figure 16-902](#) and described in [Table 16-916](#).

Figure 16-902. QUEUE_147_D Register



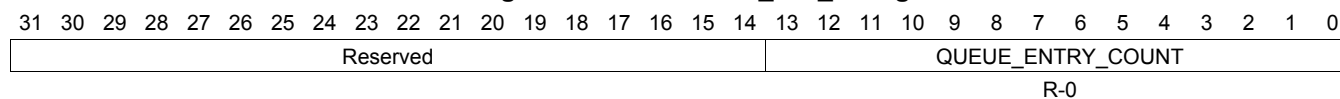
LEGEND: R/W = Read/Write; R = Read only; W1toCl = Write 1 to clear bit; -n = value after reset

Table 16-916. QUEUE_147_D Register Field Descriptions

Bit	Field	Type	Reset	Description
31-5	DESC_PTR	R/W-0	0	Descriptor pointer. It will be read as zero if the queue is empty. It will indicate a 32-bit aligned address that points to a descriptor when the queue is not empty.
4-0	DESC_SIZE	R/W-0	0	Descriptor Size. It is encoded in 4-byte increments with values 0 to 31 representing 24 and so on to 148 bytes. This field will return a 0x0 when an empty queue is read. Queue Manager Queue N Registers D To save hardware resources, the queue manager internally stores descriptor size (desc_size) information in four bits. However, register D has five LSBs that specify descriptor size. As a consequence, the value of desc_size that is pushed may not be same as that is read during a pop. The value that is read back is equal to always rounded to an odd number. So, for even values, the value read back is one more than what was written. For odd values, the value read back is same as the value that was written. Note that this 5-bit field (desc_size) is unrelated to the code for size of descriptors in a descriptor region. It is just a place holder for a 5-bit value that is maintained across the push and pop operations for every descriptor managed by the queue manager.

16.5.7.627 QUEUE_148_A Register (offset = 2940h) [reset = 0h]

QUEUE_148_A is shown in [Figure 16-903](#) and described in [Table 16-917](#).

Figure 16-903. QUEUE_148_A Register


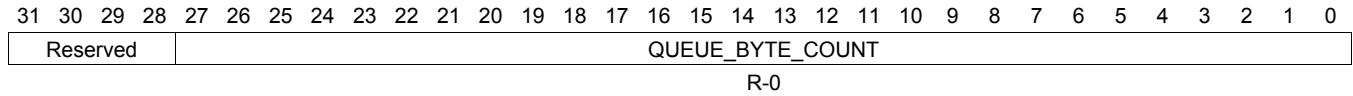
LEGEND: R/W = Read/Write; R = Read only; W1toCl = Write 1 to clear bit; -n = value after reset

Table 16-917. QUEUE_148_A Register Field Descriptions

Bit	Field	Type	Reset	Description
13-0	QUEUE_ENTRY_COUNT	R-0	0	This field indicates how many packets are currently queued on the queue. This count is incremented by 1 whenever a packet is added to the queue. This count is decremented by 1 whenever a packet is popped from the queue.

16.5.7.628 QUEUE_148_B Register (offset = 2944h) [reset = 0h]

QUEUE_148_B is shown in [Figure 16-904](#) and described in [Table 16-918](#).

Figure 16-904. QUEUE_148_B Register


LEGEND: R/W = Read/Write; R = Read only; W1toCl = Write 1 to clear bit; -n = value after reset

Table 16-918. QUEUE_148_B Register Field Descriptions

Bit	Field	Type	Reset	Description
27-0	QUEUE_BYTE_COUNT	R-0	0	This field indicates how many bytes total are contained in all of the packets which are currently queued on this queue.

16.5.7.629 QUEUE_148_C Register (offset = 2948h) [reset = 0h]

 QUEUE_148_C is shown in [Figure 16-905](#) and described in [Table 16-919](#).

Figure 16-905. QUEUE_148_C Register


LEGEND: R/W = Read/Write; R = Read only; W1toCl = Write 1 to clear bit; -n = value after reset

Table 16-919. QUEUE_148_C Register Field Descriptions

Bit	Field	Type	Reset	Description
31	HEAD_TAIL	W-0	0	Head/Tail Push Control. Set to zero in order to push packet onto tail of queue and set to one in order to push packet onto head of queue.
13-0	PACKET_SIZE	R/W-0	0	packet_size This field indicates packet size and is assumed to be zero on each packet add unless the value is explicitly overwritten. This field indicates packet size for packet pop operation.

16.5.7.630 QUEUE_148_D Register (offset = 294Ch) [reset = 0h]

 QUEUE_148_D is shown in [Figure 16-906](#) and described in [Table 16-920](#).

Figure 16-906. QUEUE_148_D Register

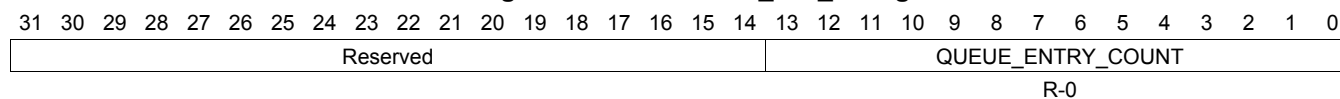

LEGEND: R/W = Read/Write; R = Read only; W1toCl = Write 1 to clear bit; -n = value after reset

Table 16-920. QUEUE_148_D Register Field Descriptions

Bit	Field	Type	Reset	Description
31-5	DESC_PTR	R/W-0	0	Descriptor pointer. It will be read as zero if the queue is empty. It will indicate a 32-bit aligned address that points to a descriptor when the queue is not empty.
4-0	DESC_SIZE	R/W-0	0	Descriptor Size. It is encoded in 4-byte increments with values 0 to 31 representing 24 and so on to 148 bytes. This field will return a 0x0 when an empty queue is read. Queue Manager Queue N Registers D To save hardware resources, the queue manager internally stores descriptor size (desc_size) information in four bits. However, register D has five LSBs that specify descriptor size. As a consequence, the value of desc_size that is pushed may not be same as that is read during a pop. The value that is read back is equal to always rounded to an odd number. So, for even values, the value read back is one more than what was written. For odd values, the value read back is same as the value that was written. Note that this 5-bit field (desc_size) is unrelated to the code for size of descriptors in a descriptor region. It is just a place holder for a 5-bit value that is maintained across the push and pop operations for every descriptor managed by the queue manager.

16.5.7.631 QUEUE_149_A Register (offset = 2950h) [reset = 0h]

QUEUE_149_A is shown in [Figure 16-907](#) and described in [Table 16-921](#).

Figure 16-907. QUEUE_149_A Register


LEGEND: R/W = Read/Write; R = Read only; W1toCl = Write 1 to clear bit; -n = value after reset

Table 16-921. QUEUE_149_A Register Field Descriptions

Bit	Field	Type	Reset	Description
13-0	QUEUE_ENTRY_COUNT	R-0	0	This field indicates how many packets are currently queued on the queue. This count is incremented by 1 whenever a packet is added to the queue. This count is decremented by 1 whenever a packet is popped from the queue.

16.5.7.632 QUEUE_149_B Register (offset = 2954h) [reset = 0h]

QUEUE_149_B is shown in [Figure 16-908](#) and described in [Table 16-922](#).

Figure 16-908. QUEUE_149_B Register

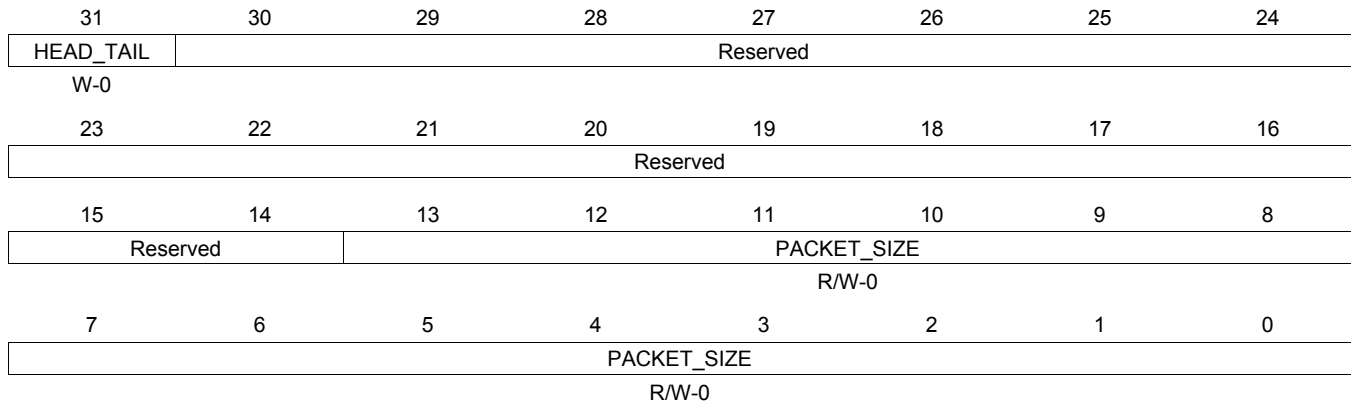

LEGEND: R/W = Read/Write; R = Read only; W1toCl = Write 1 to clear bit; -n = value after reset

Table 16-922. QUEUE_149_B Register Field Descriptions

Bit	Field	Type	Reset	Description
27-0	QUEUE_BYTE_COUNT	R-0	0	This field indicates how many bytes total are contained in all of the packets which are currently queued on this queue.

16.5.7.633 QUEUE_149_C Register (offset = 2958h) [reset = 0h]

 QUEUE_149_C is shown in [Figure 16-909](#) and described in [Table 16-923](#).

Figure 16-909. QUEUE_149_C Register


LEGEND: R/W = Read/Write; R = Read only; W1toCl = Write 1 to clear bit; -n = value after reset

Table 16-923. QUEUE_149_C Register Field Descriptions

Bit	Field	Type	Reset	Description
31	HEAD_TAIL	W-0	0	Head/Tail Push Control. Set to zero in order to push packet onto tail of queue and set to one in order to push packet onto head of queue.
13-0	PACKET_SIZE	R/W-0	0	packet_size This field indicates packet size and is assumed to be zero on each packet add unless the value is explicitly overwritten. This field indicates packet size for packet pop operation.

16.5.7.634 QUEUE_149_D Register (offset = 295Ch) [reset = 0h]

QUEUE_149_D is shown in [Figure 16-910](#) and described in [Table 16-924](#).

Figure 16-910. QUEUE_149_D Register

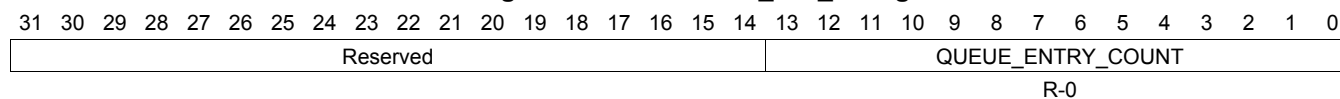

LEGEND: R/W = Read/Write; R = Read only; W1toCl = Write 1 to clear bit; -n = value after reset

Table 16-924. QUEUE_149_D Register Field Descriptions

Bit	Field	Type	Reset	Description
31-5	DESC_PTR	R/W-0	0	Descriptor pointer. It will be read as zero if the queue is empty. It will indicate a 32-bit aligned address that points to a descriptor when the queue is not empty.
4-0	DESC_SIZE	R/W-0	0	Descriptor Size. It is encoded in 4-byte increments with values 0 to 31 representing 24 and so on to 148 bytes. This field will return a 0x0 when an empty queue is read. Queue Manager Queue N Registers D To save hardware resources, the queue manager internally stores descriptor size (desc_size) information in four bits. However, register D has five LSBs that specify descriptor size. As a consequence, the value of desc_size that is pushed may not be same as that is read during a pop. The value that is read back is equal to always rounded to an odd number. So, for even values, the value read back is one more than what was written. For odd values, the value read back is same as the value that was written. Note that this 5-bit field (desc_size) is unrelated to the code for size of descriptors in a descriptor region. It is just a place holder for a 5-bit value that is maintained across the push and pop operations for every descriptor managed by the queue manager.

16.5.7.635 QUEUE_150_A Register (offset = 2960h) [reset = 0h]

QUEUE_150_A is shown in [Figure 16-911](#) and described in [Table 16-925](#).

Figure 16-911. QUEUE_150_A Register


LEGEND: R/W = Read/Write; R = Read only; W1toCl = Write 1 to clear bit; -n = value after reset

Table 16-925. QUEUE_150_A Register Field Descriptions

Bit	Field	Type	Reset	Description
13-0	QUEUE_ENTRY_COUNT	R-0	0	This field indicates how many packets are currently queued on the queue. This count is incremented by 1 whenever a packet is added to the queue. This count is decremented by 1 whenever a packet is popped from the queue.

16.5.7.636 QUEUE_150_B Register (offset = 2964h) [reset = 0h]

QUEUE_150_B is shown in [Figure 16-912](#) and described in [Table 16-926](#).

Figure 16-912. QUEUE_150_B Register


LEGEND: R/W = Read/Write; R = Read only; W1toCl = Write 1 to clear bit; -n = value after reset

Table 16-926. QUEUE_150_B Register Field Descriptions

Bit	Field	Type	Reset	Description
27-0	QUEUE_BYTE_COUNT	R-0	0	This field indicates how many bytes total are contained in all of the packets which are currently queued on this queue.

16.5.7.637 QUEUE_150_C Register (offset = 2968h) [reset = 0h]

 QUEUE_150_C is shown in [Figure 16-913](#) and described in [Table 16-927](#).

Figure 16-913. QUEUE_150_C Register


LEGEND: R/W = Read/Write; R = Read only; W1toCl = Write 1 to clear bit; -n = value after reset

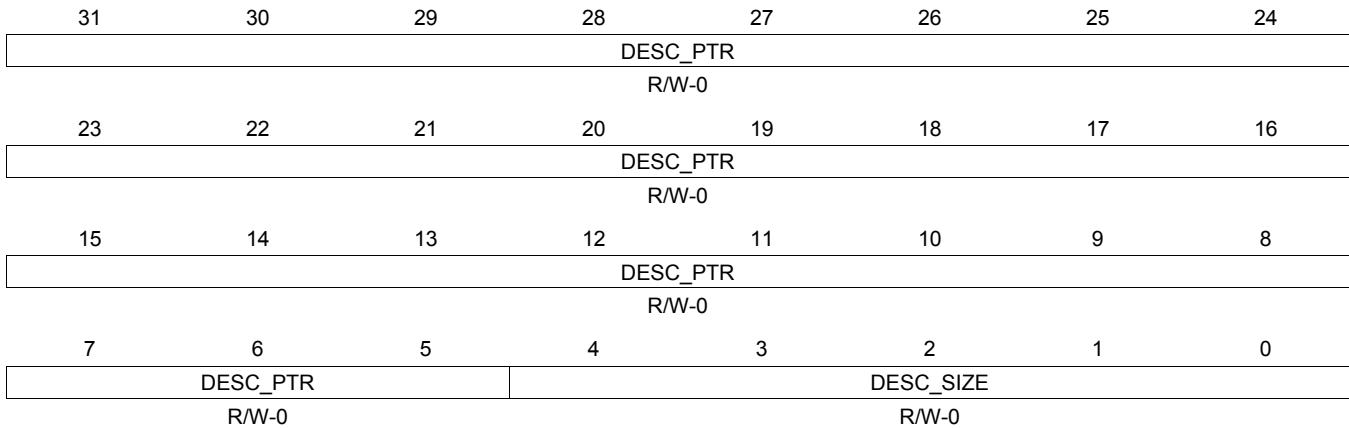
Table 16-927. QUEUE_150_C Register Field Descriptions

Bit	Field	Type	Reset	Description
31	HEAD_TAIL	W-0	0	Head/Tail Push Control. Set to zero in order to push packet onto tail of queue and set to one in order to push packet onto head of queue.
13-0	PACKET_SIZE	R/W-0	0	packet_size This field indicates packet size and is assumed to be zero on each packet add unless the value is explicitly overwritten. This field indicates packet size for packet pop operation.

16.5.7.638 QUEUE_150_D Register (offset = 296Ch) [reset = 0h]

QUEUE_150_D is shown in [Figure 16-914](#) and described in [Table 16-928](#).

Figure 16-914. QUEUE_150_D Register



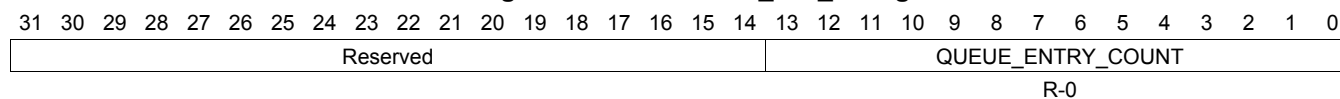
LEGEND: R/W = Read/Write; R = Read only; W1toCl = Write 1 to clear bit; -n = value after reset

Table 16-928. QUEUE_150_D Register Field Descriptions

Bit	Field	Type	Reset	Description
31-5	DESC_PTR	R/W-0	0	Descriptor pointer. It will be read as zero if the queue is empty. It will indicate a 32-bit aligned address that points to a descriptor when the queue is not empty.
4-0	DESC_SIZE	R/W-0	0	Descriptor Size. It is encoded in 4-byte increments with values 0 to 31 representing 24 and so on to 148 bytes. This field will return a 0x0 when an empty queue is read. Queue Manager Queue N Registers D To save hardware resources, the queue manager internally stores descriptor size (desc_size) information in four bits. However, register D has five LSBs that specify descriptor size. As a consequence, the value of desc_size that is pushed may not be same as that is read during a pop. The value that is read back is equal to always rounded to an odd number. So, for even values, the value read back is one more than what was written. For odd values, the value read back is same as the value that was written. Note that this 5-bit field (desc_size) is unrelated to the code for size of descriptors in a descriptor region. It is just a place holder for a 5-bit value that is maintained across the push and pop operations for every descriptor managed by the queue manager.

16.5.7.639 QUEUE_151_A Register (offset = 2970h) [reset = 0h]

QUEUE_151_A is shown in [Figure 16-915](#) and described in [Table 16-929](#).

Figure 16-915. QUEUE_151_A Register


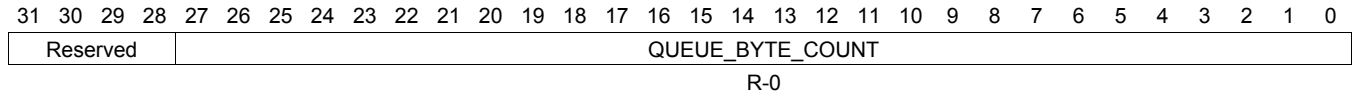
LEGEND: R/W = Read/Write; R = Read only; W1toCl = Write 1 to clear bit; -n = value after reset

Table 16-929. QUEUE_151_A Register Field Descriptions

Bit	Field	Type	Reset	Description
13-0	QUEUE_ENTRY_COUNT	R-0	0	This field indicates how many packets are currently queued on the queue. This count is incremented by 1 whenever a packet is added to the queue. This count is decremented by 1 whenever a packet is popped from the queue.

16.5.7.640 QUEUE_151_B Register (offset = 2974h) [reset = 0h]

 QUEUE_151_B is shown in [Figure 16-916](#) and described in [Table 16-930](#).

Figure 16-916. QUEUE_151_B Register


LEGEND: R/W = Read/Write; R = Read only; W1toCl = Write 1 to clear bit; -n = value after reset

Table 16-930. QUEUE_151_B Register Field Descriptions

Bit	Field	Type	Reset	Description
27-0	QUEUE_BYTE_COUNT	R-0	0	This field indicates how many bytes total are contained in all of the packets which are currently queued on this queue.

16.5.7.641 QUEUE_151_C Register (offset = 2978h) [reset = 0h]

 QUEUE_151_C is shown in [Figure 16-917](#) and described in [Table 16-931](#).

Figure 16-917. QUEUE_151_C Register


LEGEND: R/W = Read/Write; R = Read only; W1toCl = Write 1 to clear bit; -n = value after reset

Table 16-931. QUEUE_151_C Register Field Descriptions

Bit	Field	Type	Reset	Description
31	HEAD_TAIL	W-0	0	Head/Tail Push Control. Set to zero in order to push packet onto tail of queue and set to one in order to push packet onto head of queue.
13-0	PACKET_SIZE	R/W-0	0	packet_size This field indicates packet size and is assumed to be zero on each packet add unless the value is explicitly overwritten. This field indicates packet size for packet pop operation.

16.5.7.642 QUEUE_151_D Register (offset = 297Ch) [reset = 0h]

QUEUE_151_D is shown in [Figure 16-918](#) and described in [Table 16-932](#).

Figure 16-918. QUEUE_151_D Register



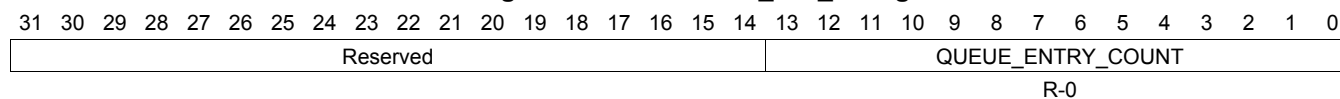
LEGEND: R/W = Read/Write; R = Read only; W1toCl = Write 1 to clear bit; -n = value after reset

Table 16-932. QUEUE_151_D Register Field Descriptions

Bit	Field	Type	Reset	Description
31-5	DESC_PTR	R/W-0	0	Descriptor pointer. It will be read as zero if the queue is empty. It will indicate a 32-bit aligned address that points to a descriptor when the queue is not empty.
4-0	DESC_SIZE	R/W-0	0	Descriptor Size. It is encoded in 4-byte increments with values 0 to 31 representing 24 and so on to 148 bytes. This field will return a 0x0 when an empty queue is read. Queue Manager Queue N Registers D To save hardware resources, the queue manager internally stores descriptor size (desc_size) information in four bits. However, register D has five LSBs that specify descriptor size. As a consequence, the value of desc_size that is pushed may not be same as that is read during a pop. The value that is read back is equal to always rounded to an odd number. So, for even values, the value read back is one more than what was written. For odd values, the value read back is same as the value that was written. Note that this 5-bit field (desc_size) is unrelated to the code for size of descriptors in a descriptor region. It is just a place holder for a 5-bit value that is maintained across the push and pop operations for every descriptor managed by the queue manager.

16.5.7.643 QUEUE_152_A Register (offset = 2980h) [reset = 0h]

QUEUE_152_A is shown in [Figure 16-919](#) and described in [Table 16-933](#).

Figure 16-919. QUEUE_152_A Register


LEGEND: R/W = Read/Write; R = Read only; W1toCl = Write 1 to clear bit; -n = value after reset

Table 16-933. QUEUE_152_A Register Field Descriptions

Bit	Field	Type	Reset	Description
13-0	QUEUE_ENTRY_COUNT	R-0	0	This field indicates how many packets are currently queued on the queue. This count is incremented by 1 whenever a packet is added to the queue. This count is decremented by 1 whenever a packet is popped from the queue.

16.5.7.644 QUEUE_152_B Register (offset = 2984h) [reset = 0h]

QUEUE_152_B is shown in [Figure 16-920](#) and described in [Table 16-934](#).

Figure 16-920. QUEUE_152_B Register


LEGEND: R/W = Read/Write; R = Read only; W1toCl = Write 1 to clear bit; -n = value after reset

Table 16-934. QUEUE_152_B Register Field Descriptions

Bit	Field	Type	Reset	Description
27-0	QUEUE_BYTE_COUNT	R-0	0	This field indicates how many bytes total are contained in all of the packets which are currently queued on this queue.

16.5.7.645 QUEUE_152_C Register (offset = 2988h) [reset = 0h]

 QUEUE_152_C is shown in [Figure 16-921](#) and described in [Table 16-935](#).

Figure 16-921. QUEUE_152_C Register


LEGEND: R/W = Read/Write; R = Read only; W1toCl = Write 1 to clear bit; -n = value after reset

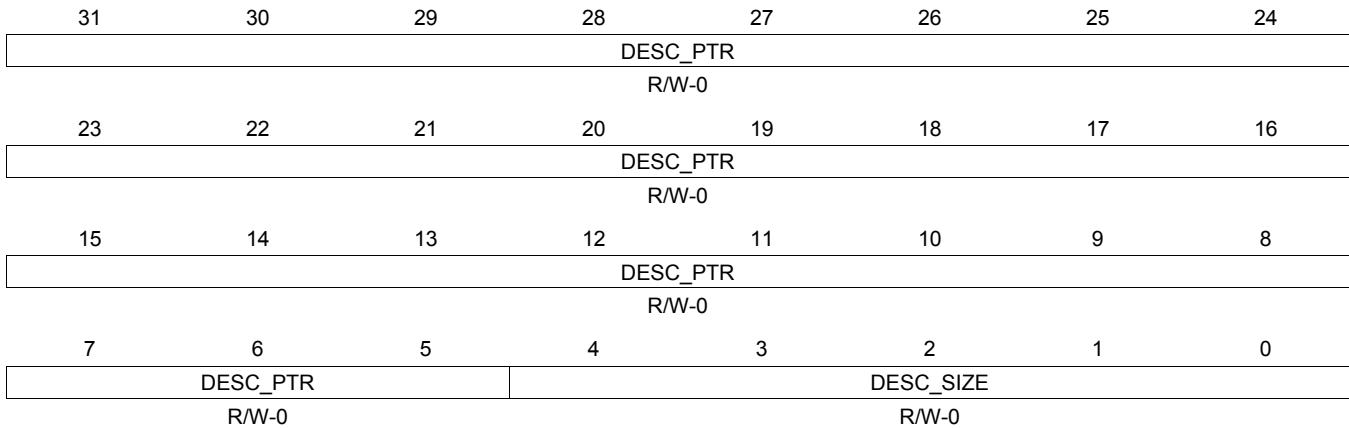
Table 16-935. QUEUE_152_C Register Field Descriptions

Bit	Field	Type	Reset	Description
31	HEAD_TAIL	W-0	0	Head/Tail Push Control. Set to zero in order to push packet onto tail of queue and set to one in order to push packet onto head of queue.
13-0	PACKET_SIZE	R/W-0	0	packet_size This field indicates packet size and is assumed to be zero on each packet add unless the value is explicitly overwritten. This field indicates packet size for packet pop operation.

16.5.7.646 QUEUE_152_D Register (offset = 298Ch) [reset = 0h]

QUEUE_152_D is shown in [Figure 16-922](#) and described in [Table 16-936](#).

Figure 16-922. QUEUE_152_D Register



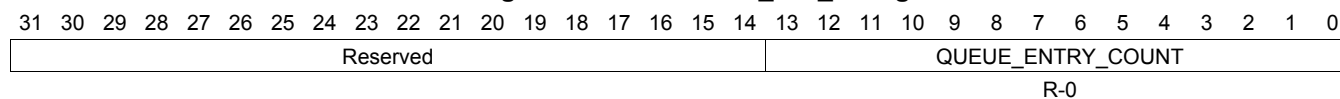
LEGEND: R/W = Read/Write; R = Read only; W1toCl = Write 1 to clear bit; -n = value after reset

Table 16-936. QUEUE_152_D Register Field Descriptions

Bit	Field	Type	Reset	Description
31-5	DESC_PTR	R/W-0	0	Descriptor pointer. It will be read as zero if the queue is empty. It will indicate a 32-bit aligned address that points to a descriptor when the queue is not empty.
4-0	DESC_SIZE	R/W-0	0	Descriptor Size. It is encoded in 4-byte increments with values 0 to 31 representing 24 and so on to 148 bytes. This field will return a 0x0 when an empty queue is read. Queue Manager Queue N Registers D To save hardware resources, the queue manager internally stores descriptor size (desc_size) information in four bits. However, register D has five LSBs that specify descriptor size. As a consequence, the value of desc_size that is pushed may not be same as that is read during a pop. The value that is read back is equal to always rounded to an odd number. So, for even values, the value read back is one more than what was written. For odd values, the value read back is same as the value that was written. Note that this 5-bit field (desc_size) is unrelated to the code for size of descriptors in a descriptor region. It is just a place holder for a 5-bit value that is maintained across the push and pop operations for every descriptor managed by the queue manager.

16.5.7.647 QUEUE_153_A Register (offset = 2990h) [reset = 0h]

QUEUE_153_A is shown in [Figure 16-923](#) and described in [Table 16-937](#).

Figure 16-923. QUEUE_153_A Register


LEGEND: R/W = Read/Write; R = Read only; W1toCl = Write 1 to clear bit; -n = value after reset

Table 16-937. QUEUE_153_A Register Field Descriptions

Bit	Field	Type	Reset	Description
13-0	QUEUE_ENTRY_COUNT	R-0	0	This field indicates how many packets are currently queued on the queue. This count is incremented by 1 whenever a packet is added to the queue. This count is decremented by 1 whenever a packet is popped from the queue.

16.5.7.648 QUEUE_153_B Register (offset = 2994h) [reset = 0h]

QUEUE_153_B is shown in [Figure 16-924](#) and described in [Table 16-938](#).

Figure 16-924. QUEUE_153_B Register

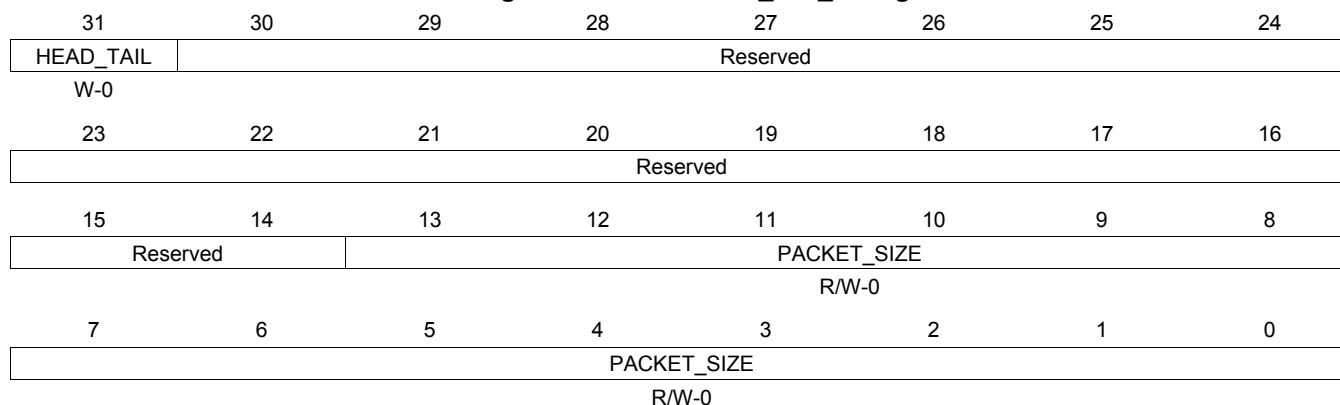

LEGEND: R/W = Read/Write; R = Read only; W1toCl = Write 1 to clear bit; -n = value after reset

Table 16-938. QUEUE_153_B Register Field Descriptions

Bit	Field	Type	Reset	Description
27-0	QUEUE_BYTE_COUNT	R-0	0	This field indicates how many bytes total are contained in all of the packets which are currently queued on this queue.

16.5.7.649 QUEUE_153_C Register (offset = 2998h) [reset = 0h]

 QUEUE_153_C is shown in [Figure 16-925](#) and described in [Table 16-939](#).

Figure 16-925. QUEUE_153_C Register


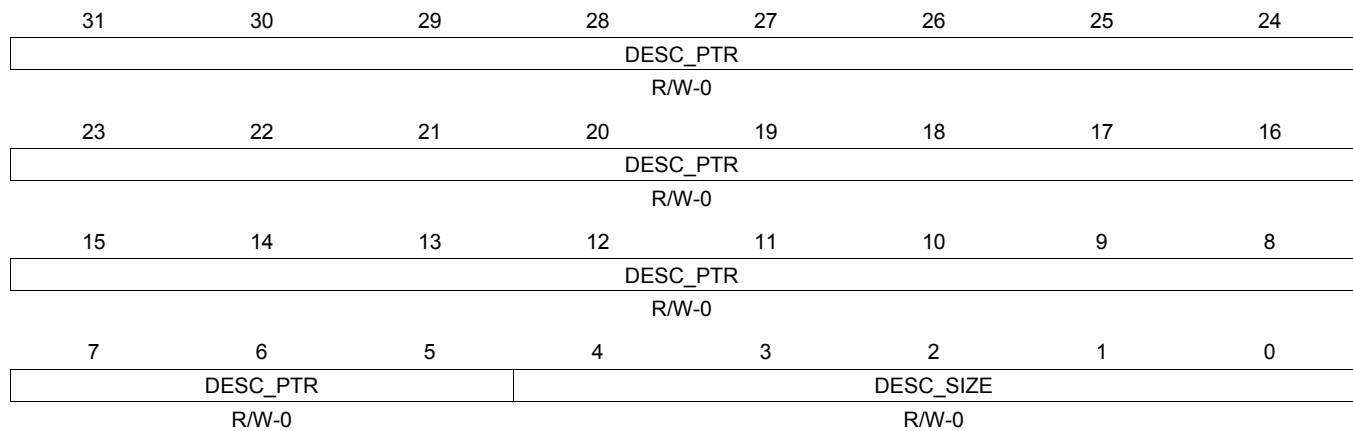
LEGEND: R/W = Read/Write; R = Read only; W1toCl = Write 1 to clear bit; -n = value after reset

Table 16-939. QUEUE_153_C Register Field Descriptions

Bit	Field	Type	Reset	Description
31	HEAD_TAIL	W-0	0	Head/Tail Push Control. Set to zero in order to push packet onto tail of queue and set to one in order to push packet onto head of queue.
13-0	PACKET_SIZE	R/W-0	0	packet_size This field indicates packet size and is assumed to be zero on each packet add unless the value is explicitly overwritten. This field indicates packet size for packet pop operation.

16.5.7.650 QUEUE_153_D Register (offset = 299Ch) [reset = 0h]

QUEUE_153_D is shown in [Figure 16-926](#) and described in [Table 16-940](#).

Figure 16-926. QUEUE_153_D Register


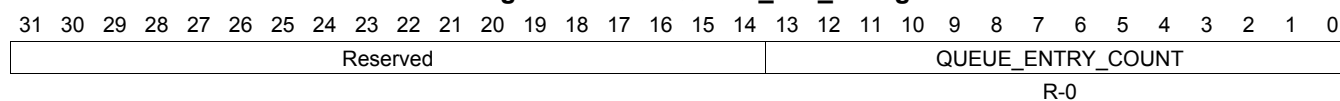
LEGEND: R/W = Read/Write; R = Read only; W1toCl = Write 1 to clear bit; -n = value after reset

Table 16-940. QUEUE_153_D Register Field Descriptions

Bit	Field	Type	Reset	Description
31-5	DESC_PTR	R/W-0	0	Descriptor pointer. It will be read as zero if the queue is empty. It will indicate a 32-bit aligned address that points to a descriptor when the queue is not empty.
4-0	DESC_SIZE	R/W-0	0	Descriptor Size. It is encoded in 4-byte increments with values 0 to 31 representing 24 and so on to 148 bytes. This field will return a 0x0 when an empty queue is read. Queue Manager Queue N Registers D To save hardware resources, the queue manager internally stores descriptor size (desc_size) information in four bits. However, register D has five LSBs that specify descriptor size. As a consequence, the value of desc_size that is pushed may not be same as that is read during a pop. The value that is read back is equal to always rounded to an odd number. So, for even values, the value read back is one more than what was written. For odd values, the value read back is same as the value that was written. Note that this 5-bit field (desc_size) is unrelated to the code for size of descriptors in a descriptor region. It is just a place holder for a 5-bit value that is maintained across the push and pop operations for every descriptor managed by the queue manager.

16.5.7.651 QUEUE_154_A Register (offset = 29A0h) [reset = 0h]

QUEUE_154_A is shown in [Figure 16-927](#) and described in [Table 16-941](#).

Figure 16-927. QUEUE_154_A Register


LEGEND: R/W = Read/Write; R = Read only; W1toCl = Write 1 to clear bit; -n = value after reset

Table 16-941. QUEUE_154_A Register Field Descriptions

Bit	Field	Type	Reset	Description
13-0	QUEUE_ENTRY_COUNT	R-0	0	This field indicates how many packets are currently queued on the queue. This count is incremented by 1 whenever a packet is added to the queue. This count is decremented by 1 whenever a packet is popped from the queue.

16.5.7.652 QUEUE_154_B Register (offset = 29A4h) [reset = 0h]

QUEUE_154_B is shown in [Figure 16-928](#) and described in [Table 16-942](#).

Figure 16-928. QUEUE_154_B Register


LEGEND: R/W = Read/Write; R = Read only; W1toCl = Write 1 to clear bit; -n = value after reset

Table 16-942. QUEUE_154_B Register Field Descriptions

Bit	Field	Type	Reset	Description
27-0	QUEUE_BYTE_COUNT	R-0	0	This field indicates how many bytes total are contained in all of the packets which are currently queued on this queue.

16.5.7.653 QUEUE_154_C Register (offset = 29A8h) [reset = 0h]

 QUEUE_154_C is shown in [Figure 16-929](#) and described in [Table 16-943](#).

Figure 16-929. QUEUE_154_C Register


LEGEND: R/W = Read/Write; R = Read only; W1toCl = Write 1 to clear bit; -n = value after reset

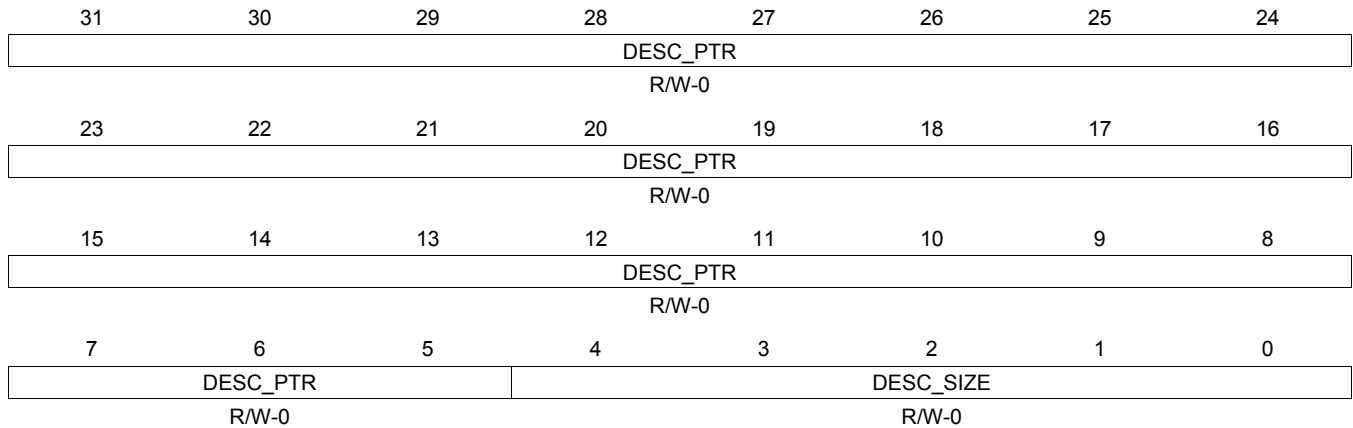
Table 16-943. QUEUE_154_C Register Field Descriptions

Bit	Field	Type	Reset	Description
31	HEAD_TAIL	W-0	0	Head/Tail Push Control. Set to zero in order to push packet onto tail of queue and set to one in order to push packet onto head of queue.
13-0	PACKET_SIZE	R/W-0	0	packet_size This field indicates packet size and is assumed to be zero on each packet add unless the value is explicitly overwritten. This field indicates packet size for packet pop operation.

16.5.7.654 QUEUE_154_D Register (offset = 29ACh) [reset = 0h]

QUEUE_154_D is shown in [Figure 16-930](#) and described in [Table 16-944](#).

Figure 16-930. QUEUE_154_D Register



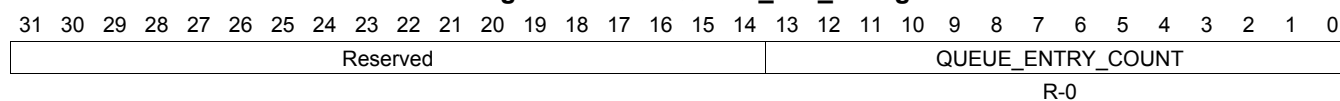
LEGEND: R/W = Read/Write; R = Read only; W1toCl = Write 1 to clear bit; -n = value after reset

Table 16-944. QUEUE_154_D Register Field Descriptions

Bit	Field	Type	Reset	Description
31-5	DESC_PTR	R/W-0	0	Descriptor pointer. It will be read as zero if the queue is empty. It will indicate a 32-bit aligned address that points to a descriptor when the queue is not empty.
4-0	DESC_SIZE	R/W-0	0	Descriptor Size. It is encoded in 4-byte increments with values 0 to 31 representing 24 and so on to 148 bytes. This field will return a 0x0 when an empty queue is read. Queue Manager Queue N Registers D To save hardware resources, the queue manager internally stores descriptor size (desc_size) information in four bits. However, register D has five LSBs that specify descriptor size. As a consequence, the value of desc_size that is pushed may not be same as that is read during a pop. The value that is read back is equal to always rounded to an odd number. So, for even values, the value read back is one more than what was written. For odd values, the value read back is same as the value that was written. Note that this 5-bit field (desc_size) is unrelated to the code for size of descriptors in a descriptor region. It is just a place holder for a 5-bit value that is maintained across the push and pop operations for every descriptor managed by the queue manager.

16.5.7.655 QUEUE_155_A Register (offset = 29B0h) [reset = 0h]

QUEUE_155_A is shown in [Figure 16-931](#) and described in [Table 16-945](#).

Figure 16-931. QUEUE_155_A Register


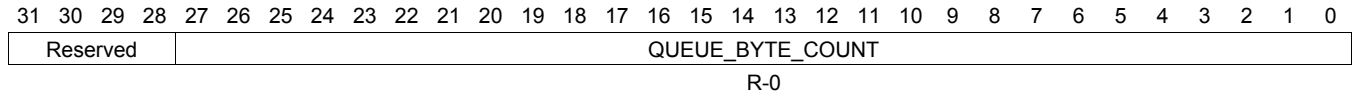
LEGEND: R/W = Read/Write; R = Read only; W1toCl = Write 1 to clear bit; -n = value after reset

Table 16-945. QUEUE_155_A Register Field Descriptions

Bit	Field	Type	Reset	Description
13-0	QUEUE_ENTRY_COUNT	R-0	0	This field indicates how many packets are currently queued on the queue. This count is incremented by 1 whenever a packet is added to the queue. This count is decremented by 1 whenever a packet is popped from the queue.

16.5.7.656 QUEUE_155_B Register (offset = 29B4h) [reset = 0h]

QUEUE_155_B is shown in [Figure 16-932](#) and described in [Table 16-946](#).

Figure 16-932. QUEUE_155_B Register


LEGEND: R/W = Read/Write; R = Read only; W1toCl = Write 1 to clear bit; -n = value after reset

Table 16-946. QUEUE_155_B Register Field Descriptions

Bit	Field	Type	Reset	Description
27-0	QUEUE_BYTE_COUNT	R-0	0	This field indicates how many bytes total are contained in all of the packets which are currently queued on this queue.

16.5.7.657 QUEUE_155_C Register (offset = 29B8h) [reset = 0h]

 QUEUE_155_C is shown in [Figure 16-933](#) and described in [Table 16-947](#).

Figure 16-933. QUEUE_155_C Register

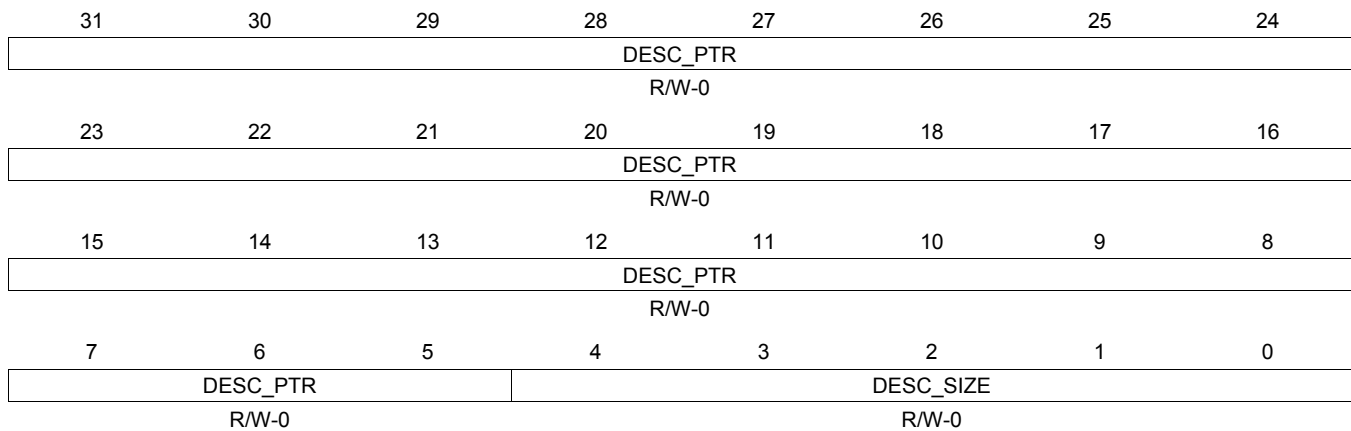

LEGEND: R/W = Read/Write; R = Read only; W1toCl = Write 1 to clear bit; -n = value after reset

Table 16-947. QUEUE_155_C Register Field Descriptions

Bit	Field	Type	Reset	Description
31	HEAD_TAIL	W-0	0	Head/Tail Push Control. Set to zero in order to push packet onto tail of queue and set to one in order to push packet onto head of queue.
13-0	PACKET_SIZE	R/W-0	0	packet_size This field indicates packet size and is assumed to be zero on each packet add unless the value is explicitly overwritten. This field indicates packet size for packet pop operation.

16.5.7.658 QUEUE_155_D Register (offset = 29BCh) [reset = 0h]

QUEUE_155_D is shown in [Figure 16-934](#) and described in [Table 16-948](#).

Figure 16-934. QUEUE_155_D Register


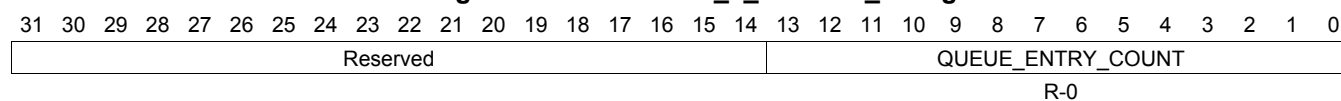
LEGEND: R/W = Read/Write; R = Read only; W1toCl = Write 1 to clear bit; -n = value after reset

Table 16-948. QUEUE_155_D Register Field Descriptions

Bit	Field	Type	Reset	Description
31-5	DESC_PTR	R/W-0	0	Descriptor pointer. It will be read as zero if the queue is empty. It will indicate a 32-bit aligned address that points to a descriptor when the queue is not empty.
4-0	DESC_SIZE	R/W-0	0	Descriptor Size. It is encoded in 4-byte increments with values 0 to 31 representing 24 and so on to 148 bytes. This field will return a 0x0 when an empty queue is read. Queue Manager Queue N Registers D To save hardware resources, the queue manager internally stores descriptor size (desc_size) information in four bits. However, register D has five LSBs that specify descriptor size. As a consequence, the value of desc_size that is pushed may not be same as that is read during a pop. The value that is read back is equal to always rounded to an odd number. So, for even values, the value read back is one more than what was written. For odd values, the value read back is same as the value that was written. Note that this 5-bit field (desc_size) is unrelated to the code for size of descriptors in a descriptor region. It is just a place holder for a 5-bit value that is maintained across the push and pop operations for every descriptor managed by the queue manager.

16.5.7.659 QUEUE_0_STATUS_A Register (offset = 3000h) [reset = 0h]

 QUEUE_0_STATUS_A is shown in [Figure 16-935](#) and described in [Table 16-949](#).

Figure 16-935. QUEUE_0_STATUS_A Register


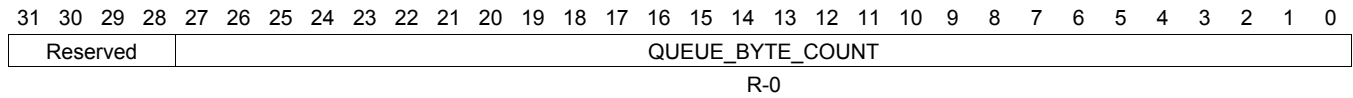
LEGEND: R/W = Read/Write; R = Read only; W1toCl = Write 1 to clear bit; -n = value after reset

Table 16-949. QUEUE_0_STATUS_A Register Field Descriptions

Bit	Field	Type	Reset	Description
13-0	QUEUE_ENTRY_COUNT	R-0	0	This field indicates how many packets are currently queued on the queue. Queue Manager Queue N Status Registers A

16.5.7.660 QUEUE_0_STATUS_B Register (offset = 3004h) [reset = 0h]

QUEUE_0_STATUS_B is shown in [Figure 16-936](#) and described in [Table 16-950](#).

Figure 16-936. QUEUE_0_STATUS_B Register


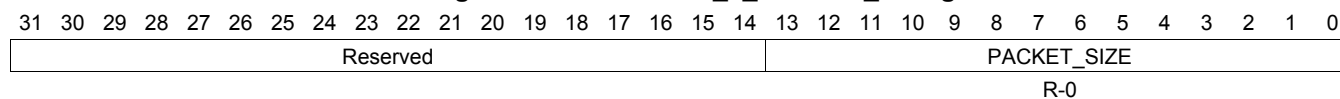
LEGEND: R/W = Read/Write; R = Read only; W1toCl = Write 1 to clear bit; -n = value after reset

Table 16-950. QUEUE_0_STATUS_B Register Field Descriptions

Bit	Field	Type	Reset	Description
27-0	QUEUE_BYTE_COUNT	R-0	0	This field indicates how many bytes total are contained in all of the packets which are currently queued on this queue. Queue_Manager_Queue_n_Status_B Registers B

16.5.7.661 QUEUE_0_STATUS_C Register (offset = 3008h) [reset = 0h]

QUEUE_0_STATUS_C is shown in [Figure 16-937](#) and described in [Table 16-951](#).

Figure 16-937. QUEUE_0_STATUS_C Register


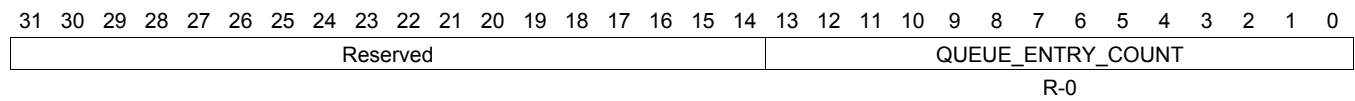
LEGEND: R/W = Read/Write; R = Read only; W1toCl = Write 1 to clear bit; -n = value after reset

Table 16-951. QUEUE_0_STATUS_C Register Field Descriptions

Bit	Field	Type	Reset	Description
13-0	PACKET_SIZE	R-0	0	This field indicates packet size of the head element of a queue. Queue_Manager_Queue_N_Status_C Registers C

16.5.7.662 QUEUE_1_STATUS_A Register (offset = 3010h) [reset = 0h]

 QUEUE_1_STATUS_A is shown in [Figure 16-938](#) and described in [Table 16-952](#).

Figure 16-938. QUEUE_1_STATUS_A Register


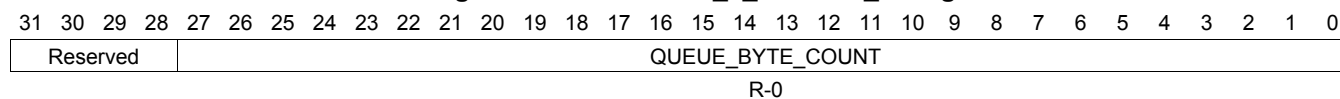
LEGEND: R/W = Read/Write; R = Read only; W1toCl = Write 1 to clear bit; -n = value after reset

Table 16-952. QUEUE_1_STATUS_A Register Field Descriptions

Bit	Field	Type	Reset	Description
13-0	QUEUE_ENTRY_COUNT	R-0	0	This field indicates how many packets are currently queued on the queue. Queue Manager Queue N Status Registers A

16.5.7.663 QUEUE_1_STATUS_B Register (offset = 3014h) [reset = 0h]

QUEUE_1_STATUS_B is shown in [Figure 16-939](#) and described in [Table 16-953](#).

Figure 16-939. QUEUE_1_STATUS_B Register


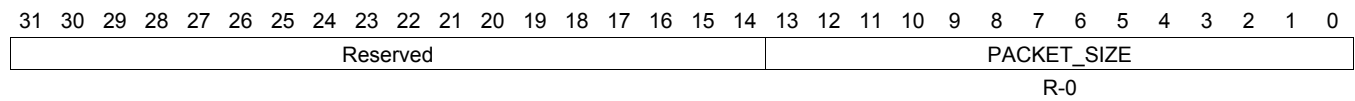
LEGEND: R/W = Read/Write; R = Read only; W1toCl = Write 1 to clear bit; -n = value after reset

Table 16-953. QUEUE_1_STATUS_B Register Field Descriptions

Bit	Field	Type	Reset	Description
27-0	QUEUE_BYTE_COUNT	R-0	0	This field indicates how many bytes total are contained in all of the packets which are currently queued on this queue. Queue_Manager_Queue_n_Status_B Registers B

16.5.7.664 QUEUE_1_STATUS_C Register (offset = 3018h) [reset = 0h]

QUEUE_1_STATUS_C is shown in [Figure 16-940](#) and described in [Table 16-954](#).

Figure 16-940. QUEUE_1_STATUS_C Register


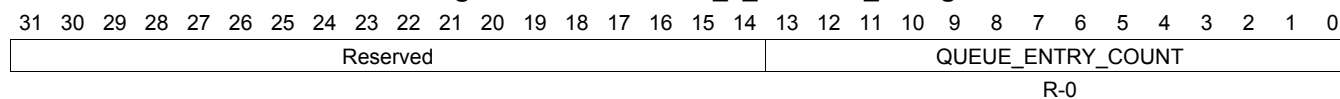
LEGEND: R/W = Read/Write; R = Read only; W1toCl = Write 1 to clear bit; -n = value after reset

Table 16-954. QUEUE_1_STATUS_C Register Field Descriptions

Bit	Field	Type	Reset	Description
13-0	PACKET_SIZE	R-0	0	This field indicates packet size of the head element of a queue. Queue_Manager_Queue_N_Status_C Registers C

16.5.7.665 QUEUE_2_STATUS_A Register (offset = 3020h) [reset = 0h]

 QUEUE_2_STATUS_A is shown in [Figure 16-941](#) and described in [Table 16-955](#).

Figure 16-941. QUEUE_2_STATUS_A Register


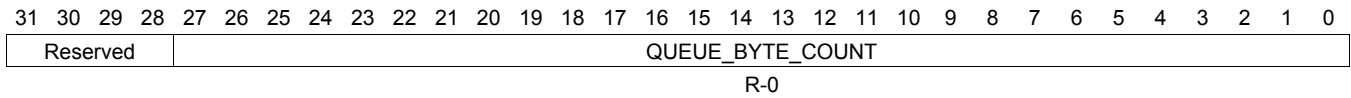
LEGEND: R/W = Read/Write; R = Read only; W1toCl = Write 1 to clear bit; -n = value after reset

Table 16-955. QUEUE_2_STATUS_A Register Field Descriptions

Bit	Field	Type	Reset	Description
13-0	QUEUE_ENTRY_COUNT	R-0	0	This field indicates how many packets are currently queued on the queue. Queue Manager Queue N Status Registers A

16.5.7.666 QUEUE_2_STATUS_B Register (offset = 3024h) [reset = 0h]

QUEUE_2_STATUS_B is shown in [Figure 16-942](#) and described in [Table 16-956](#).

Figure 16-942. QUEUE_2_STATUS_B Register


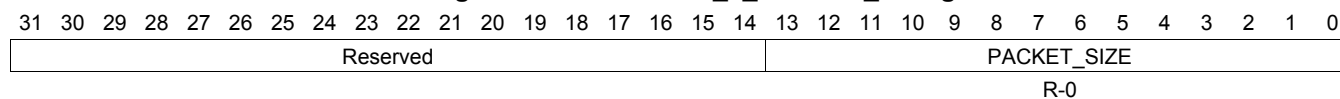
LEGEND: R/W = Read/Write; R = Read only; W1toCl = Write 1 to clear bit; -n = value after reset

Table 16-956. QUEUE_2_STATUS_B Register Field Descriptions

Bit	Field	Type	Reset	Description
27-0	QUEUE_BYTE_COUNT	R-0	0	This field indicates how many bytes total are contained in all of the packets which are currently queued on this queue. Queue_Manager_Queue_n_Status_B Registers B

16.5.7.667 QUEUE_2_STATUS_C Register (offset = 3028h) [reset = 0h]

QUEUE_2_STATUS_C is shown in [Figure 16-943](#) and described in [Table 16-957](#).

Figure 16-943. QUEUE_2_STATUS_C Register


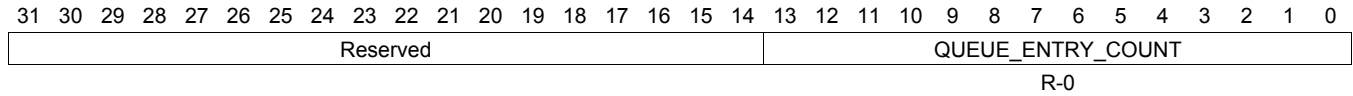
LEGEND: R/W = Read/Write; R = Read only; W1toCl = Write 1 to clear bit; -n = value after reset

Table 16-957. QUEUE_2_STATUS_C Register Field Descriptions

Bit	Field	Type	Reset	Description
13-0	PACKET_SIZE	R-0	0	This field indicates packet size of the head element of a queue. Queue_Manager_Queue_N_Status_C Registers C

16.5.7.668 QUEUE_3_STATUS_A Register (offset = 3030h) [reset = 0h]

 QUEUE_3_STATUS_A is shown in [Figure 16-944](#) and described in [Table 16-958](#).

Figure 16-944. QUEUE_3_STATUS_A Register


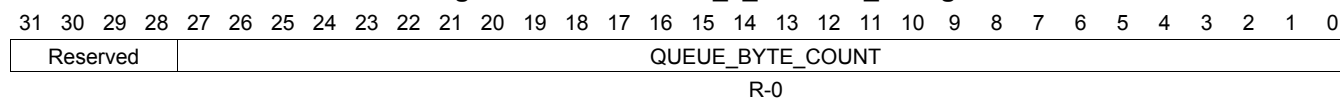
LEGEND: R/W = Read/Write; R = Read only; W1toCl = Write 1 to clear bit; -n = value after reset

Table 16-958. QUEUE_3_STATUS_A Register Field Descriptions

Bit	Field	Type	Reset	Description
13-0	QUEUE_ENTRY_COUNT	R-0	0	This field indicates how many packets are currently queued on the queue. Queue Manager Queue N Status Registers A

16.5.7.669 QUEUE_3_STATUS_B Register (offset = 3034h) [reset = 0h]

 QUEUE_3_STATUS_B is shown in [Figure 16-945](#) and described in [Table 16-959](#).

Figure 16-945. QUEUE_3_STATUS_B Register


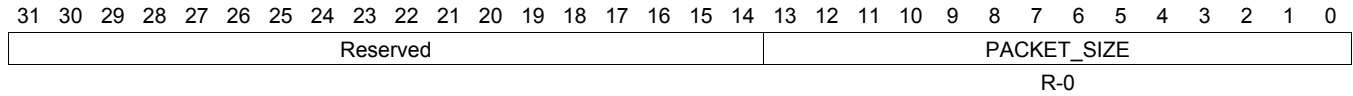
LEGEND: R/W = Read/Write; R = Read only; W1toCl = Write 1 to clear bit; -n = value after reset

Table 16-959. QUEUE_3_STATUS_B Register Field Descriptions

Bit	Field	Type	Reset	Description
27-0	QUEUE_BYTE_COUNT	R-0	0	This field indicates how many bytes total are contained in all of the packets which are currently queued on this queue. Queue_Manager_Queue_n_Status_B Registers B

16.5.7.670 QUEUE_3_STATUS_C Register (offset = 3038h) [reset = 0h]

 QUEUE_3_STATUS_C is shown in [Figure 16-946](#) and described in [Table 16-960](#).

Figure 16-946. QUEUE_3_STATUS_C Register


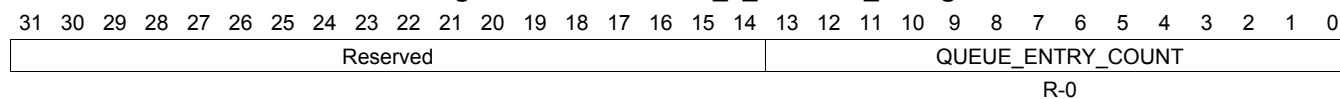
LEGEND: R/W = Read/Write; R = Read only; W1toCl = Write 1 to clear bit; -n = value after reset

Table 16-960. QUEUE_3_STATUS_C Register Field Descriptions

Bit	Field	Type	Reset	Description
13-0	PACKET_SIZE	R-0	0	This field indicates packet size of the head element of a queue. Queue_Manager_Queue_N_Status_C Registers C

16.5.7.671 QUEUE_4_STATUS_A Register (offset = 3040h) [reset = 0h]

QUEUE_4_STATUS_A is shown in [Figure 16-947](#) and described in [Table 16-961](#).

Figure 16-947. QUEUE_4_STATUS_A Register


LEGEND: R/W = Read/Write; R = Read only; W1toCl = Write 1 to clear bit; -n = value after reset

Table 16-961. QUEUE_4_STATUS_A Register Field Descriptions

Bit	Field	Type	Reset	Description
13-0	QUEUE_ENTRY_COUNT	R-0	0	This field indicates how many packets are currently queued on the queue. Queue Manager Queue N Status Registers A

16.5.7.672 QUEUE_4_STATUS_B Register (offset = 3044h) [reset = 0h]

QUEUE_4_STATUS_B is shown in [Figure 16-948](#) and described in [Table 16-962](#).

Figure 16-948. QUEUE_4_STATUS_B Register

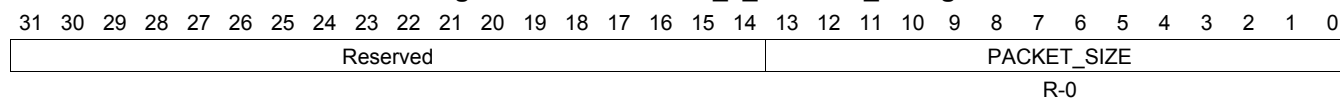

LEGEND: R/W = Read/Write; R = Read only; W1toCl = Write 1 to clear bit; -n = value after reset

Table 16-962. QUEUE_4_STATUS_B Register Field Descriptions

Bit	Field	Type	Reset	Description
27-0	QUEUE_BYTE_COUNT	R-0	0	This field indicates how many bytes total are contained in all of the packets which are currently queued on this queue. Queue_Manager_Queue_n_Status_B Registers B

16.5.7.673 QUEUE_4_STATUS_C Register (offset = 3048h) [reset = 0h]

QUEUE_4_STATUS_C is shown in [Figure 16-949](#) and described in [Table 16-963](#).

Figure 16-949. QUEUE_4_STATUS_C Register


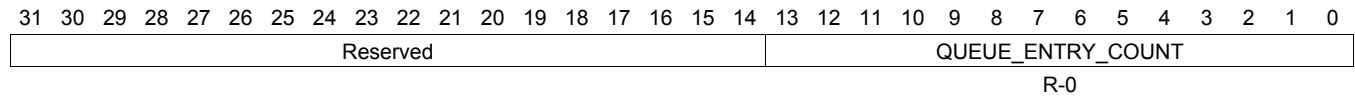
LEGEND: R/W = Read/Write; R = Read only; W1toCl = Write 1 to clear bit; -n = value after reset

Table 16-963. QUEUE_4_STATUS_C Register Field Descriptions

Bit	Field	Type	Reset	Description
13-0	PACKET_SIZE	R-0	0	This field indicates packet size of the head element of a queue. Queue_Manager_Queue_N_Status_C Registers C

16.5.7.674 QUEUE_5_STATUS_A Register (offset = 3050h) [reset = 0h]

 QUEUE_5_STATUS_A is shown in [Figure 16-950](#) and described in [Table 16-964](#).

Figure 16-950. QUEUE_5_STATUS_A Register


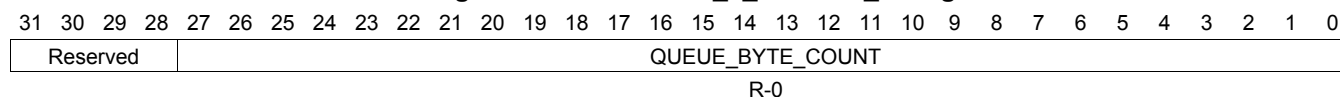
LEGEND: R/W = Read/Write; R = Read only; W1toCl = Write 1 to clear bit; -n = value after reset

Table 16-964. QUEUE_5_STATUS_A Register Field Descriptions

Bit	Field	Type	Reset	Description
13-0	QUEUE_ENTRY_COUNT	R-0	0	This field indicates how many packets are currently queued on the queue. Queue Manager Queue N Status Registers A

16.5.7.675 QUEUE_5_STATUS_B Register (offset = 3054h) [reset = 0h]

QUEUE_5_STATUS_B is shown in [Figure 16-951](#) and described in [Table 16-965](#).

Figure 16-951. QUEUE_5_STATUS_B Register


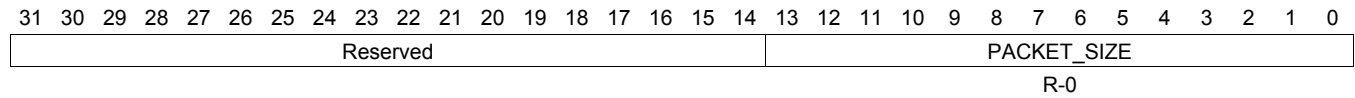
LEGEND: R/W = Read/Write; R = Read only; W1toCl = Write 1 to clear bit; -n = value after reset

Table 16-965. QUEUE_5_STATUS_B Register Field Descriptions

Bit	Field	Type	Reset	Description
27-0	QUEUE_BYTE_COUNT	R-0	0	This field indicates how many bytes total are contained in all of the packets which are currently queued on this queue. Queue_Manager_Queue_n_Status_B Registers B

16.5.7.676 QUEUE_5_STATUS_C Register (offset = 3058h) [reset = 0h]

 QUEUE_5_STATUS_C is shown in [Figure 16-952](#) and described in [Table 16-966](#).

Figure 16-952. QUEUE_5_STATUS_C Register


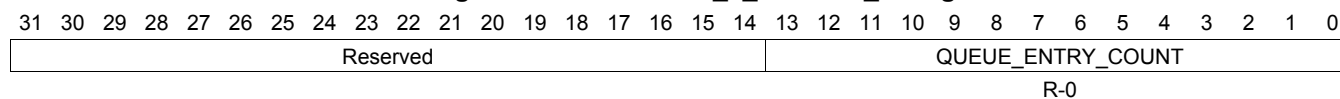
LEGEND: R/W = Read/Write; R = Read only; W1toCl = Write 1 to clear bit; -n = value after reset

Table 16-966. QUEUE_5_STATUS_C Register Field Descriptions

Bit	Field	Type	Reset	Description
13-0	PACKET_SIZE	R-0	0	This field indicates packet size of the head element of a queue. Queue_Manager_Queue_N_Status_C Registers C

16.5.7.677 QUEUE_6_STATUS_A Register (offset = 3060h) [reset = 0h]

QUEUE_6_STATUS_A is shown in [Figure 16-953](#) and described in [Table 16-967](#).

Figure 16-953. QUEUE_6_STATUS_A Register


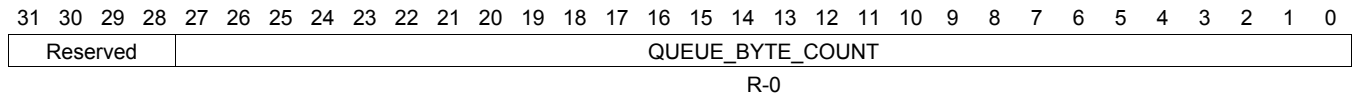
LEGEND: R/W = Read/Write; R = Read only; W1toCl = Write 1 to clear bit; -n = value after reset

Table 16-967. QUEUE_6_STATUS_A Register Field Descriptions

Bit	Field	Type	Reset	Description
13-0	QUEUE_ENTRY_COUNT	R-0	0	This field indicates how many packets are currently queued on the queue. Queue Manager Queue N Status Registers A

16.5.7.678 QUEUE_6_STATUS_B Register (offset = 3064h) [reset = 0h]

 QUEUE_6_STATUS_B is shown in [Figure 16-954](#) and described in [Table 16-968](#).

Figure 16-954. QUEUE_6_STATUS_B Register


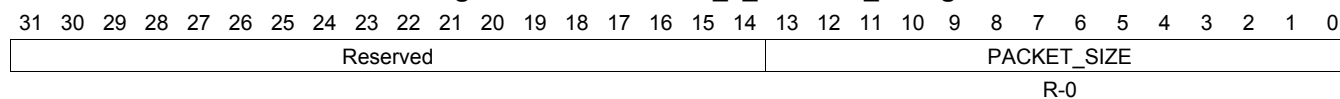
LEGEND: R/W = Read/Write; R = Read only; W1toCl = Write 1 to clear bit; -n = value after reset

Table 16-968. QUEUE_6_STATUS_B Register Field Descriptions

Bit	Field	Type	Reset	Description
27-0	QUEUE_BYTE_COUNT	R-0	0	This field indicates how many bytes total are contained in all of the packets which are currently queued on this queue. Queue_Manager_Queue_n_Status_B Registers B

16.5.7.679 QUEUE_6_STATUS_C Register (offset = 3068h) [reset = 0h]

QUEUE_6_STATUS_C is shown in [Figure 16-955](#) and described in [Table 16-969](#).

Figure 16-955. QUEUE_6_STATUS_C Register


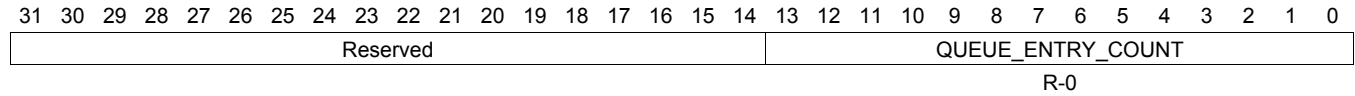
LEGEND: R/W = Read/Write; R = Read only; W1toCl = Write 1 to clear bit; -n = value after reset

Table 16-969. QUEUE_6_STATUS_C Register Field Descriptions

Bit	Field	Type	Reset	Description
13-0	PACKET_SIZE	R-0	0	This field indicates packet size of the head element of a queue. Queue_Manager_Queue_N_Status_C Registers C

16.5.7.680 QUEUE_7_STATUS_A Register (offset = 3070h) [reset = 0h]

 QUEUE_7_STATUS_A is shown in [Figure 16-956](#) and described in [Table 16-970](#).

Figure 16-956. QUEUE_7_STATUS_A Register


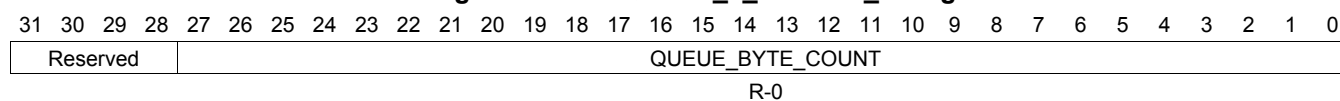
LEGEND: R/W = Read/Write; R = Read only; W1toCl = Write 1 to clear bit; -n = value after reset

Table 16-970. QUEUE_7_STATUS_A Register Field Descriptions

Bit	Field	Type	Reset	Description
13-0	QUEUE_ENTRY_COUNT	R-0	0	This field indicates how many packets are currently queued on the queue. Queue Manager Queue N Status Registers A

16.5.7.681 QUEUE_7_STATUS_B Register (offset = 3074h) [reset = 0h]

QUEUE_7_STATUS_B is shown in [Figure 16-957](#) and described in [Table 16-971](#).

Figure 16-957. QUEUE_7_STATUS_B Register


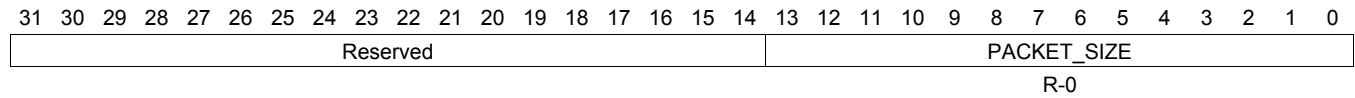
LEGEND: R/W = Read/Write; R = Read only; W1toCl = Write 1 to clear bit; -n = value after reset

Table 16-971. QUEUE_7_STATUS_B Register Field Descriptions

Bit	Field	Type	Reset	Description
27-0	QUEUE_BYTE_COUNT	R-0	0	This field indicates how many bytes total are contained in all of the packets which are currently queued on this queue. Queue_Manager_Queue_n_Status_B Registers B

16.5.7.682 QUEUE_7_STATUS_C Register (offset = 3078h) [reset = 0h]

QUEUE_7_STATUS_C is shown in [Figure 16-958](#) and described in [Table 16-972](#).

Figure 16-958. QUEUE_7_STATUS_C Register


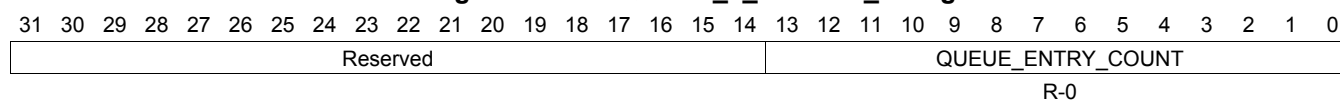
LEGEND: R/W = Read/Write; R = Read only; W1toCl = Write 1 to clear bit; -n = value after reset

Table 16-972. QUEUE_7_STATUS_C Register Field Descriptions

Bit	Field	Type	Reset	Description
13-0	PACKET_SIZE	R-0	0	This field indicates packet size of the head element of a queue. Queue_Manager_Queue_N_Status_C Registers C

16.5.7.683 QUEUE_8_STATUS_A Register (offset = 3080h) [reset = 0h]

QUEUE_8_STATUS_A is shown in [Figure 16-959](#) and described in [Table 16-973](#).

Figure 16-959. QUEUE_8_STATUS_A Register


LEGEND: R/W = Read/Write; R = Read only; W1toCl = Write 1 to clear bit; -n = value after reset

Table 16-973. QUEUE_8_STATUS_A Register Field Descriptions

Bit	Field	Type	Reset	Description
13-0	QUEUE_ENTRY_COUNT	R-0	0	This field indicates how many packets are currently queued on the queue. Queue Manager Queue N Status Registers A

16.5.7.684 QUEUE_8_STATUS_B Register (offset = 3084h) [reset = 0h]

 QUEUE_8_STATUS_B is shown in [Figure 16-960](#) and described in [Table 16-974](#).

Figure 16-960. QUEUE_8_STATUS_B Register

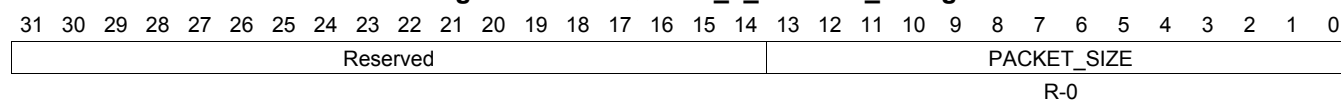

LEGEND: R/W = Read/Write; R = Read only; W1toCl = Write 1 to clear bit; -n = value after reset

Table 16-974. QUEUE_8_STATUS_B Register Field Descriptions

Bit	Field	Type	Reset	Description
27-0	QUEUE_BYTE_COUNT	R-0	0	This field indicates how many bytes total are contained in all of the packets which are currently queued on this queue. Queue_Manager_Queue_n_Status_B Registers B

16.5.7.685 QUEUE_8_STATUS_C Register (offset = 3088h) [reset = 0h]

 QUEUE_8_STATUS_C is shown in [Figure 16-961](#) and described in [Table 16-975](#).

Figure 16-961. QUEUE_8_STATUS_C Register


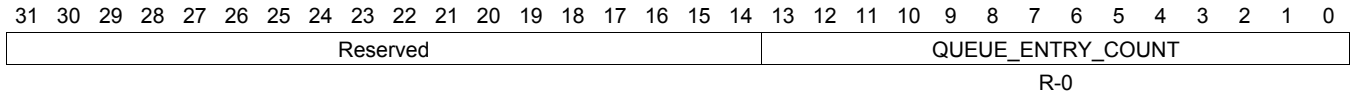
LEGEND: R/W = Read/Write; R = Read only; W1toCl = Write 1 to clear bit; -n = value after reset

Table 16-975. QUEUE_8_STATUS_C Register Field Descriptions

Bit	Field	Type	Reset	Description
13-0	PACKET_SIZE	R-0	0	This field indicates packet size of the head element of a queue. Queue_Manager_Queue_N_Status_C Registers C

16.5.7.686 QUEUE_9_STATUS_A Register (offset = 3090h) [reset = 0h]

 QUEUE_9_STATUS_A is shown in [Figure 16-962](#) and described in [Table 16-976](#).

Figure 16-962. QUEUE_9_STATUS_A Register


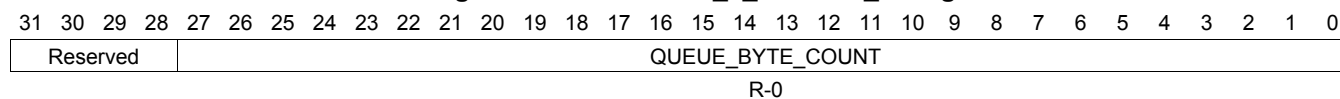
LEGEND: R/W = Read/Write; R = Read only; W1toCl = Write 1 to clear bit; -n = value after reset

Table 16-976. QUEUE_9_STATUS_A Register Field Descriptions

Bit	Field	Type	Reset	Description
13-0	QUEUE_ENTRY_COUNT	R-0	0	This field indicates how many packets are currently queued on the queue. Queue Manager Queue N Status Registers A

16.5.7.687 QUEUE_9_STATUS_B Register (offset = 3094h) [reset = 0h]

 QUEUE_9_STATUS_B is shown in [Figure 16-963](#) and described in [Table 16-977](#).

Figure 16-963. QUEUE_9_STATUS_B Register


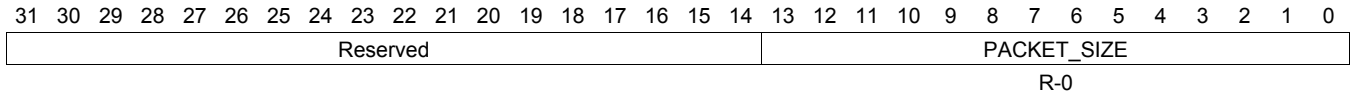
LEGEND: R/W = Read/Write; R = Read only; W1toCl = Write 1 to clear bit; -n = value after reset

Table 16-977. QUEUE_9_STATUS_B Register Field Descriptions

Bit	Field	Type	Reset	Description
27-0	QUEUE_BYTE_COUNT	R-0	0	This field indicates how many bytes total are contained in all of the packets which are currently queued on this queue. Queue_Manager_Queue_n_Status_B Registers B

16.5.7.688 QUEUE_9_STATUS_C Register (offset = 3098h) [reset = 0h]

 QUEUE_9_STATUS_C is shown in [Figure 16-964](#) and described in [Table 16-978](#).

Figure 16-964. QUEUE_9_STATUS_C Register


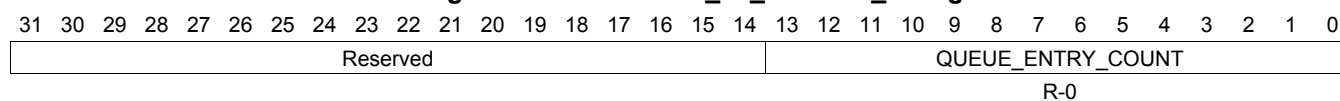
LEGEND: R/W = Read/Write; R = Read only; W1toCl = Write 1 to clear bit; -n = value after reset

Table 16-978. QUEUE_9_STATUS_C Register Field Descriptions

Bit	Field	Type	Reset	Description
13-0	PACKET_SIZE	R-0	0	This field indicates packet size of the head element of a queue. Queue_Manager_Queue_N_Status_C Registers C

16.5.7.689 QUEUE_10_STATUS_A Register (offset = 30A0h) [reset = 0h]

QUEUE_10_STATUS_A is shown in [Figure 16-965](#) and described in [Table 16-979](#).

Figure 16-965. QUEUE_10_STATUS_A Register


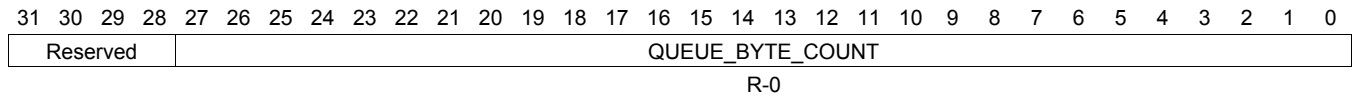
LEGEND: R/W = Read/Write; R = Read only; W1toCl = Write 1 to clear bit; -n = value after reset

Table 16-979. QUEUE_10_STATUS_A Register Field Descriptions

Bit	Field	Type	Reset	Description
13-0	QUEUE_ENTRY_COUNT	R-0	0	This field indicates how many packets are currently queued on the queue. Queue Manager Queue N Status Registers A

16.5.7.690 QUEUE_10_STATUS_B Register (offset = 30A4h) [reset = 0h]

QUEUE_10_STATUS_B is shown in [Figure 16-966](#) and described in [Table 16-980](#).

Figure 16-966. QUEUE_10_STATUS_B Register


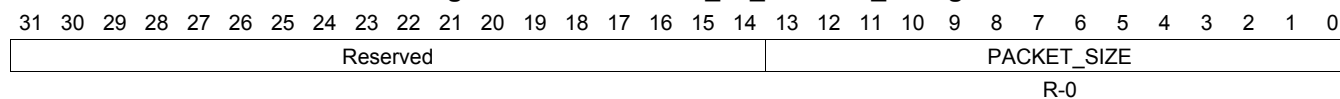
LEGEND: R/W = Read/Write; R = Read only; W1toCl = Write 1 to clear bit; -n = value after reset

Table 16-980. QUEUE_10_STATUS_B Register Field Descriptions

Bit	Field	Type	Reset	Description
27-0	QUEUE_BYTE_COUNT	R-0	0	This field indicates how many bytes total are contained in all of the packets which are currently queued on this queue. Queue_Manager_Queue_n_Status_B Registers B

16.5.7.691 QUEUE_10_STATUS_C Register (offset = 30A8h) [reset = 0h]

QUEUE_10_STATUS_C is shown in [Figure 16-967](#) and described in [Table 16-981](#).

Figure 16-967. QUEUE_10_STATUS_C Register


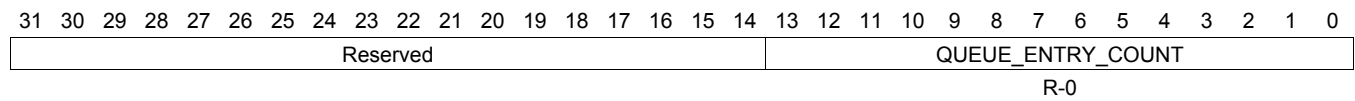
LEGEND: R/W = Read/Write; R = Read only; W1toCl = Write 1 to clear bit; -n = value after reset

Table 16-981. QUEUE_10_STATUS_C Register Field Descriptions

Bit	Field	Type	Reset	Description
13-0	PACKET_SIZE	R-0	0	This field indicates packet size of the head element of a queue. Queue_Manager_Queue_N_Status_C Registers C

16.5.7.692 QUEUE_11_STATUS_A Register (offset = 30B0h) [reset = 0h]

 QUEUE_11_STATUS_A is shown in [Figure 16-968](#) and described in [Table 16-982](#).

Figure 16-968. QUEUE_11_STATUS_A Register


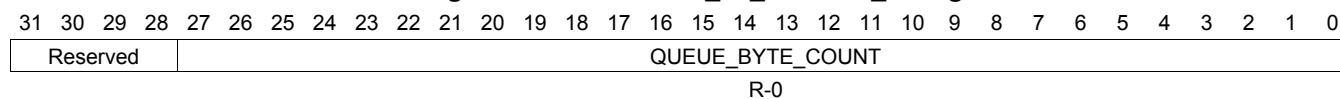
LEGEND: R/W = Read/Write; R = Read only; W1toCl = Write 1 to clear bit; -n = value after reset

Table 16-982. QUEUE_11_STATUS_A Register Field Descriptions

Bit	Field	Type	Reset	Description
13-0	QUEUE_ENTRY_COUNT	R-0	0	This field indicates how many packets are currently queued on the queue. Queue Manager Queue N Status Registers A

16.5.7.693 QUEUE_11_STATUS_B Register (offset = 30B4h) [reset = 0h]

QUEUE_11_STATUS_B is shown in [Figure 16-969](#) and described in [Table 16-983](#).

Figure 16-969. QUEUE_11_STATUS_B Register


LEGEND: R/W = Read/Write; R = Read only; W1toCl = Write 1 to clear bit; -n = value after reset

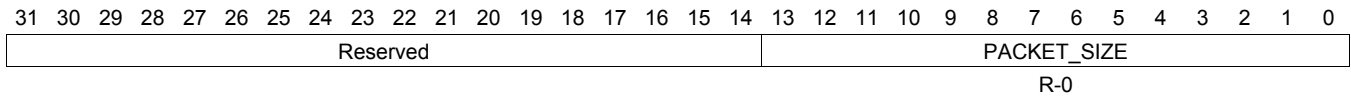
Table 16-983. QUEUE_11_STATUS_B Register Field Descriptions

Bit	Field	Type	Reset	Description
27-0	QUEUE_BYTE_COUNT	R-0	0	This field indicates how many bytes total are contained in all of the packets which are currently queued on this queue. Queue_Manager_Queue_n_Status_B Registers B

16.5.7.694 QUEUE_11_STATUS_C Register (offset = 30B8h) [reset = 0h]

QUEUE_11_STATUS_C is shown in [Figure 16-970](#) and described in [Table 16-984](#).

Figure 16-970. QUEUE_11_STATUS_C Register



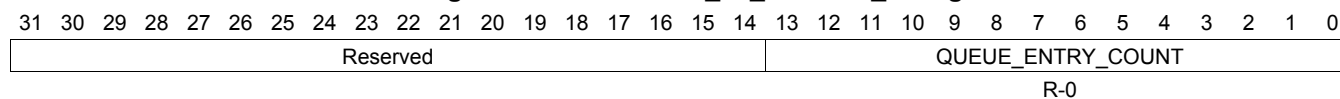
LEGEND: R/W = Read/Write; R = Read only; W1toCl = Write 1 to clear bit; -n = value after reset

Table 16-984. QUEUE_11_STATUS_C Register Field Descriptions

Bit	Field	Type	Reset	Description
13-0	PACKET_SIZE	R-0	0	This field indicates packet size of the head element of a queue. Queue_Manager_Queue_N_Status_C Registers C

16.5.7.695 QUEUE_12_STATUS_A Register (offset = 30C0h) [reset = 0h]

QUEUE_12_STATUS_A is shown in [Figure 16-971](#) and described in [Table 16-985](#).

Figure 16-971. QUEUE_12_STATUS_A Register


LEGEND: R/W = Read/Write; R = Read only; W1toCl = Write 1 to clear bit; -n = value after reset

Table 16-985. QUEUE_12_STATUS_A Register Field Descriptions

Bit	Field	Type	Reset	Description
13-0	QUEUE_ENTRY_COUNT	R-0	0	This field indicates how many packets are currently queued on the queue. Queue Manager Queue N Status Registers A

16.5.7.696 QUEUE_12_STATUS_B Register (offset = 30C4h) [reset = 0h]

QUEUE_12_STATUS_B is shown in [Figure 16-972](#) and described in [Table 16-986](#).

Figure 16-972. QUEUE_12_STATUS_B Register



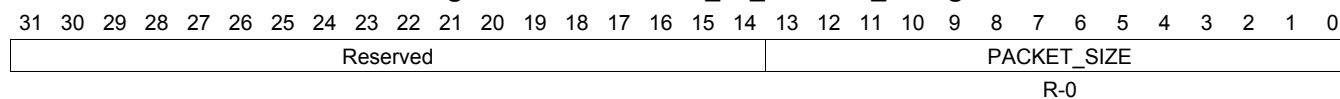
LEGEND: R/W = Read/Write; R = Read only; W1toCl = Write 1 to clear bit; -n = value after reset

Table 16-986. QUEUE_12_STATUS_B Register Field Descriptions

Bit	Field	Type	Reset	Description
27-0	QUEUE_BYTE_COUNT	R-0	0	This field indicates how many bytes total are contained in all of the packets which are currently queued on this queue. Queue_Manager_Queue_n_Status_B Registers B

16.5.7.697 QUEUE_12_STATUS_C Register (offset = 30C8h) [reset = 0h]

QUEUE_12_STATUS_C is shown in [Figure 16-973](#) and described in [Table 16-987](#).

Figure 16-973. QUEUE_12_STATUS_C Register


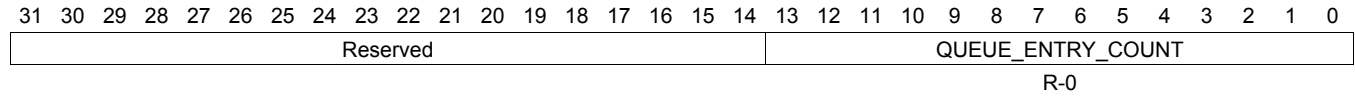
LEGEND: R/W = Read/Write; R = Read only; W1toCl = Write 1 to clear bit; -n = value after reset

Table 16-987. QUEUE_12_STATUS_C Register Field Descriptions

Bit	Field	Type	Reset	Description
13-0	PACKET_SIZE	R-0	0	This field indicates packet size of the head element of a queue. Queue_Manager_Queue_N_Status_C Registers C

16.5.7.698 QUEUE_13_STATUS_A Register (offset = 30D0h) [reset = 0h]

 QUEUE_13_STATUS_A is shown in [Figure 16-974](#) and described in [Table 16-988](#).

Figure 16-974. QUEUE_13_STATUS_A Register


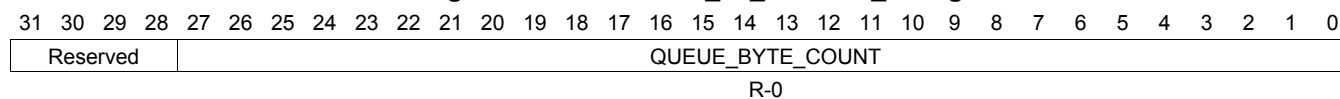
LEGEND: R/W = Read/Write; R = Read only; W1toCl = Write 1 to clear bit; -n = value after reset

Table 16-988. QUEUE_13_STATUS_A Register Field Descriptions

Bit	Field	Type	Reset	Description
13-0	QUEUE_ENTRY_COUNT	R-0	0	This field indicates how many packets are currently queued on the queue. Queue Manager Queue N Status Registers A

16.5.7.699 QUEUE_13_STATUS_B Register (offset = 30D4h) [reset = 0h]

QUEUE_13_STATUS_B is shown in [Figure 16-975](#) and described in [Table 16-989](#).

Figure 16-975. QUEUE_13_STATUS_B Register


LEGEND: R/W = Read/Write; R = Read only; W1toCl = Write 1 to clear bit; -n = value after reset

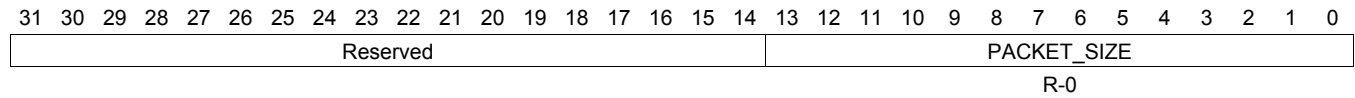
Table 16-989. QUEUE_13_STATUS_B Register Field Descriptions

Bit	Field	Type	Reset	Description
27-0	QUEUE_BYTE_COUNT	R-0	0	This field indicates how many bytes total are contained in all of the packets which are currently queued on this queue. Queue_Manager_Queue_n_Status_B Registers B

16.5.7.700 QUEUE_13_STATUS_C Register (offset = 30D8h) [reset = 0h]

QUEUE_13_STATUS_C is shown in [Figure 16-976](#) and described in [Table 16-990](#).

Figure 16-976. QUEUE_13_STATUS_C Register



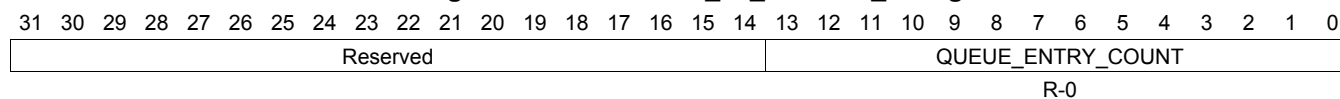
LEGEND: R/W = Read/Write; R = Read only; W1toCl = Write 1 to clear bit; -n = value after reset

Table 16-990. QUEUE_13_STATUS_C Register Field Descriptions

Bit	Field	Type	Reset	Description
13-0	PACKET_SIZE	R-0	0	This field indicates packet size of the head element of a queue. Queue_Manager_Queue_N_Status_C Registers C

16.5.7.701 QUEUE_14_STATUS_A Register (offset = 30E0h) [reset = 0h]

QUEUE_14_STATUS_A is shown in [Figure 16-977](#) and described in [Table 16-991](#).

Figure 16-977. QUEUE_14_STATUS_A Register


LEGEND: R/W = Read/Write; R = Read only; W1toCl = Write 1 to clear bit; -n = value after reset

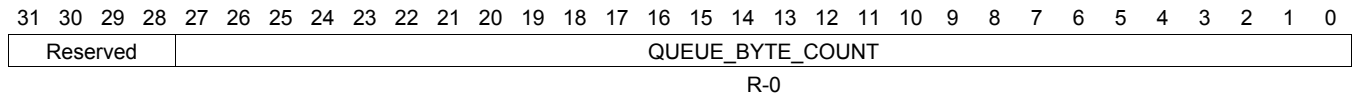
Table 16-991. QUEUE_14_STATUS_A Register Field Descriptions

Bit	Field	Type	Reset	Description
13-0	QUEUE_ENTRY_COUNT	R-0	0	This field indicates how many packets are currently queued on the queue. Queue Manager Queue N Status Registers A

16.5.7.702 QUEUE_14_STATUS_B Register (offset = 30E4h) [reset = 0h]

QUEUE_14_STATUS_B is shown in [Figure 16-978](#) and described in [Table 16-992](#).

Figure 16-978. QUEUE_14_STATUS_B Register



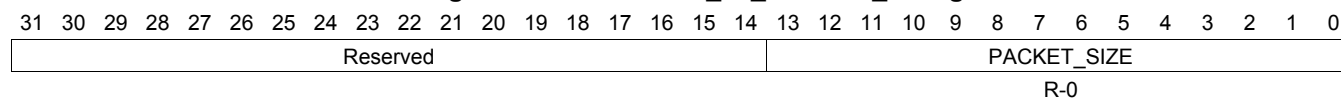
LEGEND: R/W = Read/Write; R = Read only; W1toCl = Write 1 to clear bit; -n = value after reset

Table 16-992. QUEUE_14_STATUS_B Register Field Descriptions

Bit	Field	Type	Reset	Description
27-0	QUEUE_BYTE_COUNT	R-0	0	This field indicates how many bytes total are contained in all of the packets which are currently queued on this queue. Queue_Manager_Queue_n_Status_B Registers B

16.5.7.703 QUEUE_14_STATUS_C Register (offset = 30E8h) [reset = 0h]

QUEUE_14_STATUS_C is shown in [Figure 16-979](#) and described in [Table 16-993](#).

Figure 16-979. QUEUE_14_STATUS_C Register


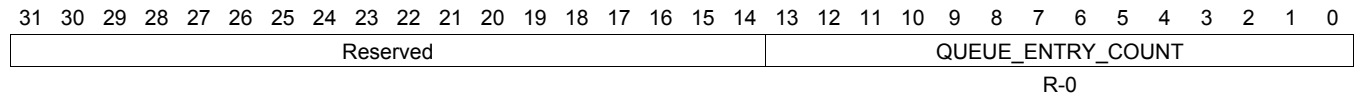
LEGEND: R/W = Read/Write; R = Read only; W1toCl = Write 1 to clear bit; -n = value after reset

Table 16-993. QUEUE_14_STATUS_C Register Field Descriptions

Bit	Field	Type	Reset	Description
13-0	PACKET_SIZE	R-0	0	This field indicates packet size of the head element of a queue. Queue_Manager_Queue_N_Status_C Registers C

16.5.7.704 QUEUE_15_STATUS_A Register (offset = 30F0h) [reset = 0h]

 QUEUE_15_STATUS_A is shown in [Figure 16-980](#) and described in [Table 16-994](#).

Figure 16-980. QUEUE_15_STATUS_A Register


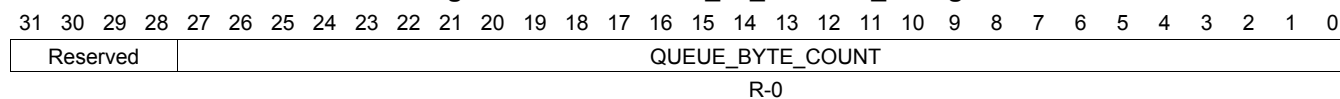
LEGEND: R/W = Read/Write; R = Read only; W1toCl = Write 1 to clear bit; -n = value after reset

Table 16-994. QUEUE_15_STATUS_A Register Field Descriptions

Bit	Field	Type	Reset	Description
13-0	QUEUE_ENTRY_COUNT	R-0	0	This field indicates how many packets are currently queued on the queue. Queue Manager Queue N Status Registers A

16.5.7.705 QUEUE_15_STATUS_B Register (offset = 30F4h) [reset = 0h]

QUEUE_15_STATUS_B is shown in [Figure 16-981](#) and described in [Table 16-995](#).

Figure 16-981. QUEUE_15_STATUS_B Register


LEGEND: R/W = Read/Write; R = Read only; W1toCl = Write 1 to clear bit; -n = value after reset

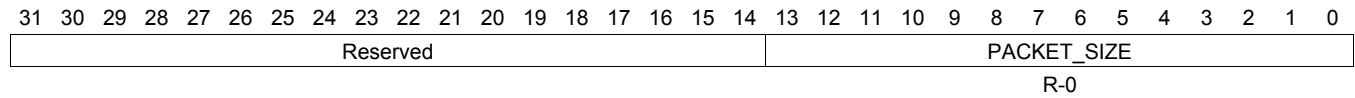
Table 16-995. QUEUE_15_STATUS_B Register Field Descriptions

Bit	Field	Type	Reset	Description
27-0	QUEUE_BYTE_COUNT	R-0	0	This field indicates how many bytes total are contained in all of the packets which are currently queued on this queue. Queue_Manager_Queue_n_Status_B Registers B

16.5.7.706 QUEUE_15_STATUS_C Register (offset = 30F8h) [reset = 0h]

QUEUE_15_STATUS_C is shown in [Figure 16-982](#) and described in [Table 16-996](#).

Figure 16-982. QUEUE_15_STATUS_C Register



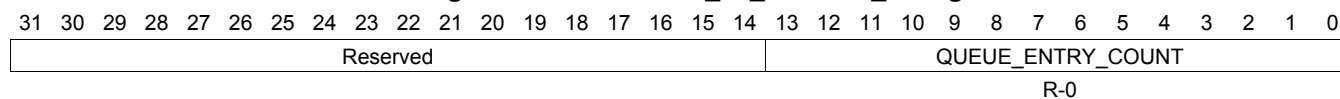
LEGEND: R/W = Read/Write; R = Read only; W1toCl = Write 1 to clear bit; -n = value after reset

Table 16-996. QUEUE_15_STATUS_C Register Field Descriptions

Bit	Field	Type	Reset	Description
13-0	PACKET_SIZE	R-0	0	This field indicates packet size of the head element of a queue. Queue_Manager_Queue_N_Status_C Registers C

16.5.7.707 QUEUE_16_STATUS_A Register (offset = 3100h) [reset = 0h]

QUEUE_16_STATUS_A is shown in [Figure 16-983](#) and described in [Table 16-997](#).

Figure 16-983. QUEUE_16_STATUS_A Register


LEGEND: R/W = Read/Write; R = Read only; W1toCl = Write 1 to clear bit; -n = value after reset

Table 16-997. QUEUE_16_STATUS_A Register Field Descriptions

Bit	Field	Type	Reset	Description
13-0	QUEUE_ENTRY_COUNT	R-0	0	This field indicates how many packets are currently queued on the queue. Queue Manager Queue N Status Registers A

16.5.7.708 QUEUE_16_STATUS_B Register (offset = 3104h) [reset = 0h]

QUEUE_16_STATUS_B is shown in [Figure 16-984](#) and described in [Table 16-998](#).

Figure 16-984. QUEUE_16_STATUS_B Register



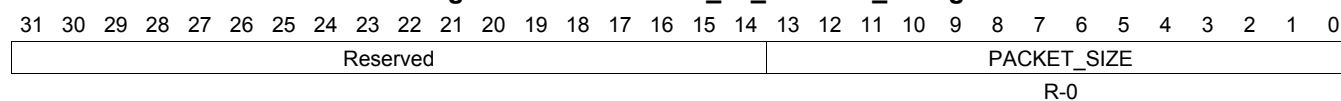
LEGEND: R/W = Read/Write; R = Read only; W1toCl = Write 1 to clear bit; -n = value after reset

Table 16-998. QUEUE_16_STATUS_B Register Field Descriptions

Bit	Field	Type	Reset	Description
27-0	QUEUE_BYTE_COUNT	R-0	0	This field indicates how many bytes total are contained in all of the packets which are currently queued on this queue. Queue_Manager_Queue_n_Status_B Registers B

16.5.7.709 QUEUE_16_STATUS_C Register (offset = 3108h) [reset = 0h]

 QUEUE_16_STATUS_C is shown in [Figure 16-985](#) and described in [Table 16-999](#).

Figure 16-985. QUEUE_16_STATUS_C Register


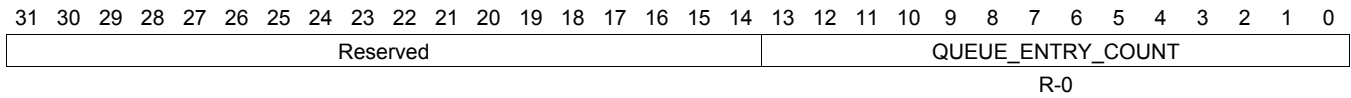
LEGEND: R/W = Read/Write; R = Read only; W1toCl = Write 1 to clear bit; -n = value after reset

Table 16-999. QUEUE_16_STATUS_C Register Field Descriptions

Bit	Field	Type	Reset	Description
13-0	PACKET_SIZE	R-0	0	This field indicates packet size of the head element of a queue. Queue_Manager_Queue_N_Status_C Registers C

16.5.7.710 QUEUE_17_STATUS_A Register (offset = 3110h) [reset = 0h]

QUEUE_17_STATUS_A is shown in [Figure 16-986](#) and described in [Table 16-1000](#).

Figure 16-986. QUEUE_17_STATUS_A Register


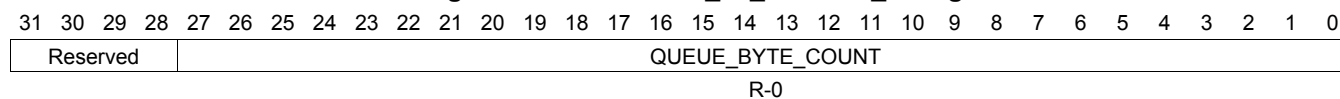
LEGEND: R/W = Read/Write; R = Read only; W1toCl = Write 1 to clear bit; -n = value after reset

Table 16-1000. QUEUE_17_STATUS_A Register Field Descriptions

Bit	Field	Type	Reset	Description
13-0	QUEUE_ENTRY_COUNT	R-0	0	This field indicates how many packets are currently queued on the queue. Queue Manager Queue N Status Registers A

16.5.7.711 QUEUE_17_STATUS_B Register (offset = 3114h) [reset = 0h]

QUEUE_17_STATUS_B is shown in [Figure 16-987](#) and described in [Table 16-1001](#).

Figure 16-987. QUEUE_17_STATUS_B Register


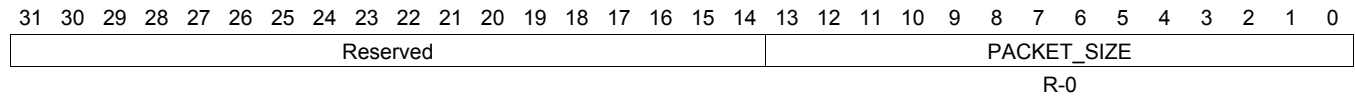
LEGEND: R/W = Read/Write; R = Read only; W1toCl = Write 1 to clear bit; -n = value after reset

Table 16-1001. QUEUE_17_STATUS_B Register Field Descriptions

Bit	Field	Type	Reset	Description
27-0	QUEUE_BYTE_COUNT	R-0	0	This field indicates how many bytes total are contained in all of the packets which are currently queued on this queue. Queue_Manager_Queue_n_Status_B Registers B

16.5.7.712 QUEUE_17_STATUS_C Register (offset = 3118h) [reset = 0h]

 QUEUE_17_STATUS_C is shown in [Figure 16-988](#) and described in [Table 16-1002](#).

Figure 16-988. QUEUE_17_STATUS_C Register


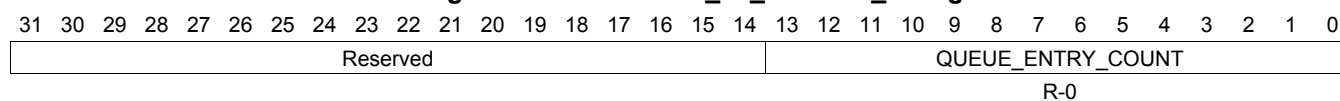
LEGEND: R/W = Read/Write; R = Read only; W1toCl = Write 1 to clear bit; -n = value after reset

Table 16-1002. QUEUE_17_STATUS_C Register Field Descriptions

Bit	Field	Type	Reset	Description
13-0	PACKET_SIZE	R-0	0	This field indicates packet size of the head element of a queue. Queue_Manager_Queue_N_Status_C Registers C

16.5.7.713 QUEUE_18_STATUS_A Register (offset = 3120h) [reset = 0h]

QUEUE_18_STATUS_A is shown in [Figure 16-989](#) and described in [Table 16-1003](#).

Figure 16-989. QUEUE_18_STATUS_A Register


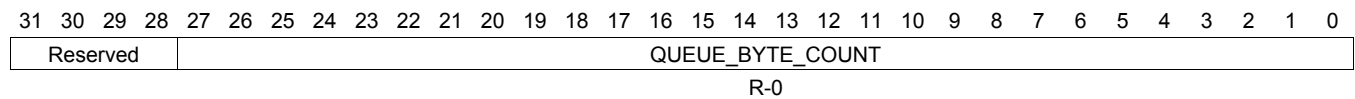
LEGEND: R/W = Read/Write; R = Read only; W1toCl = Write 1 to clear bit; -n = value after reset

Table 16-1003. QUEUE_18_STATUS_A Register Field Descriptions

Bit	Field	Type	Reset	Description
13-0	QUEUE_ENTRY_COUNT	R-0	0	This field indicates how many packets are currently queued on the queue. Queue Manager Queue N Status Registers A

16.5.7.714 QUEUE_18_STATUS_B Register (offset = 3124h) [reset = 0h]

QUEUE_18_STATUS_B is shown in [Figure 16-990](#) and described in [Table 16-1004](#).

Figure 16-990. QUEUE_18_STATUS_B Register


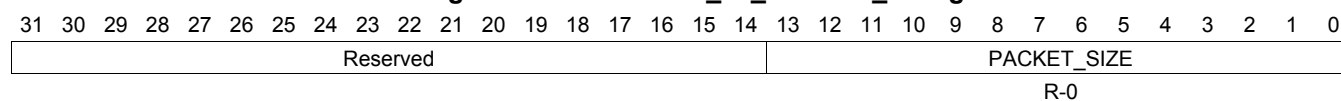
LEGEND: R/W = Read/Write; R = Read only; W1toCl = Write 1 to clear bit; -n = value after reset

Table 16-1004. QUEUE_18_STATUS_B Register Field Descriptions

Bit	Field	Type	Reset	Description
27-0	QUEUE_BYTE_COUNT	R-0	0	This field indicates how many bytes total are contained in all of the packets which are currently queued on this queue. Queue_Manager_Queue_n_Status_B Registers B

16.5.7.715 QUEUE_18_STATUS_C Register (offset = 3128h) [reset = 0h]

QUEUE_18_STATUS_C is shown in [Figure 16-991](#) and described in [Table 16-1005](#).

Figure 16-991. QUEUE_18_STATUS_C Register


LEGEND: R/W = Read/Write; R = Read only; W1toCl = Write 1 to clear bit; -n = value after reset

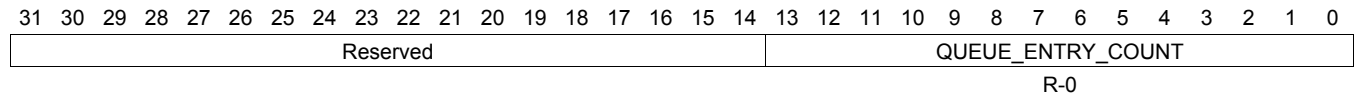
Table 16-1005. QUEUE_18_STATUS_C Register Field Descriptions

Bit	Field	Type	Reset	Description
13-0	PACKET_SIZE	R-0	0	This field indicates packet size of the head element of a queue. Queue_Manager_Queue_N_Status_C Registers C

16.5.7.716 QUEUE_19_STATUS_A Register (offset = 3130h) [reset = 0h]

QUEUE_19_STATUS_A is shown in [Figure 16-992](#) and described in [Table 16-1006](#).

Figure 16-992. QUEUE_19_STATUS_A Register



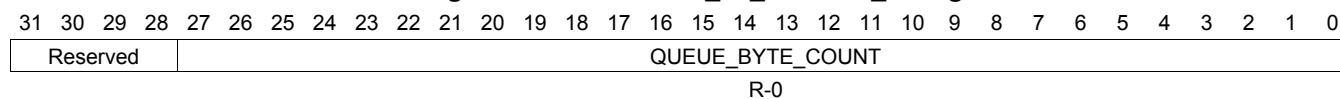
LEGEND: R/W = Read/Write; R = Read only; W1toCl = Write 1 to clear bit; -n = value after reset

Table 16-1006. QUEUE_19_STATUS_A Register Field Descriptions

Bit	Field	Type	Reset	Description
13-0	QUEUE_ENTRY_COUNT	R-0	0	This field indicates how many packets are currently queued on the queue. Queue Manager Queue N Status Registers A

16.5.7.717 QUEUE_19_STATUS_B Register (offset = 3134h) [reset = 0h]

QUEUE_19_STATUS_B is shown in [Figure 16-993](#) and described in [Table 16-1007](#).

Figure 16-993. QUEUE_19_STATUS_B Register


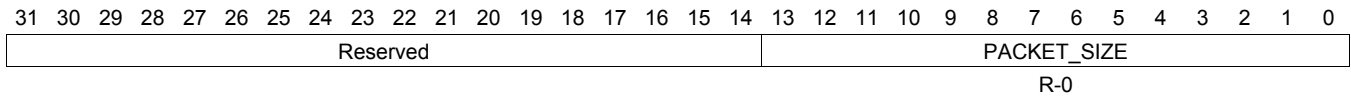
LEGEND: R/W = Read/Write; R = Read only; W1toCl = Write 1 to clear bit; -n = value after reset

Table 16-1007. QUEUE_19_STATUS_B Register Field Descriptions

Bit	Field	Type	Reset	Description
27-0	QUEUE_BYTE_COUNT	R-0	0	This field indicates how many bytes total are contained in all of the packets which are currently queued on this queue. Queue_Manager_Queue_n_Status_B Registers B

16.5.7.718 QUEUE_19_STATUS_C Register (offset = 3138h) [reset = 0h]

 QUEUE_19_STATUS_C is shown in [Figure 16-994](#) and described in [Table 16-1008](#).

Figure 16-994. QUEUE_19_STATUS_C Register


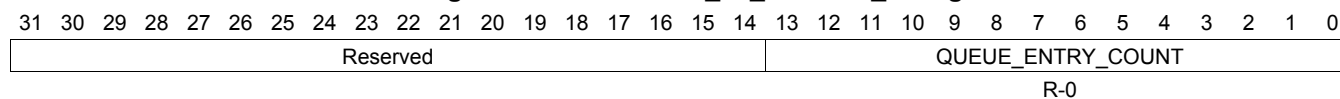
LEGEND: R/W = Read/Write; R = Read only; W1toCl = Write 1 to clear bit; -n = value after reset

Table 16-1008. QUEUE_19_STATUS_C Register Field Descriptions

Bit	Field	Type	Reset	Description
13-0	PACKET_SIZE	R-0	0	This field indicates packet size of the head element of a queue. Queue_Manager_Queue_N_Status_C Registers C

16.5.7.719 QUEUE_20_STATUS_A Register (offset = 3140h) [reset = 0h]

QUEUE_20_STATUS_A is shown in [Figure 16-995](#) and described in [Table 16-1009](#).

Figure 16-995. QUEUE_20_STATUS_A Register


LEGEND: R/W = Read/Write; R = Read only; W1toCl = Write 1 to clear bit; -n = value after reset

Table 16-1009. QUEUE_20_STATUS_A Register Field Descriptions

Bit	Field	Type	Reset	Description
13-0	QUEUE_ENTRY_COUNT	R-0	0	This field indicates how many packets are currently queued on the queue. Queue Manager Queue N Status Registers A

16.5.7.720 QUEUE_20_STATUS_B Register (offset = 3144h) [reset = 0h]

 QUEUE_20_STATUS_B is shown in [Figure 16-996](#) and described in [Table 16-1010](#).

Figure 16-996. QUEUE_20_STATUS_B Register

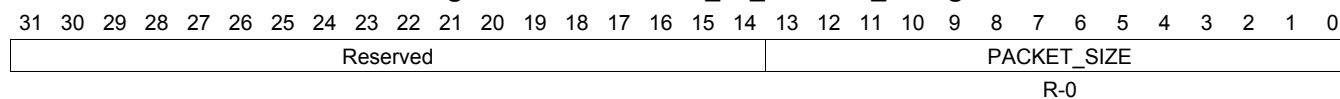

LEGEND: R/W = Read/Write; R = Read only; W1toCl = Write 1 to clear bit; -n = value after reset

Table 16-1010. QUEUE_20_STATUS_B Register Field Descriptions

Bit	Field	Type	Reset	Description
27-0	QUEUE_BYTE_COUNT	R-0	0	This field indicates how many bytes total are contained in all of the packets which are currently queued on this queue. Queue_Manager_Queue_n_Status_B Registers B

16.5.7.721 QUEUE_20_STATUS_C Register (offset = 3148h) [reset = 0h]

QUEUE_20_STATUS_C is shown in [Figure 16-997](#) and described in [Table 16-1011](#).

Figure 16-997. QUEUE_20_STATUS_C Register


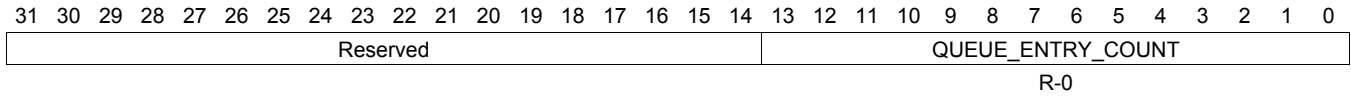
LEGEND: R/W = Read/Write; R = Read only; W1toCl = Write 1 to clear bit; -n = value after reset

Table 16-1011. QUEUE_20_STATUS_C Register Field Descriptions

Bit	Field	Type	Reset	Description
13-0	PACKET_SIZE	R-0	0	This field indicates packet size of the head element of a queue. Queue_Manager_Queue_N_Status_C Registers C

16.5.7.722 QUEUE_21_STATUS_A Register (offset = 3150h) [reset = 0h]

 QUEUE_21_STATUS_A is shown in [Figure 16-998](#) and described in [Table 16-1012](#).

Figure 16-998. QUEUE_21_STATUS_A Register


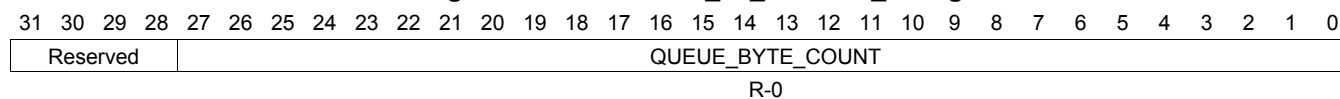
LEGEND: R/W = Read/Write; R = Read only; W1toCl = Write 1 to clear bit; -n = value after reset

Table 16-1012. QUEUE_21_STATUS_A Register Field Descriptions

Bit	Field	Type	Reset	Description
13-0	QUEUE_ENTRY_COUNT	R-0	0	This field indicates how many packets are currently queued on the queue. Queue Manager Queue N Status Registers A

16.5.7.723 QUEUE_21_STATUS_B Register (offset = 3154h) [reset = 0h]

QUEUE_21_STATUS_B is shown in [Figure 16-999](#) and described in [Table 16-1013](#).

Figure 16-999. QUEUE_21_STATUS_B Register


LEGEND: R/W = Read/Write; R = Read only; W1toCl = Write 1 to clear bit; -n = value after reset

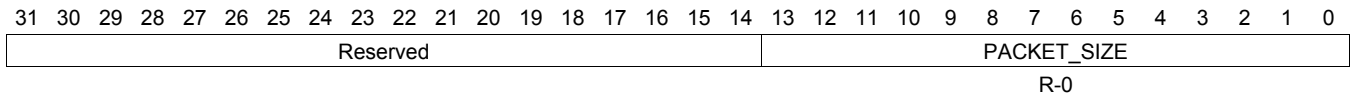
Table 16-1013. QUEUE_21_STATUS_B Register Field Descriptions

Bit	Field	Type	Reset	Description
27-0	QUEUE_BYTE_COUNT	R-0	0	This field indicates how many bytes total are contained in all of the packets which are currently queued on this queue. Queue_Manager_Queue_n_Status_B Registers B

16.5.7.724 QUEUE_21_STATUS_C Register (offset = 3158h) [reset = 0h]

QUEUE_21_STATUS_C is shown in [Figure 16-1000](#) and described in [Table 16-1014](#).

Figure 16-1000. QUEUE_21_STATUS_C Register



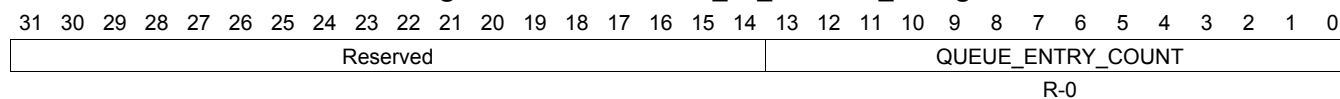
LEGEND: R/W = Read/Write; R = Read only; W1toCl = Write 1 to clear bit; -n = value after reset

Table 16-1014. QUEUE_21_STATUS_C Register Field Descriptions

Bit	Field	Type	Reset	Description
13-0	PACKET_SIZE	R-0	0	This field indicates packet size of the head element of a queue. Queue_Manager_Queue_N_Status_C Registers C

16.5.7.725 QUEUE_22_STATUS_A Register (offset = 3160h) [reset = 0h]

QUEUE_22_STATUS_A is shown in [Figure 16-1001](#) and described in [Table 16-1015](#).

Figure 16-1001. QUEUE_22_STATUS_A Register


LEGEND: R/W = Read/Write; R = Read only; W1toCl = Write 1 to clear bit; -n = value after reset

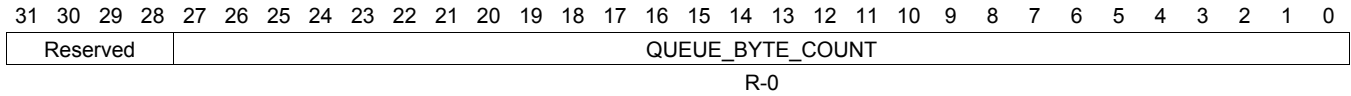
Table 16-1015. QUEUE_22_STATUS_A Register Field Descriptions

Bit	Field	Type	Reset	Description
13-0	QUEUE_ENTRY_COUNT	R-0	0	This field indicates how many packets are currently queued on the queue. Queue Manager Queue N Status Registers A

16.5.7.726 QUEUE_22_STATUS_B Register (offset = 3164h) [reset = 0h]

QUEUE_22_STATUS_B is shown in [Figure 16-1002](#) and described in [Table 16-1016](#).

Figure 16-1002. QUEUE_22_STATUS_B Register



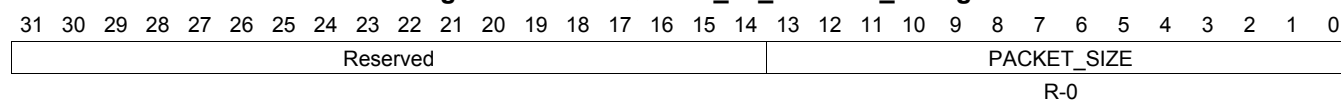
LEGEND: R/W = Read/Write; R = Read only; W1toCl = Write 1 to clear bit; -n = value after reset

Table 16-1016. QUEUE_22_STATUS_B Register Field Descriptions

Bit	Field	Type	Reset	Description
27-0	QUEUE_BYTE_COUNT	R-0	0	This field indicates how many bytes total are contained in all of the packets which are currently queued on this queue. Queue_Manager_Queue_n_Status_B Registers B

16.5.7.727 QUEUE_22_STATUS_C Register (offset = 3168h) [reset = 0h]

QUEUE_22_STATUS_C is shown in [Figure 16-1003](#) and described in [Table 16-1017](#).

Figure 16-1003. QUEUE_22_STATUS_C Register


LEGEND: R/W = Read/Write; R = Read only; W1toCl = Write 1 to clear bit; -n = value after reset

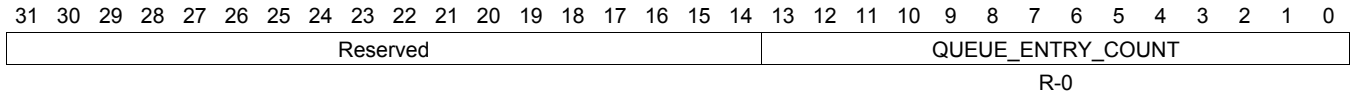
Table 16-1017. QUEUE_22_STATUS_C Register Field Descriptions

Bit	Field	Type	Reset	Description
13-0	PACKET_SIZE	R-0	0	This field indicates packet size of the head element of a queue. Queue_Manager_Queue_N_Status_C Registers C

16.5.7.728 QUEUE_23_STATUS_A Register (offset = 3170h) [reset = 0h]

QUEUE_23_STATUS_A is shown in [Figure 16-1004](#) and described in [Table 16-1018](#).

Figure 16-1004. QUEUE_23_STATUS_A Register



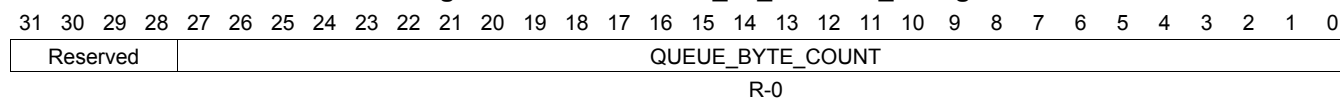
LEGEND: R/W = Read/Write; R = Read only; W1toCl = Write 1 to clear bit; -n = value after reset

Table 16-1018. QUEUE_23_STATUS_A Register Field Descriptions

Bit	Field	Type	Reset	Description
13-0	QUEUE_ENTRY_COUNT	R-0	0	This field indicates how many packets are currently queued on the queue. Queue Manager Queue N Status Registers A

16.5.7.729 QUEUE_23_STATUS_B Register (offset = 3174h) [reset = 0h]

QUEUE_23_STATUS_B is shown in [Figure 16-1005](#) and described in [Table 16-1019](#).

Figure 16-1005. QUEUE_23_STATUS_B Register


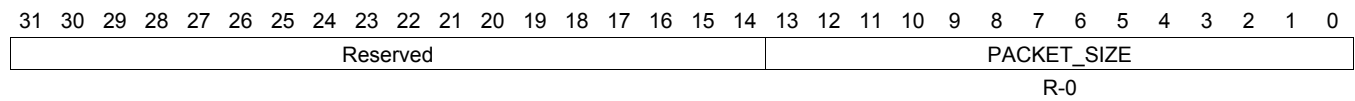
LEGEND: R/W = Read/Write; R = Read only; W1toCl = Write 1 to clear bit; -n = value after reset

Table 16-1019. QUEUE_23_STATUS_B Register Field Descriptions

Bit	Field	Type	Reset	Description
27-0	QUEUE_BYTE_COUNT	R-0	0	This field indicates how many bytes total are contained in all of the packets which are currently queued on this queue. Queue_Manager_Queue_n_Status_B Registers B

16.5.7.730 QUEUE_23_STATUS_C Register (offset = 3178h) [reset = 0h]

 QUEUE_23_STATUS_C is shown in [Figure 16-1006](#) and described in [Table 16-1020](#).

Figure 16-1006. QUEUE_23_STATUS_C Register


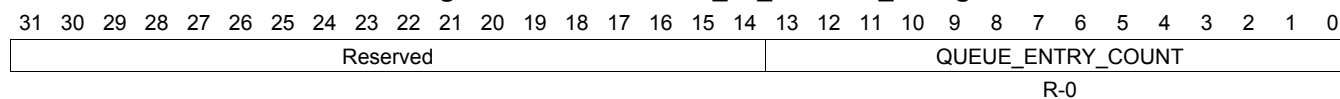
LEGEND: R/W = Read/Write; R = Read only; W1toCl = Write 1 to clear bit; -n = value after reset

Table 16-1020. QUEUE_23_STATUS_C Register Field Descriptions

Bit	Field	Type	Reset	Description
13-0	PACKET_SIZE	R-0	0	This field indicates packet size of the head element of a queue. Queue_Manager_Queue_N_Status_C Registers C

16.5.7.731 QUEUE_24_STATUS_A Register (offset = 3180h) [reset = 0h]

 QUEUE_24_STATUS_A is shown in [Figure 16-1007](#) and described in [Table 16-1021](#).

Figure 16-1007. QUEUE_24_STATUS_A Register


LEGEND: R/W = Read/Write; R = Read only; W1toCl = Write 1 to clear bit; -n = value after reset

Table 16-1021. QUEUE_24_STATUS_A Register Field Descriptions

Bit	Field	Type	Reset	Description
13-0	QUEUE_ENTRY_COUNT	R-0	0	This field indicates how many packets are currently queued on the queue. Queue Manager Queue N Status Registers A

16.5.7.732 QUEUE_24_STATUS_B Register (offset = 3184h) [reset = 0h]

QUEUE_24_STATUS_B is shown in [Figure 16-1008](#) and described in [Table 16-1022](#).

Figure 16-1008. QUEUE_24_STATUS_B Register



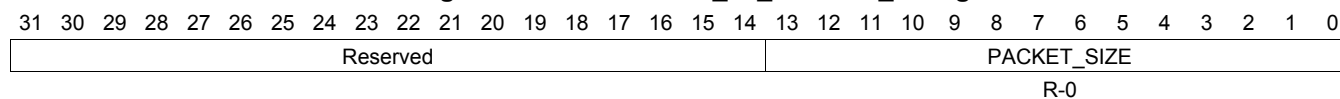
LEGEND: R/W = Read/Write; R = Read only; W1toCl = Write 1 to clear bit; -n = value after reset

Table 16-1022. QUEUE_24_STATUS_B Register Field Descriptions

Bit	Field	Type	Reset	Description
27-0	QUEUE_BYTE_COUNT	R-0	0	This field indicates how many bytes total are contained in all of the packets which are currently queued on this queue. Queue_Manager_Queue_n_Status_B Registers B

16.5.7.733 QUEUE_24_STATUS_C Register (offset = 3188h) [reset = 0h]

QUEUE_24_STATUS_C is shown in [Figure 16-1009](#) and described in [Table 16-1023](#).

Figure 16-1009. QUEUE_24_STATUS_C Register


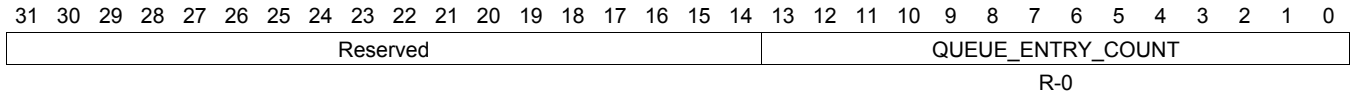
LEGEND: R/W = Read/Write; R = Read only; W1toCl = Write 1 to clear bit; -n = value after reset

Table 16-1023. QUEUE_24_STATUS_C Register Field Descriptions

Bit	Field	Type	Reset	Description
13-0	PACKET_SIZE	R-0	0	This field indicates packet size of the head element of a queue. Queue_Manager_Queue_N_Status_C Registers C

16.5.7.734 QUEUE_25_STATUS_A Register (offset = 3190h) [reset = 0h]

 QUEUE_25_STATUS_A is shown in [Figure 16-1010](#) and described in [Table 16-1024](#).

Figure 16-1010. QUEUE_25_STATUS_A Register


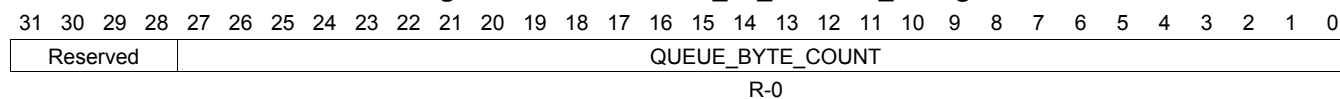
LEGEND: R/W = Read/Write; R = Read only; W1toCl = Write 1 to clear bit; -n = value after reset

Table 16-1024. QUEUE_25_STATUS_A Register Field Descriptions

Bit	Field	Type	Reset	Description
13-0	QUEUE_ENTRY_COUNT	R-0	0	This field indicates how many packets are currently queued on the queue. Queue Manager Queue N Status Registers A

16.5.7.735 QUEUE_25_STATUS_B Register (offset = 3194h) [reset = 0h]

 QUEUE_25_STATUS_B is shown in [Figure 16-1011](#) and described in [Table 16-1025](#).

Figure 16-1011. QUEUE_25_STATUS_B Register


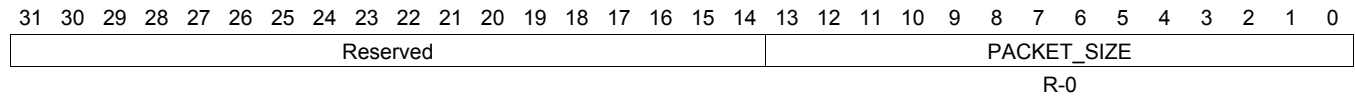
LEGEND: R/W = Read/Write; R = Read only; W1toCl = Write 1 to clear bit; -n = value after reset

Table 16-1025. QUEUE_25_STATUS_B Register Field Descriptions

Bit	Field	Type	Reset	Description
27-0	QUEUE_BYTE_COUNT	R-0	0	This field indicates how many bytes total are contained in all of the packets which are currently queued on this queue. Queue_Manager_Queue_n_Status_B Registers B

16.5.7.736 QUEUE_25_STATUS_C Register (offset = 3198h) [reset = 0h]

 QUEUE_25_STATUS_C is shown in [Figure 16-1012](#) and described in [Table 16-1026](#).

Figure 16-1012. QUEUE_25_STATUS_C Register


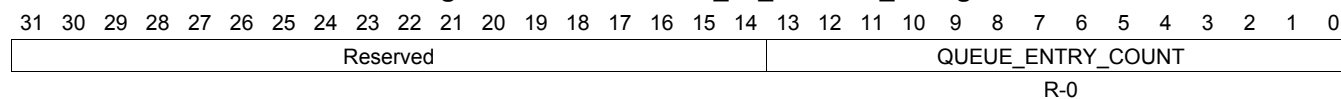
LEGEND: R/W = Read/Write; R = Read only; W1toCl = Write 1 to clear bit; -n = value after reset

Table 16-1026. QUEUE_25_STATUS_C Register Field Descriptions

Bit	Field	Type	Reset	Description
13-0	PACKET_SIZE	R-0	0	This field indicates packet size of the head element of a queue. Queue_Manager_Queue_N_Status_C Registers C

16.5.7.737 QUEUE_26_STATUS_A Register (offset = 31A0h) [reset = 0h]

QUEUE_26_STATUS_A is shown in [Figure 16-1013](#) and described in [Table 16-1027](#).

Figure 16-1013. QUEUE_26_STATUS_A Register


LEGEND: R/W = Read/Write; R = Read only; W1toCl = Write 1 to clear bit; -n = value after reset

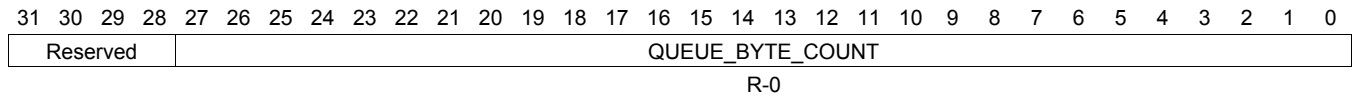
Table 16-1027. QUEUE_26_STATUS_A Register Field Descriptions

Bit	Field	Type	Reset	Description
13-0	QUEUE_ENTRY_COUNT	R-0	0	This field indicates how many packets are currently queued on the queue. Queue Manager Queue N Status Registers A

16.5.7.738 QUEUE_26_STATUS_B Register (offset = 31A4h) [reset = 0h]

QUEUE_26_STATUS_B is shown in [Figure 16-1014](#) and described in [Table 16-1028](#).

Figure 16-1014. QUEUE_26_STATUS_B Register



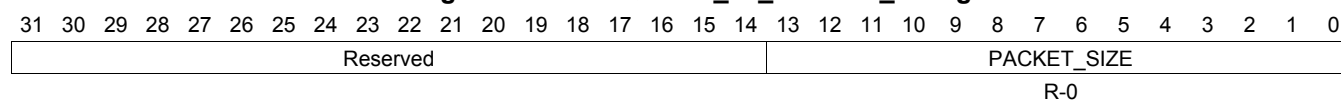
LEGEND: R/W = Read/Write; R = Read only; W1toCl = Write 1 to clear bit; -n = value after reset

Table 16-1028. QUEUE_26_STATUS_B Register Field Descriptions

Bit	Field	Type	Reset	Description
27-0	QUEUE_BYTE_COUNT	R-0	0	This field indicates how many bytes total are contained in all of the packets which are currently queued on this queue. Queue_Manager_Queue_n_Status_B Registers B

16.5.7.739 QUEUE_26_STATUS_C Register (offset = 31A8h) [reset = 0h]

QUEUE_26_STATUS_C is shown in [Figure 16-1015](#) and described in [Table 16-1029](#).

Figure 16-1015. QUEUE_26_STATUS_C Register


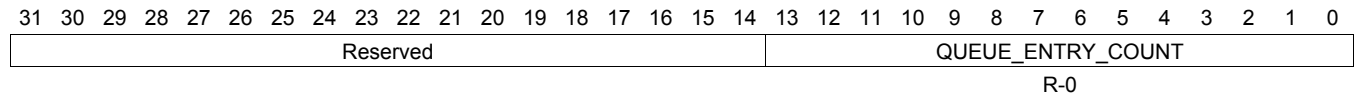
LEGEND: R/W = Read/Write; R = Read only; W1toCl = Write 1 to clear bit; -n = value after reset

Table 16-1029. QUEUE_26_STATUS_C Register Field Descriptions

Bit	Field	Type	Reset	Description
13-0	PACKET_SIZE	R-0	0	This field indicates packet size of the head element of a queue. Queue_Manager_Queue_N_Status_C Registers C

16.5.7.740 QUEUE_27_STATUS_A Register (offset = 31B0h) [reset = 0h]

 QUEUE_27_STATUS_A is shown in [Figure 16-1016](#) and described in [Table 16-1030](#).

Figure 16-1016. QUEUE_27_STATUS_A Register


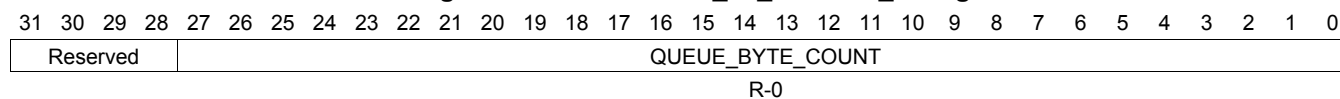
LEGEND: R/W = Read/Write; R = Read only; W1toCl = Write 1 to clear bit; -n = value after reset

Table 16-1030. QUEUE_27_STATUS_A Register Field Descriptions

Bit	Field	Type	Reset	Description
13-0	QUEUE_ENTRY_COUNT	R-0	0	This field indicates how many packets are currently queued on the queue. Queue Manager Queue N Status Registers A

16.5.7.741 QUEUE_27_STATUS_B Register (offset = 31B4h) [reset = 0h]

QUEUE_27_STATUS_B is shown in [Figure 16-1017](#) and described in [Table 16-1031](#).

Figure 16-1017. QUEUE_27_STATUS_B Register


LEGEND: R/W = Read/Write; R = Read only; W1toCl = Write 1 to clear bit; -n = value after reset

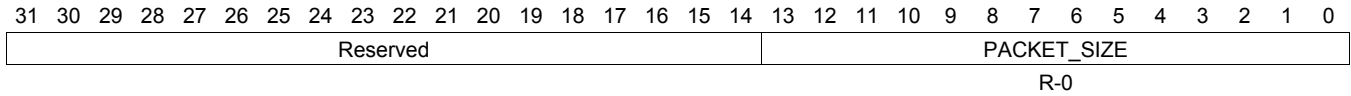
Table 16-1031. QUEUE_27_STATUS_B Register Field Descriptions

Bit	Field	Type	Reset	Description
27-0	QUEUE_BYTE_COUNT	R-0	0	This field indicates how many bytes total are contained in all of the packets which are currently queued on this queue. Queue_Manager_Queue_n_Status_B Registers B

16.5.7.742 QUEUE_27_STATUS_C Register (offset = 31B8h) [reset = 0h]

QUEUE_27_STATUS_C is shown in [Figure 16-1018](#) and described in [Table 16-1032](#).

Figure 16-1018. QUEUE_27_STATUS_C Register



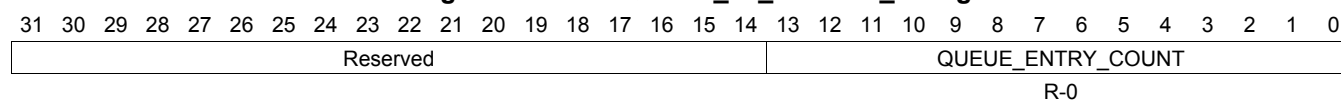
LEGEND: R/W = Read/Write; R = Read only; W1toCl = Write 1 to clear bit; -n = value after reset

Table 16-1032. QUEUE_27_STATUS_C Register Field Descriptions

Bit	Field	Type	Reset	Description
13-0	PACKET_SIZE	R-0	0	This field indicates packet size of the head element of a queue. Queue_Manager_Queue_N_Status_C Registers C

16.5.7.743 QUEUE_28_STATUS_A Register (offset = 31C0h) [reset = 0h]

 QUEUE_28_STATUS_A is shown in [Figure 16-1019](#) and described in [Table 16-1033](#).

Figure 16-1019. QUEUE_28_STATUS_A Register


LEGEND: R/W = Read/Write; R = Read only; W1toCl = Write 1 to clear bit; -n = value after reset

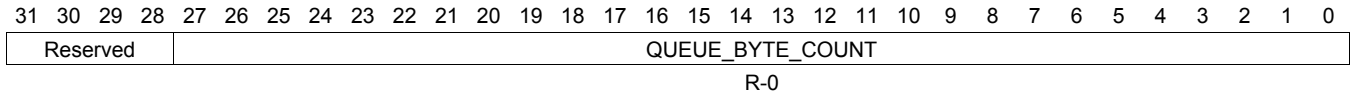
Table 16-1033. QUEUE_28_STATUS_A Register Field Descriptions

Bit	Field	Type	Reset	Description
13-0	QUEUE_ENTRY_COUNT	R-0	0	This field indicates how many packets are currently queued on the queue. Queue Manager Queue N Status Registers A

16.5.7.744 QUEUE_28_STATUS_B Register (offset = 31C4h) [reset = 0h]

QUEUE_28_STATUS_B is shown in [Figure 16-1020](#) and described in [Table 16-1034](#).

Figure 16-1020. QUEUE_28_STATUS_B Register



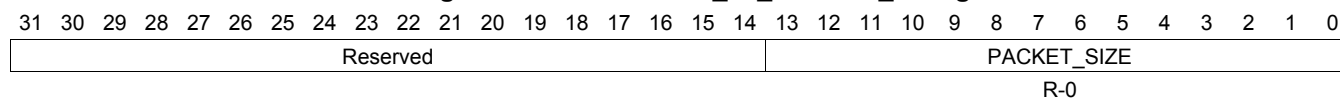
LEGEND: R/W = Read/Write; R = Read only; W1toCl = Write 1 to clear bit; -n = value after reset

Table 16-1034. QUEUE_28_STATUS_B Register Field Descriptions

Bit	Field	Type	Reset	Description
27-0	QUEUE_BYTE_COUNT	R-0	0	This field indicates how many bytes total are contained in all of the packets which are currently queued on this queue. Queue_Manager_Queue_n_Status_B Registers B

16.5.7.745 QUEUE_28_STATUS_C Register (offset = 31C8h) [reset = 0h]

QUEUE_28_STATUS_C is shown in [Figure 16-1021](#) and described in [Table 16-1035](#).

Figure 16-1021. QUEUE_28_STATUS_C Register


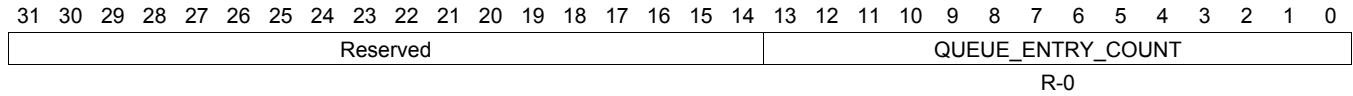
LEGEND: R/W = Read/Write; R = Read only; W1toCl = Write 1 to clear bit; -n = value after reset

Table 16-1035. QUEUE_28_STATUS_C Register Field Descriptions

Bit	Field	Type	Reset	Description
13-0	PACKET_SIZE	R-0	0	This field indicates packet size of the head element of a queue. Queue_Manager_Queue_N_Status_C Registers C

16.5.7.746 QUEUE_29_STATUS_A Register (offset = 31D0h) [reset = 0h]

 QUEUE_29_STATUS_A is shown in [Figure 16-1022](#) and described in [Table 16-1036](#).

Figure 16-1022. QUEUE_29_STATUS_A Register


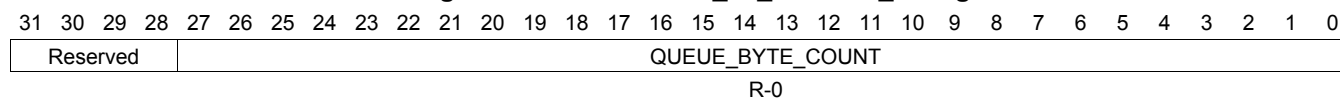
LEGEND: R/W = Read/Write; R = Read only; W1toCl = Write 1 to clear bit; -n = value after reset

Table 16-1036. QUEUE_29_STATUS_A Register Field Descriptions

Bit	Field	Type	Reset	Description
13-0	QUEUE_ENTRY_COUNT	R-0	0	This field indicates how many packets are currently queued on the queue. Queue Manager Queue N Status Registers A

16.5.7.747 QUEUE_29_STATUS_B Register (offset = 31D4h) [reset = 0h]

QUEUE_29_STATUS_B is shown in [Figure 16-1023](#) and described in [Table 16-1037](#).

Figure 16-1023. QUEUE_29_STATUS_B Register


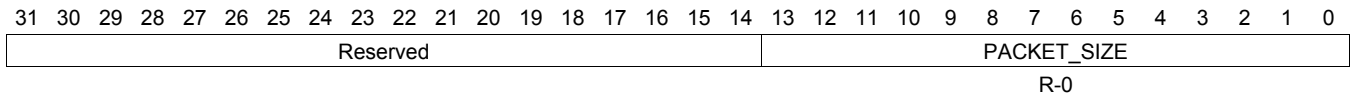
LEGEND: R/W = Read/Write; R = Read only; W1toCl = Write 1 to clear bit; -n = value after reset

Table 16-1037. QUEUE_29_STATUS_B Register Field Descriptions

Bit	Field	Type	Reset	Description
27-0	QUEUE_BYTE_COUNT	R-0	0	This field indicates how many bytes total are contained in all of the packets which are currently queued on this queue. Queue_Manager_Queue_n_Status_B Registers B

16.5.7.748 QUEUE_29_STATUS_C Register (offset = 31D8h) [reset = 0h]

 QUEUE_29_STATUS_C is shown in [Figure 16-1024](#) and described in [Table 16-1038](#).

Figure 16-1024. QUEUE_29_STATUS_C Register


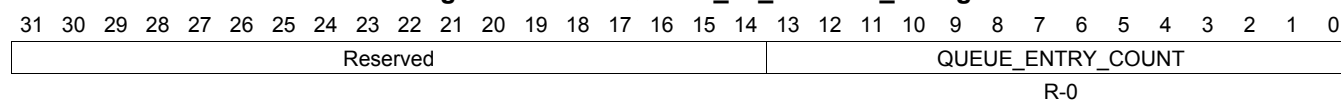
LEGEND: R/W = Read/Write; R = Read only; W1toCl = Write 1 to clear bit; -n = value after reset

Table 16-1038. QUEUE_29_STATUS_C Register Field Descriptions

Bit	Field	Type	Reset	Description
13-0	PACKET_SIZE	R-0	0	This field indicates packet size of the head element of a queue. Queue_Manager_Queue_N_Status_C Registers C

16.5.7.749 QUEUE_30_STATUS_A Register (offset = 31E0h) [reset = 0h]

 QUEUE_30_STATUS_A is shown in [Figure 16-1025](#) and described in [Table 16-1039](#).

Figure 16-1025. QUEUE_30_STATUS_A Register


LEGEND: R/W = Read/Write; R = Read only; W1toCl = Write 1 to clear bit; -n = value after reset

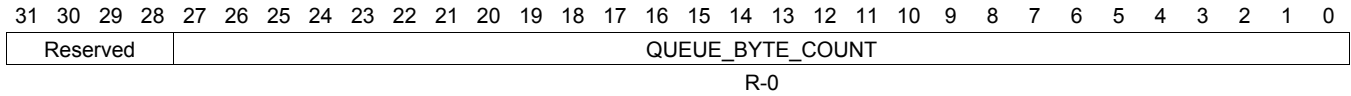
Table 16-1039. QUEUE_30_STATUS_A Register Field Descriptions

Bit	Field	Type	Reset	Description
13-0	QUEUE_ENTRY_COUNT	R-0	0	This field indicates how many packets are currently queued on the queue. Queue Manager Queue N Status Registers A

16.5.7.750 QUEUE_30_STATUS_B Register (offset = 31E4h) [reset = 0h]

QUEUE_30_STATUS_B is shown in [Figure 16-1026](#) and described in [Table 16-1040](#).

Figure 16-1026. QUEUE_30_STATUS_B Register



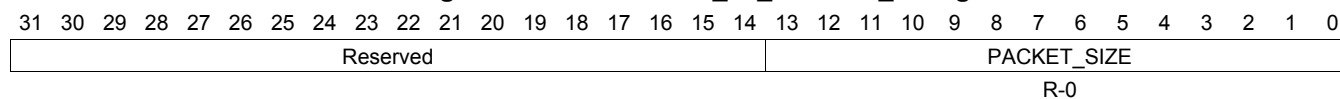
LEGEND: R/W = Read/Write; R = Read only; W1toCl = Write 1 to clear bit; -n = value after reset

Table 16-1040. QUEUE_30_STATUS_B Register Field Descriptions

Bit	Field	Type	Reset	Description
27-0	QUEUE_BYTE_COUNT	R-0	0	This field indicates how many bytes total are contained in all of the packets which are currently queued on this queue. Queue_Manager_Queue_n_Status_B Registers B

16.5.7.751 QUEUE_30_STATUS_C Register (offset = 31E8h) [reset = 0h]

QUEUE_30_STATUS_C is shown in [Figure 16-1027](#) and described in [Table 16-1041](#).

Figure 16-1027. QUEUE_30_STATUS_C Register


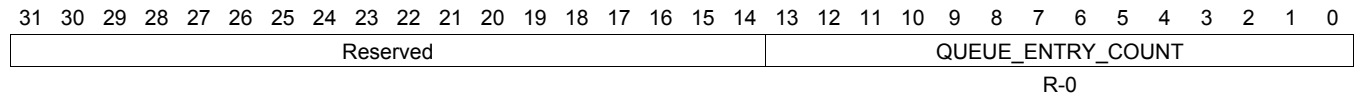
LEGEND: R/W = Read/Write; R = Read only; W1toCl = Write 1 to clear bit; -n = value after reset

Table 16-1041. QUEUE_30_STATUS_C Register Field Descriptions

Bit	Field	Type	Reset	Description
13-0	PACKET_SIZE	R-0	0	This field indicates packet size of the head element of a queue. Queue_Manager_Queue_N_Status_C Registers C

16.5.7.752 QUEUE_31_STATUS_A Register (offset = 31F0h) [reset = 0h]

 QUEUE_31_STATUS_A is shown in [Figure 16-1028](#) and described in [Table 16-1042](#).

Figure 16-1028. QUEUE_31_STATUS_A Register


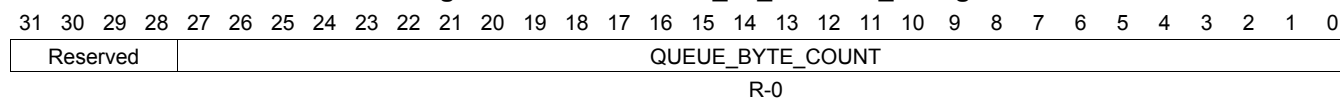
LEGEND: R/W = Read/Write; R = Read only; W1toCl = Write 1 to clear bit; -n = value after reset

Table 16-1042. QUEUE_31_STATUS_A Register Field Descriptions

Bit	Field	Type	Reset	Description
13-0	QUEUE_ENTRY_COUNT	R-0	0	This field indicates how many packets are currently queued on the queue. Queue Manager Queue N Status Registers A

16.5.7.753 QUEUE_31_STATUS_B Register (offset = 31F4h) [reset = 0h]

QUEUE_31_STATUS_B is shown in [Figure 16-1029](#) and described in [Table 16-1043](#).

Figure 16-1029. QUEUE_31_STATUS_B Register


LEGEND: R/W = Read/Write; R = Read only; W1toCl = Write 1 to clear bit; -n = value after reset

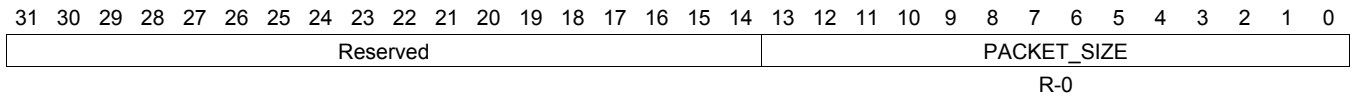
Table 16-1043. QUEUE_31_STATUS_B Register Field Descriptions

Bit	Field	Type	Reset	Description
27-0	QUEUE_BYTE_COUNT	R-0	0	This field indicates how many bytes total are contained in all of the packets which are currently queued on this queue. Queue_Manager_Queue_n_Status_B Registers B

16.5.7.754 QUEUE_31_STATUS_C Register (offset = 31F8h) [reset = 0h]

QUEUE_31_STATUS_C is shown in [Figure 16-1030](#) and described in [Table 16-1044](#).

Figure 16-1030. QUEUE_31_STATUS_C Register



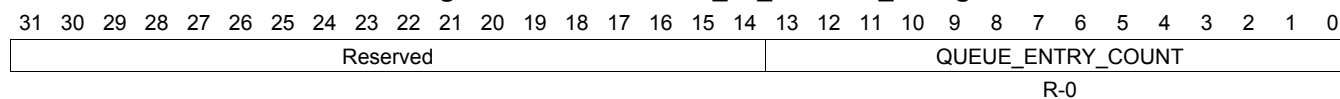
LEGEND: R/W = Read/Write; R = Read only; W1toCl = Write 1 to clear bit; -n = value after reset

Table 16-1044. QUEUE_31_STATUS_C Register Field Descriptions

Bit	Field	Type	Reset	Description
13-0	PACKET_SIZE	R-0	0	This field indicates packet size of the head element of a queue. Queue_Manager_Queue_N_Status_C Registers C

16.5.7.755 QUEUE_32_STATUS_A Register (offset = 3200h) [reset = 0h]

QUEUE_32_STATUS_A is shown in [Figure 16-1031](#) and described in [Table 16-1045](#).

Figure 16-1031. QUEUE_32_STATUS_A Register


LEGEND: R/W = Read/Write; R = Read only; W1toCl = Write 1 to clear bit; -n = value after reset

Table 16-1045. QUEUE_32_STATUS_A Register Field Descriptions

Bit	Field	Type	Reset	Description
13-0	QUEUE_ENTRY_COUNT	R-0	0	This field indicates how many packets are currently queued on the queue. Queue Manager Queue N Status Registers A

16.5.7.756 QUEUE_32_STATUS_B Register (offset = 3204h) [reset = 0h]

QUEUE_32_STATUS_B is shown in [Figure 16-1032](#) and described in [Table 16-1046](#).

Figure 16-1032. QUEUE_32_STATUS_B Register

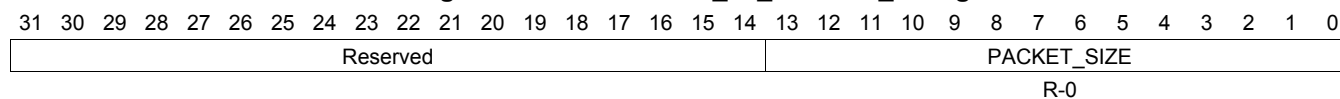

LEGEND: R/W = Read/Write; R = Read only; W1toCl = Write 1 to clear bit; -n = value after reset

Table 16-1046. QUEUE_32_STATUS_B Register Field Descriptions

Bit	Field	Type	Reset	Description
27-0	QUEUE_BYTE_COUNT	R-0	0	This field indicates how many bytes total are contained in all of the packets which are currently queued on this queue. Queue_Manager_Queue_n_Status_B Registers B

16.5.7.757 QUEUE_32_STATUS_C Register (offset = 3208h) [reset = 0h]

QUEUE_32_STATUS_C is shown in [Figure 16-1033](#) and described in [Table 16-1047](#).

Figure 16-1033. QUEUE_32_STATUS_C Register


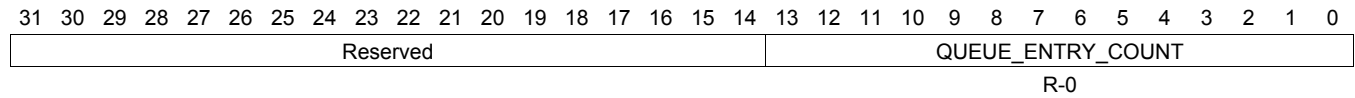
LEGEND: R/W = Read/Write; R = Read only; W1toCl = Write 1 to clear bit; -n = value after reset

Table 16-1047. QUEUE_32_STATUS_C Register Field Descriptions

Bit	Field	Type	Reset	Description
13-0	PACKET_SIZE	R-0	0	This field indicates packet size of the head element of a queue. Queue_Manager_Queue_N_Status_C Registers C

16.5.7.758 QUEUE_33_STATUS_A Register (offset = 3210h) [reset = 0h]

 QUEUE_33_STATUS_A is shown in [Figure 16-1034](#) and described in [Table 16-1048](#).

Figure 16-1034. QUEUE_33_STATUS_A Register


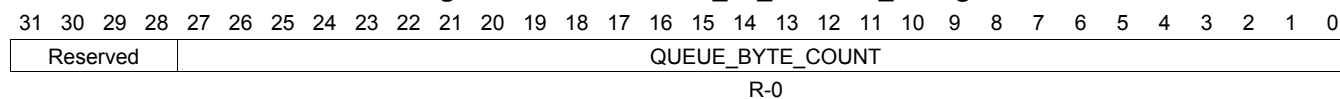
LEGEND: R/W = Read/Write; R = Read only; W1toCl = Write 1 to clear bit; -n = value after reset

Table 16-1048. QUEUE_33_STATUS_A Register Field Descriptions

Bit	Field	Type	Reset	Description
13-0	QUEUE_ENTRY_COUNT	R-0	0	This field indicates how many packets are currently queued on the queue. Queue Manager Queue N Status Registers A

16.5.7.759 QUEUE_33_STATUS_B Register (offset = 3214h) [reset = 0h]

QUEUE_33_STATUS_B is shown in [Figure 16-1035](#) and described in [Table 16-1049](#).

Figure 16-1035. QUEUE_33_STATUS_B Register


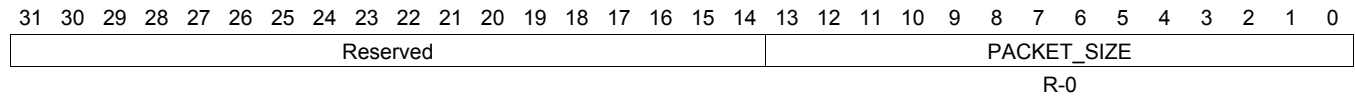
LEGEND: R/W = Read/Write; R = Read only; W1toCl = Write 1 to clear bit; -n = value after reset

Table 16-1049. QUEUE_33_STATUS_B Register Field Descriptions

Bit	Field	Type	Reset	Description
27-0	QUEUE_BYTE_COUNT	R-0	0	This field indicates how many bytes total are contained in all of the packets which are currently queued on this queue. Queue_Manager_Queue_n_Status_B Registers B

16.5.7.760 QUEUE_33_STATUS_C Register (offset = 3218h) [reset = 0h]

 QUEUE_33_STATUS_C is shown in [Figure 16-1036](#) and described in [Table 16-1050](#).

Figure 16-1036. QUEUE_33_STATUS_C Register


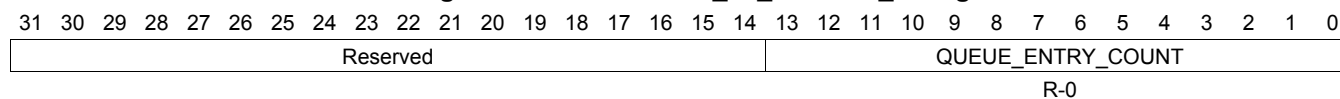
LEGEND: R/W = Read/Write; R = Read only; W1toCl = Write 1 to clear bit; -n = value after reset

Table 16-1050. QUEUE_33_STATUS_C Register Field Descriptions

Bit	Field	Type	Reset	Description
13-0	PACKET_SIZE	R-0	0	This field indicates packet size of the head element of a queue. Queue_Manager_Queue_N_Status_C Registers C

16.5.7.761 QUEUE_34_STATUS_A Register (offset = 3220h) [reset = 0h]

QUEUE_34_STATUS_A is shown in [Figure 16-1037](#) and described in [Table 16-1051](#).

Figure 16-1037. QUEUE_34_STATUS_A Register


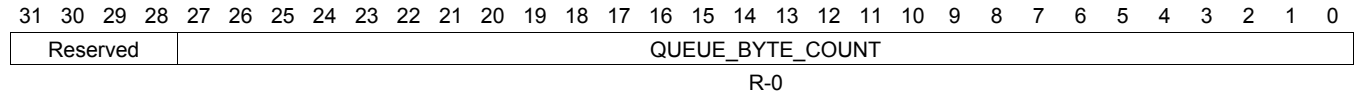
LEGEND: R/W = Read/Write; R = Read only; W1toCl = Write 1 to clear bit; -n = value after reset

Table 16-1051. QUEUE_34_STATUS_A Register Field Descriptions

Bit	Field	Type	Reset	Description
13-0	QUEUE_ENTRY_COUNT	R-0	0	This field indicates how many packets are currently queued on the queue. Queue Manager Queue N Status Registers A

16.5.7.762 QUEUE_34_STATUS_B Register (offset = 3224h) [reset = 0h]

 QUEUE_34_STATUS_B is shown in [Figure 16-1038](#) and described in [Table 16-1052](#).

Figure 16-1038. QUEUE_34_STATUS_B Register


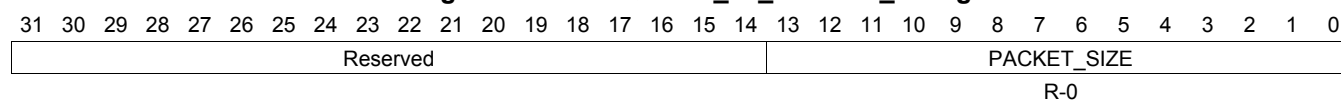
LEGEND: R/W = Read/Write; R = Read only; W1toCl = Write 1 to clear bit; -n = value after reset

Table 16-1052. QUEUE_34_STATUS_B Register Field Descriptions

Bit	Field	Type	Reset	Description
27-0	QUEUE_BYTE_COUNT	R-0	0	This field indicates how many bytes total are contained in all of the packets which are currently queued on this queue. Queue_Manager_Queue_n_Status_B Registers B

16.5.7.763 QUEUE_34_STATUS_C Register (offset = 3228h) [reset = 0h]

 QUEUE_34_STATUS_C is shown in [Figure 16-1039](#) and described in [Table 16-1053](#).

Figure 16-1039. QUEUE_34_STATUS_C Register


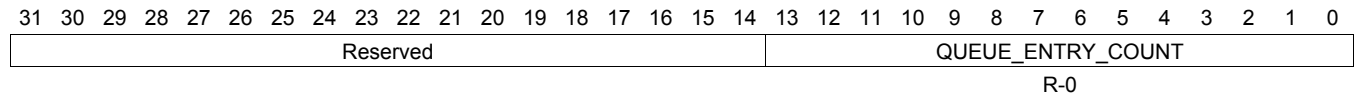
LEGEND: R/W = Read/Write; R = Read only; W1toCl = Write 1 to clear bit; -n = value after reset

Table 16-1053. QUEUE_34_STATUS_C Register Field Descriptions

Bit	Field	Type	Reset	Description
13-0	PACKET_SIZE	R-0	0	This field indicates packet size of the head element of a queue. Queue_Manager_Queue_N_Status_C Registers C

16.5.7.764 QUEUE_35_STATUS_A Register (offset = 3230h) [reset = 0h]

 QUEUE_35_STATUS_A is shown in [Figure 16-1040](#) and described in [Table 16-1054](#).

Figure 16-1040. QUEUE_35_STATUS_A Register


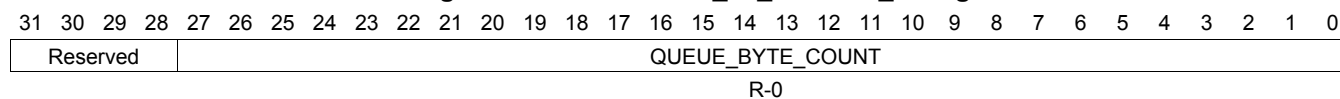
LEGEND: R/W = Read/Write; R = Read only; W1toCl = Write 1 to clear bit; -n = value after reset

Table 16-1054. QUEUE_35_STATUS_A Register Field Descriptions

Bit	Field	Type	Reset	Description
13-0	QUEUE_ENTRY_COUNT	R-0	0	This field indicates how many packets are currently queued on the queue. Queue Manager Queue N Status Registers A

16.5.7.765 QUEUE_35_STATUS_B Register (offset = 3234h) [reset = 0h]

 QUEUE_35_STATUS_B is shown in [Figure 16-1041](#) and described in [Table 16-1055](#).

Figure 16-1041. QUEUE_35_STATUS_B Register


LEGEND: R/W = Read/Write; R = Read only; W1toCl = Write 1 to clear bit; -n = value after reset

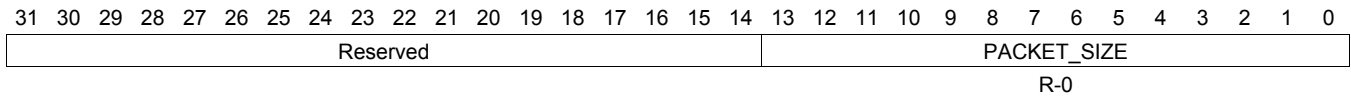
Table 16-1055. QUEUE_35_STATUS_B Register Field Descriptions

Bit	Field	Type	Reset	Description
27-0	QUEUE_BYTE_COUNT	R-0	0	This field indicates how many bytes total are contained in all of the packets which are currently queued on this queue. Queue_Manager_Queue_n_Status_B Registers B

16.5.7.766 QUEUE_35_STATUS_C Register (offset = 3238h) [reset = 0h]

QUEUE_35_STATUS_C is shown in [Figure 16-1042](#) and described in [Table 16-1056](#).

Figure 16-1042. QUEUE_35_STATUS_C Register



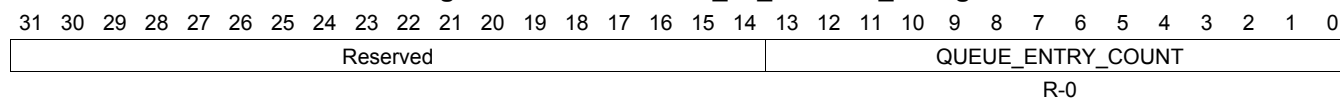
LEGEND: R/W = Read/Write; R = Read only; W1toCl = Write 1 to clear bit; -n = value after reset

Table 16-1056. QUEUE_35_STATUS_C Register Field Descriptions

Bit	Field	Type	Reset	Description
13-0	PACKET_SIZE	R-0	0	This field indicates packet size of the head element of a queue. Queue_Manager_Queue_N_Status_C Registers C

16.5.7.767 QUEUE_36_STATUS_A Register (offset = 3240h) [reset = 0h]

 QUEUE_36_STATUS_A is shown in [Figure 16-1043](#) and described in [Table 16-1057](#).

Figure 16-1043. QUEUE_36_STATUS_A Register


LEGEND: R/W = Read/Write; R = Read only; W1toCl = Write 1 to clear bit; -n = value after reset

Table 16-1057. QUEUE_36_STATUS_A Register Field Descriptions

Bit	Field	Type	Reset	Description
13-0	QUEUE_ENTRY_COUNT	R-0	0	This field indicates how many packets are currently queued on the queue. Queue Manager Queue N Status Registers A

16.5.7.768 QUEUE_36_STATUS_B Register (offset = 3244h) [reset = 0h]

 QUEUE_36_STATUS_B is shown in [Figure 16-1044](#) and described in [Table 16-1058](#).

Figure 16-1044. QUEUE_36_STATUS_B Register

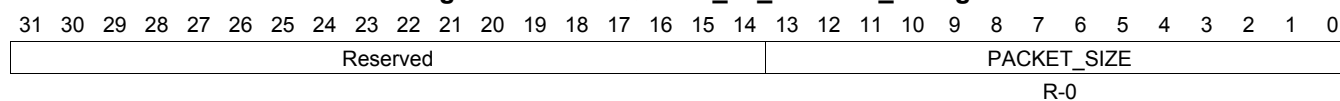

LEGEND: R/W = Read/Write; R = Read only; W1toCl = Write 1 to clear bit; -n = value after reset

Table 16-1058. QUEUE_36_STATUS_B Register Field Descriptions

Bit	Field	Type	Reset	Description
27-0	QUEUE_BYTE_COUNT	R-0	0	This field indicates how many bytes total are contained in all of the packets which are currently queued on this queue. Queue_Manager_Queue_n_Status_B Registers B

16.5.7.769 QUEUE_36_STATUS_C Register (offset = 3248h) [reset = 0h]

QUEUE_36_STATUS_C is shown in [Figure 16-1045](#) and described in [Table 16-1059](#).

Figure 16-1045. QUEUE_36_STATUS_C Register


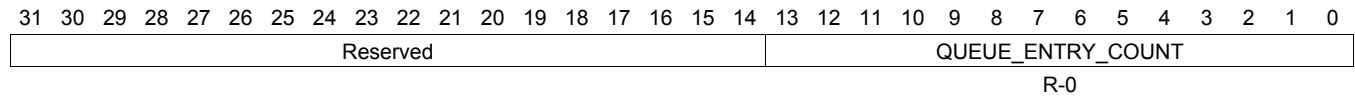
LEGEND: R/W = Read/Write; R = Read only; W1toCl = Write 1 to clear bit; -n = value after reset

Table 16-1059. QUEUE_36_STATUS_C Register Field Descriptions

Bit	Field	Type	Reset	Description
13-0	PACKET_SIZE	R-0	0	This field indicates packet size of the head element of a queue. Queue_Manager_Queue_N_Status_C Registers C

16.5.7.770 QUEUE_37_STATUS_A Register (offset = 3250h) [reset = 0h]

 QUEUE_37_STATUS_A is shown in [Figure 16-1046](#) and described in [Table 16-1060](#).

Figure 16-1046. QUEUE_37_STATUS_A Register


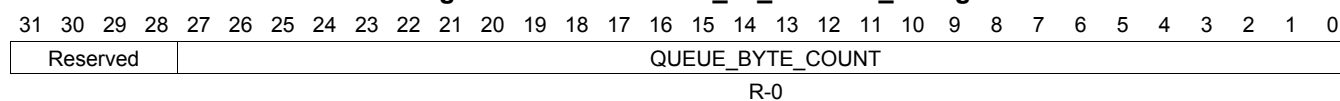
LEGEND: R/W = Read/Write; R = Read only; W1toCl = Write 1 to clear bit; -n = value after reset

Table 16-1060. QUEUE_37_STATUS_A Register Field Descriptions

Bit	Field	Type	Reset	Description
13-0	QUEUE_ENTRY_COUNT	R-0	0	This field indicates how many packets are currently queued on the queue. Queue Manager Queue N Status Registers A

16.5.7.771 QUEUE_37_STATUS_B Register (offset = 3254h) [reset = 0h]

QUEUE_37_STATUS_B is shown in [Figure 16-1047](#) and described in [Table 16-1061](#).

Figure 16-1047. QUEUE_37_STATUS_B Register


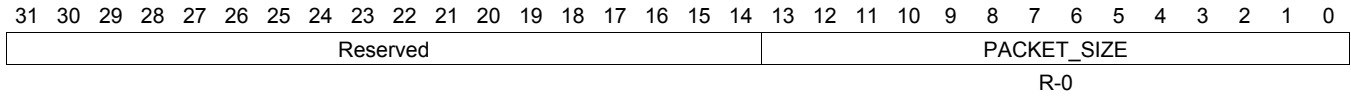
LEGEND: R/W = Read/Write; R = Read only; W1toCl = Write 1 to clear bit; -n = value after reset

Table 16-1061. QUEUE_37_STATUS_B Register Field Descriptions

Bit	Field	Type	Reset	Description
27-0	QUEUE_BYTE_COUNT	R-0	0	This field indicates how many bytes total are contained in all of the packets which are currently queued on this queue. Queue_Manager_Queue_n_Status_B Registers B

16.5.7.772 QUEUE_37_STATUS_C Register (offset = 3258h) [reset = 0h]

 QUEUE_37_STATUS_C is shown in [Figure 16-1048](#) and described in [Table 16-1062](#).

Figure 16-1048. QUEUE_37_STATUS_C Register


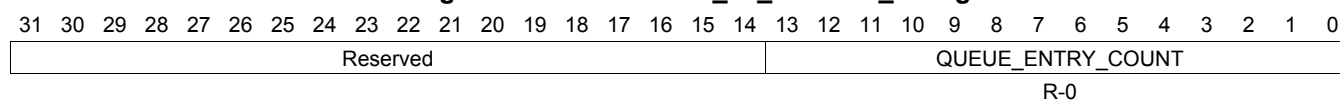
LEGEND: R/W = Read/Write; R = Read only; W1toCl = Write 1 to clear bit; -n = value after reset

Table 16-1062. QUEUE_37_STATUS_C Register Field Descriptions

Bit	Field	Type	Reset	Description
13-0	PACKET_SIZE	R-0	0	This field indicates packet size of the head element of a queue. Queue_Manager_Queue_N_Status_C Registers C

16.5.7.773 QUEUE_38_STATUS_A Register (offset = 3260h) [reset = 0h]

 QUEUE_38_STATUS_A is shown in [Figure 16-1049](#) and described in [Table 16-1063](#).

Figure 16-1049. QUEUE_38_STATUS_A Register


LEGEND: R/W = Read/Write; R = Read only; W1toCl = Write 1 to clear bit; -n = value after reset

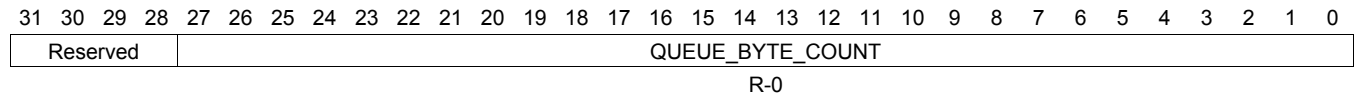
Table 16-1063. QUEUE_38_STATUS_A Register Field Descriptions

Bit	Field	Type	Reset	Description
13-0	QUEUE_ENTRY_COUNT	R-0	0	This field indicates how many packets are currently queued on the queue. Queue Manager Queue N Status Registers A

16.5.7.774 QUEUE_38_STATUS_B Register (offset = 3264h) [reset = 0h]

QUEUE_38_STATUS_B is shown in [Figure 16-1050](#) and described in [Table 16-1064](#).

Figure 16-1050. QUEUE_38_STATUS_B Register



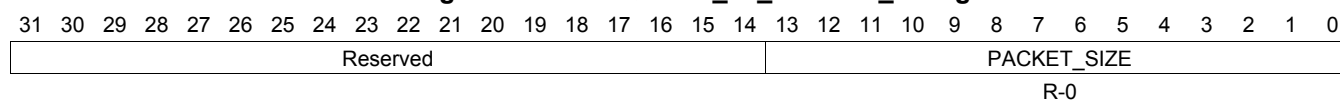
LEGEND: R/W = Read/Write; R = Read only; W1toCl = Write 1 to clear bit; -n = value after reset

Table 16-1064. QUEUE_38_STATUS_B Register Field Descriptions

Bit	Field	Type	Reset	Description
27-0	QUEUE_BYTE_COUNT	R-0	0	This field indicates how many bytes total are contained in all of the packets which are currently queued on this queue. Queue_Manager_Queue_n_Status_B Registers B

16.5.7.775 QUEUE_38_STATUS_C Register (offset = 3268h) [reset = 0h]

QUEUE_38_STATUS_C is shown in [Figure 16-1051](#) and described in [Table 16-1065](#).

Figure 16-1051. QUEUE_38_STATUS_C Register


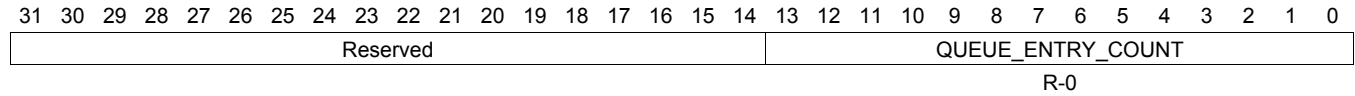
LEGEND: R/W = Read/Write; R = Read only; W1toCl = Write 1 to clear bit; -n = value after reset

Table 16-1065. QUEUE_38_STATUS_C Register Field Descriptions

Bit	Field	Type	Reset	Description
13-0	PACKET_SIZE	R-0	0	This field indicates packet size of the head element of a queue. Queue_Manager_Queue_N_Status_C Registers C

16.5.7.776 QUEUE_39_STATUS_A Register (offset = 3270h) [reset = 0h]

 QUEUE_39_STATUS_A is shown in [Figure 16-1052](#) and described in [Table 16-1066](#).

Figure 16-1052. QUEUE_39_STATUS_A Register


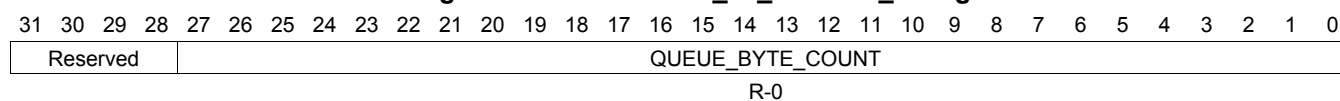
LEGEND: R/W = Read/Write; R = Read only; W1toCl = Write 1 to clear bit; -n = value after reset

Table 16-1066. QUEUE_39_STATUS_A Register Field Descriptions

Bit	Field	Type	Reset	Description
13-0	QUEUE_ENTRY_COUNT	R-0	0	This field indicates how many packets are currently queued on the queue. Queue Manager Queue N Status Registers A

16.5.7.777 QUEUE_39_STATUS_B Register (offset = 3274h) [reset = 0h]

QUEUE_39_STATUS_B is shown in [Figure 16-1053](#) and described in [Table 16-1067](#).

Figure 16-1053. QUEUE_39_STATUS_B Register


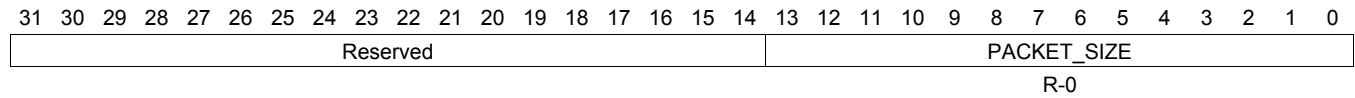
LEGEND: R/W = Read/Write; R = Read only; W1toCl = Write 1 to clear bit; -n = value after reset

Table 16-1067. QUEUE_39_STATUS_B Register Field Descriptions

Bit	Field	Type	Reset	Description
27-0	QUEUE_BYTE_COUNT	R-0	0	This field indicates how many bytes total are contained in all of the packets which are currently queued on this queue. Queue_Manager_Queue_n_Status_B Registers B

16.5.7.778 QUEUE_39_STATUS_C Register (offset = 3278h) [reset = 0h]

QUEUE_39_STATUS_C is shown in [Figure 16-1054](#) and described in [Table 16-1068](#).

Figure 16-1054. QUEUE_39_STATUS_C Register


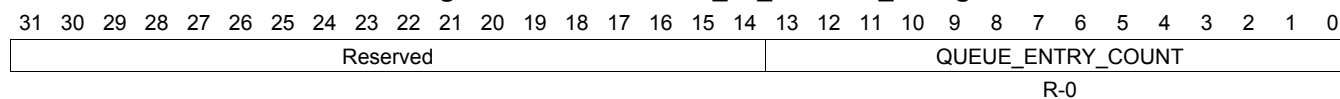
LEGEND: R/W = Read/Write; R = Read only; W1toCl = Write 1 to clear bit; -n = value after reset

Table 16-1068. QUEUE_39_STATUS_C Register Field Descriptions

Bit	Field	Type	Reset	Description
13-0	PACKET_SIZE	R-0	0	This field indicates packet size of the head element of a queue. Queue_Manager_Queue_N_Status_C Registers C

16.5.7.779 QUEUE_40_STATUS_A Register (offset = 3280h) [reset = 0h]

QUEUE_40_STATUS_A is shown in [Figure 16-1055](#) and described in [Table 16-1069](#).

Figure 16-1055. QUEUE_40_STATUS_A Register


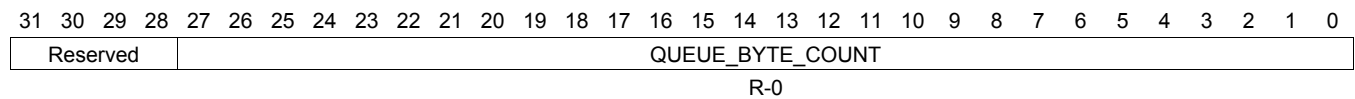
LEGEND: R/W = Read/Write; R = Read only; W1toCl = Write 1 to clear bit; -n = value after reset

Table 16-1069. QUEUE_40_STATUS_A Register Field Descriptions

Bit	Field	Type	Reset	Description
13-0	QUEUE_ENTRY_COUNT	R-0	0	This field indicates how many packets are currently queued on the queue. Queue Manager Queue N Status Registers A

16.5.7.780 QUEUE_40_STATUS_B Register (offset = 3284h) [reset = 0h]

 QUEUE_40_STATUS_B is shown in [Figure 16-1056](#) and described in [Table 16-1070](#).

Figure 16-1056. QUEUE_40_STATUS_B Register


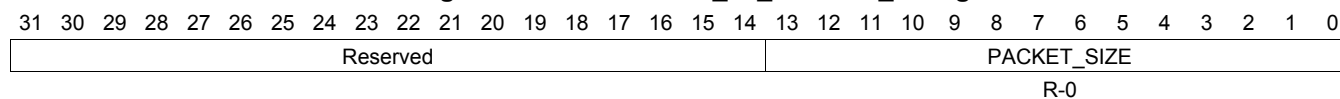
LEGEND: R/W = Read/Write; R = Read only; W1toCl = Write 1 to clear bit; -n = value after reset

Table 16-1070. QUEUE_40_STATUS_B Register Field Descriptions

Bit	Field	Type	Reset	Description
27-0	QUEUE_BYTE_COUNT	R-0	0	This field indicates how many bytes total are contained in all of the packets which are currently queued on this queue. Queue_Manager_Queue_n_Status_B Registers B

16.5.7.781 QUEUE_40_STATUS_C Register (offset = 3288h) [reset = 0h]

QUEUE_40_STATUS_C is shown in [Figure 16-1057](#) and described in [Table 16-1071](#).

Figure 16-1057. QUEUE_40_STATUS_C Register


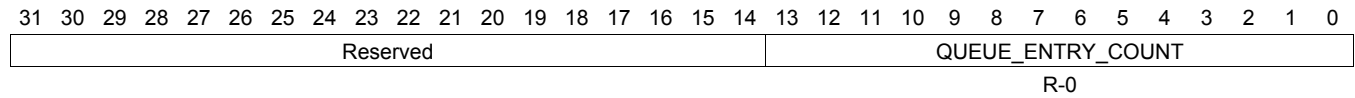
LEGEND: R/W = Read/Write; R = Read only; W1toCl = Write 1 to clear bit; -n = value after reset

Table 16-1071. QUEUE_40_STATUS_C Register Field Descriptions

Bit	Field	Type	Reset	Description
13-0	PACKET_SIZE	R-0	0	This field indicates packet size of the head element of a queue. Queue_Manager_Queue_N_Status_C Registers C

16.5.7.782 QUEUE_41_STATUS_A Register (offset = 3290h) [reset = 0h]

 QUEUE_41_STATUS_A is shown in [Figure 16-1058](#) and described in [Table 16-1072](#).

Figure 16-1058. QUEUE_41_STATUS_A Register


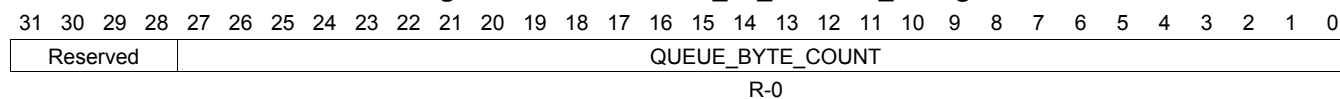
LEGEND: R/W = Read/Write; R = Read only; W1toCl = Write 1 to clear bit; -n = value after reset

Table 16-1072. QUEUE_41_STATUS_A Register Field Descriptions

Bit	Field	Type	Reset	Description
13-0	QUEUE_ENTRY_COUNT	R-0	0	This field indicates how many packets are currently queued on the queue. Queue Manager Queue N Status Registers A

16.5.7.783 QUEUE_41_STATUS_B Register (offset = 3294h) [reset = 0h]

QUEUE_41_STATUS_B is shown in [Figure 16-1059](#) and described in [Table 16-1073](#).

Figure 16-1059. QUEUE_41_STATUS_B Register


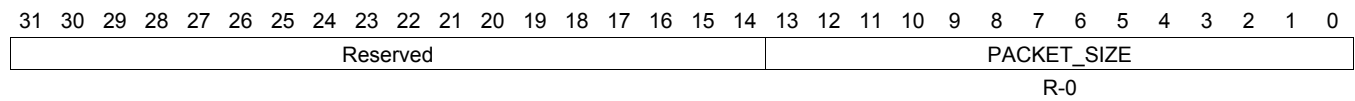
LEGEND: R/W = Read/Write; R = Read only; W1toCl = Write 1 to clear bit; -n = value after reset

Table 16-1073. QUEUE_41_STATUS_B Register Field Descriptions

Bit	Field	Type	Reset	Description
27-0	QUEUE_BYTE_COUNT	R-0	0	This field indicates how many bytes total are contained in all of the packets which are currently queued on this queue. Queue_Manager_Queue_n_Status_B Registers B

16.5.7.784 QUEUE_41_STATUS_C Register (offset = 3298h) [reset = 0h]

 QUEUE_41_STATUS_C is shown in [Figure 16-1060](#) and described in [Table 16-1074](#).

Figure 16-1060. QUEUE_41_STATUS_C Register


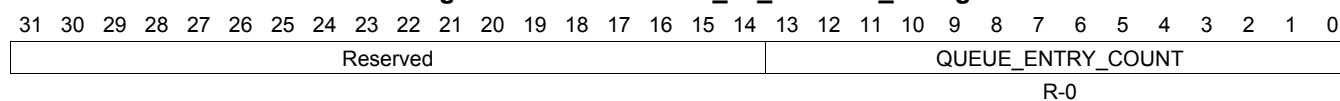
LEGEND: R/W = Read/Write; R = Read only; W1toCl = Write 1 to clear bit; -n = value after reset

Table 16-1074. QUEUE_41_STATUS_C Register Field Descriptions

Bit	Field	Type	Reset	Description
13-0	PACKET_SIZE	R-0	0	This field indicates packet size of the head element of a queue. Queue_Manager_Queue_N_Status_C Registers C

16.5.7.785 QUEUE_42_STATUS_A Register (offset = 32A0h) [reset = 0h]

QUEUE_42_STATUS_A is shown in [Figure 16-1061](#) and described in [Table 16-1075](#).

Figure 16-1061. QUEUE_42_STATUS_A Register


LEGEND: R/W = Read/Write; R = Read only; W1toCl = Write 1 to clear bit; -n = value after reset

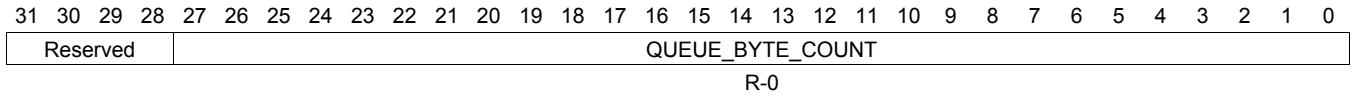
Table 16-1075. QUEUE_42_STATUS_A Register Field Descriptions

Bit	Field	Type	Reset	Description
13-0	QUEUE_ENTRY_COUNT	R-0	0	This field indicates how many packets are currently queued on the queue. Queue Manager Queue N Status Registers A

16.5.7.786 QUEUE_42_STATUS_B Register (offset = 32A4h) [reset = 0h]

QUEUE_42_STATUS_B is shown in [Figure 16-1062](#) and described in [Table 16-1076](#).

Figure 16-1062. QUEUE_42_STATUS_B Register



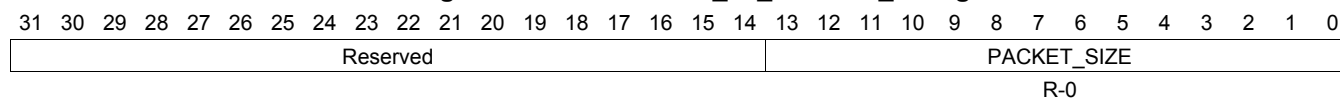
LEGEND: R/W = Read/Write; R = Read only; W1toCl = Write 1 to clear bit; -n = value after reset

Table 16-1076. QUEUE_42_STATUS_B Register Field Descriptions

Bit	Field	Type	Reset	Description
27-0	QUEUE_BYTE_COUNT	R-0	0	This field indicates how many bytes total are contained in all of the packets which are currently queued on this queue. Queue_Manager_Queue_n_Status_B Registers B

16.5.7.787 QUEUE_42_STATUS_C Register (offset = 32A8h) [reset = 0h]

QUEUE_42_STATUS_C is shown in [Figure 16-1063](#) and described in [Table 16-1077](#).

Figure 16-1063. QUEUE_42_STATUS_C Register


LEGEND: R/W = Read/Write; R = Read only; W1toCl = Write 1 to clear bit; -n = value after reset

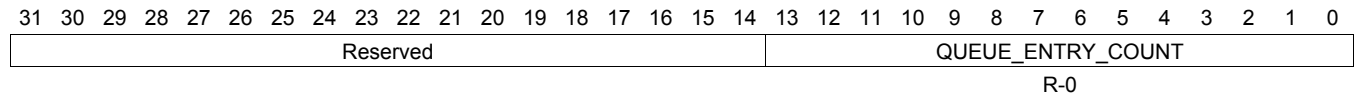
Table 16-1077. QUEUE_42_STATUS_C Register Field Descriptions

Bit	Field	Type	Reset	Description
13-0	PACKET_SIZE	R-0	0	This field indicates packet size of the head element of a queue. Queue_Manager_Queue_N_Status_C Registers C

16.5.7.788 QUEUE_43_STATUS_A Register (offset = 32B0h) [reset = 0h]

QUEUE_43_STATUS_A is shown in [Figure 16-1064](#) and described in [Table 16-1078](#).

Figure 16-1064. QUEUE_43_STATUS_A Register



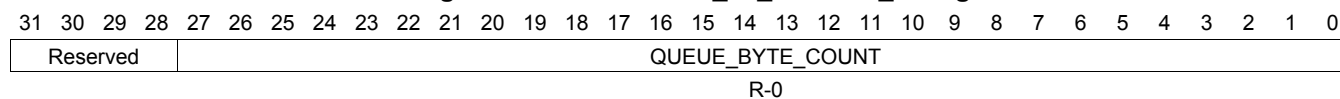
LEGEND: R/W = Read/Write; R = Read only; W1toCl = Write 1 to clear bit; -n = value after reset

Table 16-1078. QUEUE_43_STATUS_A Register Field Descriptions

Bit	Field	Type	Reset	Description
13-0	QUEUE_ENTRY_COUNT	R-0	0	This field indicates how many packets are currently queued on the queue. Queue Manager Queue N Status Registers A

16.5.7.789 QUEUE_43_STATUS_B Register (offset = 32B4h) [reset = 0h]

 QUEUE_43_STATUS_B is shown in [Figure 16-1065](#) and described in [Table 16-1079](#).

Figure 16-1065. QUEUE_43_STATUS_B Register


LEGEND: R/W = Read/Write; R = Read only; W1toCl = Write 1 to clear bit; -n = value after reset

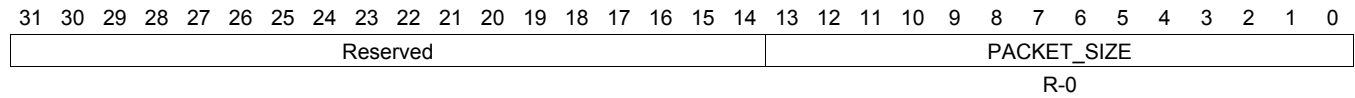
Table 16-1079. QUEUE_43_STATUS_B Register Field Descriptions

Bit	Field	Type	Reset	Description
27-0	QUEUE_BYTE_COUNT	R-0	0	This field indicates how many bytes total are contained in all of the packets which are currently queued on this queue. Queue_Manager_Queue_n_Status_B Registers B

16.5.7.790 QUEUE_43_STATUS_C Register (offset = 32B8h) [reset = 0h]

QUEUE_43_STATUS_C is shown in [Figure 16-1066](#) and described in [Table 16-1080](#).

Figure 16-1066. QUEUE_43_STATUS_C Register



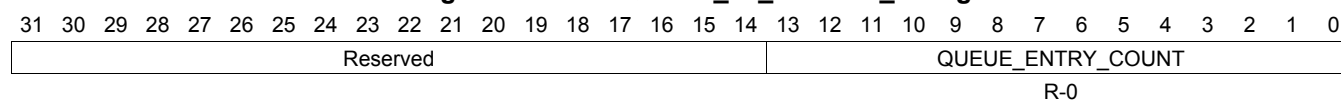
LEGEND: R/W = Read/Write; R = Read only; W1toCl = Write 1 to clear bit; -n = value after reset

Table 16-1080. QUEUE_43_STATUS_C Register Field Descriptions

Bit	Field	Type	Reset	Description
13-0	PACKET_SIZE	R-0	0	This field indicates packet size of the head element of a queue. Queue_Manager_Queue_N_Status_C Registers C

16.5.7.791 QUEUE_44_STATUS_A Register (offset = 32C0h) [reset = 0h]

 QUEUE_44_STATUS_A is shown in [Figure 16-1067](#) and described in [Table 16-1081](#).

Figure 16-1067. QUEUE_44_STATUS_A Register


LEGEND: R/W = Read/Write; R = Read only; W1toCl = Write 1 to clear bit; -n = value after reset

Table 16-1081. QUEUE_44_STATUS_A Register Field Descriptions

Bit	Field	Type	Reset	Description
13-0	QUEUE_ENTRY_COUNT	R-0	0	This field indicates how many packets are currently queued on the queue. Queue Manager Queue N Status Registers A

16.5.7.792 QUEUE_44_STATUS_B Register (offset = 32C4h) [reset = 0h]

QUEUE_44_STATUS_B is shown in [Figure 16-1068](#) and described in [Table 16-1082](#).

Figure 16-1068. QUEUE_44_STATUS_B Register



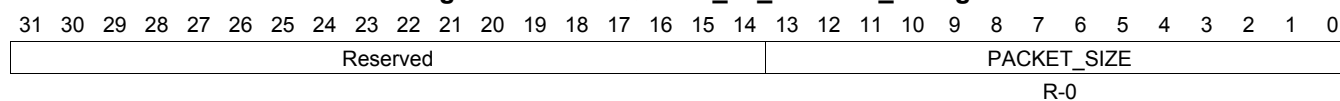
LEGEND: R/W = Read/Write; R = Read only; W1toCl = Write 1 to clear bit; -n = value after reset

Table 16-1082. QUEUE_44_STATUS_B Register Field Descriptions

Bit	Field	Type	Reset	Description
27-0	QUEUE_BYTE_COUNT	R-0	0	This field indicates how many bytes total are contained in all of the packets which are currently queued on this queue. Queue_Manager_Queue_n_Status_B Registers B

16.5.7.793 QUEUE_44_STATUS_C Register (offset = 32C8h) [reset = 0h]

QUEUE_44_STATUS_C is shown in [Figure 16-1069](#) and described in [Table 16-1083](#).

Figure 16-1069. QUEUE_44_STATUS_C Register


LEGEND: R/W = Read/Write; R = Read only; W1toCl = Write 1 to clear bit; -n = value after reset

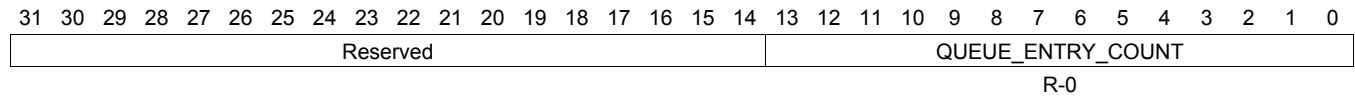
Table 16-1083. QUEUE_44_STATUS_C Register Field Descriptions

Bit	Field	Type	Reset	Description
13-0	PACKET_SIZE	R-0	0	This field indicates packet size of the head element of a queue. Queue_Manager_Queue_N_Status_C Registers C

16.5.7.794 QUEUE_45_STATUS_A Register (offset = 32D0h) [reset = 0h]

QUEUE_45_STATUS_A is shown in [Figure 16-1070](#) and described in [Table 16-1084](#).

Figure 16-1070. QUEUE_45_STATUS_A Register



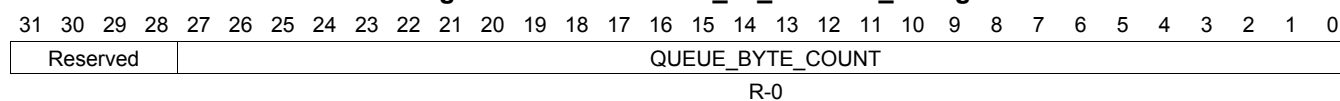
LEGEND: R/W = Read/Write; R = Read only; W1toCl = Write 1 to clear bit; -n = value after reset

Table 16-1084. QUEUE_45_STATUS_A Register Field Descriptions

Bit	Field	Type	Reset	Description
13-0	QUEUE_ENTRY_COUNT	R-0	0	This field indicates how many packets are currently queued on the queue. Queue Manager Queue N Status Registers A

16.5.7.795 QUEUE_45_STATUS_B Register (offset = 32D4h) [reset = 0h]

QUEUE_45_STATUS_B is shown in [Figure 16-1071](#) and described in [Table 16-1085](#).

Figure 16-1071. QUEUE_45_STATUS_B Register


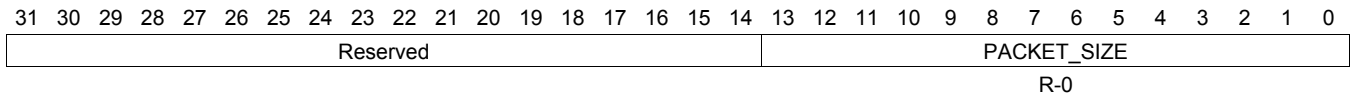
LEGEND: R/W = Read/Write; R = Read only; W1toCl = Write 1 to clear bit; -n = value after reset

Table 16-1085. QUEUE_45_STATUS_B Register Field Descriptions

Bit	Field	Type	Reset	Description
27-0	QUEUE_BYTE_COUNT	R-0	0	This field indicates how many bytes total are contained in all of the packets which are currently queued on this queue. Queue_Manager_Queue_n_Status_B Registers B

16.5.7.796 QUEUE_45_STATUS_C Register (offset = 32D8h) [reset = 0h]

 QUEUE_45_STATUS_C is shown in [Figure 16-1072](#) and described in [Table 16-1086](#).

Figure 16-1072. QUEUE_45_STATUS_C Register


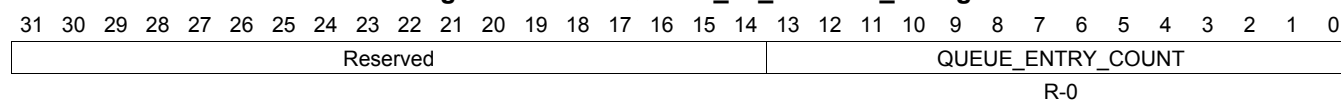
LEGEND: R/W = Read/Write; R = Read only; W1toCl = Write 1 to clear bit; -n = value after reset

Table 16-1086. QUEUE_45_STATUS_C Register Field Descriptions

Bit	Field	Type	Reset	Description
13-0	PACKET_SIZE	R-0	0	This field indicates packet size of the head element of a queue. Queue_Manager_Queue_N_Status_C Registers C

16.5.7.797 QUEUE_46_STATUS_A Register (offset = 32E0h) [reset = 0h]

 QUEUE_46_STATUS_A is shown in [Figure 16-1073](#) and described in [Table 16-1087](#).

Figure 16-1073. QUEUE_46_STATUS_A Register


LEGEND: R/W = Read/Write; R = Read only; W1toCl = Write 1 to clear bit; -n = value after reset

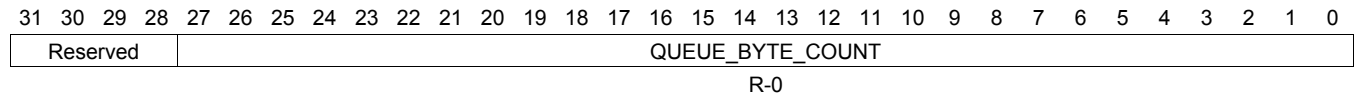
Table 16-1087. QUEUE_46_STATUS_A Register Field Descriptions

Bit	Field	Type	Reset	Description
13-0	QUEUE_ENTRY_COUNT	R-0	0	This field indicates how many packets are currently queued on the queue. Queue Manager Queue N Status Registers A

16.5.7.798 QUEUE_46_STATUS_B Register (offset = 32E4h) [reset = 0h]

QUEUE_46_STATUS_B is shown in [Figure 16-1074](#) and described in [Table 16-1088](#).

Figure 16-1074. QUEUE_46_STATUS_B Register



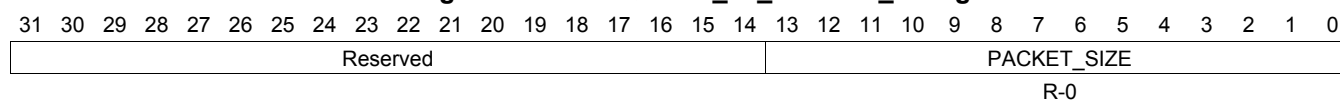
LEGEND: R/W = Read/Write; R = Read only; W1toCl = Write 1 to clear bit; -n = value after reset

Table 16-1088. QUEUE_46_STATUS_B Register Field Descriptions

Bit	Field	Type	Reset	Description
27-0	QUEUE_BYTE_COUNT	R-0	0	This field indicates how many bytes total are contained in all of the packets which are currently queued on this queue. Queue_Manager_Queue_n_Status_B Registers B

16.5.7.799 QUEUE_46_STATUS_C Register (offset = 32E8h) [reset = 0h]

QUEUE_46_STATUS_C is shown in [Figure 16-1075](#) and described in [Table 16-1089](#).

Figure 16-1075. QUEUE_46_STATUS_C Register


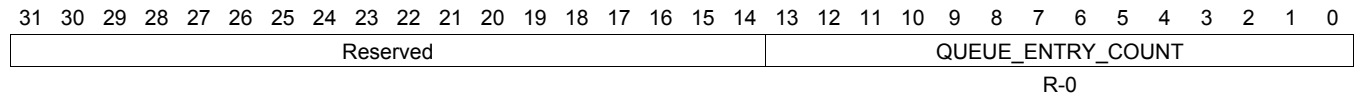
LEGEND: R/W = Read/Write; R = Read only; W1toCl = Write 1 to clear bit; -n = value after reset

Table 16-1089. QUEUE_46_STATUS_C Register Field Descriptions

Bit	Field	Type	Reset	Description
13-0	PACKET_SIZE	R-0	0	This field indicates packet size of the head element of a queue. Queue_Manager_Queue_N_Status_C Registers C

16.5.7.800 QUEUE_47_STATUS_A Register (offset = 32F0h) [reset = 0h]

 QUEUE_47_STATUS_A is shown in [Figure 16-1076](#) and described in [Table 16-1090](#).

Figure 16-1076. QUEUE_47_STATUS_A Register


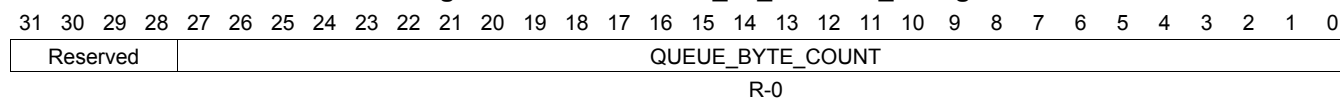
LEGEND: R/W = Read/Write; R = Read only; W1toCl = Write 1 to clear bit; -n = value after reset

Table 16-1090. QUEUE_47_STATUS_A Register Field Descriptions

Bit	Field	Type	Reset	Description
13-0	QUEUE_ENTRY_COUNT	R-0	0	This field indicates how many packets are currently queued on the queue. Queue Manager Queue N Status Registers A

16.5.7.801 QUEUE_47_STATUS_B Register (offset = 32F4h) [reset = 0h]

QUEUE_47_STATUS_B is shown in [Figure 16-1077](#) and described in [Table 16-1091](#).

Figure 16-1077. QUEUE_47_STATUS_B Register


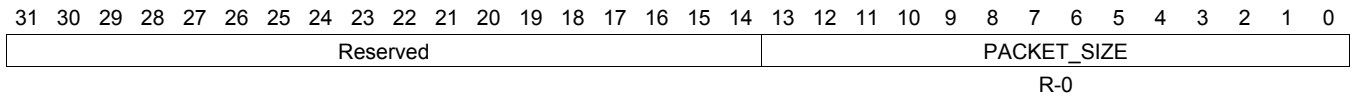
LEGEND: R/W = Read/Write; R = Read only; W1toCl = Write 1 to clear bit; -n = value after reset

Table 16-1091. QUEUE_47_STATUS_B Register Field Descriptions

Bit	Field	Type	Reset	Description
27-0	QUEUE_BYTE_COUNT	R-0	0	This field indicates how many bytes total are contained in all of the packets which are currently queued on this queue. Queue_Manager_Queue_n_Status_B Registers B

16.5.7.802 QUEUE_47_STATUS_C Register (offset = 32F8h) [reset = 0h]

 QUEUE_47_STATUS_C is shown in [Figure 16-1078](#) and described in [Table 16-1092](#).

Figure 16-1078. QUEUE_47_STATUS_C Register


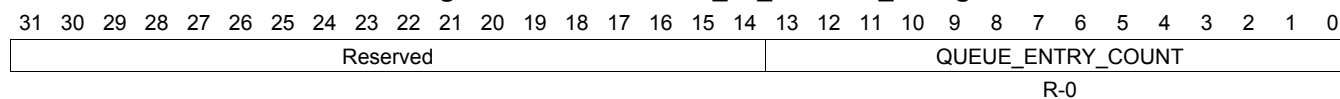
LEGEND: R/W = Read/Write; R = Read only; W1toCl = Write 1 to clear bit; -n = value after reset

Table 16-1092. QUEUE_47_STATUS_C Register Field Descriptions

Bit	Field	Type	Reset	Description
13-0	PACKET_SIZE	R-0	0	This field indicates packet size of the head element of a queue. Queue_Manager_Queue_N_Status_C Registers C

16.5.7.803 QUEUE_48_STATUS_A Register (offset = 3300h) [reset = 0h]

QUEUE_48_STATUS_A is shown in [Figure 16-1079](#) and described in [Table 16-1093](#).

Figure 16-1079. QUEUE_48_STATUS_A Register


LEGEND: R/W = Read/Write; R = Read only; W1toCl = Write 1 to clear bit; -n = value after reset

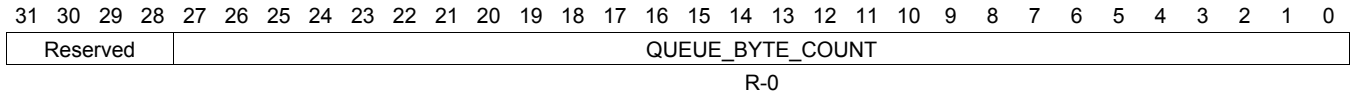
Table 16-1093. QUEUE_48_STATUS_A Register Field Descriptions

Bit	Field	Type	Reset	Description
13-0	QUEUE_ENTRY_COUNT	R-0	0	This field indicates how many packets are currently queued on the queue. Queue Manager Queue N Status Registers A

16.5.7.804 QUEUE_48_STATUS_B Register (offset = 3304h) [reset = 0h]

QUEUE_48_STATUS_B is shown in [Figure 16-1080](#) and described in [Table 16-1094](#).

Figure 16-1080. QUEUE_48_STATUS_B Register



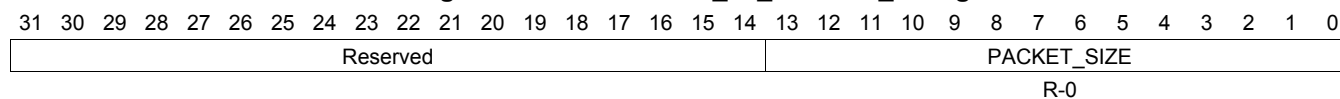
LEGEND: R/W = Read/Write; R = Read only; W1toCl = Write 1 to clear bit; -n = value after reset

Table 16-1094. QUEUE_48_STATUS_B Register Field Descriptions

Bit	Field	Type	Reset	Description
27-0	QUEUE_BYTE_COUNT	R-0	0	This field indicates how many bytes total are contained in all of the packets which are currently queued on this queue. Queue_Manager_Queue_n_Status_B Registers B

16.5.7.805 QUEUE_48_STATUS_C Register (offset = 3308h) [reset = 0h]

QUEUE_48_STATUS_C is shown in [Figure 16-1081](#) and described in [Table 16-1095](#).

Figure 16-1081. QUEUE_48_STATUS_C Register


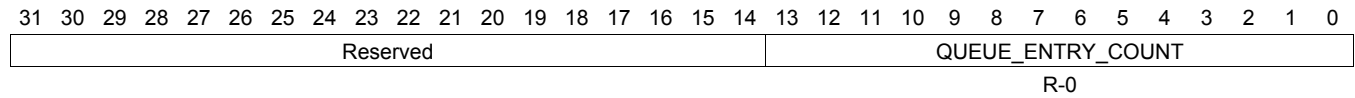
LEGEND: R/W = Read/Write; R = Read only; W1toCl = Write 1 to clear bit; -n = value after reset

Table 16-1095. QUEUE_48_STATUS_C Register Field Descriptions

Bit	Field	Type	Reset	Description
13-0	PACKET_SIZE	R-0	0	This field indicates packet size of the head element of a queue. Queue_Manager_Queue_N_Status_C Registers C

16.5.7.806 QUEUE_49_STATUS_A Register (offset = 3310h) [reset = 0h]

 QUEUE_49_STATUS_A is shown in [Figure 16-1082](#) and described in [Table 16-1096](#).

Figure 16-1082. QUEUE_49_STATUS_A Register


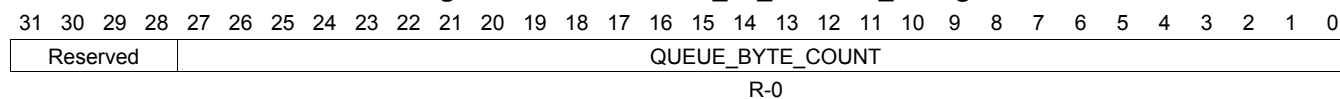
LEGEND: R/W = Read/Write; R = Read only; W1toCl = Write 1 to clear bit; -n = value after reset

Table 16-1096. QUEUE_49_STATUS_A Register Field Descriptions

Bit	Field	Type	Reset	Description
13-0	QUEUE_ENTRY_COUNT	R-0	0	This field indicates how many packets are currently queued on the queue. Queue Manager Queue N Status Registers A

16.5.7.807 QUEUE_49_STATUS_B Register (offset = 3314h) [reset = 0h]

QUEUE_49_STATUS_B is shown in [Figure 16-1083](#) and described in [Table 16-1097](#).

Figure 16-1083. QUEUE_49_STATUS_B Register


LEGEND: R/W = Read/Write; R = Read only; W1toCl = Write 1 to clear bit; -n = value after reset

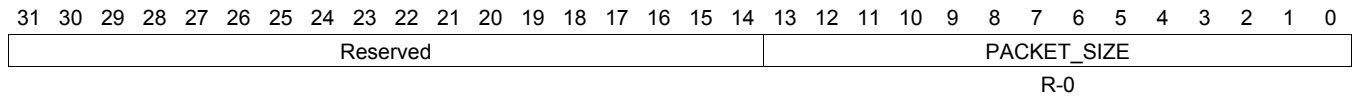
Table 16-1097. QUEUE_49_STATUS_B Register Field Descriptions

Bit	Field	Type	Reset	Description
27-0	QUEUE_BYTE_COUNT	R-0	0	This field indicates how many bytes total are contained in all of the packets which are currently queued on this queue. Queue_Manager_Queue_n_Status_B Registers B

16.5.7.808 QUEUE_49_STATUS_C Register (offset = 3318h) [reset = 0h]

QUEUE_49_STATUS_C is shown in [Figure 16-1084](#) and described in [Table 16-1098](#).

Figure 16-1084. QUEUE_49_STATUS_C Register



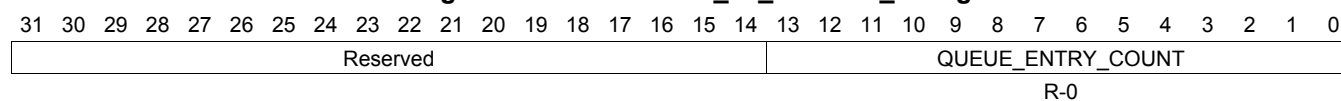
LEGEND: R/W = Read/Write; R = Read only; W1toCl = Write 1 to clear bit; -n = value after reset

Table 16-1098. QUEUE_49_STATUS_C Register Field Descriptions

Bit	Field	Type	Reset	Description
13-0	PACKET_SIZE	R-0	0	This field indicates packet size of the head element of a queue. Queue_Manager_Queue_N_Status_C Registers C

16.5.7.809 QUEUE_50_STATUS_A Register (offset = 3320h) [reset = 0h]

QUEUE_50_STATUS_A is shown in [Figure 16-1085](#) and described in [Table 16-1099](#).

Figure 16-1085. QUEUE_50_STATUS_A Register


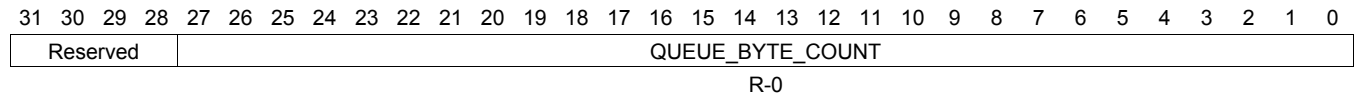
LEGEND: R/W = Read/Write; R = Read only; W1toCl = Write 1 to clear bit; -n = value after reset

Table 16-1099. QUEUE_50_STATUS_A Register Field Descriptions

Bit	Field	Type	Reset	Description
13-0	QUEUE_ENTRY_COUNT	R-0	0	This field indicates how many packets are currently queued on the queue. Queue Manager Queue N Status Registers A

16.5.7.810 QUEUE_50_STATUS_B Register (offset = 3324h) [reset = 0h]

 QUEUE_50_STATUS_B is shown in [Figure 16-1086](#) and described in [Table 16-1100](#).

Figure 16-1086. QUEUE_50_STATUS_B Register


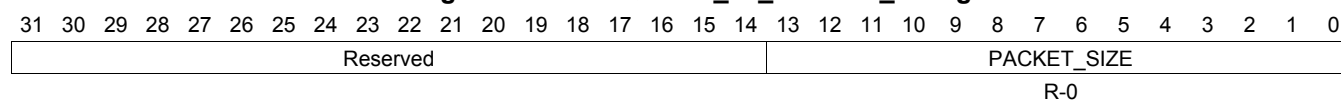
LEGEND: R/W = Read/Write; R = Read only; W1toCl = Write 1 to clear bit; -n = value after reset

Table 16-1100. QUEUE_50_STATUS_B Register Field Descriptions

Bit	Field	Type	Reset	Description
27-0	QUEUE_BYTE_COUNT	R-0	0	This field indicates how many bytes total are contained in all of the packets which are currently queued on this queue. Queue_Manager_Queue_n_Status_B Registers B

16.5.7.811 QUEUE_50_STATUS_C Register (offset = 3328h) [reset = 0h]

QUEUE_50_STATUS_C is shown in [Figure 16-1087](#) and described in [Table 16-1101](#).

Figure 16-1087. QUEUE_50_STATUS_C Register


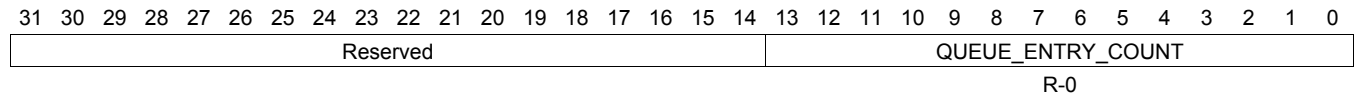
LEGEND: R/W = Read/Write; R = Read only; W1toCl = Write 1 to clear bit; -n = value after reset

Table 16-1101. QUEUE_50_STATUS_C Register Field Descriptions

Bit	Field	Type	Reset	Description
13-0	PACKET_SIZE	R-0	0	This field indicates packet size of the head element of a queue. Queue_Manager_Queue_N_Status_C Registers C

16.5.7.812 QUEUE_51_STATUS_A Register (offset = 3330h) [reset = 0h]

 QUEUE_51_STATUS_A is shown in [Figure 16-1088](#) and described in [Table 16-1102](#).

Figure 16-1088. QUEUE_51_STATUS_A Register


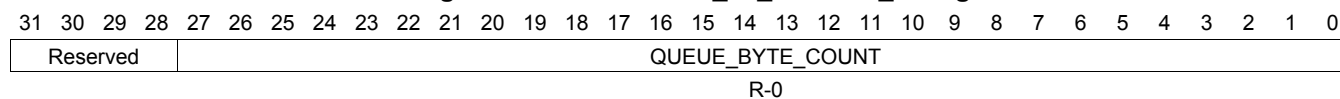
LEGEND: R/W = Read/Write; R = Read only; W1toCl = Write 1 to clear bit; -n = value after reset

Table 16-1102. QUEUE_51_STATUS_A Register Field Descriptions

Bit	Field	Type	Reset	Description
13-0	QUEUE_ENTRY_COUNT	R-0	0	This field indicates how many packets are currently queued on the queue. Queue Manager Queue N Status Registers A

16.5.7.813 QUEUE_51_STATUS_B Register (offset = 3334h) [reset = 0h]

 QUEUE_51_STATUS_B is shown in [Figure 16-1089](#) and described in [Table 16-1103](#).

Figure 16-1089. QUEUE_51_STATUS_B Register


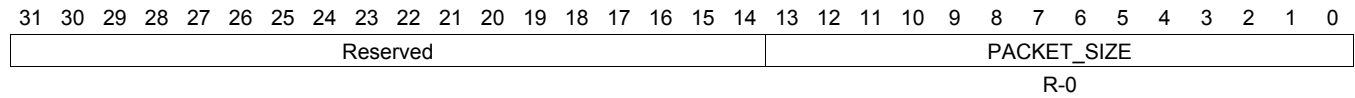
LEGEND: R/W = Read/Write; R = Read only; W1toCl = Write 1 to clear bit; -n = value after reset

Table 16-1103. QUEUE_51_STATUS_B Register Field Descriptions

Bit	Field	Type	Reset	Description
27-0	QUEUE_BYTE_COUNT	R-0	0	This field indicates how many bytes total are contained in all of the packets which are currently queued on this queue. Queue_Manager_Queue_n_Status_B Registers B

16.5.7.814 QUEUE_51_STATUS_C Register (offset = 3338h) [reset = 0h]

 QUEUE_51_STATUS_C is shown in [Figure 16-1090](#) and described in [Table 16-1104](#).

Figure 16-1090. QUEUE_51_STATUS_C Register


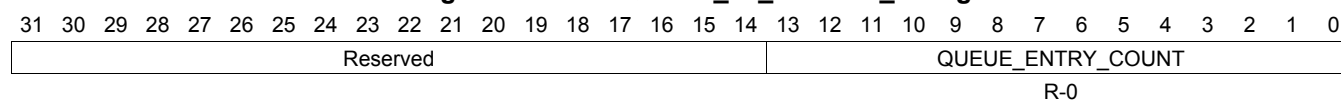
LEGEND: R/W = Read/Write; R = Read only; W1toCl = Write 1 to clear bit; -n = value after reset

Table 16-1104. QUEUE_51_STATUS_C Register Field Descriptions

Bit	Field	Type	Reset	Description
13-0	PACKET_SIZE	R-0	0	This field indicates packet size of the head element of a queue. Queue_Manager_Queue_N_Status_C Registers C

16.5.7.815 QUEUE_52_STATUS_A Register (offset = 3340h) [reset = 0h]

QUEUE_52_STATUS_A is shown in [Figure 16-1091](#) and described in [Table 16-1105](#).

Figure 16-1091. QUEUE_52_STATUS_A Register


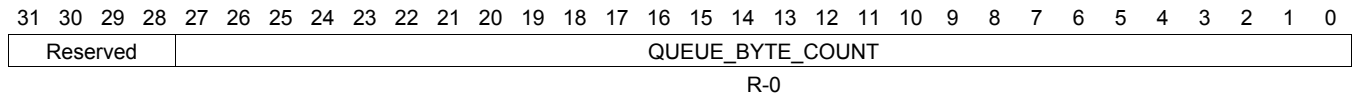
LEGEND: R/W = Read/Write; R = Read only; W1toCl = Write 1 to clear bit; -n = value after reset

Table 16-1105. QUEUE_52_STATUS_A Register Field Descriptions

Bit	Field	Type	Reset	Description
13-0	QUEUE_ENTRY_COUNT	R-0	0	This field indicates how many packets are currently queued on the queue. Queue Manager Queue N Status Registers A

16.5.7.816 QUEUE_52_STATUS_B Register (offset = 3344h) [reset = 0h]

 QUEUE_52_STATUS_B is shown in [Figure 16-1092](#) and described in [Table 16-1106](#).

Figure 16-1092. QUEUE_52_STATUS_B Register


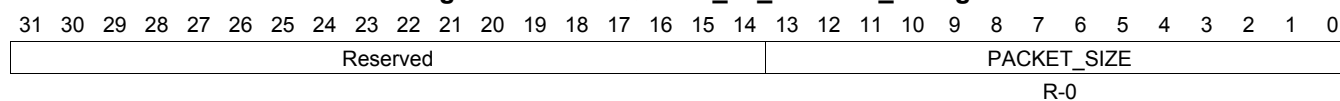
LEGEND: R/W = Read/Write; R = Read only; W1toCl = Write 1 to clear bit; -n = value after reset

Table 16-1106. QUEUE_52_STATUS_B Register Field Descriptions

Bit	Field	Type	Reset	Description
27-0	QUEUE_BYTE_COUNT	R-0	0	This field indicates how many bytes total are contained in all of the packets which are currently queued on this queue. Queue_Manager_Queue_n_Status_B Registers B

16.5.7.817 QUEUE_52_STATUS_C Register (offset = 3348h) [reset = 0h]

QUEUE_52_STATUS_C is shown in [Figure 16-1093](#) and described in [Table 16-1107](#).

Figure 16-1093. QUEUE_52_STATUS_C Register


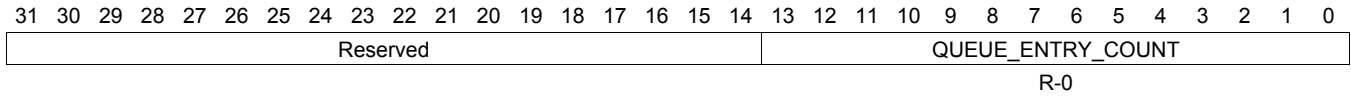
LEGEND: R/W = Read/Write; R = Read only; W1toCl = Write 1 to clear bit; -n = value after reset

Table 16-1107. QUEUE_52_STATUS_C Register Field Descriptions

Bit	Field	Type	Reset	Description
13-0	PACKET_SIZE	R-0	0	This field indicates packet size of the head element of a queue. Queue_Manager_Queue_N_Status_C Registers C

16.5.7.818 QUEUE_53_STATUS_A Register (offset = 3350h) [reset = 0h]

 QUEUE_53_STATUS_A is shown in [Figure 16-1094](#) and described in [Table 16-1108](#).

Figure 16-1094. QUEUE_53_STATUS_A Register


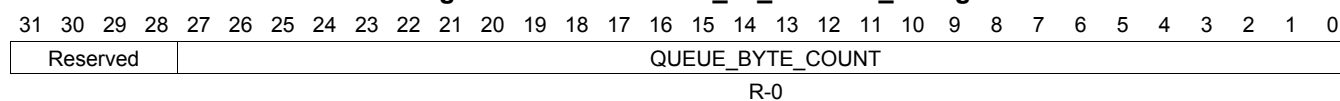
LEGEND: R/W = Read/Write; R = Read only; W1toCl = Write 1 to clear bit; -n = value after reset

Table 16-1108. QUEUE_53_STATUS_A Register Field Descriptions

Bit	Field	Type	Reset	Description
13-0	QUEUE_ENTRY_COUNT	R-0	0	This field indicates how many packets are currently queued on the queue. Queue Manager Queue N Status Registers A

16.5.7.819 QUEUE_53_STATUS_B Register (offset = 3354h) [reset = 0h]

 QUEUE_53_STATUS_B is shown in [Figure 16-1095](#) and described in [Table 16-1109](#).

Figure 16-1095. QUEUE_53_STATUS_B Register


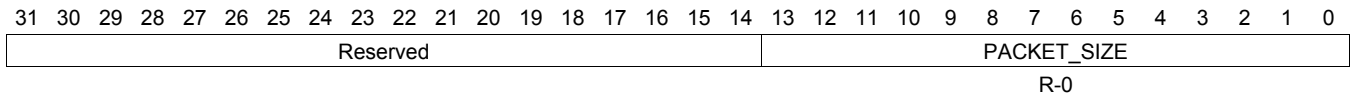
LEGEND: R/W = Read/Write; R = Read only; W1toCl = Write 1 to clear bit; -n = value after reset

Table 16-1109. QUEUE_53_STATUS_B Register Field Descriptions

Bit	Field	Type	Reset	Description
27-0	QUEUE_BYTE_COUNT	R-0	0	This field indicates how many bytes total are contained in all of the packets which are currently queued on this queue. Queue_Manager_Queue_n_Status_B Registers B

16.5.7.820 QUEUE_53_STATUS_C Register (offset = 3358h) [reset = 0h]

 QUEUE_53_STATUS_C is shown in [Figure 16-1096](#) and described in [Table 16-1110](#).

Figure 16-1096. QUEUE_53_STATUS_C Register


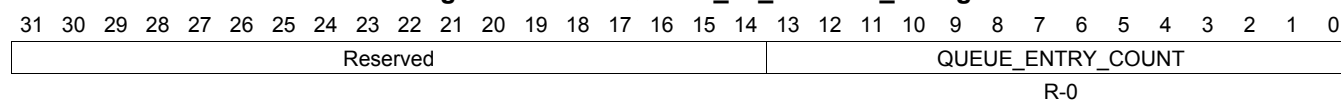
LEGEND: R/W = Read/Write; R = Read only; W1toCl = Write 1 to clear bit; -n = value after reset

Table 16-1110. QUEUE_53_STATUS_C Register Field Descriptions

Bit	Field	Type	Reset	Description
13-0	PACKET_SIZE	R-0	0	This field indicates packet size of the head element of a queue. Queue_Manager_Queue_N_Status_C Registers C

16.5.7.821 QUEUE_54_STATUS_A Register (offset = 3360h) [reset = 0h]

 QUEUE_54_STATUS_A is shown in [Figure 16-1097](#) and described in [Table 16-1111](#).

Figure 16-1097. QUEUE_54_STATUS_A Register


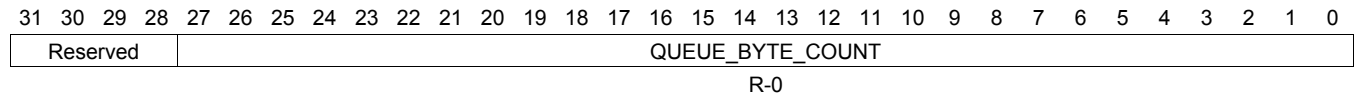
LEGEND: R/W = Read/Write; R = Read only; W1toCl = Write 1 to clear bit; -n = value after reset

Table 16-1111. QUEUE_54_STATUS_A Register Field Descriptions

Bit	Field	Type	Reset	Description
13-0	QUEUE_ENTRY_COUNT	R-0	0	This field indicates how many packets are currently queued on the queue. Queue Manager Queue N Status Registers A

16.5.7.822 QUEUE_54_STATUS_B Register (offset = 3364h) [reset = 0h]

 QUEUE_54_STATUS_B is shown in [Figure 16-1098](#) and described in [Table 16-1112](#).

Figure 16-1098. QUEUE_54_STATUS_B Register


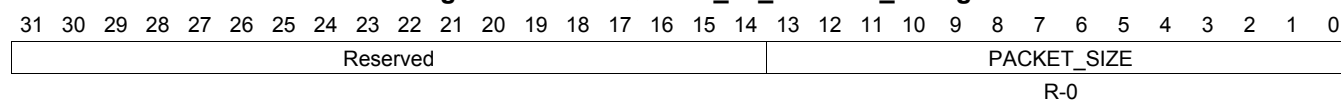
LEGEND: R/W = Read/Write; R = Read only; W1toCl = Write 1 to clear bit; -n = value after reset

Table 16-1112. QUEUE_54_STATUS_B Register Field Descriptions

Bit	Field	Type	Reset	Description
27-0	QUEUE_BYTE_COUNT	R-0	0	This field indicates how many bytes total are contained in all of the packets which are currently queued on this queue. Queue_Manager_Queue_n_Status_B Registers B

16.5.7.823 QUEUE_54_STATUS_C Register (offset = 3368h) [reset = 0h]

 QUEUE_54_STATUS_C is shown in [Figure 16-1099](#) and described in [Table 16-1113](#).

Figure 16-1099. QUEUE_54_STATUS_C Register


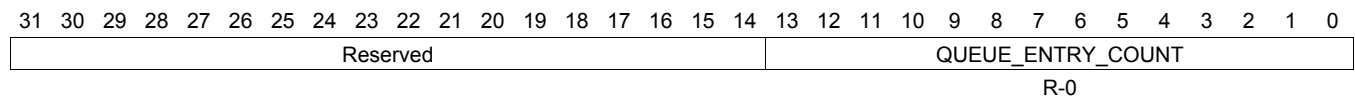
LEGEND: R/W = Read/Write; R = Read only; W1toCl = Write 1 to clear bit; -n = value after reset

Table 16-1113. QUEUE_54_STATUS_C Register Field Descriptions

Bit	Field	Type	Reset	Description
13-0	PACKET_SIZE	R-0	0	This field indicates packet size of the head element of a queue. Queue_Manager_Queue_N_Status_C Registers C

16.5.7.824 QUEUE_55_STATUS_A Register (offset = 3370h) [reset = 0h]

 QUEUE_55_STATUS_A is shown in [Figure 16-1100](#) and described in [Table 16-1114](#).

Figure 16-1100. QUEUE_55_STATUS_A Register


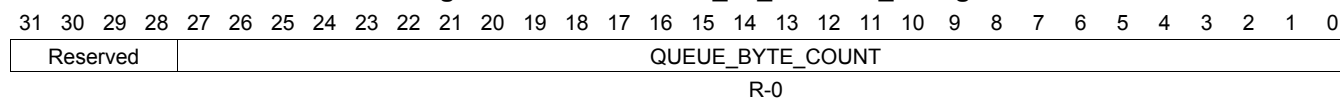
LEGEND: R/W = Read/Write; R = Read only; W1toCl = Write 1 to clear bit; -n = value after reset

Table 16-1114. QUEUE_55_STATUS_A Register Field Descriptions

Bit	Field	Type	Reset	Description
13-0	QUEUE_ENTRY_COUNT	R-0	0	This field indicates how many packets are currently queued on the queue. Queue Manager Queue N Status Registers A

16.5.7.825 QUEUE_55_STATUS_B Register (offset = 3374h) [reset = 0h]

 QUEUE_55_STATUS_B is shown in [Figure 16-1101](#) and described in [Table 16-1115](#).

Figure 16-1101. QUEUE_55_STATUS_B Register


LEGEND: R/W = Read/Write; R = Read only; W1toCl = Write 1 to clear bit; -n = value after reset

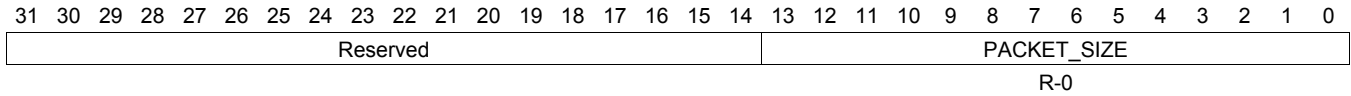
Table 16-1115. QUEUE_55_STATUS_B Register Field Descriptions

Bit	Field	Type	Reset	Description
27-0	QUEUE_BYTE_COUNT	R-0	0	This field indicates how many bytes total are contained in all of the packets which are currently queued on this queue. Queue_Manager_Queue_n_Status_B Registers B

16.5.7.826 QUEUE_55_STATUS_C Register (offset = 3378h) [reset = 0h]

QUEUE_55_STATUS_C is shown in [Figure 16-1102](#) and described in [Table 16-1116](#).

Figure 16-1102. QUEUE_55_STATUS_C Register



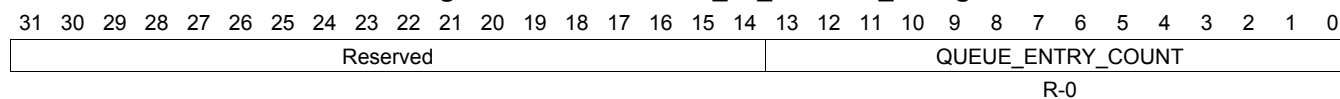
LEGEND: R/W = Read/Write; R = Read only; W1toCl = Write 1 to clear bit; -n = value after reset

Table 16-1116. QUEUE_55_STATUS_C Register Field Descriptions

Bit	Field	Type	Reset	Description
13-0	PACKET_SIZE	R-0	0	This field indicates packet size of the head element of a queue. Queue_Manager_Queue_N_Status_C Registers C

16.5.7.827 QUEUE_56_STATUS_A Register (offset = 3380h) [reset = 0h]

QUEUE_56_STATUS_A is shown in [Figure 16-1103](#) and described in [Table 16-1117](#).

Figure 16-1103. QUEUE_56_STATUS_A Register


LEGEND: R/W = Read/Write; R = Read only; W1toCl = Write 1 to clear bit; -n = value after reset

Table 16-1117. QUEUE_56_STATUS_A Register Field Descriptions

Bit	Field	Type	Reset	Description
13-0	QUEUE_ENTRY_COUNT	R-0	0	This field indicates how many packets are currently queued on the queue. Queue Manager Queue N Status Registers A

16.5.7.828 QUEUE_56_STATUS_B Register (offset = 3384h) [reset = 0h]

 QUEUE_56_STATUS_B is shown in [Figure 16-1104](#) and described in [Table 16-1118](#).

Figure 16-1104. QUEUE_56_STATUS_B Register

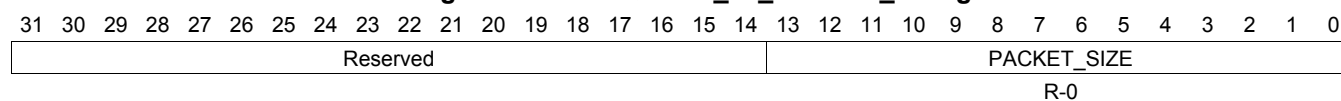

LEGEND: R/W = Read/Write; R = Read only; W1toCl = Write 1 to clear bit; -n = value after reset

Table 16-1118. QUEUE_56_STATUS_B Register Field Descriptions

Bit	Field	Type	Reset	Description
27-0	QUEUE_BYTE_COUNT	R-0	0	This field indicates how many bytes total are contained in all of the packets which are currently queued on this queue. Queue_Manager_Queue_n_Status_B Registers B

16.5.7.829 QUEUE_56_STATUS_C Register (offset = 3388h) [reset = 0h]

QUEUE_56_STATUS_C is shown in [Figure 16-1105](#) and described in [Table 16-1119](#).

Figure 16-1105. QUEUE_56_STATUS_C Register


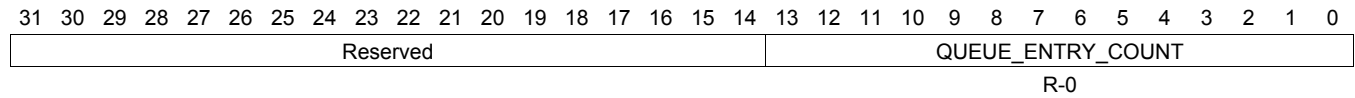
LEGEND: R/W = Read/Write; R = Read only; W1toCl = Write 1 to clear bit; -n = value after reset

Table 16-1119. QUEUE_56_STATUS_C Register Field Descriptions

Bit	Field	Type	Reset	Description
13-0	PACKET_SIZE	R-0	0	This field indicates packet size of the head element of a queue. Queue_Manager_Queue_N_Status_C Registers C

16.5.7.830 QUEUE_57_STATUS_A Register (offset = 3390h) [reset = 0h]

 QUEUE_57_STATUS_A is shown in [Figure 16-1106](#) and described in [Table 16-1120](#).

Figure 16-1106. QUEUE_57_STATUS_A Register


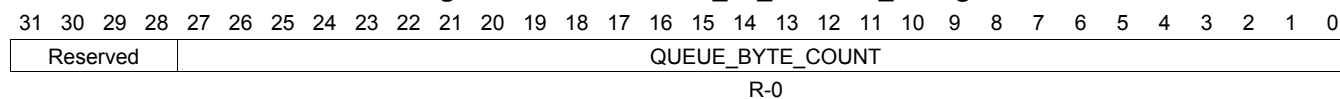
LEGEND: R/W = Read/Write; R = Read only; W1toCl = Write 1 to clear bit; -n = value after reset

Table 16-1120. QUEUE_57_STATUS_A Register Field Descriptions

Bit	Field	Type	Reset	Description
13-0	QUEUE_ENTRY_COUNT	R-0	0	This field indicates how many packets are currently queued on the queue. Queue Manager Queue N Status Registers A

16.5.7.831 QUEUE_57_STATUS_B Register (offset = 3394h) [reset = 0h]

 QUEUE_57_STATUS_B is shown in [Figure 16-1107](#) and described in [Table 16-1121](#).

Figure 16-1107. QUEUE_57_STATUS_B Register


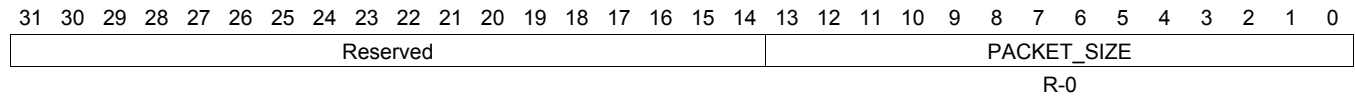
LEGEND: R/W = Read/Write; R = Read only; W1toCl = Write 1 to clear bit; -n = value after reset

Table 16-1121. QUEUE_57_STATUS_B Register Field Descriptions

Bit	Field	Type	Reset	Description
27-0	QUEUE_BYTE_COUNT	R-0	0	This field indicates how many bytes total are contained in all of the packets which are currently queued on this queue. Queue_Manager_Queue_n_Status_B Registers B

16.5.7.832 QUEUE_57_STATUS_C Register (offset = 3398h) [reset = 0h]

 QUEUE_57_STATUS_C is shown in [Figure 16-1108](#) and described in [Table 16-1122](#).

Figure 16-1108. QUEUE_57_STATUS_C Register


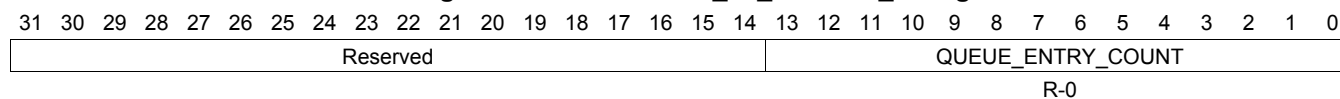
LEGEND: R/W = Read/Write; R = Read only; W1toCl = Write 1 to clear bit; -n = value after reset

Table 16-1122. QUEUE_57_STATUS_C Register Field Descriptions

Bit	Field	Type	Reset	Description
13-0	PACKET_SIZE	R-0	0	This field indicates packet size of the head element of a queue. Queue_Manager_Queue_N_Status_C Registers C

16.5.7.833 QUEUE_58_STATUS_A Register (offset = 33A0h) [reset = 0h]

QUEUE_58_STATUS_A is shown in [Figure 16-1109](#) and described in [Table 16-1123](#).

Figure 16-1109. QUEUE_58_STATUS_A Register


LEGEND: R/W = Read/Write; R = Read only; W1toCl = Write 1 to clear bit; -n = value after reset

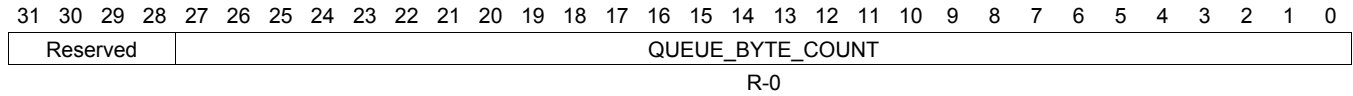
Table 16-1123. QUEUE_58_STATUS_A Register Field Descriptions

Bit	Field	Type	Reset	Description
13-0	QUEUE_ENTRY_COUNT	R-0	0	This field indicates how many packets are currently queued on the queue. Queue Manager Queue N Status Registers A

16.5.7.834 QUEUE_58_STATUS_B Register (offset = 33A4h) [reset = 0h]

QUEUE_58_STATUS_B is shown in [Figure 16-1110](#) and described in [Table 16-1124](#).

Figure 16-1110. QUEUE_58_STATUS_B Register



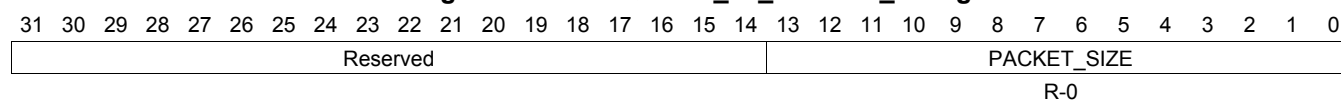
LEGEND: R/W = Read/Write; R = Read only; W1toCl = Write 1 to clear bit; -n = value after reset

Table 16-1124. QUEUE_58_STATUS_B Register Field Descriptions

Bit	Field	Type	Reset	Description
27-0	QUEUE_BYTE_COUNT	R-0	0	This field indicates how many bytes total are contained in all of the packets which are currently queued on this queue. Queue_Manager_Queue_n_Status_B Registers B

16.5.7.835 QUEUE_58_STATUS_C Register (offset = 33A8h) [reset = 0h]

QUEUE_58_STATUS_C is shown in [Figure 16-1111](#) and described in [Table 16-1125](#).

Figure 16-1111. QUEUE_58_STATUS_C Register


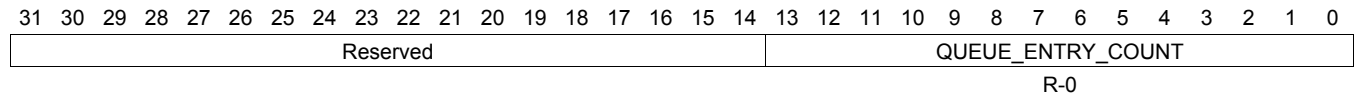
LEGEND: R/W = Read/Write; R = Read only; W1toCl = Write 1 to clear bit; -n = value after reset

Table 16-1125. QUEUE_58_STATUS_C Register Field Descriptions

Bit	Field	Type	Reset	Description
13-0	PACKET_SIZE	R-0	0	This field indicates packet size of the head element of a queue. Queue_Manager_Queue_N_Status_C Registers C

16.5.7.836 QUEUE_59_STATUS_A Register (offset = 33B0h) [reset = 0h]

 QUEUE_59_STATUS_A is shown in [Figure 16-1112](#) and described in [Table 16-1126](#).

Figure 16-1112. QUEUE_59_STATUS_A Register


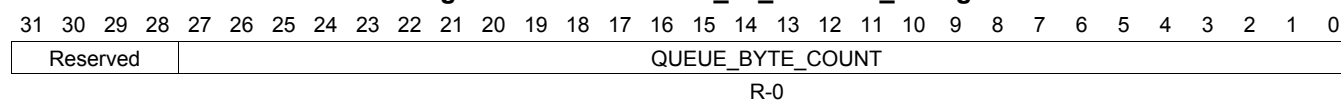
LEGEND: R/W = Read/Write; R = Read only; W1toCl = Write 1 to clear bit; -n = value after reset

Table 16-1126. QUEUE_59_STATUS_A Register Field Descriptions

Bit	Field	Type	Reset	Description
13-0	QUEUE_ENTRY_COUNT	R-0	0	This field indicates how many packets are currently queued on the queue. Queue Manager Queue N Status Registers A

16.5.7.837 QUEUE_59_STATUS_B Register (offset = 33B4h) [reset = 0h]

QUEUE_59_STATUS_B is shown in [Figure 16-1113](#) and described in [Table 16-1127](#).

Figure 16-1113. QUEUE_59_STATUS_B Register


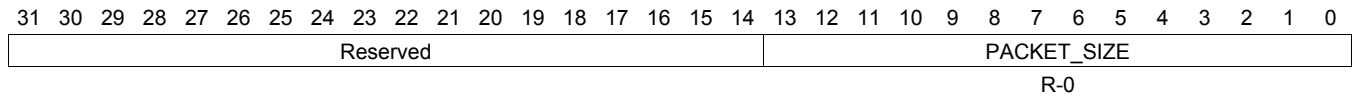
LEGEND: R/W = Read/Write; R = Read only; W1toCl = Write 1 to clear bit; -n = value after reset

Table 16-1127. QUEUE_59_STATUS_B Register Field Descriptions

Bit	Field	Type	Reset	Description
27-0	QUEUE_BYTE_COUNT	R-0	0	This field indicates how many bytes total are contained in all of the packets which are currently queued on this queue. Queue_Manager_Queue_n_Status_B Registers B

16.5.7.838 QUEUE_59_STATUS_C Register (offset = 33B8h) [reset = 0h]

 QUEUE_59_STATUS_C is shown in [Figure 16-1114](#) and described in [Table 16-1128](#).

Figure 16-1114. QUEUE_59_STATUS_C Register


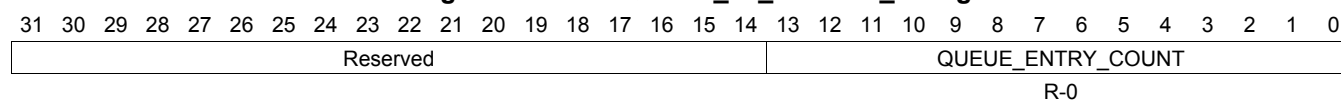
LEGEND: R/W = Read/Write; R = Read only; W1toCl = Write 1 to clear bit; -n = value after reset

Table 16-1128. QUEUE_59_STATUS_C Register Field Descriptions

Bit	Field	Type	Reset	Description
13-0	PACKET_SIZE	R-0	0	This field indicates packet size of the head element of a queue. Queue_Manager_Queue_N_Status_C Registers C

16.5.7.839 QUEUE_60_STATUS_A Register (offset = 33C0h) [reset = 0h]

 QUEUE_60_STATUS_A is shown in [Figure 16-1115](#) and described in [Table 16-1129](#).

Figure 16-1115. QUEUE_60_STATUS_A Register


LEGEND: R/W = Read/Write; R = Read only; W1toCl = Write 1 to clear bit; -n = value after reset

Table 16-1129. QUEUE_60_STATUS_A Register Field Descriptions

Bit	Field	Type	Reset	Description
13-0	QUEUE_ENTRY_COUNT	R-0	0	This field indicates how many packets are currently queued on the queue. Queue Manager Queue N Status Registers A

16.5.7.840 QUEUE_60_STATUS_B Register (offset = 33C4h) [reset = 0h]

QUEUE_60_STATUS_B is shown in [Figure 16-1116](#) and described in [Table 16-1130](#).

Figure 16-1116. QUEUE_60_STATUS_B Register

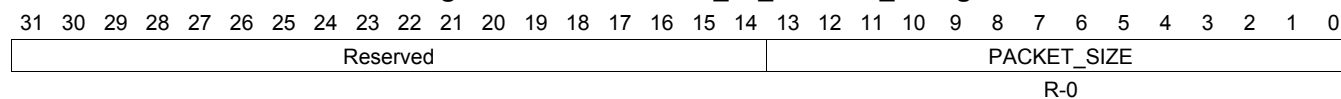

LEGEND: R/W = Read/Write; R = Read only; W1toCl = Write 1 to clear bit; -n = value after reset

Table 16-1130. QUEUE_60_STATUS_B Register Field Descriptions

Bit	Field	Type	Reset	Description
27-0	QUEUE_BYTE_COUNT	R-0	0	This field indicates how many bytes total are contained in all of the packets which are currently queued on this queue. Queue_Manager_Queue_n_Status_B Registers B

16.5.7.841 QUEUE_60_STATUS_C Register (offset = 33C8h) [reset = 0h]

QUEUE_60_STATUS_C is shown in [Figure 16-1117](#) and described in [Table 16-1131](#).

Figure 16-1117. QUEUE_60_STATUS_C Register


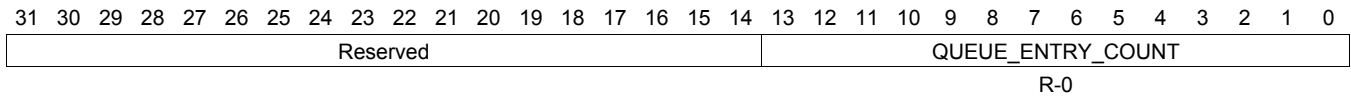
LEGEND: R/W = Read/Write; R = Read only; W1toCl = Write 1 to clear bit; -n = value after reset

Table 16-1131. QUEUE_60_STATUS_C Register Field Descriptions

Bit	Field	Type	Reset	Description
13-0	PACKET_SIZE	R-0	0	This field indicates packet size of the head element of a queue. Queue_Manager_Queue_N_Status_C Registers C

16.5.7.842 QUEUE_61_STATUS_A Register (offset = 33D0h) [reset = 0h]

 QUEUE_61_STATUS_A is shown in [Figure 16-1118](#) and described in [Table 16-1132](#).

Figure 16-1118. QUEUE_61_STATUS_A Register


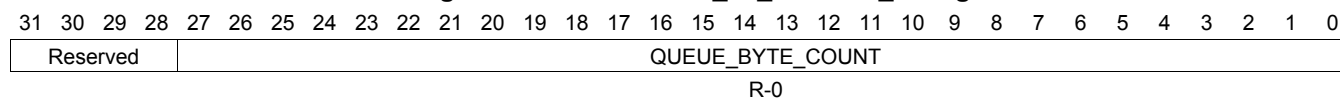
LEGEND: R/W = Read/Write; R = Read only; W1toCl = Write 1 to clear bit; -n = value after reset

Table 16-1132. QUEUE_61_STATUS_A Register Field Descriptions

Bit	Field	Type	Reset	Description
13-0	QUEUE_ENTRY_COUNT	R-0	0	This field indicates how many packets are currently queued on the queue. Queue Manager Queue N Status Registers A

16.5.7.843 QUEUE_61_STATUS_B Register (offset = 33D4h) [reset = 0h]

QUEUE_61_STATUS_B is shown in [Figure 16-1119](#) and described in [Table 16-1133](#).

Figure 16-1119. QUEUE_61_STATUS_B Register


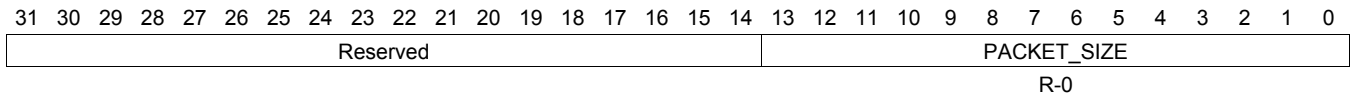
LEGEND: R/W = Read/Write; R = Read only; W1toCl = Write 1 to clear bit; -n = value after reset

Table 16-1133. QUEUE_61_STATUS_B Register Field Descriptions

Bit	Field	Type	Reset	Description
27-0	QUEUE_BYTE_COUNT	R-0	0	This field indicates how many bytes total are contained in all of the packets which are currently queued on this queue. Queue_Manager_Queue_n_Status_B Registers B

16.5.7.844 QUEUE_61_STATUS_C Register (offset = 33D8h) [reset = 0h]

 QUEUE_61_STATUS_C is shown in [Figure 16-1120](#) and described in [Table 16-1134](#).

Figure 16-1120. QUEUE_61_STATUS_C Register


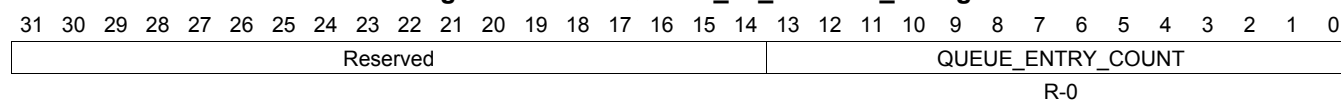
LEGEND: R/W = Read/Write; R = Read only; W1toCl = Write 1 to clear bit; -n = value after reset

Table 16-1134. QUEUE_61_STATUS_C Register Field Descriptions

Bit	Field	Type	Reset	Description
13-0	PACKET_SIZE	R-0	0	This field indicates packet size of the head element of a queue. Queue_Manager_Queue_N_Status_C Registers C

16.5.7.845 QUEUE_62_STATUS_A Register (offset = 33E0h) [reset = 0h]

QUEUE_62_STATUS_A is shown in [Figure 16-1121](#) and described in [Table 16-1135](#).

Figure 16-1121. QUEUE_62_STATUS_A Register


LEGEND: R/W = Read/Write; R = Read only; W1toCl = Write 1 to clear bit; -n = value after reset

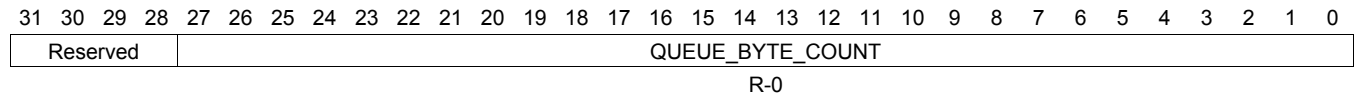
Table 16-1135. QUEUE_62_STATUS_A Register Field Descriptions

Bit	Field	Type	Reset	Description
13-0	QUEUE_ENTRY_COUNT	R-0	0	This field indicates how many packets are currently queued on the queue. Queue Manager Queue N Status Registers A

16.5.7.846 QUEUE_62_STATUS_B Register (offset = 33E4h) [reset = 0h]

QUEUE_62_STATUS_B is shown in [Figure 16-1122](#) and described in [Table 16-1136](#).

Figure 16-1122. QUEUE_62_STATUS_B Register



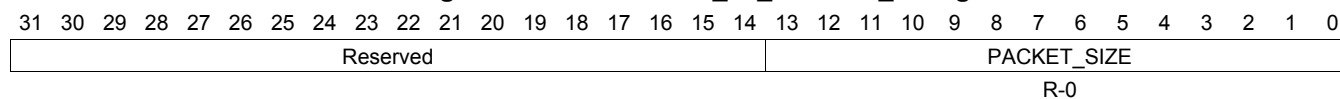
LEGEND: R/W = Read/Write; R = Read only; W1toCl = Write 1 to clear bit; -n = value after reset

Table 16-1136. QUEUE_62_STATUS_B Register Field Descriptions

Bit	Field	Type	Reset	Description
27-0	QUEUE_BYTE_COUNT	R-0	0	This field indicates how many bytes total are contained in all of the packets which are currently queued on this queue. Queue_Manager_Queue_n_Status_B Registers B

16.5.7.847 QUEUE_62_STATUS_C Register (offset = 33E8h) [reset = 0h]

QUEUE_62_STATUS_C is shown in [Figure 16-1123](#) and described in [Table 16-1137](#).

Figure 16-1123. QUEUE_62_STATUS_C Register


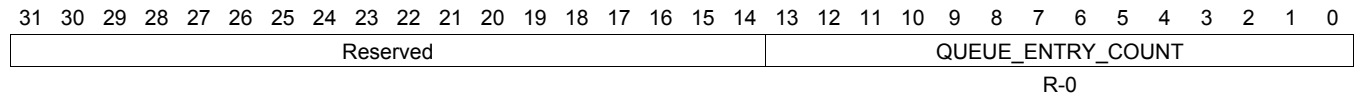
LEGEND: R/W = Read/Write; R = Read only; W1toCl = Write 1 to clear bit; -n = value after reset

Table 16-1137. QUEUE_62_STATUS_C Register Field Descriptions

Bit	Field	Type	Reset	Description
13-0	PACKET_SIZE	R-0	0	This field indicates packet size of the head element of a queue. Queue_Manager_Queue_N_Status_C Registers C

16.5.7.848 QUEUE_63_STATUS_A Register (offset = 33F0h) [reset = 0h]

 QUEUE_63_STATUS_A is shown in [Figure 16-1124](#) and described in [Table 16-1138](#).

Figure 16-1124. QUEUE_63_STATUS_A Register


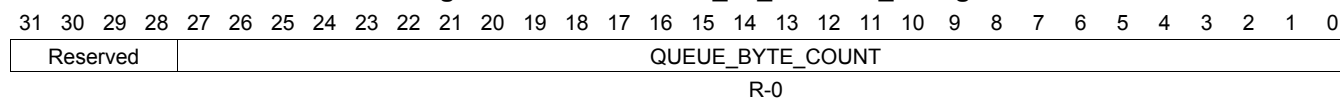
LEGEND: R/W = Read/Write; R = Read only; W1toCl = Write 1 to clear bit; -n = value after reset

Table 16-1138. QUEUE_63_STATUS_A Register Field Descriptions

Bit	Field	Type	Reset	Description
13-0	QUEUE_ENTRY_COUNT	R-0	0	This field indicates how many packets are currently queued on the queue. Queue Manager Queue N Status Registers A

16.5.7.849 QUEUE_63_STATUS_B Register (offset = 33F4h) [reset = 0h]

QUEUE_63_STATUS_B is shown in [Figure 16-1125](#) and described in [Table 16-1139](#).

Figure 16-1125. QUEUE_63_STATUS_B Register


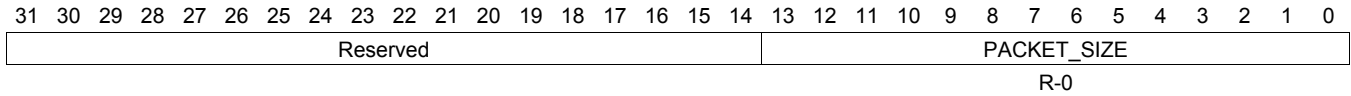
LEGEND: R/W = Read/Write; R = Read only; W1toCl = Write 1 to clear bit; -n = value after reset

Table 16-1139. QUEUE_63_STATUS_B Register Field Descriptions

Bit	Field	Type	Reset	Description
27-0	QUEUE_BYTE_COUNT	R-0	0	This field indicates how many bytes total are contained in all of the packets which are currently queued on this queue. Queue_Manager_Queue_n_Status_B Registers B

16.5.7.850 QUEUE_63_STATUS_C Register (offset = 33F8h) [reset = 0h]

 QUEUE_63_STATUS_C is shown in [Figure 16-1126](#) and described in [Table 16-1140](#).

Figure 16-1126. QUEUE_63_STATUS_C Register


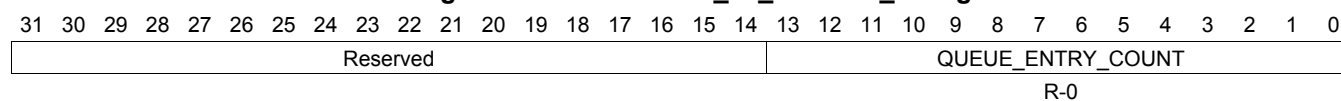
LEGEND: R/W = Read/Write; R = Read only; W1toCl = Write 1 to clear bit; -n = value after reset

Table 16-1140. QUEUE_63_STATUS_C Register Field Descriptions

Bit	Field	Type	Reset	Description
13-0	PACKET_SIZE	R-0	0	This field indicates packet size of the head element of a queue. Queue_Manager_Queue_N_Status_C Registers C

16.5.7.851 QUEUE_64_STATUS_A Register (offset = 3400h) [reset = 0h]

 QUEUE_64_STATUS_A is shown in [Figure 16-1127](#) and described in [Table 16-1141](#).

Figure 16-1127. QUEUE_64_STATUS_A Register


LEGEND: R/W = Read/Write; R = Read only; W1toCl = Write 1 to clear bit; -n = value after reset

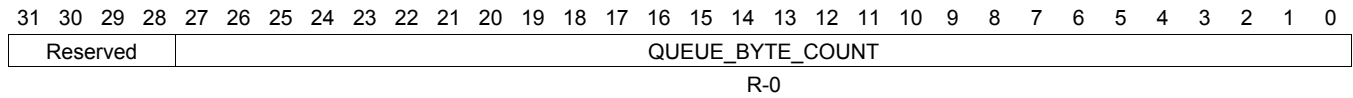
Table 16-1141. QUEUE_64_STATUS_A Register Field Descriptions

Bit	Field	Type	Reset	Description
13-0	QUEUE_ENTRY_COUNT	R-0	0	This field indicates how many packets are currently queued on the queue. Queue Manager Queue N Status Registers A

16.5.7.852 QUEUE_64_STATUS_B Register (offset = 3404h) [reset = 0h]

QUEUE_64_STATUS_B is shown in [Figure 16-1128](#) and described in [Table 16-1142](#).

Figure 16-1128. QUEUE_64_STATUS_B Register



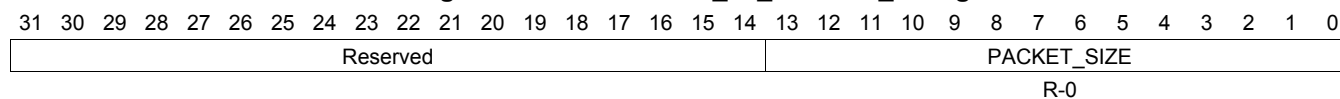
LEGEND: R/W = Read/Write; R = Read only; W1toCl = Write 1 to clear bit; -n = value after reset

Table 16-1142. QUEUE_64_STATUS_B Register Field Descriptions

Bit	Field	Type	Reset	Description
27-0	QUEUE_BYTE_COUNT	R-0	0	This field indicates how many bytes total are contained in all of the packets which are currently queued on this queue. Queue_Manager_Queue_n_Status_B Registers B

16.5.7.853 QUEUE_64_STATUS_C Register (offset = 3408h) [reset = 0h]

QUEUE_64_STATUS_C is shown in [Figure 16-1129](#) and described in [Table 16-1143](#).

Figure 16-1129. QUEUE_64_STATUS_C Register


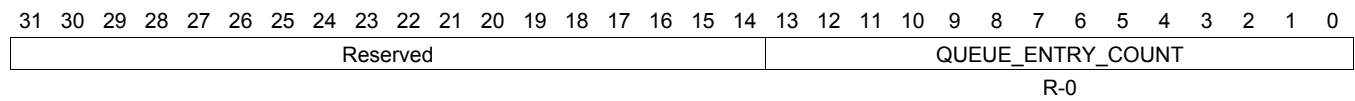
LEGEND: R/W = Read/Write; R = Read only; W1toCl = Write 1 to clear bit; -n = value after reset

Table 16-1143. QUEUE_64_STATUS_C Register Field Descriptions

Bit	Field	Type	Reset	Description
13-0	PACKET_SIZE	R-0	0	This field indicates packet size of the head element of a queue. Queue_Manager_Queue_N_Status_C Registers C

16.5.7.854 QUEUE_65_STATUS_A Register (offset = 3410h) [reset = 0h]

 QUEUE_65_STATUS_A is shown in [Figure 16-1130](#) and described in [Table 16-1144](#).

Figure 16-1130. QUEUE_65_STATUS_A Register


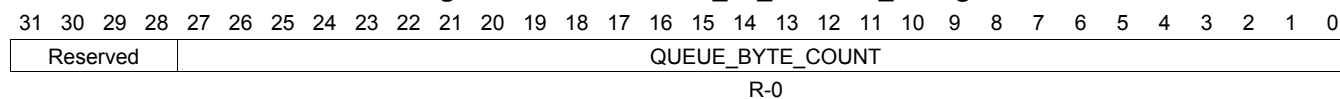
LEGEND: R/W = Read/Write; R = Read only; W1toCl = Write 1 to clear bit; -n = value after reset

Table 16-1144. QUEUE_65_STATUS_A Register Field Descriptions

Bit	Field	Type	Reset	Description
13-0	QUEUE_ENTRY_COUNT	R-0	0	This field indicates how many packets are currently queued on the queue. Queue Manager Queue N Status Registers A

16.5.7.855 QUEUE_65_STATUS_B Register (offset = 3414h) [reset = 0h]

QUEUE_65_STATUS_B is shown in [Figure 16-1131](#) and described in [Table 16-1145](#).

Figure 16-1131. QUEUE_65_STATUS_B Register


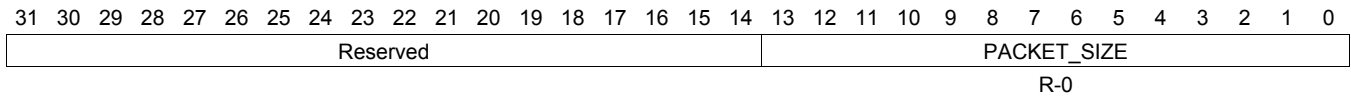
LEGEND: R/W = Read/Write; R = Read only; W1toCl = Write 1 to clear bit; -n = value after reset

Table 16-1145. QUEUE_65_STATUS_B Register Field Descriptions

Bit	Field	Type	Reset	Description
27-0	QUEUE_BYTE_COUNT	R-0	0	This field indicates how many bytes total are contained in all of the packets which are currently queued on this queue. Queue_Manager_Queue_n_Status_B Registers B

16.5.7.856 QUEUE_65_STATUS_C Register (offset = 3418h) [reset = 0h]

QUEUE_65_STATUS_C is shown in [Figure 16-1132](#) and described in [Table 16-1146](#).

Figure 16-1132. QUEUE_65_STATUS_C Register


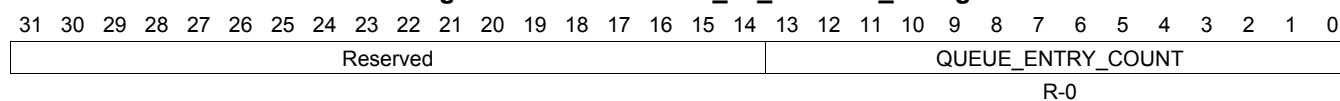
LEGEND: R/W = Read/Write; R = Read only; W1toCl = Write 1 to clear bit; -n = value after reset

Table 16-1146. QUEUE_65_STATUS_C Register Field Descriptions

Bit	Field	Type	Reset	Description
13-0	PACKET_SIZE	R-0	0	This field indicates packet size of the head element of a queue. Queue_Manager_Queue_N_Status_C Registers C

16.5.7.857 QUEUE_66_STATUS_A Register (offset = 3420h) [reset = 0h]

QUEUE_66_STATUS_A is shown in [Figure 16-1133](#) and described in [Table 16-1147](#).

Figure 16-1133. QUEUE_66_STATUS_A Register


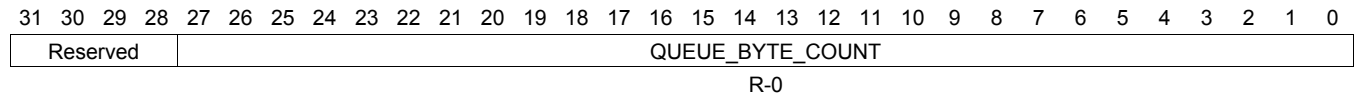
LEGEND: R/W = Read/Write; R = Read only; W1toCl = Write 1 to clear bit; -n = value after reset

Table 16-1147. QUEUE_66_STATUS_A Register Field Descriptions

Bit	Field	Type	Reset	Description
13-0	QUEUE_ENTRY_COUNT	R-0	0	This field indicates how many packets are currently queued on the queue. Queue Manager Queue N Status Registers A

16.5.7.858 QUEUE_66_STATUS_B Register (offset = 3424h) [reset = 0h]

 QUEUE_66_STATUS_B is shown in [Figure 16-1134](#) and described in [Table 16-1148](#).

Figure 16-1134. QUEUE_66_STATUS_B Register


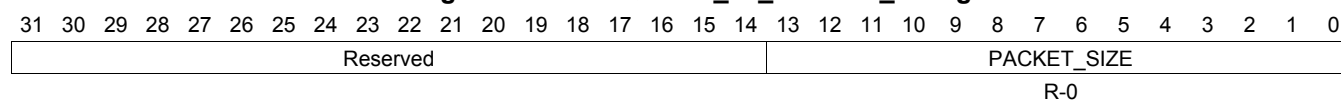
LEGEND: R/W = Read/Write; R = Read only; W1toCl = Write 1 to clear bit; -n = value after reset

Table 16-1148. QUEUE_66_STATUS_B Register Field Descriptions

Bit	Field	Type	Reset	Description
27-0	QUEUE_BYTE_COUNT	R-0	0	This field indicates how many bytes total are contained in all of the packets which are currently queued on this queue. Queue_Manager_Queue_n_Status_B Registers B

16.5.7.859 QUEUE_66_STATUS_C Register (offset = 3428h) [reset = 0h]

QUEUE_66_STATUS_C is shown in [Figure 16-1135](#) and described in [Table 16-1149](#).

Figure 16-1135. QUEUE_66_STATUS_C Register


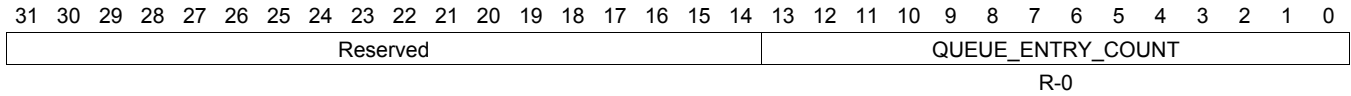
LEGEND: R/W = Read/Write; R = Read only; W1toCl = Write 1 to clear bit; -n = value after reset

Table 16-1149. QUEUE_66_STATUS_C Register Field Descriptions

Bit	Field	Type	Reset	Description
13-0	PACKET_SIZE	R-0	0	This field indicates packet size of the head element of a queue. Queue_Manager_Queue_N_Status_C Registers C

16.5.7.860 QUEUE_67_STATUS_A Register (offset = 3430h) [reset = 0h]

 QUEUE_67_STATUS_A is shown in [Figure 16-1136](#) and described in [Table 16-1150](#).

Figure 16-1136. QUEUE_67_STATUS_A Register


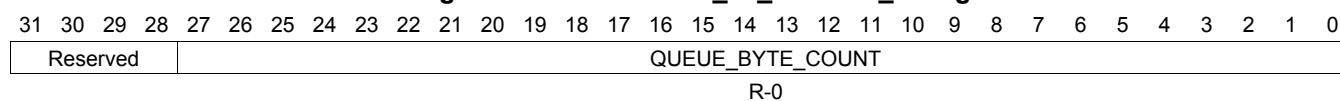
LEGEND: R/W = Read/Write; R = Read only; W1toCl = Write 1 to clear bit; -n = value after reset

Table 16-1150. QUEUE_67_STATUS_A Register Field Descriptions

Bit	Field	Type	Reset	Description
13-0	QUEUE_ENTRY_COUNT	R-0	0	This field indicates how many packets are currently queued on the queue. Queue Manager Queue N Status Registers A

16.5.7.861 QUEUE_67_STATUS_B Register (offset = 3434h) [reset = 0h]

QUEUE_67_STATUS_B is shown in [Figure 16-1137](#) and described in [Table 16-1151](#).

Figure 16-1137. QUEUE_67_STATUS_B Register


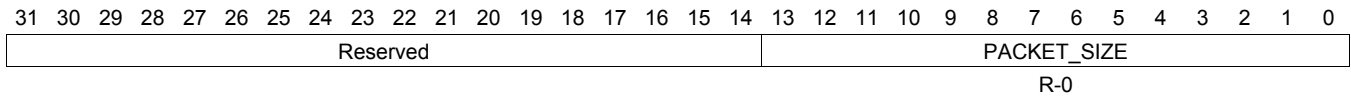
LEGEND: R/W = Read/Write; R = Read only; W1toCl = Write 1 to clear bit; -n = value after reset

Table 16-1151. QUEUE_67_STATUS_B Register Field Descriptions

Bit	Field	Type	Reset	Description
27-0	QUEUE_BYTE_COUNT	R-0	0	This field indicates how many bytes total are contained in all of the packets which are currently queued on this queue. Queue_Manager_Queue_n_Status_B Registers B

16.5.7.862 QUEUE_67_STATUS_C Register (offset = 3438h) [reset = 0h]

 QUEUE_67_STATUS_C is shown in [Figure 16-1138](#) and described in [Table 16-1152](#).

Figure 16-1138. QUEUE_67_STATUS_C Register


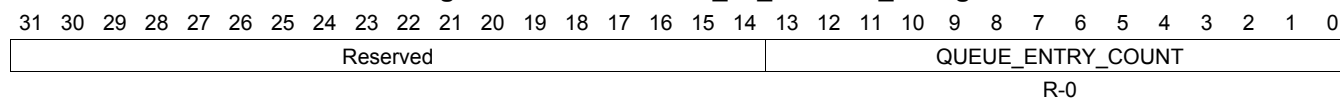
LEGEND: R/W = Read/Write; R = Read only; W1toCl = Write 1 to clear bit; -n = value after reset

Table 16-1152. QUEUE_67_STATUS_C Register Field Descriptions

Bit	Field	Type	Reset	Description
13-0	PACKET_SIZE	R-0	0	This field indicates packet size of the head element of a queue. Queue_Manager_Queue_N_Status_C Registers C

16.5.7.863 QUEUE_68_STATUS_A Register (offset = 3440h) [reset = 0h]

 QUEUE_68_STATUS_A is shown in [Figure 16-1139](#) and described in [Table 16-1153](#).

Figure 16-1139. QUEUE_68_STATUS_A Register


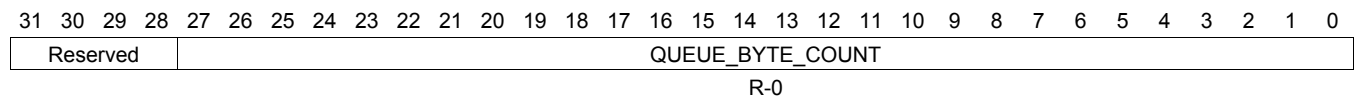
LEGEND: R/W = Read/Write; R = Read only; W1toCl = Write 1 to clear bit; -n = value after reset

Table 16-1153. QUEUE_68_STATUS_A Register Field Descriptions

Bit	Field	Type	Reset	Description
13-0	QUEUE_ENTRY_COUNT	R-0	0	This field indicates how many packets are currently queued on the queue. Queue Manager Queue N Status Registers A

16.5.7.864 QUEUE_68_STATUS_B Register (offset = 3444h) [reset = 0h]

 QUEUE_68_STATUS_B is shown in [Figure 16-1140](#) and described in [Table 16-1154](#).

Figure 16-1140. QUEUE_68_STATUS_B Register


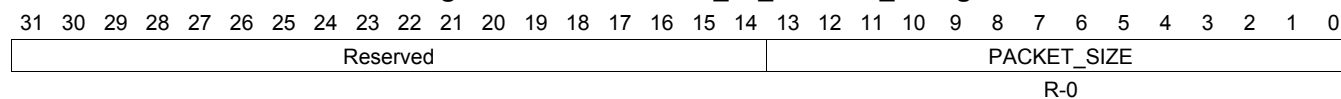
LEGEND: R/W = Read/Write; R = Read only; W1toCl = Write 1 to clear bit; -n = value after reset

Table 16-1154. QUEUE_68_STATUS_B Register Field Descriptions

Bit	Field	Type	Reset	Description
27-0	QUEUE_BYTE_COUNT	R-0	0	This field indicates how many bytes total are contained in all of the packets which are currently queued on this queue. Queue_Manager_Queue_n_Status_B Registers B

16.5.7.865 QUEUE_68_STATUS_C Register (offset = 3448h) [reset = 0h]

QUEUE_68_STATUS_C is shown in [Figure 16-1141](#) and described in [Table 16-1155](#).

Figure 16-1141. QUEUE_68_STATUS_C Register


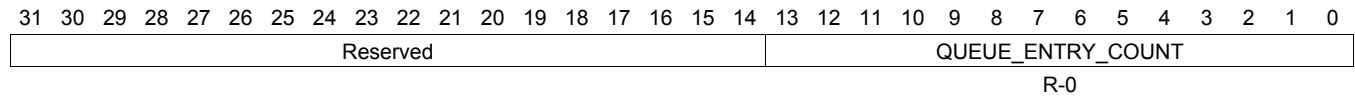
LEGEND: R/W = Read/Write; R = Read only; W1toCl = Write 1 to clear bit; -n = value after reset

Table 16-1155. QUEUE_68_STATUS_C Register Field Descriptions

Bit	Field	Type	Reset	Description
13-0	PACKET_SIZE	R-0	0	This field indicates packet size of the head element of a queue. Queue_Manager_Queue_N_Status_C Registers C

16.5.7.866 QUEUE_69_STATUS_A Register (offset = 3450h) [reset = 0h]

 QUEUE_69_STATUS_A is shown in [Figure 16-1142](#) and described in [Table 16-1156](#).

Figure 16-1142. QUEUE_69_STATUS_A Register


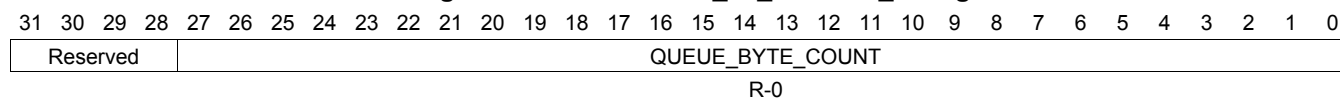
LEGEND: R/W = Read/Write; R = Read only; W1toCl = Write 1 to clear bit; -n = value after reset

Table 16-1156. QUEUE_69_STATUS_A Register Field Descriptions

Bit	Field	Type	Reset	Description
13-0	QUEUE_ENTRY_COUNT	R-0	0	This field indicates how many packets are currently queued on the queue. Queue Manager Queue N Status Registers A

16.5.7.867 QUEUE_69_STATUS_B Register (offset = 3454h) [reset = 0h]

QUEUE_69_STATUS_B is shown in [Figure 16-1143](#) and described in [Table 16-1157](#).

Figure 16-1143. QUEUE_69_STATUS_B Register


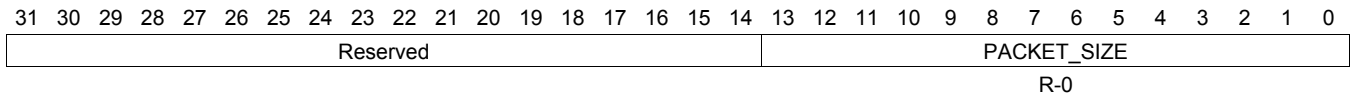
LEGEND: R/W = Read/Write; R = Read only; W1toCl = Write 1 to clear bit; -n = value after reset

Table 16-1157. QUEUE_69_STATUS_B Register Field Descriptions

Bit	Field	Type	Reset	Description
27-0	QUEUE_BYTE_COUNT	R-0	0	This field indicates how many bytes total are contained in all of the packets which are currently queued on this queue. Queue_Manager_Queue_n_Status_B Registers B

16.5.7.868 QUEUE_69_STATUS_C Register (offset = 3458h) [reset = 0h]

 QUEUE_69_STATUS_C is shown in [Figure 16-1144](#) and described in [Table 16-1158](#).

Figure 16-1144. QUEUE_69_STATUS_C Register


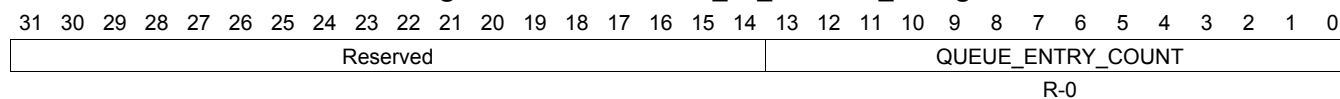
LEGEND: R/W = Read/Write; R = Read only; W1toCl = Write 1 to clear bit; -n = value after reset

Table 16-1158. QUEUE_69_STATUS_C Register Field Descriptions

Bit	Field	Type	Reset	Description
13-0	PACKET_SIZE	R-0	0	This field indicates packet size of the head element of a queue. Queue_Manager_Queue_N_Status_C Registers C

16.5.7.869 QUEUE_70_STATUS_A Register (offset = 3460h) [reset = 0h]

QUEUE_70_STATUS_A is shown in [Figure 16-1145](#) and described in [Table 16-1159](#).

Figure 16-1145. QUEUE_70_STATUS_A Register


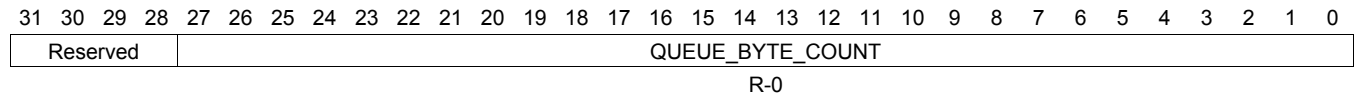
LEGEND: R/W = Read/Write; R = Read only; W1toCl = Write 1 to clear bit; -n = value after reset

Table 16-1159. QUEUE_70_STATUS_A Register Field Descriptions

Bit	Field	Type	Reset	Description
13-0	QUEUE_ENTRY_COUNT	R-0	0	This field indicates how many packets are currently queued on the queue. Queue Manager Queue N Status Registers A

16.5.7.870 QUEUE_70_STATUS_B Register (offset = 3464h) [reset = 0h]

QUEUE_70_STATUS_B is shown in [Figure 16-1146](#) and described in [Table 16-1160](#).

Figure 16-1146. QUEUE_70_STATUS_B Register


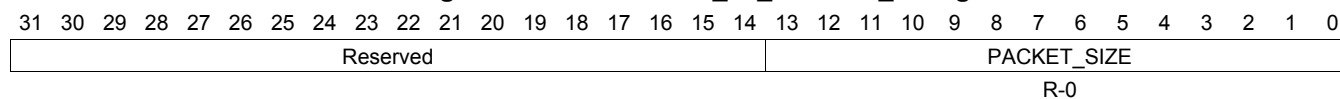
LEGEND: R/W = Read/Write; R = Read only; W1toCl = Write 1 to clear bit; -n = value after reset

Table 16-1160. QUEUE_70_STATUS_B Register Field Descriptions

Bit	Field	Type	Reset	Description
27-0	QUEUE_BYTE_COUNT	R-0	0	This field indicates how many bytes total are contained in all of the packets which are currently queued on this queue. Queue_Manager_Queue_n_Status_B Registers B

16.5.7.871 QUEUE_70_STATUS_C Register (offset = 3468h) [reset = 0h]

QUEUE_70_STATUS_C is shown in [Figure 16-1147](#) and described in [Table 16-1161](#).

Figure 16-1147. QUEUE_70_STATUS_C Register


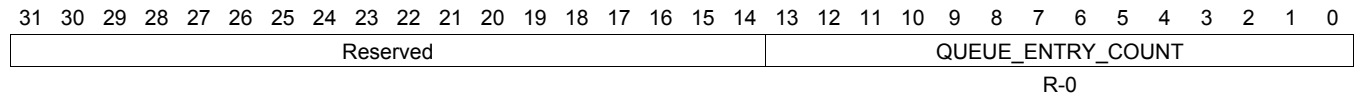
LEGEND: R/W = Read/Write; R = Read only; W1toCl = Write 1 to clear bit; -n = value after reset

Table 16-1161. QUEUE_70_STATUS_C Register Field Descriptions

Bit	Field	Type	Reset	Description
13-0	PACKET_SIZE	R-0	0	This field indicates packet size of the head element of a queue. Queue_Manager_Queue_N_Status_C Registers C

16.5.7.872 QUEUE_71_STATUS_A Register (offset = 3470h) [reset = 0h]

 QUEUE_71_STATUS_A is shown in [Figure 16-1148](#) and described in [Table 16-1162](#).

Figure 16-1148. QUEUE_71_STATUS_A Register


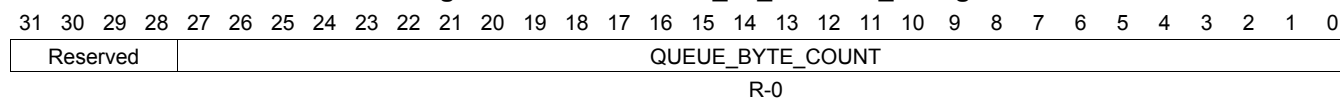
LEGEND: R/W = Read/Write; R = Read only; W1toCl = Write 1 to clear bit; -n = value after reset

Table 16-1162. QUEUE_71_STATUS_A Register Field Descriptions

Bit	Field	Type	Reset	Description
13-0	QUEUE_ENTRY_COUNT	R-0	0	This field indicates how many packets are currently queued on the queue. Queue Manager Queue N Status Registers A

16.5.7.873 QUEUE_71_STATUS_B Register (offset = 3474h) [reset = 0h]

QUEUE_71_STATUS_B is shown in [Figure 16-1149](#) and described in [Table 16-1163](#).

Figure 16-1149. QUEUE_71_STATUS_B Register


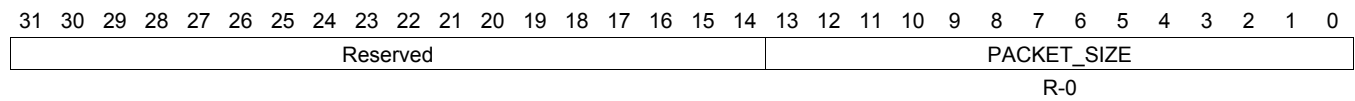
LEGEND: R/W = Read/Write; R = Read only; W1toCl = Write 1 to clear bit; -n = value after reset

Table 16-1163. QUEUE_71_STATUS_B Register Field Descriptions

Bit	Field	Type	Reset	Description
27-0	QUEUE_BYTE_COUNT	R-0	0	This field indicates how many bytes total are contained in all of the packets which are currently queued on this queue. Queue_Manager_Queue_n_Status_B Registers B

16.5.7.874 QUEUE_71_STATUS_C Register (offset = 3478h) [reset = 0h]

 QUEUE_71_STATUS_C is shown in [Figure 16-1150](#) and described in [Table 16-1164](#).

Figure 16-1150. QUEUE_71_STATUS_C Register


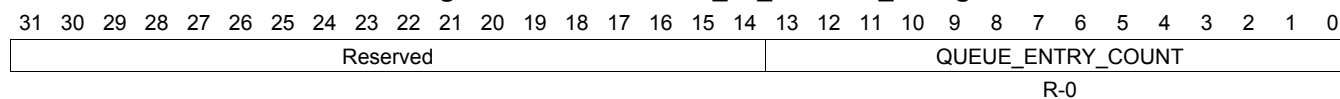
LEGEND: R/W = Read/Write; R = Read only; W1toCl = Write 1 to clear bit; -n = value after reset

Table 16-1164. QUEUE_71_STATUS_C Register Field Descriptions

Bit	Field	Type	Reset	Description
13-0	PACKET_SIZE	R-0	0	This field indicates packet size of the head element of a queue. Queue_Manager_Queue_N_Status_C Registers C

16.5.7.875 QUEUE_72_STATUS_A Register (offset = 3480h) [reset = 0h]

 QUEUE_72_STATUS_A is shown in [Figure 16-1151](#) and described in [Table 16-1165](#).

Figure 16-1151. QUEUE_72_STATUS_A Register


LEGEND: R/W = Read/Write; R = Read only; W1toCl = Write 1 to clear bit; -n = value after reset

Table 16-1165. QUEUE_72_STATUS_A Register Field Descriptions

Bit	Field	Type	Reset	Description
13-0	QUEUE_ENTRY_COUNT	R-0	0	This field indicates how many packets are currently queued on the queue. Queue Manager Queue N Status Registers A

16.5.7.876 QUEUE_72_STATUS_B Register (offset = 3484h) [reset = 0h]

QUEUE_72_STATUS_B is shown in [Figure 16-1152](#) and described in [Table 16-1166](#).

Figure 16-1152. QUEUE_72_STATUS_B Register

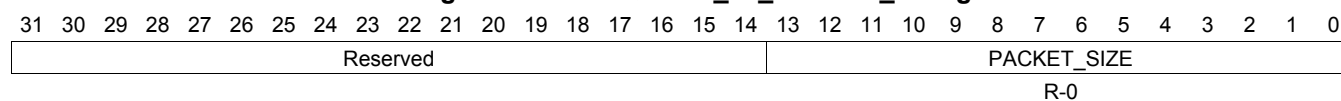

LEGEND: R/W = Read/Write; R = Read only; W1toCl = Write 1 to clear bit; -n = value after reset

Table 16-1166. QUEUE_72_STATUS_B Register Field Descriptions

Bit	Field	Type	Reset	Description
27-0	QUEUE_BYTE_COUNT	R-0	0	This field indicates how many bytes total are contained in all of the packets which are currently queued on this queue. Queue_Manager_Queue_n_Status_B Registers B

16.5.7.877 QUEUE_72_STATUS_C Register (offset = 3488h) [reset = 0h]

QUEUE_72_STATUS_C is shown in [Figure 16-1153](#) and described in [Table 16-1167](#).

Figure 16-1153. QUEUE_72_STATUS_C Register


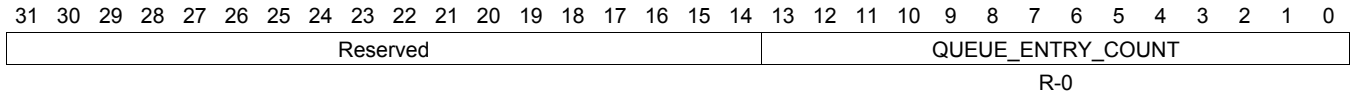
LEGEND: R/W = Read/Write; R = Read only; W1toCl = Write 1 to clear bit; -n = value after reset

Table 16-1167. QUEUE_72_STATUS_C Register Field Descriptions

Bit	Field	Type	Reset	Description
13-0	PACKET_SIZE	R-0	0	This field indicates packet size of the head element of a queue. Queue_Manager_Queue_N_Status_C Registers C

16.5.7.878 QUEUE_73_STATUS_A Register (offset = 3490h) [reset = 0h]

 QUEUE_73_STATUS_A is shown in [Figure 16-1154](#) and described in [Table 16-1168](#).

Figure 16-1154. QUEUE_73_STATUS_A Register


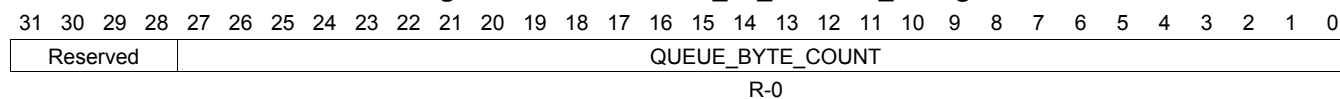
LEGEND: R/W = Read/Write; R = Read only; W1toCl = Write 1 to clear bit; -n = value after reset

Table 16-1168. QUEUE_73_STATUS_A Register Field Descriptions

Bit	Field	Type	Reset	Description
13-0	QUEUE_ENTRY_COUNT	R-0	0	This field indicates how many packets are currently queued on the queue. Queue Manager Queue N Status Registers A

16.5.7.879 QUEUE_73_STATUS_B Register (offset = 3494h) [reset = 0h]

QUEUE_73_STATUS_B is shown in [Figure 16-1155](#) and described in [Table 16-1169](#).

Figure 16-1155. QUEUE_73_STATUS_B Register


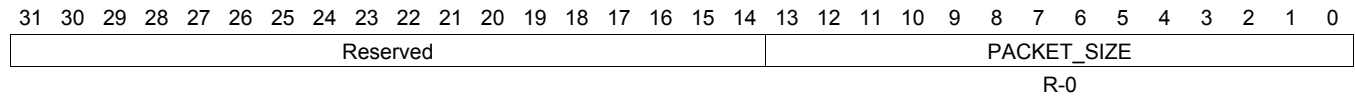
LEGEND: R/W = Read/Write; R = Read only; W1toCl = Write 1 to clear bit; -n = value after reset

Table 16-1169. QUEUE_73_STATUS_B Register Field Descriptions

Bit	Field	Type	Reset	Description
27-0	QUEUE_BYTE_COUNT	R-0	0	This field indicates how many bytes total are contained in all of the packets which are currently queued on this queue. Queue_Manager_Queue_n_Status_B Registers B

16.5.7.880 QUEUE_73_STATUS_C Register (offset = 3498h) [reset = 0h]

 QUEUE_73_STATUS_C is shown in [Figure 16-1156](#) and described in [Table 16-1170](#).

Figure 16-1156. QUEUE_73_STATUS_C Register


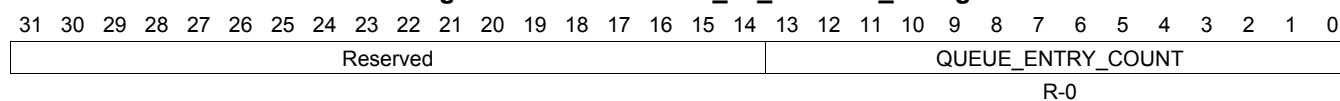
LEGEND: R/W = Read/Write; R = Read only; W1toCl = Write 1 to clear bit; -n = value after reset

Table 16-1170. QUEUE_73_STATUS_C Register Field Descriptions

Bit	Field	Type	Reset	Description
13-0	PACKET_SIZE	R-0	0	This field indicates packet size of the head element of a queue. Queue_Manager_Queue_N_Status_C Registers C

16.5.7.881 QUEUE_74_STATUS_A Register (offset = 34A0h) [reset = 0h]

QUEUE_74_STATUS_A is shown in [Figure 16-1157](#) and described in [Table 16-1171](#).

Figure 16-1157. QUEUE_74_STATUS_A Register


LEGEND: R/W = Read/Write; R = Read only; W1toCl = Write 1 to clear bit; -n = value after reset

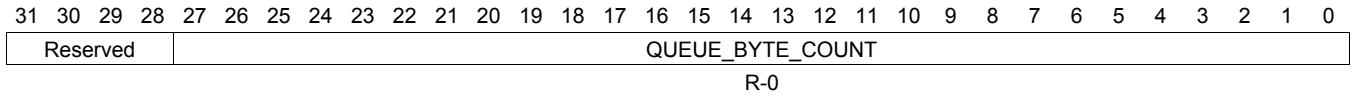
Table 16-1171. QUEUE_74_STATUS_A Register Field Descriptions

Bit	Field	Type	Reset	Description
13-0	QUEUE_ENTRY_COUNT	R-0	0	This field indicates how many packets are currently queued on the queue. Queue Manager Queue N Status Registers A

16.5.7.882 QUEUE_74_STATUS_B Register (offset = 34A4h) [reset = 0h]

QUEUE_74_STATUS_B is shown in [Figure 16-1158](#) and described in [Table 16-1172](#).

Figure 16-1158. QUEUE_74_STATUS_B Register



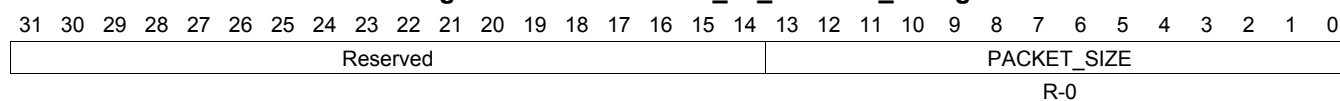
LEGEND: R/W = Read/Write; R = Read only; W1toCl = Write 1 to clear bit; -n = value after reset

Table 16-1172. QUEUE_74_STATUS_B Register Field Descriptions

Bit	Field	Type	Reset	Description
27-0	QUEUE_BYTE_COUNT	R-0	0	This field indicates how many bytes total are contained in all of the packets which are currently queued on this queue. Queue_Manager_Queue_n_Status_B Registers B

16.5.7.883 QUEUE_74_STATUS_C Register (offset = 34A8h) [reset = 0h]

QUEUE_74_STATUS_C is shown in [Figure 16-1159](#) and described in [Table 16-1173](#).

Figure 16-1159. QUEUE_74_STATUS_C Register


LEGEND: R/W = Read/Write; R = Read only; W1toCl = Write 1 to clear bit; -n = value after reset

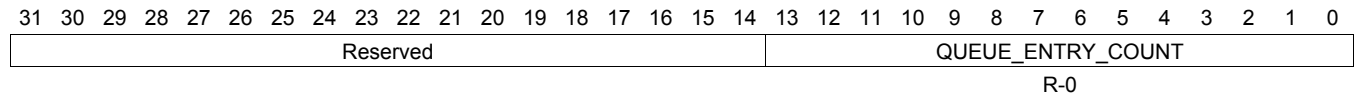
Table 16-1173. QUEUE_74_STATUS_C Register Field Descriptions

Bit	Field	Type	Reset	Description
13-0	PACKET_SIZE	R-0	0	This field indicates packet size of the head element of a queue. Queue_Manager_Queue_N_Status_C Registers C

16.5.7.884 QUEUE_75_STATUS_A Register (offset = 34B0h) [reset = 0h]

QUEUE_75_STATUS_A is shown in [Figure 16-1160](#) and described in [Table 16-1174](#).

Figure 16-1160. QUEUE_75_STATUS_A Register



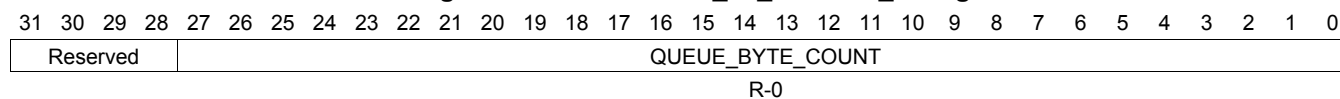
LEGEND: R/W = Read/Write; R = Read only; W1toCl = Write 1 to clear bit; -n = value after reset

Table 16-1174. QUEUE_75_STATUS_A Register Field Descriptions

Bit	Field	Type	Reset	Description
13-0	QUEUE_ENTRY_COUNT	R-0	0	This field indicates how many packets are currently queued on the queue. Queue Manager Queue N Status Registers A

16.5.7.885 QUEUE_75_STATUS_B Register (offset = 34B4h) [reset = 0h]

QUEUE_75_STATUS_B is shown in [Figure 16-1161](#) and described in [Table 16-1175](#).

Figure 16-1161. QUEUE_75_STATUS_B Register


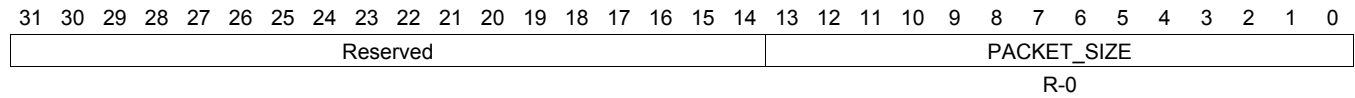
LEGEND: R/W = Read/Write; R = Read only; W1toCl = Write 1 to clear bit; -n = value after reset

Table 16-1175. QUEUE_75_STATUS_B Register Field Descriptions

Bit	Field	Type	Reset	Description
27-0	QUEUE_BYTE_COUNT	R-0	0	This field indicates how many bytes total are contained in all of the packets which are currently queued on this queue. Queue_Manager_Queue_n_Status_B Registers B

16.5.7.886 QUEUE_75_STATUS_C Register (offset = 34B8h) [reset = 0h]

 QUEUE_75_STATUS_C is shown in [Figure 16-1162](#) and described in [Table 16-1176](#).

Figure 16-1162. QUEUE_75_STATUS_C Register


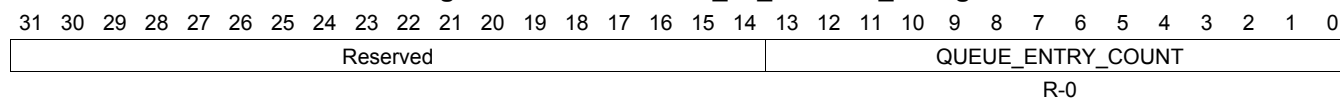
LEGEND: R/W = Read/Write; R = Read only; W1toCl = Write 1 to clear bit; -n = value after reset

Table 16-1176. QUEUE_75_STATUS_C Register Field Descriptions

Bit	Field	Type	Reset	Description
13-0	PACKET_SIZE	R-0	0	This field indicates packet size of the head element of a queue. Queue_Manager_Queue_N_Status_C Registers C

16.5.7.887 QUEUE_76_STATUS_A Register (offset = 34C0h) [reset = 0h]

QUEUE_76_STATUS_A is shown in [Figure 16-1163](#) and described in [Table 16-1177](#).

Figure 16-1163. QUEUE_76_STATUS_A Register


LEGEND: R/W = Read/Write; R = Read only; W1toCl = Write 1 to clear bit; -n = value after reset

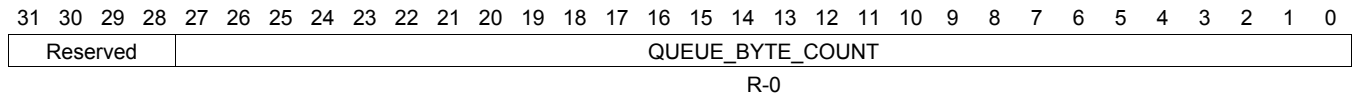
Table 16-1177. QUEUE_76_STATUS_A Register Field Descriptions

Bit	Field	Type	Reset	Description
13-0	QUEUE_ENTRY_COUNT	R-0	0	This field indicates how many packets are currently queued on the queue. Queue Manager Queue N Status Registers A

16.5.7.888 QUEUE_76_STATUS_B Register (offset = 34C4h) [reset = 0h]

QUEUE_76_STATUS_B is shown in [Figure 16-1164](#) and described in [Table 16-1178](#).

Figure 16-1164. QUEUE_76_STATUS_B Register



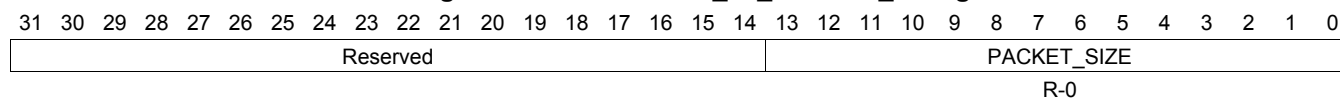
LEGEND: R/W = Read/Write; R = Read only; W1toCl = Write 1 to clear bit; -n = value after reset

Table 16-1178. QUEUE_76_STATUS_B Register Field Descriptions

Bit	Field	Type	Reset	Description
27-0	QUEUE_BYTE_COUNT	R-0	0	This field indicates how many bytes total are contained in all of the packets which are currently queued on this queue. Queue_Manager_Queue_n_Status_B Registers B

16.5.7.889 QUEUE_76_STATUS_C Register (offset = 34C8h) [reset = 0h]

QUEUE_76_STATUS_C is shown in [Figure 16-1165](#) and described in [Table 16-1179](#).

Figure 16-1165. QUEUE_76_STATUS_C Register


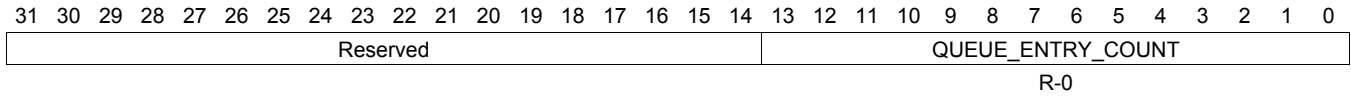
LEGEND: R/W = Read/Write; R = Read only; W1toCl = Write 1 to clear bit; -n = value after reset

Table 16-1179. QUEUE_76_STATUS_C Register Field Descriptions

Bit	Field	Type	Reset	Description
13-0	PACKET_SIZE	R-0	0	This field indicates packet size of the head element of a queue. Queue_Manager_Queue_N_Status_C Registers C

16.5.7.890 QUEUE_77_STATUS_A Register (offset = 34D0h) [reset = 0h]

 QUEUE_77_STATUS_A is shown in [Figure 16-1166](#) and described in [Table 16-1180](#).

Figure 16-1166. QUEUE_77_STATUS_A Register


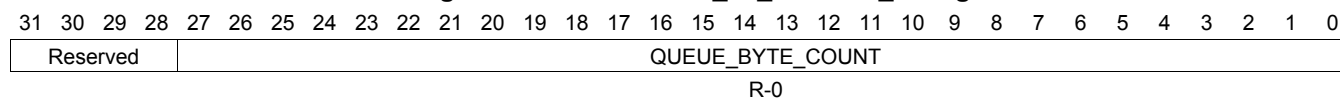
LEGEND: R/W = Read/Write; R = Read only; W1toCl = Write 1 to clear bit; -n = value after reset

Table 16-1180. QUEUE_77_STATUS_A Register Field Descriptions

Bit	Field	Type	Reset	Description
13-0	QUEUE_ENTRY_COUNT	R-0	0	This field indicates how many packets are currently queued on the queue. Queue Manager Queue N Status Registers A

16.5.7.891 QUEUE_77_STATUS_B Register (offset = 34D4h) [reset = 0h]

QUEUE_77_STATUS_B is shown in [Figure 16-1167](#) and described in [Table 16-1181](#).

Figure 16-1167. QUEUE_77_STATUS_B Register


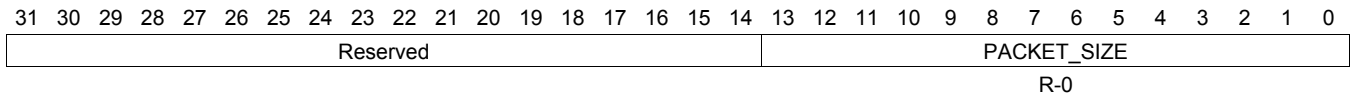
LEGEND: R/W = Read/Write; R = Read only; W1toCl = Write 1 to clear bit; -n = value after reset

Table 16-1181. QUEUE_77_STATUS_B Register Field Descriptions

Bit	Field	Type	Reset	Description
27-0	QUEUE_BYTE_COUNT	R-0	0	This field indicates how many bytes total are contained in all of the packets which are currently queued on this queue. Queue_Manager_Queue_n_Status_B Registers B

16.5.7.892 QUEUE_77_STATUS_C Register (offset = 34D8h) [reset = 0h]

QUEUE_77_STATUS_C is shown in [Figure 16-1168](#) and described in [Table 16-1182](#).

Figure 16-1168. QUEUE_77_STATUS_C Register


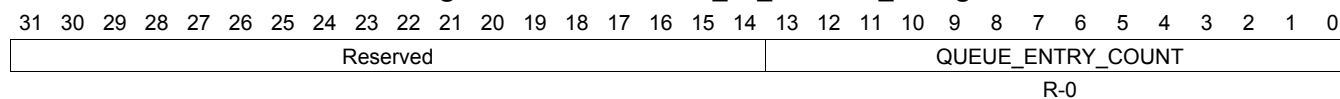
LEGEND: R/W = Read/Write; R = Read only; W1toCl = Write 1 to clear bit; -n = value after reset

Table 16-1182. QUEUE_77_STATUS_C Register Field Descriptions

Bit	Field	Type	Reset	Description
13-0	PACKET_SIZE	R-0	0	This field indicates packet size of the head element of a queue. Queue_Manager_Queue_N_Status_C Registers C

16.5.7.893 QUEUE_78_STATUS_A Register (offset = 34E0h) [reset = 0h]

QUEUE_78_STATUS_A is shown in [Figure 16-1169](#) and described in [Table 16-1183](#).

Figure 16-1169. QUEUE_78_STATUS_A Register


LEGEND: R/W = Read/Write; R = Read only; W1toCl = Write 1 to clear bit; -n = value after reset

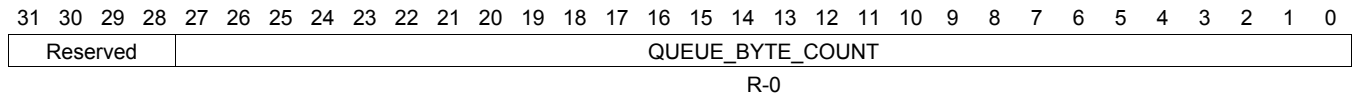
Table 16-1183. QUEUE_78_STATUS_A Register Field Descriptions

Bit	Field	Type	Reset	Description
13-0	QUEUE_ENTRY_COUNT	R-0	0	This field indicates how many packets are currently queued on the queue. Queue Manager Queue N Status Registers A

16.5.7.894 QUEUE_78_STATUS_B Register (offset = 34E4h) [reset = 0h]

QUEUE_78_STATUS_B is shown in [Figure 16-1170](#) and described in [Table 16-1184](#).

Figure 16-1170. QUEUE_78_STATUS_B Register



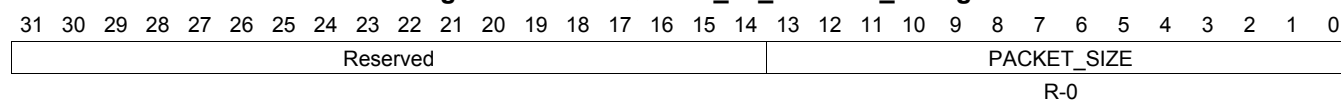
LEGEND: R/W = Read/Write; R = Read only; W1toCl = Write 1 to clear bit; -n = value after reset

Table 16-1184. QUEUE_78_STATUS_B Register Field Descriptions

Bit	Field	Type	Reset	Description
27-0	QUEUE_BYTE_COUNT	R-0	0	This field indicates how many bytes total are contained in all of the packets which are currently queued on this queue. Queue_Manager_Queue_n_Status_B Registers B

16.5.7.895 QUEUE_78_STATUS_C Register (offset = 34E8h) [reset = 0h]

QUEUE_78_STATUS_C is shown in [Figure 16-1171](#) and described in [Table 16-1185](#).

Figure 16-1171. QUEUE_78_STATUS_C Register


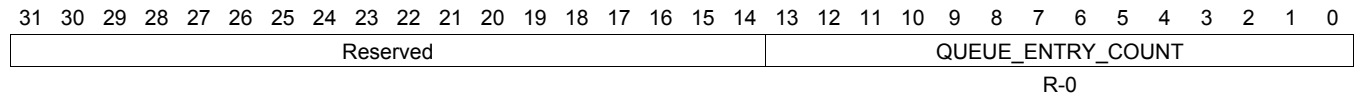
LEGEND: R/W = Read/Write; R = Read only; W1toCl = Write 1 to clear bit; -n = value after reset

Table 16-1185. QUEUE_78_STATUS_C Register Field Descriptions

Bit	Field	Type	Reset	Description
13-0	PACKET_SIZE	R-0	0	This field indicates packet size of the head element of a queue. Queue_Manager_Queue_N_Status_C Registers C

16.5.7.896 QUEUE_79_STATUS_A Register (offset = 34F0h) [reset = 0h]

 QUEUE_79_STATUS_A is shown in [Figure 16-1172](#) and described in [Table 16-1186](#).

Figure 16-1172. QUEUE_79_STATUS_A Register


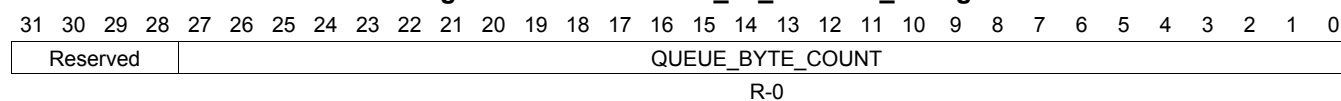
LEGEND: R/W = Read/Write; R = Read only; W1toCl = Write 1 to clear bit; -n = value after reset

Table 16-1186. QUEUE_79_STATUS_A Register Field Descriptions

Bit	Field	Type	Reset	Description
13-0	QUEUE_ENTRY_COUNT	R-0	0	This field indicates how many packets are currently queued on the queue. Queue Manager Queue N Status Registers A

16.5.7.897 QUEUE_79_STATUS_B Register (offset = 34F4h) [reset = 0h]

QUEUE_79_STATUS_B is shown in [Figure 16-1173](#) and described in [Table 16-1187](#).

Figure 16-1173. QUEUE_79_STATUS_B Register


LEGEND: R/W = Read/Write; R = Read only; W1toCl = Write 1 to clear bit; -n = value after reset

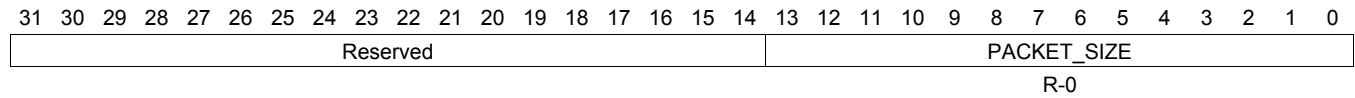
Table 16-1187. QUEUE_79_STATUS_B Register Field Descriptions

Bit	Field	Type	Reset	Description
27-0	QUEUE_BYTE_COUNT	R-0	0	This field indicates how many bytes total are contained in all of the packets which are currently queued on this queue. Queue_Manager_Queue_n_Status_B Registers B

16.5.7.898 QUEUE_79_STATUS_C Register (offset = 34F8h) [reset = 0h]

QUEUE_79_STATUS_C is shown in [Figure 16-1174](#) and described in [Table 16-1188](#).

Figure 16-1174. QUEUE_79_STATUS_C Register



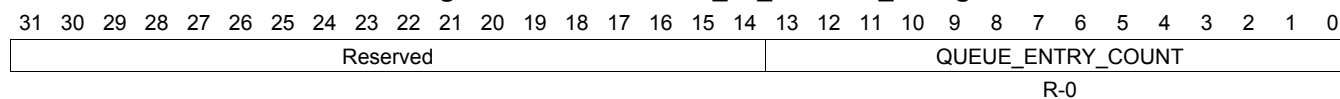
LEGEND: R/W = Read/Write; R = Read only; W1toCl = Write 1 to clear bit; -n = value after reset

Table 16-1188. QUEUE_79_STATUS_C Register Field Descriptions

Bit	Field	Type	Reset	Description
13-0	PACKET_SIZE	R-0	0	This field indicates packet size of the head element of a queue. Queue_Manager_Queue_N_Status_C Registers C

16.5.7.899 QUEUE_80_STATUS_A Register (offset = 3500h) [reset = 0h]

 QUEUE_80_STATUS_A is shown in [Figure 16-1175](#) and described in [Table 16-1189](#).

Figure 16-1175. QUEUE_80_STATUS_A Register


LEGEND: R/W = Read/Write; R = Read only; W1toCl = Write 1 to clear bit; -n = value after reset

Table 16-1189. QUEUE_80_STATUS_A Register Field Descriptions

Bit	Field	Type	Reset	Description
13-0	QUEUE_ENTRY_COUNT	R-0	0	This field indicates how many packets are currently queued on the queue. Queue Manager Queue N Status Registers A

16.5.7.900 QUEUE_80_STATUS_B Register (offset = 3504h) [reset = 0h]

QUEUE_80_STATUS_B is shown in [Figure 16-1176](#) and described in [Table 16-1190](#).

Figure 16-1176. QUEUE_80_STATUS_B Register

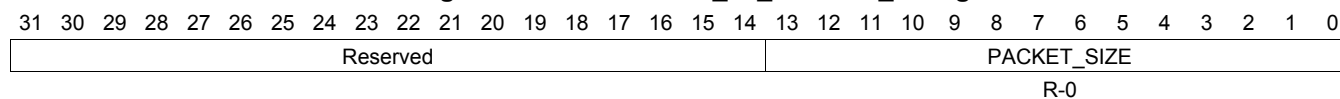

LEGEND: R/W = Read/Write; R = Read only; W1toCl = Write 1 to clear bit; -n = value after reset

Table 16-1190. QUEUE_80_STATUS_B Register Field Descriptions

Bit	Field	Type	Reset	Description
27-0	QUEUE_BYTE_COUNT	R-0	0	This field indicates how many bytes total are contained in all of the packets which are currently queued on this queue. Queue_Manager_Queue_n_Status_B Registers B

16.5.7.901 QUEUE_80_STATUS_C Register (offset = 3508h) [reset = 0h]

QUEUE_80_STATUS_C is shown in [Figure 16-1177](#) and described in [Table 16-1191](#).

Figure 16-1177. QUEUE_80_STATUS_C Register


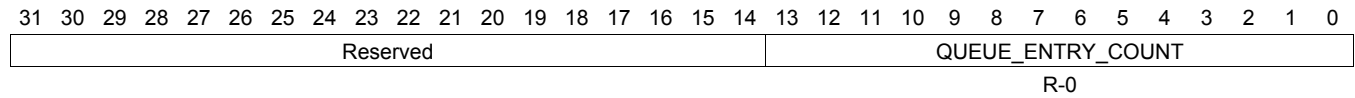
LEGEND: R/W = Read/Write; R = Read only; W1toCl = Write 1 to clear bit; -n = value after reset

Table 16-1191. QUEUE_80_STATUS_C Register Field Descriptions

Bit	Field	Type	Reset	Description
13-0	PACKET_SIZE	R-0	0	This field indicates packet size of the head element of a queue. Queue_Manager_Queue_N_Status_C Registers C

16.5.7.902 QUEUE_81_STATUS_A Register (offset = 3510h) [reset = 0h]

 QUEUE_81_STATUS_A is shown in [Figure 16-1178](#) and described in [Table 16-1192](#).

Figure 16-1178. QUEUE_81_STATUS_A Register


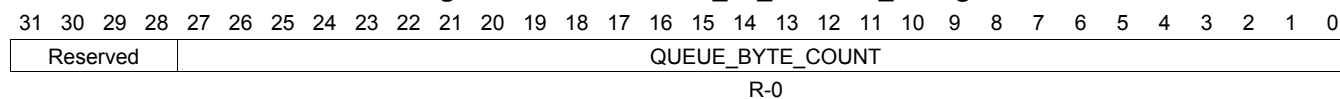
LEGEND: R/W = Read/Write; R = Read only; W1toCl = Write 1 to clear bit; -n = value after reset

Table 16-1192. QUEUE_81_STATUS_A Register Field Descriptions

Bit	Field	Type	Reset	Description
13-0	QUEUE_ENTRY_COUNT	R-0	0	This field indicates how many packets are currently queued on the queue. Queue Manager Queue N Status Registers A

16.5.7.903 QUEUE_81_STATUS_B Register (offset = 3514h) [reset = 0h]

QUEUE_81_STATUS_B is shown in [Figure 16-1179](#) and described in [Table 16-1193](#).

Figure 16-1179. QUEUE_81_STATUS_B Register


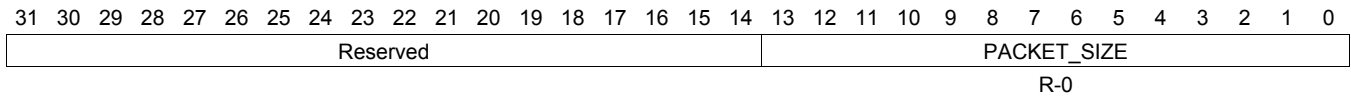
LEGEND: R/W = Read/Write; R = Read only; W1toCl = Write 1 to clear bit; -n = value after reset

Table 16-1193. QUEUE_81_STATUS_B Register Field Descriptions

Bit	Field	Type	Reset	Description
27-0	QUEUE_BYTE_COUNT	R-0	0	This field indicates how many bytes total are contained in all of the packets which are currently queued on this queue. Queue_Manager_Queue_n_Status_B Registers B

16.5.7.904 QUEUE_81_STATUS_C Register (offset = 3518h) [reset = 0h]

 QUEUE_81_STATUS_C is shown in [Figure 16-1180](#) and described in [Table 16-1194](#).

Figure 16-1180. QUEUE_81_STATUS_C Register


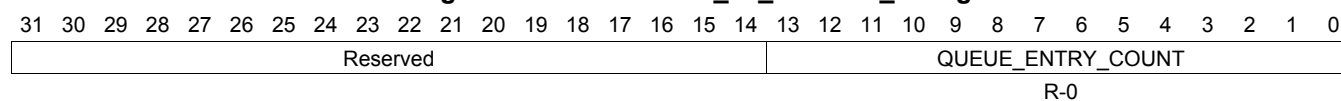
LEGEND: R/W = Read/Write; R = Read only; W1toCl = Write 1 to clear bit; -n = value after reset

Table 16-1194. QUEUE_81_STATUS_C Register Field Descriptions

Bit	Field	Type	Reset	Description
13-0	PACKET_SIZE	R-0	0	This field indicates packet size of the head element of a queue. Queue_Manager_Queue_N_Status_C Registers C

16.5.7.905 QUEUE_82_STATUS_A Register (offset = 3520h) [reset = 0h]

 QUEUE_82_STATUS_A is shown in [Figure 16-1181](#) and described in [Table 16-1195](#).

Figure 16-1181. QUEUE_82_STATUS_A Register


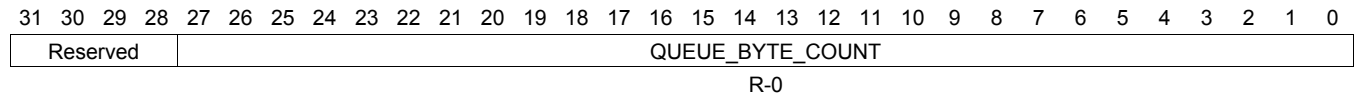
LEGEND: R/W = Read/Write; R = Read only; W1toCl = Write 1 to clear bit; -n = value after reset

Table 16-1195. QUEUE_82_STATUS_A Register Field Descriptions

Bit	Field	Type	Reset	Description
13-0	QUEUE_ENTRY_COUNT	R-0	0	This field indicates how many packets are currently queued on the queue. Queue Manager Queue N Status Registers A

16.5.7.906 QUEUE_82_STATUS_B Register (offset = 3524h) [reset = 0h]

QUEUE_82_STATUS_B is shown in [Figure 16-1182](#) and described in [Table 16-1196](#).

Figure 16-1182. QUEUE_82_STATUS_B Register


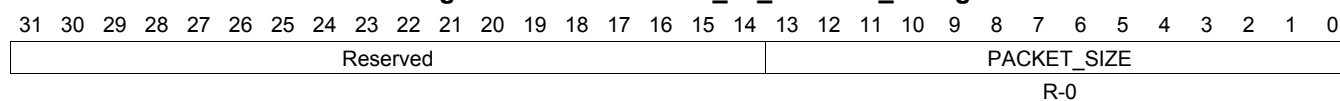
LEGEND: R/W = Read/Write; R = Read only; W1toCl = Write 1 to clear bit; -n = value after reset

Table 16-1196. QUEUE_82_STATUS_B Register Field Descriptions

Bit	Field	Type	Reset	Description
27-0	QUEUE_BYTE_COUNT	R-0	0	This field indicates how many bytes total are contained in all of the packets which are currently queued on this queue. Queue_Manager_Queue_n_Status_B Registers B

16.5.7.907 QUEUE_82_STATUS_C Register (offset = 3528h) [reset = 0h]

QUEUE_82_STATUS_C is shown in [Figure 16-1183](#) and described in [Table 16-1197](#).

Figure 16-1183. QUEUE_82_STATUS_C Register


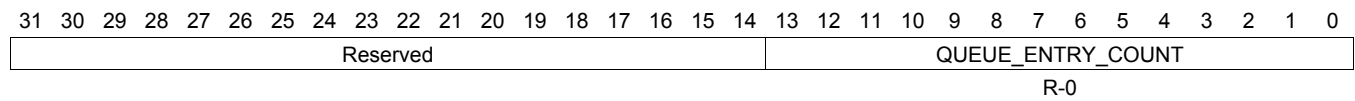
LEGEND: R/W = Read/Write; R = Read only; W1toCl = Write 1 to clear bit; -n = value after reset

Table 16-1197. QUEUE_82_STATUS_C Register Field Descriptions

Bit	Field	Type	Reset	Description
13-0	PACKET_SIZE	R-0	0	This field indicates packet size of the head element of a queue. Queue_Manager_Queue_N_Status_C Registers C

16.5.7.908 QUEUE_83_STATUS_A Register (offset = 3530h) [reset = 0h]

 QUEUE_83_STATUS_A is shown in [Figure 16-1184](#) and described in [Table 16-1198](#).

Figure 16-1184. QUEUE_83_STATUS_A Register


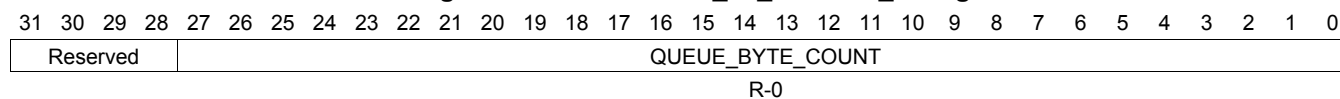
LEGEND: R/W = Read/Write; R = Read only; W1toCl = Write 1 to clear bit; -n = value after reset

Table 16-1198. QUEUE_83_STATUS_A Register Field Descriptions

Bit	Field	Type	Reset	Description
13-0	QUEUE_ENTRY_COUNT	R-0	0	This field indicates how many packets are currently queued on the queue. Queue Manager Queue N Status Registers A

16.5.7.909 QUEUE_83_STATUS_B Register (offset = 3534h) [reset = 0h]

QUEUE_83_STATUS_B is shown in [Figure 16-1185](#) and described in [Table 16-1199](#).

Figure 16-1185. QUEUE_83_STATUS_B Register


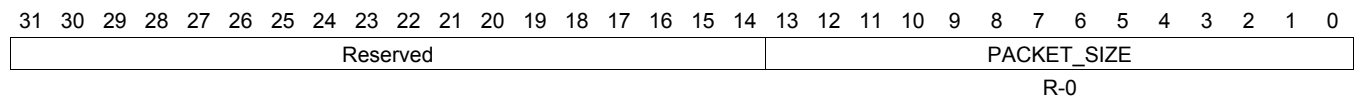
LEGEND: R/W = Read/Write; R = Read only; W1toCl = Write 1 to clear bit; -n = value after reset

Table 16-1199. QUEUE_83_STATUS_B Register Field Descriptions

Bit	Field	Type	Reset	Description
27-0	QUEUE_BYTE_COUNT	R-0	0	This field indicates how many bytes total are contained in all of the packets which are currently queued on this queue. Queue_Manager_Queue_n_Status_B Registers B

16.5.7.910 QUEUE_83_STATUS_C Register (offset = 3538h) [reset = 0h]

 QUEUE_83_STATUS_C is shown in [Figure 16-1186](#) and described in [Table 16-1200](#).

Figure 16-1186. QUEUE_83_STATUS_C Register


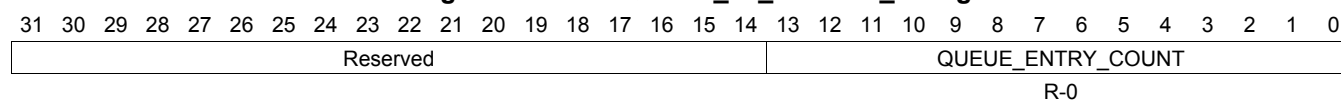
LEGEND: R/W = Read/Write; R = Read only; W1toCl = Write 1 to clear bit; -n = value after reset

Table 16-1200. QUEUE_83_STATUS_C Register Field Descriptions

Bit	Field	Type	Reset	Description
13-0	PACKET_SIZE	R-0	0	This field indicates packet size of the head element of a queue. Queue_Manager_Queue_N_Status_C Registers C

16.5.7.911 QUEUE_84_STATUS_A Register (offset = 3540h) [reset = 0h]

QUEUE_84_STATUS_A is shown in [Figure 16-1187](#) and described in [Table 16-1201](#).

Figure 16-1187. QUEUE_84_STATUS_A Register


LEGEND: R/W = Read/Write; R = Read only; W1toCl = Write 1 to clear bit; -n = value after reset

Table 16-1201. QUEUE_84_STATUS_A Register Field Descriptions

Bit	Field	Type	Reset	Description
13-0	QUEUE_ENTRY_COUNT	R-0	0	This field indicates how many packets are currently queued on the queue. Queue Manager Queue N Status Registers A

16.5.7.912 QUEUE_84_STATUS_B Register (offset = 3544h) [reset = 0h]

 QUEUE_84_STATUS_B is shown in [Figure 16-1188](#) and described in [Table 16-1202](#).

Figure 16-1188. QUEUE_84_STATUS_B Register

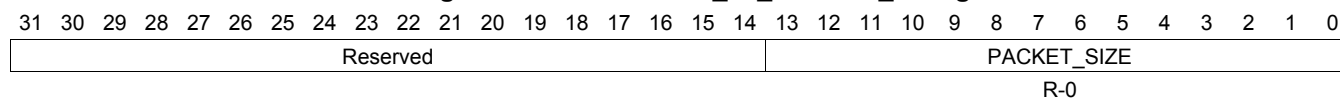

LEGEND: R/W = Read/Write; R = Read only; W1toCl = Write 1 to clear bit; -n = value after reset

Table 16-1202. QUEUE_84_STATUS_B Register Field Descriptions

Bit	Field	Type	Reset	Description
27-0	QUEUE_BYTE_COUNT	R-0	0	This field indicates how many bytes total are contained in all of the packets which are currently queued on this queue. Queue_Manager_Queue_n_Status_B Registers B

16.5.7.913 QUEUE_84_STATUS_C Register (offset = 3548h) [reset = 0h]

QUEUE_84_STATUS_C is shown in [Figure 16-1189](#) and described in [Table 16-1203](#).

Figure 16-1189. QUEUE_84_STATUS_C Register


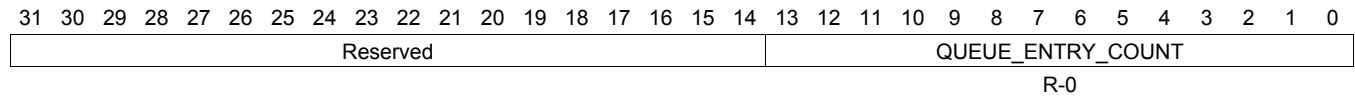
LEGEND: R/W = Read/Write; R = Read only; W1toCl = Write 1 to clear bit; -n = value after reset

Table 16-1203. QUEUE_84_STATUS_C Register Field Descriptions

Bit	Field	Type	Reset	Description
13-0	PACKET_SIZE	R-0	0	This field indicates packet size of the head element of a queue. Queue_Manager_Queue_N_Status_C Registers C

16.5.7.914 QUEUE_85_STATUS_A Register (offset = 3550h) [reset = 0h]

 QUEUE_85_STATUS_A is shown in [Figure 16-1190](#) and described in [Table 16-1204](#).

Figure 16-1190. QUEUE_85_STATUS_A Register


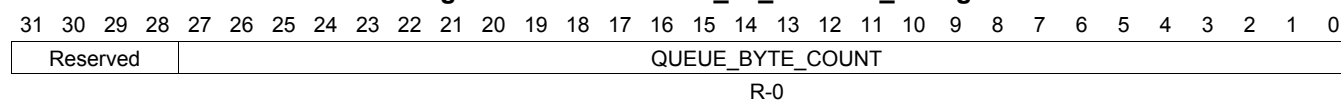
LEGEND: R/W = Read/Write; R = Read only; W1toCl = Write 1 to clear bit; -n = value after reset

Table 16-1204. QUEUE_85_STATUS_A Register Field Descriptions

Bit	Field	Type	Reset	Description
13-0	QUEUE_ENTRY_COUNT	R-0	0	This field indicates how many packets are currently queued on the queue. Queue Manager Queue N Status Registers A

16.5.7.915 QUEUE_85_STATUS_B Register (offset = 3554h) [reset = 0h]

QUEUE_85_STATUS_B is shown in [Figure 16-1191](#) and described in [Table 16-1205](#).

Figure 16-1191. QUEUE_85_STATUS_B Register


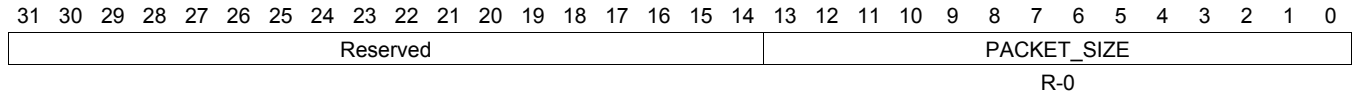
LEGEND: R/W = Read/Write; R = Read only; W1toCl = Write 1 to clear bit; -n = value after reset

Table 16-1205. QUEUE_85_STATUS_B Register Field Descriptions

Bit	Field	Type	Reset	Description
27-0	QUEUE_BYTE_COUNT	R-0	0	This field indicates how many bytes total are contained in all of the packets which are currently queued on this queue. Queue_Manager_Queue_n_Status_B Registers B

16.5.7.916 QUEUE_85_STATUS_C Register (offset = 3558h) [reset = 0h]

 QUEUE_85_STATUS_C is shown in [Figure 16-1192](#) and described in [Table 16-1206](#).

Figure 16-1192. QUEUE_85_STATUS_C Register


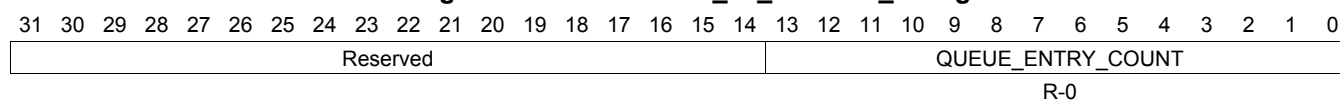
LEGEND: R/W = Read/Write; R = Read only; W1toCl = Write 1 to clear bit; -n = value after reset

Table 16-1206. QUEUE_85_STATUS_C Register Field Descriptions

Bit	Field	Type	Reset	Description
13-0	PACKET_SIZE	R-0	0	This field indicates packet size of the head element of a queue. Queue_Manager_Queue_N_Status_C Registers C

16.5.7.917 QUEUE_86_STATUS_A Register (offset = 3560h) [reset = 0h]

 QUEUE_86_STATUS_A is shown in [Figure 16-1193](#) and described in [Table 16-1207](#).

Figure 16-1193. QUEUE_86_STATUS_A Register


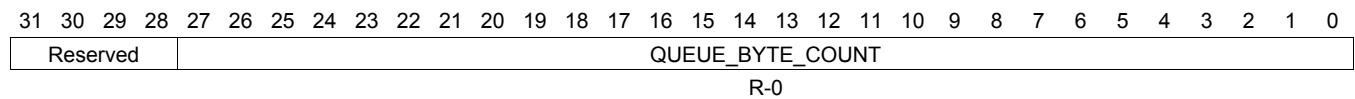
LEGEND: R/W = Read/Write; R = Read only; W1toCl = Write 1 to clear bit; -n = value after reset

Table 16-1207. QUEUE_86_STATUS_A Register Field Descriptions

Bit	Field	Type	Reset	Description
13-0	QUEUE_ENTRY_COUNT	R-0	0	This field indicates how many packets are currently queued on the queue. Queue Manager Queue N Status Registers A

16.5.7.918 QUEUE_86_STATUS_B Register (offset = 3564h) [reset = 0h]

 QUEUE_86_STATUS_B is shown in [Figure 16-1194](#) and described in [Table 16-1208](#).

Figure 16-1194. QUEUE_86_STATUS_B Register


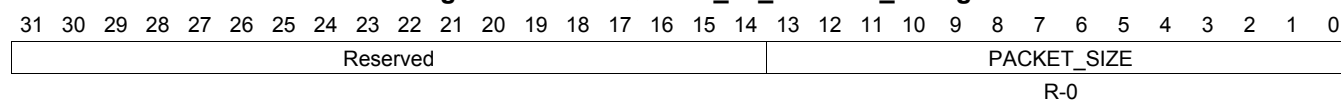
LEGEND: R/W = Read/Write; R = Read only; W1toCl = Write 1 to clear bit; -n = value after reset

Table 16-1208. QUEUE_86_STATUS_B Register Field Descriptions

Bit	Field	Type	Reset	Description
27-0	QUEUE_BYTE_COUNT	R-0	0	This field indicates how many bytes total are contained in all of the packets which are currently queued on this queue. Queue_Manager_Queue_n_Status_B Registers B

16.5.7.919 QUEUE_86_STATUS_C Register (offset = 3568h) [reset = 0h]

QUEUE_86_STATUS_C is shown in [Figure 16-1195](#) and described in [Table 16-1209](#).

Figure 16-1195. QUEUE_86_STATUS_C Register


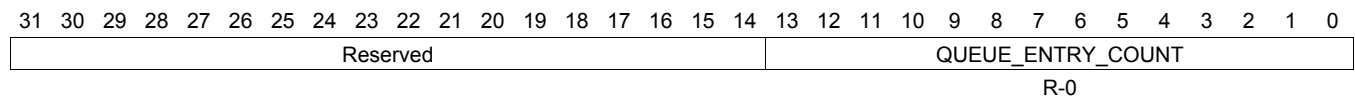
LEGEND: R/W = Read/Write; R = Read only; W1toCl = Write 1 to clear bit; -n = value after reset

Table 16-1209. QUEUE_86_STATUS_C Register Field Descriptions

Bit	Field	Type	Reset	Description
13-0	PACKET_SIZE	R-0	0	This field indicates packet size of the head element of a queue. Queue_Manager_Queue_N_Status_C Registers C

16.5.7.920 QUEUE_87_STATUS_A Register (offset = 3570h) [reset = 0h]

 QUEUE_87_STATUS_A is shown in [Figure 16-1196](#) and described in [Table 16-1210](#).

Figure 16-1196. QUEUE_87_STATUS_A Register


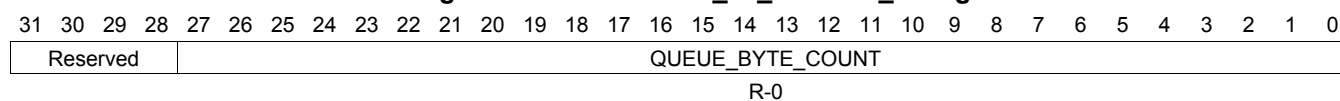
LEGEND: R/W = Read/Write; R = Read only; W1toCl = Write 1 to clear bit; -n = value after reset

Table 16-1210. QUEUE_87_STATUS_A Register Field Descriptions

Bit	Field	Type	Reset	Description
13-0	QUEUE_ENTRY_COUNT	R-0	0	This field indicates how many packets are currently queued on the queue. Queue Manager Queue N Status Registers A

16.5.7.921 QUEUE_87_STATUS_B Register (offset = 3574h) [reset = 0h]

QUEUE_87_STATUS_B is shown in [Figure 16-1197](#) and described in [Table 16-1211](#).

Figure 16-1197. QUEUE_87_STATUS_B Register


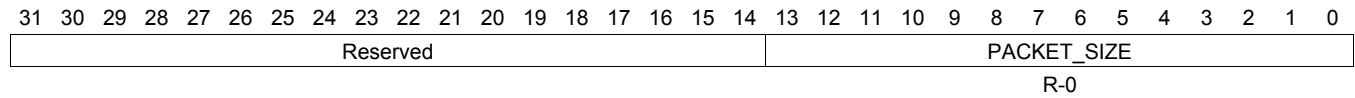
LEGEND: R/W = Read/Write; R = Read only; W1toCl = Write 1 to clear bit; -n = value after reset

Table 16-1211. QUEUE_87_STATUS_B Register Field Descriptions

Bit	Field	Type	Reset	Description
27-0	QUEUE_BYTE_COUNT	R-0	0	This field indicates how many bytes total are contained in all of the packets which are currently queued on this queue. Queue_Manager_Queue_n_Status_B Registers B

16.5.7.922 QUEUE_87_STATUS_C Register (offset = 3578h) [reset = 0h]

 QUEUE_87_STATUS_C is shown in [Figure 16-1198](#) and described in [Table 16-1212](#).

Figure 16-1198. QUEUE_87_STATUS_C Register


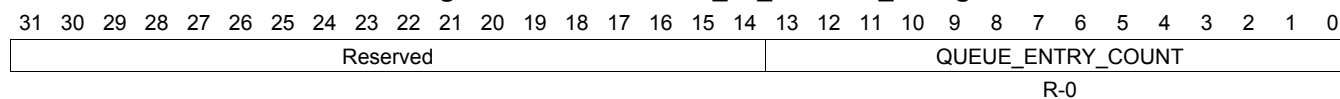
LEGEND: R/W = Read/Write; R = Read only; W1toCl = Write 1 to clear bit; -n = value after reset

Table 16-1212. QUEUE_87_STATUS_C Register Field Descriptions

Bit	Field	Type	Reset	Description
13-0	PACKET_SIZE	R-0	0	This field indicates packet size of the head element of a queue. Queue_Manager_Queue_N_Status_C Registers C

16.5.7.923 QUEUE_88_STATUS_A Register (offset = 3580h) [reset = 0h]

QUEUE_88_STATUS_A is shown in [Figure 16-1199](#) and described in [Table 16-1213](#).

Figure 16-1199. QUEUE_88_STATUS_A Register


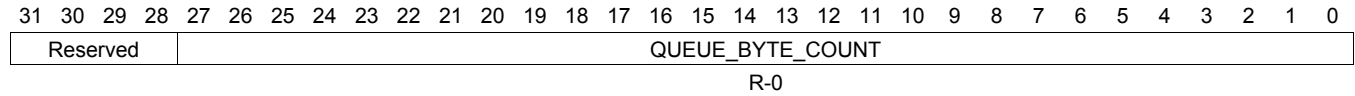
LEGEND: R/W = Read/Write; R = Read only; W1toCl = Write 1 to clear bit; -n = value after reset

Table 16-1213. QUEUE_88_STATUS_A Register Field Descriptions

Bit	Field	Type	Reset	Description
13-0	QUEUE_ENTRY_COUNT	R-0	0	This field indicates how many packets are currently queued on the queue. Queue Manager Queue N Status Registers A

16.5.7.924 QUEUE_88_STATUS_B Register (offset = 3584h) [reset = 0h]

 QUEUE_88_STATUS_B is shown in [Figure 16-1200](#) and described in [Table 16-1214](#).

Figure 16-1200. QUEUE_88_STATUS_B Register


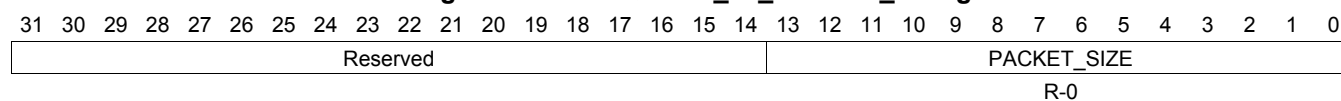
LEGEND: R/W = Read/Write; R = Read only; W1toCl = Write 1 to clear bit; -n = value after reset

Table 16-1214. QUEUE_88_STATUS_B Register Field Descriptions

Bit	Field	Type	Reset	Description
27-0	QUEUE_BYTE_COUNT	R-0	0	This field indicates how many bytes total are contained in all of the packets which are currently queued on this queue. Queue_Manager_Queue_n_Status_B Registers B

16.5.7.925 QUEUE_88_STATUS_C Register (offset = 3588h) [reset = 0h]

QUEUE_88_STATUS_C is shown in [Figure 16-1201](#) and described in [Table 16-1215](#).

Figure 16-1201. QUEUE_88_STATUS_C Register


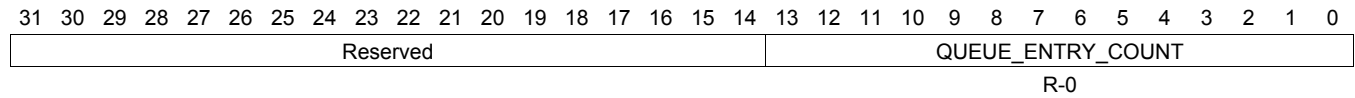
LEGEND: R/W = Read/Write; R = Read only; W1toCl = Write 1 to clear bit; -n = value after reset

Table 16-1215. QUEUE_88_STATUS_C Register Field Descriptions

Bit	Field	Type	Reset	Description
13-0	PACKET_SIZE	R-0	0	This field indicates packet size of the head element of a queue. Queue_Manager_Queue_N_Status_C Registers C

16.5.7.926 QUEUE_89_STATUS_A Register (offset = 3590h) [reset = 0h]

 QUEUE_89_STATUS_A is shown in [Figure 16-1202](#) and described in [Table 16-1216](#).

Figure 16-1202. QUEUE_89_STATUS_A Register


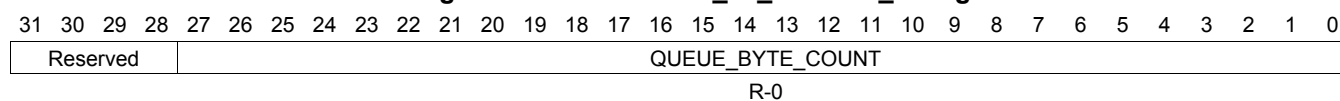
LEGEND: R/W = Read/Write; R = Read only; W1toCl = Write 1 to clear bit; -n = value after reset

Table 16-1216. QUEUE_89_STATUS_A Register Field Descriptions

Bit	Field	Type	Reset	Description
13-0	QUEUE_ENTRY_COUNT	R-0	0	This field indicates how many packets are currently queued on the queue. Queue Manager Queue N Status Registers A

16.5.7.927 QUEUE_89_STATUS_B Register (offset = 3594h) [reset = 0h]

QUEUE_89_STATUS_B is shown in [Figure 16-1203](#) and described in [Table 16-1217](#).

Figure 16-1203. QUEUE_89_STATUS_B Register


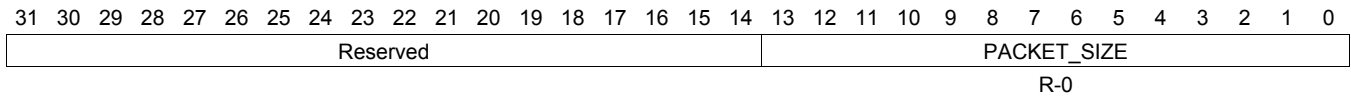
LEGEND: R/W = Read/Write; R = Read only; W1toCl = Write 1 to clear bit; -n = value after reset

Table 16-1217. QUEUE_89_STATUS_B Register Field Descriptions

Bit	Field	Type	Reset	Description
27-0	QUEUE_BYTE_COUNT	R-0	0	This field indicates how many bytes total are contained in all of the packets which are currently queued on this queue. Queue_Manager_Queue_n_Status_B Registers B

16.5.7.928 QUEUE_89_STATUS_C Register (offset = 3598h) [reset = 0h]

 QUEUE_89_STATUS_C is shown in [Figure 16-1204](#) and described in [Table 16-1218](#).

Figure 16-1204. QUEUE_89_STATUS_C Register


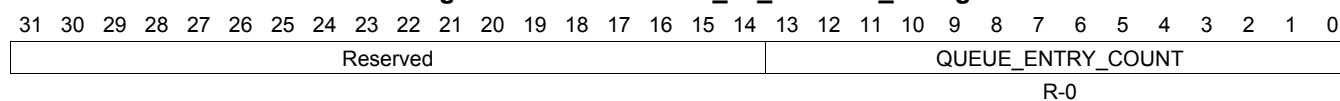
LEGEND: R/W = Read/Write; R = Read only; W1toCl = Write 1 to clear bit; -n = value after reset

Table 16-1218. QUEUE_89_STATUS_C Register Field Descriptions

Bit	Field	Type	Reset	Description
13-0	PACKET_SIZE	R-0	0	This field indicates packet size of the head element of a queue. Queue_Manager_Queue_N_Status_C Registers C

16.5.7.929 QUEUE_90_STATUS_A Register (offset = 35A0h) [reset = 0h]

QUEUE_90_STATUS_A is shown in [Figure 16-1205](#) and described in [Table 16-1219](#).

Figure 16-1205. QUEUE_90_STATUS_A Register


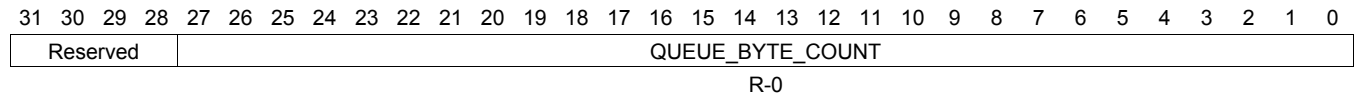
LEGEND: R/W = Read/Write; R = Read only; W1toCl = Write 1 to clear bit; -n = value after reset

Table 16-1219. QUEUE_90_STATUS_A Register Field Descriptions

Bit	Field	Type	Reset	Description
13-0	QUEUE_ENTRY_COUNT	R-0	0	This field indicates how many packets are currently queued on the queue. Queue Manager Queue N Status Registers A

16.5.7.930 QUEUE_90_STATUS_B Register (offset = 35A4h) [reset = 0h]

QUEUE_90_STATUS_B is shown in [Figure 16-1206](#) and described in [Table 16-1220](#).

Figure 16-1206. QUEUE_90_STATUS_B Register


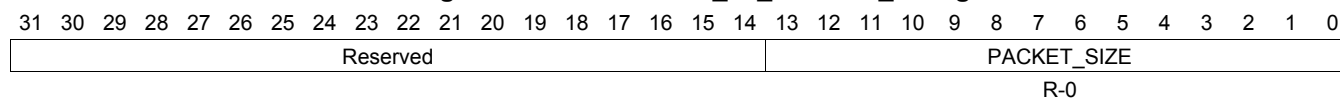
LEGEND: R/W = Read/Write; R = Read only; W1toCl = Write 1 to clear bit; -n = value after reset

Table 16-1220. QUEUE_90_STATUS_B Register Field Descriptions

Bit	Field	Type	Reset	Description
27-0	QUEUE_BYTE_COUNT	R-0	0	This field indicates how many bytes total are contained in all of the packets which are currently queued on this queue. Queue_Manager_Queue_n_Status_B Registers B

16.5.7.931 QUEUE_90_STATUS_C Register (offset = 35A8h) [reset = 0h]

QUEUE_90_STATUS_C is shown in [Figure 16-1207](#) and described in [Table 16-1221](#).

Figure 16-1207. QUEUE_90_STATUS_C Register


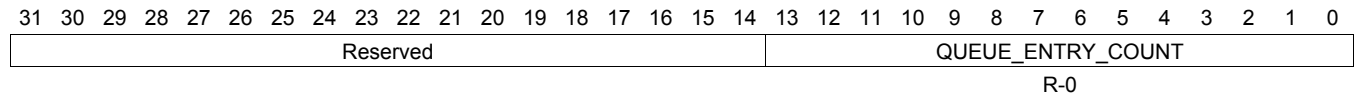
LEGEND: R/W = Read/Write; R = Read only; W1toCl = Write 1 to clear bit; -n = value after reset

Table 16-1221. QUEUE_90_STATUS_C Register Field Descriptions

Bit	Field	Type	Reset	Description
13-0	PACKET_SIZE	R-0	0	This field indicates packet size of the head element of a queue. Queue_Manager_Queue_N_Status_C Registers C

16.5.7.932 QUEUE_91_STATUS_A Register (offset = 35B0h) [reset = 0h]

 QUEUE_91_STATUS_A is shown in [Figure 16-1208](#) and described in [Table 16-1222](#).

Figure 16-1208. QUEUE_91_STATUS_A Register


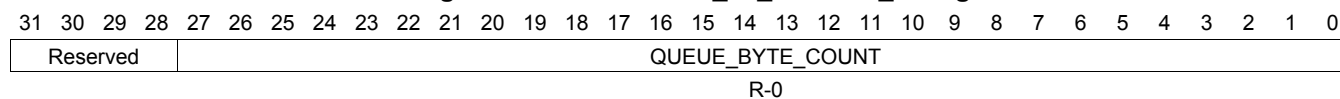
LEGEND: R/W = Read/Write; R = Read only; W1toCl = Write 1 to clear bit; -n = value after reset

Table 16-1222. QUEUE_91_STATUS_A Register Field Descriptions

Bit	Field	Type	Reset	Description
13-0	QUEUE_ENTRY_COUNT	R-0	0	This field indicates how many packets are currently queued on the queue. Queue Manager Queue N Status Registers A

16.5.7.933 QUEUE_91_STATUS_B Register (offset = 35B4h) [reset = 0h]

QUEUE_91_STATUS_B is shown in [Figure 16-1209](#) and described in [Table 16-1223](#).

Figure 16-1209. QUEUE_91_STATUS_B Register


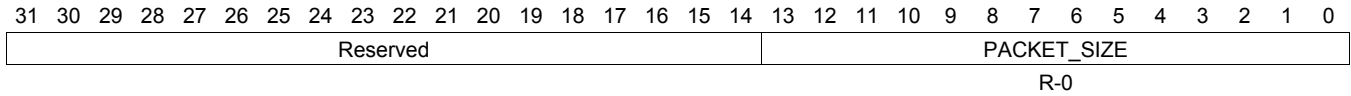
LEGEND: R/W = Read/Write; R = Read only; W1toCl = Write 1 to clear bit; -n = value after reset

Table 16-1223. QUEUE_91_STATUS_B Register Field Descriptions

Bit	Field	Type	Reset	Description
27-0	QUEUE_BYTE_COUNT	R-0	0	This field indicates how many bytes total are contained in all of the packets which are currently queued on this queue. Queue_Manager_Queue_n_Status_B Registers B

16.5.7.934 QUEUE_91_STATUS_C Register (offset = 35B8h) [reset = 0h]

 QUEUE_91_STATUS_C is shown in [Figure 16-1210](#) and described in [Table 16-1224](#).

Figure 16-1210. QUEUE_91_STATUS_C Register


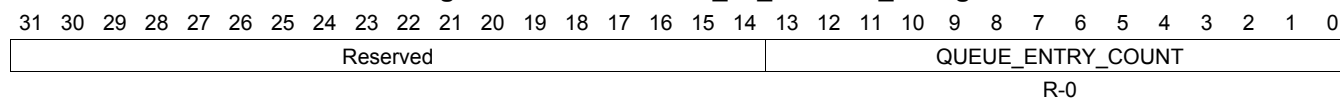
LEGEND: R/W = Read/Write; R = Read only; W1toCl = Write 1 to clear bit; -n = value after reset

Table 16-1224. QUEUE_91_STATUS_C Register Field Descriptions

Bit	Field	Type	Reset	Description
13-0	PACKET_SIZE	R-0	0	This field indicates packet size of the head element of a queue. Queue_Manager_Queue_N_Status_C Registers C

16.5.7.935 QUEUE_92_STATUS_A Register (offset = 35C0h) [reset = 0h]

 QUEUE_92_STATUS_A is shown in [Figure 16-1211](#) and described in [Table 16-1225](#).

Figure 16-1211. QUEUE_92_STATUS_A Register


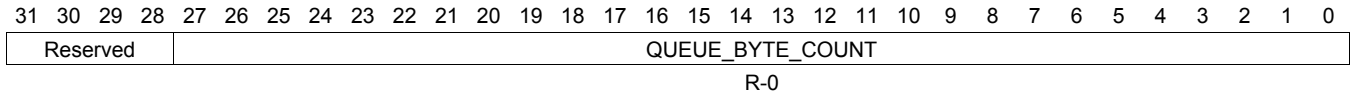
LEGEND: R/W = Read/Write; R = Read only; W1toCl = Write 1 to clear bit; -n = value after reset

Table 16-1225. QUEUE_92_STATUS_A Register Field Descriptions

Bit	Field	Type	Reset	Description
13-0	QUEUE_ENTRY_COUNT	R-0	0	This field indicates how many packets are currently queued on the queue. Queue Manager Queue N Status Registers A

16.5.7.936 QUEUE_92_STATUS_B Register (offset = 35C4h) [reset = 0h]

QUEUE_92_STATUS_B is shown in [Figure 16-1212](#) and described in [Table 16-1226](#).

Figure 16-1212. QUEUE_92_STATUS_B Register


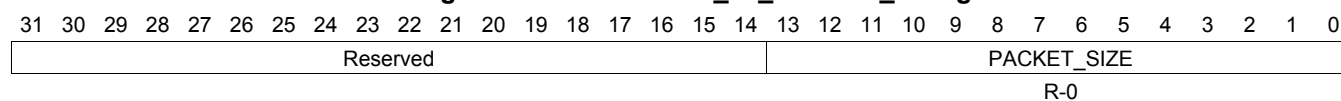
LEGEND: R/W = Read/Write; R = Read only; W1toCl = Write 1 to clear bit; -n = value after reset

Table 16-1226. QUEUE_92_STATUS_B Register Field Descriptions

Bit	Field	Type	Reset	Description
27-0	QUEUE_BYTE_COUNT	R-0	0	This field indicates how many bytes total are contained in all of the packets which are currently queued on this queue. Queue_Manager_Queue_n_Status_B Registers B

16.5.7.937 QUEUE_92_STATUS_C Register (offset = 35C8h) [reset = 0h]

QUEUE_92_STATUS_C is shown in [Figure 16-1213](#) and described in [Table 16-1227](#).

Figure 16-1213. QUEUE_92_STATUS_C Register


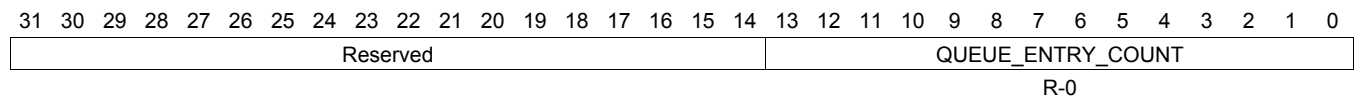
LEGEND: R/W = Read/Write; R = Read only; W1toCl = Write 1 to clear bit; -n = value after reset

Table 16-1227. QUEUE_92_STATUS_C Register Field Descriptions

Bit	Field	Type	Reset	Description
13-0	PACKET_SIZE	R-0	0	This field indicates packet size of the head element of a queue. Queue_Manager_Queue_N_Status_C Registers C

16.5.7.938 QUEUE_93_STATUS_A Register (offset = 35D0h) [reset = 0h]

 QUEUE_93_STATUS_A is shown in [Figure 16-1214](#) and described in [Table 16-1228](#).

Figure 16-1214. QUEUE_93_STATUS_A Register


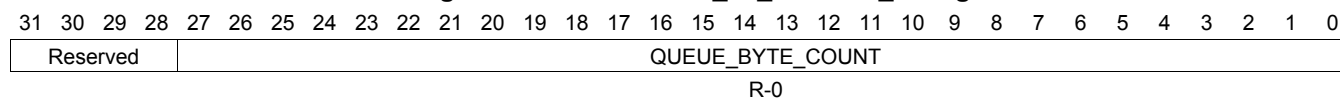
LEGEND: R/W = Read/Write; R = Read only; W1toCl = Write 1 to clear bit; -n = value after reset

Table 16-1228. QUEUE_93_STATUS_A Register Field Descriptions

Bit	Field	Type	Reset	Description
13-0	QUEUE_ENTRY_COUNT	R-0	0	This field indicates how many packets are currently queued on the queue. Queue Manager Queue N Status Registers A

16.5.7.939 QUEUE_93_STATUS_B Register (offset = 35D4h) [reset = 0h]

QUEUE_93_STATUS_B is shown in [Figure 16-1215](#) and described in [Table 16-1229](#).

Figure 16-1215. QUEUE_93_STATUS_B Register


LEGEND: R/W = Read/Write; R = Read only; W1toCl = Write 1 to clear bit; -n = value after reset

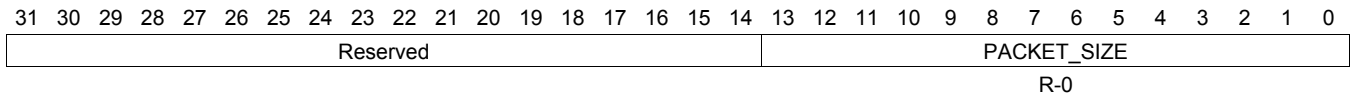
Table 16-1229. QUEUE_93_STATUS_B Register Field Descriptions

Bit	Field	Type	Reset	Description
27-0	QUEUE_BYTE_COUNT	R-0	0	This field indicates how many bytes total are contained in all of the packets which are currently queued on this queue. Queue_Manager_Queue_n_Status_B Registers B

16.5.7.940 QUEUE_93_STATUS_C Register (offset = 35D8h) [reset = 0h]

QUEUE_93_STATUS_C is shown in [Figure 16-1216](#) and described in [Table 16-1230](#).

Figure 16-1216. QUEUE_93_STATUS_C Register



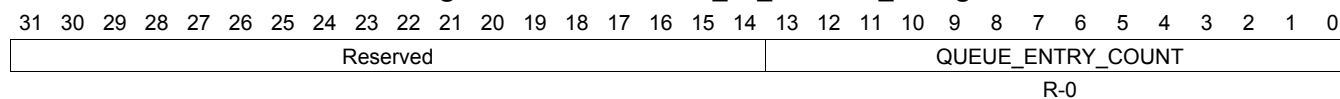
LEGEND: R/W = Read/Write; R = Read only; W1toCl = Write 1 to clear bit; -n = value after reset

Table 16-1230. QUEUE_93_STATUS_C Register Field Descriptions

Bit	Field	Type	Reset	Description
13-0	PACKET_SIZE	R-0	0	This field indicates packet size of the head element of a queue. Queue_Manager_Queue_N_Status_C Registers C

16.5.7.941 QUEUE_94_STATUS_A Register (offset = 35E0h) [reset = 0h]

QUEUE_94_STATUS_A is shown in [Figure 16-1217](#) and described in [Table 16-1231](#).

Figure 16-1217. QUEUE_94_STATUS_A Register


LEGEND: R/W = Read/Write; R = Read only; W1toCl = Write 1 to clear bit; -n = value after reset

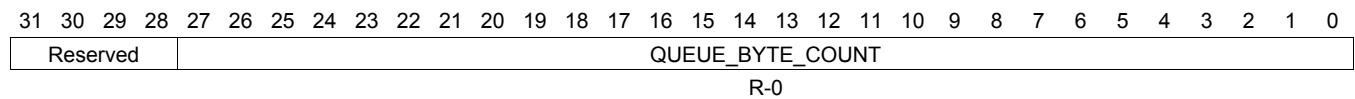
Table 16-1231. QUEUE_94_STATUS_A Register Field Descriptions

Bit	Field	Type	Reset	Description
13-0	QUEUE_ENTRY_COUNT	R-0	0	This field indicates how many packets are currently queued on the queue. Queue Manager Queue N Status Registers A

16.5.7.942 QUEUE_94_STATUS_B Register (offset = 35E4h) [reset = 0h]

QUEUE_94_STATUS_B is shown in [Figure 16-1218](#) and described in [Table 16-1232](#).

Figure 16-1218. QUEUE_94_STATUS_B Register



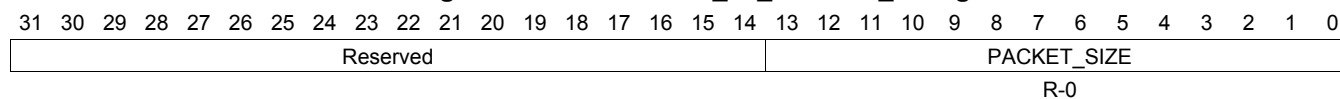
LEGEND: R/W = Read/Write; R = Read only; W1toCl = Write 1 to clear bit; -n = value after reset

Table 16-1232. QUEUE_94_STATUS_B Register Field Descriptions

Bit	Field	Type	Reset	Description
27-0	QUEUE_BYTE_COUNT	R-0	0	This field indicates how many bytes total are contained in all of the packets which are currently queued on this queue. Queue_Manager_Queue_n_Status_B Registers B

16.5.7.943 QUEUE_94_STATUS_C Register (offset = 35E8h) [reset = 0h]

QUEUE_94_STATUS_C is shown in [Figure 16-1219](#) and described in [Table 16-1233](#).

Figure 16-1219. QUEUE_94_STATUS_C Register


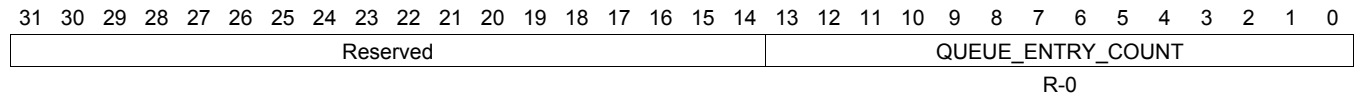
LEGEND: R/W = Read/Write; R = Read only; W1toCl = Write 1 to clear bit; -n = value after reset

Table 16-1233. QUEUE_94_STATUS_C Register Field Descriptions

Bit	Field	Type	Reset	Description
13-0	PACKET_SIZE	R-0	0	This field indicates packet size of the head element of a queue. Queue_Manager_Queue_N_Status_C Registers C

16.5.7.944 QUEUE_95_STATUS_A Register (offset = 35F0h) [reset = 0h]

 QUEUE_95_STATUS_A is shown in [Figure 16-1220](#) and described in [Table 16-1234](#).

Figure 16-1220. QUEUE_95_STATUS_A Register


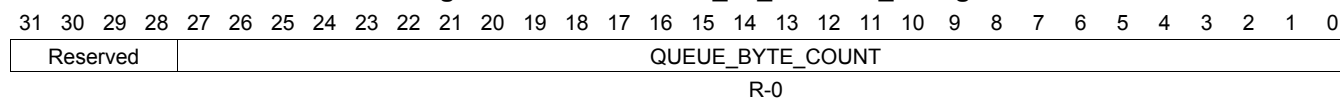
LEGEND: R/W = Read/Write; R = Read only; W1toCl = Write 1 to clear bit; -n = value after reset

Table 16-1234. QUEUE_95_STATUS_A Register Field Descriptions

Bit	Field	Type	Reset	Description
13-0	QUEUE_ENTRY_COUNT	R-0	0	This field indicates how many packets are currently queued on the queue. Queue Manager Queue N Status Registers A

16.5.7.945 QUEUE_95_STATUS_B Register (offset = 35F4h) [reset = 0h]

QUEUE_95_STATUS_B is shown in [Figure 16-1221](#) and described in [Table 16-1235](#).

Figure 16-1221. QUEUE_95_STATUS_B Register


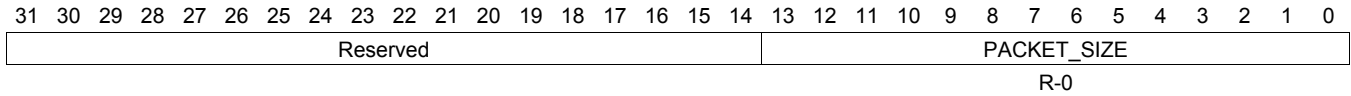
LEGEND: R/W = Read/Write; R = Read only; W1toCl = Write 1 to clear bit; -n = value after reset

Table 16-1235. QUEUE_95_STATUS_B Register Field Descriptions

Bit	Field	Type	Reset	Description
27-0	QUEUE_BYTE_COUNT	R-0	0	This field indicates how many bytes total are contained in all of the packets which are currently queued on this queue. Queue_Manager_Queue_n_Status_B Registers B

16.5.7.946 QUEUE_95_STATUS_C Register (offset = 35F8h) [reset = 0h]

 QUEUE_95_STATUS_C is shown in [Figure 16-1222](#) and described in [Table 16-1236](#).

Figure 16-1222. QUEUE_95_STATUS_C Register


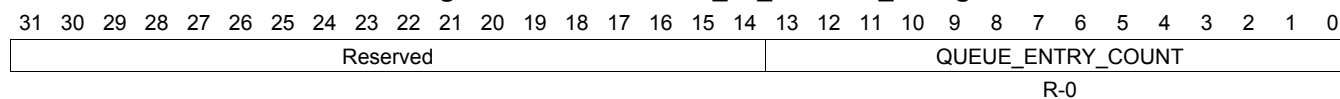
LEGEND: R/W = Read/Write; R = Read only; W1toCl = Write 1 to clear bit; -n = value after reset

Table 16-1236. QUEUE_95_STATUS_C Register Field Descriptions

Bit	Field	Type	Reset	Description
13-0	PACKET_SIZE	R-0	0	This field indicates packet size of the head element of a queue. Queue_Manager_Queue_N_Status_C Registers C

16.5.7.947 QUEUE_96_STATUS_A Register (offset = 3600h) [reset = 0h]

QUEUE_96_STATUS_A is shown in [Figure 16-1223](#) and described in [Table 16-1237](#).

Figure 16-1223. QUEUE_96_STATUS_A Register


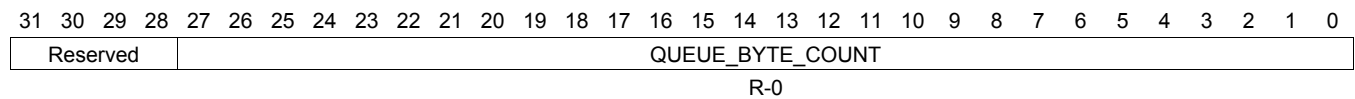
LEGEND: R/W = Read/Write; R = Read only; W1toCl = Write 1 to clear bit; -n = value after reset

Table 16-1237. QUEUE_96_STATUS_A Register Field Descriptions

Bit	Field	Type	Reset	Description
13-0	QUEUE_ENTRY_COUNT	R-0	0	This field indicates how many packets are currently queued on the queue. Queue Manager Queue N Status Registers A

16.5.7.948 QUEUE_96_STATUS_B Register (offset = 3604h) [reset = 0h]

 QUEUE_96_STATUS_B is shown in [Figure 16-1224](#) and described in [Table 16-1238](#).

Figure 16-1224. QUEUE_96_STATUS_B Register


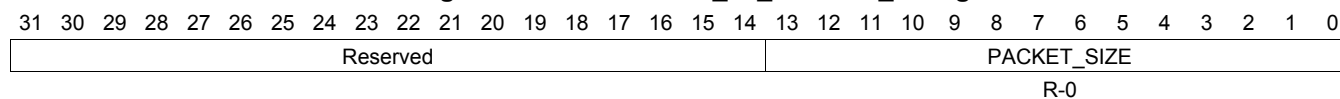
LEGEND: R/W = Read/Write; R = Read only; W1toCl = Write 1 to clear bit; -n = value after reset

Table 16-1238. QUEUE_96_STATUS_B Register Field Descriptions

Bit	Field	Type	Reset	Description
27-0	QUEUE_BYTE_COUNT	R-0	0	This field indicates how many bytes total are contained in all of the packets which are currently queued on this queue. Queue_Manager_Queue_n_Status_B Registers B

16.5.7.949 QUEUE_96_STATUS_C Register (offset = 3608h) [reset = 0h]

QUEUE_96_STATUS_C is shown in [Figure 16-1225](#) and described in [Table 16-1239](#).

Figure 16-1225. QUEUE_96_STATUS_C Register


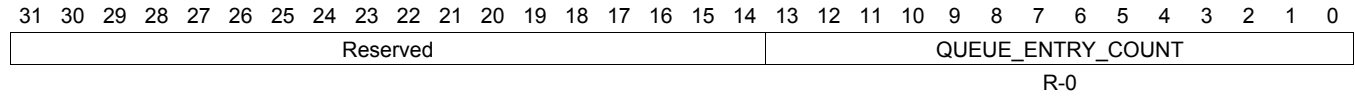
LEGEND: R/W = Read/Write; R = Read only; W1toCl = Write 1 to clear bit; -n = value after reset

Table 16-1239. QUEUE_96_STATUS_C Register Field Descriptions

Bit	Field	Type	Reset	Description
13-0	PACKET_SIZE	R-0	0	This field indicates packet size of the head element of a queue. Queue_Manager_Queue_N_Status_C Registers C

16.5.7.950 QUEUE_97_STATUS_A Register (offset = 3610h) [reset = 0h]

 QUEUE_97_STATUS_A is shown in [Figure 16-1226](#) and described in [Table 16-1240](#).

Figure 16-1226. QUEUE_97_STATUS_A Register


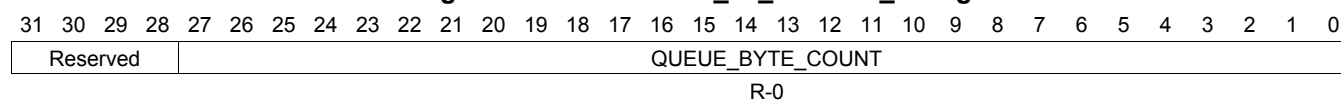
LEGEND: R/W = Read/Write; R = Read only; W1toCl = Write 1 to clear bit; -n = value after reset

Table 16-1240. QUEUE_97_STATUS_A Register Field Descriptions

Bit	Field	Type	Reset	Description
13-0	QUEUE_ENTRY_COUNT	R-0	0	This field indicates how many packets are currently queued on the queue. Queue Manager Queue N Status Registers A

16.5.7.951 QUEUE_97_STATUS_B Register (offset = 3614h) [reset = 0h]

QUEUE_97_STATUS_B is shown in [Figure 16-1227](#) and described in [Table 16-1241](#).

Figure 16-1227. QUEUE_97_STATUS_B Register


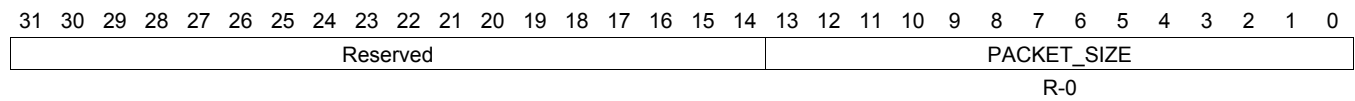
LEGEND: R/W = Read/Write; R = Read only; W1toCl = Write 1 to clear bit; -n = value after reset

Table 16-1241. QUEUE_97_STATUS_B Register Field Descriptions

Bit	Field	Type	Reset	Description
27-0	QUEUE_BYTE_COUNT	R-0	0	This field indicates how many bytes total are contained in all of the packets which are currently queued on this queue. Queue_Manager_Queue_n_Status_B Registers B

16.5.7.952 QUEUE_97_STATUS_C Register (offset = 3618h) [reset = 0h]

 QUEUE_97_STATUS_C is shown in [Figure 16-1228](#) and described in [Table 16-1242](#).

Figure 16-1228. QUEUE_97_STATUS_C Register


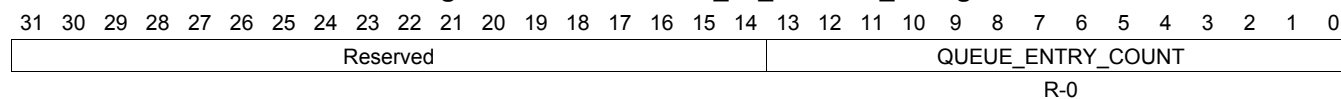
LEGEND: R/W = Read/Write; R = Read only; W1toCl = Write 1 to clear bit; -n = value after reset

Table 16-1242. QUEUE_97_STATUS_C Register Field Descriptions

Bit	Field	Type	Reset	Description
13-0	PACKET_SIZE	R-0	0	This field indicates packet size of the head element of a queue. Queue_Manager_Queue_N_Status_C Registers C

16.5.7.953 QUEUE_98_STATUS_A Register (offset = 3620h) [reset = 0h]

QUEUE_98_STATUS_A is shown in [Figure 16-1229](#) and described in [Table 16-1243](#).

Figure 16-1229. QUEUE_98_STATUS_A Register


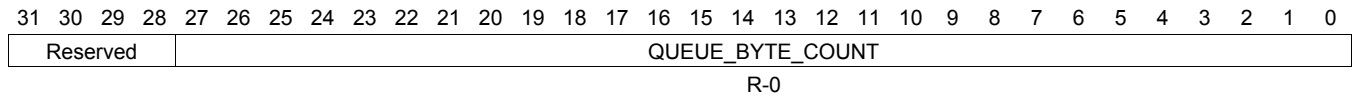
LEGEND: R/W = Read/Write; R = Read only; W1toCl = Write 1 to clear bit; -n = value after reset

Table 16-1243. QUEUE_98_STATUS_A Register Field Descriptions

Bit	Field	Type	Reset	Description
13-0	QUEUE_ENTRY_COUNT	R-0	0	This field indicates how many packets are currently queued on the queue. Queue Manager Queue N Status Registers A

16.5.7.954 QUEUE_98_STATUS_B Register (offset = 3624h) [reset = 0h]

 QUEUE_98_STATUS_B is shown in [Figure 16-1230](#) and described in [Table 16-1244](#).

Figure 16-1230. QUEUE_98_STATUS_B Register


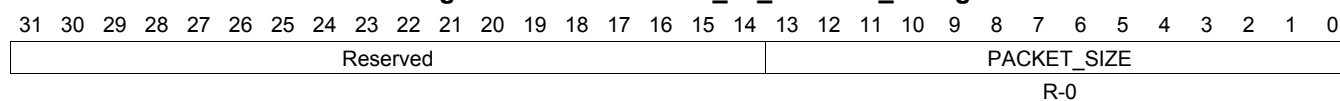
LEGEND: R/W = Read/Write; R = Read only; W1toCl = Write 1 to clear bit; -n = value after reset

Table 16-1244. QUEUE_98_STATUS_B Register Field Descriptions

Bit	Field	Type	Reset	Description
27-0	QUEUE_BYTE_COUNT	R-0	0	This field indicates how many bytes total are contained in all of the packets which are currently queued on this queue. Queue_Manager_Queue_n_Status_B Registers B

16.5.7.955 QUEUE_98_STATUS_C Register (offset = 3628h) [reset = 0h]

QUEUE_98_STATUS_C is shown in [Figure 16-1231](#) and described in [Table 16-1245](#).

Figure 16-1231. QUEUE_98_STATUS_C Register


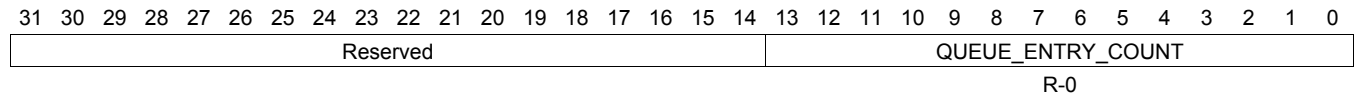
LEGEND: R/W = Read/Write; R = Read only; W1toCl = Write 1 to clear bit; -n = value after reset

Table 16-1245. QUEUE_98_STATUS_C Register Field Descriptions

Bit	Field	Type	Reset	Description
13-0	PACKET_SIZE	R-0	0	This field indicates packet size of the head element of a queue. Queue_Manager_Queue_N_Status_C Registers C

16.5.7.956 QUEUE_99_STATUS_A Register (offset = 3630h) [reset = 0h]

 QUEUE_99_STATUS_A is shown in [Figure 16-1232](#) and described in [Table 16-1246](#).

Figure 16-1232. QUEUE_99_STATUS_A Register


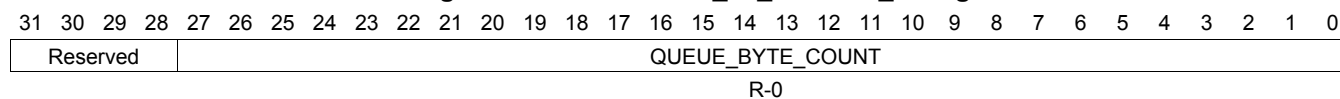
LEGEND: R/W = Read/Write; R = Read only; W1toCl = Write 1 to clear bit; -n = value after reset

Table 16-1246. QUEUE_99_STATUS_A Register Field Descriptions

Bit	Field	Type	Reset	Description
13-0	QUEUE_ENTRY_COUNT	R-0	0	This field indicates how many packets are currently queued on the queue. Queue Manager Queue N Status Registers A

16.5.7.957 QUEUE_99_STATUS_B Register (offset = 3634h) [reset = 0h]

QUEUE_99_STATUS_B is shown in [Figure 16-1233](#) and described in [Table 16-1247](#).

Figure 16-1233. QUEUE_99_STATUS_B Register


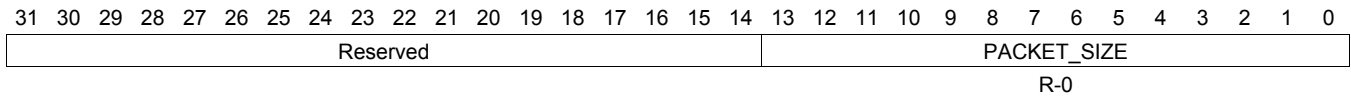
LEGEND: R/W = Read/Write; R = Read only; W1toCl = Write 1 to clear bit; -n = value after reset

Table 16-1247. QUEUE_99_STATUS_B Register Field Descriptions

Bit	Field	Type	Reset	Description
27-0	QUEUE_BYTE_COUNT	R-0	0	This field indicates how many bytes total are contained in all of the packets which are currently queued on this queue. Queue_Manager_Queue_n_Status_B Registers B

16.5.7.958 QUEUE_99_STATUS_C Register (offset = 3638h) [reset = 0h]

 QUEUE_99_STATUS_C is shown in [Figure 16-1234](#) and described in [Table 16-1248](#).

Figure 16-1234. QUEUE_99_STATUS_C Register


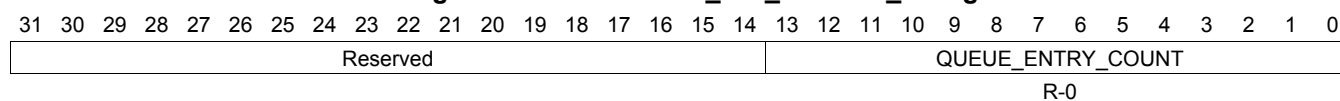
LEGEND: R/W = Read/Write; R = Read only; W1toCl = Write 1 to clear bit; -n = value after reset

Table 16-1248. QUEUE_99_STATUS_C Register Field Descriptions

Bit	Field	Type	Reset	Description
13-0	PACKET_SIZE	R-0	0	This field indicates packet size of the head element of a queue. Queue_Manager_Queue_N_Status_C Registers C

16.5.7.959 QUEUE_100_STATUS_A Register (offset = 3640h) [reset = 0h]

QUEUE_100_STATUS_A is shown in [Figure 16-1235](#) and described in [Table 16-1249](#).

Figure 16-1235. QUEUE_100_STATUS_A Register


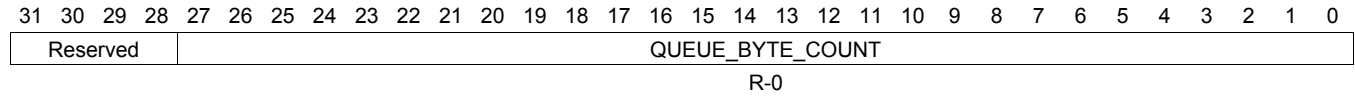
LEGEND: R/W = Read/Write; R = Read only; W1toCl = Write 1 to clear bit; -n = value after reset

Table 16-1249. QUEUE_100_STATUS_A Register Field Descriptions

Bit	Field	Type	Reset	Description
13-0	QUEUE_ENTRY_COUNT	R-0	0	This field indicates how many packets are currently queued on the queue. Queue Manager Queue N Status Registers A

16.5.7.960 QUEUE_100_STATUS_B Register (offset = 3644h) [reset = 0h]

 QUEUE_100_STATUS_B is shown in [Figure 16-1236](#) and described in [Table 16-1250](#).

Figure 16-1236. QUEUE_100_STATUS_B Register


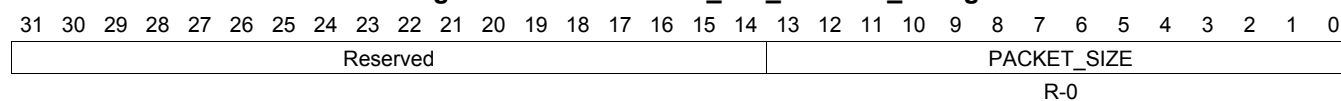
LEGEND: R/W = Read/Write; R = Read only; W1toCl = Write 1 to clear bit; -n = value after reset

Table 16-1250. QUEUE_100_STATUS_B Register Field Descriptions

Bit	Field	Type	Reset	Description
27-0	QUEUE_BYTE_COUNT	R-0	0	This field indicates how many bytes total are contained in all of the packets which are currently queued on this queue. Queue_Manager_Queue_n_Status_B Registers B

16.5.7.961 QUEUE_100_STATUS_C Register (offset = 3648h) [reset = 0h]

QUEUE_100_STATUS_C is shown in [Figure 16-1237](#) and described in [Table 16-1251](#).

Figure 16-1237. QUEUE_100_STATUS_C Register


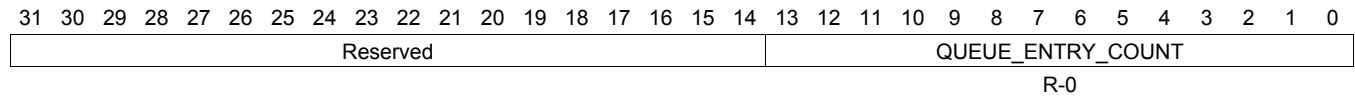
LEGEND: R/W = Read/Write; R = Read only; W1toCl = Write 1 to clear bit; -n = value after reset

Table 16-1251. QUEUE_100_STATUS_C Register Field Descriptions

Bit	Field	Type	Reset	Description
13-0	PACKET_SIZE	R-0	0	This field indicates packet size of the head element of a queue. Queue_Manager_Queue_N_Status_C Registers C

16.5.7.962 QUEUE_101_STATUS_A Register (offset = 3650h) [reset = 0h]

 QUEUE_101_STATUS_A is shown in [Figure 16-1238](#) and described in [Table 16-1252](#).

Figure 16-1238. QUEUE_101_STATUS_A Register


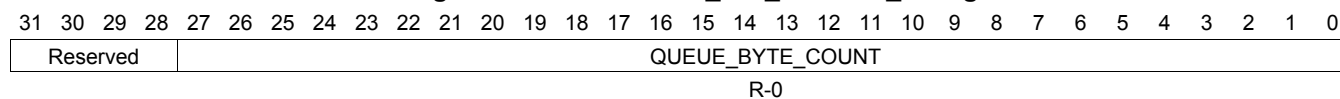
LEGEND: R/W = Read/Write; R = Read only; W1toCl = Write 1 to clear bit; -n = value after reset

Table 16-1252. QUEUE_101_STATUS_A Register Field Descriptions

Bit	Field	Type	Reset	Description
13-0	QUEUE_ENTRY_COUNT	R-0	0	This field indicates how many packets are currently queued on the queue. Queue Manager Queue N Status Registers A

16.5.7.963 QUEUE_101_STATUS_B Register (offset = 3654h) [reset = 0h]

QUEUE_101_STATUS_B is shown in [Figure 16-1239](#) and described in [Table 16-1253](#).

Figure 16-1239. QUEUE_101_STATUS_B Register


LEGEND: R/W = Read/Write; R = Read only; W1toCl = Write 1 to clear bit; -n = value after reset

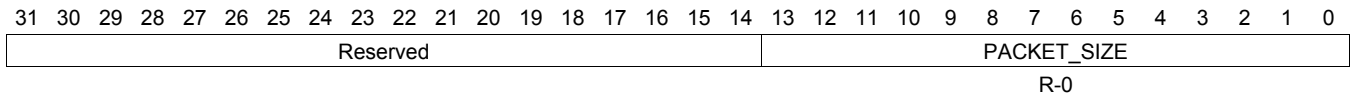
Table 16-1253. QUEUE_101_STATUS_B Register Field Descriptions

Bit	Field	Type	Reset	Description
27-0	QUEUE_BYTE_COUNT	R-0	0	This field indicates how many bytes total are contained in all of the packets which are currently queued on this queue. Queue_Manager_Queue_n_Status_B Registers B

16.5.7.964 QUEUE_101_STATUS_C Register (offset = 3658h) [reset = 0h]

QUEUE_101_STATUS_C is shown in [Figure 16-1240](#) and described in [Table 16-1254](#).

Figure 16-1240. QUEUE_101_STATUS_C Register



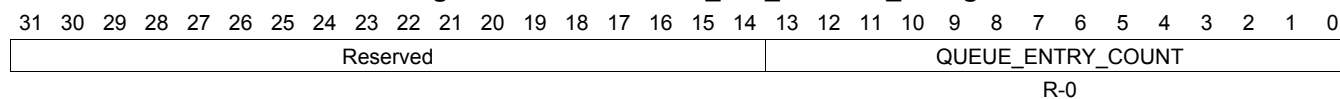
LEGEND: R/W = Read/Write; R = Read only; W1toCl = Write 1 to clear bit; -n = value after reset

Table 16-1254. QUEUE_101_STATUS_C Register Field Descriptions

Bit	Field	Type	Reset	Description
13-0	PACKET_SIZE	R-0	0	This field indicates packet size of the head element of a queue. Queue_Manager_Queue_N_Status_C Registers C

16.5.7.965 QUEUE_102_STATUS_A Register (offset = 3660h) [reset = 0h]

 QUEUE_102_STATUS_A is shown in [Figure 16-1241](#) and described in [Table 16-1255](#).

Figure 16-1241. QUEUE_102_STATUS_A Register


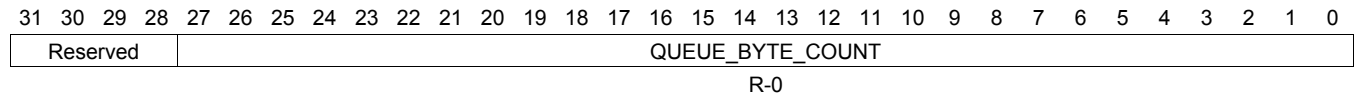
LEGEND: R/W = Read/Write; R = Read only; W1toCl = Write 1 to clear bit; -n = value after reset

Table 16-1255. QUEUE_102_STATUS_A Register Field Descriptions

Bit	Field	Type	Reset	Description
13-0	QUEUE_ENTRY_COUNT	R-0	0	This field indicates how many packets are currently queued on the queue. Queue Manager Queue N Status Registers A

16.5.7.966 QUEUE_102_STATUS_B Register (offset = 3664h) [reset = 0h]

 QUEUE_102_STATUS_B is shown in [Figure 16-1242](#) and described in [Table 16-1256](#).

Figure 16-1242. QUEUE_102_STATUS_B Register


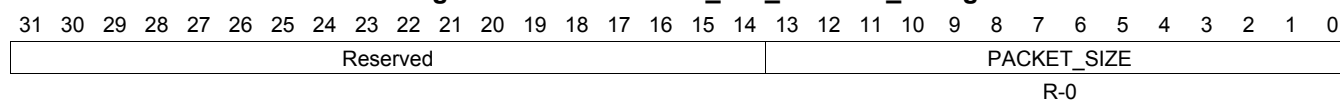
LEGEND: R/W = Read/Write; R = Read only; W1toCl = Write 1 to clear bit; -n = value after reset

Table 16-1256. QUEUE_102_STATUS_B Register Field Descriptions

Bit	Field	Type	Reset	Description
27-0	QUEUE_BYTE_COUNT	R-0	0	This field indicates how many bytes total are contained in all of the packets which are currently queued on this queue. Queue_Manager_Queue_n_Status_B Registers B

16.5.7.967 QUEUE_102_STATUS_C Register (offset = 3668h) [reset = 0h]

QUEUE_102_STATUS_C is shown in [Figure 16-1243](#) and described in [Table 16-1257](#).

Figure 16-1243. QUEUE_102_STATUS_C Register


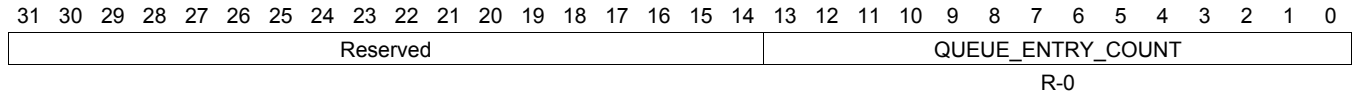
LEGEND: R/W = Read/Write; R = Read only; W1toCl = Write 1 to clear bit; -n = value after reset

Table 16-1257. QUEUE_102_STATUS_C Register Field Descriptions

Bit	Field	Type	Reset	Description
13-0	PACKET_SIZE	R-0	0	This field indicates packet size of the head element of a queue. Queue_Manager_Queue_N_Status_C Registers C

16.5.7.968 QUEUE_103_STATUS_A Register (offset = 3670h) [reset = 0h]

 QUEUE_103_STATUS_A is shown in [Figure 16-1244](#) and described in [Table 16-1258](#).

Figure 16-1244. QUEUE_103_STATUS_A Register


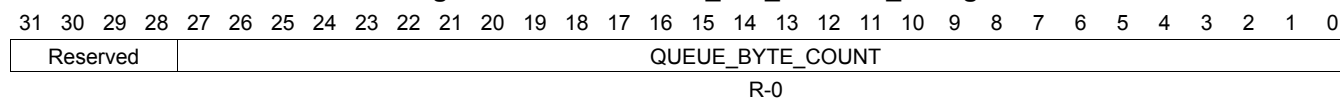
LEGEND: R/W = Read/Write; R = Read only; W1toCl = Write 1 to clear bit; -n = value after reset

Table 16-1258. QUEUE_103_STATUS_A Register Field Descriptions

Bit	Field	Type	Reset	Description
13-0	QUEUE_ENTRY_COUNT	R-0	0	This field indicates how many packets are currently queued on the queue. Queue Manager Queue N Status Registers A

16.5.7.969 QUEUE_103_STATUS_B Register (offset = 3674h) [reset = 0h]

 QUEUE_103_STATUS_B is shown in [Figure 16-1245](#) and described in [Table 16-1259](#).

Figure 16-1245. QUEUE_103_STATUS_B Register


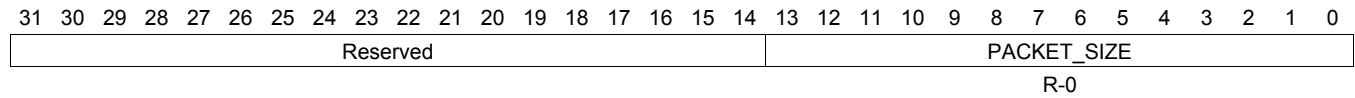
LEGEND: R/W = Read/Write; R = Read only; W1toCl = Write 1 to clear bit; -n = value after reset

Table 16-1259. QUEUE_103_STATUS_B Register Field Descriptions

Bit	Field	Type	Reset	Description
27-0	QUEUE_BYTE_COUNT	R-0	0	This field indicates how many bytes total are contained in all of the packets which are currently queued on this queue. Queue_Manager_Queue_n_Status_B Registers B

16.5.7.970 QUEUE_103_STATUS_C Register (offset = 3678h) [reset = 0h]

 QUEUE_103_STATUS_C is shown in [Figure 16-1246](#) and described in [Table 16-1260](#).

Figure 16-1246. QUEUE_103_STATUS_C Register


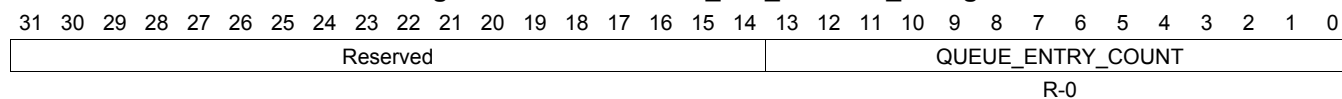
LEGEND: R/W = Read/Write; R = Read only; W1toCl = Write 1 to clear bit; -n = value after reset

Table 16-1260. QUEUE_103_STATUS_C Register Field Descriptions

Bit	Field	Type	Reset	Description
13-0	PACKET_SIZE	R-0	0	This field indicates packet size of the head element of a queue. Queue_Manager_Queue_N_Status_C Registers C

16.5.7.971 QUEUE_104_STATUS_A Register (offset = 3680h) [reset = 0h]

QUEUE_104_STATUS_A is shown in [Figure 16-1247](#) and described in [Table 16-1261](#).

Figure 16-1247. QUEUE_104_STATUS_A Register


LEGEND: R/W = Read/Write; R = Read only; W1toCl = Write 1 to clear bit; -n = value after reset

Table 16-1261. QUEUE_104_STATUS_A Register Field Descriptions

Bit	Field	Type	Reset	Description
13-0	QUEUE_ENTRY_COUNT	R-0	0	This field indicates how many packets are currently queued on the queue. Queue Manager Queue N Status Registers A

16.5.7.972 QUEUE_104_STATUS_B Register (offset = 3684h) [reset = 0h]

QUEUE_104_STATUS_B is shown in [Figure 16-1248](#) and described in [Table 16-1262](#).

Figure 16-1248. QUEUE_104_STATUS_B Register



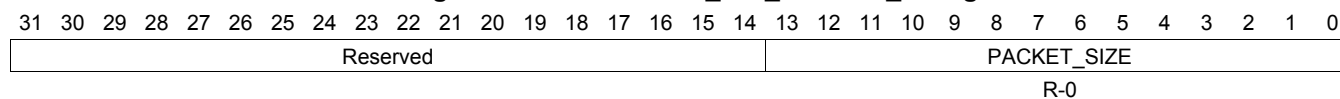
LEGEND: R/W = Read/Write; R = Read only; W1toCl = Write 1 to clear bit; -n = value after reset

Table 16-1262. QUEUE_104_STATUS_B Register Field Descriptions

Bit	Field	Type	Reset	Description
27-0	QUEUE_BYTE_COUNT	R-0	0	This field indicates how many bytes total are contained in all of the packets which are currently queued on this queue. Queue_Manager_Queue_n_Status_B Registers B

16.5.7.973 QUEUE_104_STATUS_C Register (offset = 3688h) [reset = 0h]

QUEUE_104_STATUS_C is shown in [Figure 16-1249](#) and described in [Table 16-1263](#).

Figure 16-1249. QUEUE_104_STATUS_C Register


LEGEND: R/W = Read/Write; R = Read only; W1toCl = Write 1 to clear bit; -n = value after reset

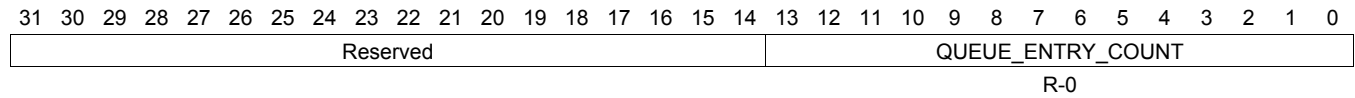
Table 16-1263. QUEUE_104_STATUS_C Register Field Descriptions

Bit	Field	Type	Reset	Description
13-0	PACKET_SIZE	R-0	0	This field indicates packet size of the head element of a queue. Queue_Manager_Queue_N_Status_C Registers C

16.5.7.974 QUEUE_105_STATUS_A Register (offset = 3690h) [reset = 0h]

QUEUE_105_STATUS_A is shown in [Figure 16-1250](#) and described in [Table 16-1264](#).

Figure 16-1250. QUEUE_105_STATUS_A Register



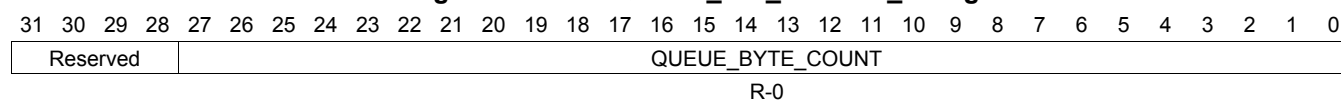
LEGEND: R/W = Read/Write; R = Read only; W1toCl = Write 1 to clear bit; -n = value after reset

Table 16-1264. QUEUE_105_STATUS_A Register Field Descriptions

Bit	Field	Type	Reset	Description
13-0	QUEUE_ENTRY_COUNT	R-0	0	This field indicates how many packets are currently queued on the queue. Queue Manager Queue N Status Registers A

16.5.7.975 QUEUE_105_STATUS_B Register (offset = 3694h) [reset = 0h]

QUEUE_105_STATUS_B is shown in [Figure 16-1251](#) and described in [Table 16-1265](#).

Figure 16-1251. QUEUE_105_STATUS_B Register


LEGEND: R/W = Read/Write; R = Read only; W1toCl = Write 1 to clear bit; -n = value after reset

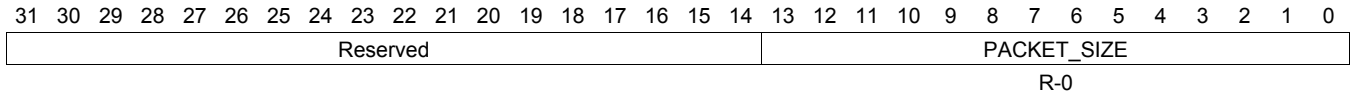
Table 16-1265. QUEUE_105_STATUS_B Register Field Descriptions

Bit	Field	Type	Reset	Description
27-0	QUEUE_BYTE_COUNT	R-0	0	This field indicates how many bytes total are contained in all of the packets which are currently queued on this queue. Queue_Manager_Queue_n_Status_B Registers B

16.5.7.976 QUEUE_105_STATUS_C Register (offset = 3698h) [reset = 0h]

QUEUE_105_STATUS_C is shown in [Figure 16-1252](#) and described in [Table 16-1266](#).

Figure 16-1252. QUEUE_105_STATUS_C Register



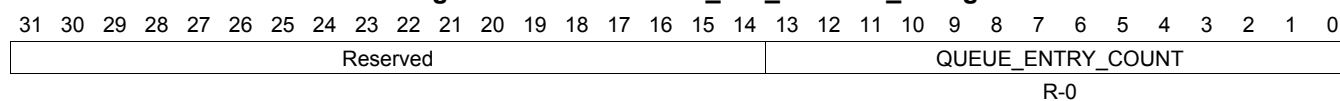
LEGEND: R/W = Read/Write; R = Read only; W1toCl = Write 1 to clear bit; -n = value after reset

Table 16-1266. QUEUE_105_STATUS_C Register Field Descriptions

Bit	Field	Type	Reset	Description
13-0	PACKET_SIZE	R-0	0	This field indicates packet size of the head element of a queue. Queue_Manager_Queue_N_Status_C Registers C

16.5.7.977 QUEUE_106_STATUS_A Register (offset = 36A0h) [reset = 0h]

QUEUE_106_STATUS_A is shown in [Figure 16-1253](#) and described in [Table 16-1267](#).

Figure 16-1253. QUEUE_106_STATUS_A Register


LEGEND: R/W = Read/Write; R = Read only; W1toCl = Write 1 to clear bit; -n = value after reset

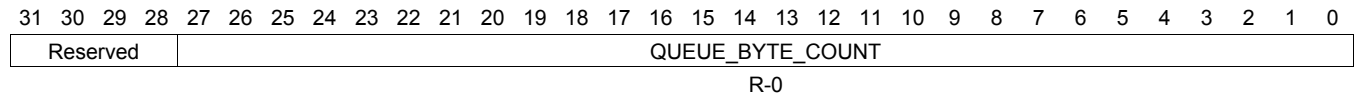
Table 16-1267. QUEUE_106_STATUS_A Register Field Descriptions

Bit	Field	Type	Reset	Description
13-0	QUEUE_ENTRY_COUNT	R-0	0	This field indicates how many packets are currently queued on the queue. Queue Manager Queue N Status Registers A

16.5.7.978 QUEUE_106_STATUS_B Register (offset = 36A4h) [reset = 0h]

QUEUE_106_STATUS_B is shown in [Figure 16-1254](#) and described in [Table 16-1268](#).

Figure 16-1254. QUEUE_106_STATUS_B Register



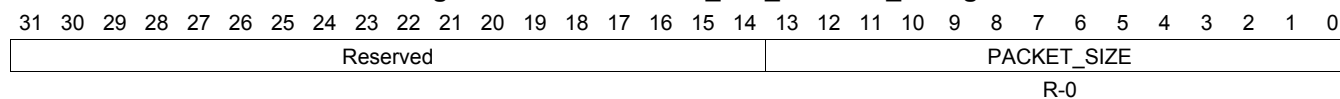
LEGEND: R/W = Read/Write; R = Read only; W1toCl = Write 1 to clear bit; -n = value after reset

Table 16-1268. QUEUE_106_STATUS_B Register Field Descriptions

Bit	Field	Type	Reset	Description
27-0	QUEUE_BYTE_COUNT	R-0	0	This field indicates how many bytes total are contained in all of the packets which are currently queued on this queue. Queue_Manager_Queue_n_Status_B Registers B

16.5.7.979 QUEUE_106_STATUS_C Register (offset = 36A8h) [reset = 0h]

QUEUE_106_STATUS_C is shown in [Figure 16-1255](#) and described in [Table 16-1269](#).

Figure 16-1255. QUEUE_106_STATUS_C Register


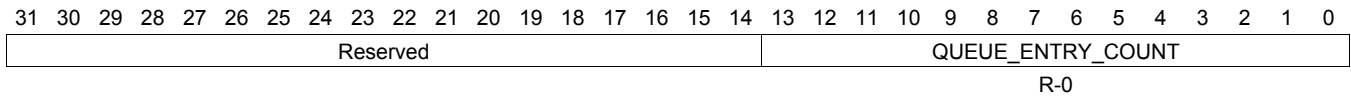
LEGEND: R/W = Read/Write; R = Read only; W1toCl = Write 1 to clear bit; -n = value after reset

Table 16-1269. QUEUE_106_STATUS_C Register Field Descriptions

Bit	Field	Type	Reset	Description
13-0	PACKET_SIZE	R-0	0	This field indicates packet size of the head element of a queue. Queue_Manager_Queue_N_Status_C Registers C

16.5.7.980 QUEUE_107_STATUS_A Register (offset = 36B0h) [reset = 0h]

 QUEUE_107_STATUS_A is shown in [Figure 16-1256](#) and described in [Table 16-1270](#).

Figure 16-1256. QUEUE_107_STATUS_A Register


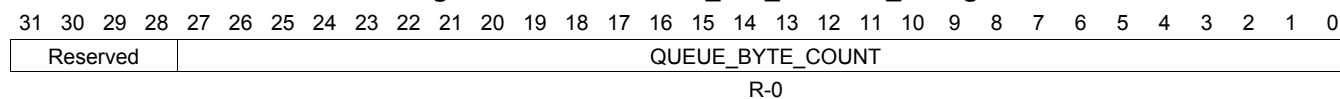
LEGEND: R/W = Read/Write; R = Read only; W1toCl = Write 1 to clear bit; -n = value after reset

Table 16-1270. QUEUE_107_STATUS_A Register Field Descriptions

Bit	Field	Type	Reset	Description
13-0	QUEUE_ENTRY_COUNT	R-0	0	This field indicates how many packets are currently queued on the queue. Queue Manager Queue N Status Registers A

16.5.7.981 QUEUE_107_STATUS_B Register (offset = 36B4h) [reset = 0h]

QUEUE_107_STATUS_B is shown in [Figure 16-1257](#) and described in [Table 16-1271](#).

Figure 16-1257. QUEUE_107_STATUS_B Register


LEGEND: R/W = Read/Write; R = Read only; W1toCl = Write 1 to clear bit; -n = value after reset

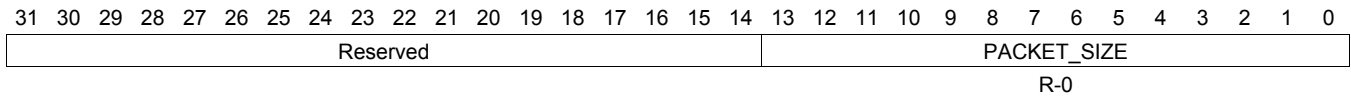
Table 16-1271. QUEUE_107_STATUS_B Register Field Descriptions

Bit	Field	Type	Reset	Description
27-0	QUEUE_BYTE_COUNT	R-0	0	This field indicates how many bytes total are contained in all of the packets which are currently queued on this queue. Queue_Manager_Queue_n_Status_B Registers B

16.5.7.982 QUEUE_107_STATUS_C Register (offset = 36B8h) [reset = 0h]

QUEUE_107_STATUS_C is shown in [Figure 16-1258](#) and described in [Table 16-1272](#).

Figure 16-1258. QUEUE_107_STATUS_C Register



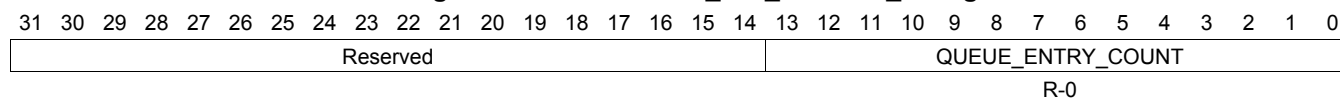
LEGEND: R/W = Read/Write; R = Read only; W1toCl = Write 1 to clear bit; -n = value after reset

Table 16-1272. QUEUE_107_STATUS_C Register Field Descriptions

Bit	Field	Type	Reset	Description
13-0	PACKET_SIZE	R-0	0	This field indicates packet size of the head element of a queue. Queue_Manager_Queue_N_Status_C Registers C

16.5.7.983 QUEUE_108_STATUS_A Register (offset = 36C0h) [reset = 0h]

 QUEUE_108_STATUS_A is shown in [Figure 16-1259](#) and described in [Table 16-1273](#).

Figure 16-1259. QUEUE_108_STATUS_A Register


LEGEND: R/W = Read/Write; R = Read only; W1toCl = Write 1 to clear bit; -n = value after reset

Table 16-1273. QUEUE_108_STATUS_A Register Field Descriptions

Bit	Field	Type	Reset	Description
13-0	QUEUE_ENTRY_COUNT	R-0	0	This field indicates how many packets are currently queued on the queue. Queue Manager Queue N Status Registers A

16.5.7.984 QUEUE_108_STATUS_B Register (offset = 36C4h) [reset = 0h]

QUEUE_108_STATUS_B is shown in [Figure 16-1260](#) and described in [Table 16-1274](#).

Figure 16-1260. QUEUE_108_STATUS_B Register



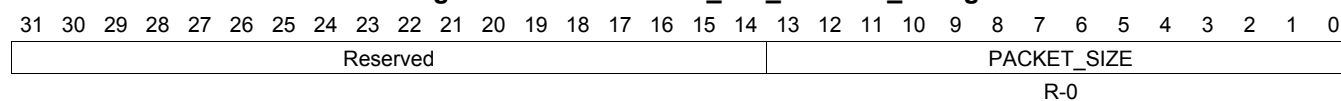
LEGEND: R/W = Read/Write; R = Read only; W1toCl = Write 1 to clear bit; -n = value after reset

Table 16-1274. QUEUE_108_STATUS_B Register Field Descriptions

Bit	Field	Type	Reset	Description
27-0	QUEUE_BYTE_COUNT	R-0	0	This field indicates how many bytes total are contained in all of the packets which are currently queued on this queue. Queue_Manager_Queue_n_Status_B Registers B

16.5.7.985 QUEUE_108_STATUS_C Register (offset = 36C8h) [reset = 0h]

QUEUE_108_STATUS_C is shown in [Figure 16-1261](#) and described in [Table 16-1275](#).

Figure 16-1261. QUEUE_108_STATUS_C Register


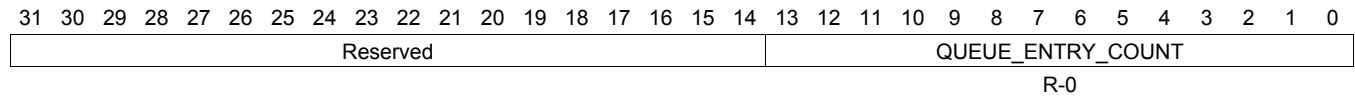
LEGEND: R/W = Read/Write; R = Read only; W1toCl = Write 1 to clear bit; -n = value after reset

Table 16-1275. QUEUE_108_STATUS_C Register Field Descriptions

Bit	Field	Type	Reset	Description
13-0	PACKET_SIZE	R-0	0	This field indicates packet size of the head element of a queue. Queue_Manager_Queue_N_Status_C Registers C

16.5.7.986 QUEUE_109_STATUS_A Register (offset = 36D0h) [reset = 0h]

 QUEUE_109_STATUS_A is shown in [Figure 16-1262](#) and described in [Table 16-1276](#).

Figure 16-1262. QUEUE_109_STATUS_A Register


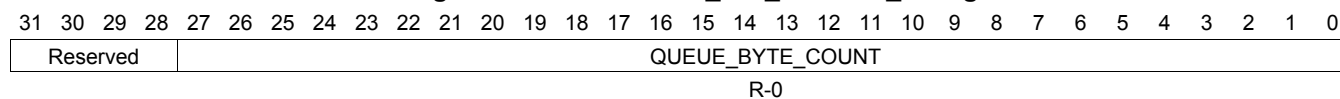
LEGEND: R/W = Read/Write; R = Read only; W1toCl = Write 1 to clear bit; -n = value after reset

Table 16-1276. QUEUE_109_STATUS_A Register Field Descriptions

Bit	Field	Type	Reset	Description
13-0	QUEUE_ENTRY_COUNT	R-0	0	This field indicates how many packets are currently queued on the queue. Queue Manager Queue N Status Registers A

16.5.7.987 QUEUE_109_STATUS_B Register (offset = 36D4h) [reset = 0h]

 QUEUE_109_STATUS_B is shown in [Figure 16-1263](#) and described in [Table 16-1277](#).

Figure 16-1263. QUEUE_109_STATUS_B Register


LEGEND: R/W = Read/Write; R = Read only; W1toCl = Write 1 to clear bit; -n = value after reset

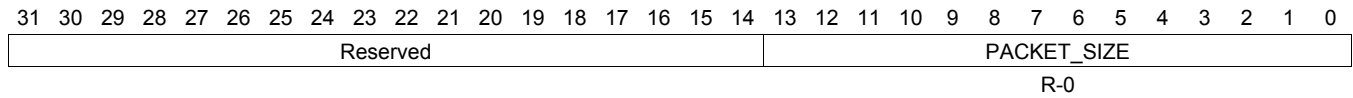
Table 16-1277. QUEUE_109_STATUS_B Register Field Descriptions

Bit	Field	Type	Reset	Description
27-0	QUEUE_BYTE_COUNT	R-0	0	This field indicates how many bytes total are contained in all of the packets which are currently queued on this queue. Queue_Manager_Queue_n_Status_B Registers B

16.5.7.988 QUEUE_109_STATUS_C Register (offset = 36D8h) [reset = 0h]

QUEUE_109_STATUS_C is shown in [Figure 16-1264](#) and described in [Table 16-1278](#).

Figure 16-1264. QUEUE_109_STATUS_C Register



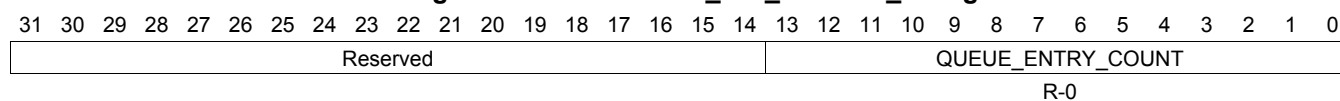
LEGEND: R/W = Read/Write; R = Read only; W1toCl = Write 1 to clear bit; -n = value after reset

Table 16-1278. QUEUE_109_STATUS_C Register Field Descriptions

Bit	Field	Type	Reset	Description
13-0	PACKET_SIZE	R-0	0	This field indicates packet size of the head element of a queue. Queue_Manager_Queue_N_Status_C Registers C

16.5.7.989 QUEUE_110_STATUS_A Register (offset = 36E0h) [reset = 0h]

 QUEUE_110_STATUS_A is shown in [Figure 16-1265](#) and described in [Table 16-1279](#).

Figure 16-1265. QUEUE_110_STATUS_A Register


LEGEND: R/W = Read/Write; R = Read only; W1toCl = Write 1 to clear bit; -n = value after reset

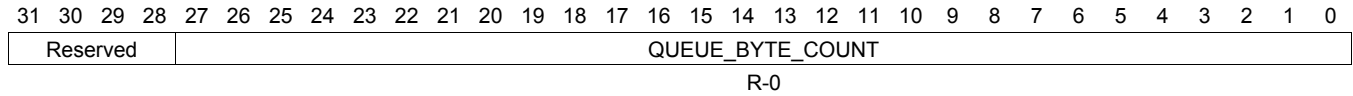
Table 16-1279. QUEUE_110_STATUS_A Register Field Descriptions

Bit	Field	Type	Reset	Description
13-0	QUEUE_ENTRY_COUNT	R-0	0	This field indicates how many packets are currently queued on the queue. Queue Manager Queue N Status Registers A

16.5.7.990 QUEUE_110_STATUS_B Register (offset = 36E4h) [reset = 0h]

QUEUE_110_STATUS_B is shown in [Figure 16-1266](#) and described in [Table 16-1280](#).

Figure 16-1266. QUEUE_110_STATUS_B Register



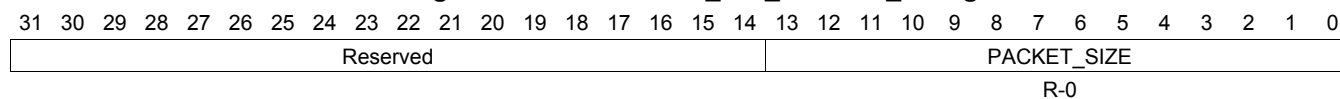
LEGEND: R/W = Read/Write; R = Read only; W1toCl = Write 1 to clear bit; -n = value after reset

Table 16-1280. QUEUE_110_STATUS_B Register Field Descriptions

Bit	Field	Type	Reset	Description
27-0	QUEUE_BYTE_COUNT	R-0	0	This field indicates how many bytes total are contained in all of the packets which are currently queued on this queue. Queue_Manager_Queue_n_Status_B Registers B

16.5.7.991 QUEUE_110_STATUS_C Register (offset = 36E8h) [reset = 0h]

QUEUE_110_STATUS_C is shown in [Figure 16-1267](#) and described in [Table 16-1281](#).

Figure 16-1267. QUEUE_110_STATUS_C Register


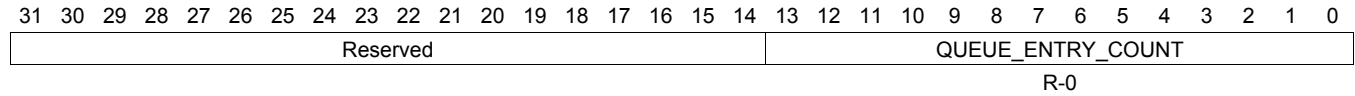
LEGEND: R/W = Read/Write; R = Read only; W1toCl = Write 1 to clear bit; -n = value after reset

Table 16-1281. QUEUE_110_STATUS_C Register Field Descriptions

Bit	Field	Type	Reset	Description
13-0	PACKET_SIZE	R-0	0	This field indicates packet size of the head element of a queue. Queue_Manager_Queue_N_Status_C Registers C

16.5.7.992 QUEUE_111_STATUS_A Register (offset = 36F0h) [reset = 0h]

 QUEUE_111_STATUS_A is shown in [Figure 16-1268](#) and described in [Table 16-1282](#).

Figure 16-1268. QUEUE_111_STATUS_A Register


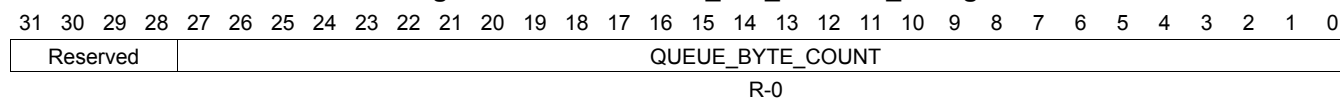
LEGEND: R/W = Read/Write; R = Read only; W1toCl = Write 1 to clear bit; -n = value after reset

Table 16-1282. QUEUE_111_STATUS_A Register Field Descriptions

Bit	Field	Type	Reset	Description
13-0	QUEUE_ENTRY_COUNT	R-0	0	This field indicates how many packets are currently queued on the queue. Queue Manager Queue N Status Registers A

16.5.7.993 QUEUE_111_STATUS_B Register (offset = 36F4h) [reset = 0h]

 QUEUE_111_STATUS_B is shown in [Figure 16-1269](#) and described in [Table 16-1283](#).

Figure 16-1269. QUEUE_111_STATUS_B Register


LEGEND: R/W = Read/Write; R = Read only; W1toCl = Write 1 to clear bit; -n = value after reset

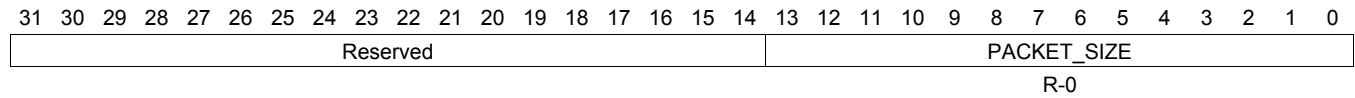
Table 16-1283. QUEUE_111_STATUS_B Register Field Descriptions

Bit	Field	Type	Reset	Description
27-0	QUEUE_BYTE_COUNT	R-0	0	This field indicates how many bytes total are contained in all of the packets which are currently queued on this queue. Queue_Manager_Queue_n_Status_B Registers B

16.5.7.994 QUEUE_111_STATUS_C Register (offset = 36F8h) [reset = 0h]

QUEUE_111_STATUS_C is shown in [Figure 16-1270](#) and described in [Table 16-1284](#).

Figure 16-1270. QUEUE_111_STATUS_C Register



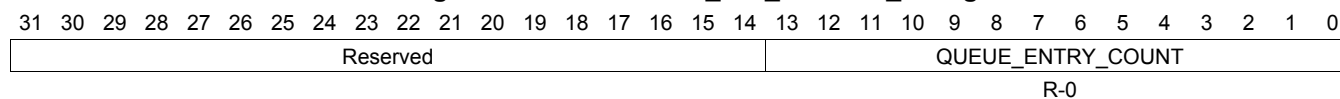
LEGEND: R/W = Read/Write; R = Read only; W1toCl = Write 1 to clear bit; -n = value after reset

Table 16-1284. QUEUE_111_STATUS_C Register Field Descriptions

Bit	Field	Type	Reset	Description
13-0	PACKET_SIZE	R-0	0	This field indicates packet size of the head element of a queue. Queue_Manager_Queue_N_Status_C Registers C

16.5.7.995 QUEUE_112_STATUS_A Register (offset = 3700h) [reset = 0h]

 QUEUE_112_STATUS_A is shown in [Figure 16-1271](#) and described in [Table 16-1285](#).

Figure 16-1271. QUEUE_112_STATUS_A Register


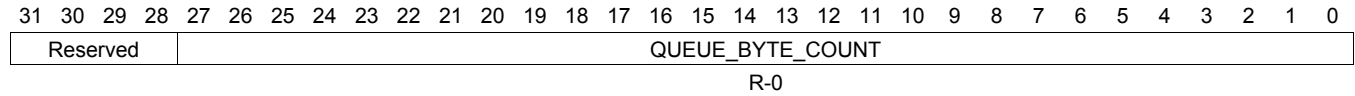
LEGEND: R/W = Read/Write; R = Read only; W1toCl = Write 1 to clear bit; -n = value after reset

Table 16-1285. QUEUE_112_STATUS_A Register Field Descriptions

Bit	Field	Type	Reset	Description
13-0	QUEUE_ENTRY_COUNT	R-0	0	This field indicates how many packets are currently queued on the queue. Queue Manager Queue N Status Registers A

16.5.7.996 QUEUE_112_STATUS_B Register (offset = 3704h) [reset = 0h]

 QUEUE_112_STATUS_B is shown in [Figure 16-1272](#) and described in [Table 16-1286](#).

Figure 16-1272. QUEUE_112_STATUS_B Register


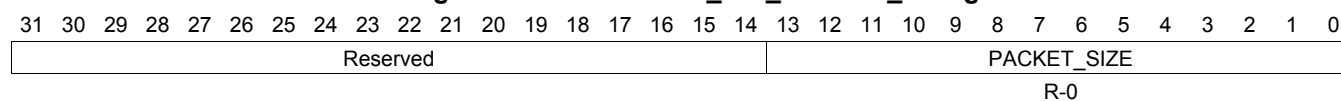
LEGEND: R/W = Read/Write; R = Read only; W1toCl = Write 1 to clear bit; -n = value after reset

Table 16-1286. QUEUE_112_STATUS_B Register Field Descriptions

Bit	Field	Type	Reset	Description
27-0	QUEUE_BYTE_COUNT	R-0	0	This field indicates how many bytes total are contained in all of the packets which are currently queued on this queue. Queue_Manager_Queue_n_Status_B Registers B

16.5.7.997 QUEUE_112_STATUS_C Register (offset = 3708h) [reset = 0h]

QUEUE_112_STATUS_C is shown in [Figure 16-1273](#) and described in [Table 16-1287](#).

Figure 16-1273. QUEUE_112_STATUS_C Register


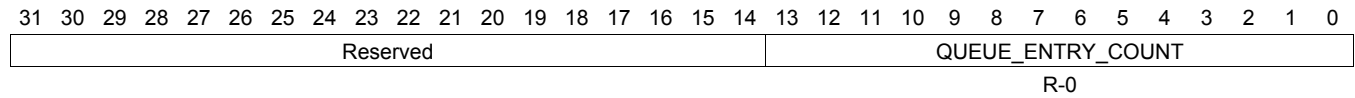
LEGEND: R/W = Read/Write; R = Read only; W1toCl = Write 1 to clear bit; -n = value after reset

Table 16-1287. QUEUE_112_STATUS_C Register Field Descriptions

Bit	Field	Type	Reset	Description
13-0	PACKET_SIZE	R-0	0	This field indicates packet size of the head element of a queue. Queue_Manager_Queue_N_Status_C Registers C

16.5.7.998 QUEUE_113_STATUS_A Register (offset = 3710h) [reset = 0h]

 QUEUE_113_STATUS_A is shown in [Figure 16-1274](#) and described in [Table 16-1288](#).

Figure 16-1274. QUEUE_113_STATUS_A Register


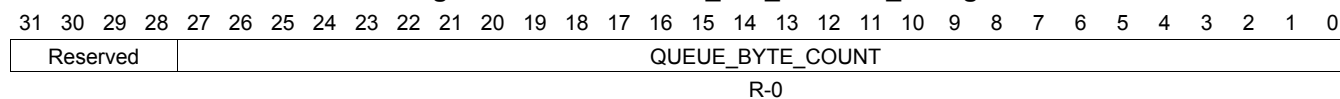
LEGEND: R/W = Read/Write; R = Read only; W1toCl = Write 1 to clear bit; -n = value after reset

Table 16-1288. QUEUE_113_STATUS_A Register Field Descriptions

Bit	Field	Type	Reset	Description
13-0	QUEUE_ENTRY_COUNT	R-0	0	This field indicates how many packets are currently queued on the queue. Queue Manager Queue N Status Registers A

16.5.7.999 QUEUE_113_STATUS_B Register (offset = 3714h) [reset = 0h]

QUEUE_113_STATUS_B is shown in [Figure 16-1275](#) and described in [Table 16-1289](#).

Figure 16-1275. QUEUE_113_STATUS_B Register


LEGEND: R/W = Read/Write; R = Read only; W1toCl = Write 1 to clear bit; -n = value after reset

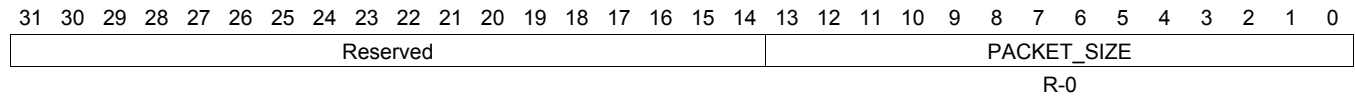
Table 16-1289. QUEUE_113_STATUS_B Register Field Descriptions

Bit	Field	Type	Reset	Description
27-0	QUEUE_BYTE_COUNT	R-0	0	This field indicates how many bytes total are contained in all of the packets which are currently queued on this queue. Queue_Manager_Queue_n_Status_B Registers B

16.5.7.1000 QUEUE_113_STATUS_C Register (offset = 3718h) [reset = 0h]

QUEUE_113_STATUS_C is shown in [Figure 16-1276](#) and described in [Table 16-1290](#).

Figure 16-1276. QUEUE_113_STATUS_C Register



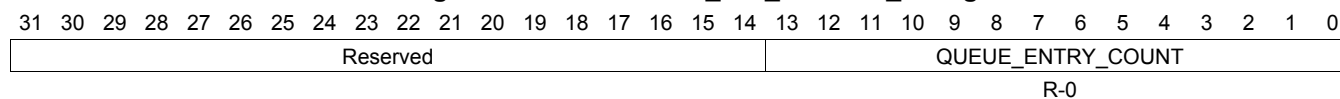
LEGEND: R/W = Read/Write; R = Read only; W1toCl = Write 1 to clear bit; -n = value after reset

Table 16-1290. QUEUE_113_STATUS_C Register Field Descriptions

Bit	Field	Type	Reset	Description
13-0	PACKET_SIZE	R-0	0	This field indicates packet size of the head element of a queue. Queue_Manager_Queue_N_Status_C Registers C

16.5.7.1001 QUEUE_114_STATUS_A Register (offset = 3720h) [reset = 0h]

QUEUE_114_STATUS_A is shown in [Figure 16-1277](#) and described in [Table 16-1291](#).

Figure 16-1277. QUEUE_114_STATUS_A Register


LEGEND: R/W = Read/Write; R = Read only; W1toCl = Write 1 to clear bit; -n = value after reset

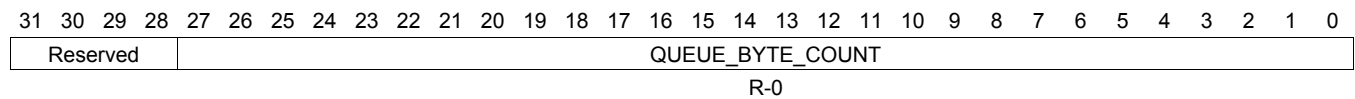
Table 16-1291. QUEUE_114_STATUS_A Register Field Descriptions

Bit	Field	Type	Reset	Description
13-0	QUEUE_ENTRY_COUNT	R-0	0	This field indicates how many packets are currently queued on the queue. Queue Manager Queue N Status Registers A

16.5.7.1002 QUEUE_114_STATUS_B Register (offset = 3724h) [reset = 0h]

QUEUE_114_STATUS_B is shown in [Figure 16-1278](#) and described in [Table 16-1292](#).

Figure 16-1278. QUEUE_114_STATUS_B Register



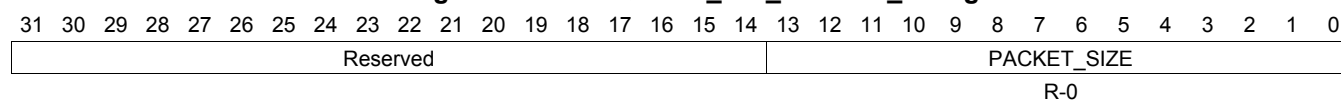
LEGEND: R/W = Read/Write; R = Read only; W1toCl = Write 1 to clear bit; -n = value after reset

Table 16-1292. QUEUE_114_STATUS_B Register Field Descriptions

Bit	Field	Type	Reset	Description
27-0	QUEUE_BYTE_COUNT	R-0	0	This field indicates how many bytes total are contained in all of the packets which are currently queued on this queue. Queue_Manager_Queue_n_Status_B Registers B

16.5.7.1003 QUEUE_114_STATUS_C Register (offset = 3728h) [reset = 0h]

QUEUE_114_STATUS_C is shown in [Figure 16-1279](#) and described in [Table 16-1293](#).

Figure 16-1279. QUEUE_114_STATUS_C Register


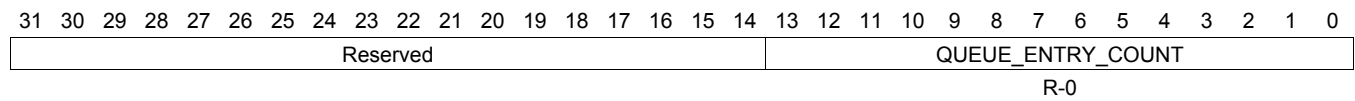
LEGEND: R/W = Read/Write; R = Read only; W1toCl = Write 1 to clear bit; -n = value after reset

Table 16-1293. QUEUE_114_STATUS_C Register Field Descriptions

Bit	Field	Type	Reset	Description
13-0	PACKET_SIZE	R-0	0	This field indicates packet size of the head element of a queue. Queue_Manager_Queue_N_Status_C Registers C

16.5.7.1004 QUEUE_115_STATUS_A Register (offset = 3730h) [reset = 0h]

 QUEUE_115_STATUS_A is shown in [Figure 16-1280](#) and described in [Table 16-1294](#).

Figure 16-1280. QUEUE_115_STATUS_A Register


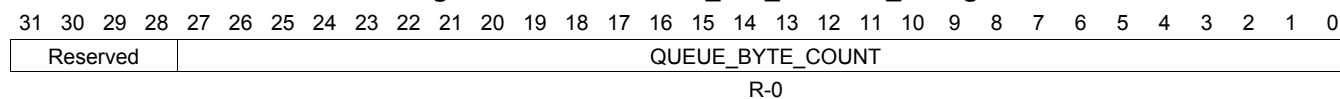
LEGEND: R/W = Read/Write; R = Read only; W1toCl = Write 1 to clear bit; -n = value after reset

Table 16-1294. QUEUE_115_STATUS_A Register Field Descriptions

Bit	Field	Type	Reset	Description
13-0	QUEUE_ENTRY_COUNT	R-0	0	This field indicates how many packets are currently queued on the queue. Queue Manager Queue N Status Registers A

16.5.7.1005 QUEUE_115_STATUS_B Register (offset = 3734h) [reset = 0h]

QUEUE_115_STATUS_B is shown in [Figure 16-1281](#) and described in [Table 16-1295](#).

Figure 16-1281. QUEUE_115_STATUS_B Register


LEGEND: R/W = Read/Write; R = Read only; W1toCl = Write 1 to clear bit; -n = value after reset

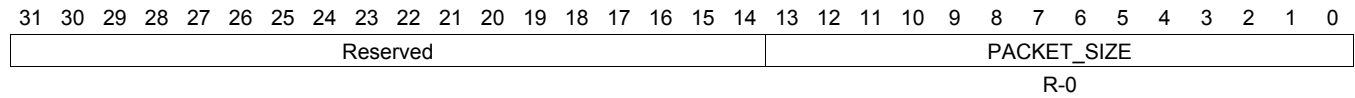
Table 16-1295. QUEUE_115_STATUS_B Register Field Descriptions

Bit	Field	Type	Reset	Description
27-0	QUEUE_BYTE_COUNT	R-0	0	This field indicates how many bytes total are contained in all of the packets which are currently queued on this queue. Queue_Manager_Queue_n_Status_B Registers B

16.5.7.1006 QUEUE_115_STATUS_C Register (offset = 3738h) [reset = 0h]

QUEUE_115_STATUS_C is shown in [Figure 16-1282](#) and described in [Table 16-1296](#).

Figure 16-1282. QUEUE_115_STATUS_C Register



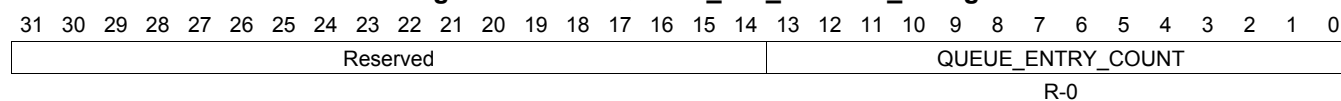
LEGEND: R/W = Read/Write; R = Read only; W1toCl = Write 1 to clear bit; -n = value after reset

Table 16-1296. QUEUE_115_STATUS_C Register Field Descriptions

Bit	Field	Type	Reset	Description
13-0	PACKET_SIZE	R-0	0	This field indicates packet size of the head element of a queue. Queue_Manager_Queue_N_Status_C Registers C

16.5.7.1007 QUEUE_116_STATUS_A Register (offset = 3740h) [reset = 0h]

QUEUE_116_STATUS_A is shown in [Figure 16-1283](#) and described in [Table 16-1297](#).

Figure 16-1283. QUEUE_116_STATUS_A Register


LEGEND: R/W = Read/Write; R = Read only; W1toCl = Write 1 to clear bit; -n = value after reset

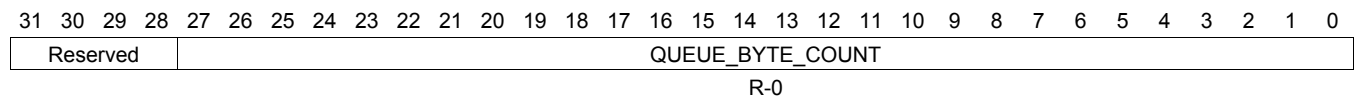
Table 16-1297. QUEUE_116_STATUS_A Register Field Descriptions

Bit	Field	Type	Reset	Description
13-0	QUEUE_ENTRY_COUNT	R-0	0	This field indicates how many packets are currently queued on the queue. Queue Manager Queue N Status Registers A

16.5.7.1008 QUEUE_116_STATUS_B Register (offset = 3744h) [reset = 0h]

QUEUE_116_STATUS_B is shown in [Figure 16-1284](#) and described in [Table 16-1298](#).

Figure 16-1284. QUEUE_116_STATUS_B Register



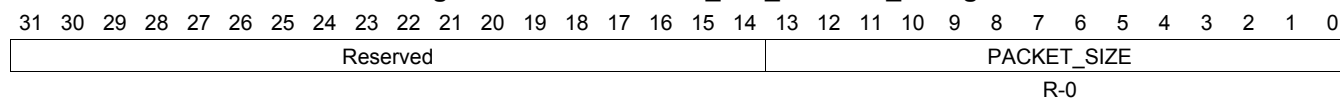
LEGEND: R/W = Read/Write; R = Read only; W1toCl = Write 1 to clear bit; -n = value after reset

Table 16-1298. QUEUE_116_STATUS_B Register Field Descriptions

Bit	Field	Type	Reset	Description
27-0	QUEUE_BYTE_COUNT	R-0	0	This field indicates how many bytes total are contained in all of the packets which are currently queued on this queue. Queue_Manager_Queue_n_Status_B Registers B

16.5.7.1009 QUEUE_116_STATUS_C Register (offset = 3748h) [reset = 0h]

QUEUE_116_STATUS_C is shown in [Figure 16-1285](#) and described in [Table 16-1299](#).

Figure 16-1285. QUEUE_116_STATUS_C Register


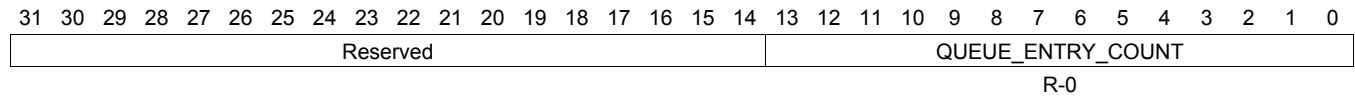
LEGEND: R/W = Read/Write; R = Read only; W1toCl = Write 1 to clear bit; -n = value after reset

Table 16-1299. QUEUE_116_STATUS_C Register Field Descriptions

Bit	Field	Type	Reset	Description
13-0	PACKET_SIZE	R-0	0	This field indicates packet size of the head element of a queue. Queue_Manager_Queue_N_Status_C Registers C

16.5.7.1010 QUEUE_117_STATUS_A Register (offset = 3750h) [reset = 0h]

 QUEUE_117_STATUS_A is shown in [Figure 16-1286](#) and described in [Table 16-1300](#).

Figure 16-1286. QUEUE_117_STATUS_A Register


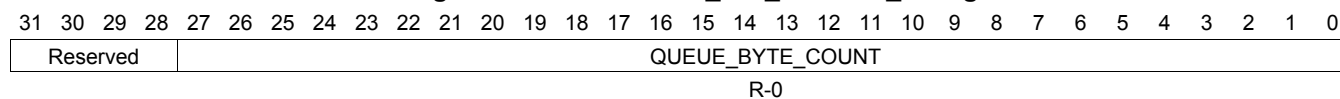
LEGEND: R/W = Read/Write; R = Read only; W1toCl = Write 1 to clear bit; -n = value after reset

Table 16-1300. QUEUE_117_STATUS_A Register Field Descriptions

Bit	Field	Type	Reset	Description
13-0	QUEUE_ENTRY_COUNT	R-0	0	This field indicates how many packets are currently queued on the queue. Queue Manager Queue N Status Registers A

16.5.7.1011 QUEUE_117_STATUS_B Register (offset = 3754h) [reset = 0h]

QUEUE_117_STATUS_B is shown in [Figure 16-1287](#) and described in [Table 16-1301](#).

Figure 16-1287. QUEUE_117_STATUS_B Register


LEGEND: R/W = Read/Write; R = Read only; W1toCl = Write 1 to clear bit; -n = value after reset

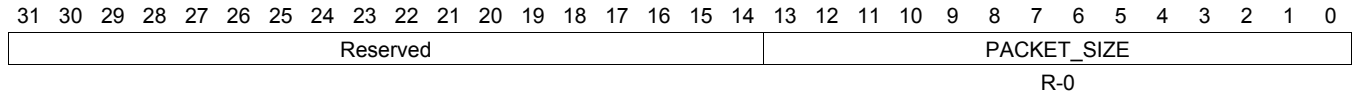
Table 16-1301. QUEUE_117_STATUS_B Register Field Descriptions

Bit	Field	Type	Reset	Description
27-0	QUEUE_BYTE_COUNT	R-0	0	This field indicates how many bytes total are contained in all of the packets which are currently queued on this queue. Queue_Manager_Queue_n_Status_B Registers B

16.5.7.1012 QUEUE_117_STATUS_C Register (offset = 3758h) [reset = 0h]

QUEUE_117_STATUS_C is shown in [Figure 16-1288](#) and described in [Table 16-1302](#).

Figure 16-1288. QUEUE_117_STATUS_C Register



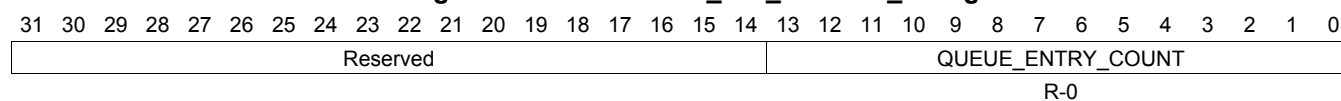
LEGEND: R/W = Read/Write; R = Read only; W1toCl = Write 1 to clear bit; -n = value after reset

Table 16-1302. QUEUE_117_STATUS_C Register Field Descriptions

Bit	Field	Type	Reset	Description
13-0	PACKET_SIZE	R-0	0	This field indicates packet size of the head element of a queue. Queue_Manager_Queue_N_Status_C Registers C

16.5.7.1013 QUEUE_118_STATUS_A Register (offset = 3760h) [reset = 0h]

QUEUE_118_STATUS_A is shown in [Figure 16-1289](#) and described in [Table 16-1303](#).

Figure 16-1289. QUEUE_118_STATUS_A Register


LEGEND: R/W = Read/Write; R = Read only; W1toCl = Write 1 to clear bit; -n = value after reset

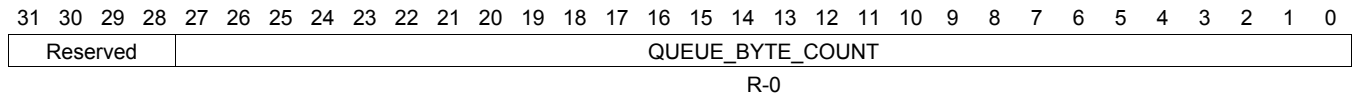
Table 16-1303. QUEUE_118_STATUS_A Register Field Descriptions

Bit	Field	Type	Reset	Description
13-0	QUEUE_ENTRY_COUNT	R-0	0	This field indicates how many packets are currently queued on the queue. Queue Manager Queue N Status Registers A

16.5.7.1014 QUEUE_118_STATUS_B Register (offset = 3764h) [reset = 0h]

QUEUE_118_STATUS_B is shown in [Figure 16-1290](#) and described in [Table 16-1304](#).

Figure 16-1290. QUEUE_118_STATUS_B Register



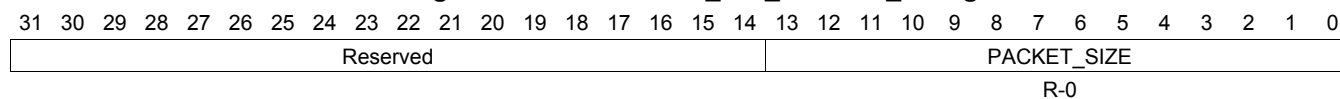
LEGEND: R/W = Read/Write; R = Read only; W1toCl = Write 1 to clear bit; -n = value after reset

Table 16-1304. QUEUE_118_STATUS_B Register Field Descriptions

Bit	Field	Type	Reset	Description
27-0	QUEUE_BYTE_COUNT	R-0	0	This field indicates how many bytes total are contained in all of the packets which are currently queued on this queue. Queue_Manager_Queue_n_Status_B Registers B

16.5.7.1015 QUEUE_118_STATUS_C Register (offset = 3768h) [reset = 0h]

QUEUE_118_STATUS_C is shown in [Figure 16-1291](#) and described in [Table 16-1305](#).

Figure 16-1291. QUEUE_118_STATUS_C Register


LEGEND: R/W = Read/Write; R = Read only; W1toCl = Write 1 to clear bit; -n = value after reset

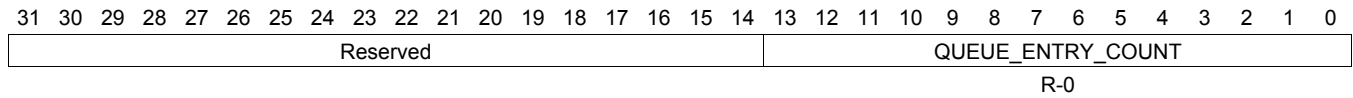
Table 16-1305. QUEUE_118_STATUS_C Register Field Descriptions

Bit	Field	Type	Reset	Description
13-0	PACKET_SIZE	R-0	0	This field indicates packet size of the head element of a queue. Queue_Manager_Queue_N_Status_C Registers C

16.5.7.1016 QUEUE_119_STATUS_A Register (offset = 3770h) [reset = 0h]

QUEUE_119_STATUS_A is shown in [Figure 16-1292](#) and described in [Table 16-1306](#).

Figure 16-1292. QUEUE_119_STATUS_A Register



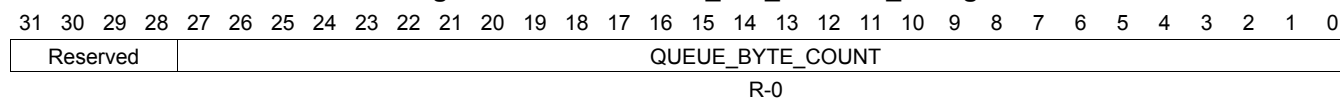
LEGEND: R/W = Read/Write; R = Read only; W1toCl = Write 1 to clear bit; -n = value after reset

Table 16-1306. QUEUE_119_STATUS_A Register Field Descriptions

Bit	Field	Type	Reset	Description
13-0	QUEUE_ENTRY_COUNT	R-0	0	This field indicates how many packets are currently queued on the queue. Queue Manager Queue N Status Registers A

16.5.7.1017 QUEUE_119_STATUS_B Register (offset = 3774h) [reset = 0h]

QUEUE_119_STATUS_B is shown in [Figure 16-1293](#) and described in [Table 16-1307](#).

Figure 16-1293. QUEUE_119_STATUS_B Register


LEGEND: R/W = Read/Write; R = Read only; W1toCl = Write 1 to clear bit; -n = value after reset

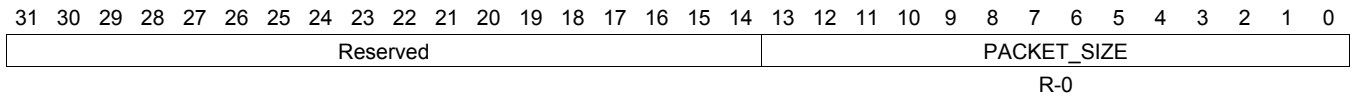
Table 16-1307. QUEUE_119_STATUS_B Register Field Descriptions

Bit	Field	Type	Reset	Description
27-0	QUEUE_BYTE_COUNT	R-0	0	This field indicates how many bytes total are contained in all of the packets which are currently queued on this queue. Queue_Manager_Queue_n_Status_B Registers B

16.5.7.1018 QUEUE_119_STATUS_C Register (offset = 3778h) [reset = 0h]

QUEUE_119_STATUS_C is shown in [Figure 16-1294](#) and described in [Table 16-1308](#).

Figure 16-1294. QUEUE_119_STATUS_C Register



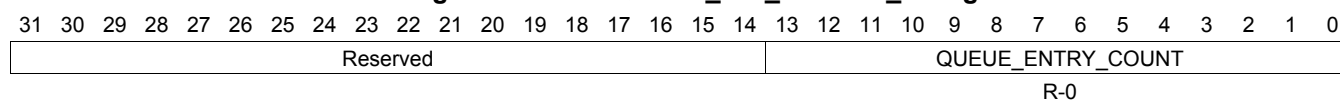
LEGEND: R/W = Read/Write; R = Read only; W1toCl = Write 1 to clear bit; -n = value after reset

Table 16-1308. QUEUE_119_STATUS_C Register Field Descriptions

Bit	Field	Type	Reset	Description
13-0	PACKET_SIZE	R-0	0	This field indicates packet size of the head element of a queue. Queue_Manager_Queue_N_Status_C Registers C

16.5.7.1019 QUEUE_120_STATUS_A Register (offset = 3780h) [reset = 0h]

QUEUE_120_STATUS_A is shown in [Figure 16-1295](#) and described in [Table 16-1309](#).

Figure 16-1295. QUEUE_120_STATUS_A Register


LEGEND: R/W = Read/Write; R = Read only; W1toCl = Write 1 to clear bit; -n = value after reset

Table 16-1309. QUEUE_120_STATUS_A Register Field Descriptions

Bit	Field	Type	Reset	Description
13-0	QUEUE_ENTRY_COUNT	R-0	0	This field indicates how many packets are currently queued on the queue. Queue Manager Queue N Status Registers A

16.5.7.1020 QUEUE_120_STATUS_B Register (offset = 3784h) [reset = 0h]

 QUEUE_120_STATUS_B is shown in [Figure 16-1296](#) and described in [Table 16-1310](#).

Figure 16-1296. QUEUE_120_STATUS_B Register

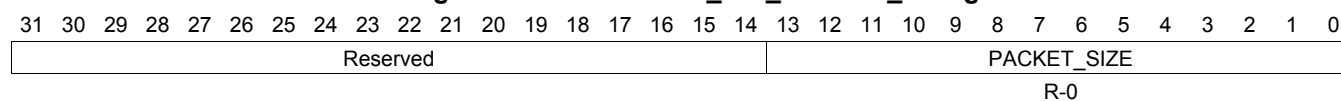

LEGEND: R/W = Read/Write; R = Read only; W1toCl = Write 1 to clear bit; -n = value after reset

Table 16-1310. QUEUE_120_STATUS_B Register Field Descriptions

Bit	Field	Type	Reset	Description
27-0	QUEUE_BYTE_COUNT	R-0	0	This field indicates how many bytes total are contained in all of the packets which are currently queued on this queue. Queue_Manager_Queue_n_Status_B Registers B

16.5.7.1021 QUEUE_120_STATUS_C Register (offset = 3788h) [reset = 0h]

QUEUE_120_STATUS_C is shown in [Figure 16-1297](#) and described in [Table 16-1311](#).

Figure 16-1297. QUEUE_120_STATUS_C Register


LEGEND: R/W = Read/Write; R = Read only; W1toCl = Write 1 to clear bit; -n = value after reset

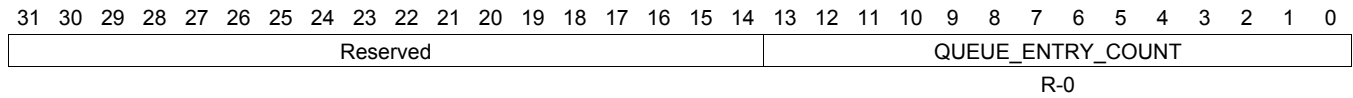
Table 16-1311. QUEUE_120_STATUS_C Register Field Descriptions

Bit	Field	Type	Reset	Description
13-0	PACKET_SIZE	R-0	0	This field indicates packet size of the head element of a queue. Queue_Manager_Queue_N_Status_C Registers C

16.5.7.1022 QUEUE_121_STATUS_A Register (offset = 3790h) [reset = 0h]

QUEUE_121_STATUS_A is shown in [Figure 16-1298](#) and described in [Table 16-1312](#).

Figure 16-1298. QUEUE_121_STATUS_A Register



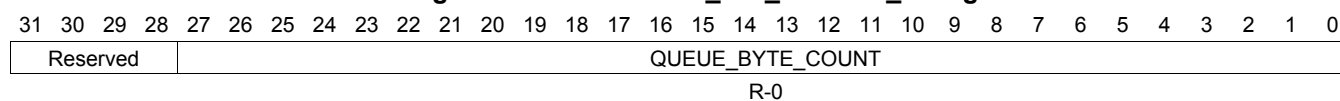
LEGEND: R/W = Read/Write; R = Read only; W1toCl = Write 1 to clear bit; -n = value after reset

Table 16-1312. QUEUE_121_STATUS_A Register Field Descriptions

Bit	Field	Type	Reset	Description
13-0	QUEUE_ENTRY_COUNT	R-0	0	This field indicates how many packets are currently queued on the queue. Queue Manager Queue N Status Registers A

16.5.7.1023 QUEUE_121_STATUS_B Register (offset = 3794h) [reset = 0h]

QUEUE_121_STATUS_B is shown in [Figure 16-1299](#) and described in [Table 16-1313](#).

Figure 16-1299. QUEUE_121_STATUS_B Register


LEGEND: R/W = Read/Write; R = Read only; W1toCl = Write 1 to clear bit; -n = value after reset

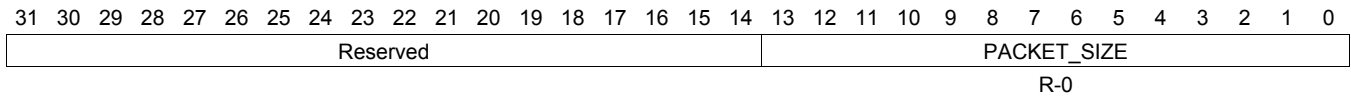
Table 16-1313. QUEUE_121_STATUS_B Register Field Descriptions

Bit	Field	Type	Reset	Description
27-0	QUEUE_BYTE_COUNT	R-0	0	This field indicates how many bytes total are contained in all of the packets which are currently queued on this queue. Queue_Manager_Queue_n_Status_B Registers B

16.5.7.1024 QUEUE_121_STATUS_C Register (offset = 3798h) [reset = 0h]

QUEUE_121_STATUS_C is shown in [Figure 16-1300](#) and described in [Table 16-1314](#).

Figure 16-1300. QUEUE_121_STATUS_C Register



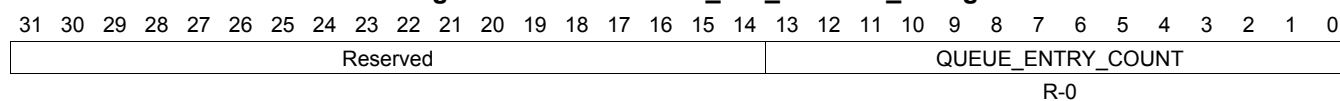
LEGEND: R/W = Read/Write; R = Read only; W1toCl = Write 1 to clear bit; -n = value after reset

Table 16-1314. QUEUE_121_STATUS_C Register Field Descriptions

Bit	Field	Type	Reset	Description
13-0	PACKET_SIZE	R-0	0	This field indicates packet size of the head element of a queue. Queue_Manager_Queue_N_Status_C Registers C

16.5.7.1025 QUEUE_122_STATUS_A Register (offset = 37A0h) [reset = 0h]

QUEUE_122_STATUS_A is shown in [Figure 16-1301](#) and described in [Table 16-1315](#).

Figure 16-1301. QUEUE_122_STATUS_A Register


LEGEND: R/W = Read/Write; R = Read only; W1toCl = Write 1 to clear bit; -n = value after reset

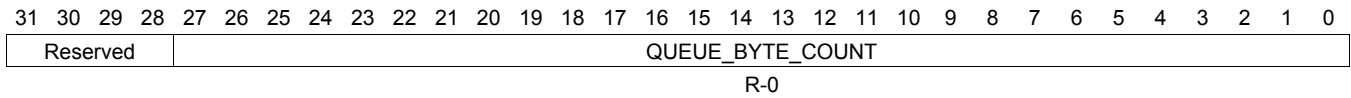
Table 16-1315. QUEUE_122_STATUS_A Register Field Descriptions

Bit	Field	Type	Reset	Description
13-0	QUEUE_ENTRY_COUNT	R-0	0	This field indicates how many packets are currently queued on the queue. Queue Manager Queue N Status Registers A

16.5.7.1026 QUEUE_122_STATUS_B Register (offset = 37A4h) [reset = 0h]

QUEUE_122_STATUS_B is shown in [Figure 16-1302](#) and described in [Table 16-1316](#).

Figure 16-1302. QUEUE_122_STATUS_B Register



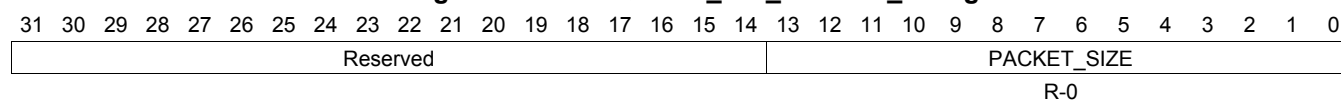
LEGEND: R/W = Read/Write; R = Read only; W1toCl = Write 1 to clear bit; -n = value after reset

Table 16-1316. QUEUE_122_STATUS_B Register Field Descriptions

Bit	Field	Type	Reset	Description
27-0	QUEUE_BYTE_COUNT	R-0	0	This field indicates how many bytes total are contained in all of the packets which are currently queued on this queue. Queue_Manager_Queue_n_Status_B Registers B

16.5.7.1027 QUEUE_122_STATUS_C Register (offset = 37A8h) [reset = 0h]

QUEUE_122_STATUS_C is shown in [Figure 16-1303](#) and described in [Table 16-1317](#).

Figure 16-1303. QUEUE_122_STATUS_C Register


LEGEND: R/W = Read/Write; R = Read only; W1toCl = Write 1 to clear bit; -n = value after reset

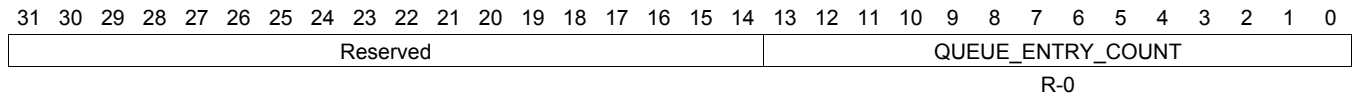
Table 16-1317. QUEUE_122_STATUS_C Register Field Descriptions

Bit	Field	Type	Reset	Description
13-0	PACKET_SIZE	R-0	0	This field indicates packet size of the head element of a queue. Queue_Manager_Queue_N_Status_C Registers C

16.5.7.1028 QUEUE_123_STATUS_A Register (offset = 37B0h) [reset = 0h]

QUEUE_123_STATUS_A is shown in [Figure 16-1304](#) and described in [Table 16-1318](#).

Figure 16-1304. QUEUE_123_STATUS_A Register



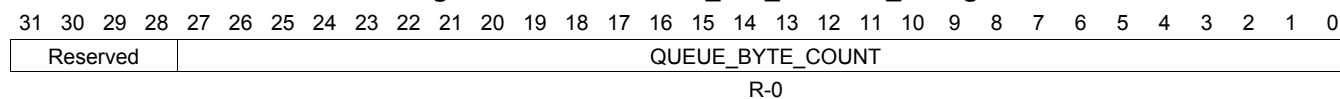
LEGEND: R/W = Read/Write; R = Read only; W1toCl = Write 1 to clear bit; -n = value after reset

Table 16-1318. QUEUE_123_STATUS_A Register Field Descriptions

Bit	Field	Type	Reset	Description
13-0	QUEUE_ENTRY_COUNT	R-0	0	This field indicates how many packets are currently queued on the queue. Queue Manager Queue N Status Registers A

16.5.7.1029 QUEUE_123_STATUS_B Register (offset = 37B4h) [reset = 0h]

QUEUE_123_STATUS_B is shown in [Figure 16-1305](#) and described in [Table 16-1319](#).

Figure 16-1305. QUEUE_123_STATUS_B Register


LEGEND: R/W = Read/Write; R = Read only; W1toCl = Write 1 to clear bit; -n = value after reset

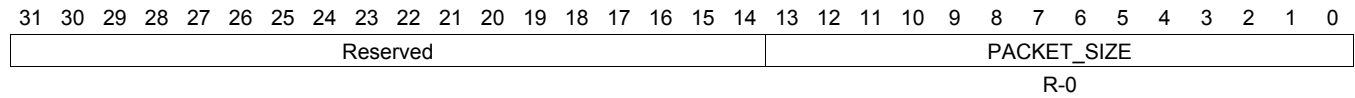
Table 16-1319. QUEUE_123_STATUS_B Register Field Descriptions

Bit	Field	Type	Reset	Description
27-0	QUEUE_BYTE_COUNT	R-0	0	This field indicates how many bytes total are contained in all of the packets which are currently queued on this queue. Queue_Manager_Queue_n_Status_B Registers B

16.5.7.1030 QUEUE_123_STATUS_C Register (offset = 37B8h) [reset = 0h]

QUEUE_123_STATUS_C is shown in [Figure 16-1306](#) and described in [Table 16-1320](#).

Figure 16-1306. QUEUE_123_STATUS_C Register



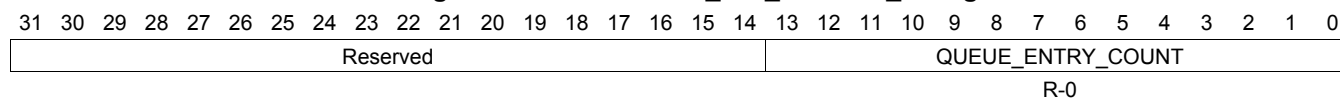
LEGEND: R/W = Read/Write; R = Read only; W1toCl = Write 1 to clear bit; -n = value after reset

Table 16-1320. QUEUE_123_STATUS_C Register Field Descriptions

Bit	Field	Type	Reset	Description
13-0	PACKET_SIZE	R-0	0	This field indicates packet size of the head element of a queue. Queue_Manager_Queue_N_Status_C Registers C

16.5.7.1031 QUEUE_124_STATUS_A Register (offset = 37C0h) [reset = 0h]

QUEUE_124_STATUS_A is shown in [Figure 16-1307](#) and described in [Table 16-1321](#).

Figure 16-1307. QUEUE_124_STATUS_A Register


LEGEND: R/W = Read/Write; R = Read only; W1toCl = Write 1 to clear bit; -n = value after reset

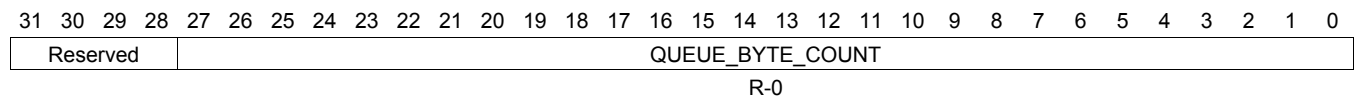
Table 16-1321. QUEUE_124_STATUS_A Register Field Descriptions

Bit	Field	Type	Reset	Description
13-0	QUEUE_ENTRY_COUNT	R-0	0	This field indicates how many packets are currently queued on the queue. Queue Manager Queue N Status Registers A

16.5.7.1032 QUEUE_124_STATUS_B Register (offset = 37C4h) [reset = 0h]

QUEUE_124_STATUS_B is shown in [Figure 16-1308](#) and described in [Table 16-1322](#).

Figure 16-1308. QUEUE_124_STATUS_B Register



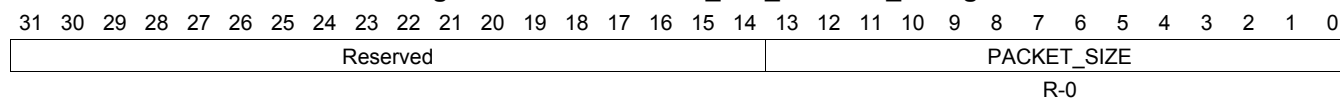
LEGEND: R/W = Read/Write; R = Read only; W1toCl = Write 1 to clear bit; -n = value after reset

Table 16-1322. QUEUE_124_STATUS_B Register Field Descriptions

Bit	Field	Type	Reset	Description
27-0	QUEUE_BYTE_COUNT	R-0	0	This field indicates how many bytes total are contained in all of the packets which are currently queued on this queue. Queue_Manager_Queue_n_Status_B Registers B

16.5.7.1033 QUEUE_124_STATUS_C Register (offset = 37C8h) [reset = 0h]

QUEUE_124_STATUS_C is shown in [Figure 16-1309](#) and described in [Table 16-1323](#).

Figure 16-1309. QUEUE_124_STATUS_C Register


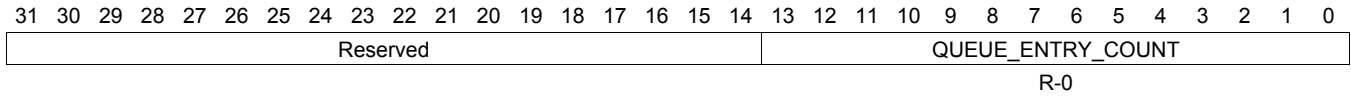
LEGEND: R/W = Read/Write; R = Read only; W1toCl = Write 1 to clear bit; -n = value after reset

Table 16-1323. QUEUE_124_STATUS_C Register Field Descriptions

Bit	Field	Type	Reset	Description
13-0	PACKET_SIZE	R-0	0	This field indicates packet size of the head element of a queue. Queue_Manager_Queue_N_Status_C Registers C

16.5.7.1034 QUEUE_125_STATUS_A Register (offset = 37D0h) [reset = 0h]

 QUEUE_125_STATUS_A is shown in [Figure 16-1310](#) and described in [Table 16-1324](#).

Figure 16-1310. QUEUE_125_STATUS_A Register


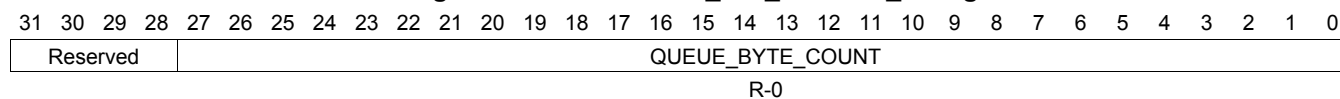
LEGEND: R/W = Read/Write; R = Read only; W1toCl = Write 1 to clear bit; -n = value after reset

Table 16-1324. QUEUE_125_STATUS_A Register Field Descriptions

Bit	Field	Type	Reset	Description
13-0	QUEUE_ENTRY_COUNT	R-0	0	This field indicates how many packets are currently queued on the queue. Queue Manager Queue N Status Registers A

16.5.7.1035 QUEUE_125_STATUS_B Register (offset = 37D4h) [reset = 0h]

QUEUE_125_STATUS_B is shown in [Figure 16-1311](#) and described in [Table 16-1325](#).

Figure 16-1311. QUEUE_125_STATUS_B Register


LEGEND: R/W = Read/Write; R = Read only; W1toCl = Write 1 to clear bit; -n = value after reset

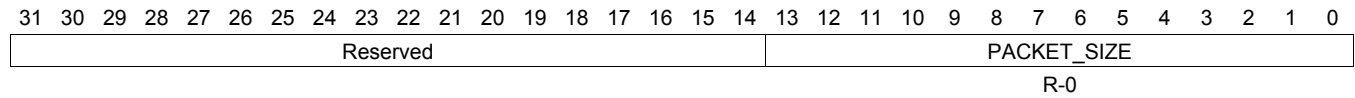
Table 16-1325. QUEUE_125_STATUS_B Register Field Descriptions

Bit	Field	Type	Reset	Description
27-0	QUEUE_BYTE_COUNT	R-0	0	This field indicates how many bytes total are contained in all of the packets which are currently queued on this queue. Queue_Manager_Queue_n_Status_B Registers B

16.5.7.1036 QUEUE_125_STATUS_C Register (offset = 37D8h) [reset = 0h]

QUEUE_125_STATUS_C is shown in [Figure 16-1312](#) and described in [Table 16-1326](#).

Figure 16-1312. QUEUE_125_STATUS_C Register



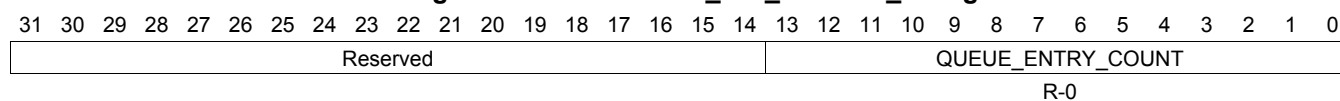
LEGEND: R/W = Read/Write; R = Read only; W1toCl = Write 1 to clear bit; -n = value after reset

Table 16-1326. QUEUE_125_STATUS_C Register Field Descriptions

Bit	Field	Type	Reset	Description
13-0	PACKET_SIZE	R-0	0	This field indicates packet size of the head element of a queue. Queue_Manager_Queue_N_Status_C Registers C

16.5.7.1037 QUEUE_126_STATUS_A Register (offset = 37E0h) [reset = 0h]

QUEUE_126_STATUS_A is shown in [Figure 16-1313](#) and described in [Table 16-1327](#).

Figure 16-1313. QUEUE_126_STATUS_A Register


LEGEND: R/W = Read/Write; R = Read only; W1toCl = Write 1 to clear bit; -n = value after reset

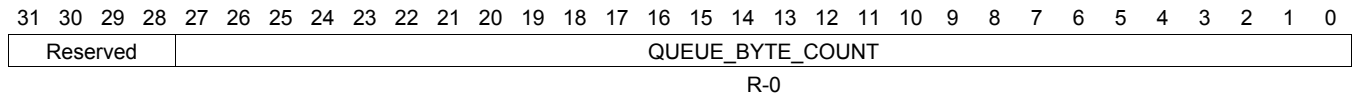
Table 16-1327. QUEUE_126_STATUS_A Register Field Descriptions

Bit	Field	Type	Reset	Description
13-0	QUEUE_ENTRY_COUNT	R-0	0	This field indicates how many packets are currently queued on the queue. Queue Manager Queue N Status Registers A

16.5.7.1038 QUEUE_126_STATUS_B Register (offset = 37E4h) [reset = 0h]

QUEUE_126_STATUS_B is shown in [Figure 16-1314](#) and described in [Table 16-1328](#).

Figure 16-1314. QUEUE_126_STATUS_B Register



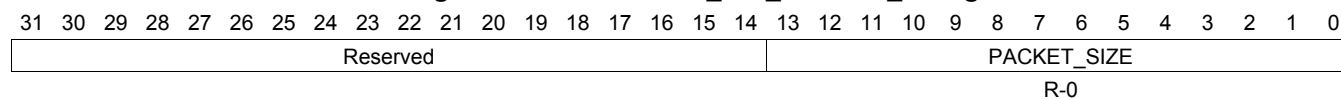
LEGEND: R/W = Read/Write; R = Read only; W1toCl = Write 1 to clear bit; -n = value after reset

Table 16-1328. QUEUE_126_STATUS_B Register Field Descriptions

Bit	Field	Type	Reset	Description
27-0	QUEUE_BYTE_COUNT	R-0	0	This field indicates how many bytes total are contained in all of the packets which are currently queued on this queue. Queue_Manager_Queue_n_Status_B Registers B

16.5.7.1039 QUEUE_126_STATUS_C Register (offset = 37E8h) [reset = 0h]

QUEUE_126_STATUS_C is shown in [Figure 16-1315](#) and described in [Table 16-1329](#).

Figure 16-1315. QUEUE_126_STATUS_C Register


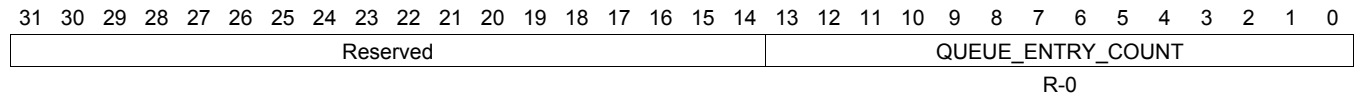
LEGEND: R/W = Read/Write; R = Read only; W1toCl = Write 1 to clear bit; -n = value after reset

Table 16-1329. QUEUE_126_STATUS_C Register Field Descriptions

Bit	Field	Type	Reset	Description
13-0	PACKET_SIZE	R-0	0	This field indicates packet size of the head element of a queue. Queue_Manager_Queue_N_Status_C Registers C

16.5.7.1040 QUEUE_127_STATUS_A Register (offset = 37F0h) [reset = 0h]

 QUEUE_127_STATUS_A is shown in [Figure 16-1316](#) and described in [Table 16-1330](#).

Figure 16-1316. QUEUE_127_STATUS_A Register


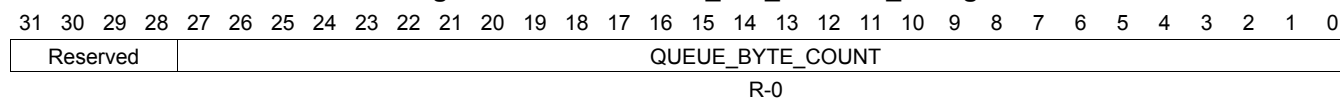
LEGEND: R/W = Read/Write; R = Read only; W1toCl = Write 1 to clear bit; -n = value after reset

Table 16-1330. QUEUE_127_STATUS_A Register Field Descriptions

Bit	Field	Type	Reset	Description
13-0	QUEUE_ENTRY_COUNT	R-0	0	This field indicates how many packets are currently queued on the queue. Queue Manager Queue N Status Registers A

16.5.7.1041 QUEUE_127_STATUS_B Register (offset = 37F4h) [reset = 0h]

QUEUE_127_STATUS_B is shown in [Figure 16-1317](#) and described in [Table 16-1331](#).

Figure 16-1317. QUEUE_127_STATUS_B Register


LEGEND: R/W = Read/Write; R = Read only; W1toCl = Write 1 to clear bit; -n = value after reset

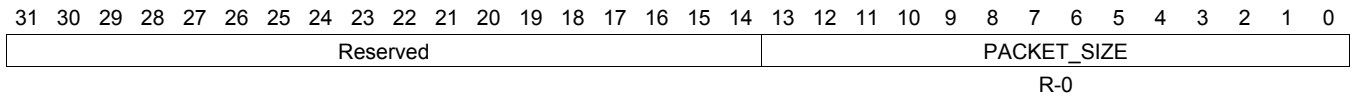
Table 16-1331. QUEUE_127_STATUS_B Register Field Descriptions

Bit	Field	Type	Reset	Description
27-0	QUEUE_BYTE_COUNT	R-0	0	This field indicates how many bytes total are contained in all of the packets which are currently queued on this queue. Queue_Manager_Queue_n_Status_B Registers B

16.5.7.1042 QUEUE_127_STATUS_C Register (offset = 37F8h) [reset = 0h]

QUEUE_127_STATUS_C is shown in [Figure 16-1318](#) and described in [Table 16-1332](#).

Figure 16-1318. QUEUE_127_STATUS_C Register



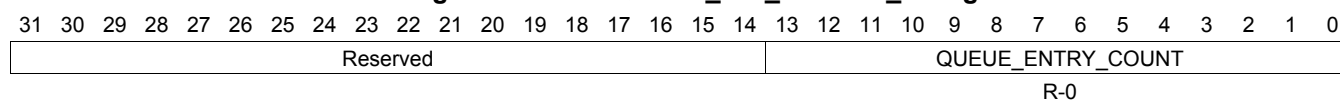
LEGEND: R/W = Read/Write; R = Read only; W1toCl = Write 1 to clear bit; -n = value after reset

Table 16-1332. QUEUE_127_STATUS_C Register Field Descriptions

Bit	Field	Type	Reset	Description
13-0	PACKET_SIZE	R-0	0	This field indicates packet size of the head element of a queue. Queue_Manager_Queue_N_Status_C Registers C

16.5.7.1043 QUEUE_128_STATUS_A Register (offset = 3800h) [reset = 0h]

QUEUE_128_STATUS_A is shown in [Figure 16-1319](#) and described in [Table 16-1333](#).

Figure 16-1319. QUEUE_128_STATUS_A Register


LEGEND: R/W = Read/Write; R = Read only; W1toCl = Write 1 to clear bit; -n = value after reset

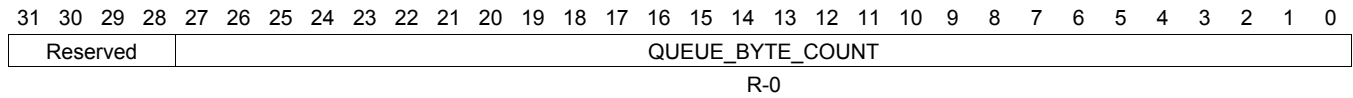
Table 16-1333. QUEUE_128_STATUS_A Register Field Descriptions

Bit	Field	Type	Reset	Description
13-0	QUEUE_ENTRY_COUNT	R-0	0	This field indicates how many packets are currently queued on the queue. Queue Manager Queue N Status Registers A

16.5.7.1044 QUEUE_128_STATUS_B Register (offset = 3804h) [reset = 0h]

QUEUE_128_STATUS_B is shown in [Figure 16-1320](#) and described in [Table 16-1334](#).

Figure 16-1320. QUEUE_128_STATUS_B Register



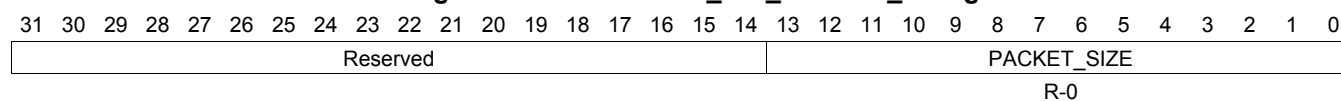
LEGEND: R/W = Read/Write; R = Read only; W1toCl = Write 1 to clear bit; -n = value after reset

Table 16-1334. QUEUE_128_STATUS_B Register Field Descriptions

Bit	Field	Type	Reset	Description
27-0	QUEUE_BYTE_COUNT	R-0	0	This field indicates how many bytes total are contained in all of the packets which are currently queued on this queue. Queue_Manager_Queue_n_Status_B Registers B

16.5.7.1045 QUEUE_128_STATUS_C Register (offset = 3808h) [reset = 0h]

QUEUE_128_STATUS_C is shown in [Figure 16-1321](#) and described in [Table 16-1335](#).

Figure 16-1321. QUEUE_128_STATUS_C Register


LEGEND: R/W = Read/Write; R = Read only; W1toCl = Write 1 to clear bit; -n = value after reset

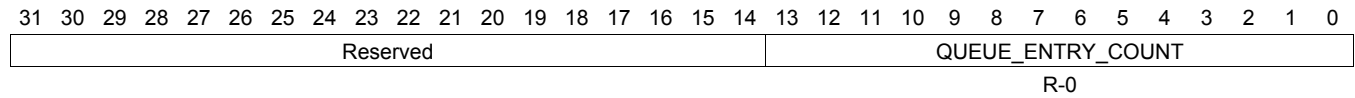
Table 16-1335. QUEUE_128_STATUS_C Register Field Descriptions

Bit	Field	Type	Reset	Description
13-0	PACKET_SIZE	R-0	0	This field indicates packet size of the head element of a queue. Queue_Manager_Queue_N_Status_C Registers C

16.5.7.1046 QUEUE_129_STATUS_A Register (offset = 3810h) [reset = 0h]

QUEUE_129_STATUS_A is shown in [Figure 16-1322](#) and described in [Table 16-1336](#).

Figure 16-1322. QUEUE_129_STATUS_A Register



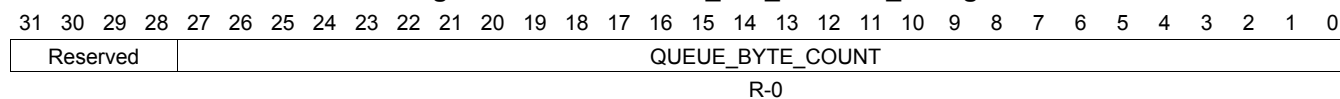
LEGEND: R/W = Read/Write; R = Read only; W1toCl = Write 1 to clear bit; -n = value after reset

Table 16-1336. QUEUE_129_STATUS_A Register Field Descriptions

Bit	Field	Type	Reset	Description
13-0	QUEUE_ENTRY_COUNT	R-0	0	This field indicates how many packets are currently queued on the queue. Queue Manager Queue N Status Registers A

16.5.7.1047 QUEUE_129_STATUS_B Register (offset = 3814h) [reset = 0h]

QUEUE_129_STATUS_B is shown in [Figure 16-1323](#) and described in [Table 16-1337](#).

Figure 16-1323. QUEUE_129_STATUS_B Register


LEGEND: R/W = Read/Write; R = Read only; W1toCl = Write 1 to clear bit; -n = value after reset

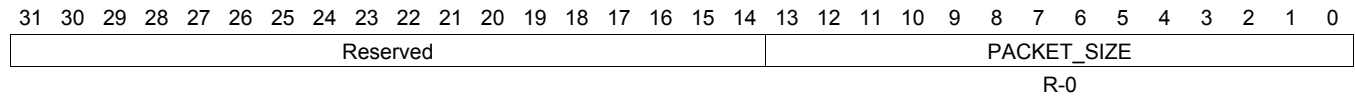
Table 16-1337. QUEUE_129_STATUS_B Register Field Descriptions

Bit	Field	Type	Reset	Description
27-0	QUEUE_BYTE_COUNT	R-0	0	This field indicates how many bytes total are contained in all of the packets which are currently queued on this queue. Queue_Manager_Queue_n_Status_B Registers B

16.5.7.1048 QUEUE_129_STATUS_C Register (offset = 3818h) [reset = 0h]

QUEUE_129_STATUS_C is shown in [Figure 16-1324](#) and described in [Table 16-1338](#).

Figure 16-1324. QUEUE_129_STATUS_C Register



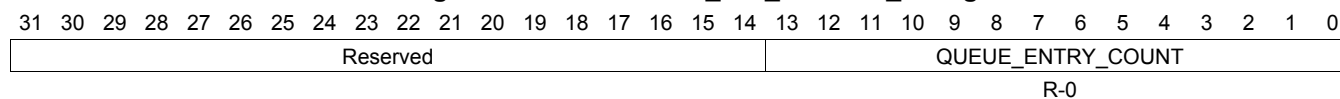
LEGEND: R/W = Read/Write; R = Read only; W1toCl = Write 1 to clear bit; -n = value after reset

Table 16-1338. QUEUE_129_STATUS_C Register Field Descriptions

Bit	Field	Type	Reset	Description
13-0	PACKET_SIZE	R-0	0	This field indicates packet size of the head element of a queue. Queue_Manager_Queue_N_Status_C Registers C

16.5.7.1049 QUEUE_130_STATUS_A Register (offset = 3820h) [reset = 0h]

QUEUE_130_STATUS_A is shown in [Figure 16-1325](#) and described in [Table 16-1339](#).

Figure 16-1325. QUEUE_130_STATUS_A Register


LEGEND: R/W = Read/Write; R = Read only; W1toCl = Write 1 to clear bit; -n = value after reset

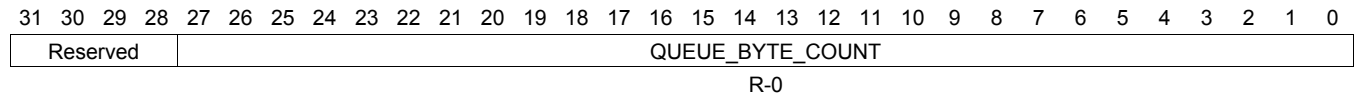
Table 16-1339. QUEUE_130_STATUS_A Register Field Descriptions

Bit	Field	Type	Reset	Description
13-0	QUEUE_ENTRY_COUNT	R-0	0	This field indicates how many packets are currently queued on the queue. Queue Manager Queue N Status Registers A

16.5.7.1050 QUEUE_130_STATUS_B Register (offset = 3824h) [reset = 0h]

QUEUE_130_STATUS_B is shown in [Figure 16-1326](#) and described in [Table 16-1340](#).

Figure 16-1326. QUEUE_130_STATUS_B Register



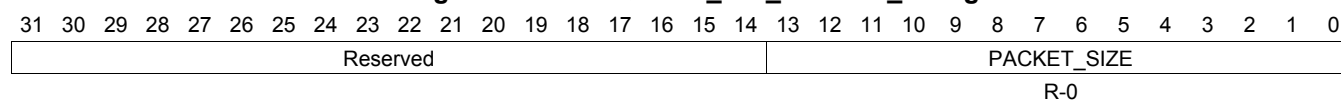
LEGEND: R/W = Read/Write; R = Read only; W1toCl = Write 1 to clear bit; -n = value after reset

Table 16-1340. QUEUE_130_STATUS_B Register Field Descriptions

Bit	Field	Type	Reset	Description
27-0	QUEUE_BYTE_COUNT	R-0	0	This field indicates how many bytes total are contained in all of the packets which are currently queued on this queue. Queue_Manager_Queue_n_Status_B Registers B

16.5.7.1051 QUEUE_130_STATUS_C Register (offset = 3828h) [reset = 0h]

QUEUE_130_STATUS_C is shown in [Figure 16-1327](#) and described in [Table 16-1341](#).

Figure 16-1327. QUEUE_130_STATUS_C Register


LEGEND: R/W = Read/Write; R = Read only; W1toCl = Write 1 to clear bit; -n = value after reset

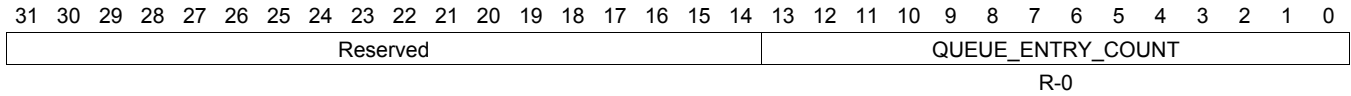
Table 16-1341. QUEUE_130_STATUS_C Register Field Descriptions

Bit	Field	Type	Reset	Description
13-0	PACKET_SIZE	R-0	0	This field indicates packet size of the head element of a queue. Queue_Manager_Queue_N_Status_C Registers C

16.5.7.1052 QUEUE_131_STATUS_A Register (offset = 3830h) [reset = 0h]

QUEUE_131_STATUS_A is shown in [Figure 16-1328](#) and described in [Table 16-1342](#).

Figure 16-1328. QUEUE_131_STATUS_A Register



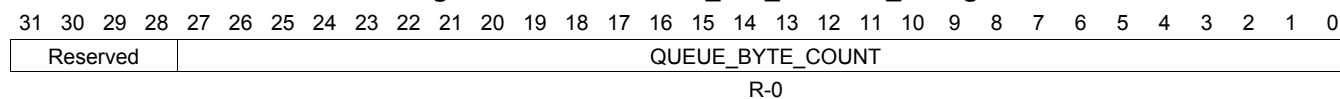
LEGEND: R/W = Read/Write; R = Read only; W1toCl = Write 1 to clear bit; -n = value after reset

Table 16-1342. QUEUE_131_STATUS_A Register Field Descriptions

Bit	Field	Type	Reset	Description
13-0	QUEUE_ENTRY_COUNT	R-0	0	This field indicates how many packets are currently queued on the queue. Queue Manager Queue N Status Registers A

16.5.7.1053 QUEUE_131_STATUS_B Register (offset = 3834h) [reset = 0h]

QUEUE_131_STATUS_B is shown in [Figure 16-1329](#) and described in [Table 16-1343](#).

Figure 16-1329. QUEUE_131_STATUS_B Register


LEGEND: R/W = Read/Write; R = Read only; W1toCl = Write 1 to clear bit; -n = value after reset

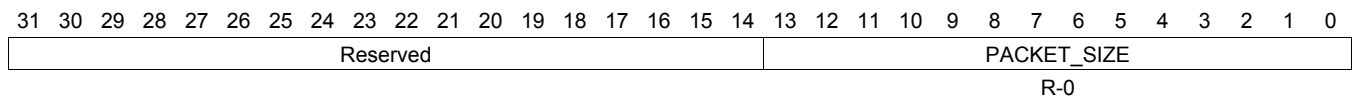
Table 16-1343. QUEUE_131_STATUS_B Register Field Descriptions

Bit	Field	Type	Reset	Description
27-0	QUEUE_BYTE_COUNT	R-0	0	This field indicates how many bytes total are contained in all of the packets which are currently queued on this queue. Queue_Manager_Queue_n_Status_B Registers B

16.5.7.1054 QUEUE_131_STATUS_C Register (offset = 3838h) [reset = 0h]

QUEUE_131_STATUS_C is shown in [Figure 16-1330](#) and described in [Table 16-1344](#).

Figure 16-1330. QUEUE_131_STATUS_C Register



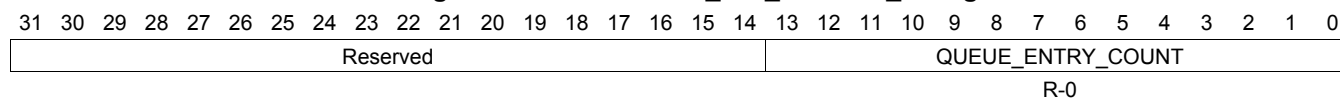
LEGEND: R/W = Read/Write; R = Read only; W1toCl = Write 1 to clear bit; -n = value after reset

Table 16-1344. QUEUE_131_STATUS_C Register Field Descriptions

Bit	Field	Type	Reset	Description
13-0	PACKET_SIZE	R-0	0	This field indicates packet size of the head element of a queue. Queue_Manager_Queue_N_Status_C Registers C

16.5.7.1055 QUEUE_132_STATUS_A Register (offset = 3840h) [reset = 0h]

 QUEUE_132_STATUS_A is shown in [Figure 16-1331](#) and described in [Table 16-1345](#).

Figure 16-1331. QUEUE_132_STATUS_A Register


LEGEND: R/W = Read/Write; R = Read only; W1toCl = Write 1 to clear bit; -n = value after reset

Table 16-1345. QUEUE_132_STATUS_A Register Field Descriptions

Bit	Field	Type	Reset	Description
13-0	QUEUE_ENTRY_COUNT	R-0	0	This field indicates how many packets are currently queued on the queue. Queue Manager Queue N Status Registers A

16.5.7.1056 QUEUE_132_STATUS_B Register (offset = 3844h) [reset = 0h]

 QUEUE_132_STATUS_B is shown in [Figure 16-1332](#) and described in [Table 16-1346](#).

Figure 16-1332. QUEUE_132_STATUS_B Register

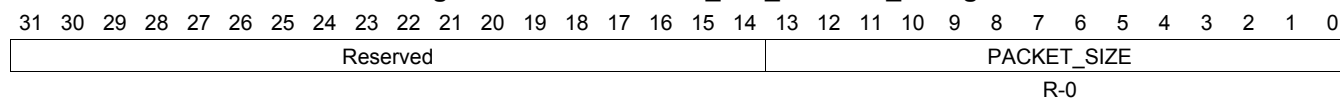

LEGEND: R/W = Read/Write; R = Read only; W1toCl = Write 1 to clear bit; -n = value after reset

Table 16-1346. QUEUE_132_STATUS_B Register Field Descriptions

Bit	Field	Type	Reset	Description
27-0	QUEUE_BYTE_COUNT	R-0	0	This field indicates how many bytes total are contained in all of the packets which are currently queued on this queue. Queue_Manager_Queue_n_Status_B Registers B

16.5.7.1057 QUEUE_132_STATUS_C Register (offset = 3848h) [reset = 0h]

QUEUE_132_STATUS_C is shown in [Figure 16-1333](#) and described in [Table 16-1347](#).

Figure 16-1333. QUEUE_132_STATUS_C Register


LEGEND: R/W = Read/Write; R = Read only; W1toCl = Write 1 to clear bit; -n = value after reset

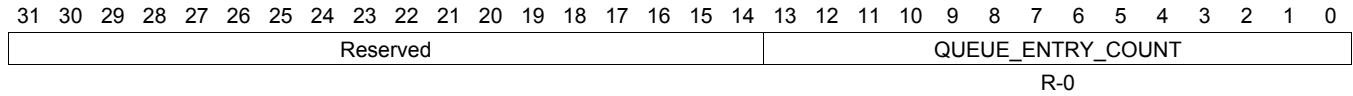
Table 16-1347. QUEUE_132_STATUS_C Register Field Descriptions

Bit	Field	Type	Reset	Description
13-0	PACKET_SIZE	R-0	0	This field indicates packet size of the head element of a queue. Queue_Manager_Queue_N_Status_C Registers C

16.5.7.1058 QUEUE_133_STATUS_A Register (offset = 3850h) [reset = 0h]

QUEUE_133_STATUS_A is shown in [Figure 16-1334](#) and described in [Table 16-1348](#).

Figure 16-1334. QUEUE_133_STATUS_A Register



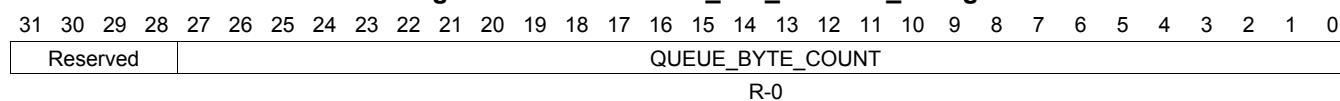
LEGEND: R/W = Read/Write; R = Read only; W1toCl = Write 1 to clear bit; -n = value after reset

Table 16-1348. QUEUE_133_STATUS_A Register Field Descriptions

Bit	Field	Type	Reset	Description
13-0	QUEUE_ENTRY_COUNT	R-0	0	This field indicates how many packets are currently queued on the queue. Queue Manager Queue N Status Registers A

16.5.7.1059 QUEUE_133_STATUS_B Register (offset = 3854h) [reset = 0h]

QUEUE_133_STATUS_B is shown in [Figure 16-1335](#) and described in [Table 16-1349](#).

Figure 16-1335. QUEUE_133_STATUS_B Register


LEGEND: R/W = Read/Write; R = Read only; W1toCl = Write 1 to clear bit; -n = value after reset

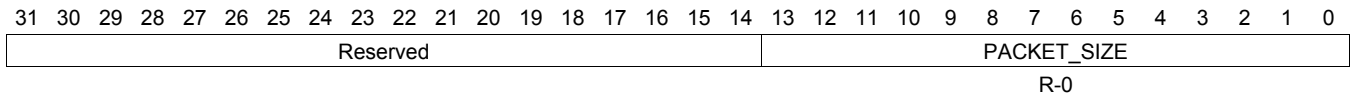
Table 16-1349. QUEUE_133_STATUS_B Register Field Descriptions

Bit	Field	Type	Reset	Description
27-0	QUEUE_BYTE_COUNT	R-0	0	This field indicates how many bytes total are contained in all of the packets which are currently queued on this queue. Queue_Manager_Queue_n_Status_B Registers B

16.5.7.1060 QUEUE_133_STATUS_C Register (offset = 3858h) [reset = 0h]

QUEUE_133_STATUS_C is shown in [Figure 16-1336](#) and described in [Table 16-1350](#).

Figure 16-1336. QUEUE_133_STATUS_C Register



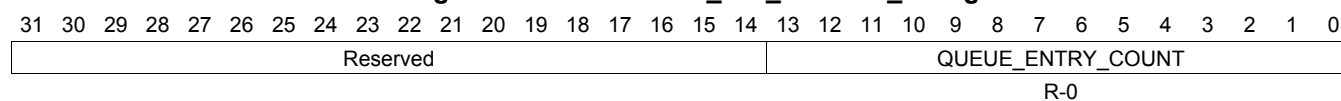
LEGEND: R/W = Read/Write; R = Read only; W1toCl = Write 1 to clear bit; -n = value after reset

Table 16-1350. QUEUE_133_STATUS_C Register Field Descriptions

Bit	Field	Type	Reset	Description
13-0	PACKET_SIZE	R-0	0	This field indicates packet size of the head element of a queue. Queue_Manager_Queue_N_Status_C Registers C

16.5.7.1061 QUEUE_134_STATUS_A Register (offset = 3860h) [reset = 0h]

QUEUE_134_STATUS_A is shown in [Figure 16-1337](#) and described in [Table 16-1351](#).

Figure 16-1337. QUEUE_134_STATUS_A Register


LEGEND: R/W = Read/Write; R = Read only; W1toCl = Write 1 to clear bit; -n = value after reset

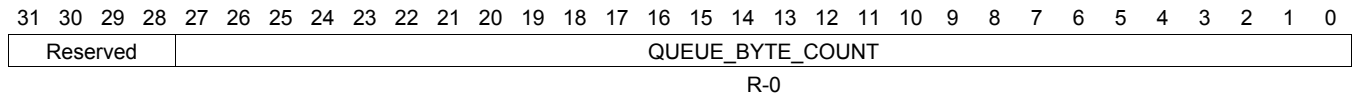
Table 16-1351. QUEUE_134_STATUS_A Register Field Descriptions

Bit	Field	Type	Reset	Description
13-0	QUEUE_ENTRY_COUNT	R-0	0	This field indicates how many packets are currently queued on the queue. Queue Manager Queue N Status Registers A

16.5.7.1062 QUEUE_134_STATUS_B Register (offset = 3864h) [reset = 0h]

QUEUE_134_STATUS_B is shown in [Figure 16-1338](#) and described in [Table 16-1352](#).

Figure 16-1338. QUEUE_134_STATUS_B Register



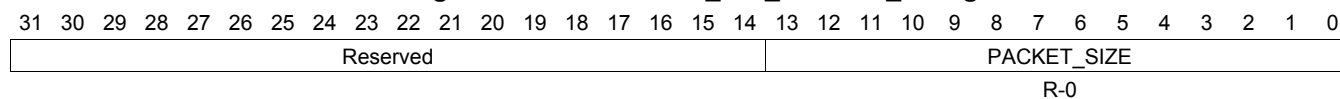
LEGEND: R/W = Read/Write; R = Read only; W1toCl = Write 1 to clear bit; -n = value after reset

Table 16-1352. QUEUE_134_STATUS_B Register Field Descriptions

Bit	Field	Type	Reset	Description
27-0	QUEUE_BYTE_COUNT	R-0	0	This field indicates how many bytes total are contained in all of the packets which are currently queued on this queue. Queue_Manager_Queue_n_Status_B Registers B

16.5.7.1063 QUEUE_134_STATUS_C Register (offset = 3868h) [reset = 0h]

QUEUE_134_STATUS_C is shown in [Figure 16-1339](#) and described in [Table 16-1353](#).

Figure 16-1339. QUEUE_134_STATUS_C Register


LEGEND: R/W = Read/Write; R = Read only; W1toCl = Write 1 to clear bit; -n = value after reset

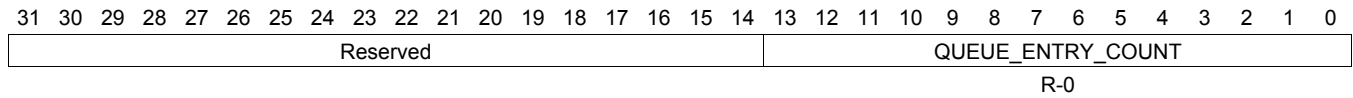
Table 16-1353. QUEUE_134_STATUS_C Register Field Descriptions

Bit	Field	Type	Reset	Description
13-0	PACKET_SIZE	R-0	0	This field indicates packet size of the head element of a queue. Queue_Manager_Queue_N_Status_C Registers C

16.5.7.1064 QUEUE_135_STATUS_A Register (offset = 3870h) [reset = 0h]

QUEUE_135_STATUS_A is shown in [Figure 16-1340](#) and described in [Table 16-1354](#).

Figure 16-1340. QUEUE_135_STATUS_A Register



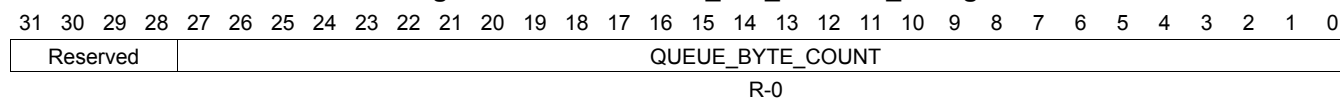
LEGEND: R/W = Read/Write; R = Read only; W1toCl = Write 1 to clear bit; -n = value after reset

Table 16-1354. QUEUE_135_STATUS_A Register Field Descriptions

Bit	Field	Type	Reset	Description
13-0	QUEUE_ENTRY_COUNT	R-0	0	This field indicates how many packets are currently queued on the queue. Queue Manager Queue N Status Registers A

16.5.7.1065 QUEUE_135_STATUS_B Register (offset = 3874h) [reset = 0h]

QUEUE_135_STATUS_B is shown in [Figure 16-1341](#) and described in [Table 16-1355](#).

Figure 16-1341. QUEUE_135_STATUS_B Register


LEGEND: R/W = Read/Write; R = Read only; W1toCl = Write 1 to clear bit; -n = value after reset

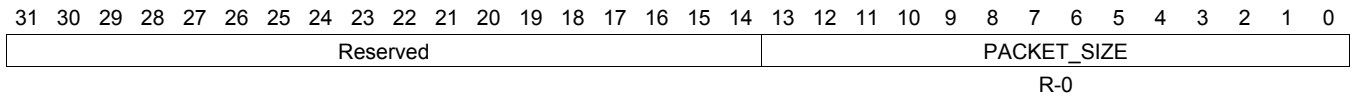
Table 16-1355. QUEUE_135_STATUS_B Register Field Descriptions

Bit	Field	Type	Reset	Description
27-0	QUEUE_BYTE_COUNT	R-0	0	This field indicates how many bytes total are contained in all of the packets which are currently queued on this queue. Queue_Manager_Queue_n_Status_B Registers B

16.5.7.1066 QUEUE_135_STATUS_C Register (offset = 3878h) [reset = 0h]

QUEUE_135_STATUS_C is shown in [Figure 16-1342](#) and described in [Table 16-1356](#).

Figure 16-1342. QUEUE_135_STATUS_C Register



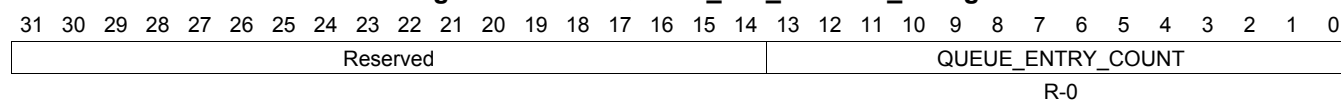
LEGEND: R/W = Read/Write; R = Read only; W1toCl = Write 1 to clear bit; -n = value after reset

Table 16-1356. QUEUE_135_STATUS_C Register Field Descriptions

Bit	Field	Type	Reset	Description
13-0	PACKET_SIZE	R-0	0	This field indicates packet size of the head element of a queue. Queue_Manager_Queue_N_Status_C Registers C

16.5.7.1067 QUEUE_136_STATUS_A Register (offset = 3880h) [reset = 0h]

QUEUE_136_STATUS_A is shown in [Figure 16-1343](#) and described in [Table 16-1357](#).

Figure 16-1343. QUEUE_136_STATUS_A Register


LEGEND: R/W = Read/Write; R = Read only; W1toCl = Write 1 to clear bit; -n = value after reset

Table 16-1357. QUEUE_136_STATUS_A Register Field Descriptions

Bit	Field	Type	Reset	Description
13-0	QUEUE_ENTRY_COUNT	R-0	0	This field indicates how many packets are currently queued on the queue. Queue Manager Queue N Status Registers A

16.5.7.1068 QUEUE_136_STATUS_B Register (offset = 3884h) [reset = 0h]

QUEUE_136_STATUS_B is shown in [Figure 16-1344](#) and described in [Table 16-1358](#).

Figure 16-1344. QUEUE_136_STATUS_B Register



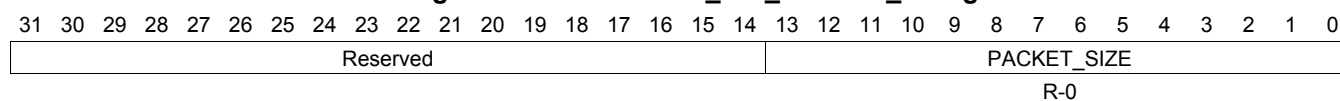
LEGEND: R/W = Read/Write; R = Read only; W1toCl = Write 1 to clear bit; -n = value after reset

Table 16-1358. QUEUE_136_STATUS_B Register Field Descriptions

Bit	Field	Type	Reset	Description
27-0	QUEUE_BYTE_COUNT	R-0	0	This field indicates how many bytes total are contained in all of the packets which are currently queued on this queue. Queue_Manager_Queue_n_Status_B Registers B

16.5.7.1069 QUEUE_136_STATUS_C Register (offset = 3888h) [reset = 0h]

QUEUE_136_STATUS_C is shown in [Figure 16-1345](#) and described in [Table 16-1359](#).

Figure 16-1345. QUEUE_136_STATUS_C Register


LEGEND: R/W = Read/Write; R = Read only; W1toCl = Write 1 to clear bit; -n = value after reset

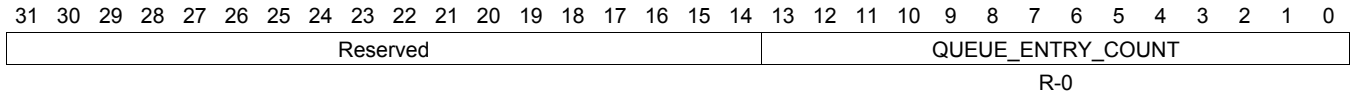
Table 16-1359. QUEUE_136_STATUS_C Register Field Descriptions

Bit	Field	Type	Reset	Description
13-0	PACKET_SIZE	R-0	0	This field indicates packet size of the head element of a queue. Queue_Manager_Queue_N_Status_C Registers C

16.5.7.1070 QUEUE_137_STATUS_A Register (offset = 3890h) [reset = 0h]

QUEUE_137_STATUS_A is shown in [Figure 16-1346](#) and described in [Table 16-1360](#).

Figure 16-1346. QUEUE_137_STATUS_A Register



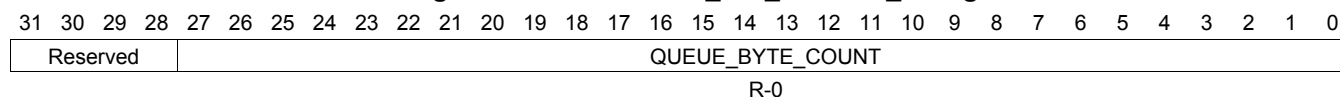
LEGEND: R/W = Read/Write; R = Read only; W1toCl = Write 1 to clear bit; -n = value after reset

Table 16-1360. QUEUE_137_STATUS_A Register Field Descriptions

Bit	Field	Type	Reset	Description
13-0	QUEUE_ENTRY_COUNT	R-0	0	This field indicates how many packets are currently queued on the queue. Queue Manager Queue N Status Registers A

16.5.7.1071 QUEUE_137_STATUS_B Register (offset = 3894h) [reset = 0h]

 QUEUE_137_STATUS_B is shown in [Figure 16-1347](#) and described in [Table 16-1361](#).

Figure 16-1347. QUEUE_137_STATUS_B Register


LEGEND: R/W = Read/Write; R = Read only; W1toCl = Write 1 to clear bit; -n = value after reset

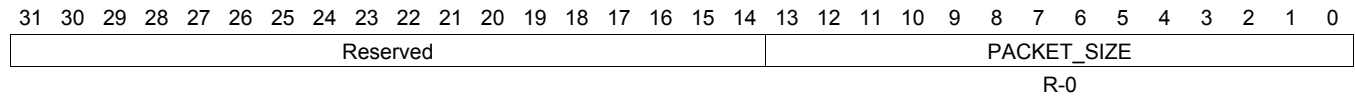
Table 16-1361. QUEUE_137_STATUS_B Register Field Descriptions

Bit	Field	Type	Reset	Description
27-0	QUEUE_BYTE_COUNT	R-0	0	This field indicates how many bytes total are contained in all of the packets which are currently queued on this queue. Queue_Manager_Queue_n_Status_B Registers B

16.5.7.1072 QUEUE_137_STATUS_C Register (offset = 3898h) [reset = 0h]

QUEUE_137_STATUS_C is shown in [Figure 16-1348](#) and described in [Table 16-1362](#).

Figure 16-1348. QUEUE_137_STATUS_C Register



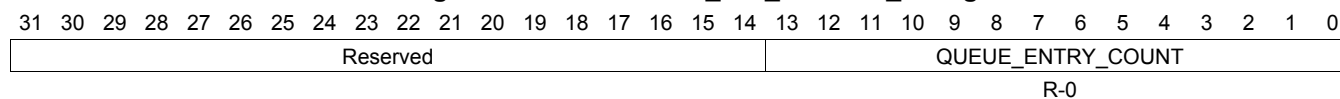
LEGEND: R/W = Read/Write; R = Read only; W1toCl = Write 1 to clear bit; -n = value after reset

Table 16-1362. QUEUE_137_STATUS_C Register Field Descriptions

Bit	Field	Type	Reset	Description
13-0	PACKET_SIZE	R-0	0	This field indicates packet size of the head element of a queue. Queue_Manager_Queue_N_Status_C Registers C

16.5.7.1073 QUEUE_138_STATUS_A Register (offset = 38A0h) [reset = 0h]

QUEUE_138_STATUS_A is shown in [Figure 16-1349](#) and described in [Table 16-1363](#).

Figure 16-1349. QUEUE_138_STATUS_A Register


LEGEND: R/W = Read/Write; R = Read only; W1toCl = Write 1 to clear bit; -n = value after reset

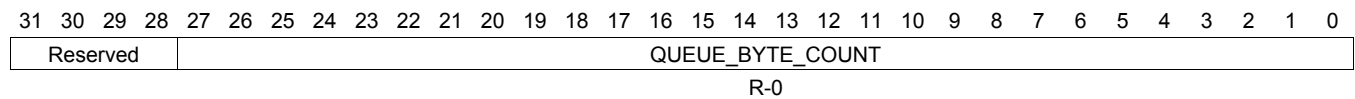
Table 16-1363. QUEUE_138_STATUS_A Register Field Descriptions

Bit	Field	Type	Reset	Description
13-0	QUEUE_ENTRY_COUNT	R-0	0	This field indicates how many packets are currently queued on the queue. Queue Manager Queue N Status Registers A

16.5.7.1074 QUEUE_138_STATUS_B Register (offset = 38A4h) [reset = 0h]

QUEUE_138_STATUS_B is shown in [Figure 16-1350](#) and described in [Table 16-1364](#).

Figure 16-1350. QUEUE_138_STATUS_B Register



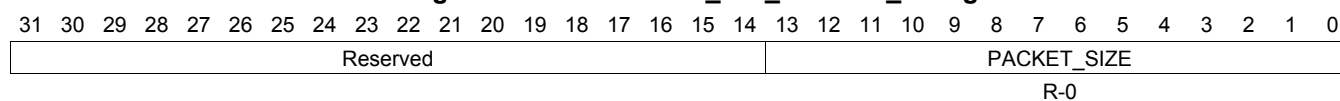
LEGEND: R/W = Read/Write; R = Read only; W1toCl = Write 1 to clear bit; -n = value after reset

Table 16-1364. QUEUE_138_STATUS_B Register Field Descriptions

Bit	Field	Type	Reset	Description
27-0	QUEUE_BYTE_COUNT	R-0	0	This field indicates how many bytes total are contained in all of the packets which are currently queued on this queue. Queue_Manager_Queue_n_Status_B Registers B

16.5.7.1075 QUEUE_138_STATUS_C Register (offset = 38A8h) [reset = 0h]

QUEUE_138_STATUS_C is shown in [Figure 16-1351](#) and described in [Table 16-1365](#).

Figure 16-1351. QUEUE_138_STATUS_C Register


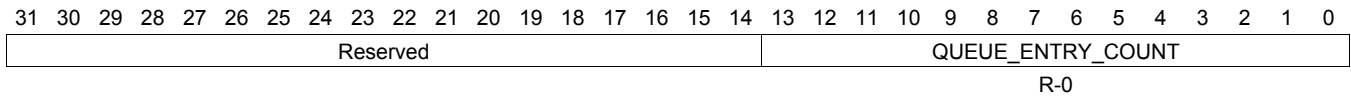
LEGEND: R/W = Read/Write; R = Read only; W1toCl = Write 1 to clear bit; -n = value after reset

Table 16-1365. QUEUE_138_STATUS_C Register Field Descriptions

Bit	Field	Type	Reset	Description
13-0	PACKET_SIZE	R-0	0	This field indicates packet size of the head element of a queue. Queue_Manager_Queue_N_Status_C Registers C

16.5.7.1076 QUEUE_139_STATUS_A Register (offset = 38B0h) [reset = 0h]

 QUEUE_139_STATUS_A is shown in [Figure 16-1352](#) and described in [Table 16-1366](#).

Figure 16-1352. QUEUE_139_STATUS_A Register


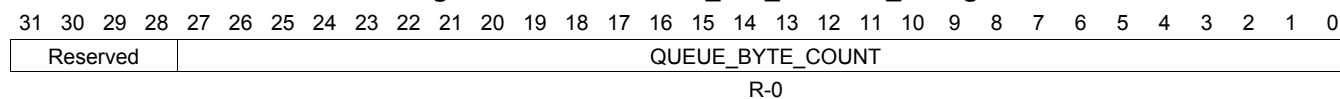
LEGEND: R/W = Read/Write; R = Read only; W1toCl = Write 1 to clear bit; -n = value after reset

Table 16-1366. QUEUE_139_STATUS_A Register Field Descriptions

Bit	Field	Type	Reset	Description
13-0	QUEUE_ENTRY_COUNT	R-0	0	This field indicates how many packets are currently queued on the queue. Queue Manager Queue N Status Registers A

16.5.7.1077 QUEUE_139_STATUS_B Register (offset = 38B4h) [reset = 0h]

QUEUE_139_STATUS_B is shown in [Figure 16-1353](#) and described in [Table 16-1367](#).

Figure 16-1353. QUEUE_139_STATUS_B Register


LEGEND: R/W = Read/Write; R = Read only; W1toCl = Write 1 to clear bit; -n = value after reset

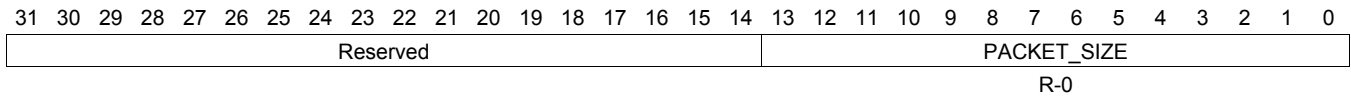
Table 16-1367. QUEUE_139_STATUS_B Register Field Descriptions

Bit	Field	Type	Reset	Description
27-0	QUEUE_BYTE_COUNT	R-0	0	This field indicates how many bytes total are contained in all of the packets which are currently queued on this queue. Queue_Manager_Queue_n_Status_B Registers B

16.5.7.1078 QUEUE_139_STATUS_C Register (offset = 38B8h) [reset = 0h]

QUEUE_139_STATUS_C is shown in [Figure 16-1354](#) and described in [Table 16-1368](#).

Figure 16-1354. QUEUE_139_STATUS_C Register



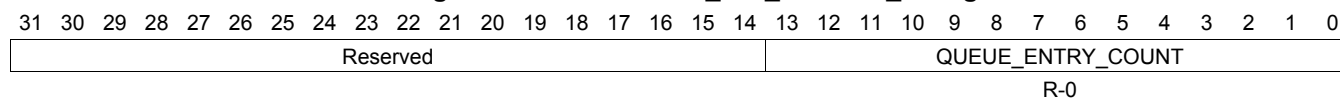
LEGEND: R/W = Read/Write; R = Read only; W1toCl = Write 1 to clear bit; -n = value after reset

Table 16-1368. QUEUE_139_STATUS_C Register Field Descriptions

Bit	Field	Type	Reset	Description
13-0	PACKET_SIZE	R-0	0	This field indicates packet size of the head element of a queue. Queue_Manager_Queue_N_Status_C Registers C

16.5.7.1079 QUEUE_140_STATUS_A Register (offset = 38C0h) [reset = 0h]

QUEUE_140_STATUS_A is shown in [Figure 16-1355](#) and described in [Table 16-1369](#).

Figure 16-1355. QUEUE_140_STATUS_A Register


LEGEND: R/W = Read/Write; R = Read only; W1toCl = Write 1 to clear bit; -n = value after reset

Table 16-1369. QUEUE_140_STATUS_A Register Field Descriptions

Bit	Field	Type	Reset	Description
13-0	QUEUE_ENTRY_COUNT	R-0	0	This field indicates how many packets are currently queued on the queue. Queue Manager Queue N Status Registers A

16.5.7.1080 QUEUE_140_STATUS_B Register (offset = 38C4h) [reset = 0h]

QUEUE_140_STATUS_B is shown in [Figure 16-1356](#) and described in [Table 16-1370](#).

Figure 16-1356. QUEUE_140_STATUS_B Register



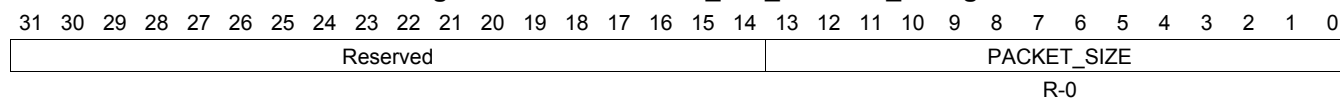
LEGEND: R/W = Read/Write; R = Read only; W1toCl = Write 1 to clear bit; -n = value after reset

Table 16-1370. QUEUE_140_STATUS_B Register Field Descriptions

Bit	Field	Type	Reset	Description
27-0	QUEUE_BYTE_COUNT	R-0	0	This field indicates how many bytes total are contained in all of the packets which are currently queued on this queue. Queue_Manager_Queue_n_Status_B Registers B

16.5.7.1081 QUEUE_140_STATUS_C Register (offset = 38C8h) [reset = 0h]

QUEUE_140_STATUS_C is shown in [Figure 16-1357](#) and described in [Table 16-1371](#).

Figure 16-1357. QUEUE_140_STATUS_C Register


LEGEND: R/W = Read/Write; R = Read only; W1toCl = Write 1 to clear bit; -n = value after reset

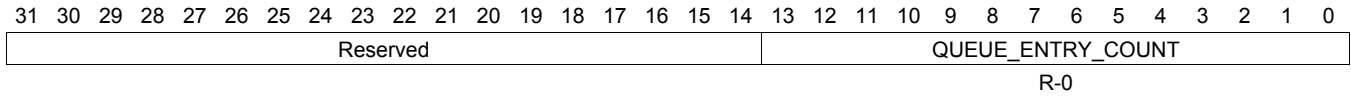
Table 16-1371. QUEUE_140_STATUS_C Register Field Descriptions

Bit	Field	Type	Reset	Description
13-0	PACKET_SIZE	R-0	0	This field indicates packet size of the head element of a queue. Queue_Manager_Queue_N_Status_C Registers C

16.5.7.1082 QUEUE_141_STATUS_A Register (offset = 38D0h) [reset = 0h]

QUEUE_141_STATUS_A is shown in [Figure 16-1358](#) and described in [Table 16-1372](#).

Figure 16-1358. QUEUE_141_STATUS_A Register



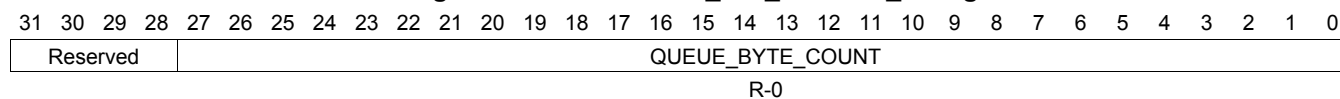
LEGEND: R/W = Read/Write; R = Read only; W1toCl = Write 1 to clear bit; -n = value after reset

Table 16-1372. QUEUE_141_STATUS_A Register Field Descriptions

Bit	Field	Type	Reset	Description
13-0	QUEUE_ENTRY_COUNT	R-0	0	This field indicates how many packets are currently queued on the queue. Queue Manager Queue N Status Registers A

16.5.7.1083 QUEUE_141_STATUS_B Register (offset = 38D4h) [reset = 0h]

QUEUE_141_STATUS_B is shown in [Figure 16-1359](#) and described in [Table 16-1373](#).

Figure 16-1359. QUEUE_141_STATUS_B Register


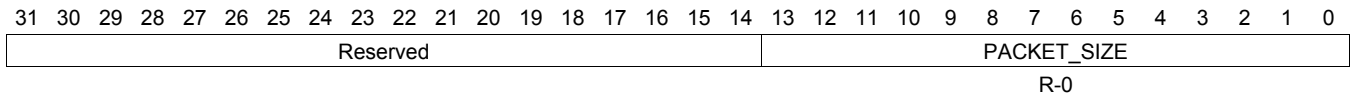
LEGEND: R/W = Read/Write; R = Read only; W1toCl = Write 1 to clear bit; -n = value after reset

Table 16-1373. QUEUE_141_STATUS_B Register Field Descriptions

Bit	Field	Type	Reset	Description
27-0	QUEUE_BYTE_COUNT	R-0	0	This field indicates how many bytes total are contained in all of the packets which are currently queued on this queue. Queue_Manager_Queue_n_Status_B Registers B

16.5.7.1084 QUEUE_141_STATUS_C Register (offset = 38D8h) [reset = 0h]

 QUEUE_141_STATUS_C is shown in [Figure 16-1360](#) and described in [Table 16-1374](#).

Figure 16-1360. QUEUE_141_STATUS_C Register


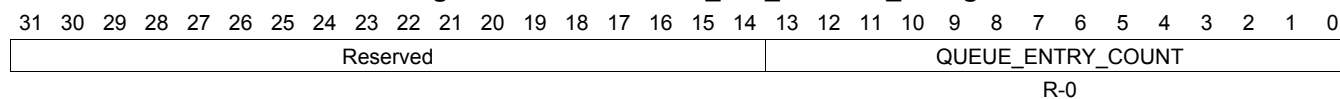
LEGEND: R/W = Read/Write; R = Read only; W1toCl = Write 1 to clear bit; -n = value after reset

Table 16-1374. QUEUE_141_STATUS_C Register Field Descriptions

Bit	Field	Type	Reset	Description
13-0	PACKET_SIZE	R-0	0	This field indicates packet size of the head element of a queue. Queue_Manager_Queue_N_Status_C Registers C

16.5.7.1085 QUEUE_142_STATUS_A Register (offset = 38E0h) [reset = 0h]

 QUEUE_142_STATUS_A is shown in [Figure 16-1361](#) and described in [Table 16-1375](#).

Figure 16-1361. QUEUE_142_STATUS_A Register


LEGEND: R/W = Read/Write; R = Read only; W1toCl = Write 1 to clear bit; -n = value after reset

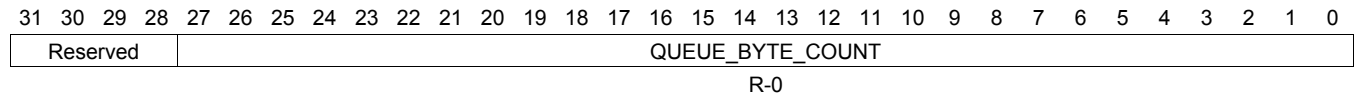
Table 16-1375. QUEUE_142_STATUS_A Register Field Descriptions

Bit	Field	Type	Reset	Description
13-0	QUEUE_ENTRY_COUNT	R-0	0	This field indicates how many packets are currently queued on the queue. Queue Manager Queue N Status Registers A

16.5.7.1086 QUEUE_142_STATUS_B Register (offset = 38E4h) [reset = 0h]

QUEUE_142_STATUS_B is shown in [Figure 16-1362](#) and described in [Table 16-1376](#).

Figure 16-1362. QUEUE_142_STATUS_B Register



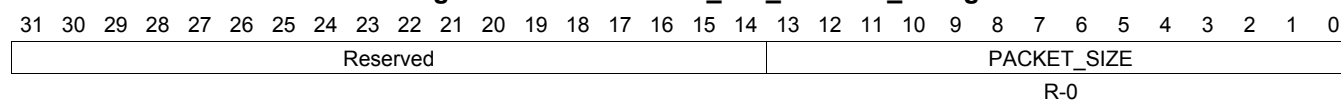
LEGEND: R/W = Read/Write; R = Read only; W1toCl = Write 1 to clear bit; -n = value after reset

Table 16-1376. QUEUE_142_STATUS_B Register Field Descriptions

Bit	Field	Type	Reset	Description
27-0	QUEUE_BYTE_COUNT	R-0	0	This field indicates how many bytes total are contained in all of the packets which are currently queued on this queue. Queue_Manager_Queue_n_Status_B Registers B

16.5.7.1087 QUEUE_142_STATUS_C Register (offset = 38E8h) [reset = 0h]

QUEUE_142_STATUS_C is shown in [Figure 16-1363](#) and described in [Table 16-1377](#).

Figure 16-1363. QUEUE_142_STATUS_C Register


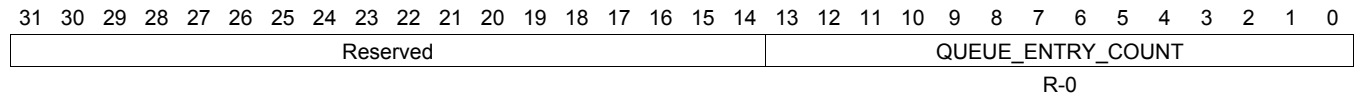
LEGEND: R/W = Read/Write; R = Read only; W1toCl = Write 1 to clear bit; -n = value after reset

Table 16-1377. QUEUE_142_STATUS_C Register Field Descriptions

Bit	Field	Type	Reset	Description
13-0	PACKET_SIZE	R-0	0	This field indicates packet size of the head element of a queue. Queue_Manager_Queue_N_Status_C Registers C

16.5.7.1088 QUEUE_143_STATUS_A Register (offset = 38F0h) [reset = 0h]

 QUEUE_143_STATUS_A is shown in [Figure 16-1364](#) and described in [Table 16-1378](#).

Figure 16-1364. QUEUE_143_STATUS_A Register


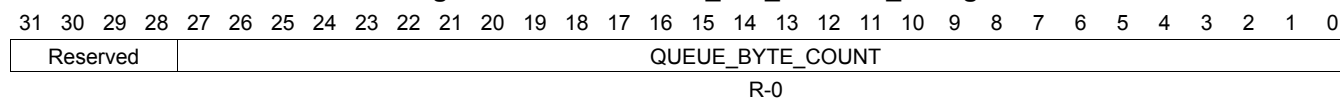
LEGEND: R/W = Read/Write; R = Read only; W1toCl = Write 1 to clear bit; -n = value after reset

Table 16-1378. QUEUE_143_STATUS_A Register Field Descriptions

Bit	Field	Type	Reset	Description
13-0	QUEUE_ENTRY_COUNT	R-0	0	This field indicates how many packets are currently queued on the queue. Queue Manager Queue N Status Registers A

16.5.7.1089 QUEUE_143_STATUS_B Register (offset = 38F4h) [reset = 0h]

QUEUE_143_STATUS_B is shown in [Figure 16-1365](#) and described in [Table 16-1379](#).

Figure 16-1365. QUEUE_143_STATUS_B Register


LEGEND: R/W = Read/Write; R = Read only; W1toCl = Write 1 to clear bit; -n = value after reset

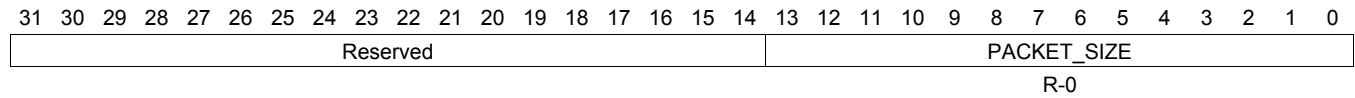
Table 16-1379. QUEUE_143_STATUS_B Register Field Descriptions

Bit	Field	Type	Reset	Description
27-0	QUEUE_BYTE_COUNT	R-0	0	This field indicates how many bytes total are contained in all of the packets which are currently queued on this queue. Queue_Manager_Queue_n_Status_B Registers B

16.5.7.1090 QUEUE_143_STATUS_C Register (offset = 38F8h) [reset = 0h]

QUEUE_143_STATUS_C is shown in [Figure 16-1366](#) and described in [Table 16-1380](#).

Figure 16-1366. QUEUE_143_STATUS_C Register



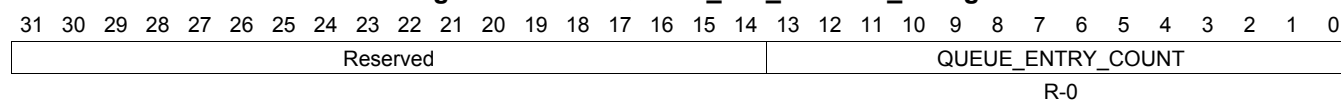
LEGEND: R/W = Read/Write; R = Read only; W1toCl = Write 1 to clear bit; -n = value after reset

Table 16-1380. QUEUE_143_STATUS_C Register Field Descriptions

Bit	Field	Type	Reset	Description
13-0	PACKET_SIZE	R-0	0	This field indicates packet size of the head element of a queue. Queue_Manager_Queue_N_Status_C Registers C

16.5.7.1091 QUEUE_144_STATUS_A Register (offset = 3900h) [reset = 0h]

QUEUE_144_STATUS_A is shown in [Figure 16-1367](#) and described in [Table 16-1381](#).

Figure 16-1367. QUEUE_144_STATUS_A Register


LEGEND: R/W = Read/Write; R = Read only; W1toCl = Write 1 to clear bit; -n = value after reset

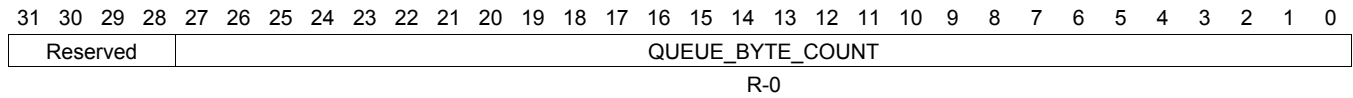
Table 16-1381. QUEUE_144_STATUS_A Register Field Descriptions

Bit	Field	Type	Reset	Description
13-0	QUEUE_ENTRY_COUNT	R-0	0	This field indicates how many packets are currently queued on the queue. Queue Manager Queue N Status Registers A

16.5.7.1092 QUEUE_144_STATUS_B Register (offset = 3904h) [reset = 0h]

QUEUE_144_STATUS_B is shown in [Figure 16-1368](#) and described in [Table 16-1382](#).

Figure 16-1368. QUEUE_144_STATUS_B Register



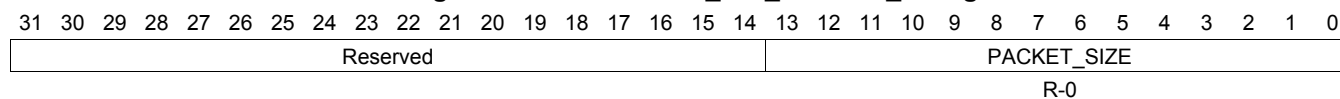
LEGEND: R/W = Read/Write; R = Read only; W1toCl = Write 1 to clear bit; -n = value after reset

Table 16-1382. QUEUE_144_STATUS_B Register Field Descriptions

Bit	Field	Type	Reset	Description
27-0	QUEUE_BYTE_COUNT	R-0	0	This field indicates how many bytes total are contained in all of the packets which are currently queued on this queue. Queue_Manager_Queue_n_Status_B Registers B

16.5.7.1093 QUEUE_144_STATUS_C Register (offset = 3908h) [reset = 0h]

QUEUE_144_STATUS_C is shown in [Figure 16-1369](#) and described in [Table 16-1383](#).

Figure 16-1369. QUEUE_144_STATUS_C Register


LEGEND: R/W = Read/Write; R = Read only; W1toCl = Write 1 to clear bit; -n = value after reset

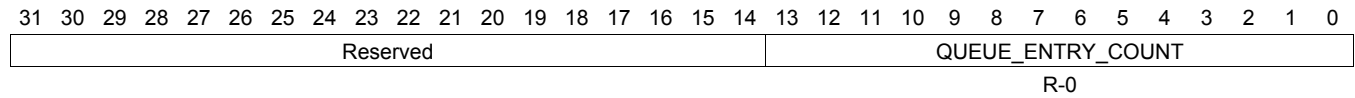
Table 16-1383. QUEUE_144_STATUS_C Register Field Descriptions

Bit	Field	Type	Reset	Description
13-0	PACKET_SIZE	R-0	0	This field indicates packet size of the head element of a queue. Queue_Manager_Queue_N_Status_C Registers C

16.5.7.1094 QUEUE_145_STATUS_A Register (offset = 3910h) [reset = 0h]

QUEUE_145_STATUS_A is shown in [Figure 16-1370](#) and described in [Table 16-1384](#).

Figure 16-1370. QUEUE_145_STATUS_A Register



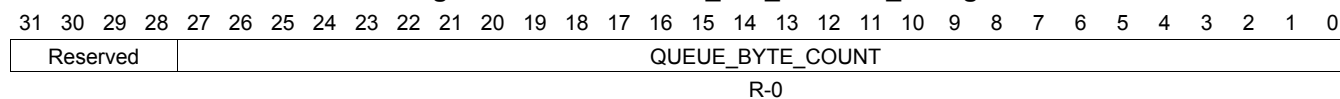
LEGEND: R/W = Read/Write; R = Read only; W1toCl = Write 1 to clear bit; -n = value after reset

Table 16-1384. QUEUE_145_STATUS_A Register Field Descriptions

Bit	Field	Type	Reset	Description
13-0	QUEUE_ENTRY_COUNT	R-0	0	This field indicates how many packets are currently queued on the queue. Queue Manager Queue N Status Registers A

16.5.7.1095 QUEUE_145_STATUS_B Register (offset = 3914h) [reset = 0h]

QUEUE_145_STATUS_B is shown in [Figure 16-1371](#) and described in [Table 16-1385](#).

Figure 16-1371. QUEUE_145_STATUS_B Register


LEGEND: R/W = Read/Write; R = Read only; W1toCl = Write 1 to clear bit; -n = value after reset

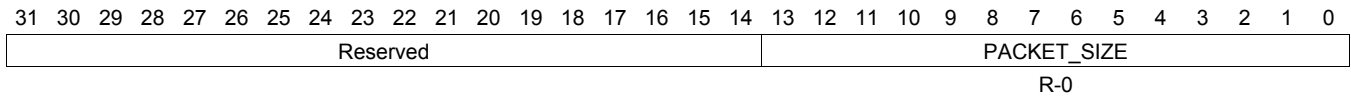
Table 16-1385. QUEUE_145_STATUS_B Register Field Descriptions

Bit	Field	Type	Reset	Description
27-0	QUEUE_BYTE_COUNT	R-0	0	This field indicates how many bytes total are contained in all of the packets which are currently queued on this queue. Queue_Manager_Queue_n_Status_B Registers B

16.5.7.1096 QUEUE_145_STATUS_C Register (offset = 3918h) [reset = 0h]

QUEUE_145_STATUS_C is shown in [Figure 16-1372](#) and described in [Table 16-1386](#).

Figure 16-1372. QUEUE_145_STATUS_C Register



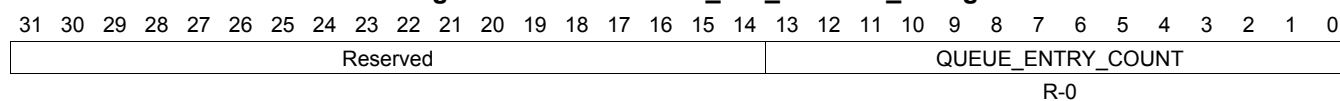
LEGEND: R/W = Read/Write; R = Read only; W1toCl = Write 1 to clear bit; -n = value after reset

Table 16-1386. QUEUE_145_STATUS_C Register Field Descriptions

Bit	Field	Type	Reset	Description
13-0	PACKET_SIZE	R-0	0	This field indicates packet size of the head element of a queue. Queue_Manager_Queue_N_Status_C Registers C

16.5.7.1097 QUEUE_146_STATUS_A Register (offset = 3920h) [reset = 0h]

QUEUE_146_STATUS_A is shown in [Figure 16-1373](#) and described in [Table 16-1387](#).

Figure 16-1373. QUEUE_146_STATUS_A Register


LEGEND: R/W = Read/Write; R = Read only; W1toCl = Write 1 to clear bit; -n = value after reset

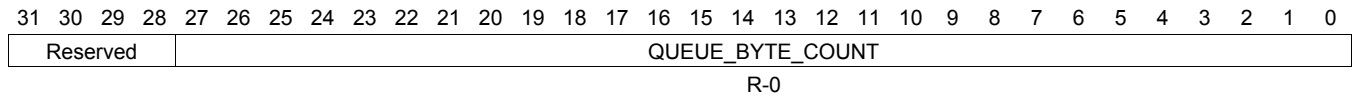
Table 16-1387. QUEUE_146_STATUS_A Register Field Descriptions

Bit	Field	Type	Reset	Description
13-0	QUEUE_ENTRY_COUNT	R-0	0	This field indicates how many packets are currently queued on the queue. Queue Manager Queue N Status Registers A

16.5.7.1098 QUEUE_146_STATUS_B Register (offset = 3924h) [reset = 0h]

QUEUE_146_STATUS_B is shown in [Figure 16-1374](#) and described in [Table 16-1388](#).

Figure 16-1374. QUEUE_146_STATUS_B Register



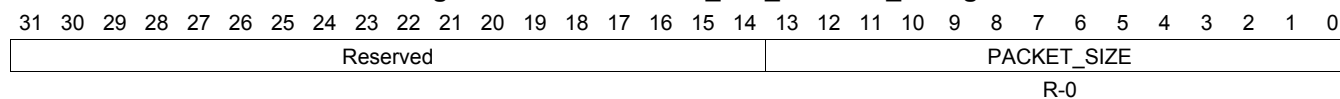
LEGEND: R/W = Read/Write; R = Read only; W1toCl = Write 1 to clear bit; -n = value after reset

Table 16-1388. QUEUE_146_STATUS_B Register Field Descriptions

Bit	Field	Type	Reset	Description
27-0	QUEUE_BYTE_COUNT	R-0	0	This field indicates how many bytes total are contained in all of the packets which are currently queued on this queue. Queue_Manager_Queue_n_Status_B Registers B

16.5.7.1099 QUEUE_146_STATUS_C Register (offset = 3928h) [reset = 0h]

QUEUE_146_STATUS_C is shown in [Figure 16-1375](#) and described in [Table 16-1389](#).

Figure 16-1375. QUEUE_146_STATUS_C Register


LEGEND: R/W = Read/Write; R = Read only; W1toCl = Write 1 to clear bit; -n = value after reset

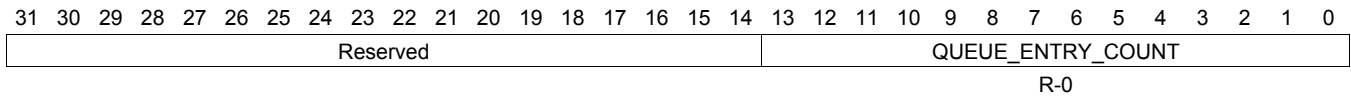
Table 16-1389. QUEUE_146_STATUS_C Register Field Descriptions

Bit	Field	Type	Reset	Description
13-0	PACKET_SIZE	R-0	0	This field indicates packet size of the head element of a queue. Queue_Manager_Queue_N_Status_C Registers C

16.5.7.1100 QUEUE_147_STATUS_A Register (offset = 3930h) [reset = 0h]

QUEUE_147_STATUS_A is shown in [Figure 16-1376](#) and described in [Table 16-1390](#).

Figure 16-1376. QUEUE_147_STATUS_A Register



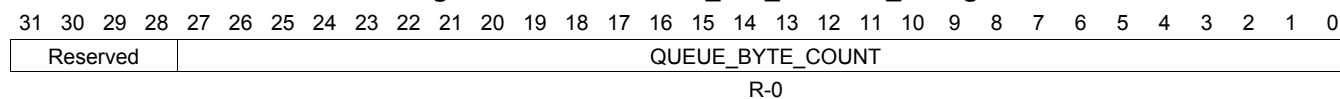
LEGEND: R/W = Read/Write; R = Read only; W1toCl = Write 1 to clear bit; -n = value after reset

Table 16-1390. QUEUE_147_STATUS_A Register Field Descriptions

Bit	Field	Type	Reset	Description
13-0	QUEUE_ENTRY_COUNT	R-0	0	This field indicates how many packets are currently queued on the queue. Queue Manager Queue N Status Registers A

16.5.7.1101 QUEUE_147_STATUS_B Register (offset = 3934h) [reset = 0h]

QUEUE_147_STATUS_B is shown in [Figure 16-1377](#) and described in [Table 16-1391](#).

Figure 16-1377. QUEUE_147_STATUS_B Register


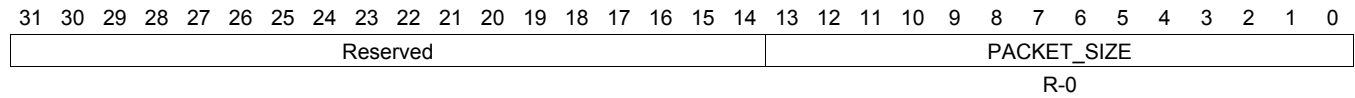
LEGEND: R/W = Read/Write; R = Read only; W1toCl = Write 1 to clear bit; -n = value after reset

Table 16-1391. QUEUE_147_STATUS_B Register Field Descriptions

Bit	Field	Type	Reset	Description
27-0	QUEUE_BYTE_COUNT	R-0	0	This field indicates how many bytes total are contained in all of the packets which are currently queued on this queue. Queue_Manager_Queue_n_Status_B Registers B

16.5.7.1102 QUEUE_147_STATUS_C Register (offset = 3938h) [reset = 0h]

QUEUE_147_STATUS_C is shown in [Figure 16-1378](#) and described in [Table 16-1392](#).

Figure 16-1378. QUEUE_147_STATUS_C Register


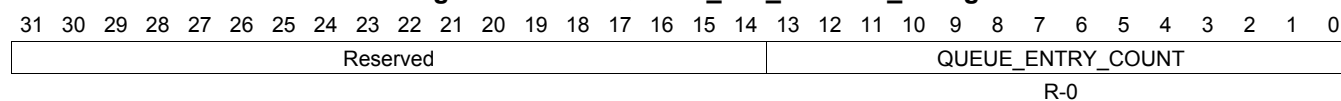
LEGEND: R/W = Read/Write; R = Read only; W1toCl = Write 1 to clear bit; -n = value after reset

Table 16-1392. QUEUE_147_STATUS_C Register Field Descriptions

Bit	Field	Type	Reset	Description
13-0	PACKET_SIZE	R-0	0	This field indicates packet size of the head element of a queue. Queue_Manager_Queue_N_Status_C Registers C

16.5.7.1103 QUEUE_148_STATUS_A Register (offset = 3940h) [reset = 0h]

QUEUE_148_STATUS_A is shown in [Figure 16-1379](#) and described in [Table 16-1393](#).

Figure 16-1379. QUEUE_148_STATUS_A Register


LEGEND: R/W = Read/Write; R = Read only; W1toCl = Write 1 to clear bit; -n = value after reset

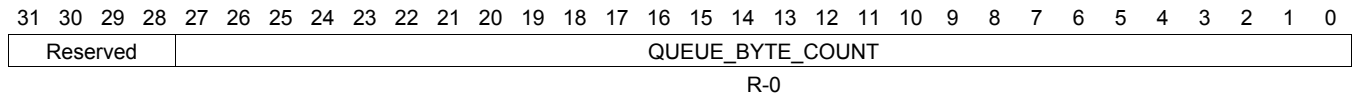
Table 16-1393. QUEUE_148_STATUS_A Register Field Descriptions

Bit	Field	Type	Reset	Description
13-0	QUEUE_ENTRY_COUNT	R-0	0	This field indicates how many packets are currently queued on the queue. Queue Manager Queue N Status Registers A

16.5.7.1104 QUEUE_148_STATUS_B Register (offset = 3944h) [reset = 0h]

QUEUE_148_STATUS_B is shown in [Figure 16-1380](#) and described in [Table 16-1394](#).

Figure 16-1380. QUEUE_148_STATUS_B Register



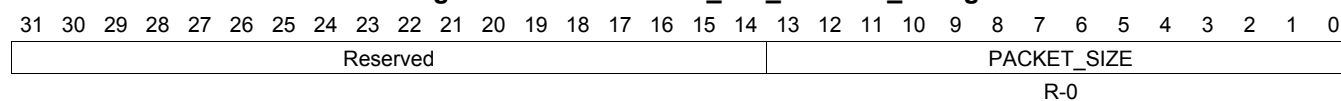
LEGEND: R/W = Read/Write; R = Read only; W1toCl = Write 1 to clear bit; -n = value after reset

Table 16-1394. QUEUE_148_STATUS_B Register Field Descriptions

Bit	Field	Type	Reset	Description
27-0	QUEUE_BYTE_COUNT	R-0	0	This field indicates how many bytes total are contained in all of the packets which are currently queued on this queue. Queue_Manager_Queue_n_Status_B Registers B

16.5.7.1105 QUEUE_148_STATUS_C Register (offset = 3948h) [reset = 0h]

QUEUE_148_STATUS_C is shown in [Figure 16-1381](#) and described in [Table 16-1395](#).

Figure 16-1381. QUEUE_148_STATUS_C Register


LEGEND: R/W = Read/Write; R = Read only; W1toCl = Write 1 to clear bit; -n = value after reset

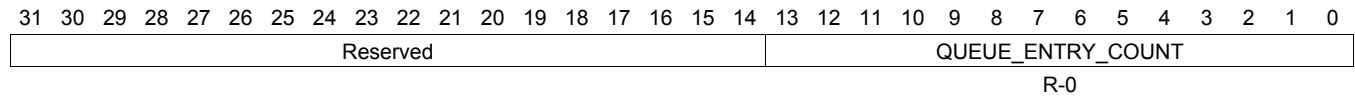
Table 16-1395. QUEUE_148_STATUS_C Register Field Descriptions

Bit	Field	Type	Reset	Description
13-0	PACKET_SIZE	R-0	0	This field indicates packet size of the head element of a queue. Queue_Manager_Queue_N_Status_C Registers C

16.5.7.1106 QUEUE_149_STATUS_A Register (offset = 3950h) [reset = 0h]

QUEUE_149_STATUS_A is shown in [Figure 16-1382](#) and described in [Table 16-1396](#).

Figure 16-1382. QUEUE_149_STATUS_A Register



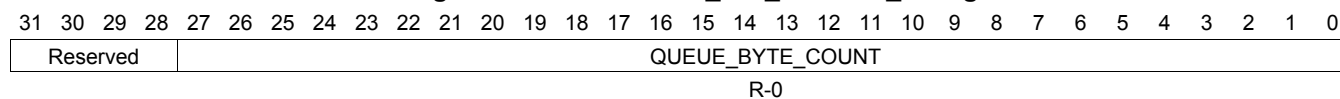
LEGEND: R/W = Read/Write; R = Read only; W1toCl = Write 1 to clear bit; -n = value after reset

Table 16-1396. QUEUE_149_STATUS_A Register Field Descriptions

Bit	Field	Type	Reset	Description
13-0	QUEUE_ENTRY_COUNT	R-0	0	This field indicates how many packets are currently queued on the queue. Queue Manager Queue N Status Registers A

16.5.7.1107 QUEUE_149_STATUS_B Register (offset = 3954h) [reset = 0h]

QUEUE_149_STATUS_B is shown in [Figure 16-1383](#) and described in [Table 16-1397](#).

Figure 16-1383. QUEUE_149_STATUS_B Register


LEGEND: R/W = Read/Write; R = Read only; W1toCl = Write 1 to clear bit; -n = value after reset

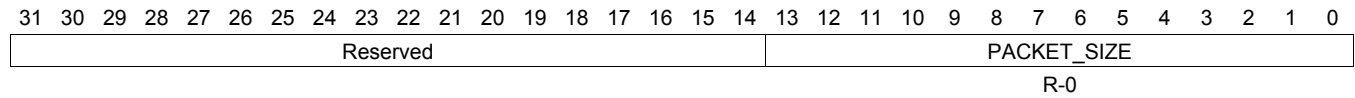
Table 16-1397. QUEUE_149_STATUS_B Register Field Descriptions

Bit	Field	Type	Reset	Description
27-0	QUEUE_BYTE_COUNT	R-0	0	This field indicates how many bytes total are contained in all of the packets which are currently queued on this queue. Queue_Manager_Queue_n_Status_B Registers B

16.5.7.1108 QUEUE_149_STATUS_C Register (offset = 3958h) [reset = 0h]

QUEUE_149_STATUS_C is shown in [Figure 16-1384](#) and described in [Table 16-1398](#).

Figure 16-1384. QUEUE_149_STATUS_C Register



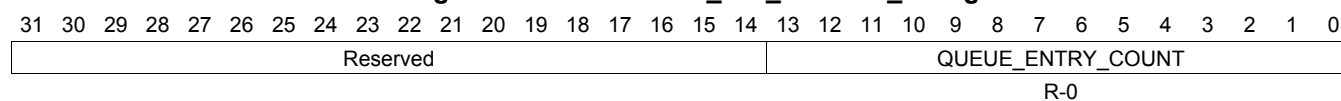
LEGEND: R/W = Read/Write; R = Read only; W1toCl = Write 1 to clear bit; -n = value after reset

Table 16-1398. QUEUE_149_STATUS_C Register Field Descriptions

Bit	Field	Type	Reset	Description
13-0	PACKET_SIZE	R-0	0	This field indicates packet size of the head element of a queue. Queue_Manager_Queue_N_Status_C Registers C

16.5.7.1109 QUEUE_150_STATUS_A Register (offset = 3960h) [reset = 0h]

QUEUE_150_STATUS_A is shown in [Figure 16-1385](#) and described in [Table 16-1399](#).

Figure 16-1385. QUEUE_150_STATUS_A Register


LEGEND: R/W = Read/Write; R = Read only; W1toCl = Write 1 to clear bit; -n = value after reset

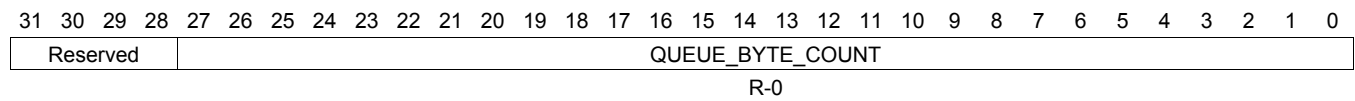
Table 16-1399. QUEUE_150_STATUS_A Register Field Descriptions

Bit	Field	Type	Reset	Description
13-0	QUEUE_ENTRY_COUNT	R-0	0	This field indicates how many packets are currently queued on the queue. Queue Manager Queue N Status Registers A

16.5.7.1110 QUEUE_150_STATUS_B Register (offset = 3964h) [reset = 0h]

QUEUE_150_STATUS_B is shown in [Figure 16-1386](#) and described in [Table 16-1400](#).

Figure 16-1386. QUEUE_150_STATUS_B Register



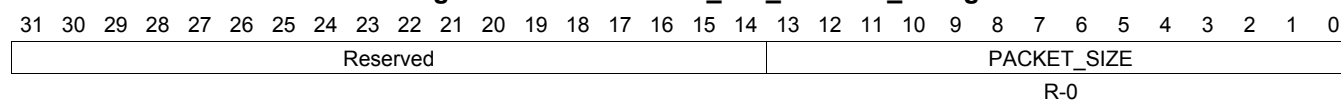
LEGEND: R/W = Read/Write; R = Read only; W1toCl = Write 1 to clear bit; -n = value after reset

Table 16-1400. QUEUE_150_STATUS_B Register Field Descriptions

Bit	Field	Type	Reset	Description
27-0	QUEUE_BYTE_COUNT	R-0	0	This field indicates how many bytes total are contained in all of the packets which are currently queued on this queue. Queue_Manager_Queue_n_Status_B Registers B

16.5.7.1111 QUEUE_150_STATUS_C Register (offset = 3968h) [reset = 0h]

QUEUE_150_STATUS_C is shown in [Figure 16-1387](#) and described in [Table 16-1401](#).

Figure 16-1387. QUEUE_150_STATUS_C Register


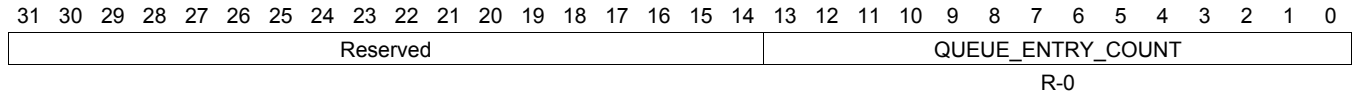
LEGEND: R/W = Read/Write; R = Read only; W1toCl = Write 1 to clear bit; -n = value after reset

Table 16-1401. QUEUE_150_STATUS_C Register Field Descriptions

Bit	Field	Type	Reset	Description
13-0	PACKET_SIZE	R-0	0	This field indicates packet size of the head element of a queue. Queue_Manager_Queue_N_Status_C Registers C

16.5.7.1112 QUEUE_151_STATUS_A Register (offset = 3970h) [reset = 0h]

 QUEUE_151_STATUS_A is shown in [Figure 16-1388](#) and described in [Table 16-1402](#).

Figure 16-1388. QUEUE_151_STATUS_A Register


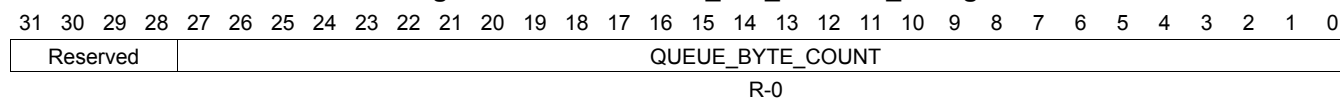
LEGEND: R/W = Read/Write; R = Read only; W1toCl = Write 1 to clear bit; -n = value after reset

Table 16-1402. QUEUE_151_STATUS_A Register Field Descriptions

Bit	Field	Type	Reset	Description
13-0	QUEUE_ENTRY_COUNT	R-0	0	This field indicates how many packets are currently queued on the queue. Queue Manager Queue N Status Registers A

16.5.7.1113 QUEUE_151_STATUS_B Register (offset = 3974h) [reset = 0h]

QUEUE_151_STATUS_B is shown in [Figure 16-1389](#) and described in [Table 16-1403](#).

Figure 16-1389. QUEUE_151_STATUS_B Register


LEGEND: R/W = Read/Write; R = Read only; W1toCl = Write 1 to clear bit; -n = value after reset

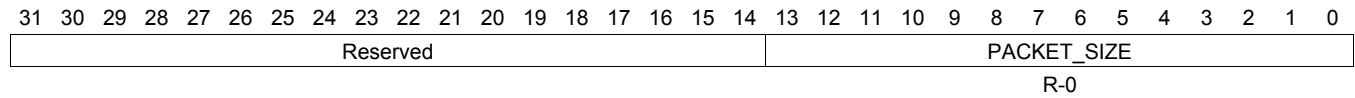
Table 16-1403. QUEUE_151_STATUS_B Register Field Descriptions

Bit	Field	Type	Reset	Description
27-0	QUEUE_BYTE_COUNT	R-0	0	This field indicates how many bytes total are contained in all of the packets which are currently queued on this queue. Queue_Manager_Queue_n_Status_B Registers B

16.5.7.1114 QUEUE_151_STATUS_C Register (offset = 3978h) [reset = 0h]

QUEUE_151_STATUS_C is shown in [Figure 16-1390](#) and described in [Table 16-1404](#).

Figure 16-1390. QUEUE_151_STATUS_C Register



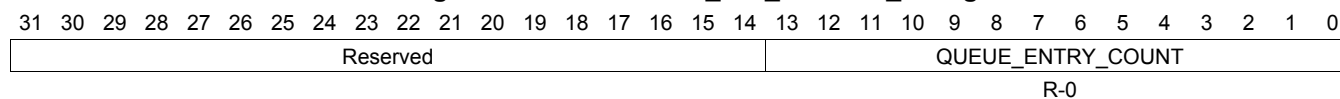
LEGEND: R/W = Read/Write; R = Read only; W1toCl = Write 1 to clear bit; -n = value after reset

Table 16-1404. QUEUE_151_STATUS_C Register Field Descriptions

Bit	Field	Type	Reset	Description
13-0	PACKET_SIZE	R-0	0	This field indicates packet size of the head element of a queue. Queue_Manager_Queue_N_Status_C Registers C

16.5.7.1115 QUEUE_152_STATUS_A Register (offset = 3980h) [reset = 0h]

QUEUE_152_STATUS_A is shown in [Figure 16-1391](#) and described in [Table 16-1405](#).

Figure 16-1391. QUEUE_152_STATUS_A Register


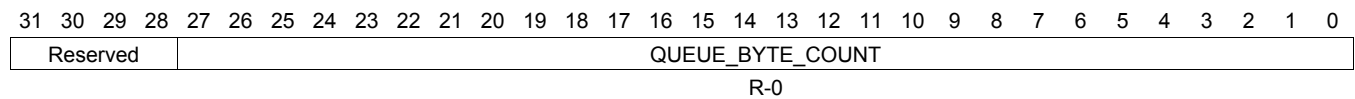
LEGEND: R/W = Read/Write; R = Read only; W1toCl = Write 1 to clear bit; -n = value after reset

Table 16-1405. QUEUE_152_STATUS_A Register Field Descriptions

Bit	Field	Type	Reset	Description
13-0	QUEUE_ENTRY_COUNT	R-0	0	This field indicates how many packets are currently queued on the queue. Queue Manager Queue N Status Registers A

16.5.7.1116 QUEUE_152_STATUS_B Register (offset = 3984h) [reset = 0h]

QUEUE_152_STATUS_B is shown in [Figure 16-1392](#) and described in [Table 16-1406](#).

Figure 16-1392. QUEUE_152_STATUS_B Register


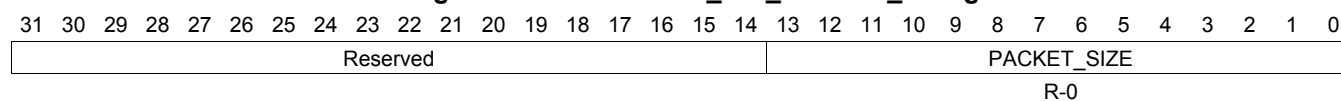
LEGEND: R/W = Read/Write; R = Read only; W1toCl = Write 1 to clear bit; -n = value after reset

Table 16-1406. QUEUE_152_STATUS_B Register Field Descriptions

Bit	Field	Type	Reset	Description
27-0	QUEUE_BYTE_COUNT	R-0	0	This field indicates how many bytes total are contained in all of the packets which are currently queued on this queue. Queue_Manager_Queue_n_Status_B Registers B

16.5.7.1117 QUEUE_152_STATUS_C Register (offset = 3988h) [reset = 0h]

QUEUE_152_STATUS_C is shown in [Figure 16-1393](#) and described in [Table 16-1407](#).

Figure 16-1393. QUEUE_152_STATUS_C Register


LEGEND: R/W = Read/Write; R = Read only; W1toCl = Write 1 to clear bit; -n = value after reset

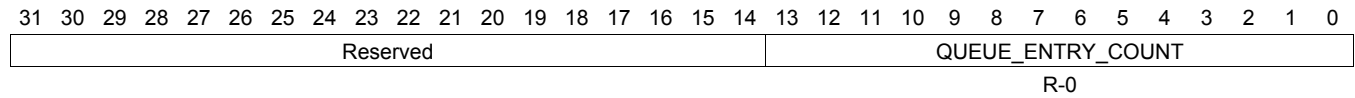
Table 16-1407. QUEUE_152_STATUS_C Register Field Descriptions

Bit	Field	Type	Reset	Description
13-0	PACKET_SIZE	R-0	0	This field indicates packet size of the head element of a queue. Queue_Manager_Queue_N_Status_C Registers C

16.5.7.1118 QUEUE_153_STATUS_A Register (offset = 3990h) [reset = 0h]

QUEUE_153_STATUS_A is shown in [Figure 16-1394](#) and described in [Table 16-1408](#).

Figure 16-1394. QUEUE_153_STATUS_A Register



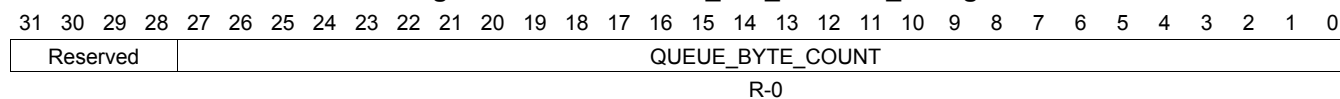
LEGEND: R/W = Read/Write; R = Read only; W1toCl = Write 1 to clear bit; -n = value after reset

Table 16-1408. QUEUE_153_STATUS_A Register Field Descriptions

Bit	Field	Type	Reset	Description
13-0	QUEUE_ENTRY_COUNT	R-0	0	This field indicates how many packets are currently queued on the queue. Queue Manager Queue N Status Registers A

16.5.7.1119 QUEUE_153_STATUS_B Register (offset = 3994h) [reset = 0h]

QUEUE_153_STATUS_B is shown in [Figure 16-1395](#) and described in [Table 16-1409](#).

Figure 16-1395. QUEUE_153_STATUS_B Register


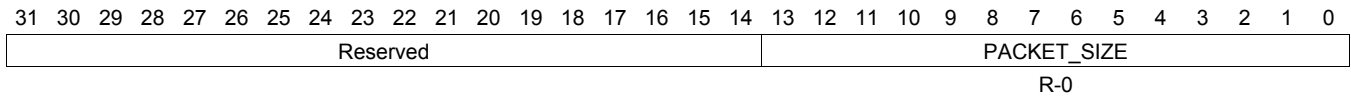
LEGEND: R/W = Read/Write; R = Read only; W1toCl = Write 1 to clear bit; -n = value after reset

Table 16-1409. QUEUE_153_STATUS_B Register Field Descriptions

Bit	Field	Type	Reset	Description
27-0	QUEUE_BYTE_COUNT	R-0	0	This field indicates how many bytes total are contained in all of the packets which are currently queued on this queue. Queue_Manager_Queue_n_Status_B Registers B

16.5.7.1120 QUEUE_153_STATUS_C Register (offset = 3998h) [reset = 0h]

 QUEUE_153_STATUS_C is shown in [Figure 16-1396](#) and described in [Table 16-1410](#).

Figure 16-1396. QUEUE_153_STATUS_C Register


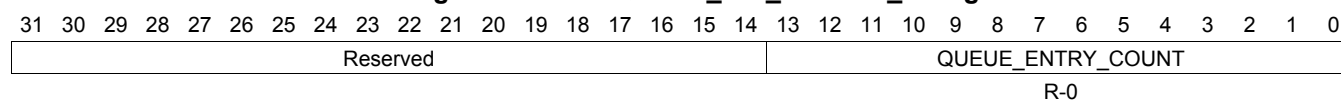
LEGEND: R/W = Read/Write; R = Read only; W1toCl = Write 1 to clear bit; -n = value after reset

Table 16-1410. QUEUE_153_STATUS_C Register Field Descriptions

Bit	Field	Type	Reset	Description
13-0	PACKET_SIZE	R-0	0	This field indicates packet size of the head element of a queue. Queue_Manager_Queue_N_Status_C Registers C

16.5.7.1121 QUEUE_154_STATUS_A Register (offset = 39A0h) [reset = 0h]

QUEUE_154_STATUS_A is shown in [Figure 16-1397](#) and described in [Table 16-1411](#).

Figure 16-1397. QUEUE_154_STATUS_A Register


LEGEND: R/W = Read/Write; R = Read only; W1toCl = Write 1 to clear bit; -n = value after reset

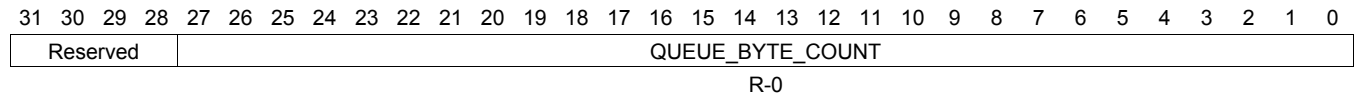
Table 16-1411. QUEUE_154_STATUS_A Register Field Descriptions

Bit	Field	Type	Reset	Description
13-0	QUEUE_ENTRY_COUNT	R-0	0	This field indicates how many packets are currently queued on the queue. Queue Manager Queue N Status Registers A

16.5.7.1122 QUEUE_154_STATUS_B Register (offset = 39A4h) [reset = 0h]

QUEUE_154_STATUS_B is shown in [Figure 16-1398](#) and described in [Table 16-1412](#).

Figure 16-1398. QUEUE_154_STATUS_B Register



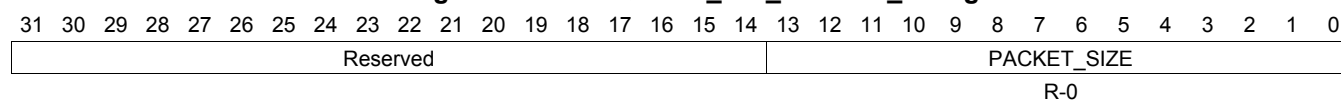
LEGEND: R/W = Read/Write; R = Read only; W1toCl = Write 1 to clear bit; -n = value after reset

Table 16-1412. QUEUE_154_STATUS_B Register Field Descriptions

Bit	Field	Type	Reset	Description
27-0	QUEUE_BYTE_COUNT	R-0	0	This field indicates how many bytes total are contained in all of the packets which are currently queued on this queue. Queue_Manager_Queue_n_Status_B Registers B

16.5.7.1123 QUEUE_154_STATUS_C Register (offset = 39A8h) [reset = 0h]

QUEUE_154_STATUS_C is shown in [Figure 16-1399](#) and described in [Table 16-1413](#).

Figure 16-1399. QUEUE_154_STATUS_C Register


LEGEND: R/W = Read/Write; R = Read only; W1toCl = Write 1 to clear bit; -n = value after reset

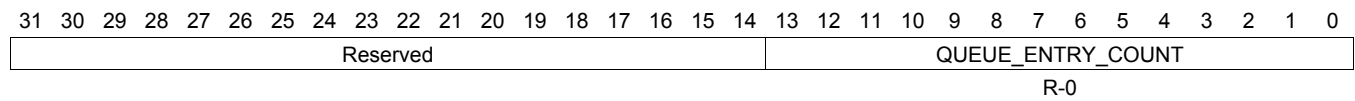
Table 16-1413. QUEUE_154_STATUS_C Register Field Descriptions

Bit	Field	Type	Reset	Description
13-0	PACKET_SIZE	R-0	0	This field indicates packet size of the head element of a queue. Queue_Manager_Queue_N_Status_C Registers C

16.5.7.1124 QUEUE_155_STATUS_A Register (offset = 39B0h) [reset = 0h]

QUEUE_155_STATUS_A is shown in [Figure 16-1400](#) and described in [Table 16-1414](#).

Figure 16-1400. QUEUE_155_STATUS_A Register



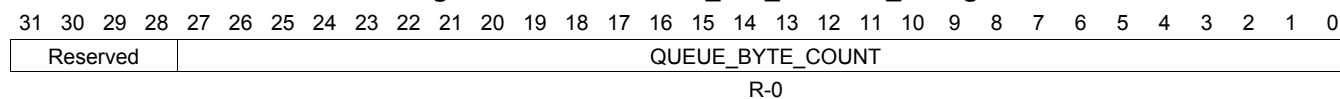
LEGEND: R/W = Read/Write; R = Read only; W1toCl = Write 1 to clear bit; -n = value after reset

Table 16-1414. QUEUE_155_STATUS_A Register Field Descriptions

Bit	Field	Type	Reset	Description
13-0	QUEUE_ENTRY_COUNT	R-0	0	This field indicates how many packets are currently queued on the queue. Queue Manager Queue N Status Registers A

16.5.7.1125 QUEUE_155_STATUS_B Register (offset = 39B4h) [reset = 0h]

QUEUE_155_STATUS_B is shown in [Figure 16-1401](#) and described in [Table 16-1415](#).

Figure 16-1401. QUEUE_155_STATUS_B Register


LEGEND: R/W = Read/Write; R = Read only; W1toCl = Write 1 to clear bit; -n = value after reset

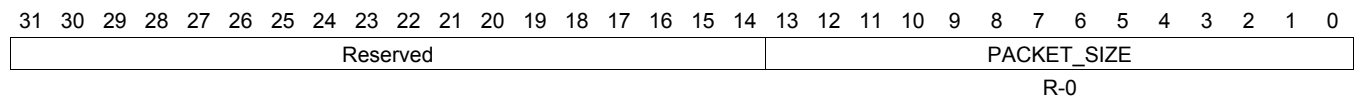
Table 16-1415. QUEUE_155_STATUS_B Register Field Descriptions

Bit	Field	Type	Reset	Description
27-0	QUEUE_BYTE_COUNT	R-0	0	This field indicates how many bytes total are contained in all of the packets which are currently queued on this queue. Queue_Manager_Queue_n_Status_B Registers B

16.5.7.1126 QUEUE_155_STATUS_C Register (offset = 39B8h) [reset = 0h]

QUEUE_155_STATUS_C is shown in [Figure 16-1402](#) and described in [Table 16-1416](#).

Figure 16-1402. QUEUE_155_STATUS_C Register



LEGEND: R/W = Read/Write; R = Read only; W1toCl = Write 1 to clear bit; -n = value after reset

Table 16-1416. QUEUE_155_STATUS_C Register Field Descriptions

Bit	Field	Type	Reset	Description
13-0	PACKET_SIZE	R-0	0	This field indicates packet size of the head element of a queue. Queue_Manager_Queue_N_Status_C Registers C

Interprocessor Communication

This chapter describes the interprocessor communication of the device.

Topic	Page
17.1 Mailbox	3997
17.2 Spinlock	4067

17.1 Mailbox

17.1.1 Introduction

17.1.1.1 Features

Global features of the Mailbox module are:

- OCP slave interface (L4) supports:
 - 32-bit data bus width
 - 8/16/32 bit access supported
 - 9-bit address bus width
 - Burst not supported
- 8 mailbox sub-modules
- Each mailbox sub module allows 1-way communication between 2 initiators
- Flexible mailbox/initiators assignment scheme
- 4 messages per mailbox sub-module
- 32-bit message width
- Support of 16/32-bit addressing scheme
- Non-intrusive emulation
- 4 interrupts (one per user: 1 to MPU Subsystem, 2 to PRU-ICSS, and 1 to WakeM3)

17.1.1.2 Unsupported Features

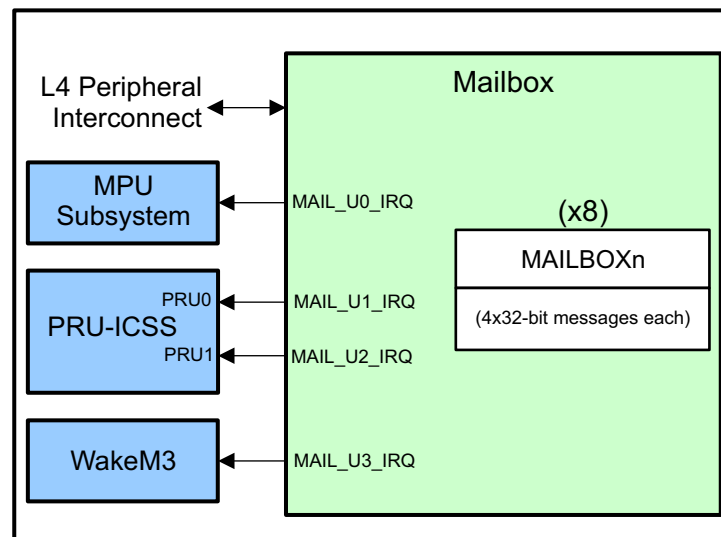
There are no unsupported features for Mailbox on this device.

17.1.2 Integration

This device contains a single instantiation of the Mailbox module at the system level. The mailbox function is made of eight sub-module mailboxes each supporting a 1-way communication between two initiators. The communication protocol from the sender to the receiver is implemented with mailbox registers using interrupts. The sender sends information to the receiver by writing to the mailbox. Interrupt signaling is used to notify the receiver a message has been queued or the sender for overflow situation.

The eight mailboxes are enough to handle communications between the MPU Subsystem, PRU-ICSS PRUs, and WakeM3. Note that because the WakeM3 has access only to L4_Wakeup peripherals it does not have access to the Mailbox registers. A mailbox interrupt can still be sent to the M3 to trigger message notification. The actual message payload must be placed in either M3 internal memory or in the Control Module Interprocessor Message registers (IPC_MSG_REG{0-7}).

Figure 17-1. Mailbox Integration



17.1.2.1 Mailbox Connectivity Attributes

The general connectivity for the Mailbox is shown in [Table 17-1](#).

Table 17-1. Mailbox Connectivity Attributes

Attributes	Type
Power Domain	Peripheral Domain
Clock Domain	L4PER_L4LS_GCLK
Reset Signals	PER_DOM_RST_N
Idle/Wakeup Signals	Smart Idle
Interrupt Requests	4 Interrupts mail_u0 (MBINT0) – to MPU Subsystem mail_u1 – to PRU-ICSS (PRU0) mail_u2 – to PRU-ICSS (PRU1) mail_u3 – to WakeM3
DMA Requests	None
Physical Address	L4 Peripheral slave port

17.1.2.2 Mailbox Clock and Reset Management

The mailbox function operates from the L4 interface clock.

Table 17-2. Mailbox Clock Signals

Clock Signal	Max Freq	Reference / Source	Comments
Functional / Interface clock	100 MHz	CORE_CLKOUTM4 / 2	pd_per_l4ls_gclk From PRCM

17.1.2.3 Mailbox Pin List

The Mailbox module does not include any external interface pins.

17.1.3 Functional Description

This device has the following mailbox instances:

- System mailbox

[Table 17-3](#) shows Mailbox Implementation in this device, where u is the user number and m is the mailbox number.

Table 17-3. Mailbox Implementation

Mailbox Type	User Number(u)	Mailbox Number(m)	Messages per Mailbox
System mailbox	0 to 3	0 to 7	4

The mailbox module provides a means of communication through message queues among the users (depending on the mailbox module instance). The individual mailbox modules (8 for the system mailbox instance), or FIFOs, can associate (or de-associate) with any of the processors using the MAILBOX_IRQENABLE_SET_u (or MAILBOX_IRQENABLE_CLR_u) register.

The system mailbox module includes the following user subsystems:

- User 0: MPU Subsystem (u = 0)
- User 1: PRU_ICSS PRU0 (u = 1)
- User 2: PRU_ICSS PRU1 (u = 2)
- User 3: WakeM3 (u = 3)

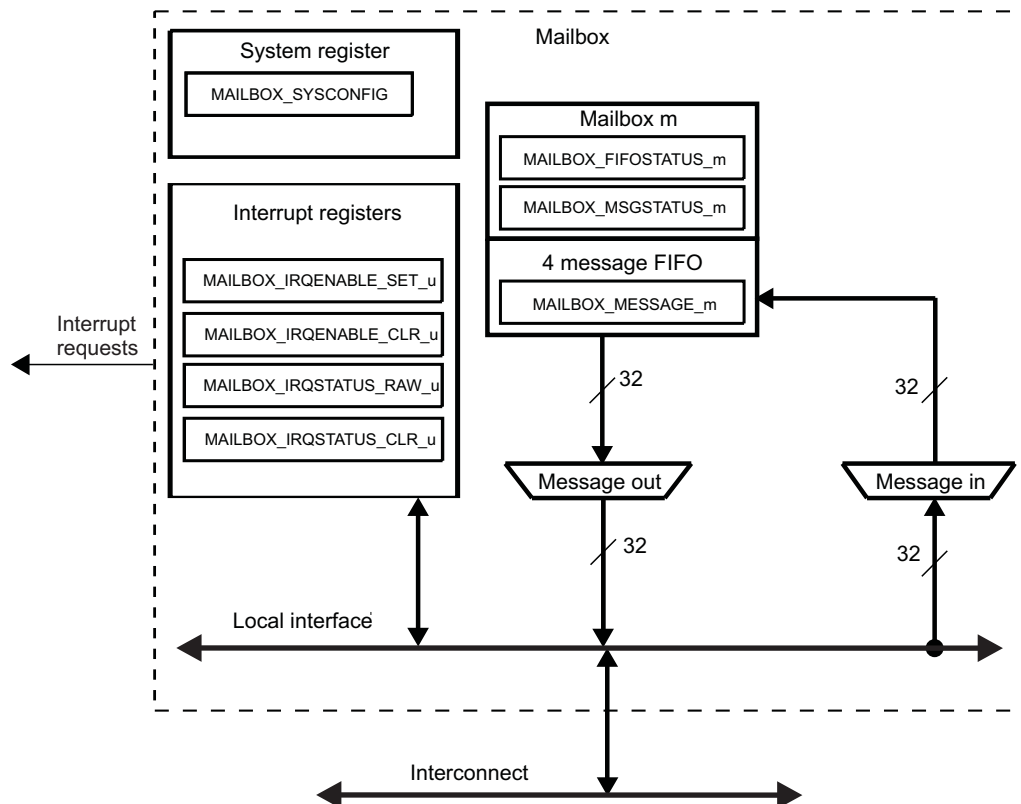
Each user has a dedicated interrupt signal from the corresponding mailbox module instance and dedicated interrupt enabling and status registers. Each MAILBOX_IRQSTATUS_RAW_u/MAILBOX_IRQSTATUS_CLR_u interrupt status register corresponds to a particular user.

For the system mailbox instance, a user can query its interrupt status register through the L4_STANDARD interconnect.

17.1.3.1 Mailbox Block Diagram

Figure 17-2 shows the mailbox block diagram.

Figure 17-2. Mailbox Block Diagram



17.1.3.2 Software Reset

The mailbox module supports a software reset through the MAILBOX_SYSCONFIG[0].SOFTRESET bit. Setting this bit to 1 enables an active software reset that is functionally equivalent to a hardware reset. Reading the MAILBOX_SYSCONFIG[0] SOFTRESET bit gives the status of the software reset:

- Read 1: the software reset is on-going
- Read 0: the software reset is complete

The software must ensure that the software reset completes before doing mailbox operations.

17.1.3.3 Power Management

Table 17-4 describes power-management features available for the mailbox module.

Table 17-4. Local Power Management Features

Feature	Registers	Description
Clock autogating	NA	Feature not available
Slave idle modes	MAILBOX_SYSCONFIG[3:2].SIDLEMODE	Force-idle, no-idle and smart-idle modes are available
Clock activity	NA	Feature not available
Master standby modes	NA	Feature not available
Global wake-up enable	NA	Feature not available
Wake-up sources enable	NA	Feature not available

The mailbox module can be configured using the MAILBOX_SYSCONFIG[3:2] SIDLEMODE bit field to one of the following acknowledgment modes:

- Force-idle mode (SIDLEMODE = 0x0): The mailbox module immediately enters the idle state on receiving a low-power-mode request from the PRCM module. In this mode, the software must ensure that there are no asserted output interrupts before requesting this mode to go into the idle state.
- No-idle mode (SIDLEMODE = 0x1): The mailbox module never enters the idle state.
- Smart-idle mode (SIDLEMODE = 0x2): After receiving a low-power-mode request from the PRCM module, the mailbox module enters the idle state only after all asserted output interrupts are acknowledged.

17.1.3.4 Interrupt Requests

An interrupt request allows the user of the mailbox to be notified when a message is received or when the message queue is not full. There is one interrupt per user. [Table 17-5](#) lists the event flags, and their mask, that can cause module interrupts.

Table 17-5. Interrupt Events

Non-Maskable Event Flag ⁽¹⁾	Maskable Event Flag	Event Mask Bit	Event Unmask Bit	Description
MAILBOX_IRQSTATUS_RAW_u[0+m*2].NEWM_SGSTATUSUUMBm	MAILBOX_IRQSTATUS_CLR_u[0+m*2].NEWM_SGSTATUSUUMBm	MAILBOX_IRQENABLE_CLR_u[0+m*2].		
MAILBOX_IRQSTATUS_RAW_u[0+m*2].NEWM_SGSTATUSUUMBm	MAILBOX_IRQSTATUS_CLR_u[0+m*2].NEWM_SGSTATUSUUMBm	MAILBOX_IRQENABLE_CLR_u[0+m*2]. NEWMSGSTATUSUUMBm	MAILBOX_IRQENABLE_SET_u[0+m*2]. NEWMSGSTATUSUUMBm	Mailbox m receives a new message
MAILBOX_IRQSTATUS_RAW_u[1+m*2].NOTFULLSTATUSUMBm	MAILBOX_IRQSTATUS_CLR_u[1+m*2].NOTFULLSTATUSUMBm	MAILBOX_IRQENABLE_CLR_u[1+m*2]. NOTFULLSTATUSUMBm	MAILBOX_IRQENABLE_SET_u[1+m*2]. NOTFULLSTATUSUMBm	Mailbox m message queue is not full

⁽¹⁾ MAILBOX.MAILBOX_IRQSTATUS_RAW_u register is mostly used for debug purposes.

CAUTION

Once an event generating the interrupt request has been processed by the software, it must be cleared by writing a logical 1 in the corresponding bit of the MAILBOX_IRQSTATUS_CLR_u register. Writing a logical 1 in a bit of the MAILBOX_IRQSTATUS_CLR_u register will also clear to 0 the corresponding bit in the appropriate MAILBOX_IRQSTATUS_RAW_u register.

An event can generate an interrupt request when a logical 1 is written to the corresponding unmask bit in the MAILBOX_IRQENABLE_SET_u register. Events are reported in the appropriate MAILBOX_IRQSTATUS_CLR_u and MAILBOX_IRQSTATUS_RAW_u registers.

An event stops generating interrupt requests when a logical 1 is written to the corresponding mask bit in the MAILBOX_IRQENABLE_CLR_u register. Events are only reported in the appropriate MAILBOX_IRQSTATUS_RAW_u register.

In case of the MAILBOX_IRQSTATUS_RAW_u register, the event is reported in the corresponding bit even if the interrupt request generation is disabled for this event.

17.1.3.5 Assignment

17.1.3.5.1 Description

To assign a receiver to a mailbox, set the new message interrupt enable bit corresponding to the desired mailbox in the MAILBOX_IRQENABLE_SET_u register. The receiver reads the MAILBOX_MESSAGE_m register to retrieve a message from the mailbox.

An alternate method for the receiver that does not use the interrupts is to poll the MAILBOX_FIFOSTATUS_m and/or MAILBOX_MSGSTATUS_m registers to know when to send or retrieve a message to or from the mailbox. This method does not require assigning a receiver to a mailbox. Because this method does not include the explicit assignment of the mailbox, the software must avoid having multiple receivers use the same mailbox, which can result in incoherency.

To assign a sender to a mailbox, set the queue-not-full interrupt enable bit of the desired mailbox in the MAILBOX_IRQENABLE_SET_u register, where u is the number of the sending user. However, direct allocation of a mailbox to a sender is not recommended because it can cause the sending processor to be constantly interrupted.

It is recommended that register polling be used to:

- Check the status of either the MAILBOX_FIFOSTATUS_m or MAILBOX_MSGSTATUS_m registers
- Write the message to the corresponding MAILBOX_MESSAGE_m register, if space is available

The sender might use the queue-not-full interrupt when the initial mailbox status check indicates the mailbox is full. In this case, the sender can enable the queue-not-full interrupt for its mailbox in the appropriate MAILBOX_IRQENABLE_SET_u register. This allows the sender to be notified by interrupt only when a FIFO queue has at least one available entry.

Reading the MAILBOX_IRQSTATUS_CLR_u register determines the status of the new message and the queue-not-full interrupts for a particular user. Writing 1 to the corresponding bit in the MAILBOX_IRQSTATUS_CLR_u register acknowledges, and subsequently clears, an interrupt.

CAUTION

Assigning multiple senders or multiple receivers to the same mailbox is not recommended.

17.1.3.6 Sending and Receiving Messages

17.1.3.6.1 Description

When a 32-bit message is written to the MAILBOX_MESSAGE_m register, the message is appended into the FIFO queue. This queue holds four messages. If the queue is full, the message is discarded. Queue overflow can be avoided by first reading the MAILBOX_FIFOSTATUS_m register to check that the mailbox message queue is not full before writing a new message to it. Reading the MAILBOX_MESSAGE_m register returns the message at the beginning of the FIFO queue and removes it from the queue. If the FIFO queue is empty when the MAILBOX_MESSAGE_m register is read, the value 0 is returned. The new message interrupt is asserted when at least one message is in the mailbox message FIFO queue. To determine the number of messages in the mailbox message FIFO queue, read the MAILBOX_MSGSTATUS_m register.

17.1.3.7 16-Bit Register Access

17.1.3.7.1 Description

So that 16-bit processors can access the mailbox module, the module allows 16-bit register read and write access, with restrictions for the MAILBOX_MESSAGE_m registers. The 16-bit half-words are organized in little endian fashion; that is, the least-significant 16 bits are at the low address and the most-significant 16 bits are at the high address (low address + 0x02). All mailbox module registers can be read or written to directly using individual 16-bit accesses with no restriction on interleaving, except the MAILBOX_MESSAGE_m registers, which must always be accessed by either single 32-bit accesses or two consecutive 16-bit accesses.

CAUTION

When using 16-bit accesses to the MAILBOX_MESSAGE_m registers, the order of access must be the least-significant half-word first (low address) and the most-significant half-word last (high address). This requirement is because of the update operation by the message FIFO of the MAILBOX_MSGSTATUS_m registers. The update of the FIFO queue contents and the associated status registers and possible interrupt generation occurs only when the most-significant 16 bits of a MAILBOX_MESSAGE_m are accessed.

17.1.4 Programming Guide

17.1.4.1 Low-level Programming Models

This section covers the low-level hardware programming sequences for configuration and usage of the mailbox module.

17.1.4.1.1 Global Initialization

17.1.4.1.1.1 Surrounding Modules Global Initialization

This section identifies the requirements of initializing the surrounding modules when the mailbox module is to be used for the first time after a device reset. This initialization of surrounding modules is based on the integration of the mailbox.

See [Section 17.1.2](#) for further information.

Table 17-6. Global Initialization of Surrounding Modules for System Mailbox

Surrounding Modules	Comments
PRCM	Mailbox functional/interface clock must be enabled.
Interrupt Controllers	MPU interrupt controller must be configured to enable the interrupt request generation to the MPU.

17.1.4.1.1.2 Mailbox Global Initialization

17.1.4.1.1.2.1 Main Sequence - Mailbox Global Initialization

This procedure initializes the mailbox module after a power-on or software reset.

Table 17-7. Mailbox Global Initialization

	Register/Bitfield/Programming Model	Value
Perform a software reset	MAILBOX_SYSCONFIG[0].SOFTRESET	1
Wait until reset is complete	MAILBOX_SYSCONFIG[0].SOFTRESET	0
Set idle mode configuration	MAILBOX_SYSCONFIG[3:2].SIDLEMODE	0x-

17.1.4.1.2 Operational Modes Configuration

17.1.4.1.2.1 Main Sequence - Sending a Message (Polling Method)

Table 17-8. Sending a Message (Polling Method)

Step	Register/Bitfield/Programming Model	Value
IF : Is FIFO full ?	MAILBOX_FIFOSTATUS_m[0].FIFOFULL MB	=1h
Wait until at least one message slot is available	MAILBOX_FIFOSTATUS_m[0].FIFOFULL MB	=0h
ELSE		
Write message	MAILBOX_MESSAGE_m[31:0].MESSAG EVALUEMBM	----h
ENDIF		

17.1.4.1.2.2 Main Sequence - Sending a Message (Interrupt Method)

Table 17-9. Sending a Message (Interrupt Method)

Step	Register/Bitfield/Programming Model	Value
IF : Is FIFO full ?	MAILBOX_FIFOSTATUS_m[0].FIFOFULL MB	=1h
Enable interrupt event	MAILBOX_IRQENABLE_SET_u[1+ m*2]	1h
User(processor) can perform another task until interrupt occurs		
ELSE		
Write message	MAILBOX_MESSAGE_m[31:0].MESSAG EVALUEMBM	----h
ENDIF		

17.1.4.1.2.3 Main Sequence - Receiving a Message (Polling Method)

Table 17-10. Receiving a Message (Polling Method)

Step	Register/Bitfield/Programming Model	Value
IF : Number of messages is not equal to 0	MAILBOX_MSGSTATUS_m[2:0].NBOFM SGMB	!=0h
Read message	MAILBOX_MESSAGE_m[31:0].MESSAG EVALUEMBM	----h
ENDIF		

17.1.4.1.2.4 Main Sequence - Receiving a Message (Interrupt Method)

Table 17-11. Receiving a Message (Interrupt Method)

Step	Register/Bitfield/Programming Model	Value
Enable interrupt event	MAILBOX_IRQENABLE_SET_u[0 + m*2]	1h
User(processor) can perform anothr task until interrupt occurs		

17.1.4.1.3 Events Servicing

17.1.4.1.3.1 Sending Mode

Table 17-12 describes the events servicing in sending mode.

Table 17-12. Events Servicing in Sending Mode

Step	Register/Bitfield/Programming Model	Value
Read interrupt status bit	MAILBOX_IRQSTATUS_CLR_u[1 + m*2]	1
Write message	MAILBOX_MESSAGE_m[31:0].MESSAG EVALUEMBM	----h
Write 1 to acknowledge interrupt	MAILBOX_IRQSTATUS_CLR_u[1 + m*2]	1

17.1.4.1.3.2 Receiving Mode

Table 17-13 describes the events servicing in receiving mode.

Table 17-13. Events Servicing in Receiving Mode

Step	Register/Bitfield/Programming Model	Value
Read interrupt status bit	MAILBOX_IRQSTATUS_CLR_u[0 + m*2]	1
IF : Number of messages is not equal to 0 ?	MAILBOX_MSGSTATUS_m[2:0].NBOFM SGMB	!=0h
Read message	MAILBOX_MESSAGE_m[31:0].MESSAG EVALUEMBM	----h
ELSE		
Write 1 to acknowledge interrupt	MAILBOX_IRQSTATUS_CLR_u[0 + m*2]	1
ENDIF		

17.1.5 MAILBOX Registers

Table 17-14 lists the memory-mapped registers for the MAILBOX. All register offset addresses not listed in Table 17-14 should be considered as reserved locations and the register contents should not be modified.

Table 17-14. MAILBOX REGISTERS

Offset	Acronym	Register Name	Section
0h	REVISION	This register contains the IP revision code	Section 17.1.5.1
10h	SYSCONFIG	This register controls the various parameters of the OCP interface	Section 17.1.5.2
40h	MESSAGE_0	The message register stores the next to be read message of the mailbox. Reads remove the message from the FIFO queue	Section 17.1.5.3
44h	MESSAGE_1	The message register stores the next to be read message of the mailbox. Reads remove the message from the FIFO queue	Section 17.1.5.4
48h	MESSAGE_2	The message register stores the next to be read message of the mailbox. Reads remove the message from the FIFO queue	Section 17.1.5.5
4Ch	MESSAGE_3	The message register stores the next to be read message of the mailbox. Reads remove the message from the FIFO queue	Section 17.1.5.6
50h	MESSAGE_4	The message register stores the next to be read message of the mailbox. Reads remove the message from the FIFO queue	Section 17.1.5.7
54h	MESSAGE_5	The message register stores the next to be read message of the mailbox. Reads remove the message from the FIFO queue	Section 17.1.5.8
58h	MESSAGE_6	The message register stores the next to be read message of the mailbox. Reads remove the message from the FIFO queue	Section 17.1.5.9
5Ch	MESSAGE_7	The message register stores the next to be read message of the mailbox. Reads remove the message from the FIFO queue	Section 17.1.5.10
80h	FIFOSTATUS_0	The message register stores the next to be read message of the mailbox. Reads remove the message from the FIFO queue	Section 17.1.5.11
84h	FIFOSTATUS_1	The message register stores the next to be read message of the mailbox. Reads remove the message from the FIFO queue	Section 17.1.5.12
88h	FIFOSTATUS_2	The message register stores the next to be read message of the mailbox. Reads remove the message from the FIFO queue	Section 17.1.5.13
8Ch	FIFOSTATUS_3	The message register stores the next to be read message of the mailbox. Reads remove the message from the FIFO queue	Section 17.1.5.14
90h	FIFOSTATUS_4	The message register stores the next to be read message of the mailbox. Reads remove the message from the FIFO queue	Section 17.1.5.15
94h	FIFOSTATUS_5	The message register stores the next to be read message of the mailbox. Reads remove the message from the FIFO queue	Section 17.1.5.16
98h	FIFOSTATUS_6	The message register stores the next to be read message of the mailbox. Reads remove the message from the FIFO queue	Section 17.1.5.17
9Ch	FIFOSTATUS_7	The message register stores the next to be read message of the mailbox. Reads remove the message from the FIFO queue	Section 17.1.5.18
C0h	MSGSTATUS_0	The message status register has the status of the messages in the mailbox	Section 17.1.5.19
C4h	MSGSTATUS_1	The message status register has the status of the messages in the mailbox	Section 17.1.5.20

Table 17-14. MAILBOX REGISTERS (continued)

Offset	Acronym	Register Name	Section
C8h	MSGSTATUS_2	The message status register has the status of the messages in the mailbox	Section 17.1.5.21
CCh	MSGSTATUS_3	The message status register has the status of the messages in the mailbox	Section 17.1.5.22
D0h	MSGSTATUS_4	The message status register has the status of the messages in the mailbox	Section 17.1.5.23
D4h	MSGSTATUS_5	The message status register has the status of the messages in the mailbox	Section 17.1.5.24
D8h	MSGSTATUS_6	The message status register has the status of the messages in the mailbox	Section 17.1.5.25
DCh	MSGSTATUS_7	The message status register has the status of the messages in the mailbox	Section 17.1.5.26
100h	IRQSTATUS_RAW_0	The interrupt status register has the status for each event that may be responsible for the generation of an interrupt to the corresponding user - write 1 to a given bit resets this bit. This register is mainly used for debug purpose.	Section 17.1.5.27
104h	IRQSTATUS_CLR_0	The interrupt status register has the status combined with irq-enable for each event that may be responsible for the generation of an interrupt to the corresponding user - write 1 to a given bit resets this bit.	Section 17.1.5.28
108h	IRQENABLE_SET_0	The interrupt enable register enables to unmask the module internal source of interrupt to the corresponding user. This register is write 1 to set.	Section 17.1.5.29
10Ch	IRQENABLE_CLR_0	The interrupt enable register enables to mask the module internal source of interrupt to the corresponding user. This register is write 1 to clear.	Section 17.1.5.30
110h	IRQSTATUS_RAW_1	The interrupt status register has the status for each event that may be responsible for the generation of an interrupt to the corresponding user - write 1 to a given bit resets this bit. This register is mainly used for debug purpose.	Section 17.1.5.31
114h	IRQSTATUS_CLR_1	The interrupt status register has the status combined with irq-enable for each event that may be responsible for the generation of an interrupt to the corresponding user - write 1 to a given bit resets this bit.	Section 17.1.5.32
118h	IRQENABLE_SET_1	The interrupt enable register enables to unmask the module internal source of interrupt to the corresponding user. This register is write 1 to set.	Section 17.1.5.33
11Ch	IRQENABLE_CLR_1	The interrupt enable register enables to mask the module internal source of interrupt to the corresponding user. This register is write 1 to clear.	Section 17.1.5.34
120h	IRQSTATUS_RAW_2	The interrupt status register has the status for each event that may be responsible for the generation of an interrupt to the corresponding user - write 1 to a given bit resets this bit. This register is mainly used for debug purpose.	Section 17.1.5.35
124h	IRQSTATUS_CLR_2	The interrupt status register has the status combined with irq-enable for each event that may be responsible for the generation of an interrupt to the corresponding user - write 1 to a given bit resets this bit.	Section 17.1.5.36
128h	IRQENABLE_SET_2	The interrupt enable register enables to unmask the module internal source of interrupt to the corresponding user. This register is write 1 to set.	Section 17.1.5.37

Table 17-14. MAILBOX REGISTERS (continued)

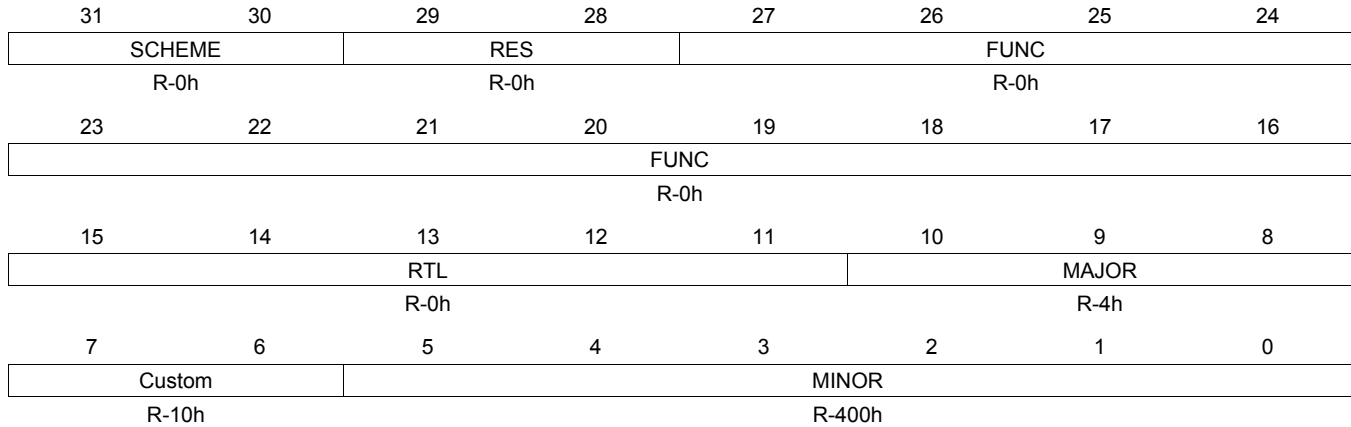
Offset	Acronym	Register Name	Section
12Ch	IRQENABLE_CLR_2	The interrupt enable register enables to mask the module internal source of interrupt to the corresponding user. This register is write 1 to clear.	Section 17.1.5.38
130h	IRQSTATUS_RAW_3	The interrupt status register has the status for each event that may be responsible for the generation of an interrupt to the corresponding user - write 1 to a given bit resets this bit. This register is mainly used for debug purpose.	Section 17.1.5.39
134h	IRQSTATUS_CLR_3	The interrupt status register has the status combined with irq-enable for each event that may be responsible for the generation of an interrupt to the corresponding user - write 1 to a given bit resets this bit.	Section 17.1.5.40
138h	IRQENABLE_SET_3	The interrupt enable register enables to unmask the module internal source of interrupt to the corresponding user. This register is write 1 to set.	Section 17.1.5.41
13Ch	IRQENABLE_CLR_3	The interrupt enable register enables to mask the module internal source of interrupt to the corresponding user. This register is write 1 to clear.	Section 17.1.5.42

17.1.5.1 REVISION Register (offset = 0h) [reset = 400h]

REVISION is shown in [Figure 17-3](#) and described in [Table 17-15](#).

This register contains the IP revision code

Figure 17-3. REVISION Register



LEGEND: R/W = Read/Write; R = Read only; W1toCl = Write 1 to clear bit; -n = value after reset

Table 17-15. REVISION Register Field Descriptions

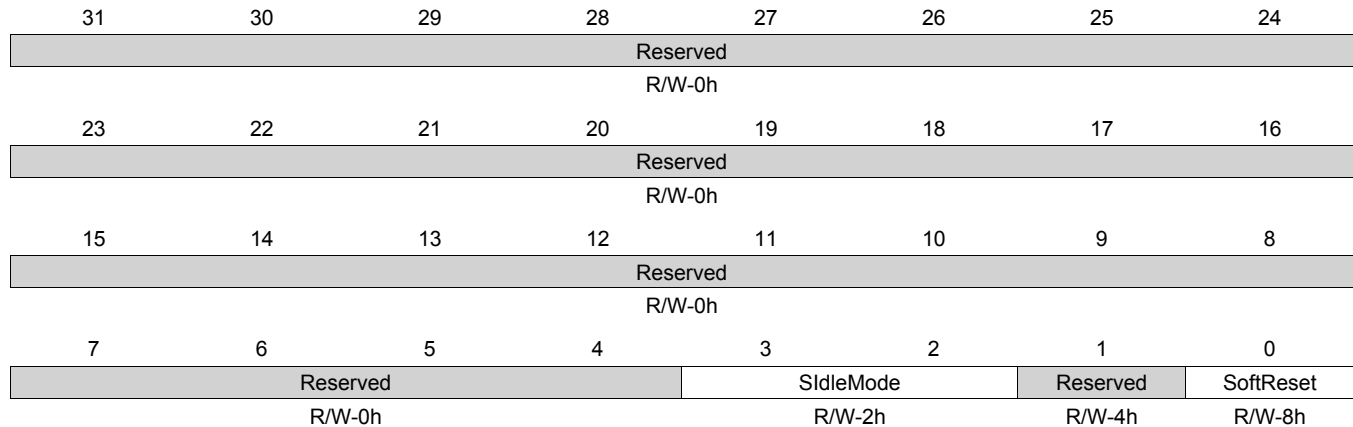
Bit	Field	Type	Reset	Description
31-30	SCHEME	R	0h	Not defined yet
29-28	RES	R	0h	Reserved
27-16	FUNC	R	0h	Not defined yet
15-11	RTL	R	0h	Not defined yet
10-8	MAJOR	R	4h	IP-Major Revision
7-6	Custom	R	10h	Not Defined Yet
5-0	MINOR	R	400h	IP-Minor Revision

17.1.5.2 SYSCONFIG Register (offset = 10h) [reset = 8h]

SYSCONFIG is shown in [Figure 17-4](#) and described in [Table 17-16](#).

This register controls the various parameters of the OCP interface

Figure 17-4. SYSCONFIG Register



LEGEND: R/W = Read/Write; R = Read only; W1toCl = Write 1 to clear bit; -n = value after reset

Table 17-16. SYSCONFIG Register Field Descriptions

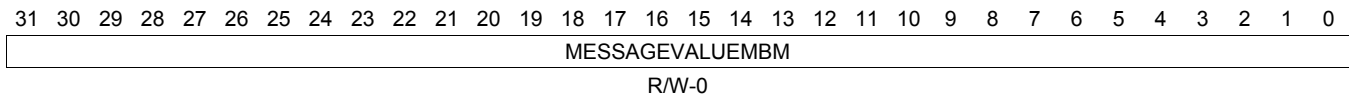
Bit	Field	Type	Reset	Description
31-4	Reserved	R/W	0h	Write 0's for future compatibility Reads returns 0
3-2	SIdleMode	R/W	2h	
1	Reserved	R/W	4h	Write 0's for future compatibility Read returns 0
0	SoftReset	R/W	8h	Software reset. This bit is automatically reset by the hardware. During reads, it always return 0 0 = Normal : Normal mode 1 = Reset : The module is reset

17.1.5.3 MESSAGE_0 Register (offset = 40h) [reset = 0h]

MESSAGE_0 is shown in [Figure 17-5](#) and described in [Table 17-17](#).

The message register stores the next to be read message of the mailbox. Reads remove the message from the FIFO queue

Figure 17-5. MESSAGE_0 Register



LEGEND: R/W = Read/Write; R = Read only; W1toCl = Write 1 to clear bit; -n = value after reset

Table 17-17. MESSAGE_0 Register Field Descriptions

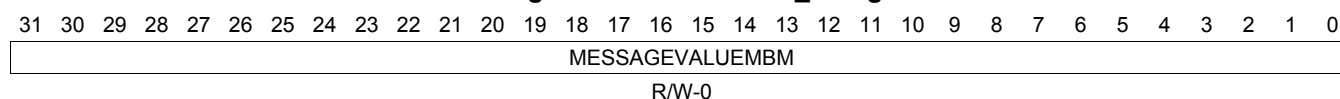
Bit	Field	Type	Reset	Description
31-0	MESSAGEVALUEMBM	R/W-0	0	Message in Mailbox. The message register stores the next to be read message of the mailbox. Reads remove the message from the FIFO queue.

17.1.5.4 MESSAGE_1 Register (offset = 44h) [reset = 0h]

MESSAGE_1 is shown in [Figure 17-6](#) and described in [Table 17-18](#).

The message register stores the next to be read message of the mailbox. Reads remove the message from the FIFO queue

Figure 17-6. MESSAGE_1 Register



LEGEND: R/W = Read/Write; R = Read only; W1toCl = Write 1 to clear bit; -n = value after reset

Table 17-18. MESSAGE_1 Register Field Descriptions

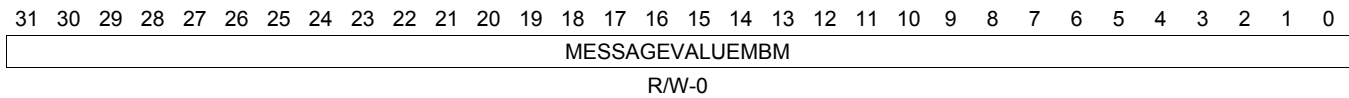
Bit	Field	Type	Reset	Description
31-0	MESSAGEVALUEMBM	R/W-0	0	Message in Mailbox. The message register stores the next to be read message of the mailbox. Reads remove the message from the FIFO queue.

17.1.5.5 MESSAGE_2 Register (offset = 48h) [reset = 0h]

MESSAGE_2 is shown in [Figure 17-7](#) and described in [Table 17-19](#).

The message register stores the next to be read message of the mailbox. Reads remove the message from the FIFO queue

Figure 17-7. MESSAGE_2 Register



LEGEND: R/W = Read/Write; R = Read only; W1toCl = Write 1 to clear bit; -n = value after reset

Table 17-19. MESSAGE_2 Register Field Descriptions

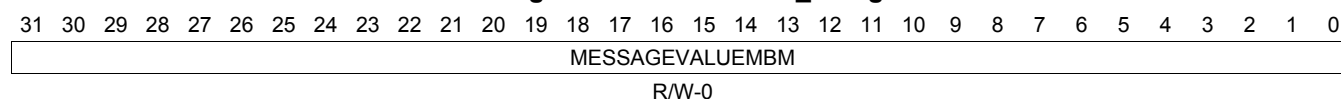
Bit	Field	Type	Reset	Description
31-0	MESSAGEVALUEMBM	R/W-0	0	Message in Mailbox. The message register stores the next to be read message of the mailbox. Reads remove the message from the FIFO queue.

17.1.5.6 MESSAGE_3 Register (offset = 4Ch) [reset = 0h]

MESSAGE_3 is shown in [Figure 17-8](#) and described in [Table 17-20](#).

The message register stores the next to be read message of the mailbox. Reads remove the message from the FIFO queue

Figure 17-8. MESSAGE_3 Register



LEGEND: R/W = Read/Write; R = Read only; W1toCl = Write 1 to clear bit; -n = value after reset

Table 17-20. MESSAGE_3 Register Field Descriptions

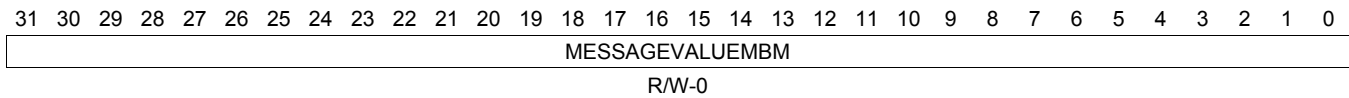
Bit	Field	Type	Reset	Description
31-0	MESSAGEVALUEMBM	R/W-0	0	Message in Mailbox. The message register stores the next to be read message of the mailbox. Reads remove the message from the FIFO queue.

17.1.5.7 MESSAGE_4 Register (offset = 50h) [reset = 0h]

MESSAGE_4 is shown in [Figure 17-9](#) and described in [Table 17-21](#).

The message register stores the next to be read message of the mailbox. Reads remove the message from the FIFO queue

Figure 17-9. MESSAGE_4 Register



LEGEND: R/W = Read/Write; R = Read only; W1toCl = Write 1 to clear bit; -n = value after reset

Table 17-21. MESSAGE_4 Register Field Descriptions

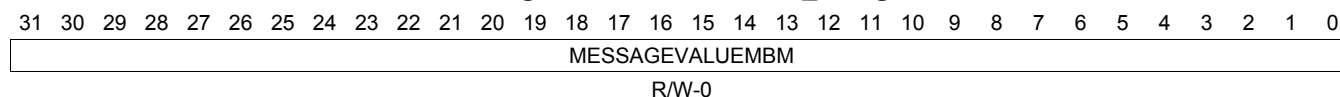
Bit	Field	Type	Reset	Description
31-0	MESSAGEVALUEMBM	R/W-0	0	Message in Mailbox. The message register stores the next to be read message of the mailbox. Reads remove the message from the FIFO queue.

17.1.5.8 MESSAGE_5 Register (offset = 54h) [reset = 0h]

MESSAGE_5 is shown in [Figure 17-10](#) and described in [Table 17-22](#).

The message register stores the next to be read message of the mailbox. Reads remove the message from the FIFO queue

Figure 17-10. MESSAGE_5 Register



LEGEND: R/W = Read/Write; R = Read only; W1toCl = Write 1 to clear bit; -n = value after reset

Table 17-22. MESSAGE_5 Register Field Descriptions

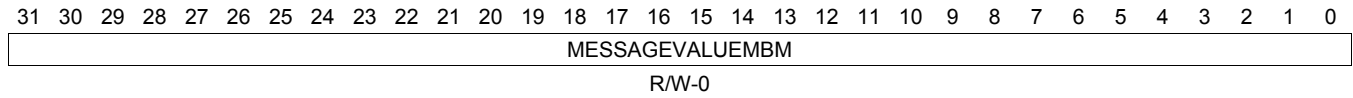
Bit	Field	Type	Reset	Description
31-0	MESSAGEVALUEMBM	R/W-0	0	Message in Mailbox. The message register stores the next to be read message of the mailbox. Reads remove the message from the FIFO queue.

17.1.5.9 MESSAGE_6 Register (offset = 58h) [reset = 0h]

MESSAGE_6 is shown in [Figure 17-11](#) and described in [Table 17-23](#).

The message register stores the next to be read message of the mailbox. Reads remove the message from the FIFO queue

Figure 17-11. MESSAGE_6 Register



LEGEND: R/W = Read/Write; R = Read only; W1toCl = Write 1 to clear bit; -n = value after reset

Table 17-23. MESSAGE_6 Register Field Descriptions

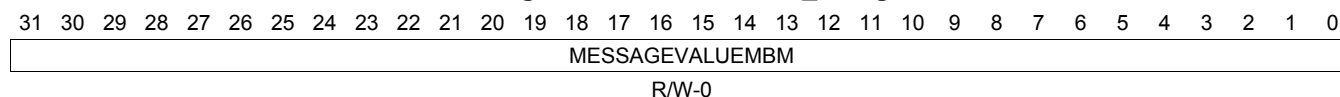
Bit	Field	Type	Reset	Description
31-0	MESSAGEVALUEMBM	R/W-0	0	Message in Mailbox. The message register stores the next to be read message of the mailbox. Reads remove the message from the FIFO queue.

17.1.5.10 MESSAGE_7 Register (offset = 5Ch) [reset = 0h]

MESSAGE_7 is shown in [Figure 17-12](#) and described in [Table 17-24](#).

The message register stores the next to be read message of the mailbox. Reads remove the message from the FIFO queue

Figure 17-12. MESSAGE_7 Register



LEGEND: R/W = Read/Write; R = Read only; W1toCl = Write 1 to clear bit; -n = value after reset

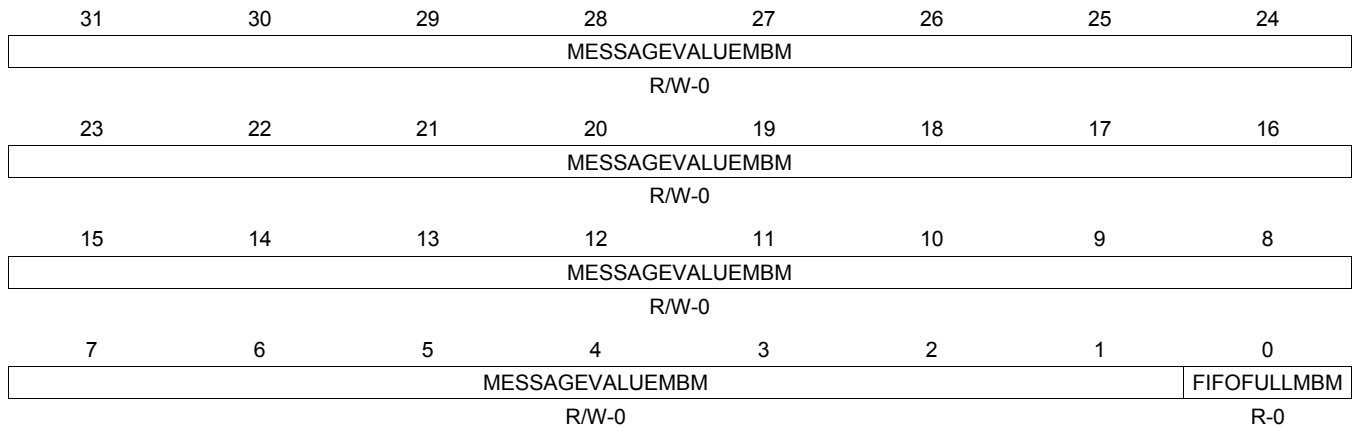
Table 17-24. MESSAGE_7 Register Field Descriptions

Bit	Field	Type	Reset	Description
31-0	MESSAGEVALUEMBM	R/W-0	0	Message in Mailbox. The message register stores the next to be read message of the mailbox. Reads remove the message from the FIFO queue.

17.1.5.11 FIFOSTATUS_0 Register (offset = 80h) [reset = 0h]

FIFOSTATUS_0 is shown in [Figure 17-13](#) and described in [Table 17-25](#).

The message register stores the next to be read message of the mailbox. Reads remove the message from the FIFO queue

Figure 17-13. FIFOSTATUS_0 Register


LEGEND: R/W = Read/Write; R = Read only; W1toCl = Write 1 to clear bit; -n = value after reset

Table 17-25. FIFOSTATUS_0 Register Field Descriptions

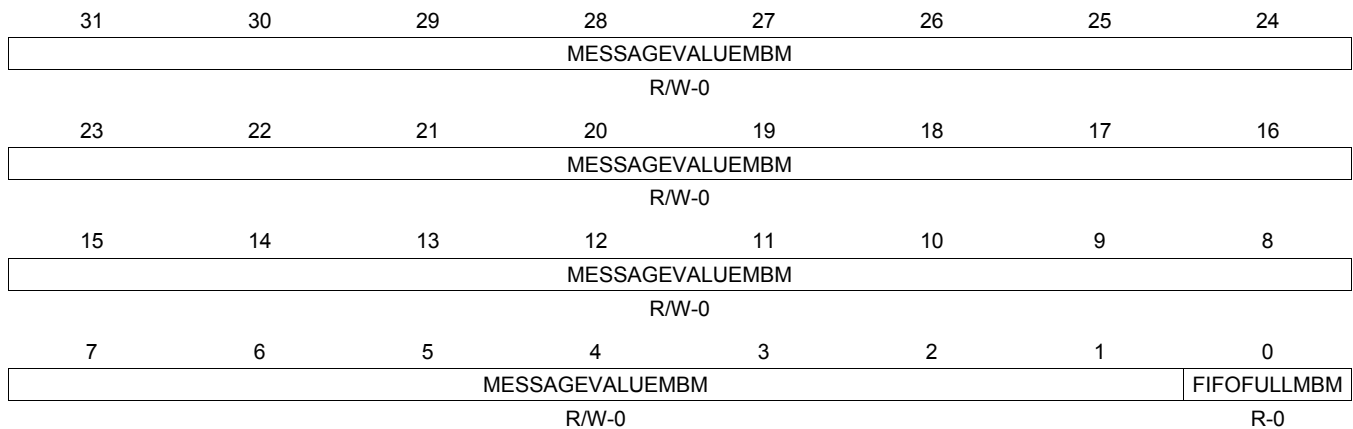
Bit	Field	Type	Reset	Description
31-1	MESSAGEVALUEMBM	R/W-0	0	Message in Mailbox. The message register stores the next to be read message of the mailbox. Reads remove the message from the FIFO queue.
0	FIFOFULLMBM	R-0	0	Full flag for Mailbox 0 = NotFull : Mailbox FIFO is not full 1 = Full : Mailbox FIFO is full

17.1.5.12 FIFOSTATUS_1 Register (offset = 84h) [reset = 0h]

FIFOSTATUS_1 is shown in [Figure 17-14](#) and described in [Table 17-26](#).

The message register stores the next to be read message of the mailbox. Reads remove the message from the FIFO queue

Figure 17-14. FIFOSTATUS_1 Register



LEGEND: R/W = Read/Write; R = Read only; W1toCl = Write 1 to clear bit; -n = value after reset

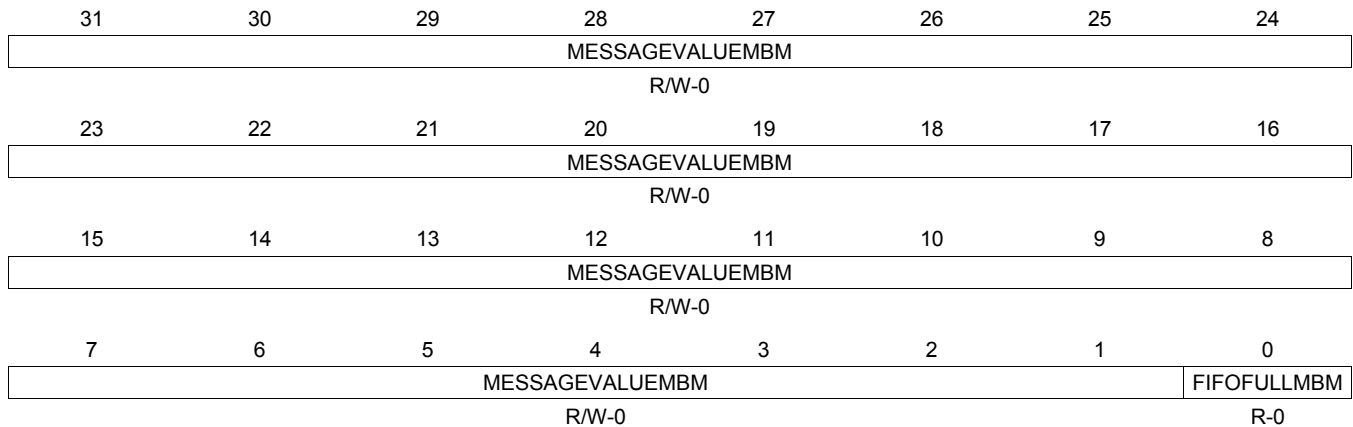
Table 17-26. FIFOSTATUS_1 Register Field Descriptions

Bit	Field	Type	Reset	Description
31-1	MESSAGEVALUEMBM	R/W-0	0	Message in Mailbox. The message register stores the next to be read message of the mailbox. Reads remove the message from the FIFO queue.
0	FIFOFULLMBM	R-0	0	Full flag for Mailbox 0 = NotFull : Mailbox FIFO is not full 1 = Full : Mailbox FIFO is full

17.1.5.13 FIFOSTATUS_2 Register (offset = 88h) [reset = 0h]

FIFOSTATUS_2 is shown in [Figure 17-15](#) and described in [Table 17-27](#).

The message register stores the next to be read message of the mailbox. Reads remove the message from the FIFO queue

Figure 17-15. FIFOSTATUS_2 Register


LEGEND: R/W = Read/Write; R = Read only; W1toCl = Write 1 to clear bit; -n = value after reset

Table 17-27. FIFOSTATUS_2 Register Field Descriptions

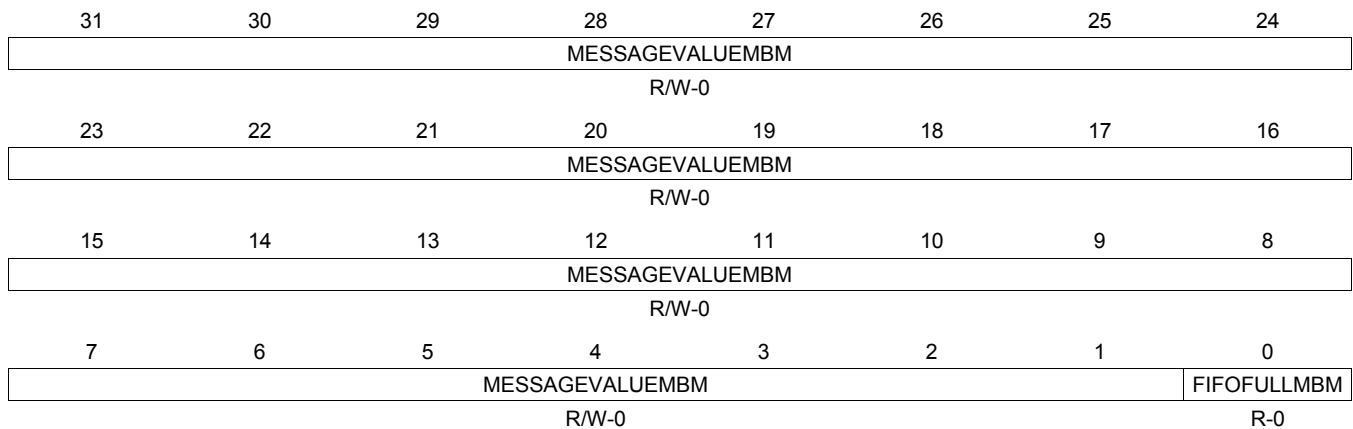
Bit	Field	Type	Reset	Description
31-1	MESSAGEVALUEMBM	R/W-0	0	Message in Mailbox. The message register stores the next to be read message of the mailbox. Reads remove the message from the FIFO queue.
0	FIFOFULLMBM	R-0	0	Full flag for Mailbox 0 = NotFull : Mailbox FIFO is not full 1 = Full : Mailbox FIFO is full

17.1.5.14 FIFOSTATUS_3 Register (offset = 8Ch) [reset = 0h]

FIFOSTATUS_3 is shown in [Figure 17-16](#) and described in [Table 17-28](#).

The message register stores the next to be read message of the mailbox. Reads remove the message from the FIFO queue

Figure 17-16. FIFOSTATUS_3 Register



LEGEND: R/W = Read/Write; R = Read only; W1toCl = Write 1 to clear bit; -n = value after reset

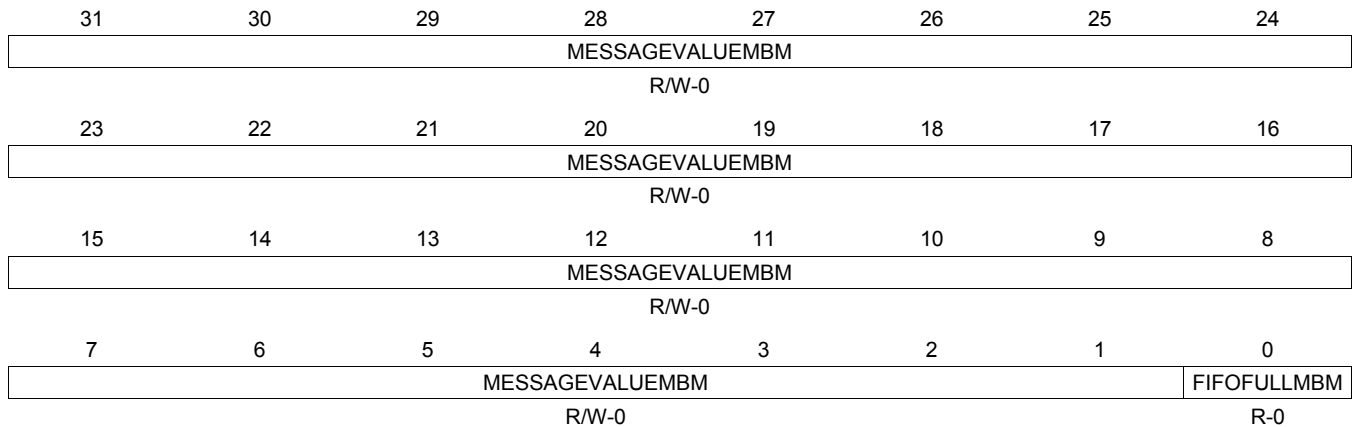
Table 17-28. FIFOSTATUS_3 Register Field Descriptions

Bit	Field	Type	Reset	Description
31-1	MESSAGEVALUEMBM	R/W-0	0	Message in Mailbox. The message register stores the next to be read message of the mailbox. Reads remove the message from the FIFO queue.
0	FIFOFULLMBM	R-0	0	Full flag for Mailbox 0 = NotFull : Mailbox FIFO is not full 1 = Full : Mailbox FIFO is full

17.1.5.15 FIFOSTATUS_4 Register (offset = 90h) [reset = 0h]

FIFOSTATUS_4 is shown in [Figure 17-17](#) and described in [Table 17-29](#).

The message register stores the next to be read message of the mailbox. Reads remove the message from the FIFO queue

Figure 17-17. FIFOSTATUS_4 Register


LEGEND: R/W = Read/Write; R = Read only; W1toCl = Write 1 to clear bit; -n = value after reset

Table 17-29. FIFOSTATUS_4 Register Field Descriptions

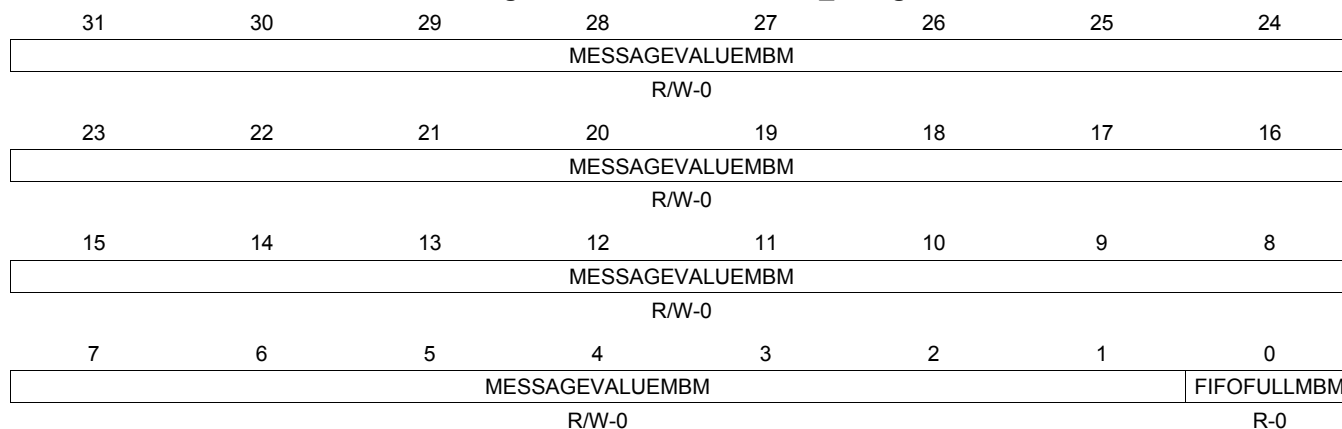
Bit	Field	Type	Reset	Description
31-1	MESSAGEVALUEMBM	R/W-0	0	Message in Mailbox. The message register stores the next to be read message of the mailbox. Reads remove the message from the FIFO queue.
0	FIFOFULLMBM	R-0	0	Full flag for Mailbox 0 = NotFull : Mailbox FIFO is not full 1 = Full : Mailbox FIFO is full

17.1.5.16 FIFOSTATUS_5 Register (offset = 94h) [reset = 0h]

FIFOSTATUS_5 is shown in [Figure 17-18](#) and described in [Table 17-30](#).

The message register stores the next to be read message of the mailbox. Reads remove the message from the FIFO queue

Figure 17-18. FIFOSTATUS_5 Register



LEGEND: R/W = Read/Write; R = Read only; W1toCl = Write 1 to clear bit; -n = value after reset

Table 17-30. FIFOSTATUS_5 Register Field Descriptions

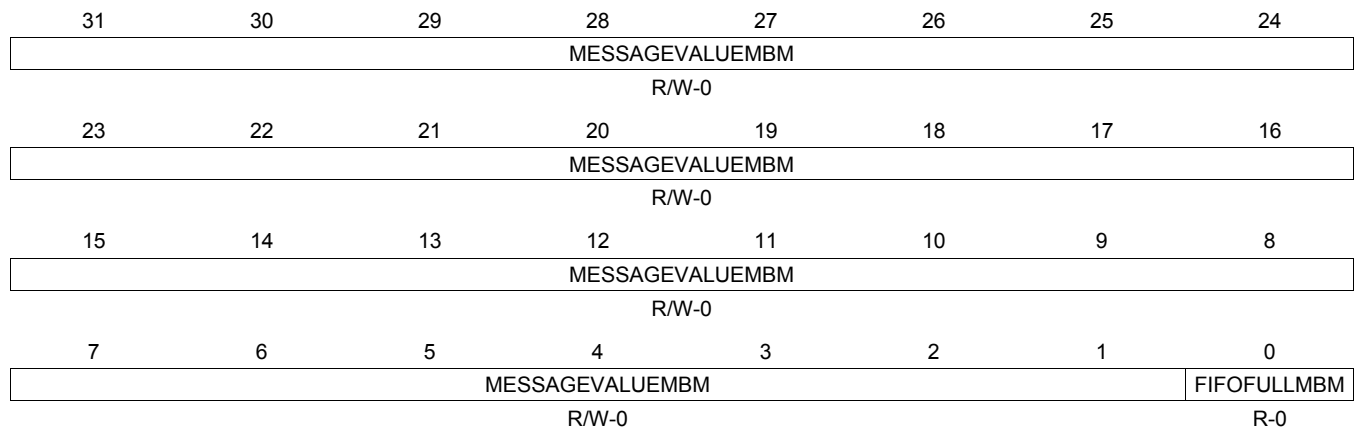
Bit	Field	Type	Reset	Description
31-1	MESSAGEVALUEMBM	R/W-0	0	Message in Mailbox. The message register stores the next to be read message of the mailbox. Reads remove the message from the FIFO queue.
0	FIFOFULLMBM	R-0	0	Full flag for Mailbox 0 = NotFull : Mailbox FIFO is not full 1 = Full : Mailbox FIFO is full

17.1.5.17 FIFOSTATUS_6 Register (offset = 98h) [reset = 0h]

FIFOSTATUS_6 is shown in [Figure 17-19](#) and described in [Table 17-31](#).

The message register stores the next to be read message of the mailbox. Reads remove the message from the FIFO queue

Figure 17-19. FIFOSTATUS_6 Register



LEGEND: R/W = Read/Write; R = Read only; W1toCl = Write 1 to clear bit; -n = value after reset

Table 17-31. FIFOSTATUS_6 Register Field Descriptions

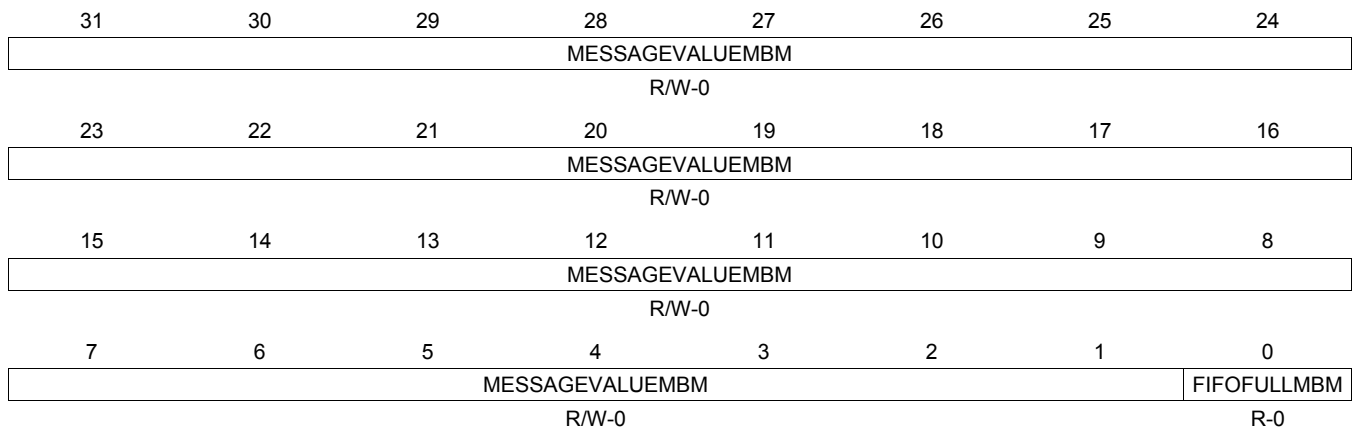
Bit	Field	Type	Reset	Description
31-1	MESSAGEVALUEMBM	R/W-0	0	Message in Mailbox. The message register stores the next to be read message of the mailbox. Reads remove the message from the FIFO queue.
0	FIFOFULLMBM	R-0	0	Full flag for Mailbox 0 = NotFull : Mailbox FIFO is not full 1 = Full : Mailbox FIFO is full

17.1.5.18 FIFOSTATUS_7 Register (offset = 9Ch) [reset = 0h]

FIFOSTATUS_7 is shown in [Figure 17-20](#) and described in [Table 17-32](#).

The message register stores the next to be read message of the mailbox. Reads remove the message from the FIFO queue

Figure 17-20. FIFOSTATUS_7 Register



LEGEND: R/W = Read/Write; R = Read only; W1toCl = Write 1 to clear bit; -n = value after reset

Table 17-32. FIFOSTATUS_7 Register Field Descriptions

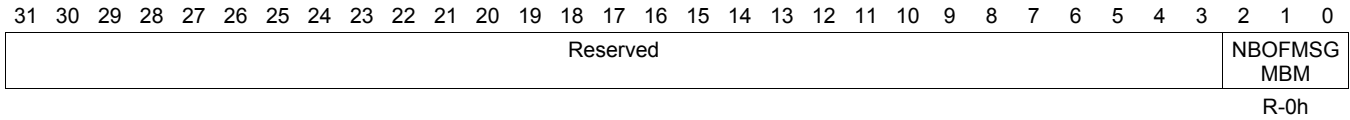
Bit	Field	Type	Reset	Description
31-1	MESSAGEVALUEMBM	R/W-0	0	Message in Mailbox. The message register stores the next to be read message of the mailbox. Reads remove the message from the FIFO queue.
0	FIFOFULLMBM	R-0	0	Full flag for Mailbox 0 = NotFull : Mailbox FIFO is not full 1 = Full : Mailbox FIFO is full

17.1.5.19 MSGSTATUS_0 Register (offset = C0h) [reset = 0h]

MSGSTATUS_0 is shown in [Figure 17-21](#) and described in [Table 17-33](#).

The message status register has the status of the messages in the mailbox

Figure 17-21. MSGSTATUS_0 Register



LEGEND: R/W = Read/Write; R = Read only; W1toCl = Write 1 to clear bit; -n = value after reset

Table 17-33. MSGSTATUS_0 Register Field Descriptions

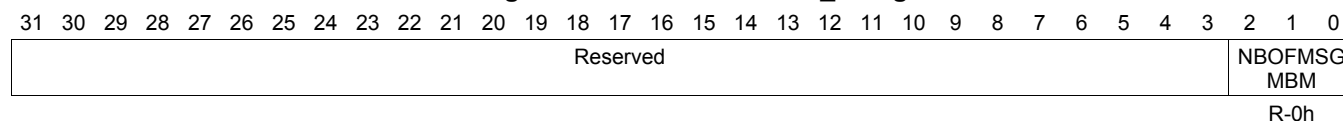
Bit	Field	Type	Reset	Description
2-0	NBOFMSGMBM	R	0h	Number of unread messages in Mailbox. Limited to four messages per mailbox.

17.1.5.20 MSGSTATUS_1 Register (offset = C4h) [reset = 0h]

MSGSTATUS_1 is shown in [Figure 17-22](#) and described in [Table 17-34](#).

The message status register has the status of the messages in the mailbox

Figure 17-22. MSGSTATUS_1 Register



LEGEND: R/W = Read/Write; R = Read only; W1toCl = Write 1 to clear bit; -n = value after reset

Table 17-34. MSGSTATUS_1 Register Field Descriptions

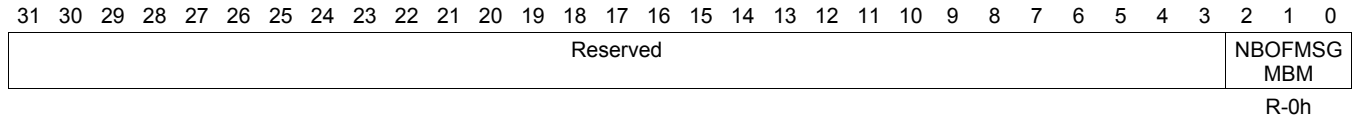
Bit	Field	Type	Reset	Description
2-0	NBOFMSGMBM	R	0h	Number of unread messages in Mailbox. Limited to four messages per mailbox.

17.1.5.21 MSGSTATUS_2 Register (offset = C8h) [reset = 0h]

MSGSTATUS_2 is shown in [Figure 17-23](#) and described in [Table 17-35](#).

The message status register has the status of the messages in the mailbox

Figure 17-23. MSGSTATUS_2 Register



LEGEND: R/W = Read/Write; R = Read only; W1toCl = Write 1 to clear bit; -n = value after reset

Table 17-35. MSGSTATUS_2 Register Field Descriptions

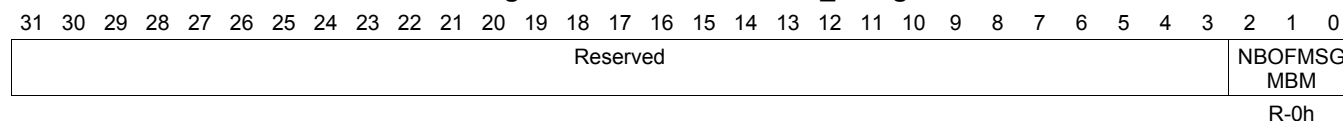
Bit	Field	Type	Reset	Description
2-0	NBOFMSGMBM	R	0h	Number of unread messages in Mailbox. Limited to four messages per mailbox.

17.1.5.22 MSGSTATUS_3 Register (offset = CCh) [reset = 0h]

MSGSTATUS_3 is shown in [Figure 17-24](#) and described in [Table 17-36](#).

The message status register has the status of the messages in the mailbox

Figure 17-24. MSGSTATUS_3 Register



LEGEND: R/W = Read/Write; R = Read only; W1toCl = Write 1 to clear bit; -n = value after reset

Table 17-36. MSGSTATUS_3 Register Field Descriptions

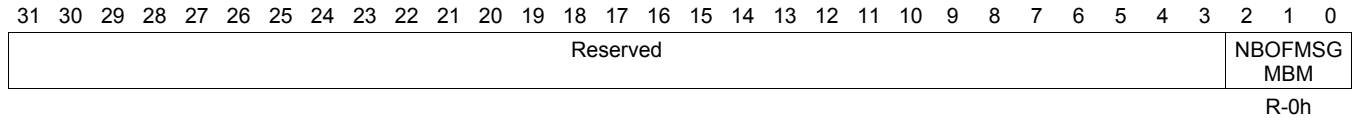
Bit	Field	Type	Reset	Description
2-0	NBOFMSGMBM	R	0h	Number of unread messages in Mailbox. Limited to four messages per mailbox.

17.1.5.23 MSGSTATUS_4 Register (offset = D0h) [reset = 0h]

MSGSTATUS_4 is shown in [Figure 17-25](#) and described in [Table 17-37](#).

The message status register has the status of the messages in the mailbox

Figure 17-25. MSGSTATUS_4 Register



LEGEND: R/W = Read/Write; R = Read only; W1toCl = Write 1 to clear bit; -n = value after reset

Table 17-37. MSGSTATUS_4 Register Field Descriptions

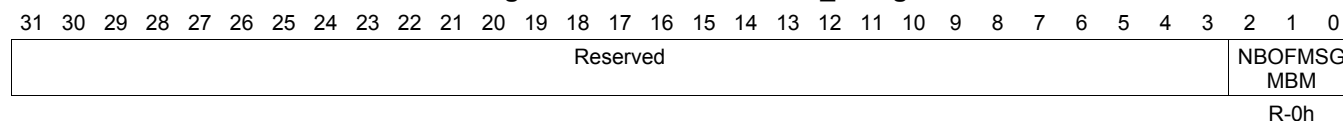
Bit	Field	Type	Reset	Description
2-0	NBOFMSGMBM	R	0h	Number of unread messages in Mailbox. Limited to four messages per mailbox.

17.1.5.24 MSGSTATUS_5 Register (offset = D4h) [reset = 0h]

MSGSTATUS_5 is shown in [Figure 17-26](#) and described in [Table 17-38](#).

The message status register has the status of the messages in the mailbox

Figure 17-26. MSGSTATUS_5 Register



LEGEND: R/W = Read/Write; R = Read only; W1toCl = Write 1 to clear bit; -n = value after reset

Table 17-38. MSGSTATUS_5 Register Field Descriptions

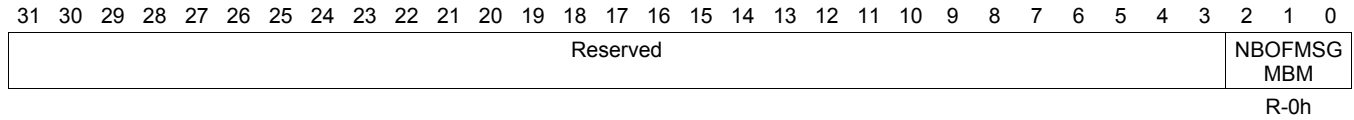
Bit	Field	Type	Reset	Description
2-0	NBOFMSGMBM	R	0h	Number of unread messages in Mailbox. Limited to four messages per mailbox.

17.1.5.25 MSGSTATUS_6 Register (offset = D8h) [reset = 0h]

MSGSTATUS_6 is shown in [Figure 17-27](#) and described in [Table 17-39](#).

The message status register has the status of the messages in the mailbox

Figure 17-27. MSGSTATUS_6 Register



LEGEND: R/W = Read/Write; R = Read only; W1toCl = Write 1 to clear bit; -n = value after reset

Table 17-39. MSGSTATUS_6 Register Field Descriptions

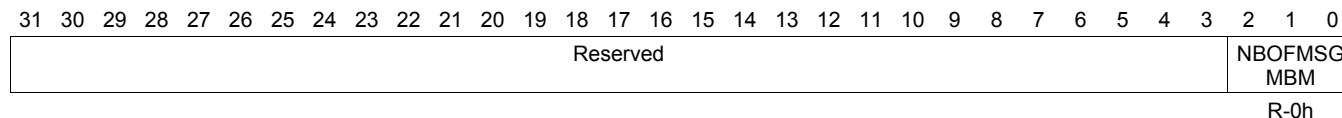
Bit	Field	Type	Reset	Description
2-0	NBOFMSGMBM	R	0h	Number of unread messages in Mailbox. Limited to four messages per mailbox.

17.1.5.26 MSGSTATUS_7 Register (offset = DCh) [reset = 0h]

MSGSTATUS_7 is shown in [Figure 17-28](#) and described in [Table 17-40](#).

The message status register has the status of the messages in the mailbox

Figure 17-28. MSGSTATUS_7 Register



LEGEND: R/W = Read/Write; R = Read only; W1toCl = Write 1 to clear bit; -n = value after reset

Table 17-40. MSGSTATUS_7 Register Field Descriptions

Bit	Field	Type	Reset	Description
2-0	NBOFMSGMBM	R	0h	Number of unread messages in Mailbox. Limited to four messages per mailbox.

17.1.5.27 IRQSTATUS_RAW_0 Register (offset = 100h) [reset = 0h]

IRQSTATUS_RAW_0 is shown in [Figure 17-29](#) and described in [Table 17-41](#).

The interrupt status register has the status for each event that may be responsible for the generation of an interrupt to the corresponding user - write 1 to a given bit resets this bit. This register is mainly used for debug purpose.

Figure 17-29. IRQSTATUS_RAW_0 Register

31	30	29	28	27	26	25	24
Reserved							
23	22	21	20	19	18	17	16
Reserved							
15	14	13	12	11	10	9	8
NotFullStatusU uMB7	NewMSGStatus UuMB7	NotFullStatusU uMB6	NewMSGStatus UuMB6	NotFullStatusU uMB5	NewMSGStatus UuMB5	NotFullStatusU uMB4	NewMSGStatus UuMB4
R/W-0h	R/W-0h	R/W-0h	R/W-0h	R/W-0h	R/W-0h	R/W-0h	R/W-0h
7	6	5	4	3	2	1	0
NotFullStatusU uMB3	NewMSGStatus UuMB3	NotFullStatusU uMB2	NewMSGStatus UuMB2	NotFullStatusU uMB1	NewMSGStatus UuMB1	NotFullStatusU uMB0	NewMSGStatus UuMB0
R/W-0h	R/W-0h	R/W-0h	R/W-0h	R/W-0h	R/W-0h	R/W-0h	R/W-0h

LEGEND: R/W = Read/Write; R = Read only; W1toCl = Write 1 to clear bit; -n = value after reset

Table 17-41. IRQSTATUS_RAW_0 Register Field Descriptions

Bit	Field	Type	Reset	Description
15	NotFullStatusUuMB7	R/W	0h	Not Full Status bit for User u, Mailbox 7 0 = NoAction : No action 1 = SetEvent : Set the event (for debug)
14	NewMSGStatusUuMB7	R/W	0h	New Message Status bit for User u, Mailbox 7 0 = NoAction : No action 1 = SetEvent : Set the event (for debug)
13	NotFullStatusUuMB6	R/W	0h	Not Full Status bit for User u, Mailbox 6 0 = NoAction : No action 1 = SetEvent : Set the event (for debug)
12	NewMSGStatusUuMB6	R/W	0h	New Message Status bit for User u, Mailbox 6 0 = NoAction : No action 1 = SetEvent : Set the event (for debug)
11	NotFullStatusUuMB5	R/W	0h	Not Full Status bit for User u, Mailbox 5 0 = NoAction : No action 1 = SetEvent : Set the event (for debug)
10	NewMSGStatusUuMB5	R/W	0h	New Message Status bit for User u, Mailbox 5 0 = NoAction : No action 1 = SetEvent : Set the event (for debug)
9	NotFullStatusUuMB4	R/W	0h	Not Full Status bit for User u, Mailbox 4 0 = NoAction : No action 1 = SetEvent : Set the event (for debug)
8	NewMSGStatusUuMB4	R/W	0h	New Message Status bit for User u, Mailbox 4 0 = NoAction : No action 1 = SetEvent : Set the event (for debug)
7	NotFullStatusUuMB3	R/W	0h	Not Full Status bit for User u, Mailbox 3 0 = NoAction : No action 1 = SetEvent : Set the event (for debug)

Table 17-41. IRQSTATUS_RAW_0 Register Field Descriptions (continued)

Bit	Field	Type	Reset	Description
6	NewMSGStatusUuMB3	R/W	0h	New Message Status bit for User u, Mailbox 3 0 = NoAction : No action 1 = SetEvent : Set the event (for debug)
5	NotFullStatusUuMB2	R/W	0h	Not Full Status bit for User u, Mailbox 2 0 = NoAction : No action 1 = SetEvent : Set the event (for debug)
4	NewMSGStatusUuMB2	R/W	0h	New Message Status bit for User u, Mailbox 2 0 = NoAction : No action 1 = SetEvent : Set the event (for debug)
3	NotFullStatusUuMB1	R/W	0h	Not Full Status bit for User u, Mailbox 1 0 = NoAction : No action 1 = SetEvent : Set the event (for debug)
2	NewMSGStatusUuMB1	R/W	0h	New Message Status bit for User u, Mailbox 1 0 = NoAction : No action 1 = SetEvent : Set the event (for debug)
1	NotFullStatusUuMB0	R/W	0h	Not Full Status bit for User u, Mailbox 0 0 = NoAction : No action 1 = SetEvent : Set the event (for debug)
0	NewMSGStatusUuMB0	R/W	0h	New Message Status bit for User u, Mailbox 0 0 = NoAction : No action 1 = SetEvent : Set the event (for debug)

17.1.5.28 IRQSTATUS_CLR_0 Register (offset = 104h) [reset = 0h]

IRQSTATUS_CLR_0 is shown in [Figure 17-30](#) and described in [Table 17-42](#).

The interrupt status register has the status combined with irq-enable for each event that may be responsible for the generation of an interrupt to the corresponding user - write 1 to a given bit resets this bit.

Figure 17-30. IRQSTATUS_CLR_0 Register

31	30	29	28	27	26	25	24
Reserved							
23	22	21	20	19	18	17	16
Reserved							
15	14	13	12	11	10	9	8
NotFullStatusU uMB7	NewMSGStatus UuMB7	NotFullStatusU uMB6	NewMSGStatus UuMB6	NotFullStatusU uMB5	NewMSGStatus UuMB5	NotFullStatusU uMB4	NewMSGStatus UuMB4
R/W-0h	R/W-0h	R/W-0h	R/W-0h	R/W-0h	R/W-0h	R/W-0h	R/W-0h
7	6	5	4	3	2	1	0
NotFullStatusU uMB3	NewMSGStatus UuMB3	NotFullStatusU uMB2	NewMSGStatus UuMB2	NotFullStatusU uMB1	NewMSGStatus UuMB1	NotFullStatusU uMB0	NewMSGStatus UuMB0
R/W-0h	R/W-0h	R/W-0h	R/W-0h	R/W-0h	R/W-0h	R/W-0h	R/W-0h

LEGEND: R/W = Read/Write; R = Read only; W1toCl = Write 1 to clear bit; -n = value after reset

Table 17-42. IRQSTATUS_CLR_0 Register Field Descriptions

Bit	Field	Type	Reset	Description
15	NotFullStatusUuMB7	R/W	0h	Not Full Status bit for User u, Mailbox 7 0 = NoAction : No action 1 = SetEvent : Set the event (for debug)
14	NewMSGStatusUuMB7	R/W	0h	New Message Status bit for User u, Mailbox 7 0 = NoAction : No action 1 = SetEvent : Set the event (for debug)
13	NotFullStatusUuMB6	R/W	0h	Not Full Status bit for User u, Mailbox 6 0 = NoAction : No action 1 = SetEvent : Set the event (for debug)
12	NewMSGStatusUuMB6	R/W	0h	New Message Status bit for User u, Mailbox 6 0 = NoAction : No action 1 = SetEvent : Set the event (for debug)
11	NotFullStatusUuMB5	R/W	0h	Not Full Status bit for User u, Mailbox 5 0 = NoAction : No action 1 = SetEvent : Set the event (for debug)
10	NewMSGStatusUuMB5	R/W	0h	New Message Status bit for User u, Mailbox 5 0 = NoAction : No action 1 = SetEvent : Set the event (for debug)
9	NotFullStatusUuMB4	R/W	0h	Not Full Status bit for User u, Mailbox 4 0 = NoAction : No action 1 = SetEvent : Set the event (for debug)
8	NewMSGStatusUuMB4	R/W	0h	New Message Status bit for User u, Mailbox 4 0 = NoAction : No action 1 = SetEvent : Set the event (for debug)
7	NotFullStatusUuMB3	R/W	0h	Not Full Status bit for User u, Mailbox 3 0 = NoAction : No action 1 = SetEvent : Set the event (for debug)

Table 17-42. IRQSTATUS_CLR_0 Register Field Descriptions (continued)

Bit	Field	Type	Reset	Description
6	NewMSGStatusUuMB3	R/W	0h	New Message Status bit for User u, Mailbox 3 0 = NoAction : No action 1 = SetEvent : Set the event (for debug)
5	NotFullStatusUuMB2	R/W	0h	Not Full Status bit for User u, Mailbox 2 0 = NoAction : No action 1 = SetEvent : Set the event (for debug)
4	NewMSGStatusUuMB2	R/W	0h	New Message Status bit for User u, Mailbox 2 0 = NoAction : No action 1 = SetEvent : Set the event (for debug)
3	NotFullStatusUuMB1	R/W	0h	Not Full Status bit for User u, Mailbox 1 0 = NoAction : No action 1 = SetEvent : Set the event (for debug)
2	NewMSGStatusUuMB1	R/W	0h	New Message Status bit for User u, Mailbox 1 0 = NoAction : No action 1 = SetEvent : Set the event (for debug)
1	NotFullStatusUuMB0	R/W	0h	Not Full Status bit for User u, Mailbox 0 0 = NoAction : No action 1 = SetEvent : Set the event (for debug)
0	NewMSGStatusUuMB0	R/W	0h	New Message Status bit for User u, Mailbox 0 0 = NoAction : No action 1 = SetEvent : Set the event (for debug)

17.1.5.29 IRQENABLE_SET_0 Register (offset = 108h) [reset = 0h]

IRQENABLE_SET_0 is shown in [Figure 17-31](#) and described in [Table 17-43](#).

The interrupt enable register enables to unmask the module internal source of interrupt to the corresponding user. This register is write 1 to set.

Figure 17-31. IRQENABLE_SET_0 Register

31	30	29	28	27	26	25	24
Reserved							
23	22	21	20	19	18	17	16
Reserved							
15	14	13	12	11	10	9	8
NotFullStatusU uMB7	NewMSGStatus UuMB7	NotFullStatusU uMB6	NewMSGStatus UuMB6	NotFullStatusU uMB5	NewMSGStatus UuMB5	NotFullStatusU uMB4	NewMSGStatus UuMB4
R/W-0h	R/W-0h	R/W-0h	R/W-0h	R/W-0h	R/W-0h	R/W-0h	R/W-0h
7	6	5	4	3	2	1	0
NotFullStatusU uMB3	NewMSGStatus UuMB3	NotFullStatusU uMB2	NewMSGStatus UuMB2	NotFullStatusU uMB1	NewMSGStatus UuMB1	NotFullStatusU uMB0	NewMSGStatus UuMB0
R/W-0h	R/W-0h	R/W-0h	R/W-0h	R/W-0h	R/W-0h	R/W-0h	R/W-0h

LEGEND: R/W = Read/Write; R = Read only; W1toCl = Write 1 to clear bit; -n = value after reset

Table 17-43. IRQENABLE_SET_0 Register Field Descriptions

Bit	Field	Type	Reset	Description
15	NotFullStatusUuMB7	R/W	0h	Not Full Status bit for User u, Mailbox 7 0 = NoAction : No action 1 = SetEvent : Set the event (for debug)
14	NewMSGStatusUuMB7	R/W	0h	New Message Status bit for User u, Mailbox 7 0 = NoAction : No action 1 = SetEvent : Set the event (for debug)
13	NotFullStatusUuMB6	R/W	0h	Not Full Status bit for User u, Mailbox 6 0 = NoAction : No action 1 = SetEvent : Set the event (for debug)
12	NewMSGStatusUuMB6	R/W	0h	New Message Status bit for User u, Mailbox 6 0 = NoAction : No action 1 = SetEvent : Set the event (for debug)
11	NotFullStatusUuMB5	R/W	0h	Not Full Status bit for User u, Mailbox 5 0 = NoAction : No action 1 = SetEvent : Set the event (for debug)
10	NewMSGStatusUuMB5	R/W	0h	New Message Status bit for User u, Mailbox 5 0 = NoAction : No action 1 = SetEvent : Set the event (for debug)
9	NotFullStatusUuMB4	R/W	0h	Not Full Status bit for User u, Mailbox 4 0 = NoAction : No action 1 = SetEvent : Set the event (for debug)
8	NewMSGStatusUuMB4	R/W	0h	New Message Status bit for User u, Mailbox 4 0 = NoAction : No action 1 = SetEvent : Set the event (for debug)
7	NotFullStatusUuMB3	R/W	0h	Not Full Status bit for User u, Mailbox 3 0 = NoAction : No action 1 = SetEvent : Set the event (for debug)

Table 17-43. IRQENABLE_SET_0 Register Field Descriptions (continued)

Bit	Field	Type	Reset	Description
6	NewMSGStatusUuMB3	R/W	0h	New Message Status bit for User u, Mailbox 3 0 = NoAction : No action 1 = SetEvent : Set the event (for debug)
5	NotFullStatusUuMB2	R/W	0h	Not Full Status bit for User u, Mailbox 2 0 = NoAction : No action 1 = SetEvent : Set the event (for debug)
4	NewMSGStatusUuMB2	R/W	0h	New Message Status bit for User u, Mailbox 2 0 = NoAction : No action 1 = SetEvent : Set the event (for debug)
3	NotFullStatusUuMB1	R/W	0h	Not Full Status bit for User u, Mailbox 1 0 = NoAction : No action 1 = SetEvent : Set the event (for debug)
2	NewMSGStatusUuMB1	R/W	0h	New Message Status bit for User u, Mailbox 1 0 = NoAction : No action 1 = SetEvent : Set the event (for debug)
1	NotFullStatusUuMB0	R/W	0h	Not Full Status bit for User u, Mailbox 0 0 = NoAction : No action 1 = SetEvent : Set the event (for debug)
0	NewMSGStatusUuMB0	R/W	0h	New Message Status bit for User u, Mailbox 0 0 = NoAction : No action 1 = SetEvent : Set the event (for debug)

17.1.5.30 IRQENABLE_CLR_0 Register (offset = 10Ch) [reset = 0h]

IRQENABLE_CLR_0 is shown in [Figure 17-32](#) and described in [Table 17-44](#).

The interrupt enable register enables to mask the module internal source of interrupt to the corresponding user. This register is write 1 to clear.

Figure 17-32. IRQENABLE_CLR_0 Register

31	30	29	28	27	26	25	24
Reserved							
23	22	21	20	19	18	17	16
Reserved							
15	14	13	12	11	10	9	8
NotFullStatusU uMB7	NewMSGStatus UuMB7	NotFullStatusU uMB6	NewMSGStatus UuMB6	NotFullStatusU uMB5	NewMSGStatus UuMB5	NotFullStatusU uMB4	NewMSGStatus UuMB4
R/W-0h	R/W-0h	R/W-0h	R/W-0h	R/W-0h	R/W-0h	R/W-0h	R/W-0h
7	6	5	4	3	2	1	0
NotFullStatusU uMB3	NewMSGStatus UuMB3	NotFullStatusU uMB2	NewMSGStatus UuMB2	NotFullStatusU uMB1	NewMSGStatus UuMB1	NotFullStatusU uMB0	NewMSGStatus UuMB0
R/W-0h	R/W-0h	R/W-0h	R/W-0h	R/W-0h	R/W-0h	R/W-0h	R/W-0h

LEGEND: R/W = Read/Write; R = Read only; W1toCl = Write 1 to clear bit; -n = value after reset

Table 17-44. IRQENABLE_CLR_0 Register Field Descriptions

Bit	Field	Type	Reset	Description
15	NotFullStatusUuMB7	R/W	0h	Not Full Status bit for User u, Mailbox 7 0 = NoAction : No action 1 = SetEvent : Set the event (for debug)
14	NewMSGStatusUuMB7	R/W	0h	New Message Status bit for User u, Mailbox 7 0 = NoAction : No action 1 = SetEvent : Set the event (for debug)
13	NotFullStatusUuMB6	R/W	0h	Not Full Status bit for User u, Mailbox 6 0 = NoAction : No action 1 = SetEvent : Set the event (for debug)
12	NewMSGStatusUuMB6	R/W	0h	New Message Status bit for User u, Mailbox 6 0 = NoAction : No action 1 = SetEvent : Set the event (for debug)
11	NotFullStatusUuMB5	R/W	0h	Not Full Status bit for User u, Mailbox 5 0 = NoAction : No action 1 = SetEvent : Set the event (for debug)
10	NewMSGStatusUuMB5	R/W	0h	New Message Status bit for User u, Mailbox 5 0 = NoAction : No action 1 = SetEvent : Set the event (for debug)
9	NotFullStatusUuMB4	R/W	0h	Not Full Status bit for User u, Mailbox 4 0 = NoAction : No action 1 = SetEvent : Set the event (for debug)
8	NewMSGStatusUuMB4	R/W	0h	New Message Status bit for User u, Mailbox 4 0 = NoAction : No action 1 = SetEvent : Set the event (for debug)
7	NotFullStatusUuMB3	R/W	0h	Not Full Status bit for User u, Mailbox 3 0 = NoAction : No action 1 = SetEvent : Set the event (for debug)

Table 17-44. IRQENABLE_CLR_0 Register Field Descriptions (continued)

Bit	Field	Type	Reset	Description
6	NewMSGStatusUuMB3	R/W	0h	New Message Status bit for User u, Mailbox 3 0 = NoAction : No action 1 = SetEvent : Set the event (for debug)
5	NotFullStatusUuMB2	R/W	0h	Not Full Status bit for User u, Mailbox 2 0 = NoAction : No action 1 = SetEvent : Set the event (for debug)
4	NewMSGStatusUuMB2	R/W	0h	New Message Status bit for User u, Mailbox 2 0 = NoAction : No action 1 = SetEvent : Set the event (for debug)
3	NotFullStatusUuMB1	R/W	0h	Not Full Status bit for User u, Mailbox 1 0 = NoAction : No action 1 = SetEvent : Set the event (for debug)
2	NewMSGStatusUuMB1	R/W	0h	New Message Status bit for User u, Mailbox 1 0 = NoAction : No action 1 = SetEvent : Set the event (for debug)
1	NotFullStatusUuMB0	R/W	0h	Not Full Status bit for User u, Mailbox 0 0 = NoAction : No action 1 = SetEvent : Set the event (for debug)
0	NewMSGStatusUuMB0	R/W	0h	New Message Status bit for User u, Mailbox 0 0 = NoAction : No action 1 = SetEvent : Set the event (for debug)

17.1.5.31 IRQSTATUS_RAW_1 Register (offset = 110h) [reset = 0h]

IRQSTATUS_RAW_1 is shown in [Figure 17-33](#) and described in [Table 17-45](#).

The interrupt status register has the status for each event that may be responsible for the generation of an interrupt to the corresponding user - write 1 to a given bit resets this bit. This register is mainly used for debug purpose.

Figure 17-33. IRQSTATUS_RAW_1 Register

31	30	29	28	27	26	25	24
Reserved							
23	22	21	20	19	18	17	16
Reserved							
15	14	13	12	11	10	9	8
NotFullStatusU uMB7	NewMSGStatus UuMB7	NotFullStatusU uMB6	NewMSGStatus UuMB6	NotFullStatusU uMB5	NewMSGStatus UuMB5	NotFullStatusU uMB4	NewMSGStatus UuMB4
R/W-0h	R/W-0h	R/W-0h	R/W-0h	R/W-0h	R/W-0h	R/W-0h	R/W-0h
7	6	5	4	3	2	1	0
NotFullStatusU uMB3	NewMSGStatus UuMB3	NotFullStatusU uMB2	NewMSGStatus UuMB2	NotFullStatusU uMB1	NewMSGStatus UuMB1	NotFullStatusU uMB0	NewMSGStatus UuMB0
R/W-0h	R/W-0h	R/W-0h	R/W-0h	R/W-0h	R/W-0h	R/W-0h	R/W-0h

LEGEND: R/W = Read/Write; R = Read only; W1toCl = Write 1 to clear bit; -n = value after reset

Table 17-45. IRQSTATUS_RAW_1 Register Field Descriptions

Bit	Field	Type	Reset	Description
15	NotFullStatusUuMB7	R/W	0h	Not Full Status bit for User u, Mailbox 7 0 = NoAction : No action 1 = SetEvent : Set the event (for debug)
14	NewMSGStatusUuMB7	R/W	0h	New Message Status bit for User u, Mailbox 7 0 = NoAction : No action 1 = SetEvent : Set the event (for debug)
13	NotFullStatusUuMB6	R/W	0h	Not Full Status bit for User u, Mailbox 6 0 = NoAction : No action 1 = SetEvent : Set the event (for debug)
12	NewMSGStatusUuMB6	R/W	0h	New Message Status bit for User u, Mailbox 6 0 = NoAction : No action 1 = SetEvent : Set the event (for debug)
11	NotFullStatusUuMB5	R/W	0h	Not Full Status bit for User u, Mailbox 5 0 = NoAction : No action 1 = SetEvent : Set the event (for debug)
10	NewMSGStatusUuMB5	R/W	0h	New Message Status bit for User u, Mailbox 5 0 = NoAction : No action 1 = SetEvent : Set the event (for debug)
9	NotFullStatusUuMB4	R/W	0h	Not Full Status bit for User u, Mailbox 4 0 = NoAction : No action 1 = SetEvent : Set the event (for debug)
8	NewMSGStatusUuMB4	R/W	0h	New Message Status bit for User u, Mailbox 4 0 = NoAction : No action 1 = SetEvent : Set the event (for debug)
7	NotFullStatusUuMB3	R/W	0h	Not Full Status bit for User u, Mailbox 3 0 = NoAction : No action 1 = SetEvent : Set the event (for debug)

Table 17-45. IRQSTATUS_RAW_1 Register Field Descriptions (continued)

Bit	Field	Type	Reset	Description
6	NewMSGStatusUuMB3	R/W	0h	New Message Status bit for User u, Mailbox 3 0 = NoAction : No action 1 = SetEvent : Set the event (for debug)
5	NotFullStatusUuMB2	R/W	0h	Not Full Status bit for User u, Mailbox 2 0 = NoAction : No action 1 = SetEvent : Set the event (for debug)
4	NewMSGStatusUuMB2	R/W	0h	New Message Status bit for User u, Mailbox 2 0 = NoAction : No action 1 = SetEvent : Set the event (for debug)
3	NotFullStatusUuMB1	R/W	0h	Not Full Status bit for User u, Mailbox 1 0 = NoAction : No action 1 = SetEvent : Set the event (for debug)
2	NewMSGStatusUuMB1	R/W	0h	New Message Status bit for User u, Mailbox 1 0 = NoAction : No action 1 = SetEvent : Set the event (for debug)
1	NotFullStatusUuMB0	R/W	0h	Not Full Status bit for User u, Mailbox 0 0 = NoAction : No action 1 = SetEvent : Set the event (for debug)
0	NewMSGStatusUuMB0	R/W	0h	New Message Status bit for User u, Mailbox 0 0 = NoAction : No action 1 = SetEvent : Set the event (for debug)

17.1.5.32 IRQSTATUS_CLR_1 Register (offset = 114h) [reset = 0h]

IRQSTATUS_CLR_1 is shown in [Figure 17-34](#) and described in [Table 17-46](#).

The interrupt status register has the status combined with irq-enable for each event that may be responsible for the generation of an interrupt to the corresponding user - write 1 to a given bit resets this bit.

Figure 17-34. IRQSTATUS_CLR_1 Register

31	30	29	28	27	26	25	24
Reserved							
23	22	21	20	19	18	17	16
Reserved							
15	14	13	12	11	10	9	8
NotFullStatusU uMB7	NewMSGStatus UuMB7	NotFullStatusU uMB6	NewMSGStatus UuMB6	NotFullStatusU uMB5	NewMSGStatus UuMB5	NotFullStatusU uMB4	NewMSGStatus UuMB4
R/W-0h	R/W-0h	R/W-0h	R/W-0h	R/W-0h	R/W-0h	R/W-0h	R/W-0h
7	6	5	4	3	2	1	0
NotFullStatusU uMB3	NewMSGStatus UuMB3	NotFullStatusU uMB2	NewMSGStatus UuMB2	NotFullStatusU uMB1	NewMSGStatus UuMB1	NotFullStatusU uMB0	NewMSGStatus UuMB0
R/W-0h	R/W-0h	R/W-0h	R/W-0h	R/W-0h	R/W-0h	R/W-0h	R/W-0h

LEGEND: R/W = Read/Write; R = Read only; W1toCl = Write 1 to clear bit; -n = value after reset

Table 17-46. IRQSTATUS_CLR_1 Register Field Descriptions

Bit	Field	Type	Reset	Description
15	NotFullStatusUuMB7	R/W	0h	Not Full Status bit for User u, Mailbox 7 0 = NoAction : No action 1 = SetEvent : Set the event (for debug)
14	NewMSGStatusUuMB7	R/W	0h	New Message Status bit for User u, Mailbox 7 0 = NoAction : No action 1 = SetEvent : Set the event (for debug)
13	NotFullStatusUuMB6	R/W	0h	Not Full Status bit for User u, Mailbox 6 0 = NoAction : No action 1 = SetEvent : Set the event (for debug)
12	NewMSGStatusUuMB6	R/W	0h	New Message Status bit for User u, Mailbox 6 0 = NoAction : No action 1 = SetEvent : Set the event (for debug)
11	NotFullStatusUuMB5	R/W	0h	Not Full Status bit for User u, Mailbox 5 0 = NoAction : No action 1 = SetEvent : Set the event (for debug)
10	NewMSGStatusUuMB5	R/W	0h	New Message Status bit for User u, Mailbox 5 0 = NoAction : No action 1 = SetEvent : Set the event (for debug)
9	NotFullStatusUuMB4	R/W	0h	Not Full Status bit for User u, Mailbox 4 0 = NoAction : No action 1 = SetEvent : Set the event (for debug)
8	NewMSGStatusUuMB4	R/W	0h	New Message Status bit for User u, Mailbox 4 0 = NoAction : No action 1 = SetEvent : Set the event (for debug)
7	NotFullStatusUuMB3	R/W	0h	Not Full Status bit for User u, Mailbox 3 0 = NoAction : No action 1 = SetEvent : Set the event (for debug)

Table 17-46. IRQSTATUS_CLR_1 Register Field Descriptions (continued)

Bit	Field	Type	Reset	Description
6	NewMSGStatusUuMB3	R/W	0h	New Message Status bit for User u, Mailbox 3 0 = NoAction : No action 1 = SetEvent : Set the event (for debug)
5	NotFullStatusUuMB2	R/W	0h	Not Full Status bit for User u, Mailbox 2 0 = NoAction : No action 1 = SetEvent : Set the event (for debug)
4	NewMSGStatusUuMB2	R/W	0h	New Message Status bit for User u, Mailbox 2 0 = NoAction : No action 1 = SetEvent : Set the event (for debug)
3	NotFullStatusUuMB1	R/W	0h	Not Full Status bit for User u, Mailbox 1 0 = NoAction : No action 1 = SetEvent : Set the event (for debug)
2	NewMSGStatusUuMB1	R/W	0h	New Message Status bit for User u, Mailbox 1 0 = NoAction : No action 1 = SetEvent : Set the event (for debug)
1	NotFullStatusUuMB0	R/W	0h	Not Full Status bit for User u, Mailbox 0 0 = NoAction : No action 1 = SetEvent : Set the event (for debug)
0	NewMSGStatusUuMB0	R/W	0h	New Message Status bit for User u, Mailbox 0 0 = NoAction : No action 1 = SetEvent : Set the event (for debug)

17.1.5.33 IRQENABLE_SET_1 Register (offset = 118h) [reset = 0h]

IRQENABLE_SET_1 is shown in [Figure 17-35](#) and described in [Table 17-47](#).

The interrupt enable register enables to unmask the module internal source of interrupt to the corresponding user. This register is write 1 to set.

Figure 17-35. IRQENABLE_SET_1 Register

31	30	29	28	27	26	25	24
Reserved							
23	22	21	20	19	18	17	16
Reserved							
15	14	13	12	11	10	9	8
NotFullStatusU uMB7	NewMSGStatus UuMB7	NotFullStatusU uMB6	NewMSGStatus UuMB6	NotFullStatusU uMB5	NewMSGStatus UuMB5	NotFullStatusU uMB4	NewMSGStatus UuMB4
R/W-0h	R/W-0h	R/W-0h	R/W-0h	R/W-0h	R/W-0h	R/W-0h	R/W-0h
7	6	5	4	3	2	1	0
NotFullStatusU uMB3	NewMSGStatus UuMB3	NotFullStatusU uMB2	NewMSGStatus UuMB2	NotFullStatusU uMB1	NewMSGStatus UuMB1	NotFullStatusU uMB0	NewMSGStatus UuMB0
R/W-0h	R/W-0h	R/W-0h	R/W-0h	R/W-0h	R/W-0h	R/W-0h	R/W-0h

LEGEND: R/W = Read/Write; R = Read only; W1toCl = Write 1 to clear bit; -n = value after reset

Table 17-47. IRQENABLE_SET_1 Register Field Descriptions

Bit	Field	Type	Reset	Description
15	NotFullStatusUuMB7	R/W	0h	Not Full Status bit for User u, Mailbox 7 0 = NoAction : No action 1 = SetEvent : Set the event (for debug)
14	NewMSGStatusUuMB7	R/W	0h	New Message Status bit for User u, Mailbox 7 0 = NoAction : No action 1 = SetEvent : Set the event (for debug)
13	NotFullStatusUuMB6	R/W	0h	Not Full Status bit for User u, Mailbox 6 0 = NoAction : No action 1 = SetEvent : Set the event (for debug)
12	NewMSGStatusUuMB6	R/W	0h	New Message Status bit for User u, Mailbox 6 0 = NoAction : No action 1 = SetEvent : Set the event (for debug)
11	NotFullStatusUuMB5	R/W	0h	Not Full Status bit for User u, Mailbox 5 0 = NoAction : No action 1 = SetEvent : Set the event (for debug)
10	NewMSGStatusUuMB5	R/W	0h	New Message Status bit for User u, Mailbox 5 0 = NoAction : No action 1 = SetEvent : Set the event (for debug)
9	NotFullStatusUuMB4	R/W	0h	Not Full Status bit for User u, Mailbox 4 0 = NoAction : No action 1 = SetEvent : Set the event (for debug)
8	NewMSGStatusUuMB4	R/W	0h	New Message Status bit for User u, Mailbox 4 0 = NoAction : No action 1 = SetEvent : Set the event (for debug)
7	NotFullStatusUuMB3	R/W	0h	Not Full Status bit for User u, Mailbox 3 0 = NoAction : No action 1 = SetEvent : Set the event (for debug)

Table 17-47. IRQENABLE_SET_1 Register Field Descriptions (continued)

Bit	Field	Type	Reset	Description
6	NewMSGStatusUuMB3	R/W	0h	New Message Status bit for User u, Mailbox 3 0 = NoAction : No action 1 = SetEvent : Set the event (for debug)
5	NotFullStatusUuMB2	R/W	0h	Not Full Status bit for User u, Mailbox 2 0 = NoAction : No action 1 = SetEvent : Set the event (for debug)
4	NewMSGStatusUuMB2	R/W	0h	New Message Status bit for User u, Mailbox 2 0 = NoAction : No action 1 = SetEvent : Set the event (for debug)
3	NotFullStatusUuMB1	R/W	0h	Not Full Status bit for User u, Mailbox 1 0 = NoAction : No action 1 = SetEvent : Set the event (for debug)
2	NewMSGStatusUuMB1	R/W	0h	New Message Status bit for User u, Mailbox 1 0 = NoAction : No action 1 = SetEvent : Set the event (for debug)
1	NotFullStatusUuMB0	R/W	0h	Not Full Status bit for User u, Mailbox 0 0 = NoAction : No action 1 = SetEvent : Set the event (for debug)
0	NewMSGStatusUuMB0	R/W	0h	New Message Status bit for User u, Mailbox 0 0 = NoAction : No action 1 = SetEvent : Set the event (for debug)

17.1.5.34 IRQENABLE_CLR_1 Register (offset = 11Ch) [reset = 0h]

IRQENABLE_CLR_1 is shown in [Figure 17-36](#) and described in [Table 17-48](#).

The interrupt enable register enables to mask the module internal source of interrupt to the corresponding user. This register is write 1 to clear.

Figure 17-36. IRQENABLE_CLR_1 Register

31	30	29	28	27	26	25	24
Reserved							
23	22	21	20	19	18	17	16
Reserved							
15	14	13	12	11	10	9	8
NotFullStatusU uMB7	NewMSGStatus UuMB7	NotFullStatusU uMB6	NewMSGStatus UuMB6	NotFullStatusU uMB5	NewMSGStatus UuMB5	NotFullStatusU uMB4	NewMSGStatus UuMB4
R/W-0h	R/W-0h	R/W-0h	R/W-0h	R/W-0h	R/W-0h	R/W-0h	R/W-0h
7	6	5	4	3	2	1	0
NotFullStatusU uMB3	NewMSGStatus UuMB3	NotFullStatusU uMB2	NewMSGStatus UuMB2	NotFullStatusU uMB1	NewMSGStatus UuMB1	NotFullStatusU uMB0	NewMSGStatus UuMB0
R/W-0h	R/W-0h	R/W-0h	R/W-0h	R/W-0h	R/W-0h	R/W-0h	R/W-0h

LEGEND: R/W = Read/Write; R = Read only; W1toCl = Write 1 to clear bit; -n = value after reset

Table 17-48. IRQENABLE_CLR_1 Register Field Descriptions

Bit	Field	Type	Reset	Description
15	NotFullStatusUuMB7	R/W	0h	Not Full Status bit for User u, Mailbox 7 0 = NoAction : No action 1 = SetEvent : Set the event (for debug)
14	NewMSGStatusUuMB7	R/W	0h	New Message Status bit for User u, Mailbox 7 0 = NoAction : No action 1 = SetEvent : Set the event (for debug)
13	NotFullStatusUuMB6	R/W	0h	Not Full Status bit for User u, Mailbox 6 0 = NoAction : No action 1 = SetEvent : Set the event (for debug)
12	NewMSGStatusUuMB6	R/W	0h	New Message Status bit for User u, Mailbox 6 0 = NoAction : No action 1 = SetEvent : Set the event (for debug)
11	NotFullStatusUuMB5	R/W	0h	Not Full Status bit for User u, Mailbox 5 0 = NoAction : No action 1 = SetEvent : Set the event (for debug)
10	NewMSGStatusUuMB5	R/W	0h	New Message Status bit for User u, Mailbox 5 0 = NoAction : No action 1 = SetEvent : Set the event (for debug)
9	NotFullStatusUuMB4	R/W	0h	Not Full Status bit for User u, Mailbox 4 0 = NoAction : No action 1 = SetEvent : Set the event (for debug)
8	NewMSGStatusUuMB4	R/W	0h	New Message Status bit for User u, Mailbox 4 0 = NoAction : No action 1 = SetEvent : Set the event (for debug)
7	NotFullStatusUuMB3	R/W	0h	Not Full Status bit for User u, Mailbox 3 0 = NoAction : No action 1 = SetEvent : Set the event (for debug)

Table 17-48. IRQENABLE_CLR_1 Register Field Descriptions (continued)

Bit	Field	Type	Reset	Description
6	NewMSGStatusUuMB3	R/W	0h	New Message Status bit for User u, Mailbox 3 0 = NoAction : No action 1 = SetEvent : Set the event (for debug)
5	NotFullStatusUuMB2	R/W	0h	Not Full Status bit for User u, Mailbox 2 0 = NoAction : No action 1 = SetEvent : Set the event (for debug)
4	NewMSGStatusUuMB2	R/W	0h	New Message Status bit for User u, Mailbox 2 0 = NoAction : No action 1 = SetEvent : Set the event (for debug)
3	NotFullStatusUuMB1	R/W	0h	Not Full Status bit for User u, Mailbox 1 0 = NoAction : No action 1 = SetEvent : Set the event (for debug)
2	NewMSGStatusUuMB1	R/W	0h	New Message Status bit for User u, Mailbox 1 0 = NoAction : No action 1 = SetEvent : Set the event (for debug)
1	NotFullStatusUuMB0	R/W	0h	Not Full Status bit for User u, Mailbox 0 0 = NoAction : No action 1 = SetEvent : Set the event (for debug)
0	NewMSGStatusUuMB0	R/W	0h	New Message Status bit for User u, Mailbox 0 0 = NoAction : No action 1 = SetEvent : Set the event (for debug)

17.1.5.35 IRQSTATUS_RAW_2 Register (offset = 120h) [reset = 0h]

IRQSTATUS_RAW_2 is shown in [Figure 17-37](#) and described in [Table 17-49](#).

The interrupt status register has the status for each event that may be responsible for the generation of an interrupt to the corresponding user - write 1 to a given bit resets this bit. This register is mainly used for debug purpose.

Figure 17-37. IRQSTATUS_RAW_2 Register

31	30	29	28	27	26	25	24
Reserved							
23	22	21	20	19	18	17	16
Reserved							
15	14	13	12	11	10	9	8
NotFullStatusU uMB7	NewMSGStatus UuMB7	NotFullStatusU uMB6	NewMSGStatus UuMB6	NotFullStatusU uMB5	NewMSGStatus UuMB5	NotFullStatusU uMB4	NewMSGStatus UuMB4
R/W-0h	R/W-0h	R/W-0h	R/W-0h	R/W-0h	R/W-0h	R/W-0h	R/W-0h
7	6	5	4	3	2	1	0
NotFullStatusU uMB3	NewMSGStatus UuMB3	NotFullStatusU uMB2	NewMSGStatus UuMB2	NotFullStatusU uMB1	NewMSGStatus UuMB1	NotFullStatusU uMB0	NewMSGStatus UuMB0
R/W-0h	R/W-0h	R/W-0h	R/W-0h	R/W-0h	R/W-0h	R/W-0h	R/W-0h

LEGEND: R/W = Read/Write; R = Read only; W1toCl = Write 1 to clear bit; -n = value after reset

Table 17-49. IRQSTATUS_RAW_2 Register Field Descriptions

Bit	Field	Type	Reset	Description
15	NotFullStatusUuMB7	R/W	0h	Not Full Status bit for User u, Mailbox 7 0 = NoAction : No action 1 = SetEvent : Set the event (for debug)
14	NewMSGStatusUuMB7	R/W	0h	New Message Status bit for User u, Mailbox 7 0 = NoAction : No action 1 = SetEvent : Set the event (for debug)
13	NotFullStatusUuMB6	R/W	0h	Not Full Status bit for User u, Mailbox 6 0 = NoAction : No action 1 = SetEvent : Set the event (for debug)
12	NewMSGStatusUuMB6	R/W	0h	New Message Status bit for User u, Mailbox 6 0 = NoAction : No action 1 = SetEvent : Set the event (for debug)
11	NotFullStatusUuMB5	R/W	0h	Not Full Status bit for User u, Mailbox 5 0 = NoAction : No action 1 = SetEvent : Set the event (for debug)
10	NewMSGStatusUuMB5	R/W	0h	New Message Status bit for User u, Mailbox 5 0 = NoAction : No action 1 = SetEvent : Set the event (for debug)
9	NotFullStatusUuMB4	R/W	0h	Not Full Status bit for User u, Mailbox 4 0 = NoAction : No action 1 = SetEvent : Set the event (for debug)
8	NewMSGStatusUuMB4	R/W	0h	New Message Status bit for User u, Mailbox 4 0 = NoAction : No action 1 = SetEvent : Set the event (for debug)
7	NotFullStatusUuMB3	R/W	0h	Not Full Status bit for User u, Mailbox 3 0 = NoAction : No action 1 = SetEvent : Set the event (for debug)

Table 17-49. IRQSTATUS_RAW_2 Register Field Descriptions (continued)

Bit	Field	Type	Reset	Description
6	NewMSGStatusUuMB3	R/W	0h	New Message Status bit for User u, Mailbox 3 0 = NoAction : No action 1 = SetEvent : Set the event (for debug)
5	NotFullStatusUuMB2	R/W	0h	Not Full Status bit for User u, Mailbox 2 0 = NoAction : No action 1 = SetEvent : Set the event (for debug)
4	NewMSGStatusUuMB2	R/W	0h	New Message Status bit for User u, Mailbox 2 0 = NoAction : No action 1 = SetEvent : Set the event (for debug)
3	NotFullStatusUuMB1	R/W	0h	Not Full Status bit for User u, Mailbox 1 0 = NoAction : No action 1 = SetEvent : Set the event (for debug)
2	NewMSGStatusUuMB1	R/W	0h	New Message Status bit for User u, Mailbox 1 0 = NoAction : No action 1 = SetEvent : Set the event (for debug)
1	NotFullStatusUuMB0	R/W	0h	Not Full Status bit for User u, Mailbox 0 0 = NoAction : No action 1 = SetEvent : Set the event (for debug)
0	NewMSGStatusUuMB0	R/W	0h	New Message Status bit for User u, Mailbox 0 0 = NoAction : No action 1 = SetEvent : Set the event (for debug)

17.1.5.36 IRQSTATUS_CLR_2 Register (offset = 124h) [reset = 0h]

IRQSTATUS_CLR_2 is shown in [Figure 17-38](#) and described in [Table 17-50](#).

The interrupt status register has the status combined with irq-enable for each event that may be responsible for the generation of an interrupt to the corresponding user - write 1 to a given bit resets this bit.

Figure 17-38. IRQSTATUS_CLR_2 Register

31	30	29	28	27	26	25	24
Reserved							
23	22	21	20	19	18	17	16
Reserved							
15	14	13	12	11	10	9	8
NotFullStatusU uMB7	NewMSGStatus UuMB7	NotFullStatusU uMB6	NewMSGStatus UuMB6	NotFullStatusU uMB5	NewMSGStatus UuMB5	NotFullStatusU uMB4	NewMSGStatus UuMB4
R/W-0h	R/W-0h	R/W-0h	R/W-0h	R/W-0h	R/W-0h	R/W-0h	R/W-0h
7	6	5	4	3	2	1	0
NotFullStatusU uMB3	NewMSGStatus UuMB3	NotFullStatusU uMB2	NewMSGStatus UuMB2	NotFullStatusU uMB1	NewMSGStatus UuMB1	NotFullStatusU uMB0	NewMSGStatus UuMB0
R/W-0h	R/W-0h	R/W-0h	R/W-0h	R/W-0h	R/W-0h	R/W-0h	R/W-0h

LEGEND: R/W = Read/Write; R = Read only; W1toCl = Write 1 to clear bit; -n = value after reset

Table 17-50. IRQSTATUS_CLR_2 Register Field Descriptions

Bit	Field	Type	Reset	Description
15	NotFullStatusUuMB7	R/W	0h	Not Full Status bit for User u, Mailbox 7 0 = NoAction : No action 1 = SetEvent : Set the event (for debug)
14	NewMSGStatusUuMB7	R/W	0h	New Message Status bit for User u, Mailbox 7 0 = NoAction : No action 1 = SetEvent : Set the event (for debug)
13	NotFullStatusUuMB6	R/W	0h	Not Full Status bit for User u, Mailbox 6 0 = NoAction : No action 1 = SetEvent : Set the event (for debug)
12	NewMSGStatusUuMB6	R/W	0h	New Message Status bit for User u, Mailbox 6 0 = NoAction : No action 1 = SetEvent : Set the event (for debug)
11	NotFullStatusUuMB5	R/W	0h	Not Full Status bit for User u, Mailbox 5 0 = NoAction : No action 1 = SetEvent : Set the event (for debug)
10	NewMSGStatusUuMB5	R/W	0h	New Message Status bit for User u, Mailbox 5 0 = NoAction : No action 1 = SetEvent : Set the event (for debug)
9	NotFullStatusUuMB4	R/W	0h	Not Full Status bit for User u, Mailbox 4 0 = NoAction : No action 1 = SetEvent : Set the event (for debug)
8	NewMSGStatusUuMB4	R/W	0h	New Message Status bit for User u, Mailbox 4 0 = NoAction : No action 1 = SetEvent : Set the event (for debug)
7	NotFullStatusUuMB3	R/W	0h	Not Full Status bit for User u, Mailbox 3 0 = NoAction : No action 1 = SetEvent : Set the event (for debug)

Table 17-50. IRQSTATUS_CLR_2 Register Field Descriptions (continued)

Bit	Field	Type	Reset	Description
6	NewMSGStatusUuMB3	R/W	0h	New Message Status bit for User u, Mailbox 3 0 = NoAction : No action 1 = SetEvent : Set the event (for debug)
5	NotFullStatusUuMB2	R/W	0h	Not Full Status bit for User u, Mailbox 2 0 = NoAction : No action 1 = SetEvent : Set the event (for debug)
4	NewMSGStatusUuMB2	R/W	0h	New Message Status bit for User u, Mailbox 2 0 = NoAction : No action 1 = SetEvent : Set the event (for debug)
3	NotFullStatusUuMB1	R/W	0h	Not Full Status bit for User u, Mailbox 1 0 = NoAction : No action 1 = SetEvent : Set the event (for debug)
2	NewMSGStatusUuMB1	R/W	0h	New Message Status bit for User u, Mailbox 1 0 = NoAction : No action 1 = SetEvent : Set the event (for debug)
1	NotFullStatusUuMB0	R/W	0h	Not Full Status bit for User u, Mailbox 0 0 = NoAction : No action 1 = SetEvent : Set the event (for debug)
0	NewMSGStatusUuMB0	R/W	0h	New Message Status bit for User u, Mailbox 0 0 = NoAction : No action 1 = SetEvent : Set the event (for debug)

17.1.5.37 IRQENABLE_SET_2 Register (offset = 128h) [reset = 0h]

IRQENABLE_SET_2 is shown in [Figure 17-39](#) and described in [Table 17-51](#).

The interrupt enable register enables to unmask the module internal source of interrupt to the corresponding user. This register is write 1 to set.

Figure 17-39. IRQENABLE_SET_2 Register

31	30	29	28	27	26	25	24
Reserved							
23	22	21	20	19	18	17	16
Reserved							
15	14	13	12	11	10	9	8
NotFullStatusU uMB7	NewMSGStatus UuMB7	NotFullStatusU uMB6	NewMSGStatus UuMB6	NotFullStatusU uMB5	NewMSGStatus UuMB5	NotFullStatusU uMB4	NewMSGStatus UuMB4
R/W-0h	R/W-0h	R/W-0h	R/W-0h	R/W-0h	R/W-0h	R/W-0h	R/W-0h
7	6	5	4	3	2	1	0
NotFullStatusU uMB3	NewMSGStatus UuMB3	NotFullStatusU uMB2	NewMSGStatus UuMB2	NotFullStatusU uMB1	NewMSGStatus UuMB1	NotFullStatusU uMB0	NewMSGStatus UuMB0
R/W-0h	R/W-0h	R/W-0h	R/W-0h	R/W-0h	R/W-0h	R/W-0h	R/W-0h

LEGEND: R/W = Read/Write; R = Read only; W1toCl = Write 1 to clear bit; -n = value after reset

Table 17-51. IRQENABLE_SET_2 Register Field Descriptions

Bit	Field	Type	Reset	Description
15	NotFullStatusUuMB7	R/W	0h	Not Full Status bit for User u, Mailbox 7 0 = NoAction : No action 1 = SetEvent : Set the event (for debug)
14	NewMSGStatusUuMB7	R/W	0h	New Message Status bit for User u, Mailbox 7 0 = NoAction : No action 1 = SetEvent : Set the event (for debug)
13	NotFullStatusUuMB6	R/W	0h	Not Full Status bit for User u, Mailbox 6 0 = NoAction : No action 1 = SetEvent : Set the event (for debug)
12	NewMSGStatusUuMB6	R/W	0h	New Message Status bit for User u, Mailbox 6 0 = NoAction : No action 1 = SetEvent : Set the event (for debug)
11	NotFullStatusUuMB5	R/W	0h	Not Full Status bit for User u, Mailbox 5 0 = NoAction : No action 1 = SetEvent : Set the event (for debug)
10	NewMSGStatusUuMB5	R/W	0h	New Message Status bit for User u, Mailbox 5 0 = NoAction : No action 1 = SetEvent : Set the event (for debug)
9	NotFullStatusUuMB4	R/W	0h	Not Full Status bit for User u, Mailbox 4 0 = NoAction : No action 1 = SetEvent : Set the event (for debug)
8	NewMSGStatusUuMB4	R/W	0h	New Message Status bit for User u, Mailbox 4 0 = NoAction : No action 1 = SetEvent : Set the event (for debug)
7	NotFullStatusUuMB3	R/W	0h	Not Full Status bit for User u, Mailbox 3 0 = NoAction : No action 1 = SetEvent : Set the event (for debug)

Table 17-51. IRQENABLE_SET_2 Register Field Descriptions (continued)

Bit	Field	Type	Reset	Description
6	NewMSGStatusUuMB3	R/W	0h	New Message Status bit for User u, Mailbox 3 0 = NoAction : No action 1 = SetEvent : Set the event (for debug)
5	NotFullStatusUuMB2	R/W	0h	Not Full Status bit for User u, Mailbox 2 0 = NoAction : No action 1 = SetEvent : Set the event (for debug)
4	NewMSGStatusUuMB2	R/W	0h	New Message Status bit for User u, Mailbox 2 0 = NoAction : No action 1 = SetEvent : Set the event (for debug)
3	NotFullStatusUuMB1	R/W	0h	Not Full Status bit for User u, Mailbox 1 0 = NoAction : No action 1 = SetEvent : Set the event (for debug)
2	NewMSGStatusUuMB1	R/W	0h	New Message Status bit for User u, Mailbox 1 0 = NoAction : No action 1 = SetEvent : Set the event (for debug)
1	NotFullStatusUuMB0	R/W	0h	Not Full Status bit for User u, Mailbox 0 0 = NoAction : No action 1 = SetEvent : Set the event (for debug)
0	NewMSGStatusUuMB0	R/W	0h	New Message Status bit for User u, Mailbox 0 0 = NoAction : No action 1 = SetEvent : Set the event (for debug)

17.1.5.38 IRQENABLE_CLR_2 Register (offset = 12Ch) [reset = 0h]

IRQENABLE_CLR_2 is shown in [Figure 17-40](#) and described in [Table 17-52](#).

The interrupt enable register enables to mask the module internal source of interrupt to the corresponding user. This register is write 1 to clear.

Figure 17-40. IRQENABLE_CLR_2 Register

31	30	29	28	27	26	25	24
Reserved							
23	22	21	20	19	18	17	16
Reserved							
15	14	13	12	11	10	9	8
NotFullStatusU uMB7	NewMSGStatus UuMB7	NotFullStatusU uMB6	NewMSGStatus UuMB6	NotFullStatusU uMB5	NewMSGStatus UuMB5	NotFullStatusU uMB4	NewMSGStatus UuMB4
R/W-0h	R/W-0h	R/W-0h	R/W-0h	R/W-0h	R/W-0h	R/W-0h	R/W-0h
7	6	5	4	3	2	1	0
NotFullStatusU uMB3	NewMSGStatus UuMB3	NotFullStatusU uMB2	NewMSGStatus UuMB2	NotFullStatusU uMB1	NewMSGStatus UuMB1	NotFullStatusU uMB0	NewMSGStatus UuMB0
R/W-0h	R/W-0h	R/W-0h	R/W-0h	R/W-0h	R/W-0h	R/W-0h	R/W-0h

LEGEND: R/W = Read/Write; R = Read only; W1toCl = Write 1 to clear bit; -n = value after reset

Table 17-52. IRQENABLE_CLR_2 Register Field Descriptions

Bit	Field	Type	Reset	Description
15	NotFullStatusUuMB7	R/W	0h	Not Full Status bit for User u, Mailbox 7 0 = NoAction : No action 1 = SetEvent : Set the event (for debug)
14	NewMSGStatusUuMB7	R/W	0h	New Message Status bit for User u, Mailbox 7 0 = NoAction : No action 1 = SetEvent : Set the event (for debug)
13	NotFullStatusUuMB6	R/W	0h	Not Full Status bit for User u, Mailbox 6 0 = NoAction : No action 1 = SetEvent : Set the event (for debug)
12	NewMSGStatusUuMB6	R/W	0h	New Message Status bit for User u, Mailbox 6 0 = NoAction : No action 1 = SetEvent : Set the event (for debug)
11	NotFullStatusUuMB5	R/W	0h	Not Full Status bit for User u, Mailbox 5 0 = NoAction : No action 1 = SetEvent : Set the event (for debug)
10	NewMSGStatusUuMB5	R/W	0h	New Message Status bit for User u, Mailbox 5 0 = NoAction : No action 1 = SetEvent : Set the event (for debug)
9	NotFullStatusUuMB4	R/W	0h	Not Full Status bit for User u, Mailbox 4 0 = NoAction : No action 1 = SetEvent : Set the event (for debug)
8	NewMSGStatusUuMB4	R/W	0h	New Message Status bit for User u, Mailbox 4 0 = NoAction : No action 1 = SetEvent : Set the event (for debug)
7	NotFullStatusUuMB3	R/W	0h	Not Full Status bit for User u, Mailbox 3 0 = NoAction : No action 1 = SetEvent : Set the event (for debug)

Table 17-52. IRQENABLE_CLR_2 Register Field Descriptions (continued)

Bit	Field	Type	Reset	Description
6	NewMSGStatusUuMB3	R/W	0h	New Message Status bit for User u, Mailbox 3 0 = NoAction : No action 1 = SetEvent : Set the event (for debug)
5	NotFullStatusUuMB2	R/W	0h	Not Full Status bit for User u, Mailbox 2 0 = NoAction : No action 1 = SetEvent : Set the event (for debug)
4	NewMSGStatusUuMB2	R/W	0h	New Message Status bit for User u, Mailbox 2 0 = NoAction : No action 1 = SetEvent : Set the event (for debug)
3	NotFullStatusUuMB1	R/W	0h	Not Full Status bit for User u, Mailbox 1 0 = NoAction : No action 1 = SetEvent : Set the event (for debug)
2	NewMSGStatusUuMB1	R/W	0h	New Message Status bit for User u, Mailbox 1 0 = NoAction : No action 1 = SetEvent : Set the event (for debug)
1	NotFullStatusUuMB0	R/W	0h	Not Full Status bit for User u, Mailbox 0 0 = NoAction : No action 1 = SetEvent : Set the event (for debug)
0	NewMSGStatusUuMB0	R/W	0h	New Message Status bit for User u, Mailbox 0 0 = NoAction : No action 1 = SetEvent : Set the event (for debug)

17.1.5.39 IRQSTATUS_RAW_3 Register (offset = 130h) [reset = 0h]

IRQSTATUS_RAW_3 is shown in [Figure 17-41](#) and described in [Table 17-53](#).

The interrupt status register has the status for each event that may be responsible for the generation of an interrupt to the corresponding user - write 1 to a given bit resets this bit. This register is mainly used for debug purpose.

Figure 17-41. IRQSTATUS_RAW_3 Register

31	30	29	28	27	26	25	24
Reserved							
23	22	21	20	19	18	17	16
Reserved							
15	14	13	12	11	10	9	8
NotFullStatusU uMB7	NewMSGStatus UuMB7	NotFullStatusU uMB6	NewMSGStatus UuMB6	NotFullStatusU uMB5	NewMSGStatus UuMB5	NotFullStatusU uMB4	NewMSGStatus UuMB4
R/W-0h	R/W-0h	R/W-0h	R/W-0h	R/W-0h	R/W-0h	R/W-0h	R/W-0h
7	6	5	4	3	2	1	0
NotFullStatusU uMB3	NewMSGStatus UuMB3	NotFullStatusU uMB2	NewMSGStatus UuMB2	NotFullStatusU uMB1	NewMSGStatus UuMB1	NotFullStatusU uMB0	NewMSGStatus UuMB0
R/W-0h	R/W-0h	R/W-0h	R/W-0h	R/W-0h	R/W-0h	R/W-0h	R/W-0h

LEGEND: R/W = Read/Write; R = Read only; W1toCl = Write 1 to clear bit; -n = value after reset

Table 17-53. IRQSTATUS_RAW_3 Register Field Descriptions

Bit	Field	Type	Reset	Description
15	NotFullStatusUuMB7	R/W	0h	Not Full Status bit for User u, Mailbox 7 0 = NoAction : No action 1 = SetEvent : Set the event (for debug)
14	NewMSGStatusUuMB7	R/W	0h	New Message Status bit for User u, Mailbox 7 0 = NoAction : No action 1 = SetEvent : Set the event (for debug)
13	NotFullStatusUuMB6	R/W	0h	Not Full Status bit for User u, Mailbox 6 0 = NoAction : No action 1 = SetEvent : Set the event (for debug)
12	NewMSGStatusUuMB6	R/W	0h	New Message Status bit for User u, Mailbox 6 0 = NoAction : No action 1 = SetEvent : Set the event (for debug)
11	NotFullStatusUuMB5	R/W	0h	Not Full Status bit for User u, Mailbox 5 0 = NoAction : No action 1 = SetEvent : Set the event (for debug)
10	NewMSGStatusUuMB5	R/W	0h	New Message Status bit for User u, Mailbox 5 0 = NoAction : No action 1 = SetEvent : Set the event (for debug)
9	NotFullStatusUuMB4	R/W	0h	Not Full Status bit for User u, Mailbox 4 0 = NoAction : No action 1 = SetEvent : Set the event (for debug)
8	NewMSGStatusUuMB4	R/W	0h	New Message Status bit for User u, Mailbox 4 0 = NoAction : No action 1 = SetEvent : Set the event (for debug)
7	NotFullStatusUuMB3	R/W	0h	Not Full Status bit for User u, Mailbox 3 0 = NoAction : No action 1 = SetEvent : Set the event (for debug)

Table 17-53. IRQSTATUS_RAW_3 Register Field Descriptions (continued)

Bit	Field	Type	Reset	Description
6	NewMSGStatusUuMB3	R/W	0h	New Message Status bit for User u, Mailbox 3 0 = NoAction : No action 1 = SetEvent : Set the event (for debug)
5	NotFullStatusUuMB2	R/W	0h	Not Full Status bit for User u, Mailbox 2 0 = NoAction : No action 1 = SetEvent : Set the event (for debug)
4	NewMSGStatusUuMB2	R/W	0h	New Message Status bit for User u, Mailbox 2 0 = NoAction : No action 1 = SetEvent : Set the event (for debug)
3	NotFullStatusUuMB1	R/W	0h	Not Full Status bit for User u, Mailbox 1 0 = NoAction : No action 1 = SetEvent : Set the event (for debug)
2	NewMSGStatusUuMB1	R/W	0h	New Message Status bit for User u, Mailbox 1 0 = NoAction : No action 1 = SetEvent : Set the event (for debug)
1	NotFullStatusUuMB0	R/W	0h	Not Full Status bit for User u, Mailbox 0 0 = NoAction : No action 1 = SetEvent : Set the event (for debug)
0	NewMSGStatusUuMB0	R/W	0h	New Message Status bit for User u, Mailbox 0 0 = NoAction : No action 1 = SetEvent : Set the event (for debug)

17.1.5.40 IRQSTATUS_CLR_3 Register (offset = 134h) [reset = 0h]

IRQSTATUS_CLR_3 is shown in [Figure 17-42](#) and described in [Table 17-54](#).

The interrupt status register has the status combined with irq-enable for each event that may be responsible for the generation of an interrupt to the corresponding user - write 1 to a given bit resets this bit.

Figure 17-42. IRQSTATUS_CLR_3 Register

31	30	29	28	27	26	25	24
Reserved							
23	22	21	20	19	18	17	16
Reserved							
15	14	13	12	11	10	9	8
NotFullStatusU uMB7	NewMSGStatus UuMB7	NotFullStatusU uMB6	NewMSGStatus UuMB6	NotFullStatusU uMB5	NewMSGStatus UuMB5	NotFullStatusU uMB4	NewMSGStatus UuMB4
R/W-0h	R/W-0h	R/W-0h	R/W-0h	R/W-0h	R/W-0h	R/W-0h	R/W-0h
7	6	5	4	3	2	1	0
NotFullStatusU uMB3	NewMSGStatus UuMB3	NotFullStatusU uMB2	NewMSGStatus UuMB2	NotFullStatusU uMB1	NewMSGStatus UuMB1	NotFullStatusU uMB0	NewMSGStatus UuMB0
R/W-0h	R/W-0h	R/W-0h	R/W-0h	R/W-0h	R/W-0h	R/W-0h	R/W-0h

LEGEND: R/W = Read/Write; R = Read only; W1toCl = Write 1 to clear bit; -n = value after reset

Table 17-54. IRQSTATUS_CLR_3 Register Field Descriptions

Bit	Field	Type	Reset	Description
15	NotFullStatusUuMB7	R/W	0h	Not Full Status bit for User u, Mailbox 7 0 = NoAction : No action 1 = SetEvent : Set the event (for debug)
14	NewMSGStatusUuMB7	R/W	0h	New Message Status bit for User u, Mailbox 7 0 = NoAction : No action 1 = SetEvent : Set the event (for debug)
13	NotFullStatusUuMB6	R/W	0h	Not Full Status bit for User u, Mailbox 6 0 = NoAction : No action 1 = SetEvent : Set the event (for debug)
12	NewMSGStatusUuMB6	R/W	0h	New Message Status bit for User u, Mailbox 6 0 = NoAction : No action 1 = SetEvent : Set the event (for debug)
11	NotFullStatusUuMB5	R/W	0h	Not Full Status bit for User u, Mailbox 5 0 = NoAction : No action 1 = SetEvent : Set the event (for debug)
10	NewMSGStatusUuMB5	R/W	0h	New Message Status bit for User u, Mailbox 5 0 = NoAction : No action 1 = SetEvent : Set the event (for debug)
9	NotFullStatusUuMB4	R/W	0h	Not Full Status bit for User u, Mailbox 4 0 = NoAction : No action 1 = SetEvent : Set the event (for debug)
8	NewMSGStatusUuMB4	R/W	0h	New Message Status bit for User u, Mailbox 4 0 = NoAction : No action 1 = SetEvent : Set the event (for debug)
7	NotFullStatusUuMB3	R/W	0h	Not Full Status bit for User u, Mailbox 3 0 = NoAction : No action 1 = SetEvent : Set the event (for debug)

Table 17-54. IRQSTATUS_CLR_3 Register Field Descriptions (continued)

Bit	Field	Type	Reset	Description
6	NewMSGStatusUuMB3	R/W	0h	New Message Status bit for User u, Mailbox 3 0 = NoAction : No action 1 = SetEvent : Set the event (for debug)
5	NotFullStatusUuMB2	R/W	0h	Not Full Status bit for User u, Mailbox 2 0 = NoAction : No action 1 = SetEvent : Set the event (for debug)
4	NewMSGStatusUuMB2	R/W	0h	New Message Status bit for User u, Mailbox 2 0 = NoAction : No action 1 = SetEvent : Set the event (for debug)
3	NotFullStatusUuMB1	R/W	0h	Not Full Status bit for User u, Mailbox 1 0 = NoAction : No action 1 = SetEvent : Set the event (for debug)
2	NewMSGStatusUuMB1	R/W	0h	New Message Status bit for User u, Mailbox 1 0 = NoAction : No action 1 = SetEvent : Set the event (for debug)
1	NotFullStatusUuMB0	R/W	0h	Not Full Status bit for User u, Mailbox 0 0 = NoAction : No action 1 = SetEvent : Set the event (for debug)
0	NewMSGStatusUuMB0	R/W	0h	New Message Status bit for User u, Mailbox 0 0 = NoAction : No action 1 = SetEvent : Set the event (for debug)

17.1.5.41 IRQENABLE_SET_3 Register (offset = 138h) [reset = 0h]

IRQENABLE_SET_3 is shown in [Figure 17-43](#) and described in [Table 17-55](#).

The interrupt enable register enables to unmask the module internal source of interrupt to the corresponding user. This register is write 1 to set.

Figure 17-43. IRQENABLE_SET_3 Register

31	30	29	28	27	26	25	24
Reserved							
23	22	21	20	19	18	17	16
Reserved							
15	14	13	12	11	10	9	8
NotFullStatusU uMB7	NewMSGStatus UuMB7	NotFullStatusU uMB6	NewMSGStatus UuMB6	NotFullStatusU uMB5	NewMSGStatus UuMB5	NotFullStatusU uMB4	NewMSGStatus UuMB4
R/W-0h	R/W-0h	R/W-0h	R/W-0h	R/W-0h	R/W-0h	R/W-0h	R/W-0h
7	6	5	4	3	2	1	0
NotFullStatusU uMB3	NewMSGStatus UuMB3	NotFullStatusU uMB2	NewMSGStatus UuMB2	NotFullStatusU uMB1	NewMSGStatus UuMB1	NotFullStatusU uMB0	NewMSGStatus UuMB0
R/W-0h	R/W-0h	R/W-0h	R/W-0h	R/W-0h	R/W-0h	R/W-0h	R/W-0h

LEGEND: R/W = Read/Write; R = Read only; W1toCl = Write 1 to clear bit; -n = value after reset

Table 17-55. IRQENABLE_SET_3 Register Field Descriptions

Bit	Field	Type	Reset	Description
15	NotFullStatusUuMB7	R/W	0h	Not Full Status bit for User u, Mailbox 7 0 = NoAction : No action 1 = SetEvent : Set the event (for debug)
14	NewMSGStatusUuMB7	R/W	0h	New Message Status bit for User u, Mailbox 7 0 = NoAction : No action 1 = SetEvent : Set the event (for debug)
13	NotFullStatusUuMB6	R/W	0h	Not Full Status bit for User u, Mailbox 6 0 = NoAction : No action 1 = SetEvent : Set the event (for debug)
12	NewMSGStatusUuMB6	R/W	0h	New Message Status bit for User u, Mailbox 6 0 = NoAction : No action 1 = SetEvent : Set the event (for debug)
11	NotFullStatusUuMB5	R/W	0h	Not Full Status bit for User u, Mailbox 5 0 = NoAction : No action 1 = SetEvent : Set the event (for debug)
10	NewMSGStatusUuMB5	R/W	0h	New Message Status bit for User u, Mailbox 5 0 = NoAction : No action 1 = SetEvent : Set the event (for debug)
9	NotFullStatusUuMB4	R/W	0h	Not Full Status bit for User u, Mailbox 4 0 = NoAction : No action 1 = SetEvent : Set the event (for debug)
8	NewMSGStatusUuMB4	R/W	0h	New Message Status bit for User u, Mailbox 4 0 = NoAction : No action 1 = SetEvent : Set the event (for debug)
7	NotFullStatusUuMB3	R/W	0h	Not Full Status bit for User u, Mailbox 3 0 = NoAction : No action 1 = SetEvent : Set the event (for debug)

Table 17-55. IRQENABLE_SET_3 Register Field Descriptions (continued)

Bit	Field	Type	Reset	Description
6	NewMSGStatusUuMB3	R/W	0h	New Message Status bit for User u, Mailbox 3 0 = NoAction : No action 1 = SetEvent : Set the event (for debug)
5	NotFullStatusUuMB2	R/W	0h	Not Full Status bit for User u, Mailbox 2 0 = NoAction : No action 1 = SetEvent : Set the event (for debug)
4	NewMSGStatusUuMB2	R/W	0h	New Message Status bit for User u, Mailbox 2 0 = NoAction : No action 1 = SetEvent : Set the event (for debug)
3	NotFullStatusUuMB1	R/W	0h	Not Full Status bit for User u, Mailbox 1 0 = NoAction : No action 1 = SetEvent : Set the event (for debug)
2	NewMSGStatusUuMB1	R/W	0h	New Message Status bit for User u, Mailbox 1 0 = NoAction : No action 1 = SetEvent : Set the event (for debug)
1	NotFullStatusUuMB0	R/W	0h	Not Full Status bit for User u, Mailbox 0 0 = NoAction : No action 1 = SetEvent : Set the event (for debug)
0	NewMSGStatusUuMB0	R/W	0h	New Message Status bit for User u, Mailbox 0 0 = NoAction : No action 1 = SetEvent : Set the event (for debug)

17.1.5.42 IRQENABLE_CLR_3 Register (offset = 13Ch) [reset = 0h]

IRQENABLE_CLR_3 is shown in [Figure 17-44](#) and described in [Table 17-56](#).

The interrupt enable register enables to mask the module internal source of interrupt to the corresponding user. This register is write 1 to clear.

Figure 17-44. IRQENABLE_CLR_3 Register

31	30	29	28	27	26	25	24
Reserved							
23	22	21	20	19	18	17	16
Reserved							
15	14	13	12	11	10	9	8
NotFullStatusU uMB7	NewMSGStatus UuMB7	NotFullStatusU uMB6	NewMSGStatus UuMB6	NotFullStatusU uMB5	NewMSGStatus UuMB5	NotFullStatusU uMB4	NewMSGStatus UuMB4
R/W-0h	R/W-0h	R/W-0h	R/W-0h	R/W-0h	R/W-0h	R/W-0h	R/W-0h
7	6	5	4	3	2	1	0
NotFullStatusU uMB3	NewMSGStatus UuMB3	NotFullStatusU uMB2	NewMSGStatus UuMB2	NotFullStatusU uMB1	NewMSGStatus UuMB1	NotFullStatusU uMB0	NewMSGStatus UuMB0
R/W-0h	R/W-0h	R/W-0h	R/W-0h	R/W-0h	R/W-0h	R/W-0h	R/W-0h

LEGEND: R/W = Read/Write; R = Read only; W1toCl = Write 1 to clear bit; -n = value after reset

Table 17-56. IRQENABLE_CLR_3 Register Field Descriptions

Bit	Field	Type	Reset	Description
15	NotFullStatusUuMB7	R/W	0h	Not Full Status bit for User u, Mailbox 7 0 = NoAction : No action 1 = SetEvent : Set the event (for debug)
14	NewMSGStatusUuMB7	R/W	0h	New Message Status bit for User u, Mailbox 7 0 = NoAction : No action 1 = SetEvent : Set the event (for debug)
13	NotFullStatusUuMB6	R/W	0h	Not Full Status bit for User u, Mailbox 6 0 = NoAction : No action 1 = SetEvent : Set the event (for debug)
12	NewMSGStatusUuMB6	R/W	0h	New Message Status bit for User u, Mailbox 6 0 = NoAction : No action 1 = SetEvent : Set the event (for debug)
11	NotFullStatusUuMB5	R/W	0h	Not Full Status bit for User u, Mailbox 5 0 = NoAction : No action 1 = SetEvent : Set the event (for debug)
10	NewMSGStatusUuMB5	R/W	0h	New Message Status bit for User u, Mailbox 5 0 = NoAction : No action 1 = SetEvent : Set the event (for debug)
9	NotFullStatusUuMB4	R/W	0h	Not Full Status bit for User u, Mailbox 4 0 = NoAction : No action 1 = SetEvent : Set the event (for debug)
8	NewMSGStatusUuMB4	R/W	0h	New Message Status bit for User u, Mailbox 4 0 = NoAction : No action 1 = SetEvent : Set the event (for debug)
7	NotFullStatusUuMB3	R/W	0h	Not Full Status bit for User u, Mailbox 3 0 = NoAction : No action 1 = SetEvent : Set the event (for debug)

Table 17-56. IRQENABLE_CLR_3 Register Field Descriptions (continued)

Bit	Field	Type	Reset	Description
6	NewMSGStatusUuMB3	R/W	0h	New Message Status bit for User u, Mailbox 3 0 = NoAction : No action 1 = SetEvent : Set the event (for debug)
5	NotFullStatusUuMB2	R/W	0h	Not Full Status bit for User u, Mailbox 2 0 = NoAction : No action 1 = SetEvent : Set the event (for debug)
4	NewMSGStatusUuMB2	R/W	0h	New Message Status bit for User u, Mailbox 2 0 = NoAction : No action 1 = SetEvent : Set the event (for debug)
3	NotFullStatusUuMB1	R/W	0h	Not Full Status bit for User u, Mailbox 1 0 = NoAction : No action 1 = SetEvent : Set the event (for debug)
2	NewMSGStatusUuMB1	R/W	0h	New Message Status bit for User u, Mailbox 1 0 = NoAction : No action 1 = SetEvent : Set the event (for debug)
1	NotFullStatusUuMB0	R/W	0h	Not Full Status bit for User u, Mailbox 0 0 = NoAction : No action 1 = SetEvent : Set the event (for debug)
0	NewMSGStatusUuMB0	R/W	0h	New Message Status bit for User u, Mailbox 0 0 = NoAction : No action 1 = SetEvent : Set the event (for debug)

17.2 Spinlock

17.2.1 SPINLOCK Registers

Table 17-57 lists the memory-mapped registers for the SPINLOCK. All register offset addresses not listed in Table 17-57 should be considered as reserved locations and the register contents should not be modified.

Table 17-57. SPINLOCK REGISTERS

Offset	Acronym	Register Name	Section
0h	REV	Read-only IP revision identifier (X.Y.R) used by software to determine features, bugs and compatibility of an instance of this the Spin Lock module.	Section 17.2.1.1
10h	SYSCONFIG	This register controls the various parameters of the OCP interface. Note that several fields are present by read-only.	Section 17.2.1.2
14h	SYSTATUS	This register provides status information about this instance of the Spin Lock module.	Section 17.2.1.3
800h	LOCK_REG_0	This register is read when attempting to acquire a lock. The lock is automatically taken if it was not taken and the value returned by the read is zero. If the lock was already taken, then the read returns one. Writing a zero to this register frees the lock.	Section 17.2.1.4
804h	LOCK_REG_1	This register is read when attempting to acquire a lock. The lock is automatically taken if it was not taken and the value returned by the read is zero. If the lock was already taken, then the read returns one. Writing a zero to this register frees the lock.	Section 17.2.1.5
808h	LOCK_REG_2	This register is read when attempting to acquire a lock. The lock is automatically taken if it was not taken and the value returned by the read is zero. If the lock was already taken, then the read returns one. Writing a zero to this register frees the lock.	Section 17.2.1.6
80Ch	LOCK_REG_3	This register is read when attempting to acquire a lock. The lock is automatically taken if it was not taken and the value returned by the read is zero. If the lock was already taken, then the read returns one. Writing a zero to this register frees the lock.	Section 17.2.1.7
810h	LOCK_REG_4	This register is read when attempting to acquire a lock. The lock is automatically taken if it was not taken and the value returned by the read is zero. If the lock was already taken, then the read returns one. Writing a zero to this register frees the lock.	Section 17.2.1.8
814h	LOCK_REG_5	This register is read when attempting to acquire a lock. The lock is automatically taken if it was not taken and the value returned by the read is zero. If the lock was already taken, then the read returns one. Writing a zero to this register frees the lock.	Section 17.2.1.9
818h	LOCK_REG_6	This register is read when attempting to acquire a lock. The lock is automatically taken if it was not taken and the value returned by the read is zero. If the lock was already taken, then the read returns one. Writing a zero to this register frees the lock.	Section 17.2.1.10
81Ch	LOCK_REG_7	This register is read when attempting to acquire a lock. The lock is automatically taken if it was not taken and the value returned by the read is zero. If the lock was already taken, then the read returns one. Writing a zero to this register frees the lock.	Section 17.2.1.11
820h	LOCK_REG_8	This register is read when attempting to acquire a lock. The lock is automatically taken if it was not taken and the value returned by the read is zero. If the lock was already taken, then the read returns one. Writing a zero to this register frees the lock.	Section 17.2.1.12

Table 17-57. SPINLOCK REGISTERS (continued)

Offset	Acronym	Register Name	Section
824h	LOCK_REG_9	This register is read when attempting to acquire a lock. The lock is automatically taken if it was not taken and the value returned by the read is zero. If the lock was already taken, then the read returns one. Writing a zero to this register frees the lock.	Section 17.2.1.13
828h	LOCK_REG_10	This register is read when attempting to acquire a lock. The lock is automatically taken if it was not taken and the value returned by the read is zero. If the lock was already taken, then the read returns one. Writing a zero to this register frees the lock.	Section 17.2.1.14
82Ch	LOCK_REG_11	This register is read when attempting to acquire a lock. The lock is automatically taken if it was not taken and the value returned by the read is zero. If the lock was already taken, then the read returns one. Writing a zero to this register frees the lock.	Section 17.2.1.15
830h	LOCK_REG_12	This register is read when attempting to acquire a lock. The lock is automatically taken if it was not taken and the value returned by the read is zero. If the lock was already taken, then the read returns one. Writing a zero to this register frees the lock.	Section 17.2.1.16
834h	LOCK_REG_13	This register is read when attempting to acquire a lock. The lock is automatically taken if it was not taken and the value returned by the read is zero. If the lock was already taken, then the read returns one. Writing a zero to this register frees the lock.	Section 17.2.1.17
838h	LOCK_REG_14	This register is read when attempting to acquire a lock. The lock is automatically taken if it was not taken and the value returned by the read is zero. If the lock was already taken, then the read returns one. Writing a zero to this register frees the lock.	Section 17.2.1.18
83Ch	LOCK_REG_15	This register is read when attempting to acquire a lock. The lock is automatically taken if it was not taken and the value returned by the read is zero. If the lock was already taken, then the read returns one. Writing a zero to this register frees the lock.	Section 17.2.1.19
840h	LOCK_REG_16	This register is read when attempting to acquire a lock. The lock is automatically taken if it was not taken and the value returned by the read is zero. If the lock was already taken, then the read returns one. Writing a zero to this register frees the lock.	Section 17.2.1.20
844h	LOCK_REG_17	This register is read when attempting to acquire a lock. The lock is automatically taken if it was not taken and the value returned by the read is zero. If the lock was already taken, then the read returns one. Writing a zero to this register frees the lock.	Section 17.2.1.21
848h	LOCK_REG_18	This register is read when attempting to acquire a lock. The lock is automatically taken if it was not taken and the value returned by the read is zero. If the lock was already taken, then the read returns one. Writing a zero to this register frees the lock.	Section 17.2.1.22
84Ch	LOCK_REG_19	This register is read when attempting to acquire a lock. The lock is automatically taken if it was not taken and the value returned by the read is zero. If the lock was already taken, then the read returns one. Writing a zero to this register frees the lock.	Section 17.2.1.23
850h	LOCK_REG_20	This register is read when attempting to acquire a lock. The lock is automatically taken if it was not taken and the value returned by the read is zero. If the lock was already taken, then the read returns one. Writing a zero to this register frees the lock.	Section 17.2.1.24

Table 17-57. SPINLOCK REGISTERS (continued)

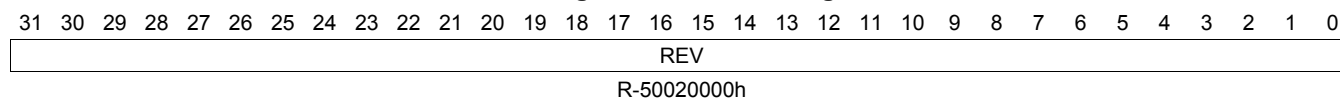
Offset	Acronym	Register Name	Section
854h	LOCK_REG_21	This register is read when attempting to acquire a lock. The lock is automatically taken if it was not taken and the value returned by the read is zero. If the lock was already taken, then the read returns one. Writing a zero to this register frees the lock.	Section 17.2.1.25
858h	LOCK_REG_22	This register is read when attempting to acquire a lock. The lock is automatically taken if it was not taken and the value returned by the read is zero. If the lock was already taken, then the read returns one. Writing a zero to this register frees the lock.	Section 17.2.1.26
85Ch	LOCK_REG_23	This register is read when attempting to acquire a lock. The lock is automatically taken if it was not taken and the value returned by the read is zero. If the lock was already taken, then the read returns one. Writing a zero to this register frees the lock.	Section 17.2.1.27
860h	LOCK_REG_24	This register is read when attempting to acquire a lock. The lock is automatically taken if it was not taken and the value returned by the read is zero. If the lock was already taken, then the read returns one. Writing a zero to this register frees the lock.	Section 17.2.1.28
864h	LOCK_REG_25	This register is read when attempting to acquire a lock. The lock is automatically taken if it was not taken and the value returned by the read is zero. If the lock was already taken, then the read returns one. Writing a zero to this register frees the lock.	Section 17.2.1.29
868h	LOCK_REG_26	This register is read when attempting to acquire a lock. The lock is automatically taken if it was not taken and the value returned by the read is zero. If the lock was already taken, then the read returns one. Writing a zero to this register frees the lock.	Section 17.2.1.30
86Ch	LOCK_REG_27	This register is read when attempting to acquire a lock. The lock is automatically taken if it was not taken and the value returned by the read is zero. If the lock was already taken, then the read returns one. Writing a zero to this register frees the lock.	Section 17.2.1.31
870h	LOCK_REG_28	This register is read when attempting to acquire a lock. The lock is automatically taken if it was not taken and the value returned by the read is zero. If the lock was already taken, then the read returns one. Writing a zero to this register frees the lock.	Section 17.2.1.32
874h	LOCK_REG_29	This register is read when attempting to acquire a lock. The lock is automatically taken if it was not taken and the value returned by the read is zero. If the lock was already taken, then the read returns one. Writing a zero to this register frees the lock.	Section 17.2.1.33
878h	LOCK_REG_30	This register is read when attempting to acquire a lock. The lock is automatically taken if it was not taken and the value returned by the read is zero. If the lock was already taken, then the read returns one. Writing a zero to this register frees the lock.	Section 17.2.1.34
87Ch	LOCK_REG_31	This register is read when attempting to acquire a lock. The lock is automatically taken if it was not taken and the value returned by the read is zero. If the lock was already taken, then the read returns one. Writing a zero to this register frees the lock.	Section 17.2.1.35

17.2.1.1 REV Register (offset = 0h) [reset = 50020000h]

REV is shown in [Figure 17-45](#) and described in [Table 17-58](#).

Read-only IP revision identifier (X.Y.R) used by software to determine features, bugs and compatibility of an instance of this the Spin Lock module.

Figure 17-45. REV Register



LEGEND: R/W = Read/Write; R = Read only; W1toCl = Write 1 to clear bit; -n = value after reset

Table 17-58. REV Register Field Descriptions

Bit	Field	Type	Reset	Description
31-0	REV	R	50020000h	IP Revision Code.

17.2.1.2 SYSCONFIG Register (offset = 10h) [reset = 11h]

SYSCONFIG is shown in [Figure 17-46](#) and described in [Table 17-59](#).

This register controls the various parameters of the OCP interface. Note that several fields are present by read-only.

Figure 17-46. SYSCONFIG Register

31	30	29	28	27	26	25	24
Reserved							
R-0h							
23	22	21	20	19	18	17	16
Reserved							
R-0h							
15	14	13	12	11	10	9	8
Reserved							CLOCKACTIVITY
R-0h							R-0h
7	6	5	4	3	2	1	0
Reserved			SIDLEMODE		ENWAKEUP	SOFTRESET	AUTOGATING
R-0h			R-2h		R-4h	W-8h	R-11h

LEGEND: R/W = Read/Write; R = Read only; W1toCl = Write 1 to clear bit; -n = value after reset

Table 17-59. SYSCONFIG Register Field Descriptions

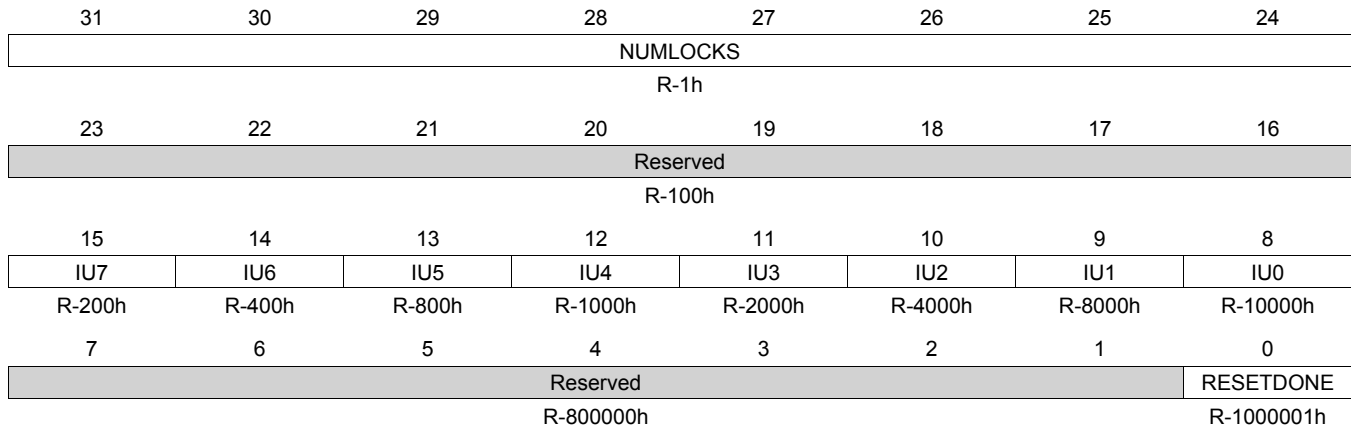
Bit	Field	Type	Reset	Description
31-9	Reserved	R	0h	
8	CLOCKACTIVITY	R	0h	Indicates whether the module requires the OCP when in IDLE mode. 0 = NOTREQUIRED : OCP clock is not required by the module during IDLE mode and may be switched off. 1 = REQUIRED : OCP clock is required by the module, even during idle mode.
7-5	Reserved	R	0h	
4-3	SIDLEMODE	R	2h	Control of the slave interface power management IDLE request acknowledgement. 0 = FORCEIDLE : IDLE request is acknowledged unconditionally and immediately. 1 = NOIDLE : IDLE request is never acknowledged. 2 = SMARTIDLE : IDLE request acknowledgement is based on the internal module activity. 3 = unused3 : Reserved. Do not use.
2	ENWAKEUP	R	4h	Asynchronous wakeup generation. 0 = NOWAKEUPGEN : Wakeup generation is disabled. 1 = WAKEUPGEN1 : Enable wakeup generation.
1	SOFTRESET	W	8h	Module software reset. 0 = NOOP : No Description 1 = DORESET : Start a soft reset sequence of the Spin Lock module.
0	AUTOGATING	R	11h	Internal OCP clock gating strategy. 0 = FREERUNNING : OCP clock is not gated when OCP interface is idle. 1 = GATED : Automatic internal OCP clock gating strategy is applied, based on the OCP interface activity.

17.2.1.3 SYSTATUS Register (offset = 14h) [reset = 1000001h]

SYSTATUS is shown in [Figure 17-47](#) and described in [Table 17-60](#).

This register provides status information about this instance of the Spin Lock module.

Figure 17-47. SYSTATUS Register



LEGEND: R/W = Read/Write; R = Read only; W1toCl = Write 1 to clear bit; -n = value after reset

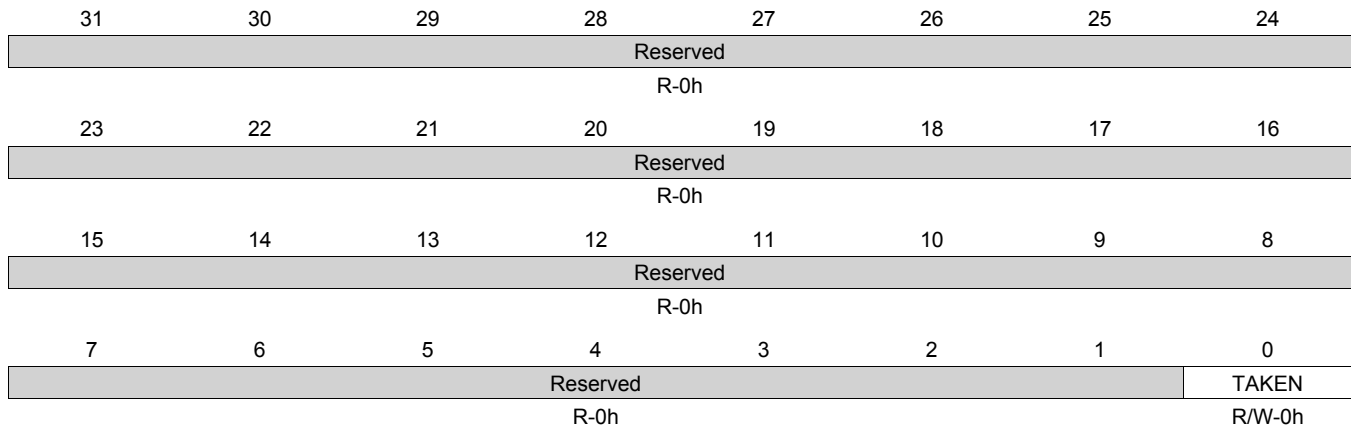
Table 17-60. SYSTATUS Register Field Descriptions

Bit	Field	Type	Reset	Description
31-24	NUMLOCKS	R	1h	
23-16	Reserved	R	100h	
15	IU7	R	200h	
14	IU6	R	400h	
13	IU5	R	800h	
12	IU4	R	1000h	
11	IU3	R	2000h	
10	IU2	R	4000h	
9	IU1	R	8000h	In-Use flag 1, covering lock registers 32 - 63. Reads as one only if one or more lock registers in this range are TAKEN. If no lock registers are implemented in this range, then this flag always reads as 0.
8	IU0	R	10000h	In-Use flag 0, covering lock registers 0 - 31. Reads as one only if one or more lock registers in this range are TAKEN.
7-1	Reserved	R	800000h	reserved
0	RESETDONE	R	1000001h	0: Reset in progress. 1: Reset is completed.

17.2.1.4 LOCK_REG_0 Register (offset = 800h) [reset = 0h]

LOCK_REG_0 is shown in [Figure 17-48](#) and described in [Table 17-61](#).

This register is read when attempting to acquire a lock. The lock is automatically taken if it was not taken and the value returned by the read is zero. If the lock was already taken, then the read returns one. Writing a zero to this register frees the lock.

Figure 17-48. LOCK_REG_0 Register


LEGEND: R/W = Read/Write; R = Read only; W1toCl = Write 1 to clear bit; -n = value after reset

Table 17-61. LOCK_REG_0 Register Field Descriptions

Bit	Field	Type	Reset	Description
31-1	Reserved	R	0h	
0	TAKEN	R/W	0h	

17.2.1.5 LOCK_REG_1 Register (offset = 804h) [reset = 0h]

LOCK_REG_1 is shown in [Figure 17-49](#) and described in [Table 17-62](#).

This register is read when attempting to acquire a lock. The lock is automatically taken if it was not taken and the value returned by the read is zero. If the lock was already taken, then the read returns one. Writing a zero to this register frees the lock.

Figure 17-49. LOCK_REG_1 Register

31	30	29	28	27	26	25	24
Reserved							
R-0h							
23	22	21	20	19	18	17	16
Reserved							
R-0h							
15	14	13	12	11	10	9	8
Reserved							
R-0h							
7	6	5	4	3	2	1	0
Reserved							TAKEN
R-0h							R/W-0h

LEGEND: R/W = Read/Write; R = Read only; W1toCl = Write 1 to clear bit; -n = value after reset

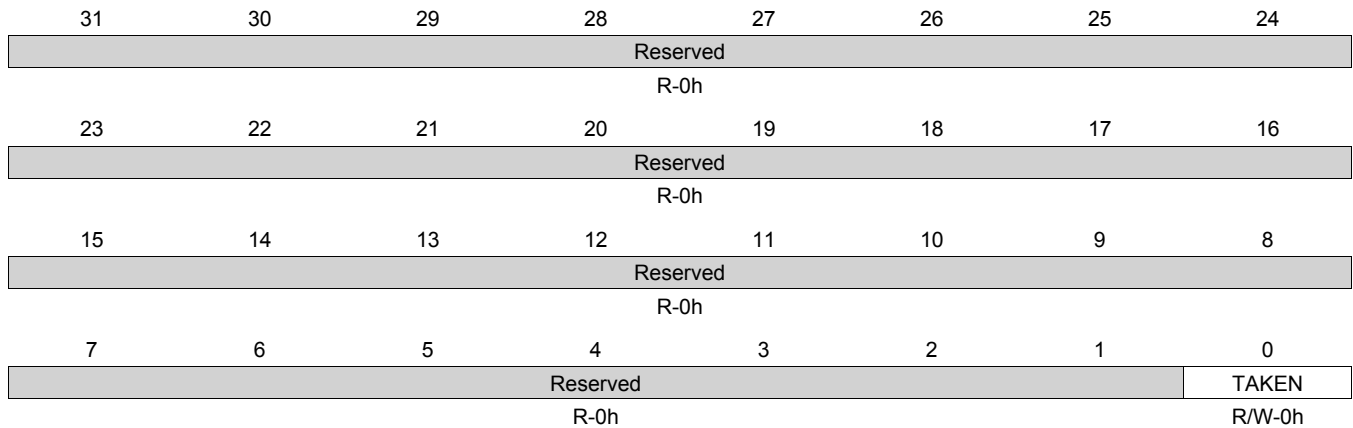
Table 17-62. LOCK_REG_1 Register Field Descriptions

Bit	Field	Type	Reset	Description
31-1	Reserved	R	0h	
0	TAKEN	R/W	0h	

17.2.1.6 LOCK_REG_2 Register (offset = 808h) [reset = 0h]

LOCK_REG_2 is shown in [Figure 17-50](#) and described in [Table 17-63](#).

This register is read when attempting to acquire a lock. The lock is automatically taken if it was not taken and the value returned by the read is zero. If the lock was already taken, then the read returns one. Writing a zero to this register frees the lock.

Figure 17-50. LOCK_REG_2 Register


LEGEND: R/W = Read/Write; R = Read only; W1toCl = Write 1 to clear bit; -n = value after reset

Table 17-63. LOCK_REG_2 Register Field Descriptions

Bit	Field	Type	Reset	Description
31-1	Reserved	R	0h	
0	TAKEN	R/W	0h	

17.2.1.7 LOCK_REG_3 Register (offset = 80Ch) [reset = 0h]

LOCK_REG_3 is shown in [Figure 17-51](#) and described in [Table 17-64](#).

This register is read when attempting to acquire a lock. The lock is automatically taken if it was not taken and the value returned by the read is zero. If the lock was already taken, then the read returns one. Writing a zero to this register frees the lock.

Figure 17-51. LOCK_REG_3 Register

31	30	29	28	27	26	25	24
Reserved							
R-0h							
23	22	21	20	19	18	17	16
Reserved							
R-0h							
15	14	13	12	11	10	9	8
Reserved							
R-0h							
7	6	5	4	3	2	1	0
Reserved							TAKEN
R-0h							R/W-0h

LEGEND: R/W = Read/Write; R = Read only; W1toCl = Write 1 to clear bit; -n = value after reset

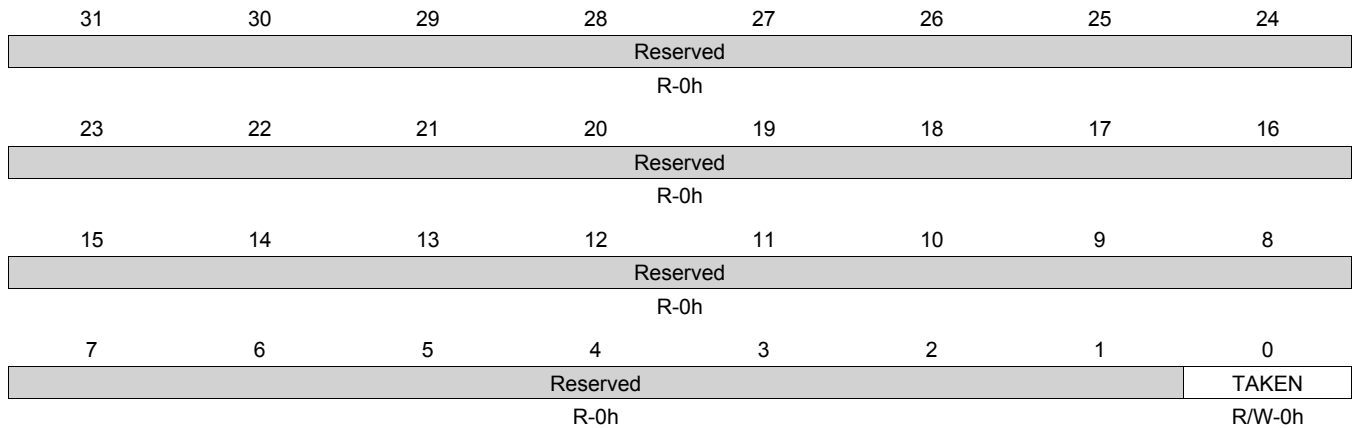
Table 17-64. LOCK_REG_3 Register Field Descriptions

Bit	Field	Type	Reset	Description
31-1	Reserved	R	0h	
0	TAKEN	R/W	0h	

17.2.1.8 LOCK_REG_4 Register (offset = 810h) [reset = 0h]

LOCK_REG_4 is shown in [Figure 17-52](#) and described in [Table 17-65](#).

This register is read when attempting to acquire a lock. The lock is automatically taken if it was not taken and the value returned by the read is zero. If the lock was already taken, then the read returns one. Writing a zero to this register frees the lock.

Figure 17-52. LOCK_REG_4 Register


LEGEND: R/W = Read/Write; R = Read only; W1toCl = Write 1 to clear bit; -n = value after reset

Table 17-65. LOCK_REG_4 Register Field Descriptions

Bit	Field	Type	Reset	Description
31-1	Reserved	R	0h	
0	TAKEN	R/W	0h	

17.2.1.9 LOCK_REG_5 Register (offset = 814h) [reset = 0h]

LOCK_REG_5 is shown in [Figure 17-53](#) and described in [Table 17-66](#).

This register is read when attempting to acquire a lock. The lock is automatically taken if it was not taken and the value returned by the read is zero. If the lock was already taken, then the read returns one. Writing a zero to this register frees the lock.

Figure 17-53. LOCK_REG_5 Register

31	30	29	28	27	26	25	24
Reserved							
R-0h							
23	22	21	20	19	18	17	16
Reserved							
R-0h							
15	14	13	12	11	10	9	8
Reserved							
R-0h							
7	6	5	4	3	2	1	0
Reserved							TAKEN
R-0h							R/W-0h

LEGEND: R/W = Read/Write; R = Read only; W1toCl = Write 1 to clear bit; -n = value after reset

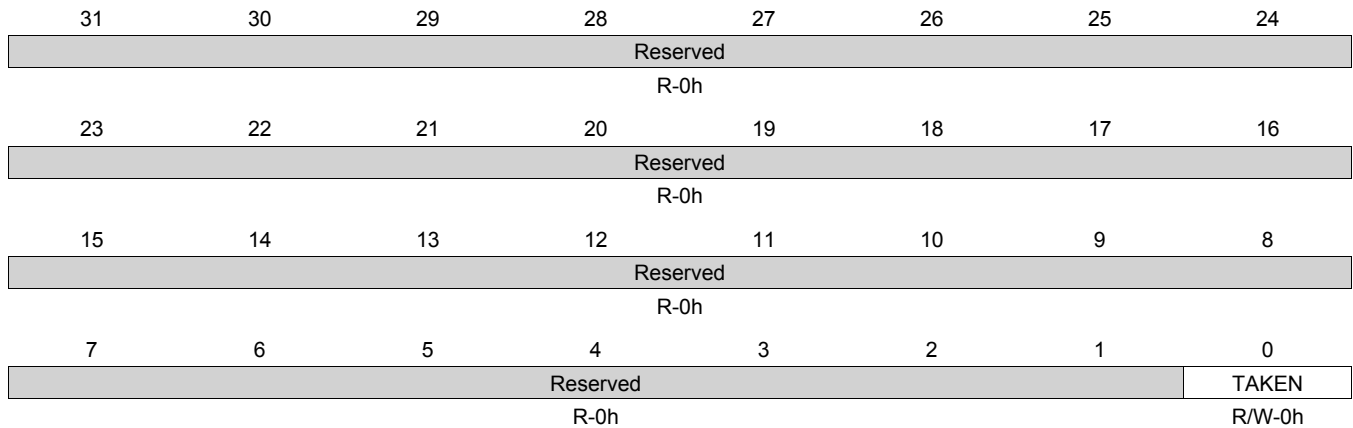
Table 17-66. LOCK_REG_5 Register Field Descriptions

Bit	Field	Type	Reset	Description
31-1	Reserved	R	0h	
0	TAKEN	R/W	0h	

17.2.1.10 LOCK_REG_6 Register (offset = 818h) [reset = 0h]

LOCK_REG_6 is shown in [Figure 17-54](#) and described in [Table 17-67](#).

This register is read when attempting to acquire a lock. The lock is automatically taken if it was not taken and the value returned by the read is zero. If the lock was already taken, then the read returns one. Writing a zero to this register frees the lock.

Figure 17-54. LOCK_REG_6 Register


LEGEND: R/W = Read/Write; R = Read only; W1toCl = Write 1 to clear bit; -n = value after reset

Table 17-67. LOCK_REG_6 Register Field Descriptions

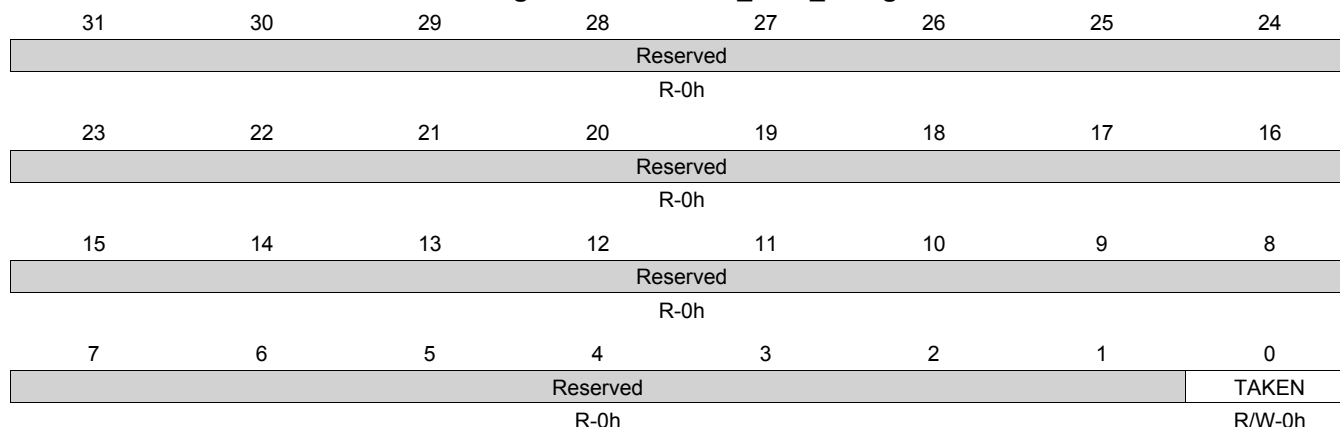
Bit	Field	Type	Reset	Description
31-1	Reserved	R	0h	
0	TAKEN	R/W	0h	

17.2.1.11 LOCK_REG_7 Register (offset = 81Ch) [reset = 0h]

LOCK_REG_7 is shown in [Figure 17-55](#) and described in [Table 17-68](#).

This register is read when attempting to acquire a lock. The lock is automatically taken if it was not taken and the value returned by the read is zero. If the lock was already taken, then the read returns one. Writing a zero to this register frees the lock.

Figure 17-55. LOCK_REG_7 Register



LEGEND: R/W = Read/Write; R = Read only; W1toCl = Write 1 to clear bit; -n = value after reset

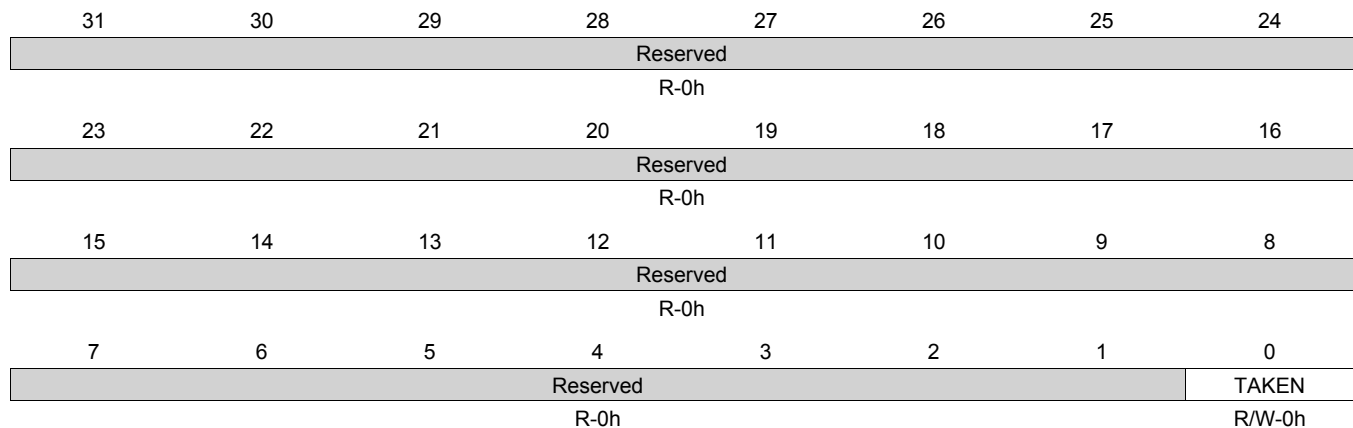
Table 17-68. LOCK_REG_7 Register Field Descriptions

Bit	Field	Type	Reset	Description
31-1	Reserved	R	0h	
0	TAKEN	R/W	0h	

17.2.1.12 LOCK_REG_8 Register (offset = 820h) [reset = 0h]

LOCK_REG_8 is shown in [Figure 17-56](#) and described in [Table 17-69](#).

This register is read when attempting to acquire a lock. The lock is automatically taken if it was not taken and the value returned by the read is zero. If the lock was already taken, then the read returns one. Writing a zero to this register frees the lock.

Figure 17-56. LOCK_REG_8 Register


LEGEND: R/W = Read/Write; R = Read only; W1toCl = Write 1 to clear bit; -n = value after reset

Table 17-69. LOCK_REG_8 Register Field Descriptions

Bit	Field	Type	Reset	Description
31-1	Reserved	R	0h	
0	TAKEN	R/W	0h	

17.2.1.13 LOCK_REG_9 Register (offset = 824h) [reset = 0h]

LOCK_REG_9 is shown in [Figure 17-57](#) and described in [Table 17-70](#).

This register is read when attempting to acquire a lock. The lock is automatically taken if it was not taken and the value returned by the read is zero. If the lock was already taken, then the read returns one. Writing a zero to this register frees the lock.

Figure 17-57. LOCK_REG_9 Register

31	30	29	28	27	26	25	24
Reserved							
R-0h							
23	22	21	20	19	18	17	16
Reserved							
R-0h							
15	14	13	12	11	10	9	8
Reserved							
R-0h							
7	6	5	4	3	2	1	0
Reserved							TAKEN
R-0h							R/W-0h

LEGEND: R/W = Read/Write; R = Read only; W1toCl = Write 1 to clear bit; -n = value after reset

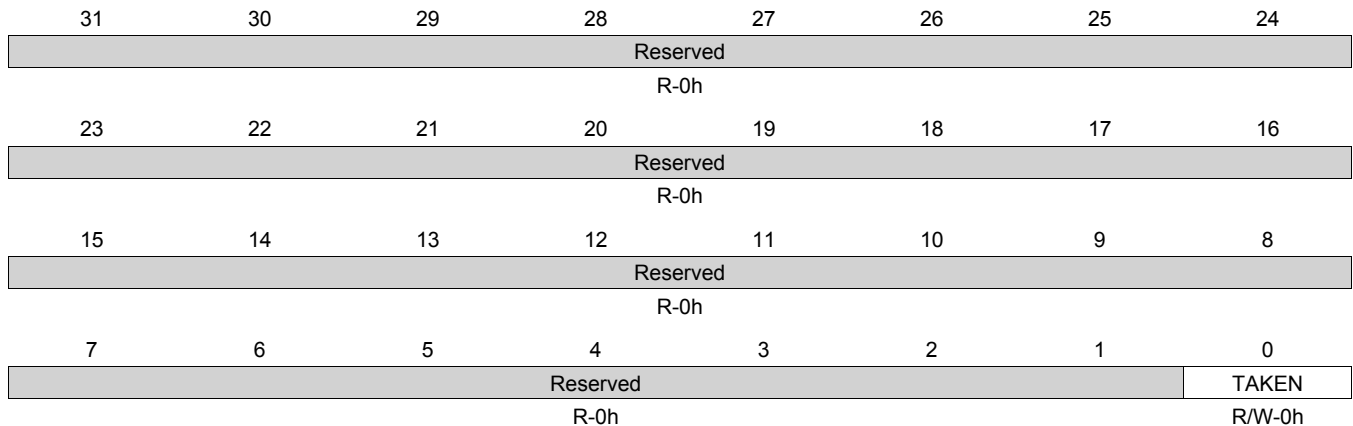
Table 17-70. LOCK_REG_9 Register Field Descriptions

Bit	Field	Type	Reset	Description
31-1	Reserved	R	0h	
0	TAKEN	R/W	0h	

17.2.1.14 LOCK_REG_10 Register (offset = 828h) [reset = 0h]

LOCK_REG_10 is shown in [Figure 17-58](#) and described in [Table 17-71](#).

This register is read when attempting to acquire a lock. The lock is automatically taken if it was not taken and the value returned by the read is zero. If the lock was already taken, then the read returns one. Writing a zero to this register frees the lock.

Figure 17-58. LOCK_REG_10 Register


LEGEND: R/W = Read/Write; R = Read only; W1toCl = Write 1 to clear bit; -n = value after reset

Table 17-71. LOCK_REG_10 Register Field Descriptions

Bit	Field	Type	Reset	Description
31-1	Reserved	R	0h	
0	TAKEN	R/W	0h	

17.2.1.15 LOCK_REG_11 Register (offset = 82Ch) [reset = 0h]

LOCK_REG_11 is shown in [Figure 17-59](#) and described in [Table 17-72](#).

This register is read when attempting to acquire a lock. The lock is automatically taken if it was not taken and the value returned by the read is zero. If the lock was already taken, then the read returns one. Writing a zero to this register frees the lock.

Figure 17-59. LOCK_REG_11 Register

31	30	29	28	27	26	25	24
Reserved							
R-0h							
23	22	21	20	19	18	17	16
Reserved							
R-0h							
15	14	13	12	11	10	9	8
Reserved							
R-0h							
7	6	5	4	3	2	1	0
Reserved							TAKEN
R-0h							R/W-0h

LEGEND: R/W = Read/Write; R = Read only; W1toCl = Write 1 to clear bit; -n = value after reset

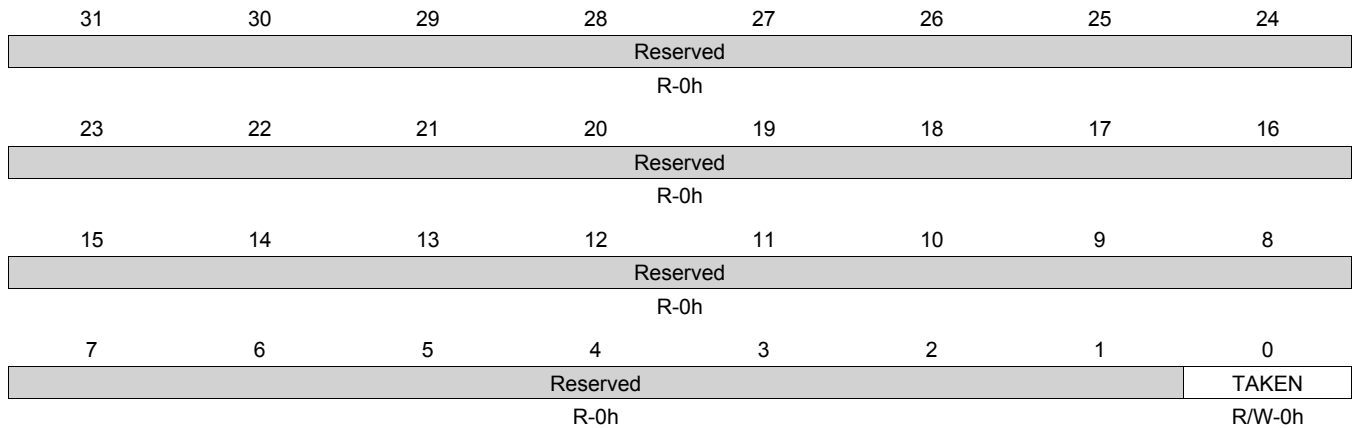
Table 17-72. LOCK_REG_11 Register Field Descriptions

Bit	Field	Type	Reset	Description
31-1	Reserved	R	0h	
0	TAKEN	R/W	0h	

17.2.1.16 LOCK_REG_12 Register (offset = 830h) [reset = 0h]

LOCK_REG_12 is shown in [Figure 17-60](#) and described in [Table 17-73](#).

This register is read when attempting to acquire a lock. The lock is automatically taken if it was not taken and the value returned by the read is zero. If the lock was already taken, then the read returns one. Writing a zero to this register frees the lock.

Figure 17-60. LOCK_REG_12 Register


LEGEND: R/W = Read/Write; R = Read only; W1toCl = Write 1 to clear bit; -n = value after reset

Table 17-73. LOCK_REG_12 Register Field Descriptions

Bit	Field	Type	Reset	Description
31-1	Reserved	R	0h	
0	TAKEN	R/W	0h	

17.2.1.17 LOCK_REG_13 Register (offset = 834h) [reset = 0h]

LOCK_REG_13 is shown in [Figure 17-61](#) and described in [Table 17-74](#).

This register is read when attempting to acquire a lock. The lock is automatically taken if it was not taken and the value returned by the read is zero. If the lock was already taken, then the read returns one. Writing a zero to this register frees the lock.

Figure 17-61. LOCK_REG_13 Register

31	30	29	28	27	26	25	24
Reserved							
R-0h							
23	22	21	20	19	18	17	16
Reserved							
R-0h							
15	14	13	12	11	10	9	8
Reserved							
R-0h							
7	6	5	4	3	2	1	0
Reserved							TAKEN
R-0h							R/W-0h

LEGEND: R/W = Read/Write; R = Read only; W1toCl = Write 1 to clear bit; -n = value after reset

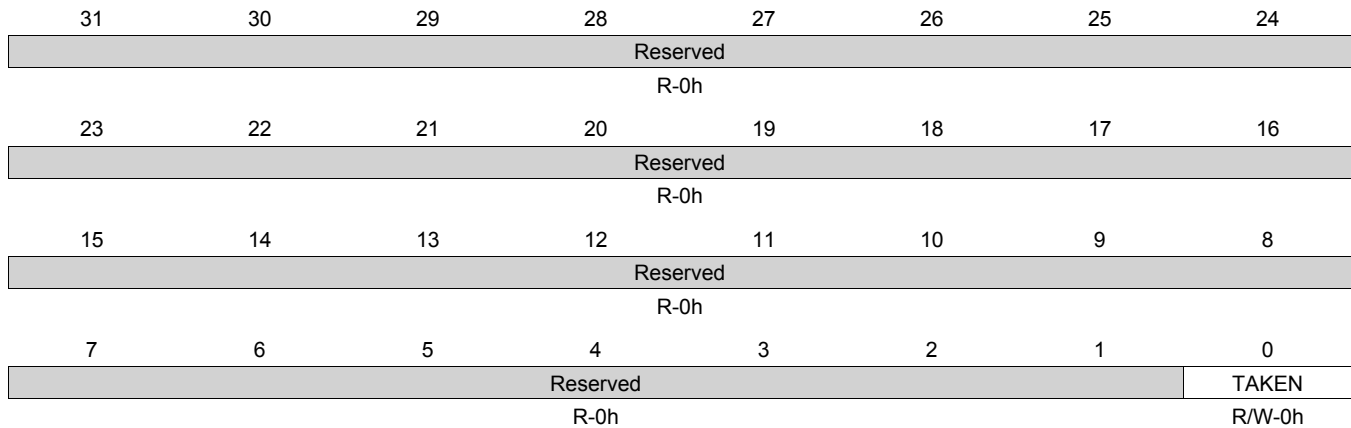
Table 17-74. LOCK_REG_13 Register Field Descriptions

Bit	Field	Type	Reset	Description
31-1	Reserved	R	0h	
0	TAKEN	R/W	0h	

17.2.1.18 LOCK_REG_14 Register (offset = 838h) [reset = 0h]

LOCK_REG_14 is shown in [Figure 17-62](#) and described in [Table 17-75](#).

This register is read when attempting to acquire a lock. The lock is automatically taken if it was not taken and the value returned by the read is zero. If the lock was already taken, then the read returns one. Writing a zero to this register frees the lock.

Figure 17-62. LOCK_REG_14 Register


LEGEND: R/W = Read/Write; R = Read only; W1toCl = Write 1 to clear bit; -n = value after reset

Table 17-75. LOCK_REG_14 Register Field Descriptions

Bit	Field	Type	Reset	Description
31-1	Reserved	R	0h	
0	TAKEN	R/W	0h	

17.2.1.19 LOCK_REG_15 Register (offset = 83Ch) [reset = 0h]

LOCK_REG_15 is shown in [Figure 17-63](#) and described in [Table 17-76](#).

This register is read when attempting to acquire a lock. The lock is automatically taken if it was not taken and the value returned by the read is zero. If the lock was already taken, then the read returns one. Writing a zero to this register frees the lock.

Figure 17-63. LOCK_REG_15 Register

31	30	29	28	27	26	25	24
Reserved							
R-0h							
23	22	21	20	19	18	17	16
Reserved							
R-0h							
15	14	13	12	11	10	9	8
Reserved							
R-0h							
7	6	5	4	3	2	1	0
Reserved							TAKEN
R-0h							R/W-0h

LEGEND: R/W = Read/Write; R = Read only; W1toCl = Write 1 to clear bit; -n = value after reset

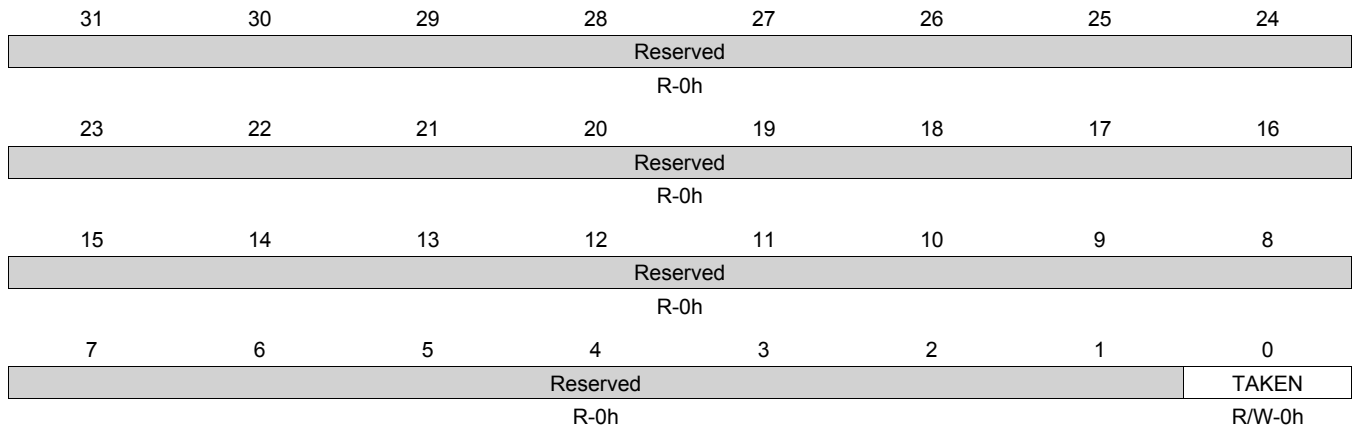
Table 17-76. LOCK_REG_15 Register Field Descriptions

Bit	Field	Type	Reset	Description
31-1	Reserved	R	0h	
0	TAKEN	R/W	0h	

17.2.1.20 LOCK_REG_16 Register (offset = 840h) [reset = 0h]

LOCK_REG_16 is shown in [Figure 17-64](#) and described in [Table 17-77](#).

This register is read when attempting to acquire a lock. The lock is automatically taken if it was not taken and the value returned by the read is zero. If the lock was already taken, then the read returns one. Writing a zero to this register frees the lock.

Figure 17-64. LOCK_REG_16 Register


LEGEND: R/W = Read/Write; R = Read only; W1toCl = Write 1 to clear bit; -n = value after reset

Table 17-77. LOCK_REG_16 Register Field Descriptions

Bit	Field	Type	Reset	Description
31-1	Reserved	R	0h	
0	TAKEN	R/W	0h	

17.2.1.21 LOCK_REG_17 Register (offset = 844h) [reset = 0h]

LOCK_REG_17 is shown in [Figure 17-65](#) and described in [Table 17-78](#).

This register is read when attempting to acquire a lock. The lock is automatically taken if it was not taken and the value returned by the read is zero. If the lock was already taken, then the read returns one. Writing a zero to this register frees the lock.

Figure 17-65. LOCK_REG_17 Register

31	30	29	28	27	26	25	24
Reserved							
R-0h							
23	22	21	20	19	18	17	16
Reserved							
R-0h							
15	14	13	12	11	10	9	8
Reserved							
R-0h							
7	6	5	4	3	2	1	0
Reserved							TAKEN
R-0h							R/W-0h

LEGEND: R/W = Read/Write; R = Read only; W1toCl = Write 1 to clear bit; -n = value after reset

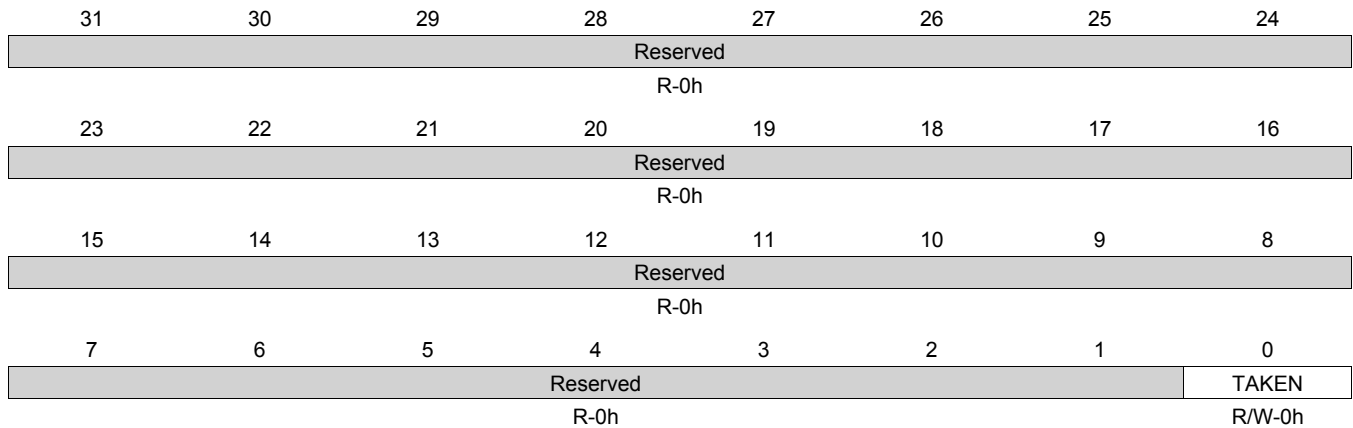
Table 17-78. LOCK_REG_17 Register Field Descriptions

Bit	Field	Type	Reset	Description
31-1	Reserved	R	0h	
0	TAKEN	R/W	0h	

17.2.1.22 LOCK_REG_18 Register (offset = 848h) [reset = 0h]

LOCK_REG_18 is shown in [Figure 17-66](#) and described in [Table 17-79](#).

This register is read when attempting to acquire a lock. The lock is automatically taken if it was not taken and the value returned by the read is zero. If the lock was already taken, then the read returns one. Writing a zero to this register frees the lock.

Figure 17-66. LOCK_REG_18 Register


LEGEND: R/W = Read/Write; R = Read only; W1toCl = Write 1 to clear bit; -n = value after reset

Table 17-79. LOCK_REG_18 Register Field Descriptions

Bit	Field	Type	Reset	Description
31-1	Reserved	R	0h	
0	TAKEN	R/W	0h	

17.2.1.23 LOCK_REG_19 Register (offset = 84Ch) [reset = 0h]

LOCK_REG_19 is shown in [Figure 17-67](#) and described in [Table 17-80](#).

This register is read when attempting to acquire a lock. The lock is automatically taken if it was not taken and the value returned by the read is zero. If the lock was already taken, then the read returns one. Writing a zero to this register frees the lock.

Figure 17-67. LOCK_REG_19 Register

31	30	29	28	27	26	25	24
Reserved							
R-0h							
23	22	21	20	19	18	17	16
Reserved							
R-0h							
15	14	13	12	11	10	9	8
Reserved							
R-0h							
7	6	5	4	3	2	1	0
Reserved							TAKEN
R-0h							R/W-0h

LEGEND: R/W = Read/Write; R = Read only; W1toCl = Write 1 to clear bit; -n = value after reset

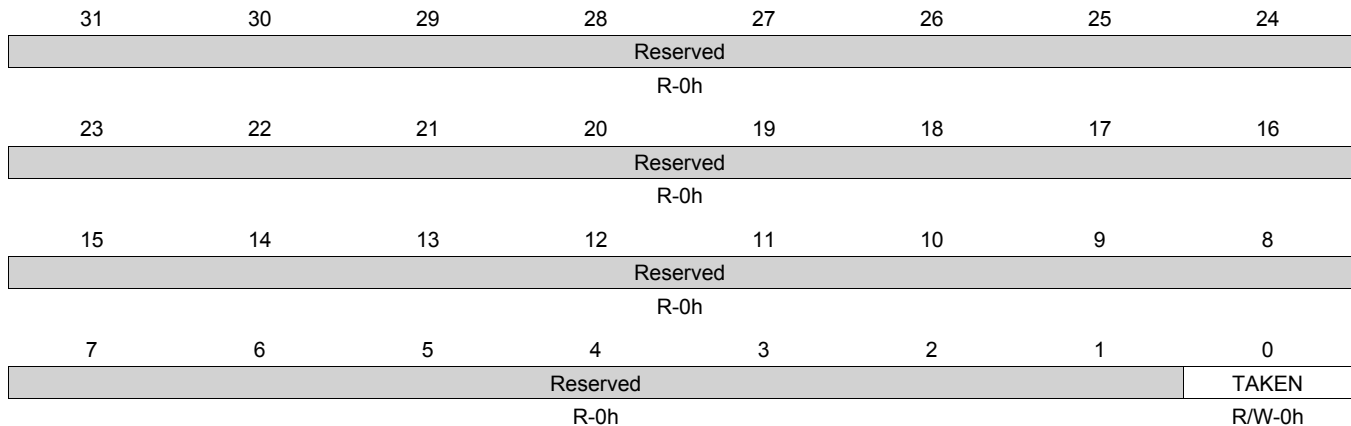
Table 17-80. LOCK_REG_19 Register Field Descriptions

Bit	Field	Type	Reset	Description
31-1	Reserved	R	0h	
0	TAKEN	R/W	0h	

17.2.1.24 LOCK_REG_20 Register (offset = 850h) [reset = 0h]

LOCK_REG_20 is shown in [Figure 17-68](#) and described in [Table 17-81](#).

This register is read when attempting to acquire a lock. The lock is automatically taken if it was not taken and the value returned by the read is zero. If the lock was already taken, then the read returns one. Writing a zero to this register frees the lock.

Figure 17-68. LOCK_REG_20 Register


LEGEND: R/W = Read/Write; R = Read only; W1toCl = Write 1 to clear bit; -n = value after reset

Table 17-81. LOCK_REG_20 Register Field Descriptions

Bit	Field	Type	Reset	Description
31-1	Reserved	R	0h	
0	TAKEN	R/W	0h	

17.2.1.25 LOCK_REG_21 Register (offset = 854h) [reset = 0h]

LOCK_REG_21 is shown in [Figure 17-69](#) and described in [Table 17-82](#).

This register is read when attempting to acquire a lock. The lock is automatically taken if it was not taken and the value returned by the read is zero. If the lock was already taken, then the read returns one. Writing a zero to this register frees the lock.

Figure 17-69. LOCK_REG_21 Register

31	30	29	28	27	26	25	24
Reserved							
R-0h							
23	22	21	20	19	18	17	16
Reserved							
R-0h							
15	14	13	12	11	10	9	8
Reserved							
R-0h							
7	6	5	4	3	2	1	0
Reserved							TAKEN
R-0h							R/W-0h

LEGEND: R/W = Read/Write; R = Read only; W1toCl = Write 1 to clear bit; -n = value after reset

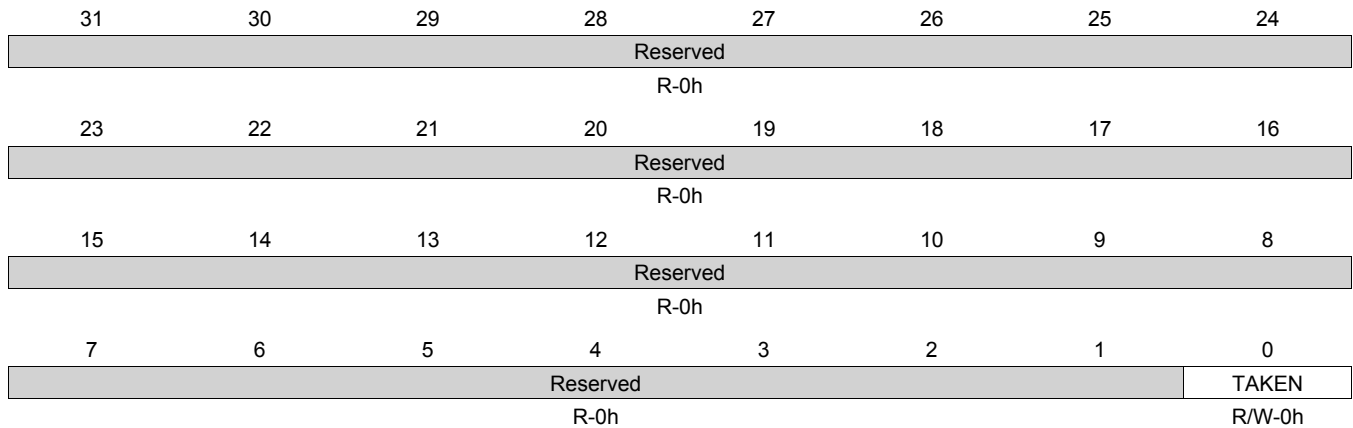
Table 17-82. LOCK_REG_21 Register Field Descriptions

Bit	Field	Type	Reset	Description
31-1	Reserved	R	0h	
0	TAKEN	R/W	0h	

17.2.1.26 LOCK_REG_22 Register (offset = 858h) [reset = 0h]

LOCK_REG_22 is shown in [Figure 17-70](#) and described in [Table 17-83](#).

This register is read when attempting to acquire a lock. The lock is automatically taken if it was not taken and the value returned by the read is zero. If the lock was already taken, then the read returns one. Writing a zero to this register frees the lock.

Figure 17-70. LOCK_REG_22 Register


LEGEND: R/W = Read/Write; R = Read only; W1toCl = Write 1 to clear bit; -n = value after reset

Table 17-83. LOCK_REG_22 Register Field Descriptions

Bit	Field	Type	Reset	Description
31-1	Reserved	R	0h	
0	TAKEN	R/W	0h	

17.2.1.27 LOCK_REG_23 Register (offset = 85Ch) [reset = 0h]

LOCK_REG_23 is shown in [Figure 17-71](#) and described in [Table 17-84](#).

This register is read when attempting to acquire a lock. The lock is automatically taken if it was not taken and the value returned by the read is zero. If the lock was already taken, then the read returns one. Writing a zero to this register frees the lock.

Figure 17-71. LOCK_REG_23 Register

31	30	29	28	27	26	25	24
Reserved							
R-0h							
23	22	21	20	19	18	17	16
Reserved							
R-0h							
15	14	13	12	11	10	9	8
Reserved							
R-0h							
7	6	5	4	3	2	1	0
Reserved							TAKEN
R-0h							R/W-0h

LEGEND: R/W = Read/Write; R = Read only; W1toCl = Write 1 to clear bit; -n = value after reset

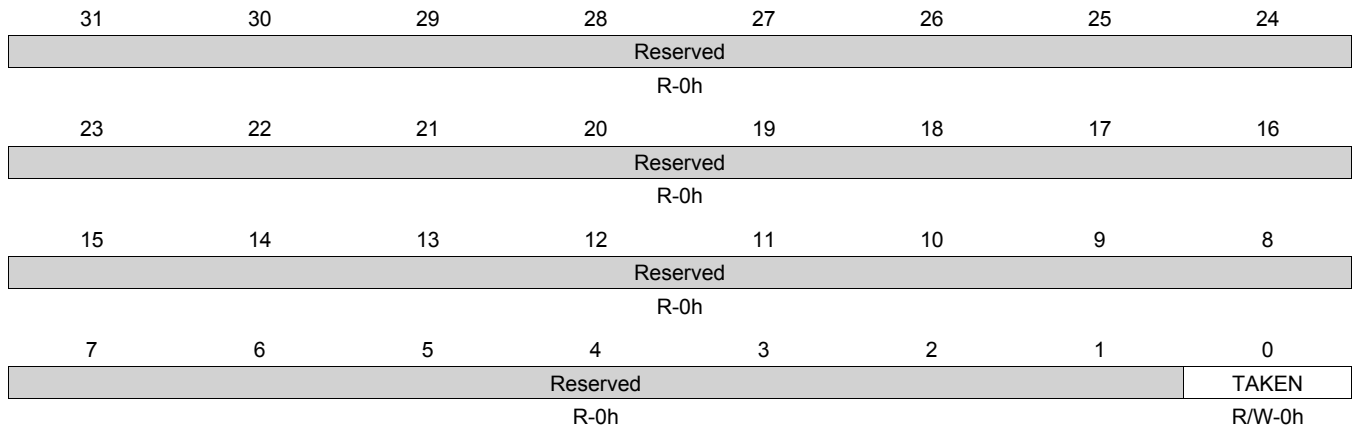
Table 17-84. LOCK_REG_23 Register Field Descriptions

Bit	Field	Type	Reset	Description
31-1	Reserved	R	0h	
0	TAKEN	R/W	0h	

17.2.1.28 LOCK_REG_24 Register (offset = 860h) [reset = 0h]

LOCK_REG_24 is shown in [Figure 17-72](#) and described in [Table 17-85](#).

This register is read when attempting to acquire a lock. The lock is automatically taken if it was not taken and the value returned by the read is zero. If the lock was already taken, then the read returns one. Writing a zero to this register frees the lock.

Figure 17-72. LOCK_REG_24 Register


LEGEND: R/W = Read/Write; R = Read only; W1toCl = Write 1 to clear bit; -n = value after reset

Table 17-85. LOCK_REG_24 Register Field Descriptions

Bit	Field	Type	Reset	Description
31-1	Reserved	R	0h	
0	TAKEN	R/W	0h	

17.2.1.29 LOCK_REG_25 Register (offset = 864h) [reset = 0h]

LOCK_REG_25 is shown in [Figure 17-73](#) and described in [Table 17-86](#).

This register is read when attempting to acquire a lock. The lock is automatically taken if it was not taken and the value returned by the read is zero. If the lock was already taken, then the read returns one. Writing a zero to this register frees the lock.

Figure 17-73. LOCK_REG_25 Register

31	30	29	28	27	26	25	24
Reserved							
R-0h							
23	22	21	20	19	18	17	16
Reserved							
R-0h							
15	14	13	12	11	10	9	8
Reserved							
R-0h							
7	6	5	4	3	2	1	0
Reserved							TAKEN
R-0h							R/W-0h

LEGEND: R/W = Read/Write; R = Read only; W1toCl = Write 1 to clear bit; -n = value after reset

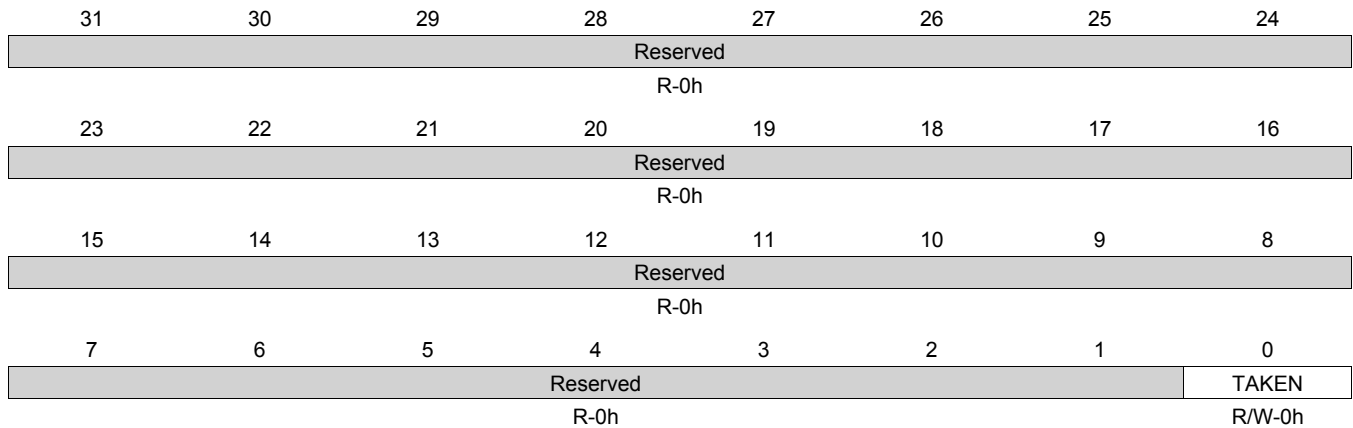
Table 17-86. LOCK_REG_25 Register Field Descriptions

Bit	Field	Type	Reset	Description
31-1	Reserved	R	0h	
0	TAKEN	R/W	0h	

17.2.1.30 LOCK_REG_26 Register (offset = 868h) [reset = 0h]

LOCK_REG_26 is shown in [Figure 17-74](#) and described in [Table 17-87](#).

This register is read when attempting to acquire a lock. The lock is automatically taken if it was not taken and the value returned by the read is zero. If the lock was already taken, then the read returns one. Writing a zero to this register frees the lock.

Figure 17-74. LOCK_REG_26 Register


LEGEND: R/W = Read/Write; R = Read only; W1toCl = Write 1 to clear bit; -n = value after reset

Table 17-87. LOCK_REG_26 Register Field Descriptions

Bit	Field	Type	Reset	Description
31-1	Reserved	R	0h	
0	TAKEN	R/W	0h	

17.2.1.31 LOCK_REG_27 Register (offset = 86Ch) [reset = 0h]

LOCK_REG_27 is shown in [Figure 17-75](#) and described in [Table 17-88](#).

This register is read when attempting to acquire a lock. The lock is automatically taken if it was not taken and the value returned by the read is zero. If the lock was already taken, then the read returns one. Writing a zero to this register frees the lock.

Figure 17-75. LOCK_REG_27 Register

31	30	29	28	27	26	25	24
Reserved							
R-0h							
23	22	21	20	19	18	17	16
Reserved							
R-0h							
15	14	13	12	11	10	9	8
Reserved							
R-0h							
7	6	5	4	3	2	1	0
Reserved							TAKEN
R-0h							R/W-0h

LEGEND: R/W = Read/Write; R = Read only; W1toCl = Write 1 to clear bit; -n = value after reset

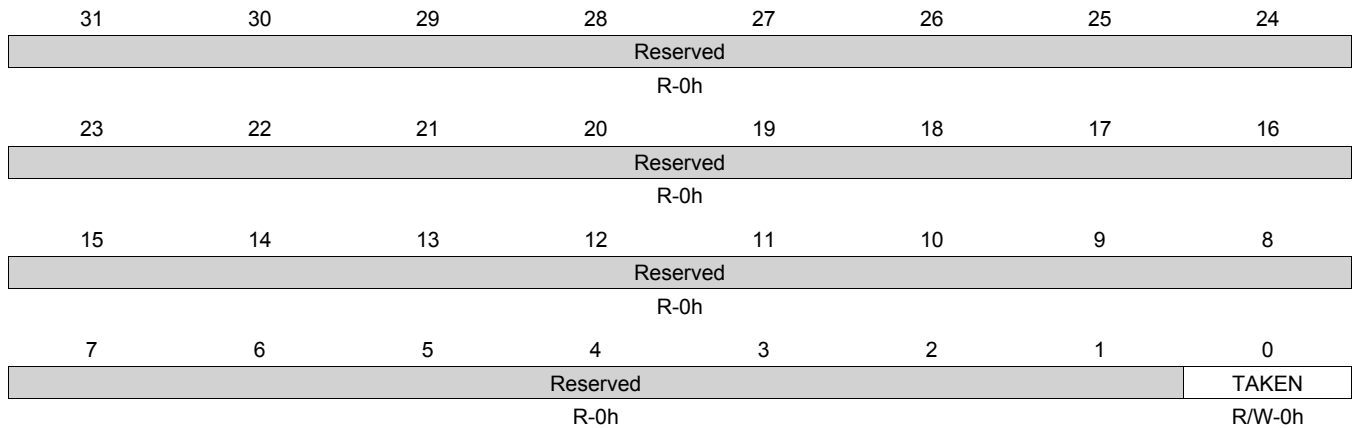
Table 17-88. LOCK_REG_27 Register Field Descriptions

Bit	Field	Type	Reset	Description
31-1	Reserved	R	0h	
0	TAKEN	R/W	0h	

17.2.1.32 LOCK_REG_28 Register (offset = 870h) [reset = 0h]

LOCK_REG_28 is shown in [Figure 17-76](#) and described in [Table 17-89](#).

This register is read when attempting to acquire a lock. The lock is automatically taken if it was not taken and the value returned by the read is zero. If the lock was already taken, then the read returns one. Writing a zero to this register frees the lock.

Figure 17-76. LOCK_REG_28 Register


LEGEND: R/W = Read/Write; R = Read only; W1toCl = Write 1 to clear bit; -n = value after reset

Table 17-89. LOCK_REG_28 Register Field Descriptions

Bit	Field	Type	Reset	Description
31-1	Reserved	R	0h	
0	TAKEN	R/W	0h	

17.2.1.33 LOCK_REG_29 Register (offset = 874h) [reset = 0h]

LOCK_REG_29 is shown in [Figure 17-77](#) and described in [Table 17-90](#).

This register is read when attempting to acquire a lock. The lock is automatically taken if it was not taken and the value returned by the read is zero. If the lock was already taken, then the read returns one. Writing a zero to this register frees the lock.

Figure 17-77. LOCK_REG_29 Register

31	30	29	28	27	26	25	24
Reserved							
R-0h							
23	22	21	20	19	18	17	16
Reserved							
R-0h							
15	14	13	12	11	10	9	8
Reserved							
R-0h							
7	6	5	4	3	2	1	0
Reserved							TAKEN
R-0h							R/W-0h

LEGEND: R/W = Read/Write; R = Read only; W1toCl = Write 1 to clear bit; -n = value after reset

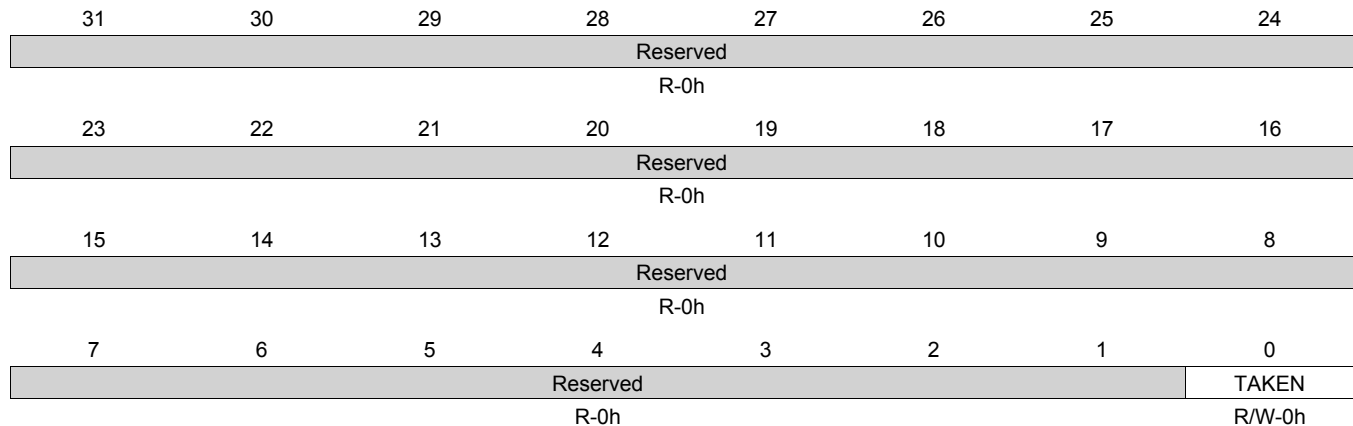
Table 17-90. LOCK_REG_29 Register Field Descriptions

Bit	Field	Type	Reset	Description
31-1	Reserved	R	0h	
0	TAKEN	R/W	0h	

17.2.1.34 LOCK_REG_30 Register (offset = 878h) [reset = 0h]

LOCK_REG_30 is shown in [Figure 17-78](#) and described in [Table 17-91](#).

This register is read when attempting to acquire a lock. The lock is automatically taken if it was not taken and the value returned by the read is zero. If the lock was already taken, then the read returns one. Writing a zero to this register frees the lock.

Figure 17-78. LOCK_REG_30 Register


LEGEND: R/W = Read/Write; R = Read only; W1toCl = Write 1 to clear bit; -n = value after reset

Table 17-91. LOCK_REG_30 Register Field Descriptions

Bit	Field	Type	Reset	Description
31-1	Reserved	R	0h	
0	TAKEN	R/W	0h	

17.2.1.35 LOCK_REG_31 Register (offset = 87Ch) [reset = 0h]

LOCK_REG_31 is shown in [Figure 17-79](#) and described in [Table 17-92](#).

This register is read when attempting to acquire a lock. The lock is automatically taken if it was not taken and the value returned by the read is zero. If the lock was already taken, then the read returns one. Writing a zero to this register frees the lock.

Figure 17-79. LOCK_REG_31 Register

31	30	29	28	27	26	25	24
Reserved							
R-0h							
23	22	21	20	19	18	17	16
Reserved							
R-0h							
15	14	13	12	11	10	9	8
Reserved							
R-0h							
7	6	5	4	3	2	1	0
Reserved							TAKEN
R-0h							R/W-0h

LEGEND: R/W = Read/Write; R = Read only; W1toCl = Write 1 to clear bit; -n = value after reset

Table 17-92. LOCK_REG_31 Register Field Descriptions

Bit	Field	Type	Reset	Description
31-1	Reserved	R	0h	
0	TAKEN	R/W	0h	

Multimedia Card (MMC)

This chapter describes the MMC of the device.

Topic	Page
18.1 Introduction	4106
18.2 Functional Description	4112
18.3 Low-Level Programming Models	4145
18.4 Multimedia Card Registers	4150

18.1 Introduction

18.1.1 MMCHS Features

The general features of the MMCHS host controller IP are:

- Built-in 1024-byte buffer for read or write
- Two DMA channels, one interrupt line
- Clock support
 - 96-MHz functional clock source input
 - up to 384Mbit/sec (48MByte/sec) in MMC mode 8-bit data transfer
 - up to 192Mbit/sec (24MByte/sec) in High-Speed SD mode 4-bit data transfer
 - up to 24Mbit/sec (3MByte/sec) in Default SD mode 1-bit data transfer
- Support for SDA 3.0 Part A2 programming model
- Serial link supports full compliance with:
 - MMC command/response sets as defined in the MMC standard specification v4.3.
 - SD command/response sets as defined in the SD Physical Layer specification v2.00
 - SDIO command/response sets and interrupt/read-wait suspend-resume operations as defined in the SD part E1 specification v 2.00
 - SD Host Controller Standard Specification sets as defined in the SD card specification Part A2 v2.00

18.1.2 Unsupported MMCHS Features

The MMCHS module features not supported in this device are shown in [Table 18-1](#).

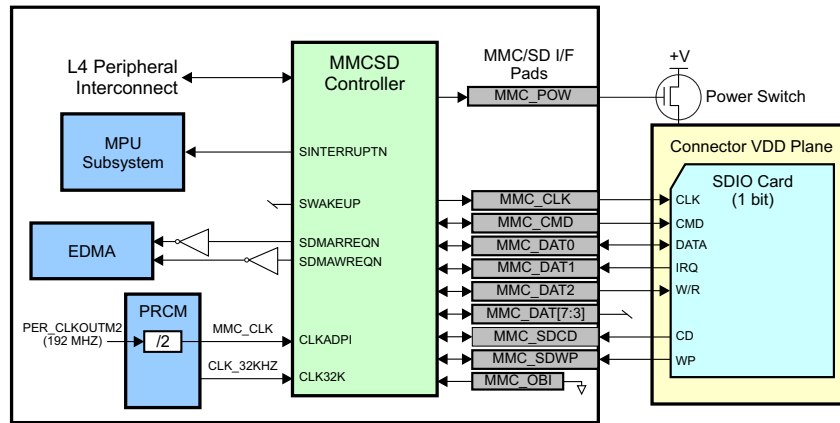
Table 18-1. Unsupported MMCHS Features

Feature	Reason
MMC Out-of-band interrupts	MMC_OBI input tied low
Master DMA operation	Disabled through synthesis parameter
Card Supply Control (MMCHS(1-2))	Signal not pinned out
Dual Data Rate (DDR) mode	Timing not supported

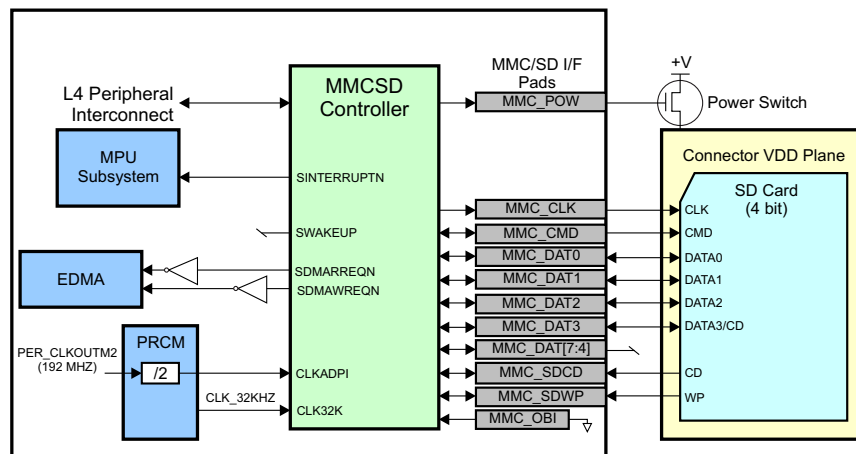
Integration

This device contains three instances of the Multimedia Card (MMC), Secure Digital (SD), and Secure Digital I/O (SDIO) high speed interface module (MMCHS). The controller provides an interface to an MMC, SD memory card or SDIO card.

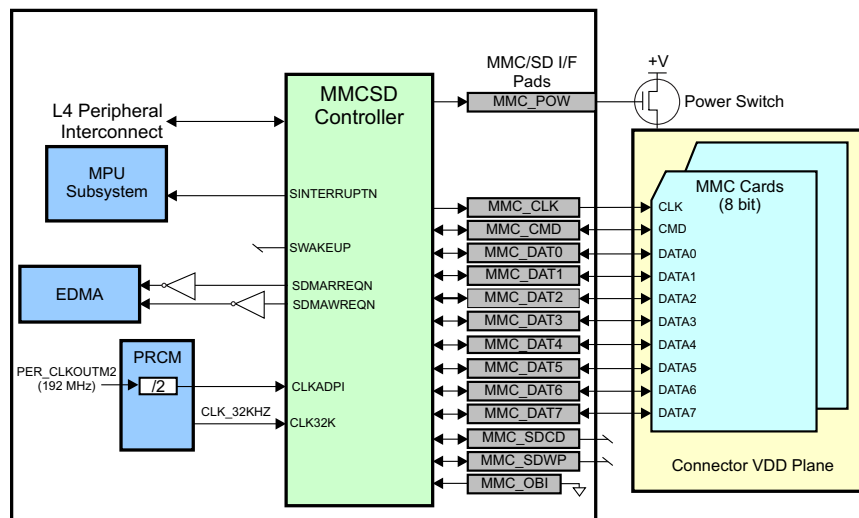
The application interface is responsible for managing transaction semantics; the MMC/SDIO host controller deals with MMC/SDIO protocol at transmission level, packing data, adding CRC, start/end bit and checking for syntactical correctness. [MMCHS Module SDIO Application](#) through [MMCHS Module MMC Application](#) below show examples of systems using the MMCHS controller. Note that the power switch control is only available on the MMCHS0 interface.



MMCHS Module SDIO Application



MMCHS SD (4-bit) Card Application



MMCHS Module MMC Application

MMCHS Connectivity Attributes

MMCHS Module MMC Application (continued)

The general connectivity attributes for the three MMCHS modules are shown in [MMCHS Connectivity Attributes](#).

MMCHS Connectivity Attributes

Attributes	Type
Power Domain	Peripheral Domain
Clock Domain	PD_PER_L4LS_GCLK (OCP) PD_PER_MMC_FCLK (Func) CLK_32KHZ (Debounce)
Reset Signals	PER_DOM_RST_N
Idle/Wakeup Signals	Smart Idle
Interrupt Requests	1 interrupt per instance to MPU Subsystem (MMCSdXINT)
DMA Requests	2 DMA requests per instance to EDMA (SDTXEVTx, SDRXEVTx) (Active low, need to be inverted in glue logic)
Physical Address	L4 Peripheral slave port

MMCHS Clock and Reset Management

The MMCHS controller has separate bus interface and functional clocks. The debounce clock is created by dividing the 96-MHz (48 MHz @ OPP50) clock in the PRCM by two and then dividing the resulting 48-MHz (24 MHz @ OPP50) clock by a fixed 732.4219 (366.2109 @ OPP50) in the Control Module to get a 32-kHz clock. This clock is fed back into the PRCM for clock gating. (See the CLK32KDIVRATIO_CTRL register in [Chapter 9, Control Module](#), for more details).

MMCHS Clock Signals

Clock Signal	Max Freq	Reference / Source	Comments
CLK Interface clock	100 MHz	CORE_CLKOUTM4 / 2	pd_per_l4ls_gclk from PRCM
CLKADPI Functional clock	48 MHz	PER_CLKOUTM2 / 2	pd_per_mmc_fclk from PRCM
CLK32 Input de-bounce clock	32.768 KHz	CLK_24 / 732.4219	clk_32KHz from PRCM

MMCHS Pin List

The MMCHS interface pins are summarized in [MMCHS Pin List](#).

MMCHS Pin List

Pin	Type	Description
MMCx_CLK	I/O ⁽¹⁾	MMC/SD serial clock output
MMCx_CMD	I/O	MMC/SD command signal
MMCx_DAT0	I/O	MMC/SD data signal
MMCx_DAT1	I/O	MMC/SD data signal, SDIO interrupt input
MMCx_DAT2	I/O	MMC/SD data signal, SDIO read wait output
MMCx_DAT[7:3]	I/O	MMC/SD data signals
MMCx_POW	O	MMC/SD power supply control (MMCHS 0 only)
MMCx_SDCD	I	SD card detect (from connector)
MMCx_SDWP	I	SD write protect (from connector)
MMCx_OBI	I	MMC out of band interrupt

⁽¹⁾ This output signal is also used as a retiming input. The associated CONF_*<module>*_*<pin>*_RXACTIVE bit for the output clock must be set to 1 to enable the clock input back to the module. It is also recommended to place a 33-ohm resistor in series (close to the processor) to avoid signal reflections.

The direction of the data lines depends on the selected data transfer mode as summarized in [DAT Line Direction for Data Transfer Modes](#).

DAT Line Direction for Data Transfer Modes

	MMC/SD 1-bit mode	MMC/SD 4-bit mode	MMC/SD 8-bit mode	SDIO 1-bit mode	SDIO 4-bit mode
DAT[0]	I/O	I/O	I/O	I/O	I/O
DAT[1]	I ⁽¹⁾	I/O	I/O	I ⁽²⁾	I/O or I ⁽²⁾
DAT[2]	I ⁽¹⁾	I/O	I/O	I/O ⁽³⁾	I/O or O ⁽³⁾
DAT[3]	I ⁽¹⁾	I/O	I/O	I ⁽¹⁾	I/O
DAT[4]	I ⁽¹⁾	I ⁽¹⁾	I/O	I ⁽¹⁾	I ⁽¹⁾
DAT[5]	I ⁽¹⁾	I ⁽¹⁾	I/O	I ⁽¹⁾	I ⁽¹⁾
DAT[6]	I ⁽¹⁾	I ⁽¹⁾	I/O	I ⁽¹⁾	I ⁽¹⁾
DAT[7]	I ⁽¹⁾	I ⁽¹⁾	I/O	I ⁽¹⁾	I ⁽¹⁾

⁽¹⁾ Hi-Z state to avoid bus conflict.

⁽²⁾ To support incoming interrupt from the SDIO card.

⁽³⁾ To support read wait to the SDIO card. By default it is Input, Output only in read wait period.

The direction of the MMCHS data buffers are controlled by ADPDATDIROQ signals. ADPDATDIROQ[i] = 1 sets the corresponding DAT signal(s) in read position (input) and ADPDATDIROQ[i] = 0 sets the corresponding DAT signal(s) in write position (output). Additionally, the ADPDATDIRLS signals are provided (with opposite polarity) to control the direction of external level shifters. The value of these control signals for the various data modes are summarized in [ADPDATDIROQ and ADPDATDIRLS Signal States](#).

ADPDATDIROQ and ADPDATDIRLS Signal States

	MMC/SD 1-bit mode	MMC/SD 4-bit mode	MMC/SD 8-bit mode	SDIO 1-bit mode	SDIO 4-bit mode
DAT[0]	ADPDATDIRLS[0] = 0 / 1 ADPDATDIROQ[0] = 1 / 0	ADPDATDIRLS[0] = 0 / 1 ADPDATDIROQ[0] = 1 / 0	ADPDATDIRLS[0] = 0 / 1 ADPDATDIROQ[0] = 1 / 0	ADPDATDIRLS[0] = 0 / 1	ADPDATDIRLS[0] = 0 / 1 ADPDATDIROQ[0] = 1 / 0
DAT[2]	ADPDATDIRLS[2] = 0 ADPDATDIROQ[2] = 1	ADPDATDIRLS[2] = 0 / 1 ADPDATDIROQ[2] = 1 / 0	ADPDATDIRLS[2] = 0 / 1 ADPDATDIROQ[2] = 1 / 0	ADPDATDIRLS[2] = 0 / 1 ADPDATDIROQ[2] = 1 / 0	ADPDATDIRLS[2] = 0 / 1 ADPDATDIROQ[2] = 1 / 0
DAT[1]	ADPDATDIRLS[1] = 0	ADPDATDIRLS[1] = 0 / 1	ADPDATDIRLS[1] = 0 / 1	ADPDATDIRLS[1] = 0	ADPDATDIRLS[1] = 0 / 1
DAT[3]	ADPDATDIROQ[1] = 1	ADPDATDIROQ[1] = 1 / 0	ADPDATDIROQ[1] = 1 / 0	ADPDATDIROQ[1] = 1	ADPDATDIROQ[1] = 1 / 0
DAT[4]	ADPDATDIRLS[3] = 0	ADPDATDIRLS[3] = 0	ADPDATDIRLS[3] = 0 / 1	ADPDATDIRLS[3] = 0	ADPDATDIRLS[3] = 0
DAT[5]	ADPDATDIROQ[3] = 1	ADPDATDIROQ[3] = 1	ADPDATDIROQ[3] = 1 / 0	ADPDATDIROQ[3] = 1	ADPDATDIROQ[3] = 1
DAT[6]					
DAT[7]					

ADPDATDIRLS_x = 0 for input and 1 for output — these signals are not pinned out on this device.

ADPDATDIROQ_x = 0 for output and 1 for input.

Grayed cells indicate that the data line is not used in the selected transfer mode.

18.2 Functional Description

One MMC/SD/SDIO host controller can support one MMC memory card, one SD card, or one SDIO card.

Other combinations (for example, two SD cards, one MMC card, and one SD card) are not supported through a single controller.

18.2.1 MMC/SD/SDIO Functional Modes

18.2.1.1 MMC/SD/SDIO Connected to an MMC, an SD Card, or an SDIO Card

Figure 18-1 shows the MMC/SD/SDIO1 and MMC/SD/SDIO2 host controllers connected to an MMC, an SD, or an SDIO card and its related external connections.

Figure 18-1. MMC/SD1/2 Connectivity to an MMC/SD Card

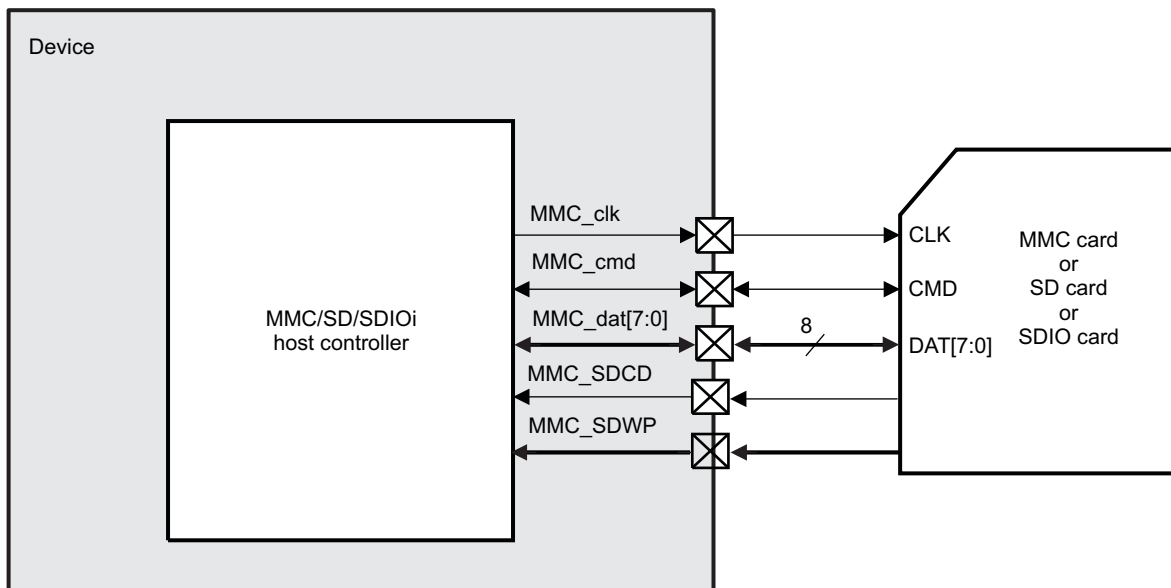


Figure 18-2. MMC/SD0 Connectivity to an MMC/SD Card

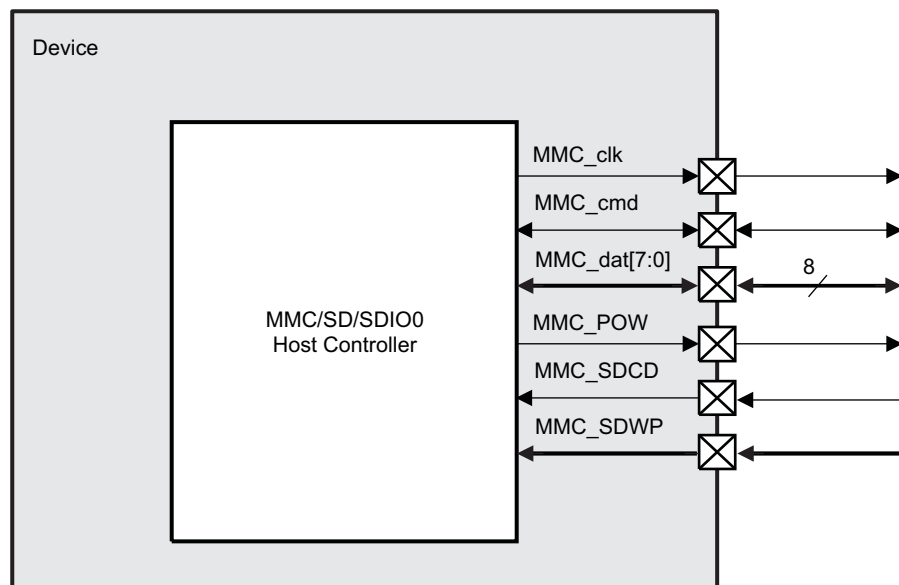


Figure 18-2 shows the MMC/SD/SDIO0 host controller connected to an MMC, SD, or SDIO card and its related external connections. Note that MMC/SD/SDIO0 uses the same signals as MMC/SD/SDIO1 and 2 but adds MMC_POW.

The following MMC/SD/SDIO controller pins are used

- **MMC_CMD** This pin is used for two-way communication between the connected card and the MMC/SD/SDIO controller. The MMC/SD/SDIO controller transmits commands to the card and the memory card drives responses to the commands on this pin.
- **MMC_DAT7-0** Depending on which type of card you are using, you may need to connect 1, 4, or 8 data lines. The number of DAT pins (the data bus width) is set by the Data Transfer Width (DTW) bit in the MMC control register (SD_HCTL). For more information, see , *MULTIMEDIA_CARD Registers*.
- **MMC_CLK** This pin provides the clock to the memory card from the MMC/SD controller.
- **MMC_POW** Used for MMC/SD card's cards on/off power supply control. When high, denotes power-on condition.
- **MMC_SDCD** This input pin serves as the MMC/SD/SDIO carrier detect. This signal is received from a mechanical switch on the slot.
- **MMC_SDWP** This input pin is used for the SD/SDIO card's write protect. This signal is received from a mechanical protect switch on the slot (system dependant). Applicable only for SD and SDIO cards that have a mechanical sliding tablet on the side of the card.

Note: The MMC_CLK pin functions as an output but must be configured as an I/O to internally loopback the clock to time the inputs.

Table 18-2 provides a summary of these pins.

Table 18-2. MMC/SD/SDIO Controller Pins and Descriptions

Pin	Type	1-Bit Mode	4-Bit Mode	8-Bit Mode	Reset Value
MMC_CLK ⁽¹⁾	O	Clock Line	Clock Line	Clock Line	High impedance
MMC_CMD	I/O	Command Line	Command Line	Command Line	High impedance
MMC_DAT0	I/O	Data Line 0	Data Line 0	Data Line 0	0
MMC_DAT1	I/O	(not used)	Data Line 1	Data Line 1	0
MMC_DAT2	I/O	(not used)	Data Line 2	Data Line 2	0
MMC_DAT3	I/O	(not used)	Data Line 3	Data Line 3	0
MMC_DAT4	I/O	(not used)	(not used)	Data Line 4	0
MMC_DAT5	I/O	(not used)	(not used)	Data Line 5	0
MMC_DAT6	I/O	(not used)	(not used)	Data Line 6	0
MMC_DAT7	I/O	(not used)	(not used)	Data Line 7	0

⁽¹⁾ The MMC_CLK pin functions as an output but must be configured as an I/O to internally loopback the clock to time the inputs.

18.2.1.2 Protocol and Data Format

The bus protocol between the MMC/SD/SDIO host controller and the card is message-based. Each message is represented by one of the following parts:

Command: A command starts an operation. The command is transferred serially from the MMC/SD/SDIO host controller to the card on the mmc_cmd line.

Response: A response is an answer to a command. The response is sent from the card to the MMC/SD/SDIO host controller. It is transferred serially on the mmc_cmd line.

Data: Data are transferred from the MMC/SD/SDIO host controller to the card or from a card to the MMC/SD/SDIO host controller using the DATA lines.

Busy: The mmc_dat0 signal is maintained low by the card as far as it is programming the data received.

CRC status: CRC result is sent by the card through the mmc_dat0 line when executing a write transfer. In the case of transmission error, occurring on any of the active data lines, the card sends a negative CRC status on mmc_dat0. In the case of successful transmission, over all active data lines, the card sends a positive CRC status on mmc_dat0 and starts the data programming procedure.

18.2.1.2.1 Protocol

There are two types of data transfer:

- Sequential operation
- Block-oriented operation

There are specific commands for each type of operation (sequential or block-oriented). See the *Multimedia Card System Specification*, the *SD Memory Card Specifications*, and the *SDIO Card Specification, Part E1* for details about commands and programming sequences supported by the MMC, SD, and SDIO cards.

CAUTION

Stream commands are supported only by MMC cards.

Figure 18-3 and Figure 18-4 show how sequential operations are defined. Sequential operation is only for 1-bit transfer and initiates a continuous data stream. The transfer terminates when a stop command follows on the mmc_cmd line.

Figure 18-3. Sequential Read Operation (MMC Cards Only)

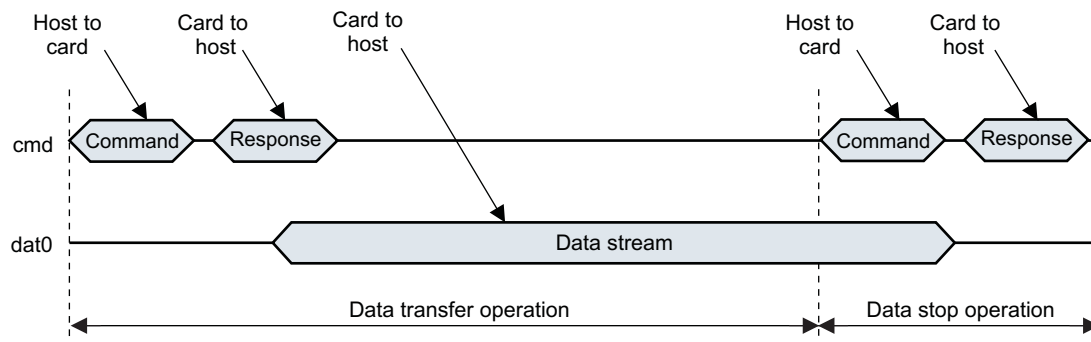


Figure 18-4. Sequential Write Operation (MMC Cards Only)

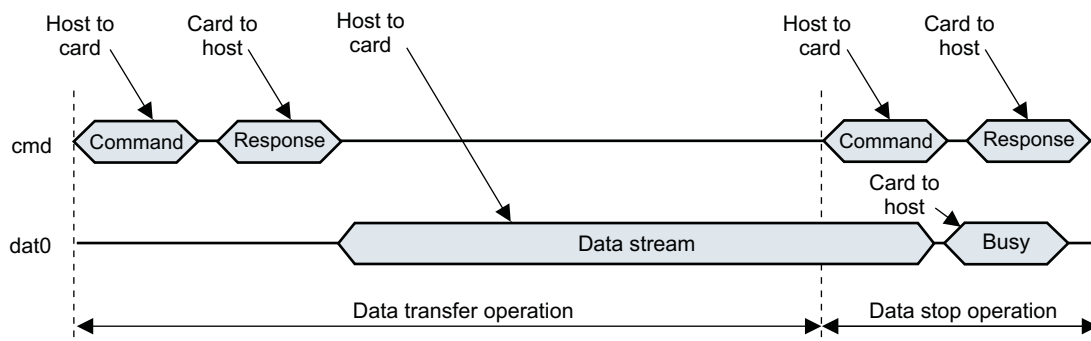


Figure 18-5 and Figure 18-6 show how multiple block-oriented operations are defined. A multiple block-oriented operation sends a data block plus CRC bits. The transfer terminates when a stop command follows on the mmc_cmd line. These operations are available for all kinds of cards.

Figure 18-5. Multiple Block Read Operation (MMC Cards Only)

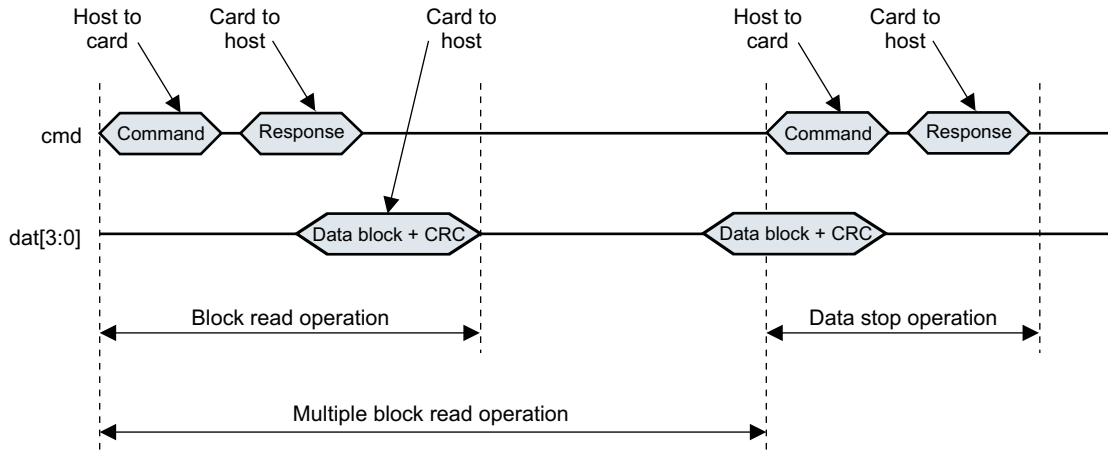
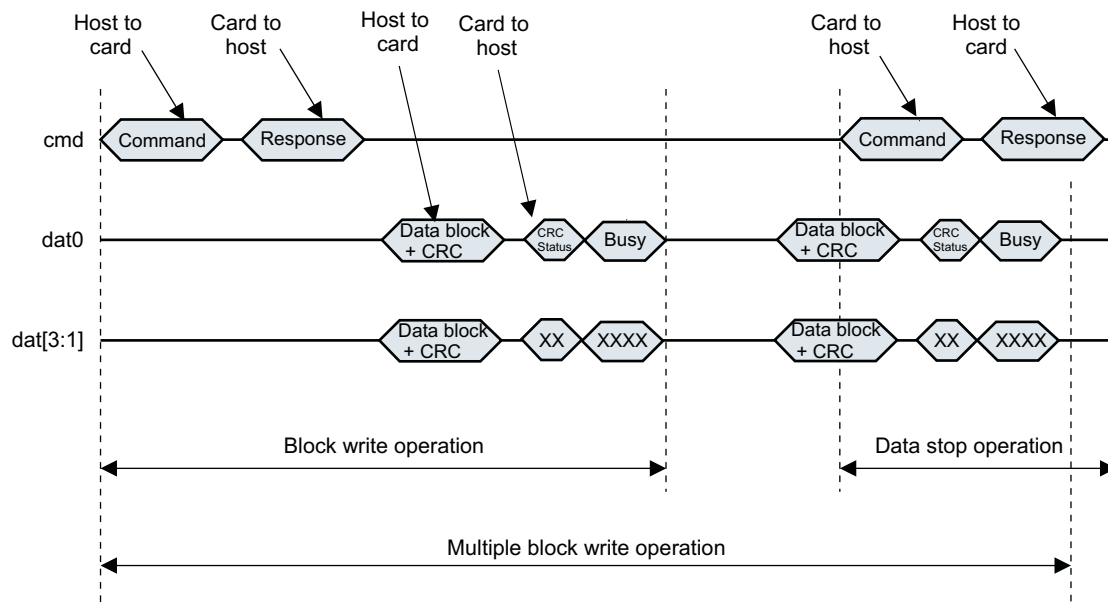


Figure 18-6. Multiple Block Write Operation (MMC Cards Only)



NOTE:

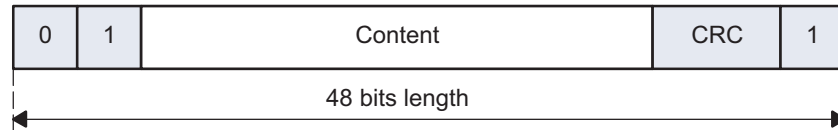
1. The card busy signal is not always generated by the card; the previous examples show a particular case.
2. It is the software's responsibility to do a software reset after a data timeout to ensure that mmc_clk is stopped. The software reset is done by setting bit 26 in the SD_SYSCTL register to 1.
3. For multiblock transfer, and especially for MMC cards, you can abort a transfer without using a stop command. Use a CMD23 before a data transfer to define the number of blocks that will be transferred, then the transfer stops automatically after the last block (provided the MMC card supports this feature).

18.2.1.2.2 Data Format

Coding Scheme for Command Token

Command packets always start with 0 and end with 1. The second bit is a transmitter bit1 for a host command. The content is the command index (coded by 6 bits) and an argument (for example, an address), coded by 32 bits. The content is protected by 7-bit CRC checksum (see [Figure 18-7](#)).

Figure 18-7. Command Token Format



Coding Scheme for Response Token

Response packets always start with 0 and end with a 1. The second bit is a transmitter bit0 for a card response. The content is different for each type of response (R1, R2, R3, R4, R5, and R6) and the content is protected by 7-bit CRC checksum. Depending on the type of commands sent to the card, the SD_CMD register must be configured differently to avoid false CRC or index errors to be flagged on command response (see [Table 18-3](#)). For more details about response types, see the *Multimedia Card System Specification*, the *SD Memory Card Specification*, or the *SDIO Card Specification*.

Table 18-3. Response Type Summary⁽¹⁾

Response Type SD_CMD[17:16] RSP_TYPE	Index Check Enable SD_CMD[20] CICE	CRC Check Enable SD_CMD[19] CCCE	Name of Response Type
00	0	0	No Response
01	0	1	R2
10	0	0	R3 (R4 for SD cards)
10	1	1	R1, R6, R5 (R7 for SD cards)
11	1	1	R1b, R5b

⁽¹⁾ The MMC/SD/SDIO host controller assumes that both clocks may be switched off, whatever the value set in the SD_SYSCONFIG[9:8] CLOCKACTIVITY bit.

[Figure 18-8](#) and [Figure 18-9](#) depict the 48-bit and 136-bit response packets.

Figure 18-8. 48-Bit Response Packet (R1, R3, R4, R5, R6)

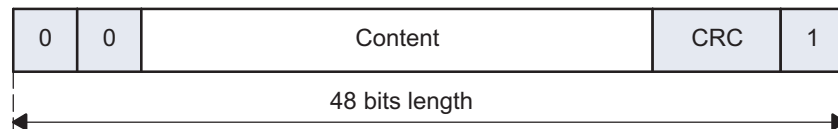
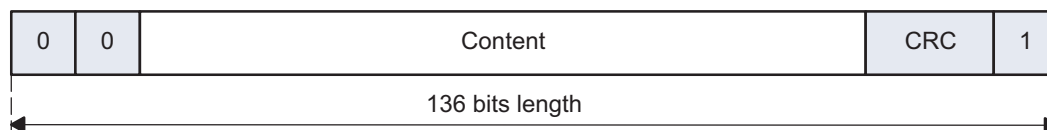


Figure 18-9. 136-Bit Response Packet (R2)



Coding Scheme for Data Token

Data tokens always start with 0 and end with 1 (see [Figure 18-10](#), [Figure 18-11](#), [Figure 18-12](#), and [Figure 18-13](#)).

Figure 18-10. Data Packet for Sequential Transfer (1-Bit)

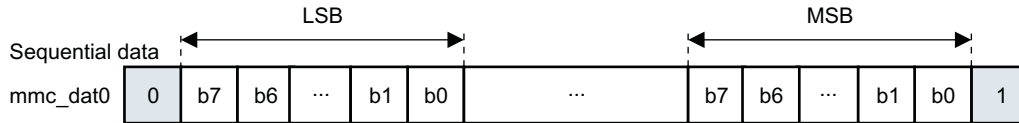


Figure 18-11. Data Packet for Block Transfer (1-Bit)

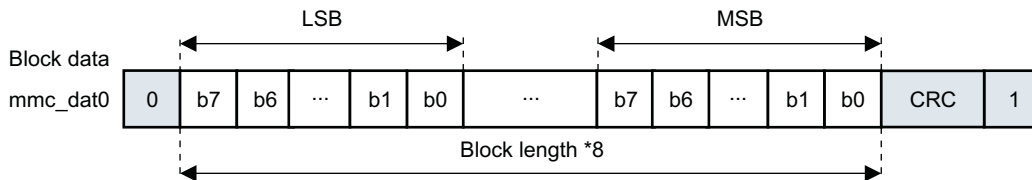


Figure 18-12. Data Packet for Block Transfer (4-Bit)

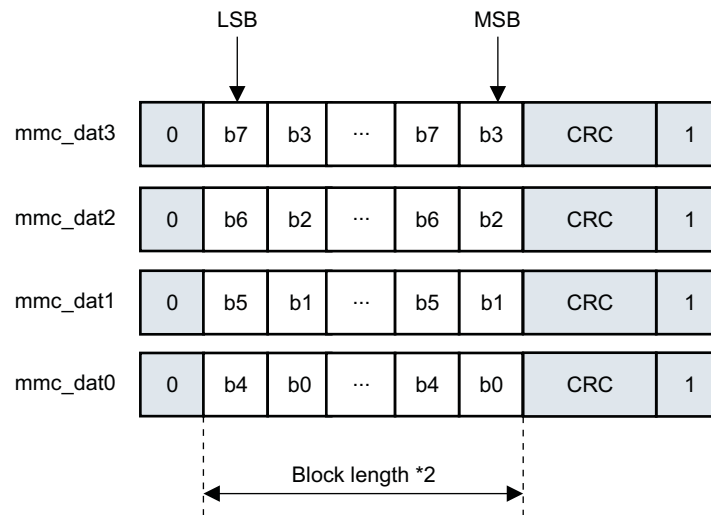
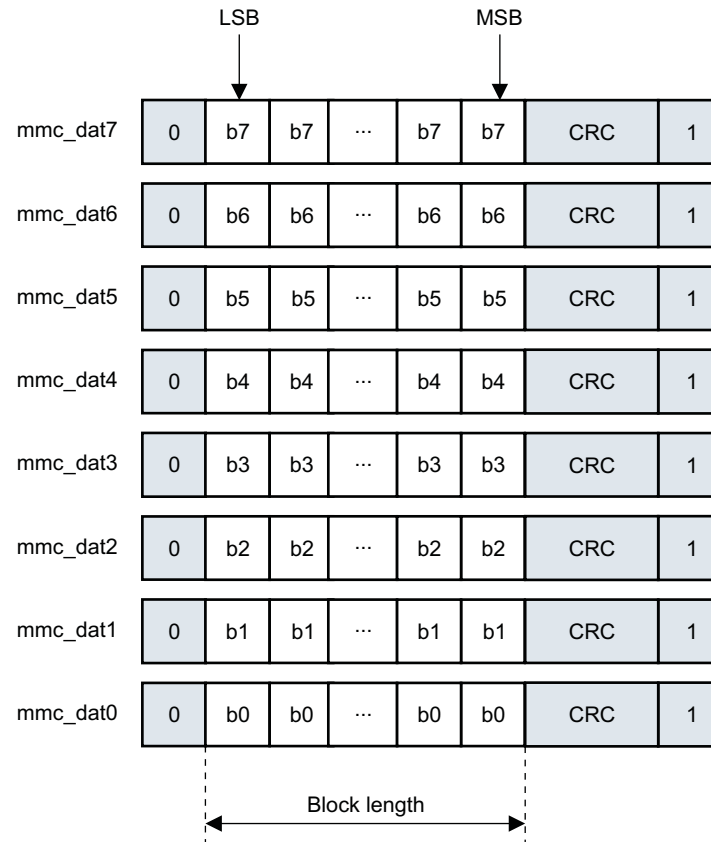


Figure 18-13. Data Packet for Block Transfer (8-Bit)


18.2.2 Resets

18.2.2.1 Hardware Reset

The module is reinitialized by the hardware.

The SD_SYSSTATUS[0] RESETDONE bit can be monitored by the software to check if the module is ready-to-use after a hardware reset.

This hardware reset signal has a global reset action on the module. All configuration registers and all state machines are reset in all clock domains.

18.2.2.2 Software Reset

The module is reinitialized by software through the SD_SYSCONFIG[1] SOFTRESET bit. This bit has the same action on the module logic as the hardware signal except for:

- Debounce logic
- SD_PSTATE, SD_CAPA, and SD_CUR_CAPA registers (see corresponding register descriptions)

The SOFTRESET bit is active high. The bit is automatically reinitialized to 0 by the hardware. The SD_SYSCTL[24] SRA bit has the same action as the SOFTRESET bit on the design.

The SD_SYSSTATUS[0] RESETDONE bit can be monitored by the software to check if the module is ready-to-use after a software reset.

Moreover, two partial software reset bits are provided:

- SD_SYSCTL[26] SRD bit

- SD_SYSCTL[25] SRC bit

These two reset bits are useful to reinitialize data or command processes respectively in case of line conflict. When set to 1, a reset process is automatically released when the reset completes:

- The SD_SYSCTL[26] SRD bit resets all finite state-machines and status management that handle data transfers on both the interface and functional side.
- The SD_SYSCTL[25] SRC bit resets all finite state-machines and status management that handle command transfers on both the interface and functional side.

NOTE: If **any** of the clock inputs are not present for the MMC/SD/SDIO peripheral, the software reset will not complete.

18.2.3 Power Management

The MMC/SD/SDIO host controller can enter into different modes and save power:

- Normal mode
- Idle mode

The two modes are mutually exclusive (the module can be in normal mode or in idle mode). The MMC/SD/SDIO host controller is compliant with the PRCM module handshake protocol. When the MMC/SD/SDIO power domain is off, the only way to wake up the power domain and different MMC/SD/SDIO clocks is to monitor the mmc_dat1 input pin state via a different GPIO line for each MMC/SD/SDIO interface.

18.2.3.1 Normal Mode

The autogating of interface and functional clocks occurs when the following conditions are met:

- The SD_SYSCONFIG[0] AUTOIDLE bit is set to 1.
- There is no transaction on the MMC interface.

The autogating of interface and functional clocks stops when the following conditions are met:

- A register access occurs through the L3 (or L4) interconnect.
- A wake-up event occurs (an interrupt from a SDIO card).
- A transaction on the MMC/SD/SDIO interface starts.

Then the MMC/SD/SDIO host controller enters in low-power state even if SD_SYSCONFIG[0] AUTOIDLE is cleared to 0. The functional clock is internally switched off and only interconnect read and write accesses are allowed.

18.2.3.2 Idle Mode

The clocks provided to MMC/SD/SDIO are switched off upon a PRCM module request. They are switched back upon module request. The MMC/SD/SDIO host controller complies with the PRCM module handshaking protocol:

- Idle request from the system power manager
- Idle acknowledgment from the MMC/SD/SDIO host controller

The idle acknowledgment varies according to the SD_SYSCONFIG[4:3] SIDLEMODE bit field:

- 0: Force-idle mode. The MMC/SD/SDIO host controller acknowledges the system power manager request unconditionally.
- 1h: No-idle mode. The MMC/SD/SDIO host controller ignores the system power manager request and behaves normally as if the request was not asserted.
- 2h: Smart-idle mode. The MMC/SD/SDIO host controller acknowledges the system power manager request according to its internal state.
- 3h: Reserved.

During the smart-idle mode period, the MMC/SD/SDIO host controller acknowledges that the OCP and Functional clocks may be switched off whatever the value set in the SD_SYSCONFIG[9:8] CLOCKACTIVITY field.

18.2.3.3 Transition from Normal Mode to Smart-Idle Mode

Smart-idle mode is enabled when the SD_SYSCONFIG[4:3] SIDLEMODE bit field is set to 2h or 3h. The MMC/SD/SDIO host controller goes into idle mode when the PRCM issues an idle request, according to its internal activity. The MMC/SD/SDIO host controller acknowledges the idle request from the PRCM after ensuring the following:

- The current multi/single-block transfer is completed.
- Any interrupt or DMA request is asserted.
- There is no card interrupt on the SD_dat1 signal.

As long as the MMC/SD/SDIO controller does not acknowledge the idle request, if an event occurs, the MMC/SD/SDIO host controller can still generate an interrupt or a DMA request. In this case, the module ignores the idle request from the PRCM.

As soon as the MMC/SD/SDIO controller acknowledges the idle request from the PRCM:

- If Smart-Idle mode the module does not assert any new interrupt or DMA request

18.2.3.4 Transition from Smart-Idle Mode to Normal Mode

The MMC/SD/SDIO host controller detects the end of the idle period when the PRCM deasserts the idle request. For the wake-up event, there is a corresponding interrupt status in the SD_STAT register. The MMC/SD/SDIO host controller operates the conversion between wake-up and interrupt (or DMA request) upon exit from smart-idle mode if the associated enable bit is set in the SD_ISE register.

Interrupts and wake-up events have independent enable/disable controls, accessible through the SD_HCTL and SD_ISE registers. The overall consistency must be ensured by software.

The interrupt status register SD_STAT is updated with the event that caused the wake-up in the CIRQ bit when the SD_IE[8] CIRQ_ENABLE associated bit is enabled. Then, the wake-up event at the origin of the transition from smart-idle mode to normal mode is converted into its corresponding interrupt or DMA request. (The SD_STAT register is updated and the status of the interrupt signal changes.)

When the idle request from the PRCM is deasserted, the module switches back to normal mode. The module is fully operational.

18.2.3.5 Force-Idle Mode

Force-idle mode is enabled when the SD_SYSCONFIG[4:3] SIDLEMODE bit field is cleared to 0. Force-idle mode is an idle mode where the MMC/SD/SDIO host controller responds unconditionally to the idle request from the PRCM. Moreover, in this mode, the MMC/SD/SDIO host controller unconditionally deasserts interrupts and DMA request lines are asserted.

The transition from normal mode to force-idle mode does not affect the bits of the SD_STAT register. In force-idle mode, the interrupt and DMA request lines are deasserted. Interface Clock (OCP) and functional clock (CLKADPI) can be switched off.

CAUTION

In Force-idle mode, an idle request from the PRCM during a command or a data transfer can lead to an unexpected and unpredictable result. When the module is idle, any access to the module generates an error as long as the OCP clock is alive.

The module exits the force-idle mode when the PRCM deasserts the idle request. Then the module switches back to normal mode. The module is fully operational. Interrupt and DMA request lines are optionally asserted one clock cycle later.

18.2.3.6 Local Power Management

Table 18-4 describes power-management features available for the MMC/SD/SDIO modules.

Table 18-4. Local Power Management Features

Feature	Registers	Description
Clock Auto Gating	SD_SYSCONFIG AUTOIDLE bit	This bit allows a local power optimization inside module, by gating the OCP clock upon the interface activity or gating the CLKADPI clock upon the internal activity.
Slave Idle Modes	SD_SYSCONFIG SIDLEMODE bit	Force-idle, No-idle, and Smart-idle modes
Clock Activity	SD_SYSCONFIG CLOCKACTIVITY bit	Please see Table 18-5 for configuration details.
Global Wake-Up Enable	SD_SYSCONFIG ENAWAKEUP bit	This bit enables the wake-up feature at module level.
Wake-Up Sources Enable	SD_HCTL register	This register holds one active high enable bit per event source able to generate wake-up signal.

Table 18-5. Clock Activity Settings

CLOCKACTIVITY Values	Clock State When Module is in IDLE State		Features Available when Module is in IDLE State	Wake-Up Events
	OCP Clock	CLKADPI		
00	OFF	OFF	None	Card Interrupt
10	OFF	ON	None	
01	ON	OFF	None	
11	ON	ON	All	

CAUTION

The PRCM module has no hardware means of reading CLOCKACTIVITY settings. Thus, software must ensure consistent programming between the CLOCKACTIVITY and MMC clock PRCM control bits.

18.2.4 Interrupt Requests

Several internal module events can generate an interrupt. Each interrupt has a status bit, an interrupt enable bit, and a signal status enable:

- The status of each type of interrupt is automatically updated in the SD_STAT register; it indicates which service is required.
- The interrupt status enable bits of the SD_IE register enable/disable the automatic update of the SD_STAT register on an event-by-event basis.
- The interrupt signal enable bits of the SD_ISE register enable/disable the transmission of an interrupt request on the interrupt line MMC_IRQ (from the MMC/SD/SDIO host controller to the MPU subsystem interrupt controller) on an event-by-event basis.

If an interrupt status is disabled in the SD_IE register, then the corresponding interrupt request is not transmitted, and the value of the corresponding interrupt signal enable in the SD_ISE register is ignored.

When an interrupt event occurs, the corresponding status bit is automatically set to 1 (the MMC/SD/SDIO host controller updates the status bit) in the SD_STAT register. If later a mask is applied on the interrupt in the SD_ISE register, the interrupt request is deactivated.

When the interrupt source has not been serviced, if the interrupt status is cleared in the SD_STAT register and the corresponding mask is removed from the SD_ISE register, the interrupt status is not asserted again in the SD_STAT register and the MMC/SD/SDIO host controller does not transmit an interrupt request.

CAUTION

If the buffer write ready interrupt (BWR) or the buffer read ready only interrupt (BRR) are not serviced and are cleared in the SD_STAT register, and the corresponding mask is removed, then the MMC/SD/SDIO host controller will wait for the service of the interrupt without updating the status SD_STAT or transmitting an interrupt request.

Table 18-6 lists the event flags, and their mask, that can cause module interrupts.

Table 18-6. Events

Event Flag	Event Mask	Map To	Description
SD_STAT[29] BADA	SD_IE[29] BADA_ENABLE	MMC_IRQ	Bad Access to Data space. This bit is set automatically to indicate a bad access to buffer when not allowed. This bit is set during a read access to the data register (SD_DATA) while buffer reads are not allowed (SD_PSTATE[11] BRE=0). This bit is set during a write access to the data register (SD_DATA) while buffer writes are not allowed (SD_STATE[10] BWE=0)
SD_STAT[28] CERR	SD_IE[28] CERR_ENABLE	MMC_IRQ	Card Error. This bit is set automatically when there is at least one error in a response of type R1, R1b, R6, R5 or R5b. Only bits referenced as type E(error) in status field in the response can set a card status error. An error bit in the response is flagged only if corresponding bit in card status response errors SD_CSRE is set. There is not card detection for auto CMD12 command.
SD_STAT[25] ADMAE	SD_IE[25] ADMAE_ENABLE	MMC_IRQ	ADMA error. This bit is set when the host controller detects errors during ADMA based data transfer. The stat of the ADMA at an error occurrence is saved in the ADMA Error Status Register. In addition, the host controller generates this interrupt when it detects invalid descriptor data (Valid=0) at the ST_FDS state.
SD_STAT[24] ACE	SD_IE[24] ACE_ENABLE	MMC_IRQ	Auto CMD12 error. This bit is set automatically when one of the bits in Auto CMD12 Error status register has changed from 0 to 1
SD_STAT[22] DEB	SD_IE[22] DEB_ENABLE	MMC_IRQ	Data End Bit error. This bit is set automatically when detecting a 0 at the end bit position of read data on DAT line or at the end position of the CRC status in write mode.

Table 18-6. Events (continued)

Event Flag	Event Mask	Map To	Description
SD_STAT[21] DCRC	SD_IE[21] DCRC_ENABLE	MMC_IRQ	Data CRC error. This bit is set automatically when there is a CRC16 error in the data phase response following a block read command or if there is a 3-bit CRC status different of a position "010" token during a block write command.
SD_STAT[20] DTO	SD_IE[20] DTO_ENABLE	MMC_IRQ	Data Timeout error. This bit is set automatically according to the following conditions: A) busy timeout for R1b, R5b response. B) busy timeout after write CRC status. C) write CRC status timeout, or D) read data timeout.
SD_STAT[19] CIE	SD_IE[19] CIE_ENABLE	MMC_IRQ	Command Index Error. This bit is set automatically when response index differs from corresponding command index previously emitted. The check is enabled through SD_CMD[20] CICE bit.
SD_STAT[18] CEB	SD_IE[18] CEB_ENABLE	MMC_IRQ	Command End Bit error. This bit is set automatically when detecting a 0 at the end bit position of a command response.
SD_STAT[17] CCRC	SD_IE[17] CCRC_ENABLE	MMC_IRQ	Command CRC error. This bit is set automatically when there is a CRC7 error in the command response. CRC check is enabled through the SD_CMD[19] CCCE bit.
SD_STAT[16] CTO	SD_IE[16] CTO_ENABLE	MMC_IRQ	Command Timeout error. This bit is set automatically when no response is received within 64 clock cycles from the end bit of the command. For commands the reply within 5 clock cycles, the timeout is still detected at 64 clock cycles.
SD_STAT[15] ERRI	SD_IE[15] ERRI_ENABLE	MMC_IRQ	Error Interrupt. If any of the bits in the Error Interrupt Status register (SD_STAT[24:15]) are set, the this bit is set to 1.
SD_STAT[10] BSR	SD_IE[10] BSR_ENABLE	MMC_IRQ	Boot Status Received interrupt. This bit is set automatically when SD_CON[18] BOOT_CF0 is set to 1 or 2h and boot status is received on the dat0 line. This interrupt is only used for MMC cards.
SD_STAT[8] CIRQ	SD_IE[8] CIRQ_ENABLE	MMC_IRQ	Card Interrupt. This bit is only used for SD, SDIO, and CE-ATA cards. In 1-bit mode, interrupt source is asynchronous (can be a source of asynchronous wake-up). In 4-bit mode, interrupt source is sampled during the interrupt cycle. In CE-ATA mode, interrupt source is detected when the card drive CMD line to zero during one cycle after data transmission end.
SD_STAT[5] BRR	SD_IE[5] BRR_ENABLE	MMC_IRQ	Buffer Read ready. This bit is set automatically during a read operation to the card when one block specified by SD_BLK[10:0] BLEN is completely written in the buffer. It indicates that the memory card has filled out the buffer and the local host needs to empty the buffer by reading it.
SD_STAT[4] BWR	SD_IE[4] BWR_ENABLE	MMC_IRQ	Buffer Write ready. This bit is automatically set during a write operation to the card when the host can write a complete block as specified by SD_BLK[10:0] BLEN. It indicates that the memory card has emptied one block from the buffer and the local host is able to write one block of data into the buffer.
SD_STAT[3] DMA	SD_IE[3] DMA_ENABLE	MMC_IRQ	DMA interrupt. This status is set when an interrupt is required in the ADMA instruction and after the data transfer is complete.
SD_STAT[2] BGE	SD_IE[2] BGE_ENABLE	MMC_IRQ	Block Gap event. When a stop at block gap is requested (SD_HCTL[16] SBGR), this bit is automatically set when transaction is stopped at the block gap during a read or write operation.
SD_STAT[1] TC	SD_IE[1] TC_ENABLE	MMC_IRQ	Transfer completed. This bit is always set when a read/write transfer is completed or between two blocks when the transfer is stopped due to a stop at block gap requested (SD_HCTL[16] SBGR). In read mode this bit is automatically set on completion of a read transfer (SD_PSTATE[9] RTA). In write mode, this bit is automatically set on completion of the DAT line use (SD_PSTATE[2] DLA).
SD_STAT[0] CC	SD_IE[0] CC_ENABLE	MMC_IRQ	Command complete. This bit is set when a 1-to-0 transition occurs in the register command inhibit (SD_PSTATE[0] CMDI). If the command is a type for which no response is expected, then the command complete interrupt is generated at the end of the command. A command timeout error (SD_STAT[16] CTO) has higher priority than command complete (SD_STAT[0] CC). If a response is expected but none is received, the a Command Timeout error is detected and signaled instead of the Command Complete interrupt.

18.2.4.1 Interrupt-Driven Operation

An interrupt enable bit must be set in the SD_IE register to enable the module internal source of interrupt.

When an interrupt event occurs, the single interrupt line is asserted and the LH must:

- Read the SD_STAT register to identify which event occurred.
- Write 1 into the corresponding bit of the SD_STAT register to clear the interrupt status and release the interrupt line (if a read is done after this write, this would return 0).

NOTE: In the SD_STAT register, Card Interrupt (CIRQ) and Error Interrupt (ERRI) bits cannot be cleared.

The SD_STAT[8] CIRQ status bit must be masked by disabling the SD_IE[8] CIRQ_ENABLE bit (cleared to 0), then the interrupt routine must clear SDIO interrupt source in SDIO card common control register (CCCR).

The SD_STAT[15] ERRI bit is automatically cleared when all status bits in SD_STAT[31:16] are cleared.

18.2.4.2 Polling

When the interrupt capability of an event is disabled in the SD_ISE register, the interrupt line is not asserted:

- Software can poll the status bit in the SD_STAT register to detect when the corresponding event occurs.
- Writing 1 into the corresponding bit of the SD_STAT register clears the interrupt status and does not affect the interrupt line state.

NOTE: Please see the note in [Section 18.2.4.1](#) concerning CIRQ and ERRI bits clearing.

18.2.5 DMA Modes

The device supports DMA slave mode only. In this case, the controller is slave on DMA transaction managed by two separated requests (SDMAWREQN and SDMARREQN)

18.2.5.1 DMA Slave Mode Operations

The MMC/SD/SDIO controller can be interfaced with a DMA controller. At system level, the advantage is to discharge the local host (LH) of the data transfers. The module does not support wide DMA access (above 1024 bytes) for SD cards as specified in the *SD Card Specification* and *SD Host Controller Standard Specification*.

The DMA request is issued if the following conditions are met:

- The SD_CMD[0] DE bit is set to 1 to trigger the initial DMA request (the write must be done when running the data transfer command).
- A command was emitted on the SD_cmd line.
- There is enough space in the buffer of the MMC/SD/SDIO controller to write an entire block (BLEN writes).

18.2.5.1.1 DMA Receive Mode

In a DMA block read operation (single or multiple), the request signal SDMARREQN is asserted to its active level when a complete block is written in the buffer. The block size transfer is specified in the SD_BLK[10:0] BLEN field.

The SDMARREQN signal is deasserted to its inactive level when the sDMA has read one single word from the buffer. Only one request is sent per block; the DMA controller can make a 1-shot read access or several DMA bursts, in which case the DMA controller must manage the number of burst accesses, according to block size BLEN field.

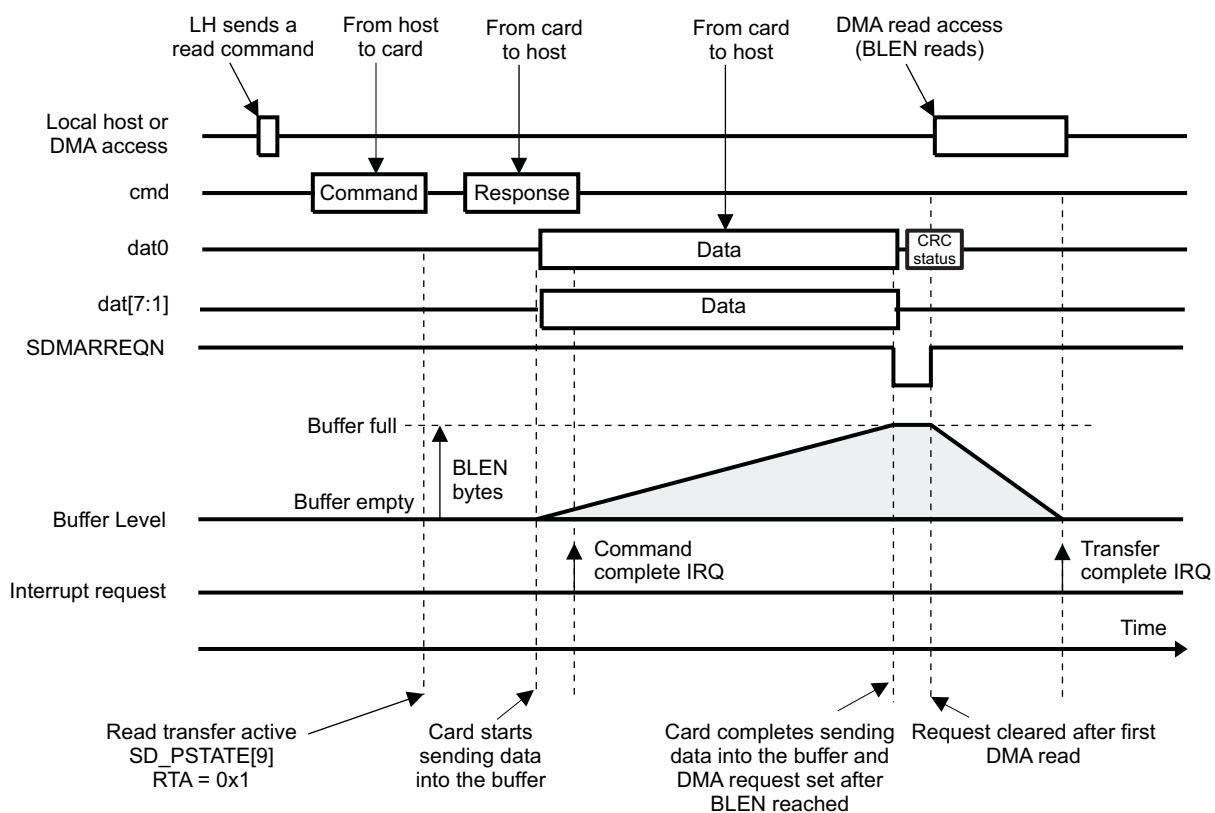
New DMA requests are internally masked if the sDMA has not read exactly BLEN bytes and a new complete block is not ready. As DMA accesses are in 32-bit, then the number of sDMA read is $\text{Integer}(\text{BLEN}/4)+1$.

The receive buffer never overflows. In multiple block transfers for block size above 512 bytes, when the buffer gets full, the MMC_CLK clock signal (provided to the card) is momentarily stopped until the sDMA or the MPU performs a read access, which reads a complete block in the buffer.

Figure 18-14 provides a summary:

- DMA transfer size = BLEN buffer size in one shot or by burst
- One DMA request per block

Figure 18-14. DMA Receive Mode



18.2.5.1.2 DMA Transmit Mode

In a DMA block write operation (single or multiple), the request signal SDMAWREQN is asserted to its active level when a complete block is to be written to the buffer. The block size transfer is specified in the SD_BLK[10:0] BLEN field.

The SDMAWREQN signal is deasserted to its inactive level when the sDMA has written one single word to the buffer.

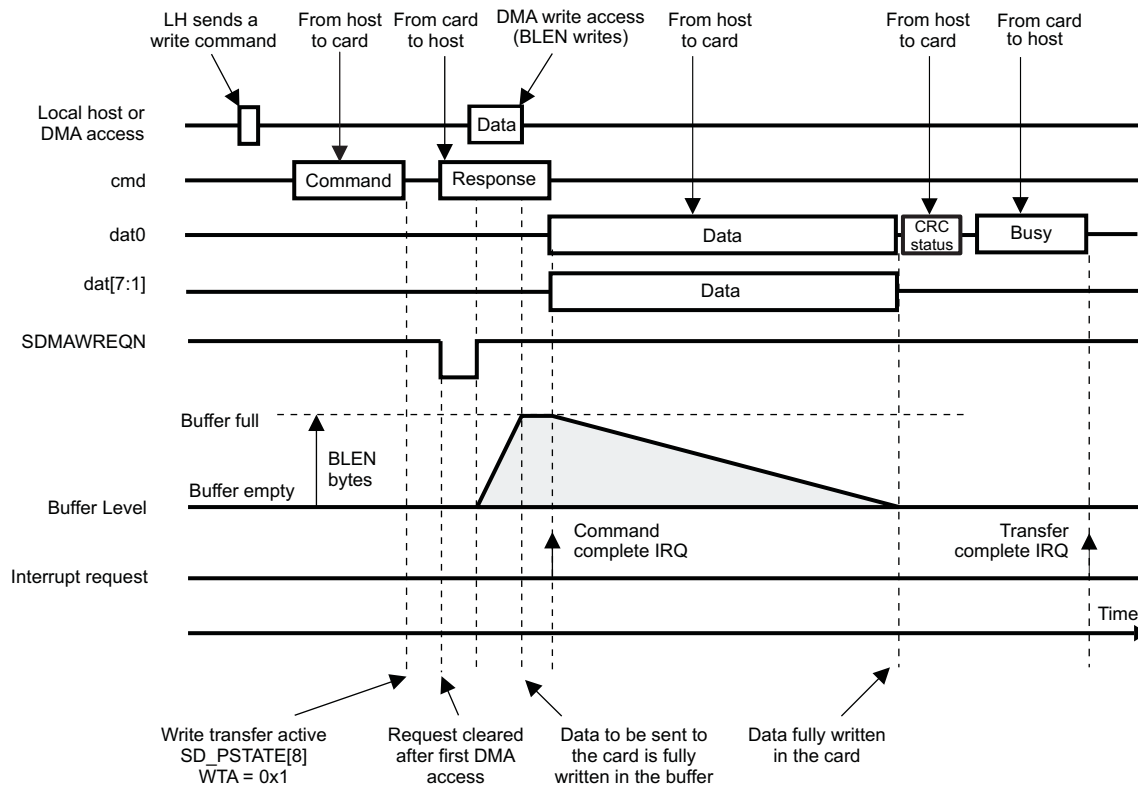
Only one request is sent per block; the DMA controller can make a 1-shot write access or multiple write DMA bursts, in which case the DMA controller must manage the number of burst accesses, according to block size BLEN field.

New DMA requests are internally masked if the sDMA has not written exactly BLEN bytes (as DMA accesses are in 32-bit, then the number of sDMA read is $\text{Integer}(\text{BLEN}/4)+1$) and if there is not enough memory space to write a complete block in the buffer.

Figure 18-15 provides a summary:

- DMA transfer size = BLEN buffer size in one shot or by burst
- One DMA request per block

Figure 18-15. DMA Transmit Mode



18.2.6 Mode Selection

The MMC/SD/SDIO host controller can be used in two modes, MMC and SD/SDIO modes. It has been designed to be the most transparent with the type of card. The type of the card connected is differentiated by the software initialization procedure.

Software identifies the type of card connected during software initialization. For each given card type, there are corresponding commands. Some commands are not supported by all cards. See the *Multimedia Card System Specification*, the *SD Memory Card Specifications*, and the *SDIO Card Specification, Part E1* for more details.

The purpose of the module is to transfer commands and data, to whatever card is connected, respecting the protocol of the connected card. Writes and reads to the card must respect the appropriate protocol of that card.

18.2.7 Buffer Management

18.2.7.1 Data Buffer

The MMC/SD/SDIO host controller uses a data buffer. This buffer transfers data from one data bus (Interconnect) to another data bus (SD, SDIO, or MMC card bus) and vice versa.

The buffer is the heart of the interface and ensures the transfer between the two interfaces (L4 and the card). To enhance performance, the data buffer is completed by a prefetch register and a post-write buffer that are not accessible by the host controller.

The read access time of the prefetch register is faster than the one of the data buffer. The prefetch register allows data to be read from the data buffer at an increased speed by preloading data into the prefetch register.

The entry point of the data buffer, the prefetch buffer, and the post-write buffer is the 32-bit register SD_DATA. A write access to the SD_DATA register followed by a read access from the SD_DATA register corresponds to a write access to the post-write buffer followed by a read access to the prefetch buffer. As a consequence, it is normal that the data of the write access to the SD_DATA register and the data of the read access to the SD_DATA register are different.

The number of 32-bit accesses to the SD_DATA register that are needed to read (or write) a data block with a size of SD_BLK[10:0] BLEN, and equals the rounded up result of BLEN divided by 4. The maximum block size supported by the host controller is hard-coded in the register SD_CAPA[17:16] MBL field and cannot be changed.

A read access to the SD_DATA register is allowed only when the buffer read enable status is set to 1 (SD_PSTATE[11] BRE); otherwise, a bad access (SD_STAT[29] BADA) is signaled.

A write access to the SD_DATA register is allowed only when the buffer write enable status is set to 1 (SD_PSTATE[10] BWE); otherwise, a bad access (SD_STAT[29] BADA) is signaled and the data is not written.

The data buffer has two modes of operation to store and read of the first and second portions of the data buffer:

- When the size of the data block to transfer is less than or equal to MEM_SIZE/2 (in double buffering), two data transfers can occur from one data bus to the other data bus and vice versa at the same time. The MMC/SD/SDIO controller uses the two portions of the data buffer in a ping-pong manner so that storing and reading of the first and second portions of the data buffer are automatically interchanged from time to time so that data may be read from one portion (for instance, through a DMA read access on the interconnect bus) while data (for instance, from the card) is being stored into the other portion and vice versa. When BLEN is less than or equal to 200h (that is, less or equal to 512Bytes), each of the two portions of the buffer that can be used have a size of BLEN (that is, 32-bits x BLEN div by 4). Not more than this total size of 2 times 32-bits x BLEN div by 4 can be used.
- When the size of the data block to transfer is larger than MEM_SIZE/2, only one data transfer can occur from one data bus to the other data bus at a time. The MMC/SD/SDIO host controller uses the entire data buffer as a single portion. In this mode, a bad access (SD_STAT[29] BADA) is signaled when two data transfers occur from one data bus to the other data bus and vice versa at the same time.

CAUTION

The SD_CMD[4] DDIR bit must be configured before a transfer to indicate the direction of the transfer.

Figure 18-16 shows the buffer management for writing and Figure 18-17 shows the buffer management for reading.

Figure 18-16. Buffer Management for a Write

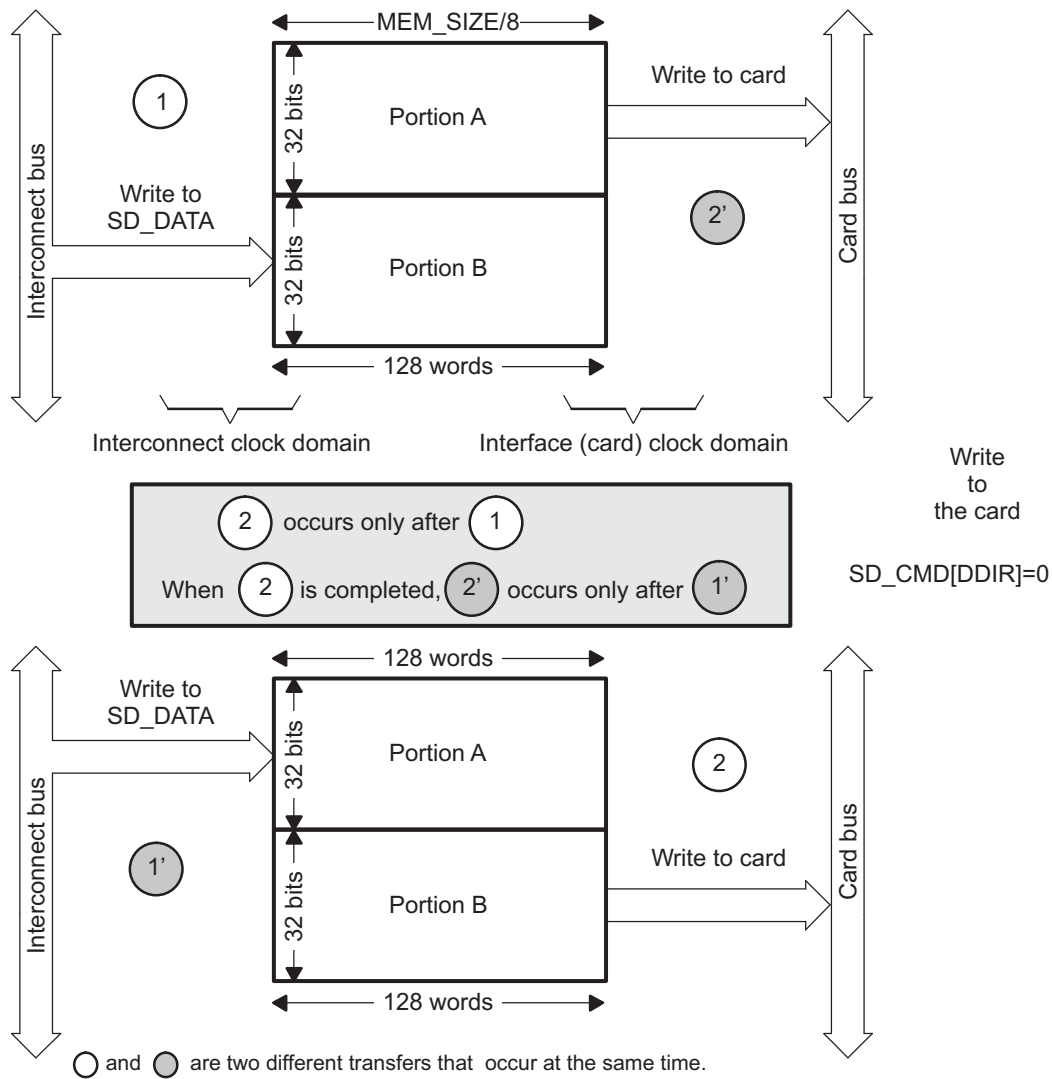
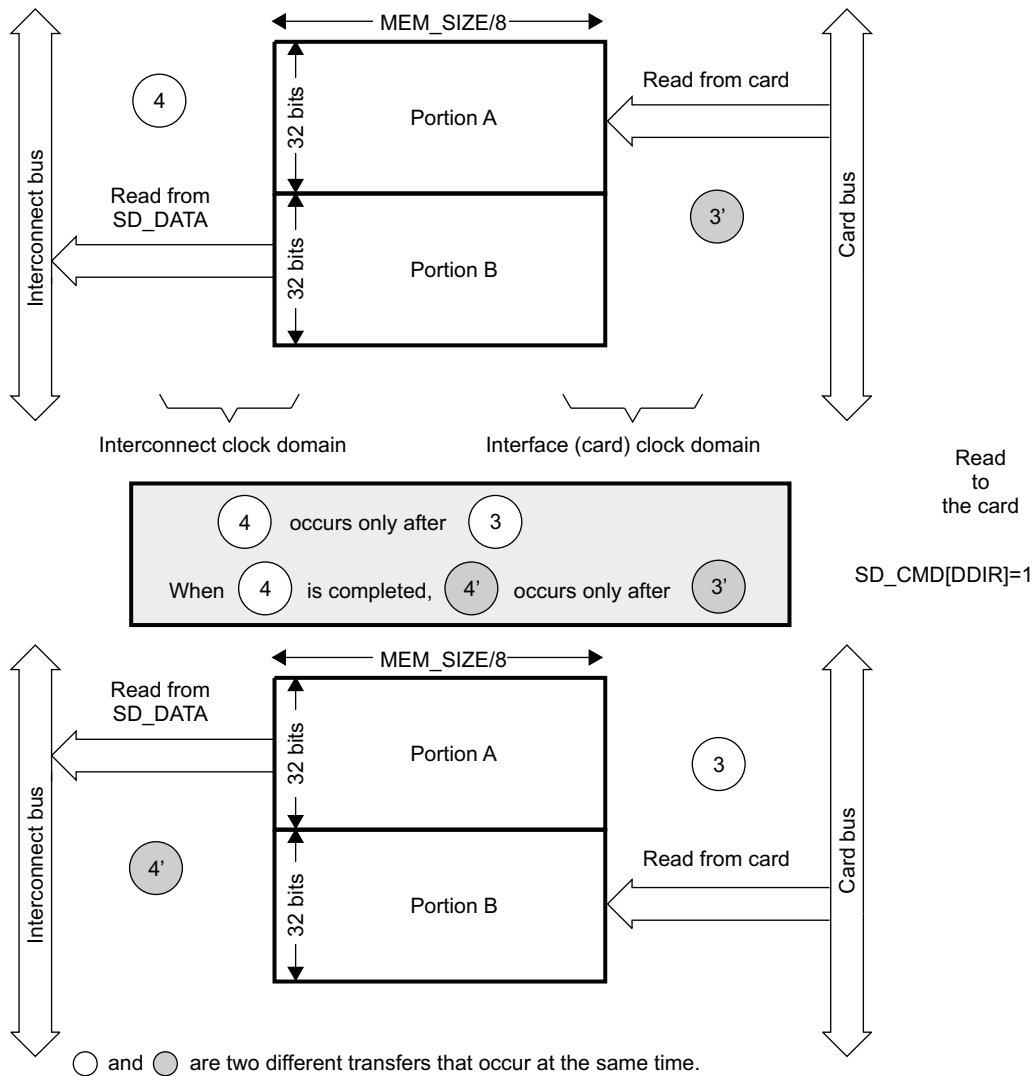


Figure 18-17. Buffer Management for a Read



18.2.7.1.1 Memory Size, Block Length, and Buffer Management Relationship

The maximum block length and buffer management that can be targeted by system depend on memory depth setting.

Table 18-7. Memory Size, BLEN, and Buffer Relationship

Memory Size([5:2] MEMSIZE in bytes)	512	1024	2048	4096
Maximum block length supported	512	1024	2048	2048
Double-buffering for maximum block length	N/A	BLEN <= 512	BLEN <= 1024	BLEN <= 2048
Single-buffering for block length	BLEN<=512	512 < BLEN <= 1024	1024 < BLEN <= 2048	N/A

18.2.7.1.2 Data Buffer Status

The data buffer status is defined in the following interrupt status register and status register:

- Interrupt status registers (see):
 - SD_STAT[29] BADA Bad access to data space
 - SD_STAT[5] BRR Buffer read ready
 - SD_STAT[4] BWR Buffer write ready
- Status registers (see):
 - SD_PSTATE[11] BRE Buffer read enable
 - SD_PSTATE[10] BWE Buffer write enable

18.2.8 Transfer Process

The process of a transfer is dependent on the type of command. It can be with or without a response, with or without data.

18.2.8.1 Different Types of Commands

Different types of commands are specific to MMC, SD, or SDIO cards. See the *Multimedia Card System Specification*, the *SD Memory Card Specifications*, the *SDIO Card Specification, Part E1*, or the *SD Card Specification, Part A2, SD Host Controller Standard Specification* for more details.

18.2.8.2 Different Types of Responses

Different types of responses are specific to MMC, SD, or SDIO cards. See the *Multimedia Card System Specification*, the *SD Memory Card Specifications*, the *SDIO Card Specification, Part E1*, or the *SD Card Specification, Part A2, SD Host Controller Standard Specification* for more details.

Table 18-8 shows how the MMC, SD, and SDIO responses are stored in the SD_RSPxx registers.

Table 18-8. MMC, SD, SDIO Responses in the SD_RSPxx Registers

Kind of Response	Response Field	Response Register
R1, R1b (normal response), R3, R4, R5, R5b, R6, R7	RESP[39:8] ⁽¹⁾	SD_RSP10[31:0]
R1b (Auto CMD12 response)	RESP[39:8] ⁽¹⁾	SD_RSP76[31:0]
R2	RESP[127:0] ⁽¹⁾	SD_RSP76[31:0] SD_RSP54[31:0] SD_RSP32[31:0] SD_RSP10[31:0]

⁽¹⁾ RESP refers to the command response format described in the specifications mentioned above.

When the host controller modifies part of the SD_RSPxx registers, it preserves the unmodified bits.

The host controller stores the Auto CMD12 response in the SD_RSP76[31:0] register because the Host Controller may have a multiple block data DAT line transfer executing concurrently with a command. This allows the host controller to avoid overwriting the Auto CMD12 response with the command response stored in SD_RSP10 register and vice versa.

18.2.9 Transfer or Command Status and Error Reporting

Flags in the MMC/SD/SDIO host controller show status of communication with the card:

- A timeout (of a command, a data, or a response)
- A CRC

Error conditions generate interrupts. See [Table 18-9](#) and register description for more details.

Table 18-9. CC and TC Values Upon Error Detected

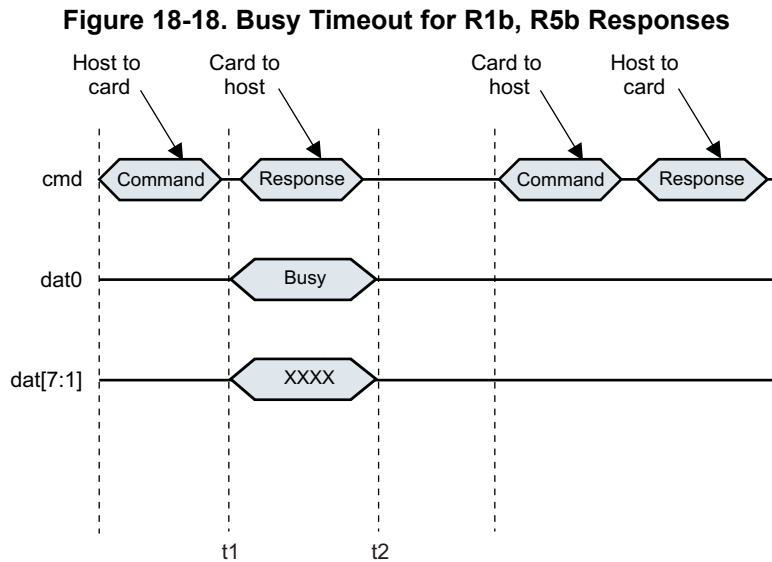
Error hold in the SD_STAT Register	CC	TC	Comments
29 BADA			No dependency with CC or TC. BADA is related to the register accesses. Its assertion is not dependent of the ongoing transfer.
28 CERR	1		CC is set upon CERR.
22 DEB		1	TC is set upon DEB.
21 DCRC		1	TC is set upon DCRC.
20 DTO			DTO and TC are mutually exclusive. DCRC and DEB cannot occur with DTO.
19 CIE	1		CC is set upon CIE.
18 CEB	1		CC is set upon CEB.
17 CCRC	1		CC can be set upon CCRC - See CTO comment
16 CTO			CTO and CC are mutually exclusive. CIE, CEB and CERR cannot occur with CTO. CTO can occur at the same time as CCRC it indicates a command abort due to a contention on CMD line. In this case no CC appears.

SD_STAT[21] DCRC event can be asserted in the following conditions:

- Busy timeout for R1b, R5b response type
- Busy timeout after write CRC status
- Write CRC status timeout
- Read data timeout
- Boot acknowledge timeout

18.2.9.1 Busy Timeout for R1b, R5b Response Type

Figure 18-18 shows DCRD event condition asserted when there is a busy timeout for R1b or R5b responses.

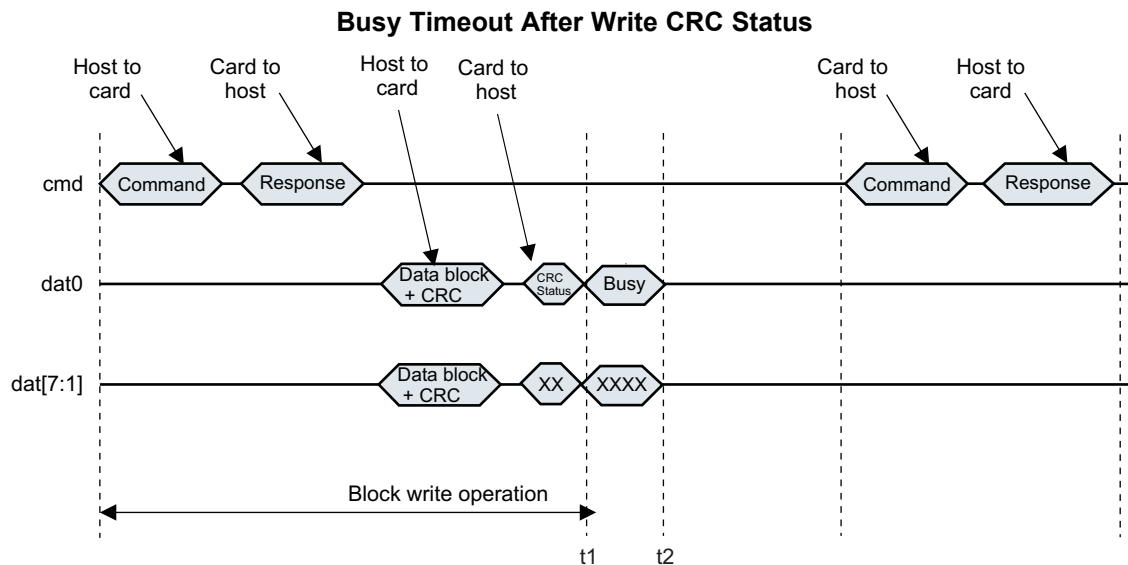


t1 - Data timeout counter is loaded and starts after R1b, R5b response type.

t2 - Data timeout counter stops and if it is 0, SD_STAT[21] DCRC is generated.

18.2.9.2 Busy Timeout After Write CRC Status

Busy Timeout After Write CRC Status shows DCRC event condition asserted when there is busy timeout after write CRC status.



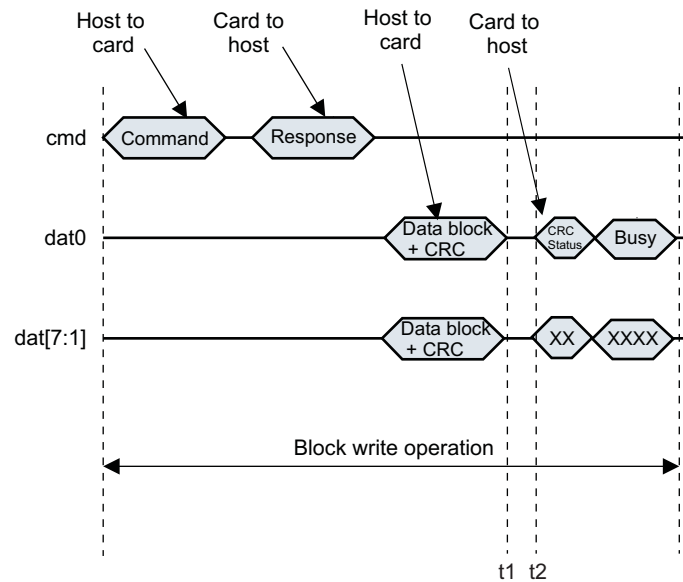
t1 - Data timeout counter is loaded and starts after CRC status.

t2 - Data timeout counter stops and if it is 0, SD_STAT[21] DCRC is generated.

18.2.9.3 Write CRC Status Timeout

Figure 18-19 shows DCRC event condition asserted when there is write CRC status timeout.

Figure 18-19. Write CRC Status Timeout



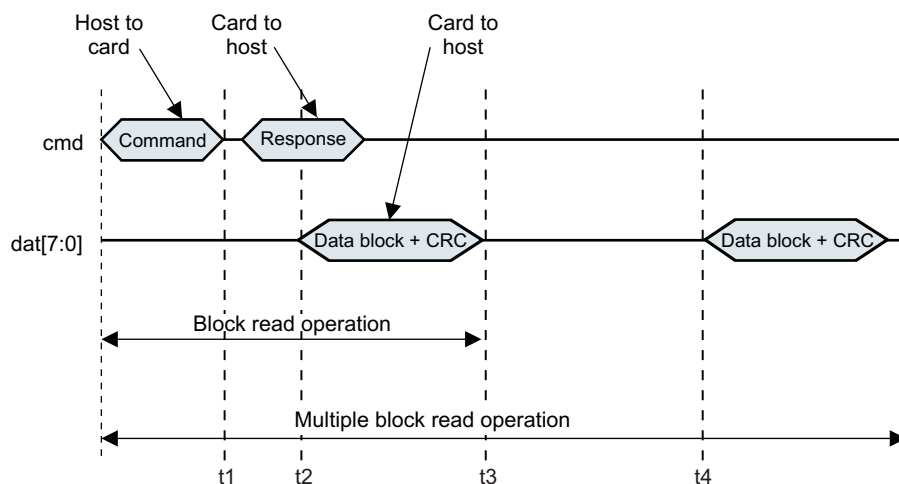
t1 - Data timeout counter is loaded and starts after Data block + CRC.

t2 - Data timeout counter stops and if it is 0, SD_STAT[21] DCRC is generated.

18.2.9.4 Read Data Timeout

Figure 18-20 shows DCRC event condition asserted when there is read data timeout.

Figure 18-20. Read Data Timeout



t1 - Data timeout counter is loaded and starts after Command transmission.

t2 - Data timeout counter stops and if it is 0, SD_STAT[21] DCRC is generated.

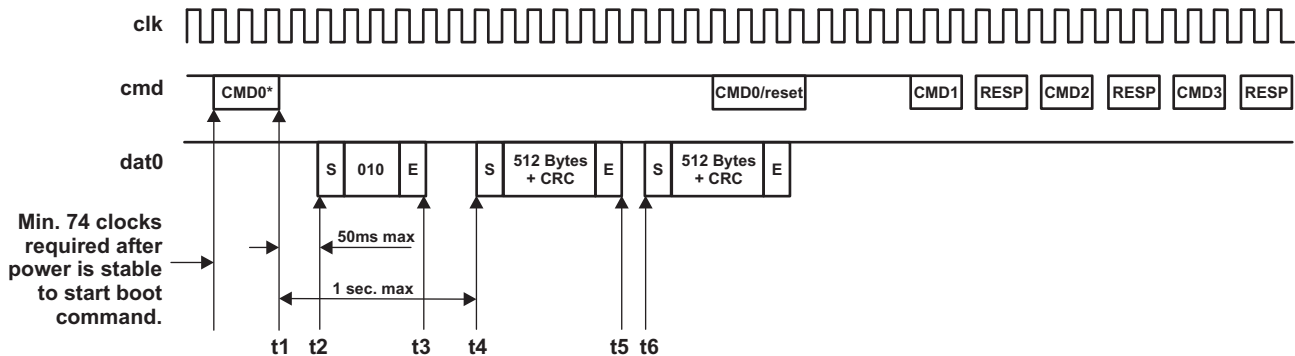
t3 - Data timeout counter is loaded and starts after Data block + CRC transmission.

t4 - Data timeout counter stops and if it is 0, SD_STAT[21] DCRC is generated.

18.2.9.5 Boot Acknowledge Timeout

Figure 18-21 shows DCRC event condition asserted when there is boot acknowledge timeout and CMD0 is used.

Figure 18-21. Boot Acknowledge Timeout When Using CMD0



* Refer to MMC Specification for correct argument.

t1 - Data timeout counter is loaded and starts after CMD0.

t2 - Data timeout counter stops and if it is 0, SD_STAT[21] DCRC is generated.

t3 - Data timeout counter is loaded and starts.

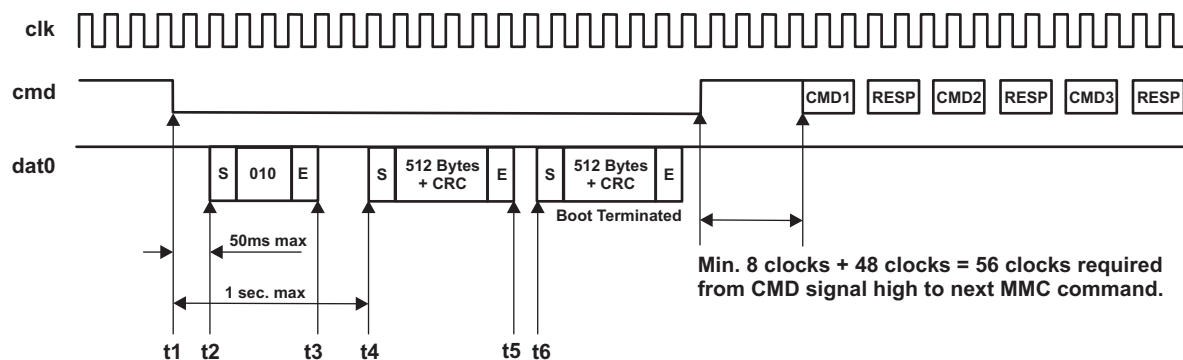
t4 - Data timeout counter stops and if it is 0, SD_STAT[21] DCRC is generated.

t5 - Data timeout counter is loaded and starts after Data + CRC transmission.

t6 - Data timeout counter stops and if it is 0, SD_STAT[21] DCRC is generated.

Figure 18-22 shows DCRC event condition asserted when there is boot acknowledge timeout and CMD line is held low.

Figure 18-22. Boot Acknowledge Timeout When CMD Held Low



t1 - Data timeout counter is loaded and starts after cmd line is tied to 0.

t2 - Data timeout counter stops and if it is 0, SD_STAT[21] DCRC is generated.

t3 - Data timeout counter is loaded and starts.

t4 - Data timeout counter stops and if it is 0, SD_STAT[21] DCRC is generated.

t5 - Data timeout counter is loaded and starts after Data + CRC transmission.

t6 - Data timeout counter stops and if it is 0, SD_STAT[21] DCRC is generated.

18.2.10 Auto Command 12 Timings

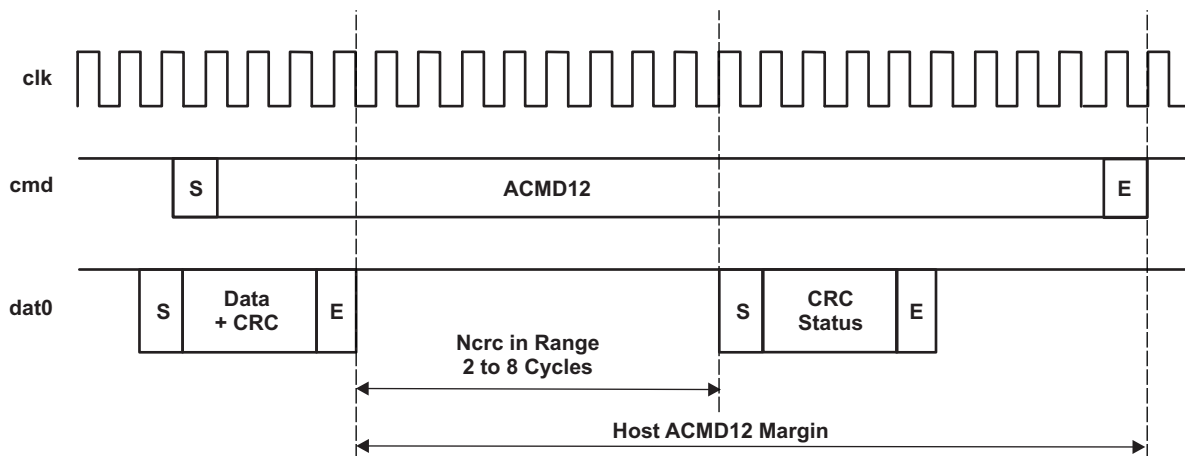
With the UHS definition of SD cards with higher frequency for MMC clocks up to 208, SD standard imposes a specific timing for Auto CMD12 "end bit" arrival.

18.2.10.1 Auto Command 12 Timings During Write Transfer

A margin named *N_{ncrc}* in range of 2 to 8 cycles has been defined for SDR50 and SDR104 card components for write data transfers, as auto command 12 'end bit' shall arrive after the CRC status "end bit".

Figure 18-23 shows auto CMD12 timings during write transfer.

Figure 18-23. Auto CMD12 Timing During Write Transfer



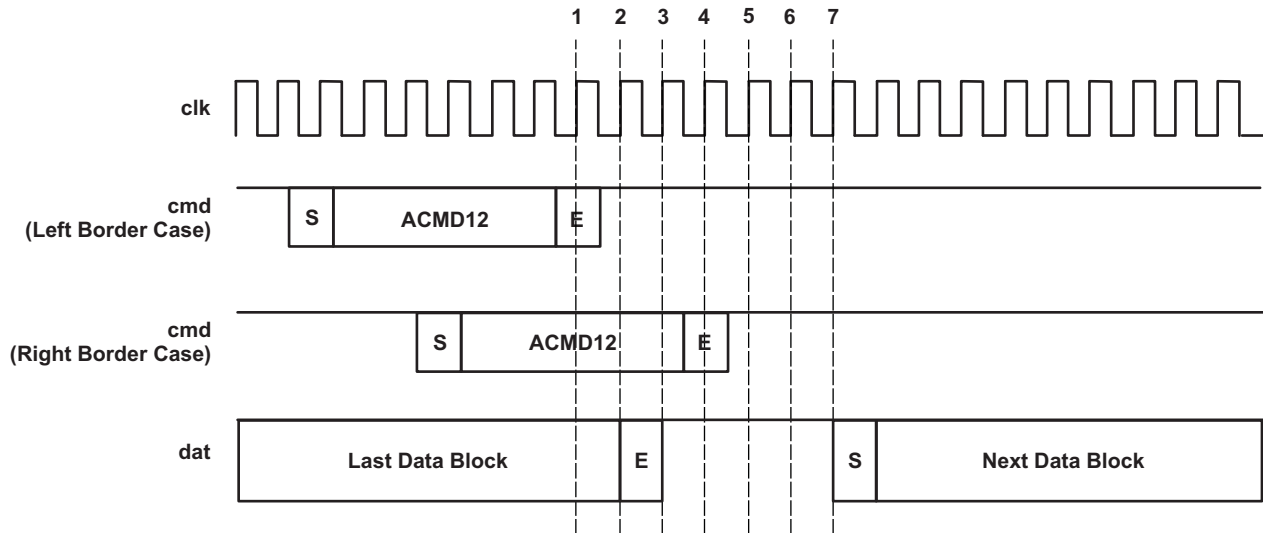
The Host controller has a margin of 18 clock cycles to make sure that auto CMD12 'end bit' arrives after the CRC status. This margin does not depend on MMC bus configuration, DDR or standard transfer, 1,4 or 8 bus width.

18.2.10.2 Auto Command 12 Timings During Read Transfer

With UHS very high speed cards gap timing between 2 successive cards has been extended to 4 cycles instead of 2. By the way it gives more flexibility for Host Auto CMD12 arrival in order to receive the last complete and reliable block. SD controller only follows the 'Left Border Case' defined by SD UHS specification.

Figure 18-24 shows ACMD12 timings during read transfer.

Figure 18-24. Auto Command 12 Timings During Read Transfer



The Auto CMD12 arrival sent by the Host controller is not sensitive to the MMC bus configuration whether it is DDR or standard transfer and whether it is a 1,4 or 8 bit bus width transfer.

18.2.11 Transfer Stop

Whenever a transfer is initiated, the transmission may be willed to stop whereas it is still not finished. Several cases can be faced depending on the transfer type:

- Multiple blocks oriented transfers (for which transfer length is known)
- Continuous stream transfers (which have an infinite length)

NOTE: Since the MMC/SD/SDIO controller manages transfers based on a block granularity, the buffer will accept a block only if there is enough space to completely store it. Consequently, if a block is pending in the buffer, no command will be sent to the card because the card clock will be shut off by the controller.

The MMC/SD/SDIO controller includes two features which make a transfer stop more convenient and easier to manage:

- Auto CMD12 (for MMC and SD only).

This feature is enabled by setting the SD_CMD[2] ACEN bit to 1 (this setting is relevant for a MMC/SD transfer with a known number of blocks to transfer). When the Auto CMD12 feature is enabled, the MMC/SD/SDIO controller will automatically issue a CMD12 command when the expected number of blocks has been exchanged.

- Stop at block gap

This feature is enabled by setting the SD_HCTL[16] SBGR bit to 1. When enabled, this capability holds the transfer on until the end of a block boundary. If a stop transmission is needed, software can use this pause to send a CMD12 to the card.

Table 18-10 shows the common ways to stop a transfer, indicating command to send and features to enable.

Table 18-10. MMC/SD/SDIO Controller Transfer Stop Command Summary

		WRITE Transfer		READ Transfer	
		MMC/SD	SDIO	MMC/SD	SDIO
Single block		Transfer ends automatically Wait TC	Transfer ends automatically Wait TC	Transfer ends automatically Wait TC	Transfer ends automatically Wait TC
Multi blocks (finite or infinite)	Before the programmed block boundary	Send CMD12 Wait TC	Send CMD52 Wait TC	Send CMD12 Wait TC	Send CMD52 Wait TC
	Stop at the end of the transfer (finite transfer only)	Auto CMD12 active Transfer ends automatically Wait TC	Set SD_HCTL[16] SBGR bit to 1. Send CMD52 Wait TC	Auto CMD12 active Transfer ends automatically Wait TC	If READ_WAIT supported Stop at block gap Wait TC If READ_WAIT not supported Send CMD52 Wait TC

NOTE: The MMC/SD/SDIO controller will send the stop command to the card on a block boundary, regardless the moment the command was written to the controller registers.

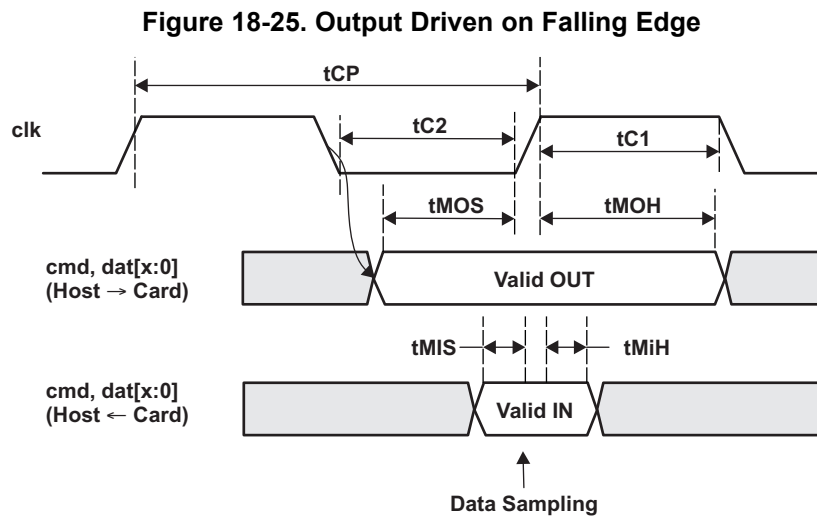
18.2.12 Output Signals Generation

The MMC/SD/SDIO output signals can be driven on either falling edge or rising edge depending on the SD_HCTL[2] HSPE bit. This feature allows to reach better timing performance, and thus to increase data transfer frequency.

18.2.12.1 Generation on Falling Edge of MMC Clock

The controller is by default in this mode to maximize hold timings. In this case, SD_HCTL[2] HSPE bit is cleared to 0.

Figure 18-25 shows the output signals of the module when generating from the falling edge of the MMC clock.



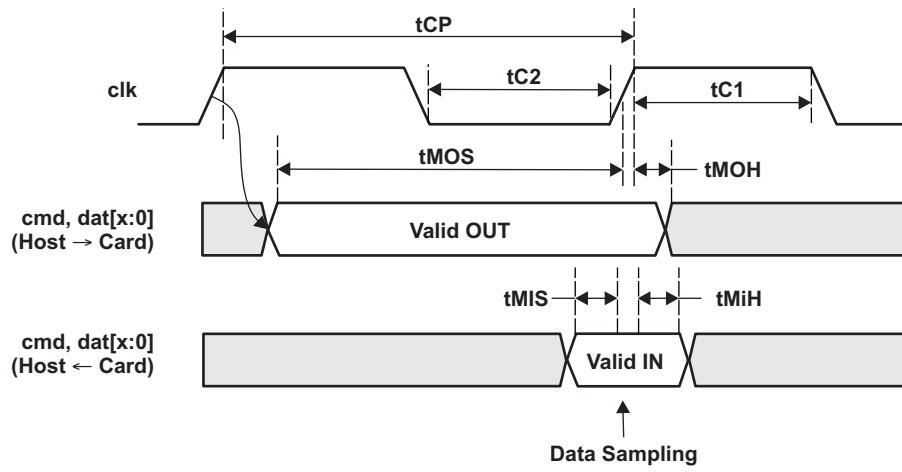
18.2.12.2 Generation on Rising Edge of MMC Clock

This mode increases setup timings and allows reaching higher bus frequency. This feature is activated by setting SD_HCTL[2] HSPE bit to 1. The controller shall be set in this mode to support SDR transfers.

NOTE: Do not use this feature in Dual Data Rate mode (when SD_CON[19] DDR is set to 1).

Figure 18-26 shows the output signals of the module when generating from the rising edge of the MMC clock.

Figure 18-26. Output Driven on Rising Edge



18.2.13 Card Boot Mode Management

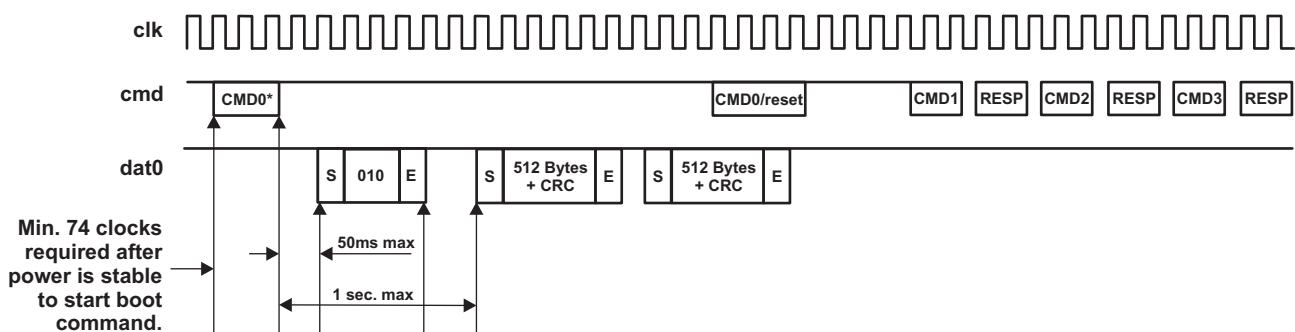
Boot Operation Mode allows the MMC/SD/SDIO host controller to read boot data from the connected slave (MMC device) by keeping CMD line low after power-on (or sending CMD0 with specific argument) before issuing CMD1. The data can be read from either boot area or user area, depending on register setting. Power-on boot defines a way for the boot-code to be accessed by the MMC/SD/SDIO host controller without an upper-level software driver, speeding the time it takes for a controller to access the boot code.

The two possible ways to issue a boot command (either issuing a CMD0 or driving the CMD line to 0 during the whole boot phase) are described in the following sections.

18.2.13.1 Boot Mode Using CMD0

Figure 18-27 shows the timing diagram of a boot sequence using CMD0.

Figure 18-27. Boot Mode With CMD0

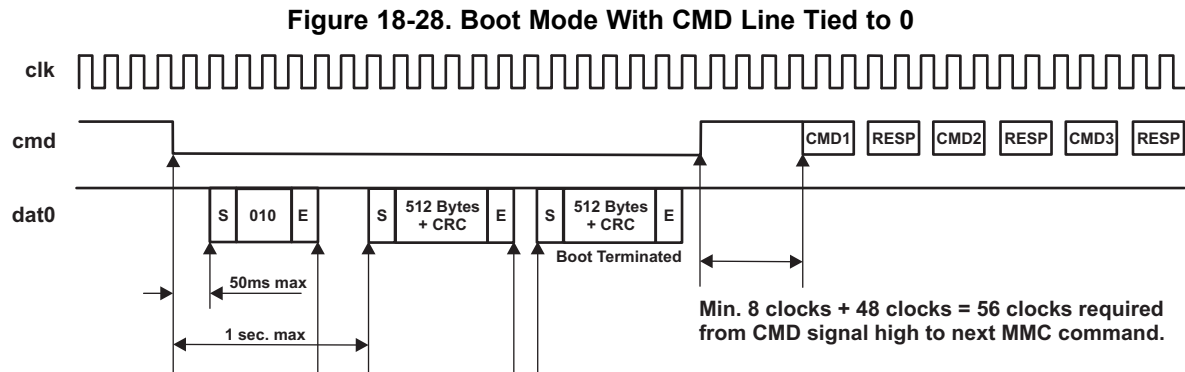


* Refer to MMC Specification for correct argument.

- Configure:
 - MMCHS_CON[BOOT_CF0] to 0
 - MMCHS_CON[BOOT_ACK] (if an acknowledge will be received) to 0x1
 - MMCHS_BLK with the correct block length and number of block
 - MMCHS_SYSCTL[DTO] for timeout
 - If transfer is done in DDR mode also set MMCHS_CON[DDR] to 1.
- Write register MMCHS_ARG with correct argument (see MMC Specification).
- Write in MMCHS_CMD register to start CMD0 transfer with these bit fields set:
 - INDX set to 0x00
 - DP set to '1'
 - DDIR set to '1'
 - MSBS set to '1'
 - BCE set to '1'
- If boot status is not received within the timing defined, the MMCHS_STAT[DTO] will be generated. Otherwise the MMCHS_STAT[BSR] is arisen.
- After the transfer is complete, the controller will generate the MMCHS_STAT[TC], and then the system can emit another CMD0 (MMCHS_CON[BOOT_ACK] previously cleared to 0x0) to exit the card from boot state.
- If the system wants to abort the boot sequence it must issue a CMD0 with MMCHS_CMD[CMD_TYPE] set to 0x3 (MMCHS_CON[BOOT_ACK] previously cleared to 0x0) during the transfer to abort transfer and enable card to exit from boot state.

18.2.13.2 Boot Mode With CMD Held Low

Figure 18-28 shows the timing diagram of a boot sequence with CMD line tied to 0.



- Configure:
 - MMCHS_CON[BOOT_CF0] and MMCHS_CON[BOOT_ACK] (if an acknowledge will be received) to 0x1
 - MMCHS_BLK with correct block length and number of block
 - MMCHS_SYSTCL[DTO] for timeout
 - If transfer is done in DDR mode also set MMCHS_CON[DDR] to 1.
- Write in MMCHS_CMD register to start boot sequence with:
 - DP set to '1'
 - DDIR set to '1'
 - MSBS set to '1'
 - BCE set to '1'
 - This leads the controller to force CMD line to '0'.
- If the boot status is not received within the timing defined, the MMCHS_STAT[DTO] will be generated. Otherwise the MMCHS_STAT[BSR] is arisen.
- After the transfer is complete, the controller will generate the MMCHS_STAT[TC], and then the system must clear MMCHS_CON[BOOT_CF0] to 0x0 to release the CMD line and enable the card to exit from boot state.
- If the system wants to abort the boot sequence it must clear MMCHS_CON[BOOT_CF0] to 0x0 during transfer to enable the card to exit from boot state.

18.2.14 CE-ATA Command Completion Disable Management

The MMC/SD/SDIO controller supports CE-ATA features, in particular the detection of command completion token. When a command that requires a command completion signal (SD_CON[12] CEATA and SD_CMD[2] ACEN set to 1) is launched, the host system is no longer allowed to emit a new command in parallel of data transfer unless it is a command completion disable token.

The settings to emit a command completion disable token follow:

- SD_CON[12] CEATA is set to 1.
- SD_CON[2] HR set to 1.
- Clear the SD_ARG register.
- Write into SD_CMD register with value 0000 0000h.

When a command completion disable token was emitted (that is, SD_STAT[0] CC received), the host system is again allowed to emit another type of command (for example a transfer abort command CMD12 to abort transfer).

A critical case can be met when command completion signal disable (CCSD) is emitted during the last data block transfer, the sequence on command line could be sent very close to command completion signal (CCS) token sent by the card.

Three cases can be met:

- CCS is receive just before CCSD is emitted:
An interrupt CIRQ is generated with CCS detection, CCSD is transmitted to card then an interrupt CC is generated when CCSD ends. In this case, card consider the CCSD sequence.
- CCS is not generated or generated during the CCSD transfer:
The CCS bit cannot be detected (conflict is not possible as they drive the same level on command line, then no CIRQ interrupt is generated; besides CC interrupt is generated when CCSD ends).
- CCS is generated without CCSD token required:
Only the interrupt CIRQ is generated when CCS is detected.

18.2.15 Test Registers

Test registers are available to be compliant with SD Host controller specification. This feature is useful to generate interrupts manually for driver debugging. The Force Event register (SD_FE) is used to control the Error Interrupt Status and Auto CMD12 Error Status. The System Test register (SD_SYSTEST) is used to control the signals that connect to I/O pins when the module is configured in system test (SD_CON[4] MODE = 1) mode for boundary connectivity verification.

18.2.16 MMC/SD/SDIO Hardware Status Features

Table 18-11 summarizes the MMC/SD/SDIO hardware status features.

Table 18-11. MMC/SD/SDIO Hardware Status Features

Feature	Type	Register/Bit Field/Observability Control	Description
Interrupt flags		See Section 18.2.4 .	
CMD line signal level	Status	[24] CLEV	Indicates the level of the cmd line
DAT lines signal level	Status	[23:20] DLEV	Indicates the level of the data lines
Buffer read enable	Status	[11] BRE	Readable data exists in the buffer.
Buffer write enable	Status	[10] BWE	Indicates whether there is enough space in the buffer to write BLEN bytes of data
Read transfer active	Status	[9] RTA	This status is used for detecting completion of a read transfer.
Write transfer active	Status	[8] WTA	This status indicates a write transfer active.
Data line active	Status	[2] DLA	Indicates whether the data lines are active
Command Inhibit (data lines)	Status	[1] DATI	Indicates whether issuing of command using data lines is allowed
Command inhibit (CMD line)	Status	[0] CMDI	Indicates whether issuing of command using CMD line is allowed

18.3 Low-Level Programming Models

18.3.1 Surrounding Modules Global Initialization

This section identifies the requirements of initializing the surrounding modules when the module has to be used for the first time after a device reset. This initialization of surrounding modules is based on the integration and environment of the MMC/SD/SDIO modules.

Table 18-12. Global Init for Surrounding Modules

Surrounding Modules	Comments
PRCM	Module interface and functional clocks must be enabled. For more information, see Chapter 8, Power, Reset, and Clock Management .
Control module	Module-specific pad muxing and configuration must be set in the control module. See Chapter 9, Control Module .
(optional) MPU INTC	MPU INTC configuration must be done to enable the interrupts from the SD module. See Chapter 6, Interrupts .
(optional) EDMA	DMA configuration must be done to enable the module DMA channel requests. See Chapter 11, EDMA .
(optional) Interconnect	For more information about the interconnect configuration, see Chapter 10, Interconnects .

NOTE: The MPU interrupt controller and the EDMA configurations are necessary, if the interrupt and DMA based communication modes are used.

18.3.2 MMC/SD/SDIO Controller Initialization Flow

The next sections outline the four steps to initialize the MMC/SD/SDIO controller:

- Initialize Clocks
- Software reset of the controller
- Set module's hardware capabilities
- Set module's Idle and Wake-Up modes

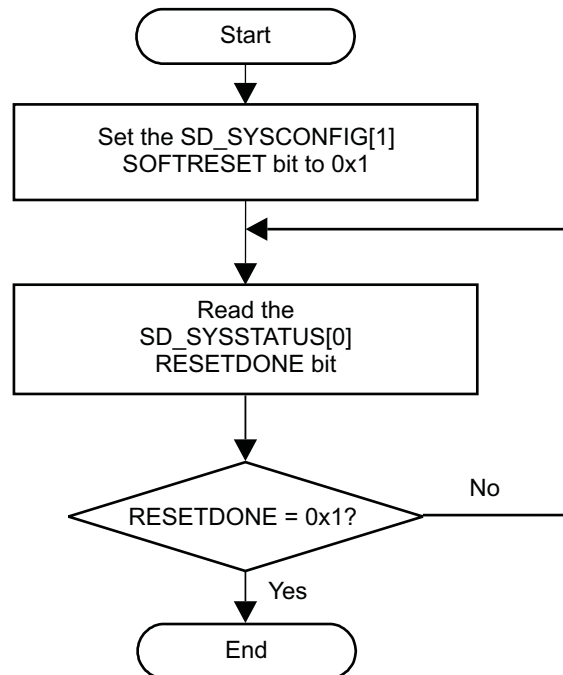
18.3.2.1 Enable OCP and CLKADPI Clocks

Prior to any SD register access one must enable the SD OCP clock and CLKADPI clock in PRCM module registers. For more information, see [Chapter 8, Power, Reset, and Clock Management](#).

18.3.2.2 SD Soft Reset Flow

Figure 18-29 shows the soft reset process of MMC/SD/SDIO controller.

Figure 18-29. MMC/SD/SDIO Controller Software Reset Flow



18.3.2.3 Set SD Default Capabilities

Software must read capabilities (in boot ROM for instance) and is allowed to set (write) SD_CAPA[26:24] and SD_CUR_CAPA[23:0] registers before the MMC/SD/SDIO host driver is started.

18.3.2.4 Wake-Up Configuration

Table 18-13 details SD controller wake-up configuration.

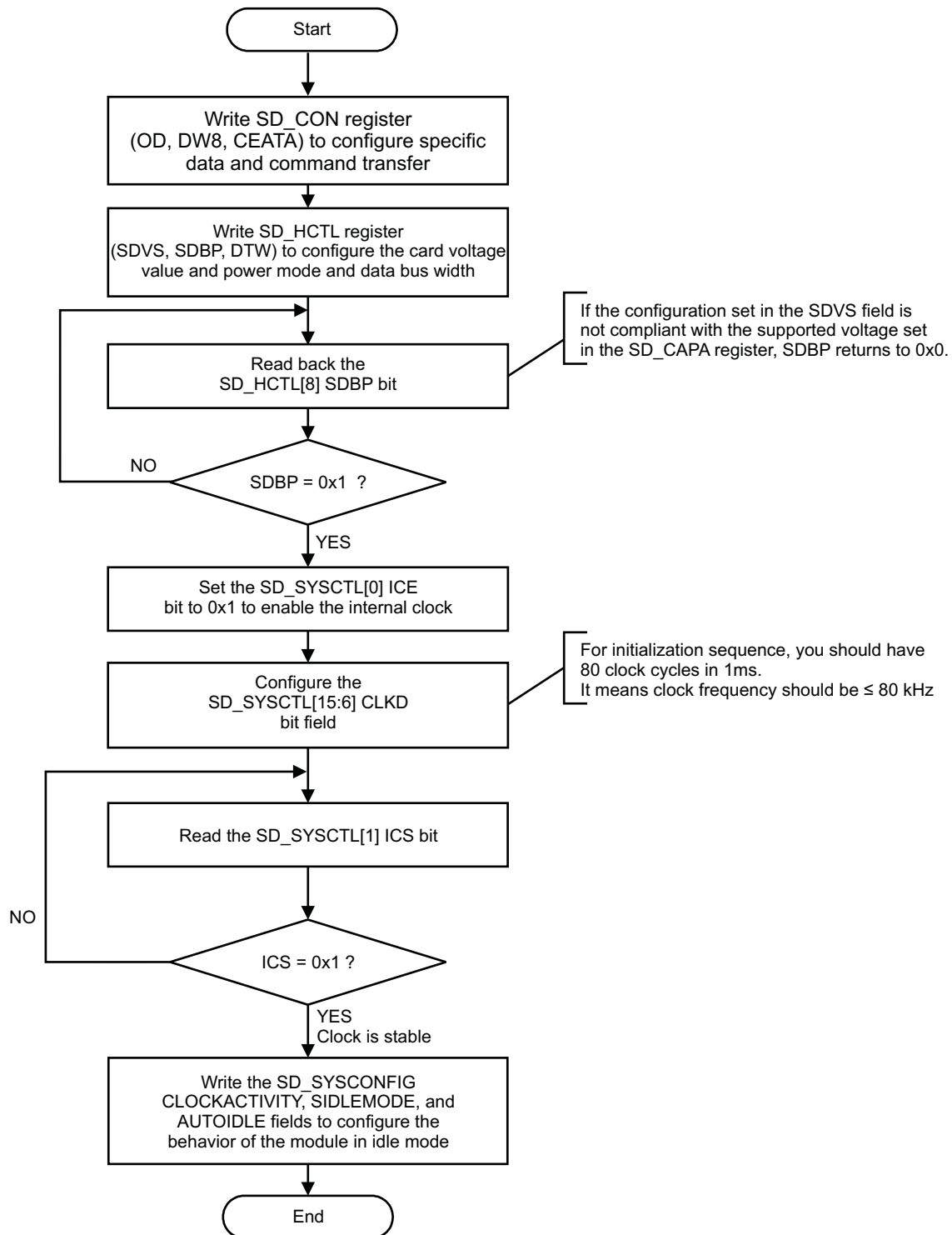
Table 18-13. MMC/SD/SDIO Controller Wake-Up Configuration

Step	Access Type	Register/Bit Field/Programming Model
Configure wake-up bit (if necessary).	W	SD_SYSCONFIG[2] ENAWAKEUP
Enable wake-up events on SD card interrupt (if necessary).	W	SD_HCTL[24] IWE
SDIO Card only Enable card interrupt (if necessary).	W	SD_IE[8] CIRQENABLE

18.3.2.5 MMC Host and Bus Configuration

Figure 18-30 details the MMC bus configuration process.

Figure 18-30. MMC/SD/SDIO Controller Bus Configuration Flow



18.3.3 Operational Modes Configuration

18.3.3.1 Basic Operations for MMC/SD/SDIO Host Controller

The MMC/SD/SDIO controller performs data transfers: data to card (referred to as write transfers) and data from card (referred to as read transfers).

The host controller requires transfers to run on a block-by-block basis, rather than on a DMA burst size basis. A single DMA request (or block request interrupt) is signaled for each block. Pipelining is supported as long as the block size is less than one half of the memory buffer size.

18.3.3.2 Card Detection, Identification, and Selection

Figure 18-31 and Figure 18-32 show the card identification and selection process.

Figure 18-31. MMC/SD/SDIO Controller Card Identification and Selection - Part 1

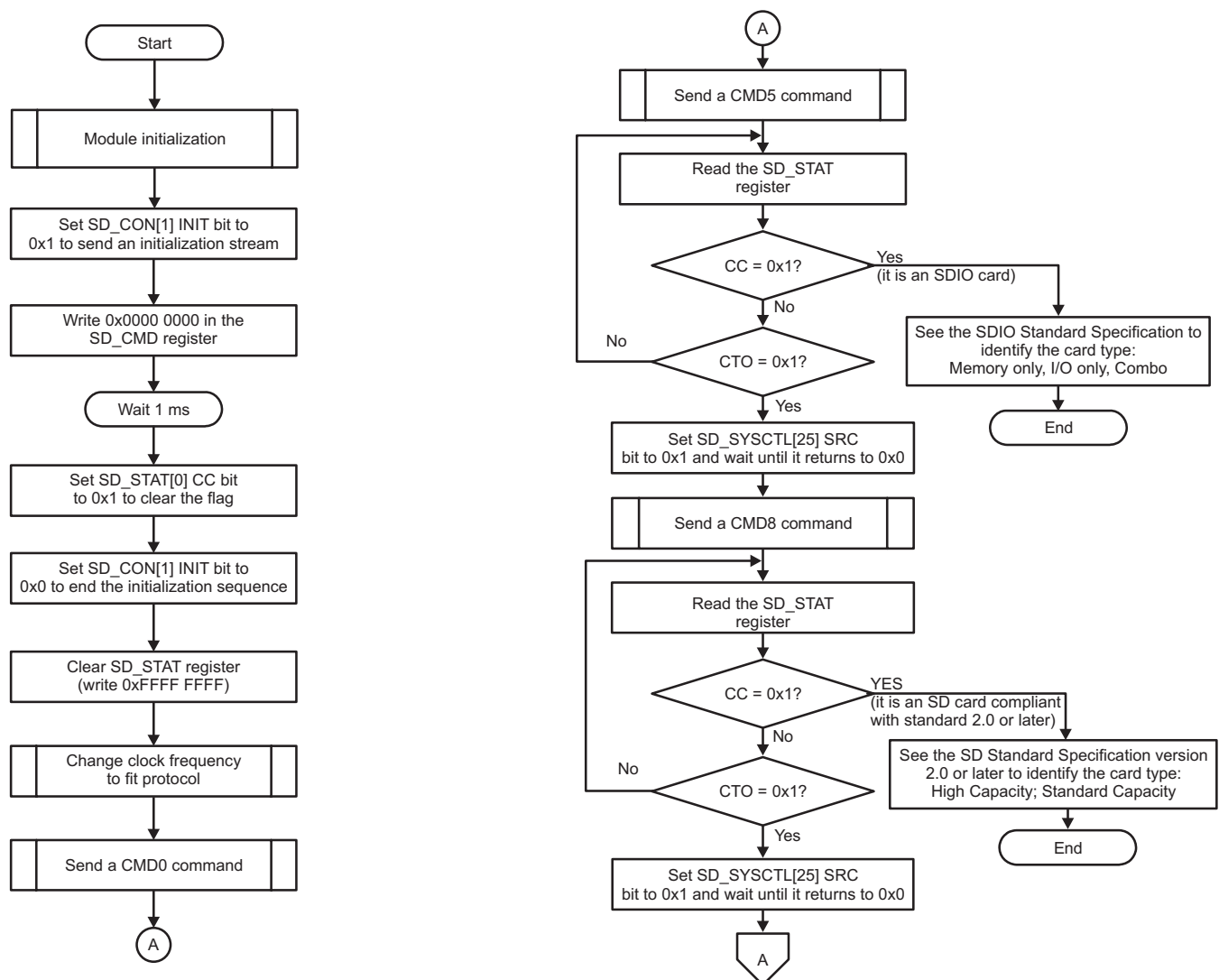
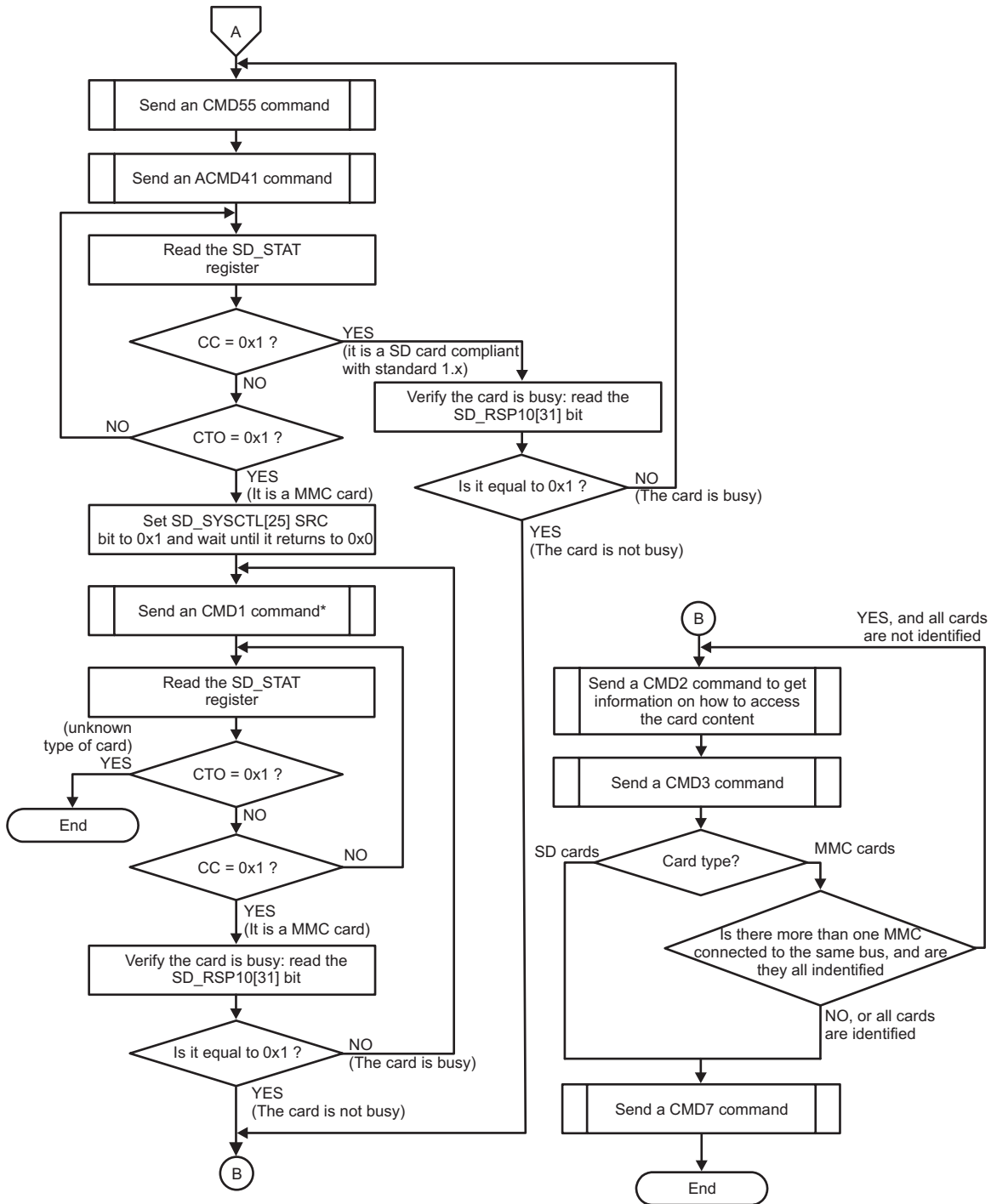


Figure 18-32. MMC/SD/SDIO Controller Card Identification and Selection - Part 2



*With OCR 0.

18.4 Multimedia Card Registers

CAUTION

The MMC/SD/SDIO registers are limited to 32-bit data accesses. 16-bit and 8-bit are not allowed and can corrupt register content.

18.4.1 MULTIMEDIA_CARD Registers

Table 18-14 lists the memory-mapped registers for the MULTIMEDIA_CARD. All register offset addresses not listed in Table 18-14 should be considered as reserved locations and the register contents should not be modified.

Table 18-14. MULTIMEDIA_CARD Registers

Offset	Acronym	Register Name	Section
110h	SD_SYSCONFIG	System Configuration	Section 18.4.1.1
114h	SD_SYSSTATUS	System Status	Section 18.4.1.2
124h	SD_CSRE	Card status response error	Section 18.4.1.3
128h	SD_SYSTEST	System Test	Section 18.4.1.4
12Ch	SD_CON	Configuration	Section 18.4.1.5
130h	SD_PWCNT	Power counter	Section 18.4.1.6
200h	SD_SDMASA	SDMA System address:	Section 18.4.1.7
204h	SD_BLK	Transfer Length Configuration	Section 18.4.1.8
208h	SD_ARG	Command argument	Section 18.4.1.9
20Ch	SD_CMD	Command and transfer mode	Section 18.4.1.10
210h	SD_RSP10	Command Response 0 and 1	Section 18.4.1.11
214h	SD_RSP32	Command Response 2 and 3	Section 18.4.1.12
218h	SD_RSP54	Command Response 4 and 5	Section 18.4.1.13
21Ch	SD_RSP76	Command Response 6 and 7	Section 18.4.1.14
220h	SD_DATA	Data	Section 18.4.1.15
224h	SD_PSTATE	Present state	Section 18.4.1.16
228h	SD_HCTL	Host Control	Section 18.4.1.17
22Ch	SD_SYSCCTL	SD system control	Section 18.4.1.18
230h	SD_STAT	SD interrupt status	Section 18.4.1.19
234h	SD_IE	SD interrupt enable	Section 18.4.1.20
238h	SD_ISE	SD interrupt enable set	Section 18.4.1.21
23Ch	SD_AC12	Auto CMD12 Error Status	Section 18.4.1.22
240h	SD_CAPA	Capabilities	Section 18.4.1.23
248h	SD_CUR_CAPA	Maximum current capabilities	Section 18.4.1.24
250h	SD_FE	Force Event	Section 18.4.1.25
254h	SD_ADMAES	ADMA Error Status	Section 18.4.1.26
258h	SD_ADMASAL	ADMA System address Low bits	Section 18.4.1.27
25Ch	SD_ADMASAH	ADMA System address High bits	Section 18.4.1.28
2FCh	SD_REV	Versions	Section 18.4.1.29

18.4.1.1 SD_SYSCONFIG Register (offset = 110h) [reset = 0h]

SD_SYSCONFIG is shown in [Figure 18-33](#) and described in [Table 18-15](#).

This register allows controlling various parameters of the OCP interface.

Figure 18-33. SD_SYSCONFIG Register

31	30	29	28	27	26	25	24
RESERVED							
R-0h							
23	22	21	20	19	18	17	16
RESERVED							
R-0h							
15	14	13	12	11	10	9	8
RESERVED		RESERVED		RESERVED		CLOCKACTIVITY	
R-0h		R-0h		R-0h		R/W-0h	
7	6	5	4	3	2	1	0
RESERVED			SIDLEMODE		ENAWAKEUP	SOFTRESET	AUTOIDLE
R-0h			R/W-0h		R/W-0h	R/W-0h	R/W-0h

LEGEND: R/W = Read/Write; R = Read only; W1toCl = Write 1 to clear bit; -n = value after reset

Table 18-15. SD_SYSCONFIG Register Field Descriptions

Bit	Field	Type	Reset	Description
31-14	RESERVED	R	0h	
13-12	RESERVED	R	0h	
11-10	RESERVED	R	0h	
9-8	CLOCKACTIVITY	R/W	0h	Clocks activity during wake up mode period. Bit 8 is the Interface clock. Bit 9 is the Functional clock. 0h = Interface and Functional clock may be switched off. 1h = Interface clock is maintained. Functional clock may be switched-off. 2h = Functional clock is maintained. Interface clock may be switched-off. 3h = Interface and Functional clocks are maintained.
7-5	RESERVED	R	0h	
4-3	SIDLEMODE	R/W	0h	Power management 0h = If an idle request is detected, the MMC/SD/SDIO host controller acknowledges it unconditionally and goes in Inactive mode. Interrupt and DMA requests are unconditionally deasserted. 1h = If an idle request is detected, the request is ignored and the module keeps on behaving normally. 2h = If an idle request is detected, the module will switch to wake up mode based on its internal activity, and the wake up capability can be used if the wake up capability is enabled (bit SD_SYSCONFIG[2] ENAWAKEUP bit is set to 1). 3h = Reserved.
2	ENAWAKEUP	R/W	0h	Wake-up feature control 0h = Wake-up capability is disabled. 1h = Wake-up capability is enabled.
1	SOFTRESET	R/W	0h	Software reset. The bit is automatically reset by the hardware. During reset, it always returns 0. 0h (W) = No effect 0h (R) = Normal mode 1h (W) = Trigger a module reset. 1h (R) = The module is reset.

Table 18-15. SD_SYSCONFIG Register Field Descriptions (continued)

Bit	Field	Type	Reset	Description
0	AUTOIDLE	R/W	0h	Internal Clock gating strategy 0h (R) = Clocks are free-running. 1h (W) = Automatic clock gating strategy is applied, based on the interconnect and MMC interface activity.

18.4.1.2 SD_SYSSTATUS Register (offset = 114h) [reset = 0h]

SD_SYSSTATUS is shown in [Figure 18-34](#) and described in [Table 18-16](#).

This register provides status information about the module excluding the interrupt status information.

Figure 18-34. SD_SYSSTATUS Register

31	30	29	28	27	26	25	24
RESERVED							
R-0h							
23	22	21	20	19	18	17	16
RESERVED							
R-0h							
15	14	13	12	11	10	9	8
RESERVED							
R-0h							
7	6	5	4	3	2	1	0
RESERVED							RESETDONE
R-0h							R-0h

LEGEND: R/W = Read/Write; R = Read only; W1toCl = Write 1 to clear bit; -n = value after reset

Table 18-16. SD_SYSSTATUS Register Field Descriptions

Bit	Field	Type	Reset	Description
31-1	RESERVED	R	0h	
0	RESETDONE	R	0h	Internal Reset Monitoring. Note the debounce clock, the interface clock and the functional clock shall be provided to the MMC/SD/SDIO host controller to allow the internal reset monitoring. 0h = Internal module reset is on-going 1h = Reset completed

18.4.1.3 SD_CSRE Register (offset = 124h) [reset = 0h]

SD_CSRE is shown in [Figure 18-35](#) and described in [Table 18-17](#).

This register enables the host controller to detect card status errors of response type R1, R1b for all cards and of R5, R5b and R6 response for cards types SD or SDIO. When a bit SD_CSRE[i] is set to 1, if the corresponding bit at the same position in the response SD_RSP10[i] is set to 1, the host controller indicates a card error (SD_STAT[28] CERR bit) interrupt status to avoid the host driver reading the response register (SD_RSP10). No automatic card error detection for autoCMD12 is implemented; the host system has to check autoCMD12 response register (SD_RSP76) for possible card errors.

Figure 18-35. SD_CSRE Register

31	30	29	28	27	26	25	24	23	22	21	20	19	18	17	16	15	14	13	12	11	10	9	8	7	6	5	4	3	2	1	0
CSRE																															
R/W-0h																															

LEGEND: R/W = Read/Write; R = Read only; W1toCl = Write 1 to clear bit; -n = value after reset

Table 18-17. SD_CSRE Register Field Descriptions

Bit	Field	Type	Reset	Description
31-0	CSRE	R/W	0h	Card status response error

18.4.1.4 SD_SYSTEST Register (offset = 128h) [reset = 0h]

SD_SYSTEST is shown in [Figure 18-36](#) and described in [Table 18-18](#).

This register is used to control the signals that connect to I/O pins when the module is configured in system test (SYSTEST) mode for boundary connectivity verification. In SYSTEST mode, a write into SD_CMD register will not start a transfer. The buffer behaves as a stack accessible only by the local host (push and pop operations). In this mode, the Transfer Block Size (SD_BLK[10:0] BLEN bits) and the Blocks count for current transfer (SD_BLK[31:16] NBLK bits) are needed to generate a Buffer write ready interrupt (SD_STAT[4] BWR bit) or a Buffer read ready interrupt (SD_STAT[5] BRR bit) and DMA requests if enabled.

Figure 18-36. SD_SYSTEST Register

31	30	29	28	27	26	25	24
RESERVED							
R-0h							
23	22	21	20	19	18	17	16
RESERVED							OBI
R-0h							R/W-0h
15	14	13	12	11	10	9	8
SDCD	SDWP	WAKD	SSB	D7D	D6D	D5D	D4D
R/W-0h	R/W-0h	R/W-0h	R/W-0h	R/W-0h	R/W-0h	R/W-0h	R/W-0h
7	6	5	4	3	2	1	0
D3D	D2D	D1D	D0D	DDIR	CDAT	CDIR	MCKD
R/W-0h	R/W-0h	R/W-0h	R/W-0h	R/W-0h	R/W-0h	R/W-0h	R/W-0h

LEGEND: R/W = Read/Write; R = Read only; W1toCl = Write 1 to clear bit; -n = value after reset

Table 18-18. SD_SYSTEST Register Field Descriptions

Bit	Field	Type	Reset	Description
31-17	RESERVED	R	0h	
16	OBI	R/W	0h	Out-of-band interrupt (OBI) data value. 0h = The out-of-band interrupt pin is driven low. 1h = The out-of-band interrupt pin is driven high.
15	SDCD	R/W	0h	Card detect input signal (SDCD) data value 0h = The card detect pin is driven low. 1h = The card detect pin is driven high.
14	SDWP	R/W	0h	Write protect input signal (SDWP) data value 0h = The write protect pin SDWP is driven low. 1h = The write protect pin SDWP is driven high.
13	WAKD	R/W	0h	Wake request output signal data value. 0h (W) = The pin SWAKEUP is driven low. 0h (R) = No action. Returns 0. 1h (W) = The pin SWAKEUP is driven high. 1h (R) = No action. Returns 1.
12	SSB	R/W	0h	Set status bit. This bit must be cleared prior attempting to clear a status bit of the interrupt status register (SD_STAT). 0h (W) = Clear this SSB bit field. Writing 0 does not clear already set status bits. 0h (R) = No action. Returns 0. 1h (W) = Force to 1 all status bits of the interrupt status register (SD_STAT) only if the corresponding bit field in the Interrupt signal enable register (SD_ISE) is set. 1h (R) = No action. Returns 1.

Table 18-18. SD_SYSTEST Register Field Descriptions (continued)

Bit	Field	Type	Reset	Description
11	D7D	R/W	0h	DAT7 input/output signal data value. 0h (W) = If SD_SYSTEST[3] DDIR bit = 0 (output mode direction), the DAT7 line is driven low. If SD_SYSTEST[3] DDIR bit = 1 (input mode direction), no effect. 0h (R) = If SD_SYSTEST[3] DDIR bit = 1 (input mode direction), returns the value on the DAT7 line (low). If SD_SYSTEST[3] DDIR bit = 0 (output mode direction), returns 0. 1h (W) = If SD_SYSTEST[3] DDIR bit = 0 (output mode direction), the DAT7 line is driven high. If SD_SYSTEST[3] DDIR bit = 1 (input mode direction), no effect. 1h (R) = If SD_SYSTEST[3] DDIR bit = 1 (input mode direction), returns the value on the DAT7 line (high) If SD_SYSTEST[3] DDIR bit = 0 (output mode direction), returns 1.
10	D6D	R/W	0h	DAT6 input/output signal data value. 0h (W) = If SD_SYSTEST[3] DDIR bit = 0 (output mode direction), the DAT6 line is driven low. If SD_SYSTEST[3] DDIR bit = 1 (input mode direction), no effect. 0h (R) = If SD_SYSTEST[3] DDIR bit = 1 (input mode direction), returns the value on the DAT6 line (low). If SD_SYSTEST[3] DDIR bit = 0 (output mode direction), returns 0. 1h (W) = If SD_SYSTEST[3] DDIR bit = 0 (output mode direction), the DAT6 line is driven high. If SD_SYSTEST[3] DDIR bit = 1 (input mode direction), no effect. 1h (R) = If SD_SYSTEST[3] DDIR bit = 1 (input mode direction), returns the value on the DAT6 line (high) If SD_SYSTEST[3] DDIR bit = 0 (output mode direction), returns 1.
9	D5D	R/W	0h	DAT5 input/output signal data value. 0h (W) = If SD_SYSTEST[3] DDIR bit = 0 (output mode direction), the DAT5 line is driven low. If SD_SYSTEST[3] DDIR bit = 1 (input mode direction), no effect. 0h (R) = If SD_SYSTEST[3] DDIR bit = 1 (input mode direction), returns the value on the DAT5 line (low). If SD_SYSTEST[3] DDIR bit = 0 (output mode direction), returns 0. 1h (W) = If SD_SYSTEST[3] DDIR bit = 0 (output mode direction), the DAT5 line is driven high. If SD_SYSTEST[3] DDIR bit = 1 (input mode direction), no effect. 1h (R) = If SD_SYSTEST[3] DDIR bit = 1 (input mode direction), returns the value on the DAT5 line (high) If SD_SYSTEST[3] DDIR bit = 0 (output mode direction), returns 1.
8	D4D	R/W	0h	DAT4 input/output signal data value. 0h (W) = If SD_SYSTEST[3] DDIR bit = 0 (output mode direction), the DAT4 line is driven low. If SD_SYSTEST[3] DDIR bit = 1 (input mode direction), no effect. 0h (R) = If SD_SYSTEST[3] DDIR bit = 1 (input mode direction), returns the value on the DAT4 line (low). If SD_SYSTEST[3] DDIR bit = 0 (output mode direction), returns 0. 1h (W) = If SD_SYSTEST[3] DDIR bit = 0 (output mode direction), the DAT4 line is driven high. If SD_SYSTEST[3] DDIR bit = 1 (input mode direction), no effect. 1h (R) = If SD_SYSTEST[3] DDIR bit = 1 (input mode direction), returns the value on the DAT4 line (high) If SD_SYSTEST[3] DDIR bit = 0 (output mode direction), returns 1.

Table 18-18. SD_SYSTEST Register Field Descriptions (continued)

Bit	Field	Type	Reset	Description
7	D3D	R/W	0h	<p>DAT3 input/output signal data value.</p> <p>0h (W) = If SD_SYSTEST[3] DDIR bit = 0 (output mode direction), the DAT3 line is driven low. If SD_SYSTEST[3] DDIR bit = 1 (input mode direction), no effect.</p> <p>0h (R) = If SD_SYSTEST[3] DDIR bit = 1 (input mode direction), returns the value on the DAT3 line (low). If SD_SYSTEST[3] DDIR bit = 0 (output mode direction), returns 0.</p> <p>1h (W) = If SD_SYSTEST[3] DDIR bit = 0 (output mode direction), the DAT3 line is driven high. If SD_SYSTEST[3] DDIR bit = 1 (input mode direction), no effect.</p> <p>1h (R) = If SD_SYSTEST[3] DDIR bit = 1 (input mode direction), returns the value on the DAT3 line (high) If SD_SYSTEST[3] DDIR bit = 0 (output mode direction), returns 1.</p>
6	D2D	R/W	0h	<p>DAT2 input/output signal data value.</p> <p>0h (W) = If SD_SYSTEST[3] DDIR bit = 0 (output mode direction), the DAT2 line is driven low. If SD_SYSTEST[3] DDIR bit = 1 (input mode direction), no effect.</p> <p>0h (R) = If SD_SYSTEST[3] DDIR bit = 1 (input mode direction), returns the value on the DAT2 line (low). If SD_SYSTEST[3] DDIR bit = 0 (output mode direction), returns 0.</p> <p>1h (W) = If SD_SYSTEST[3] DDIR bit = 0 (output mode direction), the DAT2 line is driven high. If SD_SYSTEST[3] DDIR bit = 1 (input mode direction), no effect.</p> <p>1h (R) = If SD_SYSTEST[3] DDIR bit = 1 (input mode direction), returns the value on the DAT2 line (high) If SD_SYSTEST[3] DDIR bit = 0 (output mode direction), returns 1.</p>
5	D1D	R/W	0h	<p>DAT1 input/output signal data value.</p> <p>0h (W) = If SD_SYSTEST[3] DDIR bit = 0 (output mode direction), the DAT1 line is driven low. If SD_SYSTEST[3] DDIR bit = 1 (input mode direction), no effect.</p> <p>0h (R) = If SD_SYSTEST[3] DDIR bit = 1 (input mode direction), returns the value on the DAT1 line (low). If SD_SYSTEST[3] DDIR bit = 0 (output mode direction), returns 0.</p> <p>1h (W) = If SD_SYSTEST[3] DDIR bit = 0 (output mode direction), the DAT1 line is driven high. If SD_SYSTEST[3] DDIR bit = 1 (input mode direction), no effect.</p> <p>1h (R) = If SD_SYSTEST[3] DDIR bit = 1 (input mode direction), returns the value on the DAT1 line (high) If SD_SYSTEST[3] DDIR bit = 0 (output mode direction), returns 1.</p>
4	D0D	R/W	0h	<p>DAT0 input/output signal data value.</p> <p>0h (W) = If SD_SYSTEST[3] DDIR bit = 0 (output mode direction), the DAT0 line is driven low. If SD_SYSTEST[3] DDIR bit = 1 (input mode direction), no effect.</p> <p>0h (R) = If SD_SYSTEST[3] DDIR bit = 1 (input mode direction), returns the value on the DAT0 line (low). If SD_SYSTEST[3] DDIR bit = 0 (output mode direction), returns 0.</p> <p>1h (W) = If SD_SYSTEST[3] DDIR bit = 0 (output mode direction), the DAT0 line is driven high. If SD_SYSTEST[3] DDIR bit = 1 (input mode direction), no effect.</p> <p>1h (R) = If SD_SYSTEST[3] DDIR bit = 1 (input mode direction), returns the value on the DAT0 line (high) If SD_SYSTEST[3] DDIR bit = 0 (output mode direction), returns 1.</p>
3	DDIR	R/W	0h	<p>Control of the DAT [7:0] pins direction.</p> <p>0h (W) = The DAT lines are outputs (host to card).</p> <p>0h (R) = No action. Returns 0.</p> <p>1h (W) = The DAT lines are inputs (card to host).</p> <p>1h (R) = No action. Returns 1.</p>

Table 18-18. SD_SYSTEST Register Field Descriptions (continued)

Bit	Field	Type	Reset	Description
2	CDAT	R/W	0h	CMD input/output signal data value 0h (W) = If SD_SYSTEST[1] CDIR bit = 0 (output mode direction), the CMD line is driven low. If SD_SYSTEST[1] CDIR bit = 1 (input mode direction), no effect. 0h (R) = If SD_SYSTEST[1] CDIR bit = 1 (input mode direction), returns the value on the CMD line (low). If SD_SYSTEST[1] CDIR bit = 0 (output mode direction), returns 0 . 1h (W) = If SD_SYSTEST[1] CDIR bit = 0 (output mode direction), the CMD line is driven high. If SD_SYSTEST[1] CDIR bit = 1 (input mode direction), no effect. 1h (R) = If SD_SYSTEST[1] CDIR bit = 1 (input mode direction), returns the value on the CMD line (high) If SD_SYSTEST[1] CDIR bit = 0 (output mode direction), returns 1 .
1	CDIR	R/W	0h	Control of the CMD pin direction 0h (W) = The CMD line is an output (host to card). 0h (R) = No action. Returns 0. 1h (W) = The CMD line is an input (card to host) . 1h (R) = No action. Returns 1.
0	MCKD	R/W	0h	MMC clock output signal data value 0h (W) = The output clock is driven low. 0h (R) = No action. Returns 0. 1h (W) = The output clock is driven high. 1h (R) = No action. Returns 1.

18.4.1.5 SD_CON Register (offset = 12Ch) [reset = 0h]

SD_CON is shown in [Figure 18-37](#) and described in [Table 18-19](#).

This register is used: To select the functional mode for any card. To send an initialization sequence to any card. To enable the detection on the mmc_dat[1] signal of a card interrupt for SDIO cards only. It also configures the parameters related to the card detect and write protect input signals

Figure 18-37. SD_CON Register

31	30	29	28	27	26	25	24
RESERVED							
R-0h							
23	22	21	20	19	18	17	16
RESERVED		SDMA_LnE	DMA_MnS	DDR	BOOT_CF0	BOOT_ACK	CLKEXTFREE
R-0h		R/W-0h	R/W-0h	R/W-0h	R/W-0h	R/W-0h	R/W-0h
15	14	13	12	11	10	9	8
PADEN	RESERVED		CEATA	CTPL	DVAL		WPP
R/W-0h	R-0h		R/W-0h	R/W-0h	R/W-0h		R/W-0h
7	6	5	4	3	2	1	0
CDP	MIT	DW8	MODE	STR	HR	INIT	OD
R/W-0h	R/W-0h	R/W-0h	R/W-0h	R/W-0h	R/W-0h	R/W-0h	R/W-0h

LEGEND: R/W = Read/Write; R = Read only; W1toCl = Write 1 to clear bit; -n = value after reset

Table 18-19. SD_CON Register Field Descriptions

Bit	Field	Type	Reset	Description
31-22	RESERVED	R	0h	
21	SDMA_LnE	R/W	0h	Slave DMA Level/Edge Request. The waveform of the DMA request can be configured either edge sensitive with early de-assertion on first access to SD_DATA register or late de-assertion, request remains active until last allowed data written into SD_DATA. 0h = Slave DMA edge sensitive. 1h = Slave DMA level sensitive.
20	DMA_MnS	R/W	0h	DMA Master or Slave selection. When this bit is set and the controller is configured to use the DMA, Ocp master interface is used to get datas from system using ADMA2 procedure (direct access to the memory). This option is only available if generic parameter MADMA_EN is asserted to 1. 0h = The controller is slave on data transfers with system. 1h = Not available on this device.
19	DDR	R/W	0h	Dual Data Rate mode. When this register is set, the controller uses both clock edge to emit or receive data. Odd bytes are transmitted on falling edges and even bytes are transmitted on rise edges. It only applies on Data bytes and CRC, Start, end bits and CRC status are kept full cycle. This bit field is only meaningful and active for even clock divider ratio of SD_SYSCTL[CLKD], it is insensitive to SD_HCTL[HSPE] setting. Note: DDR mode is not supported on AM335x. Always set this bit to 0. 0h = Standard modeData are transmitted on a single edge. 1h = Data Bytes and CRC are transmitted on both edges.

Table 18-19. SD_CON Register Field Descriptions (continued)

Bit	Field	Type	Reset	Description
18	BOOT_CF0	R/W	0h	Boot Status Supported. This register is set when the CMD line needs to be forced to 0 for a boot sequence. CMD line is driven to 0 after writing in SD_CMD. The line is released when this bit field is de-asserted and aborts data transfer in case of a pending transaction. 0h (W) = CMD line forced to 0 is enabled. 0h (R) = CMD line not forced. 1h (W) = CMD line forced to 0 is enabled and will be active after writing into SD_CMD register. 1h (R) = CMD line is released when it was previously forced to 0 by a boot sequence.
17	BOOT_ACK	R/W	0h	Book acknowledge received. When this bit is set the controller should receive a boot status on DAT0 line after next command issued. If no status is received a data timeout will be generated. 0h = No acknowledge to be received. 1h = A boot status will be received on DAT0 line after issuing a command.
16	CLKEXTFREE	R/W	0h	External clock free running. This register is used to maintain card clock out of transfer transaction to enable slave module (for example to generate a synchronous interrupt on mmc_dat[1]). The Clock will be maintain only if SD_SYSCCTL[2] CEN bit is set. 0h = External card clock is cut off outside active transaction period. 1h = External card clock is maintain even out of active transaction period only if SD_SYSCCTL[2] CEN bit is set.
15	PADEN	R/W	0h	Control power for MMC lines. This register is only useful when MMC PADs contain power saving mechanism to minimize its leakage power. It works as a GPIO that directly control the ACTIVE pin of PADs. Excepted for mmc_dat[1] , the signal is also combine outside the module with the dedicated power control SD_CON[11] CTPL bit. 0h = ADPIDLE module pin is not forced, it is automatically generated by the MMC fsms. 1h = ADPIDLE module pin is forced to active state
14-13	RESERVED	R	0h	
12	CEATA	R/W	0h	CE-ATA control mode (MMC cards compliant with CE-ATA). This bit selects the active level of the out-of-band interrupt coming from MMC cards. The usage of the Out-of-Band signal (OBI) is not supported. 0h = Standard MMC/SD/SDIO mode. 1h = CE-ATA mode. Next commands are considered as CE-ATA commands.
11	CTPL	R/W	0h	Control Power for mmc_dat[1] line (SD cards). By default, this bit is cleared to 0 and the host controller automatically disables all the input buffers outside of a transaction to minimize the leakage current. SDIO cards. When this bit is set to 1, the host controller automatically disables all the input buffers except the buffer of mmc_dat[1] outside of a transaction in order to detect asynchronous card interrupt on mmc_dat[1] line and minimize the leakage current of the buffers. 0h = Disable all the input buffers outside of a transaction. 1h = Disable all the input buffers except the buffer of mmc_dat[1] outside of a transaction.

Table 18-19. SD_CON Register Field Descriptions (continued)

Bit	Field	Type	Reset	Description
10-9	DVAL	R/W	0h	<p>Debounce filter value (all cards). This register is used to define a debounce period to filter the card detect input signal (SDCD). The usage of the card detect input signal (SDCD) is optional and depends on the system integration and the type of the connector housing that accommodates the card.</p> <p>0h = 33 us debounce period 1h = 231 us debounce period 2h = 1 ms debounce period 3h = 8.4 ms debounce period</p>
8	WPP	R/W	0h	<p>Write protect polarity (SD and SDIO cards only). This bit selects the active level of the write protect input signal (SDWP). The usage of the write protect input signal (SDWP) is optional and depends on the system integration and the type of the connector housing that accommodates the card.</p> <p>0h = Active high level 1h = Active low level</p>
7	CDP	R/W	0h	<p>Card detect polarity (all cards). This bit selects the active level of the write protect input signal (SDWP). The usage of the write protect input signal (SDWP) is optional and depends on the system integration and the type of the connector housing that accommodates the card.</p> <p>0h = Active high level 1h = Active low level</p>
6	MIT	R/W	0h	<p>MMC interrupt command (MMC cards only). This bit must be set to 1, when the next write access to the command register (SD_CMD) is for writing a MMC interrupt command (CMD40) requiring the command timeout detection to be disabled for the command response.</p> <p>0h = Command timeout enabled. 1h = Command timeout disabled.</p>
5	DW8	R/W	0h	<p>8-bit mode MMC select (MMC cards only). For SD/SDIO cards, this bit must be cleared to 0. For MMC card, this bit must be set following a valid SWITCH command (CMD6) with the correct value and extend CSD index written in the argument. Prior to this command, the MMC card configuration register (CSD and EXT_CSD) must be verified for compliancy with MMC standard specification.</p> <p>0h = 1-bit or 4-bit data width 1h = 8-bit data width</p>
4	MODE	R/W	0h	<p>Mode select (all cards). This bit selects the functional mode.</p> <p>0h = Functional mode. Transfers to the MMC/SD/SDIO cards follow the card protocol. The MMC clock is enabled. MMC/SD transfers are operated under the control of the SD_CMD register.</p> <p>1h = SYSTEST mode. SYSTEST mode. The signal pins are configured as general-purpose input/output and the 1024-byte buffer is configured as a stack memory accessible only by the local host or system DMA. The pins retain their default type (input, output or in-out). SYSTEST mode is operated under the control of the SYSTEST register.</p>

Table 18-19. SD_CON Register Field Descriptions (continued)

Bit	Field	Type	Reset	Description
3	STR	R/W	0h	Stream command (MMC cards only). This bit must be set to 1 only for the stream data transfers (read or write) of the adtc commands. Stream read is a class 1 command (CMD11READ_DAT_UNTIL_STOP). Stream write is a class 3 command (CMD20WRITE_DAT_UNTIL_STOP). 0h = Block oriented data transfer 1h = Stream oriented data transfer
2	HR	R/W	0h	Broadcast host response (MMC cards only). This register is used to force the host to generate a 48-bit response for bc command type. It can be used to terminate the interrupt mode by generating a CMD40 response by the core. In order to have the host response to be generated in open drain mode, the register SD_CON[OD] must be set to 1. When SD_CON[12] CEATA bit is set to 1 and SD_ARG cleared to 0, when writing 0000 0000h into SD_CMD register, the host controller performs a 'command completion signal disable' token (i.e., mmc_cmd line held to 0 during 47 cycles followed by a 1). 0h = The host does not generate a 48-bit response instead of a command. 1h = The host generates a 48-bit response instead of a command or a command completion signal disable token.
1	INIT	R/W	0h	Send initialization stream (all cards). When this bit is set to 1, and the card is idle, an initialization sequence is sent to the card. An initialization sequence consists of setting the mmc_cmd line to 1 during 80 clock cycles. The initialization sequence is mandatory - but it is not required to do it through this bit - this bit makes it easier. Clock divider (SD_SYCTL [15:6] CLKD bits) should be set to ensure that 80 clock periods are greater than 1ms. Note: In this mode, there is no command sent to the card and no response is expected. A command complete interrupt will be generated once the initialization sequence is completed. SD_STAT[0] CC bit can be polled. 0h = The host does not send an initialization sequence 1h = The host sends an initialization sequence
0	OD	R/W	0h	Card open drain mode (MMC cards only). This bit must be set to 1 for MMC card commands 1, 2, 3 and 40, and if the MMC card bus is operating in open-drain mode during the response phase to the command sent. Typically, during card identification mode when the card is either in idle, ready or ident state. It is also necessary to set this bit to 1, for a broadcast host response (see Broadcast host response register SD_CON[2] HR bit). 0h = No open drain 1h = Open drain or broadcast host response

18.4.1.6 SD_PWCNT Register (offset = 130h) [reset = 0h]

SD_PWCNT is shown in [Figure 18-38](#) and described in [Table 18-20](#).

This register is used to program a mmc counter to delay command transfers after activating the PAD power, this value depends on PAD characteristics and voltage.

Figure 18-38. SD_PWCNT Register

31	30	29	28	27	26	25	24	23	22	21	20	19	18	17	16	15	14	13	12	11	10	9	8	7	6	5	4	3	2	1	0
RESERVED																PWCNT															
R-0h																R/W-0h															

LEGEND: R/W = Read/Write; R = Read only; W1toCl = Write 1 to clear bit; -n = value after reset

Table 18-20. SD_PWCNT Register Field Descriptions

Bit	Field	Type	Reset	Description
31-16	RESERVED	R	0h	
15-0	PWCNT	R/W	0h	Power counter register. This register is used to introduce a delay between the PAD ACTIVE pin assertion and the command issued. 0h = No additional delay added 1h = TCF delay (card clock period) 2h = TCF x 2 delay (card clock period) FFFEh = TCF x 65534 delay (card clock period) FFFFh = TCF x 65535 delay (card clock period)

18.4.1.7 SD_SDMA Register (offset = 200h) [reset = 0h]

SD_SDMA is shown in [Figure 18-39](#) and described in [Table 18-21](#).

This register is used to program a mmc counter to delay command transfers after activating the PAD power. This value depends on PAD characteristics and voltage.

Figure 18-39. SD_SDMA Register

31	30	29	28	27	26	25	24	23	22	21	20	19	18	17	16	15	14	13	12	11	10	9	8	7	6	5	4	3	2	1	0
SDMA_SYSADDR																															
R-0h																															

LEGEND: R/W = Read/Write; R = Read only; W1toCl = Write 1 to clear bit; -n = value after reset

Table 18-21. SD_SDMA Register Field Descriptions

Bit	Field	Type	Reset	Description
31-0	SDMA_SYSADDR	R	0h	This register contains the system memory address for a SDMA transfer. When the Host Controller stops a SDMA transfer, this register shall point to the system address of the next contiguous data position. It can be accessed only if no transaction is executing (i.e., after a transaction has stopped). Read operations during transfers may return an invalid value. The Host Driver shall initialize this register before starting a SDMA transaction. After SDMA has stopped, the next system address of the next contiguous data position can be read from this register. The SDMA transfer waits at the every boundary specified by the Host SDMA Buffer Boundary in the Block Size register. The Host Controller generates DMA Interrupt to request the Host Driver to update this register. The Host Driver sets the next system address of the next data position to this register. When the most upper byte of this register (003h) is written, the Host Controller restarts the SDMA transfer. When restarting SDMA by the Resume command or by setting Continue Request in the Block Gap Control register, the Host Controller shall start at the next contiguous address stored here in the SDMA System Address register. ADMA does not use this register.

18.4.1.8 SD_BLK Register (offset = 204h) [reset = 0h]

SD_BLK is shown in [Figure 18-40](#) and described in [Table 18-22](#).

This register shall be used for any card. SD_BLK[BLNK] is the block size register. SD_BLK[NBLK] is the block count register.

Figure 18-40. SD_BLK Register

31	30	29	28	27	26	25	24	23	22	21	20	19	18	17	16
NBLK															
R/W-0h															
15	14	13	12	11	10	9	8	7	6	5	4	3	2	1	0
RESERVED											BLNK				
R-0h											R/W-0h				

LEGEND: R/W = Read/Write; R = Read only; W1toCl = Write 1 to clear bit; -n = value after reset

Table 18-22. SD_BLK Register Field Descriptions

Bit	Field	Type	Reset	Description
31-16	NBLK	R/W	0h	<p>Blocks count for current transfer.</p> <p>This register is enabled when Block count Enable (SD_CMD[1] BCE bit) is set to 1 and is valid only for multiple block transfers. Setting the block count to 0 results no data blocks being transferred. Note: The host controller decrements the block count after each block transfer and stops when the count reaches zero.</p> <p>This register can be accessed only if no transaction is executing (i.e., after a transaction has stopped).</p> <p>Read operations during transfers may return an invalid value and write operation will be ignored.</p> <p>In suspend context, the number of blocks yet to be transferred can be determined by reading this register.</p> <p>When restoring transfer context prior to issuing a Resume command, The local host shall restore the previously saved block count.</p> <p>0h = Stop count 1h = 1 block 2h = 2 blocks FFFFh = 65535 blocks</p>
15-12	RESERVED	R	0h	
11-0	BLNK	R/W	0h	<p>Transfer block size.</p> <p>This register specifies the block size for block data transfers. Read operations during transfers may return an invalid value, and write operations are ignored.</p> <p>When a CMD12 command is issued to stop the transfer, a read of the BLNK field after transfer completion (SD_STAT[1] TC bit set to 1) will not return the true byte number of data length while the stop occurs but the value written in this register before transfer is launched.</p> <p>0h = No data transfer 1h = 1 byte block length 2h = 2 bytes block length 3h = 3 bytes block length 1FFh = 511 bytes block length 200h = 512 bytes block length 7FFh = 2047 bytes block length 800h = 2048 bytes block length</p>

18.4.1.9 SD_ARG Register (offset = 208h) [reset = 0h]

SD_ARG is shown in [Figure 18-41](#) and described in [Table 18-23](#).

This register contains command argument specified as bit 39-8 of Command-Format. These registers must be initialized prior to sending the command itself to the card (write action into the register SD_CMD register). Only exception is for a command index specifying stuff bits in arguments, making a write unnecessary.

Figure 18-41. SD_ARG Register

31	30	29	28	27	26	25	24	23	22	21	20	19	18	17	16	15	14	13	12	11	10	9	8	7	6	5	4	3	2	1	0
ARG																															
R/W-0h																															

LEGEND: R/W = Read/Write; R = Read only; W1toCl = Write 1 to clear bit; -n = value after reset

Table 18-23. SD_ARG Register Field Descriptions

Bit	Field	Type	Reset	Description
31-0	ARG	R/W	0h	Command argument bits [31:0] .

18.4.1.10 SD_CMD Register (offset = 20Ch) [reset = 0h]

SD_CMD is shown in [Figure 18-42](#) and described in [Table 18-24](#).

SD_CMD[31:16] = the command register. SD_CMD[15:0] = the transfer mode. This register configures the data and command transfers. A write into the most significant byte send the command. A write into SD_CMD[15:0] registers during data transfer has no effect. This register can be used for any card. In SYSTEST mode, a write into SD_CMD register will not start a transfer.

Figure 18-42. SD_CMD Register

31	30	29	28	27	26	25	24
RESERVED			INDX				
R-0h			R/W-0h				
23	22	21	20	19	18	17	16
CMD_TYPE		DP	CICE	CCCE	RESERVED	RSP_TYPE	
R/W-0h		R/W-0h	R/W-0h	R/W-0h	R-0h	R/W-0h	
15	14	13	12	11	10	9	8
RESERVED							
R-0h							
7	6	5	4	3	2	1	0
RESERVED		MSBS	DDIR	RESERVED	ACEN	BCE	DE
R-0h		R/W-0h	R/W-0h	R-0h	R/W-0h	R/W-0h	R/W-0h

LEGEND: R/W = Read/Write; R = Read only; W1toCl = Write 1 to clear bit; -n = value after reset

Table 18-24. SD_CMD Register Field Descriptions

Bit	Field	Type	Reset	Description
31-30	RESERVED	R	0h	

Table 18-24. SD_CMD Register Field Descriptions (continued)

Bit	Field	Type	Reset	Description
29-24	INDX	R/W	0h	Command index binary encoded value from 0 to 63 specifying the command number send to card. 0h = CMD0 or ACMD0 1h = CMD1 or ACMD1 2h = CMD2 or ACMD2 3h = CMD3 or ACMD3 4h = CMD4 or ACMD4 5h = CMD5 or ACMD5 6h = CMD6 or ACMD6 7h = CMD7 or ACMD7 8h = CMD8 or ACMD8 9h = CMD9 or ACMD9 Ah = CMD10 or ACMD10 Bh = CMD11 or ACMD11 Ch = CMD12 or ACMD12 Dh = CMD13 or ACMD13 Eh = CMD14 or ACMD14 Fh = CMD15 or ACMD15 10h = CMD16 or ACMD16 11h = CMD17 or ACMD17 12h = CMD18 or ACMD18 13h = CMD19 or ACMD19 14h = CMD20 or ACMD20 15h = CMD21 or ACMD21 16h = CMD22 or ACMD22 17h = CMD23 or ACMD23 18h = CMD24 or ACMD24 19h = CMD25 or ACMD25 1Ah = CMD26 or ACMD26 1Bh = CMD27 or ACMD27 1Ch = CMD28 or ACMD28 1Dh = CMD29 or ACMD29 1Eh = CMD30 or ACMD30 1Fh = CMD31 or ACMD31 20h = CMD32 or ACMD32 21h = CMD33 or ACMD33 22h = CMD34 or ACMD34 23h = CMD35 or ACMD35 24h = CMD36 or ACMD36 25h = CMD37 or ACMD37 26h = CMD38 or ACMD38 27h = CMD39 or ACMD39 28h = CMD40 or ACMD40 29h = CMD41 or ACMD41 2Ah = CMD42 or ACMD42 2Bh = CMD43 or ACMD43 2Ch = CMD44 or ACMD44 2Dh = CMD45 or ACMD45 2Eh = CMD46 or ACMD46 2Fh = CMD47 or ACMD47 30h = CMD48 or ACMD48 31h = CMD49 or ACMD49 32h = CMD50 or ACMD5 33h = CMD51 or ACMD5 34h = CMD52 or ACMD5 35h = CMD53 or ACMD5

Table 18-24. SD_CMD Register Field Descriptions (continued)

Bit	Field	Type	Reset	Description
				36h = CMD54 or ACMD5 37h = CMD55 or ACMD5 38h = CMD56 or ACMD5 39h = CMD57 or ACMD5 3Ah = CMD58 or ACMD5 3Bh = CMD59 or ACMD5 3Ch = CMD60 or ACMD60 3Dh = CMD61 or ACMD61 3Eh = CMD62 or ACMD62 3Fh = CMD63 or ACMD63
23-22	CMD_TYPE	R/W	0h	Command type. This register specifies three types of special commands: Suspend, Resume and Abort. These bits shall be cleared to 0b00 for all other commands. 0h = Others commands 1h = Upon CMD52 "Bus Suspend" operation 2h = Upon CMD52 "Function Select" operation 3h = Upon CMD12 or CMD52 "I/O Abort" command
21	DP	R/W	0h	Data present select. This register indicates that data is present and mmc_dat line shall be used. It must be cleared to 0 in the following conditions: Command using only mmc_cmd line. Command with no data transfer but using busy signal on mmc_dat0. Resume command. 0h = Command with no data transfer 1h = Command with data transfer
20	CICE	R/W	0h	Command Index check enable. This bit must be set to 1 to enable index check on command response to compare the index field in the response against the index of the command. If the index is not the same in the response as in the command, it is reported as a command index error (SD_STAT[19] CIE bit set to 1) NoteThe CICE bit cannot be configured for an Auto CMD12, then index check is automatically checked when this command is issued. 0h = Index check disable 1h = Index check enable
19	CCCE	R/W	0h	Command CRC check enable. This bit must be set to 1 to enable CRC7 check on command response to protect the response against transmission errors on the bus. If an error is detected, it is reported as a command CRC error (SD_STAT[17] CCRC bit set to 1). NoteThe CCCE bit cannot be configured for an Auto CMD12, and then CRC check is automatically checked when this command is issued. 0h = CRC7 check disable 1h = CRC7 check enable
18	RESERVED	R	0h	
17-16	RSP_TYPE	R/W	0h	Response type. This bits defines the response type of the command. 0h = No response 1h = Response Length 136 bits 2h = Response Length 48 bits 3h = Response Length 48 bits with busy after response
15-6	RESERVED	R	0h	

Table 18-24. SD_CMD Register Field Descriptions (continued)

Bit	Field	Type	Reset	Description
5	MSBS	R/W	0h	Multi/Single block select. This bit must be set to 1 for data transfer in case of multi block command. For any others command this bit shall be cleared to 0. 0h = Single block. If this bit is 0, it is not necessary to set the register SD_BLK[31:16] NBLK bits. 1h = Multi block. When Block Count is disabled (SD_CMD[1] BCE bit is cleared to 0) in Multiple block transfers (SD_CMD[5] MSBS bit is set to 1), the module can perform infinite transfer.
4	DDIR	R/W	0h	Data transfer Direction. Select This bit defines either data transfer will be a read or a write. 0h = Data Write (host to card) 1h = Data Read (card to host)
3	RESERVED	R	0h	
2	ACEN	R/W	0h	Auto CMD12 Enable (SD cards only). When this bit is set to 1, the host controller issues a CMD12 automatically after the transfer completion of the last block. The Host Driver shall not set this bit to issue commands that do not require CMD12 to stop data transfer. In particular, secure commands do not require CMD12. For CE-ATA commands (SD_CON[12] CEATA bit set to 1), auto CMD12 is useless therefore when this bit is set the mechanism to detect command completion signal, named CCS, interrupt is activated. 0h = Auto CMD12 disable 1h = Auto CMD12 enable or CCS detection enabled.
1	BCE	R/W	0h	Block Count Enable (Multiple block transfers only). This bit is used to enable the block count register (SD_BLK [31:16] NBLK bits). When Block Count is disabled (SD_CMD[1] BCE bit is cleared to 0) in Multiple block transfers (SD_CMD[5] MSBS bits is set to 1), the module can perform infinite transfer. 0h = Block count disabled for infinite transfer. 1h = Block count enabled for multiple block transfer with known number of blocks
0	DE	R/W	0h	DMA Enable. This bit is used to enable DMA mode for host data access. 0h = DMA mode disable 1h = DMA mode enable

18.4.1.11 SD_RSP10 Register (offset = 210h) [reset = 0h]

SD_RSP10 is shown in [Figure 18-43](#) and described in [Table 18-25](#).

This 32-bit register holds bits positions [31:0] of command response type R1, R1b, R2, R3, R4, R5, R5b, or R6.

Figure 18-43. SD_RSP10 Register

31	30	29	28	27	26	25	24	23	22	21	20	19	18	17	16	15	14	13	12	11	10	9	8	7	6	5	4	3	2	1	0
RSP1																RSP0															
R-0h																R-0h															

LEGEND: R/W = Read/Write; R = Read only; W1toCl = Write 1 to clear bit; -n = value after reset

Table 18-25. SD_RSP10 Register Field Descriptions

Bit	Field	Type	Reset	Description
31-16	RSP1	R	0h	Command Response [31:16]
15-0	RSP0	R	0h	Command Response [15:0]

18.4.1.12 SD_RSP32 Register (offset = 214h) [reset = 0h]

SD_RSP32 is shown in [Figure 18-44](#) and described in [Table 18-26](#).

This 32-bit register holds bits positions [63:32] of command response type R2.

Figure 18-44. SD_RSP32 Register

31	30	29	28	27	26	25	24	23	22	21	20	19	18	17	16	15	14	13	12	11	10	9	8	7	6	5	4	3	2	1	0
RSP3																RSP2															
R-0h																R-0h															

LEGEND: R/W = Read/Write; R = Read only; W1toCl = Write 1 to clear bit; -n = value after reset

Table 18-26. SD_RSP32 Register Field Descriptions

Bit	Field	Type	Reset	Description
31-16	RSP3	R	0h	Command Response [63:48]
15-0	RSP2	R	0h	Command Response [47:32]

18.4.1.13 SD_RSP54 Register (offset = 218h) [reset = 0h]

SD_RSP54 is shown in [Figure 18-45](#) and described in [Table 18-27](#).

This 32-bit register holds bits positions [95:64] of command response type R2.

Figure 18-45. SD_RSP54 Register

31	30	29	28	27	26	25	24	23	22	21	20	19	18	17	16	15	14	13	12	11	10	9	8	7	6	5	4	3	2	1	0
RSP5																RSP4															
R-0h																R-0h															

LEGEND: R/W = Read/Write; R = Read only; W1toCl = Write 1 to clear bit; -n = value after reset

Table 18-27. SD_RSP54 Register Field Descriptions

Bit	Field	Type	Reset	Description
31-16	RSP5	R	0h	Command Response [95:80]
15-0	RSP4	R	0h	Command Response [79:64]

18.4.1.14 SD_RSP76 Register (offset = 21Ch) [reset = 0h]

SD_RSP76 is shown in [Figure 18-46](#) and described in [Table 18-28](#).

This 32-bit register holds bits positions [127:96] of command response type R2.

Figure 18-46. SD_RSP76 Register

31	30	29	28	27	26	25	24	23	22	21	20	19	18	17	16	15	14	13	12	11	10	9	8	7	6	5	4	3	2	1	0
RSP7																RSP6															
R-0h																R-0h															

LEGEND: R/W = Read/Write; R = Read only; W1toCl = Write 1 to clear bit; -n = value after reset

Table 18-28. SD_RSP76 Register Field Descriptions

Bit	Field	Type	Reset	Description
31-16	RSP7	R	0h	Command Response [127:112]
15-0	RSP6	R	0h	Command Response [111:96]

18.4.1.15 SD_DATA Register (offset = 220h) [reset = 0h]

SD_DATA is shown in [Figure 18-47](#) and described in [Table 18-29](#).

This register is the 32-bit entry point of the buffer for read or write data transfers. The buffer size is 32bitsx256(1024 bytes). Bytes within a word are stored and read in little endian format. This buffer can be used as two 512 byte buffers to transfer data efficiently without reducing the throughput. Sequential and contiguous access is necessary to increment the pointer correctly. Random or skipped access is not allowed. In little endian, if the local host accesses this register byte-wise or 16bit-wise, the least significant byte (bits [7:0]) must always be written/read first. The update of the buffer address is done on the most significant byte write for full 32-bit DATA register or on the most significant byte of the last word of block transfer. Example 1Byte or 16-bit access: Mbyteen[3:0]=0001 (1-byte) => Mbyteen[3:0]=0010 (1-byte) => Mbyteen[3:0]=1100 (2-bytes) OK. Mbyteen[3:0]=0001 (1-byte) => Mbyteen[3:0]=0010 (1-byte) => Mbyteen[3:0]=0100 (1-byte) OK. Mbyteen[3:0]=0001 (1-byte) => Mbyteen[3:0]=0010 (1-byte) => Mbyteen[3:0]=1000 (1-byte) Bad.

Figure 18-47. SD_DATA Register

31	30	29	28	27	26	25	24	23	22	21	20	19	18	17	16	15	14	13	12	11	10	9	8	7	6	5	4	3	2	1	0
DATA																															
R/W-0h																															

LEGEND: R/W = Read/Write; R = Read only; W1toCl = Write 1 to clear bit; -n = value after reset

Table 18-29. SD_DATA Register Field Descriptions

Bit	Field	Type	Reset	Description
31-0	DATA	R/W	0h	Data register [31:0]. In functional mode (SD_CON[4] MODE bit set to the default value 0): A read access to this register is allowed only when the buffer read enable status is set to 1 (SD_PSTATE[11] BRE bit), otherwise a bad access (SD_STAT[29] BADA bit) is signaled. A write access to this register is allowed only when the buffer write enable status is set to 1 (SD_PSTATE[10] BWE bit), otherwise a bad access (SD_STAT[29] BADA bit) is signaled and the data is not written.

18.4.1.16 SD_PSTATE Register (offset = 224h) [reset = 0h]

SD_PSTATE is shown in [Figure 18-48](#) and described in [Table 18-30](#).

The Host can get the status of the Host controller from this 32-bit read only register.

Figure 18-48. SD_PSTATE Register

31	30	29	28	27	26	25	24
RESERVED							CLEV
R-0h							R-0h
23	22	21	20	19	18	17	16
DLEV				WP	CDPL	CSS	CINS
R-0h				R-0h	R-0h	R-0h	R-0h
15	14	13	12	11	10	9	8
RESERVED				BRE	BWE	RTA	WTA
R-0h				R-0h	R-0h	R-0h	R-0h
7	6	5	4	3	2	1	0
RESERVED					DLA	DATI	CMDI
R-0h					R-0h	R-0h	R-0h

LEGEND: R/W = Read/Write; R = Read only; W1toCl = Write 1 to clear bit; -n = value after reset

Table 18-30. SD_PSTATE Register Field Descriptions

Bit	Field	Type	Reset	Description
31-25	RESERVED	R	0h	
24	CLEV	R	0h	mmc_cmd line signal level. This status is used to check the mmc_cmd line level to recover from errors, and for debugging. The value of this register after reset depends on the mmc_cmd line level at that time. 0h = The mmc_cmd line level is 0. 1h = The mmc_cmd line level is 1.
23-20	DLEV	R	0h	mmc_dat [3:0] line signal level mmc_dat3 equal to or greater than bit 23. mmc_dat2 equal to or greater than bit 22. mmc_dat1 equal to or greater than bit 21. mmc_dat0 equal to or greater than bit 20. This status is used to check mmc_dat line level to recover from errors, and for debugging. This is especially useful in detecting the busy signal level from mmc_dat0 . The value of these registers after reset depends on the mmc_dat lines level at that time.
19	WP	R	0h	Write Protect. MMC/SD/SDIO1 only. SDIO cards only. This bit reflects the write protect input pin (SDWP) level. The value of this register after reset depends one the protect input pin (SDWP) level at that time. 0h = If SD_CON[8] WPP is cleared to 0 (default), the card is write protected, otherwise the card is not write protected. 1h = If SD_CON[8] WPP is cleared to 0 (default), the card is not write protected, otherwise the card is write protected.

Table 18-30. SD_PSTATE Register Field Descriptions (continued)

Bit	Field	Type	Reset	Description
18	CDPL	R	0h	Card Detect Pin Level. MMC/SD/SDIO1 only. SDIO cards only. This bit reflects the inverse value of the card detect input pin (SDCD). Debouncing is not performed on this bit and is valid only when Card State is stable. (SD_PSTATE[17] is set to 1). This bit must be debounced by software. The value of this register after reset depends on the card detect input pin (SDCD) level at that time. 0h = The value of the card detect input pin (SDCD) is 1. 1h = The value of the card detect input pin (SDCD) is 0.
17	CSS	R	0h	Card State Stable. This bit is used for testing. It is set to 1 only when Card Detect Pin Level is stable (SD_PSTATE[18] CPDL). Debouncing is performed on the card detect input pin (SDCD) to detect card stability. This bit is not affected by software reset. 0h = Reset or Debouncing. 1h = Reset or Debouncing.
16	CINS	R	0h	Card inserted. This bit is the debounced value of the card detect input pin (SDCD). An inactive to active transition of the card detect input pin (SDCD) will generate a card insertion interrupt (SD_STAT[CINS]). A active to inactive transition of the card detect input pin (SDCD) will generate a card removal interrupt (SD_STAT[REM]). This bit is not affected by a software reset. 0h = If SD_CON[CDP] is cleared to 0 (default), no card is detected. The card may have been removed from the card slot. If SD_CON[CDP] is set to 1, the card has been inserted. 1h = If SD_CON[CDP] is cleared to 0 (default), the card has been inserted from the card slot. If SD_CON[CDP] is set to 1, no card is detected. The card may have been removed from the card slot.
15-12	RESERVED	R	0h	
11	BRE	R	0h	Buffer read enable. This bit is used for non-DMA read transfers. It indicates that a complete block specified by SD_BLK [10:0] BLEN bits has been written in the buffer and is ready to be read. It is cleared to 0 when the entire block is read from the buffer. It is set to 1 when a block data is ready in the buffer and generates the Buffer read ready status of interrupt (SD_STAT[5] BRR bit). 0h = Read BLEN bytes disable 1h = Read BLEN bytes enable. Readable data exists in the buffer.
10	BWE	R	0h	Buffer Write enable. This status is used for non-DMA write transfers. It indicates if space is available for write data. 0h = There is no room left in the buffer to write BLEN bytes of data. 1h = There is enough space in the buffer to write BLEN bytes of data.
9	RTA	R	0h	Read transfer active. This status is used for detecting completion of a read transfer. It is set to 1 after the end bit of read command or by activating a continue request (SD_HCTL[17] CR bit) following a stop at block gap request. This bit is cleared to 0 when all data have been read by the local host after last block or after a stop at block gap request. 0h = No valid data on the mmc_dat lines. 1h = Read data transfer on going.

Table 18-30. SD_PSTATE Register Field Descriptions (continued)

Bit	Field	Type	Reset	Description
8	WTA	R	0h	Write transfer active. This status indicates a write transfer active. It is set to 1 after the end bit of write command or by activating a continue request (SD_HCTL[17] CR bit) following a stop at block gap request. This bit is cleared to 0 when CRC status has been received after last block or after a stop at block gap request. 0h = No valid data on the mmc_dat lines. 1h = Write data transfer on going.
7-3	RESERVED	R	0h	
2	DLA	R	0h	mmc_dat line active. This status bit indicates whether one of the mmc_dat lines is in use. In the case of read transactions (card to host) This bit is set to 1 after the end bit of read command or by activating continue request SD_HCTL[17] CR bit. This bit is cleared to 0 when the host controller received the end bit of the last data block or at the beginning of the read wait mode. In the case of write transactions (host to card) This bit is set to 1 after the end bit of write command or by activating continue request SD_HCTL[17] CR bit. This bit is cleared to 0 on the end of busy event for the last block. The host controller must wait 8 clock cycles with line not busy to really consider not "busy state" or after the busy block as a result of a stop at gap request. 0h = mmc_dat line inactive 1h = mmc_dat line active
1	DATI	R	0h	Command inhibit (mmc_dat). This status bit is generated if either mmc_dat line is active (SD_PSTATE[2] DLA bit) or Read transfer is active (SD_PSTATE[9] RTA bit) or when a command with busy is issued. This bit prevents the local host to issue a command. A change of this bit from 1 to 0 generates a transfer complete interrupt (SD_STAT[1] TC bit). 0h = Issuing of command using the mmc_dat lines is allowed 1h = Issuing of command using mmc_dat lines is not allowed
0	CMDI	R	0h	Command inhibit(mmc_cmd). This status bit indicates that the mmc_cmd line is in use. This bit is cleared to 0 when the most significant byte is written into the command register. This bit is not set when Auto CMD12 is transmitted. This bit is cleared to 0 in either the following cases: After the end bit of the command response, excepted if there is a command conflict error (SD_STAT[17] CCRC bit or SD_STAT[18] CEB bit set to 1) or a Auto CMD12 is not executed (SD_AC12[0] ACNE bit). After the end bit of the command without response (SD_CMD [17:16] RSP_TYPE bits set to "00"). In case of a command data error is detected (SD_STAT[19] CTO bit set to 10, this register is not automatically cleared. 0h = Issuing of command using mmc_cmd line is allowed 1h = Issuing of command using mmc_cmd line is not allowed

18.4.1.17 SD_HCTL Register (offset = 228h) [reset = 0h]

SD_HCTL is shown in [Figure 18-49](#) and described in [Table 18-31](#).

This register defines the host controls to set power, wake-up and transfer parameters. SD_HCTL[31:24] = Wake-up control. SD_HCTL[23:16] = Block gap control. SD_HCTL[15:8] = Power control. SD_HCTL[7:0] = Host control. If your device does not support MMC cards, then those bits in this register which are meant for MMC card use should be assumed to be reserved.

Figure 18-49. SD_HCTL Register

31	30	29	28	27	26	25	24
RESERVED				OBWE	REM	INS	IWE
R-0h				R/W-0h	R/W-0h	R/W-0h	R/W-0h
23	22	21	20	19	18	17	16
RESERVED				IBG	RWC	CR	SBGR
R-0h				R/W-0h	R/W-0h	R/W-0h	R/W-0h
15	14	13	12	11	10	9	8
RESERVED				SDVS			SDBP
R-0h				R/W-0h			R/W-0h
7	6	5	4	3	2	1	0
CDSS	CDTL	RESERVED	DMAS		HSPE	DTW	RESERVED
R/W-0h	R/W-0h	R-0h	R/W-0h		R/W-0h	R/W-0h	R-0h

LEGEND: R/W = Read/Write; R = Read only; W1toCl = Write 1 to clear bit; -n = value after reset

Table 18-31. SD_HCTL Register Field Descriptions

Bit	Field	Type	Reset	Description
31-28	RESERVED	R	0h	
27	OBWE	R/W	0h	Wake-up event enable for 'out-of-band' Interrupt. This bit enables wake-up events for 'out-of-band' assertion. Wake-up is generated if the wake-up feature is enabled (SD_SYSCONFIG[2] ENAWAKEUP bit). The write to this register is ignored when SD_CON[14] OBIE bit is not set. 0h = Disable wake-up on 'out-of-band' Interrupt 1h = Enable wake-up on 'out-of-band' Interrupt
26	REM	R/W	0h	Wake-up event enable on SD card removal. This bit enables wake-up events for card removal assertion. Wake-up is generated if the wake-up feature is enabled (SD_SYSCONFIG[2] ENAWAKEUP bit). 0h = Disable wake-up on card removal 1h = Enable wake-up on card removal
25	INS	R/W	0h	Wake-up event enable on SD card insertion This bit enables wake-up events for card insertion assertion. Wake-up is generated if the wake-up feature is enabled (SD_SYSCONFIG[2] ENAWAKEUP bit). 0h = Disable wake-up on card insertion 1h = Enable wake-up on card insertion
24	IWE	R/W	0h	Wake-up event enable on SD card interrupt. This bit enables wake-up events for card interrupt assertion. Wake-up is generated if the wake-up feature is enabled (SD_SYSCONFIG[2] ENAWAKEUP bit) and enable status bit is set (SD_IE[8] CIRQ_ENABLE bit). 0h = Disable wake-up on card interrupt 1h = Enable wake-up on card interrupt
23-20	RESERVED	R	0h	

Table 18-31. SD_HCTL Register Field Descriptions (continued)

Bit	Field	Type	Reset	Description
19	IBG	R/W	0h	Interrupt block at gap. This bit is valid only in 4-bit mode of SDIO card to enable interrupt detection in the interrupt cycle at block gap for a multiple block transfer. For MMC cards and for SD card this bit should be cleared to 0. 0h = Disable interrupt detection at the block gap in 4-bit mode 1h = Enable interrupt detection at the block gap in 4-bit mode
18	RWC	R/W	0h	Read wait control. The read wait function is optional only for SDIO cards. If the card supports read wait, this bit must be enabled, then requesting a stop at block gap (SD_HCTL[16] SBGR bit) generates a read wait period after the current end of block. Be careful, if read wait is not supported it may cause a conflict on mmc_dat line. 0h = Disable read wait control. Suspend/resume cannot be supported. 1h = Enable read wait control
17	CR	R/W	0h	Continue request. This bit is used to restart a transaction that was stopped by requesting a stop at block gap (SD_HCTL[16] SBGR bit). Set this bit to 1 restarts the transfer. The bit is automatically cleared to 0 by the host controller when transfer has restarted, that is, mmc_dat line is active (SD_PSTATE[2] DLA bit) or transferring data (SD_PSTATE[8] WTA bit). The Stop at block gap request must be disabled (SD_HCTL[16] SBGR bit =0) before setting this bit. 0h = No affect 1h = Transfer restart
16	SBGR	R/W	0h	Stop at block gap request. This bit is used to stop executing a transaction at the next block gap. The transfer can restart with a continue request (SD_HCTL[17] CR bit) or during a suspend/resume sequence. In case of read transfer, the card must support read wait control. In case of write transfer, the host driver shall set this bit after all block data written. Until the transfer completion (SD_STAT[1] TC bit set to 1), the host driver shall leave this bit set to 1. If this bit is set, the local host shall not write to the data register (SD_DATA). 0h = Transfer mode 1h = Stop at block gap
15-12	RESERVED	R	0h	
11-9	SDVS	R/W	0h	SD bus voltage select (All cards). The host driver should set these bits to select the voltage level for the card according to the voltage supported by the system (SD_CAPA[26] VS18 bit, SD_CAPA[25] VS30 bit, SD_CAPA[24] VS33 bit) before starting a transfer. If MMCHS 2: This field must be set to 5h. If MMCHS 3: This field must be set to 5h. 5h = 1.8 V (Typical) 6h = 3.0 V (Typical) 7h = 3.3 V (Typical)

Table 18-31. SD_HCTL Register Field Descriptions (continued)

Bit	Field	Type	Reset	Description
8	SDBP	R/W	0h	SD bus power. Before setting this bit, the host driver shall select the SD bus voltage (SD_HCTL [11:9] SDVS bits). If the host controller detects the No card state, this bit is automatically cleared to 0. If the module is power off, a write in the command register (SD_CMD) will not start the transfer. A write to this bit has no effect if the selected SD bus voltage is not supported according to capability register (SD_CAPA[VS*]). 0h = Power off 1h = Power on
7	CDSS	R/W	0h	Card Detect Signal Selection. This bit selects source for the card detection. When the source for the card detection is switched, the interrupt should be disabled during the switching period by clearing the Interrupt Status/Signal Enable register in order to mask unexpected interrupt being caused by the glitch. The Interrupt Status/Signal Enable should be disabled during over the period of debouncing. 0h = SDCD# is selected (for normal use). 1h = The Card Detect Test Level is selected (for test purposes).
6	CDTL	R/W	0h	Card Detect Test Level. This bit is enabled while the Card Detect Signal Selection is set to 1 and it indicates card inserted or not. 0 = No card 1 = Card inserted.
5	RESERVED	R	0h	
4-3	DMAS	R/W	0h	DMA Select. One of the supported DMA modes can be selected. The host driver shall check support of DMA modes by referencing the Capabilities register. Use of selected DMA is determined by DMA Enable of the Transfer Mode register. This register is only meaningful when MADMA_EN is set to 1. When MADMA_EN is cleared to 0 the bit field is read only and returned value is 0. 0h = Reserved 1h = Reserved 2h = 32-bit Address ADMA2 is selected. 3h = Reserved
2	HSPE	R/W	0h	High Speed Enable. Before setting this bit, the Host Driver shall check the High Speed Support in the Capabilities register. If this bit is cleared to 0 (default), the Host Controller outputs CMD line and DAT lines at the falling edge of the SD Clock. If this bit is set to 1, the Host Controller outputs CMD line and DAT lines at the rising edge of the SD Clock. This bit shall not be set when dual data rate mode is activated in SD_CON[DDR]. 0h = Normal speed mode 1h = High speed mode
1	DTW	R/W	0h	Data transfer width. This bit must be set following a valid SET_BUS_WIDTH command (ACMD6) with the value written in bit 1 of the argument. Prior to this command, the SD card configuration register (SCR) must be verified for the supported bus width by the SD card. 0h = 1-bit Data width (mmc_dat0 used) 1h = 4-bit Data width (mmc_dat[3:0] used)
0	RESERVED	R	0h	

18.4.1.18 SD_SYSCTL Register (offset = 22Ch) [reset = 0h]

SD_SYSCTL is shown in [Figure 18-50](#) and described in [Table 18-32](#).

This register defines the system controls to set software resets, clock frequency management and data timeout. SD_SYSCTL[31:24] = Software resets. SD_SYSCTL[23:16] = Timeout control. SD_SYSCTL[15:0] = Clock control.

Figure 18-50. SD_SYSCTL Register

31	30	29	28	27	26	25	24	23	22	21	20	19	18	17	16
RESERVED				SRD	SRC	SRA	RESERVED				DTO				
R-0h				R/W-0h	R/W-0h	R/W-0h	R-0h				R/W-0h				
15	14	13	12	11	10	9	8	7	6	5	4	3	2	1	0
CLKD								RESERVED				CEN	ICS	ICE	
R/W-0h								R-0h				R/W-0h	R-0h	R/W-0h	

LEGEND: R/W = Read/Write; R = Read only; W1toCl = Write 1 to clear bit; -n = value after reset

Table 18-32. SD_SYSCTL Register Field Descriptions

Bit	Field	Type	Reset	Description
31-27	RESERVED	R	0h	
26	SRD	R/W	0h	Software reset for mmc_dat line. This bit is set to 1 for reset and released to 0 when completed. Due to additional implementation logic, the reset does not immediately start when asserted. The proper procedure is: (a) Set to 1 to start reset, (b) Poll for 1 to identify start of reset, and (c) Poll for 0 to identify reset is complete. mmc_dat finite state machine in both clock domain are also reset. These registers are cleared by the SD_SYSCTL[26] SRD bit: SD_DATA, SD_PSTATEBRE, BWE, RTA, WTA, DLA and DATI. SD_HCTLSBGR and CR. SD_STATBRR, BWR, BGE and TC Interconnect and MMC buffer data management is reinitialized. Note: If a soft reset is issued when an interrupt is asserted, data may be lost. 0h = Reset completed 1h = Software reset for mmc_dat line
25	SRC	R/W	0h	Software reset for mmc_cmd line. This bit is set to 1 for reset and released to 0 when completed. Due to additional implementation logic, the reset does not immediately start when asserted. The proper procedure is: (a) Set to 1 to start reset, (b) Poll for 1 to identify start of reset, and (c) Poll for 0 to identify reset is complete. mmc_cmd finite state machine in both clock domain are also reset. These registers are cleared by the SD_SYSCTL[25] SRC bit: SD_PSTATECMDI. SD_STATCC Interconnect and MMC command status management is reinitialized. Note: If a soft reset is issued when an interrupt is asserted, data may be lost. 0h = Reset completed 1h = Software reset for mmc_cmd line
24	SRA	R/W	0h	Software reset for all. This bit is set to 1 for reset, and released to 0 when completed. This reset affects the entire host controller except for the card detection circuit and capabilities registers. 0h = Reset completed 1h = Software reset for all the design
23-20	RESERVED	R	0h	

Table 18-32. SD_SYSTL Register Field Descriptions (continued)

Bit	Field	Type	Reset	Description
19-16	DTO	R/W	0h	Data timeout counter value and busy timeout. This value determines the interval by which mmc_dat lines timeouts are detected. The host driver needs to set this bit field based on: The maximum read access time (NAC) (Refer to the SD Specification Part1 Physical Layer). The data read access time values (TAAC and NSAC) in the card specific data register (CSD) of the card. The timeout clock base frequency (SD_CAPA [5:0] TCF bits). If the card does not respond within the specified number of cycles, a data timeout error occurs (SD_STAT[20] DTO bit). The SD_SYSTL[19,16] DTO bit field is also used to check busy duration, to generate busy timeout for commands with busy response or for busy programming during a write command. Timeout on CRC status is generated if no CRC token is present after a block write. 0h = $TCF \times 2^{13}$ 1h = $TCF \times 2^{14}$ Eh = $TCF \times 2^{27}$ Fh = Reserved
15-6	CLKD	R/W	0h	Clock frequency select. These bits define the ratio between a reference clock frequency (system dependant) and the output clock frequency on the mmc_clk pin of either the memory card (MMC, SD, or SDIO). 0h = Clock Ref bypass 1h = Clock Ref bypass 2h = Clock Ref / 2 3h = Clock Ref / 3 3FFh = Clock Ref / 1023
5-3	RESERVED	R	0h	
2	CEN	R/W	0h	Clock enable. This bit controls if the clock is provided to the card or not. 0h = The clock is not provided to the card . Clock frequency can be changed . 1h = The clock is provided to the card and can be automatically gated when SD_SYSCONFIG[0] AUTOIDLE bit is set to 1 (default value). The host driver shall wait to set this bit to 1 until the Internal clock is stable (SD_SYSTL[1] ICS bit).
1	ICS	R	0h	Internal clock stable (status)This bit indicates either the internal clock is stable or not. 0h = The internal clock is not stable. 1h = The internal clock is stable after enabling the clock (SD_SYSTL[0] ICE bit) or after changing the clock ratio (SD_SYSTL[15:6] CLKD bits).
0	ICE	R/W	0h	Internal clock enable. This register controls the internal clock activity. In very low power state, the internal clock is stopped. NoteThe activity of the debounce clock (used for wake-up events) and the interface clock (used for reads and writes to the module register map) are not affected by this register. 0h = The internal clock is stopped (very low power state). 1h = The internal clock oscillates and can be automatically gated when SD_SYSCONFIG[0] AUTOIDLE bit is set to 1 (default value).

18.4.1.19 SD_STAT Register (offset = 230h) [reset = 0h]

SD_STAT is shown in [Figure 18-51](#) and described in [Table 18-33](#).

The interrupt status regroups all the status of the module internal events that can generate an interrupt. SD_STAT[31:16] = Error Interrupt Status. SD_STAT[15:0] = Normal Interrupt Status. The error bits are located in the upper 16 bits of the SD_STAT register. All bits are cleared by writing a 1 to them.

Additionally, bits 15 and 8 serve as special error bits. These cannot be cleared by writing a 1 to them. Bit 15 (ERRI) is automatically cleared when the error causing to ERRI to be set is handled. (that is, when bits 31:16 are cleared, bit 15 will be automatically cleared). Bit 8 (CIRQ) is cleared by writing a 0 to SD_IE[8] (masking the interrupt) and servicing the interrupt.

Figure 18-51. SD_STAT Register

31	30	29	28	27	26	25	24
RESERVED		BADA	CERR	RESERVED		ADMAE	ACE
R-0h		R/W-0h	R/W-0h	R-0h		R/W-0h	R/W-0h
23	22	21	20	19	18	17	16
RESERVED	DEB	DCRC	DTO	CIE	CEB	CCRC	CTO
R-0h	R/W-0h	R/W-0h	R/W-0h	R/W-0h	R/W-0h	R/W-0h	R/W-0h
15	14	13	12	11	10	9	8
ERRI	RESERVED				BSR	OBI	CIRQ
R-0h	R-0h				R/W-0h	R-0h	R-0h
7	6	5	4	3	2	1	0
CREM	CINS	BRR	BWR	DMA	BGE	TC	CC
R/W-0h	R/W-0h	R/W-0h	R/W-0h	R/W-0h	R/W-0h	R/W-0h	R/W-0h

LEGEND: R/W = Read/Write; R = Read only; W1toCl = Write 1 to clear bit; -n = value after reset

Table 18-33. SD_STAT Register Field Descriptions

Bit	Field	Type	Reset	Description
31-30	RESERVED	R	0h	
29	BADA	R/W	0h	Bad access to data space. This bit is set automatically to indicate a bad access to buffer when not allowed: During a read access to the data register (SD_DATA) while buffer reads are not allowed (SD_PSTATE[11] BRE bit=0). During a write access to the data register (SD_DATA) while buffer writes are not allowed (SD_PSTATE[10] BWE bit=0). 0h (W) = Status bit unchanged 0h (R) = No interrupt 1h (W) = Status is cleared. 1h (R) = Bad access
28	CERR	R/W	0h	Card error. This bit is set automatically when there is at least one error in a response of type R1, R1b, R6, R5 or R5b. Only bits referenced as type E (error) in status field in the response can set a card status error. An error bit in the response is flagged only if corresponding bit in card status response error SD_CSRE is set. There is no card error detection for autoCMD12 command. The host driver shall read SD_RSP76 register to detect error bits in the command response. 0h (W) = Status bit unchanged 0h (R) = No error 1h (W) = Status is cleared. 1h (R) = Card error
27-26	RESERVED	R	0h	

Table 18-33. SD_STAT Register Field Descriptions (continued)

Bit	Field	Type	Reset	Description
25	ADMAE	R/W	0h	ADMA Error. This bit is set when the Host Controller detects errors during ADMA based data transfer. The state of the ADMA at an error occurrence is saved in the ADMA Error Status Register. In addition, the Host Controller generates this interrupt when it detects invalid descriptor data (Valid=0) at the ST_FDS state. ADMA Error State in the ADMA Error Status indicates that an error occurs in ST_FDS state. The Host Driver may find that Valid bit is not set at the error descriptor. 0h (W) = Status bit unchanged 0h (R) = No interrupt 1h (W) = Status is cleared. 1h (R) = ADMA error
24	ACE	R/W	0h	Auto CMD12 error. This bit is set automatically when one of the bits in Auto CMD12 Error status register has changed from 0 to 1. 0h (W) = Status bit unchanged 0h (R) = No error 1h (W) = Status is cleared. 1h (R) = AutoCMD12 error
23	RESERVED	R	0h	
22	DEB	R/W	0h	Data End Bit error. This bit is set automatically when detecting a 0 at the end bit position of read data on mmc_dat line or at the end position of the CRC status in write mode. 0h (W) = Status bit unchanged 0h (R) = No error 1h (W) = Status is cleared. 1h (R) = Data end bit error
21	DCRC	R/W	0h	Data CRC Error. This bit is set automatically when there is a CRC16 error in the data phase response following a block read command or if there is a 3-bit CRC status different of a position "010" token during a block write command. 0h (W) = Status bit unchanged 0h (R) = No error 1h (W) = Status is cleared. 1h (R) = Data CRC error
20	DTO	R/W	0h	Data timeout error. This bit is set automatically according to the following conditions: Busy timeout for R1b, R5b response type. Busy timeout after write CRC status. Write CRC status timeout. Read data timeout. 0h (W) = Status bit unchanged 0h (R) = No error 1h (W) = Status is cleared. 1h (R) = Time out
19	CIE	R/W	0h	Command index error. This bit is set automatically when response index differs from corresponding command index previously emitted. It depends on the enable bit (SD_CMD[20] CICE). 0h (W) = Status bit unchanged 0h (R) = No error 1h (W) = Status is cleared. 1h (R) = Command index error

Table 18-33. SD_STAT Register Field Descriptions (continued)

Bit	Field	Type	Reset	Description
18	CEB	R/W	0h	Command end bit error. This bit is set automatically when detecting a 0 at the end bit position of a command response. 0h (W) = Status bit unchanged 0h (R) = No error 1h (W) = Status is cleared. 1h (R) = Command end bit error
17	CCRC	R/W	0h	Command CRC error. This bit is set automatically when there is a CRC7 error in the command response depending on the enable bit (SD_CMD[19] CCCE). 0h (W) = Status bit unchanged 0h (R) = No error 1h (W) = Status is cleared. 1h (R) = Command CRC error
16	CTO	R/W	0h	Command timeout error. This bit is set automatically when no response is received within 64 clock cycles from the end bit of the command. For commands that reply within 5 clock cycles - the timeout is still detected at 64 clock cycles. 0h (W) = Status bit unchanged 0h (R) = No error 1h (W) = Status is cleared. 1h (R) = Time Out
15	ERRI	R	0h	Error interrupt. If any of the bits in the Error Interrupt Status register (SD_STAT [31:16]) are set, then this bit is set to 1. Therefore the host driver can efficiently test for an error by checking this bit first. Writes to this bit are ignored. 0h (R) = No interrupt 1h (R) = Error interrupt event(s) occurred
14-11	RESERVED	R	0h	
10	BSR	R/W	0h	Boot Status Received Interrupt. This bit is set automatically when SD_CON[BOOT] is set 1 or 2 and a boot status is received on DAT[0] line. This interrupt is only useful for MMC card. 0h (W) = Status bit unchanged 0h (R) = No interrupt 1h (W) = Status is cleared. 1h (R) = Boot Status Received Interrupt occurred.
9	OBI	R	0h	Out-of-band interrupt (This interrupt is only useful for MMC card). This bit is set automatically when SD_CON[14] OBIE bit is set and an out-of-band interrupt occurs on OBI pin. The interrupt detection depends on polarity controlled by SD_CON[13] OBIP bit. The out-of-band interrupt signal is a system specific feature for future use, this signal is not required for existing specification implementation. 0h (W) = Status bit unchanged 0h (R) = No out-of-band interrupt 1h (W) = Status is cleared. 1h (R) = Interrupt out-of-band occurs

Table 18-33. SD_STAT Register Field Descriptions (continued)

Bit	Field	Type	Reset	Description
8	CIRQ	R	0h	Card interrupt. This bit is only used for SD and SDIO cards. In 1-bit mode, interrupt source is asynchronous (can be a source of asynchronous wake-up). In 4-bit mode, interrupt source is sampled during the interrupt cycle. In CE-ATA mode, interrupt source is detected when the card drives mmc_cmd line to zero during one cycle after data transmission end. All modes above are fully exclusive. The controller interrupt must be clear by setting SD_IE[8] CIRQ_ENABLE to 0, then the host driver must start the interrupt service with card (clearing card interrupt status) to remove card interrupt source. Otherwise the Controller interrupt will be reasserted as soon as SD_IE[8] CIRQ_ENABLE is set to 1. Writes to this bit are ignored. 0h (R) = No card interrupt 1h (R) = Generate card interrupt
7	CREM	R/W	0h	Card Removal. This bit is set automatically when SD_PSTATE[CINS] changes from 1 to 0. A clear of this bit doesn't affect Card inserted present state (SD_PSTATE[CINS]). 0h (W) = Status bit unchanged 0h (R) = Card State stable or debouncing 1h (W) = Status is cleared 1h (R) = Card Removed
6	CINS	R/W	0h	Card Insertion. This bit is set automatically when SD_PSTATE[CINS] changes from 0 to 1. A clear of this bit doesn't affect Card inserted present state (SD_PSTATE[CINS]). 0h (W) = Status bit unchanged 0h (R) = Card State stable or debouncing 1h (W) = Status is cleared. 1h (R) = Card inserted
5	BRR	R/W	0h	Buffer read ready. This bit is set automatically during a read operation to the card (see class 2 - block oriented read commands) when one block specified by the SD_BLK [10:0] BLEN bit field is completely written in the buffer. It indicates that the memory card has filled out the buffer and that the local host needs to empty the buffer by reading it. Note: If the DMA receive-mode is enabled, this bit is never set instead a DMA receive request to the main DMA controller of the system is generated. 0h (W) = Status bit unchanged 0h (R) = Not ready to read buffer 1h (W) = Status is cleared. 1h (R) = Ready to read buffer

Table 18-33. SD_STAT Register Field Descriptions (continued)

Bit	Field	Type	Reset	Description
4	BWR	R/W	0h	<p>Buffer write ready. This bit is set automatically during a write operation to the card (see class 4 - block oriented write command) when the host can write a complete block as specified by SD_BLK [10:0] BLEN. It indicates that the memory card has emptied one block from the buffer and that the local host is able to write one block of data into the buffer. Note: If the DMA transmit mode is enabled, this bit is never set instead, a DMA transmit request to the main DMA controller of the system is generated. 0h (W) = Status bit unchanged 0h (R) = Not ready to write buffer 1h (W) = Status is cleared. 1h (R) = Ready to write buffer</p>
3	DMA	R/W	0h	<p>DMA Interrupt. This status is set when an interrupt is required in the ADMA instruction and after the data transfer completion. 0h (W) = Status bit unchanged 0h (R) = DMA Interrupt detected 1h (W) = Status is cleared. 1h (R) = No DMA Interrupt</p>
2	BGE	R/W	0h	<p>Block gap event. When a stop at block gap is requested (SD_HCTL[16] SBGR bit), this bit is automatically set when transaction is stopped at the block gap during a read or write operation. 0h (W) = Status bit unchanged 0h (R) = No block gap event 1h (W) = Status is cleared 1h (R) = Transaction stopped at block gap</p>
1	TC	R/W	0h	<p>Transfer completed. This bit is always set when a read/write transfer is completed or between two blocks when the transfer is stopped due to a stop at block gap request (SD_HCTL[16] SBGR bit). 0h (W) = Status bit unchanged 0h (R) = No transfer complete 1h (W) = Status is cleared 1h (R) = Data transfer complete</p>
0	CC	R/W	0h	<p>Command complete. This bit is set when a 1-to-0 transition occurs in the register command inhibit (SD_PSTATE[0] CMDI bit) 0h (W) = Status bit unchanged 0h (R) = No command complete 1h (W) = Status is cleared 1h (R) = Command complete</p>

18.4.1.20 SD_IE Register (offset = 234h) [reset = 0h]

SD_IE is shown in [Figure 18-52](#) and described in [Table 18-34](#).

This register allows to enable/disable the module to set status bits, on an event-by-event basis.
SD_IE[31:16] = Error Interrupt Status Enable. SD_IE[15:0] = Normal Interrupt Status Enable.

Figure 18-52. SD_IE Register

31	30	29	28	27	26	25	24
RESERVED		BADA_ENABL E	CERR_ENABL E	RESERVED		ADMA_ENABL E	ACE_ENABLE
R-0h		R/W-0h	R/W-0h	R-0h		R/W-0h	R/W-0h
23	22	21	20	19	18	17	16
RESERVED	DEB_ENABLE	DCRC_ENABL E	DTO_ENABLE	CIE_ENABLE	CEB_ENABLE	CCRC_ENABL E	CTO_ENABLE
R-0h	R/W-0h	R/W-0h	R/W-0h	R/W-0h	R/W-0h	R/W-0h	R/W-0h
15	14	13	12	11	10	9	8
NULL	RESERVED				BSR_ENABLE	OBI_ENABLE	CIRQ_ENABLE
R-0h	R-0h				R/W-0h	R/W-0h	R/W-0h
7	6	5	4	3	2	1	0
CREM_ENABL E	CINS_ENABLE	BRR_ENABLE	BWR_ENABLE	DMA_ENABLE	BGE_ENABLE	TC_ENABLE	CC_ENABLE
R/W-0h	R/W-0h	R/W-0h	R/W-0h	R/W-0h	R/W-0h	R/W-0h	R/W-0h

LEGEND: R/W = Read/Write; R = Read only; W1toCl = Write 1 to clear bit; -n = value after reset

Table 18-34. SD_IE Register Field Descriptions

Bit	Field	Type	Reset	Description
31-30	RESERVED	R	0h	
29	BADA_ENABLE	R/W	0h	Bad access to data space interrupt enable 0h = Masked 1h = Enabled
28	CERR_ENABLE	R/W	0h	Card error interrupt enable 0h = Masked 1h = Enabled
27-26	RESERVED	R	0h	
25	ADMA_ENABLE	R/W	0h	ADMA error Interrupt Enable 0h = Masked 1h = Enabled
24	ACE_ENABLE	R/W	0h	Auto CMD12 error interrupt enable 0h = Masked 1h = Enabled
23	RESERVED	R	0h	
22	DEB_ENABLE	R/W	0h	Data end bit error interrupt enable 0h = Masked 1h = Enabled
21	DCRC_ENABLE	R/W	0h	Data CRC error interrupt enable 0h = Masked 1h = Enabled
20	DTO_ENABLE	R/W	0h	Data timeout error interrupt enable 0h = Masked 1h = Enabled
19	CIE_ENABLE	R/W	0h	Command index error interrupt enable 0h = Masked 1h = Enabled

Table 18-34. SD_IE Register Field Descriptions (continued)

Bit	Field	Type	Reset	Description
18	CEB_ENABLE	R/W	0h	Command end bit error interrupt enable 0h = Masked 1h = Enabled
17	CCRC_ENABLE	R/W	0h	Command CRC error interrupt enable 0h = Masked 1h = Enabled
16	CTO_ENABLE	R/W	0h	Command timeout error interrupt enable 0h = Masked 1h = Enabled
15	NULL	R	0h	Fixed to 0. The host driver shall control error interrupts using the Error Interrupt Signal Enable register. Writes to this bit are ignored.
14-11	RESERVED	R	0h	
10	BSR_ENABLE	R/W	0h	Boot Status Interrupt Enable A write to this register when SD_CON[BOOT] is cleared to 0 is ignored. 0h = Masked 1h = Enabled
9	OBI_ENABLE	R/W	0h	Out-of-band interrupt enable A write to this register when SD_CON[14] OBIE is cleared to 0 is ignored. 0h = Masked 1h = Enabled
8	CIRQ_ENABLE	R/W	0h	Card interrupt enable. A clear of this bit also clears the corresponding status bit. During 1-bit mode, if the interrupt routine does not remove the source of a card interrupt in the SDIO card, the status bit is reasserted when this bit is set to 1. This bit must be set to 1 when entering in smart idle mode to enable system to identity wake-up event and to allow controller to clear internal wake-up source. 0h = Masked 1h = Enabled
7	CREM_ENABLE	R/W	0h	Card Removal interrupt Enable This bit must be set to 1 when entering in smart idle mode to enable system to identity wake-up event and to allow controller to clear internal wake-up source. 0h = Masked 1h = Enabled
6	CINS_ENABLE	R/W	0h	Card Insertion interrupt Enable This bit must be set to 1 when entering in smart idle mode to enable system to identity wake-up event and to allow controller to clear internal wake-up source. 0h = Masked 1h = Enabled
5	BRR_ENABLE	R/W	0h	Buffer read ready interrupt enable 0h = Masked 1h = Enabled
4	BWR_ENABLE	R/W	0h	Buffer write ready interrupt enable 0h = Masked 1h = Enabled
3	DMA_ENABLE	R/W	0h	DMA interrupt enable 0h = Masked 1h = Enable
2	BGE_ENABLE	R/W	0h	Block gap event interrupt enable 0h = Masked 1h = Enabled

Table 18-34. SD_IE Register Field Descriptions (continued)

Bit	Field	Type	Reset	Description
1	TC_ENABLE	R/W	0h	Transfer completed interrupt enable 0h = Masked 1h = Enabled
0	CC_ENABLE	R/W	0h	Command completed interrupt enable 0h = Masked 1h = Enabled

18.4.1.21 SD_ISE Register (offset = 238h) [reset = 0h]

SD_ISE is shown in [Figure 18-53](#) and described in [Table 18-35](#).

This register allows you to enable/disable the module to set status bits, on an event-by-event basis. SD_ISE[31:16] = Error Interrupt Signal Enable. SD_ISE[15:0] = Normal Interrupt Signal Enable.

Figure 18-53. SD_ISE Register

31	30	29	28	27	26	25	24
RESERVED		BADA_SIGEN	CERR_SIGEN	RESERVED		ADMA_SIGEN	ACE_SIGEN
R-0h		R/W-0h	R/W-0h	R-0h		R/W-0h	R/W-0h
23	22	21	20	19	18	17	16
RESERVED	DEB_SIGEN	DCRC_SIGEN	DTO_SIGEN	CIE_SIGEN	CEB_SIGEN	CCRC_SIGEN	CTO_SIGEN
R-0h	R/W-0h	R/W-0h	R/W-0h	R/W-0h	R/W-0h	R/W-0h	R/W-0h
15	14	13	12	11	10	9	8
NULL	RESERVED				BSR_SIGEN	OBI_SIGEN	CIRQ_SIGEN
R-0h	R-0h				R/W-0h	R/W-0h	R/W-0h
7	6	5	4	3	2	1	0
CREM_SIGEN	CINS_SIGEN	BRR_SIGEN	BWR_SIGEN	DMA_SIGEN	BGE_SIGEN	TC_SIGEN	CC_SIGEN
R/W-0h	R/W-0h	R/W-0h	R/W-0h	R/W-0h	R/W-0h	R/W-0h	R/W-0h

LEGEND: R/W = Read/Write; R = Read only; W1toCl = Write 1 to clear bit; -n = value after reset

Table 18-35. SD_ISE Register Field Descriptions

Bit	Field	Type	Reset	Description
31-30	RESERVED	R	0h	
29	BADA_SIGEN	R/W	0h	Bad access to data space interrupt enable 0h = Masked 1h = Enabled
28	CERR_SIGEN	R/W	0h	Card error interrupt signal status enable 0h = Masked 1h = Enabled
27-26	RESERVED	R	0h	
25	ADMA_SIGEN	R/W	0h	ADMA error signal status enable 0h = Masked 1h = Enabled
24	ACE_SIGEN	R/W	0h	Auto CMD12 error signal status enable 0h = Masked 1h = Enabled
23	RESERVED	R	0h	
22	DEB_SIGEN	R/W	0h	Data end bit error signal status enable 0h = Masked 1h = Enabled
21	DCRC_SIGEN	R/W	0h	Data CRC error signal status enable 0h = Masked 1h = Enabled
20	DTO_SIGEN	R/W	0h	Data timeout error signal status enable 0h = Masked. The host controller provides the clock to the card until the card sends the data or the transfer is aborted. 1h = Enabled
19	CIE_SIGEN	R/W	0h	Command index error signal status enable 0h = Masked 1h = Enabled

Table 18-35. SD_ISE Register Field Descriptions (continued)

Bit	Field	Type	Reset	Description
18	CEB_SIGEN	R/W	0h	Command end bit error signal status enable 0h = Masked 1h = Enabled
17	CCRC_SIGEN	R/W	0h	Command CRC error signal status enable 0h = Masked 1h = Enabled
16	CTO_SIGEN	R/W	0h	Command timeout error signal status enable 0h = Masked 1h = Enabled
15	NULL	R	0h	Fixed to 0. The host driver shall control error interrupts using the error interrupt signal enable register. Writes to this bit are ignored.
14-11	RESERVED	R	0h	
10	BSR_SIGEN	R/W	0h	Boot Status signal status enable. A write to this register when SD_CON[BOOT] is cleared to 0 is ignored 0h = Masked 1h = Enabled
9	OBI_SIGEN	R/W	0h	Out-of-band interrupt signal status enable. A write to this register when SD_CON[14] OBIE is cleared to 0 is ignored. 0h = Masked 1h = Enabled
8	CIRQ_SIGEN	R/W	0h	Card interrupt signal status enable. A clear of this bit also clears the corresponding status bit. During 1-bit mode, if the interrupt routine does not remove the source of a card interrupt in the SDIO card, the status bit is reasserted when this bit is set to 1. This bit must be set to 1 when entering in smart idle mode to enable system to identify wake-up event and to allow controller to clear internal wake-up source. 0h = Masked 1h = Enabled
7	CREM_SIGEN	R/W	0h	Card Removal signal status enable This bit must be set to 1 when entering in smart idle mode to enable system to identify wake-up event and to allow controller to clear internal wake-up source. 0h = Masked 1h = Enabled
6	CINS_SIGEN	R/W	0h	Card Insertion signal status enable. This bit must be set to 1 when entering in smart idle mode to enable system to identify wake-up event and to allow controller to clear internal wake-up source. 0h = Masked 1h = Enabled
5	BRR_SIGEN	R/W	0h	Buffer read ready signal status enable 0h = Masked 1h = Enabled
4	BWR_SIGEN	R/W	0h	Buffer write ready signal status enable 0h = Masked 1h = Enabled
3	DMA_SIGEN	R/W	0h	DMA signal status enable 0h = Masked 1h = Enabled

Table 18-35. SD_ISE Register Field Descriptions (continued)

Bit	Field	Type	Reset	Description
2	BGE_SIGEN	R/W	0h	Block gap event signal status enable 0h = Masked 1h = Enabled
1	TC_SIGEN	R/W	0h	Transfer completed signal status enable 0h = Masked 1h = Enabled
0	CC_SIGEN	R/W	0h	Command completed signal status enable 0h = Masked 1h = Enabled

18.4.1.22 SD_AC12 Register (offset = 23Ch) [reset = 0h]

SD_AC12 is shown in [Figure 18-54](#) and described in [Table 18-36](#).

The host driver may determine which of the errors cases related to Auto CMD12 has occurred by checking this SD_AC12 register when an auto CMD12 error interrupt occurs. This register is valid only when auto CMD12 is enabled (SD_CMD[2] ACEN bit) and auto CMD12Error (SD_STAT[24] ACE bit) is set to 1. These bits are automatically reset when starting a new adtc command with data.

Figure 18-54. SD_AC12 Register

31	30	29	28	27	26	25	24
RESERVED							
R-0h							
23	22	21	20	19	18	17	16
RESERVED							
R-0h							
15	14	13	12	11	10	9	8
RESERVED							
R-0h							
7	6	5	4	3	2	1	0
CNI	RESERVED		ACIE	ACEB	ACCE	ACTO	ACNE
R-0h	R-0h		R-0h	R-0h	R-0h	R-0h	R-0h

LEGEND: R/W = Read/Write; R = Read only; W1toCl = Write 1 to clear bit; -n = value after reset

Table 18-36. SD_AC12 Register Field Descriptions

Bit	Field	Type	Reset	Description
31-8	RESERVED	R	0h	
7	CNI	R	0h	Command not issue by auto CMD12 error. If this bit is set to 1, it means that pending command is not executed due to auto CMD12 error ACEB, ACCE, ACTO, or ACNE. 0h = Not error 1h = Command not issued
6-5	RESERVED	R	0h	
4	ACIE	R	0h	Auto CMD12 index error. This bit is a set to 1 when response index differs from corresponding command auto CMD12 index previously emitted. This bit depends on the command index check enable (SD_CMD[20] CICE bit). 0h = No error 1h = Auto CMD12 index error
3	ACEB	R	0h	Auto CMD12 end bit error. This bit is set to 1 when detecting a 0 at the end bit position of auto CMD12 command response. 0h = No error 1h = AutoCMD12 end bit error
2	ACCE	R	0h	Auto CMD12 CRC error. This bit is automatically set to 1 when a CRC7 error is detected in the auto CMD12 command response depending on the enable in the SD_CMD[19] CCCE bit. 0h = No error 1h = Auto CMD12 CRC error
1	ACTO	R	0h	Auto CMD12 timeout error. This bit is set to 1 if no response is received within 64 clock cycles from the end bit of the auto CMD12 command. 0h = No error 1h = Auto CMD12 time out

Table 18-36. SD_AC12 Register Field Descriptions (continued)

Bit	Field	Type	Reset	Description
0	ACNE	R	0h	Auto CMD12 not executed. This bit is set to 1 if multiple block data transfer command has started and if an error occurs in command before auto CMD12 starts. 0h = Auto CMD12 executed 1h = Auto CMD12 not executed

18.4.1.23 SD_CAPA Register (offset = 240h) [reset = 0h]

SD_CAPA is shown in [Figure 18-55](#) and described in [Table 18-37](#).

This register lists the capabilities of the MMC/SD/SDIO host controller.

Figure 18-55. SD_CAPA Register

31	30	29	28	27	26	25	24
RESERVED			BUS_64BIT	RESERVED	VS18	VS30	VS33
R-0h			R/W-0h	R-0h	R/W-0h	R/W-0h	R/W-0h
23	22	21	20	19	18	17	16
SRS	DS	HSS	RESERVED	AD2S	RESERVED	MBL	
R-0h	R-0h	R-0h	R-0h	R-0h	R-0h	R-0h	
15	14	13	12	11	10	9	8
RESERVED				BCF			
R-0h				R-0h			
7	6	5	4	3	2	1	0
TCU	RESERVED	TCF					
R-0h	R-0h	R-0h					

LEGEND: R/W = Read/Write; R = Read only; W1toCl = Write 1 to clear bit; -n = value after reset

Table 18-37. SD_CAPA Register Field Descriptions

Bit	Field	Type	Reset	Description
31-29	RESERVED	R	0h	
28	BUS_64BIT	R/W	0h	64 Bit System Bus Support. Setting 1 to this bit indicates that the Host Controller supports 64-bit address descriptor mode and is connected to 64-bit address system bus. 0h (R) = 32-bit System bus address 1h (R) = 64-bit System bus address
27	RESERVED	R	0h	
26	VS18	R/W	0h	Voltage support 1.8 V. Initialization of this register (via a write access to this register) depends on the system capabilities. The host driver shall not modify this register after the initialization. This register is only reinitialized by a hard reset (via mmc_RESET signal). 0h (W) = 1.8 V not supported 0h (R) = 1.8 V not supported 1h (W) = 1.8 V supported 1h (R) = 1.8 V supported
25	VS30	R/W	0h	Voltage support 3.0V. Initialization of this register (via a write access to this register) depends on the system capabilities. The host driver shall not modify this register after the initialization. This register is only reinitialized by a hard reset (via mmc_RESET signal). 0h (W) = 3.0 V not supported 0h (R) = 3.0 V not supported 1h (W) = 3.0 V supported 1h (R) = 3.0 V supported

Table 18-37. SD_CAPA Register Field Descriptions (continued)

Bit	Field	Type	Reset	Description
24	VS33	R/W	0h	Voltage support 3.3V. Initialization of this register (via a write access to this register) depends on the system capabilities. The host driver shall not modify this register after the initialization. This register is only reinitialized by a hard reset (via mmc_RESET signal). 0h (W) = 3.3 V not supported 0h (R) = 3.3 V not supported 1h (W) = 3.3 V supported 1h (R) = 3.3 V supported
23	SRS	R	0h	Suspend/resume support (SDIO cards only). This bit indicates whether the host controller supports Suspend/Resume functionality. 0h = The Host controller does not suspend/resume functionality. 1h = The Host controller supports suspend/resume functionality.
22	DS	R	0h	DMA support. This bit indicates that the Host controller is able to use DMA to transfer data between system memory and the Host controller directly. 0h = DMA not supported 1h = DMA supported
21	HSS	R	0h	High-speed support. This bit indicates that the host controller supports high speed operations and can supply an up-to-52 MHz clock to the card. 0h = DMA not supported 1h = DMA supported
20	RESERVED	R	0h	
19	AD2S	R	0h	This bit indicates whether the Host Controller is capable of using ADMA2. It depends on setting of generic parameter MADMA_EN. 0h = ADMA2 supported 1h = ADMA2 not supported
18	RESERVED	R	0h	
17-16	MBL	R	0h	Maximum block length. This value indicates the maximum block size that the host driver can read and write to the buffer in the host controller. The host controller supports 512 bytes and 1024 bytes block transfers. 0h = 512 bytes 1h = 1024 bytes 2h = 2048 bytes
15-14	RESERVED	R	0h	
13-8	BCF	R	0h	Base clock frequency for clock provided to the card. ARRAY(0x1bfe1b0)
7	TCU	R	0h	Timeout clock unit. This bit shows the unit of base clock frequency used to detect Data Timeout Error (SD_STAT[20] DTO bit). 0h = kHz 1h = MHz
6	RESERVED	R	0h	
5-0	TCF	R	0h	Timeout clock frequency. The timeout clock frequency is used to detect Data Timeout Error (SD_STAT[20] DTO bit). 0h = The timeout clock frequency depends on the frequency of the clock provided to the card. The value of the timeout clock frequency is not available in this register.

18.4.1.24 SD_CUR_CAPA Register (offset = 248h) [reset = 0h]

SD_CUR_CAPA is shown in [Figure 18-56](#) and described in [Table 18-38](#).

This register indicates the maximum current capability for each voltage. The value is meaningful if the voltage support is set in the capabilities register (SD_CAPA). Initialization of this register (via a write access to this register) depends on the system capabilities. The host driver shall not modify this register after the initialization. This register is only reinitialized by a hard reset (via mmc_RESET signal).

Figure 18-56. SD_CUR_CAPA Register

31	30	29	28	27	26	25	24	23	22	21	20	19	18	17	16	15	14	13	12	11	10	9	8	7	6	5	4	3	2	1	0
RESERVED								CUR_1V8				CUR_3V0				CUR_3V3															
R-0h								R/W-0h				R/W-0h				R/W-0h															

LEGEND: R/W = Read/Write; R = Read only; W1toCl = Write 1 to clear bit; -n = value after reset

Table 18-38. SD_CUR_CAPA Register Field Descriptions

Bit	Field	Type	Reset	Description
31-24	RESERVED	R	0h	
23-16	CUR_1V8	R/W	0h	Maximum current for 1.8 V 0h (R) = The maximum current capability for this voltage is not available. Feature not implemented.
15-8	CUR_3V0	R/W	0h	Maximum current for 3.0 V 0h (R) = The maximum current capability for this voltage is not available. Feature not implemented.
7-0	CUR_3V3	R/W	0h	Maximum current for 3.3 V 0h (R) = The maximum current capability for this voltage is not available. Feature not implemented.

18.4.1.25 SD_FE Register (offset = 250h) [reset = 0h]

SD_FE is shown in [Figure 18-57](#) and described in [Table 18-39](#).

The Force Event register is not a physically implemented register. Rather, it is an address at which the Error Interrupt Status register can be written. The effect of a write to this address will be reflected in the Error Interrupt Status Register, if corresponding bit of the Error Interrupt Status Enable Register is set.

Figure 18-57. SD_FE Register

31	30	29	28	27	26	25	24
RESERVED		FE_BADA	FE_CERR	RESERVED		FE_ADMAE	FE_ACE
R-0h		W-0h	W-0h	R-0h		W-0h	W-0h
23	22	21	20	19	18	17	16
RESERVED	FE_DEB	FE_DCRC	FE_DTO	FE_CIE	FE_CEB	FE_CCRC	FE_CTO
R-0h	W-0h	W-0h	W-0h	W-0h	W-0h	W-0h	W-0h
15	14	13	12	11	10	9	8
RESERVED							
R-0h							
7	6	5	4	3	2	1	0
FE_CNI	RESERVED		FE_ACIE	FE_ACEB	FE_ACCE	FE_ACTO	FE_ACNE
W-0h	R-0h		W-0h	W-0h	W-0h	W-0h	W-0h

LEGEND: R/W = Read/Write; R = Read only; W1toCl = Write 1 to clear bit; -n = value after reset

Table 18-39. SD_FE Register Field Descriptions

Bit	Field	Type	Reset	Description
31-30	RESERVED	R	0h	
29	FE_BADA	W	0h	Force Event Bad access to data space. 0h = No effect; no interrupt 1h = Interrupt forced.
28	FE_CERR	W	0h	Force Event Card error 0h = No effect; no interrupt 1h = Interrupt forced.
27-26	RESERVED	R	0h	
25	FE_ADMAE	W	0h	Force Event ADMA error 0h = No effect; no interrupt 1h = Interrupt forced.
24	FE_ACE	W	0h	Force Event Auto CMD12 error. 0h = No effect; no interrupt 1h = Interrupt forced.
23	RESERVED	R	0h	
22	FE_DEB	W	0h	Force Event Data End Bit error. 0h = No effect; no interrupt 1h = Interrupt forced.
21	FE_DCRC	W	0h	Force Event Data CRC error 0h = No effect; no interrupt 1h = Interrupt forced.
20	FE_DTO	W	0h	Force Event Data timeout error 0h = No effect; no interrupt 1h = Interrupt forced.
19	FE_CIE	W	0h	Force Event Command index error 0h = No effect; no interrupt 1h = Interrupt forced.

Table 18-39. SD_FE Register Field Descriptions (continued)

Bit	Field	Type	Reset	Description
18	FE_CEB	W	0h	Force Event Command end bit error 0h = No effect; no interrupt 1h = Interrupt forced.
17	FE_CCRC	W	0h	Force Event Comemand CRC error 0h = No effect; no interrupt 1h = Interrupt forced.
16	FE_CTO	W	0h	Force Event Command Timeout error 0h = No effect; no interrupt 1h = Interrupt forced.
15-8	RESERVED	R	0h	
7	FE_CNI	W	0h	Force Event Command not issue by Auto CMD12 error 0h = No effect; no interrupt 1h = Interrupt forced.
6-5	RESERVED	R	0h	
4	FE_ACIE	W	0h	Force Event Auto CMD12 index error 0h = No effect; no interrupt 1h = Interrupt forced.
3	FE_ACEB	W	0h	Force Event Auto CMD12 end bit error 0h = No effect; no interrupt 1h = Interrupt forced.
2	FE_ACCE	W	0h	Force Event Auto CMD12 CRC error 0h = No effect; no interrupt 1h = Interrupt forced.
1	FE_ACTO	W	0h	Force Event Auto CMD12 timeout error 0h = No effect; no interrupt 1h = Interrupt forced.
0	FE_ACNE	W	0h	Force Event Auto CMD12 not executed. 0h = No effect; no interrupt. 1h = Interrupt forced.

18.4.1.26 SD_ADMAES Register (offset = 254h) [reset = 0h]

SD_ADMAES is shown in [Figure 18-58](#) and described in [Table 18-40](#).

When an ADMA Error Interrupt has occurred, the ADMA Error States field in this register holds the ADMA state and the ADMA System Address Register holds the address around the error descriptor. For recovering the error, the Host Driver requires the ADMA state to identify the error descriptor address as follows: ST_STOP: Previous location set in the ADMA System Address register is the error descriptor address. ST_FDS: Current location set in the ADMA System Address register is the error descriptor address. ST_CADR: This state is never set because do not generate ADMA error in this state. ST_TFR: Previous location set in the ADMA System Address register is the error descriptor address. In the case of a write operation, the Host Driver should use ACMD22 to get the number of written block rather than using this information, since unwritten data may exist in the Host Controller. The Host Controller generates the ADMA Error Interrupt when it detects invalid descriptor data (Valid = 0) at the ST_FDS state. In this case, ADMA Error State indicates that an error occurs at ST_FDS state. The Host Driver may find that the Valid bit is not set in the error descriptor.

Figure 18-58. SD_ADMAES Register

31	30	29	28	27	26	25	24	23	22	21	20	19	18	17	16
RESERVED															
R-0h															
15	14	13	12	11	10	9	8	7	6	5	4	3	2	1	0
RESERVED													LME	AES	
R-0h													W-0h	R/W-0h	

LEGEND: R/W = Read/Write; R = Read only; W1toCl = Write 1 to clear bit; -n = value after reset

Table 18-40. SD_ADMAES Register Field Descriptions

Bit	Field	Type	Reset	Description
31-3	RESERVED	R	0h	
2	LME	W	0h	ADMA Length Mismatch Error: While Block Count Enable is being set, the total data length specified by the Descriptor table is different from that specified by the Block Count and Block Length. Total data length cannot be divided by the block length. 0h = No error 1h = Error
1-0	AES	R/W	0h	ADMA Error State. This field indicates the state of ADMA when an error occurred during an ADMA data transfer. This field never indicates "10" because ADMA never stops in this state. 0h (R) = ST_STOP (Stop DMA). Contents of the SYS_SDR register 1h (W) = ST_STOP (Stop DMA). Points to the error descriptor. 2h (R) = Never set this state. (Not used) 3h (W) = ST_TFR (Transfer Data). Points to the 'next' of the error descriptor.

18.4.1.27 SD_ADMA_SAL Register (offset = 258h) [reset = 0h]

SD_ADMA_SAL is shown in [Figure 18-59](#) and described in [Table 18-41](#).

This register holds the byte address of the executing command of the Descriptor table. The 32-bit Address Descriptor uses the lower 32 bits of this register. At the start of ADMA, the Host Driver shall set the start address of the Descriptor table.

Figure 18-59. SD_ADMA_SAL Register

31	30	29	28	27	26	25	24	23	22	21	20	19	18	17	16	15	14	13	12	11	10	9	8	7	6	5	4	3	2	1	0
ADMA_A32B																															
R/W-0h																															

LEGEND: R/W = Read/Write; R = Read only; W1toCl = Write 1 to clear bit; -n = value after reset

Table 18-41. SD_ADMA_SAL Register Field Descriptions

Bit	Field	Type	Reset	Description
31-0	ADMA_A32B	R/W	0h	The ADMA increments this register address, which points to the next line, whenever fetching a Descriptor line. When the ADMA Error Interrupt is generated, this register holds the valid Descriptor address depending on the ADMA state. The Host Driver shall program the Descriptor Table on a 32-bit boundary and set the 32-bit boundary address to this register. ADMA2 ignores the lower 2 bits of this register and assumes it to be 00b.

18.4.1.28 SD_ADMA_SAH Register (offset = 25Ch) [reset = 0h]

SD_ADMA_SAH is shown in [Figure 18-60](#) and described in [Table 18-42](#).

Figure 18-60. SD_ADMA_SAH Register

31	30	29	28	27	26	25	24	23	22	21	20	19	18	17	16	15	14	13	12	11	10	9	8	7	6	5	4	3	2	1	0
ADMA_A32B																															
R/W-0h																															

LEGEND: R/W = Read/Write; R = Read only; W1toCl = Write 1 to clear bit; -n = value after reset

Table 18-42. SD_ADMA_SAH Register Field Descriptions

Bit	Field	Type	Reset	Description
31-0	ADMA_A32B	R/W	0h	ADMA_A32B.

18.4.1.29 SD_REV Register (offset = 2FCh) [reset = 31010000h]

SD_REV is shown in [Figure 18-61](#) and described in [Table 18-43](#).

This register contains the hard coded RTL vendor revision number, the version number of SD specification compliancy and a slot status bit. SD_REV[31:16] = Host Controller Version. SD_REV[15:0] = Slot Interrupt Status.

Figure 18-61. SD_REV Register

31	30	29	28	27	26	25	24	23	22	21	20	19	18	17	16
VREV								SREV							
R-31h								R-1h							
15	14	13	12	11	10	9	8	7	6	5	4	3	2	1	0
RESERVED															SIS
R-0h															R-0h

LEGEND: R/W = Read/Write; R = Read only; W1toCl = Write 1 to clear bit; -n = value after reset

Table 18-43. SD_REV Register Field Descriptions

Bit	Field	Type	Reset	Description
31-24	VREV	R	31h	Vendor Version Number. Bits 7 to 4 are the major revision, bits 3 to 0 are the minor revision. Examples: 10h for 1.0 and 21h for 2.1. Reset value is 31h.
23-16	SREV	R	1h	Specification Version Number. This status indicates the Standard SD Host Controller Specification Version. The upper and lower 4 bits indicate the version. Reset value is 01h. 0h = SD Host Specification Version 1.0
15-1	RESERVED	R	0h	
0	SIS	R	0h	Slot Interrupt Status. This status bit indicates the inverted state of interrupt signal for the module. By a power on reset or by setting a software reset for all (SD_SYSCTL[24] SRA), the interrupt signal shall be deasserted and this status shall read 0.

Universal Asynchronous Receiver/Transmitter (UART)

This chapter describes the UART of the device.

Topic	Page
19.1 Introduction	4208
19.2 Integration	4210
19.3 Functional Description	4214
19.4 UART/IrDA/CIR Basic Programming Model.....	4257
19.5 UART Registers	4266

19.1 Introduction

19.1.1 UART Mode Features

The general features of the UART/IrDA module when operating in UART mode are:

- 16C750 compatibility
- Baud rate from 300 bps up to 3.6864 Mbps
- Auto-baud between 1200 bps and 115.2 Kbps
- Software/Hardware flow control
 - Programmable Xon/Xoff characters
 - Programmable Auto-RTS and Auto CTS
- Programmable serial interface characteristics
 - 5, 6, 7, or 8-bit characters
 - Even, odd, mark (always 1), space (always 0), or no parity (non-parity bit frame) bit generation and detection
 - 1, 1.5, or 2 stop bit generation
- False start bit detection
- Line break generation and detection
- Modem control functions (CTS, RTS, DSR, DTR, RI, and DCD)
- Fully prioritized interrupt system controls
- Internal test and loopback capabilities

19.1.2 IrDA Mode Features

The general features of the UART/IrDA when operating in IrDA mode are:

- Support of IrDA 1.4 slow infrared (SIR), medium infrared (MIR) and fast infrared (FIR) communications (very fast infrared (VFIR) is not supported)
- Frame formatting: addition of variable xBOF characters and EOF characters
- Uplink/downlink CRC generation/detection
- Asynchronous transparency (automatic insertion of break character)
- 8-entry status FIFO (with selectable trigger levels) available to monitor frame length and frame errors
- Framing error, cyclic redundancy check (CRC) error, illegal symbol (FIR), abort pattern (SIR, MIR) detection

19.1.3 CIR Mode Features

The general features of the UART/IrDA when operating in CIR mode are:

- Support of consumer infrared (CIR) for remote control applications
- Transmit and receive
- Free data format (supports any remote control private standards)
- Selectable bit rate
- Configurable carrier frequency
- 1/2, 5/12, 1/3 or 1/4 carrier duty cycle

19.1.4 Unsupported UART Features

The following UART/IrDA module features are not supported in this device.

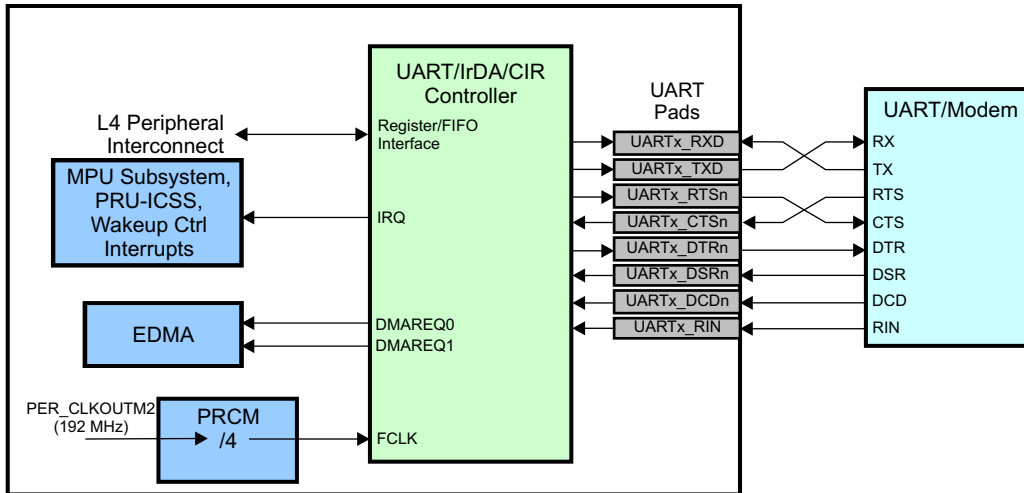
Table 19-1. Unsupported UART Features

Feature	Reason
Full modem control on UART0	DCD, DSR, DTR, RI not pinned-out
Full modem control on UART2-5	DCD, DSR, DTR, RI not pinned-out
Device wake-up on UART1-5	Wake-up not supported - no SWake connection

19.2 Integration

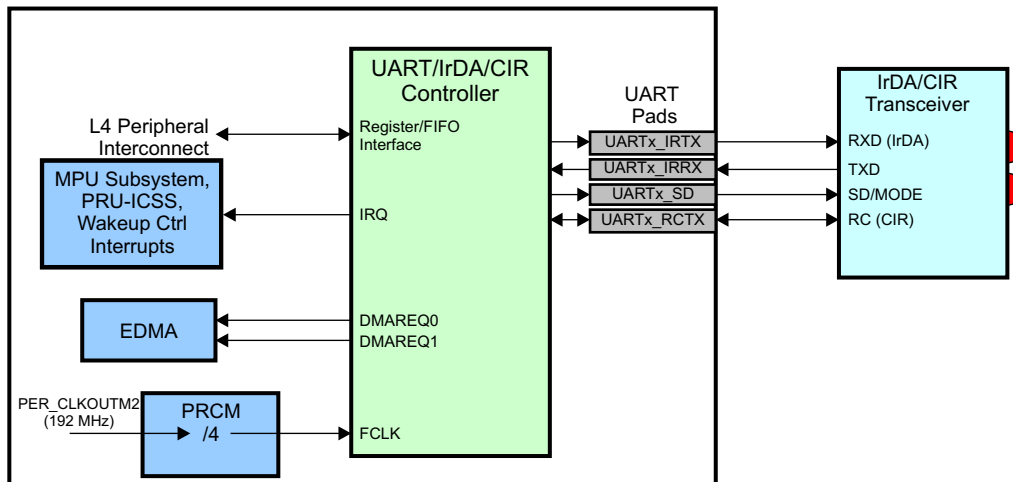
This device contains 6 instantiations of the UART/IrDA (UARTIRDAOCP) peripheral. There are six UART modules called UART0 – UART5. UART0 provides wakeup capability. Only UART 1 provides full modem control signals. All UARTs support IrDA and CIR modes and RTS/CTS flow control (subject to pin muxing configuration). [Figure 19-1](#) shows an example of system connectivity using UART communication with hardware handshake.

Figure 19-1. UART/IrDA Module — UART Application



[Figure 19-2](#) shows an example of system connectivity using infrared communication with remote control (consumer infrared).

Figure 19-2. UART/IrDA Module — IrDA/CIR Application



19.2.1 UART Connectivity Attributes

The general connectivity attributes for each of the UART modules are shown in [Table 19-2](#) and [Table 19-3](#).

Table 19-2. UART0 Connectivity Attributes

Attributes	Type
Power Domain	Wake-Up Domain
Clock Domain	PD_WKUP_L4_WKUP_GCLK (OCP) PD_WKUP_UART0_GFCLK (Func)

Table 19-2. UART0 Connectivity Attributes (continued)

Attributes	Type
Reset Signals	WKUP_DOM_RST_N
Idle/Wakeup Signals	Smart Idle / Wakeup
Interrupt Requests	1 interrupt to MPU Subsystem (UART0INT), PRU-ICSS (nirq) and WakeM3
DMA Requests	2 DMA requests to EDMA (TX – UTXEVT0, RX – URXEVT0)
Physical Address	L4 Wakeup slave port

Table 19-3. UART1–5 Connectivity Attributes

Attributes	Type
Power Domain	Peripheral Domain
Clock Domain	PD_PER_L4LS_GCLK (OCP) PD_PER_UART_GFCLK (Func)
Reset Signals	PER_DOM_RST_N
Idle/Wakeup Signals	Smart Idle
Interrupt Requests	UART1-2 1 interrupt per instance to MPU Subsystem (UART1INT, UART2INT) and PRU-ICSS (nirq) UART3-5 1 interrupt per instance to only MPU Subsystem (UART3INT, UART4INT, UART5INT)
DMA Requests	2 DMA requests per instance to EDMA (TX – UTXEVTx, RX – URXEVTx)
Physical Address	L4 Peripheral slave port

19.2.2 UART Clock and Reset Management

The UART modules use separate functional and bus interface clocks.

Table 19-4. UART0 Clock Signals

Clock Signal	Max Freq	Reference / Source	Comments
CLK Interface clock From PRCM	100 MHz	CORE_CLKOUTM4 / 2	pd_wkup_l4_wkup_gclk
FCLK Functional clock From PRCM	48 MHz	PER_CLKOUTM2 / 4	pd_wkup_uart0_gfclk

Table 19-5. UART1–5 Clock Signals

Clock Signal	Max Freq	Reference / Source	Comments
CLK Interface clock	100 MHz	CORE_CLKOUTM4 / 2	pd_per_l4ls_gclk From PRCM
FCLK Functional clock	48 MHz	PER_CLKOUTM2 / 4	pd_per_uart_gfclk From PRCM

For UART operation, the functional clock is used to produce a baud rate up to 3.6M bits/s. [Table 19-6](#) lists the supported baud rates, the requested divider, and the corresponding error versus the standard baud rate.

Table 19-6. UART Mode Baud and Error Rates

Baud rate	Over sampling	Divisor	Error (%)
300	16	10000	0
600	16	5000	0
1200	16	2500	0
2400	16	1250	0
4800	16	625	0
9600	16	313	0.16
14400	16	208	0.16
19200	16	156	0.16
28800	16	104	0.16
38400	16	78	0.16
57600	16	52	0.16
115200	16	26	0.16
230400	16	13	0.16
460800	13	8	0.16
921600	13	4	0.16
1843200	13	2	0.16
3000000	16	1	0
3686400	13	1	0.16

For IrDA operation, the internal functional clock divisor allows generation of SIR, MIR, or FIR baud rates as shown in [Table 19-7](#).

Table 19-7. IrDA Mode Baud and Error Rates

Baud rate	IR mode	Encoding	Divisor	Error (%)
2400	SIR	3/16	1250	0
9600	SIR	3/16	312	0.16
19200	SIR	3/16	156	0.16
38400	SIR	3/16	78	0.16
57600	SIR	3/16	52	0.16
115200	SIR	3/16	26	0.16
576000	MIR	1/4	2	0
1152000	MIR	1/4	1	0
4000000	FIR	4PPM	1	0

19.2.3 UART Pin List

The UART interface pins are listed in [Table 19-8](#). Pin functionality depends on the selected operating mode of the module.

Table 19-8. UART Pin List

Pin	Type	Description
UARTx_RXD / IRRX / RCRX	I	UART / IrDA / CIR Receive Data
UARTx_TXD / IRTX / RCTX	OZ	UART / IrDA / CIR Transmit Data
UARTx_RTSn / SD	OZ	UART Request to Send / IrDA Mode
UARTx_CTSn	I	UART Clear to Send
UARTx_DTRn ⁽¹⁾	OZ	UART Data Terminal Ready
UARTx_DSRn ⁽¹⁾	I	UART Data Set Ready
UARTx_DCDn ⁽¹⁾	I	UART Data Carrier Detect
UARTx_RIn ⁽¹⁾	I	UART Ring Indicator

⁽¹⁾ UART1 only

The UART module can operate in three different modes based on the MODE_SELECT bits. The signal muxing based on these mode bits is shown in [Table 19-9](#).

Table 19-9. UART Muxing Control

UARTx_TXD / IRTX / RCTX Function	UARTx_RXD / IRRX / RCRX Function	UARTx_RTSn / SD Function	UARTx_CTSn Function	Mode
TXD	RXD	RTSn	CTSn	UART
IRTX	IRRX	SD	not used	IrDA (SIR, MIR, FIR)
RCTX	RCRX	SD	not used	CIR

19.3 Functional Description

19.3.1 Block Diagram

The UART/IrDA/CIR module can be divided into three main blocks:

- FIFO management
- Mode selection
- Protocol formatting

FIFO management is common to all functions and enables the transmission and reception of data from the host processor point of view.

There are two modes:

- Function mode: Routes the data to the chosen function (UART, IrDA, or CIR) and enables the mechanism corresponding to the chosen function
- Register mode: Enables conditional access to registers

For more information about mode configuration, see [Section 19.3.7, Mode Selection](#).

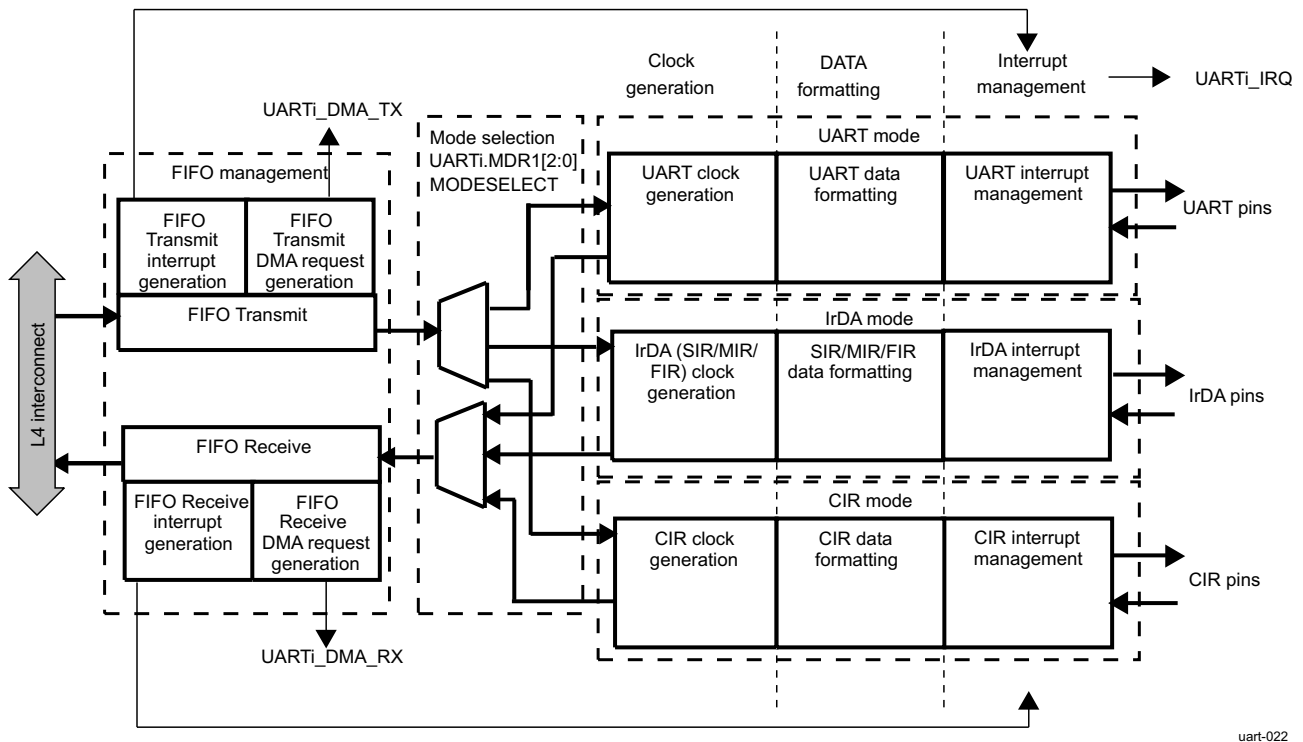
Protocol formatting has three subcategories:

- Clock generation: The 48-MHz input clock generates all necessary clocks.
- Data formatting: Each function uses its own state-machine that is responsible for the transition between FIFO data and frame data associated with it.
- Interrupt management: Different interrupt types are generated depending on the chosen function:
 - UART mode interrupts: Seven interrupts prioritized in six different levels
 - IrDA mode interrupts: Eight interrupts. The interrupt line is activated when any interrupt is generated (there is no priority).
 - CIR mode interrupts: A subset of existing IrDA mode interrupts is used.
 In each mode, when an interrupt is generated, the UART_IIR register indicates the interrupt type.

In parallel with these functional blocks, a power-saving strategy exists for each function.

[Figure 19-3](#) is the UART/IrDA/CIR block diagram.

Figure 19-3. UART/IrDA/CIR Functional Specification Block Diagram



uart-022

19.3.2 Clock Configuration

Each UART uses a 48-MHz functional clock for its logic and to generate external interface signals. Each UART uses an interface clock for register accesses. The PRCM module generates and controls all these clocks (for more information, see *Clock Domain Module Attributes*, in [Chapter 8, Power, Reset, and Clock Management](#)).

The idle and wake-up processes use a handshake protocol between the PRCM and the UART (for a description of the protocol, see *Module-Level Clock Management* in [Chapter 8, Power, Reset, and Clock Management](#)). The UARTi.UART_SYSC[4:3] IDLEMODE bit field controls UART idle mode.

19.3.3 Software Reset

The UARTi.UART_SYSC[1] SOFTRESET bit controls the software reset; setting this bit to 1 triggers a software reset functionally equivalent to hardware reset.

19.3.4 Power Management

19.3.4.1 UART Mode Power Management

19.3.4.1.1 Module Power Saving

In UART modes, sleep mode is enabled by setting the UARTi.UART_IER[4] SLEEP_MODE bit to 1 (when the UARTi.UART_EFR[4] ENHANCED_EN bit is set to 1).

Sleep mode is entered when all the following conditions exist:

- The serial data input line, uarti_rx, is idle.
- The TX FIFO and TX shift register are empty.
- The RX FIFO is empty.
- The only pending interrupts are THR interrupts.

Sleep mode is a good way to lower UART power consumption, but this state can be achieved only when the UART is set to modem mode. Therefore, even if the UART has no key role functionally, it must be initialized in a functional mode to take advantage of sleep mode.

In sleep mode, the module clock and baud rate clock are stopped internally. Because most registers are clocked by these clocks, this greatly reduces power consumption. The module wakes up when a change is detected on the `uarti_rx` line, when data is written to the TX FIFO, and when there is a change in the state of the modem input pins.

An interrupt can be generated on a wake-up event by setting the `UARTi.UART_SCR[4] RX_CTS_WU_EN` bit to 1. To understand how to manage the interrupt, see [Section 19.3.5.2, Wake-Up Interrupt](#).

NOTE: There must be no writing to the divisor latches, `UARTi.UART_DLL` and `UARTi.UART_DLH`, to set the baud clock (BCLK) while in sleep mode. It is advisable to disable sleep mode using the `UARTi.UART_IER[4] SLEEP_MODE` bit before writing to the `UARTi.UART_DLL` register or the `UARTi.UART_DLH` register.

19.3.4.1.2 System Power Saving

Sleep and auto-idle modes are embedded power-saving features. Power-reduction techniques can be applied at the system level by shutting down certain internal clock and power domains of the device.

The UART supports an idle req/idle ack handshaking protocol used at the system level to shut down the UART clocks in a clean and controlled manner and to switch the UART from interrupt-generation mode to wake-up generation mode for unmasked events (see the `UARTi.UART_SYSC[2] ENAWAKEUP` bit and the `UARTi.UART_WER` register).

For more information, see *Module Level Clock Management* in [Chapter 8, Power, Reset, and Clock Management](#).

19.3.4.2 IrDA/CIR Mode Power Management

19.3.4.2.1 Module Power Saving

In IrDA/CIR modes, sleep mode is enabled by setting the `UARTi.MDR[3] IR_SLEEP` bit to 1.

Sleep mode is entered when all the following conditions exist:

- The serial data input line, `uarti.rx_irrx`, is idle.
- The TX FIFO and TX shift register are empty.
- The RX FIFO is empty.
- No interrupts are pending except THR interrupts.

The module wakes up when a change is detected on the `uarti_rx_irrx` line or when data is written to the TX FIFO.

19.3.4.2.2 System Power Saving

System power saving for the IrDA/CIR mode has the same function as for the UART mode (see [Section 19.3.4.1.2, System Power Saving](#)).

19.3.4.3 Local Power Management

[Table 19-10](#) describes power-management features available for the UART.

NOTE: For information about source clock gating and sleep/wake-up transitions description, see *Module-Level Clock Management* in [Chapter 8, Power, Reset, and Clock Management](#).

Table 19-10. Local Power-Management Features

Feature	Registers	Description
Clock autogating	UART_SYSC[0] AUTOIDLE	This bit allows local power optimization in the module by gating the UARTi_ICLK clock on interface activity or gating the UARTi_FCLK clock on internal activity.
Slave idle modes	UART_SYSC[4:3] IDLEMODE	Force-idle, no-idle, smart-idle, and smart-idle wakeup-capable modes are available
Clock activity	N/A	Feature not available
Master standby modes	N/A	Feature not available
Global wake-up enable	UART_SYSC[2] ENAWAKEUP	This bit enables the wake-up feature at module level.
Wake-Up sources enable	N/A	Feature not available

19.3.5 Interrupt Requests

The UART IrDA CIR module generates interrupts. All interrupts can be enabled/disabled by writing to the appropriate bit in the interrupt enable register (IER). The interrupt status of the device can be checked at any time by reading the interrupt identification register (IIR). The UART, IrDA, and CIR modes have different interrupts in the UART IrDA CIR module and therefore have different IER and IIR mappings according to the selected mode.

19.3.5.1 UART Mode Interrupt Management

19.3.5.1.1 UART Interrupts

UART mode includes seven possible interrupts prioritized to six levels.

When an interrupt is generated, the interrupt identification register (UARTi.UART_IIR) sets the UARTi.UART_IIR[0] IT_PENDING bit to 0 to indicate that an interrupt is pending, and indicates the type of interrupt through the UARTi.UART_IIR[5:1] bit field. [Table 19-11](#) summarizes the interrupt control functions.

Table 19-11. UART Mode Interrupts

UART_IIR[5:0]	Priority Level	Interrupt Type	Interrupt Source	Interrupt Reset Method
000001	None	None	None	None
000110	1	Receiver line status	OE, FE, PE, or BI errors occur in characters in the RX FIFO.	FE, PE, BI: Read the UART_RHR register. OE: Read the UART_LSR register.
001100	2	RX time-out	Stale data in RX FIFO	Read the UART_RHR register.
000100	2	RHR interrupt	DRDY (data ready) (FIFO disable) RX FIFO above trigger level (FIFO enable)	Read the UART_RHR register until the interrupt condition disappears.
000010	3	THR interrupt	TFE (UART_THR empty) (FIFO disable) TX FIFO below trigger level (FIFO enable)	Write to the UART_THR until the interrupt condition disappears.
000000	4	Modem status	See the UART_MSR register.	Read the UART_MSR register.
010000	5	XOFF interrupt/special character interrupt	Receive XOFF characters/special character	Receive XON character(s), if XOFF interrupt/read of the UART_IIR register, if special character interrupt.
100000	6	CTS, RTS, DSR	RTS pin or CTS pin or DSR change state from active (low) to inactive (high).	Read the UART_IIR register.

For the receiver-line status interrupt, the RX_FIFO_STS bit (UARTi.UART_LSR[7]) generates the interrupt.

For the XOFF interrupt, if an XOFF flow character detection caused the interrupt, the interrupt is cleared by an XON flow character detection. If special character detection caused the interrupt, the interrupt is cleared by a read of the UARTi.UART_IIR register.

19.3.5.2 Wake-Up Interrupt

Wake-up interrupt is a special interrupt that works differently from other interrupts. This interrupt is enabled when the UARTi.UART_SCR[4] RXCTSDSRWAKEUPENABLE bit is set to 1. The UARTi.UART_IIR register is not modified when this occurs; the UARTi.UART_SSR[1] RXCTSDSRWAKEUPSTS bit must be checked to detect a wake-up event.

When a wake-up interrupt occurs, it can be cleared only by resetting the UARTi.UART_SCR[4] RXCTSDSRWAKEUPENABLE bit. This bit must be re-enabled (set to 1) after the current wake-up interrupt event is processed to detect the next incoming wake-up event.

A wake-up interrupt can also occur if the WER[7] TXWAKEUPEN bit is set to 1 and one of the following occurs:

- THR interrupt occurred if it is enabled (omitted if TX DMA request is enabled).
- TX DMA request occurred if it is enabled.
- TX_STATUS_IT occurred if it is enabled (only IrDA and CIR modes). Cannot be used with THR interrupt.

CAUTION

Wake-Up interface implementation in IrDA mode is based on the UARTi_SIDLEACK low-to-high transition instead of the UARTi_SIDLEACK state.

This does not ensure wake-up event generation as expected when configured in smart-idle mode, and the system wakes up for a short period.

19.3.5.3 IrDA Mode Interrupt Management

19.3.5.3.1 IrDA Interrupts

The IrDA function generates interrupts. All interrupts can be enabled and disabled by writing to the appropriate bit in the interrupt enable register (UARTi.UART_IER). The interrupt status of the device can be checked by reading the interrupt identification register (UARTi.UART_IIR).

UART, IrDA, and CIR modes have different interrupts in the UART/IrDA/CIR module and, therefore, different UARTi.UART_IER and UARTi.UART_IIR mappings, depending on the selected mode.

IrDA modes have eight possible interrupts (see [Table 19-12](#)). The interrupt line is activated when any interrupt is generated (there is no priority).

Table 19-12. IrDA Mode Interrupts

UART_IIR Bit	Interrupt Type	Interrupt Source	Interrupt Reset Method
0	RHR interrupt	DRDY (data ready) (FIFO disable) RX FIFO above trigger level (FIFO enable)	Read the UART_RHR register until the interrupt condition disappears.
1	THR interrupt	TFE (UART_THR empty) (FIFO disable) TX FIFO below trigger level (FIFO enable)	Write to the UART_THR until the interrupt condition disappears.

Table 19-12. IrDA Mode Interrupts (continued)

UART_IIR Bit	Interrupt Type	Interrupt Source	Interrupt Reset Method
2	Last byte in RX FIFO	Last byte of frame in RX FIFO is available to be read at the RHR port.	Read the UART_RHR register.
3	RX overrun	Write to the UART_RHR register when the RX FIFO is full.	Read UART_RESUME register.
4	Status FIFO interrupt	Status FIFO triggers level reached.	Read STATUS FIFO.
5	TX status	<ol style="list-style-type: none"> UART_THR empty before EOF sent. Last bit of transmission of the IrDA frame occurred, but with an underrun error. OR Transmission of the last bit of the IrDA frame completed successfully. 	<ol style="list-style-type: none"> Read the UART_RESUME register. OR Read the UART_IIR register.
6	Receiver line status interrupt	CRC, ABORT, or frame-length error is written into the STATUS FIFO.	Read the STATUS FIFO (read until empty - maximum of eight reads required).
7	Received EOF	Received end-of-frame	Read the UART_IIR register.

19.3.5.4 CIR Mode Interrupt Management

19.3.5.4.1 CIR Interrupts

The CIR function generates interrupts that can be enabled and disabled by writing to the appropriate bit in the interrupt enable register (UARTi.UART_IER). The interrupt status of the device can be checked by reading the interrupt identification register (UARTi.UART_IIR).

UART, IrDA, and CIR modes have different interrupts in the UART/IrDA/CIR module and, therefore, different UARTi.UART_IER and UARTi.UART_IIR mappings, depending on the selected mode.

Table 19-13 lists the interrupt modes to be maintained. In CIR mode, the sole purpose of the UARTi.UART_IIR[5] bit is to indicate that the last bit of infrared data was passed to the `uart_cts_rctx` pin.

Table 19-13. CIR Mode Interrupts

UART_IIR Bit Number	Interrupt Type	Interrupt Source	Interrupt Reset Method
0	RHR interrupt	DRDY (data ready) (FIFO disable) RX FIFO above trigger level (FIFO enable)	Read UART_RHR until interrupt condition disappears.
1	THR interrupt	TFE (UART_THR empty) (FIFO disable) TX FIFO below trigger level (FIFO enable)	Write to the UART_THR register until the interrupt condition disappears.
2	RX_STOP_IT	Receive stop interrupt (depending on value set in the BOF Length Register (UART_EBLR)).	Read IIR
3	RX overrun	Write to RHR when RX FIFO is full.	Read RESUME register.
4	N/A for CIR mode	N/A for CIR mode	N/A for CIR mode
5	TX status	Transmission of the last bit of the frame is complete successfully.	Read the UART_IIR register.
6	N/A for CIR mode	N/A for CIR mode	N/A for CIR mode
7	N/A for CIR mode	N/A for CIR mode	N/A for CIR mode

19.3.6 FIFO Management

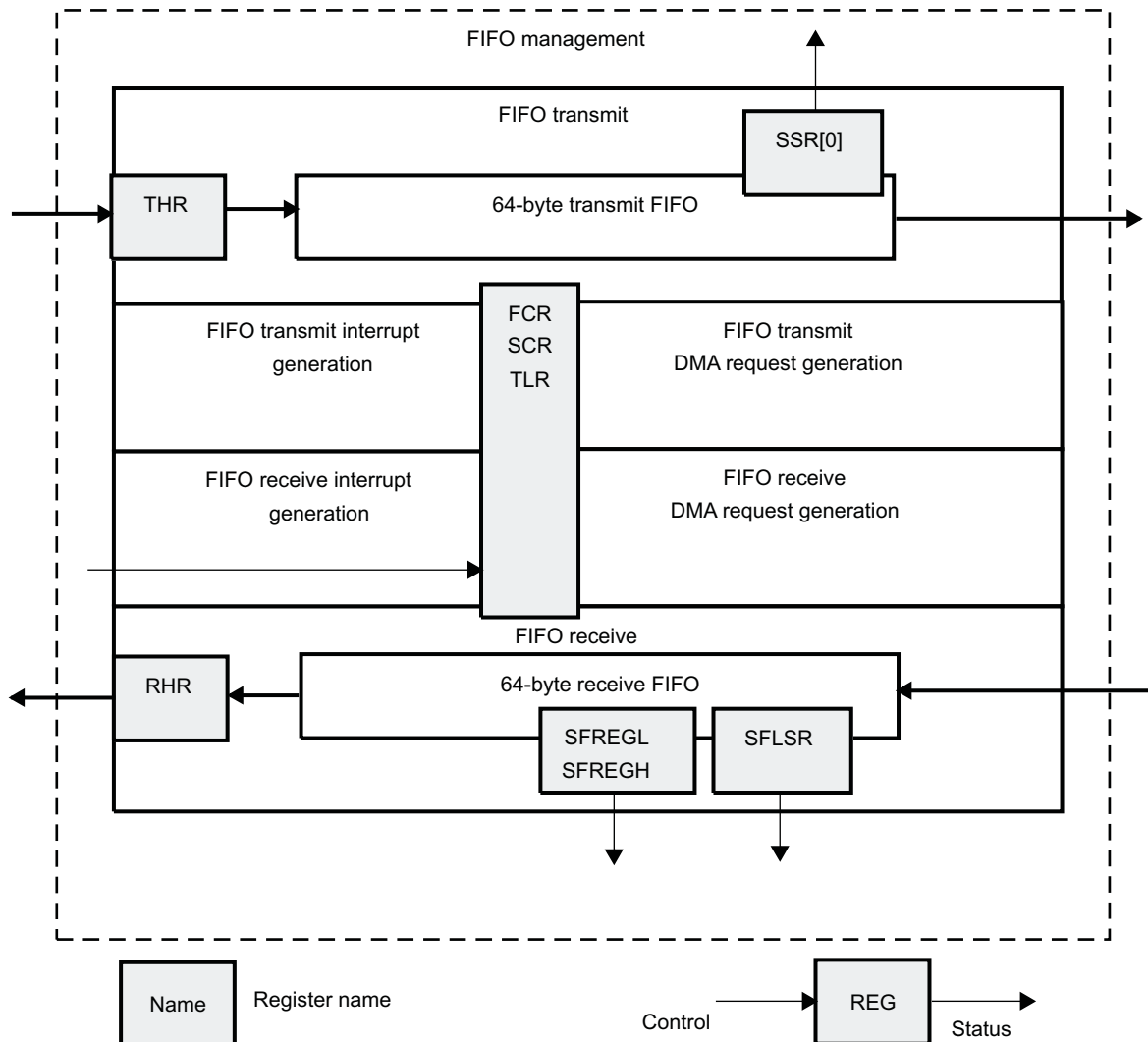
The FIFO is accessed by reading and writing the UARTi.UART_RHR and UARTi.UART_THR registers. Parameters are controlled using the FIFO control register (UARTi.UART_FCR) and supplementary control register (UARTi.UART_SCR). Reading the UARTi.UART_SSR[0] TX_FIFO_FULL bit at 1 means the FIFO is full.

The UARTi.UART_TLR register controls the FIFO trigger level, which enables DMA and interrupt generation. After reset, transmit (TX) and receive (RX) FIFOs are disabled; thus, the trigger level is the default value of 1 byte. [Figure 19-4](#) shows the FIFO management registers.

NOTE: Data in the UARTi.UART_RHR register is not overwritten when an overflow occurs.

NOTE: The UARTi.UART_SFLSR, UARTi.UART_SFREGL, and UARTi.UART_SFREGH status registers are used in IrDA mode only. For use, see [Section 19.3.8.2.6, IrDA Data Formatting](#).

Figure 19-4. FIFO Management Registers



uart-023

19.3.6.1 FIFO Trigger

19.3.6.1.1 Transmit FIFO Trigger

Table 19-14 lists the TX FIFO trigger level settings.

Table 19-14. TX FIFO Trigger Level Setting Summary

UART_SCR[6]	UART_TLR[3:0]	TX FIFO Trigger Level
0	= 0x0	Defined by the UARTi.UART_FCR[5:4] TX_FIFO_TRIG bit field (8,16, 32, or 56 spaces)
0	!= 0x0	Defined by the UARTi.UART_TLR[3:0] TX_FIFO_TRIG_DMA bit field (from 4 to 60 spaces with a granularity of 4 spaces)
1	Value	Defined by the concatenated value of TX_FIFO_TRIG_DMA and TX_FIFO_TRIG (from 1 to 63 spaces with a granularity of 1 space) Note: The combination of TX_FIFO_TRIG_DMA = 0x0 and TX_FIFO_TRIG = 0x0 (all zeros) is not supported (minimum of one space required). All zeros result in unpredictable behavior.

19.3.6.1.2 Receive FIFO Trigger

Table 19-15 lists the RX FIFO trigger level settings.

Table 19-15. RX FIFO Trigger Level Setting Summary

UART_SCR[7]	UART_TLR[7:4]	RX FIFO Trigger Level
0	= 0x0	Defined by the UARTi.UART_FCR[7:6] RX_FIFO_TRIG bit field (8,16, 56, or 60 characters)
0	!= 0x0	Defined by the UARTi.UART_TLR[7:4] RX_FIFO_TRIG_DMA bit field (from 4 to 60 characters with a granularity of 4 characters)
1	Value	Defined by the concatenated value of RX_FIFO_TRIG_DMA and RX_FIFO_TRIG (from 1 to 63 characters with a granularity of 1 character) Note: The combination of RX_FIFO_TRIG_DMA = 0x0 and RX_FIFO_TRIG = 0x0 (all zeros) is not supported (minimum of one character required). All zeros result in unpredictable behavior.

The receive threshold is programmed using the UARTi.UART_TCR[7:4] RX_FIFO_TRIG_START and UARTi.UART_TCR[3:0] RX_FIFO_TRIG_HALT bit fields:

- Trigger levels from 0 to 60 bytes are available with a granularity of 4 (trigger level = 4 x [4-bit register value]).
- To ensure correct device operation, ensure that RX_FIFO_TRIG_HALT RX_FIFO_TRIG when auto-RTS is enabled.

$$\text{Delay} = [4 + 16 \times (1 + \text{CHAR_LENGTH} + \text{Parity} + \text{Stop } 0.5)] \times \text{Baud_rate} + 4 \times \text{FCLK}$$

NOTE: The RTS signal is deasserted after the UART module receives the data over RX_FIFO_TRIG_HALT. Delay means how long the UART module takes to deassert the RTS signal after reaching RX_FIFO_TRIG_HALT.

- In FIFO interrupt mode with flow control, ensure that the trigger level to HALT transmission is greater than or equal to the RX FIFO trigger level (the UARTi.UART_TCR[7:4] RX_FIFO_TRIG_START bit field or the UARTi.UART_FCR[7:6] RX_FIFO_TRIG bit field); otherwise, FIFO operation stalls. In FIFO DMA mode with flow control, this concept does not exist, because a DMA request is sent when a byte is received.

19.3.6.2 FIFO Interrupt Mode

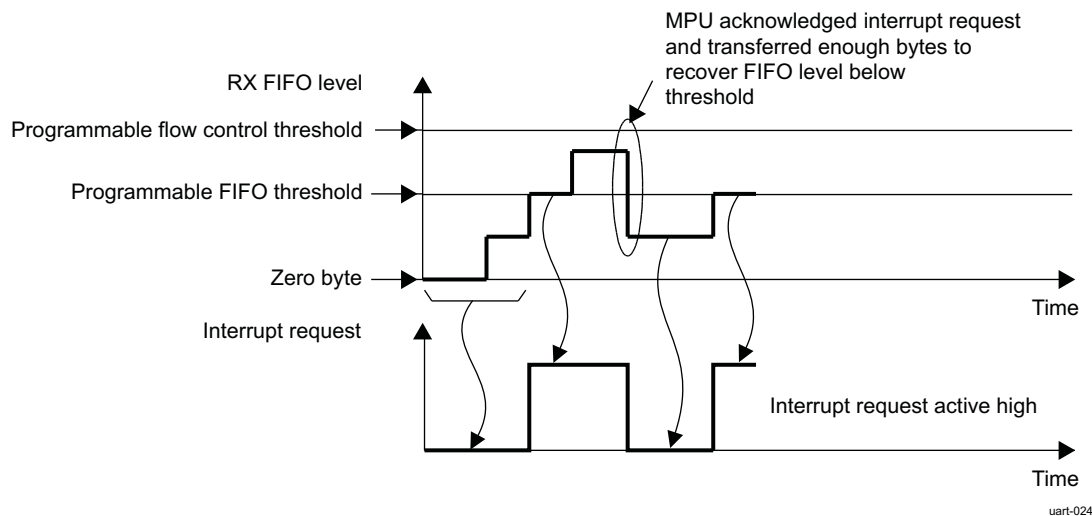
In FIFO interrupt mode (the FIFO control register UARTi.UART_FCR[0] FIFO_EN bit is set to 1 and relevant interrupts are enabled by the UARTi.UART_IER register), an interrupt signal informs the processor of the status of the receiver and transmitter. These interrupts are raised when the RX/TX FIFO threshold (the UARTi.UART_TLR[7:4] RX_FIFO_TRIG_DMA and UARTi.UART_TLR[3:0] TX_FIFO_TRIG_DMA bit fields or the UARTi.UART_FCR[7:6] RX_FIFO_TRIG and UARTi.UART_FCR[5:4] TX_FIFO_TRIG bit fields, respectively) is reached.

The interrupt signals instruct the MPU to transfer data to the destination (from the UART in receive mode and/or from any source to the UART FIFO in transmit mode).

When UART flow control is enabled with interrupt capabilities, the UART flow control FIFO threshold (the UARTi.UART_TCR[3:0] RX_FIFO_TRIG_HALT bit field) must be greater than or equal to the RX FIFO threshold.

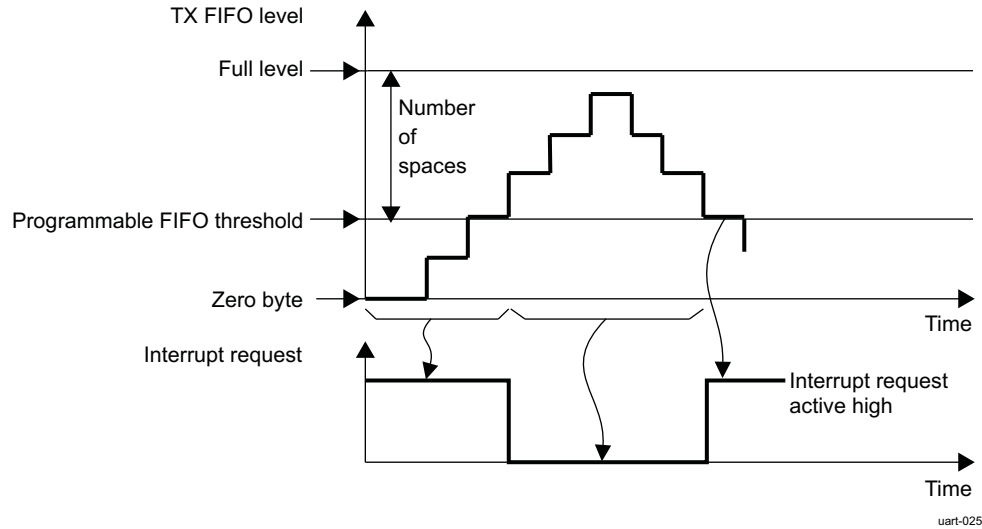
Figure 19-5 shows the generation of the RX FIFO interrupt request.

Figure 19-5. RX FIFO Interrupt Request Generation



In receive mode, no interrupt is generated until the RX FIFO reaches its threshold. Once low, the interrupt can be deasserted only when the MPU has handled enough bytes to put the FIFO level below threshold. The flow control threshold is set at a higher value than the FIFO threshold.

Figure 19-6 shows the generation of the TX FIFO interrupt request.

Figure 19-6. TX FIFO Interrupt Request Generation


In transmit mode, an interrupt request is automatically asserted when the TX FIFO is empty. This request is deasserted when the TX FIFO crosses the threshold level. The interrupt line is deasserted until a sufficient number of elements is transmitted to go below the TX FIFO threshold.

19.3.6.3 FIFO Polled Mode Operation

In FIFO polled mode (the UARTi.UART_FCR[0] FIFO_EN bit is set to 0 and the relevant interrupts are disabled by the UARTi.UART_IER register), the status of the receiver and transmitter can be checked by polling the line status register (UARTi.UART_LSR).

This mode is an alternative to the FIFO interrupt mode of operation in which the status of the receiver and transmitter is automatically determined by sending interrupts to the MPU.

19.3.6.4 FIFO DMA Mode Operation

Although DMA operation includes four modes (DMA modes 0 through 3), assume that mode 1 is used. (Mode 2 and mode 3 are legacy modes that use only one DMA request for each module.)

In mode 2, the remaining DMA request is used for RX. In mode 3, the remaining DMA request is used for TX.

DMA requests in mode 2 and mode 3 use the following signals:

- S_DMA_48
- S_DMA_50
- S_DMA_52/D_DMA_10
- S_DMA_54

The following signals are not used by the module in mode 2 and mode 3:

- S_DMA_49
- S_DMA_51
- S_DMA_53/D_DMA_11
- S_DMA_55

These signals can be selected as follows:

- When the UARTi.UART_SCR[0] DMA_MODE_CTL bit is set to 0, setting the UARTi.UART_FCR[3]DMA_MODE bit to 0 enables DMA mode 0. Setting the DMA_MODE bit to 1 enables DMA mode 1.
- When the DMA_MODE_CTL bit is set to 1, the UARTi.UART_SCR[2:1]DMA_MODE_2 bit field determines DMA mode 0 to mode 3 based on the supplementary control register (UART_SCR) description.

For example:

- If no DMA operation is desired, set the DMA_MODE_CTL bit to 1 and the DMA_MODE_2 bit field to 0x0. (The DMA_MODE bit is discarded.)
- If DMA mode 1 is desired, set the DMA_MODE_CTL bit to 0 and the DMA_MODE bit to 1, or set the DMA_MODE_CTL bit to 1 and the DMA_MODE_2 bit field to 01. (The DMA_MODE bit is discarded.)

If the FIFOs are disabled (the UARTi.UART_FCR[0] FIFO_EN bit is set to 0), the DMA occurs in single-character transfers.

When DMA mode 0 is programmed, the signals associated with DMA operation are not active.

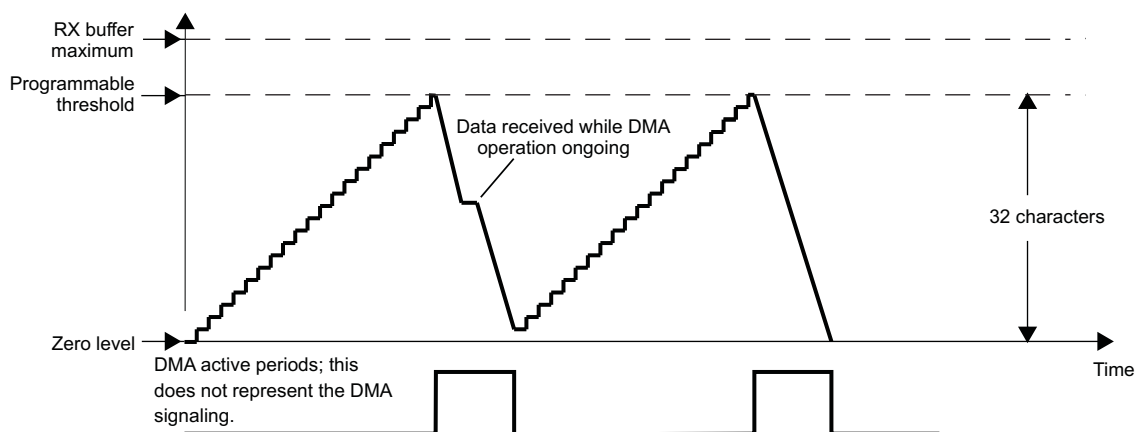
Depending on UART_MDR3[2] SET_DMA_TX_THRESHOLD, the threshold can be programmed different ways:

- SET_TX_DMA_THRESHOLD = 1:
The threshold value will be the value of the UART_TX_DMA_THRESHOLD register. If SET_TX_DMA_THRESHOLD + TX trigger spaces 64, then the default method of threshold is used: threshold value = TX FIFO size.
- SET_TX_DMA_THRESHOLD = 0:
The threshold value = TX FIFO size - TX trigger space. The TX DMA line is asserted if the TX FIFO level is lower than the threshold. It remains asserted until TX trigger spaces number of bytes are written into the FIFO. The DMA line is then deasserted and the FIFO level is compared with the threshold value.

19.3.6.4.1 DMA Transfers (DMA Mode 1, 2, or 3)

Figure 19-7 through Figure 19-10 show the supported DMA operations.

Figure 19-7. Receive FIFO DMA Request Generation (32 Characters)

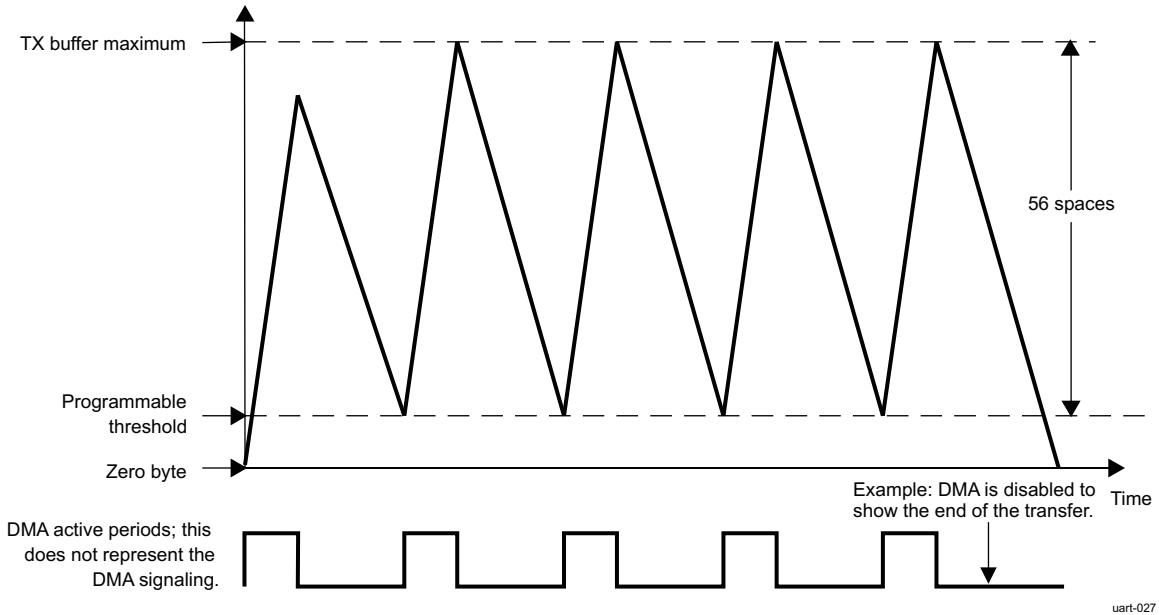


uart-026

In receive mode, a DMA request is generated when the RX FIFO reaches its threshold level defined in the trigger level register (UARTi.UART_TLR). This request is deasserted when the number of bytes defined by the threshold level is read by the sDMA.

In transmit mode, a DMA request is automatically asserted when the TX FIFO is empty. This request is deasserted when the number of bytes defined by the number of spaces in the UARTi.UART_TLR register is written by the sDMA. If an insufficient number of characters is written, the DMA request stays active.

Figure 19-8. Transmit FIFO DMA Request Generation (56 Spaces)



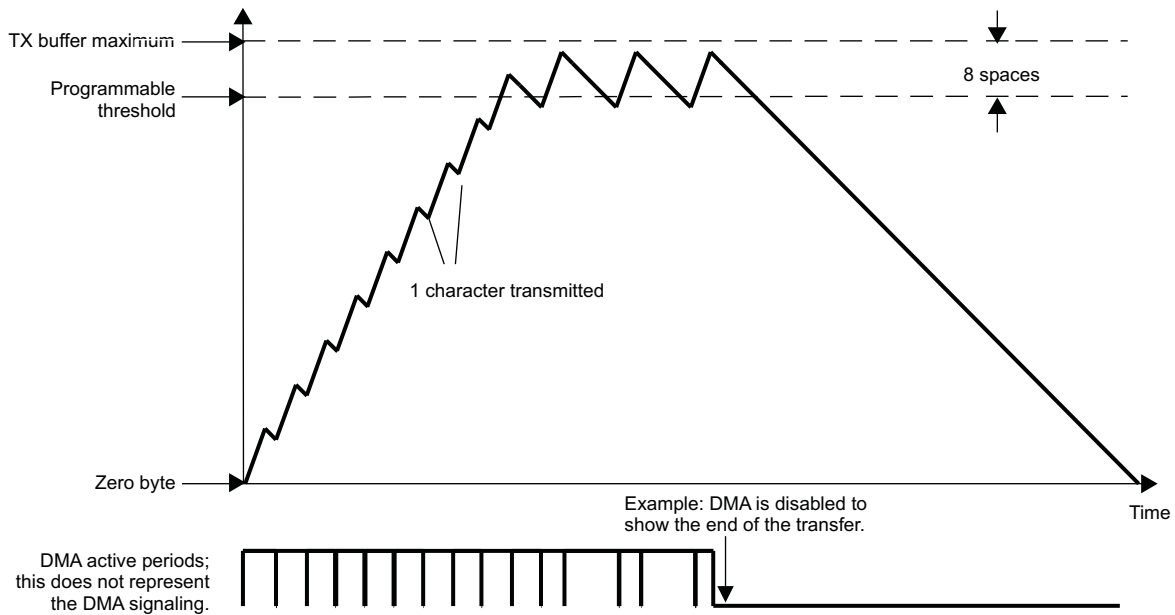
The DMA request is again asserted if the FIFO can receive the number of bytes defined by the UARTi.UART_TLR register.

The threshold can be programmed in a number of ways. Figure 19-8 shows a DMA transfer operating with a space setting of 56 that can arise from using the auto settings in the UARTi.UART_FCR[5:4] TX_FIFO_TRIG bit field or the UARTi.UART_TLR[3:0] TX_FIFO_TRIG_DMA bit field concatenated with the TX_FIFO_TRIG bit field.

The setting of 56 spaces in the UART/IrDA/CIR module must correlate with the settings of the sDMA so that the buffer does not overflow (program the DMA request size of the LH controller to equal the number of spaces in the UART/IrDA/CIR module).

Figure 19-9 shows an example with eight spaces to show the buffer level crossing the space threshold. The LH DMA controller settings must correspond to those of the UART/IrDA/CIR module.

Figure 19-9. Transmit FIFO DMA Request Generation (8 Spaces)



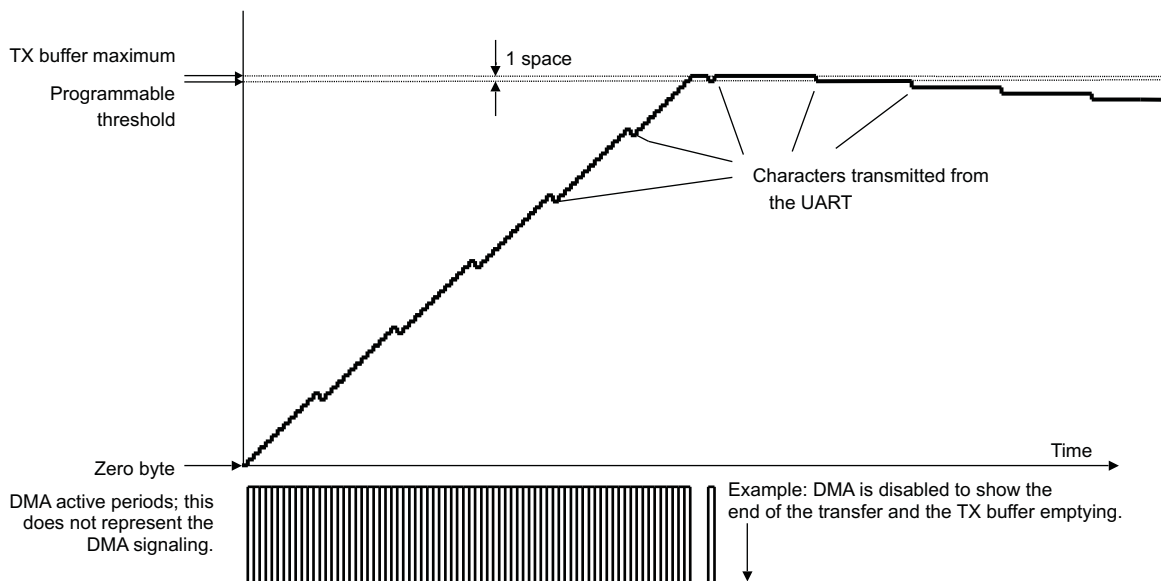
uart-028

The next example shows the setting of one space that uses the DMA for each transfer of one character to the transmit buffer (see Figure 19-10). The buffer is filled faster than the baud rate at which data is transmitted to the TX pin. Eventually, the buffer is completely full and the DMA operations stop transferring data to the transmit buffer.

On two occasions, the buffer holds the maximum amount of data words; shortly after this, the DMA is disabled to show the slower transmission of the data words to the TX pin. Eventually, the buffer is emptied at the rate specified by the baud rate settings of the UARTi.UART_DLL and UARTi.UART_DLH registers.

The DMA settings must correspond to the system LH DMA controller settings to ensure correct operation of this logic.

Figure 19-10. Transmit FIFO DMA Request Generation (1 Space)



uart-029

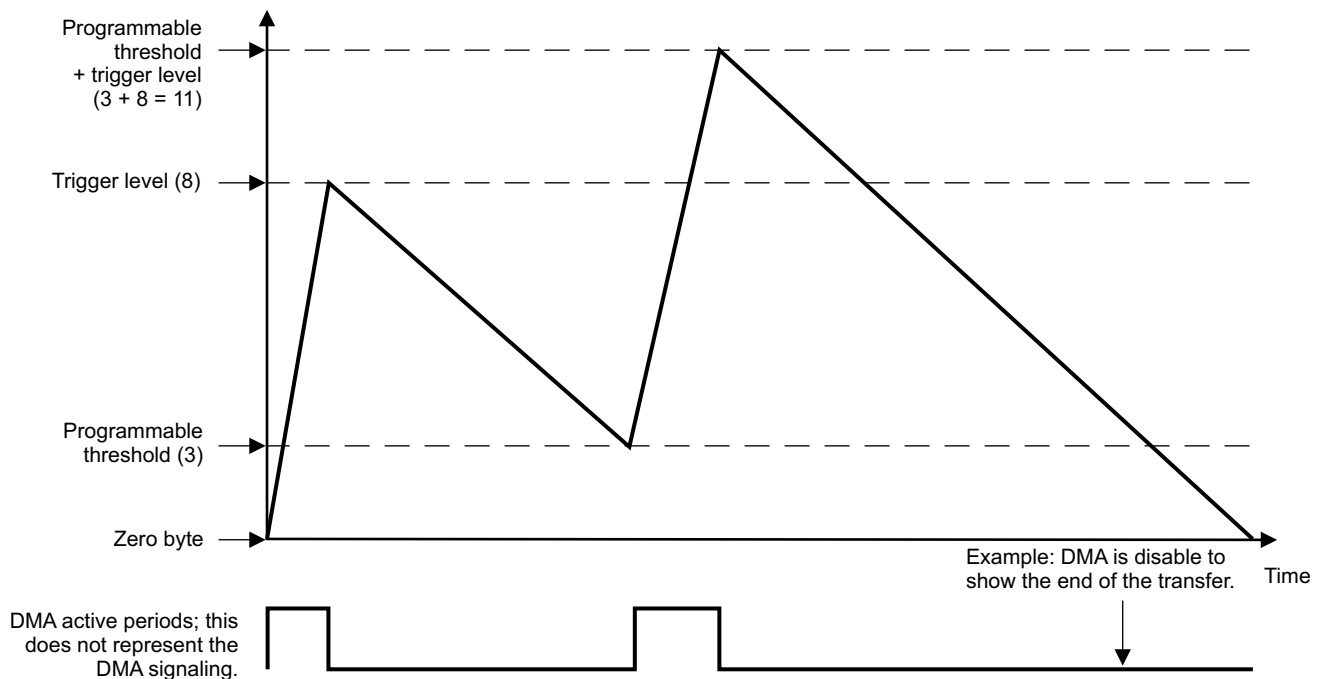
The final example shows the setting of eight spaces, but setting the TX DMA threshold directly by setting the `UART_MDR3[1]SET_DMA_RX_THRESHOLD` bit and the `UART_TX_DMA_THRESHOLD` register (see Figure 19-11). In the example, `UART_TX_DMA_THRESHOLD[2:0]TX_DMA_THRESHOLD = 3` and the trigger level is 8. The buffer is filled at a faster rate than the baud rate transmits data to the TX pin. The buffer is filled with 8 bytes and the DMA operations stop transferring data to the transmit buffer. When the buffer is emptied to the threshold level by transmission, the DMA operation activates again to fill the buffer with 8 bytes.

Eventually, the buffer is emptied at the rate specified by the baud rate settings of the `UART_DLL` and `UART_DLH` registers.

If the selected threshold level plus the trigger level exceed the maximum buffer size, the original TX DMA threshold method is used to prevent TX overrun, regardless of the value of the `UART_MDR3[1]SET_DMA_RX_THRESHOLD` bit.

The DMA settings must correspond to the settings of the system local host DMA controller to ensure the correct operation of this logic.

Figure 19-11. Transmit FIFO DMA Request Generation Using Direct TX DMA Threshold Programming. (Threshold = 3; Spaces = 8)

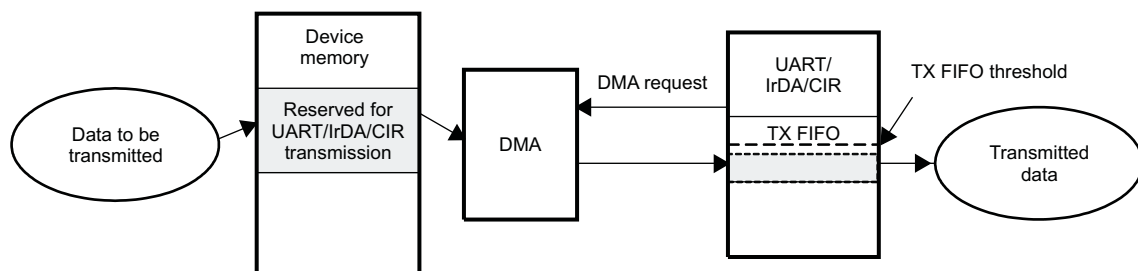


uart-035

19.3.6.4.2 DMA Transmission

Figure 19-12 shows DMA transmission.

Figure 19-12. DMA Transmission



uart-030

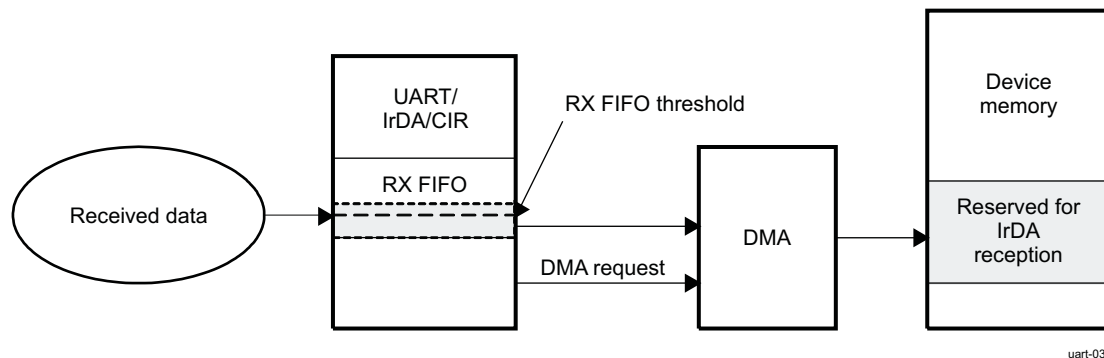
1. Data to be transmitted are put in the device memory reserved for UART/IrDA/CIR transmission by the DMA:
 - (a) Until the TX FIFO trigger level is not reached, a DMA request is generated
 - (b) An element (1 byte) is transferred from the SDRAM to the TX FIFO at each DMA request (DMA element synchronization).
2. Data in the TX FIFO are automatically transmitted.
3. The end of the transmission is signaled by the UARTi.UART_THR empty (TX FIFO empty).

NOTE: In IrDA mode, the transmission does not end immediately after the TX FIFO empties, at which point the last data byte, the CRC field, and the stop flag still must be transmitted; thus, the end of transmission occurs a few milliseconds after the UARTi.UART_THR register empties.

19.3.6.4.3 DMA Reception

Figure 19-13 shows DMA reception.

Figure 19-13. DMA Reception



1. Enable the reception.
2. Received data are put in the RX FIFO.
3. Data are transferred from the RX FIFO to the device memory by the DMA:
 - (a) At each received byte, the RX FIFO trigger level (one character) is reached and a DMA request is generated.
 - (b) An element (1 byte) is transferred from the RX FIFO to the SDRAM at each DMA request (DMA element synchronization).
4. The end of the reception is signaled by the EOF interrupt.

19.3.7 Mode Selection

19.3.7.1 Register Access Modes

19.3.7.1.1 Operational Mode and Configuration Modes

Register access depends on the register access mode, although register access modes are not correlated to functional mode selection. Three different modes are available:

- Operational mode
- Configuration mode A
- Configuration mode B

Operational mode is the selected mode when the function is active; serial data transfer can be performed in this mode.

Configuration mode A and configuration mode B are used during module initialization steps. These modes enable access to configuration registers, which are hidden in the operational mode. The modes are used when the module is inactive (no serial data transfer processed) and only for initialization or reconfiguration of the module.

The value of the UARTi.UART_LCR register determines the register access mode (see [Table 19-16](#)).

Table 19-16. UART/IrDA/CIR Register Access Mode Programming (Using UART_LCR)

Mode	Condition
Configuration mode A	UART_LCR[7] = 0x1 and UART_LCR[7:0] != 0xBF
Configuration mode B	UART_LCR[7] = 0x1 and UART_LCR[7:0] = 0xBF
Operational mode	UART_LCR[7] = 0x0

19.3.7.1.2 Register Access Submode

In each access register mode (operational mode or configuration mode A/B), some register accesses are conditional on the programming of a submode (MSR_SPR, TCR_TLR, and XOFF).

[Table 19-17](#) through [Table 19-19](#) summarize the register access submodes.

Table 19-17. Subconfiguration Mode A Summary

Mode	Condition
MSR_SPR	(UART_EFR[4] = 0x0 or UART_MCR[6] = 0x0)
TCR_TLR	UART_EFR[4] = 0x1 and UART_MCR[6] = 0x1

Table 19-18. Subconfiguration Mode B Summary

Mode	Condition
TCR_TLR	UART_EFR[4] = 0x1 and UART_MCR[6] = 0x1
XOFF	(UART_EFR[4] = 0x0 or UART_MCR[6] = 0x0)

Table 19-19. Suboperational Mode Summary

Mode	Condition
MSR_SPR	UART_EFR[4] = 0x0 or UART_MCR[6] = 0x0
TCR_TLR	UART_EFR[4] = 0x1 and UART_MCR[6] = 0x1

19.3.7.1.3 Registers Available for the Register Access Modes

[Table 19-20](#) lists the names of the register bits in each access register mode. Gray shading indicates that the register does not depend on the register access mode (available in all modes).

Table 19-20. UART/IrDA/CIR Register Access Mode Overview

Address Offset	Registers					
	Configuration Mode A		Configuration Mode B		Operational Mode	
	Read	Write	Read	Write	Read	Write
0x000	UART_DLL	UART_DLL	UART_DLL	UART_DLL	UART_RHR	UART_THR
0x004	UART_DLH	UART_DLH	UART_DLH	UART_DLH	UART_IER	UART_IER
0x008	UART_IIR	UART_FCR	UART_EFR	UART_EFR	UART_IIR	UART_FCR
0x00C	UART_LCR	UART_LCR	UART_LCR	UART_LCR	UART_LCR	UART_LCR
0x010	UART_MCR	UART_MCR	UART_XON1_ADD R1	UART_XON1_AD DR1	UART_MCR	UART_MCR

Table 19-20. UART/IrDA/CIR Register Access Mode Overview (continued)

Address Offset	Registers					
	Configuration Mode A		Configuration Mode B		Operational Mode	
	Read	Write	Read	Write	Read	Write
0x014	UART_LSR	–	UART_XON2_ADD R2	UART_XON2_AD DR2	UART_LSR	–
0x018	UART_MSR (1)/UART_TCR (2)	UART_TCR (2)	UART_TCR (2)/UART_XOFF1 (3)	UART_TCR (2)/UART_XOFF1 (3)	UART_MSR (1)/UART_TCR (2)	UART_TCR (2)
0x01C	UART_SPR (1)/UART_TLR (2)	UART_SPR (1)/UART_TLR (2)	UART_TLR (2)/UART_XOFF2 (3)	UART_TLR (2)/UART_XOFF2 (3)	UART_SPR (1)/UART_TLR (2)	UART_SPR (1)/UART_TLR (2)
0x020	UART_MDR1	UART_MDR1	UART_MDR1	UART_MDR1	UART_MDR1	UART_MDR1
0x024	UART_MDR2	UART_MDR2	UART_MDR2	UART_MDR2	UART_MDR2	UART_MDR2
0x028	UART_SFLSR	UART_TXFLL	UART_SFLSR	UART_TXFLL	UART_SFLSR	UART_TXFLL
0x02C	UART_RESUM E	UART_TXFLH	UART_RESUME	UART_TXFLH	UART_RESUME	UART_TXFLH
0x030	UART_SFREG L	UART_RXFLL	UART_SFREG L	UART_RXFLL	UART_SFREG L	UART_RXFLL
0x034	UART_SFREG H	UART_RXFLH	UART_SFREG H	UART_RXFLH	UART_SFREG H	UART_RXFLH
0x038	UART_UASR	–	UART_UASR	–	UART_BLR	UART_BLR
0x03C	–	–	–	–	UART_ACREG	UART_ACREG
0x040	UART_SCR	UART_SCR	UART_SCR	UART_SCR	UART_SCR	UART_SCR
0x044	UART_SSR	–	UART_SSR	–	UART_SSR	–
0x048	–	–	–	–	UART_EBLR	UART_EBLR
0x050	UART_MVR	–	UART_MVR	–	UART_MVR	–
0x054	UART_SYSC	UART_SYSC	UART_SYSC	UART_SYSC	UART_SYSC	UART_SYSC
0x058	UART_SYSS	–	UART_SYSS	–	UART_SYSS	–
0x05C	UART_WER	UART_WER	UART_WER	UART_WER	UART_WER	UART_WER
0x060	UART_CFPS	UART_CFPS	UART_CFPS	UART_CFPS	UART_CFPS	UART_CFPS
0x064	UART_RXFIFO_LVL	UART_RXFIFO_LVL	UART_RXFIFO_LVL	UART_RXFIFO_LVL	UART_RXFIFO_LVL	UART_RXFIFO_LVL
0x068	UART_TXFIFO_LVL	UART_TXFIFO_LVL	UART_TXFIFO_LVL	UART_TXFIFO_LVL	UART_TXFIFO_LVL	UART_TXFIFO_LVL
0x06C	UART_IER2	UART_IER2	UART_IER2	UART_IER2	UART_IER2	UART_IER2
0x070	UART_ISR2	UART_ISR2	UART_ISR2	UART_ISR2	UART_ISR2	UART_ISR2
0x074	UART_FREQ_SEL	UART_FREQ_S EL	UART_FREQ_SEL	UART_FREQ_S EL	UART_FREQ_SEL	UART_FREQ_S EL
0x080	UART_MDR3	UART_MDR3	UART_MDR3	UART_MDR3	UART_MDR3	UART_MDR3
0x084	UART_TX_DMA_THRESHOLD	UART_TX_DMA_THRESHOLD	UART_TX_DMA_THRESHOLD	UART_TX_DMA_THRESHOLD	UART_TX_DMA_THRESHOLD	UART_TX_DMA_THRESHOLD

(1) MSR_SPR mode is active (see [Section 19.3.7.1.2, Register Access Submode](#))

(2) TCR_TLR mode is active (see [Section 19.3.7.1.2, Register Access Submode](#))

(3) XOFF mode is active (see [Section 19.3.7.1.2, Register Access Submode](#))

19.3.7.2 UART/IrDA (SIR, MIR, FIR)/CIR Mode Selection

To select a mode, set the UARTi.UART_MDR1[2:0] MODESELECT bit field (see [Table 19-21](#)).

Table 19-21. UART Mode Selection

Value	Mode
0x0:	UART 16x mode
0x1:	SIR mode
0x2:	UART 16x auto-baud
0x3:	UART 13x mode
0x4:	MIR mode
0x5:	FIR mode
0x6:	CIR mode

MODESELECT is effective when the module is in operational mode (see [Section 19.3.7.1, Register Access Modes](#)).

19.3.7.2.1 Registers Available for the UART Function

Only the registers listed in [Table 19-22](#) are used for the UART function.

Table 19-22. UART Mode Register Overview^{(1) (2)}

Address Offset	Registers					
	Configuration Mode A		Configuration Mode B		Operational Mode	
	Read	Write	Read	Write	Read	Write
0x000	UART_DLL	UART_DLL	UART_DLL	UART_DLL	UART_RHR	UART_THR
0x004	UART_DLH	UART_DLH	UART_DLH	UART_DLH	UART_IER(UART)	UART_IER(UART)
0x008	UART_IIR	UART_FCR	UART_EFR[4]	UART_EFR[4]	UART_IIR(UART)	UART_FCR(UART)
0x00C	UART_LCR	UART_LCR	UART_LCR	UART_LCR	UART_LCR	UART_LCR
0x010	UART_MCR	UART_MCR	UART_XON1_ADD R1	UART_XON1_ADD R1	UART_MCR	UART_MCR
0x014	UART_LSR(UART)	–	UART_XON2_ADD R2	UART_XON2_ADD R2	UART_LSR(UART)	–
0x018	UART_MSR/UART_TCR	UART_TCR	UART_XOFF1/UART_TCR	UART_XOFF1/UART_TCR	UART_MSR/UART_TCR	UART_TCR
0x01C	UART_TLR/UART_SPR	UART_TLR/UART_SPR	UART_TLR/UART_XOFF2	UART_TLR/UART_XOFF2	UART_TLR/UART_SPR	UART_TLR/UART_SPR
0x020	UART_MDR1	UART_MDR1[2:0]	UART_MDR1[2:0]	UART_MDR1[2:0]	UART_MDR1[2:0]	UART_MDR1[2:0]
0x024	UART_MDR2	UART_MDR2	UART_MDR2	UART_MDR2	UART_MDR2	UART_MDR2
0x028	–	–	–	–	–	–
0x02C	–	–	–	–	–	–
0x030	–	–	–	–	–	–
0x034	–	–	–	–	–	–
0x038	UART_UASR	–	UART_UASR	–	–	–
0x03C	–	–	–	–	–	–
0x040	UART_SCR	UART_SCR	UART_SCR	UART_SCR	UART_SCR	UART_SCR
0x044	UART_SSR	–	UART_SSR	–	UART_SSR	–
0x048	–	–	–	–	–	–
0x050	UART_MVR	–	UART_MVR	–	UART_MVR	–
0x054	UART_SYSC	UART_SYSC	UART_SYSC	UART_SYSC	UART_SYSC	UART_SYSC
0x058	UART_SYSS	–	UART_SYSS	–	UART_SYSS	–

⁽¹⁾ REGISTER_NAME(UART) notation indicates that the register exists for other functions (IrDA or CIR), but fields have different meanings for other functions.

⁽²⁾ REGISTER_NAME[m:n] notation indicates that only register bits numbered m to n apply to the UART function.

Table 19-22. UART Mode Register Overview^{(1) (2)} (continued)

Address Offset	Registers					
	Configuration Mode A		Configuration Mode B		Operational Mode	
	Read	Write	Read	Write	Read	Write
0x05C	UART_WER	UART_WER	UART_WER	UART_WER	UART_WER	UART_WER
0x060	–	–	–	–	–	–
0x064	UART_RXFIFO_LVL	UART_RXFIFO_LVL	UART_RXFIFO_LVL	UART_RXFIFO_LVL	UART_RXFIFO_LVL	UART_RXFIFO_LVL
0x068	UART_TXFIFO_LVL	UART_TXFIFO_LVL	UART_TXFIFO_LVL	UART_TXFIFO_LVL	UART_TXFIFO_LVL	UART_TXFIFO_LVL
0x06C	UART_IER2	UART_IER2	UART_IER2	UART_IER2	UART_IER2	UART_IER2
0x070	UART_ISR2	UART_ISR2	UART_ISR2	UART_ISR2	UART_ISR2	UART_ISR2
0x074	UART_FREQ_SEL	UART_FREQ_SEL	UART_FREQ_SEL	UART_FREQ_SEL	UART_FREQ_SEL	UART_FREQ_SEL
0x080	UART_MDR3	UART_MDR3	UART_MDR3	UART_MDR3	UART_MDR3	UART_MDR3
0x084	UART_TX_DMA_THRESHOLD	UART_TX_DMA_THRESHOLD	UART_TX_DMA_THRESHOLD	UART_TX_DMA_THRESHOLD	UART_TX_DMA_THRESHOLD	UART_TX_DMA_THRESHOLD

19.3.7.2.2 Registers Available for the IrDA Function

Only the registers listed in [Table 19-23](#) are used for the IrDA function.

Table 19-23. IrDA Mode Register Overview^{(1) (2)}

Address Offset	Registers					
	Configuration Mode A		Configuration Mode B		Operational Mode	
	Read	Write	Read	Write	Read	Write
0x000	UART_DLL	UART_DLL	UART_DLL	UART_DLL	UART_RHR	UART_THR
0x004	UART_DLH	UART_DLH	UART_DLH	UART_DLH	UART_IER(IrDA)	UART_IER(IrDA)
0x008	UART_IIR	UART_FCR	UART_EFR[4]	UART_EFR[4]	UART_IIR(IrDA)	UART_FCR(IrDA)
0x00C	UART_LCR[7]	UART_LCR[7]	UART_LCR[7]	UART_LCR[7]	UART_LCR[7]	UART_LCR[7]
0x010	–	–	UART_XON1_ADD R1	UART_XON1_ADD R1	–	–
0x014	UART_LSR(IrDA)	–	UART_XON2_ADD R2	UART_XON2_ADD R2	UART_LSR(IrDA)	–
0x018	UART_MSR/UART_TCR	UART_TCR	UART_TCR	UART_TCR	UART_MSR/UART_TCR	UART_TCR
0x01C	UART_TLR/UART_SPR	UART_TLR/UART_SPR	UART_TLR	UART_TLR	UART_TLR/UART_SPR	UART_TLR/UART_SPR
0x020	UART_MDR1	UART_MDR1	UART_MDR1	UART_MDR1	UART_MDR1	UART_MDR1
0x024	UART_MDR2	UART_MDR2	UART_MDR2	UART_MDR2	UART_MDR2	UART_MDR2
0x028	UART_SFSLR	UART_TXFLL	UART_SFSLR	UART_TXFLL	UART_SFSLR	UART_TXFLL
0x02C	UART_RESUME	UART_TXFLH	UART_RESUME	UART_TXFLH	UART_RESUME	UART_TXFLH
0x030	UART_SFREG L	UART_RXFLL	UART_SFREG L	UART_RXFLL	UART_SFREG L	UART_RXFLL
0x034	UART_SFREG H	UART_RXFLH	UART_SFREG H	UART_RXFLH	UART_SFREG H	UART_RXFLH

⁽¹⁾ REGISTER_NAME(UART) notation indicates that the register exists for other functions (IrDA or CIR), but fields have different meanings for other functions.

⁽²⁾ REGISTER_NAME[m:n] notation indicates that only register bits numbered m to n apply to the UART function.

Table 19-23. IrDA Mode Register Overview^{(1) (2)} (continued)

Address Offset	Registers					
	Configuration Mode A		Configuration Mode B		Operational Mode	
	Read	Write	Read	Write	Read	Write
0x038	–	–	–	–	UART_BLR	UART_BLR
0x03C	–	–	–	–	UART_ACREG	UART_ACREG
0x040	UART_SCR	UART_SCR	UART_SCR	UART_SCR	UART_SCR	UART_SCR
0x044	UART_SSR	–	UART_SSR	–	UART_SSR	–
0x048	–	–	–	–	UART_EBLR	UART_EBLR
0x050	UART_MVR	–	UART_MVR	–	UART_MVR	–
0x054	UART_SYSC	UART_SYSC	UART_SYSC	UART_SYSC	UART_SYSC	UART_SYSC
0x058	UART_SYSS	–	UART_SYSS	–	UART_SYSS	–
0x05C	UART_WER[6:4]	UART_WER[6:4]	UART_WER[6:4]	UART_WER[6:4]	UART_WER[6:4]	UART_WER[6:4]
0x060	–	–	–	–	–	–
0x064	UART_RXFIFO_LVL	UART_RXFIFO_LVL	UART_RXFIFO_LVL	UART_RXFIFO_LVL	UART_RXFIFO_LVL	UART_RXFIFO_LVL
0x068	UART_TXFIFO_LVL	UART_TXFIFO_LVL	UART_TXFIFO_LVL	UART_TXFIFO_LVL	UART_TXFIFO_LVL	UART_TXFIFO_LVL
0x06C	UART_IER2	UART_IER2	UART_IER2	UART_IER2	UART_IER2	UART_IER2
0x070	UART_ISR2	UART_ISR2	UART_ISR2	UART_ISR2	UART_ISR2	UART_ISR2
0x074	UART_FREQ_SEL	UART_FREQ_SEL	UART_FREQ_SEL	UART_FREQ_SEL	UART_FREQ_SEL	UART_FREQ_SEL
0x080	UART_MDR3	UART_MDR3	UART_MDR3	UART_MDR3	UART_MDR3	UART_MDR3
0x084	UART_TX_DMA_THRESHOLD	UART_TX_DMA_THRESHOLD	UART_TX_DMA_THRESHOLD	UART_TX_DMA_THRESHOLD	UART_TX_DMA_THRESHOLD	UART_TX_DMA_THRESHOLD

19.3.7.2.3 Registers Available for the CIR Function

Only the registers listed in [Table 19-24](#) are used for the CIR function.

Table 19-24. CIR Mode Register Overview^{(1) (2)}

Address Offset	Registers					
	Configuration Mode A		Configuration Mode B		Operational Mode	
	Read	Write	Read	Write	Read	Write
0x000	UART_DLL	UART_DLL	UART_DLL	UART_DLL	–	UART_THR
0x004	UART_DLH	UART_DLH	UART_DLH	UART_DLH	UART_IER(CIR)	UART_IER(CIR)
0x008	UART_IIR	UART_FCR	UART_EFR	UART_EFR	UART_IIR(CIR)	UART_FCR(CIR)
0x00C	UART_LCR	UART_LCR[7]	UART_LCR[7]	UART_LCR[7]	UART_LCR[7]	UART_LCR[7]
0x010	–	–	–	–	–	–
0x014	UART_LSR(IrDA)	–	–	–	UART_LSR(IrDA)	–
0x018	UART_MSR/UART_TCR	UART_TCR	UART_TCR	UART_TCR	UART_MSR/UART_TCR	UART_TCR
0x01C	UART_TLR/UART_SPR	UART_TLR/UART_SPR	UART_TLR	UART_TLR	UART_TLR/UART_SPR	UART_TLR/UART_SPR

⁽¹⁾ REGISTER_NAME(UART) notation indicates that the register exists for other functions (IrDA or CIR), but fields have different meanings for other functions.

⁽²⁾ REGISTER_NAME[m:n] notation indicates that only register bits numbered m to n apply to the UART function.

Table 19-24. CIR Mode Register Overview^{(1) (2)} (continued)

Address Offset	Registers					
	Configuration Mode A		Configuration Mode B		Operational Mode	
	Read	Write	Read	Write	Read	Write
0x020	UART_MDR1[3:0]	UART_MDR1[3:0]	UART_MDR1[3:0]	UART_MDR1[3:0]	UART_MDR1[3:0]	UART_MDR1[3:0]
0x024	UART_MDR2	UART_MDR2	UART_MDR2	UART_MDR2	UART_MDR2	UART_MDR2
0x028	–	–	–	–	–	–
0x02C	UART_RESUME	–	UART_RESUME	–	UART_RESUME	–
0x030	–	–	–	–	–	–
0x034	–	–	–	–	–	–
0x038	–	–	–	–	–	–
0x03C	–	–	–	–	UART_ACREG	UART_ACREG
0x040	UART_SCR	UART_SCR	UART_SCR	UART_SCR	UART_SCR	UART_SCR
0x044	UART_SSR	–	UART_SSR	–	UART_SSR	–
0x048	–	–	–	–	UART_EBLR	UART_EBLR
0x050	UART_MVR	–	UART_MVR	–	UART_MVR	–
0x054	UART_SYSC	UART_SYSC	UART_SYSC	UART_SYSC	UART_SYSC	UART_SYSC
0x058	UART_SYSS	–	UART_SYSS	–	UART_SYSS	–
0x05C	UART_WER[6:4]	UART_WER[6:4]	UART_WER[6:4]	UART_WER[6:4]	UART_WER[6:4]	UART_WER[6:4]
0x060	UART_CFPS	UART_CFPS	UART_CFPS	UART_CFPS	UART_CFPS	UART_CFPS
0x064	UART_RXFIFO_LVL	UART_RXFIFO_LVL	UART_RXFIFO_LVL	UART_RXFIFO_LVL	UART_RXFIFO_LVL	UART_RXFIFO_LVL
0x068	UART_TXFIFO_LVL	UART_TXFIFO_LVL	UART_TXFIFO_LVL	UART_TXFIFO_LVL	UART_TXFIFO_LVL	UART_TXFIFO_LVL
0x06C	UART_IER2	UART_IER2	UART_IER2	UART_IER2	UART_IER2	UART_IER2
0x070	UART_ISR2	UART_ISR2	UART_ISR2	UART_ISR2	UART_ISR2	UART_ISR2
0x074	UART_FREQ_SEL	UART_FREQ_SEL	UART_FREQ_SEL	UART_FREQ_SEL	UART_FREQ_SEL	UART_FREQ_SEL
0x080	UART_MDR3	UART_MDR3	UART_MDR3	UART_MDR3	UART_MDR3	UART_MDR3
0x084	UART_TX_DMA_THRESHOLD	UART_TX_DMA_THRESHOLD	UART_TX_DMA_THRESHOLD	UART_TX_DMA_THRESHOLD	UART_TX_DMA_THRESHOLD	UART_TX_DMA_THRESHOLD

19.3.8 Protocol Formatting

The UART/IRDA module can operate in seven different modes:

1. UART 16x mode (≤ 230.4 Kbits/s), UART16x ≤ 460 Kbits/s if MDR3[1] is set
2. UART 16x mode with autobauding (≥ 1200 bits/s and ≤ 115.2 Kbits/s) if MDR3[1] is not set
3. UART 13x mode (≥ 460.8 Kbits/s) if MDR3[1] is not set
4. IrDA SIR mode (≤ 115.2 Kbits/s) if MDR3[1] is not set
5. IrDA MIR mode (0.576 and 1.152 Mbits/s) if MDR3[1] is not set
6. IrDA FIR mode (4 Mbits/s) if MDR3[1] is not set
7. CIR mode (programmable modulation rates specific to remote control applications) if MDR3[1] is not set

The module performs a serial-to-parallel conversion on received data characters and a parallel-to-serial conversion on transmitted data characters by the processor. The complete status of each channel of the module and each received character/frame can be read at any time during functional operation via the line status register (LSR).

The module can be placed in an alternate mode (FIFO mode) to relieve the processor of excessive software overhead by buffering received/transmitted characters.

Both the receiver and transmitter FIFOs can store up to 64 bytes of data (plus three additional bits of error status per byte for the receiver FIFO) and have selectable trigger levels. Both interrupts and DMA are available to control the data flow between the LH and the module.

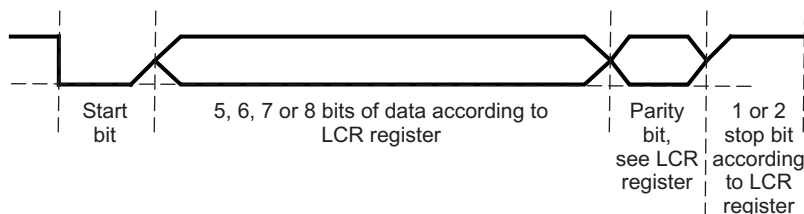
19.3.8.1 UART Mode

The UART uses a wired interface for serial communication with a remote device.

The UART module is functionally compatible with the TL16C750 UART and is also functionally compatible to earlier designs, such as the TL16C550. The UART module can use hardware or software flow control to manage transmission and reception. Hardware flow control significantly reduces software overhead and increases system efficiency by automatically controlling serial data flow using the RTS output and CTS input signals. Software flow control automatically controls data flow by using programmable XON/XOFF characters.

The UART modem module is enhanced with an autobauding functionality which in control mode allows to automatically set the speed, the number of bit per character, the parity selected.

Figure 19-14. UART Data Format

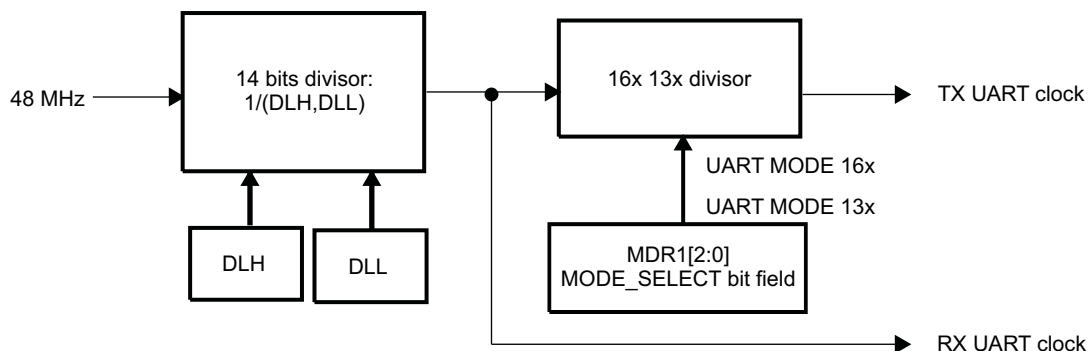


19.3.8.1.1 UART Clock Generation: Baud Rate Generation

The UART function contains a programmable baud generator and a set of fixed dividers that divide the 48-MHz clock input down to the expected baud rate.

Figure 19-15 shows the baud rate generator and associated controls.

Figure 19-15. Baud Rate Generation



uart-032

CAUTION

Before initializing or modifying clock parameter controls (UARTi.UART_DLH, UARTi.UART_DLL), MODE_SELECT = DISABLE (UARTi.UART_MDR1[2:0]) must be set to 0x7. Failure to observe this rule can result in unpredictable module behavior.

19.3.8.1.2 Choosing the Appropriate Divisor Value

Two divisor values are:

- UART 16x mode: Divisor value = Operating frequency/(16x baud rate)
- UART 13x mode: Divisor value = Operating frequency/(13x baud rate)

Table 19-25 describes the UART baud rate settings.

Table 19-25. UART Baud Rate Settings (48-MHz Clock)

Baud Rate	Baud Multiple	DLH,DLL (Decimal)	DLH,DLL (Hex)	Actual Baud Rate	Error (%)
0.3 kbps	16x	10000	0x27, 0x10	0.3 kbps	0
0.6 kbps	16x	5000	0x13, 0x88	0.6 kbps	0
1.2 kbps	16x	2500	0x09, 0xC4	1.2 kbps	0
2.4 kbps	16x	1250	0x04, 0xE2	2.4 kbps	0
4.8 kbps	16x	625	0x02, 0x71	4.8 kbps	0
9.6 kbps	16x	312	0x01, 0x38	9.6153 kbps	+0.16
14.4 kbps	16x	208	0x00, 0xD0	14.423 kbps	+0.16
19.2 kbps	16x	156	0x00, 0x9C	19.231 kbps	+0.16
28.8 kbps	16x	104	0x00, 0x68	28.846 kbps	+0.16
38.4 kbps	16x	78	0x00, 0x4E	38.462 kbps	+0.16
57.6 kbps	16x	52	0x00, 0x34	57.692 kbps	+0.16
115.2 kbps	16x	26	0x00, 0x1A	115.38 kbps	+0.16
230.4 kbps	16x	13	0x00, 0x0D	230.77 kbps	+0.16
460.8 kbps	13x	8	0x00, 0x08	461.54 kbps	+0.16
921.6 kbps	13x	4	0x00, 0x04	923.08 kbps	+0.16
1.843 Mbps	13x	2	0x00, 0x02	1.846 Mbps	+0.16
3.6884 Mbps	13x	1	0x00, 0x01	3.6923 Mbps	+0.16

19.3.8.1.3 UART Data Formatting

The UART can use hardware flow control to manage transmission and reception. Hardware flow control significantly reduces software overhead and increases system efficiency by automatically controlling serial data flow using the RTS output and CTS input signals.

The UART is enhanced with the autobauding function. In control mode, autobauding lets the speed, the number of bits per character, and the parity selected be set automatically.

19.3.8.1.3.1 Frame Formatting

When autobauding is not used, frame format attributes must be defined in the UARTi.UART_LCR register.

Character length is specified using the UARTi.UART_LCR[1:0] CHAR_LENGTH bit field.

The number of stop-bits is specified using the UARTi.UART_LCR[2] NB_STOP bit.

The parity bit is programmed using the UARTi.UART_LCR[5:3] PARITY_EN, PARITY_TYPE_1, and PARITY_TYPE_2 bit fields (see Table 19-26).

Table 19-26. UART Parity Bit Encoding

PARITY_EN	PARITY_TYPE_1	PARITY_TYPE_2	Parity
0	N/A	N/A	No parity
1	0	0	Odd parity
1	1	0	Even parity
1	0	1	Forced 1
1	1	1	Forced 0

19.3.8.1.3.2 Hardware Flow Control

Hardware flow control is composed of auto-CTS and auto-RTS. Auto-CTS and auto-RTS can be enabled and disabled independently by programming the UARTi.UART_EFR[7:6] AUTO_CTS_EN and AUTO_RTS_EN bit fields, respectively.

With auto-CTS, uarti_cts must be active before the module can transmit data.

Auto-RTS activates the uarti_rts output only when there is enough room in the RX FIFO to receive data. It deactivates the uarti_rts output when the RX FIFO is sufficiently full. The HALT and RESTORE trigger levels in the UARTi.UART_TCR register determine the levels at which uarti_rts is activated and deactivated.

If auto-CTS and auto-RTS are enabled, data transmission does not occur unless the RX FIFO has empty space. Thus, overrun errors are eliminated during hardware flow control. If auto-CTS and auto-RTS are not enabled, overrun errors occur if the transmit data rate exceeds the RX FIFO latency.

- Auto-RTS:

Auto-RTS data flow control originates in the receiver block. The RX FIFO trigger levels used in auto-RTS are stored in the UARTi.UART_TCR register. uarti_rts is active if the RX FIFO level is below the HALT trigger level in the UARTi.UART_TCR[3:0] RX_FIFO_TRIG_HALT bit field. When the RX FIFO HALT trigger level is reached, uarti_rts is deasserted. The sending device (for example, another UART) can send an additional byte after the trigger level is reached because it may not recognize the deassertion of RTS until it begins sending the additional byte.

uarti_rts is automatically reasserted when the RX FIFO reaches the RESUME trigger level programmed by the UARTi.UART_TCR[7:4] RX_FIFO_TRIG_START bit field. This reassertion requests the sending device to resume transmission.

In this case, uarti_rts is an active-low signal.

- Auto-CTS:

The transmitter circuitry checks uarti_cts before sending the next data byte. When uarti_cts is active, the transmitter sends the next byte. To stop the transmitter from sending the next byte, uarti_cts must be deasserted before the middle of the last stop-bit currently sent.

The auto-CTS function reduces interrupts to the host system. When auto-CTS flow control is enabled, the uarti_cts state changes do not have to trigger host interrupts because the device automatically controls its own transmitter. Without auto-CTS, the transmitter sends any data present in the transmit FIFO, and a receiver overrun error can result.

In this case, uarti_cts is an active-low signal.

19.3.8.1.3.3 Software Flow Control

Software flow control is enabled through the enhanced feature register (UARTi.UART_EFR) and the modem control register (UARTi.UART_MCR). Different combinations of software flow control can be enabled by setting different combinations of the UARTi.UART_EFR[3:0] bit field (see [Table 19-27](#)).

Two other enhanced features relate to software flow control:

- XON any function (UARTi.UART_MCR[5]): Operation resumes after receiving any character after the XOFF character is recognized. If special character detect is enabled and special character is received after XOFF1, it does not resume transmission. The special character is stored in the RX FIFO.

NOTE: The XON-any character is written into the RX FIFO even if it is a software flow character.

- Special character (UARTi.UART_EFR[5]): Incoming data is compared to XOFF2. When the special character is detected, the XOFF interrupt (UARTi.UART_IIR[4]) is set, but it does not halt transmission. The XOFF interrupt is cleared by a read of UARTi.UART_IIR. The special character is transferred to the RX FIFO. Special character does not work with XON2, XOFF2, or sequential XOFFs.

Table 19-27. UART_EFR[3:0] Software Flow Control Options

Bit 3	Bit 2	Bit 1	Bit 0	TX, RX Software Flow Controls
0	0	X	X	No transmit flow control
1	0	X	X	Transmit XON1, XOFF1
0	1	X	X	Transmit XON2, XOFF2
1	1	X	X	Transmit XON1, XON2: XOFF1, XOFF2 ⁽¹⁾
X	X	0	0	No receive flow control
X	X	1	0	Receiver compares XON1, XOFF1
X	X	0	1	Receiver compares XON2, XOFF2
X	X	1	1	Receiver compares XON1, XON2: XOFF1, XOFF2 ⁽¹⁾

⁽¹⁾ In these cases, the XON1 and XON2 characters or the XOFF1 and XOFF2 characters must be transmitted/received sequentially with XON1/XOFF1 followed by XON2/XOFF2.
 XON1 is defined in the UARTi.UART_XON1_ADDR1[7:0] XON_WORD1 bit field. XON2 is defined in the UARTi.UART_XON2_ADDR2[7:0] XON_WORD2 bit field.
 XOFF1 is defined in the UARTi.UART_XOFF1[7:0] XOFF_WORD1 bit field. XOFF2 is defined in the UARTi.UART_XOFF2[7:0] XOFF_WORD2 bit field.

19.3.8.1.3.3.1 Receive (RX)

When software flow control operation is enabled, the UART compares incoming data with XOFF1/2 programmed characters (in certain cases, XOFF1 and XOFF2 must be received sequentially). When the correct XOFF characters are received, transmission stops after transmission of the current character completes. Detection of XOFF also sets the UARTi.UART_IIR[4] bit (if enabled by UARTi.UART_IER[5]) and causes the interrupt line to go low.

To resume transmission, an XON1/2 character must be received (in certain cases, XON1 and XON2 must be received sequentially). When the correct XON characters are received, the UARTi.UART_IIR[4] bit is cleared and the XOFF interrupt disappears.

NOTE: When a parity, framing, or break error occurs while receiving a software flow control character, this character is treated as normal data and is written to the RX FIFO.

When XON-any and special character detect are disabled and software flow control is enabled, no valid XON or XOFF characters are written to the RX FIFO. For example, when UARTi.UART_EFR[1:0] = 0x2, if XON1 and XOFF1 characters are received, they are not written to the RX FIFO.

When pairs of software flow characters are programmed to be received sequentially (UARTi.UART_EFR[1:0] = 0x3), the software flow characters are not written to the RX FIFO if they are received sequentially. However, received XON1/XOFF1 characters must be written to the RX FIFO if the subsequent character is not XON2/XOFF2.

19.3.8.1.3.3.2 Transmit (TX)

Two XOFF1 characters are transmitted when the RX FIFO passes the trigger level programmed by UARTi.UART_TCR[3:0]. As soon as the RX FIFO reaches the trigger level programmed by UARTi.UART_TCR[7:4], two XON1 characters are sent, so the data transfer recovers.

NOTE: If software flow control is disabled after an XOFF character is sent, the module transmits XON characters automatically to enable normal transmission.

The transmission of XOFF(s)/XON(s) follows the same protocol as transmission of an ordinary byte from the TX FIFO. This means that even if the word length is 5, 6, or 7 characters, the 5, 6, or 7 LSBs of XOFF1/2 and XON1/2 are transmitted. The 5, 6, or 7 bits of a character are seldom transmitted, but this function is included to maintain compatibility with earlier designs.

It is assumed that software flow control and hardware flow control are never enabled simultaneously.

19.3.8.1.3.4 Autobauding Modes

In autobauding mode, the UART can extract transfer characteristics (speed, length, and parity) from an "at" (AT) command (ASCII code). These characteristics are used to receive data after an AT and to send data.

The following AT commands are valid:

```

AT      DATA  <CR>
at      DATA  <CR>
A/
a/

```

A line break during the acquisition of the sequence AT is not recognized, and an echo function is not implemented in hardware.

A/ and a/ are not used to extract characteristics, but they must be recognized because of their special meaning. A/ or a/ is used to instruct the software to repeat the last received AT command; therefore, an a/ always follows an AT, and transfer characteristics are not expected to change between an AT and an a/.

When a valid AT is received, AT and all subsequent data, including the final <CR> (0x0D), are saved to the RX FIFO. The autobaud state-machine waits for the next valid AT command. If an a/ (A/) is received, the a/ (A/) is saved in the RX FIFO and the state-machine waits for the next valid AT command.

On the first successful detection of the baud rate, the UART activates an interrupt to signify that the AT (upper or lower case) sequence is detected. The UARTi.UART_UASR register reflects the correct settings for the baud rate detected. Interrupt activity can continue in this fashion when a subsequent character is received. Therefore, it is recommended that the software enable the RHR interrupt when using the autobaud mode.

The following settings are detected in autobaud mode with a module clock of 48 MHz:

- Speed:
 - 115.2K baud
 - 57.6K baud
 - 38.4K baud
 - 28.8K baud
 - 19.2K baud
 - 14.4K baud
 - 9.6K baud
 - 4.8K baud
 - 2.4K baud
 - 1.2K baud
- Length: 7 or 8 bits
- Parity: Odd, even, or space

NOTE: The combination of 7-bit character plus space parity is not supported.

Autobauding mode is selected when the UARTi.UART_MDR1[2:0] MODE_SELECT bit field is set to 0x2. In UART autobauding mode, UARTi.UART_DLL, UARTi.UART_DLH, and UARTi.UART_LCR[5:0] bit field settings are not used; instead, UART_UASR is updated with the configuration detected by the autobauding logic.

UART_UASR Autobauding Status Register Use

This register is used to set up transmission according to the characteristics of the previous reception instead of the UARTi.UART_LCR, UARTi.UART_DLL, and UARTi.UART_DLH registers when the UART is in autobauding mode.

To reset the autobauding hardware (to start a new AT detection) or to set the UART in standard mode (no autobaud), the UARTi.UART_MDR1[2:0] MODE_SELECT bit field must be set to reset state (0x7) and then to the UART in autobauding mode (0x2) or to the UART in standard mode (0x0).

Use limitation:

- Only 7- and 8-bit characters (5- and 6-bit not supported)
- 7-bit character with space parity not supported
- Baud rate between 1200 and 115,200 bps (10 possibilities)

19.3.8.1.3.5 Error Detection

When the UARTi.UART_LSR register is read, the UARTi.UART_LSR[4:2] bit field reflects the error bits (BI: break condition, FE: framing error, PE: parity error) of the character at the top of the RX FIFO (the next character to be read). Therefore, reading the UARTi.UART_LSR register and then reading the UARTi.UART_RHR register identifies errors in a character.

Reading the UARTi.UART_RHR register updates the BI, FE, and PE bits (see [Table 19-11](#) for the UART mode interrupts).

The UARTi.UART_LSR[7] RX_FIFO_STS bit is set when there is an error in the RX FIFO and is cleared only when no errors remain in the RX FIFO.

NOTE: Reading the UARTi.UART_LSR register does not cause an increment of the RX FIFO read pointer. The RX FIFO read pointer is incremented by reading the UARTi.UART_RHR register.

Reading the UARTi.UART_LSR register clears the OE bit if it is set (see [Table 19-11](#) for the UART mode interrupts).

19.3.8.1.3.6 Overrun During Receive

Overrun during receive occurs if the RX state-machine tries to write data into the RX FIFO when it is already full. When overrun occurs, the device interrupts the MPU with the UARTi.UART_IIR[5:1] IT_TYPE bit field set to 0x3 (receiver line status error) and discards the remaining portion of the frame.

Overrun also causes an internal flag to be set, which disables further reception. Before the next frame can be received, the MPU must:

- Reset the RX FIFO.
- Read the UARTi.UART_RESUME register, which clears the internal flag.

19.3.8.1.3.7 Time-Out and Break Conditions

19.3.8.1.3.7.1 Time-Out Counter

An RX idle condition is detected when the receiver line (uarti_rx) is high for a time that equals 4x the programmed word length + 12 bits. uarti_rx is sampled midway through each bit.

For sleep mode, the counter is reset when there is activity on uarti_rx.

For the time-out interrupt, the counter counts only when there is data in the RX FIFO, and the count is reset when there is activity on uarti_rx or when the UARTi.UART_RHR register is read.

19.3.8.1.3.7.2 Break Condition

When a break condition occurs, uarti_tx is pulled low. A break condition is activated by setting the UARTi.UART_LCR[6] BREAK_EN bit. The break condition is not aligned on word stream (a break condition can occur in the middle of a character). The only way to send a break condition on a full character is:

1. Reset the TX FIFO (if enabled).
2. Wait for the transmit shift register to empty (the UARTi.UART_LSR[6] TX_SR_E bit is set to 1).

3. Take a guard time according to stop-bit definition.
4. Set the BREAK_EN bit to 1.

The break condition is asserted while the BREAK_EN bit is set to 1.

The time-out counter and break condition apply only to UART modem operation and not to IrDA/CIR mode operation.

19.3.8.2 IrDA Mode

19.3.8.2.1 Slow Infrared (SIR) Mode

In SIR mode, data transfers take place between the LH and peripheral devices at speeds of up to 115200 bauds. A SIR transmit frame starts with start flags (either a single 0xC0, multiple 0xC0, or a single 0xC0 preceded by a number of 0xFF flags), followed by frame data, CRC-16, and ends with a stop flag (0xC1). The bit format for a single word uses a single start bit, eight data bits, and one stop bit. The format is unaffected by the use and settings of the LCR register.

Note that BLR[6] is used to select whether to use 0xC0 or 0xFF start patterns when multiple start flags are required.

The SIR transmit state machine attaches start flags, CRC-16, and stop flags. It checks the outgoing data to establish if data transparency is required.

SIR transparency is carried out if the outgoing data, between the start and stop flags, contains 0xC0, 0xC1, or 0x7D. If one of these is about to be transmitted, then the SIR state machine sends an escape character (0x7D) first, then inverts the fifth bit of the real data to be sent and sends this data immediately after the 0x7D character.

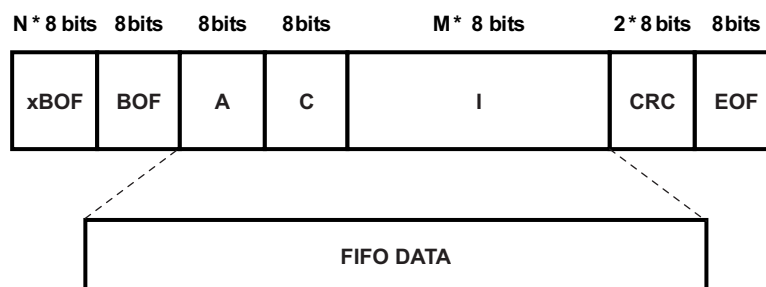
The SIR receive state machine recovers the receive clock, removes the start flags, removes any transparency from the incoming data, and determines frame boundary with reception of the stop flag. It also checks for errors, such as frame abort (0x7D character followed immediately by a 0xC1 stop flag, without transparency), CRC error, and frame-length error. At the end of a frame reception, the LH reads the line status register (LSR) to find out possible errors of the received frame.

Data can be transferred both ways by the module, but when the device is transmitting the IR RX circuitry is automatically disabled by hardware. See bit 5 in the auxiliary control register (ACREG) for a description of the logical operation. **Note:** This applies to all three modes SIR, MIR, and FIR.

The infrared output in SIR mode can either be 1.6µs or 3/16 encoding, selected by the PULSETYPE bit of the Auxiliary Control Register (ACREG[7]). In 1.6µs encoding, the infrared pulse width is 1.6µs and in 3/16 encoding the infrared pulse width is 3/16 of a bit duration (1/ baud-rate). The receiver supports both 3/16 and 1.6µs pulse duration by default. The transmitting device must send at least two start flags at the start of each frame for back-to-back frames. **Note:** Reception supports variable-length stop bits.

19.3.8.2.1.1 Frame Format

Figure 19-16. IrDA SIR Frame Format



The CRC is applied on the address (A), control (C) and information (I) bytes.

Note: The two words of CRC are written in the FIFO in reception.

19.3.8.2.1.2 Asynchronous Transparency

Before transmitting a byte, the UART IrDA controller examines each byte of the payload and the CRC field (between BOF and EOF). For each byte equal to 0xC0 (BOF), 0xC1 (EOF), or 0x7D (control escape) it does the following.

In transmission

1. Inserts a control escape (CE) byte preceding the byte.
2. Complements bit 5 of the byte (i.e., exclusive OR's the byte with 0x20).

The byte sent for the CRC computation is the initial byte written in the TX FIFO (before the XOR with 0x20).

In reception

For the A, C, I, CRC field:

1. Compare the byte with CE byte, and if not equal send it to the CRC detector and store it in the RX FIFO.
2. If equal to CE, discard the CE byte.
3. Complements the bit 5 of the byte following the CE.
4. Send the complemented byte to the CRC detector and store it in the RX FIFO.

19.3.8.2.1.3 Abort Sequence

The transmitter may decide to prematurely close a frame. The transmitter aborts by sending the following sequence: 0x7DC1. The abort pattern closes the frame without a CRC field or an ending flag.

It is possible to abort a transmission frame by programming the ABORTEN bit of the Auxiliary Control Register (ACREG[1]). When this bit is set to 1, 0x7D and 0xC1 are transmitted and the frame is not terminated with CRC or stop flags. The receiver treats a frame as an aborted frame when a 0x7D character, followed immediately by a 0xC1 character, has been received without transparency.

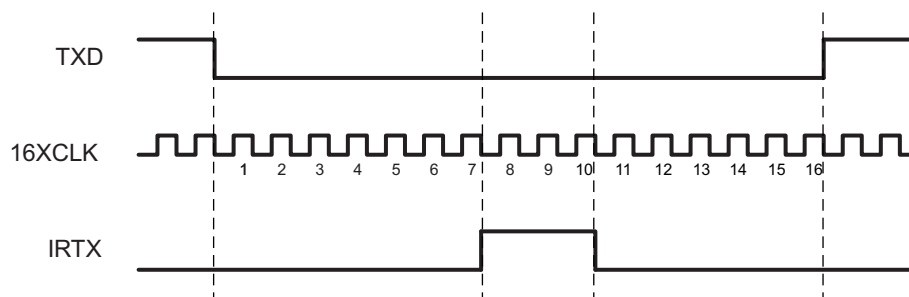
19.3.8.2.1.4 Pulse Shaping

In SIR mode, both the 3/16th and the 1.6µs pulse duration methods are supported in receive and transmit. ACREG[7] selects the pulse width method in transmit mode.

19.3.8.2.1.5 Encoder

Serial data from the transmit state machine is encoded to transmit data to the optoelectronics. While the serial data input to the (TXD) is high, the output (IRTX) is always low, and the counter used to form a pulse on IRTX is continuously cleared. After TXD resets to 0, IRTX rises on the falling edge of the 7th 16XCLK. On the falling edge of the 10th 16XCLK pulse, IRTX falls, creating a 3-clock-wide pulse. While TXD stays low, a pulse is transmitted during the 7th to the 10th clock of each 16-clock bit cycle.

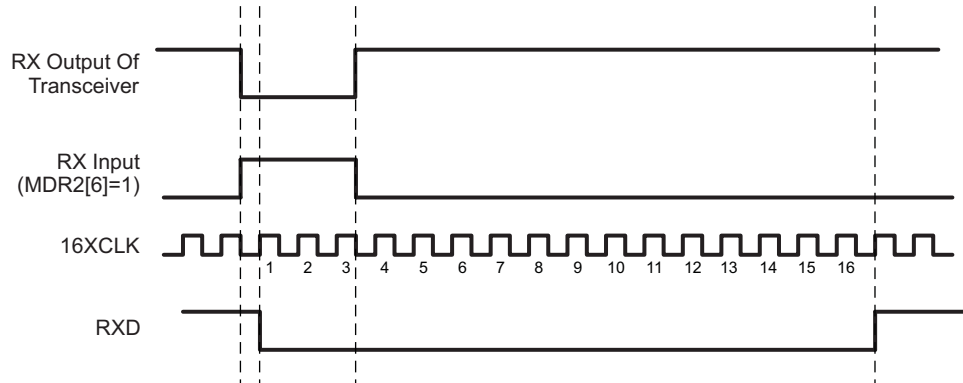
Figure 19-17. IrDA Encoding Mechanism



19.3.8.2.1.6 Decoder

After reset, RXD is high and the 4-bit counter is cleared. When a rising edge is detected on RX, RXD falls on the next rising edge of 16XCLK with sufficient setup time. RXD stays low for 16 cycles (16XCLK) and then returns to high as required by the IrDA specification. As long as no pulses (rising edges) are detected on the RX, RXD remains high.

Figure 19-18. IrDA Decoding Mechanism



The operation of the RX input can be disabled with DISIRRX bit of the Auxiliary Control Register (ACREG[5]). Furthermore, the MDR2[6] can be used to invert the signal from the transceiver (RX output) pin to the IRRX logic inside the UART.

19.3.8.2.1.7 IR Address Checking

In all IR modes, if address checking has been enabled, only frames intended for the device are written to the RX FIFO. This is to avoid receiving frames not meant for this device in a multi-point infrared environment. It is possible to program two frame addresses that the UART IrDA receives with XON1/ADDR1 and XON2/ADDR2 registers. Selecting address1 checking is done by setting EFR[0] to 1; address2 checking is done by setting EFR[1] to 1.

Setting EFR[1:0] to 0 disables all address checking operations. If both bits are set, then the incoming frame is checked for both private and public addresses. If address checking is disabled, then all received frames are written into the reception FIFO.

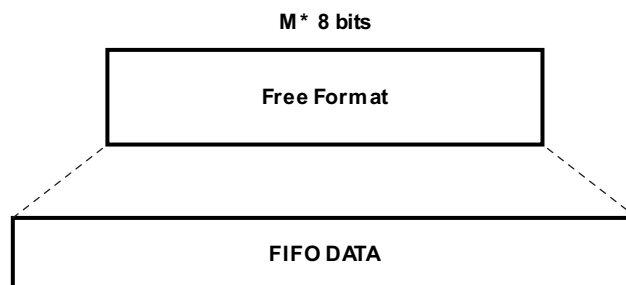
19.3.8.2.1.8 SIR Free Format Mode

To allow complete software flexibility in the transmission and reception of Infrared data packets, the SIR free format mode is a sub-function of the existing SIR mode such that all frames going to and from the FIFO buffers are untouched with respect to appending and removing control characters and CRC values. In the transmission phase, the mode uses the IRTX pin, as in SIR mode.

This mode corresponds to a UART mode with a pulse modulation of 3/16 of baud-rate pulse width.

For example, a normal SIR packet has BOF control and CRC error checking data appended (transmitting) or removed (receiving) from the data going to and from the FIFOs. In SIR free format mode, only the data termed the FIFO DATA area, illustrated in Figure 19-19, would be transmitted and received.

Figure 19-19. SIR Free Format Mode



In this mode, the entire FIFO data packet is to be constructed (encoded and decoded) by the LH software.

The SIR free format mode is selected by setting the module in UART mode (MDR1[2:0] = 000) and the MDR2[3] register bit to one to allow the pulse shaping. As the bit format is to remain the same, some UART mode configuration registers need to be set at specific value:

- LCR[1:0] = "11" (8 data bits)
- LCR[2] = 0 (1 stop bit)
- LCR[3] = 0 (no parity)
- ACREG[7] = 0 (3/16 of baud-rate pulse width)

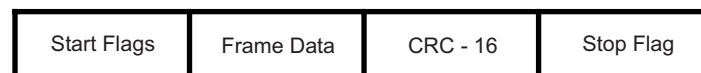
The features defined through MDR2[6] and ACREG[5] are also supported.

Note: - All other configuration registers need to be at the reset value. The UART mode interrupts are used for the SIR free format mode, but many of them are not relevant (e.g., XOFF, RTS, CTS, Modem status register).

19.3.8.2.2 Medium Infrared (MIR) Mode

In MIR mode, data transfers take place between LH and peripheral devices at 0.576 or 1.152 Mb/s speed. A MIR transmit frame starts with start flags (at least two), followed by a frame data, CRC-16, and ends with a stop flag.

Figure 19-20. MIR Transmit Frame Format



On transmit, the MIR state machine attaches start flags, CRC-16, and stop flags. It also looks for five consecutive values of 1 in the frame data and automatically inserts a zero after five consecutive values of one (this is called bit stuffing).

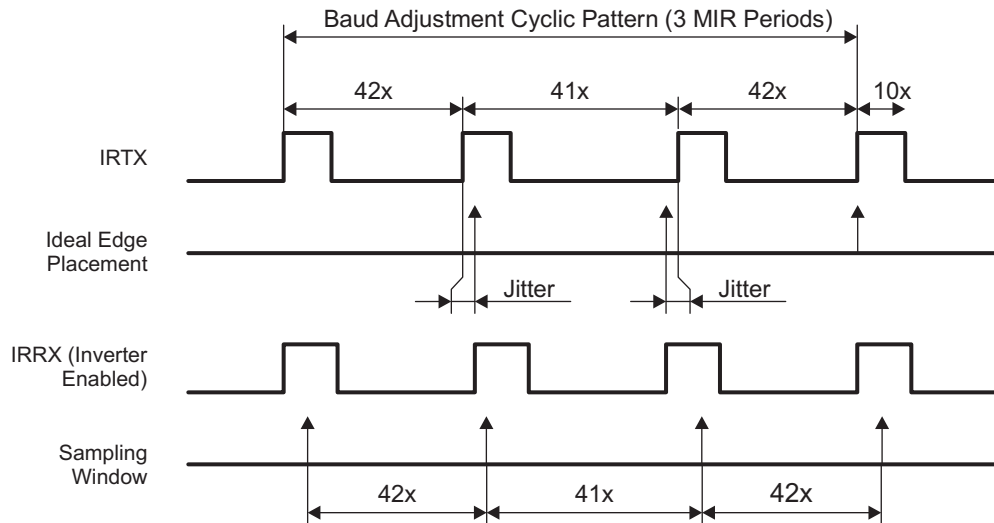
On receive, the MIR receive state machine recovers the receive clock, removes the start flags, de-stuffs the incoming data, and determines frame boundary with reception of the stop flag. It also checks for errors, such as frame abort, CRC error, or frame-length error. At the end of a frame reception, the LH reads the line status register (LSR) to find possible errors of received frame.

Data can be transferred both ways by the module but when the device is transmitting, the IR RX circuitry is automatically disabled by hardware. See bit 5 in the auxiliary control register (ACREG) for a description of the logical operation. **Note:** This applies to all three modes SIR, MIR and FIR.

19.3.8.2.2.1 MIR Encoder/Decoder

In order to meet MIR baud-rate tolerance of +/-0.1% with a 48-MHz clock input, a 42-41-42 encoding/decoding adjustment is performed. The reference start point is the first start flag and the 42-41-42 cyclic pattern is repeated until the stop flag is sent or detected. The jitter created this way is within MIR tolerances. The pulse width is not exactly 1/4 but within tolerances defined by the IrDA specifications.

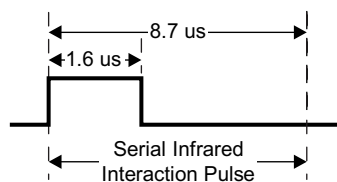
Figure 19-21. MIR BAUD Rate Adjustment Mechanism



19.3.8.2.2.2 SIP Generation

In MIR and FIR operation modes, the transmitter needs to send a serial infrared interaction pulse (SIP) at least once every 500 ms. The purpose of the SIP is to let slow devices (operating in SIR mode) know that the medium is currently occupied. The SIP pulse is shown in [Figure 19-22](#)

Figure 19-22. SIP Pulse



When the SIPMODE bit of Mode Definition Register 1 (MDR1[6]) equals 1, the TX state machine will always send one SIP at the end of a transmission frame. But when MDR1[6] = 0, the transmission of the SIP depends on the SENDSIP bit of the Auxiliary Control Register (ACREG[3]). The system (LH) can set ACREG[3] at least once every 500ms. The advantage of this approach over the default approach is that the TX state machine does not need to send the SIP at the end of each frame which may reduce the overhead required

19.3.8.2.3 Fast Infrared (FIR) Mode

In FIR mode, data transfers take place between LH and peripheral devices at 4 Mbits/s speed. A FIR transmit frame starts with a preamble, followed by a start flag, frame data, CRC-32, and ends with a stop flag.

Figure 19-23. FIR Transmit Frame Format



On transmit, the FIR transmit state machine attaches the preamble, start flag, CRC-32, and stop flag. It also encodes the transmit data into 4PPM format. It also generates the serial infrared interaction pulse (SIP).

On receive, the FIR receive state machine recovers the receive clock, removes the start flag, decodes the 4PPM incoming data, and determines frame boundary with a reception of the stop flag. It also checks for errors such as an illegal symbol, a CRC error, and a frame-length error. At the end of a frame reception, the LH reads the line status register (LSR) to find out possible errors of the received frame.

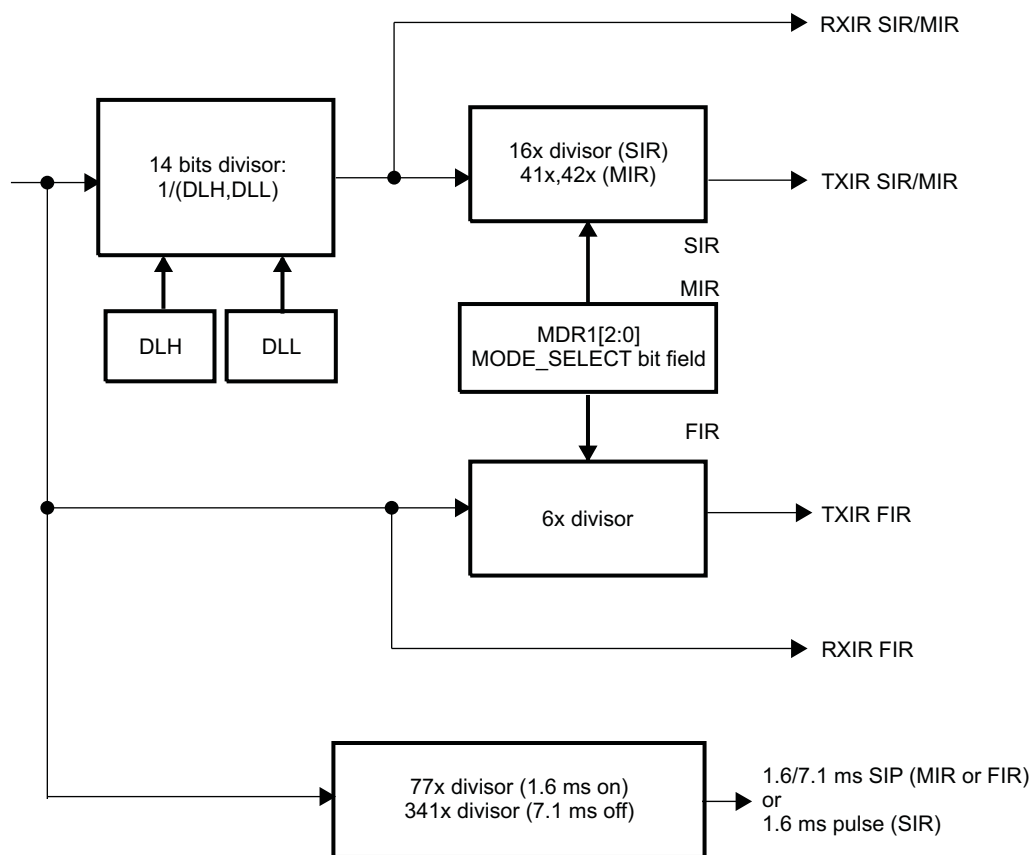
Data can be transferred both ways by the module but when the device is transmitting, the IR RX circuitry is automatically disabled by hardware. See bit 5 in the auxiliary control register (ACREG) for a description of the logical operation. **Note:** This applies to all three modes of SIR, MIR, and FIR.

19.3.8.2.4 IrDA Clock Generation: Baud Generator

The IrDA function contains a programmable baud generator and a set of fixed dividers that divide the 48-MHz clock input down to the expected baud rate.

Figure 19-24 shows the baud rate generator and associated controls.

Figure 19-24. Baud Rate Generator



uart-033

CAUTION

Before initializing or modifying clock parameter controls (UARTi.UART_DLH, UARTi.UART_DLL), MODE_SELECT=DISABLE (UARTi.UART_MDR1[2:0]) must be set to 0x7. Failure to observe this rule can result in unpredictable module behavior.

19.3.8.2.5 Choosing the Appropriate Divisor Value

Three divisor values are:

- SIR mode: Divisor value = Operating frequency/(16x baud rate)
- MIR mode: Divisor value = Operating frequency/(41x/42x baud rate)
- FIR mode: Divisor value = None

Table 19-28 lists the IrDA baud rate settings.

Table 19-28. IrDA Baud Rate Settings

Baud Rate	IR Mode	Baud Multiple	Encoding	DLH, DLL (Decimal)	Actual Baud Rate	Error (%)	Source Jitter (%)	Pulse Duration
2.4 kbps	SIR	16x	3/16	1250	2.4 kbps	0	0	78.1 μ s
9.6 kbps	SIR	16x	3/16	312	9.6153 kbps	+0.16	0	19.5 μ s
19.2 kbps	SIR	16x	3/16	156	19.231 kbps	+0.16	0	9.75 μ s
38.4 kbps	SIR	16x	3/16	78	38.462 kbps	+0.16	0	4.87 μ s
57.6 kbps	SIR	16x	3/16	52	57.692 kbps	+0.16	0	3.25 μ s
115.2 kbps	SIR	16x	3/16	26	115.38 kbps	+0.16	0	1.62 μ s
0.576 Mbps	MIR	41x/42x	1/4	2	0.5756 Mbps ⁽¹⁾	0	+1.63/-0.80	416 ns
1.152 Mbps	MIR	41x/42x	1/4	1	1.1511 Mbps ⁽¹⁾	0	+1.63/-0.80	208 ns
4 Mbps	FIR	6x	4 PPM	-	4 Mbps	0	0	125 ns

⁽¹⁾ Average value

NOTE: Baud rate error and source jitter table values do not include 48-MHz reference clock error and jitter.

19.3.8.2.6 IrDA Data Formatting

The methods described in this section apply to all IrDA modes (SIR, MIR, and FIR).

19.3.8.2.6.1 IR RX Polarity Control

The UARTi.UART_MDR2[6] IRRXINVERT bit provides the flexibility to invert the uarti_rx_irrx pin in the UART to ensure that the protocol at the output of the transceiver has the same polarity at module level. By default, the uarti_rx_irrx pin is inverted because most transceivers invert the IR receive pin.

19.3.8.2.6.2 IrDA Reception Control

The module can transmit and receive data, but when the device is transmitting, the IR RX circuitry is automatically disabled by hardware.

Operation of the uarti_rx_irrx input can be disabled by the UARTi.UART_ACREG[5] DIS_IR_RX bit.

19.3.8.2.6.3 IR Address Checking

In all IR modes, when address checking is enabled, only frames intended for the device are written to the RX FIFO. This restriction avoids receiving frames not meant for this device in a multipoint infrared environment. It is possible to program two frame addresses that the UART IrDA receives, with the UARTi.UART_XON1_ADDR1[7:0] XON_WORD1 and UARTi.UART_XON2_ADDR2[7:0] XON_WORD2 bit fields.

Setting the UART_EFR[0] bit to 1 selects address1 checking. Setting the UART_EFR[1] bit to 1 selects address2 checking. Setting the UART_EFR[1:0] bit field to 0 disables all address checking operations. If both bits are set, the incoming frame is checked for private and public addresses.

If address checking is disabled, all received frames write to the RX FIFO.

19.3.8.2.6.4 Frame Closing

A transmission frame can be terminated in two ways:

- Frame-length method: Set the UARTi.UART_MDR1[7] FRAME_END_MODE bit to 0. The MPU writes the value of the frame length to the UARTi.UART_TXFLH and UARTi.UART_TXFLL registers. The device automatically attaches end flags to the frame when the number of bytes transmitted equals the value of the frame length.
- Set-EOT bit method: Set the FRAME_END_MODE bit to 1. The MPU writes 1 to the UARTi.UART_ACREG[0] EOT bit just before it writes the last byte to the TX FIFO. When the MPU writes the last byte to the TX FIFO, the device internally sets the tag bit for that character in the TX FIFO. As the TX state-machine reads data from the TX FIFO, it uses this tag-bit information to attach end flags and correctly terminate the frame.

19.3.8.2.6.5 Store and Controlled Transmission

In store and controlled transmission (SCT) mode, the MPU starts writing data to the TX FIFO. Then, after writing a part of a frame (for a bigger frame) or an entire frame (a small frame; that is, a supervisory frame), the MPU writes 1 to the UARTi.UART_ACREG[2] SCTX_EN bit (deferred TX start) to start transmission.

SCT mode is enabled by setting the UARTi.UART_MDR1[5] SCT bit to 1. This transmission method differs from normal mode, in which data transmission starts immediately after data is written to the TX FIFO. SCT mode is useful for sending short frames without TX underrun.

19.3.8.2.6.6 Error Detection

When the UARTi.UART_LSR register is read, the UARTi.UART_LSR[4:2] bit field reflects the error bits [FL, CRC, ABORT] of the frame at the top of the STATUS FIFO (the next frame status to be read).

The error is triggered by an interrupt (for IrDA mode interrupts, see [Table 19-12](#)). The STATUS FIFO must be read until empty (a maximum of eight reads is required).

19.3.8.2.6.7 Underrun During Transmission

Underrun during transmission occurs when the TX FIFO is empty before the end of the frame is transmitted. When underrun occurs, the device closes the frame with end flags but attaches an incorrect CRC value. The receiving device detects a CRC error and discards the frame; it can then ask for a retransmission.

Underrun also causes an internal flag to be set, which disables additional transmissions. Before the next frame can be transmitted, the MPU must:

- Reset the TX FIFO.
- Read the UARTi.UART_RESUME register, which clears the internal flag.

This function can be disabled by the UARTi.UART_ACREG[4] DIS_TX_UNDERRUN bit, compensated by the extension of the stop-bit in transmission if the TX FIFO is empty.

19.3.8.2.6.8 Overrun During Receive

Overrun during receive for the IrDA mode has the same function as that for the UART mode (see [Section 19.3.8.1.3.6, Overrun During Receive](#)).

19.3.8.2.6.9 Status FIFO

In IrDA modes, a status FIFO records the received frame status. When a complete frame is received, the length of the frame and the error bits associated with the frame are written to the status FIFO.

Reading the UARTi.UART_SFREGH[3:0] MSB and UARTi.UART_SFREGL[3:0] (LSB) bit fields obtains the frame length. The frame error status is read in the UARTi.UART_SFLSR register. Reading the UARTi.UART_SFLSR register increments the status FIFO read pointer. Because the status FIFO is eight entries deep, it can hold the status of eight frames.

The MPU uses the frame-length information to locate the frame boundary in the received frame data. The MPU can screen bad frames using the error status information and can later request the sender to resend only the bad frames.

This status FIFO can be used effectively in DMA mode because the MPU must be interrupted only when the programmed status FIFO trigger level is reached, not each time a frame is received.

19.3.8.2.7 SIR Mode Data Formatting

This section provides specific instructions for SIR mode programming.

19.3.8.2.7.1 Abort Sequence

The transmitter can prematurely close a frame (abort) by sending the sequence 0x7DC1. The abort pattern closes the frame without a CRC field or an ending flag.

A transmission frame can be aborted by setting the UARTi.UART_ACREG[1] ABORT_EN bit to 1. When this bit is set to 1, 0x7D and 0xC1 are transmitted and the frame is not terminated with CRC or stop flags.

When a 0x7D character followed immediately by a 0xC1 character is received without transparency, the receiver treats a frame as an aborted frame.

CAUTION

When the TX FIFO is not empty and the UARTi.UART_MDR1[5] SCT bit is set to 1, the UART IrDA starts a new transfer with data of a previous frame when the aborted frame is sent. Therefore, the TX FIFO must be reset before sending an aborted frame.

19.3.8.2.7.2 Pulse Shaping

SIR mode supports the 3/16 or the 1.6- μ s pulse duration methods in receive and transmit. The UARTi.UART_ACREG[7] PULSE_TYPE bit selects the pulse width method in the transmit mode.

19.3.8.2.7.3 SIR Free Format Programming

The SIR FF mode is selected by setting the module in the UART mode (UARTi.UART_MDR1[2:0] MODE_SELECT = 0x0) and the UARTi.UART_MDR2[3] UART_PULSE bit to 1 to allow pulse shaping.

Because the bit format stays the same, some UART mode configuration registers must be set at specific values:

- UARTi.UART_LCR[1:0] CHAR_LENGTH bit field = 0x3 (8 data bits)
- UARTi.UART_LCR[2] NB_STOP bit = 0x0 (1 stop-bit)
- UARTi.UART_LCR[3] PARITY_EN bit = 0x0 (no parity)

The UART mode interrupts are used for the SIR FF mode, but many are not relevant (XOFF, RTS, CTS, modem status register, etc.).

19.3.8.2.8 MIR and FIR Mode Data Formatting

This section describes common instructions for FIR and MIR mode programming.

At the end of a frame reception, the MPU reads the line status register (UARTi.UART_LSR) to detect errors in the received frame.

When the UARTi.UART_MDR1[6] SIP_MODE bit is set to 1, the TX state-machine always sends one SIP at the end of a transmission frame. However, when the SIP_MODE bit is set to 0, SIP transmission depends on the UARTi.UART_ACREG[3] SEND_SIP bit.

The MPU can set the SEND_SIP bit at least once every 500 ms. The advantage of this approach over the default approach is that the TX state-machine does not have to send the SIP at the end of each frame, thus reducing the overhead required.

19.3.8.3 CIR Mode

In consumer infrared mode, the infrared operation is designed to function as a programmable (universal) remote control. By setting the MDR1 register, the UART can be set to CIR mode in the same way as the other IrDA modes are set using the MDR1 register.

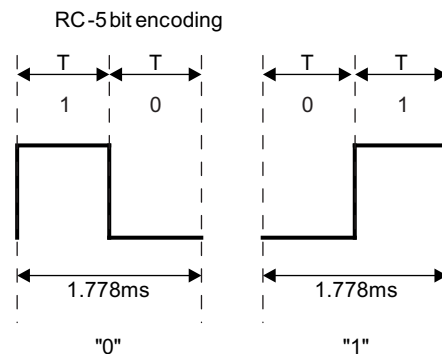
The CIR mode uses a variable pulse width modulation technique (based on multiples of a programmable T period) to encompass the various formats of infrared encoding for remote control applications. The CIR logic is to transmit and receive data packets according to the user definable frame structure and packet content.

19.3.8.3.1 Consumer IR Encoding

There are two distinct methods of encoding for remote control applications. The first uses time extended bit forms i.e. a variable pulse distance (or duration) whereby the difference between a logic one and logic zero is the length of the pulse width; and the second is the use of a bi-phase where the encoding of the logic zero and one is in the change of signal level from 1→0 or 0→1 respectively. Japanese manufacturers tend to favor the use of pulse duration encoding whereas European manufacturers favor the use of bi-phase encoding.

The CIR mode is designed to use a completely flexible free format encoding where a digit '1' from the TX/RX FIFO is to be transmitted/received as a modulated pulse with duration T. Equally, a '0' is to be transmitted/received as a blank duration T. The protocol of the data is to be constructed and deciphered by the host CPU. For example, the RC-5 protocol using Manchester encoding can be emulated as using a "01" pair for one and "10" pair for a zero.

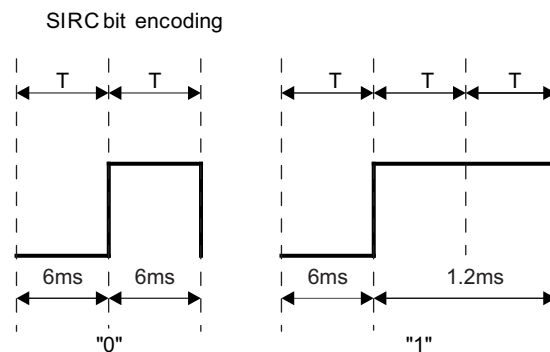
Figure 19-25. RC-5 Bit Encoding



Since the CIR mode logic does not impose a fixed format for infrared packets of data, the CPU software is at liberty to define the format through the use of simple data structures that will then be modulated into an industry standard, such as RC5 or SIRC. To send a sequence of "0101" in RC5, the host software must write an eight bit binary character of "10011001" to the data TX FIFO of the UART.

For SIRC, the modulation length (i.e. multiples of T) is the method to distinguish between a "1" or a "0". The following SIRC digits show the difference in encoding between this and RC5 for example. Note: the pulse width is extended for "1" digits.

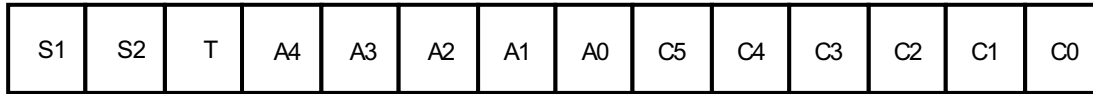
Figure 19-26. SIRC Bit Encoding



To construct comprehensive packets that constitute remote control commands, the host software must combine a number of eight bit data characters in a sequence that follows one of the universally accepted formats. For illustrative purposes, a standard RC5 frame is described below (the SIRC format follows this). Each of the above fields in RC-5 can be considered as two T pulses (digital bits) from the TX and RX FIFOs.

The standard RC5 format as seen by the UART_IrDA in CIR mode.

Figure 19-27. RC-5 Standard Packet Format



Where:

S1, S2: Start bits (always 1)

T: Toggle bit

A4–A0: Address (or system) bits

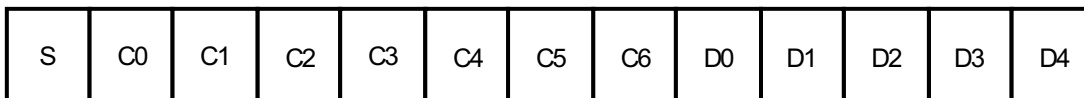
C5–C0: Command bits

The toggle bit T changes each time a new command is transmitted to allow detection of pressing the same key twice (or effectively receiving the same data from the host consecutively). Since a code is being sent as long as the CPU transmits characters to the UART for transmission, a brief delay in the transmission of the same command would be detected by the use of the toggle bit. The address bits define the machine or device that the Infrared transmission is intended for and the command defines the operation.

To accommodate an extended RC5 format, the S2 bit is replaced by a further command bit (C6) that allows the command range to increase to 7-bits. This format is known as the extended RC-5 format.

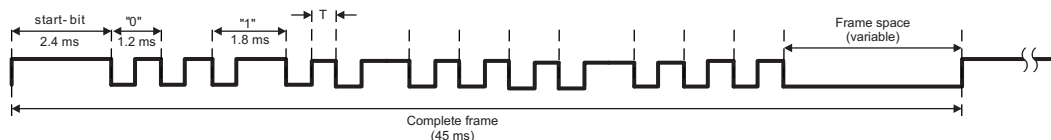
The SIRC encoding uses the duration of modulation for mark and space; hence the duration of data bits inside the standard frame length will vary depending upon the logic 1 content. The packet format and bit encoding is illustrated below. There is one start bit of two milliseconds and control codes followed by data that constitute the whole frame.

Figure 19-28. SIRC Packet Format



It should be noted that the encoding must take a standard duration but the contents of the data may vary. This implies that the control software for emitting and receiving data packets must exercise a scheme of inter-packet delay, where the emission of successive packets can only be done after a real time delay has expired.

Figure 19-29. SIRC Bit Transmission Example

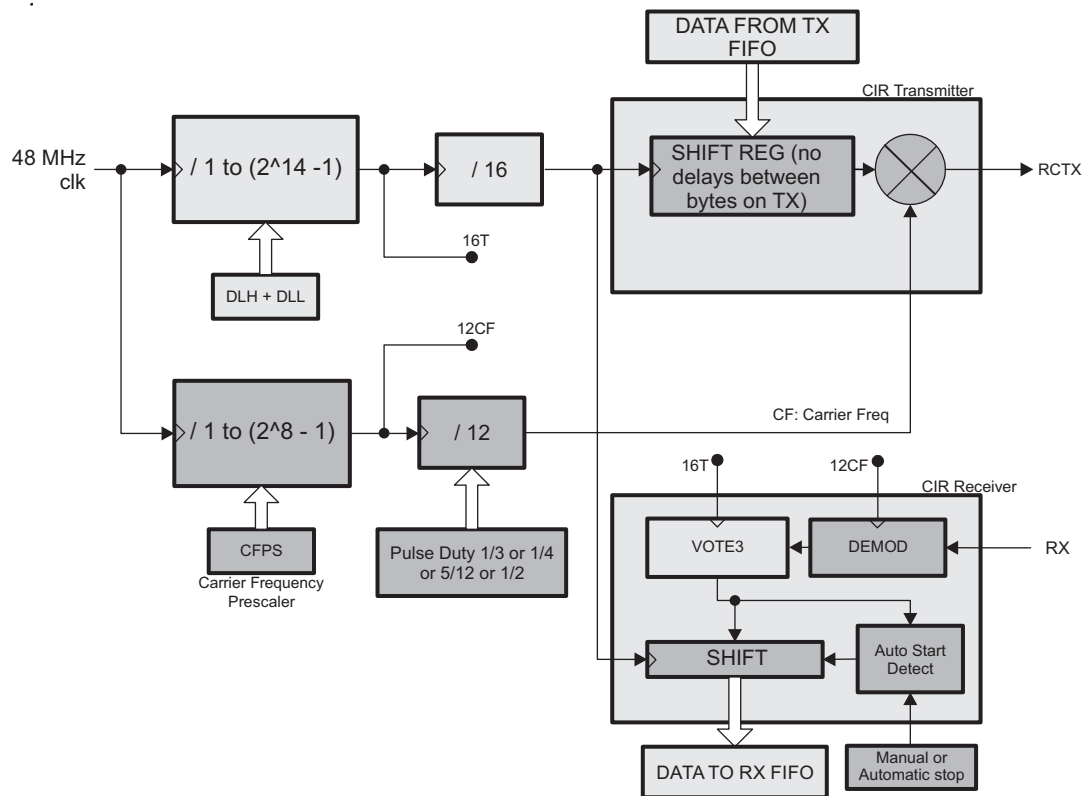


It is beyond the scope of this document to describe all encoding methods and techniques, the previous information was provided to illustrate the consideration required to employ different encoding methods for different industry standard protocols. The user should refer to industry standard documentation for specific methods of encoding and protocol usage.

19.3.8.3.2 CIR Mode Operation

Depending on the encoding method (variable pulse distance / bi-phase), the LH should develop a data structure that combines the 1 and 0 with a T period in order to encode the complete frame to transmit. This can then be transmitted to the infrared output with a method of modulation shown in the following diagram.

Figure 19-30. CIR Mode Block Components



In transmission, the LH software must exercise an element of real time control for transmitting data packets; they must each be emitted at a constant delay from the start bits of each of the individual packets which means when sending a series of packets, the packet to packet delay must respect a specific delay. To control this delay 2 methods can be used:

- By filling the TX FIFO with a number of zero bit which is transmitted with a T period.
- By using an external system timer which controls the delay either between each start of frame or between the end of a frame and the start of the next one. This can be performed:
 - By controlling the start of the frame through the configuration register MDR1[5] and ACREG[2] depending on the timer status (in case of control the delay between each start of frame).
 - By using the TX_STATUS interrupt IIR[5] to pre-load the next frame in the TX FIFO and to control the start of the timer (in case of control the delay between end of frame and start of next frame).

In reception, there are two ways to stop it :

- The LH can disable the reception by setting the ACREG[5] to 1 when it considers that the reception is finished because a large number of 0 has been received. To receive a new frame, the ACREG[5] must be set to 0.
- A specific mechanism, depending on the value set in the BOF length register (EBLR), allows for automatically stopping the reception. If the value set in the EBLR register is different than 0, this features is enabled and count a number of bit received at 0. When the counter achieves the value defined in the EBLR register, the reception is automatically stopped and RX_STOP_IT (IIR[2]) is set. When a 1 is detected on the RCRX pin, the reception is automatically enabled.

Note: There's a limitation when receiving data in UART CIR mode. The IrDA transceivers on the market have a common characteristic that shrinks the hold time of the received modulation pulse. The UART filtering schema on receiving is based on the same encoding mechanism used in transmission.

For the following scenario:

- Shift register period: 0.9 us
- Modulation frequency: 36 Khz
- Duty cycle: 1/4 of a modulation frequency period

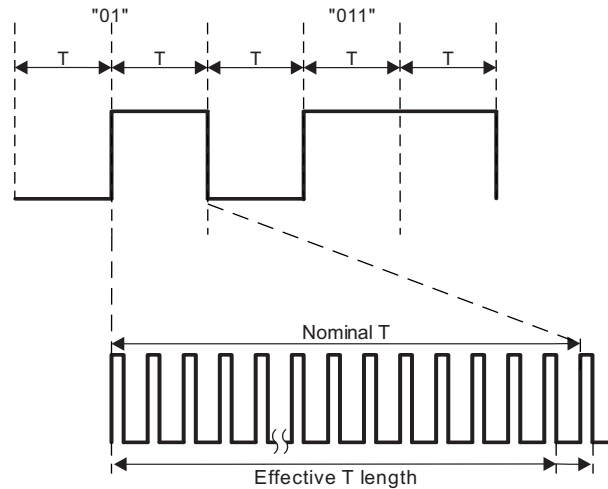
The data sent in these conditions would look like 7us pulses within 28us period. The UART expects to receive similar incoming data on receive, but available transceiver timing characteristics typically send 2us modulated pulses. Those will be filtered out and RX FIFO won't receive any data.

This does not affect UART CIR mode in transmission.

Note: The CIR RX demodulation can be bypassed by setting the MDR3[0] register bit.

19.3.8.3.3 Carrier Modulation

Looking closer at the actual modulation pulses of the infrared data stream, it should be noted that each modulated pulse that constitutes a digit is in fact a train of on/off pulses.

Figure 19-31. CIR Pulse Modulation


A minimum of 4 modulation pulses per bit is required by the module.

Based on the requested modulation frequency, the CFPS register must be set with the correct dividing value to provide the more accurate pulse frequency:

Dividing value = $(FCLK/12)/MODfreq$

Where FCLK = System clock frequency (48 MHz)

12 = real value of BAUD multiple

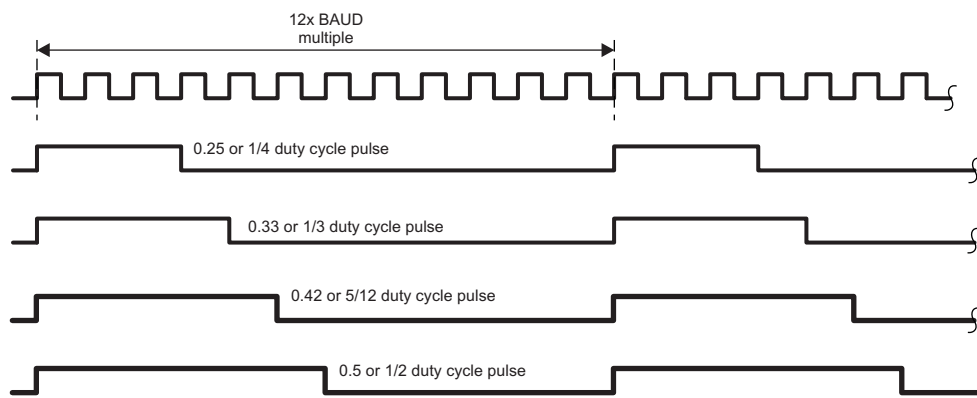
MODfreq = Effective frequency of the modulation (MHz)

Example: For a targeted modulation frequency of 36 kHz, the CFPS value must be set to 111 in decimal which provide an modulation frequency of 36.04 kHz.

Note: The CFPS register is to start with a reset value of 105 (decimal) which translates to a frequency of 38.1 kHz.

The duty cycle of these pulses is user defined by the pulse duty register bits in the MDR2 configuration register.

MDR2[5:4]	Duty Cycle (High Level)
00	1/4
01	1/3
10	5/12
11	1/2

Figure 19-32. CIR Modulation Duty Cycle


The transmission logic ensures that all pulses are transmitted completely; i.e., there is no cut off of any pulses during its transmission. Furthermore, while transmitting continuous bytes back-to-back, no delay is inserted between two transmitted bytes. **Note:** The CIR RX demodulation can be bypassed by setting the MDR3[0] register bit. This bit will not affect the transmission modulation.

19.3.8.3.4 Frequency Divider Values

The data transferred is a succession of pulse with a T period. Depending on the standards used, the T period is defined through the DLL and DLH registers which defined the value to divide the functional clock (48 MHz):

Dividing value = $(FCLK/16)/Tfreq$

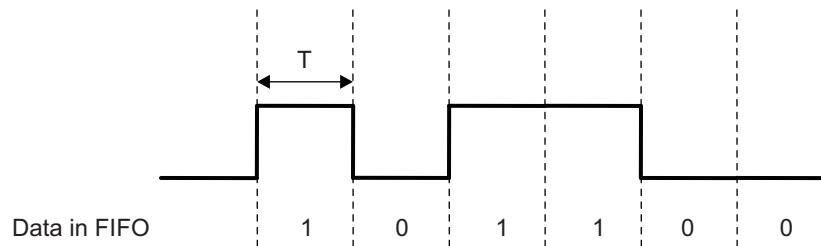
Where FCLK = System clock frequency (48 MHz)

16 = real value of BAUD multiple

Tfreq = Effective frequency of the T pulse (MHz)

In an example case using a variable pulse duration definitions:

Figure 19-33. Variable Pulse Duration Definitions



For a logical "1", the pulse duration is equal to 2T and for a logical "0", it's equal to 4T.

If T = 0.56 ms, the value coded into the DLH and DLL register must be 1680 in decimal.

19.4 UART/IrDA/CIR Basic Programming Model

19.4.1 UART Programming Model

19.4.1.1 Quick Start

This section describes the procedure for operating the UART with FIFO and DMA or interrupts. This three-part procedure ensures the quick start of the UART. It does not cover every UART feature.

The first programming model covers software reset of the UART. The second programming model describes FIFO and DMA configuration. The last programming model describes protocol, baud rate, and interrupt configuration.

NOTE: Each programming model can be used independently of the other two; for instance, reconfiguring the FIFOs and DMA settings only.

Each programming model can be executed starting from any UART register access mode (register modes, submodes, and other register dependencies). However, if the UART register access mode is known before executing the programming model, some steps that enable or restore register access are optional. For more information, see [Section 19.3.7.1, Register Access Modes](#).

19.4.1.1.1 Software Reset

To clear the UART registers, perform the following steps:

1. Initiate a software reset:
Set the UARTi.UART_SYSC[1] SOFTRESET bit to 1.
2. Wait for the end of the reset operation:
Poll the UARTi.UART_SYSS[0] RESETDONE bit until it equals 1.

19.4.1.1.2 FIFOs and DMA Settings

To enable and configure the receive and transmit FIFOs and program the DMA mode, perform the following steps:

1. Switch to register configuration mode B to access the UARTi.UART_EFR register:
 - (a) Save the current UARTi.UART_LCR register value.
 - (b) Set the UARTi.UART_LCR register value to 0x00BF.
2. Enable register submode TCR_TLR to access the UARTi.UART_TLR register (part 1 of 2):
 - (a) Save the UARTi.UART_EFR[4] ENHANCED_EN value.
 - (b) Set the UARTi.UART_EFR[4] ENHANCED_EN bit to 1.
3. Switch to register configuration mode A to access the UARTi.UART_MCR register:
Set the UARTi.UART_LCR register value to 0x0080.
4. Enable register submode TCR_TLR to access the UARTi.UART_TLR register (part 2 of 2):
 - (a) Save the UARTi.UART_MCR[6] TCR_TLR value.
 - (b) Set the UARTi.UART_MCR[6] TCR_TLR bit to 1.
5. Enable the FIFO; load the new FIFO triggers (part 1 of 3) and the new DMA mode (part 1 of 2):
Set the following bits to the desired values:
 - UARTi.UART_FCR[7:6] RX_FIFO_TRIG
 - UARTi.UART_FCR[5:4] TX_FIFO_TRIG
 - UARTi.UART_FCR[3] DMA_MODE
 - UARTi.UART_FCR[0] FIFO_ENABLE (0: Disable the FIFO; 1: Enable the FIFO)

NOTE: The UARTi.UART_FCR register is not readable.

6. Switch to register configuration mode B to access the UARTi.UART_EFR register:
Set the UARTi.UART_LCR register value to 0x00BF.
7. Load the new FIFO triggers (part 2 of 3):
Set the following bits to the desired values:
 - UARTi.UART_TLR[7:4] RX_FIFO_TRIG_DMA
 - UARTi.UART_TLR[3:0] TX_FIFO_TRIG_DMA
8. Load the new FIFO triggers (part 3 of 3) and the new DMA mode (part 2 of 2):
Set the following bits to the desired values:
 - UARTi.UART_SCR[7] RX_TRIG_GRANU1
 - UARTi.UART_SCR[6] TX_TRIG_GRANU1
 - UARTi.UART_SCR[2:1] DMA_MODE_2
 - UARTi.UART_SCR[0] DMA_MODE_CTL
9. Restore the UARTi.UART_EFR[4] ENHANCED_EN value saved in Step 2a.
10. Switch to register configuration mode A to access the UARTi.UART_MCR register:
Set the UARTi.UART_LCR register value to 0x0080.
11. Restore the UARTi.UART_MCR[6] TCR_TLR value saved in Step 4a.
12. Restore the UARTi.UART_LCR value saved in Step 1a.

Triggers are used to generate interrupt and DMA requests. See [Section 19.3.6.1.1, Transmit FIFO Trigger](#), to choose the following values:

- UARTi.UART_FCR[5:4] TX_FIFO_TRIG
- UARTi.UART_TLR[3:0] TX_FIFO_TRIG_DMA
- UARTi.UART_SCR[6] TX_TRIG_GRANU1

Triggers are used to generate interrupt and DMA requests. See [Section 19.3.6.1.2, Receive FIFO Trigger](#), to choose the following values:

- UARTi.UART_FCR[7:6] RX_FIFO_TRIG
- UARTi.UART_TLR[7:4] RX_FIFO_TRIG_DMA
- UARTi.UART_SCR[7] RX_TRIG_GRANU1

DMA mode enables DMA requests. See [Section 19.3.6.4, FIFO DMA Mode Operation](#), to choose the following values:

- UARTi.UART_FCR[3] DMA_MODE
- UARTi.UART_SCR[2:1] DMA_MODE_2
- UARTi.UART_SCR[0] DMA_MODE_CTL

19.4.1.1.3 Protocol, Baud Rate, and Interrupt Settings

To program the protocol, baud rate, and interrupt settings, perform the following steps:

1. Disable UART to access the UARTi.UART_DLL and UARTi.UART_DLH registers:
Set the UARTi.UART_MDR1[2:0] MODE_SELECT bit field to 0x7.
2. Switch to register configuration mode B to access the UARTi.UART_EFR register:
Set the UARTi.UART_LCR register value to 0x00BF.
3. Enable access to the UARTi.UART_IER[7:4] bit field:
 - (a) Save the UARTi.UART_EFR[4] ENHANCED_EN value.
 - (b) Set the UARTi.UART_EFR[4] ENHANCED_EN bit to 1.
4. Switch to register operational mode to access the UARTi.UART_IER register:
Set the UARTi.UART_LCR register value to 0x0000.

5. Clear the UARTi.UART_IER register (set the UARTi.UART_IER[4] SLEEP_MODE bit to 0 to change the UARTi.UART_DLL and UARTi.UART_DLH registers). Set the UARTi.UART_IER register value to 0x0000.
 6. Switch to register configuration mode B to access the UARTi.UART_DLL and UARTi.UART_DLH registers:
Set the UARTi.UART_LCR register value to 0x00BF.
 7. Load the new divisor value:
Set the UARTi.UART_DLL[7:0] CLOCK_LSB and UARTi.UART_DLH[5:0] CLOCK_MSB bit fields to the desired values.
 8. Switch to register operational mode to access the UARTi.UART_IER register:
Set the UARTi.UART_LCR register value to 0x0000.
 9. Load the new interrupt configuration (0: Disable the interrupt; 1: Enable the interrupt):
Set the following bits to the desired values:
 - UARTi.UART_IER[7] CTS_IT
 - UARTi.UART_IER[6] RTS_IT
 - UARTi.UART_IER[5] XOFF_IT
 - UARTi.UART_IER[4] SLEEP_MODE
 - UARTi.UART_IER[3] MODEM_STS_IT
 - UARTi.UART_IER[2] LINE_STS_IT
 - UARTi.UART_IER[1] THR_IT
 - UARTi.UART_IER[0] RHR_IT
 10. Switch to register configuration mode B to access the UARTi.UART_EFR register:
Set the UARTi.UART_LCR register value to 0x00BF.
 11. Restore the UARTi.UART_EFR[4] ENHANCED_EN value saved in Step 3a.
 12. Load the new protocol formatting (parity, stop-bit, character length) and switch to register operational mode:
Set the UARTi.UART_LCR[7] DIV_EN bit to 0.
Set the UARTi.UART_LCR[6] BREAK_EN bit to 0.
Set the following bits to the desired values:
 - UARTi.UART_LCR[5] PARITY_TYPE_2
 - UARTi.UART_LCR[4] PARITY_TYPE_1
 - UARTi.UART_LCR[3] PARITY_EN
 - UARTi.UART_LCR[2] NB_STOP
 - UARTi.UART_LCR[1:0] CHAR_LENGTH
 13. Load the new UART mode:
Set the UARTi.UART_MDR1[2:0] MODE_SELECT bit field to the desired value.
- See [Section 19.3.8.1.2, Choosing the Appropriate Divisor Value](#), to choose the following values:
- UARTi.UART_DLL[7:0] CLOCK_LSB
 - UARTi.UART_DLH[5:0] CLOCK_MSB
 - UARTi.UART_MDR1[2:0] MODE_SELECT
- See [Section 19.3.8.1.3.1, Frame Formatting](#), to choose the following values:
- UARTi.UART_LCR[5] PARITY_TYPE_2
 - UARTi.UART_LCR[4] PARITY_TYPE_1
 - UARTi.UART_LCR[3] PARITY_EN
 - UARTi.UART_LCR[2] NB_STOP
 - UARTi.UART_LCR[1:0] CHAR_LENGTH

19.4.1.2 Hardware and Software Flow Control Configuration

This section describes the programming steps to enable and configure hardware and software flow control. Hardware and software flow control cannot be used at the same time.

NOTE: Each programming model can be executed starting from any UART register access mode (register modes, submodes, and other register dependencies). However, if the UART register access mode is known before executing the programming model, some steps that enable or restore register access are optional. For more information, see [Section 19.3.7.1, Register Access Modes](#).

19.4.1.2.1 Hardware Flow Control Configuration

To enable and configure hardware flow control, perform the following steps:

1. Switch to register configuration mode A to access the UARTi.UART_MCR register:
 - (a) Save the current UARTi.UART_LCR register value.
 - (b) Set the UARTi.UART_LCR register value to 0x0080.
2. Enable register submode TCR_TLR to access the UARTi.UART_TCR register (part 1 of 2):
 - (a) Save the UARTi.UART_MCR[6] TCR_TLR value.
 - (b) Set the UARTi.UART_MCR[6] TCR_TLR bit to 1.
3. Switch to register configuration mode B to access the UARTi.UART_EFR register:
Set the UARTi.UART_LCR register value to 0x00BF.
4. Enable register submode TCR_TLR to access the UARTi.UART_TCR register (part 2 of 2):
 - (a) Save the UARTi.UART_EFR[4] ENHANCED_EN value.
 - (b) Set the UARTi.UART_EFR[4] ENHANCED_EN bit to 1.
5. Load the new start and halt trigger values for hardware flow control:
Set the following bits to the desired values:
 - UARTi.UART_TCR[7:4] AUTO_RTS_START
 - UARTi.UART_TCR[3:0] AUTO_RTS_HALT
6. Enable or disable receive and transmit hardware flow control mode and restore the UARTi.UART_EFR[4] ENHANCED_EN value saved in Step 4a.
Set the following bits to the desired values:
 - UARTi.UART_EFR[7] AUTO_CTS_EN (0: Disable; 1: Enable)
 - UARTi.UART_EFR[6] AUTO_RTS_EN (0: Disable; 1: Enable)
 Restore the UARTi.UART_EFR[4] ENHANCED_EN bit to the saved value.
7. Switch to register configuration mode A to access the UARTi.UART_MCR register:
Set the UARTi.UART_LCR register value to 0x0080.
8. Restore the UARTi.UART_MCR[6] TCR_TLR value saved in Step 2a.
9. Restore the UARTi.UART_LCR value saved in Step 1a.

See [Section 19.3.8.1.3.2, Hardware Flow Control](#), to choose the following values:

- UARTi.UART_EFR[7] AUTO_CTS_EN
- UARTi.UART_EFR[6] AUTO_RTS_EN
- UARTi.UART_TCR[7:4] AUTO_RTS_START
- UARTi.UART_TCR[3:0] AUTO_RTS_HALT

19.4.1.2.2 Software Flow Control Configuration

To enable and configure software flow control, perform the following steps:

1. Switch to register configuration mode B to access the UARTi.UART_EFR register.

- (a) Save the current UARTi.UART_LCR register value.
- (b) Set the UARTi.UART_LCR register value to 0x00BF.
2. Enable register submode XOFF to access the UARTi.UART_XOFF1 and UARTi.UART_XOFF2 registers:
 - (a) Save the UARTi.UART_EFR[4] ENHANCED_EN value.
 - (b) Set the UARTi.UART_EFR[4] ENHANCED_EN bit to 0.
3. Load the new software flow control characters:

Set the following bits to the desired values:

 - UARTi.UART_XON1_ADDR1[7:0] XON_WORD1
 - UARTi.UART_XON2_ADDR2[7:0] XON_WORD2
 - UARTi.UART_XOFF1[7:0] XOFF_WORD1
 - UARTi.UART_XOFF2[7:0] XOFF_WORD2
4. Enable access to the UARTi.UART_MCR[7:5] bit field and enable register submode TCR_TLR to access the UARTi.UART_TCR register (part 1 of 2):

Set the UARTi.UART_EFR[4] ENHANCED_EN bit to 1.
5. Switch to register configuration mode A to access the UARTi.UART_MCR register:

Set the UARTi.UART_LCR register value to 0x0080.
6. Enable register submode TCR_TLR to access the UARTi.UART_TCR register (part 2 of 2) and enable or disable XON any function:
 - (a) Save the UARTi.UART_MCR[6] TCR_TLR value.
 - (b) Set the UARTi.UART_MCR[6] TCR_TLR bit to 1.
 - (c) Set the UARTi.UART_MCR[5] XON_EN bit to the desired value (0: Disable; 1: Enable).
7. Switch to register configuration mode B to access the UARTi.UART_EFR register:

Set the UARTi.UART_LCR register value to 0x00BF.
8. Load the new start and halt trigger values for software flow control:

Set the following bits to the desired values:

 - UARTi.UART_TCR[7:4] AUTO_RTS_START
 - UARTi.UART_TCR[3:0] AUTO_RTS_HALT
9. Enable or disable special character function and load the new software flow control mode and restore the UARTi.UART_EFR[4] ENHANCED_EN value saved in Step 2a:

Set the following bits to the desired values:

 - UARTi.UART_EFR[5] SPEC_CHAR (0: Disable; 1: Enable)
 - UARTi.UART_EFR[3:0] SW_FLOW_CONTROL

Restore the UARTi.UART_EFR[4] ENHANCED_EN bit to the saved value.
10. Switch to register configuration mode A to access the UARTi.UART_MCR register:

Set the UARTi.UART_LCR register value to 0x0080.
11. Restore the UARTi.UART_MCR[6] TCR_TLR bit value saved in Step 6a.
12. Restore the UARTi.UART_LCR value saved in Step 1a.

See [Section 19.3.8.1.3.3](#), *Software Flow Control*, to choose the following values:

- UARTi.UART_EFR[5] SPEC_CHAR
- UARTi.UART_EFR[3:0] SW_FLOW_CONTROL
- UARTi.UART_TCR[7:4] AUTO_RTS_START
- UARTi.UART_TCR[3:0] AUTO_RTS_HALT
- UARTi.UART_XON1_ADDR1[7:0] XON_WORD1
- UARTi.UART_XON2_ADDR2[7:0] XON_WORD2
- UARTi.UART_XOFF1[7:0] XOFF_WORD1

- UARTi.UART_XOFF2[7:0] XOFF_WORD2

19.4.2 IrDA Programming Model

19.4.2.1 SIR Mode

19.4.2.1.1 Receive

The following programming model explains how to program the module to receive an IrDA frame with parity forced to 1, baud rate = 112.5KB, FIFOs disabled, 2 stop-bits, and 8-bit word length:

1. Disable the UART before accessing the UARTi.UART_DLL and UARTi.UART_DLH registers:
Set the UARTi.UART_MDR1[2:0] MODE_SELECT bit field to 0x7.
2. Grant access to the UART_DLL and UART_DLH registers (the UART_LCR[7] DIV_EN bit = 1):
UARTi.UART_LCR = 0x80 (Data format is unaffected by the use and settings of the UARTi.UART_LCR register in IrDA mode.)
3. Load the new baud rate (115.2 kbps):
UARTi.UART_DLL = 0x1A
UARTi.UART_DLH = 0x00
4. Set SIR mode:
UARTi.UART_MDR1[2:0] MODE_SELECT = 0x1
5. Disable access to the UART_DLL and UART_DLH registers and switch to register operational mode:
UARTi.UART_LCR = 0x00.
6. Optional: Enable the RHR interrupt:
UARTi.UART_IER[0] RHR_IT = 0x1

19.4.2.1.2 Transmit

The following programming model explains how to program the module to transmit an IrDA 6-byte frame with no parity, baud rate = 112.5 kbps, FIFOs disabled, 3/16 encoding, 2 stop-bits, and 7-bit word length:

1. Disable the UART before accessing the UARTi.UART_DLL and UARTi.UART_DLH registers:
Set the UART_MDR1[2:0] MODE_SELECT bit field to 0x7.
2. Grant access to the UART_EFR register:
UARTi.UART_LCR = 0xBF
3. Enable the enhanced features (the UART_EFR[4] ENAHNCED_EN bit = 1):
Set the UARTi.UART_EFR register value to 0x10.
4. Grant access to the UART_DLL and UART_DLH registers (the UART_LCR[7] DIV_EN bit = 1):
UARTi.UART_LCR = 0x80 (Data format is unaffected by the use and settings of the UARTi.UART_LCR register in IrDA mode.)
5. Load the new baud rate (115.2 kbps):
UARTi.UART_DLL = 0x1A
UARTi.UART_DLH = 0x00
6. Set SIR mode (the UART_MDR1[2:0] MODE_SELECT bit field = 0x1):
UARTi.UART_MDR1 = 0x01
7. Disable access to the UART_DLL and UART_DLH registers and switch to register operational mode:
UARTi.UART_LCR = 0x00.
8. Force DTR output to active:
UARTi.UART_MCR[0] DTR = 1
9. Optional: Enable the THR interrupt:
UARTi.UART_IER[1] THR_IT = 1
10. Set transmit frame length to 6 bytes:
UARTi.UART_TXFLL = 0x06
11. Set 7 starts of frame transmission:
UARTi.UART_EBLR = 0x08
12. Optional: Set SIR pulse width to be 1.6 us:
UARTi.UART_ACREG[7] PULSE_TYPE = 1
13. Load the UART_THR register with the data to be transmitted.

19.4.2.2 MIR Mode

19.4.2.2.1 Receive

The following programming model explains how to program the module to receive an IrDA frame with no parity, baud rate = 1.152 Mbps, and FIFOs disabled.

1. Disable the UART before accessing the UARTi.UART_DLL and UARTi.UART_DLH registers:
Set the UARTi.UART_MDR1[2:0] MODE_SELECT bit field to 0x7.
2. Grant access to the UART_DLL and UART_DLH registers (UART_LCR[7] DIV_EN bit = 1):
UARTi.UART_LCR = 0x80 (Data format is unaffected by the use and settings of the UARTi.UART_LCR register in IrDA mode.)
3. Load the new baud rate (1.152 Mbps):
UARTi.UART_DLL = 0x01
UARTi.UART_DLH = 0x00
4. Set MIR mode:
UARTi.UART_MDR1[2:0] MODE_SELECT = 0x4
5. Disable access to the UART_DLL and UART_DLH registers and switch to register operational mode:
UARTi.UART_LCR = 0x00
6. Force DTR output to active (UART_MCR[0] DTR = 1):
Force RTS output to active (UART_MCR[1] RTS = 1).
UARTi.UART_MCR = 0x3
7. Optional: Enable the RHR interrupt:
UARTi.UART_IER[0] RHR_IT = 1

19.4.2.2.2 Transmit

The following programming model explains how to program the module to transmit an IrDA 60-byte frame with no parity, baud rate = 1.152 Mbps, and FIFOs disabled:

1. Disable the UART before accessing the UARTi.UART_DLL and UARTi.UART_DLH registers:
Set the UARTi.UART_MDR1[2:0] MODE_SELECT bit field to 0x7.
2. Grant access to the UART_DLL and UART_DLH registers (UART_LCR[7] DIV_EN bit = 1):
UARTi.UART_LCR = 0x80 (Data format is unaffected by the use and settings of the UARTi.UART_LCR register in IrDA mode.)
3. Load the new baud rate (1.152 Mbps):
UARTi.UART_DLL = 0x01
UARTi.UART_DLH = 0x00
4. Set MIR mode:
UARTi.UART_MDR1[2:0] MODE_SELECT = 0x4
5. Disable access to the UART_DLL and UART_DLH registers and switch to register operational mode:
UARTi.UART_LCR = 0x00
6. Force DTR output to active:
UARTi.UART_MCR[0] DTR = 1
7. Optional: Enable the THR interrupt:
UARTi.UART_IER[1] THR_IT = 1
8. Set the frame length to 60 bytes:
UARTi.UART_TXFLL = 0x3C
9. Optional: Transmit eight additional starts of frame (MIR mode requires two starts):
UARTi.UART_EBLR = 0x08
10. SIP is sent at the end of transmission:
UARTi.UART_ACREG[3] = 1
11. Load the UART_THR register with the data to be transmitted.

19.4.2.3 FIR Mode

19.4.2.3.1 Receive

The following programming model explains how to program the module to receive the IrDA frame with no parity, baud rate = 4 Mbps, FIFOs enabled, 8-bit word length.

1. Disable the UART before accessing the UARTi.UART_DLL and UARTi.UART_DLH registers:
Set the UARTi.UART_MDR1[2:0] MODE_SELECT bit field to 0x7.
2. Grant access to the UART_DLL and UART_DLH registers (UART_LCR[7] DIV_EN bit = 1):
UARTi.UART_LCR = 0x80 (Data format is unaffected by the use and settings of the UARTi.UART_LCR register in IrDA mode.)
3. FIFO clear and enable:
UARTi.UART_FCR = 0x7 (TX/RX FIFO trigger: UART_FCR[7:6] and UART_FCR[5:4])
UARTi.UART_LCR[7] = 0
4. Set FIR mode:
UARTi.UART_MDR1[2:0] MODE_SELECT = 0x5
5. Set frame length:
UARTi.UART_RXFLL = 0xA (Data + CRC + STOP)
6. Disable access to the UARTi.UART_DLL registers and UARTi.UART_DLH and switch to register operational mode:
UARTi.UART_LCR[7] DIV_EN = 0x0
7. Optional: Enable the RHR interrupt:
UARTi.UART_IER[0] RHR_IT = 1

19.4.2.3.2 Transmit

The following programming model explains how to program the module to transmit an IrDA 4-byte frame with no parity, baud rate = 4 Mbps, FIFOs enabled, and 8-bit word length.

1. Disable the UART before accessing the UARTi.UART_DLL and UARTi.UART_DLH registers:
Set the UARTi.UART_MDR1[2:0] MODE_SELECT bit field to 0x7.
2. Grant access to EFR_REG:
UARTi.UART_LCR = 0xBF
3. Enable the enhanced features (EFR_REG[4] ENAHNCED_EN = 0x1):
UARTi.UART_EFR = 0x10
4. FIFO clear and enable:
UARTi.UART_FCR = 0x7 (TX/RX FIFO trigger: UART_FCR[7:6] and UART_FCR[5:4]).
UARTi.UART_LCR[7] = 0
5. Set FIR mode and enable auto-SIP mode:
UARTi.UART_MDR1 = 0x45
6. Set frame length:
UARTi.UART_TXFLL = 0x4
UARTi.UART_TXFLH = 0x0
UARTi.UART_RXFLL = 0xA (Data + CRC + STOP)
UARTi.UART_RXFLH = 0x0
7. Force DTR output to active:
UARTi.UART_MCR[0] DTR = 0x1
8. Optional: Enable the THR interrupt:
UARTi.UART_IER[1] THR_IT = 0x1
9. Optional: Transmit eight additional starts of frame (MIR mode requires two starts):
UARTi.UART_EBLR = 0x08
10. SIP is sent at the end of transmission:
UARTi.UART_ACREG[3] = 1
11. Load the UART_THR register with the data to be transmitted.

19.5 UART Registers

19.5.1 UART Registers

Table 19-29 lists the memory-mapped registers for the UART. All register offset addresses not listed in Table 19-29 should be considered as reserved locations and the register contents should not be modified.

Table 19-29. UART Registers

Offset	Acronym	Register Name	Section
0h	THR	Transmit Holding Register	Section 19.5.1.1
0h	RHR	Receiver Holding Register	Section 19.5.1.2
0h	DLL	Divisor Latches Low Register	Section 19.5.1.3
4h	IER_IRDA	Interrupt Enable Register (IrDA)	Section 19.5.1.4
4h	IER_CIR	Interrupt Enable Register (CIR)	Section 19.5.1.5
4h	IER_UART	Interrupt Enable Register (UART)	Section 19.5.1.6
4h	DLH	Divisor Latches High Register	Section 19.5.1.7
8h	EFR	Enhanced Feature Register	Section 19.5.1.8
8h	IIR_UART	Interrupt Identification Register (UART)	Section 19.5.1.9
8h	IIR_CIR	Interrupt Identification Register (CIR)	Section 19.5.1.10
8h	FCR	FIFO Control Register	Section 19.5.1.11
8h	IIR_IRDA	Interrupt Identification Register (IrDA)	Section 19.5.1.12
Ch	LCR	Line Control Register	Section 19.5.1.13
10h	MCR	Modem Control Register	Section 19.5.1.14
10h	XON1_ADDR1	XON1/ADDR1 Register	Section 19.5.1.15
14h	XON2_ADDR2	XON2/ADDR2 Register	Section 19.5.1.16
14h	LSR_CIR	Line Status Register (CIR)	Section 19.5.1.17
14h	LSR_IRDA	Line Status Register (IrDA)	Section 19.5.1.18
14h	LSR_UART	Line Status Register (UART)	Section 19.5.1.19
18h	TCR	Transmission Control Register	Section 19.5.1.20
18h	MSR	Modem Status Register	Section 19.5.1.21
18h	XOFF1	XOFF1 Register	Section 19.5.1.22
1Ch	SPR	Scratchpad Register	Section 19.5.1.23
1Ch	TLR	Trigger Level Register	Section 19.5.1.24
1Ch	XOFF2	XOFF2 Register	Section 19.5.1.25
20h	MDR1	Mode Definition Register 1	Section 19.5.1.26
24h	MDR2	Mode Definition Register 2	Section 19.5.1.27
28h	TXFLL	Transmit Frame Length Low Register	Section 19.5.1.28
28h	SFLSR	Status FIFO Line Status Register	Section 19.5.1.29
2Ch	RESUME	RESUME Register	Section 19.5.1.30
2Ch	TXFLH	Transmit Frame Length High Register	Section 19.5.1.31
30h	RXFLL	Received Frame Length Low Register	Section 19.5.1.32
30h	SFREGL	Status FIFO Register Low	Section 19.5.1.33
34h	SFREGH	Status FIFO Register High	Section 19.5.1.34
34h	RXFLH	Received Frame Length High Register	Section 19.5.1.35
38h	BLR	BOF Control Register	Section 19.5.1.36
38h	UASR	UART Autobauding Status Register	Section 19.5.1.37
3Ch	ACREG	Auxiliary Control Register	Section 19.5.1.38
40h	SCR	Supplementary Control Register	Section 19.5.1.39
44h	SSR	Supplementary Status Register	Section 19.5.1.40
48h	EBLR	BOF Length Register	Section 19.5.1.41

Table 19-29. UART Registers (continued)

Offset	Acronym	Register Name	Section
50h	MVR	Module Version Register	Section 19.5.1.42
54h	SYSC	System Configuration Register	Section 19.5.1.43
58h	SYSS	System Status Register	Section 19.5.1.44
5Ch	WER	Wake-Up Enable Register	Section 19.5.1.45
60h	CFPS	Carrier Frequency Prescaler Register	Section 19.5.1.46
64h	RXFIFO_LVL	Received FIFO Level Register	Section 19.5.1.47
68h	TXFIFO_LVL	Transmit FIFO Level Register	Section 19.5.1.48
6Ch	IER2	IER2 Register	Section 19.5.1.49
70h	ISR2	ISR2 Register	Section 19.5.1.50
74h	FREQ_SEL	FREQ_SEL Register	Section 19.5.1.51
80h	MDR3	Mode Definition Register 3	Section 19.5.1.52
84h	TX_DMA_THRESHOLD	TX DMA Threshold Register	Section 19.5.1.53

19.5.1.1 THR Register (offset = 0h) [reset = 0h]

THR is shown in [Figure 19-34](#) and described in [Table 19-30](#).

The transmit holding register (THR) is selected with the register bit setting of LCR[7] = 0. The transmitter section consists of the transmit holding register and the transmit shift register. The transmit holding register is a 64-byte FIFO. The MPU writes data to the THR. The data is placed in the transmit shift register where it is shifted out serially on the TX output. If the FIFO is disabled, location zero of the FIFO is used to store the data.

Figure 19-34. THR Register

15	14	13	12	11	10	9	8
RESERVED							
R-0h							
7	6	5	4	3	2	1	0
THR							
W-0h							

LEGEND: R/W = Read/Write; R = Read only; W1toCl = Write 1 to clear bit; -n = value after reset

Table 19-30. THR Register Field Descriptions

Bit	Field	Type	Reset	Description
15-8	RESERVED	R	0h	
7-0	THR	W	0h	Transmit holding register. Value 0 to FFh.

19.5.1.2 RHR Register (offset = 0h) [reset = 0h]

RHR is shown in [Figure 19-35](#) and described in [Table 19-31](#).

The receiver holding register (RHR) is selected with the register bit setting of LCR[7] = 0. The receiver section consists of the receiver holding register and the receiver shift register. The RHR is actually a 64-byte FIFO. The receiver shift register receives serial data from RX input. The data is converted to parallel data and moved to the RHR. If the FIFO is disabled, location zero of the FIFO is used to store the single data character. If an overflow occurs, the data in the RHR is not overwritten.

Figure 19-35. RHR Register

15	14	13	12	11	10	9	8
RESERVED							
R-0h							
7	6	5	4	3	2	1	0
RHR							
R-0h							

LEGEND: R/W = Read/Write; R = Read only; W1toCl = Write 1 to clear bit; -n = value after reset

Table 19-31. RHR Register Field Descriptions

Bit	Field	Type	Reset	Description
15-8	RESERVED	R	0h	
7-0	RHR	R	0h	Receive holding register. Value 0 to FFh.

19.5.1.3 DLL Register (offset = 0h) [reset = 0h]

DLL is shown in [Figure 19-36](#) and described in [Table 19-32](#).

The divisor latches low register (DLL) is selected with a register bit setting of LCR[7] not equal to BFh or LCR[7] = BFh. The divisor latches low register (DLL) with the DLH register stores the 14-bit divisor for generation of the baud clock in the baud rate generator. DLH stores the most-significant part of the divisor, DLL stores the least-significant part of the divisor. DLL and DLH can be written to only before sleep mode is enabled (before IER[4] is set).

Figure 19-36. DLL Register

15	14	13	12	11	10	9	8
RESERVED							
R-0h							
7	6	5	4	3	2	1	0
CLOCK_LSB							
R/W-0h							

LEGEND: R/W = Read/Write; R = Read only; W1toCl = Write 1 to clear bit; -n = value after reset

Table 19-32. DLL Register Field Descriptions

Bit	Field	Type	Reset	Description
15-8	RESERVED	R	0h	
7-0	CLOCK_LSB	R/W	0h	Divisor latches low. Stores the 8 LSB divisor value. Value 0 to FFh.

19.5.1.4 IER_IRDA Register (offset = 4h) [reset = 0h]

IER_IRDA is shown in [Figure 19-37](#) and described in [Table 19-33](#).

The following interrupt enable register (IER) description is for IrDA mode. The IrDA IER is selected with a register bit setting of LCR[7] = 0. In IrDA mode, EFR[4] has no impact on the access to IER[7:4]. The IrDA interrupt enable register (IER) can be programmed to enable/disable any interrupt. There are 8 types of interrupt in these modes, received EOF, LSR interrupt, TX status, status FIFO interrupt, RX overrun, last byte in RX FIFO, THR interrupt, and RHR interrupt. Each interrupt can be enabled/disabled individually. The TXSTATUSIT interrupt reflects two possible conditions. The MDR2[0] bit should be read to determine the status in the event of this interrupt.

Figure 19-37. IER_IRDA Register

15	14	13	12	11	10	9	8
RESERVED							
R-0h							
7	6	5	4	3	2	1	0
EOFIT	LINESTSIT	TXSTATUSIT	STSFIFOTRIGIT	RXOVERRUNIT	LASTRXBYTEIT	THRIT	RHRIT
R/W-0h	R/W-0h	R/W-0h	R/W-0h	R/W-0h	R/W-0h	R/W-0h	R/W-0h

LEGEND: R/W = Read/Write; R = Read only; W1toCl = Write 1 to clear bit; -n = value after reset

Table 19-33. IER_IRDA Register Field Descriptions

Bit	Field	Type	Reset	Description
15-8	RESERVED	R	0h	
7	EOFIT	R/W	0h	EOFIT 0h = Disables the received EOF interrupt. 1h = Enables the received EOF interrupt.
6	LINESTSIT	R/W	0h	LINESTSIT 0h = Disables the receiver line status interrupt. 1h = Enables the receiver line status interrupt.
5	TXSTATUSIT	R/W	0h	TXSTATUSIT 0h = Disables the TX status interrupt. 1h = Enables the TX status interrupt.
4	STSFIFOTRIGIT	R/W	0h	STSFIFOTRIGIT 0h = Disables status FIFO trigger level interrupt. 1h = Enables status FIFO trigger level interrupt.
3	RXOVERRUNIT	R/W	0h	RXOVERRUNIT 0h = Disables the RX overrun interrupt. 1h = Enables the RX overrun interrupt.
2	LASTRXBYTEIT	R/W	0h	LASTRXBYTEIT 0h = Disables the last byte of frame in RX FIFO interrupt. 1h = Enables the last byte of frame in RX FIFO interrupt.
1	THRIT	R/W	0h	THRIT 0h = Disables the THR interrupt. 1h = Enables the THR interrupt.
0	RHRIT	R/W	0h	RHRIT 0h = Disables the RHR interrupt. 1h = Enables the RHR interrupt.

19.5.1.5 IER_CIR Register (offset = 4h) [reset = 0h]

IER_CIR is shown in [Figure 19-38](#) and described in [Table 19-34](#).

The following interrupt enable register (IER) description is for CIR mode. The CIR IER is selected with a register bit setting of LCR[7] = 0. In IrDA mode, EFR[4] has no impact on the access to IER[7:4]. The CIR interrupt enable register (IER) can be programmed to enable/disable any interrupt. There are 5 types of interrupt in these modes, TX status, RX overrun, RX stop interrupt, THR interrupt, and RHR interrupt. Each interrupt can be enabled/disabled individually. In CIR mode, the TXSTATUSIT bit has only one meaning corresponding to the case MDR2[0] = 0. The RXSTOPIT interrupt is generated based on the value set in the BOF Length register (EBLR).

Figure 19-38. IER_CIR Register

15	14	13	12	11	10	9	8	
RESERVED								
R-0h								
7	6	5	4	3	2	1	0	
RESERVED		TXSTATUSIT	RESERVED		RXOVERRUNIT	RXSTOPIT	THRIT	RHRIT
R-0h		R/W-0h	R-0h		R/W-0h	R/W-0h	R/W-0h	R/W-0h

LEGEND: R/W = Read/Write; R = Read only; W1toCl = Write 1 to clear bit; -n = value after reset

Table 19-34. IER_CIR Register Field Descriptions

Bit	Field	Type	Reset	Description
15-6	RESERVED	R	0h	
5	TXSTATUSIT	R/W	0h	TXSTATUSIT. 0h = Disables the TX status interrupt. 1h = Enables the TX status interrupt.
4	RESERVED	R	0h	
3	RXOVERRUNIT	R/W	0h	RXOVERRUNIT. 0h = Disables the RX overrun interrupt. 1h = Enables the RX overrun interrupt.
2	RXSTOPIT	R/W	0h	RXSTOPIT. 0h = Disables the RX stop interrupt. 1h = Enables the RX stop interrupt.
1	THRIT	R/W	0h	THRIT. 0h = Disables the THR interrupt. 1h = Enables the THR interrupt.
0	RHRIT	R/W	0h	RHRIT. 0h = Disables the RHR interrupt. 1h = Enables the RHR interrupt.

19.5.1.6 IER_UART Register (offset = 4h) [reset = 0h]

IER_UART is shown in [Figure 19-39](#) and described in [Table 19-35](#).

The following interrupt enable register (IER) description is for UART mode. The UART IER is selected with a register bit setting of LCR[7] = 0. In UART mode, IER[7:4] can only be written when EFR[4] = 1. The interrupt enable register (IER) can be programmed to enable/disable any interrupt. There are seven types of interrupt in this mode: receiver error, RHR interrupt, THR interrupt, XOFF received and CTS (active-low)/RTS (active-low) change of state from low to high. Each interrupt can be enabled/disabled individually. There is also a sleep mode enable bit. The UART interrupt enable register (IER) is shown in and described in .

Figure 19-39. IER_UART Register

15	14	13	12	11	10	9	8
RESERVED							
R-0h							
7	6	5	4	3	2	1	0
CTSIT	RTSIT	XOFFIT	SLEEPMODE	MODEMSTSIT	LINESTSIT	THRIT	RHRIT
R/W-0h	R/W-0h	R/W-0h	R/W-0h	R/W-0h	R/W-0h	R/W-0h	R/W-0h

LEGEND: R/W = Read/Write; R = Read only; W1toCl = Write 1 to clear bit; -n = value after reset

Table 19-35. IER_UART Register Field Descriptions

Bit	Field	Type	Reset	Description
15-8	RESERVED	R	0h	
7	CTSIT	R/W	0h	Can be written only when EFR[4] = 1. 0h = Disables the CTS (active-low) interrupt. 1h = Enables the CTS (active-low) interrupt.
6	RTSIT	R/W	0h	Can be written only when EFR[4] = 1. 0h = Disables the RTS (active-low) interrupt. 1h = Enables the RTS (active-low) interrupt.
5	XOFFIT	R/W	0h	Can be written only when EFR[4] = 1. 0h = Disables the XOFF interrupt. 1h = Enables the XOFF interrupt.
4	SLEEPMODE	R/W	0h	Can be only written when EFR[4] = 1. 0h = Disables sleep mode. 1h = Enables sleep mode (stop baud rate clock when the module is inactive).
3	MODEMSTSIT	R/W	0h	MODEMSTSIT. 0h = Disables the modem status register interrupt. 1h = Enables the modem status register interrupt
2	LINESTSIT	R/W	0h	LINESTSIT. 0h = Disables the receiver line status interrupt. 1h = Enables the receiver line status interrupt.
1	THRIT	R/W	0h	THRIT. 0h = Disables the THR interrupt. 1h = Enables the THR interrupt.
0	RHRIT	R/W	0h	RHRIT. 0h = Disables the RHR interrupt and time out interrupt. 1h = Enables the RHR interrupt and time out interrupt.

19.5.1.7 DLH Register (offset = 4h) [reset = 0h]

DLH is shown in [Figure 19-40](#) and described in [Table 19-36](#).

The divisor latches high register (DLH) is selected with a register bit setting of LCR[7] not equal to BFh or LCR[7] = BFh. The divisor latches high register (DLH) with the DLL register stores the 14-bit divisor for generation of the baud clock in the baud rate generator. DLH stores the most-significant part of the divisor, DLL stores the least-significant part of the divisor. DLL and DLH can be written to only before sleep mode is enabled (before IER[4] is set).

Figure 19-40. DLH Register

15	14	13	12	11	10	9	8
RESERVED							
R-0h							
7	6	5	4	3	2	1	0
RESERVED			CLOCK_MSB				
R-0h			R/W-0h				

LEGEND: R/W = Read/Write; R = Read only; W1toCl = Write 1 to clear bit; -n = value after reset

Table 19-36. DLH Register Field Descriptions

Bit	Field	Type	Reset	Description
15-6	RESERVED	R	0h	
5-0	CLOCK_MSB	R/W	0h	Divisor latches high. Stores the 6 MSB divisor value. Value 0 to 3Fh.

19.5.1.8 EFR Register (offset = 8h) [reset = 0h]

EFR is shown in [Figure 19-41](#) and described in [Table 19-37](#).

The enhanced feature register (EFR) is selected with a register bit setting of LCR[7] = BFh. The enhanced feature register (EFR) enables or disables enhanced features. Most enhanced functions apply only to UART modes, but EFR[4] enables write accesses to FCR[5:4], the TX trigger level, which is also used in IrDA modes.

Figure 19-41. EFR Register

15	14	13	12	11	10	9	8
RESERVED							
R-0h							
7	6	5	4	3	2	1	0
AUTOCTSEN	AUTORTSEN	SPECIALCHAR DETECT	ENHANCEDEN	SWFLOWCONTROL			
R/W-0h	R/W-0h	R/W-0h	R/W-0h	R/W-0h			

LEGEND: R/W = Read/Write; R = Read only; W1toCl = Write 1 to clear bit; -n = value after reset

Table 19-37. EFR Register Field Descriptions

Bit	Field	Type	Reset	Description
15-8	RESERVED	R	0h	
7	AUTOCTSEN	R/W	0h	Auto-CTS enable bit (UART mode only). 0h = Normal operation. 1h = Auto-CTS flow control is enabled; transmission is halted when the CTS (active-low) pin is high (inactive).
6	AUTORTSEN	R/W	0h	Auto-RTS enable bit (UART mode only). 0h = Normal operation. 1h = Auto-RTS flow control is enabled; RTS (active-low) pin goes high (inactive) when the receiver FIFO HALT trigger level, TCR[3:0], is reached and goes low (active) when the receiver FIFO RESTORE transmission trigger level is reached.
5	SPECIALCHARDETECT	R/W	0h	Special character detect (UART mode only). 0h = Normal operation. 1h = Special character detect enable. Received data is compared with XOFF2 data. If a match occurs, the received data is transferred to RX FIFO and the IIR[4] bit is set to 1 to indicate that a special character was detected.
4	ENHANCEDEN	R/W	0h	Enhanced functions write enable bit. 0h = Disables writing to IER[7:4], FCR[5:4], and MCR[7:5]. 1h = Enables writing to IER[7:4], FCR[5:4], and MCR[7:5].

Table 19-37. EFR Register Field Descriptions (continued)

Bit	Field	Type	Reset	Description
3-0	SWFLOWCONTROL	R/W	0h	<p>Combinations of software flow control can be selected by programming this bit.</p> <p>XON1 and XON2 should be set to different values if the software flow control is enabled.</p> <p>The TX and RX software flow control options are as follows.</p> <p>EFR[3] = 0, EFR[2] = 0, EFR[1] = X, and EFR[0] = X, then: No transmit flow control.</p> <p>EFR[3] = 1, EFR[2] = 0, EFR[1] = X, and EFR[0] = X, then: Transmit XON1, XOFF1.</p> <p>EFR[3] = 0, EFR[2] = 1, EFR[1] = X, and EFR[0] = X, then: Transmit XON2, XOFF2.</p> <p>EFR[3] = 1, EFR[2] = 1, EFR[1] = X, and EFR[0] = X, then: Transmit XON1, XON2 or XOFF1, XOFF2.</p> <p>The XON1 and XON2 characters or the XOFF1 and XOFF2 characters must be transmitted/received sequentially with XON1/XOFF1 followed by XON2/XOFF2.</p> <p>EFR[3] = X, EFR[2] = X, EFR[1] = 0, and EFR[0] = 0, then: No receive flow control.</p> <p>EFR[3] = X, EFR[2] = X, EFR[1] = 1, and EFR[0] = 0, then: Receiver compares XON1, XOFF1.</p> <p>EFR[3] = X, EFR[2] = X, EFR[1] = 0, and EFR[0] = 1, then: Receiver compares XON2, XOFF2.</p> <p>EFR[3] = X, EFR[2] = X, EFR[1] = 1, and EFR[0] = 1, then: Receiver compares XON1, XON2 or XOFF1, XOFF2.</p> <p>The XON1 and XON2 characters or the XOFF1 and XOFF2 characters must be transmitted/received sequentially with XON1/XOFF1 followed by XON2/XOFF2.</p> <p>In IrDA mode, EFR[1] and EFR[0] select the IR address to check (see IR Address Checking).</p>

19.5.1.9 IIR_UART Register (offset = 8h) [reset = 1h]

IIR_UART is shown in [Figure 19-42](#) and described in [Table 19-38](#).

The following interrupt identification register (IIR) description is for UART mode. The UART IIR is selected with a register bit setting of LCR[7] = 0 or LCR[7] not equal to BFh. The UART interrupt identification register (IIR) is a read-only register that provides the source of the interrupt. An interrupt source can be flagged only if enabled in the IER register.

Figure 19-42. IIR_UART Register

15	14	13	12	11	10	9	8
RESERVED							
R-0h							
7	6	5	4	3	2	1	0
FCR_MIRROR		IT_TYPE					IT_PENDING
R-0h		R-0h					R-1h

LEGEND: R/W = Read/Write; R = Read only; W1toCl = Write 1 to clear bit; -n = value after reset

Table 19-38. IIR_UART Register Field Descriptions

Bit	Field	Type	Reset	Description
15-8	RESERVED	R	0h	
7-6	FCR_MIRROR	R	0h	Mirror the contents of FCR[0] on both bits.
5-1	IT_TYPE	R	0h	Seven possible interrupts in UART mode. Other combinations never occur: 0h = Modem interrupt. Priority = 4. 1h = THR interrupt. Priority = 3. 2h = RHR interrupt. Priority = 2. 3h = Receiver line status error. Priority = 1. 4h = Reserved 5h = Reserved 6h = Rx timeout. Priority = 2. 7h = Reserved 8h = Xoff/special character. Priority = 5. 9h = Reserved, from 9h to Fh. 10h = CTS (active-low), RTS (active-low), DSR (active-low) change state from active (low) to inactive (high). Priority = 6. 11h = Reserved, from 11 to 1Fh.
0	IT_PENDING	R	1h	Interrupt pending. 0h = An interrupt is pending. 1h = No interrupt is pending.

19.5.1.10 IIR_CIR Register (offset = 8h) [reset = 0h]

IIR_CIR is shown in [Figure 19-43](#) and described in [Table 19-39](#).

The following interrupt identification register (IIR) description is for CIR mode. The CIR IIR is selected with a register bit setting of LCR[7] = 0 or LCR[7] not equal to BFh. The CIR interrupt identification register (IIR) is a read-only register that provides the source of the interrupt. An interrupt source can be flagged only if enabled in the IER register.

Figure 19-43. IIR_CIR Register

15	14	13	12	11	10	9	8	
RESERVED								
R-0h								
7	6	5	4	3	2	1	0	
RESERVED		TXSTATUSIT	RESERVED		RXOEIT	RXSTOPIT	THRIT	RHRIT_
R-0h		R-0h	R-0h		R-0h	R-0h	R-0h	R-0h

LEGEND: R/W = Read/Write; R = Read only; W1toCl = Write 1 to clear bit; -n = value after reset

Table 19-39. IIR_CIR Register Field Descriptions

Bit	Field	Type	Reset	Description
15-6	RESERVED	R	0h	
5	TXSTATUSIT	R	0h	TXSTATUSIT 0h = TX status interrupt inactive 1h = TX status interrupt active
4	RESERVED	R	0h	
3	RXOEIT	R	0h	RXOEIT 0h = RX overrun interrupt inactive 1h = RX overrun interrupt active
2	RXSTOPIT	R	0h	RXSTOPIT 0h = Receive stop interrupt is inactive 1h = Receive stop interrupt is active
1	THRIT	R	0h	THRIT 0h = THR interrupt inactive 1h = THR interrupt active
0	RHRIT_	R	0h	RHRIT 0h = RHR interrupt inactive 1h = RHR interrupt active

19.5.1.11 FCR Register (offset = 8h) [reset = 0h]

FCR is shown in [Figure 19-44](#) and described in [Table 19-40](#).

The FIFO control register (FCR) is selected with a register bit setting of LCR[7] = 0 or LCR[7] not equal to BFh. FCR[5:4] can only be written when EFR[4] = 1.

Figure 19-44. FCR Register

15	14	13	12	11	10	9	8
RESERVED							
R-0h							
7	6	5	4	3	2	1	0
RX_FIFO_TRIG		TX_FIFO_TRIG		DMA_MODE	TX_FIFO_CLE AR	RX_FIFO_CLE AR	FIFO_EN
W-0h		W-0h		W-0h	W-0h	W-0h	W-0h

LEGEND: R/W = Read/Write; R = Read only; W1toCl = Write 1 to clear bit; -n = value after reset

Table 19-40. FCR Register Field Descriptions

Bit	Field	Type	Reset	Description
15-8	RESERVED	R	0h	
7-6	RX_FIFO_TRIG	W	0h	Sets the trigger level for the RX FIFO: If SCR[7] = 0 and TLR[7] to TLR[4] not equal to 0000, RX_FIFO_TRIG is not considered. If SCR[7] = 1, RX_FIFO_TRIG is 2 LSB of the trigger level (1 to 63 on 6 bits) with the granularity 1. If SCR[7] = 0 and TLR[7] to TLR[4] = 0000, then: 0h = 8 characters 1h = 16 characters 2h = 56 characters 3h = 60 characters
5-4	TX_FIFO_TRIG	W	0h	Can be written only if EFR[4] = 1. Sets the trigger level for the TX FIFO: If SCR[6] = 0 and TLR[3] to TLR[0] not equal to 0000, TX_FIFO_TRIG is not considered. If SCR[6] = 1, TX_FIFO_TRIG is 2 LSB of the trigger level (1 to 63 on 6 bits) with a granularity of 1. If SCR[6] = 0 and TLR[3] to TLR[0] = 0000, then: 0h = 8 characters 1h = 16 characters 2h = 32 characters 3h = 56 characters
3	DMA_MODE	W	0h	Can be changed only when the baud clock is not running (DLL and DLH cleared to 0). If SCR[0] = 0, this register is considered. 0h = DMA_MODE 0 (No DMA). 1h = DMA_MODE 1 (UART_NDMA_REQ[0] in TX, UART_NDMA_REQ[1] in RX).
2	TX_FIFO_CLEAR	W	0h	TX_FIFO_CLEAR. 0h = No change. 1h = Clears the transmit FIFO and resets its counter logic to 0. Returns to 0 after clearing FIFO.
1	RX_FIFO_CLEAR	W	0h	RX_FIFO_CLEAR. 0h = No change. 1h = Clears the receive FIFO and resets its counter logic to 0. Returns to 0 after clearing FIFO.
0	FIFO_EN	W	0h	Can be changed only when the baud clock is not running (DLL and DLH cleared to 0). 0h = Disables the transmit and receive FIFOs. The transmit and receive holding registers are 1-byte FIFOs. 1h = Enables the transmit and receive FIFOs. The transmit and receive holding registers are 64-byte FIFOs.

19.5.1.12 IIR_IRDA Register (offset = 8h) [reset = 0h]

 IIR_IRDA is shown in [Figure 19-45](#) and described in [Table 19-41](#).

Figure 19-45. IIR_IRDA Register

15		14		13		12		11		10		9		8	
RESERVED															
R-0h															
7		6		5		4		3		2		1		0	
EOF_IT		LINE_STS_IT		TX_STATUS_IT		STS_FIFO_IT		RX_OE_IT		RX_FIFO_LAST_BYTE_IT		THR_IT		RHR_IT	
R-0h		R-0h		R-0h		R-0h		R-0h		R-0h		R-0h		R-0h	

LEGEND: R/W = Read/Write; R = Read only; W1toCl = Write 1 to clear bit; -n = value after reset

Table 19-41. IIR_IRDA Register Field Descriptions

Bit	Field	Type	Reset	Description
15-8	RESERVED	R	0h	
7	EOF_IT	R	0h	EOF_IT 0h = Received EOF interrupt inactive. 1h = Received EOF interrupt active.
6	LINE_STS_IT	R	0h	LINE_STS_IT 0h = Receiver line status interrupt inactive. 1h = Receiver line status interrupt active.
5	TX_STATUS_IT	R	0h	TX_STATUS_IT 0h = TX status interrupt inactive. 1h = TX status interrupt active.
4	STS_FIFO_IT	R	0h	STS_FIFO_IT 0h = Status FIFO trigger level interrupt inactive. 1h = Status FIFO trigger level interrupt active.
3	RX_OE_IT	R	0h	RX_OE_IT 0h = RX overrun interrupt inactive. 1h = RX overrun interrupt active.
2	RX_FIFO_LAST_BYTE_IT	R	0h	RX_FIFO_LAST_BYTE_IT 0h = Last byte of frame in RX FIFO interrupt inactive. 1h = Last byte of frame in RX FIFO interrupt active.
1	THR_IT	R	0h	THR_IT 0h = THR interrupt inactive. 1h = THR interrupt active.
0	RHR_IT	R	0h	RHR_IT 0h = RHR interrupt inactive. 1h = RHR interrupt active.

19.5.1.13 LCR Register (offset = Ch) [reset = 0h]

LCR is shown in [Figure 19-46](#) and described in [Table 19-42](#).

The line control register (LCR) is selected with a bit register setting of LCR[7] = 0, LCR[7] not equal to BFh, or LCR[7] = BFh. As soon as LCR[6] is set to 1, the TX line is forced to 0 and remains in this state as long as LCR[6] = 1.

Figure 19-46. LCR Register

15	14	13	12	11	10	9	8
RESERVED							
R-0h							
7	6	5	4	3	2	1	0
DIV_EN	BREAK_EN	PARITY_TYPE 2	PARITY_TYPE 1	PARITY_EN	NB_STOP	CHAR_LENGTH	
R/W-0h	R/W-0h	R/W-0h	R/W-0h	R/W-0h	R/W-0h	R/W-0h	

LEGEND: R/W = Read/Write; R = Read only; W1toCl = Write 1 to clear bit; -n = value after reset

Table 19-42. LCR Register Field Descriptions

Bit	Field	Type	Reset	Description
15-8	RESERVED	R	0h	
7	DIV_EN	R/W	0h	Divisor latch enable. 0h = Normal operating condition. 1h = Divisor latch enable. Allows access to DLL and DLH.
6	BREAK_EN	R/W	0h	Break control bit. Note: When LCR[6] is set to 1, the TX line is forced to 0 and remains in this state as long as LCR[6] = 1. 0h = Normal operating condition. 1h = Forces the transmitter output to go low to alert the communication terminal.
5	PARITY_TYPE2	R/W	0h	If LCR[3] = 1, then: 0h = If LCR[5] = 0, LCR[4] selects the forced parity format. 1h = If LCR[5] = 1 and LCR[4] = 0, the parity bit is forced to 1 in the transmitted and received data. If LCR[5] = 1 and LCR[4] = 1, the parity bit is forced to 0 in the transmitted and received data.
4	PARITY_TYPE1	R/W	0h	If LCR[3] = 1, then: 0h = Odd parity is generated. 1h = Even parity is generated.
3	PARITY_EN	R/W	0h	Parity bit. 0h = No parity. 1h = A parity bit is generated during transmission, and the receiver checks for received parity.
2	NB_STOP	R/W	0h	Specifies the number of stop bits. 0h = 1 stop bit (word length = 5, 6, 7, 8). 1h = 1.5 stop bits (word length = 5) or 2 stop bits (word length = 6, 7, 8).
1-0	CHAR_LENGTH	R/W	0h	Specifies the word length to be transmitted or received. 0h = 5 bits 1h = 6 bits 2h = 7 bits 3h = 8 bit

19.5.1.14 MCR Register (offset = 10h) [reset = 0h]

MCR is shown in [Figure 19-47](#) and described in [Table 19-43](#).

The modem control register (MCR) is selected with a register bit setting of LCR[7] = 0 or LCR[7] not equal to BFh. MCR[7:5] can only be written when EFR[4] = 1. Bits 3-0 control the interface with the modem, data set, or peripheral device that is emulating the modem.

Figure 19-47. MCR Register

15	14	13	12	11	10	9	8
RESERVED							
R-0h							
7	6	5	4	3	2	1	0
RESERVED	TCRTLR	XONEN	LOOPBACKEN	CDSTSCH	RISTSCH	RTS	DTR
R-0h	R/W-0h	R/W-0h	R/W-0h	R/W-0h	R/W-0h	R/W-0h	R/W-0h

LEGEND: R/W = Read/Write; R = Read only; W1toCl = Write 1 to clear bit; -n = value after reset

Table 19-43. MCR Register Field Descriptions

Bit	Field	Type	Reset	Description
15-7	RESERVED	R	0h	
6	TCRTLR	R/W	0h	Can be written only when EFR[4] = 1. 0h = No action. 1h = Enables access to the TCR and TLR registers.
5	XONEN	R/W	0h	Can be written only when EFR[4] = 1. 0h = Disable XON any function. 1h = Enable XON any function.
4	LOOPBACKEN	R/W	0h	Loopback mode enable. 0h = Normal operating mode. 1h = Enable local loopback mode (internal). In this mode, the MCR[3:0] signals are looped back into MSR[7:4]. The transmit output is looped back to the receive input internally.
3	CDSTSCH	R/W	0h	CDSTSCH. 0h = In loopback mode, forces DCD (active-low) input high and IRQ outputs to INACTIVE state. 1h = In loopback mode, forces DCD (active-low) input low and IRQ outputs to INACTIVE state.
2	RISTSCH	R/W	0h	RISTSCH. 0h = In loopback mode, forces RI (active-low) input inactive (high). 1h = In loopback mode, forces RI (active-low) input active (low).
1	RTS	R/W	0h	In loopback mode, controls MSR[4]. If auto-RTS is enabled, the RTS (active-low) output is controlled by hardware flow control. 0h = Force RTS (active-low) output to inactive (high). 1h = Force RTS (active-low) output to active (low).
0	DTR	R/W	0h	DTR. 0h = Force DTR (active-low) output (used in loopback mode) to inactive (high). 1h = Force DTR (active-low) output (used in loopback mode) to active (low).

19.5.1.15 XON1_ADDR1 Register (offset = 10h) [reset = 0h]

XON1_ADDR1 is shown in [Figure 19-48](#) and described in [Table 19-44](#).

The XON1/ADDR1 registers are selected with a register bit setting of LCR[7] = BFh. In UART mode, XON1 character; in IrDA mode, ADDR1 address 1.

Figure 19-48. XON1_ADDR1 Register

15	14	13	12	11	10	9	8
RESERVED							
R-0h							
7	6	5	4	3	2	1	0
XONWORD1							
R/W-0h							

LEGEND: R/W = Read/Write; R = Read only; W1toCl = Write 1 to clear bit; -n = value after reset

Table 19-44. XON1_ADDR1 Register Field Descriptions

Bit	Field	Type	Reset	Description
15-8	RESERVED	R	0h	
7-0	XONWORD1	R/W	0h	Stores the 8 bit XON1 character in UART modes and ADDR1 address 1 in IrDA modes.

19.5.1.16 XON2_ADDR2 Register (offset = 14h) [reset = 0h]

XON2_ADDR2 is shown in [Figure 19-49](#) and described in [Table 19-45](#).

The XON2/ADDR2 registers are selected with a register bit setting of LCR[7] = BFh. In UART mode, XON2 character; in IrDA mode, ADDR2 address 2.

Figure 19-49. XON2_ADDR2 Register

15	14	13	12	11	10	9	8
RESERVED							
R-0h							
7	6	5	4	3	2	1	0
XONWORD2							
R/W-0h							

LEGEND: R/W = Read/Write; R = Read only; W1toCl = Write 1 to clear bit; -n = value after reset

Table 19-45. XON2_ADDR2 Register Field Descriptions

Bit	Field	Type	Reset	Description
15-8	RESERVED	R	0h	
7-0	XONWORD2	R/W	0h	Stores the 8 bit XON2 character in UART modes and ADDR2 address 2 in IrDA modes.

19.5.1.17 LSR_CIR Register (offset = 14h) [reset = 81h]

LSR_CIR is shown in [Figure 19-50](#) and described in [Table 19-46](#).

The following line status register (LSR) description is for CIR mode. The CIR LSR is selected with a register bit setting of LCR[7] = 0 or LCR[7] not equal to BFh.

Figure 19-50. LSR_CIR Register

15	14	13	12	11	10	9	8
RESERVED							
R-0h							
7	6	5	4	3	2	1	0
THREMPY	RESERVED	RXSTOP	RESERVED				RXFIFOE
R-1h	R-0h	R-0h	R-0h				R-1h

LEGEND: R/W = Read/Write; R = Read only; W1toCl = Write 1 to clear bit; -n = value after reset

Table 19-46. LSR_CIR Register Field Descriptions

Bit	Field	Type	Reset	Description
15-8	RESERVED	R	0h	
7	THREMPY	R	1h	THREMPY. 0h = Transmit holding register (TX FIFO) is not empty. 1h = Transmit hold register (TX FIFO) is empty. The transmission is not necessarily completed.
6	RESERVED	R	0h	
5	RXSTOP	R	0h	The RXSTOP is generated based on the value set in the BOF Length register (EBLR). 0h = Reception is on going or waiting for a new frame. 1h = Reception is completed. It is cleared on a single read of the LSR register.
4-1	RESERVED	R	0h	
0	RXFIFOE	R	1h	RXFIFOE. 0h = At least one data character in the RX FIFO. 1h = No data in the receive FIFO.

19.5.1.18 LSR_IRDA Register (offset = 14h) [reset = A3h]

LSR_IRDA is shown in [Figure 19-51](#) and described in [Table 19-47](#).

The following line status register (LSR) description is for IrDA mode. The IrDA LSR is selected with a register bit setting of LCR[7] = 0 or LCR[7] not equal to BFh. When the IrDA line status register (LSR) is read, LSR[4:2] reflect the error bits (FL, CRC, ABORT) of the frame at the top of the status FIFO (next frame status to be read).

Figure 19-51. LSR_IRDA Register

15	14	13	12	11	10	9	8
RESERVED							
R-0h							
7	6	5	4	3	2	1	0
THR_EMPTY	STS_FIFO_FULL	RX_LAST_BYTE	FRAME_TOO_LONG	ABORT	CRC	STS_FIFO_E	RX_FIFO_E
R-1h	R-0h	R-1h	R-0h	R-0h	R-0h	R-1h	R-1h

LEGEND: R/W = Read/Write; R = Read only; W1toCl = Write 1 to clear bit; -n = value after reset

Table 19-47. LSR_IRDA Register Field Descriptions

Bit	Field	Type	Reset	Description
15-8	RESERVED	R	0h	
7	THR_EMPTY	R	1h	THR_EMPTY. 0h = Transmit holding register (TX FIFO) is not empty. 1h = Transmit hold register (TX FIFO) is empty. The transmission is not necessarily completed.
6	STS_FIFO_FULL	R	0h	STS_FIFO_FULL. 0h = Status FIFO is not full. 1h = Status FIFO is full.
5	RX_LAST_BYTE	R	1h	RX_LAST_BYTE. 0h = The RX FIFO (RHR) does not contain the last byte of the frame to be read. 1h = The RX FIFO (RHR) contains the last byte of the frame to be read. This bit is set to 1 only when the last byte of a frame is available to be read. It is used to determine the frame boundary. It is cleared on a single read of the LSR register.
4	FRAME_TOO_LONG	R	0h	FRAME_TOO_LONG. 0h = No frame-too-long error in frame. 1h = Frame-too-long error in the frame at the top of the status FIFO (next character to be read). This bit is set to 1 when a frame exceeding the maximum length (set by RXFLH and RXFLL registers) is received. When this error is detected, current frame reception is terminated. Reception is stopped until the next START flag is detected.
3	ABORT	R	0h	ABORT. 0h = No abort pattern error in frame. 1h(Read) = Abort pattern received. SIR and Mlabort pattern. FIR: Illegal symbol.
2	CRC	R	0h	CRC. 0h = No CRC error in frame. 1h = CRC error in the frame at the top of the status FIFO (next character to be read).
1	STS_FIFO_E	R	1h	STS_FIFO_E. 0h = Status FIFO is not empty. 1h = Status FIFO is empty.

Table 19-47. LSR_IRDA Register Field Descriptions (continued)

Bit	Field	Type	Reset	Description
0	RX_FIFO_E	R	1h	RX_FIFO_E. 0h = At least one data character in the RX FIFO. 1h = No data in the receive FIFO.

19.5.1.19 LSR_UART Register (offset = 14h) [reset = 60h]

LSR_UART is shown in [Figure 19-52](#) and described in [Table 19-48](#).

The following line status register (LSR) description is for UART mode. The UART LSR is selected with a register bit setting of LCR[7] = 0 or LCR[7] not equal to BFh. When the UART line status register (LSR) is read, LSR[4:2] reflect the error bits (BI, FE, PE) of the character at the top of the RX FIFO (next character to be read). Therefore, reading the LSR and then reading the RHR identifies errors in a character. Reading RHR updates BI, FE, and PE. LSR [7] is set when there is an error anywhere in the RX FIFO and is cleared only when there are no more errors remaining in the RX FIFO. Reading the LSR does not cause an increment of the RX FIFO read pointer. The RX FIFO read pointer is incremented by reading the RHR. Reading LSR clears OE if set.

Figure 19-52. LSR_UART Register

15	14	13	12	11	10	9	8
RESERVED							
R-0h							
7	6	5	4	3	2	1	0
RXFIFOSTS	TXSRE	TXFIFOE	RXBI	RXFE	RXPE	RXOE	RXFIFOE
R-0h	R-1h	R-1h	R-0h	R-0h	R-0h	R-0h	R-0h

LEGEND: R/W = Read/Write; R = Read only; W1toCl = Write 1 to clear bit; -n = value after reset

Table 19-48. LSR_UART Register Field Descriptions

Bit	Field	Type	Reset	Description
15-8	RESERVED	R	0h	
7	RXFIFOSTS	R	0h	RXFIFOSTS. 0h = Normal operation. 1h = At least one parity error, framing error, or break indication in the RX FIFO. Bit 7 is cleared when no errors are present in the RX FIFO.
6	TXSRE	R	1h	TXSRE. 0h = Transmitter hold (TX FIFO) and shift registers are not empty. 1h = Transmitter hold (TX FIFO) and shift registers are empty.
5	TXFIFOE	R	1h	TXFIFOE. 0h = Transmit hold register (TX FIFO) is not empty. 1h = Transmit hold register (TX FIFO) is empty. The transmission is not necessarily completed.
4	RXBI	R	0h	RXBI. 0h = No break condition. 1h = A break was detected while the data being read from the RX FIFO was being received (RX input was low for one character + 1 bit time frame).
3	RXFE	R	0h	RXFE. 0h = No framing error in data being read from RX FIFO. 1h = Framing error occurred in data being read from RX FIFO (received data did not have a valid stop bit).
2	RXPE	R	0h	RXPE. 0h = No parity error in data being read from RX FIFO. 1h = Parity error in data being read from RX FIFO.
1	RXOE	R	0h	RXOE. 0h = No overrun error. 1h = Overrun error occurred. Set when the character held in the receive shift register is not transferred to the RX FIFO. This case occurs only when receive FIFO is full.

Table 19-48. LSR_UART Register Field Descriptions (continued)

Bit	Field	Type	Reset	Description
0	RXFIFOE	R	0h	RXFIFOE. 0h = No data in the receive FIFO. 1h = At least one data character in the RX FIFO.

19.5.1.20 TCR Register (offset = 18h) [reset = 0h]

TCR is shown in [Figure 19-53](#) and described in [Table 19-49](#).

The transmission control register (TCR) is selected with a register bit setting of LCR[7] = 0, LCR[7] not equal to BFh, or LCR[7] = BFh. The TCR is accessible only when EFR[4] = 1 and MCR[6] = 1. The transmission control register (TCR) stores the receive FIFO threshold levels to start/stop transmission during hardware flow control. Trigger levels from 0-60 bytes are available with a granularity of 4. Trigger level = 4 x [4-bit register value]. You must ensure that TCR[3:0] > TCR[7:4], whenever auto-RTS or software flow control is enabled to avoid a misoperation of the device. In FIFO interrupt mode with flow control, you have to also ensure that the trigger level to HALT transmission is greater or equal to receive FIFO trigger level (either TLR[7:4] or FCR[7:6]); otherwise, FIFO operation stalls. In FIFO DMA mode with flow control, this concept does not exist because the DMA request is sent each time a byte is received.

Figure 19-53. TCR Register

15	14	13	12	11	10	9	8
RESERVED							
R-0h							
7	6	5	4	3	2	1	0
RXFIFOTRIGSTART				RXFIFOTRIGHALT			
R/W-0h				R/W-0h			

LEGEND: R/W = Read/Write; R = Read only; W1toCl = Write 1 to clear bit; -n = value after reset

Table 19-49. TCR Register Field Descriptions

Bit	Field	Type	Reset	Description
15-8	RESERVED	R	0h	
7-4	RXFIFOTRIGSTART	R/W	0h	RX FIFO trigger level to RESTORE transmission (0 to 60).
3-0	RXFIFOTRIGHALT	R/W	0h	RX FIFO trigger level to HALT transmission (0 to 60).

19.5.1.21 MSR Register (offset = 18h) [reset = 0h]

MSR is shown in [Figure 19-54](#) and described in [Table 19-50](#).

The modem status register (MSR) is selected with a register bit setting of LCR[7] = 0 or LCR[7] not equal to BFh. The modem status register (MSR) provides information about the current state of the control lines from the modem, data set, or peripheral device to the Local Host. It also indicates when a control input from the modem changes state.

Figure 19-54. MSR Register

15		14		13		12		11		10		9		8	
RESERVED															
R-0h															
7		6		5		4		3		2		1		0	
NCD_STS		NRI_STS		NDSR_STS		NCTS_STS		DCD_STS		RI_STS		DSR_STS		CTS_STS	
R-0h		R-0h		R-0h		R-0h		R-0h		R-0h		R-0h		R-0h	

LEGEND: R/W = Read/Write; R = Read only; W1toCl = Write 1 to clear bit; -n = value after reset

Table 19-50. MSR Register Field Descriptions

Bit	Field	Type	Reset	Description
15-8	RESERVED	R	0h	
7	NCD_STS	R	0h	This bit is the complement of the DCD (active-low) input. In loopback mode, it is equivalent to MCR[3].
6	NRI_STS	R	0h	This bit is the complement of the RI (active-low) input. In loopback mode, it is equivalent to MCR[2].
5	NDSR_STS	R	0h	This bit is the complement of the DSR (active-low) input. In loopback mode, it is equivalent to MCR[0].
4	NCTS_STS	R	0h	This bit is the complement of the CTS (active-low) input. In loopback mode, it is equivalent to MCR[1].
3	DCD_STS	R	0h	DCD_STS. 0h = No change. 1h = Indicates that DCD (active-low) input (or MCR[3] in loopback mode) has changed. Cleared on a read.
2	RI_STS	R	0h	RI_STS. 0h = No change. 1h = Indicates that RI (active-low) input (or MCR[2] in loopback mode) changed state from low to high. Cleared on a read.
1	DSR_STS	R	0h	DSR_STS. 0h = No change. 1h = Indicates that DSR (active-low) input (or MCR[0] in loopback mode) changed state. Cleared on a read.
0	CTS_STS	R	0h	CTS_STS. 0h = No change. 1h = Indicates that CTS (active-low) input (or MCR[1] in loopback mode) changed state. Cleared on a read.

19.5.1.22 XOFF1 Register (offset = 18h) [reset = 0h]

XOFF1 is shown in [Figure 19-55](#) and described in [Table 19-51](#).

The XOFF1 register is selected with a register bit setting of LCR[7] = BFh. In UART mode, XOFF1 character.

Figure 19-55. XOFF1 Register

15	14	13	12	11	10	9	8
RESERVED							
R-0h							
7	6	5	4	3	2	1	0
XOFFWORD1							
R/W-0h							

LEGEND: R/W = Read/Write; R = Read only; W1toCl = Write 1 to clear bit; -n = value after reset

Table 19-51. XOFF1 Register Field Descriptions

Bit	Field	Type	Reset	Description
15-8	RESERVED	R	0h	
7-0	XOFFWORD1	R/W	0h	Stores the 8 bit XOFF1 character in UART modes.

19.5.1.23 SPR Register (offset = 1Ch) [reset = 0h]

SPR is shown in [Figure 19-56](#) and described in [Table 19-52](#).

The scratchpad register (SPR) is selected with a register bit setting of LCR[7] = 0 or LCR[7] not equal to BFh. The scratchpad register (SPR) is a read/write register that does not control the module. It is a scratchpad register used to hold temporary data.

Figure 19-56. SPR Register

15	14	13	12	11	10	9	8
RESERVED							
R-0h							
7	6	5	4	3	2	1	0
SPR_WORD							
R/W-0h							

LEGEND: R/W = Read/Write; R = Read only; W1toCl = Write 1 to clear bit; -n = value after reset

Table 19-52. SPR Register Field Descriptions

Bit	Field	Type	Reset	Description
15-8	RESERVED	R	0h	
7-0	SPR_WORD	R/W	0h	Scratchpad register.

19.5.1.24 TLR Register (offset = 1Ch) [reset = 0h]

TLR is shown in [Figure 19-57](#) and described in [Table 19-53](#).

The trigger level register is selected with a register bit setting of LCR[7] = 0, LCR[7] not equal to BFh, or LCR[7] = BFh. The TLR is accessible only when EFR[4] = 1 and MCR[6] = 1. This register stores the programmable transmit and receive FIFO trigger levels used for DMA and IRQ generation.

Figure 19-57. TLR Register

15	14	13	12	11	10	9	8
RESERVED							
R-0h							
7	6	5	4	3	2	1	0
RX_FIFO_TRIG_DMA				TX_FIFO_TRIG_DMA			
R/W-0h				R/W-0h			

LEGEND: R/W = Read/Write; R = Read only; W1toCl = Write 1 to clear bit; -n = value after reset

Table 19-53. TLR Register Field Descriptions

Bit	Field	Type	Reset	Description
15-8	RESERVED	R	0h	
7-4	RX_FIFO_TRIG_DMA	R/W	0h	Receive FIFO trigger level. Following is a summary of settings for the RX FIFO trigger level. SCR[7] = 0, and TLR[7] to TLR[4]=0, then: Defined by FCR[7] and FCR[6] (either 8, 16, 56, 60 characters). SCR[7] = 0, and TLR[7] to TLR[4] not equal to 0000, then: Defined by TLR[7] to TLR[4] (from 4 to 60 characters with a granularity of 4 characters). SCR[7] = 1, and TLR[7] to TLR[4] = any value, then: Defined by the concatenated value of TLR[7] to TLR[4] and FCR[7] and FCR[6] (from 1 to 63 characters with a granularity of 1 character). Note: the combination of TLR[7] to TLR[4] = 0000 and FCR[7] and FCR[6] = 00 (all zeros) is not supported (minimum of 1 character is required). All zeros results in unpredictable behavior.
3-0	TX_FIFO_TRIG_DMA	R/W	0h	Transmit FIFO trigger level. Following is a summary of settings for the TX FIFO trigger level. SCR[6] = 0, and TLR[3] to TLR[0] = 0, then: Defined by FCR[5] and FCR[4] (either 8, 16, 32, 56 characters). SCR[6] = 0, and TLR[3] to TLR[0] not equal to 0000, then: Defined by TLR[3] to TLR[0] (from 4 to 60 characters with a granularity of 4 characters). SCR[6] = 1, and TLR[3] to TLR[0] = any value, then: Defined by the concatenated value of TLR[3] and TLR[0] and FCR[5] and FCR[4] (from 1 to 63 characters with a granularity of 1 character). Note: the combination of TLR[3] to TLR[0] = 0000 and FCR[5] and FCR[4] = 00 (all zeros) is not supported (minimum of 1 character is required). All zeros results in unpredictable behavior.

19.5.1.25 XOFF2 Register (offset = 1Ch) [reset = 0h]

XOFF2 is shown in [Figure 19-58](#) and described in [Table 19-54](#).

The XOFF2 register is selected with a register bit setting of LCR[7] = BFh. In UART mode, XOFF2 character.

Figure 19-58. XOFF2 Register

15	14	13	12	11	10	9	8
RESERVED							
R-0h							
7	6	5	4	3	2	1	0
XOFFWORD2							
R/W-0h							

LEGEND: R/W = Read/Write; R = Read only; W1toCl = Write 1 to clear bit; -n = value after reset

Table 19-54. XOFF2 Register Field Descriptions

Bit	Field	Type	Reset	Description
15-8	RESERVED	R	0h	
7-0	XOFFWORD2	R/W	0h	Stores the 8 bit XOFF2 character in UART modes.

19.5.1.26 MDR1 Register (offset = 20h) [reset = 7h]

MDR1 is shown in [Figure 19-59](#) and described in [Table 19-55](#).

The mode definition register 1 (MDR1) is selected with a register bit setting of LCR[7] = 0, LCR[7] not equal to BFh, or LCR[7] = BFh. The mode of operation is programmed by writing to MDR1[2:0]; therefore, the mode definition register 1 (MDR1) must be programmed on startup after configuration of the configuration registers (DLL, DLH, and LCR). The value of MDR1[2:0] must not be changed again during normal operation. If the module is disabled by setting the MODESELECT field to 7h, interrupt requests can still be generated unless disabled through the interrupt enable register (IER). In this case, UART mode interrupts are visible. Reading the interrupt identification register (IIR) shows the UART mode interrupt flags.

Figure 19-59. MDR1 Register

15	14	13	12	11	10	9	8
RESERVED							
R-0h							
7	6	5	4	3	2	1	0
FRAMEENDMODE	SIPMODE	SCT	SETTXIR	IRSLEEP	MODESELECT		
R/W-0h	R/W-0h	R/W-0h	R/W-0h	R/W-0h	R/W-7h		

LEGEND: R/W = Read/Write; R = Read only; W1toCl = Write 1 to clear bit; -n = value after reset

Table 19-55. MDR1 Register Field Descriptions

Bit	Field	Type	Reset	Description
15-8	RESERVED	R	0h	
7	FRAMEENDMODE	R/W	0h	IrDA mode only. 0h = Frame-length method. 1h = Set EOT bit method.
6	SIPMODE	R/W	0h	MIR/FIR modes only. 0h = Manual SIP mode: SIP is generated with the control of ACREG[3]. 1h = Automatic SIP mode: SIP is generated after each transmission.
5	SCT	R/W	0h	Store and control the transmission. 0h = Starts the infrared transmission when a value is written to the THR register. 1h = Starts the infrared transmission with the control of ACREG[2]. Note: Before starting any transmission, there must be no reception ongoing.
4	SETTXIR	R/W	0h	Used to configure the infrared transceiver. 0h = If MDR2[7] = 0, no action; if MDR2[7] = 1, TXIR pin output is forced low. 1h = TXIR pin output is forced high (not dependant of MDR2[7] value).
3	IRSLEEP	R/W	0h	IrDA/CIR sleep mode. 0h = IrDA/CIR sleep mode disabled. 1h = IrDA/CIR sleep mode enabled.
2-0	MODESELECT	R/W	7h	UART/IrDA/CIR mode selection. 0h = UART 16x mode. 1h = SIR mode. 2h = UART 16x auto-baud. 3h = UART 13x mode. 4h = MIR mode. 5h = FIR mode. 6h = CIR mode. 7h = Disable (default state).

19.5.1.27 MDR2 Register (offset = 24h) [reset = 0h]

MDR2 is shown in [Figure 19-60](#) and described in [Table 19-56](#).

The mode definition register 2 (MDR2) is selected with a register bit setting of LCR[7] = 0, LCR[7] not equal to BFh, or LCR[7] = BFh. The MDR2[0] bit describes the status of the TX status interrupt in IIR[5]. The IRTXUNDERRUN bit must be read after a TX status interrupt occurs. The MDR2[2:1] bits set the trigger level for the frame status FIFO (8 entries) and must be programmed before the mode is programmed in MDR1[2:0]. The MDR2[6] bit gives the flexibility to invert the RX pin inside the UART module to ensure that the protocol at the input of the transceiver module has the same polarity at module level. By default, the RX pin is inverted because most of transceiver invert the IR receive pin.

Figure 19-60. MDR2 Register

15	14	13	12	11	10	9	8
RESERVED							
R-0h							
7	6	5	4	3	2	1	0
SETTXIRALT	IRRXINVERT	CIRPULSEMODE		UARTPULSE	STSFIFOTRIG		IRTXUNDERRUN
R/W-0h	R/W-0h	R/W-0h		R/W-0h	R/W-0h		R-0h

LEGEND: R/W = Read/Write; R = Read only; W1toCl = Write 1 to clear bit; -n = value after reset

Table 19-56. MDR2 Register Field Descriptions

Bit	Field	Type	Reset	Description
15-8	RESERVED	R	0h	
7	SETTXIRALT	R/W	0h	Provides alternate functionality for MDR1[4]. 0h = Normal mode 1h = Alternate mode for SETTXIR
6	IRRXINVERT	R/W	0h	Only for IR mode (IrDA and CIR). Invert RX pin in the module before the voting or sampling system logic of the infrared block. This does not affect the RX path in UART modem modes. 0h = Inversion is performed. 1h = No inversion is performed.
5-4	CIRPULSEMODE	R/W	0h	CIR pulse modulation definition. Defines high level of the pulse width associated with a digit: 0h = Pulse width of 3 from 12 cycles. 1h = Pulse width of 4 from 12 cycles. 2h = Pulse width of 5 from 12 cycles. 3h = Pulse width of 6 from 12 cycles.
3	UARTPULSE	R/W	0h	UART mode only. Used to allow pulse shaping in UART mode. 0h = Normal UART mode. 1h = UART mode with pulse shaping.
2-1	STSFIFOTRIG	R/W	0h	Only for IrDA mode. Frame status FIFO threshold select: 0h = 1 entry 1h = 4 entries 2h = 7 entries 3h = 8 entries
0	IRTXUNDERRUN	R	0h	IrDA transmission status interrupt. When the TX status interrupt (IIR[5]) occurs, the meaning of the interrupt is: 0h = The last bit of the frame was transmitted successfully without error. 1h = An underrun occurred. The last bit of the frame was transmitted but with an underrun error. The bit is reset to 0 when the RESUME register is read.

19.5.1.28 TXFLL Register (offset = 28h) [reset = 0h]

TXFLL is shown in [Figure 19-61](#) and described in [Table 19-57](#).

The transmit frame length low register (TXFLL) is selected with a register bit setting of LCR[7] = 0, LCR[7] not equal to BFh, or LCR[7] = BFh. The transmit frame length low register (TXFLL) and the TXFLH register hold the 13-bit transmit frame length (expressed in bytes). TXFLL holds the LSBs and TXFLH holds the MSBs. The frame length value is used if the frame length method of frame closing is used.

Figure 19-61. TXFLL Register

15	14	13	12	11	10	9	8
RESERVED							
R-0h							
7	6	5	4	3	2	1	0
TXFLL							
W-0h							

LEGEND: R/W = Read/Write; R = Read only; W1toCl = Write 1 to clear bit; -n = value after reset

Table 19-57. TXFLL Register Field Descriptions

Bit	Field	Type	Reset	Description
15-8	RESERVED	R	0h	
7-0	TXFLL	W	0h	LSB register used to specify the frame length.

19.5.1.29 SFLSR Register (offset = 28h) [reset = 0h]

SFLSR is shown in [Figure 19-62](#) and described in [Table 19-58](#).

The status FIFO line status register (SFLSR) is selected with a register bit setting of LCR[7] = 0, LCR[7] not equal to BFh, or LCR[7] = BFh. Reading the status FIFO line status register (SFLSR) effectively reads frame status information from the status FIFO. This register does not physically exist. Reading this register increments the status FIFO read pointer (SFREGL and SFREGH must be read first). Top of RX FIFO = Next frame to be read from RX FIFO.

Figure 19-62. SFLSR Register

15	14	13	12	11	10	9	8
RESERVED							
R-0h							
7	6	5	4	3	2	1	0
RESERVED			OE_ERROR	FRAME_TOO_LONG_ERROR	ABORT_DETECT	CRC_ERROR	RESERVED
R-0h			R-0h	R-0h	R-0h	R-0h	R-0h

LEGEND: R/W = Read/Write; R = Read only; W1toCl = Write 1 to clear bit; -n = value after reset

Table 19-58. SFLSR Register Field Descriptions

Bit	Field	Type	Reset	Description
15-5	RESERVED	R	0h	
4	OE_ERROR	R	0h	OE_ERROR. 0h = No error 1h = Overrun error in RX FIFO when frame at top of RX FIFO was received.
3	FRAME_TOO_LONG_ERROR	R	0h	FRAME_TOO_LONG_ERROR. 0h = No error 1h = Frame-length too long error in frame at top of RX FIFO.
2	ABORT_DETECT	R	0h	ABORT_DETECT. 0h = No error 1h = Abort pattern detected in frame at top of RX FIFO.
1	CRC_ERROR	R	0h	CRC_ERROR. 0h = No error 1h = CRC error in frame at top of RX FIFO.
0	RESERVED	R	0h	

19.5.1.30 RESUME Register (offset = 2Ch) [reset = 0h]

RESUME is shown in [Figure 19-63](#) and described in [Table 19-59](#).

The RESUME register is selected with a register bit setting of LCR[7] = 0, LCR[7] not equal to BFh, or LCR[7] = BFh. The RESUME register is used to clear internal flags, which halt transmission/reception when an underrun/overflow error occurs. Reading this register resumes the halted operation. This register does not physically exist and always reads as 00.

Figure 19-63. RESUME Register

15	14	13	12	11	10	9	8
RESERVED							
R-0h							
7	6	5	4	3	2	1	0
RESUME							
R-0h							

LEGEND: R/W = Read/Write; R = Read only; W1toCl = Write 1 to clear bit; -n = value after reset

Table 19-59. RESUME Register Field Descriptions

Bit	Field	Type	Reset	Description
15-8	RESERVED	R	0h	
7-0	RESUME	R	0h	Dummy read to restart the TX or RX, value 0 to FFh.

19.5.1.31 TXFLH Register (offset = 2Ch) [reset = 0h]

TXFLH is shown in [Figure 19-64](#) and described in [Table 19-60](#).

The transmit frame length high register (TXFLH) is selected with a register bit setting of LCR[7] = 0, LCR[7] not equal to BFh, or LCR[7] = BFh. The transmit frame length high register (TXFLH) and the TXFLL register hold the 13-bit transmit frame length (expressed in bytes). TXFLL holds the LSBs and TXFLH holds the MSBs. The frame length value is used if the frame length method of frame closing is used.

Figure 19-64. TXFLH Register

15	14	13	12	11	10	9	8
RESERVED							
R-0h							
7	6	5	4	3	2	1	0
RESERVED				TXFLH			
R-0h				W-0h			

LEGEND: R/W = Read/Write; R = Read only; W1toCl = Write 1 to clear bit; -n = value after reset

Table 19-60. TXFLH Register Field Descriptions

Bit	Field	Type	Reset	Description
15-5	RESERVED	R	0h	
4-0	TXFLH	W	0h	MSB register used to specify the frame length, value 0 to 1Fh.

19.5.1.32 RXFLL Register (offset = 30h) [reset = 0h]

RXFLL is shown in [Figure 19-65](#) and described in [Table 19-61](#).

The received frame length low register (RXFLL) is selected with a register bit setting of LCR[7] = 0, LCR[7] not equal to BFh, or LCR[7] = BFh. The received frame length low register (RXFLL) and the RXFLH register hold the 12-bit receive maximum frame length. RXFLL holds the LSBs and RXFLH holds the MSBs. If the intended maximum receive frame length is n bytes, program RXFLL and RXFLH to be $n + 3$ in SIR or MIR modes and $n + 6$ in FIR mode (+3 and +6 are the result of frame format with CRC and stop flag; two bytes are associated with the FIR stop flag).

Figure 19-65. RXFLL Register

15	14	13	12	11	10	9	8
RESERVED							
R-0h							
7	6	5	4	3	2	1	0
RXFLL							
W-0h							

LEGEND: R/W = Read/Write; R = Read only; W1toCl = Write 1 to clear bit; -n = value after reset

Table 19-61. RXFLL Register Field Descriptions

Bit	Field	Type	Reset	Description
15-8	RESERVED	R	0h	
7-0	RXFLL	W	0h	LSB register used to specify the frame length in reception, value 0 to FFh.

19.5.1.33 SFREGL Register (offset = 30h) [reset = 0h]

SFREGL is shown in [Figure 19-66](#) and described in [Table 19-62](#).

The status FIFO register low (SFREGL) is selected with a register bit setting of LCR[7] = 0, LCR[7] not equal to BFh, or LCR[7] = BFh. The frame lengths of received frames are written into the status FIFO. This information can be read by reading the status FIFO register low (SFREGL) and the status FIFO register high (SFREGH). These registers do not physically exist. The LSBs are read from SFREGL and the MSBs are read from SFREGH. Reading these registers does not alter the status FIFO read pointer. These registers must be read before the pointer is incremented by reading the SFLSR.

Figure 19-66. SFREGL Register

15	14	13	12	11	10	9	8
RESERVED							
R-0h							
7	6	5	4	3	2	1	0
SFREGL							
R-0h							

LEGEND: R/W = Read/Write; R = Read only; W1toCl = Write 1 to clear bit; -n = value after reset

Table 19-62. SFREGL Register Field Descriptions

Bit	Field	Type	Reset	Description
15-8	RESERVED	R	0h	
7-0	SFREGL	R	0h	LSB part of the frame length, value 0 to FFh.

19.5.1.34 SFREGH Register (offset = 34h) [reset = 0h]

SFREGH is shown in [Figure 19-67](#) and described in [Table 19-63](#).

The status FIFO register high (SFREGH) is selected with a register bit setting of LCR[7] = 0, LCR[7] not equal to BFh, or LCR[7] = BFh. The frame lengths of received frames are written into the status FIFO. This information can be read by reading the status FIFO register low (SFREGL) and the status FIFO register high (SFREGH). These registers do not physically exist. The LSBs are read from SFREGL and the MSBs are read from SFREGH. Reading these registers does not alter the status FIFO read pointer. These registers must be read before the pointer is incremented by reading the SFLSR.

Figure 19-67. SFREGH Register

15	14	13	12	11	10	9	8
RESERVED							
R-0h							
7	6	5	4	3	2	1	0
RESERVED				SFREGH			
R-0h				R-0h			

LEGEND: R/W = Read/Write; R = Read only; W1toCl = Write 1 to clear bit; -n = value after reset

Table 19-63. SFREGH Register Field Descriptions

Bit	Field	Type	Reset	Description
15-4	RESERVED	R	0h	
3-0	SFREGH	R	0h	MSB part of the frame length, value 0 to Fh.

19.5.1.35 RXFLH Register (offset = 34h) [reset = 0h]

RXFLH is shown in [Figure 19-68](#) and described in [Table 19-64](#).

The received frame length high register (RXFLH) is selected with a register bit setting of LCR[7] = 0, LCR[7] not equal to BFh, or LCR[7] = BFh. The received frame length high register (RXFLH) and the RXFLL register hold the 12-bit receive maximum frame length. RXFLL holds the LSBs and RXFLH holds the MSBs. If the intended maximum receive frame length is n bytes, program RXFLL and RXFLH to be n + 3 in SIR or MIR modes and n + 6 in FIR mode (+3 and +6 are the result of frame format with CRC and stop flag; two bytes are associated with the FIR stop flag).

Figure 19-68. RXFLH Register

15	14	13	12	11	10	9	8
RESERVED							
R-0h							
7	6	5	4	3	2	1	0
RESERVED				RXFLH			
R-0h				W-0h			

LEGEND: R/W = Read/Write; R = Read only; W1toCl = Write 1 to clear bit; -n = value after reset

Table 19-64. RXFLH Register Field Descriptions

Bit	Field	Type	Reset	Description
15-4	RESERVED	R	0h	
3-0	RXFLH	W	0h	MSB register used to specify the frame length in reception, value 0 to Fh.

19.5.1.36 BLR Register (offset = 38h) [reset = 40h]

BLR is shown in [Figure 19-69](#) and described in [Table 19-65](#).

The BOF control register (BLR) is selected with a register bit setting of LCR[7] = 0. The BLR[6] bit is used to select whether C0h or FFh start patterns are to be used, when multiple start flags are required in SIR mode. If only one start flag is required, this is always C0h. If n start flags are required, either (n - 1) C0h or (n - 1) FFh flags are sent, followed by a single C0h flag (immediately preceding the first data byte).

Figure 19-69. BLR Register

15	14	13	12	11	10	9	8
RESERVED							
R-0h							
7	6	5	4	3	2	1	0
STSFIFORESET	XBOFTYPE	RESERVED					
R/W-0h	R/W-1h	R-0h					

LEGEND: R/W = Read/Write; R = Read only; W1toCl = Write 1 to clear bit; -n = value after reset

Table 19-65. BLR Register Field Descriptions

Bit	Field	Type	Reset	Description
15-8	RESERVED	R	0h	
7	STSFIFORESET	R/W	0h	Status FIFO reset. This bit is self-clearing.
6	XBOFTYPE	R/W	1h	SIR xBOF select. 0h = FFh start pattern is used. 1h = C0h start pattern is used.
5-0	RESERVED	R	0h	

19.5.1.37 UASR Register (offset = 38h) [reset = 0h]

UASR is shown in [Figure 19-70](#) and described in [Table 19-66](#).

The UART autobauding status register (UASR) is selected with a register bit setting of LCR[7] not equal to BFh or LCR[7] = BFh. The UART autobauding status register (UASR) returns the speed, the number of bits by characters, and the type of parity in UART autobauding mode. In autobauding mode, the input frequency of the UART modem must be fixed to 48 MHz. Any other module clock frequency results in incorrect baud rate recognition. This register is used to set up transmission according to characteristics of previous reception, instead of LCR, DLL, and DLH registers when UART is in autobauding mode. To reset the autobauding hardware (to start a new AT detection) or to set the UART in standard mode (no autobaud), MDR1[2:0] must be set to 7h (reset state), then set to 2h (UART in autobaud mode) or cleared to 0 (UART in standard mode). Usage limitation: Only 7 and 8 bits character (5 and 6 bits not supported). 7 bits character with space parity not supported. Baud rate between 1200 and 115 200 bp/s (10 possibilities).

Figure 19-70. UASR Register

15	14	13	12	11	10	9	8
RESERVED							
R-0h							
7	6	5	4	3	2	1	0
PARITYTYPE		BITBYCHAR		SPEED			
R-0h		R-0h		R-0h			

LEGEND: R/W = Read/Write; R = Read only; W1toCl = Write 1 to clear bit; -n = value after reset

Table 19-66. UASR Register Field Descriptions

Bit	Field	Type	Reset	Description
15-8	RESERVED	R	0h	
7-6	PARITYTYPE	R	0h	Type of the parity in UART autobauding mode. 0h = No parity identified 1h = Parity space 2h = Even parity 3h = Odd parity
5	BITBYCHAR	R	0h	Number of bits by characters. 0h = 7-bit character identified. 1h = 8-bit character identified.
4-0	SPEED	R	0h	Speed. 0h = No speed identified. 1h = 115 200 baud 2h = 57 600 baud 3h = 38 400 baud 4h = 28 800 baud 5h = 19 200 baud 6h = 14 400 baud 7h = 9600 baud 8h = 4800 baud 9h = 2400 baud Ah = 1200 baud Bh = Reserved from Bh to 1Fh.

19.5.1.38 ACREG Register (offset = 3Ch) [reset = 0h]

ACREG is shown in [Figure 19-71](#) and described in [Table 19-67](#).

The auxiliary control register (ACREG) is selected with a register bit setting of LCR[7] = 0. If transmit FIFO is not empty and MDR1[5] = 1, IrDA starts a new transfer with data of previous frame as soon as abort frame has been sent. Therefore, TX FIFO must be reset before sending an abort frame. It is recommended to disable TX FIFO underrun capability by masking corresponding underrun interrupt. When disabling underrun by setting ACREG[4] = 1, unknown data is sent over TX line.

Figure 19-71. ACREG Register

15		14		13		12		11		10		9		8	
RESERVED															
R-0h															
7		6		5		4		3		2		1		0	
PULSETYPE		SDMOD		DISIRRX		DISTXUNDER RUN		SENDSIP		SCTXEN		ABORTEN		EOTEN	
R/W-0h		R/W-0h		R/W-0h		R/W-0h		R/W-0h		R/W-0h		R/W-0h		R/W-0h	

LEGEND: R/W = Read/Write; R = Read only; W1toCl = Write 1 to clear bit; -n = value after reset

Table 19-67. ACREG Register Field Descriptions

Bit	Field	Type	Reset	Description
15-8	RESERVED	R	0h	
7	PULSETYPE	R/W	0h	SIR pulse-width select: 0h = 3/16 of baud-rate pulse width 1h = 1.6 microseconds
6	SDMOD	R/W	0h	Primary output used to configure transceivers. Connected to the SD/MODE input pin of IrDA transceivers. 0h = SD pin is set to high. 1h = SD pin is set to low.
5	DISIRRX	R/W	0h	Disable RX input. 0h = Normal operation (RX input automatically disabled during transmit, but enabled outside of transmit operation). 1h = Disables RX input (permanent state; independent of transmit).
4	DISTXUNDERRUN	R/W	0h	Disable TX underrun. 0h = Long stop bits cannot be transmitted. TX underrun is enabled. 1h = Long stop bits can be transmitted.
3	SENDSIP	R/W	0h	MIR/FIR modes only. Send serial infrared interaction pulse (SIP). If this bit is set during an MIR/FIR transmission, the SIP is sent at the end of it. This bit is automatically cleared at the end of the SIP transmission. 0h = No action. 1h = Send SIP pulse.
2	SCTXEN	R/W	0h	Store and control TX start. When MDR1[5] = 1 and the LH writes 1 to this bit, the TX state-machine starts frame transmission. This bit is self-clearing.
1	ABORTEN	R/W	0h	Frame abort. The LH can intentionally abort transmission of a frame by writing 1 to this bit. Neither the end flag nor the CRC bits are appended to the frame.
0	EOTEN	R/W	0h	EOT (end-of-transmission) bit. The LH writes 1 to this bit just before it writes the last byte to the TX FIFO in the set-EOT bit frame-closing method. This bit is automatically cleared when the LH writes to the THR (TX FIFO).

19.5.1.39 SCR Register (offset = 40h) [reset = 0h]

SCR is shown in [Figure 19-72](#) and described in [Table 19-68](#).

The supplementary control register (SCR) is selected with a register bit setting of LCR[7] = 0, LCR[7] not equal to BFh, or LCR[7] = BFh. Bit 4 enables the wake-up interrupt, but this interrupt is not mapped into the IIR register. Therefore, when an interrupt occurs and there is no interrupt pending in the IIR register, the SSR[1] bit must be checked. To clear the wake-up interrupt, bit SCR[4] must be reset to 0.

Figure 19-72. SCR Register

15	14	13	12	11	10	9	8
RESERVED							
R-0h							
7	6	5	4	3	2	1	0
RXTRIGGRAN U1	TXTRIGGRAN U1	DSRIT	RXCTSDSRWA KEUPENABLE	TXEMPTYCTLI T	DMAMODE2		DMAMODECTL
R/W-0h	R/W-0h	R/W-0h	R/W-0h	R/W-0h	R/W-0h		R/W-0h

LEGEND: R/W = Read/Write; R = Read only; W1toCl = Write 1 to clear bit; -n = value after reset

Table 19-68. SCR Register Field Descriptions

Bit	Field	Type	Reset	Description
15-8	RESERVED	R	0h	
7	RXTRIGGRANU1	R/W	0h	RXTRIGGRANU1 0h = Disables the granularity of 1 for trigger RX level. 1h = Enables the granularity of 1 for trigger RX level.
6	TXTRIGGRANU1	R/W	0h	TXTRIGGRANU1 0h = Disables the granularity of 1 for trigger TX level. 1h = Enables the granularity of 1 for trigger TX level.
5	DSRIT	R/W	0h	DSRIT 0h = Disables DSR (active-low) interrupt. 1h = Enables DSR (active-low) interrupt.
4	RXCTSDSRWAKEUPENABLE	R/W	0h	RX CTS wake-up enable. 0h = Disables the WAKE UP interrupt and clears SSR[1]. 1h = Waits for a falling edge of RX, CTS (active-low), or DSR (active-low) pins to generate an interrupt.
3	TXEMPTYCTLIT	R/W	0h	TXEMPTYCTLIT 0h = Normal mode for THR interrupt. 1h = THR interrupt is generated when TX FIFO and TX shift register are empty.
2-1	DMAMODE2	R/W	0h	Specifies the DMA mode valid if SCR[0] = 1, then: 0h = DMA mode 0 (no DMA). 1h = DMA mode 1 (UARTnDMAREQ[0] in TX, UARTnDMAREQ[1] in RX) 2h = DMA mode 2 (UARTnDMAREQ[0] in RX) 3h = DMA mode 3 (UARTnDMAREQ[0] in TX)
0	DMAMODECTL	R/W	0h	DMAMODECTL 0h = The DMAMODE is set with FCR[3]. 1h = The DMAMODE is set with SCR[2:1].

19.5.1.40 SSR Register (offset = 44h) [reset = 4h]

SSR is shown in [Figure 19-73](#) and described in [Table 19-69](#).

The supplementary status register (SSR) is selected with a register bit setting of LCR[7] = 0, LCR[7] not equal to BFh, or LCR[7] = BFh. Bit 1 is reset only when SCR[4] is reset to 0.

Figure 19-73. SSR Register

15	14	13	12	11	10	9	8
RESERVED							
R-0h							
7	6	5	4	3	2	1	0
RESERVED					DMACOUNTE RRST	RXCTSDSRWA KEUPSTS	TXFIFOFULL
R-0h					R/W-1h	R-0h	R-0h

LEGEND: R/W = Read/Write; R = Read only; W1toCl = Write 1 to clear bit; -n = value after reset

Table 19-69. SSR Register Field Descriptions

Bit	Field	Type	Reset	Description
15-3	RESERVED	R	0h	
2	DMACOUNTERRST	R/W	1h	DMACOUNTERRST. 0h = The DMA counter will not be reset, if the corresponding FIFO is reset (via FCR[1] or FCR[2]). 1h = The DMA counter will be reset, if the corresponding FIFO is reset (via FCR[1] or FCR[2]).
1	RXCTSDSRWAKEUPSTS	R	0h	Pin falling edge detection: Reset only when SCR[4] is reset to 0. 0h = No falling-edge event on RX, CTS (active-low), and DSR (active-low). 1h = A falling edge occurred on RX, CTS (active-low), or DSR (active-low).
0	TXFIFOFULL	R	0h	TXFIFOFULL. 0h = TX FIFO is not full. 1h = TX FIFO is full.

19.5.1.41 EBLR Register (offset = 48h) [reset = 0h]

EBLR is shown in [Figure 19-74](#) and described in [Table 19-70](#).

The BOF length register (EBLR) is selected with a register bit setting of LCR[7] = 0. In IrDA SIR operation, the BOF length register (EBLR) specifies the number of BOF + xBOFs to transmit. The value set into this register must consider the BOF character; therefore, to send only one BOF with no XBOF, this register must be set to 1. To send one BOF with n XBOFs, this register must be set to n + 1. Furthermore, the value 0 sends 1 BOF plus 255 XBOFs. In IrDA MIR mode, the BOF length register (EBLR) specifies the number of additional start flags (MIR protocol mandates a minimum of 2 start flags). In CIR mode, the BOF length register (EBLR) specifies the number of consecutive zeros to be received before generating the RXSTOP interrupt (IIR[2]). All the received zeros are stored in the RX FIFO. When the register is cleared to 0, this feature is deactivated and always in reception state, which is disabled by setting the ACREG[5] bit to 1. If the RX_STOP interrupt occurs before a byte boundary, the remaining bits of the last byte are filled with zeros and then passed into the RX FIFO.

Figure 19-74. EBLR Register

15	14	13	12	11	10	9	8
RESERVED							
R-0h							
7	6	5	4	3	2	1	0
EBLR							
R/W-0h							

LEGEND: R/W = Read/Write; R = Read only; W1toCl = Write 1 to clear bit; -n = value after reset

Table 19-70. EBLR Register Field Descriptions

Bit	Field	Type	Reset	Description
15-8	RESERVED	R	0h	
7-0	EBLR	R/W	0h	IrDA mode: This register allows definition of up to 176 xBOFs, the maximum required by IrDA specification. CIR mode: This register specifies the number of consecutive zeros to be received before generating the RXSTOP interrupt (IIR[2]). 0h = Feature disabled. 1h = Generate RXSTOP interrupt after receiving 1 zero bit. FFh = Generate RXSTOP interrupt after receiving 255 zero bits.

19.5.1.42 MVR Register (offset = 50h) [reset = 0h]

MVR is shown in [Figure 19-75](#) and described in [Table 19-71](#).

The module version register (MVR) is selected with a register bit setting of LCR[7] = 0, LCR[7] not equal to BFh, or LCR[7] = BFh. The reset value is fixed by hardware and corresponds to the RTL revision of this module. A reset has no effect on the value returned.

Figure 19-75. MVR Register

15	14	13	12	11	10	9	8
RESERVED					MAJORREV		
R-0h					R-0h		
7	6	5	4	3	2	1	0
RESERVED		MINORREV_					
R-0h		R-0h					

LEGEND: R/W = Read/Write; R = Read only; W1toCl = Write 1 to clear bit; -n = value after reset

Table 19-71. MVR Register Field Descriptions

Bit	Field	Type	Reset	Description
15-11	RESERVED	R	0h	
10-8	MAJORREV	R	0h	Major revision number of the module.
7-6	RESERVED	R	0h	
5-0	MINORREV_	R	0h	Minor revision number of the module.

19.5.1.43 SYSC Register (offset = 54h) [reset = 0h]

SYSC is shown in [Figure 19-76](#) and described in [Table 19-72](#).

The system configuration register (SYSC) is selected with a register bit setting of LCR[7] = 0, LCR[7] not equal to BFh, or LCR[7] = BFh. The AUTOIDLE bit controls a power-saving technique to reduce the logic power consumption of the module interface; that is, when the feature is enabled, the interface clock is gated off until the module interface is accessed. When the SOFTRESET bit is set high, it causes a full device reset.

Figure 19-76. SYSC Register

15	14	13	12	11	10	9	8
RESERVED							
R-0h							
7	6	5	4	3	2	1	0
RESERVED			IDLEMODE		ENAWAKEUP	SOFTRESET	AUTOIDLE
R-0h			R/W-0h		R/W-0h	R/W-0h	R/W-0h

LEGEND: R/W = Read/Write; R = Read only; W1toCl = Write 1 to clear bit; -n = value after reset

Table 19-72. SYSC Register Field Descriptions

Bit	Field	Type	Reset	Description
15-5	RESERVED	R	0h	
4-3	IDLEMODE	R/W	0h	Power management req/ack control. 0h = Force idle: Idle request is acknowledged unconditionally. 1h = No-idle: Idle request is never acknowledged. 2h = Smart idle: Acknowledgement to an idle request is given based in the internal activity of the module. 3h = Smart idle Wakeup: Acknowledgement to an idle request is given based in the internal activity of the module. The module is allowed to generate wakeup request. Only available on UART0.
2	ENAWAKEUP	R/W	0h	Wakeup control. 0h = Wakeup is disabled. 1h = Wakeup capability is enabled.
1	SOFTRESET	R/W	0h	Software reset. Set this bit to 1 to trigger a module reset. This bit is automatically reset by the hardware. Read returns 0. 0h = Normal mode. 1h = Module is reset.
0	AUTOIDLE	R/W	0h	Internal interface clock-gating strategy. 0h = Clock is running. 1h = Reserved.

19.5.1.44 SYSS Register (offset = 58h) [reset = 0h]

SYSS is shown in [Figure 19-77](#) and described in [Table 19-73](#).

The system status register (SYSS) is selected with a register bit setting of LCR[7] = 0, LCR[7] not equal to BFh, or LCR[7] = BFh.

Figure 19-77. SYSS Register

15	14	13	12	11	10	9	8
RESERVED							
R-0h							
7	6	5	4	3	2	1	0
RESERVED							RESETDONE
R-0h							R-0h

LEGEND: R/W = Read/Write; R = Read only; W1toCl = Write 1 to clear bit; -n = value after reset

Table 19-73. SYSS Register Field Descriptions

Bit	Field	Type	Reset	Description
15-1	RESERVED	R	0h	
0	RESETDONE	R	0h	Internal reset monitoring. 0h = Internal module reset is ongoing. 1h = Reset complete.

19.5.1.45 WER Register (offset = 5Ch) [reset = FFh]

WER is shown in [Figure 19-78](#) and described in [Table 19-74](#).

The wake-up enable register (WER) is selected with a register bit setting of LCR[7] = 0, LCR[7] not equal to BFh, or LCR[7] = BFh. The wake-up enable register (WER) is used to mask and unmask a UART event that subsequently notifies the system. An event is any activity in the logic that can cause an interrupt and/or an activity that requires the system to wake up. Even if wakeup is disabled for certain events, if these events are also an interrupt to the UART, the UART still registers the interrupt as such.

Figure 19-78. WER Register

15		14		13		12		11		10		9		8	
RESERVED															
R-0h															
7		6		5		4		3		2		1		0	
TXWAKEUPEN	RLS__INTERR UPT	RHR__INTERR UPT	RX__ACTIVITY	DCD__ACTIVIT Y	RI__ACTIVITY	DSR__ACTIVIT Y	CTS__ACTIVIT Y								
R/W-1h	R/W-1h	R/W-1h	R/W-1h	R/W-1h	R/W-1h	R/W-1h	R/W-1h								

LEGEND: R/W = Read/Write; R = Read only; W1toCl = Write 1 to clear bit; -n = value after reset

Table 19-74. WER Register Field Descriptions

Bit	Field	Type	Reset	Description
15-8	RESERVED	R	0h	
7	TXWAKEUPEN	R/W	1h	Wake-up interrupt. 0h = Event is not allowed to wake up the system. 1h = Event can wake up the system: Event can be: THRIT or TXDMA request and/or TXSATUSIT.
6	RLS__INTERRUPT	R/W	1h	Receiver line status interrupt. 0h = Event is not allowed to wake up the system. 1h = Event can wake up the system.
5	RHR__INTERRUPT	R/W	1h	RHR interrupt. 0h = Event is not allowed to wake up the system. 1h = Event can wake up the system.
4	RX__ACTIVITY	R/W	1h	RX_ACTIVITY. 0h = Event is not allowed to wake up the system. 1h = Event can wake up the system.
3	DCD__ACTIVITY	R/W	1h	DCD_ACTIVITY. 0h = Event is not allowed to wake up the system. 1h = Event can wake up the system.
2	RI__ACTIVITY	R/W	1h	RI_ACTIVITY. 0h = Event is not allowed to wake up the system. 1h = Event can wake up the system.
1	DSR__ACTIVITY	R/W	1h	DSR_ACTIVITY. 0h = Event is not allowed to wake up the system. 1h = Event can wake up the system.
0	CTS__ACTIVITY	R/W	1h	CTS_ACTIVITY. 0h = Event is not allowed to wake up the system. 1h = Event can wake up the system.

19.5.1.46 CFPS Register (offset = 60h) [reset = 69h]

CFPS is shown in [Figure 19-79](#) and described in [Table 19-75](#).

The carrier frequency prescaler register (CFPS) is selected with a register bit setting of LCR[7] = 0, LCR[7] not equal to BFh, or LCR[7] = BFh. Since the consumer IR (CIR) works at modulation rates of 30-56.8 kHz, the 48 MHz clock must be prescaled before the clock can drive the IR logic. The carrier frequency prescaler register (CFPS) sets the divisor rate to give a range to accommodate the remote control requirements in BAUD multiples of 12x. The value of the CFPS at reset is 105 decimal (69h), which equates to a 38.1 kHz output from starting conditions. The 48 MHz carrier is prescaled by the CFPS that is then divided by the 12x BAUD multiple.

Figure 19-79. CFPS Register

15	14	13	12	11	10	9	8
RESERVED							
R-0h							
7	6	5	4	3	2	1	0
CFPS							
R/W-69h							

LEGEND: R/W = Read/Write; R = Read only; W1toCl = Write 1 to clear bit; -n = value after reset

Table 19-75. CFPS Register Field Descriptions

Bit	Field	Type	Reset	Description
15-8	RESERVED	R	0h	
7-0	CFPS	R/W	69h	System clock frequency prescaler at (12x multiple). CFPS = 0 is not supported. Examples for CFPS values follow. Target Frequency (kHz) = 30, CFPS (decimal) = 133, Actual Frequency (kHz) = 30.08. Target Frequency (kHz) = 32.75, CFPS (decimal) = 122, Actual Frequency (kHz) = 32.79. Target Frequency (kHz) = 36, CFPS (decimal) = 111, Actual Frequency (kHz) = 36.04. Target Frequency (kHz) = 36.7, CFPS (decimal) = 109, Actual Frequency (kHz) = 36.69. Target Frequency (kHz) = 38, CFPS (decimal) = 105, Actual Frequency (kHz) = 38.1. Target Frequency (kHz) = 40, CFPS (decimal) = 100, Actual Frequency (kHz) = 40. Target Frequency (kHz) = 56.8, CFPS (decimal) = 70, Actual Frequency (kHz) = 57.14.

19.5.1.47 RXFIFO_LVL Register (offset = 64h) [reset = 0h]

RXFIFO_LVL is shown in [Figure 19-80](#) and described in [Table 19-76](#).

Figure 19-80. RXFIFO_LVL Register

15	14	13	12	11	10	9	8
RESERVED							
R-0h							
7	6	5	4	3	2	1	0
RXFIFO_LVL							
R-0h							

LEGEND: R/W = Read/Write; R = Read only; W1toCl = Write 1 to clear bit; -n = value after reset

Table 19-76. RXFIFO_LVL Register Field Descriptions

Bit	Field	Type	Reset	Description
15-8	RESERVED	R	0h	
7-0	RXFIFO_LVL	R	0h	Level of the RX FIFO

19.5.1.48 TXFIFO_LVL Register (offset = 68h) [reset = 0h]

TXFIFO_LVL is shown in [Figure 19-81](#) and described in [Table 19-77](#).

Figure 19-81. TXFIFO_LVL Register

15	14	13	12	11	10	9	8
RESERVED							
R-0h							
7	6	5	4	3	2	1	0
TXFIFO_LVL							
R-0h							

LEGEND: R/W = Read/Write; R = Read only; W1toCl = Write 1 to clear bit; -n = value after reset

Table 19-77. TXFIFO_LVL Register Field Descriptions

Bit	Field	Type	Reset	Description
15-8	RESERVED	R	0h	
7-0	TXFIFO_LVL	R	0h	Level of the TX FIFO

19.5.1.49 IER2 Register (offset = 6Ch) [reset = 0h]

IER2 is shown in [Figure 19-82](#) and described in [Table 19-78](#).

The IER2 enables RX/TX FIFOs empty corresponding interrupts.

Figure 19-82. IER2 Register

15	14	13	12	11	10	9	8
RESERVED							
R-0h							
7	6	5	4	3	2	1	0
RESERVED						EN_TXFIFO_E MPTY	EN_RXFIFO_E MPTY
R-0h						R/W-0h	R/W-0h

LEGEND: R/W = Read/Write; R = Read only; W1toCl = Write 1 to clear bit; -n = value after reset

Table 19-78. IER2 Register Field Descriptions

Bit	Field	Type	Reset	Description
15-2	RESERVED	R	0h	
1	EN_TXFIFO_EMPTY	R/W	0h	EN_TXFIFO_EMPTY. 0h = Disables EN_TXFIFO_EMPTY interrupt. 1h = Enables EN_TXFIFO_EMPTY interrupt.
0	EN_RXFIFO_EMPTY	R/W	0h	Number of bits by characters. 0h = Disables EN_RXFIFO_EMPTY interrupt. 1h = Enables EN_RXFIFO_EMPTY interrupt.

19.5.1.50 ISR2 Register (offset = 70h) [reset = 0h]

ISR2 is shown in [Figure 19-83](#) and described in [Table 19-79](#).

The interrupt status register 2 (ISR2) is selected with a register bit setting of LCR[7] = 0, LCR[7] not equal to BFh, or LCR[7] = BFh. The ISR2 displays the status of RX/TX FIFOs empty corresponding interrupts.

Figure 19-83. ISR2 Register

15	14	13	12	11	10	9	8
RESERVED							
R-0h							
7	6	5	4	3	2	1	0
RESERVED						TXFIFO_EMPTY_STS	RXFIFO_EMPTY_STS
R-0h						R/W-0h	R/W-0h

LEGEND: R/W = Read/Write; R = Read only; W1toCl = Write 1 to clear bit; -n = value after reset

Table 19-79. ISR2 Register Field Descriptions

Bit	Field	Type	Reset	Description
15-2	RESERVED	R	0h	
1	TXFIFO_EMPTY_STS	R/W	0h	TXFIFO_EMPTY_STS. 0h = TXFIFO_EMPTY interrupt not pending. 1h = TXFIFO_EMPTY interrupt pending.
0	RXFIFO_EMPTY_STS	R/W	0h	RXFIFO_EMPTY_STS. 0h = RXFIFO_EMPTY interrupt not pending. 1h = RXFIFO_EMPTY interrupt pending.

19.5.1.51 **FREQ_SEL Register (offset = 74h) [reset = 0h]**

FREQ_SEL is shown in [Figure 19-84](#) and described in [Table 19-80](#).

Figure 19-84. FREQ_SEL Register

15	14	13	12	11	10	9	8
RESERVED							
R-0h							
7	6	5	4	3	2	1	0
FREQ_SEL							
R/W-0h							

LEGEND: R/W = Read/Write; R = Read only; W1toCl = Write 1 to clear bit; -n = value after reset

Table 19-80. FREQ_SEL Register Field Descriptions

Bit	Field	Type	Reset	Description
15-8	RESERVED	R	0h	
7-0	FREQ_SEL	R/W	0h	Sets the sample per bit if non default frequency is used. MDR3[1] must be set to 1 after this value is set. Must be equal or higher then 6.

19.5.1.52 MDR3 Register (offset = 80h) [reset = 0h]

MDR3 is shown in [Figure 19-85](#) and described in [Table 19-81](#).

The mode definition register 3 (MDR3) is selected with a register bit setting of LCR[7] = 0, LCR[7] not equal to BFh, or LCR[7] = BFh. The DISABLE_CIR_RX_DEMOD register bit will force the CIR receiver to bypass demodulation of received data if set. See the CIR Mode Block Components. The NONDEFAULT_FREQ register bit allows the user to set sample per bit by writing it into FREQ_SEL register. Set it if non-default (48 MHz) fclk frequency is used to achieve a less than 2% error rate. Changing this bit (to any value) will automatically disable the device by setting MDR[2:0] to 111 .

Figure 19-85. MDR3 Register

15	14	13	12	11	10	9	8
RESERVED							
R-0h							
7	6	5	4	3	2	1	0
RESERVED					SET_DMA_TX_THRESHOLD	NONDEFAULT_FREQ	DISABLE_CIR_RX_DEMOD
R-0h					R/W-0h	R/W-0h	R/W-0h

LEGEND: R/W = Read/Write; R = Read only; W1toCl = Write 1 to clear bit; -n = value after reset

Table 19-81. MDR3 Register Field Descriptions

Bit	Field	Type	Reset	Description
15-3	RESERVED	R	0h	
2	SET_DMA_TX_THRESHOLD	R/W	0h	SET_DMA_TX_THRESHOLD. 0h = Disable use of TX DMA Threshold register. Use 64-TX trigger as DMA threshold. 1h = Enable to set different TX DMA threshold in the TX DMA Threshold register.
1	NONDEFAULT_FREQ	R/W	0h	NONDEFAULT_FREQ. 0h = Disables using NONDEFAULT fclk frequencies. 1h = Enables using NONDEFAULT fclk frequencies (set FREQ_SEL and DLH/DLL).
0	DISABLE_CIR_RX_DEMOD	R/W	0h	DISABLE_CIR_RX_DEMOD. 0h = Enables CIR RX demodulation. 1h = Disables CIR RX demodulation.

19.5.1.53 TX_DMA_THRESHOLD Register (offset = 84h) [reset = 0h]

TX_DMA_THRESHOLD is shown in [Figure 19-86](#) and described in [Table 19-82](#).

The TX DMA threshold register is selected with a register bit setting of LCR[7] = 0, LCR[7] not equal to BFh, or LCR[7] = BFh.

Figure 19-86. TX_DMA_THRESHOLD Register

15	14	13	12	11	10	9	8
RESERVED							
R-0h							
7	6	5	4	3	2	1	0
RESERVED		TX_DMA_THRESHOLD					
R-0h		R/W-0h					

LEGEND: R/W = Read/Write; R = Read only; W1toCl = Write 1 to clear bit; -n = value after reset

Table 19-82. TX_DMA_THRESHOLD Register Field Descriptions

Bit	Field	Type	Reset	Description
15-6	RESERVED	R	0h	
5-0	TX_DMA_THRESHOLD	R/W	0h	Used to manually set the TX DMA threshold level. UART_MDR3[2] SET_TX_DMA_THRESHOLD must be 1 and must be value + tx_trigger_level = 64 (TX FIFO size). If not, 64_tx_trigger_level will be used without modifying the value of this register.

Timers

This chapter describes the timers for the device.

Topic	Page
20.1 DMTimer	4325
20.2 DMTimer 1ms	4359
20.3 RTC_SS	4395
20.4 WATCHDOG	4444

20.1 DMTimer

20.1.1 Introduction

20.1.1.1 Overview

The timer module contains a free running upward counter with auto reload capability on overflow. The timer counter can be read and written in real-time (while counting). The timer module includes compare logic to allow an interrupt event on a programmable counter matching value.

A dedicated output signal can be pulsed or toggled on overflow and match event. This output offers a timing stamp trigger signal or PWM (pulse-width modulation) signal sources. A dedicated output signal can be used for general purpose PORGPOCFG (directly driven by bit 14 of the TCLR register). A dedicated input signal is used to trigger automatic timer counter capture and interrupt event, on programmable input signal transition type. A programmable clock divider (prescaler) allows reduction of the timer input clock frequency. All internal timer interrupt sources are merged in one module interrupt line and one wake-up line. Each internal interrupt source can be independently enabled/disabled.

This module is controllable through the OCP peripheral bus.

As two clock domains are managed inside this module, resynchronization is done by special logic between the OCP clock domain and the Timer clock domain. At reset, synchronization logic allows utilization of all ratios between the OCP clock and the Timer clock. A drawback of this mode is that full-resynchronization path is used with access latency performance impact in terms of OCP clock cycles. In order to improve module access latency, and under restricted conditions on clocks ratios, write-posted mode can be used by setting the POSTED bit of the System Control Register (TSCR). Under this mode, write posted mode is enabled, meaning that OCP write command is granted before the write process completes in the timer clock domain. This mode allows software to do concurrent writes on Dual Mode timer registers and to observe write process completion (synchronization) at the software level by reading independent write posted status bits in the Write Posted Status Register (TWPS).

20.1.1.2 Features

The timer consists of the following features:

- Counter timer with compare and capture modes
- Auto-reload mode
- Start-stop mode
- Programmable divider clock source
- 16-32 bit addressing
- “On the fly” read/write registers
- Interrupts generated on overflow, compare and capture
- Interrupt enable
- Wake-up enable (only for Timer0)
- Write posted mode
- Dedicated input trigger for capture mode and dedicated output trigger/PWM signal
- Dedicated output signal for general purpose use PORGPOCFG
- OCP interface compatible

The Timer resolution and interrupt period are dependent on the selected input clock and clock prescaler value. Example resolutions for common clock values are shown in [Table 20-1](#).

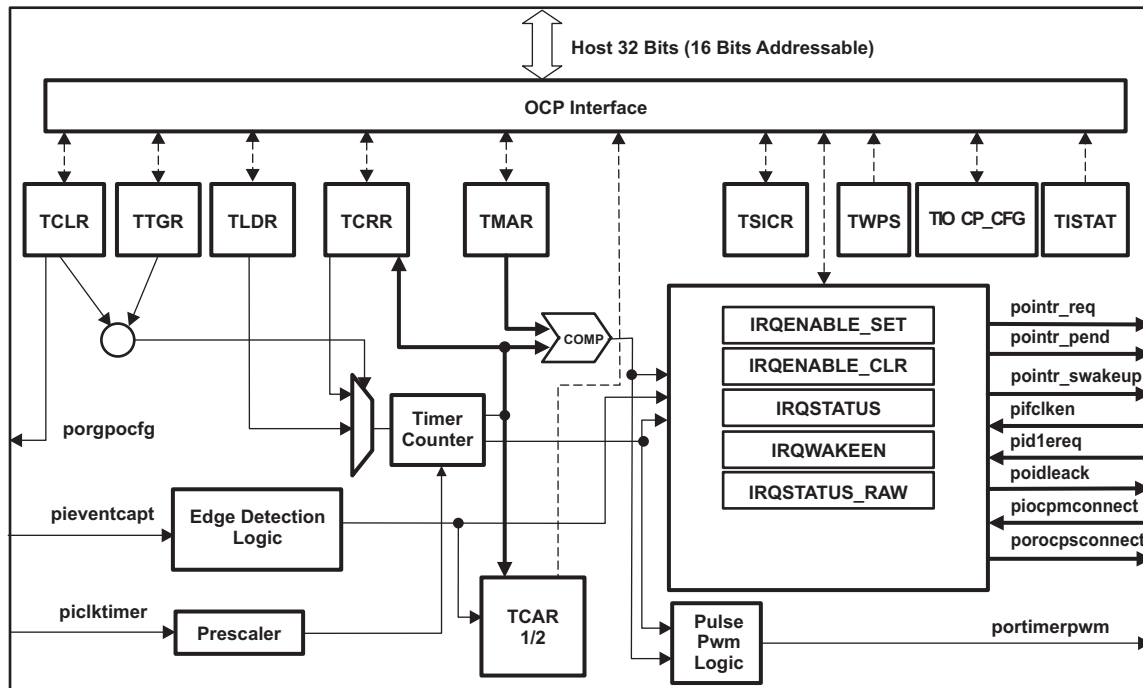
Table 20-1. Timer Resolution and Maximum Range

Clock	Prescaler	Resolution	Interrupt Period Range
32.768 KHz	1 (min)	31.25 us	31.25 us to ~36h 35m
	256 (max)	8 ms	8 ms to ~391d 22h 48m
25 MHz	1 (min)	40 ns	40 ns to ~171.8s
	256 (max)	10.24 us	~20.5 us to ~24h 32m

20.1.1.3 Functional Block Diagram

Figure 20-1 shows a block diagram of the timer.

Figure 20-1. Timer Block Diagram



20.1.2 Integration

The integration of Timer0 and Timer2-7 is shown in [Figure 20-2](#) and [Figure 20-3](#).

Figure 20-2. Timer0 Integration

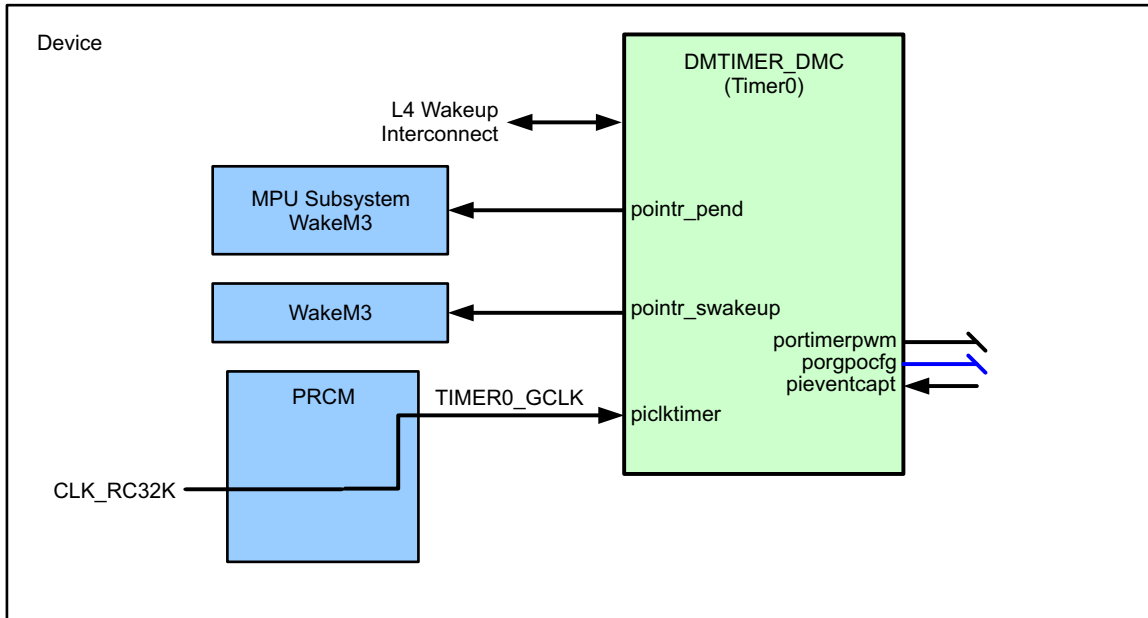
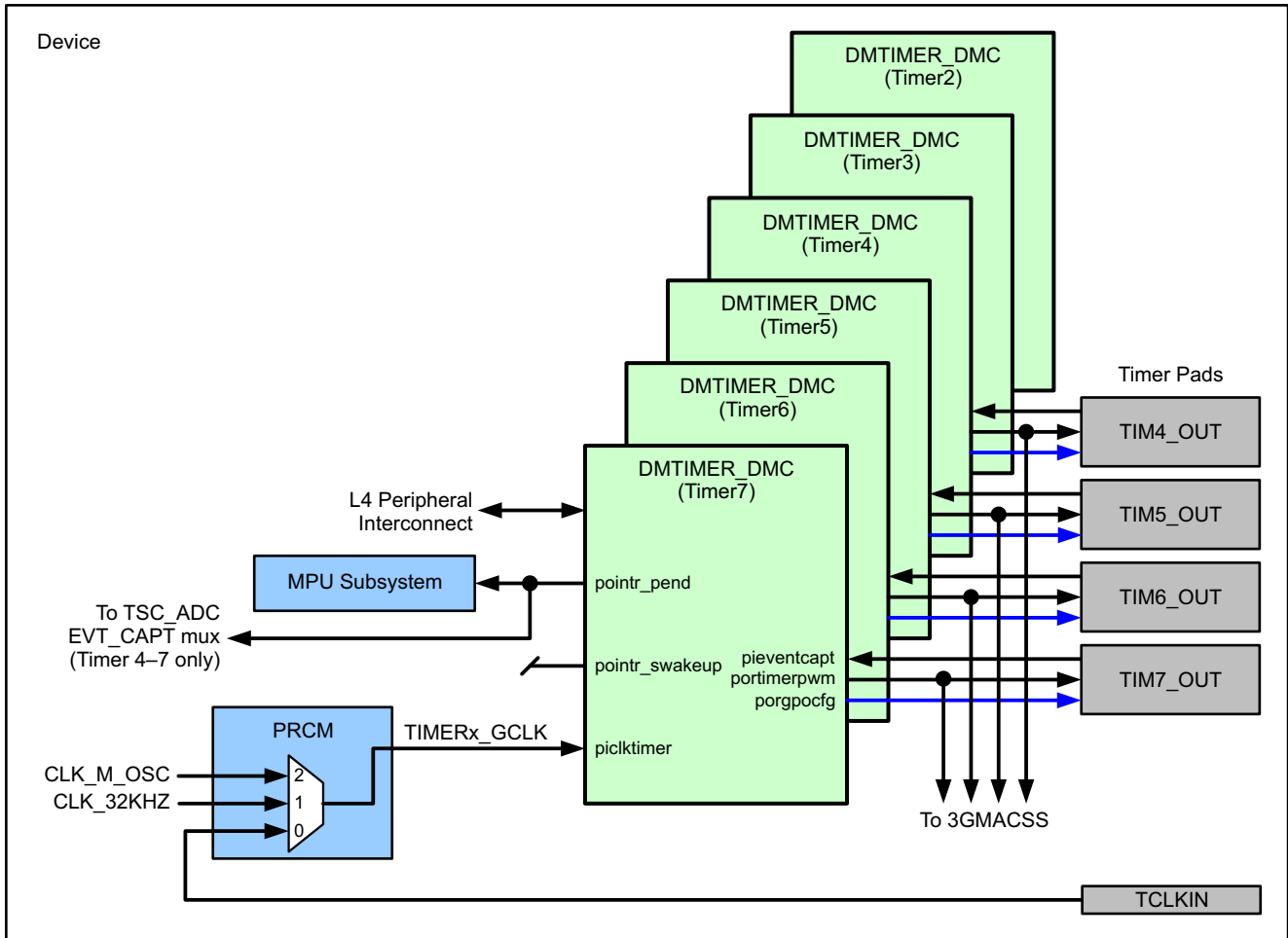


Figure 20-3. Timer2-7 Integration



20.1.2.1 Timer Connectivity Attributes

Table 20-2. Timer[0] Connectivity Attributes

Attributes	Type
Power domain	Wakeup domain
Clock Domain	PD_WKUP_L4_WKUP_GCLK (Interface/OCP) PD_WKUP_TIMER0_GCLK (Func)
Reset Signals	WKUP_DOM_RST_N
Idle/Wakeup Signals	Idle Slave Wakeup
Interrupt Requests	1 to MPU Subsystem (TINT0), 1 to WakeM3
DMA Requests	None
Physical Address	L4 Wakeup slave port

Table 20-3. Timer[2–7] Connectivity Attributes

Attributes	Type
Power Domain	Peripheral Domain
Clock Domain	PD_PER_L4LS_GCLK (OCP) Functional Clocks: PD_PER_TIMER2_GCLK (Timer 2) PD_PER_TIMER3_GCLK (Timer 3) PD_PER_TIMER4_GCLK (Timer 4) PD_PER_TIMER5_GCLK (Timer 5) PD_PER_TIMER6_GCLK (Timer 6) PD_PER_TIMER7_GCLK (Timer 7)
Reset Signals	PER_DOM_RST_N
Idle/Wakeup Signals	Smart Idle (No wakeup capabilities)
Interrupt Requests	1 per timer module to MPU Subsystem (TINT2 - TINT7) Also to TSC_ADC event capture mux for Timer 4–Timer7
DMA Requests	Interrupt requests are redirected as DMA requests: 1 per instance (TINTx)
Physical Address	L4 Peripheral slave port

20.1.2.2 Timer Clock and Reset Management

Each DMTimer[2–7] functional clock is selected within the PRCM using the associated CLKSEL_TIMERx_CLK register from three possible sources:

- The system clock (CLK_M_OSC)
- The PER PLL generated 32.768 KHz clock (CLK_32KHZ)
- The TCLKIN external timer input clock.

The DMTimer 0 functional clock is fixed to use the internal 32KHz RC Clock (CLK_RC32K).

20.1.2.3 Timer Clock Signals

Table 20-4. Timer Clock Signals

Clock Signal	Max Freq	Reference / Source	Comments
Timer[0] Clock Signals			
PICKOCP Interface clock	100 MHz	CORE_CLKOUTM4 / 2	pd_wkup_l4_wkup_gclk from PRCM
PICKTIMER Functional clock	26 MHz ⁽¹⁾	CLK_RC32K CLK_M_OSC	pd_wkup_timer0_gclk from PRCM
Timer[2–7] Clock Signals			
PICKOCP Interface clock	100 MHz	CORE_CLKOUTM4 / 2	pd_per_l4ls_gclk from PRCM
PICKTIMER Functional clock	26 MHz ⁽¹⁾	CLK_M_OSC CLK_32KHZ (PER_CLKOUTM2 / 5859.375) TCLKIN	pd_per_timer2_gclk pd_per_timer3_gclk pd_per_timer4_gclk pd_per_timer5_gclk pd_per_timer6_gclk pd_per_timer7_gclk from PRCM

⁽¹⁾ PICKTIMER must be less than or equal to PICKOCP/4.

20.1.2.4 Timer Pin List

The timer PIEVENTCAPT input and PORTIMERPWM output signals are muxed onto a single TIMER I/O pad. The pad direction (and hence the pin function) are controlled from within the DMTimer module using the PORGPOCFG signal as an output enable.

Table 20-5. Timer Pin List

Pin	Type	Description
TCLKIN	I	External timer clock source
TIMER4	I/O	Timer 4 trigger input or PWM output
TIMER5	I/O	Timer 5 trigger input or PWM output
TIMER6	I/O	Timer 6 trigger input or PWM output
TIMER7	I/O	Timer 7 trigger input or PWM output

20.1.3 Functional Description

The general-purpose timer is an upward counter. It supports 3 functional modes:

- Timer mode
- Capture mode
- Compare mode

By default, after core reset, the capture and compare modes are disabled.

20.1.3.1 Timer Mode Functionality

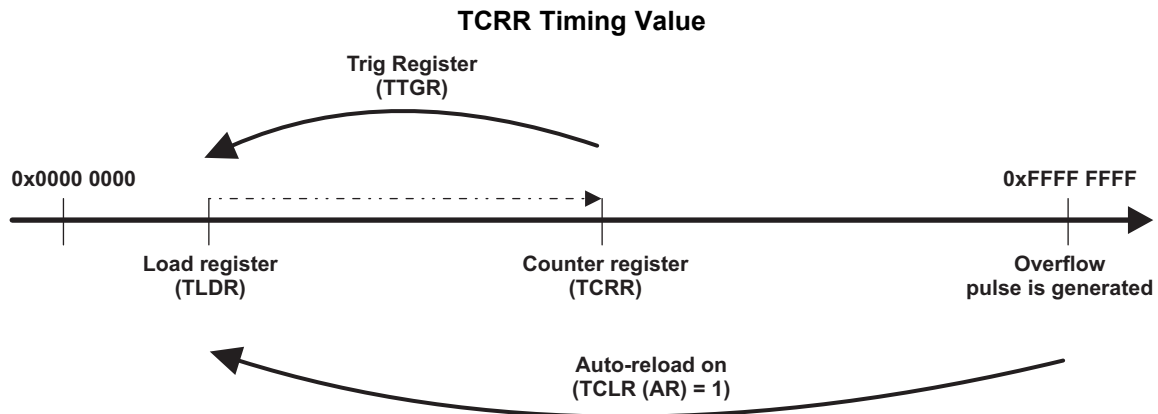
The timer is an upward counter that can be started and stopped at any time through the Timer Control Register (TCLR ST bit). The Timer Counter Register (TCRR) can be loaded when stopped or on the fly (while counting). TCRR can be loaded directly by a TCRR Write access with the new timer value. TCRR can also be loaded with the value held in the Timer Load Register (TLDR) by a trigger register (TTGR) Write access. The TCRR loading is done regardless of the value written to TTGR. The value of the timer counter register (TCRR) can be read when stopped or captured on the fly by a TCRR Read access. The timer is stopped and the counter value is cleared to “0” when the module’s reset is asserted. The timer is maintained in stop after reset is released. When the timer is stopped, TCRR is frozen. The timer can be restarted from the frozen value unless TCRR has been reloaded with a new value.

In the one shot mode (TCLR AR bit = 0), the counter is stopped after counting overflow (counter value remains at zero).

When the auto-reload mode is enabled (TCLR AR bit = 1), the TCRR is reloaded with the Timer Load Register (TLDR) value after a counting overflow.

It is not recommended to put the overflow value (FFFF FFFFh) in TLDR because it can lead to undesired results.

An interrupt can be issued on overflow if the overflow interrupt enable bit is set in the timer Interrupt Enable Register (IRQENABLE_SET OVF_IT_FLAG bit = 1). A dedicated output pin (PORTIMERPWM) is programmed through TCLR (TRG and PT bits) to generate one positive pulse (prescaler duration) or to invert the current value (toggle mode) when an overflow occurs.



20.1.3.2 Capture Mode Functionality

The timer value in TCRR can be captured and saved in TCAR1 or TCAR2 function of the mode selected in TCLR through the field CAPT_MODE when a transition is detected on the module input pin (PIEVENTCAPT). The edge detection circuitry monitors transitions on the input pin (PIEVENTCAPT).

Rising transition, falling transition or both can be selected in TCLR (TCM bit) to trigger the timer counter capture. The module sets the IRQSTATUS (TCAR_IT_FLAG bit) when an active transition is detected and at the same time the counter value TCRR is stored in one of the timer capture registers TCAR1 or TCAR2 as follows:

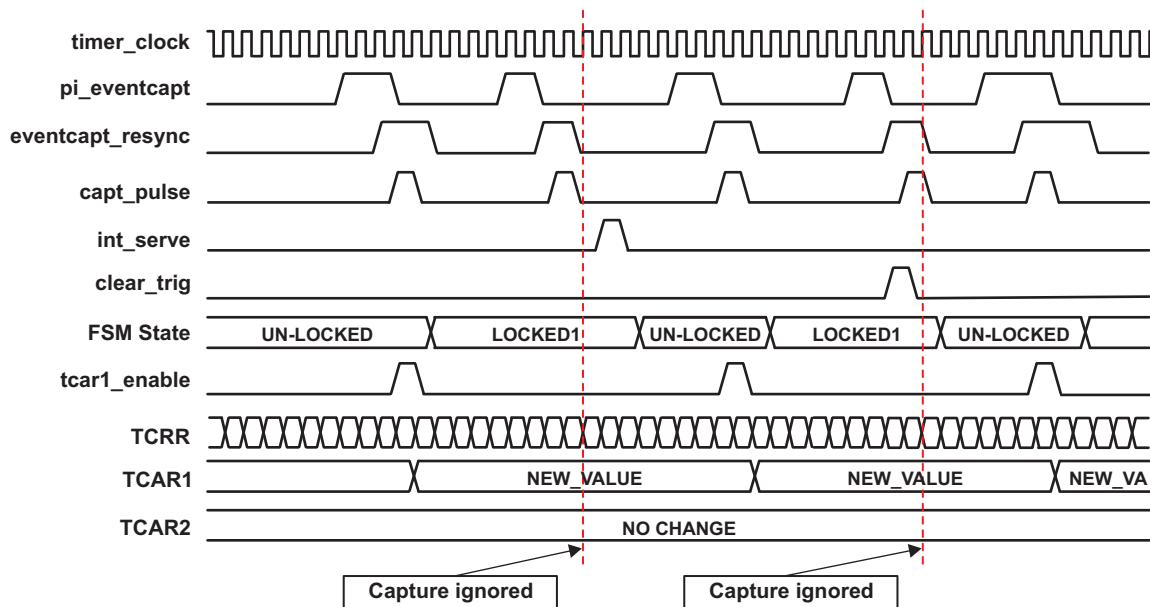
- If TCLR's CAPT_MODE field is 0 then, on the first enabled capture event, the value of the counter register is saved in TCAR1 register and all the next events are ignored (no update on TCAR1 and no interrupt triggering) until the detection logic is reset or the interrupt status register is cleared on TCAR's position writing a 1 in it.
- If TCLR's CAPT_MODE field is 1 then, on the first enabled captured event, the counter value is saved in TCAR1 register and, on the second enabled capture event, the value of the counter register is saved in TCAR2 register. All the other events are ignored (no update on TCAR1/2 and no interrupt triggering) until the detection logic is reset or the interrupt status register is cleared on TCAR's position writing a 1 in it. This mechanism is useful for period calculation of a clock if that clock is connected to the PIEVENTCAPT input pin.

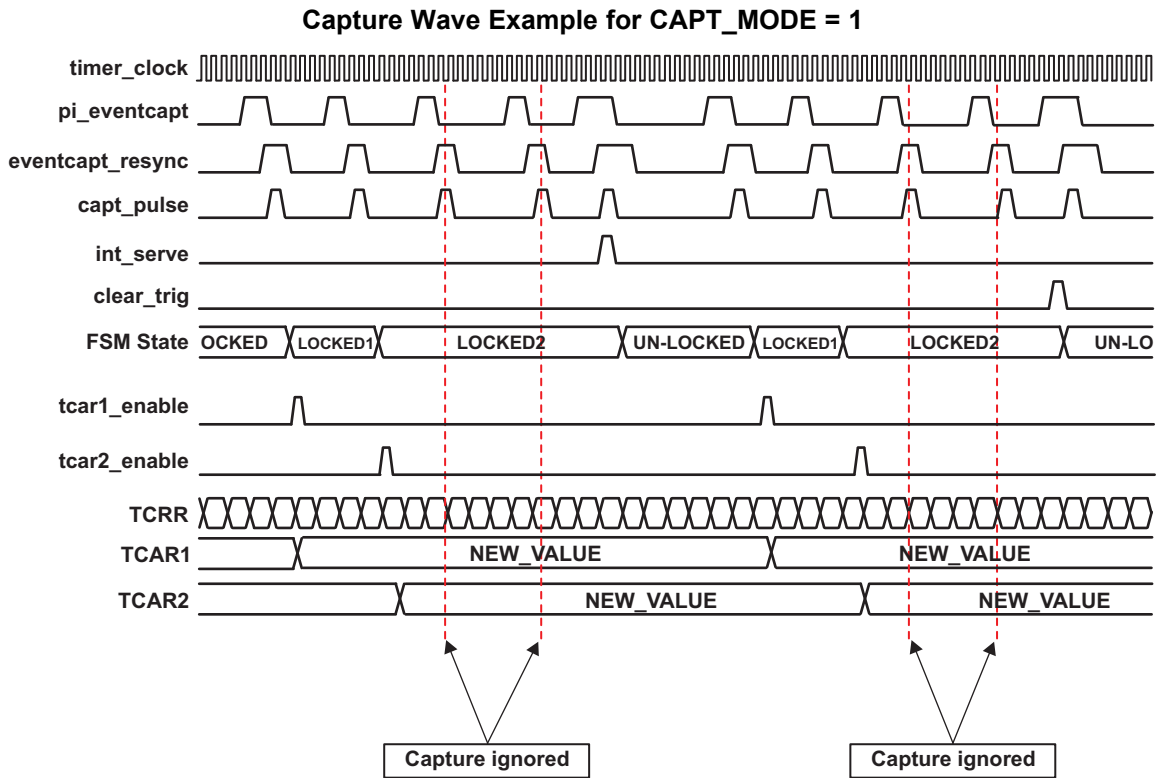
The edge detection logic is reset (a new capture is enabled) when the active capture interrupt is served. The TCAR_IT_FLAG bit of IRQSTATUS (previously 1) is cleared. The timer functional clock (input to prescaler) is used to sample the input pin (PIEVENTCAPT). Negative or positive pulses can be detected when the pulse time exceeds the functional clock period. An interrupt can be issued on transition detection if the capture interrupt enable bit is set in the Timer Interrupt Enable Register IRQENABLE_SET (TCAR_IT_FLAG bit).

In [Capture Wave Example for CAPT_MODE = 0](#), the TCM value is 01 and CAPT_MODE is 0 - only rising edge of the PIEVENTCAPT will trigger a capture in TCAR and only TCAR1 will update.

In [Capture Wave Example for CAPT_MODE = 1](#), the TCM value is 01 and CAPT_MODE is 1 - only rising edge of the PIEVENTCAPT will trigger a capture in TCAR1 on first enabled event and TCAR2 will update on the second enabled event.

Capture Wave Example for CAPT_MODE = 0





20.1.3.3 Compare Mode Functionality

When Compare Enable TCLR (CE bit) is set to 1, the timer value (TCRR) is permanently compared to the value held in timer match register (TMAR). TMAR value can be loaded at any time (timer counting or stop). When the TCRR and the TMAR values match, an interrupt can be issued if the IRQENABLE_SET (MAT_EN_FLAG bit) is set. The correct implementation is to write a compare value in TMAR register before setting TCLR (CE bit) to avoid any unwanted interrupts due to a reset value matching effect.

The dedicated output pin (PORTIMERPWM) can be programmed through TCLR (TRG and PT bits) to generate one positive pulse (TIMER clock duration) or to invert the current value (toggle mode) when an overflow and a match occur.

20.1.3.4 Prescaler Functionality

A prescaler counter can be used to divide the timer counter input clock frequency. The prescaler is enabled when TCLR bit 5 is set (PRE). The 2^n division ratio value (PTV) can be configured in the TCLR register. The prescaler counter is reset when the timer counter is stopped or reloaded on the fly.

Table 20-6. Prescaler Functionality

Contexts	Prescaler Counter	Timer Counter
Overflow (when Auto-reload on)	Reset	TLDR
TCRR Write	Reset	TCRR
TTGR Write	Reset	TLDR
Stop	Reset	Frozen

20.1.3.5 Pulse-Width Modulation

The timer can be configured to provide a programmable pulse-width modulation (PORTIMERPWM) output. The PORTIMERPWM output pin can be configured to toggle on a specified event. TCLR (TRG bits) determines on which register value the PORTIMERPWM pin toggles. Either overflow or match can be used to toggle the PORTIMERPWM pin, when a compare condition occurs.

In case of overflow and match mode, the match event will be ignored from the moment the mode was set-up until the first overflow event occurs (see [Capture Wave Example for CAPT_MODE = 1](#)).

The TCLR (SCPWM bit) can be programmed to set or clear the PORTIMERPWM output signal while the counter is stopped or the triggering is off only. This allows fixing a deterministic state of the output pin when modulation is stopped. The modulation is synchronously stopped when the TRG bit is cleared and an overflow has occurred.

In the following timing diagram, the internal overflow pulse is set each time (FFFF FFFFh – TLDR + 1) value is reached, and the internal match pulse is set when the counter reaches TMAR register value. According to TCLR (TRG and PT bits) programming value, the timer provides pulse or PWM on the output pin (PORTIMERPWM).

The TLDR and TMAR registers must keep values smaller than the overflow value (FFFF FFFFh) with at least 2 units. In case the PWM trigger events are both overflow and match, the difference between the values kept in TMAR register and the value in TLDR must be at least 2 units. When match event is used, the compare mode TCLR (CE) must be set.

In [Figure 20-4](#), TCLR (SCPWM bit) is cleared to 0. In [Figure 20-5](#), TCLR (SCPWM bit) is set to 1.

Figure 20-4. Timing Diagram of Pulse-Width Modulation with SCPWM = 0

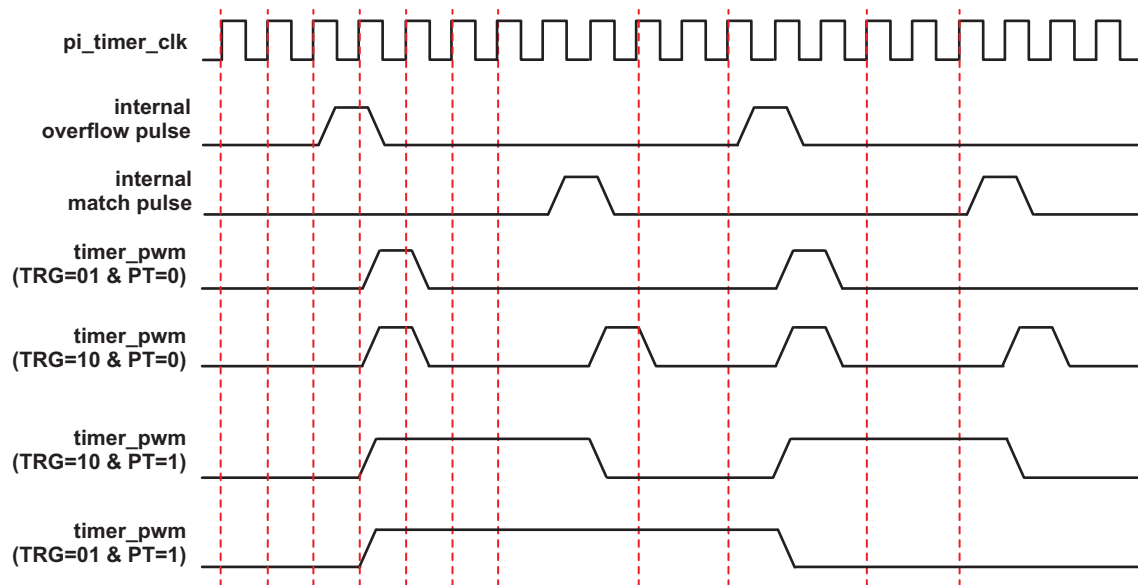
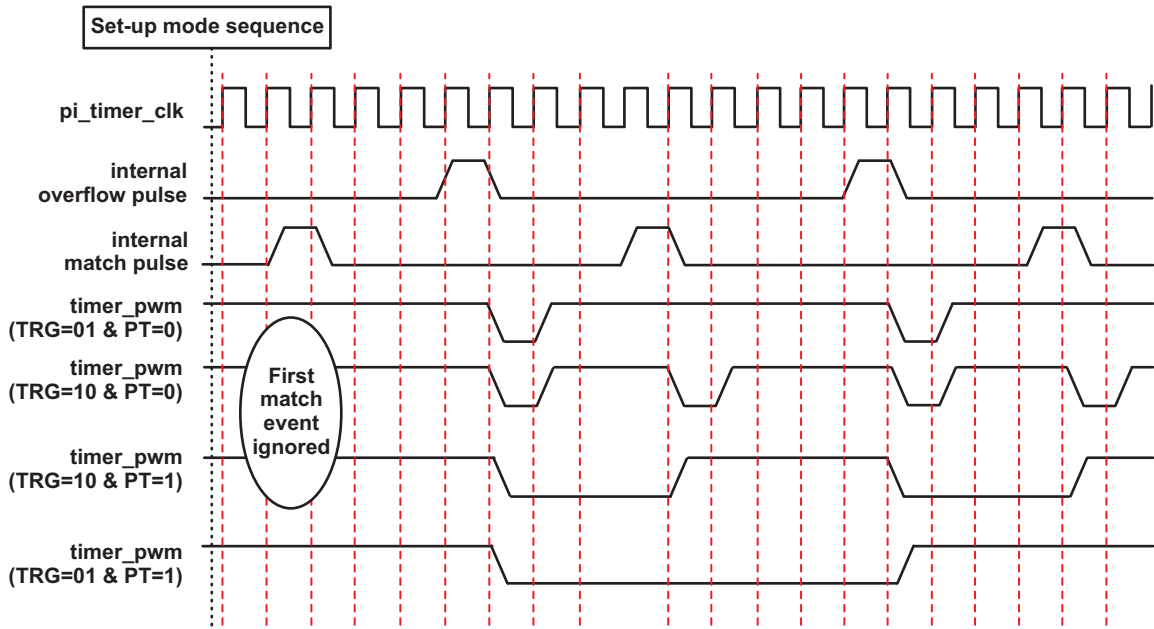


Figure 20-5. Timing Diagram of Pulse-Width Modulation with SCPWM = 1



20.1.3.6 Timer Counting Rate

The timer counter is composed of a prescaler stage and a timer counter. Prescaler stage is clocked with the timer clock and acts as a clock divider for the timer counter stage. The ratio can be managed by accessing the ratio definition field of the control register (PTV and PRE of TCLR). See [Table 20-7](#).

The timer rate is defined by:

- The value of the prescaler fields (PRE and PTV of TCLR register)
- The value loaded into the Timer Load Register (TLDR).

Table 20-7. Prescaler Clock Ratios Value

PRE	PTV	Divisor (PS)
0	X	1
1	0	2
1	1	4
1	2	8
1	3	16
1	4	32
1	5	64
1	6	128
1	7	256

The timer rate equation is as follows:

$$(FFFF\ FFFFh - TLDR + 1) \times \text{timer Clock period} \times \text{Clock Divider (PS)}$$

With timer Clock period = 1/ timer Clock frequency and PS = 2(PTV + 1).

As an example, if we consider a timer clock input of 32 kHz, with a PRE field equal to 0, the timer output period is:

Table 20-8. Value and Corresponding Interrupt Period

TLDR	Interrupt period
0000 0000h	37 h
FFFF 0000h	2 s
FFFF FFF0h	500 us
FFFF FFFEh	62.5 us

20.1.3.7 Dual Mode Timer Under Emulation

To configure the Timer to stop during emulation suspend events (for example, debugger breakpoints), set up the Timer and the Debug Subsystem:

1. Set TIOCP_CFG.EMUFREE=0. This will allow the Suspend_Control signal from the Debug Subsystem ([Chapter 27](#)) to stop and start the Timer. Note that if EMUFREE=1, the Suspend_Control signal is ignored and the Timer is free running regardless of any debug suspend event. This EMUFREE bit gives local control from a module perspective to gate the suspend signal coming from the Debug Subsystem.
2. Set the appropriate xxx_Suspend_Control register = 0x9, as described in [Section 27.1.1.1, Debug Suspend Support for Peripherals](#). Choose the register appropriate to the peripheral you want to suspend during a suspend event.

20.1.3.8 Accessing Registers

All registers are 32-bit wide, accessible via OCP interface with 16-bit or 32-bit OCP access (Read/Write). The 32-bit registers write update in 16 bits access must be LSB16 first and the second write access must be MSB16. For the write operation, the module allows skipping the MSB access if the user does not need to update the 16 MSB bits of the register, but only for the OCP registers (TIDR, TIOCP_CFG, IRQSTATUS_RAW, IRQSTATUS, IRQENABLE_SET, IRQENABLE_CLR, IRQWAKEEN and TSICR). The write operation on any functional register (TCLR, TCRR, TLDR, TTGR and TMAR) must be complete (the MSB must be written even if the MSB data is not used).

20.1.3.8.1 Programming the Timer Registers

The TLDR, TCRR, TCLR, TIOCP_CFG, IRQSTATUS, IRQENABLE_SET, IRQENABLE_CLR, IRQWAKEEN, TTGR, TSICR and TMAR registers write is done synchronously with OCP clock, by the host, using the OCP bus protocol.

20.1.3.8.2 Reading the Timer Registers

The counter register (TCRR) is a 32-bit “atomic datum” and 16-bit capture is done on the 16-bit LSB first to allow atomic LSB16 + MSB16 capture. Atomic capture is also performed for the TCAR1 and TCAR2 registers as they may change due to internal processes.

20.1.3.8.3 OCP Error Generation

The timer module responds with error indication in the following cases:

Error on write transactions

- Assert the PORSRESP = ERR signal in the same cycle as PORSCMDACCEPTED.
- Use the ERR code for PORSRESP during the response phase.

Error on read transactions

- Assert the PORSRESP = ERR signal in the same cycle as PORSCMDACCEPTED.
- Use the ERR code for PORSRESP during the response phase. PORSDATA in this case is not valid.

Table 20-9. OCP Error Reporting

Error Type	Response: SRESP = ERR
Unsupported PIOCPMCMDCMD command	Yes
Address error: Read or write to a non-existing internal address	No
Read to write-only registers and write to read-only registers	No
Unaligned address (PIOCPMADDR ≠ 00) on read/write transaction	Yes
Unsupported PIOCPMBYTEEN on read/write transaction	Yes

NOTE: Byte enable “0000” is a supported byte enable.

20.1.3.9 Posted Mode Selection

A choice between the two synchronization modes will be made taking into account the frequency ratio and the stall periods that can be supported by the system, without impacting the global performance.

The posted mode selection applies only to functional registers that require synchronization on/from timer clock domain. For write operation, the registers affected by this posted/non-posted selection are: TCLR, TLDR, TCRR, TTGR and TMAR. For read operation, the register affected by this posted/non-posted selection are: TCRR, TCAR1 and TCAR2.

The OCP clock domain synchronous registers TIDR, TIOCP_CFG, TISTAT, IRQSTATUS, IRQSTATUS_RAW, IRQENABLE_SET, IRQENABLE_CLR, IRQWAKEEN, TWPS and TSICR are not affected by the posted/non-posted mode selection; the write/read operation is effective and acknowledged (command accepted) after one OCP clock cycle from the command assertion.

Non-Posted Mode can be used when $\text{freq}(\text{timer}) < \text{freq}(\text{OCP})/4$, but it is recommended to use the Posted Mode, because Non-Posted Mode will delay the 'command accept' and the transaction latency will be as described in the below chapters. Posted mode offers an OCP interface latency improvement when $\text{freq}(\text{timer}) < \text{freq}(\text{OCP})/4$. Refer to the AM335x errata for advisories associated with Posted mode.

20.1.3.10 Write Registers Access

20.1.3.10.1 Write Posted

This mode can be used only if the functional frequency range is $\text{freq}(\text{timer}) < \text{freq}(\text{OCP})/4$.

This mode is used if TSICR (POSTED bit) is set to 1 in the timer control register.

This mode uses a posted-write scheme to update any internal register. The write transaction is immediately acknowledged on the OCP interface, although the effective write operation will occur later, due to a resynchronisation in the timer clock domain. This has the advantage of not stalling either the interconnect system, or the CPU that requested the write transaction. For each register, a status bit is provided, that is set if there is a pending write access to this register.

In this mode, it is mandatory that the CPU checks the status bit prior to any write access. In case a write is attempted to a register with a previous access pending, the previous access is discarded without notice (this can lead to unexpected results also).

There is one status bit per register, accessible in the Timer Write Posted Status Register. When the timer module operates in this mode, there is an automatic sampling of the current timer counter value, in an OCP-synchronized capture register. Consequently, any read access to the timer counter register does not add any re-synchronization latency; the current value is always available.

A register read following a write posted register (on the same register) is not ensured to read the previous write value if the write posted process is not completed. Software synchronization should be used to avoid a non-coherent read.

The drawback of this automatic update mechanism is that it assumes a given relationship between the OCP interface frequency and the timer functional frequency.

This posted period is defined as the interval between the posted write access request and the reset of the posted bit in TWPS register, and can be quantified:

$$T(\text{reset posted max.}) = 3 \text{ OCP clock} + 2.5 \text{ TIMER clock}$$

The time when the write accomplishes is:

$$T(\text{write accomplish}) = 1 \text{ OCP clock} + 2.5 \text{ TIMER clock}$$

20.1.3.10.2 Write Non-Posted

This mode is functional regardless of the ratio between the OCP interface frequency and the functional clock frequency. The recommended functional frequency range is $\text{freq}(\text{timer}) \geq \text{freq}(\text{OCP})/4$.

This mode is used if TSICR (POSTED bit) is cleared to 0 in the timer control register.

Note: This mode is not recommended on this device.

This mode uses a non posted-write scheme to update any internal register. That means the write transaction will not be acknowledged on the OCP interface, until the effective write operation occurs, after the resynchronisation in the timer clock domain. The drawback is that both the interconnect system and the CPU are stalled during this period.

- The latency of the interrupt serving is increased, as the interconnect system and CPU are stalled.
- An interconnect logic, including time-out logic to detect erroneous transactions, can generate an unwanted system abort event.

The stall period is defined as the interval between the non-posted write access request and the rise of the command accept signal and can be quantified:

$$T(\text{stall max.}) = 3 \text{ OCP clock} + 2.5 \text{ TIMER clock}$$

The time when the write accomplishes is:

$$T(\text{write accomplish}) = 1 \text{ OCP clock} + 2.5 \text{ TIMER clock}$$

A register read following a write to the same register is always coherent.

20.1.3.11 Read Registers Access

20.1.3.11.1 Read Posted

This mode can be used only if the functional frequency range is $\text{freq}(\text{timer}) < \text{freq}(\text{OCP})/4$.

This mode is used if TSICR (POSTED bit) is set to 1 in the timer control register.

This mode uses a posted-read scheme, for reading any internal register. The read transaction is immediately acknowledged on the OCP interface, and the value to be read has been previously resynchronised. This has the advantage of not stalling either the interconnect system, or the CPU that requested the read transaction. Refer to the AM335x errata for advisories associated with Posted mode.

20.1.3.11.2 Read Non-Posted

This mode is functional whatever the ratio between the OCP interface frequency and the functional clock frequency. Recommended functional frequency range is $\text{freq}(\text{timer}) \geq \text{freq}(\text{OCP})/4$.

This mode is used if TSICR (POSTED bit) is cleared to 0 in the timer control register.

This mode uses a non posted-read scheme, for reading any internal register. The read transaction will not be acknowledged on the OCP interface, until the effective read operation occurs, after the resynchronisation in the timer clock domain. The drawback is that both the interconnect system and the CPU are stalled during this period.

- The latency of the interrupt serving is increased, as the interconnect system and the CPU are stalled.
- An interconnect system including time-out logic to detect erroneous transactions can generate an unwanted system abort event.

This mode applies only to three registers: TCRR, TCAR1 and TCAR2, which need resynchronisation from functional to OCP clock domains.

The stall period is defined as the interval between the non-posted read access request and the rise of the command accept signal and can be quantified:

$$T(\text{stall max.}) = 3 \text{ OCP clock} + 2.5 \text{ TIMER clock}$$

The time when the value is sampled is:

$$T(\text{read sample}) = 1 \text{ OCP clock} + 2.5 \text{ TIMER clock}$$

20.1.4 Use Cases

20.1.5 TIMER Registers

Table 20-10 lists the memory-mapped registers for the TIMER. All register offset addresses not listed in Table 20-10 should be considered as reserved locations and the register contents should not be modified.

Table 20-10. TIMER Registers

Offset	Acronym	Register Name	Section
0h	TIDR	Identification Register	Section 20.1.5.1
10h	TIOCP_CFG	Timer OCP Configuration Register	Section 20.1.5.2
20h	IRQ_EOI	Timer IRQ End-of-Interrupt Register	Section 20.1.5.3
24h	IRQSTATUS_RAW	Timer Status Raw Register	Section 20.1.5.4
28h	IRQSTATUS	Timer Status Register	Section 20.1.5.5
2Ch	IRQENABLE_SET	Timer Interrupt Enable Set Register	Section 20.1.5.6
30h	IRQENABLE_CLR	Timer Interrupt Enable Clear Register	Section 20.1.5.7
34h	IRQWAKEEN	Timer IRQ Wakeup Enable Register	Section 20.1.5.8
38h	TCLR	Timer Control Register	Section 20.1.5.9
3Ch	TCRR	Timer Counter Register	Section 20.1.5.10
40h	TLDR	Timer Load Register	Section 20.1.5.11
44h	TTGR	Timer Trigger Register	Section 20.1.5.12
48h	TWPS	Timer Write Posting Bits Register	Section 20.1.5.13
4Ch	TMAR	Timer Match Register	Section 20.1.5.14
50h	TCAR1	Timer Capture Register	Section 20.1.5.15
54h	TSICR	Timer Synchronous Interface Control Register	Section 20.1.5.16
58h	TCAR2	Timer Capture Register	Section 20.1.5.17

20.1.5.1 TIDR Register (offset = 0h) [reset = 40000100h]

TIDR is shown in [Figure 20-6](#) and described in [Table 20-11](#).

This read only register contains the revision number of the module. A write to this register has no effect. This register is used by software to track features, bugs, and compatibility.

Figure 20-6. TIDR Register

31	30	29	28	27	26	25	24
SCHEME		RESERVED			FUNC		
R/W-1h		R-0h			R/W-0h		
23	22	21	20	19	18	17	16
FUNC							
R/W-0h							
15	14	13	12	11	10	9	8
R_RTL				X_MAJOR			
R/W-0h				R/W-1h			
7	6	5	4	3	2	1	0
CUSTOM		Y_MINOR					
R/W-0h		R/W-0h					

LEGEND: R/W = Read/Write; R = Read only; W1toCl = Write 1 to clear bit; -n = value after reset

Table 20-11. TIDR Register Field Descriptions

Bit	Field	Type	Reset	Description
31-30	SCHEME	R/W	1h	Used to distinguish between old scheme and current.
29-28	RESERVED	R	0h	
27-16	FUNC	R/W	0h	Function indicates a software compatible module family.
15-11	R_RTL	R/W	0h	RTL Version (R).
10-8	X_MAJOR	R/W	1h	Major Revision (X).
7-6	CUSTOM	R/W	0h	Indicates a special version for a particular device.
5-0	Y_MINOR	R/W	0h	Minor Revision (Y).

20.1.5.2 TIOCP_CFG Register (offset = 10h) [reset = 0h]

TIOCP_CFG is shown in [Figure 20-7](#) and described in [Table 20-12](#).

This register allows controlling various parameters of the OCP interface.

Figure 20-7. TIOCP_CFG Register

31	30	29	28	27	26	25	24
RESERVED							
R-0h							
23	22	21	20	19	18	17	16
RESERVED							
R-0h							
15	14	13	12	11	10	9	8
RESERVED							
R-0h							
7	6	5	4	3	2	1	0
RESERVED				IDLEMODE		EMUFREE	SOFTRESET
R-0h				R/W-0h		R/W-0h	R/W-0h

LEGEND: R/W = Read/Write; R = Read only; W1toCl = Write 1 to clear bit; -n = value after reset

Table 20-12. TIOCP_CFG Register Field Descriptions

Bit	Field	Type	Reset	Description
31-4	RESERVED	R	0h	
3-2	IDLEMODE	R/W	0h	Power management, req/ack control 0h = Force-idle mode: local target's idle state follows (acknowledges) the system's idle requests unconditionally, i.e. regardless of the IP module's internal requirements. Backup mode, for debug only. 1h = No-idle mode: local target never enters idle state. Backup mode, for debug only. 2h = Smart-idle mode: local target's idle state eventually follows (acknowledges) the system's idle requests, depending on the IP module's internal requirements. IP module shall not generate (IRQ- or DMA-request-related) wakeup events. 3h = Smart-idle wakeup-capable mode: local target's idle state eventually follows (acknowledges) the system's idle requests, depending on the IP module's internal requirements. IP module may generate (IRQ- or DMA-request-related) wakeup events when in idle state. Only available for Timer0. Not available for Timer2-7
1	EMUFREE	R/W	0h	Sensitivity to emulation (debug) suspend event from Debug Subsystem. 0h = The timer is frozen during a debug suspend event. 1h = The timer runs free, and Debug suspend event is ignored.
0	SOFTRESET	R/W	0h	Software reset. 0h = No action. 1h = Reset ongoing.

20.1.5.3 IRQ_EOI Register (offset = 20h) [reset = 0h]

IRQ_EOI is shown in [Figure 20-8](#) and described in [Table 20-13](#).

This module supports DMA events with its interrupt signal. This register must be written to after the DMA completes in order for subsequent DMA events to be triggered from this module.

Figure 20-8. IRQ_EOI Register

31	30	29	28	27	26	25	24
RESERVED							
R-0h							
23	22	21	20	19	18	17	16
RESERVED							
R-0h							
15	14	13	12	11	10	9	8
RESERVED							
R-0h							
7	6	5	4	3	2	1	0
RESERVED							DMAEvent_Ack
R-0h							R/W-0h

LEGEND: R/W = Read/Write; R = Read only; W1toCl = Write 1 to clear bit; -n = value after reset

Table 20-13. IRQ_EOI Register Field Descriptions

Bit	Field	Type	Reset	Description
31-1	RESERVED	R	0h	
0	DMAEvent_Ack	R/W	0h	Write 0 to acknowledge DMA event has been completed. Module will be able to generate another DMA event only when the previous one has been acknowledged using this register. Reads always returns 0

20.1.5.4 IRQSTATUS_RAW Register (offset = 24h) [reset = 0h]

IRQSTATUS_RAW is shown in [Figure 20-9](#) and described in [Table 20-14](#).

Component interrupt request status. Check the corresponding secondary status register. Raw status is set even if event is not enabled. Write 1 to set the (raw) status, mostly for debug.

Figure 20-9. IRQSTATUS_RAW Register

31	30	29	28	27	26	25	24
RESERVED							
R-0h							
23	22	21	20	19	18	17	16
RESERVED							
R-0h							
15	14	13	12	11	10	9	8
RESERVED							
R-0h							
7	6	5	4	3	2	1	0
RESERVED					TCAR_IT_FL G	OVF_IT_FLAG	MAT_IT_FLAG
R-0h					R/W-0h	R/W-0h	R/W-0h

LEGEND: R/W = Read/Write; R = Read only; W1toCl = Write 1 to clear bit; -n = value after reset

Table 20-14. IRQSTATUS_RAW Register Field Descriptions

Bit	Field	Type	Reset	Description
31-3	RESERVED	R	0h	
2	TCAR_IT_FLAG	R/W	0h	IRQ status for Capture 0h = No event pending 1h = IRQ event pending
1	OVF_IT_FLAG	R/W	0h	IRQ status for Overflow 0h = No event pending 1h = IRQ event pending
0	MAT_IT_FLAG	R/W	0h	IRQ status for Match 0h = No event pending 1h = IRQ event pending

20.1.5.5 IRQSTATUS Register (offset = 28h) [reset = 0h]

IRQSTATUS is shown in [Figure 20-10](#) and described in [Table 20-15](#).

Component interrupt request status. Check the corresponding secondary status register. Enabled status is not set unless event is enabled. Write 1 to clear the status after interrupt has been serviced (raw status gets cleared, that is, even if not enabled).

Figure 20-10. IRQSTATUS Register

31	30	29	28	27	26	25	24
RESERVED							
R-0h							
23	22	21	20	19	18	17	16
RESERVED							
R-0h							
15	14	13	12	11	10	9	8
RESERVED							
R-0h							
7	6	5	4	3	2	1	0
RESERVED					TCAR_IT_FL G	OVF_IT_FLAG	MAT_IT_FLAG
R-0h					R/W-0h	R/W-0h	R/W-0h

LEGEND: R/W = Read/Write; R = Read only; W1toCl = Write 1 to clear bit; -n = value after reset

Table 20-15. IRQSTATUS Register Field Descriptions

Bit	Field	Type	Reset	Description
31-3	RESERVED	R	0h	
2	TCAR_IT_FLAG	R/W	0h	IRQ status for Capture 0h = No event pending 1h = IRQ event pending
1	OVF_IT_FLAG	R/W	0h	IRQ status for Overflow 0h = No event pending 1h = IRQ event pending
0	MAT_IT_FLAG	R/W	0h	IRQ status for Match 0h = No event pending 1h = IRQ event pending

20.1.5.6 IRQENABLE_SET Register (offset = 2Ch) [reset = 0h]

IRQENABLE_SET is shown in [Figure 20-11](#) and described in [Table 20-16](#).

Component interrupt request enable. Write 1 to set (enable interrupt). Readout equal to corresponding _CLR register.

Figure 20-11. IRQENABLE_SET Register

31	30	29	28	27	26	25	24
RESERVED							
R-0h							
23	22	21	20	19	18	17	16
RESERVED							
R-0h							
15	14	13	12	11	10	9	8
RESERVED							
R-0h							
7	6	5	4	3	2	1	0
RESERVED					TCAR_EN_FL G	OVF_EN_FL G	MAT_EN_FL G
R-0h					R/W-0h	R/W-0h	R/W-0h

LEGEND: R/W = Read/Write; R = Read only; W1toCl = Write 1 to clear bit; -n = value after reset

Table 20-16. IRQENABLE_SET Register Field Descriptions

Bit	Field	Type	Reset	Description
31-3	RESERVED	R	0h	
2	TCAR_EN_FLAG	R/W	0h	IRQ enable for Capture 0h = IRQ event is disabled 1h = IRQ event is enabled
1	OVF_EN_FLAG	R/W	0h	IRQ enable for Overflow 0h = IRQ event is disabled 1h = IRQ event is enabled
0	MAT_EN_FLAG	R/W	0h	IRQ enable for Match 0h = IRQ event is disabled 1h = IRQ event is enabled

20.1.5.7 IRQENABLE_CLR Register (offset = 30h) [reset = 0h]

IRQENABLE_CLR is shown in [Figure 20-12](#) and described in [Table 20-17](#).

Component interrupt request enable. Write 1 to clear (disable interrupt). Readout equal to corresponding _SET register.

Figure 20-12. IRQENABLE_CLR Register

31	30	29	28	27	26	25	24
RESERVED							
R-0h							
23	22	21	20	19	18	17	16
RESERVED							
R-0h							
15	14	13	12	11	10	9	8
RESERVED							
R-0h							
7	6	5	4	3	2	1	0
RESERVED					TCAR_EN_FL G	OVF_EN_FL G	MAT_EN_FL G
R-0h					R/W-0h	R/W-0h	R/W-0h

LEGEND: R/W = Read/Write; R = Read only; W1toCl = Write 1 to clear bit; -n = value after reset

Table 20-17. IRQENABLE_CLR Register Field Descriptions

Bit	Field	Type	Reset	Description
31-3	RESERVED	R	0h	
2	TCAR_EN_FLAG	R/W	0h	IRQ enable for Capture 0h = IRQ event is disabled 1h = Clear IRQ enable
1	OVF_EN_FLAG	R/W	0h	IRQ enable for Overflow 0h = IRQ event is disabled 1h = Clear IRQ enable
0	MAT_EN_FLAG	R/W	0h	IRQ enable for Match 0h = IRQ event is disabled 1h = Clear IRQ enable

20.1.5.8 IRQWAKEEN Register (offset = 34h) [reset = 0h]

IRQWAKEEN is shown in [Figure 20-13](#) and described in [Table 20-18](#).

Wakeup-enabled events taking place when module is idle will generate an asynchronous wakeup.

Figure 20-13. IRQWAKEEN Register

31	30	29	28	27	26	25	24
RESERVED							
R-0h							
23	22	21	20	19	18	17	16
RESERVED							
R-0h							
15	14	13	12	11	10	9	8
RESERVED							
R-0h							
7	6	5	4	3	2	1	0
RESERVED					TCAR_WUP_EN NA	OVF_WUP_EN A	MAT_WUP_EN A
R-0h					R/W-0h	R/W-0h	R/W-0h

LEGEND: R/W = Read/Write; R = Read only; W1toCl = Write 1 to clear bit; -n = value after reset

Table 20-18. IRQWAKEEN Register Field Descriptions

Bit	Field	Type	Reset	Description
31-3	RESERVED	R	0h	
2	TCAR_WUP_ENA	R/W	0h	Wakeup generation for Capture 0h = Wakeup disabled 1h = Wakeup enabled
1	OVF_WUP_ENA	R/W	0h	Wakeup generation for Overflow 0h = Wakeup disabled 1h = Wakeup enabled
0	MAT_WUP_ENA	R/W	0h	Wakeup generation for Match 0h = Wakeup disabled 1h = Wakeup enabled

20.1.5.9 TCLR Register (offset = 38h) [reset = 0h]

TCLR is shown in [Figure 20-14](#) and described in [Table 20-19](#).

When the TCM field passed from (00) to any other combination then the TCAR_IT_FLAG and the edge detection logic are cleared. The ST bit of TCLR register may be updated from the OCP interface or reset due to one-shot overflow. The OCP interface update has the priority.

Figure 20-14. TCLR Register

31	30	29	28	27	26	25	24
RESERVED							
R-0h							
23	22	21	20	19	18	17	16
RESERVED							
R-0h							
15	14	13	12	11	10	9	8
RESERVED	GPO_CFG	CAPT_MODE	PT	TRG		TCM	
R-0h	R/W-0h	R/W-0h	R/W-0h	R/W-0h		R/W-0h	
7	6	5	4	3	2	1	0
SCPWM	CE	PRE	PTV		AR	ST	
R/W-0h	R/W-0h	R/W-0h	R/W-0h		R/W-0h	R/W-0h	

LEGEND: R/W = Read/Write; R = Read only; W1toCl = Write 1 to clear bit; -n = value after reset

Table 20-19. TCLR Register Field Descriptions

Bit	Field	Type	Reset	Description
31-15	RESERVED	R	0h	
14	GPO_CFG	R/W	0h	General purpose output this register drives directly the PORGPOCFG output pin 0h = PORGPOCFG drives 0 and configures the timer pin as an output. 1h = PORGPOCFG drives 1 and configures the timer pin as an input.
13	CAPT_MODE	R/W	0h	Capture mode. 0h = Single capture 1h = Capture on second event
12	PT	R/W	0h	Pulse or toggle mode on PORTIMERPWM output pin 0h = Pulse 1h = Toggle
11-10	TRG	R/W	0h	Trigger output mode on PORTIMERPWM output pin 0h = No trigger 1h = Trigger on overflow 2h = Trigger on overflow and match 3h = Reserved
9-8	TCM	R/W	0h	Transition Capture Mode on PIEVENTCAPT input pin 0h = No capture 1h = Capture on low to high transition 2h = Capture on high to low transition 3h = Capture on both edge transition
7	SCPWM	R/W	0h	This bit should be set or clear while the timer is stopped or the trigger is off 0h = Clear the PORTIMERPWM output pin and select positive pulse for pulse mode 1h = Set the PORTIMERPWM output pin and select negative pulse for pulse mode

Table 20-19. TCLR Register Field Descriptions (continued)

Bit	Field	Type	Reset	Description
6	CE	R/W	0h	0h = Compare mode is disabled 1h = Compare mode is enabled
5	PRE	R/W	0h	Prescaler enable 0h = The TIMER clock input pin clocks the counter 1h = The divided input pin clocks the counter
4-2	PTV	R/W	0h	Pre-scale clock Timer value
1	AR	R/W	0h	0h = One shot timer 1h = Auto-reload timer
0	ST	R/W	0h	In the case of one-shot mode selected (AR = 0), this bit is automatically reset by internal logic when the counter is overflowed. 0h (R) = Stop timeOnly the counter is frozen 1h = Start timer

20.1.5.10 TCRR Register (offset = 3Ch) [reset = 0h]

TCRR is shown in [Figure 20-15](#) and described in [Table 20-20](#).

The TCRR register is a 32-bit register, 16-bit addressable. The MCU can perform a 32-bit access or two 16-bit accesses to access the register. Note that since the OCP clock is completely asynchronous with the timer clock, some synchronization is done in order to make sure that the TCRR value is not read while it is being incremented. In 16-bit mode the following sequence must be followed to read the TCRR register properly: First, perform an OCP Read Transaction to Read the lower 16-bit of the TCRR register (offset = 28h). When the TCRR is read and synchronized, the lower 16-bit LSBs are driven onto the output OCP data bus and the upper 16-bit MSBs of the TCRR register are stored in a temporary register. Second, perform an OCP Read Transaction to read the upper 16-bit of the TCRR register (offset = 2Ah). During this Read, the value of the upper 16-bit MSBs that has been temporary register is forwarded onto the output OCP data bus. So, to read the value of TCRR correctly, the first OCP read access has to be to the lower 16-bit (offset = 28h), followed by OCP read access to the upper 16-bit (offset = 2Ah). As the TCRR is updated using more sources (shadow_in_tcrr, incremented value of tcrr, TLDR and 0), a priority order will be defined: The first priority is the OCP update. The second is the reload way (triggered through TTGR reg. or following an auto-reload overflow). The third is the one-shot overflow reset to 0. The last is the incremented value.

Figure 20-15. TCRR Register

31	30	29	28	27	26	25	24	23	22	21	20	19	18	17	16	15	14	13	12	11	10	9	8	7	6	5	4	3	2	1	0
TIMER_COUNTER																															
R/W-0h																															

LEGEND: R/W = Read/Write; R = Read only; W1toCl = Write 1 to clear bit; -n = value after reset

Table 20-20. TCRR Register Field Descriptions

Bit	Field	Type	Reset	Description
31-0	TIMER_COUNTER	R/W	0h	Value of TIMER counter

20.1.5.11 TLDR Register (offset = 40h) [reset = 0h]

TLDR is shown in [Figure 20-16](#) and described in [Table 20-21](#).

LOAD_VALUE must be different than the timer overflow value (FFFF FFFFh).

Figure 20-16. TLDR Register

31	30	29	28	27	26	25	24	23	22	21	20	19	18	17	16	15	14	13	12	11	10	9	8	7	6	5	4	3	2	1	0
LOAD_VALUE																															
R/W-0h																															

LEGEND: R/W = Read/Write; R = Read only; W1toCl = Write 1 to clear bit; -n = value after reset

Table 20-21. TLDR Register Field Descriptions

Bit	Field	Type	Reset	Description
31-0	LOAD_VALUE	R/W	0h	Timer counter value loaded on overflow in auto-reload mode or on TTGR write access

20.1.5.12 TTGR Register (offset = 44h) [reset = FFFFFFFh]

TTGR is shown in [Figure 20-17](#) and described in [Table 20-22](#).

The read value of this register is always FFFF FFFFh.

Figure 20-17. TTGR Register

31	30	29	28	27	26	25	24	23	22	21	20	19	18	17	16	15	14	13	12	11	10	9	8	7	6	5	4	3	2	1	0
TTGR_VALUE																															
R/W-FFFFFFFh																															

LEGEND: R/W = Read/Write; R = Read only; W1toCl = Write 1 to clear bit; -n = value after reset

Table 20-22. TTGR Register Field Descriptions

Bit	Field	Type	Reset	Description
31-0	TTGR_VALUE	R/W	FFFFFFFh	Writing in the TTGR register, TCRR will be loaded from TLDR and prescaler counter will be cleared. Reload will be done regardless of the AR field value of TCLR register.

20.1.5.13 TWPS Register (offset = 48h) [reset = 0h]

TWPS is shown in [Figure 20-18](#) and described in [Table 20-23](#).

In posted mode the software must read the pending write status bits (Timer Write Posted Status register bits [4:0]) to insure that following write access will not be discarded due to on going write synchronization process. These bits are automatically cleared by internal logic when the write to the corresponding register is acknowledged.

Figure 20-18. TWPS Register

31	30	29	28	27	26	25	24
RESERVED							
R-0h							
23	22	21	20	19	18	17	16
RESERVED							
R-0h							
15	14	13	12	11	10	9	8
RESERVED							
R-0h							
7	6	5	4	3	2	1	0
RESERVED			W_PEND_TMAR	W_PEND_TTGR	W_PEND_TLDR	W_PEND_TCRR	W_PEND_TCLR
R-0h			R	R	R	R	R
R-0h			R/W-0h	R/W-0h	R/W-0h	R/W-0h	R/W-0h

LEGEND: R/W = Read/Write; R = Read only; W1toCl = Write 1 to clear bit; -n = value after reset

Table 20-23. TWPS Register Field Descriptions

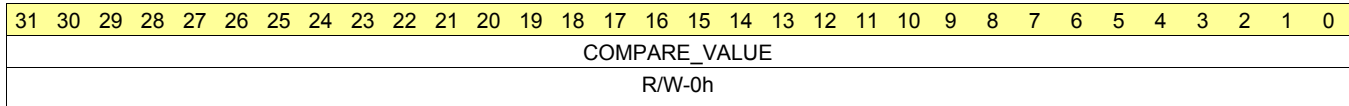
Bit	Field	Type	Reset	Description
31-5	RESERVED	R	0h	
4	W_PEND_TMAR	R/W	0h	When equal to 1, a write is pending to the TMAR register
3	W_PEND_TTGR	R/W	0h	When equal to 1, a write is pending to the TTGR register
2	W_PEND_TLDR	R/W	0h	When equal to 1, a write is pending to the TLDR register
1	W_PEND_TCRR	R/W	0h	When equal to 1, a write is pending to the TCRR register
0	W_PEND_TCLR	R/W	0h	When equal to 1, a write is pending to the TCLR register

20.1.5.14 TMAR Register (offset = 4Ch) [reset = 0h]

TMAR is shown in [Figure 20-19](#) and described in [Table 20-24](#).

The compare logic consists of a 32-bit wide, read/write data TMAR register and logic to compare counter's current value with the value stored in the TMAR register.

Figure 20-19. TMAR Register



LEGEND: R/W = Read/Write; R = Read only; W1toCl = Write 1 to clear bit; -n = value after reset

Table 20-24. TMAR Register Field Descriptions

Bit	Field	Type	Reset	Description
31-0	COMPARE_VALUE	R/W	0h	Value to be compared to the timer counter

20.1.5.15 TCAR1 Register (offset = 50h) [reset = 0h]

TCAR1 is shown in [Figure 20-20](#) and described in [Table 20-25](#).

When the appropriate (rising, falling or both) transition is detected in the edge detection logic the current counter value is stored to the TCAR1 register. Note that since the OCP clock is completely asynchronous with the timer clock, some synchronization is done in order to make sure that the TCAR1 value is not read while it is being updated due to some capture event. In 16-bit mode the following sequence must be followed to read the TCAR1 register properly:

Figure 20-20. TCAR1 Register

31	30	29	28	27	26	25	24	23	22	21	20	19	18	17	16	15	14	13	12	11	10	9	8	7	6	5	4	3	2	1	0
CAPTURED_VALUE																															
R/W-0h																															

LEGEND: R/W = Read/Write; R = Read only; W1toCl = Write 1 to clear bit; -n = value after reset

Table 20-25. TCAR1 Register Field Descriptions

Bit	Field	Type	Reset	Description
31-0	CAPTURED_VALUE	R/W	0h	Timer counter value captured on an external event trigger

20.1.5.16 TSICR Register (offset = 54h) [reset = 0h]

TSICR is shown in [Figure 20-21](#) and described in [Table 20-26](#).

Access to this register is not stalled even if the timer is in non-posted mode configuration. To abort any wrong behavior, software can permanently reset the functional part of the module. Also in case of a wrong hardware PIFREQRATIO tied the POSTED field can be reprogrammed on the fly, so deadlock situation cannot happen. Reset value of POSTED depends on hardware integration module at design time. Software must read POSTED field to get the hardware module configuration.

Figure 20-21. TSICR Register

31	30	29	28	27	26	25	24
RESERVED							
R-0h							
23	22	21	20	19	18	17	16
RESERVED							
R-0h							
15	14	13	12	11	10	9	8
RESERVED							
R-0h							
7	6	5	4	3	2	1	0
RESERVED					POSTED	SFT	RESERVED
R-0h					R/W-0h	R/W-0h	R-0h

LEGEND: R/W = Read/Write; R = Read only; W1toCl = Write 1 to clear bit; -n = value after reset

Table 20-26. TSICR Register Field Descriptions

Bit	Field	Type	Reset	Description
31-3	RESERVED	R	0h	
2	POSTED	R/W	0h	PIFREQRATIO 0h = Posted mode inactive: will delay the command accept output signal. 1h = Posted mode active (clocks ratio needs to fit freq (timer) less than freq (OCP)/4 frequency requirement)
1	SFT	R/W	0h	This bit resets all the function parts of the module. During reads it always returns 0. 0h = Software reset is enabled 1h = Software reset is disabled
0	RESERVED	R	0h	

20.1.5.17 TCAR2 Register (offset = 58h) [reset = 0h]

TCAR2 is shown in [Figure 20-22](#) and described in [Table 20-27](#).

When the appropriate (rising, falling or both) transition is detected in the edge detection logic and the capture on second event is activated from the control register (TCLR), the current counter value is stored to the TCAR2 register. Note that since the OCP clock is completely asynchronous with the timer clock, some synchronization is done in order to make sure that the TCAR2 value is not read while it is being updated due to some capture event. In 16-bit mode the following sequence must be followed to read the TCAR2 register properly: First, perform an OCP Read Transaction to Read the lower 16-bits of the TCAR2 register. Second, perform an OCP Read Transaction to read the upper 16-bits of the TCAR2 register.

Figure 20-22. TCAR2 Register

31	30	29	28	27	26	25	24	23	22	21	20	19	18	17	16	15	14	13	12	11	10	9	8	7	6	5	4	3	2	1	0
CAPTURED_VALUE																															
R/W-0h																															

LEGEND: R/W = Read/Write; R = Read only; W1toCl = Write 1 to clear bit; -n = value after reset

Table 20-27. TCAR2 Register Field Descriptions

Bit	Field	Type	Reset	Description
31-0	CAPTURED_VALUE	R/W	0h	Timer counter value captured on an external event trigger

20.2 DMTimer 1ms

20.2.1 Introduction

This peripheral is a 32-bit timer offering:

- Counter timer with compare and capture modes
- Auto-reload mode
- Start-stop mode
- Generate 1 ms tick with 32768-Hz functional clock
- Programmable divider clock source
- 16–32 bit addressing
- On-the-fly read/write registers
- Interrupts generated on overflow, compare and capture
- Interrupt enable
- Wake-up enable
- Write posted mode
- Dedicated input trigger for capture mode and dedicated output trigger/PWM signal
- Dedicated output signal for general purpose use PORGPOCFG
- OCP interface compatible

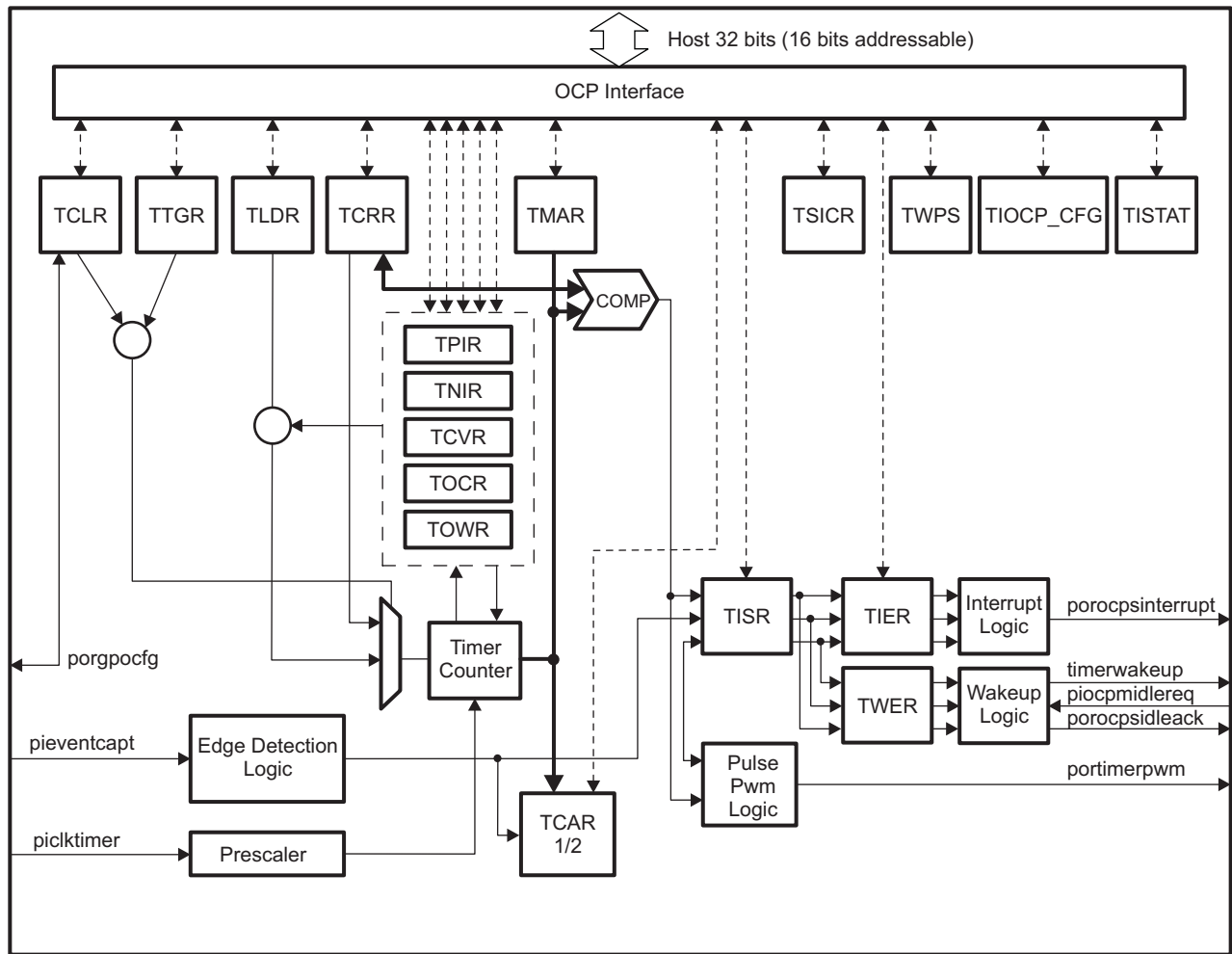
The timer module contains a free running upward counter with auto reload capability on overflow. The timer counter can be read and written on the fly (while counting). The timer module includes compare logic to allow interrupt event on programmable counter matching value.

A dedicated output signal can be pulsed or toggled on overflow and match event. This output offers timing stamp trigger signal or PWM (pulse width modulation) signal sources. A dedicated output signal can be used for general purpose PORGPOCFG (directly driven by the bit 14 of the TCLR register). A dedicated input signal is used to trigger automatic timer counter capture and interrupt event, on programmable input signal transition type. A programmable clock divider (prescaler) allows reduction of the timer input clock frequency. All internal timer interrupt sources are merged in one module interrupt line and one wake-up line. Each internal interrupt source can be independently enabled/disabled with a dedicated bit of TIER register for the interrupt features and a dedicated bit of TWER for the wake-up.

This module is controllable through the OCP peripheral bus.

As two clocks domains are managed inside this module, resynchronization is done by special logic between OCP clock domain and Timer clock domain. At reset, synchronization logic allows utilization of all ratios between OCP clock and Timer clock. Drawback of this mode is that full-resynchronization path is used with access latency performance impact in terms of OCP clock cycles. In order to improve module access latency, and under restricted conditions on clocks ratios (cf. 7.1 Write posted), write-posted mode can be used by setting POSTED bit of System Control register (TSICR). Under this mode, write posted mode is enabled, meaning that OCP write command is granted before the write process completes in the timer clock domain. This mode allows software (SW) to do concurrent writes on Dual Mode timer registers and to observe write process completion (synchronization) at SW level by reading independent write posted status bits in the Write Posted Status Register (TWPS).

Figure 20-23. Block Diagram



20.2.2 Integration

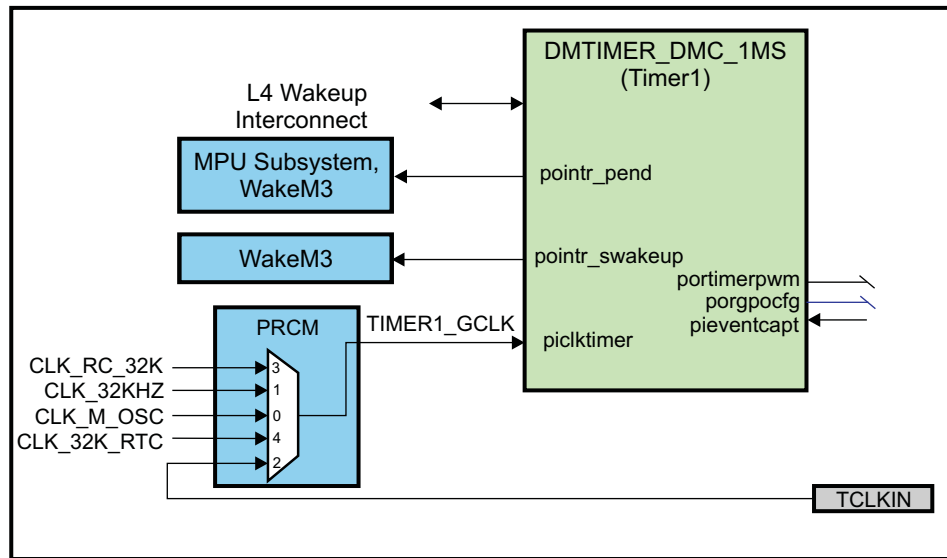


Figure 20-24. DMTimer 1 ms Integration

20.2.2.1 Timer Connectivity Attributes

Table 20-28. Timer1 Connectivity Attributes

Attributes	Type
Power Domain	Wakeup Domain
Clock Domain	PD_WKUP_L4_WKUP_GCLK (OCP) PD_WKUP_TIMER1_GCLK (Func)
Reset Signals	WKUP_DOM_RST_N
Idle/Wakeup Signals	Smart Idle / Slave Wakeup
Interrupt Requests	1 to MPU Subsystem (TINT1_1MS) and WakeM3
DMA Requests	None
Physical Address	L4 Wakeup slave port

20.2.2.2 Timer Clock and Reset Management

The DMTimer1 1ms timer functional clock can be selected from one of five sources using the CLKSEL_TIMER1MS_CLK register in the PRCM:

- The system clock (CLK_M_OSC)
- The PER PLL generated 32.768 KHz clock (CLK_32KHZ)
- The TCLKIN external timer input clock
- The on-chip ~32.768 KHz oscillator (CLK_RC32K)
- The external 32.768 KHz oscillator/clock (CLK_32K_RTC)

20.2.2.3 Timer Clock Signals

Table 20-29. Timer Clock Signals

Clock Signal	Max Freq	Reference / Source	Comments
Timer1 (1ms) Clock Signals			
PICKOCP Interface clock	100 MHz	CORE_CLKOUTM4 / 2	pd_wkup_i4_wkup_gclk from PRCM
PICKTIMER Functional clock	26 MHz ⁽¹⁾	CLK_M_OSC CLK_32KHZ (PER_CLKOUTM2 / 5859.375) TCLKIN CLK_RC32K CLK_32K_RTC	pd_wkup_timer1_gclk from PRCM

⁽¹⁾ PICKTIMER must be less than or equal to PICKOCP/4.

20.2.3 Functional Description

The general-purpose timer is an upward counter. It supports three functional modes:

- Timer mode
- Capture mode
- Compare mode

By default, after core reset, the capture and compare modes are disabled.

20.2.3.1 Timer Mode Functionality

The timer is an upward counter that can be started and stopped at any time through the Timer Control Register (TCLR ST bit). The Timer Counter Register (TCRR) can be loaded when stopped or on the fly (while counting). TCRR can be loaded directly by a TCRR Write access with the new timer value. TCRR can also be loaded with the value held in the Timer Load Register (TLDR) by a trigger register (TTGR) Write access. The TCRR loading is done regardless of the value written to the TTGR register. The timer counter register TCRR value can be read when stopped or captured on the fly by a TCRR Read access. The timer is stopped and the counter value set to "0" when the module's reset is asserted. The timer is maintained in stop after reset is released. When the timer is stopped, TCRR is frozen. The timer can be restarted from the frozen value unless TCRR has been reloaded with a new value.

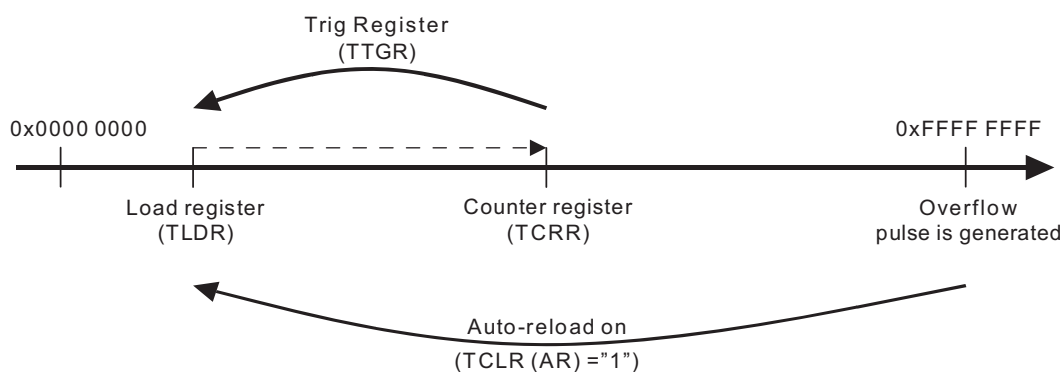
In the one shot mode (TCLR AR bit = "0"), the counter is stopped after counting overflow (counter value remains at zero).

When the auto-reload mode is enabled (TCLR AR bit = "1"), the TCRR is reloaded with the TLDR value after a counting overflow.

It is not recommended to put the overflow value (0xFFFFFFFF) in TLDR because it can lead to undesired results.

An interrupt can be issued on overflow if the overflow interrupt enable bit is set in the timer Interrupt Enable Register (TIER OVF_IT_ENA bit = "1"). A dedicated output pin (PORTIMERPWM) is programmed through TCLR (TRG and PT bits) to generate one positive pulse (prescaler duration) or to invert the current value (toggle mode) when an overflow occurs.

Figure 20-25. TCRR Timing Value

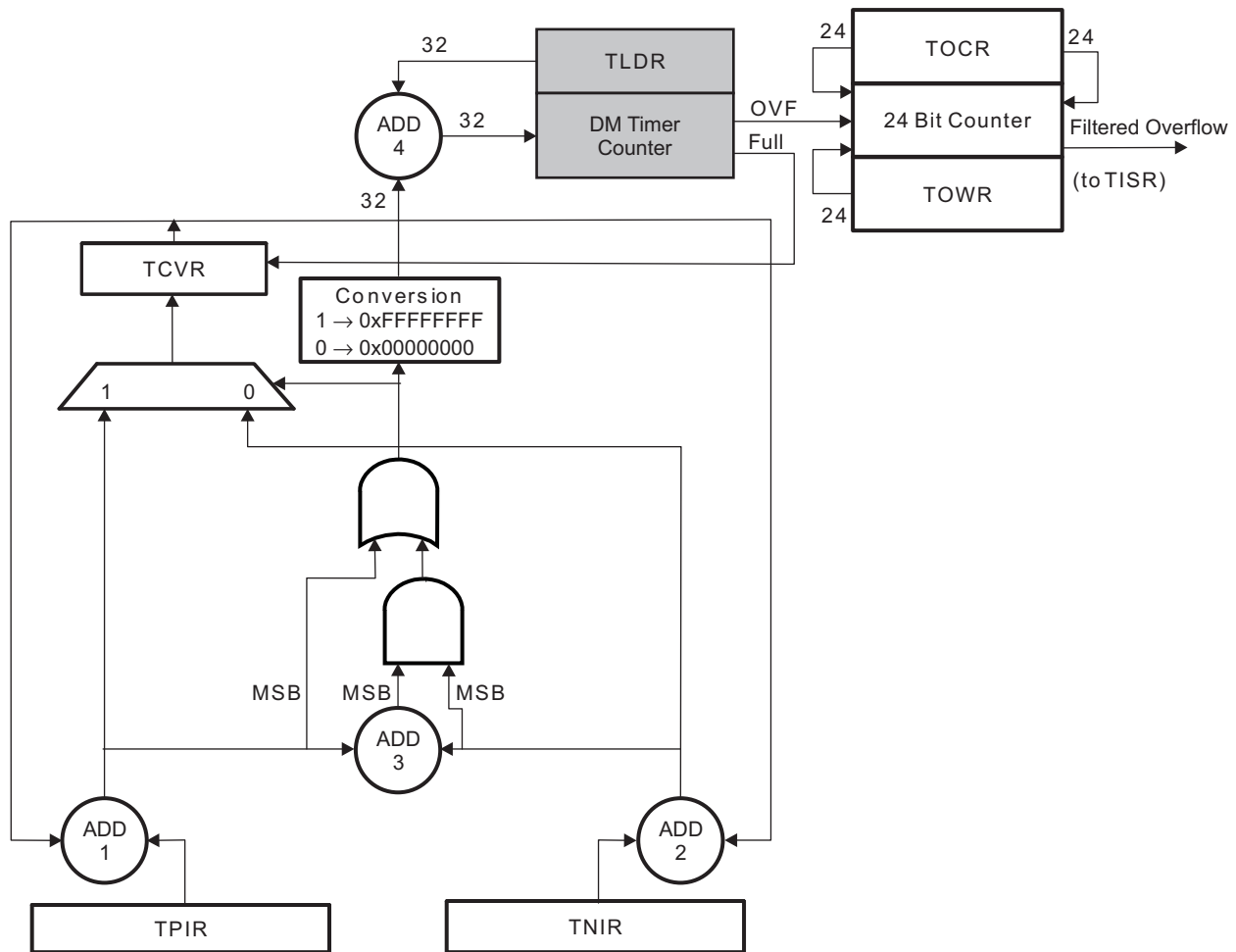


20.2.3.1.1 1 ms Tick Generation

To minimize the error between a true 1ms tick and the tick generated by the 32768 Hz timer, the sequencing of the sub-1ms periods and the over-1ms periods must be shuffled.

An additional block (1ms block) is used to correct this error.

In this implementation, the increment sequencing is automatically managed by the timer to minimize the error. The value of the Timer Positive Increment register (TPIR) and Timer Negative Increment register (TNIR) only need to be defined by the user. An auto adaptation mechanism is used to simplify the programming model.

Figure 20-26. 1ms Module Block Diagram


The TPIR, TNIR, TCCR and adders Add1–3 are used to define whether the next value loaded in the TCRR will be the value of the TLDR (sub-period value) or the value of TLDR – 1 (over-period value).

The following table shows the value loaded in TCRR according to the sign of the result of Add1, Add2 and Add3. MSB = '0' means a positive value, MSB = '1' means a negative value.

Table 20-30. Value Loaded in TCRR to Generate 1ms Tick

Add1 MSB	Add2 MSB	Add3 MSB	TCRR
0	0	0	TLDR
0	0	1	TLDR
0	1	0	TLDR
0	1	1	TLDR - 1
1	0	0	N.A.
1	0	1	N.A.
1	1	0	TLDR - 1
1	1	1	TLDR - 1

The values of TPIR and TNIR registers are calculated with formula:

$$\text{Positive Increment Value} = ((\text{INTEGER}[\text{Fclk} * \text{Ttick}] + 1) * 1\text{e}6) - (\text{Fclk} * \text{Ttick} * 1\text{e}6)$$

$$\text{Negative Increment Value} = (\text{INTEGER}[\text{Fclk} * \text{Ttick}] * 1\text{e}6) - (\text{Fclk} * \text{Ttick} * 1\text{e}6)$$

where:

Fclk – clock frequency (KHz)

Ttick – tick period (ms)

The Timer Overflow Counter Register (TOCR) and the Timer Overflow Wrapping Register (TOWR) are used for interrupt filtering. When the timer overflows, it increments the 24 bit TOCR register. When the 24-bit TOCR register value matches the value in the 24 bit TOWR register and timer overflow is asserted, the TOCR is reset and an interrupt is generated to TISR.

With the Conversion block in reset state (Positive Increment register, Negative Increment register and Counter Value register are all zeroed), the programming model and the behavior of the DMtimer_dmc1ms remain unchanged.

For 1 ms tick with a 32768-Hz clock:

$$\text{TPIR} = 232000$$

$$\text{TNIR} = -768000$$

$$\text{TLDR} = 0\text{x}\text{FFFFFFE0}$$

NOTE: Any value of the tick period can be generated with the appropriate values of the TPIR, TNIR and TLDR registers.

By default, the TPIR, TNIR, TCVR, TOCR, TOWR registers and the associated logic are in reset mode (all 0s) and have no action on the programming model of the DMtimer_dmc1ms.

20.2.3.2 Capture Mode Functionality

The timer value in TCRR can be captured and saved in TCAR1 or TCAR2 function of the mode selected in TCLR through the field CAPT_MODE when a transition is detected on the module input pin (PIEVENTCAPT). The edge detection circuitry monitors transitions on the input pin (PIEVENTCAPT).

Rising transition, falling transition or both can be selected in TCLR (TCM bit) to trigger the timer counter capture. The module sets the TISR (TCAR_IT_FLAG bit) when an active transition is detected and at the same time the counter value TCRR is stored in one of the timer capture registers TCAR1 or TCAR2 as follows:

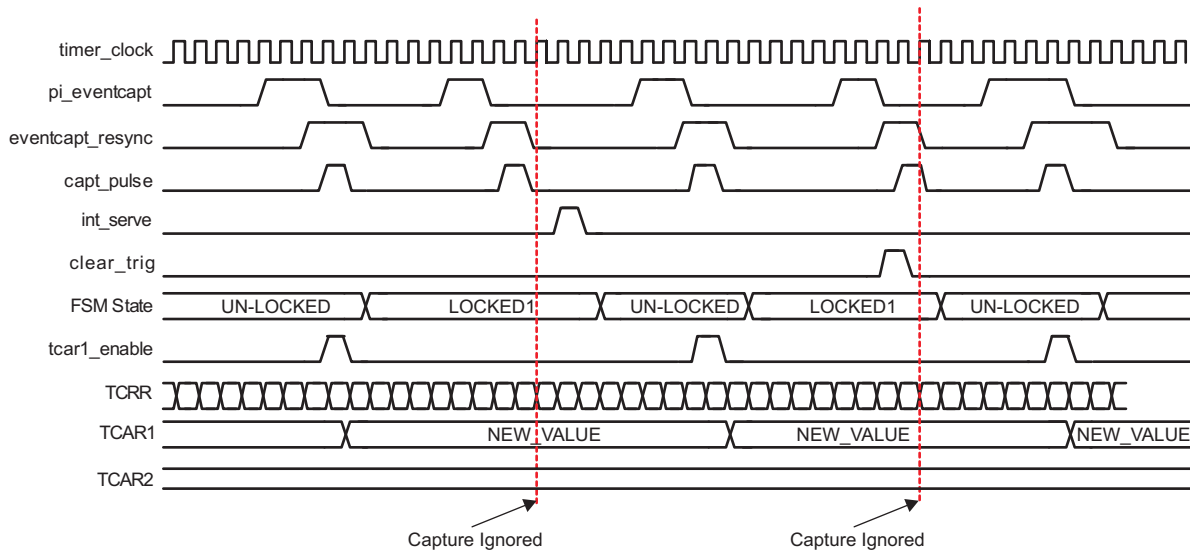
- If TCLR's CAPT_MODE field is "0" then, on the first enabled capture event, the value of the counter register is saved in TCAR1 register and all the next events are ignored (no update on TCAR1 and no interrupt triggering) until the detection logic is reset or the interrupt status register is cleared on TCAR's position by writing a "1" to it.
- If TCLR's CAPT_MODE field is "1" then, on the first enabled captured event, the counter value is saved in TCAR1 register and, on the second enabled capture event, the value of the counter register is saved in TCAR2 register. If capture interrupt is enabled, the interrupt will be asserted on the second event capture. All the other events are ignored (no update on TCAR1/2 and no interrupt triggering) until the detection logic is reset or the interrupt status register is cleared on TCAR's position writing a "1" in it. This mechanism is useful for period calculation of a clock if that clock is connected to the PIENTCAPT input pin.

The edge detection logic is reset (a new capture is enabled) when the active capture interrupt is served. The TCAR_IT_FLAG bit of TISR (previously '1') is cleared by writing a "1" to it or when the edge detection mode bits TCLR (TCM bit) passed from the No Capture Mode detection to any other modes. The timer functional clock (input to prescaler) is used to sample the input pin (PIEVENTCAPT). Negative or positive input pulses can be detected when the pulse time exceeds the functional clock period. An interrupt can be issued on transition detection if the capture interrupt enable bit is set in the Timer Interrupt Enable Register TIER (TCAR_IT_ENA bit).

See the following examples:

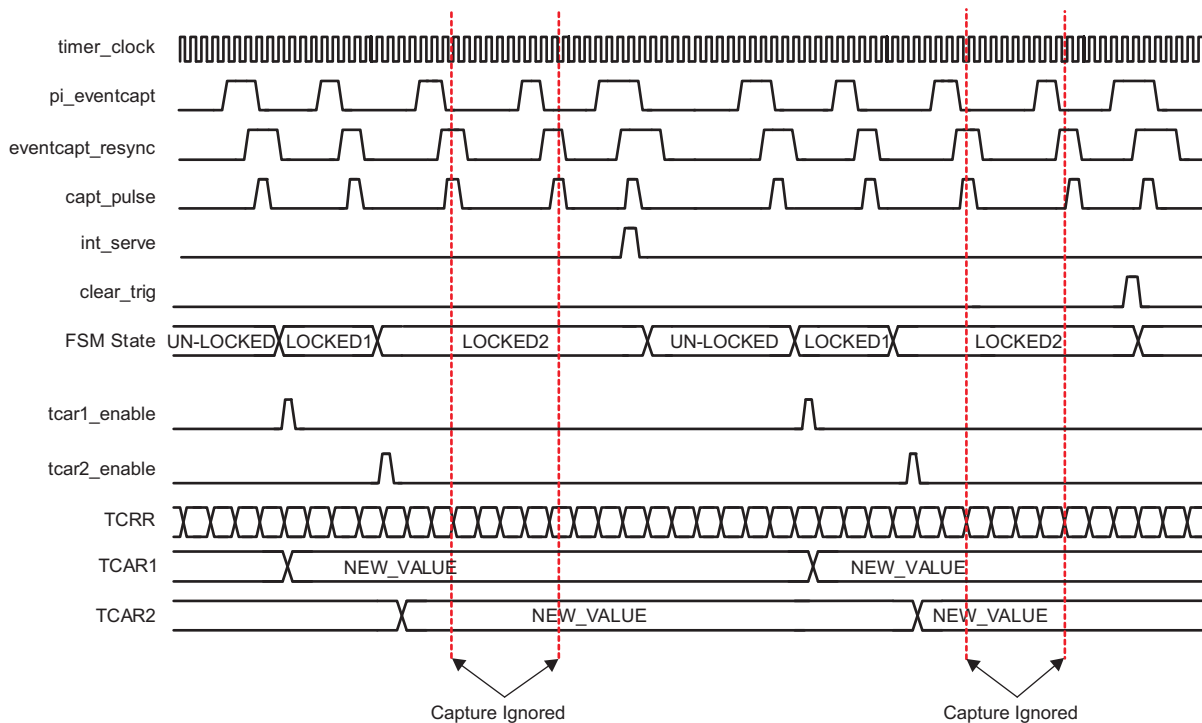
In the next wave, the TCM value is "01" and CAPT_MODE is "0"- only rising edge of the PIEVENTCAPT will trigger a capture in TCAR and only TCAR1 will update.

Figure 20-27. Capture Wave Example for CAPT_MODE 0



In the following example, the TCM value is "01" and CAPT_MODE is "1"- only rising edge of the PIEVENTCAPT will trigger a capture in TCAR1 on first enabled event and TCAR2 will update on the second enabled event.

Figure 20-28. Capture Wave Example for CAPT_MODE 1



20.2.3.3 Compare Mode Functionality

When Compare Enable TCLR (CE bit) is set to “1”, the timer value (TCRR) is permanently compared to the value held in timer match register (TMAR). TMAR value can be loaded at any time (timer counting or stop). When the TCRR and the TMAR values match, an interrupt can be issued if the TIER (MAT_IT_ENA bit) is set. The correct implementation is to write a compare value in TMAR register before setting TCLR (CE bit) to avoid any unwanted interrupts due to a reset value matching effect.

The dedicated output pin (PORTIMERPWM) can be programmed through TCLR (TRG and PT bits) to generate one positive pulse (TIMER clock duration) or to invert the current value (toggle mode) when an overflow and a match occur.

20.2.3.4 Prescaler Functionality

A prescaler counter can be used to divide the timer counter input clock frequency. The prescaler is enabled when TCLR bit 5 is set (PRE). The 2^n division ratio value (PTV) can be configured in the TCLR register.

The prescaler counter is reset when the timer counter is stopped or reloaded on the fly.

Table 20-31. Prescaler/Timer Reload Values Versus Contexts

Contexts	Prescaler Counter	Timer Counter
Overflow (when Auto-reload on)	reset	TLDR
TCRR Write	reset	TCRR
TTGR Write	reset	TLDR
Stop	reset	Frozen

20.2.3.5 Pulse-Width Modulation

The timer can be configured to provide a programmable pulse-width modulation (PORTIMERPWM) output. The PORTIMERPWM output pin can be configured to toggle on a specified event. TCLR (TRG bits) determines on which register value the PORTIMERPWM pin toggles. Either overflow or match can be used to toggle the PORTIMERPWM pin, when a compare condition occurs.

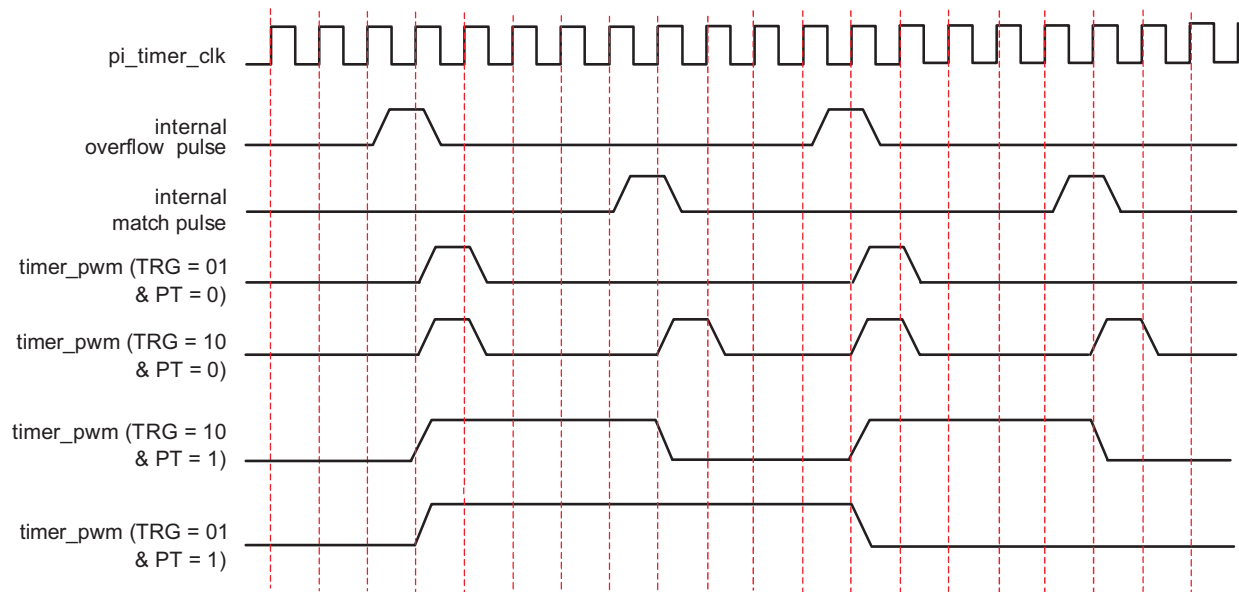
In case of overflow and match mode, the match event will be ignored from the moment the mode was set-up until the first overflow event occurs

The TCLR (SCPWM bit) can be programmed to set or clear the PORTIMERPWM output signal while the counter is stopped or the triggering is off only. This allows fixing a deterministic state of the output pin when modulation is stopped. The modulation is synchronously stopped when TRG bit is cleared and an overflow has occurred.

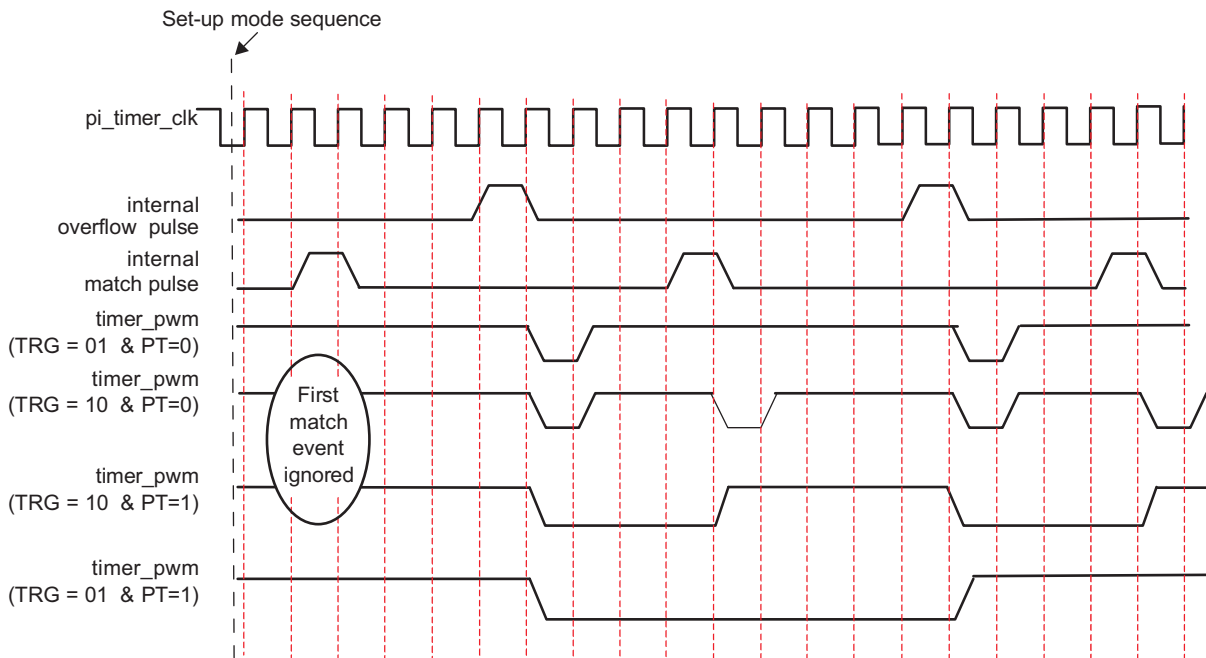
In the following timing diagram, the internal overflow pulse is set each time $(0xFFFF FFFF - TLDR + 1)$ value is reached, and the internal match pulse is set when the counter reaches TMAR register value. According to TCLR (TRG and PT bits) programming value, the timer provides pulse or PWM on the output pin (PORTIMERPWM).

The TLDR and TMAR registers must keep values smaller than the overflow value $(0xFFFFFFFF)$ with at least 2 units. In case the PWM trigger events are both overflow and match, the difference between the values kept in TMAR register and the value in TLDR must be at least 2 units. When match event is used, the compare mode TCLR (CE) must be set.

On the following wave TCLR (SCPWM bit) is set to '0'.

Figure 20-29. Timing Diagram of Pulse-Width Modulation, SCPWM Bit = 0


On the next wave TCLR (SCPWM bit) is set to '1'.

Figure 20-30. Timing Diagram of Pulse-Width Modulation, SCPWM Bit = 1


20.2.3.6 Timer Interrupt Control

The timer can issue an overflow interrupt, a timer match interrupt and a timer capture interrupt. Each internal interrupt source can be independently enabled/disabled in the Interrupt Enable Register (TIER). When the interrupt event has been issued, the associated interrupt status bit is set in the Timer Status Register (TISR). The pending interrupt event is reset when the set status bit is overwritten by a "1" value. Reading the Interrupt Status Register and writing the value back allows for a fast acknowledge interrupt process.

20.2.3.7 Sleep Mode Request and Acknowledge

Upon a Sleep mode request issued by the host processor (the Idle Request PIOCPSIDLEREQ signal is active), the timer module will enter Sleep mode according to the IdleMode field of the System configuration register (see TIOCP_CFG).

If the IdleMode field sets No-Idle mode, the Timer does not enter Sleep mode and the Idle acknowledge signal (POROCPSIDLEACK) is never asserted.

If the IdleMode field sets Force-Idle mode, the timer enters Sleep mode independently of the internal module state and the Idle acknowledge signal (POROCPSIDLEACK) is unconditionally asserted.

If the IdleMode field sets Smart-Idle mode, the timer module evaluates its internal capability to have the interface/functional clock switched off. Depending on the ClockActivity field, setting the timer module evaluates the internal activity and asserts the Idle acknowledge signal (POROCPSIDLEACK), entering in Sleep mode, ready to issue a wake-up request.

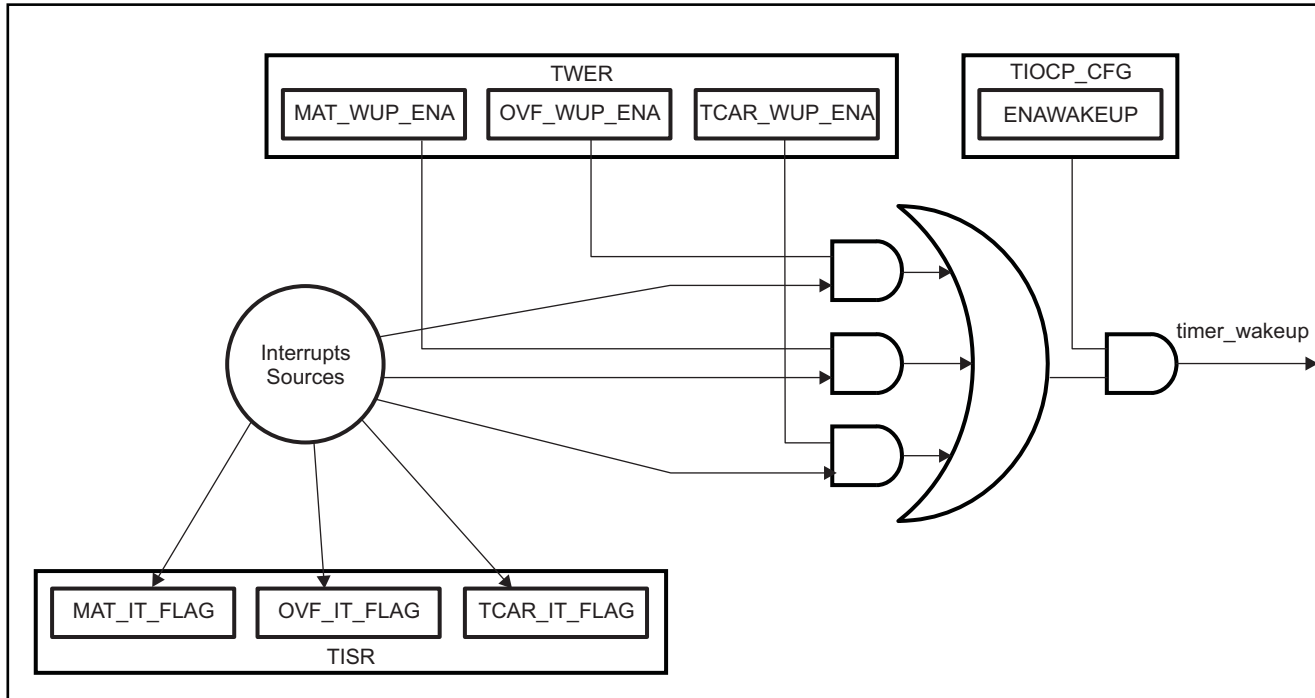
The following table describes the Smart Idle behavior according to the clock activity setting:

Table 20-32. SmartIdle - Clock Activity Field Configuration

Clock Activity	Functional Clock	OCP Clock	Module Behavior
11	ON	ON	The Idle acknowledge signal is asserted when there are no pending activities on the OCP clock domain, without evaluating the pending activities on the functional clock domain. (The module will enter in Sleep mode and if a pending interrupt event is finished during Idle mode the wake-up signal will be asserted).
10	ON	OFF	
01	OFF	ON	The Idle acknowledge signal is asserted when there are no pending activities on the functional and OCP clock domains (Improved latency in assertion of Idle acknowledge). The Wake-up capability of the module is disabled.
00	OFF	OFF	

This wake-up request is effectively sent only if the field ENAWAKEUP of TIOCP_CFG enables the timer wake-up capability. When the system is awoken, the Idle Request signal goes inactive and the wake-up request signal is also de-asserted.

Figure 20-31. Wake-up Request Generation



20.2.3.7.1 Wake-up Line Release

When the host processor receives a wake-up request issued by the timer peripheral, the interface clock is re-activated: the host processor deactivates the PIOCPSIDLEREQ, the timer deactivates the POROCPSIDLEACK signal and then the host can read the corresponding bit in TISR to find out which interrupt source has triggered a wake-up request. After acknowledging the wake-up request, the processor resets the status bit and releases the interrupt line by writing a '1' in the corresponding bit of the TISR register.

20.2.3.8 Timer Counting Rate

The dmtimer's counter is composed of a prescaler stage and a timer counter.

The prescaler clock ratio can be managed by accessing the ratio definition field of the control register (PTV and PRE of TCLR).

The timer rate is defined by:

- The value of the prescaler fields (PRE and PTV of TCLR register)
- The value loaded into the Timer Load Register (TLDR).

Table 20-33. Prescaler Clock Ratios Value

PRE	PTV	Divisor (PS)
0	X	1
1	0	2
1	1	4
1	2	8
1	3	16
1	4	32

Table 20-33. Prescaler Clock Ratios Value (continued)

PRE	PTV	Divisor (PS)
1	5	64
1	6	128
1	7	256

The timer rate equation is as follows:

$$(0xFFFF FFFF - TLDR + 1) \times \text{timer Clock period} \times \text{Clock Divider (PS)}$$

With timer Clock period = 1/ timer Clock frequency and PS = 2(PTV + 1).

As example, if we consider a timer clock input of 32 KHz, with a PRE field equals to "0", the timer output period is:

Table 20-34. Value and Corresponding Interrupt Period

TLDR	Interrupt Period
0x0000 0000	37 h
0xFFFF 0000	2 s
0xFFFF FFF0	500 us
0xFFFF FFFE	62.5 us

20.2.3.9 Timer Behavior During Emulation

To configure the Timer to stop during emulation suspend events (for example, debugger breakpoints), set up the Timer and the Debug Subsystem:

1. Set TIOCP_CFG.EMUFREE=0. This will allow the Suspend_Control signal from the Debug Subsystem ([Chapter 27](#)) to stop and start the Timer. Note that if EMUFREE=1, the Suspend_Control signal is ignored and the Timer is free running regardless of any debug suspend event. This EMUFREE bit gives local control from a module perspective to gate the suspend signal coming from the Debug Subsystem.
2. Set the appropriate xxx_Suspend_Control register = 0x9, as described in [Section 27.1.1.1, Debug Suspend Support for Peripherals](#). Choose the register appropriate to the peripheral you want to suspend during a suspend event.

20.2.4 DMTIMER_1MS Registers

[Table 20-35](#) lists the memory-mapped registers for the DMTIMER_1MS. All register offset addresses not listed in [Table 20-35](#) should be considered as reserved locations and the register contents should not be modified.

Table 20-35. DMTIMER_1MS REGISTERS

Offset	Acronym	Register Name	Section
0h	TIDR	This register contains the IP revision code	Section 20.2.4.1
10h	TIOCP_CFG	This register controls the various parameters of the OCP interface	Section 20.2.4.2
14h	TISTAT	This register provides status information about the module, excluding the interrupt status information	Section 20.2.4.3
18h	TISR	The Timer Status Register is used to determine which of the timer events requested an interrupt.	Section 20.2.4.4
1Ch	TIER	This register controls (enable/disable) the interrupt events	Section 20.2.4.5
20h	TWER	This register controls (enable/disable) the wakeup feature on specific interrupt events	Section 20.2.4.6
24h	TCLR	This register controls optional features specific to the timer functionality	Section 20.2.4.7

Table 20-35. DMTIMER_1MS REGISTERS (continued)

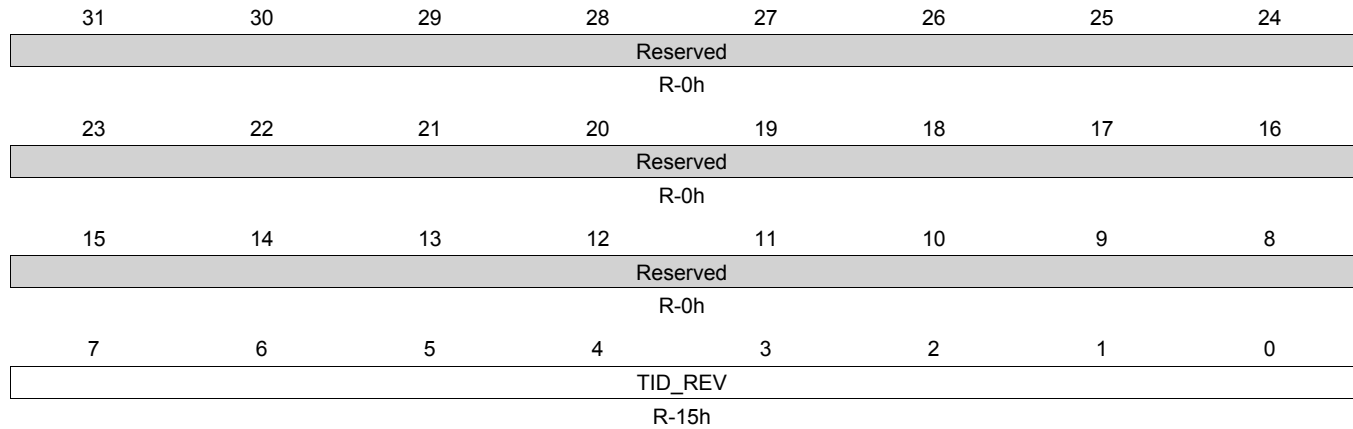
Offset	Acronym	Register Name	Section
28h	TCRR	This register holds the value of the internal counter	Section 20.2.4.8
2Ch	TLDR	This register holds the timer's load value	Section 20.2.4.9
30h	TTGR	This register triggers a counter reload of timer by writing any value in it.	Section 20.2.4.10
34h	TWPS	This register contains the write posting bits for all writable functional registers	Section 20.2.4.11
38h	TMAR	This register holds the match value to be compared with the counter's value	Section 20.2.4.12
3Ch	TCAR1	This register holds the value of the first counter register capture	Section 20.2.4.13
40h	TSICR	Timer Synchronous Interface Control Register	Section 20.2.4.14
44h	TCAR2	This register holds the value of the second counter register capture	Section 20.2.4.15
48h	TPIR	This register is used for 1ms tick generation. The TPIR register holds the value of the positive increment. The value of this register is added with the value of the TCVR to define whether next value loaded in TCRR will be the sub-period value or the over-period value.	Section 20.2.4.16
4Ch	TNIR	This register is used for 1ms tick generation. The TNIR register holds the value of the negative increment. The value of this register is added with the value of the TCVR to define whether next value loaded in TCRR will be the sub-period value or the over-period value.	Section 20.2.4.17
50h	TCVR	This register is used for 1ms tick generation. The TCVR register defines whether next value loaded in TCRR will be the sub-period value or the over-period value.	Section 20.2.4.18
54h	TOCR	This register is used to mask the tick interrupt for a selected number of ticks.	Section 20.2.4.19
58h	TOWR	This register holds the number of masked overflow interrupts.	Section 20.2.4.20

20.2.4.1 TIDR Register (offset = 0h) [reset = 15h]

TIDR is shown in [Figure 20-32](#) and described in [Table 20-36](#).

This register contains the IP revision code

Figure 20-32. TIDR Register



LEGEND: R/W = Read/Write; R = Read only; W1toCl = Write 1 to clear bit; -n = value after reset

Table 20-36. TIDR Register Field Descriptions

Bit	Field	Type	Reset	Description
31-8	Reserved	R	0h	Reads return 0
7-0	TID_REV	R	15h	IP revision [7:4] Major revision [3:0] Minor revision Examples: 0x10 for 1.0, 0x21 for 2.1

20.2.4.2 TIOCP_CFG Register (offset = 10h) [reset = 0h]

TIOCP_CFG is shown in [Figure 20-33](#) and described in [Table 20-37](#).

This register controls the various parameters of the OCP interface

Figure 20-33. TIOCP_CFG Register

31	30	29	28	27	26	25	24
Reserved							
R/W-0h							
23	22	21	20	19	18	17	16
Reserved							
R/W-0h							
15	14	13	12	11	10	9	8
Reserved						ClockActivity	
R/W-0h						R/W-0h	
7	6	5	4	3	2	1	0
Reserved		EmuFree	IdleMode		EnaWakeup	SoftReset	Autoldle
R/W-0h		R/W-0h	R/W-0h		R/W-0h	R/W-0h	R/W-0h

LEGEND: R/W = Read/Write; R = Read only; W1toCl = Write 1 to clear bit; -n = value after reset

Table 20-37. TIOCP_CFG Register Field Descriptions

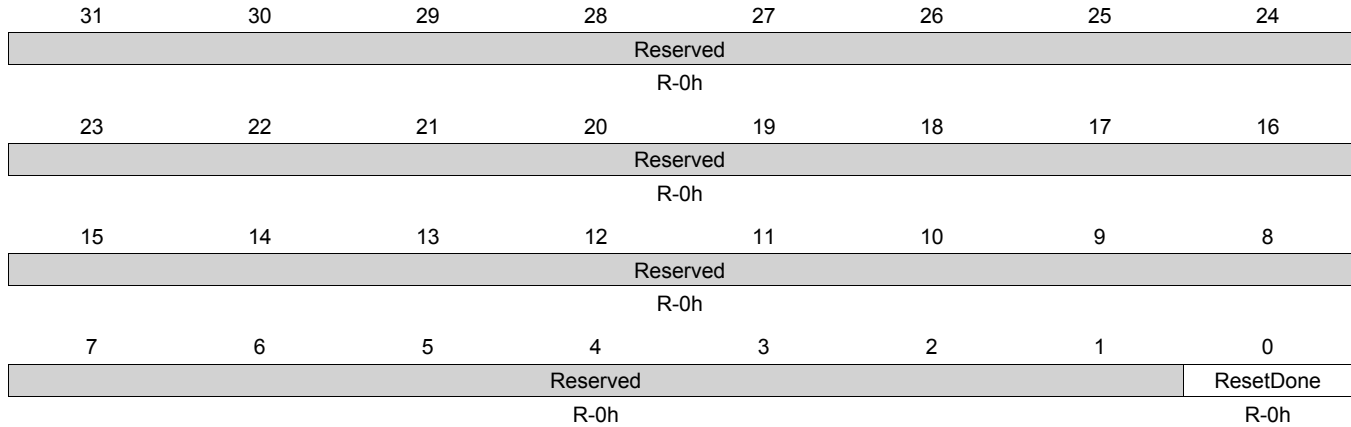
Bit	Field	Type	Reset	Description
31-10	Reserved	R/W	0h	
9-8	ClockActivity	R/W	0h	
7-6	Reserved	R/W	0h	Write 0's for future compatibility Reads return 0
5	EmuFree	R/W	0h	Sensitivity to emulation (debug) suspend event from Debug Subsystem. 0 = timer_frozen : Timer counter frozen during a debug suspend event. 1 = timer_free : Timer counter free-running. Debug suspend event is ignored.
4-3	IdleMode	R/W	0h	Power Management, req/ack control 0 = fidle : Force-idle. An idle request is acknowledged unconditionally 1 = nidle : No-idle. An idle request is never acknowledged 2 = sidle : Smart-idle. Acknowledgment to an idle request is given based on the internal activity of the module 3 = Smart-idle wakeup capable. Acknowledgment to an idle request is given based on the internal activity of the module. The module may generate wakeup events when in idle state.
2	EnaWakeup	R/W	0h	Wake-up feature global control 0 = nowake : No wakeup line assertion in idle mode 1 = enbwake : Wakeup line assertion enabled in smart-idle mode
1	SoftReset	R/W	0h	Software reset. This bit is automatically reset by the hardware. During reads, it always return 0 0 = nmode : Normal mode 1 = rstmode : The module is reset
0	Autoldle	R/W	0h	Internal OCP clock gating strategy 0 = clkfree : OCP clock is free-running 1 = clkgate : Automatic OCP clock gating strategy is applied, based on the OCP interface activity

20.2.4.3 TISTAT Register (offset = 14h) [reset = 0h]

TISTAT is shown in [Figure 20-34](#) and described in [Table 20-38](#).

This register provides status information about the module, excluding the interrupt status information

Figure 20-34. TISTAT Register



LEGEND: R/W = Read/Write; R = Read only; W1toCl = Write 1 to clear bit; -n = value after reset

Table 20-38. TISTAT Register Field Descriptions

Bit	Field	Type	Reset	Description
31-1	Reserved	R	0h	Reads return 0 Reserved for OCP-socket status information
0	ResetDone	R	0h	Internal reset monitoring 0 = rstongoing : Internal module reset in on-going 1 = rstcomp : Reset completed

20.2.4.4 TISR Register (offset = 18h) [reset = 0h]

TISR is shown in [Figure 20-35](#) and described in [Table 20-39](#).

The Timer Status Register is used to determine which of the timer events requested an interrupt.

Figure 20-35. TISR Register

31	30	29	28	27	26	25	24
Reserved							
R-0h							
23	22	21	20	19	18	17	16
Reserved							
R-0h							
15	14	13	12	11	10	9	8
Reserved							
R-0h							
7	6	5	4	3	2	1	0
Reserved					TCAR_IT_FL G	OVF_IT_FLAG	MAT_IT_FLAG
R-0h					R/W1toCl-0h	R/W1toCl-0h	R/W1toCl-0h

LEGEND: R/W = Read/Write; R = Read only; W1toCl = Write 1 to clear bit; -n = value after reset

Table 20-39. TISR Register Field Descriptions

Bit	Field	Type	Reset	Description
31-3	Reserved	R	0h	Reads return 0
2	TCAR_IT_FLAG	R/W1toCl	0h	indicates when an external pulse transition of the correct polarity is detected on the external pin PIEVENTCAPT 0 = TCAR_IT_FLAG_0 : no capture interrupt request 1 = TACR_IT_FLAG_1 : capture interrupt request
1	OVF_IT_FLAG	R/W1toCl	0h	TCRR overflow 0 = OVF_IT_FLAG_0 : no overflow interrupt request 1 = OVF_IT_FLAG_1 : overflow interrupt pending
0	MAT_IT_FLAG	R/W1toCl	0h	the compare result of TCRR and TMAR 0 = MAT_IT_FLAG_0 : no compare interrupt request 1 = MAT_IT_FLAG_1 : compare interrupt pending

20.2.4.5 TIER Register (offset = 1Ch) [reset = 0h]

TIER is shown in [Figure 20-36](#) and described in [Table 20-40](#).

This register controls (enable/disable) the interrupt events

Figure 20-36. TIER Register

31	30	29	28	27	26	25	24
Reserved							
R-0h							
23	22	21	20	19	18	17	16
Reserved							
R-0h							
15	14	13	12	11	10	9	8
Reserved							
R-0h							
7	6	5	4	3	2	1	0
Reserved					TCAR_IT_ENA	OVF_IT_ENA	MAT_IT_ENA
R-0h					R/W-0h	R/W-0h	R/W-0h

LEGEND: R/W = Read/Write; R = Read only; W1toCl = Write 1 to clear bit; -n = value after reset

Table 20-40. TIER Register Field Descriptions

Bit	Field	Type	Reset	Description
31-3	Reserved	R	0h	Reads return 0
2	TCAR_IT_ENA	R/W	0h	Enable capture interrupt 0 = Dsb_capt : Disable capture interrupt 1 = Enb_capt : Enable capture interrupt
1	OVF_IT_ENA	R/W	0h	Enable overflow interrupt 0 = Dsb_ovf : Disable overflow interrupt 1 = Enb_ovf : Enable overflow interrupt
0	MAT_IT_ENA	R/W	0h	Enable match interrupt 0 = Dsb_match : Disable match interrupt 1 = Enb_match : Enable match interrupt

20.2.4.6 TWER Register (offset = 20h) [reset = 0h]

TWER is shown in [Figure 20-37](#) and described in [Table 20-41](#).

This register controls (enable/disable) the wakeup feature on specific interrupt events

Figure 20-37. TWER Register

31	30	29	28	27	26	25	24
Reserved							
R-0h							
23	22	21	20	19	18	17	16
Reserved							
R-0h							
15	14	13	12	11	10	9	8
Reserved							
R-0h							
7	6	5	4	3	2	1	0
Reserved					TCAR_WUP_ENA	OVF_WUP_ENA	MAT_WUP_ENA
R-0h					R/W-0h	R/W-0h	R/W-0h

LEGEND: R/W = Read/Write; R = Read only; W1toCl = Write 1 to clear bit; -n = value after reset

Table 20-41. TWER Register Field Descriptions

Bit	Field	Type	Reset	Description
31-3	Reserved	R	0h	Reads return 0
2	TCAR_WUP_ENA	R/W	0h	Enable capture wake-up 0 = DsbWupCap : Disable capture wake-up 1 = EnbWupCapt : Enable capture wake-up
1	OVF_WUP_ENA	R/W	0h	Enable overflow wake-up 0 = DsbWupOvf : Disable overflow wake-up 1 = EnbWupOvf : Enable overflow wake-up
0	MAT_WUP_ENA	R/W	0h	Enable match wake-up 0 = DsbWupMat : Disable match wake-up 1 = EnbWupMat : Enable match wake-up

20.2.4.7 TCLR Register (offset = 24h) [reset = 0h]

TCLR is shown in [Figure 20-38](#) and described in [Table 20-42](#).

This register controls optional features specific to the timer functionality

Figure 20-38. TCLR Register

31	30	29	28	27	26	25	24
Reserved							
R-0h							
23	22	21	20	19	18	17	16
Reserved							
R-0h							
15	14	13	12	11	10	9	8
Reserved	GPO_CFG	CAPT_MODE	PT	TRG		TCM	
R-0h	R/W-0h	R/W-0h	R/W-0h	R/W-0h		R/W-0h	
7	6	5	4	3	2	1	0
SCPWM	CE	PRE	PTV		AR		ST
R/W-0h	R/W-0h	R/W-0h	R/W-0h		R/W-0h		R/W-0h

LEGEND: R/W = Read/Write; R = Read only; W1toCl = Write 1 to clear bit; -n = value after reset

Table 20-42. TCLR Register Field Descriptions

Bit	Field	Type	Reset	Description
31-15	Reserved	R	0h	Reads return 0
14	GPO_CFG	R/W	0h	
13	CAPT_MODE	R/W	0h	Capture mode select bit (first/second) 0 = First_capt : Capture the first enabled capture event in TCAR1 1 = Sec_capt : Capture the second enabled capture event in TCAR2
12	PT	R/W	0h	Pulse or Toggle select bit 0 = pulse : pulse modulation 1 = toggle : toggle modulation
11-10	TRG	R/W	0h	Trigger Output Mode 0 = no_trg : No trigger 1 = ovf_trg : Overflow trigger 2 = ovf_mat_trg : Overflow and match trigger 3 = reserved : Reserved
9-8	TCM	R/W	0h	Transition Capture Mode 0 = no_edge : No capture 1 = rise_edge : Capture on rising edges of PIEVETCAPT 2 = fall_edge : Capture on falling edges of PIEVETCAPT 3 = booth_edges : Capture on booth edges of PIEVETCAPT
7	SCPWM	R/W	0h	Pulse Width Modulation output pin default value 0 = def_low : default value of PORPWM: 0 1 = def_high : default value of PORPWM: 1
6	CE	R/W	0h	Compare enable 0 = dsb_cmp : Compare disabled 1 = enb_cmp : Compare enabled
5	PRE	R/W	0h	Prescaler enable 0 = no_prescal : Prescaler disabled 1 = prescal_on : Prescaler enabled
4-2	PTV	R/W	0h	Trigger Output Mode

Table 20-42. TCLR Register Field Descriptions (continued)

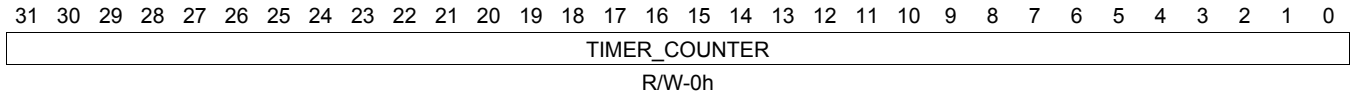
Bit	Field	Type	Reset	Description
1	AR	R/W	0h	Auto-reload mode 0 = one_shot : One shot mode overflow 1 = auto_rel : Auto-reload mode overflow
0	ST	R/W	0h	Start/Stop timer control 0 = cnt_stop : Stop the timer 1 = cnt_start : Start the timer

20.2.4.8 TCRR Register (offset = 28h) [reset = 0h]

TCRR is shown in [Figure 20-39](#) and described in [Table 20-43](#).

This register holds the value of the internal counter

Figure 20-39. TCRR Register



LEGEND: R/W = Read/Write; R = Read only; W1toCl = Write 1 to clear bit; -n = value after reset

Table 20-43. TCRR Register Field Descriptions

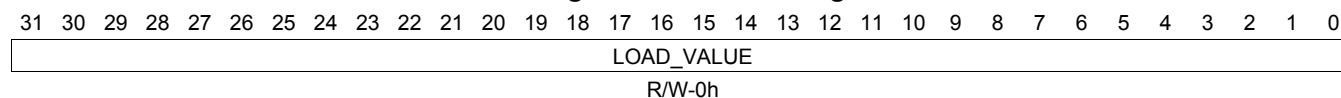
Bit	Field	Type	Reset	Description
31-0	TIMER_COUNTER	R/W	0h	The value of the timer counter register

20.2.4.9 TLDR Register (offset = 2Ch) [reset = 0h]

TLDR is shown in [Figure 20-40](#) and described in [Table 20-44](#).

This register holds the timer's load value

Figure 20-40. TLDR Register



LEGEND: R/W = Read/Write; R = Read only; W1toCl = Write 1 to clear bit; -n = value after reset

Table 20-44. TLDR Register Field Descriptions

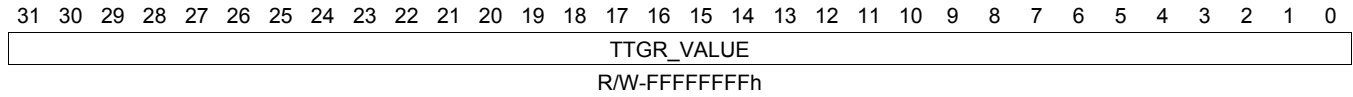
Bit	Field	Type	Reset	Description
31-0	LOAD_VALUE	R/W	0h	The value of the timer load register

20.2.4.10 TTGR Register (offset = 30h) [reset = FFFFFFFFh]

TTGR is shown in [Figure 20-41](#) and described in [Table 20-45](#).

This register triggers a counter reload of timer by writing any value in it.

Figure 20-41. TTGR Register



LEGEND: R/W = Read/Write; R = Read only; W1toCl = Write 1 to clear bit; -n = value after reset

Table 20-45. TTGR Register Field Descriptions

Bit	Field	Type	Reset	Description
31-0	TTGR_VALUE	R/W	FFFFFFFh	The value of the trigger register During reads, it always returns "0xFFFFFFFF"

20.2.4.11 TWPS Register (offset = 34h) [reset = 0h]

TWPS is shown in [Figure 20-42](#) and described in [Table 20-46](#).

This register contains the write posting bits for all writ-able functional registers

Figure 20-42. TWPS Register

31	30	29	28	27	26	25	24
Reserved							
R-0h							
23	22	21	20	19	18	17	16
Reserved							
R-0h							
15	14	13	12	11	10	9	8
Reserved						W_PEND_TO WR	W_PEND_TO CR
R-0h						R-0h	R-0h
7	6	5	4	3	2	1	0
W_PEND_TCV R	W_PEND_TNI R	W_PEND_TPIR R	W_PEND_TMA R	W_PEND_TTG R	W_PEND_TLD R	W_PEND_TCR R	W_PEND_TCL R
R-0h	R-0h	R-0h	R-0h	R-0h	R-0h	R-0h	R-0h

LEGEND: R/W = Read/Write; R = Read only; W1toCl = Write 1 to clear bit; -n = value after reset

Table 20-46. TWPS Register Field Descriptions

Bit	Field	Type	Reset	Description
31-10	Reserved	R	0h	Reads return 0
9	W_PEND_TOWR	R	0h	Write pending for register TOWR 0 = OWR_nPend : No Overflow Wrapping Register write pending. 1 = OWR_Pend : Overflow Wrapping Register write pending.
8	W_PEND_TOCR	R	0h	Write pending for register TOCR 0 = OCR_nPend : No Overflow Counter Register write pending. 1 = OCR_Pend : Overflow Counter Register write pending.
7	W_PEND_TCVR	R	0h	Write pending for register TCVR 0 = CVR_nPend : No Counter Register write pending. 1 = CVR_Pend : Counter Register write pending.
6	W_PEND_TNIR	R	0h	Write pending for register TNIR 0 = NIR_nPend : No Negativ Increment Register write pending. 1 = NIR_Pend : Negativ Increment Register write pending.
5	W_PEND_TPIR	R	0h	Write pending for register TPIR 0 = PIR_nPend : No Positive Increment Register write pending. 1 = PIR_Pend : Positive Increment Register write pending.
4	W_PEND_TMAR	R	0h	Write pending for register TMAR 0 = MAR_nPend : No Match Register write pending 1 = MAR_Pend : Match Register write pending
3	W_PEND_TTGR	R	0h	Write pending for register TTGR 0 = TGR_nPend : No Trigger Register write pending 1 = TGR_Pend : Trigger Register write pending
2	W_PEND_TLDR	R	0h	Write pending for register TLDR 0 = LDR_nPend : No Load Register write pending 1 = LDR_Pend : Load Register write pending

Table 20-46. TWPS Register Field Descriptions (continued)

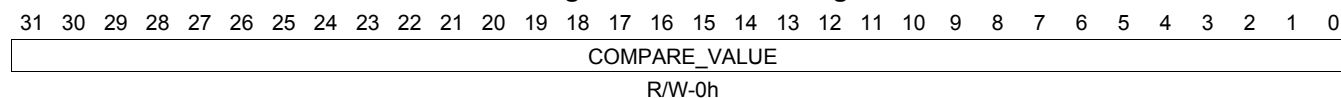
Bit	Field	Type	Reset	Description
1	W_PEND_TCRR	R	0h	Write pending for register TCRR 0 = CRR_nPend : No Counter Register write pending 1 = CRR_Pend : Counter Register write pending
0	W_PEND_TCLR	R	0h	Write pending for register TCLR 0 = CLR_nPend : No Control Register write pending 1 = CLR_Pend : Control Register write pending

20.2.4.12 TMAR Register (offset = 38h) [reset = 0h]

TMAR is shown in [Figure 20-43](#) and described in [Table 20-47](#).

This register holds the match value to be compared with the counter's value

Figure 20-43. TMAR Register



LEGEND: R/W = Read/Write; R = Read only; W1toCl = Write 1 to clear bit; -n = value after reset

Table 20-47. TMAR Register Field Descriptions

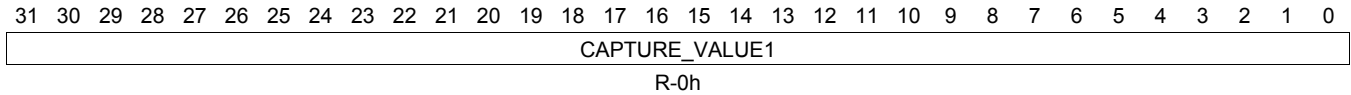
Bit	Field	Type	Reset	Description
31-0	COMPARE_VALUE	R/W	0h	The value of the match register

20.2.4.13 TCAR1 Register (offset = 3Ch) [reset = 0h]

TCAR1 is shown in [Figure 20-44](#) and described in [Table 20-48](#).

This register holds the value of the first counter register capture

Figure 20-44. TCAR1 Register



LEGEND: R/W = Read/Write; R = Read only; W1toCl = Write 1 to clear bit; -n = value after reset

Table 20-48. TCAR1 Register Field Descriptions

Bit	Field	Type	Reset	Description
31-0	CAPTURE_VALUE1	R	0h	The value of first captured counter register

20.2.4.14 TSICR Register (offset = 40h) [reset = 0h]

TSICR is shown in [Figure 20-45](#) and described in [Table 20-49](#).

Timer Synchronous Interface Control Register

Figure 20-45. TSICR Register

31	30	29	28	27	26	25	24
Reserved							
R-0h							
23	22	21	20	19	18	17	16
Reserved							
R-0h							
15	14	13	12	11	10	9	8
Reserved							
R-0h							
7	6	5	4	3	2	1	0
Reserved					POSTED	SFT	Reserved
R-0h					R/W-0h	R/W-0h	R-0h

LEGEND: R/W = Read/Write; R = Read only; W1toCl = Write 1 to clear bit; -n = value after reset

Table 20-49. TSICR Register Field Descriptions

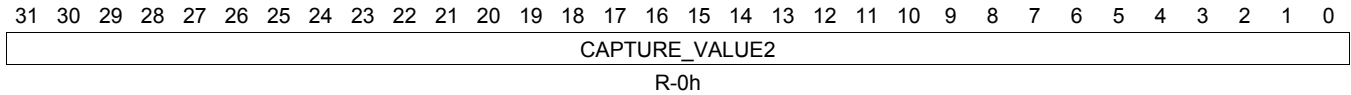
Bit	Field	Type	Reset	Description
31-3	Reserved	R	0h	Reads return 0
2	POSTED	R/W	1h	PIFREQRATIO 0x0 = Posted mode inactive: will delay the command accept output signal. 0x1 = Posted mode active (clocks ratio needs to fit freq (timer) less than freq (OCP)/4 frequency requirement).
1	SFT	R/W	0h	This bit reset all the functional part of the module 0 = SFT_0 : software reset is disabled 1 = SFT_1 : software reset is enabled
0	Reserved	R	0h	Reads return 0

20.2.4.15 TCAR2 Register (offset = 44h) [reset = 0h]

TCAR2 is shown in [Figure 20-46](#) and described in [Table 20-50](#).

This register holds the value of the second counter register capture

Figure 20-46. TCAR2 Register



LEGEND: R/W = Read/Write; R = Read only; W1toCl = Write 1 to clear bit; -n = value after reset

Table 20-50. TCAR2 Register Field Descriptions

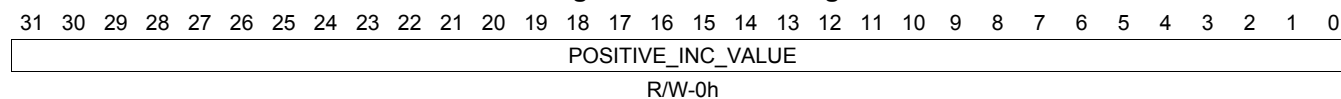
Bit	Field	Type	Reset	Description
31-0	CAPTURE_VALUE2	R	0h	The value of second captured counter register

20.2.4.16 TPIR Register (offset = 48h) [reset = 0h]

TPIR is shown in [Figure 20-47](#) and described in [Table 20-51](#).

This register is used for 1ms tick generation. The TPIR register holds the value of the positive increment. The value of this register is added with the value of the TCVR to define whether next value loaded in TCRR will be the sub-period value or the over-period value.

Figure 20-47. TPIR Register



LEGEND: R/W = Read/Write; R = Read only; W1toCl = Write 1 to clear bit; -n = value after reset

Table 20-51. TPIR Register Field Descriptions

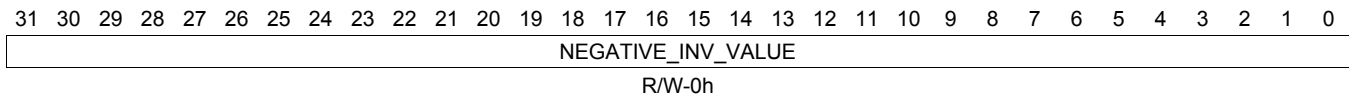
Bit	Field	Type	Reset	Description
31-0	POSITIVE_INC_VALUE	R/W	0h	The value of the positive increment.

20.2.4.17 TNIR Register (offset = 4Ch) [reset = 0h]

TNIR is shown in [Figure 20-48](#) and described in [Table 20-52](#).

This register is used for 1ms tick generation. The TNIR register holds the value of the negative increment. The value of this register is added with the value of the TCVR to define whether next value loaded in TCRR will be the sub-period value or the over-period value.

Figure 20-48. TNIR Register



LEGEND: R/W = Read/Write; R = Read only; W1toCl = Write 1 to clear bit; -n = value after reset

Table 20-52. TNIR Register Field Descriptions

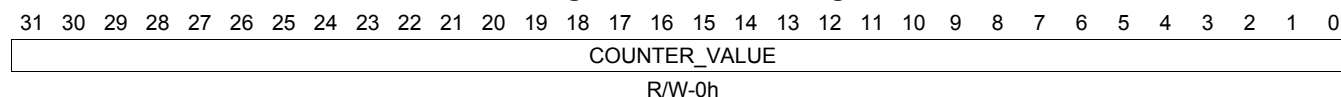
Bit	Field	Type	Reset	Description
31-0	NEGATIVE_INV_VALUE	R/W	0h	The value of the negative increment.

20.2.4.18 TCVR Register (offset = 50h) [reset = 0h]

TCVR is shown in [Figure 20-49](#) and described in [Table 20-53](#).

This register is used for 1ms tick generation. The TCVR register defines whether next value loaded in TCRR will be the sub-period value or the over-period value.

Figure 20-49. TCVR Register



LEGEND: R/W = Read/Write; R = Read only; W1toCl = Write 1 to clear bit; -n = value after reset

Table 20-53. TCVR Register Field Descriptions

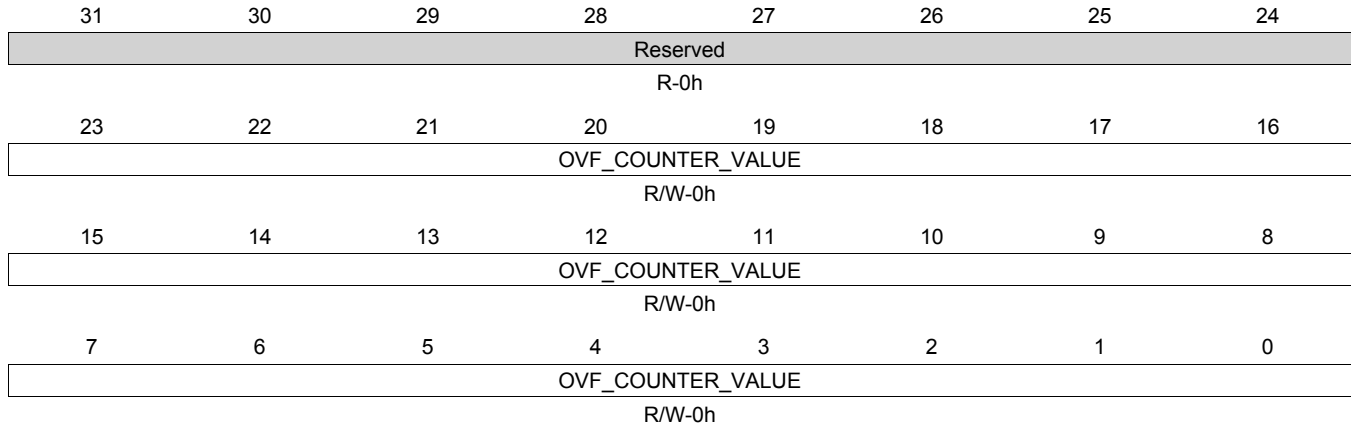
Bit	Field	Type	Reset	Description
31-0	COUNTER_VALUE	R/W	0h	The value of CVR counter.

20.2.4.19 TOCR Register (offset = 54h) [reset = 0h]

TOCR is shown in [Figure 20-50](#) and described in [Table 20-54](#).

This register is used to mask the tick interrupt for a selected number of ticks.

Figure 20-50. TOCR Register



LEGEND: R/W = Read/Write; R = Read only; W1toCl = Write 1 to clear bit; -n = value after reset

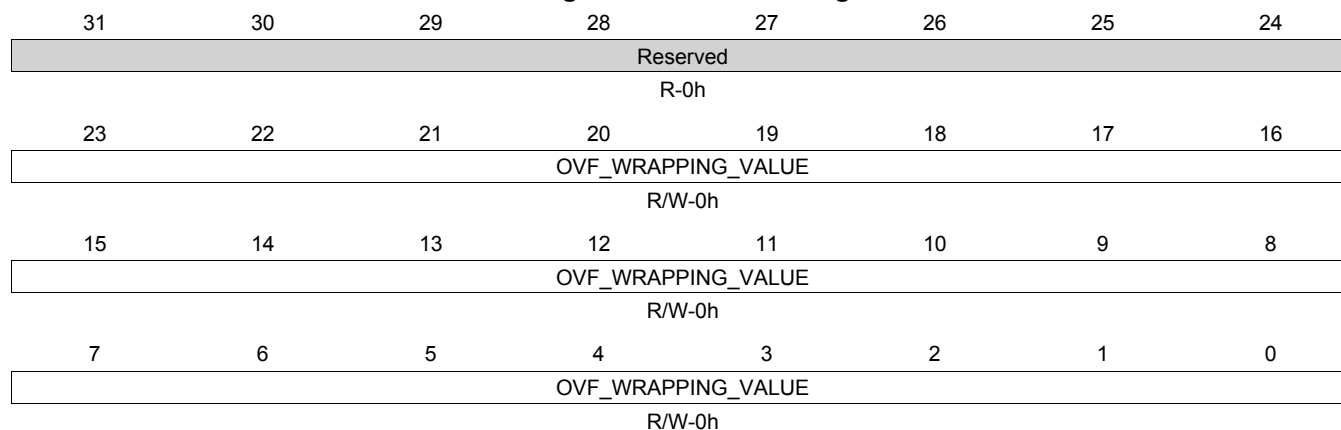
Table 20-54. TOCR Register Field Descriptions

Bit	Field	Type	Reset	Description
31-24	Reserved	R	0h	Reads return 0.
23-0	OVF_COUNTER_VALUE	R/W	0h	The number of overflow events.

20.2.4.20 TOWR Register (offset = 58h) [reset = 0h]

TOWR is shown in [Figure 20-51](#) and described in [Table 20-55](#).

This register holds the number of masked overflow interrupts.

Figure 20-51. TOWR Register


LEGEND: R/W = Read/Write; R = Read only; W1toCl = Write 1 to clear bit; -n = value after reset

Table 20-55. TOWR Register Field Descriptions

Bit	Field	Type	Reset	Description
31-24	Reserved	R	0h	Reads return 0
23-0	OVF_WRAPPING_VALU E	R/W	0h	The number of masked interrupts.

20.3 RTC_SS

20.3.1 Introduction

The real-time clock is a precise timer which can generate interrupts on intervals specified by the user. Interrupts can occur every second, minute, hour, or day. The clock itself can track the passage of real time for durations of several years, provided it has a sufficient power source the whole time.

The basic purpose for the RTC is to keep time of day. The other equally important purpose of RTC is for Digital Rights management. Some degree of tamper proofing is needed to ensure that simply stopping, resetting, or corrupting the RTC does not go unnoticed so that if this occurs, the application can re-acquire the time of day from a trusted source. The final purpose of the RTC is to wake the rest of chip up from a power down state.

Alarms are available to interrupt the CPU at a particular time, or at periodic time intervals, such as once per minute or once per day. In addition, the RTC can interrupt the CPU every time the calendar and time registers are updated, or at programmable periodic intervals.

20.3.1.1 Features

The real-time clock (RTC) provides the following features:

- 100-year calendar (xx00 to xx99)
- Counts seconds, minutes, hours, day of the week, date, month, and year with leap year compensation
- Binary-coded-decimal (BCD) representation of time, calendar, and alarm
- 12-hour clock mode (with AM and PM) or 24-hour clock mode
- Alarm interrupt
- Periodic interrupt
- Single interrupt to the CPU
- Supports external 32.768-kHz crystal or external clock source of the same frequency

20.3.1.2 Unsupported RTC Features

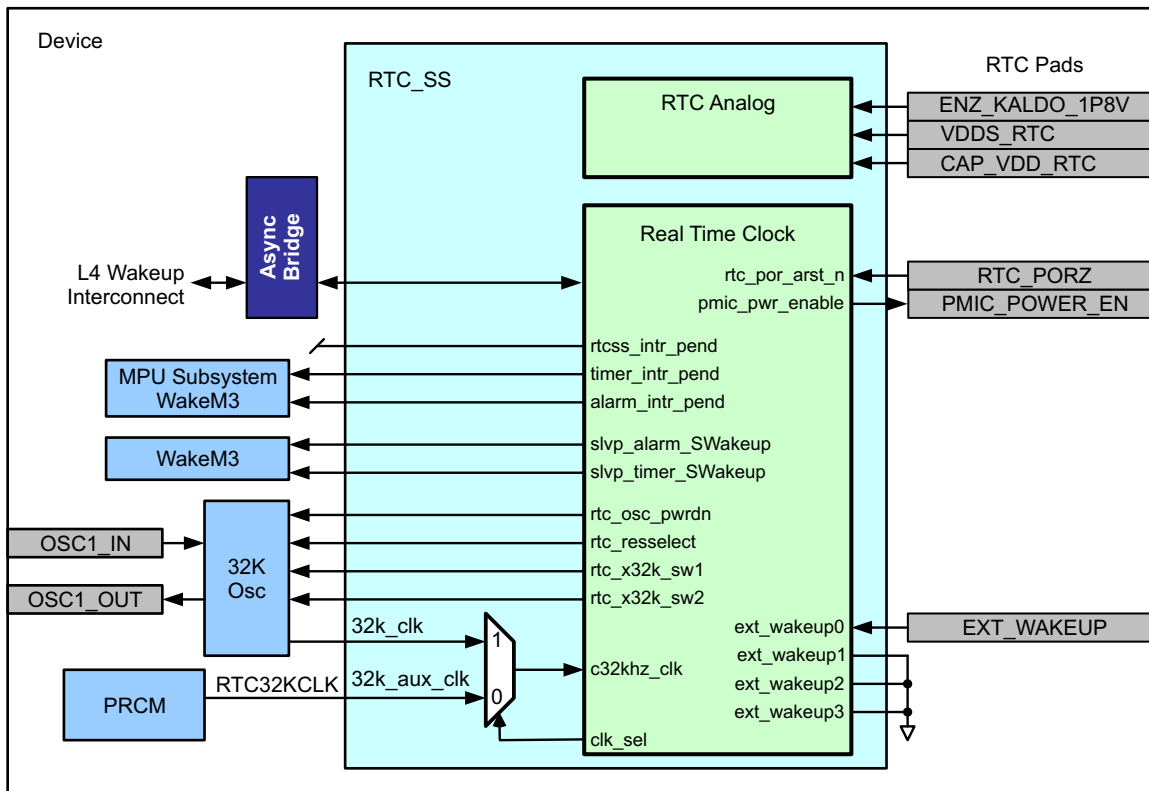
This device supports only a single RTC external wake-up event.

20.3.2 Integration

This device includes a Real-Time Clock Subsystem (RTCSS) module to allow easy tracking of time and date and the generation of real time alarms.

The integration of the RTC is shown in [Figure 20-52](#).

Figure 20-52. RTC Integration



20.3.2.1 RTC Connectivity Attributes

The general connectivity for the RTC module in the device is shown in [Table 20-56](#).

Table 20-56. RTC Module Connectivity Attributes

Attributes	Type
Power Domain	RTC
Clock Domain	PD_RTC_L4_RTC_GCLK (Interface/OCP) PD_RTC_RTC32KCLK (Func) CLK_32K_RTC (Func)
Reset Signals	RTC_DOM_RST_N
Idle/Wakeup Signals	Smart Idle/Wakeup
Interrupt Requests	4 Interrupts Alarm interrupt to MPU Subsystem (RTCINT) and WakeM3 Timer interrupt to MPU Subsystem (RTCALARMINT) and WakeM3 Alarm wakeup to WakeM3 Timer wakeup to WakeM3
DMA Requests	None
Physical Address	L4 Wakeup slave port

20.3.2.2 RTC Clock and Reset Management

The RTC functional clock (c32khz_clk input) is sourced by default from the CLK32_KHZ clock derived from the Peripheral PLL. It can also be sourced from the 32-KHz oscillator through a clock mux within and controlled by the RTC_SS.

Table 20-57. RTC Clock Signals

Clock Signal	Max Freq	Reference / Source	Comments
ocp_clk (Interface clock)	100 MHz	CORE_CLKOUTM4 / 2	pd_rtc_l4_rtc_gclk From PRCM
rtc_32K_clk_rtc_32k_clk (Oscillator functional clock)	32.768 KHz	OSC1_IN	CLK_32K_RTC From OSC1_IN
rtc_32k_clk_rtc_32k_aux_clk (Internal functional clock)	32.768 KHz	PER_CLKOUTM2 / 5859.3752	pd_rtc_rtc_32kclk From PRCM

20.3.2.3 RTC Pin List

The RTC module does not include any external interface pins.

Table 20-58. RTC Pin List

Pin	Type	Description
RTC_PORz	I	RTC Power On Reset
EXT_WAKEUP	I	External wakeup
PMIC_POWER_EN	O	Power enable control for external power management IC
Analog Signals		
ENZ_KALDO_1P8V	I	Enable 1.8V LDO
VDDS_RTC	P	1.8V Voltage Supply
CAP_VDD_RTC	A	Decoupling Cap when internal 1.8 V LDO is enabled, 1.1 V supply when internal 1.8 V LDO is disabled.

20.3.3 Functional Description

This section defines the module interrupt capabilities and requirements.

20.3.3.1 Functional Block Diagram

Figure 20-53 shows the RTC module block diagram. Figure 20-54 shows a functional block diagram of the RTC.

Figure 20-53. RTC Block Diagram

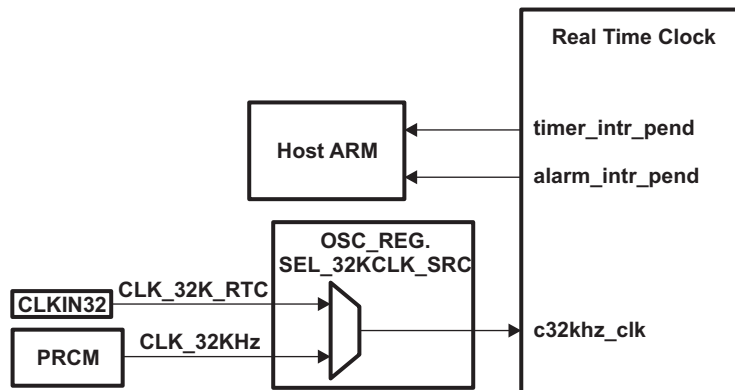
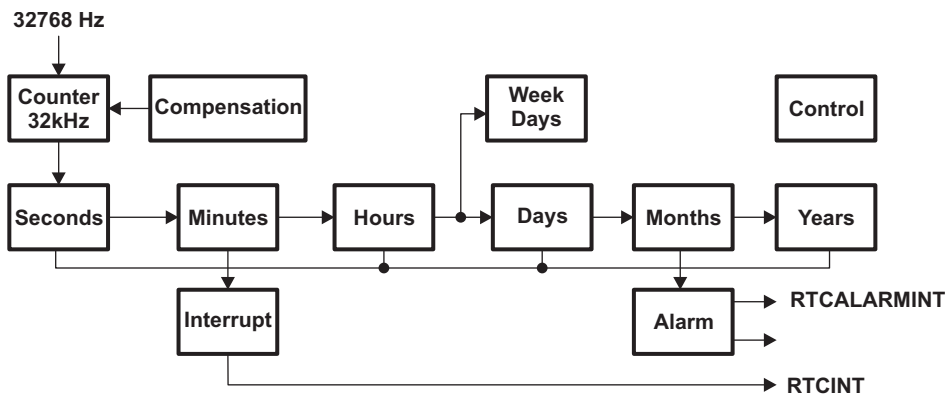


Figure 20-54. RTC Functional Block Diagram



20.3.3.2 Clock Source

The clock reference for the RTC can be sourced from an external crystal (used with the 32K RTC Oscillator), an external 32KHz oscillator, or from the Peripheral PLL. The RTC has an internal oscillator buffer to support direct operation with a crystal. The crystal is connected between pins RTC_XTALIN and RTC_XTALOUT. RTC_XTALIN is the input to the on-chip oscillator and RTC_XTALOUT is the output from the oscillator back to the crystal. The oscillator can be enabled or disabled by using the RTC_OSC_REG register. For more information about the RTC crystal connection, see your device-specific data manual.

An external 32.768-kHz clock oscillator may be used instead of a crystal. In such a case, the clock source is connected to RTC_XTALIN, and RTC_XTALOUT is left unconnected.

The source of the 32-KHz clock is selected using the OSC_CLK.SEL_32KCLK_SRC bit.

If the RTC is not used, the RTC_XTALIN pin should be held low and RTC_XTALOUT should be left unconnected. The RTC_disable bit in the control register (CTRL_REG) can be set to save power; however, the RTC_disable bit should not be cleared once it has been set. If the application requires the RTC module to stop and continue, the STOP_RTC bit in CTRL_REG should be used instead.

20.3.3.3 Signal Descriptions

Table 20-59 lists the signals and their descriptions for the RTC.

Table 20-59. RTC Signals

Signal	I/O	Description
RTC_XTALIN	I	RTC time base input signal. RTC_XTALIN can either be driven with a 32.768-kHz reference clock, or RTC_XTALIN and RTC_XTALOUT can be connected to an external crystal. This signal is the input to the RTC internal oscillator.
RTC_XTALOUT	O	RTC time base output signal. RTC_XTALOUT is the output from the RTC internal oscillator. If a crystal is not used as the time base for RTC_XTALIN, RTC_XTALOUT should be left unconnected.

20.3.3.4 Interrupt Support

20.3.3.4.1 CPU Interrupts

The RTC generates two interrupt outputs:

- timer_intr (RTCINT) is a timer interrupt.
- alarm_intr (RTCALARMINT) is an alarm interrupt.

NOTE: Both interrupt outputs support high-level and high-pulse.

20.3.3.4.2 Interrupt Description

20.3.3.4.2.1 Timer Interrupt RTCINT (timer_intr)

The timer interrupt can be generated periodically: every second, every minute, every hour, or every day (see INTERRUPTS_REG[1:0] for a description of how to set this up). The IT_TIMER bit of the interrupt register enables this interrupt. The timer interrupt is active-low.

The RTC_STATUS_REG[5:2] are only updated at each new interrupt and occur according to Table 20-60. For example, bit 2 (SEC) will always be set when one second has passed. It will also be set when one minute has passed since the completion of one minute also marks the completion of one second (from 59 seconds to 60 seconds). The same holds true for hours and days: each of them will also correspond to the passing of a second.

Conversely, bit 5 (DAY) will always be set when a day has passed. It might also be set when an hour, minute, or second has passed. However, this only occurs when the elapsed hour, minute, or second corresponds to the start of a new day.

Table 20-60. Interrupt Trigger Events

	One day has passed	One hour has passed	One minute has passed	One second has passed
STATUS_REG[5] (DAY)	1	0/1 ⁽¹⁾	0/1 ⁽¹⁾	0/1 ⁽¹⁾
STATUS_REG[4] (HOUR)	1	1	0/1 ⁽¹⁾	0/1 ⁽¹⁾
STATUS_REG[3] (MIN)	1	1	1	0/1 ⁽¹⁾
STATUS_REG[2] (SEC)	1	1	1	1

⁽¹⁾ This event is only triggered when the elapsed time unit (for example, Day) corresponds to the passage of another unit (for example, Seconds). For example, when the clock ticks from 00:23:59:59 (days : hours : minutes : seconds) to 01:00:00:00.

20.3.3.4.2.2 Alarm Interrupt RTCALARMINT (alarm_intr)

The alarm interrupt can be generated when the time set into TC ALARM registers is exactly the same as in the TC registers. This interrupt is then generated if the IT_ALARM bit of the interrupts register is set. This interrupt is low-level sensitive. RTC_STATUS_REG[6] indicates that IRQ_ALARM_CHIP has occurred. This interrupt is disabled by writing '1' into the RTC_STATUS_REG[6].

To set up an alarm:

- Modify the ALARM_SECONDS, ALARM_MINUTES, ALARM_HOURS, ALARM_DAY, ALARM_WEEK, ALARM_MONTH, and ALARM_YEAR registers to the exact time you want an alarm to generate.
- Set the IT_ALARM bit in the RTC_INTERRUPTS register to enable the alarm interrupt.

20.3.3.5 Programming/Usage Guide

20.3.3.5.1 Time/Calendar Data Format

The time and calendar data in the RTC is stored as binary-coded decimal (BCD) format. In BCD format, the decimal numbers 0 through 9 are encoded with their binary equivalent. Although most of the time/calendar registers have 4 bits assigned to each BCD digit, some of the register fields are shorter since the range of valid numbers may be limited. For example, only 3 bits are required to represent the day of the week (WEEKS_REG) since only BCD numbers 1 through 7 are required. The following time and calendar registers are supported (BCD Format):

Note that the ALARM registers which share the names above also share the same BCD formatting.

- SECOND - Second Count (00-59)
- MINUTE - Minute Count (00-59)
- HOUR - Hour Count (12HR: 01-12; 24HR: 00-23)
- DAY - Day of the Month Count (01-31)
- WEEK - Day of the Week (0-6: SUN = 0)
- MONTH - Month Count (01-12; JAN = 1)
- YEAR - Year Count (00-99)

20.3.3.5.2 Register Access

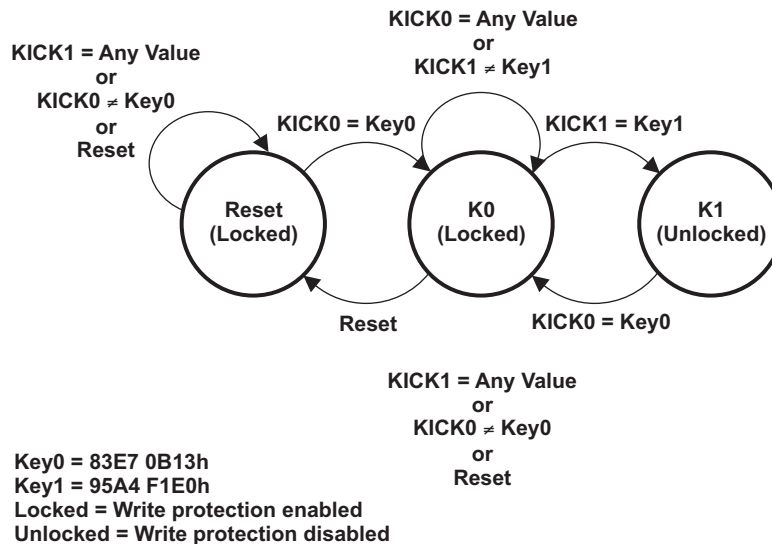
The three register types are as follows and each has its own access constraints:

- TC and TC alarm registers
- General registers
- Compensation registers

20.3.3.5.3 OCP MMR Spurious WRT Protection

The module also contains a kicker mechanism (Figure 20-55) to prevent any spurious writes from changing the register values. This mechanism requires two MMR writes to the Kick0 and Kick1 registers with exact data values before the kicker lock mechanism is released. Once released, the MMRs are writeable. The Kick0 data is 83E7 0B13h; the Kick1 data is 95A4 F1E0h. Note that it remains in an unlocked state until an OCP reset or invalid data pattern is written to one of the Kick0 or Kick1 registers.

Figure 20-55. Kick Register State Machine Diagram



- S0 is the Reset/Idle state
- S1 is an OCP wrt cycle of 83E7 0B13h at Kick0 completed state
- S2 is the UNLOCK MMR WRT state
- S0 -> S1 when OCP wrt cycle of 83E7 0B13h at Kick0
- S1 -> S2 when OCP wrt cycle of 95A4 F1E0h at Kick1
- S1 -> S0 when OCP reset event
- S2 -> S0 when OCP reset event OR OCP wrt cycle of NOT 83E7 0B13h at Kick0 OR OCP wrt cycle at Kick1
- S2 ->S1 when OCP wrt cycle of 83E7 0B13h at Kick0

20.3.3.5.4 Reading the Timer/Calendar (TC) Registers

The TC registers have a read-show register. The reading of the Seconds register will update all of the TC registers. For example, the Year will only get updated on a reading of the Seconds register. The time/calendar registers are updated every second as the time changes. During a read of the SECONDS register, the RTC copies the current values of the time/date registers into shadow read registers. This isolation assures that the CPU can capture all the time/date values at the moment of the SECONDS read request and not be subject to changing register values from time updates.

If desired, the RTC also provides a one-time-triggered minute-rounding feature to round the MINUTE:SECOND registers to the nearest minute (with zero seconds). This feature is enabled by setting the ROUND_30S bit in the control register (CTRL); the RTC automatically rounds the time values to the nearest minute upon the next read of the SECONDS register.

NOTE: Software should always read the Seconds register first. However, the software does not have to poll any status bit to determine when to read the TC registers. [Table 20-61](#) defines the TC set that gets shadowed.

Table 20-61. RTC Register Names and Values

Time Unit	Range	Remarks
Year	00 to 99	
Month	01 to 12	
Day	01 to 31	Months 1, 3, 5, 7, 8, 10, 12
	01 to 30	Months 4, 6, 9, 11
	01 to 29	Month 2 (leap year)
	01 to 28	Month 2 (common year)
Week	00 to 06	Day of week
Hour	00 to 23	24 hour mode
	01 to 12	AM/PM mode
Minute	00 to 59	
Seconds	00 to 59	

20.3.3.5.4.1 Rounding Seconds

Time can be rounded to the closest minute, by setting the ROUND_30S bit of the control register. When this bit is set, TC values are set to the closest minute value at the next second. The ROUND_30S bit will be automatically cleared when rounding time is performed.

Example:

- If current time is 10H59M45S, round operation will change time to 11H00M00S.
- If current time is 10H59M29S, round operation will change time to 10H59M00S.

20.3.3.5.5 Modifying the TC Registers

To write correct data from/to the TC and TC alarm registers and read the TC alarm registers, the ARM must first read the BUSY bit of the STATUS register until BUSY is equal to zero. Once the BUSY flag is zero, there is a 15 μ s access period in which the ARM can program the TC and TC alarm registers. Once the 15 μ s access period passes, the BUSY flag has to be read again from the STATUS register as described previously. If the ARM accesses the TC registers outside of the access period, then the access is not guaranteed.

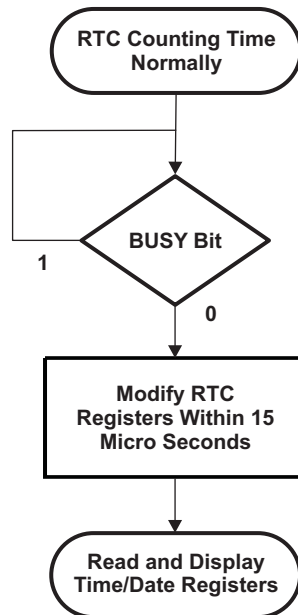
The ARM can access the STATUS_REG and CTRL_REG at any time, with the exception of CTRL_REG[5] which can only be changed when the RTC is stopped. The ARM can stop the RTC by clearing the STOP_RTC bit of the control register. After clearing this bit, the RUN bit in the STATUS_REG (bit 1) needs to be checked to verify the RTC has in fact stopped. Once this is confirmed, the TC values can be updated. After the values have been updated, the RTC can be re-started by resetting the STOP_RTC bit.

NOTE: After writing to a TC register, the user must wait 4 OCP clock cycles before reading the value from the register. If this wait time is not observed and the TC register is accessed, then old data will be read from the register.

CAUTION

In order to remove any possibility of interrupting the register's read process, thus introducing a potential risk of violating the authorized 15-microsecond access period, it is strongly recommended that you disable all incoming interrupts during the register read process.

Figure 20-56. Flow Control for Updating RTC Registers



20.3.3.5.5.1 General Registers

The ARM can access the STATUS_REG and the CTRL_REG at any time (except the CTRL_REG[5] bit which must be changed only when the RTC is stopped). For the INTERRUPTS_REG, the ARM should respect the available access period to prevent false interrupts.

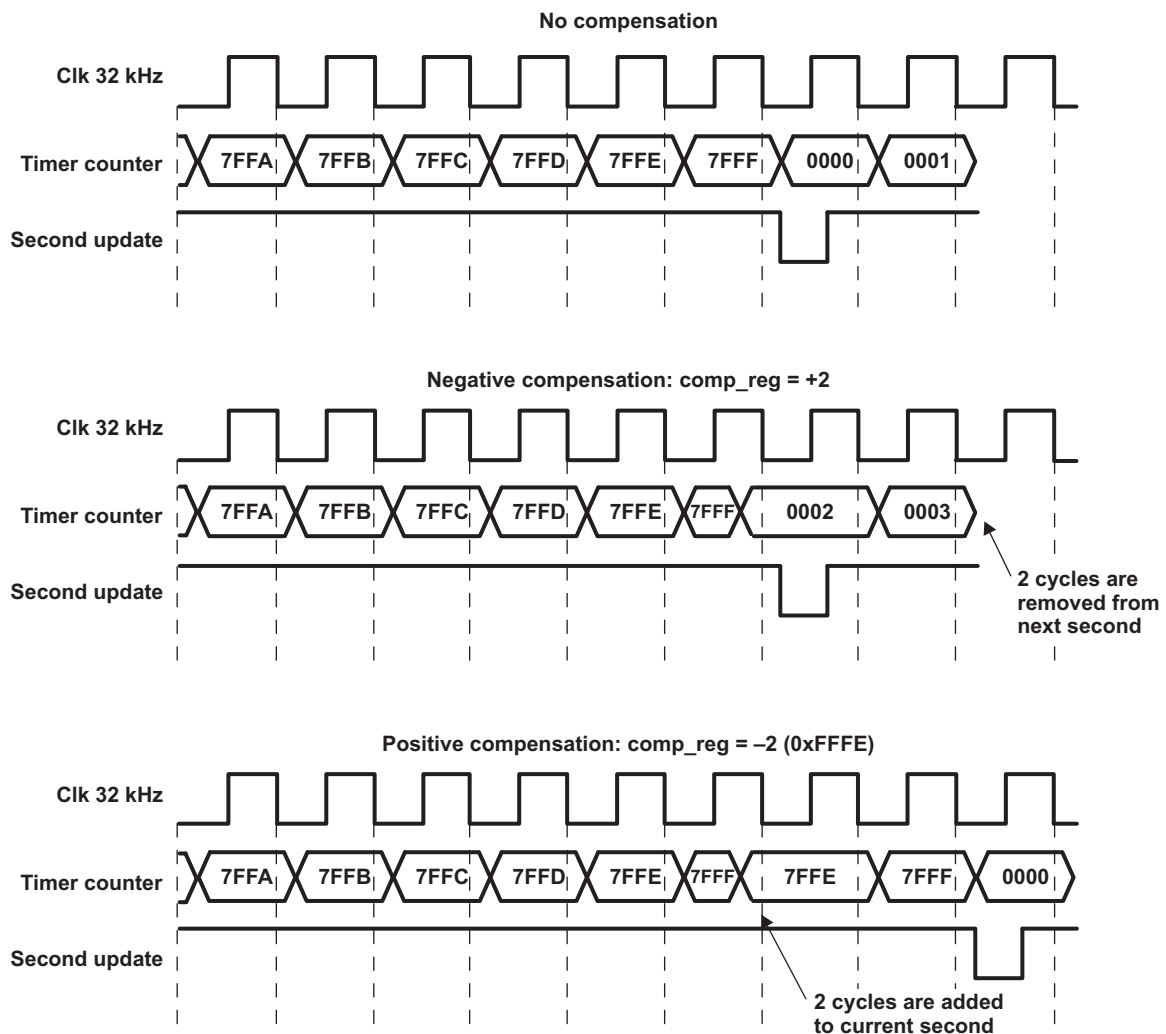
The RTC_DISABLE bit of the CTRL register must only be used to completely disable the RTC function. When this bit is set, the 32 kHz clock is gated, and the RTC is frozen. From this point, resetting this bit to zero can lead to unexpected behavior. In order to save power, this bit should only be used if the RTC function is unwanted in the application.

20.3.3.5.6 Crystal Compensation

To compensate for any inaccuracy of the 32 kHz oscillator, the ARM can perform a calibration of the oscillator frequency, calculate the drift compensation versus one-hour period, and load the compensation registers with the drift compensation value. Auto compensation is enabled by AUTO_COMP_EN bit in the RTC_CTRL register. If the COMP_REG value is positive, compensation occurs after the second change event. COMP_REG cycles are removed from the next second. If the COMP_REG value is negative, compensation occurs before the second change event. COMP_REG cycles are added to the current second. This enables compensation with a 1 32-kHz period accuracy each hour. The waveform below summarizes positive and negative compensation effect.

Access to the COMP_MSB_REG and COMP_LSB_REG registers must respect the available access period. These registers should not be updated during compensation (first second of each hour), but it is alright to update them during the second preceding a compensation event. For example, the ARM could load the compensation value into these registers after each hour event, during an available access period.

Figure 20-57. Compensation Illustration



20.3.3.6 Scratch Registers

The RTC provides three general-purpose registers (SCRATCHx_REG) that can be used to store 32-bit words -- these registers have no functional purpose for the RTC. Software using the RTC may find the SCRATCHx registers to be useful in indicating RTC states. For example, the SCRATCHx_REG registers may be used to indicate write-protection lock status or unintentional power downs. To indicate write-protection, the software should write a unique value to one of the SCRATCHx_REG registers when write-protection is disabled and another unique value when write-protection is enabled again. In this way, the lock-status of the registers can be determined quickly by reading the SCRATCH register. To indicate unintentional power downs, the software should write a unique value to one of the SCRATCHx_REG registers when RTC is configured and enabled. If the RTC is unintentionally powered down, the value written to the SCRATCH register is cleared.

20.3.3.7 Power Management

The RTC supports the power idle protocol. It has two SWakeup ports: one for the alarm event and one for a timer event.

When the RTC is in IDLE mode, the OCP clock is turned off and the 32 kHz clock remains on. The time and calendar continue to count in IDLE mode. When the RTC is placed back in FUNCTIONAL mode, the TC registers can be read.

The Alarm SWakeup event can be used to wakeup the RTC when it is in IDLE state. In order to do so, the alarm needs to be set and enabled before RTC enters the IDLE state. Once this is done, the SWakeup will occur when the alarm event triggers.

NOTE: Since SWakeup is not periodic, using it to wake up the RTC when in IDLE state is not recommended. Please use Alarm SWakeup instead.

20.3.3.8 Power Management—System Level (PMIC Mode)

The RTC generates pmic_power_en control which can be used to control an external PMIC.

Table 20-62. pmic_power_en Description

Port	Direction	Function
rtc_pwronrstn	Input	Not optional. RTC true power on domain reset. Only assert when RTC has lost power. Always de-assert when RTC voltage is greater than Vmin. The port remains de-asserted during normal operations.
pmic_power_en	Output	Optional. Can be used to control an external PMIC. 0 = OFF 1 = ON (reset state) ON → OFF (Turn OFF) By ALARM2 event OFF → ON (Turn ON) By ALARM event OR ext_wakeup event
ext_wakeup	Input	

20.3.4 Use Cases

The following list includes high-level steps to start using the RTC:

1. Enable the module clock domains (for details on which clock domain, see [Section 20.3.2, Integration](#)).
2. Enable the RTC module using CTRL_REG.RTC_disable.
3. Enable the 32K clock from PER PLL, if using the internal RTC oscillator.
4. Write to the kick registers (KICK0R, KICK1R) in the RTC.
5. Configure the timer in RTCSS for desired application (set time and date, alarm wakeup, and so on).
6. Start the RTC (in CTRL_REG.STOP_RTC).

20.3.5 RTC Registers

[Table 20-63](#) lists the memory-mapped registers for the RTC. All register offset addresses not listed in [Table 20-63](#) should be considered as reserved locations and the register contents should not be modified.

Table 20-63. RTC Registers

Offset	Acronym	Register Name	Section
0h	SECONDS_REG	Seconds Register	Section 20.3.5.1
4h	MINUTES_REG	Minutes Register	Section 20.3.5.2
8h	HOURS_REG	Hours Register	Section 20.3.5.3
Ch	DAYS_REG	Day of the Month Register	Section 20.3.5.4
10h	MONTHS_REG	Month Register	Section 20.3.5.5
14h	YEARS_REG	Year Register	Section 20.3.5.6
18h	WEEKS_REG	Day of the Week Register	Section 20.3.5.7
20h	ALARM_SECONDS_REG	Alarm Seconds Register	Section 20.3.5.8
24h	ALARM_MINUTES_REG	Alarm Minutes Register	Section 20.3.5.9
28h	ALARM_HOURS_REG	Alarm Hours Register	Section 20.3.5.10
2Ch	ALARM_DAYS_REG	Alarm Day of the Month Register	Section 20.3.5.11
30h	ALARM_MONTHS_REG	Alarm Months Register	Section 20.3.5.12
34h	ALARM_YEARS_REG	Alarm Years Register	Section 20.3.5.13
40h	RTC_CTRL_REG	Control Register	Section 20.3.5.14
44h	RTC_STATUS_REG	Status Register	Section 20.3.5.15
48h	RTC_INTERRUPTS_REG	Interrupt Enable Register	Section 20.3.5.16
4Ch	RTC_COMP_LSB_REG	Compensation (LSB) Register	Section 20.3.5.17
50h	RTC_COMP_MSB_REG	Compensation (MSB) Register	Section 20.3.5.18
54h	RTC_OSC_REG	Oscillator Register	Section 20.3.5.19
60h	RTC_SCRATCH0_REG	Scratch 0 Register (General-Purpose)	Section 20.3.5.20
64h	RTC_SCRATCH1_REG	Scratch 1 Register (General-Purpose)	Section 20.3.5.21
68h	RTC_SCRATCH2_REG	Scratch 2 Register (General-Purpose)	Section 20.3.5.22
6Ch	KICK0R	Kick 0 Register (Write Protect)	Section 20.3.5.23
70h	KICK1R	Kick 1 Register (Write Protect)	Section 20.3.5.24
74h	RTC_REVISION	Revision Register	Section 20.3.5.25
78h	RTC_SYSCONFIG	System Configuration Register	Section 20.3.5.26
7Ch	RTC_IRQWAKEEN	Wakeup Enable Register	Section 20.3.5.27
80h	ALARM2_SECONDS_REG	Alarm2 Seconds Register	Section 20.3.5.28
84h	ALARM2_MINUTES_REG	Alarm2 Minutes Register	Section 20.3.5.29
88h	ALARM2_HOURS_REG	Alarm2 Hours Register	Section 20.3.5.30
8Ch	ALARM2_DAYS_REG	Alarm2 Day of the Month Register	Section 20.3.5.31
90h	ALARM2_MONTHS_REG	Alarm2 Months Register	Section 20.3.5.32
94h	ALARM2_YEARS_REG	Alarm2 Years Register	Section 20.3.5.33
98h	RTC_PMIC	RTC PMIC Register	Section 20.3.5.34

Table 20-63. RTC Registers (continued)

Offset	Acronym	Register Name	Section
9Ch	RTC_DEBOUNCE	RTC Debounce Register	Section 20.3.5.35

20.3.5.1 SECONDS_REG Register (offset = 0h) [reset = 0h]

SECONDS_REG is shown in [Figure 20-58](#) and described in [Table 20-64](#).

The SECONDS_REG is used to program the required seconds value of the current time. Seconds are stored as BCD format. In BCD format, the decimal numbers 0 through 9 are encoded with their binary equivalent. If the seconds value is 45, then the value of SEC0 is 5 and value of SEC1 is 4.

Figure 20-58. SECONDS_REG Register

31	30	29	28	27	26	25	24	23	22	21	20	19	18	17	16
RESERVED															
R-0h															
15	14	13	12	11	10	9	8	7	6	5	4	3	2	1	0
RESERVED									SEC1			SEC0			
R-0h									R/W-0h			R/W-0h			

LEGEND: R/W = Read/Write; R = Read only; W1toCl = Write 1 to clear bit; -n = value after reset

Table 20-64. SECONDS_REG Register Field Descriptions

Bit	Field	Type	Reset	Description
31-7	RESERVED	R	0h	
6-4	SEC1	R/W	0h	2nd digit of seconds, Range is 0 to 5
3-0	SEC0	R/W	0h	1st digit of seconds, Range is 0 to 9

20.3.5.2 MINUTES_REG Register (offset = 4h) [reset = 0h]

MINUTES_REG is shown in [Figure 20-59](#) and described in [Table 20-65](#).

The MINUTES_REG is used to program the minutes value of the current time. Minutes are stored as BCD format. In BCD format, the decimal numbers 0 through 9 are encoded with their binary equivalent. If the minutes value is 32, then the value of MIN0 is 2 and value of MIN1 is 3.

Figure 20-59. MINUTES_REG Register

31	30	29	28	27	26	25	24	23	22	21	20	19	18	17	16
RESERVED															
R-0h															
15	14	13	12	11	10	9	8	7	6	5	4	3	2	1	0
RESERVED									MIN1			MIN0			
R-0h									R/W-0h			R/W-0h			

LEGEND: R/W = Read/Write; R = Read only; W1toCl = Write 1 to clear bit; -n = value after reset

Table 20-65. MINUTES_REG Register Field Descriptions

Bit	Field	Type	Reset	Description
31-7	RESERVED	R	0h	
6-4	MIN1	R/W	0h	2nd digit of minutes, Range is 0 to 5
3-0	MIN0	R/W	0h	1st digit of minutes, Range is 0 to 9

20.3.5.3 HOURS_REG Register (offset = 8h) [reset = 0h]

HOURS_REG is shown in [Figure 20-60](#) and described in [Table 20-66](#).

The HOURS_REG is used to program the hours value of the current time. Hours are stored as BCD format. In BCD format, the decimal numbers 0 through 9 are encoded with their binary equivalent. In 24Hr time mode if you want to set the hour as 18, then HOUR0 is set as 8 and HOUR1 is set as 1.

Figure 20-60. HOURS_REG Register

31	30	29	28	27	26	25	24
RESERVED							
R-0h							
23	22	21	20	19	18	17	16
RESERVED							
R-0h							
15	14	13	12	11	10	9	8
RESERVED							
R-0h							
7	6	5	4	3	2	1	0
PM_nAM	RESERVED	HOUR1		HOUR0			
R/W-0h	R-0h	R/W-0h		R/W-0h			

LEGEND: R/W = Read/Write; R = Read only; W1toCl = Write 1 to clear bit; -n = value after reset

Table 20-66. HOURS_REG Register Field Descriptions

Bit	Field	Type	Reset	Description
31-8	RESERVED	R	0h	
7	PM_nAM	R/W	0h	Only used in PM_AM mode (otherwise 0) 0h = AM 1h = PM
6	RESERVED	R	0h	
5-4	HOUR1	R/W	0h	2nd digit of hours, Range is 0 to 2
3-0	HOUR0	R/W	0h	1st digit of hours, Range is 0 to 9

20.3.5.4 DAYS_REG Register (offset = Ch) [reset = 1h]

DAYS_REG is shown in [Figure 20-61](#) and described in [Table 20-67](#).

The DAYS_REG is used to program the day of the month value of the current date. Days are stored as BCD format. In BCD format, the decimal numbers 0 through 9 are encoded with their binary equivalent. If the day value of the date is 28, DAY0 is set as 8 and DAY1 is set as 2.

Figure 20-61. DAYS_REG Register

31	30	29	28	27	26	25	24	23	22	21	20	19	18	17	16
RESERVED															
R-0h															
15	14	13	12	11	10	9	8	7	6	5	4	3	2	1	0
RESERVED										DAY1		DAY0			
R-0h										R/W-0h		R/W-1h			

LEGEND: R/W = Read/Write; R = Read only; W1toCl = Write 1 to clear bit; -n = value after reset

Table 20-67. DAYS_REG Register Field Descriptions

Bit	Field	Type	Reset	Description
31-6	RESERVED	R	0h	
5-4	DAY1	R/W	0h	2nd digit of days, Range is 0 to 3
3-0	DAY0	R/W	1h	1st digit of days, Range is 0 to 9

20.3.5.5 MONTHS_REG Register (offset = 10h) [reset = 1h]

MONTHS_REG is shown in [Figure 20-62](#) and described in [Table 20-68](#).

The MONTHS_REG is used to set the month in the year value of the current date. Months are stored as BCD format. In BCD format, the decimal numbers 0 through 9 are encoded with their binary equivalent. Usual notation is taken for month value: 1 = January, 2 = February, continuing until 12 = December.

Figure 20-62. MONTHS_REG Register

31	30	29	28	27	26	25	24
RESERVED							
R-0h							
23	22	21	20	19	18	17	16
RESERVED							
R-0h							
15	14	13	12	11	10	9	8
RESERVED							
R-0h							
7	6	5	4	3	2	1	0
RESERVED			MONTH1	MONTH0			
R-0h			R/W-0h	R/W-1h			

LEGEND: R/W = Read/Write; R = Read only; W1toCl = Write 1 to clear bit; -n = value after reset

Table 20-68. MONTHS_REG Register Field Descriptions

Bit	Field	Type	Reset	Description
31-5	RESERVED	R	0h	
4	MONTH1	R/W	0h	2nd digit of months, Range is 0 to 1
3-0	MONTH0	R/W	1h	1st digit of months, Range is 0 to 9

20.3.5.6 YEARS_REG Register (offset = 14h) [reset = 0h]

YEARS_REG is shown in [Figure 20-63](#) and described in [Table 20-69](#).

The YEARS_REG is used to program the year value of the current date. The year value is represented by only the last 2 digits and is stored as BCD format. In BCD format, the decimal numbers 0 through 9 are encoded with their binary equivalent. The year 1979 is programmed as 79 with YEAR0 set as 9 and YEAR1 set as 7.

Figure 20-63. YEARS_REG Register

31	30	29	28	27	26	25	24	23	22	21	20	19	18	17	16
RESERVED															
R-0h															
15	14	13	12	11	10	9	8	7	6	5	4	3	2	1	0
RESERVED								YEAR1				YEAR0			
R-0h								R/W-0h				R/W-0h			

LEGEND: R/W = Read/Write; R = Read only; W1toCl = Write 1 to clear bit; -n = value after reset

Table 20-69. YEARS_REG Register Field Descriptions

Bit	Field	Type	Reset	Description
31-8	RESERVED	R	0h	
7-4	YEAR1	R/W	0h	2nd digit of years, Range is 0 to 9
3-0	YEAR0	R/W	0h	1st digit of years, Range is 0 to 9

20.3.5.7 WEEKS_REG Register (offset = 18h) [reset = 0h]

WEEKS_REG is shown in [Figure 20-64](#) and described in [Table 20-70](#).

The WEEKS_REG is used to program the day of the week value of the current date. The day of the week is stored as BCD format. In BCD format, the decimal numbers 0 through 9 are encoded with their binary equivalent. Sunday is treated as 0, Monday 1, and ending at Saturday with 6.

Figure 20-64. WEEKS_REG Register

31	30	29	28	27	26	25	24	23	22	21	20	19	18	17	16
RESERVED															
R-0h															
15	14	13	12	11	10	9	8	7	6	5	4	3	2	1	0
RESERVED													WEEK		
R-0h													R/W-0h		

LEGEND: R/W = Read/Write; R = Read only; W1toCl = Write 1 to clear bit; -n = value after reset

Table 20-70. WEEKS_REG Register Field Descriptions

Bit	Field	Type	Reset	Description
31-3	RESERVED	R	0h	
2-0	WEEK	R/W	0h	1st digit of days in a week, Range from 0 (Sunday) to 6 (Saturday)

20.3.5.8 ALARM_SECONDS_REG Register (offset = 20h) [reset = 0h]

ALARM_SECONDS_REG is shown in [Figure 20-65](#) and described in [Table 20-71](#).

The ALARM_SECONDS_REG is used to program the second value for the alarm interrupt. Seconds are stored as BCD format. In BCD format, the decimal numbers 0 through 9 are encoded with their binary equivalent.

Figure 20-65. ALARM_SECONDS_REG Register

31	30	29	28	27	26	25	24	23	22	21	20	19	18	17	16
RESERVED															
R-0h															
15	14	13	12	11	10	9	8	7	6	5	4	3	2	1	0
RESERVED									ALARMSEC1			ALARMSEC0			
R-0h									R/W-0h			R/W-0h			

LEGEND: R/W = Read/Write; R = Read only; W1toCl = Write 1 to clear bit; -n = value after reset

Table 20-71. ALARM_SECONDS_REG Register Field Descriptions

Bit	Field	Type	Reset	Description
31-7	RESERVED	R	0h	
6-4	ALARMSEC1	R/W	0h	2nd digit of seconds, Range is 0 to 5
3-0	ALARMSEC0	R/W	0h	1st digit of seconds, Range is 0 to 9

20.3.5.9 ALARM_MINUTES_REG Register (offset = 24h) [reset = 0h]

ALARM_MINUTES_REG is shown in [Figure 20-66](#) and described in [Table 20-72](#).

The ALARM_MINUTES_REG is used to program the minute value for the alarm interrupt. Minutes are stored as BCD format. In BCD format, the decimal numbers 0 through 9 are encoded with their binary equivalent.

Figure 20-66. ALARM_MINUTES_REG Register

31	30	29	28	27	26	25	24
RESERVED							
R-0h							
23	22	21	20	19	18	17	16
RESERVED							
R-0h							
15	14	13	12	11	10	9	8
RESERVED							
R-0h							
7	6	5	4	3	2	1	0
RESERVED	ALARM_MIN1			ALARM_MIN0			
R-0h	R/W-0h			R/W-0h			

LEGEND: R/W = Read/Write; R = Read only; W1toCl = Write 1 to clear bit; -n = value after reset

Table 20-72. ALARM_MINUTES_REG Register Field Descriptions

Bit	Field	Type	Reset	Description
31-7	RESERVED	R	0h	
6-4	ALARM_MIN1	R/W	0h	2nd digit of minutes, Range is 0 to 5
3-0	ALARM_MIN0	R/W	0h	1st digit of minutes, Range is 0 to 9

20.3.5.10 ALARM_HOURS_REG Register (offset = 28h) [reset = 0h]

ALARM_HOURS_REG is shown in [Figure 20-67](#) and described in [Table 20-73](#).

The ALARM_HOURS_REG is used to program the hour value for the alarm interrupt. Hours are stored as BCD format. In BCD format, the decimal numbers 0 through 9 are encoded with their binary equivalent.

Figure 20-67. ALARM_HOURS_REG Register

31	30	29	28	27	26	25	24
RESERVED							
R-0h							
23	22	21	20	19	18	17	16
RESERVED							
R-0h							
15	14	13	12	11	10	9	8
RESERVED							
R-0h							
7	6	5	4	3	2	1	0
ALARM_PM_n AM	RESERVED	ALARM_HOUR1		ALARM_HOUR0			
R/W-0h	R-0h	R/W-0h		R/W-0h			

LEGEND: R/W = Read/Write; R = Read only; W1toCl = Write 1 to clear bit; -n = value after reset

Table 20-73. ALARM_HOURS_REG Register Field Descriptions

Bit	Field	Type	Reset	Description
31-8	RESERVED	R	0h	
7	ALARM_PM_nAM	R/W	0h	Only used in PM_AM mode (otherwise 0) 0h = AM 1h = PM
6	RESERVED	R	0h	
5-4	ALARM_HOUR1	R/W	0h	2nd digit of hours, Range is 0 to 2
3-0	ALARM_HOUR0	R/W	0h	1st digit of hours, Range is 0 to 9

20.3.5.11 ALARM_DAYS_REG Register (offset = 2Ch) [reset = 1h]

ALARM_DAYS_REG is shown in [Figure 20-68](#) and described in [Table 20-74](#).

The ALARM_DAYS_REG is used to program the day of the month value for the alarm interrupt. Days are stored as BCD format. In BCD format, the decimal numbers 0 through 9 are encoded with their binary equivalent.

Figure 20-68. ALARM_DAYS_REG Register

31	30	29	28	27	26	25	24
RESERVED							
R-0h							
23	22	21	20	19	18	17	16
RESERVED							
R-0h							
15	14	13	12	11	10	9	8
RESERVED							
R-0h							
7	6	5	4	3	2	1	0
RESERVED		ALARM_DAY1		ALARM_DAY0			
R-0h		R/W-0h		R/W-1h			

LEGEND: R/W = Read/Write; R = Read only; W1toCl = Write 1 to clear bit; -n = value after reset

Table 20-74. ALARM_DAYS_REG Register Field Descriptions

Bit	Field	Type	Reset	Description
31-6	RESERVED	R	0h	
5-4	ALARM_DAY1	R/W	0h	2nd digit for days, Range from 0 to 3
3-0	ALARM_DAY0	R/W	1h	1st digit for days, Range from 0 to 9

20.3.5.12 ALARM_MONTHS_REG Register (offset = 30h) [reset = 1h]

ALARM_MONTHS_REG is shown in [Figure 20-69](#) and described in [Table 20-75](#).

The ALARM_MONTHS_REG is used to program the month in the year value for the alarm interrupt. The month is stored as BCD format. In BCD format, the decimal numbers 0 through 9 are encoded with their binary equivalent.

Figure 20-69. ALARM_MONTHS_REG Register

31	30	29	28	27	26	25	24
RESERVED							
R-0h							
23	22	21	20	19	18	17	16
RESERVED							
R-0h							
15	14	13	12	11	10	9	8
RESERVED							
R-0h							
7	6	5	4	3	2	1	0
RESERVED			ALARM_MONT H1	ALARM_MONTH0			
R-0h			R/W-0h	R/W-1h			

LEGEND: R/W = Read/Write; R = Read only; W1toCl = Write 1 to clear bit; -n = value after reset

Table 20-75. ALARM_MONTHS_REG Register Field Descriptions

Bit	Field	Type	Reset	Description
31-5	RESERVED	R	0h	
4	ALARM_MONTH1	R/W	0h	2nd digit of months, Range from 0 to 1
3-0	ALARM_MONTH0	R/W	1h	1st digit of months, Range from 0 to 9

20.3.5.13 ALARM_YEARS_REG Register (offset = 34h) [reset = 0h]

ALARM_YEARS_REG is shown in [Figure 20-70](#) and described in [Table 20-76](#).

The ALARM_YEARS_REG is used to program the year for the alarm interrupt. Only the last two digits are used to represent the year and is stored as BCD format. In BCD format, the decimal numbers 0 through 9 are encoded with their binary equivalent.

Figure 20-70. ALARM_YEARS_REG Register

31	30	29	28	27	26	25	24	23	22	21	20	19	18	17	16
RESERVED															
R-0h															
15	14	13	12	11	10	9	8	7	6	5	4	3	2	1	0
RESERVED								ALARM_YEAR1				ALARM_YEAR0			
R-0h								R/W-0h				R/W-0h			

LEGEND: R/W = Read/Write; R = Read only; W1toCl = Write 1 to clear bit; -n = value after reset

Table 20-76. ALARM_YEARS_REG Register Field Descriptions

Bit	Field	Type	Reset	Description
31-8	RESERVED	R	0h	
7-4	ALARM_YEAR1	R/W	0h	2nd digit of years, Range from 0 to 9
3-0	ALARM_YEAR0	R/W	0h	1st digit of years, Range from 0 to 9

20.3.5.14 RTC_CTRL_REG Register (offset = 40h) [reset = 0h]

RTC_CTRL_REG is shown in [Figure 20-71](#) and described in [Table 20-77](#).

The RTC_CTRL_REG contains the controls to enable/disable the RTC, set the 12/24 hour time mode, to enable the 30 second rounding feature, and to STOP/START the RTC. The SET_32_COUNTER bit must only be used when the RTC is frozen. The RTC_DISABLE bit must only be used to completely disable the RTC function. When this bit is set, the 32 kHz clock is gated and the RTC is frozen. From this point, resetting this bit to zero can lead to unexpected behavior. This bit should only be used if the RTC function is unwanted in the application, in order to save power. MODE_12_24: It is possible to switch between the two modes at any time without disturbing the RTC. Read or write is always performed with the current mode. Auto compensation is enabled by the AUTO_COMP bit. If the COMP_REG value is positive, compensation occurs after the second change event. COMP_REG cycles are removed from the next second. If the COMP_REG value is negative, compensation occurs before the second change event. COMP_REG cycles are added to the current second. This enables it to compensate with one 32-kHz period accuracy each hour. The ROUND_30S bit is a toggle bit; the ARM can only write 1 and the RTC clears it. If the ARM sets the ROUND_30S bit and then reads it, the ARM reads 1 until the round-to-the-closest-minute is performed at the next second. The ARM can stop the RTC by clearing the STOP_RTC bit (owing to internal resynchronization, the RUN bit of the status register (STATUS_REG) must be checked to ensure that the RTC is frozen), then update TC values, and re-start the RTC by resetting the STOP_RTC bit.

Figure 20-71. RTC_CTRL_REG Register

31	30	29	28	27	26	25	24
RESERVED							
R-0h							
23	22	21	20	19	18	17	16
RESERVED							
R-0h							
15	14	13	12	11	10	9	8
RESERVED							
R-0h							
7	6	5	4	3	2	1	0
RESERVED	RTC_DISABLE	SET_32_COUNTER	TEST_MODE	MODE_12_24	AUTO_COMP	ROUND_30S	STOP_RTC
R-0h	R/W-0h	R/W-0h	R/W-0h	R/W-0h	R/W-0h	R/W-0h	R/W-0h

LEGEND: R/W = Read/Write; R = Read only; W1toCl = Write 1 to clear bit; -n = value after reset

Table 20-77. RTC_CTRL_REG Register Field Descriptions

Bit	Field	Type	Reset	Description
31-7	RESERVED	R	0h	
6	RTC_DISABLE	R/W	0h	Disable RTC module and gate 32-kHz reference clock. 0h = RTC enable 1h = RTC disable (no 32 kHz clock)
5	SET_32_COUNTER	R/W	0h	Set the 32-kHz counter with the value stored in the compensation registers when the SET_32_COUNTER bit is set. 0h = No action. 1h = Set the 32Khz counter with compensation registers value
4	TEST_MODE	R/W	0h	Test mode. 0h = Functional mode 1h = Test mode (Auto compensation is enabled when the 32Khz counter reaches its end)

Table 20-77. RTC_CTRL_REG Register Field Descriptions (continued)

Bit	Field	Type	Reset	Description
3	MODE_12_24	R/W	0h	Enable 12-hour mode for HOURS and ALARMHOURS registers. 0h = 24-hr mode 1h = 12-hour mode
2	AUTO_COMP	R/W	0h	Enable oscillator compensation mode. 0h = No auto compensation 1h = Auto compensation enabled
1	ROUND_30S	R/W	0h	Enable one-time rounding to nearest minute on next time register read. 0h = No update 1h = Time is rounded to the nearest minute
0	STOP_RTC	R/W	0h	Stop the RTC 32-kHz counter. 0h = RTC is frozen 1h = RTC is running

20.3.5.15 RTC_STATUS_REG Register (offset = 44h) [reset = 0h]

RTC_STATUS_REG is shown in [Figure 20-72](#) and described in [Table 20-78](#).

The RTC_STATUS_REG contains bits that signal the status of interrupts, events to the processor. Status for the alarm interrupt and timer events are notified by the register. The alarm interrupt keeps its low level until the ARM writes 1 in the ALARM bit of the RTC_STATUS_REG register. ALARM2: This bit will indicate the status of the alarm interrupt. Writing a 1 to the bit clears the interrupt. ALARM: This bit will indicate the status of the alarm interrupt. Writing a 1 to the bit clears the interrupt. ONE_DAY_EVENT1: This bit will indicate if a day event has occurred. An interrupt will be generated to the processor based on the masking of the interrupt controller. ONE_HR_EVENT1: This bit will indicate if an hour event has occurred. An interrupt will be generated to the processor based on the masking of the interrupt controller. ONE_MIN_EVENT1: This bit will indicate if a minute event has occurred. An interrupt will be generated to the processor based on the masking of the interrupt controller. ONE_SEC_EVENT1: This bit will indicate if a second event has occurred. An interrupt will be generated to the processor based on the masking of the interrupt controller. RUN: This bit will indicate if RTC is frozen or it is running. The RUN bit shows the real state of the RTC. Indeed, because the STOP_RTC signal is resynchronized on 32-kHz clock the action of this bit is delayed. BUSY: This bit will give the status of RTC module. The Time and alarm registers can be modified only when this bit is 0. The timer interrupt is a negative edge sensitive low-level pulse (1 OCP cycle duration).

Figure 20-72. RTC_STATUS_REG Register

31	30	29	28	27	26	25	24
RESERVED							
R-0h							
23	22	21	20	19	18	17	16
RESERVED							
R-0h							
15	14	13	12	11	10	9	8
RESERVED							
R-0h							
7	6	5	4	3	2	1	0
ALARM2	ALARM	ONE_DAY_EV ENT	ONE_HR_EVE NT	ONE_MIN_EVE NT	ONE_SEC_EV ENT	RUN	BUSY
R/W-0h	R/W-0h	R-0h	R-0h	R-0h	R-0h	R-0h	R-0h

LEGEND: R/W = Read/Write; R = Read only; W1toCl = Write 1 to clear bit; -n = value after reset

Table 20-78. RTC_STATUS_REG Register Field Descriptions

Bit	Field	Type	Reset	Description
31-8	RESERVED	R	0h	
7	ALARM2	R/W	0h	Indicates that an alarm2 interrupt has been generated. Software needs to wait 31 us before it clears this status to allow pmic_pwr_enable 1->0 transition.
6	ALARM	R/W	0h	Indicates that an alarm interrupt has been generated
5	ONE_DAY_EVENT	R	0h	One day has occurred
4	ONE_HR_EVENT	R	0h	One hour has occurred
3	ONE_MIN_EVENT	R	0h	One minute has occurred
2	ONE_SEC_EVENT	R	0h	One second has occurred
1	RUN	R	0h	RTC is frozen or is running. 0h = RTC is frozen 1h = RTC is running
0	BUSY	R	0h	Status of RTC module. 0h = Updating event in more than 15 s 1h = Updating event

20.3.5.16 RTC_INTERRUPTS_REG Register (offset = 48h) [reset = 0h]

RTC_INTERRUPTS_REG is shown in [Figure 20-73](#) and described in [Table 20-79](#).

The RTC_INTERRUPTS_REG is used to enable or disable the RTC from generating interrupts. The timer interrupt and alarm interrupt can be controlled using this register. The ARM must respect the BUSY period to prevent spurious interrupt. To set a period timer interrupt, the respective period value must be set in the EVERY field. For example, to set a periodic timer interrupt for every hour, the EVERY field has to be set to 2. Along with this the IT_TIMER bit also has to be set for the periodic interrupt to be generated. IT_ALARM bit has to be set to generate an alarm interrupt.

Figure 20-73. RTC_INTERRUPTS_REG Register

31	30	29	28	27	26	25	24
RESERVED							
R-0h							
23	22	21	20	19	18	17	16
RESERVED							
R-0h							
15	14	13	12	11	10	9	8
RESERVED							
R-0h							
7	6	5	4	3	2	1	0
RESERVED			IT_ALARM2	IT_ALARM	IT_TIMER	EVERY	
R-0h			R/W-0h	R/W-0h	R/W-0h	R/W-0h	

LEGEND: R/W = Read/Write; R = Read only; W1toCl = Write 1 to clear bit; -n = value after reset

Table 20-79. RTC_INTERRUPTS_REG Register Field Descriptions

Bit	Field	Type	Reset	Description
31-5	RESERVED	R	0h	
4	IT_ALARM2	R/W	0h	Enable one interrupt when the alarm value is reached (TC ALARM2 registers) by the TC registers
3	IT_ALARM	R/W	0h	Enable one interrupt when the alarm value is reached (TC ALARM registers) by the TC registers
2	IT_TIMER	R/W	0h	Enable periodic interrupt. 0h = Interrupt disabled 1h = Interrupt enabled
1-0	EVERY	R/W	0h	Interrupt period. 0h = Every second 1h = Every minute 2h = Every hour 3h = Every day

20.3.5.17 RTC_COMP_LSB_REG Register (offset = 4Ch) [reset = 0h]

RTC_COMP_LSB_REG is shown in [Figure 20-74](#) and described in [Table 20-80](#).

The COMP_LSB_REG is used to program the LSB value of the 32 kHz periods to be added to the 32 kHz counter every hour. This is used to compensate the oscillator drift. The COMP_LSB_REG works together with the compensation (MSB) register (COMP_MSB_REG). The AUTOCOMP bit in the control register (CTRL_REG) must be enabled for compensation to take place. This register must be written in two's complement. That means that to add one 32-kHz oscillator period every hour, the ARM must write FFFFh into RTC_COMP_MSB_REG and RTC_COMP_LSB_REG. To remove one 32-kHz oscillator period every hour, the ARM must write 0001h into RTC_COMP_MSB_REG and RTC_COMP_LSB_REG. The 7FFFh value is forbidden.

Figure 20-74. RTC_COMP_LSB_REG Register

31	30	29	28	27	26	25	24	23	22	21	20	19	18	17	16
RESERVED															
R-0h															
15	14	13	12	11	10	9	8	7	6	5	4	3	2	1	0
RESERVED								RTC_COMP_LSB							
R-0h								R/W-0h							

LEGEND: R/W = Read/Write; R = Read only; W1toCl = Write 1 to clear bit; -n = value after reset

Table 20-80. RTC_COMP_LSB_REG Register Field Descriptions

Bit	Field	Type	Reset	Description
31-8	RESERVED	R	0h	
7-0	RTC_COMP_LSB	R/W	0h	Indicates number of 32-kHz periods to be added into the 32-kHz counter every hour

20.3.5.18 RTC_COMP_MSB_REG Register (offset = 50h) [reset = 0h]

RTC_COMP_MSB_REG is shown in [Figure 20-75](#) and described in [Table 20-81](#).

The COMP_MSB_REG is used to program the MSB value of the 32 kHz periods to be added to the 32 kHz counter every hour. This is used to compensate the oscillator drift. The COMP_MSB_REG works together with the compensation (LSB) register (COMP_LSB_REG) to set the hourly oscillator compensation value. The AUTOCOMP bit in the control register (CTRL_REG) must be enabled for compensation to take place. This register must be written in two's complement. That means that to add one 32-kHz oscillator period every hour, the ARM must write FFFFh into RTC_COMP_MSB_REG and RTC_COMP_LSB_REG. To remove one 32-kHz oscillator period every hour, the ARM must write 0001h into RTC_COMP_MSB_REG and RTC_COMP_LSB_REG. The 7FFFh value is forbidden.

Figure 20-75. RTC_COMP_MSB_REG Register

31	30	29	28	27	26	25	24	23	22	21	20	19	18	17	16
RESERVED															
R-0h															
15	14	13	12	11	10	9	8	7	6	5	4	3	2	1	0
RESERVED								RTC_COMP_MSB							
R-0h								R/W-0h							

LEGEND: R/W = Read/Write; R = Read only; W1toCl = Write 1 to clear bit; -n = value after reset

Table 20-81. RTC_COMP_MSB_REG Register Field Descriptions

Bit	Field	Type	Reset	Description
31-8	RESERVED	R	0h	
7-0	RTC_COMP_MSB	R/W	0h	Indicates number of 32-kHz periods to be added into the 32-kHz counter every hour

20.3.5.19 RTC_OSC_REG Register (offset = 54h) [reset = 10h]

RTC_OSC_REG is shown in [Figure 20-76](#) and described in [Table 20-82](#).

Figure 20-76. RTC_OSC_REG Register

31	30	29	28	27	26	25	24
RESERVED							
R-0h							
23	22	21	20	19	18	17	16
RESERVED							
R-0h							
15	14	13	12	11	10	9	8
RESERVED							
R-0h							
7	6	5	4	3	2	1	0
RESERVED	EN_32KCLK	RESERVED	OSC32K_GZ	SEL_32KCLK_SRC	RES_SELECT	SW2	SW1
R-0h	R/W-0h	R-0h	R/W-1h	R/W-0h	R/W-0h	R/W-0h	R/W-0h

LEGEND: R/W = Read/Write; R = Read only; W1toCl = Write 1 to clear bit; -n = value after reset

Table 20-82. RTC_OSC_REG Register Field Descriptions

Bit	Field	Type	Reset	Description
31-7	RESERVED	R	0h	
6	EN_32KCLK	R/W	0h	32-kHz clock enable post clock mux of rtc_32k_clk_rtc_32k_aux_clk and rtc_32k_clk_rtc_32k_clk 0h = Disable. 1h = Enable.
5	RESERVED	R	0h	
4	OSC32K_GZ	R/W	1h	Disable the oscillator and apply high impedance to the output 0h = Enable 1h = Disabled and high impedance
3	SEL_32KCLK_SRC	R/W	0h	32-kHz clock source select 0h = Selects internal clock source, namely rtc_32k_clk_rtc_32k_aux_clk 1h = Selects external clock source, namely rtc_32k_clk_rtc_32k_clk that is from the 32-kHz oscillator
2	RES_SELECT	R/W	0h	External feedback resistor 0h = Internal 1h = External
1	SW2	R/W	0h	Inverter size adjustment
0	SW1	R/W	0h	Inverter size adjustment

20.3.5.20 RTC_SCRATCH0_REG Register (offset = 60h) [reset = 0h]

RTC_SCRATCH0_REG is shown in [Figure 20-77](#) and described in [Table 20-83](#).

The RTC_SCRATCH0_REG is used to hold some required values for the RTC register.

Figure 20-77. RTC_SCRATCH0_REG Register

31	30	29	28	27	26	25	24	23	22	21	20	19	18	17	16	15	14	13	12	11	10	9	8	7	6	5	4	3	2	1	0
RTCSCRATCH0																															
R/W-0h																															

LEGEND: R/W = Read/Write; R = Read only; W1toCl = Write 1 to clear bit; -n = value after reset

Table 20-83. RTC_SCRATCH0_REG Register Field Descriptions

Bit	Field	Type	Reset	Description
31-0	RTCSCRATCH0	R/W	0h	Scratch registers, available to program

20.3.5.21 RTC_SCRATCH1_REG Register (offset = 64h) [reset = 0h]

RTC_SCRATCH1_REG is shown in [Figure 20-78](#) and described in [Table 20-84](#).

The RTC_SCRATCH1_REG is used to hold some required values for the RTC register.

Figure 20-78. RTC_SCRATCH1_REG Register

31	30	29	28	27	26	25	24	23	22	21	20	19	18	17	16	15	14	13	12	11	10	9	8	7	6	5	4	3	2	1	0
RTCSCRATCH1																															
R/W-0h																															

LEGEND: R/W = Read/Write; R = Read only; W1toCl = Write 1 to clear bit; -n = value after reset

Table 20-84. RTC_SCRATCH1_REG Register Field Descriptions

Bit	Field	Type	Reset	Description
31-0	RTCSCRATCH1	R/W	0h	Scratch registers, available to program

20.3.5.22 RTC_SCRATCH2_REG Register (offset = 68h) [reset = 0h]

RTC_SCRATCH2_REG is shown in [Figure 20-79](#) and described in [Table 20-85](#).

The RTC_SCRATCH2_REG is used to hold some required values for the RTC register.

Figure 20-79. RTC_SCRATCH2_REG Register

31	30	29	28	27	26	25	24	23	22	21	20	19	18	17	16	15	14	13	12	11	10	9	8	7	6	5	4	3	2	1	0
RTCSCRATCH2																															
R/W-0h																															

LEGEND: R/W = Read/Write; R = Read only; W1toCl = Write 1 to clear bit; -n = value after reset

Table 20-85. RTC_SCRATCH2_REG Register Field Descriptions

Bit	Field	Type	Reset	Description
31-0	RTCSCRATCH2	R/W	0h	Scratch registers, available to program

20.3.5.23 KICK0R Register (offset = 6Ch) [reset = 0h]

KICK0R is shown in [Figure 20-80](#) and described in [Table 20-86](#).

The kick registers (KICKnR) are used to enable and disable write protection on the RTC registers. Out of reset, the RTC registers are write-protected. To disable write protection, correct keys must be written to the KICKnR registers. The Kick0 register allows writing to unlock the kick0 data. To disable RTC register write protection, the value of 83E7 0B13h must be written to KICK0R, followed by the value of 95A4 F1E0h written to KICK1R. RTC register write protection is enabled when any value is written to KICK0R.

Figure 20-80. KICK0R Register

31	30	29	28	27	26	25	24	23	22	21	20	19	18	17	16	15	14	13	12	11	10	9	8	7	6	5	4	3	2	1	0
KICK0_																															
W-0h																															

LEGEND: R/W = Read/Write; R = Read only; W1toCl = Write 1 to clear bit; -n = value after reset

Table 20-86. KICK0R Register Field Descriptions

Bit	Field	Type	Reset	Description
31-0	KICK0_	W	0h	Kick0 data

20.3.5.24 KICK1R Register (offset = 70h) [reset = 0h]

KICK1R is shown in [Figure 20-81](#) and described in [Table 20-87](#).

The kick registers (KICKnR) are used to enable and disable write protection on the RTC registers. Out of reset, the RTC registers are write-protected. To disable write protection, correct keys must be written to the KICKnR registers. The Kick1 register allows writing to unlock the kick1 data and the kicker mechanism to write to other MMRs. To disable RTC register write protection, the value of 83E7 0B13h must be written to KICK0R, followed by the value of 95A4 F1E0h written to KICK1R.

Figure 20-81. KICK1R Register

31	30	29	28	27	26	25	24	23	22	21	20	19	18	17	16	15	14	13	12	11	10	9	8	7	6	5	4	3	2	1	0
KICK1																															
W-0h																															

LEGEND: R/W = Read/Write; R = Read only; W1toCl = Write 1 to clear bit; -n = value after reset

Table 20-87. KICK1R Register Field Descriptions

Bit	Field	Type	Reset	Description
31-0	KICK1	W	0h	Kick1 data

20.3.5.25 RTC_REVISION Register (offset = 74h) [reset = 4EB00904h]

RTC_REVISION is shown in [Figure 20-82](#) and described in [Table 20-88](#).

Figure 20-82. RTC_REVISION Register

31	30	29	28	27	26	25	24
SCHEME		RESERVED			FUNC		
R-1h		R-0h			R-EB0h		
23	22	21	20	19	18	17	16
FUNC							
R-EB0h							
15	14	13	12	11	10	9	8
R_RTL				X_MAJOR			
R-1h				R-1h			
7	6	5	4	3	2	1	0
CUSTOM		Y_MINOR					
R-0h		R-4h					

LEGEND: R/W = Read/Write; R = Read only; W1toCl = Write 1 to clear bit; -n = value after reset

Table 20-88. RTC_REVISION Register Field Descriptions

Bit	Field	Type	Reset	Description
31-30	SCHEME	R	1h	Used to distinguish between old scheme and current
29-28	RESERVED	R	0h	
27-16	FUNC	R	EB0h	Function indicates a software compatible module family
15-11	R_RTL	R	1h	RTL Version (R)
10-8	X_MAJOR	R	1h	Major Revision
7-6	CUSTOM	R	0h	Indicates a special version for a particular device
5-0	Y_MINOR	R	4h	Minor Revision (Y)

20.3.5.26 RTC_SYSCONFIG Register (offset = 78h) [reset = 2h]

 RTC_SYSCONFIG is shown in [Figure 20-83](#) and described in [Table 20-89](#).

Figure 20-83. RTC_SYSCONFIG Register

31	30	29	28	27	26	25	24
RESERVED							
R-0h							
23	22	21	20	19	18	17	16
RESERVED							
R-0h							
15	14	13	12	11	10	9	8
RESERVED							
R-0h							
7	6	5	4	3	2	1	0
RESERVED						IDLEMODE	
R-0h						R/W-2h	

LEGEND: R/W = Read/Write; R = Read only; W1toCl = Write 1 to clear bit; -n = value after reset

Table 20-89. RTC_SYSCONFIG Register Field Descriptions

Bit	Field	Type	Reset	Description
31-2	RESERVED	R	0h	
1-0	IDLEMODE	R/W	2h	Configuration of the local target state management mode, By definition target can handle read/write transaction as long as it is out of IDLE state. 0h = Force-idle mode: local target's idle state follows (acknowledges) the system's idle requests unconditionally, i.e., regardless of the IP module's internal requirements; Backup mode, for debug only. 1h = No-idle mode: local target never enters idle state, Backup mode, for debug only. 2h = Smart-idle mode: local target's state eventually follows (acknowledges) the system's idle requests, depending on the IP module's internal requirements, IP module shall not generate (IRQ- or DMA-request-related) wakeup events. 3h = Smart-idle wakeup-capable mode: local target's idle state eventually follows (acknowledges) the system's idle requests, depending on the IP module's internal requirements, IP module may generate (IRQ- or DMA-request-related) wakeup events when in idle state.

20.3.5.27 RTC_IRQWAKEEN Register (offset = 7Ch) [reset = 0h]

 RTC_IRQWAKEEN is shown in [Figure 20-84](#) and described in [Table 20-90](#).

Figure 20-84. RTC_IRQWAKEEN Register

31	30	29	28	27	26	25	24
RESERVED							
R-0h							
23	22	21	20	19	18	17	16
RESERVED							
R-0h							
15	14	13	12	11	10	9	8
RESERVED							
R-0h							
7	6	5	4	3	2	1	0
RESERVED						ALARM_WAKE EN	TIMER_WAKE EN
R-0h						R/W-0h	R/W-0h

LEGEND: R/W = Read/Write; R = Read only; W1toCl = Write 1 to clear bit; -n = value after reset

Table 20-90. RTC_IRQWAKEEN Register Field Descriptions

Bit	Field	Type	Reset	Description
31-2	RESERVED	R	0h	
1	ALARM_WAKEEN	R/W	0h	Wakeup generation for event Alarm. 0h = Wakeup disabled 1h = Wakeup enabled
0	TIMER_WAKEEN	R/W	0h	Wakeup generation for event Timer. 0h = Wakeup disabled 1h = Wakeup enabled

20.3.5.28 ALARM2_SECONDS_REG Register (offset = 80h) [reset = 0h]

ALARM2_SECONDS_REG is shown in [Figure 20-85](#) and described in [Table 20-91](#).

The ALARM2_SECONDS_REG is used to program the second value for the alarm2 time. Seconds are stored as BCD format. In BCD format, the decimal numbers 0 through 9 are encoded with their binary equivalent.

Figure 20-85. ALARM2_SECONDS_REG Register

31	30	29	28	27	26	25	24
RESERVED							
R-0h							
23	22	21	20	19	18	17	16
RESERVED							
R-0h							
15	14	13	12	11	10	9	8
RESERVED							
R-0h							
7	6	5	4	3	2	1	0
RESERVED	ALARM2_SEC1			ALARM2_SEC0			
R-0h	R/W-0h			R/W-0h			

LEGEND: R/W = Read/Write; R = Read only; W1toCl = Write 1 to clear bit; -n = value after reset

Table 20-91. ALARM2_SECONDS_REG Register Field Descriptions

Bit	Field	Type	Reset	Description
31-7	RESERVED	R	0h	
6-4	ALARM2_SEC1	R/W	0h	2nd digit of seconds, Range is 0 to 5
3-0	ALARM2_SEC0	R/W	0h	1st digit of seconds, Range is 0 to 9

20.3.5.29 ALARM2_MINUTES_REG Register (offset = 84h) [reset = 0h]

ALARM2_MINUTES_REG is shown in [Figure 20-86](#) and described in [Table 20-92](#).

The ALARM2_MINUTES_REG is used to program the minute value for the alarm2 time. Minutes are stored as BCD format. In BCD format, the decimal numbers 0 through 9 are encoded with their binary equivalent.

Figure 20-86. ALARM2_MINUTES_REG Register

31	30	29	28	27	26	25	24
RESERVED							
R-0h							
23	22	21	20	19	18	17	16
RESERVED							
R-0h							
15	14	13	12	11	10	9	8
RESERVED							
R-0h							
7	6	5	4	3	2	1	0
RESERVED	ALARM2_MIN1			ALARM2_MIN0			
R-0h	R/W-0h			R/W-0h			

LEGEND: R/W = Read/Write; R = Read only; W1toCl = Write 1 to clear bit; -n = value after reset

Table 20-92. ALARM2_MINUTES_REG Register Field Descriptions

Bit	Field	Type	Reset	Description
31-7	RESERVED	R	0h	
6-4	ALARM2_MIN1	R/W	0h	2nd digit of minutes, Range is 0 to 5
3-0	ALARM2_MIN0	R/W	0h	1st digit of minutes, Range is 0 to 9

20.3.5.30 ALARM2_HOURS_REG Register (offset = 88h) [reset = 0h]

ALARM2_HOURS_REG is shown in [Figure 20-87](#) and described in [Table 20-93](#).

The ALARM2_HOURS_REG is used to program the hour value for the alarm2 time. Hours are stored as BCD format. In BCD format, the decimal numbers 0 through 9 are encoded with their binary equivalent.

Figure 20-87. ALARM2_HOURS_REG Register

31	30	29	28	27	26	25	24
RESERVED							
R-0h							
23	22	21	20	19	18	17	16
RESERVED							
R-0h							
15	14	13	12	11	10	9	8
RESERVED							
R-0h							
7	6	5	4	3	2	1	0
ALARM2_PM_nAM	RESERVED	ALARM2_HOUR1		ALARM2_HOUR0			
R/W-0h	R-0h	R/W-0h		R/W-0h			

LEGEND: R/W = Read/Write; R = Read only; W1toCl = Write 1 to clear bit; -n = value after reset

Table 20-93. ALARM2_HOURS_REG Register Field Descriptions

Bit	Field	Type	Reset	Description
31-8	RESERVED	R	0h	
7	ALARM2_PM_nAM	R/W	0h	Only used in PM_AM mode (otherwise 0) 0h = AM 1h = PM
6	RESERVED	R	0h	
5-4	ALARM2_HOUR1	R/W	0h	2nd digit of hours, Range is 0 to 2
3-0	ALARM2_HOUR0	R/W	0h	1st digit of hours, Range is 0 to 9

20.3.5.31 ALARM2_DAYS_REG Register (offset = 8Ch) [reset = 1h]

ALARM2_DAYS_REG is shown in [Figure 20-88](#) and described in [Table 20-94](#).

The ALARM2_DAYS_REG is used to program the day of the month value for the alarm2 date. Days are stored as BCD format. In BCD format, the decimal numbers 0 through 9 are encoded with their binary equivalent.

Figure 20-88. ALARM2_DAYS_REG Register

31	30	29	28	27	26	25	24
RESERVED							
R-0h							
23	22	21	20	19	18	17	16
RESERVED							
R-0h							
15	14	13	12	11	10	9	8
RESERVED							
R-0h							
7	6	5	4	3	2	1	0
RESERVED		ALARM2_DAY1		ALARM2_DAY0			
R-0h		R/W-0h		R/W-1h			

LEGEND: R/W = Read/Write; R = Read only; W1toCl = Write 1 to clear bit; -n = value after reset

Table 20-94. ALARM2_DAYS_REG Register Field Descriptions

Bit	Field	Type	Reset	Description
31-6	RESERVED	R	0h	
5-4	ALARM2_DAY1	R/W	0h	2nd digit for days, Range from 0 to 3
3-0	ALARM2_DAY0	R/W	1h	1st digit for days, Range from 0 to 9

20.3.5.32 ALARM2_MONTHS_REG Register (offset = 90h) [reset = 1h]

ALARM2_MONTHS_REG is shown in [Figure 20-89](#) and described in [Table 20-95](#).

The ALARM2_MONTHS_REG is used to program the month in the year value for the alarm2 date. The month is stored as BCD format. In BCD format, the decimal numbers 0 through 9 are encoded with their binary equivalent.

Figure 20-89. ALARM2_MONTHS_REG Register

31	30	29	28	27	26	25	24
RESERVED							
R-0h							
23	22	21	20	19	18	17	16
RESERVED							
R-0h							
15	14	13	12	11	10	9	8
RESERVED							
R-0h							
7	6	5	4	3	2	1	0
RESERVED			ALARM2_MON TH1	ALARM2_MONTH0			
R-0h			R/W-0h	R/W-1h			

LEGEND: R/W = Read/Write; R = Read only; W1toCl = Write 1 to clear bit; -n = value after reset

Table 20-95. ALARM2_MONTHS_REG Register Field Descriptions

Bit	Field	Type	Reset	Description
31-5	RESERVED	R	0h	
4	ALARM2_MONTH1	R/W	0h	2nd digit of months, Range from 0 to 1
3-0	ALARM2_MONTH0	R/W	1h	1st digit of months, Range from 0 to 9

20.3.5.33 ALARM2_YEARS_REG Register (offset = 94h) [reset = 0h]

ALARM2_YEARS_REG is shown in [Figure 20-90](#) and described in [Table 20-96](#).

The ALARM2_YEARS_REG is used to program the year for the alarm2 date. Only the last two digits are used to represent the year and stored as BCD format. In BCD format, the decimal numbers 0 through 9 are encoded with their binary equivalent.

Figure 20-90. ALARM2_YEARS_REG Register

31	30	29	28	27	26	25	24	23	22	21	20	19	18	17	16
RESERVED															
R-0h															
15	14	13	12	11	10	9	8	7	6	5	4	3	2	1	0
RESERVED								ALARM2_YEAR1				ALARM2_YEAR0			
R-0h								R/W-0h				R/W-0h			

LEGEND: R/W = Read/Write; R = Read only; W1toCl = Write 1 to clear bit; -n = value after reset

Table 20-96. ALARM2_YEARS_REG Register Field Descriptions

Bit	Field	Type	Reset	Description
31-8	RESERVED	R	0h	
7-4	ALARM2_YEAR1	R/W	0h	2nd digit of years, Range from 0 to 9
3-0	ALARM2_YEAR0	R/W	0h	1st digit of years, Range from 0 to 9

20.3.5.34 RTC_PMIC Register (offset = 98h) [reset = 0h]

 RTC_PMIC is shown in [Figure 20-91](#) and described in [Table 20-97](#).

Figure 20-91. RTC_PMIC Register

31	30	29	28	27	26	25	24
RESERVED							
R-0h							
23	22	21	20	19	18	17	16
RESERVED					PWR_ENABLE_SM		PWR_ENABLE_EN
R-0h					R-0h		R/W-0h
15	14	13	12	11	10	9	8
EXT_WAKEUP_STATUS				EXT_WAKEUP_DB_EN			
R/W-0h				R/W-0h			
7	6	5	4	3	2	1	0
EXT_WAKEUP_POL				EXT_WAKEUP_EN			
R/W-0h				R/W-0h			

LEGEND: R/W = Read/Write; R = Read only; W1toCl = Write 1 to clear bit; -n = value after reset

Table 20-97. RTC_PMIC Register Field Descriptions

Bit	Field	Type	Reset	Description
31-19	RESERVED	R	0h	
18-17	PWR_ENABLE_SM	R	0h	Power state machine state. 00b = Idle/Default. 01b = Shutdown (ALARM2 and PWR_ENABLE_EN is set to 1). Note: 31 us latency from ALARM2 event). 10b = Time-based wakeup (ALARM status is set). 11b = External-event-based wakeup (one or more bit set in EXT_WAKEUP_STATUS).
16	PWR_ENABLE_EN	R/W	0h	Enable for PMIC_POWER_EN signal. 0b = Disable. When Disabled, pmic_power_en signal will always be driven as 1, ON state. 1b = Enable. When Enabled: pmic_power_en signal will be controlled by ext_wakeup, alarm, and alarm2 ON -> OFF (Turn OFF) only by ALARM2 event OFF -> ON (TURN ON) only by ALARM event OR ext_wakeup event.
15-12	EXT_WAKEUP_STATUS	R/W	0h	External wakeup status. Write 1 to clear EXT_WAKEUP_STATUS[n] status of ext_wakeup[n]. 0b = External wakeup event has not occurred. 1b = External wakeup event has occurred.
11-8	EXT_WAKEUP_DB_EN	R/W	0h	External wakeup debounce enabled. EXT_WAKEUP_DB_EN[n] controls ext_wakeup[n]. 0b = Disable. 1b = Enable. When enabled, RTC_DEBOUNCE_REG defines the debounce time.
7-4	EXT_WAKEUP_POL	R/W	0h	External wakeup inputs polarity. EXT_WAKEUP_POL[n] controls ext_wakeup[n]. 0b = Active high. 1b = Active low.
3-0	EXT_WAKEUP_EN	R/W	0h	Enable external wakeup inputs. EXT_WAKEUP_EN[n] controls ext_wakeup[n]. 0b = External wakeup disabled. 1b = External wakeup enabled.

20.3.5.35 RTC_DEBOUNCE Register (offset = 9Ch) [reset = 0h]

RTC_DEBOUNCE is shown in [Figure 20-92](#) and described in [Table 20-98](#).

The debounce timer uses the 32768-Hz clock. It allows choosing the timing or the accuracy of debouncing. A register receives a bit from the reference pin. You will choose the timing if you use the debouncing like a timer, or you will choose the accuracy if you use the debouncing like a real debouncing. The debouncing will be finished when the reference pin will stay the same value (defined in DEBOUNCE_REG) for a defined time.

Figure 20-92. RTC_DEBOUNCE Register

31	30	29	28	27	26	25	24	23	22	21	20	19	18	17	16
RESERVED															
R-0h															
15	14	13	12	11	10	9	8	7	6	5	4	3	2	1	0
RESERVED								DEBOUNCE_REG							
R-0h								R/W-0h							

LEGEND: R/W = Read/Write; R = Read only; W1toCl = Write 1 to clear bit; -n = value after reset

Table 20-98. RTC_DEBOUNCE Register Field Descriptions

Bit	Field	Type	Reset	Description
31-8	RESERVED	R	0h	
7-0	DEBOUNCE_REG	R/W	0h	Debounce time. A value, n, other than 0 results in a debounce time of $30.52 \text{ s} \cdot (n+1)$. 0h = Debounce time is 30.52 s.

20.4 WATCHDOG

20.4.1 Introduction

The watchdog timer is an upward counter capable of generating a pulse on the reset pin and an interrupt to the device system modules following an overflow condition. The watchdog timer serves resets to the PRCM module and serves watchdog interrupts to the host ARM. The reset of the PRCM module causes a warm reset of the device.

The watchdog timer can be accessed, loaded, and cleared by registers through the L4 interface. The timer clock input is a 32-kHz clock.

The watchdog timer connects to a single target agent port on the L4 interconnect. The default state of the watchdog timer is enabled and not running.

20.4.1.1 Features

The main features of the watchdog timer controllers are:

- L4 slave interface support:
 - 32-bit data bus width
 - 32-/16-bit access supported
 - 8-bit access not supported
 - 11-bit address bus width
 - Burst mode not supported
 - Write nonposted transaction mode only
- Free-running 32-bit upward counter
- Programmable divider clock source (2^n where $n = 0-7$)
- On-the-fly read/write register (while counting)
- Subset programming model of the GP timer
- The watchdog timers are reset either on power-on or after a warm reset before they start counting.
- Reset or interrupt actions when a timer overflow condition occurs
- The watchdog timer generates a reset or an interrupt in its hardware integration.

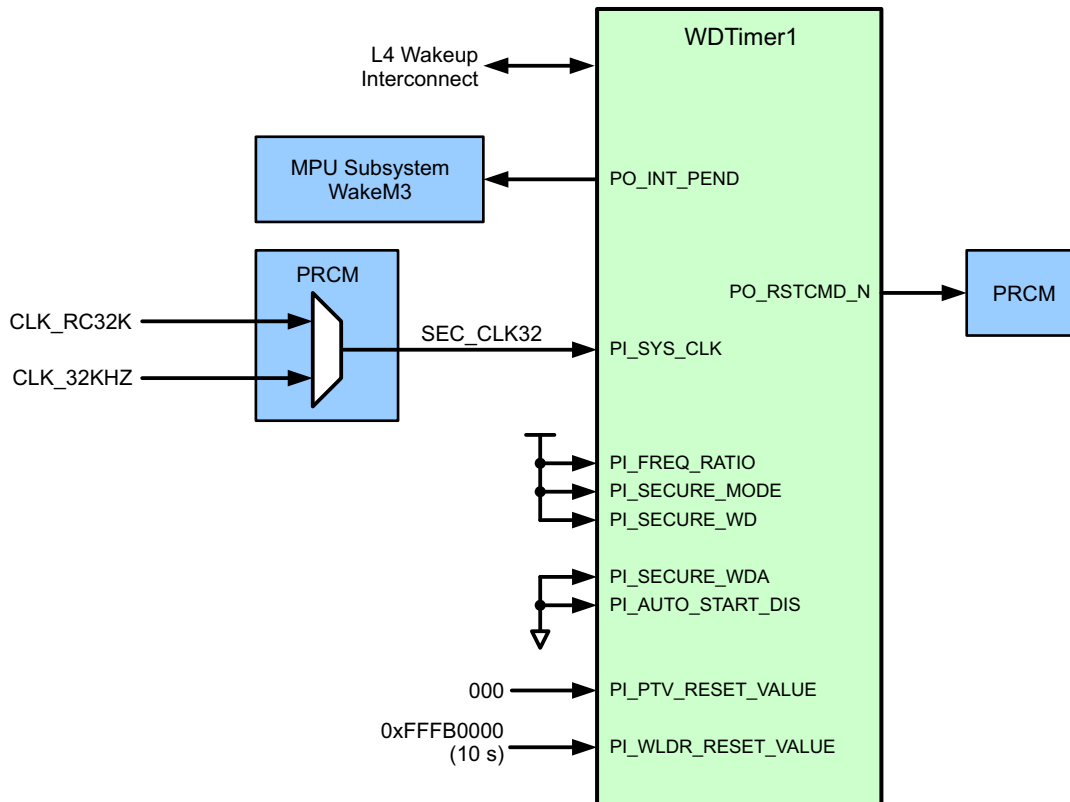
20.4.1.2 Unsupported Features

There are no unsupported WD Timer features in this device.

20.4.2 Integration

The integration of the WD Timer is shown in [Figure 20-93](#).

Figure 20-93. WDTimer Integration



20.4.2.1 Public WD Timer Connectivity Attributes

The general connectivity for the WD Timer module in this device is shown in [Table 20-99](#).

Table 20-99. Public WD Timer Module Connectivity Attributes

Attributes	Type
Power Domain	Wakeup Domain
Clock Domain	PD_WKUP_L4_WKUP_GCLK (OCP) PD_WKUP_WDT1_GCLK (Func)
Reset Signals	WKUP_DOM_RST_N
Idle/Wakeup Signals	Smart Idle / Slave Wakeup
Interrupt Requests	1 Interrupt to MPU Subsystem (WDT1INT) and WakeM3
DMA Requests	None
Physical Address	L4 Wakeup slave port

20.4.2.2 Public WD Timer Clock and Reset Management

The Watchdog Timer functional clock (pi_sys_clk input) is sourced from either the on-chip ~32768 Hz oscillator (CLK_RC32K) or the PER PLL generated 32.768 KHz clock (CLK_32KHZ) as selected using CLKSEL_WDT1_CLK[CLKSEL] in the PRCM.

Table 20-100. Public WD Timer Clock Signals

Clock Signal	Max Freq	Reference / Source	Comments
PI_OCP_CLK Interface clock	100 MHz	CORE_CLKOUTM4 / 2	pd_wkup_l4_wkup_gclk from PRCM
PI_SYS_CLK Functional clock	32768 Hz	CLK_RC32K or CLK_32KHZ (PER_CLKOUTM2 / 5859.375)	pd_wkup_wdt1_gclk from PRCM

20.4.3 Functional Description

20.4.3.1 Power Management

There are two clock domains in the watchdog timers:

- Functional clock domain: WDTi_FCLK is a 32 kHz watchdog timer functional clock. It is used to clock the watchdog timer internal logic.
- Interface clock domain: WDTi_ICLK is a 125 MHz watchdog timer interface clock. It is used to synchronize the watchdog timer L4 port to the L4 interconnect. All accesses from the interconnect are synchronous to WDTi_ICLK.

In this device, the clocks to the watchdog timers are always On. The clocks cannot be turned off if the watchdog timers are not being used.

20.4.3.2 Interrupts

Table 20-101 list the event flags, and their masks, that cause module interrupts.

Table 20-101. Watchdog Timer Events

Event Flag	Event Mask	Mapping	Comments
WDT_WIRQSTAT[0] EVENT_OVF	WDT_WIRQENSET/WDT_WIRQENCLR[0] OVF_IT_ENA	WDTINT	Watchdog timer overflow
WDT_WIRQSTAT[1] EVENT_DLY	WDT_WIRQENSET/WDT_WIRQENCLR[1] DLY_IT_ENA	WDTINT	Watchdog delay value reached

20.4.3.3 General Watchdog Timer Operation

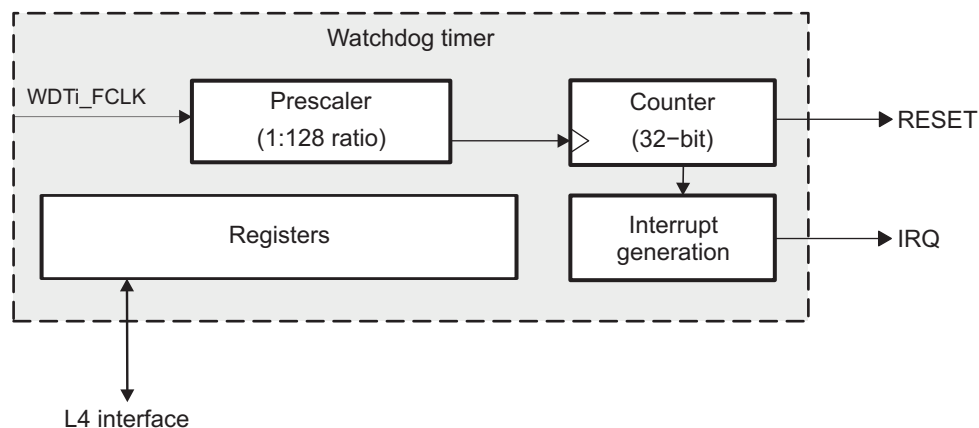
The watchdog timers are based on an upward 32-bit counter coupled with a prescaler. The counter overflow is signaled through two independent signals: a simple reset signal and an interrupt signal, both active low. Figure 20-94 is a functional block diagram of the watchdog timer.

The interrupt generation mechanism is controlled through the WDT_WIRQENSET/WDT_WIRQENCLR and WDT_WIRQSTAT registers.

The prescaler ratio can be set from 1 to 128 by accessing the WDT_WCLR[4:2] PTV bit field and the WDT_WCLR[5] PRE bit of the watchdog control register (WDT_WCLR).

The current timer value can be accessed on-the-fly by reading the watchdog timer counter register (WDT_WCRR), modified by accessing the watchdog timer load register (WDT_WLDR) (no on-the-fly update), or reloaded by following a specific reload sequence on the watchdog timer trigger register (WDT_WTGR). A start/stop sequence applied to the watchdog timer start/stop register (WDT_WSPPR) can start and stop the watchdog timers.

Figure 20-94. 32-Bit Watchdog Timer Functional Block Diagram



20.4.3.4 Reset Context

The watchdog timers are enabled after reset. [Table 20-102](#) lists the default reset values of the two watchdog timer load registers (the WDT_WLDR) and prescaler ratios (the WDT_WCLR[4:2] PTV bit field). To get these values, software must read the corresponding WDT_WCLR[4:2] PTV bit field and the 32-bit register to retrieve the static configuration of the module.

Table 20-102. Count and Prescaler Default Reset Values

Timer	WDT_WLDR Reset Value	PTV Reset Value
WDT	FFFF FFBEh	0

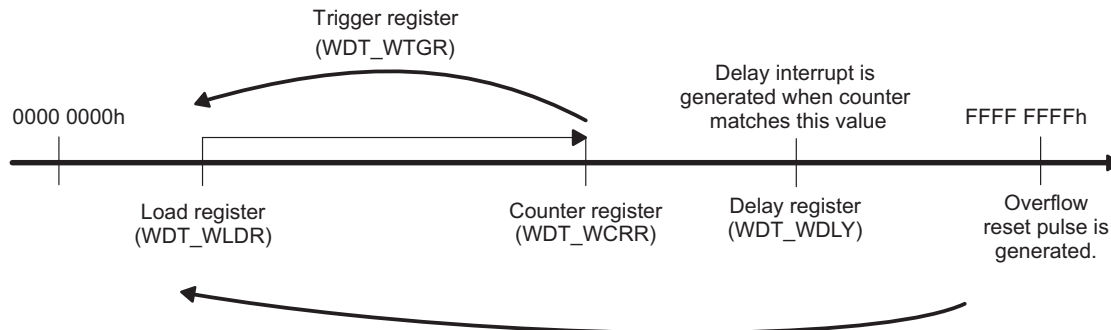
20.4.3.5 Overflow/Reset Generation

When the watchdog timer counter register (WDT_WCRR) overflows, an active-low reset pulse is generated to the PRCM module. This RESET pulse causes the PRCM module to generate global WARM reset of the device, which causes the nRESETIN_OUT pin to be driven out of the device. This pulse is one prescaled timer clock cycle wide and occurs at the same time as the timer counter overflow.

After reset generation, the counter is automatically reloaded with the value stored in the watchdog load register (WDT_WLDR) and the prescaler is reset (the prescaler ratio remains unchanged). When the reset pulse output is generated, the timer counter begins incrementing again.

[Figure 20-95](#) shows a general functional view of the watchdog timers.

Figure 20-95. Watchdog Timers General Functional View



20.4.3.6 Prescaler Value/Timer Reset Frequency

Each watchdog timer is composed of a prescaler stage and a timer counter.

The timer rate is defined by the following values:

- Value of the prescaler fields (the WDT_WCLR[5] PRE bit and the WDT_WCLR[4:2] PTV bit field)
- Value loaded into the timer load register (WDT_WLDR)

The prescaler stage is clocked with the timer clock and acts as a clock divider for the timer counter stage. The ratio is managed by accessing the ratio definition field (the WDT_WCLR[4:2] PTV bit field) and is enabled with the WDT_WCLR[5] PRE bit.

[Table 20-103](#) lists the prescaler clock ratio values.

Table 20-103. Prescaler Clock Ratio Values

WDT_WCLR[5] PRE	WDT_WCLR[4:2] PTV	Clock Divider (PS)
0	X	1
1	0	1
1	1	2
1	2	4
1	3	8
1	4	16
1	5	32
1	6	64
1	7	128

Thus the watchdog timer overflow rate is expressed as:

$$OVF_Rate = (FFFF\ FFFFh - WDT_WLDR + 1) \times (wd\text{-functional clock period}) \times PS$$

where wd-functional clock period = $1/(wd\text{-functional clock frequency})$ and PS = $2^{(PTV)}$

CAUTION

Internal resynchronization causes some latency in any software write to WDT_WSPR before WDT_WSPR is updated with the programmed value:

$1.5 \times \text{functional clock cycles} \leq \text{write_WDT_WSPR_latency} \leq 2.5 \times \text{functional clock cycles}$

Remember to consider this latency whenever the watchdog timer must be started or stopped.

For example, for a timer clock input of 32 kHz with a prescaler ratio value of 1 (clock divided by 2) and WDT_WCLR[5] PRE = 1 (clock divider enabled), the reset period is as listed in [Table 20-104](#).

Table 20-104. Reset Period Examples

WDT_WLDR Value	Reset Period
0000 0000h	74 h 56 min
FFFF 0000h	4 s
FFFF FFF0h	1 ms
FFFF FFFFh	62.5 us

CAUTION

- Ensure that the reloaded value allows the correct operation of the application. When a watchdog timer is enabled, software must periodically trigger a reload before the counter overflows. Hence, the value of the WDT_WLDR[31:0] bit field must be chosen according to the ongoing activity preceding the watchdog reload.
- Due to design reasons, WDT_WLDR[31:0] = FFFF FFFFh is a special case, although such a value of WDT_WLDR is meaningless. When WDT_WLDR is programmed with the overflow value, a triggering event generates a reset/interrupt one functional clock cycle later, even if the watchdog timer is stopped.

Table 20-105 lists the default reset periods for the watchdog timers.

Table 20-105. Default Watchdog Timer Reset Periods

Watchdog Timers	Clock Source	Default Reset Period
WDT	32 kHz	2 s

20.4.3.7 Triggering a Timer Reload

To reload the timer counter and reset the prescaler before reaching overflow, a reload command is executed by accessing the watchdog timer trigger register (WDT_WTGR) using a specific reload sequence.

The specific reload sequence is performed whenever the written value on the WDT_WTGR register differs from its previous value. In this case, reload is executed in the same way as an overflow autoreload, but without the generation of a reset pulse.

The timer counter is loaded with the value of the watchdog timer load register (the WDT_WLDR[31:0] TIMER_LOAD bit field), and the prescaler is reset.

20.4.3.8 Start/Stop Sequence for Watchdog Timers (Using the WDT_WSPR Register)

To start and stop a watchdog timer, access must be made through the start/stop register (WDT_WSPR) using a specific sequence.

To disable the timer, follow this sequence:

1. Write XXXX AAAAh in WDT_WSPR.
2. Poll for posted write to complete using WDT_WWPS.W_PEND_WSPR.
3. Write XXXX 5555h in WDT_WSPR.
4. Poll for posted write to complete using WDT_WWPS.W_PEND_WSPR.

To enable the timer, follow this sequence:

1. Write XXXX BBBBh in WDT_WSPR.
2. Poll for posted write to complete using WDT_WWPS.W_PEND_WSPR.
3. Write XXXX 4444h in WDT_WSPR.
4. Poll for posted write to complete using WDT_WWPS.W_PEND_WSPR.

All other write sequences on the WDT_WSPR register have no effect on the start/stop feature of the module.

20.4.3.9 Modifying Timer Count/Load Values and Prescaler Setting

To modify the timer counter value (the WDT_WCRR register), prescaler ratio (the WDT_WCLR[4:2] PTV bit field), delay configuration value (the WDT_WDLY[31:0] DLY_VALUE bit field), or the load value (the WDT_WLDR[31:0] TIMER_LOAD bit field), the watchdog timer must be disabled by using the start/stop sequence (the WDT_WSPR register).

After a write access, the load register value and prescaler ratio registers are updated immediately, but new values are considered only after the next consecutive counter overflow or after a new trigger command (the WDT_WTGR register).

20.4.3.10 Watchdog Counter Register Access Restriction (WDT_WCRR Register)

A 32-bit shadow register is implemented to read a coherent value of the WDT_WCRR register because the WDT_WCRR register is directly related to the timer counter value and is updated on the timer clock (WDT_FCLK). The shadow register is updated by a 16-bit LSB read command.

NOTE: Although the L4 clock (WDT_ICLK) is completely asynchronous with the timer clock (WDT_FCLK), some synchronization is performed to ensure that the value of the WDT_WCRR register is not read while it is being incremented.

When 32-bit read access is performed, the shadow register is not updated. Read access is performed directly from the accessed register.

To ensure that a coherent value is read inside WDT_WCRR, the first read access is to the lower 16 bits (offset = 8h), followed by read access to the upper 16 bits (offset = Ah).

20.4.3.11 Watchdog Timer Interrupt Generation

When an interrupt source occurs, the interrupt status bit (the WDT_WIRQSTAT[0] EVENT_OVF or WDT_WIRQSTAT[1] EVENT_DLY bit) is set to 1. The output interrupt line (WDTi_IRQ) is asserted (active low) when status (the EVENT_xxx bit) and enable (the xxx_IT_ENA bit) flags are set to 1; the order is not relevant. Writing 1 to the enable bit (the status is already set at 1) also triggers the interrupt in the normal order (enable first, status next). The pending interrupt event is cleared when the set status bit is overwritten by a value of 1 by a write command in the WDT_WIRQSTAT register. Reading the WDT_WIRQSTAT register and writing the value back allows a fast interrupt acknowledge process.

The watchdog timer issues an overflow interrupt if this interrupt is enabled in the watchdog interrupt enable register (WDT_WIRQENSET[0] OVF_IT_ENA = 1). When the overflow occurs, the interrupt status bit (the WDT_WIRQSTAT[0] EVENT_OVF bit) is set to 1. The output interrupt line (WDT_IRQ) is asserted (active low) when status (EVENT_OVF) and enable (OVF_IT_ENA) flags are set to 1; the order is not relevant. This interrupt can be disabled by setting the WDT_WIRQENCLR[0] OVF_IT_ENA bit to 1.

The watchdog can issue the delay interrupt if this interrupt is enabled in the interrupt enable register (WDT_WIRQENSET[1] DLY_IT_ENA = 1). When the counter is running and the counter value matches the value stored in the delay configuration register (WDT_WDLY), the corresponding interrupt status bit is set in the watchdog status register (WDT_WIRQSTAT) and the output interrupt line is asserted (active low) when the flag (EVENT_DLY) and enable (DLY_IT_ENA) bits are 1 in the WDT_WIRQSTAT and WDT_WIRQENSET registers, respectively; the order (normally enable, then flag), is not relevant. This interrupt can be disabled by setting the WDT_WIRQENCLR[1] DLY_IT_ENA bit to 1.

NOTE: Writing 0 to the WDT_WIRQSTAT[0] EVENT_OVF bit or the WDT_WIRQSTAT[1] EVENT_DLY bit has no effect.

The two clock domains are resynchronized because the interrupt event is generated on the functional clock domain (WDTi_FCLK) during the updating of the interrupt status register (WDT_WIRQSTAT).

The WDT_WDLY register is used to specify the value of the delay configuration register. The delay time to interrupt is the difference between the reload value stored in the counter load register (WDT_WLDR) and the programmed value in this register (WDT_WDLY).

Use the following formula to estimate the delay time:

$$\text{Delay time period} = (\text{WDT_WDLY} - \text{WDT_WLDR} + 1) \times \text{Timer clock period} \times \text{Clock divider}$$

Where:

- Timer clock period = 1/(Timer clock frequency)
- Clock divider = 2**PTV

If the counter value (WDT_WCRR) reaches the programmed value (WDT_WDLY), the status bit (EVENT_DLY) gets set in the interrupt status register (WDT_WIRQSTAT), and an interrupt occurs if the corresponding enable bit is set in the interrupt enable register (WDT_WIRQENSET).

CAUTION

If the reload event occurs (after a triggering sequence or after a reset sequence) before reaching the programmed value (WDT_WDLY[31:0] WDLY_VALUE), no interrupt is generated.

Also, no interrupt is generated if the value programmed in the delay configuration register (WDT_WDLY) is less than the value stored in the counter load register (WDT_WLDR).

20.4.3.12 Watchdog Timers Under Emulation

To configure the WDT to stop during emulation suspend events (for example, debugger breakpoints), set up the WDT and the Debug Subsystem:

1. Set WDT_WDSC.EMUFREE=0. This will allow the Suspend_Control signal from the Debug Subsystem ([Chapter 27](#)) to stop and start the WDT. Note that if EMUFREE=1, the Suspend_Control signal is ignored and the WDT is free running regardless of any debug suspend event. This EMUFREE bit gives local control from a module perspective to gate the suspend signal coming from the Debug Subsystem.
2. Set the appropriate xxx_Suspend_Control register = 0x9, as described in [Section 27.1.1.1, Debug Suspend Support for Peripherals](#). Choose the register appropriate to the peripheral you want to suspend during a suspend event.

20.4.3.13 Accessing Watchdog Timer Registers

Posted/nonposted selection applies only to functional registers that require synchronization on/from the timer functional clock domain (WDTi_FCLK). For write/read operation, the following registers are affected:

- WDT_WCLR
- WDT_WCRR
- WDT_WLDR
- WDT_WTGR
- WDT_WDLY
- WDT_WSPR

The timer interface clock domain synchronous registers are not affected by the posted/nonposted selection; the write/read operation is effective and acknowledged (command accepted) after one WDT_ICLK cycle from the command assertion. The timer interface clock domain synchronous registers are:

- WDT_WIDR
- WDT_WDSC
- WDT_WDST
- WDT_WIRQSTATRAW
- WDT_WIRQSTAT
- WDT_WIRQENSET
- WDT_WIRQENCLR
- WDT_WWPS

20.4.3.14 Low-Level Programming Model

This section covers the low-level hardware programming sequences for configuration and use of the module.

20.4.3.14.1 Global Initialization

20.4.3.14.1.1 Surrounding Modules Global Initialization

This section identifies the requirements for initializing the surrounding modules when the watchdog timer is to be used for the first time after a device reset. This initialization of surrounding modules is based on the integration and environment of the watchdog timer (see [Table 20-106](#)).

Table 20-106. Global Initialization of Surrounding Modules

Surrounding Modules	Comments
PRCM	The module interface and functional clocks must be enabled.
Control module	Module-specific pad multiplexing must be set in the control module.
MPU INTC	The MPU INTC configuration must be performed to enable the interrupts from the watchdog timer.

20.4.3.14.1.2 Main Sequence – Watchdog Timer Module Global Initialization

[Table 20-107](#) lists the steps for initializing the watchdog timer module when the module is to be used for the first time.

Table 20-107. Watchdog Timer Module Global Initialization

Step	Register/Bit Field/Programming Model	Value
Execute software reset.	WDT_WDSC[1] SOFTRESET	1
Wait until reset release?	WDT_WDSC[1] SOFTRESET	0
Enable delay interrupt.	WDT_WIRQENSET[1] ENABLE_DLY	1
Enable overflow interrupt.	WDT_WIRQENSET[0] ENABLE_OVF	1

20.4.3.14.2 Operational Mode Configuration

20.4.3.14.2.1 Main Sequence – Watchdog Timer Basic Configuration

[Table 20-108](#) lists the steps for the basic configuration of the watchdog timer.

Table 20-108. Watchdog Timer Basic Configuration

Step	Register/Bit Field/Programming Model	Value
Disable the watchdog timer.	See Section 20.4.3.14.2.2 .	
Set prescaler value.	WDT_WCLR[4:2] PTV	xxx
Enable prescaler.	WDT_WCLR[5] PRE	1
Load delay configuration value.	WDT_WDLY	xxx
Load timer counter value.	WDT_WCRR	xxx
Enable the watchdog timer.	See Section 20.4.3.14.2.3 .	

20.4.3.14.2.2 Subsequence – Disable the Watchdog Timer

Table 20-109 lists the steps to disable the watchdog timer.

Table 20-109. Disable the Watchdog Timer

Step	Register/Bit Field/Programming Model	Value
Write disable sequence Data1.	WDT_WSPR	XXXX AAAAh
Write disable sequence Data2.	WDT_WSPR	XXXX 5555h

20.4.3.14.2.3 Subsequence – Enable the Watchdog Timer

Table 20-110 lists the steps to enable the watchdog timer.

Table 20-110. Enable the Watchdog Timer

Step	Register/Bit Field/Programming Model	Value
Write enable sequence Data1.	WDT_WSPR	XXXX BBBBh
Write enable sequence Data2.	WDT_WSPR	XXXX 4444h

20.4.4 Watchdog Registers

CAUTION

The watchdog timers registers are limited to 32-bit and 16-bit data accesses; 8-bit access is not allowed and can corrupt register content.

NOTE:

- The WDT_WISR and WDT_WIRQSTATRAW registers have the same functionality. The WDT_WISR register is used for software backward compatibility.
- The WDT_WIER and WDT_WIRQENSET/WDT_WIRQENCLR registers have the same functionality. The WDT_WIER register is used for software backward compatibility.
- The WDT_WIRQSTATRAW and WDT_WIRQSTAT registers give the same information when read. The WDT_WIRQSTATRAW register is used for debug.

20.4.4.1 WATCHDOG_TIMER Registers

Table 20-111 lists the memory-mapped registers for the WATCHDOG_TIMER. All register offset addresses not listed in Table 20-111 should be considered as reserved locations and the register contents should not be modified.

Table 20-111. WATCHDOG_TIMER Registers

Offset	Acronym	Register Name	Section
0h	WDT_WIDR	Watchdog Identification Register	Section 20.4.4.1.1
10h	WDT_WDSC	Watchdog System Control Register	Section 20.4.4.1.2
14h	WDT_WDST	Watchdog Status Register	Section 20.4.4.1.3
18h	WDT_WISR	Watchdog Interrupt Status Register	Section 20.4.4.1.4
1Ch	WDT_WIER	Watchdog Interrupt Enable Register	Section 20.4.4.1.5
24h	WDT_WCLR	Watchdog Control Register	Section 20.4.4.1.6
28h	WDT_WCRR	Watchdog Counter Register	Section 20.4.4.1.7

Table 20-111. WATCHDOG_TIMER Registers (continued)

Offset	Acronym	Register Name	Section
2Ch	WDT_WLDR	Watchdog Load Register	Section 20.4.4.1.8
30h	WDT_WTGR	Watchdog Trigger Register	Section 20.4.4.1.9
34h	WDT_WWPS	Watchdog Write Posting Bits Register	Section 20.4.4.1.10
44h	WDT_WDLY	Watchdog Delay Configuration Register	Section 20.4.4.1.11
48h	WDT_WSPR	Watchdog Start/Stop Register	Section 20.4.4.1.12
54h	WDT_WIRQSTATRAW	Watchdog Raw Interrupt Status Register	Section 20.4.4.1.13
58h	WDT_WIRQSTAT	Watchdog Interrupt Status Register	Section 20.4.4.1.14
5Ch	WDT_WIRQENSET	Watchdog Interrupt Enable Set Register	Section 20.4.4.1.15
60h	WDT_WIRQENCLR	Watchdog Interrupt Enable Clear Register	Section 20.4.4.1.16

20.4.4.1.1 WDT_WIDR Register (offset = 0h) [reset = 0h]

WDT_WIDR is shown in [Figure 20-96](#) and described in [Table 20-112](#).

Watchdog Identification Register

Figure 20-96. WDT_WIDR Register

31	30	29	28	27	26	25	24	23	22	21	20	19	18	17	16	15	14	13	12	11	10	9	8	7	6	5	4	3	2	1	0
REVISION																															
R-0h																															

LEGEND: R/W = Read/Write; R = Read only; W1toCl = Write 1 to clear bit; -n = value after reset

Table 20-112. WDT_WIDR Register Field Descriptions

Bit	Field	Type	Reset	Description
31-0	REVISION	R	0h	IP Revision

20.4.4.1.2 WDT_WDSC Register (offset = 10h) [reset = 10h]

WDT_WDSC is shown in [Figure 20-97](#) and described in [Table 20-113](#).

The Watchdog System Control Register controls the various parameters of the L4 interface.

Figure 20-97. WDT_WDSC Register

31	30	29	28	27	26	25	24
RESERVED							
R-0h							
23	22	21	20	19	18	17	16
RESERVED							
R-0h							
15	14	13	12	11	10	9	8
RESERVED							
R-0h							
7	6	5	4	3	2	1	0
RESERVED		EMUFREE	IDLEMODE		RESERVED	SOFTRESET	RESERVED
R-0h		R/W-0h	R/W-2h		R-0h	R/W-0h	R-0h

LEGEND: R/W = Read/Write; R = Read only; W1toCl = Write 1 to clear bit; -n = value after reset

Table 20-113. WDT_WDSC Register Field Descriptions

Bit	Field	Type	Reset	Description
31-6	RESERVED	R	0h	
5	EMUFREE	R/W	0h	Sensitivity to emulation (debug) suspend event from Debug Subsystem. 0h = Timer counter frozen during debug suspend event. 1h = Timer counter free-running, and Debug suspend event is ignored.
4-3	IDLEMODE	R/W	2h	Configuration of the local target state management mode. By definition, target can handle read/write transaction as long as it is out of IDLE state. 0h = Force-idle mode: local target's idle state follows (acknowledges) the system's idle requests unconditionally, i.e. regardless of the IP module's internal requirements. Backup mode, for debug only. 1h = No-idle mode: local target never enters idle state. Backup mode, for debug only. 2h = Smart-idle mode: local target's idle state eventually follows (acknowledges) the system's idle requests, depending on the IP module's internal requirements. IP module shall not generate (IRQ- or DMA-request-related) wakeup events. 3h = Smart-idle wakeup-capable mode: local target's idle state eventually follows (acknowledges) the system's idle requests, depending on the IP module's internal requirements. IP module may generate (IRQ- or DMA-request-related) wakeup events when in idle state.
2	RESERVED	R	0h	
1	SOFTRESET	R/W	0h	Software reset. (Optional) 0h (W) = No action 0h (R) = Reset done, no pending action 1h (W) = Initiate software reset. 1h (R) = Reset (software or other) ongoing
0	RESERVED	R	0h	

20.4.4.1.3 WDT_WDST Register (offset = 14h) [reset = 1h]

WDT_WDST is shown in [Figure 20-98](#) and described in [Table 20-114](#).

The Watchdog Status Register provides status information about the module.

Figure 20-98. WDT_WDST Register

31	30	29	28	27	26	25	24
RESERVED							
R-0h							
23	22	21	20	19	18	17	16
RESERVED							
R-0h							
15	14	13	12	11	10	9	8
RESERVED							
R-0h							
7	6	5	4	3	2	1	0
RESERVED							RESETDONE
R-0h							R-1h

LEGEND: R/W = Read/Write; R = Read only; W1toCl = Write 1 to clear bit; -n = value after reset

Table 20-114. WDT_WDST Register Field Descriptions

Bit	Field	Type	Reset	Description
31-1	RESERVED	R	0h	
0	RESETDONE	R	1h	Internal module reset monitoring 0h = Internal module reset is ongoing. 1h = Reset completed

20.4.4.1.4 WDT_WISR Register (offset = 18h) [reset = 0h]

WDT_WISR is shown in [Figure 20-99](#) and described in [Table 20-115](#).

The Watchdog Interrupt Status Register shows which interrupt events are pending inside the module.

Figure 20-99. WDT_WISR Register

31	30	29	28	27	26	25	24
RESERVED							
R-0h							
23	22	21	20	19	18	17	16
RESERVED							
R-0h							
15	14	13	12	11	10	9	8
RESERVED							
R-0h							
7	6	5	4	3	2	1	0
RESERVED						DLY_IT_FLAG	OVF_IT_FLAG
R-0h						R/W-0h	R/W-0h

LEGEND: R/W = Read/Write; R = Read only; W1toCl = Write 1 to clear bit; -n = value after reset

Table 20-115. WDT_WISR Register Field Descriptions

Bit	Field	Type	Reset	Description
31-2	RESERVED	R	0h	
1	DLY_IT_FLAG	R/W	0h	Pending delay interrupt status. 0h (W) = Status unchanged 0h (R) = No delay interrupt pending 1h (W) = Status bit cleared 1h (R) = Delay interrupt pending
0	OVF_IT_FLAG	R/W	0h	Pending overflow interrupt status. 0h (W) = Status unchanged 0h (R) = No overflow interrupt pending 1h (W) = Status bit cleared 1h (R) = Overflow interrupt pending

20.4.4.1.5 WDT_WIER Register (offset = 1Ch) [reset = 0h]

WDT_WIER is shown in [Figure 20-100](#) and described in [Table 20-116](#).

The Watchdog Interrupt Enable Register controls (enable/disable) the interrupt events.

Figure 20-100. WDT_WIER Register

31	30	29	28	27	26	25	24
RESERVED							
R-0h							
23	22	21	20	19	18	17	16
RESERVED							
R-0h							
15	14	13	12	11	10	9	8
RESERVED							
R-0h							
7	6	5	4	3	2	1	0
RESERVED						DLY_IT_ENA	OVF_IT_ENA
R-0h						R/W-0h	R/W-0h

LEGEND: R/W = Read/Write; R = Read only; W1toCl = Write 1 to clear bit; -n = value after reset

Table 20-116. WDT_WIER Register Field Descriptions

Bit	Field	Type	Reset	Description
31-2	RESERVED	R	0h	
1	DLY_IT_ENA	R/W	0h	Delay interrupt enable/disable 0h = Disable delay interrupt. 1h = Enable delay interrupt.
0	OVF_IT_ENA	R/W	0h	Overflow interrupt enable/disable 0h = Disable overflow interrupt. 1h = Enable overflow interrupt.

20.4.4.1.6 WDT_WCLR Register (offset = 24h) [reset = 20h]

WDT_WCLR is shown in [Figure 20-101](#) and described in [Table 20-117](#).

The Watchdog Control Register controls the prescaler stage of the counter.

Figure 20-101. WDT_WCLR Register

31	30	29	28	27	26	25	24
RESERVED							
R-0h							
23	22	21	20	19	18	17	16
RESERVED							
R-0h							
15	14	13	12	11	10	9	8
RESERVED							
R-0h							
7	6	5	4	3	2	1	0
RESERVED		PRE	PTV			RESERVED	
R-0h		R/W-1h	R/W-0h			R-0h	

LEGEND: R/W = Read/Write; R = Read only; W1toCl = Write 1 to clear bit; -n = value after reset

Table 20-117. WDT_WCLR Register Field Descriptions

Bit	Field	Type	Reset	Description
31-6	RESERVED	R	0h	
5	PRE	R/W	1h	Prescaler enable/disable configuration 0h = Prescaler disabled 1h = Prescaler enabled
4-2	PTV	R/W	0h	Prescaler value. The timer counter is prescaled with the value: 2**PTV. Example: PTV = 3 then counter increases value if started after 8 functional clock periods. On reset, it is loaded from PI_PTV_RESET_VALUE input port.
1-0	RESERVED	R	0h	

20.4.4.1.7 WDT_WCRR Register (offset = 28h) [reset = 0h]

WDT_WCRR is shown in [Figure 20-102](#) and described in [Table 20-118](#).

The Watchdog Counter Register holds the value of the internal counter.

Figure 20-102. WDT_WCRR Register

31	30	29	28	27	26	25	24	23	22	21	20	19	18	17	16	15	14	13	12	11	10	9	8	7	6	5	4	3	2	1	0
TIMER_COUNTER																															
R/W-0h																															

LEGEND: R/W = Read/Write; R = Read only; W1toCl = Write 1 to clear bit; -n = value after reset

Table 20-118. WDT_WCRR Register Field Descriptions

Bit	Field	Type	Reset	Description
31-0	TIMER_COUNTER	R/W	0h	Value of the timer counter register

20.4.4.1.8 WDT_WLDR Register (offset = 2Ch) [reset = 0h]

WDT_WLDR is shown in [Figure 20-103](#) and described in [Table 20-119](#).

The Watchdog Load Register holds the timer load value.

Figure 20-103. WDT_WLDR Register

31	30	29	28	27	26	25	24	23	22	21	20	19	18	17	16	15	14	13	12	11	10	9	8	7	6	5	4	3	2	1	0
TIMER_LOAD																															
R/W-0h																															

LEGEND: R/W = Read/Write; R = Read only; W1toCl = Write 1 to clear bit; -n = value after reset

Table 20-119. WDT_WLDR Register Field Descriptions

Bit	Field	Type	Reset	Description
31-0	TIMER_LOAD	R/W	0h	Value of the timer load register

20.4.4.1.9 WDT_WTGR Register (offset = 30h) [reset = 0h]

WDT_WTGR is shown in [Figure 20-104](#) and described in [Table 20-120](#).

Writing a different value than the one already written in the Watchdog Trigger Register does a watchdog counter reload.

Figure 20-104. WDT_WTGR Register

31	30	29	28	27	26	25	24	23	22	21	20	19	18	17	16	15	14	13	12	11	10	9	8	7	6	5	4	3	2	1	0
TTGR_VALUE																															
R/W-0h																															

LEGEND: R/W = Read/Write; R = Read only; W1toCl = Write 1 to clear bit; -n = value after reset

Table 20-120. WDT_WTGR Register Field Descriptions

Bit	Field	Type	Reset	Description
31-0	TTGR_VALUE	R/W	0h	Value of the trigger register

20.4.4.1.10 WDT_WWPS Register (offset = 34h) [reset = 0h]

WDT_WWPS is shown in [Figure 20-105](#) and described in [Table 20-121](#).

The Watchdog Write Posting Bits Register contains the write posting bits for all writeable functional registers.

Figure 20-105. WDT_WWPS Register

31	30	29	28	27	26	25	24
RESERVED							
R-0h							
23	22	21	20	19	18	17	16
RESERVED							
R-0h							
15	14	13	12	11	10	9	8
RESERVED							
R-0h							
7	6	5	4	3	2	1	0
RESERVED		W_PEND_WDL Y	W_PEND_WSP R	W_PEND_WT GR	W_PEND_WLD R	W_PEND_WC RR	W_PEND_WCL R
R-0h		R-0h	R-0h	R-0h	R-0h	R-0h	R-0h

LEGEND: R/W = Read/Write; R = Read only; W1toCl = Write 1 to clear bit; -n = value after reset

Table 20-121. WDT_WWPS Register Field Descriptions

Bit	Field	Type	Reset	Description
31-6	RESERVED	R	0h	
5	W_PEND_WDLY	R	0h	Write pending for register WDLY 0h = No register write pending 1h = Register write pending
4	W_PEND_WSPR	R	0h	Write pending for register WSPR 0h = No register write pending 1h = Register write pending
3	W_PEND_WTGR	R	0h	Write pending for register WTGR 0h = No register write pending 1h = Register write pending
2	W_PEND_WLDR	R	0h	Write pending for register WLDR 0h = No register write pending 1h = Register write pending
1	W_PEND_WCRR	R	0h	Write pending for register WCRR 0h = No register write pending 1h = Register write pending
0	W_PEND_WCLR	R	0h	Write pending for register WCLR 0h = No register write pending 1h = Register write pending

20.4.4.1.11 WDT_WDLY Register (offset = 44h) [reset = 0h]

WDT_WDLY is shown in [Figure 20-106](#) and described in [Table 20-122](#).

The Watchdog Delay Configuration Register holds the delay value that controls the internal pre-overflow event detection.

Figure 20-106. WDT_WDLY Register

31	30	29	28	27	26	25	24	23	22	21	20	19	18	17	16	15	14	13	12	11	10	9	8	7	6	5	4	3	2	1	0
WDLY_VALUE																															
R/W-0h																															

LEGEND: R/W = Read/Write; R = Read only; W1toCl = Write 1 to clear bit; -n = value after reset

Table 20-122. WDT_WDLY Register Field Descriptions

Bit	Field	Type	Reset	Description
31-0	WDLY_VALUE	R/W	0h	Value of the delay register

20.4.4.1.12 WDT_WSPR Register (offset = 48h) [reset = 0h]

WDT_WSPR is shown in [Figure 20-107](#) and described in [Table 20-123](#).

The Watchdog Start/Stop Register holds the start-stop value that controls the internal start-stop FSM.

Figure 20-107. WDT_WSPR Register

31	30	29	28	27	26	25	24	23	22	21	20	19	18	17	16	15	14	13	12	11	10	9	8	7	6	5	4	3	2	1	0
WSPR_VALUE																															
R/W-0h																															

LEGEND: R/W = Read/Write; R = Read only; W1toCl = Write 1 to clear bit; -n = value after reset

Table 20-123. WDT_WSPR Register Field Descriptions

Bit	Field	Type	Reset	Description
31-0	WSPR_VALUE	R/W	0h	Value of the start-stop register

20.4.4.1.13 WDT_WIRQSTATRAW Register (offset = 54h) [reset = 0h]

WDT_WIRQSTATRAW is shown in [Figure 20-108](#) and described in [Table 20-124](#).

In the Watchdog Raw Interrupt Status Register, IRQ unmasked status, status set per-event raw interrupt status vector, line 0. Raw status is set even if event is not enabled. Write 1 to set the (raw) status, mostly for debug.

Figure 20-108. WDT_WIRQSTATRAW Register

31	30	29	28	27	26	25	24
RESERVED							
R-0h							
23	22	21	20	19	18	17	16
RESERVED							
R-0h							
15	14	13	12	11	10	9	8
RESERVED							
R-0h							
7	6	5	4	3	2	1	0
RESERVED						EVENT_DLY	EVENT_OVF
R-0h						R/W1S-0h	R/W1S-0h

LEGEND: R/W = Read/Write; R = Read only; W1toCl = Write 1 to clear bit; -n = value after reset

Table 20-124. WDT_WIRQSTATRAW Register Field Descriptions

Bit	Field	Type	Reset	Description
31-2	RESERVED	R	0h	
1	EVENT_DLY	R/W1S	0h	Settable raw status for delay event 0h (W) = No action 0h (R) = No event pending 1h (W) = Set event (debug) 1h (R) = Event pending
0	EVENT_OVF	R/W1S	0h	Settable raw status for overflow event 0h (W) = No action 0h (R) = No event pending 1h (W) = Set event (debug) 1h (R) = Event pending

20.4.4.1.14 WDT_WIRQSTAT Register (offset = 58h) [reset = 0h]

WDT_WIRQSTAT is shown in [Figure 20-109](#) and described in [Table 20-125](#).

In the Watchdog Interrupt Status Register, IRQ masked status, status clear per-event enabled interrupt status vector, line 0. Enabled status is not set unless event is enabled. Write 1 to clear the status after interrupt has been serviced (raw status gets cleared, that is, even if not enabled).

Figure 20-109. WDT_WIRQSTAT Register

31	30	29	28	27	26	25	24
RESERVED							
R-0h							
23	22	21	20	19	18	17	16
RESERVED							
R-0h							
15	14	13	12	11	10	9	8
RESERVED							
R-0h							
7	6	5	4	3	2	1	0
RESERVED						EVENT_DLY	EVENT_OVF
R-0h						R/W1C-0h	R/W1C-0h

LEGEND: R/W = Read/Write; R = Read only; W1toCl = Write 1 to clear bit; -n = value after reset

Table 20-125. WDT_WIRQSTAT Register Field Descriptions

Bit	Field	Type	Reset	Description
31-2	RESERVED	R	0h	
1	EVENT_DLY	R/W1C	0h	Clearable, enabled status for delay event 0h (W) = No action 0h (R) = No (enabled) event pending 1h (W) = Clear (raw) event 1h (R) = Event pending
0	EVENT_OVF	R/W1C	0h	Clearable, enabled status for overflow event 0h (W) = No action 0h (R) = No (enabled) event pending 1h (W) = Clear (raw) event 1h (R) = Event pending

20.4.4.1.15 WDT_WIRQENSET Register (offset = 5Ch) [reset = 0h]

WDT_WIRQENSET is shown in [Figure 20-110](#) and described in [Table 20-126](#).

In the Watchdog Interrupt Enable Set Register, IRQ enable set per-event interrupt enable bit vector, line 0. Write 1 to set (enable interrupt). Readout equal to corresponding _CLR register.

Figure 20-110. WDT_WIRQENSET Register

31	30	29	28	27	26	25	24
RESERVED							
R-0h							
23	22	21	20	19	18	17	16
RESERVED							
R-0h							
15	14	13	12	11	10	9	8
RESERVED							
R-0h							
7	6	5	4	3	2	1	0
RESERVED						ENABLE_DLY	ENABLE_OVF
R-0h						R/W1S-0h	R/W1S-0h

LEGEND: R/W = Read/Write; R = Read only; W1toCl = Write 1 to clear bit; -n = value after reset

Table 20-126. WDT_WIRQENSET Register Field Descriptions

Bit	Field	Type	Reset	Description
31-2	RESERVED	R	0h	
1	ENABLE_DLY	R/W1S	0h	Enable for delay event 0h (W) = No action 0h (R) = Interrupt disabled (masked) 1h (W) = Enable interrupt. 1h (R) = Interrupt enabled
0	ENABLE_OVF	R/W1S	0h	Enable for overflow event 0h (W) = No action 0h (R) = Interrupt disabled (masked) 1h (W) = Enable interrupt. 1h (R) = Interrupt enabled

20.4.4.1.16 WDT_WIRQENCLR Register (offset = 60h) [reset = 0h]

WDT_WIRQENCLR is shown in [Figure 20-111](#) and described in [Table 20-127](#).

In the Watchdog Interrupt Enable Clear Register, IRQ enable clear per-event interrupt enable bit vector, line 0. Write 1 to clear (disable interrupt). Readout equal to corresponding _SET register.

Figure 20-111. WDT_WIRQENCLR Register

31	30	29	28	27	26	25	24
RESERVED							
R-0h							
23	22	21	20	19	18	17	16
RESERVED							
R-0h							
15	14	13	12	11	10	9	8
RESERVED							
R-0h							
7	6	5	4	3	2	1	0
RESERVED						ENABLE_DLY	ENABLE_OVF
R-0h						R/W1C-0h	R/W1C-0h

LEGEND: R/W = Read/Write; R = Read only; W1toCl = Write 1 to clear bit; -n = value after reset

Table 20-127. WDT_WIRQENCLR Register Field Descriptions

Bit	Field	Type	Reset	Description
31-2	RESERVED	R	0h	
1	ENABLE_DLY	R/W1C	0h	Enable for delay event 0h (W) = No action 0h (R) = Interrupt disabled (masked) 1h (W) = Disable interrupt. 1h (R) = Interrupt enabled
0	ENABLE_OVF	R/W1C	0h	Enable for overflow event 0h (W) = No action 0h (R) = Interrupt disabled (masked) 1h (W) = Disable interrupt. 1h (R) = Interrupt enabled

I2C

This chapter describes the I2C of the device.

Topic	Page
21.1 Introduction	4473
21.2 Integration	4474
21.3 Functional Description	4476
21.4 I2C Registers	4490

21.1 Introduction

The multi-master I2C peripheral provides an interface between a CPU and any I2C-bus-compatible device that connects via the I2C serial bus. External components attached to the I2C bus can serially transmit/receive up to 8-bit data to/from the CPU device through the two-wire I2C interface.

The I2C bus is a multi-master bus. The I2C controller does support the multi-master mode that allows more than one device capable of controlling the bus to be connected to it. Each I2C device is recognized by a unique address and can operate as either transmitter or receiver, according to the function of the device. In addition to being a transmitter or receiver, a device connected to the I2C bus can also be considered as master or slave when performing data transfers. Note that a master device is the device which initiates a data transfer on the bus and generates the clock signals to permit that transfer. During this transfer, any device addressed by this master is considered a slave.

21.1.1 I2C Features

The general features of the I2C controller are:

- Compliant with Philips I2C specification version 2.1
- Supports standard mode (up to 100K bits/s) and fast mode (up to 400K bits/s).
- Multimaster transmitter/slave receiver mode
- Multimaster receiver/slave transmitter mode
- Combined master transmit/receive and receive/transmit modes
- 7-bit and 10-bit device addressing modes
- Built-in 32-byte FIFO for buffered read or writes in each module
- Programmable clock generation
- Two DMA channels, one interrupt line

21.1.2 Unsupported I2C Features

The I2C module features not supported in this device are shown in [Table 21-1](#).

Table 21-1. Unsupported I2C Features

Feature	Reason
SCCB Protocol	SCCB signal not pinned out
High Speed (3.4 MBPS) operation	Not supported

21.2 Integration

This device includes three instantiations of the I2C module. This peripheral implements the multi-master I2C bus which allows serial transfer of 8-bit data to/from other I2C master/slave devices through a two-wire interface. There are three I2C modules instantiations called I2C0, I2C1, and I2C2. The I2C0 module is located in the Wake-up power domain. Figure 21-1 and Figure 21-2 show examples of a system with multiple I2C-compatible devices.

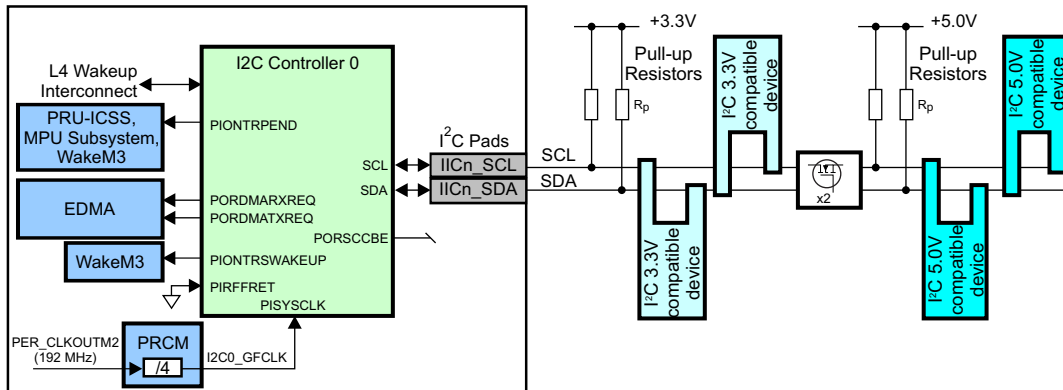


Figure 21-1. I2C0 Integration and Bus Application

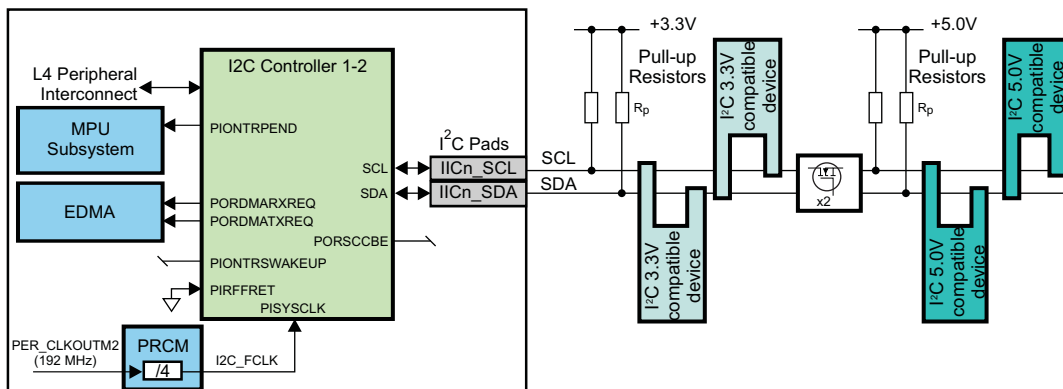


Figure 21-2. I2C(1-2) Integration and Bus Application

21.2.1 I2C Connectivity Attributes

The general connectivity attributes for the I2C module are shown in Table 21-2 and Table 21-3.

Table 21-2. I2C0 Connectivity Attributes

Attributes	Type
Power Domain	Wake-up Domain
Clock Domain	PD_WKUP_L4_WKUP_GCLK (Interface/OCP) PD_WKUP_I2C0_GFCLK (Func)
Reset Signals	WKUP_DOM_RST_N
Idle/Wakeup Signals	Smart Idle / Wakeup
Interrupt Requests	1 interrupt to MPU Subsystem (I2C0INT), PRU-ICSS, and WakeM3
DMA Requests	2 DMA requests to EDMA (I2CTXEVT0, I2CRXEVT0)
Physical Address	L4 Wakeup slave port

Table 21-3. I2C(1–2) Connectivity Attributes

Attributes	Type
Power Domain	Peripheral Domain
Clock Domain	PD_PER_L4LS_GCLK (Interface/OCP) PD_PER_I2C_FCLK (Func)
Reset Signals	PER_DOM_RST_N
Idle/Wakeup Signals	Smart Idle
Interrupt Requests	1 interrupt per instance to MPU Subsystem (I2C1INT, I2C2INT)
DMA Requests	2 DMA requests per instance to EDMA (I2CTXEVTx, I2CRXEVTx)
Physical Address	L4 Peripheral slave port

21.2.2 I2C Clock and Reset Management

The I2C controllers have separate bus interface and functional clocks. During power-down mode, the I2Cx_SCL and I2Cx_SDA are configured as inputs.

Table 21-4. I2C Clock Signals

Clock Signal	Max Freq	Reference / Source	Comments
I2C0 Clock Signals			
PIOCPCLK Interface clock	MHz		pd_wkup_i4_wkup_gclk From PRCM
PISYSCLK Functional clock	48 MHz	PER_CLKOUTM2 / 4	pd_wkup_i2c0_gfclk From PRCM
I2C(1-2) Clock Signals			
PIOCPCLK Interface clock	100 MHz	CORE_CLKOUTM4 / 2	pd_per_i4ls_gclk From PRCM
PISYSCLK Functional clock	48 MHz	PER_CLKOUTM2 / 4	pd_per_ic2_fclk From PRCM

21.2.3 I2C Pin List

The external signals (I2Cx_SDA, I2Cx_SCL) on the device use standard LVCMOS I/Os and may not meet full compliance with the I2C specifications for Fast-mode devices for slope control and input filtering (spike suppression) to improve the EMC behavior.

Table 21-5. I2C Pin List

Pin	Type	Description
I2Cx_SCL	I/OD ⁽¹⁾	I2C serial clock (open drain)
I2Cx_SDA	I/OD	I2C serial data (open drain)

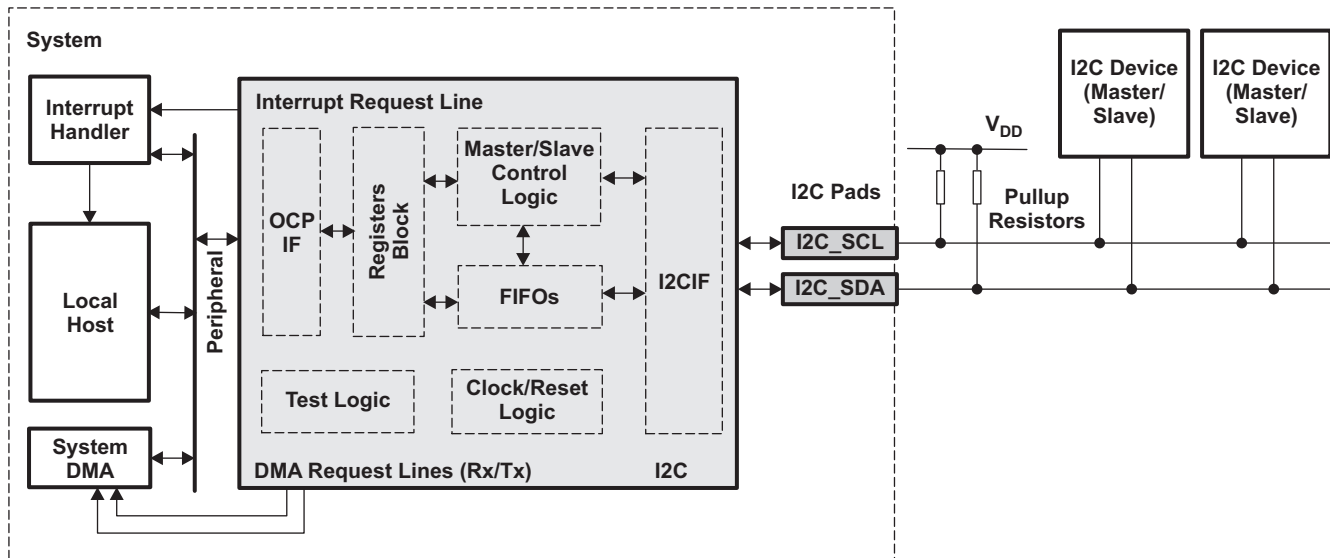
⁽¹⁾ This output signal is also used as a retiming input. The associated CONF_<module>_<pin>_RXACTIVE bit for the output clock must be set to 1 to enable the clock input back to the module.

21.3 Functional Description

21.3.1 Functional Block Diagram

Figure 21-3 shows an example of a system with multiple I2C compatible devices in which the I2C serial ports are all connected together for a two-way transfer from one device to other devices.

Figure 21-3. I2C Functional Block Diagram



The I2C peripheral consists of the following primary blocks:

- A serial interface: one data pin (I2C_SDA) and one clock pin (I2C_SCL).
- Data registers to temporarily hold receive data and transmit data traveling between the I2C_SDA pin and the CPU or the DMA controller.
- Control and status registers
- A peripheral data bus interface to enable the CPU and the DMA controller to access the I2C peripheral registers.
- A clock synchronizer to synchronize the I2C input clock (from the processor clock generator) and the clock on the I2C_SCL pin, and to synchronize data transfers with masters of different clock speeds.
- A prescaler to divide down the input clock that is driven to the I2C peripheral
- A noise filter on each of the two pins, I2C_SDA and I2C_SCL
- An arbitrator to handle arbitration between the I2C peripheral (when it is a master) and another master
- Interrupt generation logic, so that an interrupt can be sent to the CPU
- DMA event generation logic to send an interrupt to the CPU upon reception and data transmission of data.

21.3.2 I2C Master/Slave Controller Signals

Data is communicated to devices interfacing with the I2C via the serial data line (SDA) and the serial clock line (SCL). These two wires can carry information between a device and others connected to the I2C bus. Both SDA and SCL are bi-directional pins. They must be connected to a positive supply voltage via a pull-up resistor. When the bus is free, both pins are high. The driver of these two pins has an open drain to perform the required wired-AND function.

An example of multiple I2C modules that are connected for a two-way transfer from one device to other devices is shown in Figure 21-4.

Figure 21-4. Multiple I2C Modules Connected

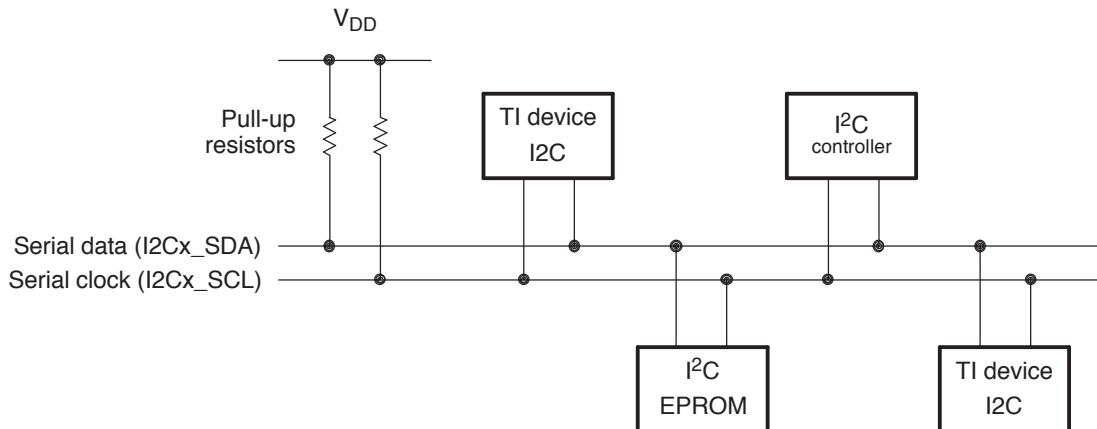


Table 21-6. Signal Pads

I2C Mode		
Name	Default Operating Mode	Description
I2C_SCL	In/ Out	I2C serial CLK line Open-drain output buffer. Requires external pull-up resistor (Rp).
I2C_SDA	In/ Out	I2C serial data line Open-drain output buffer. Requires external pull-up resistor (Rp).

21.3.3 I2C Reset

The I2C module can be reset in the following three ways:

- A system reset (PIRSTNA = 0). A device reset causes the system reset. All registers are reset to power up reset values.
- A software reset by setting the SRST bit in the I2C_SYSC register. This bit has exactly the same action on the module logic as the system bus reset. All registers are reset to power up reset values.
- The I2C_EN bit in the I2C_CON register can be used to hold the I2C module in reset. When the system bus reset is removed (PIRSTNA = 1), I2C_EN = 0 keeps the functional part of I2C module in reset state and all configuration registers can be accessed. I2C_EN = 0 does not reset the registers to power up reset values.

Table 21-7. Reset State of I2C Signals

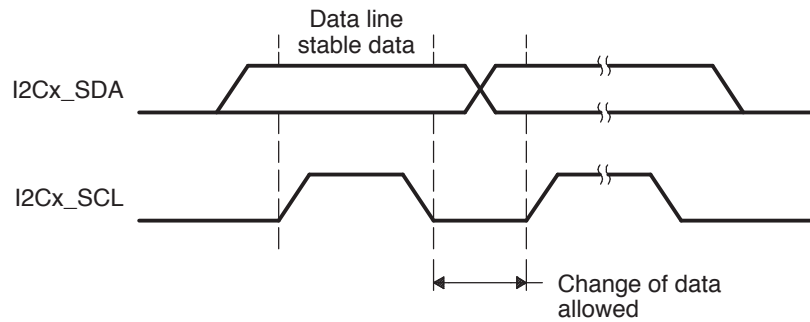
Pin	I/O/Z ⁽¹⁾	System Reset	I2C Reset
			(I2C_EN = 0)
SDA	I/O/Z	High impedance	High impedance
SCL	I/O/Z	High impedance	High impedance

⁽¹⁾ I = Input, O = Output, Z = High impedance

21.3.4 Data Validity

The data on the SDA line must be stable during the high period of the clock. The high and low states of the data line can only change when the clock signal on the SCL line is LOW.

Figure 21-5. Bit Transfer on the I2C Bus

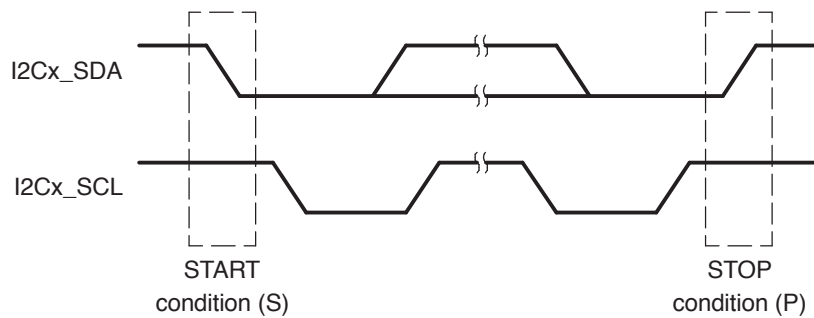


21.3.5 START & STOP Conditions

The I2C module generates START and STOP conditions when it is configured as a master.

- START condition is a high-to-low transition on the SDA line while SCL is high.
- STOP condition is a low-to-high transition on the SDA line while SCL is high.
- The bus is considered to be busy after the START condition (BB = 1) and free after the STOP condition (BB = 0).

Figure 21-6. Start and Stop Condition Events

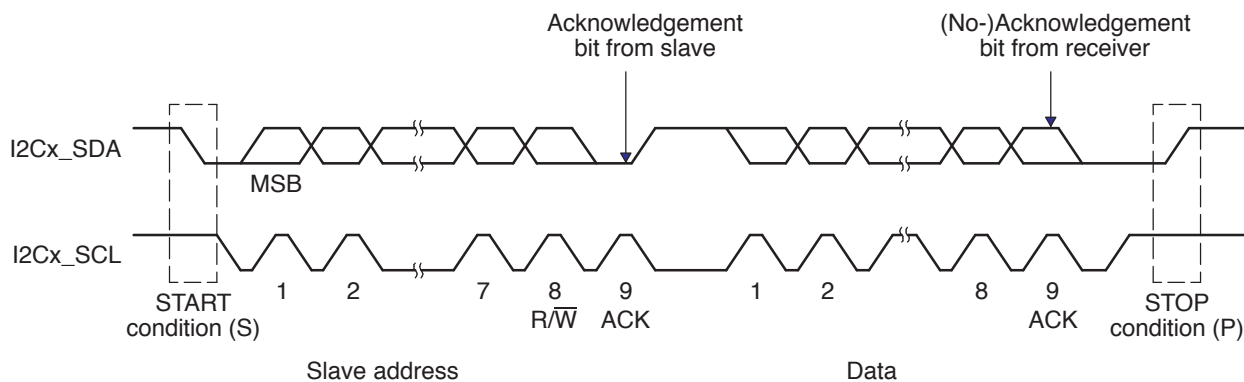


21.3.6 I2C Operation

21.3.6.1 Serial Data Formats

The I2C controller operates in 8-bit word data format (byte write access supported for the last access). Each byte put on the SDA line is 8 bits long. The number of bytes that can be transmitted or received is restricted by the value programmed in the DCOUNT register. The data is transferred with the most significant bit (MSB) first. Each byte is followed by an acknowledge bit from the I2C module if it is in receiver mode.

Figure 21-7. I2C Data Transfer



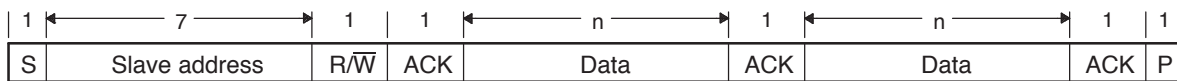
The I2C module supports two data formats, as shown in [Figure 21-8](#):

- 7-bit/10-bit addressing format
- 7-bit/10-bit addressing format with repeated start condition

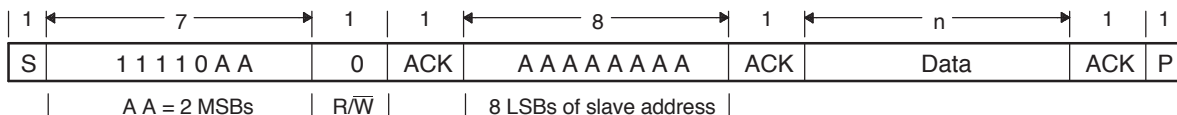
The first byte after a start condition (S) always consists of 8 bits. In the acknowledge mode, an extra bit dedicated for acknowledgment is inserted after each byte. In the addressing formats with 7-bit addresses, the first byte is composed of 7 MSB slave address bits and 1 LSB R/nW bit. In the addressing formats with 10-bit addresses, the first byte is composed of 7 MSB slave address bits, such as 11110XX, where XX is the two MSB of the 10-bit addresses, and 1 LSB R/nW bit, which is 0 in this case.

The least significant R/nW of the address byte indicates the direction of transmission of the following data bytes. If R/nW is 0, the master writes data into the selected slave; if it is 1, the master reads data out of the slave.

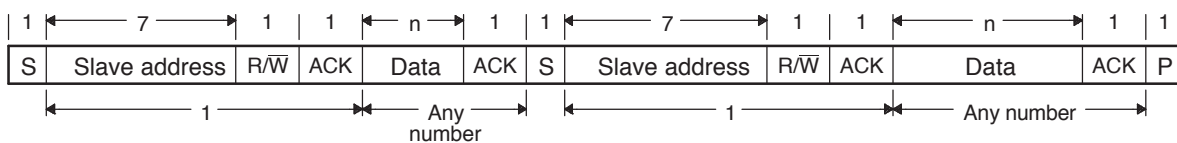
Figure 21-8. I2C Data Transfer Formats



7-Bit Addressing Format



10-Bit Addressing Format



7-Bit Addressing Format With Repeated START Condition

21.3.6.2 Master Transmitter

In this mode, data assembled in one of the previously described data formats is shifted out on the serial data line SDA in synch with the self-generated clock pulses on the serial clock line SCL. The clock pulses are inhibited and SCL held low when the intervention of the processor is required (XUDF) after a byte has been transmitted.

21.3.6.3 Master Receiver

This mode can only be entered from the master transmitter mode. With either of the address formats (Figure 21-8 (a), (b), and (c)), the master receiver is entered after the slave address byte and bit R/W₀ has been transmitted, if R/W₀ is high. Serial data bits received on bus line SDA are shifted in synch with the self-generated clock pulses on SCL. The clock pulses are inhibited and SCL held low when the intervention of the processor is required (ROVR) after a byte has been transmitted. At the end of a transfer, it generates the stop condition.

21.3.6.4 Slave Transmitter

This mode can only be entered from the slave receiver mode. With either of the address formats (Figure 21-8 (a), (b), and (c)), the slave transmitter is entered if the slave address byte is the same as its own address and bit R/W₀ has been transmitted, if R/W₀ is high. The slave transmitter shifts the serial data out on the data line SDA in synch with the clock pulses that are generated by the master device. It does not generate the clock but it can hold clock line SCL low while intervention of the CPU is required (XUDF).

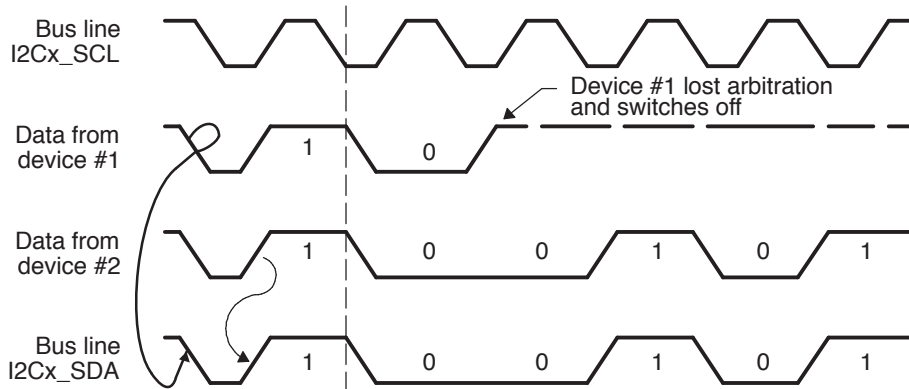
21.3.6.5 Slave Receiver

In this mode, serial data bits received on the bus line SDA are shifted-in in synch with the clock pulses on SCL that are generated by the master device. It does not generate the clock but it can hold clock line SCL low while intervention of the CPU is required (ROVR) following the reception of a byte.

21.3.7 Arbitration

If two or more master transmitters start a transmission on the same bus almost simultaneously, an arbitration procedure is invoked. The arbitration procedure uses the data presented on the serial bus by the competing transmitters. When a transmitter senses that a high signal it has presented on the bus has been overruled by a low signal, it switches to the slave receiver mode, sets the arbitration lost (AL) flag, and generates the arbitration lost interrupt. Figure 21-9 shows the arbitration procedure between two devices. The arbitration procedure gives priority to the device that transmits the serial data stream with the lowest binary value. Should two or more devices send identical first bytes, arbitration continues on the subsequent bytes.

Figure 21-9. Arbitration Procedure Between Two Master Transmitters

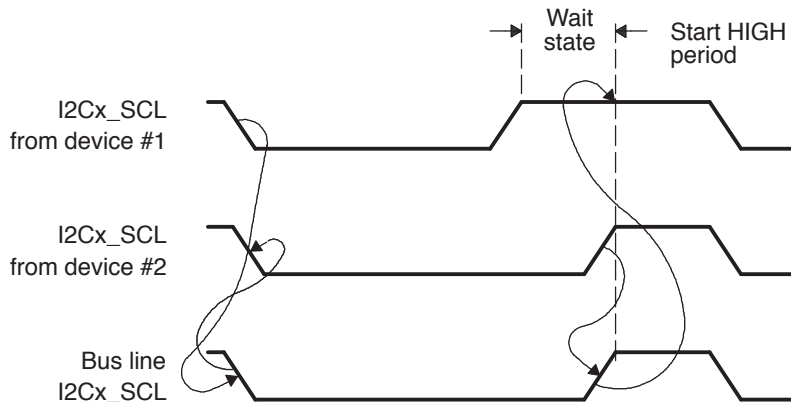


21.3.8 I2C Clock Generation and I2C Clock Synchronization

Under normal conditions, only one master device generates the clock signal, SCL. During the arbitration procedure, however, there are two or more master devices and the clock must be synchronized so that the data output can be compared. The wired-AND property of the clock line means that a device that first generates a low period of the clock line overrules the other devices. At this high/low transition, the clock generators of the other devices are forced to start generation of their own low period. The clock line is then held low by the device with the longest low period, while the other devices that finish their low periods must wait for the clock line to be released before starting their high periods. A synchronized signal on the clock line is thus obtained, where the slowest device determines the length of the low period and the fastest the length of the high period.

If a device pulls down the clock line for a longer time, the result is that all clock generators must enter the WAIT-state. In this way a slave can slow down a fast master and the slow device can create enough time to store a received byte or to prepare a byte to be transmitted (Clock Stretching). Figure 21-10 illustrates the clock synchronization.

Note: If the SCL or SDA lines are stuck low, the Bus Clear operation is supported. If the clock line (SCL) is stuck low, the preferred procedure is to reset the bus using the hardware reset signal if your I2C devices have hardware reset inputs. If the I2C devices do not have hardware reset inputs, cycle power to the devices to activate the mandatory internal power-on reset (POR) circuit. If the data line (SDA) is stuck low, the master should send nine clock pulses. The device that held the bus low should release it sometime within those nine clocks. If not, use the hardware reset or cycle power to clear the bus.

Figure 21-10. Synchronization of Two I2C Clock Generators


21.3.9 Prescaler (SCLK/ICLK)

The I2C module is operated with a functional clock (SCLK) frequency that can be in a range of 12-100 MHz, according to I2C mode that must be used (an internal ~24 MHz clock (ICLK) is recommended in case of F/S operation mode e). Note that the frequency of the functional clock influences directly the I2C bus performance and timings.

The internal clock used for I2C logic - ICLK - is generated via the I2C prescaler block. The prescaler consists of a 4-bit register - I2C_PSC, and is used to divide the system clock (SCLK) to obtain the internal required clock for the I2C module.

21.3.10 Noise Filter

The noise filter is used to suppress any noise that is 50 ns or less, in the case of F/S mode of operation. It is designed to suppress noise with one ICLK. The noise filter is always one ICLK cycle, regardless of the bus speed. For FS mode (prescaler = 4, ICLK = 24 MHz), the maximum width of the suppressed spikes is 41.6 ns. To ensure a correct filtering, the prescaler must be programmed accordingly.

21.3.11 I2C Interrupts

The I2C module generates 12 types of interrupt: addressed as slave, bus free (stop condition detected), access error, start condition, arbitration-lost, noacknowledge, general call, registers-ready-for-access, receive and transmit data, receive and transmit draining. These 12 interrupts are accompanied with 12 interrupt masks and flags defined in the I2C_IRQENABLE_SET and respectively I2C_IRQSTATUS_RAW registers. Note that all these 12 interrupt events are sharing the same hardware interrupt line.

- Addressed As Slave interrupt (AAS) is generated to inform the Local Host that an external master addressed the module as a slave. When this interrupt occurs, the CPU can check the I2C_ACTOA status register to check which of the 4 own addresses was used by the external master to access the module.
- Bus Free interrupt (BF) is generated to inform the Local Host that the I2C bus became free (when a Stop Condition is detected on the bus) and the module can initiate his own I2C transaction.
- Start Condition interrupt (STC) is generated after the module being in idle mode have detected (synchronously or asynchronously) a possible Start Condition on the bus (signalized with WakeUp).
- Access Error interrupt (AERR) is generated if a Data read access is performed while RX FIFO is empty or a Data write access is performed while TX FIFO is full.
- Arbitration lost interrupt (AL) is generated when the I2C arbitration procedure is lost.
- No-acknowledge interrupt (NACK) is generated when the master I2C does not receive acknowledge from the receiver.
- General call interrupt (GC) is generated when the device detects the address of all zeros (8 bits).
- Registers-ready-for-access interrupt (ARDY) is generated by the I2C when the previously programmed address, data, and command have been performed and the status bits have been updated. This

interrupt is used to let the CPU know that the I2C registers are ready for access.

- Receive interrupt/status (RRDY) is generated when there is received data ready to be read by the CPU from the I2C_DATA register (see the FIFO Management subsection for a complete description of required conditions for interrupt generation). The CPU can alternatively poll this bit to read the received data from the I2C_DATA register.
- Transmit interrupt/status (XRDY) is generated when the CPU needs to put more data in the I2C_DATA register after the transmitted data has been shifted out on the SDA pin (see the FIFO Management subsection for a complete description of required conditions for interrupt generation). The CPU can alternatively poll this bit to write the next transmitted data into the I2C_DATA register.
- Receive draining interrupt (RDR) is generated when the transfer length is not a multiple of threshold value, to inform the CPU that it can read the amount of data left to be transferred and to enable the draining mechanism (see [Section 21.3.14.4, *Draining Feature*](#), for additional details).
- Transmit draining interrupt (XDR) is generated when the transfer length is not a multiple of threshold value, to inform the CPU that it can read the amount of data left to be written and to enable the draining mechanism (see [Section 21.3.14.4, *Draining Feature*](#), for additional details).

When the interrupt signal is activated, the Local Host must read the I2C_IRQSTATUS_RAW register to define the type of the interrupt, process the request, and then write into these registers the correct value to clear the interrupt flag.

21.3.12 DMA Events

The I2C module can generate two DMA requests events, read (I2C_DMA_RX) and write (I2C_DMA_TX) that can be used by the DMA controller to synchronously read received data from the I2C_DATA or write transmitted data to the I2C_DATA register. The DMA read and write requests are generated in a similar manner as RRDY and XRDY, respectively.

The I2C DMA request signals (I2C_DMA_TX and I2C_DMA_RX) are activated according to the FIFO Management subsection.

21.3.13 Interrupt and DMA Events

I2C has two DMA channels (Tx and Rx).

I2C has one interrupt line for all the interrupt requests.

For the event and interrupt numbers, see the device-specific datasheet.

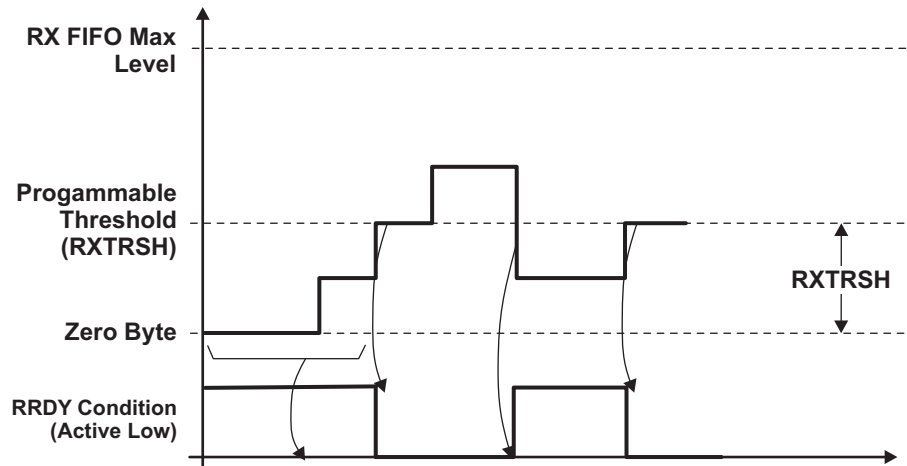
21.3.14 FIFO Management

The I2C module implements two internal 32-bytes FIFOs with dual clock for RX and TX modes. The depth of the FIFOs can be configured at integration via a generic parameter which will also be reflected in I2C_IRQSTATUS_RAW.FIFODEPTH register.

21.3.14.1 FIFO Interrupt Mode Operation

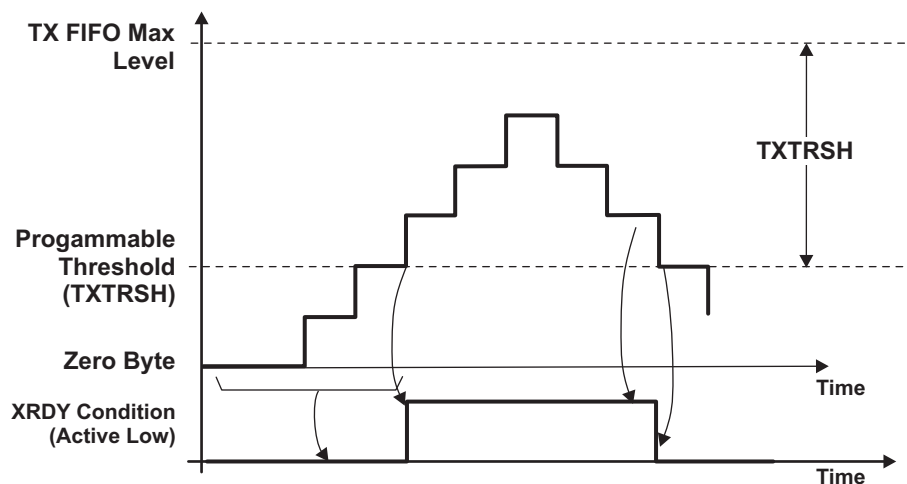
In FIFO interrupt mode (relevant interrupts enabled via I2C_IRQENABLE_SET register), the processor is informed of the status of the receiver and transmitter by an interrupt signal. These interrupts are raised when receive/transmit FIFO threshold (defined by I2C_BUF.TXTRSH or I2C_BUF.RXTRSH) are reached; the interrupt signals instruct the Local Host to transfer data to the destination (from the I2C module in receive mode and/or from any source to the I2C FIFO in transmit mode).

[Figure 21-11](#) and [Figure 21-12](#), respectively, illustrate receive and transmit operations from FIFO management point of view.

Figure 21-11. Receive FIFO Interrupt Request Generation


Note that in [Figure 21-11](#), the RRDY Condition illustrates that the condition for generating a RRDY interrupt is achieved. The interrupt request is generated when this signal is active, and it can be cleared only by the CPU by writing a 1 in the corresponding interrupt flag. If the condition is still present after clearing the previous interrupt, another interrupt request will be generated.

In receive mode, RRDY interrupt is not generated until the FIFO reaches its receive threshold. Once low, the interrupt can only be de-asserted when the Local Host has handled enough bytes to make the FIFO level below threshold. For each interrupt, the Local Host can be configured to read an amount of bytes equal with the value of the RX FIFO threshold + 1.

Figure 21-12. Transmit FIFO Interrupt Request Generation


Note that in [Figure 21-12](#), the XRDY Condition illustrates that the condition for generating a XRDY interrupt is achieved. The interrupt request is generated when this condition is achieved (when TX FIFO is empty, or the TX FIFO threshold is not reached and there are still data bytes to be transferred in the TX FIFO), and it can be cleared only by the CPU by writing a 1 in the corresponding interrupt flag after transmitting the configured number of bytes. If the condition is still present after clearing the previous interrupt, another interrupt request will be generated.

Note that in interrupt mode, the module offers two options for the CPU application to handle the interrupts:

- When detecting an interrupt request (XRDY or RRDY type), the CPU can write/read one data byte to/from the FIFO and then clear the interrupt. The module will not reassert the interrupt until the

interrupt condition is not met.

- When detecting an interrupt request (XRDY or RRDY type), the CPU can be programmed to write/read the amount of data bytes specified by the corresponding FIFO threshold (I2C_BUF.TXTRSH + 1 or I2C_BUF.RXTRSH + 1). In this case, the interrupt condition will be cleared and the next interrupt will be asserted again when the XRDY or RRDY condition will be again met.

If the second interrupt serving approach is used, an additional mechanism (draining feature) is implemented for the case when the transfer length is not a multiple of FIFO threshold (see [Section 21.3.14.4, Draining Feature](#)).

In slave TX mode, the draining feature cannot be used, since the transfer length is not known at the configuration time, and the external master can end the transfer at any point by not acknowledging one data byte.

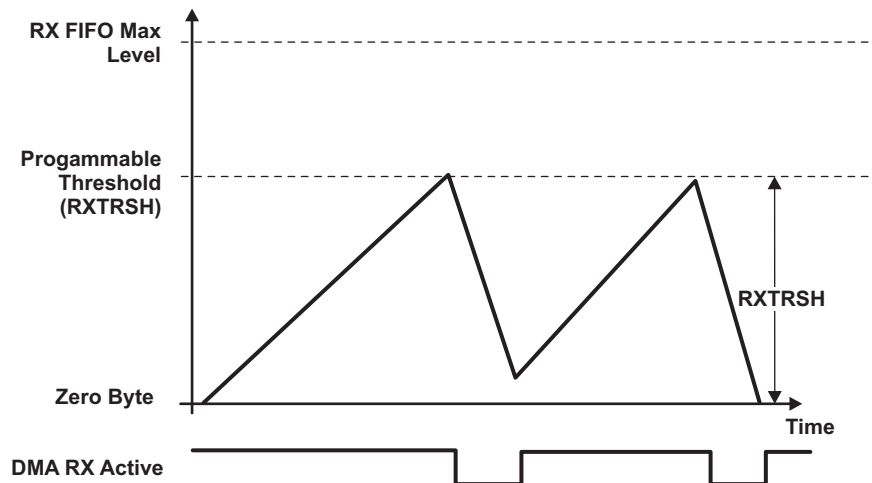
21.3.14.2 FIFO Polling Mode Operation

In FIFO polled mode (I2C_IRQENABLE_SET.XRDY_IE and I2C_IRQENABLE_SET.RRDY_IE disabled and DMA disabled), the status of the module (receiver or transmitter) can be checked by polling the XRDY and RRDY status registers (I2C_IRQSTATUS_RAW) (RDR and XDR can also be polled if draining feature must be used). The XRDY and RRDY flags are accurately reflecting the interrupt conditions mentioned in Interrupt Mode. This mode is an alternative to the FIFO interrupt mode of operation, where the status of the receiver and transmitter is automatically known by means of interrupts sent to the CPU.

21.3.14.3 FIFO DMA Mode Operation

In receive mode, a DMA request is generated as soon as the receive FIFO exceeds its threshold level defined in the threshold level register (I2C_BUF.RXTRSH + 1). This request should be de-asserted when the number of bytes defined by the threshold level has been read by the DMA, by setting the I2C_DMARXENABLE_CLR.DMARX_ENABLE_CLEAR field.

Figure 21-13. Receive FIFO DMA Request Generation



In transmit mode, a DMA request is automatically asserted when the transmit FIFO is empty. This request should be de-asserted when the number of bytes defined by the number in the threshold register (I2C_BUF.TXTHRS+1) has been written in the FIFO by the DMA, by setting the I2C_DMATXENABLE_CLR.DMATX_ENABLE_CLEAR field. If an insufficient number of characters are written, then the DMA request will remain active. [Figure 21-14](#) and [Figure 21-15](#) illustrate DMA TX transfers with different values for TXTRSH.

Figure 21-14. Transmit FIFO DMA Request Generation (High Threshold)

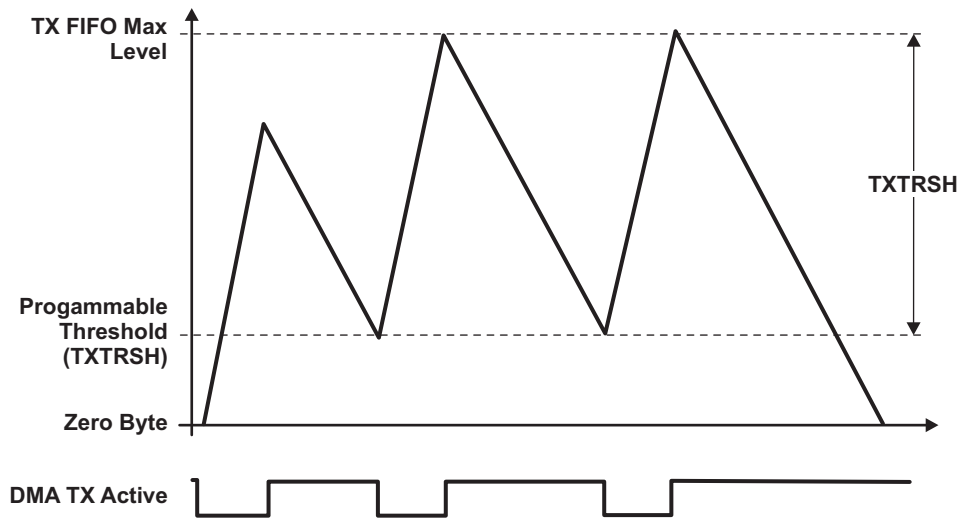
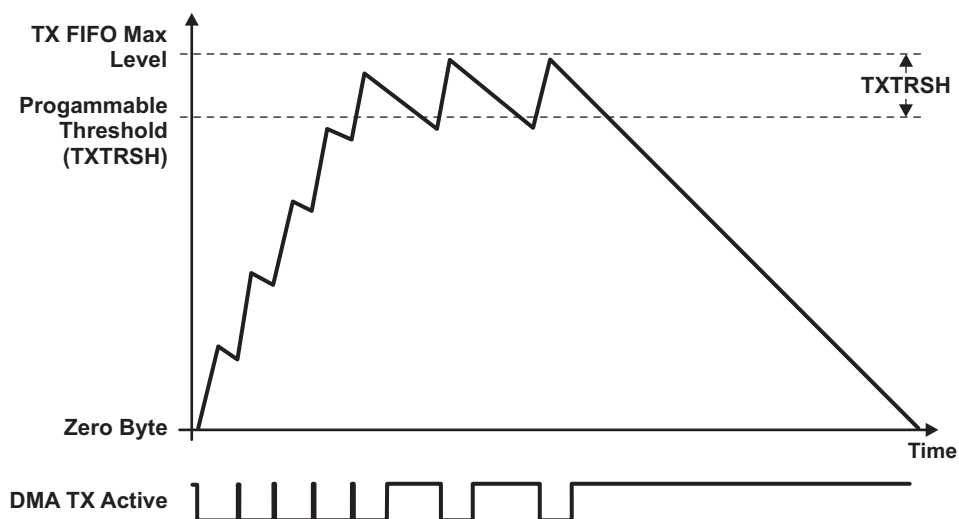


Figure 21-15. Transmit FIFO DMA Request Generation (Low Threshold)



Note that also in DMA mode it is possible to have a transfer whose length is not multiple of the configured FIFO threshold. In this case, the DMA draining feature is also used for transferring the additional bytes of the transfer (see [Section 21.3.14.4, Draining Feature](#), for additional details).

According to the desired operation mode, the programmer must set the FIFO thresholds according to the following table (note that only the interface/OCP side thresholds can be programmed; the I2C side thresholds are default equals to 1). Note that the thresholds must be set consistent with the DMA channel length.

In I2C Slave RX Mode, the Local Host can program the RX threshold with the desired value, and use the FIFO draining feature at the end of the I2C transfer to extract from the FIFO the remaining bytes if the threshold is not reached (see [Section 21.3.14.4, Draining Feature](#), for additional details).

Note that in I2C Slave TX Mode, the TX FIFO threshold should be set to 1 (I2C_BUF.TXTRSH=0, default value), since the length of the transfer may not be known at configuration time. In this way, the interrupt (or accordingly, DMA) requests will be generated for each byte requested by the remote I2C master to be transferred over the I2C bus. This configuration will prevent the I2C core to request additional data from the CPU or from the DMA controller (using IRQ or DMA), data that will eventually not be extracted from the FIFO by the external master (which can use not acknowledge at any time to end the transfer). If the TX threshold is not set to 1, the module will generate an interrupt or assert a DMA only when the external master requests a byte and the FIFO is empty. However, in this case the TX FIFO will require to be cleared at the end of the transfer.

The I2C module offers the possibility to the user to clear the RX or TX FIFO. This is achieved through I2C_BUF.RXFIFO_CLR and I2C_BUF.TXFIFO_CLR registers, which act like software reset for the FIFOs. In DMA mode, these bits will also reset the DMA state machines.

The FIFO clearing feature can be used when the module is configured as a transmitter, the external receiver responds with a NACK in the middle of the transfer, and there is still data in TX FIFO waiting to be transferred.

On the Functional (I2C) domain, the thresholds can always be considered equal to 1. This means that the I2C Core can start transferring data on the I2C bus whenever it has data in the FIFOs (FIFO is not empty).

21.3.14.4 Draining Feature

The Draining Feature is implemented by the I2C core for handling the end of the transfers whose length is not a multiple of FIFO threshold value, and offers the possibility to transfer the remaining amount of bytes (since the threshold is not reached).

Note that this feature prevents the CPU or the DMA controller to attempt more FIFO accesses than necessary (for example, to generate at the end of a transfer a DMA RX request having in the FIFO less bytes than the configured DMA transfer length). Otherwise, an Access Error interrupt will be generated (see I2C_IRQSTATUS_RAW.AERR interrupt).

The Draining mechanism will generate an interrupt (I2C_IRQSTATUS_RAW.RDR or I2C_IRQSTATUS_RAW.XDR) at the end of the transfer informing the CPU that it needs to check the amount of data left to be transferred (I2C_BUFSTAT.TXSTAT or RXSTAT) and to enable the Draining Feature of the DMA controller if DMA mode is enabled (by re-configuring the DMA transfer length according to this value), or perform only the required number of data accesses, if DMA mode is disabled.

In receiving mode (master or slave), if the RX FIFO threshold is not reached but the transfer was ended on the I2C bus and there is still data left in the FIFO (less than the threshold), the receive draining interrupt (I2C_IRQSTATUS_RAW.RDR) will be asserted to inform the local host that it can read the amount of data in the FIFO (I2C_BUFSTAT.RXSTAT). The CPU will perform a number of data read accesses equal with RXSTAT value (if interrupt or polling mode) or re-configure the DMA controller with the required value in order to drain the FIFO.

In master transmit mode, if the TX FIFO threshold is not reached but the amount of data remaining to be written in the FIFO is less than TXTRSH, the transmit draining interrupt (I2C_IRQSTATUS_RAW.XDR) will be asserted to inform the local host that it can read the amount of data remained to be written in the TX FIFO (I2C_BUFSTAT.TXSTAT). The CPU will need to write the required number of data bytes (specified by TXSTAT value) or re-configure the DMA controller with the required value in order to transfer the last bytes to the FIFO.

Note that in master mode, the CPU can alternatively skip the checking of TXSTAT and RXSTAT values since it can obtain internally this information (by computing DATACOUNT modulo TX/RXTHRS).

The draining feature is disabled by default, and it can be enabled using I2C_IRQENABLE_SET.XDR_IE or I2C_IRQENABLE_SET.RDR_IE registers (default disabled) only for the transfers with length not equal with the threshold value.

21.3.15 How to Program I2C

21.3.15.1 Module Configuration Before Enabling the Module

1. Program the prescaler to obtain an approximately 12-MHz I2C module clock (I2C_PSC = x; this value is to be calculated and is dependent on the System clock frequency).
2. Program the I2C clock to obtain 100 Kbps or 400 Kbps (SCLL = x and SCLH = x; these values are to be calculated and are dependent on the System clock frequency).
3. Configure its own address (I2C_OA = x) - only in case of I2C operating mode (F/S mode).
4. Take the I2C module out of reset (I2C_CON:I2C_EN = 1).

21.3.15.2 Initialization Procedure

1. Configure the I2C mode register (I2C_CON) bits.
2. Enable interrupt masks (I2C_IRQENABLE_SET), if using interrupt for transmit/receive data.
3. Enable the DMA (I2C_BUF and I2C_DMA/RX/TX/ENABLE_SET) and program the DMA controller) - only in case of I2C operating mode (F/S mode), if using DMA for transmit/receive data.

21.3.15.3 Configure Slave Address and DATA Counter Registers

In master mode, configure the slave address (I2C_SA = x) and the number of byte associated with the transfer (I2C_CNT = x).

21.3.15.4 Initiate a Transfer

Poll the bus busy (BB) bit in the I2C status register (I2C_IRQSTATUS_RAW). If it is cleared to 0 (bus not busy), configure START/STOP (I2C_CON: STT / I2C_CON: STP condition to initiate a transfer) - only in case of I2C operating mode (F/S mode).

21.3.15.5 Receive Data

Poll the receive data ready interrupt flag bit (RRDY) in the I2C status register (I2C_IRQSTATUS_RAW), use the RRDY interrupt (I2C_IRQENABLE_SET.RRDY_IE set) or use the DMA RX (I2C_BUF.RDMA_EN set together with I2C_DMARXENABLE_SET) to read the received data in the data receive register (I2C_DATA). Use draining feature (I2C_IRQSTATUS_RAW.RDR enabled by I2C_IRQENABLE_SET.RDR_IE)) if the transfer length is not equal with FIFO threshold.

21.3.15.6 Transmit Data

Poll the transmit data ready interrupt flag bit (XRDY) in the I2C status register (I2C_IRQSTATUS_RAW), use the XRDY interrupt (I2C_IRQENABLE_SET.XRDY_IE set) or use the DMA TX (I2C_BUF.XDMA_EN set together with I2C_DMATXENABLE_SET) to write data into the data transmit register (I2C_DATA). Use draining feature (I2C_IRQSTATUS_RAW.XDR enabled by I2C_IRQENABLE_SET.XDR_IE)) if the transfer length is not equal with FIFO threshold.

21.3.16 I2C Behavior During Emulation

To configure the I2C to stop during emulation suspend events (for example, debugger breakpoints), set up the I2C and the Debug Subsystem:

1. Set I2C_SYSTEST.FREE=0. This will allow the Suspend_Control signal from the Debug Subsystem ([Chapter 27](#)) to stop and start the I2C. Note that if FREE=1, the Suspend_Control signal is ignored and the I2C is free running regardless of any debug suspend event. This FREE bit gives local control from a module perspective to gate the suspend signal coming from the Debug Subsystem.
2. Set the appropriate xxx_Suspend_Control register = 0x9, as described in [Section 27.1.1.1, Debug Suspend Support for Peripherals](#). Choose the register appropriate to the peripheral you want to suspend during a suspend event.

21.4 I2C Registers

NOTE: All bits defined as reserved must be written by software with 0s, for preserving future compatibility. When read, any reserved bit returns 0. Also, note that it is good software practice to use complete mask patterns for setting or testing individually bit fields within a register.

21.4.1 I2C Registers

Table 21-8 lists the memory-mapped registers for the I2C. All register offset addresses not listed in Table 21-8 should be considered as reserved locations and the register contents should not be modified.

Table 21-8. I2C Registers

Offset	Acronym	Register Name	Section
0h	I2C_REVNB_LO	Module Revision Register (low bytes)	Section 21.4.1.1
4h	I2C_REVNB_HI	Module Revision Register (high bytes)	Section 21.4.1.2
10h	I2C_SYSC	System Configuration Register	Section 21.4.1.3
24h	I2C_IRQSTATUS_RAW	I2C Status Raw Register	Section 21.4.1.4
28h	I2C_IRQSTATUS	I2C Status Register	Section 21.4.1.5
2Ch	I2C_IRQENABLE_SET	I2C Interrupt Enable Set Register	Section 21.4.1.6
30h	I2C_IRQENABLE_CLR	I2C Interrupt Enable Clear Register	Section 21.4.1.7
34h	I2C_WE	I2C Wakeup Enable Register	Section 21.4.1.8
38h	I2C_DMARXENABLE_SET	Receive DMA Enable Set Register	Section 21.4.1.9
3Ch	I2C_DMATXENABLE_SET	Transmit DMA Enable Set Register	Section 21.4.1.10
40h	I2C_DMARXENABLE_CLR	Receive DMA Enable Clear Register	Section 21.4.1.11
44h	I2C_DMATXENABLE_CLR	Transmit DMA Enable Clear Register	Section 21.4.1.12
48h	I2C_DMARXWAKE_EN	Receive DMA Wakeup Register	Section 21.4.1.13
4Ch	I2C_DMATXWAKE_EN	Transmit DMA Wakeup Register	Section 21.4.1.14
90h	I2C_SYSS	System Status Register	Section 21.4.1.15
94h	I2C_BUF	Buffer Configuration Register	Section 21.4.1.16
98h	I2C_CNT	Data Counter Register	Section 21.4.1.17
9Ch	I2C_DATA	Data Access Register	Section 21.4.1.18
A4h	I2C_CON	I2C Configuration Register	Section 21.4.1.19
A8h	I2C_OA	I2C Own Address Register	Section 21.4.1.20
ACh	I2C_SA	I2C Slave Address Register	Section 21.4.1.21
B0h	I2C_PSC	I2C Clock Prescaler Register	Section 21.4.1.22
B4h	I2C_SCLL	I2C SCL Low Time Register	Section 21.4.1.23
B8h	I2C_SCLH	I2C SCL High Time Register	Section 21.4.1.24
BCh	I2C_SYSTEST	System Test Register	Section 21.4.1.25
C0h	I2C_BUFSTAT	I2C Buffer Status Register	Section 21.4.1.26
C4h	I2C_OA1	I2C Own Address 1 Register	Section 21.4.1.27
C8h	I2C_OA2	I2C Own Address 2 Register	Section 21.4.1.28
CCh	I2C_OA3	I2C Own Address 3 Register	Section 21.4.1.29
D0h	I2C_ACTOA	Active Own Address Register	Section 21.4.1.30
D4h	I2C_SBLOCK	I2C Clock Blocking Enable Register	Section 21.4.1.31

21.4.1.1 I2C_REVNB_LO Register (offset = 0h) [reset = 0h]

I2C_REVNB_LO is shown in [Figure 21-16](#) and described in [Table 21-9](#).

This read-only register contains the hard-coded revision number of the module. A write to this register has no effect. I2C controller with interrupt using interrupt vector register (I2C_IV) is revision 1.x. I2C controller with interrupt using status register bits (I2C_IRQSTATUS_RAW) is revision 2.x.

Figure 21-16. I2C_REVNB_LO Register

31	30	29	28	27	26	25	24	23	22	21	20	19	18	17	16
RESERVED															
R-0h															
15	14	13	12	11	10	9	8	7	6	5	4	3	2	1	0
RTL				MAJOR				CUSTOM				MINOR			
R-0h				R-0h				R-0h				R-0h			

LEGEND: R/W = Read/Write; R = Read only; W1toCl = Write 1 to clear bit; -n = value after reset

Table 21-9. I2C_REVNB_LO Register Field Descriptions

Bit	Field	Type	Reset	Description
31-16	RESERVED	R	0h	
15-11	RTL	R	0h	RTL version.
10-8	MAJOR	R	0h	Major Revision. This field changes when there is a major feature change. This field does not change due to bug fix, or minor feature change.
7-6	CUSTOM	R	0h	Indicates a special version for a particular device. Consequence of use may avoid use of standard Chip Support Library (CSL) / Drivers. 0 if non-custom.
5-0	MINOR	R	0h	Minor Revision This field changes when features are scaled up or down. This field does not change due to bug fix, or major feature change.

21.4.1.2 I2C_REVNB_HI Register (offset = 4h) [reset = 0h]

I2C_REVNB_HI is shown in [Figure 21-17](#) and described in [Table 21-10](#).

A reset has no effect on the value returned.

Figure 21-17. I2C_REVNB_HI Register

31	30	29	28	27	26	25	24
RESERVED							
R-0h							
23	22	21	20	19	18	17	16
RESERVED							
R-0h							
15	14	13	12	11	10	9	8
SCHEME		RESERVED			FUNC		
R-0h		R-0h			R-0h		
7	6	5	4	3	2	1	0
FUNC							
R-0h							

LEGEND: R/W = Read/Write; R = Read only; W1toCl = Write 1 to clear bit; -n = value after reset

Table 21-10. I2C_REVNB_HI Register Field Descriptions

Bit	Field	Type	Reset	Description
31-16	RESERVED	R	0h	
15-14	SCHEME	R	0h	Used to distinguish between old Scheme and current. Spare bit to encode future schemes.
13-12	RESERVED	R	0h	
11-0	FUNC	R	0h	Function: Indicates a software compatible module family

21.4.1.3 I2C_SYSC Register (offset = 10h) [reset = 0h]

I2C_SYSC is shown in [Figure 21-18](#) and described in [Table 21-11](#).

This register allows controlling various parameters of the peripheral interface.

Figure 21-18. I2C_SYSC Register

31	30	29	28	27	26	25	24
RESERVED							
R-0h							
23	22	21	20	19	18	17	16
RESERVED							
R-0h							
15	14	13	12	11	10	9	8
RESERVED						CLKACTIVITY	
R-0h						R/W-0h	
7	6	5	4	3	2	1	0
RESERVED			IDLEMODE		ENAWAKEUP	SRST	AUTOIDLE
R-0h			R/W-0h		R/W-0h	R/W-0h	R/W-0h

LEGEND: R/W = Read/Write; R = Read only; W1toCl = Write 1 to clear bit; -n = value after reset

Table 21-11. I2C_SYSC Register Field Descriptions

Bit	Field	Type	Reset	Description
31-10	RESERVED	R	0h	
9-8	CLKACTIVITY	R/W	0h	<p>Clock Activity selection bits. Those bits (one bit for each clock signal present on the boundary of the module) are set to 1 to disable external clock gating mechanism in Idle Mode. Values after reset are low (for both 2 bits). Note: If the System (functional) Clock is cut-off, the module will assert a WakeUp event when it asynchronously detects a Start Condition on the I2C Bus. Note that in this case the first transfer will not be taken into account by the module (NACK will be detected by the external master).</p> <p>0h = Both clocks can be cut off 1h = Only Interface/OCP clock must be kept active; system clock can be cut off 2h = Only system clock must be kept active; Interface/OCP clock can be cut off 3h = Both clocks must be kept active</p>
7-5	RESERVED	R	0h	
4-3	IDLEMODE	R/W	0h	<p>Idle Mode selection bits. These two bits are used to select one of the idle mode operation mechanisms. Value after reset is 00 (Force Idle).</p> <p>1h = No Idle mode 2h = Smart Idle mode 3h = Smart-idle wakeup. Available only on I2C0.</p>
2	ENAWAKEUP	R/W	0h	<p>Enable Wakeup control bit. When this bit is set to 1, the module enables its own wakeup mechanism. Value after reset is low.</p> <p>0h = Wakeup mechanism is disabled 1h = Wakeup mechanism is enabled</p>

Table 21-11. I2C_SYSC Register Field Descriptions (continued)

Bit	Field	Type	Reset	Description
1	SRST	R/W	0h	SoftReset bit. When this bit is set to 1, entire module is reset as for the hardware reset. This bit is automatically cleared to 0 by the core and it is only reset by the hardware reset. During reads, it always returns 0. Value after reset is low. 0h = Normal mode 1h = The module is reset
0	AUTOIDLE	R/W	0h	Autoidle bit. When this bit is set to 1, the module activates its own idle mode mechanism. By evaluating its internal state, the module can decide to gate part of his internal clock tree in order to improve the overall power consumption. Value after reset is high. 0h = Auto Idle mechanism is disabled 1h = Auto Idle mechanism is enabled

21.4.1.4 I2C_IRQSTATUS_RAW Register (offset = 24h) [reset = 0h]

I2C_IRQSTATUS_RAW is shown in [Figure 21-19](#) and described in [Table 21-12](#).

This register provides core status information for interrupt handling, showing all active events (enabled and not enabled). The fields are read-write. Writing a 1 to a bit will set it to 1, that is, trigger the IRQ (mostly for debug). Writing a 0 will have no effect, that is, the register value will not be modified. Only enabled, active events will trigger an actual interrupt request on the IRQ output line.

Figure 21-19. I2C_IRQSTATUS_RAW Register

31	30	29	28	27	26	25	24
RESERVED							
R-0h							
23	22	21	20	19	18	17	16
RESERVED							
R-0h							
15	14	13	12	11	10	9	8
RESERVED	XDR	RDR	BB	ROVR	XUDF	AAS	BF
R-0h	R/W-0h	R/W-0h	R-0h	R/W-0h	R/W-0h	R/W-0h	R/W-0h
7	6	5	4	3	2	1	0
AERR	STC	GC	XRDY	RRDY	ARDY	NACK	AL
R/W-0h	R/W-0h	R/W-0h	R/W-0h	R/W-0h	R/W-0h	R/W-0h	R/W-0h

LEGEND: R/W = Read/Write; R = Read only; W1toCl = Write 1 to clear bit; -n = value after reset

Table 21-12. I2C_IRQSTATUS_RAW Register Field Descriptions

Bit	Field	Type	Reset	Description
31-15	RESERVED	R	0h	
14	XDR	R/W	0h	<p>Transmit draining IRQ status. I2C Master Transmit mode only. This read/clear only bit is set to 1 when the module is configured as a master transmitter, the TX FIFO level is below the configured threshold (TXTRSH) and the amount of data still to be transferred is less than TXTRSH.</p> <p>When this bit is set to 1 by the core, CPU must read the I2C_BUFSTAT.TXSTAT register in order to check the amount of data that need to be written in the TX FIFO.</p> <p>Then, according to the mode set (DMA or interrupt), the CPU can enable the DMA draining feature of the DMA controller with the number of data bytes to be transferred (I2C_BUFSTAT.TXSTAT), or generate write data accesses according to this value (IRQ mode). The interrupt needs to be cleared after the DMA controller was reconfigured (if DMA mode enabled), or before generating data accesses to the FIFO (if IRQ mode enabled).</p> <p>If the corresponding interrupt was enabled, an interrupt is signaled to the local host.</p> <p>The CPU can also poll this bit.</p> <p>For more details about TDR generation, refer to the FIFO Management subsection.</p> <p>The CPU can only clear this bit by writing a 1 into this register. A write 0 has no effect.</p> <p>Value after reset is low.</p> <p>0h = Transmit draining inactive 1h = Transmit draining enabled</p>

Table 21-12. I2C_IRQSTATUS_RAW Register Field Descriptions (continued)

Bit	Field	Type	Reset	Description
13	RDR	R/W	0h	<p>Receive draining IRQ status. I2C Receive mode only. This read/clear only bit is set to 1 when the module is configured as a receiver, a stop condition was received on the bus and the RX FIFO level is below the configured threshold (RXTRSH). When this bit is set to 1 by the core, CPU must read the I2C_BUFSTAT.RXSTAT register in order to check the amount of data left to be transferred from the FIFO. Then, according to the mode set (DMA or interrupt), the CPU needs to enable the draining feature of the DMA controller with the number of data bytes to be transferred (I2C_BUFSTAT.RXSTAT), or generate read data accesses according to this value (IRQ mode). The interrupt needs to be cleared after the DMA controller was reconfigured (if DMA mode enabled), or before generating data accesses to the FIFO (if IRQ mode enabled). If the corresponding interrupt was enabled, an interrupt is signaled to the local host. The CPU can also poll this bit. For more details about RDR generation, refer to the FIFO Management subsection. The CPU can only clear this bit by writing a 1 into this register. A write 0 has no effect. Value after reset is low. 0h = Receive draining inactive 1h = Receive draining enabled</p>
12	BB	R	0h	<p>This read-only bit indicates the state of the serial bus. In slave mode, on reception of a start condition, the device sets BB to 1. BB is cleared to 0 after reception of a stop condition. In master mode, the software controls BB. To start a transmission with a start condition, MST, TRX, and STT must be set to 1 in the I2C_CON register. To end a transmission with a stop condition, STP must be set to 1 in the I2C_CON register. When BB = 1 and STT = 1, a restart condition is generated. Value after reset is low. 0h = Bus is free 1h = Bus is occupied</p>
11	ROVR	R/W	0h	<p>Receive overrun status. Writing into this bit has no effect. I2C receive mode only. This read-only bit indicates whether the receiver has experienced overrun. Overrun occurs when the shift register is full and the receive FIFO is full. An overrun condition does not result in a data loss the peripheral is just holding the bus (low on SCL) and prevents other bytes from being received. ROVR is set to 1 when the I2C has recognized an overrun. ROVR is clear when reading I2C_DATA register, or when resetting the I2C (I2C_CON:I2C_EN = 0). Value after reset is low. 0h = Normal operation 1h = Receiver overrun</p>

Table 21-12. I2C_IRQSTATUS_RAW Register Field Descriptions (continued)

Bit	Field	Type	Reset	Description
10	XUDF	R/W	0h	<p>Transmit underflow status. Writing into this bit has no effect. I2C transmit mode only. This read-only bit indicates whether the transmitter has experienced underflow. In master transmit mode, underflow occurs when the shift register is empty, the transmit FIFO is empty, and there are still some bytes to transmit (DCOUNT 0). In slave transmit mode, underflow occurs when the shift register is empty, the transmit FIFO is empty, and there are still some bytes to transmit (read request from external I2C master). XUDF is set to 1 when the I2C has recognized an underflow. The core holds the line till the underflow cause has disappeared. XUDF is clear when writing I2C_DATA register or resetting the I2C (I2C_CON:I2C_EN = 0). Value after reset is low. 0h = Normal operation 1h = Transmit underflow</p>
9	AAS	R/W	0h	<p>Address recognized as slave IRQ status. I2C mode only. This read only bit is set to 1 by the device when it has recognized its own slave address (or one of the alternative own addresses), or an address of all zeros (8 bits). When this bit is set to 1 by the core, an interrupt is signaled to the local host if the interrupt was enabled. This bit can be cleared in 2 ways: One way is if the interrupt was enabled, it will be cleared by writing 1 into this register (writing 0 has no effect). The other way is if the interrupt was not enabled, the AAS bit is reset to 0 by restart or stop. Value after reset is low. 0h = No action 1h = Address recognized</p>
8	BF	R/W	0h	<p>I2C mode only. This read only bit is set to 1 by the device when the I2C bus became free (after a transfer is ended on the bus stop condition detected). This interrupt informs the Local Host that it can initiate its own I2C transfer on the bus. When this bit is set to 1 by the core, an interrupt is signaled to the local host if the interrupt was enabled. The CPU can only clear this bit by writing a 1 into this register. Writing 0 has no effect. Value after reset is low. 0h = No action 1h = Bus Free</p>
7	AERR	R/W	0h	<p>Access Error IRQ status. I2C mode only. This read/clear only bit is set to 1 by the device if an Interface/OCP write access is performed to I2C_DATA while the TX FIFO is full or if an Interface/OCP read access is performed to the I2C_DATA while the RX FIFO is empty. Note that, when the RX FIFO is empty, a read access will return to the previous read data value. When the TX FIFO is full, a write access is ignored. In both events, the FIFO pointers will not be updated. When this bit is set to 1 by the core, an interrupt is signaled to the local host if the interrupt was enabled. The CPU can only clear this bit by writing a 1 into this register. Writing 0 has no effect. Value after reset is low. 0h = No action 1h = Access Error</p>

Table 21-12. I2C_IRQSTATUS_RAW Register Field Descriptions (continued)

Bit	Field	Type	Reset	Description
6	STC	R/W	0h	<p>Start Condition IRQ status. I2C mode only.</p> <p>This read/clear only bit is set to 1 by the device if previously the module was in idle mode and a start condition was asynchronously detected on the I2C Bus and signalized with an Wakeup (if the I2C_SYSC.ClockActivity allows the system clock to be cut-off). When the Active Mode will be restored and the interrupt generated, this bit will indicate the reason of the wakeup.</p> <p>Note 1: The corresponding interrupt for this bit should be enabled only if the module was configured to allow the possibility of cutting-off the system clock while in Idle State (I2C_SYSC.ClockActivity = 00 or 01).</p> <p>Note 2: The first transfer (corresponding to the detected start condition) will be lost (not taken into account by the module) and it will be used only for generating the WakeUp enable for restoring the Active Mode of the module.</p> <p>On the I2C line, the external master which generated the transfer will detect this behavior as a not acknowledge to the address phase and will possibly restart the transfer.</p> <p>The CPU can only clear this bit by writing a 1 into this register. Writing 0 has no effect. Value after reset is low.</p> <p>0h = No action 1h = Start Condition detected</p>
5	GC	R/W	0h	<p>General call IRQ status. Set to '1' by core when General call address detected and interrupt signaled to MPUSS. Write '1' to clear. I2C mode only.</p> <p>This read/clear only bit is set to 1 by the device if it detects the address of all zeros (8 bits) (general call). When this bit is set to 1 by the core, an interrupt is signaled to the local host if the interrupt was enabled. The CPU can only clear this bit by writing a 1 into this register. Writing 0 has no effect.</p> <p>Note: When this bit is set to 1, AAS also reads as 1. Value after reset is low.</p> <p>0h = No general call detected 1h = General call address detected</p>

Table 21-12. I2C_IRQSTATUS_RAW Register Field Descriptions (continued)

Bit	Field	Type	Reset	Description
4	XRDY	R/W	0h	<p>Transmit data ready IRQ status. Set to '1' by core when transmitter and when new data is requested. When set to '1' by core, an interrupt is signaled to MPUSS. Write '1' to clear.</p> <p>Transmit mode only (I2C mode). This read/clear only bit (XRDY) is set to 1 when the I2C peripheral is a master or slave transmitter, the CPU needs to send data through the I2C bus, and the module (transmitter) requires new data to be served.</p> <p>Note that a master transmitter requests new data if the FIFO TX level is below the threshold (TXTRSH) and the required amount of data remained to be transmitted (I2C_BUFSTAT.TXSTAT) is greater than the threshold.</p> <p>A slave transmitter requests new data when the FIFO TX level is below the threshold (if TXTRSH > 1), or anytime there is a read request from external master (for each acknowledge received from the master), if TXTRSH = 1.</p> <p>When this bit is set to 1 by the core, an interrupt is signaled to the local host if the interrupt was enabled.</p> <p>The CPU can also poll this bit (refer to the FIFO Management subsection for details about XRDY generation).</p> <p>The CPU can only clear this bit by writing a 1 into this register. Writing 0 has no effect.</p> <p>Note: If the DMA transmit mode is enabled (I2C_BUF.XDMA_EN is set, together with I2C_DMATXENABLE_SET), this bit is forced to 0 and no interrupt will be generated instead, a DMA TX request to the main DMA controller of the system is generated.</p> <p>Value after reset is low. 0h = Transmission ongoing 1h = Transmit data ready</p>
3	RRDY	R/W	0h	<p>Receive mode only (I2C mode). This read/clear only RRDY is set to 1 when the RX FIFO level is above the configured threshold (RXTRSH). When this bit is set to 1 by the core, CPU is able to read new data from the I2C_DATA register. If the corresponding interrupt was enabled, an interrupt is signaled to the local host.</p> <p>The CPU to read the received data in I2C_DATA register can also poll this bit (refer to the FIFO Management subsection for details about RRDY generation).</p> <p>The CPU can only clear this bit by writing a 1 into this register. A write 0 has no effect.</p> <p>If the DMA receive mode is enabled (I2C_BUF.RDMA_EN is set, together with I2C_DMARXENABLE_SET), this bit is forced to 0 and no interrupt will be generated instead a DMA RX request to the main DMA controller of the system is generated.</p> <p>Value after reset is low. 0h = Receive FIFO threshold not reached 1h = Receive data ready for read (RX FIFO threshold reached)</p>

Table 21-12. I2C_IRQSTATUS_RAW Register Field Descriptions (continued)

Bit	Field	Type	Reset	Description
2	ARDY	R/W	0h	<p>I2C mode only.</p> <p>This read/clear only bit, when set to 1, indicates that the previously programmed data and command (receive or transmit, master or slave) has been performed and status bit has been updated. The CPU uses this flag to let it know that the I2C registers are ready to be accessed again.</p> <p>The CPU can only clear this bit by writing a 1 into this register. A write 0 has no effect.</p> <p>Mode: I2C Master transmit, Others: STP = 1, ARDY Set Condition: DCOUNT = 0.</p> <p>Mode: I2C Master receive, Others: STP = 1, ARDY Set Condition: DCOUNT = 0 and receiver FIFO empty Mode: I2C Master transmit, Others: STP = 0, ARDY Set Condition: DCOUNT passed 0 Mode: I2C Master receive, Others: STP = 0, ARDY Set Condition: DCOUNT passed 0 and receiver FIFO empty Mode: I2C Master transmit, Others: n/a, ARDY Set Condition: Stop or restart condition received from master Mode: I2C Slave receive, Others: n/a, ARDY Set Condition: Stop or restart condition and receiver FIFO empty</p> <p>Value after reset is low.</p> <p>0h = No action 1h = Access ready</p>
1	NACK	R/W	0h	<p>No acknowledgment IRQ status.</p> <p>Bit is set when No Acknowledge has been received, an interrupt is signaled to MPUSS.</p> <p>Write '1' to clear this bit.</p> <p>I2C mode only.</p> <p>The read/clear only No Acknowledge flag bit is set when the hardware detects No Acknowledge has been received.</p> <p>When a NACK event occurs on the bus, this bit is set to 1, the core automatically ends the transfer and clears the MST/STP bits in the I2C_CON register and the I2C becomes a slave.</p> <p>Clearing the FIFOs from remaining data might be required.</p> <p>The CPU can only clear this bit by writing a 1 into this register. Writing 0 has no effect.</p> <p>Value after reset is low.</p> <p>0h = Normal operation 1h = Not Acknowledge detected</p>
0	AL	R/W	0h	<p>Arbitration lost IRQ status.</p> <p>This bit is automatically set by the hardware when it loses the Arbitration in master transmit mode, an interrupt is signaled to MPUSS.</p> <p>During reads, it always returns 0.</p> <p>I2C mode only.</p> <p>The read/clear only Arbitration Lost flag bit is set to 1 when the device (configured in master mode) detects it has lost an arbitration (in Address Phase).</p> <p>This happens when two or more masters initiate a transfer on the I2C bus almost simultaneously or when the I2C attempts to start a transfer while BB (bus busy) is 1.</p> <p>When this is set to 1 due to arbitration lost, the core automatically clears the MST/STP bits in the I2C_CON register and the I2C becomes a slave receiver.</p> <p>The CPU can only clear this bit by writing a 1 to this register. Writing 0 has no effect.</p> <p>Value after reset is low.</p> <p>0h = Normal operation 1h = Arbitration lost detected</p>

21.4.1.5 I2C_IRQSTATUS Register (offset = 28h) [reset = 0h]

I2C_IRQSTATUS is shown in [Figure 21-20](#) and described in [Table 21-13](#).

This register provides core status information for interrupt handling, showing all active and enabled events and masking the others. The fields are read-write. Writing a 1 to a bit will clear it to 0, that is, clear the IRQ. Writing a 0 will have no effect, that is, the register value will not be modified. Only enabled, active events will trigger an actual interrupt request on the IRQ output line. For all the internal fields of the I2C_IRQSTATUS register, the descriptions given in the I2C_IRQSTATUS_RAW subsection are valid.

Figure 21-20. I2C_IRQSTATUS Register

31	30	29	28	27	26	25	24
RESERVED							
R-0h							
23	22	21	20	19	18	17	16
RESERVED							
R-0h							
15	14	13	12	11	10	9	8
RESERVED	XDR	RDR	BB	ROVR	XUDF	AAS	BF
R-0h	R/W-0h	R/W-0h	R/W-0h	R/W-0h	R/W-0h	R/W-0h	R/W-0h
7	6	5	4	3	2	1	0
AERR	STC	GC	XRDY	RRDY	ARDY	NACK	AL
R/W-0h	R/W-0h	R/W-0h	R/W-0h	R/W-0h	R/W-0h	R/W-0h	R/W-0h

LEGEND: R/W = Read/Write; R = Read only; W1toCl = Write 1 to clear bit; -n = value after reset

Table 21-13. I2C_IRQSTATUS Register Field Descriptions

Bit	Field	Type	Reset	Description
31-15	RESERVED	R	0h	
14	XDR	R/W	0h	Transmit draining IRQ enabled status. 0h = Transmit draining inactive 1h = Transmit draining enabled
13	RDR	R/W	0h	Receive draining IRQ enabled status. 0h = Receive draining inactive 1h = Receive draining enabled
12	BB	R/W	0h	Bus busy enabled status. Writing into this bit has no effect. 0h = Bus is free 1h = Bus is occupied
11	ROVR	R/W	0h	Receive overrun enabled status. Writing into this bit has no effect. 0h = Normal operation 1h = Receiver overrun
10	XUDF	R/W	0h	Transmit underflow enabled status. Writing into this bit has no effect. 0h = Normal operation 1h = Transmit underflow
9	AAS	R/W	0h	Address recognized as slave IRQ enabled status. 0h = No action 1h = Address recognized
8	BF	R/W	0h	Bus Free IRQ enabled status. 0h = No action 1h = Bus free
7	AERR	R/W	0h	Access Error IRQ enabled status. 0h = No action 1h = Access error

Table 21-13. I2C_IRQSTATUS Register Field Descriptions (continued)

Bit	Field	Type	Reset	Description
6	STC	R/W	0h	Start Condition IRQ enabled status. 0h = No action 1h = Start condition detected
5	GC	R/W	0h	General call IRQ enabled status. Set to '1' by core when General call address detected and interrupt signaled to MPUSS. Write '1' to clear. 0h = No general call detected 1h = General call address detected
4	XRDY	R/W	0h	Transmit data ready IRQ enabled status. Set to '1' by core when transmitter and when new data is requested. When set to '1' by core, an interrupt is signaled to MPUSS. Write '1' to clear. 0h = Transmission ongoing 1h = Transmit data ready
3	RRDY	R/W	0h	Receive data ready IRQ enabled status. Set to '1' by core when receiver mode, a new data is able to be read. When set to '1' by core, an interrupt is signaled to MPUSS. Write '1' to clear. 0h = No data available 1h = Receive data available
2	ARDY	R/W	0h	Register access ready IRQ enabled status. When set to '1' it indicates that previous access has been performed and registers are ready to be accessed again. An interrupt is signaled to MPUSS. Write '1' to clear. 0h = Module busy 1h = Access ready
1	NACK	R/W	0h	No acknowledgment IRQ enabled status. Bit is set when No Acknowledge has been received, an interrupt is signaled to MPUSS. Write '1' to clear this bit. 0h = Normal operation 1h = Not Acknowledge detected
0	AL	R/W	0h	Arbitration lost IRQ enabled status. This bit is automatically set by the hardware when it loses the Arbitration in master transmit mode, an interrupt is signaled to MPUSS. During reads, it always returns 0. 0h = Normal operation 1h = Arbitration lost detected

21.4.1.6 I2C_IRQENABLE_SET Register (offset = 2Ch) [reset = 0h]

I2C_IRQENABLE_SET is shown in [Figure 21-21](#) and described in [Table 21-14](#).

All 1-bit fields enable a specific interrupt event to trigger an interrupt request. Writing a 1 to a bit will enable the field. Writing a 0 will have no effect, that is, the register value will not be modified. For all the internal fields of the I2C_IRQENABLE_SET register, the descriptions given in the I2C_IRQSTATUS_RAW subsection are valid.

Figure 21-21. I2C_IRQENABLE_SET Register

31	30	29	28	27	26	25	24
RESERVED							
R-0h							
23	22	21	20	19	18	17	16
RESERVED							
R-0h							
15	14	13	12	11	10	9	8
RESERVED	XDR_IE	RDR_IE	RESERVED	ROVR	XUDF	AAS_IE	BF_IE
R-0h	R/W-0h	R/W-0h	R-0h	R/W-0h	R/W-0h	R/W-0h	R/W-0h
7	6	5	4	3	2	1	0
AERR_IE	STC_IE	GC_IE	XRDY_IE	RRDY_IE	ARDY_IE	NACK_IE	AL_IE
R/W-0h	R/W-0h	R/W-0h	R/W-0h	R/W-0h	R/W-0h	R/W-0h	R/W-0h

LEGEND: R/W = Read/Write; R = Read only; W1toCl = Write 1 to clear bit; -n = value after reset

Table 21-14. I2C_IRQENABLE_SET Register Field Descriptions

Bit	Field	Type	Reset	Description
31-15	RESERVED	R	0h	
14	XDR_IE	R/W	0h	Transmit draining interrupt enable set. Mask or unmask the interrupt signaled by bit in I2C_STAT[XDR]. 0h = Transmit draining interrupt disabled 1h = Transmit draining interrupt enabled
13	RDR_IE	R/W	0h	Receive draining interrupt enable set. Mask or unmask the interrupt signaled by bit in I2C_STAT[RDR]. 0h = Receive draining interrupt disabled 1h = Receive draining interrupt enabled
12	RESERVED	R	0h	
11	ROVR	R/W	0h	Receive overrun enable set. 0h = Receive overrun interrupt disabled 1h = Receive draining interrupt enabled
10	XUDF	R/W	0h	Transmit underflow enable set. 0h = Transmit underflow interrupt disabled 1h = Transmit underflow interrupt enabled
9	AAS_IE	R/W	0h	Addressed as slave interrupt enable set. Mask or unmask the interrupt signaled by bit in I2C_STAT[AAS]. 0h = Addressed as slave interrupt disabled 1h = Addressed as slave interrupt enabled
8	BF_IE	R/W	0h	Bus free interrupt enable set. Mask or unmask the interrupt signaled by bit in I2C_STAT[BF]. 0h = Bus free interrupt disabled 1h = Bus free interrupt enabled
7	AERR_IE	R/W	0h	Access error interrupt enable set. Mask or unmask the interrupt signaled by bit in I2C_STAT[AERR]. 0h = Access error interrupt disabled 1h = Access error interrupt enabled

Table 21-14. I2C_IRQENABLE_SET Register Field Descriptions (continued)

Bit	Field	Type	Reset	Description
6	STC_IE	R/W	0h	Start condition interrupt enable set. Mask or unmask the interrupt signaled by bit in I2C_STAT[STC]. 0h = Start condition interrupt disabled 1h = Start condition interrupt enabled
5	GC_IE	R/W	0h	General call interrupt enable set. Mask or unmask the interrupt signaled by bit in I2C_STAT[GC]. 0h = General call interrupt disabled 1h = General call interrupt enabled
4	XRDY_IE	R/W	0h	Transmit data ready interrupt enable set. Mask or unmask the interrupt signaled by bit in I2C_STAT[XRDY]. 0h = Transmit data ready interrupt disabled 1h = Transmit data ready interrupt enabled
3	RRDY_IE	R/W	0h	Receive data ready interrupt enable set. Mask or unmask the interrupt signaled by bit in I2C_STAT[RRDY]. 0h = Receive data ready interrupt disabled 1h = Receive data ready interrupt enabled
2	ARDY_IE	R/W	0h	Register access ready interrupt enable set. Mask or unmask the interrupt signaled by bit in I2C_STAT[ARDY]. 0h = Register access ready interrupt disabled 1h = Register access ready interrupt enabled
1	NACK_IE	R/W	0h	No acknowledgment interrupt enable set. Mask or unmask the interrupt signaled by bit in I2C_STAT[NACK]. 0h = Not Acknowledge interrupt disabled 1h = Not Acknowledge interrupt enabled
0	AL_IE	R/W	0h	Arbitration lost interrupt enable set. Mask or unmask the interrupt signaled by bit in I2C_STAT[AL]. 0h = Arbitration lost interrupt disabled 1h = Arbitration lost interrupt enabled

21.4.1.7 I2C_IRQENABLE_CLR Register (offset = 30h) [reset = 0h]

I2C_IRQENABLE_CLR is shown in [Figure 21-22](#) and described in [Table 21-15](#).

All 1-bit fields clear a specific interrupt event. Writing a 1 to a bit will disable the interrupt field. Writing a 0 will have no effect, that is, the register value will not be modified. For all the internal fields of the I2C_IRQENABLE_CLR register, the descriptions given in the I2C_IRQSTATUS_RAW subsection are valid.

Figure 21-22. I2C_IRQENABLE_CLR Register

31	30	29	28	27	26	25	24
RESERVED							
R-0h							
23	22	21	20	19	18	17	16
RESERVED							
R-0h							
15	14	13	12	11	10	9	8
RESERVED	XDR_IE	RDR_IE	RESERVED	ROVR	XUDF	AAS_IE	BF_IE
R-0h	R/W-0h	R/W-0h	R-0h	R/W-0h	R/W-0h	R/W-0h	R/W-0h
7	6	5	4	3	2	1	0
AERR_IE	STC_IE	GC_IE	XRDY_IE	RRDY_IE	ARDY_IE	NACK_IE	AL_IE
R/W-0h	R/W-0h	R/W-0h	R/W-0h	R/W-0h	R/W-0h	R/W-0h	R/W-0h

LEGEND: R/W = Read/Write; R = Read only; W1toCl = Write 1 to clear bit; -n = value after reset

Table 21-15. I2C_IRQENABLE_CLR Register Field Descriptions

Bit	Field	Type	Reset	Description
31-15	RESERVED	R	0h	
14	XDR_IE	R/W	0h	Transmit draining interrupt enable clear. Mask or unmask the interrupt signaled by bit in I2C_STAT[XDR]. 0h = Transmit draining interrupt disabled 1h = Transmit draining interrupt enabled
13	RDR_IE	R/W	0h	Receive draining interrupt enable clear. Mask or unmask the interrupt signaled by bit in I2C_STAT[RDR]. 0h = Receive draining interrupt disabled 1h = Receive draining interrupt enabled
12	RESERVED	R	0h	
11	ROVR	R/W	0h	Receive overrun enable clear. 0h = Receive overrun interrupt disabled 1h = Receive draining interrupt enabled
10	XUDF	R/W	0h	Transmit underflow enable clear. 0h = Transmit underflow interrupt disabled 1h = Transmit underflow interrupt enabled
9	AAS_IE	R/W	0h	Addressed as slave interrupt enable clear. Mask or unmask the interrupt signaled by bit in I2C_STAT[AAS]. 0h = Addressed as slave interrupt disabled 1h = Addressed as slave interrupt enabled
8	BF_IE	R/W	0h	Bus Free interrupt enable clear. Mask or unmask the interrupt signaled by bit in I2C_STAT[BF]. 0h = Bus free interrupt disabled 1h = Bus free interrupt enabled
7	AERR_IE	R/W	0h	Access error interrupt enable clear. Mask or unmask the interrupt signaled by bit in I2C_STAT[AERR]. 0h = Access error interrupt disabled 1h = Access error interrupt enabled

Table 21-15. I2C_IRQENABLE_CLR Register Field Descriptions (continued)

Bit	Field	Type	Reset	Description
6	STC_IE	R/W	0h	Start condition interrupt enable clear. Mask or unmask the interrupt signaled by bit in I2C_STAT[STC]. 0h = Start condition interrupt disabled 1h = Start condition interrupt enabled
5	GC_IE	R/W	0h	General call interrupt enable clear. Mask or unmask the interrupt signaled by bit in I2C_STAT[GC]. 0h = General call interrupt disabled 1h = General call interrupt enabled
4	XRDY_IE	R/W	0h	Transmit data ready interrupt enable clear. Mask or unmask the interrupt signaled by bit in I2C_STAT[XRDY]. 0h = Transmit data ready interrupt disabled 1h = Transmit data ready interrupt enabled
3	RRDY_IE	R/W	0h	Receive data ready interrupt enable set. Mask or unmask the interrupt signaled by bit in I2C_STAT[RRDY]. 0h = Receive data ready interrupt disabled 1h = Receive data ready interrupt enabled
2	ARDY_IE	R/W	0h	Register access ready interrupt enable clear. Mask or unmask the interrupt signaled by bit in I2C_STAT[ARDY]. 0h = Register access ready interrupt disabled 1h = Register access ready interrupt enabled
1	NACK_IE	R/W	0h	No acknowledgment interrupt enable clear. Mask or unmask the interrupt signaled by bit in I2C_STAT[NACK]. 0h = Not Acknowledge interrupt disabled 1h = Not Acknowledge interrupt enabled
0	AL_IE	R/W	0h	Arbitration lost interrupt enable clear. Mask or unmask the interrupt signaled by bit in I2C_STAT[AL]. 0h = Arbitration lost interrupt disabled 1h = Arbitration lost interrupt enabled

21.4.1.8 I2C_WE Register (offset = 34h) [reset = 0h]

I2C_WE is shown in [Figure 21-23](#) and described in [Table 21-16](#).

Every 1-bit field in the I2C_WE register enables a specific (synchronous) IRQ request source to generate an asynchronous wakeup (on the appropriate swakeup line). When a bit location is set to 1 by the local host, a wakeup is signaled to the local host if the corresponding event is captured by the core of the I2C controller. Value after reset is low (all bits). There is no need for an Access Error WakeUp event, since this event occurs only when the module is in Active Mode (for Interface/OCP accesses to FIFO) and is signaled by an interrupt. With the exception of Start Condition WakeUp, which is asynchronously detected when the Functional clock is turned-off, all the other WakeUp events require the Functional (System) clock to be enabled.

Figure 21-23. I2C_WE Register

31	30	29	28	27	26	25	24
RESERVED							
R-0h							
23	22	21	20	19	18	17	16
RESERVED							
R-0h							
15	14	13	12	11	10	9	8
RESERVED	XDR_WE	RDR_WE	RESERVED	ROVR_WE	XUDF_WE	AAS_WE	BF_WE
R-0h	R/W-0h	R/W-0h	R-0h	R/W-0h	R/W-0h	R/W-0h	R/W-0h
7	6	5	4	3	2	1	0
RESERVED	STC_WE	GC_WE	RESERVED	DRDY_WE	ARDY_WE	NACK_WE	AL_WE
R-0h	R/W-0h	R/W-0h	R-0h	R/W-0h	R/W-0h	R/W-0h	R/W-0h

LEGEND: R/W = Read/Write; R = Read only; W1toCl = Write 1 to clear bit; -n = value after reset

Table 21-16. I2C_WE Register Field Descriptions

Bit	Field	Type	Reset	Description
31-15	RESERVED	R	0h	
14	XDR_WE	R/W	0h	Transmit draining wakeup enable. This read/write bit is used to enable or disable wakeup signal generation when I2C module is in idle mode, the TX FIFO level is below the threshold and the amount of data left to be transferred is less than TXTRSH value. This allows for the module to inform the CPU that it can check the amount of data to be written to the FIFO. 0h = Transmit draining wakeup disabled 1h = Transmit draining wakeup enabled
13	RDR_WE	R/W	0h	Receive draining wakeup enable. This read/write bit is used to enable or disable wakeup signal generation when I2C is in idle mode, configured as a receiver, and it has detected a stop condition on the bus but the RX FIFO threshold is not reached (but the FIFO is not empty). This allows for the module to inform the CPU that it can check the amount of data to be transferred from the FIFO. 0h = Receive draining wakeup disabled 1h = Receive draining wakeup enabled
12	RESERVED	R	0h	
11	ROVR_WE	R/W	0h	Receive overrun wakeup enable 0h = Receive overrun wakeup disabled 1h = Receive overrun wakeup enabled
10	XUDF_WE	R/W	0h	Transmit underflow wakeup enable 0h = Transmit underflow wakeup disabled 1h = Transmit underflow wakeup enabled

Table 21-16. I2C_WE Register Field Descriptions (continued)

Bit	Field	Type	Reset	Description
9	AAS_WE	R/W	0h	Address as slave IRQ wakeup enable. This read/write bit is used to enable or disable wakeup signal generation when I2C module is in idle mode, and external master addresses the I2C module as a slave. This allows for the module to inform the CPU that it can check which of the own addresses was used by the external master to access the I2C core. 0h = Addressed as slave wakeup disabled 1h = Addressed as slave wakeup enabled
8	BF_WE	R/W	0h	Bus free IRQ wakeup enable. This read/write bit is used to enable or disable wakeup signal generation when I2C module is in idle mode and the I2C bus became free. This allows for the module to inform the CPU that it can initiate its own transfer on the I2C line. 0h = Bus Free wakeup disabled 1h = Bus Free wakeup enabled
7	RESERVED	R	0h	
6	STC_WE	R/W	0h	Start condition IRQ wakeup set. This read/write bit is used to enable or disable wakeup signal generation when I2C module is in idle mode (with the functional clock inactive) and a possible start condition is detected on the I2C line. The STC WakeUp is generated only if the I2C_SYSC.ClockActivity field indicates that the functional clock can be disabled. Note that if the functional clock is not active, the start condition is asynchronously detected (no filtering and synchronization is used). For this reason, it is possible that the signaled start condition to be a glitch. If the functional clock cannot be disabled (I2C_SYSC.ClockActivity = 10 or 11), the programmer should not enable this wakeup, since the module has other synchronously detected WakeUp event that might be used to exit from idle mode, only if the detected transfer is accessing the I2C module. 0h = Start condition wakeup disabled 1h = Start condition wakeup enabled
5	GC_WE	R/W	0h	General call IRQ wakeup enable. This read/write bit is used to enable or disable wakeup signal generation when I2C module is in idle mode and a general call is received on I2C line. 0h = General call wakeup disabled 1h = General call wakeup enabled
4	RESERVED	R	0h	
3	DRDY_WE	R/W	0h	Receive/Transmit data ready IRQ wakeup enable. This read/write bit is used to enable or disable wakeup signal generation when I2C module is involved into a long transfer and no more registers accesses are performed on the interface (for example module are set in F/S I2C master transmitter mode and FIFO is full). If in the middle of such a transaction, the FIFO buffer needs more data to be transferred, CPU must be informed to write (in case of transmitter mode) or read (if receiver mode) in/from the FIFO. 0h = Transmit/receive data ready wakeup disabled 1h = Transmit/receive data ready wakeup enabled
2	ARDY_WE	R/W	0h	Register access ready IRQ wakeup enable. This read/write bit is used to enable or disable wakeup signal generation when I2C module is involved into a long transfer and no more registers accesses are performed on the interface (for example the module is set in F/S I2C master transmitter mode and FIFO is full). If the current transaction is finished, the module needs to inform CPU about transmission completion. 0h = Register access ready wakeup disabled 1h = Register access ready wakeup enabled

Table 21-16. I2C_WE Register Field Descriptions (continued)

Bit	Field	Type	Reset	Description
1	NACK_WE	R/W	0h	<p>No acknowledgment IRQ wakeup enable.</p> <p>This read/write bit is used to enable or disable wakeup signal generation when I2C module is involved into a long transfer and no more registers accesses are performed on the interface (for example the module is set in F/S I2C master transmitter mode and FIFO is full).</p> <p>If in the middle of such of a transaction a Not Acknowledgment event is raised, the module needs to inform CPU about transmission error.</p> <p>0h = Not Acknowledge wakeup disabled 1h = Not Acknowledge wakeup enabled</p>
0	AL_WE	R/W	0h	<p>Arbitration lost IRQ wakeup enable.</p> <p>This read/write bit is used to enable or disable wakeup signal generation when I2C module is configured as a master and it loses the arbitration.</p> <p>This wake up is very useful when the module is configured as a master transmitter, all the necessary data is provided in the FIFO Tx, STT is enabled and the module enters in Idle Mode.</p> <p>If the module loses the arbitration, an Arbitration Lost event is raised and the module needs to inform CPU about transmission error.</p> <p>Note: The AL wakeup must be enabled only for multimaster communication.</p> <p>If the AL_WE is not enabled and the scenario described above occurs, the module will not be able to inform the CPU about the state of the transfer and it will be blocked in an undetermined state.</p> <p>0h = Arbitration lost wakeup disabled 1h = Arbitration lost wakeup enabled</p>

21.4.1.9 I2C_DMARXENABLE_SET Register (offset = 38h) [reset = 0h]

I2C_DMARXENABLE_SET is shown in [Figure 21-24](#) and described in [Table 21-17](#).

The 1-bit field enables a receive DMA request. Writing a 1 to this field will set it to 1. Writing a 0 will have no effect, that is, the register value is not modified. Note that the I2C_BUF.RDMA_EN field is the global (slave) DMA enabler, and that it is disabled by default. The I2C_BUF.RDMA_EN field should also be set to 1 to enable a receive DMA request.

Figure 21-24. I2C_DMARXENABLE_SET Register

31	30	29	28	27	26	25	24
RESERVED							
R-0h							
23	22	21	20	19	18	17	16
RESERVED							
R-0h							
15	14	13	12	11	10	9	8
RESERVED							
R-0h							
7	6	5	4	3	2	1	0
RESERVED							DMARX_ENABLE_SET
R-0h							R/W-0h

LEGEND: R/W = Read/Write; R = Read only; W1toCl = Write 1 to clear bit; -n = value after reset

Table 21-17. I2C_DMARXENABLE_SET Register Field Descriptions

Bit	Field	Type	Reset	Description
31-1	RESERVED	R	0h	
0	DMARX_ENABLE_SET	R/W	0h	Receive DMA channel enable set.

21.4.1.10 I2C_DMATXENABLE_SET Register (offset = 3Ch) [reset = 0h]

I2C_DMATXENABLE_SET is shown in [Figure 21-25](#) and described in [Table 21-18](#).

The 1-bit field enables a transmit DMA request. Writing a 1 to this field will set it to 1. Writing a 0 will have no effect, that is, the register value is not modified. Note that the I2C_BUF.XDMA_EN field is the global (slave) DMA enabler, and that it is disabled by default. The I2C_BUF.XDMA_EN field should also be set to 1 to enable a transmit DMA request.

Figure 21-25. I2C_DMATXENABLE_SET Register

31	30	29	28	27	26	25	24
RESERVED							
R-0h							
23	22	21	20	19	18	17	16
RESERVED							
R-0h							
15	14	13	12	11	10	9	8
RESERVED							
R-0h							
7	6	5	4	3	2	1	0
RESERVED							DMATX_TRANSMIT_SET
R-0h							R/W-0h

LEGEND: R/W = Read/Write; R = Read only; W1toCl = Write 1 to clear bit; -n = value after reset

Table 21-18. I2C_DMATXENABLE_SET Register Field Descriptions

Bit	Field	Type	Reset	Description
31-1	RESERVED	R	0h	
0	DMATX_TRANSMIT_SET	R/W	0h	Transmit DMA channel enable set.

21.4.1.11 I2C_DMARXENABLE_CLR Register (offset = 40h) [reset = 0h]

I2C_DMARXENABLE_CLR is shown in [Figure 21-26](#) and described in [Table 21-19](#).

The 1-bit field disables a receive DMA request. Writing a 1 to a bit will clear it to 0. Another result of setting to 1 the DMARX_ENABLE_CLEAR field, is the reset of the DMA RX request and wakeup lines. Writing a 0 will have no effect, that is, the register value is not modified.

Figure 21-26. I2C_DMARXENABLE_CLR Register

31	30	29	28	27	26	25	24
RESERVED							
R-0h							
23	22	21	20	19	18	17	16
RESERVED							
R-0h							
15	14	13	12	11	10	9	8
RESERVED							
R-0h							
7	6	5	4	3	2	1	0
RESERVED							DMARX_ENABLE_CLEAR
R-0h							R/W-0h

LEGEND: R/W = Read/Write; R = Read only; W1toCl = Write 1 to clear bit; -n = value after reset

Table 21-19. I2C_DMARXENABLE_CLR Register Field Descriptions

Bit	Field	Type	Reset	Description
31-1	RESERVED	R	0h	
0	DMARX_ENABLE_CLEAR	R/W	0h	Receive DMA channel enable clear.

21.4.1.12 I2C_DMATXENABLE_CLR Register (offset = 44h) [reset = 0h]

I2C_DMATXENABLE_CLR is shown in [Figure 21-27](#) and described in [Table 21-20](#).

The 1-bit field disables a transmit DMA request. Writing a 1 to a bit will clear it to 0. Another result of setting to 1 the DMATX_ENABLE_CLEAR field, is the reset of the DMA TX request and wakeup lines. Writing a 0 will have no effect, that is, the register value is not modified.

Figure 21-27. I2C_DMATXENABLE_CLR Register

31	30	29	28	27	26	25	24
RESERVED							
R-0h							
23	22	21	20	19	18	17	16
RESERVED							
R-0h							
15	14	13	12	11	10	9	8
RESERVED							
R-0h							
7	6	5	4	3	2	1	0
RESERVED							DMARX_ENABLE_CLEAR
R-0h							R/W-0h

LEGEND: R/W = Read/Write; R = Read only; W1toCl = Write 1 to clear bit; -n = value after reset

Table 21-20. I2C_DMATXENABLE_CLR Register Field Descriptions

Bit	Field	Type	Reset	Description
31-1	RESERVED	R	0h	
0	DMARX_ENABLE_CLEAR	R/W	0h	Receive DMA channel enable clear.

21.4.1.13 I2C_DMARXWAKE_EN Register (offset = 48h) [reset = 0h]

I2C_DMARXWAKE_EN is shown in [Figure 21-28](#) and described in [Table 21-21](#).

All 1-bit fields enable a specific (synchronous) DMA request source to generate an asynchronous wakeup (on the appropriate wakeup line). Note that the I2C_SYSC.ENAWAKEUP field is the global (slave) wakeup enabler, and that it is disabled by default.

Figure 21-28. I2C_DMARXWAKE_EN Register

31	30	29	28	27	26	25	24
RESERVED							
R-0h							
23	22	21	20	19	18	17	16
RESERVED							
R-0h							
15	14	13	12	11	10	9	8
RESERVED	XDR	RDR	RESERVED	ROVR	XUDF	AAS	BF
R-0h	R/W-0h	R/W-0h	R-0h	R/W-0h	R/W-0h	R/W-0h	R/W-0h
7	6	5	4	3	2	1	0
RESERVED	STC	GC	RESERVED	DRDY	ARDY	NACK	AL
R-0h	R/W-0h	R/W-0h	R-0h	R/W-0h	R/W-0h	R/W-0h	R/W-0h

LEGEND: R/W = Read/Write; R = Read only; W1toCl = Write 1 to clear bit; -n = value after reset

Table 21-21. I2C_DMARXWAKE_EN Register Field Descriptions

Bit	Field	Type	Reset	Description
31-15	RESERVED	R	0h	
14	XDR	R/W	0h	Transmit draining wakeup set. 0h = Transmit draining interrupt disabled 1h = Transmit draining interrupt enabled
13	RDR	R/W	0h	Receive draining wakeup set. 0h = Receive draining interrupt disabled 1h = Receive draining interrupt enabled
12	RESERVED	R	0h	
11	ROVR	R/W	0h	Receive overrun wakeup set. 0h = Receive overrun interrupt disabled 1h = Receive draining interrupt enabled
10	XUDF	R/W	0h	Transmit underflow wakeup set. 0h = Transmit underflow interrupt disabled 1h = Transmit underflow interrupt enabled
9	AAS	R/W	0h	Address as slave IRQ wakeup set. 0h = Addressed as slave interrupt disabled 1h = Addressed as slave interrupt enabled
8	BF	R/W	0h	Bus free IRQ wakeup set. 0h = Bus free wakeup disabled 1h = Bus free wakeup enabled
7	RESERVED	R	0h	
6	STC	R/W	0h	Start condition IRQ wakeup set. 0h = Start condition wakeup disabled 1h = Start condition wakeup enabled
5	GC	R/W	0h	General call IRQ wakeup set. 0h = General call wakeup disabled 1h = General call wakeup enabled
4	RESERVED	R	0h	

Table 21-21. I2C_DMARXWAKE_EN Register Field Descriptions (continued)

Bit	Field	Type	Reset	Description
3	DRDY	R/W	0h	Receive/transmit data ready IRQ wakeup set. 0h = Transmit/receive data ready wakeup disabled 1h = Transmit/receive data ready wakeup enabled
2	ARDY	R/W	0h	Register access ready IRQ wakeup set. 0h = Register access ready wakeup disabled 1h = Register access ready wakeup enabled
1	NACK	R/W	0h	No acknowledgment IRQ wakeup set. 0h = Not Acknowledge wakeup disabled 1h = Not Acknowledge wakeup enabled
0	AL	R/W	0h	Arbitration lost IRQ wakeup set. 0h = Arbitration lost wakeup disabled 1h = Arbitration lost wakeup enabled

21.4.1.14 I2C_DMATXWAKE_EN Register (offset = 4Ch) [reset = 0h]

I2C_DMATXWAKE_EN is shown in [Figure 21-29](#) and described in [Table 21-22](#).

All 1-bit fields enable a specific (synchronous) DMA request source to generate an asynchronous wakeup (on the appropriate wakeup line). Note that the I2C_SYSC.ENAWAKEUP field is the global (slave) wakeup enabler, and that it is disabled by default.

Figure 21-29. I2C_DMATXWAKE_EN Register

31	30	29	28	27	26	25	24
RESERVED							
R-0h							
23	22	21	20	19	18	17	16
RESERVED							
R-0h							
15	14	13	12	11	10	9	8
RESERVED	XDR	RDR	RESERVED	ROVR	XUDF	AAS	BF
R-0h	R/W-0h	R/W-0h	R-0h	R/W-0h	R/W-0h	R/W-0h	R/W-0h
7	6	5	4	3	2	1	0
RESERVED	STC	GC	RESERVED	DRDY	ARDY	NACK	AL
R-0h	R/W-0h	R/W-0h	R-0h	R/W-0h	R/W-0h	R/W-0h	R/W-0h

LEGEND: R/W = Read/Write; R = Read only; W1toCl = Write 1 to clear bit; -n = value after reset

Table 21-22. I2C_DMATXWAKE_EN Register Field Descriptions

Bit	Field	Type	Reset	Description
31-15	RESERVED	R	0h	
14	XDR	R/W	0h	Transmit draining wakeup set. 0h = Transmit draining interrupt disabled 1h = Transmit draining interrupt enabled
13	RDR	R/W	0h	Receive draining wakeup set. 0h = Receive draining interrupt disabled 1h = Receive draining interrupt enabled
12	RESERVED	R	0h	
11	ROVR	R/W	0h	Receive overrun wakeup set. 0h = Receive overrun interrupt disabled 1h = Receive draining interrupt enabled
10	XUDF	R/W	0h	Transmit underflow wakeup set. 0h = Transmit underflow interrupt disabled 1h = Transmit underflow interrupt enabled
9	AAS	R/W	0h	Address as slave IRQ wakeup set. 0h = Addressed as slave interrupt disabled 1h = Addressed as slave interrupt enabled
8	BF	R/W	0h	Bus free IRQ wakeup set. 0h = Bus free wakeup disabled 1h = Bus free wakeup enabled
7	RESERVED	R	0h	
6	STC	R/W	0h	Start condition IRQ wakeup set. 0h = Start condition wakeup disabled 1h = Start condition wakeup enabled
5	GC	R/W	0h	General call IRQ wakeup set. 0h = General call wakeup disabled 1h = General call wakeup enabled
4	RESERVED	R	0h	

Table 21-22. I2C_DMATXWAKE_EN Register Field Descriptions (continued)

Bit	Field	Type	Reset	Description
3	DRDY	R/W	0h	Receive/transmit data ready IRQ wakeup set. 0h = Transmit/receive data ready wakeup disabled 1h = Transmit/receive data ready wakeup enabled
2	ARDY	R/W	0h	Register access ready IRQ wakeup set. 0h = Register access ready wakeup disabled 1h = Register access ready wakeup enabled
1	NACK	R/W	0h	No acknowledgment IRQ wakeup set. 0h = Not Acknowledge wakeup disabled 1h = Not Acknowledge wakeup enabled
0	AL	R/W	0h	Arbitration lost IRQ wakeup set. 0h = Arbitration lost wakeup disabled 1h = Arbitration lost wakeup enabled

21.4.1.15 I2C_SYSS Register (offset = 90h) [reset = 0h]

 I2C_SYSS is shown in [Figure 21-30](#) and described in [Table 21-23](#).

Figure 21-30. I2C_SYSS Register

31	30	29	28	27	26	25	24
RESERVED							
R-0h							
23	22	21	20	19	18	17	16
RESERVED							
R-0h							
15	14	13	12	11	10	9	8
RESERVED							
R-0h							
7	6	5	4	3	2	1	0
RESERVED							RDONE
R-0h							R/W-0h

LEGEND: R/W = Read/Write; R = Read only; W1toCl = Write 1 to clear bit; -n = value after reset

Table 21-23. I2C_SYSS Register Field Descriptions

Bit	Field	Type	Reset	Description
31-1	RESERVED	R	0h	
0	RDONE	R/W	0h	Reset done bit. This read-only bit indicates the state of the reset in case of hardware reset, global software reset (I2C_SYSC.SRST) or partial software reset (I2C_CON.I2C_EN). The module must receive all its clocks before it can grant a reset-completed status. Value after reset is low. 0h = Internal module reset in ongoing 1h = Reset completed

21.4.1.16 I2C_BUF Register (offset = 94h) [reset = 0h]

I2C_BUF is shown in [Figure 21-31](#) and described in [Table 21-24](#).

This read/write register enables DMA transfers and allows the configuration of FIFO thresholds for the FIFO management (see the FIFO Management subsection).

Figure 21-31. I2C_BUF Register

31	30	29	28	27	26	25	24
RESERVED							
R-0h							
23	22	21	20	19	18	17	16
RESERVED							
R-0h							
15	14	13	12	11	10	9	8
RDMA_EN	RXFIFO_CLR	RXTRSH					
R/W-0h	R/W-0h	R/W-0h					
7	6	5	4	3	2	1	0
XDMA_EN	TXFIFO_CLR	TXTRSH					
R/W-0h	R/W-0h	R/W-0h					

LEGEND: R/W = Read/Write; R = Read only; W1toCl = Write 1 to clear bit; -n = value after reset

Table 21-24. I2C_BUF Register Field Descriptions

Bit	Field	Type	Reset	Description
31-16	RESERVED	R	0h	
15	RDMA_EN	R/W	0h	Receive DMA channel enable. When this bit is set to 1, the receive DMA channel is enabled and the receive data ready status bit (I2C_IRQSTATUS_RAW: RRDY) is forced to 0 by the core. Value after reset is low. 0h = Receive DMA channel disabled 1h = Receive DMA channel enabled
14	RXFIFO_CLR	R/W	0h	Receive FIFO clear. When set, receive FIFO is cleared (hardware reset for RX FIFO generated). This bit is automatically reset by the hardware. During reads, it always returns 0. Value after reset is low. 0h = Normal mode 1h = Rx FIFO is reset
13-8	RXTRSH	R/W	0h	Threshold value for FIFO buffer in RX mode. The receive threshold value is used to specify the trigger level for data receive transfers. The value is specified from the Interface/OCF point of view. Value after reset is 00h. For the FIFO management description, see the FIFO Management subsection. Note 1: programmed threshold cannot exceed the actual depth of the FIFO. Note 2: the threshold must not be changed while a transfer is in progress (after STT was configured or after the module was addressed as a slave). 0h = Receive Threshold value = 1 1h = Receive Threshold value = 2 3Fh = Receive Threshold value = 64

Table 21-24. I2C_BUF Register Field Descriptions (continued)

Bit	Field	Type	Reset	Description
7	XDMA_EN	R/W	0h	<p>Transmit DMA channel enable.</p> <p>When this bit is set to 1, the transmit DMA channel is enabled and the transmit data ready status (I2C_IRQSTATUS_RAW: XRDY) bit is forced to 0 by the core.</p> <p>Value after reset is low.</p> <p>0h = Transmit DMA channel disabled 1h = Transmit DMA channel enabled</p>
6	TXFIFO_CLR	R/W	0h	<p>Transmit FIFO clear.</p> <p>When set, transmit FIFO is cleared (hardware reset for TX FIFO). This bit is automatically reset by the hardware.</p> <p>During reads, it always returns 0.</p> <p>Value after reset is low.</p> <p>0h = Normal mode 1h = Tx FIFO is reset</p>
5-0	TXTRSH	R/W	0h	<p>Threshold value for FIFO buffer in TX mode.</p> <p>The Transmit Threshold value is used to specify the trigger level for data transfers.</p> <p>The value is specified from the OCP point of view.</p> <p>Value after reset is 00h</p> <p>Note 1: programmed threshold cannot exceed the actual depth of the FIFO. 2: the threshold must not be changed while a transfer is in progress (after STT was configured or after the module was addressed as a slave).</p> <p>0h = Transmit Threshold value = 1 1h = Transmit Threshold value = 2 3Fh = Transmit Threshold value = 64</p>

21.4.1.17 I2C_CNT Register (offset = 98h) [reset = 0h]

I2C_CNT is shown in [Figure 21-32](#) and described in [Table 21-25](#).

CAUTION: During an active transfer phase (between STT having been set to 1 and reception of ARDY), no modification must be done in this register. Changing it may result in an unpredictable behavior. This read/write register is used to control the numbers of bytes in the I2C data payload.

Figure 21-32. I2C_CNT Register

31	30	29	28	27	26	25	24	23	22	21	20	19	18	17	16	15	14	13	12	11	10	9	8	7	6	5	4	3	2	1	0
RESERVED																DCOUNT															
R-0h																R/W-0h															

LEGEND: R/W = Read/Write; R = Read only; W1toCl = Write 1 to clear bit; -n = value after reset

Table 21-25. I2C_CNT Register Field Descriptions

Bit	Field	Type	Reset	Description
31-16	RESERVED	R	0h	
15-0	DCOUNT	R/W	0h	<p>Data count. I2C Master Mode only (receive or transmit F/S). This 16-bit countdown counter decrements by 1 for every byte received or sent through the I2C interface. A write initializes DCOUNT to a saved initial value. A read returns the number of bytes that are yet to be received or sent. A read into DCOUNT returns the initial value only before a start condition and after a stop condition. When DCOUNT reaches 0, the core generates a stop condition if a stop condition was specified (I2C_CON.STP = 1) and the ARDY status flag is set to 1 in the I2C_IRQSTATUS_RAW register. Note that DCOUNT must not be reconfigured after I2C_CON.STT was enabled and before ARDY is received.</p> <p>Note 1: In case of I2C mode of operation, if I2C_CON.STP = 0, then the I2C asserts SCL = 0 when DCOUNT reaches 0. The CPU can then reprogram DCOUNT to a new value and resume sending or receiving data with a new start condition (restart). This process repeats until the CPU sets to 1 the I2C_CON.STP bit. The ARDY flag is set each time DCOUNT reaches 0 and DCOUNT is reloaded to its initial value. Values after reset are low (all 16 bits).</p> <p>Note 2: Since for DCOUNT = 0, the transfer length is 65536, the module does not allow the possibility to initiate zero data bytes transfers. 0h = Data counter = 65536 bytes (216) 1h = Data counter = 1 bytes FFFFh = Data counter = 65535 bytes (216 - 1)</p>

21.4.1.18 I2C_DATA Register (offset = 9Ch) [reset = 0h]

I2C_DATA is shown in [Figure 21-33](#) and described in [Table 21-26](#).

This register is the entry point for the local host to read data from or write data to the FIFO buffer.

Figure 21-33. I2C_DATA Register

31	30	29	28	27	26	25	24	23	22	21	20	19	18	17	16	15	14	13	12	11	10	9	8	7	6	5	4	3	2	1	0
RESERVED														DATA																	
R-0h														R/W-0h																	

LEGEND: R/W = Read/Write; R = Read only; W1toCl = Write 1 to clear bit; -n = value after reset

Table 21-26. I2C_DATA Register Field Descriptions

Bit	Field	Type	Reset	Description
31-8	RESERVED	R	0h	
7-0	DATA	R/W	0h	<p>Transmit/Receive data FIFO endpoint.</p> <p>When read, this register contains the received I2C data.</p> <p>When written, this register contains the byte value to transmit over the I2C data.</p> <p>In SYSTEST loop back mode (I2C_SYSTEST: TMODE = 11), this register is also the entry/receive point for the data.</p> <p>Values after reset are unknown (all 8-bits).</p> <p>Note: A read access, when the buffer is empty, returns the previous read data value.</p> <p>A write access, when the buffer is full, is ignored.</p> <p>In both events, the FIFO pointers are not updated and an Access Error (AERR) Interrupt is generated.</p>

21.4.1.19 I2C_CON Register (offset = A4h) [reset = 0h]

I2C_CON is shown in [Figure 21-34](#) and described in [Table 21-27](#).

During an active transfer phase (between STT having been set to 1 and reception of ARDY), no modification must be done in this register (except STP enable). Changing it may result in an unpredictable behavior.

Figure 21-34. I2C_CON Register

31	30	29	28	27	26	25	24
RESERVED							
R-0h							
23	22	21	20	19	18	17	16
RESERVED							
R-0h							
15	14	13	12	11	10	9	8
I2C_EN	RESERVED	OPMODE		STB	MST	TRX	XSA
R/W-0h	R-0h	R/W-0h		R/W-0h	R/W-0h	R/W-0h	R/W-0h
7	6	5	4	3	2	1	0
XOA0	XOA1	XOA2	XOA3	RESERVED		STP	STT
R/W-0h	R/W-0h	R/W-0h	R/W-0h	R-0h		R/W-0h	R/W-0h

LEGEND: R/W = Read/Write; R = Read only; W1toCl = Write 1 to clear bit; -n = value after reset

Table 21-27. I2C_CON Register Field Descriptions

Bit	Field	Type	Reset	Description
31-16	RESERVED	R	0h	
15	I2C_EN	R/W	0h	I2C module enable. When this bit is cleared to 0, the I2C controller is not enabled and reset. When 0, receive and transmit FIFOs are cleared and all status bits are set to their default values. All configuration registers (I2C_IRQENABLE_SET, I2C_IRQWAKE_SET, I2C_BUF, I2C_CNT, I2C_CON, I2C_OA, I2C_SA, I2C_PSC, I2C_SCLL and I2C_SCLH) are not reset, they keep their initial values and can be accessed. The CPU must set this bit to 1 for normal operation. Value after reset is low. 0h = Controller in reset. FIFO are cleared and status bits are set to their default value. 1h = Module enabled
14	RESERVED	R	0h	
13-12	OPMODE	R/W	0h	Operation mode selection. These two bits select module operation mode. Value after reset is 00. 0h = I2C Fast/Standard mode 1h = Reserved 2h = Reserved 3h = Reserved
11	STB	R/W	0h	Start byte mode (I2C master mode only). The start byte mode bit is set to 1 by the CPU to configure the I2C in start byte mode (I2C_SA = 0000 0001). See the Philips I2C spec for more details [1]. Value after reset is low. 0h = Normal mode 1h = Start byte mode

Table 21-27. I2C_CON Register Field Descriptions (continued)

Bit	Field	Type	Reset	Description
10	MST	R/W	0h	Master/slave mode (I2C mode only). When this bit is cleared, the I2C controller is in the slave mode and the serial clock (SCL) is received from the master device. When this bit is set, the I2C controller is in the master mode and generates the serial clock. Note: This bit is automatically cleared at the end of the transfer on a detected stop condition, in case of arbitration lost or when the module is configured as a master but addressed as a slave by an external master. Value after reset is low. 0h = Slave mode 1h = Master mode
9	TRX	R/W	0h	Transmitter/receiver mode (i2C master mode only). When this bit is cleared, the I2C controller is in the receiver mode and data on data line SDA is shifted into the receiver FIFO and can be read from I2C_DATA register. When this bit is set, the I2C controller is in the transmitter mode and the data written in the transmitter FIFO via I2C_DATA is shifted out on data line SDA. Value after reset is low. The operating modes are defined as follows: MST = 0, TRX = x, Operating Mode = Slave receiver. MST = 0, TRX = x, Operating Mode = Slave transmitter. MST = 1, TRX = 0, Operating Modes = Master receiver. MST = 1, TRX = 0, Operating Modes = Master transmitter. 0h = Receiver mode 1h = Transmitter mode
8	XSA	R/W	0h	Expand slave address. (I2C mode only). When set, this bit expands the slave address to 10-bit. Value after reset is low. 0h = 7-bit address mode 1h = 10-bit address mode
7	XOA0	R/W	0h	Expand own address 0. (I2C mode only). When set, this bit expands the base own address (OA0) to 10-bit. Value after reset is low. 0h = 7-bit address mode 1h = 10-bit address mode
6	XOA1	R/W	0h	Expand own address 1. (I2C mode only). When set, this bit expands the first alternative own address (OA1) to 10-bit. Value after reset is low. 0h = 7-bit address mode 1h = 10-bit address mode
5	XOA2	R/W	0h	Expand own address 2. (I2C mode only). When set, this bit expands the second alternative own address (OA2) to 10-bit. Value after reset is low. 0h = 7-bit address mode. (I2C mode only). 1h = 10-bit address mode
4	XOA3	R/W	0h	Expand own address 3. When set, this bit expands the third alternative own address (OA3) to 10-bit. Value after reset is low. 0h = 7-bit address mode 1h = 10-bit address mode

Table 21-27. I2C_CON Register Field Descriptions (continued)

Bit	Field	Type	Reset	Description
3-2	RESERVED	R	0h	
1	STP	R/W	0h	<p>Stop condition (I2C master mode only). This bit can be set to a 1 by the CPU to generate a stop condition. It is reset to 0 by the hardware after the stop condition has been generated.</p> <p>The stop condition is generated when DCOUNT passes 0. When this bit is not set to 1 before the end of the transfer (DCOUNT = 0), the stop condition is not generated and the SCL line is hold to 0 by the master, which can re-start a new transfer by setting the STT bit to 1.</p> <p>Value after reset is low 0h = No action or stop condition detected 1h = Stop condition queried</p>
0	STT	R/W	0h	<p>Start condition (I2C master mode only). This bit can be set to a 1 by the CPU to generate a start condition. It is reset to 0 by the hardware after the start condition has been generated.</p> <p>The start/stop bits can be configured to generate different transfer formats.</p> <p>Value after reset is low.</p> <p>Note: DCOUNT is data count value in I2C_CNT register. STT = 1, STP = 0, Conditions = Start, Bus Activities = S-A-D. STT = 0, STP = 1, Conditions = Stop, Bus Activities = P. STT = 1, STP = 1, Conditions = Start-Stop (DCOUNT=n), Bus Activities = S-A-D..(n)..D-P. STT = 1, STP = 0, Conditions = Start (DCOUNT=n), Bus Activities = S-A-D..(n)..D.</p> <p>0h = No action or start condition detected 1h = Start condition queried</p>

21.4.1.20 I2C_OA Register (offset = A8h) [reset = 0h]

I2C_OA is shown in [Figure 21-35](#) and described in [Table 21-28](#).

CAUTION: During an active transfer phase (between STT having been set to 1 and reception of ARDY), no modification must be done in this register. Changing it may result in an unpredictable behavior. This register is used to specify the module's base I2C 7-bit or 10-bit address (base own address).

Figure 21-35. I2C_OA Register

31	30	29	28	27	26	25	24	23	22	21	20	19	18	17	16	15	14	13	12	11	10	9	8	7	6	5	4	3	2	1	0
RESERVED														OA																	
R-0h														R/W-0h																	

LEGEND: R/W = Read/Write; R = Read only; W1toCl = Write 1 to clear bit; -n = value after reset

Table 21-28. I2C_OA Register Field Descriptions

Bit	Field	Type	Reset	Description
31-10	RESERVED	R	0h	
9-0	OA	R/W	0h	Own address. This field specifies either: A 10-bit address coded on OA [9:0] when XOA (Expand Own Address, I2C_CON[7]) is set to 1. or A 7-bit address coded on OA [6:0] when XOA (Expand Own Address, I2C_CON[7]) is cleared to 0. In this case, OA [9:7] bits must be cleared to 000 by application software. Value after reset is low (all 10 bits).

21.4.1.21 I2C_SA Register (offset = ACh) [reset = 0h]

I2C_SA is shown in [Figure 21-36](#) and described in [Table 21-29](#).

CAUTION: During an active transfer phase (between STT having been set to 1 and reception of ARDY), no modification must be done in this register. Changing it may result in an unpredictable behavior. This register is used to specify the addressed I2C module 7-bit or 10-bit address (slave address).

Figure 21-36. I2C_SA Register

31	30	29	28	27	26	25	24	23	22	21	20	19	18	17	16	15	14	13	12	11	10	9	8	7	6	5	4	3	2	1	0
RESERVED												SA																			
R-0h												R/W-0h																			

LEGEND: R/W = Read/Write; R = Read only; W1toCl = Write 1 to clear bit; -n = value after reset

Table 21-29. I2C_SA Register Field Descriptions

Bit	Field	Type	Reset	Description
31-10	RESERVED	R	0h	
9-0	SA	R/W	0h	Slave address. This field specifies either: A 10-bit address coded on SA [9:0] when XSA (Expand Slave Address, I2C_CON[8]) is set to 1. or A 7-bit address coded on SA [6:0] when XSA (Expand Slave Address, I2C_CON[8]) is cleared to 0. In this case, SA [9:7] bits must be cleared to 000 by application software. Value after reset is low (all 10 bits).

21.4.1.22 I2C_PSC Register (offset = B0h) [reset = 0h]

I2C_PSC is shown in [Figure 21-37](#) and described in [Table 21-30](#).

CAUTION: During an active mode (I2C_EN bit in I2C_CON register is set to 1), no modification must be done in this register. Changing it may result in an unpredictable behavior. This register is used to specify the internal clocking of the I2C peripheral core.

Figure 21-37. I2C_PSC Register

31	30	29	28	27	26	25	24	23	22	21	20	19	18	17	16	15	14	13	12	11	10	9	8	7	6	5	4	3	2	1	0
RESERVED																PSC															
R-0h																R/W-0h															

LEGEND: R/W = Read/Write; R = Read only; W1toCl = Write 1 to clear bit; -n = value after reset

Table 21-30. I2C_PSC Register Field Descriptions

Bit	Field	Type	Reset	Description
31-8	RESERVED	R	0h	
7-0	PSC	R/W	0h	Fast/Standard mode prescale sampling clock divider value. The core uses this 8-bit value to divide the system clock (SCLK) and generates its own internal sampling clock (ICLK) for Fast and Standard operation modes. The core logic is sampled at the clock rate of the system clock for the module divided by (PSC + 1). Value after reset is low (all 8 bits). 0h = Divide by 1 1h = Divide by 2 FFh = Divide by 256

21.4.1.23 I2C_SCLL Register (offset = B4h) [reset = 0h]

I2C_SCLL is shown in [Figure 21-38](#) and described in [Table 21-31](#).

CAUTION: During an active mode (I2C_EN bit in I2C_CON register is set to 1), no modification must be done in this register. Changing it may result in an unpredictable behavior. This register is used to determine the SCL low time value when master.

Figure 21-38. I2C_SCLL Register

31	30	29	28	27	26	25	24	23	22	21	20	19	18	17	16	15	14	13	12	11	10	9	8	7	6	5	4	3	2	1	0
RESERVED																SCLL															
R-0h																R/W-0h															

LEGEND: R/W = Read/Write; R = Read only; W1toCl = Write 1 to clear bit; -n = value after reset

Table 21-31. I2C_SCLL Register Field Descriptions

Bit	Field	Type	Reset	Description
31-8	RESERVED	R	0h	
7-0	SCLL	R/W	0h	Fast/Standard mode SCL low time. I2C master mode only, (FS). This 8-bit value is used to generate the SCL low time value (tLOW) when the peripheral is operated in master mode. $t_{LOW} = (SCLL + 7) * ICLK$ time period, Value after reset is low (all 8 bits).

21.4.1.24 I2C_SCLH Register (offset = B8h) [reset = 0h]

I2C_SCLH is shown in [Figure 21-39](#) and described in [Table 21-32](#).

CAUTION: During an active mode (I2C_EN bit in I2C_CON register is set to 1), no modification must be done in this register. Changing it may result in an unpredictable behavior. This register is used to determine the SCL high time value when master.

Figure 21-39. I2C_SCLH Register

31	30	29	28	27	26	25	24	23	22	21	20	19	18	17	16	15	14	13	12	11	10	9	8	7	6	5	4	3	2	1	0
RESERVED																SCLH															
R-0h																R/W-0h															

LEGEND: R/W = Read/Write; R = Read only; W1toCl = Write 1 to clear bit; -n = value after reset

Table 21-32. I2C_SCLH Register Field Descriptions

Bit	Field	Type	Reset	Description
31-8	RESERVED	R	0h	
7-0	SCLH	R/W	0h	Fast/Standard mode SCL low time. I2C master mode only, (FS). This 8-bit value is used to generate the SCL high time value (tHIGH) when the peripheral is operated in master mode. - tHIGH = (SCLH + 5) * ICLK time period. Value after reset is low (all 8 bits).

21.4.1.25 I2C_SYSTEST Register (offset = BCh) [reset = 0h]

I2C_SYSTEST is shown in [Figure 21-40](#) and described in [Table 21-33](#).

CAUTION: Never enable this register for normal I2C operation. This register is used to facilitate system-level tests by overriding some of the standard functional features of the peripheral. It allows testing of SCL counters, controlling the signals that connect to I/O pins, or creating digital loop-back for self-test when the module is configured in system test (SYSTEST) mode. It also provides stop/non-stop functionality in the debug mode.

Figure 21-40. I2C_SYSTEST Register

31	30	29	28	27	26	25	24
RESERVED							
R-0h							
23	22	21	20	19	18	17	16
RESERVED							
R-0h							
15	14	13	12	11	10	9	8
ST_EN	FREE	TMODE		SSB	RESERVED		SCL_I_FUNC
R/W-0h	R/W-0h	R/W-0h		R/W-0h	R-0h		R-0h
7	6	5	4	3	2	1	0
SCL_O_FUNC	SDA_I_FUNC	SDA_O_FUNC	RESERVED	SCL_I	SCL_O	SDA_I	SDA_O
R-0h	R-0h	R-0h	R-0h	R-0h	R-0h	R-0h	R-0h

LEGEND: R/W = Read/Write; R = Read only; W1toCl = Write 1 to clear bit; -n = value after reset

Table 21-33. I2C_SYSTEST Register Field Descriptions

Bit	Field	Type	Reset	Description
31-16	RESERVED	R	0h	
15	ST_EN	R/W	0h	System test enable. This bit must be set to 1 to permit other system test registers bits to be set. Value after reset is low. 0h = Normal mode. All others bits in register are read only. 1h = System test enabled. Permit other system test registers bits to be set.
14	FREE	R/W	0h	Free running mode (on breakpoint). This bit is used to determine the state of the I2C controller when a breakpoint is encountered in the HLL debugger. Note: This bit can be set independently of ST_EN value. FREE = 0: the I2C controller stops immediately after completion of the on-going bit transfer. Stopping the transfer is achieved by forcing the SCL line low. Note that in this case there will be no status register updates. FREE = 1: the I2C interface runs free. When Suspend indication will be asserted, there will be no accesses on the OCP Interface (the CPU is in debug mode) and consequently the FIFOs will reach full/empty state (according to RX or TX modes) and the I2C SDA line will be kept low. Note that the status registers will be updated, but no DMA, IRQ or WakeUp will be generated. The status registers likely to be updated in this mode are: I2C_IRQSTATUS_RAW.XRDY, I2C_IRQSTATUS_RAW.RRDY, I2C_IRQSTATUS_RAW.XUDF, I2C_IRQSTATUS_RAW.ROVR, I2C_IRQSTATUS_RAW.ARDY and I2C_IRQSTATUS_RAW.NACK. Value after reset is low. 0h = Stop mode (on breakpoint condition). If Master mode, it stops after completion of the on-going bit transfer. In slave mode, it stops during the phase transfer when 1 byte is completely transmitted/received. 1h = Free running mode

Table 21-33. I2C_SYSTEST Register Field Descriptions (continued)

Bit	Field	Type	Reset	Description
13-12	TMODE	R/W	0h	<p>Test mode select.</p> <p>In normal functional mode (ST_EN = 0), these bits are don't care. They are always read as 00 and a write is ignored.</p> <p>In system test mode (ST_EN = 1), these bits can be set according to the following table to permit various system tests.</p> <p>Values after reset are low (2 bits).</p> <p>SCL counter test mode: in this mode, the SCL pin is driven with a permanent clock as if mastered with the parameters set in the I2C_PSC, I2C_SCLL, and I2C_SCLH registers.</p> <p>Loop back mode: in the master transmit mode only, data transmitted out of the I2C_DATA register (write action) is received in the same I2C_DATA register via an internal path through the FIFO buffer.</p> <p>The DMA and interrupt requests are normally generated if enabled.</p> <p>SDA/SCL IO mode: in this mode, the SCL IO and SDA IO are controlled via the I2C_SYSTEST [5:0] register bits.</p> <p>0h = Functional mode (default) 1h = Reserved 2h = Test of SCL counters (SCLL, SCLH, PSC). SCL provides a permanent clock with master mode. 3h = Loop back mode select + SDA/SCL IO mode select</p>
11	SSB	R/W	0h	<p>Set status bits.</p> <p>Writing 1 into this bit also sets the 6 read/clear-only status bits contained in I2C_IRQSTATUS_RAW register (bits 5:0) to 1.</p> <p>Writing 0 into this bit doesn't clear status bits that are already set only writing 1 into a set status bit can clear it (see I2C_IRQSTATUS_RAW operation).</p> <p>This bit must be cleared prior attempting to clear a status bit.</p> <p>Value after reset is low.</p> <p>0h = No action. 1h = Set all interrupt status bits to 1.</p>
10-9	RESERVED	R	0h	
8	SCL_I_FUNC	R	0h	<p>SCL line input value (functional mode).</p> <p>This read-only bit returns the logical state taken by the SCL line (either 1 or 0).</p> <p>It is active both in functional and test mode.</p> <p>Value after reset is low.</p> <p>0h (R) = Read 0 from SCL line 1h (R) = Read 1 from SCL line</p>
7	SCL_O_FUNC	R	0h	<p>SCL line output value (functional mode).</p> <p>This read-only bit returns the value driven by the module on the SCL line (either 1 or 0).</p> <p>It is active both in functional and test mode.</p> <p>Value after reset is low.</p> <p>0h (R) = Driven 0 on SCL line 1h (R) = Driven 1 on SCL line</p>
6	SDA_I_FUNC	R	0h	<p>SDA line input value (functional mode).</p> <p>This read-only bit returns the logical state taken by the SDA line (either 1 or 0).</p> <p>It is active both in functional and test mode.</p> <p>Value after reset is low.</p> <p>0h (R) = Read 0 from SDA line 1h (R) = Read 1 from SDA line</p>
5	SDA_O_FUNC	R	0h	<p>SDA line output value (functional mode).</p> <p>This read-only bit returns the value driven by the module on the SDA line (either 1 or 0).</p> <p>It is active both in functional and test mode.</p> <p>Value after reset is low.</p> <p>0h (R) = Driven 0 to SDA line 1h (R) = Driven 1 to SDA line</p>
4	RESERVED	R	0h	

Table 21-33. I2C_SYSTEST Register Field Descriptions (continued)

Bit	Field	Type	Reset	Description
3	SCL_I	R	0h	<p>SCL line sense input value.</p> <p>In normal functional mode (ST_EN = 0), this read-only bit always reads 0.</p> <p>In system test mode (ST_EN = 1 and TMODE = 11), this read-only bit returns the logical state taken by the SCL line (either 1 or 0).</p> <p>Value after reset is low.</p> <p>0h (R) = Read 0 from SCL line 1h (R) = Read 1 from SCL line</p>
2	SCL_O	R	0h	<p>SCL line drive output value.</p> <p>In normal functional mode (ST_EN = 0), this bit is don't care. It always reads 0 and a write is ignored.</p> <p>In system test mode (ST_EN = 1 and TMODE = 11), a 0 forces a low level on the SCL line and a 1 puts the I2C output driver to a high-impedance state.</p> <p>Value after reset is low.</p> <p>0h (R) = Forces 0 on the SCL data line 1h (R) = SCL output driver in high-impedance state</p>
1	SDA_I	R	0h	<p>SDA line sense input value.</p> <p>In normal functional mode (ST_EN = 0), this read-only bit always reads 0.</p> <p>In system test mode (ST_EN = 1 and TMODE = 11), this read-only bit returns the logical state taken by the SDA line (either 1 or 0).</p> <p>Value after reset is low.</p> <p>0h (R) = Read 0 from SDA line 1h (R) = Read 1 from SDA line</p>
0	SDA_O	R	0h	<p>SDA line drive output value.</p> <p>In normal functional mode (ST_EN = 0), this bit is don't care. It reads as 0 and a write is ignored.</p> <p>In system test mode (ST_EN = 1 and TMODE = 11), a 0 forces a low level on the SDA line and a 1 puts the I2C output driver to a high-impedance state.</p> <p>Value after reset is low.</p> <p>0h = Write 0 to SDA line 1h = Write 1 to SDA line</p>

21.4.1.26 I2C_BUFSTAT Register (offset = C0h) [reset = 0h]

I2C_BUFSTAT is shown in [Figure 21-41](#) and described in [Table 21-34](#).

This read-only register reflects the status of the internal buffers for the FIFO management (see the FIFO Management subsection).

Figure 21-41. I2C_BUFSTAT Register

31	30	29	28	27	26	25	24
RESERVED							
R-0h							
23	22	21	20	19	18	17	16
RESERVED							
R-0h							
15	14	13	12	11	10	9	8
FIFODEPTH				RXSTAT			
R-0h				R-0h			
7	6	5	4	3	2	1	0
RESERVED				TXSTAT			
R-0h				R-0h			

LEGEND: R/W = Read/Write; R = Read only; W1toCl = Write 1 to clear bit; -n = value after reset

Table 21-34. I2C_BUFSTAT Register Field Descriptions

Bit	Field	Type	Reset	Description
31-16	RESERVED	R	0h	
15-14	FIFODEPTH	R	0h	Internal FIFO buffers depth. This read-only bit indicates the internal FIFO buffer depth. Value after reset is given by the boundary module generic parameter. 0h = 8-bytes FIFO 1h = 16-bytes FIFO 2h = 32-bytes FIFO 3h = 64-bytes FIFO
13-8	RXSTAT	R	0h	RX buffer status. This read-only field indicates the number of bytes to be transferred from the FIFO at the end of the I2C transfer (when RDR is asserted). It corresponds to the level indication of the RX FIFO (number of written locations). Value after reset is 0.
7-6	RESERVED	R	0h	
5-0	TXSTAT	R	0h	TX buffer status. This read-only field indicates the number of data bytes still left to be written in the TX FIFO (it is equal with the initial value of I2C_CNT.DCOUNT minus the number of data bytes already written in the TX FIFO through the OCP Interface). Value after reset is equal with 0.

21.4.1.27 I2C_OA1 Register (offset = C4h) [reset = 0h]

I2C_OA1 is shown in [Figure 21-42](#) and described in [Table 21-35](#).

CAUTION: During an active transfer phase (between STT has been set to 1 and receiving of ARDY), no modification must be done in this register. Changing it may result in an unpredictable behavior. This register is used to specify the first alternative I2C 7-bit or 10-bit address (own address 1 - OA1).

Figure 21-42. I2C_OA1 Register

31	30	29	28	27	26	25	24	23	22	21	20	19	18	17	16	15	14	13	12	11	10	9	8	7	6	5	4	3	2	1	0
RESERVED														OA1																	
R-0h														R/W-0h																	

LEGEND: R/W = Read/Write; R = Read only; W1toCl = Write 1 to clear bit; -n = value after reset

Table 21-35. I2C_OA1 Register Field Descriptions

Bit	Field	Type	Reset	Description
31-10	RESERVED	R	0h	
9-0	OA1	R/W	0h	Own address 1. This field specifies either: A 10-bit address coded on OA1 [9:0] when XOA1 (Expand Own Address 1 - XOA1, I2C_CON[6]) is set to 1. A 7-bit address coded on OA1 [6:0] when XOA1 (Expand Own Address 1 XOA1, I2C_CON[6]) is cleared to 0. In this case, OA1 [9:7] bits must be cleared to 000 by application software. Value after reset is low (all 10 bits).

21.4.1.28 I2C_OA2 Register (offset = C8h) [reset = 0h]

I2C_OA2 is shown in [Figure 21-43](#) and described in [Table 21-36](#).

CAUTION: During an active transfer phase (between STT has been set to 1 and receiving of ARDY), no modification must be done in this register. Changing it may result in an unpredictable behavior. This register is used to specify the first alternative I2C 7-bit or 10-bit address (own address 2 - OA2).

Figure 21-43. I2C_OA2 Register

31	30	29	28	27	26	25	24	23	22	21	20	19	18	17	16	15	14	13	12	11	10	9	8	7	6	5	4	3	2	1	0
RESERVED														OA2																	
R-0h														R/W-0h																	

LEGEND: R/W = Read/Write; R = Read only; W1toCl = Write 1 to clear bit; -n = value after reset

Table 21-36. I2C_OA2 Register Field Descriptions

Bit	Field	Type	Reset	Description
31-10	RESERVED	R	0h	
9-0	OA2	R/W	0h	Own address 2. This field specifies either: A 10-bit address coded on OA2 [9:0] when XOA1 (Expand Own Address 2 - XOA2, I2C_CON[5]) is set to 1. A 7-bit address coded on OA2 [6:0] when XOA2 (Expand Own Address 2 XOA2, I2C_CON[5]) is cleared to 0. In this case, OA2 [9:7] bits must be cleared to 000 by application software. Value after reset is low (all 10 bits).

21.4.1.29 I2C_OA3 Register (offset = CCh) [reset = 0h]

I2C_OA3 is shown in [Figure 21-44](#) and described in [Table 21-37](#).

CAUTION: During an active transfer phase (between STT has been set to 1 and receiving of ARDY), no modification must be done in this register. Changing it may result in an unpredictable behavior. This register is used to specify the first alternative I2C 7-bit or 10-bit address (own address 3 - OA3).

Figure 21-44. I2C_OA3 Register

31	30	29	28	27	26	25	24	23	22	21	20	19	18	17	16	15	14	13	12	11	10	9	8	7	6	5	4	3	2	1	0
RESERVED														OA3																	
R-0h														R/W-0h																	

LEGEND: R/W = Read/Write; R = Read only; W1toCl = Write 1 to clear bit; -n = value after reset

Table 21-37. I2C_OA3 Register Field Descriptions

Bit	Field	Type	Reset	Description
31-10	RESERVED	R	0h	
9-0	OA3	R/W	0h	Own address 2. This field specifies either: A 10-bit address coded on OA3 [9:0] when XOA3 (Expand Own Address 3 - XOA3, I2C_CON[4]) is set to 1. A 7-bit address coded on OA3 [6:0] when XOA1 (Expand Own Address 3 XOA3, I2C_CON[4]) is cleared to 0. In this case, OA3 [9:7] bits must be cleared to 000 by application software. Value after reset is low (all 10 bits).

21.4.1.30 I2C_ACTOA Register (offset = D0h) [reset = 0h]

I2C_ACTOA is shown in [Figure 21-45](#) and described in [Table 21-38](#).

This read-only register is used to indicate which one of the module's four own addresses the external master used when addressing the module. The CPU can read this register when the AAS indication was activated. The indication is cleared at the end of the transfer.

Figure 21-45. I2C_ACTOA Register

31	30	29	28	27	26	25	24
RESERVED							
R-0h							
23	22	21	20	19	18	17	16
RESERVED							
R-0h							
15	14	13	12	11	10	9	8
RESERVED							
R-0h							
7	6	5	4	3	2	1	0
RESERVED				OA3_ACT	OA2_ACT	OA1_ACT	OA0_ACT
R-0h				R-0h	R-0h	R-0h	R-0h

LEGEND: R/W = Read/Write; R = Read only; W1toCl = Write 1 to clear bit; -n = value after reset

Table 21-38. I2C_ACTOA Register Field Descriptions

Bit	Field	Type	Reset	Description
31-4	RESERVED	R	0h	
3	OA3_ACT	R	0h	Own address 3 active. When a bit location is set to 1 by the core, it signals to the Local Host that an external master using the corresponding own address addressed the module. Value after reset is low. 0h = Own address inactive 1h = Own address active
2	OA2_ACT	R	0h	Own address 2 active. When a bit location is set to 1 by the core, it signals to the Local Host that an external master using the corresponding own address addressed the module. Value after reset is low. 0h = Own address inactive 1h = Own address active
1	OA1_ACT	R	0h	Own address 1 active. When a bit location is set to 1 by the core, it signals to the Local Host that an external master using the corresponding own address addressed the module. Value after reset is low. 0h = Own address inactive 1h = Own address active
0	OA0_ACT	R	0h	Own address 0 active. When a bit location is set to 1 by the core, it signals to the Local Host that an external master using the corresponding own address addressed the module. Value after reset is low. 0h = Own address inactive 1h = Own address active

21.4.1.31 I2C_SBLOCK Register (offset = D4h) [reset = 0h]

I2C_SBLOCK is shown in [Figure 21-46](#) and described in [Table 21-39](#).

This read/write register controls the automatic blocking of I2C clock feature in slave mode. It is used for the Local Host to configure for which of the 4 own addresses, the core must block the I2C clock (keep SCL line low) right after the Address Phase, when it is addressed as a slave.

Figure 21-46. I2C_SBLOCK Register

31	30	29	28	27	26	25	24
RESERVED							
R-0h							
23	22	21	20	19	18	17	16
RESERVED							
R-0h							
15	14	13	12	11	10	9	8
RESERVED							
R-0h							
7	6	5	4	3	2	1	0
RESERVED				OA3_EN	OA2_EN	OA1_EN	OA0_EN
R-0h				R/W-0h	R/W-0h	R/W-0h	R/W-0h

LEGEND: R/W = Read/Write; R = Read only; W1toCl = Write 1 to clear bit; -n = value after reset

Table 21-39. I2C_SBLOCK Register Field Descriptions

Bit	Field	Type	Reset	Description
31-4	RESERVED	R	0h	
3	OA3_EN	R/W	0h	Enable I2C clock blocking for own address 3. When the CPU sets a bit location to 1, if an external master using the corresponding own address addresses the core, the core will block the I2C clock right after the address phase. For releasing the I2C clock the CPU must write 0 in the corresponding field. Value after reset is low. 0h = I2C clock released 1h = I2C clock blocked
2	OA2_EN	R/W	0h	Enable I2C clock blocking for own address 2. When the CPU sets a bit location to 1, if an external master using the corresponding own address addresses the core, the core will block the I2C clock right after the address phase. For releasing the I2C clock the CPU must write 0 in the corresponding field. Value after reset is low. 0h = I2C clock released 1h = I2C clock blocked
1	OA1_EN	R/W	0h	Enable I2C clock blocking for own address 1. When the CPU sets a bit location to 1, if an external master using the corresponding own address addresses the core, the core will block the I2C clock right after the address phase. For releasing the I2C clock the CPU must write 0 in the corresponding field. Value after reset is low. 0h = I2C clock released 1h = I2C clock blocked

Table 21-39. I2C_SBLOCK Register Field Descriptions (continued)

Bit	Field	Type	Reset	Description
0	OA0_EN	R/W	0h	<p>Enable I2C clock blocking for own address 0. When the CPU sets a bit location to 1, if an external master using the corresponding own address addresses the core, the core will block the I2C clock right after the address phase. For releasing the I2C clock the CPU must write 0 in the corresponding field.</p> <p>Value after reset is low.</p> <p>0h = I2C clock released 1h = I2C clock blocked</p>

Multichannel Audio Serial Port (McASP)

This chapter describes the McASP of the device.

Topic	Page
22.1 Introduction	4542
22.2 Integration	4544
22.3 Functional Description	4546
22.4 Registers	4599

22.1 Introduction

22.1.1 Purpose of the Peripheral

The multichannel audio serial port (McASP) functions as a general-purpose audio serial port optimized for the needs of multichannel audio applications. The McASP is useful for time-division multiplexed (TDM) stream, Inter-Integrated Sound (I2S) protocols, and intercomponent digital audio interface transmission (DIT). The McASP consists of transmit and receive sections that may operate synchronized, or completely independently with separate master clocks, bit clocks, and frame syncs, and using different transmit modes with different bit-stream formats. The McASP module also includes serializers that can be individually enabled to either transmit or receive.

22.1.2 Features

Features of the McASP include:

- Two independent clock generator modules for transmit and receive.
 - Clocking flexibility allows the McASP to receive and transmit at different rates. For example, the McASP can receive data at 48 kHz but output up-sampled data at 96 kHz or 192 kHz.
- Independent transmit and receive modules, each includes:
 - Programmable clock and frame sync generator.
 - TDM streams from 2 to 32, and 384 time slots.
 - Support for time slot sizes of 8, 12, 16, 20, 24, 28, and 32 bits.
 - Data formatter for bit manipulation.
- Individually assignable serial data pins (up to 6 pins).
- Glueless connection to audio analog-to-digital converters (ADC), digital-to-analog converters (DAC), codec, digital audio interface receiver (DIR), and S/PDIF transmit physical layer components.
- Wide variety of I2S and similar bit-stream format.
- Integrated digital audio interface transmitter (DIT) supports (up to 10 transmit pins):
 - S/PDIF, IEC60958-1, AES-3 formats.
 - Enhanced channel status/user data RAM.
- 384-slot TDM with external digital audio interface receiver (DIR) device.
 - For DIR reception, an external DIR receiver integrated circuit should be used with I2S output format and connected to the McASP receive section.
- Extensive error checking and recovery.
 - Transmit underruns and receiver overruns due to the system not meeting real-time requirements.
 - Early or late frame sync in TDM mode.
 - Out-of-range high-frequency master clock for both transmit and receive.
 - External error signal coming into the AMUTEIN input.
 - DMA error due to incorrect programming.

22.1.3 Protocols Supported

The McASP supports a wide variety of protocols.

- Transmit section supports:
 - Wide variety of I2S and similar bit-stream formats.
 - TDM streams from 2 to 32 time slots.
 - S/PDIF, IEC60958-1, AES-3 formats.
- Receive section supports:
 - Wide variety of I2S and similar bit-stream formats.
 - TDM streams from 2 to 32 time slots.
 - TDM stream of 384 time slots specifically designed for easy interface to external digital interface receiver (DIR) device transmitting DIR frames to McASP using the I2S protocol (one time slot for each DIR subframe).

The transmit and receive sections may each be individually programmed to support the following options on the basic serial protocol:

- Programmable clock and frame sync polarity (rising or falling edge): ACLKR/X, AHCLKR/X, and AFSR/X.
- Slot length (number of bits per time slot): 8, 12, 16, 20, 24, 28, 32 bits supported.
- Word length (bits per word): 8, 12, 16, 20, 24, 28, 32 bits; always less than or equal to the time slot length.
- First-bit data delay: 0, 1, 2 bit clocks.
- Left/right alignment of word inside slot.
- Bit order: MSB first or LSB first.
- Bit mask/pad/rotate function.
 - Automatically aligns data internally in either Q31 or integer formats.
 - Automatically masks nonsignificant bits (sets to 0, 1, or extends value of another bit).

In DIT mode for McASP, additional features of the transmitter are:

- Transmit-only mode 384 time slots (subframe) per frame.
- Bi-phase encoded 3.3 V output.
- Support for consumer and professional applications.
- Channel status RAM (384 bits).
- User data RAM (384 bits).
- Separate valid bit (V) for subframe A, B.

In I2S mode, the transmit and receive sections can support simultaneous transfers on up to all serial data pins operating as 192 kHz stereo channels.

In DIT mode, the transmitter can support a 192 kHz frame rate (stereo) on up to all serial data pins simultaneously (note that the internal bit clock for DIT runs two times faster than the equivalent bit clock for I2S mode, due to the need to generate Biphase Mark Encoded Data).

22.1.4 Unsupported McASP Features

The unsupported McASP features in this device include the following.

Table 22-1. Unsupported McASP Features

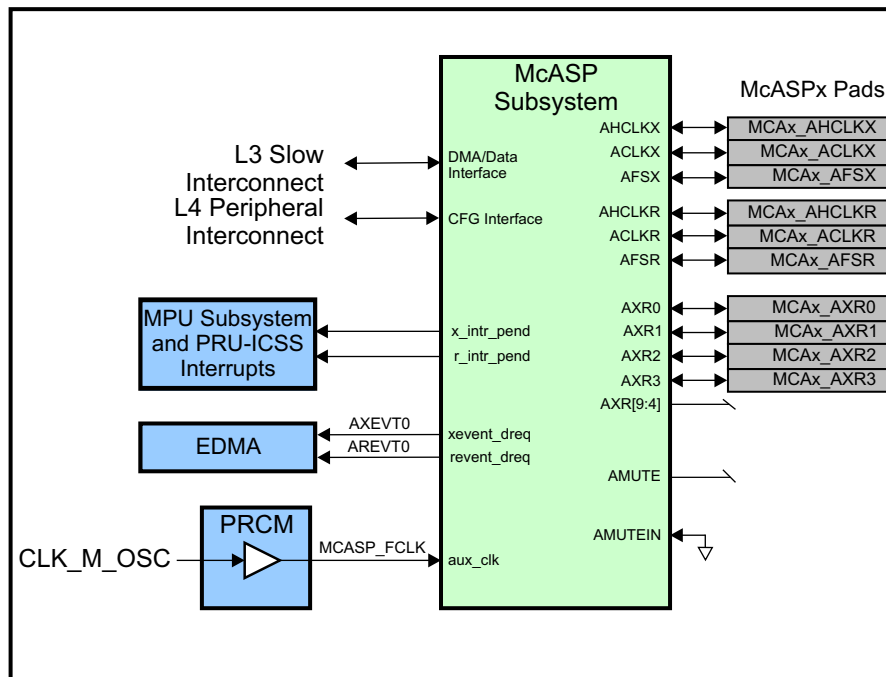
Feature	Reason
AXR[9:4]	Signals are not pinned out
AMUTE	Not connected
AMUTEIN	Not connected

22.2 Integration

The device contains two instantiations of the McASP subsystem: McASP0 and McASP1. The McASP subsystem includes a McASP peripheral, and transmit/receive buffers.

Each McASP is configured with four serializers.

Figure 22-1. McASP0–1 Integration



22.2.1 McASP Connectivity Attributes

The general connectivity attributes for the McASP modules are summarized in [Table 22-2](#)

Table 22-2. McASP Connectivity Attributes

Attributes	Type
Power Domain	Peripheral Domain
Clock Domain	PD_PER_L3S_GCLK (OCP Clock) PD_PER_MCASP_FCLK (Aux Clock)
Reset Signals	PER_DOM_RST_N
Idle/Wakeup Signals	Smart Idle
Interrupt Requests	1 Transmit Interrupt per instance x_intr_pend - to MPU Subsystem (MCATXINTx) and PRU-ICSS (mcasep_x_intr_pend) 1 Receive Interrupt r_intr_pend - to MPU Subsystem (MCARXINTx) and PRU-ICSS (mcasep_r_intr_pend)
DMA Requests	2 DMA requests per instance to EDMA (Transmit: AXEVTx, Receive: AREVTx)
Physical Address	L3 Slow slave port (data) L4 Peripheral slave port (CFG)

22.2.2 McASP Clock and Reset Management

The McASP module uses functional clocks either generated internally (master mode) or supplied from its serial interface (slave mode). The internal interconnect interface clock is used for the module internal OCP interface. Internal registers select the source of the functional clocks and the applied divider ratio.

Table 22-3. McASP Clock Signals

Clock Signal	Max Freq	Reference / Source	Comments
ocp_clk Interface clock	100 MHz	CORE_CLKOUTM4 / 2	pd_per_l3s_gclk From PRCM
auxclk Functional clock	26 MHz ⁽¹⁾	CLK_M_OSC	pd_per_mcaspl_fclk From PRCM

⁽¹⁾ The maximum frequency may change in certain low power modes. For more timing information for different operating performance points (OPPs), see the device datasheet *AM335x Sitara Processors* (literature number [SPRS717](#)).

22.2.3 McASP Pin List

The McASP external interface signals are shown in [Table 22-4](#).

Table 22-4. McASP Pin List

Pin	Type	Description
McASP _x _AXR[3:0]	I/O	Audio transmit/receive pin
McASP _x _ACLKX ⁽¹⁾	I/O	Transmit clock
McASP _x _FSX ⁽¹⁾	I/O	Frame synch for transmit
McASP _x _AHCLKX ⁽¹⁾	I/O	High speed transmit clock
McASP _x _ACLKR ⁽¹⁾	I/O	Receive clock
McASP _x _FSR ⁽¹⁾	I/O	Frame synch for receive
McASP _x _AHCLKR ⁽¹⁾	I/O	High speed receive clock

⁽¹⁾ These signals are also used as inputs to re-time or sync data. The associated CONF_<module>_<pin>_RXACTIVE bit for these signals must be set to 1 to enable the inputs back to the module. It is also recommended to place a 33-ohm resistor in series (close to the processor) on each of these signals to avoid signal reflections.

22.3 Functional Description

22.3.1 Overview

Figure 22-2 shows the major blocks of the McASP. The McASP has independent receive/transmit clock generators and frame sync generators, error-checking logic, and up to four serial data pins. See the device-specific data manual for the number of data pins available on your device.

All the McASP pins on the device may be individually programmed as general-purpose I/O (GPIO) if they are not used for serial port functions.

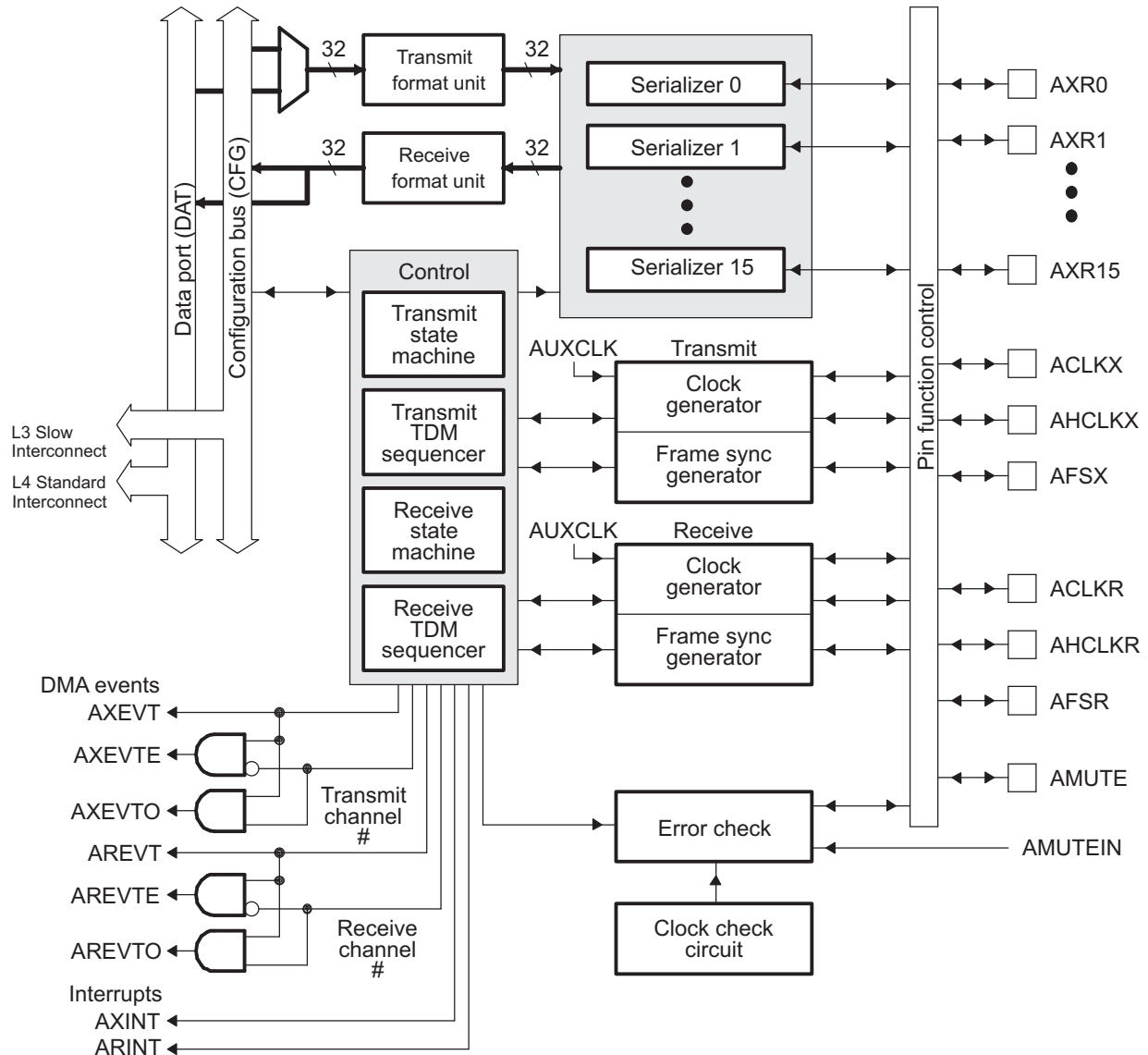
The McASP includes the following pins:

- Serializers;
 - Data pins AXRn: Up to four pins.
- Transmit clock generator:
 - AHCLKX: McASP transmit high-frequency master clock.
 - ACLKX: McASP transmit bit clock.
- Transmit Frame Sync Generator;
 - AFSX: McASP transmit frame sync or left/right clock (LRCLK).
- Receive clock generator;
 - AHCLKR: McASP receive high-frequency master clock.
 - ACLKR: McASP receive bit clock.
- Receive Frame Sync Generator;
 - AFSR: McASP receive frame sync or left/right clock (LRCLK).
- Mute in/out;
 - AMUTEIN: McASP mute input (from external device).
 - AMUTE: McASP mute output.
 - Data pins AXRn.

22.3.2 Functional Block Diagram

Figure 22-2 shows the major blocks of the McASP. The McASP has independent receive/transmit clock generators and frame sync generators.

Figure 22-2. McASP Block Diagram



- A McASP has 6 serial data pins.
- B AMUTEIN is not a dedicated McASP pin, but typically comes from one of the external interrupt pins.

22.3.2.1 System Level Connections

Figure 22-3 through Figure 22-7 show examples of McASP usage in digital audio encoder/decoder systems.

Figure 22-3. McASP to Parallel 2-Channel DACs

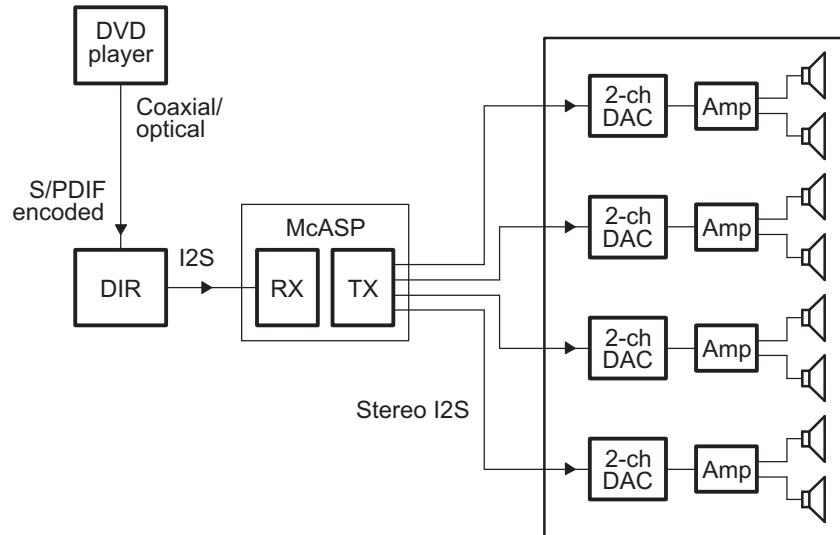


Figure 22-4. McASP to 6-Channel DAC and 2-Channel DAC

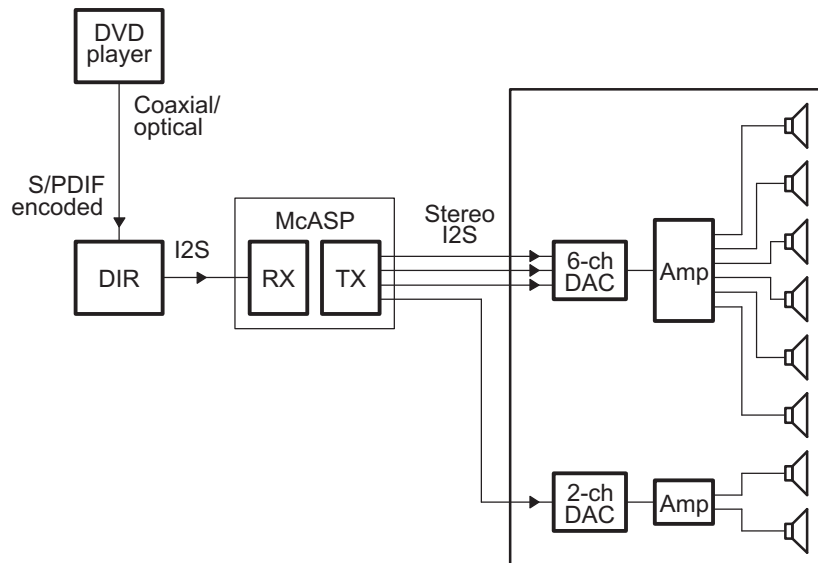


Figure 22-5. McASP to Digital Amplifier

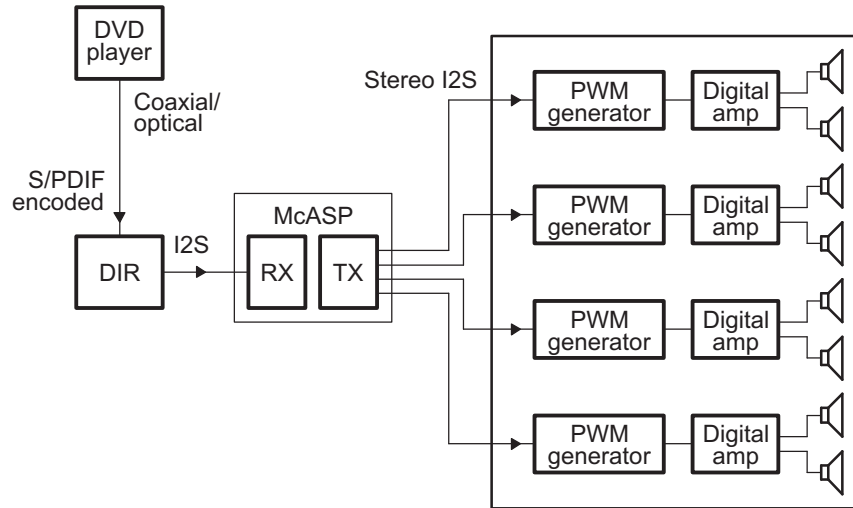


Figure 22-6. McASP as Digital Audio Encoder

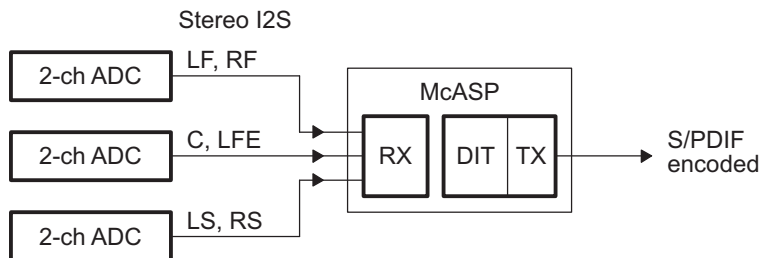
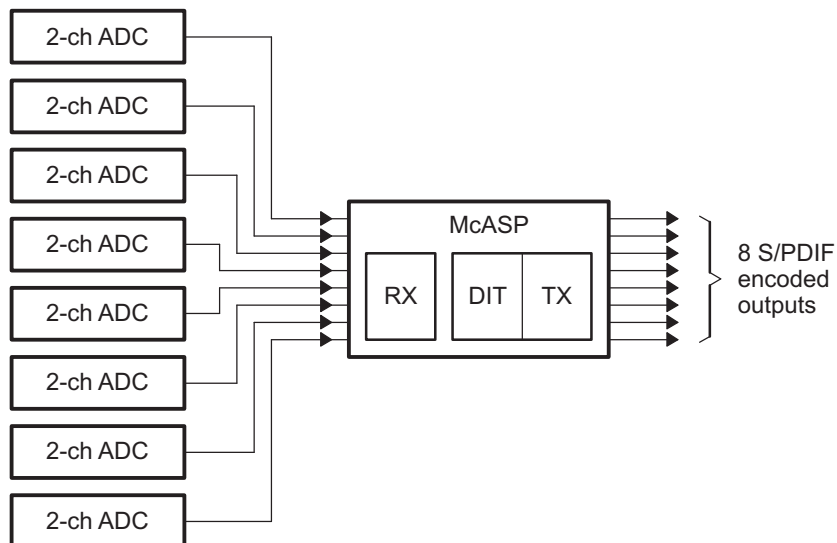


Figure 22-7. McASP as 16 Channel Digital Processor



22.3.3 Industry Standard Compliance Statement

The McASP supports the following industry standard interfaces.

22.3.3.1 TDM Format

The McASP transmitter and receiver support the multichannel, synchronous time-division-multiplexed (TDM) format via the TDM transfer mode. Within this transfer mode, a wide variety of serial data formats are supported, including formats compatible with devices using the Inter-Integrated Sound (I2S) protocol. This section briefly discusses the TDM format and the I2S protocol.

22.3.3.1.1 TDM Format

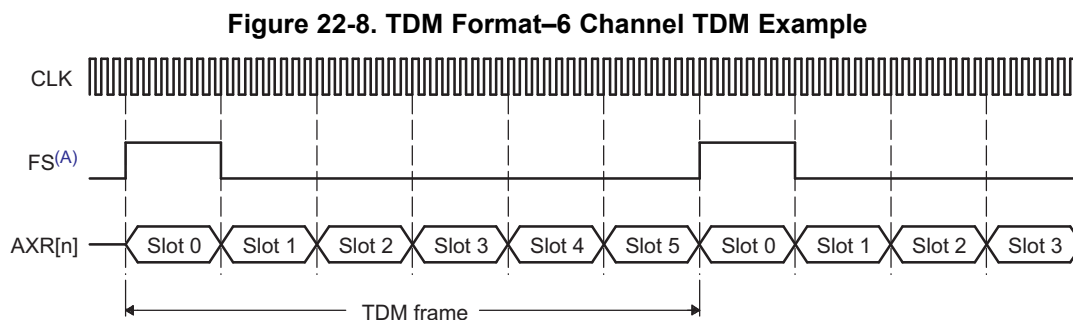
The TDM format is typically used when communicating between integrated circuit devices on the same printed circuit board or on another printed circuit board within the same piece of equipment. For example, the TDM format is used to transfer data between the processor and one or more analog-to-digital converter (ADC), digital-to-analog converter (DAC), or S/PDIF receiver (DIR) devices.

The TDM format consists of three components in a basic synchronous serial transfer: the clock, the data, and the frame sync. In a TDM transfer, all data bits (AXR_n) are synchronous to the serial clock (ACLKX or ACLKR). The data bits are grouped into words and slots (as defined in [Section 22.3.4](#)). The "slots" are also commonly referred to as "time slots" or "channels" in TDM terminology. A frame consists of multiple slots (or channels). Each TDM frame is defined by the frame sync signal (AFSX or AFSR). Data transfer is continuous and periodic, since the TDM format is most commonly used to communicate with data converters that operate at a fixed sample rate.

There are no delays between slots. The last bit of slot N is followed immediately on the next serial clock cycle with the first bit of slot N + 1, and the last bit of the last slot is followed immediately on the next serial clock with the first bit of the first slot. However, the frame sync may be offset from the first bit of the first slot with a 0, 1, or 2-cycle delay.

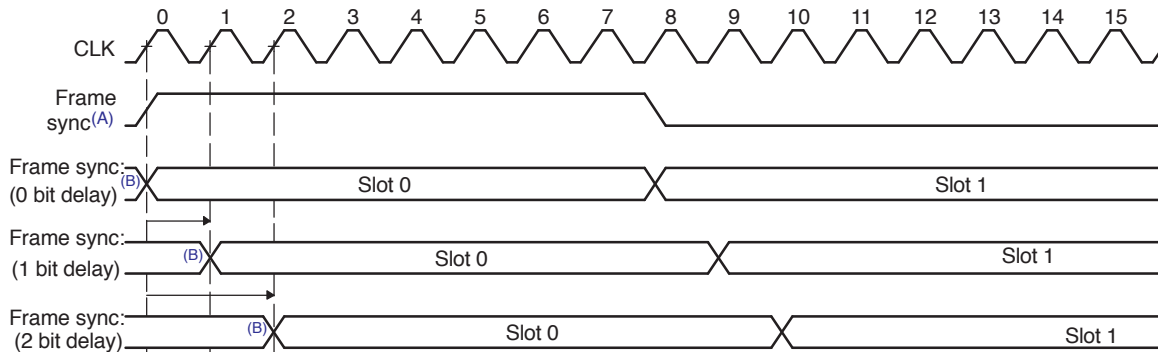
It is required that the transmitter and receiver in the system agree on the number of bits per slot, since the determination of a slot boundary is not made by the frame sync signal (although the frame sync marks the beginning of slot 0 and the beginning of a new frame).

[Figure 22-8](#) shows the TDM format. [Figure 22-9](#) shows the different bit delays from the frame sync.



A FS duration of slot is shown. FS duration of single bit is also supported.

Figure 22-9. TDM Format Bit Delays from Frame Sync



- A FS duration of slot is shown. FS duration of single bit is also supported.
- B Last bit of last slot of previous frame. No gap between this bit and the first bit of slot 0 is allowed.

In a typical audio system, one frame of data is transferred during each data converter sample period f_s . To support multiple channels, the choices are to either include more time slots per frame (thus operating with a higher bit clock rate), or to use additional data pins to transfer the same number of channels (thus operating with a slower bit clock rate).

For example, a particular six channel DAC may be designed to transfer over a single serial data pin AXRn as shown in Figure 22-8. In this case the serial clock must run fast enough to transfer a total of 6 channels within each frame period. Alternatively, a similar six channel DAC may be designed to use three serial data pins AXR[0,1,2], transferring two channels of data on each pin during each sample period. In the latter case, if the sample period remains the same, the serial clock can run three times slower than the former case. The McASP is flexible enough to support either type of DAC.

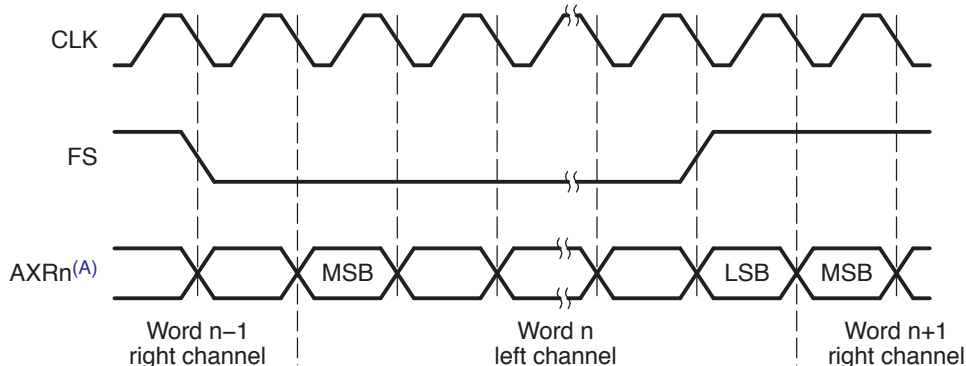
22.3.3.1.2 Inter-Integrated Sound (I2S) Format

The inter-integrated sound (I2S) format is used extensively in audio interfaces. The TDM transfer mode of the McASP supports the I2S format when configured to 2 slots per frame.

I2S format is specifically designed to transfer a stereo channel (left and right) over a single data pin AXRn. "Slots" are also commonly referred to as "channels". The frame width duration in the I2S format is the same as the slot size. The frame signal is also referred to as "word select" in the I2S format. Figure 22-10 shows the I2S protocol.

The McASP supports transfer of multiple stereo channels over multiple AXRn pins.

Figure 22-10. Inter-Integrated Sound (I2S) Format



- A 1 to 6 data pins may be supported.

22.3.3.2 S/PDIF Coding Format

The McASP transmitter supports the S/PDIF format with 3.3V biphasemark encoded output. The S/PDIF format is supported by the digital audio interface transmit (DIT) transfer mode of the McASP. This section briefly discusses the S/PDIF coding format.

22.3.3.2.1 Biphasemark Code (BMC)

In S/PDIF format, the digital signal is coded using the biphasemark code (BMC). The clock, frame, and data are embedded in only one signal—the data pin AXRn. In the BMC system, each data bit is encoded into two logical states (00, 01, 10, or 11) at the pin. These two logical states form a cell. The duration of the cell, which equals to the duration of the data bit, is called a time interval. A logical 1 is represented by two transitions of the signal within a time interval, which corresponds to a cell with logical states 01 or 10. A logical 0 is represented by one transition within a time interval, which corresponds to a cell with logical states 00 or 11. In addition, the logical level at the start of a cell is inverted from the level at the end of the previous cell. Figure 22-11 and Table 22-5 show how data is encoded to the BMC format.

As shown in Figure 22-11, the frequency of the clock is twice the unencoded data bit rate. In addition, the clock is always programmed to $128 \times f_s$, where f_s is the sample rate (see Section 22.3.3.2.3 for details on how this clock rate is derived based on the S/PDIF format). The device receiving in S/PDIF format can recover the clock and frame information from the BMC signal.

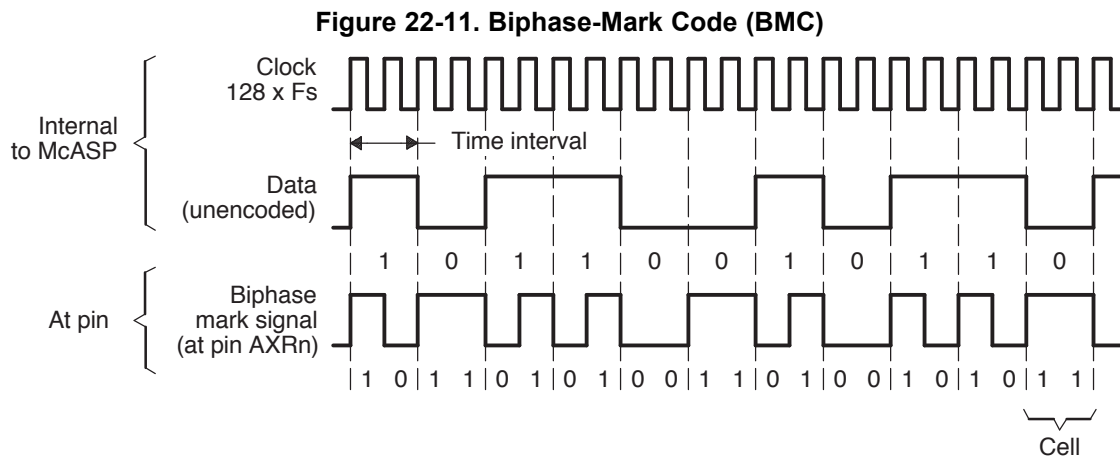


Table 22-5. Biphasemark Encoder

Data (Unencoded)	Previous State at Pin AXRn	BMC-Encoded Cell Output at AXRn
0	0	11
0	1	00
1	0	10
1	1	01

22.3.3.2.2 Subframe Format

Every audio sample transmitted in a subframe consists of 32 S/PDIF time intervals (or cells), numbered from 0 to 31. Figure 22-12 shows a subframe.

- **Time intervals 0-3** carry one of the three permitted preambles to signify the type of audio sample in the current subframe. The preamble is *not* encoded in BMC format, and therefore the preamble code can contain more than two consecutive 0 or 1 logical states in a row. See Table 22-6.
- **Time intervals 4-27** carry the audio sample word in linear 2s-complement representation. The most-significant bit (MSB) is carried by time interval 27. When a 24-bit coding range is used, the least-significant bit (LSB) is in time interval 4. When a 20-bit coding range is used, time intervals 8-27 carry the audio sample word with the LSB in time interval 8. Time intervals 4-7 may be used for other applications and are designated auxiliary sample bits.
- If the source provides fewer bits than the interface allows (either 20 or 24), the unused LSBs are set to logical 0. For a nonlinear PCM audio application or a data application, the main data field may carry any other information.
- **Time interval 28** carries the validity bit (V) associated with the main data field in the subframe.
- **Time interval 29** carries the user data channel (U) associated with the main data field in the subframe.
- **Time interval 30** carries the channel status information (C) associated with the main data field in the subframe. The channel status indicates if the data in the subframe is digital audio or some other type of data.
- **Time interval 31** carries a parity bit (P) such that time intervals 4-31 carry an even number of 1s and an even number of 0s (even parity). As shown in Table 22-6, the preambles (time intervals 0-3) are also defined with even parity.

Figure 22-12. S/PDIF Subframe Format

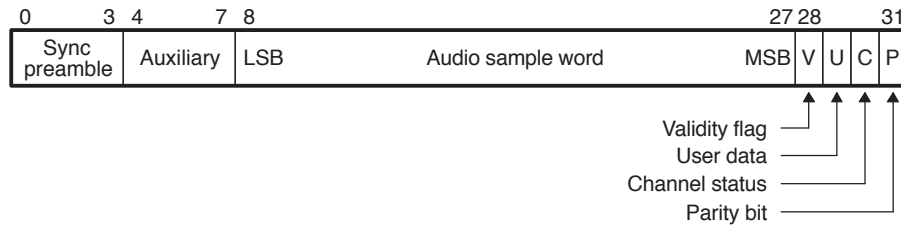


Table 22-6. Preamble Codes

Preamble Code ⁽¹⁾	Previous Logical State	Logical States on pin AXRn ⁽²⁾	Description
B (or Z)	0	1110 1000	Start of a block and subframe 1
M (or X)	0	1110 0010	Subframe 1
W (or Y)	0	1110 0100	Subframe 2

⁽¹⁾ Historically, preamble codes are referred to as B, M, W. For use in professional applications, preambles are referred to as Z, X, Y, respectively.

⁽²⁾ The preamble is not BMC encoded. Each logical state is synchronized to the serial clock. These 8 logical states make up time slots (cells) 0 to 3 in the S/PDIF stream.

As shown in Table 22-6, the McASP DIT only generates one polarity of preambles and it assumes the previous logical state to be 0. This is because the McASP assures an even-polarity encoding scheme when transmitting in DIT mode. If an underrun condition occurs, the DIT resynchronizes to the correct logic level on the AXRn pin before continuing with the next transmission.

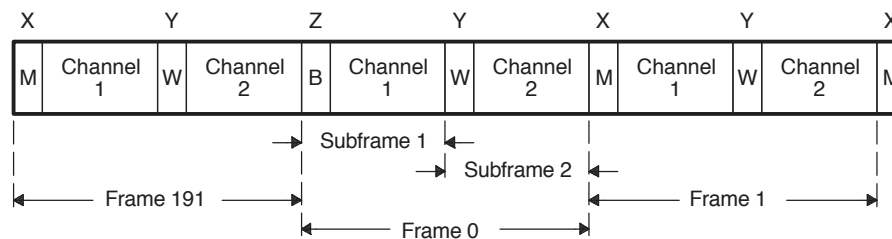
22.3.3.2.3 Frame Format

An S/PDIF frame is composed of two subframes (Figure 22-13). For linear coded audio applications, the rate of frame transmission normally corresponds exactly to the source sampling frequency f_s . The S/PDIF format clock rate is therefore $128 \times f_s$ ($128 = 32 \text{ cells/subframe} \times 2 \text{ clocks/cell} \times 2 \text{ subframes/sample}$). For example, for an S/PDIF stream at a 192 kHz sampling frequency, the serial clock is $128 \times 192 \text{ kHz} = 24.58 \text{ MHz}$.

In 2-channel operation mode, the samples taken from both channels are transmitted by time multiplexing in consecutive subframes. Both subframes contain valid data. The first subframe (**left** or **A** channel in stereophonic operation and **primary** channel in monophonic operation) normally starts with preamble M. However, the preamble of the first subframe changes to preamble B once every 192 frames to identify the start of the block structure used to organize the channel status information. The second subframe (**right** or **B** channel in stereophonic operation and **secondary** channel in monophonic operation) always starts with preamble W.

In single-channel operation mode in a professional application, the frame format is the same as in the 2-channel mode. Data is carried in the first subframe and may be duplicated in the second subframe. If the second subframe is not carrying duplicate data, cell 28 (validity bit) is set to logical 1.

Figure 22-13. S/PDIF Frame Format



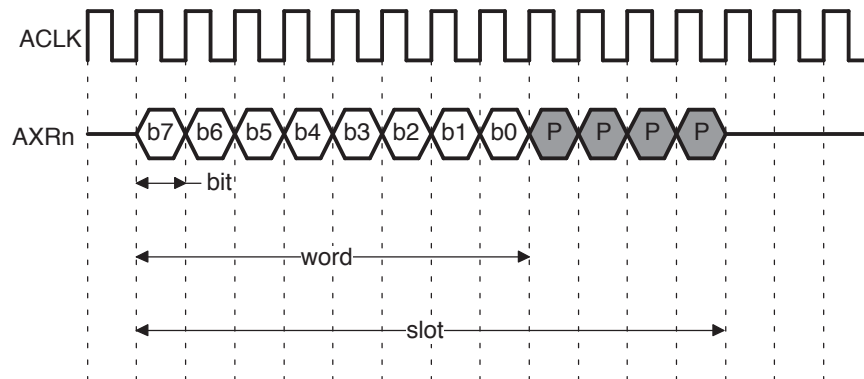
22.3.4 Definition of Terms

The serial bit stream transmitted or received by the McASP is a long sequence of 1s and 0s, either output or input on one of the audio transmit/receive pins (AXRn). However, the sequence has a hierarchical organization that can be described in terms of frames of data, slots, words, and bits.

A basic synchronous serial interface consists of three important components: clock, frame sync, and data. Figure 22-14 shows two of the three basic components—the clock (ACLK) and the data (AXRn). Figure 22-14 does not specify whether the clock is for transmit (ACLKX) or receive (ACLKR) because the definitions of terms apply to both receive and transmit interfaces. In operation, the transmitter uses ACLKX as the serial clock, and the receiver uses ACLKR as the serial clock. Optionally, the receiver can use ACLKX as the serial clock when the transmitter and receiver of the McASP are configured to operate synchronously.

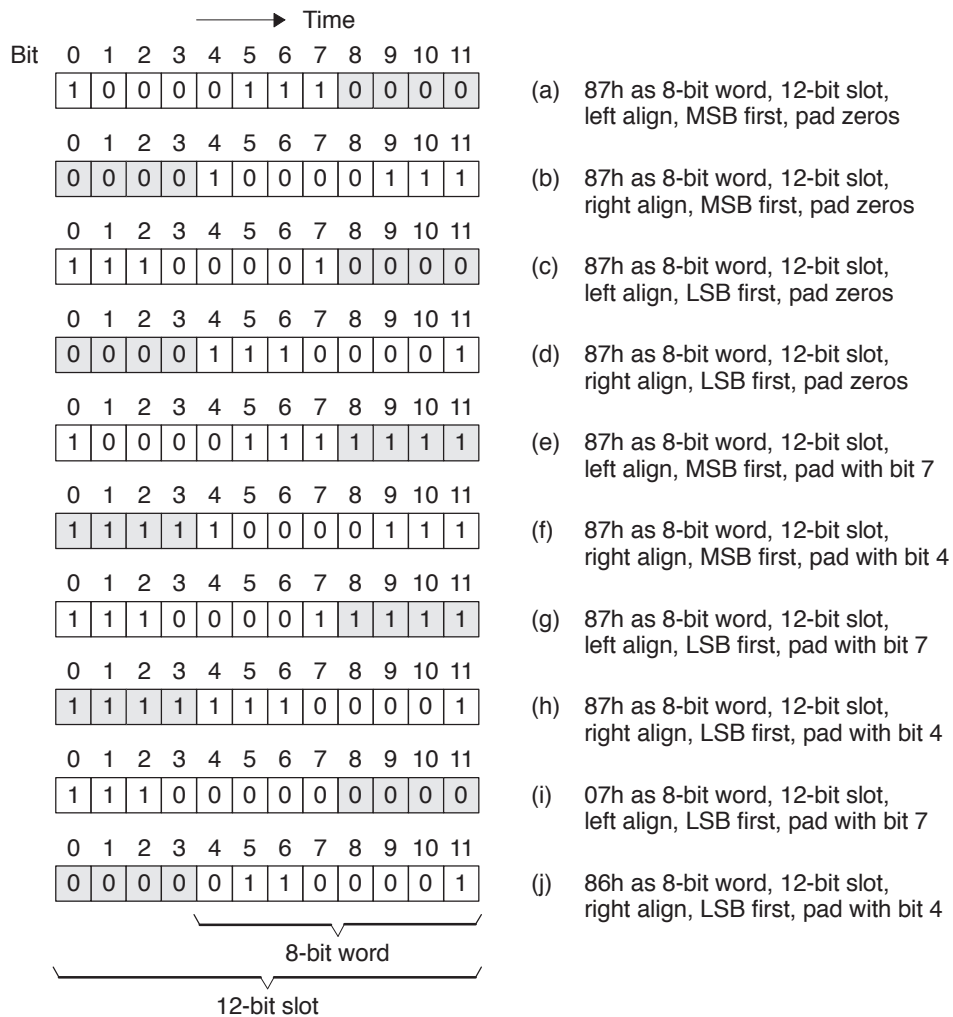
- Bit** A bit is the smallest entity in the serial data stream. The beginning and end of each bit is marked by an edge of the serial clock. The duration of a bit is a serial clock period. A 1 is represented by a logic high on the AXRn pin for the entire duration of the bit. A 0 is represented by a logic low on the AXRn pin for the entire duration of the bit.
- Word** A word is a group of bits that make up the data being transferred between the processor and the external device. Figure 22-14 shows an 8-bit word.
- Slot** A slot consists of the bits that make up the word, and may consist of additional bits used to pad the word to a convenient number of bits for the interface between the processor and the external device. In Figure 22-14, the audio data consists of only 8 bits of useful data (8-bit word), but it is padded with 4 zeros (12-bit slot) to satisfy the desired protocol in interfacing to an external device. Within a slot, the bits may be shifted in/out of the McASP on the AXRn pin either MSB or LSB first. When the word size is smaller than the slot size, the word may be aligned to the left (beginning) of the slot or to the right (end) of the slot. The additional bits in the slot not belonging to the word may be padded with 0, 1, or with one of the bits (the MSB or the LSB typically) from the data word. These options are shown in Figure 22-15.

Figure 22-14. Definition of Bit, Word, and Slot



- (1) b7:b0 - bits. Bits b7 to b0 form a word.
- (2) P - pad bits. Bits b7 to b0, together with the four pad bits, form a slot.
- (3) In this example, the data is transmitted MSB first, left aligned.

Figure 22-15. Bit Order and Word Alignment Within a Slot Examples



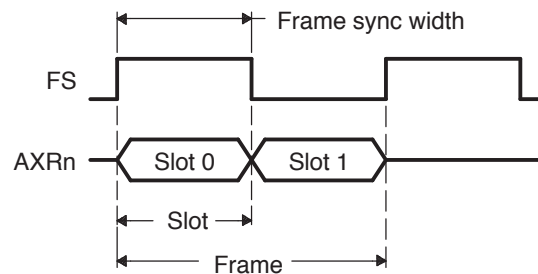
- | | | | |
|---|-------------------------------|---|--------------------------|
| 1 | Unshaded: bit belongs to word | 1 | Shaded: bit is a pad bit |
|---|-------------------------------|---|--------------------------|

The third basic element of a synchronous serial interface is the frame synchronization signal, also referred to as frame sync in this document.

Frame A frame contains one or multiple slots, as determined by the desired protocol. Figure 22-16 shows an example frame of data and the frame definitions. Figure 22-16 does not specify whether the frame sync (FS) is for transmit (AFSX) or receive (AFSR) because the definitions of terms apply to both receive and transmit interfaces. In operation, the transmitter uses AFSX and the receiver uses AFSR. Optionally, the receiver can use AFSX as the frame sync when the transmitter and receiver of the McASP are configured to operate synchronously.

This section only shows the generic definition of the frame sync. See Section 22.3.3 and Section 22.3.8.1 for details on the frame sync formats required for the different transfer modes and protocols (burst mode, TDM mode and I2S format, DIT mode and S/PDIF format).

Figure 22-16. Definition of Frame and Frame Sync Width



(1) In this example, there are two slots in a frame, and FS duration of slot length is shown.

Other terms used throughout the document:

TDM	Time-division multiplexed. See Section 22.3.3.1 for details on the TDM protocol.
DIR	Digital audio interface receive. The McASP does not natively support receiving in the S/PDIF format. The McASP supports I2S format output by an external DIR device.
DIT	Digital audio interface transmit. The McASP supports transmitting in S/PDIF format on up to all data pins configured as outputs.
I2S	Inter-Integrated Sound protocol, commonly used on audio interfaces. The McASP supports the I2S protocol as part of the TDM mode (when configured as a 2-slot frame).
Slot or Time Slot	For TDM format, the term time slot is interchangeable with the term slot defined in this section. For DIT format, a McASP time slot corresponds to a DIT subframe.

22.3.5 Clock and Frame Sync Generators

The McASP clock generators are able to produce two independent clock zones: transmit and receive clock zones. The serial clock generators may be programmed independently for the transmit section and the receive section, and may be completely asynchronous to each other. The serial clock (clock at the bit rate) may be sourced:

- Internally - by passing through two clock dividers off the internal clock source (AUXCLK).
- Externally - directly from ACLKR/X pin.
- Mixed - an external high-frequency clock is input to the McASP on either the AHCLKX or AHCLKR pins, and divided down to produce the bit rate clock.

In the internal/mixed cases, the bit rate clock is generated internally and should be driven out on the ACLKX (for transmit) or ACLKR (for receive) pins. In the internal case, an internally-generated high-frequency clock may be driven out onto the AHCLKX or AHCLKR pins to serve as a reference clock for other components in the system.

The McASP requires a minimum of a bit clock and a frame sync to operate, and provides the capability to reference these clocks from an external high-frequency master clock. In DIT mode, it is possible to use only internally-generated clocks and frame syncs.

22.3.5.1 Transmit Clock

The transmit bit clock, ACLKX, (Figure 22-17) may be either externally sourced from the ACLKX pin or internally generated, as selected by the CLKXM bit. If internally generated (CLKXM = 1), the clock is divided down by a programmable bit clock divider (CLKXDIV) from the transmit high-frequency master clock (AHCLKX).

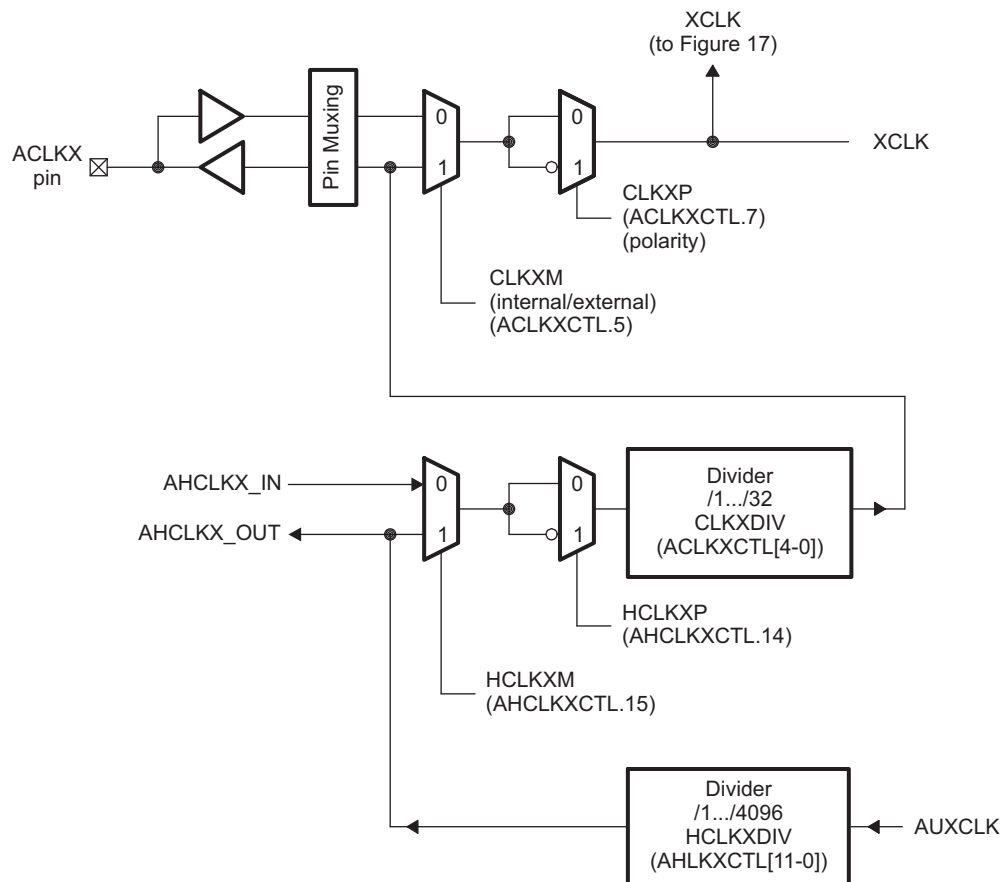
Internally, the McASP always shifts transmit data at the rising edge of the internal transmit clock, XCLK, (Figure 22-17). The CLKXP mux determines if ACLKX needs to be inverted to become XCLK. If CLKXP = 0, the CLKXP mux directly passes ACLKX to XCLK. As a result, the McASP shifts transmit data at the rising edge of ACLKX. If CLKXP = 1, the CLKXP mux passes the inverted version of ACLKX to XCLK. As a result, the McASP shifts transmit data at the falling edge of ACLKX.

The transmit high-frequency master clock, AHCLKX, may be either externally sourced from the AHCLKX pin or internally generated, as selected by the HCLKXM bit. If internally generated (HCLKXM = 1), the clock is divided down by a programmable high clock divider (HCLKXDIV) from McASP internal clock source AUXCLK. The transmit high-frequency master clock may be (but is not required to be) output on the AHCLKX pin where it is available to other devices in the system.

The transmit clock configuration is controlled by the following registers:

- ACLKXCTL.
- AHCLKXCTL.

Figure 22-17. Transmit Clock Generator Block Diagram



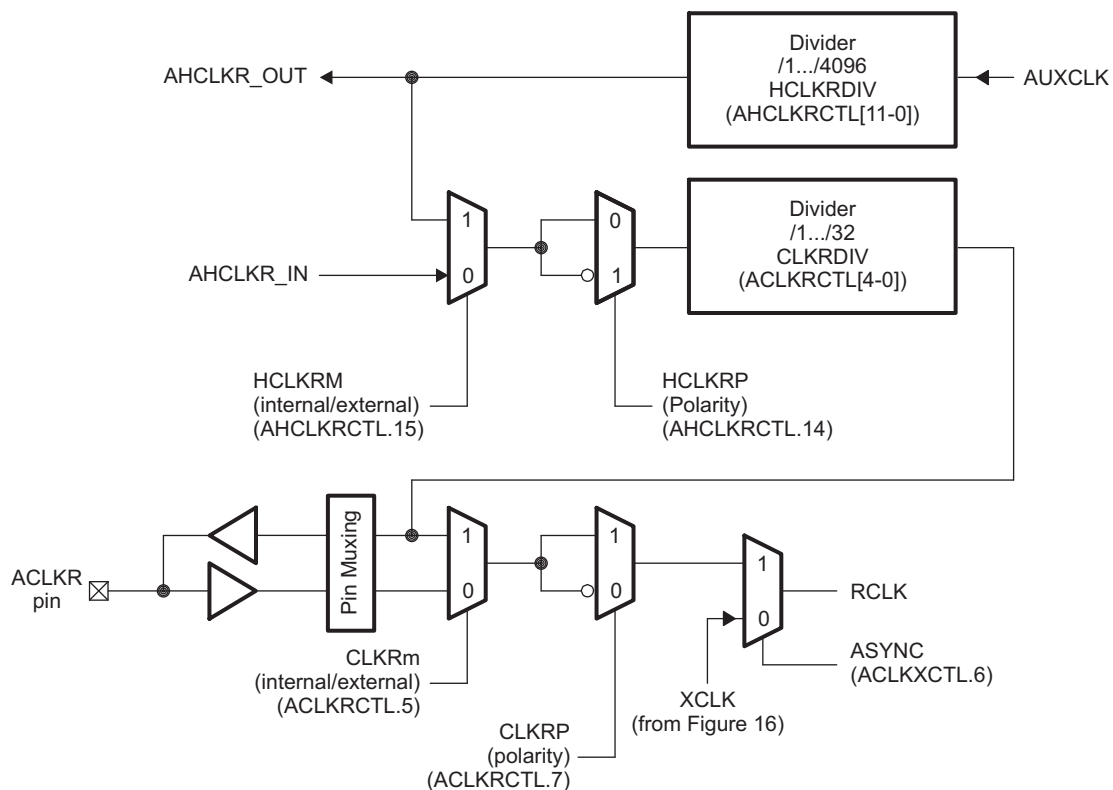
22.3.5.2 Receive Clock

The receiver also has the option to operate synchronously from the ACLKX and AFSX signals. This is achieved when the ASYNC bit in the transmit clock control register (ACLKXCTL) is cleared to 0 (see [Figure 22-18](#)). The receiver may be configured with different polarity (CLKRP) and frame sync data delay options from those options of the transmitter.

The receive clock configuration is controlled by the following registers:

- ACLKRCTL.
- AHCLKRCTL.

Figure 22-18. Receive Clock Generator Block Diagram



22.3.5.3 Frame Sync Generator

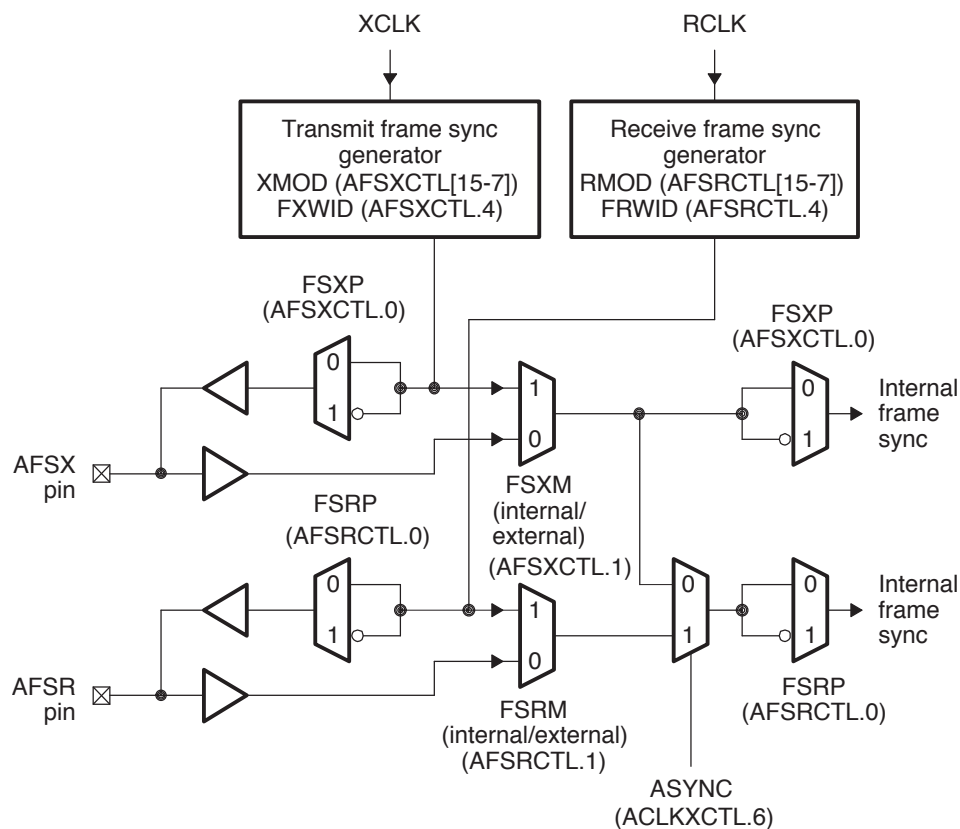
There are two different modes for frame sync: burst and TDM. A block diagram of the frame sync generator is shown in Figure 22-19. The frame sync options are programmed by the receive and transmit frame sync control registers (AFSRCTL and AFSXCTL). The options are:

- Internally-generated or externally-generated.
- Frame sync polarity: rising edge or falling edge.
- Frame sync width: single bit or single word.
- Bit delay: 0, 1, or 2 cycles before the first data bit.

The transmit frame sync pin is AFSX and the receive frame sync pin is AFSR. A typical usage for these pins is to carry the left/right clock (LRCLK) signal when transmitting and receiving stereo data.

Regardless if the AFSX/AFSR is internally generated or externally sourced, the polarity of AFSX/AFSR is determined by FSXP/FSRP, respectively, to be either rising or falling edge. If FSXP/FSRP = 0, the frame sync polarity is rising edge. If FSRP/FSRP = 1, the frame sync polarity is falling edge.

Figure 22-19. Frame Sync Generator Block Diagram



22.3.5.4 Clocking Examples

Some examples of processes using the McASP clocking and frame flexibility are:

- Receive data from a DVD at 48 kHz, but output up-sampled or decoded audio at 96 kHz or 192 kHz. This could be accomplished by inputting a high-frequency master clock (for example, $512 \times$ receive FS), receiving with an internally-generated bit clock ratio of divide-by-8, and transmitting with an internally-generated bit clock ratio of divide-by-4 or divide-by-2.
- Transmit/receive data based on one sample rate (for example, 44.1 kHz), and transmit/receive data at a different sample rate (for example, 48 kHz).

22.3.5.5 Crystal Considerations

When choosing a high frequency input crystal for the device, consider the maximum functional clock frequency of the McASP module versus the maximum external receive/transmit clock AHCLKR/AHCLKX, especially when planning to generate the clocks internally. For example, if the maximum transmit clock AHCLKX is 25 MHz, a master oscillator CLK_M_OSC of 26 MHz requires a divide-by-2. However, master oscillator of 25 MHz enables full performance of the transmit clock.

22.3.6 Signal Descriptions

The signals used on the McASP audio interface are listed in [Table 22-7](#).

Table 22-7. McASP Interface Signals

Pin	I/O/Z	Device Reset (RESET = 0)	Description
Transmitter Control			
AHCLKX	I/O/Z	Input	Transmit high-frequency master clock
AFSX	I/O/Z	Input	Transmit frame sync or left/right clock (LRCLK)
ACLKX	I/O/Z	Input	Transmit bit clock
Receiver Control			
AHCLKR	I/O/Z	Input	Receive high-frequency master clock
AFSR	I/O/Z	Input	Receive frame sync or left/right clock (LRCLK)
ACLKR	I/O/Z	Input	Receive bit clock
Mute			
AMUTE	I/O/Z	Input	Mute output
AMUTEIN	I/O/Z	Input	Mute input
Data			
AXRn	I/O/Z	Input	TX/RX data pins

22.3.7 Pin Multiplexing

The McASP signals share pins with other processor functions. For detailed information on the McASP pin multiplexing and configuration, see the pin multiplexing information in the device-specific data manual.

22.3.8 Transfer Modes

22.3.8.1 Burst Transfer Mode

The McASP supports a burst transfer mode, which is useful for nonaudio data such as passing control information between two processors. Burst transfer mode uses a synchronous serial format similar to the TDM mode. The frame sync generation is not periodic or time-driven as in TDM mode, but data driven, and the frame sync is generated for each data word transferred.

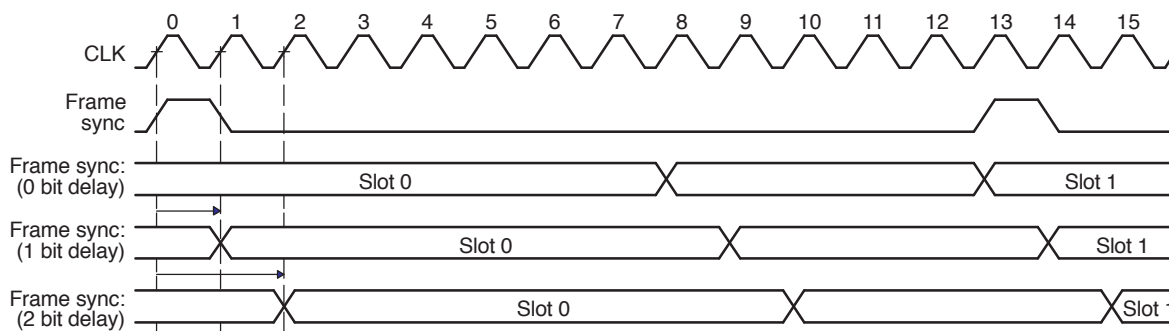
When operating in burst frame sync mode (Figure 22-20), as specified for transmit (XMOD = 0 in AFSXCTL) and receive (RMOD = 0 in AFSRCTL), one slot is shifted for each active edge of the frame sync signal that is recognized. Additional clocks after the slot and before the next frame sync edge are ignored.

In burst frame sync mode, the frame sync delay may be specified as 0, 1, or 2 serial clock cycles. This is the delay between the frame sync active edge and the start of the slot. The frame sync signal lasts for a single bit clock duration (FRWID = 0 in AFSRCTL, FXWID = 0 in AFSXCTL).

For transmit, when generating the transmit frame sync internally, the frame sync begins when the previous transmission has completed and when all the XBUF[n] (for every serializer set to operate as a transmitter) has been updated with new data.

For receive, when generating the receive frame sync internally, frame sync begins when the previous transmission has completed and when all the RBUF[n] (for every serializer set to operate as a receiver) has been read.

Figure 22-20. Burst Frame Sync Mode



The control registers must be configured as follows for the burst transfer mode. The burst mode specific bit fields are in bold face:

- **PFUNC**: The clock, frame, data pins must be configured for McASP function.
- **PDIR**: The clock, frame, data pins must be configured to the direction desired.
- **PDOUT**, **PDIN**, **PDSET**, **PDCLR**: Not applicable. Leave at default.
- **GBLCTL**: Follow the initialization sequence in Section 22.3.12.2 to configure this register.
- **AMUTE**: Not applicable. Leave at default.
- **DLBCTL**: If loopback mode is desired, configure this register according to Section 22.3.10.5, otherwise leave this register at default.
- **DITCTL**: **DITEN** must be left at default 0 to select non-DIT mode. Leave the register at default.
- **RMASK/XMASK**: Mask desired bits according to Section 22.3.9.2 and Section 22.3.10.3.
- **RFMT/XFMT**: Program all fields according to data format desired. See Section 22.3.10.3.
- **AFSRCTL/AFSXCTL**: Clear **RMOD/XMOD** bits to 0 to indicate burst mode. Clear **FRWID/FXWID** bits to 0 for single bit frame sync duration. Configure other fields as desired.
- **ACLKRCTL/ACLKXCTL**: Program all fields according to bit clock desired. See Section 22.3.5.
- **AHCLKRCTL/AHCLKXCTL**: Program all fields according to high-frequency clock desired. See Section 22.3.5.

- RTDM/XTDM: Program RTDMS0/XTDMS0 to 1 to indicate one active slot only. Leave other fields at default.
- RINTCTL/XINTCTL: Program all fields according to interrupts desired.
- RCLKCHK/XCLKCHK: Not applicable. Leave at default.
- SRCTLn: Program SRMOD to inactive/transmitter/receiver as desired. DISMOD is not applicable and should be left at default.
- DITCSRA[n], DITCSRB[n], DITUDRA[n], DITUDRB[n]: Not applicable. Leave at default.

22.3.8.2 Time-Division Multiplexed (TDM) Transfer Mode

The McASP time-division multiplexed (TDM) transfer mode supports the TDM format discussed in [Section 22.3.3.1](#).

Transmitting data in the TDM transfer mode requires a minimum set of pins:

- ACLKX - transmit bit clock.
- AFSX - transmit frame sync (or commonly called left/right clock).
- One or more serial data pins, AXRn, whose serializers have been configured to transmit.

The transmitter has the option to receive the ACLKX bit clock as an input, or to generate the ACLKX bit clock by dividing down the AHCLKX high-frequency master clock. The transmitter can either generate AHCLKX internally or receive AHCLKX as an input. See [Section 22.3.5.1](#).

Similarly, to receive data in the TDM transfer mode requires a minimum set of pins:

- ACLKR - receive bit clock.
- AFSR - receive frame sync (or commonly called left/right clock).
- One or more serial data pins, AXRn, whose serializers have been configured to receive.

The receiver has the option to receive the ACLKR bit clock as an input or to generate the ACLKR bit clock by dividing down the AHCLKR high-frequency master clock. The receiver can either generate AHCLKR internally or receive AHCLKR as an input. See [Section 22.3.5.2](#) and [Section 22.3.5.3](#).

The control registers must be configured as follows for the TDM mode. The TDM mode specific bit fields are in bold face:

- PFUNC: The clock, frame, data pins must be configured for McASP function.
- PDIR: The clock, frame, data pins must be configured to the direction desired.
- PDOUT, PDIN, PDSET, PDCLR: Not applicable. Leave at default.
- GBLCTL: Follow the initialization sequence in [Section 22.3.12.2](#) to configure this register.
- AMUTE: Program all fields according to mute control desired.
- DLBCTL: If loopback mode is desired, configure this register according to [Section 22.3.10.5](#), otherwise leave this register at default.
- DITCTL: DITEN must be left at default 0 to select TDM mode. Leave the register at default.
- RMASK/XMASK: Mask desired bits according to [Section 22.3.9.2](#) and [Section 22.3.10.3](#).
- RFMT/XFMT: Program all fields according to data format desired. See [Section 22.3.10.3](#).
- AFSRCTL/AFSXCTL: Set **RMOD/XMOD** bits to 2-32 for TDM mode. Configure other fields as desired.
- ACLKRCTL/ACLKXCTL: Program all fields according to bit clock desired. See [Section 22.3.5](#).
- AHCLKRCTL/AHCLKXCTL: Program all fields according to high-frequency clock desired. See [Section 22.3.5](#).
- RTDM/XTDM: Program all fields according to the time slot characteristics desired.
- RINTCTL/XINTCTL: Program all fields according to interrupts desired.
- RCLKCHK/XCLKCHK: Program all fields according to clock checking desired.
- SRCTLn: Program all fields according to serializer operation desired.
- DITCSRA[n], DITCSRB[n], DITUDRA[n], DITUDRB[n]: Not applicable. Leave at default.

22.3.8.2.1 TDM Time Slots

TDM mode on the McASP can extend to support multiprocessor applications, with up to 32 time slots per frame. For each of the time slots, the McASP may be configured to participate or to be inactive by configuring XTDM and/or RTDM (this allows multiple processors to communicate on the same TDM serial bus).

The TDM sequencer (separate ones for transmit and receive) functions in this mode. The TDM sequencer counts the slots beginning with the frame sync. For each slot, the TDM sequencer checks the respective bit in either XTDM or RTDM to determine if the McASP should transmit/receive in that time slot.

If the transmit/receive bit is active, the McASP functions normally during that time slot; otherwise, the McASP is inactive during that time slot; no update to the buffer occurs, and no event is generated.

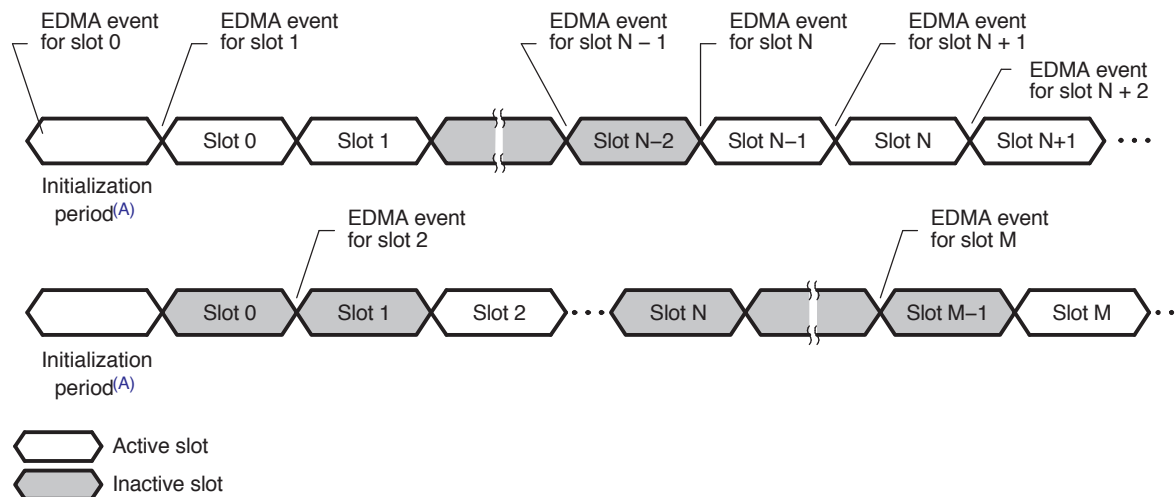
Transmit pins are automatically set to a high-impedance state, 0, or 1 during that slot, as determined by bit DISMOD in SRCTL[n].

Figure 22-21 shows when the transmit DMA event AXEVT is generated. See Section 22.3.10.1.1 for details on data ready and the initialization period indication. The transmit DMA event for an active time slot (slot N) is generated during the previous time slot (slot N - 1), regardless if the previous time slot (slot N - 1) is active or inactive.

During an active transmit time slot (slot N), if the next time slot (slot N + 1) is configured to be active, the copy from XRBUF[n] to XRSR[n] generates the DMA event for time slot N + 1. If the next time slot (slot N + 1) is configured to be inactive, then the DMA event will be delayed to time slot M - 1. In this case, slot M is the next active time slot. The DMA event for time slot M is generated during the first bit time of slot M - 1.

The receive DMA request generation does not need this capability, since the receive DMA event is generated after data is received in the buffer (looks back in time). If a time slot is disabled, then no data is copied to the buffer for that time slot and no DMA event is generated.

Figure 22-21. Transmit DMA Event (AXEVT) Generation in TDM Time Slots



A See Section 22.3.12.2, step 7a.

22.3.8.2.2 Special 384 Slot TDM Mode for Connection to External DIR

The McASP receiver also supports a 384 time slot TDM mode (DIR mode), to support S/PDIF, AES-3, IEC-60958 receiver ICs whose natural block (block corresponds to McASP frame) size is 384 samples. The advantage to using the 384 time slot TDM mode is that interrupts may be generated synchronous to the S/PDIF, AES-3, IEC-60958, such as the last slot interrupt.

The receive TDM time slot register (RTDM) should be programmed to all 1s during reception of a DIR block. Other TDM functionalities (for example, inactive slots) are not supported (only the slot counter counts the 384 subframes in a block).

To receive data in the DIR mode, the following pins are typically needed:

- ACLKR - receive bit clock.
- AFSR - receive frame sync (or commonly called left/right clock). In this mode, AFSR should be connected to a DIR which outputs a start of block signal, instead of LRCLK.
- One or more serial data pins, AXRn, whose serializers have been configured to receive.

For this special DIR mode, the control registers can be configured just as for TDM mode, except set RMOD in AFSRCTL to 384 to receive 384 time slots.

22.3.8.3 Digital Audio Interface Transmit (DIT) Transfer Mode

In addition to the TDM and burst transfer modes, which are suitable for transmitting audio data between ICs inside the same system, the digital audio interface transmit (DIT) transfer mode of the McASP also supports transmission of audio data in the S/PDIF, AES-3, or IEC-60958 format. These formats are designed to carry audio data between different systems through an optical or coaxial cable. The DIT mode only applies to serializers configured as transmitters, not receivers. See [Section 22.3.3.2](#) for a description of the S/PDIF format.

22.3.8.3.1 Transmit DIT Encoding

The McASP operation in DIT mode is basically identical to the 2 time slot TDM mode, but the data transmitted is output as a biphase mark encoded bit stream, with preamble, channel status, user data, validity, and parity automatically stuffed into the bit stream by the McASP. The McASP includes separate validity bits for even/odd subframes and two 384-bit RAM modules to hold channel status and user data bits.

The transmit TDM time slot register (XTDM) should be programmed to all 1s during DIT mode. TDM functionality is not supported in DIT mode, except that the TDM slot counter counts the DIT subframes.

To transmit data in the DIT mode, the following pins are typically needed:

- AHCLKX - transmit high-frequency master clock.
- One or more serial data pins, AXRn, whose serializers have been configured to transmit.

AHCLKX is optional (the internal clock source may be used instead), but if used as a reference, the processor provides a clock check circuit that continually monitors the AHCLKX input for stability.

If the McASP is configured to transmit in the DIT mode on more than one serial data pin, the bit streams on all pins will be synchronized. In addition, although they will carry unique audio data, they will carry the same channel status, user data, and validity information.

The actual 24-bit audio data must always be in bit positions 23-0 after passing through the first three stages of the transmit format unit.

For left-aligned Q31 data, the following transmit format unit settings process the data into right aligned 24-bit audio data ready for transmission:

- XROT = 010 (rotate right by 8 bits).
- XRVRS = 0 (no bit reversal, LSB first).
- XMASK = FFFF FF00h-FFFF 0000h (depending upon whether 24, 23, 22, 21, 20, 19, 18, 17, or 16 valid audio data bits are present).
- XPAD = 00 (pad extra bits with 0).

For right-aligned data, the following transmit format unit settings process the data into right aligned 24-bit audio data ready for transmission:

- XROT = 000 (rotate right by 0 bits).
- XRVRS = 0 (no bit reversal, LSB first).
- XMASK = 00FF FFFFh to 0000 FFFFh (depending upon whether 24, 23, 22, 21, 20, 19, 18, 17, or 16 valid audio data bits are present).
- XPAD = 00 (pad extra bits with 0).

22.3.8.3.2 **Transmit DIT Clock and Frame Sync Generation**

The DIT transmitter only works in the following configuration:

- In transmit frame control register (AFSXCTL):
 - Internally-generated transmit frame sync, FSXM = 1.
 - Rising-edge frame sync, FSXP = 0.
 - Bit-width frame sync, FXWID = 0.
 - 384-slot TDM, XMOD = 1 1000 0000b.
- In transmit clock control register (ACLKXCTL), ASYNC = 1.
- In transmit bitstream format register (XFMT), XSSZ = 1111 (32-bit slot size).

All combinations of AHCLKX and ACLKX are supported.

This is a summary of the register configurations required for DIT mode. The DIT mode specific bit fields are in bold face:

- PFUNC: The data pins must be configured for McASP function. If AHCLKX is used, it must also be configured for McASP function.
- PDIR: The data pins must be configured as outputs. If AHCLKX is used as an input reference, it should be configured as input. If internal clock source AUXCLK is used as the reference clock, it may be output on the AHCLKX pin by configuring AHCLKX as an output.
- PDOUT, PDIN, PDSET, PDCLR: Not applicable for DIT operation. Leave at default.
- GBLCTL: Follow the initialization sequence in [Section 22.3.12.2](#) to configure this register.
- AMUTE: Program all fields according to mute control desired.
- DLBCTL: Not applicable. Loopback is not supported for DIT mode. Leave at default.
- DITCTL: **DITEN** bit must be set to 1 to enable DIT mode. Configure other bits as desired.
- RMASK: Not applicable. Leave at default.
- RFMT: Not applicable. Leave at default.
- AFSRCTL: Not applicable. Leave at default.
- ACLKRCTL: Not applicable. Leave at default.
- AHCLKRCTL: Not applicable. Leave at default.
- RTDM: Not applicable. Leave at default.
- RINTCTL: Not applicable. Leave at default.
- RCLKCHK: Not applicable. Leave at default.
- **XMASK**: Mask desired bits according to the discussion in this section, depending upon left-aligned or right-aligned internal data.

- **XFMT: XDADLY = 0. XRVRS = 0. XPAD = 0. XPBIT = default (not applicable). XSSZ = Fh** (32-bit slot). XBUSEL = configured as desired. **XROT** bit is configured according to the discussion in this section, either 0 or 8-bit rotate.
- **AFSXCTL**: Configure the bits according to the discussion in this section.
- **ACLKXCTL: ASYNC = 1**. Program CLKXDIV bits to obtain the bit clock rate desired. Configure CLKXP and CLKXM bits as desired, because CLKX is not actually used in the DIT protocol.
- **AHCLKXCTL**: Program all fields according to high-frequency clock desired.
- **XTDM**: Set to FFFF FFFFh for all active slots for DIT transfers.
- XINTCTL: Program all fields according to interrupts desired.
- XCLKCHK: Program all fields according to clock checking desired.
- SRCTLn: Set **SRMOD = 1** (transmitter) for the DIT pins. DISMOD field is don't care for DIT mode.
- **DITCSRA[n], DITCSRB[n]**: Program the channel status bits as desired.
- **DITUDRA[n], DITUDRB[n]**: Program the user data bits as desired.

22.3.8.3.3 DIT Channel Status and User Data Register Files

The channel status registers (DITCSRA_n and DITCSRB_n) and user data registers (DITUDRA_n and DITUDRB_n) are not double buffered. Typically the programmer uses one of the synchronizing interrupts, such as last slot, to create an event at a safe time so the register may be updated. In addition, the CPU reads the transmit TDM slot counter to determine which word of the register is being used.

It is a requirement that the software avoid writing to the word of user data and channel status that are being used to encode the current time slot; otherwise, it will be indeterminate whether the old or new data is used to encode the bitstream.

The DIT subframe format is defined in [Section 22.3.3.2.2](#). The channel status information (C) and User Data (U) are defined in these DIT control registers:

- DITCSRA0 to DITCSRA5: The 192 bits in these six registers contain the channel status information for the LEFT channel within each frame.
- DITCSRB0 to DITCSRB5: The 192 bits in these six registers contain the channel status information for the RIGHT channel within each frame.
- DITUDRA0 to DITUDRA5: The 192 bits in these six registers contain the user data information for the LEFT channel within each frame.
- DITUDRB0 to DITUDRB5: The 192 bits in these six registers contain the user data information for the RIGHT channel within each frame.

The S/PDIF block format is shown in [Figure 22-13](#). There are 192 frames within a block (frame 0 to frame 191). Within each frame there are two subframes (subframe 1 and 2 for left and right channels, respectively). The channel status and user data information sent on each subframe is summarized in [Table 22-8](#).

Table 22-8. Channel Status and User Data for Each DIT Block

Frame	Subframe	Preamble	Channel Status defined in:	User Data defined in:
Defined by DITCSRA0, DITCSRB0, DITUDRA0, DITUDRB0				
0	1 (L)	B	DITCSRA0[0]	DITUDRA0[0]
0	2 (R)	W	DITCSRB0[0]	DITUDRB0[0]
1	1 (L)	M	DITCSRA0[1]	DITUDRA0[1]
1	2 (R)	W	DITCSRB0[1]	DITUDRB0[1]
2	1 (L)	M	DITCSRA0[2]	DITUDRA0[2]
2	2 (R)	W	DITCSRB0[2]	DITUDRB0[2]
31	1 (L)	M	DITCSRA0[31]	DITUDRA0[31]
31	2 (R)	W	DITCSRB0[31]	DITUDRB0[31]
Defined by DITCSRA1, DITCSRB1, DITUDRA1, DITUDRB1				
32	1 (L)	M	DITCSRA1[0]	DITUDRA1[0]
32	2 (R)	W	DITCSRB1[0]	DITUDRB1[0]
63	1 (L)	M	DITCSRA1[31]	DITUDRA1[31]
63	2 (R)	W	DITCSRB1[31]	DITUDRB1[31]
Defined by DITCSRA2, DITCSRB2, DITUDRA2, DITUDRB2				
64	1 (L)	M	DITCSRA2[0]	DITUDRA2[0]
64	2 (R)	W	DITCSRB2[0]	DITUDRB2[0]
95	1 (L)	M	DITCSRA2[31]	DITUDRA2[31]
95	2 (R)	W	DITCSRB2[31]	DITUDRB2[31]
Defined by DITCSRA3, DITCSRB3, DITUDRA3, DITUDRB3				
96	1 (L)	M	DITCSRA3[0]	DITUDRA3[0]
96	2 (R)	W	DITCSRB3[0]	DITUDRB3[0]
127	1 (L)	M	DITCSRA3[31]	DITUDRA3[31]
127	2 (R)	W	DITCSRB3[31]	DITUDRB3[31]
Defined by DITCSRA4, DITCSRB4, DITUDRA4, DITUDRB4				
128	1 (L)	M	DITCSRA4[0]	DITUDRA4[0]
128	2 (R)	W	DITCSRB4[0]	DITUDRB4[0]
159	1 (L)	M	DITCSRA4[31]	DITUDRA4[31]
159	2 (R)	W	DITCSRB4[31]	DITUDRB4[31]
Defined by DITCSRA5, DITCSRB5, DITUDRA5, DITUDRB5				
160	1 (L)	M	DITCSRA5[0]	DITUDRA5[0]
160	2 (R)	W	DITCSRB5[0]	DITUDRB5[0]
191	1 (L)	M	DITCSRA5[31]	DITUDRA5[31]
191	2 (R)	W	DITCSRB5[31]	DITUDRB5[31]

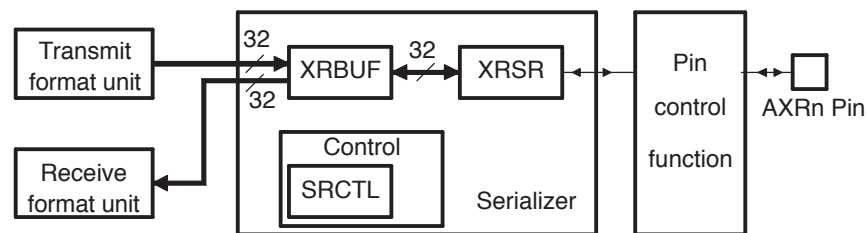
22.3.9 General Architecture

22.3.9.1 Serializers

Figure 22-22 shows the block diagram of the serializer and its interface to other units within the McASP. The serializers take care of shifting serial data in and out of the McASP. Each serializer consists of a shift register (XRSR), a data buffer (XRBUF), a control register (SRCTL), and logic to support the data alignment options of the McASP. For each serializer, there is a dedicated serial data pin (AXRn) and a dedicated control register (SRCTL[n]). The control register allows the serializer to be configured as a transmitter, receiver, or as inactive. When configured as a transmitter the serializer shifts out data to the serial data pin AXRn. When configured as a receiver, the serializer shifts in data from the AXRn pin. The serializer is clocked from the transmit/receive section clock (ACLKX/ACLKR) if configured to transmit/receive respectively.

All serializers that are configured to transmit operate in lock-step. Similarly, all serializers that are configured to receive also operate in lock-step. This means that at most there are two zones per McASP, one for transmit and one for receive.

Figure 22-22. Individual Serializer and Connections Within McASP



For receive, data is shifted in through the AXRn pin to the shift register XRSR. Once the entire slot of data is collected in the XRSR, the data is copied to the data buffer XRBUF. The data is now ready to be read by the processor through the RBUF register, which is an alias of the XRBUF for receive. When the processor reads from the RBUF, the McASP passes the data from RBUF through the receive format unit and returns the formatted data to the processor.

For transmit, the processor services the McASP by writing data into the XBUF register, which is an alias of the XRBUF for transmit. The data automatically passes through the transmit format unit before actually reaching the XRBUF register in the serializer. The data is then copied from XRBUF to XRSR, and shifted out from the AXRn synchronously to the serial clock.

In DIT mode, in addition to the data, the serializer shifts out other DIT-specific information accordingly (preamble, user data, etc.).

The serializer configuration is controlled by SRCTL[n].

22.3.9.2 Format Unit

The McASP has two data formatting units, one for transmit and one for receive. These units automatically remap the data bits within the transmitted and received words between a natural format for the processor (such as a Q31 representation) and the required format for the external serial device (such as "I2S format"). During the remapping process, the format unit also can mask off certain bits or perform sign extension.

Since all transmitters share the same data formatting unit, the McASP only supports one transmit format at a time. For example, the McASP will not transmit in "I2S format" on serializer 0, while transmitting "Left Justified" on serializer 1. Likewise, the receiver section of the McASP only supports one data format at a time, and this format applies to all receiving serializers. However, the McASP can transmit in one format while receiving in a completely different format.

This formatting unit consists of three stages:

- Bit mask and pad (masks off bits, performs sign extension)
- Rotate right (aligns data within word)
- Bit reversal (selects between MSB first or LSB first)

Figure 22-23 shows a block diagram of the receive formatting unit, and Figure 22-24 shows the transmit formatting unit. Note that the order in which data flows through the three stages is different between the transmit and receive formatting units.

Figure 22-23. Receive Format Unit

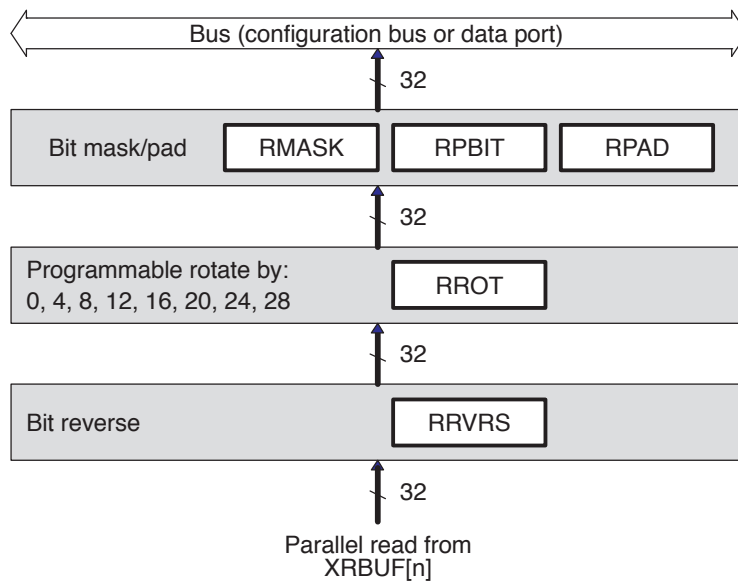
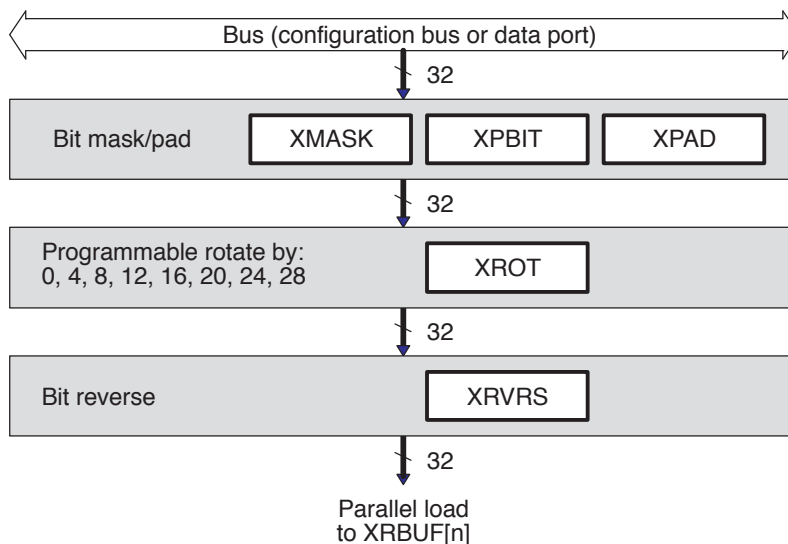


Figure 22-24. Transmit Format Unit



The bit mask and pad stage includes a full 32-bit mask register, allowing selected individual bits to either pass through the stage unchanged, or be masked off. The bit mask and pad then pad the value of the masked off bits by inserting either a 0, a 1, or one of the original 32 bits as the pad value. The last option allows for sign-extension when the sign bit is selected to pad the remaining bits.

The rotate right stage performs bitwise rotation by a multiple of 4 bits (between 0 and 28 bits), programmable by the (R/X)FMT register. Note that this is a rotation process, not a shifting process, so bit 0 gets shifted back into bit 31 during the rotation.

The bit reversal stage either passes all 32 bits directly through, or swaps them. This allows for either MSB or LSB first data formats. If bit reversal is not enabled, then the McASP will naturally transmit and receive in an LSB first order.

Finally, note that the (R/X)DATDLY bits in (R/X)FMT also determine the data format. For example, the difference between I2S format and left-justified is determined by the delay between the frame sync edge and the first data bit of a given time slot. For I2S format, (R/X)DATDLY should be set to a 1-bit delay, whereas for left-justified format, it should be set to a 0-bit delay.

The combination of all the options in (R/X)FMT means that the McASP supports a wide variety of data formats, both on the serial data lines, and in the internal processor representation.

[Section 22.3.10.3](#) provides more detail and specific examples. The examples use internal representation in integer and Q31 notation, but other fractional notations are also possible.

22.3.9.3 State Machine

The receive and transmit sections have independent state machines. Each state machine controls the interactions between the various units in the respective section. In addition, the state machine keeps track of error conditions and serial port status.

No serial transfers can occur until the respective state machine is released from reset. See initialization sequence for details ([Section 22.3.12](#)).

The receive state machine is controlled by the RFMT register, and it reports the McASP status and error conditions in the RSTAT register. Similarly, the transmit state machine is controlled by the XFMT register, and it reports the McASP status and error conditions in the XSTAT register.

22.3.9.4 TDM Sequencer

There are separate TDM sequencers for the transmit section and the receive section. Each TDM sequencer keeps track of the slot count. In addition, the TDM sequencer checks the bits of (R/X)TDM and determines if the McASP should receive/transmit in that time slot.

If the McASP should participate (transmit/receive bit is active) in the time slot, the McASP functions normally. If the McASP should not participate (transmit/receive bit is inactive) in the time slot, no transfers between the XRBUF and XRSR registers in the serializer would occur during that time slot. In addition, the serializers programmed as transmitters place their data output pins in a predetermined state (logic low, high, or high impedance) as programmed by each serializer control register (SRCTL). Refer also to [Section 22.3.8.2](#) for details on how DMA event or interrupt generations are handled during inactive time slots in TDM mode.

The receive TDM sequencer is controlled by register RTDM and reports current receive slot to RSLOT. The transmit TDM sequencer is controlled by register XTDM and reports current transmit slot to XSLOT.

22.3.9.5 Clock Check Circuit

A common source of error in audio systems is a serial clock failure due to instabilities in the off-chip DIR circuit. To detect a clock error quickly, a clock-check circuit is included in the McASP for both transmit and receive clocks, since both may be sourced from off chip.

The clock check circuit can detect and recover from transmit and receive clock failures. See [Section 22.3.10.4.6](#) for implementation and programming details.

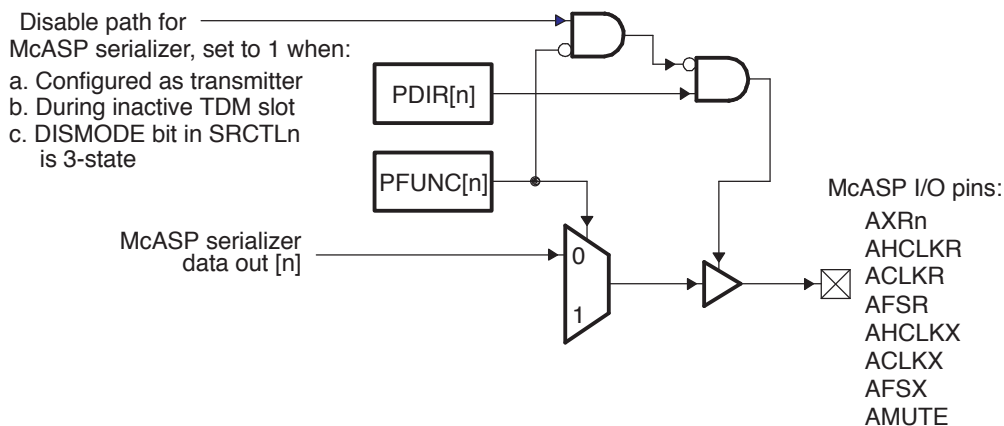
22.3.9.6 Pin Function Control

All McASP pins except AMUTEIN are bidirectional input/output pins. In addition, these bidirectional pins function either as McASP or general-purpose I/O (GPIO) pins. The following registers control the pin functions:

- Pin function register (PFUNC): selects pin to function as McASP or GPIO.
- Pin direction register (PDIR): selects pin to be input or output.
- Pin data input register (PDIN): shows data input at the pin.
- Pin data output register (PDOUT): data to be output at the pin if the pin is configured as GPIO output (PFUNC[n] = 1 and PDIR[n] = 1). Not applicable when the pin is configured as McASP pin (PFUNC[n] = 0).
- Pin data set register (PDSET): alias of PDOUT. Writing a 1 to PDSET[n] sets the respective PDOUT[n] to 1. Writing a 0 has no effect. Applicable only when the pin is configured as GPIO output (PFUNC[n] = 1 and PDIR[n] = 1).
- Pin data clear register (PDCLR): alias of PDOUT. Writing a 1 to PDCLR[n] clears the respective PDOUT[n] to 0. Writing a 0 has no effect. Applicable only when the pin is configured as GPIO output (PFUNC[n] = 1 and PDIR[n] = 1).

See the register descriptions in [Section 22.4](#) for details on the mapping of each McASP pin to the register bits. [Figure 22-25](#) shows the pin control block diagram.

Figure 22-25. McASP I/O Pin Control Block Diagram



22.3.9.6.1 McASP Pin Control-Transmit and Receive

You must correctly set the McASP GPIO registers PFUNC and PDIR, even when McASP pins are used for their serial port (non-GPIO) function.

Serial port functions include:

- Clock pins (ACLKX, ACLKR, AHCLKX, AHCLKR, AFSX, AFSR) used as clock inputs and outputs.
- Serializer data pins (AXRn) used to transmit or receive.
- AMUTE used as a mute output signal.

When using these pins in their serial port function, you must clear PFUNC[n] to 0 for each pin.

Also, certain outputs require PDIR[n] = 1, such as clock pins used as clock outputs, serializer data pins used to transmit, and AMUTE used as mute output.

Clock inputs and serializers configured to receive must have PDIR[n] = 0.

PFUNC and PDIR do not control the AMUTEIN signal, it is usually tied to a device level interrupt pin (consult device datasheet). If used as a mute input, this pin needs to be configured as an input in the appropriate peripheral.

Finally, there is an important advantage to having separate control of pin direction (by PDIR), and the choice of internal versus external clocking (by CLKRM/CLKXM). Depending on the specific device and usage, you might select an external clock (CLKRM = 0), while enabling the internal clock divider, and the clock pin as an output in the PDIR register (PDIR[ACLKR] = 1). In this case, the bit clock is an output (PDIR[ACLKR] = 1) and, therefore, routed to the ACLKR pin. However, because CLKRM = 0, the bit clock is then routed back to the McASP module as an "external" clock source. This may result in less skew between the clock inside the McASP and the clock in the external device, thus producing more balanced setup and hold times for a particular system. As a result, this may allow a higher serial clock rate interface.

22.3.10 Operation

This section discusses the operation of the McASP.

22.3.10.1 Data Transmission and Reception

The processor services the McASP by writing data to the XBUF register(s) for transmit operations, and by reading data from the RBUF register(s) for receive operations. The McASP sets status flag and notifies the processor whenever data is ready to be serviced. [Section 22.3.10.1.1](#) discusses data ready status in detail.

The XBUF and RBUF registers can be accessed through one of the two peripheral ports of the device:

- The data port (DAT): This port is dedicated for data transfers on the device.
- The configuration bus (CFG): This port is used for both data transfers and peripheral configuration control on the device.

[Section 22.3.10.1.2](#) and [Section 22.3.10.1.3](#) discuss how to perform transfers through the data port and the configuration bus.

Either the CPU or the DMA can be used to service the McASP through any of these two peripheral ports. The CPU and DMA usages are discussed in [Section 22.3.10.1.4](#) and [Section 22.3.14.2](#).

22.3.10.1.1 Data Ready Status and Event/Interrupt Generation

22.3.10.1.1.1 Transmit Data Ready

The transmit data ready flag XDATA bit in the XSTAT register reflects the status of the XBUF register. The XDATA flag is set when data is transferred from the XRBUF[n] buffers to the XRSR[n] shift registers, indicating that the XBUF is empty and ready to accept new data from the processor. This flag is cleared when the XDATA bit is written with a 1, or when all the serializers configured as transmitters are written by the processor.

Whenever XDATA is set, an DMA event AXEVT is automatically generated to notify the DMA of the XBUF empty status. An interrupt AXINT is also generated if XDATA interrupt is enabled in the XINTCTL register (See [Section 22.3.13.2](#) for details).

For DMA requests, the McASP does not require XSTAT to be read between DMA events. This means that even if XSTAT already has the XDATA flag set to 1 from a previous request, the next transfer triggers another DMA request.

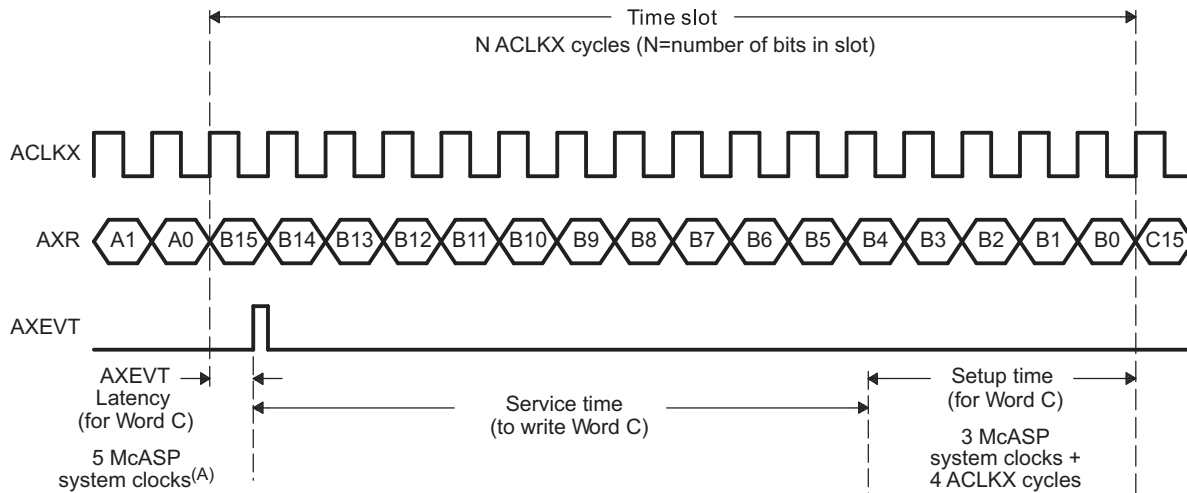
Since all serializers act in lockstep, only one DMA event is generated to indicate that all active transmit serializers are ready to be written to with new data.

[Figure 22-26](#) shows the timing details of when AXEVT is generated at the McASP boundary. In this example, as soon as the last bit (bit A0) of Word A is transmitted, the McASP sets the XDATA flag and generates an AXEVT event. However, it takes up to 5 McASP system clocks (AXEVT Latency) before AXEVT is active at the McASP boundary. Upon AXEVT, the processor can begin servicing the McASP by writing Word C into the XBUF (Processor Service Time). The processor must write Word C into the XBUF no later than the setup time required by the McASP (Setup Time).

The maximum Processor Service Time ([Figure 22-26](#)) can be calculated as:

Processor Service Time = Time Slot - AXEVT Latency - Setup Time

Figure 22-26. Processor Service Time Upon Transmit DMA Event (AXEVT)



A Refer to the device-specific data manual for the McASP system clock source. This is not the same as AUXCLK.

Example 22-1. Processor Service Time Calculation for Transmit DMA Event (AXEVT)

The following is an example to show how to calculate Processor Service Time. Assume the following setup:

- McASP transmits in I2S format at 192 kHz frame rate. Assume slot size is 32 bit.

With the above setup, we obtain the following parameters corresponding to [Figure 22-26](#):

- Calculation of McASP system clock cycle:
 - System functional clock = 26 MHz
 - Therefore, McASP system clock cycle = $1/26\text{MHz} = 38.5 \text{ ns}$.
- Calculation of ACLKX clock cycle:
 - This example has two 32-bit slots per frame, for a total of 64 bits per frame.
 - ACLKX clock cycle is $(1/192 \text{ kHz})/64 = 81.4 \text{ ns}$.
- Time Slot between AXEVT events:
 - For I2S format, McASP generates two AXEVT events per 192 kHz frame.
 - Therefore, Time Slot between AXEVT events is $(1/192 \text{ kHz})/2 = 2604 \text{ ns}$.
- AXEVT Latency:
 - = 5 McASP system clocks
 - = $38.5 \text{ ns} \times 5 = 192.5 \text{ ns}$
- Setup Time
 - = 3 McASP system clocks + 4 ACLKX cycles
 - = $(38.5 \text{ ns} \times 3) + (81.4 \text{ ns} \times 4)$
 - = 441.1 ns
- Processor Service Time
 - = Time Slot - AXEVT Latency - Setup Time
 - = $2604 \text{ ns} - 441.1 \text{ ns} - 192.5 \text{ ns}$
 - = 1970.4 ns

22.3.10.1.1.2 Receive Data Ready

Similarly, the receive data ready flag RDATA bit in the RSTAT reflects the status of the RBUF register. The RDATA flag is set when data is transferred from the XRSR[n] shift registers to the XRBUF[n] buffers, indicating that the RBUF contains received data and is ready to have the processor read the data. This flag is cleared when the RDATA bit is written with a 1, or when all the serializers configured as receivers are read.

Whenever RDATA is set, an DMA event AREVT is automatically generated to notify the DMA of the RBUF ready status. An interrupt ARINT is also generated if RDATA interrupt is enabled in the RINTCTL register (See [Section 22.3.13.3](#) for details).

For DMA requests, the McASP does not require RSTAT to be read between DMA events. This means that even if RSTAT already has the RDATA flag set to 1 from a previous request, the next transfer triggers another DMA request.

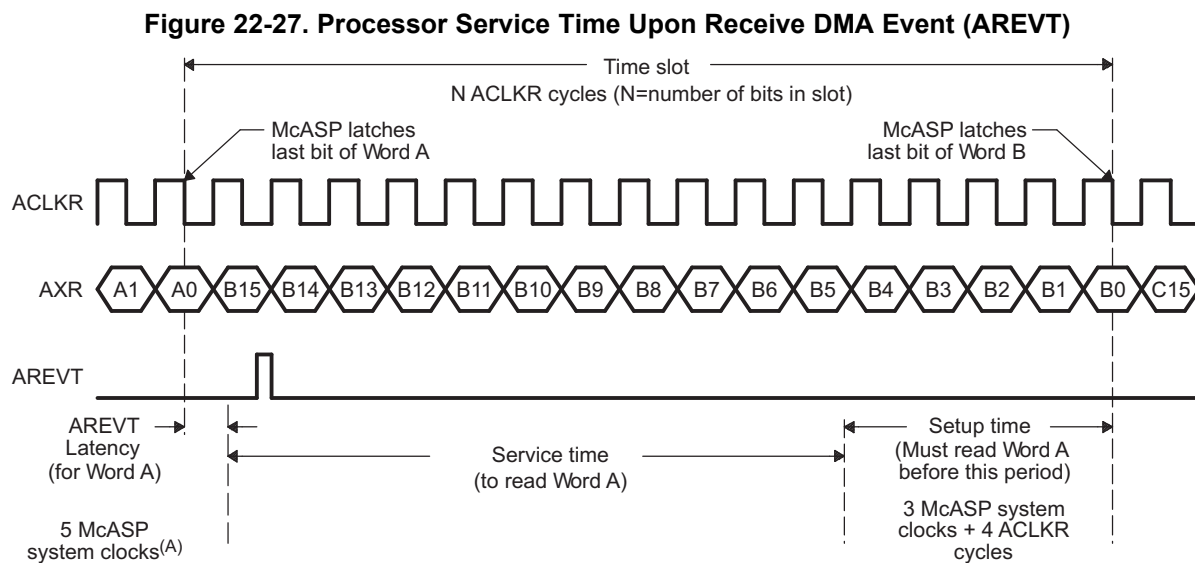
Since all serializers act in lockstep, only one DMA event is generated to indicate that all active receive serializers are ready to receive new data.

[Figure 22-27](#) shows the timing details of when AREVT is generated at the McASP boundary. In this example, as soon as the last bit (bit A0) of Word A is received, the McASP sets the RDATA flag and generates an AREVT event. However, it takes up to 5 McASP system clocks (AREVT Latency) before AREVT is active at the McASP boundary. Upon AREVT, the processor can begin servicing the McASP by reading Word A from the RBUF (Processor Service Time). The processor must read Word A from the XBUF no later than the setup time required by the McASP (Setup Time).

The maximum Processor Service Time ([Figure 22-27](#)) can be calculated as:

Processor Service Time = Time Slot - AREVT Latency - Setup Time

The Processor Service Time calculation for receive is similar to the calculation for transmit. See [Example 22-1](#) for Processor Service Time calculation using transmit as an example.



A The device uses SYSCLK2 as the McASP system clock source.

22.3.10.1.2 Transfers Through the Data Port (DAT)

NOTE: To perform internal transfers through the data port, clear XBUSEL/RBUSEL bit to 0 in the respective XFMT/RFMT registers. Failure to do so will result in software malfunction.

Typically, you will access the McASP XRBUF registers through the data port. To access through the data port, simply have the CPU or DMA access the XRBUF through its data port location. Through the data port, the DMA/CPU can service all the serializers through a single address. The McASP automatically cycles through the appropriate serializers.

For transmit operations through the data port, the DMA/CPU should write to the same XBUF data port address to service all of the active transmit serializers. In addition, the DMA/CPU should write to the XBUF for all active transmit serializers in incremental (although not necessarily consecutive) order. For example, if serializers 0, 4, and 5, are set up as active transmitters, the DMA/CPU should write to the XBUF data port address four times with data for serializers 0, 4, and 5, upon each transmit data ready event. This exact servicing order must be followed so that data appears in the appropriate serializers.

Similarly, for receive operations through the data port, the DMA/CPU should read from the same RBUF data port address to service all of the active receive serializers. In addition, reads from the active receive serializers through the data port return data in incremental (although not necessarily consecutive) order. For example, if serializers 1, 2, and 3, are set up as active receivers, the DMA/CPU should read from the RBUF data port address four times to obtain data for serializers 1, 2, and 3, in this exact order, upon each receive data ready event.

When transmitting, the DMA/CPU must write data to each serializer configured as "active" and "transmit" within each time slot. Failure to do so results in a buffer underrun condition ([Section 22.3.10.4.2](#)). Similarly, when receiving, data must be read from each serializer configured as "active" and "receive" within each time slot. Failure to do so results in a buffer overrun condition ([Section 22.3.10.4.3](#)).

To perform internal transfers through the data port, clear XBUSEL/RBUSEL bit to 0 in the respective XFMT/RFMT registers.

22.3.10.1.3 Transfers Through the Configuration Bus (CFG)

NOTE: To perform internal transfers through the configuration bus, set XBUSEL/RBUSEL bit to 1 in the respective XFMT/RFMT registers. Failure to do so will result in software malfunction.

In this method, the DMA/CPU accesses the XRBUF registers through the configuration bus address. The exact XRBUF register address for any particular serializer is determined by adding the offset for that particular serializer to the base address for the particular McASP. XRBUF for the serializers configured as transmitters is given the name XBUF n . For example, the XRBUF associated with transmit serializer 2 is named XBUF2. Similarly, XRBUF for the serializers configured as receivers is given the name RBUF n .

Accessing the XRBUF registers through the data port is different because the CPU/DMA only needs to access one single address. When accessing through the configuration bus, the CPU/DMA must provide the exact XBUF n or RBUF n address for each access.

When transmitting, DMA/CPU must write data to each serializer configured as "active" and "transmit" within each time slot. Failure to do so results in a buffer underrun condition ([Section 22.3.10.4.2](#)). Similarly when receiving, data must be read from each serializer configured as "active" and "receive" within each time slot. Failure to do so results in a buffer overrun condition ([Section 22.3.10.4.3](#)).

To perform internal transfers through the configuration bus, set XBUSEL/RBUSEL bit to 1 in the respective XFMT/RFMT registers.

22.3.10.1.4 Using the CPU for McASP Servicing

The CPU can be used to service the McASP through interrupt (upon AXINT/ARINT interrupts) or through polling the XDATA bit in the XSTAT register. As discussed in [Section 22.3.10.1.2](#) and [Section 22.3.10.1.3](#), the CPU can access through either the data port or through the configuration bus.

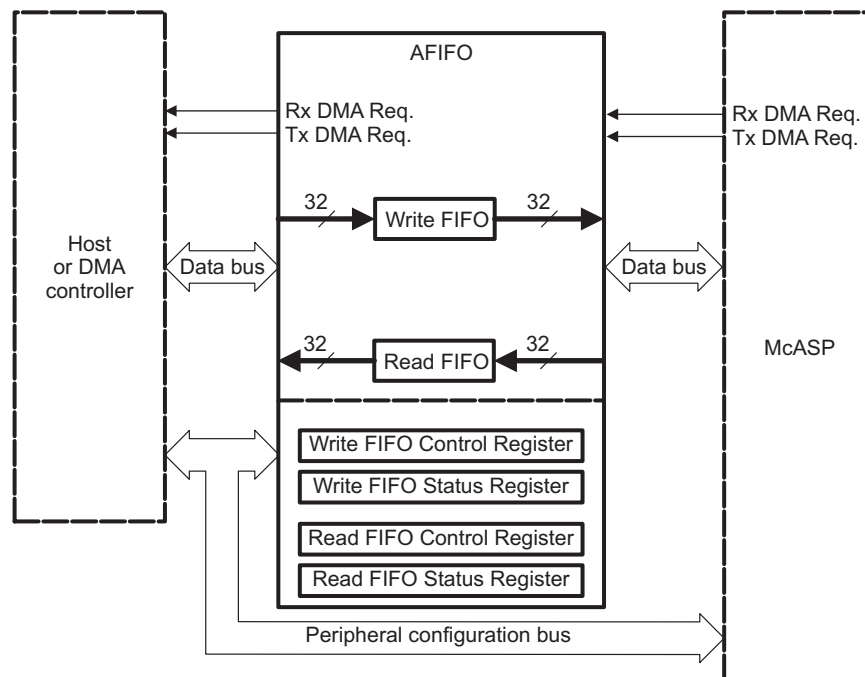
To use the CPU to service the McASP through interrupts, the XDATA/RDATA bit must be enabled in the respective XINTCTL/RINTCTL registers, to generate interrupts AXINT/ARINT to the CPU upon data ready.

22.3.10.2 McASP Audio FIFO (AFIFO)

The AFIFO contains two FIFOs: one Read FIFO (RFIFO), and one Write FIFO (WFIFO). To ensure backward compatibility with existing software, both the Read and Write FIFOs are disabled by default. See [Figure 22-28](#) for a high-level block diagram of the AFIFO.

The AFIFO may be enabled/disabled and configured via the WFIFOCTL and RFIFOCTL registers. Note that if the Read or Write FIFO is to be enabled, it must be enabled prior to initializing the receive/transmit section of the McASP (see [Section 22.3.12.2](#) for details).

Figure 22-28. McASP Audio FIFO (AFIFO) Block Diagram



22.3.10.2.1 AFIFO Data Transmission

When the Write FIFO is disabled, transmit DMA requests pass through directly from the McASP to the host/DMA controller. Whether the WFIFO is enabled or disabled, the McASP generates transmit DMA requests as needed; the AFIFO is “invisible” to the McASP.

When the Write FIFO is enabled, transmit DMA requests from the McASP are sent to the AFIFO, which in turn generates transmit DMA requests to the host/DMA controller.

If the Write FIFO is enabled, upon a transmit DMA request from the McASP, the WFIFO writes *WNUMDMA* 32-bit words to the McASP if and when there are at least *WNUMDMA* words in the Write FIFO. If there are not, the WFIFO waits until this condition has been satisfied. At that point, it writes *WNUMDMA* words to the McASP. (See description for WFIFOCTL.WNUMDMA.)

If the host CPU writes to the Write FIFO, independent of a transmit DMA request, the WFIFO will accept host writes until full. After this point, excess data will be discarded.

Note that when the WFIFO is first enabled, it will immediately issue a transmit DMA request to the host. This is because it begins in an empty state, and is therefore ready to accept data.

22.3.10.2.1.1 Transmit DMA Event Pacer

The AFIFO may be configured to delay making a transmit DMA request to the host until the Write FIFO has enough space for a specified number of words. In this situation, the number of transmit DMA requests to the host or DMA controller is reduced.

If the Write FIFO has space to accept *WNUMEVT* 32-bit words, it generates a transmit DMA request to the host and then waits for a response. Once *WNUMEVT* words have been written to the FIFO, it checks again to see if there is space for *WNUMEVT* 32-bit words. If there is space, it generates another transmit DMA request to the host, and so on. In this fashion, the Write FIFO will attempt to stay filled.

Note that if transmit DMA event pacing is desired, *WFIFOCTL.WNUMEVT* should be set to a non-zero integer multiple of the value in *WFIFOCTL.WNUMDMA*. If transmit DMA event pacing is not desired, then the value in *WFIFOCTL.WNUMEVT* should be set equal to the value in *WFIFOCTL.WNUMDMA*.

22.3.10.2.2 AFIFO Data Reception

When the Read FIFO is disabled, receive DMA requests pass through directly from McASP to the host/DMA controller. Whether the RFIFO is enabled or disabled, the McASP generates receive DMA requests as needed; the AFIFO is “invisible” to the McASP.

When the Read FIFO is enabled, receive DMA requests from the McASP are sent to the AFIFO, which in turn generates receive DMA requests to the host/DMA controller.

If the Read FIFO is enabled and the McASP makes a receive DMA request, the RFIFO reads *RNUMDMA* 32-bit words from the McASP, if and when the RFIFO has space for *RNUMDMA* words. If it does not, the RFIFO waits until this condition has been satisfied; at that point, it reads *RNUMDMA* words from the McASP. (See description for *RFIFOCTL.RNUMDMA*.)

If the host CPU reads the Read FIFO, independent of a receive DMA request, and the RFIFO at that time contains less than *RNUMEVT* words, those words will be read correctly, emptying the FIFO.

22.3.10.2.2.1 Receive DMA Event Pacer

The AFIFO may be configured to delay making a receive DMA request to the host until the Read FIFO contains a specified number of words. In this situation, the number of receive DMA requests to the host or DMA controller is reduced.

If the Read FIFO contains at least *RNUMEVT* 32-bit words, it generates a receive DMA request to the host and then waits for a response. Once *RNUMEVT* 32-bit words have been read from the RFIFO, the RFIFO checks again to see if it contains at least another *RNUMEVT* words. If it does, it generates another receive DMA request to the host, and so on. In this fashion, the Read FIFO will attempt to stay empty.

Note that if receive DMA event pacing is desired, *RFIFOCTL.RNUMEVT* should be set to a non-zero integer multiple of the value in *RFIFOCTL.RNUMDMA*. If receive DMA event pacing is not desired, then the value in *RFIFOCTL.RNUMEVT* should be set equal to the value in *RFIFOCTL.RNUMDMA*.

22.3.10.2.3 Arbitration Between Transmit and Receive DMA Requests

If both the WFIFO and the RFIFO are enabled and a transmit DMA request and receive DMA request occur simultaneously, priority is given to the transmit DMA request. Once a transfer is in progress, it is allowed to complete.

If only the WFIFO is enabled and a transmit DMA request and receive DMA request occur simultaneously, priority is given to the transmit DMA request. Once a transfer is in progress, it is allowed to complete.

If only the RFIFO is enabled and a transmit DMA request and receive DMA request occur simultaneously, priority is given to the receive DMA request. Once a transfer is in progress, it is allowed to complete.

22.3.10.3 Formatter

22.3.10.3.1 Transmit Bit Stream Data Alignment

The McASP transmitter supports serial formats of:

- Slot (or Time slot) size = 8, 12, 16, 20, 24, 28, 32 bits.
- Word size \leq Slot size.
- Alignment: when more bits/slot than bits/words, then:
 - Left aligned = word shifted first, remaining bits are pad.
 - Right aligned = pad bits are shifted first, word occupies the last bits in slot.
- Order: order of bits shifted out:
 - MSB: most-significant bit of word is shifted out first, last bit is LSB.
 - LSB: least-significant bit of word is shifted out last, last bit is MSB.

Hardware support for these serial formats comes from the programmable options in the transmit bitstream format register (XFMT):

- XRVRS: bit reverse (1) or no bit reverse (0).
- XROT: rotate right by 0, 4, 8, 12, 16, 20, 24, or 28 bits.
- XSSZ: transmit slot size of 8, 12, 16, 20, 24, 28, or 32 bits.

XSSZ should always be programmed to match the slot size of the serial stream. The word size is not directly programmed into the McASP, but rather is used to determine the rotation needed in the XROT field.

Table 22-9 and Figure 22-29 show the XRVRS and XROT fields for each serial format and for both integer and Q31 fractional internal representations.

This discussion assumes that all slot size (SLOT in Table 22-9) and word size (WORD in Table 22-9) options are multiples of 4, since the transmit rotate right unit only supports rotation by multiples of 4. However, the bit mask/pad unit does allow for any number of significant digits. For example, a Q31 number may have 19 significant digits (word) and be transmitted in a 24-bit slot; this would be formatted as a word size of 20 bits and a slot size of 24 bits. However, it is possible to set the bit mask unit to only pass the 19 most-significant digits (program the mask value to FFFF E000h). The digits that are not significant can be set to a selected pad value, which can be any one of the significant digits, a fixed value of 0, or a fixed value of 1.

The transmit bit mask/pad unit operates on data as an initial step of the transmit format unit (see Figure 22-24), and the data is aligned in the same representation as it is written to the transmitter by the processor (typically Q31 or integer).

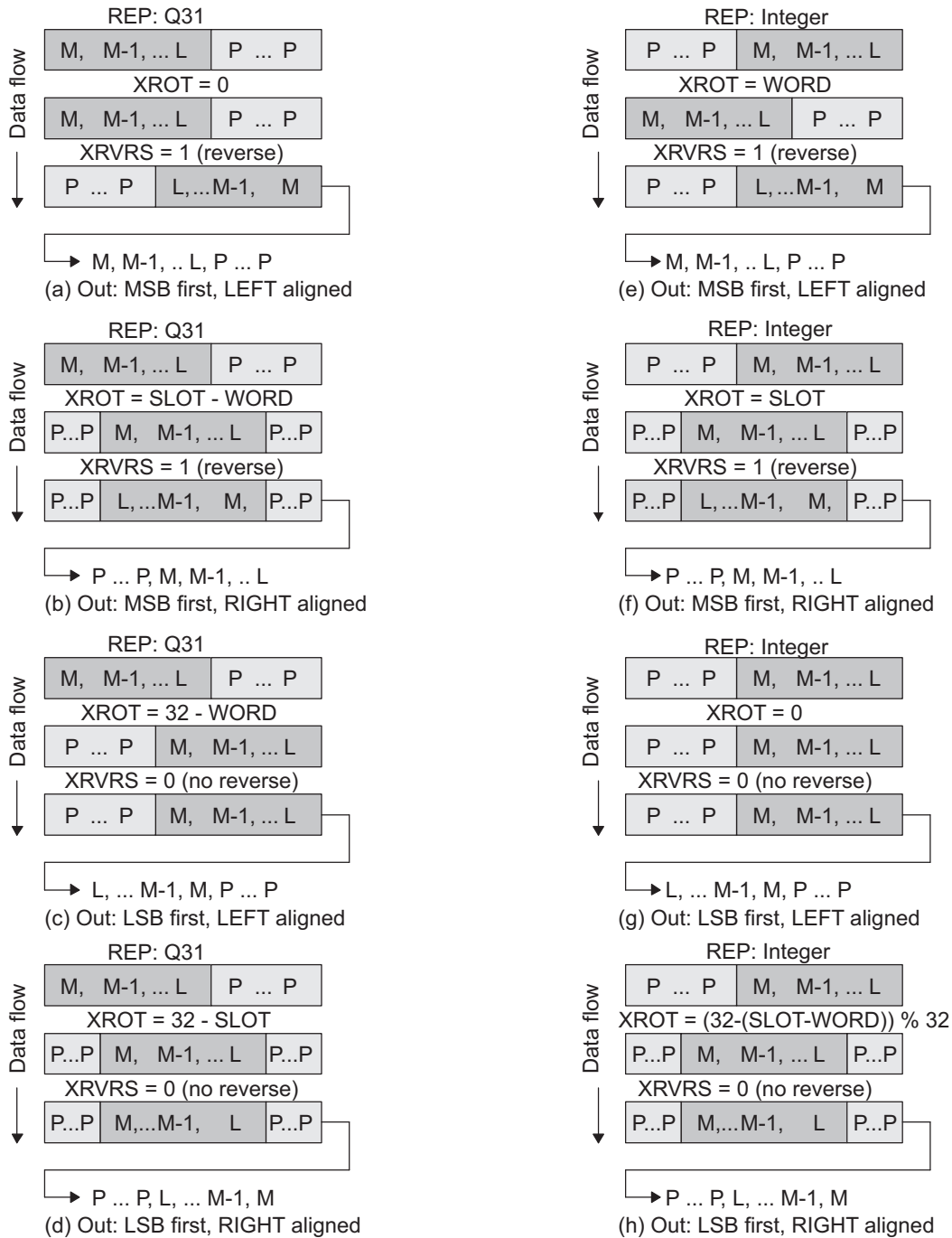
Table 22-9. Transmit Bitstream Data Alignment

Figure 22-29	Bit Stream Order	Bit Stream Alignment	Internal Numeric Representation	XFMT Bit	
				XROT ⁽¹⁾	XRVRS
(a) ⁽²⁾	MSB first	Left aligned	Q31 fraction	0	1
(b)	MSB first	Right aligned	Q31 fraction	SLOT - WORD	1
(c)	LSB first	Left aligned	Q31 fraction	32 - WORD	0
(d)	LSB first	Right aligned	Q31 fraction	32 - SLOT	0
(e) ⁽²⁾	MSB first	Left aligned	Integer	WORD	1
(f)	MSB first	Right aligned	Integer	SLOT	1
(g)	LSB first	Left aligned	Integer	0	0
(h)	LSB first	Right aligned	Integer	(32 - (SLOT - WORD)) % 32	0

⁽¹⁾ WORD = Word size rounded up to the nearest multiple of 4; SLOT = slot size; % = modulo operator

⁽²⁾ To transmit in I2S format, use MSB first, left aligned, and also select XDATDLY = 01 (1 bit delay)

Figure 22-29. Data Flow Through Transmit Format Unit, Illustrated



22.3.10.3.2 Receive Bit Stream Data Alignment

The McASP receiver supports serial formats of:

- Slot or time slot size = 8, 12, 16, 20, 24, 28, 32 bits.
- Word size ≤ Slot size.
- Alignment when more bits/slot than bits/words, then:
 - Left aligned = word shifted first, remaining bits are pad.
 - Right aligned = pad bits are shifted first, word occupies the last bits in slot.
- Order of bits shifted out:
 - MSB: most-significant bit of word is shifted out first, last bit is LSB.
 - LSB: least-significant bit of word is shifted out last, last bit is MSB.

Hardware support for these serial formats comes from the programmable options in the receive bitstream format register (RFMT):

- RRVRS: bit reverse (1) or no bit reverse (0).
- RROT: rotate right by 0, 4, 8, 12, 16, 20, 24, or 28 bits.
- RSSZ: receive slot size of 8, 12, 16, 20, 24, 28, or 32 bits.

RSSZ should always be programmed to match the slot size of the serial stream. The word size is not directly programmed into the McASP, but rather is used to determine the rotation needed in the RROT field.

Table 22-10 and Figure 22-30 show the RRVRS and RROT fields for each serial format and for both integer and Q31 fractional internal representations.

This discussion assumes that all slot size and word size options are multiples of 4; since the receive rotate right unit only supports rotation by multiples of 4. However, the bit mask/pad unit does allow for any number of significant digits. For example, a Q31 number may have 19 significant digits (word) and be transmitted in a 24-bit slot; this would be formatted as a word size of 20 bits and a slot size of 24 bits. However, it is possible to set the bit mask unit to only pass the 19 most-significant digits (program the mask value to FFFF E000h). The digits that are not significant can be set to a selected pad value, which can be any one of the significant digits, a fixed value of 0, or a fixed value of 1.

The receive bit mask/pad unit operates on data as the final step of the receive format unit (see Figure 22-23), and the data is aligned in the same representation as it is read from the receiver by the processor (typically Q31 or integer).

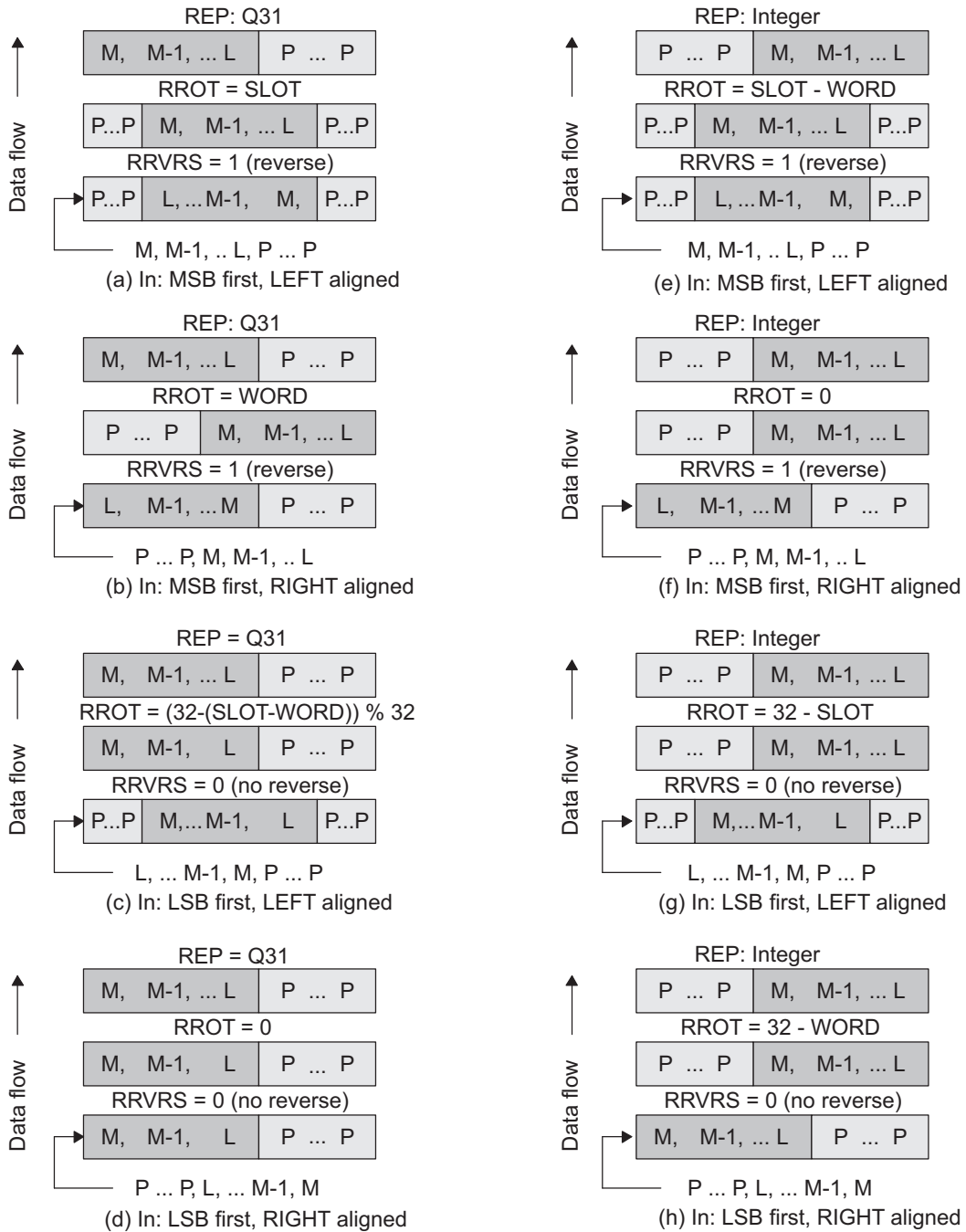
Table 22-10. Receive Bitstream Data Alignment

Figure 22-30	Bit Stream Order	Bit Stream Alignment	Internal Numeric Representation	RFMT Bit	
				RROT ⁽¹⁾	RRVRS
(a) ⁽²⁾	MSB first	Left aligned	Q31 fraction	SLOT	1
(b)	MSB first	Right aligned	Q31 fraction	WORD	1
(c)	LSB first	Left aligned	Q31 fraction	$(32 - (\text{SLOT} - \text{WORD})) \% 32$	0
(d)	LSB first	Right aligned	Q31 fraction	0	0
(e) ⁽²⁾	MSB first	Left aligned	Integer	SLOT - WORD	1
(f)	MSB first	Right aligned	Integer	0	1
(g)	LSB first	Left aligned	Integer	32 - SLOT	0
(h)	LSB first	Right aligned	Integer	32 - WORD	0

⁽¹⁾ WORD = Word size rounded up to the nearest multiple of 4; SLOT = slot size; % = modulo operator

⁽²⁾ To transmit in I2S format, select MSB first, left aligned, and also select RDATDLY = 01 (1 bit delay)

Figure 22-30. Data Flow Through Receive Format Unit, Illustrated



22.3.10.4 Error Handling and Management

To support the design of a robust audio system, the McASP includes error-checking capability for the serial protocol, data underrun, and data overrun. In addition, the McASP includes a timer that continually measures the high-frequency master clock every 32 AHCLKX/AHCLKR clock cycles. The timer value can be read to get a measurement of the clock frequency and has a minimum and maximum range setting that can set an error flag if the master clock goes out of a specified range.

Upon the detection of any one or more errors (software selectable), or the assertion of the AMUTEIN input pin, the AMUTE output pin may be asserted to a high or low level to immediately mute the audio output. In addition, an interrupt may be generated if desired, based on any one or more of the error sources.

22.3.10.4.1 Unexpected Frame Sync Error

An unexpected frame sync occurs when:

- In burst mode, when the next active edge of the frame sync occurs early such that the current slot will not be completed by the time the next slot is scheduled to begin.
- In TDM mode, a further constraint is that the frame sync must occur exactly during the correct bit clock (not a cycle earlier or later) and only before slot 0. An unexpected frame sync occurs if this condition is not met.

When an unexpected frame sync occurs, there are two possible actions depending upon when the unexpected frame sync occurs:

1. Early: An early unexpected frame sync occurs when the McASP is in the process of completing the current frame and a new frame sync is detected (not including overlap that occurs due to a 1 or 2 bit frame sync delay). When an early unexpected frame sync occurs:
 - Error interrupt flag is set (XSYNCERR, if an unexpected transmit frame sync occurs; RSYNCERR, if an unexpected receive frame sync occurs).
 - Current frame is not resynchronized. The number of bits in the current frame is completed. The next frame sync, which occurs after the current frame is completed, will be resynchronized.
2. Late: A late unexpected frame sync occurs when there is a gap or delay between the last bit of the previous frame and the first bit of the next frame. When a late unexpected frame sync occurs (as soon as the gap is detected):
 - Error interrupt flag is set (XSYNCERR, if an unexpected transmit frame sync occurs; RSYNCERR, if an unexpected receive frame sync occurs).
 - Resynchronization occurs upon the arrival of the next frame sync.

Late frame sync is detected the same way in both burst mode and TDM mode; however, in burst mode, late frame sync is not meaningful and its interrupt enable should not be set.

22.3.10.4.2 Buffer Underrun Error - Transmitter

A buffer underrun can only occur for serializers programmed to be transmitters. A buffer underrun occurs when the serializer is instructed by the transmit state machine to transfer data from XRBUF[n] to XRSR[n], but XRBUF[n] has not yet been written with new data since the last time the transfer occurred. When this occurs, the transmit state machine sets the XUNDRN flag.

An underrun is checked only once per time slot. The XUNDRN flag is set when an underrun condition occurs. Once set, the XUNDRN flag remains set until the processor explicitly writes a 1 to the XUNDRN bit to clear the XUNDRN bit.

In DIT mode, a pair of BMC zeros is shifted out when an underrun occurs (four bit times at $128 \times f_s$). By shifting out a pair of zeros, a clock may be recovered on the receiver. To recover, reset the McASP and start again with the proper initialization.

In TDM mode, during an underrun case, a long stream of zeros are shifted out causing the DACs to mute. To recover, reset the McASP and start again with the proper initialization.

22.3.10.4.3 Buffer Overrun Error - Receiver

A buffer overrun can only occur for serializers programmed to be receivers. A buffer overrun occurs when the serializer is instructed to transfer data from XRSR[n] to XRBUF[n], but XRBUF[n] has not yet been read by either the DMA or the processor. When this occurs, the receiver state machine sets the ROVRN flag. However, the individual serializer writes over the data in the XRBUF[n] register (destroying the previous sample) and continues shifting.

An overrun is checked only once per time slot. The ROVRN flag is set when an overrun condition occurs. It is possible that an overrun occurs on one time slot but then the processor catches up and does not cause an overrun on the following time slots. However, once the ROVRN flag is set, it remains set until the processor explicitly writes a 1 to the ROVRN bit to clear the ROVRN bit.

22.3.10.4.4 DMA Error - Transmitter

A transmit DMA error, as indicated by the XDMAERR flag in the XSTAT register, occurs when the DMA (or CPU) writes more words to the DAT port of the McASP than it should. For each DMA event, the DMA should write exactly as many words as there are serializers enabled as transmitters.

XDMAERR indicates that the DMA (or CPU) wrote too many words to the McASP for a given transmit DMA event. Writing too few words results in a transmit underrun error setting XUNDRN in XSTAT.

While XDMAERR occurs infrequently, an occurrence indicates a serious loss of synchronization between the McASP and the DMA or CPU. You should reinitialize both the McASP transmitter and the DMA to resynchronize them.

22.3.10.4.5 DMA Error - Receiver

A receive DMA error, as indicated by the RDMAERR flag in the RSTAT register, occurs when the DMA (or CPU) reads more words from the DAT port of the McASP than it should. For each DMA event, the DMA should read exactly as many words as there are serializers enabled as receivers.

RDMAERR indicates that the DMA (or CPU) read too many words from the McASP for a given receive DMA event. Reading too few words results in a receiver overrun error setting ROVRN in RSTAT.

While RDMAERR occurs infrequently, an occurrence indicates a serious loss of synchronization between the McASP and the DMA or CPU. You should reinitialize both the McASP receiver and the DMA to resynchronize them.

22.3.10.4.6 Clock Failure Detection

22.3.10.4.6.1 Clock-Failure Check Startup

It is expected, initially, that the clock-failure circuits will generate an error until at least one measurement has been taken. Therefore, the clock failure interrupts, clock switch, and mute functions should not immediately be enabled, but be enabled only after a specific startup procedure. The startup procedure is:

1. For the transmit clock failure check:
 - (a) Configure transmit clock failure detect logic (XMIN, XMAX, XPS) in the transmit clock check control register (XCLKCHK).
 - (b) Clear transmit clock failure flag (XCKFAIL) in the transmit status register (XSTAT).
 - (c) Wait until first measurement is taken (> 32 AHCLKX clock periods).
 - (d) Verify no clock failure is detected.
 - (e) Repeat steps b–d until clock is running and is no longer issuing clock failure errors.
 - (f) After the transmit clock is measured and falls within the acceptable range, the following may be enabled:
 - (i) transmit clock failure interrupt enable bit (XCKFAIL) in the transmitter interrupt control register (XINTCTL).
 - (ii) transmit clock failure detect autoswitch enable bit (XCKFAILSW) in the transmit clock check control register (XCLKCHK).
 - (iii) mute option (XCKFAIL) in the mute control register (AMUTE).
2. For the receive clock failure check:
 - (a) Configure receive clock failure detect logic (RMIN, RMAX, RPS) in the receive clock check control register (RCLKCHK).
 - (b) Clear receive clock failure flag (RCKFAIL) in the receive status register (RSTAT).
 - (c) Wait until first measurement is taken (> 32 AHCLKR clock periods).
 - (d) Verify no clock failure is detected.
 - (e) Repeat steps b–d until clock is running and is no longer issuing clock failure errors.
 - (f) After the receive clock is measured and falls within the acceptable range, the following may be enabled:
 - (i) receive clock failure interrupt enable bit (RCKFAIL) in the receiver interrupt control register (RINTCTL).
 - (ii) mute option (RCKFAIL) in the mute control register (AMUTE).

22.3.10.4.6.2 Transmit Clock Failure Check and Recovery

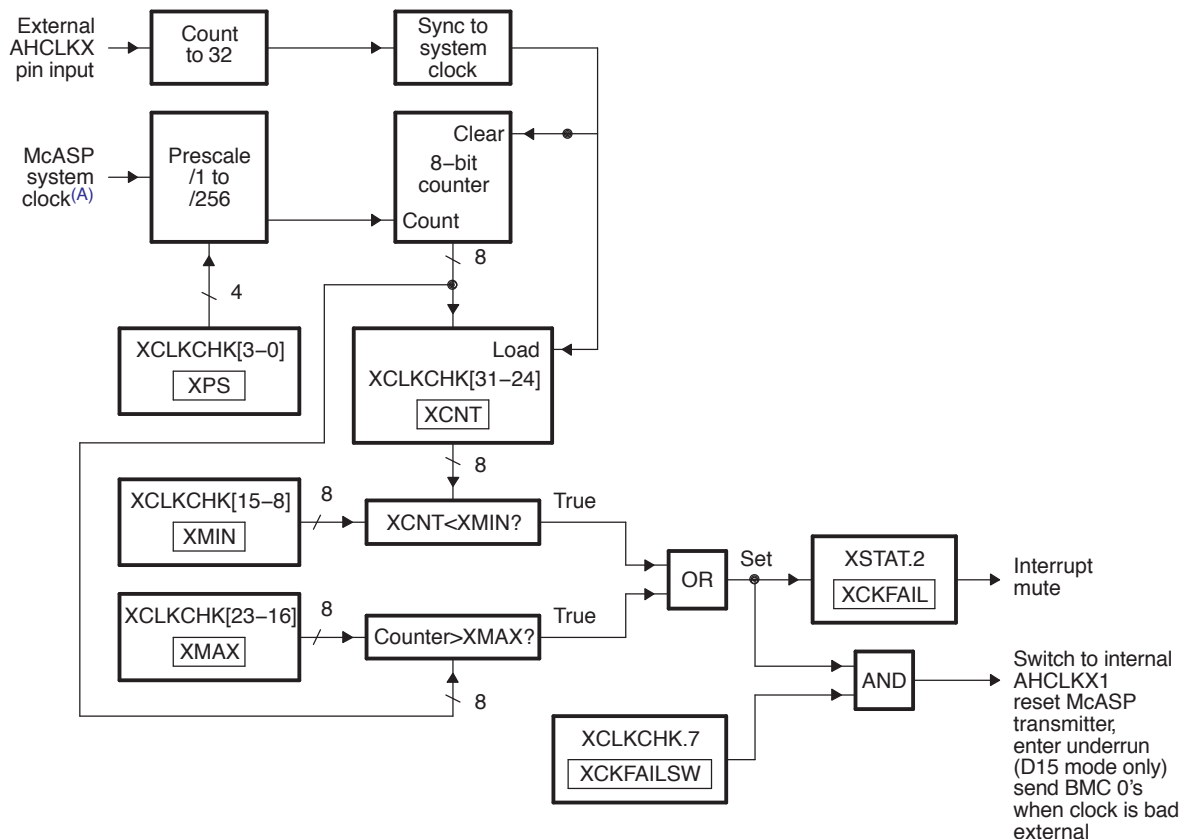
The transmit clock failure check circuit (Figure 22-31) works off both the internal McASP system clock and the external high-frequency serial clock (AHCLKX). It continually counts the number of system clocks for every 32 high rate serial clock (AHCLKX) periods, and stores the count in XCNT of the transmit clock check control register (XCLKCHK) every 32 high rate serial clock cycles.

The logic compares the count against a user-defined minimum allowable boundary (XMIN), and automatically flags an interrupt (XCKFAIL in XSTAT) when an out-of-range condition occurs. An out-of-range minimum condition occurs when the count is smaller than XMIN. The logic continually compares the current count (from the running system clock counter) against the maximum allowable boundary (XMAX). This is in case the external clock completely stops, so that the counter value is not copied to XCNT. An out-of-range maximum condition occurs when the count is greater than XMAX. Note that the XMIN and XMAX fields are 8-bit unsigned values, and the comparison is performed using unsigned arithmetic.

An out-of-range count may indicate either that an unstable clock was detected, or that the audio source has changed and a new sample rate is being used.

In order for the transmit clock failure check circuit to operate correctly, the high-frequency serial clock divider must be taken out of reset regardless if AHCLKX is internally generated or externally sourced.

Figure 22-31. Transmit Clock Failure Detection Circuit Block Diagram



A Refer to device data manual for the McASP system clock source. This is not the same as AUXCLK.

The following actions are taken if a clock failure is detected:

1. Transmit clock failure flag (XCKFAIL) in XSTAT is set. This causes an interrupt if transmit clock failure interrupt enable bit (XCKFAIL) in XINTCTL is set.

In addition (only supported for DIT mode), if the transmit clock failure detect autoswitch enable bit (XCKFAILSW) in XCLKCHK is set, the following additional steps are taken to change the clock source from external to internal:

1. High-frequency transmit clock source bit (HCLKXM) in AHCLKXCTL is set to 1 and internal serial clock divider is selected. However, AHCLKX pin direction does not change to an output while XCKFAIL is set.
2. The internal clock divider is reset, so that the next clock it produces is a full period. However, the transmit clock divide ratio bits (HCLKXDIV) in AHCLKXCTL are not affected, so the internal clock divider generates clocks at the rate configured.
3. The transmit section is reset for a single serial clock period.
4. The transmit section is released from reset and attempts to begin transmitting. If data is available, it begins transmitting immediately; otherwise, it enters the underrun state. An initial underrun is certain to occur, the pattern 1100 (BMC zeroes) should be shifted out initially.

To change back to an external clock, take the following actions:

1. Wait for the external clock to stabilize again. This can be checked by polling the transmit clock count (XCNT) in XCLKCHK.
2. Reset the transmit section according to the startup procedure in [Section 22.3.10.4.6.1](#).

22.3.10.4.6.3 Receive Clock Failure Check and Recovery

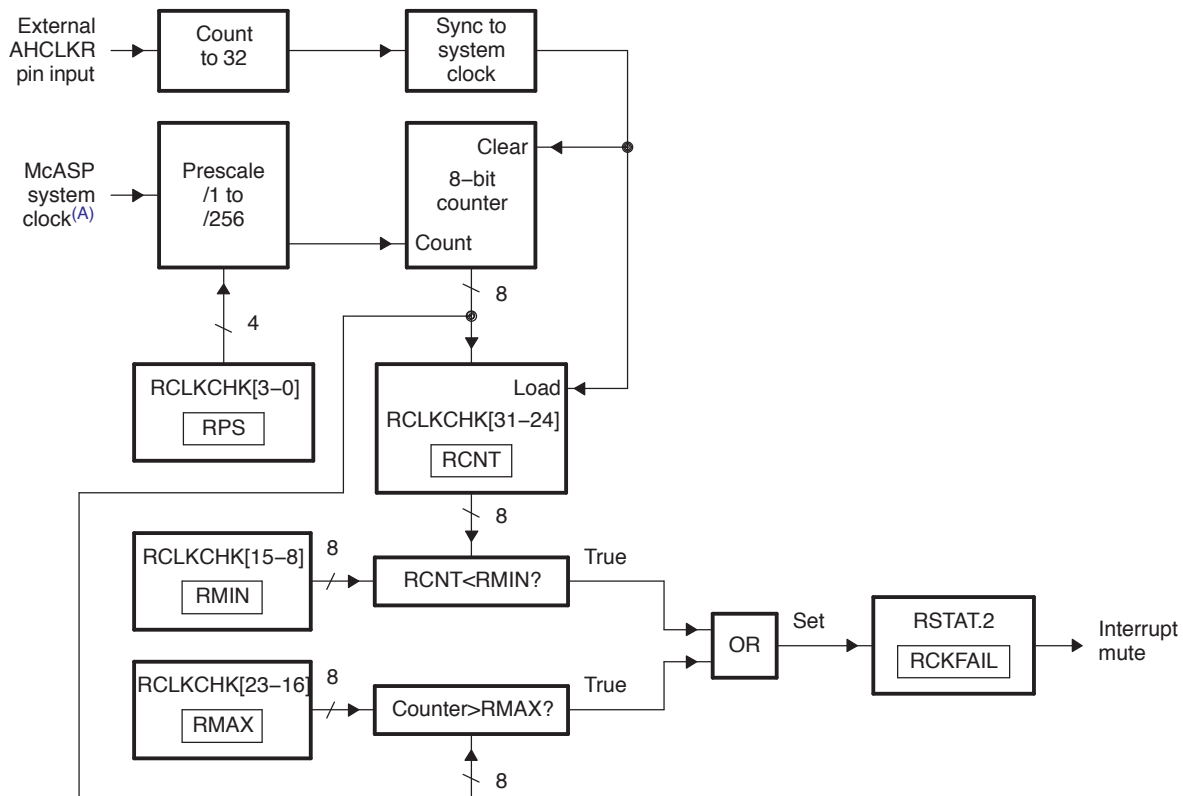
The receive clock failure check circuit (Figure 22-32) works off both the internal McASP system clock and the external high-frequency serial clock (AHCLKR). It continually counts the number of system clocks for every 32 high rate serial clock (AHCLKR) periods, and stores the count in RCNT of the receive clock check control register (RCLKCHK) every 32 high rate serial clock cycles.

The logic compares the count against a user-defined minimum allowable boundary (RMIN) and automatically flags an interrupt (RCKFAIL in RSTAT) when an out-of-range condition occurs. An out-of-range minimum condition occurs when the count is smaller than RMIN. The logic continually compares the current count (from the running system clock counter) against the maximum allowable boundary (RMAX). This is in case the external clock completely stops, so that the counter value is not copied to RCNT. An out-of-range maximum condition occurs when the count is greater than RMAX. Note that the RMIN and RMAX fields are 8-bit unsigned values, and the comparison is performed using unsigned arithmetic.

An out-of-range count may indicate either that an unstable clock was detected or that the audio source has changed and a new sample rate is being used.

In order for the receive clock failure check circuit to operate correctly, the high-frequency serial clock divider must be taken out of reset regardless if AHCLKR is internally generated or externally sourced.

Figure 22-32. Receive Clock Failure Detection Circuit Block Diagram



A Refer to device data manual for the McASP system clock source. This is not the same as AUXCLK.

22.3.10.5 Loopback Modes

The McASP features a digital loopback mode (DLB) that allows testing of the McASP code in TDM mode with a single processor device. In loopback mode, output of the transmit serializers is connected internally to the input of the receive serializers. Therefore, you can check the receive data against the transmit data to ensure that the McASP settings are correct. Digital loopback mode applies to TDM mode only (2 to 32 slots in a frame). It does not apply to DIT mode (XMOD = 180h) or burst mode (XMOD = 0).

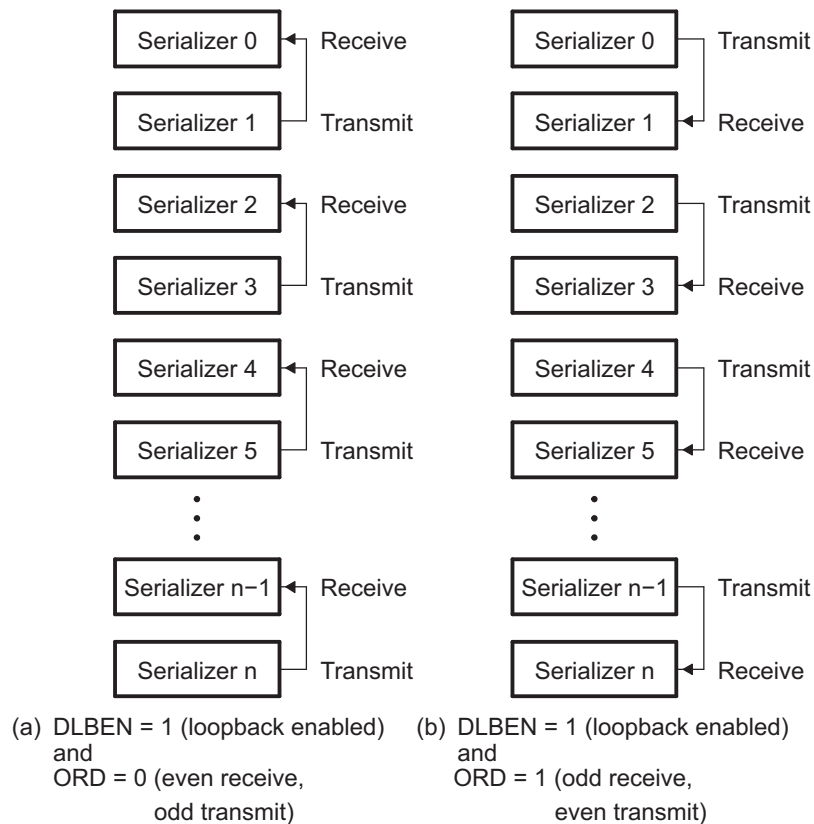
Figure 22-33 shows the basic logical connection of the serializers in loopback mode. Two types of loopback connections are possible, selected by the ORD bit in the digital loopback control register (DLBCTL) as follows:

- ORD = 0: Outputs of odd serializers are connected to inputs of even serializers. If this mode is selected, you should configure odd serializers to be transmitters and even serializers to be receivers.
- ORD = 1: Outputs of even serializers are connected to inputs of odd serializers. If this mode is selected, you should configure even serializers to be transmitters and odd serializers to be receivers.

Data can be externally visible at the I/O pin of the transmit serializer if the pin is configured as a McASP output pin by setting the corresponding PFUNC bit to 0 and PDIR bit to 1.

In loopback mode, the transmit clock and frame sync are used by both the transmit and receive sections of the McASP. The transmit and receive sections operate synchronously. This is achieved by setting the MODE bit of the DLBCTL register to 01b and the ASYNC bit of the ACLKXCTL register to 0.

Figure 22-33. Serializers in Loopback Mode



22.3.10.5.1 Loopback Mode Configurations

This is a summary of the settings required for digital loopback mode for TDM format:

- The DLBEN bit in DLBCTL must be set to 1 to enable loopback mode.
- The MODE bits in DLBCTL must be set to 01b for both the transmit and receive sections to use the transmit clock and frame sync generator.
- The ORD bit in DLBCTL must be programmed appropriately to select odd or even serializers to be transmitters or receivers. The corresponding serializers must be configured accordingly.
- The ASYNC bit in ACLKXCTL must be cleared to 0 to ensure synchronous transmit and receive operations.
- RMOD field in AFSRCTL and XMOD field in AFSXCTL must be set to 2h to 20h to indicate TDM mode. Loopback mode does not apply to DIT or burst mode.

22.3.11 Reset Considerations

The McASP has two reset sources: software reset and hardware reset.

22.3.11.1 Software Reset Considerations

The transmitter and receiver portions of the McASP may be put in reset through the global control register (GBLCTL). Note that a valid serial clock must be supplied to the desired portion of the McASP (transmit and/or receive) in order to assert the software reset bits in GBLCTL. see [Section 22.3.12.2](#) for details on how to ensure reset has occurred.

The entire McASP module may also be reset through the Power and Sleep Controller (PSC). Note that from the McASP perspective, this reset appears as a hardware reset to the entire module.

22.3.11.2 Hardware Reset Considerations

When the McASP is reset due to device reset, the entire serial port (including the transmitter and receiver state machines, and other registers) is reset.

22.3.12 Setup and Initialization

This section discusses steps necessary to use the McASP module.

22.3.12.1 Considerations When Using a McASP

The following is a list of things to be considered for systems using a McASP:

22.3.12.1.1 Clocks

For each receive and transmit section:

- External or internal generated bit clock and high frequency clock?
- If internally generated, what is the bit clock speed and the high frequency clock speed?
- Clock polarity?
- External or internal generated frame sync?
- If internally generated, what is frame sync speed?
- Frame sync polarity?
- Frame sync width?
- Transmit and receive sync or asynchronous?

22.3.12.1.2 Data Pins

For each pin of each McASP:

- McASP or GPIO?
- Input or output?

22.3.12.1.3 Data Format

For each transmit and receive data:

- Internal numeric representation (integer, Q31 fraction)?
- I2S or DIT (transmit only)?
- Time slot delay (0, 1, or 2 bit)?
- Alignment (left or right)?
- Order (MSB first, LSB first)?
- Pad (if yes, pad with what value)?
- Slot size?
- Rotate?
- Mask?

22.3.12.1.4 Data Transfers

- Internal: DMA or CPU?
- External: TDM or burst?
- Bus: configuration bus (CFG) or data port (DAT)?

22.3.12.2 Transmit/Receive Section Initialization

You must follow the following steps to properly configure the McASP. If external clocks are used, they should be present prior to the following initialization steps.

1. Reset McASP to default values by setting GBLCTL = 0.
2. Configure all McASP registers except GBLCTL in the following order:
 - (a) Power Idle SYSCONFIG: PWRIDLESYSCONFIG.
 - (b) Receive registers: RMASK, RFMT, AFSRCTL, ACLKRCTL, AHCLKRCTL, RTDM, RINTCTL, RCLKCHK. If external clocks AHCLKR and/or ACLKR are used, they must be running already for proper synchronization of the GBLCTL register.
 - (c) Transmit registers: XMASK, XFMT, AFSXCTL, ACLKXCTL, AHCLKXCTL, XTDM, XINTCTL, XCLKCHK. If external clocks AHCLKX and/or ACLKX are used, they must be running already for proper synchronization of the GBLCTL register.
 - (d) Serializer registers: SRCTL[n].
 - (e) Global registers: Registers PFUNC, PDIR, DITCTL, DLBCTL, AMUTE. Note that PDIR should only be programmed after the clocks and frames are set up in the steps above. This is because the moment a clock pin is configured as an output in PDIR, the clock pin starts toggling at the rate defined in the corresponding clock control register. Therefore you must ensure that the clock control register is configured appropriately before you set the pin to be an output. A similar argument applies to the frame sync pins. Also note that the reset state for the transmit high-frequency clock divide register (HCLKXDIV) is divide-by-1, and the divide-by-1 clocks are not gated by the transmit high-frequency clock divider reset enable (XHCLKRST).
 - (f) DIT registers: For DIT mode operation, set up registers DITCSRA[n], DITCSR[n], DITUDRA[n], and DITUDRB[n].
3. Start the respective high-frequency serial clocks AHCLKX and/or AHCLKR. This step is necessary even if external high-frequency serial clocks are used:
 - (a) Take the respective internal high-frequency serial clock divider(s) out of reset by setting the RHCLKRST bit for the receiver and/or the XHCLKRST bit for the transmitter in GBLCTL. All other bits in GBLCTL should be held at 0.
 - (b) Read back from GBLCTL to ensure the bit(s) to which you wrote are successfully latched in GBLCTL before you proceed.

4. Start the respective serial clocks ACLKX and/or ACLKR. This step can be skipped if external serial clocks are used and they are running:
 - (a) Take the respective internal serial clock divider(s) out of reset by setting the RCLKRST bit for the receiver and/or the XCLKRST bit for the transmitter in GBLCTL. All other bits in GBLCTL should be left at the previous state.
 - (b) Read back from GBLCTL to ensure the bit(s) to which you wrote are successfully latched in GBLCTL before you proceed.
5. Setup data acquisition as required:
 - (a) If DMA is used to service the McASP, set up data acquisition as desired and start the DMA in this step, before the McASP is taken out of reset.
 - (b) If CPU interrupt is used to service the McASP, enable the transmit and/ or receive interrupt as required.
 - (c) If CPU polling is used to service the McASP, no action is required in this step.
6. Activate serializers.
 - (a) Before starting, clear the respective transmitter and receiver status registers by writing XSTAT = FFFFh and RSTAT = FFFFh.
 - (b) Take the respective serializers out of reset by setting the RSRCLR bit for the receiver and/or the XSRCLR bit for the transmitter in GBLCTL. All other bits in GBLCTL should be left at the previous state.
 - (c) Read back from GBLCTL to ensure the bit(s) to which you wrote are successfully latched in GBLCTL before you proceed.
7. Verify that all transmit buffers are serviced. Skip this step if the transmitter is not used. Also, skip this step if time slot 0 is selected as inactive (special cases, see [Figure 22-21](#), second waveform). As soon as the transmit serializer is taken out of reset, XDATA in the XSTAT register is set, indicating that XBUF is empty and ready to be serviced. The XDATA status causes an DMA event AXEVT to be generated, and can cause an interrupt AXINT to be generated if it is enabled in the XINTCTL register.
 - (a) If DMA is used to service the McASP, the DMA automatically services the McASP upon receiving AXEVT. Before proceeding in this step, you should verify that the XDATA bit in the XSTAT is cleared to 0, indicating that all transmit buffers are already serviced by the DMA.
 - (b) If CPU interrupt is used to service the McASP, interrupt service routine is entered upon the AXINT interrupt. The interrupt service routine should service the XBUF registers. Before proceeding in this step, you should verify that the XDATA bit in XSTAT is cleared to 0, indicating that all transmit buffers are already serviced by the CPU.
 - (c) If CPU polling is used to service the McASP, the XBUF registers should be written to in this step.
8. Release state machines from reset.
 - (a) Take the respective state machine(s) out of reset by setting the RSMRST bit for the receiver and/or the XSMRST bit for the transmitter in GBLCTL. All other bits in GBLCTL should be left at the previous state.
 - (b) Read back from GBLCTL to ensure the bit(s) to which you wrote are successfully latched in GBLCTL before you proceed.
9. Release frame sync generators from reset. Note that it is necessary to release the internal frame sync generators from reset, even if an external frame sync is being used, because the frame sync error detection logic is built into the frame sync generator.
 - (a) Take the respective frame sync generator(s) out of reset by setting the RFRST bit for the receiver, and/or the XFRST bit for the transmitter in GBLCTL. All other bits in GBLCTL should be left at the previous state.
 - (b) Read back from GBLCTL to ensure the bit(s) to which you wrote are successfully latched in GBLCTL before you proceed.
10. Upon the first frame sync signal, McASP transfers begin. The McASP synchronizes to an edge on the frame sync pin, not the level on the frame sync pin. This makes it easy to release the state machine and frame sync generators from reset.
 - (a) For example, if you configure the McASP for a rising edge transmit frame sync, then you do not need to wait for a low level on the frame sync pin before releasing the McASP transmitter state

machine and frame sync generators from reset.

22.3.12.3 Separate Transmit and Receive Initialization

In many cases, it is desirable to separately initialize the McASP transmitter and receiver. For example, you may delay the initialization of the transmitter until the type of data coming in on the receiver is recognized. Or a change in the incoming data stream on the receiver may necessitate a reinitialization of the transmitter.

In this case, you may still follow the sequence outlined in [Section 22.3.12.2](#), but use it for each section (transmit, receive) individually. The GBLCTL register is aliased to RGBLCTL and XGBLCTL to facilitate separate initialization of transmit and receive sections.

22.3.12.4 Importance of Reading Back GBLCTL

In [Section 22.3.12.2](#), steps 3b, 4b, 6c, 8b, and 9b state that GBLCTL should be read back until the bits that were written are successfully latched. This is important, because the transmitter and receiver state machines run off of the respective bit clocks, which are typically about tens to hundreds of times slower than the processor's internal bus clock. Therefore, it takes many cycles between when the processor writes to GBLCTL (or RGBLCTL and XGBLCTL), and when the McASP actually recognizes the write operation. If you skip this step, then the McASP may never see the reset bits in the global control registers get asserted and de-asserted; resulting in an uninitialized McASP.

Therefore, the logic in McASP has been implemented such that once the processor writes GBLCTL, RGBLCTL, or XGBLCTL, the resulting write is not visible by reading back GBLCTL until the McASP has recognized the change. This typically requires two bit clocks plus two processor bus clocks to occur.

Also, if the bit clocks can be completely stopped, any software that polls GBLCTL should be implemented with a time-out. If GBLCTL does not have a time-out, and the bit clock stops, the changes written to GBLCTL will not be reflected until the bit clock restarts.

Finally, please note that while RGBLCTL and XGBLCTL allow separate changing of the receive and transmit halves of GBLCTL, they also immediately reflect the updated value (useful for debug purposes). Only GBLCTL can be used for the read back step.

22.3.12.5 Synchronous Transmit and Receive Operation (ASYNC = 0)

When ASYNC = 0 in ACLKXCTL, the transmit and receive sections operate synchronously from the transmit section clock and transmit frame sync signals ([Figure 22-17](#)). The receive section may have a different (but compatible in terms of slot size) data format.

When ASYNC = 0, the receive frame sync generator is internally disabled. If the AFSX pin is configured as an output, it serves as the frame sync signal for both transmit and receive. The AFSR pin should not be used because the transmit frame sync generator output, which is used by both the transmitter and the receiver when ASYNC = 0, is not propagated to the AFSR pin ([Figure 22-19](#)).

When ASYNC = 0, the transmit and receive sections must share some common settings, since they both use the same clock and frame sync signals:

- DITEN = 0 in DITCTL (TDM mode is enabled).
- The total number of bits per frame must be the same (that is, $RSSZ \times RMOD$ must equal $XSSZ \times XMOD$).
- Both transmit and receive should either be specified as burst or TDM mode, but not mixed.
- The settings in ACLKRCTL are irrelevant.
- FSXM must match FSRM.
- FXWID must match FRWID.

For all other settings, the transmit and receive sections may be programmed independently.

22.3.12.6 Asynchronous Transmit and Receive Operation (ASYNC = 1)

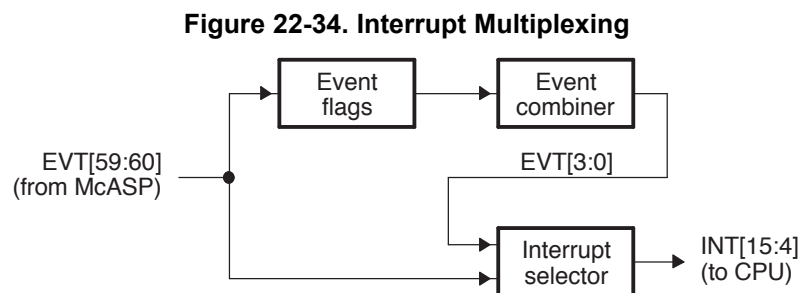
When ASYNC = 1 in ACLKXCTL, the transmit and receive sections operate completely independently and have separate clock and frame sync signals ([Figure 22-17](#), [Figure 22-18](#), and [Figure 22-19](#)). The events generated by each section come asynchronously.

22.3.13 Interrupts

22.3.13.1 Interrupt Multiplexing

The processor includes an interrupt controller (INTC) to manage CPU interrupts. The INTC maps the device events to 12 CPU interrupts. The McASP generates 4 interrupts to the processor.

The event inputs can be routed to 12 maskable interrupts to the CPU (INT[15:4]). The INTC interrupt selector allows the McASP system events to be routed to any of the 12 CPU interrupt inputs. Furthermore, the INTC provides status flags and allows the combination of events, as shown in Figure 22-34. You must properly configure the INTC by enabling, masking, and routing the McASP system events to the desired CPU interrupts.



22.3.13.2 Transmit Data Ready Interrupt

The transmit data ready interrupt (XDATA) is generated if XDATA is 1 in the XSTAT register and XDATA is also enabled in XINTCTL. Section 22.3.10.1.1 provides details on when XDATA is set in the XSTAT register.

A transmit start of frame interrupt (XSTAFRM) is triggered by the recognition of transmit frame sync. A transmit last slot interrupt (XLAST) is a qualified version of the data ready interrupt (XDATA). It has the same behavior as the data ready interrupt, but is further qualified by having the data requested belonging to the last slot (the slot that just ended was next-to-last TDM slot, current slot is last slot).

22.3.13.3 Receive Data Ready Interrupt

The receive data ready interrupt (RDATA) is generated if RDATA is 1 in the RSTAT register and RDATA is also enabled in RINTCTL. Section 22.3.10.1.2 provides details on when RDATA is set in the RSTAT register.

A receiver start of frame interrupt (RSTAFRM) is triggered by the recognition of a receiver frame sync. A receiver last slot interrupt (RLAST) is a qualified version of the data ready interrupt (RDATA). It has the same behavior as the data ready interrupt, but is further qualified by having the data in the buffer come from the last TDM time slot (the slot that just ended was last TDM slot).

22.3.13.4 Error Interrupts

Upon detection, the following error conditions generate interrupt flags:

- In the receive status register (RSTAT):
 - Receiver overrun (ROVRN).
 - Unexpected receive frame sync (RSYNCERR).
 - Receive clock failure (RCKFAIL).
 - Receive DMA error (RDMAERR).

- In the transmit status register (XSTAT):
 - Transmit underrun (XUNDRN).
 - Unexpected transmit frame sync (XSYNCERR).
 - Transmit clock failure (XCKFAIL).
 - Transmit DMA error (XDMAERR).

Each interrupt source also has a corresponding enable bit in the receive interrupt control register (RINTCTL) and transmit interrupt control register (XINTCTL). If the enable bit is set in RINTCTL or XINTCTL, an interrupt is requested when the interrupt flag is set in RSTAT or XSTAT. If the enable bit is not set, no interrupt request is generated. However, the interrupt flag may be polled.

22.3.13.5 Audio Mute (AMUTE) Function

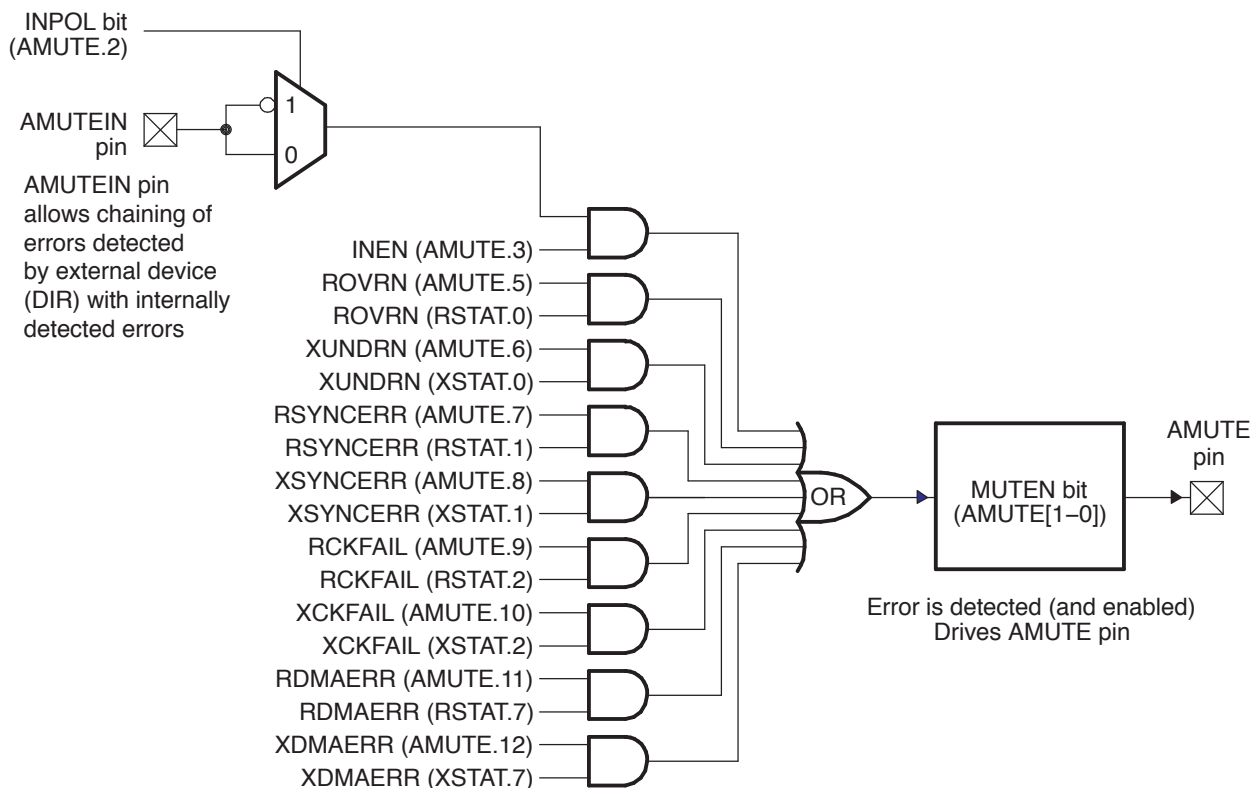
The McASP includes an automatic audio mute function (Figure 22-35) that asserts in hardware the AMUTE pin to a preprogrammed output state, as selected by the MUTEN bit in the audio mute control register (AMUTE). The AMUTE pin is asserted when one of the interrupt flags is set or an external device issues an error signal on the AMUTEIN input. Typically, the AMUTEIN input is shared with a device interrupt pin (for example EXT_INT4).

The AMUTEIN input allows the on-chip logic to consider a mute input from other devices in the system, so that all errors may be considered. The AMUTEIN input has a programmable polarity to allow it to adapt to different devices, as selected by the INPOL bit in AMUTE, and it must be enabled explicitly.

In addition to the external AMUTEIN input, the AMUTE pin output may be asserted when one of the error interrupt flags is set and its mute function is enabled in AMUTE.

When one or more of the errors is detected and enabled, the AMUTE pin is driven to an active state that is selected by MUTEN in AMUTE. The active polarity of the AMUTE pin is programmable by MUTEN (and the inactive polarity is the opposite of the active polarity). The AMUTE pin remains driven active until software clears all the error interrupt flags that are enabled to mute, and until the AMUTEIN is inactive.

Figure 22-35. Audio Mute (AMUTE) Block Diagram



22.3.13.6 Multiple Interrupts

This only applies to interrupts and not to DMA requests. The following terms are defined:

- **Active Interrupt Request:** a flag in RSTAT or XSTAT is set and the interrupt is enabled in RINTCTL or XINTCTL.
- **Outstanding Interrupt Request:** An interrupt request has been issued on one of the McASP transmit/receive interrupt ports, but that request has not yet been serviced.
- **Serviced:** The CPU writes to RSTAT or XSTAT to clear one or more of the active interrupt request flags.

The first interrupt request to become active for the transmitter with the interrupt flag set in XSTAT and the interrupt enabled in XINTCTL generates a request on the McASP transmit interrupt port AXINT.

If more than one interrupt request becomes active in the same cycle, a single interrupt request is generated on the McASP transmit interrupt port. Subsequent interrupt requests that become active while the first interrupt request is outstanding do not immediately generate a new request pulse on the McASP transmit interrupt port.

The transmit interrupt is serviced with the CPU writing to XSTAT. If any interrupt requests are active after the write, a new request is generated on the McASP transmit interrupt port.

The receiver operates in a similar way, but using RSTAT, RINTCTL, and the McASP receive interrupt port ARINT.

One outstanding interrupt request is allowed on each port, so a transmit and a receive interrupt request may both be outstanding at the same time.

22.3.14 EDMA Event Support

22.3.14.1 EDMA Events

There are 6 EDMA events.

22.3.14.2 Using the DMA for McASP Servicing

The most typical scenario is to use the DMA to service the McASP through the data port, although the DMA can also service the McASP through the configuration bus. Two possibilities exist for using the DMA events to service the McASP:

1. Use **AXEVT/AREVT**: Triggered upon each XDATA/RDATA transition from 0 to 1.
2. Use **AXEVTO/AREVTO** and **AXEVTE/AREVTE**: Alternating AXEVT/AREVT events for odd/even slots. Upon AXEVT/AREVT, AXEVTO/AREVTO is triggered if the event is for an odd channel, and AXEVTE/AREVTE is triggered if the event is for an even channel.

NOTE: Check the device-specific data manual to see if AXEVTO/AREVTO and AXEVTE/AREVTE are supported. These are optional.

[Figure 22-36](#) and [Figure 22-37](#) show an example audio system with six audio channels (LF, RF, LS, RS, C, and LFE) transmitted from three AXRn pins on the McASP. [Figure 22-36](#) and [Figure 22-37](#) show when events AXEVT, AXEVTO, and AXEVTE are triggered. [Figure 22-36](#) and [Figure 22-37](#) also apply for the receive audio channels and show when events AREVT, AREVTO, and AREVTE are triggered.

You can either use the DMA to service the McASP upon events AXEVT and AREVT ([Figure 22-36](#)) or upon events AXEVTO, AREVTO, AXEVTE, and AREVTE ([Figure 22-37](#)).

Figure 22-36. DMA Events in an Audio Example—Two Events (Scenario 1)

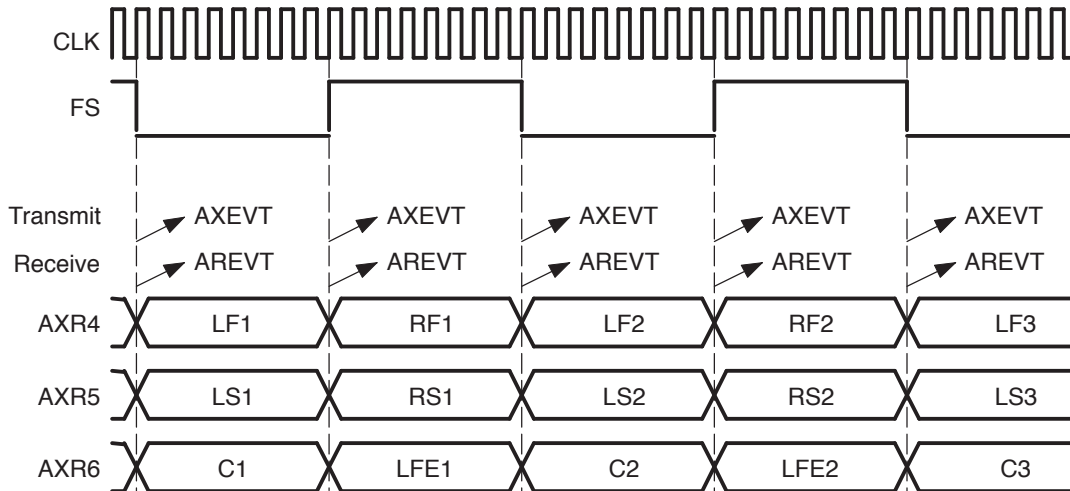
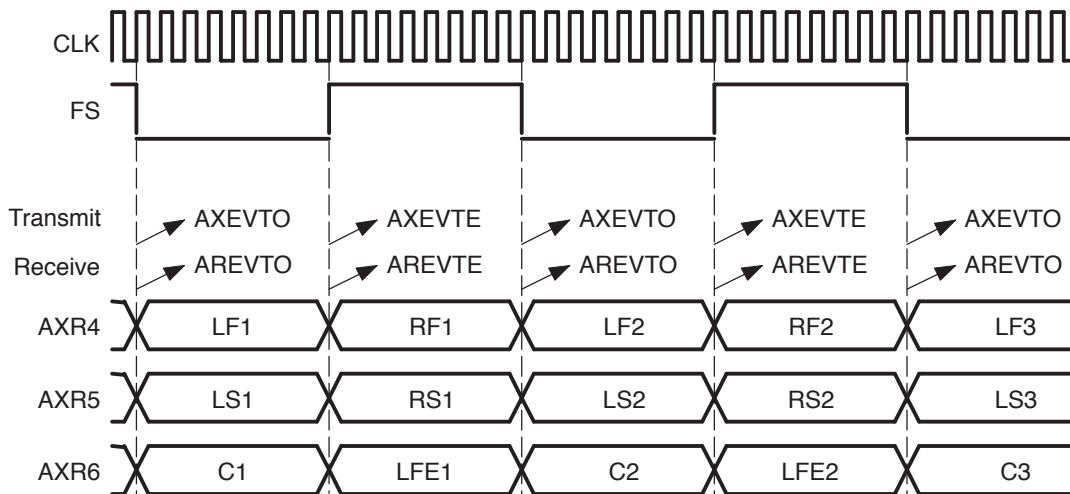


Figure 22-37. DMA Events in an Audio Example—Four Events (Scenario 2)



In scenario 1 (Figure 22-36), a DMA event AXEVT/AREVT is triggered on each time slot. In the example, AXEVT is triggered for each of the transmit audio channel time slot (Time slot for channels LF, LS, and C; and time slot for channels RF, RS, LFE). Similarly, AREVT is triggered for each of the receive audio channel time slot. Scenario 1 allows for the use of a single DMA to transmit all audio channels, and a single DMA to receive all audio channels.

In scenario 2 (Figure 22-37), two alternating DMA events are triggered for each time slot. In the example, AXEVTE (even) is triggered for the time slot for the even audio channels (LF, LS, C) and AXEVT (odd) is triggered for the time slot for the odd audio channels (RF, RS, LFE). AXEVT and AXEVTE alternate in time. The same is true in the receive direction with the use of AREVTO and AREVTE. This scenario allows for the use of two DMA channels (odd and even) to transmit all audio channels, and two DMA channels to receive all audio channels.

Here are some guidelines on using the different DMA events:

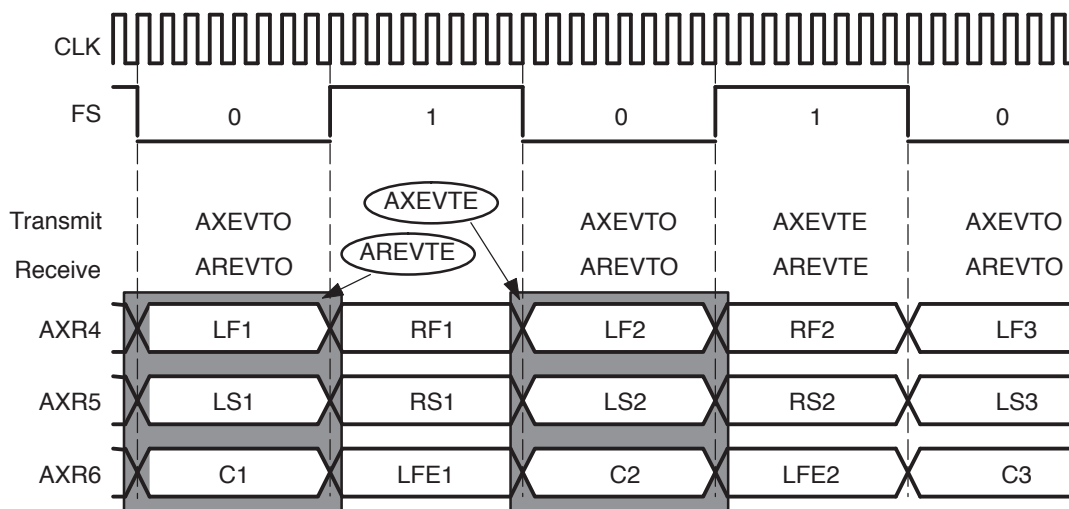
- Either use AXEVT, or the combination of AXEVTO and AXEVTE, to service the McASP. Never use all three at the same time. Similarly for receive, either use AREVT, or the combination of AREVTO and AREVTE.
- The McASP generates transmit DMA events independently from receive DMA events; therefore, separate schemes can be used for transmit and receive DMA. For example, scenario 1 could be used for the transmit data (AXEVT) and scenario 2 could be used for the receive data (AREVTO, AREVTE), and conversely.

Note the difference between DMA event generation and the CPU interrupt generation. DMA events are generated automatically upon data ready; whereas CPU interrupt generation needs to be enabled in the XINTCTL/RINTCTL register.

In [Figure 22-37](#), scenario 2, each transmit DMA request is for data in the next time slot, while each receive DMA request is for data in the previous time slot. For example, [Figure 22-38](#) shows a circled AXEVTE event for an even time slot transmit DMA request. The transmitter always requests a DMA transfer for data it will need to transmit during the next time slot. So, in this example, the circled event AXEVTE is a request for data for samples LF2, LS2, and C2.

On the other hand, the circled AREVTE event is an even time slot receive DMA request. The receiver always requests a DMA transfer for data it received during the previous time slot. In this example, the circled event AREVTE is a request for samples LF1, LS1, and C1.

Figure 22-38. DMA Events in an Audio Example



22.3.15 Power Management

The McASP can be placed in reduced power modes to conserve power during periods of low activity.

22.3.16 Emulation Considerations

NOTE: The receive buffer registers (RBUF n) and transmit buffer registers (XBUF n) should not be accessed by the emulator when the McASP is running. Such an access will cause the RRDY/XRDY bit in the serializer control register n (SRCTL n) to be updated.

The McASP does not support the emulation suspend.

22.4 Registers

22.4.1 MCASP Registers

Table 22-11 lists the memory-mapped registers for the MCASP. All register offset addresses not listed in Table 22-11 should be considered as reserved locations and the register contents should not be modified.

Table 22-11. MCASP Registers

Offset	Acronym	Register Name	Section
0h	REV	Revision Identification Register	Section 22.4.1.1
4h	PWRIDLESYSCONFIG	Power Idle SYSCONFIG Register	Section 22.4.1.2
10h	PFUNC	Pin Function Register	Section 22.4.1.3
14h	PDIR	Pin Direction Register	Section 22.4.1.4
18h	PDOUT	Pin Data Output Register	Section 22.4.1.5
1Ch	PDIN	Pin Data Input Register	Section 22.4.1.6
20h	PDCLR	Pin Data Clear Register	Section 22.4.1.7
44h	GBLCTL	Global Control Register	Section 22.4.1.8
48h	AMUTE	Audio Mute Control Register	Section 22.4.1.9
4Ch	DLBCTL	Digital Loopback Control Register	Section 22.4.1.10
50h	DITCTL	DIT Mode Control Register	Section 22.4.1.11
60h	RGBLCTL	Receiver Global Control Register	Section 22.4.1.12
64h	RMASK	Receive Format Unit Bit Mask Register	Section 22.4.1.13
68h	RFMT	Receive Bit Stream Format Register	Section 22.4.1.14
6Ch	AFSRCTL	Receive Frame Sync Control Register	Section 22.4.1.15
70h	ACLKRCTL	Receive Clock Control Register	Section 22.4.1.16
74h	AHCLKRCTL	Receive High-Frequency Clock Control Register	Section 22.4.1.17
78h	RTDM	Receive TDM Time Slot 0-31 Register	Section 22.4.1.18
7Ch	RINTCTL	Receiver Interrupt Control Register	Section 22.4.1.19
80h	RSTAT	Receiver Status Register	Section 22.4.1.20
84h	RSLOT	Current Receive TDM Time Slot Register	Section 22.4.1.21
88h	RCLKCHK	Receive Clock Check Control Register	Section 22.4.1.22
8Ch	REVTCTL	Receiver DMA Event Control Register	Section 22.4.1.23
A0h	XGBLCTL	Transmitter Global Control Register	Section 22.4.1.24
A4h	XMASK	Transmit Format Unit Bit Mask Register	Section 22.4.1.25
A8h	XFMT	Transmit Bit Stream Format Register	Section 22.4.1.26
ACh	AFSXCTL	Transmit Frame Sync Control Register	Section 22.4.1.27
B0h	ACLKXCTL	Transmit Clock Control Register	Section 22.4.1.28
B4h	AHCLKXCTL	Transmit High-Frequency Clock Control Register	Section 22.4.1.29
B8h	XTDM	Transmit TDM Time Slot 0-31 Register	Section 22.4.1.30
BCh	XINTCTL	Transmitter Interrupt Control Register	Section 22.4.1.31
C0h	XSTAT	Transmitter Status Register	Section 22.4.1.32
C4h	XSLOT	Current Transmit TDM Time Slot Register	Section 22.4.1.33
C8h	XCLKCHK	Transmit Clock Check Control Register	Section 22.4.1.34
CCh	XEVTCTL	Transmitter DMA Event Control Register	Section 22.4.1.35
100h to 114h	DITCSRA_0 to DITCSRA_5	Left (Even TDM Time Slot) Channel Status Registers (DIT Mode)	Section 22.4.1.36
118h to 12Ch	DITCSRB_0 to DITCSRB_5	Right (Odd TDM Time Slot) Channel Status Registers (DIT Mode)	Section 22.4.1.37
130h to 144h	DITUDRA_0 to DITUDRA_5	Left (Even TDM Time Slot) Channel User Data Registers (DIT Mode)	Section 22.4.1.38
148h to 15Ch	DITUDRB_0 to DITUDRB_5	Right (Odd TDM Time Slot) Channel User Data Registers (DIT Mode)	Section 22.4.1.39

Table 22-11. MCASP Registers (continued)

Offset	Acronym	Register Name	Section
180h to 194h	SRCTL_0 to SRCTL_5	Serializer Control Registers	Section 22.4.1.40
200h to 214h	XBUF_0 to XBUF_5	Transmit Buffer Register for Serializers	Section 22.4.1.41
280h to 294h	RBUF_0 to RBUF_5	Receive Buffer Register for Serializers	Section 22.4.1.42
1000h	WFIFOCTL	Write FIFO Control Register	Section 22.4.1.43
1004h	WFIFOSTS	Write FIFO Status Register	Section 22.4.1.44
1008h	RFIFOCTL	Read FIFO Control Register	Section 22.4.1.45
100Ch	RFIFOSTS	Read FIFO Status Register	Section 22.4.1.46

22.4.1.1 REV Register (offset = 0h) [reset = 44300A02h]

REV is shown in [Figure 22-39](#) and described in [Table 22-12](#).

The revision identification register (REV) contains identification data for the peripheral.

Figure 22-39. REV Register

31	30	29	28	27	26	25	24	23	22	21	20	19	18	17	16	15	14	13	12	11	10	9	8	7	6	5	4	3	2	1	0
REV																															
R-44300A02h																															

LEGEND: R/W = Read/Write; R = Read only; W1toCl = Write 1 to clear bit; -n = value after reset

Table 22-12. REV Register Field Descriptions

Bit	Field	Type	Reset	Description
31-0	REV	R	44300A02h	Identifies revision of peripheral.

22.4.1.2 PWRIDLESYSCONFIG Register (offset = 4h) [reset = 2h]

 PWRIDLESYSCONFIG is shown in [Figure 22-40](#) and described in [Table 22-13](#).

Figure 22-40. PWRIDLESYSCONFIG Register

31	30	29	28	27	26	25	24	
RESERVED								
R-0h								
23	22	21	20	19	18	17	16	
RESERVED								
R-0h								
15	14	13	12	11	10	9	8	
RESERVED								
R-0h								
7	6	5	4	3	2	1	0	
RESERVED		Other				IDLEMODE		
R-0h		R/W-0h				R/W-2h		

LEGEND: R/W = Read/Write; R = Read only; W1toCl = Write 1 to clear bit; -n = value after reset

Table 22-13. PWRIDLESYSCONFIG Register Field Descriptions

Bit	Field	Type	Reset	Description
31-6	RESERVED	R	0h	
5-2	Other	R/W	0h	Reserved for future programming.
1-0	IDLEMODE	R/W	2h	Power management Configuration of the local target state management mode. By definition, target can handle read/write transaction as long as it is out of IDLE state. 0h = Force-idle mode: local target's idle state follows (acknowledges) the system's idle requests unconditionally, i.e. regardless of the IP module's internal requirements. Backup mode, for debug only. 1h = No-idle mode: local target never enters idle state. Backup mode, for debug only. 2h = Smart-idle mode: local target's idle state eventually follows (acknowledges) the system's idle requests, depending on the IP module's internal requirements. IP module shall not generate (IRQ- or DMA-request-related) wakeup events. 3h = Reserved.

22.4.1.3 PFUNC Register (offset = 10h) [reset = 0h]

PFUNC is shown in [Figure 22-41](#) and described in [Table 22-14](#).

The pin function register (PFUNC) specifies the function of AXRn, ACLKX, AHCLKX, AFSX, ACLKR, AHCLKR, and AFSR pins as either a McASP pin or a general-purpose input/output (GPIO) pin. CAUTION: Writing a value other than 0 to reserved bits in this register may cause improper device operation.

Figure 22-41. PFUNC Register

31	30	29	28	27	26	25	24
AFSR	AHCLKR	ACLKR	AFSX	AHCLKX	ACLKX	AMUTE	RESERVED
R/W-0h	R/W-0h	R/W-0h	R/W-0h	R/W-0h	R/W-0h	R/W-0h	R-0h
23	22	21	20	19	18	17	16
RESERVED							
R-0h							
15	14	13	12	11	10	9	8
RESERVED							
R-0h							
7	6	5	4	3	2	1	0
RESERVED				AXR			
R-0h				R/W-0h			

LEGEND: R/W = Read/Write; R = Read only; W1toCl = Write 1 to clear bit; -n = value after reset

Table 22-14. PFUNC Register Field Descriptions

Bit	Field	Type	Reset	Description
31	AFSR	R/W	0h	Determines if AFSR pin functions as McASP or GPIO. 0h = Pin functions as McASP pin. 1h = Pin functions as GPIO pin.
30	AHCLKR	R/W	0h	Determines if AHCLKR pin functions as McASP or GPIO. 0h = Pin functions as McASP pin. 1h = Pin functions as GPIO pin.
29	ACLKR	R/W	0h	Determines if ACLKR pin functions as McASP or GPIO. 0h = Pin functions as McASP pin. 1h = Pin functions as GPIO pin.
28	AFSX	R/W	0h	Determines if AFSX pin functions as McASP or GPIO. 0h = Pin functions as McASP pin. 1h = Pin functions as GPIO pin.
27	AHCLKX	R/W	0h	Determines if AHCLKX pin functions as McASP or GPIO. 0h = Pin functions as McASP pin. 1h = Pin functions as GPIO pin.
26	ACLKX	R/W	0h	Determines if ACLKX pin functions as McASP or GPIO. 0h = Pin functions as McASP pin. 1h = Pin functions as GPIO pin.
25	AMUTE	R/W	0h	Determines if AMUTE pin functions as McASP or GPIO. 0h = Pin functions as McASP pin. 1h = Pin functions as GPIO pin.
24-4	RESERVED	R	0h	
3-0	AXR	R/W	0h	Determines if AXRn pin functions as McASP or GPIO. 0h = Pin functions as McASP pin. 1h = Pin functions as GPIO pin.

22.4.1.4 PDIR Register (offset = 14h) [reset = 0h]

PDIR is shown in [Figure 22-42](#) and described in [Table 22-15](#).

The pin direction register (PDIR) specifies the direction of AXRn, ACLKX, AHCLKX, AFSX, ACLKR, AHCLKR, and AFSR pins as either an input or an output pin. Regardless of the pin function register (PFUNC) setting, each PDIR bit must be set to 1 for the specified pin to be enabled as an output and each PDIR bit must be cleared to 0 for the specified pin to be an input. For example, if the McASP is configured to use an internally-generated bit clock and the clock is to be driven out to the system, the PFUNC bit must be cleared to 0 (McASP function) and the PDIR bit must be set to 1 (an output). When AXRn is configured to transmit, the PFUNC bit must be cleared to 0 (McASP function) and the PDIR bit must be set to 1 (an output). Similarly, when AXRn is configured to receive, the PFUNC bit must be cleared to 0 (McASP function) and the PDIR bit must be cleared to 0 (an input). CAUTION: Writing a value other than 0 to reserved bits in this register may cause improper device operation.

Figure 22-42. PDIR Register

31	30	29	28	27	26	25	24
AFSR	AHCLKR	ACLKR	AFSX	AHCLKX	ACLKX	AMUTE	RESERVED
R/W-0h	R/W-0h	R/W-0h	R/W-0h	R/W-0h	R/W-0h	R/W-0h	R-0h
23	22	21	20	19	18	17	16
RESERVED							
R-0h							
15	14	13	12	11	10	9	8
RESERVED							
R-0h							
7	6	5	4	3	2	1	0
RESERVED				AXR			
R-0h				R/W-0h			

LEGEND: R/W = Read/Write; R = Read only; W1toCl = Write 1 to clear bit; -n = value after reset

Table 22-15. PDIR Register Field Descriptions

Bit	Field	Type	Reset	Description
31	AFSR	R/W	0h	Determines if AFSR pin functions as an input or output. 0h = Pin functions as input. 1h = Pin functions as output.
30	AHCLKR	R/W	0h	Determines if AHCLKR pin functions as an input or output. 0h = Pin functions as input. 1h = Pin functions as output.
29	ACLKR	R/W	0h	Determines if ACLKR pin functions as an input or output. 0h = Pin functions as input. 1h = Pin functions as output.
28	AFSX	R/W	0h	Determines if AFSX pin functions as an input or output. 0h = Pin functions as input. 1h = Pin functions as output.
27	AHCLKX	R/W	0h	Determines if AHCLKX pin functions as an input or output. 0h = Pin functions as input. 1h = Pin functions as output.
26	ACLKX	R/W	0h	Determines if ACLKX pin functions as an input or output. 0h = Pin functions as input. 1h = Pin functions as output.
25	AMUTE	R/W	0h	Determines if AMUTE pin functions as an input or output. 0h = Pin functions as input. 1h = Pin functions as output.
24-4	RESERVED	R	0h	

Table 22-15. PDIR Register Field Descriptions (continued)

Bit	Field	Type	Reset	Description
3-0	AXR	R/W	0h	Determines if AXRn pin functions as an input or output. 0h = Pin functions as input. 1h = Pin functions as output.

22.4.1.5 PDOUT Register (offset = 18h) [reset = 0h]

PDOUT is shown in [Figure 22-43](#) and described in [Table 22-16](#).

The pin data output register (PDOUT) holds a value for data out at all times, and may be read back at all times. The value held by PDOUT is not affected by writing to PDIR and PFUNC. However, the data value in PDOUT is driven out onto the McASP pin only if the corresponding bit in PFUNC is set to 1 (GPIO function) and the corresponding bit in PDIR is set to 1 (output). When reading data, returns the corresponding bit value in PDOUT[n], does not return input from I/O pin; when writing data, writes to the corresponding PDOUT[n] bit. PDOUT has these aliases or alternate addresses: PDSET When written to at this address, writing a 1 to a bit in PDSET sets the corresponding bit in PDOUT to 1; writing a 0 has no effect and keeps the bits in PDOUT unchanged. PDCLR When written to at this address, writing a 1 to a bit in PDCLR clears the corresponding bit in PDOUT to 0; writing a 0 has no effect and keeps the bits in PDOUT unchanged. There is only one set of data out bits, PDOUT[31-0]. The other registers, PDSET and PDCLR, are just different addresses for the same control bits, with different behaviors during writes. CAUTION: Writing a value other than 0 to reserved bits in this register may cause improper device operation.

Figure 22-43. PDOUT Register

31	30	29	28	27	26	25	24
AFSR	AHCLKR	ACLKR	AFSX	AHCLKX	ACLKX	AMUTE	RESERVED
R/W-0h	R/W-0h	R/W-0h	R/W-0h	R/W-0h	R/W-0h	R/W-0h	R-0h
23	22	21	20	19	18	17	16
RESERVED							
R-0h							
15	14	13	12	11	10	9	8
RESERVED							
R-0h							
7	6	5	4	3	2	1	0
RESERVED				AXR			
R-0h				R/W-0h			

LEGEND: R/W = Read/Write; R = Read only; W1toCl = Write 1 to clear bit; -n = value after reset

Table 22-16. PDOUT Register Field Descriptions

Bit	Field	Type	Reset	Description
31	AFSR	R/W	0h	Determines drive on AFSR output pin when the corresponding PFUNC[31] and PDIR[31] bits are set to 1. 0h = Pin drives low. 1h = Pin drives high.
30	AHCLKR	R/W	0h	Determines drive on AHCLKR output pin when the corresponding PFUNC[30] and PDIR[30] bits are set to 1. 0h = Pin drives low. 1h = Pin drives high.
29	ACLKR	R/W	0h	Determines drive on ACLKR output pin when the corresponding PFUNC[29] and PDIR[29] bits are set to 1. 0h = Pin drives low. 1h = Pin drives high.
28	AFSX	R/W	0h	Determines drive on AFSX output pin when the corresponding PFUNC[28] and PDIR[28] bits are set to 1. 0h = Pin drives low. 1h = Pin drives high.
27	AHCLKX	R/W	0h	Determines drive on AHCLKX output pin when the corresponding PFUNC[27] and PDIR[27] bits are set to 1. 0h = Pin drives low. 1h = Pin drives high.

Table 22-16. PDOUT Register Field Descriptions (continued)

Bit	Field	Type	Reset	Description
26	ACLKX	R/W	0h	Determines drive on ACLKX output pin when the corresponding PFUNC[26] and PDIR[26] bits are set to 1. 0h = Pin drives low. 1h = Pin drives high.
25	AMUTE	R/W	0h	Determines drive on AMUTE output pin when the corresponding PFUNC[25] and PDIR[25] bits are set to 1. 0h = Pin drives low. 1h = Pin drives high.
24-4	RESERVED	R	0h	
3-0	AXR	R/W	0h	Determines drive on AXR[n] output pin when the corresponding PFUNC[n] and PDIR[n] bits are set to 1. 0h = Pin drives low. 1h = Pin drives high.

22.4.1.6 PDIN Register (offset = 1Ch) [reset = 0h]

PDIN is shown in [Figure 22-44](#) and described in [Table 22-17](#).

The pin data input register (PDIN) holds the I/O pin state of each of the McASP pins. PDIN allows the actual value of the pin to be read, regardless of the state of PFunc and PDir. The value after reset for registers 1 through 15 and 24 through 31 depends on how the pins are being driven. **CAUTION:** Writing a value other than 0 to reserved bits in this register may cause improper device operation.

Figure 22-44. PDIN Register

31	30	29	28	27	26	25	24
AFSR	AHCLKR	ACLKR	AFSX	AHCLKX	ACLKX	AMUTE	RESERVED
R/W-0h	R/W-0h	R/W-0h	R/W-0h	R/W-0h	R/W-0h	R/W-0h	R-0h
23	22	21	20	19	18	17	16
RESERVED							
R-0h							
15	14	13	12	11	10	9	8
RESERVED							
R-0h							
7	6	5	4	3	2	1	0
RESERVED				AXR			
R-0h				R/W-0h			

LEGEND: R/W = Read/Write; R = Read only; W1toCl = Write 1 to clear bit; -n = value after reset

Table 22-17. PDIN Register Field Descriptions

Bit	Field	Type	Reset	Description
31	AFSR	R/W	0h	Logic level on AFSR pin. 0h = Pin is logic low. 1h = Pin is logic high.
30	AHCLKR	R/W	0h	Logic level on AHCLKR pin. 0h = Pin is logic low. 1h = Pin is logic high.
29	ACLKR	R/W	0h	Logic level on ACLKR pin. 0h = Pin is logic low. 1h = Pin is logic high.
28	AFSX	R/W	0h	Logic level on AFSX pin. 0h = Pin is logic low. 1h = Pin is logic high.
27	AHCLKX	R/W	0h	Logic level on AHCLKX pin. 0h = Pin is logic low. 1h = Pin is logic high.
26	ACLKX	R/W	0h	Logic level on ACLKX pin. 0h = Pin is logic low. 1h = Pin is logic high.
25	AMUTE	R/W	0h	Logic level on AMUTE pin. 0h = Pin is logic low. 1h = Pin is logic high.
24-4	RESERVED	R	0h	
3-0	AXR	R/W	0h	Logic level on AXR[n] pin. 0h = Pin is logic low. 1h = Pin is logic high.

22.4.1.7 PDCLR Register (offset = 20h) [reset = 0h]

PDCLR is shown in [Figure 22-45](#) and described in [Table 22-18](#).

The pin data clear register (PDCLR) is an alias of the pin data output register (PDOUT) for writes only. Writing a 1 to the PDCLR bit clears the corresponding bit in PDOUT and, if PFUNC = 1 (GPIO function) and PDIR = 1 (output), drives a logic low on the pin. PDCLR is useful for a multitasking system because it allows you to clear to a logic low only the desired pin(s) within a system without affecting other I/O pins controlled by the same McASP. CAUTION: Writing a value other than 0 to reserved bits in this register may cause improper device operation.

Figure 22-45. PDCLR Register

31		30		29		28		27		26		25		24	
AFSR		AHCLKR		ACLKR		AFSX		AHCLKX		ACLKX		AMUTE		RESERVED	
R/W-0h		R/W-0h		R/W-0h		R/W-0h		R/W-0h		R/W-0h		R/W-0h		R-0h	
23		22		21		20		19		18		17		16	
RESERVED															
R-0h															
15		14		13		12		11		10		9		8	
RESERVED															
R-0h															
7		6		5		4		3		2		1		0	
RESERVED								AXR							
R-0h								R/W-0h							

LEGEND: R/W = Read/Write; R = Read only; W1toCl = Write 1 to clear bit; -n = value after reset

Table 22-18. PDCLR Register Field Descriptions

Bit	Field	Type	Reset	Description
31	AFSR	R/W	0h	Allows the corresponding AFSR bit in PDOUT to be cleared to a logic low without affecting other I/O pins controlled by the same port. 0h = No effect. 1h = PDOUT[31] bit is cleared to 0.
30	AHCLKR	R/W	0h	Allows the corresponding AHCLKR bit in PDOUT to be cleared to a logic low without affecting other I/O pins controlled by the same port. 0h = No effect. 1h = PDOUT[30] bit is cleared to 0.
29	ACLKR	R/W	0h	Allows the corresponding ACLKR bit in PDOUT to be cleared to a logic low without affecting other I/O pins controlled by the same port. 0h = No effect. 1h = PDOUT[29] bit is cleared to 0.
28	AFSX	R/W	0h	Allows the corresponding AFSX bit in PDOUT to be cleared to a logic low without affecting other I/O pins controlled by the same port. 0h = No effect. 1h = PDOUT[28] bit is cleared to 0.
27	AHCLKX	R/W	0h	Allows the corresponding AHCLKX bit in PDOUT to be cleared to a logic low without affecting other I/O pins controlled by the same port. 0h = No effect. 1h = PDOUT[27] bit is cleared to 0.
26	ACLKX	R/W	0h	Allows the corresponding ACLKX bit in PDOUT to be cleared to a logic low without affecting other I/O pins controlled by the same port. 0h = No effect. 1h = PDOUT[26] bit is cleared to 0.

Table 22-18. PDCLR Register Field Descriptions (continued)

Bit	Field	Type	Reset	Description
25	AMUTE	R/W	0h	Allows the corresponding AMUTE bit in PDOUT to be cleared to a logic low without affecting other I/O pins controlled by the same port. 0h = No effect. 1h = PDOUT[25] bit is cleared to 0.
24-4	RESERVED	R	0h	
3-0	AXR	R/W	0h	Allows the corresponding AXR[n] bit in PDOUT to be cleared to a logic low without affecting other I/O pins controlled by the same port. 0h = No effect. 1h = PDOUT[n] bit is cleared to 0.

22.4.1.8 GBLCTL Register (offset = 44h) [reset = 0h]

GBLCTL is shown in [Figure 22-46](#) and described in [Table 22-19](#).

The global control register (GBLCTL) provides initialization of the transmit and receive sections. The bit fields in GBLCTL are synchronized and latched by the corresponding clocks (ACLKX for bits 12-8 and ACLKR for bits 4-0). Before GBLCTL is programmed, you must ensure that serial clocks are running. If the corresponding external serial clocks, ACLKX and ACLKR, are not yet running, you should select the internal serial clock source in AHCLKXCTL, AHCLKRCTL, ACLKXCTL, and ACLKRCTL before GBLCTL is programmed. Also, after programming any bits in GBLCTL you should not proceed until you have read back from GBLCTL and verified that the bits are latched in GBLCTL.

Figure 22-46. GBLCTL Register

31	30	29	28	27	26	25	24
RESERVED							
R-0h							
23	22	21	20	19	18	17	16
RESERVED							
R-0h							
15	14	13	12	11	10	9	8
RESERVED			XFRST	XSMRST	XSRCLR	XHCLKRST	XCLKRST
R-0h			R/W-0h	R/W-0h	R/W-0h	R/W-0h	R/W-0h
7	6	5	4	3	2	1	0
RESERVED			RFRST	RSMRST	RSRCLR	RHCLKRST	RCLKRST
R-0h			R/W-0h	R/W-0h	R/W-0h	R/W-0h	R/W-0h

LEGEND: R/W = Read/Write; R = Read only; W1toCl = Write 1 to clear bit; -n = value after reset

Table 22-19. GBLCTL Register Field Descriptions

Bit	Field	Type	Reset	Description
31-13	RESERVED	R	0h	
12	XFRST	R/W	0h	Transmit frame sync generator reset enable bit. 0h = Transmit frame sync generator is reset. 1h = Transmit frame sync generator is active. When released from reset, the transmit frame sync generator begins counting serial clocks and generating frame sync as programmed.
11	XSMRST	R/W	0h	Transmit state machine reset enable bit. 0h = Transmit state machine is held in reset. AXRn pin state: If PFUNC[n] = 0 and PDIR[n] = 1; then the serializer drives the AXRn pin to the state specified for inactive time slot (as determined by DISMOD bits in SRCTL). 1h = Transmit state machine is released from reset. When released from reset, the transmit state machine immediately transfers data from XRBUF[n] to XRSR[n]. The transmit state machine sets the underrun flag (XUNDRN) in XSTAT, if XRBUF[n] have not been preloaded with data before reset is released. The transmit state machine also immediately begins detecting frame sync and is ready to transmit. Transmit TDM time slot begins at slot 0 after reset is released.
10	XSRCLR	R/W	0h	Transmit serializer clear enable bit. By clearing then setting this bit, the transmit buffer is flushed to an empty state (XDATA = 1). If XSMRST = 1, XSRCLR = 1, XDATA = 1, and XBUF is not loaded with new data before the start of the next active time slot, an underrun will occur. 0h = Transmit serializers are cleared. 1h = Transmit serializers are active. When the transmit serializers are first taken out of reset (XSRCLR changes from 0 to 1), the transmit data ready bit (XDATA) in XSTAT is set to indicate XBUF is ready to be written.

Table 22-19. GBLCTL Register Field Descriptions (continued)

Bit	Field	Type	Reset	Description
9	XHCLKRST	R/W	0h	Transmit high-frequency clock divider reset enable bit. 0h = Transmit high-frequency clock divider is held in reset and passes through its input as divide-by-1. 1h = Transmit high-frequency clock divider is running.
8	XCLKRST	R/W	0h	Transmit clock divider reset enable bit. 0h = Transmit clock divider is held in reset. When the clock divider is in reset, it passes through a divide-by-1 of its input. 1h = Transmit clock divider is running.
7-5	RESERVED	R	0h	
4	RFRST	R/W	0h	Receive frame sync generator reset enable bit. 0h = Receive frame sync generator is reset. 1h = Receive frame sync generator is active. When released from reset, the receive frame sync generator begins counting serial clocks and generating frame sync as programmed.
3	RSMRST	R/W	0h	Receive state machine reset enable bit. 0h = Receive state machine is held in reset. 1h = Receive state machine is released from reset. When released from reset, the receive state machine immediately begins detecting frame sync and is ready to receive. Receive TDM time slot begins at slot 0 after reset is released.
2	RSRCLR	R/W	0h	Receive serializer clear enable bit. By clearing then setting this bit, the receive buffer is flushed. 0h = Receive serializers are cleared. 1h = Receive serializers are active.
1	RHCLKRST	R/W	0h	Receive high-frequency clock divider reset enable bit. 0h = Receive high-frequency clock divider is held in reset and passes through its input as divide-by-1. 1h = Receive high-frequency clock divider is running.
0	RCLKRST	R/W	0h	Receive high-frequency clock divider reset enable bit. 0h = Receive clock divider is held in reset. When the clock divider is in reset, it passes through a divide-by-1 of its input. 1h = Receive clock divider is running.

22.4.1.9 AMUTE Register (offset = 48h) [reset = 0h]

AMUTE is shown in [Figure 22-47](#) and described in [Table 22-20](#).

The audio mute control register (AMUTE) controls the McASP audio mute (AMUTE) output pin. The value after reset for register 4 depends on how the pins are being driven.

Figure 22-47. AMUTE Register

31	30	29	28	27	26	25	24
RESERVED							
R-0h							
23	22	21	20	19	18	17	16
RESERVED							
R-0h							
15	14	13	12	11	10	9	8
RESERVED			XDMAERR	RDMAERR	XCKFAIL	RCKFAIL	XSYNCERR
R-0h			R/W-0h	R/W-0h	R/W-0h	R/W-0h	R/W-0h
7	6	5	4	3	2	1	0
RSYNCERR	XUNDRN	ROVRN	INSTAT	INEN	INPOL	MUTEN	
R/W-0h	R/W-0h	R/W-0h	R-0h	R/W-0h	R/W-0h	R/W-0h	

LEGEND: R/W = Read/Write; R = Read only; W1toCl = Write 1 to clear bit; -n = value after reset

Table 22-20. AMUTE Register Field Descriptions

Bit	Field	Type	Reset	Description
31-13	RESERVED	R	0h	
12	XDMAERR	R/W	0h	If transmit DMA error (XDMAERR), drive AMUTE active enable bit. 0h = Drive is disabled. Detection of transmit DMA error is ignored by AMUTE. 1h = Drive is enabled (active). Upon detection of transmit DMA error, AMUTE is active and is driven according to MUTEN bit.
11	RDMAERR	R/W	0h	If receive DMA error (RDMAERR), drive AMUTE active enable bit. 0h = Drive is disabled. Detection of receive DMA error is ignored by AMUTE. 1h = Drive is enabled (active). Upon detection of receive DMA error, AMUTE is active and is driven according to MUTEN bit.
10	XCKFAIL	R/W	0h	If transmit clock failure (XCKFAIL), drive AMUTE active enable bit. 0h = Drive is disabled. Detection of transmit clock failure is ignored by AMUTE. 1h = Drive is enabled (active). Upon detection of transmit clock failure, AMUTE is active and is driven according to MUTEN bit.
9	RCKFAIL	R/W	0h	If receive clock failure (RCKFAIL), drive AMUTE active enable bit. 0h = Drive is disabled. Detection of receive clock failure is ignored by AMUTE. 1h = Drive is enabled (active). Upon detection of receive clock failure, AMUTE is active and is driven according to MUTEN bit.
8	XSYNCERR	R/W	0h	If unexpected transmit frame sync error (XSYNCERR), drive AMUTE active enable bit. 0h = Drive is disabled. Detection of unexpected transmit frame sync error is ignored by AMUTE. 1h = Drive is enabled (active). Upon detection of unexpected transmit frame sync error, AMUTE is active and is driven according to MUTEN bit.

Table 22-20. AMUTE Register Field Descriptions (continued)

Bit	Field	Type	Reset	Description
7	RSYNCERR	R/W	0h	If unexpected receive frame sync error (RSYNCERR), drive AMUTE active enable bit. 0h = Drive is disabled. Detection of unexpected receive frame sync error is ignored by AMUTE. 1h = Drive is enabled (active). Upon detection of unexpected receive frame sync error, AMUTE is active and is driven according to MUTEN bit.
6	XUNDRN	R/W	0h	If transmit underrun error (XUNDRN), drive AMUTE active enable bit. 0h = Drive is disabled. Detection of transmit underrun error is ignored by AMUTE. 1h = Drive is enabled (active). Upon detection of transmit underrun error, AMUTE is active and is driven according to MUTEN bit.
5	ROVRN	R/W	0h	If receiver overrun error (ROVRN), drive AMUTE active enable bit. 0h = Drive is disabled. Detection of receiver overrun error is ignored by AMUTE. 1h = Drive is enabled (active). Upon detection of receiver overrun error, AMUTE is active and is driven according to MUTEN bit.
4	INSTAT	R	0h	Determines drive on AXRn pin when PFunc[n] and PDir[n] bits are set to 1. 0h = AMUTEIN pin is inactive. 1h = AMUTEIN pin is active. Audio mute in error is detected.
3	INEN	R/W	0h	Drive AMUTE active when AMUTEIN error is active (INSTAT = 1). 0h = Drive is disabled. AMUTEIN is ignored by AMUTE. 1h = Drive is enabled (active). INSTAT = 1 drives AMUTE active.
2	INPOL	R/W	0h	Audio mute in (AMUTEIN) polarity select bit. 0h = Polarity is active high. A high on AMUTEIN sets INSTAT to 1. 1h = Polarity is active low. A low on AMUTEIN sets INSTAT to 1.
1-0	MUTEN	R/W	0h	AMUTE pin enable bit (unless overridden by GPIO registers). 0h = AMUTE pin is disabled, pin goes to tri-state condition. 1h = AMUTE pin is driven high if error is detected. 2h = AMUTE pin is driven low if error is detected. 3h = Reserved

22.4.1.10 DLBCTL Register (offset = 4Ch) [reset = 0h]

DLBCTL is shown in [Figure 22-48](#) and described in [Table 22-21](#).

The digital loopback control register (DLBCTL) controls the internal loopback settings of the McASP in TDM mode.

Figure 22-48. DLBCTL Register

31	30	29	28	27	26	25	24
RESERVED							
R-0h							
23	22	21	20	19	18	17	16
RESERVED							
R-0h							
15	14	13	12	11	10	9	8
RESERVED							
R-0h							
7	6	5	4	3	2	1	0
RESERVED				MODE		ORD	DLBEN
R-0h				R/W-0h		R/W-0h	R/W-0h

LEGEND: R/W = Read/Write; R = Read only; W1toCl = Write 1 to clear bit; -n = value after reset

Table 22-21. DLBCTL Register Field Descriptions

Bit	Field	Type	Reset	Description
31-4	RESERVED	R	0h	
3-2	MODE	R/W	0h	<p>Loopback generator mode bits.</p> <p>Applies only when loopback mode is enabled (DLBEN = 1).</p> <p>0h = Default and reserved on loopback mode (DLBEN = 1). When in non-loopback mode (DLBEN = 0), MODE should be left at default (00). When in loopback mode (DLBEN = 1), MODE = 00 is reserved and is not applicable.</p> <p>1h = Transmit clock and frame sync generators used by both transmit and receive sections. When in loopback mode (DLBEN = 1), MODE must be 01.</p> <p>2h = Reserved.</p> <p>3h = Reserved.</p>
1	ORD	R/W	0h	<p>Loopback order bit when loopback mode is enabled (DLBEN = 1).</p> <p>0h = Odd serializers N + 1 transmit to even serializers N that receive. The corresponding serializers must be programmed properly.</p> <p>1h = Even serializers N transmit to odd serializers N + 1 that receive. The corresponding serializers must be programmed properly.</p>
0	DLBEN	R/W	0h	<p>Loopback mode enable bit.</p> <p>0h = Loopback mode is disabled.</p> <p>1h = Loopback mode is enabled.</p>

22.4.1.11 DITCTL Register (offset = 50h) [reset = 0h]

DITCTL is shown in [Figure 22-49](#) and described in [Table 22-22](#).

The DIT mode control register (DITCTL) controls DIT operations of the McASP.

Figure 22-49. DITCTL Register

31	30	29	28	27	26	25	24
RESERVED							
R-0h							
23	22	21	20	19	18	17	16
RESERVED							
R-0h							
15	14	13	12	11	10	9	8
RESERVED							
R-0h							
7	6	5	4	3	2	1	0
RESERVED				VB	VA	RESERVED	DITEN
R-0h				R/W-0h	R/W-0h	R-0h	R/W-0h

LEGEND: R/W = Read/Write; R = Read only; W1toCl = Write 1 to clear bit; -n = value after reset

Table 22-22. DITCTL Register Field Descriptions

Bit	Field	Type	Reset	Description
31-4	RESERVED	R	0h	
3	VB	R/W	0h	Valid bit for odd time slots (DIT right subframe). 0h = V bit is 0 during odd DIT subframes. 1h = V bit is 1 during odd DIT subframes.
2	VA	R/W	0h	Valid bit for even time slots (DIT left subframe). 0h = V bit is 0 during even DIT subframes. 1h = V bit is 1 during even DIT subframes.
1	RESERVED	R	0h	
0	DITEN	R/W	0h	DIT mode enable bit. DITEN should only be changed while the XSMRST bit in GBLCTL is in reset (and for startup, XSRCLR also in reset). However, it is not necessary to reset the XCLKRST or XHCLKRST bits in GBLCTL to change DITEN. 0h = DIT mode is disabled. Transmitter operates in TDM or burst mode. 1h = DIT mode is enabled. Transmitter operates in DIT encoded mode.

22.4.1.12 RGBLCTL Register (offset = 60h) [reset = 0h]

RGBLCTL is shown in [Figure 22-50](#) and described in [Table 22-23](#).

Alias of the global control register (GBLCTL). Writing to the receiver global control register (RGBLCTL) affects only the receive bits of GBLCTL (bits 4-0). Reads from RGBLCTL return the value of GBLCTL. RGBLCTL allows the receiver to be reset independently from the transmitter.

Figure 22-50. RGBLCTL Register

31	30	29	28	27	26	25	24
RESERVED							
R-0h							
23	22	21	20	19	18	17	16
RESERVED							
R-0h							
15	14	13	12	11	10	9	8
RESERVED			XFRST	XSMRST	XSRCLR	XHCLKRST	XCLKRST
R-0h			R-0h	R-0h	R-0h	R-0h	R-0h
7	6	5	4	3	2	1	0
RESERVED			RFRST	RSMRST	RSRCLR	RHCLKRST	RCLKRST
R-0h			R/W-0h	R/W-0h	R/W-0h	R/W-0h	R/W-0h

LEGEND: R/W = Read/Write; R = Read only; W1toCl = Write 1 to clear bit; -n = value after reset

Table 22-23. RGBLCTL Register Field Descriptions

Bit	Field	Type	Reset	Description
31-13	RESERVED	R	0h	
12	XFRST	R	0h	Transmit frame sync generator reset enable bit. A read of this bit returns the XFRST bit value of GBLCTL. Writes have no effect.
11	XSMRST	R	0h	Transmit state machine reset enable bit. A read of this bit returns the XSMRST bit value of GBLCTL. Writes have no effect.
10	XSRCLR	R	0h	Transmit serializer clear enable bit. A read of this bit returns the XSRCLR bit value of GBLCTL. Writes have no effect.
9	XHCLKRST	R	0h	Transmit high-frequency clock divider reset enable bit. A read of this bit returns the XHCLKRST bit value of GBLCTL. Writes have no effect.
8	XCLKRST	R	0h	Transmit clock divider reset enable bit. A read of this bit returns the XCLKRST bit value of GBLCTL. Writes have no effect.
7-5	RESERVED	R	0h	
4	RFRST	R/W	0h	Receive frame sync generator reset enable bit. A write to this bit affects the RFRST bit of GBLCTL. 0h = Receive frame sync generator is reset. 1h = Receive frame sync generator is active.
3	RSMRST	R/W	0h	Receive state machine reset enable bit. A write to this bit affects the RSMRST bit of GBLCTL. 0h = Receive state machine is held in reset. 1h = Receive state machine is released from reset.
2	RSRCLR	R/W	0h	Receive serializer clear enable bit. A write to this bit affects the RSRCLR bit of GBLCTL. 0h = Receive serializers are cleared. 1h = Receive serializers are active.

Table 22-23. RGBLCTL Register Field Descriptions (continued)

Bit	Field	Type	Reset	Description
1	RHCLKRST	R/W	0h	Receive high-frequency clock divider reset enable bit. A write to this bit affects the RHCLKRST bit of GBLCTL. 0h = Receive high-frequency clock divider is held in reset and passes through its input as divide-by-1. 1h = Receive high-frequency clock divider is running.
0	RCLKRST	R/W	0h	Receive clock divider reset enable bit. A write to this bit affects the RCLKRST bit of GBLCTL. 0h = Receive clock divider is held in reset. 1h = Receive clock divider is running.

22.4.1.13 RMASK Register (offset = 64h) [reset = 0h]

RMASK is shown in [Figure 22-51](#) and described in [Table 22-24](#).

The receive format unit bit mask register (RMASK) determines which bits of the received data are masked off and padded with a known value before being read by the CPU or DMA.

Figure 22-51. RMASK Register

31	30	29	28	27	26	25	24	23	22	21	20	19	18	17	16	15	14	13	12	11	10	9	8	7	6	5	4	3	2	1	0
RMASK																															
R/W-0h																															

LEGEND: R/W = Read/Write; R = Read only; W1toCl = Write 1 to clear bit; -n = value after reset

Table 22-24. RMASK Register Field Descriptions

Bit	Field	Type	Reset	Description
31-0	RMASK	R/W	0h	Receive data mask n enable bit. 0h = Corresponding bit of receive data (after passing through reverse and rotate units) is masked out and then padded with the selected bit pad value (RPAD and RPBIT bits in RFMT). 1h = Corresponding bit of receive data (after passing through reverse and rotate units) is returned to CPU or DMA.

22.4.1.14 RFMT Register (offset = 68h) [reset = 0h]

RFMT is shown in [Figure 22-52](#) and described in [Table 22-25](#).

The receive bit stream format register (RFMT) configures the receive data format.

Figure 22-52. RFMT Register

31	30	29	28	27	26	25	24
RESERVED							
R-0h							
23	22	21	20	19	18	17	16
RESERVED						RDATDLY	
R-0h						R/W-0h	
15	14	13	12	11	10	9	8
RRVRS	RPAD		RPBIT				
R/W-0h	R/W-0h		R/W-0h				
7	6	5	4	3	2	1	0
RSSZ				RBUSEL		RROT	
R/W-0h				R/W-0h		R/W-0h	

LEGEND: R/W = Read/Write; R = Read only; W1toCl = Write 1 to clear bit; -n = value after reset

Table 22-25. RFMT Register Field Descriptions

Bit	Field	Type	Reset	Description
31-18	RESERVED	R	0h	
17-16	RDATDLY	R/W	0h	Receive bit delay. 0h = 0-bit delay. The first receive data bit, AXRn, occurs in same ACLKR cycle as the receive frame sync (AFSR). 1h = 1-bit delay. The first receive data bit, AXRn, occurs one ACLKR cycle after the receive frame sync (AFSR). 2h = 2-bit delay. The first receive data bit, AXRn, occurs two ACLKR cycles after the receive frame sync (AFSR). 3h = Reserved.
15	RRVRS	R/W	0h	Receive serial bitstream order. 0h = Bitstream is LSB first. No bit reversal is performed in receive format bit reverse unit. 1h = Bitstream is MSB first. Bit reversal is performed in receive format bit reverse unit.
14-13	RPAD	R/W	0h	Pad value for extra bits in slot not belonging to the word. This field only applies to bits when RMASK[n] = 0. 0h = Pad extra bits with 0. 1h = Pad extra bits with 1. 2h = Pad extra bits with one of the bits from the word as specified by RPBIT bits. 3h = Reserved.
12-8	RPBIT	R/W	0h	RPBIT value determines which bit (as read by the CPU or DMA from RBUF[n]) is used to pad the extra bits. This field only applies when RPAD = 2h. 0h = Pad with bit 0 value. 1h = Pad with bit 1 to bit 31 value from 1h to 1Fh.

Table 22-25. RFMT Register Field Descriptions (continued)

Bit	Field	Type	Reset	Description
7-4	RSSZ	R/W	0h	Receive slot size. 0h = Reserved. 1h = Reserved. 2h = Reserved. 3h = Slot size is 8 bits. 4h = Reserved 5h = Slot size is 12 bits. 6h = Reserved 7h = Slot size is 16 bits. 8h = Reserved 9h = Slot size is 20 bits. Ah = Reserved Bh = Slot size is 24 bits Ch = Reserved Dh = Slot size is 28 bits. Eh = Reserved Fh = Slot size is 32 bits.
3	RBUSEL	R/W	0h	Selects whether reads from serializer buffer XRBUF[n] originate from the configuration bus (CFG) or the data (DAT) port. 0h = Reads from XRBUF[n] originate on data port. Reads from XRBUF[n] on configuration bus are ignored. 1h = Reads from XRBUF[n] originate on configuration bus. Reads from XRBUF[n] on data port are ignored.
2-0	RROT	R/W	0h	Right-rotation value for receive rotate right format unit. 0h = Rotate right by 0 (no rotation). 1h = Rotate right by 4 bit positions. 2h = Rotate right by 8 bit positions. 3h = Rotate right by 12 bit positions. 4h = Rotate right by 16 bit positions. 5h = Rotate right by 20 bit positions. 6h = Rotate right by 24 bit positions. 7h = Rotate right by 28 bit positions.

22.4.1.15 AFSRCTL Register (offset = 6Ch) [reset = 0h]

AFSRCTL is shown in [Figure 22-53](#) and described in [Table 22-26](#).

The receive frame sync control register (AFSRCTL) configures the receive frame sync (AFSR).

Figure 22-53. AFSRCTL Register

31	30	29	28	27	26	25	24
RESERVED							
R-0h							
23	22	21	20	19	18	17	16
RESERVED							
R-0h							
15	14	13	12	11	10	9	8
RMOD							
R/W-0h							
7	6	5	4	3	2	1	0
RMOD	RESERVED		FRWID	RESERVED		FSRM	FSRP
R/W-0h	R-0h		R/W-0h	R-0h		R/W-0h	R/W-0h

LEGEND: R/W = Read/Write; R = Read only; W1toCl = Write 1 to clear bit; -n = value after reset

Table 22-26. AFSRCTL Register Field Descriptions

Bit	Field	Type	Reset	Description
31-16	RESERVED	R	0h	
15-7	RMOD	R/W	0h	Receive frame sync mode select bits. 1FFh = Reserved from 181h to 1FFh. 0h = Burst mode. 1h = Reserved. 2h = 2-slot TDM (I2S mode) to 32-slot TDM from 2h to 20h. 21h = Reserved from 21h to 17Fh. 180h = 384-slot TDM (external DIR IC inputting 384-slot DIR frames to McASP over I2S interface). 181h = Reserved from 181h to 1FFh.
6-5	RESERVED	R	0h	
4	FRWID	R/W	0h	Receive frame sync width select bit indicates the width of the receive frame sync (AFSR) during its active period. 0h = Single bit. 1h = Single word.
3-2	RESERVED	R	0h	
1	FSRM	R/W	0h	Receive frame sync generation select bit. 0h = Externally-generated receive frame sync. 1h = Internally-generated receive frame sync.
0	FSRP	R/W	0h	Receive frame sync polarity select bit. 0h = A rising edge on receive frame sync (AFSR) indicates the beginning of a frame. 1h = A falling edge on receive frame sync (AFSR) indicates the beginning of a frame.

22.4.1.16 ACLKRCTL Register (offset = 70h) [reset = 0h]

ACLKRCTL is shown in [Figure 22-54](#) and described in [Table 22-27](#).

The receive clock control register (ACLKRCTL) configures the receive bit clock (ACLKR) and the receive clock generator.

Figure 22-54. ACLKRCTL Register

31	30	29	28	27	26	25	24
RESERVED							
R-0h							
23	22	21	20	19	18	17	16
RESERVED							
R-0h							
15	14	13	12	11	10	9	8
RESERVED							
R-0h							
7	6	5	4	3	2	1	0
CLKRP	RESERVED	CLKRM	CLKRDIV				
R/W-0h	R-0h	R/W-0h	R/W-0h				

LEGEND: R/W = Read/Write; R = Read only; W1toCl = Write 1 to clear bit; -n = value after reset

Table 22-27. ACLKRCTL Register Field Descriptions

Bit	Field	Type	Reset	Description
31-8	RESERVED	R	0h	
7	CLKRP	R/W	0h	Receive bitstream clock polarity select bit. 0h = Falling edge. Receiver samples data on the falling edge of the serial clock, so the external transmitter driving this receiver must shift data out on the rising edge of the serial clock. 1h = Rising edge. Receiver samples data on the rising edge of the serial clock, so the external transmitter driving this receiver must shift data out on the falling edge of the serial clock.
6	RESERVED	R	0h	
5	CLKRM	R/W	0h	Receive bit clock source bit. Note that this bit does not have any effect, if ACLKXCTL.ASYNC = 0. 0h = External receive clock source from ACLKR pin. 1h = Internal receive clock source from output of programmable bit clock divider.
4-0	CLKRDIV	R/W	0h	Receive bit clock divide ratio bits determine the divide-down ratio from AHCLKR to ACLKR. Note that this bit does not have any effect, if ACLKXCTL.ASYNC = 0. 0h = Divide-by-1. 1h = Divide-by-2. 2h = Divide-by-3 to divide-by-32 from 2h to 1Fh.

22.4.1.17 AHCLKRCTL Register (offset = 74h) [reset = 0h]

AHCLKRCTL is shown in [Figure 22-55](#) and described in [Table 22-28](#).

The receive high-frequency clock control register (AHCLKRCTL) configures the receive high-frequency master clock (AHCLKR) and the receive clock generator.

Figure 22-55. AHCLKRCTL Register

31	30	29	28	27	26	25	24
RESERVED							
R-0h							
23	22	21	20	19	18	17	16
RESERVED							
R-0h							
15	14	13	12	11	10	9	8
HCLKRM	HCLKRP	RESERVED		HCLKRDIV			
R/W-0h	R/W-0h	R-0h		R/W-0h			
7	6	5	4	3	2	1	0
HCLKRDIV							
R/W-0h							

LEGEND: R/W = Read/Write; R = Read only; W1toCl = Write 1 to clear bit; -n = value after reset

Table 22-28. AHCLKRCTL Register Field Descriptions

Bit	Field	Type	Reset	Description
31-16	RESERVED	R	0h	
15	HCLKRM	R/W	0h	Receive high-frequency clock source bit. 0h = External receive high-frequency clock source from AHCLKR pin. 1h = Internal receive high-frequency clock source from output of programmable high clock divider.
14	HCLKRP	R/W	0h	Receive bitstream high-frequency clock polarity select bit. 0h = AHCLKR is not inverted before programmable bit clock divider. In the special case where the receive bit clock (ACLKR) is internally generated and the programmable bit clock divider is set to divide-by-1 (CLKRDIV = 0 in ACLKCTL), AHCLKR is directly passed through to the ACLKR pin. 1h = AHCLKR is inverted before programmable bit clock divider. In the special case where the receive bit clock (ACLKR) is internally generated and the programmable bit clock divider is set to divide-by-1 (CLKRDIV = 0 in ACLKCTL), AHCLKR is directly passed through to the ACLKR pin.
13-12	RESERVED	R	0h	
11-0	HCLKRDIV	R/W	0h	Receive high-frequency clock divide ratio bits determine the divide-down ratio from AUXCLK to AHCLKR. 0h = Divide-by-1. 1h = Divide-by-2. 2h = Divide-by-3 to divide-by-4096 from 2h to FFFh.

22.4.1.18 RTDM Register (offset = 78h) [reset = 0h]

RTDM is shown in [Figure 22-56](#) and described in [Table 22-29](#).

The receive TDM time slot register (RTDM) specifies which TDM time slot the receiver is active.

Figure 22-56. RTDM Register

31	30	29	28	27	26	25	24	23	22	21	20	19	18	17	16	15	14	13	12	11	10	9	8	7	6	5	4	3	2	1	0
RTDMS																															
R/W-0h																															

LEGEND: R/W = Read/Write; R = Read only; W1toCl = Write 1 to clear bit; -n = value after reset

Table 22-29. RTDM Register Field Descriptions

Bit	Field	Type	Reset	Description
31-0	RTDMS	R/W	0h	Receiver mode during TDM time slot n. 0h = Receive TDM time slot n is inactive. The receive serializer does not shift in data during this slot. 1h = Receive TDM time slot n is active. The receive serializer shifts in data during this slot.

22.4.1.19 RINTCTL Register (offset = 7Ch) [reset = 0h]

RINTCTL is shown in [Figure 22-57](#) and described in [Table 22-30](#).

The receiver interrupt control register (RINTCTL) controls generation of the McASP receive interrupt (RINT). When the register bit(s) is set to 1, the occurrence of the enabled McASP condition(s) generates RINT. See the RSTAT register for a description of the interrupt conditions.

Figure 22-57. RINTCTL Register

31	30	29	28	27	26	25	24
RESERVED							
R-0h							
23	22	21	20	19	18	17	16
RESERVED							
R-0h							
15	14	13	12	11	10	9	8
RESERVED							
R-0h							
7	6	5	4	3	2	1	0
RSTAfrm	RESERVED	RDATA	RLAST	RDMAERR	RCKFAIL	RSYNCERR	ROVRN
R/W-0h	R-0h	R/W-0h	R/W-0h	R/W-0h	R/W-0h	R/W-0h	R/W-0h

LEGEND: R/W = Read/Write; R = Read only; W1toCl = Write 1 to clear bit; -n = value after reset

Table 22-30. RINTCTL Register Field Descriptions

Bit	Field	Type	Reset	Description
31-8	RESERVED	R	0h	
7	RSTAfrm	R/W	0h	Receive start of frame interrupt enable bit. 0h = Interrupt is disabled. A receive start of frame interrupt does not generate a McASP receive interrupt (RINT). 1h = Interrupt is enabled. A receive start of frame interrupt generates a McASP receive interrupt (RINT).
6	RESERVED	R	0h	
5	RDATA	R/W	0h	Receive data ready interrupt enable bit. 0h = Interrupt is disabled. A receive data ready interrupt does not generate a McASP receive interrupt (RINT). 1h = Interrupt is enabled. A receive data ready interrupt generates a McASP receive interrupt (RINT).
4	RLAST	R/W	0h	Receive last slot interrupt enable bit. 0h = Interrupt is disabled. A receive last slot interrupt does not generate a McASP receive interrupt (RINT). 1h = Interrupt is enabled. A receive last slot interrupt generates a McASP receive interrupt (RINT).
3	RDMAERR	R/W	0h	Receive DMA error interrupt enable bit. 0h = Interrupt is disabled. A receive DMA error interrupt does not generate a McASP receive interrupt (RINT). 1h = Interrupt is enabled. A receive DMA error interrupt generates a McASP receive interrupt (RINT).
2	RCKFAIL	R/W	0h	Receive clock failure interrupt enable bit. 0h = Interrupt is disabled. A receive clock failure interrupt does not generate a McASP receive interrupt (RINT). 1h = Interrupt is enabled. A receive clock failure interrupt generates a McASP receive interrupt (RINT).

Table 22-30. RINTCTL Register Field Descriptions (continued)

Bit	Field	Type	Reset	Description
1	RSYNCERR	R/W	0h	Unexpected receive frame sync interrupt enable bit. 0h = Interrupt is disabled. An unexpected receive frame sync interrupt does not generate a McASP receive interrupt (RINT). 1h = Interrupt is enabled. An unexpected receive frame sync interrupt generates a McASP receive interrupt (RINT).
0	ROVRN	R/W	0h	Receiver overrun interrupt enable bit. 0h = Interrupt is disabled. A receiver overrun interrupt does not generate a McASP receive interrupt (RINT). 1h = Interrupt is enabled. A receiver overrun interrupt generates a McASP receive interrupt (RINT).

22.4.1.20 RSTAT Register (offset = 80h) [reset = 0h]

RSTAT is shown in [Figure 22-58](#) and described in [Table 22-31](#).

The receiver status register (RSTAT) provides the receiver status and receive TDM time slot number. If the McASP logic attempts to set an interrupt flag in the same cycle that the CPU writes to the flag to clear it, the McASP logic has priority and the flag remains set. This also causes a new interrupt request to be generated.

Figure 22-58. RSTAT Register

31	30	29	28	27	26	25	24
RESERVED							
R-0h							
23	22	21	20	19	18	17	16
RESERVED							
R-0h							
15	14	13	12	11	10	9	8
RESERVED							RERR
R-0h							R/W-0h
7	6	5	4	3	2	1	0
RDMAERR	RSTAFRM	RDATA	RLAST	RTDMSLOT	RCKFAIL	RSYNCERR	ROVRN
R/W1C-0h	R/W1C-0h	R/W1C-0h	R/W1C-0h	R-0h	R/W1C-0h	R/W1C-0h	R/W1C-0h

LEGEND: R/W = Read/Write; R = Read only; W1toCl = Write 1 to clear bit; -n = value after reset

Table 22-31. RSTAT Register Field Descriptions

Bit	Field	Type	Reset	Description
31-9	RESERVED	R	0h	
8	RERR	R/W	0h	RERR bit always returns a logic-OR of: ROVRN OR RSYNCERR OR RCKFAIL OR RDMAERR. Allows a single bit to be checked to determine if a receiver error interrupt has occurred. 0h = No errors have occurred. 1h = An error has occurred.
7	RDMAERR	R/W1C	0h	Receive DMA error flag. RDMAERR is set when the CPU or DMA reads more serializers through the data port in a given time slot than were programmed as receivers. Causes a receive interrupt (RINT), if this bit is set and RDMAERR in RINTCTL is set. This bit is cleared by writing a 1 to this bit. Writing a 0 to this bit has no effect. 0h = Receive DMA error did not occur. 1h = Receive DMA error did occur.
6	RSTAFRM	R/W1C	0h	Receive start of frame flag. Causes a receive interrupt (RINT), if this bit is set and RSTAFRM in RINTCTL is set. This bit is cleared by writing a 1 to this bit. Writing a 0 to this bit has no effect. 0h = No new receive frame sync (AFSR) is detected. 1h = A new receive frame sync (AFSR) is detected.
5	RDATA	R/W1C	0h	Receive data ready flag. Causes a receive interrupt (RINT), if this bit is set and RDATA in RINTCTL is set. This bit is cleared by writing a 1 to this bit. Writing a 0 to this bit has no effect. 0h = No new data in RBUF. 1h = Data is transferred from XRSR to RBUF and ready to be serviced by the CPU or DMA. When RDATA is set, it always causes a DMA event (AREVT).

Table 22-31. RSTAT Register Field Descriptions (continued)

Bit	Field	Type	Reset	Description
4	RLAST	R/W1C	0h	Receive last slot flag. RLAST is set along with RDATA, if the current slot is the last slot in a frame. Causes a receive interrupt (RINT), if this bit is set and RLAST in RINTCTL is set. This bit is cleared by writing a 1 to this bit. Writing a 0 to this bit has no effect. 0h = Current slot is not the last slot in a frame. 1h = Current slot is the last slot in a frame. RDATA is also set.
3	RTDMSLOT	R	0h	Returns the LSB of RSLLOT. Allows a single read of RSTAT to determine whether the current TDM time slot is even or odd. 0h = Current TDM time slot is odd. 1h = Current TDM time slot is even.
2	RCKFAIL	R/W1C	0h	Receive clock failure flag. RCKFAIL is set when the receive clock failure detection circuit reports an error. Causes a receive interrupt (RINT), if this bit is set and RCKFAIL in RINTCTL is set. This bit is cleared by writing a 1 to this bit. Writing a 0 to this bit has no effect. 0h = Receive clock failure did not occur. 1h = Receive clock failure did occur.
1	RSYNCERR	R/W1C	0h	Unexpected receive frame sync flag. RSYNCERR is set when a new receive frame sync (AFSR) occurs before it is expected. Causes a receive interrupt (RINT), if this bit is set and RSYNCERR in RINTCTL is set. This bit is cleared by writing a 1 to this bit. Writing a 0 to this bit has no effect. 0h = Unexpected receive frame sync did not occur. 1h = Unexpected receive frame sync did occur.
0	ROVRN	R/W1C	0h	Receiver overrun flag. ROVRN is set when the receive serializer is instructed to transfer data from XRSR to RBUF, but the former data in RBUF has not yet been read by the CPU or DMA. Causes a receive interrupt (RINT), if this bit is set and ROVRN in RINTCTL is set. This bit is cleared by writing a 1 to this bit. Writing a 0 to this bit has no effect. 0h = Receiver overrun did not occur. 1h = Receiver overrun did occur.

22.4.1.21 RSL0T Register (offset = 84h) [reset = 0h]

RSL0T is shown in [Figure 22-59](#) and described in [Table 22-32](#).

The current receive TDM time slot register (RSL0T) indicates the current time slot for the receive data frame.

Figure 22-59. RSL0T Register

31	30	29	28	27	26	25	24	23	22	21	20	19	18	17	16	15	14	13	12	11	10	9	8	7	6	5	4	3	2	1	0
RESERVED																RSL0TCNT															
R-0h																R-0h															

LEGEND: R/W = Read/Write; R = Read only; W1toCl = Write 1 to clear bit; -n = value after reset

Table 22-32. RSL0T Register Field Descriptions

Bit	Field	Type	Reset	Description
31-9	RESERVED	R	0h	
8-0	RSL0TCNT	R	0h	0-17Fh = Current receive time slot count. Legal values: 0 to 383 (17Fh). TDM function is not supported for > 32 time slots. However, TDM time slot counter may count to 383 when used to receive a DIR block (transferred over TDM format).

22.4.1.22 RCLKCHK Register (offset = 88h) [reset = 0h]

RCLKCHK is shown in [Figure 22-60](#) and described in [Table 22-33](#).

The receive clock check control register (RCLKCHK) configures the receive clock failure detection circuit.

Figure 22-60. RCLKCHK Register

31	30	29	28	27	26	25	24	23	22	21	20	19	18	17	16
RCNT								RMAX							
R-0h								R/W-0h							
15	14	13	12	11	10	9	8	7	6	5	4	3	2	1	0
RMIN								RESERVED				RPS			
R/W-0h								R-0h				R/W-0h			

LEGEND: R/W = Read/Write; R = Read only; W1toCl = Write 1 to clear bit; -n = value after reset

Table 22-33. RCLKCHK Register Field Descriptions

Bit	Field	Type	Reset	Description
31-24	RCNT	R	0h	Receive clock count value (from previous measurement). The clock circuit continually counts the number of system clocks for every 32 receive high-frequency master clock (AHCLKR) signals, and stores the count in RCNT until the next measurement is taken.
23-16	RMAX	R/W	0h	Receive clock maximum boundary. This 8 bit unsigned value sets the maximum allowed boundary for the clock check counter after 32 receive high-frequency master clock (AHCLKR) signals have been received. If the current counter value is greater than RMAX after counting 32 AHCLKR signals, RCKFAIL in RSTAT is set. The comparison is performed using unsigned arithmetic.
15-8	RMIN	R/W	0h	Receive clock minimum boundary. This 8 bit unsigned value sets the minimum allowed boundary for the clock check counter after 32 receive high-frequency master clock (AHCLKR) signals have been received. If RCNT is less than RMIN after counting 32 AHCLKR signals, RCKFAIL in RSTAT is set. The comparison is performed using unsigned arithmetic.
7-4	RESERVED	R	0h	
3-0	RPS	R/W	0h	Receive clock check prescaler value. 0h = McASP system clock divided by 1. 1h = McASP system clock divided by 2. 2h = McASP system clock divided by 4. 3h = McASP system clock divided by 8. 4h = McASP system clock divided by 16. 5h = McASP system clock divided by 32. 6h = McASP system clock divided by 64. 7h = McASP system clock divided by 128. 8h = McASP system clock divided by 256. 9h = Reserved from 9h to Fh.

22.4.1.23 REVTCTL Register (offset = 8Ch) [reset = 0h]

REVTCTL is shown in [Figure 22-61](#) and described in [Table 22-34](#).

The receiver DMA event control register (REVTCTL) contains a disable bit for the receiver DMA event. Note for device-specific registers: Accessing REVTCTL not implemented on a specific device may cause improper operation.

Figure 22-61. REVTCTL Register

31	30	29	28	27	26	25	24
RESERVED							
R-0h							
23	22	21	20	19	18	17	16
RESERVED							
R-0h							
15	14	13	12	11	10	9	8
RESERVED							
R-0h							
7	6	5	4	3	2	1	0
RESERVED							RDATDMA
R-0h							R/W-0h

LEGEND: R/W = Read/Write; R = Read only; W1toCl = Write 1 to clear bit; -n = value after reset

Table 22-34. REVTCTL Register Field Descriptions

Bit	Field	Type	Reset	Description
31-1	RESERVED	R	0h	
0	RDATDMA	R/W	0h	Receive data DMA request enable bit. If writing to this bit, always write the default value of 0. 0h = Receive data DMA request is enabled. 1h = Reserved

22.4.1.24 XGBLCTL Register (offset = A0h) [reset = 0h]

XGBLCTL is shown in [Figure 22-62](#) and described in [Table 22-35](#).

Alias of the global control register (GBLCTL). Writing to the transmitter global control register (XGBLCTL) affects only the transmit bits of GBLCTL (bits 12-8). Reads from XGBLCTL return the value of GBLCTL. XGBLCTL allows the transmitter to be reset independently from the receiver. See the GBLCTL register for a detailed description of GBLCTL.

Figure 22-62. XGBLCTL Register

31	30	29	28	27	26	25	24
RESERVED							
R-0h							
23	22	21	20	19	18	17	16
RESERVED							
R-0h							
15	14	13	12	11	10	9	8
RESERVED			XFRST	XSMRST	XSRCLR	XHCLKRST	XCLKRST
R-0h			R/W-0h	R/W-0h	R/W-0h	R/W-0h	R/W-0h
7	6	5	4	3	2	1	0
RESERVED			RFRST	RSMRST	RSRCLR	RHCLKRST	RCLKRST
R-0h			R-0h	R-0h	R-0h	R-0h	R-0h

LEGEND: R/W = Read/Write; R = Read only; W1toCl = Write 1 to clear bit; -n = value after reset

Table 22-35. XGBLCTL Register Field Descriptions

Bit	Field	Type	Reset	Description
31-13	RESERVED	R	0h	
12	XFRST	R/W	0h	Transmit frame sync generator reset enable bit. A write to this bit affects the XFRST bit of GBLCTL. 0h = Transmit frame sync generator is reset. 1h = Transmit frame sync generator is active.
11	XSMRST	R/W	0h	Transmit state machine reset enable bit. A write to this bit affects the XSMRST bit of GBLCTL. 0h = Transmit state machine is held in reset. 1h = Transmit state machine is released from reset.
10	XSRCLR	R/W	0h	Transmit serializer clear enable bit. A write to this bit affects the XSRCLR bit of GBLCTL. 0h = Transmit serializers are cleared. 1h = Transmit serializers are active.
9	XHCLKRST	R/W	0h	Transmit high-frequency clock divider reset enable bit. A write to this bit affects the XHCLKRST bit of GBLCTL. 0h = Transmit high-frequency clock divider is held in reset. 1h = Transmit high-frequency clock divider is running.
8	XCLKRST	R/W	0h	Transmit clock divider reset enable bit. A write to this bit affects the XCLKRST bit of GBLCTL. 0h = Transmit clock divider is held in reset. 1h = Transmit clock divider is running.
7-5	RESERVED	R	0h	
4	RFRST	R	0h	Receive frame sync generator reset enable bit. A read of this bit returns the RFRST bit value of GBLCTL. Writes have no effect.
3	RSMRST	R	0h	Receive state machine reset enable bit. A read of this bit returns the RSMRST bit value of GBLCTL. Writes have no effect.
2	RSRCLR	R	0h	Receive serializer clear enable bit. A read of this bit returns the RSRCLR bit value of GBLCTL. Writes have no effect.

Table 22-35. XGBLCTL Register Field Descriptions (continued)

Bit	Field	Type	Reset	Description
1	RHCLKRST	R	0h	Receive high-frequency clock divider reset enable bit. A read of this bit returns the RHCLKRST bit value of GBLCTL. Writes have no effect.
0	RCLKRST	R	0h	Receive clock divider reset enable bit. A read of this bit returns the RCLKRST bit value of GBLCTL. Writes have no effect.

22.4.1.25 XMASK Register (offset = A4h) [reset = 0h]

XMASK is shown in [Figure 22-63](#) and described in [Table 22-36](#).

The transmit format unit bit mask register (XMASK) determines which bits of the transmitted data are masked off and padded with a known value before being shifted out the McASP.

Figure 22-63. XMASK Register

31	30	29	28	27	26	25	24	23	22	21	20	19	18	17	16	15	14	13	12	11	10	9	8	7	6	5	4	3	2	1	0
XMASK																															
R/W-0h																															

LEGEND: R/W = Read/Write; R = Read only; W1toCl = Write 1 to clear bit; -n = value after reset

Table 22-36. XMASK Register Field Descriptions

Bit	Field	Type	Reset	Description
31-0	XMASK	R/W	0h	Transmit data mask n enable bit. 0h = Corresponding bit of transmit data (before passing through reverse and rotate units) is masked out and then padded with the selected bit pad value (XPAD and XPBIT bits in XFMT), which is transmitted out the McASP in place of the original bit. 1h = Corresponding bit of transmit data (before passing through reverse and rotate units) is transmitted out the McASP.

22.4.1.26 XFMT Register (offset = A8h) [reset = 0h]

XFMT is shown in [Figure 22-64](#) and described in [Table 22-37](#).

The transmit bit stream format register (XFMT) configures the transmit data format.

Figure 22-64. XFMT Register

31	30	29	28	27	26	25	24
RESERVED							
R-0h							
23	22	21	20	19	18	17	16
RESERVED						XDATDLY	
R-0h						R/W-0h	
15	14	13	12	11	10	9	8
XRVRS		XPAD		XPBIT			
R/W-0h		R/W-0h		R/W-0h			
7	6	5	4	3	2	1	0
XSSZ				XBUSEL		XROT	
R/W-0h				R/W-0h		R/W-0h	

LEGEND: R/W = Read/Write; R = Read only; W1toCl = Write 1 to clear bit; -n = value after reset

Table 22-37. XFMT Register Field Descriptions

Bit	Field	Type	Reset	Description
31-18	RESERVED	R	0h	
17-16	XDATDLY	R/W	0h	Transmit sync bit delay. 0h = 0-bit delay. The first transmit data bit, AXRn, occurs in same ACLKX cycle as the transmit frame sync (AFSX). 1h = 1-bit delay. The first transmit data bit, AXRn, occurs one ACLKX cycle after the transmit frame sync (AFSX). 2h = 2-bit delay. The first transmit data bit, AXRn, occurs two ACLKX cycles after the transmit frame sync (AFSX). 3h = Reserved.
15	XRVRS	R/W	0h	Transmit serial bitstream order. 0h = Bitstream is LSB first. No bit reversal is performed in transmit format bit reverse unit. 1h = Bitstream is MSB first. Bit reversal is performed in transmit format bit reverse unit.
14-13	XPAD	R/W	0h	Pad value for extra bits in slot not belonging to word defined by XMASK. This field only applies to bits when XMASK[n] = 0. 0h = Pad extra bits with 0. 1h = Pad extra bits with 1. 2h = Pad extra bits with one of the bits from the word as specified by XPBIT bits. 3h = Reserved.
12-8	XPBIT	R/W	0h	XPBIT value determines which bit (as written by the CPU or DMA to XBUF[n]) is used to pad the extra bits before shifting. This field only applies when XPAD = 2h. 0h = Pad with bit 0 value. 1h = Pad with bit 1 to bit 31 value from 1h to 1Fh.

Table 22-37. XFMT Register Field Descriptions (continued)

Bit	Field	Type	Reset	Description
7-4	XSSZ	R/W	0h	Transmit slot size. 0h = Reserved. 1h = Reserved. 2h = Reserved. 3h = Slot size is 8 bits. 4h = Reserved. 5h = Slot size is 12 bits. 6h = Reserved. 7h = Slot size is 16 bits. 8h = Reserved. 9h = Slot size is 20 bits. Ah = Reserved. Bh = Slot size is 24 bits. Ch = Reserved. Dh = Slot size is 28 bits. Eh = Reserved. Fh = Slot size is 32 bits.
3	XBUSEL	R/W	0h	Selects whether writes to serializer buffer XRBUF[n] originate from the configuration bus (CFG) or the data (DAT) port. 0h = Writes to XRBUF[n] originate from the data port. Writes to XRBUF[n] from the configuration bus are ignored with no effect to the McASP. 1h = Writes to XRBUF[n] originate from the configuration bus. Writes to XRBUF[n] from the data port are ignored with no effect to the McASP.
2-0	XROT	R/W	0h	Right-rotation value for transmit rotate right format unit. 0h = Rotate right by 0 (no rotation). 1h = Rotate right by 4 bit positions. 2h = Rotate right by 8 bit positions. 3h = Rotate right by 12 bit positions. 4h = Rotate right by 16 bit positions. 5h = Rotate right by 20 bit positions. 6h = Rotate right by 24 bit positions. 7h = Rotate right by 28 bit positions.

22.4.1.27 AFSXCTL Register (offset = ACh) [reset = 0h]

AFSXCTL is shown in [Figure 22-65](#) and described in [Table 22-38](#).

The transmit frame sync control register (AFSXCTL) configures the transmit frame sync (AFSX).

Figure 22-65. AFSXCTL Register

31	30	29	28	27	26	25	24
RESERVED							
R-0h							
23	22	21	20	19	18	17	16
RESERVED							
R-0h							
15	14	13	12	11	10	9	8
XMOD							
R/W-0h							
7	6	5	4	3	2	1	0
XMOD	RESERVED		FXWID	RESERVED		FSXM	FSXP
R/W-0h	R-0h		R/W-0h	R-0h		R/W-0h	R/W-0h

LEGEND: R/W = Read/Write; R = Read only; W1toCl = Write 1 to clear bit; -n = value after reset

Table 22-38. AFSXCTL Register Field Descriptions

Bit	Field	Type	Reset	Description
31-16	RESERVED	R	0h	
15-7	XMOD	R/W	0h	Transmit frame sync mode select bits. 1FFh = Reserved from 181h to 1FFh. 0h = Burst mode. 1h = Reserved. 2h = 2-slot TDM (I2S mode) to 32-slot TDM from 2h to 20h. 21h = Reserved from 21h to 17Fh. 180h = 384-slot DIT mode. 181h = Reserved from 181h to 1FFh.
6-5	RESERVED	R	0h	
4	FXWID	R/W	0h	Transmit frame sync width select bit indicates the width of the transmit frame sync (AFSX) during its active period. 0h = Single bit. 1h = Single word.
3-2	RESERVED	R	0h	
1	FSXM	R/W	0h	Transmit frame sync generation select bit. 0h = Externally-generated transmit frame sync. 1h = Internally-generated transmit frame sync.
0	FSXP	R/W	0h	Transmit frame sync polarity select bit. 0h = A rising edge on transmit frame sync (AFSX) indicates the beginning of a frame. 1h = A falling edge on transmit frame sync (AFSX) indicates the beginning of a frame.

22.4.1.28 ACLKXCTL Register (offset = B0h) [reset = 60h]

ACLKXCTL is shown in [Figure 22-66](#) and described in [Table 22-39](#).

The transmit clock control register (ACLKXCTL) configures the transmit bit clock (ACLKX) and the transmit clock generator.

Figure 22-66. ACLKXCTL Register

31	30	29	28	27	26	25	24
RESERVED							
R-0h							
23	22	21	20	19	18	17	16
RESERVED							
R-0h							
15	14	13	12	11	10	9	8
RESERVED							
R-0h							
7	6	5	4	3	2	1	0
CLKXP	ASYNC	CLKXM	CLKXDIV				
R/W-0h	R/W-1h	R/W-1h	R/W-0h				

LEGEND: R/W = Read/Write; R = Read only; W1toCl = Write 1 to clear bit; -n = value after reset

Table 22-39. ACLKXCTL Register Field Descriptions

Bit	Field	Type	Reset	Description
31-8	RESERVED	R	0h	
7	CLKXP	R/W	0h	Transmit bitstream clock polarity select bit. 0h = Rising edge. External receiver samples data on the falling edge of the serial clock, so the transmitter must shift data out on the rising edge of the serial clock. 1h = Falling edge. External receiver samples data on the rising edge of the serial clock, so the transmitter must shift data out on the falling edge of the serial clock.
6	ASYNC	R/W	1h	Transmit/receive operation asynchronous enable bit. 0h = Synchronous. Transmit clock and frame sync provides the source for both the transmit and receive sections. 1h = Asynchronous. Separate clock and frame sync used by transmit and receive sections.
5	CLKXM	R/W	1h	Transmit bit clock source bit. 0h = External transmit clock source from ACLKX pin. 1h = Internal transmit clock source from output of programmable bit clock divider.
4-0	CLKXDIV	R/W	0h	Transmit bit clock divide ratio bits determine the divide-down ratio from AHCLKX to ACLKX. 0h = Divide-by-1. 1h = Divide-by-2. 2h = Divide-by-3 to divide-by-32 from 2h to 1Fh.

22.4.1.29 AHCLKXCTL Register (offset = B4h) [reset = 0h]

AHCLKXCTL is shown in [Figure 22-67](#) and described in [Table 22-40](#).

The transmit high-frequency clock control register (AHCLKXCTL) configures the transmit high-frequency master clock (AHCLKX) and the transmit clock generator.

Figure 22-67. AHCLKXCTL Register

31	30	29	28	27	26	25	24
RESERVED							
R-0h							
23	22	21	20	19	18	17	16
RESERVED							
R-0h							
15	14	13	12	11	10	9	8
HCLKXM	HCLKXP	RESERVED			HCLKXDIV		
R/W-0h	R/W-0h	R-0h			R/W-0h		
7	6	5	4	3	2	1	0
HCLKXDIV							
R/W-0h							

LEGEND: R/W = Read/Write; R = Read only; W1toCl = Write 1 to clear bit; -n = value after reset

Table 22-40. AHCLKXCTL Register Field Descriptions

Bit	Field	Type	Reset	Description
31-16	RESERVED	R	0h	
15	HCLKXM	R/W	0h	Transmit high-frequency clock source bit. 0h = External transmit high-frequency clock source from AHCLKX pin. 1h = Internal transmit high-frequency clock source from output of programmable high clock divider.
14	HCLKXP	R/W	0h	Transmit bitstream high-frequency clock polarity select bit. 0h = AHCLKX is not inverted before programmable bit clock divider. In the special case where the transmit bit clock (ACLKX) is internally generated and the programmable bit clock divider is set to divide-by-1 (CLKXDIV = 0 in ACLKXCTL), AHCLKX is directly passed through to the ACLKX pin. 1h = AHCLKX is inverted before programmable bit clock divider. In the special case where the transmit bit clock (ACLKX) is internally generated and the programmable bit clock divider is set to divide-by-1 (CLKXDIV = 0 in ACLKXCTL), AHCLKX is directly passed through to the ACLKX pin.
13-12	RESERVED	R	0h	
11-0	HCLKXDIV	R/W	0h	Transmit high-frequency clock divide ratio bits determine the divide-down ratio from AUXCLK to AHCLKX. 0h = Divide-by-1. 1h = Divide-by-2. 2h = Divide-by-3 to divide-by-4096 from 2h to FFFh.

22.4.1.30 XTDM Register (offset = B8h) [reset = 0h]

XTDM is shown in [Figure 22-68](#) and described in [Table 22-41](#).

The transmit TDM time slot register (XTDM) specifies in which TDM time slot the transmitter is active. TDM time slot counter range is extended to 384 slots (to support SPDIF blocks of 384 subframes). XTDM operates modulo 32, that is, XTDM specifies the TDM activity for time slots 0, 32, 64, 96, 128, and so on.

Figure 22-68. XTDM Register

31	30	29	28	27	26	25	24	23	22	21	20	19	18	17	16	15	14	13	12	11	10	9	8	7	6	5	4	3	2	1	0
XTDMS																															
R/W-0h																															

LEGEND: R/W = Read/Write; R = Read only; W1toCl = Write 1 to clear bit; -n = value after reset

Table 22-41. XTDM Register Field Descriptions

Bit	Field	Type	Reset	Description
31-0	XTDMS	R/W	0h	Transmitter mode during TDM time slot n. 0h = Transmit TDM time slot n is inactive. The transmit serializer does not shift out data during this slot. 1h = Transmit TDM time slot n is active. The transmit serializer shifts out data during this slot according to the serializer control register (SRCTL).

22.4.1.31 XINTCTL Register (offset = BCh) [reset = 0h]

XINTCTL is shown in [Figure 22-69](#) and described in [Table 22-42](#).

The transmitter interrupt control register (XINTCTL) controls generation of the McASP transmit interrupt (XINT). When the register bit(s) is set to 1, the occurrence of the enabled McASP condition(s) generates XINT. See the XSTAT register for a description of the interrupt conditions.

Figure 22-69. XINTCTL Register

31	30	29	28	27	26	25	24
RESERVED							
R-0h							
23	22	21	20	19	18	17	16
RESERVED							
R-0h							
15	14	13	12	11	10	9	8
RESERVED							
R-0h							
7	6	5	4	3	2	1	0
XSTAFRM	RESERVED	XDATA	XLAST	XDMAERR	XCKFAIL	XSYNCERR	XUNDRN
R/W-0h	R-0h	R/W-0h	R/W-0h	R/W-0h	R/W-0h	R/W-0h	R/W-0h

LEGEND: R/W = Read/Write; R = Read only; W1toCl = Write 1 to clear bit; -n = value after reset

Table 22-42. XINTCTL Register Field Descriptions

Bit	Field	Type	Reset	Description
31-8	RESERVED	R	0h	
7	XSTAFRM	R/W	0h	Transmit start of frame interrupt enable bit. 0h = Interrupt is disabled. A transmit start of frame interrupt does not generate a McASP transmit interrupt (XINT). 1h = Interrupt is enabled. A transmit start of frame interrupt generates a McASP transmit interrupt (XINT).
6	RESERVED	R	0h	
5	XDATA	R/W	0h	Transmit data ready interrupt enable bit. 0h = Interrupt is disabled. A transmit data ready interrupt does not generate a McASP transmit interrupt (XINT). 1h = Interrupt is enabled. A transmit data ready interrupt generates a McASP transmit interrupt (XINT).
4	XLAST	R/W	0h	Transmit last slot interrupt enable bit. 0h = Interrupt is disabled. A transmit last slot interrupt does not generate a McASP transmit interrupt (XINT). 1h = Interrupt is enabled. A transmit last slot interrupt generates a McASP transmit interrupt (XINT).
3	XDMAERR	R/W	0h	Transmit DMA error interrupt enable bit. 0h = Interrupt is disabled. A transmit DMA error interrupt does not generate a McASP transmit interrupt (XINT). 1h = Interrupt is enabled. A transmit DMA error interrupt generates a McASP transmit interrupt (XINT).
2	XCKFAIL	R/W	0h	Transmit clock failure interrupt enable bit. 0h = Interrupt is disabled. A transmit clock failure interrupt does not generate a McASP transmit interrupt (XINT). 1h = Interrupt is enabled. A transmit clock failure interrupt generates a McASP transmit interrupt (XINT).

Table 22-42. XINTCTL Register Field Descriptions (continued)

Bit	Field	Type	Reset	Description
1	XSYNCERR	R/W	0h	Unexpected transmit frame sync interrupt enable bit. 0h = Interrupt is disabled. An unexpected transmit frame sync interrupt does not generate a McASP transmit interrupt (XINT). 1h = Interrupt is enabled. An unexpected transmit frame sync interrupt generates a McASP transmit interrupt (XINT).
0	XUNDRN	R/W	0h	Transmitter underrun interrupt enable bit. 0h = Interrupt is disabled. A transmitter underrun interrupt does not generate a McASP transmit interrupt (XINT). 1h = Interrupt is enabled. A transmitter underrun interrupt generates a McASP transmit interrupt (XINT).

22.4.1.32 XSTAT Register (offset = C0h) [reset = 0h]

XSTAT is shown in [Figure 22-70](#) and described in [Table 22-43](#).

The transmitter status register (XSTAT) provides the transmitter status and transmit TDM time slot number. If the McASP logic attempts to set an interrupt flag in the same cycle that the CPU writes to the flag to clear it, the McASP logic has priority and the flag remains set. This also causes a new interrupt request to be generated.

Figure 22-70. XSTAT Register

31	30	29	28	27	26	25	24
RESERVED							
R-0h							
23	22	21	20	19	18	17	16
RESERVED							
R-0h							
15	14	13	12	11	10	9	8
RESERVED							XERR
R-0h							R/W-0h
7	6	5	4	3	2	1	0
XDMAERR	XSTAFRM	XDATA	XLAST	XTDMSLOT	XCKFAIL	XSYNCERR	XUNDRN
R/W1C-0h	R/W1C-0h	R/W1C-0h	R/W1C-0h	R-0h	R/W1C-0h	R/W1C-0h	R/W1C-0h

LEGEND: R/W = Read/Write; R = Read only; W1toCl = Write 1 to clear bit; -n = value after reset

Table 22-43. XSTAT Register Field Descriptions

Bit	Field	Type	Reset	Description
31-9	RESERVED	R	0h	
8	XERR	R/W	0h	XERR bit always returns a logic-OR of: XUNDRN OR XSYNCERR OR XCKFAIL OR XDMAERR. Allows a single bit to be checked to determine if a transmitter error interrupt has occurred. 0h = No errors have occurred. 1h = An error has occurred.
7	XDMAERR	R/W1C	0h	Transmit DMA error flag. XDMAERR is set when the CPU or DMA writes more serializers through the data port in a given time slot than were programmed as transmitters. Causes a transmit interrupt (XINT), if this bit is set and XDMAERR in XINTCTL is set. This bit is cleared by writing a 1 to this bit. Writing a 0 has no effect. 0h = Transmit DMA error did not occur. 1h = Transmit DMA error did occur.
6	XSTAFRM	R/W1C	0h	Transmit start of frame flag. Causes a transmit interrupt (XINT), if this bit is set and XSTAFRM in XINTCTL is set. This bit is cleared by writing a 1 to this bit. Writing a 0 has no effect. 0h = No new transmit frame sync (AFSX) is detected. 1h = A new transmit frame sync (AFSX) is detected.
5	XDATA	R/W1C	0h	Transmit data ready flag. Causes a transmit interrupt (XINT), if this bit is set and XDATA in XINTCTL is set. This bit is cleared by writing a 1 to this bit. Writing a 0 has no effect. 0h = XBUF is written and is full. 1h = Data is copied from XBUF to XRSR. XBUF is empty and ready to be written. XDATA is also set when the transmit serializers are taken out of reset. When XDATA is set, it always causes a DMA event (AXEVT).

Table 22-43. XSTAT Register Field Descriptions (continued)

Bit	Field	Type	Reset	Description
4	XLAST	R/W1C	0h	<p>Transmit last slot flag.</p> <p>XLAST is set along with XDATA, if the current slot is the last slot in a frame.</p> <p>Causes a transmit interrupt (XINT), if this bit is set and XLAST in XINTCTL is set.</p> <p>This bit is cleared by writing a 1 to this bit.</p> <p>Writing a 0 has no effect.</p> <p>0h = Current slot is not the last slot in a frame.</p> <p>1h = Current slot is the last slot in a frame. XDATA is also set.</p>
3	XTDMSLOT	R	0h	<p>Returns the LSB of XSLOT.</p> <p>Allows a single read of XSTAT to determine whether the current TDM time slot is even or odd.</p> <p>0h = Current TDM time slot is odd.</p> <p>1h = Current TDM time slot is even.</p>
2	XCKFAIL	R/W1C	0h	<p>Transmit clock failure flag.</p> <p>XCKFAIL is set when the transmit clock failure detection circuit reports an error.</p> <p>Causes a transmit interrupt (XINT), if this bit is set and XCKFAIL in XINTCTL is set.</p> <p>This bit is cleared by writing a 1 to this bit.</p> <p>Writing a 0 has no effect.</p> <p>0h = Transmit clock failure did not occur.</p> <p>1h = Transmit clock failure did occur.</p>
1	XSYNCERR	R/W1C	0h	<p>Unexpected transmit frame sync flag.</p> <p>XSYNCERR is set when a new transmit frame sync (AFSX) occurs before it is expected.</p> <p>Causes a transmit interrupt (XINT), if this bit is set and XSYNCERR in XINTCTL is set.</p> <p>This bit is cleared by writing a 1 to this bit.</p> <p>Writing a 0 has no effect.</p> <p>0h = Unexpected transmit frame sync did not occur.</p> <p>1h = Unexpected transmit frame sync did occur.</p>
0	XUNDRN	R/W1C	0h	<p>Transmitter underrun flag.</p> <p>XUNDRN is set when the transmit serializer is instructed to transfer data from XBUF to XRSR, but XBUF has not yet been serviced with new data since the last transfer.</p> <p>Causes a transmit interrupt (XINT), if this bit is set and XUNDRN in XINTCTL is set.</p> <p>This bit is cleared by writing a 1 to this bit.</p> <p>Writing a 0 has no effect.</p> <p>0h = Transmitter underrun did not occur.</p> <p>1h = Transmitter underrun did occur. For details on McASP action upon underrun conditions, see Buffer Underrun Error - Transmitter.</p>

22.4.1.33 XSLOT Register (offset = C4h) [reset = 0h]

XSLOT is shown in [Figure 22-71](#) and described in [Table 22-44](#).

The current transmit TDM time slot register (XSLOT) indicates the current time slot for the transmit data frame.

Figure 22-71. XSLOT Register

31	30	29	28	27	26	25	24	23	22	21	20	19	18	17	16	15	14	13	12	11	10	9	8	7	6	5	4	3	2	1	0
RESERVED												XSLOTCNT																			
R-0h												R-0h																			

LEGEND: R/W = Read/Write; R = Read only; W1toCl = Write 1 to clear bit; -n = value after reset

Table 22-44. XSLOT Register Field Descriptions

Bit	Field	Type	Reset	Description
31-10	RESERVED	R	0h	
9-0	XSLOTCNT	R	0h	Current transmit time slot count. Legal values: 0 to 383 (17Fh). During reset, this counter value is 383 so the next count value, which is used to encode the first DIT group of data, will be 0 and encodes the B preamble. TDM function is not supported for >32 time slots. However, TDM time slot counter may count to 383 when used to transmit a DIT block.

22.4.1.34 XCLKCHK Register (offset = C8h) [reset = 0h]

XCLKCHK is shown in [Figure 22-72](#) and described in [Table 22-45](#).

The transmit clock check control register (XCLKCHK) configures the transmit clock failure detection circuit.

Figure 22-72. XCLKCHK Register

31	30	29	28	27	26	25	24	23	22	21	20	19	18	17	16
XCNT								XMAX							
R-0h								R/W-0h							
15	14	13	12	11	10	9	8	7	6	5	4	3	2	1	0
XMIN								RESERVED				XPS			
R/W-0h								R-0h				R/W-0h			

LEGEND: R/W = Read/Write; R = Read only; W1toCl = Write 1 to clear bit; -n = value after reset

Table 22-45. XCLKCHK Register Field Descriptions

Bit	Field	Type	Reset	Description
31-24	XCNT	R	0h	Transmit clock count value (from previous measurement). The clock circuit continually counts the number of system clocks for every 32 transmit high-frequency master clock (AHCLKX) signals, and stores the count in XCNT until the next measurement is taken.
23-16	XMAX	R/W	0h	Transmit clock maximum boundary. This 8 bit unsigned value sets the maximum allowed boundary for the clock check counter after 32 transmit high-frequency master clock (AHCLKX) signals have been received. If the current counter value is greater than XMAX after counting 32 AHCLKX signals, XCKFAIL in XSTAT is set. The comparison is performed using unsigned arithmetic.
15-8	XMIN	R/W	0h	Transmit clock minimum boundary. This 8 bit unsigned value sets the minimum allowed boundary for the clock check counter after 32 transmit high-frequency master clock (AHCLKX) signals have been received. If XCNT is less than XMIN after counting 32 AHCLKX signals, XCKFAIL in XSTAT is set. The comparison is performed using unsigned arithmetic.
7-4	RESERVED	R	0h	
3-0	XPS	R/W	0h	Transmit clock check prescaler value. Fh = Reserved from 9h to Fh. 0h = McASP system clock divided by 1. 1h = McASP system clock divided by 2. 2h = McASP system clock divided by 4. 3h = McASP system clock divided by 8. 4h = McASP system clock divided by 16. 5h = McASP system clock divided by 32. 6h = McASP system clock divided by 64. 7h = McASP system clock divided by 128. 8h = McASP system clock divided by 256. 9h = Reserved from 9h to Fh.

22.4.1.35 XEVTCTL Register (offset = CCh) [reset = 0h]

XEVTCTL is shown in [Figure 22-73](#) and described in [Table 22-46](#).

The transmitter DMA event control register (XEVTCTL) contains a disable bit for the transmit DMA event. Note for device-specific registers: Accessing XEVTCTL not implemented on a specific device may cause improper device operation.

Figure 22-73. XEVTCTL Register

31	30	29	28	27	26	25	24
RESERVED							
R-0h							
23	22	21	20	19	18	17	16
RESERVED							
R-0h							
15	14	13	12	11	10	9	8
RESERVED							
R-0h							
7	6	5	4	3	2	1	0
RESERVED							XDATDMA
R-0h							R/W-0h

LEGEND: R/W = Read/Write; R = Read only; W1toCl = Write 1 to clear bit; -n = value after reset

Table 22-46. XEVTCTL Register Field Descriptions

Bit	Field	Type	Reset	Description
31-1	RESERVED	R	0h	
0	XDATDMA	R/W	0h	Transmit data DMA request enable bit. If writing to this bit, always write the default value of 0. 0h = Transmit data DMA request is enabled. 1h = Reserved

22.4.1.36 DITCSRA_0 to DITCSRA_5 Register (offset = 100h to 114h) [reset = 0h]

DITCSRA_0 to DITCSRA_5 is shown in [Figure 22-74](#) and described in [Table 22-47](#).

The DIT left channel status registers (DITCSRA) provide the status of each left channel (even TDM time slot). Each of the six 32-bit registers can store 192 bits of channel status data for a complete block of transmission. The DIT reuses the same data for the next block. It is your responsibility to update the register file in time, if a different set of data need to be sent.

Figure 22-74. DITCSRA_0 to DITCSRA_5 Register

31	30	29	28	27	26	25	24	23	22	21	20	19	18	17	16	15	14	13	12	11	10	9	8	7	6	5	4	3	2	1	0
DITCSRA																															
R/W-0h																															

LEGEND: R/W = Read/Write; R = Read only; W1toCl = Write 1 to clear bit; -n = value after reset

Table 22-47. DITCSRA_0 to DITCSRA_5 Register Field Descriptions

Bit	Field	Type	Reset	Description
31-0	DITCSRA	R/W	0h	DIT left channel status registers.

22.4.1.37 DITCSRB_0 to DITCSRB_5 Register (offset = 118h to 12Ch) [reset = 0h]

DITCSRB_0 to DITCSRB_5 is shown in [Figure 22-75](#) and described in [Table 22-48](#).

The DIT right channel status registers (DITCSRB) provide the status of each right channel (odd TDM time slot). Each of the six 32-bit registers can store 192 bits of channel status data for a complete block of transmission. The DIT reuses the same data for the next block. It is your responsibility to update the register file in time, if a different set of data need to be sent.

Figure 22-75. DITCSRB_0 to DITCSRB_5 Register

31	30	29	28	27	26	25	24	23	22	21	20	19	18	17	16	15	14	13	12	11	10	9	8	7	6	5	4	3	2	1	0
DITCSRB																															
R/W-0h																															

LEGEND: R/W = Read/Write; R = Read only; W1toCl = Write 1 to clear bit; -n = value after reset

Table 22-48. DITCSRB_0 to DITCSRB_5 Register Field Descriptions

Bit	Field	Type	Reset	Description
31-0	DITCSRB	R/W	0h	DIT right channel status registers.

22.4.1.38 DITUDRA_0 to DITUDRA_5 Register (offset = 130h to 144h) [reset = 0h]

DITUDRA_0 to DITUDRA_5 is shown in [Figure 22-76](#) and described in [Table 22-49](#).

The DIT left channel user data registers (DITUDRA) provides the user data of each left channel (even TDM time slot). Each of the six 32-bit registers can store 192 bits of user data for a complete block of transmission. The DIT reuses the same data for the next block. It is your responsibility to update the register in time, if a different set of data need to be sent.

Figure 22-76. DITUDRA_0 to DITUDRA_5 Register

31	30	29	28	27	26	25	24	23	22	21	20	19	18	17	16	15	14	13	12	11	10	9	8	7	6	5	4	3	2	1	0
DITUDRA																															
R/W-0h																															

LEGEND: R/W = Read/Write; R = Read only; W1toCl = Write 1 to clear bit; -n = value after reset

Table 22-49. DITUDRA_0 to DITUDRA_5 Register Field Descriptions

Bit	Field	Type	Reset	Description
31-0	DITUDRA	R/W	0h	DIT left channel user data registers.

22.4.1.39 DITUDRB_0 to DITUDRB_5 Register (offset = 148h to 15Ch) [reset = 0h]

DITUDRB_0 to DITUDRB_5 is shown in [Figure 22-77](#) and described in [Table 22-50](#).

The DIT right channel user data registers (DITUDRB) provides the user data of each right channel (odd TDM time slot). Each of the six 32-bit registers can store 192 bits of user data for a complete block of transmission. The DIT reuses the same data for the next block. It is your responsibility to update the register in time, if a different set of data need to be sent.

Figure 22-77. DITUDRB_0 to DITUDRB_5 Register

31	30	29	28	27	26	25	24	23	22	21	20	19	18	17	16	15	14	13	12	11	10	9	8	7	6	5	4	3	2	1	0
DITUDRB																															
R/W-0h																															

LEGEND: R/W = Read/Write; R = Read only; W1toCl = Write 1 to clear bit; -n = value after reset

Table 22-50. DITUDRB_0 to DITUDRB_5 Register Field Descriptions

Bit	Field	Type	Reset	Description
31-0	DITUDRB	R/W	0h	DIT right channel user data registers.

22.4.1.40 SRCTL_0 to SRCTL_5 Register (offset = 180h to 194h) [reset = 0h]

SRCTL_0 to SRCTL_5 is shown in [Figure 22-78](#) and described in [Table 22-51](#).

Each serializer on the McASP has a serializer control register (SRCTL). There are up to 16 serializers per McASP. Note for device-specific registers: Accessing SRCTLn not implemented on a specific device may cause improper device operation.

Figure 22-78. SRCTL_0 to SRCTL_5 Register

31	30	29	28	27	26	25	24
RESERVED							
R-0h							
23	22	21	20	19	18	17	16
RESERVED							
R-0h							
15	14	13	12	11	10	9	8
RESERVED							
R-0h							
7	6	5	4	3	2	1	0
RESERVED		RRDY	XRDY	DISMOD		SRMOD	
R-0h		R-0h	R-0h	R/W-0h		R/W-0h	

LEGEND: R/W = Read/Write; R = Read only; W1toCl = Write 1 to clear bit; -n = value after reset

Table 22-51. SRCTL_0 to SRCTL_5 Register Field Descriptions

Bit	Field	Type	Reset	Description
31-6	RESERVED	R	0h	
5	RRDY	R	0h	Receive buffer ready bit. RRDY indicates the current receive buffer state. Always reads 0 when programmed as a transmitter or as inactive. If SRMOD bit is set to receive (2h), RRDY switches from 0 to 1 whenever data is transferred from XRSR to RBUF. 0h = Receive buffer (RBUF) is empty. 1h = Receive buffer (RBUF) contains data and needs to be read before the start of the next time slot or a receiver overrun occurs.
4	XRDY	R	0h	Transmit buffer ready bit. XRDY indicates the current transmit buffer state. Always reads 0 when programmed as a receiver or as inactive. If SRMOD bit is set to transmit (1h), XRDY switches from 0 to 1 when XSRCLR in GBLCTL is switched from 0 to 1 to indicate an empty transmitter. XRDY remains set until XSRCLR is forced to 0, data is written to the corresponding transmit buffer, or SRMOD bit is changed to receive (2h) or inactive (0). 0h = Transmit buffer (XBUF) contains data. 1h = Transmit buffer (XBUF) is empty and needs to be written before the start of the next time slot or a transmit underrun occurs.
3-2	DISMOD	R/W	0h	Serializer pin drive mode bit. Drive on pin when in inactive TDM slot of transmit mode or when serializer is inactive. This field only applies if the pin is configured as a McASP pin (PFUNC = 0). 0h = Drive on pin is 3-state. 1h = Reserved. 2h = Drive on pin is logic low. 3h = Drive on pin is logic high.

Table 22-51. SRCTL_0 to SRCTL_5 Register Field Descriptions (continued)

Bit	Field	Type	Reset	Description
1-0	SRMOD	R/W	0h	Serializer mode bit. 0h = Serializer is inactive. 1h = Serializer is transmitter. 2h = Serializer is receiver. 3h = Reserved.

22.4.1.41 XBUF_0 to XBUF_5 Register (offset = 200h to 214h) [reset = 0h]

XBUF_0 to XBUF_5 is shown in [Figure 22-79](#) and described in [Table 22-52](#).

The transmit buffers for the serializers (XBUF) hold data from the transmit format unit. For transmit operations, the XBUF is an alias of the XRBUF in the serializer. Accessing XBUF registers not implemented on a specific device may cause improper device operation.

Figure 22-79. XBUF_0 to XBUF_5 Register

31	30	29	28	27	26	25	24	23	22	21	20	19	18	17	16	15	14	13	12	11	10	9	8	7	6	5	4	3	2	1	0
XBUF																															
R/W-0h																															

LEGEND: R/W = Read/Write; R = Read only; W1toCl = Write 1 to clear bit; -n = value after reset

Table 22-52. XBUF_0 to XBUF_5 Register Field Descriptions

Bit	Field	Type	Reset	Description
31-0	XBUF	R/W	0h	Transmit buffers for serializers.

22.4.1.42 RBUF_0 to RBUF_5 Register (offset = 280h to 294h) [reset = 0h]

RBUF_0 to RBUF_5 is shown in [Figure 22-80](#) and described in [Table 22-53](#).

The receive buffers for the serializers (RBUF) hold data from the serializer before the data goes to the receive format unit. For receive operations, the RBUF is an alias of the XRBUF in the serializer. Accessing XBUF registers not implemented on a specific device may cause improper device operation.

Figure 22-80. RBUF_0 to RBUF_5 Register

31	30	29	28	27	26	25	24	23	22	21	20	19	18	17	16	15	14	13	12	11	10	9	8	7	6	5	4	3	2	1	0
RBUF																															
R/W-0h																															

LEGEND: R/W = Read/Write; R = Read only; W1toCl = Write 1 to clear bit; -n = value after reset

Table 22-53. RBUF_0 to RBUF_5 Register Field Descriptions

Bit	Field	Type	Reset	Description
31-0	RBUF	R/W	0h	Receive buffers for serializers.

22.4.1.43 WFIFOCTL Register (offset = 1000h) [reset = 0h]

WFIFOCTL is shown in [Figure 22-81](#) and described in [Table 22-54](#).

The WNUMEVT and WNUMDMA values must be set prior to enabling the Write FIFO. If the Write FIFO is to be enabled, it must be enabled prior to taking the McASP out of reset

Figure 22-81. WFIFOCTL Register

31	30	29	28	27	26	25	24
RESERVED							
R-0h							
23	22	21	20	19	18	17	16
RESERVED							WENA
R-0h							R/W-0h
15	14	13	12	11	10	9	8
WNUMEVT							
R/W-0h							
7	6	5	4	3	2	1	0
WNUMDMA							
R/W-0h							

LEGEND: R/W = Read/Write; R = Read only; W1toCl = Write 1 to clear bit; -n = value after reset

Table 22-54. WFIFOCTL Register Field Descriptions

Bit	Field	Type	Reset	Description
31-17	RESERVED	R	0h	
16	WENA	R/W	0h	Write FIFO enable bit. 0h = Write FIFO is disabled. The WLVL bit in the Write FIFO status register (WFIFOSTS) is reset to 0 and pointers are initialized, that is, the Write FIFO is flushed. 1h = Write FIFO is enabled. If Write FIFO is to be enabled, it must be enabled prior to taking McASP out of reset.
15-8	WNUMEVT	R/W	0h	Write word count per DMA event (32 bit). When the Write FIFO has space for at least WNUMEVT words of data, then an AXEVT (transmit DMA event) is generated to the host/DMA controller. This value should be set to a non-zero integer multiple of the number of serializers enabled as transmitters. This value must be set prior to enabling the Write FIFO. 40h = 3 to 64 words from 3h to 40h. FFh = Reserved from 41h to FFh. 0h = 0 words 1h = 1 word 2h = 2 words 3h = 3 to 64 words from 3h to 40h. 41h = Reserved from 41h to FFh.
7-0	WNUMDMA	R/W	0h	Write word count per transfer (32 bit words). Upon a transmit DMA event from the McASP, WNUMDMA words are transferred from the Write FIFO to the McASP. This value must equal the number of McASP serializers used as transmitters. This value must be set prior to enabling the Write FIFO. FFh = Reserved from 11h to FFh. 0h = 0 words 1h = 1 word 2h = 2 words 3h = 3-16 words from 3h to 10h. 11h = Reserved from 11h to FFh.

22.4.1.44 WFIFOSTS Register (offset = 1004h) [reset = 0h]

 WFIFOSTS is shown in [Figure 22-82](#) and described in [Table 22-55](#).

Figure 22-82. WFIFOSTS Register

31	30	29	28	27	26	25	24	23	22	21	20	19	18	17	16	15	14	13	12	11	10	9	8	7	6	5	4	3	2	1	0
RESERVED																WLVL															
R-0h																R-0h															

LEGEND: R/W = Read/Write; R = Read only; W1toCl = Write 1 to clear bit; -n = value after reset

Table 22-55. WFIFOSTS Register Field Descriptions

Bit	Field	Type	Reset	Description
31-8	RESERVED	R	0h	
7-0	WLVL	R	0h	Write level (read-only). Number of 32 bit words currently in the Write FIFO. 40h = 3 to 64 words currently in Write FIFO from 3h to 40h. FFh = Reserved from 41h to FFh. 0h = 0 words currently in Write FIFO. 1h = 1 word currently in Write FIFO. 2h = 2 words currently in Write FIFO. 3h = 3 to 64 words currently in Write FIFO from 3h to 40h. 41h = Reserved from 41h to FFh.

22.4.1.45 RFIFOCTL Register (offset = 1008h) [reset = 0h]

RFIFOCTL is shown in [Figure 22-83](#) and described in [Table 22-56](#).

The RNUMEVT and RNUMDMA values must be set prior to enabling the Read FIFO. If the Read FIFO is to be enabled, it must be enabled prior to taking the McASP out of reset

Figure 22-83. RFIFOCTL Register

31	30	29	28	27	26	25	24
RESERVED							
R-0h							
23	22	21	20	19	18	17	16
RESERVED							RENA
R-0h							R/W-0h
15	14	13	12	11	10	9	8
RNUMEVT							
R/W-0h							
7	6	5	4	3	2	1	0
RNUMDMA							
R/W-0h							

LEGEND: R/W = Read/Write; R = Read only; W1toCl = Write 1 to clear bit; -n = value after reset

Table 22-56. RFIFOCTL Register Field Descriptions

Bit	Field	Type	Reset	Description
31-17	RESERVED	R	0h	
16	RENA	R/W	0h	Read FIFO enable bit. 0h = Read FIFO is disabled. The RLVL bit in the Read FIFO status register (RFIFOSTS) is reset to 0 and pointers are initialized, that is, the Read FIFO is flushed. 1h = Read FIFO is enabled. If Read FIFO is to be enabled, it must be enabled prior to taking McASP out of reset.
15-8	RNUMEVT	R/W	0h	Read word count per DMA event (32 bit). When the Read FIFO contains at least RNUMEVT words of data, then an AREVT (receive DMA event) is generated to the host/DMA controller. This value should be set to a non-zero integer multiple of the number of serializers enabled as receivers. This value must be set prior to enabling the Read FIFO. 40h = 3 to 64 words from 3h to 40h. FFh = Reserved from 41h = FFh. 0h = 0 words 1h = 1 word 2h = 2 words 3h = 3 to 64 words from 3h to 40h. 41h = Reserved from 41h to FFh.
7-0	RNUMDMA	R/W	0h	Read word count per transfer (32 bit words). Upon a receive DMA event from the McASP, the Read FIFO reads RNUMDMA words from the McASP. This value must equal the number of McASP serializers used as receivers. This value must be set prior to enabling the Read FIFO. 10h = 3 to 16 words from 3h to 10h. FFh = Reserved from 11h to FFh. 0h = 0 words 1h = 1 word 2h = 2 words 3h = 3 to 16 words from 3h to 10h. 11h = Reserved from 11h to FFh.

22.4.1.46 RFIFOSTS Register (offset = 100Ch) [reset = 0h]

 RFIFOSTS is shown in [Figure 22-84](#) and described in [Table 22-57](#).

Figure 22-84. RFIFOSTS Register

31	30	29	28	27	26	25	24	23	22	21	20	19	18	17	16	15	14	13	12	11	10	9	8	7	6	5	4	3	2	1	0
RESERVED																RLVL															
R-0h																R-0h															

LEGEND: R/W = Read/Write; R = Read only; W1toCl = Write 1 to clear bit; -n = value after reset

Table 22-57. RFIFOSTS Register Field Descriptions

Bit	Field	Type	Reset	Description
31-8	RESERVED	R	0h	
7-0	RLVL	R	0h	Read level (read-only). Number of 32 bit words currently in the Read FIFO. 40h = 3 to 64 words currently in Read FIFO from 3h to 40h. FFh = Reserved from 41h to FFh. 0h = 0 words currently in Read FIFO. 1h = 1 word currently in Read FIFO. 2h = 2 words currently in Read FIFO. 3h = 3 to 64 words currently in Read FIFO from 3h to 40h. 41h = Reserved from 41h to FFh.

Controller Area Network (CAN)

This chapter describes the controller area network for the device.

Topic	Page
23.1 Introduction	4662
23.2 Integration	4663
23.3 Functional Description	4665
23.4 Registers	4703

23.1 Introduction

23.1.1 DCAN Features

The general features of the DCAN controller are:

- Supports CAN protocol version 2.0 part A, B (ISO 11898-1)
- Bit rates up to 1 MBit/s
- Dual clock source
- 16, 32, 64 or 128 message objects (instantiated as 64 on this device)
- Individual identifier mask for each message object
- Programmable FIFO mode for message objects
- Programmable loop-back modes for self-test operation
- Suspend mode for debug support
- Software module reset
- Automatic bus on after Bus-Off state by a programmable 32-bit timer
- Message RAM parity check mechanism
- Direct access to Message RAM during test mode
- CAN Rx / Tx pins configurable as general purpose IO pins
- Two interrupt lines (plus additional parity-error interrupt line)
- RAM initialization
- DMA support

23.1.2 Unsupported DCAN Features

The DCAN module in this device does not support GPIO pin mode. All GPIO functionality is mapped through the GPIO modules and muxed at the pins. GPIO pin control signals from the DCAN modules are not connected.

23.2 Integration

The Controller Area Network is a serial communications protocol which efficiently supports distributed realtime control with a high level of security. The DCAN module supports bitrates up to 1 Mbit/s and is compliant to the CAN 2.0B protocol specification. The core IP within DCAN is provided by Bosch.

This device includes two instantiations of the DCAN controller: DCAN0 and DCAN1. Figure 23-1 shows the DCAN module integration.

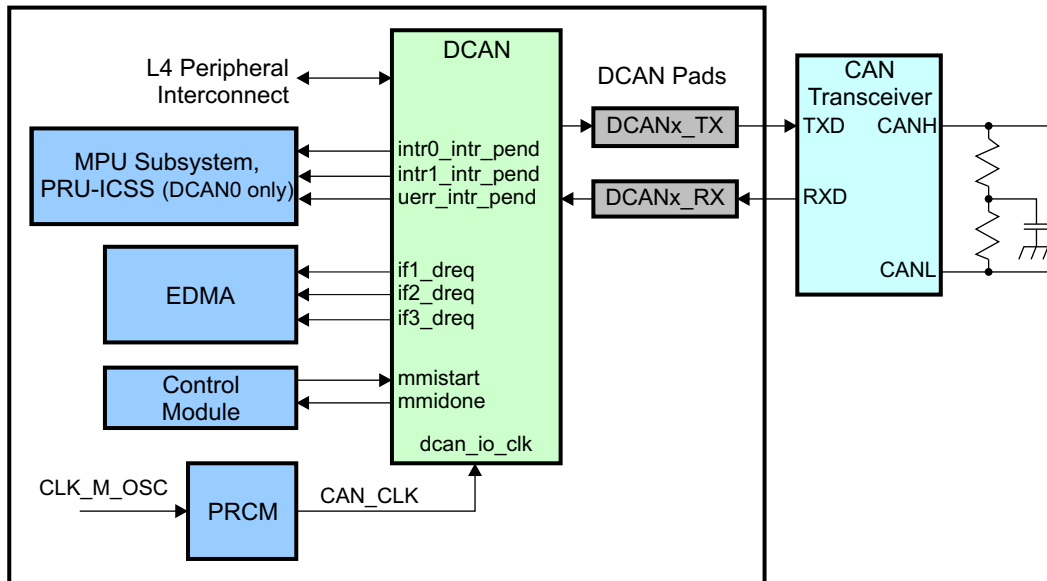


Figure 23-1. DCAN Integration

23.2.1 DCAN Connectivity Attributes

The general connectivity attributes for the DCAN module are shown in Table 23-1.

Table 23-1. DCAN Connectivity Attributes

Attributes	Type
Power Domain	Peripheral Domain
Clock Domain	PD_PER_L4LS_GCLK (OCP) PD_PER_CAN_CLK (Func)
Reset Signals	PER_DOM_RST_N
Idle/Wakeup Signals	Smart Idle
Interrupt Requests	3 Interrupts per instance Intr0 (DCANx_INT0) – Error, Status, Msg Object interrupt Intr1 (DCANx_INT1) – Msg Object interrupt Uerr (DCANx_PARITY) – Parity error interrupt All DCAN0 interrupts to MPU Subsystem and PRU-ICSS All DCAN1 interrupts to only MPU Subsystem
DMA Requests	3 DMA requests per instance to EDMA (CAN_IFxDMA)
Physical Address	L4 Peripheral slave port

23.2.2 DCAN Clock and Reset Management

The DCAN controllers have separate bus interface and functional clocks.

Table 23-2. DCAN Clock Signals

Clock Signal	Max Freq	Reference / Source	Comments
DCAN_ocp_clk Interface clock	100 MHz	CORE_CLKOUTM4 / 2	pd_per_l4ls_gclk from PRCM
DCAN_io_clk Functional clock	26 MHz	CLK_M_OSC	pd_per_can_clk from PRCM

23.2.3 DCAN Pin List

The external signals for the DCAN module are shown in the following table.

Table 23-3. DCAN Pin List

Pin	Type	Description
DCANx_TX	O	DCAN transmit line
DCANx_RX	I	DCAN receive line

23.3 Functional Description

The DCAN module performs CAN protocol communication according to ISO 11898-1. The bit rate can be programmed to values up to 1 MBit/s. Additional transceiver hardware is required for the connection to the physical layer (CAN bus).

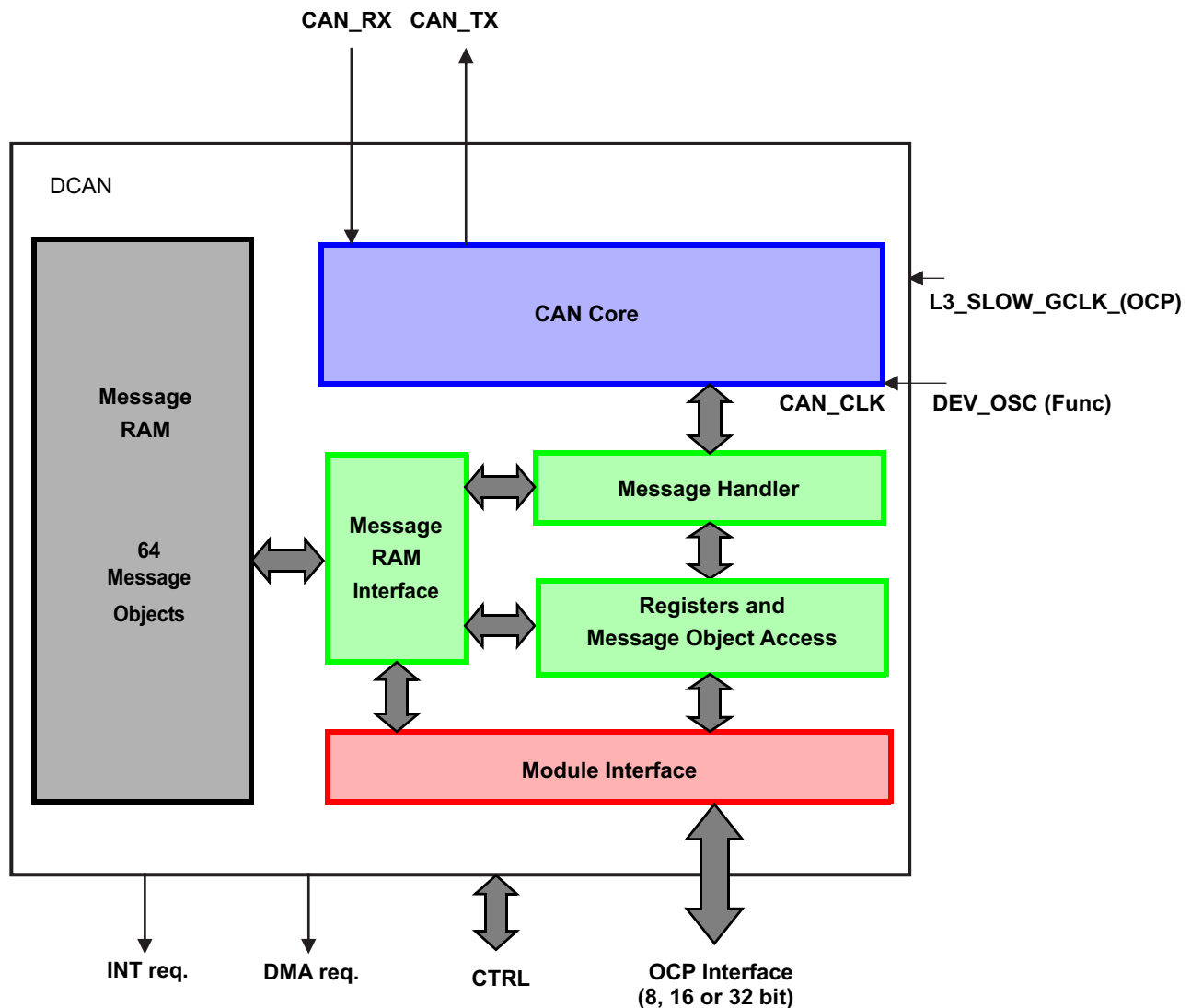
For communication on a CAN network, individual message objects can be configured. The message objects and identifier masks are stored in the message RAM.

All functions concerning the handling of messages are implemented in the message handler. Those functions are acceptance filtering, the transfer of messages between the CAN core and the message RAM, and the handling of transmission requests, as well as the generation of interrupts or DMA requests.

The register set of the DCAN module can be accessed directly by the CPU via the module interface. These registers are used to control and configure the CAN core and the message handler, and to access the message RAM.

Figure 23-2 shows the DCAN block diagram and its features are described below.

Figure 23-2. DCAN Block Diagram



23.3.1 CAN Core

The CAN core consists of the CAN protocol controller and the Rx/Tx shift register. It handles all ISO 11898-1 protocol functions.

23.3.2 Message Handler

The message handler is a state machine that controls the data transfer between the single-ported message RAM and the CAN core's Rx/Tx shift register. It also handles acceptance filtering and the interrupt/DMA request generation as programmed in the control registers.

23.3.3 Message RAM

The DCAN0 and DCAN1 enables a storage of 64 CAN messages.

23.3.4 Message RAM Interface

Three interface register sets control the CPU read and write accesses to the message RAM. There are two interface registers sets for read and write access, IF1 and IF2, and one interface register set for read access only, IF3. Additional information can be found in [Section 23.3.15.12](#).

The interface registers have the same word-length as the message RAM.

23.3.5 Registers and Message Object Access

Data consistency is ensured by indirect accesses to the message objects. During normal operation, all CPU and DMA accesses to the message RAM are done through interface registers. In a dedicated test mode, the message RAM is memory mapped and can be directly accessed by either CPU or DMA.

23.3.6 Module Interface

The DCAN module registers are accessed by the CPU or user software through a 32-bit peripheral bus interface.

23.3.7 Dual Clock Source

Two clock domains are provided to the DCAN module: the peripheral synchronous clock domain (L3_SLOW_GCLK) and the peripheral asynchronous clock source domain (CLK_M_OSC) for CAN_CLK.

23.3.8 CAN Operation

After hardware reset, the Init bit in the CAN control register (CTL) is set and all CAN protocol functions are disabled. The CAN module must be initialized before operating it. [Figure 23-3](#) illustrates the basic initialization flow for the CAN module.

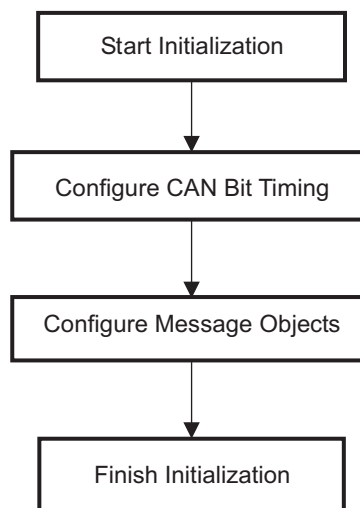
23.3.8.1 CAN Module Initialization

A general CAN module initialization would mean the following two critical steps:

- Configuration of the CAN bit timing
- Configuration of message objects

To initialize the CAN controller, the CPU has to set up the CAN bit timing and those message objects that have to be used for CAN communication. Message objects that are not needed, can be deactivated.

Figure 23-3. CAN Module General Initialization Flow



23.3.8.1.1 Configuration of CAN Bit Timing

The CAN module must be in initialization mode to configure the CAN bit timing.

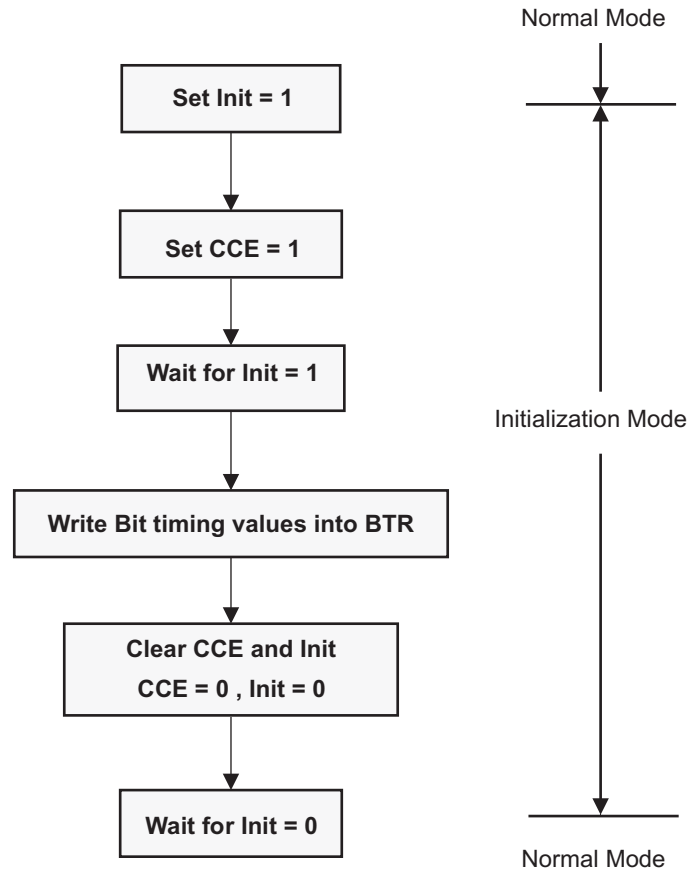
For CAN bit timing software configuration flow, see [Figure 23-4](#).

Step 1: Enter *initialization mode* by setting the Init (Initialization) bit in the CAN control register.

While the Init bit is set, the message transfer from and to the CAN bus is stopped, and the status of the CAN_TX output is recessive (high).

The CAN error counters are not updated. Setting the Init bit does not change any other configuration register.

Also, note that the CAN module is in initialization mode on hardware reset and during Bus-Off.

Figure 23-4. CAN Bit-Timing Configuration


Step 2: Set the Configure Change Enable (CCE) bit in the CAN control register.

The access to the Bit Timing register (BTR) for the configuration of the bit timing is enabled when both the Init and CCE bits in the CAN Control register are set.

Step 3: Wait for the Init bit to get set. This would make sure that the module has entered *Initialization mode*.

Step 4: Write the bit timing values into the bit timing register. See [Section 23.3.16.2](#) for the BTR value calculation for a given bit timing.

Step 5: Clear the CCE and Init bit.

Step 6: Wait for the Init bit to clear. This would ensure that the module has come out of *initialization mode*.

Following these steps, the module comes to operation by synchronizing itself to the CAN bus, provided the BTR is configured as per the CAN bus baud rate, although the message objects have to be configured before carrying out any communication.

NOTE: The module will not come out of the *initialization mode* if any incorrect BTR values are written in step 4.

NOTE: The required message objects should be configured as transmit or receive objects before the start of data transfer as explained in [Section 23.3.8.1](#).

23.3.8.1.2 Configuration of Message Objects

The message objects can be configured only through the interface registers; the CPU does not have direct access to the message object (message RAM) . Familiarize yourself with the interface register set (IFx) usage (see [Section 23.3.17](#)) and the message object structure (see [Section 23.3.18](#)) before configuring the message objects.

For more information regarding the procedure to configure the message objects, see [Section 23.3.14](#). All the message objects should be configured to particular identifiers or set to not valid before the message transfer is started. It is possible to change the configuration of message objects during normal operation (that is between data transfers).

NOTE: The message objects initialization is independent of the bit-timing configuration.

23.3.8.1.3 DCAN RAM Hardware Initialization

The memory hardware initialization for the DCAN module is enabled in the device control register (DCAN_RAMINIT) which initializes the RAM with zeros and sets parity bits accordingly. Wait for the RAMINIT_DONE bit to be set to ensure successful RAM initialization. Ensure the clock to the DCAN module is enabled before starting this initialization.

For more details on RAM hardware initialization, see [Chapter 9, Control Module](#).

23.3.8.2 CAN Message Transfer (Normal Operation)

Once the DCAN is initialized and the Init bit is reset to zero, the CAN core synchronizes itself to the CAN bus and is ready for message transfer as per the configured message objects.

The CPU may enable the interrupt lines (setting IE0 and IE1 to '1') at the same time when it clears Init and CCE. The status interrupts EIE and SIE may be enabled simultaneously.

The CAN communication can be carried out in any of the following two modes: interrupt and polling.

The interrupt register points to those message objects with IntPnd = '1'. It is updated even if the interrupt lines to the CPU are disabled (IE0/IE1 are zero).

The CPU may poll all MessageObject's NewDat and TxRqst bits in parallel from the NewData X registers and the Transmission Request X Registers (TXRQ X). Polling can be made easier if all transmit objects are grouped at the low numbers and all receive objects are grouped at the high numbers.

Received messages are stored into their appropriate message objects if they pass acceptance filtering.

The whole message (including all arbitration bits, DLC and up to eight data bytes) is stored into the message object. As a consequence (e.g., when the identifier mask is used), the arbitration bits which are masked to "don't care" may change in the message object when a received message is stored.

The CPU may read or write each message at any time via the interface registers, as the message handler guarantees data consistency in case of concurrent accesses.

If a permanent message object (arbitration and control bits set up during configuration and leaving unchanged for multiple CAN transfers) exists for the message, it is possible to only update the data bytes.

If several transmit messages should be assigned to one message object, the whole message object has to be configured before the transmission of this message is requested.

The transmission of multiple message objects may be requested at the same time. They are subsequently transmitted, according to their internal priority.

Messages may be updated or set to not valid at any time, even if a requested transmission is still pending. However, the data bytes will be discarded if a message is updated before a pending transmission has started.

Depending on the configuration of the message object, a transmission may be automatically requested by the reception of a remote frame with a matching identifier.

23.3.8.2.1 Automatic Retransmission

According to the CAN Specification (ISO11898), the DCAN provides a mechanism to automatically retransmit frames which have lost arbitration or have been disturbed by errors during transmission. The frame transmission service will not be confirmed to the user before the transmission is successfully completed.

By default, this automatic retransmission is enabled. It can be disabled by setting the disable automatic retransmission (DAR) bit in the CTL register. Further details to this mode are provided in [Section 23.3.15.3](#).

23.3.8.2.2 Auto-Bus-On

By default, after the DCAN has entered Bus-Off state, the CPU can start a Bus-Off-Recovery sequence by resetting the Init bit. If this is not done, the module will stay in Bus-Off state.

The DCAN provides an automatic Auto-Bus-On feature which is enabled by bit ABO in the CTL register. If set, the DCAN module will automatically start the Bus-Off-Recovery sequence. The sequence can be delayed by a user-defined number of L3_SLOW_GCLK cycles which can be defined in the Auto-Bus-On Time register (ABOTR).

NOTE: If the DCAN goes to Bus-Off state due to a massive occurrence of CAN bus errors, it stops all bus activities and automatically sets the Init bit. Once the Init bit has been reset by the CPU or due to the Auto-Bus-On feature, the device will wait for 129 occurrences of bus Idle (equal to $129 * 11$ consecutive recessive bits) before resuming normal operation. At the end of the Bus-Off recovery sequence, the error counters will be reset.

23.3.8.3 Test Modes

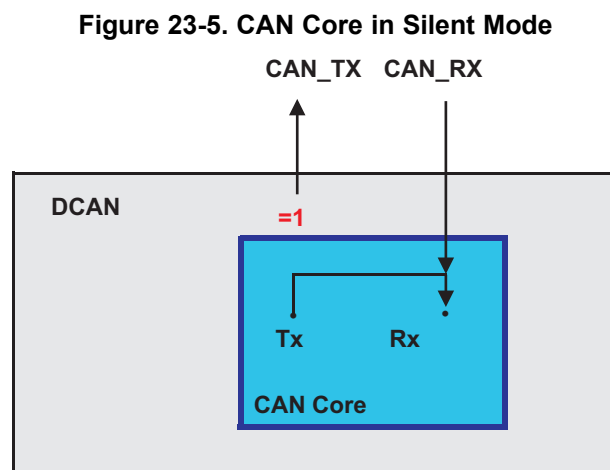
The DCAN module provides several test modes which are mainly intended for production tests or self test.

For all test modes, the Test bit in the CTL register needs to be set to one. This enables write access to the test register (TEST).

23.3.8.3.1 Silent Mode

The silent mode may be used to analyze the traffic on the CAN bus without affecting it by sending dominant bits (e.g., acknowledge bit, overload flag, active error flag). The DCAN is still able to receive valid data frames and valid remote frames, but it will not send any dominant bits. However, these are internally routed to the CAN core.

[Figure 23-5](#) shows the connection of signals CAN_TX and CAN_RX to the CAN core in silent mode. Silent mode can be activated by setting the Silent bit in the TEST register to one. In ISO 11898-1, the silent mode is called the bus monitoring mode.



23.3.8.3.2 Loopback Mode

The loopback mode is mainly intended for hardware self-test functions. In this mode, the CAN core uses internal feedback from Tx output to Rx input. Transmitted messages are treated as received messages, and can be stored into message objects if they pass acceptance filtering. The actual value of the CAN_RX input pin is disregarded by the CAN core. Transmitted messages can still be monitored at the CAN_TX pin.

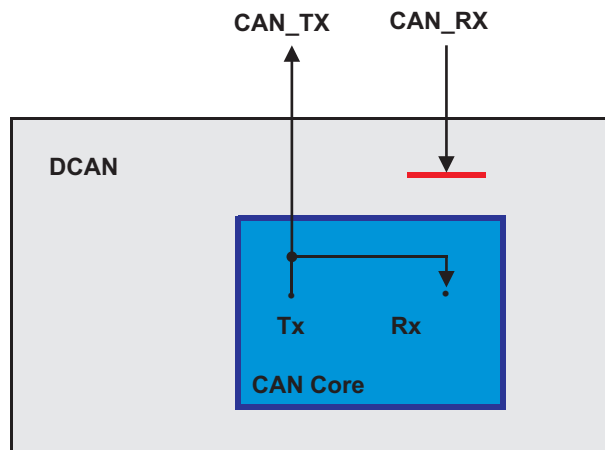
In order to be independent from external stimulation, the CAN core ignores acknowledge sampled in the acknowledge slot of a data/remote frame.

Figure 23-6 shows the connection of signals CAN_TX and CAN_RX to the CAN core in loopback mode.

Loopback mode can be activated by setting bit LBack in the TEST register to one.

NOTE: In loopback mode, the signal path from CAN core to Tx pin, the Tx pin itself, and the signal path from Tx pin back to CAN core are disregarded. For including these into the testing, see [Section 23.3.8.3.3](#).

Figure 23-6. CAN Core in Loopback Mode



23.3.8.3.3 External Loopback Mode

The external loopback mode is similar to the loopback mode; however, it includes the signal path from CAN core to Tx pin, the Tx pin itself, and the signal path from Tx pin back to CAN core. When external loopback mode is selected, the input of the CAN core is connected to the input buffer of the Tx pin.

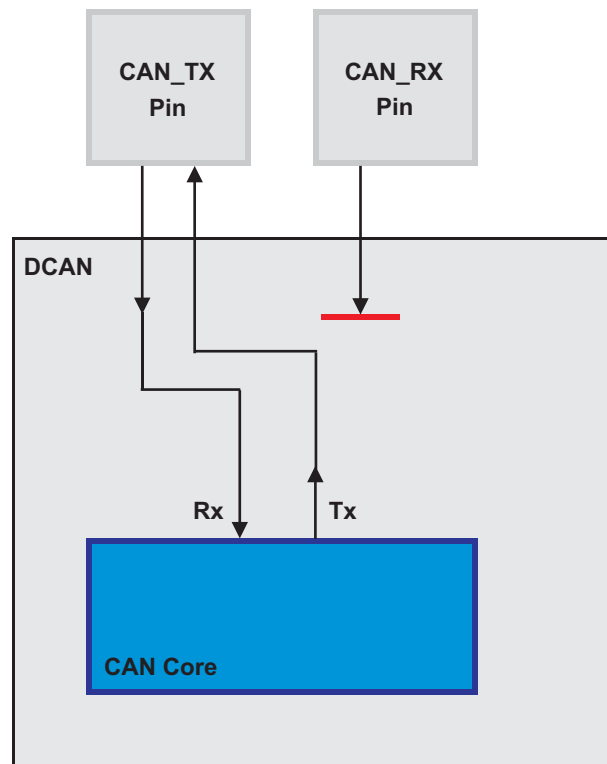
With this configuration, the Tx pin IO circuit can be tested.

External loopback mode can be activated by setting bit **EXL** in the TEST register to one.

Figure 23-7 shows the connection of signals CAN_TX and CAN_RX to the CAN core in external loopback mode.

NOTE: When loopback mode is active (LBack bit set), the ExL bit will be ignored.

Figure 23-7. CAN Core in External Loopback Mode

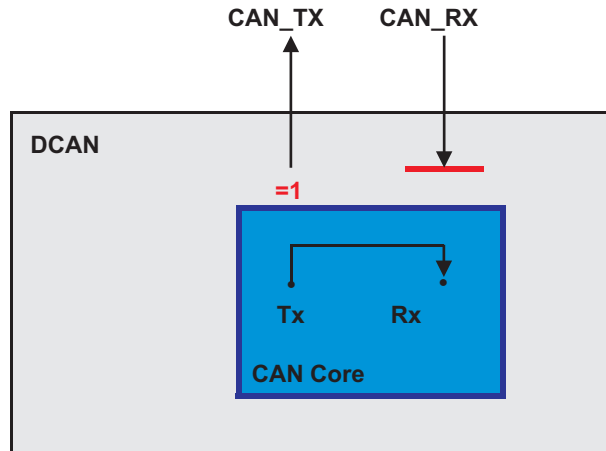


23.3.8.3.4 Loopback Mode Combined With Silent Mode

It is also possible to combine loopback mode and silent mode by setting bits LBack and Silent at the same time. This mode can be used for a “Hot Selftest,” that is, the DCAN hardware can be tested without affecting the CAN network. In this mode, the CAN_RX pin is disconnected from the CAN core and no dominant bits will be sent on the CAN_TX pin.

Figure 23-8 shows the connection of the signals CAN_TX and CAN_RX to the CAN core in case of the combination of loopback mode with silent mode.

Figure 23-8. CAN Core in Loop Back Combined With Silent Mode



23.3.8.3.5 Software Control of CAN_TX pin

Four output functions are available for the CAN transmit pin CAN_TX. In addition to its default function (serial data output), the CAN_TX pin can drive constant dominant or recessive values, or it can drive the CAN sample point signal to monitor the CAN core's bit timing.

Combined with the readable value of the CAN_RX pin, this function can be used to check the physical layer of the CAN bus.

The output mode of pin CAN_TX is selected by programming the TEST register bits Tx[1:0].

NOTE: The software control for the CAN_TX pin interferes with CAN protocol functions. For CAN message transfer or any of the test modes (loopback mode, external loopback mode or silent mode), the CAN_TX pin should operate in its default functionality.

23.3.9 Dual Clock Source

Two clock domains are provided to the DCAN module: the peripheral synchronous clock domain (L3_SLOW_GCLK) as the general module clock source, and the peripheral asynchronous clock source domain (CLK_M_OSC) provided to the CAN core (as clock source CAN_CLK) for generating the CAN bit timing.

Both clock domains can be derived from the same clock source (so that L3_SLOW_GCLK = CLK_M_OSC).

For more information on how to configure the relevant clock source registers in the system module, see [Chapter 8, Power and Clock Management](#).

Between the two clock domains, a synchronization mechanism is implemented in the DCAN module in order to ensure correct data transfer.

NOTE: If the dual clock functionality is used, then L3_SLOW_GCLK must always be higher or equal to CAN_CLK (CLK_M_OSC) (derived from the asynchronous clock source), in order to achieve a stable functionality of the DCAN. Here also the frequency shift of the modulated L3_SLOW_GCLK has to be considered:

$$f_{0, L3_SLOW_GCLK}(OCP) \pm \Delta f_{FM, L3_SLOW_GCLK}(OCP) \geq f_{CANCLK}$$

NOTE: The CAN core has to be programmed to at least 8 clock cycles per bit time. To achieve a transfer rate of 1 MBaud when using the asynchronous clock domain as the clock source for CAN_CLK (CLK_M_OSC), an oscillator frequency of 8 MHz or higher has to be used.

23.3.10 Interrupt Functionality

Interrupts can be generated on two interrupt lines: DCANINT0 and DCANINT1. These lines can be enabled by setting the IE0 and IE1 bits, respectively, in the CTL register. The interrupts are level triggered at the chip level.

The DCAN provides three groups of interrupt sources: message object interrupts, status change interrupts, and error interrupts (see [Figure 23-9](#) and [Figure 23-10](#)).

The source of an interrupt can be determined by the interrupt identifiers Int0ID/Int1ID in the interrupt register (see INT). When no interrupt is pending, the register will hold the value zero.

Each interrupt line remains active until the dedicated field (Int0ID or Int1ID) in the interrupt register (INT) again reach zero, meaning the cause of the interrupt is reset, or until IE0 or IE1 are reset.

The value 0x8000 in the Int0ID field indicates that an interrupt is pending because the CAN core has updated (not necessarily changed) the Error and Status register (ES). This interrupt has the highest priority. The CPU can update (reset) the status bits WakeUpPnd, RxOk, TxOk and LEC by reading the ES register, but a write access of the CPU will never generate or reset an interrupt.

Values between 1 and the number of the last message object indicates that the source of the interrupt is one of the message objects, Int0ID or Int1ID will point to the pending message interrupt with the highest priority. The Message Object 1 has the highest priority; the last message object has the lowest priority.

An interrupt service routine that reads the message that is the source of the interrupt may read the message and reset the message object's IntPnd at the same time (ClrIntPnd bit in the IF1CMD or IF2CMD register). When IntPnd is cleared, the interrupt register will point to the next message object with a pending interrupt.

23.3.10.1 Message Object Interrupts

Message object interrupts are generated by events from the message objects. They are controlled by the flags IntPND, TxIE and RxIE that are described in [Section 23.3.18.1](#).

Message object interrupts can be routed to either DCANINT0 or DCANINT1 line, controlled by the interrupt multiplexer register (INTMUX12 to INTMUX78).

23.3.10.2 Status Change Interrupts

The events WakeUpPnd, RxOk, TxOk and LEC in the ES register belong to the status change interrupts. The status change interrupt group can be enabled by bit in CTL register.

If SIE is set, a status change interrupt will be generated at each CAN frame, independent of bus errors or valid CAN communication, and also independent of the message RAM configuration.

Status change interrupts can only be routed to interrupt line DCAN0INT, which has to be enabled by setting the IE0 bit in the CTL register.

NOTE: Reading the error and status register will clear the WakeUpPnd flag. If in global power-down mode, the WakeUpPnd flag is cleared by such a read access before the DCAN module has been waken up by the system, the DCAN may re-assert the WakeUpPnd flag, and a second interrupt may occur.

23.3.10.3 Error Interrupts

The events PER, BOff and EWarn, monitored in the ES register, belong to the error interrupts. The error interrupt group can be enabled by setting the EIE bit in the CTL register.

Error interrupts can only be routed to interrupt line DCAN0INT, which has to be enabled by setting the IE0 bit in the CTL register.

Figure 23-9. CAN Interrupt Topology 1

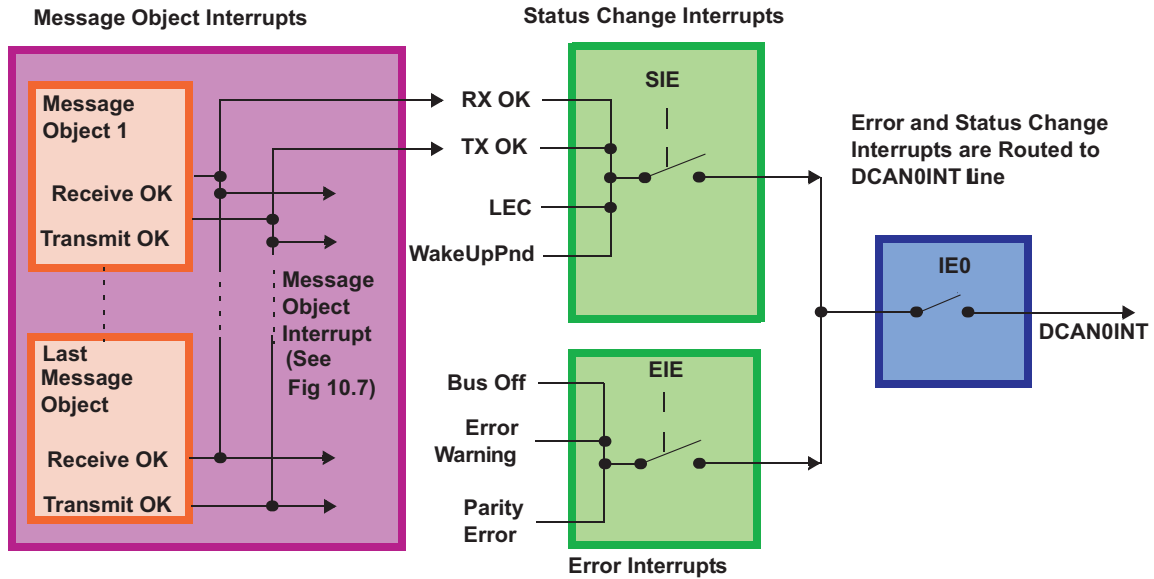
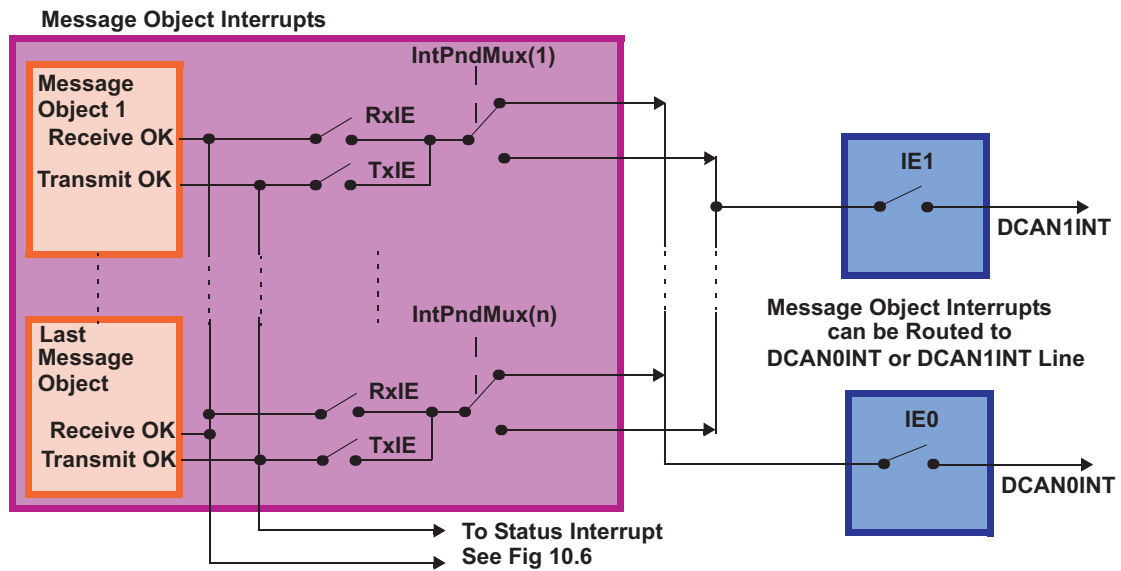


Figure 23-10. CAN Interrupt Topology 2



23.3.11 Local Power-Down Mode

The DCAN supports a local power-down mode, which can be controlled within the CTL register.

23.3.11.1 Entering Local Power-Down Mode

The local power-down mode is requested by setting the PDR bit in the CTL register.

The DCAN then finishes all transmit requests of the message objects. When all requests are done, the DCAN module waits until a bus idle state is recognized. The module will automatically set the Init bit in the CTL register to prevent any further CAN transfers, and it will also set the PDA bit in the CAN error and status register (ES). With setting the PDA bits, the DCAN module indicates that the local power-down mode has been entered.

During local power-down mode, the internal clocks of the DCAN module are turned off, but there is wakeup logic (see [Section 23.3.11.2](#)) that can be active, if enabled. Also, the actual contents of the control registers can be read back.

NOTE: In local low-power mode, the application should not clear the Init bit while PDR is set. If there are any messages in the message RAM which are configured as transmit messages and the application resets the init bit, these messages may get sent.

23.3.11.2 Wakeup From Local Power Down

There are two ways to wake up the DCAN from local power-down mode:

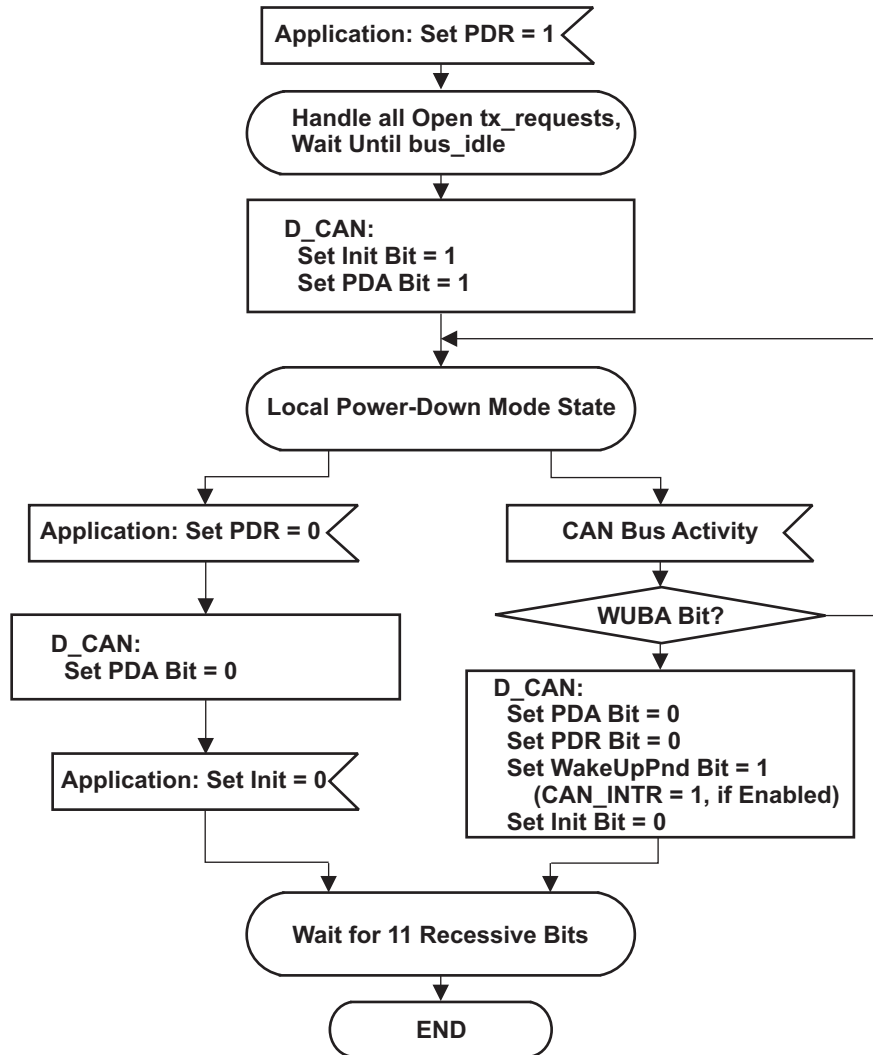
- The application could wake up the DCAN module manually by clearing the PDR bit and then clearing the Init bit in the CTL register.
- Alternatively, a CAN bus activity detection circuit can be activated by setting the wakeup on bus activity (WUBA) bit in the CTL register. If this circuit is active, on occurrence of a dominant CAN bus level, the DCAN will automatically start the wakeup sequence. It will clear the PDR bit in the CTL register and also clear the PDA bit in the error and status register. The WakeUpPnd bit in the ES register will be set. If status interrupts are enabled, also an interrupt will be generated. Finally the Init bit in the CTL register will be cleared.

After the Init bit has been cleared, the module waits until it detects 11 consecutive recessive bits on the CAN_RX pin and then goes bus-active again.

NOTE: The CAN transceiver circuit has to stay active in order to detect any CAN bus activity while the DCAN is in local power down mode. The first CAN message, which initiates the bus activity, cannot be received. This means that the first message received in power-down and automatic wake-up mode, is lost.

[Figure 23-11](#) shows a flow diagram about entering and leaving local power-down mode.

Figure 23-11. Local Power-Down Mode Flow Diagram



23.3.12 Parity Check Mechanism

The DCAN provides a parity check mechanism to ensure data integrity of message RAM data. For each word (32 bits) in message RAM, one parity bit will be calculated. The formation of the different words is according to the message RAM representation in RDA mode, see [Section 23.3.18.4](#).

Parity information is stored in the message RAM on write accesses and will be checked against the stored parity bit from message RAM on read accesses.

The Parity check functionality can be enabled or disabled by PMD bit field in the CTL register.

In case of disabled parity check, the parity bits in message RAM will be left unchanged on write access to data area and no check will be done on read access.

If parity checking is enabled, parity bits will be automatically generated and checked by the DCAN. The parity bits could be read in debug/suspend mode (see [Section 23.3.18.3](#)) or in RDA mode (see [Section 23.3.18.4](#)). However, direct write access to the parity bits is only possible in these two modes with parity check disabled.

A parity bit will be set, if the modulo-2-sum of the data bits is 1. This definition is equivalent to: The parity bit will be set, if the number of 1 bits in the data is odd.

NOTE: The parity scheme is tied to even parity at the device level.

23.3.12.1 Behavior on Parity Error

On any read access to message RAM (e.g., during start of a CAN frame transmission), the parity of the message object will be checked. If a parity error is detected, the PER bit in the ES register will be set. If error interrupts are enabled, an interrupt would also be generated. In order to avoid the transmission of invalid data over the CAN bus, the D bit of the message object will be reset.

The message object data can be read by the host CPU, independently of parity errors. Thus, the application has to ensure that the read data is valid, for example, by immediately checking the parity error code register (PERR) on parity error interrupt.

NOTE: During RAM initialization, no parity check will be done.

23.3.12.2 Parity Testing

Testing the parity mechanism can be done by enabling the bit RamDirectAccess (RDA) and manually writing the parity bits directly to the dedicated RAM locations. With this, data and parity bits could be checked when reading directly from RAM.

NOTE: If parity check was disabled, the application has to ensure correct parity bit handling in order to prevent parity errors later on when parity check is enabled.

23.3.13 Debug/Suspend Mode

The module supports the usage of an external debug unit by providing functions like pausing DCAN activities and making message RAM content accessible via OCP interface.

Before entering debug/suspend mode, the circuit will either wait until a started transmission or reception will be finished and bus idle state is recognized, or immediately interrupt a current transmission or reception. This is depending on bit IDS in the CTL register.

Afterwards, the DCAN enters debug/suspend mode, indicated by InitDbg flag in the CTL register.

During debug/suspend mode, all DCAN registers can be accessed. Reading reserved bits will return '0'. Writing to reserved bits will have no effect.

Also, the message RAM will be memory mapped. This allows the external debug unit to read the message RAM. For the memory organization, see [Section 23.3.18.3](#).

NOTE: During debug/suspend mode, the message RAM cannot be accessed via the IFx register sets.

Writing to control registers in debug/suspend mode may influence the CAN state machine and further message handling.

For debug support, the auto clear functionality of the following DCAN registers is disabled:

- ES register (clear of status flags by read)
- IF1CMD and IF2CMD (clear of DMAActive flag by read/write)

23.3.14 Configuration of Message Objects

The whole message RAM should be configured before the end of the initialization, however it is also possible to change the configuration of message objects during CAN communication.

The CAN software driver library should offer subroutines that:

- Transfer a complete message structure into a message object. (Configuration)
- Transfer the data bytes of a message into a message object and set TxRqst and NewDat. (Start a new transmission)
- Get the data bytes of a message from a message object and clear NewDat (and IntPnd). (Read received data)
- Get the complete message from a message object and clear NewDat (and IntPnd). (Read a received message, including identifier, from a message object with UMask = '1')

Parameters of the subroutines are the Message Number and a pointer to a complete message structure or to the data bytes of a message structure.

Two examples of assigning the IFx interface register sets to these subroutines are shown here:

In the first method, the tasks of the application program that may access the module are divided into two groups. Each group is restricted to the use of one of the interface register sets. The tasks of one group may interrupt tasks of the other group, but not of the same group.

In the second method, which may be a special case of the first method, there are only two tasks in the application program that access the module. A Read_Message task that uses IF2 or IF3 to get received messages from the message RAM and a Write_Message task that uses IF1 to write messages to be transmitted (or to be configured) into the message RAM. Both tasks may interrupt each other.

23.3.14.1 Configuration of a Transmit Object for Data Frames

Table 23-4 shows how a transmit object can be initialized.

Table 23-4. Initialization of a Transmit Object

MsgVal	Arb	Data	Mask	EoB	Dir	NewDat	MsgLst	RxIE	TxIE	IntPnd	RmtEn	TxRqst
1	appl.	appl.	appl.	1	1	0	0	0	appl.	0	appl.	0

The arbitration bits (ID[28:0] and Xtd bit) are given by the application. They define the identifier and type of the outgoing message. If an 11-bit identifier (standard frame) is used (Xtd = '0'), it is programmed to ID[28:18]. In this case, ID[17:0] can be ignored.

The data registers (DLC[3:0] and Data0-7) are given by the application. TxRqst and RmtEn should not be set before the data is valid.

If the TxIE bit is set, the IntPnd bit will be set after a successful transmission of the message object.

If the RmtEn bit is set, a matching received remote frame will cause the TxRqst bit to be set; the remote frame will autonomously be answered by a data frame.

The mask bits (Msk[28:0], UMask, MXtd, and MDir bits) may be used (UMask='1') to allow groups of remote frames with similar identifiers to set the TxRqst bit. The Dir bit should not be masked. For details, see Section 23.3.15.8. Identifier masking must be disabled (UMask = '0') if no remote frames are allowed to set the TxRqst bit (RmtEn = '0').

23.3.14.2 Configuration of a Transmit Object for Remote Frames

It is not necessary to configure transmit objects for the transmission of remote frames. Setting TxRqst for a receive object causes the transmission of a remote frame with the same identifier as the data frame for which this receive object is configured.

23.3.14.3 Configuration of a Single Receive Object for Data Frames

Table 23-5 shows how a receive object for data frames can be initialized.

Table 23-5. Initialization of a single Receive Object for Data Frames

MsgVal	Arb	Data	Mask	EoB	Dir	NewDat	MsgLst	RxIE	TxIE	IntPnd	RmtEn	TxRqst
1	appl.	appl.	appl.	1	0	0	0	appl.	0	0	0	0

The arbitration bits (ID[28:0] and Xtd bit) are given by the application. They define the identifier and type of accepted received messages. If an 11-bit Identifier (standard frame) is used (Xtd = '0'), it is programmed to ID[28:18]. In this case, ID[17:0] can be ignored. When a data frame with an 11-bit Identifier is received, ID[17:0] is set to '0'.

The data length code (DLC[3:0]) is given by the application. When the message handler stores a data frame in the message object, it will store the received data length code and eight data bytes. If the data length code is less than 8, the remaining bytes of the message object may be overwritten by non specified values.

The mask bits (Msk[28:0], UMask, MXtd, and MDir bits) may be used (UMask = '1') to allow groups of data frames with similar identifiers to be accepted. The Dir bit should not be masked in typical applications. If some bits of the mask bits are set to "don't care," the corresponding bits of the arbitration register will be overwritten by the bits of the stored data frame.

If the RxIE bit is set, the IntPnd bit will be set when a received data frame is accepted and stored in the message object.

If the TxRqst bit is set, the transmission of a remote frame with the same identifier as actually stored in the arbitration bits will be triggered. The content of the arbitration bits may change if the mask bits are used (UMask = '1') for acceptance filtering.

23.3.14.4 Configuration of a Single Receive Object for Remote Frames

Table 23-6 shows how a receive object for remote frames can be initialized.

Table 23-6. Initialization of a Single Receive Object for Remote Frames

MsgVal	Arb	Data	Mask	EoB	Dir	NewDat	MsgLst	RxIE	TxIE	IntPnd	RmtEn	TxRqst
1	appl.	appl.	appl.	1	1	0	0	appl.	0	0	0	0

A receive object for remote frames may be used to monitor remote frames on the CAN bus. The remote frame stored in the receive object will not trigger the transmission of a data frame. Receive objects for remote frames may be expanded to a FIFO buffer (see Section 23.3.14.5).

UMask must be set to '1.' The mask bits (Msk[28:0], UMask, MXtd, and MDir bits) may be set to "must-match" or to "don't care," to allow groups of remote frames with similar identifiers to be accepted. The Dir bit should not be masked in typical applications. For details, see Section 23.3.15.8.

The arbitration bits (ID[28:0] and Xtd bit) may be given by the application. They define the identifier and type of accepted received remote frames. If some bits of the mask bits are set to "don't care," the corresponding bits of the arbitration bits will be overwritten by the bits of the stored remote frame. If an 11-bit Identifier (standard frame) is used (Xtd = '0'), it is programmed to ID[28:18]. In this case, ID[17:0] can be ignored. When a remote frame with an 11-bit Identifier is received, ID[17:0] will be set to '0.'

The data length code (DLC[3:0]) may be given by the application. When the message handler stores a remote frame in the message object, it will store the received data length code. The data bytes of the message object will remain unchanged.

If the RxIE bit is set, the IntPnd bit will be set when a received remote frame is accepted and stored in the message object.

23.3.14.5 Configuration of a FIFO Buffer

With the exception of the EoB bit, the configuration of receive objects belonging to a FIFO buffer is the same as the configuration of a single receive object.

To concatenate multiple message objects to a FIFO buffer, the identifiers and masks (if used) of these message objects have to be programmed to matching values. Due to the implicit priority of the message objects, the message object with the lowest number will be the first message object of the FIFO buffer. The EoB bit of all message objects of a FIFO buffer except the last one have to be programmed to zero. The EoB bits of the last message object of a FIFO Buffer is set to one, configuring it as the end of the block.

23.3.15 Message Handling

When initialization is finished, the DCAN module synchronizes itself to the traffic on the CAN bus. It does acceptance filtering on received messages and stores those frames that are accepted into the designated message objects. The application has to update the data of the messages to be transmitted and to enable and request their transmission. The transmission is requested automatically when a matching remote frame is received.

The application may read messages which are received and accepted. Messages that are not read before the next messages is accepted for the same message object will be overwritten.

Messages may be read interrupt-driven or after polling of NewDat.

23.3.15.1 Message Handler Overview

The message handler state machine controls the data transfer between the Rx/Tx shift register of the CAN core and the message RAM. It performs the following tasks:

- Data transfer from message RAM to CAN core (messages to be transmitted)
- Data transfer from CAN core to the message RAM (received messages)
- Data transfer from CAN core to the acceptance filtering unit
- Scanning of message RAM for a matching message object (acceptance filtering)
- Scanning the same message object after being changed by IF1/IF2 registers when priority is the same or higher as the message the object found by last scanning
- Handling of TxRqst flags
- Handling of interrupt flags

The message handler registers contains status flags of all message objects grouped into the following topics:

- Transmission Request Flags
- New Data Flags
- Interrupt Pending Flags
- Message Valid Registers

Instead of collecting above listed status information of each message object via IFx registers separately, these message handler registers provides a fast and easy way to get an overview, for example, about all pending transmission requests.

All message handler registers are read-only.

23.3.15.2 Receive/Transmit Priority

The receive/transmit priority for the message objects is attached to the message number, not to the CAN identifier. Message object 1 has the highest priority, while the last implemented message object has the lowest priority. If more than one transmission request is pending, they are serviced due to the priority of the corresponding message object so messages with the highest priority, for example, can be placed in the message objects with the lowest numbers.

The acceptance filtering for received data frames or remote frames is also done in ascending order of message objects, so a frame that has been accepted by a message object cannot be accepted by another message object with a higher message number. The last message object may be configured to accept any data frame or remote frame that was not accepted by any other message object, for nodes that need to log the complete message traffic on the CAN bus.

23.3.15.3 Transmission of Messages in Event-Driven CAN Communication

If the shift register of the CAN core is ready for loading and if there is no data transfer between the IFx registers and message RAM, the D bits in the Message Valid register (MSGVAL12 to MSGVAL78) and the TxRqst bits in the transmission request register are evaluated. The valid message object with the highest priority pending transmission request is loaded into the shift register by the message handler and the transmission is started. The message object's NewDat bit is reset.

After a successful transmission and if no new data was written to the message object (NewDat = '0') since the start of the transmission, the TxRqst bit will be reset. If TxIE is set, IntPnd will be set after a successful transmission. If the DCAN module has lost the arbitration or if an error occurred during the transmission, the message will be retransmitted as soon as the CAN bus is free again. If meanwhile the transmission of a message with higher priority has been requested, the messages will be transmitted in the order of their priority.

If automatic retransmission mode is disabled by setting the DAR bit in the CTL register, the behavior of bits TxRqst and NewDat in the Message Control register of the interface register set is as follows:

- When a transmission starts, the TxRqst bit of the respective interface register set is reset, while bit NewDat remains set.
- When the transmission has been successfully completed, the NewDat bit is reset.

When a transmission failed (lost arbitration or error) bit NewDat remains set. To restart the transmission, the application has to set TxRqst again.

Received remote frames do not require a receive object. They will automatically trigger the transmission of a data frame, if in the matching transmit object the RmtEn bit is set.

23.3.15.4 Updating a Transmit Object

The CPU may update the data bytes of a transmit object any time via the IF1 and IF2 interface registers, neither D nor TxRqst have to be reset before the update.

Even if only part of the data bytes is to be updated, all four bytes in the corresponding IF1 or IF2 Data A register (IF1DATA or IF2DATA) or IF1 or IF2 Data B register (IF1DATB or IF2DATB) have to be valid before the content of that register is transferred to the message object. Either the CPU has to write all four bytes into the IF1/IF2 data register or the message object is transferred to the IF1/IF2 data register before the CPU writes the new data bytes.

When only the data bytes are updated, first 0x87 can be written to bits [23:16] of the IF1 and IF2 Command register (IF1CMD and IF2CMD) and then the number of the message object is written to bits [7:0] of the command register, concurrently updating the data bytes and setting TxRqst with NewDat.

To prevent the reset of TxRqst at the end of a transmission that may already be in progress while the data is updated, NewDat has to be set together with TxRqst in event driven CAN communication. For details, see [Section 23.3.15.3](#).

When NewDat is set together with TxRqst, NewDat will be reset as soon as the new transmission has started.

23.3.15.5 Changing a Transmit Object

If the number of implemented message objects is not sufficient to be used as permanent message objects only, the transmit objects may be managed dynamically. The CPU can write the whole message (arbitration, control, and data) into the interface register. The bits [23:16] of the command register can be set to 0xB7 for the transfer of the whole message object content into the message object. Neither D nor TxRqst have to be reset before this operation.

If a previously requested transmission of this message object is not completed but already in progress, it will be continued; however, it will not be repeated if it is disturbed.

To only update the data bytes of a message to be transmitted, bits [23:16] of the command register should be set to 0x87.

NOTE: After the update of the transmit object, the interface register set will contain a copy of the actual contents of the object, including the part that had not been updated.

23.3.15.6 Acceptance Filtering of Received Messages

When the arbitration and control bits (Identifier + IDE + RTR + DLC) of an incoming message are completely shifted into the shift register of the CAN core, the message handler starts the scan of the message RAM for a matching valid message object:

- The acceptance filtering unit is loaded with the arbitration bits from the CAN core shift register.
- Then the arbitration and mask bits (including MsgVal, UMask, NewDat, and EoB) of message object 1 are loaded into the acceptance filtering unit and are compared with the arbitration bits from the shift register. This is repeated for all following message objects until a matching message object is found, or until the end of the message RAM is reached.
- If a match occurs, the scanning is stopped and the message handler proceeds depending on the type of the frame (data frame or remote frame) received.

23.3.15.7 Reception of Data Frames

The message handler stores the message from the CAN core shift register into the respective message object in the message RAM. Not only the data bytes, but all arbitration bits and the data length code are stored into the corresponding message object. This ensures that the data bytes stay associated to the identifier even if arbitration mask registers are used.

The NewDat bit is set to indicate that new data (not yet seen by the CPU) has been received. The CPU should reset the NewDat bit when it reads the message object. If at the time of the reception the NewDat bit was already set, MsgLst is set to indicate that the previous data (supposedly not seen by the CPU) is lost. If the RxIE bit is set, the IntPnd bit is set, causing the interrupt register (INT) to point to this message object.

The TxRqst bit of this message object is reset to prevent the transmission of a remote frame, while the requested data frame has just been received.

23.3.15.8 Reception of Remote Frames

When a remote frame is received, three different configurations of the matching message object have to be considered:

- Dir = '1' (direction = transmit), RmtEn = '1', UMask = '1' or '0'

The TxRqst bit of this message object is set at the reception of a matching remote frame. The rest of the message object remains unchanged.

- Dir = '1' (direction = transmit), RmtEn = '0', UMask = '0'

The remote frame is ignored, this message object remains unchanged.

- Dir = '1' (direction = transmit), RmtEn = '0', UMask = '1'

The remote frame is treated similar to a received data frame. At the reception of a matching Remote Message Frame, the TxRqst bit of this message object is reset. The arbitration and control bits (Identifier + IDE + RTR + DLC) from the shift register are stored in the message object in the message RAM and the NewDat bit of this message object is set. The data bytes of the message object remain unchanged.

23.3.15.9 Reading Received Messages

The CPU may read a received message any time via the IFx interface register. The data consistency is guaranteed by the message handler state machine. Typically the CPU will write first 0x7F to bits [23:16] and then the number of the message object to bits [7:0] of the command register. That combination will transfer the entire received message from the message RAM into the interface register set. Additionally, the bits NewDat and IntPnd are cleared in the message RAM (not in the interface register set). The values of these bits in the message control register always reflect the status before resetting the bits. If the message object uses masks for acceptance filtering, the arbitration bits show which of the different matching messages has been received.

The actual value of NewDat shows whether a new message has been received since last time when this message object was read. The actual value of MsgLst shows whether more than one message has been received since the last time when this message object was read. MsgLst will not be automatically reset.

23.3.15.10 Requesting New Data for a Receive Object

By means of a remote frame, the CPU may request another CAN node to provide new data for a receive object. Setting the TxRqst bit of a receive object will cause the transmission of a remote frame with the identifier of the receive object. This remote frame triggers the other CAN node to start the transmission of the matching data frame. If the matching data frame is received before the remote frame could be transmitted, the TxRqst bit is automatically reset. Setting the TxRqst bit without changing the contents of a message object requires the value 0x84 in bits [23:16] of the IFxCMD register.

23.3.15.11 Storing Received Messages in FIFO Buffers

Several message objects may be grouped to form one or more FIFO buffers. Each FIFO buffer configured to store received messages with a particular (group of) identifier(s). Arbitration and mask registers of the FIFO buffer's message objects are identical. The end of buffer (EoB) bits of all but the last of the FIFO buffer's message objects are '0'; in the last one the EoB bit is '1.'

Received messages with identifiers matching to a FIFO buffer are stored into a message object of this FIFO buffer, starting with the message object with the lowest message number. When a message is stored into a message object of a FIFO buffer, the NewDat bit of this message object is set. By setting NewDat while EoB is '0', the message object is locked for further write accesses by the message handler until the CPU has cleared the NewDat bit.

Messages are stored into a FIFO buffer until the last message object of this FIFO buffer is reached. If none of the preceding message objects is released by writing NewDat to '0,' all further messages for this FIFO buffer will be written into the last message object of the FIFO buffer (EoB = '1') and therefore overwrite previous messages in this message object.

23.3.15.12 Reading From a FIFO Buffer

Several messages may be accumulated in a set of message objects which are concatenated to form a FIFO buffer before the application program is required (in order to avoid the loss of data) to empty the buffer.

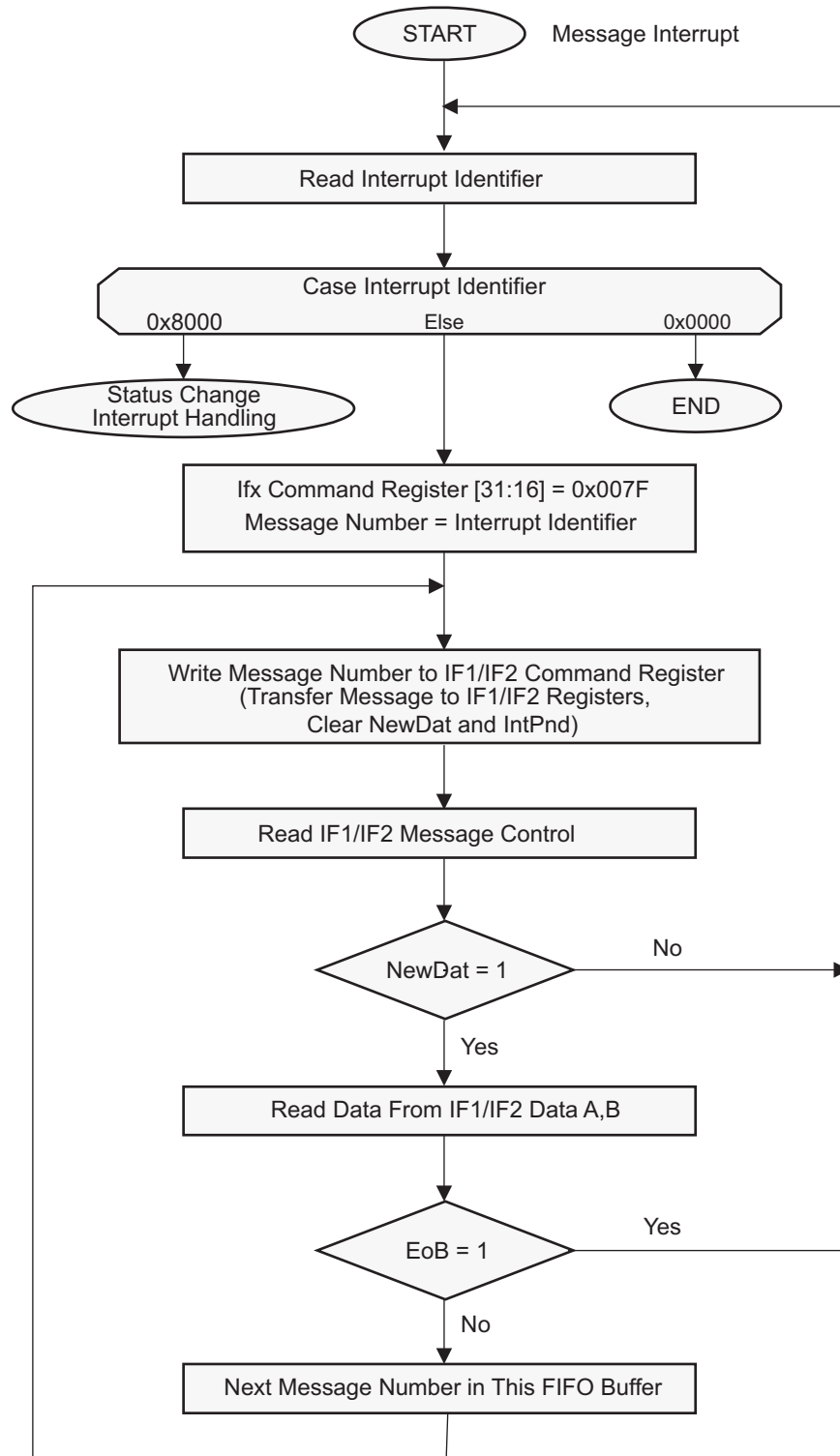
A FIFO buffer of length N will store $N-1$ plus the last received message since last time it was cleared.

A FIFO buffer is cleared by reading and resetting the NewDat bits of all its message objects, starting at the FIFO Object with the lowest message number. This should be done in a subroutine following the example shown in [Figure 23-12](#).

NOTE: All message objects of a FIFO buffer need to be read and cleared before the next batch of messages can be stored. Otherwise, true FIFO functionality can not be guaranteed, since the message objects of a partly read buffer will be re-filled according to the normal (descending) priority.

Reading from a FIFO buffer message object and resetting its NewDat bit is handled the same way as reading from a single message object.

Figure 23-12. CPU Handling of a FIFO Buffer (Interrupt Driven)



23.3.16 CAN Bit Timing

The DCAN supports bit rates between less than 1 kBit/s and 1000 kBit/s.

Each member of the CAN network has its own clock generator, typically derived from a crystal oscillator. The bit timing parameters can be configured individually for each CAN node, creating a common bit rate even though the CAN nodes' oscillator periods (f_{osc}) may be different.

The frequencies of these oscillators are not absolutely stable. Small variations are caused by changes in temperature or voltage and by deteriorating components. As long as the variations remain inside a specific oscillator tolerance range (df), the CAN nodes are able to compensate for the different bit rates by resynchronizing to the bit stream.

In many cases, the CAN bit synchronization will amend a faulty configuration of the CAN bit timing to such a degree that only occasionally an error frame is generated. In the case of arbitration however, when two or more CAN nodes simultaneously try to transmit a frame, a misplaced sample point may cause one of the transmitters to become error passive.

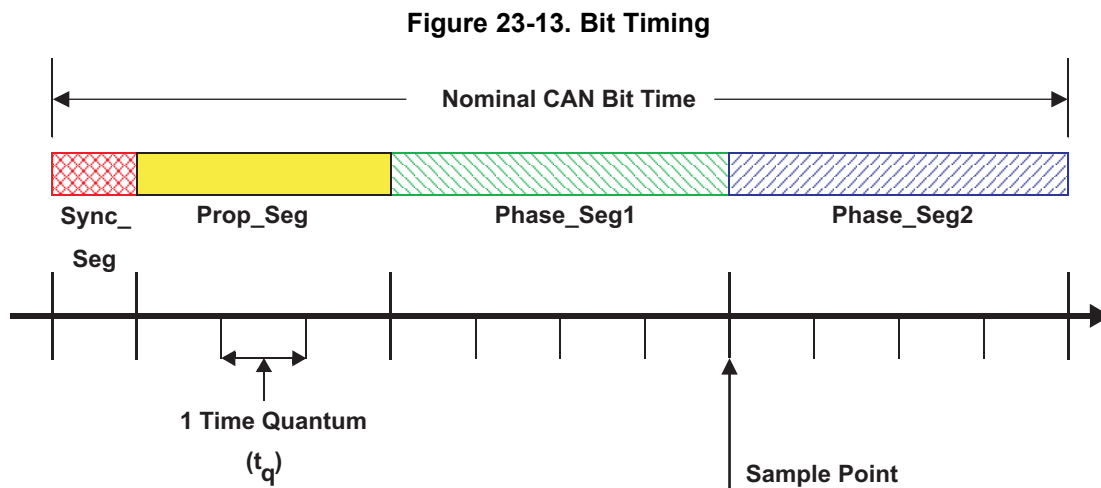
The analysis of such sporadic errors requires a detailed knowledge of the CAN bit synchronization inside a CAN node and of the CAN nodes' interaction on the CAN bus.

Even if minor errors in the configuration of the CAN bit timing do not result in immediate failure, the performance of a CAN network can be reduced significantly.

23.3.16.1 Bit Time and Bit Rate

According to the CAN specification, the bit time is divided into four segments (see [Figure 23-13](#)):

- Synchronization segment (Sync_Seg)
- Propagation time segment (Prop_Seg)
- Phase buffer segment 1 (Phase_Seg1)
- Phase buffer segment 2 (Phase_Seg2)



Each segment consists of a specific number of time quanta. The length of one time quantum (t_q), which is the basic time unit of the bit time, is given by the CAN_CLK and the baud rate prescalers (BRPE and BRP). With these two baud rate prescalers combined, divider values from 1 to 1024 can be programmed:

$$t_q = \text{Baud Rate Prescaler} / \text{CAN_CLK}$$

Apart from the fixed length of the synchronization segment, these numbers are programmable. [Table 23-7](#) describes the minimum programmable ranges required by the CAN protocol.

A given bit rate may be met by different bit time configurations.

Table 23-7. Parameters of the CAN Bit Time

Parameter	Range	Remark
Sync_Seg	1 t_q (fixed)	Synchronization of bus input to CAN_CLK
Prop_Seg	[1 8] t_q	Compensates for the physical delay times
Phase_Seg1	[1 8] t_q	May be lengthened temporarily by synchronization
Phase_Seg2	[1 8] t_q	May be shortened temporarily by synchronization
Synchronization Jump Width (SJW)	[1 4] t_q	May not be longer than either Phase Buffer Segment

NOTE: For proper functionality of the CAN network, the physical delay times and the oscillator's tolerance range have to be considered.

23.3.16.1.1 Synchronization Segment

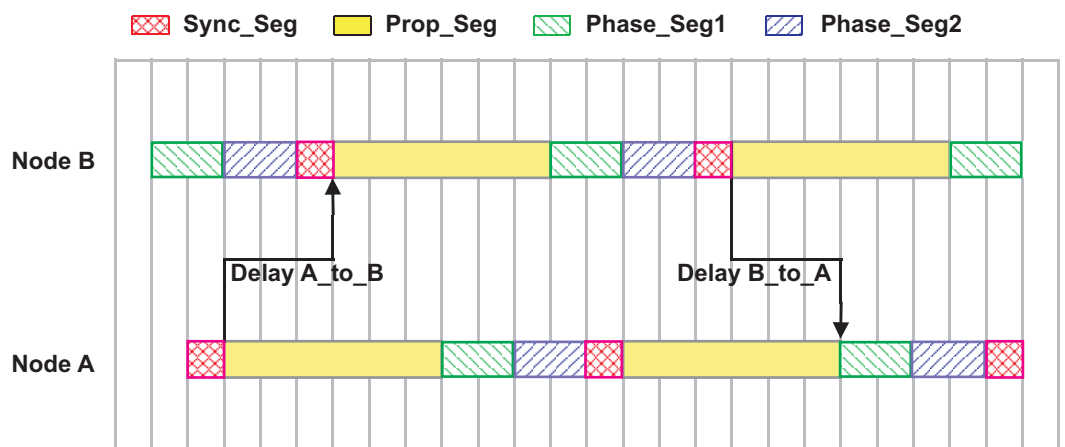
The synchronization segment (Sync_Seg) is the part of the bit time where edges of the CAN bus level are expected to occur. If an edge occurs outside of Sync_Seg, its distance to the Sync_Seg is called the phase error of this edge.

23.3.16.1.2 Propagation Time Segment

This part of the bit time is used to compensate physical delay times within the CAN network. These delay times consist of the signal propagation time on the bus and the internal delay time of the CAN nodes.

Any CAN node synchronized to the bit stream on the CAN bus can be out of phase with the transmitter of the bit stream, caused by the signal propagation time between the two nodes. The CAN protocol's nondestructive bitwise arbitration and the dominant acknowledge bit provided by receivers of CAN messages require that a CAN node transmitting a bit stream must also be able to receive dominant bits transmitted by other CAN nodes that are synchronized to that bit stream. The example in [Figure 23-14](#) shows the phase shift and propagation times between two CAN nodes.

Figure 23-14. The Propagation Time Segment



$$\text{Delay A_to_B} \geq \text{node output delay(A)} + \text{bus line delay(A/B)} + \text{node input delay(B)}$$

$$\text{Prop_Seg} \geq \text{Delay A_to_B} + \text{Delay B_to_A}$$

$$\text{Prop_Seg} \geq 2 \cdot [\max(\text{node output delay}, \text{bus line delay} + \text{node input delay})]$$

In this example, both nodes A and B are transmitters performing an arbitration for the CAN bus. The node A has sent its start of frame bit less than one bit time earlier than node B, therefore node B has synchronized itself to the received edge from recessive to dominant. Since node B has received this edge delay(A_to_B) after it has been transmitted, node B's bit timing segments are shifted with regard to node A. Node B sends an identifier with higher priority and so it will win the arbitration at a specific identifier bit when it transmits a dominant bit while node A transmits a recessive bit. The dominant bit transmitted by node B will arrive at node A after the delay (B_to_A).

Due to oscillator tolerances, the actual position of node A's sample point can be anywhere inside the nominal range of node A's Phase Buffer Segments, so the bit transmitted by node B must arrive at node A before the start of Phase_Seg1. This condition defines the length of Prop_Seg.

If the edge from recessive to dominant transmitted by node B would arrive at node A after the start of Phase_Seg1, it could happen that node A samples a recessive bit instead of a dominant bit, resulting in a bit error and the destruction of the current frame by an error flag.

This error only occurs when two nodes arbitrate for the CAN bus which have oscillators of opposite ends of the tolerance range and are separated by a long bus line; this is an example of a minor error in the bit timing configuration (Prop_Seg too short) that causes sporadic bus errors.

Some CAN implementations provide an optional 3 Sample Mode. The DCAN does not. In this mode, the CAN bus input signal passes a digital low-pass filter, using three samples and a majority logic to determine the valid bit value. This results in an additional input delay of $1 t_q$, requiring a longer Prop_Seg.

23.3.16.1.3 Phase Buffer Segments and Synchronization

The phase buffer segments (Phase_Seg1 and Phase_Seg2) and the synchronization jump width (SJW) are used to compensate for the oscillator tolerance.

The phase buffer segments surround the sample point and may be lengthened or shortened by synchronization.

The synchronization jump width (SJW) defines how far the resynchronizing mechanism may move the sample point inside the limits defined by the phase buffer segments to compensate for edge phase errors.

Synchronizations occur on edges from recessive to dominant. Their purpose is to control the distance between edges and sample points.

Edges are detected by sampling the actual bus level in each time quantum and comparing it with the bus level at the previous sample point. A synchronization may be done only if a recessive bit was sampled at the previous sample point and if the actual time quantum's bus level is dominant.

An edge is synchronous if it occurs inside of Sync_Seg; otherwise, its distance to the Sync_Seg is the edge phase error, measured in time quanta. If the edge occurs before Sync_Seg, the phase error is negative, else it is positive.

Two types of synchronization exist: hard synchronization and resynchronizing. A hard synchronization is done once at the start of a frame; inside a frame, only resynchronization is possible.

- **Hard Synchronization**

After a hard synchronization, the bit time is restarted with the end of Sync_Seg, regardless of the edge phase error. Thus hard synchronization forces the edge which has caused the hard synchronization, to lie within the synchronization segment of the restarted bit time.

- **Bit Resynchronizations**

Resynchronization leads to a shortening or lengthening of the Bit time such that the position of the sample point is shifted with regard to the edge.

When the phase error of the edge which causes resynchronization is positive, Phase_Seg1 is lengthened. If the magnitude of the phase error is less than SJW, Phase_Seg1 is lengthened by the magnitude of the phase error, else it is lengthened by SJW.

When the phase error of the edge which causes Resynchronization is negative, Phase_Seg2 is shortened. If the magnitude of the phase error is less than SJW, Phase_Seg2 is shortened by the magnitude of the phase error, else it is shortened by SJW.

If the magnitude of the phase error of the edge is less than or equal to the programmed value of SJW, the results of hard synchronization and resynchronization are the same. If the magnitude of the phase error is larger than SJW, the resynchronization cannot compensate the phase error completely, and an error of (phase error - SJW) remains.

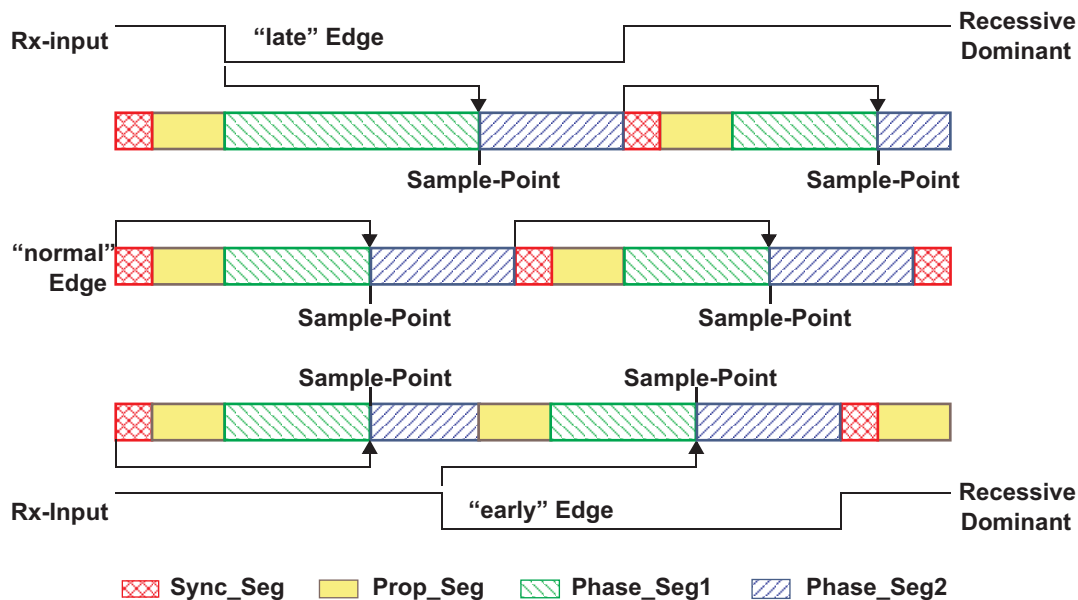
Only one synchronization may be done between two sample points. The synchronizations maintain a minimum distance between edges and sample points, giving the bus level time to stabilize and filtering out spikes that are shorter than (Prop_Seg + Phase_Seg1).

Apart from noise spikes, most synchronizations are caused by arbitration. All nodes synchronize “hard” on the edge transmitted by the “leading” transceiver that started transmitting first, but due to propagation delay times, they cannot become ideally synchronized. The leading transmitter does not necessarily win the arbitration; therefore, the receivers have to synchronize themselves to different transmitters that subsequently take the lead and that are differently synchronized to the previously leading transmitter. The same happens at the acknowledge field, where the transmitter and some of the receivers will have to synchronize to that receiver that takes the lead in the transmission of the dominant acknowledge bit.

Synchronizations after the end of the arbitration will be caused by oscillator tolerance, when the differences in the oscillator’s clock periods of transmitter and receivers sum up during the time between synchronizations (at most ten bits). These summarized differences may not be longer than the SJW, limiting the oscillator’s tolerance range.

Figure 23-15 shows how the phase buffer segments are used to compensate for phase errors. There are three drawings of each two consecutive bit timings. The upper drawing shows the synchronization on a “late” edge, the lower drawing shows the synchronization on an “early” edge, and the middle drawing is the reference without synchronization.

Figure 23-15. Synchronization on Late and Early Edges



In the first example, an edge from recessive to dominant occurs at the end of Prop_Seg. The edge is “late” since it occurs after the Sync_Seg. Reacting to the late edge, Phase_Seg1 is lengthened so that the distance from the edge to the sample point is the same as it would have been from the Sync_Seg to the sample point if no edge had occurred. The phase error of this late edge is less than SJW, so it is fully compensated and the edge from dominant to recessive at the end of the bit, which is one nominal bit time long, occurs in the Sync_Seg.

In the second example, an edge from recessive to dominant occurs during Phase_Seg2. The edge is “early” since it occurs before a Sync_Seg. Reacting to the early edge, Phase_Seg2 is shortened and Sync_Seg is omitted, so that the distance from the edge to the sample point is the same as it would have been from a Sync_Seg to the sample point if no edge had occurred. As in the previous example, the magnitude of this early edge’s phase error is less than SJW, so it is fully compensated.

The phase buffer segments are lengthened or shortened temporarily only; at the next bit time, the segments return to their nominal programmed values.

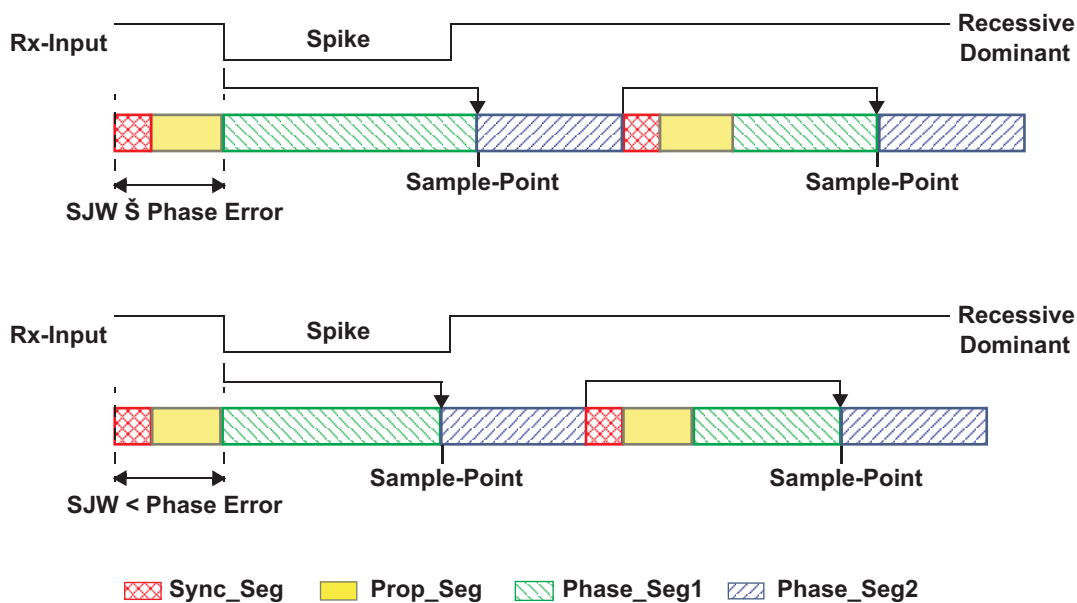
In these examples, the bit timing is seen from the point of view of the CAN implementation's state machine, where the bit time starts and ends at the sample points. The state machine omits Sync_Seg when synchronizing on an early edge because it cannot subsequently redefine that time quantum of Phase_Seg2 where the edge occurs to be the Sync_Seg.

Figure 23-16 shows how short dominant noise spikes are filtered by synchronizations. In both examples, the spike starts at the end of Prop_Seg and has the length of (Prop_Seg + Phase_Seg1).

In the first example, the synchronization jump width is greater than or equal to the phase error of the spike's edge from recessive to dominant. Therefore the sample point is shifted after the end of the spike; a recessive bus level is sampled.

In the second example, SJW is shorter than the phase error, so the sample point cannot be shifted far enough; the dominant spike is sampled as actual bus level.

Figure 23-16. Filtering of Short Dominant Spikes



23.3.16.1.4 Oscillator Tolerance Range

With the introduction of CAN protocol version 1.2, the option to synchronize on edges from dominant to recessive became obsolete. Only edges from recessive to dominant are considered for synchronization. The protocol update to version 2.0 (A and B) had no influence on the oscillator tolerance.

The tolerance range df for an oscillator's frequency f_{osc} around the nominal frequency f_{nom} with:

$$(1 - df) \cdot f_{nom} \leq f_{osc} \leq (1 + df) \cdot f_{nom}$$

depends on the proportions of Phase_Seg1, Phase_Seg2, SJW, and the bit time. The maximum tolerance df is defined by two conditions (both shall be met):

$$I: df \leq \frac{\min(TSeg1, TSeg2)}{2x(13x(bit_time - TSeg2))}$$

$$II: df \leq \frac{SJW}{20xbit_time}$$

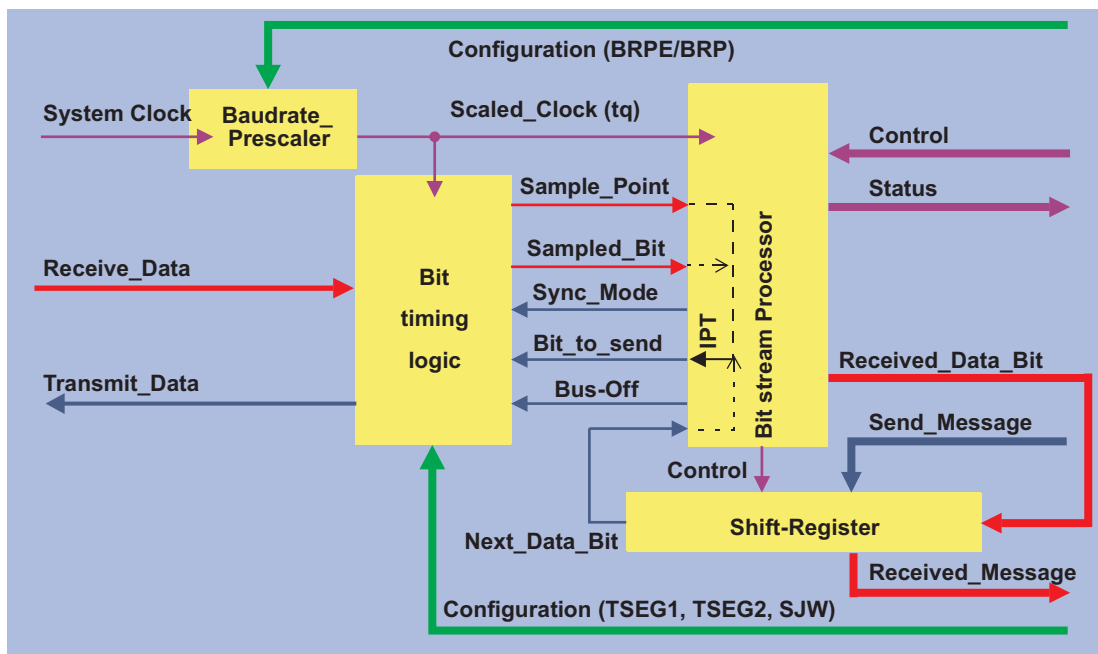
It has to be considered that SJW may not be larger than the smaller of the phase buffer segments and that the propagation time segment limits that part of the bit time that may be used for the phase buffer segments.

The combination Prop_Seg = 1 and Phase_Seg1 = Phase_Seg2 = SJW = 4 allows the largest possible oscillator tolerance of 1.58%. This combination with a propagation time segment of only 10% of the bit time is not suitable for short bit times; it can be used for bit rates of up to 125 kBit/s (bit time = 8 μ s) with a bus length of 40 m.

23.3.16.2 DCAN Bit Timing Registers

In the DCAN, the bit timing configuration is programmed in two register bytes, additionally a third byte for a baud rate prescaler extension of four bits (BRPE) is provided. The sum of Prop_Seg and Phase_Seg1 (as TSEG1) is combined with Phase_Seg2 (as TSEG2) in one byte, SJW and BRP (plus BRPE in third byte) are combined in the other byte (see Figure 23-17).

Figure 23-17. Structure of the CAN Core's CAN Protocol Controller



In this bit timing register, the components TSEG1, TSEG2, SJW and BRP have to be programmed to a numerical value that is one less than its functional value; so instead of values in the range of [1 n], values in the range of [0 -1] are programmed. That way, e.g., SJW (functional range of [1 4]) is represented by only two bits.

Therefore, the length of the bit time is (programmed values) $[TSEG1 + TSEG2 + 3] t_q$ or (functional values) $[Sync_Seg + Prop_Seg + Phase_Seg1 + Phase_Seg2] t_q$.

The data in the bit timing register (BTR) is the configuration input of the CAN protocol controller. The baud rate prescaler (configured by BRPE/BRP) defines the length of the time quantum (the basic time unit of the bit time); the bit timing logic (configured by TSEG1, TSEG2, and SJW) defines the number of time quanta in the bit time.

The processing of the bit time, the calculation of the position of the sample point, and occasional synchronizations are controlled by the bit timing state machine, which is evaluated once each time quantum. The rest of the CAN protocol controller, the bit stream processor (BSP) state machine, is evaluated once each bit time, at the sample point.

The shift register serializes the messages to be sent and parallelizes received messages. Its loading and shifting is controlled by the BSP. The BSP translates messages into frames and vice versa. It generates and discards the enclosing fixed format bits, inserts and extracts stuff bits, calculates and checks the CRC code, performs the error management, and decides which type of synchronization is to be used. It is evaluated at the sample point and processes the sampled bus input bit. The time after the sample point that is needed to calculate the next bit to be sent (e.g., data bit, CRC bit, stuff bit, error flag, or idle) is called the information processing time (IPT), which is 0 t_q for the DCAN.

Generally, the IPT is CAN controller-specific, but may not be longer than $2 t_q$. The IPC length is the lower limit of the programmed length of Phase_Seg2. In case of a synchronization, Phase_Seg2 may be shortened to a value less than IPT, which does not affect bus timing.

23.3.16.2.1 Calculation of the Bit Timing Parameters

Usually, the calculation of the bit timing configuration starts with a desired bit rate or bit time. The resulting bit time ($1 / \text{Bit rate}$) must be an integer multiple of the CAN clock period.

NOTE: 8 MHz is the minimum CAN clock frequency required to operate the DCAN at a bit rate of 1 MBit/s.

The bit time may consist of 8 to 25 time quanta. The length of the time quantum t_q is defined by the baud rate prescaler with $t_q = (\text{Baud Rate Prescaler}) / \text{CAN_CLK}$. Several combinations may lead to the desired bit time, allowing iterations of the following steps.

First part of the bit time to be defined is the Prop_Seg. Its length depends on the delay times measured in the system. A maximum bus length as well as a maximum node delay has to be defined for expandible CAN bus systems. The resulting time for Prop_Seg is converted into time quanta (rounded up to the nearest integer multiple of t_q).

The Sync_Seg is $1 t_q$ long (fixed), leaving $(\text{bit time} - \text{Prop_Seg} - 1) t_q$ for the two Phase Buffer Segments. If the number of remaining t_q is even, the Phase Buffer Segments have the same length, Phase_Seg2 = Phase_Seg1, else Phase_Seg2 = Phase_Seg1 + 1.

The minimum nominal length of Phase_Seg2 has to be regarded as well. Phase_Seg2 may not be shorter than any CAN controller's Information Processing Time in the network, which is device dependent and can be in the range of $[0 \quad 2] t_q$.

The length of the synchronization jump width is set to its maximum value, which is the minimum of four (4) and Phase_Seg1.

The oscillator tolerance range necessary for the resulting configuration is calculated by the formulas given in [Section 23.3.16.2.3](#).

If more than one configurations are possible to reach a certain Bit rate, it is recommended to choose the configuration which allows the highest oscillator tolerance range.

CAN nodes with different clocks require different configurations to come to the same bit rate. The calculation of the propagation time in the CAN network, based on the nodes with the longest delay times, is done once for the whole network.

The CAN system's oscillator tolerance range is limited by the node with the lowest tolerance range.

The calculation may show that bus length or bit rate have to be decreased or that the oscillator frequencies' stability has to be increased in order to find a protocol compliant configuration of the CAN bit timing.

The resulting configuration is written into the bit timing register:

$T\text{seg}2 = \text{Phase_Seg}2 - 1$

$T\text{seg}1 = \text{Phase_Seg}1 + \text{Prop_Seg} - 1$

$\text{SJW} = \text{SynchronizationJumpWidth} - 1$

$\text{BRP} = \text{Prescaler} - 1$

23.3.16.2.2 Example for Bit Timing at High Baud Rate

In this example, the frequency of CAN_CLK is 10 MHz, BRP is 0, the bit rate is 1 MBit/s.

t_q	100 ns	=	t_{CAN_CLK}
delay of bus driver	60 ns	=	
delay of receiver circuit	40 ns	=	
delay of bus line (40 m)	220 ns	=	
t_{Prop}	700 ns	=	$INT(2 \cdot \text{delays} + 1) = 7 \cdot t_q$
t_{SJW}	100 ns	=	$1 \cdot t_q$
t_{TSeg1}	800 ns	=	$t_{Prop} + t_{SJW}$
t_{TSeg2}	100 ns	=	Information Processing Time + $1 \cdot t_q$
$t_{Sync-Seg}$	100 ns	=	$1 \cdot t_q$
bit time	1000 ns	=	$t_{Sync-Seg} + t_{TSeg1} + t_{TSeg2}$
tolerance for CAN_CLK	0.43 %	=	$\frac{(\min(TSeg1, TSeg2))}{2x(13x(\text{bit_time} - TSeg2))}$
		=	$\frac{0.1 \mu s}{2x(13x(1 \mu s - 0.1 \mu s))}$

In this example, the concatenated bit time parameters are $(1-1)_3 \& (8-1)_4 \& (1-1)_2 \& (1-1)_6$, so the bit timing register is programmed to = 00000700.

23.3.16.2.3 Example for Bit Timing at Low Baud Rate

In this example, the frequency of CAN_CLK is 2 MHz, BRP is 1, the bit rate is 100 KBit/s.

t_q	1 μs	=	t_{CAN_CLK}
Delay of bus driver	200 ns	=	
Delay of receiver circuit	80 ns	=	
Delay of bus line (40 m)	220 ns	=	
t_{Prop}	1 μs	=	$1 \cdot t_q$
t_{SJW}	4 μs	=	$4 \cdot t_q$
t_{TSeg1}	5 μs	=	$t_{Prop} + t_{SJW}$
t_{TSeg2}	3 μs	=	Information Processing Time + $3 \cdot t_q$
$t_{Sync-Seg}$	1 μs	=	$1 \cdot t_q$
Bit time	9 μs	=	$t_{Sync-Seg} + t_{TSeg1} + t_{TSeg2}$
Tolerance for CAN_CLK		=	$\frac{(\min(TSeg1, TSeg2))}{2x(13x(\text{bit_time} - TSeg2))}$
		=	$\frac{0.1 \mu s}{2x(13x(1 \mu s - 0.1 \mu s))}$

In this example, the concatenated bit time parameters are $(3-1)_3 \& (5-1)_4 \& (4-1)_2 \& (2-1)_6$, so the bit timing register is programmed to = 0x000024C1.

23.3.17 Message Interface Register Sets

The interface register sets control the CPU read and write accesses to the message RAM. There are two interface registers sets for read/write access, IF1 and IF2 and one interface register set for read access only, IF3.

Due to the structure of the message RAM, it is not possible to change single bits or bytes of a message object. Instead, always a complete message object in the message RAM is accessed. Therefore the data transfer from the IF1/IF2 registers to the message RAM requires the message handler to perform a read-modify-write cycle: First those parts of the message object that are not to be changed are read from the message RAM into the interface register set, and after the update the whole content of the interface register set is written into the message object.

After the partial write of a message object, those parts of the interface register set that are not selected in the command register, will be set to the actual contents of the selected message object.

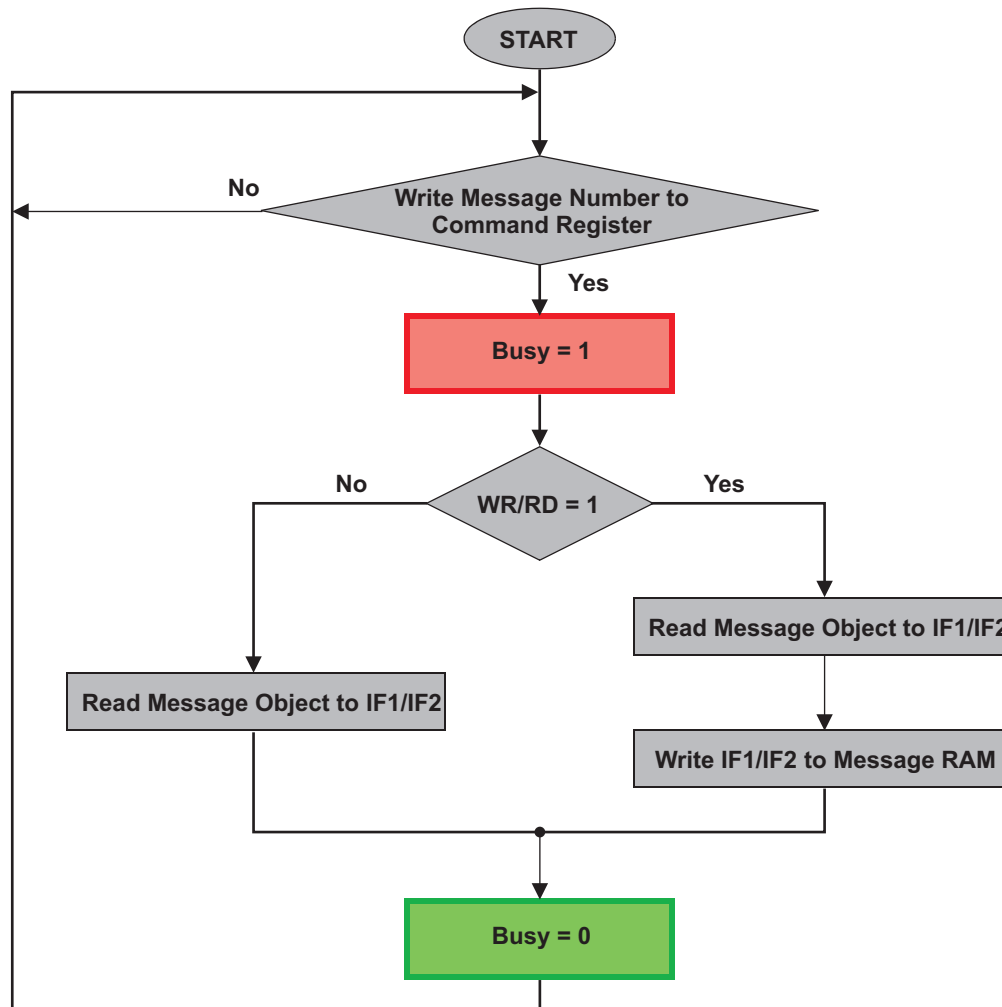
After the partial read of a message object, those parts of the interface register set that are not selected in the command register, will be left unchanged.

By buffering the data to be transferred, the interface register sets avoid conflicts between concurrent CPU accesses to the message RAM and CAN message reception and transmission. A complete message object (see [Section 23.3.18.1](#)) or parts of the message object may be transferred between the message RAM and the IF1/IF2 register set (see) in one single transfer. This transfer, performed in parallel on all selected parts of the message object, guarantees the data consistency of the CAN message.

23.3.17.1 Message Interface Register Sets 1 and 2

The IF1 and IF2 register sets control the data transfer to and from the message object. The IF1CMD and IF2CMD registers address the desired message object in the message RAM and specify whether a complete message object or only parts should be transferred. The data transfer is initiated by writing the message number to the bits [7:0] of the IF1CMD and IF2CMD register.

When the CPU initiates a data transfer between the IF1/IF2 registers and message RAM, the message handler sets the busy bit in the respective command register to '1'. After the transfer has completed, the busy bit is set back to '0' (see [Figure 23-18](#)).

Figure 23-18. Data Transfer Between IF1/IF2 Registers and Message RAM


23.3.17.2 IF3 Register Set

The IF3 register set can automatically be updated with received message objects without the need to initiate the transfer from message RAM by CPU. The intention of this feature of IF3 is to provide an interface for the DMA to read packets efficiently. The automatic update functionality can be programmed for each message object using the update enable registers IF3UPD12 to IF3UPD78.

All valid message objects in message RAM which are configured for automatic update, will be checked for active NewDat flags. If such a message object is found, it will be transferred to the IF3 register (if no previous DMA transfers are ongoing), controlled by IF3 Observation register (IF3OBS). If more than one NewDat flag is active, the message object with the lowest number has the highest priority for automatic IF3 update.

The NewDat bit in the message object will be reset by a transfer to IF3.

If DCAN internal IF3 update is complete, a DMA request is generated. The DMA request stays active until first read access to one of the IF3 registers. The DMA functionality has to be enabled by setting bit DE3 in the CTL register. Please refer to the device datasheet to find out if this DMA source is available.

NOTE: The IF3 register set can not be used for transferring data into message objects.

23.3.18 Message RAM

The DCAN message RAM contains message objects and parity bits for the message objects. There are up to 64 message objects in the message RAM.

During normal operation, accesses to the message RAM are performed via the interface register sets, and the CPU cannot directly access the message RAM.

The interface register sets IF1 and IF2 provide indirect read/write access from the CPU to the message RAM. The IF1 and IF2 register sets can buffer control and user data to be transferred to and from the message objects.

The third interface register set IF3 can be configured to automatically receive control and user data from the message RAM when a message object has been updated after reception of a CAN message. The CPU does not need to initiate the transfer from message RAM to IF3 register set.

The message handler avoids potential conflicts between concurrent accesses to message RAM and CAN frame reception/transmission.

There are two modes where the message RAM can be directly accessed by the CPU:

- Debug/Suspend mode (see [Section 23.3.18.3](#))
- RAM Direct Access (RDA) mode (see [Section 23.3.18.4](#))

23.3.18.1 Structure of Message Objects

Table 23-8 shows the structure of a message object.

The grayed fields are those parts of the message object which are represented in dedicated registers. For example, the transmit request flags of all message objects are represented in centralized transmit request registers.

Table 23-8. Structure of a Message Object

Message Object												
UMask	Msk[28:0]	MXtd	MDir	EoB	unused	NewDat	MsgLst	RxIE	TxIE	IntPnd	RmtEn	TxRqst
MsgVal	ID[28:0]	Xtd	Dir	DLC[3:0]	Data 0	Data 1	Data 2	Data 3	Data 4	Data 5	Data 6	Data 7

Table 23-9. Field Descriptions

Name	Value	Description
MsgVal	0	The message object is ignored by the message handler.
	1	The message object is to be used by the message handler. Note: This bit may be kept at level '1' even when the identifier bits ID[28:0], the control bits Xtd, Dir, or the data length code are changed. It should be reset if the Messages Object is no longer required.
UMask	0	Mask bits (Msk[28:0], MXtd and MDir) are ignored and not used for acceptance filtering.
	1	Mask bits are used for acceptance filtering. Note: If the UMask bit is set to one, the message object's mask bits have to be programmed during initialization of the message object before MsgVal is set to one.
ID[28:0]	ID[28:0]	29-bit ("extended") identifier bits
	ID[28:18]	11-bit ("standard") identifier bits
Msk[28:0]	0	The corresponding bit in the message identifier is not used for acceptance filtering (don't care).
	1	The corresponding bit in the message identifier is used for acceptance filtering.
Xtd	0	The extended identifier bit (IDE) has no effect on the acceptance filtering.
	1	The extended identifier bit (IDE) is used for acceptance filtering. Note: When 11-bit ("standard") Identifiers are used for a message object, the identifiers of received data frames are written into bits ID[28:18]. For acceptance filtering, only these bits together with mask bits Msk[28:18] are considered.
Dir	0	Direction = receive: On TxRqst, a remote frame with the identifier of this message object is transmitted. On reception of a data frame with matching identifier, the message is stored in this message object.
	1	Direction = transmit: On TxRqst, a data frame is transmitted. On reception of a remote frame with matching identifier, the TxRqst bit of this message object is set (if RmtEn = one).
MDir	0	The message direction bit (Dir) has no effect on the acceptance filtering.
	1	The message direction bit (Dir) is used for acceptance filtering.
EOB	0	The message object is part of a FIFO Buffer block and is not the last message object of this FIFO Buffer block.
	1	The message object is a single message object or the last message object in a FIFO Buffer Block. Note: This bit is used to concatenate multiple message objects to build a FIFO Buffer. For single message objects (not belonging to a FIFO Buffer), this bit must always be set to one.

Table 23-9. Field Descriptions (continued)

Name	Value	Description
NewDat	0	No new data has been written into the data bytes of this message object by the message handler since the last time when this flag was cleared by the CPU.
	1	The message handler or the CPU has written new data into the data bytes of this message object.
MsgLst	0	No message was lost since the last time when this bit was reset by the CPU.
	1	The message handler stored a new message into this message object when NewDat was still set, so the previous message has been overwritten.
RxIE	0	IntPnd will not be triggered after the successful reception of a frame.
	1	IntPnd will be triggered after the successful reception of a frame.
TxIE	0	IntPnd will not be triggered after the successful transmission of a frame.
	1	IntPnd will be triggered after the successful transmission of a frame.
IntPnd	0	This message object is not the source of an interrupt.
	1	This message object is the source of an interrupt. The interrupt Identifier in the interrupt register will point to this message object if there is no other interrupt source with higher priority.
RmtEn	0	At the reception of a remote frame, TxRqst is not changed.
	1	At the reception of a remote frame, TxRqst is set.
TxRqst	0	This message object is not waiting for a transmission.
	1	The transmission of this message object is requested and is not yet done.
DLC[3:0]	0	Data frame has 0 to 8 data bytes.
	1	Data frame has 8 data bytes. Note: The data length code of a message object must be defined to the same value as in the corresponding objects with the same identifier at other nodes. When the message handler stores a data frame, it will write the DLC to the value given by the received message.
Data 0		1st data byte of a CAN data frame
Data 1		2nd data byte of a CAN data frame
Data 2		3rd data byte of a CAN data frame
Data 3		4th data byte of a CAN data frame
Data 4		5th data byte of a CAN data frame
Data 5		6th data byte of a CAN data frame
Data 6		7th data byte of a CAN data frame
Data 7		8th data byte of a CAN data frame Note: Byte Data 0 is the first data byte shifted into the shift register of the CAN core during a reception, byte Data 7 is the last. When the message handler stores a data frame, it will write all the eight data bytes into a message object. If the data length code is less than 8, the remaining bytes of the message object may be overwritten by undefined values.

23.3.18.2 Addressing Message Objects in RAM

The starting location of a particular message object in RAM is:
 Message RAM base address + (message object number) * 0x20

This means that message object 1 starts at offset 0x0020; message object 2 starts at offset 0x0040, etc.

'0' is not a valid message object number.

The base address for DCAN0 RAM is 0x481C_D000 and DCAN1 RAM is 0x481D_1000.

Message object number 1 has the highest priority.

Table 23-10. Message RAM addressing in Debug/Suspend and RDA Mode

Message Object Number	Offset From Base Address	Word Number	Debug/Suspend Mode, see Section 23.3.18.3	RDA mode, see Section 23.3.18.4
1	0x0020	1	Parity	Data Bytes 4-7
	0x0024	2	MXtd,MDir,Mask	Data Bytes 0-3
	0x0028	3	Xtd,Dir,ID	ID[27:0],DLC
	0x002C	4	Ctrl	Mask,Xtd,Dir,ID[28]
	0x0030	5	Data Bytes 3-0	Parity,Ctrl,MXtd,MDir
	0x0034	6	Data Bytes 7-4	
31	0x03E0	1	Parity	Data Bytes 4-7
	0x03E4	2	MXtd,MDir,Mask	Data Bytes 0-3
	0x03E8	3	Xtd,Dir,ID	ID[27:0],DLC
	0x03EC	4	Ctrl	Mask,Xtd,Dir,ID[28]
	0x03F0	5	Data Bytes 3-0	Parity,Ctrl,MXtd,MDir
	0x03F4	6	Data Bytes 7-4	
63	0x07E0	1	Parity	Data Bytes 4-7
	0x07E4	2	MXtd,MDir,Mask	Data Bytes 0-3
	0x07E8	3	Xtd,Dir,ID	ID[27:0],DLC
	0x07EC	4	Ctrl	Mask,Xtd,Dir,ID[28]
	0x07F0	5	Data Bytes 3-0	Parity,Ctrl,MXtd,MDir
	0x07F4	6	Data Bytes 7-4	
last implemented (32(DCAN3) or 64)	0x0000	1	Parity	Data Bytes 4-7
	0x0004	2	MXtd,MDir,Mask	Data Bytes 0-3
	0x0008	3	Xtd,Dir,ID	ID[27:0],DLC
	0x000C	4	Ctrl	Mask,Xtd,Dir,ID[28]
	0x0010	5	Data Bytes 3-0	Parity,Ctrl,MXtd,MDir
	0x0014	6	Data Bytes 7-4	

23.3.18.3 Message RAM Representation in Debug/Suspend Mode

In debug/suspend mode, the message RAM will be memory mapped. This allows the external debug unit to access the message RAM.

NOTE: During debug/suspend mode, the message RAM cannot be accessed via the IFx register sets.

Table 23-11. Message RAM Representation in Debug/Suspend Mode

Bit #	31/ 15	30/ 14	29/ 13	29/ 12	27/ 11	26/ 10	25/ 9	24/ 8	23/ 7	22/ 6	21/ 5	20/ 4	19/ 3	18/ 2	17/ 1	16/ 0
MsgAddr + 0x00	Reserved															
	Reserved												Parity[4:0]			
MsgAddr + 0x04	MXtd	MDir	Rsvd	Msk[28:16]												
	Msk[15:0]															
MsgAddr + 0x08	Rsvd	Xtd	Dir	ID[28:16]												
	ID[15:0]															
MsgAddr + 0x0C	Reserved															
	Rsvd	MsgLst	Rsvd	UMask	TxE	RxTE	RmtEn	Rsvd	EOB	Reserved				DLC[3:0]		
MsgAddr + 0x10	Data 3								Data 2							
	Data 1								Data 0							
MsgAddr + 0x14	Data 7								Data 6							
	Data 5								Data 4							

23.3.18.4 Message RAM Representation in Direct Access Mode

When the RDA bit in the TEST register is set while the DCAN module is in test mode (test bit in the CTL register is set), the CPU has direct access to the message RAM. Due to the 32-bit bus structure, the RAM is split into word lines to support this feature. The CPU has access to one word line at a time only.

In RAM direct access mode, the RAM is represented by a continuous memory space within the address frame of the DCAN module, starting at the message RAM base address.

Note: During direct access mode, the message RAM cannot be accessed via the IFx register sets.

Any read or write to the RAM addresses for RamDirectAccess during normal operation mode (TestMode bit or RDA bit not set) will be ignored.

Table 23-12. Message RAM Representation in RAM Direct Access Mode

Bit #	31/ 15	30/ 14	29/ 13	29/ 12	27/ 11	26/ 10	25/ 9	24/ 8	23/ 7	22/ 6	21/ 5	20/ 4	19/ 3	18/ 2	17/ 1	16/ 0
MsgAddr + 0x00	Data 4								Data 5							
	Data 6								Data 7							
MsgAddr + 0x04	Data 0								Data 1							
	Data 2								Data 3							
MsgAddr + 0x08	ID[27:12]															
	ID[11:0]										DLC[3:0]					
Msk[28:13]																

Table 23-12. Message RAM Representation in RAM Direct Access Mode (continued)

Bit #	31/ 15	30/ 14	29/ 13	29/ 12	27/ 11	26/ 10	25/ 9	24/ 8	23/ 7	22/ 6	21/ 5	20/ 4	19/ 3	18/ 2	17/ 1	16/ 0
MsgAddr + 0x0C	Msk[12:0]													Xtd	Dir	ID[28]
	Reserved															Parity [4]
MsgAddr + 0x10	MsgLst				Unused			Msg Lst	UMa sk	TxE	RxT E	Rmt En	EOB	MX td	MDir	

NOTE: Writes to unused bits have no effect.

23.3.19 GIO Support

The CAN_RX and CAN_TX pins of the DCAN module can be used as general purpose IO pins, if CAN functionality is not needed. This function is controlled by the CAN TX IO control register (TIOC) and the CAN RX IO control register (RIOC).

23.4 Registers

23.4.1 DCAN Registers

Table 23-13 lists the memory-mapped registers for the DCAN. All register offset addresses not listed in Table 23-13 should be considered as reserved locations and the register contents should not be modified.

Table 23-13. DCAN Registers

Offset	Acronym	Register Name	Section
0h	CTL	CAN Control Register	Section 23.4.1.1
4h	ES	Error and Status Register	Section 23.4.1.2
8h	ERRC	Error Counter Register	Section 23.4.1.3
Ch	BTR	Bit Timing Register	Section 23.4.1.4
10h	INT	Interrupt Register	Section 23.4.1.5
14h	TEST	Test Register	Section 23.4.1.6
1Ch	PERR	Parity Error Code Register	Section 23.4.1.7
80h	ABOTR	Auto-Bus-On Time Register	Section 23.4.1.8
84h	TXRQ_X	Transmission Request X Register	Section 23.4.1.9
88h	TXRQ12	Transmission Request Register 12	Section 23.4.1.10
8Ch	TXRQ34	Transmission Request Register 34	Section 23.4.1.11
90h	TXRQ56	Transmission Request Register 56	Section 23.4.1.12
94h	TXRQ78	Transmission Request Register 78	Section 23.4.1.13
98h	NWDAT_X	New Data X Register	Section 23.4.1.14
9Ch	NWDAT12	New Data Register 12	Section 23.4.1.15
A0h	NWDAT34	New Data Register 34	Section 23.4.1.16
A4h	NWDAT56	New Data Register 56	Section 23.4.1.17
A8h	NWDAT78	New Data Register 78	Section 23.4.1.18
ACh	INTPND_X	Interrupt Pending X Register	Section 23.4.1.19
B0h	INTPND12	Interrupt Pending Register 12	Section 23.4.1.20
B4h	INTPND34	Interrupt Pending Register 34	Section 23.4.1.21
B8h	INTPND56	Interrupt Pending Register 56	Section 23.4.1.22
BCh	INTPND78	Interrupt Pending Register 78	Section 23.4.1.23
C0h	MSGVAL_X	Message Valid X Register	Section 23.4.1.24
C4h	MSGVAL12	Message Valid Register 12	Section 23.4.1.25
C8h	MSGVAL34	Message Valid Register 34	Section 23.4.1.26
CCh	MSGVAL56	Message Valid Register 56	Section 23.4.1.27
D0h	MSGVAL78	Message Valid Register 78	Section 23.4.1.28
D8h	INTMUX12	Interrupt Multiplexer Register 12	Section 23.4.1.29
DCh	INTMUX34	Interrupt Multiplexer Register 34	Section 23.4.1.30
E0h	INTMUX56	Interrupt Multiplexer Register 56	Section 23.4.1.31
E4h	INTMUX78	Interrupt Multiplexer Register 78	Section 23.4.1.32
100h	IF1CMD	IF1 Command Registers	Section 23.4.1.33
104h	IF1MSK	IF1 Mask Register	Section 23.4.1.34
108h	IF1ARB	IF1 Arbitration Register	Section 23.4.1.35
10Ch	IF1MCTL	IF1 Message Control Register	Section 23.4.1.36
110h	IF1DATA	IF1 Data A Register	Section 23.4.1.37
114h	IF1DATB	IF1 Data B Register	Section 23.4.1.38
120h	IF2CMD	IF2 Command Registers	Section 23.4.1.39
124h	IF2MSK	IF2 Mask Register	Section 23.4.1.40
128h	IF2ARB	IF2 Arbitration Register	Section 23.4.1.41
12Ch	IF2MCTL	IF2 Message Control Register	Section 23.4.1.42

Table 23-13. DCAN Registers (continued)

Offset	Acronym	Register Name	Section
130h	IF2DATA	IF2 Data A Register	Section 23.4.1.43
134h	IF2DATB	IF2 Data B Register	Section 23.4.1.44
140h	IF3OBS	IF3 Observation Register	Section 23.4.1.45
144h	IF3MSK	IF3 Mask Register	Section 23.4.1.46
148h	IF3ARB	IF3 Arbitration Register	Section 23.4.1.47
14Ch	IF3MCTL	IF3 Message Control Register	Section 23.4.1.48
150h	IF3DATA	IF3 Data A Register	Section 23.4.1.49
154h	IF3DATB	IF3 Data B Register	Section 23.4.1.50
160h	IF3UPD12	IF3 Update Enable Register 12	Section 23.4.1.51
164h	IF3UPD34	IF3 Update Enable Register 34	Section 23.4.1.52
168h	IF3UPD56	IF3 Update Enable Register 56	Section 23.4.1.53
16Ch	IF3UPD78	IF3 Update Enable Register 78	Section 23.4.1.54
1E0h	TIOC	CAN TX IO Control Register	Section 23.4.1.55
1E4h	RIOC	CAN RX IO Control Register	Section 23.4.1.56

23.4.1.1 CTL Register (offset = 0h) [reset = 1401h]

CTL is shown in [Figure 23-19](#) and described in [Table 23-14](#).

The Bus-Off recovery sequence (refer to CAN specification) cannot be shortened by setting or resetting Init bit. If the module goes Bus-Off, it will automatically set the Init bit and stop all bus activities. When the Init bit is cleared by the application again, the module will then wait for 129 occurrences of Bus Idle (129 * 11 consecutive recessive bits) before resuming normal operation. At the end of the bus-off recovery sequence, the error counters will be reset. After the Init bit is reset, each time when a sequence of 11 recessive bits is monitored, a Bit0 error code is written to the error and status register, enabling the CPU to check whether the CAN bus is stuck at dominant or continuously disturbed, and to monitor the proceeding of the bus-off recovery sequence.

Figure 23-19. CTL Register

31	30	29	28	27	26	25	24
RESERVED						WUBA	PDR
R-0h						R/W-0h	R/W-0h
23	22	21	20	19	18	17	16
RESERVED			DE3	DE2	DE1	IE1	InitDbg
R-0h			R/W-0h	R/W-0h	R/W-0h	R/W-0h	R-0h
15	14	13	12	11	10	9	8
SWR	RESERVED	PMD				ABO	IDS
R/WP-0h	R-0h	R/W-5h				R/W-0h	R/W-0h
7	6	5	4	3	2	1	0
Test	CCE	DAR	RESERVED	EIE	SIE	IE0	Init
R/W-0h	R/W-0h	R/W-0h	R-0h	R/W-0h	R/W-0h	R/W-0h	R/W-1h

LEGEND: R/W = Read/Write; R = Read only; W1toCl = Write 1 to clear bit; -n = value after reset

Table 23-14. CTL Register Field Descriptions

Bit	Field	Type	Reset	Description
31-26	RESERVED	R	0h	
25	WUBA	R/W	0h	Automatic wake up on bus activity when in local power-down mode. Note: The CAN message, which initiates the bus activity, cannot be received. This means that the first message received in power down and automatic wake-up mode, will be lost. 0h (R/W) = No detection of a dominant CAN bus level while in local power-down mode. 1h (R/W) = Detection of a dominant CAN bus level while in local power-down mode is enabled. On occurrence of a dominant CAN bus level, the wake up sequence is started.
24	PDR	R/W	0h	Request for local low power-down mode 0h (R/W) = No application request for local low power-down mode. If the application has cleared this bit while DCAN in local power-down mode, also the Init bit has to be cleared. 1h (R/W) = Local power-down mode has been requested by application. The DCAN will acknowledge the local power-down mode by setting bit PDA in the error and status register. The local clocks will be turned off by DCAN internal logic.
23-21	RESERVED	R	0h	
20	DE3	R/W	0h	Enable DMA request line for IF3. Note: A pending DMA request for IF3 remains active until first access to one of the IF3 registers. 0h (R/W) = Disabled 1h (R/W) = Enabled

Table 23-14. CTL Register Field Descriptions (continued)

Bit	Field	Type	Reset	Description
19	DE2	R/W	0h	Enable DMA request line for IF2. Note: A pending DMA request for IF2 remains active until first access to one of the IF2 registers. 0h (R/W) = Disabled 1h (R/W) = Enabled
18	DE1	R/W	0h	Enable DMA request line for IF1. Note: A pending DMA request for IF1 remains active until first access to one of the IF1 registers. 0h (R/W) = Disabled 1h (R/W) = Enabled
17	IE1	R/W	0h	Interrupt line 1 enable 0h (R/W) = Disabled - Module interrupt DCAN1INT is always low. 1h (R/W) = Enabled - interrupts will assert line DCAN1INT to one; line remains active until pending interrupts are processed.
16	InitDbg	R	0h	Internal init state while debug access 0h (R/W) = Not in debug mode, or debug mode requested but not entered. 1h (R/W) = Debug mode requested and internally entered; the DCAN is ready for debug accesses.
15	SWR	R/WP	0h	SW reset enable. Note: To execute software reset, the following procedure is necessary: (a) Set Init bit to shut down CAN communication and (b) Set SWR bit additionally to Init bit. 0h (R/W) = Normal Operation 1h (R/W) = Module is forced to reset state. This bit will automatically get cleared after execution of SW reset after one OCP clock cycle.
14	RESERVED	R	0h	
13-10	PMD	R/W	5h	Parity on/off. 5 = Parity function disabled. Others = Parity function enabled.
9	ABO	R/W	0h	Auto-Bus-On enable 0h (R/W) = The Auto-Bus-On feature is disabled 1h (R/W) = The Auto-Bus-On feature is enabled
8	IDS	R/W	0h	Interruption debug support enable 0h (R/W) = When Debug/Suspend mode is requested, DCAN will wait for a started transmission or reception to be completed before entering Debug/Suspend mode 1h (R/W) = When Debug/Suspend mode is requested, DCAN will interrupt any transmission or reception, and enter Debug/Suspend mode immediately.
7	Test	R/W	0h	Test mode enable 0h (R/W) = Normal Operation 1h (R/W) = Test Mode
6	CCE	R/W	0h	Configuration change enable 0h (R/W) = The CPU has no write access to the configuration registers. 1h (R/W) = The CPU has write access to the configuration registers (when Init bit is set).
5	DAR	R/W	0h	Disable automatic retransmission 0h (R/W) = Automatic retransmission of not successful messages enabled. 1h (R/W) = Automatic retransmission disabled.
4	RESERVED	R	0h	

Table 23-14. CTL Register Field Descriptions (continued)

Bit	Field	Type	Reset	Description
3	EIE	R/W	0h	Error interrupt enable 0h (R/W) = Disabled - PER, BOff and EWarn bits can not generate an interrupt. 1h (R/W) = Enabled - PER, BOff and EWarn bits can generate an interrupt at DCAN0INT line and affect the interrupt register.
2	SIE	R/W	0h	Status change interrupt enable 0h (R/W) = Disabled - WakeUpPnd, RxOk, TxOk and LEC bits can not generate an interrupt. 1h (R/W) = Enabled - WakeUpPnd, RxOk, TxOk and LEC can generate an interrupt at DCAN0INT line and affect the interrupt register.
1	IE0	R/W	0h	Interrupt line 0 enable 0h (R/W) = Disabled - Module interrupt DCAN0INT is always low. 1h (R/W) = Enabled - interrupts will assert line DCAN0INT to one; line remains active until pending interrupts are processed.
0	Init	R/W	1h	Initialization 0h (R/W) = Normal operation 1h (R/W) = Initialization mode is entered

23.4.1.2 ES Register (offset = 4h) [reset = 6Fh]

ES is shown in [Figure 23-20](#) and described in [Table 23-15](#).

Interrupts are generated by bits PER, BOff and EWarn (if EIE bit in CAN control register is set) and by bits WakeUpPnd, RxOk, TxOk, and LEC (if SIE bit in CAN control register is set). A change of bit EPass will not generate an interrupt. Reading the error and status register clears the WakeUpPnd, PER, RxOk and TxOk bits and set the LEC to value '7.' Additionally, the status interrupt value (0x8000) in the interrupt register will be replaced by the next lower priority interrupt value. The EOI for all other interrupts (DCANINT0 and DCANINT1) are automatically handled by hardware. For debug support, the auto clear functionality of error and status register (clear of status flags by read) is disabled when in debug/suspend mode.

Figure 23-20. ES Register

31	30	29	28	27	26	25	24
RESERVED							
R-0h							
23	22	21	20	19	18	17	16
RESERVED							
R-0h							
15	14	13	12	11	10	9	8
RESERVED					PDA	WakeUp_Pnd	PER_
R-0h					R-0h	0h	0h
7	6	5	4	3	2	1	0
BOff	EWarn	EPass	RxOk	TxOk	LEC		
R-0h	R-1h	R-1h	0h	1h	7h		

LEGEND: R/W = Read/Write; R = Read only; W1toCl = Write 1 to clear bit; -n = value after reset

Table 23-15. ES Register Field Descriptions

Bit	Field	Type	Reset	Description
31-11	RESERVED	R	0h	
10	PDA	R	0h	Local power-down mode acknowledge 0h (R/W) = DCAN is not in local power-down mode. 1h (R/W) = Application request for setting DCAN to local power-down mode was successful. DCAN is in local power-down mode.
9	WakeUp_Pnd		0h	Wake up pending. This bit can be used by the CPU to identify the DCAN as the source to wake up the system. This bit will be reset if error and status register is read. 0h (R/W) = No Wake Up is requested by DCAN. 1h (R/W) = DCAN has initiated a wake up of the system due to dominant CAN bus while module power down.
8	PER_		0h	Parity error detected. This bit will be reset if error and status register is read. 0h (R/W) = No parity error has been detected since last read access. 1h (R/W) = The parity check mechanism has detected a parity error in the Message RAM.
7	BOff	R	0h	Bus-Off state 0h (R/W) = The CAN module is not bus-off state. 1h (R/W) = The CAN module is in bus-off state.
6	EWarn	R	1h	Warning state 0h (R/W) = Both error counters are below the error warning limit of 96. 1h (R/W) = At least one of the error counters has reached the error warning limit of 96.

Table 23-15. ES Register Field Descriptions (continued)

Bit	Field	Type	Reset	Description
5	EPass	R	1h	<p>Error passive state</p> <p>0h (R/W) = On CAN Bus error, the DCAN could send active error frames.</p> <p>1h (R/W) = The CAN core is in the error passive state as defined in the CAN Specification.</p>
4	RxOk		0h	<p>Received a message successfully. This bit will be reset if error and status register is read.</p> <p>0h (R/W) = No message has been successfully received since the last time when this bit was read by the CPU. This bit is never reset by DCAN internal events.</p> <p>1h (R/W) = A message has been successfully received since the last time when this bit was reset by a read access of the CPU (independent of the result of acceptance filtering).</p>
3	TxOk		1h	<p>Transmitted a message successfully. This bit will be reset if error and status register is read.</p> <p>0h (R/W) = No message has been successfully transmitted since the last time when this bit was read by the CPU. This bit is never reset by DCAN internal events.</p> <p>1h (R/W) = A message has been successfully transmitted (error free and acknowledged by at least one other node) since the last time when this bit was reset by a read access of the CPU.</p>
2-0	LEC		7h	<p>Last error code.</p> <p>The LEC field indicates the type of the last error on the CAN bus. This field will be cleared to '0' when a message has been transferred (reception or transmission) without error.</p> <p>0h (R/W) = No error</p> <p>1h (R/W) = Stuff error. More than five equal bits in a row have been detected in a part of a received message where this is not allowed.</p> <p>2h (R/W) = Form error. A fixed format part of a received frame has the wrong format.</p> <p>3h (R/W) = Ack error. The message this CAN core transmitted was not acknowledged by another node.</p> <p>4h (R/W) = Bit1 error. During the transmission of a message (with the exception of the arbitration field), the device wanted to send a recessive level (bit of logical value '1'), but the monitored bus value was dominant.</p> <p>5h (R/W) = Bit0 error. During the transmission of a message (or acknowledge bit, or active error flag, or overload flag), the device wanted to send a dominant level (logical value '0'), but the monitored bus level was recessive. During Bus-Off recovery, this status is set each time a sequence of 11 recessive bits has been monitored. This enables the CPU to monitor the proceeding of the Bus-Off recovery sequence (indicating the bus is not stuck at dominant or continuously disturbed).</p> <p>6h (R/W) = CRC error. In a received message, the CRC check sum was incorrect. (CRC received for an incoming message does not match the calculated CRC for the received data).</p> <p>7h (R/W) = No CAN bus event was detected since the last time the CPU read the error and status register. Any read access to the error and status register re-initializes the LEC to value '7.'</p>

23.4.1.3 ERRC Register (offset = 8h) [reset = 0h]

 ERRC is shown in [Figure 23-21](#) and described in [Table 23-16](#).

Figure 23-21. ERRC Register

31	30	29	28	27	26	25	24	23	22	21	20	19	18	17	16
RESERVED															
R-0h															
15	14	13	12	11	10	9	8	7	6	5	4	3	2	1	0
RP	REC_6:0_							TEC_7:0_							
R-0h	R-0h							R-0h							

LEGEND: R/W = Read/Write; R = Read only; W1toCl = Write 1 to clear bit; -n = value after reset

Table 23-16. ERRC Register Field Descriptions

Bit	Field	Type	Reset	Description
31-16	RESERVED	R	0h	
15	RP	R	0h	Receive error passive 0h (R/W) = The receive error counter is below the error passive level. 1h (R/W) = The receive error counter has reached the error passive level as defined in the CAN specification.
14-8	REC_6:0_	R	0h	Receive error counter. Actual state of the receive error counter (values from 0 to 255).
7-0	TEC_7:0_	R	0h	Transmit error counter. Actual state of the transmit error counter (values from 0 to 255).

23.4.1.4 BTR Register (offset = Ch) [reset = 2301h]

BTR is shown in [Figure 23-22](#) and described in [Table 23-17](#).

This register is only writable if CCE and Init bits in the CAN control register are set. The CAN bit time may be programmed in the range of 8 to 25 time quanta. The CAN time quantum may be programmed in the range of 1 to 1024 CAN_CLK periods. With a CAN_CLK of 8 MHz and BRPE = 0x00, the reset value of 0x00002301 configures the DCAN for a bit rate of 500kBit/s.

Figure 23-22. BTR Register

31	30	29	28	27	26	25	24
RESERVED							
R-0h							
23	22	21	20	19	18	17	16
RESERVED				BRPE			
R-0h				R-0h			
15	14	13	12	11	10	9	8
RESERVED	TSeg2			TSeg1			
R-0h	2h			3h			
7	6	5	4	3	2	1	0
SJW		BRP					
0h		1h					

LEGEND: R/W = Read/Write; R = Read only; W1toCl = Write 1 to clear bit; -n = value after reset

Table 23-17. BTR Register Field Descriptions

Bit	Field	Type	Reset	Description
31-20	RESERVED	R	0h	
19-16	BRPE	R	0h	Baud rate prescaler extension. Valid programmed values are 0 to 15. By programming BRPE the baud rate prescaler can be extended to values up to 1024.
15	RESERVED	R	0h	
14-12	TSeg2		2h	Time segment after the sample point. Valid programmed values are 0 to 7. The actual TSeg2 value which is interpreted for the bit timing will be the programmed TSeg2 value + 1.
11-8	TSeg1		3h	Time segment before the sample point. Valid programmed values are 1 to 15. The actual TSeg1 value interpreted for the bit timing will be the programmed TSeg1 value + 1.
7-6	SJW		0h	Synchronization Jump Width. Valid programmed values are 0 to 3. The actual SJW value interpreted for the synchronization will be the programmed SJW value + 1.
5-0	BRP		1h	Baud rate prescaler. Value by which the CAN_CLK frequency is divided for generating the bit time quanta. The bit time is built up from a multiple of this quanta. Valid programmed values are 0 to 63. The actual BRP value interpreted for the bit timing will be the programmed BRP value + 1.

23.4.1.5 INT Register (offset = 10h) [reset = 0h]

INT is shown in [Figure 23-23](#) and described in [Table 23-18](#).

Figure 23-23. INT Register

31	30	29	28	27	26	25	24	23	22	21	20	19	18	17	16
RESERVED								Int1ID_23:16_							
R-0h								R-0h							
15	14	13	12	11	10	9	8	7	6	5	4	3	2	1	0
Int0ID_15_0															
R-0h															

LEGEND: R/W = Read/Write; R = Read only; W1toCl = Write 1 to clear bit; -n = value after reset

Table 23-18. INT Register Field Descriptions

Bit	Field	Type	Reset	Description
31-24	RESERVED	R	0h	
23-16	Int1ID_23:16_	R	0h	Interrupt 1 Identifier (indicates the message object with the highest pending interrupt). If several interrupts are pending, the CAN interrupt register will point to the pending interrupt with the highest priority. The DCAN1INT interrupt line remains active until Int1ID reaches value 0 (the cause of the interrupt is reset) or until IE1 is cleared. A message interrupt is cleared by clearing the message object's IntPnd bit. Among the message interrupts, the message object's interrupt priority decreases with increasing message number. 0x 00: No interrupt is pending. 0x 01-0x 80: Number of message object which caused the interrupt. 0xFF: Unused.
15-0	Int0ID_15_0	R	0h	Interrupt Identifier (the number here indicates the source of the interrupt). If several interrupts are pending, the CAN interrupt register will point to the pending interrupt with the highest priority. The DCAN0INT interrupt line remains active until Int0ID reaches value 0 (the cause of the interrupt is reset) or until IE0 is cleared. The Status interrupt has the highest priority. Among the message interrupts, the message object's interrupt priority decreases with increasing message number. 0x 0000: No interrupt is pending. 0x 0001-0x 0080: Number of message object which caused the interrupt. 0x 0081-0x7FFF: Unused (values 0081 to 7FFF). 0x 8000: Error and status register value is not 0x07. 0xFFFF: Unused.

23.4.1.6 TEST Register (offset = 14h) [reset = 0h]

TEST is shown in [Figure 23-24](#) and described in [Table 23-19](#).

For all test modes, the test bit in CAN control register needs to be set to one. If test bit is set, the RDA, EXL, Tx1, Tx0, LBack and Silent bits are writable. Bit Rx monitors the state of pin CAN_RX and therefore is only readable. All test register functions are disabled when test bit is cleared. The test register is only writable if test bit in CAN control register is set. Setting Tx[1:0] other than '00' will disturb message transfer. When the internal loop-back mode is active (bit LBack is set), bit EXL will be ignored.

Figure 23-24. TEST Register

31	30	29	28	27	26	25	24
RESERVED							
R-0h							
23	22	21	20	19	18	17	16
RESERVED							
R-0h							
15	14	13	12	11	10	9	8
RESERVED						RDA	EXL
R-0h						0h	0h
7	6	5	4	3	2	1	0
Rx	Tx_1:0_		LBack	Silent	RESERVED		
R-0h	0h		0h	0h	R-0h		

LEGEND: R/W = Read/Write; R = Read only; W1toCl = Write 1 to clear bit; -n = value after reset

Table 23-19. TEST Register Field Descriptions

Bit	Field	Type	Reset	Description
31-10	RESERVED	R	0h	
9	RDA		0h	RAM direct access enable 0h (R/W) = Normal operation 1h (R/W) = Direct access to the RAM is enabled while in test mode
8	EXL		0h	External loopback mode 0h (R/W) = Disabled 1h (R/W) = Enabled
7	Rx	R	0h	Receive pin. Monitors the actual value of the CAN_RX pin 0h (R/W) = The CAN bus is dominant 1h (R/W) = The CAN bus is recessive
6-5	Tx_1:0_		0h	Control of CAN_TX pin. 0h (R/W) = Normal operation, CAN_TX is controlled by the CAN core. 1h (R/W) = Sample point can be monitored at CAN_TX pin. 10h (R/W) = CAN_TX pin drives a dominant value. 11h (R/W) = CAN_TX pin drives a recessive value.
4	LBack		0h	Loopback mode 0h (R/W) = Disabled 1h (R/W) = Enabled
3	Silent		0h	Silent mode 0h (R/W) = Disabled 1h (R/W) = Enabled
2-0	RESERVED	R	0h	

23.4.1.7 PERR Register (offset = 1Ch) [reset = 0h]

PERR is shown in [Figure 23-25](#) and described in [Table 23-20](#).

If a parity error is detected, the PER flag will be set in the error and status register. This bit is not reset by the parity check mechanism; it must be reset by reading the error and status register. In addition to the PER flag, the parity error code register will indicate the memory area where the parity error has been detected (message number and word number). If more than one word with a parity error was detected, the highest word number with a parity error will be displayed. After a parity error has been detected, the register will hold the last error code until power is removed.

Figure 23-25. PERR Register

31	30	29	28	27	26	25	24
RESERVED							
R-0h							
23	22	21	20	19	18	17	16
RESERVED							
R-0h							
15	14	13	12	11	10	9	8
RESERVED					Word_Number		
R-0h					R-0h		
7	6	5	4	3	2	1	0
Message_Number							
R-0h							

LEGEND: R/W = Read/Write; R = Read only; W1toCl = Write 1 to clear bit; -n = value after reset

Table 23-20. PERR Register Field Descriptions

Bit	Field	Type	Reset	Description
31-11	RESERVED	R	0h	
10-8	Word_Number	R	0h	Word number where parity error has been detected. 0x 01-0x 05: RDA word number (1 to 5) of the message object (according to the message RAM representation in RDA mode).
7-0	Message_Number	R	0h	Message number. 0x 01-0x 80: Message object number where parity error has been detected.

23.4.1.8 ABOTR Register (offset = 80h) [reset = 0h]

ABOTR is shown in [Figure 23-26](#) and described in [Table 23-21](#).

On write access to the CAN control register while Auto-Bus-On timer is running, the Auto-Bus-On procedure will be aborted. During Debug/Suspend mode, running Auto-Bus-On timer will be paused.

Figure 23-26. ABOTR Register

31	30	29	28	27	26	25	24	23	22	21	20	19	18	17	16	15	14	13	12	11	10	9	8	7	6	5	4	3	2	1	0
ABO_Time																															
R/W-0h																															

LEGEND: R/W = Read/Write; R = Read only; W1toCl = Write 1 to clear bit; -n = value after reset

Table 23-21. ABOTR Register Field Descriptions

Bit	Field	Type	Reset	Description
31-0	ABO_Time	R/W	0h	Number of OCP clock cycles before a Bus-Off recovery sequence is started by clearing the Init bit. This function has to be enabled by setting bit ABO in CAN control register. The Auto-Bus-On timer is realized by a 32 bit counter that starts to count down to zero when the module goes Bus-Off. The counter will be reloaded with the preload value of the ABO time register after this phase.

23.4.1.9 TXRQ_X Register (offset = 84h) [reset = 0h]

TXRQ_X is shown in [Figure 23-27](#) and described in [Table 23-22](#).

Example 1. Bit 0 of the transmission request X register represents byte 0 of the transmission request 1 register. If one or more bits in this byte are set, bit 0 of the transmission request X register will be set.

Figure 23-27. TXRQ_X Register

31	30	29	28	27	26	25	24
RESERVED							
R-0h							
23	22	21	20	19	18	17	16
RESERVED							
R-0h							
15	14	13	12	11	10	9	8
TxRqstReg8		TxRqstReg7		TxRqstReg6		TxRqstReg5	
R-0h		R-0h		R-0h		R-0h	
7	6	5	4	3	2	1	0
TxRqstReg4		TxRqstReg3		TxRqstReg2		TxRqstReg1	
R-0h		R-0h		R-0h		R-0h	

LEGEND: R/W = Read/Write; R = Read only; W1toCl = Write 1 to clear bit; -n = value after reset

Table 23-22. TXRQ_X Register Field Descriptions

Bit	Field	Type	Reset	Description
31-16	RESERVED	R	0h	
15-14	TxRqstReg8	R	0h	TxRqstReg8
13-12	TxRqstReg7	R	0h	TxRqstReg7
11-10	TxRqstReg6	R	0h	TxRqstReg6
9-8	TxRqstReg5	R	0h	TxRqstReg5
7-6	TxRqstReg4	R	0h	TxRqstReg4
5-4	TxRqstReg3	R	0h	TxRqstReg3
3-2	TxRqstReg2	R	0h	TxRqstReg2
1-0	TxRqstReg1	R	0h	TxRqstReg1

23.4.1.10 TXRQ12 Register (offset = 88h) [reset = 0h]

TXRQ12 is shown in [Figure 23-28](#) and described in [Table 23-23](#).

The TXRQ12 to TXRQ78 registers hold the TxRqst bits of the implemented message objects. By reading out these bits, the CPU can check for pending transmission requests. The TxRqst bit in a specific message object can be set/reset by the CPU via the IF1/IF2 message interface registers, or by the message handler after reception of a remote frame or after a successful transmission.

Figure 23-28. TXRQ12 Register

31	30	29	28	27	26	25	24	23	22	21	20	19	18	17	16	15	14	13	12	11	10	9	8	7	6	5	4	3	2	1	0
TxRqs_32:17_																TxRqs_16:1_															
R-0h																R-0h															

LEGEND: R/W = Read/Write; R = Read only; W1toCl = Write 1 to clear bit; -n = value after reset

Table 23-23. TXRQ12 Register Field Descriptions

Bit	Field	Type	Reset	Description
31-16	TxRqs_32:17_	R	0h	Transmission request bits (for all message objects) 0h (R/W) = No transmission has been requested for this message object. 1h (R/W) = The transmission of this message object is requested and is not yet done.
15-0	TxRqs_16:1_	R	0h	Transmission request bits (for all message objects) 0h (R/W) = No transmission has been requested for this message object. 1h (R/W) = The transmission of this message object is requested and is not yet done.

23.4.1.11 TXRQ34 Register (offset = 8Ch) [reset = 0h]

TXRQ34 is shown in [Figure 23-29](#) and described in [Table 23-24](#).

The TXRQ12 to TXRQ78 registers hold the TxRqst bits of the implemented message objects. By reading out these bits, the CPU can check for pending transmission requests. The TxRqst bit in a specific message object can be set/reset by the CPU via the IF1/IF2 message interface registers, or by the message handler after reception of a remote frame or after a successful transmission.

Figure 23-29. TXRQ34 Register

31	30	29	28	27	26	25	24	23	22	21	20	19	18	17	16	15	14	13	12	11	10	9	8	7	6	5	4	3	2	1	0
TxRqs_64:49_																TxRqs_48:33_															
R-0h																R-0h															

LEGEND: R/W = Read/Write; R = Read only; W1toCl = Write 1 to clear bit; -n = value after reset

Table 23-24. TXRQ34 Register Field Descriptions

Bit	Field	Type	Reset	Description
31-16	TxRqs_64:49_	R	0h	Transmission request bits (for all message objects) 0h (R/W) = No transmission has been requested for this message object. 1h (R/W) = The transmission of this message object is requested and is not yet done.
15-0	TxRqs_48:33_	R	0h	Transmission request bits (for all message objects) 0h (R/W) = No transmission has been requested for this message object. 1h (R/W) = The transmission of this message object is requested and is not yet done.

23.4.1.12 TXRQ56 Register (offset = 90h) [reset = 0h]

TXRQ56 is shown in [Figure 23-30](#) and described in [Table 23-25](#).

The TXRQ12 to TXRQ78 registers hold the TxRqst bits of the implemented message objects. By reading out these bits, the CPU can check for pending transmission requests. The TxRqst bit in a specific message object can be set/reset by the CPU via the IF1/IF2 message interface registers, or by the message handler after reception of a remote frame or after a successful transmission.

Figure 23-30. TXRQ56 Register

31	30	29	28	27	26	25	24	23	22	21	20	19	18	17	16	15	14	13	12	11	10	9	8	7	6	5	4	3	2	1	0
TxRqs_96:81_																TxRqs_80:65_															
R-0h																R-0h															

LEGEND: R/W = Read/Write; R = Read only; W1toCl = Write 1 to clear bit; -n = value after reset

Table 23-25. TXRQ56 Register Field Descriptions

Bit	Field	Type	Reset	Description
31-16	TxRqs_96:81_	R	0h	Transmission request bits (for all message objects) 0h (R/W) = No transmission has been requested for this message object. 1h (R/W) = The transmission of this message object is requested and is not yet done.
15-0	TxRqs_80:65_	R	0h	Transmission request bits (for all message objects) 0h (R/W) = No transmission has been requested for this message object. 1h (R/W) = The transmission of this message object is requested and is not yet done.

23.4.1.13 TXRQ78 Register (offset = 94h) [reset = 0h]

TXRQ78 is shown in [Figure 23-31](#) and described in [Table 23-26](#).

The TXRQ12 to TXRQ78 registers hold the TxRqst bits of the implemented message objects. By reading out these bits, the CPU can check for pending transmission requests. The TxRqst bit in a specific message object can be set/reset by the CPU via the IF1/IF2 message interface registers, or by the message handler after reception of a remote frame or after a successful transmission.

Figure 23-31. TXRQ78 Register

31	30	29	28	27	26	25	24	23	22	21	20	19	18	17	16	15	14	13	12	11	10	9	8	7	6	5	4	3	2	1	0
TxRqs_128:113_																TxRqs_112:97_															
R-0h																R-0h															

LEGEND: R/W = Read/Write; R = Read only; W1toCl = Write 1 to clear bit; -n = value after reset

Table 23-26. TXRQ78 Register Field Descriptions

Bit	Field	Type	Reset	Description
31-16	TxRqs_128:113_	R	0h	Transmission request bits (for all message objects) 0h (R/W) = No transmission has been requested for this message object. 1h (R/W) = The transmission of this message object is requested and is not yet done.
15-0	TxRqs_112:97_	R	0h	Transmission request bits (for all message objects) 0h (R/W) = No transmission has been requested for this message object. 1h (R/W) = The transmission of this message object is requested and is not yet done.

23.4.1.14 NWDAT_X Register (offset = 98h) [reset = 0h]

NWDAT_X is shown in [Figure 23-32](#) and described in [Table 23-27](#).

With the new data X register, the CPU can detect if one or more bits in the different new data registers are set. Each register bit represents a group of eight message objects. If at least one of the NewDat bits of these message objects are set, the corresponding bit in the new data X register will be set. Example 1. Bit 0 of the new data X register represents byte 0 of the new data 1 register. If one or more bits in this byte are set, bit 0 of the new data X register will be set.

Figure 23-32. NWDAT_X Register

31	30	29	28	27	26	25	24
RESERVED							
R-0h							
23	22	21	20	19	18	17	16
RESERVED							
R-0h							
15	14	13	12	11	10	9	8
NewDatReg8		NewDatReg7		NewDatReg6		NewDatReg5	
R-0h		R-0h		R-0h		R-0h	
7	6	5	4	3	2	1	0
NewDatReg4		NewDatReg3		NewDatReg2		NewDatReg1	
R-0h		R-0h		R-0h		R-0h	

LEGEND: R/W = Read/Write; R = Read only; W1toCl = Write 1 to clear bit; -n = value after reset

Table 23-27. NWDAT_X Register Field Descriptions

Bit	Field	Type	Reset	Description
31-16	RESERVED	R	0h	
15-14	NewDatReg8	R	0h	NewDatReg8
13-12	NewDatReg7	R	0h	NewDatReg7
11-10	NewDatReg6	R	0h	NewDatReg6
9-8	NewDatReg5	R	0h	NewDatReg5
7-6	NewDatReg4	R	0h	NewDatReg4
5-4	NewDatReg3	R	0h	NewDatReg3
3-2	NewDatReg2	R	0h	NewDatReg2
1-0	NewDatReg1	R	0h	NewDatReg1

23.4.1.15 NWDAT12 Register (offset = 9Ch) [reset = 0h]

NWDAT12 is shown in [Figure 23-33](#) and described in [Table 23-28](#).

These registers hold the NewDat bits of the implemented message objects. By reading out these bits, the CPU can check for new data in the message objects. The NewDat bit of a specific message object can be set/reset by the CPU via the IF1/IF2 interface register sets, or by the message handler after reception of a data frame or after a successful transmission.

Figure 23-33. NWDAT12 Register

31	30	29	28	27	26	25	24	23	22	21	20	19	18	17	16	15	14	13	12	11	10	9	8	7	6	5	4	3	2	1	0
NewDat_32:17_																NewDat_16:1_															
R-0h																R-0h															

LEGEND: R/W = Read/Write; R = Read only; W1toCl = Write 1 to clear bit; -n = value after reset

Table 23-28. NWDAT12 Register Field Descriptions

Bit	Field	Type	Reset	Description
31-16	NewDat_32:17_	R	0h	New Data Bits (for all message objects) 0h (R/W) = No new data has been written into the data portion of this message object by the message handler since the last time when this flag was cleared by the CPU. 1h (R/W) = The message handler or the CPU has written new data into the data portion of this message object.
15-0	NewDat_16:1_	R	0h	New Data Bits (for all message objects) 0h (R/W) = No new data has been written into the data portion of this message object by the message handler since the last time when this flag was cleared by the CPU. 1h (R/W) = The message handler or the CPU has written new data into the data portion of this message object.

23.4.1.16 NWDAT34 Register (offset = A0h) [reset = 0h]

NWDAT34 is shown in [Figure 23-34](#) and described in [Table 23-29](#).

These registers hold the NewDat bits of the implemented message objects. By reading out these bits, the CPU can check for new data in the message objects. The NewDat bit of a specific message object can be set/reset by the CPU via the IF1/IF2 interface register sets, or by the message handler after reception of a data frame or after a successful transmission.

Figure 23-34. NWDAT34 Register

31	30	29	28	27	26	25	24	23	22	21	20	19	18	17	16	15	14	13	12	11	10	9	8	7	6	5	4	3	2	1	0
NewDat_64:49_																NewDat_48:33_															
R-0h																R-0h															

LEGEND: R/W = Read/Write; R = Read only; W1toCl = Write 1 to clear bit; -n = value after reset

Table 23-29. NWDAT34 Register Field Descriptions

Bit	Field	Type	Reset	Description
31-16	NewDat_64:49_	R	0h	<p>New Data Bits (for all message objects)</p> <p>0h (R/W) = No new data has been written into the data portion of this message object by the message handler since the last time when this flag was cleared by the CPU.</p> <p>1h (R/W) = The message handler or the CPU has written new data into the data portion of this message object.</p>
15-0	NewDat_48:33_	R	0h	<p>New Data Bits (for all message objects)</p> <p>0h (R/W) = No new data has been written into the data portion of this message object by the message handler since the last time when this flag was cleared by the CPU.</p> <p>1h (R/W) = The message handler or the CPU has written new data into the data portion of this message object.</p>

23.4.1.17 NWDAT56 Register (offset = A4h) [reset = 0h]

NWDAT56 is shown in [Figure 23-35](#) and described in [Table 23-30](#).

These registers hold the NewDat bits of the implemented message objects. By reading out these bits, the CPU can check for new data in the message objects. The NewDat bit of a specific message object can be set/reset by the CPU via the IF1/IF2 interface register sets, or by the message handler after reception of a data frame or after a successful transmission.

Figure 23-35. NWDAT56 Register

31	30	29	28	27	26	25	24	23	22	21	20	19	18	17	16	15	14	13	12	11	10	9	8	7	6	5	4	3	2	1	0
NewDat_96:81_																NewDat_80:65_															
R-0h																R-0h															

LEGEND: R/W = Read/Write; R = Read only; W1toCl = Write 1 to clear bit; -n = value after reset

Table 23-30. NWDAT56 Register Field Descriptions

Bit	Field	Type	Reset	Description
31-16	NewDat_96:81_	R	0h	New Data Bits (for all message objects) 0h (R/W) = No new data has been written into the data portion of this message object by the message handler since the last time when this flag was cleared by the CPU. 1h (R/W) = The message handler or the CPU has written new data into the data portion of this message object.
15-0	NewDat_80:65_	R	0h	New Data Bits (for all message objects) 0h (R/W) = No new data has been written into the data portion of this message object by the message handler since the last time when this flag was cleared by the CPU. 1h (R/W) = The message handler or the CPU has written new data into the data portion of this message object.

23.4.1.18 NWDAT78 Register (offset = A8h) [reset = 0h]

NWDAT78 is shown in [Figure 23-36](#) and described in [Table 23-31](#).

These registers hold the NewDat bits of the implemented message objects. By reading out these bits, the CPU can check for new data in the message objects. The NewDat bit of a specific message object can be set/reset by the CPU via the IF1/IF2 interface register sets, or by the message handler after reception of a data frame or after a successful transmission.

Figure 23-36. NWDAT78 Register

31	30	29	28	27	26	25	24	23	22	21	20	19	18	17	16	15	14	13	12	11	10	9	8	7	6	5	4	3	2	1	0
NewDat_128:113_																NewDat_112:97_															
R-0h																R-0h															

LEGEND: R/W = Read/Write; R = Read only; W1toCl = Write 1 to clear bit; -n = value after reset

Table 23-31. NWDAT78 Register Field Descriptions

Bit	Field	Type	Reset	Description
31-16	NewDat_128:113_	R	0h	New Data Bits (for all message objects) 0h (R/W) = No new data has been written into the data portion of this message object by the message handler since the last time when this flag was cleared by the CPU. 1h (R/W) = The message handler or the CPU has written new data into the data portion of this message object.
15-0	NewDat_112:97_	R	0h	New Data Bits (for all message objects) 0h (R/W) = No new data has been written into the data portion of this message object by the message handler since the last time when this flag was cleared by the CPU. 1h (R/W) = The message handler or the CPU has written new data into the data portion of this message object.

23.4.1.19 INTPND_X Register (offset = ACh) [reset = 0h]

INTPND_X is shown in [Figure 23-37](#) and described in [Table 23-32](#).

With the interrupt pending X register, the CPU can detect if one or more bits in the different interrupt pending registers are set. Each bit of this register represents a group of eight message objects. If at least one of the IntPnd bits of these message objects are set, the corresponding bit in the interrupt pending X register will be set. Example 2. Bit 0 of the interrupt pending X register represents byte 0 of the interrupt pending 1 register. If one or more bits in this byte are set, bit 0 of the interrupt pending X register will be set.

Figure 23-37. INTPND_X Register

31	30	29	28	27	26	25	24
RESERVED							
R-0h							
23	22	21	20	19	18	17	16
RESERVED							
R-0h							
15	14	13	12	11	10	9	8
IntPndReg8		IntPndReg7		IntPndReg6		IntPndReg5	
R-0h		R-0h		R-0h		R-0h	
7	6	5	4	3	2	1	0
IntPndReg4		IntPndReg3		IntPndReg2		IntPndReg1	
R-0h		R-0h		R-0h		R-0h	

LEGEND: R/W = Read/Write; R = Read only; W1toCl = Write 1 to clear bit; -n = value after reset

Table 23-32. INTPND_X Register Field Descriptions

Bit	Field	Type	Reset	Description
31-16	RESERVED	R	0h	
15-14	IntPndReg8	R	0h	IntPndReg8
13-12	IntPndReg7	R	0h	IntPndReg7
11-10	IntPndReg6	R	0h	IntPndReg6
9-8	IntPndReg5	R	0h	IntPndReg5
7-6	IntPndReg4	R	0h	IntPndReg4
5-4	IntPndReg3	R	0h	IntPndReg3
3-2	IntPndReg2	R	0h	IntPndReg2
1-0	IntPndReg1	R	0h	IntPndReg1

23.4.1.20 INTPND12 Register (offset = B0h) [reset = 0h]

INTPND12 is shown in [Figure 23-38](#) and described in [Table 23-33](#).

These registers hold the IntPnd bits of the implemented message objects. By reading out these bits, the CPU can check for pending interrupts in the message objects. The IntPnd bit of a specific message object can be set/reset by the CPU via the IF1/IF2 interface register sets, or by the message handler after a reception or a successful transmission.

Figure 23-38. INTPND12 Register

31	30	29	28	27	26	25	24	23	22	21	20	19	18	17	16	15	14	13	12	11	10	9	8	7	6	5	4	3	2	1	0
IntPnd_32:17_																IntPnd_16:1_															
R-0h																R-0h															

LEGEND: R/W = Read/Write; R = Read only; W1toCl = Write 1 to clear bit; -n = value after reset

Table 23-33. INTPND12 Register Field Descriptions

Bit	Field	Type	Reset	Description
31-16	IntPnd_32:17_	R	0h	Interrupt Pending Bits (for all message objects) 0h (R/W) = This message object is not the source of an interrupt. 1h (R/W) = This message object is the source of an interrupt.
15-0	IntPnd_16:1_	R	0h	Interrupt Pending Bits (for all message objects) 0h (R/W) = This message object is not the source of an interrupt. 1h (R/W) = This message object is the source of an interrupt.

23.4.1.21 INTPND34 Register (offset = B4h) [reset = 0h]

INTPND34 is shown in [Figure 23-39](#) and described in [Table 23-34](#).

These registers hold the IntPnd bits of the implemented message objects. By reading out these bits, the CPU can check for pending interrupts in the message objects. The IntPnd bit of a specific message object can be set/reset by the CPU via the IF1/IF2 interface register sets, or by the message handler after a reception or a successful transmission.

Figure 23-39. INTPND34 Register

31	30	29	28	27	26	25	24	23	22	21	20	19	18	17	16	15	14	13	12	11	10	9	8	7	6	5	4	3	2	1	0
IntPnd_64:49_																IntPnd_48:33_															
R-0h																R-0h															

LEGEND: R/W = Read/Write; R = Read only; W1toCl = Write 1 to clear bit; -n = value after reset

Table 23-34. INTPND34 Register Field Descriptions

Bit	Field	Type	Reset	Description
31-16	IntPnd_64:49_	R	0h	Interrupt Pending Bits (for all message objects) 0h (R/W) = This message object is not the source of an interrupt. 1h (R/W) = This message object is the source of an interrupt.
15-0	IntPnd_48:33_	R	0h	Interrupt Pending Bits (for all message objects) 0h (R/W) = This message object is not the source of an interrupt. 1h (R/W) = This message object is the source of an interrupt.

23.4.1.22 INTPND56 Register (offset = B8h) [reset = 0h]

INTPND56 is shown in [Figure 23-40](#) and described in [Table 23-35](#).

These registers hold the IntPnd bits of the implemented message objects. By reading out these bits, the CPU can check for pending interrupts in the message objects. The IntPnd bit of a specific message object can be set/reset by the CPU via the IF1/IF2 interface register sets, or by the message handler after a reception or a successful transmission.

Figure 23-40. INTPND56 Register

31	30	29	28	27	26	25	24	23	22	21	20	19	18	17	16	15	14	13	12	11	10	9	8	7	6	5	4	3	2	1	0
IntPnd_96:81_																IntPnd_80:65_															
R-0h																R-0h															

LEGEND: R/W = Read/Write; R = Read only; W1toCl = Write 1 to clear bit; -n = value after reset

Table 23-35. INTPND56 Register Field Descriptions

Bit	Field	Type	Reset	Description
31-16	IntPnd_96:81_	R	0h	Interrupt Pending Bits (for all message objects) 0h (R/W) = This message object is not the source of an interrupt. 1h (R/W) = This message object is the source of an interrupt.
15-0	IntPnd_80:65_	R	0h	Interrupt Pending Bits (for all message objects) 0h (R/W) = This message object is not the source of an interrupt. 1h (R/W) = This message object is the source of an interrupt.

23.4.1.23 INTPND78 Register (offset = BCh) [reset = 0h]

INTPND78 is shown in [Figure 23-41](#) and described in [Table 23-36](#).

These registers hold the IntPnd bits of the implemented message objects. By reading out these bits, the CPU can check for pending interrupts in the message objects. The IntPnd bit of a specific message object can be set/reset by the CPU via the IF1/IF2 interface register sets, or by the message handler after a reception or a successful transmission.

Figure 23-41. INTPND78 Register

31	30	29	28	27	26	25	24	23	22	21	20	19	18	17	16	15	14	13	12	11	10	9	8	7	6	5	4	3	2	1	0
IntPnd_128:113_																IntPnd_112:97_															
R-0h																R-0h															

LEGEND: R/W = Read/Write; R = Read only; W1toCl = Write 1 to clear bit; -n = value after reset

Table 23-36. INTPND78 Register Field Descriptions

Bit	Field	Type	Reset	Description
31-16	IntPnd_128:113_	R	0h	Interrupt Pending Bits (for all message objects) 0h (R/W) = This message object is not the source of an interrupt. 1h (R/W) = This message object is the source of an interrupt.
15-0	IntPnd_112:97_	R	0h	Interrupt Pending Bits (for all message objects) 0h (R/W) = This message object is not the source of an interrupt. 1h (R/W) = This message object is the source of an interrupt.

23.4.1.24 MSGVAL_X Register (offset = C0h) [reset = 0h]

MSGVAL_X is shown in [Figure 23-42](#) and described in [Table 23-37](#).

With the message valid X register, the CPU can detect if one or more bits in the different message valid registers are set. Each bit of this register represents a group of eight message objects. If at least one of the MsgVal bits of these message objects are set, the corresponding bit in the message valid X register will be set. Example 3. Bit 0 of the message valid X register represents byte 0 of the message valid 1 register. If one or more bits in this byte are set, bit 0 of the message valid X register will be set.

Figure 23-42. MSGVAL_X Register

31	30	29	28	27	26	25	24
RESERVED							
R-0h							
23	22	21	20	19	18	17	16
RESERVED							
R-0h							
15	14	13	12	11	10	9	8
MsgValReg8		MsgValReg7		MsgValReg6		MsgValReg5	
R-0h		R-0h		R-0h		R-0h	
7	6	5	4	3	2	1	0
MsgValReg4		MsgValReg3		MsgValReg2		MsgValReg1	
R-0h		R-0h		R-0h		R-0h	

LEGEND: R/W = Read/Write; R = Read only; W1toCl = Write 1 to clear bit; -n = value after reset

Table 23-37. MSGVAL_X Register Field Descriptions

Bit	Field	Type	Reset	Description
31-16	RESERVED	R	0h	
15-14	MsgValReg8	R	0h	MsgValReg8
13-12	MsgValReg7	R	0h	MsgValReg7
11-10	MsgValReg6	R	0h	MsgValReg6
9-8	MsgValReg5	R	0h	MsgValReg5
7-6	MsgValReg4	R	0h	MsgValReg4
5-4	MsgValReg3	R	0h	MsgValReg3
3-2	MsgValReg2	R	0h	MsgValReg2
1-0	MsgValReg1	R	0h	MsgValReg1

23.4.1.25 MSGVAL12 Register (offset = C4h) [reset = 0h]

MSGVAL12 is shown in [Figure 23-43](#) and described in [Table 23-38](#).

These registers hold the MsgVal bits of the implemented message objects. By reading out these bits, the CPU can check which message objects are valid. The MsgVal bit of a specific message object can be set/reset by the CPU via the IF1/IF2 interface register sets, or by the message handler after a reception or a successful transmission.

Figure 23-43. MSGVAL12 Register

31	30	29	28	27	26	25	24	23	22	21	20	19	18	17	16	15	14	13	12	11	10	9	8	7	6	5	4	3	2	1	0
MsgVal_32:17_																MsgVal_16:1_															
R-0h																R-0h															

LEGEND: R/W = Read/Write; R = Read only; W1toCl = Write 1 to clear bit; -n = value after reset

Table 23-38. MSGVAL12 Register Field Descriptions

Bit	Field	Type	Reset	Description
31-16	MsgVal_32:17_	R	0h	Message valid bits (for all message objects) 0h (R/W) = This message object is ignored by the message handler. 1h (R/W) = This message object is configured and will be considered by the message handler.
15-0	MsgVal_16:1_	R	0h	Message valid bits (for all message objects) 0h (R/W) = This message object is ignored by the message handler. 1h (R/W) = This message object is configured and will be considered by the message handler.

23.4.1.26 MSGVAL34 Register (offset = C8h) [reset = 0h]

MSGVAL34 is shown in [Figure 23-44](#) and described in [Table 23-39](#).

These registers hold the MsgVal bits of the implemented message objects. By reading out these bits, the CPU can check which message objects are valid. The MsgVal bit of a specific message object can be set/reset by the CPU via the IF1/IF2 interface register sets, or by the message handler after a reception or a successful transmission.

Figure 23-44. MSGVAL34 Register

31	30	29	28	27	26	25	24	23	22	21	20	19	18	17	16	15	14	13	12	11	10	9	8	7	6	5	4	3	2	1	0
MsgVal_64:49_																MsgVal_48:33_															
R-0h																R-0h															

LEGEND: R/W = Read/Write; R = Read only; W1toCl = Write 1 to clear bit; -n = value after reset

Table 23-39. MSGVAL34 Register Field Descriptions

Bit	Field	Type	Reset	Description
31-16	MsgVal_64:49_	R	0h	Message valid bits (for all message objects) 0h (R/W) = This message object is ignored by the message handler. 1h (R/W) = This message object is configured and will be considered by the message handler.
15-0	MsgVal_48:33_	R	0h	Message valid bits (for all message objects) 0h (R/W) = This message object is ignored by the message handler. 1h (R/W) = This message object is configured and will be considered by the message handler.

23.4.1.27 MSGVAL56 Register (offset = CCh) [reset = 0h]

MSGVAL56 is shown in [Figure 23-45](#) and described in [Table 23-40](#).

These registers hold the MsgVal bits of the implemented message objects. By reading out these bits, the CPU can check which message objects are valid. The MsgVal bit of a specific message object can be set/reset by the CPU via the IF1/IF2 interface register sets, or by the message handler after a reception or a successful transmission.

Figure 23-45. MSGVAL56 Register

31	30	29	28	27	26	25	24	23	22	21	20	19	18	17	16	15	14	13	12	11	10	9	8	7	6	5	4	3	2	1	0
MsgVal_96:81_																MsgVal_80:65_															
R-0h																R-0h															

LEGEND: R/W = Read/Write; R = Read only; W1toCl = Write 1 to clear bit; -n = value after reset

Table 23-40. MSGVAL56 Register Field Descriptions

Bit	Field	Type	Reset	Description
31-16	MsgVal_96:81_	R	0h	Message valid bits (for all message objects) 0h (R/W) = This message object is ignored by the message handler. 1h (R/W) = This message object is configured and will be considered by the message handler.
15-0	MsgVal_80:65_	R	0h	Message valid bits (for all message objects) 0h (R/W) = This message object is ignored by the message handler. 1h (R/W) = This message object is configured and will be considered by the message handler.

23.4.1.28 MSGVAL78 Register (offset = D0h) [reset = 0h]

MSGVAL78 is shown in [Figure 23-46](#) and described in [Table 23-41](#).

These registers hold the MsgVal bits of the implemented message objects. By reading out these bits, the CPU can check which message objects are valid. The MsgVal bit of a specific message object can be set/reset by the CPU via the IF1/IF2 interface register sets, or by the message handler after a reception or a successful transmission.

Figure 23-46. MSGVAL78 Register

31	30	29	28	27	26	25	24	23	22	21	20	19	18	17	16	15	14	13	12	11	10	9	8	7	6	5	4	3	2	1	0
MsgVal_128:113_																MsgVal_112:97_															
R-0h																R-0h															

LEGEND: R/W = Read/Write; R = Read only; W1toCl = Write 1 to clear bit; -n = value after reset

Table 23-41. MSGVAL78 Register Field Descriptions

Bit	Field	Type	Reset	Description
31-16	MsgVal_128:113_	R	0h	Message valid bits (for all message objects) 0h (R/W) = This message object is ignored by the message handler. 1h (R/W) = This message object is configured and will be considered by the message handler.
15-0	MsgVal_112:97_	R	0h	Message valid bits (for all message objects) 0h (R/W) = This message object is ignored by the message handler. 1h (R/W) = This message object is configured and will be considered by the message handler.

23.4.1.29 INTMUX12 Register (offset = D8h) [reset = 0h]

INTMUX12 is shown in [Figure 23-47](#) and described in [Table 23-42](#).

The IntMux flag determine for each message object, which of the two interrupt lines (DCAN0INT or DCAN1INT) will be asserted when the IntPnd of this message object is set. Both interrupt lines can be globally enabled or disabled by setting or clearing IE0 and IE1 bits in CAN control register. The IntPnd bit of a specific message object can be set or reset by the CPU via the IF1/IF2 interface register sets, or by message handler after reception or successful transmission of a frame. This will also affect the Int0ID resp Int1ID flags in the interrupt register.

Figure 23-47. INTMUX12 Register

31	30	29	28	27	26	25	24	23	22	21	20	19	18	17	16	15	14	13	12	11	10	9	8	7	6	5	4	3	2	1	0
IntMux																															
R-0h																															

LEGEND: R/W = Read/Write; R = Read only; W1toCl = Write 1 to clear bit; -n = value after reset

Table 23-42. INTMUX12 Register Field Descriptions

Bit	Field	Type	Reset	Description
31-0	IntMux	R	0h	IntMux[31:0] multiplexes IntPnd value to either DCAN0INT or DCAN1INT interrupt lines. The mapping from the bits to the message objects is as follows. Bit 0 -> Last implemented message object. Bit 1 -> Message object number 1. Bit 2 -> Message object number 2. 0h (R/W) = DCAN0INT line is active if corresponding IntPnd flag is one. 1h (R/W) = DCAN1INT line is active if corresponding IntPnd flag is one.

23.4.1.30 INTMUX34 Register (offset = DCh) [reset = 0h]

INTMUX34 is shown in [Figure 23-48](#) and described in [Table 23-43](#).

The IntMux flag determine for each message object, which of the two interrupt lines (DCAN0INT or DCAN1INT) will be asserted when the IntPnd of this message object is set. Both interrupt lines can be globally enabled or disabled by setting or clearing IE0 and IE1 bits in CAN control register. The IntPnd bit of a specific message object can be set or reset by the CPU via the IF1/IF2 interface register sets, or by message handler after reception or successful transmission of a frame. This will also affect the Int0ID resp Int1ID flags in the interrupt register.

Figure 23-48. INTMUX34 Register

31	30	29	28	27	26	25	24	23	22	21	20	19	18	17	16	15	14	13	12	11	10	9	8	7	6	5	4	3	2	1	0
IntMux																															
R-0h																															

LEGEND: R/W = Read/Write; R = Read only; W1toCl = Write 1 to clear bit; -n = value after reset

Table 23-43. INTMUX34 Register Field Descriptions

Bit	Field	Type	Reset	Description
31-0	IntMux	R	0h	<p>IntMux[63:32] multiplexes IntPnd value to either DCAN0INT or DCAN1INT interrupt lines.</p> <p>The mapping from the bits to the message objects is as follows.</p> <p>Bit 0 -> Last implemented message object. Bit 1 -> Message object number 1 Bit 2 -> Message object number 2.</p> <p>0h (R/W) = DCAN0INT line is active if corresponding IntPnd flag is one. 1h (R/W) = DCAN1INT line is active if corresponding IntPnd flag is one.</p>

23.4.1.31 INTMUX56 Register (offset = E0h) [reset = 0h]

INTMUX56 is shown in [Figure 23-49](#) and described in [Table 23-44](#).

The IntMux flag determine for each message object, which of the two interrupt lines (DCAN0INT or DCAN1INT) will be asserted when the IntPnd of this message object is set. Both interrupt lines can be globally enabled or disabled by setting or clearing IE0 and IE1 bits in CAN control register. The IntPnd bit of a specific message object can be set or reset by the CPU via the IF1/IF2 interface register sets, or by message handler after reception or successful transmission of a frame. This will also affect the Int0ID resp Int1ID flags in the interrupt register.

Figure 23-49. INTMUX56 Register

31	30	29	28	27	26	25	24	23	22	21	20	19	18	17	16	15	14	13	12	11	10	9	8	7	6	5	4	3	2	1	0
IntMux																															
R-0h																															

LEGEND: R/W = Read/Write; R = Read only; W1toCl = Write 1 to clear bit; -n = value after reset

Table 23-44. INTMUX56 Register Field Descriptions

Bit	Field	Type	Reset	Description
31-0	IntMux	R	0h	IntMux[95:64] multiplexes IntPnd value to either DCAN0INT or DCAN1INT interrupt lines. The mapping from the bits to the message objects is as follows. Bit 0 -> Last implemented message object. Bit 1 -> Message object number 1. Bit 2 -> Message object number 2. 0h (R/W) = DCAN0INT line is active if corresponding IntPnd flag is one. 1h (R/W) = DCAN1INT line is active if corresponding IntPnd flag is one.

23.4.1.32 INTMUX78 Register (offset = E4h) [reset = 0h]

INTMUX78 is shown in [Figure 23-50](#) and described in [Table 23-45](#).

The IntMux flag determine for each message object, which of the two interrupt lines (DCAN0INT or DCAN1INT) will be asserted when the IntPnd of this message object is set. Both interrupt lines can be globally enabled or disabled by setting or clearing IE0 and IE1 bits in CAN control register. The IntPnd bit of a specific message object can be set or reset by the CPU via the IF1/IF2 interface register sets, or by message handler after reception or successful transmission of a frame. This will also affect the Int0ID resp Int1ID flags in the interrupt register.

Figure 23-50. INTMUX78 Register

31	30	29	28	27	26	25	24	23	22	21	20	19	18	17	16	15	14	13	12	11	10	9	8	7	6	5	4	3	2	1	0
IntMux																															
R-0h																															

LEGEND: R/W = Read/Write; R = Read only; W1toCl = Write 1 to clear bit; -n = value after reset

Table 23-45. INTMUX78 Register Field Descriptions

Bit	Field	Type	Reset	Description
31-0	IntMux	R	0h	<p>IntMux[127:96] multiplexes IntPnd value to either DCAN0INT or DCAN1INT interrupt lines.</p> <p>The mapping from the bits to the message objects is as follows.</p> <p>Bit 0 -> Last implemented message object. Bit 1 -> Message object number 1. Bit 2 -> Message object number 2.</p> <p>0h (R/W) = DCAN0INT line is active if corresponding IntPnd flag is one. 1h (R/W) = DCAN1INT line is active if corresponding IntPnd flag is one.</p>

23.4.1.33 IF1CMD Register (offset = 100h) [reset = 0h]

IF1CMD is shown in [Figure 23-51](#) and described in [Table 23-46](#).

The IF1 Command Register (IF1CMD) configures and initiates the transfer between the IF1 register sets and the message RAM. It is configurable which portions of the message object should be transferred. A transfer is started when the CPU writes the message number to bits [7:0] of the IF1 command register. With this write operation, the Busy bit is automatically set to '1' to indicate that a transfer is in progress. After 4 to 14 OCP clock cycles, the transfer between the interface register and the message RAM will be completed and the Busy bit is cleared. The maximum number of cycles is needed when the message transfer concurs with a CAN message transmission, acceptance filtering, or message storage. If the CPU writes to both IF1 command registers consecutively (request of a second transfer while first transfer is still in progress), the second transfer will start after the first one has been completed. While Busy bit is one, IF1 register sets are write protected. For debug support, the auto clear functionality of the IF1 command registers (clear of DMAActive flag by r/w) is disabled during Debug/Suspend mode. If an invalid Message Number is written to bits [7:0] of the IF1 command register, the message handler may access an implemented (valid) message object instead.

Figure 23-51. IF1CMD Register

31	30	29	28	27	26	25	24
RESERVED							
R-0h							
23	22	21	20	19	18	17	16
WR_RD	Mask	Arb	Control	ClrIntPnd	TxRqst_NewDa t	Data_A	Data_B
0h	0h	0h	0h	0h	0h	0h	0h
15	14	13	12	11	10	9	8
Busy	DMAActive	RESERVED					
0h	0h	R-0h					
7	6	5	4	3	2	1	0
Message_Number							
0h							

LEGEND: R/W = Read/Write; R = Read only; W1toCl = Write 1 to clear bit; -n = value after reset

Table 23-46. IF1CMD Register Field Descriptions

Bit	Field	Type	Reset	Description
31-24	RESERVED	R	0h	
23	WR_RD		0h	Write/Read 0h (R/W) = Direction = Read: Transfer direction is from the message object addressed by Message Number (Bits [7:0]) to the IF1 register set. 1h (R/W) = Direction = Write: Transfer direction is from the IF1 register set to the message object addressed by Message Number (Bits [7:0]).
22	Mask		0h	Access mask bits 0h (R/W) = Mask bits will not be changed 1h (R/W) = Direction = Read: The mask bits (identifier mask + MDir + MXtd) will be transferred from the message object addressed by Message Number (Bits [7:0]) to the IF1 register set. Direction = Write: The mask bits (identifier mask + MDir + MXtd) will be transferred from the IF1 register set to the message object addressed by Message Number (Bits [7:0]).

Table 23-46. IF1CMD Register Field Descriptions (continued)

Bit	Field	Type	Reset	Description
21	Arb		0h	<p>Access arbitration bits</p> <p>0h (R/W) = Arbitration bits will not be changed</p> <p>1h (R/W) = Direction = Read: The Arbitration bits (Identifier + Dir + Xtd + MsgVal) will be transferred from the message object addressed by Message Number (Bits [7:0]) to the corresponding IF1 register set. Direction = Write: The Arbitration bits (Identifier + Dir + Xtd + MsgVal) will be transferred from the IF1 register set to the message object addressed by Message Number (Bits [7:0]).</p>
20	Control		0h	<p>Access control bits.</p> <p>If the TxRqst/NewDat bit in this register(Bit [18]) is set, the TxRqst/NewDat bit in the IF1 message control register will be ignored.</p> <p>0h (R/W) = Control bits will not be changed</p> <p>1h (R/W) = Direction = Read: The message control bits will be transferred from the message object addressed by message number (Bits [7:0]) to the IF1 register set. Direction = Write: The message control bits will be transferred from the IF1 register set to the message object addressed by message number (Bits [7:0]).</p>
19	ClrIntPnd		0h	<p>Clear interrupt pending bit</p> <p>0h (R/W) = IntPnd bit will not be changed</p> <p>1h (R/W) = Direction = Read: Clears IntPnd bit in the message object. Direction = Write: This bit is ignored. Copying of IntPnd flag from IF1 Registers to message RAM can only be controlled by the control flag (Bit [20]).</p>
18	TxRqst_NewDat		0h	<p>Access transmission request bit.</p> <p>Note: If a CAN transmission is requested by setting TxRqst/NewDat in this register, the TxRqst/NewDat bits in the message object will be set to one independent of the values in IF1 message control Register.</p> <p>Note: A read access to a message object can be combined with the reset of the control bits IntPnd and NewDat.</p> <p>The values of these bits transferred to the IF1 message control register always reflect the status before resetting them.</p> <p>0h (R/W) = Direction = Read: NewDat bit will not be changed. Direction = Write: TxRqst/NewDat bit will be handled according to the control bit.</p> <p>1h (R/W) = Direction = Read: Clears NewDat bit in the message object. Direction = Write: Sets TxRqst/NewDat in message object.</p>
17	Data_A		0h	<p>Access Data Bytes 0 to 3.</p> <p>0h (R/W) = Data Bytes 0-3 will not be changed.</p> <p>1h (R/W) = Direction = Read: The data bytes 0-3 will be transferred from the message object addressed by the Message Number (Bits [7:0]) to the corresponding IF1 register set. Direction = Write: The data bytes 0-3 will be transferred from the IF1 register set to the message object addressed by the Message Number (Bits [7:0]).</p> <p>Note: The duration of the message transfer is independent of the number of bytes to be transferred.</p>
16	Data_B		0h	<p>Access Data Bytes 4 to 7.</p> <p>0h (R/W) = Data Bytes 4-7 will not be changed.</p> <p>1h (R/W) = Direction = Read: The data bytes 4-7 will be transferred from the message object addressed by Message Number (Bits [7:0]) to the corresponding IF1 register set. Direction = Write: The data bytes 4-7 will be transferred from the IF1 register set to the message object addressed by message number (Bits [7:0]). Note: The duration of the message transfer is independent of the number of bytes to be transferred.</p>

Table 23-46. IF1CMD Register Field Descriptions (continued)

Bit	Field	Type	Reset	Description
15	Busy		0h	Busy flag. This bit is set to one after the message number has been written to bits 7 to 0. IF1 register set will be write protected. The bit is cleared after read/write action has been finished. 0h (R/W) = No transfer between IF1 register set and message RAM is in progress. 1h (R/W) = Transfer between IF1 register set and message RAM is in progress.
14	DMAActive		0h	Activation of DMA feature for subsequent internal IF1 update. Note: Due to the auto reset feature of the DMAActive bit, this bit has to be set for each subsequent DMA cycle separately. 0h (R/W) = DMA request line is independent of IF1 activities. 1h (R/W) = DMA is requested after completed transfer between IF1 register set and message RAM. The DMA request remains active until the first read or write to one of the IF1 registers; an exception is a write to Message Number (Bits [7:0]) when DMAActive is one.
13-8	RESERVED	R	0h	
7-0	Message_Number		0h	Number of message object in message RAM which is used for data transfer. 0h (R/W) = Invalid message number. 1h (R/W) = Valid message numbers (value 01 to 80). 80h (R/W) = Valid message number. 81h (R/W) = Invalid message numbers (value 81 to FF). FFh (R/W) = Invalid message numbers.

23.4.1.34 IF1MSK Register (offset = 104h) [reset = E000000h]

IF1MSK is shown in [Figure 23-52](#) and described in [Table 23-47](#).

The bits of the IF1 mask registers mirror the mask bits of a message object. While Busy bit of IF1 command register is one, IF1 register set is write protected.

Figure 23-52. IF1MSK Register

31	30	29	28	27	26	25	24
MXtd	MDir	RESERVED	Msk_28:0_				
1h	1h	R-1h	0h				
23	22	21	20	19	18	17	16
Msk_28:0_							
0h							
15	14	13	12	11	10	9	8
Msk_28:0_							
0h							
7	6	5	4	3	2	1	0
Msk_28:0_							
0h							

LEGEND: R/W = Read/Write; R = Read only; W1toCl = Write 1 to clear bit; -n = value after reset

Table 23-47. IF1MSK Register Field Descriptions

Bit	Field	Type	Reset	Description
31	MXtd		1h	Mask Extended Identifier. When 11 bit (standard) identifiers are used for a message object, the identifiers of received data frames are written into bits ID28 to ID18. For acceptance filtering, only these bits together with mask bits Msk28 to Msk18 are considered. 0h (R/W) = The extended identifier bit (IDE) has no effect on the acceptance filtering. 1h (R/W) = The extended identifier bit (IDE) is used for acceptance filtering.
30	MDir		1h	Mask Message Direction 0h (R/W) = The message direction bit (Dir) has no effect on the acceptance filtering. 1h (R/W) = The message direction bit (Dir) is used for acceptance filtering.
29	RESERVED	R	1h	
28-0	Msk_28:0_		0h	Identifier Mask 0h (R/W) = The corresponding bit in the identifier of the message object is not used for acceptance filtering (don't care). 1h (R/W) = The corresponding bit in the identifier of the message object is used for acceptance filtering.

23.4.1.35 IF1ARB Register (offset = 108h) [reset = 0h]

IF1ARB is shown in [Figure 23-53](#) and described in [Table 23-48](#).

The bits of the IF1 arbitration registers mirror the arbitration bits of a message object. While Busy bit of IF1 command register is one, IF1 register set is write protected.

Figure 23-53. IF1ARB Register

31	30	29	28	27	26	25	24
MsgVal	Xtd	Dir	ID28_to_ID0				
0h	0h	0h	0h				
23	22	21	20	19	18	17	16
ID28_to_ID0							
0h							
15	14	13	12	11	10	9	8
ID28_to_ID0							
0h							
7	6	5	4	3	2	1	0
ID28_to_ID0							
0h							

LEGEND: R/W = Read/Write; R = Read only; W1toCl = Write 1 to clear bit; -n = value after reset

Table 23-48. IF1ARB Register Field Descriptions

Bit	Field	Type	Reset	Description
31	MsgVal		0h	Message valid. The CPU should reset the MsgVal bit of all unused Messages Objects during the initialization before it resets bit Init in the CAN control register. This bit must also be reset before the identifier ID28 to ID0, the control bits Xtd, Dir or DLC3 to DLC0 are modified, or if the messages object is no longer required. 0h (R/W) = The message object is ignored by the message handler. 1h (R/W) = The message object is to be used by the message handler.
30	Xtd		0h	Extended identifier 0h (R/W) = The 11-bit (standard) Identifier is used for this message object. 1h (R/W) = The 29-bit (extended) Identifier is used for this message object.
29	Dir		0h	Message direction 0h (R/W) = Direction = receive: On TxRqst, a remote frame with the identifier of this message object is transmitted. On reception of a data frame with matching identifier, this message is stored in this message object. 1h (R/W) = Direction = transmit: On TxRqst, the respective message object is transmitted as a data frame. On reception of a remote frame with matching identifier, the TxRqst bit of this message object is set (if RmtEn = 1).
28-0	ID28_to_ID0		0h	Message identifier. ID28 to ID0 is equal to 29 bit identifier (extended frame) ID28 to ID18 is equal to 11 bit identifier (standard frame)

23.4.1.36 IF1MCTL Register (offset = 10Ch) [reset = 0h]

IF1MCTL is shown in [Figure 23-54](#) and described in [Table 23-49](#).

The bits of the IF1 message control registers mirror the message control bits of a message object. While Busy bit of IF1 command register is one, IF1 register set is write protected.

Figure 23-54. IF1MCTL Register

31	30	29	28	27	26	25	24
RESERVED							
R-0h							
23	22	21	20	19	18	17	16
RESERVED							
R-0h							
15	14	13	12	11	10	9	8
NewDat	MsgLst	IntPnd	UMask	TxIE	RxIE	RmtEn	TxRqst
0h	0h	0h	0h	0h	0h	0h	0h
7	6	5	4	3	2	1	0
EoB	RESERVED			DLC			
0h	R-0h			0h			

LEGEND: R/W = Read/Write; R = Read only; W1toCl = Write 1 to clear bit; -n = value after reset

Table 23-49. IF1MCTL Register Field Descriptions

Bit	Field	Type	Reset	Description
31-16	RESERVED	R	0h	
15	NewDat		0h	New data 0h (R/W) = No new data has been written into the data portion of this message object by the message handler since the last time when this flag was cleared by the CPU. 1h (R/W) = The message handler or the CPU has written new data into the data portion of this message object.
14	MsgLst		0h	Message lost (only valid for message objects with direction = receive) 0h (R/W) = No message lost since the last time when this bit was reset by the CPU. 1h (R/W) = The message handler stored a new message into this object when NewDat was still set, so the previous message has been overwritten.
13	IntPnd		0h	Interrupt pending 0h (R/W) = This message object is not the source of an interrupt. 1h (R/W) = This message object is the source of an interrupt. The Interrupt Identifier in the interrupt register will point to this message object if there is no other interrupt source with higher priority.
12	UMask		0h	Use acceptance mask. If the UMask bit is set to one, the message object's mask bits have to be programmed during initialization of the message object before MsgVal is set to one. 0h (R/W) = Mask ignored 1h (R/W) = Use mask (Msk[28:0], MXtd, and MDir) for acceptance filtering
11	TxIE		0h	Transmit interrupt enable 0h (R/W) = IntPnd will not be triggered after the successful transmission of a frame. 1h (R/W) = IntPnd will be triggered after the successful transmission of a frame.

Table 23-49. IF1MCTL Register Field Descriptions (continued)

Bit	Field	Type	Reset	Description
10	RxIE		0h	Receive interrupt enable 0h (R/W) = IntPnd will not be triggered after the successful reception of a frame. 1h (R/W) = IntPnd will be triggered after the successful reception of a frame.
9	RmtEn		0h	Remote enable 0h (R/W) = At the reception of a remote frame, TxRqst is not changed. 1h (R/W) = At the reception of a remote frame, TxRqst is set.
8	TxRqst		0h	Transmit request 0h (R/W) = This message object is not waiting for a transmission. 1h (R/W) = The transmission of this message object is requested and is not yet done.
7	EoB		0h	Data frame has 0 to 8 data bits. Note: This bit is used to concatenate multiple message objects to build a FIFO Buffer. For single message objects (not belonging to a FIFO Buffer), this bit must always be set to one. 0h (R/W) = Data frame has 8 data bytes. 1h (R/W) = Note: The data length code of a message object must be defined the same as in all the corresponding objects with the same identifier at other nodes. When the message handler stores a data frame, it will write the DLC to the value given by the received message.
6-4	RESERVED	R	0h	
3-0	DLC		0h	Data length code. Note: The data length code of a message object must be defined the same as in all the corresponding objects with the same identifier at other nodes. When the message handler stores a data frame, it will write the DLC to the value given by the received message. 0x 0-0x 8: Data frame has 0-8 data bytes. 0x 9-0x 15: Data frame has 8 data bytes.

23.4.1.37 IF1DATA Register (offset = 110h) [reset = 0h]

IF1DATA is shown in [Figure 23-55](#) and described in [Table 23-50](#).

The data bytes of CAN messages are stored in the IF1 registers in the following order: (1) In a CAN data frame, Data 0 is the first, and Data 7 is the last byte to be transmitted or received. (2) In CAN's serial bit stream, the MSB of each byte will be transmitted first.

Figure 23-55. IF1DATA Register

31	30	29	28	27	26	25	24	23	22	21	20	19	18	17	16	15	14	13	12	11	10	9	8	7	6	5	4	3	2	1	0
Data_3								Data_2								Data_1								Data_0							
0h								0h								0h								0h							

LEGEND: R/W = Read/Write; R = Read only; W1toCl = Write 1 to clear bit; -n = value after reset

Table 23-50. IF1DATA Register Field Descriptions

Bit	Field	Type	Reset	Description
31-24	Data_3		0h	Data 3.
23-16	Data_2		0h	Data 2.
15-8	Data_1		0h	Data 1.
7-0	Data_0		0h	Data 0.

23.4.1.38 IF1DATB Register (offset = 114h) [reset = 0h]

IF1DATB is shown in [Figure 23-56](#) and described in [Table 23-51](#).

The data bytes of CAN messages are stored in the IF1 registers in the following order: (1) In a CAN data frame, Data 0 is the first, and Data 7 is the last byte to be transmitted or received. (2) In CAN's serial bit stream, the MSB of each byte will be transmitted first.

Figure 23-56. IF1DATB Register

31	30	29	28	27	26	25	24	23	22	21	20	19	18	17	16	15	14	13	12	11	10	9	8	7	6	5	4	3	2	1	0
Data_7								Data_6								Data_5								Data_4							
0h								0h								0h								0h							

LEGEND: R/W = Read/Write; R = Read only; W1toCl = Write 1 to clear bit; -n = value after reset

Table 23-51. IF1DATB Register Field Descriptions

Bit	Field	Type	Reset	Description
31-24	Data_7		0h	Data 7.
23-16	Data_6		0h	Data 6.
15-8	Data_5		0h	Data 5.
7-0	Data_4		0h	Data 4.

23.4.1.39 IF2CMD Register (offset = 120h) [reset = 0h]

IF2CMD is shown in [Figure 23-57](#) and described in [Table 23-52](#).

The IF2 Command Register (IF1CMD) configures and initiates the transfer between the IF2 register sets and the message RAM. It is configurable which portions of the message object should be transferred. A transfer is started when the CPU writes the message number to bits [7:0] of the IF2 command register. With this write operation, the Busy bit is automatically set to '1' to indicate that a transfer is in progress. After 4 to 14 OCP clock cycles, the transfer between the interface register and the message RAM will be completed and the Busy bit is cleared. The maximum number of cycles is needed when the message transfer concurs with a CAN message transmission, acceptance filtering, or message storage. If the CPU writes to both IF2 command registers consecutively (request of a second transfer while first transfer is still in progress), the second transfer will start after the first one has been completed. While Busy bit is one, IF2 register sets are write protected. For debug support, the auto clear functionality of the IF2 command registers (clear of DMAActive flag by r/w) is disabled during Debug/Suspend mode. If an invalid Message Number is written to bits [7:0] of the IF2 command register, the message handler may access an implemented (valid) message object instead.

Figure 23-57. IF2CMD Register

31	30	29	28	27	26	25	24
RESERVED							
R-0h							
23	22	21	20	19	18	17	16
WR_RD	Mask	Arb	Control	ClrIntPnd	TxRqst_NewDa t	Data_A	Data_B
0h	0h	0h	0h	0h	0h	0h	0h
15	14	13	12	11	10	9	8
Busy	DMAActive	RESERVED					
0h	0h	R-0h					
7	6	5	4	3	2	1	0
Message_Number							
0h							

LEGEND: R/W = Read/Write; R = Read only; W1toCl = Write 1 to clear bit; -n = value after reset

Table 23-52. IF2CMD Register Field Descriptions

Bit	Field	Type	Reset	Description
31-24	RESERVED	R	0h	
23	WR_RD		0h	Write/Read 0h (R/W) = Direction = Read: Transfer direction is from the message object addressed by Message Number (Bits [7:0]) to the IF2 register set. 1h (R/W) = Direction = Write: Transfer direction is from the IF2 register set to the message object addressed by Message Number (Bits [7:0]).
22	Mask		0h	Access mask bits 0h (R/W) = Mask bits will not be changed 1h (R/W) = Direction = Read: The mask bits (identifier mask + MDir + MXtd) will be transferred from the message object addressed by Message Number (Bits [7:0]) to the IF2 register set. Direction = Write: The mask bits (identifier mask + MDir + MXtd) will be transferred from the IF2 register set to the message object addressed by Message Number (Bits [7:0]).

Table 23-52. IF2CMD Register Field Descriptions (continued)

Bit	Field	Type	Reset	Description
21	Arb		0h	<p>Access arbitration bits</p> <p>0h (R/W) = Arbitration bits will not be changed</p> <p>1h (R/W) = Direction = Read: The Arbitration bits (Identifier + Dir + Xtd + MsgVal) will be transferred from the message object addressed by Message Number (Bits [7:0]) to the corresponding IF2 register set. Direction = Write: The Arbitration bits (Identifier + Dir + Xtd + MsgVal) will be transferred from the IF2 register set to the message object addressed by Message Number (Bits [7:0]).</p>
20	Control		0h	<p>Access control bits.</p> <p>If the TxRqst/NewDat bit in this register(Bit [18]) is set, the TxRqst/NewDat bit in the IF2 message control register will be ignored.</p> <p>0h (R/W) = Control bits will not be changed</p> <p>1h (R/W) = Direction = Read: The message control bits will be transferred from the message object addressed by message number (Bits [7:0]) to the IF2 register set. Direction = Write: The message control bits will be transferred from the IF2 register set to the message object addressed by message number (Bits [7:0]).</p>
19	ClrIntPnd		0h	<p>Clear interrupt pending bit</p> <p>0h (R/W) = IntPnd bit will not be changed</p> <p>1h (R/W) = Direction = Read: Clears IntPnd bit in the message object. Direction = Write: This bit is ignored. Copying of IntPnd flag from IF2 Registers to message RAM can only be controlled by the control flag (Bit [20]).</p>
18	TxRqst_NewDat		0h	<p>Access transmission request bit.</p> <p>Note: If a CAN transmission is requested by setting TxRqst/NewDat in this register, the TxRqst/NewDat bits in the message object will be set to one independent of the values in IF2 message control Register.</p> <p>Note: A read access to a message object can be combined with the reset of the control bits IntPnd and NewDat.</p> <p>The values of these bits transferred to the IF2 message control register always reflect the status before resetting them.</p> <p>0h (R/W) = Direction = Read: NewDat bit will not be changed. Direction = Write: TxRqst/NewDat bit will be handled according to the control bit.</p> <p>1h (R/W) = Direction = Read: Clears NewDat bit in the message object. Direction = Write: Sets TxRqst/NewDat in message object.</p>
17	Data_A		0h	<p>Access Data Bytes 0 to 3.</p> <p>0h (R/W) = Data Bytes 0-3 will not be changed.</p> <p>1h (R/W) = Direction = Read: The data bytes 0-3 will be transferred from the message object addressed by the Message Number (Bits [7:0]) to the corresponding IF2 register set. Direction = Write: The data bytes 0-3 will be transferred from the IF2 register set to the message object addressed by the Message Number (Bits [7:0]).</p> <p>Note: The duration of the message transfer is independent of the number of bytes to be transferred.</p>
16	Data_B		0h	<p>Access Data Bytes 4 to 7.</p> <p>0h (R/W) = Data Bytes 4-7 will not be changed.</p> <p>1h (R/W) = Direction = Read: The data bytes 4-7 will be transferred from the message object addressed by Message Number (Bits [7:0]) to the corresponding IF2 register set. Direction = Write: The data bytes 4-7 will be transferred from the IF2 register set to the message object addressed by message number (Bits [7:0]). Note: The duration of the message transfer is independent of the number of bytes to be transferred.</p>

Table 23-52. IF2CMD Register Field Descriptions (continued)

Bit	Field	Type	Reset	Description
15	Busy		0h	<p>Busy flag.</p> <p>This bit is set to one after the message number has been written to bits 7 to 0.</p> <p>IF2 register set will be write protected.</p> <p>The bit is cleared after read/write action has been finished.</p> <p>0h (R/W) = No transfer between IF2 register set and message RAM is in progress.</p> <p>1h (R/W) = Transfer between IF2 register set and message RAM is in progress.</p>
14	DMAActive		0h	<p>Activation of DMA feature for subsequent internal IF2 update.</p> <p>Note: Due to the auto reset feature of the DMAActive bit, this bit has to be set for each subsequent DMA cycle separately.</p> <p>0h (R/W) = DMA request line is independent of IF2 activities.</p> <p>1h (R/W) = DMA is requested after completed transfer between IF2 register set and message RAM. The DMA request remains active until the first read or write to one of the IF2 registers; an exception is a write to Message Number (Bits [7:0]) when DMAActive is one.</p>
13-8	RESERVED	R	0h	
7-0	Message_Number		0h	<p>Number of message object in message RAM which is used for data transfer.</p> <p>0h (R/W) = Invalid message number.</p> <p>1h (R/W) = Valid message numbers (values 01 to 80).</p> <p>80h (R/W) = Valid message number.</p> <p>81h (R/W) = Invalid message numbers (values 81 to FF).</p> <p>FFh (R/W) = Invalid message number.</p>

23.4.1.40 IF2MSK Register (offset = 124h) [reset = E000000h]

IF2MSK is shown in [Figure 23-58](#) and described in [Table 23-53](#).

The bits of the IF2 mask registers mirror the mask bits of a message object. While Busy bit of IF2 command register is one, IF2 register set is write protected.

Figure 23-58. IF2MSK Register

31	30	29	28	27	26	25	24
MXtd	MDir	RESERVED	Msk_28:0_				
1h	1h	R-1h	0h				
23	22	21	20	19	18	17	16
Msk_28:0_							
0h							
15	14	13	12	11	10	9	8
Msk_28:0_							
0h							
7	6	5	4	3	2	1	0
Msk_28:0_							
0h							

LEGEND: R/W = Read/Write; R = Read only; W1toCl = Write 1 to clear bit; -n = value after reset

Table 23-53. IF2MSK Register Field Descriptions

Bit	Field	Type	Reset	Description
31	MXtd		1h	Mask Extended Identifier. When 11 bit (standard) identifiers are used for a message object, the identifiers of received data frames are written into bits ID28 to ID18. For acceptance filtering, only these bits together with mask bits Msk28 to Msk18 are considered. 0h (R/W) = The extended identifier bit (IDE) has no effect on the acceptance filtering. 1h (R/W) = The extended identifier bit (IDE) is used for acceptance filtering.
30	MDir		1h	Mask Message Direction 0h (R/W) = The message direction bit (Dir) has no effect on the acceptance filtering. 1h (R/W) = The message direction bit (Dir) is used for acceptance filtering.
29	RESERVED	R	1h	
28-0	Msk_28:0_		0h	Identifier Mask 0h (R/W) = The corresponding bit in the identifier of the message object is not used for acceptance filtering (don't care). 1h (R/W) = The corresponding bit in the identifier of the message object is used for acceptance filtering.

23.4.1.41 IF2ARB Register (offset = 128h) [reset = 0h]

IF2ARB is shown in [Figure 23-59](#) and described in [Table 23-54](#).

The bits of the IF2 arbitration registers mirror the arbitration bits of a message object. While Busy bit of IF2 command register is one, IF2 register set is write protected.

Figure 23-59. IF2ARB Register

31	30	29	28	27	26	25	24
MsgVal	Xtd	Dir	ID28_to_ID0				
0h	0h	0h	0h				
23	22	21	20	19	18	17	16
ID28_to_ID0							
0h							
15	14	13	12	11	10	9	8
ID28_to_ID0							
0h							
7	6	5	4	3	2	1	0
ID28_to_ID0							
0h							

LEGEND: R/W = Read/Write; R = Read only; W1toCl = Write 1 to clear bit; -n = value after reset

Table 23-54. IF2ARB Register Field Descriptions

Bit	Field	Type	Reset	Description
31	MsgVal		0h	<p>Message valid.</p> <p>The CPU should reset the MsgVal bit of all unused Messages Objects during the initialization before it resets bit Init in the CAN control register.</p> <p>This bit must also be reset before the identifier ID28 to ID0, the control bits Xtd, Dir or DLC3 to DLC0 are modified, or if the messages object is no longer required.</p> <p>0h (R/W) = The message object is ignored by the message handler.</p> <p>1h (R/W) = The message object is to be used by the message handler.</p>
30	Xtd		0h	<p>Extended identifier</p> <p>0h (R/W) = The 11-bit (standard) Identifier is used for this message object.</p> <p>1h (R/W) = The 29-bit (extended) Identifier is used for this message object.</p>
29	Dir		0h	<p>Message direction</p> <p>0h (R/W) = Direction = receive: On TxRqst, a remote frame with the identifier of this message object is transmitted. On reception of a data frame with matching identifier, this message is stored in this message object.</p> <p>1h (R/W) = Direction = transmit: On TxRqst, the respective message object is transmitted as a data frame. On reception of a remote frame with matching identifier, the TxRqst bit of this message object is set (if RmtEn = 1).</p>
28-0	ID28_to_ID0		0h	<p>Message identifier.</p> <p>ID28 to ID0 is equal to 29-bit identifier (extended frame) ID28 to ID18 is equal to 11-bit identifier (standard frame)</p>

23.4.1.42 IF2MCTL Register (offset = 12Ch) [reset = 0h]

IF2MCTL is shown in [Figure 23-60](#) and described in [Table 23-55](#).

The bits of the IF2 message control registers mirror the message control bits of a message object. While Busy bit of IF2 command register is one, IF2 register set is write protected.

Figure 23-60. IF2MCTL Register

31	30	29	28	27	26	25	24
RESERVED							
R-0h							
23	22	21	20	19	18	17	16
RESERVED							
R-0h							
15	14	13	12	11	10	9	8
NewDat	MsgLst	IntPnd	UMask	TxIE	RxIE	RmtEn	TxRqst
0h	0h	0h	0h	0h	0h	0h	0h
7	6	5	4	3	2	1	0
EoB	RESERVED			DLC			
0h	R-0h			0h			

LEGEND: R/W = Read/Write; R = Read only; W1toCl = Write 1 to clear bit; -n = value after reset

Table 23-55. IF2MCTL Register Field Descriptions

Bit	Field	Type	Reset	Description
31-16	RESERVED	R	0h	
15	NewDat		0h	New data 0h (R/W) = No new data has been written into the data portion of this message object by the message handler since the last time when this flag was cleared by the CPU. 1h (R/W) = The message handler or the CPU has written new data into the data portion of this message object.
14	MsgLst		0h	Message lost (only valid for message objects with direction = receive) 0h (R/W) = No message lost since the last time when this bit was reset by the CPU. 1h (R/W) = The message handler stored a new message into this object when NewDat was still set, so the previous message has been overwritten.
13	IntPnd		0h	Interrupt pending 0h (R/W) = This message object is not the source of an interrupt. 1h (R/W) = This message object is the source of an interrupt. The Interrupt Identifier in the interrupt register will point to this message object if there is no other interrupt source with higher priority.
12	UMask		0h	Use acceptance mask. If the UMask bit is set to one, the message object's mask bits have to be programmed during initialization of the message object before MsgVal is set to one. 0h (R/W) = Mask ignored 1h (R/W) = Use mask (Msk[28:0], MXtd, and MDir) for acceptance filtering
11	TxIE		0h	Transmit interrupt enable 0h (R/W) = IntPnd will not be triggered after the successful transmission of a frame. 1h (R/W) = IntPnd will be triggered after the successful transmission of a frame.

Table 23-55. IF2MCTL Register Field Descriptions (continued)

Bit	Field	Type	Reset	Description
10	RxIE		0h	Receive interrupt enable 0h (R/W) = IntPnd will not be triggered after the successful reception of a frame. 1h (R/W) = IntPnd will be triggered after the successful reception of a frame.
9	RmtEn		0h	Remote enable 0h (R/W) = At the reception of a remote frame, TxRqst is not changed. 1h (R/W) = At the reception of a remote frame, TxRqst is set.
8	TxRqst		0h	Transmit request 0h (R/W) = This message object is not waiting for a transmission. 1h (R/W) = The transmission of this message object is requested and is not yet done.
7	EoB		0h	Data frame has 0 to 8 data bits. Note: This bit is used to concatenate multiple message objects to build a FIFO Buffer. For single message objects (not belonging to a FIFO Buffer), this bit must always be set to one. 0h (R/W) = Data frame has 8 data bytes. 1h (R/W) = Note: The data length code of a message object must be defined the same as in all the corresponding objects with the same identifier at other nodes. When the message handler stores a data frame, it will write the DLC to the value given by the received message.
6-4	RESERVED	R	0h	
3-0	DLC		0h	Data length code. Note: The data length code of a message object must be defined the same as in all the corresponding objects with the same identifier at other nodes. When the message handler stores a data frame, it will write the DLC to the value given by the received message. 0x 0-0x 8: Data frame has 0-8 data bytes. 0x 9-0x 15: Data frame has 8 data bytes.

23.4.1.43 IF2DATA Register (offset = 130h) [reset = 0h]

IF2DATA is shown in [Figure 23-61](#) and described in [Table 23-56](#).

The data bytes of CAN messages are stored in the IF2 registers in the following order: (1) In a CAN data frame, Data 0 is the first, and Data 7 is the last byte to be transmitted or received. (2) In CAN's serial bit stream, the MSB of each byte will be transmitted first.

Figure 23-61. IF2DATA Register

31	30	29	28	27	26	25	24	23	22	21	20	19	18	17	16	15	14	13	12	11	10	9	8	7	6	5	4	3	2	1	0
Data_3								Data_2								Data_1								Data_0							
0h								0h								0h								0h							

LEGEND: R/W = Read/Write; R = Read only; W1toCl = Write 1 to clear bit; -n = value after reset

Table 23-56. IF2DATA Register Field Descriptions

Bit	Field	Type	Reset	Description
31-24	Data_3		0h	Data 3.
23-16	Data_2		0h	Data 2.
15-8	Data_1		0h	Data 1.
7-0	Data_0		0h	Data 0.

23.4.1.44 IF2DATB Register (offset = 134h) [reset = 0h]

IF2DATB is shown in [Figure 23-62](#) and described in [Table 23-57](#).

The data bytes of CAN messages are stored in the IF2 registers in the following order: (1) In a CAN data frame, Data 0 is the first, and Data 7 is the last byte to be transmitted or received. (2) In CAN's serial bit stream, the MSB of each byte will be transmitted first.

Figure 23-62. IF2DATB Register

31	30	29	28	27	26	25	24	23	22	21	20	19	18	17	16	15	14	13	12	11	10	9	8	7	6	5	4	3	2	1	0
Data_7								Data_6								Data_5								Data_4							
0h								0h								0h								0h							

LEGEND: R/W = Read/Write; R = Read only; W1toCl = Write 1 to clear bit; -n = value after reset

Table 23-57. IF2DATB Register Field Descriptions

Bit	Field	Type	Reset	Description
31-24	Data_7		0h	Data 7.
23-16	Data_6		0h	Data 6.
15-8	Data_5		0h	Data 5.
7-0	Data_4		0h	Data 4.

23.4.1.45 IF3OBS Register (offset = 140h) [reset = 0h]

IF3OBS is shown in [Figure 23-63](#) and described in [Table 23-58](#).

The IF3 register set can automatically be updated with received message objects without the need to initiate the transfer from message RAM by CPU. The observation flags (Bits [4:0]) in the IF3 observation register are used to determine, which data sections of the IF3 interface register set have to be read in order to complete a DMA read cycle. After all marked data sections are read, the DCAN is enabled to update the IF3 interface register set with new data. Any access order of single bytes or half-words is supported. When using byte or half-word accesses, a data section is marked as completed, if all bytes are read. Note: If IF3 Update Enable is used and no Observation flag is set, the corresponding message objects will be copied to IF3 without activating the DMA request line and without waiting for DMA read accesses. A write access to this register aborts a pending DMA cycle by resetting the DMA line and enables updating of IF3 interface register set with new data. To avoid data inconsistency, the DMA controller should be disabled before reconfiguring IF3 observation register. The status of the current read-cycle can be observed via status flags (Bits [12:8]). If an interrupt line is available for IF3, an interrupt will be generated by IF3Upd flag. See the device-specific data sheet for the availability of this interrupt source. With this interrupt, the observation status bits and the IF3Upd bit could be used by the application to realize the notification about new IF3 content in polling or interrupt mode.

Figure 23-63. IF3OBS Register

31	30	29	28	27	26	25	24
RESERVED							
R-0h							
23	22	21	20	19	18	17	16
RESERVED							
R-0h							
15	14	13	12	11	10	9	8
IF3_Upd	RESERVED		IF3_SDB	IF3_SDA	IF3_SC	IF3_SA	IF3_SM
R-0h	R-0h		R-0h	R-0h	R-0h	R-0h	R-0h
7	6	5	4	3	2	1	0
RESERVED			DataB	DataA	Ctrl	Arb	Mask
R-0h			R/W-0h	R/W-0h	R/W-0h	R/W-0h	R/W-0h

LEGEND: R/W = Read/Write; R = Read only; W1toCl = Write 1 to clear bit; -n = value after reset

Table 23-58. IF3OBS Register Field Descriptions

Bit	Field	Type	Reset	Description
31-16	RESERVED	R	0h	
15	IF3_Upd	R	0h	IF3 Update Data 0h (R/W) = No new data has been loaded since last IF3 read. 1h (R/W) = New data has been loaded since last IF3 read.
14-13	RESERVED	R	0h	
12	IF3_SDB	R	0h	IF3 Status of Data B read access 0h (R/W) = All Data B bytes are already read out, or are not marked to be read. 1h (R/W) = Data B section has still data to be read out.
11	IF3_SDA	R	0h	IF3 Status of Data A read access 0h (R/W) = All Data A bytes are already read out, or are not marked to be read. 1h (R/W) = Data A section has still data to be read out.
10	IF3_SC	R	0h	IF3 Status of control bits read access 0h (R/W) = All control section bytes are already read out, or are not marked to be read. 1h (R/W) = Control section has still data to be read out.

Table 23-58. IF3OBS Register Field Descriptions (continued)

Bit	Field	Type	Reset	Description
9	IF3_SA	R	0h	IF3 Status of Arbitration data read access 0h (R/W) = All Arbitration data bytes are already read out, or are not marked to be read. 1h (R/W) = Arbitration section has still data to be read out.
8	IF3_SM	R	0h	IF3 Status of Mask data read access 0h (R/W) = All mask data bytes are already read out, or are not marked to be read. 1h (R/W) = Mask section has still data to be read out.
7-5	RESERVED	R	0h	
4	DataB	R/W	0h	Data B read observation 0h (R/W) = Data B section has not to be read. 1h (R/W) = Data B section has to be read to enable next IF3 update.
3	DataA	R/W	0h	Data A read observation 0h (R/W) = Data A section has not to be read. 1h (R/W) = Data A section has to be read to enable next IF3 update.
2	Ctrl	R/W	0h	Ctrl read observation 0h (R/W) = Ctrl section has not to be read. 1h (R/W) = Ctrl section has to be read to enable next IF3 update.
1	Arb	R/W	0h	Arbitration data read observation 0h (R/W) = Arbitration data has not to be read. 1h (R/W) = Arbitration data has to be read to enable next IF3 update.
0	Mask	R/W	0h	Mask data read observation 0h (R/W) = Mask data has not to be read. 1h (R/W) = Mask data has to be read to enable next IF3 update.

23.4.1.46 IF3MSK Register (offset = 144h) [reset = E000000h]

 IF3MSK is shown in [Figure 23-64](#) and described in [Table 23-59](#).

Figure 23-64. IF3MSK Register

31	30	29	28	27	26	25	24
MXtd	MDir	RESERVED	Msk_28:0_				
R-1h	R-1h	R-1h	0h				
23	22	21	20	19	18	17	16
Msk_28:0_							
0h							
15	14	13	12	11	10	9	8
Msk_28:0_							
0h							
7	6	5	4	3	2	1	0
Msk_28:0_							
0h							

LEGEND: R/W = Read/Write; R = Read only; W1toCl = Write 1 to clear bit; -n = value after reset

Table 23-59. IF3MSK Register Field Descriptions

Bit	Field	Type	Reset	Description
31	MXtd	R	1h	Mask Extended Identifier. When 11 bit (standard) identifiers are used for a message object, the identifiers of received data frames are written into bits ID28 to ID18. For acceptance filtering, only these bits together with mask bits Msk28 to Msk18 are considered. 0h (R/W) = The extended identifier bit (IDE) has no effect on the acceptance filtering. 1h (R/W) = The extended identifier bit (IDE) is used for acceptance filtering.
30	MDir	R	1h	Mask Message Direction 0h (R/W) = The message direction bit (Dir) has no effect on the acceptance filtering. 1h (R/W) = The message direction bit (Dir) is used for acceptance filtering.
29	RESERVED	R	1h	
28-0	Msk_28:0_		0h	Identifier Mask 0h (R/W) = The corresponding bit in the identifier of the message object is not used for acceptance filtering (don't care). 1h (R/W) = The corresponding bit in the identifier of the message object is used for acceptance filtering.

23.4.1.47 IF3ARB Register (offset = 148h) [reset = 0h]

IF3ARB is shown in [Figure 23-65](#) and described in [Table 23-60](#).

Figure 23-65. IF3ARB Register

31	30	29	28	27	26	25	24
MsgVal	Xtd	Dir	ID28_to_ID0				
R-0h	R-0h	R-0h	R-0h				
23	22	21	20	19	18	17	16
ID28_to_ID0							
R-0h							
15	14	13	12	11	10	9	8
ID28_to_ID0							
R-0h							
7	6	5	4	3	2	1	0
ID28_to_ID0							
R-0h							

LEGEND: R/W = Read/Write; R = Read only; W1toCl = Write 1 to clear bit; -n = value after reset

Table 23-60. IF3ARB Register Field Descriptions

Bit	Field	Type	Reset	Description
31	MsgVal	R	0h	<p>Message Valid.</p> <p>The CPU should reset the MsgVal bit of all unused Messages Objects during the initialization before it resets bit Init in the CAN control register.</p> <p>This bit must also be reset before the identifier ID28 to ID0, the control bits Xtd, Dir or DLC3 to DLC0 are modified, or if the messages object is no longer required.</p> <p>0h (R/W) = The message object is ignored by the message handler.</p> <p>1h (R/W) = The message object is to be used by the message handler.</p>
30	Xtd	R	0h	<p>Extended Identifier</p> <p>0h (R/W) = The 11-bit (standard) Identifier is used for this message object.</p> <p>1h (R/W) = The 29-bit (extended) Identifier is used for this message object.</p>
29	Dir	R	0h	<p>Message Direction</p> <p>0h (R/W) = Direction = receive: On TxRqst, a remote frame with the identifier of this message object is transmitted. On reception of a data frame with matching identifier, this message is stored in this message object.</p> <p>1h (R/W) = Direction = transmit: On TxRqst, the respective message object is transmitted as a data frame. On reception of a remote frame with matching identifier, the TxRqst bit of this message object is set (if RmtEn = 1).</p>
28-0	ID28_to_ID0	R	0h	<p>Message Identifier.</p> <p>ID28 to ID0 is equal to 29 bit Identifier (extended frame).</p> <p>ID28 to ID18 is equal to 11 bit Identifier (standard frame).</p>

23.4.1.48 IF3MCTL Register (offset = 14Ch) [reset = 0h]

 IF3MCTL is shown in [Figure 23-66](#) and described in [Table 23-61](#).

Figure 23-66. IF3MCTL Register

31	30	29	28	27	26	25	24
RESERVED							
R-0h							
23	22	21	20	19	18	17	16
RESERVED							
R-0h							
15	14	13	12	11	10	9	8
NewDat	MsgLst	IntPnd	UMask	TxIE	RxIE	RmtEn	TxRqst
R-0h	R-0h	R-0h	R-0h	R-0h	R-0h	R-0h	R-0h
7	6	5	4	3	2	1	0
EoB	RESERVED				DLC		
R-0h	R-0h				R-0h		

LEGEND: R/W = Read/Write; R = Read only; W1toCl = Write 1 to clear bit; -n = value after reset

Table 23-61. IF3MCTL Register Field Descriptions

Bit	Field	Type	Reset	Description
31-16	RESERVED	R	0h	
15	NewDat	R	0h	New Data 0h (R/W) = No new data has been written into the data portion of this message object by the message handler since the last time when this flag was cleared by the CPU. 1h (R/W) = The message handler or the CPU has written new data into the data portion of this message object.
14	MsgLst	R	0h	Message Lost (only valid for message objects with direction = receive) 0h (R/W) = No message lost since the last time when this bit was reset by the CPU. 1h (R/W) = The message handler stored a new message into this object when NewDat was still set, so the previous message has been overwritten.
13	IntPnd	R	0h	Interrupt Pending 0h (R/W) = This message object is not the source of an interrupt. 1h (R/W) = This message object is the source of an interrupt. The Interrupt Identifier in the interrupt register will point to this message object if there is no other interrupt source with higher priority.
12	UMask	R	0h	Use Acceptance Mask 0h (R/W) = Mask ignored 1h (R/W) = Use mask (Msk[28:0], MXtd, and MDir) for acceptance filtering. If the UMask bit is set to one, the message object's mask bits have to be programmed during initialization of the message object before MsgVal is set to one.
11	TxIE	R	0h	Transmit Interrupt enable 0h (R/W) = IntPnd will not be triggered after the successful transmission of a frame. 1h (R/W) = IntPnd will be triggered after the successful transmission of a frame.
10	RxIE	R	0h	Receive Interrupt enable 0h (R/W) = IntPnd will not be triggered after the successful reception of a frame. 1h (R/W) = IntPnd will be triggered after the successful reception of a frame.

Table 23-61. IF3MCTL Register Field Descriptions (continued)

Bit	Field	Type	Reset	Description
9	RmtEn	R	0h	Remote enable 0h (R/W) = At the reception of a remote frame, TxRqst is not changed. 1h (R/W) = At the reception of a remote frame, TxRqst is set.
8	TxRqst	R	0h	Transmit Request 0h (R/W) = This message object is not waiting for a transmission. 1h (R/W) = The transmission of this message object is requested and is not yet done.
7	EoB	R	0h	Data frame has 0 to 8 data bits. Note: This bit is used to concatenate multiple message objects to build a FIFO Buffer. For single message objects (not belonging to a FIFO Buffer), this bit must always be set to one. 0h (R/W) = Data frame has 8 data bytes. 1h (R/W) = Note: The data length code of a message object must be defined the same as in all the corresponding objects with the same identifier at other nodes. When the message handler stores a data frame, it will write the DLC to the value given by the received message.
6-4	RESERVED	R	0h	
3-0	DLC	R	0h	Data Length Code. Note: The data length code of a message object must be defined the same as in all the corresponding objects with the same identifier at other nodes. When the message handler stores a data frame, it will write the DLC to the value given by the received message. 0x 0-0x 8: Data frame has 0-8 data bytes. 0x 9-0x 15: Data frame has 8 data bytes.

23.4.1.49 IF3DATA Register (offset = 150h) [reset = 0h]

IF3DATA is shown in [Figure 23-67](#) and described in [Table 23-62](#).

The data bytes of CAN messages are stored in the IF3 registers in the following order. In a CAN data frame, Data 0 is the first, and Data 7 is the last byte to be transmitted or received. In CAN's serial bit stream, the MSB of each byte will be transmitted first.

Figure 23-67. IF3DATA Register

31	30	29	28	27	26	25	24	23	22	21	20	19	18	17	16	15	14	13	12	11	10	9	8	7	6	5	4	3	2	1	0
Data_3								Data_2								Data_1								Data_0							
R-0h								R-0h								R-0h								R-0h							

LEGEND: R/W = Read/Write; R = Read only; W1toCl = Write 1 to clear bit; -n = value after reset

Table 23-62. IF3DATA Register Field Descriptions

Bit	Field	Type	Reset	Description
31-24	Data_3	R	0h	Data 3.
23-16	Data_2	R	0h	Data 2.
15-8	Data_1	R	0h	Data 1.
7-0	Data_0	R	0h	Data 0.

23.4.1.50 IF3DATB Register (offset = 154h) [reset = 0h]

IF3DATB is shown in [Figure 23-68](#) and described in [Table 23-63](#).

The data bytes of CAN messages are stored in the IF3 registers in the following order. In a CAN data frame, Data 0 is the first, and Data 7 is the last byte to be transmitted or received. In CAN's serial bit stream, the MSB of each byte will be transmitted first.

Figure 23-68. IF3DATB Register

31	30	29	28	27	26	25	24	23	22	21	20	19	18	17	16	15	14	13	12	11	10	9	8	7	6	5	4	3	2	1	0
Data_7								Data_6								Data_5								Data_4							
R-0h								R-0h								R-0h								R-0h							

LEGEND: R/W = Read/Write; R = Read only; W1toCl = Write 1 to clear bit; -n = value after reset

Table 23-63. IF3DATB Register Field Descriptions

Bit	Field	Type	Reset	Description
31-24	Data_7	R	0h	Data 7.
23-16	Data_6	R	0h	Data 6.
15-8	Data_5	R	0h	Data 5.
7-0	Data_4	R	0h	Data 4.

23.4.1.51 IF3UPD12 Register (offset = 160h) [reset = 0h]

IF3UPD12 is shown in [Figure 23-69](#) and described in [Table 23-64](#).

The automatic update functionality of the IF3 register set can be configured for each message object. A message object is enabled for automatic IF3 update, if the dedicated IF3UpdEn flag is set. This means that an active NewDat flag of this message object (e.g due to reception of a CAN frame) will trigger an automatic copy of the whole message object to IF3 register set. IF3 Update enable should not be set for transmit objects.

Figure 23-69. IF3UPD12 Register

31	30	29	28	27	26	25	24	23	22	21	20	19	18	17	16	15	14	13	12	11	10	9	8	7	6	5	4	3	2	1	0
IF3UpdEn_32:17_																IF3UpdEn_16:1_															
R/W-0h																R/W-0h															

LEGEND: R/W = Read/Write; R = Read only; W1toCl = Write 1 to clear bit; -n = value after reset

Table 23-64. IF3UPD12 Register Field Descriptions

Bit	Field	Type	Reset	Description
31-16	IF3UpdEn_32:17_	R/W	0h	IF3 Update Enabled (for all message objects) 0h (R/W) = Automatic IF3 update is disabled for this message object. 1h (R/W) = Automatic IF3 update is enabled for this message object. A message object is scheduled to be copied to IF3 register set, if NewDat flag of the message object is active.
15-0	IF3UpdEn_16:1_	R/W	0h	IF3 Update Enabled (for all message objects) 0h (R/W) = Automatic IF3 update is disabled for this message object. 1h (R/W) = Automatic IF3 update is enabled for this message object. A message object is scheduled to be copied to IF3 register set, if NewDat flag of the message object is active.

23.4.1.52 IF3UPD34 Register (offset = 164h) [reset = 0h]

IF3UPD34 is shown in [Figure 23-70](#) and described in [Table 23-65](#).

The automatic update functionality of the IF3 register set can be configured for each message object. A message object is enabled for automatic IF3 update, if the dedicated IF3UpdEn flag is set. This means that an active NewDat flag of this message object (e.g due to reception of a CAN frame) will trigger an automatic copy of the whole message object to IF3 register set. IF3 Update enable should not be set for transmit objects.

Figure 23-70. IF3UPD34 Register

31	30	29	28	27	26	25	24	23	22	21	20	19	18	17	16	15	14	13	12	11	10	9	8	7	6	5	4	3	2	1	0
IF3UpdEn_64:49_																IF3UpdEn_48:33_															
R/W-0h																R/W-0h															

LEGEND: R/W = Read/Write; R = Read only; W1toCl = Write 1 to clear bit; -n = value after reset

Table 23-65. IF3UPD34 Register Field Descriptions

Bit	Field	Type	Reset	Description
31-16	IF3UpdEn_64:49_	R/W	0h	IF3 Update Enabled (for all message objects) 0h (R/W) = Automatic IF3 update is disabled for this message object. 1h (R/W) = Automatic IF3 update is enabled for this message object. A message object is scheduled to be copied to IF3 register set, if NewDat flag of the message object is active.
15-0	IF3UpdEn_48:33_	R/W	0h	IF3 Update Enabled (for all message objects) 0h (R/W) = Automatic IF3 update is disabled for this message object. 1h (R/W) = Automatic IF3 update is enabled for this message object. A message object is scheduled to be copied to IF3 register set, if NewDat flag of the message object is active.

23.4.1.53 IF3UPD56 Register (offset = 168h) [reset = 0h]

IF3UPD56 is shown in [Figure 23-71](#) and described in [Table 23-66](#).

The automatic update functionality of the IF3 register set can be configured for each message object. A message object is enabled for automatic IF3 update, if the dedicated IF3UpdEn flag is set. This means that an active NewDat flag of this message object (e.g due to reception of a CAN frame) will trigger an automatic copy of the whole message object to IF3 register set. IF3 Update enable should not be set for transmit objects.

Figure 23-71. IF3UPD56 Register

31	30	29	28	27	26	25	24	23	22	21	20	19	18	17	16	15	14	13	12	11	10	9	8	7	6	5	4	3	2	1	0
IF3UpdEn_96:81_																IF3UpdEn_80:65_															
R/W-0h																R/W-0h															

LEGEND: R/W = Read/Write; R = Read only; W1toCl = Write 1 to clear bit; -n = value after reset

Table 23-66. IF3UPD56 Register Field Descriptions

Bit	Field	Type	Reset	Description
31-16	IF3UpdEn_96:81_	R/W	0h	IF3 Update Enabled (for all message objects) 0h (R/W) = Automatic IF3 update is disabled for this message object. 1h (R/W) = Automatic IF3 update is enabled for this message object. A message object is scheduled to be copied to IF3 register set, if NewDat flag of the message object is active.
15-0	IF3UpdEn_80:65_	R/W	0h	IF3 Update Enabled (for all message objects) 0h (R/W) = Automatic IF3 update is disabled for this message object. 1h (R/W) = Automatic IF3 update is enabled for this message object. A message object is scheduled to be copied to IF3 register set, if NewDat flag of the message object is active.

23.4.1.54 IF3UPD78 Register (offset = 16Ch) [reset = 0h]

IF3UPD78 is shown in [Figure 23-72](#) and described in [Table 23-67](#).

The automatic update functionality of the IF3 register set can be configured for each message object. A message object is enabled for automatic IF3 update, if the dedicated IF3UpdEn flag is set. This means that an active NewDat flag of this message object (e.g due to reception of a CAN frame) will trigger an automatic copy of the whole message object to IF3 register set. IF3 Update enable should not be set for transmit objects.

Figure 23-72. IF3UPD78 Register

31	30	29	28	27	26	25	24	23	22	21	20	19	18	17	16
IF3UpdEn_128:113_															
R/W-0h															
15	14	13	12	11	10	9	8	7	6	5	4	3	2	1	0
IF3UpdEn_112:97_															
R/W-0h															

LEGEND: R/W = Read/Write; R = Read only; W1toCl = Write 1 to clear bit; -n = value after reset

Table 23-67. IF3UPD78 Register Field Descriptions

Bit	Field	Type	Reset	Description
31-16	IF3UpdEn_128:113_	R/W	0h	IF3 Update Enabled (for all message objects) 0h (R/W) = Automatic IF3 update is disabled for this message object. 1h (R/W) = Automatic IF3 update is enabled for this message object. A message object is scheduled to be copied to IF3 register set, if NewDat flag of the message object is active.
15-0	IF3UpdEn_112:97_	R/W	0h	IF3 Update Enabled (for all message objects) 0h (R/W) = Automatic IF3 update is disabled for this message object. 1h (R/W) = Automatic IF3 update is enabled for this message object. A message object is scheduled to be copied to IF3 register set, if NewDat flag of the message object is active.

23.4.1.55 TIOC Register (offset = 1E0h) [reset = 0h]

TIOC is shown in [Figure 23-73](#) and described in [Table 23-68](#).

The CAN_TX pin of the DCAN module can be used as general purpose IO pin if CAN function is not needed. The values of the IO control registers are only writable if Init bit of the CAN control register is set. The OD, Func, Dir and Out bits of the CAN TX IO control register are forced to certain values when Init bit of CAN control register is reset (see bit descriptions).

Figure 23-73. TIOC Register

31	30	29	28	27	26	25	24
RESERVED							
R-0h							
23	22	21	20	19	18	17	16
RESERVED					PU	PD	OD
R-0h					R/W-0h	R/W-0h	0h
15	14	13	12	11	10	9	8
RESERVED							
R-0h							
7	6	5	4	3	2	1	0
RESERVED				Func	Dir	Out	In
R-0h				0h	0h	0h	R-0h

LEGEND: R/W = Read/Write; R = Read only; W1toCl = Write 1 to clear bit; -n = value after reset

Table 23-68. TIOC Register Field Descriptions

Bit	Field	Type	Reset	Description
31-19	RESERVED	R	0h	
18	PU	R/W	0h	CAN_TX pull up/pull down select. This bit is only active when CAN_TX is configured to be an input. 0h (R/W) = CAN_TX pull down is selected, when pull logic is active (PD = 0). 1h (R/W) = CAN_TX pull up is selected, when pull logic is active (PD = 0).
17	PD	R/W	0h	CAN_TX pull disable. This bit is only active when CAN_TX is configured to be an input. 0h (R/W) = CAN_TX pull is active 1h (R/W) = CAN_TX pull is disabled
16	OD		0h	CAN_TX open drain enable. This bit is only active when CAN_TX is configured to be in GIO mode (TIOC.Func=0). Forced to '0' if Init bit of CAN control register is reset. 0h (R/W) = The CAN_TX pin is configured in push/pull mode. 1h (R/W) = The CAN_TX pin is configured in open drain mode.
15-4	RESERVED	R	0h	
3	Func		0h	CAN_TX function. This bit changes the function of the CAN_TX pin. Forced to '1' if Init bit of CAN control register is reset. 0h (R/W) = CAN_TX pin is in GIO mode. 1h (R/W) = CAN_TX pin is in functional mode (as an output to transmit CAN data).
2	Dir		0h	CAN_TX data direction. This bit controls the direction of the CAN_TX pin when it is configured to be in GIO mode only (TIOC.Func=0). Forced to '1' if Init bit of CAN control register is reset. 0h (R/W) = The CAN_TX pin is an input. 1h (R/W) = The CAN_TX pin is an output

Table 23-68. TIOC Register Field Descriptions (continued)

Bit	Field	Type	Reset	Description
1	Out		0h	CAN_TX data out write. This bit is only active when CAN_TX pin is configured to be in GIO mode (TIOC.Func = 0) and configured to be an output pin (TIOC.Dir = 1). The value of this bit indicates the value to be output to the CAN_TX pin. Forced to Tx output of the CAN core, if Init bit of CAN control register is reset. 0h (R/W) = The CAN_TX pin is driven to logic low 1h (R/W) = The CAN_TX pin is driven to logic high
0	In	R	0h	CAN_TX data in. Note: When CAN_TX pin is connected to a CAN transceiver, an external pullup resistor has to be used to ensure that the CAN bus will not be disturbed (e.g. while reset of the DCAN module). 0h (R/W) = The CAN_TX pin is at logic low 1h (R/W) = The CAN_TX pin is at logic high

23.4.1.56 RIOCR Register (offset = 1E4h) [reset = 0h]

RIOCR is shown in [Figure 23-74](#) and described in [Table 23-69](#).

The CAN_RX pin of the DCAN module can be used as general purpose IO pin if CAN function is not needed. The values of the IO control registers are writable only if Init bit of CAN control register is set. The OD, Func and Dir bits of the CAN RX IO control register are forced to certain values when the Init bit of CAN control register is reset (see bit descriptions).

Figure 23-74. RIOCR Register

31	30	29	28	27	26	25	24
RESERVED							
R-0h							
23	22	21	20	19	18	17	16
RESERVED					PU	PD	OD
R-0h					R/W-0h	R/W-0h	0h
15	14	13	12	11	10	9	8
RESERVED							
R-0h							
7	6	5	4	3	2	1	0
RESERVED				Func	Dir	Out	In
R-0h				0h	0h	0h	R-0h

LEGEND: R/W = Read/Write; R = Read only; W1toCl = Write 1 to clear bit; -n = value after reset

Table 23-69. RIOCR Register Field Descriptions

Bit	Field	Type	Reset	Description
31-19	RESERVED	R	0h	
18	PU	R/W	0h	CAN_RX pull up/pull down select. This bit is only active when CAN_RX is configured to be an input. 0h (R/W) = CAN_RX pull down is selected, when pull logic is active (PD = 0). 1h (R/W) = CAN_T=RX pull up is selected, when pull logic is active (PD = 0).
17	PD	R/W	0h	CAN_RX pull disable. This bit is only active when CAN_TX is configured to be an input. 0h (R/W) = CAN_RX pull is active 1h (R/W) = CAN_RX pull is disabled
16	OD		0h	CAN_RX open drain enable. This bit is only active when CAN_RX is configured to be in GIO mode (TIOC.Func=0). Forced to '0' if Init bit of CAN control register is reset. 0h (R/W) = The CAN_RX pin is configured in push/pull mode. 1h (R/W) = The CAN_RX pin is configured in open drain mode.
15-4	RESERVED	R	0h	
3	Func		0h	CAN_RX function. This bit changes the function of the CAN_RX pin. Forced to '1' if Init bit of CAN control register is reset. 0h (R/W) = CAN_RX pin is in GIO mode. 1h (R/W) = CAN_RX pin is in functional mode (as an output to transmit CAN data).
2	Dir		0h	CAN_RX data direction. This bit controls the direction of the CAN_RX pin when it is configured to be in GIO mode only (TIOC.Func=0). Forced to '1' if Init bit of CAN control register is reset. 0h (R/W) = The CAN_RX pin is an input. 1h (R/W) = The CAN_RX pin is an output

Table 23-69. RIOC Register Field Descriptions (continued)

Bit	Field	Type	Reset	Description
1	Out		0h	<p>CAN_RX data out write.</p> <p>This bit is only active when CAN_RX pin is configured to be in GIO mode (TIOC.Func = 0) and configured to be an output pin (TIOC.Dir = 1).</p> <p>The value of this bit indicates the value to be output to the CAN_RX pin.</p> <p>Forced to Tx output of the CAN core, if Init bit of CAN control register is reset.</p> <p>0h (R/W) = The CAN_RX pin is driven to logic low 1h (R/W) = The CAN_RX pin is driven to logic high</p>
0	In	R	0h	<p>CAN_RX data in.</p> <p>Note: When CAN_RX pin is connected to a CAN transceiver, an external pullup resistor has to be used to ensure that the CAN bus will not be disturbed (for example, while reset of the DCAN module).</p> <p>0h (R/W) = The CAN_RX pin is at logic low 1h (R/W) = The CAN_RX pin is at logic high</p>

Multichannel Serial Port Interface (McSPI)

This chapter describes the McSPI of the device.

Topic	Page
24.1 Introduction	4775
24.2 Integration	4776
24.3 Functional Description	4778
24.4 McSPI Registers	4812

24.1 Introduction

This document is intended to provide programmers with a functional presentation of the Master/Slave Multichannel Serial Port Interface (McSPI) module. It also provides a register description and a module configuration example.

McSPI is a general-purpose receive/transmit master/slave controller that can interface with up to four slave external devices or one single external master. It allows a duplex, synchronous, serial communication between a CPU and SPI compliant external devices (Slaves and Masters).

24.1.1 McSPI Features

The general features of the SPI controller are:

- Buffered receive/transmit data register per channel (1 word deep)
- Multiple SPI word access with one channel using a FIFO
- Two DMA requests per channel, one interrupt line
- Single interrupt line, for multiple interrupt source events
- Serial link interface supports:
 - Full duplex / Half duplex
 - Multi-channel master or single channel slave operations
 - Programmable 1-32 bit transmit/receive shift operations.
 - Wide selection of SPI word lengths continuous from 4 to 32 bits
- Up to four SPI channels
- SPI word Transmit / Receive slot assignment based on round robin arbitration
- SPI configuration per channel (clock definition, enable polarity and word width)
- Clock generation supports:
 - Programmable master clock generation (operating from fixed 48-MHz functional clock input)
 - Selectable clock phase and clock polarity per chip select.

24.1.2 Unsupported McSPI Features

This device supports only two chip selects per module. Module wakeup during slave mode operation is not supported, as noted in *McSPI Clock and Reset Management*.

Table 24-1. Unsupported McSPI Features

Feature	Reason
Chip selects 2 and 3	Not pinned out
Slave mode wakeup	SWAKEUP not connected
Retention during power down	Module not synthesized with retention enabled

24.2 Integration

This device includes two instantiations of McSPI: SPI0 and SPI1. The McSPI module is a general-purpose receive/transmit master/slave controller that can interface with either up to four slave external devices or one single external master. [Figure 24-1](#) shows the example of a system with multiple external slave SPI compatible devices and [Figure 24-2](#) shows the example of a system with an external master.

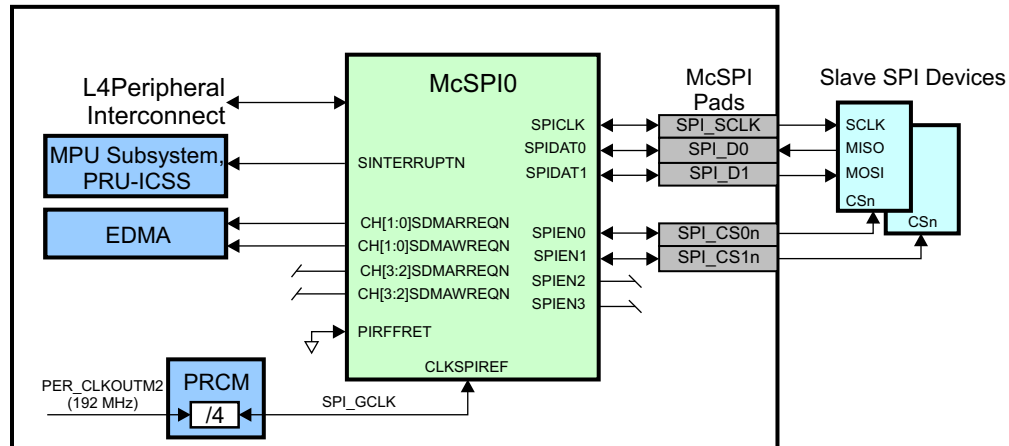


Figure 24-1. SPI Master Application

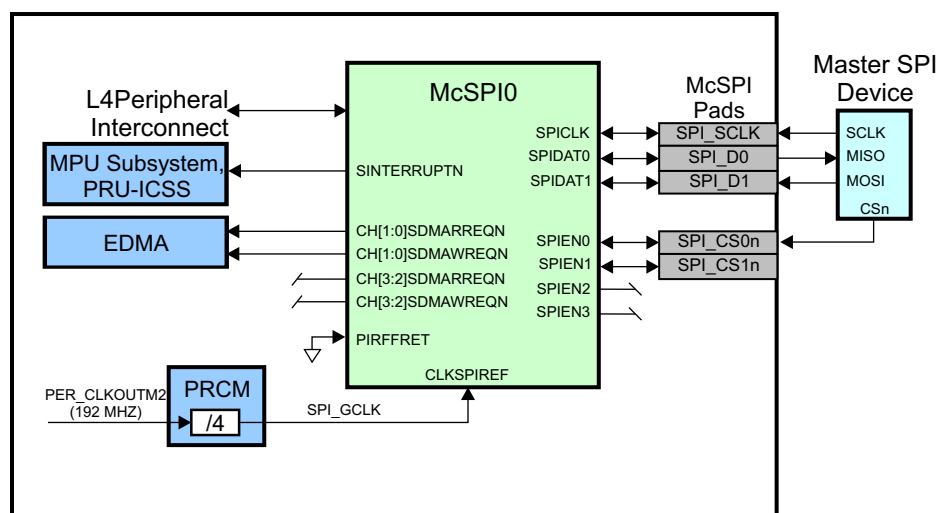


Figure 24-2. SPI Slave Application

24.2.1 McSPI Connectivity Attributes

The general connectivity attributes for the McSPI module are shown in [Table 24-2](#).

Table 24-2. McSPI Connectivity Attributes

Attributes	Type
Power Domain	Peripheral Domain
Clock Domain	PD_PER_L4LS_GCLK (Interface/OCP) PD_PER_SPI_GCLK (Func)
Reset Signals	PER_DOM_RST_N
Idle/Wakeup Signals	Smart Idle
Interrupt Requests	1 interrupt to MPU subsystem and PRU-ICSS (McSPI0INT) 1 interrupt to MPU subsystem only (McSPI1INT)
DMA Requests	4 DMA requests per instance to EDMA <ul style="list-style-type: none"> • 1 RX request for CS0 (SPIREVT0) • 1 TX request for CS0 (SPIX EVT0) • 1 RX request for CS1 (SPIREVT1) • 1 TX request for CS1 (SPIX EVT1)
Physical Address	L4 Peripheral slave port

24.2.2 McSPI Clock and Reset Management

The SPI module clocks can be woken up in two manners: by the SPI module itself using the SWAKEUP signal (refer to the module functional spec for detailed conditions), or directly from an external SPI master device by detecting an active low level on its chip select input pin (CS0n) using a GPIO attached to that device pin. Neither of these methods is supported on the device.

Table 24-3. McSPI Clock Signals

Clock Signal	Max Freq	Reference / Source	Comments
CLK Interface clock	100 MHz	CORE_CLKOUTM4 / 2	pd_per_l4ls_gclk From PRCM
CLKSPIREF Functional clock	48 MHz	PER_CLKOUTM2 / 4	pd_per_spi_gclk From PRCM

24.2.3 McSPI Pin List

The McSPI interface pins are summarized in [Table 24-4](#).

Table 24-4. McSPI Pin List

Pin	Type	Description
SPIx_SCLK	I/O ⁽¹⁾	SPI serial clock (output when master, input when slave)
SPIx_D0	I/O	Can be configured as either input or output (MOSI or MISO)
SPIx_D1	I/O	Can be configured as either input or output (MOSI or MISO)
SPIx_CS0	I/O	SPI chip select 0 output when master, input when slave (active low)
SPIx_CS1	O	SPI chip select 1 output when master, input when slave (active low)

⁽¹⁾ This output signal is also used as a re-timing input. The associated CONF_<module>_<pin>_RXACTIVE bit for the output clock must be set to 1 to enable the clock input back to the module.

24.3 Functional Description

24.3.1 SPI Transmission

This section describes the transmissions supported by McSPI. The SPI protocol is a synchronous protocol that allows a master device to initiate serial communication with a slave device. Data is exchanged between these devices. A slave select line (SPIEN) can be used to allow selection of an individual slave SPI device. Slave devices that are not selected do not interfere with SPI bus activities. Connected to multiple external devices, McSPI exchanges data with a single SPI device at a time through two main modes:

- Two data pins interface mode. (See [Section 24.3.1.1](#))
- Single data pin interface mode (recommended for half-duplex transmission). (See [Section 24.3.1.2](#))

The flexibility of McSPI allows exchanging data with several formats through programmable parameters described in [Section 24.3.1.3](#).

24.3.1.1 Two Data Pins Interface Mode

The two data pins interface mode, allows a full duplex SPI transmission where data is transmitted (shifted out serially) and received (shifted in serially) simultaneously on separate data lines SPIDAT [0] and SPIDAT [1]. Data leaving the master exits on transmit serial data line also known as MOSI: MasterOutSlaveIn. Data leaving the slave exits on the receive data line also known as MISO: MasterInSlaveOut.

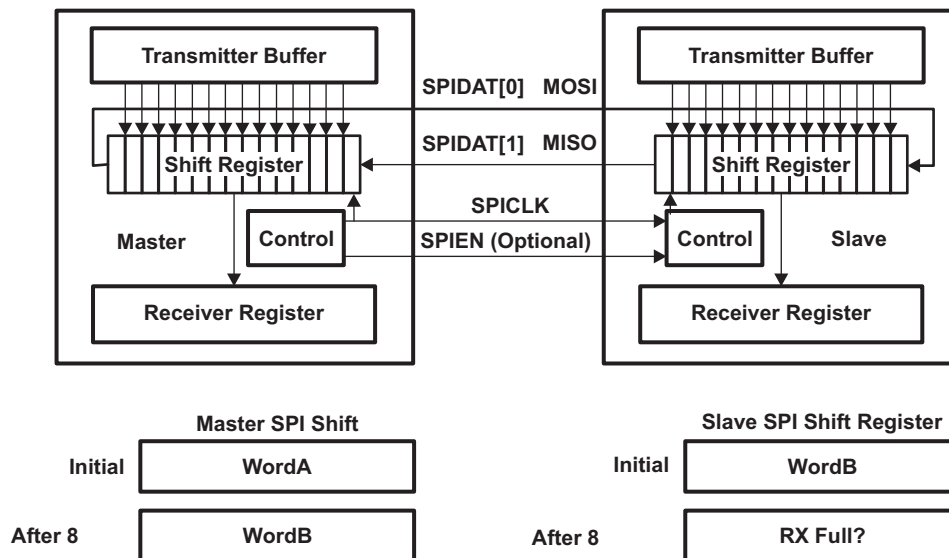
McSPI has a unified SPI port control: SPIDAT [1:0] can be independently configured as receive or transmit lines. The user has the responsibility to program which data line to use and in which direction (receive or transmit), according to the external slave/master connection.

The serial clock (SPICLK) synchronizes shifting and sampling of the information on the two serial data lines (SPIDAT [1:0]). Each time a bit is transferred out from the Master, one bit is transferred in from Slave.

Figure 24-3 shows an example of a full duplex system with a Master device on the left and a Slave device on the right. After 8 cycles of the serial clock SPICLK, the WordA has been transferred from the master to the slave. At the same time, the 8-bit WordB has been transferred from the slave to the master.

When referring to the master device, the control block transmits the clock SPICLK and the enable signal SPIEN (optional, see , *McSPI_MODULCTRL*).

Figure 24-3. SPI Full-Duplex Transmission



24.3.1.2 Single Data Pin Interface Mode

In single data pin interface mode, under software control, a single data line is used to alternatively transmit and receive data (Half duplex transmission).

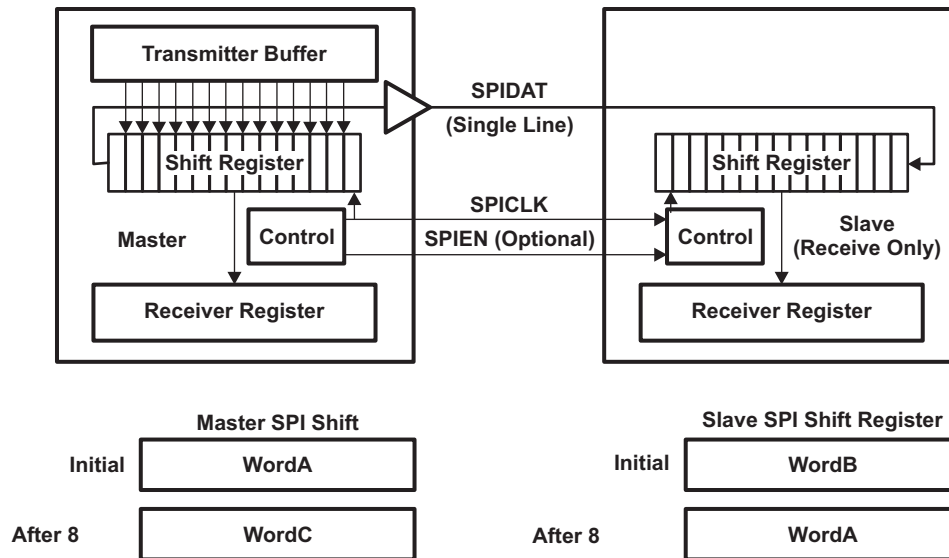
McSPI has a unified SPI port control: SPIDAT [1:0] can be independently configured as receive or transmit lines. The user has the responsibility to program which data line to use and in which direction (receive or transmit), according to the external slave/master connection.

As for a full duplex transmission, the serial clock (SPICLK) synchronizes shifting and sampling of the information on the single serial data line.

24.3.1.2.1 Example With a Receive-Only Slave

Figure 24-4 shows a half duplex system with a Master device on the left and a receive-only Slave device on the right. Each time a bit is transferred out from the Master, one bit is transferred in the Slave. After 8 cycles of the serial clock SPICLK, the 8-bit WordA has been transferred from the master to the slave.

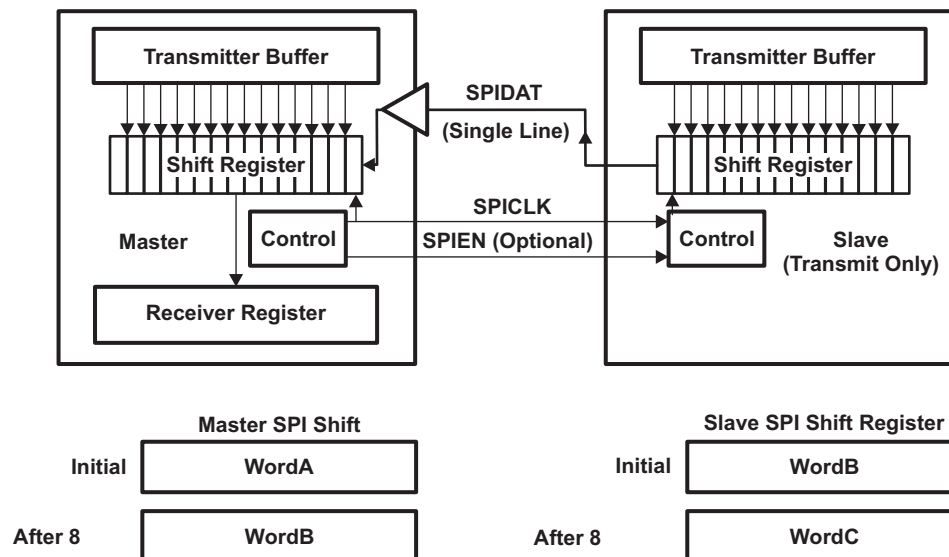
Figure 24-4. SPI Half-Duplex Transmission (Receive-only Slave)



24.3.1.2.2 Example With a Transmit-Only Slave

Figure 24-5 shows a half duplex system with a Master device on the left and a transmit-only Slave device on the right. Each time a bit is transferred out from the Slave, one bit is transferred in the Master. After 8 cycles of the serial clock SPICLK, the 8-bit WordA has been transferred from the slave to the master.

Figure 24-5. SPI Half-Duplex Transmission (Transmit-Only Slave)



24.3.1.3 Transfer Formats

This section describes the transfer formats supported by McSPI.

The flexibility of McSPI allows setting the parameters of the SPI transfer:

- SPI word length
- SPI enable generation programmable
- SPI enable assertion
- SPI enable polarity
- SPI clock frequency
- SPI clock phase
- SPI clock polarity

The consistency between SPI word length, clock phase and clock polarity of the master SPI device and the communicating slave device remains under software responsibility.

24.3.1.3.1 Programmable Word Length

McSPI supports any SPI word from 4 to 32 bits long.

The SPI word length can be changed between transmissions to allow a master device to communicate with peripheral slaves having different requirements.

24.3.1.3.2 Programmable SPI Enable Generation

McSPI is able to generate or not generate SPI enable. If management of chip select is de-asserted, a point-to-point connection is mandatory. Only a single master of a slave device can be connected to the SPI bus.

24.3.1.3.3 Programmable SPI Enable (SPIEN)

The polarity of the SPIEN signals is programmable. SPIEN signals can be active high or low.

The assertion of the SPIEN signals is programmable. SPIEN signals can be manually asserted or automatically asserted.

Two consecutive words for two different slave devices may go along with active SPIEN signals with different polarity.

24.3.1.3.4 Programmable SPI Clock (SPICLK)

The phase and the polarity of the SPI serial clock are programmable when McSPI is a SPI master device or a SPI slave device. The baud rate of the SPI serial clock is programmable when McSPI is a SPI master.

When McSPI is operating as a slave, the serial clock SPICLK is an input from the master.

24.3.1.3.5 Bit Rate

In Master Mode, an internal reference clock CLKSPIREF is used as an input of a programmable divider to generate bit rate of the serial clock SPICLK. Granularity of this clock divider can be changed.

24.3.1.3.6 Polarity and Phase

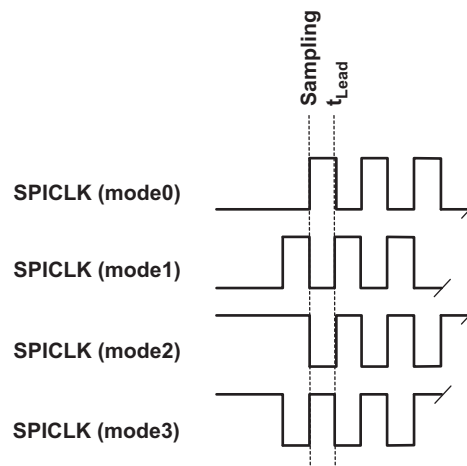
McSPI supports four sub-modes of the SPI format transfer that depend on the polarity (POL) and the phase (PHA) of the SPI serial clock (SPICLK). Table 24-5 and Figure 24-6 show a summary of the four sub-modes. Software selects one of four combinations of serial clock phase and polarity.

Two consecutive SPI words for two different slave devices may go along with active SPICLK signal with different phase and polarity.

Table 24-5. Phase and Polarity Combinations

Polarity (POL)	Phase (PHA)	SPI Mode	Comments
0	0	mode0	SPICLK active high and sampling occurs on the rising edge.
0	1	mode1	SPICLK active high and sampling occurs on the falling edge.
1	0	mode2	SPICLK active low and sampling occurs on the falling edge.
1	1	mode3	SPICLK active low and sampling occurs on the rising edge.

Figure 24-6. Phase and Polarity Combinations



24.3.1.3.7 Transfer Format With PHA = 0

This section describes the concept of a SPI transmission with the SPI mode0 and the SPI mode2.

In the transfer format with PHA = 0, SPIEN is activated a half cycle of SPICLK ahead of the first SPICLK edge.

In both master and slave modes, McSPI drives the data lines at the time of SPIEN is asserted.

Each data frame is transmitted starting with the MSB. At the extremity of both SPI data lines, the first bit of SPI word is valid a half-cycle of SPICLK after the SPIEN assertion.

Therefore, the first edge of the SPICLK line is used by the master to sample the first data bit sent by the slave. On the same edge, the first data bit sent by the master is sampled by the slave.

On the next SPICLK edge, the received data bit is shifted into the shift register, and a new data bit is transmitted on the serial data line.

This process continues for a total of pulses on the SPICLK line defined by the SPI word length programmed in the master device, with data being latched on odd numbered edges and shifted on even numbered edges.

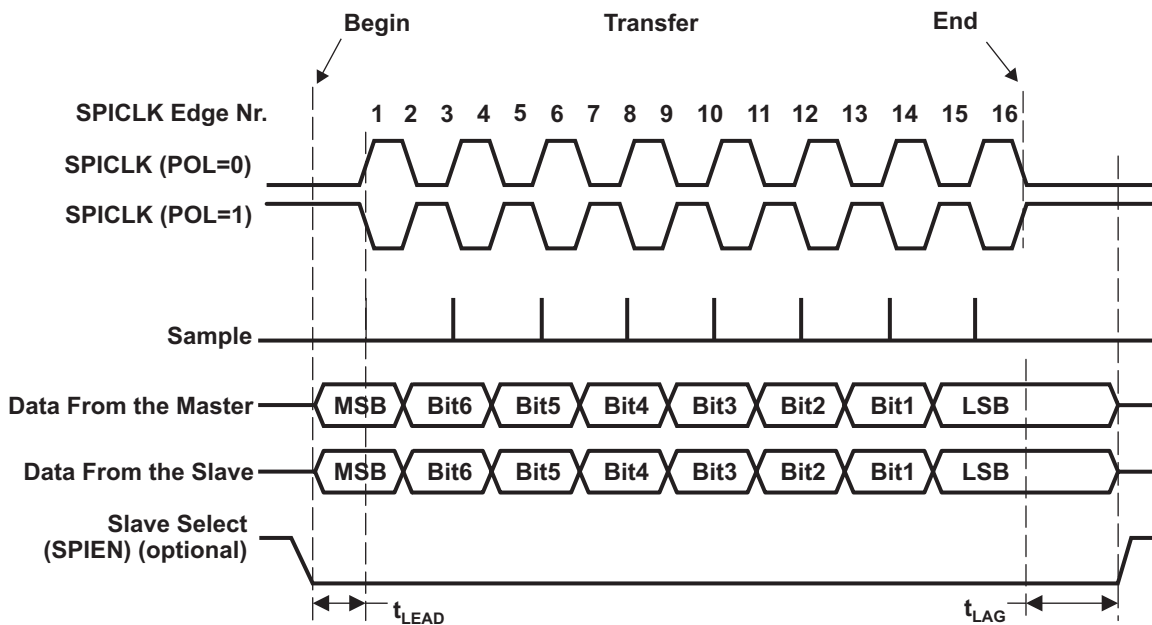
Figure 24-7 is a timing diagram of a SPI transfer for the SPI mode0 and the SPI mode2, when McSPI is master or slave, with the frequency of SPICLK equals to the frequency of CLKSPIREF. It should not be used as a replacement for SPI timing information and requirements detailed in the data manual.

When McSPI is in slave mode, if the SPIEN line is not de-asserted between successive transmissions then the content of the Transmitter register is not transmitted, instead the last received SPI word is transmitted.

In master mode, the SPIEN line must be negated and reasserted between each successive SPI word. This is because the slave select pin freezes the data in its shift register and does not allow it to be altered if PHA bit equals 0.

In 3-pin mode without using the SPIEN signal, the controller provides the same waveform but with SPIEN forced to low state. In slave mode, SPIEN is useless.

Figure 24-7. Full Duplex Single Transfer Format with PHA = 0



24.3.1.3.8 Transfer Format With PHA = 1

This section describes SPI full duplex transmission with the SPI mode1 and the SPI mode3.

In the transfer format with PHA = 1, SPIEN is activated a delay (t_{LEAD}) ahead of the first SPICLK edge.

In both master and slave modes, McSPI drives the data lines on the first SPICLK edge.

Each data frame is transmitted starting with the MSB. At the extremity of both SPI data lines, the first bit of SPI word is valid on the next SPICLK edge, a half-cycle later of SPICLK. It is the sampling edge for both the master and slave.

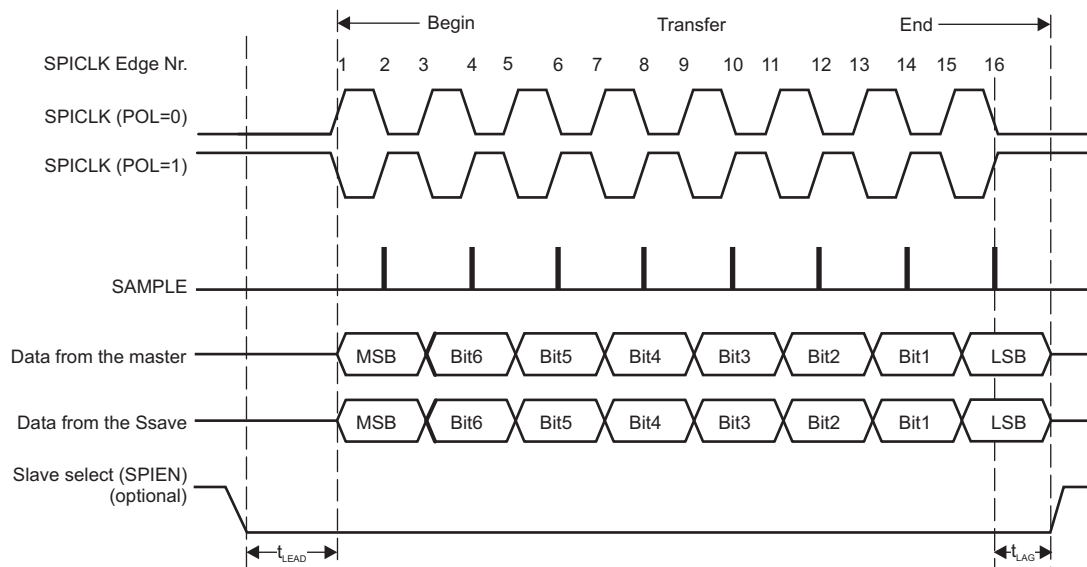
When the third edge occurs, the received data bit is shifted into the shift register. The next data bit of the master is provided to the serial input pin of the slave.

This process continues for a total of pulses on the SPICLK line defined by the word length programmed in the master device, with data being latched on even numbered edges and shifted on odd numbered edges.

Figure 24-8 is a timing diagram of a SPI transfer for the SPI mode1 and the SPI mode3, when McSPI is master or slave, with the frequency of SPICLK equals to the frequency of CLKSPIREF. It should not be used as a replacement for SPI timing information and requirements detailed in the data manual.

The SPIEN line may remain active between successive transfers. In 3-pin mode without using the SPIEN signal, the controller provides the same waveform but with SPIEN forced to low state. In slave mode SPIEN is useless.

Figure 24-8. Full Duplex Single Transfer Format With PHA = 1



24.3.2 Master Mode

McSPI is in master mode when the bit MS of the register MCSPI_MODULCTRL is cleared.

In master mode McSPI supports multi-channel communication with up to 4 independent SPI communication channel contexts. McSPI initiates a data transfer on the data lines (SPIDAT [1:0]) and generates clock (SPICLK) and control signals (SPIEN) to a single SPI slave device at a time.

24.3.2.1 Dedicated Resources Per Channel

In the following sections, the letter "i" indicates the channel number that can be 0, 1, 2 or 3. Each channel has the following dedicated resources:

- Its own channel enable, programmable with the bit EN of the register MCSPI_CH(i)CTRL. Disabling the channel, outside data word transmission, remains under user responsibility.
- Its own transmitter register MCSPI_TX on top of the common shift register. If the transmitter register is empty, the status bit TXS of the register MCSPI_CH(i)STAT is set.
- Its own receiver register MCSPI_RX on top of the common shift register. If the receiver register is full, the status bit RXS of the register MCSPI_CH(i)STAT is set.
- A fixed SPI ENABLE line allocation (SPIEN[i] port for channel "i"), SPI enable management is optional.
- Its own communication configuration with the following parameters via the register MCSPI_CH(i)CONF
 - Transmit/Receive modes, programmable with the bit TRM.
 - Interface mode (Two data pins or Single data pin) and data pins assignment, both programmable with the bits IS and DPE.
 - SPI word length, programmable with the bits WL.
 - SPIEN polarity, programmable with the bit EPOL.
 - SPIEN kept active between words, programmable with the bit FORCE.
 - Turbo mode, programmable with the bit TURBO.
 - SPICLK frequency, programmable with the bit CLKD, the granularity of clock division can be changed using CLKG bit, the clock ratio is then concatenated with MCSPI_CH(i)CTRL[EXTCLK] value.
 - SPICLK polarity, programmable with the bit POL
 - SPICLK phase, programmable with the bit PHA.
 - Start bit polarity, programmable with the bit SBPOL
 - Use a FIFO Buffer or not (see the following note), programmable with FFER and FFEW, depending on transfer mode, (MCSPI_CH(i)CONF[TRM]).
- Two DMA requests events, read and write, to synchronize read/write accesses of the DMA controller with the activity of McSPI. The DMA requests are enabled with the bits DMAR and DMAW.
- Three interrupts events

Note: When more than one channel has an FIFO enable bit field (FFER or FFEW) set, the FIFO will not be used on any channel. Software must ensure that only one enabled channel is configured to use the FIFO buffer.

The transfers will use the latest loaded parameters of the register MCSPI_CH(i)CONF.

The configuration parameters SPIEN polarity, Turbo mode, SPICLK phase and SPICLK polarity can be loaded in the MCSPI_CH(i)CONF register only when the channel is disabled. The user has the responsibility to change the other parameters of the MCSPI_CH(i)CONF register when no transfer occurs on the SPI interface.

24.3.2.2 Interrupt Events in Master Mode

In master mode, the interrupt events related to the transmitter register state are TX_empty and TX_underflow. The interrupt event related to the receiver register state is RX_full.

24.3.2.2.1 TX_empty

The event TX_empty is activated when a channel is enabled and its transmitter register becomes empty (transient event). Enabling channel automatically raises this event, except for the Master receive only mode. (See [Section 24.3.2.5](#)). When the FIFO buffer is enabled (MCSPi_CH(i)CONF[FFEW] set to 1), the TX_empty is asserted as soon as there is enough space in the buffer to write a number of bytes defined by MCSPi_XFERLEVEL[AEL].

Transmitter register must be loaded to remove the source of the interrupt and the TX_empty interrupt status bit must be cleared for interrupt line de-assertion (if event enabled as interrupt source). (See [Section 24.3.4](#)).

When FIFO is enabled, no new TX_empty event will be asserted as soon as CPU has not performed the number of writes into the transmitter register defined by MCSPi_XFERLEVEL[AEL]. It is the responsibility of CPU to perform the right number of writes.

24.3.2.2.2 TX_underflow

The event TX_underflow is activated when the channel is enabled and if the transmitter register or FIFO is empty (not updated with new data) at the time of shift register assignment.

The TX_underflow is a harmless warning in master mode.

To avoid having TX_underflow event at the beginning of a transmission, the event TX_underflow is not activated when no data has been loaded into the transmitter register since channel has been enabled.

To avoid having a TX_underflow event, the Transmit Register (MCSPi_TX(i)) should be loaded as infrequently as possible.

TX_underflow interrupt status bit must be cleared for interrupt line de-assertion (if event enable as interrupt source).

Note: When more than one channel has an FIFO enable bit field (FFER or FFEW) set, the FIFO will not be used on any channel. Software must ensure that only one enabled channel is configured to use the FIFO buffer.

24.3.2.2.3 RX_full

The event RX_full is activated when channel is enabled and receiver register becomes filled (transient event). When FIFO buffer is enabled (MCSPi_CH(i)CONF[FFER] set to 1), the RX_full is asserted when the number of bytes in the buffer equals the level defined by MCSPi_XFERLEVEL[AFL].

Receiver register must be read to remove source of interrupt and RX_full interrupt status bit must be cleared for interrupt line de-assertion (if event enabled as interrupt source).

When the FIFO is enabled, no new RX_FULL event will be asserted once the CPU has read the number of bytes defined by MCSPi_XFERLEVEL[AFL]. It is the responsibility of the CPU to perform the correct number of read operations.

24.3.2.2.4 End of Word Count

The event end of word (EOW) count is activated when channel is enabled and configured to use the built-in FIFO. This interrupt is raised when the controller had performed the number of transfers defined in the MCSPi_XFERLEVEL[WCNT] register. If the value was programmed to 0000h, the counter is not enabled and this interrupt is not generated.

The EOW count interrupt also indicates that the SPI transfer has halted on the channel using the FIFO buffer.

The EOW interrupt status bit must be cleared for interrupt line de-assertion (if event enable as interrupt source).

24.3.2.3 Master Transmit and Receive Mode

This mode is programmable per channel (bit TRM of register MCSPI_CH(i)CONF).

The channel access to the shift registers, for transmission/reception, is based on its transmitter and receiver register state and round robin arbitration.

The channel that meets the rules below is included in the round robin list of already active channels scheduled for transmission and/or reception. The arbiter skips the channel that does not meet the rules and search for the next following enabled channel, in rotation.

Rule 1: Only enabled channels (bit EN of the register MCSPI_CH(i)CTRL), can be scheduled for transmission and/or reception.

Rule 2: An enabled channel can be scheduled if its transmitter register is not empty (bit TXS of the register MCSPI_CH(i)STAT) or its FIFO is not empty when the buffer is used for the corresponding channel (bit FFE of the register MCSPI_CH(i)STAT) at the time of shift register assignment. If the transmitter register or FIFO is empty, at the time of shift register assignment, the event TX_underflow is activated and the next enabled channel with new data to transmit is scheduled. (See also transmit only mode).

Rule 3: An enabled channel can be scheduled if its receive register is not full (bit RXS of the register MCSPI_CH(i)STAT) or its FIFO is not full when the buffer is used for the corresponding channel (bit FFF of the register MCSPI_CH(i)STAT) at the time of shift register assignment. (See also receive only mode). Therefore the receiver register or FIFO cannot be overwritten. The RX_overflow bit, in the MCSPI_IRQSTATUS register is never set in this mode.

On completion of SPI word transfer (bit EOT of the register MCSPI_CH(i)STAT is set) the updated transmitter register for the next scheduled channel is loaded into the shift register. This bit is meaningless when using the Buffer for this channel. The serialization (transmit and receive) starts according to the channel communication configuration. On serialization completion the received data is transferred to the channel receive register.

The built-in FIFO is available in this mode and if configured in one data direction, transmit or receive, then the FIFO is seen as a unique 64-byte buffer. If configured in both data directions, transmit and receive, then the FIFO is split into two separate 32-byte buffers with their own address space management. In this last case, the definition of AEL and AFL levels is based on 32 bytes and is under CPU responsibility.

24.3.2.4 Master Transmit-Only Mode

This mode eliminates the need for the CPU to read the receiver register (minimizing data movement) when only transmission is meaningful.

The master transmit only mode is programmable per channel (bits TRM of the register MCSPI_CH(i)CONF).

In master transmit only mode, transmission starts after data is loaded into the transmitter register.

Rule 1 and **Rule 2**, defined above, are applicable in this mode.

Rule 3, defined above, is not applicable: In master transmit only mode, the receiver register or FIFO state "full" does not prevent transmission, and the receiver register is always overwritten with the new SPI word. This event in the receiver register is not significant when only transmission is meaningful. So, the RX_overflow bit, in the MCSPI_IRQSTATUS register is never set in this mode.

The McSPI module automatically disables the RX_full interrupt status. The corresponding interrupt request and DMA Read request are not generated in master transmit only mode.

The status of the serialization completion is given by the bit EOT of the register MCSPI_CH(i)STAT. This bit is meaningless when using the Buffer for this channel.

The built-in FIFO is available in this mode and can be configured with FFEW bit field in the MCSPI_CH(i)CONF register, then the FIFO is seen as a unique 64-byte buffer.

24.3.2.5 Master Receive-Only Mode

This mode eliminates the need for the CPU to refill the transmitter register (minimizing data movement) when only reception is meaningful.

The master receive mode is programmable per channel (bits TRM of the register MCSPI_CH(i)CONF).

The master receive only mode enables channel scheduling only on empty state of the receiver register.

Rule 1 and **Rule 3**, defined above, are applicable in this mode.

Rule 2, defined above, is not applicable: In master receive only mode, after the first loading of the transmitter register of the enabled channel, the transmitter register state is maintained as full. The content of the transmitter register is always loaded into the shift register, at the time of shift register assignment. So, after the first loading of the transmitter register, the bits TX_empty and TX_underflow, in the MCSPI_IRQSTATUS register are never set in this mode.

The status of the serialization completion is given by the bit EOT of the register MCSPI_CH(i)STAT. The bit RX_full in the MCSPI_IRQSTATUS register is set when a received data is loaded from the shift register to the receiver register. This bit is meaningless when using the Buffer for this channel.

The built-in FIFO is available in this mode and can be configured with FFER bit field in the MCSPI_CH(i)CONF register, then the FIFO is seen as a unique 64-byte buffer.

24.3.2.6 Single-Channel Master Mode

When the SPI is configured as a master device with a single enabled channel, the assertion of the SPIM_CSX signal can be controlled in two different ways:

- In 3 pin mode : MCSPI_MODULCTRL[1] PIN34 and MCSPI_MODULCTRL[0] SINGLE bit are set to 1, the controller transmit SPI word as soon as transmit register or FIFO is not empty.
- In 4 pin mode : MCSPI_MODULCTRL[1] PIN34 bit is cleared to 0 and MCSPI_MODULCTRL[0] SINGLE bit is set to 1, SPIEN assertion/deassertion controlled by Software. (See [Section 24.3.2.6.1](#)) using the MCSPI_CH(i)CONF[20] FORCE bit.

24.3.2.6.1 Programming Tips When Switching to Another Channel

When a single channel is enabled and data transfer is ongoing:

- Wait for completion of the SPI word transfer (bit EOT of the register MCSPI_CH(i)STAT is set) before disabling the current channel and enabling a different channel.
- Disable the current channel first, and then enable the other channel.

24.3.2.6.2 Keep SPIEN Active Mode (Force SPIEN)

Continuous transfers are manually allowed by keeping the SPIEN signal active for successive SPI words transfer. Several sequences (configuration/enable/disable of the channel) can be run without deactivating the SPIEN line. This mode is supported by all channels and any master sequence can be used (transmit-receive, transmit-only, receive-only).

Keeping the SPIEN active mode is supported when:

- A single channel is used (bit MCSPI_MODULCTRL[Single] is set to 1).
- Transfer parameters of the transfer are loaded in the configuration register (MCSPI_CH(i)CONF) in the appropriate channel.

The state of the SPIEN signal is programmable.

- Writing 1 into the bit FORCE of the register MCSPI_CH(i)CONF drives high the SPIEN line when MCSPI_CH(i)CONF[EPOL] is set to zero, and drives it low when MCSPI_CH(i)CONF[EPOL] is set.
- Writing 0 into the bit FORCE of the register MCSPI_CH(i)CONF drives low the SPIEN line when MCSPI_CH(i)CONF[EPOL] is set to zero, and drives it high when MCSPI_CH(i)CONF[EPOL] is set.
- A single channel is enabled (MCSPI_CH(i)CTRL[En] set to 1) . The first enabled channel activates the SPIEN line.

Once the channel is enabled, the SPIEN signal is activated with the programmed polarity.

As in multi-channel master mode, the start of the transfer depends on the status of the transmitter register, the status of the receiver register and the mode defined by the bits TRM in the configuration register (transmit only, receive only or transmit and receive) of the enabled channel.

The status of the serialization completion of each SPI word is given by the bit EOT of the register MCSPI_CH(i)STAT. The bit RX_full in the MCSPI_IRQSTATUS register is set when a received data is loaded from the shift register to the receiver register.

A change in the configuration parameters is propagated directly on the SPI interface. If the SPIEN signal is activated the user must insure that the configuration is changed only between SPI words, in order to avoid corrupting the current transfer.

NOTE: The SPIEN polarity, the SPICLK phase and SPICLK polarity must not be modified when the SPIEN signal is activated. The Transmit/Receive mode, programmable with the bit TRM can be modified only when the channel is disabled. The channel can be disabled and enabled while the SPIEN signal is activated.

The delay between SPI words that requires the connected SPI slave device to switch from one configuration (transmit only for instance) to another (receive only for instance) must be handled under software responsibility.

At the end of the last SPI word, the channel must be deactivated (MCSPI_CH(i)CTRL[En] is cleared to 0) and the SPIEN can be forced to its inactive state (MCSPI_CH(i)CONF[Force]).

Figure 24-9 and Figure 24-10 show successive transfers with SPIEN kept active low with a different configuration for each SPI word in respectively single data pin interface mode and two data pins interface mode. The arrows indicate when the channel is disabled before a change in the configuration parameters and enabled again.

Figure 24-9. Continuous Transfers With SPIEN Maintained Active (Single-Data-Pin Interface Mode)

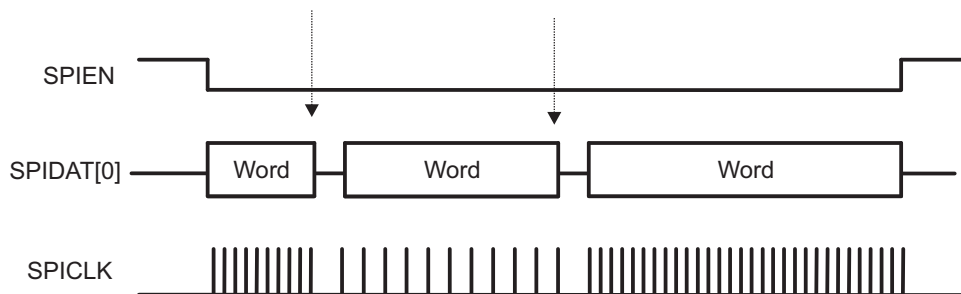
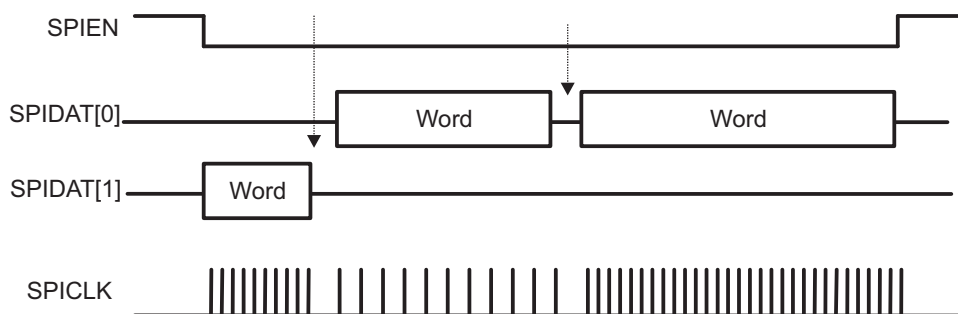


Figure 24-10. Continuous Transfers With SPIEN Maintained Active (Dual-Data-Pin Interface Mode)



-
- NOTE:** The turbo mode is also supported for the Keep SPIEN active mode when the following conditions are met:
- A single channel will be explicitly used (bit MCSPi_MODULCTRL[Single] is set to 1).
 - The turbo mode is enabled in the configuration of the channel (bit Turbo of the register MCSPi_CH(i)CONF).
-

24.3.2.6.3 Turbo Mode

The purpose of the Turbo mode is to improve the throughput of the SPI interface when a single channel is enabled, by allowing transfers until the shift register and the receiver register are full.

This mode is programmable per channel (bit Turbo of the register MCSPi_CH(i)CONF). When several channels are enabled, the bit Turbo of the registers MCSPi_CH(i)CONF has no effect, and the channel access to the shift registers remains as described in [Section 24.3.2.3](#).

In Turbo mode, **Rule 1** and **Rule 2** defined in [Section 24.3.2.3](#) are applicable but Rule 3 is not applicable. An enabled channel can be scheduled if its receive register is full (bit RXS of the register MCSPi_CH(i)STAT) at the time of shift register assignment until the shift register is full.

In Turbo mode, **Rule 1** and **Rule 2** defined in [Section 24.3.2.3](#) are applicable but Rule 3 is not applicable. An enabled channel can be scheduled if its receive register is full (bit RXS of the register MCSPi_CH(i)STAT) at the time of shift register assignment until the shift register is full.

The receiver register cannot be overwritten in Turbo mode. In consequence the RX_overflow bit, in MCSPi_IRQSTATUS register is never set in this mode.

24.3.2.7 Start Bit Mode

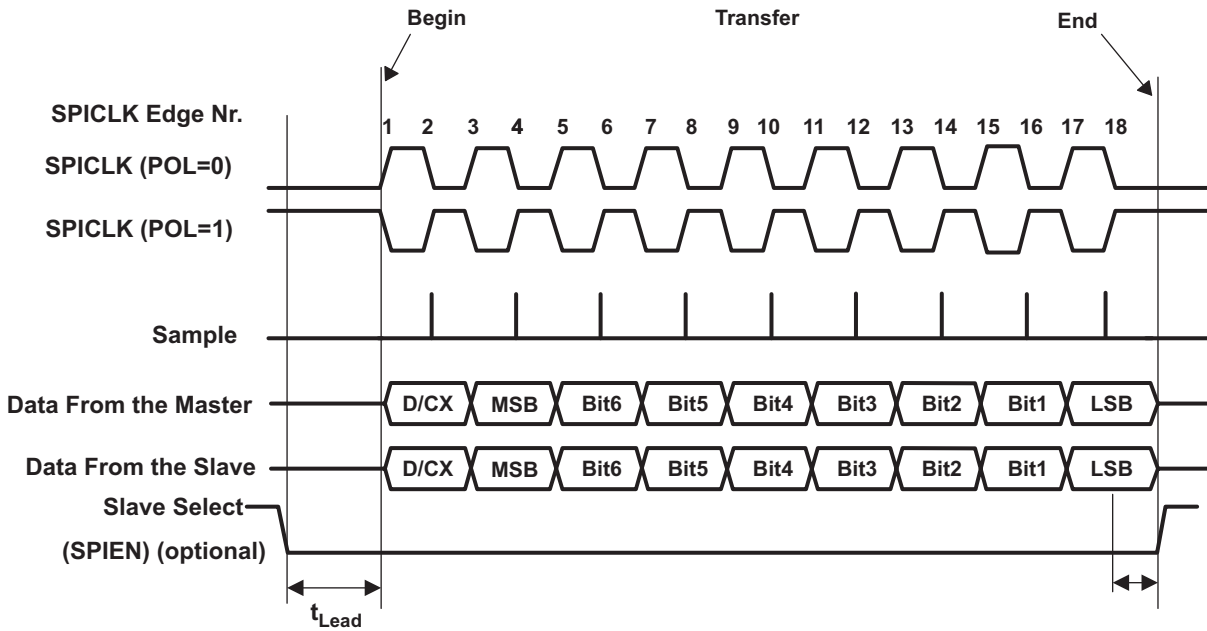
The purpose of the start bit mode is to add an extended bit before the SPI word transmission specified by word length WL. This feature is only available in master mode.

This mode is programmable per channel using the start bit enable (SBE) bit of the register MCSPi_CH(i)CONF.

The polarity of the extended bit is programmable per channel and it indicates whether the next SPI word must be handled as a command when SBPOL is cleared to 0 or as a data or a parameter when SBPOL is set to 1. Moreover start bit polarity SBPOL can be changed dynamically during start bit mode transfer without disabling the channel for reconfiguration, in this case you have the responsibility to configure the SBPOL bit before writing the SPI word to be transmitted in TX register.

The start bit mode could be used at the same time as turbo mode and/or manual chip select mode. In this case only one channel could be used, no round-robin arbitration is possible.

Figure 24-11. Extended SPI Transfer With Start Bit PHA = 1

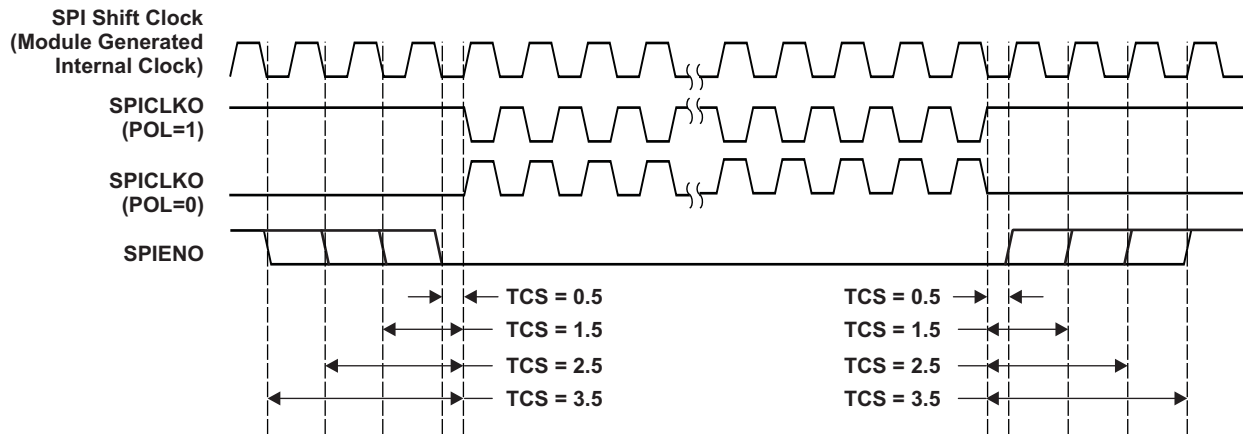


24.3.2.8 Chip-Select Timing Control

The chip select timing control is only available in master mode with automatic chip select generation (FORCE bit field is cleared to 0), to add a programmable delay between chip select assertion and first clock edge or chip select removal and last clock edge. The option is available only in 4 pin mode MCSPI_MODULCTRL[1] PIN34 is cleared to 0.

This mode is programmable per channel (bit TCS of the register MCSPI_CH(i)CONF). Figure 24-12 shows the chip-select SPIEN timing control.

Figure 24-12. Chip-Select SPIEN Timing Controls



NOTE: Because of the design implementation for transfers using a clock divider ratio set to 1 (clock bypassed), a half cycle must be added to the value between chip-select assertion and the first clock edge with PHA = 1 or between chip-select removal and the last clock edge with PHA = 0.

With an odd clock divider ratio which occurs when granularity is one clock cycle, that means that MCSPI_CH(i)CONF[CLKG] is set to 1 and MCSPI_CH(i)CONF[CLKD] has an even value, the clock duty cycle is not 50%, then one of the high level or low level duration is selected to be added to TCS delay.

Table 24-6 summarizes all delays between chip select and first (setup) or last (hold) clock edge.

In 3-pin mode this option is useless, the chip select SPIEN is forced to low state.

Table 24-6. Chip Select ↔ Clock Edge Delay Depending on Configuration

Clock Ratio F_{ratio}	Clock Phase PHA	Chip Select ↔ Clock Edge Delay	
		Setup	Hold
1	0	$T_{ref} \times (TCS + \frac{1}{2})$	$T_{ref} \times (TCS + 1)$
	1	$T_{ref} \times (TCS + 1)$	$T_{ref} \times (TCS + \frac{1}{2})$
Even ≥ 2	x	$T_{ref} \times F_{ratio} \times (TCS + \frac{1}{2})$	$T_{ref} \times F_{ratio} \times (TCS + \frac{1}{2})$
Odd ≥ 3 (only with MCSPI_CH(i)CONF[CLKG] set to 1)	0	$T_{ref} \times [(F_{ratio} \times TCS) + (F_{ratio} + \frac{1}{2})]$	$T_{ref} \times [(F_{ratio} \times TCS) + (F_{ratio} + \frac{1}{2})]$
	1	$T_{ref} \times [(F_{ratio} \times TCS) + (F_{ratio} - \frac{1}{2})]$	$T_{ref} \times [(F_{ratio} \times TCS) + (F_{ratio} - \frac{1}{2})]$

T_{ref} = CLKSPIREF period in ns. F_{ratio} = SPI clock division ratio

The clock divider ratio depends on divider granularity MCSPI_CH(i)CONF[CLKG]:

- MCSPI_CH(i)CONF[CLKG] = 0 : granularity is power of two.
 $F_{ratio} = 2^{MCSPI_CH(i)CONF[CLKD]}$
- MCSPI_CH(i)CONF[CLKG] = 1 : granularity is one cycle.
 $F_{ratio} = MCSPI_CH(i)CTRL[EXTCLK] \times MCSPI_CH(i)CONF[CLKD] + 1$

24.3.2.9 Clock Ratio Granularity

By default the clock division ratio is defined by the register MCSPI_CH(i)CONF[CLKD] with power of two granularity leading to a clock division in range 1 to 32768, in this case the duty cycle is always 50%. With bit MCSPI_CH(i)CONF[CLKG] the clock division granularity can be changed to one clock cycle, in that case the register MCSPI_CH(i)CTRL[EXTCLK] is concatenated with MCSPI_CH(i)CONF[CLKD] to give a 12-bit width division ratio in range 1 to 4096.

When granularity is one clock cycle (MCSPI_CH(i)CONF[CLKG] set to 1), for odd value of clock ratio the clock duty cycle is kept to 50-50 using falling edge of clock reference CLKSPIREF.

Table 24-7. CLKSPIO High/Low Time Computation

Clock Ratio F_{ratio}	CLKSPIO High Time	CLKSPIO Low Time
1	T_{high_ref}	T_{low_ref}
Even ≥ 2	$t_{ref} \times (F_{ratio}/2)$	$t_{ref} \times (F_{ratio}/2)$
Odd ≥ 3	$t_{ref} \times (F_{ratio}/2)$	$t_{ref} \times (F_{ratio}/2)$

T_{ref} = CLKSPIREF period in ns. T_{high_ref} = CLKSPIREF high Time period in ns. T_{low_ref} = CLKSPIREF low Time period in ns. F_{ratio} = SPI clock division ratio

$F_{ratio} = MCSPI_CH(i)CTRL[EXTCLK] \times MCSPI_CH(i)CONF[CLKD] + 1$

For odd ratio value the duty cycle is calculated as below:

$$Duty_cycle = \frac{1}{2}$$

Granularity examples: With a clock source frequency of 48 MHz:

Table 24-8. Clock Granularity Examples

MCSPI_CH (i)CTRL EXTCLK	MCSPI_CH (i)CONF CLKD	MCSPI_CH (i)CONF CLKG	F_{ratio}	MCSPI_CH (i)CONF PHA	MCSPI_CH (i)CONF POL	Thigh (ns)	Tlow (ns)	Tperiod (ns)	Duty Cycle	Fout (MHz)
X	0	0	1	X	X	10.4	10.4	20.8	50-50	48
X	1	0	2	X	X	20.8	20.8	41.6	50-50	24
X	2	0	4	X	X	41.6	41.6	83.2	50-50	12
X	3	0	8	X	X	83.2	83.2	166.4	50-50	6
0	0	1	1	X	X	10.4	10.4	20.8	50-50	48
0	1	1	2	X	X	20.8	20.8	41.6	50-50	24
0	2	1	3	1	0	31.2	31.2	62.4	50-50	16
0	2	1	3	1	1	31.2	31.2	62.4	50-50	16
0	3	1	4	X	X	41.6	41.6	83.2	50-50	12
5	0	1	81	1	0	842.4	842.4	1684.8	50-50	0.592
5	7	1	88	X	X	915.2	915.2	1830.4	50-50	0.545

24.3.2.10 FIFO Buffer Management

The McSPI controller has a built-in 64-byte buffer in order to unload DMA or interrupt handler and improve data throughput.

This buffer can be used by only one channel and is selected by setting MCSPI_CH(i)CONF[FFER] and/or MCSPI_CH(i)CONF[FFEW] to 1.

If several channels are selected and several FIFO enable bit fields set to 1, the controller forces the buffer to be disabled for all channels. It is the responsibility of the driver to enable the buffer for only one channel.

The buffer can be used in the modes defined below:

- Master or Slave mode.
- Transmit only, Receive only or Transmit/Receive mode.
- Single channel or turbo mode, or in normal round robin mode. In round robin mode the buffer is used by only one channel.
- All word length MCSPI_CH(i)CONF[WL] are supported.

Two levels AEL and AFL located in MCSPI_XFERLEVEL register rule the buffer management. The granularity of these levels is one byte, then it is not aligned with SPI word length. It is the responsibility of the driver to set these values as a multiple of SPI word length defined in MCSPI_CH(i)CONF[WL]. The number of byte written in the FIFO depends on word length (see [Table 24-9](#)).

Table 24-9. FIFO Writes, Word Length Relationship

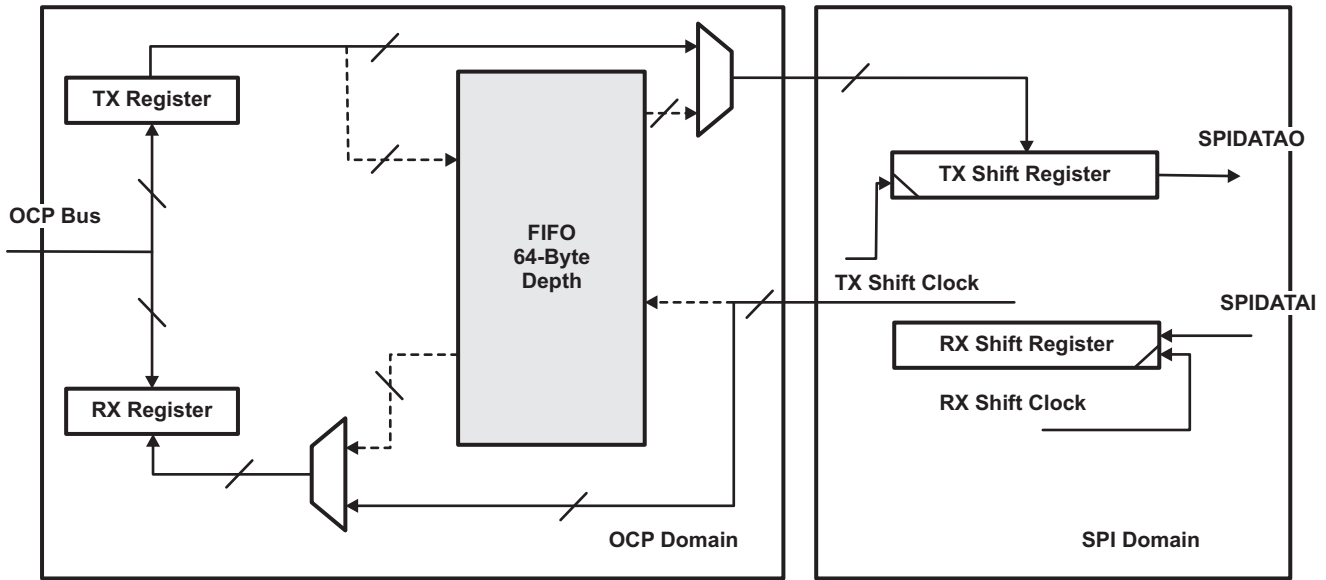
	SPI Word Length WL		
	$3 \leq WL \leq 7$	$8 \leq WL \leq 15$	$16 \leq WL \leq 31$
Number of byte written in the FIFO	1 byte	2 bytes	4 bytes

24.3.2.10.1 Split FIFO

The FIFO can be split into two part when module is configured in transmit/receive mode MCSPI_CH(i)CONF[TRM] is cleared to 0 and MCSPI_CH(i)CONF[FFER] and MCSPI_CH(i)CONF[FFEW] asserted. Then system can access a 32-byte depth FIFO per direction.

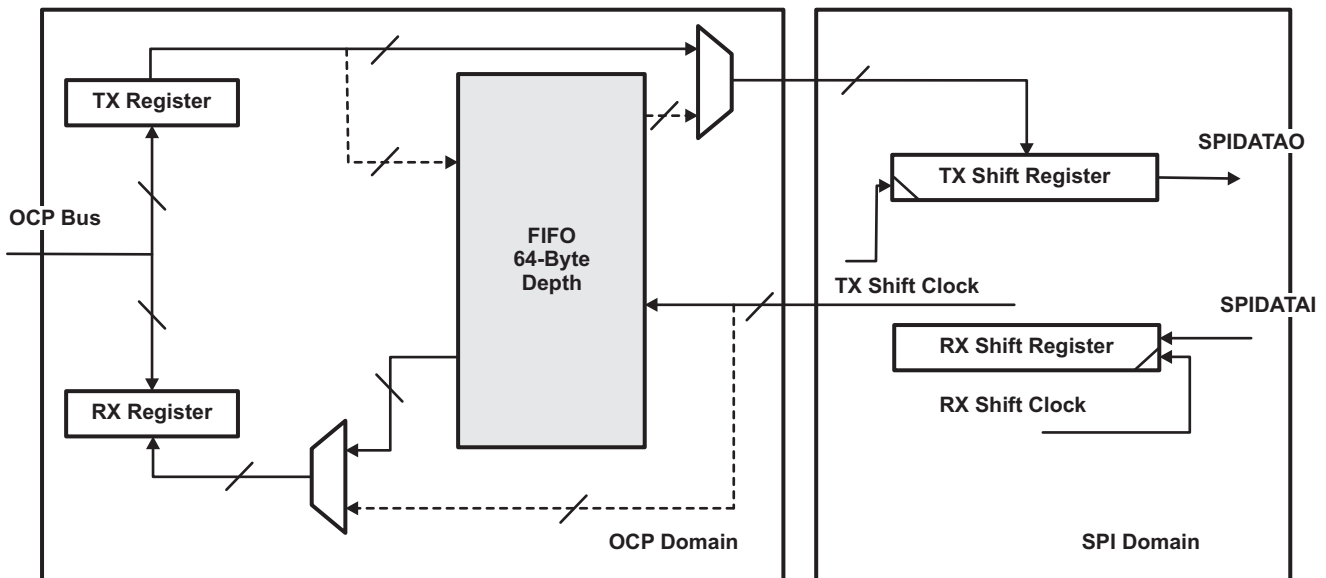
The FIFO buffer pointers are reset when the corresponding channel is enabled or FIFO configuration changes.

Figure 24-13. Transmit/Receive Mode With No FIFO Used



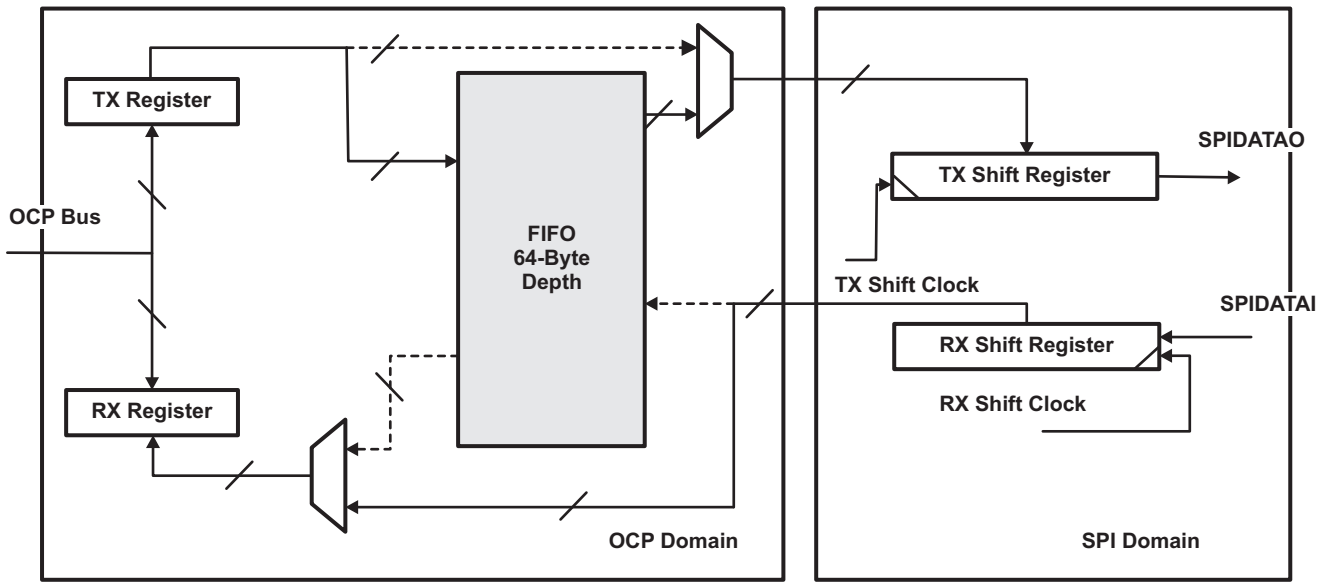
Configuration:
 MCSPI_CH(i)CONF[TRM]=0x0 Transmit/receive mode
 MCSPI_CH(i)CONF[FFRE]=0x0 FIFO disabled on receive path
 MCSPI_CH(i)CONF[FFWE]=0x0 FIFO disabled on transmit path

Figure 24-14. Transmit/Receive Mode With Only Receive FIFO Enabled



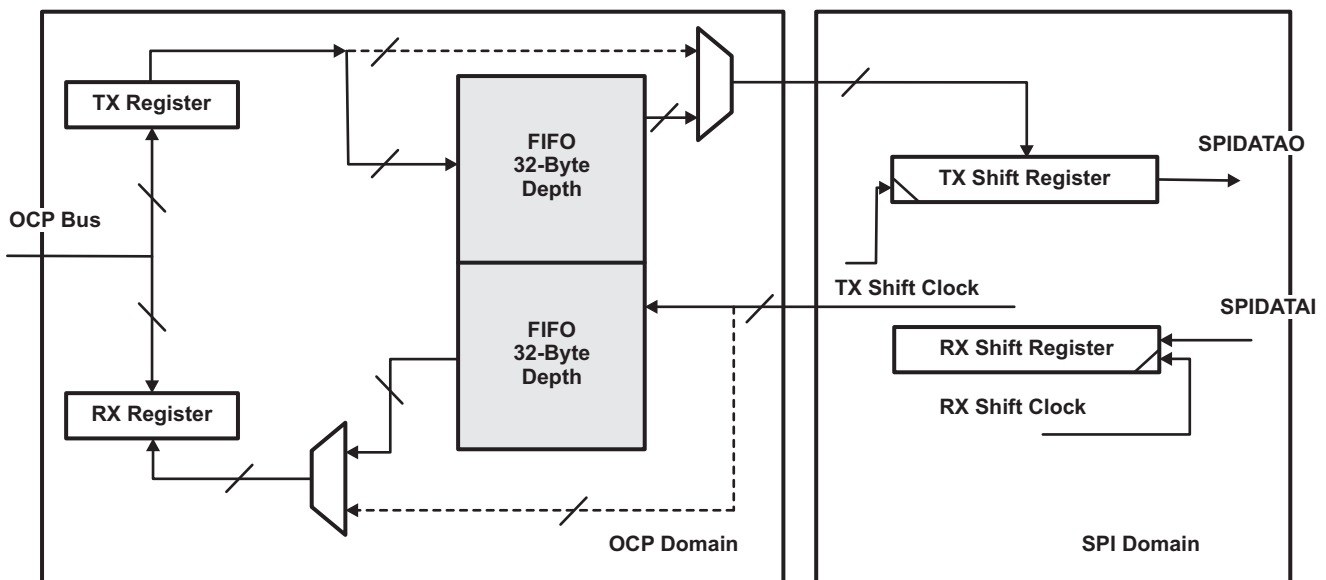
Configuration:
 MCSPI_CH(i)CONF[TRM]=0x0 Transmit/receive mode
 MCSPI_CH(i)CONF[FFRE]=0x1 FIFO enabled on receive path
 MCSPI_CH(i)CONF[FFWE]=0x0 FIFO disabled on transmit path

Figure 24-15. Transmit/Receive Mode With Only Transmit FIFO Used



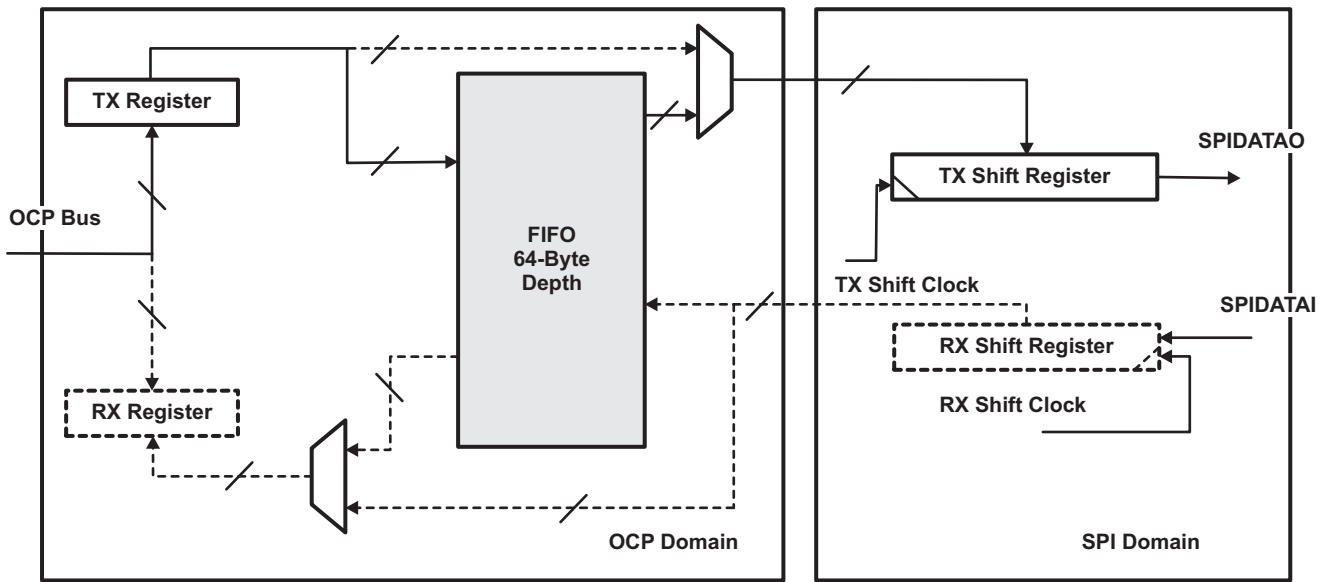
Configuration:
 MCSPI_CH(i)CONF[TRM]=0x0 Transmit/receive mode
 MCSPI_CH(i)CONF[FFRE]=0x0 FIFO disabled on receive path
 MCSPI_CH(i)CONF[FFWE]=0x1 FIFO enabled on transmit path

Figure 24-16. Transmit/Receive Mode With Both FIFO Direction Used



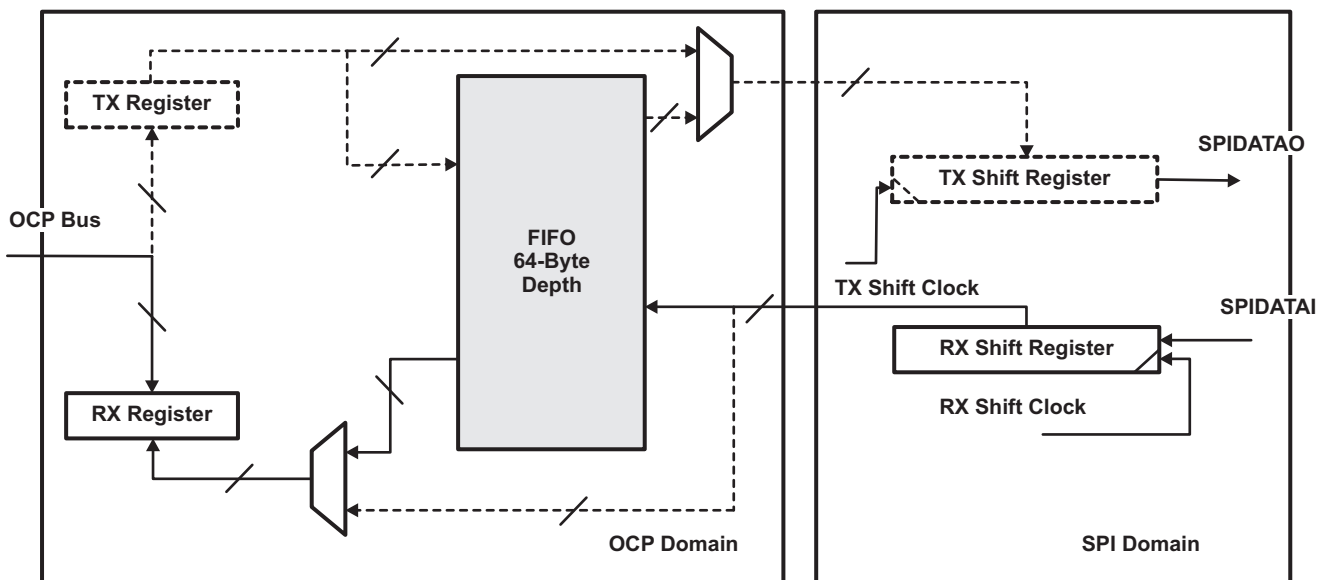
Configuration:
 MCSPI_CH(i)CONF[TRM]=0x0 Transmit/receive mode
 MCSPI_CH(i)CONF[FFRE]=0x1 FIFO enabled on receive path
 MCSPI_CH(i)CONF[FFWE]=0x0 FIFO disabled on transmit path

Figure 24-17. Transmit-Only Mode With FIFO Used



Configuration:
 MCSPI_CH(i)CONF[TRM]=0x2 Transmit only mode
 MCSPI_CH(i)CONF[FFRE]=0x1 FIFO enabled on transmit path
 MCSPI_CH(i)CONF[FFWE] not applicable

Figure 24-18. Receive-Only Mode With FIFO Used



Configuration:
 MCSPI_CH(i)CONF[TRM]=012 Receive only mode
 MCSPI_CH(i)CONF[FFRE]=0x1 FIFO enabled on receive path
 MCSPI_CH(i)CONF[FFWE] not applicable

24.3.2.10.2 Buffer Almost Full

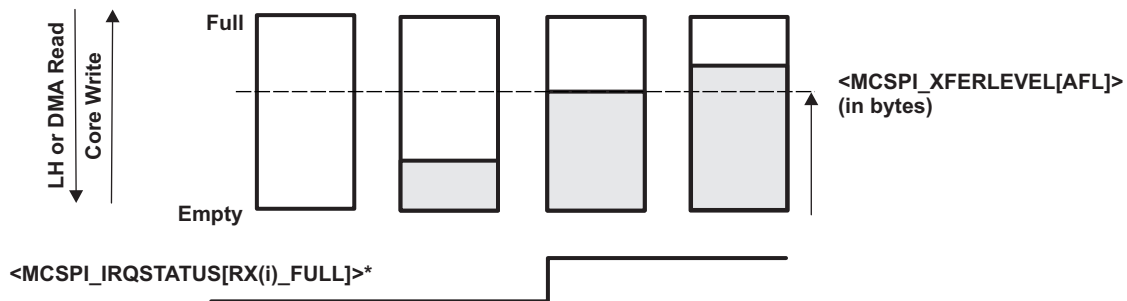
The bit field `MCSPi_XFERLEVEL[AFL]` is needed when the buffer is used to receive SPI word from a slave (`MCSPi_CH(i)CONF[FFER]` must be set to 1). It defines the almost full buffer status.

When FIFO pointer reaches this level an interrupt or a DMA request is sent to the CPU to enable system to read `AFL+1` bytes from receive register. Be careful `AFL+1` must correspond to a multiple value of `MCSPi_CH(i)CONF[WL]`.

When DMA is used, the request is de-asserted after the first receive register read.

No new request will be asserted until the system has performed the correct number of read operations from the buffer.

Figure 24-19. Buffer Almost Full Level (AFL)



* non-DMA mode only. In DMA mode, the DMA RX request is asserted to its active level under identical conditions.

NOTE: `SPI_IRQSTATUS` register bits are not available in DMA mode. In DMA mode, the `SPIm_DMA_RXn` request is asserted on the same conditions as the `SPI_IRQSTATUS RXn_FULL` flag.

24.3.2.10.3 Buffer Almost Empty

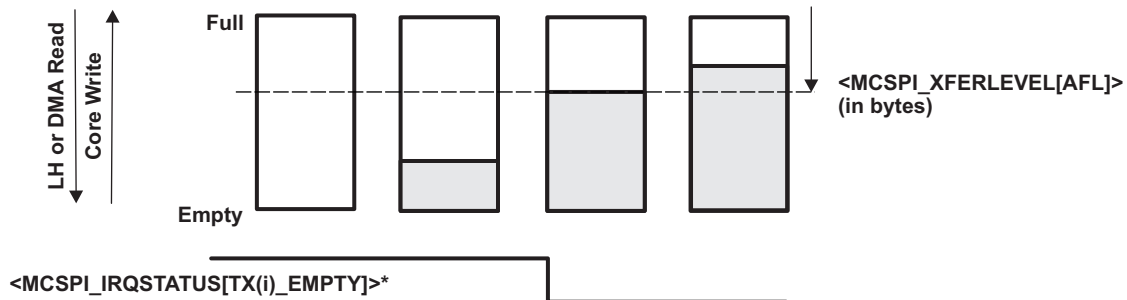
The bitfield MCSPI_XFERLEVEL[AEL] is needed when the buffer is used to transmit SPI word to a slave (MCSPI_CH(i)CONF[FFEW] must be set to 1). It defines the almost empty buffer status.

When FIFO pointer has not reached this level an interrupt or a DMA request is sent to the CPU to enable system to write AEL+1 bytes to transmit register. Be careful AEL+1 must correspond to a multiple value of MCSPI_CH(i)CONF[WL].

When DMA is used, the request is de-asserted after the first transmit register write.

No new request will be asserted until the system has performed the correct number of write operations.

Figure 24-20. Buffer Almost Empty Level (AEL)



* non-DMA mode only. In DMA mode, the DMA TX request is asserted to its active level under identical conditions.

24.3.2.10.4 End of Transfer Management

When the FIFO buffer is enabled for a channel, the user should configure the MCSPI_XFERLEVEL register, the AEL and AFL levels, and, especially, the WCNT bit field to define the number of SPI word to be transferred using the FIFO. This should be done before enabling the channel.

This counter allows the controller to stop the transfer correctly after a defined number of SPI words have been transferred. If WCNT is cleared to 0, the counter is not used and the user must stop the transfer manually by disabling the channel, in this case the user doesn't know how many SPI transfers have been done. For receive transfer, software shall poll the corresponding FFE bit field and read the Receive register to empty the FIFO buffer.

When End Of Word count interrupt is generated, the user can disable the channel and poll on MCSPI_CH(i)STAT[FFE] register to know if SPI word is still there in FIFO buffer and read last words.

24.3.2.10.5 Multiple SPI Word Access

The CPU has the ability to perform multiple SPI word access to the receive or transmit registers within a single 32-bit OCP access by setting the bit field MCSPI_MODULCTRL[MOA] to '1' under specific conditions:

- The channel selected has the FIFO enable.
- Only FIFO sense enabled support the kind of access.
- The bit field MCSPI_MODULCTRL[MOA] is set to 1
- Only 32-bit OCP access and data width can be performed to receive or transmit registers, for other kind of access the CPU must de-assert MCSPI_MODULCTRL[MOA] bit fields.
- The Level MCSPI_XFERLEVEL[AEL] and MCSPI_XFERLEVEL[AFL] must be 32-bit aligned , it means that $AEL[0] = AEL[1] = 1$ or $AFL[0] = AFL[1] = 1$.
- If MCSPI_XFERLEVEL[WCNT] is used it must be configured according to SPI word length.
- The word length of SPI words allows to perform multiple SPI access, that means that $MCSPI_CH(i)CONF[WL] < 16$.

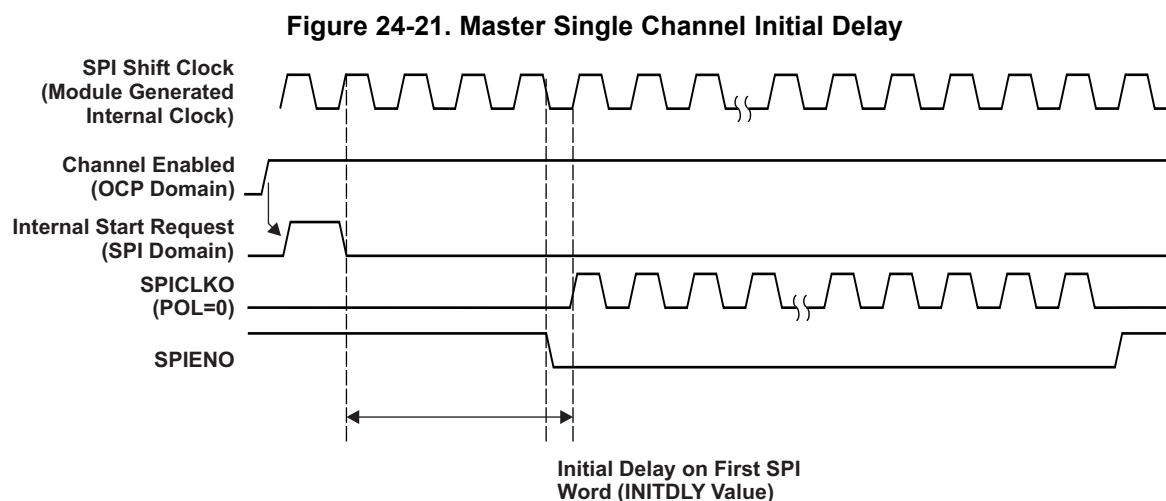
Number of SPI word access depending on SPI word length:

- $3 \leq WL \leq 7$, SPI word length smaller or equal to byte length, four SPI words accessed per 32-bit OCP read/write. If word count is used (MCSPI_XFERLEVEL[WCNT]), set the bit field to $WCNT[0]=WCNT[1]=0$.
- $8 \leq WL \leq 15$, SPI word length greater than byte or equal to 16-bit length, two SPI words accessed per 32-bit OCP read/write. If word count is used (MCSPI_XFERLEVEL[WCNT]), set the bit field to $WCNT[0]=0$.
- $16 \leq WL$ multiple SPI word access not applicable.

24.3.2.11 First SPI Word Delayed

The McSPI controller has the ability to delay the first SPI word transfer to give time for system to complete some parallel processes or fill the FIFO in order to improve transfer bandwidth. This delay is applied only on first SPI word after SPI channel enabled and first write in Transmit register. It is based on output clock frequency.

This option is meaningful in master mode and single channel mode, MCSPI_MODULCTRL[SINGLE] = 1.



Few delay values are available: No delay, 4/8/16/32 SPI cycles.

Its accuracy is half cycle in clock bypass mode and depends on clock polarity and phase.

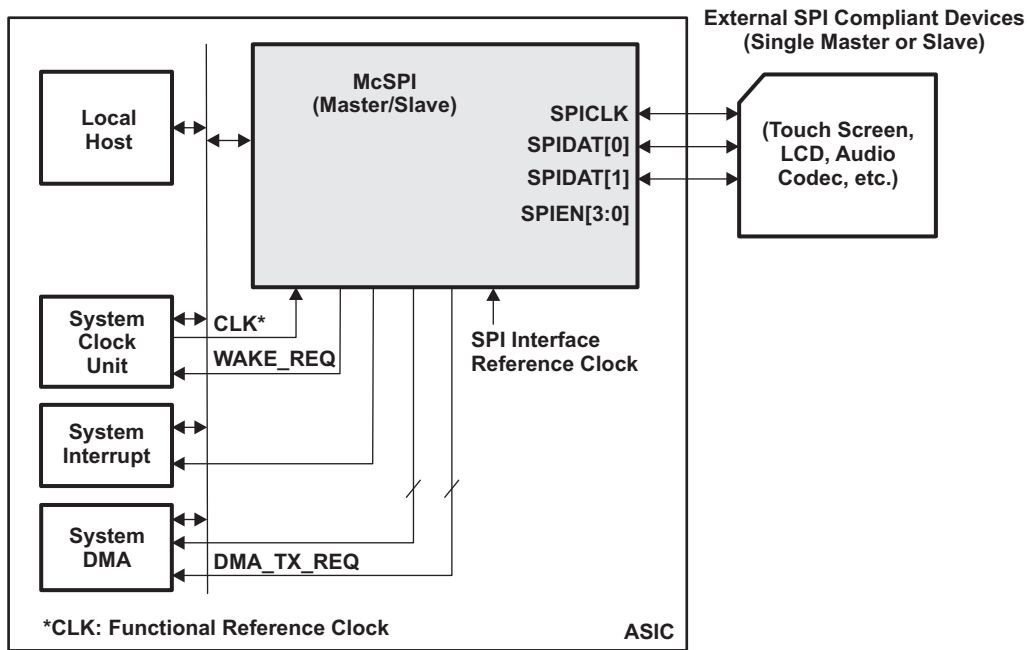
24.3.2.12 3- or 4-Pin Mode

External SPI bus interface can be configured to use a restricted set of pins using the bit field MCSPI_MODULCTRL[PIN34] and depending on targeted application:

- If MCSPI_MODULCTRL[PIN34] is cleared to 0 (default value) the controller is in 4-pin mode using the SPI pins SPICLK, SOMI, SIMO and chip enable CS.
- If MCSPI_MODULCTRL[PIN34] is set to 1 the controller is in 3-pin mode using the SPI pins SPICLK, SOMI and SIMO.

In 3-pin mode it is mandatory to put the controller in single channel master mode (MCSPI_MODULECTRL[SINGLE] asserted) and to connect only one SPI device on the bus.

Figure 24-22. 3-Pin Mode System Overview



In 3-pin mode all options related to chip select management are useless:

- MCSPI_CHxCONF[EPOL]
- MCSPI_CHxCONF[TCS0]
- MCSPI_CHxCONF[FORCE]

The chip select pin SPIEN is forced to '0' in this mode.

24.3.3 Slave Mode

McSPI is in slave mode when the bit MS of the register MCSPI_MODULCTRL is set.

In slave mode, McSPI can be connected to up to 4 external SPI master devices. McSPI handles transactions with a single SPI master device at a time.

In slave mode, McSPI initiates data transfer on the data lines (SPIDAT[1;0]) when it receives an SPI clock (SPICLK) from the external SPI master device.

The controller is able to work with or without a chip select SPIEN depending on MCSPI_MODULCTRL[PIN34] bit setting. It also supports transfers without a dead cycle between two successive words.

24.3.3.1 Dedicated Resources

In slave mode, enabling a channel that is not channel 0 has no effect. Only channel 0 can be enabled. The channel 0, in slave mode has the following resources:

- Its own channel enable, programmable with the bit EN of the register MCSPI_CH0CTRL. This channel should be enabled before transmission and reception. Disabling the channel, outside data word transmission, remains under user responsibility.
- Any of the 4 ports SPIEN[3:0] can be used as a slave SPI device enable. This is programmable with the bits SPIENSLV of the register MCSPI_CH0CONF.
- Its own transmitter register MCSPI_TX on top of the common shift register. If the transmitter register is empty, the status bit TXS of the register MCSPI_CH0STAT is set. When McSPI is selected by an external master (active signal on the SPIEN port assigned to channel 0), the transmitter register content of channel0 is always loaded in shift register whether it has been updated or not. The transmitter register should be loaded before McSPI is selected by a master.
- Its own receiver register MCSPI_RX on top of the common shift register. If the receiver register is full, the status bit RXS of the register MCSPI_CH0STAT is set.

NOTE: The transmitter register and receiver registers of the other channels are not used. Read from or Write in the registers of a channel other than 0 has no effect.

- Its own communication configuration with the following parameters via the register MCSPI_CH0CONF:
 - Transmit/Receive modes, programmable with the bit TRM.
 - Interface mode (Two data pins or Single data pin) and data pins assignment, both programmable with the bits IS and DPE.
 - SPI word length, programmable with the bits WL.
 - SPIEN polarity, programmable with the bit EPOL.
 - SPICLK polarity, programmable with the bit POL.
 - SPICLK phase, programmable with the bit PHA.
 - Use a FIFO buffer or not, programmable with FFER and FFEW, depending on transfer mode TRM.

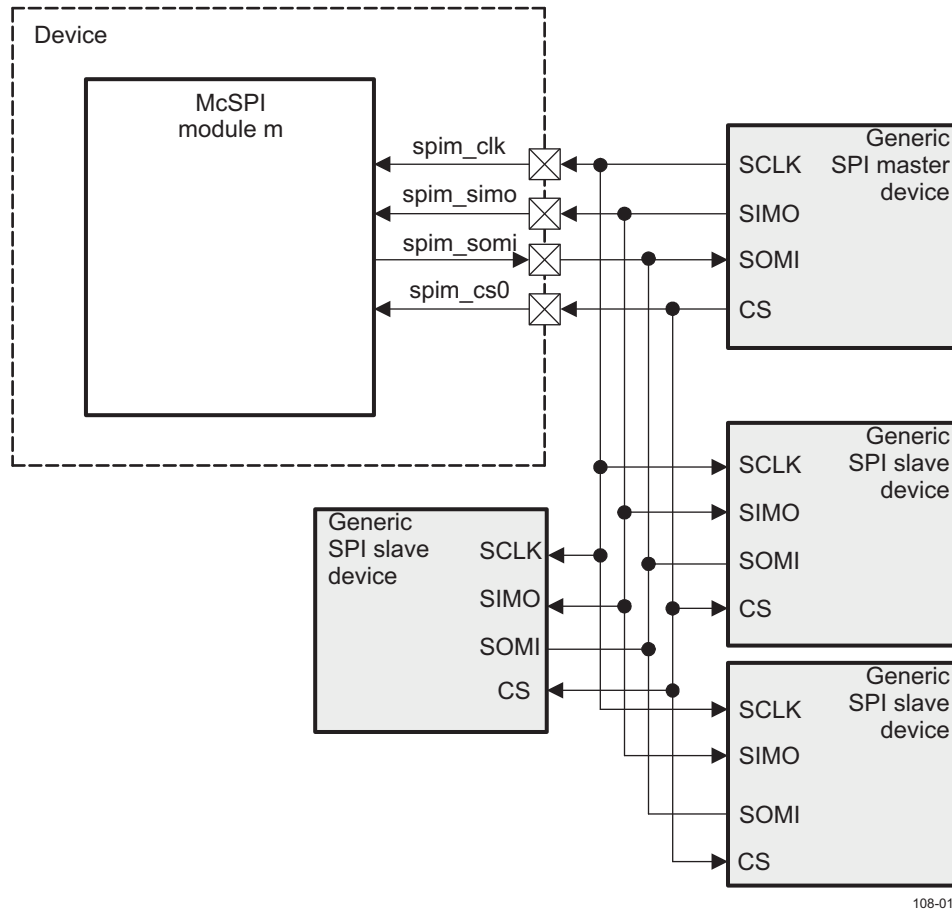
The SPICLK frequency of a transfer is controlled by the external SPI master connected to McSPI. The bits CLKD0 of the MCSPI_CH0CONF register are not used in slave mode.

NOTE: The configuration of the channel can be loaded in the MCSPI_CH0CONF register only when the channel is disabled.

- Two DMA requests events, read and write, to synchronize read/write accesses of the DMA controller with the activity of McSPI. The DMA requests are enabled with the bits DMAR and DMAW of the MCSPI_CH0CONF register.
- Four interrupts events.

Figure 24-23 shows an example of four slaves wired on a single master device.

Figure 24-23. Example of SPI Slave with One Master and Multiple Slave Devices on Channel 0



24.3.3.2 Interrupt Events in Slave Mode

The interrupt events related to the transmitter register state are TX_empty and TX_underflow. The interrupt events related to the receiver register state are RX_full and RX_overflow.

24.3.3.2.1 TX_EMPTY

The event TX_empty is activated when the channel is enabled and its transmitter register becomes empty. Enabling channel automatically raises this event. When FIFO buffer is enabled (MCSPi_CH(i)CONF[FFEW] set to 1), the TX_empty is asserted as soon as there is enough space in buffer to write a number of byte defined by MCSPi_XFERLEVEL[AEL].

Transmitter register must be load to remove source of interrupt and TX_empty interrupt status bit must be cleared for interrupt line de-assertion (if event enable as interrupt source).

When FIFO is enabled, no new TX_empty event will be asserted unless the host performs the number of writes to the transmitter register defined by MCSPi_XFERLEVEL[AEL]. It is the responsibility of the Local Host to perform the right number of writes.

24.3.3.2.2 TX_UNDERFLOW

The event TX_underflow is activated when channel is enabled and if the transmitter register or FIFO (if use of buffer is enabled) is empty (not updated with new data) when an external master device starts a data transfer with McSPI (transmit and receive).

When the FIFO is enabled, the data read while the underflow flag is set will not be the last word written to the FIFO.

The TX_underflow indicates an error (data loss) in slave mode.

To avoid having TX_underflow event at the beginning of a transmission, the event TX_underflow is not activated when no data has been loaded into the transmitter register since channel has been enabled.

TX_underflow interrupt status bit must be cleared for interrupt line de-assertion (if event enable as interrupt source).

24.3.3.2.3 RX_FULL

The event RX_FULL is activated when channel is enabled and receiver becomes filled (transient event). When FIFO buffer is enabled (MCSPI_CH(i)CONF[FFER] set to 1), the RX_FULL is asserted as soon as there is a number of bytes holds in buffer to read defined by MCSPI_XFERLEVEL[AFL].

Receiver register must be read to remove source of interrupt and RX_full interrupt status bit must be cleared for interrupt line de-assertion (if event enable as interrupt source).

When FIFO is enabled, no new RX_FULL event will be asserted unless the host has performed the number of reads from the receive register defined by MCSPI_XFERLEVEL[AFL]. It is the responsibility of Local Host to perform the right number of reads.

24.3.3.2.4 RX_OVERFLOW

The RX0_OVERFLOW event is activated in slave mode in either transmit-and-receive or receive-only mode, when a channel is enabled and the SPI_RXn register or FIFO is full when a new SPI word is received. The SPI_RXn register is always overwritten with the new SPI word. If the FIFO is enabled, data within the FIFO is overwritten, it must be considered as corrupted. The RX0_OVERFLOW event should not appear in slave mode using the FIFO.

The RX0_OVERFLOW indicates an error (data loss) in slave mode.

The SPI_IRQSTATUS[3] RX0_OVERFLOW interrupt status bit must be cleared for interrupt line deassertion (if the event is enabled as the interrupt source).

24.3.3.2.5 End of Word Count

The event end of word (EOW) count is activated when channel is enabled and configured to use the built-in FIFO. This interrupt is raised when the controller had performed the number of transfer defined in MCSPI_XFERLEVEL[WCNT] register. If the value was programmed to 0000h, the counter is not enabled and this interrupt is not generated.

The EOW count interrupt also indicates that the SPI transfer has halted on the channel using the FIFO buffer.

The EOW interrupt status bit must be cleared for interrupt line de-assertion (if event enable as interrupt source).

24.3.3.3 Slave Transmit-and-Receive Mode

The slave transmit and receive mode is programmable (TRM bit cleared to 0 in the register MCSPI_CH(i)CONF).

After the channel is enabled, transmission and reception proceeds with interrupt and DMA request events.

In slave transmit and receive mode, transmitter register should be loaded before McSPI is selected by an external SPI master device.

Transmitter register or FIFO (if enabled) content is always loaded into the shift register whether it has been updated or not. The event TX_underflow is activated accordingly, and does not prevent transmission.

On completion of SPI word transfer (bit EOT of the register MCSPI_CH(i)STAT is set) the received data is transferred to the channel receive register. This bit is meaningless when using the Buffer for this channel.

The built-in FIFO is available in this mode and can be configured in one data direction, transmit or receive, then the FIFO is seen as a unique 64-byte buffer. It can also be configured in both data directions, transmit and receive, then the FIFO is split into two separate 32-byte buffers with their own address space management.

24.3.3.4 Slave Receive-Only Mode

The slave receive-only mode is programmable (MCSPI_CH(i)CONF[TRM] set to 01).

In receive-only mode, the transmitter register should be loaded before McSPI is selected by an external SPI master device. Transmitter register or FIFO (if enabled) content is always loaded into the shift register whether it has been updated or not. The event TX_underflow is activated accordingly, and does not prevent transmission.

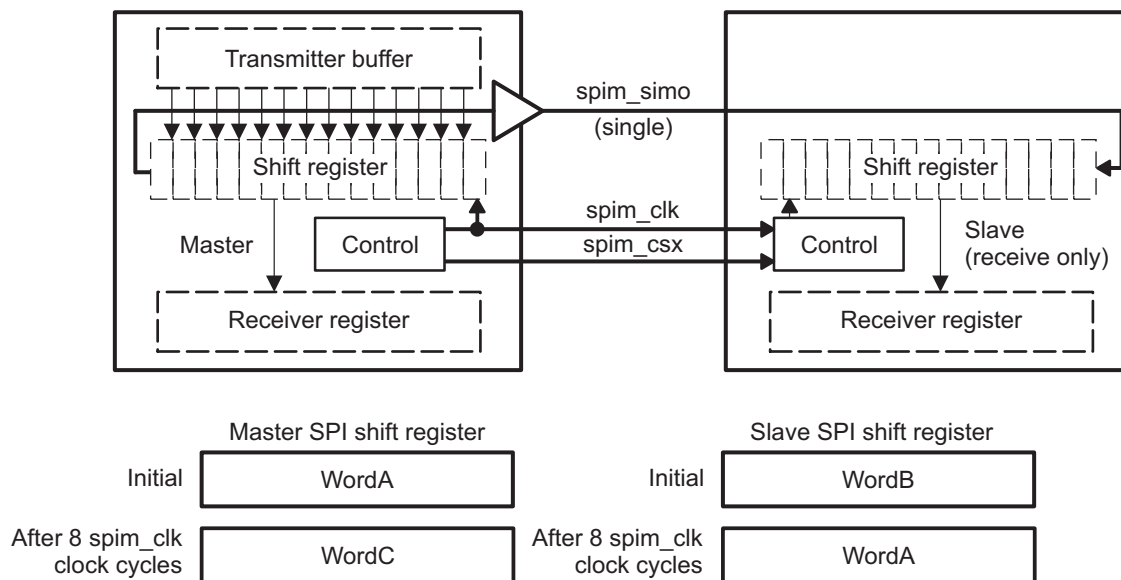
When an SPI word transfer completes (the MCSPI_CH(i)STAT[EOT] bit (with $I = 0$) is set to 1), the received data is transferred to the channel receive register.

To use McSPI as a slave receive-only device with MCSPI_CH(i)CONF[TRM]=00, the user has the responsibility to disable the TX_empty and TX_underflow interrupts and DMA write requests due to the transmitter register state.

On completion of SPI word transfer (bit EOT of the register MCSPI_CH(i)STAT is set) the received data is transferred to the channel receive register. This bit is meaningless when using the Buffer for this channel. The built-in FIFO is available in this mode and can be configured with FFER bit field in the MCSPI_CH(i)CONF register, then the FIFO is seen as a unique 64-byte buffer.

Figure 24-24 shows an example of a half-duplex system with a master device on the left and a receive-only slave device on the right. Each time one bit transfers out from the master, one bit transfers in to the slave. If WordA is 8 bits, then after eight cycles of the serial clock spim_clk, WordA transfers from the master to the slave.

Figure 24-24. SPI Half-Duplex Transmission (Receive-Only Slave)



108-032

24.3.3.5 Slave Transmit-Only Mode

The slave transmit-only mode is programmable (MCSPI_CH(i)CONF[TRM] set to 10). This mode eliminates the need for the CPU to read the receiver register (minimizing data movement) when only transmission is meaningful.

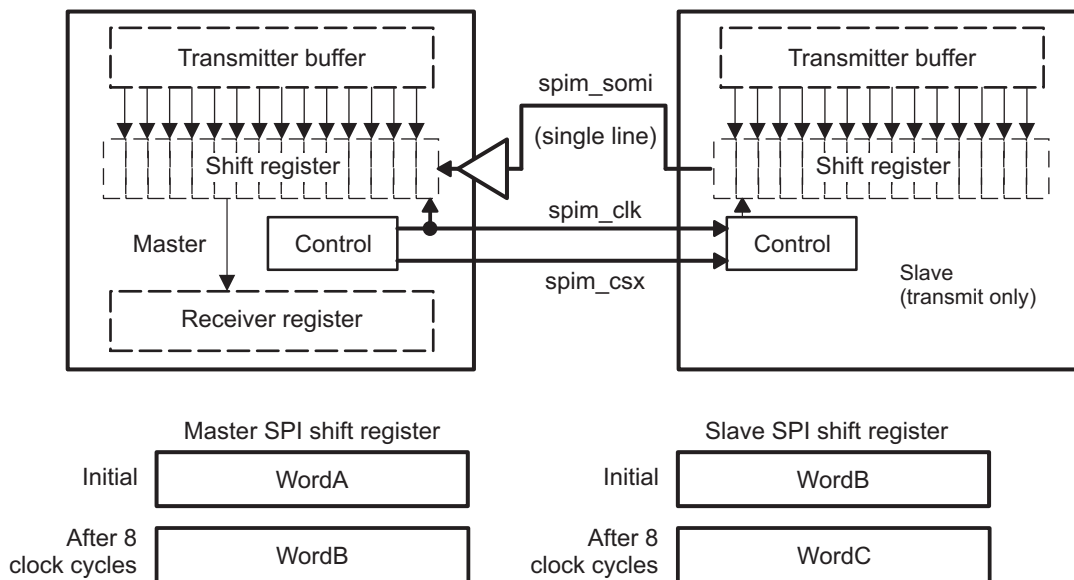
To use McSPI as a slave transmit-only device with MCSPI_CH(i)CONF[TRM]=10, the user should disable the RX_full and RX_overflow interrupts and DMA read requests due to the receiver register state.

On completion of SPI word transfer the bit EOT of the register MCSPI_CH(i)STAT is set. This bit is meaningless when using the Buffer for this channel.

The built-in FIFO is available in this mode and can be configured with FFER bit field in the MCSPI_CH(i)CONF register, then the FIFO is seen as a unique 64-byte buffer.

Figure 24-25 shows a half-duplex system with a master device on the left and a transmit-only slave device on the right. Each time a bit transfers out from the slave device, one bit transfers in the master. If WordB is 8-bits, then after eight cycles of the serial clock spim_clk, WordB transfers from the slave to the master.

Figure 24-25. SPI Half-Duplex Transmission (Transmit-Only Slave)



108-031

24.3.4 Interrupts

According to its transmitter register state and its receiver register state each channel can issue interrupt events if they are enabled.

The interrupt events are listed in the Section 24.3.2.2 and in Section 24.3.3.2.

Each interrupt event has a status bit, in the MCSPI_IRQSTATUS register, which indicates service is required, and an interrupt enable bit, in the MCSPI_IRQENABLE register, which enables the status to generate hardware interrupt requests.

When an interrupt occurs and it is later masked (IRQENABLE), the interrupt line is not asserted again even if the interrupt source has not been serviced.

McSPI supports interrupt driven operation and polling.

24.3.4.1 Interrupt-Driven Operation

Alternatively, an interrupt enable bit, in the MCSPI_IRQENABLE register, can be set to enable each of the events to generate interrupt requests when the corresponding event occurs. Status bits are automatically set by hardware logic conditions.

When an event occurs (the single interrupt line is asserted), the CPU must:

- Read the MCSPI_IRQSTATUS register to identify which event occurred,
- Read the receiver register that corresponds to the event in order to remove the source of an RX_full event, or write into the transmitter register that corresponds to the event in order to remove the source of a TX_empty event. No action is needed to remove the source of the events TX_underflow and RX_overflow.
- Write a 1 into the corresponding bit of MCSPI_IRQSTATUS register to clear the interrupt status, and release the interrupt line.

The interrupt status bit should always be reset after the channel is enabled and before the event is enabled as an interrupt source.

24.3.4.2 Polling

When the interrupt capability of an event is disabled in the MCSPI_IRQENABLE register, the interrupt line is not asserted and:

- The status bits in the MCSPI_IRQSTATUS register can be polled by software to detect when the corresponding event occurs.
- Once the expected event occurs, CPU must read the receiver register that corresponds to the event in order to remove the source of an RX_full event, or write into the transmitter register that corresponds to the event in order to remove the source of a TX_empty event. No action is needed to remove the source of the events TX_underflow and RX_overflow.
- Writing a 1 into the corresponding bit of MCSPI_IRQSTATUS register clears the interrupt status and does not affect the interrupt line state.

24.3.5 DMA Requests

McSPI can be interfaced with a DMA controller. At system level, the advantage is to free the local host of the data transfers.

According to its transmitter register state, its receiver register state or FIFO level (if use of buffer for the channel) each channel can issue DMA requests if they are enabled.

The DMA requests need to be disabled in order to get TX and RX interrupts, in order to define either the end of the transfer or the transfer of the last words for the modes listed below:

- Master transmit-only
- Master normal receive-only mode
- Master turbo receive-only mode
- Slave transmit-only

There are two DMA request lines per channel. The management of DMA requests differ according to use of FIFO buffer or not.

24.3.5.1 FIFO Buffer Disabled

The DMA Read request line is asserted when the channel is enabled and a new data is available in the receive register of the channel. DMA Read request can be individually masked with the bit DMAR of the register MCSPI_CH(i)CONF. The DMA Read request line is de-asserted on read completion of the receive register of the channel.

The DMA Write request line is asserted when the channel is enabled and the transmitter register of the channel is empty. DMA Write request can be individually masked with the bit DMAW of the register MCSPI_CH(i)CONF. The DMA Write request line is de-asserted on load completion of the transmitter register of the channel.

Only one SPI word can be transmitted/received per OCP bus access to write/read the transmit or receive register.

24.3.5.2 FIFO Buffer Enabled

The DMA Read request line is asserted when the channel is enabled and a number of bytes defined in MCSPI_XFERLEVEL[AFL] bit field is hold in FIFO buffer for the receive register of the channel. DMA Read request can be individually masked with the bit DMAR of the register MCSPI_CH(i)CONF. The DMA Read request line is de-asserted on the first SPI word read completion of the receive register of the channel. No new DMA request will be asserted again as soon as user has not performed the right number of read accesses defined by MCSPI_XFERLEVEL[AFL] it is under user responsibility.

The DMA Write request line is asserted when the channel is enabled and the number of bytes hold in FIFO buffer is below the level defined by the MCSPI_XFERLEVEL[AEL] bit field. DMA Write request can be individually masked with the bit DMAW of the register MCSPI_CH(i)CONF. The DMA Write request line is de-asserted on load completion of the first SPI word in the transmitter register of the channel. No new DMA request will be asserted again as soon as user has not performed the right number of write accesses defined by MCSPI_XFERLEVEL[AEL] it is under user responsibility.

Only one SPI word can be transmitted/received per OCP bus access to write/read the transmit or receive FIFO.

24.3.5.3 DMA 256-Bit Aligned Addresses

The controller has two registers, MCSPI_DAFTX and MCSPI_DAFRX, used only with an enabled channel which manages the FIFO to be compliant the a DMA handler providing only 256-bit aligned addresses.

This features is activated when the bit field MCSPI_MODULCTRL[FDDA] is set to '1' and only one enabled channel have its bit field MCSPI_CH(i)CONF[FFEW] or MCSPI_CH(i)CONF[FFER] enabled.

In this case the registers MCSPI_TX(i) and MCSPI_RX(i) are not used and data is managed through registers MCSPI_DAFTX and MCSPI_DAFRX.

24.3.6 Emulation Mode

The MReqDebug input differentiates a regular access of a processor (application access), from an emulator access.

Application access: MReqDebug = 0

In functional mode, the consequences of a read of a receiver register MCSPI_RX(i) are the following:

- The source of an RX(i)_Full event in the MCSPI_IRQSTATUS register is removed, if it was enabled in the MCSPI_IRQENABLE register.
- The RX(i)S status bit in the MCSPI_IRQSTATUS register is cleared.
- In master mode, depending on the round robin arbitration, and the transmitter register state, the channel may access to the shift register for transmission/reception.

Emulator access: MReqDebug = 1

In emulation mode, McSPI behavior is the same as in functional mode but a read of a receiver register MCSPI_RX(i) is not intrusive:

- MCSPI_RX(i) is still considered as not read. When the FIFO buffer is enabled, pointers are not updated.
- The source of an RX(i)_Full event in the MCSPI_IRQSTATUS register is not removed. The RX(i)S status bit in the MCSPI_CH(i)STAT register is held steady.

In emulation mode, as in functional mode, based on the ongoing data transfers, the status bits of the MCSPI_CH(i)STAT register may be optionally updated, the interrupt and DMA request lines may be optionally asserted.

24.3.7 Power Saving Management

Independently of the module operational modes (Transmit and/or Receive), two modes of operations are defined from a power management perspective: normal and idle modes.

The two modes are temporally fully exclusive.

24.3.7.1 Normal Mode

Both the Interface, or OCP, clock and SPI clock (CLKSPIREF) provided to McSPI must be active for both master and slave modes. The auto-gating of the module OCP clock and SPI clock occurs when the following conditions are met:

- The bit Autoidle of the register MCSPI_SYSCONFIG is set.
- In master mode, there is no data to transmit or receive in all channels.
- In slave mode, the SPI is not selected by the external SPI master device and no OCP accesses.

Autogating of the module OCP clock and SPI clock stops when the following conditions are met:

- In master mode, an OCP access occurs.
- In slave mode, an OCP access occurs or McSPI is selected by an external SPI master device.

24.3.7.2 Idle Mode

The OCP clock and SPI clock provided to McSPI may be switched off on system power manager request and switched back on module request.

McSPI is compliant with the power management handshaking protocol: idle request from the system power manager, idle acknowledgement from McSPI.

The idle acknowledgement in response to an idle request from the system power manager varies according to a programmable mode in the MCSPI_SYSCONFIG register: No idle mode, force idle mode, and smart idle mode.

- When programmed for no idle mode (the bit SIdleMode of the register MCSPI_SYSCONFIG is set to "01"), the module ignores the system power manager request, and behaves normally, as if the request was not asserted.
- When programmed for smart idle mode (the bit SIdleMode of the register MCSPI_SYSCONFIG is set to "10"), the module acknowledges the system power manager request according to its internal state.
- When programmed for force idle mode (the bit SIdleMode of the register MCSPI_SYSCONFIG is set to "00"), the module acknowledges the system power manager request unconditionally.

The OCP clock will be optionally switched off, during the smart idle mode period, if the bit ClockActivity of the register MCSPI_SYSCONFIG is set.

The SPI clock will be optionally switched off, during the smart idle mode period, if the second bit ClockActivity of the register MCSPI_SYSCONFIG is set.

McSPI assumes that both clocks may be switched off whatever the value set in the field ClockActivity of the register MCSPI_SYSCONFIG.

24.3.7.2.1 Transitions from Normal Mode to Smart-Idle Mode

The module detects an idle request when the synchronous signal IdleReq is asserted.

When IdleReq is asserted, any access to the module will generate an error as long as the OCP clock is alive.

When configured as a slave device, McSPI responds to the idle request by asserting the SIdleAck signal (idle acknowledgement) only after completion of the current transfer (SPIEN slave selection signal deasserted by the external master) and if interrupt or DMA request lines are not asserted.

As a master device, McSPI responds to the idle request by asserting the SIdleAck signal (idle acknowledgement) only after completion of all the channel data transfers and if interrupt or DMA request lines are not asserted.

As long as SIdleAck is not asserted, if an event occurs, the module can still generate an interrupt or a DMA request after IdleReq assertion. In this case, the module ignores the idle request and SIdleAck will not get asserted: The system power manager will abort the power mode transition procedure. It is then the responsibility of the system to de-assert IdleReq before attempting to access the module.

When SIdleAck is asserted, the module does not assert any new interrupt or DMA request.

24.3.7.2.2 Transition From Smart-Idle Mode to Normal Mode

McSPI detects the end of the idle period when the idle request signal (IdleReq) is deasserted.

Upon IdleReq de-assertion, the module switches back to normal mode and de-asserts SIdleAck signal. The module is fully operational.

24.3.7.2.3 Force-Idle Mode

Force-idle mode is enabled as follows:

- The bit SIdleMode of the register MCSPI_SYSCONFIG is cleared to “00” (Force Idle).

The force idle mode is an idle mode where McSPI responds unconditionally to the idle request by asserting the SIdleAck signal and by deasserting unconditionally the interrupt and DMA request lines if asserted.

The transition from normal mode to idle mode does not affect the interrupt event bits of the MCSPI_IRQSTATUS register.

In force-idle mode, the module is supposed to be disabled at that time, so the interrupt and DMA request lines are likely deasserted. OCP clock and SPI clock provided to McSPI can be switched off.

An idle request during an SPI data transfer can lead to an unexpected and unpredictable result, and is under software responsibility.

Any access to the module in force idle mode will generate an error as long as the OCP clock is alive and IdleReq is asserted.

The module exits the force idle mode when:

- The idle request signal (IdleReq) is de-asserted.

Upon IdleReq de-assertion, the module switches back to normal mode and de-asserts SIdleAck signal. The module is fully operational. The interrupt and DMA request lines are optionally asserted a clock cycle later.

24.3.8 System Test Mode

McSPI is in system test mode (SYSTEST) when the bit System_Test of the register MCSPI_MODULCTRL is set.

The SYSTEST mode is used to check in a very simple manner the correctness of the system interconnect either internally to interrupt handler, or power manager, or externally to SPI I/Os.

I/O verification can be performed in SYSTEST mode by toggling the outputs and capturing the logic state of the inputs. (See MCSPI_SYST register definition in)

24.3.9 Reset

24.3.9.1 Internal Reset Monitoring

The module is reset by the hardware when an active-low reset signal, synchronous to the OCP interface clock is asserted on the input pin RESETN.

This hardware reset signal has a global reset action on the module. All configuration registers and all state machines are reset, in all clock domains.

Additionally, the module can be reset by software through the bit SoftReset of the register MCSPI_SYSCONFIG. This bit has exactly the same action on the module logic as the hardware RESETN signal. The register MCSPI_SYSCONFIG is not sensitive to software reset. The SoftReset control bit is active high. The bit is automatically reset to 0 by the hardware.

A global ResetDone status bit is provided in the status register MCSPI_SYSSTATUS. This bit is set to 1 when all the different clock domains resets (OCP domain and SPI domains) have been released (logical AND).

The global ResetDone status bit can be monitored by the software to check if the module is ready-to-use following a reset (either hardware or software).

The clock CLKSPIREF must be provided to the module, in order to allow the ResetDone status bit to be set.

When used in slave mode, the clock CLKSPIREF is needed only during the reset phase. The clock CLKSPIREF can be switched off after the ResetDone status is set.

24.3.10 Access to Data Registers

This section details the supported data accesses (read or write) from/to the data receiver registers MCSPI_RX(i) and data transmitter registers MCSPI_TX(i).

Supported access:

McSPI supports only one SPI word per register (receiver or transmitter) and does not support successive 8-bit or 16-bit accesses for a single SPI word.

The SPI word received is always right justified on LSbit of the 32bit register MCSPI_RX(i), and the SPI word to transmit is always right justified on LSbit of the 32bit register MCSPI_TX(i).

The upper bits, above SPI word length, are ignored and the content of the data registers is not reset between the SPI data transfers.

The coherence between the number of bits of the SPI Word, the number of bits of the access and the enabled byte remains under the user's responsibility. Only aligned accesses are supported.

In Master mode, data should not be written in the transmit register when the channel is disabled.

24.3.11 Programming Aid

24.3.11.1 Module Initialization

- Hard or soft reset.
- Read MCSPI_SYSSTATUS.
- Check if reset is done.
- Module configuration: (a) Write into MCSPI_MODULCTRL (b) Write into MCSPI_SYSCONFIG.
- Before the ResetDone bit is set, the clocks CLK and CLKSPIREF must be provided to the module.
- To avoid hazardous behavior, it is advised to reset the module before changing from MASTER mode to SLAVE mode or from SLAVE mode to MASTER mode.

24.3.11.2 Common Transfer Sequence

McSPI module allows the transfer of one or several words, according to different modes:

- MASTER, MASTER Turbo, SLAVE
- TRANSMIT - RECEIVE, TRANSMIT ONLY, RECEIVE ONLY
- Write and Read requests: Interrupts, DMA
- SPIEN lines assertion/deassertion: automatic, manual

For all these flows, the host process contains the main process and the interrupt routines. The interrupt routines are called on the interrupt signals or by an internal call if the module is used in polling mode.

In multi-channel master mode, the flows of different channels can be run simultaneously.

24.3.11.3 Main Program

- Interrupt Initialization: (a) Reset status bits in MCSPI_IRQSTATUS (b) Enable interrupts in MCSPI_IRQENA.

- Channel Configuration: Write MCSPI_CH(i)CONF.
- Start the channel: Write 0000 0001h in MCSPI_CH(i)CTRL.
- First write request: TX empty - Generate DMA write event/ polling TX empty flag by CPU to write First transmit word into MCSPI_TX(i).
- End of transfer: Stop the channel by writing 0000 0000h in MCSPI_CH(i)CTRL

The end of transfer depends on the transfer mode.

In multi-channel master mode, be careful not to overwrite the bits of other channels when initializing MCSPI_IRQSTATUS and MCSPI_IRQENABLE.

24.3.12 Interrupt and DMA Events

McSPI has two DMA requests (Rx and Tx) per channel. It also has one interrupt line for all the interrupt requests.

24.4 McSPI Registers

24.4.1 SPI Registers

Table 24-10 lists the memory-mapped registers for the SPI. All register offset addresses not listed in Table 24-10 should be considered as reserved locations and the register contents should not be modified.

Table 24-10. SPI Registers

Offset	Acronym	Register Name	Section
0h	MCSPi_REVISION	McSPI revision register	Section 24.4.1.1
110h	MCSPi_SYSCONFIG	McSPI system configuration register	Section 24.4.1.2
114h	MCSPi_SYSSTATUS	McSPI system status register	Section 24.4.1.3
118h	MCSPi_IRQSTATUS	McSPI interrupt status register	Section 24.4.1.4
11Ch	MCSPi_IRQENABLE	McSPI interrupt enable register	Section 24.4.1.5
124h	MCSPi_SYST	McSPI system register	Section 24.4.1.6
128h	MCSPi_MODULCTRL	McSPI module control register	Section 24.4.1.7
12Ch	MCSPi_CH0CONF	McSPI channel 0 configuration register	Section 24.4.1.8
130h	MCSPi_CH0STAT	McSPI channel 0 status register	Section 24.4.1.9
134h	MCSPi_CH0CTRL	McSPI channel 0 control register	Section 24.4.1.10
138h	MCSPi_TX0	McSPI channel 0 FIFO transmit buffer register	Section 24.4.1.11
13Ch	MCSPi_RX0	McSPI channel 0 FIFO receive buffer register	Section 24.4.1.12
140h	MCSPi_CH1CONF	McSPI channel 1 configuration register	Section 24.4.1.13
144h	MCSPi_CH1STAT	McSPI channel 1 status register	Section 24.4.1.14
148h	MCSPi_CH1CTRL	McSPI channel 1 control register	Section 24.4.1.15
14Ch	MCSPi_TX1	McSPI channel 1 FIFO transmit buffer register	Section 24.4.1.16
150h	MCSPi_RX1	McSPI channel 1 FIFO receive buffer register	Section 24.4.1.17
154h	MCSPi_CH2CONF	McSPI channel 2 configuration register	Section 24.4.1.18
158h	MCSPi_CH2STAT	McSPI channel 2 status register	Section 24.4.1.19
15Ch	MCSPi_CH2CTRL	McSPI channel 2 control register	Section 24.4.1.20
160h	MCSPi_TX2	McSPI channel 2 FIFO transmit buffer register	Section 24.4.1.21
164h	MCSPi_RX2	McSPI channel 2 FIFO receive buffer register	Section 24.4.1.22
168h	MCSPi_CH3CONF	McSPI channel 3 configuration register	Section 24.4.1.23
16Ch	MCSPi_CH3STAT	McSPI channel 3 status register	Section 24.4.1.24
170h	MCSPi_CH3CTRL	McSPI channel 3 control register	Section 24.4.1.25
174h	MCSPi_TX3	McSPI channel 3 FIFO transmit buffer register	Section 24.4.1.26
178h	MCSPi_RX3	McSPI channel 3 FIFO receive buffer register	Section 24.4.1.27
17Ch	MCSPi_XFERLEVEL	McSPI transfer levels register	Section 24.4.1.28

Table 24-10. SPI Registers (continued)

Offset	Acronym	Register Name	Section
180h	MCSPi_DAFTX	McSPI DMA address aligned FIFO transmitter register	Section 24.4.1.29
1A0h	MCSPi_DAFRX	McSPI DMA address aligned FIFO receiver register	Section 24.4.1.30

24.4.1.1 MCSPI_REVISION Register (offset = 0h) [reset = 300000h]

MCSPI_REVISION is shown in [Figure 24-26](#) and described in [Table 24-11](#).

The McSPI system configuration register (MCSPI_REVISION) allows control of various parameters of the module interface. It is not sensitive to software reset.

Figure 24-26. MCSPI_REVISION Register

31	30	29	28	27	26	25	24
SCHEME		RESERVED			FUNC		
R-0h		R-0h			R-30h		
23	22	21	20	19	18	17	16
FUNC							
R-30h							
15	14	13	12	11	10	9	8
R_RTL				X_MAJOR			
R-0h				R-0h			
7	6	5	4	3	2	1	0
CUSTOM		Y_MINOR					
R/W-0h		R/W-0h					

LEGEND: R/W = Read/Write; R = Read only; W1toCl = Write 1 to clear bit; -n = value after reset

Table 24-11. MCSPI_REVISION Register Field Descriptions

Bit	Field	Type	Reset	Description
31-30	SCHEME	R	0h	Used to distinguish between old scheme and current. 0h = Legacy scheme. 1h = Revision 0.8 scheme.
29-28	RESERVED	R	0h	
27-16	FUNC	R	30h	Function indicates a software compatible module family. If there is no level of software compatibility a new Func number (and hence REVISION) should be assigned.
15-11	R_RTL	R	0h	R_RTL bit.
10-8	X_MAJOR	R	0h	X_MAJOR bit.
7-6	CUSTOM	R/W	0h	CUSTOM bit.
5-0	Y_MINOR	R/W	0h	Y_MINOR bit.

24.4.1.2 MCSPI_SYSCONFIG Register (offset = 110h) [reset = 0h]

MCSPI_SYSCONFIG is shown in [Figure 24-27](#) and described in [Table 24-12](#).

The McSPI system configuration register (MCSPI_SYSCONFIG) allows control of various parameters of the module interface. It is not sensitive to software reset.

Figure 24-27. MCSPI_SYSCONFIG Register

31	30	29	28	27	26	25	24
RESERVED							
R-0h							
23	22	21	20	19	18	17	16
RESERVED							
R-0h							
15	14	13	12	11	10	9	8
RESERVED						CLOCKACTIVITY	
R-0h						R/W-0h	
7	6	5	4	3	2	1	0
RESERVED			SIDLEMODE		RESERVED	SOFTRESET	AUTOIDLE
R-0h			R/W-0h		R-0h	R/W-0h	R/W-0h

LEGEND: R/W = Read/Write; R = Read only; W1toCl = Write 1 to clear bit; -n = value after reset

Table 24-12. MCSPI_SYSCONFIG Register Field Descriptions

Bit	Field	Type	Reset	Description
31-10	RESERVED	R	0h	
9-8	CLOCKACTIVITY	R/W	0h	Clocks activity during wake-up mode period. 0h = OCP and Functional clocks may be switched off. 1h = OCP clock is maintained. Functional clock may be switched-off. 2h = Functional clock is maintained. OCP clock may be switched-off. 3h = OCP and Functional clocks are maintained.
7-5	RESERVED	R	0h	
4-3	SIDLEMODE	R/W	0h	Power management. 0h = If an idle request is detected, the McSPI acknowledges it unconditionally and goes in Inactive mode. Interrupt, DMA requests are unconditionally de-asserted. 1h = If an idle request is detected, the request is ignored and keeps on behaving normally. 2h = Smart-idle mode: local target's idle state eventually follows (acknowledges) the system's idle requests, depending on the IP module's internal requirements. 3h = Reserved.
2	RESERVED	R	0h	
1	SOFTRESET	R/W	0h	Software reset. During reads it always returns 0. 0h = (write) Normal mode. 1h = (write) Set this bit to 1 to trigger a module reset. The bit is automatically reset by the hardware.
0	AUTOIDLE	R/W	0h	Internal OCP Clock gating strategy. 0h = OCP clock is free-running. 1h = Automatic OCP clock gating strategy is applied, based on the OCP interface activity.

24.4.1.3 MCSPI_SYSSTATUS Register (offset = 114h) [reset = 0h]

MCSPI_SYSSTATUS is shown in [Figure 24-28](#) and described in [Table 24-13](#).

The McSPI system status register (MCSPI_SYSSTATUS) provides status information about the module excluding the interrupt status information.

Figure 24-28. MCSPI_SYSSTATUS Register

31	30	29	28	27	26	25	24
RESERVED							
R-0h							
23	22	21	20	19	18	17	16
RESERVED							
R-0h							
15	14	13	12	11	10	9	8
RESERVED							
R-0h							
7	6	5	4	3	2	1	0
RESERVED							RESETDONE
R-0h							R-0h

LEGEND: R/W = Read/Write; R = Read only; W1toCl = Write 1 to clear bit; -n = value after reset

Table 24-13. MCSPI_SYSSTATUS Register Field Descriptions

Bit	Field	Type	Reset	Description
31-1	RESERVED	R	0h	
0	RESETDONE	R	0h	Internal Reset Monitoring. 0h = Internal module reset is on-going 1h = Reset completed

24.4.1.4 MCSPI_IRQSTATUS Register (offset = 118h) [reset = 0h]

MCSPI_IRQSTATUS is shown in [Figure 24-29](#) and described in [Table 24-14](#).

The McSPI interrupt status register (MCSPI_IRQSTATUS) regroups all the status of the module internal events that can generate an interrupt.

Figure 24-29. MCSPI_IRQSTATUS Register

31	30	29	28	27	26	25	24
RESERVED							
R-0h							
23	22	21	20	19	18	17	16
RESERVED						EOW	RESERVED
R-0h						R/W-0h	R-0h
15	14	13	12	11	10	9	8
RESERVED	RX3_FULL	TX3_UNDERFLOW	TX3_EMPTY	RESERVED	RX2_FULL	TX2_UNDERFLOW	TX2_EMPTY
R-0h	R/W-0h	R/W-0h	R/W-0h	R-0h	R/W-0h	R/W-0h	R/W-0h
7	6	5	4	3	2	1	0
RESERVED	RX1_FULL	TX1_UNDERFLOW	TX1_EMPTY	RX0_OVERFLOW	RX0_FULL	TX0_UNDERFLOW	TX0_EMPTY
R-0h	R/W-0h	R/W-0h	R/W-0h	R/W-0h	R/W-0h	R/W-0h	R/W-0h

LEGEND: R/W = Read/Write; R = Read only; W1toCl = Write 1 to clear bit; -n = value after reset

Table 24-14. MCSPI_IRQSTATUS Register Field Descriptions

Bit	Field	Type	Reset	Description
31-18	RESERVED	R	0h	
17	EOW	R/W	0h	End of word (EOW) count event when a channel is enabled using the FIFO buffer and the channel has sent the number of McSPI words defined by the MCSPI_XFERLEVEL[WCNT]. 0h (W) = Event status bit is unchanged. 0h (R) = Event false. 1h (W) = Event status bit is reset. 1h (R) = Event is pending.
16	RESERVED	R	0h	
15	RESERVED	R	0h	
14	RX3_FULL	R/W	0h	Receiver register is full or almost full. Only when Channel 3 is enabled. This bit indicate FIFO almost full status when built-in FIFO is used for receive register (MCSPI_CH3CONF[FFE3R] is set). 0h (W) = Event status bit is unchanged. 0h (R) = Event false. 1h (W) = Event status bit is reset. 1h (R) = Event is pending.
13	TX3_UNDERFLOW	R/W	0h	Transmitter register underflow. Only when Channel 3 is enabled. The transmitter register is empty (not updated by Host or DMA with new data) before its time slot assignment. Exception: No TX_underflow event when no data has been loaded into the transmitter register since channel has been enabled. 0h (W) = Event status bit is unchanged. 0h (R) = Event false. 1h (W) = Event status bit is reset. 1h (R) = Event is pending.

Table 24-14. MCSPI_IRQSTATUS Register Field Descriptions (continued)

Bit	Field	Type	Reset	Description
12	TX3_EMPTY	R/W	0h	Transmitter register is empty or almost empty. This bit indicate FIFO almost full status when built-in FIFO is used for transmit register (MCSPI_CH3CONF[FFE3W] is set). Note: Enabling the channel automatically raises this event. 0h (W) = Event status bit is unchanged. 0h (R) = Event false. 1h (W) = Event status bit is reset. 1h (R) = Event is pending.
11	RESERVED	R	0h	
10	RX2_FULL	R/W	0h	Receiver register full or almost full. Channel 2 This bit indicate FIFO almost full status when built-in FIFO is used for receive register (MCSPI_CH3CONF[FFE2R] is set). 0h (W) = Event status bit is unchanged. 0h (R) = Event false. 1h (W) = Event status bit is reset. 1h (R) = Event is pending.
9	TX2_UNDERFLOW	R/W	0h	Transmitter register underflow. Channel 2 0h (W) = Event status bit is unchanged. 0h (R) = Event false. 1h (W) = Event status bit is reset. 1h (R) = Event is pending.
8	TX2_EMPTY	R/W	0h	Transmitter register empty or almost empty. Channel 2. This bit indicate FIFO almost full status when built-in FIFO is used for transmit register (MCSPI_CH3CONF[FFE2W] is set). 0h (W) = Event status bit is unchanged. 0h (R) = Event false. 1h (W) = Event status bit is reset. 1h (R) = Event is pending.
7	RESERVED	R	0h	
6	RX1_FULL	R/W	0h	Receiver register full or almost full. Channel 1. This bit indicate FIFO almost full status when built-in FIFO is use for receive register (MCSPI_CH3CONF[FFE1R] is set). 0h (W) = Event status bit is unchanged. 0h (R) = Event false. 1h (W) = Event status bit is reset. 1h (R) = Event is pending.
5	TX1_UNDERFLOW	R/W	0h	Transmitter register underflow. Channel 1. 0h (W) = Event status bit is unchanged. 0h (R) = Event false. 1h (W) = Event status bit is reset. 1h (R) = Event is pending.
4	TX1_EMPTY	R/W	0h	Transmitter register empty or almost empty. Channel 1. This bit indicate FIFO almost full status when built-in FIFO is use for transmit register (MCSPI_CH3CONF[FFE1W] is set). 0h (W) = Event status bit is unchanged. 0h (R) = Event false. 1h (W) = Event status bit is reset. 1h (R) = Event is pending.

Table 24-14. MCSPi_IRQSTATUS Register Field Descriptions (continued)

Bit	Field	Type	Reset	Description
3	RX0_OVERFLOW	R/W	0h	Receiver register overflow (slave mode only). Channel 0. 0h (W) = Event status bit is unchanged. 0h (R) = Event false. 1h (W) = Event status bit is reset. 1h (R) = Event is pending.
2	RX0_FULL	R/W	0h	Receiver register full or almost full. Channel 0. Receiver register full or almost full. Channel 0 0h (W) = Event status bit is unchanged. 0h (R) = Event false. 1h (W) = Event status bit is reset. 1h (R) = Event is pending.
1	TX0_UNDERFLOW	R/W	0h	Transmitter register underflow. Channel 0. 0h (W) = Event status bit is unchanged. 0h (R) = Event false. 1h (W) = Event status bit is reset. 1h (R) = Event is pending.
0	TX0_EMPTY	R/W	0h	Transmitter register empty or almost empty. Channel 0. This bit indicate FIFO almost full status when built-in FIFO is use for transmit register (MCSPi_CH3CONF[FFE0W] is set). 0h (W) = Event status bit is unchanged. 0h (R) = Event false. 1h (W) = Event status bit is reset. 1h (R) = Event is pending.

24.4.1.5 MCSPI_IRQENABLE Register (offset = 11Ch) [reset = 0h]

MCSPI_IRQENABLE is shown in [Figure 24-30](#) and described in [Table 24-15](#).

This McSPI interrupt enable register (MCSPI_IRQENABLE) enables/disables the module internal sources of interrupt, on an event-by-event basis.

Figure 24-30. MCSPI_IRQENABLE Register

31	30	29	28	27	26	25	24
RESERVED							
R-0h							
23	22	21	20	19	18	17	16
RESERVED						EOWKE	RESERVED
R-0h						R/W-0h	R-0h
15	14	13	12	11	10	9	8
RESERVED	RX3_FULL__E NABLE	TX3_UNDERFL OW__ENABLE	TX3_EMPTY__ ENABLE	RESERVED	RX2_FULL__E NABLE	TX2_UNDERFL OW__ENABLE	TX2_EMPTY__ ENABLE
R-0h	R/W-0h	R/W-0h	R/W-0h	R-0h	R/W-0h	R/W-0h	R/W-0h
7	6	5	4	3	2	1	0
RESERVED	RX1_FULL__E NABLE	TX1_UNDERFL OW__ENABLE	TX1_EMPTY__ ENABLE	RX0_OVERFL OW__ENABLE	RX0_FULL__E NABLE	TX0_UNDERFL OW__ENABLE	TX0_EMPTY__ ENABLE
R-0h	R/W-0h	R/W-0h	R/W-0h	R/W-0h	R/W-0h	R/W-0h	R/W-0h

LEGEND: R/W = Read/Write; R = Read only; W1toCl = Write 1 to clear bit; -n = value after reset

Table 24-15. MCSPI_IRQENABLE Register Field Descriptions

Bit	Field	Type	Reset	Description
31-18	RESERVED	R	0h	
17	EOWKE	R/W	0h	End of word count interrupt enable. 0h = Interrupt is disabled. 1h = Interrupt is enabled.
16	RESERVED	R	0h	
15	RESERVED	R	0h	
14	RX3_FULL__ENABLE	R/W	0h	MCSPI_RX3 receiver register full or almost full interrupt enable (channel 3). 0h = Interrupt is disabled. 1h = Interrupt is enabled.
13	TX3_UNDERFLOW__ENABLE	R/W	0h	MCSPI_TX3 transmitter register underflow interrupt enable (channel 3). 0h = Interrupt is disabled. 1h = Interrupt is enabled.
12	TX3_EMPTY__ENABLE	R/W	0h	MCSPI_TX3 transmitter register empty or almost empty interrupt enable (channel 3). 0h = Interrupt is disabled. 1h = Interrupt is enabled.
11	RESERVED	R	0h	
10	RX2_FULL__ENABLE	R/W	0h	MCSPI_RX2 receiver register full or almost full interrupt enable (channel 2). 0h = Interrupt is disabled. 1h = Interrupt is enabled.
9	TX2_UNDERFLOW__ENABLE	R/W	0h	MCSPI_TX2 transmitter register underflow interrupt enable (channel 2). 0h = Interrupt is disabled. 1h = Interrupt is enabled.

Table 24-15. MCSPI_IRQENABLE Register Field Descriptions (continued)

Bit	Field	Type	Reset	Description
8	TX2_EMPTY__ENABLE	R/W	0h	MCSPI_TX2 transmitter register empty or almost empty interrupt enable (channel 2). 0h = Interrupt is disabled. 1h = Interrupt is enabled.
7	RESERVED	R	0h	
6	RX1_FULL__ENABLE	R/W	0h	MCSPI_RX1 receiver register full or almost full interrupt enable (channel 1) 0h = Interrupt is disabled. 1h = Interrupt is enabled.
5	TX1_UNDERFLOW__ENABLE	R/W	0h	MCSPI_TX1 transmitter register underflow interrupt enable (channel 1). 0h = Interrupt is disabled. 1h = Interrupt is enabled.
4	TX1_EMPTY__ENABLE	R/W	0h	MCSPI_TX1 transmitter register empty or almost empty interrupt enable (channel 1). 0h = Interrupt is disabled. 1h = Interrupt is enabled.
3	RX0_OVERFLOW__ENABLE	R/W	0h	MCSPI_RX0 receiver register overflow interrupt enable (channel 0). 0h = Interrupt is disabled. 1h = Interrupt is enabled.
2	RX0_FULL__ENABLE	R/W	0h	MCSPI_RX0 receiver register full or almost full interrupt enable (channel 0). 0h = Interrupt is disabled. 1h = Interrupt is enabled.
1	TX0_UNDERFLOW__ENABLE	R/W	0h	MCSPI_TX0 transmitter register underflow interrupt enable (channel 0). 0h = Interrupt is disabled. 1h = Interrupt is enabled.
0	TX0_EMPTY__ENABLE	R/W	0h	MCSPI_TX0 transmitter register empty or almost empty interrupt enable (channel 0). 0h = Interrupt is disabled. 1h = Interrupt is enabled.

24.4.1.6 MCSPI_SYST Register (offset = 124h) [reset = 0h]

MCSPI_SYST is shown in [Figure 24-31](#) and described in [Table 24-16](#).

This McSPI system register (MCSPI_SYST) is used to configure the system interconnect either internally to the peripheral bus or externally to the device I/O pads, when the module is configured in the system test (SYSTEST) mode.

Figure 24-31. MCSPI_SYST Register

31	30	29	28	27	26	25	24
RESERVED							
R-0h							
23	22	21	20	19	18	17	16
RESERVED							
R-0h							
15	14	13	12	11	10	9	8
RESERVED				SSB	SPIENDIR	SPIDATDIR1	SPIDATDIR0
R-0h				R/W-0h	R/W-0h	R/W-0h	R/W-0h
7	6	5	4	3	2	1	0
RESERVED	SPICLK	SPIDAT_1	SPIDAT_0	SPIEN_3	SPIEN_2	SPIEN_1	SPIEN_0
R-0h	R/W-0h	R/W-0h	R/W-0h	R/W-0h	R/W-0h	R/W-0h	R/W-0h

LEGEND: R/W = Read/Write; R = Read only; W1toCl = Write 1 to clear bit; -n = value after reset

Table 24-16. MCSPI_SYST Register Field Descriptions

Bit	Field	Type	Reset	Description
31-12	RESERVED	R	0h	
11	SSB	R/W	0h	Set status bit. This bit must be cleared prior attempting to clear a status bit of the MCSPI_IRQSTATUS register. 0h = No action. Writing 0 does not clear already set status bits. This bit must be cleared prior attempting to clear a status bit of the MCSPI_IRQSTATUS register. 1h = Writing 1 sets to 1 all status bits contained in the MCSPI_IRQSTATUS register. Writing 1 into this bit sets to 1 all status bits contained in the MCSPI_IRQSTATUS register.
10	SPIENDIR	R/W	0h	Sets the direction of the SPIEN [3:0] lines and SPICLK line. 0h = Output (as in master mode). 1h = Input (as in slave mode).
9	SPIDATDIR1	R/W	0h	Sets the direction of the SPIDAT[1]. 0h = Output 1h = Input
8	SPIDATDIR0	R/W	0h	Sets the direction of the SPIDAT[0]. 0h = Output 1h = Input
7	RESERVED	R	0h	
6	SPICLK	R/W	0h	SPICLK line (signal data value) 0h = If MCSPI_SYST[SPIENDIR] = 1 (input mode direction), this bit returns the value on the CLKSPI line (high or low), and a write into this bit has no effect. 1h = If MCSPI_SYST[SPIENDIR] = 0 (output mode direction), the CLKSPI line is driven high or low according to the value written into this register.

Table 24-16. MCSPI_SYST Register Field Descriptions (continued)

Bit	Field	Type	Reset	Description
5	SPIDAT_1	R/W	0h	<p>SPIDAT[1] line (signal data value)</p> <p>0h = If MCSPI_SYST[SPIDATDIR1] = 0 (output mode direction), the SPIDAT[1] line is driven high or low according to the value written into this register.</p> <p>1h = If MCSPI_SYST[SPIDATDIR1] = 1 (input mode direction), this bit returns the value on the SPIDAT[1] line (high or low), and a write into this bit has no effect.</p>
4	SPIDAT_0	R/W	0h	<p>SPIDAT[0] line (signal data value)</p> <p>0h = If MCSPI_SYST[SPIDATDIR0] = 0 (output mode direction), the SPIDAT[0] line is driven high or low according to the value written into this register.</p> <p>1h = If MCSPI_SYST[SPIDATDIR0] = 1 (input mode direction), this bit returns the value on the SPIDAT[0] line (high or low), and a write into this bit has no effect.</p>
3	SPIEN_3	R/W	0h	<p>SPIEN[3] line (signal data value)</p> <p>0h = If MCSPI_SYST[SPIENDIR] = 0 (output mode direction), the SPIEN[3] line is driven high or low according to the value written into this register.</p> <p>1h = If MCSPI_SYST[SPIENDIR] = 1 (input mode direction), this bit returns the value on the SPIEN[3] line (high or low), and a write into this bit has no effect.</p>
2	SPIEN_2	R/W	0h	<p>SPIEN[2] line (signal data value)</p> <p>0h = If MCSPI_SYST[SPIENDIR] = 0 (output mode direction), the SPIEN[2] line is driven high or low according to the value written into this register.</p> <p>1h = If MCSPI_SYST[SPIENDIR] = 1 (input mode direction), this bit returns the value on the SPIEN[2] line (high or low), and a write into this bit has no effect.</p>
1	SPIEN_1	R/W	0h	<p>SPIEN[1] line (signal data value)</p> <p>0h = If MCSPI_SYST[SPIENDIR] = 0 (output mode direction), the SPIEN[1] line is driven high or low according to the value written into this register.</p> <p>1h = If MCSPI_SYST[SPIENDIR] = 1 (input mode direction), this bit returns the value on the SPIEN[1] line (high or low), and a write into this bit has no effect.</p>
0	SPIEN_0	R/W	0h	<p>SPIEN[0] line (signal data value)</p> <p>0h = If MCSPI_SYST[SPIENDIR] = 0 (output mode direction), the SPIEN[0] line is driven high or low according to the value written into this register.</p> <p>1h = If MCSPI_SYST[SPIENDIR] = 1 (input mode direction), this bit returns the value on the SPIEN[0] line (high or low), and a write into this bit has no effect.</p>

24.4.1.7 MCSPI_MODULCTRL Register (offset = 128h) [reset = 0x0000_0004h]

 MCSPI_MODULCTRL is shown in [Figure 24-32](#) and described in [Table 24-17](#).

This McSPI module control register (MCSPI_MODULCTRL) is used to configure the serial port interface.

Figure 24-32. MCSPI_MODULCTRL Register

31	30	29	28	27	26	25	24
RESERVED							
R-0h							
23	22	21	20	19	18	17	16
RESERVED							
R-0h							
15	14	13	12	11	10	9	8
RESERVED							FDAA
R-0h							R/W-0h
7	6	5	4	3	2	1	0
MOA	INITDLY			SYSTEM_TES T	MS	PIN34	SINGLE
R/W-0h	R/W-0h			R/W-0h	R/W-0h	R/W-0h	R/W-0h

LEGEND: R/W = Read/Write; R = Read only; W1toCl = Write 1 to clear bit; -n = value after reset

Table 24-17. MCSPI_MODULCTRL Register Field Descriptions

Bit	Field	Type	Reset	Description
31-9	RESERVED	R	0h	
8	FDAA	R/W	0h	FIFO DMA Address 256 bit aligned. This register is used when a FIFO is managed by the module and DMA connected to the controller provides only 256 bit aligned address. If this bit is set the enabled channel which uses the FIFO has its datas managed through MCSPI_DAFTX and MCSPI_DAFRX registers instead of MCSPI_TX(i) and MCSPI_RX(i) registers. 0h = FIFO data managed by MCSPI_TX(i) and MCSPI_RX(i) registers. 1h = FIFO data managed by MCSPI_DAFTX and MCSPI_DAFRX registers.
7	MOA	R/W	0h	Multiple word ocp access. This register can only be used when a channel is enabled using a FIFO. It allows the system to perform multiple SPI word access for a single 32 bit OCP word access. This is possible for WL less than 16. 0h = Multiple word access disabled 1h = Multiple word access enabled with FIFO
6-4	INITDLY	R/W	0h	Initial SPI delay for first transfer. This register is an option only available in SINGLE master mode, The controller waits for a delay to transmit the first SPI word after channel enabled and corresponding TX register filled. This delay is based on SPI output frequency clock, No clock output provided to the boundary and chip select is not active in 4 pin mode within this period. 0h = No delay for first SPI transfer 1h = The controller wait 4 SPI bus clock 2h = The controller wait 8 SPI bus clock 3h = The controller wait 16 SPI bus clock 4h = The controller wait 32 SPI bus clock 5h = Reserved from 5h to Fh. Fh = Reserved from 5h to Fh.

Table 24-17. MCSPI_MODULCTRL Register Field Descriptions (continued)

Bit	Field	Type	Reset	Description
3	SYSTEM_TEST	R/W	0h	Enables the system test mode 0h = Functional mode 1h = System test mode (SYSTEST)
2	MS	R/W	0h	Master/ Slave 0h = Master - The module generates the SPICLK and SPIEN[3:0] 1h = Slave - The module receives the SPICLK and SPIEN[3:0]
1	PIN34	R/W	0h	Pin mode selection. This register is used to configure the SPI pin mode, in master or slave mode. If asserted the controller only use SIMO,SOMI and SPICLK clock pin for SPI transfers. 0h = SPIEN is used as a chip select. 1h = SPIEN is not used. In this mode all related option to chip select have no meaning.
0	SINGLE	R/W	0h	Single channel / Multi Channel (master mode only). 0h = More than one channel will be used in master mode. 1h = Only one channel will be used in master mode. This bit must be set in Force SPIEN mode.

24.4.1.8 MCSPI_CH0CONF Register (offset = 12Ch) [reset = 0x0006_0000h]

 MCSPI_CH0CONF is shown in [Figure 24-33](#) and described in [Table 24-18](#).

The McSPI channel 0 configuration register (MCSPI_CH0CONF) is used to configure channel 0.

Figure 24-33. MCSPI_CH0CONF Register

31	30	29	28	27	26	25	24
RESERVED		CLKG	FFER	FFEW	TCS		SBPOL
R-0h		R/W-0h	R/W-0h	R/W-0h	R/W-0h		R/W-0h
23	22	21	20	19	18	17	16
SBE	SPIENSLV		FORCE	TURBO	IS	DPE1	DPE0
R/W-0h	R/W-0h		R/W-0h	R/W-0h	R/W-0h	R/W-0h	R/W-0h
15	14	13	12	11	10	9	8
DMAR	DMAW	TRM		WL			
R/W-0h	R/W-0h	R/W-0h		R/W-0h			
7	6	5	4	3	2	1	0
WL	EPOL	CLKD				POL	PHA
R/W-0h	R/W-0h	R/W-0h				R/W-0h	R/W-0h

LEGEND: R/W = Read/Write; R = Read only; W1toCl = Write 1 to clear bit; -n = value after reset

Table 24-18. MCSPI_CH0CONF Register Field Descriptions

Bit	Field	Type	Reset	Description
31-30	RESERVED	R	0h	
29	CLKG	R/W	0h	Clock divider granularity. This register defines the granularity of channel clock divider: power of two or one clock cycle granularity. When this bit is set the register MCSPI_CHCTRL[EXTCLK] must be configured to reach a maximum of 4096 clock divider ratio. Then The clock divider ratio is a concatenation of MCSPI_CHCONF[CLKD] and MCSPI_CHCTRL[EXTCLK] values. 0h = Clock granularity of power of 2 1h = 1 clock cycle granularity
28	FFER	R/W	0h	FIFO enabled for receive. Only one channel can have this bit set. 0h = The buffer is not used to receive data. 1h = The buffer is used to receive data.
27	FFEW	R/W	0h	FIFO enabled for transmit. Only one channel can have this bit set. 0h = The buffer is not used to transmit data. 1h = The buffer is used to transmit data.
26-25	TCS	R/W	0h	Chip select time control. These two bits define the number of interface clock cycles between CS toggling and first or last edge of SPI clock. 0h = 0.5 clock cycles 1h = 1.5 clock cycles 2h = 2.5 clock cycles 3h = 3.5 clock cycles
24	SBPOL	R/W	0h	Start bit polarity. 0h = Start bit polarity is held to 0 during SPI transfer. 1h = Start bit polarity is held to 1 during SPI transfer.
23	SBE	R/W	0h	Start bit enable for SPI transfer. 0h = Default SPI transfer length as specified by WL bit field. 1h = Start bit D/CX added before SPI transfer. Polarity is defined by MCSPI_CH0CONF[SBPOL].

Table 24-18. MCSPI_CH0CONF Register Field Descriptions (continued)

Bit	Field	Type	Reset	Description
22-21	SPIENSLV	R/W	0h	Channel 0 only and slave mode only: SPI slave select signal detection. Reserved bits (read returns 0) for other cases. 0h = Detection enabled only on SPIEN[0] 1h = Detection enabled only on SPIEN[1] 2h = Detection enabled only on SPIEN[2] 3h = Detection enabled only on SPIEN[3]
20	FORCE	R/W	0h	Manual SPIEN assertion to keep SPIEN active between SPI words (single channel master mode only). 0h = Writing 0 into this bit drives low the SPIEN line when MCSPI_CHCONF0[EPOL]=0, and drives it high when MCSPI_CHCONF0[EPOL]=1. 1h = Writing 1 into this bit drives high the SPIEN line when MCSPI_CHCONF0[EPOL]=0, and drives it low when MCSPI_CHCONF0[EPOL]=1
19	TURBO	R/W	0h	Turbo mode. 0h = Turbo is deactivated (recommended for single SPI word transfer). 1h = Turbo is activated to maximize the throughput for multi-SPI word transfers.
18	IS	R/W	0h	Input select 0h = Data line 0 (SPIDAT[0]) selected for reception. 1h = Data line 1 (SPIDAT[1]) selected for reception.
17	DPE1	R/W	0h	Transmission enable for data line 1 (SPIDATAGZEN[1]) 0h = Data line 1 (SPIDAT[1]) selected for transmission 1h = No transmission on data line 1 (SPIDAT[1])
16	DPE0	R/W	0h	Transmission enable for data line 0 (SPIDATAGZEN[0]) 0h = Data line 0 (SPIDAT[0]) selected for transmission 1h = No transmission on data line 0 (SPIDAT[0])
15	DMAR	R/W	0h	DMA read request. The DMA read request line is asserted when the channel is enabled and new data is available in the receive register of the channel. The DMA read request line is deasserted on read completion of the receive register of the channel. 0h = DMA read request is disabled. 1h = DMA read request is enabled.
14	DMAW	R/W	0h	DMA write request. The DMA write request line is asserted when the channel is enabled and the MCSPI_TX0 register of the channel is empty. The DMA write request line is deasserted on load completion of the MCSPI_TX0 register of the channel. 0h = DMA write request is disabled. 1h = DMA write request is enabled.
13-12	TRM	R/W	0h	Transmit/receive modes. 0h = Transmit and receive mode 1h = Receive-only mode 2h = Transmit-only mode 3h = Reserved

Table 24-18. MCSPI_CH0CONF Register Field Descriptions (continued)

Bit	Field	Type	Reset	Description
11-7	WL	R/W	0h	SPI word length. 0h = Reserved 1h = Reserved 2h = Reserved 3h = The SPI word is 4-bits long. 4h = The SPI word is 5-bits long 5h = The SPI word is 6-bits long 6h = The SPI word is 7-bits long 7h = The SPI word is 8-bits long 8h = The SPI word is 9-bits long 9h = The SPI word is 10-bits long Ah = The SPI word is 11-bits long Bh = The SPI word is 12-bits long Ch = The SPI word is 13-bits long Dh = The SPI word is 14-bits long Eh = The SPI word is 15-bits long Fh = The SPI word is 16-bits long 10h = The SPI word is 17-bits long 11h = The SPI word is 18-bits long 12h = The SPI word is 19-bits long 13h = The SPI word is 20-bits long 14h = The SPI word is 21-bits long 15h = The SPI word is 22-bits long 16h = The SPI word is 23-bits long 17h = The SPI word is 24-bits long 18h = The SPI word is 25-bits long 19h = The SPI word is 26-bits long 1Ah = The SPI word is 27-bits long 1Bh = The SPI word is 28-bits long 1Ch = The SPI word is 29-bits long 1Dh = The SPI word is 30-bits long 1Eh = The SPI word is 31-bits long 1Fh = The SPI word is 32-bits long
6	EPOL	R/W	0h	SPIEN polarity 0h = SPIEN is held high during the active state. 1h = SPIEN is held low during the active state.

Table 24-18. MCSPI_CH0CONF Register Field Descriptions (continued)

Bit	Field	Type	Reset	Description
5-2	CLKD	R/W	0h	<p>Frequency divider for SPICLK (only when the module is a Master SPI device).</p> <p>A programmable clock divider divides the SPI reference clock (CLKSPIREF) with a 4 bit value, and results in a new clock SPICLK available to shift-in and shift-out data.</p> <p>By default the clock divider ratio has a power of two granularity when MCSPI_CHCONF[CLKG] is cleared, Otherwise this register is the 4 LSB bit of a 12 bit register concatenated with clock divider extension MCSPI_CHCTRL[EXTCLK] register.</p> <p>The value description below defines the clock ratio when MCSPI_CHCONF[CLKG] is cleared to 0.</p> <p>0h = Divide by 1. 1h = Divide by 2. 2h = Divide by 4. 3h = Divide by 8. 4h = Divide by 16. 5h = Divide by 32. 6h = Divide by 64. 7h = Divide by 128. 8h = Divide by 256. 9h = Divide by 512. Ah = Divide by 1024. Bh = Divide by 2048. Ch = Divide by 4096. Dh = Divide by 8192. Eh = Divide by 16384. Fh = Divide by 32768.</p>
1	POL	R/W	0h	<p>SPICLK polarity</p> <p>0h = SPICLK is held high during the active state 1h = SPICLK is held low during the active state</p>
0	PHA	R/W	0h	<p>SPICLK phase</p> <p>0h = Data are latched on odd numbered edges of SPICLK 1h = Data are latched on even numbered edges of SPICLK</p>

24.4.1.9 MCSPI_CH0STAT Register (offset = 130h) [reset = 0h]

MCSPI_CH0STAT is shown in [Figure 24-34](#) and described in [Table 24-19](#).

The McSPI channel 0 status register (MCSPI_CH0STAT) provides status information about the McSPI channel 0 FIFO transmit buffer register (MCSPI_TX0) and the McSPI channel 0 FIFO receive buffer register (MCSPI_RX0) of channel 0.

Figure 24-34. MCSPI_CH0STAT Register

31	30	29	28	27	26	25	24
RESERVED							
R-0h							
23	22	21	20	19	18	17	16
RESERVED							
R-0h							
15	14	13	12	11	10	9	8
RESERVED							
R-0h							
7	6	5	4	3	2	1	0
RESERVED	RXFFF	RXFFE	TXFFF	TXFFE	EOT	TXS	RXS
R-0h	R-0h	R-0h	R-0h	R-0h	R-0h	R-0h	R-0h

LEGEND: R/W = Read/Write; R = Read only; W1toCl = Write 1 to clear bit; -n = value after reset

Table 24-19. MCSPI_CH0STAT Register Field Descriptions

Bit	Field	Type	Reset	Description
31-7	RESERVED	R	0h	
6	RXFFF	R	0h	Channel 0 FIFO receive buffer full status. 0h = FIFO receive buffer is not full. 1h = FIFO receive buffer is full.
5	RXFFE	R	0h	Channel 0 FIFO receive buffer empty status. 0h = FIFO receive buffer is not empty. 1h = FIFO receive buffer is empty.
4	TXFFF	R	0h	Channel 0 FIFO transmit buffer full status. 0h = FIFO transmit buffer is not full. 1h = FIFO transmit buffer is full.
3	TXFFE	R	0h	Channel 0 FIFO transmit buffer empty status. 0h = FIFO transmit buffer is not empty. 1h = FIFO transmit buffer is empty.
2	EOT	R	0h	Channel 0 end-of-transfer status. The definitions of beginning and end of transfer vary with master versus slave and the transfer format (transmit/receive mode, turbo mode). 0h = This flag is automatically cleared when the shift register is loaded with the data from the transmitter register (beginning of transfer). 1h = This flag is automatically set to one at the end of an SPI transfer.
1	TXS	R	0h	Channel 0 transmitter register status. The bit is cleared when the host writes the most significant byte of the SPI word in the MCSPI_TX0 register. The bit is set when enabling the channel 0, and also when the SPI word is transferred from the MCSPI_TX0 register to the shift register. 0h = Register is full. 1h = Register is empty.

Table 24-19. MCSPI_CH0STAT Register Field Descriptions (continued)

Bit	Field	Type	Reset	Description
0	RXS	R	0h	Channel 0 receiver register status. The bit is cleared when enabling the channel i, and also when the host reads the most significant byte of the received SPI word from the MCSPI_RX0 register. The bit is set when the received SPI word is transferred from the shift register to the MCSPI_RX0 register. 0h = Register is empty. 1h = Register is full.

24.4.1.10 MCSPI_CH0CTRL Register (offset = 134h) [reset = 0h]

 MCSPI_CH0CTRL is shown in [Figure 24-35](#) and described in [Table 24-20](#).

Figure 24-35. MCSPI_CH0CTRL Register

31	30	29	28	27	26	25	24	23	22	21	20	19	18	17	16
RESERVED															
R-0h															
15	14	13	12	11	10	9	8	7	6	5	4	3	2	1	0
EXTCLK								RESERVED							EN
R/W-0h								R-0h							R/W-0h

LEGEND: R/W = Read/Write; R = Read only; W1toCl = Write 1 to clear bit; -n = value after reset

Table 24-20. MCSPI_CH0CTRL Register Field Descriptions

Bit	Field	Type	Reset	Description
31-16	RESERVED	R	0h	
15-8	EXTCLK	R/W	0h	Clock ratio extension. Used to concatenate with the CLKD bit field in MCSPI_CH0CONF for clock ratio only when granularity is 1 clock cycle (CLKG bit in MCSPI_CH0CONF set to 1). Then the maximum value reached is a 4096 clock divider ratio. 0h = Clock ratio is CLKD + 1 1h = Clock ratio is CLKD + 1 + 16 FFh = Clock ratio is CLKD + 1 + 4080
7-1	RESERVED	R	0h	
0	EN	R/W	0h	Channel 0 enable. 0h = Channel 0 is not active. 1h = Channel 0 is active.

24.4.1.11 MCSPI_TX0 Register (offset = 138h) [reset = 0h]

MCSPI_TX0 is shown in [Figure 24-36](#) and described in [Table 24-21](#).

Figure 24-36. MCSPI_TX0 Register

31	30	29	28	27	26	25	24	23	22	21	20	19	18	17	16	15	14	13	12	11	10	9	8	7	6	5	4	3	2	1	0
TDATA																															
R/W-0h																															

LEGEND: R/W = Read/Write; R = Read only; W1toCl = Write 1 to clear bit; -n = value after reset

Table 24-21. MCSPI_TX0 Register Field Descriptions

Bit	Field	Type	Reset	Description
31-0	TDATA	R/W	0h	Channel 0 data to transmit.

24.4.1.12 MCSPI_RX0 Register (offset = 13Ch) [reset = 0h]

MCSPI_RX0 is shown in [Figure 24-37](#) and described in [Table 24-22](#).

The McSPI channel 0 FIFO receive buffer register (MCSPI_RX0) contains a single McSPI word received through the serial link. Little endian host access SPI 8 bit word on 0; big endian host accesses on 3h.

Figure 24-37. MCSPI_RX0 Register

31	30	29	28	27	26	25	24	23	22	21	20	19	18	17	16	15	14	13	12	11	10	9	8	7	6	5	4	3	2	1	0
RDATA																															
R-0h																															

LEGEND: R/W = Read/Write; R = Read only; W1toCl = Write 1 to clear bit; -n = value after reset

Table 24-22. MCSPI_RX0 Register Field Descriptions

Bit	Field	Type	Reset	Description
31-0	RDATA	R	0h	Channel 0 received data.

24.4.1.13 MCSPI_CH1CONF Register (offset = 140h) [reset = 0h]

MCSPI_CH1CONF is shown in [Figure 24-38](#) and described in [Table 24-23](#).

The McSPI channel 1 configuration register (MCSPI_CH1CONF) is used to configure channel 1.

Figure 24-38. MCSPI_CH1CONF Register

31	30	29	28	27	26	25	24
RESERVED		CLKG	FFER	FFEW	TCS		SBPOL
R-0h		R/W-0h	R/W-0h	R/W-0h	R/W-0h		R/W-0h
23	22	21	20	19	18	17	16
SBE	SPIENSLV		FORCE	TURBO	IS	DPE1	DPE0
R/W-0h	R/W-0h		R/W-0h	R/W-0h	R/W-0h	R/W-0h	R/W-0h
15	14	13	12	11	10	9	8
DMAR	DMAW	TRM		WL			
R/W-0h	R/W-0h	R/W-0h		R/W-0h			
7	6	5	4	3	2	1	0
WL	EPOL	CLKD				POL	PHA
R/W-0h	R/W-0h	R/W-0h				R/W-0h	R/W-0h

LEGEND: R/W = Read/Write; R = Read only; W1toCl = Write 1 to clear bit; -n = value after reset

Table 24-23. MCSPI_CH1CONF Register Field Descriptions

Bit	Field	Type	Reset	Description
31-30	RESERVED	R	0h	
29	CLKG	R/W	0h	Clock divider granularity. This register defines the granularity of channel clock divider: power of two or one clock cycle granularity. When this bit is set the register MCSPI_CHCTRL[EXTCLK] must be configured to reach a maximum of 4096 clock divider ratio. Then The clock divider ratio is a concatenation of MCSPI_CHCONF[CLKD] and MCSPI_CHCTRL[EXTCLK] values. 0h = Clock granularity of power of 2 1h = 1 clock cycle granularity
28	FFER	R/W	0h	FIFO enabled for receive. Only one channel can have this bit set. 0h = The buffer is not used to receive data. 1h = The buffer is used to receive data.
27	FFEW	R/W	0h	FIFO enabled for transmit. Only one channel can have this bit set. 0h = The buffer is not used to transmit data. 1h = The buffer is used to transmit data.
26-25	TCS	R/W	0h	Chip select time control. These two bits define the number of interface clock cycles between CS toggling and first or last edge of SPI clock. 0h = 0.5 clock cycles 1h = 1.5 clock cycles 2h = 2.5 clock cycles 3h = 3.5 clock cycles
24	SBPOL	R/W	0h	Start bit polarity. 0h = Start bit polarity is held to 0 during SPI transfer. 1h = Start bit polarity is held to 1 during SPI transfer.
23	SBE	R/W	0h	Start bit enable for SPI transfer. 0h = Default SPI transfer length as specified by WL bit field. 1h = Start bit D/CX added before SPI transfer. Polarity is defined by MCSPI_CH1CONF[SBPOL].

Table 24-23. MCSPI_CH1CONF Register Field Descriptions (continued)

Bit	Field	Type	Reset	Description
22-21	SPIENSLV	R/W	0h	Channel 0 only and slave mode only: SPI slave select signal detection. Reserved bits (read returns 0) for other cases. 0h = Detection enabled only on SPIEN[0] 1h = Detection enabled only on SPIEN[1] 2h = Detection enabled only on SPIEN[2] 3h = Detection enabled only on SPIEN[3]
20	FORCE	R/W	0h	Manual SPIEN assertion to keep SPIEN active between SPI words (single channel master mode only). 0h = Writing 0 into this bit drives low the SPIEN line when MCSPI_CHCONF1[EPOL]=0, and drives it high when MCSPI_CHCONF1[EPOL]=1. 1h = Writing 1 into this bit drives high the SPIEN line when MCSPI_CHCONF1[EPOL]=0, and drives it low when MCSPI_CHCONF1[EPOL]=1
19	TURBO	R/W	0h	Turbo mode. 0h = Turbo is deactivated (recommended for single SPI word transfer). 1h = Turbo is activated to maximize the throughput for multi-SPI word transfers.
18	IS	R/W	0h	Input select 0h = Data line 0 (SPIDAT[0]) selected for reception. 1h = Data line 1 (SPIDAT[1]) selected for reception.
17	DPE1	R/W	0h	Transmission enable for data line 1 (SPIDATAGZEN[1]) 0h = Data line 1 (SPIDAT[1]) selected for transmission 1h = No transmission on data line 1 (SPIDAT[1])
16	DPE0	R/W	0h	Transmission enable for data line 0 (SPIDATAGZEN[0]) 0h = Data line 0 (SPIDAT[0]) selected for transmission 1h = No transmission on data line 0 (SPIDAT[0])
15	DMAR	R/W	0h	DMA read request. The DMA read request line is asserted when the channel is enabled and new data is available in the receive register of the channel. The DMA read request line is deasserted on read completion of the receive register of the channel. 0h = DMA read request is disabled. 1h = DMA read request is enabled.
14	DMAW	R/W	0h	DMA write request. The DMA write request line is asserted when the channel is enabled and the MCSPI_TX1 register of the channel is empty. The DMA write request line is deasserted on load completion of the MCSPI_TX1 register of the channel. 0h = DMA write request is disabled. 1h = DMA write request is enabled.
13-12	TRM	R/W	0h	Transmit/receive modes. 0h = Transmit and receive mode 1h = Receive-only mode 2h = Transmit-only mode 3h = Reserved

Table 24-23. MCSPI_CH1CONF Register Field Descriptions (continued)

Bit	Field	Type	Reset	Description
11-7	WL	R/W	0h	SPI word length. 0h = Reserved 1h = Reserved 2h = Reserved 3h = The SPI word is 4-bits long. 4h = The SPI word is 5-bits long 5h = The SPI word is 6-bits long 6h = The SPI word is 7-bits long 7h = The SPI word is 8-bits long 8h = The SPI word is 9-bits long 9h = The SPI word is 10-bits long Ah = The SPI word is 11-bits long Bh = The SPI word is 12-bits long Ch = The SPI word is 13-bits long Dh = The SPI word is 14-bits long Eh = The SPI word is 15-bits long Fh = The SPI word is 16-bits long 10h = The SPI word is 17-bits long 11h = The SPI word is 18-bits long 12h = The SPI word is 19-bits long 13h = The SPI word is 20-bits long 14h = The SPI word is 21-bits long 15h = The SPI word is 22-bits long 16h = The SPI word is 23-bits long 17h = The SPI word is 24-bits long 18h = The SPI word is 25-bits long 19h = The SPI word is 26-bits long 1Ah = The SPI word is 27-bits long 1Bh = The SPI word is 28-bits long 1Ch = The SPI word is 29-bits long 1Dh = The SPI word is 30-bits long 1Eh = The SPI word is 31-bits long 1Fh = The SPI word is 32-bits long
6	EPOL	R/W	0h	SPIEN polarity 0h = SPIEN is held high during the active state. 1h = SPIEN is held low during the active state.

Table 24-23. MCSPI_CH1CONF Register Field Descriptions (continued)

Bit	Field	Type	Reset	Description
5-2	CLKD	R/W	0h	Frequency divider for SPICLK (only when the module is a Master SPI device). A programmable clock divider divides the SPI reference clock (CLKSPIREF) with a 4 bit value, and results in a new clock SPICLK available to shift-in and shift-out data. By default the clock divider ratio has a power of two granularity when MCSPI_CHCONF[CLKG] is cleared, Otherwise this register is the 4 LSB bit of a 12 bit register concatenated with clock divider extension MCSPI_CHCTRL[EXTCLK] register. The value description below defines the clock ratio when MCSPI_CHCONF[CLKG] is cleared to 0. 0h = Divide by 1. 1h = Divide by 2. 2h = Divide by 4. 3h = Divide by 8. 4h = Divide by 16. 5h = Divide by 32. 6h = Divide by 64. 7h = Divide by 128. 8h = Divide by 256. 9h = Divide by 512. Ah = Divide by 1024. Bh = Divide by 2048. Ch = Divide by 4096. Dh = Divide by 8192. Eh = Divide by 16384. Fh = Divide by 32768.
1	POL	R/W	0h	SPICLK polarity 0h = SPICLK is held high during the active state 1h = SPICLK is held low during the active state
0	PHA	R/W	0h	SPICLK phase 0h = Data are latched on odd numbered edges of SPICLK 1h = Data are latched on even numbered edges of SPICLK

24.4.1.14 MCSPI_CH1STAT Register (offset = 144h) [reset = 0h]

MCSPI_CH1STAT is shown in [Figure 24-39](#) and described in [Table 24-24](#).

The McSPI channel 1 status register (MCSPI_CH1STAT) provides status information about the McSPI channel 1 FIFO transmit buffer register (MCSPI_TX1) and the McSPI channel 1 FIFO receive buffer register (MCSPI_RX1) of channel 1.

Figure 24-39. MCSPI_CH1STAT Register

31	30	29	28	27	26	25	24
RESERVED							
R-0h							
23	22	21	20	19	18	17	16
RESERVED							
R-0h							
15	14	13	12	11	10	9	8
RESERVED							
R-0h							
7	6	5	4	3	2	1	0
RESERVED	RXFFF	RXFFE	TXFFF	TXFFE	EOT	TXS	RXS
R-0h	R-0h	R-0h	R-0h	R-0h	R-0h	R-0h	R-0h

LEGEND: R/W = Read/Write; R = Read only; W1toCl = Write 1 to clear bit; -n = value after reset

Table 24-24. MCSPI_CH1STAT Register Field Descriptions

Bit	Field	Type	Reset	Description
31-7	RESERVED	R	0h	
6	RXFFF	R	0h	Channel 1 FIFO receive buffer full status. 0h = FIFO receive buffer is not full. 1h = FIFO receive buffer is full.
5	RXFFE	R	0h	Channel 1 FIFO receive buffer empty status. 0h = FIFO receive buffer is not empty. 1h = FIFO receive buffer is empty.
4	TXFFF	R	0h	Channel 1 FIFO transmit buffer full status. 0h = FIFO transmit buffer is not full. 1h = FIFO transmit buffer is full.
3	TXFFE	R	0h	Channel 1 FIFO transmit buffer empty status. 0h = FIFO transmit buffer is not empty. 1h = FIFO transmit buffer is empty.
2	EOT	R	0h	Channel 1 end-of-transfer status. The definitions of beginning and end of transfer vary with master versus slave and the transfer format (transmit/receive mode, turbo mode). 0h = This flag is automatically cleared when the shift register is loaded with the data from the transmitter register (beginning of transfer). 1h = This flag is automatically set to one at the end of an SPI transfer.
1	TXS	R	0h	Channel 1 transmitter register status. The bit is cleared when the host writes the most significant byte of the SPI word in the MCSPI_TX1 register. The bit is set when enabling the channel 1, and also when the SPI word is transferred from the MCSPI_TX1 register to the shift register. 0h = Register is full. 1h = Register is empty.

Table 24-24. MCSPI_CH1STAT Register Field Descriptions (continued)

Bit	Field	Type	Reset	Description
0	RXS	R	0h	<p>Channel 1 receiver register status.</p> <p>The bit is cleared when enabling the channel i, and also when the host reads the most significant byte of the received SPI word from the MCSPI_RX1 register.</p> <p>The bit is set when the received SPI word is transferred from the shift register to the MCSPI_RX1 register.</p> <p>0h = Register is empty. 1h = Register is full.</p>

24.4.1.15 MCSPI_CH1CTRL Register (offset = 148h) [reset = 0h]

MCSPI_CH1CTRL is shown in [Figure 24-40](#) and described in [Table 24-25](#).

Figure 24-40. MCSPI_CH1CTRL Register

31	30	29	28	27	26	25	24	23	22	21	20	19	18	17	16
RESERVED															
R-0h															
15	14	13	12	11	10	9	8	7	6	5	4	3	2	1	0
EXTCLK								RESERVED							EN
R/W-0h								R-0h							R/W-0h

LEGEND: R/W = Read/Write; R = Read only; W1toCl = Write 1 to clear bit; -n = value after reset

Table 24-25. MCSPI_CH1CTRL Register Field Descriptions

Bit	Field	Type	Reset	Description
31-16	RESERVED	R	0h	
15-8	EXTCLK	R/W	0h	Clock ratio extension. Used to concatenate with the CLKD bit field in MCSPI_CH1CONF for clock ratio only when granularity is 1 clock cycle (CLKG bit in MCSPI_CH1CONF set to 1). Then the maximum value reached is a 4096 clock divider ratio. 0h = Clock ratio is CLKD + 1 1h = Clock ratio is CLKD + 1 + 16 FFh = Clock ratio is CLKD + 1 + 4080
7-1	RESERVED	R	0h	
0	EN	R/W	0h	Channel 1 enable. 0h = Channel 1 is not active. 1h = Channel 1 is active.

24.4.1.16 MCSPI_TX1 Register (offset = 14Ch) [reset = 0h]

MCSPI_TX1 is shown in [Figure 24-41](#) and described in [Table 24-26](#).

Figure 24-41. MCSPI_TX1 Register

31	30	29	28	27	26	25	24	23	22	21	20	19	18	17	16	15	14	13	12	11	10	9	8	7	6	5	4	3	2	1	0
																	TDATA														
																	R/W-0h														

LEGEND: R/W = Read/Write; R = Read only; W1toCl = Write 1 to clear bit; -n = value after reset

Table 24-26. MCSPI_TX1 Register Field Descriptions

Bit	Field	Type	Reset	Description
31-0	TDATA	R/W	0h	Channel 1 data to transmit.

24.4.1.17 MCSPI_RX1 Register (offset = 150h) [reset = 0h]

MCSPi_RX1 is shown in [Figure 24-42](#) and described in [Table 24-27](#).

The McSPI channel 1 FIFO receive buffer register (MCSPi_RX1) contains a single McSPI word received through the serial link. Little endian host access SPI 8 bit word on 0; big endian host accesses on 3h.

Figure 24-42. MCSPI_RX1 Register

31	30	29	28	27	26	25	24	23	22	21	20	19	18	17	16	15	14	13	12	11	10	9	8	7	6	5	4	3	2	1	0
RDATA																															
R-0h																															

LEGEND: R/W = Read/Write; R = Read only; W1toCl = Write 1 to clear bit; -n = value after reset

Table 24-27. MCSPI_RX1 Register Field Descriptions

Bit	Field	Type	Reset	Description
31-0	RDATA	R	0h	Channel 1 received data.

24.4.1.18 MCSPI_CH2CONF Register (offset = 154h) [reset = 0h]

MCSPI_CH2CONF is shown in [Figure 24-43](#) and described in [Table 24-28](#).

The McSPI channel 2 configuration register (MCSPI_CH2CONF) is used to configure channel 2.

Figure 24-43. MCSPI_CH2CONF Register

31	30	29	28	27	26	25	24
RESERVED		CLKG	FFER	FFEW	TCS		SBPOL
R-0h		R/W-0h	R/W-0h	R/W-0h	R/W-0h		R/W-0h
23	22	21	20	19	18	17	16
SBE	SPIENSLV		FORCE	TURBO	IS	DPE1	DPE0
R/W-0h	R/W-0h		R/W-0h	R/W-0h	R/W-0h	R/W-0h	R/W-0h
15	14	13	12	11	10	9	8
DMAR	DMAW	TRM		WL			
R/W-0h	R/W-0h	R/W-0h		R/W-0h			
7	6	5	4	3	2	1	0
WL	EPOL	CLKD				POL	PHA
R/W-0h	R/W-0h	R/W-0h				R/W-0h	R/W-0h

LEGEND: R/W = Read/Write; R = Read only; W1toCl = Write 1 to clear bit; -n = value after reset

Table 24-28. MCSPI_CH2CONF Register Field Descriptions

Bit	Field	Type	Reset	Description
31-30	RESERVED	R	0h	
29	CLKG	R/W	0h	Clock divider granularity. This register defines the granularity of channel clock divider: power of two or one clock cycle granularity. When this bit is set the register MCSPI_CHCTRL[EXTCLK] must be configured to reach a maximum of 4096 clock divider ratio. Then The clock divider ratio is a concatenation of MCSPI_CHCONF[CLKD] and MCSPI_CHCTRL[EXTCLK] values. 0h = Clock granularity of power of 2 1h = 1 clock cycle granularity
28	FFER	R/W	0h	FIFO enabled for receive. Only one channel can have this bit set. 0h = The buffer is not used to receive data. 1h = The buffer is used to receive data.
27	FFEW	R/W	0h	FIFO enabled for transmit. Only one channel can have this bit set. 0h = The buffer is not used to transmit data. 1h = The buffer is used to transmit data.
26-25	TCS	R/W	0h	Chip select time control. These two bits define the number of interface clock cycles between CS toggling and first or last edge of SPI clock. 0h = 0.5 clock cycles 1h = 1.5 clock cycles 2h = 2.5 clock cycles 3h = 3.5 clock cycles
24	SBPOL	R/W	0h	Start bit polarity. 0h = Start bit polarity is held to 0 during SPI transfer. 1h = Start bit polarity is held to 1 during SPI transfer.
23	SBE	R/W	0h	Start bit enable for SPI transfer. 0h = Default SPI transfer length as specified by WL bit field. 1h = Start bit D/CX added before SPI transfer. Polarity is defined by MCSPI_CH2CONF[SBPOL].

Table 24-28. MCSPI_CH2CONF Register Field Descriptions (continued)

Bit	Field	Type	Reset	Description
22-21	SPIENSLV	R/W	0h	Channel 0 only and slave mode only: SPI slave select signal detection. Reserved bits (read returns 0) for other cases. 0h = Detection enabled only on SPIEN[0] 1h = Detection enabled only on SPIEN[1] 2h = Detection enabled only on SPIEN[2] 3h = Detection enabled only on SPIEN[3]
20	FORCE	R/W	0h	Manual SPIEN assertion to keep SPIEN active between SPI words (single channel master mode only). 0h = Writing 0 into this bit drives the SPIEN line when MCSPI_CHCONF2[EPOL]=0, and drives it high when MCSPI_CHCONF2[EPOL]=1. 1h = Writing 1 into this bit drives low high the SPIEN line when MCSPI_CHCONF2[EPOL]=0, and drives it low when MCSPI_CHCONF2[EPOL]=1
19	TURBO	R/W	0h	Turbo mode. 0h = Turbo is deactivated (recommended for single SPI word transfer). 1h = Turbo is activated to maximize the throughput for multi-SPI word transfers.
18	IS	R/W	0h	Input select 0h = Data line 0 (SPIDAT[0]) selected for reception. 1h = Data line 1 (SPIDAT[1]) selected for reception.
17	DPE1	R/W	0h	Transmission enable for data line 1 (SPIDATAGZEN[1]) 0h = Data line 1 (SPIDAT[1]) selected for transmission 1h = No transmission on data line 1 (SPIDAT[1])
16	DPE0	R/W	0h	Transmission enable for data line 0 (SPIDATAGZEN[0]) 0h = Data line 0 (SPIDAT[0]) selected for transmission 1h = No transmission on data line 0 (SPIDAT[0])
15	DMAR	R/W	0h	DMA read request. The DMA read request line is asserted when the channel is enabled and new data is available in the receive register of the channel. The DMA read request line is deasserted on read completion of the receive register of the channel. 0h = DMA read request is disabled. 1h = DMA read request is enabled.
14	DMAW	R/W	0h	DMA write request. The DMA write request line is asserted when the channel is enabled and the MCSPI_TX2 register of the channel is empty. The DMA write request line is deasserted on load completion of the MCSPI_TX2 register of the channel. 0h = DMA write request is disabled. 1h = DMA write request is enabled.
13-12	TRM	R/W	0h	Transmit/receive modes. 0h = Transmit and receive mode 1h = Receive-only mode 2h = Transmit-only mode 3h = Reserved

Table 24-28. MCSPI_CH2CONF Register Field Descriptions (continued)

Bit	Field	Type	Reset	Description
11-7	WL	R/W	0h	SPI word length. 0h = Reserved 1h = Reserved 2h = Reserved 3h = The SPI word is 4-bits long. 4h = The SPI word is 5-bits long 5h = The SPI word is 6-bits long 6h = The SPI word is 7-bits long 7h = The SPI word is 8-bits long 8h = The SPI word is 9-bits long 9h = The SPI word is 10-bits long Ah = The SPI word is 11-bits long Bh = The SPI word is 12-bits long Ch = The SPI word is 13-bits long Dh = The SPI word is 14-bits long Eh = The SPI word is 15-bits long Fh = The SPI word is 16-bits long 10h = The SPI word is 17-bits long 11h = The SPI word is 18-bits long 12h = The SPI word is 19-bits long 13h = The SPI word is 20-bits long 14h = The SPI word is 21-bits long 15h = The SPI word is 22-bits long 16h = The SPI word is 23-bits long 17h = The SPI word is 24-bits long 18h = The SPI word is 25-bits long 19h = The SPI word is 26-bits long 1Ah = The SPI word is 27-bits long 1Bh = The SPI word is 28-bits long 1Ch = The SPI word is 29-bits long 1Dh = The SPI word is 30-bits long 1Eh = The SPI word is 31-bits long 1Fh = The SPI word is 32-bits long
6	EPOL	R/W	0h	SPIEN polarity 0h = SPIEN is held high during the active state. 1h = SPIEN is held low during the active state.

Table 24-28. MCSPI_CH2CONF Register Field Descriptions (continued)

Bit	Field	Type	Reset	Description
5-2	CLKD	R/W	0h	<p>Frequency divider for SPICLK (only when the module is a Master SPI device).</p> <p>A programmable clock divider divides the SPI reference clock (CLKSPIREF) with a 4 bit value, and results in a new clock SPICLK available to shift-in and shift-out data.</p> <p>By default the clock divider ratio has a power of two granularity when MCSPI_CHCONF[CLKG] is cleared, Otherwise this register is the 4 LSB bit of a 12 bit register concatenated with clock divider extension MCSPI_CHCTRL[EXTCLK] register.</p> <p>The value description below defines the clock ratio when MCSPI_CHCONF[CLKG] is cleared to 0.</p> <p>0h = Divide by 1. 1h = Divide by 2. 2h = Divide by 4. 3h = Divide by 8. 4h = Divide by 16. 5h = Divide by 32. 6h = Divide by 64. 7h = Divide by 128. 8h = Divide by 256. 9h = Divide by 512. Ah = Divide by 1024. Bh = Divide by 2048. Ch = Divide by 4096. Dh = Divide by 8192. Eh = Divide by 16384. Fh = Divide by 32768.</p>
1	POL	R/W	0h	<p>SPICLK polarity</p> <p>0h = SPICLK is held high during the active state 1h = SPICLK is held low during the active state</p>
0	PHA	R/W	0h	<p>SPICLK phase</p> <p>0h = Data are latched on odd numbered edges of SPICLK 1h = Data are latched on even numbered edges of SPICLK</p>

24.4.1.19 MCSPI_CH2STAT Register (offset = 158h) [reset = 0h]

MCSPI_CH2STAT is shown in [Figure 24-44](#) and described in [Table 24-29](#).

The McSPI channel 2 status register (MCSPI_CH2STAT) provides status information about the McSPI channel 2 FIFO transmit buffer register (MCSPI_TX2) and the McSPI channel 2 FIFO receive buffer register (MCSPI_RX2) of channel 2.

Figure 24-44. MCSPI_CH2STAT Register

31	30	29	28	27	26	25	24
RESERVED							
R-0h							
23	22	21	20	19	18	17	16
RESERVED							
R-0h							
15	14	13	12	11	10	9	8
RESERVED							
R-0h							
7	6	5	4	3	2	1	0
RESERVED	RXFFF	RXFFE	TXFFF	TXFFE	EOT	TXS	RXS
R-0h	R-0h	R-0h	R-0h	R-0h	R-0h	R-0h	R-0h

LEGEND: R/W = Read/Write; R = Read only; W1toCl = Write 1 to clear bit; -n = value after reset

Table 24-29. MCSPI_CH2STAT Register Field Descriptions

Bit	Field	Type	Reset	Description
31-7	RESERVED	R	0h	
6	RXFFF	R	0h	Channel 2 FIFO receive buffer full status. 0h = FIFO receive buffer is not full. 1h = FIFO receive buffer is full.
5	RXFFE	R	0h	Channel 2 FIFO receive buffer empty status. 0h = FIFO receive buffer is not empty. 1h = FIFO receive buffer is empty.
4	TXFFF	R	0h	Channel 2 FIFO transmit buffer full status. 0h = FIFO transmit buffer is not full. 1h = FIFO transmit buffer is full.
3	TXFFE	R	0h	Channel 2 FIFO transmit buffer empty status. 0h = FIFO transmit buffer is not empty. 1h = FIFO transmit buffer is empty.
2	EOT	R	0h	Channel 2 end-of-transfer status. The definitions of beginning and end of transfer vary with master versus slave and the transfer format (transmit/receive mode, turbo mode). 0h = This flag is automatically cleared when the shift register is loaded with the data from the transmitter register (beginning of transfer). 1h = This flag is automatically set to one at the end of an SPI transfer.
1	TXS	R	0h	Channel 2 transmitter register status. The bit is cleared when the host writes the most significant byte of the SPI word in the MCSPI_TX2 register. The bit is set when enabling the channel 2, and also when the SPI word is transferred from the MCSPI_TX2 register to the shift register. 0h = Register is full. 1h = Register is empty.

Table 24-29. MCSPI_CH2STAT Register Field Descriptions (continued)

Bit	Field	Type	Reset	Description
0	RXS	R	0h	Channel 2 receiver register status. The bit is cleared when enabling the channel i, and also when the host reads the most significant byte of the received SPI word from the MCSPI_RX2 register. The bit is set when the received SPI word is transferred from the shift register to the MCSPI_RX2 register. 0h = Register is empty. 1h = Register is full.

24.4.1.20 MCSPI_CH2CTRL Register (offset = 15Ch) [reset = 0h]

 MCSPI_CH2CTRL is shown in [Figure 24-45](#) and described in [Table 24-30](#).

Figure 24-45. MCSPI_CH2CTRL Register

31	30	29	28	27	26	25	24	23	22	21	20	19	18	17	16
RESERVED															
R-0h															
15	14	13	12	11	10	9	8	7	6	5	4	3	2	1	0
EXTCLK								RESERVED							EN
R/W-0h								R-0h							R/W-0h

LEGEND: R/W = Read/Write; R = Read only; W1toCl = Write 1 to clear bit; -n = value after reset

Table 24-30. MCSPI_CH2CTRL Register Field Descriptions

Bit	Field	Type	Reset	Description
31-16	RESERVED	R	0h	
15-8	EXTCLK	R/W	0h	Clock ratio extension. Used to concatenate with the CLKD bit field in MCSPI_CH2CONF for clock ratio only when granularity is 1 clock cycle (CLKG bit in MCSPI_CH2CONF set to 1). Then the maximum value reached is a 4096 clock divider ratio. 0h = Clock ratio is CLKD + 1 1h = Clock ratio is CLKD + 1 + 16 FFh = Clock ratio is CLKD + 1 + 4080
7-1	RESERVED	R	0h	
0	EN	R/W	0h	Channel 2 enable. 0h = Channel 2 is not active. 1h = Channel 2 is active.

24.4.1.21 MCSPI_TX2 Register (offset = 160h) [reset = 0h]

MCSPI_TX2 is shown in [Figure 24-46](#) and described in [Table 24-31](#).

Figure 24-46. MCSPI_TX2 Register

31	30	29	28	27	26	25	24	23	22	21	20	19	18	17	16	15	14	13	12	11	10	9	8	7	6	5	4	3	2	1	0
TDATA																															
R/W-0h																															

LEGEND: R/W = Read/Write; R = Read only; W1toCl = Write 1 to clear bit; -n = value after reset

Table 24-31. MCSPI_TX2 Register Field Descriptions

Bit	Field	Type	Reset	Description
31-0	TDATA	R/W	0h	Channel 2 data to transmit.

24.4.1.22 MCSPI_RX2 Register (offset = 164h) [reset = 0h]

MCSPI_RX2 is shown in [Figure 24-47](#) and described in [Table 24-32](#).

The McSPI channel 2 FIFO receive buffer register (MCSPI_RX2) contains a single McSPI word received through the serial link. Little endian host access SPI 8 bit word on 0; big endian host accesses on 3h.

Figure 24-47. MCSPI_RX2 Register

31	30	29	28	27	26	25	24	23	22	21	20	19	18	17	16	15	14	13	12	11	10	9	8	7	6	5	4	3	2	1	0
RDATA																															
R-0h																															

LEGEND: R/W = Read/Write; R = Read only; W1toCl = Write 1 to clear bit; -n = value after reset

Table 24-32. MCSPI_RX2 Register Field Descriptions

Bit	Field	Type	Reset	Description
31-0	RDATA	R	0h	Channel 2 received data.

24.4.1.23 MCSPI_CH3CONF Register (offset = 168h) [reset = 0h]

MCSPI_CH3CONF is shown in [Figure 24-48](#) and described in [Table 24-33](#).

The McSPI channel 3 configuration register (MCSPI_CH3CONF) is used to configure channel 3.

Figure 24-48. MCSPI_CH3CONF Register

31	30	29	28	27	26	25	24
RESERVED		CLKG	FFER	FFEW	TCS		SBPOL
R-0h		R/W-0h	R/W-0h	R/W-0h	R/W-0h		R/W-0h
23	22	21	20	19	18	17	16
SBE	SPIENSLV		FORCE	TURBO	IS	DPE1	DPE0
R/W-0h	R/W-0h		R/W-0h	R/W-0h	R/W-0h	R/W-0h	R/W-0h
15	14	13	12	11	10	9	8
DMAR	DMAW	TRM		WL			
R/W-0h	R/W-0h	R/W-0h		R/W-0h			
7	6	5	4	3	2	1	0
WL	EPOL	CLKD				POL	PHA
R/W-0h	R/W-0h	R/W-0h				R/W-0h	R/W-0h

LEGEND: R/W = Read/Write; R = Read only; W1toCl = Write 1 to clear bit; -n = value after reset

Table 24-33. MCSPI_CH3CONF Register Field Descriptions

Bit	Field	Type	Reset	Description
31-30	RESERVED	R	0h	
29	CLKG	R/W	0h	Clock divider granularity. This register defines the granularity of channel clock divider: power of two or one clock cycle granularity. When this bit is set the register MCSPI_CHCTRL[EXTCLK] must be configured to reach a maximum of 4096 clock divider ratio. Then The clock divider ratio is a concatenation of MCSPI_CHCONF[CLKD] and MCSPI_CHCTRL[EXTCLK] values. 0h = Clock granularity of power of 2 1h = 1 clock cycle granularity
28	FFER	R/W	0h	FIFO enabled for receive. Only one channel can have this bit set. 0h = The buffer is not used to receive data. 1h = The buffer is used to receive data.
27	FFEW	R/W	0h	FIFO enabled for transmit. Only one channel can have this bit set. 0h = The buffer is not used to transmit data. 1h = The buffer is used to transmit data.
26-25	TCS	R/W	0h	Chip select time control. These two bits define the number of interface clock cycles between CS toggling and first or last edge of SPI clock. 0h = 0.5 clock cycles 1h = 1.5 clock cycles 2h = 2.5 clock cycles 3h = 3.5 clock cycles
24	SBPOL	R/W	0h	Start bit polarity. 0h = Start bit polarity is held to 0 during SPI transfer. 1h = Start bit polarity is held to 1 during SPI transfer.
23	SBE	R/W	0h	Start bit enable for SPI transfer. 0h = Default SPI transfer length as specified by WL bit field. 1h = Start bit D/CX added before SPI transfer. Polarity is defined by MCSPI_CH3CONF[SBPOL].

Table 24-33. MCSPI_CH3CONF Register Field Descriptions (continued)

Bit	Field	Type	Reset	Description
22-21	SPIENSLV	R/W	0h	Channel 0 only and slave mode only: SPI slave select signal detection. Reserved bits (read returns 0) for other cases. 0h = Detection enabled only on SPIEN[0] 1h = Detection enabled only on SPIEN[1] 2h = Detection enabled only on SPIEN[2] 3h = Detection enabled only on SPIEN[3]
20	FORCE	R/W	0h	Manual SPIEN assertion to keep SPIEN active between SPI words (single channel master mode only). 0h = Writing 0 into this bit drives low the SPIEN line when MCSPI_CHCONF3[EPOL]=0, and drives it high when MCSPI_CHCONF3[EPOL]=1. 1h = Writing 1 into this bit drives high the SPIEN line when MCSPI_CHCONF3[EPOL]=0, and drives it low when MCSPI_CHCONF3[EPOL]=1
19	TURBO	R/W	0h	Turbo mode. 0h = Turbo is deactivated (recommended for single SPI word transfer). 1h = Turbo is activated to maximize the throughput for multi-SPI word transfers.
18	IS	R/W	0h	Input select 0h = Data line 0 (SPIDAT[0]) selected for reception. 1h = Data line 1 (SPIDAT[1]) selected for reception.
17	DPE1	R/W	0h	Transmission enable for data line 1 (SPIDATAGZEN[1]) 0h = Data line 1 (SPIDAT[1]) selected for transmission 1h = No transmission on data line 1 (SPIDAT[1])
16	DPE0	R/W	0h	Transmission enable for data line 0 (SPIDATAGZEN[0]) 0h = Data line 0 (SPIDAT[0]) selected for transmission 1h = No transmission on data line 0 (SPIDAT[0])
15	DMAR	R/W	0h	DMA read request. The DMA read request line is asserted when the channel is enabled and new data is available in the receive register of the channel. The DMA read request line is deasserted on read completion of the receive register of the channel. 0h = DMA read request is disabled. 1h = DMA read request is enabled.
14	DMAW	R/W	0h	DMA write request. The DMA write request line is asserted when the channel is enabled and the MCSPI_TX3 register of the channel is empty. The DMA write request line is deasserted on load completion of the MCSPI_TX3 register of the channel. 0h = DMA write request is disabled. 1h = DMA write request is enabled.
13-12	TRM	R/W	0h	Transmit/receive modes. 0h = Transmit and receive mode 1h = Receive-only mode 2h = Transmit-only mode 3h = Reserved

Table 24-33. MCSPI_CH3CONF Register Field Descriptions (continued)

Bit	Field	Type	Reset	Description
11-7	WL	R/W	0h	SPI word length. 0h = Reserved 1h = Reserved 2h = Reserved 3h = The SPI word is 4-bits long. 4h = The SPI word is 5-bits long 5h = The SPI word is 6-bits long 6h = The SPI word is 7-bits long 7h = The SPI word is 8-bits long 8h = The SPI word is 9-bits long 9h = The SPI word is 10-bits long Ah = The SPI word is 11-bits long Bh = The SPI word is 12-bits long Ch = The SPI word is 13-bits long Dh = The SPI word is 14-bits long Eh = The SPI word is 15-bits long Fh = The SPI word is 16-bits long 10h = The SPI word is 17-bits long 11h = The SPI word is 18-bits long 12h = The SPI word is 19-bits long 13h = The SPI word is 20-bits long 14h = The SPI word is 21-bits long 15h = The SPI word is 22-bits long 16h = The SPI word is 23-bits long 17h = The SPI word is 24-bits long 18h = The SPI word is 25-bits long 19h = The SPI word is 26-bits long 1Ah = The SPI word is 27-bits long 1Bh = The SPI word is 28-bits long 1Ch = The SPI word is 29-bits long 1Dh = The SPI word is 30-bits long 1Eh = The SPI word is 31-bits long 1Fh = The SPI word is 32-bits long
6	EPOL	R/W	0h	SPIEN polarity 0h = SPIEN is held high during the active state. 1h = SPIEN is held low during the active state.

Table 24-33. MCSPI_CH3CONF Register Field Descriptions (continued)

Bit	Field	Type	Reset	Description
5-2	CLKD	R/W	0h	Frequency divider for SPICLK (only when the module is a Master SPI device). A programmable clock divider divides the SPI reference clock (CLKSPIREF) with a 4 bit value, and results in a new clock SPICLK available to shift-in and shift-out data. By default the clock divider ratio has a power of two granularity when MCSPI_CHCONF[CLKG] is cleared, Otherwise this register is the 4 LSB bit of a 12 bit register concatenated with clock divider extension MCSPI_CHCTRL[EXTCLK] register. The value description below defines the clock ratio when MCSPI_CHCONF[CLKG] is cleared to 0. 0h = Divide by 1. 1h = Divide by 2. 2h = Divide by 4. 3h = Divide by 8. 4h = Divide by 16. 5h = Divide by 32. 6h = Divide by 64. 7h = Divide by 128. 8h = Divide by 256. 9h = Divide by 512. Ah = Divide by 1024. Bh = Divide by 2048. Ch = Divide by 4096. Dh = Divide by 8192. Eh = Divide by 16384. Fh = Divide by 32768.
1	POL	R/W	0h	SPICLK polarity 0h = SPICLK is held high during the active state 1h = SPICLK is held low during the active state
0	PHA	R/W	0h	SPICLK phase 0h = Data are latched on odd numbered edges of SPICLK 1h = Data are latched on even numbered edges of SPICLK

24.4.1.24 MCSPI_CH3STAT Register (offset = 16Ch) [reset = 0h]

MCSPI_CH3STAT is shown in [Figure 24-49](#) and described in [Table 24-34](#).

The McSPI channel 3 status register (MCSPI_CH3STAT) provides status information about the McSPI channel 3 FIFO transmit buffer register (MCSPI_TX3) and the McSPI channel 3 FIFO receive buffer register (MCSPI_RX3) of channel 3.

Figure 24-49. MCSPI_CH3STAT Register

31	30	29	28	27	26	25	24
RESERVED							
R-0h							
23	22	21	20	19	18	17	16
RESERVED							
R-0h							
15	14	13	12	11	10	9	8
RESERVED							
R-0h							
7	6	5	4	3	2	1	0
RESERVED	RXFFF	RXFFE	TXFFF	TXFFE	EOT	TXS	RXS
R-0h	R-0h	R-0h	R-0h	R-0h	R-0h	R-0h	R-0h

LEGEND: R/W = Read/Write; R = Read only; W1toCl = Write 1 to clear bit; -n = value after reset

Table 24-34. MCSPI_CH3STAT Register Field Descriptions

Bit	Field	Type	Reset	Description
31-7	RESERVED	R	0h	
6	RXFFF	R	0h	Channel 3 FIFO receive buffer full status. 0h = FIFO receive buffer is not full. 1h = FIFO receive buffer is full.
5	RXFFE	R	0h	Channel 3 FIFO receive buffer empty status. 0h = FIFO receive buffer is not empty. 1h = FIFO receive buffer is empty.
4	TXFFF	R	0h	Channel 3 FIFO transmit buffer full status. 0h = FIFO transmit buffer is not full. 1h = FIFO transmit buffer is full.
3	TXFFE	R	0h	Channel 3 FIFO transmit buffer empty status. 0h = FIFO transmit buffer is not empty. 1h = FIFO transmit buffer is empty.
2	EOT	R	0h	Channel 3 end-of-transfer status. The definitions of beginning and end of transfer vary with master versus slave and the transfer format (transmit/receive mode, turbo mode). 0h = This flag is automatically cleared when the shift register is loaded with the data from the transmitter register (beginning of transfer). 1h = This flag is automatically set to one at the end of an SPI transfer.
1	TXS	R	0h	Channel 3 transmitter register status. The bit is cleared when the host writes the most significant byte of the SPI word in the MCSPI_TX3 register. The bit is set when enabling the channel 3, and also when the SPI word is transferred from the MCSPI_TX3 register to the shift register. 0h = Register is full. 1h = Register is empty.

Table 24-34. MCSPI_CH3STAT Register Field Descriptions (continued)

Bit	Field	Type	Reset	Description
0	RXS	R	0h	Channel 3 receiver register status. The bit is cleared when enabling the channel i, and also when the host reads the most significant byte of the received SPI word from the MCSPI_RX3 register. The bit is set when the received SPI word is transferred from the shift register to the MCSPI_RX3 register. 0h = Register is empty. 1h = Register is full.

24.4.1.25 MCSPI_CH3CTRL Register (offset = 170h) [reset = 0h]

MCSPI_CH3CTRL is shown in [Figure 24-50](#) and described in [Table 24-35](#).

Figure 24-50. MCSPI_CH3CTRL Register

31	30	29	28	27	26	25	24	23	22	21	20	19	18	17	16
RESERVED															
R-0h															
15	14	13	12	11	10	9	8	7	6	5	4	3	2	1	0
EXTCLK								RESERVED							EN
R/W-0h								R-0h							R/W-0h

LEGEND: R/W = Read/Write; R = Read only; W1toCl = Write 1 to clear bit; -n = value after reset

Table 24-35. MCSPI_CH3CTRL Register Field Descriptions

Bit	Field	Type	Reset	Description
31-16	RESERVED	R	0h	
15-8	EXTCLK	R/W	0h	Clock ratio extension. Used to concatenate with the CLKD bit field in MCSPI_CH3CONF for clock ratio only when granularity is 1 clock cycle (CLKG bit in MCSPI_CH3CONF set to 1). Then the maximum value reached is a 4096 clock divider ratio. 0h = Clock ratio is CLKD + 1 1h = Clock ratio is CLKD + 1 + 16 FFh = Clock ratio is CLKD + 1 + 4080
7-1	RESERVED	R	0h	
0	EN	R/W	0h	Channel 3 enable. 0h = Channel 3 is not active. 1h = Channel 3 is active.

24.4.1.26 MCSPI_TX3 Register (offset = 174h) [reset = 0h]

MCSPI_TX3 is shown in [Figure 24-51](#) and described in [Table 24-36](#).

Figure 24-51. MCSPI_TX3 Register

31	30	29	28	27	26	25	24	23	22	21	20	19	18	17	16	15	14	13	12	11	10	9	8	7	6	5	4	3	2	1	0
TDATA																															
R/W-0h																															

LEGEND: R/W = Read/Write; R = Read only; W1toCl = Write 1 to clear bit; -n = value after reset

Table 24-36. MCSPI_TX3 Register Field Descriptions

Bit	Field	Type	Reset	Description
31-0	TDATA	R/W	0h	Channel 3 data to transmit.

24.4.1.27 MCSPI_RX3 Register (offset = 178h) [reset = 0h]

MCSPi_RX3 is shown in [Figure 24-52](#) and described in [Table 24-37](#).

The McSPI channel 3 FIFO receive buffer register (MCSPi_RX3) contains a single McSPI word received through the serial link. Little endian host access SPI 8 bit word on 0; big endian host accesses on 3h.

Figure 24-52. MCSPI_RX3 Register

31	30	29	28	27	26	25	24	23	22	21	20	19	18	17	16	15	14	13	12	11	10	9	8	7	6	5	4	3	2	1	0
RDATA																															
R-0h																															

LEGEND: R/W = Read/Write; R = Read only; W1toCl = Write 1 to clear bit; -n = value after reset

Table 24-37. MCSPI_RX3 Register Field Descriptions

Bit	Field	Type	Reset	Description
31-0	RDATA	R	0h	Channel 3 received data.

24.4.1.28 MCSPI_XFERLEVEL Register (offset = 17Ch) [reset = 0h]

MCSPI_XFERLEVEL is shown in [Figure 24-53](#) and described in [Table 24-38](#).

The McSPI transfer levels register (MCSPI_XFERLEVEL) provides the transfer levels needed while using the FIFO buffer during transfer.

Figure 24-53. MCSPI_XFERLEVEL Register

31	30	29	28	27	26	25	24	23	22	21	20	19	18	17	16	15	14	13	12	11	10	9	8	7	6	5	4	3	2	1	0
WCNT											AFL											AEL									
R/W-0h											R/W-0h											R/W-0h									

LEGEND: R/W = Read/Write; R = Read only; W1toCl = Write 1 to clear bit; -n = value after reset

Table 24-38. MCSPI_XFERLEVEL Register Field Descriptions

Bit	Field	Type	Reset	Description
31-16	WCNT	R/W	0h	SPI word counter. Holds the programmable value of the number of SPI words to be transferred on the channel that is using the FIFO buffer. When the transfer has started, a read back of this register returns the current SPI word transfer index. 0h = Counter not used 1h = 1 SPI word FFFEh = 65534 SPI word FFFFh = 65535 SPI word
15-8	AFL	R/W	0h	Buffer almost full. Holds the programmable almost full level value used to determine almost full buffer condition. If you want an interrupt or a DMA read request to be issued during a receive operation when the data buffer holds at least n bytes, then the buffer MCSPI_MODULCTRL[AFL] must be set with n - 1. 0h = 1 byte 1h = 2 bytes FFh = 256 bytes
7-0	AEL	R/W	0h	Buffer almost empty. Holds the programmable almost empty level value used to determine almost empty buffer condition. If you want an interrupt or a DMA write request to be issued during a transmit operation when the data buffer is able to receive n bytes, then the buffer MCSPI_MODULCTRL[AEL] must be set with n - 1. 0h = 1 byte 1h = 2 bytes FFh = 256 bytes

24.4.1.29 MCSPI_DAFTX Register (offset = 180h) [reset = 0h]

MCSPI_DAFTX is shown in [Figure 24-54](#) and described in [Table 24-39](#).

The McSPI DMA address aligned FIFO transmitter register (MCSPI_DAFTX) contains the SPI words to transmit on the serial link when FIFO is used and the DMA address is aligned on 256 bit. This register is an image of one of the MCSPI_TX(i) registers corresponding to the channel which have its FIFO enabled. The SPI words are transferred with MSB first. See Chapter Access to data registers for the list of supported accesses.

Figure 24-54. MCSPI_DAFTX Register

31	30	29	28	27	26	25	24	23	22	21	20	19	18	17	16	15	14	13	12	11	10	9	8	7	6	5	4	3	2	1	0
DAFTDATA																															
R/W-0h																															

LEGEND: R/W = Read/Write; R = Read only; W1toCl = Write 1 to clear bit; -n = value after reset

Table 24-39. MCSPI_DAFTX Register Field Descriptions

Bit	Field	Type	Reset	Description
31-0	DAFTDATA	R/W	0h	FIFO Data to transmit with DMA 256 bit aligned address. This register is used only when MCSPI_MODULCTRL[FDAA] is set to 1, and only one of the MCSPI_CH(i)CONF[FFEW] of enabled channels is set. Without these conditions, any access to this register will return a null value.

24.4.1.30 MCSPI_DAFRX Register (offset = 1A0h) [reset = 0h]

MCSPI_DAFRX is shown in [Figure 24-55](#) and described in [Table 24-40](#).

The McSPI DMA address aligned FIFO receiver register (MCSPI_DAFRX) contains the SPI words to received on the serial link when FIFO used and DMA address is aligned on 256 bit. This register is an image of one of MCSPI_RX(i) register corresponding to the channel which have its FIFO enabled.

Figure 24-55. MCSPI_DAFRX Register

31	30	29	28	27	26	25	24	23	22	21	20	19	18	17	16	15	14	13	12	11	10	9	8	7	6	5	4	3	2	1	0
DAFRDATA																															
R-0h																															

LEGEND: R/W = Read/Write; R = Read only; W1toCl = Write 1 to clear bit; -n = value after reset

Table 24-40. MCSPI_DAFRX Register Field Descriptions

Bit	Field	Type	Reset	Description
31-0	DAFRDATA	R	0h	FIFO Received Data with DMA 256 bit aligned address. This register is used only when MCSPI_MODULCTRL[FDAA] is set to 1, and only one of the MCSPI_CH(i)CONF[FFER] of enabled channels is set. Without these conditions, any access to this register will return a null value.

General-Purpose Input/Output

This chapter describes the GPIO of the device.

Topic	Page
25.1 Introduction	4866
25.2 Integration	4867
25.3 Functional Description	4870
25.4 GPIO Registers	4877

25.1 Introduction

25.1.1 Purpose of the Peripheral

The general-purpose interface combines four general-purpose input/output (GPIO) modules. Each GPIO module provides 32 dedicated general-purpose pins with input and output capabilities; thus, the general-purpose interface supports up to 128 (4 × 32) pins. These pins can be configured for the following applications:

- Data input (capture)/output (drive)
- Keyboard interface with a debounce cell
- Interrupt generation in active mode upon the detection of external events. Detected events are processed by two parallel independent interrupt-generation submodules to support biprocessor operations.

25.1.2 GPIO Features

Each GPIO module is made up of 32 identical channels. Each channel can be configured to be used in the following applications:

- Data input/output
- Keyboard interface with a de-bouncing cell
- Synchronous interrupt generation (in active mode) upon the detection of external events (signal transition(s) and/or signal level(s))
- Wake-up request generation (in Idle mode) upon the detection of signal transition(s)

Global features of the GPIO interface are:

- Synchronous interrupt requests from each channel are processed by two identical interrupt generation sub-modules to be used independently by the ARM Subsystem
- Wake-up requests from input channels are merged together to issue one wake-up signal to the system
- Shared registers can be accessed through “Set & Clear” protocol

25.1.3 Unsupported GPIO Features

The wake-up feature of the GPIO modules is only supported on GPIO0.

25.2 Integration

The device instantiates four GPIO_V2 modules. Each GPIO module provides the support for 32 dedicated pins with input and output configuration capabilities. Input signals can be used to generate interruptions and wake-up signal. Two Interrupt lines are available for bi-processor operation. Pins can be dedicated to be used as a keyboard controller.

With four GPIO modules, the device allows for a maximum of 128 GPIO pins. (The exact number available varies as a function of the device configuration and pin muxing.) GPIO0 is in the Wakeup domain and may be used to wakeup the device via external sources. GPIO[1:3] are located in the peripheral domain.

Figure 25-1 and Figure 25-2 show the GPIO integration.

Figure 25-1. GPIO0 Module Integration

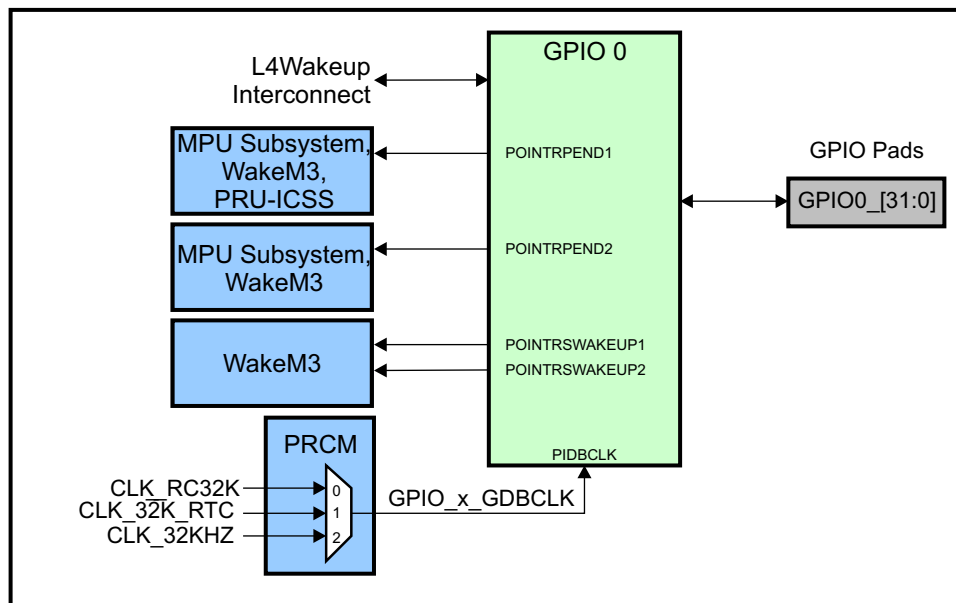
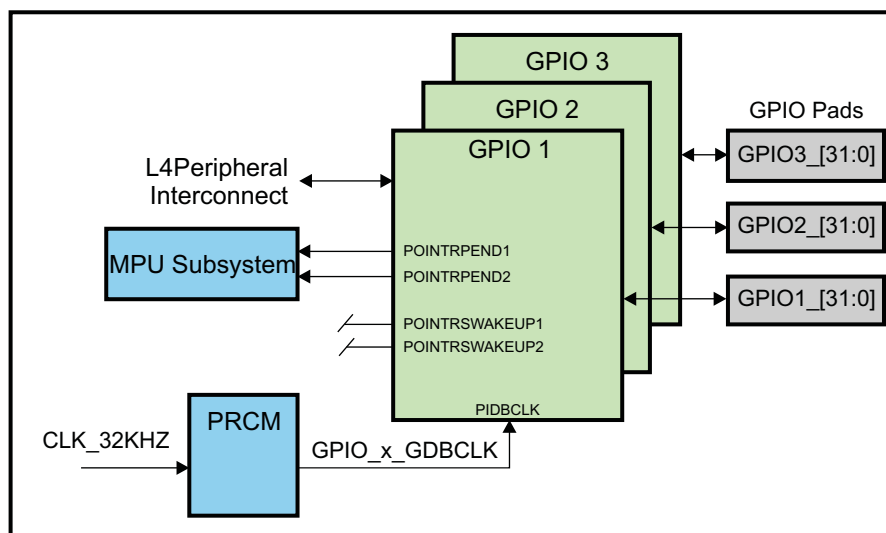


Figure 25-2. GPIO[1–3] Module Integration



25.2.1 GPIO Connectivity Attributes

The general connectivity attributes for the GPIO modules in the device are shown in [Table 25-1](#) and [Table 25-2](#).

Table 25-1. GPIO0 Connectivity Attributes

Attributes	Type
Power Domain	Wakeup Domain
Clock Domain	PD_WKUP_L4_WKUP_GCLK (OCP) GPIO_0_GDBCLK (Debounce)
Reset Signals	WKUP_DOM_RST_N
Idle/Wakeup Signals	Smart Idle / Slave Wakeup
Interrupt Requests	Two Interrupts: INTRPEND1 (GPIOINT0A) to MPU subsystem, PRU-ICSS (POINTRPEND1), and WakeM3 INTRPEND2 (GPIOINT0B) to MPU subsystem and WakeM3
DMA Requests	Interrupt Requests are redirected as DMA requests: 1 DMA request (GPIOEVT0)
Physical Address	L4 Wakeup slave port

Table 25-2. GPIO[1:3] Connectivity Attributes

Attributes	Type
Power Domain	Peripheral Domain
Clock Domain	PD_PER_L4LS_GCLK (OCP) GPIO_1_GDBCLK (GPIO1 Debounce) GPIO_2_GDBCLK (GPIO2 Debounce) GPIO_3_GDBCLK (GPIO3 Debounce)
Reset Signals	PER_DOM_RST_N
Idle/Wakeup Signals	Smart Idle
Interrupt Requests	Two Interrupts: INTRPEND1 (GPIOINTxA) to MPU subsystem INTRPEND2 (GPIOINTxB) to MPU subsystem
DMA Requests	Interrupt Requests are redirected as DMA requests: 1 DMA request only for GPIO1 (GPIOEVT1) and GPIO2 (GPIOEVT2)
Physical Address	L4 Peripheral slave port

25.2.2 GPIO Clock and Reset Management

The GPIO modules require two clocks: The de-bounce clock is used for the de-bouncing cells. The interface clock provided by the peripheral bus (L4 interface) is also the functional clock and is used through the entire GPIO module (except within the de-bouncing sub-module). It clocks the OCP interface and the internal logic. For GPIO0 the debounce clock is selected from one of three sources using the CLKSEL_GPIO0_DBCLK register in the PRCM:

- The on-chip ~32.768 KHz oscillator (CLK_RC32K)
- The PER PLL generated 32.768 KHz clock (CLK_32KHZ)
- The external 32.768 KHz oscillator/clock (CLK_32K_RTC)

Table 25-3. GPIO Clock Signals

Clock Signal	Max Freq	Reference / Source	Comments
GPIO0			
Functional / Interface clock	100 MHz	CORE_CLKOUTM4 / 2	pd_wkup_l4_wkup_gclk From PRCM
Debounce Functional clock	32.768 KHz	CLK_RC32K CLK_32KHZ (PER_CLKOUTM2 / 5859.375) CLK_32K_RTC	pd_wkup_gpio0_gdbclk From PRCM
GPIO[1:3]			

Table 25-3. GPIO Clock Signals (continued)

Clock Signal	Max Freq	Reference / Source	Comments
Functional / Interface clock	100 MHz	CORE_CLKOUTM4 / 2	pd_per_l4ls_gclk From PRCM
Debounce Functional clock (GPIO1)	32.768 KHz	CLK_32KHZ (PER_CLKOUTM2 / 5859.375)	pd_per_gpio_1_gdbclk From PRCM
Debounce Functional clock (GPIO2)	32.768 KHz	CLK_32KHZ (PER_CLKOUTM2 / 5859.375)	pd_per_gpio_2_gdbclk From PRCM
Debounce Functional clock (GPIO3)	32.768 KHz	CLK_32KHZ (PER_CLKOUTM2 / 5859.375)	pd_per_gpio_3_gdbclk From PRCM

25.2.3 GPIO Pin List

Each GPIO module includes 32 interface I/Os. These signals are designated as shown in [Table 25-4](#). Note that for this device, most of these signals will be multiplexed with functional signals from other interfaces.

Table 25-4. GPIO Pin List

Pin	Type	Description
GPIO0_[31:0]	I/O	General Purpose Input-Output pins
GPIO1_[31:0]		
GPIO2_[31:0]		
GPIO3_[31:0]		
GPIO4_[31:0]		
GPIO5_[31:0]		

25.3 Functional Description

This section discusses the operational details and basic functions of the GPIO peripheral.

25.3.1 Operating Modes

Four operating modes are defined for the module:

- **Active mode:** the module is running synchronously on the interface clock, interrupt can be generated according to the configuration and the external signals.
- **Idle mode:** the module is in a waiting state, interface clock can be stopped, no interrupt can be generated. Check the chip top-level functional specification for the availability of the debouncing clock while in Idle mode.
- **Inactive mode:** the module has no activity, interface clock can be stopped, no interrupt can be generated.
- **Disabled mode:** the module is not used, internal clock paths are gated, no interrupt request can be generated.

The Idle and Inactive modes are configured within the module and activated on request by the host processor through system interface sideband signals. The Disabled mode is set by software through a dedicated configuration bit. It unconditionally gates the internal clock paths not use for the system interface. All module registers are 8, 16 or 32-bit accessible through the OCP compatible interface (little endian encoding). In active mode, the event detection (level or transition) is performed in the GPIO module using the interface clock. The detection's precision is set by the frequency of this clock and the selected internal gating scheme.

25.3.2 Clocking and Reset Strategy

25.3.2.1 Clocks

GPIO module runs using two clocks:

- The debouncing clock is used for the debouncing sub-module logic (without the corresponding configuration registers). This module can sample the input line and filters the input level using a programmed delay.
- The interface clock provided by the peripheral bus (OCP compatible system interface). It is used through the entire GPIO module (except within the debouncing sub-module logic). It clocks the OCP interface and the internal logic. Clock gating features allow adapting the module power consumption to the activity.

25.3.2.2 Clocks, Gating and Active Edge Definitions

The interface clock provided by the peripheral bus (OCP compatible system interface) is used through the entire GPIO module. Two clock domains are defined: the OCP interface and the internal logic. Each clock domain can be controlled independently. Sampling operations for the data capture and for the events detection are done using the rising edge. The data loaded in the data output register (GPIO_DATAOUT) is set at the output GPIO pins synchronously with the rising edge of the interface clock.

Five clock gating features are available:

- Clock for the system interface logic can be gated when the module is not accessed, if the AUTOIDLE configuration bit in the system configuration register (GPIO_SYSCONFIG) is set. Otherwise, this logic is free running on the interface clock.
- Clock for the input data sample logic can be gated when the data in register is not accessed.
- Four clock groups are used for the logic in the synchronous events detection. Each 8 input GPIO_V2 pins group will have a separate enable signal depending on the edge/level detection register setting. If a group requires no detection, then the corresponding clock will be gated. All channels are also gated using a 'one out of N' scheme. N can take the values 1, 2, 4 or 8. The interface clock is enabled for this logic one cycle every N cycles. When N is equal to 1, there is no gating and this logic is free running on the interface clock. When N is between 2 to 8, this logic is running at the equivalent frequency of interface clock frequency divided by N.

- In Inactive mode, all internal clock paths are gated.
- In Disabled mode, all internal clock paths not used for the system interface are gated. All GPIO registers are accessible synchronously with the interface clock.

25.3.2.3 Sleep Mode Request and Acknowledge

Upon a Sleep mode request issued by the host processor, the GPIO module goes to the Idle mode according to the IDLEMODE field in the system configuration register (GPIO_SYSCONFIG).

- IDLEMODE = 0 (Force-Idle mode): the GPIO goes in Inactive mode independently of the internal module state and the Idle acknowledge is unconditionally sent. In Force-Idle mode, the module is in Inactive mode.
- IDLEMODE = 1h (No-Idle mode): the GPIO does not go to the Idle mode and the Idle acknowledge is never sent.
- IDLEMODE = 2h (Smart-Idle mode) or IDLEMODE = 3h (Smart-Idle mode): the GPIO module evaluates its internal capability to have the interface clock switched off. Once there is no more internal activity (the data input register completed to capture the input GPIO pins, there is no pending interrupt, all interrupt status bits are cleared, and there is no write access to GPIO_DEBOUNCINGTIME register pending to be synchronized), the Idle acknowledge is asserted and the GPIO enters Idle mode. When the system is awake, the Idle Request goes inactive, the Idle acknowledge signals are immediately de-asserted.

NOTE: Idle mode request and Idle acknowledge are system interface sideband signals. Once the GPIO acknowledges the Sleep mode request (Idle acknowledge has been sent), the interface clock can be stopped anytime.

Upon a Sleep mode request issued by the host processor, the GPIO module goes to the Idle mode only if there is no active bit in GPIO_IRQSTATUS_RAW_n registers.

25.3.2.4 Reset

The OCP hardware Reset signal has a global reset action on the GPIO. All configuration registers, all DFFs clocked with the Interface clock or Debouncing clock and all internal state machines are reset when the OCP hardware Reset is active (low level). The RESETDONE bit in the system status register (GPIO_SYSSTATUS) monitors the internal reset status: it is set when the Reset is completed on both OCP and Debouncing clock domains. The software Reset (SOFTRESET bit in the system configuration register) has the same effect as the OCP hardware Reset signal, and the RESETDONE bit in GPIO_SYSSTATUS is updated in the same condition.

25.3.3 Interrupt Features

25.3.3.1 Functional Description

In order to generate an interrupt request to a host processor upon a defined event (level or logic transition) occurring on a GPIO pin, the GPIO configuration registers have to be programmed as follows:

- Interrupts for the GPIO channel must be enabled in the GPIO_IRQSTATUS_SET_0 and/or GPIO_IRQSTATUS_SET_1 registers.
- The expected event(s) on input GPIO to trigger the interrupt request has to be selected in the GPIO_LEVELDETECT0, GPIO_LEVELDETECT1, GPIO_RISINGDETECT, and GPIO_FALLINGDETECT registers.

For instance, interrupt generation on both edges on input k is configured by setting to 1 the kth bit in registers GPIO_RISINGDETECT and GPIO_FALLINGDETECT along with the interrupt enabling for one or both interrupt lines (GPIO_IRQSTATUS_SET_n).

NOTE: All interrupt sources (the 32 input GPIO channels) are merged together to issue two synchronous interrupt requests 1 and 2.

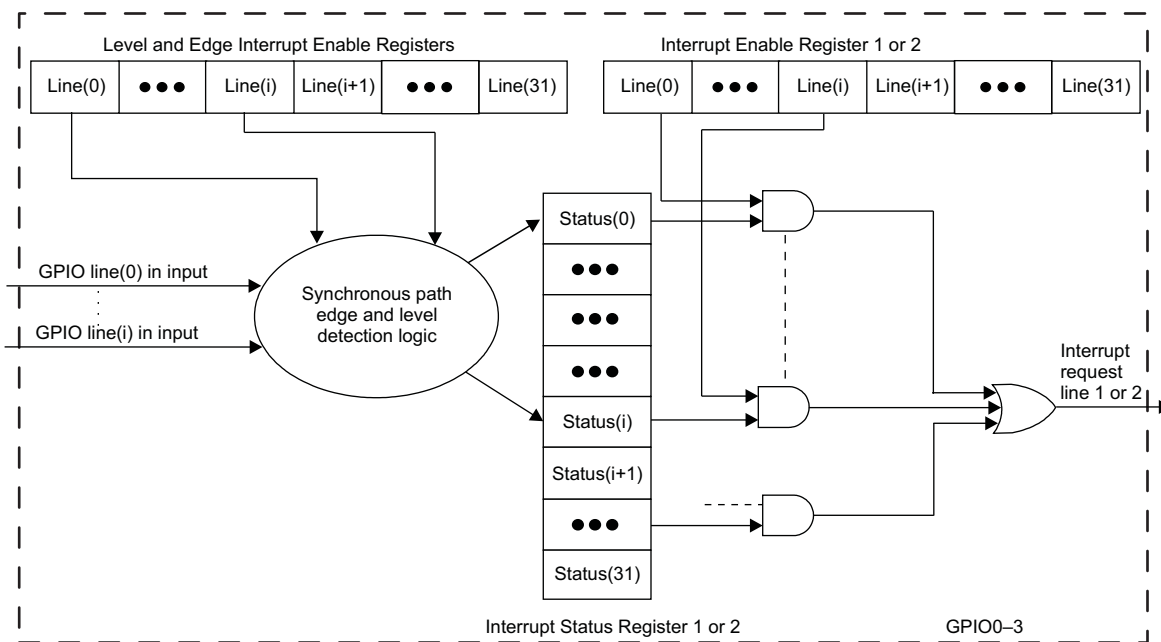
25.3.3.2 Synchronous Path: Interrupt Request Generation

In Active mode, once the GPIO configuration registers have been set to enable the interrupt generation, a synchronous path (Figure 25-3) samples the transitions and levels on the input GPIO with the internally gated interface clock. When an event matches the programmed settings, the corresponding bit in the GPIO_IRQSTATUS_RAW_n registers is set to 1 and, on the following interface clock cycle, the interrupt lines 1 and/or 2 are activated (depending on the GPIO_IRQSTATUS_SET_n registers).

Due to the sampling operation, the minimum pulse width on the input GPIO to trigger a synchronous interrupt request is two times the internally gated interface clock period (the internally gated interface clock period is equal to N times the interface clock period). This minimum pulse width has to be met before and after any expected level transition detection. Level detection requires the selected level to be stable for at least two times the internally gated interface clock period to trigger a synchronous interrupt.

As the module is synchronous, latency is minimal between the expected event occurrence and the activation of the interrupt line(s). This should not exceed 3 internally gated interface clock cycles + 2 interface clock cycles when the debouncing feature is not used. When the debouncing feature is active, the latency depends on the GPIO_DEBOUNCINGTIME register value and should be less than 3 internally gated interface clock cycles + 2 interface clock cycles + GPIO_DEBOUNCINGTIME value debouncing clock cycles + 3 debouncing clock cycles.

Figure 25-3. Interrupt Request Generation



25.3.3.3 Interrupt Line Release

When the host processor receives an interrupt request issued by the GPIO module, it can read the corresponding GPIO_IRQSTATUS_n register to find out which input GPIO has triggered the interrupt. After servicing the interrupt, the processor resets the status bit and releases the interrupt line by writing a 1 in the corresponding bit of the GPIO_IRQSTATUS_n register. If there is still a pending interrupt request to serve (all bits in the GPIO_IRQSTATUS_RAW_n register not masked by the GPIO_IRQSTATUS_SET_n, which are not cleared by setting the GPIO_IRQSTATUS_CLR_n), the interrupt line will be re-asserted.

25.3.4 General-Purpose Interface Basic Programming Model

25.3.4.1 Power Saving by Grouping the Edge/Level Detection

Each GPIO module implements four gated clocks used by the edge/level detection logic to save power. Each group of eight input GPIO pins generates a separate enable signal depending on the edge/level detection register setting (because the input is 32 bits, four groups of eight inputs are defined for each GPIO module). If a group requires no edge/level detection, then the corresponding clock is gated (cut off). Grouping the edge/level enable can save the power consumption of the module as described in the following example.

If any of the registers:

- GPIO_LEVELDETECT0
- GPIO_LEVELDETECT1
- GPIO_RISINGDETECT
- GPIO_FALLINGDETECT

are set to 0101 0101h, then all clocks are active (power consumption is high);

are set to 0000 00FFh, then a single clock is active.

NOTE: When the clocks are enabled by writing to the GPIO_LEVELDETECT0, GPIO_LEVELDETECT1, GPIO_RISINGDETECT, and GPIO_FALLINGDETECT registers, the detection starts after 5 clock cycles. This period is required to clean the synchronization edge/level detection pipeline.

The mechanism is independent of each clock group. If the clock has been started before a new setting is performed, the following is recommended: first, set the new detection required; second, disable the previous setting (if necessary). In this way, the corresponding clock is not gated and the detection starts immediately.

25.3.4.2 Set and Clear Instructions

The GPIO module implements the set-and-clear protocol register update for the data output and interrupt enable registers. This protocol is an alternative to the atomic test and set operations and consists of writing operations at dedicated addresses (one address for setting bit[s] and one address for clearing bit[s]). The data to write is 1 at bit position(s) to clear (or to set) and 0 at unaffected bit(s).

Registers can be accessed in two ways:

- Standard: Full register read and write operations at the primary register address
- Set and clear (recommended): Separate addresses are provided to set (and clear) bits in registers. Writing 1 at these addresses sets (or clears) the corresponding bit into the equivalent register; writing a 0 has no effect.

Therefore, for these registers, three addresses are defined for one unique physical register. Reading these addresses has the same effect and returns the register value.

25.3.4.2.1 Clear Instruction

25.3.4.2.1.1 Clear Interrupt Enable Registers (*GPIO_IRQSTATUS_CLR_0* and *GPIO_IRQSTATUS_CLR_1*):

- A write operation in the clear interrupt enable1 (or enable2) register clears the corresponding bit in the interrupt enable1 (or enable2) register when the written bit is 1; a written bit at 0 has no effect.
- A read of the clear interrupt enable1 (or enable2) register returns the value of the interrupt enable1 (or enable2) register.

25.3.4.2.1.2 Clear Data Output Register (*GPIO_CLEARDATAOUT*):

- A write operation in the clear data output register clears the corresponding bit in the data output register when the written bit is 1; a written bit at 0 has no effect.
- A read of the clear data output register returns the value of the data output register.

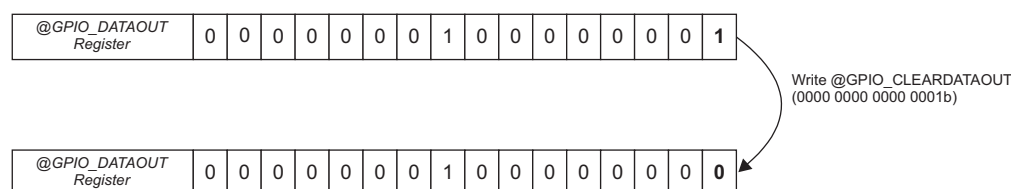
25.3.4.2.1.3 Clear Instruction Example

Assume the data output register (or one of the interrupt enable registers) contains the binary value, 0000 0001 0000 0001h, and you want to clear bit 0.

With the clear instruction feature, write 0000 0000 0000 0001h at the address of the clear data output register (or at the address of the clear interrupt enable register). After this write operation, a reading of the data output register (or the interrupt enable register) returns 0000 0001 0000 0000h; bit 0 is cleared.

NOTE: Although the general-purpose interface registers are 32-bits wide, only the 16 least-significant bits are represented in this example.

Figure 25-4. Write @ GPIO_CLEARDATAOUT Register Example



25.3.4.2.2 Set Instruction

25.3.4.2.2.1 Set Interrupt Enable Registers (*GPIO_IRQSTATUS_SET_0* and *GPIO_IRQSTATUS_SET_1*):

- A write operation in the set interrupt enable1 (or enable2) register sets the corresponding bit in the interrupt enable1 (or enable2) register when the written bit is 1; a written bit at 0 has no effect.
- A read of the set interrupt enable1 (or enable2) register returns the value of the interrupt enable1 (or enable2) register.

25.3.4.2.2.2 Set Data Output Register (*GPIO_SETDATAOUT*):

- A write operation in the set data output register sets the corresponding bit in the data output register when the written bit is 1; a written bit at 0 has no effect.
- A read of the set data output register returns the value of the data output register.

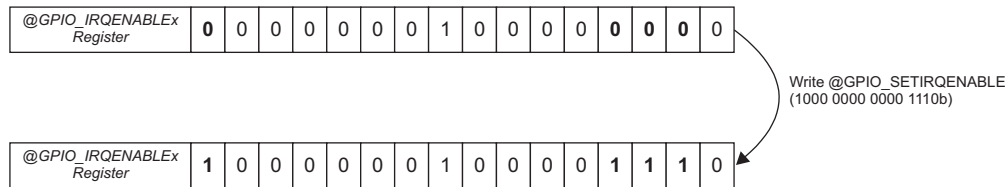
25.3.4.2.2.3 Set Instruction Example

Assume the interrupt enable1 (or enable2) register (or the data output register) contains the binary value, 0000 0001 0000 0000h, and you want to set bits 15, 3, 2, and 1.

With the set instruction feature, write 1000 0000 0000 1110h at the address of the set interrupt enable1 (or enable2) register (or at the address of the set data output register). After this write operation, a reading of the interrupt enable1 (or enable2) register (or the data output register) returns 1000 0001 0000 1110h; bits 15, 3, 2, and 1 are set.

NOTE: Although the general-purpose interface registers are 32-bits wide, only the 16 least-significant bits are represented in this example.

Figure 25-5. Write @ GPIO_SETIRQENABLEx Register Example



25.3.4.3 Data Input (Capture)/Output (Drive)

The output enable register (GPIO_OE) controls the output/input capability for each pin. At reset, all the GPIO-related pins are configured as input and output capabilities are disabled. This register is not used within the module; its only function is to carry the pads configuration.

When configured as an output (the desired bit reset in GPIO_OE), the value of the corresponding bit in the GPIO_DATAOUT register is driven on the corresponding GPIO pin. Data is written to the data output register synchronously with the interface clock. This register can be accessed with read/write operations or by using the alternate set and clear protocol register update feature. This feature lets you set or clear specific bits of this register with a single write access to the set data output register (GPIO_SETDATAOUT) or to the clear data output register (GPIO_CLEARDATAOUT) address. If the application uses a pin as an output and does not want interrupt generation from this pin, the application must properly configure the interrupt enable registers.

When configured as an input (the desired bit set to 1 in GPIO_OE), the state of the input can be read from the corresponding bit in the GPIO_DATAIN register. The input data is sampled synchronously with the interface clock and then captured in the data input register synchronously with the interface clock. When the GPIO pin levels change, they are captured into this register after two interface clock cycles (the required cycles to synchronize and to write data). If the application uses a pin as an input, the application must properly configure the interrupt enable registers to the interrupt as needed.

25.3.4.4 Debouncing Time

To enable the debounce feature for a pin, the GPIO configuration registers must be programmed as follows:

- The GPIO pin must be configured as input in the output enable register (write 1 to the corresponding bit of the GPIO_OE register).
- The debouncing time must be set in the debouncing value register (GPIO_DEBOUNCINGTIME). The GPIO_DEBOUNCINGTIME register is used to set the debouncing time for all input lines in the GPIO module. The value is global for all the ports of one GPIO module, so up to six different debouncing values are possible. The debounce cell is running with the debounce clock (32 kHz). This register represents the number of the clock cycle(s) (one cycle is 31 microseconds long) to be used.

The following formula describes the required input stable time to be propagated to the debounced output:

$$\text{Debouncing time} = (\text{DEBOUNCETIME} + 1) \times 31 \mu\text{s}$$

Where the DEBOUNCETIME field value in the GPIO_DEBOUNCINGTIME register is from 0 to 255.

- The debouncing feature must be enabled in the debouncing enable register (write 1 to the corresponding DEBOUNCEENABLE bit in the GPIO_DEBOUNCENABLE register).

25.3.4.5 GPIO as a Keyboard Interface

The general-purpose interface can be used as a keyboard interface (Figure 25-6). You can dedicate channels based on the keyboard matrix = * c). Figure 25-6 shows row channels configured as inputs with the input debounce feature enabled. The row channels are driven high with an external pull-up. Column channels are configured as outputs and drive a low level.

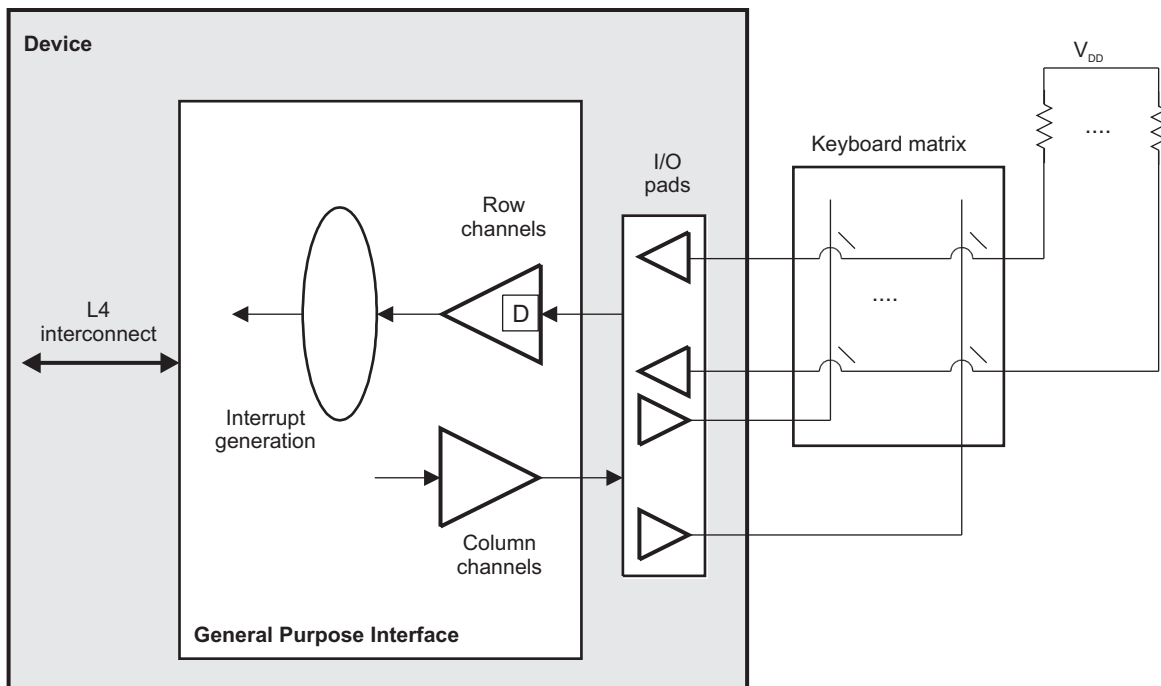
When a keyboard matrix key is pressed, the corresponding row and column lines are shorted together and a low level is driven on the corresponding row channel. This generates an interrupt based on the proper configuration (see Section 25.3.3).

When the keyboard interrupt is received, the processor can disable the keyboard interrupt and scan the column channels for the key coordinates.

- The scanning sequence has as many states as column channels: For each step in the sequence, the processor drives one column channel low and the others high.
- The processor reads the values of the row channels and thus detects which keys in the column are pressed.

At the end of the scanning sequence, the processor establishes which keys are pressed. The keyboard interface can then be reconfigured in the interrupt waiting state.

Figure 25-6. General-Purpose Interface Used as a Keyboard Interface



25.4 GPIO Registers

25.4.1 GPIO Registers

Table 25-5 lists the memory-mapped registers for the GPIO. All register offset addresses not listed in Table 25-5 should be considered as reserved locations and the register contents should not be modified.

Table 25-5. GPIO Registers

Offset	Acronym	Register Name	Section
0h	GPIO_REVISION		Section 25.4.1.1
10h	GPIO_SYSCONFIG		Section 25.4.1.2
20h	GPIO_EOI		Section 25.4.1.3
24h	GPIO_IRQSTATUS_RAW_0		Section 25.4.1.4
28h	GPIO_IRQSTATUS_RAW_1		Section 25.4.1.5
2Ch	GPIO_IRQSTATUS_0		Section 25.4.1.6
30h	GPIO_IRQSTATUS_1		Section 25.4.1.7
34h	GPIO_IRQSTATUS_SET_0		Section 25.4.1.8
38h	GPIO_IRQSTATUS_SET_1		Section 25.4.1.9
3Ch	GPIO_IRQSTATUS_CLR_0		Section 25.4.1.10
40h	GPIO_IRQSTATUS_CLR_1		Section 25.4.1.11
44h	GPIO_IRQWAKEN_0		Section 25.4.1.12
48h	GPIO_IRQWAKEN_1		Section 25.4.1.13
114h	GPIO_SYSSTATUS		Section 25.4.1.14
130h	GPIO_CTRL		Section 25.4.1.15
134h	GPIO_OE		Section 25.4.1.16
138h	GPIO_DATAIN		Section 25.4.1.17
13Ch	GPIO_DATAOUT		Section 25.4.1.18
140h	GPIO_LEVELDETECT0		Section 25.4.1.19
144h	GPIO_LEVELDETECT1		Section 25.4.1.20
148h	GPIO_RISINGDETECT		Section 25.4.1.21
14Ch	GPIO_FALLINGDETECT		Section 25.4.1.22
150h	GPIO_DEBOUNCENABLE		Section 25.4.1.23
154h	GPIO_DEBOUNCINGTIME		Section 25.4.1.24
190h	GPIO_CLEARDATAOUT		Section 25.4.1.25
194h	GPIO_SETDATAOUT		Section 25.4.1.26

25.4.1.1 GPIO_REVISION Register (offset = 0h) [reset = 50600801h]

GPIO_REVISION is shown in [Figure 25-7](#) and described in [Table 25-6](#).

The GPIO revision register is a read only register containing the revision number of the GPIO module. A write to this register has no effect, the same as the reset.

Figure 25-7. GPIO_REVISION Register

31	30	29	28	27	26	25	24
SCHEME		RESERVED			FUNC		
R-1h		R-1h			R-60h		
23	22	21	20	19	18	17	16
FUNC							
R-60h							
15	14	13	12	11	10	9	8
RTL				MAJOR			
R-1h				R-0h			
7	6	5	4	3	2	1	0
CUSTOM		MINOR					
R-0h		R-1h					

LEGEND: R/W = Read/Write; R = Read only; W1toCl = Write 1 to clear bit; -n = value after reset

Table 25-6. GPIO_REVISION Register Field Descriptions

Bit	Field	Type	Reset	Description
31-30	SCHEME	R	1h	Used to distinguish between old Scheme and current.
29-28	RESERVED	R	1h	
27-16	FUNC	R	60h	Indicates a software compatible module family.
15-11	RTL	R	1h	RTL version
10-8	MAJOR	R	0h	Major Revision
7-6	CUSTOM	R	0h	Indicates a special version for a particular device.
5-0	MINOR	R	1h	Minor Revision

25.4.1.2 GPIO_SYSCONFIG Register (offset = 10h) [reset = 0h]

GPIO_SYSCONFIG is shown in [Figure 25-8](#) and described in [Table 25-7](#).

The GPIO_SYSCONFIG register controls the various parameters of the L4 interconnect. When the AUTOIDLE bit is set, the GPIO_DATAIN read command has a 3 OCP cycle latency due to the data in sample gating mechanism. When the AUTOIDLE bit is not set, the GPIO_DATAIN read command has a 2 OCP cycle latency.

Figure 25-8. GPIO_SYSCONFIG Register

31	30	29	28	27	26	25	24
RESERVED							
R-0h							
23	22	21	20	19	18	17	16
RESERVED							
R-0h							
15	14	13	12	11	10	9	8
RESERVED							
R-0h							
7	6	5	4	3	2	1	0
RESERVED			IDLEMODE	ENAWAKEUP	SOFTRESET	AUTOIDLE	
R-0h			R/W-0h	R/W-0h	R/W-0h	R/W-0h	

LEGEND: R/W = Read/Write; R = Read only; W1toCl = Write 1 to clear bit; -n = value after reset

Table 25-7. GPIO_SYSCONFIG Register Field Descriptions

Bit	Field	Type	Reset	Description
31-5	RESERVED	R	0h	
4-3	IDLEMODE	R/W	0h	Power Management, Req/Ack control. 0h = Force-idle. An idle request is acknowledged unconditionally 1h = No-idle. An idle request is never acknowledged 2h = Smart-idle. Acknowledgment to an idle request is given based on the internal activity of the module 3h = Smart Idle Wakeup (GPIO0 only)
2	ENAWAKEUP	R/W	0h	0h = Wakeup generation is disabled. 1h = Wakeup capability is enabled upon expected transition on input GPIO pin.
1	SOFTRESET	R/W	0h	Software reset. This bit is automatically reset by the hardware. During reads, it always returns 0. 0h = Normal mode 1h = The module is reset
0	AUTOIDLE	R/W	0h	Internal interface clock gating strategy 0h = Internal Interface OCP clock is free-running 1h = Automatic internal OCP clock gating, based on the OCP interface activity

25.4.1.3 GPIO_EOI Register (offset = 20h) [reset = 0h]

GPIO_EOI is shown in [Figure 25-9](#) and described in [Table 25-8](#).

This module supports DMA events with its interrupt signal. This register must be written to after the DMA completes in order for subsequent DMA events to be triggered from this module.

Figure 25-9. GPIO_EOI Register

31	30	29	28	27	26	25	24
RESERVED							
R-0h							
23	22	21	20	19	18	17	16
RESERVED							
R-0h							
15	14	13	12	11	10	9	8
RESERVED							
R-0h							
7	6	5	4	3	2	1	0
RESERVED							DMAEvent_Ack
R-0h							R/W-0h

LEGEND: R/W = Read/Write; R = Read only; W1toCl = Write 1 to clear bit; -n = value after reset

Table 25-8. GPIO_EOI Register Field Descriptions

Bit	Field	Type	Reset	Description
31-1	RESERVED	R	0h	
0	DMAEvent_Ack	R/W	0h	Write 0 to acknowledge DMA event has been completed. Module will be able to generate another DMA event only when the previous one has been acknowledged using this register. Reads always returns 0.

25.4.1.4 GPIO_IRQSTATUS_RAW_0 Register (offset = 24h) [reset = 0h]

GPIO_IRQSTATUS_RAW_0 is shown in [Figure 25-10](#) and described in [Table 25-9](#).

The GPIO_IRQSTATUS_RAW_0 register provides core status information for the interrupt handling, showing all active events (enabled and not enabled). The fields are read-write. Writing a 1 to a bit sets it to 1, that is, triggers the IRQ (mostly for debug). Writing a 0 has no effect, that is, the register value is not be modified. Only enabled, active events trigger an actual interrupt request on the IRQ output line.

Figure 25-10. GPIO_IRQSTATUS_RAW_0 Register

31	30	29	28	27	26	25	24	23	22	21	20	19	18	17	16	15	14	13	12	11	10	9	8	7	6	5	4	3	2	1	0
INTLINE[n]																															
R/W-0h																															

LEGEND: R/W = Read/Write; R = Read only; W1toCl = Write 1 to clear bit; -n = value after reset

Table 25-9. GPIO_IRQSTATUS_RAW_0 Register Field Descriptions

Bit	Field	Type	Reset	Description
31-0	INTLINE[n]	R/W	0h	Interrupt n status. 0h = No effect. 1h = IRQ is triggered.

25.4.1.5 GPIO_IRQSTATUS_RAW_1 Register (offset = 28h) [reset = 0h]

GPIO_IRQSTATUS_RAW_1 is shown in [Figure 25-11](#) and described in [Table 25-10](#).

The GPIO_IRQSTATUS_RAW_1 register provides core status information for the interrupt handling, showing all active events (enabled and not enabled). The fields are read-write. Writing a 1 to a bit sets it to 1, that is, triggers the IRQ (mostly for debug). Writing a 0 has no effect, that is, the register value is not be modified. Only enabled, active events trigger an actual interrupt request on the IRQ output line.

Figure 25-11. GPIO_IRQSTATUS_RAW_1 Register

31	30	29	28	27	26	25	24	23	22	21	20	19	18	17	16	15	14	13	12	11	10	9	8	7	6	5	4	3	2	1	0
INTLINE[n]																															
R/W-0h																															

LEGEND: R/W = Read/Write; R = Read only; W1toCl = Write 1 to clear bit; -n = value after reset

Table 25-10. GPIO_IRQSTATUS_RAW_1 Register Field Descriptions

Bit	Field	Type	Reset	Description
31-0	INTLINE[n]	R/W	0h	Interrupt n status. 0h = No effect. 1h = IRQ is triggered.

25.4.1.6 GPIO_IRQSTATUS_0 Register (offset = 2Ch) [reset = 0h]

GPIO_IRQSTATUS_0 is shown in [Figure 25-12](#) and described in [Table 25-11](#).

The GPIO_IRQSTATUS_0 register provides core status information for the interrupt handling, showing all active events which have been enabled. The fields are read-write. Writing a 1 to a bit clears the bit to 0, that is, clears the IRQ. Writing a 0 has no effect, that is, the register value is not modified. Only enabled, active events trigger an actual interrupt request on the IRQ output line.

Figure 25-12. GPIO_IRQSTATUS_0 Register

31	30	29	28	27	26	25	24	23	22	21	20	19	18	17	16	15	14	13	12	11	10	9	8	7	6	5	4	3	2	1	0
INTLINE[n]																															
R/W1C-0h																															

LEGEND: R/W = Read/Write; R = Read only; W1toCl = Write 1 to clear bit; -n = value after reset

Table 25-11. GPIO_IRQSTATUS_0 Register Field Descriptions

Bit	Field	Type	Reset	Description
31-0	INTLINE[n]	R/W1C	0h	Interrupt n status. 0h (W) = No effect. 0h (R) = IRQ is not triggered. 1h (W) = Clears the IRQ. 1h (R) = IRQ is triggered.

25.4.1.7 GPIO_IRQSTATUS_1 Register (offset = 30h) [reset = 0h]

GPIO_IRQSTATUS_1 is shown in [Figure 25-13](#) and described in [Table 25-12](#).

The GPIO_IRQSTATUS_1 register provides core status information for the interrupt handling, showing all active events which have been enabled. The fields are read-write. Writing a 1 to a bit clears the bit to 0, that is, clears the IRQ. Writing a 0 has no effect, that is, the register value is not modified. Only enabled, active events trigger an actual interrupt request on the IRQ output line.

Figure 25-13. GPIO_IRQSTATUS_1 Register

31	30	29	28	27	26	25	24	23	22	21	20	19	18	17	16	15	14	13	12	11	10	9	8	7	6	5	4	3	2	1	0
INTLINE[n]																															
R/W1C-0h																															

LEGEND: R/W = Read/Write; R = Read only; W1toCl = Write 1 to clear bit; -n = value after reset

Table 25-12. GPIO_IRQSTATUS_1 Register Field Descriptions

Bit	Field	Type	Reset	Description
31-0	INTLINE[n]	R/W1C	0h	Interrupt n status. 0h (W) = No effect. 0h (R) = IRQ is not triggered. 1h (W) = Clears the IRQ. 1h (R) = IRQ is triggered.

25.4.1.8 GPIO_IRQSTATUS_SET_0 Register (offset = 34h) [reset = 0h]

GPIO_IRQSTATUS_SET_0 is shown in [Figure 25-14](#) and described in [Table 25-13](#).

All 1-bit fields in the GPIO_IRQSTATUS_SET_0 register enable a specific interrupt event to trigger an interrupt request. Writing a 1 to a bit enables the interrupt field. Writing a 0 has no effect, that is, the register value is not modified.

Figure 25-14. GPIO_IRQSTATUS_SET_0 Register

31	30	29	28	27	26	25	24	23	22	21	20	19	18	17	16	15	14	13	12	11	10	9	8	7	6	5	4	3	2	1	0
INTLINE[n]																															
R/W-0h																															

LEGEND: R/W = Read/Write; R = Read only; W1toCl = Write 1 to clear bit; -n = value after reset

Table 25-13. GPIO_IRQSTATUS_SET_0 Register Field Descriptions

Bit	Field	Type	Reset	Description
31-0	INTLINE[n]	R/W	0h	Interrupt n enable 0h = No effect. 1h = Enable IRQ generation.

25.4.1.9 GPIO_IRQSTATUS_SET_1 Register (offset = 38h) [reset = 0h]

GPIO_IRQSTATUS_SET_1 is shown in [Figure 25-15](#) and described in [Table 25-14](#).

All 1-bit fields in the GPIO_IRQSTATUS_SET_1 register enable a specific interrupt event to trigger an interrupt request. Writing a 1 to a bit enables the interrupt field. Writing a 0 has no effect, that is, the register value is not modified.

Figure 25-15. GPIO_IRQSTATUS_SET_1 Register

31	30	29	28	27	26	25	24	23	22	21	20	19	18	17	16	15	14	13	12	11	10	9	8	7	6	5	4	3	2	1	0
INTLINE[n]																															
R/W-0h																															

LEGEND: R/W = Read/Write; R = Read only; W1toCl = Write 1 to clear bit; -n = value after reset

Table 25-14. GPIO_IRQSTATUS_SET_1 Register Field Descriptions

Bit	Field	Type	Reset	Description
31-0	INTLINE[n]	R/W	0h	Interrupt n enable 0h = No effect. 1h = Enable IRQ generation.

25.4.1.10 GPIO_IRQSTATUS_CLR_0 Register (offset = 3Ch) [reset = 0h]

GPIO_IRQSTATUS_CLR_0 is shown in [Figure 25-16](#) and described in [Table 25-15](#).

All 1-bit fields in the GPIO_IRQSTATUS_CLR_0 register clear a specific interrupt event. Writing a 1 to a bit disables the interrupt field. Writing a 0 has no effect, that is, the register value is not modified.

Figure 25-16. GPIO_IRQSTATUS_CLR_0 Register

31	30	29	28	27	26	25	24	23	22	21	20	19	18	17	16	15	14	13	12	11	10	9	8	7	6	5	4	3	2	1	0
INTLINE[n]																															
R/W-0h																															

LEGEND: R/W = Read/Write; R = Read only; W1toCl = Write 1 to clear bit; -n = value after reset

Table 25-15. GPIO_IRQSTATUS_CLR_0 Register Field Descriptions

Bit	Field	Type	Reset	Description
31-0	INTLINE[n]	R/W	0h	Interrupt n enable 0h = No effect. 1h = Disable IRQ generation.

25.4.1.11 GPIO_IRQSTATUS_CLR_1 Register (offset = 40h) [reset = 0h]

GPIO_IRQSTATUS_CLR_1 is shown in [Figure 25-17](#) and described in [Table 25-16](#).

All 1-bit fields in the GPIO_IRQSTATUS_CLR_1 register clear a specific interrupt event. Writing a 1 to a bit disables the interrupt field. Writing a 0 has no effect, that is, the register value is not modified.

Figure 25-17. GPIO_IRQSTATUS_CLR_1 Register

31	30	29	28	27	26	25	24	23	22	21	20	19	18	17	16	15	14	13	12	11	10	9	8	7	6	5	4	3	2	1	0
INTLINE[n]																															
R/W-0h																															

LEGEND: R/W = Read/Write; R = Read only; W1toCl = Write 1 to clear bit; -n = value after reset

Table 25-16. GPIO_IRQSTATUS_CLR_1 Register Field Descriptions

Bit	Field	Type	Reset	Description
31-0	INTLINE[n]	R/W	0h	Interrupt n enable 0h = No effect. 1h = Disable IRQ generation.

25.4.1.12 GPIO_IRQWAKEN_0 Register (offset = 44h) [reset = 0h]

GPIO_IRQWAKEN_0 is shown in [Figure 25-18](#) and described in [Table 25-17](#).

Per-event wakeup enable vector (corresponding to first line of interrupt). Every 1-bit field in the GPIO_IRQWAKEN_0 register enables a specific (synchronous) IRQ request source to generate an asynchronous wakeup (on the appropriate wakeup line). This register allows the user to mask the expected transition on input GPIO from generating a wakeup request. The GPIO_IRQWAKEN_0 is programmed synchronously with the interface clock before any Idle mode request coming from the host processor. Note: In Force-Idle mode, the module wake-up feature is totally inhibited. The wake-up generation can also be gated at module level using the EnaWakeUp bit from GPIO_SYSCONFIG register.

Figure 25-18. GPIO_IRQWAKEN_0 Register

31	30	29	28	27	26	25	24	23	22	21	20	19	18	17	16	15	14	13	12	11	10	9	8	7	6	5	4	3	2	1	0
INTLINE																															
R/W-0h																															

LEGEND: R/W = Read/Write; R = Read only; W1toCl = Write 1 to clear bit; -n = value after reset

Table 25-17. GPIO_IRQWAKEN_0 Register Field Descriptions

Bit	Field	Type	Reset	Description
31-0	INTLINE	R/W	0h	Wakeup Enable for Interrupt Line 0h = Disable wakeup generation. 1h = Enable wakeup generation.

25.4.1.13 GPIO_IRQWAKEN_1 Register (offset = 48h) [reset = 0h]

GPIO_IRQWAKEN_1 is shown in [Figure 25-19](#) and described in [Table 25-18](#).

Per-event wakeup enable vector (corresponding to second line of interrupt). Every 1-bit field in the GPIO_IRQWAKEN_1 register enables a specific (synchronous) IRQ request source to generate an asynchronous wakeup (on the appropriate wakeup line). This register allows the user to mask the expected transition on input GPIO from generating a wakeup request. The GPIO_IRQWAKEN_1 is programmed synchronously with the interface clock before any Idle mode request coming from the host processor. Note: In Force-Idle mode, the module wake-up feature is totally inhibited. The wake-up generation can also be gated at module level using the EnaWakeUp bit from GPIO_SYSCONFIG register.

Figure 25-19. GPIO_IRQWAKEN_1 Register

31	30	29	28	27	26	25	24	23	22	21	20	19	18	17	16	15	14	13	12	11	10	9	8	7	6	5	4	3	2	1	0
INTLINE																															
R/W-0h																															

LEGEND: R/W = Read/Write; R = Read only; W1toCl = Write 1 to clear bit; -n = value after reset

Table 25-18. GPIO_IRQWAKEN_1 Register Field Descriptions

Bit	Field	Type	Reset	Description
31-0	INTLINE	R/W	0h	Wakeup Enable for Interrupt Line 0h = Disable wakeup generation. 1h = Enable wakeup generation.

25.4.1.14 GPIO_SYSSTATUS Register (offset = 114h) [reset = 0h]

GPIO_SYSSTATUS is shown in [Figure 25-20](#) and described in [Table 25-19](#).

The GPIO_SYSSTATUS register provides the reset status information about the GPIO module. It is a read-only register; a write to this register has no effect.

Figure 25-20. GPIO_SYSSTATUS Register

31	30	29	28	27	26	25	24
RESERVED							
R-0h							
23	22	21	20	19	18	17	16
RESERVED							
R-0h							
15	14	13	12	11	10	9	8
RESERVED							
R-0h							
7	6	5	4	3	2	1	0
RESERVED							RESETDONE
R-0h							R-0h

LEGEND: R/W = Read/Write; R = Read only; W1toCl = Write 1 to clear bit; -n = value after reset

Table 25-19. GPIO_SYSSTATUS Register Field Descriptions

Bit	Field	Type	Reset	Description
31-1	RESERVED	R	0h	
0	RESETDONE	R	0h	Reset status information. 0h = Internal Reset is on-going. 1h = Reset completed.

25.4.1.15 GPIO_CTRL Register (offset = 130h) [reset = 0h]

GPIO_CTRL is shown in [Figure 25-21](#) and described in [Table 25-20](#).

The GPIO_CTRL register controls the clock gating functionality. The DISABLEMODULE bit controls a clock gating feature at the module level. When set, this bit forces the clock gating for all internal clock paths. Module internal activity is suspended. System interface is not affected by this bit. System interface clock gating is controlled with the AUTOIDLE bit in the system configuration register (GPIO_SYSCONFIG). This bit is to be used for power saving when the module is not used because of the multiplexing configuration selected at the chip level. This bit has precedence over all other internal configuration bits.

Figure 25-21. GPIO_CTRL Register

31	30	29	28	27	26	25	24
RESERVED							
R-0h							
23	22	21	20	19	18	17	16
RESERVED							
R-0h							
15	14	13	12	11	10	9	8
RESERVED							
R-0h							
7	6	5	4	3	2	1	0
RESERVED					GATINGRATIO		DISABLEMODULE
R-0h					R/W-0h		R/W-0h

LEGEND: R/W = Read/Write; R = Read only; W1toCl = Write 1 to clear bit; -n = value after reset

Table 25-20. GPIO_CTRL Register Field Descriptions

Bit	Field	Type	Reset	Description
31-3	RESERVED	R	0h	
2-1	GATINGRATIO	R/W	0h	Gating Ratio. Controls the clock gating for the event detection logic. 0h = Functional clock is interface clock. 1h = Functional clock is interface clock divided by 2. 2h = Functional clock is interface clock divided by 4. 3h = Functional clock is interface clock divided by 8.
0	DISABLEMODULE	R/W	0h	Module Disable 0h = Module is enabled, clocks are not gated. 1h = Module is disabled, clocks are gated.

25.4.1.16 GPIO_OE Register (offset = 134h) [reset = FFFFFFFFh]

GPIO_OE is shown in [Figure 25-22](#) and described in [Table 25-21](#).

The GPIO_OE register is used to enable the pins output capabilities. At reset, all the GPIO related pins are configured as input and output capabilities are disabled. This register is not used within the module, its only function is to carry the pads configuration. When the application is using a pin as an output and does not want interrupt generation from this pin, the application can/has to properly configure the Interrupt Enable registers.

Figure 25-22. GPIO_OE Register

31	30	29	28	27	26	25	24	23	22	21	20	19	18	17	16	15	14	13	12	11	10	9	8	7	6	5	4	3	2	1	0
OUTPUTEN[n]																															
R/W-FFFFFFFh																															

LEGEND: R/W = Read/Write; R = Read only; W1toCl = Write 1 to clear bit; -n = value after reset

Table 25-21. GPIO_OE Register Field Descriptions

Bit	Field	Type	Reset	Description
31-0	OUTPUTEN[n]	R/W	FFFFFFFh	Output Data Enable 0h = The corresponding GPIO port is configured as an output. 1h = The corresponding GPIO port is configured as an input.

25.4.1.17 GPIO_DATAIN Register (offset = 138h) [reset = 0h]

GPIO_DATAIN is shown in [Figure 25-23](#) and described in [Table 25-22](#).

The GPIO_DATAIN register is used to register the data that is read from the GPIO pins. The GPIO_DATAIN register is a read-only register. The input data is sampled synchronously with the interface clock and then captured in the GPIO_DATAIN register synchronously with the interface clock. So, after changing, GPIO pin levels are captured into this register after two interface clock cycles (the required cycles to synchronize and to write the data). When the AUTOIDLE bit in the system configuration register (GPIO_SYSCONFIG) is set, the GPIO_DATAIN read command has a 3 OCP cycle latency due to the data in sample gating mechanism. When the AUTOIDLE bit is not set, the GPIO_DATAIN read command has a 2 OCP cycle latency.

Figure 25-23. GPIO_DATAIN Register

31	30	29	28	27	26	25	24	23	22	21	20	19	18	17	16	15	14	13	12	11	10	9	8	7	6	5	4	3	2	1	0
DATAIN																															
R-0h																															

LEGEND: R/W = Read/Write; R = Read only; W1toCl = Write 1 to clear bit; -n = value after reset

Table 25-22. GPIO_DATAIN Register Field Descriptions

Bit	Field	Type	Reset	Description
31-0	DATAIN	R	0h	Sampled Input Data

25.4.1.18 GPIO_DATAOUT Register (offset = 13Ch) [reset = 0h]

GPIO_DATAOUT is shown in [Figure 25-24](#) and described in [Table 25-23](#).

The GPIO_DATAOUT register is used for setting the value of the GPIO output pins. Data is written to the GPIO_DATAOUT register synchronously with the interface clock. This register can be accessed with direct read/write operations or using the alternate Set/Clear feature. This feature enables to set or clear specific bits of this register with a single write access to the set data output register (GPIO_SETDATAOUT) or to the clear data output register (GPIO_CLEARDATAOUT) address.

Figure 25-24. GPIO_DATAOUT Register

31	30	29	28	27	26	25	24	23	22	21	20	19	18	17	16	15	14	13	12	11	10	9	8	7	6	5	4	3	2	1	0
DATAOUT																															
R/W-0h																															

LEGEND: R/W = Read/Write; R = Read only; W1toCl = Write 1 to clear bit; -n = value after reset

Table 25-23. GPIO_DATAOUT Register Field Descriptions

Bit	Field	Type	Reset	Description
31-0	DATAOUT	R/W	0h	Data to set on output pins

25.4.1.19 GPIO_LEVELDETECT0 Register (offset = 140h) [reset = 0h]

GPIO_LEVELDETECT0 is shown in [Figure 25-25](#) and described in [Table 25-24](#).

The GPIO_LEVELDETECT0 register is used to enable/disable for each input lines the low-level (0) detection to be used for the interrupt request generation. Enabling at the same time high-level detection and low-level detection for one given pin makes a constant interrupt generator.

Figure 25-25. GPIO_LEVELDETECT0 Register

31	30	29	28	27	26	25	24	23	22	21	20	19	18	17	16	15	14	13	12	11	10	9	8	7	6	5	4	3	2	1	0
LEVELDETECT0[n]																															
R/W-0h																															

LEGEND: R/W = Read/Write; R = Read only; W1toCl = Write 1 to clear bit; -n = value after reset

Table 25-24. GPIO_LEVELDETECT0 Register Field Descriptions

Bit	Field	Type	Reset	Description
31-0	LEVELDETECT0[n]	R/W	0h	Low Level Interrupt Enable 0h = Disable the IRQ assertion on low-level detect. 1h = Enable the IRQ assertion on low-level detect.

25.4.1.20 GPIO_LEVELDETECT1 Register (offset = 144h) [reset = 0h]

GPIO_LEVELDETECT1 is shown in [Figure 25-26](#) and described in [Table 25-25](#).

The GPIO_LEVELDETECT1 register is used to enable/disable for each input lines the high-level (1) detection to be used for the interrupt request generation. Enabling at the same time high-level detection and low-level detection for one given pin makes a constant interrupt generator.

Figure 25-26. GPIO_LEVELDETECT1 Register

31	30	29	28	27	26	25	24	23	22	21	20	19	18	17	16	15	14	13	12	11	10	9	8	7	6	5	4	3	2	1	0
LEVELDETECT1[n]																															
R/W-0h																															

LEGEND: R/W = Read/Write; R = Read only; W1toCl = Write 1 to clear bit; -n = value after reset

Table 25-25. GPIO_LEVELDETECT1 Register Field Descriptions

Bit	Field	Type	Reset	Description
31-0	LEVELDETECT1[n]	R/W	0h	High Level Interrupt Enable 0h = Disable the IRQ assertion on high-level detect. 1h = Enable the IRQ assertion on high-level detect.

25.4.1.21 GPIO_RISINGDETECT Register (offset = 148h) [reset = 0h]

GPIO_RISINGDETECT is shown in [Figure 25-27](#) and described in [Table 25-26](#).

The GPIO_RISINGDETECT register is used to enable/disable for each input lines the rising-edge (transition 0 to 1) detection to be used for the interrupt request generation.

Figure 25-27. GPIO_RISINGDETECT Register

31	30	29	28	27	26	25	24	23	22	21	20	19	18	17	16	15	14	13	12	11	10	9	8	7	6	5	4	3	2	1	0
RISINGDETECT[n]																															
R/W-0h																															

LEGEND: R/W = Read/Write; R = Read only; W1toCl = Write 1 to clear bit; -n = value after reset

Table 25-26. GPIO_RISINGDETECT Register Field Descriptions

Bit	Field	Type	Reset	Description
31-0	RISINGDETECT[n]	R/W	0h	Rising Edge Interrupt Enable 0h = Disable IRQ on rising-edge detect. 1h = Enable IRQ on rising-edge detect.

25.4.1.22 GPIO_FALLINGDETECT Register (offset = 14Ch) [reset = 0h]

GPIO_FALLINGDETECT is shown in [Figure 25-28](#) and described in [Table 25-27](#).

The GPIO_FALLINGDETECT register is used to enable/disable for each input lines the falling-edge (transition 1 to 0) detection to be used for the interrupt request generation.

Figure 25-28. GPIO_FALLINGDETECT Register

31	30	29	28	27	26	25	24	23	22	21	20	19	18	17	16	15	14	13	12	11	10	9	8	7	6	5	4	3	2	1	0
FALLINGDETECT[n]																															
R/W-0h																															

LEGEND: R/W = Read/Write; R = Read only; W1toCl = Write 1 to clear bit; -n = value after reset

Table 25-27. GPIO_FALLINGDETECT Register Field Descriptions

Bit	Field	Type	Reset	Description
31-0	FALLINGDETECT[n]	R/W	0h	Falling Edge Interrupt Enable 0h = Disable IRQ on falling-edge detect. 1h = Enable IRQ on falling-edge detect.

25.4.1.23 GPIO_DEBOUNCENABLE Register (offset = 150h) [reset = 0h]

GPIO_DEBOUNCENABLE is shown in [Figure 25-29](#) and described in [Table 25-28](#).

The GPIO_DEBOUNCENABLE register is used to enable/disable the debouncing feature for each input line.

Figure 25-29. GPIO_DEBOUNCENABLE Register

31	30	29	28	27	26	25	24	23	22	21	20	19	18	17	16	15	14	13	12	11	10	9	8	7	6	5	4	3	2	1	0
DEBOUNCEENABLE[n]																															
R/W-0h																															

LEGEND: R/W = Read/Write; R = Read only; W1toCl = Write 1 to clear bit; -n = value after reset

Table 25-28. GPIO_DEBOUNCENABLE Register Field Descriptions

Bit	Field	Type	Reset	Description
31-0	DEBOUNCEENABLE[n]	R/W	0h	Input Debounce Enable 0h = Disable debouncing feature on the corresponding input port. 1h = Enable debouncing feature on the corresponding input port.

25.4.1.24 GPIO_DEBOUNCINGTIME Register (offset = 154h) [reset = 0h]

GPIO_DEBOUNCINGTIME is shown in [Figure 25-30](#) and described in [Table 25-29](#).

The GPIO_DEBOUNCINGTIME register controls debouncing time (the value is global for all ports). The debouncing cell is running with the debouncing clock (32 kHz), this register represents the number of the clock cycle(s) (31 s long) to be used.

Figure 25-30. GPIO_DEBOUNCINGTIME Register

31	30	29	28	27	26	25	24	23	22	21	20	19	18	17	16
RESERVED															
R/W-0h															
15	14	13	12	11	10	9	8	7	6	5	4	3	2	1	0
RESERVED								DEBOUNCETIME							
R/W-0h								R/W-0h							

LEGEND: R/W = Read/Write; R = Read only; W1toCl = Write 1 to clear bit; -n = value after reset

Table 25-29. GPIO_DEBOUNCINGTIME Register Field Descriptions

Bit	Field	Type	Reset	Description
31-8	RESERVED	R/W	0h	
7-0	DEBOUNCETIME	R/W	0h	Input Debouncing Value in 31 microsecond steps. Debouncing Value = (DEBOUNCETIME + 1) * 31 microseconds

25.4.1.25 GPIO_CLEARDATAOUT Register (offset = 190h) [reset = 0h]

GPIO_CLEARDATAOUT is shown in [Figure 25-31](#) and described in [Table 25-30](#).

Writing a 1 to a bit in the GPIO_CLEARDATAOUT register clears to 0 the corresponding bit in the GPIO_DATAOUT register; writing a 0 has no effect. A read of the GPIO_CLEARDATAOUT register returns the value of the data output register (GPIO_DATAOUT).

Figure 25-31. GPIO_CLEARDATAOUT Register

31	30	29	28	27	26	25	24	23	22	21	20	19	18	17	16	15	14	13	12	11	10	9	8	7	6	5	4	3	2	1	0
INTLINE[n]																															
R/W-0h																															

LEGEND: R/W = Read/Write; R = Read only; W1toCl = Write 1 to clear bit; -n = value after reset

Table 25-30. GPIO_CLEARDATAOUT Register Field Descriptions

Bit	Field	Type	Reset	Description
31-0	INTLINE[n]	R/W	0h	Clear Data Output Register 0h = No effect 1h = Clear the corresponding bit in the GPIO_DATAOUT register.

25.4.1.26 GPIO_SETDATAOUT Register (offset = 194h) [reset = 0h]

GPIO_SETDATAOUT is shown in [Figure 25-32](#) and described in [Table 25-31](#).

Writing a 1 to a bit in the GPIO_SETDATAOUT register sets to 1 the corresponding bit in the GPIO_DATAOUT register; writing a 0 has no effect. A read of the GPIO_SETDATAOUT register returns the value of the data output register (GPIO_DATAOUT).

Figure 25-32. GPIO_SETDATAOUT Register

31	30	29	28	27	26	25	24	23	22	21	20	19	18	17	16	15	14	13	12	11	10	9	8	7	6	5	4	3	2	1	0
INTLINE[n]																															
R/W-0h																															

LEGEND: R/W = Read/Write; R = Read only; W1toCl = Write 1 to clear bit; -n = value after reset

Table 25-31. GPIO_SETDATAOUT Register Field Descriptions

Bit	Field	Type	Reset	Description
31-0	INTLINE[n]	R/W	0h	Set Data Output Register 0h = No effect 1h = Set the corresponding bit in the GPIO_DATAOUT register.

Initialization

This chapter describes the initialization of the device.

Topic	Page
26.1 Functional Description	4905

26.1 Functional Description

This chapter describes the booting functionality of the device, referred hereafter as ROM Code. The booting functionality covers the following features:

Memory Booting: Booting the device by starting code stored on permanent memories like flash-memory or memory cards. This process is usually performed after either device cold or warm reset.

Peripheral Booting: Booting the device by downloading the executable code over a communication interface like UART, USB or Ethernet. This process is intended for flashing a device.

The device always starts up in secure mode. The ROM Code takes care of early initialization. The ROM code switches the device into public mode. Hence the Public ROM Code provides run-time services for cache maintenance.

26.1.1 Architecture

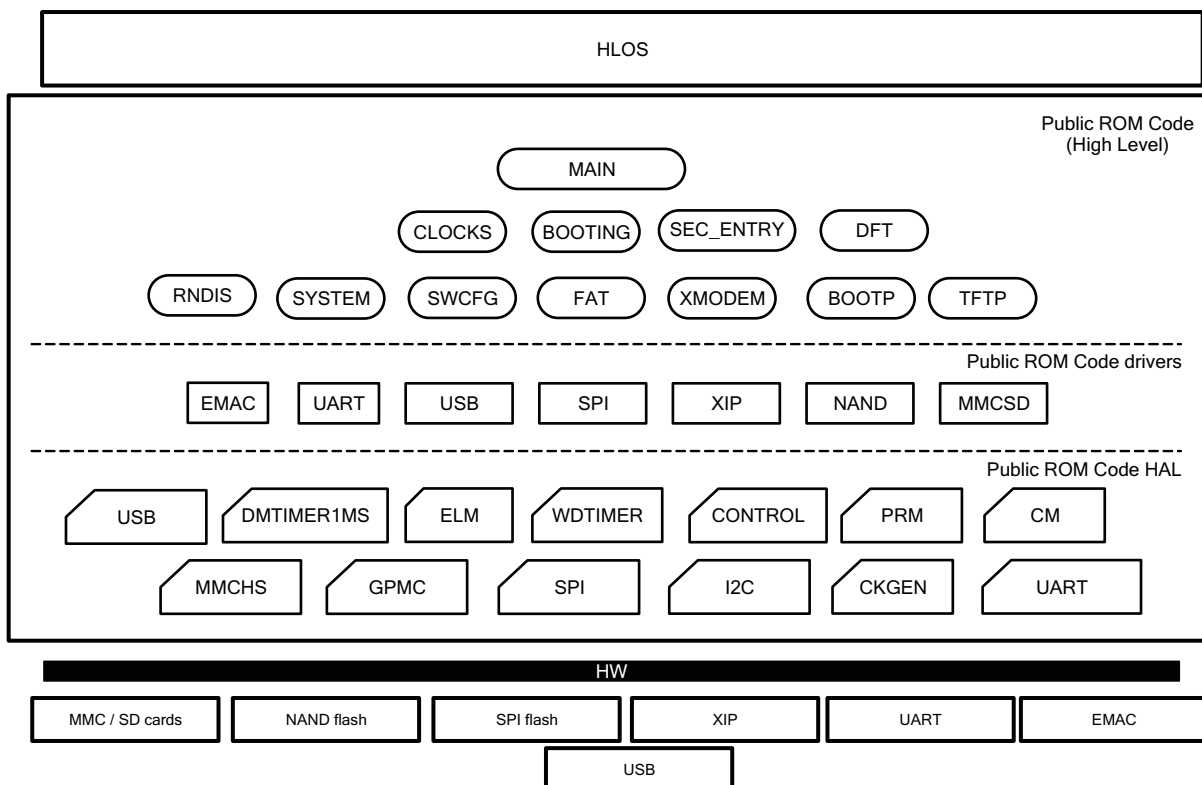
The architecture of the Public ROM Code is shown in [Figure 26-1](#). It is split into three main layers with a top-down approach: high-level, drivers, and hardware abstraction layer (HAL). One layer communicates with a lower level layer through a unified interface.

The high level layer is in charge of the main tasks of the Public ROM Code: watchdog and clocks configuration and main booting routine.

The drivers layer implements the logical and communication protocols for any booting device in accordance with the interface specification.

Finally the HAL implements the lowest level code for interacting with the hardware infrastructure IPs. End booting devices are attached to device IO pads.

Figure 26-1. Public ROM Code Architecture



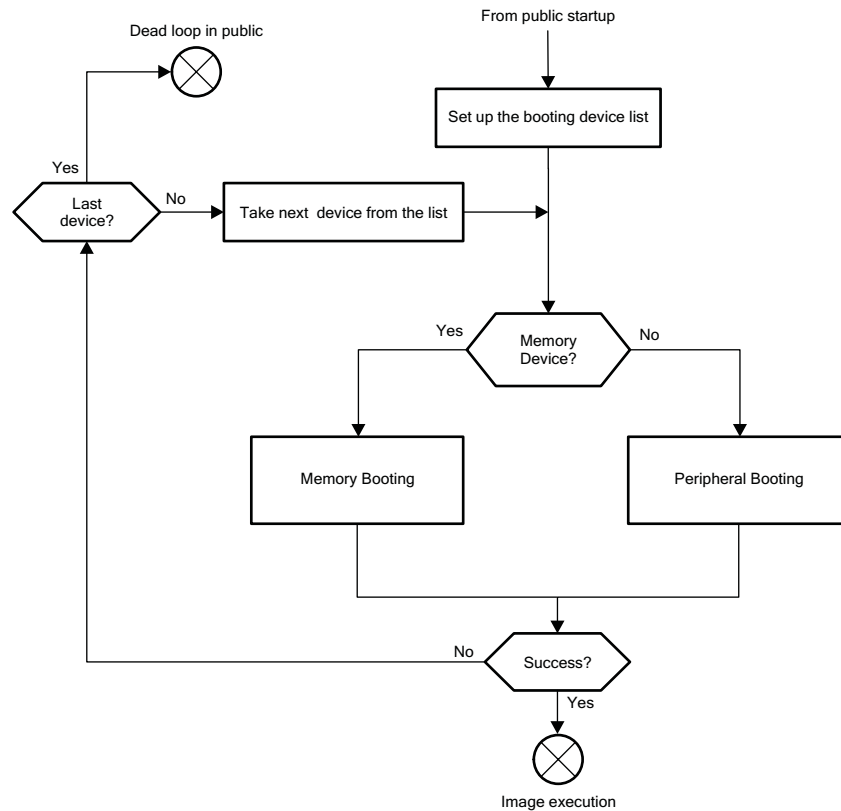
26.1.2 Functionality

[Figure 26-2](#) illustrates the high level flow for the Public ROM Code booting procedure. The ROM Code performs platform configuration and initialization as part of the public start-up procedure.

The booting device list is created based on the **SYSBOOT** pins. A booting device can be a **memory booting device** (soldered flash memory or temporarily booting device like memory card) or a **peripheral interface** connected to a host.

The main loop of the booting procedure goes through the booting device list and tries to search for an image from the currently selected booting device. This loop is exited if a valid booting image is found and successfully executed or upon watchdog expiration.

Figure 26-2. Public ROM Code Boot Procedure



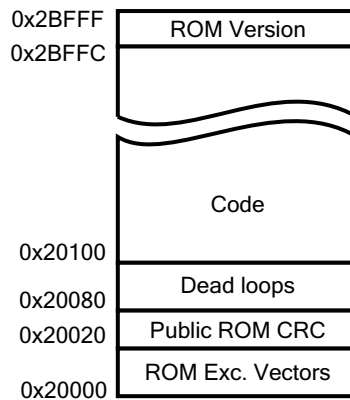
26.1.3 Memory Map

26.1.3.1 Public ROM Memory Map

The on-chip ROM memory map is shown in [Figure 26-3](#). The Public ROM Code mapping consists in the following:

- Exception vectors
- CRC
- Dead loops collection
- Code and const data sections
- ROM Version

Figure 26-3. ROM Memory Map



Public ROM Exception Vectors

[Table 26-1](#) lists the Public ROM exception vectors. The reset exception is redirected to the Public ROM Code startup. Other exceptions are redirected to their RAM handlers by loading appropriate addresses into the PC register.

Table 26-1. ROM Exception Vectors

Address	Exception	Content
20000h	Reset	Branch to the Public ROM Code startup
20004h	Undefined	PC = 4030CE04h
20008h	SWI	PC = 4030CE08h
2000Ch	Pre-fetch abort	PC = 4030CE0Ch
20010h	Data abort	PC = 4030CE10h
20014h	Unused	PC = 4030CE14h
20018h	IRQ	PC = 4030CE18h
2001Ch	FIQ	PC = 4030CE1Ch

Public ROM Code CRC

The Public ROM Code CRC is calculated as 32 bit CRC code (CRC-32-IEEE 802.3) for the address range 20000h–2BFFFh. The four bytes CRC code is stored at location 20020h.

Dead Loops

Built-in dead loops are used for different purposes as shown in below [Table 26-2](#). All dead loops are branch instructions coded in ARM mode. The fixed location of these dead loops facilitates debugging and testing. The first seven dead loops are default exception handlers linked with RAM exception vectors. The dead loops might be called directly from the user code. However there exists a special function which can be called from ROM Code in order to execute a dead loop. The function is an assembly code in ARM mode which takes the dead loop address from R0 register. The main purpose of the function is to go in a dead loop until the watchdog expires and resets the device. The function is located at address 200C0h. In addition the function clears global cold reset status upon issuing the global SW reset.

Table 26-2. Dead Loops

Address	Purpose
20080h	Undefined exception default handler
20084h	SWI exception default handler
20088h	Pre-fetch abort exception default handler
2008Ch	Data abort exception default handler
20090h	Unused exception default handler
20094h	IRQ exception default handler
20098h	FIQ exception default handler
2009Ch	Validation tests PASS
200A0h	Validation tests FAIL
200A4h	Reserved
200A8h	Image not executed or returned.
200ACh	Reserved
200B0h	Reserved
200B4h	Reserved
200B8h	Reserved
200BCh	Reserved

Code

This space is used to hold code and constant data.

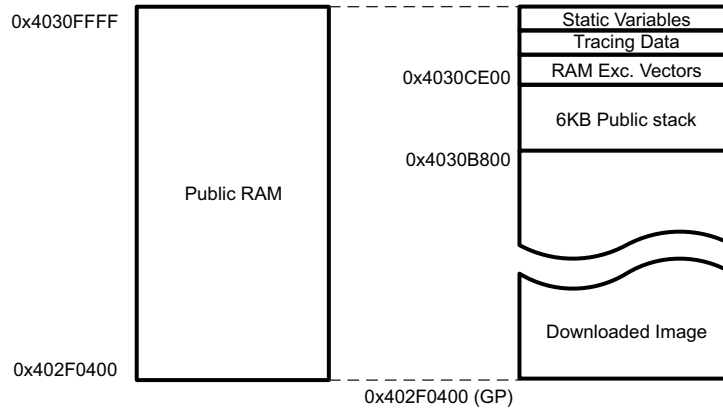
Public ROM Code Version

The ROM Code version consists of two decimal numbers: major and minor. It can be used to identify the ROM Code release version in a given IC (e.g., useful to identify an IC version). The ROM Code version is a 32bits hexadecimal value located at address 2BFFCh.

26.1.3.2 Public RAM Memory Map

The Public ROM Code makes use of the on chip RAM module connected to the L3 interconnect (further referred to as **L3 RAM**). Its usage is shown in [Figure 26-4](#). The Public RAM memory map ranges from address 402F0400h to 4030FFFFh on a **GP Device**.

Figure 26-4. Public RAM Memory Map



Download Image

This area is used by the Public ROM Code to store the downloaded boot image. It can be up to 109KB.

Public Stack

Space reserved for stack.

RAM Exception Vectors

The RAM exception vectors enable a simple means for redirecting exceptions to custom handlers. [Table 26-3](#) shows content of the RAM space reserved for RAM vectors. The first seven addresses are ARM instructions which load the value located in the subsequent seven addresses into the PC register. These instructions are executed when an exception occurs since they are called from the ROM exception vectors. Undefined, SWI, Unused and FIQ exceptions are redirected to a hardcoded dead loop. Pre-fetch abort, data abort, and IRQ exception are redirected to pre-defined ROM handlers. User code can redirect any exception to a custom handler either by writing its address to the appropriate location from 4030CE24h to 4030CE3Ch or by overriding the branch (load into PC) instruction between addresses from 4030CE04h to 4030CE1Ch.

Table 26-3. RAM Exception Vectors

Address	Exception	Content
4030CE00h	Reserved	Reserved
4030CE04h	Undefined	PC = [4030CE24h]
4030CE08h	SWI	PC = [4030CE28h]
4030CE0Ch	Pre-fetch abort	PC = [4030CE2Ch]
4030CE10h	Data abort	PC = [4030CE30h]
4030CE14h	Unused	PC = [4030CE34h]
4030CE18h	IRQ	PC = [4030CE38h]
4030CE1Ch	FIQ	PC = [4030CE3Ch]
4030CE20h	Reserved	20090h
4030CE24h	Undefined	20080h
4030CE28h	SWI	20084h

Table 26-3. RAM Exception Vectors (continued)

Address	Exception	Content
4030CE2Ch	Pre-fetch abort	Address of default pre-fetch abort handler ⁽¹⁾
4030CE30h	Data abort	Address of default data abort handler ⁽¹⁾
4030CE34h	Unused	20090h
4030CE38h	IRQ	Address of default IRQ handler
4030CE3Ch	FIQ	20098h

⁽¹⁾ The default handlers for pre-fetch and data abort are performing reads from CP15 debug registers to retrieve the reason of the abort:

- In case of pre-fetch abort: the IFAR register is read from CP15 and stored into R0. The IFSR register is read and stored into the R1 register. Then the ROM Code jumps to the pre-fetch abort dead loop (20088h).
- In case of data abort: the DFAR register is read from CP15 and stored into R0. The DFSR register is read and stored into the R1 register. Then the ROM Code jumps to the data abort dead loop (2008Ch).

Tracing Data

This area contains trace vectors reflecting the execution path of the public boot. [Section 26.1.12](#) describes the usage of the different trace vectors and lists all the possible trace codes.

Table 26-4. Tracing Data

Address	Size[bytes]	Description
4030CE40h	4	Current tracing vector, word 1
4030CE44h	4	Current tracing vector, word 2
4030CE48h	4	Current tracing vector, word 3
4030CE4Ch	4	Current copy of the PRM_RSTST register (reset reasons)
4030CE50h	4	Cold reset run tracing vector, word 1
4030CE54h	4	Cold reset run tracing vector, word 2
4030CE58h	4	Cold reset run tracing vector, word 3
4030CE5Ch	4	Reserved
4030CE60h	4	Reserved
4030CE64h	4	Reserved

Static Variables

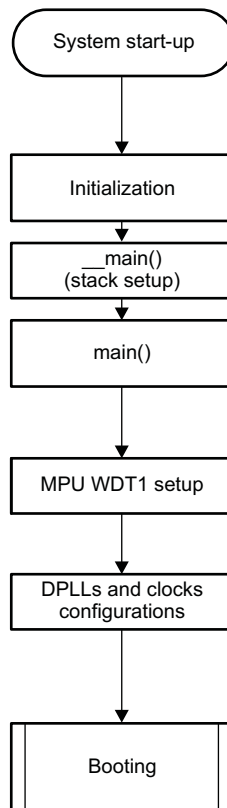
This area contains the ROM Code static variables used during boot time.

26.1.4 Start-up and Configuration

26.1.4.1 ROM Code Start-up

The Public ROM Code is physically located at the address 20000h.

Figure 26-5. ROM Code Startup Sequence



Upon system startup, the CPU performs the public-side initialization and stack setup (compiler auto generated C- initialization or “scatter loading”). Then it configures the watchdog timer 1 (set to three minutes), performs system clocks configuration. Finally it jumps to the booting routine.

26.1.4.2 CPU State at Public Startup

The CPU **L1 instruction cache** and **branch prediction** mechanisms are not activated as part of the public boot process. The public vector base address is configured to the reset vector of Public ROM Code (20000h). MMU is left switched off during the public boot (hence L1 data cache off).

26.1.4.3 Clocking Configuration

The device supports the following frequencies based on SYSBOOT[15:14]

Table 26-5. Crystal Frequencies Supported

SYSBOOT[15:14]	Crystal Frequency
00b	19.2 MHz
01b	24 MHz
10b	25 MHz
11b	26 MHz

The ROM Code configures the clocks and DPLLs which are necessary for ROM Code execution:

- L3 ADPLLs locked to provide 200MHz clocks for peripheral blocks.
- DDR DPLL locked to provide 400MHz.
- MPU ADPLLs is locked to provide 500 MHz for the A8.
- PER ADPLLJ is locked to provide 960MHz and 192MHz for peripheral blocks.

Table 26-6 summarizes the ROM Code default settings for clocks. This default configuration enables all the ROM Code functionalities with minimized needs on power during boot.

Table 26-6. ROM Code Default Clock Settings

Clock	Frequency [MHz]	Source
L3F_CLK	200	CORE_CLKOUTM4
SPI_CLK	48	PER_CLKOUTM2
MMC_CLK	96	PER_CLKOUTM2
UART_CLK	48	PER_CLKOUTM2
I2C_CLK	48	PER_CLKOUTM2
MPU_CLK	500	MPU_PLL
USB_PHY_CLK	960 MHz	PER_CLKDCOLDO

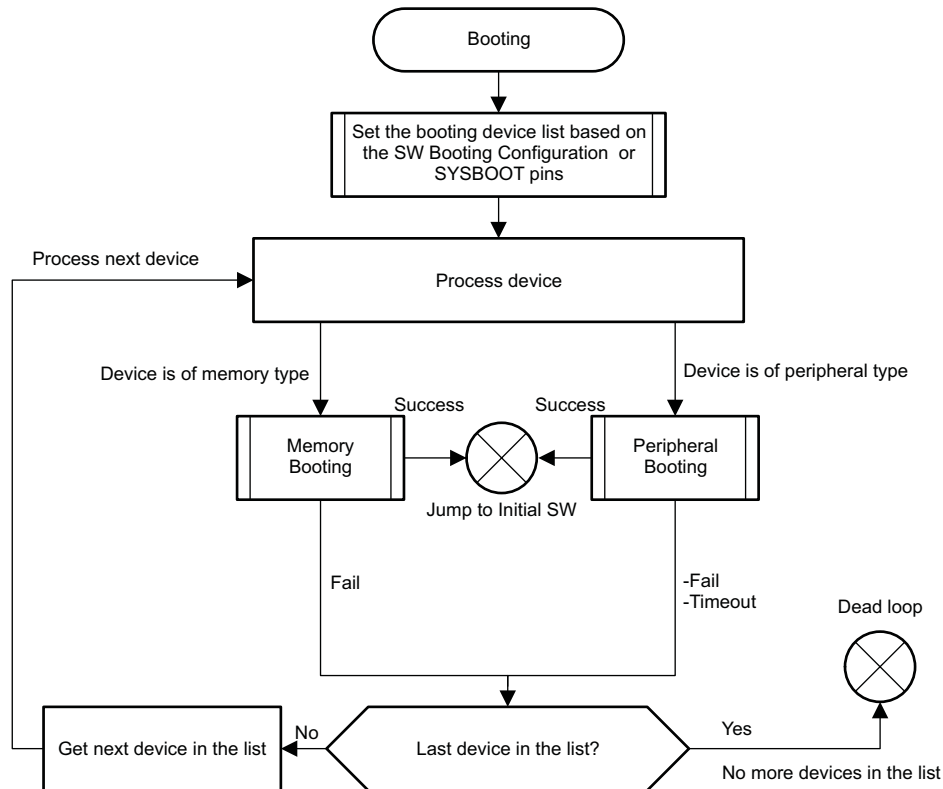
The DPLLs and PRCM clock dividers are configured with the ROM Code default values after cold or warm reset in order to give the same working conditions to the Public ROM Code sequence.

26.1.5 Booting

26.1.5.1 Overview

Figure 26-6 shows the booting procedure. First a **booting device list** is created. The list consists of all devices which will be searched for a booting image. The list is filled in based on the **SYSBOOT**.

Figure 26-6. ROM Code Booting Procedure



Once the booting device list is set up, the booting routine examines the devices enumerated in the list sequentially and either executes the memory booting or peripheral booting procedure depending on the booting device type. The memory booting procedure is executed when the booting device type is one of NOR, NAND, MMC or SPI-EEPROM. The peripheral booting is executed when the booting device type is Ethernet, USB or UART.

The memory booting procedure reads data from a memory type device. If a valid booting image is found and successfully read from the external memory device, the code begins to execute.

The peripheral booting procedure downloads data from a host (commonly a PC) to the device device by means of Ethernet, USB or UART links. The ROM Code uses a host-slave logical protocol for synchronization. Upon successful UART, USB or Ethernet connection the host sends the image binary contents. The peripheral booting procedure is described in detail in [Section 26.1.8](#).

If the memory or peripheral booting fails for all devices enumerated in the device list then the ROM Code gets into a loop, waiting for the watchdog to reset the system.

26.1.5.2 Device List

The ROM Code creates the **device list** based on information gathered from the **SYSBOOT configuration pins** sensed in the control module. The pins are used to index the device table from which the list of devices is extracted

26.1.5.2.1 SYSBOOT Configuration Pins

[Table 26-7](#) contains the SYSBOOT configuration pins.

Table 26-7. SYSBOOT Configuration Pins^[4]

SYSBOOT[15:14]	SYSBOOT[13:12]	SYSBOOT[11:10]	SYSBOOT[9]	SYSBOOT[8]	SYSBOOT[7:6]	SYSBOOT[5]	SYSBOOT[4:0]	Boot Sequence					
For all boot modes: Crystal Frequency	For all boot modes: Set to 00b for normal operation	For XIP boot: Muxed or non-muxed device For NAND boot: must be 00b	For NAND and NANDI2C boot: NAND ECC For Fast External Boot: must be 0b	For XIP boot: Bus width	For EMAC boot: PHY mode	For all boot modes: CLKOUT1 output enabled/disabled on XDMA_EVENT_INTR0							
CONTROL_STATUS[23:22]	CONTROL_STATUS[21:20]	CONTROL_STATUS[19:18]	CONTROL_STATUS[17]	CONTROL_STATUS[16]	CONTROL_STATUS[7:6]	CONTROL_STATUS[5]	CONTROL_STATUS[4:0]						
								1st	2nd	3rd	4th		
							00000b	Reserved					
00b = 19.2MHz 01b = 24MHz 10b = 25MHz 11b = 26MHz	00b (all other values reserved)	For XIP boot: 00b = non-muxed device 10b = muxed device x1b = reserved	Don't care for ROM code ^[3]	0 = 8-bit device 1 = 16-bit device	Don't care for ROM code	0 = CLKOUT1 disabled 1 = CLKOUT1 enabled	00001b	UART0	XIP w/ WAIT ^[1] (MUX2) ^[2] ¹	MMC0	SPI0		
00b = 19.2MHz 01b = 24MHz 10b = 25MHz 11b = 26MHz	00b (all other values reserved)	For NAND boot: must be 00b	0 = ECC done by ROM 1 = ECC handled by NAND	Don't care for ROM code	Don't care for ROM code	0 = CLKOUT1 disabled 1 = CLKOUT1 enabled	00010b	UART0	SPI0	NAND	NANDI2C		
00b = 19.2MHz 01b = 24MHz 10b = 25MHz 11b = 26MHz	00b (all other values reserved)	For XIP boot: 00b = non-muxed device 10b = muxed device x1b = reserved	Don't care for ROM code	0 = 8-bit device 1 = 16-bit device	Don't care for ROM code	0 = CLKOUT1 disabled 1 = CLKOUT1 enabled	00011b	UART0	SPI0	XIP (MUX2) ^[2] ¹	MMC0		
00b = 19.2MHz 01b = 24MHz 10b = 25MHz 11b = 26MHz	00b (all other values reserved)	For XIP boot: 00b = non-muxed device 10b = muxed device x1b = reserved For NAND boot: must be 00b	0 = ECC done by ROM 1 = ECC handled by NAND	0 = 8-bit device 1 = 16-bit device	Don't care for ROM code	0 = CLKOUT1 disabled 1 = CLKOUT1 enabled	00100b	UART0	XIP w/ WAIT ^[1] (MUX1)	MMC0	NAND		

Table 26-7. SYSBOOT Configuration Pins^[4] (continued)

SYSBOOT[15:14]	SYSBOOT[13:12]	SYSBOOT[11:10]	SYSBOOT[9]	SYSBOOT[8]	SYSBOOT[7:6]	SYSBOOT[5]	SYSBOOT[4:0]	Boot Sequence			
								UART0	XIP (MUX1) ^[2] 1	SPI0	NANDI2C
00b = 19.2MHz 01b = 24MHz 10b = 25MHz 11b = 26MHz	00b (all other values reserved)	For XIP boot: 00b = non-muxed device 10b = muxed device x1b = reserved For NAND boot: must be 00b	0 = ECC done by ROM 1 = ECC handled by NAND	0 = 8-bit device 1 = 16-bit device	Don't care for ROM code	0 = CLKOUT1 disabled 1 = CLKOUT1 enabled	00101b	UART0	XIP (MUX1) ^[2] 1	SPI0	NANDI2C
00b = 19.2MHz 01b = 24MHz 10b = 25MHz 11b = 26MHz	00b (all other values reserved)	For NAND boot: must be 00b	0 = ECC done by ROM 1 = ECC handled by NAND	Don't care for ROM code	00b = MII 01b = RMII 10b = Reserved 11b = RGMII w/o internal delay	0 = CLKOUT1 disabled 1 = CLKOUT1 enabled	00110b	EMAC1	SPI0	NAND	NANDI2C
00b = 19.2MHz 01b = 24MHz 10b = 25MHz 11b = 26MHz	00b (all other values reserved)	For XIP boot: 00b = non-muxed device 10b = muxed device x1b = reserved For NAND boot: must be 00b	0 = ECC done by ROM 1 = ECC handled by NAND	0 = 8-bit device 1 = 16-bit device	00b = MII 01b = RMII 10b = Reserved 11b = RGMII w/o internal delay	0 = CLKOUT1 disabled 1 = CLKOUT1 enabled	00111b	EMAC1	MMC0	XIP w/ WAIT ^[1] (MUX2) ^[2] 1	NAND
00b = 19.2MHz 01b = 24MHz 10b = 25MHz 11b = 26MHz	00b (all other values reserved)	For XIP boot: 00b = non-muxed device 10b = muxed device x1b = reserved For NAND boot: must be 0	0 = ECC done by ROM 1 = ECC handled by NAND	0 = 8-bit device 1 = 16-bit device	00b = MII 01b = RMII 10b = Reserved 11b = RGMII w/o internal delay	0 = CLKOUT1 disabled 1 = CLKOUT1 enabled	01000b	EMAC1	MMC0	XIP (MUX2) ^[2] 1	NANDI2C
00b = 19.2MHz 01b = 24MHz 10b = 25MHz 11b = 26MHz	00b (all other values reserved)	For XIP boot: 00b = non-muxed device 10b = muxed device x1b = reserved For NAND boot: must be 00b	0 = ECC done by ROM 1 = ECC handled by NAND	0 = 8-bit device 1 = 16-bit device	00b = MII 01b = RMII 10b = Reserved 11b = RGMII w/o internal delay	0 = CLKOUT1 disabled 1 = CLKOUT1 enabled	01001b	EMAC1	XIP w/ WAIT ^[1] (MUX1) ^[2] 1	NAND	MMC0

Table 26-7. SYSBOOT Configuration Pins^[4] (continued)

SYSBOOT[15:14]	SYSBOOT[13:12]	SYSBOOT[11:10]	SYSBOOT[9]	SYSBOOT[8]	SYSBOOT[7:6]	SYSBOOT[5]	SYSBOOT[4:0]	Boot Sequence			
								EMAC1	XIP (MUX1) ^[2] 1	SPI0	NANDI2C
00b = 19.2MHz 01b = 24MHz 10b = 25MHz 11b = 26MHz	00b (all other values reserved)	For XIP boot: 00b = non-muxed device 10b = muxed device x1b = reserved For NAND boot: must be 00b	0 = ECC done by ROM 1 = ECC handled by NAND	0 = 8-bit device 1 = 16-bit device	00b = MII 01b = RMII 10b = Reserved 11b = RGMII w/o internal delay	0 = CLKOUT1 disabled 1 = CLKOUT1 enabled	01010b	EMAC1	XIP (MUX1) ^[2] 1	SPI0	NANDI2C
00b = 19.2MHz 01b = 24MHz 10b = 25MHz 11b = 26MHz	00b (all other values reserved)	For NAND boot: must be 00b	0 = ECC done by ROM 1 = ECC handled by NAND	Don't care for ROM code	Don't care for ROM code	0 = CLKOUT1 disabled 1 = CLKOUT1 enabled	01011b	USB0	NAND	SPI0	MMC0
00b = 19.2MHz 01b = 24MHz 10b = 25MHz 11b = 26MHz	00b (all other values reserved)	For XIP boot: 00b = non-muxed device 10b = muxed device x1b = reserved For NAND boot: must be 00b	0 = ECC done by ROM 1 = ECC handled by NAND	0 = 8-bit device 1 = 16-bit device	Don't care for ROM code	0 = CLKOUT1 disabled 1 = CLKOUT1 enabled	01100b	USB0	NAND	XIP (MUX2) ^[2] 1	NANDI2C
00b = 19.2MHz 01b = 24MHz 10b = 25MHz 11b = 26MHz	00b (all other values reserved)	For XIP boot: 00b = non-muxed device 10b = muxed device x1b = reserved For NAND boot: must be 00b	0 = ECC done by ROM 1 = ECC handled by NAND	0 = 8-bit device 1 = 16-bit device	Don't care for ROM code	0 = CLKOUT1 disabled 1 = CLKOUT1 enabled	01101b	USB0	NAND	XIP (MUX1) ^[2] 1	SPI0
							01110b	Reserved			
00b = 19.2MHz 01b = 24MHz 10b = 25MHz 11b = 26MHz	00b (all other values reserved)	Don't care for ROM code	Don't care for ROM code	Don't care for ROM code	00b = MII 01b = RMII 10b = Reserved 11b = RGMII w/o internal delay	0 = CLKOUT1 disabled 1 = CLKOUT1 enabled	01111b	UART0	EMAC1	Reserved	Reserved

Table 26-7. SYSBOOT Configuration Pins^[4] (continued)

SYSBOOT[15:14]	SYSBOOT[13:12]	SYSBOOT[11:10]	SYSBOOT[9]	SYSBOOT[8]	SYSBOOT[7:6]	SYSBOOT[5]	SYSBOOT[4:0]	Boot Sequence			
								XIP (MUX1) ^[2] 1	UART0	EMAC1	MMC0
00b = 19.2MHz 01b = 24MHz 10b = 25MHz 11b = 26MHz	00b (all other values reserved)	00b = non-muxed device 10b = muxed device x1b = reserved	Don't care for ROM code	0 = 8-bit device 1 = 16-bit device	00b = MII 01b = RMII 10b = Reserved 11b = RGMII w/o internal delay	0 = CLKOUT1 disabled 1 = CLKOUT1 enabled	10000b	XIP (MUX1) ^[2] 1	UART0	EMAC1	MMC0
00b = 19.2MHz 01b = 24MHz 10b = 25MHz 11b = 26MHz	00b (all other values reserved)	00b = non-muxed device 10b = muxed device x1b = reserved	Don't care for ROM code	0 = 8-bit device 1 = 16-bit device	00b = MII 01b = RMII 10b = Reserved 11b = RGMII w/o internal delay	0 = CLKOUT1 disabled 1 = CLKOUT1 enabled	10001b	XIP w/ WAIT ^[1] (MUX1) ^[2] 1	UART0	EMAC1	MMC0
00b = 19.2MHz 01b = 24MHz 10b = 25MHz 11b = 26MHz	00b (all other values reserved)	For NAND boot: must be 00b	0 = ECC done by ROM 1 = ECC handled by NAND	Don't care for ROM code	Don't care for ROM code	0 = CLKOUT1 disabled 1 = CLKOUT1 enabled	10010b	NAND	NANDI2C	USB0	UART0
00b = 19.2MHz 01b = 24MHz 10b = 25MHz 11b = 26MHz	00b (all other values reserved)	For NAND boot: must be 00b	0 = ECC done by ROM 1 = ECC handled by NAND	Don't care for ROM code	Don't care for ROM code	0 = CLKOUT1 disabled 1 = CLKOUT1 enabled	10011b	NAND	NANDI2C	MMC0	UART0
00b = 19.2MHz 01b = 24MHz 10b = 25MHz 11b = 26MHz	00b (all other values reserved)	For NAND boot: must be 00b	0 = ECC done by ROM 1 = ECC handled by NAND	Don't care for ROM code	00b = MII 01b = RMII 10b = Reserved 11b = RGMII w/o internal delay	0 = CLKOUT1 disabled 1 = CLKOUT1 enabled	10100b	NAND	NAND12C	SPI0	EMAC1
00b = 19.2MHz 01b = 24MHz 10b = 25MHz 11b = 26MHz	00b (all other values reserved)	For NAND boot: must be 00b	0 = ECC done by ROM 1 = ECC handled by NAND	Don't care for ROM code	00b = MII 01b = RMII 10b = Reserved 11b = RGMII w/o internal delay	0 = CLKOUT1 disabled 1 = CLKOUT1 enabled	10101b	NANDI2C	MMC0	EMAC1	UART0

Table 26-7. SYSBOOT Configuration Pins^[4] (continued)

SYSBOOT[15:14]	SYSBOOT[13:12]	SYSBOOT[11:10]	SYSBOOT[9]	SYSBOOT[8]	SYSBOOT[7:6]	SYSBOOT[5]	SYSBOOT[4:0]	Boot Sequence			
00b = 19.2MHz 01b = 24MHz 10b = 25MHz 11b = 26MHz	00b (all other values reserved)	Don't care for ROM code	Don't care for ROM code	Don't care for ROM code	00b = MII 01b = RMII 10b = Reserved 11b = RGMII w/o internal delay	0 = CLKOUT1 disabled 1 = CLKOUT1 enabled	10110b	SPI0	MMC0	UART0	EMAC1
00b = 19.2MHz 01b = 24MHz 10b = 25MHz 11b = 26MHz	00b (all other values reserved)	Don't care for ROM code	Don't care for ROM code	Don't care for ROM code	Don't care for ROM code	0 = CLKOUT1 disabled 1 = CLKOUT1 enabled	10111b	MMC0	SPI0	UART0	USB0
00b = 19.2MHz 01b = 24MHz 10b = 25MHz 11b = 26MHz	00b (all other values reserved)	Don't care for ROM code	Don't care for ROM code	Don't care for ROM code	Don't care for ROM code	0 = CLKOUT1 disabled 1 = CLKOUT1 enabled	11000b	SPI0	MMC0	USB0	UART0
00b = 19.2MHz 01b = 24MHz 10b = 25MHz 11b = 26MHz	00b (all other values reserved)	Don't care for ROM code	Don't care for ROM code	Don't care for ROM code	00b = MII 01b = RMII 10b = Reserved 11b = RGMII w/o internal delay	0 = CLKOUT1 disabled 1 = CLKOUT1 enabled	11001b	SPI0	MMC0	EMAC1	UART0
00b = 19.2MHz 01b = 24MHz 10b = 25MHz 11b = 26MHz	00b (all other values reserved)	For XIP boot: 00b = non-muxed device 10b = muxed device x1b = reserved	Don't care for ROM code	0 = 8-bit device 1 = 16-bit device	Don't care for ROM code	0 = CLKOUT1 disabled 1 = CLKOUT1 enabled	11010b	XIP (MUX2) ^[2] ₁	UART0	SPI0	MMC0
00b = 19.2MHz 01b = 24MHz 10b = 25MHz 11b = 26MHz	00b (all other values reserved)	For XIP boot: 00b = non-muxed device 10b = muxed device x1b = reserved	Don't care for ROM code	0 = 8-bit device 1 = 16-bit device	Don't care for ROM code	0 = CLKOUT1 disabled 1 = CLKOUT1 enabled	11011b	XIP w/ WAIT ^[1] (MUX2) ^[2] ₁	UART0	SPI0	MMC0
00b = 19.2MHz 01b = 24MHz 10b = 25MHz 11b = 26MHz	00b (all other values reserved)	Don't care for ROM code	Don't care for ROM code	Don't care for ROM code	Don't care for ROM code	0 = CLKOUT1 disabled 1 = CLKOUT1 enabled	11100b	MMC1	MMC0	UART0	USB0

Table 26-7. SYSBOOT Configuration Pins^[4] (continued)

SYSBOOT[15:14]	SYSBOOT[13:12]	SYSBOOT[11:10]	SYSBOOT[9]	SYSBOOT[8]	SYSBOOT[7:6]	SYSBOOT[5]	SYSBOOT[4:0]	Boot Sequence			
							11101b	Reserved			
							11110b	Reserved			
00b = 19.2MHz 01b = 24MHz 10b = 25MHz 11b = 26MHz	00b (all other values reserved)	For Fast External Boot: 00b = non-muxed device 10b = muxed device x1b = reserved	For Fast External Boot: must be 0b	0 = 8-bit device 1 = 16-bit device	00b = MII 01b = RMII 10b = Reserved 11b = RGMII w/o internal delay	0 = CLKOUT1 disabled 1 = CLKOUT1 enabled	11111b	Fast External Boot	EMAC1	UART0	Reserved

SYSBOOT Configuration Pins Notes:

1. WAIT is monitored on GPMC_WAIT0.
2. MUX1 and MUX2 designate which group of XIP signals are used. Each group is defined in [Table 26-9](#).
3. Note that even though some bits may be a "don't care" for ROM code, all SYSBOOT values are latched into the CONTROL_STATUS register and may be used by software after ROM execution has completed.
4. SYSBOOT[15:0] terminals are respectively LCD_DATA[15:0] inputs, latched on the rising edge of PWRONRSTn.

The ROM Code uses the row pointed by the SYSBOOT pins value. The device list is filled in with the 1st to 4th devices.

[Table 26-7](#) is the decoding table for SYSBOOT pin configuration. The following shortcuts are used in the table:

- MMC1: MMC or SD card (MMC port 1)
- MMC0: MMC or SD card (MMC port 0)
- NAND / NANDI2C: NAND flash memory / read geometry from EEPROM on I2C0
- XIP: NOR or other XIP device without wait monitoring
- XIP w/ WAIT: NOR or other XIP device with wait monitoring
- MUX1: Boot with XIP_MUX1 signals detailed in [Table 26-9](#)
- MUX2: Boot with XIP_MUX2 signals detailed in [Table 26-9](#)
- UART0: UART interface (UART port 0)
- EMAC1: Ethernet interface (EMAC port 1)
- SPI0: SPI EEPROM (SPI 0, CS0)
- USB0: USB interface (USB0)

Note: For any SYSBOOT value that is selected, please be aware of the pin muxing implications. For example, if the boot mode selected is EMAC1, NAND, SPI0, NANDI2C, the device will drive EMAC, GPMC, SPI and I2C pins, in that order, depending on which boot device finally succeeds. Ensure that if a specific boot mode in the sequence chosen is not used that the components using those particular signals do not conflict with the ROM driving those signals (or external components are not in contention with the ROM using these signals). For specific details of the pins driven by each device, please refer the description of that boot device later in this chapter.

To extend the boot flow to boot from devices that are not natively supported by the ROM, SPI boot can be used. For example, to be able to boot from a USB stick, the system can be configured to boot from a SPI flash, and the code for configuring the USB and booting from a USB stick can be loaded into the SPI flash. This is known as a secondary boot.

The values corresponding to SYSBOOT[4:0]= x1111 provide a bypass mode booting feature.

The fast external boot feature consists of minimal execution by the ROM Code for configuring the GPMC interface and then directly jump to the code contained in the connected NOR flash device.

26.1.6 Fast External Booting

26.1.6.1 Overview

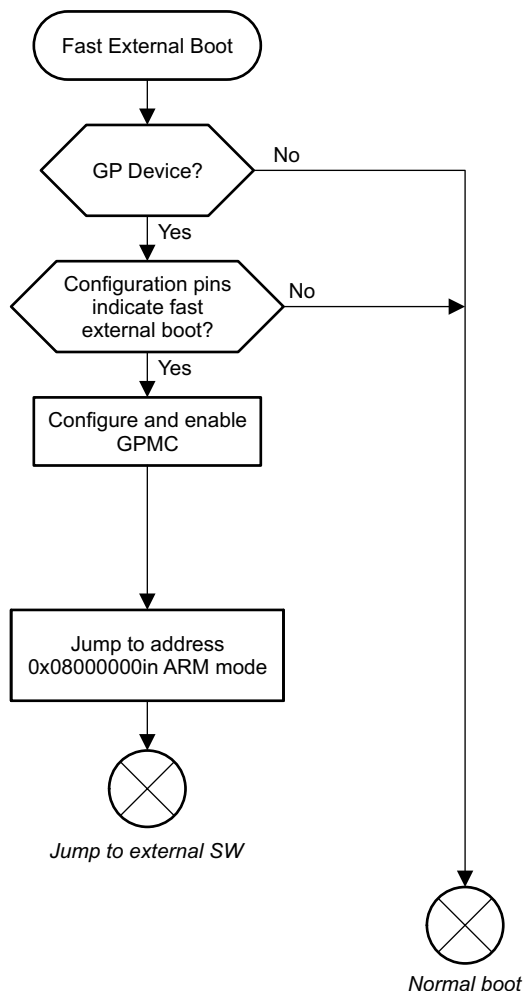
The Fast External boot feature:

- Consists of a blind jump in ARM mode to address 0x08000000 in an external XIP device connected to CS0
- The jump is performed with minimum on-chip ROM Code execution (only configures GPMC interface), without configuring any PLL
- Allows the customer to create its own booting code
- Is set up by means of the configuration pins, see [Table 26-7](#).
- Addr/Data muxed device or a non-muxed (selected using SYSBOOT[11:10]) device in connected in XIP_MUX2 configuration
- Bus width selected by SYSBOOT[8]
- CS0 chip select
- No wait monitoring is available

26.1.6.2 External Booting

Figure 26-7 shows the Fast External Boot procedure. The code does not make use of RAM and is designed for fast execution.

Figure 26-7. Fast External Boot

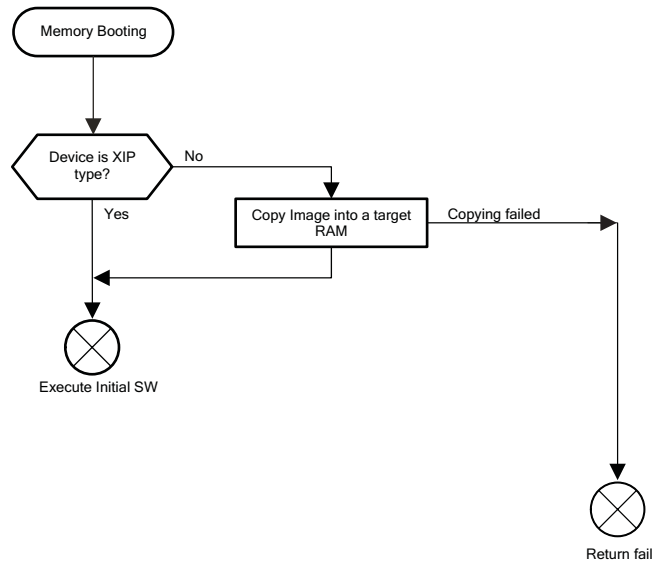


26.1.7 Memory Booting

26.1.7.1 Overview

The memory booting procedure takes care of starting an external code located in memory device types.

Figure 26-8. Memory Booting



There are two groups of memory booting devices distinguished by the need of **code shadowing**. The code shadowing means copying a code from a non-directly addressable device into a location (typically a RAM area) from where the code can be executed. Devices which are directly addressable are called eExecute In Place (XIP) devices.

The Memory Booting flowchart is shown in [Figure 26-8](#). The second step is about performing the shadowing of the image that is copying the image from external mass storage (non-XIP) into internal RAM. Failure in image copy results in Memory Booting returning to the main booting procedure which will select the next device for booting. The next sections detail procedures for device initialization and detection in addition to the description of the sector read routine for each supported device type. A sector is a logical unit of 512 bytes.

The detection of whether an image is present or not on a selected device depends on the first few bytes. On a **GP Device** type a booting image is considered to be present when the first four bytes of the sector is not equal to 0000 0000h or FFFF FFFFh.

During the first read sector call, sectors are copied to a temporary RAM buffer. Once the image is found and destination address is known, the content of the temporary buffer is moved to the target RAM location so it is needed to re-read the first image sector. On a **GP Device** the GP header is discarded, therefore only executable code is located in RAM with the first executable instruction located at the destination address.

The Image authentication and execution is detailed in [Section 26.1.10](#). For more information about image formats and contents, see [Section 26.1.9](#)

MMC/SD cards and NAND devices can hold up to four copies of the booting image. Therefore the ROM Code searches for one valid image out of the four if present by walking over the first four blocks of the mass storage space. Other XIP devices (NOR) use only one copy of the booting image.

26.1.7.2 XIP Memory

The ROM Code can boot directly from XIP devices. A typical XIP device is a NOR flash memory. Support for XIP devices is performed under the following assumptions:

- Uses GPMC as the communication interface
- Up to 1Gbit (128Mbytes) memories can be connected
- Both x8 and x16 data bus width
- Asynchronous protocol
- Supports address/data multiplexed mode and non-muxed mode
- GPMC clock is 100-MHz
- Device connected to CS0 mapped to address 0x08000000.
- Wait pin signal WAIT0 monitored depending on the SYSBOOT pin configuration (XIP / XIP w/ WAIT).
- Flexible muxing options for gpmc_a0-gpmc_a11 for non-muxed XIP devices

Depending on the SYSBOOT pins, the GPMC is configured to use the WAIT signal connected on the WAIT0 pin or not. Wait pin polarity is set to stall accessing memory when the WAIT0 pin is low. The wait monitoring is intended to be used with memories which require long time for initialization after reset or need to pause while reading data. The boot procedure from XIP device can be described as such:

- Configure GPMC for XIP device access.
- Set the image location to 0x08000000.
- Verify if bootable image is present at the image location.
- If the image has been found, start the execution.
- If the image has not been found, return from XIP booting to the main booting loop.

26.1.7.2.1 XIP Initialization and Detection

- GPMC initialization

[Figure 26-9](#) and [Table 26-8](#) describe the GPMC timing settings set for XIP boot and other address-data accessible devices.

Figure 26-9. GPMC XIP Timings

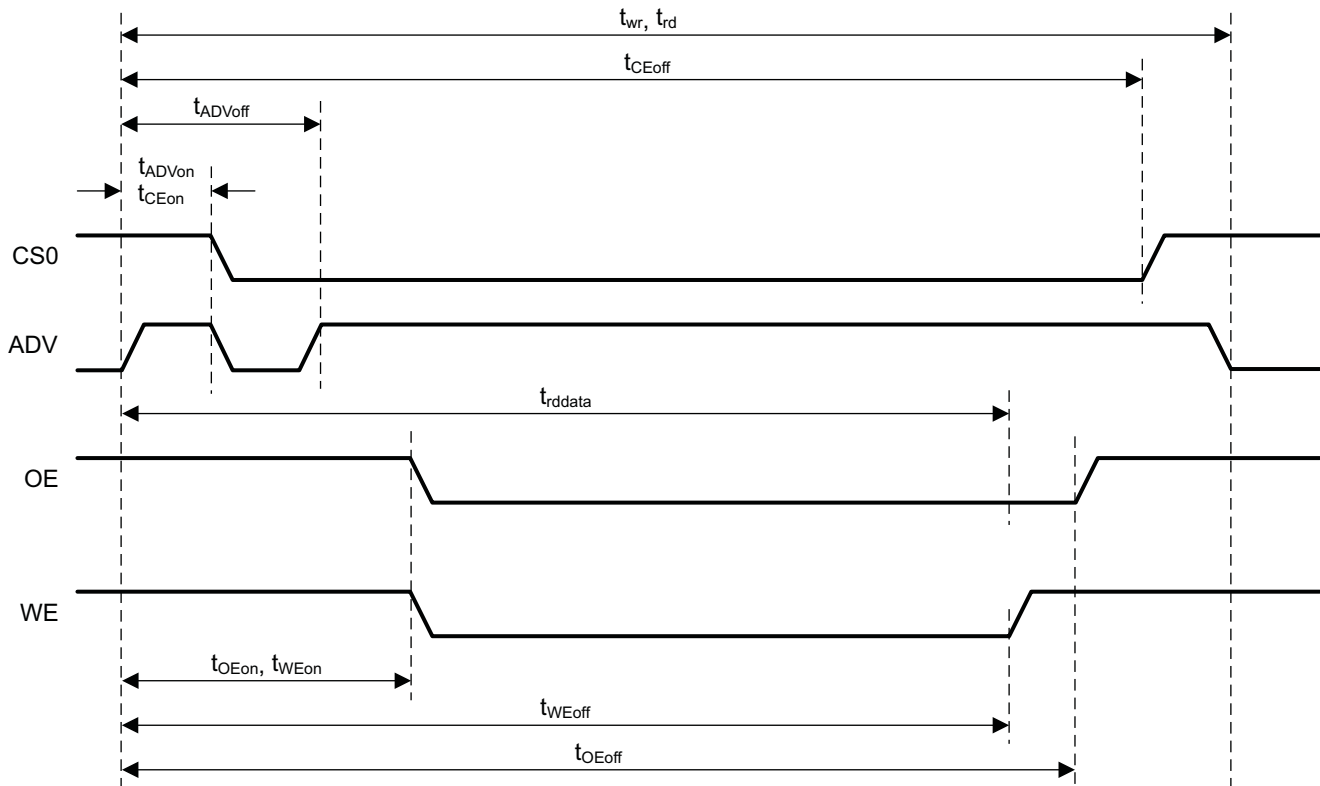


Table 26-8. XIP Timings Parameters

Parameter	Description	Value (clock cycles)
t_{wr}	write cycle period	17
t_{rd}	read cycle period	17
t_{CEon}	CE low time	0
t_{CEoff}	CE high time	16
t_{ADVon}	ADV low time	1
t_{ADVoff}	ADV high time	2
t_{OEon}	OE low time	3
t_{WEon}	WE low time	3
t_{rddata}	data latch time	15
t_{OEOff}	OE high time	16
t_{WEOff}	WE high time	15
$t_{CSXTRADelay}$	CS Extra Delay	1/4

The one clock cycle is 20ns, which corresponds to 50-MHz frequency.

- Device detection

There is no specific identification routine executed prior to booting from an XIP device.

26.1.7.2.2 Pins Used

The list of device pins that are configured by the ROM in the case of NOR boot mode are as follows. Please note that all the pins might not be driven at boot time. The decision as to which pins need to be driven is done based on the type of NOR flash selected. The pins that are not listed below are not configured by the ROM code and are left at power-on defaults. Specifically, external logic is needed to isolate the upper address lines (A12–A27) of the NOR flash from the device pins and drive them low during non-muxed NOR boot. Similarly for Muxed NOR Boot, address lines A16 and above to the memory are not controlled by the ROM and need to be managed externally during boot to ensure proper addressing to the all memory signals.

Once the initial software starts running, it can appropriately configure the pinmux setting for the lines and remove the isolation to allow GPMC to drive all the address lines.

Table 26-9. Pins Used for Non-Muxed NOR Boot

Signal name	Pin used in XIP_MUX1 ⁽¹⁾ mode	Pin used in XIP_MUX2 ⁽¹⁾ mode
CS0	GPMC_CSN0	GPMC_CSN0
ADV_N_ALE	GPMC_ADV_N_ALE	GPMC_ADV_N_ALE
OEN_REN	GPMC_OEN_REN	GPMC_OEN_REN
BE0N_CLE	GPMC_BEN0_CLE	GPMC_BEN0_CLE
BE1N	GPMC_BE1N	GPMC_CSN2 and GPMC_BE1N ⁽²⁾
CLK	GPMC_CLK	none
WEN	GPMC_WEN	GPMC_WEN
WAIT0	GPMC_WAIT0	GPMC_WAIT0
WAIT1	none	GPMC_CLK
AD0 - AD15	GPMC_AD0 - GPMC_AD15	GPMC_AD0 - GPMC_AD15
A0	GPMC_A0	LCD_DATA0
A1	GPMC_A1	LCD_DATA1
A2	GPMC_A2	LCD_DATA2
A3	GPMC_A3	LCD_DATA3
A4	GPMC_A4	LCD_DATA4
A5	GPMC_A5	LCD_DATA5
A6	GPMC_A6	LCD_DATA6
A7	GPMC_A7	LCD_DATA7
A8	GPMC_A8	LCD_VSYNC
A9	GPMC_A9	LCD_HSYNC
A10	GPMC_A10	LCD_PCLK
A11	GPMC_A11	LCD_AC_BIAS_EN

⁽¹⁾ XIP_MUX1 and XIP_MUX2 do not correspond to the pin mux modes that are defined for each terminal. This table identifies which pins are used in each boot mode.

⁽²⁾ The GPMC_CSN2 and GPMC_BE1N terminals are driven in this mode with the BE1N signal.

Table 26-10. Pins Used for Muxed NOR Boot

Signal name	Pin used in XIP_MUX1 ⁽¹⁾ mode	Pin used in XIP_MUX2 ⁽¹⁾ mode
CS0	GPMC_CSN0	GPMC_CSN0
ADV_N_ALE	GPMC_ADV_N_ALE	GPMC_ADV_N_ALE
OEN_REN	GPMC_OEN_REN	GPMC_OEN_REN
BE0N_CLE	GPMC_BEN0_CLE	GPMC_BEN0_CLE
BE1N	GPMC_BE1N	GPMC_CSN2 and GPMC_BE1N ⁽²⁾
CLK	GPMC_CLK	none
WEN	GPMC_WEN	GPMC_WEN
WAIT0	GPMC_WAIT0	GPMC_WAIT0
WAIT1	none	GPMC_CLK
AD0 - AD15	GPMC_AD0 - GPMC_AD15	GPMC_AD0 - GPMC_AD15

⁽¹⁾ XIP_MUX1 and XIP_MUX2 do not correspond to the pin mux modes that are defined for each terminal. This table identifies which pins are used in each boot mode.

⁽²⁾ The GPMC_CSN2 and GPMC_BE1N terminals are driven in this mode with the BE1N signal.

26.1.7.2.3 Sysboot Pins

Some of the SYSBOOT pins have special meanings when NOR boot is selected.

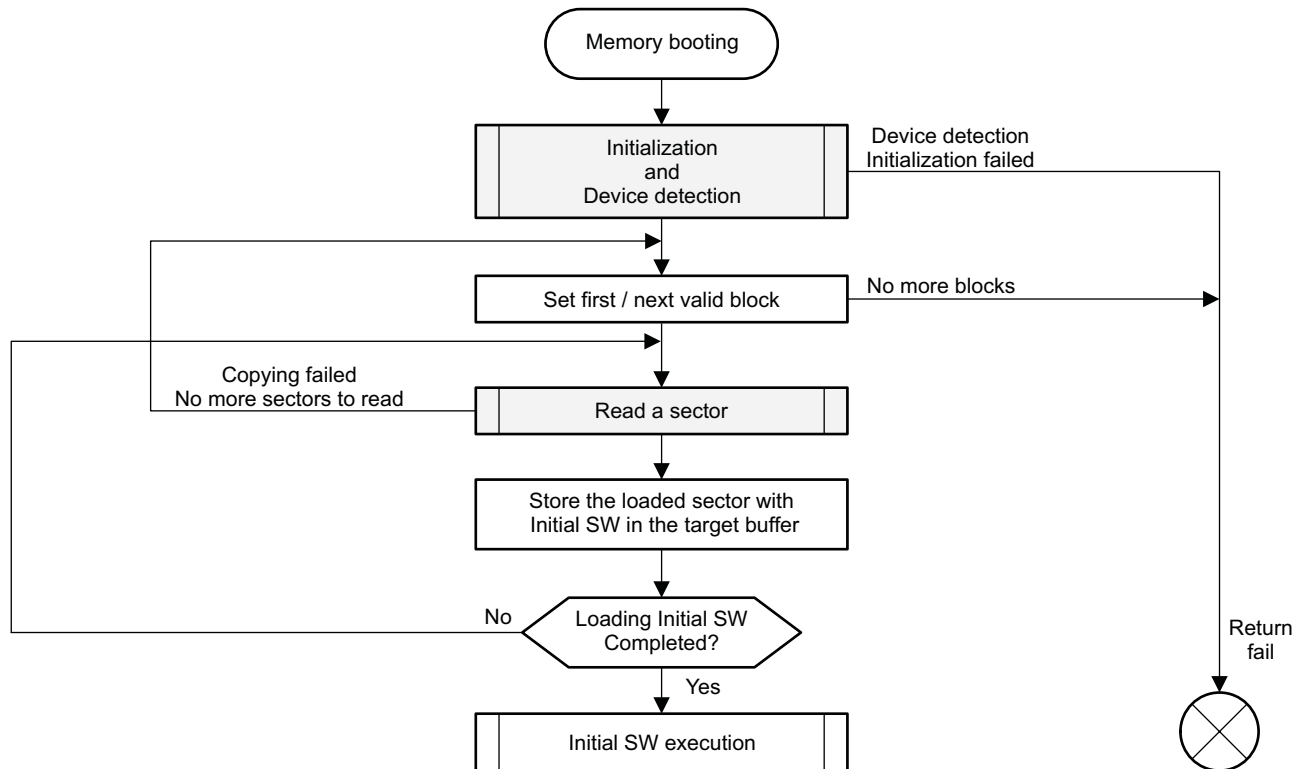
Table 26-11. Special SYSBOOT Pins for NOR Boot

SYSBOOT[n]	Description
[8]	0 = 8-bit device 1 = 16-bit device
[11:10]	00b = Non-muxed device 10b = Muxed device x1b = Reserved

26.1.7.3 Image Shadowing for Non-XIP Memories

26.1.7.3.1 Shadowing on GP Device

The GP Device shadowing uses the approach in [Figure 26-10](#).

Figure 26-10. Image Shadowing on GP Device


26.1.7.4 NAND

The NAND flash memory is not XIP and requires shadowing before the code can be executed.

26.1.7.4.1 Features

- Uses GPMC as the communication interface
- Device from 512Mbit (64MByte)
- x8 and x16 bus width
- Support for large page size (2048 bytes + 64 spare bytes) or very large page size 4096 bytes + 128 / 218 spare bytes)
- Only supports devices where Chip Select can be de-asserted during read, program or erase cycles, without interrupting the operation
- Device Identification based on ONFI or ROM table
- ECC correction : 8 bits/sector for most devices (16b/sector for devices with large spare area)
- Support for disabling ECC correction, so that the in-built ECC correction mechanisms on some NANDs can be used.
- GPMC timings adjusted for NAND access
- GPMC clock is 50MHz
- Device connected to GPMC_CS0
- Wait pin signal GPMC_WAIT0 connected to NAND BUSY output
- Four physical blocks are searched for an image. Thmmce block size depends on device.

26.1.7.4.2 Initialization and Detection

The initialization routine for NAND devices consists in three parts: GPMC initialization, device detection with parameters determination and finally bad block detection.

ONFI Support

The NAND identification starts with ONFI detection. For more information on ONFI standard, see the Open NAND Flash Interface Specification (<http://www.onfi.org>).

GPMC Initialization

The GPMC interface is configured as such it can be used for accessing NAND devices. The address bus is released since a NAND device does not use it. The data bus width is initially set to 16 bits; and changed to 8 bits if needed after device parameters determination. The following scheme is applied since NAND devices require different timings when compared to regular NOR devices:

Figure 26-11. GPMC NAND Timings

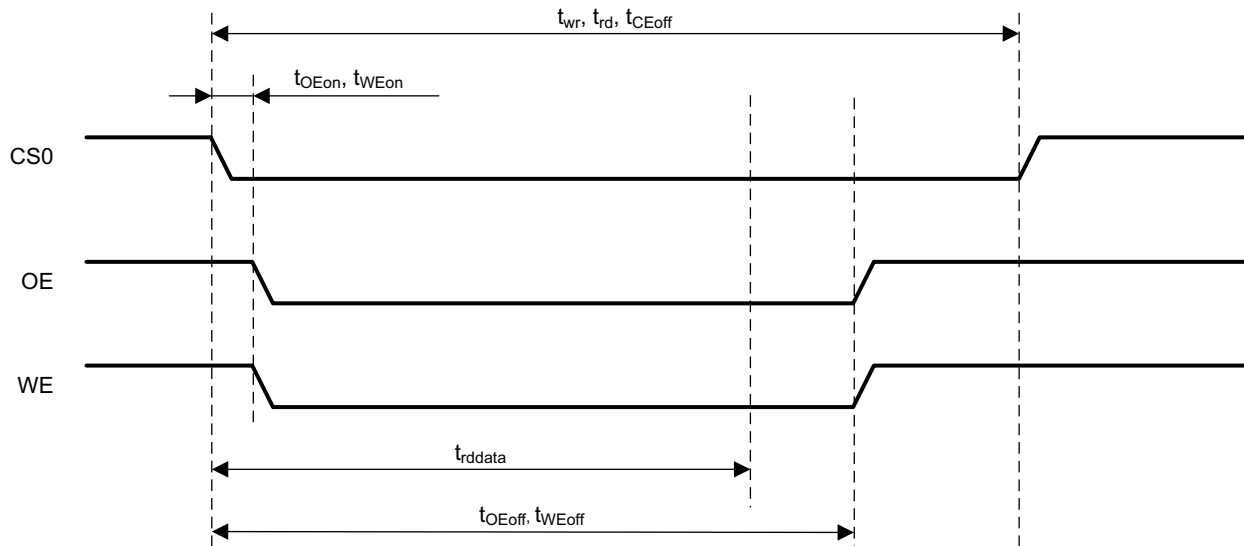


Table 26-12. NAND Timings Parameters

Parameter	Description	Value [clock cycles]
t_{wr}	write cycle period	30
t_{rd}	read cycle period	30
t_{CEon}	CE low (not marked on the figure)	0
t_{OEon}	CE low to OE low time	7
t_{WEon}	CE low to WE low time	5
t_{rddata}	CE low to data latch time	21
t_{OEoff}	CE low to OE high time	24
t_{WEoff}	CE low to WE high time	22

Figure 26-11 and Table 26-12 describes the timings configured for NAND device access. The one clock cycle is 20 ns, which correspond to 50-MHz frequency.

Device Detection and Parameters

The ROM Code first performs an initial wait for device auto initialization (with 250ms timeout) with polling of the ready information. Then, it needs to identify the NAND type connected to the GPMC interface. The GPMC is initialized using 8 bits, asynchronous mode. The NAND device is reset (command FFh) and its status is polled until ready for operation (with 200ms timeout). The ONFI Read ID (command 90h / address 20h) is sent to the NAND device. If it replies with the ONFI signature (4 bytes) then a Read parameters page (command ECh) is sent. If the parameters page does not have the ONFI signature, then the ONFI identification fails. If the ONFI identification passes, the information shown in Table 26-13 is then extracted: page size, spare area size, number of pages per block, and the addressing mode. The remaining data bytes from the parameters page stream are simply ignored.

Table 26-13. ONFI Parameters Page Description

Offset	Description	Size (bytes)
6	Features supported	2
80	Number of data bytes per page	4
84	Number of spare bytes per page	2
92	Number of pages per block	4
101	Number of address cycles	1

If the ONFI Read ID command fails (it will be the case with any device not supporting ONFI) then the device is reset again with polling for device to be ready (with 200ms timeout). Then, the standard Read ID (command 90h / address 00h) is sent. If the Device ID (2nd byte of the ID byte stream) is recognized as being a supported device then the device parameters are extracted from an internal ROM Code table. The list of supported devices is shown in [Table 26-14](#).

Table 26-14. Supported NAND Devices

Capacity	Device ID	Bus Width	Page size
512 Mb	F0	x8	2048
512 Mb	C0	x16	2048
512 Mb	A0	x8	2048
512 Mb	B0	x16	2048
512 Mb	F2	x8	2048
512 Mb	C2	x16	2048
512 Mb	A2	x8	2048
512 Mb	B2	x16	2048
1 Gb	F1	x8	2048
1 Gb	C1	x16	2048
1 Gb	A1	x8	2048
1 Gb	B1	x16	2048
2 Gb	DA	x8	2048
2 Gb	CA	x16	2048
2 Gb	AA	x8	2048
2 Gb	BA	x16	2048
2 Gb	83	x8	2048
2 Gb	93	x16	2048
4 Gb	DC	x8	2048
4 Gb	CC	x16	2048
4 Gb	AC	x8	2048/4096
4 Gb	BC	x16	2048/4096
4 Gb	84	x8	2048
4 Gb	94	x16	2048
8 Gb	D3	x8	2048/4096
8 Gb	C3	x16	2048/4096
8 Gb	A3	x8	2048/4096
8 Gb	B3	x16	2048/4096
8 Gb	85	x8	2048
8 Gb	95	x16	2048
16 Gb	D5	x8	2048/4096
16 Gb	C5	x16	2048/4096
16 Gb	A5	x8	2048/4096
16 Gb	B5	x16	2048/4096

Table 26-14. Supported NAND Devices (continued)

Capacity	Device ID	Bus Width	Page size
16 Gb	86	x8	2048
16 Gb	96	x16	2048
32 Gb	D7	x8	2048/4096
32 Gb	C7	x16	2048/4096
32 Gb	A7	x8	2048/4096
32 Gb	B7	x16	2048/4096
32 Gb	87	x8	2048
32 Gb	97	x16	2048
64 Gb	DE	x8	2048/4096
64 Gb	CE	x16	2048/4096
64 Gb	AE	x8	2048/4096
64 Gb	BE	x16	2048/4096

When the parameters are retrieved from the ROM table: page size and block size is updated based on 4th byte of NAND ID data. Due to inconsistency amongst different manufacturers, only devices which has been recognized to be at least 2Gb (included) have these parameters updated. Therefore, the ROM Code supports 4kB page devices but only if their size, according to the table, is at least 2Gb. Devices which are smaller than 2Gb have the block size parameter fixed to 128kB. [Table 26-15](#) shows the 4th ID Data byte encoding used in ROM Code.

Table 26-15. 4th NAND ID Data Byte

Item	Description	I/O #							
		7	6	5	4	3	2	1	0
Page Size	1kB							0	0
	2kB							0	1
	4kB							1	0
	8kB							1	1
Cell type	2 levels					0	0		
	4 levels					0	1		
	8 levels					1	0		
	16 levels					1	1		
Block Size	64kB			0	0				
	128kB			0	1				
	256kB			1	0				
	512kB			1	1				

Reading NAND Geometry From I2C EEPROM

ROM supports a special boot mode called NANDI2C to support NAND devices whose geometry cannot be detected by the ROM automatically using methods described in the previous section. If this boot mode is selected, the ROM code tries to read NAND geometry from an I2C EEPROM. If the read is successful, ROM code then proceeds to next steps of NAND boot, beginning with reading bad blocks information.

The list of device pins that are configured by the ROM in the case of NANDI2C boot mode. (This is in addition to the NAND boot pins described in the previous sections.)

Table 26-16. Pins Used for NANDI2C Boot for I2C EEPROM Access

Signal name	Pin Used in Device
I2C SCL	i2c0_scl
I2C SDA	i2c0_sda

ROM accesses the I2C EEPROM at I2C slave address **0x50** and reads 7 bytes starting from address offset **0x80**. The format of this (NAND geometry information) is as follows:

Table 26-17. NAND Geometry Information on I2C EEPROM

Byte address	Information	
	Upper nibble	Lower nibble
0x80	Magic Number – 0x10	
0x81	Magic Number – 0xb3	
0x82	Magic Number – 0x57	
0x83	Magic Number – 0xa6	
0x84	NAND column address (word/byte offset within a page) size in bytes, Example: 2	NAND row address (page offset) size in bytes. Example: 3
0x85	Page size (2^N) exponent "N". Example (for page size of 2048): 11	Pages per block (2^N) exponent "N" Example (for number of blocks 64): 6
0x86	NAND bus width 0 = 8-bit device 1 = 16-bit device	ECC Type 00b = No ECC 01b = BCH8 10b = BCH16 11b = Reserved

ECC Correction

The default ECC correction applied is BCH 8b/sector using the GPMC and ELM hardware.

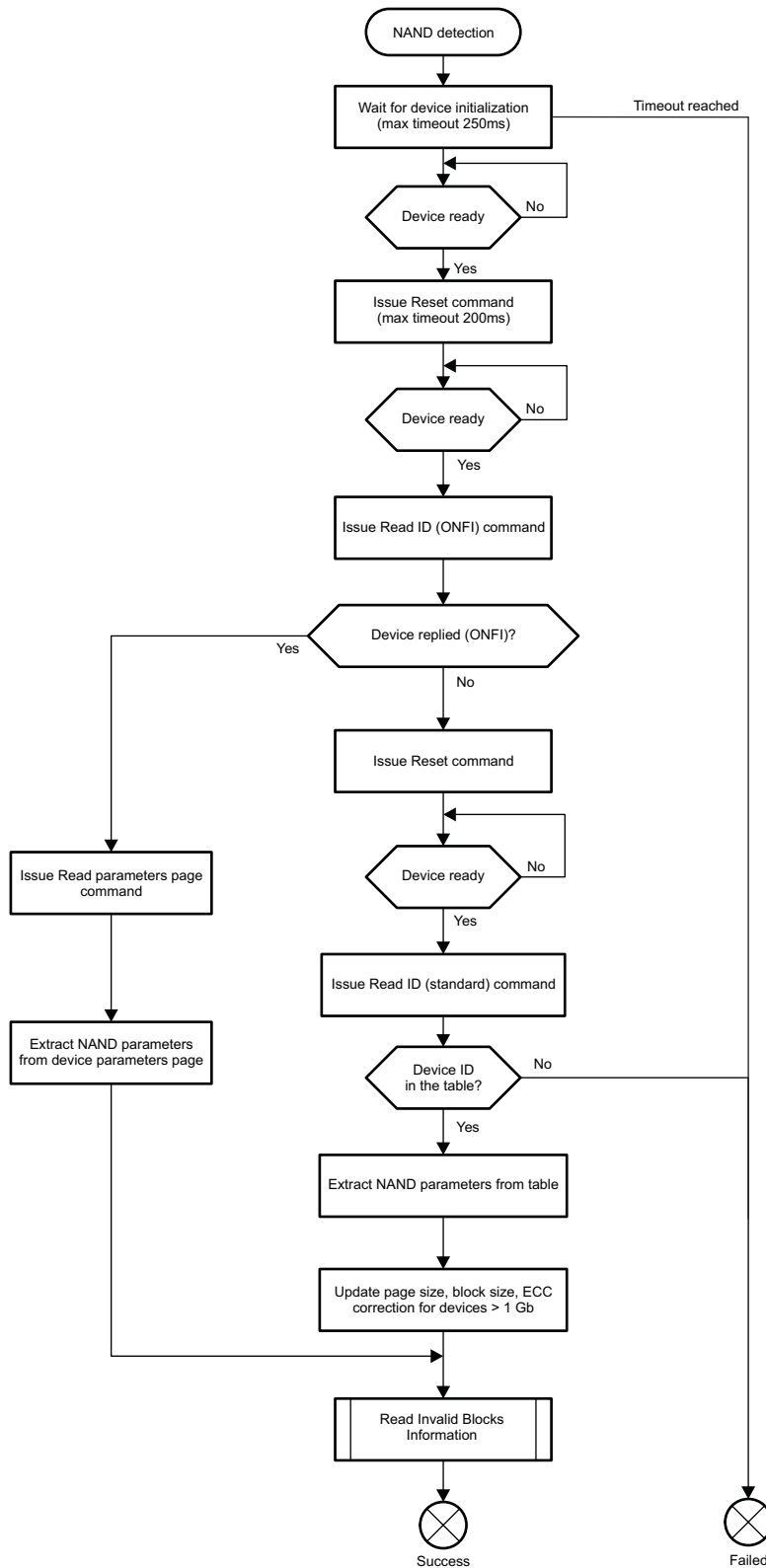
For device ID codes D3h, C3h, D5h, C5h, D7h, C7h, DEh, CEh when manufacturer code (first ID byte) is 98h the Cell type information is checked in the 4th byte of ID data. If it is equal to 10b then the ECC correction applied is BCH 16b/sector.

In addition ECC computation done by the ROM can be turned off completely by using SYSBOOT[9]. This is particularly useful when interfacing with NAND devices that have built in ECC engines.

Table 26-18. ECC Configuration for NAND Boot

SYSBOOT[9]	ECC Computation
0	ECC done by ROM
1	ECC handled by NAND

Figure 26-12. NAND Device Detection



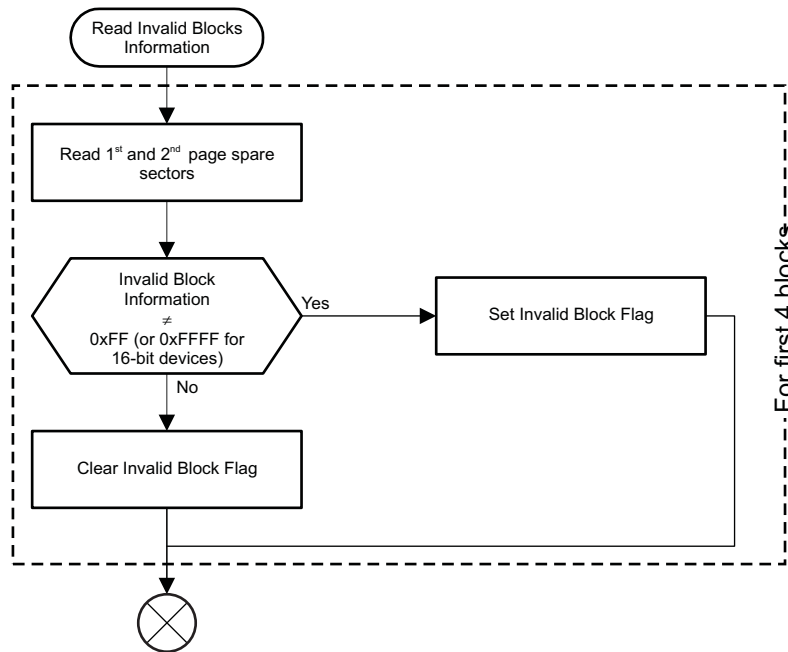
The detection procedure is described in [Figure 26-12](#). Once the device has been successfully detected, the ROM Code changes GPMC to 16-bit bus width if necessary.

Bad Block Verification

Invalid blocks are blocks which contain invalid bits whose reliability cannot be guaranteed by the manufacturer. Those bits are identified in the factory or during the programming and reported in the initial invalid block information located in the spare area on the 1st and 2nd page of each block. Since the ROM Code is looking for an image in the first four blocks, it must detect block validity status of these blocks. Blocks which are detected as invalid are not accessed later on. Blocks validity status is coded in the spare areas of the first two pages of a block (first byte equal to FFh in 1st and 2nd pages for an 8 bits device / first word equal to FFFFh in 1st and 2nd page for a 16bits device).

Figure 26-13 depicts the invalid block detection routine. The routine consists in reading spare areas and checking validity data pattern.

Figure 26-13. NAND Invalid Blocks Detection



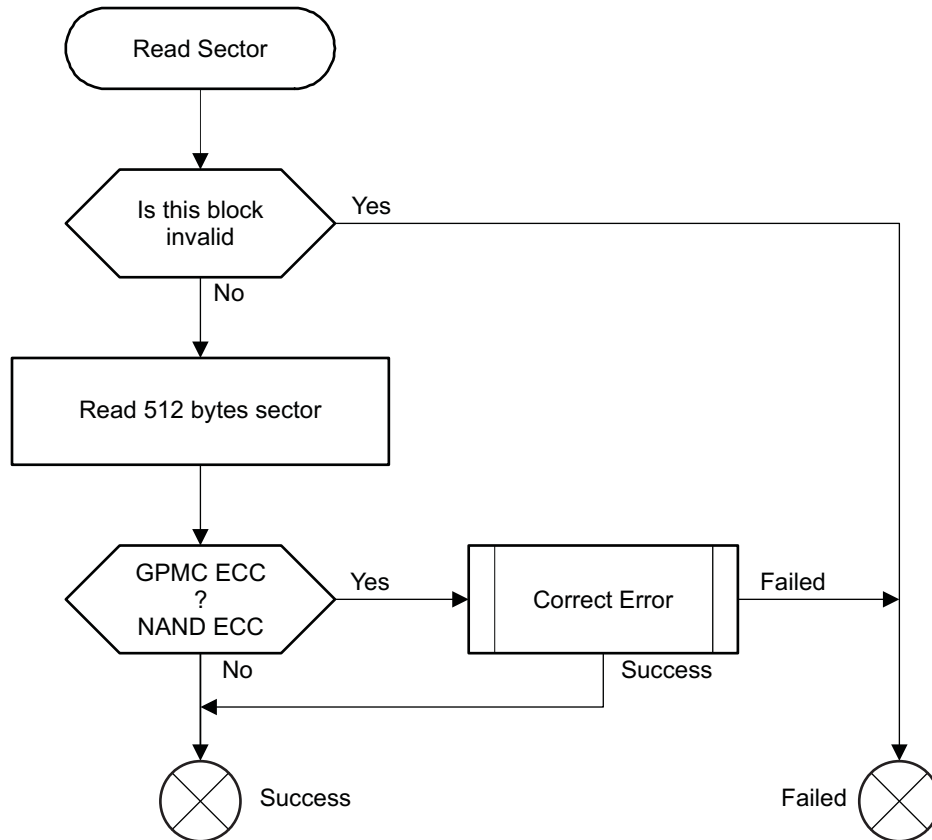
26.1.7.4.2.1 NAND Read Sector Procedure

The ROM Code reads data from NAND devices in 512 bytes sectors. The read function fails in two cases:

- The accessed sector is within a block marked as invalid
- The accessed sector contains an error which cannot be corrected with ECC

Figure 26-14 shows the read sector routine for NAND devices. The ROM Code uses normal read (command 00h 30h) for reading NAND page data.

Figure 26-14. NAND Read Sector Procedure



Page data can contain errors due to memory alteration. The ROM Code uses an ECC correction algorithm to detect and possibly correct those errors. The ECC algorithm used is BCH with capability for correcting 8b or 16b errors per sector. The BCH data is automatically calculated by the GPMC on reading each 512 bytes sector. The computed ECC is compared against ECC stored in the spare area for the corresponding page. Depending on the page size, the amount of ECC data bytes stored in the corresponding spare area is different. [Figure 26-15](#) and [Figure 26-16](#) show the mapping of ECC data inside the spare area for respectively 2KB-page and 4KB- page devices. If both ECC data are equal then the Read Sector function returns the read 512 bytes sector without error. Otherwise the ROM Code tries to correct error(s) in the corresponding sector (this procedure is assisted by the ELM hardware) and returns the data if successful. If errors are uncorrectable, the function returns with FAIL.

Figure 26-15. ECC Data Mapping for 2 KB Page and 8b BCH Encoding

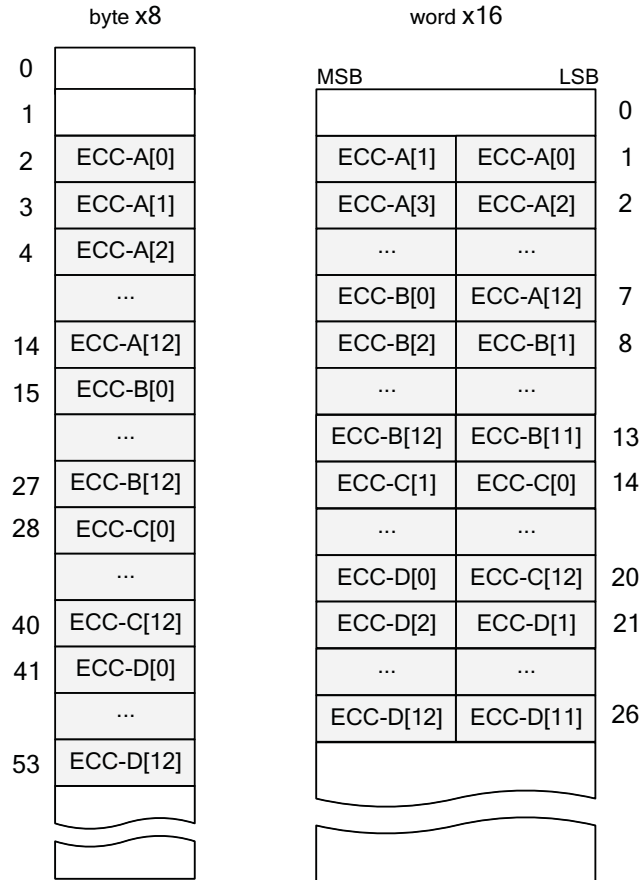
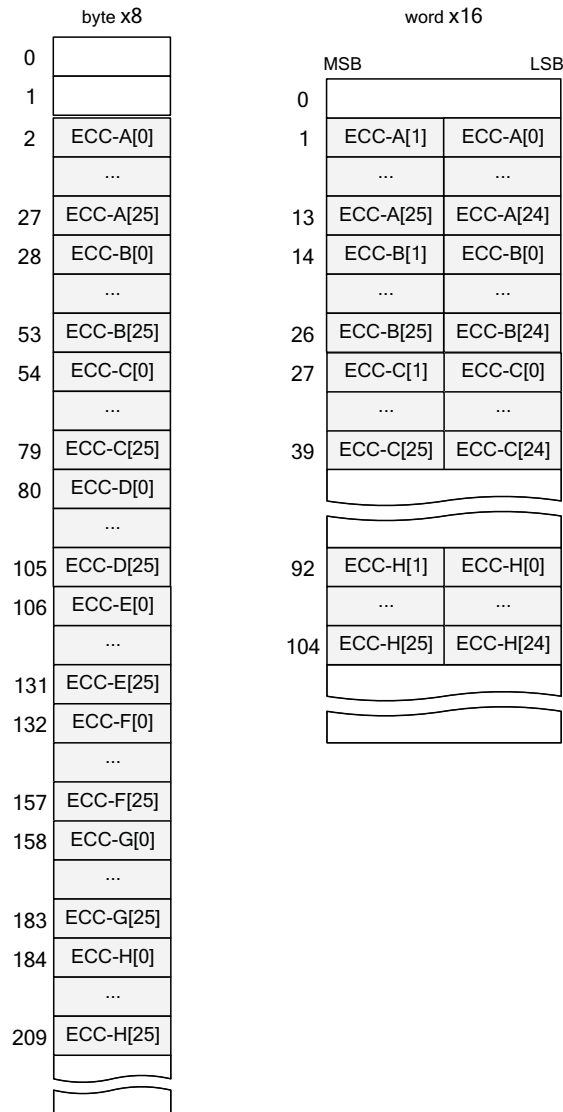


Figure 26-16. ECC Data Mapping for 4 KB Page and 16b BCH Encoding



26.1.7.4.2.2 Pins Used

The list of device pins that are configured by the ROM in the case of NAND boot mode are as follows. Please note that all the pins might not be driven at boot time.

NOTE: Caution must be taken when using an 8-bit NAND. The ROM initially configures all address and data signals (AD0-AD15) the GPMC uses when attempting to read configuration values from the NAND. If you use an 8-bit NAND, and connect AD15-AD8 to other functions (GPIOs, for example), there may be contention on these signals during the boot phase. AD15-AD8 are configured as outputs and will be driven by the ROM if NAND boot is selected. Ensure external circuits will not be in contention with these driven outputs.

Table 26-19. Pins Used for NAND Boot

Signal name	Pin Used in Device
CS0	GPMC_CS0
ADV_N_ALE	GPMC_ADV_N_ALE
OEN_REN	GPMC_OEN_REN
BE0N_CLE	GPMC_BE0N_CLE
BE1N	GPMC_BE1N
WEN	GPMC_WEN
WAIT	GPMC_WAIT0
CLK	GPMC_CLK
AD0 - AD15	GPMC_AD0 - GPMC_AD15

26.1.7.4.2.3 SYSBOOT Pins

SYSBOOT[11:10] has a special meaning when NAND boot is selected. SYSBOOT[11:10] must be 0.

26.1.7.5 MMC / SD Cards

26.1.7.5.1 Overview

The ROM Code supports booting from MMC / SD cards in the following conditions:

- MMC/SD Cards compliant to the Multimedia Card System Specification and Secure Digital I/O Card Specification of low and high capacities.
- MMC/SD cards connected to MMC0 or MMC1.
- Support for 3.3/1.8 V on MMC0 and MMC1.
- Initial 1-bit MMC Mode, optional 4-bit mode, if device supports it.
- Clock Frequency: identification mode: 400 KHz; data transfer mode up to 10 MHz.
- Only one card connected to the bus.
- Raw mode, image data read directly from sectors in the user area.
- File system mode (FAT12/16/32 supported with or without Master Boot Record), image data is read from a booting file.

26.1.7.5.2 System Interconnection

Each interface has booting restrictions on which type of memory it supports: -

- MMC0 supports booting from the MMC/SD card cage and also supports booting from eMMC/eSD/managed NAND memory devices with less than 4GB capacity.
- MMC1 supports booting from eMMC/eSD/managed NAND memory device with 4GB capacity or greater.

The restriction is a result of many eMMC devices not being compliant with the eMMC v4.41 specification. If you have the need to boot from two different card cages, many MMC/SD cards will boot from MMC1, but for maximum compatibility only MMC0 should be used to boot from the card cage. Similarly for maximum compatibility, booting from eMMC/eSD/managed NAND should only be performed on MMC1.

Note that the above restrictions only apply to booting from each port. Drivers can be written for either port to support any desired interface.

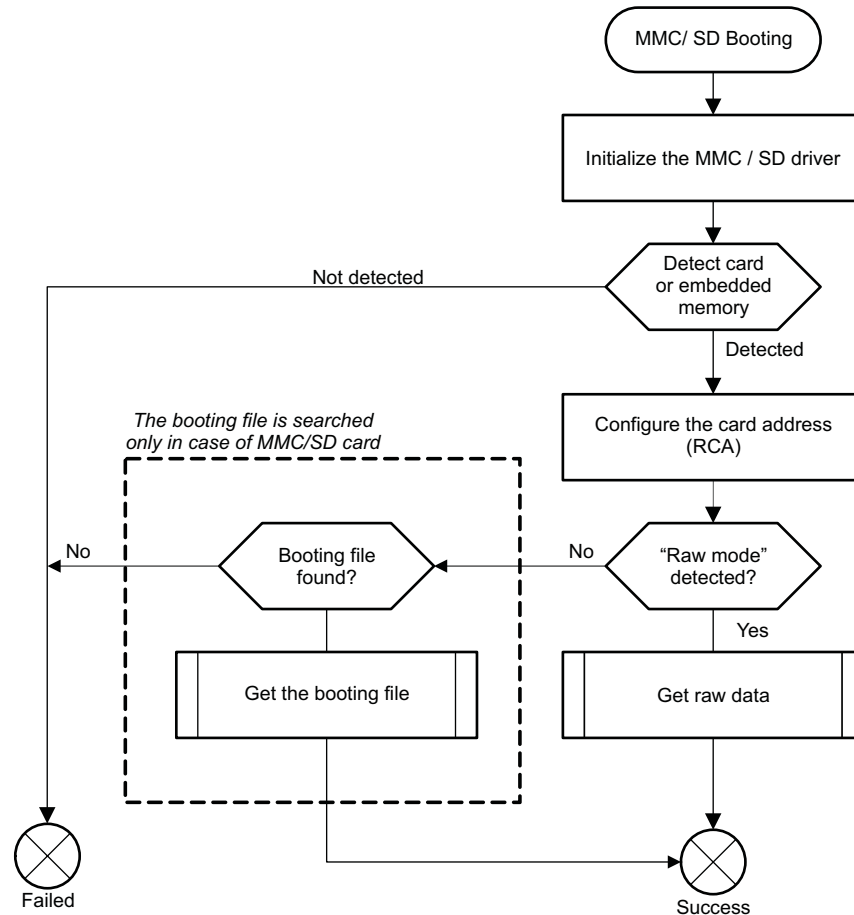
Note:

- The ROM Code does not handle the card detection feature on card cage.
- If MMC1 is used the GPMC interface is not usable, due to pin muxing options.
- MMC1 supports sector mode without querying the card.

26.1.7.5.3 Booting Procedure

The high level flowchart of the eMMC / eSD and MMC/SD booting procedure is depicted in [Figure 26-17](#). The booting file is searched only in case of booting from a card. eMMC/eSD embedded memories only support raw mode.

Figure 26-17. MMC/SD Booting



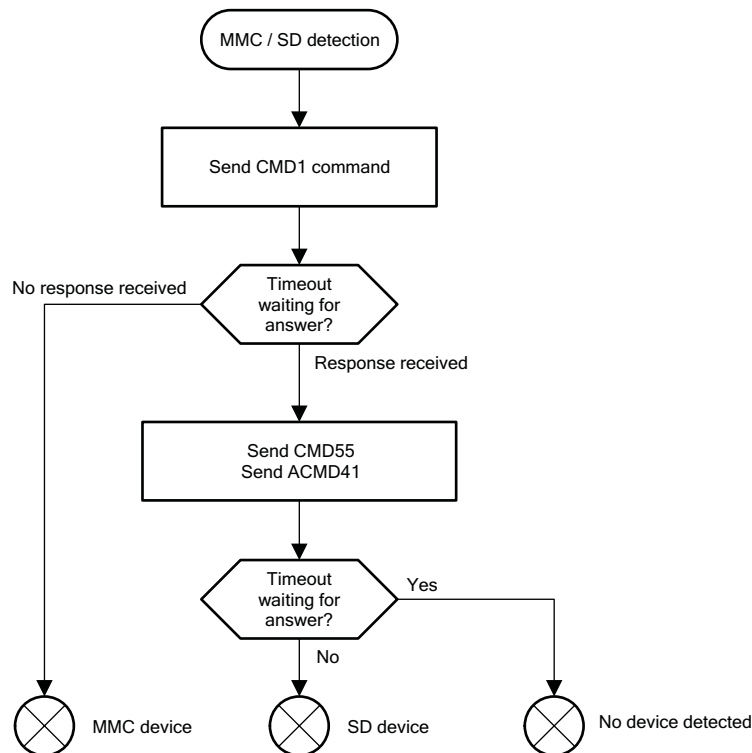
26.1.7.5.4 Initialization and Detection

The ROM Code attempts to initialize the memory device or card connected on MMC interface. If neither memory device nor card is detected then the ROM Code carries on to the next booting device. The standard identification process and **Relative Card Address (RCA)** assignment are used. However, the ROM Code assumes that only one memory or card is present on the bus. This first sequence is done using the CMD signal which is common to SD and MMC devices.

MMC and SD standards detail this phase as **initialization phase**. Both standards differ in the first commands involved: **CMD1** and **ACMD41**. The ROM Code uses this difference in command set to discriminate between MMC and SD devices: CMD1 is supported only by the MMC standard whereas ACMD41 is only supported by SD standard. The ROM Code first sends a CMD1 to the device and gets a response only if an MMC device is connected. If no response is received then ACMD41 (ACMD41 is made out of CMD55 and ACMD41) is sent and a response is expected from an SD device. If no response is received then it is assumed that no device is connected and the ROM Code exits the MMC/SD Booting procedure with FAIL. This is detection procedure shown in [Figure 26-18](#).

Another point to note is the difference in the arguments to CMD1 between MMC0 and MMC1. At first the ROM queries the card with CMD1, ARG = 0, to get the OCR from the card. On MMC0, the response from the card is simply reflected back to the card as the argument for all subsequent CMD1, till the card is in the READY state. On MMC1, Bit30 of the response received from the card is set to 1 by the ROM, and this modified value is used as the argument for subsequent CMD1. This is done to indicate to the card that the ROM supports sector addressing. This mode might not be compatible with older (older than v4.4) versions of cards.

Figure 26-18. MMC/SD Detection Procedure



As previously mentioned the contents of an MMC/SD card may be formatted as raw binary or within a FAT filesystem. eMMC / eSD devices only support raw mode. The ROM Code reads out raw sectors from image or the booting file within the file system and boots from it.

26.1.7.5.5 MMC/SD Read Sector Procedure in Raw Mode

In raw mode the booting image can be located at one of the four consecutive locations in the main area: offset 0x0 / 0x20000 (128KB) / 0x40000 (256KB) / 0x60000 (384KB). For this reason, a booting image shall not exceed 128KB in size. However it is possible to flash a device with an image greater than 128KB starting at one of the aforementioned locations. Therefore the ROM Code does not check the image size. The only drawback is that the image will cross the subsequent image boundary.

The raw mode is detected by reading sectors #0, #256, #512, #768. The content of these sectors is then verified for presence of a TOC structure as described in [Section 26.1.9](#). In the case of a **GP Device**, a Configuration Header (CH) **must** be located in the first sector followed by a **GP header**. The CH might be void (only containing a CHSETTINGS item for which the Valid field is zero).

26.1.7.5.5.1 Configuration Header

For Raw Mode, the Configuration Header should be formatted as in [Table 26-20](#):

Table 26-20. Configuration Header TOC Item

Offset	Field	Size (Bytes)	Value	Description
0x0000	Start	4	0x000000a0	Offset from the start address of TOC to the actual address of a section.
0x0004	Size	4	0x00000050	Size of a section
0x0008	Reserved	4	0x00000000	Unused
0x000C	Reserved	4		Unused
0x0010	Reserved	4		Unused
0x0014	Filename	12	0x45534843 0x4e495454 0x00005347	12-character name of a section, including the zero (0) terminator (these are the ASCII characters for 'CHSETTINGS').
0x0020	Closing item	4	0xFFFFFFFF	32 bytes of 0xFF to signify the end of the TOC item.
0x0024	Closing item	4		
0x0028	Closing item	4		
0x002C	Closing item	4		
0x0030	Closing item	4		
0x0034	Closing item	4		
0x0038	Closing item	4		
0x003C	Closing item	4		

Table 26-21. Configuration Header Settings

Offset	Field	Value	Description
0000h	Section key	0xC0C0C0C1	Key used for section verification
0004h	Valid	0x00	Enables or disables the section. 00h: Disable. Other: Enable.
0005h	Version	0x001	Configuration header version. Others: For future use
0006h	Reserved	0x00	Set the reset of the header (offset 0x6 to 0xe0) to 0x00.
...			
0xe0			

26.1.7.5.6 MMC/SD Read Sector Procedure in FAT Mode

MMC/SD Cards may hold a FAT file system which ROM Code is able to read and process. The image used by the booting procedure is taken from a specific booting file named "MLO". This file has to be located in the root directory on an active primary partition of type FAT12/16 or FAT32.

An MMC/SD card can be configured either as floppy-like or hard-drive-like.

- When acting as floppy-like, the content of the card is a single file system without any Master Boot Record (MBR) holding a partition table
- When acting as hard-drive-like, an MBR is present in the first sector of the card. This MBR holds a table of partitions, one of which must be FAT12/16/32, primary and active.

The card should always hold an MBR except for MMC cards using floppy-like file system (please refer to the CSD internal Register fields FILE_FORMAT_GRP and FILE_FORMAT in the MultiMedia Card System Specification). However, depending on the used operating system the MMC/SD card will be formatted either with partition(s) (using an MBR) or without. The ROM Code supports both types; this is described in the following section.

The ROM Code retrieves a map of the booting file from the FAT table. The booting file map is a collection of all FAT table entries related to the booting file (a FAT entry points to a cluster holding part of the file). The booting procedure uses this map to access any 512 byte sector within the booting file without involving ROM Code FAT module.

The sector read procedure utilizes standard MMC/SD raw data read function. The sector address is generated based on the booting memory file map collected during the initialization. Hence the ROM Code can address sectors freely within the booting file space.

26.1.7.5.7 FAT File system

This paragraph describes functions which are used by the ROM Code, it is not intended to fully describe the Master Boot Record and the FAT file system:

- How to recognize if a sector is the 1st sector of an MBR
- How to recognize if a sector is the 1st sector of a FAT12/16/32
- How to find the 1st cluster of the booting file
- How to buffer the booting file FAT entries.

Some memory devices which support file systems can be formatted with or without MBR, therefore the first task of the ROM Code is to detect whether or not the device is holding an MBR in the first sector.

If this is the case, an active FAT12/16/32 partition is searched in all 4 MBR partition entries, based on the Type field. If the MBR entries are not valid or if no useable partition is found then the ROM Code returns to the Booting procedure with FAIL. The Extended partitions are not checked, the booting file must reside in a primary partition.

If a partition is found then its first sector is read and used further on. If no MBR is present (in case of a floppy-like system), the first sector of the device is read and used further on.

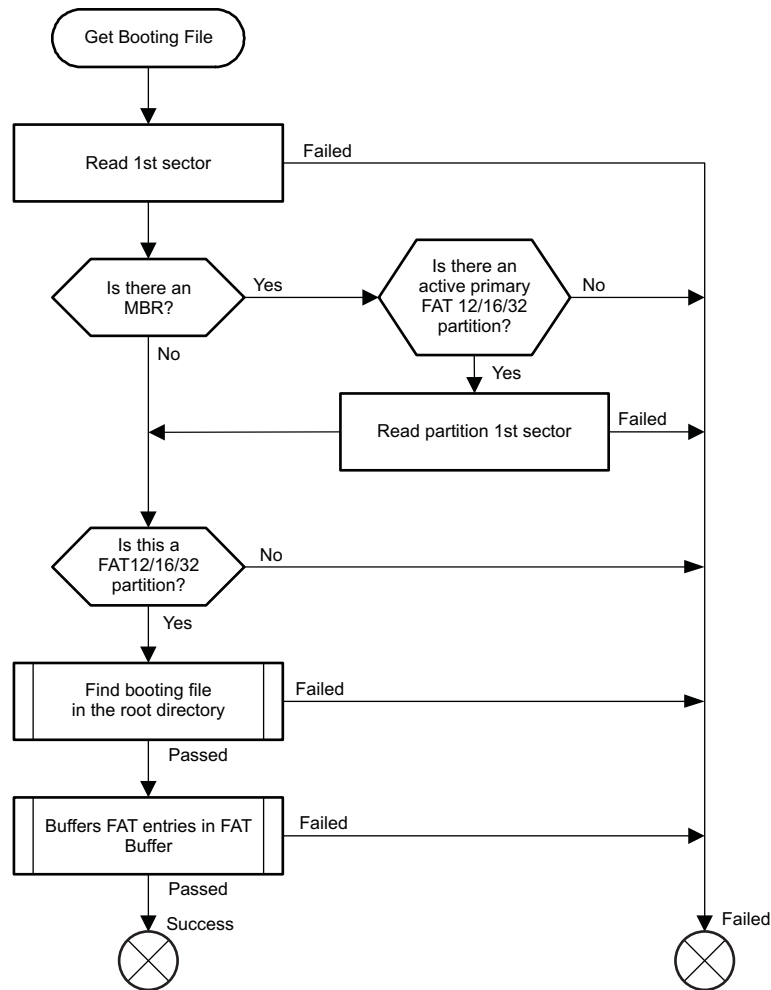
The read sector is checked to be a valid FAT12/16 or FAT32 partition. If this fails, in case another partition type is used (i.e. Linux FS or any other) or if the partition is not valid, the ROM Code returns with FAIL.

Otherwise, the Root Directory entries are searched for a file named depending on the booting device. The Long File Names (LFN) format is not used and **only File Names in 8.3 Format are searched for**. If no valid file is found, the ROM Code returns with FAIL.

Once the file has been found, the ROM Code reads the File Allocation Table (FAT) and buffers the singly-linked chain of clusters in a FAT Buffer which will be used by the Booting Procedure to access the file directly sector by sector. For FAT12/16 and for FAT32 (valid if a specific flag has been set in the FAT32 Boot Sector), there exist multiples copies of the FAT (ROM Code supports only 2 copies). When buffering FAT entries, the 2 FATs are compared. If they are not the same, only entries from the last FAT are used. The FAT Buffer holds sector numbers and not cluster numbers. The ROM Code converts each cluster entry to one or several sector entries if applicable.

The whole process is described in [Figure 26-19](#). Every part related to MBR or FAT12/16/32 is described in the next paragraph.

Figure 26-19. MMC/SD Booting, Get Booting File



26.1.7.5.7.1 Master Boot Record (MBR)

The Master Boot Record is the 1st sector of a memory device. It is made out of some executable code and 4 partition entries. The aim of such a structure is to be able to divide the hard disk in partitions mostly used to boot different systems (i.e. Microsoft Windows™, Linux,). Its structure is described in Table 26-22 and Table 26-23. The valid partition types searched by the ROM Code are described in Table 26-24.

Table 26-22. Master Boot Record Structure

Offset	Length[bytes]	Entry Description	Value
0000h	446	Optional Code	
01BEh	16	Partition Table Entry	(see Table 26-23)
01CEh	16	Partition Table Entry	(see Table 26-23)
01DEh	16	Partition Table Entry	(see Table 26-23)
01EEh	16	Partition Table Entry	(see Table 26-23)
01FEh	2	Signature	AA55h

Table 26-23. Partition Entry

Offset	Length[bytes]	Entry Description	Value
0000h	1	Partition State	00h: Inactive 80h: Active
0001h	1	Partition Start Head	H_s
0002h	2	Partition Start Cylinder and Sector	$C_s[7:0]-C_s[9:8]-S_s[5:0]$
0004h	1	Partition Type	See Table 26-24 for partial partition types
0005h	16	Partition End Head	H_e
0006h	2	Partition End Cylinder and Sector	$C_e[7:0]-C_e[9:8]-S_e[5:0]$
0008h	4	First sector position relative to the beginning of media	$LBA_s=C_s.H.S+H_s.S+S_s-1$
000Ch	4	Number of sectors in partition	$LBA_e=C_e.H.S+H_e.S+S_e-1Nbs=LBA_e-LBA_s+1$

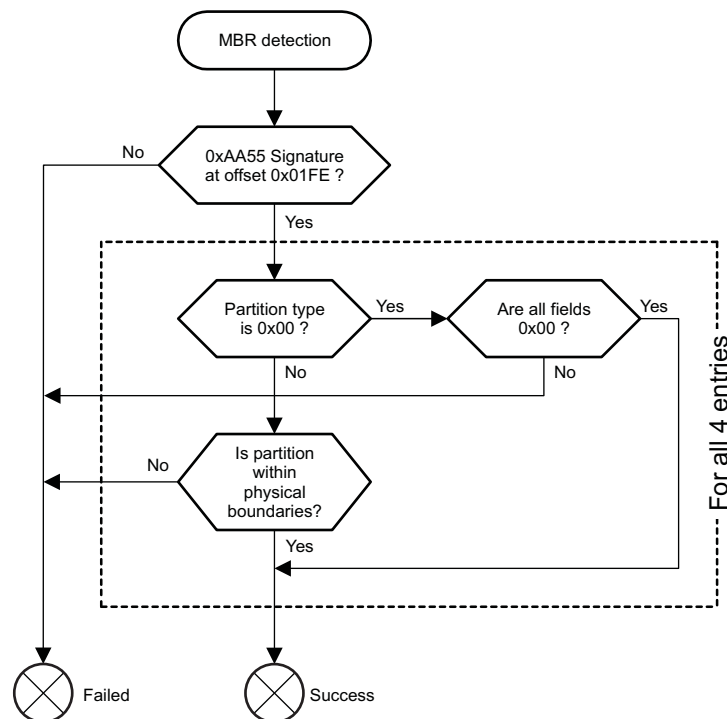
Table 26-24. Partition Types

Partition Type	Description
01h	FAT12
04h, 06h, 0Eh	FAT16
0Bh, 0Ch, 0Fh	FAT32

The way the ROM Code detects whether a sector is the 1st sector of an MBR or not is described in [Figure 26-20](#).

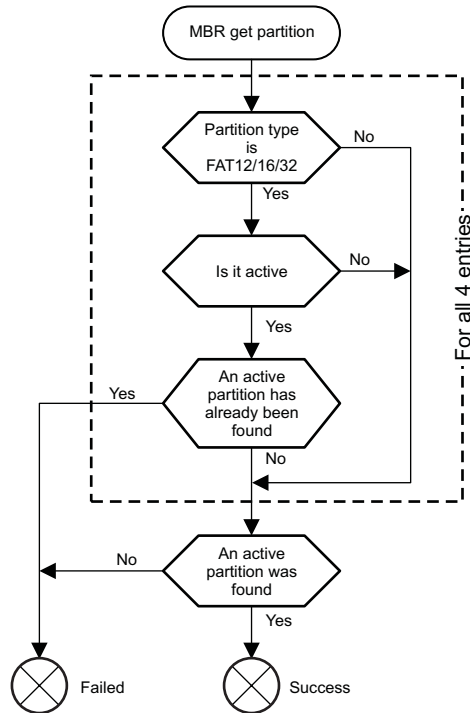
The ROM Code first checks if the signature is present. Each partition entry is checked:

- If its type is set to 00h then all fields in the entry must be 00h
- The partition is checked to be within physical boundaries, i.e. the partition is located inside and its size fits the total physical sectors.

Figure 26-20. MBR Detection Procedure


Once identified, the ROM Code gets the partition using the procedure described in Figure 26-21. The partition type is checked to be FAT12/16 or FAT32. Its state must be 00h or 80h (if there are more than one active partition the test fails). The ROM Code returns with FAIL if no active primary FAT12/16/32 could be found.

Figure 26-21. MBR, Get Partition



26.1.7.5.7.2 FAT12/16/32 Boot Sector

The FAT file system is made out of several parts:

- Boot Sector which holds the BIOS Parameter Block (BPB)
- File Allocation Table (FAT) which describes the use of each cluster of the partition
- Data Area which holds the Files, Directories and Root Directory (for FAT12/16, the Root Directory has a specific fixed location).

The Boot Sector is described in Table 26-25.

Note: In the following description, all the fields whose names start with BPB_ are part of the BPB. All the fields whose names start with BS_ are part of the Boot Sector and not really part of the BPB (not mandatory), they are not used at all by the ROM Code.

Table 26-25. FAT Boot Sector

Offset	Length[bytes]	Name	Description
0000h	3	BS_jmpBoot	Jump Instruction to Boot Code (not used)
0003h	8	BS_OEMName	Name of the System which created the partition
000Bh	2	BPB_BytsPerSec	Counts of Bytes per sector (usually 512)
000Dh	1	BPB_SecPerClus	Number of sectors per allocation unit
000Eh	2	BPB_RsvdSecCnt	Number of reserved sectors for the Boot SectorFor FAT12/16 is 1, for FAT32, usually 32
0010h	1	BPB_NumFATs	Number of copies of FAT, usually 2

Table 26-25. FAT Boot Sector (continued)

Offset	Length[bytes]	Name	Description	
0011h	2	BPB_RootEntCnt	For FAT12/16, number of 32 bytes entries in the Root Directory (multiple of BPB_BytsPerSec/32)For FAT32 this value is 0	
0013h	2	BPB_TotSec16	Total Count of sectors on the volume. If the size is bigger than 10000h or for FAT32, this field is 0 and BPB_TotSec32 holds the value	
0015h	1	BPB_Media	Media Type, usually F8h: fixed, non-removable	
0016h	2	BPB_FATSz16	For FAT12/16, size in sectors of one FATFor FAT32, holds 0	
0018h	2	BPB_SecPerTrk	Number of sectors per track, 63 for SD/MMC	
001Ah	2	BPB_NumHeads	Number of heads, 255 for SD/MMC	
001Ch	4	BPB_HiddSec	Number of sectors preceeding the partition	
0020h	4	BPB_TotSec32	Total Count of sectors on the volume. If the size is smaller than 10000h (for FAT12/16), this field is 0 and BPB_TotSec16 is valid	
FAT12/16	0024h	1	BS_DrvNum	Drive Number
	0025h	1	BS_Reserved1	00h
	0026h	1	BS_BootSig	Extended Boot Signature 29h. Indicates that the following 3 fields are present
	0027h	4	BS_VolID	Volume Serial Number
	002Bh	11	BS_VolLab	Volume Label
	0036h	8	BS_FilSysType	File system Type: "FAT12", "FAT16", "FAT32".Note: This field is not mandatory (i.e BS_) therefore it cannot be used to indentify the partition type.

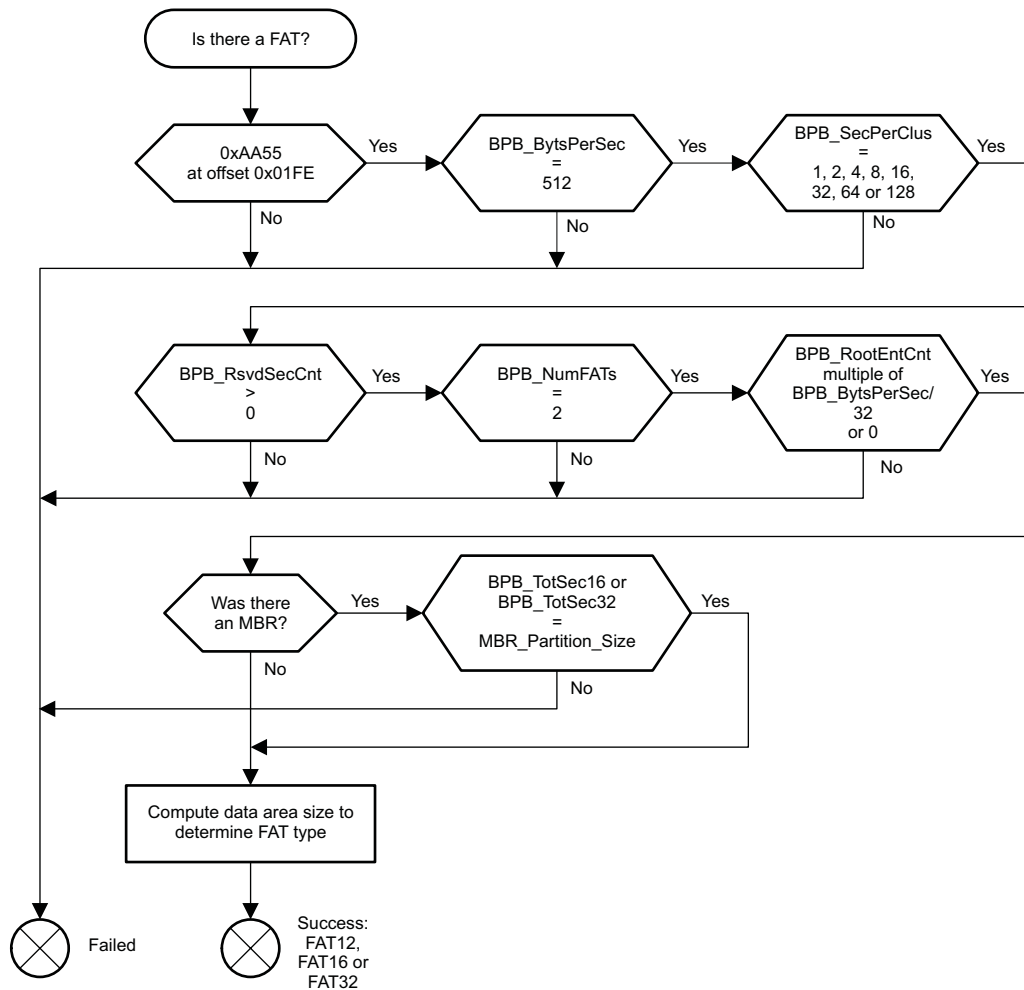
Table 26-25. FAT Boot Sector (continued)

Offset	Length[bytes]	Name	Description	
FAT32	0024h	4	BPB_FATsZ32	Size in sectors of one FAT. Field BPB_FATsZ16 must be 0
	0028h	2	BPB_ExtFlags	FAT Flags:
				[7]: 0=FAT is mirrored; 1=Only one FAT is used
				[3:0]: Number of used FAT if no mirroring used
	002Ah	2	BPB_FSVer	File system Version Number
	002Ch	4	BPB_RootClus	First Cluster number of the Root Directory
	0030h	2	BPB_FSInfo	Sector number of FSINFO Structure in the reserved-area, usually 1
	0032h	2	BPB_BkBootSec	If non-zero, indicates the sector number in the reserved-area of a copy of the Boot Sector
	0034h	12	BPB_Reserved	Reserved, set to 00h
	0040h	1	BS_DrvNum	Drive Number
	0041h	1	BS_Reserved1	00h
	0042h	1	BS_BootSig	Extended Boot Signature 29h. Indicates that the following 3 fields are present
	0043h	4	BS_VolID	Volume Serial Number
	0047h	11	BS_VolLab	Volume Label
	0052h	8	BS_FilSysType	File system Type: "FAT12", "FAT16", "FAT32". Note: This field is not mandatory (i.e BS_) therefore it cannot be used to identify the partition type.
01FEh	2	BPB_Signature	AA55h	

To check whether or not a sector holds a valid FAT12/16/32 partition, only fields starting with BPB can be checked as they are mandatory. The fields starting from offset 0024h to 01FDh cannot be used for the check as they will differ if using FAT12/16 or FAT32. The procedure is described in Figure 30. First the ROM Code checks if the *BPB_Signature* is equal to AA55h. Then it checks some fields which must have some specific values (*BPB_BytsPerSec*, *BPB_SecPerClus*, *BPB_RsvdSecCnt*, *BPB_NumFATs*, *BPB_RootEntCnt*) If the geometry of the device is known (valid CHS for device size < 4Gbytes) then it is compared against *BPB_SecPerTrk* and *BPB_NumHeads* fields. If an MBR was found before, the partition size is also checked:

The field *BPB_ToSec16* is used if the total number of sectors is below 65518 (in this case *BPB_TotSec32*=0), otherwise *BPB_TotSec32* is used (*BPB_TotSec16*=0). The partition sector offset is also checked: *BPB_HiddSec* = *MBR_Partition_Offset* (if this value is not 0 as some operating systems do not update this field correctly). The last step is to decide which type of FAT file system it is. The ROM Code computes the number of clusters in the Data Area part of the partition:

Where *Nb clusters* is given by the size of the Data Area:

Figure 26-22. FAT Detection Procedure


26.1.7.5.7.3 FAT12/16/32 Root Directory

The next task for the ROM Code is to find the booting file named “MLO” inside the Root Directory of the FAT12/16/32 file system. The file is not searched in any other location.

For a FAT12/16 file system, the Root Directory has a fixed location which is cluster 0. For a FAT32 file system, its cluster location is given by *BPB_RootClus*. The general formulae to find the sector number (relative to device sector 0, not partition sector 0) of a cluster is given by:

$$Cluster_{sector} = BPB_RsvdSecCnt + BPB_NumFATs \times BPB_FATSz + Cluster \times BPB_SecPerClus$$

Note: *BPB_FatSz* is *BPB_FatSz16* for FAT12/16 or *BPB_FatSz32* for FAT32

Note: the *BPB_HiddSec* field can contain 0 even though the FAT file system is located somewhere other than on sector 0 (floppy-like). The ROM Code actually uses the partition offset taken from the MBR instead of this field which can be wrong. If no MBR was found (floppy-like) the value 0 is used.

Each entry in the Root Directory is 32 bytes long and hold information about the file, i.e. filename, date of creation, rights, cluster location etc. This is described in [Table 26-26](#).

The ROM Code checks each entry in the Root Directory until either the booting file is found or the entry is empty (first byte is 00h) or when the end of the Root Directory has been reached. Entries with ATTR_LONG_NAME attribute (LFN) and with first byte at E5h (erased file) are ignored. When found, the first cluster offset of the file is read from the DIR_FstClusHi/DIR_FstClusLo fields.

There is a slight difference between FAT12/16 and FAT32 when handling the Root Directory. On FAT12/16, this directory has a fixed location (see above) and length fixed by *BPB_RootEntCnt* which is the total number of 32 bytes entries. Handling this directory is therefore straight forward. On FAT32, the Root Directory is like a standard file, the File Allocation Table (FAT) has to be used in order to retrieve each sector of the Directory. The way the FAT is handled is described in the next paragraph.

Table 26-26. FAT Directory Entry

Offset	Length[bytes]	Name	Description
0000h	11	DIR_Name	Short Name (8+3)
000Bh	1	DIR_Attr	File Attributes:
			ATTR_READ_ONLY 01h
			ATTR_HIDDEN 02h
			ATTR_SYSTEM 04h
			ATTR_VOLUME_ID 08h
			ATTR_DIRECTORY 10h
			ATTR_ARCHIVE 20h
			ATTR_LONG_NAME ATTR_READ_ONLY ATTR_HIDDEN ATTR_SYSTEM ATTR_VOLUME_ID
000Ch	1	DIR_NTRes	Reserved, set to 00h
000Dh	1	DIR_CrtTimeTenth	Millisecond stamp at file creation
000Eh	2	DIR_CrtTime	Time file was created
0010h	2	DIR_CrtDate	Date file was created
0012h	2	DIR_LstAccDate	Last Access date
0014h	2	DIR_FstClusHi	High word of this entry's first cluster number
0016h	2	DIR_WrtTime	Time of last write
0018h	2	DIR_WrtDate	Date of last write
001Ah	2	DIR_FstClusLo	Low word of this entry's first cluster number
001Ch	4	DIR_FileSize	File size in bytes

26.1.7.5.7.4 FAT12/16/32 File Allocation Table

The ROM Code needs to read the FAT in order to retrieve sectors either for the booting file or for the Root Directory (in case the file system is FAT32).

There can be multiple copies of the FAT inside the file system (ROM Code supports only 2) located after the Boot Sector:

$$FATn_{sector} = BPB_HiddSec + BPB_RsvdSecCnt + BPB_FatSz \times n$$

Its size is given by *BPB_FATs16* or *BPB_FATs32*. The ROM Code checks each copy of the FAT if identical. In case the values are different, the ROM Code uses the value from the last FAT copy.

With FAT32 file system, the copy system can be disabled according to a flag located in *BPB_ExtFlags[7]*. If this flag is set then FAT *BPB_ExtFlags[3:0]* is used. In this case no verification is made by the ROM Code with other copies of FAT.

The FAT is a simple array of values each referring to a cluster located in the Data Area. One entry of the array is 12, 16 or 32 bits depending on the file system in use.

The value inside an entry defines whether the cluster is being used or not and if another cluster has to be taken into account. This creates a singly-linked chain of clusters defining the file. The meaning of an entry is described in [Table 26-27](#).

Note: For compatibility reasons, clusters 0 and 1 are not used for files and those entries must contain FF8h and FFFh (for FAT12); FFF8h and FFFFh (for FAT16); ?FFFFFF8h and ?FFFFFFFh (for FAT32).

Table 26-27. FAT Entry Description

FAT12	FAT16	FAT32	Description
000h	0000h	?0000000h	Free Cluster
001h	0001h	?0000001h	Reserved Cluster
002h-FEFh	0002h-FFEFh	00000002h-?FFFFFFEFh	Used Cluster; value points to next cluster
FF0h-FF6h	FFF0h-FFF6h	?FFFFFFF0h-?FFFFFFF6h	Reserved values
FF7h	FFF7h	?FFFFFFF7h	Bad Cluster
FF8h-FFFh	FFF8h-FFFh	?FFFFFFF8h-?FFFFFFFh	Last Cluster in File

Note: FAT32 uses only bits [27:0], the upper 4 bits are usually 0 and should be left untouched.

When accessing the Root Directory for FAT32, the ROM Code just starts from the Root Directory Cluster entry and follows the linked chain to retrieve the clusters.

When the booting file has been found, the ROM Code buffers each FAT entry corresponding to the file in a sector way. This means each cluster is translated to one or several sectors depending on how many sectors are in a cluster (*BPB_SecPerClus*). This buffer is used later on by the booting procedure to access the file.

26.1.7.5.8 Pins Used

The list of device pins that are configured by the ROM in the case of MMC boot mode are as follows. Please note that all the pins might not be driven at boot time.

Table 26-28. Pins Used for MMC0 Boot

Signal name	Pin Used in Device
clk	mmc0_clk
cmd	mmc0_cmd
dat0	mmc0_dat0
dat1	mmc0_dat1
dat2	mmc0_dat2
dat3	mmc0_dat3

Table 26-29. Pins Used for MMC1 Boot

Signal name	Pin Used in Device
clk	gpmc_csn1
cmd	gpmc_csn2
dat0	gpmc_ad0
dat1	gpmc_ad1
dat2	gpmc_ad2
dat3	gpmc_ad3

26.1.7.6 SPI

SPI EEPROMs or SPI flashes have an EEPROM or NOR flash backend and they connect to the device using the serial SPI protocol.

These devices typically operate in three stages: the command stage, the address stage and the data transfer stage. The command is usually an 8 bit value followed by the address (depending on the size of the device) followed by the data to be read or written.

Because of the need for fewer pins, these devices are comparatively inexpensive, easy for board layout, and are the devices of choice when cost, complexity and form factor are critical considerations.

26.1.7.6.1 Features

- Supports 12-MHz clock (50% duty cycle).
- Supports only SPI Mode 3 (clock polarity = 1, clock phase = 1).
- Supports only 24-bit addressable EEPROMs.
- Supports only 4-pin SPI mode (CS, CLK, Serial Input, Serial Output).
- The boot devices must be connected to chip select 0 and must support the read command (03h).
- The boot image is copied into internal memory and then executed.

26.1.7.6.2 Initialization and Detection

The ROM Code initializes the SPI controller, pin muxing and clocks for communicating with the SPI device. The controller is initialized in Mode 3 and the clock is setup to operate at 12 MHz. There is no specific device identification routine that is executed by the ROM code to identify whether a boot device is preset or not. If no SPI device is present, the sector read will return only 0xFFFFFFFF and the SPI boot will be treated as failed.

26.1.7.6.3 SPI Read Sector Procedure

The ROM Code reads SPI data from the boot device in 512 byte sectors. For each call to the SPI Read Sector routine, the SPI Read Command (0x03) is sent along with the 24 bit start address of the data to be read. Each Sector = 512bytes and the ROM bootloader will attempt the following:

1. Read Sector 1, Check the address: 0x0
2. Read Sector 2, Check the address: 0x200
3. Read Sector 3, Check the address: 0x400
4. Read Sector 4, Check the address: 0x600

The addresses mentioned above should contain the image size. If the value of the addresses mentioned above is neither 0x0 nor 0xFFFFFFFF, then the boot will proceed else it will move to the next sector. If no image is found after checking four sectors, the ROM bootloader will move to the next device.

From the next iteration onwards, a dummy value is transmitted on the master out line and the data is received on the master in line. This needs to be done because SPI protocol always operated in full duplex mode. The dummy data transmitted by the ROM is the Read Command appended to the start address. The data from the boot device is received MSB first.

As the A8 is a little-endian processor, and SPI operates in a big-endian format, this means that while writing to the flash, care needs to be taken to write the image in a big-endian format. This way we can avoid doing the endian conversion at boot time, thus improving boot performance.

26.1.7.6.4 Pins Used

The list of device pins that are configured by the ROM in the case of SPI boot mode are as follows. Please note that all the pins might not be driven at boot time.

Table 26-30. Pins Used for SPI Boot

Signal name	Pin Used in Device
cs	spi0_cs0
miso	spi0_d0
mosi	spi0_d1
clk	spi0_sclk

26.1.7.7 Blocks and Sectors Search Summary

Table 26-31 summarizes numbers of blocks and sectors which are searched during the memory booting from devices requiring image shadowing. NAND is organized with blocks, which are erasable units.

Table 26-31. Blocks and Sectors Searched on Non-XIP Memories

Memory	Maximum Number of Blocks Checked	Number of Sectors Searched
NAND	first 4	Number of sectors in one block ⁽¹⁾
SPI, eMMC/eSD and MMC/SD cards (raw mode)	first 4	1

⁽¹⁾ Depends on NAND geometry

Regarding MMC/SD card booting in FAT mode, the file system area is searched for one file.

26.1.8 Peripheral Booting

26.1.8.1 Overview

The ROM Code can boot from three different peripheral interfaces:

- EMAC: 1000/100/10 Mbps Ethernet, using standard TCP/IP network boot protocols BOOTP and TFTP
- USB: Full speed, client mode
- UART: 115.2Kbps, 8 bits, no parity, 1 stop bit, no flow control

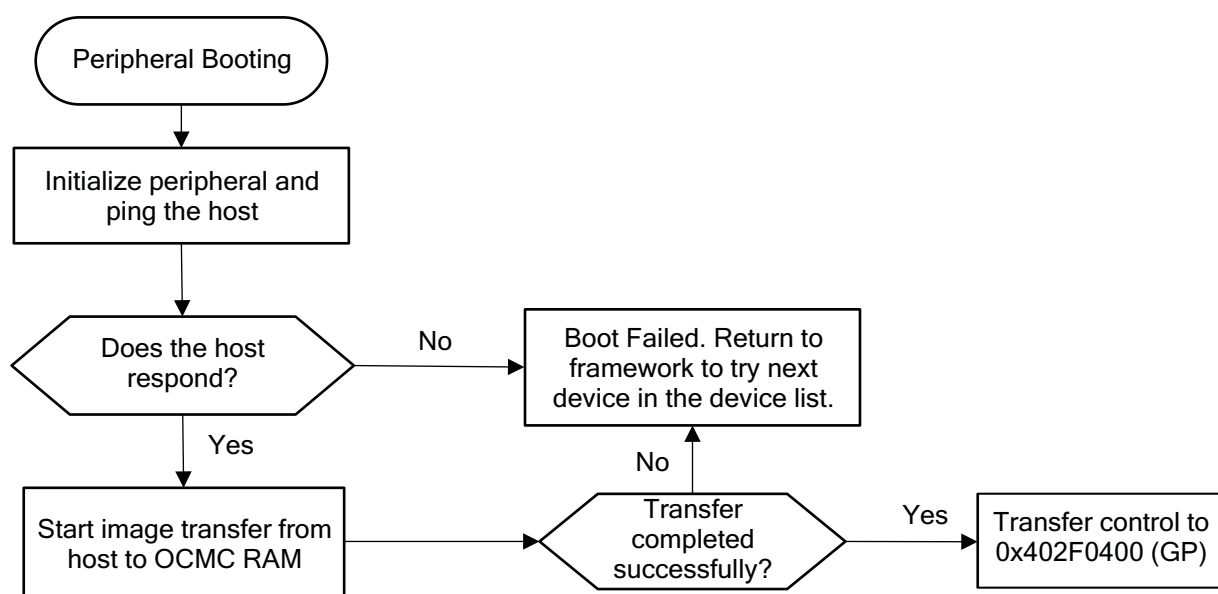
The purpose of booting from a **peripheral interface** is to download a **boot image** from an external host (typically a PC). This booting method is mostly used for programming flash memories connected to the device (e.g. in the case of initial flashing, firmware update or servicing).

26.1.8.2 Boot Image Location and Size

The boot image is downloaded directly into internal RAM at the location 0x402F0400 on GP devices. The maximum size of downloaded image is 109 KB.

26.1.8.3 Peripheral Boot Procedure Overview

Figure 26-23. Peripheral Booting Procedure



26.1.8.4 EMAC Boot Procedure

NOTE: See *AM335x ARM Cortex-A8 Microprocessors (MPUs) Silicon Errata* (literature number [SPRZ360](#)) for limitations of EMAC booting.

26.1.8.4.1 Device Initialization

- EMAC boot uses the CPGMAC port 1 of the device
- Supports connection to external Ethernet PHY using the MII, RMII, RGMII and MDIO pins, based on SYSBOOT pin settings
- In dual-port configurations, the ROM code assumes that the Ethernet PHY with the lowest MDIO address (0-31) is connected to CPGMAC port 1
- Device uses EFUSE registers [mac_id0_lo](#) and [mac_id0_hi](#) in the control module for Ethernet MAC address of the device
- Device detects if the PHY is alive on the MDIO interface and
 - Reads the STATUS register to check if Ethernet link is active
 - Reads the CONTROL register to detect the auto-negotiated mode of operation
 - Is the mode full-duplex or half duplex
 - Speed of operation, 1000/100/10 Mbps. Link speed is determined by reading the Auto-Negotiation Advertisement and Auto-Negotiation Link Partner Base Page Ability registers in the external PHY. (**Note:** See [Silicon Revision Functional Differences and Enhancements](#), *Silicon Revision Functional Differences and Enhancements*, for differences in operation based on AM335x silicon revision.)
 - Waits for five seconds for auto negotiation to complete before timing out
- ROM expects an external 50-MHz reference clock requirement when using RMII

26.1.8.4.2 BOOTP (RFC 951)

The device then proceeds to obtain the IP and Boot information using BOOTP protocol. The device prepares and broadcasts the BOOTP message that has the following information:

- Device MAC address in “chaddr” field – to uniquely identify the device to the server.
- “vender-class-identifier” option number 60 (RFC 1497, RFC 1533). Servers could use this information to identify the device type. The value present is **“AM335x ROM”**. (Note: See [Silicon Revision Functional Differences and Enhancements](#), *Silicon Revision Functional Differences and Enhancements*, for differences in operation based on AM335x silicon revision.)
- “Client-identifier” option number 61 (RFC 1497, RFC 1533). This has the ASIC-ID structure which contains additional info for the device.

The device then expects a BOOTP response that provides the following information for the booting to proceed

- Device IP address from “yiaddr” field
- Subnetmask from extended option 1 (RFC 1497, RFC 1533)
- Gateway IP from extended option number 3 (RFC 1497, RFC 1533) or from “giaddr” field of BOOTP response.
- Boot image filename from “file” field
- TFTP server IP address from the “siaddr” field

Timeouts and retries:

- Exponentially increasing timeouts starting from 4s, doubling for each retry.
- 5 retries

26.1.8.4.3 TFTP (RFC 1350)

After a successful BOOTP completion, the device initiates the TFTP download of the boot image into SRAM. The device has the capability to reach a TFTP server within the local subnet or outside, through the gateway.

Timeouts and retries:

- Timeout of 1s to receive a response for the READ request
- 5 retries for the READ request
- Retries are managed by server once data transfer starts (server re-sends a data packet if the ACK was not received within a timeout value)
- Device has a 60s timeout to complete the data transfer, to handle the scenario if the server dies in the middle of a data transfer

26.1.8.4.4 Pins Used

The list of device pins that are configured by the ROM in the case of EMAC boot mode are as follows. Please note that all the pins might not be driven at boot time.

Table 26-32. Pins Used for EMAC Boot in MII Mode

Signal Name	Pin Used in Device	Pin Mux Mode
gmii1_col	MII1_COL	0
gmii1_crs	MII1_CRCS	0
gmii1_rxer	MII1_RX_ER	0
gmii1_txen	MII1_TX_EN	0
gmii1_rxdv	MII1_RX_DV	0
gmii1_txd[3:0]	MII1_TXD[3:0]	0
gmii1_txclk	MII1_TX_CLK	0
gmii1_rxclk	MII1_RX_CLK	0
gmii1_rxd[3:0]	MII1_RXD[3:0]	0
mdio_data	MDIO	0
mdio_clk	MDC	0

Table 26-33. Pins Used for EMAC Boot in RGMII Mode

Signal Name	Pin Used in Device	Pin Mux Mode
rgmii1_tctl	MII1_TX_EN	2
rgmii1_rctl	MII1_RX_DV	2
rgmii1_td[3:0]	MII1_TXD[3:0]	2
rgmii1_tclk	MII1_TX_CLK	2
rgmii1_rclk	MII1_RX_CLK	2
rgmii1_rd[3:0]	MII1_RXD[3:0]	2
mdio_data	MDIO	0
mdio_clk	MDC	0

Table 26-34. Pins Used for EMAC Boot in RMII Mode

Signal Name	Pin Used in Device	Pin Mux Mode
rmii1_crs_dv	MII1_CRCS	1
rmii1_rxer	MII1_RX_ER	1
rmii1_txen	MII1_TX_EN	1
rmii1_txd[1:0]	MII1_TXD[1:0]	1
rmii1_rxd[1:0]	MII1_RXD[1:0]	1
rmii1_refclk	RMII1_REF_CLK (Driven by External 50-MHz Source)	0
mdio_data	MDIO	0
mdio_clk	MDC	0

26.1.8.4.5 SYSBOOT Pins

Some of the SYSBOOT pins have special meanings when EMAC boot is selected.

Table 26-35. Ethernet PHY Mode Selection

SYSBOOT[7:6]	PHY Mode
00b	MII
01b	RMII
10b	Reserved
11b	RGMI without internal delay

26.1.8.5 UART Boot Procedure

26.1.8.5.1 Device Initialization

- UART boot uses UART0.
- UART0 is configured to run at 115200 baud, 8-bits, no parity, 1 stop bit and no flow control.

26.1.8.5.2 Boot Image Download

- UART boot uses x-modem client protocol to receive the boot image.
- Utilities like hyperterm, teraterm, minicom can be used on the PC side to download the boot image to the board
- With x-modem packet size of 1K throughout is roughly about 4KBytes/Sec.
- The ROM code will ping the host 10 times in 3s to start x-modem transfer. If host does not respond, UART boot will timeout.
- Once the transfer has started, if the host does not send any packet for 3s, UART boot will time out
- If the delay between two consecutive bytes of the same packet is more than 2ms, the host is requested to re-transmit the entire packet again
- Error checking using the CRC-16 support in x-modem. If an error is detected, the host is requested to re-transmit the packet again.

26.1.8.5.3 Pins Used

The list of device pins that are configured by the ROM in the case of UART boot mode are as follows.

Note: All the pins might not be driven at boot time.

Table 26-36. Pins Used for UART Boot

Signal name	Pin Used in Device
rx	uart0_rxd
tx	uart0_txd

26.1.8.6 USB Boot Procedure

NOTE: See *AM335x ARM Cortex-A8 Microprocessors (MPUs) Silicon Errata* (literature number [SPRZ360](#)) for limitations of USB booting.

26.1.8.6.1 Device Initialization

The ROM code supports booting from the USB interface under the following conditions:

- When the high-speed USB OTG (USBOTGHS) IP is used through USB0 interface.
- USB operates in full-speed, client mode.

- USB will operate only in device-powered mode.
- Integrated transceiver (through UTMI).
- The enumeration default timeout is 3s (USB timeout).
- ROM code uses the default value of DATAPOLARITY.

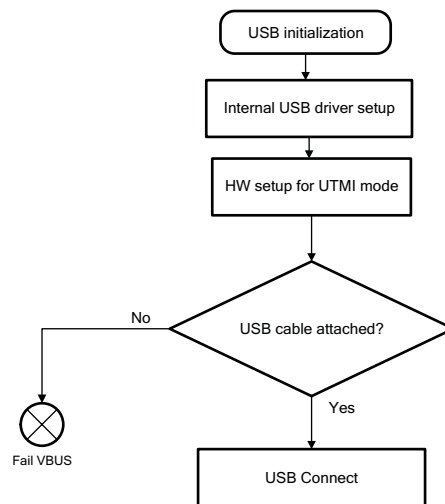
Even though using an OTG capable hardware, the ROM Code does not handle any OTG specific feature.

26.1.8.6.1.1 Overview

In case of boot from USB is chosen by the SYSBOOT pin configuration:

- The USBOTGHS hardware and PRCM clocks are configured for UTMI mode.
- The ROM Code continues with the USB procedure only if the USB cable is detected present (i.e. VBUS is detected at transceiver level and communicated as such through the UTP1 traffic). If not, the initialization procedure is aborted.
- The ROM code implements the RNDIS class driver.
- From a user's perspective, USB boot is indistinguishable from Ethernet boot. Refer to [Section 26.1.8.4.2](#) for information on the BOOTP protocol.
- The USB initialization procedure is shown in [Figure 26-24](#).

Figure 26-24. USB Initialization Procedure



26.1.8.6.1.2 Enumeration Descriptors

The device descriptor parameters which are used during enumeration are listed in [Table 26-37](#). The default Vendor ID and Product ID can be automatically overridden by the customer by programming the Efuses that are used to store these values.

Table 26-37. Customized Descriptor Parameters

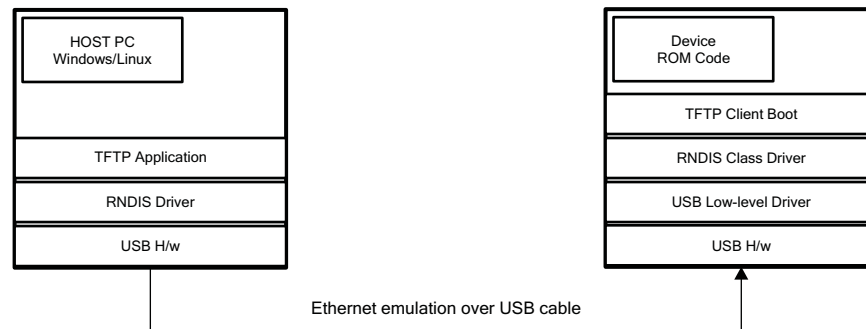
Parameter	Size [bytes]	TI Default Values
Device ID code	2	0000h
Device Class	1	02h
Device Sub-Class	1	00h
Device Protocol	1	00h
Manufacturer	String	"Texas Instruments"
Product ⁽¹⁾	String	AM335x USB
Serial number	1	0h

⁽¹⁾ See [Silicon Revision Functional Differences and Enhancements](#), *Silicon Revision Functional Differences and Enhancements*, for differences in operation based on AM335x silicon revision.

26.1.8.6.2 Image Download Procedure

- The device supports USB client boot only.
- The ROM implements as RNDIS class driver, so the device enumerates as an ethernet port.
- Standard RNDIS drivers present on Linux and Windows are picked up during the enumeration. No special drivers need to be installed.
- Once the enumeration is complete, the customer can download the boot image using any standard TFTP server application.

Figure 26-25. Image Transfer for USB Boot



26.1.8.6.3 Pins Used

The list of the device pins that are configured by the ROM in the case of USB boot mode are as follows. Please note that all the pins might not be driven at boot time.

Table 26-38. Pins Used for USB Boot

Signal Name	Pin Used in Device
USB0_DM	USB0_DM
USB0_DP	USB0_DP
USB0_ID	USB0_ID
USB0_VBUS	USB0_VBUS

26.1.8.7 ASIC ID structure

The ASIC ID size is 58 bytes for UART and 81 bytes for others. The fields of this structure are unused. This structure is included purely for legacy purposes.

26.1.9 Image Format

26.1.9.1 Overview

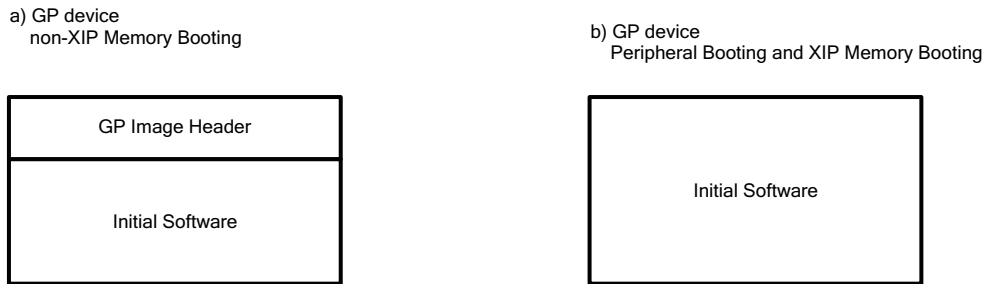
All preceding sections describe how the ROM Code searches and detects a boot image from a memory or a peripheral device type. This section describes the format of the boot image.

A boot image is basically made out of two major parts:

- The software to execute
- A header containing the destination address and size of the image for non XIP memory devices

The mandatory section of a boot image contains the software which will be loaded into the memory and executed. An overview of the image formats is shown in [Figure 26-26](#):

Figure 26-26. Image Formats on GP Devices



a) GP Non-XIP Memory Booting

Used for memories which require shadowing (e.g. MMC). Image must begin with a GP header which contains information on image size and destination address.

b) GP Peripheral Booting and XIP Memory Booting

When memory device is of XIP type (e.g. NOR) the GP header is not needed and the image can contain code for direct execution. The same image format is used for peripheral booting (where the code is transferred to internal RAM).

26.1.9.2 Image Format for GP Device

When the booting memory device is non-XIP (e.g. MMC) the image must contain a small header (referred to as GP header) with the size of the software to load and the destination address where to store it.

The GP header is not needed when booting from an XIP memory device (e.g. NOR) or in case of peripheral booting. In this case, the peripheral or memory booting image starts directly with executable code.

Table 26-39. GP Device Image Format

Field	Non-XIP Device Offset	XIP Device Offset	Size[bytes]	Description
Size	0000h	-	4	Size of the image
Destination	0004h	-	4	Address where to store the image / code entry point
Image	0008h	0000h	x	Executable code

Note: The “Destination” address field stands for both:

- Target address for the image copy from the non-XIP storage to the target XIP location (e.g., internal RAM or SDRAM)
- Entry point for image code

In other words the user must take care to locate the code entry point to the target address for image copy.

26.1.10 Code Execution

26.1.10.1 Overview

One of the early steps of the Public ROM Code execution is to search for a boot image from the requested medium (configured by the SYSBOOT pins) and copy it to RAM if needed. If the device is of GP type and boot interface is non-XIP then the image is simply copied to the provided destination address (internal or external RAM) and then executed. If the boot interface is of XIP type then the image copy is not needed and execution is directly given to the XIP memory.

26.1.10.2 Execution

The image is executed at the time the ROM Code performs the branch to the first executable instruction inside the Initial SW. For a GP Device in non-XIP, the execution address is the first word after the GP header. The branch is performed in public ARM supervisor mode. The R0 register points to the Booting Parameters structure which contains various information about the booting execution. [Table 26-40](#) details this structure.

Table 26-40. Booting Parameters Structure

Offset	Field	Size (bytes)	Description
00h	Reserved	4	Reserved
04h	Memory booting device descriptor address	4	Pointer to the memory device descriptor that has been used during the memory booting process. ⁽¹⁾
08h	Current Booting Device	1	Code of device used for booting 00h – void, no device 01h – XIP MUX1 memory 02h – XIPWAIT MUX 1 (wait monitoring on) 03h – XIP MUX2 memory 04h – XIPWAIT MUX 2 (wait monitoring on) 05h – NAND 06h – NAND with I2C 08h – MMC/SD port 0 09h – MMC/SD port 1 Bh – SPI 41h – UART0 44h – USB 46h – CPGMAC0
09h	Reset Reason	1	Current reset reason bit mask (bit=1-event present) [0] – Power-on (cold) reset [1] – Global warm software reset [2] – Reserved [3] – Reserved [4] – WDT1 timer reset [5] – Global external warm reset Other bits – Reserved Note: ROM code does not clear any of these bits.
0Ah	Reserved	1	Reserved

⁽¹⁾ More detailed information is found in each memory's booting description.

26.1.11 Wakeup

26.1.11.1 Overview

The device supports a comprehensive set of low-powered states to meet aggressive power budget requirements. The different low-power modes supported, from the lowest power consumption state to the highest power consumption state, include:

- RTC Only
- DeepSleep 0
- DeepSleep 1
- Standby
- Active

Of these states, the ROM code is involved only in the first three, as the A8 registers (particularly the PC) are preserved in all the other states. So for these modes, on wake up, execution will resume from the next instruction following the WFI.

In the RTC only mode, the ROM code involvement is trivial. A wakeup from the RTC only mode, from the ROM perspective, is indistinguishable from a power on reset. In DeepSleep 0 and DeepSleep 1 state, the ROM code should detect whether wakeup has occurred and branch to a user-defined return address rather than perform a full boot.

26.1.11.2 Wakeup Booting by ROM Code

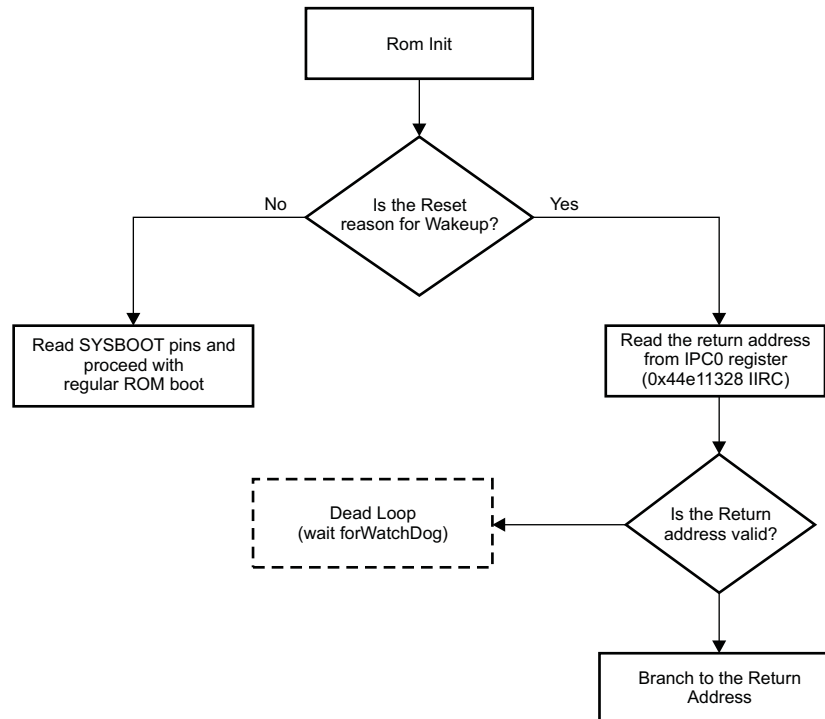
In this device, when the A8 is in OFF mode, execution begins from the reset vector on wakeup. As the reset vector lies in the ROM code, the ROM code is the first software entity that takes control of the A8 on a wakeup.

It must be noted here that in the device, in all the modes other than RTC-only, the L3 OCMC RAM is held in retention. This is a fundamental assumption of the ROM code. Because the contents of this RAM is not lost in the DeepSleep modes, it is possible to return to a location in this memory.

This does away with the need of the ROM having to restore PLL and EMIF settings, which would have been needed if the ROM had to return to a DRAM address, as DRAM is held in self-refresh. The job of dialing up the PLLs and restoring EMIF and other peripheral register values is the responsibility of the user code. The recommendation is that such restoration code be placed in the OCMC RAM.

In the past, having complex PLL and EMIF restore code in the ROM has made wakeup debugging very complicated. This has also traditionally been a source of many bugs, as the wakeup procedures are complicated and difficult to test exhaustively in pre-silicon.

The current architecture does away with these problems. The flow in the ROM on wakeup is kept simple and minimal. It only involves identifying that the reset reason is a Wakeup, and then branching to a return address, rather than proceeding with a full boot. This also helps in improving the time required to wakeup a system that is in Deep Sleep.

Figure 26-27. Wakeup Booting by ROM


26.1.12 Tracing

Tracing in the Public ROM Code includes three 32-bit vectors for which each bit corresponds to a particular “way point” in the ROM Code execution sequence (see [Table 26-4](#)). Tracing vectors are initialized at the very beginning of the startup phase and updated all along the boot process.

There are two sets of tracing vectors. The first set is the current trace information (after cold or warm reset). The second set holds a copy of trace vectors collected at the first ROM Code run after cold reset. As a consequence after a warm reset it is possible to have visibility on the boot scenario that occurred during cold reset.

Table 26-41. Tracing Vectors

Trace vector	Bit No.	Group	Meaning
1	0	General	Passed the public reset vector
1	1	General	Entered main function
1	2	General	Running after the cold reset
1	3	Boot	Main booting routine entered
1	4	Memory Boot	Memory booting started
1	5	Peripheral Boot	Peripheral booting started
1	6	Boot	Booting loop reached last device
1	7	Boot	GP header found
1	8	Boot	Reserved
1	9	Boot	Reserved
1	10	Peripheral Boot	Reserved
1	11	Peripheral Boot	Reserved
1	12	Peripheral Boot	Device initialized
1	13	Peripheral Boot	Asic Id sent
1	14	Peripheral Boot	Image received

Table 26-41. Tracing Vectors (continued)

Trace vector	Bit No.	Group	Meaning
1	15	Peripheral Boot	Peripheral booting failed
1	16	Peripheral Boot	Bootling Message not received (timeout)
1	17	Peripheral Boot	Image size not received (timeout)
1	18	Peripheral Boot	Image not received (timeout)
1	19	Reserved	Reserved
1	20	Configuration Header	CHSETTINGS found
1	21	Configuration Header	CHSETTINGS executed
1	22	Configuration Header	CHRAM executed
1	23	Configuration Header	CHFLASH executed
1	24	Configuration Header	CHMMCSO clocks executed
1	25	Configuration Header	CHMMCSO bus width executed
1	26	Reserved	Reserved
1	27	Reserved	Reserved
1	28	Reserved	Reserved
1	29	Reserved	Reserved
1	30	Reserved	Reserved
1	31	Reserved	Reserved
2	0	Companion chip	Reserved
2	1	Companion chip	Reserved
2	2	Companion chip	Reserved
2	3	Companion chip	Reserved
2	4	USB	USB connect
2	5	USB	USB configured state
2	6	USB	USB VBUS valid
2	7	USB	USB session valid
2	8	Reserved	Reserved
2	9	Reserved	Reserved
2	10	Reserved	Reserved
2	11	Reserved	Reserved
2	12	Memory Boot	Memory booting trial 0
2	13	Memory Boot	Memory booting trial 1
2	14	Memory Boot	Memory booting trial 2
2	15	Memory Boot	Memory booting trial 3
2	16	Memory Boot	Execute GP image
2	17	Peripheral Boot	Start authentication of peripheral boot image
2	18	Memory & Peripheral Boot	Jumping to Initial SW
2	19	Memory & Peripheral Boot	Reserved
2	20	Memory & Peripheral Boot	Start image authentication
2	21	Memory & Peripheral Boot	Image authentication failed
2	22	Memory & Peripheral Boot	Analyzing SpeedUp
2	23	Memory & Peripheral Boot	Speedup failed
2	24	Memory & Peripheral Boot	Reserved
2	25	Memory & Peripheral Boot	Reserved
2	26	Memory & Peripheral Boot	Reserved
2	27	Memory & Peripheral Boot	Reserved

Table 26-41. Tracing Vectors (continued)

Trace vector	Bit No.	Group	Meaning
2	28	Memory & Peripheral Boot	Authentication procedure failed
2	29	Reserved	Reserved
2	30	Reserved	Reserved
2	31	Reserved	Reserved
3	0	Memory Boot	Memory booting device NULL
3	1	Memory Boot	Memory booting device XIP
3	2	Memory Boot	Memory booting device XIPWAIT
3	3	Memory Boot	Memory booting device NAND
3	4	Memory Boot	Reserved
3	5	Memory Boot	Memory booting device MMCSD0
3	6	Reserved	Reserved
3	7	Memory Boot	Memory booting device MMCSD1
3	8	Reserved	Reserved
3	9	Reserved	Reserved
3	10	Memory Boot	Reserved
3	11	Reserved	Reserved
3	12	Reserved	Memory booting device SPI
3	13	Reserved	Reserved
3	14	Reserved	Reserved
3	15	Reserved	Reserved
3	16	Reserved	Peripheral booting device UART0
3	17	Reserved	Reserved
3	18	Peripheral Boot	Reserved
3	19	Reserved	Reserved
3	20	Peripheral Boot	Peripheral booting device USB
3	21	Peripheral Boot	Reserved
3	22	Peripheral Boot	Peripheral booting device GPGMAC0
3	23	Reserved	Reserved
3	24	Reserved	Peripheral booting device NULL
3	25	Reserved	Reserved
3	26	Reserved	Reserved
3	27	Reserved	Reserved
3	28	Reserved	Reserved
3	29	Reserved	Reserved
3	30	Reserved	Reserved
3	31	Reserved	Reserved

Debug Subsystem

This chapter describes the debug subsystem of the device. More information will be available in future revisions of this document.

Topic	Page
27.1 Functional Description	4966
27.2 Registers	4969

27.1 Functional Description

27.1.1 Debug Resource Manager (DRM)

27.1.1.1 Debug Suspend Support for Peripherals

When a processor is halted, peripherals associated with the processor must appropriately respond to this event to avoid incorrect actions.

An example of this is the action of the Watchdog Timer (WDT) during a debug halt. Typically watchdog timers fire a reset to restart a system after a timeout. The reset could be misfired during debug if a processor is halted for a fairly long time and prevents a WDT monitor from refreshing the timer.

To prevent this incorrect action, the watchdog timer supports a debug suspend event. This event allows the WDT to stop counting during a CPU halt.

Other peripherals also support a debug suspend event. The list of supported peripherals is shown in [Table 27-3](#).

Note that several peripherals have local control to gate the suspend event coming from the Debug Subsystem. For example, the WDT has an EMUFREE bit in the WDSC register to block the suspend event coming from the Debug Subsystem. Ensure this bit is set correctly to allow the suspend event to properly control the peripheral module.

Recommended Suspend Control Register Value:

Normal mode: 0x0

Suspend peripheral during debug halt: 0x9

27.1.2 Debug Ports

27.1.2.1 IEEE1149.1

The target debug interface has the following signals:

- Five standard IEEE1149.1 JTAG signals:
 - nTRST
 - TCK
 - TMS
 - TDI
 - TDO
- Two EMU [1:0] or five EMU [4:0] TI extensions, depending on the pin count (14 pins or 20 pins) in the JTAG header of the device.

[Table 27-1](#) describes the IEEE1149.1 signals.

Table 27-1. IEEE1149.1 Signals

Signal Name	Type(1)	Function	Description
nTRST	I	Test reset	When asserted (active low), causes all test and debug logic in the device to be reset along with the IEEE1149.1 interface
TCK	I	Test clock	This is the test clock used to drive an IEEE1149.1 TAP state-machine and logic.
TMS	I	Test mode select	Directs the next state of the IEEE1149.1 TAP state-machine
TDI	I	Test data input	Scans data input to the device
TDO	O	Test data output	Scans data output by the device
EMU0	I/O	Emulation 0	Channel 0 trigger, or boot mode, or trace port
EMU1	I/O	Emulation 1	Channel 1 trigger, or boot mode, or trace port
EMU2(2)	O	Emulation 2	Trace port
EMU3(2)	O	Emulation 3	Trace port
EMU4(2)	O	Emulation 4	Trace port

(1) I = Input; O = Output; I/O = Bidirectional

(2) 20-pin JTAG header only

The JTAG ID code is 0x0B98 C02F. The code is accessed through the ICEPick module embedded in the debug subsystem.

27.1.2.2 Debugger Connection

27.1.2.2.1 ICEPick Module

The debugger connects to the device through its JTAG interface. The first level of debug interface seen by the debugger is the IEEE1149.7 adapter connected to the ICEPick module embedded in the debug subsystem.

NOTE: ICEPick version D (ICEPick-D) is used in the device.

System-on-chip (SoC) designs typically have multiple processors, each having a JTAG TAP embedded in the processor. The ICEPick module manages these TAPs and the power, reset, and clock controls for modules that have TAPs.

ICEPick provides the following debug capabilities:

- Debug connect logic for enabling or disabling most ICEPick instructions
- Dynamic TAP insertion:
 - Serially linking up to 16 TAP controllers
 - Individually selecting one or more of the TAPs for scan without disrupting the instruction register (IR) state of other TAPs
- Power, reset, and clock management:
 - Provides the power and clock states of each domain
 - Provides debugger control of the power domain of a processor. Can force the domain power and clocks on, and prohibit the domain from being clock-gated or powered down while a debugger is connected.
 - Applies system reset
 - Provides wait-in-reset (WIR) boot mode
 - Provides global and local WIR release
 - Provides global and local reset blocking

The ICEPick module implements a connect register, which must be configured with a predefined key to enable the full set of JTAG instructions. When the debug connect key is properly programmed, ICEPick signals and subsystems emulation logics should be turned on.

27.1.2.2.2 Boot Modes

The initial configuration of ICEPick is determined by the level of the dpm_emu0 and dpm_emu1 pins upon POR release. At POR, dpm_emu0 and dpm_emu1 are automatically configured as inputs. The dpm_emu0 and dpm_emu1 pins are free when POR is released.

[Table 27-2](#) summarizes the ICEPick boot modes.

Table 27-2. ICEPick Boot Modes Upon POR

EMU1	EMU0	TAPs in the TDI → TDO Path	Other Effects/Comments
0	0	None	Reserved (do not use)
0	1	None	Reserved (do not use)
1	0	ICEPick	TAP only + WIR mode
1	1	ICEPick	TAP only (default mode)

27.1.2.2.2.1 Default Boot Mode

In ICEPick-only configuration, none of the secondary TAPs are selected. The ICEPick TAP is the only TAP between device-level TDI and TDO pins. This is the recommended boot mode.

27.1.2.2.2.2 Wait-In-Reset

The device can boot to invoke WIR mode. If the device is booted in this mode, all processors within the device that support a TAP through ICEPick are held in reset until released. Individual processors may be released from reset (local), or all processors held in the reset state may be released at the same time (global).

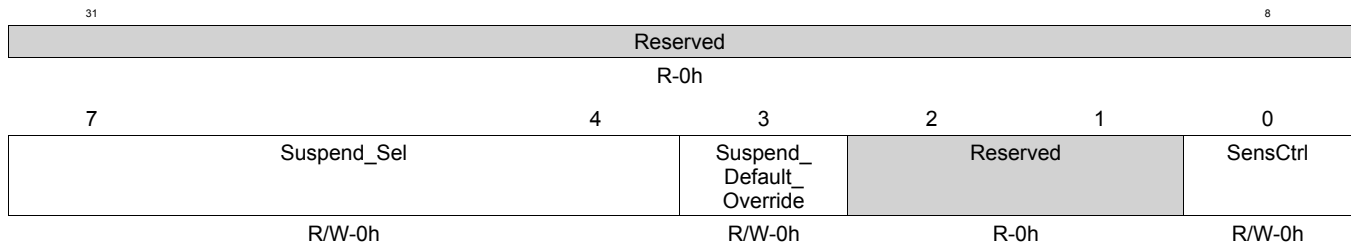
Note that the PRU processors in PRU-ICSS do not support the WIR feature.

27.2 Registers

27.2.1 Debug Resource Manager (DebugSS_DRM) Registers

Table 27-3. Debug Resource Manager (DRM) Registers

Offset	Peripheral	Register Name
200h	Watchdog Timer	Watchdog_Timer_Suspend_Control
204h	DMTimer-0	DMTimer_0_Suspend_Control
208h	DMTimer-1	DMTimer_1_Suspend_Control
20Ch	DMTimer-2	DMTimer_2_Suspend_Control
210h	DMTimer-3	DMTimer_3_Suspend_Control
214h	DMTimer-4	DMTimer_4_Suspend_Control
218h	DMTimer-5	DMTimer_5_Suspend_Control
21Ch	DMTimer-6	DMTimer_6_Suspend_Control
220h	EMAC	EMAC_Suspend_Control
224h	USB2.0	USB2_Suspend_Control
228h	I2C-0	I2C_0_Suspend_Control
22Ch	I2C-1	I2C_1_Suspend_Control
230h	I2C-2	I2C_2_Suspend_Control
234h	eHRPWM-0	eHRPWM_0_Suspend_Control
238h	eHRPWM-1	eHRPWM_1_Suspend_Control
23Ch	eHRPWM-2	eHRPWM_2_Suspend_Control
240h	CAN-0	CAN_0_Suspend_Control
244h	CAN-1	CAN_1_Suspend_Control
248h	PRU-ICSS	PRU_ICSS_Suspend_Control
260h	DMTimer-7	DMTimer_7_Suspend_Control

Figure 27-1. Suspend Control Registers


LEGEND: R/W = Read/Write; R = Read only; -n = value after reset

Table 27-4. Suspend Control Registers Field Descriptions

Bit	Field	Type	Reset	Description
31	Reserved	R	0h	
7-4	Suspend_Sel	R/W	0h	Suspend signal selection. Selects which suspend signal affects the peripheral. Only valid when Suspend_Default_Override=0 and SensCtrl=1. When read, these bits reflect the default suspend signal. 0000b: Cortex-A8 suspend signal. All other values are reserved.
3	Suspend_ Default_ Override	R/W	0h	Enable or disable the override value in Suspend_Sel. 0: Suspend_Sel field will select which suspend signal reaches the peripheral. 1: Suspend_Sel field ignored. Default suspend signal will reach the peripheral.
2-1	Reserved	R	0h	
0	SensCtrl	R/W	0h	Sensitivity Control for suspend signals. When Suspend_Default_Override=1, this bit is ignored and read as a 1. When Suspend_Default_Override=0: 0: Suspend signal will not reach the peripheral. Peripheral will act as normal even during a debug halt. 1: Suspend signal will reach the peripheral. Peripheral will be suspended during debug halt.

Revision History — Version L

Changes from July 1, 2014 to February 24, 2015	Page
• Changed Size from 20KB to 32Kb.	178
• Changed USB Queue Manager end address from 0x4740_4FFF to 0x4740_7FFF.	178
• Changed start address from 0x4740_5000 to 0x4740_8000.	178
• Changed Size from 4MB-20KB to 4MB-32KB.	178
• Added Note.	218
• Changed ELM_LOCATION_STATUS_3 Register offset from C00h to B00h.	1043
• Changed ELM_LOCATION_STATUS_4 Register offset from E00h to C00h.	1076
• Changed ELM_LOCATION_STATUS_5 Register offset from 1000h to D00h.	1109
• Changed ELM_LOCATION_STATUS_6 Register offset from 1200h to E00h.	1110
• Changed ELM_LOCATION_STATUS_7 Register offset from 1400h to F00h.	1111
• Updated image.	1153
• Set all bits for mreqprio_1 register to Reserved.	1405
• Added Note.	1836
• Updated CRC Insertion section.	1961
• Changed RX_VLAN_ENCAP values from Port 2 to Port 0.	2165
• Changed ADPDATDIROQx output from 1 to 0.	4111
• Updated bit fields for MVR Register.	4312
• Updated image.	4327
• Updated Posted Mode Selection section.	4338
• Removed Note from TSICR Register Field Descriptions.	4357
• Removed Note from TSICR Register Field Description.	4388
• Changed MCSPI_MODULCTRL Register reset from 0h to 0x0000_0004.	4824
• Changed MCSPI_CH0CONF Register reset from 0h to 0x0006_0000.	4826

Revision History

[Table A-1](#) highlights the technical changes made to the technical reference manual up to revision K.

Table A-1. Document Revision History

Reference	Additions/Modifications/Deletions
Global	Various editorial changes.
Chapter 4 <i>PRU-ICSS</i>	Added entire section.
Chapter 7 <i>Memory Subsystem</i>	Added new registers to Table 7-51 . Registers are named GPMC_BCH_RESULTx_7 where x is 0-6.
Chapter 8 <i>PRCM</i>	Changed text in Figure 8-16 .
Chapter 20 <i>Timers</i>	Changed text of first paragraph in Section 20.4.3.5 .
Chapter 24 <i>McSPI</i>	Changed Figure 24-8 . Removed section "Reset Values of Registers".

IMPORTANT NOTICE

Texas Instruments Incorporated and its subsidiaries (TI) reserve the right to make corrections, enhancements, improvements and other changes to its semiconductor products and services per JESD46, latest issue, and to discontinue any product or service per JESD48, latest issue. Buyers should obtain the latest relevant information before placing orders and should verify that such information is current and complete. All semiconductor products (also referred to herein as "components") are sold subject to TI's terms and conditions of sale supplied at the time of order acknowledgment.

TI warrants performance of its components to the specifications applicable at the time of sale, in accordance with the warranty in TI's terms and conditions of sale of semiconductor products. Testing and other quality control techniques are used to the extent TI deems necessary to support this warranty. Except where mandated by applicable law, testing of all parameters of each component is not necessarily performed.

TI assumes no liability for applications assistance or the design of Buyers' products. Buyers are responsible for their products and applications using TI components. To minimize the risks associated with Buyers' products and applications, Buyers should provide adequate design and operating safeguards.

TI does not warrant or represent that any license, either express or implied, is granted under any patent right, copyright, mask work right, or other intellectual property right relating to any combination, machine, or process in which TI components or services are used. Information published by TI regarding third-party products or services does not constitute a license to use such products or services or a warranty or endorsement thereof. Use of such information may require a license from a third party under the patents or other intellectual property of the third party, or a license from TI under the patents or other intellectual property of TI.

Reproduction of significant portions of TI information in TI data books or data sheets is permissible only if reproduction is without alteration and is accompanied by all associated warranties, conditions, limitations, and notices. TI is not responsible or liable for such altered documentation. Information of third parties may be subject to additional restrictions.

Resale of TI components or services with statements different from or beyond the parameters stated by TI for that component or service voids all express and any implied warranties for the associated TI component or service and is an unfair and deceptive business practice. TI is not responsible or liable for any such statements.

Buyer acknowledges and agrees that it is solely responsible for compliance with all legal, regulatory and safety-related requirements concerning its products, and any use of TI components in its applications, notwithstanding any applications-related information or support that may be provided by TI. Buyer represents and agrees that it has all the necessary expertise to create and implement safeguards which anticipate dangerous consequences of failures, monitor failures and their consequences, lessen the likelihood of failures that might cause harm and take appropriate remedial actions. Buyer will fully indemnify TI and its representatives against any damages arising out of the use of any TI components in safety-critical applications.

In some cases, TI components may be promoted specifically to facilitate safety-related applications. With such components, TI's goal is to help enable customers to design and create their own end-product solutions that meet applicable functional safety standards and requirements. Nonetheless, such components are subject to these terms.

No TI components are authorized for use in FDA Class III (or similar life-critical medical equipment) unless authorized officers of the parties have executed a special agreement specifically governing such use.

Only those TI components which TI has specifically designated as military grade or "enhanced plastic" are designed and intended for use in military/aerospace applications or environments. Buyer acknowledges and agrees that any military or aerospace use of TI components which have **not** been so designated is solely at the Buyer's risk, and that Buyer is solely responsible for compliance with all legal and regulatory requirements in connection with such use.

TI has specifically designated certain components as meeting ISO/TS16949 requirements, mainly for automotive use. In any case of use of non-designated products, TI will not be responsible for any failure to meet ISO/TS16949.

Products

Audio	www.ti.com/audio
Amplifiers	amplifier.ti.com
Data Converters	dataconverter.ti.com
DLP® Products	www.dlp.com
DSP	dsp.ti.com
Clocks and Timers	www.ti.com/clocks
Interface	interface.ti.com
Logic	logic.ti.com
Power Mgmt	power.ti.com
Microcontrollers	microcontroller.ti.com
RFID	www.ti-rfid.com
OMAP Applications Processors	www.ti.com/omap
Wireless Connectivity	www.ti.com/wirelessconnectivity

Applications

Automotive and Transportation	www.ti.com/automotive
Communications and Telecom	www.ti.com/communications
Computers and Peripherals	www.ti.com/computers
Consumer Electronics	www.ti.com/consumer-apps
Energy and Lighting	www.ti.com/energy
Industrial	www.ti.com/industrial
Medical	www.ti.com/medical
Security	www.ti.com/security
Space, Avionics and Defense	www.ti.com/space-avionics-defense
Video and Imaging	www.ti.com/video

TI E2E Community

e2e.ti.com