

19" TFT LCD COLOR TELEVISION

Service
Service
Service

190TW8FB/00

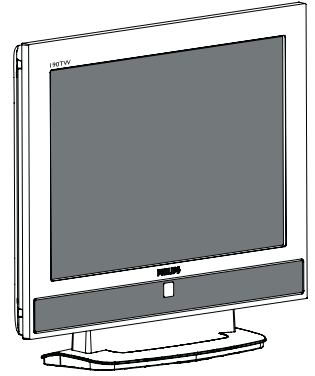

Service Manual

TABLE OF CONTENTS

Description	Page	Description	Page
Important Safety Notice	2	Block Diagram	25
Technical Data	3 ~ 4	Scaler Board Schematic Diagram	26 ~ 38
Connection	5	Power Board Schematic Diagram	39
OSD Menu Control Level Structure	6	Button Board Schematic Diagram	40
OSD Adjustment	7	LED Board Schematic Diagram	41
Remote Control Keys	8	Scaler Board Layout Side View	42 ~ 43
Safety and troubleshooting information	9	Power Board Layout Side View	44 ~ 45
Definition of Pixel Defects	10 ~ 11	Button Board Layout Side View	46
Wiring Diagram	12	LED Board Layout Side View	47
Mechanical Instructions	13 ~ 16	Exploded View	48
F/W Upload Instructions	17	Recommended Parts List	49
Electronic Instructions.....	18 ~ 19	Spare Parts List	50 ~ 56
DDC DATA	20 ~ 23	General Trouble Shooting Guide	57 ~ 71
Safety Instructions, Warnings and Notes	24	General Product Specification	72 ~ 89
		Safety Check Process	90

SAFETY NOTICE

ANY PERSON ATTEMPTING TO SERVICE THIS CHASSIS MUST FAMILIARIZE HIMSELF WITH THE CHASSIS AND BE AWARE OF THE NECESSARY SAFETY PRECAUTIONS TO BE USED WHEN SERVICING ELECTRONIC EQUIPMENT CONTAINING HIGH VOLTAGES.

CAUTION: USE A SEPARATE ISOLATION TRANSFORMER FOR THIS UNIT WHEN SERVICING.

REFER TO BACK COVER FOR IMPORTANT SAFETY GUIDELINE.



Important Safety Notice

Proper service and repair is important to the safe, reliable operation of all Philips Consumer Electronics Company** Equipment. The service procedures recommended by Philips and described in this service manual are effective methods of performing service operations. Some of these service operations require the use of tools specially designed for the purpose. The special tools should be used when and as recommended.

It is important to note that this manual contains various CAUTIONS and NOTICES which should be carefully read in order to minimize the risk of personal injury to service personnel. The possibility exists that improper service methods may damage the equipment. It is also important to understand that these CAUTIONS and NOTICES ARE NOT EXHAUSTIVE. Philips could not possibly know, evaluate and advise the service trade of all conceivable ways in which service might be done or of the possible hazardous consequences of each way. Consequently, Philips has not undertaken any such broad evaluation. Accordingly, a servicer who uses a service procedure or tool which is not recommended by Philips must first satisfy himself thoroughly that neither his safety nor the safe operation of the equipment will be jeopardized by the service method selected.

** Hereafter throughout this manual, Philips Consumer Electronics Company will be referred to as Philips.

WARNING

Critical components having special safety characteristics are identified with a ▲ by the Ref. No. in the parts list and enclosed within a broken line* (where several critical components are grouped in one area) along with the safety symbol ▲ on the schematics or exploded views.

Use of substitute replacement parts which do not have the same specified safety characteristics may create shock, fire, or other hazards.

Under no circumstances should the original design be modified or altered without written permission from Philips. Philips assumes no liability, express or implied, arising out of any unauthorized modification of design. Servicer assumes all liability.

* Broken Line



FOR PRODUCTS CONTAINING LASER :

- DANGER - In visible laser radiation when open.
AVOID DIRECT EXPOSURE TO BEAM.
- CAUTION - Use of controls or adjustments or performance of procedures other than those specified herein may result in hazardous radiation exposure.
- CAUTION - The use of optical instruments with this Product will increase eye hazard.

TO ENSURE THE CONTINUED RELIABILITY OF THIS PRODUCT, USE ONLY ORIGINAL MANUFACTURER'S REPLACEMENT PARTS, WHICH ARE LISTED WITH THEIR PART NUMBERS IN THE PARTS LIST SECTION OF THIS SERVICE MANUAL.

Take care during handling the LCD module with backlight unit

- Must mount the module using mounting holes arranged in four corners.
- Do not press on the panel, edge of the frame strongly or electric shock as this will result in damage to the screen.
- Do not scratch or press on the panel with any sharp objects, such as pencil or pen as this may result in damage to the panel.
- Protect the module from the ESD as it may damage the electronic circuit (C-MOS).
- Make certain that treatment persons body are grounded through wrist band.
- Do not leave the module in high temperature and in areas of high humidity for a long time.
- Avoid contact with water as it may a short circuit within the module.
- If the surface of panel become dirty, please wipe it off with a soft material. (Cleaning with a dirty or rough cloth may damage the panel.)

1. General Specification

	Destination	Europe	
TV System	Color System	PAL, SECAM	
	Sound System	CCIR B/G, D/K, I and L/L'	
	Stereo System	NICAM and FM Stereo (A2)	
	Channel System	Full frequency range from channel E2 (48.25 MHz) to channel E69 (855.25 MHz)	
	Sub-Title	Teletext 100 pages	
	RF-AFT	(+ / - 1.5MHz)	
LCD Panel	Maximum Resolution	1440*900	
	Panel Supplier	CMO-M190A1-L07	
	Lamp Quantity	CCFL*4	
	Display Area	19" Wide Diagonal	
	Display Color	16.7 M with FRC	
	Contrast Ratio	1000:1 (Typical)	
	Brightness	300 cd / m*2 (Typical)	
	Response Time	5 ms	
	View Angle	85°(L)/85°(R), 80°(U)/80°(D)	
I / O Functions	HDMI	For Audio & Video	
	RCA Jack *3	For Audio & Video	
	Din Jack	For S-Video	
	SCART*1	21 Pin for Video ,S-Video & RGB	
	PH Jack	For TV Input (PAL system)	
	Earphone Jack	For Audio Output	
	SPDIF	For Audio output (I2S)	
	3.5mm Stereo Jack	For PC Stereo Audio Input , Black color	
	D-Sub-15	For VGA	
Video Functions	Support PAL / NTSC / SECAM video format		
	Support 480 i , 480 p,720P, 1080i format		
	Build in motion adaptive 3D digital Comb Filter		
	Build in Teletext Functions		
Input Signal	TV System	PAL and SECAM system Receivable	
	Tuner	FQ1216-MK5	
	VGA	Horizontal input frequency range : 30~71 KHz	
		Vertical input frequency range : 50~75 Hz	
		Maximum resolution : 1440*900	
Out of Range	When input signal is out of range or down scaling support ,the OSD will show "Out of Range "within 5 seconds and LED is green		
No Signal	When there is missing signal from selected input ,the OSD will show "No Signal "within 8 seconds and LED is green		
Color Temperature	Standard	x=300 , y=310	
	Warm	x=313 , y=329	
	Cold	x=285 , y=293	
Maximum Brightness	More Than 250 cd / m*2		
Remote Controller	Key count	43 Keys	
	Effective Distance	More than 6 m +45~-45degree	
	Supplier	Panasonic	
Local Control Key	7 Keys	Power, Left, Right, Up, Down, Menu, Select	

Technical Data

Display Area & Tilt	Display Area:	19W inches diagonal
	H-Phase:	A-B Less than 1.5mm
	V-Center:	C-D Less than 1.5mm
	Tilt:	E-F Less than 1mm
Audio	Speaker	Internal speaker. 5W*2 stereo, volume adjustable.
	Treble, Bass	(+ 3db)
	Frequency Response	100~15KHz with +/-3 db variation
	THD(Total HarmonicDistortion)	Limited to 5 % at 2W (at 0.1~15 KHz)
OSD Capability	On screen display adjustment function	
ISP Fuctions	ISP (In System Programming) function available for revising driver easily.	
Power Source	Input Voltage	90 ~ 264 V / 47 ~ 63 Hz
	Input Current	0.6~1.5 A
	Max. Power	58 Watts
	PC saving Power	2Watts Max
	Stand-By Power(AV,TV)	1 Watts Max.
Mechanical	Tilt	0~15°
	VESA Mount	100*100 mm

1.2 Input & Output Signal Specification

CVBS Input	Type	Analog
	Polarity	Positive
	Level	1Vp-p (with Sync.)
	Impedance	75Ω ± 5%
S-Video Input	Interface	RCA jack, Yellow color
	Type	Analog
	Polarity	Positive
	Level	Y : 1Vp-p (with Sync.), C : 0.286Vp-p
SCART Input	Impedance	75Ω ± 5%
	Interface	DIN Jack
	Type	Analog
	Polarity	Positive
Audio Input	Impedance	75Ω ± 5%
	Interface	21 Pin Euro-SCART
	Type	Stereo R/L Channels
	Level	500mVrms
PC Stereo Input	Impedance	More than 22kΩ [
	Interface	3.5mm Stereo Jack , Black color
	Type	Stereo R/L Channels
	Level	1Vrms
Headphone Output	Impedance	More than 22kΩ [
	Interface	3.5mm Stereo Jack
	Type	Stereo R/L Channels
	Level	40mW rms/per Channel(typ.) for 32 ohm earphon
Built-in Speaker	Impedance	32 ohm
	Max. Audio output	5W + 5W (at 1.0Vp-p / 1kHz input, 10% THD max)
	Sound Distortion	1% THD max. (at 250mW/1kHz :)
	Speaker	5 W / 8 ohms
	Speaker Impedance	8 ohms at 1kHz
	Residual Hum	500uW Max.(at Min. Volume :)
	Max. Hum	1000uW Max (at Max. Volume)

Audio Line Output	Type	Stereo R/L Channels
	Level	400Vrms.
	Interface	3.5mm Stereo Jack
RF Input	Input Impedance	75 ohms
	Frequency Range	48.25~855.25 MHz (PAL)
	Video S/N Ratio	45 d B (Typical)
	Audio S/N Ratio	63 d B (Typical)
VGA Input	Sync	Level : Low = 0 to 0.8V, High = 2.0 to 5 V Polarity : Positive or Negative Impedance : 1 k ohm or higher
	RGB Signal	Level : 0 to 700mV Positive Impedance : 75Ω ± 5%
D-Sub Pin Define	1	Red Video
	2	Green Video
	3	Blue Video
	4	Ground
	5	Ground
	6	Red Ground
	7	Green Ground
	8	Blue Ground
	9	+5V (PC97)
	10	VGA-CONN(Sync GND)
	11	Ground
	12	SDA (DDC Data)
	13	Horizontal Sync
	14	Vertical Sync
	15	SCL (DDC Clock)
HDMI	Type	Type A
	Level	400mVrms
	Impedance	100Ω [
SPDIF	Type	RCA Jack
	Level	500mVpp +/- 20%

1. Connecting the power cord

- Connect the AC cord into the AC input on the back of the set.
- Connect the plug to the wall outlet as shown.

2. Setting up the remote control

- Open the cover on the back of the remote unit.
- Insert two AAA batteries (supplied) to match the polarity indicated inside the battery compartment.

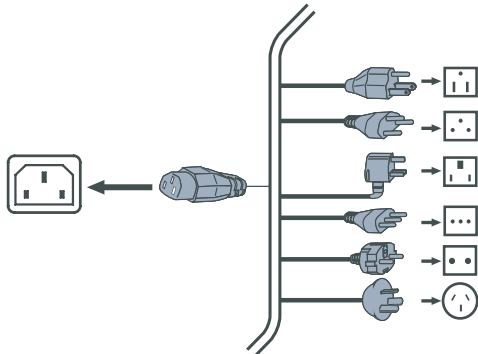

3. Connect the antenna cable to the appropriate antenna terminal on the back of the TV Monitor set as shown below.

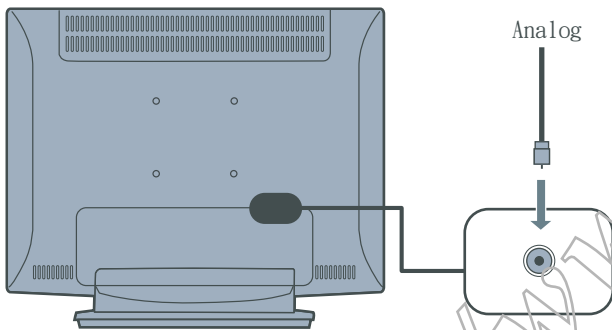

4. Connect your DVD player, VCR, STB or audio/video equipment using the SCART port located at the rear of your TV Monitor as shown.

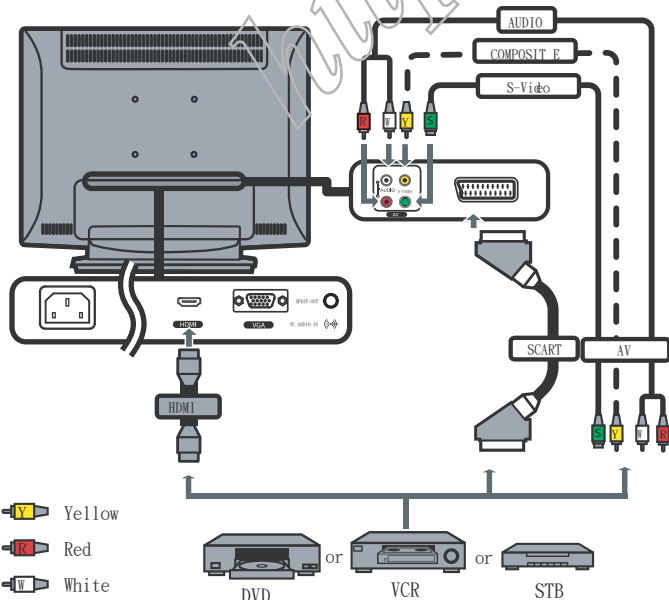

5. Accessory

In the accessory box, you will find:

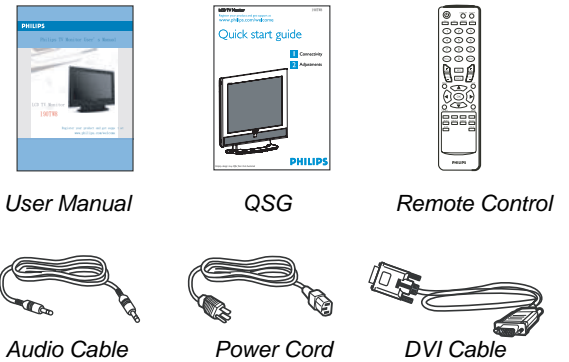

6. Function key definition

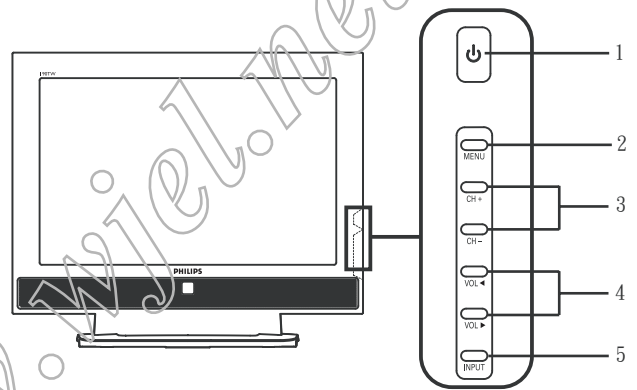

Side of set		
1		Power On/Off To switch TV monitor ON and OFF
2		Menu key Turns the OSD menu ON and OFF
3		Channel up When the OSD is on, functions the same as the Up arrow
		Channel down When the OSD is on, functions the same as the Down arrow
4		Volume up When the OSD is on, functions the same as the Right arrow
		Volume down When the OSD is on, functions the same as the Left arrow
5		Input key When the OSD is on, press this button to confirm selection

7. Quick Installation

A quick OSD (On Screen Display) that end user can only press the "Power" button to trigger the dialog appear. It contains - Menu language, Country, for you to select.



OSD Menu Control Structure

4. The OSD tree

Below is an overall view of the structure of the On-Screen Display. You can use this as a reference when you want to work your way around the different adjustments later on.

4.1 Only available for EU Model

PAL Menu Structure				ATV	S-Video	AV	Scart	VGA	HDMI	
1 st Sub Menu	2 nd Sub Menu	3 rd Sub Menu	4 th Sub Menu							
Picture	Brightness	Slider	[50] 0-100 / 1	V	V	V	V	V	V	
	Contrast	Slider	[80] 0-100 / 1	V	V	V	V	V	V	
	Colour	Slider	[70] 0-100 / 1	V	V	V	V	V	V	
	Sharpness	Slider	[4] 0-7 / 1	V	V	V	V		V	
	Backlight	Slider	[100] 0-100 / 1	V	V	V	V	V	V	
	Color Temp	Cold			V	V	V	V	V	V
		[Standard]			V	V	V	V	V	V
Warm				V	V	V	V	V	V	
Noise Reduction	Off / [Low] / Medium /		V	V	V	V		V		
Audio	Treble	Slider	[50] 0-100 / 1	V	V	V	V	V	V	
	Bass	Slider	[50] 0-100 / 1	V	V	V	V	V	V	
	Balance	Slider	[0] -50-50 / 1	V	V	V	V	V	V	
	Sound Effect	On		V	V	V	V	V	V	
		[Off]		V	V	V	V	V	V	
	AVL	On		V	V	V	V	V	V	
		[Off]		V	V	V	V	V	V	
Channel Management	Country	UK								
		France								
		Germany								
		Italy								
		Spain								
		Switzerland								
		Denmark								
		Belgium		V						
		Netherlands								
		Luxembourg								
		Czech Republic								
		Portugal								
		United Arab Emirates								
	Saudi Arabia									
	Skip	On			V					
		[Off]			V					
	Reorder			V						
	Name			V						
	Frequency			V						
	Auto Scan			V						
Manual Scan	Scan up									
	Scan down			V						
	Scan for update									
Lock This Channel	Please enter your PIN [- - - -]	Lock/[Unlock]	V							

Note:

sRGB is a standard for ensuring correct exchange of colors between different devices(e. g. Digital cameras, monitor, printers, scanners, etc.)

Using a standard unified color space, sRGB will help represent pictures taken by an sRGB compatible device correctly on your sRGB enabled Philips monitor. In that way, the colors are calibrated and you can rely on the correctness of the colors shown on your screen.

Important with the use of sRGB is that the brightness and contrast of your monitor is fixed to a predefined setting as well as the color gamut. Therefore it is important to select the sRGB setting in the monitor's OSD.

To do so, open the OSD by pressing the OK button on the side of your monitor. Move the down button to go to color and press OK again. Use the right button to go to sRGB. Then move the down button and press OK again to exit the OSD.

After this, please do not change the brightness or contrast setting of your monitor. If you change either of these, the monitor will exit the sRGB mode and go to a color temperature setting of 6500K.

Continue-

Settings	Menu Language	[English]		V	V	V	V	V	V
		Deutsch		V	V	V	V	V	V
		French		V	V	V	V	V	V
		Italian		V	V	V	V	V	V
		Spanish		V	V	V	V	V	V
		Portuguese		V	V	V	V	V	V
		Cestina		V	V	V	V	V	V
		Dansk		V	V	V	V	V	V
		Dutch		V	V	V	V	V	V
				V	V	V	V	V	V
			V	V	V	V	V	V	
	Sleep	[Off]/15/30/45/60/90/120		V	V	V	V		V
	Set PIN	Please enter your PIN	New PIN:						
[- - - -]		Type it again to confirm:	V						
Wide Mode	Full		V	V	V	V	V	V	
	4:3		V	V	V	V	V	V	
	[16:9]		V	V	V	V		V	
	Panorama		V	V	V	V		V	
	Letterbox1		V	V	V	V		V	
	Letterbox2		V	V	V	V		V	
			V	V	V	V		V	
HDMI Scan Info	[Auto] / Overscan / Underscan							V	
	[Auto]/ AV/ S-Video/ RGB						V		
Factory Default			V	V	V	V	V	V	

Adjusting the picture quality

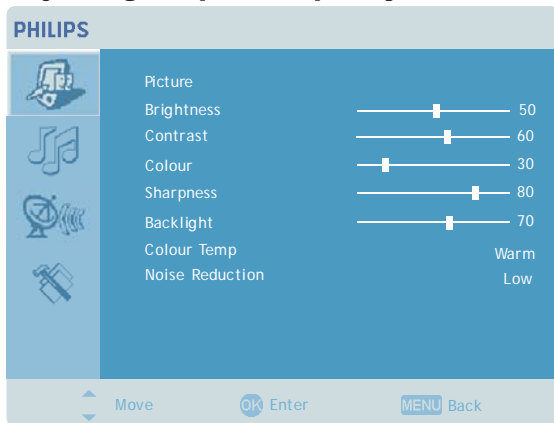

1. Press the **MENU** key to bring up the OSD.
2. Using the directional keys, select **Picture** from the OSD. Then navigate to picture element you wish to adjust.
3. Use the left or right keys to adjust the sliding scales.
4. The **Picture** menu can be used to adjust the brightness, contrast, colour, sharpness and image-related qualities.

Adjusting the audio settings

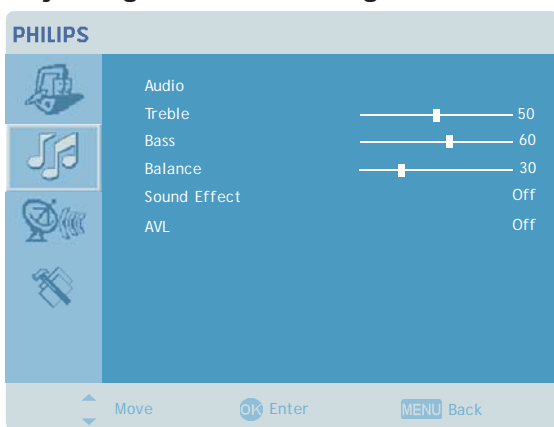

1. Press the **MENU** key to bring up the OSD.
2. Using the directional keys, select **Audio** from the on screen display. Then navigate to the feature you wish to adjust.
3. Use the left or right keys to adjust the sliding scales. Press **OK** to save.
4. The **Audio** menu can also be used to adjust the treble, bass, balance, sound effect and AVL.

Adjusting the channel management

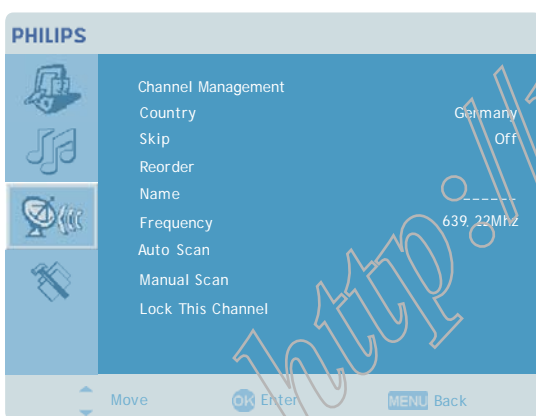

1. Press the **MENU** key to bring up the OSD.
2. Using the directional keys, select **Channel management** from the OSD.
3. Use the directional keys to navigate the menus.
4. The **Channel management** menu can be used to set the channel namings, Auto Scan, Manual Scan Channel and other related settings.

Adjusting the settings

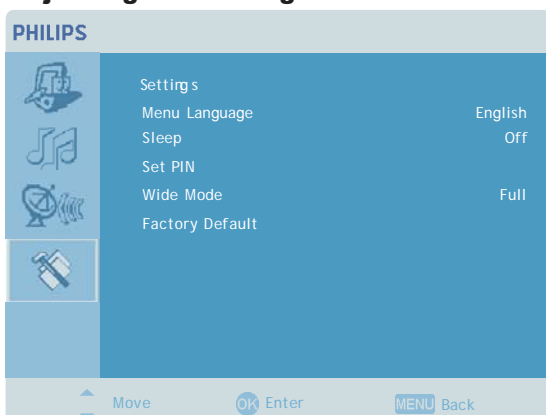

1. Press the **MENU** key to bring up the OSD.
2. Using the directional keys, select **Settings** from the OSD. Then navigate to the feature you wish to adjust.
3. The **Settings** menu can be used to adjust the menu language and other important settings.

Remote Control Keys

General Keys

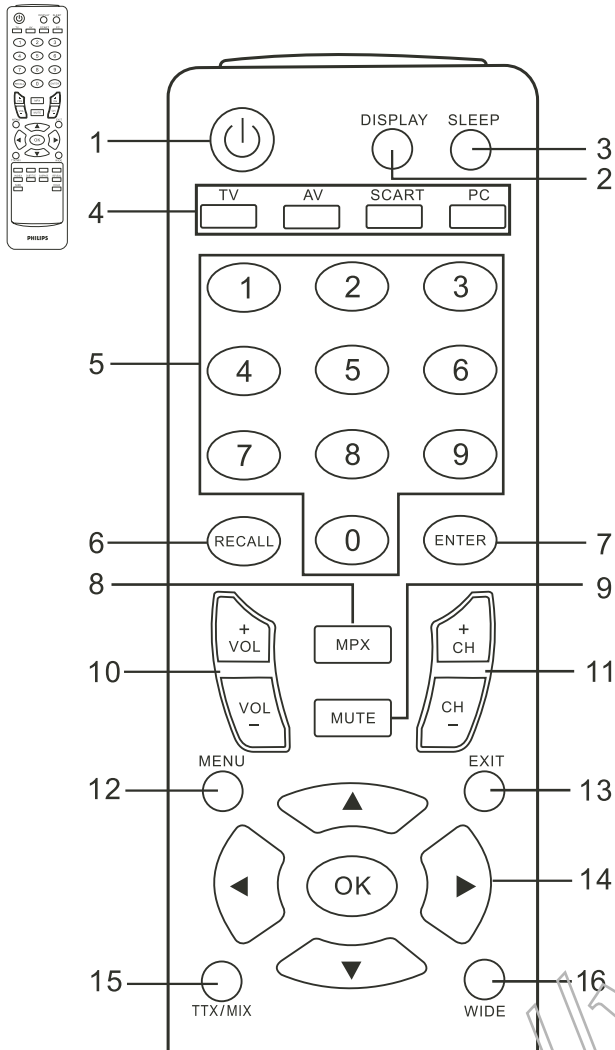

1. POWER

Press to turn your TV Monitor on/off.

2. DISPLAY

Press to display input/channel information(dependent on input/source type).

3. SLEEP

Press to set a time period after which the TV Monitor will switch itself to standby (15, 30, 45, 60, 90 or 120 minutes).

4. Input buttons

(TV/AV/SCART/PC)*Press to select correct input mode.

5. Number keys.

6. RECALL

Press to return to the previous channel.

7. ENTER

Press to confirm channel number selection.

8. MPX

Press to select the sound input, displayed in the top right- hand corner (mono, stereo, bilingual).

9. MUTE

Press to toggle audio on and off.

10. VOL (+/-)

Press to increase or decrease the volume.

11. CH (up/down)

Press to sequentially select the TV Monitor channel.

12. MENU

Press to open or close the Menu.

13. EXIT

Exit Menu.

14. Directional keys/OK

VOL (up/down), CH (up/down).

15. TTX/MIX (TELETEXT/MIX)

Press to switch from TV/AV to Teletext mode. Press to overlay teletext page on the TV Monitor image.

16. WIDE

Press to toggle scaling mode between 4:3,16:10, Full, Panorama and Letterbox 1, 2 modes.

Teletext

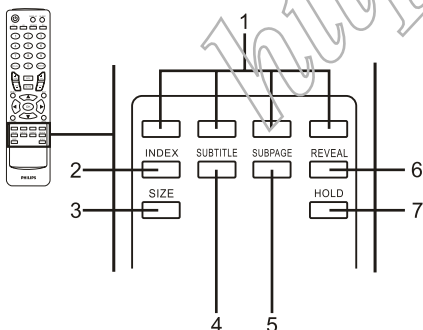

A. Colour buttons (R/G/Y/B)

Operates corresponding button on the teletext page.

B. INDEX

Press to go to the index page.

C. SIZE

Press once to zoom teletext page to 2X.Press again to resume.

D. SUBTITLE

Press to view subtitles on the screen.

E.SUBPAGE

Press to access the teletext's sub pages directly.

F. HOLD

Press to pause the current teletext page in multi-page viewing mode.0

G. REVEAL

Press to reveal hidden teletext information.

Safety precautions and maintenance

WARNING: Use of controls, adjustments or procedures other than those specified in this documentation may result in exposure to shock, electrical hazards and/or mechanical hazards.

Read and follow these instructions when connecting and using your computer monitor:

- To protect your display from possible damage, do not put excessive pressure on the LCD panel. When moving your monitor, grasp the frame to lift; do not lift the monitor by placing your hand or fingers on the LCD panel.
- Unplug the monitor if you are not going to use it for an extensive period of time.
- Unplug the monitor if you need to clean it with a slightly damp cloth. The screen may be wiped with a dry cloth when the power is off. However, never use alcohol, solvents or ammonia-based liquids.
- Consult a service technician if the monitor does not operate normally when you have followed the instructions in this manual.
- The casing cover should be opened only by qualified service personnel.
- Keep the monitor out of direct sunlight and away from stoves or any other heat source.
- Remove any object that could fall into the vents or prevent proper cooling of the monitor's electronics.
- Do not block the ventilation holes on the cabinet.
- Keep the monitor dry. To avoid electric shock, do not expose it to rain or excessive moisture.
- When positioning the monitor, make sure the power plug and outlet are easily accessible.
- If turning off the monitor by detaching the power cable or DC power cord, wait for 6 seconds before attaching the power cable or DC power cord for normal operation.
- To avoid the risk of shock or permanent damage to the set, do not expose the monitor to rain or excessive moisture.
- IMPORTANT:** Always activate a screen saver program during your application. If a still image in high contrast remains on the screen for an extended period of time, it may leave an 'after-image' or 'ghost image' on front of the screen. This is a well-known phenomenon that is caused by the shortcomings inherent in LCD technology. In most cases, the afterimage will disappear gradually over a period of time after the power has been switched off. Be aware, that the afterimage symptom cannot be repaired and is not covered under warranty.
- Warning for lifting monitor - Do not use the area underneath the logo cover to grip or lift the monitor. Placing weight on the logo cover can cause it to break away from the body and cause the monitor to fall. When lifting the monitor, place one hand under the monitor's frame.

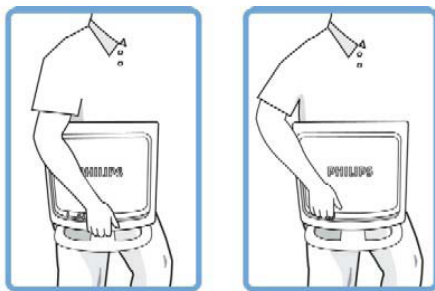

○ Do

✗ Don't

* Consult a service technician if the monitor does not operate normally when the operating instructions given in this manual have been followed.

Installation Locations

Avoid exposure to heat and extreme cold.

Do not store or use the LCD monitor in locations exposed to heat, direct sunlight or extreme cold.

Avoid moving the LCD monitor between locations with large temperature differences. Choose a site that falls within the following temperature and humidity ranges.

Temperature: 0-35°C 32-95°F

Humidity: 20-80% RH

Do not subject the LCD monitor to severe vibration or high impact conditions. Do not place the LCD monitor in the trunk of a car.

Take care not to mishandle this product by either knocking or dropping it during operation or transportation.

Do not store or use the LCD monitor in locations where there is a high level of humidity or in dusty environments. Do not allow water or other liquids to spill on or into the LCD monitor.

Trouble Shooting

This page deals with problems that can be corrected by the user. If the problem still persists after you have tried these solutions, contact your nearest Philips dealer.

Common Problems	
Having this problem	Check these items
No Picture (Power LED not lit)	<ol style="list-style-type: none"> Make sure the power cord is plugged into the power outlet and into the back of the monitor. First, ensure that the power button on the front of the monitor is in the OFF position, then press it to the ON position.
No Picture (Power LED is amber or yellow)	<ol style="list-style-type: none"> Make sure the computer is turned on. Make sure the signal cable is properly connected to your computer. Check to see if the monitor cable has bent pins. The Energy Saving feature may be activated.
Screen says	<ol style="list-style-type: none"> Make sure the monitor cable is properly connected to your computer. (Also refer to the Quick Set-Up Guide). Check to see if the monitor cable has bent pins. Make sure the computer is turned on.
Screen says	<ol style="list-style-type: none"> Make sure the monitor cable is properly connected to your computer. (Also refer to the Quick Set-Up Guide). Check to see if the monitor cable has bent pins. Make sure the computer is turned on.
AUTO button not working properly	<ol style="list-style-type: none"> The Auto Function is designed for use on standard Macintosh or IBM-compatible PCs running Microsoft Windows. It may not work properly if using nonstandard PC or video card.
Imaging Problems	
Display position is incorrect	<ol style="list-style-type: none"> Press the Auto button. Adjust the image position using the Phase/Clock of More Settings in OSD Main Controls.
Image vibrates on the screen	<ol style="list-style-type: none"> Check that the signal cable is properly connected to the graphics board or PC.
Vertical flicker appears	<ol style="list-style-type: none"> Press the Auto button. Eliminate the vertical bars using the Phase/Clock of More Settings in OSD Main Controls.
Horizontal flicker appears	<ol style="list-style-type: none"> Press the Auto button. Eliminate the vertical bars using the Phase/Clock of More Settings in OSD Main Controls.

Definition of Pixel Defects

The screen is too bright or too dark	Adjust the contrast and brightness on On-Screen Display. (The backlight of the LCD monitor has a fixed life span. When the screen becomes dark or begins to flicked, please contact your sales representative).
An after-image appears	If an image remains on the screen for an extended period of time, it may be imprinted in the screen and leave an after-image. This usually disappears after a few hours.
An after-image remains after the power has been turned off	This is characteristic of liquid crystal and is not caused by a malfunction or deterioration of the liquid crystal. The after-image will disappear after a period of time.
Green, red, blue, dark, and white dots remains	The remaining dots are normal characteristic of the liquid crystal used in today's technology.
For further assistance, refer to the Consumer Information Centers list and contact your local Philips distributor.	

Definition of Pixel Defects

This section explains the different types of pixel defects and defines acceptable defect levels of each type. In order to quality for repair or replacement under warranty, the number of pixel defects on a TFT LCD panel must exceed these acceptable levels.

1. Definition of Pixels and Sub-pixels

A pixel, or picture element, is composed of three sub pixels in the primary colors of red, green and blue. Many pixels together form an image. When all sub pixels of a pixel are lit the three colored sub pixels together appear as a single white pixel. When all are dark, the three colored sub pixels together appear as a single black pixel. Other combinations of lit and dark sub pixels appear as single pixels of other colors.

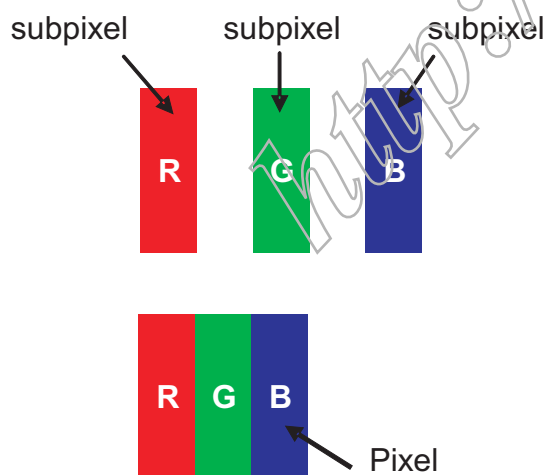

2. Types of Pixel Defects

Pixel and sub pixel defects appear on the screen in different ways. There are two categories of pixel defects and several types of sub pixel defects within each category.

Bright Dot Defects

Bright dot defects appear as pixels or sub pixels that are always lit or 'on'. That is, a bright dot is a sub-pixel that stands out on the screen when the monitor displays a dark pattern. There are the types of bright dot defects:

One lit red, green or blue sub pixel

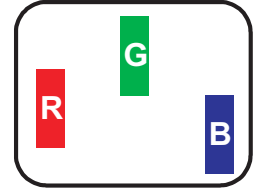

Two adjacent lit sub pixels:

- Red + Blue = Purple
- Red + Green = Yellow
- Green + Blue = Cyan (Light Blue)

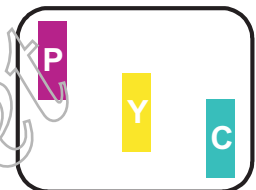

Three adjacent lit sub pixels (one white pixel)



A red or blue bright dot must be more than 50 percent brighter than neighboring dots while a green bright dot is 30 percent brighter than neighboring dots.

Black Dot Defects

Black dot defects appear as pixels or sub pixels that are always dark or 'off'. That is, a dark dot is a sub-pixel that stands out on the screen when the monitor displays a light pattern. These are the types of black dot defects:

One dark sub pixel

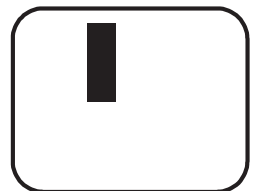

Two or three adjacent dark sub pixels



3. Proximity of Pixel Defects

Because pixel and sub pixels defects of the same type that are near to one another may be more noticeable, Philips also specifies tolerances for the proximity of pixel defects.

Perfect Panel - ISO 13406-2 Class II compliant do-defect-free-display.

BRIGHT DOT DEFECTS	ACCEPTABLE LEVEL
MODEL	190TW8
1 lit subpixel	3 or fewer
2 adjacent lit subpixels	1 or fewer
3 adjacent lit subpixels (one white pixel)	0
Distance between two bright dot defects*	>15mm
Total bright dot defects of all types	3 or fewer

BLACK DOT DEFECTS	ACCEPTABLE LEVEL
MODEL	190TW8
1 dark subpixel	5 or fewer
2 adjacent dark subpixels	2 or fewer
3 adjacent dark subpixels	0
Distance between two black dot defects*	>15mm
Total black dot defects of all types	5 or fewer

TOTAL DOT DEFECTS	ACCEPTABLE LEVEL
MODEL	190TW8
Total bright or black dot defects of all types	5 or fewer

Note:

* 1 or 2 adjacent sub pixel defects = 1 dot defect

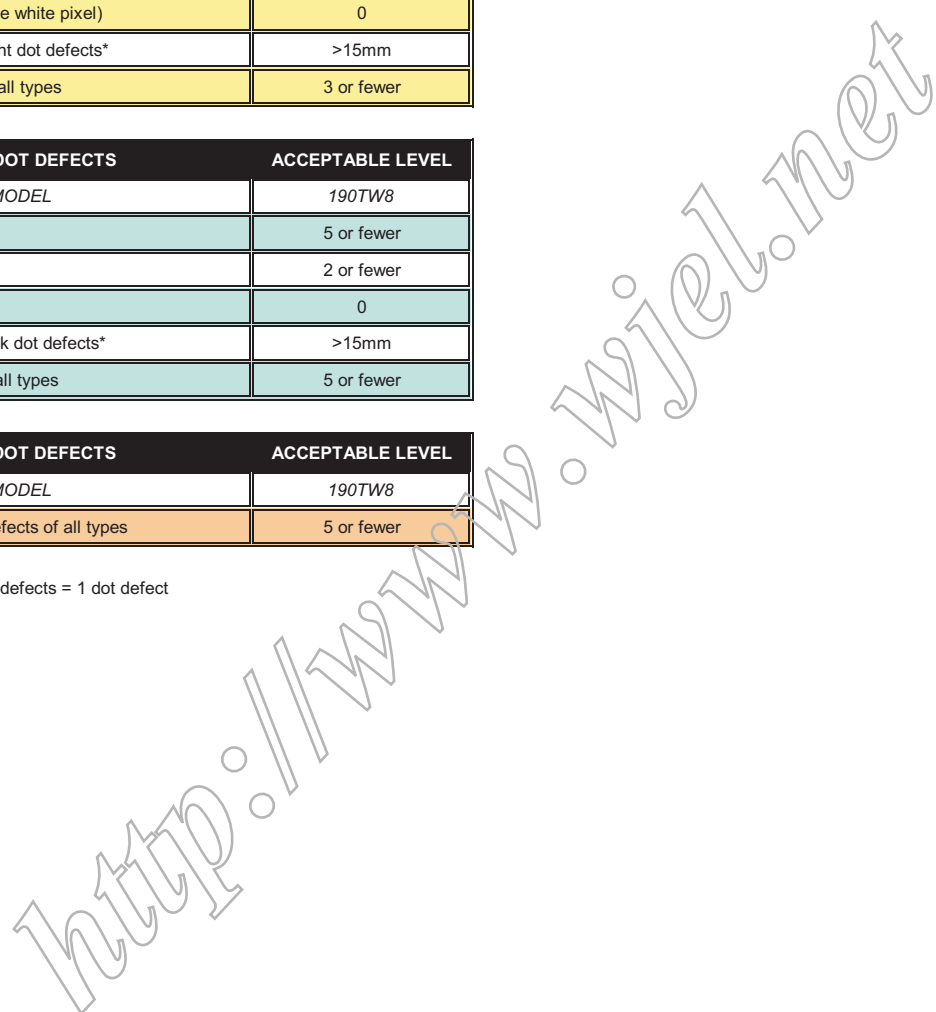

Wiring Diagram

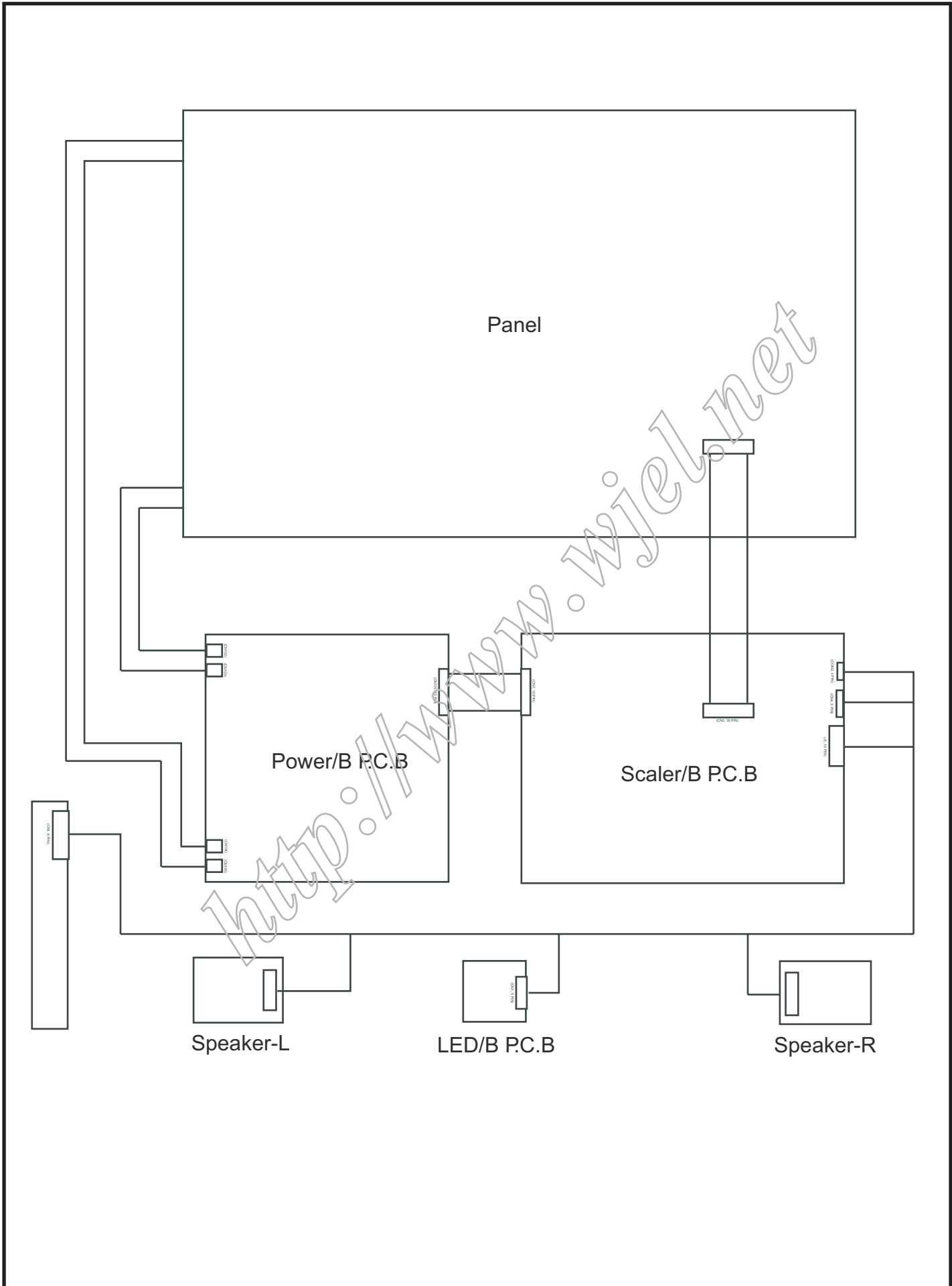

DISASSEMBLY PROCESS



Fig. 1

1. Lay down LCD TV, all tools prepared, remove 7pcs screws from rear cover.



Fig. 4

4. Disconnect the lamp cables



Fig. 2

2. Take off rear cover.



Fig. 5

5. Disconnect the LVDs cable, and take off PCB shielding.



Fig. 3

3. Disconnect the cables.



Fig. 6

6. Remove 4pcs screws from top and down side panel.



Fig. 7

7. Remove 2pcs screws from LED/B, and take off it.



Fig. 10

10. Remove 3pcs screws from left side of bezel.



Fig. 8

8. Remove 8pcs screws from Speakers, and take off them.



Fig. 11

11. Remove 3pcs screws from right side of bezel.



Fig. 9

9. Disconnect the cable from Button/B.



Fig. 12

12. Separate bezel from panel.



Fig.13

13. Remove 2pcs screws from left side of panel bracket.

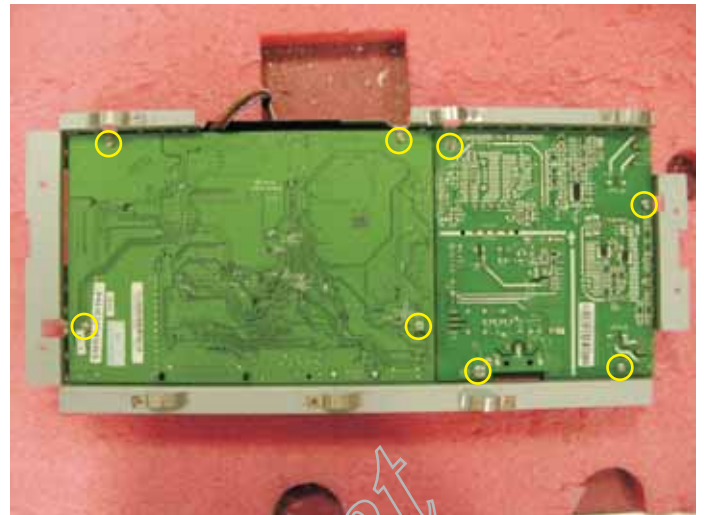

Fig.16

16. Remove 8pcs screws from Main/B and Power/B.



Fig 14

14. Remove 2pcs screws from right side of bracket.



Fig 17

17. Disconnect Main/B and Power/B.



Fig 15

15. Remove 3pcs screw screws from connector.



Fig 18

18. The Main/B.

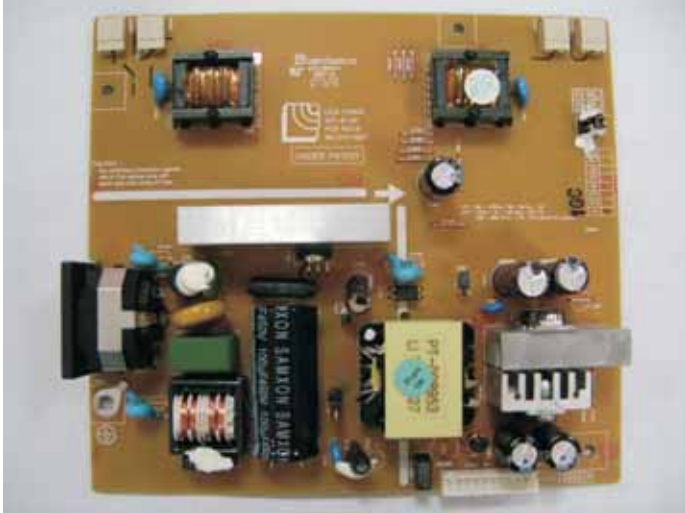

Fig. 19

19. The Power/B.



Fig 20

20. The LED/B.



Fig. 21

21. The Button/B.

F/W upload instruction

Configuration and procedure(ISP tool)

Purpose and Scope

This document contains introduction the user update firmware environment and run it on MTK tool.

Prepare to update firmware using ISP board

1. Connection ISP board between PC side and TV side.

* Using USB cable connect between ISP board and PC side, see figure 1.

* Connect ISP board and TV set by VGA cable, see figure 1



Figure 1

2. How to update firmware:

* Make sure ISP board and TV set are connection.

* Enter factory mode:

A. Use remote control, press " MENU" key to show use OSD menu and then key "5588".

B. Factory mode OSD display when setting OK.

* Executing MTK update tool



MTK tool

* Select com Port and Baud rate

* Press Reset icon

The error message will show on screen when communicate NG.

* Press lightning icon to enter update page.

* Press Browse to choose firmware file.

* Press upgrade to update firmware.

If upgrade fail please to lower Baud rate, then AC power off and turn on again. Then follow update flow to upgrade firmware again.

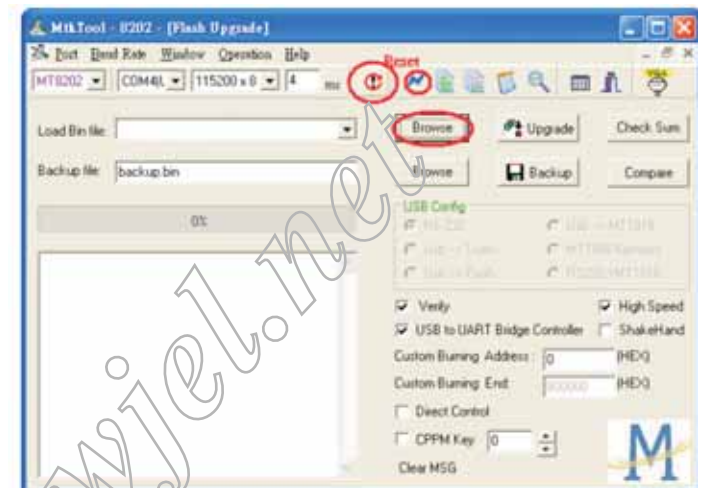

Figure 2 Update page

* When update finish, then AC power off and turn on again, see figure 3.

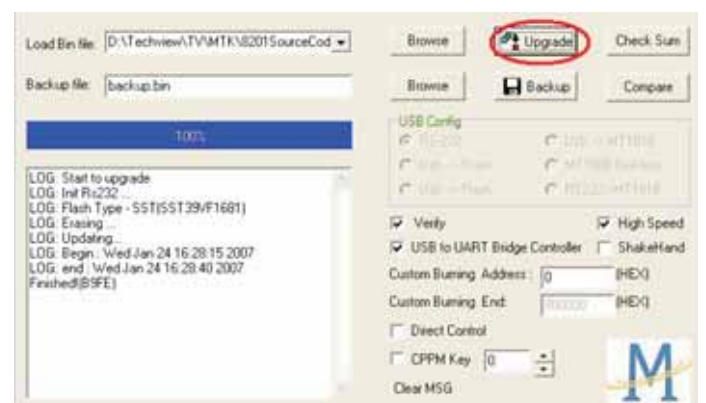

Figure 3. Finish update firmware illustration

Electronic instruction

The purpose of alignments is for the input signal and color temperature adjustment.

White balance adjusted flow

Environment
 Equipment Requirements:
 Astro VG-848 or VG-859
 Minolta CA-210
 Fluke 54200

White balance adjusted flow:

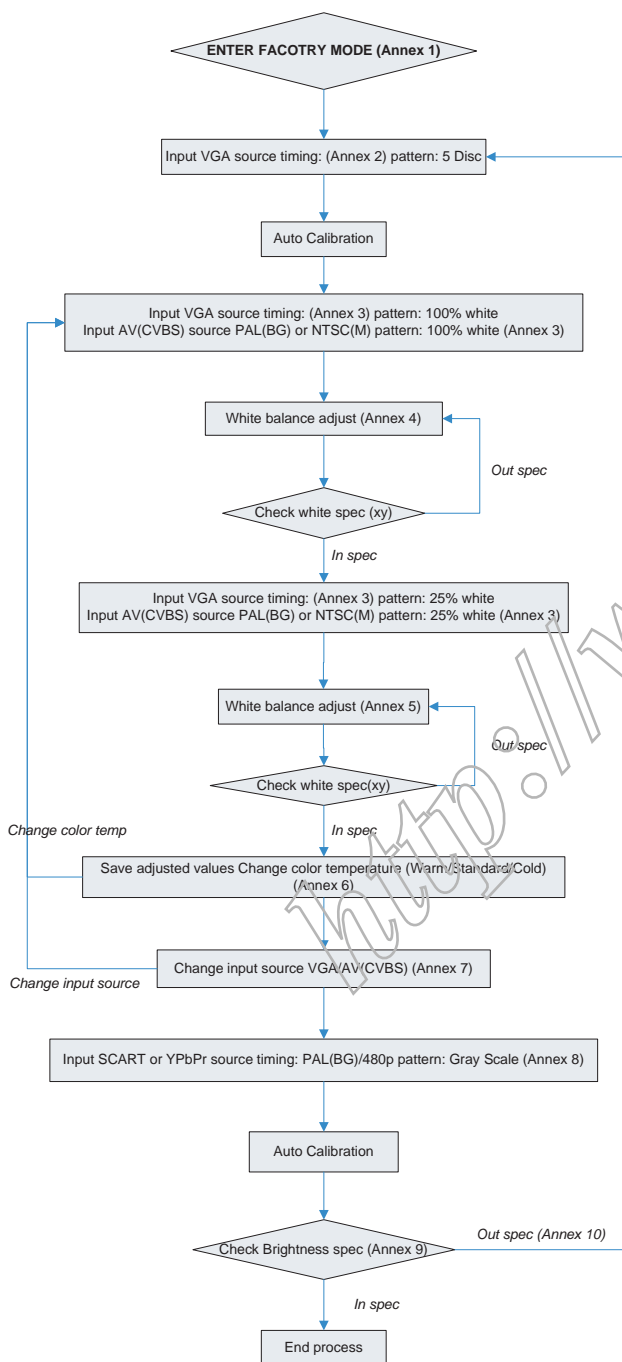

Annex 1

1. Factory mode command:
Remote Key: MENU + 5588
2. Make sure user mode at default values

Annex 2:

1. Example
E9P-PT: 1440*900@60
2. Pattern may be changed for different model.

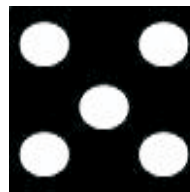

Disc Pattern

Annex 3:

1. There are two input source must be done white balance adjustment
Example: E9P-PT
A. VGA: 1440*900@60
B. AV: PAL(BG)
2. VGA adjusted value for: VGA (and DVI)
3. AV(CVBS) adjusted value for: ATV, CVBS, S-Video, SCART-RGB and HDMI

Annex 4(White point)

1. Set R/G/B offset value to 128
2. Adjust R/G/B gain value to find the saturation point
3. Follow "White Balance Adjust" rule to adjust white balance

Annex 5(Dark point)

1. Keep offset max. Value at 128
2. Follow "White Balance Adjust" rule to adjust white balance

Annex 6

1. Save adjusted value
2. Change color temp to Warm/Standard/Cold
3. Adjust RG, GG, BG, RO, GO, BO
4. Adjust CT values only to meet white spec

Annex 7

1. Change input to VGA/AV(CVBS)

Annex 8

1. Change input source to SCART-RGB to do auto Calibration
2. Timing:
SCART: PAL(BG)
3. Pattern may be changed for different mode

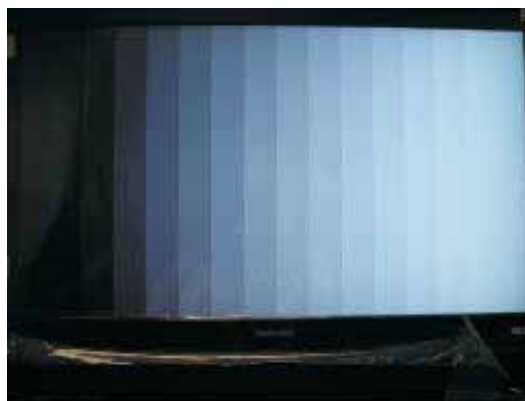

Gray Scale Pattern

Annex 9

1. In Standard mode
2. MENU/Picture/Default Setting
3. Change pattern level to 255(100%)
4. Check brightness whether over spec(250 cd/m² for E9P-PT)

Annex 10

1. Replace panel
2. Repeat white balance flow

4. $x <, y < :$

- a. Decrease B value to increase x, y value and let $x = \text{spec}, y > (=) \text{spec}$ or $x > (=) \text{spec}, y = \text{spec}$
- b. If $x = \text{spec}, y > (=) \text{spec} :$
 - 1) Decrease G value to reduce y value
 - 2) If meet spec than OK
- c. If $x > (=) \text{spec}, y = \text{spec} :$
 - 1) Decrease R value to reduce x value
 - 2) If meet spec than OK

Target value Philips (E9P-PT)

Philips	19 inch		
Color Name	Warm	Standard	Cold
Color Temp	6500K	7500K	9300K
X	0.313	0.300	0.285
Y	0.329	0.310	0.293
Factory Tolerance dx, dy	+ -0.007	+ -0.007	+ -0.007
Shipment Tolerance dx, dy	+ -0.015	+ -0.015	+ -0.015
Brightness(Level 255)	270(cd/m ²) up	250(cd/m ²) up	200(cd/m ²) up

If you have not CA-110, the following R,G and B values are for your reference.

AV Source						
Color Name	Gain			Offset		
Warm	135	131	137	124	128	117
Standard	120	117	137	125	127	110
Cold	107	110	137	128	126	112

VGA Source						
Color Name	Gain			Offset		
Warm	128	125	128	123	128	122
Standard	121	116	128	123	127	128
Cold	108	107	128	124	128	128

White Balance Adjust :

Item	1	2	3	4	R	X
X	> (=)	> (=)	<	<		
Y	> (=)	<	> (=)	<	G	Y
R	v	v	-	o		
G	v	-	v	c		X
B	-	v	v	v	B	Y

1. $x > (=), y > (=) :$

- A. Fix B value
- b. Decrease R value to reduce x value
- c. Decrease G value to reduce y value
- d. If meet spec than OK

2. $x > (=), y < :$

- a. Fix G value
- b. Decrease B value to increase x, y value and let y value to meet spec
- c. Decrease R value to reduce x value
- d. If meet spec than OK

3. $x <, y > (=) :$

- a. Fix R value
- b. Decrease B value to increase x, y value and let x value to meet spec
- c. Decrease G value to reduce y value
- d. If meet spec than OK

DDC Data

Mfg. Name : PHL
 Product Code : 0864
 Serial Number : 72300001
 Mfg. Week : 23
 Mfg. Year : 2007
 Analog DDC Signal Level : 0.700 , 0.300
 Input Support : Separate Sync.
 Feature Support : Stand By, Suspend Active Off /Very

Low Power ,
 Display Type : RGB Color
 Image Size : Max Hor.(cm) : 41
 Max Ver.(cm) : 25
 Gamma Value *100 : 220

Red x : 0.647
 Red y : 0.334
 Green x : 0.284
 Green y : 0.607
 Blue x : 0.151
 Blue y : 0.071
 White x : 0.313
 White y : 0.329

Established Timeings : 720 x 400 @70Hz [IBM VGA]
 : 640 x 480 @60Hz [IBM VGA]
 : 640 x 480 @67Hz [Mac2]
 : 640 x 480 @72Hz [VESA]
 : 640 x 480 @75Hz [VESA]
 : 800 x 600 @56Hz [VESA]
 : 800 x 600 @60Hz [VESA]
 : 800 x 600 @72Hz [VESA]
 : 800 x 600 @75Hz [VESA]
 : 832 x 624 @70Hz [Mac2]
 : 1024 x 768@60Hz [VESA]
 : 1024 x 768@70Hz [VESA]
 : 1024 x 768 @75Hz [VESA]

Standard Timings
 H . Pixels : 640
 Refresh rate : 85
 V Pixel : 480
 H . Pixels : 800
 Refresh rate : 85
 V Pixel : 600
 H . Pixels : 1024
 Refresh rate : 85
 V Pixel : 768
 H . Pixels : 1280
 Refresh rate : 60
 V Pixel : 720
 H . Pixels : 1280
 Refresh rate : 75
 V Pixel : 720
 H . Pixels : 1440
 Refresh rate : 60
 V Pixel : 900
 H . Pixels : 1440
 Refresh rate : 75
 V Pixel : 900

Block #1
 Horizontal Image Size : 410mm
 Vertical Image Size : 256 mm
 Active Pixels : 1440
 V Active Lines : 900
 H Blank : 464 Pixels
 V Blank : 34 Lines
 H Sync Offset : 80 Pixels
 V Sync Offset : 3 Lines
 H Sync Plus Width : 152 Pixels
 V Sync Plus Width : 6 Lines
 H Border : 0 Pixels
 V Border : 0 Lines

Pixels Clock : 106.50 Mhz
 Refresh Mode : Non-Interlaced
 Stero : None
 Refresh Mode : Non-Interlaced
 Stero : None
 V Polarity(+), Digital Separate

Monitor Range Limits : Min V Rate(Hz) : 50
 Max V Rate(Hz) : 76
 Min H Rate(KHz) : 30
 Max H Rate(KHz) : 83
 Max Pixels Clock : 140

Monitor Name : Philips 190TW

ASCII String : Philips

EDID CODE:

	0	1	2	3	4	5	6	7	8	9	A	B	C	D	E	F
0	00	FF	FF	FF	FF	FF	FF	00	41	0C	64	08	E1	35	4F	04
10	17	11	01	03	06	29	19	78	EA	EE	D5	A5	55	48	9B	26
20	12	50	54	5F	EE	00	31	59	45	59	61	59	81	C0	81	CF
30	95	00	95	0F	01	01	9A	29	A0	D0	51	84	22	30	50	98
40	36	00	9A	00	11	00	00	1C	00	00	00	FD	00	32	4C	1E
50	53	0E	00	0A	20	20	20	20	20	20	00	00	00	FC	00	50
60	68	69	6C	69	70	73	20	31	39	30	54	57	00	00	00	FE
70	00	50	68	69	6C	69	70	73	0A	20	20	20	20	20	00	77

**EDID Block 0, Bytes 0-127 [00H-7FH]
Block Type: EDID 1.3**

(08H-09H) ID Manufacturer Name = PHL
 (0AH-0BH) Product ID Code = 0864
 (0CH-0FH) Last 5 Digits of Serial Number = 57313
 (10H) Week of Manufacture = 23
 (11H) Year of Manufacture = 2007
 (12H) EDID Version Number = 1
 (13H) EDID Revision Number = 3
 (14H) VIDEO INPUT DEFINITION: Digital Signal
 (15H) Maximum Horizontal Image Size = 410 mm
 (16H) Maximum Vertical Image Size = 250 mm
 (17H) Display Gamma = 2.20

(18H) DPMS and Supported Feature(s): Stand-By,
 Suspend, Active Off, Preferred Timing Mode
 Display Type = R/G/B Color

(19H-22H) CHROMA INFO:
 Red x - 0.647 Green x - 0.284
 Blue x - 0.151 White x - 0.313
 Red y - 0.334 Green y - 0.607
 Blue y - 0.071 White y - 0.329

(23H) ESTABLISHED TIMING I:
 720 x 400 @ 70Hz (IBM,VGA)
 640 x 480 @ 60Hz (IBM,VGA)
 640 x 480 @ 67Hz (Apple,Mac II)
 640 x 480 @ 72Hz (VESA)
 640 x 480 @ 75Hz (VESA)
 800 x 600 @ 56Hz (VESA)
 800 x 600 @ 60Hz (VESA)

(24H) ESTABLISHED TIMING II:
 800 x 600 @ 72Hz (VESA)
 800 x 600 @ 75Hz (VESA)
 832 x 624 @ 75Hz (Apple,Mac II)
 1024 x 768 @ 60Hz (VESA)
 1024 x 768 @ 70Hz (VESA)
 1024 x 768 @ 75Hz (VESA)

(25H) Manufacturer's Reserved Timing:
 None Specified

(26H-35H) Standard Timing Identification:
 Standard Timing ID 1: 640 x 480 @85Hz
 Standard Timing ID 2: 800 x 600 @85Hz
 Standard Timing ID 3: 1024 x 768 @85Hz
 Standard Timing ID 4: 1280 x 720 @60Hz
 Standard Timing ID 5: 1280 x 720 @75Hz
 Standard Timing ID 6: 1440 x 900 @60Hz
 Standard Timing ID 7: 1440 x 900 @75Hz
 Standard Timing ID 8 - Not Used

(36H-47H) Detailed Timing / Descriptor Block 1:
 1440x900 Pixel Clock: 106.50 MHz
 Horizontal Image Size: 410 mm
 Vertical Image Size: 256 mm
 Refreshed Mode:
 Non-Interlaced Normal Display - No Stereo

Horizontal:
 Active Count: 1440 pixels
 Blanking Count: 464 pixels

Sync Offset: 80 pixels
 Sync Pulse Width: 152 pixels
 Border: 0 pixels
 Frequency: 55.93 kHz

Vertical:
 Active Count: 900 lines
 Blanking Count: 34 lines
 Sync Offset: 3 lines
 Sync Pulse Width: 6 lines
 Border: 0 lines
 Frequency: 59.89 Hz

Digital Separate,
 Horizontal Polarity (-) Vertical Polarity (+)

(48H-59H) Detailed Timing / Descriptor Block 2:

Monitor Range Limits:
 Min Vertical Freq - 50 Hz
 Max Vertical Freq - 76 Hz
 Min Horiz. Freq - 30 kHz
 Max Horiz. Freq - 83 kHz
 Pixel Clock - 140 MHz
 GTF - Not Used

(5AH-6BH) Detailed Timing / Descriptor Block 3:

Monitor Name:
 Philips 190TW

(6CH-7DH) Detailed Timing / Descriptor Block 4:

ASCII Data: Philips

(7EH) Block No: (01) Extension EDID Block(s)
 (7FH) CheckSum OK

	0	1	2	3	4	5	6	7	8	9	A	B	C	D	E	F
0	00	FF	FF	FF	FF	FF	FF	00	41	0C	64	08	E1	35	4F	04
10	17	11	01	03	80	29	19	78	EA	EE	D5	A5	55	48	9B	26
20	12	50	54	BF	EE	00	31	59	45	59	61	59	81	C0	81	CF
30	95	00	95	0F	01	01	9A	29	A0	D0	51	84	22	30	50	98
40	36	00	9A	00	11	00	00	1C	00	00	00	FD	00	32	4C	1E
50	53	0E	00	0A	20	20	20	20	20	20	00	00	00	FC	00	50
60	68	69	6C	69	70	73	20	31	39	30	54	57	00	00	00	FE
70	00	50	68	69	6C	69	70	73	0A	20	20	20	20	20	01	FE

DDC Data

**EDID Block 1, Bytes 128-255 [80H-FFH]
 Block Type: CEA EDID Timing Extension Version 3**

Extended Block Type: CEA 861B
 Detailed Timing Blocks start at Byte:(1EH)
 Native Format: (0x1)
 (03H) DTV (Underscan)
 (03H) DTV (Basic Audio)
 (03H) YCbCr (4:4:4)
 (03H) YCbCr (4:2:2)

Video Short Block Description:
 (05H) 1280 x 720 P 50Hz 16:9 Native Mode
 (06H) 1920 x 1080 I 50Hz 16:9
 (07H) 720 x 576 P 50Hz 16:9
 (08H) 720(1440) x 576 I 50Hz 16:9
 (09H) 720(1440) x 576 I 50Hz 4:3
 (0AH) 640 x 480 P 59.94/60Hz 4:3
 (0BH) 1280 x 720 P 59.94/60Hz 16:9
 (0CH) 1920 x 1080 I 59.94/60Hz 16:9
 (0DH) 720(1440) x 480 I 59.94/60Hz 16:9
 (0EH) 720(1440) x 480 I 59.94/60Hz 4:3
 (0FH) 720 x 480 P 59.94/60Hz 16:9

Audio Short Block Description: Numbers of Audio Channels (2)
 (11H) Linear PCM(IEC60958)
 Audio Supported: 32kHz, 44.1kHz, 48kHz
 Audio Bit Rate: 16bit, 20Bit, 24Bit
 Speaker Short Block Description: Payload (3 bytes 15H-17H)
 Speakers (15H): FL/FR
 16H: Reserved
 17H: Reserved
 Vendor Specific Short Block Description:
 Bytes: 03H, 0CH, 00H, 10H, 00H

(1EH - 30H) Detailed Timing Descriptions:
 1280x720 Pixel Clock: 74.25 MHz
 Horizontal Image Size: 408 mm
 Vertical Image Size: 230 mm
 Refreshed Mode:
 Non-Interlaced Normal Display - No Stereo

Horizontal:
 Active Count: 1280 pixels
 Blanking Count: 700 pixels
 Sync Offset: 440 pixels
 Sync Pulse Width: 40 pixels
 Border: 0 pixels
 Frequency: 37.50 kHz

Vertical:
 Active Count: 720 lines
 Blanking Count: 30 lines
 Sync Offset: 5 lines
 Sync Pulse Width: 5 lines
 Border: 0 lines
 Frequency: 50.00 Hz

Digital Separate, Horizontal Polarity (+) Vertical Polarity (+)

(30H - 42H) Detailed Timing Descriptions:
 720x480 Pixel Clock: 27.00 MHz
 Horizontal Image Size: 408 mm
 Vertical Image Size: 230 mm
 Refreshed Mode:
 Non-Interlaced Normal Display - No Stereo

Horizontal:
 Active Count: 720 pixels
 Blanking Count: 138 pixels
 Sync Offset: 16 pixels
 Sync Pulse Width: 62 pixels
 Border: 0 pixels
 Frequency: 31.47 kHz

Vertical:
 Active Count: 480 lines
 Blanking Count: 45 lines
 Sync Offset: 9 lines
 Sync Pulse Width: 6 lines
 Border: 0 lines
 Frequency: 59.94 Hz
 Digital Separate, Horizontal Polarity (-) Vertical Polarity (-)

(42H - 54H) Detailed Timing Descriptions:
 720x576 Pixel Clock: 27.00 MHz
 Horizontal Image Size: 408 mm
 Vertical Image Size: 230 mm
 Refreshed Mode:
 Non-Interlaced Normal Display - No Stereo

Horizontal:
 Active Count: 720 pixels
 Blanking Count: 144 pixels
 Sync Offset: 12 pixels
 Sync Pulse Width: 64 pixels
 Border: 0 pixels
 Frequency: 31.25 kHz

Vertical:
 Active Count: 576 lines
 Blanking Count: 49 lines
 Sync Offset: 5 lines
 Sync Pulse Width: 5 lines
 Border: 0 lines
 Frequency: 50.00 Hz
 Digital Separate, Horizontal Polarity (-) Vertical Polarity (-)

(54H - 66H) Detailed Timing Descriptions:
 1920x540 Pixel Clock: 74.25 Mhz
 Horizontal Image Size: 408 mm
 Vertical Image Size: 230 mm
 Refreshed Mode: Interlaced Normal Display - No Stereo

Horizontal:
 Active Count: 1920 pixels
 Blanking Count: 720 pixels
 Sync Offset: 528 pixels
 Sync Pulse Width: 44 pixels
 Border: 0 pixels
 Frequency: 28.13 kHz

Vertical:
 Active Count: 540 lines
 Blanking Count: 22 lines
 Sync Offset: 2 lines
 Sync Pulse Width: 5 lines
 Border: 0 lines
 Frequency: 50.04 Hz
 Digital Separate, Horizontal Polarity (+) Vertical Polarity (+)

Safety instruction, warnings and notes

index of this chapter:

- 1 Safety Instructions
- 2 Warnings
- 3 Notes

1 Safety Instructions

Safety regulations require that during a repair:

- a. Connect the set to the AC Power via an isolation transformer (> 800 VA).
- b. Replace safety components, indicated by the symbol ▲, only by components identical to the original ones. Any other component substitution (other than original type) may increase risk of fire or electrical shock hazard.

Safety regulations require that after a repair, the set must be returned in its original condition. Pay in particular attention to the following points:

- a. Route the wire trees correctly and fix them with the mounted cable clamps.
- b. Check the insulation of the AC Power lead for external damage.
- c. Check the strain relief of the AC Power cord for proper function.
- d. Check the electrical DC resistance between the AC Power plug and the secondary side (only for sets which have a AC Power isolated power supply):
 - * Unplug the AC Power cord and connect a wire between the two pins of the AC Power plug.
 - * Set the AC Power switch to the "on" position (keep the AC Power cord unplugged!).
 - * Measure the resistance value between the pins of the AC Power plug and the metal shielding of the tuner or the aerial connection on the set. The reading should be between 4.5 Mohm and 12 Mohm.
 - * Switch "off" the set, and remove the wire between the two Pins of the AC Power plug.
- e. Check the cabinet for defects, to avoid touching of any inner parts by the customer.

2 Warnings

- a. All ICs and many other semiconductors are susceptible to electrostatic discharges (ESD ▲). Careless handling during repair can reduce life drastically. Make sure that, during repair, you are connected with the same potential as the mass of the set by a wristband with resistance. Keep components and tools also at this same potential.
- b. Be careful during measurements in the high voltage section.
- c. Never replace modules or other components while the unit is switched "on".
- d. When you align the set, use plastic rather than metal tools. This will prevent any short circuits and the danger of a circuit becoming unstable.

3 Notes

3.1 General

Measure the voltages and waveforms with regard to the chassis ground or hot ground, depending on the tested area of circuitry. The voltages and waveforms shown in the diagrams are indicative.

The semiconductors indicated in the circuit diagram and in the parts lists, are interchangeable per position with the semiconductors in the unit, irrespective of the type indication on

3.2 Schematic Notes

All resistor values are in ohms and the value multiplier is often used to indicate the decimal point location (e.g. 2K2 indicates 2.2 Kohm).

Resistor values with no multiplier may be indicated with either an "E" or an "R" (e.g. 220E or 220R indicates 220 ohm).

All capacitor values are given in micro-farads ($\times 10^{-6}$), nano-farads ($n = \times 10^{-9}$), or pico-farads ($p = \times 10^{-12}$).

Capacitor values may also use the value multiplier as the decimal point indication (e.g. 2p2 indicates 2.2 pF).

An "asterisk" (*) indicates component usage varies. Refer to the diversity tables for the correct values.

The correct component values are listed in the Electrical Replacement Parts List. Therefore, always check this list when there is any doubt.

3.3 Lead Free Solder

Philips CE is going to produce lead-free sets (PBF) from 1.1.2005 onwards.

Lead-free sets will be indicated by the PHILIPS-lead-free logo on the Printed Wiring Boards (PWB):



Figure 2-1 Lead-free logo

This sign normally has a diameter of 6 mm, but if there is less space on a board also 3 mm is possible.

In case of doubt whether the board is lead-free or not (or with mixed technologies), you can use the following method:

- * Always use the highest temperature to solder, when using SAC305 (see also instructions below).
- * De-solder thoroughly (clean solder joints to avoid mix of two alloys).

Caution: For BGA-ICs, you must use the correct temperature profile, which is coupled to the 12NC. For an overview of these profiles, visit the website <http://www.atyourservice.ce.philips.com/>. You will find this and more technical information within the "Magazine", chapter "Workshop information".

For additional questions please contact your local repair desk.

Due to lead-free technology some rules have to be respected by the workshop during a repair:

Use only lead-free soldering tin Philips SAC305 with order code 0622 149 00106. If lead-free solder paste is required, please contact the manufacturer of your soldering equipment. In general, use of solder paste within workshops should be avoided because paste is not easy to store and to handle.

Use only adequate solder tools applicable for lead-free soldering tin. The solder tool must be able

- To reach at least a solder-tip temperature of 400 degree C.
- To stabilise the adjusted temperature at the solder-tip.
- To exchange solder-tips for different applications.

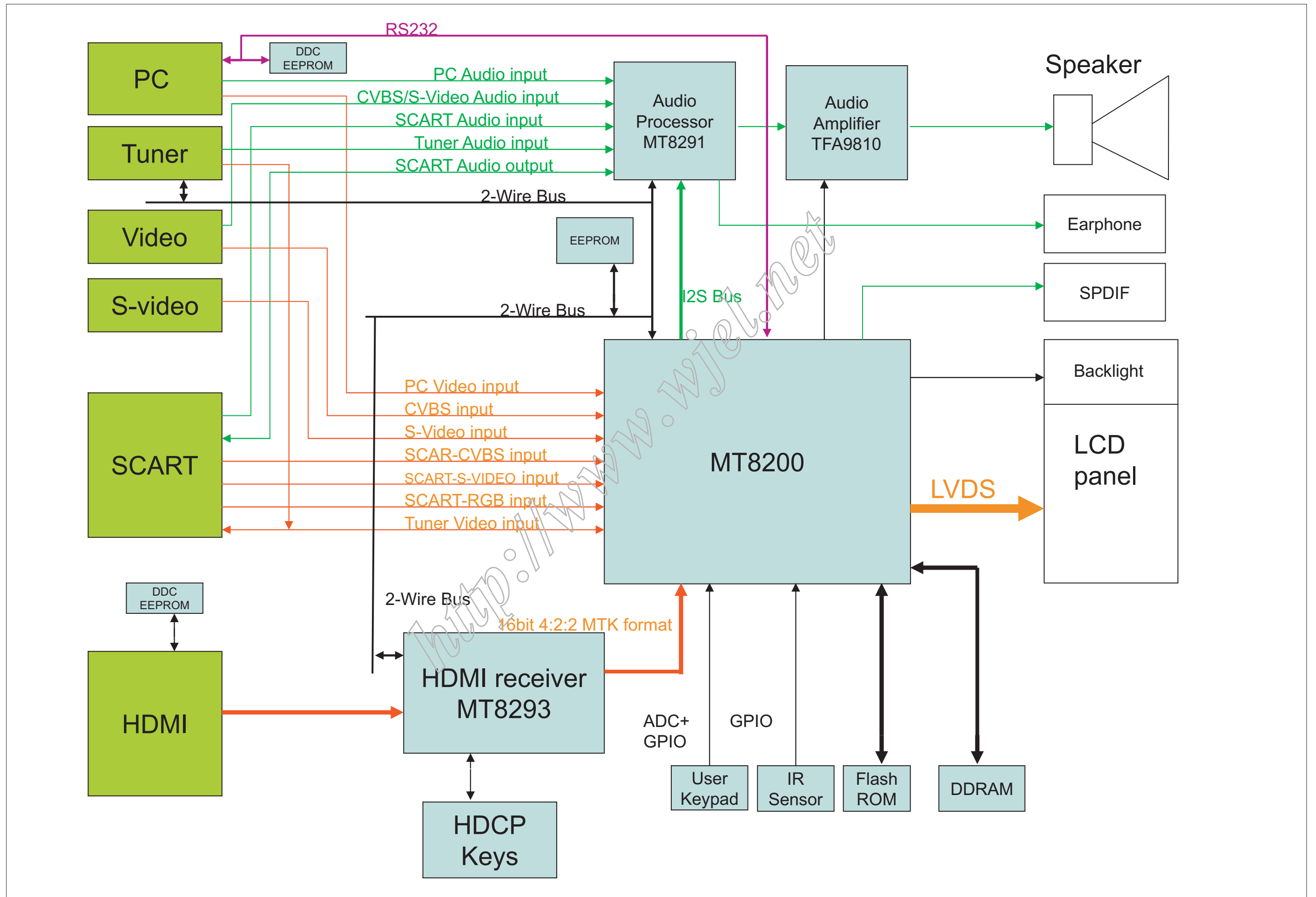

S-A01

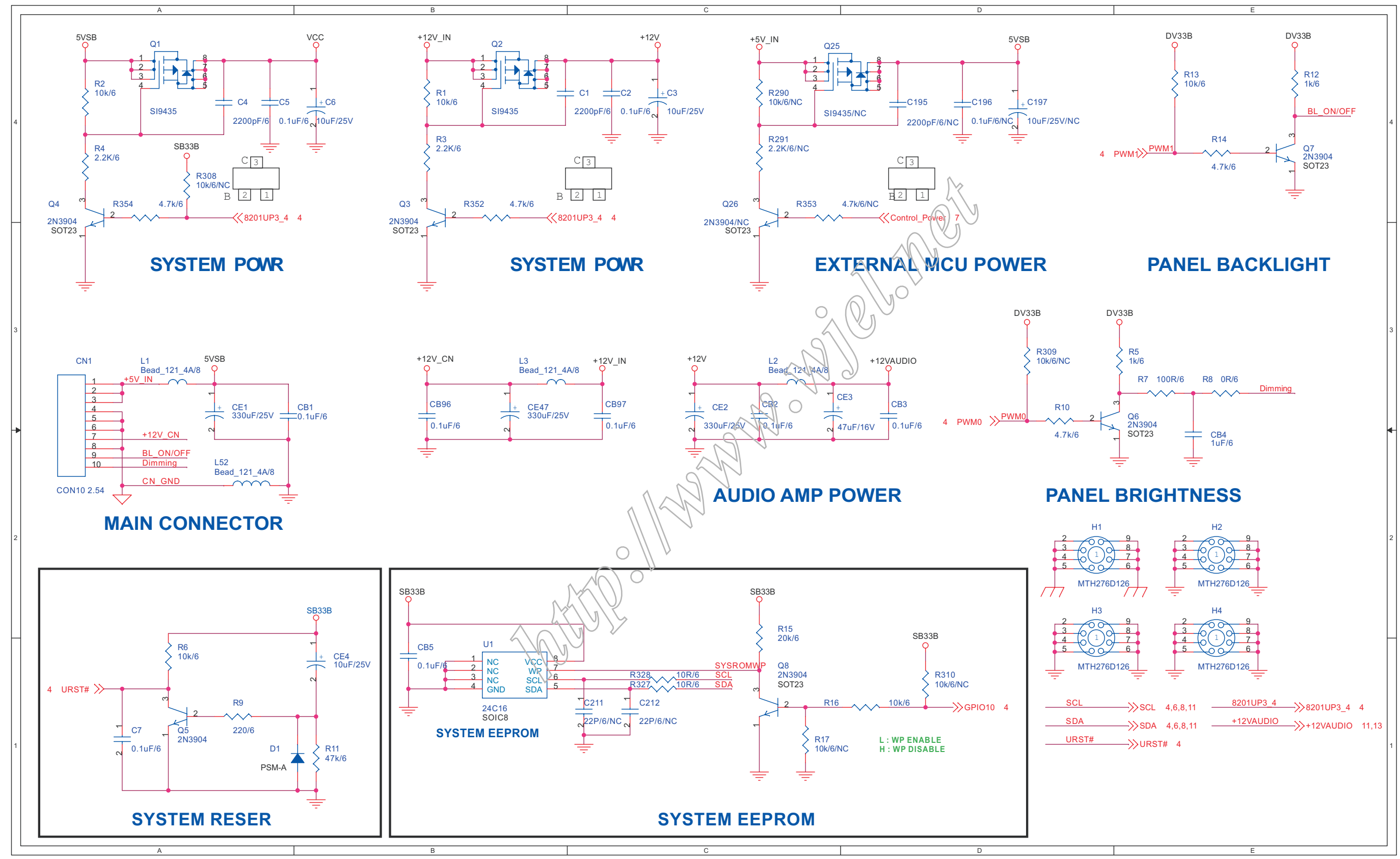

- C1 B4
- C2 C4
- C3 C4
- C4 A4
- C5 A4
- C6 B4
- C7 A1
- C195 D4
- C196 D4
- C197 D4
- C211 C1
- C212 C1
- CB1 A3
- CB2 C3
- CB3 D3
- CB4 E2
- CB5 B1
- CB96 B3
- CB97 C3
- CE1 A3
- CE2 C3
- CE3 C3
- CE4 B1
- CE47 B3
- CN1 A3
- D1 A1
- H1 D2
- H2 E2
- H3 D2
- H4 E2
- L1 A3
- L2 C3
- L3 B3
- L52 A2
- Q1 A4
- Q2 B4
- Q3 B4
- Q4 A4
- Q5 A1
- Q6 D3
- Q7 E4
- Q8 C1
- Q25 C4
- Q26 C4
- R1 B4
- R2 A4
- R3 B4
- R4 A4
- R5 E3
- R6 A1
- R7 E3
- R8 E3
- R9 A1
- R10 D3
- R11 B1
- R12 E4
- R13 E4
- R14 E4
- R15 C2
- R16 D1
- R17 C1
- R290 C4
- R291 C4
- R308 A4
- R309 D3
- R310 D1
- R327 C1
- R328 C1
- R352 B4
- R353 C4
- R354 A4
- U1 B1

S-A02

C8	D4	CB19	D1
C9	A4	CB93	A2
C10	B4	CB94	B2
C11	A4	CB95	C2
C12	A4	CE5	D3
C13	B4	CE6	E3
C14	B4	CE7	E2
C15	C4	CE44	A2
C16	C4	CE45	B2
C17	C4	CE46	C2
C18	D4	FB1	D4
C19	D3	FB2	D2
C20	A3	FB3	D2
C21	B3	FB4	D1
C22	A3	L4	D4
C23	A3	L5	B4
C24	B3	L6	B3
C25	B3	L7	D3
C26	C3	L8	D3
C27	C3	L9	A2
C28	D3	L10	B2
C29	E3	L11	C2
C30	A3	L46	B3
C31	B3	L53	C3
C32	A3	L55	B2
C33	A3	L56	B4
C34	B3	L57	C3
C35	B3	L58	C4
C36	C3	L64	A3
C37	C3	L65	A3
C38	E2	R18	A4
C39	A2	R19	A4
C40	A2	R20	B4
C41	A2	R21	C4
C42	B2	R22	A4
C43	D2	R23	A4
C44	D2	R24	B4
C45	D1	R25	C4
CB6	D4	R26	A3
CB7	D4	R27	A3
CB8	D4	R28	B3
CB9	D4	R29	C3
CB10	E3	R30	A2
CB11	E3	R31	A2
CB12	E3	U2	A4
CB13	E3	U3	C4
CB14	E2	U4	A3
CB15	D2	U5	C3
CB16	E2	U6	A3
CB17	D2	U7	C3
CB18	E2	U8	A2

Power ON alive source

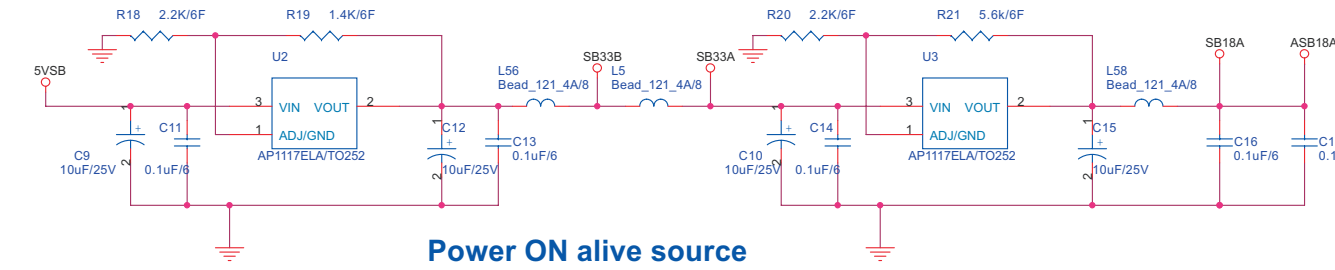

STANDBY ANALOG POWER

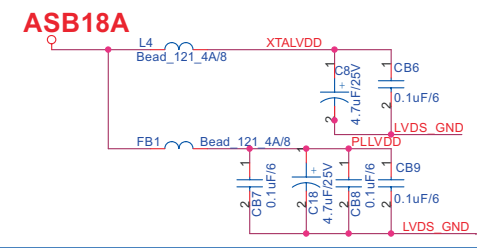

NORMAL VIDEO DAC POWER

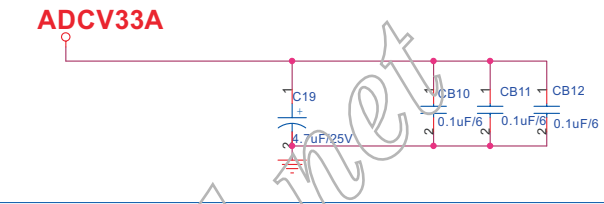

NORMAL AUDIO ADC / DAC POWER

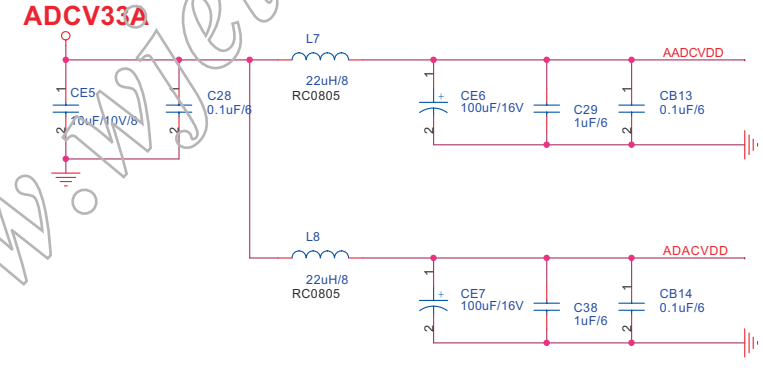

NORMAL VIDEO ADC POWER

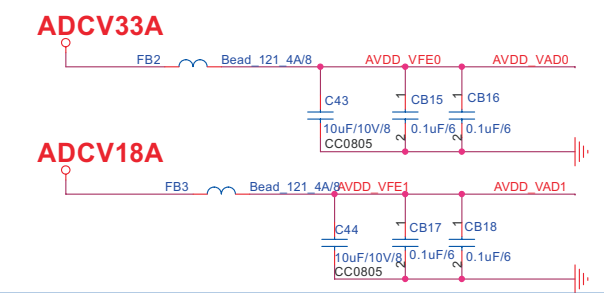

NORMAL ANALOG POWER

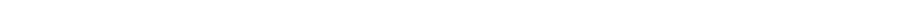
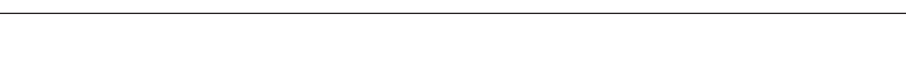
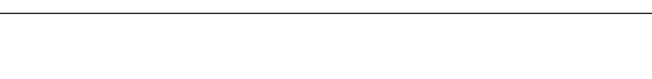
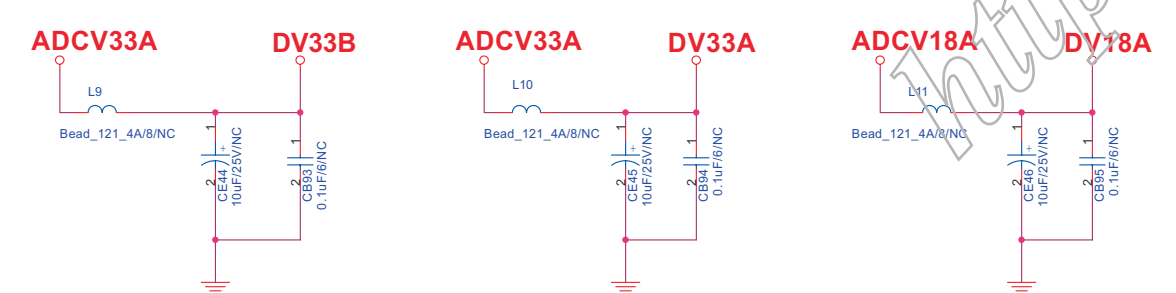
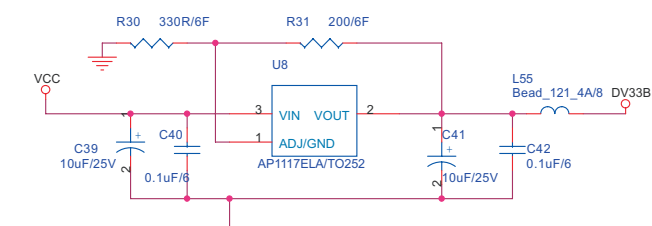
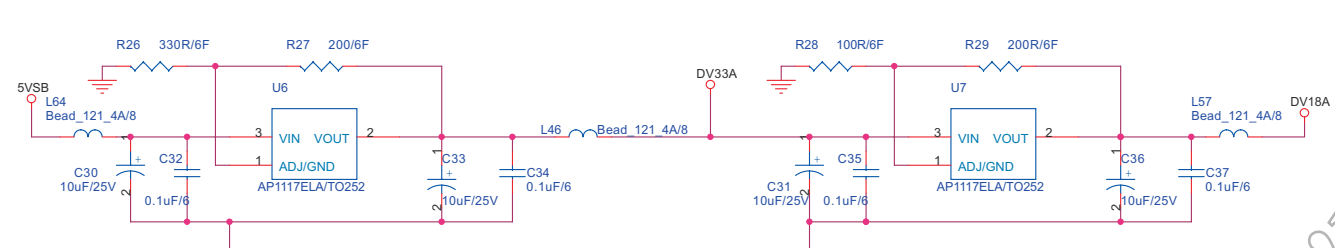
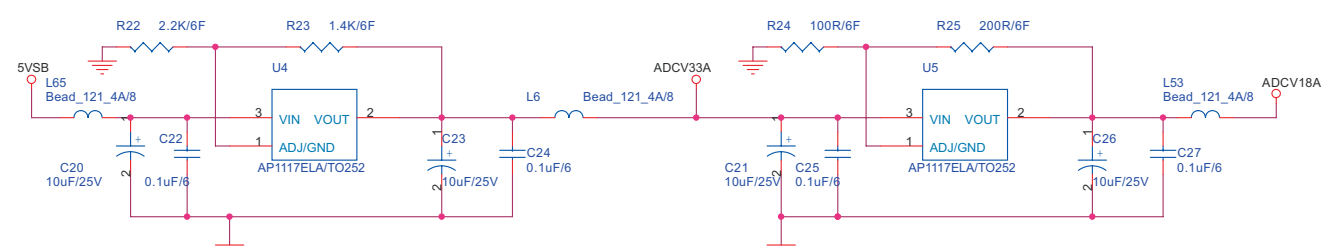
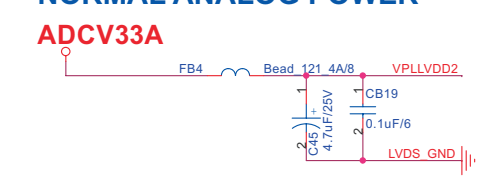

S-A03

ALE1	B1	CB30	C1
C46	A1	CB31	C1
C47	A1	CB110	D1
C48	A1	CON1	B1
C49	A3	R33	A2
C50	A3	R40	B1
C51	C1	R41	A1
C52	C1	R42	A1
C53	B1	R43	A1
C54	C1	R44	A1
C55	C1	R45	B1
C56	C1	R46	B1
C213	A1	R47	B1
C214	A1	R48	A2
C220	D1	R49	A2
C221	D1	R50	B1
C222	D1	RD1	B1
C223	D1	TP1	B4
C224	D1	TP2	B4
C225	D1	TP3	B4
C226	D1	TP4	A3
C227	D1	TP5	A2
C228	D1	TP6	A2
C229	D1	TP7	A2
C230	D1	TP9	C1
C231	D1	TP15	B1
CB20	A1	TP47	C4
CB21	A3	TP48	C4
CB22	B1	TP49	C4
CB23	B1	TP50	C4
CB24	C1	TP51	C4
CB25	C1	TP52	C4
CB26	C1	TP53	C4
CB27	C1	U9	B4
CB28	B1	WR1	B1
CB29	C1	Y1	A2

MT8201

SMD E-PAD

9.4 mm
exposed pad 9.4 mm

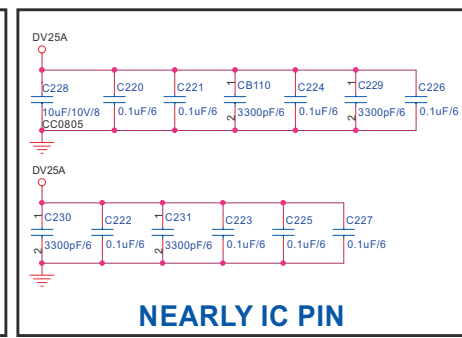
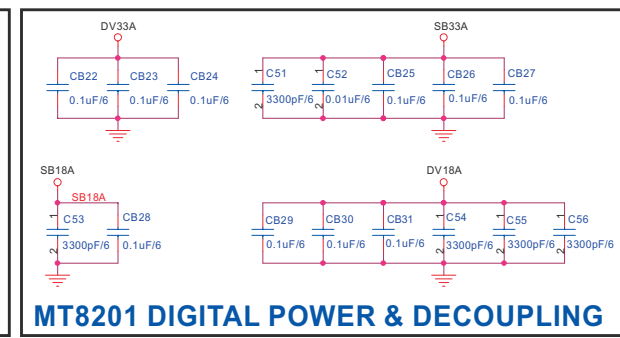
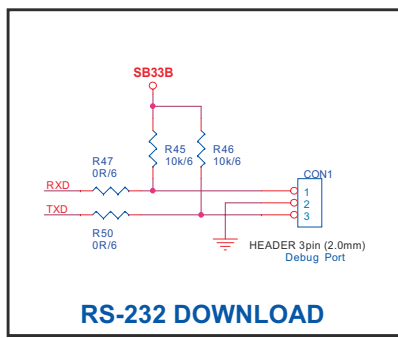
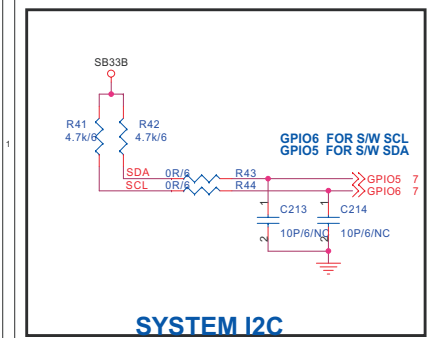
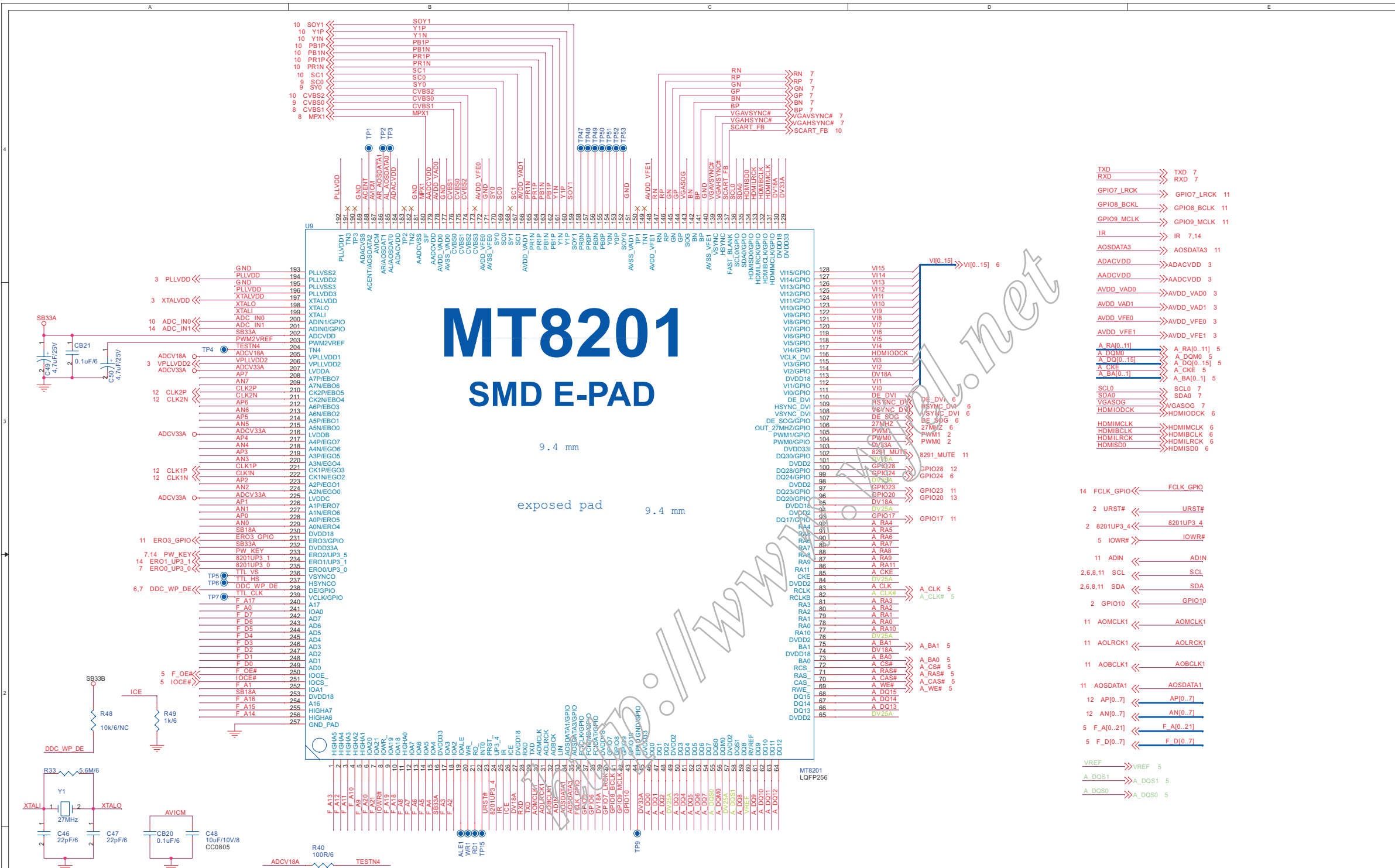

S-A04

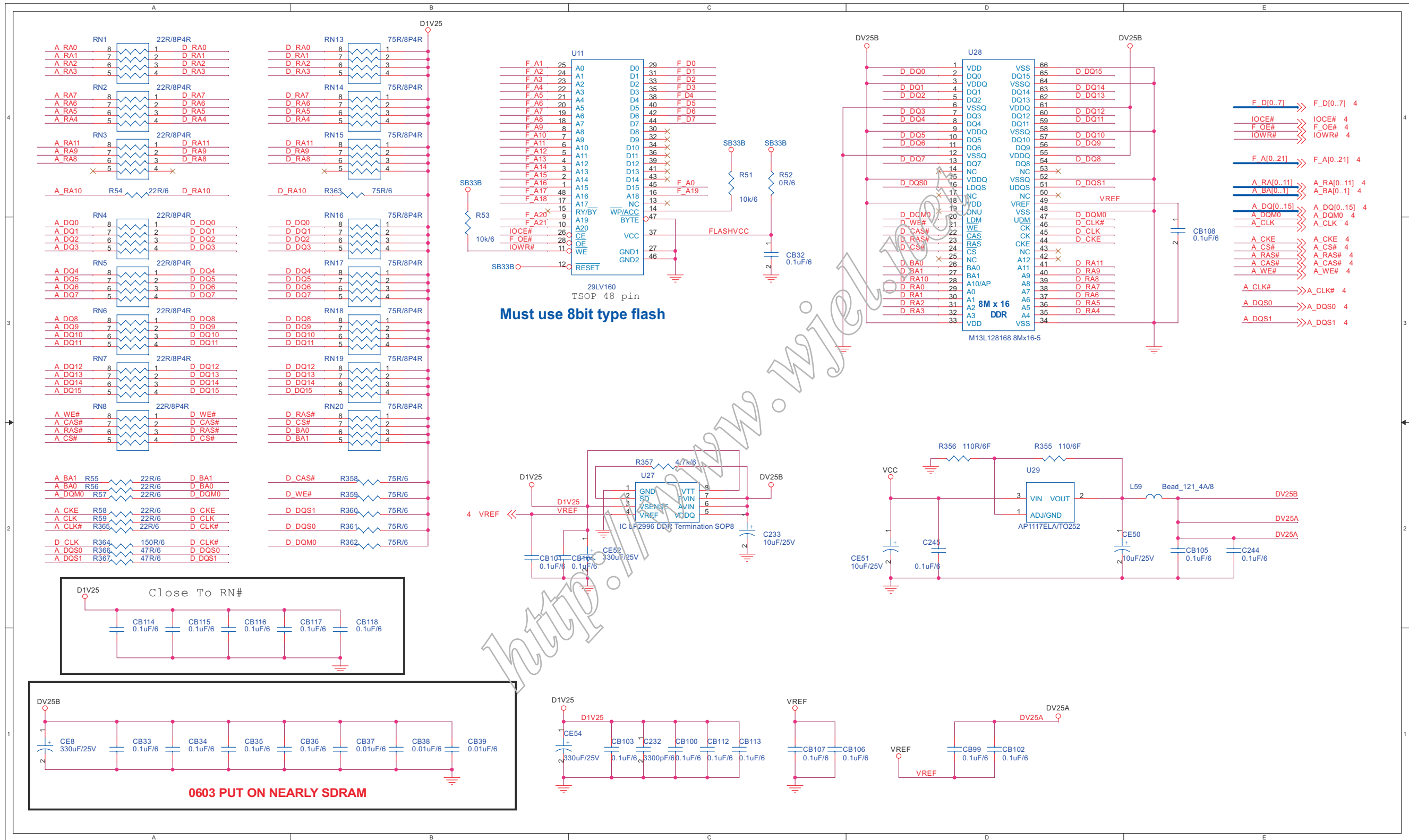

Must use 8bit type flash

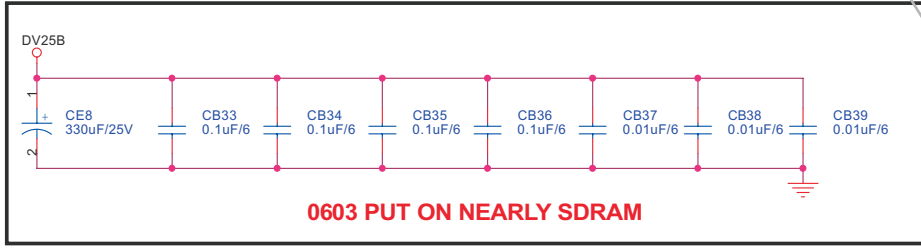
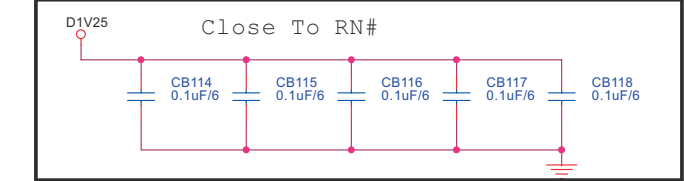

- C232 C1
- C233 C2
- C244 E2
- C452 D2
- CB32 C3
- CB34 A1
- CB33 A1
- CB35 A1
- CB36 A1
- CB37 B1
- CB38 B1
- CB39 B1
- CB99 D1
- CB100 C2
- CB101 B2
- CB102 D1
- CB103 C1
- CB104 B2
- CB105 E2
- CB106 C1
- CB107 C1
- CB108 E3
- CB112 C1
- CB113 C1
- CB114 A1
- CB115 A1
- CB116 A1
- CB117 A1
- CB118 B1
- CE8 A1
- CE50 D2
- CE51 D2
- CE52 C2
- CE54 B1
- L59 E2
- R51 C4
- R52 C4
- R53 B3
- R54 A4
- R55 A2
- R56 A2
- R57 A2
- R58 A2
- R59 A2
- R355 D2
- R356 D2
- R357 C2
- R358 B2
- R359 B2
- R360 B2
- R361 B2
- R362 B2
- R363 B4
- R364 A2
- R365 A2
- R366 A2
- R367 A2
- RN1 A4
- RN2 A4
- RN3 A4
- RN4 A3
- RN5 A3
- RN6 A3
- RN7 A3
- RN8 A3
- RN13 B4
- RN14 B4
- RN15 B4
- RN16 B3
- RN17 B3
- RN18 B3
- RN19 B3
- RN20 B3
- U11 C4
- U27 C2
- U28 D4
- U29 D2

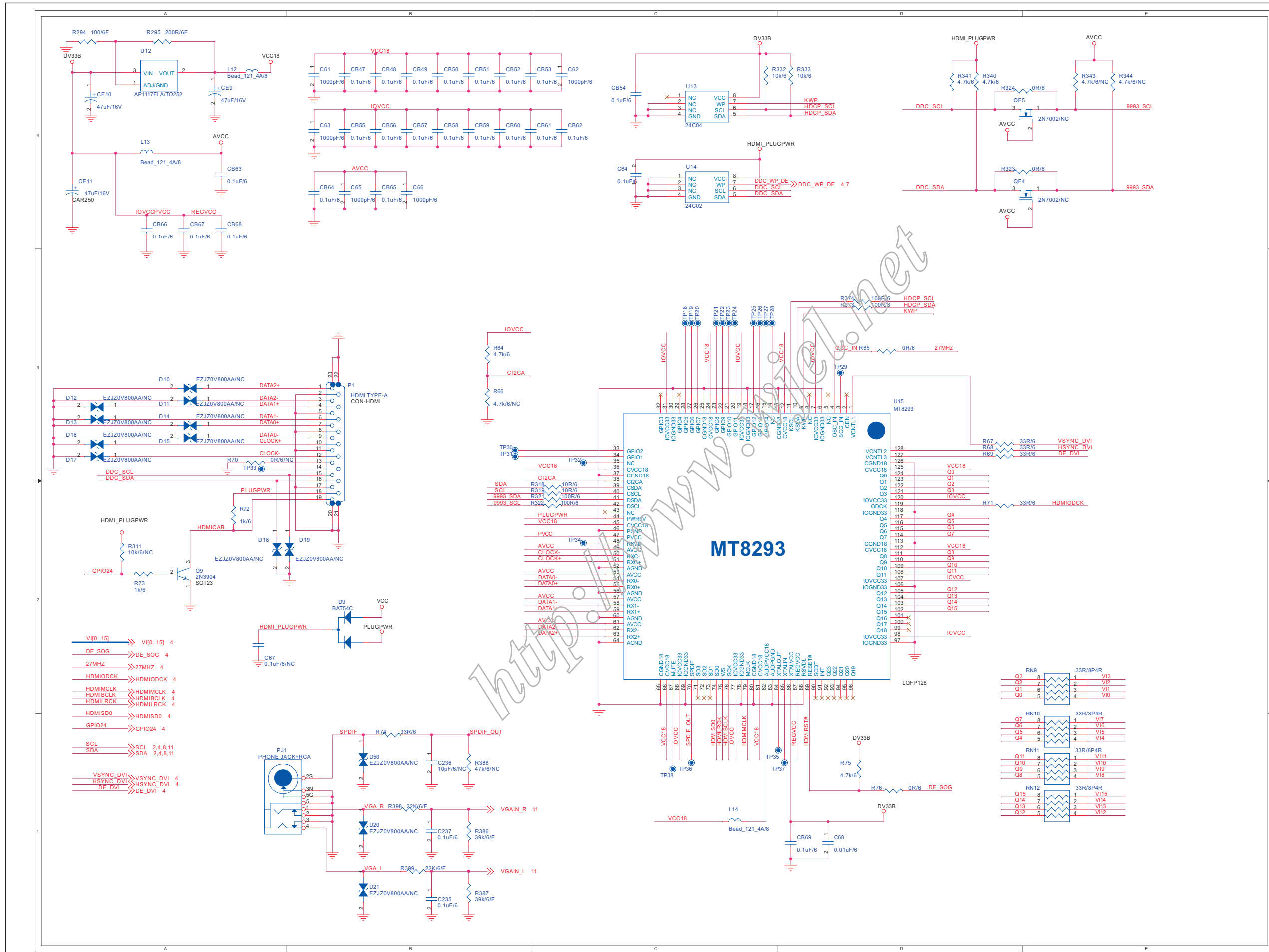

S-A05

C61	B4	R67	D3
C62	C4	R68	D3
C63	B4	R69	D3
C64	C4	R70	A3
C65	B4	R71	D2
C66	B4	R72	A2
C67	A2	R73	A2
C68	D1	R74	B1
C235	B1	R75	D1
C236	B1	R76	D1
C237	B1	R294	A4
CB47	B4	R295	A4
CB48	B4	R311	A2
CB49	B4	R318	C2
CB50	B4	R319	C2
CB51	B4	R321	C2
CB52	B4	R322	C2
CB53	B4	R323	D4
CB54	C4	R324	D4
CB55	B4	R332	C4
CB56	B4	R333	D4
CB57	B4	R340	D4
CB58	B4	R341	D4
CB59	B4	R343	E4
CB60	B4	R344	E4
CB61	B4	R373	D3
CB62	C4	R374	D3
CB63	A4	R386	B1
CB64	B4	R387	B1
CB65	B4	R388	B1
CB66	A4	R398	B1
CB67	A4	R399	B1
CB68	A4	RN9	E2
CB69	D1	RN10	E1
CE9	A4	RN11	E1
CE10	A4	RN12	E1
CE11	A4	TP18	C3
D9	B2	TP19	C3
D10	A3	TP20	C3
D11	A3	TP21	C3
D12	A3	TP22	C3
D13	A3	TP23	C3
D14	A3	TP24	C3
D15	A3	TP25	C3
D16	A3	TP26	C3
D17	A3	TP27	C3
D18	A2	TP28	C3
D19	A2	TP29	D3
D20	B1	TP30	B3
D21	B1	TP31	B3
D50	B1	TP32	C3
L12	A4	TP33	A3
L13	A4	TP34	C2
L14	C1	TP35	C1
P1	B3	TP36	C1
PJ1	A1	TP37	D1
Q9	A2	TP38	C1
QF4	E4	U12	A4
QF5	E4	U13	C4

S-A06

C69	D4	R97	C2
C70	D4	R98	D2
C71	D4	R99	D2
C72	D4	R100	D2
C73	D4	R101	D2
C74	D4	R102	D2
C75	D3	R103	D2
C76	B3	R104	D2
C77	D3	R105	A2
C78	D3	R106	A2
C79	D3	R107	A2
C80	C2	R108	C2
C81	D1	R109	C2
C82	D1	R111	C2
C198	B1	R113	C2
C199	B1	R115	C2
C200	C1	R117	C2
C201	C1	R118	D2
C202	A2	R119	C2
C203	A1	R120	D2
C258	B3	R121	D2
CB70	A1	R122	C2
D22	C4	R123	D2
D23	B4	R124	C2
D24	C4	R125	D2
D25	B3	R126	A2
D26	B3	R127	C2
D27	C3	R128	D2
D28	A2	R129	C2
D29	A2	R130	D2
L15	D4	R131	C2
L16	D4	R132	D2
L17	D3	R133	C2
L47	C1	R134	D2
P2	B4	R135	A1
R77	A4	R136	D1
R78	D4	R137	C1
R79	A4	R138	D1
R80	A4	R139	C1
R81	D4	R144	A1
R82	D4	R145	D1
R83	D4	R292	B1
R84	D4	R293	C1
R85	A4	R296	A2
R86	D4	R297	A2
R87	A4	R302	B3
R88	A4	R314	A3
R89	D3	R315	B3
R90	D3	R316	A3
R91	D3	R317	B3
R92	D3	R377	B3
R93	D3	U16	D2
R94	D2	U17	A1
R95	C2	U23	C1
R96	C2	U24	A3
		Y2	D1

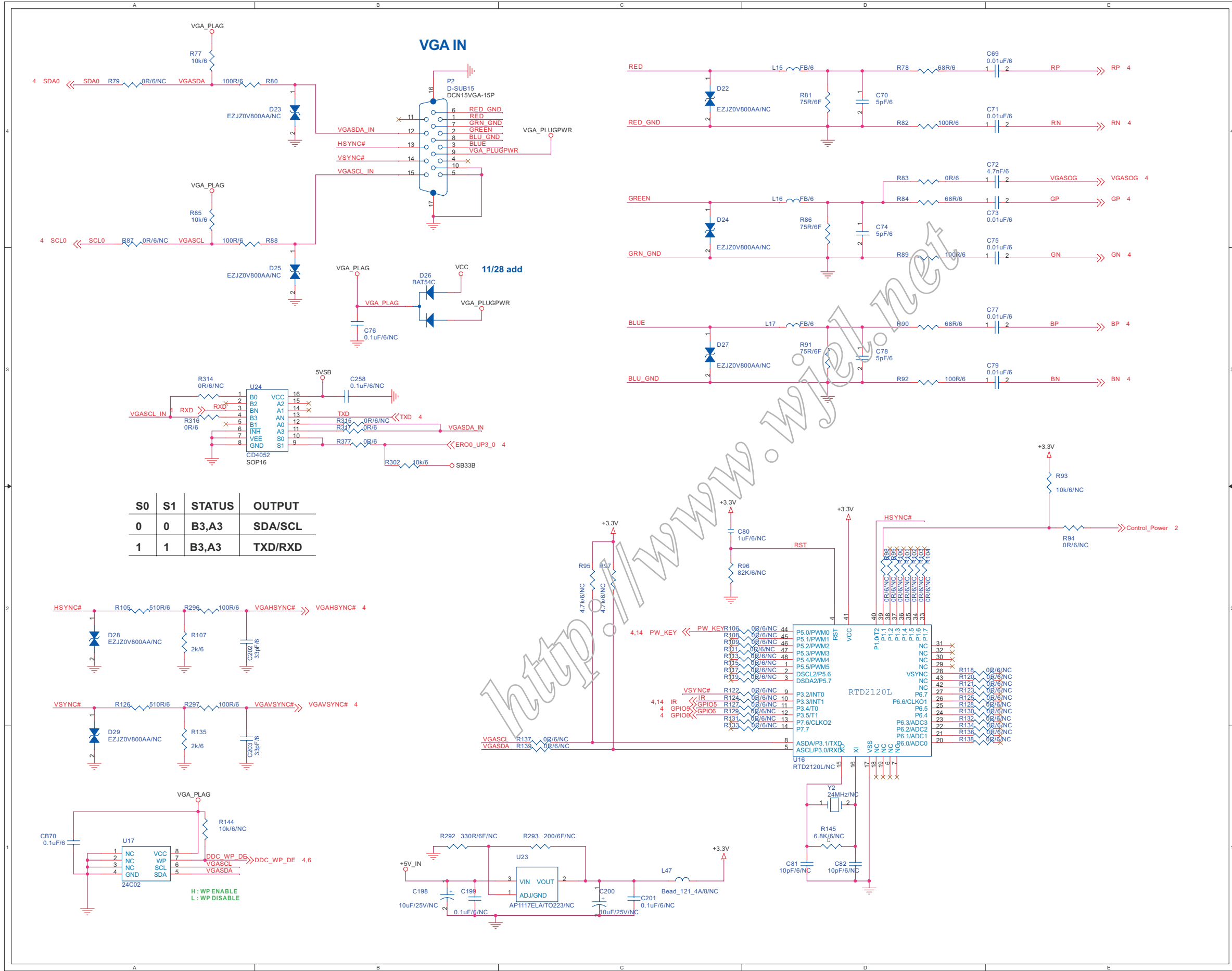

S0	S1	STATUS	OUTPUT
0	0	B3,A3	SDA/SCL
1	1	B3,A3	TXD/RXD

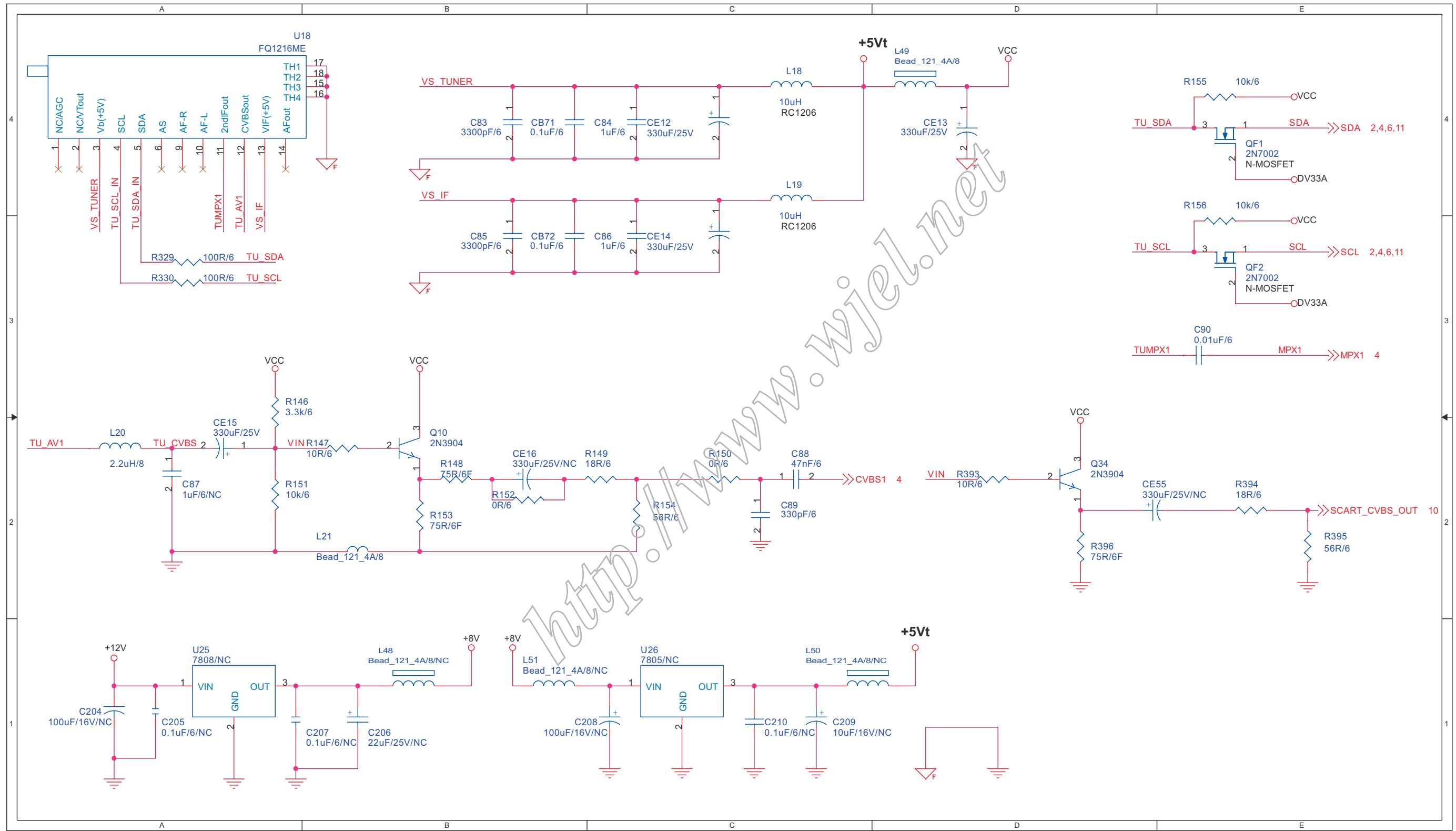

- C83 B4
- C84 C4
- C85 B3
- C86 C3
- C87 A3
- C88 C3
- C89 C3
- C90 E3
- C204 A3
- C205 A3
- C206 B3
- C207 A3
- C208 C3
- C209 C3
- C210 C3
- CB71 B4
- CB72 B3
- CE12 C4
- CE13 D4
- CE14 C3
- CE15 A3
- CE16 B3
- CE55 D3
- L18 C4
- L19 C4
- L20 A3
- L21 B3
- L48 B3
- L49 D4
- L50 C3
- L51 B3
- Q10 B3
- Q34 D3
- QF1 E4
- QF2 E3
- R146 A3
- R147 B3
- R148 B3
- R149 C3
- R150 C3
- R151 A3
- R152 B3
- R153 B3
- R154 C3
- R155 E4
- R156 E3
- R329 A3
- R330 A3
- R393 D3
- R394 E3
- R395 E3
- R396 D3
- U18 A4
- U25 A3
- U26 C3

S-A08

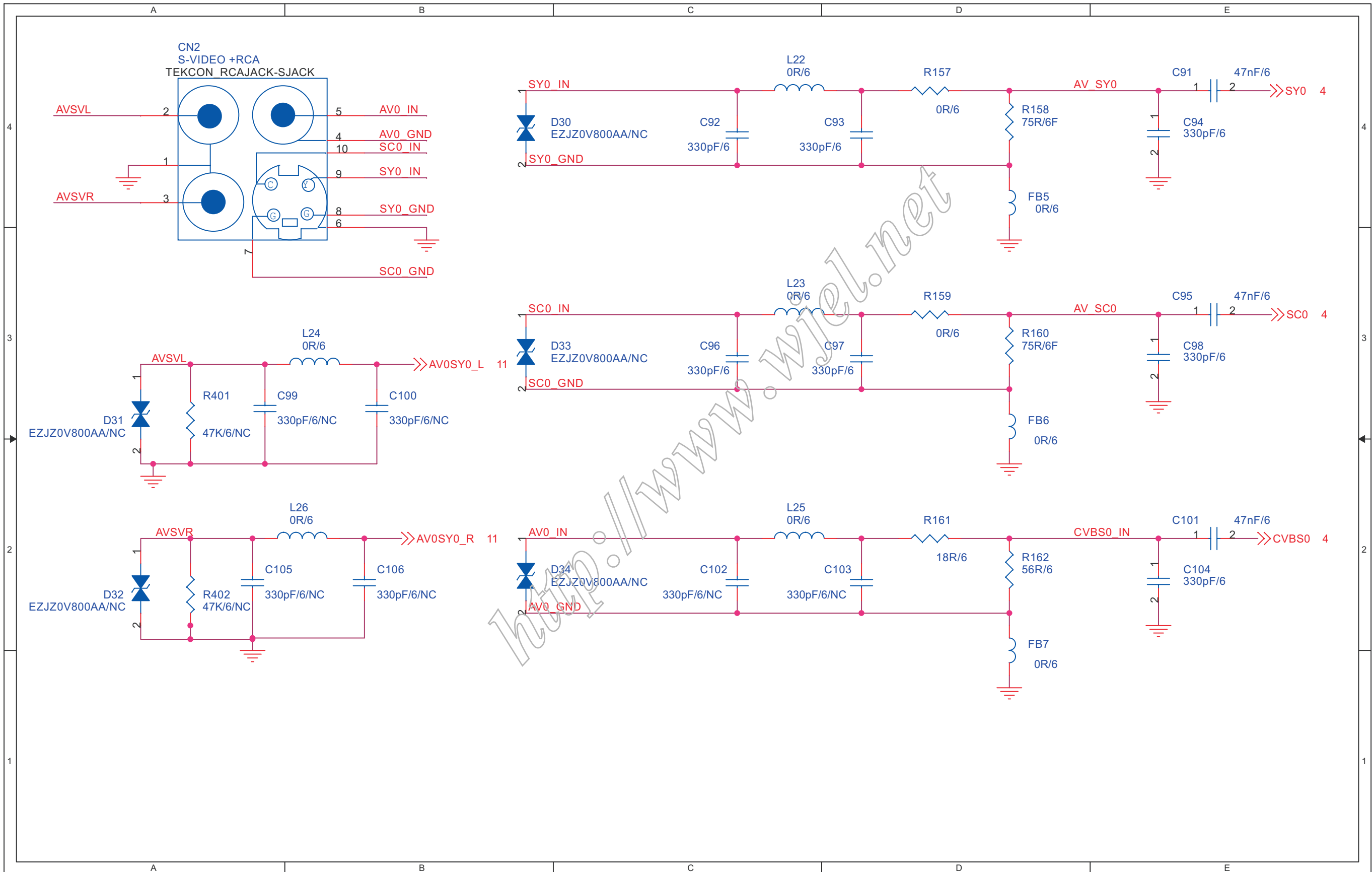

- C91 E4
- C92 C4
- C93 D4
- C94 E4
- C95 E3
- C96 C3
- C97 D3
- C98 E3
- C99 A3
- C100 B3
- C101 E2
- C102 C2
- C103 D2
- C104 E2
- C105 A2
- C106 B2
- CN2 A4
- D30 B4
- D31 A3
- D32 A2
- D33 B3
- D34 B2
- FB5 D4
- FB6 D3
- FB7 D2
- L22 C4
- L23 C3
- L24 B3
- L25 C2
- L26 A2
- R157 D4
- R158 D4
- R159 D3
- R160 D3
- R161 D2
- R162 D2
- R401 A3
- R402 A2

S-A09

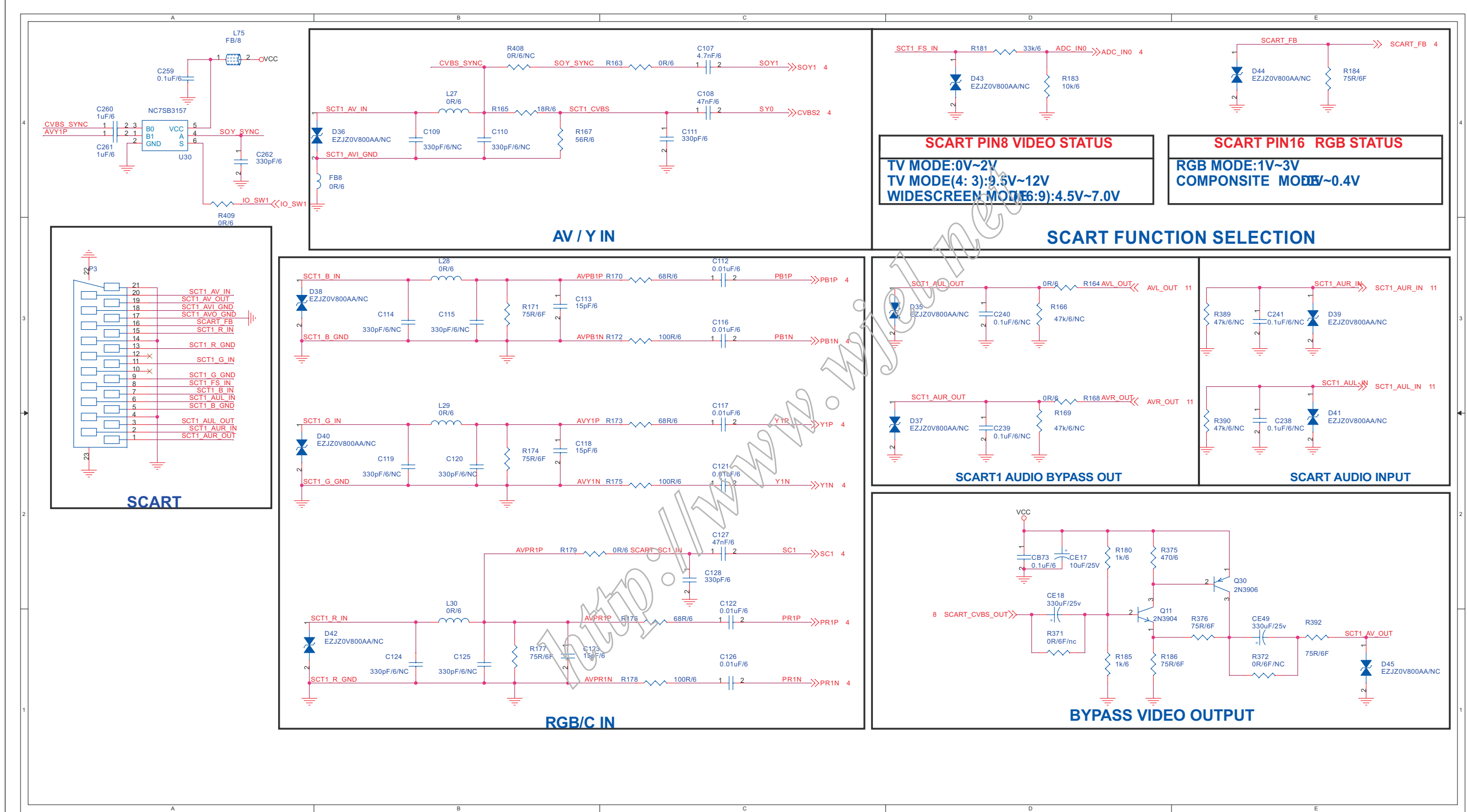

- C107 D4
- C108 D4
- C109 B4
- C110 B4
- C111 C4
- C112 D3
- C113 C3
- C114 B3
- C115 B3
- C116 D3
- C117 D2
- C118 C2
- C119 B2
- C120 B2
- C121 D2
- C122 D1
- C123 C1
- C124 B1
- C125 B1
- C126 D1
- C127 D2
- C128 D2
- C238 E2
- C239 E2
- C240 E3
- C241 E3
- C259 A4
- C260 A4
- C261 A4
- C262 A4
- CB73 E2
- CE17 E2
- CE18 E1
- CE49 E1
- D35 D3
- D36 B4
- D37 D2
- D38 B3
- D39 E3
- D40 B2
- D41 E3
- D42 B1
- D43 E4
- D44 E4
- D45 E1
- FB8 B4
- L27 B4
- L28 B3
- L29 B2
- L30 B1
- L75 A4
- P3 A3
- Q11 E1
- Q30 E2
- R163 C4
- R164 E3
- R165 B4
- R166 E3
- R167 C4

S-A10

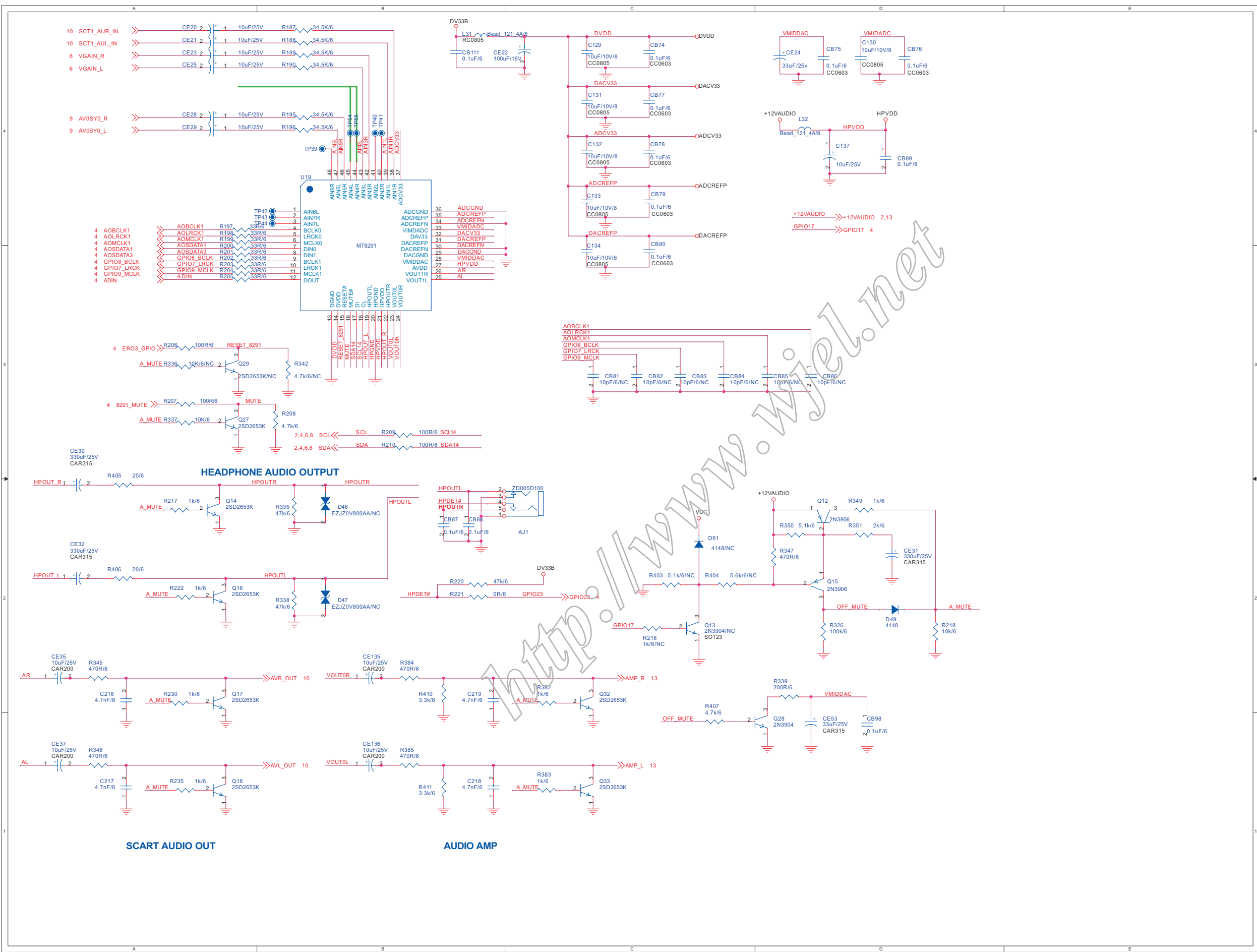

AJ1	C2	Q32	C2
C129	C4	Q33	C1
C130	D4	R187	B4
C131	C4	R188	B4
C132	C4	R189	B4
C133	C4	R195	B4
C134	C3	R196	B4
C137	D4	R197	A4
C216	A2	R198	A4
C217	A1	R199	A4
C218	B1	R200	A4
C219	B2	R201	A3
CB74	C4	R202	A3
CB75	D4	R203	A3
CB76	D4	R204	A3
CB77	C4	R205	A3
CB78	C4	R206	A3
CB79	C4	R207	A3
CB80	C3	R208	B3
CB81	C3	R209	B3
CB82	C3	R210	B3
CB83	C3	R216	C2
CB84	C3	R217	A2
CB85	D3	R218	D2
CB86	D3	R220	B2
CB87	B2	R221	B2
CB88	B2	R222	A2
CB89	D4	R230	A2
CB98	D1	R235	A1
CB111	B4	R326	D2
CE20	A4	R335	B2
CE21	A4	R336	A3
CE22	C4	R337	A3
CE23	A4	R338	B2
CE24	D4	R339	D2
CE25	A4	R342	B3
CE28	A4	R345	A2
CE29	A4	R346	A1
CE30	A2	R347	D2
CE31	D2	R349	D2
CE32	A2	R350	D2
CE35	A2	R351	D2
CE37	A1	R382	C2
CE53	D1	R383	C1
CE135	B2	R384	B2
CE136	B1	R385	B1
D46	B2	R403	C2
D47	B2	R404	C2
D49	D2	R405	A2
D61	C2	R406	A2
L31	B4	R407	C1
L32	D4	R410	B2
Q12	D2	R411	B1
Q13	C2	TP39	B4
Q14	A2	TP40	B4
Q15	D2	TP41	B4
Q16	A2	TP42	B4
Q17	A2	TP43	B4
Q18	A1	TP44	B4

S-A11

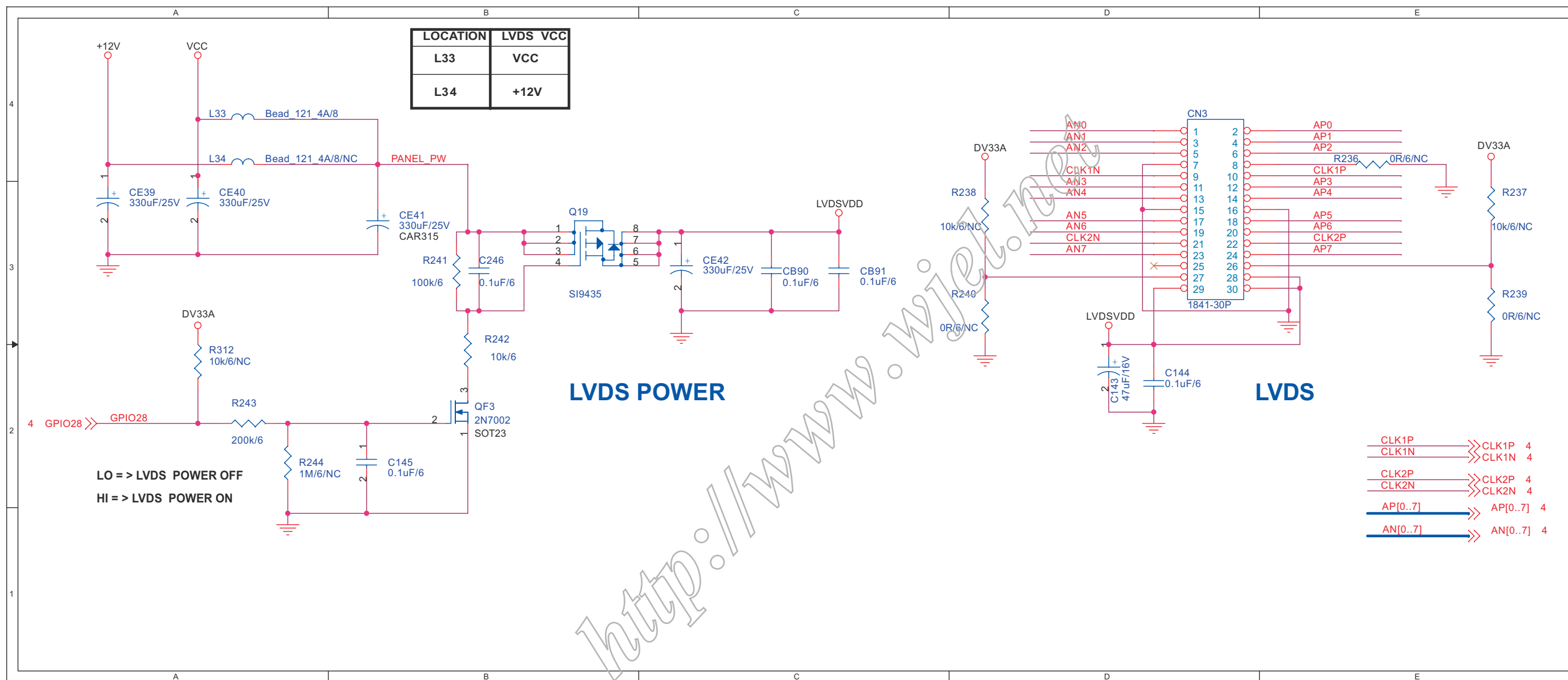

LOCATION	LVDS VCC
L33	VCC
L34	+12V

LVDS POWER

LVDS

LO => LVDS POWER OFF
HI => LVDS POWER ON

- CLK1P >>> CLK1P 4
- CLK1N >>> CLK1N 4
- CLK2P >>> CLK2P 4
- CLK2N >>> CLK2N 4
- AP[0..7] >>> AP[0..7] 4
- AN[0..7] >>> AN[0..7] 4

- C143 D2
- C144 D2
- C145 B2
- C246 B3
- CB90 C3
- CB91 C3
- CE39 A3
- CE40 A3
- CE41 B3
- CE42 C3
- CN3 D4
- L33 A4
- L34 A4
- Q19 B3
- QF3 B2
- R236 E4
- R237 E3
- R238 D3
- R239 E3
- R240 D3
- R241 B3
- R242 B3
- R243 A2
- R244 A2
- R312 A2

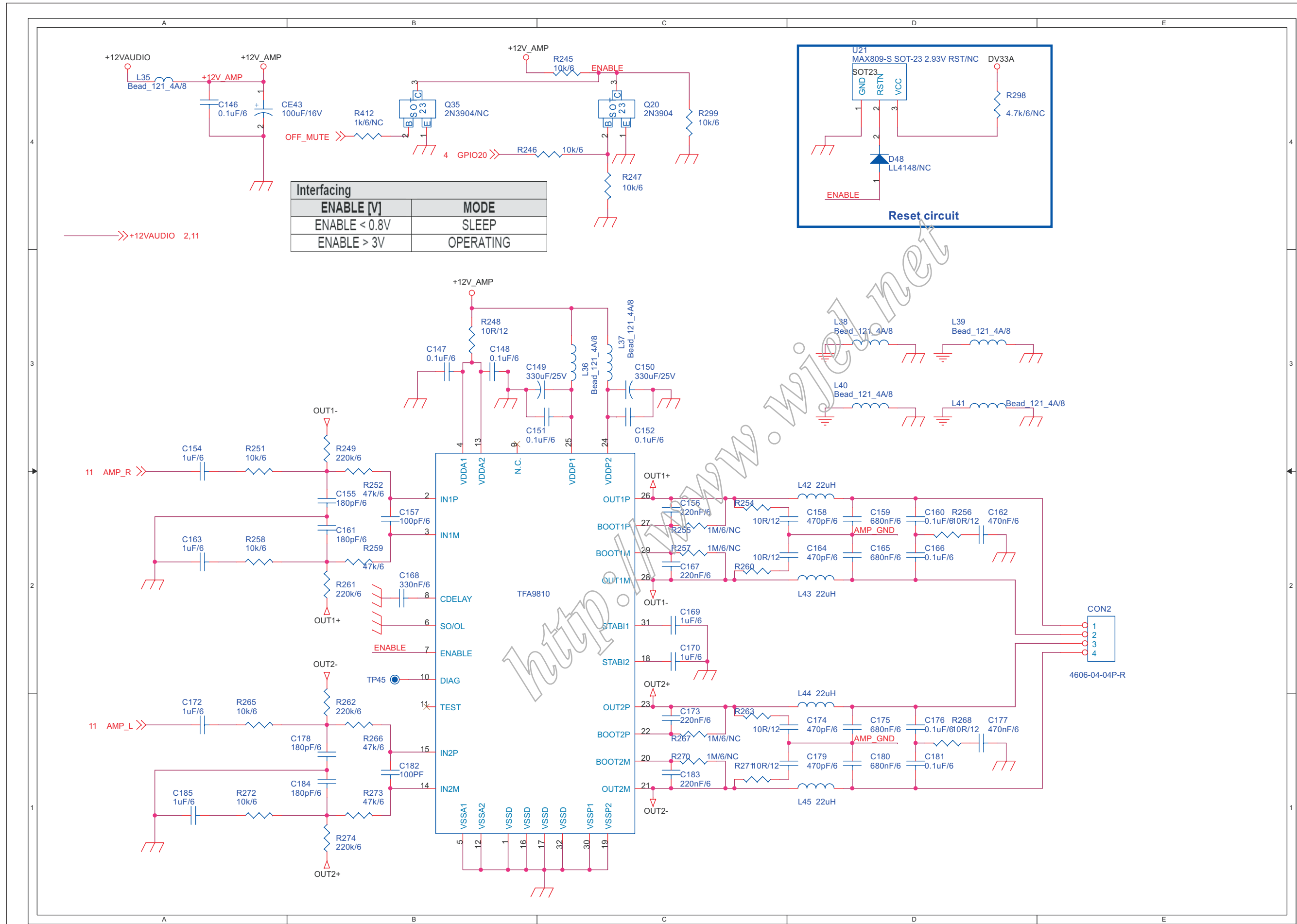

Interfacing	
ENABLE [V]	MODE
ENABLE < 0.8V	SLEEP
ENABLE > 3V	OPERATING

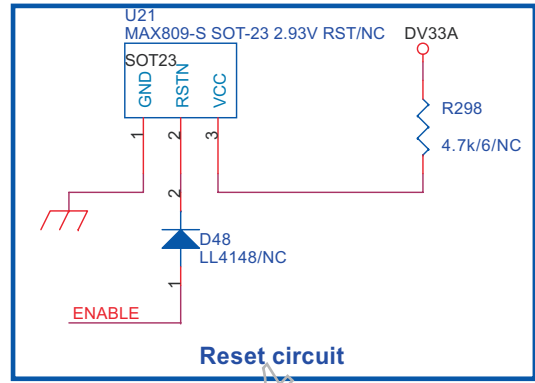

S-A12

- C146 A4 L37 C3
- C147 B3 L38 D3
- C148 B3 L39 D3
- C149 B3 L40 D3
- C150 C3 L41 D3
- C151 C3 L42 D2
- C152 C3 L43 D2
- C154 A3 L44 D2
- C155 B2 L45 D1
- C156 C2 Q20 C4
- C157 B2 Q35 B4
- C158 C2 R245 C4
- C159 D2 R246 B4
- C160 D2 R247 C4
- C161 B2 R248 B3
- C162 D2 R249 B3
- C163 A2 R251 A3
- C164 C2 R252 B3
- C165 D2 R254 C2
- C166 D2 R255 C2
- C167 C2 R256 D2
- C168 B2 R257 C2
- C169 C2 R258 A2
- C170 C2 R259 B2
- C172 A1 R260 C2
- C173 C1 R261 B2
- C174 C1 R262 B2
- C175 D1 R263 C1
- C176 D1 R265 A1
- C177 D1 R266 B1
- C178 B1 R267 C1
- C179 C1 R268 D1
- C180 D1 R270 C1
- C181 D1 R271 C1
- C182 B1 R272 A1
- C183 C1 R273 B1
- C184 B1 R274 B1
- C185 A1 R298 D4
- CE43 A4 R299 C4
- CON2 E2 R412 B4
- D48 D4 TP45 B2
- L35 A4 U21 D4
- L36 C3 U22 B3

S-A13

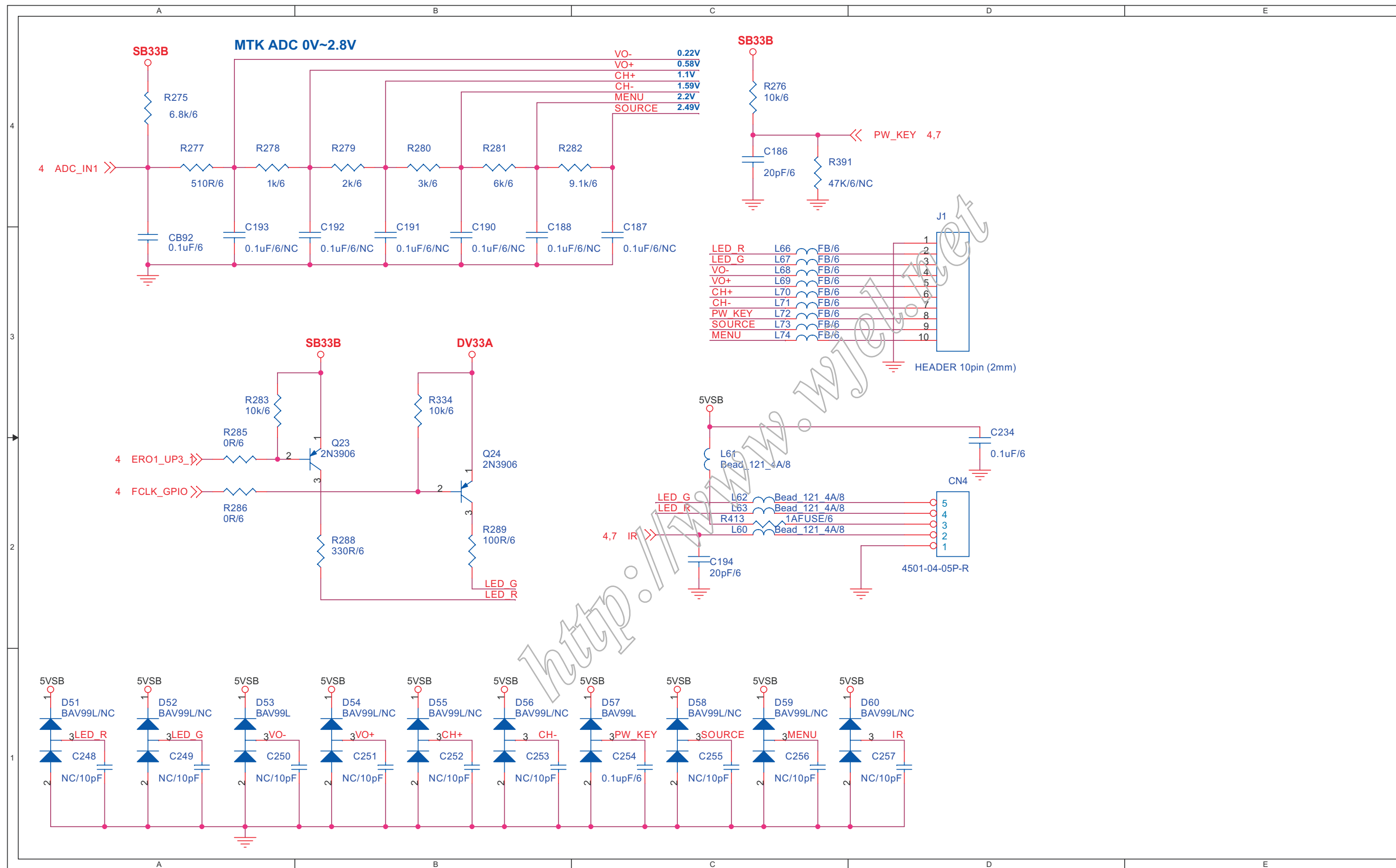

- C186 C4
- C187 C3
- C188 B3
- C190 B3
- C191 B3
- C192 B3
- C193 A3
- C194 C2
- C234 D2
- C248 A1
- C249 A1
- C250 A1
- C251 B1
- C252 B1
- C253 B1
- C254 C1
- C255 C1
- C256 C1
- C257 D1
- CB92 A3
- CN4 D2
- D51 A1
- D52 A1
- D53 A1
- D54 B1
- D55 B1
- D56 B1
- D57 C1
- D58 C1
- D59 C1
- D60 C1
- J1 D3
- L60 C2
- L61 C2
- L62 C2
- L63 C2
- L66 C3
- L67 C3
- L68 C3
- L69 C3
- L70 C3
- L71 C3
- L72 C3
- L73 C3
- L74 C3
- Q23 B2
- Q24 B2
- R275 A4
- R276 C4
- R277 A4
- R278 A4
- R279 B4
- R280 B4
- R281 B4
- R282 B4
- R283 A3
- R285 A2
- R286 A2
- R288 B2

Schematic Diagram(Power Board)

P-1

ADJ	E1	C142	E9	R61	B8
ADJ	E2	C143	F9	R61	C8
C1	B3	C144	D2	R62	C8
C2	B3	CN1	B1	R63	C8
C3	B2	CN101	C1	R64	C8
C4	B2	CN102	C11	R65	C9
C5	B4	CN103	D11	R67	B9
C6	B5	CN104	E11	R69	B9
C7	C4	CN105	E11	R70	B8
C8	C5	CN106	F5	R71	B8
C9	C5	CR1	B3	R101	E2
C10	C6	CR2	B2	R102	F2
C11	B6	CR3	B5	R103	C2
C12	B4	CR4	B6	R104	F2
C13	B3	CR5	B6	R105	F2
C50	C6	CR6	C5	R106	E3
C51	A7	CR51	B7	R107	E3
C52	A7	CR52	B7	R108	E3
C53	B7	CR54	B9	R109	E3
C54	B7	CR55	B9	R110	F3
C55	C7	CR56	B9	R111	F3
C56	B8	CR57	C9	R112	F3
C57	B8	CR58	C9	R113	F4
C58	B8	CR59	B9	R115	F4
C59	B8	CR101	E7	R117	D5
C59	B9	CR102	E7	R118	D5
C60	B9	CR103	D9	R119	D6
C62	B8	CR103	D10	R120	D7
C63	B8	CR103	E10	R121	F5
C64	B8	CR104	D10	R122	F5
C65	B9	CR106	F9	R123	F5
C65	B9	CR107	E10	R124	F5
C66	B9	CR108	F10	R125	F5
C67	B8	F1	B2	R126	F5
C69	B8	F31	B10	R127	F5
C71	B9	F52	B10	R128	F5
C72	C9	IC101	E4	R129	E6
C73	B10	IC101	C5	R130	E6
C74	B10	IC2A	B7	R131	F6
C101	D2	IC2B	C4	R132	F6
C102	D2	IC51	C7	R133	F6
C103	D2	IC52	C8	R134	F6
C104	F2	L1	B3	R135	E7
C105	F2	L2	B5	R136	E7
C106	F3	L2	B6	R137	E7
C107	F3	L51	A8	R138	F7
C108	F3	L53	B8	R139	F7
C109	F4	Q1	B5	R140	F7
C110	F4	Q101	F2	R141	F7
C111	F4	Q102	E3	R142	E8
C112	F5	Q103	D6	R143	F8
C113	D4	Q104	D6	R144	F8
C114	D4	Q105	F6	R145	D9
C114	F4	Q106	E6	R146	D10
C115	D4	Q107	F7	R146	D11
C116	D4	Q108	F7	R147	D11
C117	D6	R1	B2	R148	D11
C118	D6	R2	B2	R149	D9
C119	D7	R3	B2	R150	D10
C120	D7	R4	B2	R150	D11
C121	D7	R5	B6	R151	D11
C122	D7	R6	B4	R152	D11
C123	F6	R7	B4	R153	E9
C124	F6	R8	B4	R154	E10
C125	F7	R9	B4	R154	E11
C126	F7	R10	C4	R155	E11
C128	D9	R11	B5	R156	E11
C129	D11	R12	B5	R157	F9
C130	D9	R13	C5	R158	F10
C131	D9	R14	C5	R158	F11
C132	D11	R15	C5	R159	F11
C133	E9	R51	A6	R160	E11
C134	E9	R52	A6	R161	C2
C135	E11	R53	B6	R162	E3
C136	E9	R54	B6	R163	F4
C137	F9	R56	B7	R164	E4
C138	E11	R57	B7	T101	C8

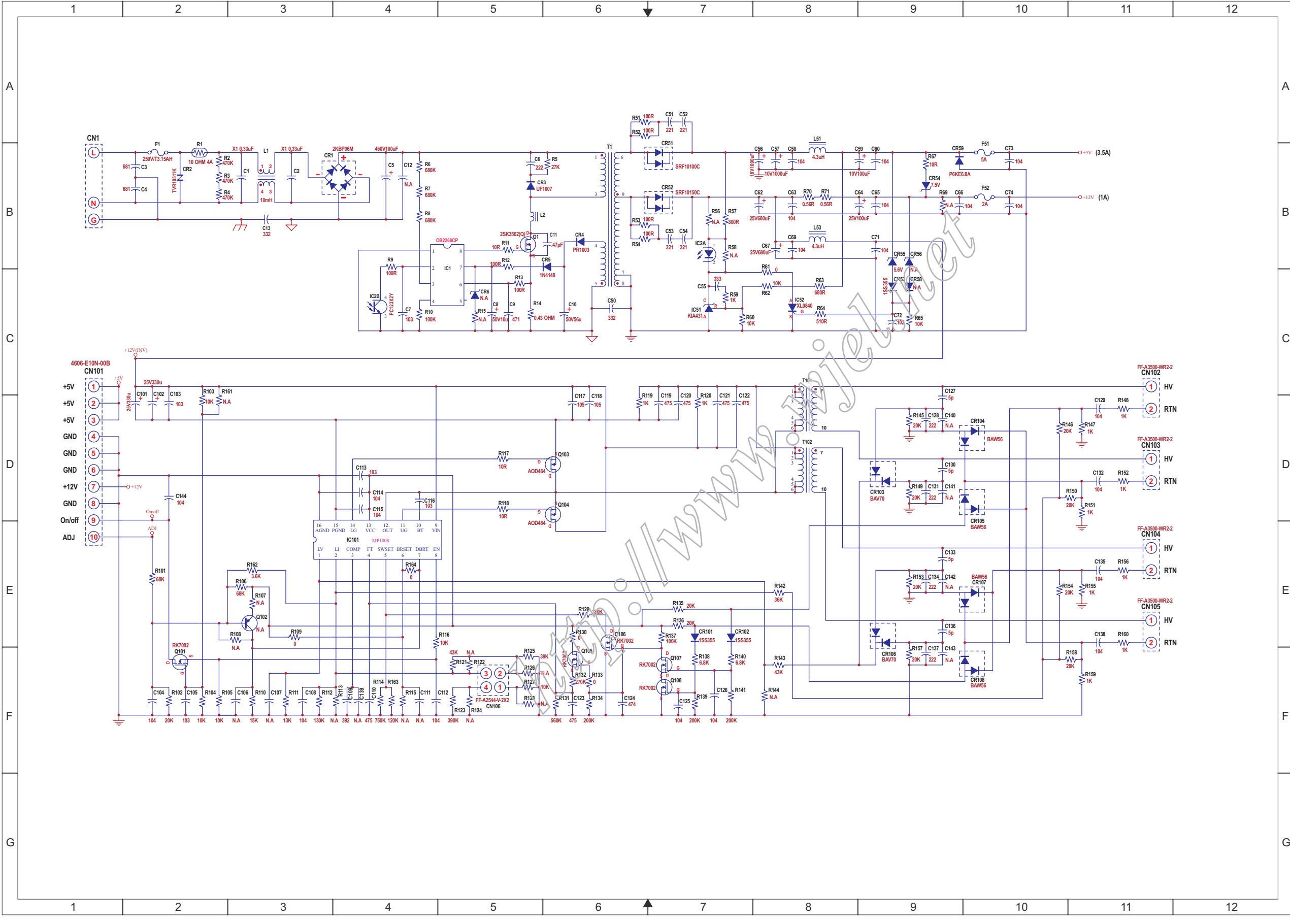

B-1

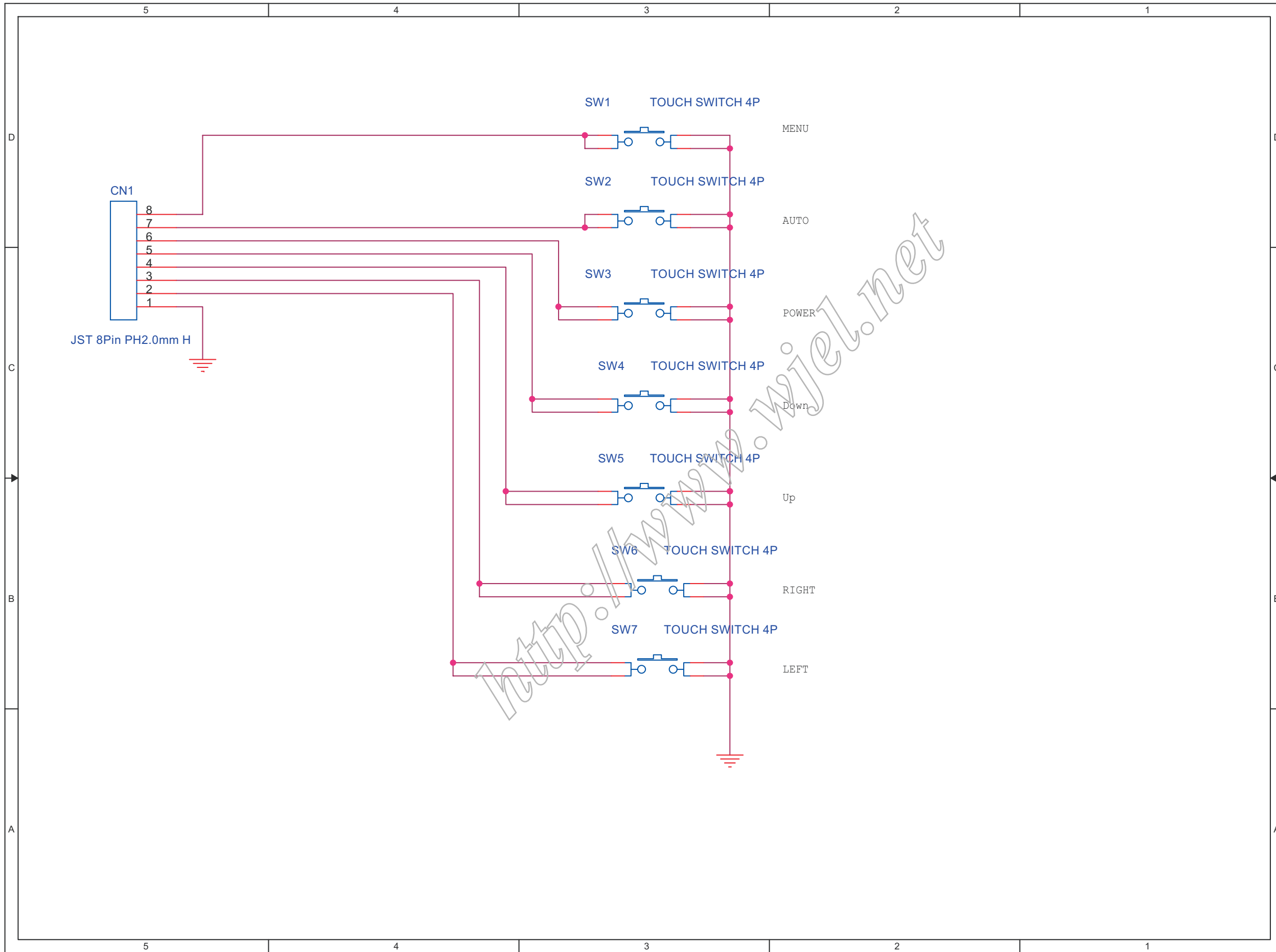

L-1

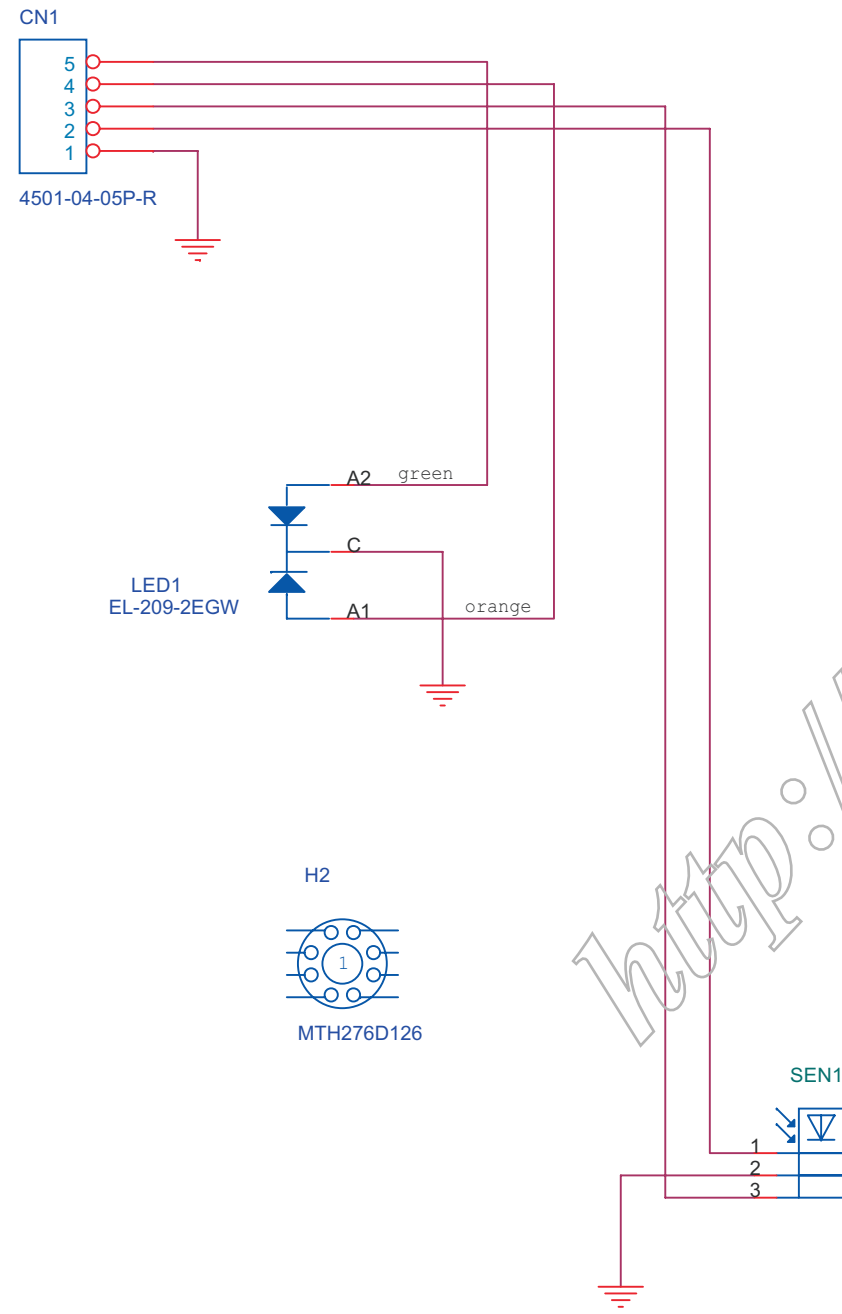

S-A

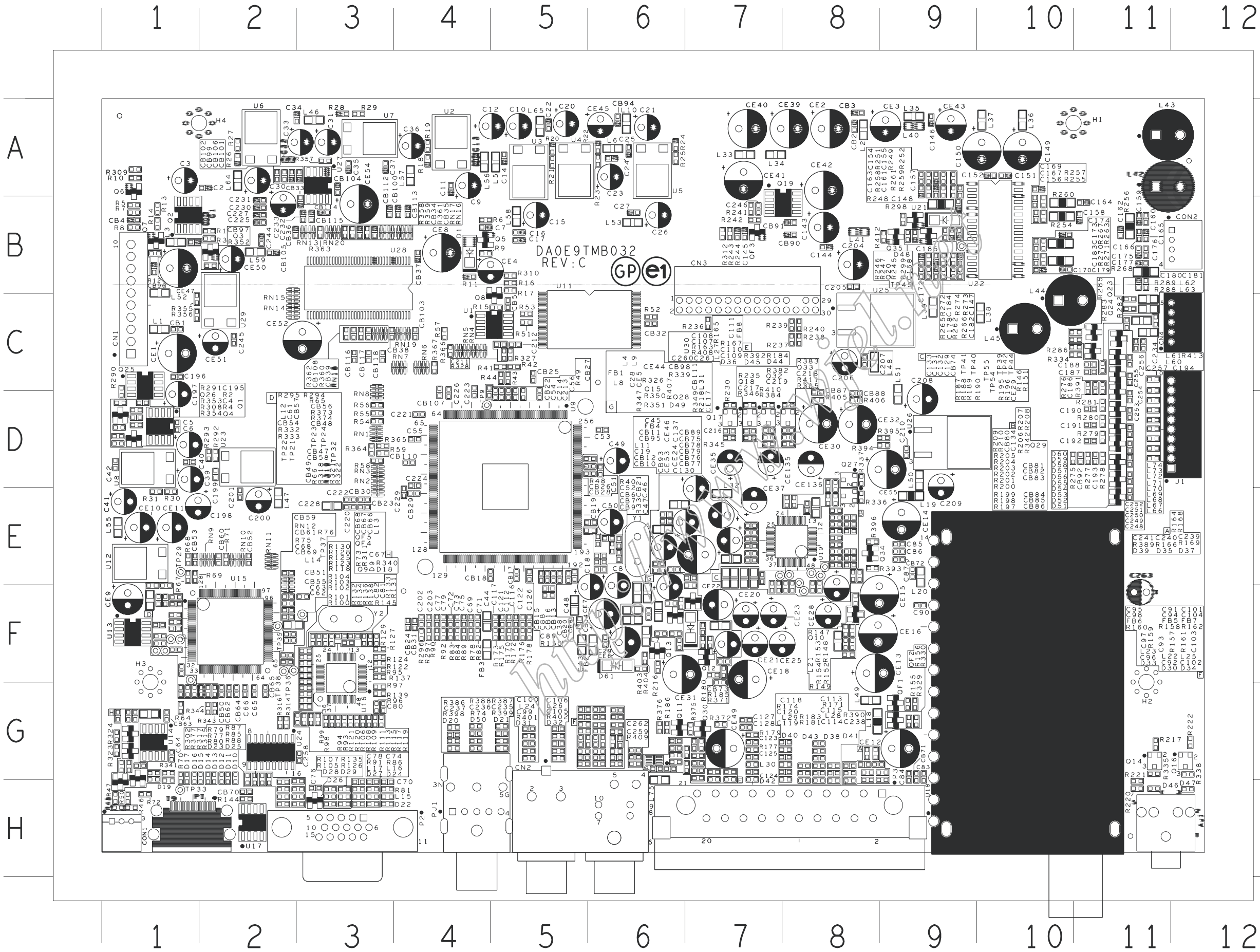

C1	A1	C5	B2	C49	A3
C3	B1	C6	A1	C50	B2
C4	A1	C7	A3	C51	B3
D8	E2	C8	A1	C52	C2
D9	D4	C9	D1	C53	C2
D10	D4	C10	D1	C54	C2
D11	D3	C11	D1	C55	D3
D12	A4	C12	D1	C56	B2
D13	D4	C13	C2	C57	B3
D14	D4	C14	C2	C58	C2
D15	A4	C15	C2	C59	B3
D16	A4	C16	C2	C60	C2
D17	A4	C17	C2	C61	D2
D18	B4	C18	C2	C62	D2
D19	B4	C19	C2	C63	D2
D20	B4	C20	C4	C64	B2
D21	B4	C21	C4	C65	B2
D22	A4	C22	C4	C66	B3
D23	B4	C23	C2	C67	B3
D24	C4	C24	C2	C68	D2
D25	C4	C25	E2	C69	B2
D26	A4	C26	A4	C70	B3
D27	E2	C27	A4	C71	E1
D28	E3	C28	A4	C72	E2
D29	E2	C29	B4	C73	E2
D30	E1	C30	B4	C74	E2
D31	E1	C31	B4	C75	E2
R108	D2	C32	B4	C76	E2
U1	A2	C33	C4	C77	E3
U2	D2	C34	B4	C78	C2
U3	A4	C35	B4	CN1	A1
U4	C2	C36	B2	CN2	C1
U5	D2	C37	B3	CN3	D4
U6	D2	C38	B2	CN4	B5
U7	B4	C39	B2	CN5	D3
U3-A1	A2	C40	B2	CN6	E2
X1	B3	C41	C2	CN7	E2
CN8	E3	C42	D2	D1	B2
CN9	E5	C43	D2	D2	B2
D32	E2	C44	C2	D3	B4
D33	E2	C45	C2	D4	A3
FB1	D4	C46	C2	D5	C4
FB2	A2	C47	D2	D6	C4
FB3	B2	C48	C2	D7	C4
FB4	A3	R18	A2	R63	A4
FB5	B3	R19	C1	R64	C4
FB6	C2	R20	D2	R65	C4
H1	D4	R21	C1	R66	C2
H2	A1	R22	D2	R67	C2
H3	A3	R23	D1	R68	C2
JP1	B3	R24	D2	R69	C2
L1	A3	R25	E4	R70	B3
L2	E1	R26	E4	R71	B3
L3	E2	R27	C4	R72	B3
L4	E2	R28	C4	R73	B2
L5	E2	R29	C4	R74	C2
L6	E2	R30	C4	R75	C2
L7	E2	R31	C4	R76	D2
L8	E3	R32	C4	R77	D2
L9	E1	R33	C4	R78	B2
L10	E1	R34	C4	R79	D2
Q1	B1	R35	C4	R80	B2
Q2	B1	R36	C4	R81	D2
Q3	A1	R37	C4	R82	D2
Q4	D1	R38	C4	R83	D2
Q5	D2	R39	C4	R84	D2
Q6	B3	R41	D3	R85	D3
Q7	E1	R42	C2	R86	E1
Q8	E1	R43	C2	R87	E1
R1	A1	R44	C4	R88	E1
R2	B1	R45	C4	R89	E2
R3	B1	R46	C2	R90	E2
R4	B1	R47	C2	R91	E2
R5	B1	R48	D3	R92	E2
R6	B1	R49	D3	R93	E2
R7	B2	R50	A4	R94	E3
R8	B1	R51	A4	R95	C2

S-B

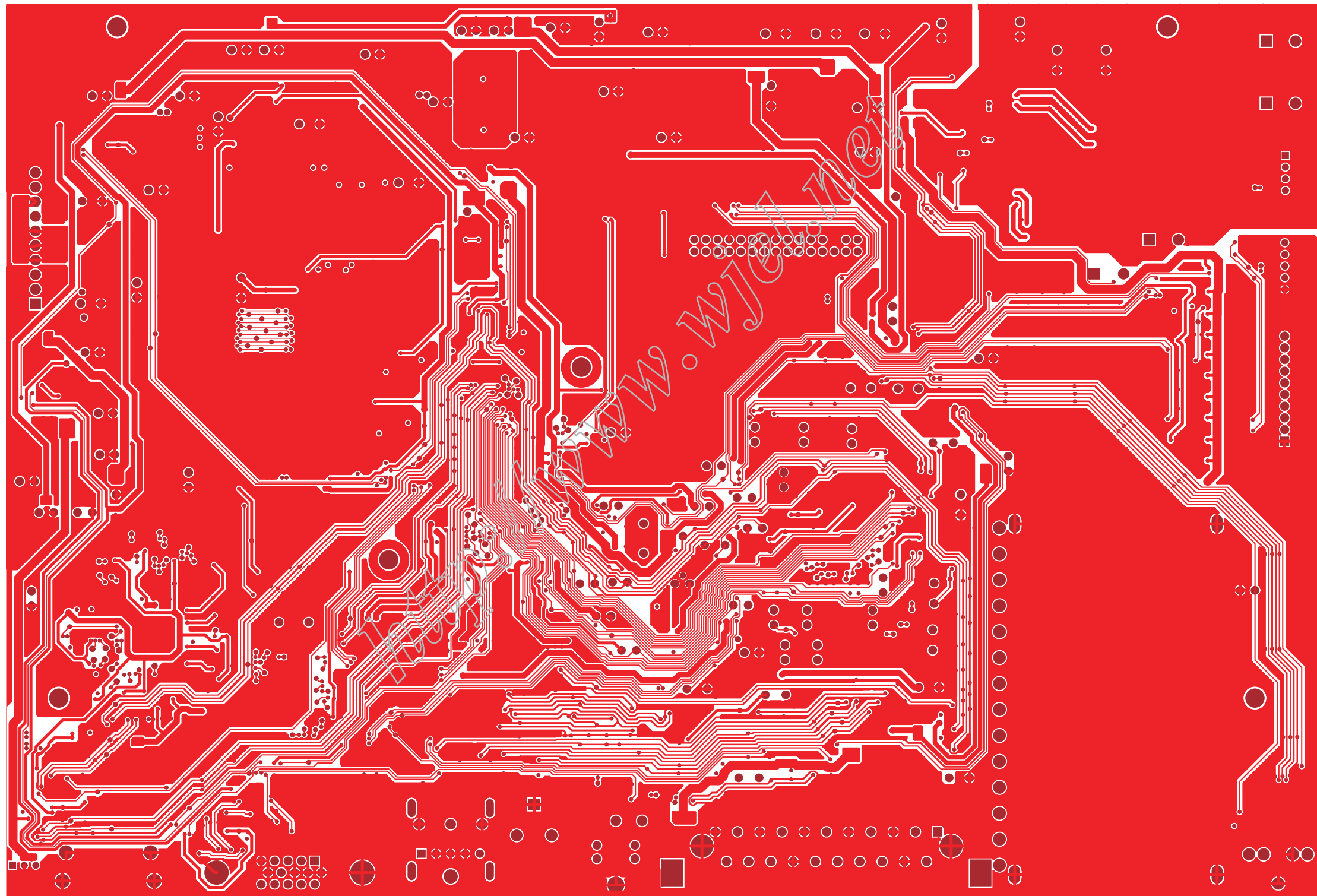

P-A

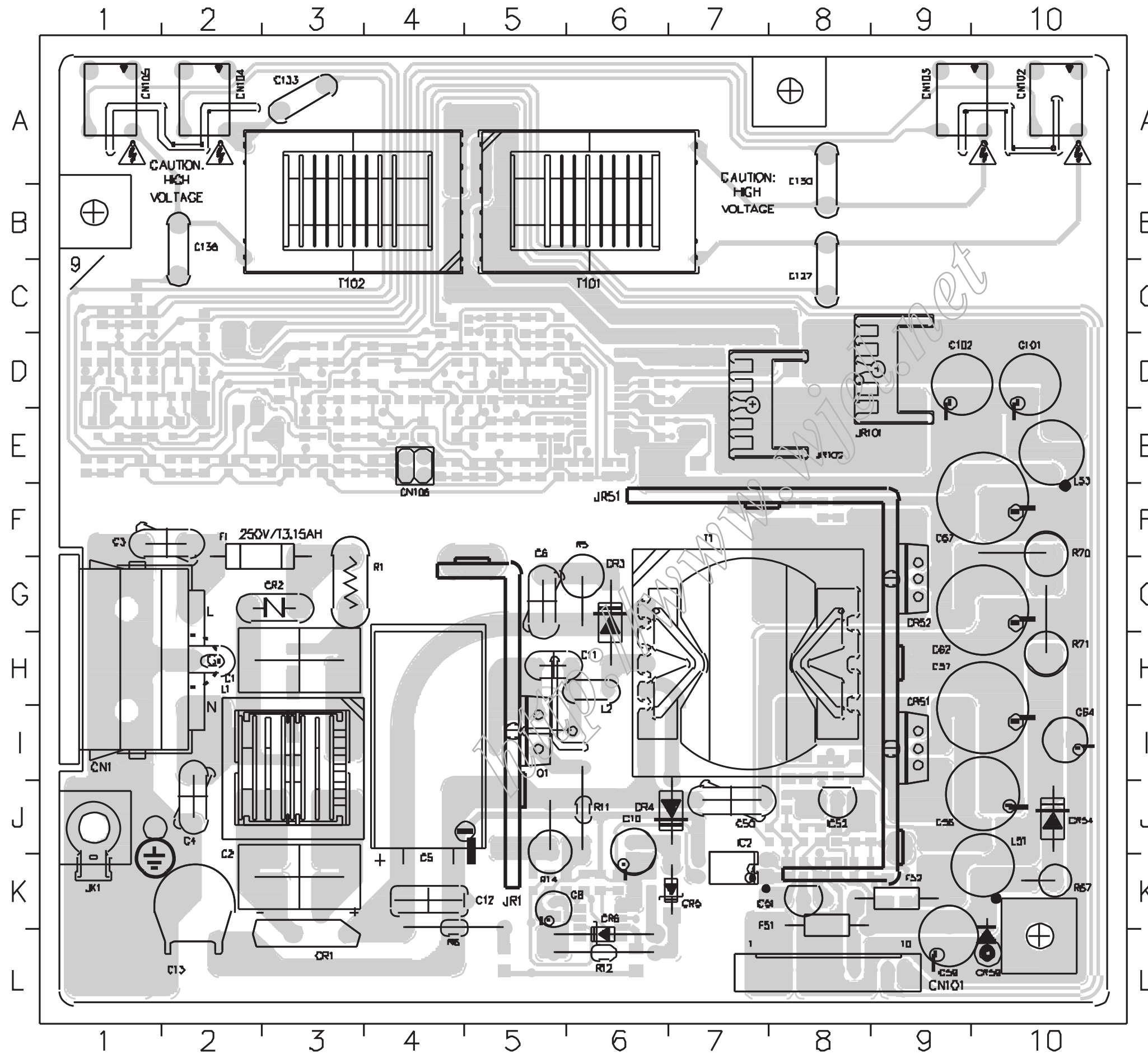

C1	H3	CR6	L6
C2	K3	CR51	I9
C3	F2	CR52	G9
C4	J2	CR54	J10
C5	J4	CR59	L10
C6	G5	F1	F2
C8	K5	F51	K8
C10	J6	F52	K9
C11	H5	IC2	K7
C12	K4	IC51	K8
C13	K2	IC52	J8
C50	J7	JR1	I5
C56	J10	JR51	H9
C57	I10	JR101	D9
C59	L9	JR102	D8
C62	G10	L1	I3
C64	I10	L2	H6
C67	F10	L51	K10
C101	D10	L53	E10
C102	D9	Q1	I5
C127	C8	R1	G3
C130	B8	R5	G6
C133	A3	R6	K4
C136	B2	R11	J6
CN1	G1	R12	L6
CN101	L8	R14	J5
CN102	A10	R67	K10
CN103	A9	R70	F10
CN104	A2	R71	H10
CN105	A10	T1	H7
CN106	E4	T101	B6
CR1	L3	T102	B3
CR2	G3	JA1	G1
CR3	G6	JK1	J1
CR4	J7	JP1	E4
CR5	K7		

P-B

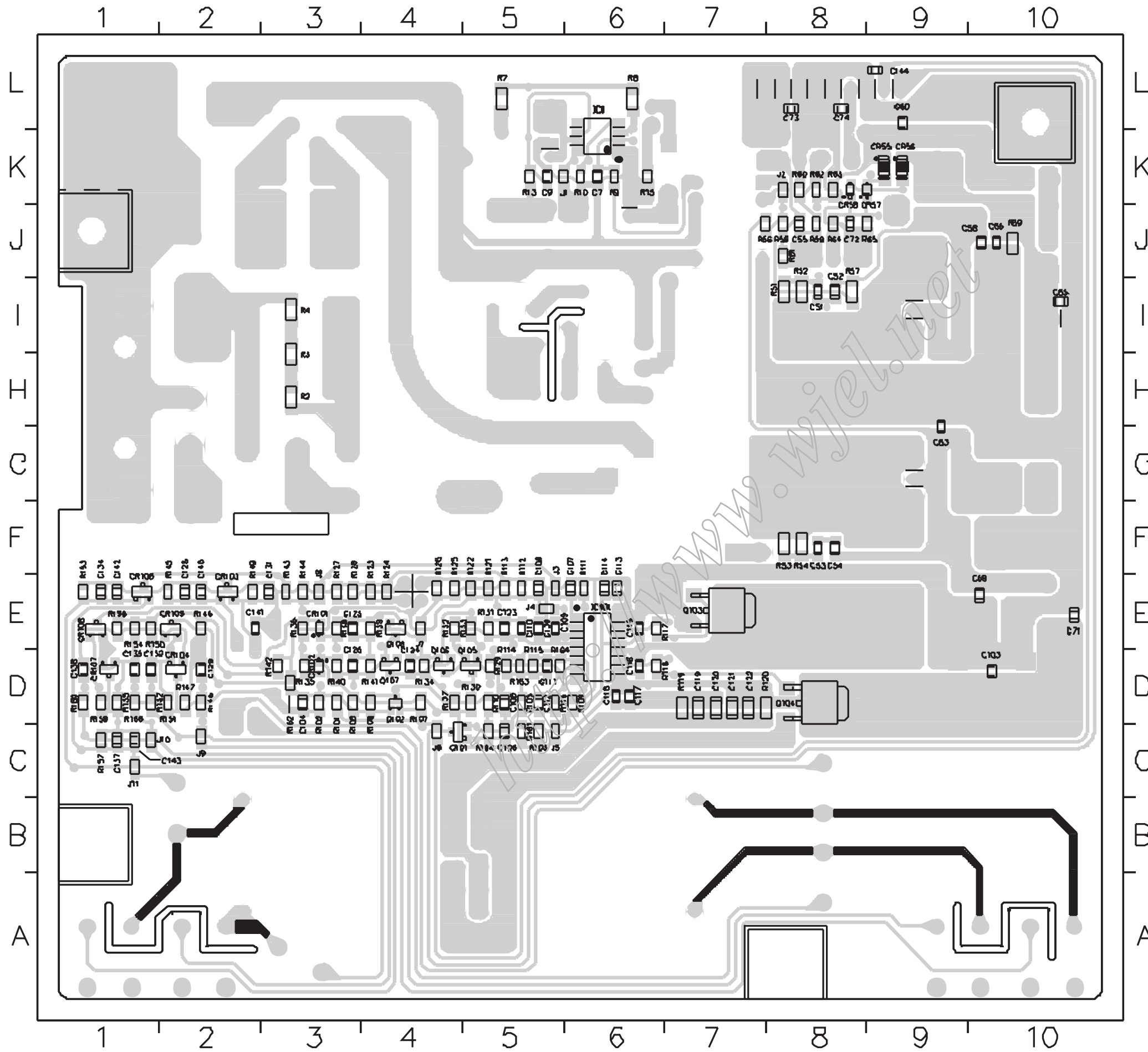

C51	I8	CR58	K8	R113	E5
C52	I8	CR101	E3	R114	D5
C53	F8	CR102	D3	R115	D5
C54	F8	CR103	E2	R116	D5
C55	J8	CR104	D2	R117	E6
C58	J10	CR105	E2	R118	D6
C60	L9	CR106	E1	R119	D7
C63	H9	CR107	D1	R120	D7
C65	I10	CR108	E1	R121	E5
C66	J10	IC1	K6	R122	E5
C69	E10	IC101	E6	R123	E4
C71	E10	Q101	C4	R124	E4
C72	J8	Q102	D4	R125	E4
C73	L8	Q103	E7	R126	E4
C74	L8	Q104	D8	R127	E3
C103	D10	Q105	D5	R128	E3
C104	D3	Q106	D4	R129	D5
C105	C5	Q107	D4	R130	D5
C106	D5	Q108	E4	R131	E5
C107	E6	R2	H3	R132	E4
C108	E5	R3	H3	R133	E5
C109	E5	R4	I3	R134	D4
C110	E5	R7	L5	R135	D3
C111	D5	R8	L6	R136	E3
C112	D5	R9	K6	R137	D4
C113	E6	R10	K6	R138	E3
C114	E6	R13	K5	R139	E4
C115	E6	R15	K6	R140	D3
C116	D6	R51	I8	R141	D4
C117	D6	R52	I8	R142	D3
C118	D6	R53	F8	R143	E3
C119	D7	R54	F8	R144	E3
C120	D7	R56	J8	R145	E2
C121	D7	R57	I8	R146	E2
C122	D7	R58	J8	R147	D2
C123	E5	R59	J8	R148	D2
C124	D4	R60	K8	R149	E2
C125	E3	R61	J8	R150	E1
C126	D3	R62	K8	R151	D2
C128	E2	R63	K8	R152	D1
C129	D2	R64	J8	R153	E1
C131	E3	R65	J8	R154	E1
C132	D1	R69	J10	R155	D1
C134	E10	R101	D3	R156	D1
C135	D1	R102	D3	R157	C1
C137	C1	R103	C5	R158	E1
C138	D1	R104	C5	R159	D1
C139	E5	R105	D5	R160	D1
C140	E2	R106	D3	R161	C5
C141	E2	R107	D4	R162	D3
C142	E1	R108	D4	R163	D5
C143	C1	R109	D6	R164	D5
C144	L9	R110	D5		
CR55	K9				

B-A

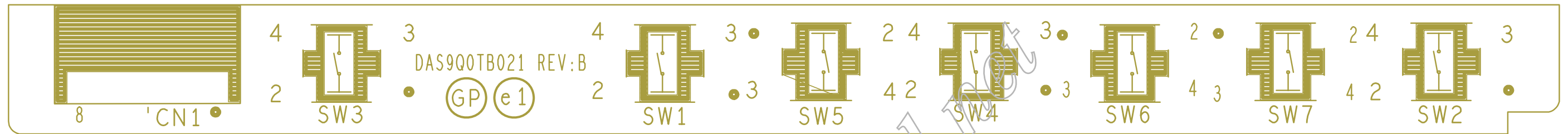

B-B



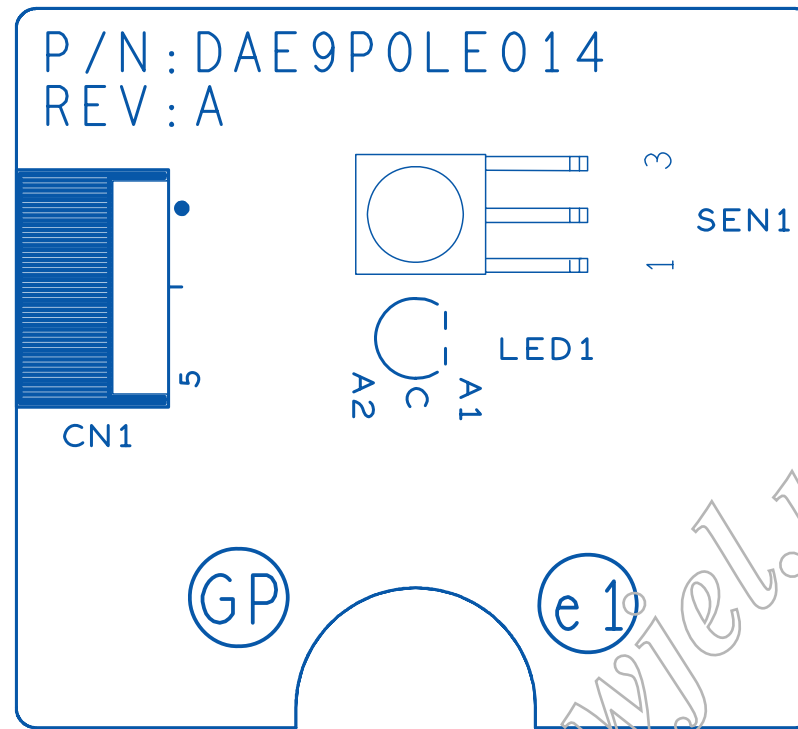

L-A

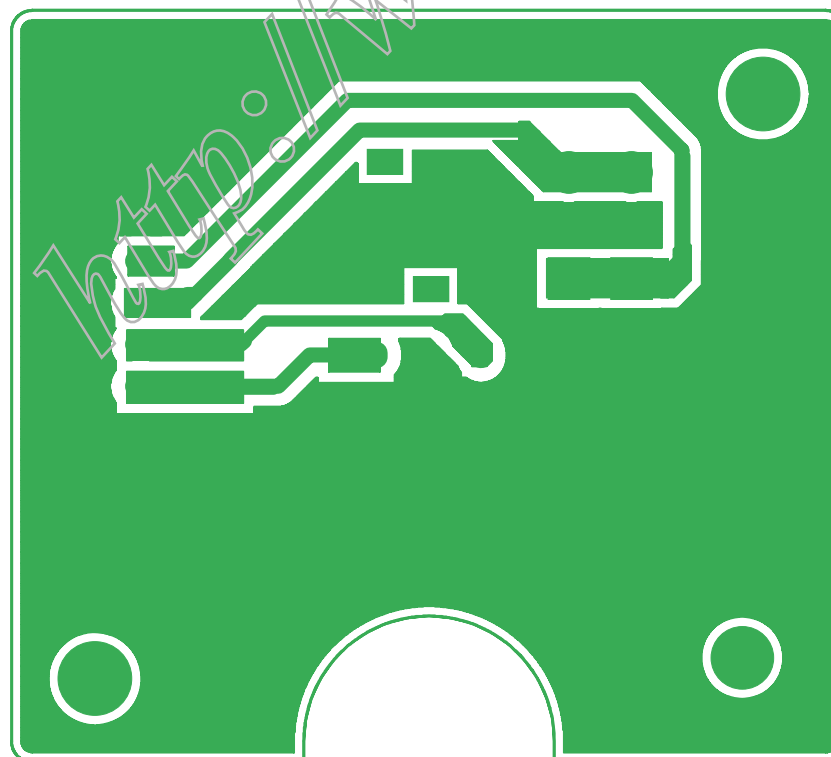

L-B

E9P Explode Diagram

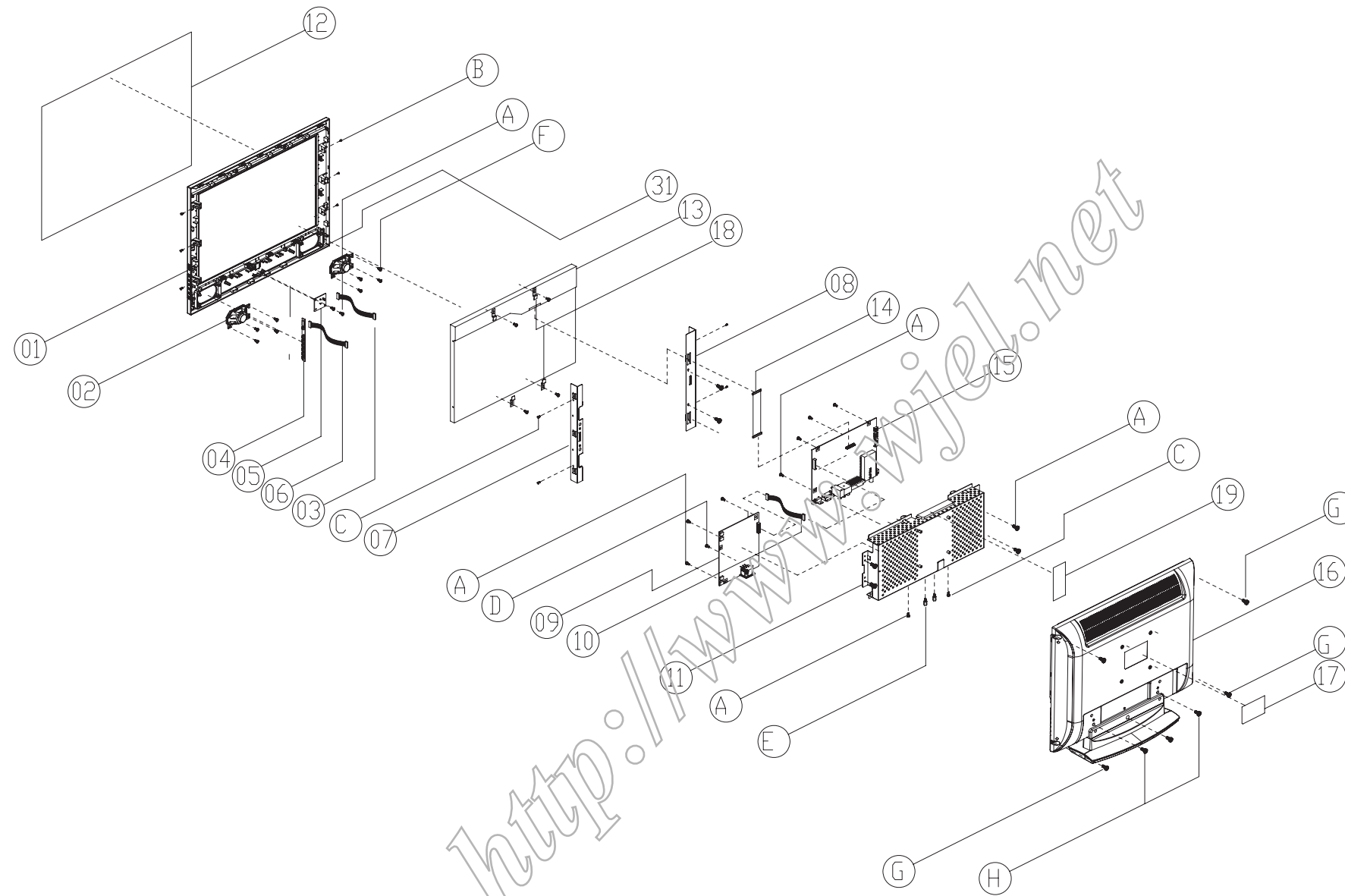

<http://www.wjw.net>

ITEM	PART NUMBER	PART DESCRIPTION	UNIT
A	MF30070BBJ1	SCREW F3.0*7.0-B (ND) GP	17
B	MM300401BJ9	SCREW M3.0*4.0-I(ND) GP	6
C	MM300501BJ3	SCREW M3.0*5.0-I(ND) GP	6
D	MM40080BBW1	SCREW M4.0*8.0-B(ND,WASHER)GP	1
E	MBL11004018	ID NUT L11(MBL11004,REV3A)GP	2
F	MH20080PBN7	SCREW H2.0*8-P(ND,WASHER) GP	8
G	MF40100BJ26	SCREW F4.0*10-B(ND) GP	5
H	MF30100PJ23	SCREW F3*10,(ND) GP	2
I			
J			
K			
L			
M			
N			

ITEM	PART NUMBER	PART DESCRIPTION	UNIT
1	34E9POLB000	E9P LCD BEZEL SUB ASSY GP	1
2	DND8508S006	SPEAKER(8,5W, 77*42*24)L32,R60 P2 GP	1
3	DD0E9TIR005	CABLE E9T-PV MB-IR(5P/5P,500MM) GP	1
4	23S9Q08B008	S9Q BUTTON/B ASSY GP	1
5	23E9POLE008	E9P LED/B ASSY(E9P-PT) GP	1
6	DD0E9TBU002	CABLE E9T-PV MB-BUTTON(8P/10P,800MM) GP	1
7	FAE9T003015	LCD BKT RIGHT E9T-PV(FAE9T003,REV3A)GP	1
8	FAE9T002019	LCD BKT LEFT E9T-PV(FAE9T002,REV3A)GP	1
9	AS05B322502	ADP/INV,TBD432AR 90-264V REV:A GP	1
10	DD0E9TPB001	CABLE E9T-PV POWER-MB(10P/10P,80MM) GP	1
11	36E9POPS006	E9P PCB SHIELDING SUB ASSY GP	1
12	JXW9ZA01019	LCD FILM W9ZAKJXW9ZA01,REV3B)GP	1
13	AA0190A1084	LCD 19" M190A1-L07 (1440*900,5MS)GP	1
14	DDWBTBLC005	CABLE LVDS(30P,150MM)WBTB GP	1
15	21E9T0MB015	E9T-PV M/B ASSY(M18201,E9P)GP	1
16	35E9POLS009	E9P LCD OOVER SUB ASSY GP	1
17	HCE9P001010	RATING LABEL E9P(HCE9P001,R3A)GP	1
18	FBE9P001019	PANEL H00K E9P(FBE9P001,REV3A)GP	4
19	FCL9V005015	AL FOIL L9VDQ-4(FCL9V005,R3A)100*80 GP	1
20			
21			
22			
23			
24			
25			

Recommended Spare Part List

190TW8 TV

49

RSPL FOR 190TW8FB/00(E9P-PT)
1 P/N: 1E9PZPPL006(CMO PANEL)

	Part Name	Philips P/N	Techview P/N	Description	Q'ty	Location	Remark
Electronic Components:	LCD panel		AA0190A1084	LCD 19" M190A1-L07 (1440*900,5MS)GP	1	Item 13 in exploded view	CMO PANEL
	MB-LCD cable		DDWBTBLC005	CABLE LVDS(30P,150MM)WBTB GP	1	Item 14 in exploded view	
	Button-MB cable		DD0E9TBU002	CABLE E9T-PV MB-BUTTON(10P/8P,700MM) GP	1	Item 6 in exploded view	
	IR-MB cable		DD0E9TIR005	CABLE E9T-PV MB-IR(5P/5P,350MM) GP	1	Item 3 in exploded view	
	Power-MB cable		DD0E9TPB001	CABLE E9T-PV POWER-MB(10P/10P,80MM) GP	1	Item 10 in exploded view	
	Speaker assembly		DND8508S006	SPEAKER(8,5W, 77*42*24)L32,R60 P2 GP	1	Item 2 in exploded view	
	IC		AJ098100009	IC(32P)CLASSDAMP TFA9810(2*12W)SOT287 GP	1	U22	2-channel power comparator for high efficiency class-D audio amplifier systems
	IC		AJ8201A0F04	IC(256P)MT8201ALE/B-L(QFP) GP	1	U9	a highly integrated single chip. It includes ADC, Video Decoder, Video Processor, Audio Processor, OSD Processor, Host Microcontroller, DRAM controller
	IC		AJ8291E0F09	IC(48P)MT8291E-L(QFP) GP	1	U19	a highly integrated stereo audio CODEC
	IC		AJ8293A#F06	IC(128P) MT8293AE-L(QFP) GP	1	U15	a fully HDMI-compliant receiver
	IC		AKD3NF*K+02	IC(66P)DDR SDR M13S128168A -5TG(TSOP)GP	1	U28	DDR SDRAM
	IC		AKE1A800Y11	IC EEPROM(8P,5V) 24LC02BT(2K*1,SOP) GP	2	U14,U17	EDID data
	IC		AKE1F800R02	IC EEPROM(8P)BR24L04F-W(512*8,SO8) GP	1	U13	HDCP KEY data
	IC		AKE1H800009	IC EEPROM(8P)AF24BC04-SI(512*8,SOIC8) GP	1	U13	HDCP KEY data
	IC		AKE25FHKZ08	IC(48P) FLASH MX29LV160CBTC-70G(TSOP)GP	1	U11	STORE FLASH ROM
	IC		AKE268AKK03	IC(48P) FLASH SST39VF1681-70-4C-EKE GP	1	U11	STORE FLASH ROM
	IC		AKE3A8S0Y10	IC EEPROM(8P)24LC16BT-I(2K*8,100KHZ) GP	1	U1	STORE Timing table, Color temperature, TV channel data
	IC		AL001084021	IC(3P) AIC1084PE(TO-252) GP	9	U2,U3,U4,U5,U6,U7,U8,U12,U29	DC to DC
	IC		AL002996C00	IC(8P) LP2996MX (SOP8) GP	1	U27	DDR Termination Regulator
	IC		AL003157107	IC(6P) NC7SB3157P6X NL SC70 GP	1	U30	Analog Switch
	IC		ALHC4052018	IC(16P) 74HC4052D(SO16)GP	1	U24	Dual 4-channel analog multiplexer, demultiplexer
	TRANSISTOR		BA039040Z19	TR SMD PMBS3904(40V,200MA) GP	19	Q3,Q4,Q5,Q6,Q7,Q8,Q9,Q10,Q11,Q14,Q16,Q17,Q18,Q20,Q27,Q28,Q32,Q33,Q34	
	TRANSISTOR		BA039060Z10	TR,SMD PMBS3906(40V,200MA) GP	5	Q12,Q15,Q23,Q24,Q30	
TRANSISTOR		BAM9435YZ17	TR MOSFET S19435BDY-E3(-30V,5.1A)GP	3	Q1,Q2,Q19		
TRANSISTOR		BAN70020Z13	TR MOSFET12N7002E-T1-E3 (60V,250MA) GP	3	QF1,QF2,QF3		
Mechanical Components:	Front bezel assembly		34E9P0LB000	E9P LCD BEZEL SUB ASSY GP	1	Item 1 in exploded view	
	Back cover assembly		35E9P0LS009	E9P LCD COVER SUB ASSY GP	1	Item 16 in exploded view	
	D-SUB to shielding		MBL11004018	IQ NUT L11(MBL11004,REV3A)GP	1	Item E in exploded view	
	Panel to L/R bracket		MM30050IBJ3	SCREW M3.0*5.0-I(NI) GP	4	Item C in exploded view	
	PCBAs to metal shielding		MF30060BBJ6	SCREW F3.0*6-B(NI)GP	16		
PCBA:	Power board		AS56B42TA04	PI 100-240V 55W 4L(140*150)TBD432AR-1 GP	1		
	Power board		AS56B42CA06	PI 100-240V 55W 4L(140*150)AIP-0169 GP	1		
	Main board		10E9P0MB001	E9T-PV M/B ASSY(MT8201,E9P)GP	1	Item 15 in exploded view	21E9T0MB015
	Bios		AZE9P0BM007	E9P-PT SW BIOS IMAGE(MT8201 CMO PAL-EU)			
	LED/B		10E9P0LB006	E9P LED/B ASSY(E9P-PT) GP	1	Item 5 in exploded view	23E9P0LE008
	Button/B		10S9T0BB006	S9Q BUTTON/B ASSY GP	1	Item 4 in exploded view	23S9Q0BB008
Accessories:	Audio cable		DD0LOTPC007	CABLE AUDIO(ST,1.8M)BLACK LOT GP	1		
	VGA cable		DD0L7WPC001	CABLE MB-VGA(15P,1.8M)L7E BLACK 5.5 GP	1		
	LCD Film		JXW9ZA01019	LCD FILM W9ZA(JXW9ZA01,REV3B)GP	1		
	Power card		DM333181801	PWR CORD B 1.8M SP-023/16A CT-12 EUR GP	1		
	Remote control		DQ731880108	REMOTE CONTROLLER(318801-0958001A) GP	1		
	Manual		HDE9P001011	MANUAL+QSG E9P(HDE9P001,R3A)GP	1		
	Battery		AHDALR03006	BATTERY LR03GW/2SK (ALKALINE 1.5V) GP	1		
	Battery		AHDALR03120	BATTERY LR03(SN) (ALKALINE,1.5V) GP	1		
Packing Material:	PE bag For LCD		HAL0T002019	PE BAG L0T(HAL0T002,REV3A)GP	1		
	PE bag For Accessories		HAS0Q001012	PE BAG S0Q(HAS0Q001,R3A)GP	1		
	Carton		HFE9P001012	CARTON E9P(HFE9P001,R3A)GP	1		
	Cushion-L		HBE9P001019	END CAP-L E9P(HBE9P001,REV3A)GP	1		
	Cushion-R		HBE9P002015	END CAP-R E9P(HBE9P002,REV3A)GP	1		

Recommended Spare Part List

>> MAIN BOARD ASSY

	10E9POMB001	E9T-PV M/B ASSY(MT8201,E9P)GP		C47	CH02206J909	CAP CHIP 22P 50V(+5%,NPO,0603) GP
	E9T203-02	21E9T0MB015 E9T M/B Schematic(MT8201)C2A		C186	CH02206J909	CAP CHIP 22P 50V(+5%,NPO,0603) GP
	31E9T0SS011	E9T-PV M/B S/S ASSY(MT8201,E9P)GP		C194	CH02206J909	CAP CHIP 22P 50V(+5%,NPO,0603) GP
	DA0E9TMB032	PCB(M/B)E9T-PV(4L,115*227,R.C)MT8201 GP		C202	CH03306J905	CAP CHIP 33P 50V(+5%,NPO,0603)GP
	E9T205-01	DA0E9TMB032 E9T PCB MB (Board file & Gerber file)		C203	CH03306J905	CAP CHIP 33P 50V(+5%,NPO,0603)GP
U14	AKE1A800Y11	IC EEPROM(8P,5V) 24LC02BT(2K*1,SOP) GP		C157	CH11006J901	CAP CHIP 100P 50V(+5%,NPO,0603) GP
U17	AKE1A800Y11	IC EEPROM(8P,5V) 24LC02BT(2K*1,SOP) GP		C182	CH11006J901	CAP CHIP 100P 50V(+5%,NPO,0603) GP
U13	AKE1F800R02	IC EEPROM(8P)BR24L04F-W(512*8,S08) GP		C89	CH13306J907	CAP CHIP 330P 50V(+5%,NPO,0603)GP
U13	AKE1H800009	IC EEPROM(8P)AF24BC04-SI(512*8,SOIC8) GP		C92	CH13306J907	CAP CHIP 330P 50V(+5%,NPO,0603)GP
U1	AKE3A850Y10	IC EEPROM(8P)24LC16BT-I(2K*8,100KHZ) GP		C93	CH13306J907	CAP CHIP 330P 50V(+5%,NPO,0603)GP
U2	AL001084021	IC(3P) AIC1084PE(TO-252) GP		C94	CH13306J907	CAP CHIP 330P 50V(+5%,NPO,0603)GP
U3	AL001084021	IC(3P) AIC1084PE(TO-252) GP		C96	CH13306J907	CAP CHIP 330P 50V(+5%,NPO,0603)GP
U4	AL001084021	IC(3P) AIC1084PE(TO-252) GP		C97	CH13306J907	CAP CHIP 330P 50V(+5%,NPO,0603)GP
U5	AL001084021	IC(3P) AIC1084PE(TO-252) GP		C98	CH13306J907	CAP CHIP 330P 50V(+5%,NPO,0603)GP
U6	AL001084021	IC(3P) AIC1084PE(TO-252) GP		C99	CH13306J907	CAP CHIP 330P 50V(+5%,NPO,0603)GP
U7	AL001084021	IC(3P) AIC1084PE(TO-252) GP		C100	CH13306J907	CAP CHIP 330P 50V(+5%,NPO,0603)GP
U8	AL001084021	IC(3P) AIC1084PE(TO-252) GP		C104	CH13306J907	CAP CHIP 330P 50V(+5%,NPO,0603)GP
U12	AL001084021	IC(3P) AIC1084PE(TO-252) GP		C105	CH13306J907	CAP CHIP 330P 50V(+5%,NPO,0603)GP
U29	AL001084021	IC(3P) AIC1084PE(TO-252) GP		C106	CH13306J907	CAP CHIP 330P 50V(+5%,NPO,0603)GP
U24	ALHC4052018	IC(16P) 74HC4052D(SO16)GP		C111	CH13306J907	CAP CHIP 330P 50V(+5%,NPO,0603)GP
Q3	BA039040Z19	TR SMD PMBS3904(40V,200MA) GP		C128	CH13306J907	CAP CHIP 330P 50V(+5%,NPO,0603)GP
Q4	BA039040Z19	TR SMD PMBS3904(40V,200MA) GP		C262	CH13306J907	CAP CHIP 330P 50V(+5%,NPO,0603)GP
Q5	BA039040Z19	TR SMD PMBS3904(40V,200MA) GP		C158	CH14706K919	CAP CHIP 470P 50V(+10%,X7R,0603) GP
Q6	BA039040Z19	TR SMD PMBS3904(40V,200MA) GP		C164	CH14706K919	CAP CHIP 470P 50V(+10%,X7R,0603) GP
Q7	BA039040Z19	TR SMD PMBS3904(40V,200MA) GP		C174	CH14706K919	CAP CHIP 470P 50V(+10%,X7R,0603) GP
Q8	BA039040Z19	TR SMD PMBS3904(40V,200MA) GP		C179	CH14706K919	CAP CHIP 470P 50V(+10%,X7R,0603) GP
Q9	BA039040Z19	TR SMD PMBS3904(40V,200MA) GP		C61	CH21006K917	CAP CHIP 1000P 50V(+10%,X7R,0603) GP
Q10	BA039040Z19	TR SMD PMBS3904(40V,200MA) GP		C62	CH21006K917	CAP CHIP 1000P 50V(+10%,X7R,0603) GP
Q11	BA039040Z19	TR SMD PMBS3904(40V,200MA) GP		C63	CH21006K917	CAP CHIP 1000P 50V(+10%,X7R,0603) GP
Q14	BA039040Z19	TR SMD PMBS3904(40V,200MA) GP		C65	CH21006K917	CAP CHIP 1000P 50V(+10%,X7R,0603) GP
Q16	BA039040Z19	TR SMD PMBS3904(40V,200MA) GP		C66	CH21006K917	CAP CHIP 1000P 50V(+10%,X7R,0603) GP
Q17	BA039040Z19	TR SMD PMBS3904(40V,200MA) GP		C1	CH22206K917	CAP CHIP 2200P 50V(+10%,X7R,0603)GP
Q18	BA039040Z19	TR SMD PMBS3904(40V,200MA) GP		C4	CH22206K917	CAP CHIP 2200P 50V(+10%,X7R,0603)GP
Q20	BA039040Z19	TR SMD PMBS3904(40V,200MA) GP		C51	CH2336K9108	CAP CHIP 3300P,50V(+10%,X7R,0603) GP
Q27	BA039040Z19	TR SMD PMBS3904(40V,200MA) GP		C53	CH2336K9108	CAP CHIP 3300P,50V(+10%,X7R,0603) GP
Q28	BA039040Z19	TR SMD PMBS3904(40V,200MA) GP		C54	CH2336K9108	CAP CHIP 3300P,50V(+10%,X7R,0603) GP
Q32	BA039040Z19	TR SMD PMBS3904(40V,200MA) GP		C55	CH2336K9108	CAP CHIP 3300P,50V(+10%,X7R,0603) GP
Q33	BA039040Z19	TR SMD PMBS3904(40V,200MA) GP		C56	CH2336K9108	CAP CHIP 3300P,50V(+10%,X7R,0603) GP
Q34	BA039040Z19	TR SMD PMBS3904(40V,200MA) GP		C83	CH2336K9108	CAP CHIP 3300P,50V(+10%,X7R,0603) GP
Q12	BA039060Z10	TR,SMD PMBS3906(40V,200MA) GP		C85	CH2336K9108	CAP CHIP 3300P,50V(+10%,X7R,0603) GP
Q15	BA039060Z10	TR,SMD PMBS3906(40V,200MA) GP		C229	CH2336K9108	CAP CHIP 3300P,50V(+10%,X7R,0603) GP
Q23	BA039060Z10	TR,SMD PMBS3906(40V,200MA) GP		C230	CH2336K9108	CAP CHIP 3300P,50V(+10%,X7R,0603) GP
Q24	BA039060Z10	TR,SMD PMBS3906(40V,200MA) GP		C231	CH2336K9108	CAP CHIP 3300P,50V(+10%,X7R,0603) GP
Q30	BA039060Z10	TR,SMD PMBS3906(40V,200MA) GP		C232	CH2336K9108	CAP CHIP 3300P,50V(+10%,X7R,0603) GP
Q1	BAM09435006	TR MOSFET ME9435A(-30V,-5.3A)SOIC8 GP		CB110	CH2336K9108	CAP CHIP 3300P,50V(+10%,X7R,0603) GP
Q2	BAM09435006	TR MOSFET ME9435A(-30V,-5.3A)SOIC8 GP		C72	CH24706K911	CAP CHIP 4700P,50V(+10%,X7R,0603)GP
Q19	BAM09435006	TR MOSFET ME9435A(-30V,-5.3A)SOIC8 GP		C107	CH24706K911	CAP CHIP 4700P,50V(+10%,X7R,0603)GP
Q1	BAM9435YZ17	TR MOSFET SI9435BDY-E3(-30V,5.1A)GP		C216	CH24706K911	CAP CHIP 4700P,50V(+10%,X7R,0603)GP
Q2	BAM9435YZ17	TR MOSFET SI9435BDY-E3(-30V,5.1A)GP		C217	CH24706K911	CAP CHIP 4700P,50V(+10%,X7R,0603)GP
Q19	BAM9435YZ17	TR MOSFET SI9435BDY-E3(-30V,5.1A)GP		C218	CH24706K911	CAP CHIP 4700P,50V(+10%,X7R,0603)GP
QF1	BAN70020Z13	TR MOSFET 2N7002E-T1-E3 (60V,250MA) GP		C219	CH24706K911	CAP CHIP 4700P,50V(+10%,X7R,0603)GP
QF2	BAN70020Z13	TR MOSFET 2N7002E-T1-E3 (60V,250MA) GP		C52	CH31006K919	CAP CHIP 0.01U 50V(+10%,X7R,0603) GP
QF3	BAN70020Z13	TR MOSFET 2N7002E-T1-E3 (60V,250MA) GP		C68	CH31006K919	CAP CHIP 0.01U 50V(+10%,X7R,0603) GP
D9	BCBAT54CZ02	DIODE SMD BAT54C(30V,200MA,SCHOTTKY)GP		C69	CH31006K919	CAP CHIP 0.01U 50V(+10%,X7R,0603) GP
D26	BCBAT54CZ02	DIODE SMD BAT54C(30V,200MA,SCHOTTKY)GP		C71	CH31006K919	CAP CHIP 0.01U 50V(+10%,X7R,0603) GP
D1	BCLL4148Z19	DIODE,SMD LL4148PT(75V,0.15A) GP		C73	CH31006K919	CAP CHIP 0.01U 50V(+10%,X7R,0603) GP
D49	BCLL4148Z19	DIODE,SMD LL4148PT(75V,0.15A) GP		C75	CH31006K919	CAP CHIP 0.01U 50V(+10%,X7R,0603) GP
C70	CH00506J904	CAP CHIP 5P,50V(+5%,NPO,0603)GP		C77	CH31006K919	CAP CHIP 0.01U 50V(+10%,X7R,0603) GP
C74	CH00506J904	CAP CHIP 5P,50V(+5%,NPO,0603)GP		C79	CH31006K919	CAP CHIP 0.01U 50V(+10%,X7R,0603) GP
C78	CH00506J904	CAP CHIP 5P,50V(+5%,NPO,0603)GP		C90	CH31006K919	CAP CHIP 0.01U 50V(+10%,X7R,0603) GP
C113	CH0156J9003	CAP CHIP 15P 50V(+5%,NPO,0603) GP		C112	CH31006K919	CAP CHIP 0.01U 50V(+10%,X7R,0603) GP
C118	CH0156J9003	CAP CHIP 15P 50V(+5%,NPO,0603) GP		C116	CH31006K919	CAP CHIP 0.01U 50V(+10%,X7R,0603) GP
C123	CH0156J9003	CAP CHIP 15P 50V(+5%,NPO,0603) GP		C117	CH31006K919	CAP CHIP 0.01U 50V(+10%,X7R,0603) GP
C46	CH02206J909	CAP CHIP 22P 50V(+5%,NPO,0603) GP		C121	CH31006K919	CAP CHIP 0.01U 50V(+10%,X7R,0603) GP
				C122	CH31006K919	CAP CHIP 0.01U 50V(+10%,X7R,0603) GP

R367	CS04703J914	RES CHIP 47 1/10W +-5%(0603) GP	R385	CS14703J916	RES CHIP 470 1/10W+-5%(0603) GP
R154	CS05603F911	RES CHIP 56 1/10W +-1%(0603) GP	R105	CS15103J917	RES CHIP 510 1/10W +-5%(0603) GP
R162	CS05603F911	RES CHIP 56 1/10W +-1%(0603) GP	R126	CS15103J917	RES CHIP 510 1/10W +-5%(0603) GP
R167	CS05603F911	RES CHIP 56 1/10W +-1%(0603) GP	R277	CS15103J917	RES CHIP 510 1/10W +-5%(0603) GP
R395	CS05603F911	RES CHIP 56 1/10W +-1%(0603) GP	R278	CS21003F912	RES CHIP 1K,1/10W,+1%(0603) GP
R78	CS06803J913	RES CHIP 68 1/10W +-5%(1608) GP	R355	CS21003F912	RES CHIP 1K,1/10W,+1%(0603) GP
R84	CS06803J913	RES CHIP 68 1/10W +-5%(1608) GP	R356	CS21003F912	RES CHIP 1K,1/10W,+1%(0603) GP
R90	CS06803J913	RES CHIP 68 1/10W +-5%(1608) GP	L72	CS21003J914	RES CHIP 1K 1/10W +-5%(0603) GP
R170	CS06803J913	RES CHIP 68 1/10W +-5%(1608) GP	R5	CS21003J914	RES CHIP 1K 1/10W +-5%(0603) GP
R173	CS06803J913	RES CHIP 68 1/10W +-5%(1608) GP	R7	CS21003J914	RES CHIP 1K 1/10W +-5%(0603) GP
R176	CS06803J913	RES CHIP 68 1/10W +-5%(1608) GP	R12	CS21003J914	RES CHIP 1K 1/10W +-5%(0603) GP
R81	CS07503F913	RES CHIP 75 1/10W +-1%(0603) GP	R49	CS21003J914	RES CHIP 1K 1/10W +-5%(0603) GP
R86	CS07503F913	RES CHIP 75 1/10W +-1%(0603) GP	R72	CS21003J914	RES CHIP 1K 1/10W +-5%(0603) GP
R91	CS07503F913	RES CHIP 75 1/10W +-1%(0603) GP	R73	CS21003J914	RES CHIP 1K 1/10W +-5%(0603) GP
R148	CS07503F913	RES CHIP 75 1/10W +-1%(0603) GP	R180	CS21003J914	RES CHIP 1K 1/10W +-5%(0603) GP
R153	CS07503F913	RES CHIP 75 1/10W +-1%(0603) GP	R185	CS21003J914	RES CHIP 1K 1/10W +-5%(0603) GP
R158	CS07503F913	RES CHIP 75 1/10W +-1%(0603) GP	R217	CS21003J914	RES CHIP 1K 1/10W +-5%(0603) GP
R160	CS07503F913	RES CHIP 75 1/10W +-1%(0603) GP	R221	CS21003J914	RES CHIP 1K 1/10W +-5%(0603) GP
R171	CS07503F913	RES CHIP 75 1/10W +-1%(0603) GP	R222	CS21003J914	RES CHIP 1K 1/10W +-5%(0603) GP
R174	CS07503F913	RES CHIP 75 1/10W +-1%(0603) GP	R230	CS21003J914	RES CHIP 1K 1/10W +-5%(0603) GP
R177	CS07503F913	RES CHIP 75 1/10W +-1%(0603) GP	R235	CS21003J914	RES CHIP 1K 1/10W +-5%(0603) GP
R184	CS07503F913	RES CHIP 75 1/10W +-1%(0603) GP	R335	CS21003J914	RES CHIP 1K 1/10W +-5%(0603) GP
R186	CS07503F913	RES CHIP 75 1/10W +-1%(0603) GP	R338	CS21003J914	RES CHIP 1K 1/10W +-5%(0603) GP
R358	CS07503F913	RES CHIP 75 1/10W +-1%(0603) GP	R349	CS21003J914	RES CHIP 1K 1/10W +-5%(0603) GP
R359	CS07503F913	RES CHIP 75 1/10W +-1%(0603) GP	R382	CS21003J914	RES CHIP 1K 1/10W +-5%(0603) GP
R360	CS07503F913	RES CHIP 75 1/10W +-1%(0603) GP	R383	CS21003J914	RES CHIP 1K 1/10W +-5%(0603) GP
R361	CS07503F913	RES CHIP 75 1/10W +-1%(0603) GP	R107	CS22003J917	RES CHIP 2K 1/10W +-5%(0603) GP
R362	CS07503F913	RES CHIP 75 1/10W +-1%(0603) GP	R135	CS22003J917	RES CHIP 2K 1/10W +-5%(0603) GP
R363	CS07503F913	RES CHIP 75 1/10W +-1%(0603) GP	R279	CS22003J917	RES CHIP 2K 1/10W +-5%(0603) GP
R376	CS07503F913	RES CHIP 75 1/10W +-1%(0603) GP	R351	CS22003J917	RES CHIP 2K 1/10W +-5%(0603) GP
R392	CS07503F913	RES CHIP 75 1/10W +-1%(0603) GP	R18	CS22203F912	RES CHIP 2.2K 1/10W,+1%(0603) GP
R396	CS07503F913	RES CHIP 75 1/10W +-1%(0603) GP	R20	CS22203F912	RES CHIP 2.2K 1/10W,+1%(0603) GP
R24	CS11003F911	RES CHIP 100 1/10W+-1%(0603)GP	R22	CS22203F912	RES CHIP 2.2K 1/10W,+1%(0603) GP
R28	CS11003F911	RES CHIP 100 1/10W+-1%(0603)GP	R3	CS22203J914	RES CHIP 2.2K 1/10W +-5%(0603) GP
R40	CS11003F911	RES CHIP 100 1/10W+-1%(0603)GP	R4	CS22203J914	RES CHIP 2.2K 1/10W +-5%(0603) GP
R80	CS11003F911	RES CHIP 100 1/10W+-1%(0603)GP	R280	CS23003F918	RES CHIP 3K 1/10W +-1%(0603) GP
R82	CS11003F911	RES CHIP 100 1/10W+-1%(0603)GP	R146	CS23303J911	RES CHIP 3.3K 1/10W +-5%(0603) GP
R88	CS11003F911	RES CHIP 100 1/10W+-1%(0603)GP	R410	CS23303J911	RES CHIP 3.3K 1/10W +-5%(0603) GP
R89	CS11003F911	RES CHIP 100 1/10W+-1%(0603)GP	R411	CS23303J911	RES CHIP 3.3K 1/10W +-5%(0603) GP
R92	CS11003F911	RES CHIP 100 1/10W+-1%(0603)GP	R19	CS21403F909	RES CHIP 1.4K 1/10W +-1%(0603) GP
R172	CS11003F911	RES CHIP 100 1/10W+-1%(0603)GP	R23	CS21403F909	RES CHIP 1.4K 1/10W +-1%(0603) GP
R175	CS11003F911	RES CHIP 100 1/10W+-1%(0603)GP	R10	CS24703J918	RES CHIP 4.7K 1/10W +-5%(0603) GP
R178	CS11003F911	RES CHIP 100 1/10W+-1%(0603)GP	R14	CS24703J918	RES CHIP 4.7K 1/10W +-5%(0603) GP
R206	CS11003F911	RES CHIP 100 1/10W+-1%(0603)GP	R41	CS24703J918	RES CHIP 4.7K 1/10W +-5%(0603) GP
R207	CS11003F911	RES CHIP 100 1/10W+-1%(0603)GP	R42	CS24703J918	RES CHIP 4.7K 1/10W +-5%(0603) GP
R289	CS11003F911	RES CHIP 100 1/10W+-1%(0603)GP	R64	CS24703J918	RES CHIP 4.7K 1/10W +-5%(0603) GP
R294	CS11003F911	RES CHIP 100 1/10W+-1%(0603)GP	R75	CS24703J918	RES CHIP 4.7K 1/10W +-5%(0603) GP
R296	CS11003F911	RES CHIP 100 1/10W+-1%(0603)GP	R208	CS24703J918	RES CHIP 4.7K 1/10W +-5%(0603) GP
R297	CS11003F911	RES CHIP 100 1/10W+-1%(0603)GP	R285	CS24703J918	RES CHIP 4.7K 1/10W +-5%(0603) GP
R321	CS11003F911	RES CHIP 100 1/10W+-1%(0603)GP	R286	CS24703J918	RES CHIP 4.7K 1/10W +-5%(0603) GP
R322	CS11003F911	RES CHIP 100 1/10W+-1%(0603)GP	R340	CS24703J918	RES CHIP 4.7K 1/10W +-5%(0603) GP
R329	CS11003F911	RES CHIP 100 1/10W+-1%(0603)GP	R341	CS24703J918	RES CHIP 4.7K 1/10W +-5%(0603) GP
R330	CS11003F911	RES CHIP 100 1/10W+-1%(0603)GP	R352	CS24703J918	RES CHIP 4.7K 1/10W +-5%(0603) GP
R373	CS11003F911	RES CHIP 100 1/10W+-1%(0603)GP	R353	CS24703J918	RES CHIP 4.7K 1/10W +-5%(0603) GP
R374	CS11003F911	RES CHIP 100 1/10W+-1%(0603)GP	R354	CS24703J918	RES CHIP 4.7K 1/10W +-5%(0603) GP
R364	CS11503F919	RES CHIP 150,1/10W,+1%(0603) GP	R357	CS24703J918	RES CHIP 4.7K 1/10W +-5%(0603) GP
R9	CS12203J912	RES CHIP 220 1/10W +-5%(0603) GP	R407	CS24703J918	RES CHIP 4.7K 1/10W +-5%(0603) GP
R26	CS13303F917	RES CHIP 330 1/10W +-1%(0603) GP	R350	CS25103F909	RES CHIP 5.1K 1/10W+-1%(0603) GP
R30	CS13303F917	RES CHIP 330 1/10W +-1%(0603) GP	R21	CS25603F907	RES CHIP 5.6K 1/10W +-1%(0603) GP
R288	CS13303J901	RESISTOR CHIP 330 1/10W +-5% (0603) GP	R275	CS26803F915	RES CHIP 6.8K 1/10W,+1%(0603) GP
R345	CS14703J916	RES CHIP 470 1/10W+-5%(0603) GP	R281	CS26803F915	RES CHIP 6.8K 1/10W,+1%(0603) GP
R346	CS14703J916	RES CHIP 470 1/10W+-5%(0603) GP	R282	CS29103F900	RES CHIP 9.1K 1/10W +-1%(0603) GP
R347	CS14703J916	RES CHIP 470 1/10W+-5%(0603) GP	R1	CS31003J916	RES CHIP 10K 1/10W +-5%(0603) GP
R375	CS14703J916	RES CHIP 470 1/10W+-5%(0603) GP	R2	CS31003J916	RES CHIP 10K 1/10W +-5%(0603) GP
R384	CS14703J916	RES CHIP 470 1/10W+-5%(0603) GP	R6	CS31003J916	RES CHIP 10K 1/10W +-5%(0603) GP

Recommended Spare Part List

R13	CS31003J916	RES CHIP 10K 1/10W +-5%(0603) GP	L18	CX16100K117	EMI FILTER FCH3216-100K(10UH 150MA) GP
R16	CS31003J916	RES CHIP 10K 1/10W +-5%(0603) GP	L19	CX16100K117	EMI FILTER FCH3216-100K(10UH 150MA) GP
R45	CS31003J916	RES CHIP 10K 1/10W +-5%(0603) GP	FB1	CX201209813	EMI FILT CHIP FBMA-11-201209-121A40 GP
R46	CS31003J916	RES CHIP 10K 1/10W +-5%(0603) GP	FB2	CX201209813	EMI FILT CHIP FBMA-11-201209-121A40 GP
R51	CS31003J916	RES CHIP 10K 1/10W +-5%(0603) GP	FB3	CX201209813	EMI FILT CHIP FBMA-11-201209-121A40 GP
R53	CS31003J916	RES CHIP 10K 1/10W +-5%(0603) GP	FB4	CX201209813	EMI FILT CHIP FBMA-11-201209-121A40 GP
R77	CS31003J916	RES CHIP 10K 1/10W +-5%(0603) GP	L1	CX201209813	EMI FILT CHIP FBMA-11-201209-121A40 GP
R85	CS31003J916	RES CHIP 10K 1/10W +-5%(0603) GP	L2	CX201209813	EMI FILT CHIP FBMA-11-201209-121A40 GP
R151	CS31003J916	RES CHIP 10K 1/10W +-5%(0603) GP	L3	CX201209813	EMI FILT CHIP FBMA-11-201209-121A40 GP
R155	CS31003J916	RES CHIP 10K 1/10W +-5%(0603) GP	L4	CX201209813	EMI FILT CHIP FBMA-11-201209-121A40 GP
R156	CS31003J916	RES CHIP 10K 1/10W +-5%(0603) GP	L5	CX201209813	EMI FILT CHIP FBMA-11-201209-121A40 GP
R183	CS31003J916	RES CHIP 10K 1/10W +-5%(0603) GP	L6	CX201209813	EMI FILT CHIP FBMA-11-201209-121A40 GP
R218	CS31003J916	RES CHIP 10K 1/10W +-5%(0603) GP	L7	CX201209813	EMI FILT CHIP FBMA-11-201209-121A40 GP
R242	CS31003J916	RES CHIP 10K 1/10W +-5%(0603) GP	L8	CX201209813	EMI FILT CHIP FBMA-11-201209-121A40 GP
R245	CS31003J916	RES CHIP 10K 1/10W +-5%(0603) GP	L12	CX201209813	EMI FILT CHIP FBMA-11-201209-121A40 GP
R246	CS31003J916	RES CHIP 10K 1/10W +-5%(0603) GP	L13	CX201209813	EMI FILT CHIP FBMA-11-201209-121A40 GP
R247	CS31003J916	RES CHIP 10K 1/10W +-5%(0603) GP	L14	CX201209813	EMI FILT CHIP FBMA-11-201209-121A40 GP
R251	CS31003J916	RES CHIP 10K 1/10W +-5%(0603) GP	L20	CX201209813	EMI FILT CHIP FBMA-11-201209-121A40 GP
R258	CS31003J916	RES CHIP 10K 1/10W +-5%(0603) GP	L21	CX201209813	EMI FILT CHIP FBMA-11-201209-121A40 GP
R265	CS31003J916	RES CHIP 10K 1/10W +-5%(0603) GP	L31	CX201209813	EMI FILT CHIP FBMA-11-201209-121A40 GP
R272	CS31003J916	RES CHIP 10K 1/10W +-5%(0603) GP	L32	CX201209813	EMI FILT CHIP FBMA-11-201209-121A40 GP
R276	CS31003J916	RES CHIP 10K 1/10W +-5%(0603) GP	L33	CX201209813	EMI FILT CHIP FBMA-11-201209-121A40 GP
R283	CS31003J916	RES CHIP 10K 1/10W +-5%(0603) GP	L35	CX201209813	EMI FILT CHIP FBMA-11-201209-121A40 GP
R299	CS31003J916	RES CHIP 10K 1/10W +-5%(0603) GP	L36	CX201209813	EMI FILT CHIP FBMA-11-201209-121A40 GP
R302	CS31003J916	RES CHIP 10K 1/10W +-5%(0603) GP	L37	CX201209813	EMI FILT CHIP FBMA-11-201209-121A40 GP
R332	CS31003J916	RES CHIP 10K 1/10W +-5%(0603) GP	L38	CX201209813	EMI FILT CHIP FBMA-11-201209-121A40 GP
R333	CS31003J916	RES CHIP 10K 1/10W +-5%(0603) GP	L39	CX201209813	EMI FILT CHIP FBMA-11-201209-121A40 GP
R334	CS31003J916	RES CHIP 10K 1/10W +-5%(0603) GP	L40	CX201209813	EMI FILT CHIP FBMA-11-201209-121A40 GP
R337	CS31003J916	RES CHIP 10K 1/10W +-5%(0603) GP	L41	CX201209813	EMI FILT CHIP FBMA-11-201209-121A40 GP
R398	CS32203F906	RES CHIP 22K 1/10W +-1%(0603) GP	L46	CX201209813	EMI FILT CHIP FBMA-11-201209-121A40 GP
R399	CS32203F906	RES CHIP 22K 1/10W +-1%(0603) GP	L49	CX201209813	EMI FILT CHIP FBMA-11-201209-121A40 GP
R181	CS33303J912	RES CHIP 33K 1/10W +-5%(0603) GP	L52	CX201209813	EMI FILT CHIP FBMA-11-201209-121A40 GP
R187	CS33303J912	RES CHIP 33K 1/10W +-5%(0603) GP	L53	CX201209813	EMI FILT CHIP FBMA-11-201209-121A40 GP
R188	CS33303J912	RES CHIP 33K 1/10W +-5%(0603) GP	L55	CX201209813	EMI FILT CHIP FBMA-11-201209-121A40 GP
R189	CS33303J912	RES CHIP 33K 1/10W +-5%(0603) GP	L56	CX201209813	EMI FILT CHIP FBMA-11-201209-121A40 GP
R190	CS33303J912	RES CHIP 33K 1/10W +-5%(0603) GP	L57	CX201209813	EMI FILT CHIP FBMA-11-201209-121A40 GP
R195	CS33303J912	RES CHIP 33K 1/10W +-5%(0603) GP	L58	CX201209813	EMI FILT CHIP FBMA-11-201209-121A40 GP
R196	CS33303J912	RES CHIP 33K 1/10W +-5%(0603) GP	L59	CX201209813	EMI FILT CHIP FBMA-11-201209-121A40 GP
R220	CS33303J912	RES CHIP 33K 1/10W +-5%(0603) GP	L60	CX201209813	EMI FILT CHIP FBMA-11-201209-121A40 GP
R386	CS33903F904	RES CHIP 39K 1/10W +-1% (0603) GP	L61	CX201209813	EMI FILT CHIP FBMA-11-201209-121A40 GP
R387	CS33903F904	RES CHIP 39K 1/10W +-1% (0603) GP	L62	CX201209813	EMI FILT CHIP FBMA-11-201209-121A40 GP
R11	CS34703J910	RES CHIP 47K 1/10W +-5%(0603) GP	L63	CX201209813	EMI FILT CHIP FBMA-11-201209-121A40 GP
R252	CS34703J910	RES CHIP 47K 1/10W +-5%(0603) GP	L64	CX201209813	EMI FILT CHIP FBMA-11-201209-121A40 GP
R259	CS34703J910	RES CHIP 47K 1/10W +-5%(0603) GP	L65	CX201209813	EMI FILT CHIP FBMA-11-201209-121A40 GP
R266	CS34703J910	RES CHIP 47K 1/10W +-5%(0603) GP	L75	CX201209813	EMI FILT CHIP FBMA-11-201209-121A40 GP
R273	CS34703J910	RES CHIP 47K 1/10W +-5%(0603) GP	C43	CH61002ME32	CAP CHIP 10UF 10V(+20%,Y5V,0805)GP
R241	CS41003J918	RES CHIP 100K 1/10W +-5%(0603) GP	C44	CH61002ME32	CAP CHIP 10UF 10V(+20%,Y5V,0805)GP
R326	CS41003J918	RES CHIP 100K 1/10W +-5%(0603) GP	C48	CH61002ME32	CAP CHIP 10UF 10V(+20%,Y5V,0805)GP
R243	CS42003J902	RES CHIP 200K 1/10W +-5%(0603) GP	C129	CH61002ME32	CAP CHIP 10UF 10V(+20%,Y5V,0805)GP
R249	CS42203J900	RES CHIP 220K 1/10W +-5%(0603) GP	C130	CH61002ME32	CAP CHIP 10UF 10V(+20%,Y5V,0805)GP
R261	CS42203J900	RES CHIP 220K 1/10W +-5%(0603) GP	C131	CH61002ME32	CAP CHIP 10UF 10V(+20%,Y5V,0805)GP
R262	CS42203J900	RES CHIP 220K 1/10W +-5%(0603) GP	C132	CH61002ME32	CAP CHIP 10UF 10V(+20%,Y5V,0805)GP
R274	CS42203J900	RES CHIP 220K 1/10W +-5%(0603) GP	C133	CH61002ME32	CAP CHIP 10UF 10V(+20%,Y5V,0805)GP
R413	DK100WFT002	FUSE SMD 1A 32V FAST(D603SEF100FM/32) GP	C134	CH61002ME32	CAP CHIP 10UF 10V(+20%,Y5V,0805)GP
L15	CX000300112	EMI FILT CHP FCM1608CF-300T06 30,0.6A GP	C228	CH61002ME32	CAP CHIP 10UF 10V(+20%,Y5V,0805)GP
L16	CX000300112	EMI FILT CHP FCM1608CF-300T06 30,0.6A GP	CE5	CH61002ME32	CAP CHIP 10UF 10V(+20%,Y5V,0805)GP
L17	CX000300112	EMI FILT CHP FCM1608CF-300T06 30,0.6A GP	C155	CH1186J9006	CAP CHIP 180P,50V(5%,NPO,0603)GP
L66	CX000300112	EMI FILT CHP FCM1608CF-300T06 30,0.6A GP	C161	CH1186J9006	CAP CHIP 180P,50V(5%,NPO,0603)GP
L67	CX000300112	EMI FILT CHP FCM1608CF-300T06 30,0.6A GP	C178	CH1186J9006	CAP CHIP 180P,50V(5%,NPO,0603)GP
L68	CX000300112	EMI FILT CHP FCM1608CF-300T06 30,0.6A GP	C184	CH1186J9006	CAP CHIP 180P,50V(5%,NPO,0603)GP
L69	CX000300112	EMI FILT CHP FCM1608CF-300T06 30,0.6A GP	L22	CX121T20006	EMI FILT CHP FBMA-11-160808-121T200MA GP
L70	CX000300112	EMI FILT CHP FCM1608CF-300T06 30,0.6A GP	L23	CX121T20006	EMI FILT CHP FBMA-11-160808-121T200MA GP
L71	CX000300112	EMI FILT CHP FCM1608CF-300T06 30,0.6A GP	L24	CX121T20006	EMI FILT CHP FBMA-11-160808-121T200MA GP
L73	CX000300112	EMI FILT CHP FCM1608CF-300T06 30,0.6A GP	L25	CX121T20006	EMI FILT CHP FBMA-11-160808-121T200MA GP
L74	CX000300112	EMI FILT CHP FCM1608CF-300T06 30,0.6A GP	L26	CX121T20006	EMI FILT CHP FBMA-11-160808-121T200MA GP

L27	CX121T20006	EMI FILT CHP FBMA-11-160808-121T200MA GP	CE37	CC610X6MD01	CAP EC 10U 50V(+/-20%.105C.5*11,5K)CXN GP
L28	CX121T20006	EMI FILT CHP FBMA-11-160808-121T200MA GP	CE50	CC610X6MD01	CAP EC 10U 50V(+/-20%.105C.5*11,5K)CXN GP
L29	CX121T20006	EMI FILT CHP FBMA-11-160808-121T200MA GP	CE51	CC610X6MD01	CAP EC 10U 50V(+/-20%.105C.5*11,5K)CXN GP
L30	CX121T20006	EMI FILT CHP FBMA-11-160808-121T200MA GP	CE135	CC610X6MD01	CAP EC 10U 50V(+/-20%.105C.5*11,5K)CXN GP
P1	DFHD19MR007	CONN SMD HDMI 19P MR(P0.5,H15.4) GP	CE136	CC610X6MD01	CAP EC 10U 50V(+/-20%.105C.5*11,5K)CXN GP
RN13	CJ075084309	RES ARRAY CHIP 75 1/16W(5%,8P4R)0603 GP	L42	CV52214KD05	IND DIP22UH+-10%1.4A(SL0912T-220K-1-N)GP
RN14	CJ075084309	RES ARRAY CHIP 75 1/16W(5%,8P4R)0603 GP	L43	CV52214KD05	IND DIP22UH+-10%1.4A(SL0912T-220K-1-N)GP
RN15	CJ075084309	RES ARRAY CHIP 75 1/16W(5%,8P4R)0603 GP	L44	CV52214KD05	IND DIP22UH+-10%1.4A(SL0912T-220K-1-N)GP
RN16	CJ075084309	RES ARRAY CHIP 75 1/16W(5%,8P4R)0603 GP	L45	CV52214KD05	IND DIP22UH+-10%1.4A(SL0912T-220K-1-N)GP
RN17	CJ075084309	RES ARRAY CHIP 75 1/16W(5%,8P4R)0603 GP	C143	CC647T4MD01	CAP EC 47U 25V(+/-20%.105C.5*11,3KHR) GP
RN18	CJ075084309	RES ARRAY CHIP 75 1/16W(5%,8P4R)0603 GP	CE3	CC647T4MD01	CAP EC 47U 25V(+/-20%.105C.5*11,3KHR) GP
RN19	CJ075084309	RES ARRAY CHIP 75 1/16W(5%,8P4R)0603 GP	CE9	CC647T4MD01	CAP EC 47U 25V(+/-20%.105C.5*11,3KHR) GP
RN20	CJ075084309	RES ARRAY CHIP 75 1/16W(5%,8P4R)0603 GP	CE10	CC647T4MD01	CAP EC 47U 25V(+/-20%.105C.5*11,3KHR) GP
R15	CS32003J919	RES CHIP 20K 1/10W +-5%(0603) GP	CE11	CC647T4MD01	CAP EC 47U 25V(+/-20%.105C.5*11,3KHR) GP
R33	CS55603J904	RES CHIP 5.6M 1/10W+-5%(0603)GP	CE11	CC647T4MD01	CAP EC 47U 25V(+/-20%.105C.5*11,3KHR) GP
U9	AJ8201A0F04	IC(256P)MT8201ALE/B-L(QFP) GP	CE6	CC710T3MD12	CAP EC 100U 16V(+/-20%.105C.6*11,3KHR) GP
U11	AKE25FHKZ08	IC(48P) FLASH MX29LV160CBTC-70G(TSOP)GP	CE7	CC710T3MD12	CAP EC 100U 16V(+/-20%.105C.6*11,3KHR) GP
U11	AKE268AKK03	IC(48P) FLASH SST39VF1681-70-4C-EKE GP	CE22	CC710T3MD12	CAP EC 100U 16V(+/-20%.105C.6*11,3KHR) GP
U15	AJ8293A#F06	IC(128P) MT8293ALE-L(QFP) GP	CE43	CC710T3MD12	CAP EC 100U 16V(+/-20%.105C.6*11,3KHR) GP
U19	AJ8291E0F09	IC(48P)MT8291E-L(QFP) GP	C149	CC733X3MD11	CAP EC 330U 16V(+/-20%.105C.8*11.5,8K)CXNGP
U22	AJ098100009	IC(32P)CLASSDAMP TFA9810(2*12W)SOT287 GP	C150	CC733X3MD11	CAP EC 330U 16V(+/-20%.105C.8*11.5,8K)CXNGP
U27	AL002996C00	IC(8P) LP2996MX (SOP8) GP	CE1	CC733X3MD11	CAP EC 330U 16V(+/-20%.105C.8*11.5,8K)CXNGP
U28	AKD3NF^K+02	IC(66P)DDR SDR M13S128168A -5TG(TSOP)GP	CE2	CC733X3MD11	CAP EC 330U 16V(+/-20%.105C.8*11.5,8K)CXNGP
D53	BCAN217T003	DIODE DAN217(80V,100MA) GP	CE8	CC733X3MD11	CAP EC 330U 16V(+/-20%.105C.8*11.5,8K)CXNGP
D57	BCAN217T003	DIODE DAN217(80V,100MA) GP	CE12	CC733X3MD11	CAP EC 330U 16V(+/-20%.105C.8*11.5,8K)CXNGP
R25	CS12003F913	RES CHIP 200 1/10W+-1%(0603) GP	CE13	CC733X3MD11	CAP EC 330U 16V(+/-20%.105C.8*11.5,8K)CXNGP
R27	CS12003F913	RES CHIP 200 1/10W+-1%(0603) GP	CE14	CC733X3MD11	CAP EC 330U 16V(+/-20%.105C.8*11.5,8K)CXNGP
R29	CS12003F913	RES CHIP 200 1/10W+-1%(0603) GP	CE15	CC733X3MD11	CAP EC 330U 16V(+/-20%.105C.8*11.5,8K)CXNGP
R31	CS12003F913	RES CHIP 200 1/10W+-1%(0603) GP	CE18	CC733X3MD11	CAP EC 330U 16V(+/-20%.105C.8*11.5,8K)CXNGP
R295	CS12003F913	RES CHIP 200 1/10W+-1%(0603) GP	CE30	CC733X3MD11	CAP EC 330U 16V(+/-20%.105C.8*11.5,8K)CXNGP
R339	CS12003F913	RES CHIP 200 1/10W+-1%(0603) GP	CE31	CC733X3MD11	CAP EC 330U 16V(+/-20%.105C.8*11.5,8K)CXNGP
U30	AL003157107	IC(6P) NC7S83157P6X_NL SC70 GP	CE32	CC733X3MD11	CAP EC 330U 16V(+/-20%.105C.8*11.5,8K)CXNGP
Y1	BG627000009	XTAL DIP 27.0MHZ(+/-20PPM,HC-49/S) GP	CE39	CC733X3MD11	CAP EC 330U 16V(+/-20%.105C.8*11.5,8K)CXNGP
C8	CC547T3MD04	CAP EC 4.7U 16V(+/-20%.105C.5*11,3KHR) GP	CE40	CC733X3MD11	CAP EC 330U 16V(+/-20%.105C.8*11.5,8K)CXNGP
C18	CC547T3MD04	CAP EC 4.7U 16V(+/-20%.105C.5*11,3KHR) GP	CE41	CC733X3MD11	CAP EC 330U 16V(+/-20%.105C.8*11.5,8K)CXNGP
C19	CC547T3MD04	CAP EC 4.7U 16V(+/-20%.105C.5*11,3KHR) GP	CE42	CC733X3MD11	CAP EC 330U 16V(+/-20%.105C.8*11.5,8K)CXNGP
C45	CC547T3MD04	CAP EC 4.7U 16V(+/-20%.105C.5*11,3KHR) GP	CE47	CC733X3MD11	CAP EC 330U 16V(+/-20%.105C.8*11.5,8K)CXNGP
C49	CC547T3MD04	CAP EC 4.7U 16V(+/-20%.105C.5*11,3KHR) GP	CE49	CC733X3MD11	CAP EC 330U 16V(+/-20%.105C.8*11.5,8K)CXNGP
C50	CC547T3MD04	CAP EC 4.7U 16V(+/-20%.105C.5*11,3KHR) GP	CE52	CC733X3MD11	CAP EC 330U 16V(+/-20%.105C.8*11.5,8K)CXNGP
C3	CC610X6MD01	CAP EC 10U 50V(+/-20%.105C.5*11,5K)CXN GP	CE54	CC733X3MD11	CAP EC 330U 16V(+/-20%.105C.8*11.5,8K)CXNGP
C6	CC610X6MD01	CAP EC 10U 50V(+/-20%.105C.5*11,5K)CXN GP	CE55	CC733X3MD11	CAP EC 330U 16V(+/-20%.105C.8*11.5,8K)CXNGP
C9	CC610X6MD01	CAP EC 10U 50V(+/-20%.105C.5*11,5K)CXN GP	P2	DFDS15FR092	CONN D-SUB 15P 3R FR(P1.15,H12.5)MINI GP
C10	CC610X6MD01	CAP EC 10U 50V(+/-20%.105C.5*11,5K)CXN GP	CON1	DFHD03MS029	CONN DIP HEADER 3P 1R MS(P2.0,H6) GP
C12	CC610X6MD01	CAP EC 10U 50V(+/-20%.105C.5*11,5K)CXN GP	CON2	DFHD04MR132	CONN DIP HEADER 4P 1R MR(P2.0,H4.1) GP
C15	CC610X6MD01	CAP EC 10U 50V(+/-20%.105C.5*11,5K)CXN GP	CN4	DFHD05MR641	CONN DIP HEADER 5P 1R MR(P2.0,H5.1) GP
C20	CC610X6MD01	CAP EC 10U 50V(+/-20%.105C.5*11,5K)CXN GP	J1	DFHD10MR324	CONN DIP HEADER 10P 1R MR(P2.0,H4.1) GP
C21	CC610X6MD01	CAP EC 10U 50V(+/-20%.105C.5*11,5K)CXN GP	CN1	DFHD10MS029	CONN DIP HEADER 10P 1R MS(P2.5,H5.75) GP
C23	CC610X6MD01	CAP EC 10U 50V(+/-20%.105C.5*11,5K)CXN GP	CN3	DFHD30MS042	CONN DIP HEADER 30P 2R MS(P2.0,H3.9) GP
C26	CC610X6MD01	CAP EC 10U 50V(+/-20%.105C.5*11,5K)CXN GP	CN2	DFRC10FR008	CONN RCA(YWR)+S(2*2)FR 10P(P14,H27)GP
C30	CC610X6MD01	CAP EC 10U 50V(+/-20%.105C.5*11,5K)CXN GP	AJ1	DFTJ05FR126	CONN DIP PHONE JACK 5P FR GP
C31	CC610X6MD01	CAP EC 10U 50V(+/-20%.105C.5*11,5K)CXN GP	U18	DR01216BD06	TUNER(DIP)FQ1216ME/TH-5(IEC-TYPE) GP
C33	CC610X6MD01	CAP EC 10U 50V(+/-20%.105C.5*11,5K)CXN GP	P3	DFSC21FR008	CONN DIP SCART 21P 2R FR(P3.81,H17) GP
C36	CC610X6MD01	CAP EC 10U 50V(+/-20%.105C.5*11,5K)CXN GP	C263	CC633T4MD04	CAP EC DIP 33U 25V(+/-20%.105C.5*11) GP
C39	CC610X6MD01	CAP EC 10U 50V(+/-20%.105C.5*11,5K)CXN GP	CE24	CC633T4MD04	CAP EC DIP 33U 25V(+/-20%.105C.5*11) GP
C41	CC610X6MD01	CAP EC 10U 50V(+/-20%.105C.5*11,5K)CXN GP	PJ1	DFTJ08FR006	CONN DIP PHONE JACK 8P +RCA FR GP
C137	CC610X6MD01	CAP EC 10U 50V(+/-20%.105C.5*11,5K)CXN GP	U9	AZHDCP00004	HDCP KEY
C233	CC610X6MD01	CAP EC 10U 50V(+/-20%.105C.5*11,5K)CXN GP		FBL7ZA05018	HEAT SINK L7ZA(FBL7ZA05, REV3A)GP
CE4	CC610X6MD01	CAP EC 10U 50V(+/-20%.105C.5*11,5K)CXN GP		FBL7ZA05	HEAT SINK
CE17	CC610X6MD01	CAP EC 10U 50V(+/-20%.105C.5*11,5K)CXN GP			
CE20	CC610X6MD01	CAP EC 10U 50V(+/-20%.105C.5*11,5K)CXN GP			
CE23	CC610X6MD01	CAP EC 10U 50V(+/-20%.105C.5*11,5K)CXN GP			
CE25	CC610X6MD01	CAP EC 10U 50V(+/-20%.105C.5*11,5K)CXN GP			
CE28	CC610X6MD01	CAP EC 10U 50V(+/-20%.105C.5*11,5K)CXN GP			
CE29	CC610X6MD01	CAP EC 10U 50V(+/-20%.105C.5*11,5K)CXN GP			
CE35	CC610X6MD01	CAP EC 10U 50V(+/-20%.105C.5*11,5K)CXN GP			

>> BUTTON BOARD ASSY

	10S9T0BB006	S9Q BUTTON/B ASSY GP
	S9Q203-02	S9Q 23S9Q0BB008 BUTTON/B BOM Schematic(A1A)
	DAS9Q0TB021	PCB(BUTTON/B) S9Q TB(1L,120*10 REV) GP
	S9Q205-03	DAS9Q0TB021 S9Q BUTTON/B Gerber file & Board File
CN1	DFHD08MR335	CONN DIP HEADER 8P 1R MR(P1.5,H4.1)GP
SW1	DHP00TSAB11	SWITCH PU-BUTTON(TSAB-2L,50MA,12)GP
SW2	DHP00TSAB11	SWITCH PU-BUTTON(TSAB-2L,50MA,12)GP
SW3	DHP00TSAB11	SWITCH PU-BUTTON(TSAB-2L,50MA,12)GP
SW4	DHP00TSAB11	SWITCH PU-BUTTON(TSAB-2L,50MA,12)GP
SW5	DHP00TSAB11	SWITCH PU-BUTTON(TSAB-2L,50MA,12)GP
SW6	DHP00TSAB11	SWITCH PU-BUTTON(TSAB-2L,50MA,12)GP
SW7	DHP00TSAB11	SWITCH PU-BUTTON(TSAB-2L,50MA,12)GP

Recommended Spare Part List

>> LED BOARD ASSY

10E9P0LB006	E9P LED/B ASSY(E9P-PT) GP
E9P203-01	23E9P0LE008 E9P-PT LED/B Schematic(A2A)
DAE9P0LE014	PCB(LED/B) E9P LED/B(1L,40*36 REV A) GP
E9P205-01	DAE9P0LE014 E9P PCB LED/B(Gerber file & Board File)
LED1	BEYG0004DA4 LED(DIP) Y/G(BHP-1L0392Y1G12MC001) GP
LED1	BEYG0014DA0 LED(DIP) YELLOW/GREEN(L-3WYGW-F01) GP
SEN1	BEBK0002DR1 LED DIP(3P) IR RECIVER TSOP34838LL1 GP
CN1	DFHD05MR641 CONN DIP HEADER 5P 1R MR(P2.0,H5.1) GP

>> PWR BOARD ASSY

AS56B42CA06	PI 100-240V 55W 4L(140*150)AIP-0169 GP
AS56B42TA04	PI 100-240V 55W 4L(140*150)TBD432AR-1 GP

>> LCD MODULE ASSY

24E9P0LA003	E9P LCD MODULE ASSY
34E9P0LB000	E9P LCD BEZEL SUB ASSY GP
EAE9P002014	LCD BEZEL E9P(EAE9P002,REV3A)GP
EBE9P001019	LENS E9P(EBE9P001,REV3A) GP
EBE9P002015	FUNCTION BUTTON E9P(EBE9P002,REV3A) GP
GBE9T005019	PANEL SPONGE E9T (GBE9T005,R3A)420*7 GP
GBE9T005	PANEL SPONGE
GBS9Q003011	PANEL SPONGE S9Q(GBS9Q03,3A)260*6*0.7 GP
GBS9Q003	PANEL SPONGE
35E9P0LS009	E9P LCD COVER SUB ASSY GP
EAE9P001018	LCD COVER E9P(EAE9P001,REV3A) GP
EAE9P003011	BASE E9P(EAE9P003,REV3A)GP
FAS9Q005012	BASE BKT S9Q(FAS9Q005,REV3A)GP
FAS9Q005	BASE BKT
FAS9Q006019	BASE PLATE S9Q(FAS9Q006,REV3A)GP
FAS9Q006	BASE PLATE
GBE9T004012	COVER SPONGE E9T(GBE9T004,R3A) 80*15 GP
GBE9T004	COVER SPONGE
GAE9P001018	BASE RUBBER CIRCLE E9P(GAE9P001,REV3A)GP
GAE9P001	BASE RUBBER CIRCLE
MM40060IL69	SCREW M4*6-I (BNI)(NYLOK))GP
MF40080IJ23	SCREW F4.0*8-I (BNI) GP
MM30040B247	SCREW M3.0*4.0-B BLACK(NYLOK)GP
GBE9T003016	COVER SPONGE E9T(GBE9T003,R3A) 8*30 GP
GBE9T003	COVER SPONGE
36E9P0PS006	E9P PCB SHIELDING ASSY GP
36E9P000	PCB SHIELDING ASSY
FAE9T001012	PCB SHIELDING E9T-PV(FAE9T001,REV3A)GP
FAE9T001	PCB SHIELDING
GBE9T001013	SHIELDINGSPONGE E9T(GBE9T001,3A)94*7.5GP
GBE9T001	SHIELDING SPONGE
DND8508S006	SPEAKER(8,5W, 77*42*24) L32,P60 P2 GP
DD0E9TBU002	CABLE E9T-PV MB-BUTTON(10P/8P,700MM) GP
DD0E9TPB001	CABLE E9T-PV POWER-MB(10P/10P,80MM) GP
DDWBTBLC005	CABLE LVDS(10P,150MM)WBTTB GP
DD0E9TIR005	CABLE E9T-PV MB-IR(5P/5P,350MM) GP

>> MISCELLANEOUS ASSY

27E9P0MA001	E9P MISCELLANEOUS ASSY GP
FBE9P001019	PANEL HOOK E9P(FBE9P001,REV3A)GP
FBE9P001	PANEL HOOK

>> SCREW KIT ASSY

29E9P0SK001	E9P SCREW KIT ASSY GP
MM30050IBJ3	SCREW M3.0*5.0-I(NI) GP
MF25060PBN0	SCREW F2.5*6-P(NI,WASHER) GP
MF30060BBJ6	SCREW F3.0*6-B(NI)GP
MBLI1004018	IO NUT LI1(MBLI1004,REV3A)GP
MBLI1004	IO NUT LI1
MM40080BBW1	SCREW M4.0*8.0-B(NI,WASHER)GP
MF40100BJ26	SCREW F4.0*10-B(BLACK) GP
MF30100PJ23	SCREW F3*10,(BNI) GP
MM30040IBJ9	SCREW M3.0*4.0-I(NI) GP
MM30050BBJ9	SCREW M3*5-B-NI-+ GP

>> PANEL KIT ASSY

2AE9P0PTM00	E9T-PV PANEL KIT ASSY(CMO,5MS)GP
AA0190A1084	LCD 19" M190A1-L07 (1440*900,5MS)GP
AZE9P0BM007	E9P-PT SW BIOS IMAGE(MT8201 CMO PAL-EU)
AZE9P0EM003	E9P-PT D-SUB EDID IMAGE CMO
AZE9P0HM000	E9P-PT HDMI EDID IMAGE(CMO)
FAE9T002019	LCD BKT LEFT E9T-PV(FAE9T002,REV3B)GP
FAE9T002	LCD BKT LEFT
FAE9T003015	LCD BKT RIGHT E9T-PV(FAE9T003,REV3C)GP
FAE9T003	LCD BKT RIGHT
FCL9V005015	AL FOIL L9VDQ-4(FCL9V005,R3A)100*80 GP
FCL9V005	AL FOIL 100*80
FCM7T004014	AL FOIL M7T(FCM7T004,REV3A) GP
FCM7T004	AL FOIL M7T

>> PACKING ASSY

28E9P0PK003	E9P-PV PACKING ASSY GP
HAL0T002019	PE BAG L0T(HAL0T002,REV3A)GP
HAL0T002	PE BAG
HBE9P001019	END CAP-L E9P(HBE9P001,REV3A)GP
HBE9P002015	END CAP-R E9P(HBE9P002,REV3A)GP
HCLM5013016	TRAVEL CARD LM5A(HCLM5013,REV3A) GP
HCLM5013	TRAVEL CARD
HCE9P001010	RATING LABEL E9P(HCE9P001,R3A)GP
HCE9P001	RATING LABEL
HCW0ZR03014	CARTON LABEL W0ZR(HCW0ZR03,REV3A)GP
HCW0ZR03	CARTON LABEL
HDE9P001011	MANUAL+QSG E9P(HDE9P001,R3A)GP
HFE9P001012	CARTON E9P(HFE9P001,R3A)GP
HFE9P002019	SPACE PLATE E9P(HFE9P002,3A)1140*990 GP
JXL7ZI04019	TYPE L7ZI-A1(JXL7ZI04,REV3A)(72MM) GP
JXW9ZA01019	LCD FILM W9ZA(JXW9ZA01,REV3B)GP
JXW9ZA01	LCD FILM
HAS0Q001012	PE BAG S0Q(HAS0Q001,R3A)GP
HAS0Q001	PE BAG
HCL70021011	HI-POT LABEL L70L(HCL70021,REV3A)GP
HCL70021	HI-POT LABEL
AHDALR03006	BATTERY LR03GW/2SK (ALKALINE 1.5V) GP
AHDALR03120	BATTERY LR03(SN) (ALKALINE,1.5V) GP
DD0L0TPC007	CABLE AUDIO(ST,1.8M)BLACK LOT GP
DD0L7WPC001	CABLE MB-VGA(15P,1.8M)L7E BLACK 5.5 GP
DM333181801	PWR CORD B 1.8M SP-023/16A CT-12 EUR GP
DQ731880108	REMOTE CONTROLLER(318801-0958001A) GP
HCW0ZR04011	ENERGY START STICKER W0ZR(HCW0ZR04,3A)GP
HCW0ZR04	ENERGY START STICKER
HFW0ZR22011	PAPER BOARD1135*985W0ZR(HFW0ZR22,R3A)GP
JXW9C001017	HANDLE UPPER W9C-B1(JXW9C001,REV3A)GP
JXW9C001	HANDLE UPPER
JXW9C002013	HANDLE DOWN W9C-B1(JXW9C002,REV3A)GP
JXW9C002	HANDLE DOWN

General Trouble Shooting Guide

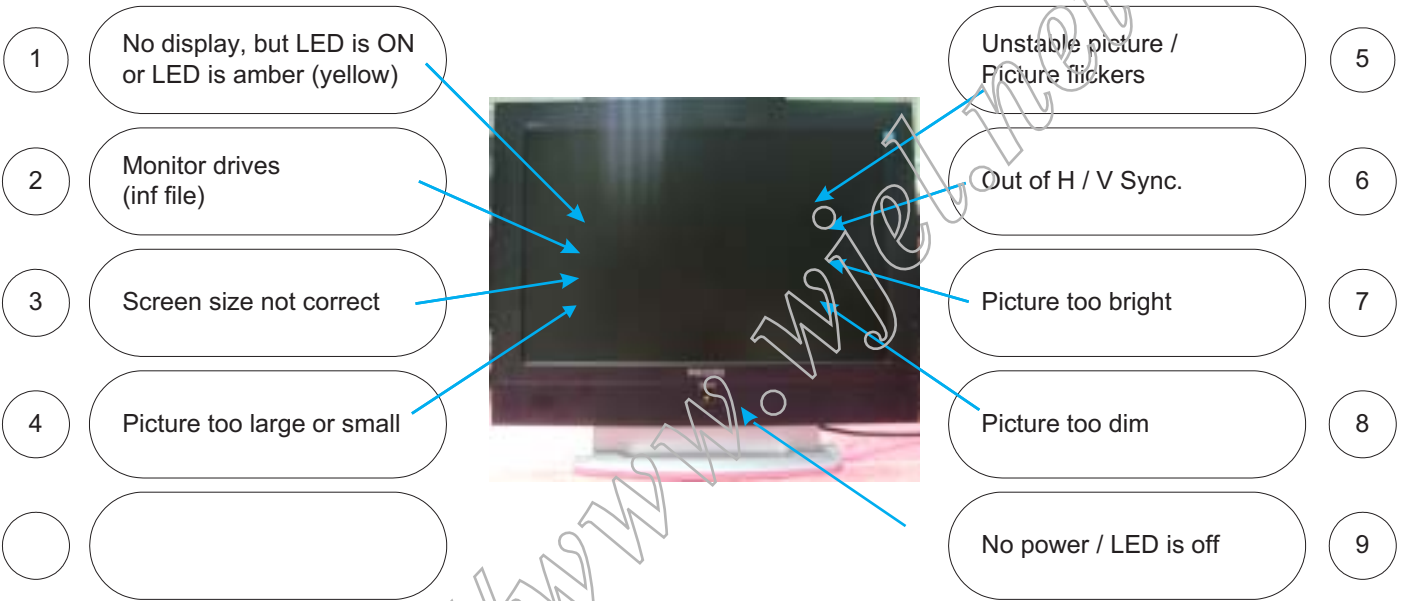

General Trouble Shooting Guide

1

No display, but LED is ON
or LED is amber (yellow)

Check point:

1. Click your mouse or type some word with your keyboard to wake up computer from saving status.
2. Check that your video cable is plugged in and does not have bent pins.

LED Amber or Green?

Continued

Note:

Do not set screen saver – at “14” minutes.
It will cause “ no display” problem as above mentioned.

Action: Change timer setting of screen saver or disable screen saver.

<http://www.wjel.net>

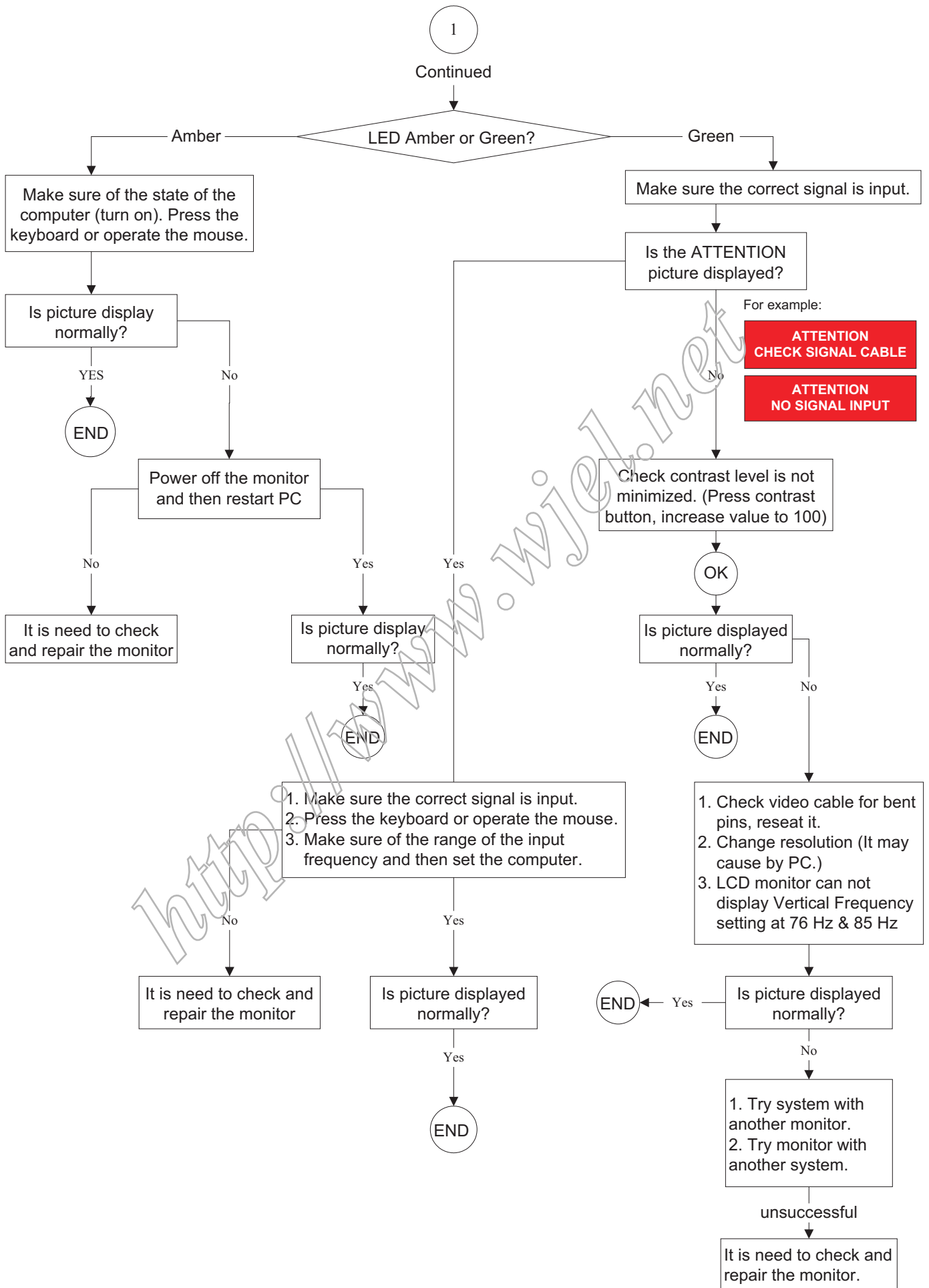

General Trouble Shooting Guide

2

Monitor drivers (inf file)

FOR WINDOWS 95/98/2000/ME OR LATER

Philips's monitors build in VESA DDC2B feature to support Plug & Play requirement for Windows 95/98/2000/Me. You can install the information file(.inf) in order to select your Philips monitor from "Monitor" dialog box in Windows 95/98/2000/Me to activate Plug & Play application. The installation procedure based on Windows 95 OEM Release 2, 98, Me and 2000 is specified as follows, (in case of connecting the monitor to the PC compliant with VESA standard with the designated signal cable, the PC reads display pixels, frequency and color feature of this monitor to optimize the picture for the monitor automatically.)
DDC: Abbreviation for Display Data Channel

**** Windows NT 4.0 does not require driver (inf file) for monitor.****

For Windows 95

For Windows 95 drivers, your monitor is listed under manufacture name "Philips Business Electronics Co."

1. Start Windows 95
2. Click the 'Start' button, point to 'setting', and then click 'control panel'.
3. Double click the 'display' icon.
4. Choose the 'setting' tab then click 'advanced...'
5. Choose 'monitor' button, point to 'change...' then click 'have disk...'
6. Click 'browse...' button then choose the appropriate drive F:(CD-ROM Drive) then click 'ok' button.
7. Click the 'ok' button then choose your monitor model and click the 'ok'.
8. Click 'close' button.

For Windows 98

For Windows 98 drivers, our monitors are listed under 2 manufactures name "Philips", and "Philips Consumer Electronics Co." Please select "Philips" when you would like to set up your monitor in Windows setting, if you can not find the right model name just as the label indication on the back of set. For those set that have been issued since the release of Window 98, drivers can be found in CD-ROM under the directory path of "\pc\driver\" or it may be downloaded at <http://www.philips.com>. Once you have installed the new driver, Windows will add a new manufacture name "Philips Business Electronics" in your system.

1. Start Windows 98
2. Click the 'Start' button, point to 'setting', and then click 'control panel'.
3. Double click the 'display' icon.
4. Choose the 'setting' tab then click 'advanced...'
5. Choose 'monitor' button, point to 'change...' then click 'next'.
6. Choose 'display a list of all the drivers in a specify location, so you can select the driver you want', then click 'next' and then click 'have disk...'
7. Click 'browse...' button then choose the appropriate drive F: (RD-ROM Drive) then click 'ok' button.
8. Click the 'ok' button then choose your monitor model and click the 'next' button.
9. Click 'finish' button then click 'close' button.

For Window Me

1. Start Window Me
2. Click the 'start' button, point to 'setting', and then click 'control panel'.
3. Double click the 'display' icon.
4. Choose the 'setting' tab then click 'advanced...'
5. Choose 'monitor' button, then click 'change...'
6. Choose 'specify the location of the driver (advanced)' and click the 'next' button.
7. Choose 'display a list of all the drivers in a specific location, so you can select the driver you want', then click 'next' and then click 'have disk...'
8. Click 'browse...' button then choose the appropriate drive F: (CD-ROM Drive) then click 'ok' button.
9. Click the 'ok' button then choose your monitor model and click the 'next' button.
10. Click 'finish' button then click 'close' button.

For Windows 2000

1. Start Windows 2000
2. Click the 'start' button, point to 'setting', and then click 'control panel'.
3. Double click the 'display' icon.
4. Choose the 'setting' tab then click 'advanced...'
5. Choose 'monitor';
- If the 'properties' button is inactive, it means your monitor is properly configured. Please stop installation.
- If the 'properties' button is active, click 'properties' button.
6. Click 'driver' and then click on 'update driver...' then click on the 'next' button.
7. Choose 'display a list of the known drivers for this device so that I can choose a specific driver' then click 'next' and then click 'have disk...'
8. Click 'browse...' button then choose the appropriate drive F: (CD-ROM Drive).
9. Click the 'open' button then click the 'ok' button.
10. Choose your monitor model and click the 'next' button.
11. Click 'finish' button and then click the 'close' button. If you can see the 'digital signature not found' window then click the 'yes' button.

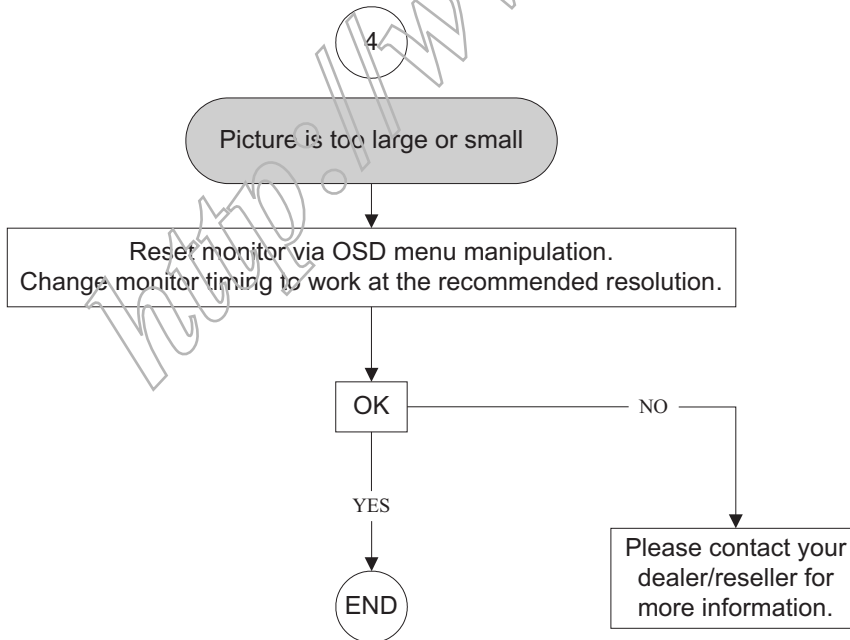
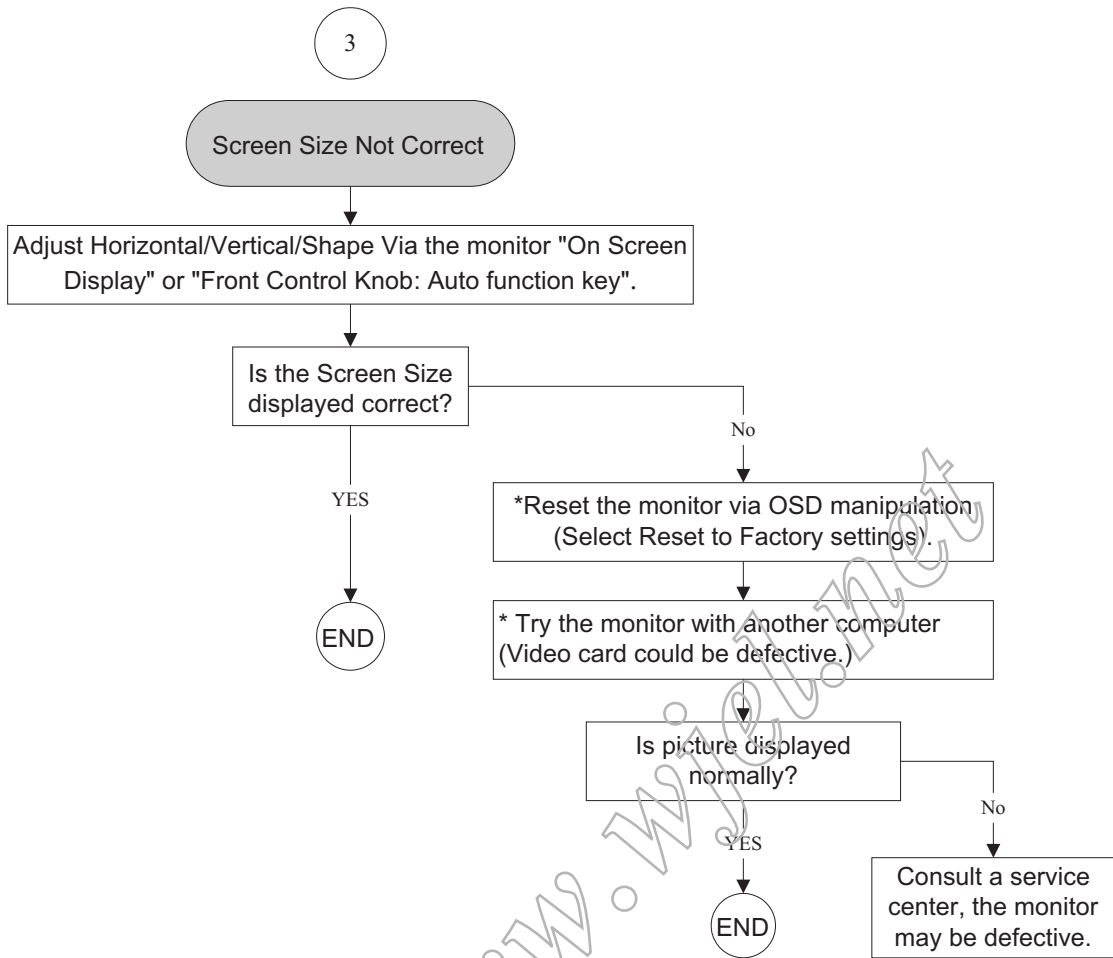

General Trouble Shooting Guide

6

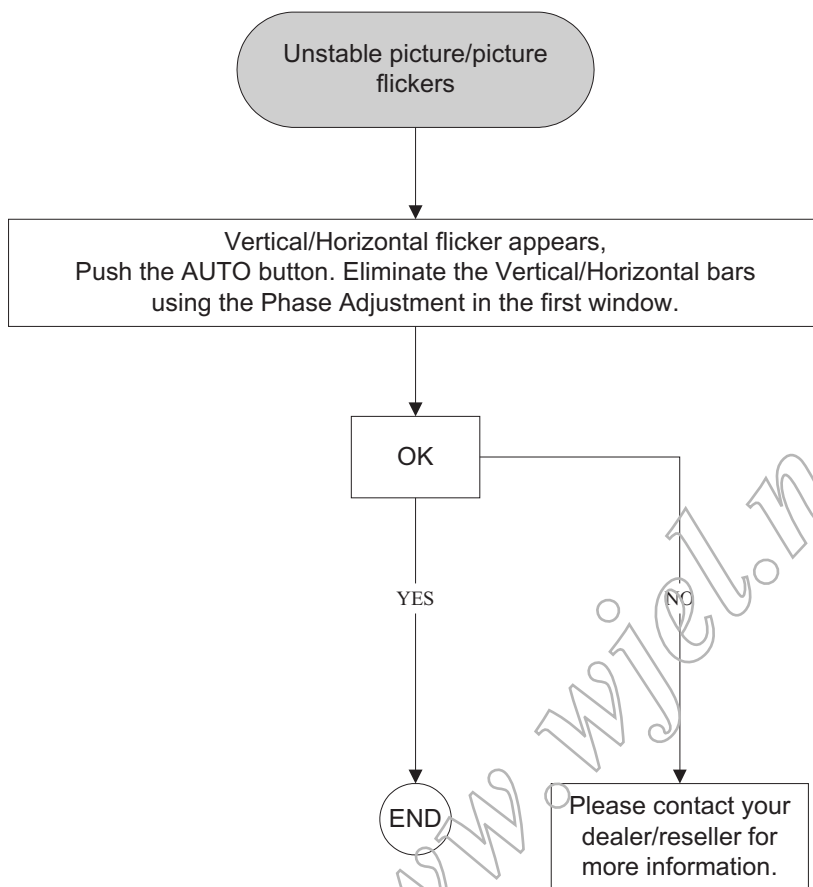

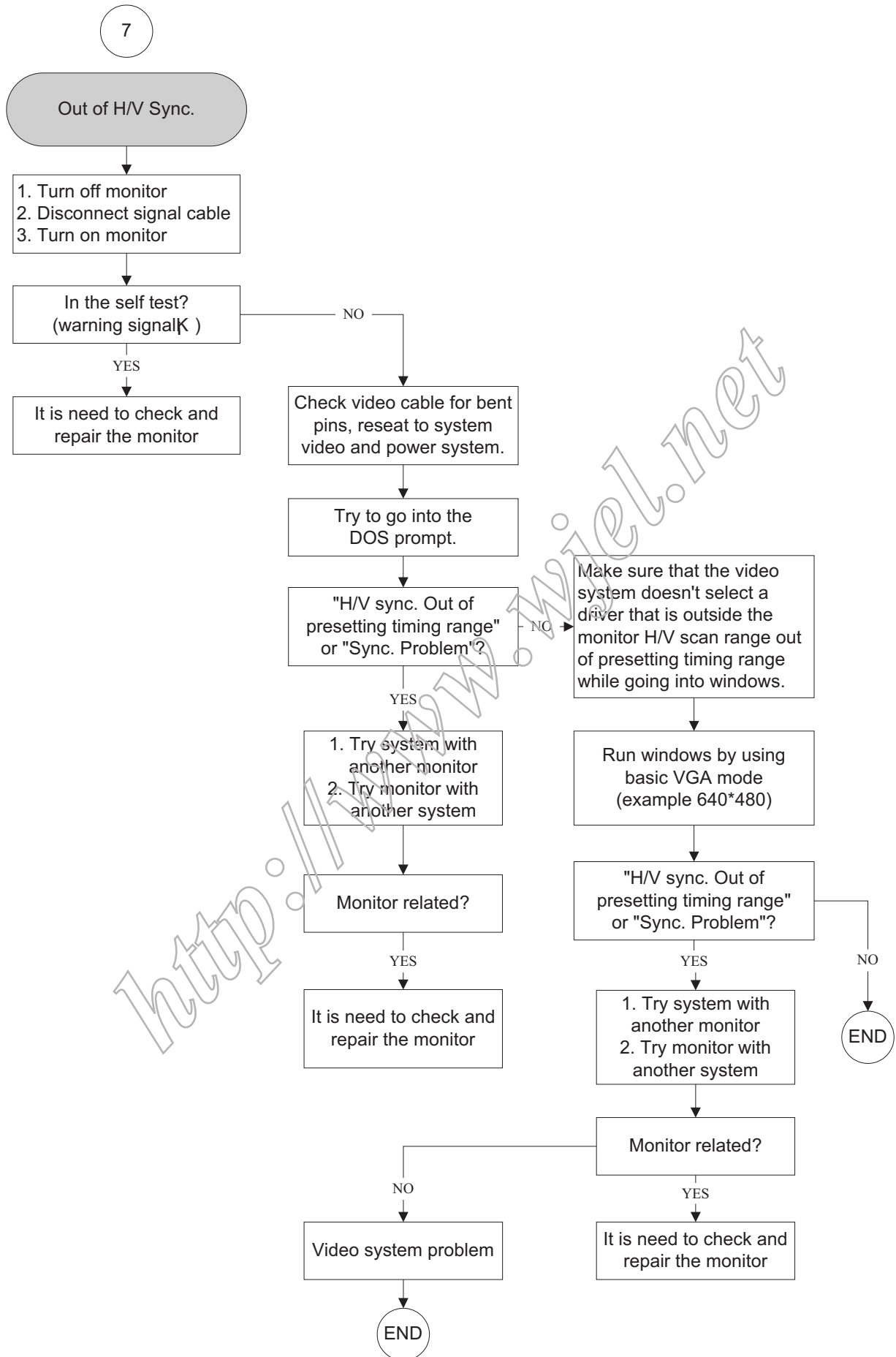

General Trouble Shooting Guide

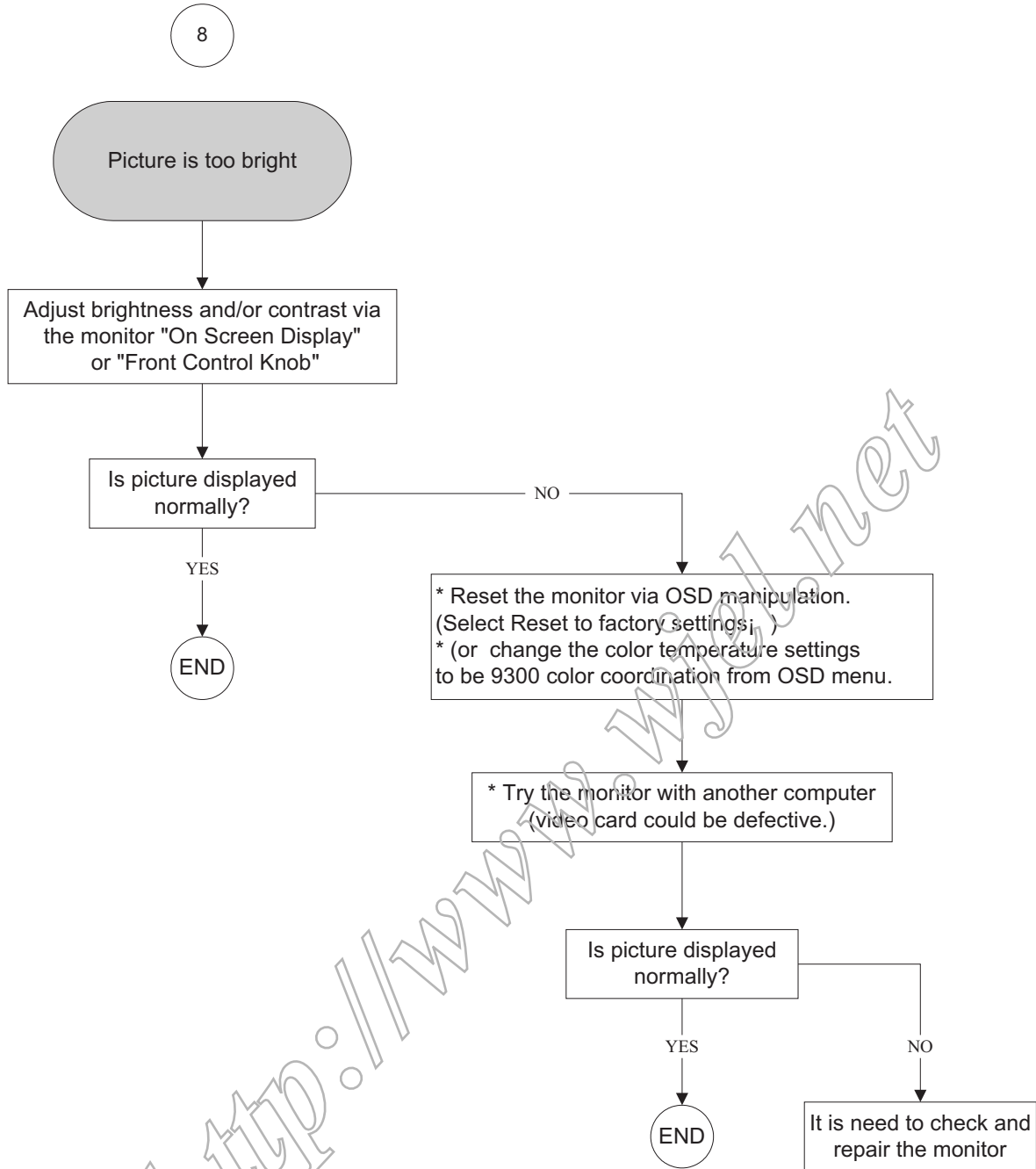

9

Picture is too dim

Adjust brightness and/or contrast via the monitor "On Screen Display" or "Front Control Knob".

Is picture displayed normally?

YES

END

Is an external Anti-Glare screen (like protective cover, touch screen...etc) being used?

Remove any external Anti-Glare screen

Is picture displayed normally?

YES

END

Note:

1. Sun light passing through a window is much brighter than monitor luminance (luminance is the measurable quantity which most closely corresponds to brightness), therefore the two worst places for a monitor is directly facing the window or directly behind the window. Position the monitor away from these two areas.

* Reset the monitor via OSD manipulation. (select Reset to factory settings)
* (or change the color temperature settings to be 9300 color coordination from OSD menu)

* Try the monitor with another computer (video card could be defective)

Is picture displayed normally?

YES

END

NO

It is need to check and repair the monitor

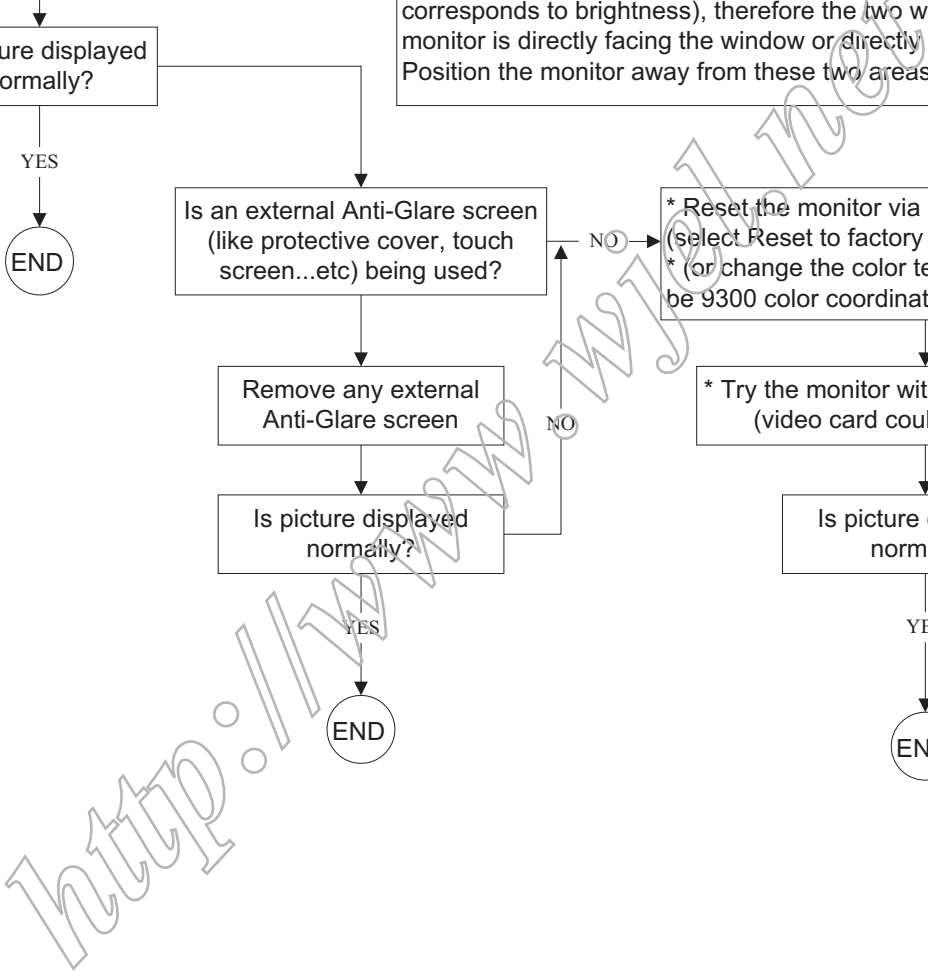

General Trouble Shooting Guide

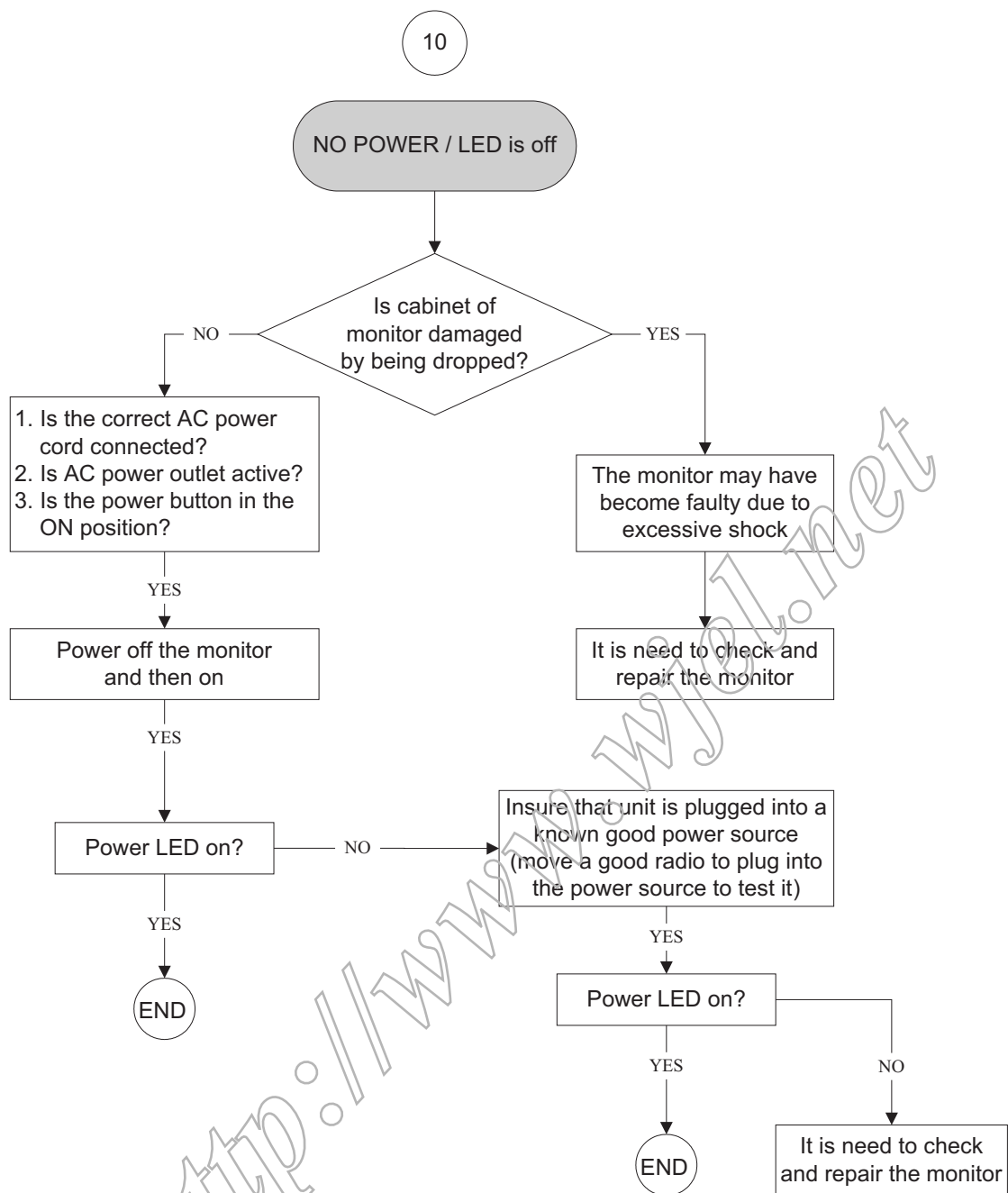

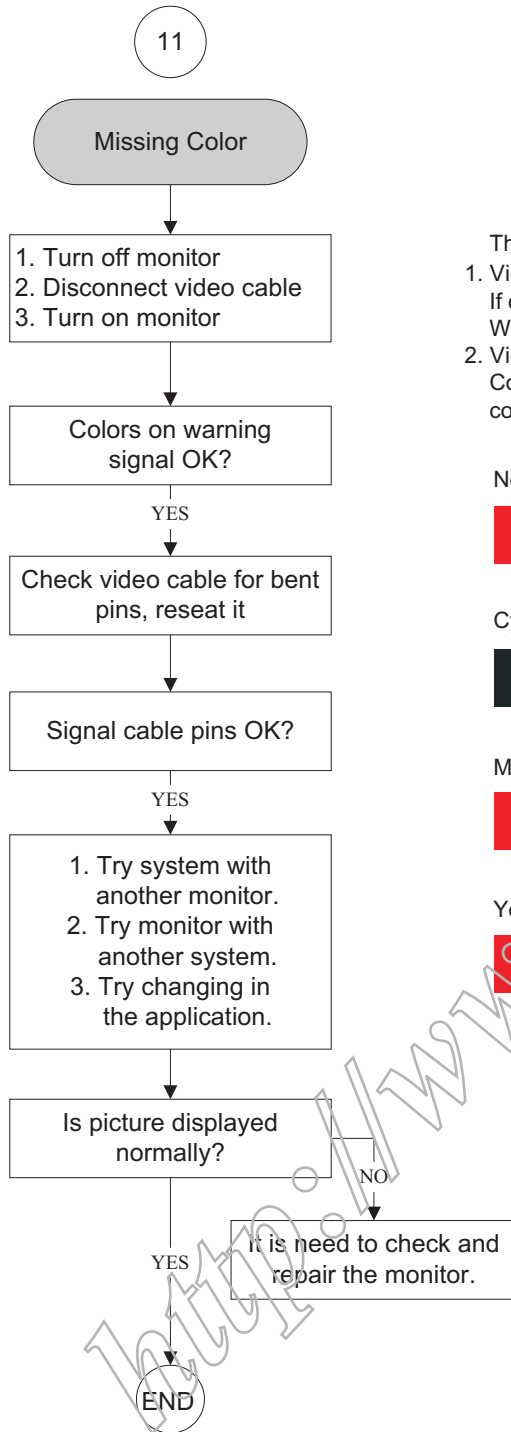

There are 2 easy ways to determine the Missing color problem.

1. View an image that is supposed to be "White".
If one of the colors (RGB) is not functioning, White can not be produced.
2. View an image that supposed to contain Red, Green and Blue.
Color problems will be apparent when one or more of these colors can not be displayed.

Normal White:



Cyan Color means that the red sub pixel is missing.



Magenta or Purple Color means that the green sub pixel is missing.



Yellow Color means that the blue sub pixel is missing.



General Trouble Shooting Guide

12

OSD MAIN MENU LOCKED

Press and hold the OSD menu key for about 10 seconds, until picture displays "OSD MAIN MENU UNLOCKED".

OK

YES

END

NO

Please contact your dealer/reseller for more information

<http://www.wjw.net>

12

OSD MAIN MENU LOCKED

Press and hold the OSD menu key for about 10 seconds, until picture displays "OSD MAIN MENU UNLOCKED".

OK

YES

NO

END

Please contact your dealer/reseller for more information

<http://www.wjcm.net>

General Trouble Shooting Guide

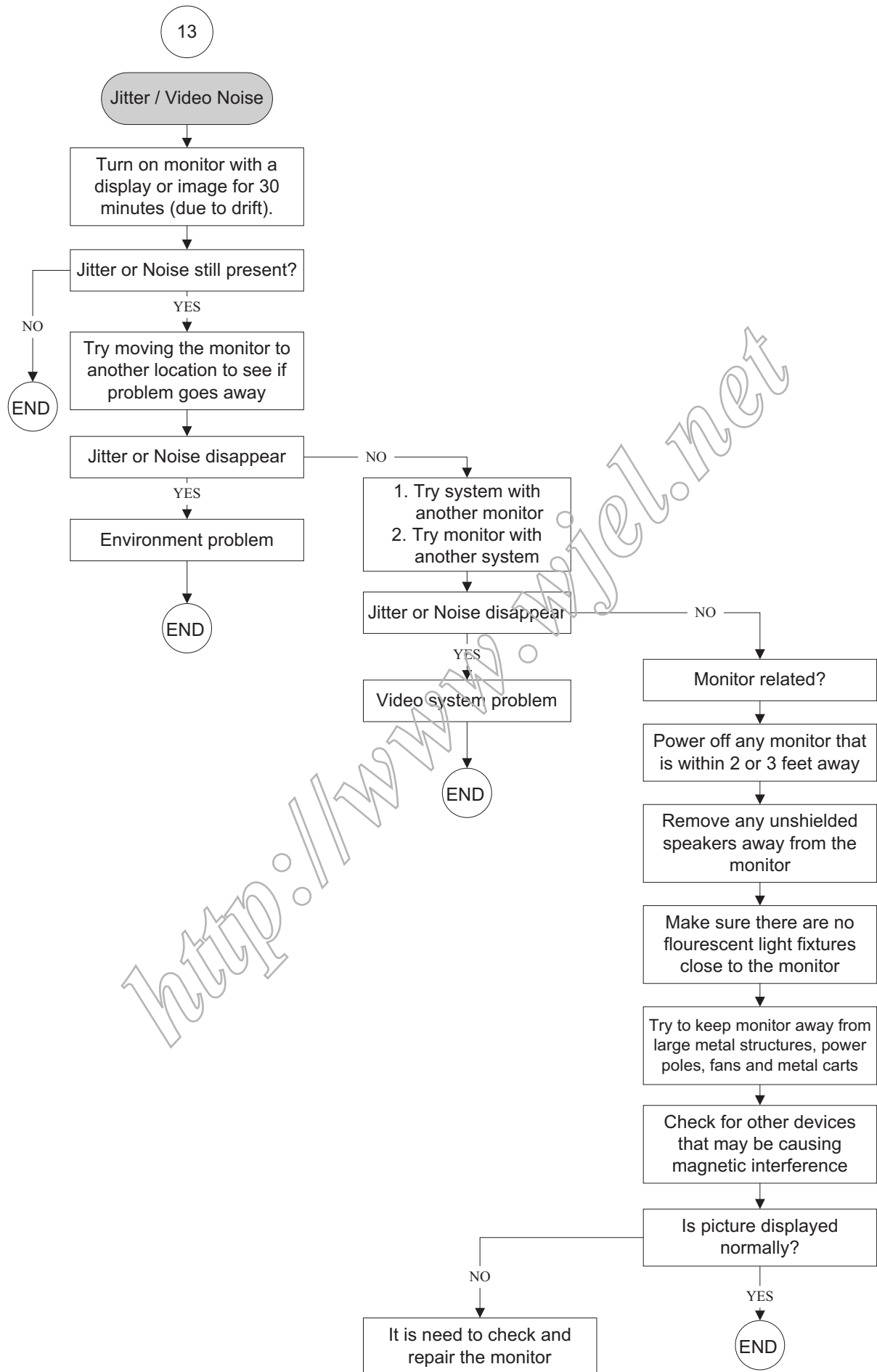

14

Power management function is not active

Verify the PC is compliant with VESA. In case all of the video signals of PC are not off, power management function is not active normally. (Repeat to power on and off power management.) There are accelerator boards not complied with VESA.

OK

YES

END

NO

Consult a service center, the monitor may be defective

<http://www.wipol.net>

General Product Specification

Specification for TVI E9P-PT
Philips Hudson 8 – 190TW8

19"W TFT LCD TV,
90 ~ 264 V , 47 ~ 63 Hz, Dual input

Table of Contents	
1	General Feature
2	Remote Key Definition
3	Local Key Definition
4	Input/Output Signal Specification
5	OSD Tree
6	Power Saving
7	PC Timing Mode
8	Broadcasting Sound
9	Teletext Operation
10	Mechanical Spec
11	Regulation and Reliability
12	Accessory

1. General Feature

	Destination	Europe
TV System	Color System	PAL, SECAM
	Sound System	CCIR B/G, D/K, I and L/L'
	Stereo System	NICAM and FM Stereo (A2)
	Channel System	Full frequency range from channel E2 (48.25 MHz) to channel E69 (855.25 MHz)
	Sub-Title	Teletext 100 pages
	RF-AFT	(+ / - 1.5MHz)
LCD Panel	Maximum Resolution	1440*900
	Panel Supplier	CMO-M190A1-L07
	Lamp Quantity	CCFL*4
	Display Area	19" Wide Diagonal
	Display Color	16.7 M with FRC
	Contrast Ratio	1000:1 (Typical)
	Brightness	300 cd / m*2 (Typical)
	Response Time	5 ms
I / O Functions	View Angle	85°(L)/85°(R), 80°(U)/80°(D)
	HDMI	For Audio & Video
	RCA Jack *3	For Audio & Video
	Din Jack	For S-Video
	SCART*1	21 Pin for Video ,S-Video & RGB
	PH Jack	For TV Input (PAL system)
	Earphone Jack	For Audio Output
	SPDIF	For Audio output (I2S)
	3.5mm Stereo Jack	For PC Stereo Audio Input , Black color
Video Functions	D-Sub-15	For VGA
	Support PAL / NTSC / SECAM video format	
	Support 480 i , 480 p,720P,1080i format	
	Build in motion adaptive 3D digital Comb Filter	
Input Signal	Build in Teletext Functions	
	TV System	PAL and SECAM system Receivable
	Tuner	FQ1216-MK5
	VGA	Horizontal input frequency range : 30~71 KHz
		Vertical input frequency range : 50~75 Hz
	Out of Range	Maximum resolution : 1440*900
		When input signal is out of range or down scaling support ,the OSD will show "Out of Range "within 5 seconds and LED is green

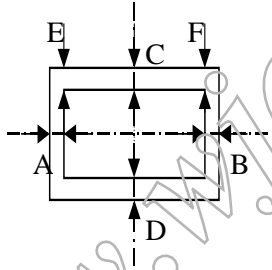
	No Signal	When there is missing signal from selected input ,the OSD will show "No Signal "within 8 seconds and LED is green
Color Temperature	Standard	x=300 , y=310
	Warm	x=313 , y=329
	Cold	x=285 , y=293
Maximum Brightness	More Than 250 cd / m*2	
Remote Controller	Key count	43 Keys
	Effective Distance	More than 6 m +45~-45degree
	Supplier	Panasonic
Local Control Key	7 Keys	Power, Left, Right, Up, Down, Menu, Select
Display Area & Tilt	Display Area:	19W inches diagonal
	H-Phase:	A-B Less than 1.5mm
	V-Center:	C-D Less than 1.5mm
	Tilt:	E-F Less than 1mm
		
Audio	Speaker	Internal speaker. 5W*2 stereo, volume adjustable.
	Treble, Bass	(+ 3db)
	Frequency Response	100~15KHz with +/-3 db variation
	THD(Total Harmonic Distortion)	Limited to 5 % at 2W (at 0.1~15 KHz)
OSD Capability	On screen display adjustment function	
ISP Fuctions	ISP (In System Programming) function available for revising driver easily.	
Power Source	Input Voltage	90 ~ 264 V , 47 ~ 63 Hz
	Input Current	0.6~1.5 A
	Max. Power	58 Watts
	PC saving Power	2Watts Max
	Stand-By Power(AV,TV)	1 Watts Max.
Mechanical	Tilt	0~15
	VESA Mount	100*100 mm

2. Remote Definition

Item	Key	Function
1	POWER	Power On/Off
2	Mute	Mute on/off
3	SLEEP	Into sleep mode: Timer Off / 15 / 30 / 45 / 60 / 90 / 120 (minutes)
4	Display	Pressing "Display" shows the source information
5	TV	ATV
6	SCART	SCART
7	AV	(AV/S-Video/HDMI)
8	PC	VGA
9	1	Number key 1
10	2	Number key 2
11	3	Number key 3
12	4	Number key 4
13	5	Number key 5
14	6	Number key 6
15	7	Number key 7
16	8	Number key 8
17	9	Number key 9
18	0	Number key 0
19	Recall	Return to previous channel
20	Enter	Enter to confirm channel selection by number key
21	Up	1.Navigate up in the OSD menu 2.channel up when OSD menu is not showed on screen
22	Down	1.Navigate down in the OSD menu 2.channel down when OSD menu is not showed on screen
23	Left	1.Navigate left in the OSD menu 2.volume down when OSD menu is not showed on screen
24	Right	1.Navigate right in the OSD menu 2.volume up when OSD menu is not showed on screen
25	OK	Selection Confirmation
26	Menu	Open/Exit Menu
27	Channel Up	In ATV mode, press this key to do Channel up,
28	Channel Down	In ATV mode, press this key to do Channel down
29	Volume up	Volume up
30	Volume down	Volume down
31	MPX	NICAM STEREO Broadcast : Stereo/Mono BILINGUAL Broadcast : Sound 1 / Sound 2 MONAURAL : Mono FM-FM STEREO Broadcast : Stereo/Mono BILINGUAL: Sound1/Sound2/Stereo/Mono
32	INDEX	Go to index page
33	SUBTITLE	When in teletext mode of any possible source, toggle subtitle on and off In digital TV mode, press it to change various, subtitle language and off in a loop. TV screen will display the status icon on the left top corner
34	TELETEXT/MIX	when in any possible source which has teletext mode, Turn teletext mode on / off and Overlay the teletext page on the TV picture
35	REVEAL	Display Hidden Information
36	SIZE	When in teletext pages, this key zoom page toggle 1X/2X and page selection by Up-arrow and Down-arrow

37	SUBPAGE	Subpage directly
38	HOLD	when in teletext pages, press this button temporarily holds the current teletext page
39	R	Red color button to do teletext operation In teletext mode,
40	G	Green color button to teletext operation In teletext mode
41	Y	Yellow color button to teletext operation In teletext mode
42	B	Blue color button to teletext operation In teletext mode
43	WIDE	Scaling Mode (4:3 /16:9 /Panorama /Letterbox1/ Letterbox2/ Letterbox3)

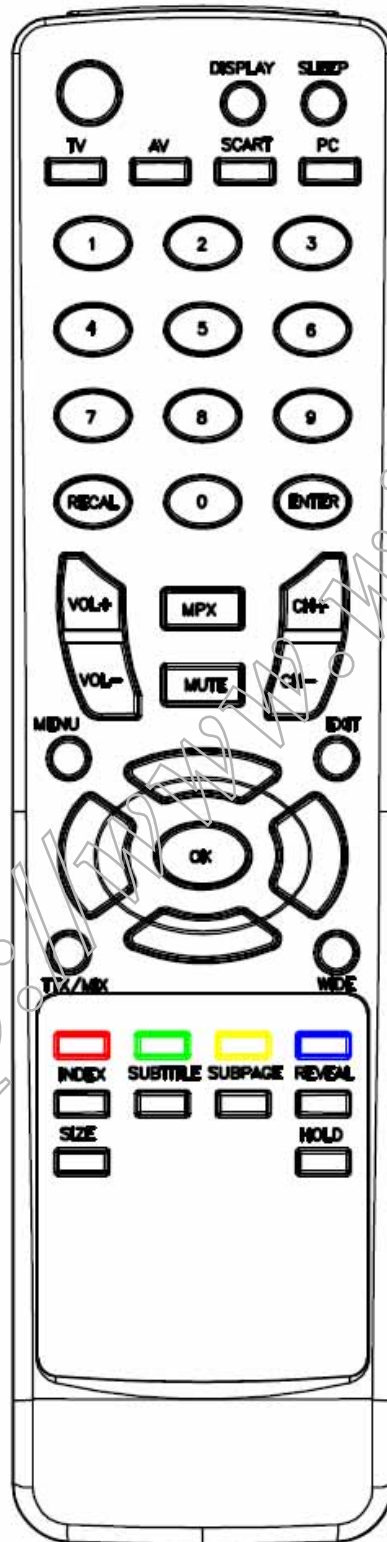

3. Local Key Definition

BUTTON		OSD On	OSD Off
1	Power	Software On / Off	
2	Menu / Exit	Press this button to open the OSD or Enter function	
3	CH Up	Press CH Up key to move selection up	Press these buttons to select the TV channel in sequence.
4	CH Down	Press CH Down key to move selection down	Press these buttons to select the TV channel in sequence.
5	Vol Left	Press Vol Left key to move selection left or to decrease value	Press these buttons to select the volume level.
6	Vol Right	Press Vol Right key to move selection right or to increase value	Press these buttons to select the volume level.
7	Input / OK	Press this button to confirm selection	Press this button to select the input source: ATV -->AV-->S-Video-->SCART -->HDMI-->VGA--> Back to ATV
	PS:	PS: SCART: RGB/S-Video/CVBS	

<http://www.wjw.com.cn>

4. Input/Output Signal Specification

CVBS Input	Type	Analog
	Polarity	Positive
	Level	1Vp-p (with Sync.)
	Impedance	75Ω± 5%
	Interface	RCA jack, Yellow color
S-Video Input	Type	Analog
	Polarity	Positive
	Level	Y : 1Vp-p (with Sync.) , C : 0.286Vp-p
	Impedance	75Ω± 5%
	Interface	DIN Jack
SCART Input	Type	Analog
	Polarity	Positive
	Impedance	75Ω± 5%
	Interface	21 Pin Euro-SCART
Audio Input	Type	Stereo R/L Channels
	Level	500mVrms
	Impedance	More than 22kΩ
	Interface	RCA Jack
	Right channel	Red color.
	Left Channel	White color
PC Stereo Input	Type	Stereo R/L Channels
	Level	1Vrms
	Impedance	More than 22kΩ
	Interface	3.5mm Stereo Jack , Black color
Headphone Output	Type	Stereo R/L Channels
	Level	40mW rms/per Channel(typ.) for 32 ohm earphone
	Impedance	32 ohm
	Interface	3.5mm Stereo Jack
Built-in Speaker	Max. Audio output	5W + 5W (at 1.0Vp-p / 1kHz input,10% THD max.)
	Sound Distortion	1% THD max. (at 250mW/1kHz :)
	Speaker	5 W / 8 ohms
	Speaker Impedance	8 ohms at 1kHz
	Residual Hum	500uW Max.(at Min. Volume :)
	Max. Hum	1000uW Max (at Max. Volume)
Audio Line Output	Type	Stereo R/L Channels
	Level	400Vrms.
	Interface	3.5mm Stereo Jack
RF Input	Input Impedance	75 ohms
	Frequency Range	48.25~855.25 MHz (PAL)
	Video S/N Ratio	45 d B (Typical)
	Audio S/N Ratio	63 d B (Typical)
VGA Input	Sync	Level : Low = 0 to 0.8V, High = 2.0 to 5 V
		Polarity : Positive or Negative

		Impedance : 1 k ohm or higher
	RGB Signal	Level : 0 to 700mV Positive
		Impedance : 75Ω± 5%

D-Sub Pin Define	1	Red Video
	2	Green Video
	3	Blue Video
	4	Ground
	5	Ground
	6	Red Ground
	7	Green Ground
	8	Blue Ground
	9	+5V (PC97)
	10	VGA-CONN(Sync GND)
	11	Ground
	12	SDA (DDC Data)
	13	Horizontal Sync
	14	Vertical Sync
	15	SCL (DDC Clock)

05/25 TVI update

HDMI	Type	Type A
	Level	400mVrms
	Impedance	100Ω
SPDIF	Type	RCA Jack
	Level	500mVpp +- 20%

5. OSD Tree

PAL Menu Structure										
1 st Sub Menu	2 nd Sub Menu	3 rd Sub Menu	4 th Sub Menu	ATV	S-Video	AV	Scart	VGA	HDMI	
Picture	Brightness	Slider	[50] 0-100 / 1	V	V	V	V	V	V	
	Contrast	Slider	[80] 0-100 / 1	V	V	V	V	V	V	
	Colour	Slider	[70] 0-100 / 1	V	V	V	V		V	
	Sharpness	Slider	[4] 0-7 / 1	V	V	V	V		V	
	Backlight	Slider	[100] 0-100 / 1	V	V	V	V	V	V	
	Color Temp	Cold			V	V	V	V	V	V
		[Standard]			V	V	V	V	V	V
		Warm			V	V	V	V	V	V
Noise Reduction	Off / [Low] / Medium / High		V	V	V	V		V		
Audio	Treble	Slider	[50] 0-100 / 1	V	V	V	V	V	V	
	Bass	Slider	[50] 0-100 / 1	V	V	V	V	V	V	
	Balance	Slider	[0] -50-50 / 1	V	V	V	V	V	V	
	Sound Effect	On			V	V	V	V	V	V
		[Off]			V	V	V	V	V	V
	AVL	On			V	V	V	V	V	V
[Off]				V	V	V	V	V	V	
Channel Management	Country	UK								
		France								
		Germany								
		Italy								
		Spain								
		Switzerland								
		Denmark								
		Belgium								
		Netherlands								
		Luxembourg								
		Czech Republic								
		Portugal								
		United Arab Emirates								
	Saudi Arabia									
Skip	On			V						

6. Power Saving

Mode	Hsync	Vsync	Video	Power	Indication	Recovery time
Power-On	On	On	Active	<58W	Green	--
PC saving	Off	On	Off	<2W	Amber	<3s
PC saving	On	Off	Off	<2W	Amber	<3s
PC saving	Off	Off	Off	<2W	Amber	<3s
Standby (AV,TV)				<1W	Amber	R/C or power key on-off
Power off	x	x	x	<1W	Amber	Turn on <5s

Sync on	Means normal operation
Sync off	Means: Hsync: $f < 1\text{kHz}$, duty cycle $> 25\%$, Vsync: $f < 10\text{Hz}$, duty cycle $> 25\%$
*	Power consumption is measured from AC source.
*	There are no power saving modes for TV, AV1, S1, SCART inputs.
*	While VGA is selected to be input, this LCD TV is equipped with a power management according to VESA DPMS. There is a delay of 5 seconds before the transition from On-state to power saving state to avoid unintentionally entering of a power saving state during display resolution and timing mode changes. During the period of delay, the LED shall indicate green color and OSD will show " POWER SAVE ". Transition from any power saving state to another can be instantaneous. The recovery from Off-state requires no manual power on.

7. PC Timing Mode

	Pixel Format	Hor. Freq.(kHz)	Hor. Polarity	Vert. Freq.(Hz)	Vertical Polarity	Standard	Format
1	640*350	31.5		70		VGA	
2	720*400	31.47	-	70	+	VGA	
3	640*480	31.47	-	60	-	VGA	
4	640*480	35		66.7		MAC	
5	640*480	37.861	-	72	-	VESA	
6	640*480	37.5	-	75	-	VESA	
7	800*600	35.156	-	56	+	VESA	
8	800*600	37.879	+	60	+	VESA	
9	800*600	48.077	+	72	+	VESA	
10	800*600	46.875	+	75	+	VESA	
11	832*624	49.72		74.5		MAC	
12	1024*768	48.36		60		VESA	
13	1024*768	56.48		70		VESA	
14	1024*768	60.02		75		VESA	
15	1280*720	44.772	-	59.855	+	VESA	16:9
16	1280*720	56.456	-	74.777	+	VESA	16:9
17	1360*768	47.72	-	59.799	+	VESA	16:9
18	1360*768	60.288	-	74.891	+	VESA	16:9
19	1440*900	55.935	-	59.887	+	VESA	16:10
20	1440*900	70.635	-	74.984	+	VESA	16:10
21	1280x1024						

Remark: This LCD TV shall have 10 or more user modes for user

8. Broadcasting Sound Standard

Order table for MPX function

Input Sound Mode		MPX Key Pressed
MICAM	Monaural	Mono
	Stereo	Stereo---Mono
	Bilingual	Sound1---Sound2
FM Stereo (A2)	Stereo	Stereo---Mono
	Bilingual	Sound1---Sound2

Reference Table

	MPX key	Mono	Stereo	Sound1	Sound2
MICAM	Monaural	Mono			
	Stereo	Analog mono	Stereo		
	Bilingual	Analog mono		NICAM-A	NICAM-B
FM (A2)	Monaural	Mono			
	Stereo	Mono	Stereo		
	Bilingual			Sound1	Sound2

9. Teletext Operation

TELETEXT/MIX	<p>TV/Teletext Mode By pressing Teletext (go to index page), screen will change from TV/AV mode to Teletext mode and vice versa and Overlay the teletext page on the TV picture</p>
Up/Down and Number Key	<p>Page Selection Page can be selected in two ways: a. Press Up or Down to increase or decrease the page number by one b. By entering the page number, using 0~9 on the remote controller</p>
Red/Green/Yellow/Blue	<p>Teletext RGBY soft key In fast text mode these correspond to differently coloured subjects, In list mode they correspond to the different coloured page numbers.</p>
HOLD	<p>Hold the page To hold the Teletext page when viewing multi-page information. Press again to return to automatic page update</p>
SIZE	<p>Zoom Teletext Page This is used to zoom page up to 2X . Press again to return.</p>
SUBTITLE	<p>Show Subtitle on the screen</p>
INDEX	Go to index page (usually page 10)
REVEAL	Display Hidden Information
SUBPAGE	Subpage directly

10. Mechanical Specification

Physical Dimension	Weight	TBD
	Height	TBD
	Depth	TBD
	Net Weight	TBD
Packing Specification	Gross Weight	TBD
	Units per Pallet	TBD
	Pallet Dimension	TBD
	40' Container Loading	TBD
	Carton Label	TBD
Cabinet Material	Display Head	ABS UL94HB
	Neck / Base	ABS UL94HB
	Internal Plastic	ABS UL94HB
	Cabinet Color Drift	The color drift due to UV-Light shall be less than 3.0 "Delta E" in the 1976 CIE L*a*b colorspace. Testing shall be performed according to the requirements of ASTM Test Method D4459-93.
	Cabinet Texture	Mold-Tech # 11010 used on all external textured surfaces.
Gap Specification	Bezel	The max. gap to the panel glass shall be less than 1.0 mm
	Bezel / Speaker Cover	The max gap between the bottom of the front bezel and the top of the speaker cover shall be less than 1.2 mm. The gap deviation must be less than 0.3mm
Others	Ergonomics	Tilt Down 0° up to 1°
	Screen Printed Parts	Artwork : TBD
	Front Panel Buttons	Tactile
	Button Alignment	The gap clearance between the buttons and the bezel surface shall be uniform
	Surface Quality	Surface color, gloss, texture, blemishes, and all other irregularities in the plastic shall comply with TVIs approval sheet.
	Fade and Color change	All external surfaces shall be sufficiently rugged to withstand normal operator usage without extreme visible deterioration in color.
Cosmetic Criteria for Molded Plastic	A surface	No defects such as knit lines, parting line, defects in texture, gate marks, flash, sinks etc. should be visible from a distance of 18 inches.
	B surface	Defects such as knit lines, parting line, defects in texture, gate marks, flash, sinks etc. should be visible from a distance of 30 inches.
	C surface	Unacceptable defects are limited to voids or breaks in the plastic or gross mold distortions.
Vibration Test	Vibration Frequency :	1 - 200 Hz
	Acceleration :	1.14 G RMS

	Sweep Time :	1 oct. / min
	Test Time :	60 min per axis, total 3 axis / 6 main face
Drop Test (100G)	Weak Corner :	76.2 cm
	Six Faces :	76.2 cm
	3 Edges	76.2 cm
Repetitive Shock Test	Bottom	30 minutes
	Side	15 minutes
	ends	15 minutes

<http://www.wjel.net>

11. Regulation & Reliability

Compliance	N. America	TBD : [FCC-B, UL (c-UL), CB, NOM.]
	S. America	TBD: [FCC-B, UL (c-UL), CB, NOM]
	China	TBD : [CCC, CB]
	Asia/PAL	TBD: [C-Tick, CE, CB]
	Taiwan	TBD: [BSMI, CB, FCC]
	Europe	TBD:[CE, CB, SASO (Saudi Arabia), GOST (Russia), ROHS, "HD" Logo]
Other Certification	HDMI	HDMI Formal Certification on all SKUs with HDMI
Power Management	SRS	SRS Formal Certification on all SKUs where SRS technology is used

Environmental Requirements

This display shall meet the following environmental requirements under normal operating conditions.

Temperature	Operating	5°C to 35°C
	Non-Operation	-20°C to 60°C
Humidity	Operating	20% to 80% (non-condensing)
	Non-Operation	10% to 85% (<40°C)(non-condensing)
Altitude	Operating	0 to 12,000 feet
	Non-Operation	0 to 40,000 feet

*Units tested at an altitude up to 12,000 feet must operate at normal conditions without exhibiting abnormal behavior such as arcing or shutdown.

Electrostatic Discharge Requirements

This display shall withstand 4kV for contact discharge and 8kV for air discharge of Electrostatic Discharge to meet the acceptance criteria as specified in EN55024.

Mean time between failure (MTBF)

**For the purposes of demonstrating the MTBF of this product, a failure is defined as the inability of the product to function in accordance with this specification. A failure event interrupts the expected operation of the product and requires service or repair to restore the product to full functionality.

**The MTBF of this product shall be demonstrated to meet or exceed 50,000 hours @ 25 °C at a 90% lower confidence limit under all operating conditions as specified in previous section. (Lamp life is not included)

**All components including power and inverter shall be derate to 80% for active devices, 80% for under worst case conditions. capacitors and 50% for resistive components, except for polarized capacitors which may be operated at 90% of voltage - which are all calculated

Mean Time Between Replace (MTTR)

**This display shall be well designed to take less than 5 minutes for replacing control board or inverter board.

**Note: If there is anything not clarified or specified on this specification, PVT sample shall be a standard reference.

12. Accessory

1	Power Cord	Length:	1.8meters +15mm/-0mm
		Cable Color:	Black color
		Quantity:	1
2	Audio Cable	Length:	1.8meters +15mm/-0mm
		Cable Color:	Black color
		Quantity:	no
3	VGA Cable	Length:	1.8meters +15mm/-0mm
		Cable Color:	Black color
		Quantity:	no
4	Remote Controller Unit	Multi-function remote controller include battery	
5	TV User Guide	Quantity:	one
6	Remote Controller User Guide	Quantity:	no
7	Warranty Card	Quantity:	no
8	Battery	Quantity:	TBD

<http://www.wjel.net>

Safety Check Process

Safety Checks

After the original service problem has been corrected, a complete safety check should be made. Be sure to check over the entire set, not just the areas where you have worked. Some previous service may have left an unsafe condition, which could be unknowingly passed on to your customer. Be sure to check all of the following:

Fire and Shock Hazard

1. Be sure all components are positioned in such a way as to avoid the possibility of adjacent component shorts. This is especially important on those chassis which are transported to and from the service shop.
2. Never release a repaired unit unless all protective devices such as insulators, barriers, covers, strain reliefs, and other hardware have been installed in accordance with the original design.
3. Soldering and wiring must be inspected to locate possible cold solder joints, solder splashes, sharp solder points, frayed leads, pinched leads, or damaged insulation (including the accord). Be certain to remove loose solder balls and all other loose foreign particles.
4. Check across-the-line components and other components for physical evidence of damage or deterioration and replace if necessary. Follow original layout, lead length and dress.
5. No lead or component should touch a receiving tube or a resistor rated at 1 watt or more. Lead tension around protruding metal surfaces or edges must be avoided.
6. Critical components having special safety characteristics are identified with an asterisk by the Ref. No in the parts list and enclosed within a broken line * (Where several critical components are grouped in one area) along with the safety symbols on the schematic diagrams and/or exploded views.
7. When servicing any unit, always use a separate isolation transformer for the chassis failure to use a separate isolation transformer may expose you to possible shock hazard, and may cause damage to servicing instruments.
8. Many electronic products use a polarized ac line cord (one wide pin on the plug). Defeating this safety feature may create a potential hazard to the service and the user. Extension cords which do not incorporate the polarizing feature should never be used.
9. After reassembly of the unit, always perform a leakage test or resistance test from the line cord to all exposed metal parts of the cabinets. Also check all metal control shafts (with knobs removed), antenna terminals, handles, screws, etc. To be sure the unit may be safely operated without danger of electrical shock.

* Broken line

Implosion

1. All picture tubes used in current model receivers are equipped with an integral implosion system care should always be used, and safety glasses worn, whenever handling any picture tube. Avoid scratching or otherwise damaging the picture tube during installation.
2. Use only replacement tubes specified by the manufacturer.

X-radiation

1. Be sure procedures and instructions to all your service personnel cover the subject of X-radiation. Potential sources of X-rays in TV receivers are the picture tube and the high voltage circuits. The basic precaution which must be exercised is to keep the high voltage at the factory recommended level.
2. To avoid possible exposure to X-radiation and electrical shock, only the manufacturer's specified anode connectors must be used.
3. It is essential that the service technician has an accurate HV meter available at all times. The calibration of this meter should be checked periodically against a reference standard.
4. When the HV circuitry is operating properly there is no possibility of an X-radiation problem. High voltage should always be kept at the manufacturer's rated value—no higher—for optimum performance. Every time a color set is serviced, the brightness should be run up and while monitoring the HV with a meter to be certain that the HV is regulated correctly and does not exceed the specified value. We suggest that you and your technicians review test procedures so that HV regulation are always checked as a standard servicing procedure, and the reason for this prudent routine is clearly understood by everyone. It is important to use an accurate and reliable HV meter. It is recommended that the HV recorded on each customer's invoice, which will demonstrate a proper concern for the customer's safety.
5. When troubleshooting and making test measurements in a receiver with a problem of excessive high voltage, reduce the line voltage by means of a variac to bring the HV into acceptable limits while troubleshooting. Do not operate the chassis longer than necessary to locate the cause of the excessive HV.

6. New picture tubes are specifically designed to withstand higher operating voltages without creating undesirable X-radiation. It is strongly recommended that any shop test fixture which is to be used with the new higher voltage chassis be equipped with one of the new type tubes designed for this service. Addition of a permanently connected HV meter to the shop test fixture is advisable. The CRT types used in these new sets should never be replaced with any other types, as this may result in excessive X-radiation.
7. It is essential to use the specified picture tube to avoid a possible X-radiation problem.
8. Most TV receivers contain some types of emergency "Hold Down" circuit to prevent HV from rising to excessive levels in the presence of a failure mode. These various circuits should be understood by all technicians servicing them, especially since many hold down circuits are inoperative as long as the receiver performs normally.

Leakage Current Cold Check

1. Unplug the ac line cord and connect a jumper between the two prongs of the plug.
2. Turn on the power switch.
3. Measure the resistance value between the jumpered ac plug and all exposed cabinet parts of the receiver, such as screw heads, antennas, and control shafts. When the exposed metallic part has a return path to the chassis, the reading should be between 1 megohm and 5.2 megohms. When the exposed metal does not have a return path to the chassis, the reading must be infinity. Remove the jumper from the ac line cord.

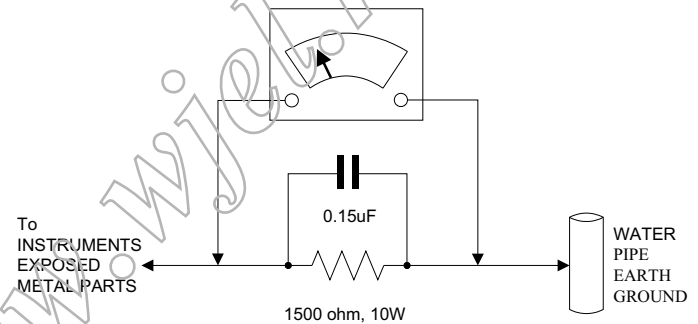

Leakage Current Hot Check

1. Do not use an isolation transformer for this test. Plug the completely reassembled receiver directly into the ac outlet.
2. Connect a 1.5k, 10W resistor paralleled by a 0.15uF capacitor between each exposed metallic cabinet part and a good earth ground such as a water pipe, as shown above.
3. Use an ac voltmeter with at least 5000 ohms volt sensitivity to measure the potential across the resistor.
4. The potential at any point should not exceed 0.75 volts. A leakage current tester may be used to make this test; leakage current must not exceed a possibility of shock hazard. The receiver should be repaired and rechecked before returning it to the customer.
5. Repeat the above procedure with the ac plug reversed. (note: an ac adapter is necessary when a polarized plug is used. Do not defeat the polarizing feature of the plug.)

Picture Tube Replacement

The primary source of X-radiation in this television receiver is the picture tube. The picture tube utilized in this chassis is specially constructed to limit X-radiation emissions. For continued X-radiation protection, the replacement tube must be the same types as the original, including suffix letter, or a Philips approved tube.

Parts Replacement

Many electrical and mechanical parts in Philips television sets have special safety related characteristics. These characteristics are often not evident from visual inspection nor can the protection afforded by them necessarily be obtained by using replacement components rated for higher voltage, wattage, etc. The use of a substitute part which does not have the same safety characteristics as the Philips recommended replacement part should in this service manual may create shock, fire, or other hazards.

WARNING: Before removing the back cover, turn the unit OFF and short the HIGH VOLTAGE to the ground.