



PAGES COMPRENANT TOUS LES INTERRUPTEURS /
PAGES INCLUDING ALL THE SWITCHES

INTERRUPTEUR DE SÉCURITÉ SAFETY SWITCH

Embrayage / Clutch
Frein / Brake



Remplace / Replaces
Snapper #5-0810

No 31-241

INTERRUPTEUR DE SÉCURITÉ SAFETY SWITCH

Normalement ouvert pour fonctionner /
Normally open to run

2 bornes / terminals

Noir / Black



Remplace / Replaces
Cub Cadet #925-0268
Dynamark #41204
MTD #725-0268, 925-0268

No 31-253

INTERRUPTEUR DE SÉCURITÉ SAFETY SWITCH

Normalement fermé /
Normally closed

7 bornes / terminals
4 positions

Interrupteur à poussoir / Push button switch

Longueur / Length 2 1/8"
Requiert trou / Requires hole 1/2"

Bouton rouge / Red button

Remplace / Replaces
Cub Cadet #725-0269, 925-0269
MTD #725-0269, 925-0269

No 31-356



INTERRUPTEUR D'ALLUMAGE IGNITION SWITCH

Universel / Universal

Trou de montage / Mounting hole 5/8"

Démarrage manuel / Manuel start

Remplace / Replaces
Snapper #1-1853, 7011853

No 31-1930



INTERRUPTEUR D'ALLUMAGE IGNITION SWITCH

5 bornes / terminals

Démarrage manuel /
Manual start

Remplace / Replaces
Ariens #03115200, 31152
AYP #2683, 2683R
Gravely #19223
Jacobson #129746, 129846
Kohler #48-099-01
Lawn-Boy #741308
Onan #378-0385
Toro/Wheel Horse #12-8140,
103990

No 31-1931



INTERRUPTEUR D'ALLUMAGE IGNITION SWITCH

Universel / Universal

Pour souffleuses à neige /
For snowblowers

Remplace / Replaces
Ariens #624097, 11134, 02456500, 52406900
AYP #135944
Homelite #JA130641
Lawn-Boy #700171
Murray #56419
Simplicity #1664804
Snapper #17817

No 31-1939



31

INTERRUPTEUR D'ALLUMAGE IGNITION SWITCH

Universel / Universal

Interrupteur à poussoir /
Push button switch

Remplace / Replaces
Snapper #1-2623, 7012623

No 31-1946





PAGES COMPRENANT TOUS LES INTERRUPTEURS /
PAGES INCLUDING ALL THE SWITCHES CONT.

□ □ NOUVEAU / NEW □ □

INTERRUPTEUR D'ALLUMAGE IGNITION SWITCH

5 bornes / terminals
3 positions
Tige de montage /
Mounting stem 5/8"



Modèles / Models
Tracteur 4 roues motrices /
4-wheels tractor 34686, 34690
Tracteur 2 roues motrices /
2-wheels tractor 35713, 35716

Remplace / Replaces
Gravely #18272

No 31-2909

INTERRUPTEUR D'ALLUMAGE IGNITION SWITCH

Universel / Universal

5 bornes / terminals
3 positions
Requiert trou / Requires hole 5/8"



Remplace / Replaces
AMF #44745, 300295
AYP #S365402, 3612R, 4406R
Bob-Cat #48032B
Dixie #20245
Dixon #4197
Grasshopper #183806
Honda #510-772-003
John Deere #AM102544, AM31995, AM102551
MTD #725-0267, 925-0267
Murray #21064, 21064PA
Noma #421064
Roper #3621R
Scag #48017, 48017-02
Snapper #7027698, 7029010
Toro #23-0660

No 31-2922

INTERRUPTEUR D'ALLUMAGE IGNITION SWITCH

7 bornes / terminals
4 positions

Pour tracteurs / For tractors
Clé non-incluse /
Key not included
Utilisé avec notre clé /
Used with our key #31-2918



Remplace / Replaces
AYP #175566, 163968
John Deere #GY20074
MTD #725-1741, 925-1741
Murray #94762

No 31-2921

INTERRUPTEUR D'ALLUMAGE IGNITION SWITCH

Universel / Universal

5 bornes / terminals

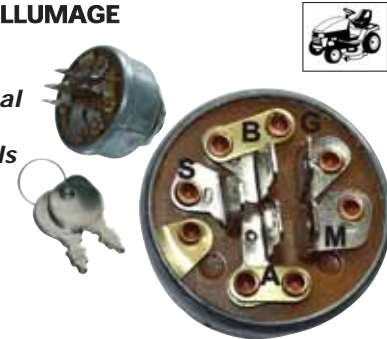

Remplace / Replaces
Sears/Roper #73232, 14615

No 31-2941

INTERRUPTEUR D'ALLUMAGE IGNITION SWITCH

Interrupteur d'allumage très
résistant avec clé / Heavy duty
ignition switch with key

Semblable à notre 31-2921,
mais de meilleure qualité /
Similar to our 31-2921 but
more higher quality

Remplace / Replaces
AYP #175566, 163968
John Deere #GY20074
MTD #725-1741, 925-1741
Murray #94762

No 31-2920

□ □ NOUVEAU / NEW □ □

INTERRUPTEUR DE DÉMARRAGE STARTER SWITCH

2 bornes / terminals
2 positions

Clé non-incluse /
Key not included



Remplace / Replaces
MTD #725-1979

No 31-3316

31





PAGES COMPRENANT TOUS LES INTERRUPTEURS /
PAGES INCLUDING ALL THE SWITCHES CONT.

INTERRUPTEUR D'ALLUMAGE IGNITION SWITCH

7 bornes / terminals
4 positions

Languettes à pression en
plastique pour insérer
dans le cadran /
Plastic snap to insert
in bezel

Remplace / Replaces
Ariens #15883



No 31-3323

INTERRUPTEUR D'ALLUMAGE IGNITION SWITCH

S'installe sur la plupart des
tracteurs Noma Signature /
Install on most Noma
Signature tractors

Clé non-incluse /
Key not included

Remplace / Replaces
AYP #144921, 163088, 178744
Murray #327355
Noma #327355
Simplicity #1718306,
1713845, 1686734



No 31-4721

□ □ NOUVEAU / NEW □ □

INTERRUPTEUR D'ALLUMAGE IGNITION SWITCH

Modèles / Models
LT, LTS, YT, ST, GT

Clé non-incluse /
Key not included

Remplace / Replaces
AYP #193350



No 31-4724

INTERRUPTEUR D'ALLUMAGE IGNITION SWITCH

Universel / Universal

Remplace / Replaces
Kohler #25-099-04, 25-099-32S
Toro/Wheel Horse #103991



No 31-7280

INTERRUPTEUR D'ALLUMAGE IGNITION SWITCH

Pour moteur 2 cylindres /
For 2 cylinders engine
14HP, 400700 vertical,
400400 horizontal et/and
18HP, 422400 horizontal,
422700 vertical

Remplace / Replaces
AYP #102972Y, 145499

Briggs & Stratton #490066, 493625, 692318
Exmark #1-543070

Husqvarna #532-10-29-72, 532-14-54-99, 532-15-89-13
Scag #48798

Toro/Wheel Horse #83-0020

Troy Bilt #1754250, 1754250P **No 31-7804**



INTERRUPTEUR D'ALLUMAGE IGNITION SWITCH

Modèles / Models
Exmark Laser ZTR,
John Deere STX, 38446

Remplace / Replaces
AYP #158913

Exmark #543070

Hustler #045898

Noma #305720

Snapper #26343, 7026343

No 31-9158



INTERRUPTEUR D'ALLUMAGE IGNITION SWITCH

6 bornes / terminals
3 positions

Pour tondeuse à support
avant John Deere /
For John Deere front
mount mower

Modèles / Models
Séries 300 et quelques
séries 200 / Series 300
and some series 200
(Magnéto / Magneto)

Remplace / Replaces
Ariens #03602300

John Deere #AM38227

No 31-9166

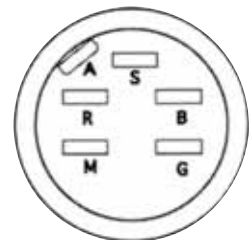

31





PAGES COMPRENANT TOUS LES INTERRUPTEURS /
PAGES INCLUDING ALL THE SWITCHES CONT.

INTERRUPTEUR D'ALLUMAGE IGNITION SWITCH

6 bornes / terminals
3 positions
Pour allumage magnéto /
For magneto ignition

Tige de montage /
Mounting stem 20 mm x 1.25"

Modèles / Models
RX63, RX95, RX85, SRX75, SRX95
Séries / Series F et/and Gator

Remplace / Replaces
John Deere #AM101561
Great Dane #TCA15075

No 31-9167



INTERRUPTEUR D'ALLUMAGE IGNITION SWITCH

3 positions

Pour moteur avant Murray /
For Murray front engine

Tracteur avec allumage
magnéto / Tractor with
magneto ignition

Remplace / Replaces
Briggs & Stratton #5411H
Murray #92377, 092377MA,
MU092377MA, MU92377

No 31-9331



INTERRUPTEUR D'ALLUMAGE IGNITION SWITCH

Allumage de batterie avec
tiges de montage 9/16" /
Battery ignition with
9/16" mounting stem

Pour / For
Gravely Promaster 20HP

Remplace / Replaces
Gravely #3115200
John Deere #AM103286,
AM32318, AM32686

No 31-9161



INTERRUPTEUR D'ALLUMAGE IGNITION SWITCH

6 bornes / terminals

Pour moteurs équipés
d'un solénoïde avec
soupape d'arrêt construit
depuis 1994 / For engines
equipped with fuel
shut-off solenoid built
since 1994

Utilisé sur les tondeuses Murray /
Used on Murray mowers

Remplace / Replaces
AYP #140301
MTD #725-1717
Murray #92556

No 31-9623



31

INTERRUPTEUR D'ALLUMAGE IGNITION SWITCH

5 bornes / terminals
4 positions

Pour / For
Gravely et/and Noma

Allumage magnéto /
Magneto ignition

Remplace / Replaces
Murray #91846, 091846MA
Noma #300687, 091846

No 31-9330

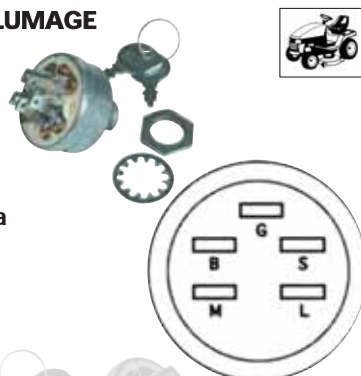

INTERRUPTEUR D'ALLUMAGE IGNITION SWITCH

6 bornes / terminals
3 positions

Pour les tracteurs à gazon
et de jardin avec moteur
Briggs & Stratton
Vanguard OHV /
For lawn and garden
tractors with
Briggs & Stratton
OHV Vanguard engine

Remplace / Replaces
MTD #725-1396, 925-1396

No 31-9853

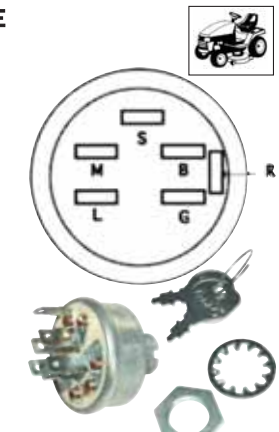



PAGES COMPRENANT TOUS LES INTERRUPTEURS /
PAGES INCLUDING ALL THE SWITCHES CONT.

INTERRUPTEUR D'ALLUMAGE IGNITION SWITCH



3 positions
À pression /
Snap mount

Clé non-incluse /
Key not included

Remplace / Replaces
Dixie/Chopper #500017
John Deere #AM122881, AM132808
MTD #725-04228, 925-04228 **No 31-9655**



INTERRUPTEUR D'ALLUMAGE IGNITION SWITCH



Modèles / Models
Stiga Park 2000 et/and
Stiga Villa 2001

Clé non-incluse /
Key not included

Remplace / Replaces
Stiga #1134-4093-01 **No 31-50241**



INTERRUPTEUR D'ALLUMAGE IGNITION SWITCH



7 bornes / terminals
4 positions

2005-2006

Clé non-incluse /
Key not included

Remplace / Replaces
Cub Cadet #725-04227A,
925-04227A, 925-04227B
MTD #725-04227A,
925-04227A, 925-04227B **No 31-9667**



□ □ NOUVEAU / NEW □ □

INTERRUPTEUR D'ALLUMAGE PTO PTO IGNITION SWITCH

7 bornes / terminals
2 positions

Pousser-tirer, à pression /
Push-pull, snap mount

Bouton noir / Black knob

Modèles / Models
RZT42, RZT50, RZT54

Remplace / Replaces
Cub Cadet #725-04174,
925-04174

N/C		N/C
	N/C	
COMA	COMB	COMC



31

INTERRUPTEUR D'ALLUMAGE IGNITION SWITCH



5 bornes / terminals
3 positions

Clé non-incluse /
Key not included

Remplace / Replaces
Cub Cadet #925-04019
MTD #725-04019, 925-04019 **No 31-9668**



□ □ NOUVEAU / NEW □ □

INTERRUPTEUR D'ALLUMAGE PTO PTO IGNITION SWITCH

7 bornes / terminals
2 positions

Pousser-tirer, à pression /
Push-pull, snap mount

Bouton jaune / Yellow knob

Modèles / Models
GT1554, GT2542, GT2550,
GT2554, SLT1550, SLT1554, Z-FORCE

Remplace / Replaces
Cub Cadet #725-04175, 925-04175
MTD #725-04175, 925-04175 **No 31-2913**

COMA	COMB	COMC
	N/C	
N/C		N/C



INTERRUPTEUR D'ALLUMAGE IGNITION SWITCH

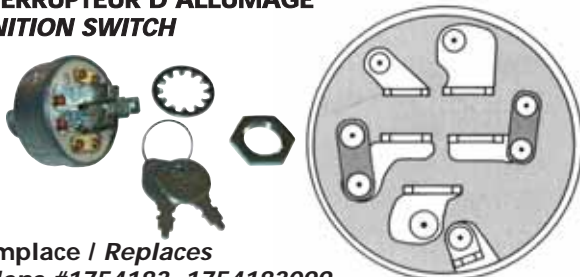

Remplace / Replaces
Bolens #1754183, 1754183099
Cub Cadet #725-3163, 925-3163
Troy Bilt #1754183,
1754183099 **No 31-9852**

□ □



PAGES COMPRENANT TOUS LES INTERRUPTEURS /
PAGES INCLUDING ALL THE SWITCHES CONT.

□ □ NOUVEAU / NEW □ □

INTERRUPTEUR D'ALLUMAGE PTO PTO IGNITION SWITCH



8 bornes / terminals
2 positions

Pousser-tirer, à pression /
Push-pull, snap mount

Bouton noir / Black knob

Modèles / Models
GT2254, GTH2642, GTH2654,
LGT2554, LGT2654, YTH2348,
YTH2448, Z-FORCE

Remplace / Replaces
AYP #196112

Husqvarna #532-19-61-12



No 31-2914

INTERRUPTEUR D'ALLUMAGE PTO PTO IGNITION SWITCH

Modèles / Models
Z42-Z54, 364365,
1515-1529, 2130-2186,
GT2000

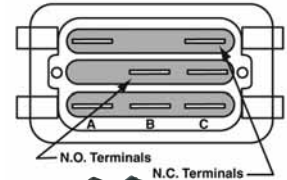

No 31-9654

Remplace / Replaces
Cub Cadet #725-3233,
925-3233

INTERRUPTEUR D'ALLUMAGE PTO PTO IGNITION SWITCH

8 bornes / terminals
2 positions

Pousser-tirer, à pression /
Push-pull, snap mount

Bouton noir / Black knob

Remplace / Replaces
AYP #169417, 174651, 174653
Bad boy #056-8058-00
Bob-Cat #1985032
Bunton #PL7994
Bush Hog #50018299
Ferris #5022180,
5022180SM, 5022182

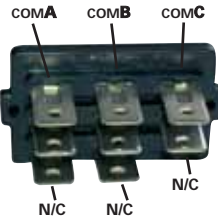

No 31-2915

INTERRUPTEUR D'ALLUMAGE PTO PTO IGNITION SWITCH

8 bornes / terminals

Pousser-tirer, à pression /
Push-pull, snap mount

Borne du coin vide /
Corner terminal blank

Bouton rouge / Red knob

Remplace / Replaces
AYP #146283, 140404, 154959,
154963, 169416, 174652
Dixon #5961, 539-117-238, 539-129-512,
539-120-023
Encore #523030, 523031
Ferris #22180, 5022180
Great Dane #D38005
Howard #02-422
Husqvarna #532-154-959, 532-169-417,
532-174-651
Hustler #771476, 77146, 776476
Murray #94927, 6201-316
Scag #483957, 27328, 481687, 483162
Simplicity #171348, 171348SM, 1714772,
1716332, 1722887
Snapper #7035658, 35658
Yazoo #101768, 539101768

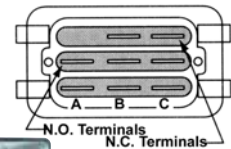

No 31-9656

INTERRUPTEUR D'ALLUMAGE PTO PTO IGNITION SWITCH

7 bornes / terminals

Pousser-tirer, à pression /
Push-pull, snap mount

Bouton or en forme de
goutte / Gold tear drop knob

Remplace / Replaces
Cub Cadet #725-04258, 925-04258
MTD #725-04258, 925-04258

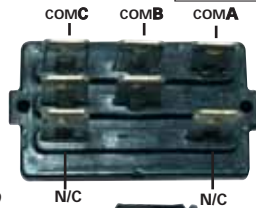

No 31-2916





PAGES COMPRENANT TOUS LES INTERRUPTEURS /
PAGES INCLUDING ALL THE SWITCHES CONT.

INTERRUPTEUR D'ALLUMAGE IGNITION SWITCH



8 bornes / terminals

Pousser-tirer, à pression /
Push-pull, snap mount

Terminal du milieu vide /
Middle terminal blank

Bouton rouge / Red knob

Remplace / Replaces

Ariens #522100, 5221, 01545600, 1545600

Exmark #633673, 1-633673, 103-5221

Grasshopper #183925

John Deere #AM118802, AM119139, AM131966,
TCA17834

Kubota #K1211-62231

MTD #725-1716, 925-1716, 725-1752

Scag #481635, 700675

Snapper #28542, 7028542

Toro/Wheel Horse #93-9999, 93-9998, 95-4108,

95-7489, 1035221, 1633673 **No 31-9657**

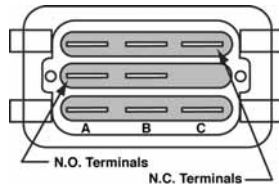

□ □ NOUVEAU / NEW □ □

INTERRUPTEUR POUSSOIR D'INTERVERROUILLAGE PLUNGER INTERLOCK SWITCH



Normalement ouvert /
Normally open

Remplace / Replaces

MTD #725-3191A,

925-3191A

No 31-2953



□ □ NOUVEAU / NEW □ □

INTERRUPTEUR D'ALLUMAGE PTO PTO IGNITION SWITCH

8 bornes / terminals

3 positions

Pousser-tirer, à pression /
Push-pull, snap mount

Bouton jaune / Yellow knob

Modèles / Models

D160, D170,

LA130, LA140, LA145, LA150,

LA155, LA165, LA175,

X130R, X140, X155R, X165

Remplace / Replaces

John Deere #GY20939

No 31-2911



□ □ NOUVEAU / NEW □ □

INTERRUPTEUR POUSSOIR D'INTERVERROUILLAGE PLUNGER INTERLOCK SWITCH

Modèles / Models

Tondeuses série 700 /

700 series mowers

Remplace / Replaces

MTD #725-04363

No 31-2950



INTERRUPTEUR POUSSOIR D'INTERVERROUILLAGE PLUNGER INTERLOCK SWITCH

Normalement fermé / Normally closed

2 bornes / terminals

2 positions

Modèles / Models

Ariens Grand Sierra 22HP,

931038-000101, 931303-00101

avec moteur Kohler / with Kohler engine

Remplace / Replaces

Ariens #30957

AYP #109869X

Bob-Cat #38383

Exmark #1-513152, 513152

Ferris #21769

John Deere #AM108483

Simplicity #1708207, 1708207SM

Snapper #27225, 7027225,

923408

No 31-9658





PAGES COMPRENANT TOUS LES INTERRUPTEURS /
PAGES INCLUDING ALL THE SWITCHES CONT.

INTERRUPTEUR POUSSOIR D'INTERVERROUILLAGE PLUNGER INTERLOCK SWITCH

Normalement ouvert/Normalement fermé /
Normally open/Normally closed
2 bornes / terminals
2 positions

Double pôles / *Double poles*
À pression / *Snap mount*

Remplace / *Replaces*
Ariens #08828100, 88281
AYP #109553X
Bob-Cat #108208
Bolens #175-1328
Bunton #PL7484
Dixon #4242, 539115802, 539101080
Encore #523034
Exmark #633111, 1-633111
Ferris #22095
Grasshopper #183894
Husqvarna #539-109553
John Deere #AM128925
MTD #725-3169A, 925-3169A
Murray #91299
Simplicity #1717050, 1717050SM
Snapper #23355, 7023355

No 31-9659



INTERRUPTEUR POUSSOIR D'INTERVERROUILLAGE PLUNGER INTERLOCK SWITCH

Normalement ouvert/Normalement fermé /
Normally open/Normally closed

Double pôles /
Double poles
À pression / *Snap mount*

Remplace / *Replaces*
MTD #925-1657A



No 31-9661



INTERRUPTEUR POUSSOIR D'INTERVERROUILLAGE PLUNGER INTERLOCK SWITCH

Normalement ouvert/Normalement fermé /
Normally open/Normally closed

Double pôles / *Double poles*
À pression / *Snap mount*

Remplace / *Replaces*
John Deere #GY20094
Murray #94136, 094136,
094136MA



No 31-9662



31



INTERRUPTEUR POUSSOIR D'INTERVERROUILLAGE PLUNGER INTERLOCK SWITCH

Normalement ouvert / *Normally open*

Remplace / *Replaces*
Ariens #36571, 03657100, 02754100
AYP #104445X
Bob-Cat #38382
Bolens #174-8723
Exmark #1-513051, 513051
Ferris #21451
Hustler #781211
John Deere #AM104884
Kubota #K2561-62251
Murray #24273
Scag #481637
Snapper #7014847, 14847, 7015707, 919098
Toro/Wheel Horse #65-7410
Yazoo #1923-025, 539001125

No 31-9660



INTERRUPTEUR POUSSOIR D'INTERVERROUILLAGE PLUNGER INTERLOCK SWITCH

Normalement ouvert / *Normally open*

Support à angle droit à pression /
Right angle snap mounted

Remplace / *Replaces*
Ariens #27541
AYP #160784
Husqvarna #532-1607-84
John Deere #AM103119
Kubota #K1122-62280, K1122-62282
MTD #725-3167, 925-3167
Murray #57211, 024273
Roper #160784
Scag #481638
Sears #160784
Simplicity #1704379, 1704379SM
Snapper #15707
Toro/Wheel Horse #82-2190

No 31-9663





PAGES COMPRENANT TOUS LES INTERRUPTEURS /
PAGES INCLUDING ALL THE SWITCHES CONT.

INTERRUPTEUR POUSSOIR D'INTERVERROUILLAGE PLUNGER INTERLOCK SWITCH

Normalement fermé / Normally closed



Support à angle droit à pression /
Right angle snap mounted



Remplace / Replaces
 AYP #121305X
 Bolens #1761083
 Cub Cadet #725-3166, 925-3166
 Exmark #740275
 Husqvarna #506-90-96-01, 532-121305
 John Deere #AM104403
 MTD #725-3166, 925-3166
 Murray #094159, 094159MA, 94159
 Scag #48717
 Simplicity #1714770, 7023354
 Snapper #2-3354, 7023354
 Troy Bilt #GW-1761083 **No 31-9664**

COMMUTATEUR GÉNÉRAL D'ÉCLAIRAGE HEADLIGHT SWITCH

Remplace / Replaces
 AYP #110712X



No 31-2936

COMMUTATEUR GÉNÉRAL D'ÉCLAIRAGE HEADLIGHT SWITCH

Pour / For
 4HP, 5.5HP et/and 9HP Vanguard
 5HP Industrial plus



Remplace / Replaces
 Briggs & Stratton #495098S **No 31-2946**

INTERRUPTEUR POUSSOIR D'INTERVERROUILLAGE PLUNGER INTERLOCK SWITCH

Normalement ouvert/Normalement fermé /
Normally open/Normally closed



Double pôles / Double poles
 À pression / Snap mount



Remplace / Replaces
 AYP #153664, 161343, 176138
 Cub Cadet #725-3164, 925-3164, 725-3164AP
 Ferris #22182, 5023455
 Husqvarna #532-153664, 532-176137, 532-176138
 MTD #725-3164A, 925-3164A
 Snapper #22886, 7022886,
 1723507, 1732006 **No 31-9665**

□ □ NOUVEAU / NEW □ □

INTERRUPTEUR D'ARRÊT STOP SWITCH



Remplace / Replaces
 Honda #36100-ZH7-W41 **No 31-2929**

31

□ □ NOUVEAU / NEW □ □

INTERRUPTEUR D'ALLUMAGE IGNITION SWITCH

2 bornes / terminals
 2 positions



Pour souffleuses avec
 moteur Zongshen /
 For snowblowers with Zongshen engine

Utilisé pour les souffleuses Craftman et Huskee /
 Used on Craftman and Huskee snowblowers

Remplace / Replaces
 MTD #951-10637 **No 31-3315**

INTERRUPTEUR D'ALLUMAGE IGNITION SWITCH



Remplace / Replaces
 Lawn-Boy #682513 **No 31-2963**

INTERRUPTEUR MARCHE/ARRÊT ON/OFF SWITCH

GLENDALE



Remplace / Replaces
 Honda #36100-ZE1-015 **No 84-3102**



PAGES COMPRENANT TOUS LES INTERRUPTEURS /
PAGES INCLUDING ALL THE SWITCHES CONT.

INTERRUPTEUR D'ARRÊT STOP SWITCH

Longueur / Length 3"

Pince courte pour bougie d'allumage /
Spark plug shorting clip

Boulon sur modèle /
Bolt on style

Pour toutes les bougies
d'allumage 14 mm / For all
14 mm spark plugs

Plaque de zinc / Zinc plate

Dirigé pour pénétrer bougie /
Pointed to penetrate plug boot

Remplace / Replaces
Briggs & Stratton #225171,
220197



Carte (12) /
Card (12)

No 31-1948

INTERRUPTEUR D'ALLUMAGE IGNITION SWITCH

Inclus plaque "Marche/Arrêt"
et écrou / Comes with "On/Off"
plate and nut



Interrupteur d'allumage pour scie à chaîne /
Chainsaw ignition switch

No 31-4720

INTERRUPTEUR À LEVIER PTO PTO TOGGLE SWITCH

S'installe sur la plupart des cadres
d'embrayage électrique /
For most box-frame electric
clutch applications



Remplace / Replaces
Cub Cadet #725-0893,
925-0893

No 31-357

INTERRUPTEUR PTO PTO SWITCH

4 bornes / terminals
2 positions

Modèles / Models
698, 699



Remplace / Replaces
MTD #725-0803C, 925-0803C **No 31-4723**

31

PAGES COMPRENANT TOUS LES SOLÉNOÏDES /
PAGES INCLUDING ALL THE SOLENOIDS

SOLÉNOÏDE SOLENOID

12 volts
3 bornes / terminals
Support à 90° / 90° mount

Boulon diamètre 1/4" /
Bolt diameter 1/4"

Borne du connecteur coulissant /
Slide connector terminal

Capacité de 80 ampères / 80 amps capacity

Remplace / Replaces
AYP #110832X
MTD #725-1426, 925-1426
Snapper #1-8817, 75671
Toro/Wheel Horse #112-0309

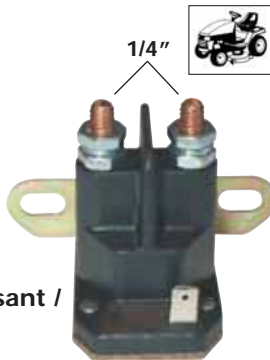

No 31-1928

SOLÉNOÏDE SOLENOID

3 bornes / terminals

Boulon diamètre 1/4" /
Bolt diameter 1/4"

Borne avec mise à la terre
intérieure w/wcrew /
Internal ground w/wcrew
terminal

Capacité de 80 ampères / 80 amps capacity

Remplace / Replaces
MTD #725-0771, 925-0771 **No 31-1929**





PAGES COMPRENANT TOUS LES SOLÉNOÏDES /
PAGES INCLUDING ALL THE SOLENOIDS CONT.

□ □ NOUVEAU / NEW □ □

SOLENOÏDE DE DÉMARREUR SOLENOID STARTER



Remplace / Replaces
Kohler #25-435-04S

No 31-1983

SOLENOÏDE SOLENOID

12 volts
3 bornes / terminals
Goujons / Studs 1/4" - 20

Remplace / Replaces
AMF #53716
Ariens #3057700
Bolens #1751569
MTD #725-0530, 725-0771,
925-0771
Murray #24285, 9924285,
424285, 7701100MA
Snapper #1-8817
Stiga #1134-946-01
Wheel Horse #111674



No 31-3319

SOLENOÏDE SOLENOID

Universel / Universal

2 bornes / terminals
2 positions

4 bornes avec support double /
4 terminals with dual mounting bracket



Poteau de borne et manchon s'adaptant aux
embouts de 1/4" / Terminal post and sleeve will
accept both 1/4"

Mise à la terre externe inclus les convertisseurs /
External ground includes spade converters

No 31-1990

SOLENOÏDE SOLENOID

12 volts
3 bornes / terminals

Universel / Universal

Poteau de borne et manchon
s'adaptant aux embouts de
1/4" / Terminal post and sleeve
will accept both 1/4"

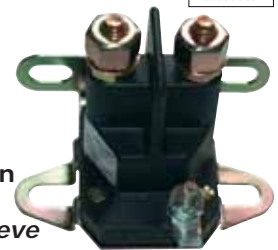

31

SOLENOÏDE SOLENOID

Universel / Universal

1 borne / terminal
2 positions

3 bornes avec support double /
3 terminals with dual mounting bracket

Poteau de borne et manchon s'adaptant aux
embouts de 1/4" / Terminal post and sleeve will
accept both 1/4"

Mise à la terre externe inclus les convertisseurs /
External ground includes spade converters

No 31-1991

Remplace / Replaces
AMF #53716
Ariens #3057700
Bolens #1751569
MTD #725-0771, 725-1426,
725-0530, 925-1426, 925-0771
Murray #424285, 924285, 21261, 24285
Noma #52323
Snapper #7018817, 7075671
Toro #111674

No 31-3317

□ □

PAGES COMPRENANT TOUS LES SOLÉNOÏDES /
PAGES INCLUDING ALL THE SOLENOIDS CONT.

SOLÉNOÏDE SOLENOID

12 volts
4 bornes / terminals
Goujons / Studs 1/4" - 20

Remplace / Replaces
Ariens #35510
AYP #192507, 146154
Bolens #1752137, 1753539
Gilson #212655
Grasshopper #184251
Gravely #45071
Lawn-Boy #740207
Simplicity #1685290
Snapper #1-8604, 7018604
Toro #28-4210, 47-1910
Wheel Horse #110116

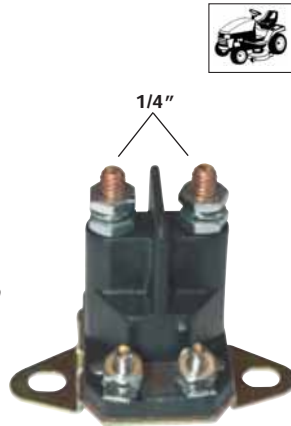

No 31-3320



SOLÉNOÏDE SOLENOID

12 volts
3 bornes / terminals :
5/16" - 18 bornes / terminals (2),
10-32 borne / terminal (1)

Remplace / Replaces
Cub Cadet #725-3001,
925-3001



No 31-3324

SOLÉNOÏDE SOLENOID

Très résistant / Heavy duty

Remplace / Replaces
John Deere #AM132990,
AM133094, AM130365,
AM138497, AM138068
MTD #725-0771
Murray #21261



No 31-9168

SOLÉNOÏDE SOLENOID

Universel / Universal

12 volts
4 bornes / terminals

Poteau de borne et manchon
s'adaptant aux embouts de
1/4" / Terminal post and sleeve
will accept both 1/4"

Les supports de montage s'adapte à la
configuration des supports de châssis et de murs /
Mounting bracket will accomodate both
chassis and wall mount configurations



No 31-3318



SOLÉNOÏDE SOLENOID

5/16" (7.94 mm)

Remplace / Replaces
Stiga #1134 2946-02

No 31-50239



SOLÉNOÏDE SOLENOID

Modèles / Models
GE340, GE390,
GX340, GX390

Remplace / Replaces
Honda

No 84-3107





UNIVERSEL / UNIVERSAL

MODULE D'ALLUMAGE ÉLECTRONIQUE ELECTRONIC IGNITION MODULE

NOVA

Le module Nova est indiqué pour les bobines d'allumage à 2 et 3 pattes des moteurs à un cylindre / *The Nova module is suitable for 2 legs and 3 legs ignition coils in single cylinder engines*



Ce module n'est cependant pas recommandé dans le cas de moteurs munis d'une batterie d'allumage ou de volants à aimants multiples / *This module is not recommended for use on engines equipped with battery ignition or flywheels with multiple magnets*

Fréquemment utilisé dans le cas de moteurs à essence à 2 et 4 temps, tels que : tondeuses, génératrices, pompes, rotoculteurs, tracteurs de jardin, scies à chaîne, débroussailleuses, coupe-herbe, go-karts, souffleuses à neige / *Widely used in 2 and 4 cycles gasoline engines as in : lawnmowers, generators, pumps, tillers, compact garden tractors, chainsaws, brushcutters, dusters, trimmers, go-karts, snowblowers*

Facile à installer / *Easy to install*

Boîtier en aluminium / *Die cast aluminum housing*

Imperméable, opérable sous toutes les conditions météo / *Waterproof, operates in any weather conditions*

No 31-1986

MODULE D'ALLUMAGE ÉLECTRONIQUE ELECTRONIC IGNITION MODULE

NOVA II

Plus petit que notre / *Smaller than our #31-1986*



No 31-8786

MODULE D'ALLUMAGE MEGA FIRE MEGA FIRE IGNITION MODULE

Résiste aux variations de température extrêmes / *Withstands extreme temperature variations*

Remplace les pointes et les condensateurs / *Replaces points and condensers*

Son design compact permet de l'installer là où l'espace est réduit / *Has a compact design allowing it to fit where other modules cannot*

Feu à basse révolution / *Fires at lower RPM's*

Application universelle / *Universal application*

Boîtier d'aluminium durable / *Durable aluminum casing*

Facile d'installation, feuille d'instruction incluse / *Easy to install, instruction sheet included*



No 31-1989

CLÉ DE CONTACT IGNITION KEY

24 clés par carte / *24 keys per card*



Pour nos interrupteurs / *For our switches*

#31-1930, 31-1931, 31-2922, 31-2941, 31-7280, 31-7804



No 31-2938

31

INTERRUPTEUR D'ALLUMAGE IGNITION SWITCH

Universel / *Universal*

5 bornes / *terminals*

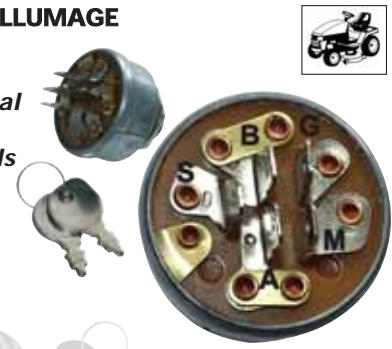

Remplace / *Replaces* Sears/Roper #73232, 14615

No 31-2941



UNIVERSEL / UNIVERSAL CONT.

RÉGULATEUR DE VOLTAGE VOLTAGE REGULATOR

Pour système de remplissage de circuit quadruple de 8 ampères / For 8 amps quad circuit charging system

Modèles / Models
Séries moteurs 422700 / Series engines 422700

Remplace / Replace
Briggs & Stratton #397809 **No 31-2924**

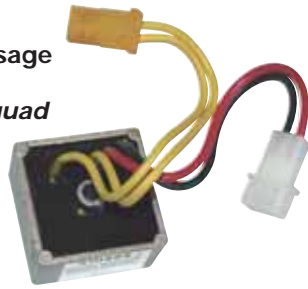

INTERRUPTEUR D'ALLUMAGE IGNITION SWITCH

Universel / Universal

Pour souffleuses à neige / For snowblowers

Remplace / Replaces
Ariens #624097, 11134, 02456500, 52406900
AYP #135944
Homelite #JA130641
Lawn-Boy #700171
Murray #56419
Simplicity #1664804
Snapper #17817

No 31-1939



31

INTERRUPTEUR D'ALLUMAGE IGNITION SWITCH

Universel / Universal

Interrupteur à poussoir / Push button switch

Remplace / Replaces
Snapper #1-2623, 7012623 **No 31-1946**



INTERRUPTEUR D'ALLUMAGE IGNITION SWITCH

Universel / Universal

Trou de montage / Mounting hole 5/8"

Démarrage manuel / Manuel start

Remplace / Replaces
Snapper #1-1853, 7011853 **No 31-1930**



INTERRUPTEUR D'ALLUMAGE IGNITION SWITCH

Universel / Universal

5 bornes / terminals
3 positions
Requiert trou / Requires hole 5/8"

Remplace / Replaces
AMF #44745, 300295
AYP #S365402, 3612R, 4406R
Bob-Cat #48032B
Dixie #20245
Dixon #4197
Grasshopper #183806
Honda #510-772-003
John Deere #AM102544, AM31995, AM102551
MTD #725-0267, 925-0267
Murray #21064, 21064PA
Noma #421064
Roper #3621R
Scag #48017, 48017-02
Snapper #7027698, 7029010
Toro #23-0660 **No 31-2922**



INTERRUPTEUR D'ALLUMAGE IGNITION SWITCH

Universel / Universal

Remplace / Replaces
Kohler #25-099-04, 25-099-32S
Toro/Wheel Horse #103991 **No 31-7280**



LUMIÈRE LIGHT

Faisceau scellé / Sealed beam L4411

12 volts, 35 watts
Diamètre / Diameter 4 1/2"
Type 1

Pour tracteurs / For tractors
D10, D12, D14, D21, 170, 180,
AC230, 232

No 31-4411



LUMIÈRE LIGHT

Faisceau scellé / Sealed beam L4414

12 volts, 18 watts
Diamètre / Diameter 4 1/2"

Pour souffleuses à neige / For snowblowers
12.8V

No 31-4414





UNIVERSEL / UNIVERSAL CONT.

**HOROMÈTRE - HEURE ET RPM
HOURMETER - HOUR AND RPM**

Longueur / Length 54 mm
Largeur / Width 32 mm
Hauteur / Height 15.5 mm



Plastique / Plastic

S'éteint automatiquement en 32 secondes /
Auto turn-off in 32 seconds

Pour tous les moteurs 2 temps et 4 temps /
For all 2 stroke and 4 stroke cylinder engines

Facile à installer avec des vis et du
ruban auto-collant / Easy to mount with screws
and self-adhesive tape

Mesure du tachomètre /
Tacho measuring range : 1 000 à/to 20 000 RPM

Précision / Accuracy : + 0.5%, - 0.1%

Minuterie / Timer : 0 à/to 19 999 heures / hours
59 minutes / minutes

Puissance par 2 x CR2032 batterie au lithium /
Powered by 2 x CR2032 lithium battery

Température de remisage /
Storage temperature : -35°C à/to 85°C

Température lors du fonctionnement /
Operating temperature : -10°C à/to 80°C

No 31-1959

□ □ NOUVEAU / NEW □ □

**HOROMÈTRE NUMÉRIQUE
DIGITAL HOURMETER**

Tourner le fil 5 fois autour
du fil de la bougie et
sécurisez avec une attache /
Wrap pick-up wire around
spark plug wire 5 times and
secure with tie-wrap



Collant à l'arrière / Sticker on back

No 31-1970

**HOROMÈTRE NUMÉRIQUE
DIGITAL HOURMETER**

Petit panneau avec support /
Small panel mount



Utilisé sur différents tracteurs /
Used on several tractors

Remplace / Replaces
AYP #169642, 177501,
110940X

No 31-1957

**SUPPORT DE FIXATION
MOUNTING BRACKET**

Horomètre non-inclus /
Hourmeter not included



No 31-1949

□ □ NOUVEAU / NEW □ □

**CAPUCHON DE BOUGIE
SPARG PLUG CONNECTOR**

5 mm



Le bout de la bougie
doit être enlever pour
que le capuchon puisse
s'insérer correctement /
The tip of the spark plug must be removed so
that the cap can be inserted correctly

Remplace / Replaces
Murray

LOT (10)
No 31-4987

**CAPUCHON DE BOUGIE
SPARK PLUG CONNECTOR**

Pour fil / For wire 5 mm



Pour scies à chaîne et coupe-herbe /
Used on chainsaws and trimmers

LOT (10)
No 31-4988

**CAPUCHON DE BOUGIE
SPARK PLUG CONNECTOR**

Type "KLG"



Pour motocyclettes, motoneiges,
tondeuses, tracteurs et plus /
For motorcycles, snowmobiles,
mowers, tractors and more

LOT (10)
No 31-1952



UNIVERSEL / UNIVERSAL CONT.

COIFFE DE BOUGIE SPARK PLUG BOOT

GLENDALE

Modèles / Models
GE140, GE160, GE200, GE240,
GE270, GE340, GE390

Remplace / Replaces
Honda #30700-ZE1-000,
30700-ZE1-013



No 84-3101

CAPUCHON DE BOUGIE SPARK PLUG CONNECTOR

Pour fil / For wire 7 mm



Remplace / Replaces
Lawn-Boy # 580339, 510231,
684698

LOT (10)
No 31-1951

COIFFE DE BOUGIE SPARK PLUG BOOT

Bouchon de bougie NGK
45 degré VB05F /
45 degree spark plug
boot NGK VB05F



Pour moteurs à soupapes en tête (étanche) /
For overhead valve engines (water tight)

No 31-1958

INTERRUPTEUR D'ALLUMAGE IGNITION SWITCH

5 bornes / terminals

Démarrage manuel /
Manual start

Remplace / Replaces
Ariens #03115200, 31152
AYP #2683, 2683R
Gravely #19223
Jacobson #129746, 129846
Kohler #48-099-01
Lawn-Boy #741308
Onan #378-0385
Toro/Wheel Horse #12-8140,
103990



No 31-1931

VÉRIFICATEUR DE COURANT IGNITION TESTER

Vérificateur de bougie
pour petit moteur /
Spark plug tester for small engine

Pour vérifier la continuité du courant /
To check the ignition continuity



No 32-9099

RUBAN ISOLANT ÉLECTRIQUE ELECTRICAL INSULATING TAPE

Ruban approuvé CSA /
CSA approved tape



LOT (10)
No 31-346

INTERRUPTEUR D'ARRÊT STOP SWITCH

Longueur / Length 3"

Pince courte pour bougie d'allumage /
Spark plug shorting clip

Boulon sur modèle /
Bolt on style

Pour toutes les bougies
d'allumage 14 mm / For all
14 mm spark plugs

Plaque de zinc / Zinc plate

Dirigé pour pénétrer bougie /
Pointed to penetrate plug boot



Carte (12) /
Card (12)

Remplace / Replaces
Briggs & Stratton #225171,
220197

No 31-1948

DÉMARREUR ÉLECTRIQUE ELECTRIC STARTER

Pour moteurs Tecumseh /
For Tecumseh engines
8HP, 10HP et/and 12HP

Voir engrenage seulement /
See gear only #98-123
Voir ensemble de vis et
boulons / See bolts and
screws kit #98-124
Voir cordon d'extension /
See extension cord #98-121



Remplace / Replaces
Tecumseh #33519A

No 98-117



Qualité originale
OEM quality



UNIVERSEL / UNIVERSAL CONT.

ENGRENAGE DE DÉMARREUR STARTER GEAR

S'installe sur / *Install on*
#88-117, 98-117

Remplace / *Replaces*
Tecumseh #37050, 37052A



No 98-123

ENSEMBLE DE VIS ET BOULONS BOLTS AND SCREWS KIT

S'installe sur / *Install on*
#88-117, 98-117

Pour démarreur 110 volts /
For 110 volts starter



No 98-124

CORDON D'EXTENSION EXTENSION CORD

Longueur / *Length* 12'

Fabriqué au Canada /
Made in Canada
Certifié CSA / *CSA Certify*



No 98-121

DÉMARREUR ÉLECTRIQUE ELECTRIC STARTER

Pour moteurs Tecumseh 7HP /
For 7HP Tecumseh engines

Voir ensemble de vis
et boulons / *See bolts*
and screws kit #98-124

Remplace / *Replaces*
Tecumseh #33328DSP



No 98-147

ATTACHE DE NYLON NYLON CABLE TIE

Longueur / *Length* 8"

Noire / *Black*



LOT (100)
No 31-4268

INTERRUPTEUR D'ALLUMAGE IGNITION SWITCH

Inclus plaque "Marche/Arrêt"
et écrou / *Comes with "On/Off"*
plate and nut

Interrupteur d'allumage pour scie à chaîne /
Chainsaw ignition switch



No 31-4720

SOLÉNOÏDE SOLENOID

Universel / *Universal*

2 bornes / *terminals*
2 positions

4 bornes avec support double /
4 terminals with dual mounting bracket

Poteau de borne et manchon s'adaptant aux
embouts de 1/4" / *Terminal post and sleeve will*
accept both 1/4"

Mise à la terre externe inclus les convertisseurs /
External ground includes spade converters



No 31-1990

31



SOLÉNOÏDE SOLENOID

Universel / *Universal*

1 borne / *terminal*
2 positions

3 bornes avec support double /
3 terminals with dual mounting bracket

Poteau de borne et manchon s'adaptant aux
embouts de 1/4" / *Terminal post and sleeve will*
accept both 1/4"

Mise à la terre externe inclus les convertisseurs /
External ground includes spade converters



No 31-1991



UNIVERSEL / UNIVERSAL CONT.

SOLÉNOÏDE SOLENOID



12 volts
3 bornes / terminals

Universel / Universal

Poteau de borne et manchon
s'adaptant aux embouts de
1/4" / Terminal post and sleeve
will accept both 1/4"

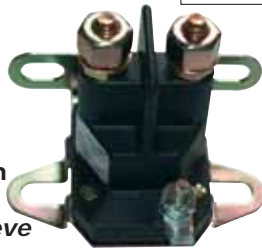

Les supports de montage s'adapte à la
configuration des supports de châssis et de murs /
Mounting bracket will accomodate both
chassis and wall mount configurations

Remplace / Replaces

AMF #53716
Ariens #3057700
Bolens #1751569
MTD #725-0771, 725-1426,
725-0530, 925-1426, 925-0771
Murray #424285, 924285, 21261, 24285
Noma #52323
Snapper #7018817, 7075671
Toro #111674

No 31-3317

SOLÉNOÏDE SOLENOID



Universel / Universal

12 volts
4 bornes / terminals

Poteau de borne et manchon
s'adaptant aux embouts de
1/4" / Terminal post and sleeve
will accept both 1/4"



Les supports de montage s'adapte à la
configuration des supports de châssis et de murs /
Mounting bracket will accomodate both
chassis and wall mount configurations

Remplace / Replaces

Ariens #35510
AYP #109081X, 109946, 146154
Bolens #1752137, 1753539
Case #C-266525, C33025
Exmark #1-513075
Gilson #212655
Grasshopper #184251
Gravely #45071
Lawn-Boy #740207
MTD #725-04437
Simplicity #170051, 16771993, 16852980, 1700751
Snapper #18604, 7018604
Toro #47-1910, 110116,
110162, 110167

No 31-3318

ARIENS

CLÉ DE CONTACT IGNITION KEY



Plastique / Plastic
Clé à pousser-tirer / Push-pull key



Modèles / Models

MTD 314-181-000, 314-180-131
314-180-000, 314-180-088, TMO-3525203

Pour souffleuses avec moteurs Tecumseh /
For snowblowers with Tecumseh engines

Remplace / Replaces

Ariens #7532000, 7500108
MTD #725-1660
Tecumseh #35062

No 31-2934

INTERRUPTEUR D'ALLUMAGE IGNITION SWITCH



5 bornes / terminals

Démarrage manuel /
Manual start



Remplace / Replaces

Ariens #03115200, 31152
AYP #2683, 2683R
Gravely #19223
Jacobson #129746, 129846
Kohler #48-099-01
Lawn-Boy #741308
Onan #378-0385
Toro/Wheel Horse #12-8140,
103990

No 31-1931

INTERRUPTEUR D'ALLUMAGE IGNITION SWITCH



Universel / Universal

Pour souffleuses à neige /
For snowblowers



Remplace / Replaces

Ariens #624097, 11134, 02456500, 52406900
AYP #135944
Homelite #JA130641
Lawn-Boy #700171
Murray #56419
Simplicity #1664804
Snapper #17817

No 31-1939





ARIENS CONT.

SOLÉNOÏDE SOLENOID

12 volts
3 bornes / terminals
Goujons / Studs 1/4" - 20

Remplace / Replaces
AMF #53716
Ariens #3057700
Bolens #1751569
MTD #725-0530, 725-0771,
925-0771
Murray #24285, 9924285,
424285, 7701100MA
Snapper #1-8817
Stiga #1134-946-01
Wheel Horse #111674



No 31-3319

SOLÉNOÏDE SOLENOID

12 volts
4 bornes / terminals
Goujons / Studs 1/4" - 20

Remplace / Replaces
Ariens #35510
AYP #192507, 146154
Bolens #1752137, 1753539
Gilson #212655
Grasshopper #184251
Gravely #45071
Lawn-Boy #740207
Simplicity #1685290
Snapper #1-8604, 7018604
Toro #28-4210, 47-1910
Wheel Horse #110116

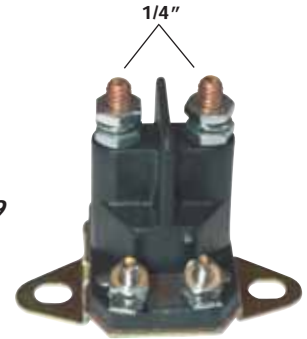

No 31-3320

SOLÉNOÏDE SOLENOID

12 volts
3 bornes / terminals

Universel / Universal

Poteau de borne et manchon
s'adaptant aux embouts de
1/4" / Terminal post and sleeve
will accept both 1/4"



Les supports de montage s'adapte à la
configuration des supports de châssis et de murs /
Mounting bracket will accomodate both
chassis and wall mount configurations

Remplace / Replaces
AMF #53716
Ariens #3057700
Bolens #1751569
MTD #725-0771, 725-1426,
725-0530, 925-1426, 925-0771
Murray #424285, 924285, 21261, 24285
Noma #52323
Snapper #7018817, 7075671
Toro #111674

No 31-3317

SOLÉNOÏDE SOLENOID

Universel / Universal

12 volts
4 bornes / terminals

Poteau de borne et manchon
s'adaptant aux embouts de
1/4" / Terminal post and sleeve
will accept both 1/4"

Les supports de montage s'adapte à la
configuration des supports de châssis et de murs /
Mounting bracket will accomodate both
chassis and wall mount configurations



31

Remplace / Replaces
Ariens #35510
AYP #109081X, 109946, 146154
Bolens #1752137, 1753539
Case #C-266525, C33025
Exmark #1-513075
Gilson #212655
Grasshopper #184251
Gravely #45071
Lawn-Boy #740207
MTD #725-04437
Simplicity #170051, 16771993, 16852980, 1700751
Snapper #18604, 7018604
Toro #47-1910, 110116,
110162, 110167

No 31-3318



ARIENS CONT.

INTERRUPTEUR D'ALLUMAGE IGNITION SWITCH

7 bornes / terminals
4 positions

Languettes à pression en
plastique pour insérer
dans le cadran /
Plastic snap to insert
in bezel

Remplace / Replaces
Ariens #15883



No 31-3323

INTERRUPTEUR D'ALLUMAGE IGNITION SWITCH

6 bornes / terminals
3 positions

Pour tondeuse à support
avant John Deere /
For John Deere front
mount mower

Modèles / Models
Séries 300 et quelques
séries 200 / Series 300
and some series 200
(Magnéto / Magneto)

Remplace / Replaces
Ariens #03602300
John Deere #AM38227

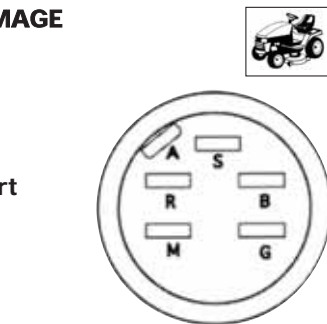

No 31-9166

INTERRUPTEUR D'ALLUMAGE IGNITION SWITCH

8 bornes / terminals

Pousser-tirer, à pression /
Push-pull, snap mount

Terminal du milieu vide /
Middle terminal blank

Bouton rouge / Red knob

Remplace / Replaces
Ariens #522100, 5221, 01545600, 1545600
Exmark #633673, 1-633673, 103-5221
Grasshopper #183925
John Deere #AM118802, AM119139, AM131966,
TCA17834
Kubota #K1211-62231
MTD #725-1716, 925-1716, 725-1752
Scag #481635, 700675
Snapper #28542, 7028542
Toro/Wheel Horse #93-9999, 93-9998, 95-4108,
95-7489, 1035221, 1633673

No 31-9657

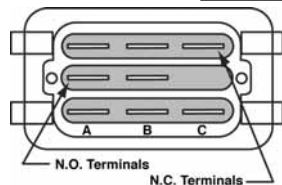

INTERRUPTEUR POUSSOIR D'INTERVERROUILLAGE PLUNGER INTERLOCK SWITCH

Normalement fermé / Normally closed
2 bornes / terminals
2 positions

Modèles / Models
Ariens Grand Sierra 22HP,
931038-000101, 931303-00101
avec moteur Kohler / with Kohler engine

Remplace / Replaces
Ariens #30957
AYP #109869X
Bob-Cat #38383
Exmark #1-513152, 513152
Ferris #21769

John Deere #AM108483
Simplicity #1708207, 1708207SM
Snapper #27225, 7027225,
923408



No 31-9658

INTERRUPTEUR POUSSOIR D'INTERVERROUILLAGE PLUNGER INTERLOCK SWITCH

Normalement ouvert/Normalement fermé /
Normally open/Normally closed
2 bornes / terminals
2 positions

Double pôles / Double poles
À pression / Snap mount

Remplace / Replaces
Ariens #08828100, 88281
AYP #109553X
Bob-Cat #108208
Bolens #175-1328
Bunton #PL7484
Dixon #4242, 539115802, 539101080
Encore #523034
Exmark #633111, 1-633111
Ferris #22095
Grasshopper #183894
Husqvarna #539-109553
John Deere #AM128925
MTD #725-3169A, 925-3169A
Murray #91299
Simplicity #1717050, 1717050SM
Snapper #23355, 7023355



No 31-9659



ARIENS CONT.

INTERRUPTEUR POUSSOIR D'INTERVERROUILLAGE PLUNGER INTERLOCK SWITCH

Normalement ouvert / Normally open



Remplace / Replaces
 Ariens #36571, 03657100, 02754100
 AYP #104445X
 Bob-Cat #38382
 Bolens #174-8723
 Exmark #1-513051, 513051
 Ferris #21451
 Hustler #781211
 John Deere #AM104884
 Kubota #K2561-62251
 Murray #24273
 Scag #481637
 Snapper #7014847, 14847, 7015707, 919098
 Toro/Wheel Horse #65-7410
 Yazoo #1923-025, 539001125 **No 31-9660**



INTERRUPTEUR POUSSOIR D'INTERVERROUILLAGE PLUNGER INTERLOCK SWITCH

Normalement ouvert / Normally open



Support à angle droit à pression /
 Right angle snap mounted

Remplace / Replaces
 Ariens #27541
 AYP #160784
 Husqvarna #532-1607-84
 John Deere #AM103119
 Kubota #K1122-62280, K1122-62282
 MTD #725-3167, 925-3167
 Murray #57211, 024273
 Roper #160784
 Scag #481638
 Sears #160784
 Simplicity #1704379, 1704379SM
 Snapper #15707
 Toro/Wheel Horse #82-2190 **No 31-9663**



BOBINE COIL

Pour / For
 4HP, 6HP, 8HP, 10HP, 12HP, 14HP

Remplace / Replaces
 Ariens #2035500
 Gravely #022152
 John Deere #AM132453, AM38411
 Kohler #231281S, 237256S, 47-145-01S,
 41-519-21S
 Kubota #12581-68900
 Tecumseh #32080, 4151921 **No 31-1781**



AYP (CRAFTMAN, HUSQVARNA, POULAN PRO, ROPER, SEARS)

HOROMÈTRE NUMÉRIQUE DIGITAL HOURMETER

Petit panneau avec support /
 Small panel mount



Utilisé sur différents tracteurs /
 Used on several tractors

Remplace / Replaces
 AYP #169642, 177501,
 110940X **No 31-1957**

INTERRUPTEUR D'ALLUMAGE PTO PTO IGNITION SWITCH

8 bornes / terminals
 2 positions

Pousser-tirer, à pression /
 Push-pull, snap mount

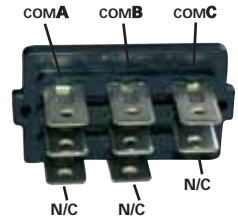

Bouton noir / Black knob

Remplace / Replaces
 AYP #169417, 174651, 174653
 Bad boy #056-8058-00
 Bob-Cat #1985032
 Bunton #PL7994
 Bush Hog #50018299
 Ferris #5022180,
 5022180SM, 5022182 **No 31-2915**



31

SOLÉNOÏDE SOLENOID

12 volts
 3 bornes / terminals
 Support à 90° / 90° mount

Boulon diamètre 1/4" /
 Bolt diameter 1/4"

Borne du connecteur coulissant /
 Slide connector terminal

Capacité de 80 ampères / 80 amps capacity

Remplace / Replaces
 AYP #110832X
 MTD #725-1426, 925-1426
 Snapper #1-8817, 75671
 Toro/Wheel Horse #112-0309 **No 31-1928**

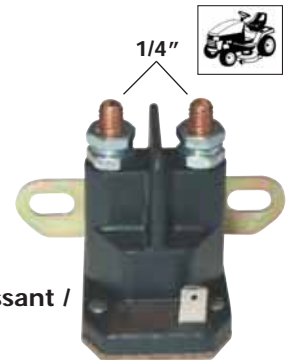



AYP (CRAFTMAN, HUSQVARNA,
POULAN PRO, ROPER, SEARS) CONT.

SOLÉNOÏDE SOLENOID



12 volts
4 bornes / terminals
Goujons / Studs 1/4" - 20

Remplace / Replaces
Ariens #35510
AYP #192507, 146154
Bolens #1752137, 1753539
Gilson #212655
Grasshopper #184251
Gravely #45071
Lawn-Boy #740207
Simplicity #1685290
Snapper #1-8604, 7018604
Toro #28-4210, 47-1910
Wheel Horse #110116

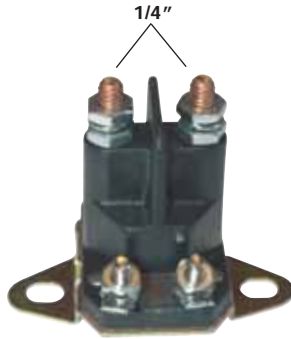

No 31-3320

SOLÉNOÏDE SOLENOID



Universel / Universal

12 volts
4 bornes / terminals

Poteau de borne et manchon
s'adaptant aux embouts de
1/4" / Terminal post and sleeve
will accept both 1/4"



Les supports de montage s'adapte à la
configuration des supports de châssis et de murs /
Mounting bracket will accomodate both
chassis and wall mount configurations

Remplace / Replaces
Ariens #35510
AYP #109081X, 109946, 146154
Bolens #1752137, 1753539
Case #C-266525, C33025
Exmark #1-513075
Gilson #212655
Grasshopper #184251
Gravely #45071
Lawn-Boy #740207
MTD #725-04437
Simplicity #170051, 16771993, 16852980, 1700751
Snapper #18604, 7018604
Toro #47-1910, 110116,
110162, 110167

No 31-3318

CLÉ DE CONTACT IGNITION KEY



Universel / Universal

Pour interrupteur en plastique Delta /
For plastic Delta switch

Poignée moulée / Molded grip

Remplace / Replaces
AYP #140401, 140402, 140403
Husqvarna #532-14-04-01, 532-14-04-02,
532-14-04-03, 532-411933, 532-411935
John Deere #AM123426, AM131946, AM135356,
AM153650, GY20680
Kohler #48-340-01S
MTD #725-1745, 925-1745
Murray #327350
Sears #140403
Simplicity #1717163,
1717163SM

No 31-2918

COMMUTATEUR GÉNÉRAL D'ÉCLAIRAGE HEADLIGHT SWITCH



Remplace / Replaces
AYP #110712X

No 31-2936

INTERRUPTEUR D'ALLUMAGE IGNITION SWITCH



5 bornes / terminals

Démarrage manuel /
Manual start



Remplace / Replaces
Ariens #03115200, 31152
AYP #2683, 2683R
Gravely #19223
Jacobson #129746, 129846
Kohler #48-099-01
Lawn-Boy #741308
Onan #378-0385
Toro/Wheel Horse #12-8140,
103990

No 31-1931





**AYP (GRAFTMAN, HUSQVARNA,
POULAN PRO, ROPER, SEARS) CONT.**

INTERRUPTEUR D'ALLUMAGE IGNITION SWITCH



Universel / *Universal*

Pour souffleuses à neige /
For snowblowers



Remplace / *Replaces*
Ariens #624097, 11134, 02456500, 52406900
AYP #135944
Homelite #JA130641
Lawn-Boy #700171
Murray #56419
Simplicity #1664804
Snapper #17817

No 31-1939

INTERRUPTEUR D'ALLUMAGE IGNITION SWITCH



Interrupteur d'allumage très
résistant avec clé / *Heavy duty
ignition switch with key*

Semblable à notre 31-2921,
mais de meilleure qualité /
*Similar to our 31-2921 but
more higher quality*



Remplace / *Replaces*
AYP #175566, 163968
John Deere #GY20074
MTD #725-1741, 925-1741
Murray #94762

No 31-2920

INTERRUPTEUR D'ALLUMAGE IGNITION SWITCH



7 bornes / *terminals*
4 positions

Pour tracteurs / *For tractors*
Clé non-incluse /
Key not included
Utilisé avec notre clé /
Used with our key #31-2918

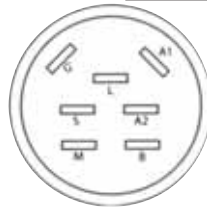

Remplace / *Replaces*
AYP #175566, 163968
John Deere #GY20074
MTD #725-1741, 925-1741
Murray #94762

No 31-2921

INTERRUPTEUR D'ALLUMAGE IGNITION SWITCH



Universel / *Universal*

5 bornes / *terminals*
3 positions
Requiert trou / *Requires hole 5/8"*



Remplace / *Replaces*
AMF #44745, 300295
AYP #S365402, 3612R, 4406R
Bob-Cat #48032B
Dixie #20245
Dixon #4197
Grasshopper #183806
Honda #510-772-003
John Deere #AM102544, AM31995, AM102551
MTD #725-0267, 925-0267
Murray #21064, 21064PA
Noma #421064
Roper #3621R
Scag #48017, 48017-02
Snapper #7027698, 7029010
Toro #23-0660



No 31-2922

INTERRUPTEUR D'ALLUMAGE IGNITION SWITCH



Universel / *Universal*

5 bornes / *terminals*



Remplace / *Replaces*
Sears/Roper #73232, 14615

No 31-2941

31





AYP (CRAFTMAN, HUSQVARNA,
POULAN PRO, ROPER, SEARS) CONT.

INTERRUPTEUR D'ALLUMAGE IGNITION SWITCH



S'installe sur la plupart des tracteurs Noma Signature /
Install on most Noma Signature tractors

Clé non-incluse /
Key not included

Remplace / Replaces
AYP #144921, 163088, 178744
Murray #327355
Noma #327355
Simplicity #1718306,
1713845, 1686734

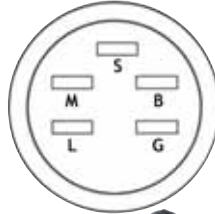

No 31-4721

□ □ NOUVEAU / NEW □ □
**INTERRUPTEUR D'ALLUMAGE
IGNITION SWITCH**



Modèles / Models
LT, LTS, YT, ST, GT

Clé non-incluse /
Key not included

Remplace / Replaces
AYP #193350



No 31-4724

□ □ NOUVEAU / NEW □ □
**INTERRUPTEUR D'ALLUMAGE
IGNITION SWITCH**



Pour moteur 2 cylindres /
For 2 cylinders engine
14HP, 400700 vertical,
400400 horizontal et/and
18HP, 422400 horizontal,
422700 vertical

Remplace / Replaces
AYP #102972Y, 145499
Briggs & Stratton #490066, 493625, 692318
Exmark #1-543070
Husqvarna #532-10-29-72, 532-14-54-99, 532-15-89-13
Scag #48798
Toro/Wheel Horse #83-0020
Troy Bilt #1754250, 1754250P **No 31-7804**



INTERRUPTEUR D'ALLUMAGE IGNITION SWITCH



6 bornes / terminals

Pour moteurs équipés
d'un solénoïde avec
soupape d'arrêt construit
depuis 1994 / For engines
equipped with fuel
shut-off solenoid built
since 1994

Utilisé sur les tondeuses Murray /
Used on Murray mowers

Remplace / Replaces
AYP #140301
MTD #725-1717
Murray #92556



No 31-9623

□ □ NOUVEAU / NEW □ □

AMPOULE HALOGÈNE HALOGEN BULB



Remplace / Replaces
AYP #401620, 532-401620
Husqvarna #401620,
532-401620

No 31-1659



RELAIS RELAY



Pour différents tracteurs AYP /
For several AYP tractors

Remplace / Replaces
AYP #109748X
Exmark #1-643275, 98-7249
Hustler #026231
Grasshopper #104-026-401
Walker #6942

No 31-9369



□ □ NOUVEAU / NEW □ □

INTERRUPTEUR D'ALLUMAGE PTO PTO IGNITION SWITCH



8 bornes / terminals
2 positions

Pousser-tirer, à pression /
Push-pull, snap mount

Bouton noir / Black knob

Modèles / Models
GT2254, GTH2642, GTH2654,
LGT2554, LGT2654, YTH2348,
YTH2448, Z-FORCE

Remplace / Replaces
AYP #196112
Husqvarna #532-19-61-12

No 31-2914

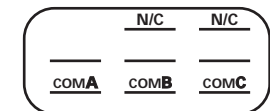



**AYP (GRAFTMAN, HUSQVARNA,
POULAN PRO, ROPER, SEARS) CONT.**

INTERRUPTEUR D'ALLUMAGE PTO PTO IGNITION SWITCH



8 bornes / terminals

Pousser-tirer, à pression /
Push-pull, snap mount

Borne du coin vide /
Corner terminal blank

Bouton rouge / Red knob

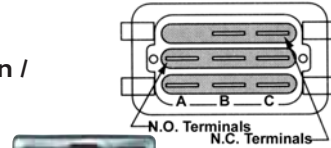

Remplace / Replaces
 AYP #146283, 140404, 154959,
 154963, 169416, 174652
 Dixon #5961, 539-117-238, 539-129-512,
 539-120-023
 Encore #523030, 523031
 Ferris #22180, 5022180
 Great Dane #D38005
 Howard #02-422
 Husqvarna #532-154-959, 532-169-417,
 532-174-651
 Hustler #771476, 77146, 776476
 Murray #94927, 6201-316
 Scag #483957, 27328, 481687, 483162
 Simplicity #171348, 171348SM, 1714772,
 1716332, 1722887
 Snapper #7035658, 35658
 Yazoo #101768, 539101768 **No 31-9656**

INTERRUPTEUR POUSSOIR D'INTERVERROUILLAGE PLUNGER INTERLOCK SWITCH



Normalement ouvert / Normalement fermé /
Normally open / Normally closed
 2 bornes / terminals
 2 positions

Double pôles / Double poles
 À pression / Snap mount

Remplace / Replaces
 Ariens #08828100, 88281
 AYP #109553X
 Bob-Cat #108208
 Bolens #175-1328
 Bunton #PL7484
 Dixon #4242, 539115802, 539101080
 Encore #523034
 Exmark #633111, 1-633111
 Ferris #22095
 Grasshopper #183894
 Husqvarna #539-109553
 John Deere #AM128925
 MTD #725-3169A, 925-3169A
 Murray #91299
 Simplicity #1717050, 1717050SM
 Snapper #23355, 7023355 **No 31-9659**



INTERRUPTEUR POUSSOIR D'INTERVERROUILLAGE PLUNGER INTERLOCK SWITCH



Normalement fermé / Normally closed
 2 bornes / terminals
 2 positions

Modèles / Models
 Ariens Grand Sierra 22HP,
 931038-000101, 931303-00101
 avec moteur Kohler / with Kohler engine

Remplace / Replaces
 Ariens #30957
 AYP #109869X
 Bob-Cat #38383
 Exmark #1-513152, 513152
 Ferris #21769
 John Deere #AM108483
 Simplicity #1708207, 1708207SM
 Snapper #27225, 7027225,
 923408 **No 31-9658**



INTERRUPTEUR POUSSOIR D'INTERVERROUILLAGE PLUNGER INTERLOCK SWITCH



Normalement ouvert / Normally open

Remplace / Replaces
 Ariens #36571, 03657100, 02754100
 AYP #104445X
 Bob-Cat #38382
 Bolens #174-8723
 Exmark #1-513051, 513051
 Ferris #21451
 Hustler #781211
 John Deere #AM104884
 Kubota #K2561-62251
 Murray #24273
 Scag #481637
 Snapper #7014847, 14847, 7015707, 919098
 Toro/Wheel Horse #65-7410
 Yazoo #1923-025, 539001125 **No 31-9660**





AYP (CRAFTMAN, HUSQVARNA,
POULAN PRO, ROPER, SEARS) CONT.

INTERRUPTEUR POUSSOIR D'INTERVERROUILLAGE PLUNGER INTERLOCK SWITCH

Normalement ouvert / *Normally open*



Support à angle droit à pression /
Right angle snap mounted

Remplace / *Replaces*

Ariens #27541

AYP #160784

Husqvarna #532-1607-84

John Deere #AM103119

Kubota #K1122-62280, K1122-62282

MTD #725-3167, 925-3167

Murray #57211, 024273

Roper #160784

Scag #481638

Sears #160784

Simplicity #1704379, 1704379SM

Snapper #15707

Toro/Wheel Horse #82-2190 **No 31-9663**



INTERRUPTEUR POUSSOIR D'INTERVERROUILLAGE PLUNGER INTERLOCK SWITCH

Normalement ouvert / Normalement fermé /
Normally open / Normally closed



Double pôles / *Double poles*
À pression / *Snap mount*



Remplace / *Replaces*

AYP #153664, 161343, 176138

Cub Cadet #725-3164, 925-3164, 725-3164AP

Ferris #22182, 5023455

Husqvarna #532-153664, 532-176137, 532-176138

MTD #725-3164A, 925-3164A

Snapper #22886, 7022886,

1723507, 1732006

No 31-9665

BOB-CAT

31



INTERRUPTEUR POUSSOIR D'INTERVERROUILLAGE PLUNGER INTERLOCK SWITCH

Normalement fermé / *Normally closed*



Support à angle droit à pression /
Right angle snap mounted

Remplace / *Replaces*

AYP #121305X

Bolens #1761083

Cub Cadet #725-3166, 925-3166

Exmark #740275

Husqvarna #506-90-96-01, 532-121305

John Deere #AM104403

MTD #725-3166, 925-3166

Murray #094159, 094159MA, 94159

Scag #48717

Simplicity #1714770, 7023354

Snapper #2-3354, 7023354

Troy Bilt #GW-1761083

No 31-9664



INTERRUPTEUR D'ALLUMAGE IGNITION SWITCH

Universel / *Universal*

5 bornes / *terminals*

3 positions

Requiert trou / *Requires hole 5/8"*



Remplace / *Replaces*

AMF #44745, 300295

AYP #S365402, 3612R, 4406R

Bob-Cat #48032B

Dixie #20245

Dixon #4197

Grasshopper #183806

Honda #510-772-003

John Deere #AM102544, AM31995, AM102551

MTD #725-0267, 925-0267

Murray #21064, 21064PA

Noma #421064

Roper #3621R

Scag #48017, 48017-02

Snapper #7027698, 7029010

Toro #23-0660

No 31-2922





BOB-CAT CONT.

INTERRUPTEUR POUSSOIR D'INTERVERROUILLAGE PLUNGER INTERLOCK SWITCH



Normalement fermé / *Normally closed*
2 bornes / *terminals*
2 positions

Modèles / *Models*
Ariens Grand Sierra 22HP,
931038-000101, 931303-00101
avec moteur Kohler / *with Kohler engine*

Remplace / *Replaces*
Ariens #30957
AYP #109869X
Bob-Cat #38383
Exmark #1-513152, 513152
Ferris #21769
John Deere #AM108483
Simplicity #1708207, 1708207SM
Snapper #27225, 7027225,
923408



No 31-9658

INTERRUPTEUR POUSSOIR D'INTERVERROUILLAGE PLUNGER INTERLOCK SWITCH



Normalement ouvert/Normalement fermé /
Normally open/Normally closed
2 bornes / *terminals*
2 positions

Double pôles / *Double poles*
À pression / *Snap mount*

Remplace / *Replaces*
Ariens #08828100, 88281
AYP #109553X
Bob-Cat #108208
Bolens #175-1328
Bunton #PL7484
Dixon #4242, 539115802, 539101080
Encore #523034
Exmark #633111, 1-633111
Ferris #22095
Grasshopper #183894
Husqvarna #539-109553
John Deere #AM128925
MTD #725-3169A, 925-3169A
Murray #91299
Simplicity #1717050, 1717050SM
Snapper #23355, 7023355



No 31-9659

INTERRUPTEUR POUSSOIR D'INTERVERROUILLAGE PLUNGER INTERLOCK SWITCH



Normalement ouvert / *Normally open*

Remplace / *Replaces*
Ariens #36571, 03657100, 02754100
AYP #104445X
Bob-Cat #38382
Bolens #174-8723
Exmark #1-513051, 513051
Ferris #21451
Hustler #781211
John Deere #AM104884
Kubota #K2561-62251
Murray #24273
Scag #481637
Snapper #7014847, 14847, 7015707, 919098
Toro/Wheel Horse #65-7410
Yazoo #1923-025, 539001125



No 31-9660

BRIGGS & STRATTON

CLAVETTE FLYWHEEL KEY



Remplace / *Replaces*
Briggs & Stratton #222698,
222698S, 61760, 4144, 5002H, 5002K
John Deere #PT7211,
LG222698S



LOT (10)

No 23-1435

POUSSOIR DE CONTACT BREAKER POINT PLUNGER

Pour moteur horizontal
et vertical / *For horizontal
and vertical engine*
2HP, 3HP, 3.5HP, 4HP,
5HP, 7HP, 8HP



Remplace / *Replaces*
Briggs & Stratton #65704

LOT (10)

No 31-1818

CLÉ DE SÛRETÉ SAFETY KEY



Pour moteur d'hiver /
For snow engine
Briggs & Stratton Intek Snow



Remplace / *Replaces*
Briggs & Stratton #695756,
794696

No 31-2933



BRIGGS & STRATTON CONT.

CONDENSATEUR D'ALLUMAGE IGNITION CONDENSER

Modèles / Models
8HP, 9HP, 10HP horizontal
19D, 23D, 193000, 200400, 233400, 243400

Voir jeu d'allumage /
See ignition set #31-1771

Remplace / Replaces
Briggs & Stratton #298060 **No 31-1775**



BOBINE D'ALLUMAGE IGNITION COIL

Pour moteur V-Twin /
For V-Twin engine

Modèles / Models
Séries / Series 4045A7, 405777,
406777, 407577, 407677, 407777,
40G777, 40H777, 445777, 446777, 543477

Remplace / Replaces
Briggs & Stratton #691060 **No 31-1767**

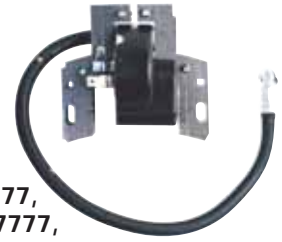

JEU D'ALLUMAGE IGNITION SET

Modèles / Models
8HP, 9HP, 10HP, 16HP horizontal
(fonte / cast iron)
19D, 23D, 193000, 200400,
233400, 243400

Voir condensateur d'allumage /
See ignition condenser #31-1775

Remplace / Replaces
Briggs & Stratton #298185 **No 31-1771**



BOBINE DE MAGNÉTO MAGNETO COIL

Modèles / Models
144000, 145000, 146000,
147000, 193000, 200400,
233400, 234400
6HP, 8HP, 9HP horizontal, vertical

Remplace / Replaces
Briggs & Stratton #298968 **No 31-1778**

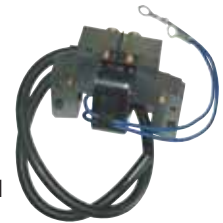

BOBINE DE MAGNÉTO MAGNETO COIL

Pour moteurs 10HP à 13HP /
For 10HP to 13HP engines
L-head et/and Vanguard
9HP, 12.5HP, 14HP

Remplace / Replaces
Briggs & Stratton #490586, 491312, 492341,
495859, 690248, 715231, 795315, 799650
John Deere #MIA11422 **No 31-1779**



31

JEU D'ALLUMAGE IGNITION SET

Modèles / Models
6B, 8B, 60100 et plus / and up,
100000, 130000, 140200,
170000, 171706, 190400,
190700, 191700, 195400, 19799
2HP à/ to 8HP

Remplace / Replaces
Briggs & Stratton #294628 **No 31-1772**



JEU D'ALLUMAGE IGNITION SET

Modèles / Models
11HP
A, B, F, H, I, K, L, M, NH, PB, Q, R, S,
T, U, W, Y, Z, 5, 6, 6F, 6R, 6S, 8, 8F,
8R, 23C, 140000, 170400, 170700

Remplace / Replaces
Briggs & Stratton #29861 **No 31-1773**



MODULE ÉLECTRONIQUE ELECTRONIC MODULE

Pour tous les modèles depuis
1962 avec 2 corps de bobine
sauf 9HP, 10HP et 16HP /
For all engines built since
1962 with 2 leg coils
except 9HP, 10HP and 16HP

Remplace / Replaces
Briggs & Stratton #394970,
395025, 5025B **No 31-1770**

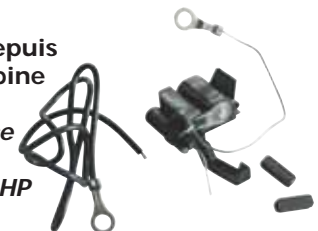



BRIGGS & STRATTON CONT.

MODULE ÉLECTRONIQUE ELECTRONIC MODULE

Modèles / Models
100200, 100900, 130200,
130900, 131200, 131400,
131900, 5HP

Remplace / Replaces
Briggs & Stratton #298316,
697037



No 31-1764

MODULE ÉLECTRONIQUE ELECTRONIC MODULE

Pour / For
2HP à/to 4HP
vertical et/and horizontal

Remplace / Replaces
Briggs & Stratton #398593,
496914, 793281



No 31-1774

MODULE ÉLECTRONIQUE ELECTRONIC MODULE

Pour / For
5HP vertical et/and horizontal

Remplace / Replaces
Briggs & Stratton #397358



No 31-1776

MODULE ÉLECTRONIQUE ELECTRONIC MODULE

Pour moteur / For engine
horizontal et/and vertical
Twin (L-Heads)
Séries / Series
400400 à/to 422700

Remplace / Replaces
Briggs & Stratton #394891



No 31-8051

MODULE ÉLECTRONIQUE ELECTRONIC MODULE

Pour / For
7HP à/to 16HP
vertical et/and horizontal
Moteur 1 cylindre /
Single cylinder engine

Remplace / Replaces
Briggs & Stratton #398811



No 31-1777

MODULE ÉLECTRONIQUE ELECTRONIC MODULE

Modèles / Models
60000, 61000, 80200,
81000, 82500, 82900,
92500, 92900, 111000
2HP, 3HP, 3.5HP, 4HP
horizontal et/and vertical

Remplace / Replaces
Briggs & Stratton #298502, 697036
Wico #WX15035



No 31-1780

BOBINE D'ALLUMAGE IGNITION COIL

Pour / For
Quantum 127802
Séries moteurs 5HP /
5HP series engines

Remplace / Replaces
Briggs & Stratton #802574,
493237, 492416, 692605



No 31-8771

FAISCEAU DE FILS WIRING HARNESS

Remplace / Replaces
Briggs & Stratton #393422,
692306



No 31-1765

RÉGULATEUR DE VOLTAGE VOLTAGE REGULATOR

10 ampères / amps
12 volts
3 bornes en rangée /
3 terminals in a row

Remplace / Replaces
Briggs & Stratton #390240
Kohler #234279/41 403 08, 41-403-08S
Tecumseh #610749



No 31-2944

RÉGULATEUR DE VOLTAGE VOLTAGE REGULATOR

Pour moteurs de 18HP, 20HP avec
système de remplissage de
10, 13, 14 et 16 ampères /
For 18HP, 20HP engines
with 10, 13, 14 and 16 amps
charging system

Remplace / Replaces
Briggs & Stratton #394890,
691185, 797182, 797375



No 31-2945



BRIGGS & STRATTON CONT.

RÉGULATEUR DE VOLTAGE VOLTAGE REGULATOR

Pour système de remplissage de circuit quadruple de 8 ampères / For 8 amps quad circuit charging system

Modèles / Models
Séries moteurs 422700 /
Series engines 422700



Remplace / Replace
Briggs & Stratton #397809 **No 31-2924**

RÉGULATEUR DE VOLTAGE VOLTAGE REGULATOR

Modèles / Models
256400, 28B700,
28M700-28Q700,
351400, 351700, 42A700

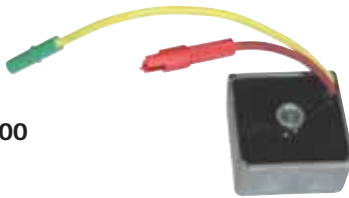

Remplace / Replaces
Briggs & Stratton #491546,
691188, 793360, 794360 **No 31-2926**

RÉGULATEUR DE VOLTAGE VOLTAGE REGULATOR

Modèles / Models
Séries moteurs 303700 /
Series engines 303700



Remplace / Replaces
Briggs & Stratton #493219 **No 31-2927**

DIODE ASSEMBLÉ DIODE ASSEMBLY

Pour / For
6HP à/to 20HP

Modèles à démarrage électrique /
Electric start models

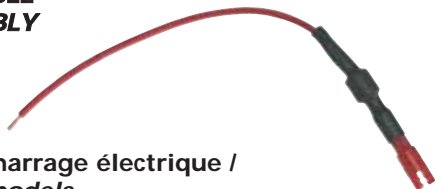

Remplace / Replaces
Briggs & Stratton #393814 **No 31-1769**

DIODE DIODE

Pour alternateurs à double circuit de 2-4 ampères / For 2-4 amps dual circuit alternators

Diode de 6 ampères au lieu de 3 comme le modèle original / Diode of 6 amps instead of OEM 3

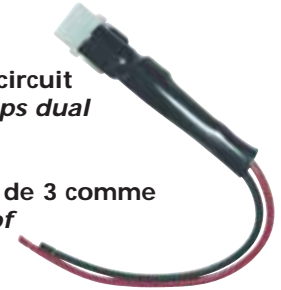

Remplace / Replaces
Briggs & Stratton #393456 **No 31-9206**

COMMUTATEUR GÉNÉRAL D'ÉCLAIRAGE HEADLIGHT SWITCH

Pour / For
4HP, 5.5HP et/and 9HP Vanguard
5HP Industrial plus



Remplace / Replaces
Briggs & Stratton #495098S **No 31-2946**

INTERRUPTEUR D'ALLUMAGE IGNITION SWITCH



Pour moteur 2 cylindres /
For 2 cylinders engine
14HP, 400700 vertical,
400400 horizontal et/and
18HP, 422400 horizontal,
422700 vertical



Remplace / Replaces
AYP #102972Y, 145499
Briggs & Stratton #490066, 493625, 692318
Exmark #1-543070
Husqvarna #532-10-29-72, 532-14-54-99, 532-15-89-13
Scag #48798
Toro/Wheel Horse #83-0020
Troy Bilt #1754250, 1754250P **No 31-7804**

INTERRUPTEUR D'ALLUMAGE IGNITION SWITCH



3 positions

Pour moteur avant Murray /
For Murray front engine

Tracteur avec allumage magnéto / Tractor with magneto ignition



Remplace / Replaces
Briggs & Stratton #5411H
Murray #92377, 092377MA,
MU092377MA, MU92377 **No 31-9331**





BRIGGS & STRATTON CONT.

INTERRUPTEUR D'ARRÊT STOP SWITCH

Longueur / Length 3"

Pince courte pour bougie d'allumage /
Spark plug shorting clip

Boulon sur modèle /
Bolt on style

Pour toutes les bougies
d'allumage 14 mm / For all
14 mm spark plugs

Plaque de zinc / Zinc plate

Dirigé pour pénétrer bougie /
Pointed to penetrate plug boot



Carte (12) /
Card (12)

Remplace / Replaces
Briggs & Stratton #225171,
220197

No 31-1948

DISPOSITIF DE RETENUE POUR BROSE DE DÉMARREUR / STARTER BRUSH RETAINER

Pour démarreur / For starter
Briggs & Stratton



Remplace / Replaces
Briggs & Stratton #691293,
497605

No 31-6810

BOUCHON DE PORTE-BROSSE BRUSH HOLDER CAP END

Pour démarreur électrique /
For electric starter
Briggs & Stratton



Remplace / Replaces
Briggs & Stratton #395537 **No 31-9353**

ENSEMBLE DE BROSSES ET COUSINETS BRUSHES AND BUSHING SET

Pour démarreur électrique /
For electric starter
Briggs & Stratton



Remplace / Replaces
Briggs & Stratton #395538 **No 31-9354**

ENSEMBLE DE BROSSES BRUSHES SET

Pour démarreur électrique
Briggs & Stratton avec
dispositif de retenue
à goupille élastique /
For Briggs & Stratton
electric starter with roll
pin starter gear retainer



Remplace / Replaces
Briggs & Stratton #490311 **No 31-9355**

ENSEMBLE DE BROSSES BRUSHES SET

Pour démarreur électrique
Briggs & Stratton avec
dispositif de retenue
d'attache en "C",
ressorts inclus /
For Briggs & Stratton
electric starter with "C"
clip starter gear retainer,
springs included

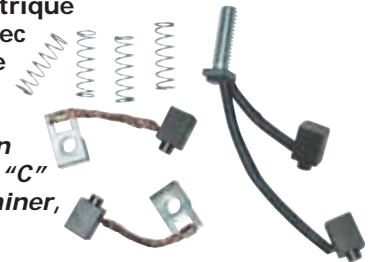

Remplace / Replaces
Briggs & Stratton #497608 **No 31-9356**

DÉMARREUR ÉLECTRIQUE ELECTRIC STARTER

Pour / For
CCW, 16 dents / teeth
12 volts



Remplace / Replaces
Briggs & Stratton #497595, 497525
John Deere #LG497595 **No 31-6812**

DÉMARREUR ÉLECTRIQUE ELECTRIC STARTER

Pour / For
CCW, 16 dents / teeth
12 volts



Pour moteur 1 cylindre en aluminium /
For single cylinder aluminum engine

Remplace / Replaces
Briggs & Stratton #396306 **No 31-6813**



BRIGGS & STRATTON CONT.

DÉMARREUR ÉLECTRIQUE ELECTRIC STARTER

Pour / For
CCW, 16 dents / teeth
12 volts

Pour la plupart des moteurs 2 cylindres /
For most twin cylinder engines



Remplace / Replaces
Briggs & Stratton #497596 **No 31-6814**

DÉMARREUR ÉLECTRIQUE ELECTRIC STARTER

Pour / For
CCW, 16 dents / teeth
12 volts

Très résistant / Heavy duty

Pour la plupart des moteurs 2 cylindres /
For most twin cylinder engines



Remplace / Replaces
Briggs & Stratton #495100,
498148 **No 31-6815**

CUB CADET

INTERRUPTEUR D'ALLUMAGE IGNITION SWITCH



7 bornes / terminals
4 positions

2005-2006

Clé non-incluse /
Key not included

Remplace / Replaces
Cub Cadet #725-04227A,
925-04227A, 925-04227B
MTD #725-04227A,
925-04227A, 925-04227B

No 31-9667



31



INTERRUPTEUR D'ALLUMAGE IGNITION SWITCH



5 bornes / terminals
3 positions

Clé non-incluse /
Key not included

Remplace / Replaces
Cub Cadet #925-04019
MTD #725-04019, 925-04019 **No 31-9668**



□ □ NOUVEAU / NEW □ □

2 CLÉS DE CONTACT 2 IGNITION KEYS



Remplace / Replaces
Cub Cadet #925-1745,
935-1745A

No 31-2910

□ □ NOUVEAU / NEW □ □

INTERRUPTEUR D'ALLUMAGE PTO PTO IGNITION SWITCH

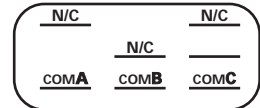

7 bornes / terminals
2 positions

Pousser-tirer, à pression /
Push-pull, snap mount

Bouton noir / Black knob

Modèles / Models
RZT42, RZT50, RZT54

Remplace / Replaces
Cub Cadet #725-04174,
925-04174

No 31-2912



INTERRUPTEUR D'ALLUMAGE PTO PTO IGNITION SWITCH



7 bornes / terminals

Pousser-tirer, à pression /
Push-pull, snap mount

Bouton or en forme de
goutte / Gold tear drop knob

Remplace / Replaces
Cub Cadet #725-04258, 925-04258
MTD #725-04258, 925-04258

No 31-2916

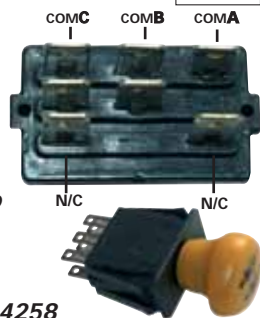

INTERRUPTEUR DE SÉCURITÉ SAFETY SWITCH

Normalement ouvert pour fonctionner /
Normally open to run

2 bornes / terminals

Noir / Black

Remplace / Replaces
Cub Cadet #925-0268
Dynamark #41204
MTD #725-0268, 925-0268

No 31-253





CUB CADET CONT.

INTERRUPTEUR DE SÉCURITÉ SAFETY SWITCH

Normalement fermé /
Normally closed

7 bornes / terminals
4 positions

Interrupteur à poussoir / Push button switch

Longueur / Length 2 1/8"
Requiert trou / Requires hole 1/2"

Bouton rouge / Red button

Remplace / Replaces
Cub Cadet #725-0269, 925-0269
MTD #725-0269, 925-0269 **No 31-356**



SOLÉNOÏDE SOLENOID

12 volts
3 bornes / terminals :
5/16" - 18 bornes / terminals (2),
10-32 borne / terminal (1)

Remplace / Replaces
Cub Cadet #725-3001,
925-3001

No 31-3324



INTERRUPTEUR D'ALLUMAGE PTO PTO IGNITION SWITCH

Modèles / Models
Z42-Z54, 364365,
1515-1529, 2130-2186,
GT2000

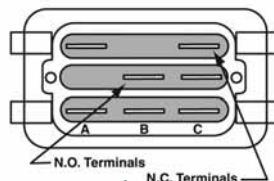

Remplace / Replaces
Cub Cadet #725-3233,
925-3233

No 31-9654



EMBRAYAGE ÉLECTRIQUE PTO PTO ELECTRIC CLUTCH

Arbre / Shaft 1"
Diamètre poulie /
Pulley diameter 6"
Courroie / Belt 5/8"

Modèles / Models
LT1045, LT1050

Remplace / Replaces
Cub Cadet #717-04174, 917-04174
Warner #5219-51 **No 31-9187**



□ □ NOUVEAU / NEW □ □

INTERRUPTEUR D'ALLUMAGE PTO PTO IGNITION SWITCH

7 bornes / terminals
2 positions

Pousser-tirer, à pression /
Push-pull, snap mount

Bouton jaune / Yellow knob

Modèles / Models
GT1554, GT2542, GT2550,
GT2554, SLT1550, SLT1554, Z-FORCE

Remplace / Replaces
Cub Cadet #725-04175, 925-04175
MTD #725-04175, 925-04175 **No 31-2913**

COMA	COMB	COMC
—	N/C	—
N/C	—	N/C



INTERRUPTEUR D'ALLUMAGE IGNITION SWITCH

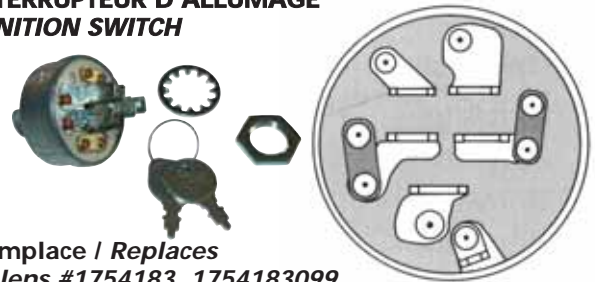

Remplace / Replaces
Bolens #1754183, 1754183099
Cub Cadet #725-3163, 925-3163
Troy Bilt #1754183,
1754183099

No 31-9852

31



INTERRUPTEUR À LEVIER PTO PTO TOGGLE SWITCH

S'installe sur la plupart des cadres
d'embrayage électrique /
For most box-frame electric
clutch applications

Remplace / Replaces
Cub Cadet #725-0893,
925-0893



No 31-357



CUB CADET CONT.

INTERRUPTEUR POUSSOIR D'INTERVERROUILLAGE PLUNGER INTERLOCK SWITCH

Normalement fermé / *Normally closed*



Support à angle droit à pression /
Right angle snap mounted

Remplace / *Replaces*

AYP #121305X

Bolens #1761083

Cub Cadet #725-3166, 925-3166

Exmark #740275

Husqvarna #506-90-96-01, 532-121305

John Deere #AM104403

MTD #725-3166, 925-3166

Murray #094159, 094159MA, 94159

Scag #48717

Simplicity #1714770, 7023354

Snapper #2-3354, 7023354

Troy Bilt #GW-1761083



No 31-9664

INTERRUPTEUR POUSSOIR D'INTERVERROUILLAGE PLUNGER INTERLOCK SWITCH

Normalement ouvert/Normalement fermé /
Normally open/Normally closed



Double pôles / *Double poles*
À pression / *Snap mount*



Remplace / *Replaces*

AYP #153664, 161343, 176138

Cub Cadet #725-3164, 925-3164, 725-3164AP

Ferris #22182, 5023455

Husqvarna #532-153664, 532-176137, 532-176138

MTD #725-3164A, 925-3164A

Snapper #22886, 7022886,

1723507, 1732006

No 31-9665

EXMARK

INTERRUPTEUR D'ALLUMAGE IGNITION SWITCH



Pour moteur 2 cylindres /
For 2 cylinders engine

14HP, 400700 vertical,

400400 horizontal et/and

18HP, 422400 horizontal,

422700 vertical



Remplace / *Replaces*

AYP #102972Y, 145499

Briggs & Stratton #490066, 493625, 692318

Exmark #1-543070

Husqvarna #532-10-29-72, 532-14-54-99, 532-15-89-13

Scag #48798

Toro/Wheel Horse #83-0020

Troy Bilt #1754250, 1754250P **No 31-7804**

INTERRUPTEUR D'ALLUMAGE IGNITION SWITCH



Modèles / *Models*

Exmark Laser ZTR,

John Deere STX, 38446

Remplace / *Replaces*

AYP #158913

Exmark #543070

Hustler #045898

Noma #305720

Snapper #26343, 7026343

No 31-9158



INTERRUPTEUR D'ALLUMAGE IGNITION SWITCH



8 bornes / *terminals*

Pousser-tirer, à pression /
Push-pull, snap mount

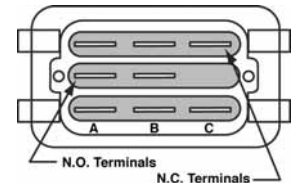

Terminal du milieu vide /
Middle terminal blank

Bouton rouge / *Red knob*



Remplace / *Replaces*

Ariens #522100, 5221, 01545600, 1545600

Exmark #633673, 1-633673, 103-5221

Grasshopper #183925

John Deere #AM118802, AM119139, AM131966,
TCA17834

Kubota #K1211-62231

MTD #725-1716, 925-1716, 725-1752

Scag #481635, 700675

Snapper #28542, 7028542

Toro/Wheel Horse #93-9999, 93-9998, 95-4108,

95-7489, 1035221, 1633673

No 31-9657

INTERRUPTEUR POUSSOIR D'INTERVERROUILLAGE PLUNGER INTERLOCK SWITCH



Normalement fermé / *Normally closed*

2 bornes / *terminals*

2 positions

Modèles / *Models*

Ariens Grand Sierra 22HP,

931038-000101, 931303-00101

avec moteur Kohler / *with Kohler engine*

Remplace / *Replaces*

Ariens #30957

AYP #109869X

Bob-Cat #38383

Exmark #1-513152, 513152

Ferris #21769

John Deere #AM108483

Simplicity #1708207, 1708207SM

Snapper #27225, 7027225,

923408

No 31-9658





EXMARK CONT.

INTERRUPTEUR POUSSOIR D'INTERVERROUILLAGE PLUNGER INTERLOCK SWITCH



Normalement ouvert / Normalement fermé /
Normally open / Normally closed
2 bornes / terminals
2 positions

Double pôles / Double poles
À pression / Snap mount



Remplace / Replaces
Ariens #08828100, 88281
AYP #109553X
Bob-Cat #108208
Bolens #175-1328
Bunton #PL7484
Dixon #4242, 539115802, 539101080
Encore #523034
Exmark #633111, 1-633111
Ferris #22095
Grasshopper #183894
Husqvarna #539-109553
John Deere #AM128925
MTD #725-3169A, 925-3169A
Murray #91299
Simplicity #1717050, 1717050SM
Snapper #23355, 7023355 **No 31-9659**

INTERRUPTEUR POUSSOIR D'INTERVERROUILLAGE PLUNGER INTERLOCK SWITCH



Normalement ouvert / *Normally open*

Remplace / Replaces
Ariens #36571, 03657100, 02754100
AYP #104445X
Bob-Cat #38382
Bolens #174-8723
Exmark #1-513051, 513051
Ferris #21451
Hustler #781211
John Deere #AM104884
Kubota #K2561-62251
Murray #24273
Scag #481637
Snapper #7014847, 14847, 7015707, 919098
Toro/Wheel Horse #65-7410
Yazoo #1923-025, 539001125 **No 31-9660**



INTERRUPTEUR POUSSOIR D'INTERVERROUILLAGE PLUNGER INTERLOCK SWITCH



Normalement fermé / *Normally closed*

Support à angle droit à pression /
Right angle snap mounted



Remplace / Replaces
AYP #121305X
Bolens #1761083
Cub Cadet #725-3166, 925-3166
Exmark #740275
Husqvarna #506-90-96-01, 532-121305
John Deere #AM104403
MTD #725-3166, 925-3166
Murray #094159, 094159MA, 94159
Scag #48717
Simplicity #1714770, 7023354
Snapper #2-3354, 7023354
Troy Bilt #GW-1761083 **No 31-9664**

SOLÉNOÏDE SOLENOID



Universel / *Universal*

12 volts
4 bornes / terminals

Poteau de borne et manchon
s'adaptant aux embouts de
1/4" / Terminal post and sleeve
will accept both 1/4"



Les supports de montage s'adapte à la
configuration des supports de châssis et de murs /
*Mounting bracket will accomodate both
chassis and wall mount configurations*

Remplace / Replaces
Ariens #35510
AYP #109081X, 109946, 146154
Bolens #1752137, 1753539
Case #C-266525, C33025
Exmark #1-513075
Gilson #212655
Grasshopper #184251
Gravely #45071
Lawn-Boy #740207
MTD #725-04437
Simplicity #170051, 16771993, 16852980, 1700751
Snapper #18604, 7018604
Toro #47-1910, 110116,
110162, 110167 **No 31-3318**

31





EXMARK CONT.

RELAIS RELAY

Pour différents tracteurs AYP /
For several AYP tractors

Remplace / Replaces
AYP #109748X
Exmark #1-643275, 98-7249
Hustler #026231
Grasshopper #104-026-401
Walker #6942



No 31-9369



RELAIS RELAY

Pour différents tracteurs AYP /
For several AYP tractors

Remplace / Replaces
AYP #109748X
Exmark #1-643275, 98-7249
Hustler #026231
Grasshopper #104-026-401
Walker #6942



No 31-9369



EMBRAYAGE ÉLECTRIQUE PTO PTO ELECTRIC CLUTCH

Arbre / Shaft 1 1/8"
Diamètre poulie /
Pulley diameter 6"

Remplace / Replaces
Exmark #633099



No 31-9200

SOLENOÏDE SOLENOID

12 volts
4 bornes / terminals
Goujons / Studs 1/4" - 20

Remplace / Replaces
Ariens #35510
AYP #192507, 146154
Bolens #1752137, 1753539
Gilson #212655
Grasshopper #184251
Gravely #45071
Lawn-Boy #740207
Simplicity #1685290
Snapper #1-8604, 7018604
Toro #28-4210, 47-1910
Wheel Horse #110116

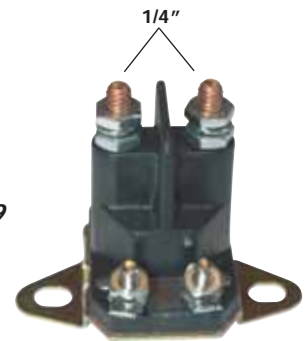

No 31-3320



31

GRASSHOPPER

INTERRUPTEUR D'ALLUMAGE IGNITION SWITCH

Universel / Universal

5 bornes / terminals
3 positions
Requiert trou / Requires hole 5/8"

Remplace / Replaces
AMF #44745, 300295
AYP #S365402, 3612R, 4406R
Bob-Cat #48032B
Dixie #20245
Dixon #4197
Grasshopper #183806
Honda #510-772-003
John Deere #AM102544, AM31995, AM102551
MTD #725-0267, 925-0267
Murray #21064, 21064PA
Noma #421064
Roper #3621R
Scag #48017, 48017-02
Snapper #7027698, 7029010
Toro #23-0660



No 31-2922



SOLENOÏDE SOLENOID

Universel / Universal

12 volts
4 bornes / terminals

Poteau de borne et manchon
s'adaptant aux embouts de
1/4" / Terminal post and sleeve
will accept both 1/4"

Les supports de montage s'adapte à la
configuration des supports de châssis et de murs /
Mounting bracket will accomodate both
chassis and wall mount configurations

Remplace / Replaces
Ariens #35510
AYP #109081X, 109946, 146154
Bolens #1752137, 1753539
Case #C-266525, C33025
Exmark #1-513075
Gilson #212655
Grasshopper #184251
Gravely #45071
Lawn-Boy #740207
MTD #725-04437
Simplicity #170051, 16771993, 16852980, 1700751
Snapper #18604, 7018604
Toro #47-1910, 110116,
110162, 110167



No 31-3318





GRAVELY

SOLÉNOÏDE SOLENOID



12 volts
4 bornes / terminals
Goujons / Studs 1/4" - 20

Remplace / Replaces
Ariens #35510
AYP #192507, 146154
Bolens #1752137, 1753539
Gilson #212655
Grasshopper #184251
Gravely #45071
Lawn-Boy #740207
Simplicity #1685290
Snapper #1-8604, 7018604
Toro #28-4210, 47-1910
Wheel Horse #110116

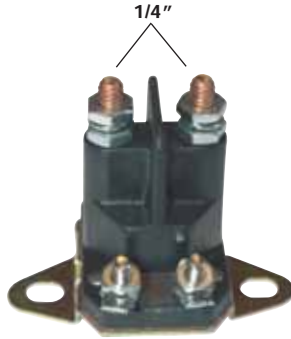

No 31-3320

SOLÉNOÏDE SOLENOID



Universel / Universal

12 volts
4 bornes / terminals

Poteau de borne et manchon
s'adaptant aux embouts de
1/4" / Terminal post and sleeve
will accept both 1/4"



Les supports de montage s'adapte à la
configuration des supports de châssis et de murs /
Mounting bracket will accomodate both
chassis and wall mount configurations

Remplace / Replaces
Ariens #35510
AYP #109081X, 109946, 146154
Bolens #1752137, 1753539
Case #C-266525, C33025
Exmark #1-513075
Gilson #212655
Grasshopper #184251
Gravely #45071
Lawn-Boy #740207
MTD #725-04437
Simplicity #170051, 16771993, 16852980, 1700751
Snapper #18604, 7018604
Toro #47-1910, 110116,
110162, 110167

No 31-3318



INTERRUPTEUR D'ALLUMAGE IGNITION SWITCH



5 bornes / terminals

Démarrage manuel /
Manual start



Remplace / Replaces
Ariens #03115200, 31152
AYP #2683, 2683R
Gravely #19223
Jacobson #129746, 129846
Kohler #48-099-01
Lawn-Boy #741308
Onan #378-0385
Toro/Wheel Horse #12-8140,
103990



No 31-1931

□ □ NOUVEAU / NEW □ □

INTERRUPTEUR D'ALLUMAGE IGNITION SWITCH

5 bornes / terminals
3 positions
Tige de montage /
Mounting stem 5/8"

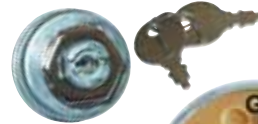

Modèles / Models
Tracteur 4 roues motrices /
4-wheels tractor 34686, 34690
Tracteur 2 roues motrices /
2-wheels tractor 35713, 35716



Remplace / Replaces
Gravely #18272

No 31-2909

31

INTERRUPTEUR D'ALLUMAGE IGNITION SWITCH



Allumage de batterie avec
tiges de montage 9/16" /
Battery ignition with
9/16" mounting stem



Pour / For
Gravely Promaster 20HP



Remplace / Replaces
Gravely #3115200
John Deere #AM103286,
AM32318, AM32686

No 31-9161



GRAVELY CONT.

BOBINE COIL

Pour / For
4HP, 6HP, 8HP, 10HP, 12HP, 14HP

Remplace / Replaces
Ariens #20355500
Gravely #022152

John Deere #AM132453, AM38411
Kohler #231281S, 237256S, 47-145-01S,
41-519-21S

Kubota #12581-68900
Tecumseh #32080, 4151921 **No 31-1781**



COIFFE DE BOUGIE SPARK PLUG BOOT

Pour / For
GX120, GX610, GX620,
GX670, GXV610, GXV620

Remplace / Replaces
Honda #30700-ZJ1-841,
30700-ZJ1-003



No 31-1985

BOBINE D'ALLUMAGE IGNITION COIL

Pour la plupart
des moteurs
série GXV120 /
For most GXV120 serie engines



Remplace / Replaces
Honda #30500-ZG9-M02
code 4581476

No 31-1758

HONDA

□ □ NOUVEAU / NEW □ □ INTERRUPTEUR D'ARRÊT STOP SWITCH



Remplace / Replaces
Honda #36100-ZH7-W41 **No 31-2929**

BOBINE D'ALLUMAGE IGNITION COIL

Modèles / Models
FG400, FG500, GC135,
GC160, GCV135, GCV160

Remplace / Replaces
Honda #30500-ZL8-004

No 31-1755



31

INTERRUPTEUR MARCHE/ARRÊT ON/OFF SWITCH

GLENDALE



Remplace / Replaces
Honda #36100-ZE1-015 **No 84-3102**

ALLUMAGE MAGNÉTO MAGNETO COIL

GLENDALE

Pour / For
GX110, GX120,
GX140, GX160, GX200

Remplace / Replaces
Honda #30500-ZE1-003

No 84-3103



COIFFE DE BOUGIE SPARK PLUG BOOT

GLENDALE

Modèles / Models
GE140, GE160, GE200, GE240,
GE270, GE340, GE390

Remplace / Replaces
Honda #30700-ZE1-000,
30700-ZE1-013 **No 84-3101**



BOBINE D'ALLUMAGE IGNITION COIL

GLENDALE

Modèles / Models
GX240, GX270,
GX340, GX390
GE240, GE270,
GE340, GE390

Remplace / Replaces
Honda #30500-ZE2-013

No 84-3104





HONDA CONT.

DÉMARREUR ÉLECTRIQUE ELECTRIC STARTER

GLENDALE

Pour moteur GX340 /
For GX340 engine

Solénoïde non inclus /
Solenoid not included
Voir / See #84-3107

Remplace / Replaces
Honda #31210-ZE3-013



No 84-3105

□ □ NOUVEAU / NEW □ □

MODULE ÉLECTRONIQUE ELECTRONIC COIL

Modèles / Models
GX610, GX620, GX670

Pour cylindre droit /
For right cylinder

Remplace / Replaces
Honda #30500-ZJ1-013, 30500-ZJ1-023,
30500-ZJ1-844



No 31-1785

SOLÉNOÏDE SOLENOID

Modèles / Models
GE340, GE390,
GX340, GX390

Remplace / Replaces
Honda



No 84-3107

□ □ NOUVEAU / NEW □ □

MODULE ÉLECTRONIQUE ELECTRONIC COIL

Modèles / Models
GX610, GX620, GX670

Pour cylindre gauche /
For left cylinder

Remplace / Replaces
Honda #30500-ZJ1-013, 30500-ZJ1-023,
30500-ZJ1-844



No 31-1791

INDICATEUR DE NIVEAU D'HUILE OIL LEVEL GAUGE

Pour moteur GX160 /
For GX160 engine

Remplace / Replaces
Honda #15510-ZE1-033 **No 84-1602310**



INDICATEUR DE NIVEAU D'HUILE OIL LEVEL GAUGE

Pour moteurs GX240, GX390 /
For GX240, GX390 engines

Remplace / Replaces
Honda #15510-ZE2-033 **No 84-2702310**



CAPTEUR DE NIVEAU D'HUILE OIL SENSOR

Pour moteurs GX160, GX390 /
For GX160, GX390 engines

Remplace / Replaces
Honda #34150-ZH7-003 **No 84-1602312**



31





HONDA CONT.

INTERRUPTEUR D'ALLUMAGE IGNITION SWITCH

Universel / *Universal*

5 bornes / *terminals*
3 positions
Requiert trou / *Requires hole 5/8"*

Remplace / *Replaces*
AMF #44745, 300295
AYP #S365402, 3612R, 4406R
Bob-Cat #48032B
Dixie #20245
Dixon #4197
Grasshopper #183806
Honda #510-772-003
John Deere #AM102544, AM31995, AM102551
MTD #725-0267, 925-0267
Murray #21064, 21064PA
Noma #421064
Roper #3621R
Scag #48017, 48017-02
Snapper #7027698, 7029010
Toro #23-0660

No 31-2922



CLÉ DE CONTACT IGNITION KEY

Universel / *Universal*

Pour interrupteur en plastique Delta /
For plastic Delta switch

Poignée moulée / *Molded grip*

Remplace / *Replaces*
AYP #140401, 140402, 140403
Husqvarna #532-14-04-01, 532-14-04-02,
532-14-04-03, 532-411933, 532-411935
John Deere #AM123426, AM131946, AM135356,
AM153650, GY20680
Kohler #48-340-01S
MTD #725-1745, 925-1745
Murray #327350
Sears #140403
Simplicity #1717163,
1717163SM

No 31-2918



COIFFE DE BOUGIE SPARK PLUG BOOT

Modèles / *Models*
232, 235, 322, 325

Remplace / *Replaces*
Husqvarna #501-485-402

No 31-4989



HUSQVARNA (AYP, CRAFTMAN, POULAN PRO, ROPER, SEARS)

31

COMMUTATEUR À RELAIS RELAY SWITCH

Pour / *For*
Husqvarna ZTH et/and
John Deere ZTRAK
Tracteur zéro degré /
Zero turn radius tractor

Remplace / *Replaces*
Bosch #0332209-150

No 31-1756



□ □ NOUVEAU / NEW □ □

AMPOULE HALOGÈNE HALOGEN BULB

Remplace / *Replaces*
AYP #401620, 532-401620
Husqvarna #401620,
532-401620

No 31-1659



INTERRUPTEUR D'ALLUMAGE IGNITION SWITCH

Pour moteur 2 cylindres /
For 2 cylinders engine
14HP, 400700 vertical,
400400 horizontal et/and
18HP, 422400 horizontal,
422700 vertical

Remplace / *Replaces*
AYP #102972Y, 145499
Briggs & Stratton #490066, 493625, 692318
Exmark #1-543070
Husqvarna #532-10-29-72, 532-14-54-99, 532-15-89-13
Scag #48798
Toro/Wheel Horse #83-0020
Troy Bilt #1754250, 1754250P

No 31-7804



COMMUTATEUR À RELAIS RELAY SWITCH

Pour / *For*
Husqvarna ZTH et/and
Country Clipper
Tracteur zéro degré /
Zero turn radius tractor

Remplace / *Replaces*
Husqvarna #539102914
Helga ID #93180 01

No 31-1757





**HUSQVARNA (AYP, CRAFTMAN,
POULAN PRO, ROPER, SEARS) CONT.**

□ □ NOUVEAU / NEW □ □

INTERRUPTEUR D'ALLUMAGE PTO PTO IGNITION SWITCH



8 bornes / terminals
2 positions

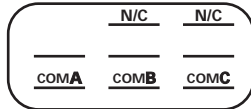

Pousser-tirer, à pression /
Push-pull, snap mount

Bouton noir / Black knob

Modèles / Models
GT2254, GTH2642, GTH2654,
LGT2554, LGT2654, YTH2348,
YTH2448, Z-FORCE



Remplace / Replaces
AYP #196112

Husqvarna #532-19-61-12 **No 31-2914**

INTERRUPTEUR D'ALLUMAGE PTO PTO IGNITION SWITCH



8 bornes / terminals

Pousser-tirer, à pression /
Push-pull, snap mount

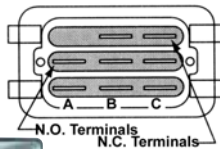

Borne du coin vide /
Corner terminal blank

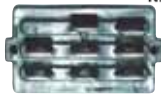

Bouton rouge / Red knob



Remplace / Replaces

AYP #146283, 140404, 154959,
154963, 169416, 174652
Dixon #5961, 539-117-238, 539-129-512,
539-120-023

Encore #523030, 523031

Ferris #22180, 5022180

Great Dane #D38005

Howard #02-422

Husqvarna #532-154-959, 532-169-417,
532-174-651

Hustler #771476, 77146, 776476

Murray #94927, 6201-316

Scag #483957, 27328, 481687, 483162

Simplicity #171348, 171348SM, 1714772,
1716332, 1722887

Snapper #7035658, 35658

Yazoo #101768, 539101768 **No 31-9656**

INTERRUPTEUR POUSSOIR D'INTERVERROUILLAGE PLUNGER INTERLOCK SWITCH



Normalement ouvert / Normalement fermé /
Normally open / Normally closed

2 bornes / terminals
2 positions

Double pôles / Double poles
À pression / Snap mount



Remplace / Replaces

Ariens #08828100, 88281

AYP #109553X

Bob-Cat #108208

Bolens #175-1328

Bunton #PL7484

Dixon #4242, 539115802, 539101080

Encore #523034

Exmark #633111, 1-633111

Ferris #22095

Grasshopper #183894

Husqvarna #539-109553

John Deere #AM128925

MTD #725-3169A, 925-3169A

Murray #91299

Simplicity #1717050, 1717050SM

Snapper #23355, 7023355 **No 31-9659**

INTERRUPTEUR POUSSOIR D'INTERVERROUILLAGE PLUNGER INTERLOCK SWITCH



Normalement ouvert / Normally open

Support à angle droit à pression /
Right angle snap mounted



Remplace / Replaces

Ariens #27541

AYP #160784

Husqvarna #532-1607-84

John Deere #AM103119

Kubota #K1122-62280, K1122-62282

MTD #725-3167, 925-3167

Murray #57211, 024273

Roper #160784

Scag #481638

Sears #160784

Simplicity #1704379, 1704379SM

Snapper #15707

Toro/Wheel Horse #82-2190 **No 31-9663**



HUSQVARNA (AYP, CRAFTMAN, POULAN PRO, ROPER, SEARS) CONT.

INTERRUPTEUR POUSSOIR D'INTERVERROUILLAGE PLUNGER INTERLOCK SWITCH

Normalement fermé / *Normally closed*



Support à angle droit à pression /
Right angle snap mounted



Remplace / *Replaces*

AYP #121305X

Bolens #1761083

Cub Cadet #725-3166, 925-3166

Exmark #740275

Husqvarna #506-90-96-01, 532-121305

John Deere #AM104403

MTD #725-3166, 925-3166

Murray #094159, 094159MA, 94159

Scag #48717

Simplicity #1714770, 7023354

Snapper #2-3354, 7023354

Troy Bilt #GW-1761083

No 31-9664

INTERRUPTEUR POUSSOIR D'INTERVERROUILLAGE PLUNGER INTERLOCK SWITCH

Normalement ouvert/Normalement fermé /
Normally open/Normally closed



Double pôles / *Double poles*
À pression / *Snap mount*



Remplace / *Replaces*

AYP #153664, 161343, 176138

Cub Cadet #725-3164, 925-3164, 725-3164AP

Ferris #22182, 5023455

Husqvarna #532-153664, 532-176137, 532-176138

MTD #725-3164A, 925-3164A

Snapper #22886, 7022886,

1723507, 1732006

No 31-9665

31



JACOBSON

INTERRUPTEUR D'ALLUMAGE IGNITION SWITCH

5 bornes / *terminals*



Démarrage manuel /
Manual start



Remplace / *Replaces*

Ariens #03115200, 31152

AYP #2683, 2683R

Gravely #19223

Jacobson #129746, 129846

Kohler #48-099-01

Lawn-Boy #741308

Onan #378-0385

Toro/Wheel Horse #12-8140,
103990

No 31-1931

JOHN DEERE

CLÉ DE CONTACT IGNITION KEY

Universel / *Universal*



Pour interrupteur en plastique Delta /
For plastic Delta switch

Poignée moulée / *Molded grip*

Remplace / *Replaces*

AYP #140401, 140402, 140403

Husqvarna #532-14-04-01, 532-14-04-02,

532-14-04-03, 532-411933, 532-411935

John Deere #AM123426, AM131946, AM135356,

AM153650, GY20680

Kohler #48-340-01S

MTD #725-1745, 925-1745

Murray #327350

Sears #140403

Simplicity #1717163,

1717163SM

No 31-2918

POINT DE CONTACT ET CONDENSATEUR CONTACT POINT AND CONDENSER

Modèles / *Models*

H70, HH60, TNT100,

TNT120, TVM170



Remplace / *Replaces*

Clinton #135-24

Jacobson #107811

John Deere #AM30947, AM30949

McCulloch #80433, 88806

Phelon #06230, 071130

Tecumseh #30547A, 30548B

No 31-1819

INTERRUPTEUR D'ALLUMAGE IGNITION SWITCH



Interrupteur d'allumage très
résistant avec clé / *Heavy duty*
ignition switch with key

Semblable à notre 31-2921,
mais de meilleure qualité /
Similar to our 31-2921 but
more higher quality

Remplace / *Replaces*

AYP #175566, 163968

John Deere #GY20074

MTD #725-1741, 925-1741

Murray #94762

No 31-2920





JOHN DEERE CONT.

INTERRUPTEUR D'ALLUMAGE IGNITION SWITCH

7 bornes / terminals
4 positions

Pour tracteurs / For tractors
Clé non-incluse /
Key not included
Utilisé avec notre clé /
Used with our key #31-2918

Remplace / Replaces
AYP #175566, 163968
John Deere #GY20074
MTD #725-1741, 925-1741
Murray #94762

No 31-2921

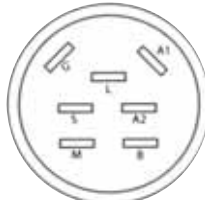

INTERRUPTEUR D'ALLUMAGE IGNITION SWITCH

Universel / Universal

5 bornes / terminals
3 positions
Requiert trou / Requires hole 5/8"

Remplace / Replaces
AMF #44745, 300295
AYP #S365402, 3612R, 4406R
Bob-Cat #48032B
Dixie #20245
Dixon #4197
Grasshopper #183806
Honda #510-772-003
John Deere #AM102544, AM31995, AM102551
MTD #725-0267, 925-0267
Murray #21064, 21064PA
Noma #421064
Roper #3621R
Scag #48017, 48017-02
Snapper #7027698, 7029010
Toro #23-0660

No 31-2922



INTERRUPTEUR D'ALLUMAGE IGNITION SWITCH

3 positions
À pression /
Snap mount

Clé non-incluse /
Key not included

Remplace / Replaces
Dixie/Chopper #500017
John Deere #AM122881, AM132808
MTD #725-04228, 925-04228

No 31-9655



INTERRUPTEUR D'ALLUMAGE IGNITION SWITCH

8 bornes / terminals

Pousser-tirer, à pression /
Push-pull, snap mount

Terminal du milieu vide /
Middle terminal blank

Bouton rouge / Red knob

Remplace / Replaces
Ariens #522100, 5221, 01545600, 1545600
Exmark #633673, 1-633673, 103-5221
Grasshopper #183925
John Deere #AM118802, AM119139, AM131966,
TCA17834
Kubota #K1211-62231
MTD #725-1716, 925-1716, 725-1752
Scag #481635, 700675
Snapper #28542, 7028542
Toro/Wheel Horse #93-9999, 93-9998, 95-4108,
95-7489, 1035221, 1633673

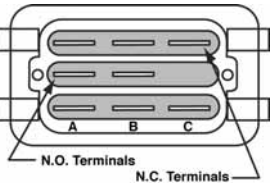

No 31-9657

INTERRUPTEUR D'ALLUMAGE IGNITION SWITCH

Allumage de batterie avec
tiges de montage 9/16" /
Battery ignition with
9/16" mounting stem

Pour / For
Gravely Promaster 20HP

Remplace / Replaces
Gravely #3115200
John Deere #AM103286,
AM32318, AM32686

No 31-9161



INTERRUPTEUR D'ALLUMAGE IGNITION SWITCH

6 bornes / terminals
3 positions

Pour tondeuse à support
avant John Deere /
For John Deere front
mount mower

Modèles / Models
Séries 300 et quelques
séries 200 / Series 300
and some series 200
(Magnéto / Magneto)

Remplace / Replaces
Ariens #03602300
John Deere #AM38227

No 31-9166

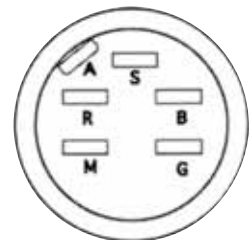

31





JOHN DEERE CONT.

INTERRUPTEUR D'ALLUMAGE IGNITION SWITCH



6 bornes / terminals
3 positions
Pour allumage magnéto /
For magneto ignition



Tige de montage /
Mounting stem 20 mm x 1.25"

Modèles / Models
RX63, RX95, RX85, SRX75, SRX95
Séries / Series F et/and Gator

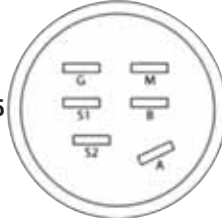

Remplace / Replaces
John Deere #AM101561
Great Dane #TCA15075

No 31-9167

□ □ NOUVEAU / NEW □ □

INTERRUPTEUR D'ALLUMAGE PTO PTO IGNITION SWITCH

8 bornes / terminals
3 positions

Pousser-tirer, à pression /
Push-pull, snap mount

Bouton jaune / Yellow knob



Modèles / Models
D160, D170,
LA130, LA140, LA145, LA150,
LA155, LA165, LA175,
X130R, X140, X155R, X165

Remplace / Replaces
John Deere #GY20939

No 31-2911

31

INTERRUPTEUR POUSSOIR D'INTERVERROUILLAGE PLUNGER INTERLOCK SWITCH



Normalement fermé / Normally closed
2 bornes / terminals
2 positions



Modèles / Models
Ariens Grand Sierra 22HP,
931038-000101, 931303-00101
avec moteur Kohler / with Kohler engine

Remplace / Replaces
Ariens #30957
AYP #109869X
Bob-Cat #38383
Exmark #1-513152, 513152
Ferris #21769
John Deere #AM108483
Simplicity #1708207, 1708207SM
Snapper #27225, 7027225,
923408



No 31-9658

INTERRUPTEUR POUSSOIR D'INTERVERROUILLAGE PLUNGER INTERLOCK SWITCH



Normalement ouvert / Normalement fermé /
Normally open / Normally closed
2 bornes / terminals
2 positions

Double pôles / Double poles
À pression / Snap mount

Remplace / Replaces
Ariens #08828100, 88281
AYP #109553X
Bob-Cat #108208
Bolens #175-1328
Bunton #PL7484
Dixon #4242, 539115802, 539101080
Encore #523034
Exmark #633111, 1-633111
Ferris #22095



Grasshopper #183894
Husqvarna #539-109553
John Deere #AM128925
MTD #725-3169A, 925-3169A
Murray #91299
Simplicity #1717050, 1717050SM
Snapper #23355, 7023355 **No 31-9659**

INTERRUPTEUR POUSSOIR D'INTERVERROUILLAGE PLUNGER INTERLOCK SWITCH



Normalement ouvert / Normally open

Remplace / Replaces
Ariens #36571, 03657100, 02754100
AYP #104445X
Bob-Cat #38382
Bolens #174-8723
Exmark #1-513051, 513051
Ferris #21451
Hustler #781211
John Deere #AM104884
Kubota #K2561-62251
Murray #24273



Scag #481637
Snapper #7014847, 14847, 7015707, 919098
Toro/Wheel Horse #65-7410
Yazoo #1923-025, 539001125 **No 31-9660**

INTERRUPTEUR POUSSOIR D'INTERVERROUILLAGE PLUNGER INTERLOCK SWITCH



Normalement ouvert / Normalement fermé /
Normally open / Normally closed

Double pôles / Double poles
À pression / Snap mount

Remplace / Replaces
John Deere #GY20094
Murray #94136, 094136,
094136MA



No 31-9662



JOHN DEERE CONT.

INTERRUPTEUR POUSSOIR D'INTERVERROUILLAGE PLUNGER INTERLOCK SWITCH

Normalement ouvert / Normally open



Support à angle droit à pression /
Right angle snap mounted

Remplace / Replaces

Ariens #27541

AYP #160784

Husqvarna #532-1607-84

John Deere #AM103119

Kubota #K1122-62280, K1122-62282

MTD #725-3167, 925-3167

Murray #57211, 024273

Roper #160784

Scag #481638

Sears #160784

Simplicity #1704379, 1704379SM

Snapper #15707

Toro/Wheel Horse #82-2190 **No 31-9663**



RÉGULATEUR DE VOLTAGE VOLTAGE REGULATOR

Pour 13, 15 et 17 ampères /

For 13, 15 and 17 amps

Système de remplissage jusqu'à moteur 18HP /
Charging system up to 18HP engine

Modèles / Models

425, 445, F911

John Deere 130, 160, 165,

170, 172, 175, 176, 180, 185,

186, 240, 242, 245, 265, 285,

320, 325, 345, F510, F525,

F710, F725

ATM 600, 622, 626

Gator : modèles 4x2 et 6x4 avec système de
remplissage 15 ampères / 4x2 and 6x4 models
with 15 amps charging system



Remplace / Replaces

John Deere #M70121, M97348

Kawasaki #21066-2056,

21033-2070

No 31-9213

INTERRUPTEUR POUSSOIR D'INTERVERROUILLAGE PLUNGER INTERLOCK SWITCH

Normalement fermé / Normally closed



Support à angle droit à pression /
Right angle snap mounted

Remplace / Replaces

AYP #121305X

Bolens #1761083

Cub Cadet #725-3166, 925-3166

Exmark #740275

Husqvarna #506-90-96-01, 532-121305

John Deere #AM104403

MTD #725-3166, 925-3166

Murray #094159, 094159MA, 94159

Scag #48717

Simplicity #1714770, 7023354

Snapper #2-3354, 7023354

Troy Bilt #GW-1761083 **No 31-9664**



BOBINE DE MAGNÉTO MAGNETO COIL

Pour moteurs 10HP à 13HP /

For 10HP to 13HP engines

L-head et/and Vanguard

9HP, 12.5HP, 14HP

Remplace / Replaces

Briggs & Stratton #490586, 491312, 492341,

495859, 690248, 715231, 795315, 799650

John Deere #MIA11422

No 31-1779



31

SOLÉNOÏDE SOLENOID

Très résistant / Heavy duty

Remplace / Replaces

John Deere #AM132990,

AM133094, AM130365,

AM138497, AM138068

MTD #725-0771

Murray #21261

No 31-9168



DÉMARREUR ÉLECTRIQUE ELECTRIC STARTER

Pour / For

CCW, 16 dents / teeth

12 volts

Remplace / Replaces

Briggs & Stratton #497595, 497525

John Deere #LG497595

No 31-6812





JOHN DEERE CONT.

CLAVETTE FLYWHEEL KEY



Remplace / Replaces
Briggs & Stratton #222698,
222698S, 61760, 4144, 5002H, 5002K
John Deere #PT7211,
LG222698S



Lot (10)
No 23-1435

KAWASAKI

BOBINE D'ALLUMAGE IGNITION COIL

Modèles / Models
TD40, TD43, TD48,
Kaaz 32CC, 33CC



Remplace / Replaces
Kawasaki #21121-2193

No 31-9215

RÉGULATEUR DE VOLTAGE VOLTAGE REGULATOR

Pour 13, 15 et 17 ampères /
For 13, 15 and 17 amps
Système de remplissage jusqu'à moteur 18HP /
Charging system up to 18HP engine

Modèles / Models
425, 445, F911
John Deere 130, 160, 165,
170, 172, 175, 176, 180, 185,
186, 240, 242, 245, 265, 285,
320, 325, 345, F510, F525,
F710, F725
ATM 600, 622, 626
Gator : modèles 4x2 et 6x4 avec système de
remplissage 15 ampères / 4x2 and 6x4 models
with 15 amps charging system



No 31-9213

Remplace / Replaces
John Deere #M70121, M97348
Kawasaki #21066-2056,
21033-2070

KOHLER

POINT DE CONTACT ET CONDENSATEUR CONTACT POINT AND CONDENSER

Remplace / Replaces
Clinton #135-5-500
Kohler #220-980, 230722,
47-150-01, 47-150-03
Tecumseh #32011A
Wico #WX13260, WX15241



No 31-1824

MODULE D'ALLUMAGE IGNITION MODULE

Qualité originale
OEM quality

Modèles / Models
CH11S, CH125S, CH14S,
CV12.5S, CV13S, CV14S,
CV15ST, CV460S, CV490S



Remplace / Replaces
Kohler #12-584-01,
12-584-01S, 12-584-04S

No 31-1821

MODULE SEMI-CONDUCTEUR SOLID STATE MODULE

Modèles / Models
CH20, CH22, CH25,
CV22, CV25, CH22S,
CH25S, CV22S



Remplace / Replaces
Kohler #24-584-11-S,
24-584-03, 24-584-15-S

No 31-1822

□ □ NOUVEAU / NEW □ □

MODULE SEMI-CONDUCTEUR SOLID STATE MODULE

Modèles / Models
CH-11, CH15, CV11, CV15,
XT7



Avec volant moteur en
aluminium / With aluminum flywheel

Remplace / Replaces
Kohler #14-584-02,
14-584-05-S

No 31-3311

□ □ NOUVEAU / NEW □ □

MODULE SEMI-CONDUCTEUR SOLID STATE MODULE

Modèles / Models
CH11S, CH12.5S, CH13S, CH14S,
CV12.5S, CV13S, CV14S, CV15S,
CV15ST, CV460S, CV490S, XT7



Avec volant moteur en acier /
With steel flywheel

Remplace / Replaces
Kohler #14-584-04-S,
14-584-01, 14-584-01-S

No 31-3314





KOHLER CONT.

BOBINE COIL

Pour / For
4HP, 6HP, 8HP, 10HP, 12HP, 14HP

Remplace / Replaces
Ariens #20355500
Gravely #022152
John Deere #AM132453, AM38411
Kohler #231281S, 237256S, 47-145-01S,
41-519-21S
Kubota #12581-68900
Tecumseh #32080, 4151921 **No 31-1781**



INTERRUPTEUR D'ALLUMAGE IGNITION SWITCH

5 bornes / terminals

Démarrage manuel /
Manual start

Remplace / Replaces
Ariens #03115200, 31152
AYP #2683, 2683R
Gravely #19223
Jacobson #129746, 129846
Kohler #48-099-01
Lawn-Boy #741308
Onan #378-0385
Toro/Wheel Horse #12-8140,
103990



No 31-1931

BOBINE D'ALLUMAGE IGNITION COIL

Qualité originale
OEM quality

Modèle / Model
Série / Serie KT

Remplace / Replaces
Kohler #52-755-48,
52-755-48S



No 31-1823

INTERRUPTEUR D'ALLUMAGE IGNITION SWITCH

Universel / Universal

Remplace / Replaces
Kohler #25-099-04, 25-099-32S
Toro/Wheel Horse #103991 **No 31-7280**



□ □ NOUVEAU / NEW □ □

BOBINE D'ALLUMAGE IGNITION COIL

Modèles / Models
CH25, CV22, CV23, CV25

Remplace / Replaces
Kohler #2458415



No 31-1754

CLÉ DE CONTACT IGNITION KEY

Universel / Universal

Pour interrupteur en plastique Delta /
For plastic Delta switch

Poignée moulée / Molded grip

Remplace / Replaces
AYP #140401, 140402, 140403
Husqvarna #532-14-04-01, 532-14-04-02,
532-14-04-03, 532-411933, 532-411935
John Deere #AM123426, AM131946, AM135356,
AM153650, GY20680
Kohler #48-340-01S
MTD #725-1745, 925-1745
Murray #327350
Sears #140403
Simplicity #1717163,
1717163SM



No 31-2918

BOBINE D'ALLUMAGE IGNITION COIL

Pour / For
18HP et/and 20HP

Modèles / Models
M18 à/to M20

Remplace / Replaces
Kohler #52-584-02-S



No 31-1825



KOHLER CONT.

RÉGULATEUR DE VOLTAGE VOLTAGE REGULATOR



Pour / For
8HP à/to 24HP moteurs / engines
Avec alternateur 15 ampères /
With 15 amps alternator

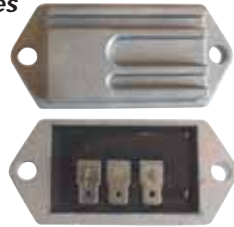

3 bornes en ligne sur
une rangée / In line
terminals 3 in a row

Modèles / Models
M8-M20, MV16, MV20, CH5, CH6,
CH11-CH15, CV11-CV15

Remplace / Replaces
Kohler #25-755-03S, 25-403-03S, 41-403-01,
41-403-04, 41-403-05,
41-403-05S, 41-403-09S **No 31-2943**

RÉGULATEUR DE VOLTAGE VOLTAGE REGULATOR



10 ampères / amps
12 volts
3 bornes en rangée /
3 terminals in a row



Remplace / Replaces
Briggs & Stratton #390240
Kohler #234279/41 403 08, 41-403-08S
Tecumseh #610749 **No 31-2944**

31



RÉGULATEUR REGULATOR

Pour moteurs 8HP à 24HP avec
alternateur 15 ampères /
For 8HP to 24HP engines
with 15 amps alternator



Design en "L" avec 2 bornes /
"L" pattern with 2 terminals

Modèles / Models
K181, K241, K301, K321, K482, K532, K582

Remplace / Replaces
Kohler #41-403-06S,
2540322S **No 31-2947**

RÉGULATEUR DE VOLTAGE VOLTAGE REGULATOR

Utilisé sur des tondeuses
commerciales à pousser avec
moteur Kohler, avec embrayage
électrique, avec démarreur à
corde et aucune batterie /
Used on commercial
walkbehind mowers
with Kohler engines with
electric clutch, rope starter
and no battery



Remplace / Replaces
Kohler #12-403-01 **No 31-6823**

ENSEMBLE DE BROSSES ET RESSORTS BRUSHES AND SPRINGS KIT



Remplace / Replaces
Kohler #82755-28 **No 31-9218**

□ □ NOUVEAU / NEW □ □

SOLENOÏDE DE DÉMARREUR SOLENOID STARTER



Remplace / Replaces
Kohler #25-435-04S **No 31-1983**

DÉMARREUR ÉLECTRIQUE ELECTRIC STARTER

Pour / For
CCW, 9 dents / teeth
12 volts

Modèles / Models
K482, K532, K582
18HP, 20HP, 22HP



Remplace / Replaces
Kohler #48-098-02,
48-098-04, 48-098-04S **No 31-6817**



KOHLER CONT.

DÉMARREUR ÉLECTRIQUE ELECTRIC STARTER

Pour / For
CCW, 13 dents / teeth
12 volts

Modèles / Models
CH100-15, CV11-15
11HP - 15HP

Remplace / Replaces
Kohler #12-098-04, 12-098-08,
12-098-13



No 31-6819

DÉMARREUR ÉLECTRIQUE ELECTRIC STARTER

Pour / For
CCW, 9 dents / teeth
12 volts

Modèles / Models
KT17, KT19, MV16, MV17, MV18
Moteurs à 2 cylindres 16HP et 19HP /
16HP and 19HP twin cylinder engines

Remplace / Replaces
Kohler #52-098-03, 52-098-09,
52-098-12



No 31-6820

DÉMARREUR ÉLECTRIQUE ELECTRIC STARTER

Pour / For
CCW, 9 dents / teeth
12 volts

Modèles / Models
KT17, KT19, KT21, M18, M20, MV20
17HP - 20HP

Remplace / Replaces
Kohler #52-098-06,
52-098-10, 52-098-13



No 31-6825

□ □ NOUVEAU / NEW □ □

DÉMARREUR ÉLECTRIQUE ELECTRIC STARTER

Pour / For
CCW, 10 dents / teeth
12 volts

Modèles / Models
CH12.5, CH13, CH14, CH15, CH18,
CH20, CH22, CH25
CV12.5, CV15S, CV16, CV18, CV20, CV22, CV25

Remplace / Replaces
Kohler #24-098-01, 24-098-01S, 25-098-08,
25-098-09S, 25-098-11S, 12-098-03S,
24-098-08S



No 31-6848

LAWN-BOY

PLOT DE CONTACT ET CONDENSATEUR CONTACT POINT AND CONDENSER



Modèles / Models
Séries / Series C et/and D

Remplace / Replaces
Lawn-Boy
Ensemble de pointe / Contact set #677254
Condensateur /
Condenser #677299



No 31-1800

BOBINE DE MAGNÉTO MAGNETO COIL

Modèles / Models
Séries / Series A et/and C

Remplace / Replaces
Lawn-Boy #580184, 582396,
582463, 582995, 580198,
580118, 580197, 580416,
582370, 582921



No 31-1806

BOBINE DE MAGNÉTO MAGNETO COIL

Modèles / Models
Série / Serie D

Remplace / Replaces
Lawn-Boy #678539



No 31-1901



LAWN-BOY CONT.

POINTE POINT



Remplace / Replaces
Lawn-Boy #580148, 580173 **No 31-1794**

MODULE D'ALLUMAGE IGNITION MODULE



Modèles / Models
Séries Or et Argent /
Gold and Silver series
1989 à/to 2003



Remplace / Replaces
Lawn-Boy #684049, 684048,
92-1152, 99-2916
Toro #99-29-16

No 31-1896

BOBINE DE MAGNÉTO MAGNETO COIL



Modèles / Models
Série / Serie D
1971 à/to 1977



Remplace / Replaces
Lawn-Boy #681542, 683321 **No 31-1899**

CAPUCHON DE BOUGIE SPARK PLUG CONNECTOR

Pour fil / For wire 7 mm



Remplace / Replaces
Lawn-Boy # 580339, 510231,
684698

**LOT (10)
No 31-1951**

INTERRUPTEUR D'ALLUMAGE IGNITION SWITCH



Remplace / Replaces
Lawn-Boy #682513

No 31-2963

31

BOBINE DE MAGNÉTO MAGNETO COIL



Petite borne / Small terminal
Couleur pâle / Pale color



Modèles / Models
Série / Serie F
1978 à/to 1982

Remplace / Replaces
Lawn-Boy #682340, 681578,
1002949

No 31-1897

SOLÉNOÏDE SOLENOID



12 volts
4 bornes / terminals
Goujons / Studs 1/4" - 20

Remplace / Replaces
Ariens #35510
AYP #192507, 146154
Bolens #1752137, 1753539
Gilson #212655
Grasshopper #184251
Gravely #45071
Lawn-Boy #740207
Simplicity #1685290
Snapper #1-8604, 7018604
Toro #28-4210, 47-1910
Wheel Horse #110116

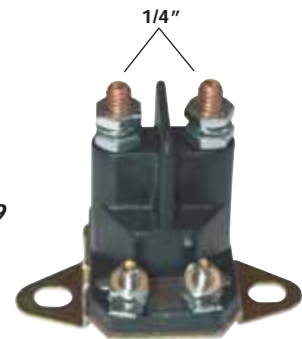

No 31-3320

BOBINE DE MAGNÉTO MAGNETO COIL



Modèles / Models
Série / Serie F
1983 à/to 1988
Couleur foncé / Dark color



Remplace / Replaces
Lawn-Boy #683215,
683080, 100-2948

No 31-1898



LAWN-BOY CONT.

SOLÉNOÏDE SOLENOID



Universel / *Universal*

12 volts
4 bornes / *terminals*

Poteau de borne et manchon
s'adaptant aux embouts de
1/4" / *Terminal post and sleeve
will accept both 1/4"*



Les supports de montage s'adapte à la
configuration des supports de châssis et de murs /
*Mounting bracket will accomodate both
chassis and wall mount configurations*

Remplace / *Replaces*
Ariens #35510
AYP #109081X, 109946, 146154
Bolens #1752137, 1753539
Case #C-266525, C33025
Exmark #1-513075
Gilson #212655
Grasshopper #184251
Gravely #45071
Lawn-Boy #740207
MTD #725-04437
Simplicity #170051, 16771993, 16852980, 1700751
Snapper #18604, 7018604
Toro #47-1910, 110116,
110162, 110167

No 31-3318

INTERRUPTEUR D'ALLUMAGE IGNITION SWITCH



Universel / *Universal*

Pour souffleuses à neige /
For snowblowers

Remplace / *Replaces*
Ariens #624097, 11134, 02456500, 52406900
AYP #135944
Homelite #JA130641
Lawn-Boy #700171
Murray #56419
Simplicity #1664804
Snapper #17817



No 31-1939

BATTERIE 12 V BATTERY 12 V



Longueur / *Length* 4 3/8"
Largeur / *Width* 3 1/4"
Hauteur / *Height* 2 11/16"

2.5 ampères / *amps*

Pour tondeuses 21"
démarrage électrique /
For 21" mowers electric start

Fil principal de 7" avec connecteur moulé,
boîtier en plastique / *7" lead wire with molded
connector, plastic case*



Remplace / *Replaces*
Toro #55-7520

No 31-8593

31

INTERRUPTEUR D'ALLUMAGE IGNITION SWITCH



5 bornes / *terminals*

Démarrage manuel /
Manual start

Remplace / *Replaces*
Ariens #03115200, 31152
AYP #2683, 2683R
Gravely #19223
Jacobson #129746, 129846
Kohler #48-099-01
Lawn-Boy #741308
Onan #378-0385
Toro/Wheel Horse #12-8140,
103990



No 31-1931

BATTERIE SCELLÉ SEALED BATTERY

WP3.3-12
Avec acide à l'intérieur /
With acid inside

Longueur / *Length* 5 1/4"
Largeur / *Width* 2 1/2"
Hauteur / *Height* 2 1/4"

Pour toutes les tondeuses Lawn-Boy
ou Toro 2000 et plus / *For all Lawn-Boy or
Toro mowers 2000 and more*

Garantie 30 jours / *30 days warranty (prorata)*

Remplace / *Replaces*
Lawn-Boy #108-9358
Toro #108-9358



No 31-8594





MTD

AMPOULE HALOGÈNE DE RECHANGE REPLACEMENT HALOGEN BULB

12 volts
27 watts
#890, GE892

Pour souffleuses MTD 1993 et plus /
For MTD snowblowers 1993 and more

Remplace / Replaces
MTD #725-1658, 925-1658,
725-1645

No 31-1658



INTERRUPTEUR D'ALLUMAGE IGNITION SWITCH

Interrupteur d'allumage très
résistant avec clé / *Heavy duty
ignition switch with key*

Semblable à notre 31-2921,
mais de meilleure qualité /
*Similar to our 31-2921 but
more higher quality*

Remplace / Replaces
AYP #175566, 163968
John Deere #GY20074
MTD #725-1741, 925-1741
Murray #94762

No 31-2920



INTERRUPTEUR D'ALLUMAGE IGNITION SWITCH

7 bornes / terminals
4 positions

Pour tracteurs / *For tractors*
Clé non-incluse /
Key not included
Utilisé avec notre clé /
Used with our key #31-2918

Remplace / Replaces
AYP #175566, 163968
John Deere #GY20074
MTD #725-1741, 925-1741
Murray #94762

No 31-2921



INTERRUPTEUR DE SÉCURITÉ SAFETY SWITCH

Normalement ouvert pour fonctionner /
Normally open to run

2 bornes / terminals

Noir / Black

Remplace / Replaces
Cub Cadet #925-0268
Dynamark #41204
MTD #725-0268, 925-0268

No 31-253



31

INTERRUPTEUR D'ALLUMAGE IGNITION SWITCH

Universel / *Universal*

5 bornes / terminals
3 positions
Requiert trou / *Requires hole 5/8"*

Remplace / Replaces
AMF #44745, 300295
AYP #S365402, 3612R, 4406R
Bob-Cat #48032B
Dixie #20245
Dixon #4197
Grasshopper #183806
Honda #510-772-003
John Deere #AM102544, AM31995, AM102551
MTD #725-0267, 925-0267
Murray #21064, 21064PA
Noma #421064
Roper #3621R
Scag #48017, 48017-02
Snapper #7027698, 7029010
Toro #23-0660

No 31-2922



INTERRUPTEUR DE SÉCURITÉ SAFETY SWITCH

Normalement fermé /
Normally closed

7 bornes / terminals
4 positions

Interrupteur à poussoir / *Push button switch*

Longueur / *Length 2 1/8"*
Requiert trou / *Requires hole 1/2"*

Bouton rouge / *Red button*

Remplace / Replaces
Cub Cadet #725-0269, 925-0269
MTD #725-0269, 925-0269

No 31-356





MTD CONT.

INTERRUPTEUR D'ALLUMAGE IGNITION SWITCH

6 bornes / terminals

Pour moteurs équipés d'un solénoïde avec soupape d'arrêt construit depuis 1994 / For engines equipped with fuel shut-off solenoid built since 1994

Utilisé sur les tondeuses Murray / Used on Murray mowers

Remplace / Replaces
AYP #140301
MTD #725-1717
Murray #92556



No 31-9623

INTERRUPTEUR D'ALLUMAGE IGNITION SWITCH

6 bornes / terminals
3 positions

Pour les tracteurs à gazon et de jardin avec moteur Briggs & Stratton Vanguard OHV / For lawn and garden tractors with Briggs & Stratton OHV Vanguard engine

Remplace / Replaces
MTD #725-1396, 925-1396

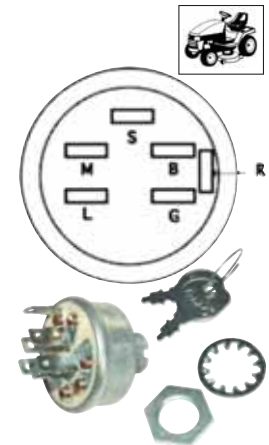

No 31-9853

INTERRUPTEUR D'ALLUMAGE IGNITION SWITCH

3 positions
À pression /
Snap mount

Clé non-incluse /
Key not included

Remplace / Replaces
Dixie/Chopper #500017
John Deere #AM122881, AM132808
MTD #725-04228, 925-04228



No 31-9655

INTERRUPTEUR D'ALLUMAGE IGNITION SWITCH

8 bornes / terminals

Pousser-tirer, à pression /
Push-pull, snap mount

Terminal du milieu vide /
Middle terminal blank

Bouton rouge / Red knob

Remplace / Replaces
Ariens #522100, 5221, 01545600, 1545600
Exmark #633673, 1-633673, 103-5221
Grasshopper #183925
John Deere #AM118802, AM119139, AM131966, TCA17834
Kubota #K1211-62231
MTD #725-1716, 925-1716, 725-1752
Scag #481635, 700675
Snapper #28542, 7028542
Toro/Wheel Horse #93-9999, 93-9998, 95-4108, 95-7489, 1035221, 1633673

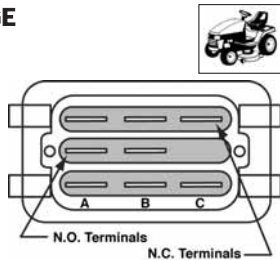

No 31-9657

INTERRUPTEUR D'ALLUMAGE IGNITION SWITCH

7 bornes / terminals
4 positions

2005-2006

Clé non-incluse /
Key not included

Remplace / Replaces
Cub Cadet #725-04227A,
925-04227A, 925-04227B
MTD #725-04227A,
925-04227A, 925-04227B



No 31-9667

INTERRUPTEUR D'ALLUMAGE IGNITION SWITCH

5 bornes / terminals
3 positions

Clé non-incluse /
Key not included

Remplace / Replaces
Cub Cadet #925-04019
MTD #725-04019, 925-04019



No 31-9668



MTD CONT.

□ □ NOUVEAU / NEW □ □

INTERRUPTEUR D'ALLUMAGE IGNITION SWITCH



2 bornes / terminals
2 positions



Pour souffleuses avec
moteur Zongshen /
For snowblowers with Zongshen engine

Utilisé pour les souffleuses Craftman et Huskee /
Used on Craftman and Huskee snowblowers

Remplace / Replaces
MTD #951-10637

No 31-3315

□ □ NOUVEAU / NEW □ □

INTERRUPTEUR DE DÉMARRAGE STARTER SWITCH



2 bornes / terminals
2 positions



Clé non-incluse /
Key not included

Remplace / Replaces
MTD #725-1979

No 31-3316

□ □ NOUVEAU / NEW □ □

INTERRUPTEUR POUSSOIR D'INTERVERROUILLAGE PLUNGER INTERLOCK SWITCH



Modèles / Models
Tondeuses série 700 /
700 series mowers



Remplace / Replaces
MTD #725-04363

No 31-2950

□ □ NOUVEAU / NEW □ □

INTERRUPTEUR POUSSOIR D'INTERVERROUILLAGE PLUNGER INTERLOCK SWITCH



Normalement ouvert /
Normally open



Remplace / Replaces
MTD #725-3191A,
925-3191A

No 31-2953

□ □ NOUVEAU / NEW □ □

INTERRUPTEUR D'ALLUMAGE PTO PTO IGNITION SWITCH

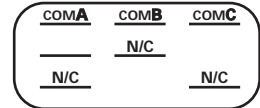

7 bornes / terminals
2 positions

Pousser-tirer, à pression /
Push-pull, snap mount

Bouton jaune / Yellow knob

Modèles / Models

GT1554, GT2542, GT2550,
GT2554, SLT1550, SLT1554, Z-FORCE



Remplace / Replaces

Cub Cadet #725-04175, 925-04175

MTD #725-04175, 925-04175 No 31-2913

31

INTERRUPTEUR D'ALLUMAGE PTO PTO IGNITION SWITCH



7 bornes / terminals

Pousser-tirer, à pression /
Push-pull, snap mount

Bouton or en forme de
goutte / Gold tear drop knob

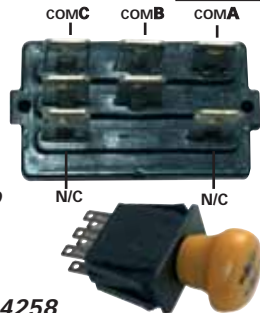

Remplace / Replaces

Cub Cadet #725-04258, 925-04258

MTD #725-04258, 925-04258 No 31-2916

INTERRUPTEUR PTO PTO SWITCH

4 bornes / terminals
2 positions

Modèles / Models

698, 699

Remplace / Replaces

MTD #725-0803C, 925-0803C No 31-4723





MTD CONT.

INTERRUPTEUR POUSSOIR D'INTERVERROUILLAGE PLUNGER INTERLOCK SWITCH



Normalement ouvert/Normalement fermé /
Normally open/Normally closed
2 bornes / terminals
2 positions

Double pôles / *Double poles*
À pression / *Snap mount*



Remplace / *Replaces*
Ariens #08828100, 88281
AYP #109553X
Bob-Cat #108208
Bolens #175-1328
Bunton #PL7484
Dixon #4242, 539115802, 539101080
Encore #523034
Exmark #633111, 1-633111
Ferris #22095
Grasshopper #183894
Husqvarna #539-109553
John Deere #AM128925
MTD #725-3169A, 925-3169A
Murray #91299
Simplicity #1717050, 1717050SM
Snapper #23355, 7023355 **No 31-9659**

INTERRUPTEUR POUSSOIR D'INTERVERROUILLAGE PLUNGER INTERLOCK SWITCH



Normalement ouvert / *Normally open*

Support à angle droit à pression /
Right angle snap mounted



Remplace / *Replaces*
Ariens #27541
AYP #160784
Husqvarna #532-1607-84
John Deere #AM103119
Kubota #K1122-62280, K1122-62282
MTD #725-3167, 925-3167
Murray #57211, 024273
Roper #160784
Scag #481638
Sears #160784
Simplicity #1704379, 1704379SM
Snapper #15707
Toro/Wheel Horse #82-2190 **No 31-9663**

INTERRUPTEUR POUSSOIR D'INTERVERROUILLAGE PLUNGER INTERLOCK SWITCH



Normalement fermé / *Normally closed*

Support à angle droit à pression /
Right angle snap mounted



Remplace / *Replaces*
AYP #121305X
Bolens #1761083
Cub Cadet #725-3166, 925-3166
Exmark #740275
Husqvarna #506-90-96-01, 532-121305
John Deere #AM104403
MTD #725-3166, 925-3166
Murray #094159, 094159MA, 94159
Scag #48717
Simplicity #1714770, 7023354
Snapper #2-3354, 7023354
Troy Bilt #GW-1761083 **No 31-9664**

31

INTERRUPTEUR POUSSOIR D'INTERVERROUILLAGE PLUNGER INTERLOCK SWITCH



Normalement ouvert/Normalement fermé /
Normally open/Normally closed

Double pôles / *Double poles*
À pression / *Snap mount*



INTERRUPTEUR POUSSOIR D'INTERVERROUILLAGE PLUNGER INTERLOCK SWITCH



Normalement ouvert/Normalement fermé /
Normally open/Normally closed

Double pôles /
Double poles
À pression / *Snap mount*



Remplace / *Replaces*
MTD #925-1657A **No 31-9661**

Remplace / *Replaces*
AYP #153664, 161343, 176138
Cub Cadet #725-3164, 925-3164, 725-3164AP
Ferris #22182, 5023455
Husqvarna #532-153664, 532-176137, 532-176138
MTD #725-3164A, 925-3164A
Snapper #22886, 7022886,
1723507, 1732006 **No 31-9665**





MTD CONT.

□ □ NOUVEAU / NEW □ □

2 CLÉS DE CONTACT 2 IGNITION KEYS

Pour souffleuses avec
moteur Zongshen /
For snowblowers with
Zongshen engine



Utilisé pour les souffleuses Craftman et Huskee /
Used on Craftman and Huskee snowblowers

Remplace / Replaces
MTD #751-10630, 951-10630,
731-05632 **No 31-4725**

□ □ NOUVEAU / NEW □ □

DÉMARREUR ÉLECTRIQUE ELECTRIC STARTER

120 volts

Pour souffleuses utilisant
les moteurs 265-JU, 270-JU,
165-SU, 370-SU, 365-SUA,
370-SUA, 370-SUB, 270-V
construits entre 2007 et 2010 /
For snowblowers using
265-JU, 270-JU, 165-SU, 370-SU, 365-SUA, 365-SUB,
370-SUA, 370-SUB, 270-V engines built
from 2007 to 2010



Remplace / Replaces
MTD #784-04027A, 984-04027, 984-5485,
784-5485, 684-04027A, 684-04027, 684-04025A,
684-04025 **No 31-6840**

31



□ □ NOUVEAU / NEW □ □

DÉMARREUR ÉLECTRIQUE ELECTRIC STARTER

120 volts

Pour souffleuses utilisant
les moteurs 478-SU, 483-SU
et 490-SU construites entre
2009 et 2010 /
For snowblowers using
478-SU, 483-SU and 490-SU
engines built from 2009 to 2010



Remplace / Replaces
MTD #951-11196, 751-11196 **No 31-6845**

CLÉ DE CONTACT IGNITION KEY



Plastique / Plastic
Clé à pousser-tirer / Push-pull key

Modèles / Models
MTD 314-181-000, 314-180-131
314-180-000, 314-180-088, TMO-3525203



Pour souffleuses avec moteurs Tecumseh /
For snowblowers with Tecumseh engines

Remplace / Replaces
Ariens #7532000, 7500108
MTD #725-1660
Tecumseh #35062 **No 31-2934**

CLÉ DE CONTACT IGNITION KEY

Universel / Universal

Pour interrupteur en plastique Delta /
For plastic Delta switch



Poignée moulée / Molded grip

Remplace / Replaces
AYP #140401, 140402, 140403
Husqvarna #532-14-04-01, 532-14-04-02,
532-14-04-03, 532-411933, 532-411935
John Deere #AM123426, AM131946, AM135356,
AM153650, GY20680
Kohler #48-340-01S
MTD #725-1745, 925-1745
Murray #327350
Sears #140403
Simplicity #1717163,
1717163SM **No 31-2918**

2 CLÉS DE CONTACT 2 IGNITION KEYS



Remplace / Replaces
MTD #725-0128, 925-0128 **No 31-2937**

SOLÉNOÏDE SOLENOID

Très résistant / Heavy duty

Remplace / Replaces
John Deere #AM132990,
AM133094, AM130365,
AM138497, AM138068
MTD #725-0771
Murray #21261



No 31-9168



MTD CONT.

SOLÉNOÏDE SOLENOID

12 volts
3 bornes / terminals
Support à 90° / 90° mount

Boulon diamètre 1/4" /
Bolt diameter 1/4"

Borne du connecteur coulissant /
Slide connector terminal

Capacité de 80 ampères / 80 amps capacity

Remplace / Replaces

AYP #110832X

MTD #725-1426, 925-1426

Snapper #1-8817, 75671

Toro/Wheel Horse #112-0309 **No 31-1928**



SOLÉNOÏDE SOLENOID

Universel / Universal

12 volts
4 bornes / terminals

Poteau de borne et manchon
s'adaptant aux embouts de
1/4" / Terminal post and sleeve
will accept both 1/4"

Les supports de montage s'adapte à la
configuration des supports de châssis et de murs /
Mounting bracket will accomodate both
chassis and wall mount configurations

Remplace / Replaces

Ariens #35510

AYP #109081X, 109946, 146154

Bolens #1752137, 1753539

Case #C-266525, C33025

Exmark #1-513075

Gilson #212655

Grasshopper #184251

Gravely #45071

Lawn-Boy #740207

MTD #725-04437

Simplicity #170051, 16771993, 16852980, 1700751

Snapper #18604, 7018604

Toro #47-1910, 110116,

110162, 110167

No 31-3318



SOLÉNOÏDE SOLENOID

3 bornes / terminals

Boulon diamètre 1/4" /
Bolt diameter 1/4"

Borne avec mise à la terre
intérieure w/wcrew /
Internal ground w/wcrew
terminal

Capacité de 80 ampères / 80 amps capacity

Remplace / Replaces

MTD #725-0771, 925-0771

No 31-1929



SOLÉNOÏDE SOLENOID

12 volts
3 bornes / terminals

Universel / Universal

Poteau de borne et manchon
s'adaptant aux embouts de
1/4" / Terminal post and sleeve
will accept both 1/4"

Les supports de montage s'adapte à la
configuration des supports de châssis et de murs /
Mounting bracket will accomodate both
chassis and wall mount configurations

Remplace / Replaces

AMF #53716

Ariens #3057700

Bolens #1751569

MTD #725-0771, 725-1426,

725-0530, 925-1426, 925-0771

Murray #424285, 924285, 21261, 24285

Noma #52323

Snapper #7018817, 7075671

Toro #111674

No 31-3317

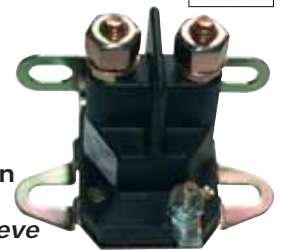

31

SOLÉNOÏDE SOLENOID

12 volts
3 bornes / terminals
Goujons / Studs 1/4" - 20

Remplace / Replaces

AMF #53716

Ariens #3057700

Bolens #1751569

MTD #725-0530, 725-0771,
925-0771

Murray #24285, 9924285,
424285, 7701100MA

Snapper #1-8817

Stiga #1134-946-01

Wheel Horse #111674

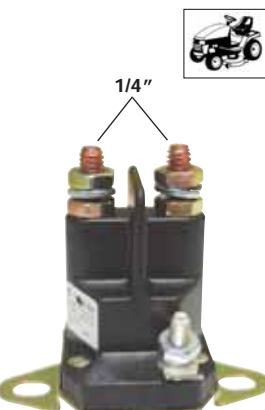

No 31-3319





MTD CONT.

COMMUTATEUR À RELAIS RELAY SWITCH



Pour / For
12 volts
20 ampères / amps

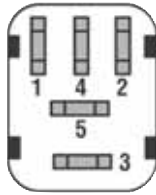

Entraînement automatique pour tondeuse et souffleur / Auto drive riding mower and snowblower

Remplace / Replaces
MTD #925-1648

No 31-3321

EMBRAYAGE ÉLECTRIQUE PTO PTO ELECTRIC PTO CLUTCH



ID 1"
Poulie / Pulley 5 1/4"
Courroie / Belt 1/2"

Qualité originale
OEM quality



Modèle / Model
809

Remplace / Replaces
MTD #717-1709, 917-1709
Warner #5215-130

No 31-9165

31

NOUVEAU / NEW



BATTERIE SCELLÉ SEALED BATTERY



UBI 1222
Avec acide à l'intérieur /
With acid inside



Longueur / Length 7"
Largeur / Width 1 3/8"
Hauteur / Height 2 3/8"



Borne gauche positive /
Left hand positive

2.2 AH ampères / amps
12 volts

Garantie 30 jours / 30 days warranty (prorata)

Remplace / Replaces
MTD #725-04323

No 31-8595

MURRAY (AMF, BRIGGS & STRATTON, CANADIANA, DYNAMARK, NOMA)

LUMIÈRE LIGHT



Modèles / Models
N1030DEL, N1232DEL



Pour toutes souffleuses /
For all snowblowers
Noma Signature

Remplace / Replaces
Noma #1156

No 31-1156

INTERRUPTEUR DE SÉCURITÉ SAFETY SWITCH

Normalement ouvert pour fonctionner /
Normally open to run

2 bornes / terminals

Noir / Black



Remplace / Replaces
Cub Cadet #925-0268
Dynamark #41204
MTD #725-0268, 925-0268

No 31-253

INTERRUPTEUR D'ALLUMAGE IGNITION SWITCH



Universel / Universal

Pour souffleuses à neige /
For snowblowers



Remplace / Replaces
Ariens #624097, 11134, 02456500, 52406900
AYP #135944

Homelite #JA130641
Lawn-Boy #700171
Murray #56419
Simplicity #1664804
Snapper #17817

No 31-1939

INTERRUPTEUR D'ALLUMAGE IGNITION SWITCH



Interrupteur d'allumage très
résistant avec clé / Heavy duty
ignition switch with key

Semblable à notre 31-2921,
mais de meilleure qualité /
Similar to our 31-2921 but
more higher quality



Remplace / Replaces
AYP #175566, 163968
John Deere #GY20074
MTD #725-1741, 925-1741
Murray #94762



No 31-2920



**MURRAY (AMF, BRIGGS & STRATTON,
CANADIANA, DYNAMARK, NOMA) CONT.**

INTERRUPTEUR D'ALLUMAGE IGNITION SWITCH



7 bornes / terminals
4 positions

Pour tracteurs / For tractors
Clé non-incluse /
Key not included
Utilisé avec notre clé /
Used with our key #31-2918

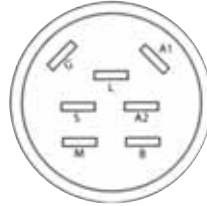

No 31-2921

Remplace / Replaces
AYP #175566, 163968
John Deere #GY20074
MTD #725-1741, 925-1741
Murray #94762

INTERRUPTEUR D'ALLUMAGE IGNITION SWITCH



Universel / Universal

5 bornes / terminals
3 positions
Requiert trou / Requires hole 5/8"



Remplace / Replaces
AMF #44745, 300295
AYP #S365402, 3612R, 4406R
Bob-Cat #48032B
Dixie #20245
Dixon #4197
Grasshopper #183806
Honda #510-772-003
John Deere #AM102544, AM31995, AM102551
MTD #725-0267, 925-0267
Murray #21064, 21064PA
Noma #421064
Roper #3621R
Scag #48017, 48017-02
Snapper #7027698, 7029010
Toro #23-0660

No 31-2922

INTERRUPTEUR D'ALLUMAGE IGNITION SWITCH



Modèles / Models
Exmark Laser ZTR,
John Deere STX, 38446

Remplace / Replaces
AYP #158913
Exmark #543070
Hustler #045898
Noma #305720
Snapper #26343, 7026343



No 31-9158

INTERRUPTEUR D'ALLUMAGE IGNITION SWITCH



5 bornes / terminals
4 positions

Pour / For
Gravely et/and Noma

Allumage magnéto /
Magneto ignition

Remplace / Replaces
Murray #91846, 091846MA
Noma #300687, 091846

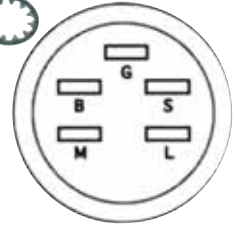

No 31-9330

INTERRUPTEUR D'ALLUMAGE IGNITION SWITCH



3 positions

Pour moteur avant Murray /
For Murray front engine

Tracteur avec allumage
magnéto / Tractor with
magneto ignition

Remplace / Replaces
Briggs & Stratton #5411H
Murray #92377, 092377MA,
MU092377MA, MU92377



No 31-9331

INTERRUPTEUR D'ALLUMAGE IGNITION SWITCH



6 bornes / terminals

Pour moteurs équipés
d'un solénoïde avec
soupape d'arrêt construit
depuis 1994 / For engines
equipped with fuel
shut-off solenoid built
since 1994

Utilisé sur les tondeuses Murray /
Used on Murray mowers

Remplace / Replaces
AYP #140301
MTD #725-1717
Murray #92556

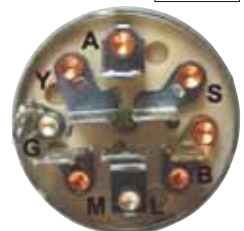

No 31-9623



**MURRAY (AMF, BRIGGS & STRATTON,
CANADIANA, DYNAMARK, NOMA) CONT.**

CLÉ DE CONTACT IGNITION KEY

Universel / *Universal*

Pour interrupteur en plastique Delta /
For plastic Delta switch

Poignée moulée / *Molded grip*

Remplace / *Replaces*
AYP #140401, 140402, 140403
Husqvarna #532-14-04-01, 532-14-04-02,
532-14-04-03, 532-411933, 532-411935
John Deere #AM123426, AM131946, AM135356,
AM153650, GY20680
Kohler #48-340-01S
MTD #725-1745, 925-1745
Murray #327350
Sears #140403
Simplicity #1717163,
1717163SM



No 31-2918

INTERRUPTEUR POUSSOIR D'INTERVERROUILLAGE PLUNGER INTERLOCK SWITCH

Normalement ouvert / *Normally open*



Support à angle droit à pression /
Right angle snap mounted

Remplace / *Replaces*
Ariens #27541
AYP #160784
Husqvarna #532-1607-84
John Deere #AM103119
Kubota #K1122-62280, K1122-62282
MTD #725-3167, 925-3167
Murray #57211, 024273
Roper #160784
Scag #481638
Sears #160784
Simplicity #1704379, 1704379SM
Snapper #15707
Toro/Wheel Horse #82-2190 **No 31-9663**



INTERRUPTEUR POUSSOIR D'INTERVERROUILLAGE PLUNGER INTERLOCK SWITCH

Normalement ouvert / *Normally open*



Remplace / *Replaces*
Ariens #36571, 03657100, 02754100
AYP #104445X
Bob-Cat #38382
Bolens #174-8723
Exmark #1-513051, 513051
Ferris #21451
Hustler #781211
John Deere #AM104884
Kubota #K2561-62251
Murray #24273
Scag #481637
Snapper #7014847, 14847, 7015707, 919098
Toro/Wheel Horse #65-7410
Yazoo #1923-025, 539001125 **No 31-9660**



31



INTERRUPTEUR POUSSOIR D'INTERVERROUILLAGE PLUNGER INTERLOCK SWITCH

Normalement ouvert / Normalement fermé /
Normally open / Normally closed



Double pôles / *Double poles*
À pression / *Snap mount*

Remplace / *Replaces*
John Deere #GY20094
Murray #94136, 094136,
094136MA



No 31-9662

INTERRUPTEUR D'ALLUMAGE IGNITION SWITCH

S'installe sur la plupart des
tracteurs Noma Signature /
*Install on most Noma
Signature tractors*



Clé non-incluse /
Key not included

Remplace / *Replaces*
AYP #144921, 163088, 178744
Murray #327355
Noma #327355
Simplicity #1718306,
1713845, 1686734

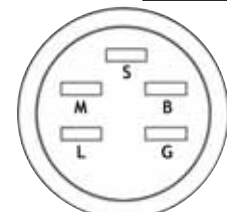

No 31-4721



**MURRAY (AMF, BRIGGS & STRATTON,
CANADIANA, DYNAMARK, NOMA) CONT.**

INTERRUPTEUR D'ALLUMAGE PTO PTO IGNITION SWITCH



8 bornes / terminals

Pousser-tirer, à pression /
Push-pull, snap mount

Borne du coin vide /
Corner terminal blank

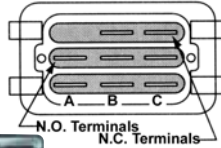

Bouton rouge / Red knob



Remplace / Replaces

AYP #146283, 140404, 154959,
154963, 169416, 174652
Dixon #5961, 539-117-238, 539-129-512,
539-120-023
Encore #523030, 523031
Ferris #22180, 5022180
Great Dane #D38005
Howard #02-422
Husqvarna #532-154-959, 532-169-417,
532-174-651
Hustler #771476, 77146, 776476
Murray #94927, 6201-316
Scag #483957, 27328, 481687, 483162
Simplicity #171348, 171348SM, 1714772,
1716332, 1722887
Snapper #7035658, 35658
Yazoo #101768, 539101768 **No 31-9656**

INTERRUPTEUR POUSSOIR D'INTERVERROUILLAGE PLUNGER INTERLOCK SWITCH



Normalement ouvert/Normalement fermé /
Normally open/Normally closed

2 bornes / terminals

2 positions

Double pôles / Double poles
À pression / Snap mount



Remplace / Replaces

Ariens #08828100, 88281
AYP #109553X
Bob-Cat #108208
Bolens #175-1328
Bunton #PL7484
Dixon #4242, 539115802, 539101080
Encore #523034
Exmark #633111, 1-633111
Ferris #22095
Grasshopper #183894
Husqvarna #539-109553
John Deere #AM128925
MTD #725-3169A, 925-3169A
Murray #91299
Simplicity #1717050, 1717050SM
Snapper #23355, 7023355 **No 31-9659**

INTERRUPTEUR POUSSOIR D'INTERVERROUILLAGE PLUNGER INTERLOCK SWITCH



Normalement fermé / Normally closed

Support à angle droit à pression /
Right angle snap mounted



Remplace / Replaces

AYP #121305X
Bolens #1761083
Cub Cadet #725-3166, 925-3166
Exmark #740275
Husqvarna #506-90-96-01, 532-121305
John Deere #AM104403
MTD #725-3166, 925-3166
Murray #094159, 094159MA, 94159
Scag #48717
Simplicity #1714770, 7023354
Snapper #2-3354, 7023354
Troy Bilt #GW-1761083 **No 31-9664**

SOLÉNOÏDE SOLENOID

Très résistant / Heavy duty



Remplace / Replaces

John Deere #AM132990,
AM133094, AM130365,
AM138497, AM138068
MTD #725-0771
Murray #21261 **No 31-9168**

31

SOLÉNOÏDE SOLENOID

12 volts
3 bornes / terminals
Goujons / Studs 1/4" - 20



Remplace / Replaces

AMF #53716
Ariens #3057700
Bolens #1751569
MTD #725-0530, 725-0771,
925-0771
Murray #24285, 9924285,
424285, 7701100MA
Snapper #1-8817
Stiga #1134-946-01
Wheel Horse #111674 **No 31-3319**





MURRAY (AMF, BRIGGS & STRATTON,
CANADIANA, DYNAMARK, NOMA) CONT.

SOLÉNOÏDE SOLENOID

12 volts
3 bornes / terminals

Universel / Universal

Poteau de borne et manchon
s'adaptant aux embouts de
1/4" / Terminal post and sleeve
will accept both 1/4"



Les supports de montage s'adapte à la
configuration des supports de châssis et de murs /
Mounting bracket will accomodate both
chassis and wall mount configurations

Remplace / Replaces
AMF #53716
Ariens #3057700
Bolens #1751569
MTD #725-0771, 725-1426,
725-0530, 925-1426, 925-0771
Murray #424285, 924285, 21261, 24285
Noma #52323
Snapper #7018817, 7075671
Toro #111674

No 31-3317

31

ONAN



PLOT DE CONTACT BREAKER POINT

Pour / For
16HP à/to 20HP

Modèles / Models
Série moteurs B / B engines series

Fabriqué par Phelon /
Manufactured by Phelon

Remplace / Replaces
Onan #160-1183
Toro #57-1183



No 31-1817

INTERRUPTEUR D'ALLUMAGE IGNITION SWITCH

5 bornes / terminals

Démarrage manuel /
Manual start

Remplace / Replaces
Ariens #03115200, 31152
AYP #2683, 2683R
Gravely #19223
Jacobson #129746, 129846
Kohler #48-099-01
Lawn-Boy #741308
Onan #378-0385
Toro/Wheel Horse #12-8140,
103990



No 31-1931

RÉGULATEUR DE VOLTAGE VOLTAGE REGULATOR

Pour moteurs de 16HP à
24HP incluant la série P /
For 16HP to 24HP engines,
including P-Serie

Remplace / Replaces
Onan #191-1748, 191-2106,
191-2277

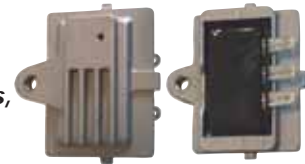

No 31-2923

ROBIN

BOBINE D'ALLUMAGE IGNITION COIL

Modèles / Models
Moteurs EY-20 /
EY-20 engines

Remplace / Replaces
Robin #EY-20



No 31-1827





SIMPLICITY

CLÉ DE CONTACT IGNITION KEY

Universel / *Universal*

Pour interrupteur en plastique Delta /
For plastic Delta switch

Poignée moulée / *Molded grip*



Remplace / *Replaces*

AYP #140401, 140402, 140403
Husqvarna #532-14-04-01, 532-14-04-02,
532-14-04-03, 532-411933, 532-411935
John Deere #AM123426, AM131946, AM135356,
AM153650, GY20680
Kohler #48-340-01S
MTD #725-1745, 925-1745
Murray #327350
Sears #140403
Simplicity #1717163,
1717163SM

No 31-2918

INTERRUPTEUR D'ALLUMAGE IGNITION SWITCH

Universel / *Universal*

Pour souffleuses à neige /
For snowblowers

Remplace / *Replaces*

Ariens #624097, 11134, 02456500, 52406900
AYP #135944
Homelite #JA130641
Lawn-Boy #700171
Murray #56419
Simplicity #1664804
Snapper #17817

No 31-1939

INTERRUPTEUR D'ALLUMAGE IGNITION SWITCH

S'installe sur la plupart des
tracteurs Noma Signature /
*Install on most Noma
Signature tractors*

Clé non-incluse /
Key not included

Remplace / *Replaces*

AYP #144921, 163088, 178744
Murray #327355
Noma #327355
Simplicity #1718306,
1713845, 1686734

No 31-4721

SOLÉNOÏDE SOLENOID

Universel / *Universal*

12 volts
4 bornes / *terminals*

Poteau de borne et manchon
s'adaptant aux embouts de
1/4" / *Terminal post and sleeve
will accept both 1/4"*

Les supports de montage s'adapte à la
configuration des supports de châssis et de murs /
*Mounting bracket will accomodate both
chassis and wall mount configurations*

Remplace / *Replaces*

Ariens #35510
AYP #109081X, 109946, 146154
Bolens #1752137, 1753539
Case #C-266525, C33025
Exmark #1-513075
Gilson #212655
Grasshopper #184251
Gravely #45071
Lawn-Boy #740207
MTD #725-04437
Simplicity #170051, 16771993, 16852980, 1700751
Snapper #18604, 7018604
Toro #47-1910, 110116,
110162, 110167

No 31-3318

SOLÉNOÏDE SOLENOID

12 volts
4 bornes / *terminals*
Goujons / *Studs 1/4" - 20*

Remplace / *Replaces*

Ariens #35510
AYP #192507, 146154
Bolens #1752137, 1753539
Gilson #212655
Grasshopper #184251
Gravely #45071
Lawn-Boy #740207
Simplicity #1685290
Snapper #1-8604, 7018604
Toro #28-4210, 47-1910
Wheel Horse #110116

No 31-3320

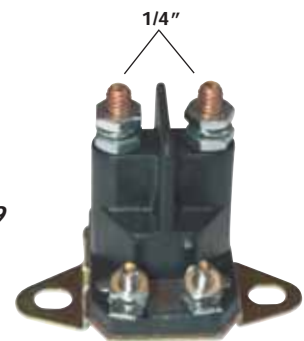
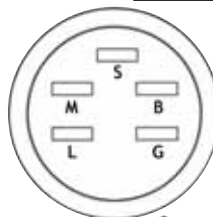



SIMPLICITY CONT.

INTERRUPTEUR D'ALLUMAGE PTO PTO IGNITION SWITCH



8 bornes / terminals

Pousser-tirer, à pression /
Push-pull, snap mount

Borne du coin vide /
Corner terminal blank

Bouton rouge / Red knob

Remplace / Replaces

AYP #146283, 140404, 154959,
154963, 169416, 174652

Dixon #5961, 539-117-238, 539-129-512,
539-120-023

Encore #523030, 523031

Ferris #22180, 5022180

Great Dane #D38005

Howard #02-422

Husqvarna #532-154-959, 532-169-417,
532-174-651

Hustler #771476, 77146, 776476

Murray #94927, 6201-316

Scag #483957, 27328, 481687, 483162

Simplicity #171348, 171348SM, 1714772,
1716332, 1722887

Snapper #7035658, 35658

Yazoo #101768, 539101768 **No 31-9656**

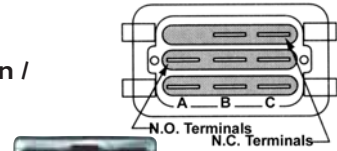

INTERRUPTEUR POUSSOIR D'INTERVERROUILLAGE PLUNGER INTERLOCK SWITCH



Normalement ouvert / Normalement fermé /
Normally open / Normally closed

2 bornes / terminals

2 positions

Double pôles / Double poles
À pression / Snap mount

Remplace / Replaces

Ariens #08828100, 88281

AYP #109553X

Bob-Cat #108208

Bolens #175-1328

Bunton #PL7484

Dixon #4242, 539115802, 539101080

Encore #523034

Exmark #633111, 1-633111

Ferris #22095

Grasshopper #183894

Husqvarna #539-109553

John Deere #AM128925

MTD #725-3169A, 925-3169A

Murray #91299

Simplicity #1717050, 1717050SM

Snapper #23355, 7023355 **No 31-9659**



31

INTERRUPTEUR POUSSOIR D'INTERVERROUILLAGE PLUNGER INTERLOCK SWITCH



Normalement fermé / Normally closed

2 bornes / terminals

2 positions

Modèles / Models

Ariens Grand Sierra 22HP,
931038-000101, 931303-00101

avec moteur Kohler / with Kohler engine

Remplace / Replaces

Ariens #30957

AYP #109869X

Bob-Cat #38383

Exmark #1-513152, 513152

Ferris #21769

John Deere #AM108483

Simplicity #1708207, 1708207SM

Snapper #27225, 7027225,
923408

No 31-9658



INTERRUPTEUR POUSSOIR D'INTERVERROUILLAGE PLUNGER INTERLOCK SWITCH



Normalement ouvert / Normally open

Support à angle droit à pression /
Right angle snap mounted

Remplace / Replaces

Ariens #27541

AYP #160784

Husqvarna #532-1607-84

John Deere #AM103119

Kubota #K1122-62280, K1122-62282

MTD #725-3167, 925-3167

Murray #57211, 024273

Roper #160784

Scag #481638

Sears #160784

Simplicity #1704379, 1704379SM

Snapper #15707

Toro/Wheel Horse #82-2190 **No 31-9663**





SIMPLICITY CONT.

INTERRUPTEUR POUSSOIR D'INTERVERROUILLAGE PLUNGER INTERLOCK SWITCH

Normalement fermé / Normally closed



Support à angle droit à pression /
Right angle snap mounted



Remplace / Replaces

AYP #121305X

Bolens #1761083

Cub Cadet #725-3166, 925-3166

Exmark #740275

Husqvarna #506-90-96-01, 532-121305

John Deere #AM104403

MTD #725-3166, 925-3166

Murray #094159, 094159MA, 94159

Scag #48717

Simplicity #1714770, 7023354

Snapper #2-3354, 7023354

Troy Bilt #GW-1761083

No 31-9664

SNAPPER

INTERRUPTEUR DE SÉCURITÉ SAFETY SWITCH

Embrayage / Clutch
Frein / Brake



Remplace / Replaces

Snapper #5-0810

No 31-241

INTERRUPTEUR D'ALLUMAGE IGNITION SWITCH

Universel / Universal

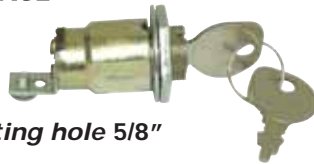

Trou de montage / Mounting hole 5/8"

Démarrage manuel / Manuel start

Remplace / Replaces

Snapper #1-1853, 7011853

No 31-1930

INTERRUPTEUR D'ALLUMAGE IGNITION SWITCH

Universel / Universal

Interrupteur à poussoir /
Push button switch



Remplace / Replaces

Snapper #1-2623, 7012623

No 31-1946

INTERRUPTEUR D'ALLUMAGE IGNITION SWITCH

8 bornes / terminals

Pousser-tirer, à pression /
Push-pull, snap mount

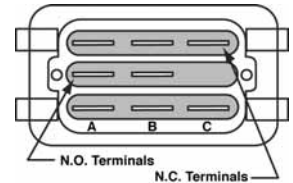

Terminal du milieu vide /
Middle terminal blank

Bouton rouge / Red knob



Remplace / Replaces

Ariens #522100, 5221, 01545600, 1545600

Exmark #633673, 1-633673, 103-5221

Grasshopper #183925

John Deere #AM118802, AM119139, AM131966,
TCA17834

Kubota #K1211-62231

MTD #725-1716, 925-1716, 725-1752

Scag #481635, 700675

Snapper #28542, 7028542

Toro/Wheel Horse #93-9999, 93-9998, 95-4108,
95-7489, 1035221, 1633673

No 31-9657

INTERRUPTEUR D'ALLUMAGE PTO PTO IGNITION SWITCH

8 bornes / terminals

Pousser-tirer, à pression /
Push-pull, snap mount

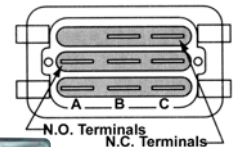

Borne du coin vide /
Corner terminal blank

Bouton rouge / Red knob



Remplace / Replaces

AYP #146283, 140404, 154959,

154963, 169416, 174652

Dixon #5961, 539-117-238, 539-129-512,
539-120-023

Encore #523030, 523031

Ferris #22180, 5022180

Great Dane #D38005

Howard #02-422

Husqvarna #532-154-959, 532-169-417,
532-174-651

Hustler #771476, 77146, 776476

Murray #94927, 6201-316

Scag #483957, 27328, 481687, 483162

Simplicity #171348, 171348SM, 1714772,
1716332, 1722887

Snapper #7035658, 35658

Yazoo #101768, 539101768

No 31-9656





SNAPPER CONT.

INTERRUPTEUR POUSSOIR D'INTERVERROUILLAGE PLUNGER INTERLOCK SWITCH



Normalement fermé / *Normally closed*
2 bornes / *terminals*
2 positions

Modèles / *Models*
Ariens Grand Sierra 22HP,
931038-000101, 931303-00101
avec moteur Kohler / *with Kohler engine*

Remplace / *Replaces*
Ariens #30957
AYP #109869X
Bob-Cat #38383
Exmark #1-513152, 513152
Ferris #21769
John Deere #AM108483
Simplicity #1708207, 1708207SM
Snapper #27225, 7027225,
923408



No 31-9658

31

INTERRUPTEUR POUSSOIR D'INTERVERROUILLAGE PLUNGER INTERLOCK SWITCH



Normalement ouvert/Normalement fermé /
Normally open/Normally closed
2 bornes / *terminals*
2 positions

Double pôles / *Double poles*
À pression / *Snap mount*

Remplace / *Replaces*
Ariens #08828100, 88281
AYP #109553X
Bob-Cat #108208
Bolens #175-1328
Bunton #PL7484
Dixon #4242, 539115802, 539101080
Encore #523034
Exmark #633111, 1-633111
Ferris #22095
Grasshopper #183894
Husqvarna #539-109553
John Deere #AM128925
MTD #725-3169A, 925-3169A
Murray #91299
Simplicity #1717050, 1717050SM
Snapper #23355, 7023355



No 31-9659

INTERRUPTEUR POUSSOIR D'INTERVERROUILLAGE PLUNGER INTERLOCK SWITCH



Normalement ouvert / *Normally open*

Remplace / *Replaces*
Ariens #36571, 03657100, 02754100
AYP #104445X
Bob-Cat #38382
Bolens #174-8723
Exmark #1-513051, 513051
Ferris #21451
Hustler #781211
John Deere #AM104884
Kubota #K2561-62251
Murray #24273
Scag #481637
Snapper #7014847, 14847, 7015707, 919098
Toro/Wheel Horse #65-7410
Yazoo #1923-025, 539001125 **No 31-9660**



INTERRUPTEUR POUSSOIR D'INTERVERROUILLAGE PLUNGER INTERLOCK SWITCH



Normalement ouvert / *Normally open*

Support à angle droit à pression /
Right angle snap mounted

Remplace / *Replaces*
Ariens #27541
AYP #160784
Husqvarna #532-1607-84
John Deere #AM103119
Kubota #K1122-62280, K1122-62282
MTD #725-3167, 925-3167
Murray #57211, 024273
Roper #160784
Scag #481638
Sears #160784
Simplicity #1704379, 1704379SM
Snapper #15707
Toro/Wheel Horse #82-2190 **No 31-9663**



INTERRUPTEUR POUSSOIR D'INTERVERROUILLAGE PLUNGER INTERLOCK SWITCH



Normalement fermé / *Normally closed*

Support à angle droit à pression /
Right angle snap mounted

Remplace / *Replaces*
AYP #121305X
Bolens #1761083
Cub Cadet #725-3166, 925-3166
Exmark #740275
Husqvarna #506-90-96-01, 532-121305
John Deere #AM104403
MTD #725-3166, 925-3166
Murray #094159, 094159MA, 94159
Scag #48717
Simplicity #1714770, 7023354
Snapper #2-3354, 7023354
Troy Bilt #GW-1761083 **No 31-9664**





SNAPPER CONT.

INTERRUPTEUR POUSSOIR D'INTERVERROUILLAGE PLUNGER INTERLOCK SWITCH



Normalement ouvert/Normalement fermé /
Normally open/Normally closed

Double pôles / Double poles
À pression / Snap mount



Remplace / Replaces
AYP #153664, 161343, 176138
Cub Cadet #725-3164, 925-3164, 725-3164AP
Ferris #22182, 5023455
Husqvarna #532-153664, 532-176137, 532-176138
MTD #725-3164A, 925-3164A
Snapper #22886, 7022886,
1723507, 1732006 **No 31-9665**

INTERRUPTEUR D'ALLUMAGE IGNITION SWITCH



Universel / Universal

5 bornes / terminals
3 positions
Requiert trou / Requires hole 5/8"



Remplace / Replaces
AMF #44745, 300295
AYP #S365402, 3612R, 4406R
Bob-Cat #48032B
Dixie #20245
Dixon #4197
Grasshopper #183806
Honda #510-772-003
John Deere #AM102544, AM31995, AM102551
MTD #725-0267, 925-0267
Murray #21064, 21064PA
Noma #421064
Roper #3621R
Scag #48017, 48017-02
Snapper #7027698, 7029010
Toro #23-0660 **No 31-2922**



INTERRUPTEUR D'ALLUMAGE IGNITION SWITCH



Universel / Universal

Pour souffleuses à neige /
For snowblowers

Remplace / Replaces
Ariens #624097, 11134, 02456500, 52406900
AYP #135944
Homelite #JA130641
Lawn-Boy #700171
Murray #56419
Simplicity #1664804
Snapper #17817 **No 31-1939**



INTERRUPTEUR D'ALLUMAGE IGNITION SWITCH



Modèles / Models
Exmark Laser ZTR,
John Deere STX, 38446

Remplace / Replaces
AYP #158913
Exmark #543070
Hustler #045898
Noma #305720
Snapper #26343, 7026343 **No 31-9158**



SOLÉNOÏDE SOLENOID



12 volts
3 bornes / terminals
Support à 90° / 90° mount

Boulon diamètre 1/4" /
Bolt diameter 1/4"

Borne du connecteur coulissant /
Slide connector terminal

Capacité de 80 ampères / 80 amps capacity

Remplace / Replaces
AYP #110832X
MTD #725-1426, 925-1426
Snapper #1-8817, 75671
Toro/Wheel Horse #112-0309 **No 31-1928**

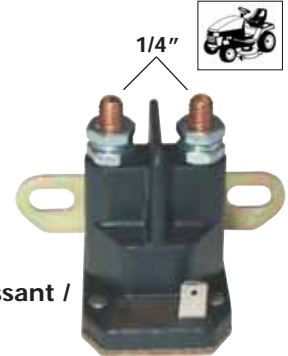

31

SOLÉNOÏDE SOLENOID



12 volts
3 bornes / terminals
Goujons / Studs 1/4" - 20

Remplace / Replaces
AMF #53716
Ariens #3057700
Bolens #1751569
MTD #725-0530, 725-0771,
925-0771
Murray #24285, 9924285,
424285, 7701100MA
Snapper #1-8817
Stiga #1134-946-01
Wheel Horse #111674 **No 31-3319**

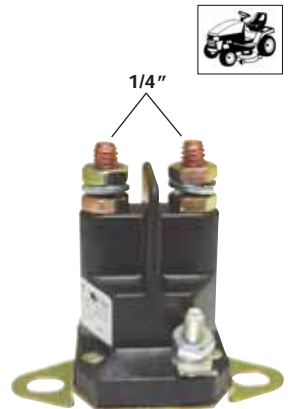



SNAPPER CONT.

SOLÉNOÏDE SOLENOID

12 volts
3 bornes / terminals

Universel / Universal

Poteau de borne et manchon
s'adaptant aux embouts de
1/4" / Terminal post and sleeve
will accept both 1/4"

Les supports de montage s'adapte à la
configuration des supports de châssis et de murs /
Mounting bracket will accomodate both
chassis and wall mount configurations

Remplace / Replaces

- AMF #53716
- Ariens #3057700
- Bolens #1751569
- MTD #725-0771, 725-1426,
725-0530, 925-1426, 925-0771
- Murray #424285, 924285, 21261, 24285
- Noma #52323
- Snapper #7018817, 7075671
- Toro #111674

No 31-3317



SOLÉNOÏDE SOLENOID

Universel / Universal

12 volts
4 bornes / terminals

Poteau de borne et manchon
s'adaptant aux embouts de
1/4" / Terminal post and sleeve
will accept both 1/4"

Les supports de montage s'adapte à la
configuration des supports de châssis et de murs /
Mounting bracket will accomodate both
chassis and wall mount configurations

Remplace / Replaces

- Ariens #35510
- AYP #109081X, 109946, 146154
- Bolens #1752137, 1753539
- Case #C-266525, C33025
- Exmark #1-513075
- Gilson #212655
- Grasshopper #184251
- Gravely #45071
- Lawn-Boy #740207
- MTD #725-04437
- Simplicity #170051, 16771993, 16852980, 1700751
- Snapper #18604, 7018604
- Toro #47-1910, 110116,
110162, 110167

No 31-3318



31



SOLÉNOÏDE SOLENOID

12 volts
4 bornes / terminals
Goujons / Studs 1/4" - 20

Remplace / Replaces

- Ariens #35510
- AYP #192507, 146154
- Bolens #1752137, 1753539
- Gilson #212655
- Grasshopper #184251
- Gravely #45071
- Lawn-Boy #740207
- Simplicity #1685290
- Snapper #1-8604, 7018604
- Toro #28-4210, 47-1910
- Wheel Horse #110116

No 31-3320

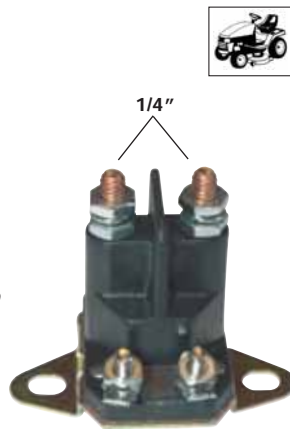

STIGA

SOLÉNOÏDE SOLENOID

5/16" (7.94 mm)

Remplace / Replaces

- Stiga #1134 2946-02

No 31-50239



INTERRUPTEUR D'ALLUMAGE IGNITION SWITCH

Modèles / Models

- Stiga Park 2000 et/and
- Stiga Villa 2001

Clé non-incluse /
Key not included

Remplace / Replaces

- Stiga #1134-4093-01

No 31-50241

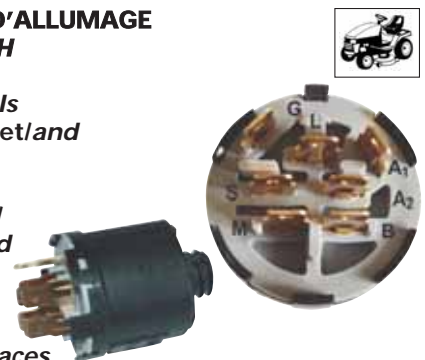



STIGA CONT.

SOLÉNOÏDE SOLENOID

12 volts
3 bornes / terminals
Goujons / Studs 1/4" - 20

Remplace / Replaces
AMF #53716
Ariens #3057700
Bolens #1751569
MTD #725-0530, 725-0771,
925-0771
Murray #24285, 9924285,
424285, 7701100MA
Snapper #1-8817
Stiga #1134-946-01
Wheel Horse #111674

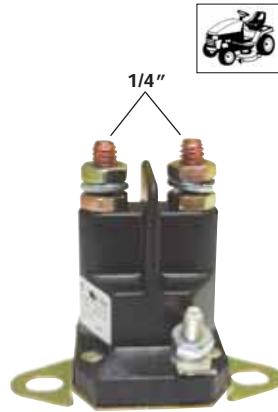

No 31-3319



TECUMSEH

POINT DE CONTACT ET CONDENSATEUR CONTACT POINT AND CONDENSER

Modèles / Models
H70, HH60, TNT100,
TNT120, TVM170

Remplace / Replaces
Clinton #135-24
Jacobson #107811
John Deere #AM30947, AM30949
McCulloch #80433, 88806
Phelon #06230, 071130
Tecumseh #30547A, 30548B



No 31-1819

ENSEMBLE DE RUPTEUR CONTACT BREAKER SET

Modèles / Models
H70, HH60, TNT100,
TNT120, TVM170

Remplace / Replaces
Tecumseh #30547



No 31-30547

Pièce originale
OEM part

CONDENSATEUR CONDENSER

Modèles / Models
H70, HH60, TNT100,
TNT120, TVM170

Remplace / Replaces
Tecumseh #30548



No 31-30548

Pièce originale
OEM part

POINT DE CONTACT ET CONDENSATEUR CONTACT POINT AND CONDENSER

Remplace / Replaces
Clinton #135-5-500
Kohler #220-980, 230722,
47-150-01, 47-150-03
Tecumseh #32011A
Wico #WX13260, WX15241



No 31-1824

BOBINE COIL

Pour / For
4HP, 6HP, 8HP, 10HP, 12HP, 14HP

Remplace / Replaces
Ariens #20355500
Gravely #022152
John Deere #AM132453, AM38411
Kohler #231281S, 237256S, 47-145-01S,
41-519-21S
Kubota #12581-68900
Tecumseh #32080, 4151921



No 31-1781

NOUVEAU / NEW

MODULE ÉLECTRONIQUE ELECTRONIC MODULE

Pour moteur / For engine
OHV110, 125, 130, 135, 140,
150, 165, 170, 175, 180

Remplace / Replaces
Tecumseh #37137, 36344,
36344A



No 31-1816

BOBINE DE MAGNÉTO MAGNETO COIL

Pour / For
3HP à/ta 10HP

Remplace / Replaces
Tecumseh #30560A,
30546



No 31-1884

BOBINE DE MAGNÉTO MAGNETO COIL

Allumage semi-conducteur /
Solid state ignition

Modèles / Models
HM80 et/and HM100 Snow King

Remplace / Replaces
Tecumseh #35135



No 31-1820



TECUMSEH CONT.

MODULE D'ALLUMAGE IGNITION MODULE



Modèles / Models

TVS, TNT EVC, H30, H35, H40, H50, H60, H70, AH600, HH50, HH60, HH70, HS40, HSK40, HSK60, HSK600, HSK635, HSK70, HSK840, HSK845, HSK850, HSK870, HSSK40, HSSK50, HSSK55, HXL35, HXL840, LAV35, LAV40, LAV50, LEV100, LEV105, LEV115, LEV120, LEV80, LEV90, LH195, HXL840, LV148, LV156, LV195, OH195, OHH60, OVRM105, OVRM120, OVRM50, OVER55, OHH45, OHH50, OHH55, OHH60, OHH65, OHSK50, OHSK55, OHSK60, OHSK65, OHSK70, OV195, OVRM60, OVRM65, TVM125, TVM140, TVS100, TVS105, TVS115, TVS120, TVS600, TVS75, TVS840, TVS90, V70, VH50, VH70, VLV126, VLV40, VLV50, VLV55, VLV60, VLV65, VLXL50, VLXL55, VSK90, VSK100



Remplace / Replaces
Tecumseh #34443A, B, C, D **No 31-8693**

CLÉ DE CONTACT IGNITION KEY



Plastique / Plastic
Clé à pousser-tirer / Push-pull key

Modèles / Models
MTD 314-181-000, 314-180-131
314-180-000, 314-180-088, TMO-3525203



Pour souffleuses avec moteurs Tecumseh /
For snowblowers with Tecumseh engines

Remplace / Replaces
Ariens #7532000, 7500108
MTD #725-1660
Tecumseh #35062

No 31-2934

CLÉ DE PLASTIQUE PLASTIC KEY



Pour souffleuse avec
moteur Snow King /
For snowblower with
Snow King engine

Remplace / Replaces
Tecumseh #35593

No 31-2939

BOUTON KNOB



Remplace / Replaces
Tecumseh #35438

No 31-2940

RÉGULATEUR DE VOLTAGE VOLTAGE REGULATOR



10 ampères / amps
12 volts
3 bornes en rangée /
3 terminals in a row



Remplace / Replaces
Briggs & Stratton #390240
Kohler #234279/41 403 08, 41-403-08S
Tecumseh #610749

No 31-2944

DÉMARREUR ÉLECTRIQUE ELECTRIC STARTER

Pour / For
CCW, 11 dents / teeth
12 volts

Modèles / Models
OH120, OH140, OH160,
OH180, HH, HV

Remplace / Replaces
Tecumseh #32510, 32817,
33835

No 31-6830



DÉMARREUR ÉLECTRIQUE ELECTRIC STARTER

Pour / For
CCW, 16 dents / teeth
12 volts

Modèles / Models
HM80, HM100, HMSK80,
HMSK100, HMSK110,
OHM90, OHM100, OHM120,
OHSK120, OHSK130, OHV120, OHV125, OHV130,
TVM195, TVM220, TVXL220, OHH50

Remplace / Replaces
Tecumseh #36463, 36680

No 31-6831





TECUMSEH CONT.

PIGNON DE DÉMARREUR STARTER DRIVE GEAR

S'installe sur notre #31-6831 /
Install on our #31-6831



No 31-6831-1

DÉMARREUR ÉLECTRIQUE ELECTRIC STARTER

Pour / For
CCW, 16 dents / teeth
12 volts



Remplace / Replaces
Tecumseh #32468A, 32468B,
33606, 35765, 35765A

No 31-6832

DÉMARREUR ÉLECTRIQUE ELECTRIC STARTER



Pour moteurs Tecumseh /
For Tecumseh engines
8HP, 10HP et/and 12HP

Qualité originale
OEM quality

Voir engrenage seulement /
See gear only #98-123
Voir ensemble de vis et
boulons / See bolts and
screws kit #98-124
Voir cordon d'extension /
See extension cord #98-121



Remplace / Replaces
Tecumseh #33519A

No 98-117

ENGRENAGE DE DÉMARREUR STARTER GEAR

S'installe sur / Install on
#88-117, 98-117



Remplace / Replaces
Tecumseh #37050, 37052A

No 98-123

ENSEMBLE DE VIS ET BOULONS BOLTS AND SCREWS KIT

S'installe sur / Install on
#88-117, 98-117

Pour démarreur 110 volts /
For 110 volts starter



No 98-124

CORDON D'EXTENSION EXTENSION CORD

Longueur / Length 12'

Fabriqué au Canada /
Made in Canada
Certifié CSA / CSA Certify



No 98-121

DÉMARREUR ÉLECTRIQUE ELECTRIC STARTER



Pour moteurs Tecumseh 7HP /
For 7HP Tecumseh engines

Voir ensemble de vis
et boulons / See bolts
and screws kit #98-124

Remplace / Replaces
Tecumseh #33328DSP



No 98-147

31

TORO (WHEEL HORSE)

INTERRUPTEUR D'ALLUMAGE IGNITION SWITCH

5 bornes / terminals

Démarrage manuel /
Manual start

Remplace / Replaces
Ariens #03115200, 31152
AYP #2683, 2683R
Gravely #19223
Jacobson #129746, 129846
Kohler #48-099-01
Lawn-Boy #741308
Onan #378-0385
Toro/Wheel Horse #12-8140,
103990



No 31-1931



TORO (WHEEL HORSE) CONT.

INTERRUPTEUR D'ALLUMAGE IGNITION SWITCH

Universel / Universal

5 bornes / terminals
3 positions
Requiert trou / Requires hole 5/8"

Remplace / Replaces
 AMF #44745, 300295
 AYP #S365402, 3612R, 4406R
 Bob-Cat #48032B
 Dixie #20245
 Dixon #4197
 Grasshopper #183806
 Honda #510-772-003
 John Deere #AM102544, AM31995, AM102551
 MTD #725-0267, 925-0267
 Murray #21064, 21064PA
 Noma #421064
 Roper #3621R
 Scag #48017, 48017-02
 Snapper #7027698, 7029010
 Toro #23-0660

No 31-2922



INTERRUPTEUR POUSSOIR D'INTERVERROUILLAGE PLUNGER INTERLOCK SWITCH

Normalement ouvert / Normally open

Remplace / Replaces
 Ariens #36571, 03657100, 02754100
 AYP #104445X
 Bob-Cat #38382
 Bolens #174-8723
 Exmark #1-513051, 513051
 Ferris #21451
 Hustler #781211
 John Deere #AM104884
 Kubota #K2561-62251
 Murray #24273
 Scag #481637
 Snapper #7014847, 14847, 7015707, 919098
 Toro/Wheel Horse #65-7410
 Yazoo #1923-025, 539001125 **No 31-9660**



INTERRUPTEUR POUSSOIR D'INTERVERROUILLAGE PLUNGER INTERLOCK SWITCH

Normalement ouvert / Normally open

Support à angle droit à pression /
Right angle snap mounted

Remplace / Replaces
 Ariens #27541
 AYP #160784
 Husqvarna #532-1607-84
 John Deere #AM103119
 Kubota #K1122-62280, K1122-62282
 MTD #725-3167, 925-3167
 Murray #57211, 024273
 Roper #160784
 Scag #481638
 Sears #160784
 Simplicity #1704379, 1704379SM
 Snapper #15707
 Toro/Wheel Horse #82-2190 **No 31-9663**



INTERRUPTEUR D'ALLUMAGE IGNITION SWITCH

Universel / Universal

Remplace / Replaces
 Kohler #25-099-04, 25-099-32S
 Toro/Wheel Horse #103991 **No 31-7280**

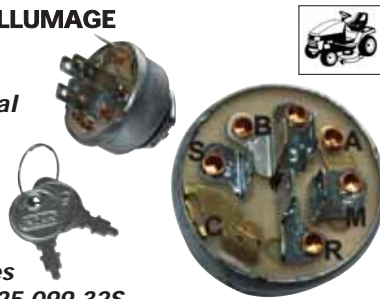

31

INTERRUPTEUR D'ALLUMAGE IGNITION SWITCH

Pour moteur 2 cylindres /
For 2 cylinders engine
 14HP, 400700 vertical,
 400400 horizontal et/and
 18HP, 422400 horizontal,
 422700 vertical

Remplace / Replaces
 AYP #102972Y, 145499
 Briggs & Stratton #490066, 493625, 692318
 Exmark #1-543070
 Husqvarna #532-10-29-72, 532-14-54-99, 532-15-89-13
 Scag #48798
 Toro/Wheel Horse #83-0020
 Troy Bilt #1754250, 1754250P **No 31-7804**



SOLÉNOÏDE SOLENOID

12 volts
 3 bornes / terminals
 Goujons / Studs 1/4" - 20

Remplace / Replaces
 AMF #53716
 Ariens #3057700
 Bolens #1751569
 MTD #725-0530, 725-0771,
 925-0771
 Murray #24285, 9924285,
 424285, 7701100MA
 Snapper #1-8817
 Stiga #1134-946-01
 Wheel Horse #111674

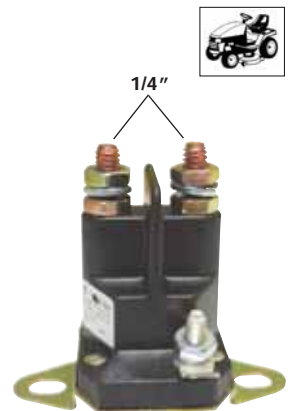

No 31-3319





TORO (WHEEL HORSE) CONT.

SOLÉNOÏDE SOLENOID

12 volts
4 bornes / terminals
Goujons / Studs 1/4" - 20

Remplace / Replaces
Ariens #35510
AYP #192507, 146154
Bolens #1752137, 1753539
Gilson #212655
Grasshopper #184251
Gravely #45071
Lawn-Boy #740207
Simplicity #1685290
Snapper #1-8604, 7018604
Toro #28-4210, 47-1910
Wheel Horse #110116

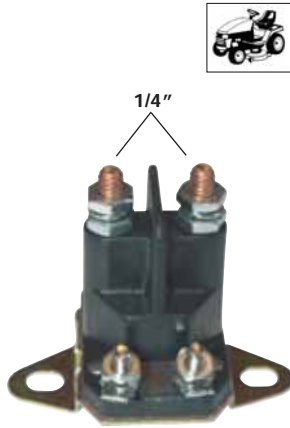

No 31-3320



SOLÉNOÏDE SOLENOID

12 volts
3 bornes / terminals

Universel / Universal

Poteau de borne et manchon
s'adaptant aux embouts de
1/4" / Terminal post and sleeve
will accept both 1/4"

Les supports de montage s'adapte à la
configuration des supports de châssis et de murs /
Mounting bracket will accomodate both
chassis and wall mount configurations

Remplace / Replaces
AMF #53716
Ariens #3057700
Bolens #1751569
MTD #725-0771, 725-1426,
725-0530, 925-1426, 925-0771
Murray #424285, 924285, 21261, 24285
Noma #52323
Snapper #7018817, 7075671
Toro #111674



No 31-3317

SOLÉNOÏDE SOLENOID

Universel / Universal

12 volts
4 bornes / terminals

Poteau de borne et manchon
s'adaptant aux embouts de
1/4" / Terminal post and sleeve
will accept both 1/4"

Les supports de montage s'adapte à la
configuration des supports de châssis et de murs /
Mounting bracket will accomodate both
chassis and wall mount configurations

Remplace / Replaces
Ariens #35510
AYP #109081X, 109946, 146154
Bolens #1752137, 1753539
Case #C-266525, C33025
Exmark #1-513075
Gilson #212655
Grasshopper #184251
Gravely #45071
Lawn-Boy #740207
MTD #725-04437
Simplicity #170051, 16771993, 16852980, 1700751
Snapper #18604, 7018604
Toro #47-1910, 110116,
110162, 110167

No 31-3318



INTERRUPTEUR D'ALLUMAGE IGNITION SWITCH

8 bornes / terminals

Pousser-tirer, à pression /
Push-pull, snap mount

Terminal du milieu vide /
Middle terminal blank

Bouton rouge / Red knob

Remplace / Replaces
Ariens #522100, 5221, 01545600, 1545600
Exmark #633673, 1-633673, 103-5221
Grasshopper #183925
John Deere #AM118802, AM119139, AM131966,
TCA17834
Kubota #K1211-62231
MTD #725-1716, 925-1716, 725-1752
Scag #481635, 700675
Snapper #28542, 7028542
Toro/Wheel Horse #93-9999, 93-9998, 95-4108,
95-7489, 1035221, 1633673

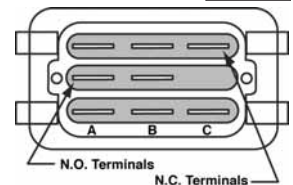

31





TORO (WHEEL HORSE) CONT.

SOLÉNOÏDE SOLENOID

12 volts
3 bornes / terminals
Support à 90° / 90° mount

Boulon diamètre 1/4" /
Bolt diameter 1/4"

Borne du connecteur coulissant /
Slide connector terminal

Capacité de 80 ampères / 80 amps capacity



Remplace / Replaces

AYP #110832X

MTD #725-1426, 925-1426

Snapper #1-8817, 75671

Toro/Wheel Horse #112-0309 **No 31-1928**

MODULE D'ALLUMAGE IGNITION MODULE

Modèles / Models
Séries Or et Argent /
Gold and Silver series
1989 à/to 2003

Remplace / Replaces

Lawn-Boy #684049, 684048,
92-1152, 99-2916

Toro #99-29-16



No 31-1896

PLOT DE CONTACT BREAKER POINT

Pour / For
16HP à/to 20HP

Modèles / Models

Série moteurs B / B engines serie

Fabriqué par Phelon /
Manufactured by Phelon

Remplace / Replaces

Onan #160-1183

Toro #57-1183



No 31-1817

BATTERIE 12 V BATTERY 12 V

Longueur / Length 4 3/8"
Largeur / Width 3 1/4"
Hauteur / Height 2 11/16"

2.5 ampères / amps

Pour tondeuses 21"
démarrage électrique /
For 21" mowers electric start

Fil principal de 7" avec connecteur moulé,
boîtier en plastique / 7" lead wire with molded
connector, plastic case

Remplace / Replaces

Toro #55-7520

No 31-8593



BATTERIE SCELLÉ SEALED BATTERY

WP3.3-12

Avec acide à l'intérieur /
With acid inside

Longueur / Length 5 1/4"
Largeur / Width 2 1/2"
Hauteur / Height 2 1/4"

Pour toutes les tondeuses Lawn-Boy
ou Toro 2000 et plus / For all Lawn-Boy or
Toro mowers 2000 and more

Garantie 30 jours / 30 days warranty (prorata)

Remplace / Replaces

Lawn-Boy #108-9358

Toro #108-9358

No 31-8594



TROY BILT

INTERRUPTEUR D'ALLUMAGE IGNITION SWITCH

Pour moteur 2 cylindres /
For 2 cylinders engine

14HP, 400700 vertical,
400400 horizontal et/and
18HP, 422400 horizontal,
422700 vertical

Remplace / Replaces

AYP #102972Y, 145499

Briggs & Stratton #490066, 493625, 692318

Exmark #1-543070

Husqvarna #532-10-29-72, 532-14-54-99, 532-15-89-13

Scag #48798

Toro/Wheel Horse #83-0020

Troy Bilt #1754250, 1754250P **No 31-7804**





TROY BILT

INTERRUPTEUR POUSSOIR D'INTERVERROUILLAGE PLUNGER INTERLOCK SWITCH

Normalement fermé / *Normally closed*



Support à angle droit à pression /
Right angle snap mounted



Remplace / *Replaces*

AYP #121305X

Bolens #1761083

Cub Cadet #725-3166, 925-3166

Exmark #740275

Husqvarna #506-90-96-01, 532-121305

John Deere #AM104403

MTD #725-3166, 925-3166

Murray #094159, 094159MA, 94159

Scag #48717

Simplicity #1714770, 7023354

Snapper #2-3354, 7023354

Troy Bilt #GW-1761083

No 31-9664

INTERRUPTEUR D'ALLUMAGE IGNITION SWITCH



Remplace / *Replaces*

Bolens #1754183, 1754183099

Cub Cadet #725-3163, 925-3163

Troy Bilt #1754183,

1754183099

No 31-9852

31



Voir batteries avec acide et batteries sans acide en page 31-76 /
See batteries with acid and batteries without acid in page 31-76



BATTERIES / BATTERIES



XTREME PLUS
Batteries sèches
vendues avec acide /
*Dry batteries sold
with acid*



XTREME
Batteries sèches /
Dry batteries

**BATTERIE
BATTERY**

XTREME
Y50-N18L-A2
Sans acide / *Without acid*

Longueur / *Length* 8 1/8"
Largeur / *Width* 3 19/32"
Hauteur / *Height* 6 11/32"

Borne droite positive /
Right hand positive

275 ampères / *amps*
12 volts

Garantie 1 an / *1 year warranty (prorata)*

No 31-1904

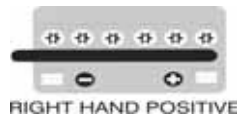

**BATTERIE
BATTERY**

XTREME
12N12A-4A1
Sans acide / *Without acid*

Longueur / *Length* 5 3/8"
Largeur / *Width* 3 3/16"
Hauteur / *Height* 6 3/8"

Borne gauche positive /
Left hand positive

113 ampères / *amps*
12 volts

Garantie 1 an / *1 year warranty (prorata)*

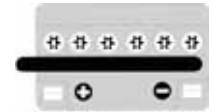

LEFT HAND POSITIVE



No 31-1906

**BATTERIE
BATTERY**

XTREME PLUS
U1-54
Avec acide à l'intérieur /
With acid inside

Longueur / *Length* 7 3/4"
Largeur / *Width* 5 1/8"
Hauteur / *Height* 7 1/4"

Borne gauche positive /
Left hand positive

220 ampères / *amps*
12 volts

Ne pas utiliser avec embrayage PTO /
Do not use with PTO clutch

Garantie 1 an / *1 year warranty (prorata)*

No 31-1905-1



**BATTERIE
BATTERY**

XTREME PLUS
12N12A-4A1
Avec acide / *With acid*

Longueur / *Length* 5 3/8"
Largeur / *Width* 3 3/16"
Hauteur / *Height* 6 3/8"

Borne gauche positive /
Left hand positive

113 ampères / *amps*
12 volts

Garantie 1 an / *1 year warranty (prorata)*

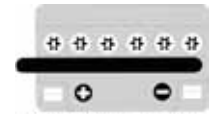

LEFT HAND POSITIVE



No 31-1906-1





BATTERIES / BATTERIES CONT.

BATTERIE BATTERY

XTREME
U1R-66

Sans acide / Without acid

Longueur / Length 7 3/4"
Largeur / Width 5 1/8"
Hauteur / Height 7 1/4"

Borne droite positive /
Right hand positive

360 ampères / amps
12 volts

Pour tracteurs avec embrayage PTO /
Use with PTO clutch tractors

Garantie 1 an / 1 year warranty (prorata)

No 31-1907



BATTERIE BATTERY

XTREME
12N14-3A-1

Sans acide / Without acid

Longueur / Length 5 5/16"
Largeur / Width 3 9/16"
Hauteur / Height 6 9/16"

Borne droite positive /
Right hand positive

128 ampères / amps
12 volts

Utiliser sur produit MTD / Use on MTD products

Garantie 1 an / 1 year warranty (prorata)

No 31-1908



BATTERIE BATTERY

XTREME PLUS
U1R-66

Avec acide à l'intérieur /
With acid inside

Longueur / Length 7 3/4"
Largeur / Width 5 1/8"
Hauteur / Height 7 1/4"

Borne droite positive /
Right hand positive

360 ampères / amps
12 volts

Pour tracteur avec embrayage PTO /
Use with PTO clutch tractor

Garantie 1 an / 1 year warranty (prorata)

No 31-1907-1



BATTERIE BATTERY

XTREME PLUS
12N14-3A-1

Avec acide / With acid

Longueur / Length 5 5/16"
Largeur / Width 3 9/16"
Hauteur / Height 6 9/16"

Borne droite positive /
Right hand positive

128 ampères / amps
12 volts

Utiliser sur tracteurs MTD / Used on MTD tractors

Garantie 1 an / 1 year warranty (prorata)





BATTERIES / BATTERIES CONT.

BATTERIE BATTERY

**XTREME PLUS
U1-66**
Avec acide à l'intérieur /
With acid inside

Longueur / Length 7 3/4"
Largeur / Width 5"
Hauteur / Height 7 1/4"

Borne gauche positive /
Left hand positive

360 ampères / amps
12 volts

Pour tracteur avec embrayage PTO /
Use with PTO clutch tractor

Garantie 1 an / 1 year warranty (prorata)

No 31-1909-1

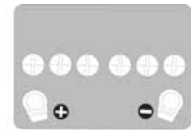

LEFT HAND POSITIVE



BATTERIE BATTERY

**XTREME
YB14A-A2**
Sans acide / Without acid

Longueur / Length 5 5/16"
Largeur / Width 3 1/2"
Hauteur / Height 6 15/16"

Borne gauche positive /
Left hand positive

190 ampères / amps
12 volts

Vissé sur le dessus /
Top screwed

Garantie 1 an /
1 year warranty (prorata)

Remplace / Replaces
Honda (ATC200ES '82-'84,
ATC200M '84-'85)
Kawasaki (KLF300C 4x4
Bayou '89-'91, KLF220A '92-'93)
Polaris (Tous les modèles / All models)
Suzuki (LT250 et/and LT300 '90-'92
Yamaha



LEFT HAND POSITIVE



Avant / Front



Latéral / Side



Dessus / Top

No 31-1919

31



BATTERIE BATTERY

**XTREME
YB16CL-B**
Sans acide / Without acid

Longueur / Length 6 15/16"
Largeur / Width 4"
Hauteur / Height 6 7/8"

Borne droite positive /
Right hand positive

240 ampères / amps
12 volts

Garantie 1 an / 1 year warranty (prorata)

Remplace / Replaces
Kawasaki (KLF400 4x4 '92-'94',
KLF300 4x4 '92 Mule)
Polaris



RIGHT HAND POSITIVE



No 31-1920

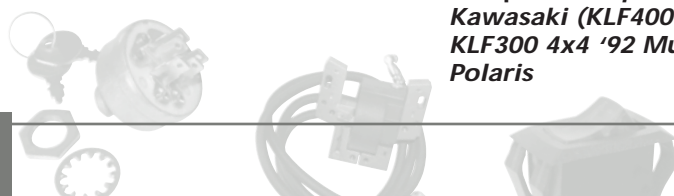



BATTERIES / BATTERIES CONT.

BATTERIE BATTERY



XTREME
YB16AL-A2
Sans acide / Without acid



Longueur / Length 8 1/2"
Largeur / Width 2 13/16"
Hauteur / Height 6 7/16"



Borne droite positive /
Right hand positive

200 ampères / amps
12 volts

Garantie 1 an / 1 year warranty (prorata)

Remplace / Replaces
Yamaha

No 31-1922

BATTERIE BATTERY



XTREME
YB10A-A2
Sans acide / Without acid



Longueur / Length 5 5/16"
Largeur / Width 3 9/16"
Hauteur / Height 6 1/8"



Borne gauche positive /
Left hand positive

160 ampères / amps
12 volts

Garantie 1 an / 1 year warranty (prorata)

Remplace / Replaces
Kawasaki / Suzuki

No 31-1962

BATTERIE BATTERY



XTREME
YB14L-A2
Sans acide / Without acid



Longueur / Length 5 3/8"
Largeur / Width 3 9/16"
Hauteur / Height 6 5/8"



Borne droite positive /
Right hand positive

190 ampères / amps
12 volts

Garantie 1 an / 1 year warranty (prorata)

Remplace / Replaces
Artic Cat

No 31-1960

BATTERIE BATTERY



XTREME
12N18-3A
Sans acide / Without acid



Longueur / Length 7 1/8"
Largeur / Width 3 11/16"
Hauteur / Height 6 3/8"



Borne droite positive /
Right hand positive

163 ampères / amps
12 volts

Garantie 1 an / 1 year warranty (prorata)

Remplace / Replaces
Stiga tracteur / tractor

No 31-1966





BATTERIES / BATTERIES CONT.

**BATTERIE
BATTERY**

XTREME
YT12-B4
Sans acide / *Without acid*

Longueur / *Length* 5 15/16"
Largeur / *Width* 2 3/4"
Hauteur / *Height* 5 1/8"

Borne gauche positive /
Left hand positive

130 ampères / *amps*
12 volts

Garantie 1 an / *1 year warranty (prorata)*

No 31-1967



**BATTERIE DURABATT
DURABATT BATTERY**

XTREME
12N5.5-3B (275 CCA)
Sans acide / *Without acid*

Longueur / *Length* 5 7/16"
Largeur / *Width* 2 3/8"
Hauteur / *Height* 5 3/16"

5.5 ampère / *amps*
12 volts

Batterie parfaite pour génératrice /
Perfect battery for generator

Garantie 1 an / *1 year warranty (prorata)*

No 31-1969



31

**BATTERIE
BATTERY**

XTREME
YT14-B4
Sans acide / *Without acid*

Longueur / *Length* 6 1/16"
Largeur / *Width* 2 3/4"
Hauteur / *Height* 5 3/4"

Borne gauche positive /
Left hand positive

135 ampères / *amps*
12 volts

Garantie 1 an / *1 year warranty (prorata)*

Remplace / *Replaces*
Yamaha
Motocyclette / *Motorcycle*

No 31-1968



**BATTERIE
BATTERY**

XTREME PLUS
YTX14-BS
Avec acide / *With acid*

Longueur / *Length* 6"
Largeur / *Width* 3 1/2"
Hauteur / *Height* 5 13/16"

Borne gauche positive /
Left hand positive

200 ampères / *amps*

Garantie 1 an / *1 year warranty (prorata)*

Remplace / *Replaces*
Honda

No 31-1916

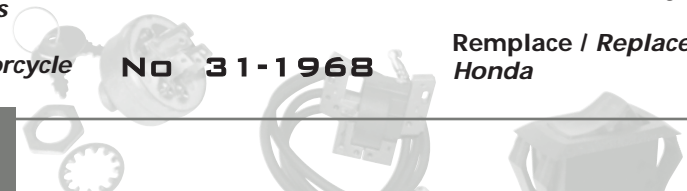



BATTERIES / BATTERIES CONT.

BATTERIE BATTERY

XTREME PLUS
YTX12-BS
Avec acide / With acid



Longueur / Length 6"
Largeur / Width 3 1/4"
Hauteur / Height 5 1/8"



Borne gauche positive /
Left hand positive

180 ampères / amps

Garantie 1 an / 1 year warranty (prorata)

Remplace / Replaces
Honda / Suzuki

No 31-1917

BATTERIE BATTERY

XTREME PLUS
YTX9-BS
Avec acide / With acid



Longueur / Length 6"
Largeur / Width 3 7/16"
Hauteur / Height 4 3/16"



Borne gauche positive /
Left hand positive

120 ampères / amps

Garantie 1 an / 1 year warranty (prorata)

Remplace / Replaces
Honda

No 31-1923

BATTERIE BATTERY

XTREME PLUS
YTX20L-BS
Avec acide / With acid



Longueur / Length 6 7/8"
Largeur / Width 3 7/16"
Hauteur / Height 6 1/8"



Borne droite positive /
Right hand positive

270 ampères / amps

Garantie 1 an / 1 year warranty (prorata)

Remplace / Replaces
Yamaha / Kawasaki

No 31-1924

BATTERIE BATTERY

XTREME PLUS
YTX20-BS
Avec acide / With acid



Longueur / Length 6 7/8"
Largeur / Width 3 7/16"
Hauteur / Height 6 1/8"



Borne gauche positive /
Left hand positive

270 ampères / amps

Garantie 1 an / 1 year warranty (prorata)

Remplace / Replaces
Motomarine / Watercraft

No 31-1925

BATTERIE BATTERY

XTREME PLUS
YTX16-BS-1
Avec acide / With acid



Longueur / Length 5 7/8"
Largeur / Width 3 7/16"
Hauteur / Height 6 3/8"



Borne gauche positive /
Left hand positive

230 ampères / amps

Garantie 1 an / 1 year warranty (prorata)

Remplace / Replaces
Suzuki VTT / ATV

No 31-1926

BATTERIE BATTERY

XTREME PLUS
X1T50L-BS
Avec acide / With acid



Longueur / Length 5 7/8"
Largeur / Width 3 7/16"
Hauteur / Height 6 3/8"



Borne droite positive /
Right hand positive

300 ampères / amps

Garantie 1 an / 1 year warranty (prorata)

Remplace / Replaces
Suzuki VTT / ATV

No 31-1927

31





BATTERIES / BATTERIES CONT.

BATTERIE 12 V BATTERY 12 V



Longueur / Length 4 3/8"
Largeur / Width 3 1/4"
Hauteur / Height 2 11/16"

2.5 ampères / amps

Pour tondeuses 21"
démarrage électrique /
For 21" mowers electric start

Fil principal de 7" avec connecteur moulé,
boîtier en plastique / 7" lead wire with molded
connector, plastic case

Remplace / Replaces
Toro #55-7520

No 31-8593



BATTERIE SCELLÉ SEALED BATTERY

WP3.3-12
Avec acide à l'intérieur /
With acid inside

Longueur / Length 5 1/4"
Largeur / Width 2 1/2"
Hauteur / Height 2 1/4"

Pour toutes les tondeuses Lawn-Boy
ou Toro 2000 et plus / For all Lawn-Boy or
Toro mowers 2000 and more

Garantie 30 jours / 30 days warranty (prorata)

Remplace / Replaces
Lawn-Boy #108-9358
Toro #108-9358

No 31-8594



31

□ □ NOUVEAU / NEW □ □

BATTERIE SCELLÉ SEALED BATTERY

UBI 1222
Avec acide à l'intérieur /
With acid inside

Longueur / Length 7"
Largeur / Width 1 3/8"
Hauteur / Height 2 3/8"

Borne gauche positive /
Left hand positive

2.2 AH ampères / amps
12 volts

Garantie 30 jours / 30 days warranty (prorata)

Remplace / Replaces
MTD #725-04323

No 31-8595



ACCESSOIRES / ACCESSORIES

CÂBLE DE BATTERIE BATTERY CABLE



No DRS	Longueur / Length	Couleur / Color
31-1932	8"	Rouge / Red
31-1953	8"	Noir / Black
31-1933	12"	Rouge / Red
31-1954	12"	Noir / Black
31-1934	16"	Rouge / Red
31-1955	16"	Noir / Black
31-1935	20"	Rouge / Red
31-1956	20"	Noir / Black

CÂBLE DE BATTERIE BATTERY CABLE



No DRS	Longueur / Length	Couleur / Color
31-1936	10'	Rouge / Red
31-1944	10'	Noir / Black

COSSE DE CÂBLE CABLE TERMINAL



No DRS	Diamètre / Diameter
31-1937 Lot (10)	3/8"
31-1938 Lot (10)	1/4"

BORNE DE BATTERIE UNIVERSELLE UNIVERSAL BATTERY TERMINAL

S'adapte à tous les câbles
de batterie de jauge 2 à 6 /
Heavy lead fits all
battery cables 2 to 6 gauge



No 31-1947



ACCESSOIRES / ACCESSORIES CONT.

FIL ÉLECTRIQUE PRIMARY WIRE



No DRS	Dimensions	Diamètre / Diameter	Couleur / Color
31-6711	Rouleau de 25' / 25' Roll	16 AWG	Rouge / Red
31-6712	Rouleau de 25' / 25' Roll	16 AWG	Noir / Black
31-6713	Rouleau de 25' / 25' Roll	16 AWG	Blanc / White
31-6714	Rouleau de 25' / 25' Roll	16 AWG	Bleu / Blue
31-6715	Rouleau de 25' / 25' Roll	16 AWG	Jaune / Yellow

FIL À BOUGIE SPARK PLUG WIRE

Diamètre / Diameter 5 mm
Longueur / Length 10'

Qualité Hypalon-Copper noir /
Quality black Hypalon-Copper



No 31-2935

FIL À BOUGIE SPARK PLUG WIRE

Diamètre / Diameter 5 mm
Longueur / Length 20'

Qualité Hypalon-Copper noir /
Quality black Hypalon-Copper



No 31-310

FIL À BOUGIE SPARK PLUG WIRE

Diamètre / Diameter 7 mm
Longueur / Length 82.5'
25 mètres / meters

Pour / For
Souffleuse, tondeuse, motoneige /
Snowblower, mower, snowmobile



No 31-312

SUPPORT DE BATTERIE BATTERY HOLD DOWN

Universel / Universal

Utiliser avec les boulons /
Use with bolts #31-9249



No 31-9248

2 BOULONS POUR BATTERIE 2 BATTERY HOLD DOWN BOLTS

Longueur / Length 8"

Filet / Thread 4 1/2"

Inclus rondelle et écrou à oreilles /
Included washer and wing nut

Utiliser avec /
Use with #31-9248



No 31-9249

FUSIBLE À LAME PLUG-IN FUSE



31

No DRS	Ampères / Amps	Couleur / Color
31-452 LOT (10)	7 1/2	Brun / Brown
31-455 LOT (10)	20	Jaune / Yellow
31-457 LOT (10)	30	Vert / Green

PORTE-FUSIBLE IN-LINE FUSE HOLDER

Porte-fusible complet avec
jauge 10" à 16" et fusible
20 ampères / Fuse holder
complete with a 10" to 16"
gauge leadwire and a
20 amps fuse



No 31-1950



NOTES

31

