

MACRO-TECH®

REFERENCE MANUAL



Models:

Macro-Tech® 602, 1202 & 2402

Some models may be exported under the name *Amcron*®.

© 2000 by Crown International, Inc., P.O. Box 1000, Elkhart, IN 46515-1000 U.S.A. Telephone: 219-294-8000. Fax: 219-294-8329. Macro-Tech® amplifiers are produced by the Professional Audio Unit of Crown International, Inc. Trademark Notice: *PIP*™, *PIP2*™, *SmartAmp*™ and *Grounded Bridge*™ are trademarks and *Amcron*®, *Crown*®, *Macro-Tech*®, *IOC*®, *ODEP*®, and *IQ System*® are registered trademarks of Crown International, Inc. Other trademarks are the property of their respective owners.



THREE YEAR FULL WARRANTY



WORLDWIDE

SUMMARY OF WARRANTY

The Crown Audio Division of Crown International, Inc., 1718 West Mishawaka Road, Elkhart, Indiana 46517-4095 U.S.A. warrants to you, the ORIGINAL PURCHASER and ANY SUBSEQUENT OWNER of each NEW Crown¹ product, for a period of three (3) years from the date of purchase by the original purchaser (the "warranty period") that the new Crown product is free of defects in materials and workmanship, and we further warrant the new Crown product regardless of the reason for failure, except as excluded in this Crown Warranty.

¹ Note: If your unit bears the name "Amcron," please substitute it for the name "Crown" in this warranty.

ITEMS EXCLUDED FROM THIS CROWN WARRANTY

This Crown Warranty is in effect only for failure of a new Crown product which occurred within the Warranty Period. It does not cover any product which has been damaged because of any intentional misuse, accident, negligence, or loss which is covered under any of your insurance contracts. This Crown Warranty also does not extend to the new Crown product if the serial number has been defaced, altered, or removed.

WHAT THE WARRANTOR WILL DO

We will remedy any defect, regardless of the reason for failure (except as excluded), by repair, replacement, or refund. We may not elect refund unless you agree, or unless we are unable to provide replacement, and repair is not practical or cannot be timely made. If a refund is elected, then you must make the defective or malfunctioning product available to us free and clear of all liens or other encumbrances. The refund will be equal to the actual purchase price, not including interest, insurance, closing costs, and other finance charges less a reasonable depreciation on the product from the date of original purchase. Warranty work can only be performed at our authorized service centers. We will remedy the defect and ship the product from the service center within a reasonable time after receipt of the defective product at our authorized service center.

HOW TO OBTAIN WARRANTY SERVICE

You must notify us of your need for warranty service not later than ninety (90) days after expiration of the warranty period. All components must be shipped in a factory pack. Corrective action will be taken within a reasonable time of the date of receipt of the defective product by our authorized service center. If the repairs made by our authorized service center are not satisfactory, notify our authorized service center immediately.

DISCLAIMER OF CONSEQUENTIAL AND INCIDENTAL DAMAGES
YOU ARE NOT ENTITLED TO RECOVER FROM US ANY INCIDENTAL DAMAGES RESULTING FROM ANY DEFECT IN THE NEW CROWN PRODUCT. THIS INCLUDES ANY DAMAGE TO ANOTHER PRODUCT OR PRODUCTS RESULTING FROM SUCH A DEFECT.

WARRANTY ALTERATIONS

No person has the authority to enlarge, amend, or modify this Crown Warranty. This Crown Warranty is not extended by the length of time which you are deprived of the use of the new Crown product. Repairs and replacement parts provided under the terms of this Crown Warranty shall carry only the unexpired portion of this Crown Warranty.

DESIGN CHANGES

We reserve the right to change the design of any product from time to time without notice and with no obligation to make corresponding changes in products previously manufactured.

LEGAL REMEDIES OF PURCHASER

No action to enforce this Crown Warranty shall be commenced later than ninety (90) days after expiration of the warranty period.

THIS STATEMENT OF WARRANTY SUPERSEDES ANY OTHERS CONTAINED IN THIS MANUAL FOR CROWN PRODUCTS.

9/90

NORTH AMERICA

SUMMARY OF WARRANTY

The Crown Audio Division of Crown International, Inc., 1718 West Mishawaka Road, Elkhart, Indiana 46517-4095 U.S.A. warrants to you, the ORIGINAL PURCHASER and ANY SUBSEQUENT OWNER of each NEW Crown product, for a period of three (3) years from the date of purchase by the original purchaser (the "warranty period") that the new Crown product is free of defects in materials and workmanship. We further warrant the new Crown product regardless of the reason for failure, except as excluded in this Warranty.

ITEMS EXCLUDED FROM THIS CROWN WARRANTY

This Crown Warranty is in effect only for failure of a new Crown product which occurred within the Warranty Period. It does not cover any product which has been damaged because of any intentional misuse, accident, negligence, or loss which is covered under any of your insurance contracts. This Crown Warranty also does not extend to the new Crown product if the serial number has been defaced, altered, or removed.

WHAT THE WARRANTOR WILL DO

We will remedy any defect, regardless of the reason for failure (except as excluded), by repair, replacement, or refund. We may not elect refund unless you agree, or unless we are unable to provide replacement, and repair is not practical or cannot be timely made. If a refund is elected, then you must make the defective or malfunctioning product available to us free and clear of all liens or other encumbrances. The refund will be equal to the actual purchase price, not including interest, insurance, closing costs, and other finance charges less a reasonable depreciation on the product from the date of original purchase. Warranty work can only be performed at our authorized service centers or at the factory. We will remedy the defect and ship the product from the service center or our factory within a reasonable time after receipt of the defective product at our authorized service center or our factory. All expenses in remedying the defect, including surface shipping costs in the United States, will be borne by us. (You must bear the expense of shipping the product between any foreign country and the port of entry in the United States and all taxes, duties, and other customs fees for such foreign shipments.)

HOW TO OBTAIN WARRANTY SERVICE

You must notify us of your need for warranty service not later than ninety (90) days after expiration of the warranty period. All components must be shipped in a factory pack, which, if needed, may be obtained from us free of charge. Corrective action will be taken within a reasonable time of the date of receipt of the defective product by us or our authorized service center. If the repairs made by us or our authorized service center are not satisfactory, notify us or our authorized service center immediately.

DISCLAIMER OF CONSEQUENTIAL AND INCIDENTAL DAMAGES
YOU ARE NOT ENTITLED TO RECOVER FROM US ANY INCIDENTAL DAMAGES RESULTING FROM ANY DEFECT IN THE NEW CROWN PRODUCT. THIS INCLUDES ANY DAMAGE TO ANOTHER PRODUCT OR PRODUCTS RESULTING FROM SUCH A DEFECT. **SOME STATES DO NOT ALLOW THE EXCLUSION OR LIMITATIONS OF INCIDENTAL OR CONSEQUENTIAL DAMAGES, SO THE ABOVE LIMITATION OR EXCLUSION MAY NOT APPLY TO YOU.**

WARRANTY ALTERATIONS

No person has the authority to enlarge, amend, or modify this Crown Warranty. This Crown Warranty is not extended by the length of time which you are deprived of the use of the new Crown product. Repairs and replacement parts provided under the terms of this Crown Warranty shall carry only the unexpired portion of this Crown Warranty.

DESIGN CHANGES

We reserve the right to change the design of any product from time to time without notice and with no obligation to make corresponding changes in products previously manufactured.

LEGAL REMEDIES OF PURCHASER

THIS CROWN WARRANTY GIVES YOU SPECIFIC LEGAL RIGHTS, YOU MAY ALSO HAVE OTHER RIGHTS WHICH VARY FROM STATE TO STATE. No action to enforce this Crown Warranty shall be commenced later than ninety (90) days after expiration of the warranty period.

THIS STATEMENT OF WARRANTY SUPERSEDES ANY OTHERS CONTAINED IN THIS MANUAL FOR CROWN PRODUCTS.

The information furnished in this manual does not include all of the details of design, production, or variations of the equipment. Nor does it cover every possible situation which may arise during installation, operation or maintenance. If your unit bears the name "Amcron," please substitute it for the name "Crown" in this manual. If you need special assistance beyond the scope of this manual, please contact our Technical Support Group.

Crown Audio Technical Support Group

Plant 2 SW, 1718 W. Mishawaka Rd., Elkhart, Indiana 46517 U.S.A.

Phone: **800-342-6939** (North America, Puerto Rico and Virgin Islands) or 219-294-8200

Fax: 219-294-8301 Fax Back (North America only): 800-294-4094 or 219-293-9200

Fax Back (International): 219-294-8100 Internet: <http://www.crownaudio.com>

IMPORTANT

**THE MACRO-TECH 2402 REQUIRES CLASS 1
OUTPUT WIRING. THE MACRO-TECH 602 &
1202 REQUIRE CLASS 2 OUTPUT WIRING.**

CAUTION

**RISK OF ELECTRIC SHOCK
DO NOT OPEN**

**TO PREVENT ELECTRIC SHOCK DO
NOT REMOVE TOP OR BOTTOM
COVERS. NO USER SERVICEABLE
PARTS INSIDE. REFER SERVICING TO
QUALIFIED SERVICE PERSONNEL.
DISCONNECT POWER CORD BE-
FORE REMOVING REAR INPUT
MODULE TO ACCESS GAIN SWITCH.**

AVIS

**RISQUE DE CHOC ÉLECTRIQUE
N'OUVREZ PAS**

**À PRÉVENIR LE CHOC ÉLECTRIQUE
N'ENLEVEZ PAS LES COUVERCLES. IL
N'Y A PAS DES PARTIES
SERVICEABLE À L'INTÉRIEUR. TOUS
REPARATIONS DOIT ÊTRE FAIRE PAR
PERSONNEL QUALIFIÉ SEULEMENT.
DÉBRANCHER LA BORNE AVANT
D'OUVRIR LA MODULE EN ARRIÈRE.**



WARNING

**TO REDUCE THE RISK OF ELECTRIC
SHOCK, DO NOT EXPOSE THIS
EQUIPMENT TO RAIN OR MOISTURE!**

Magnetic Field

CAUTION! Do not locate sensitive high-gain equipment such as preamplifiers or tape decks directly above or below the unit. Because this amplifier has a high power density, it has a strong magnetic field which can induce hum into unshielded devices that are located nearby. The field is strongest just above and below the unit.

If an equipment rack is used, we recommend locating the amplifier(s) in the bottom of the rack and the preamplifier or other sensitive equipment at the top.



The lightning bolt triangle is used to alert the user to the risk of electric shock.



The exclamation point triangle is used to alert the user to important operating or maintenance instructions.



Printed on
recycled paper.

Important Safety Instructions

- 1) Read these instructions.
- 2) Keep these instructions.
- 3) Heed all warnings.
- 4) Follow all instructions.
- 5) Do not use this apparatus near water.
- 6) Clean only with a dry cloth.
- 7) Do not block any ventilation openings. Install in accordance with the manufacturer's instructions.
- 8) Do not install near any heat sources such as radiators, heat registers, stoves, or other apparatus that produce heat.
- 9) Do not defeat the safety purpose of the polarized or grounding-type plug. A polarized plug has two blades with one wider than the other. A grounding-type plug has two blades and a third grounding prong. The wide blade or the third prong is provided for your safety. If the provided plug does not fit into your outlet, consult an electrician for replacement of the obsolete outlet.
- 10) Protect the power cord from being walked on or pinched, particularly at plugs, convenience receptacles, and the point where they exit from the apparatus.
- 11) Only use attachments/accessories specified by the manufacturer.
- 12) Use only with a cart, stand, bracket, or table specified by the manufacturer, or sold with the apparatus. When a cart is used, use caution when moving the cart/apparatus combination to avoid injury from tip-over.
- 13) Unplug this apparatus during lightning storms or when unused for long periods of time.
- 14) Refer all servicing to qualified service personnel. Servicing is required when the apparatus has been damaged in any way, such as power-supply cord or plug is damaged, liquid has been spilled or objects have fallen into the apparatus, the apparatus has been exposed to rain or moisture, does not operate normally, or has been dropped.
- 15) To reduce the risk of fire or electric shock, do not expose this apparatus to rain or moisture.



CONTENTS

1	Welcome	7
1.1	Unpacking	7
1.2	Features	7
2	Controls, Indicators & Connectors	9
3	Installation	11
3.1	Mounting	11
3.2	Cooling	11
3.3	Wiring	12
3.3.1	Stereo (Two-Channel) Operation	12
3.3.2	Bridge-Mono Operation	13
3.3.3	Parallel-Mono Operation	14
3.3.4	Input Connection	15
3.3.5	Output Connection	17
3.3.6	Additional Load Protection	19
3.4	AC Power Requirements	19
4	Operation	20
4.1	Precautions	20
4.2	Indicators	20
4.3	Protection Systems	22
4.3.1	ODEP	22
4.3.2	Standby Mode	22
4.3.3	Transformer Thermal Protection	22
4.3.4	Fuses and Circuit Breakers	23
4.4	Controls	23
4.5	Filter Cleaning	24
5	Technical Information	25
5.1	Overview	25
5.2	Circuit Theory	25
5.2.1	Stereo Operation	25
5.2.2	Bridge-Mono Operation	27
5.2.3	Parallel-Mono Operation	27
6	Specifications	28
7	AC Power Draw & Thermal Dissipation	37
8	Accessories	39
8.1	PIP and PIP2 Modules	39
8.2	Cooling Fan Options	41
8.3	Level Control Security Kit	41
9	Service	42
9.1	Worldwide Service	42
9.2	North American Service	42
9.2.1	Service at a N. American Service Center	42
9.2.2	Factory Service	42

ILLUSTRATIONS

1.1	Macro-Tech Amplifier	7
2.1	Front Panel Controls & Indicators	9
2.2	Rear Panel Controls & Connectors	10
3.1	Mounting Dimensions	11
3.2	Top View of a Rack-Mounted Unit	11
3.3	Proper Air Flow in a Rack Cabinet	11
3.4	Stereo Wiring	12
3.5	Bridge-Mono Wiring	13
3.6	Parallel-Mono Wiring	14
3.7	Unbalanced Input Wiring	15
3.8	Balanced Input Wiring	15
3.9	Balanced and Unbalanced Phone Plugs	15
3.10	Infrasonic Filter Capacitors	16
3.11	Unbalanced RFI Filters	16
3.12	Balanced RFI Filters	16
3.13	Wire Size Nomograph	17
3.14	Inductive Load (Transformer) Network	18
3.15	Loudspeaker Fuse Nomograph	19
4.1	Indicators	20
4.2	Macro-Tech ODEP and Signal/IOC Indicator States	21
4.3	Input Sensitivity and Ground Lift Switches	23
5.1	Circuit Block Diagram	26
6.1	Macro-Tech 602 Minimum Power Matrix	30
6.2	Macro-Tech 1202 Minimum Power Matrix	31
6.3	Macro-Tech 2402 Minimum Power Matrix	31
6.4	Macro-Tech 602 Maximum Power Matrix	32
6.5	Macro-Tech 1202 Maximum Power Matrix	33
6.6	Macro-Tech 2402 Maximum Power Matrix	33
6.7	Typical Frequency Response	34
6.8	Typical Damping Factor	34
6.9	Typical Output Impedance	34
6.10	Typical Phase Response	35
6.11	Typical Crosstalk for the Macro-Tech 602	35
6.12	Typical Crosstalk for the Macro-Tech 1202	36
6.13	Typical Crosstalk for the Macro-Tech 2402	36
7.1	Macro-Tech 602 Power Draw, Current Draw and Thermal Dissipation at Various Duty Cycles	37
7.2	Macro-Tech 1202 Power Draw, Current Draw and Thermal Dissipation at Various Duty Cycles	38
7.3	Macro-Tech 2402 Power Draw, Current Draw and Thermal Dissipation at Various Duty Cycles	38
8.1	PIP2 Adapter Connection	39
8.2	Installing a PIP Module	39
8.3	Installing a PIP2 Module	39
8.4	Installing a Level Control Shaft Lock	41

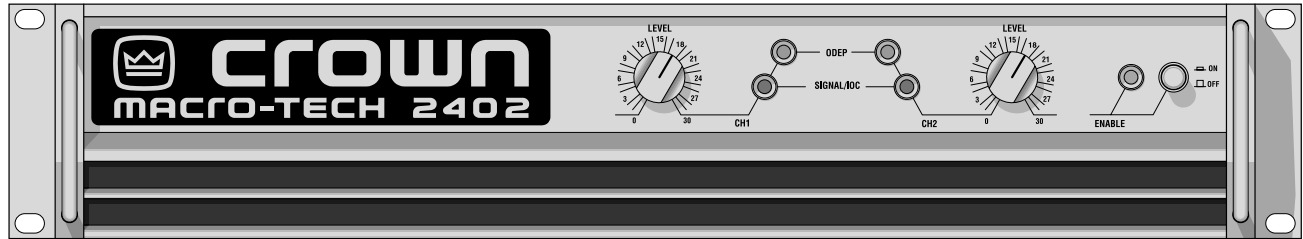
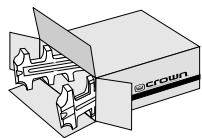

Fig. 1.1 Macro-Tech Amplifier

1 Welcome

Congratulations on your purchase of the renowned *Macro-Tech*® professional power amplifier. Macro-Tech amplifiers are designed to provide enormous levels of pure, undistorted power in a rugged low-profile package—making them *the choice* for pro sound reinforcement. They utilize our patented *ODEP*® protection circuitry to *keep the show going* long after other amplifiers have shut down. And with their *PIP*™ expandability, Macro-Tech amplifiers can be easily customized with one of our many optional input modules (see Section 8 for a list of available PIPs).

This manual will help you successfully install and use your new amplifier. Please read all instructions, warnings and cautions. Be sure to read Sections 3.3.2 and 3.3.3 if you plan to use one of the amplifier's two mono modes. Also for your protection, please send in your warranty registration card today and save your bill of sale because it is your **official proof of purchase**.



1.1 Unpacking

Please unpack and inspect your new amplifier for any damage that may have occurred during transit. If damage is found, notify the transportation company immediately. Only you, the consignee, may initiate a claim for shipping damage. Crown will be happy to cooperate fully as needed. Save the shipping carton as evidence of damage for the shipper's inspection.

Even if the unit arrived in perfect condition, as most do, save all packing materials so you will have them if you ever need to transport the unit. **NEVER SHIP THE UNIT WITHOUT THE FACTORY PACK.**

1.2 Features

Macro-Tech amplifiers use cutting edge technology to deliver the ultimate in power and value for their size, weight and price. They offer numerous advantages over conventional designs and provide benefits you can't get in amplifiers from any other manufacturer.

Here are some of their many features:

- Crown's *Grounded Bridge*™ design delivers large voltage swings without using easily stressed output-transistor configurations like conventional amplifiers. The results are lower distortion and superior reliability.
- Patented *ODEP* (Output Device Emulation Protection) circuitry compensates for overheating and overload to keep the amplifier working when others would fail.
- IOC*® (Input/Output Comparator) circuitry immediately alerts of any distortion exceeding 0.05%, providing dynamic *proof of distortion-free performance*.
- PIP* (Programmable Input Processor) connector accepts accessories that tailor the amplifier to suit specific applications.
- Enhanced *PIP2*™** (Programmable Input Processor) connector accepts new accessory modules that further tailor the amplifier to suit specific applications, including **wideband load current monitoring**.
- Two mono modes (Bridge-Mono and Parallel-Mono) for driving a wide range of load impedances.
- Very low harmonic and intermodulation distortion result in the best *dynamic transfer function* in the industry.
- High damping factor provides superior control over low-frequency drivers for a clean, accurate low end.
- Full protection against shorted outputs, mismatched loads, input/output DC, general overheating, high-frequency overloads and internal faults.
- Dedicated power supply transformers isolate channels in Stereo mode for superb crosstalk characteristics and reliability—each channel is virtually a separate amplifier.
- Balanced inputs with internal three-position sensitivity

switch and adjustable front-panel level controls.

- ❑ Versatile 5-way binding posts make it easy to connect output wiring.
 - ❑ Full protection from shorted, open and mismatched loads, general overheating. DC, high-frequency overloads, and full internal fault protection are provided by our latest protection scheme: **“Quad-Mute.”**
 - ❑ Efficient heat sinks and a self-contained forced-air cooling system dissipate heat quickly and evenly for extra amplifier protection and greater power output.
- ❑ Extra rugged, extruded aluminum front panel with ODEP and signal presence/IOC indicators for each channel, and an Enable indicator.
 - ❑ Mounts in a standard 19-inch (48.3-cm) equipment rack (units can also be stacked).
 - ❑ Three-Year, No-Fault, Full warranty completely protects your investment and guarantees its specifications.

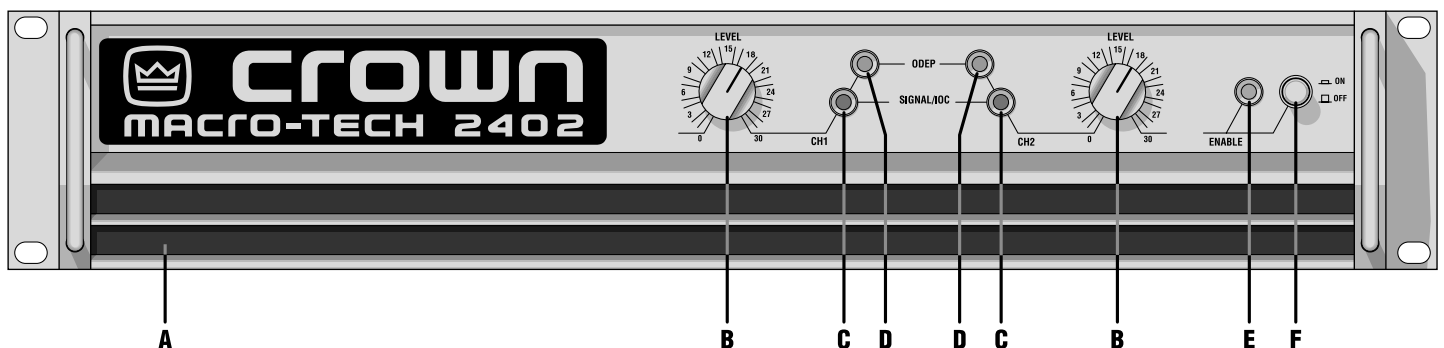

Fig. 2.1 Front Panel Controls & Indicators

2 Controls, Indicators & Connectors

A. Dust Filters

The dust filters remove large particles from the air drawn in by the cooling fan. Check the filters regularly to prevent clogging. The filter elements can be easily removed for cleaning by gently pulling them away from the front panel (see Sections 3.2 and 4.5).

B. Level Controls

The output level for each channel is set with these convenient level controls mounted on the front panel. Each level control has 31 detents for precise adjustment (see Section 4.4). A security option is available to prevent tampering (see Section 8.3).

C. Signal/IOC Indicators

These green multifunction indicators show signal presence and distortion for each channel. As signal presence indicators, they flash synchronously with the output audio signals to show their presence. As IOC (Input/Output Comparator) indicators, they flash brightly with a 0.1 second hold delay if there is a difference of 0.05% or more between the input and output signal waveforms. This provides *proof of distortion-free performance*. Note: The Channel 2 IOC indicator stays on in Parallel-Mono mode (see Section 4.2).

D. ODEP Indicators

During normal operation of the ODEP (Output Device Emulation Protection) circuitry, these amber indicators glow brightly to show the presence of reserve thermal-dynamic energy. They dim proportionally as energy reserves decrease. In the rare event that energy reserves

are depleted, the indicators turn off and ODEP proportionally limits output drive so the amplifier can safely continue operating even under severe conditions. These indicators can also help identify more unusual operating conditions (see Section 4.2).

E. Enable Indicator

This indicator lights when the amplifier has been “enabled” or turned on, and AC power is available (see Section 4.2).

F. Enable Switch

This push button is used to turn the amplifier on and off. When turned on, the output is muted for approximately four seconds to protect your system from start-up transients. (This delay can be changed. Contact Crown’s Technical Support Group for details.)

G. Power Cord

The power cord has an appropriate plug for the required voltage. 120 VAC, 60 Hz North American Macro-Tech 602s and 1202s have 14 AWG line cords and NEMA 5-15P plugs. Macro-Tech 2402s have 12 AWG line cords and NEMA 5-20P plugs. International units are shipped with an appropriate line cord and plug. See Section 7 for AC power usage.

H. Stereo/Mono Switch

The three operating modes of a Macro-Tech amplifier are controlled by this switch. Stereo mode is used for normal two-channel operation, Bridge-Mono mode is used to drive a single channel with a load impedance of at least 4 ohms, and Parallel-Mono mode is used to

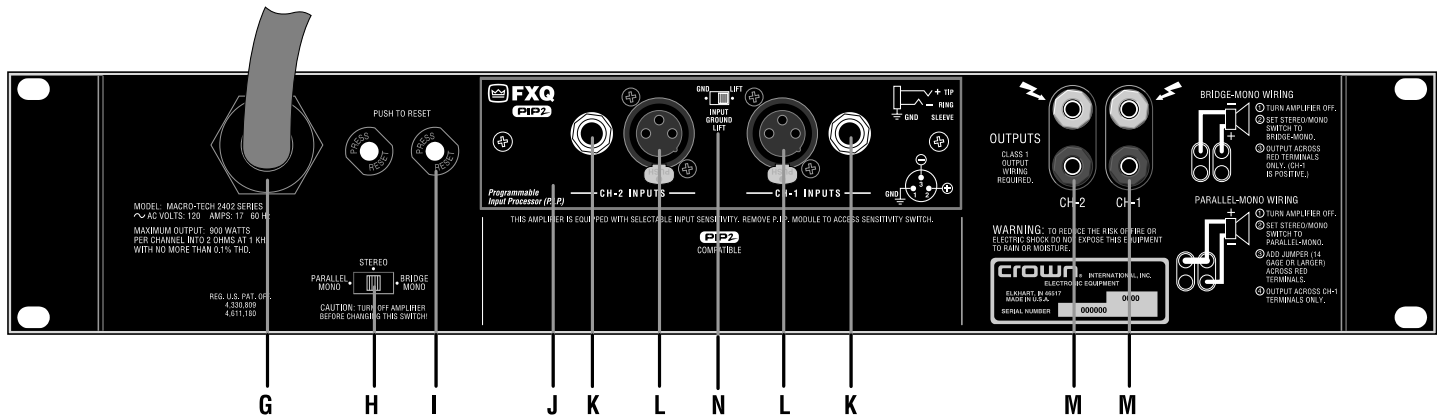

Fig. 2.2 Rear Panel Controls & Connectors
(Note: Reset Switches (Item I) only available on the Macro-Tech 2402 model.)

! drive a single channel with an impedance less than 4 ohms. **Important: Turn off the amplifier before changing the stereo/mono switch (see Section 3.3).**

I. Reset Switches (Macro-Tech 2402 only)

The Macro-Tech 2402 has a back panel Reset switch for each channel. Each switch resets the circuit breaker that protects the channel’s power supply from overload.

J. PIP Module

The standard PIP2-FXQ is included with your amplifier. It provides female three-pin XLR input connectors. A variety of other PIP modules can be used in place of the PIP2-FXQ. They add additional features that customize the amplifier for different applications (see Section 8.1 for information on available PIP modules).

□ Input Sensitivity Switch (not shown)

The three-position input sensitivity switch located inside the amplifier can be set after removing the PIP module (J). It is set at the factory to 0.775 volts for standard 1-kHz output into 8 ohms. It can also be set to 1.4 volts for standard 1-kHz output into 8 ohms, or a fixed voltage gain of 26 dB (see Section 4.4).

K. Balanced Phone Jack Inputs

Balanced 1/4-inch phone jack input connectors are provided on the PIP2-FXQ. The phone jacks can be wired for either balanced (tip, ring and sleeve) or unbalanced

(tip and sleeve) input signals. **Caution: The Channel 2 input should NOT be used in either Bridge Mono or Parallel Mono mode.** **!**

L. Balanced XLR Inputs

The factory-installed PIP2-FXQ provides a three-pin female XLR connector for balanced input to each channel. The XLR inputs are connected in parallel with the amplifier’s phone jack inputs. Because the PIP2-FXQ does not have any active circuitry, its XLR connectors can also be used as “daisy chain” outputs to connect signals from phone jack inputs to multiple amplifiers (see Section 3.3.4). **Caution: The Channel 2 input should NOT be used in either Bridge Mono or Parallel Mono mode.** **!**

M. Output Jacks

A pair of versatile 5-way binding posts is provided for the output of each channel. The 5-way binding posts accept banana plugs, spade lugs or bare wire. (European models do not accept banana plugs.)

N. Input Ground Lift Switch

The input ground lift switch is located on the PIP2-FXQ. It is used to isolate the input signal grounds from the AC (chassis) ground to help prevent ground loops that can result in unwanted hum and noise (see Section 3.3.4 for more information about preventing ground loops).

3 Installation

3.1 Mounting

Macro-Tech amplifiers are designed for standard 19-inch (48.3-cm) rack mounting and “stack” mounting without a cabinet. For more efficient cooling and extra support in a rack, it is recommended that units be stacked directly on top of each other.

Important: If the unit will be transported, it should also be securely supported at the back of the rack.

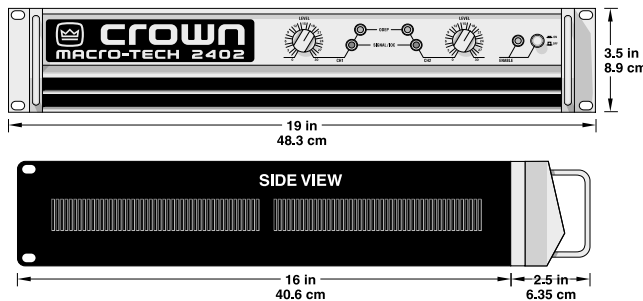

Fig. 3.1 Mounting Dimensions

3.2 Cooling

NEVER block the side or front air vents. Macro-Tech amplifiers do not need to be mounted with space between them. If you must leave open spaces in a rack for any reason, close them with blank panels to prevent air from recycling into the front of other amplifiers. Allow at least 35 cubic feet (1 cubic meter) per minute per unit for the Macro-Tech 602 and 1202, and at least 45 cubic feet (1.3 cubic meters) per minute per unit for the Macro-Tech 2402. Additional air flow may be required when driving low impedance loads at consistently high output levels. Refer to Section 7 for detailed information on thermal dissipation.

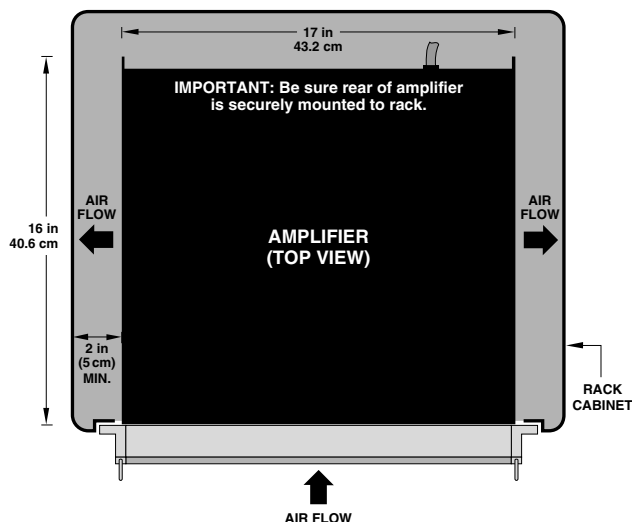

Fig. 3.2 Top View of a Rack-Mounted Unit

When mounting the amplifier in a rack, the side walls of the rack should be at least 2 inches (5 cm) away from the chassis as shown in Figure 3.2.

Tip: An easy way to verify adequate cooling is to observe the ODEP indicators while the amplifier is operating under worst-case conditions. If the indicators dim, additional cooling is recommended.

If your rack has a front door that could block air flow to the amplifier’s air intakes, you must provide adequate air flow by installing a grille in the door or by pressurizing the air behind the door. Wire grilles are recommended over perforated panels because they tend to cause less air restriction. A good choice for pressurizing the air behind a rack cabinet door is to mount a “squirrel cage” blower inside the rack (Option 1 below). At the bottom of the rack, mount the blower so it blows outside air into the space between the door and in front of the amplifiers, pressurizing the “chimney” behind the door. This blower should not blow air into or take air out of the space behind the amplifiers. For racks without a door, you can evacuate the rack by mounting the blower at the top of the rack so that air inside the cabinet is drawn out the back (Option 2 below).

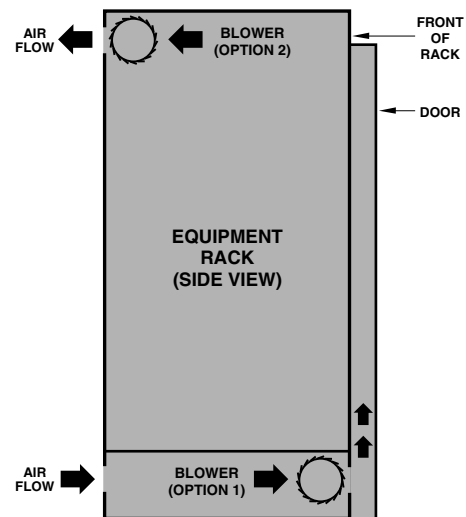

Fig. 3.3 Proper Air Flow in a Rack Cabinet

If the air supply is unusually dusty, you might want to pre-filter it using commercial furnace filters to prevent rapid loading of the unit’s own air filter. When needed, the unit’s filter can be cleaned with mild dish detergent and water (see Section 4.5).

3.3 Wiring

This section describes the most common ways to install your amplifier in a sound system. The input and output terminals are located on the back panel. Please use care when making connections, selecting signal sources and controlling the output level. The load you save may be your own! Crown assumes no liability for damaged loads resulting from careless amplifier use or deliberate overpowering.

CAUTION: Always remove power from the unit and turn the level controls off while making or changing connections. This is very important when loudspeakers are connected because it reduces the chance of loud blasts that can cause loudspeaker damage.

Macro-Tech amplifiers may be operated in one of three modes (Stereo, Bridge-Mono, and Parallel-Mono) by switching the stereo/mono switch on the back panel. There are VERY IMPORTANT wiring differences among these three modes which will be discussed next.

3.3.1 Stereo (Two-Channel) Operation

In Stereo mode, installation is very intuitive: input Channel 1 feeds output Channel 1, and input Channel 2 feeds output Channel 2. To put the amplifier in Stereo mode, first turn off the amplifier, then slide the stereo/mono switch to the center position, and properly connect the output wiring as shown in Figure 3.4. A pair of 5-way binding posts is provided for each channel to facilitate easy connection of loudspeaker wires. Observe correct loudspeaker polarity and be very careful not to short the two outputs.

CAUTION: In Stereo mode, never parallel the two outputs by directly tying them together, and never parallel them with the output of another amplifier.

Such a connection does not result in increased power output, but may result in overheating and premature activation of the protection circuitry.

Note: A method for paralleling multiple amplifiers for fail-safe redundancy is available from Crown's Technical Support Group.

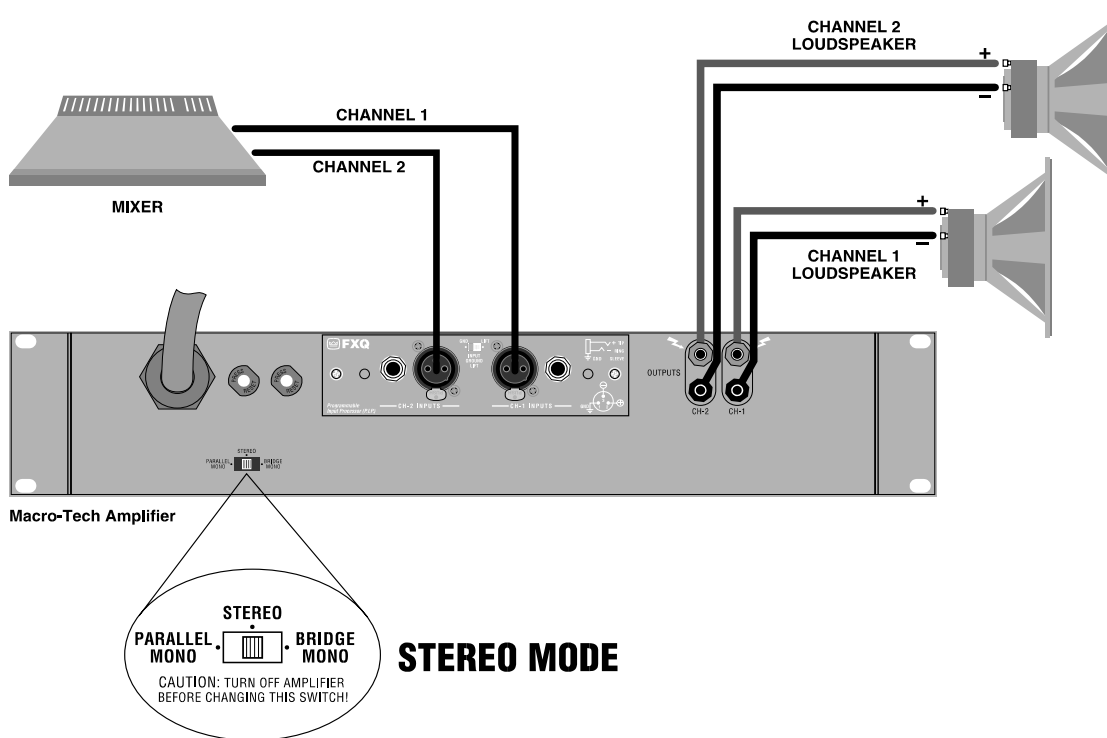

Fig. 3.4 Stereo Wiring

3.3.2 Bridge-Mono Operation

Bridge-Mono mode is intended for driving loads with a total impedance of 4 ohms or more (If the load is less than 4 ohms, see Section 3.3.3). Installing the amplifier in Bridge-Mono mode is very different from the other modes and requires special attention.

To put the amplifier in Bridge-Mono mode, turn the amplifier off and slide the stereo/mono switch to the right (as you face the back of the amplifier). Both outputs receive the signal from Channel 1 with the output of Channel 2 inverted so it can be bridged with the Channel 1 output. **DO NOT USE THE CHANNEL 2 INPUT** or the signal level and quality may be greatly degraded. Keep the Channel 2 level control turned down completely (counterclockwise).

Note: The input jack and level control of Channel 2 are

not defeated in Bridge-Mono mode. Any signal fed into Channel 2 will work against and add to or distort the signal in Channel 1.

Connect the load across the Channel 1 and 2 red binding posts with the positive lead from the load attaching to the red post of Channel 1 and the negative lead of the load attaching to the red post of Channel 2 as shown in Figure 3.5. **THE TWO BLACK BINDING POSTS ARE NOT USED AND SHOULD NOT BE SHORTED.** The load must be balanced (neither side shorted to ground).

CAUTION: Be certain all equipment (meters, switches, etc.) connected to the mono output is balanced. To prevent oscillations, both sides of the line must be isolated from the input grounds.

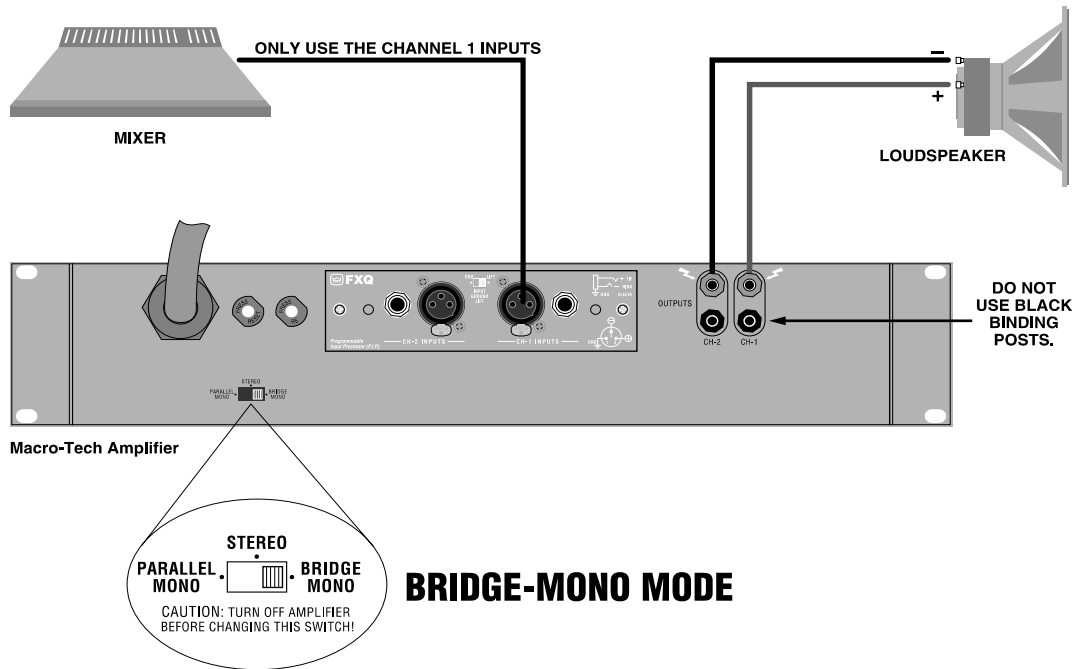

Fig. 3.5 Bridge-Mono Wiring

3.3.3 Parallel-Mono Operation

Parallel-Mono mode is intended for driving loads with a net impedance of less than 4 ohms. (See Bridge-Mono if the load is 4 ohms or greater.) Installing the amp in Parallel-Mono mode is very different from the other modes and requires special attention.

CAUTION: Do not attempt to operate in Stereo or Bridge-Mono mode until the Parallel-Mono jumper is first removed. Failure to do so will result in high distortion and excessive heating.

To put the amplifier in Parallel-Mono mode, turn it off and slide the stereo/mono switch to the left (as you face the back panel). Connect the input signal to Channel 1 only. The Channel 2 input and level control are by-

passed in this mode, so they should not be used.

Note: It is normal for the IOC indicator of Channel 2 to remain lit in Parallel-Mono mode.

Install a jumper wire between the red binding posts of both Channel 1 and 2 that is at least 14 gauge in size. Then, connect the load to the output of Channel 1 as shown in Figure 3.6. The positive lead from the load connects to the red binding post of Channel 1 and the negative lead from the load connects to the black binding post of Channel 1.

CAUTION: Remove the jumper wire before changing to Stereo or Bridge-Mono mode.

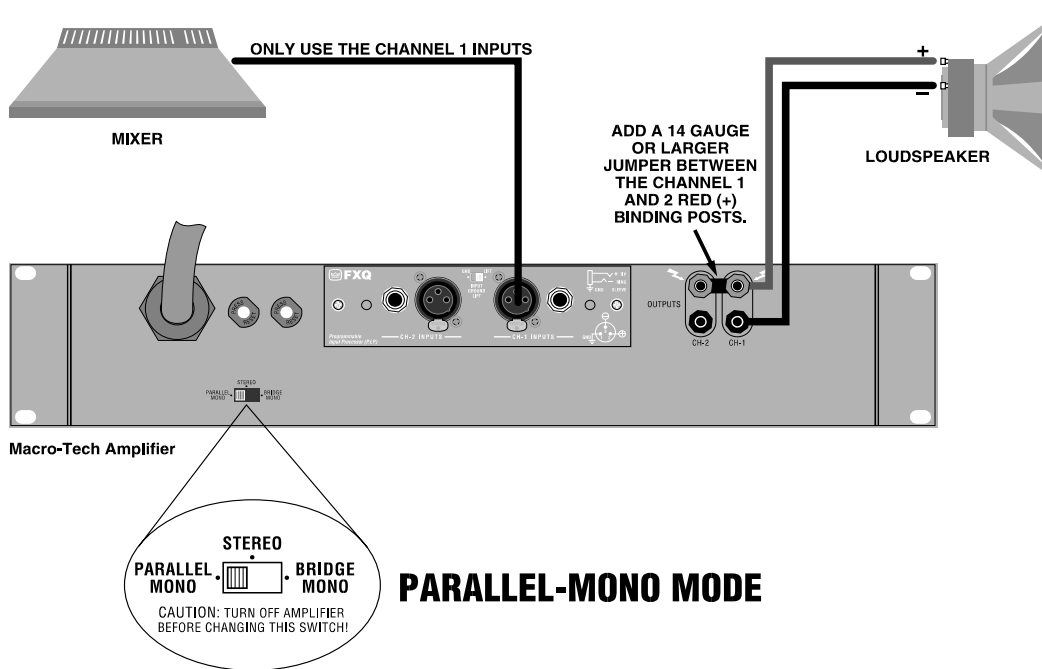

Fig. 3.6 Parallel-Mono Wiring

3.3.4 Input Connection

Both the balanced XLR and phone jack inputs have a nominal impedance of 20 k ohms (10 k ohms with unbalanced wiring) and will accept the line-level output of most devices. Female three-pin XLR input connectors and 1/4-inch jacks are provided on the standard PIP2-FXQ input module (other PIP modules are described in Section 8.1). Correct input wiring will depend on two factors: (1) whether the input signals are balanced or unbalanced, and (2) whether the signal source

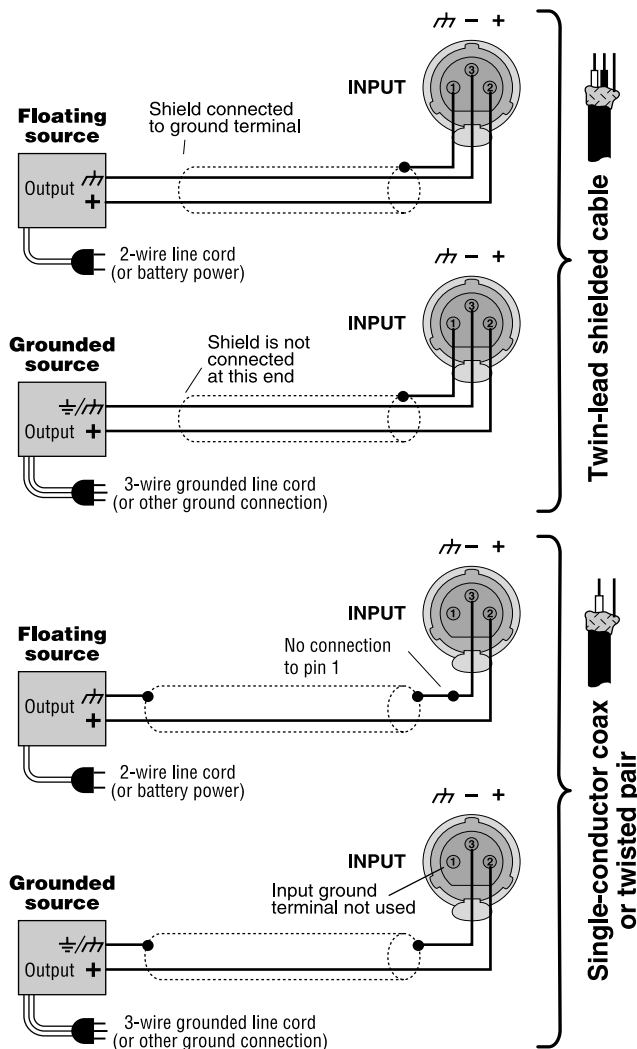

Fig. 3.7 Unbalanced Input Wiring

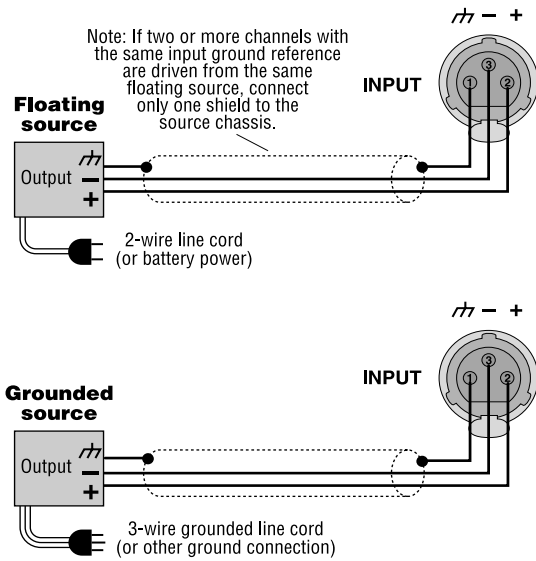

Fig. 3.8 Balanced Input Wiring

floats or has a ground reference. Figures 3.7 and 3.8 show the recommended connection techniques for each type of signal source.

The amplifier's built-in 1/4-inch phone jack input connectors can be wired similarly for balanced or unbalanced, floating or ground-referenced sources. They have a standard tip-ring-sleeve (TRS) configuration: the tip is positive (+), the ring is negative (-) and the sleeve is chassis (see Figure 3.9). Wiring for various sources follows the XLR wiring guidelines shown in Figures 3.7 and 3.8.

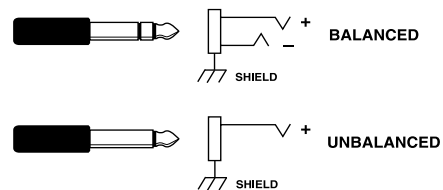

Fig. 3.9 Balanced and Unbalanced Phone Plugs

Please follow the instruction in Section 3.3.2 and 3.3.3 if the amplifier will be used in either Bridge-Mono or Parallel-Mono mode. Remember, do not use the Channel 2 input in either of these mono modes.

SOLVING INPUT PROBLEMS

Sometimes large **infrasonic** (subaudible) **frequencies** are present in the input signal. These can damage loudspeakers by overloading or overheating them. To at-

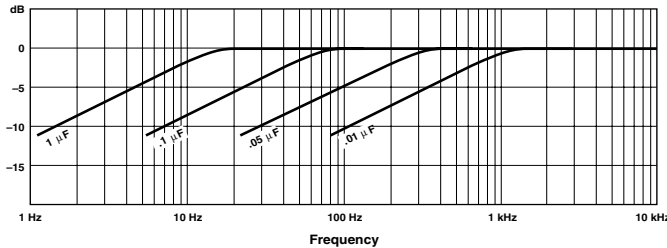
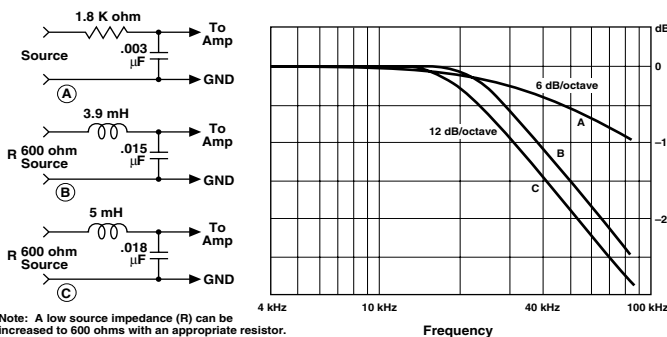

Fig. 3.10 Infrasonic Filter Capacitors

tenuate such frequencies, place a capacitor in series with the input signal line. The graph in Figure 3.10 shows some capacitor values and how they affect the frequency response. Use only low-leakage paper, mylar or tantalum capacitors.

Another problem to avoid is the presence of large levels of **radio frequencies** or RF in the input signal. Although high RF levels may not pose a threat to the amplifier, they can burn out tweeters or other loads that are sensitive to high frequencies. Extremely high RF levels can also cause your amplifier to prematurely activate its protection circuitry, resulting in inefficient



Note: A low source impedance (R) can be increased to 600 ohms with an appropriate resistor.

Fig. 3.11 Unbalanced RFI Filters

operation. RF can be introduced into the signal by local radio stations and from the bias signal of many tape recorders. To prevent high levels of input RF, install an appropriate low-pass filter in series with the the input

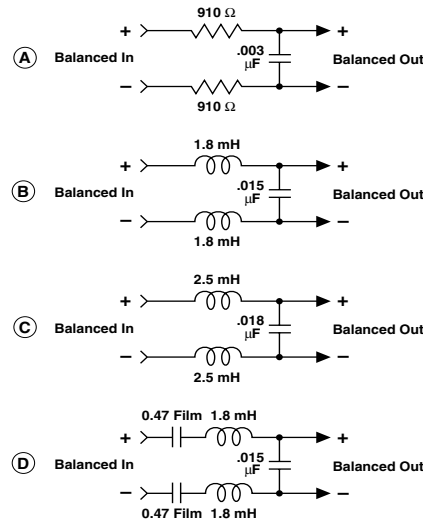

Fig. 3.12 Balanced RFI Filters

signal. Some examples of unbalanced wiring for low-pass filters are shown in Figure 3.11.

For balanced input wiring use one of the examples in Figure 3.12. Filters A, B and C correspond to the unbalanced filters above. Filter D also incorporates the infrasonic filter described previously.

A third problem to avoid is **hum**. The two most common sources of hum in an audio system are **inductive coupling** and **ground loops**.

Inductive coupling can occur when input cables are

Input Wiring Tips

1. Use only shielded cable. Cables with higher density shields are better. Spiral wrapped shield is not recommended.
2. When using unbalanced lines, keep the cables as short as possible. Avoid cable lengths greater than 10 feet (3 meters).
3. Do not run signal cables together with high-level wiring such as loudspeaker wires or AC cords. This greatly lessens the chance of hum or noise being induced into the input cables.
4. Turn the entire system off before changing connections. Turn level controls down completely before powering the system back up. Crown is not liable for damage incurred when any transducer or component is overdriven.

subjected to a magnetic field from a power cord or power transformer. One way to prevent inductive coupling is to lace the input cables together along their length and route them as far away as possible from power transformers and power cords. The use of shielded pair cable is another effective way to reduce or eliminate hum resulting from inductive coupling.

Input and output grounds are sometimes tied together for testing or metering. This can cause **feedback oscillation** from load current in the test loop. In some systems, even the AC power line may provide this feedback path. Proper grounding, input isolation and isolation of common AC devices in the system is good practice.

Use Good Output Connectors

1. To prevent possible shorts, do not expose the loudspeaker cable connectors.
2. Do not use connectors that might accidentally tie two channels together when making or breaking connections (for example, a standard three-wire stereo phone plug).
3. Connectors that can be plugged into AC power receptacles should never be used.
4. Connectors with low current-carrying capacity should not be used.
5. Connectors with any tendency to short should never be used.

3.3.5 Output Connection

Consider the power-handling capacity of your load before connecting it to the amplifier. Crown is not liable for damage incurred at any time due to overpowering. Fusing loudspeaker lines is highly recommended (see Section 3.3.6). Also, please pay close attention to the precautions provided in Section 4.1.

HOW TO DETERMINE APPROPRIATE WIRE GAUGE

It is important to use loudspeaker cables with sufficient

gauge (thickness) for the length being used. The resistance introduced by inadequate loudspeaker cables will reduce both the output power and the motion con-

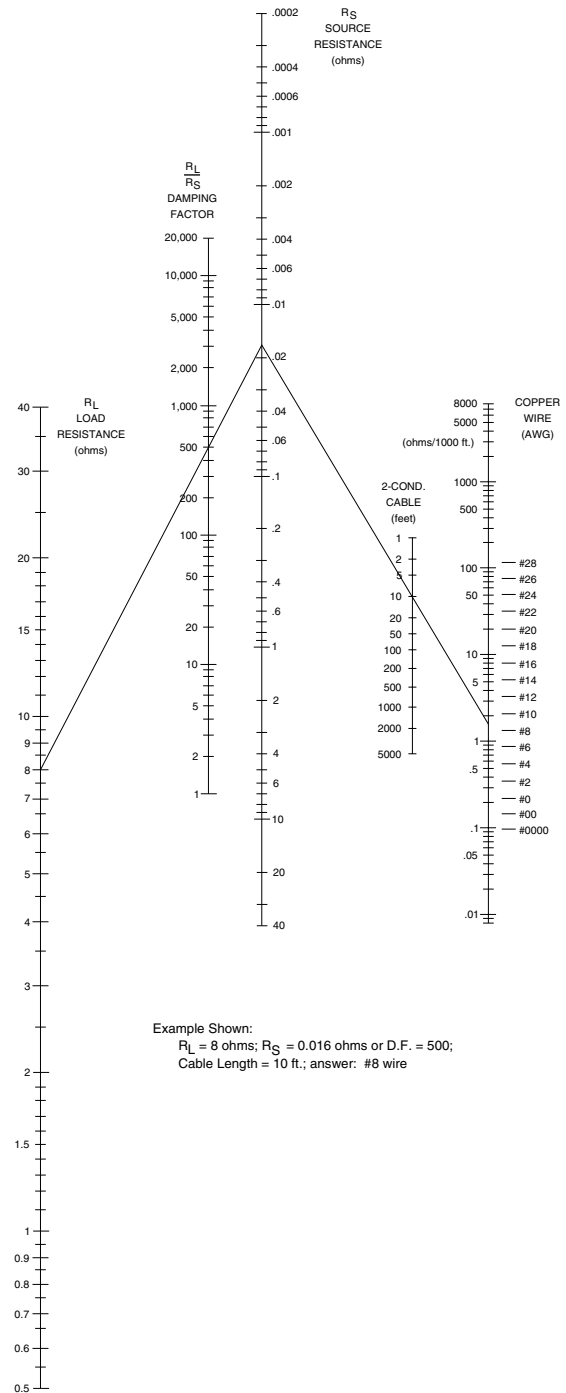

Fig. 3.13 Wire Size Nomograph

trol of the loudspeakers. The latter problem occurs because the damping factor decreases as the cable resistance increases. This is very important because the amplifier's excellent damping factor can easily be negated by insufficient loudspeaker cables.

Use the nomograph in Figure 3.13 and the procedure that follows to find the recommended wire gauge (AWG or American Wire Gauge) for your system.

1. Note the load resistance of the loudspeakers connected to each channel of the amplifier. Mark this value on the "Load Resistance" line of the nomograph.
2. Select an acceptable damping factor and mark it on the "Damping Factor" line. Your amplifier can provide an excellent damping factor of 1,000 from 10 to 400 Hz in Stereo mode with an 8-ohm load. In contrast, typical damping factors are 50 or lower. Higher damping factors yield lower distortion and greater motion control over the loudspeakers. A common damping factor for commercial applications is between 50 and 100. Higher damping factors may be desirable for live sound, but long cable lengths often limit the highest damping factor that can be achieved practically. (Under these circumstances, Crown's *IQ System*® is often used so amplifiers can be monitored and controlled when they are located very near the loudspeakers.) In recording studios and home hi-fi, a damping factor of 500 or more is very desirable.
3. Draw a line through the two points with a pencil, and continue until it intersects the "Source Resistance" line.
4. On the "2-Cond. Cable" line, mark the length of the cable run.
5. Draw a pencil line from the mark on the "Source Resistance" line through the mark on the "2-Cond. Cable" line, and on to intersect the "Annealed Copper Wire" line.
6. The required wire gauge for the selected wire length and damping factor is the value on the "Annealed Copper Wire" line. *Note: Wire size increases as the AWG gets smaller.*
7. If the size of the cable exceeds what you want to use, (1) find a way to use shorter cables, like using the IQ System, (2) settle for a lower damping factor, or (3) use more than one cable for each line. Options 1 and 2 will require the substitution of new values for cable length or damping factor in the nomograph. For option 3, estimate the effective wire gauge by subtracting 3 from the apparent wire gauge every time the number of conductors of equal gauge is doubled. So, if #10 wire is too large, two #13 wires can be substituted, or four #16 wires can be used for the same effect.

SOLVING OUTPUT PROBLEMS

Sometimes **high-frequency oscillations** occur which can cause your amplifier to prematurely activate its protection circuitry and result in inefficient operation. The effects of this problem are similar to the effects of the RF

problem described in Section 3.3.4. To prevent high-frequency oscillations:

1. Lace together the loudspeaker conductors for each channel; do not lace together the conductors from different channels. This minimizes the chance that cables will act like antennas and transmit or receive high frequencies that can cause oscillation.
2. Avoid using shielded loudspeaker cable.
3. Avoid long cable runs where the loudspeaker cables from different amplifiers share a common cable tray or cable jacket.
4. Never connect the amplifier's input and output grounds together.
5. Never tie the outputs of multiple amplifiers together.
6. Keep loudspeaker cables well separated from input cables.
7. Install a low-pass filter on each input line (similar to the RF filters described in Section 3.3.4).
8. Install input wiring according to the instructions in Section 3.3.4.

Another problem to avoid is the presence of large **subsonic currents** when primarily inductive loads are used. Examples of inductive loads are 70-volt transformers and electrostatic loudspeakers.

Inductive loads can appear as a short circuit at low frequencies. This can cause the amplifier to produce large low-frequency currents and activate its protection circuitry. Always take the precaution of installing a high-pass filter in series with the amplifier's input when inductive loads are used. A 3-pole, 18-dB-per-octave filter with a -3 dB frequency of 50 Hz is recommended (depending on the application, an even higher -3 dB frequency may be desirable). Such a filter is described with infrasonic frequency problems in Section 3.3.4.

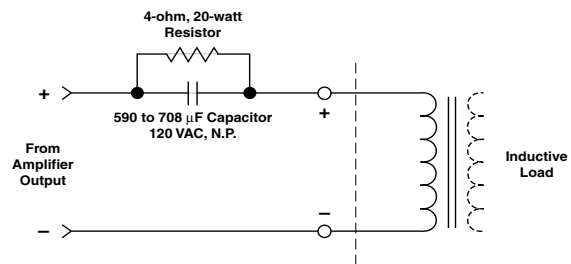

Fig. 3.14 Inductive Load (Transformer) Network

Another way to prevent the amplifier from prematurely activating its protection systems and to protect inductive loads from large low-frequency currents is to connect a 590 to 708 μF nonpolarized capacitor and 4-ohm, 20-watt resistor in series with the amplifier's output and the positive (+) lead of the transformer. The circuit shown in Figure 3.14 uses components that are available from most electronic supply stores.

3.3.6 Additional Load Protection

Macro-Tech amplifiers generate enormous power. If your loudspeakers do not have built-in protection from excessive power, it's a good idea to protect them. Loudspeakers are subject to thermal damage from sustained overpowering and mechanical damage from large transient voltages. Special fuses can be used to protect your loudspeakers in both cases.

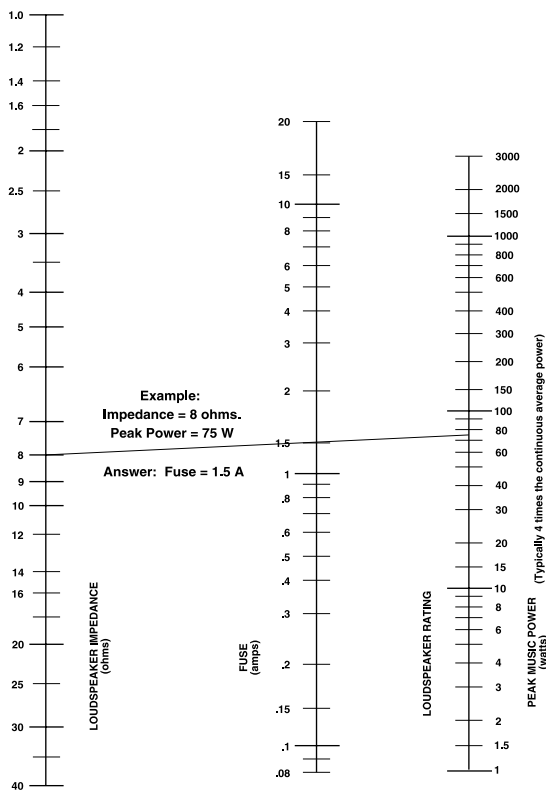

Fig. 3.15 Loudspeaker Fuse Nomograph

Two different types of fuses are required for thermal protection and voltage protection. Slow-blow fuses are usually selected to protect loudspeakers from thermal damage because they are similar to loudspeakers in the way they respond to thermal conditions over time. In contrast, high-speed instrument fuses like the Littlefuse 361000 series are used to protect loudspeakers from large transient voltages. The nomograph in Figure 3.15 can be used to select the properly rated fuse for either type of loudspeaker protection.

There are basically two approaches that can be taken when installing fuses for loudspeaker protection. A common approach is to put a single fuse in series with the output of each channel. This makes installation convenient because there is only one fuse protecting the loads on each output. The main disadvantage of this approach becomes obvious if the fuse blows because none of the loads will receive any power.

A better approach is to fuse each driver independently. This allows you to apply the most appropriate protection for the type of driver being used. In general, low-frequency drivers (woofers) are most susceptible to thermal damage and high-frequency drivers (tweeters) are usually damaged by large transient voltages. This means that your loudspeakers will tend to have better protection when the woofers are protected by slow-blow fuses and high-frequency drivers are protected by high-speed instrument fuses.

3.4 AC Power Requirements

All Macro-Tech amplifiers are shipped with an appropriate line cord. When possible, use a power receptacle on a dedicated circuit and always make sure that it can supply the correct voltage and current. We do not recommend operating your amplifier on voltages greater than 10% above or below the unit's rated voltage. For example, if your amplifier is rated for 120 VAC, the line voltage should not exceed 132 VAC. See Section 7 for power requirements under a variety of conditions.

All specifications in this manual were measured using 120 VAC, 60 Hz power, unless otherwise noted. Specifications were derived using a voltage that is accurate to within 0.5% with THD less than 1.0% under all testing conditions. Performance variations can occur at other AC voltages and frequencies. In addition, line regulation problems directly affect the output power from the amplifier.

4 Operation

4.1 Precautions

Macro-Tech amplifiers are protected from internal and external faults, but you should still take the follow precautions for optimum performance and safety:

1. Improper wiring for Stereo, Bridge-Mono and Parallel-Mono modes can result in serious operating difficulties. Refer to Section 3.3 for details.



2. **WARNING: Do not change the position of the stereo/mono switch unless the amplifier is first turned off.**



3. **CAUTION: In Parallel-Mono mode, a jumper is used between the red (+) Channel 1 and 2 output binding posts. Be sure to remove this jumper for Stereo or Bridge-Mono mode, otherwise high distortion and excessive heating will definitely occur.** Check the stereo/mono switch on the back panel for proper position.



4. **Turn off the amplifier and unplug it from the AC mains** before removing the PIP module.

5. Use care when making connections, selecting signal sources and controlling the output level. The load you save may be your own.
6. Do not short the ground lead of an output cable to the input signal ground. This may form a ground loop and cause oscillations.
7. Operate the amplifier from AC mains of not more than 10% variation above or below the selected line voltage and only the specified line frequency.



8. **Never connect the output to a power supply output, battery or power main.** Such connections may result in electrical shock.

9. Tampering with the circuitry by unqualified personnel, or making unauthorized circuit changes invalidates the warranty.

Remember: Crown is not liable for damage that results from overdriving other system components.

4.2 Indicators

The amber **Enable indicator** is provided to show that the amplifier has been turned on (or enabled), and that its low-voltage power supply and forced-air cooling system are working. It does not indicate the status of the high-voltage power supplies. For example, the Enable indicator will remain lit during unusual conditions that would cause the amplifier's protection systems to put a

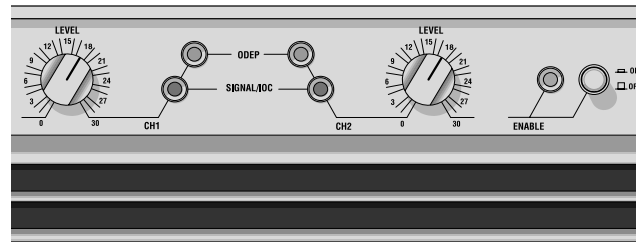

Fig. 4.1 Indicators

high-voltage power supply in “standby” mode (see Section 4.3.2).

The amber **ODEP indicators** confirm the normal operation of Crown's patented Output Device Emulation Protection circuitry. During normal operation, they glow brightly to show the presence of reserve thermal-dynamic energy. They dim proportionally as the energy reserve decreases. In the rare event that there is no reserve, the indicators turn off and ODEP proportionally limits the drive level of the output stages so the amplifier can continue safe operation even when conditions are severe. (For a more detailed description of ODEP, see Section 4.3.1.)

The ODEP indicator for the affected channel will turn off if a high-voltage power supply is put in “standby” mode, a high-voltage power supply fuse (or breaker) blows, or a transformer activates its thermal protection circuitry (see Section 4.3.2). Both ODEP indicators turn off if the amplifier loses AC power, the power switch is turned off or the low-voltage power supply fuse blows.

The green **Signal/IOC indicators** show signal presence and distortion. As signal presence indicators, they flash with normal intensity in sync with the output audio signals. As IOC (Input/Output Comparator) indicators, they flash brightly if there is any difference between the input and output signal waveforms greater than 0.05%. Because transient distortion happens quickly, a 0.1 second “hold delay” keeps the indicators on long enough to be easily noticed. The IOC function essentially provides *proof of distortion-free performance*. *Note: The Channel 2 IOC indicator will remain lit when running in Parallel-Mono mode.*

Under conditions where one of the amplifier's high-voltage power supplies is temporarily put in standby mode, the Signal/IOC indicators will stay on with full brightness. They will resume normal operation when the amplifier is no longer in standby mode.

Note: See Figure 4.2 for an explanation of the conditions that may activate standby mode.

The table in Figure 4.2 shows the possible states for the ODEP and Signal/IOC indicators. It also describes the conditions that may be associated with the different indicator states. The Enable indicator will be off with the first indicator state, "There is no power to the amplifier." All other conditions in the table will occur with the En-

able indicator turned on. It is important to note the possible states of the indicators in the rare event that you experience a problem. This can greatly aid in determining the source of problems. Please contact your local Crown representative or our Technical Support Group for further assistance.













Indicator Status	Amplifier Condition
ODEP  OFF SIGNAL/IOC  OFF	<p>There is no power to the amplifier and all indicators are off, including the Enable light. Possible reasons: (1) The amplifier's Enable switch is off. (2) The amplifier is not plugged into the power receptacle. (3) The AC circuit breaker has been tripped. (4) The amplifier's low-voltage power supply fuse has blown.</p>
ODEP  ON SIGNAL/IOC  OFF	<p>Normal operation for a channel with NO audio output. Possible reasons: (1) There is no input signal. (2) The input signal level is very low. (3) The channel's level control is turned down.</p>
ODEP  ON SIGNAL/IOC  Normal	<p>Normal operation for a channel with audio output. The ODEP indicator will remain at full intensity to show that there is reserve thermodynamic energy, and the Signal/IOC indicator will flash with normal intensity to show that the channel has audio output.</p>
ODEP  ON SIGNAL/IOC  Bright	<p>The channel's output is exceeding 0.05% distortion. The input signal level is too high and IOC is reporting output clipping.</p> <p style="text-align: center;">OR</p> <p>Channel 2 only: The amplifier is in Parallel-Mono mode. The channel 2 Signal/IOC indicator always turns on to full brightness whenever the amplifier's stereo/mono switch is set to Parallel-Mono mode.</p>
ODEP  OFF SIGNAL/IOC  Bright	<p>The amplifier channel is in standby mode. Possible reasons: (1) An IQ-PIP module like an IQ-PIP-USP2 has turned off the channel's high-voltage power supply. (2) The amplifier has just been turned on and is still in the four second turn-on delay. (3) The DC / low-frequency protection circuitry has been activated. (4) The fault protection circuitry has been activated. (5) The transformer thermal protection circuitry has been activated.</p> <p style="text-align: center;">OR</p> <p>A channel's fuse has blown or breaker has tripped. Transformer overload can cause a channel's internal fuse for its high-voltage supply to blow in a Macro-Tech 602 or 1202, and it can cause the channel's circuit breaker to trip in a Macro-Tech 2402.</p> <p style="text-align: center;">OR</p> <p>ODEP limiting has been activated. Possible reasons: (1) The amplifier's air filters are blocked and need to be cleaned. (2) There is insufficient cooling because of inadequate air flow or air that is too hot. (3) The load impedance for the channel is too low because the output is shorted or the amplifier is driving too many loudspeakers for the selected stereo/mono mode. (4) The amplifier channel is continuously being driven to very high output levels.</p>
ODEP  OFF SIGNAL/IOC  Normal	<p>ODEP limiting is about to begin. Possible reasons: (1) The amplifier's air filters are blocked and need to be cleaned. (2) There is insufficient cooling because of inadequate air flow or air that is too hot. (3) The load impedance for the channel is too low because the output is shorted or the amplifier is driving too many loudspeakers for the selected stereo/mono mode. (4) The amplifier channel is continuously being driven to very high output levels.</p>

Fig. 4.2 Macro-Tech ODEP and Signal/IOC Indicator States

4.3 Protection Systems

Macro-Tech amplifiers provide extensive protection and diagnostics capabilities. Protection systems include ODEP, “standby” mode, fuses (or breakers), and special thermal protection for the unit’s transformers.

4.3.1 ODEP

Crown invented ODEP to solve two long-standing problems in amplifier design: to prevent amplifier shutdown during demanding operation and to increase the efficiency of the output circuitry.

To do this, Crown established a rigorous program to measure the *safe operating area* (SOA) of each output transistor before installing it in an amplifier. Next, Crown designed intelligent circuitry to simulate the instantaneous operating conditions of those output transistors. Its name describes what it does: Output Device Emulation Protection or ODEP. In addition to simulating the operating conditions of the output transistors, it also compares their operation to their known SOA. If it sees that more power is about to be asked of them than they are capable of delivering under the present conditions, ODEP immediately limits the drive level until it falls within the SOA. Limiting is proportional and kept to an absolute minimum—only what is required to prevent output transistor damage.

This level of protection enables Crown to increase output efficiency to never-before-achieved levels while greatly increasing amplifier reliability.

The on-board intelligence is monitored in two ways. First, the front panel ODEP indicators show whether the amplifier is functioning correctly or if ODEP is limiting the drive level. Second, ODEP data is fed to the back panel PIP connector so advanced PIP modules like the IQ-PIP-USP2 can use it to monitor and control the amplifier.

With ODEP, the show keeps going because you get the maximum power with the maximum protection.

4.3.2 Standby Mode

An important part of a Macro-Tech amplifier's protection systems is standby mode. Standby protects the amplifier during potentially catastrophic conditions. It temporarily removes bias in all four output stages, protecting the amplifier and its loads. This advanced protection implementation, called "**Quad-Mute**," is new to the Macro-Tech series amplifiers. Standby mode can be identified using the indicator table in Figure 4.2.

Standby mode can be activated in several situations. First, if dangerous subsonic frequencies or direct cur-

rent (DC) is detected in the amplifier’s output, the unit will activate its **DC/low-frequency protection** circuitry and put the affected channels in standby. This protects the loads and prevent oscillations. The unit resumes normal operation as soon as the amplifier no longer detects dangerous low frequency or DC output. Although it is extremely unlikely that you will ever activate the amplifier’s DC/low-frequency protection system, improper source materials such as subsonic square waves or input overloads that result in excessively clipped input signals can activate this system.

The amplifier’s **fault protection** system will put an amplifier channel in standby mode in rare situations where heavy common-mode current is detected in the channel’s output. The amplifier should never output heavy common-mode current unless its circuitry is damaged in some way, and putting a channel in standby mode helps to prevent further damage.

The amplifier’s **transformer thermal protection** circuitry is activated in very unusual circumstances where the unit’s transformer temperature rises to unsafe levels. Under these abnormal conditions, the amplifier will put the channel of the affected transformer in standby mode. The amplifier will return to normal operation after the transformer cools to a safe temperature. (For more information on transformer thermal protection, refer to the following section.)

An **IQ-PIP module** may also temporarily place the amplifier in standby mode, typically for power conservation. The standby mode status can be triggered either manually or through IQ’s “auto standby” feature. If triggered via the IQ auto standby feature, the standby status will be automatically cancelled when the defined level of input signal is detected. However, if the standby status has been triggered manually, this status must be manually cancelled using IQ.

4.3.3 Transformer Thermal Protection

All Macro-Tech amplifiers have transformer thermal protection. It protects the power supplies from damage under the rare conditions of transformer temperatures rising too high. A thermal switch embedded in each transformer removes power to the channel if there is excessive heat. The switch automatically resets when the transformer cools to a safe temperature.

It is extremely unlikely that you will ever see a Macro-Tech amplifier activate transformer thermal protection as long as it is operated within rated conditions (see Section 6, *Specifications*). One reason is that ODEP keeps the amplifier working under very severe conditions. Even so, higher than rated output levels, ex-

cessively low impedance loads and unreasonably high input signals can generate more heat in the transformer than in the output devices. These conditions can overheat the transformer and activate its protection system.

Macro-Tech amplifiers are designed to keep working under conditions where other amplifiers would fail. But even when the limits of a Macro-Tech amplifier are exceeded, it will still protect itself—and your investment—from damage.

4.3.4 Fuses and Circuit Breakers

The power supplies of the Macro-Tech 602 and 1202 are protected by fuses. The power supplies of the Macro-Tech 2402 are protected by circuit breakers. With rated loads and output levels, the fuses (or circuit breakers) should only shut down the amplifier in the rare instance of a catastrophic failure. Other protection systems like ODEP keep the amplifier operational under most other severe conditions. The fuses (or circuit breakers) can also shut down the amplifier in cases where extremely low-impedance loads and high output levels result in current draw that exceeds their rating. Again, this should only be possible when operating outside rated conditions, such as when the amplifier is used to drive a 1-ohm load in Stereo mode, or when a signal overloads the input and is clipped severely.

All 120 VAC, 60 Hz units and all Macro-Tech 2402s have a separate fuse for the low-voltage power supply. All units have separate fuses or breakers for the high-voltage power supplies.

Macro-Tech amplifiers do not blow their fuses or trip their breakers unless something is wrong. In the rare event that an internal fuse blows, please refer the unit to a qualified technician. If a breaker in a Macro-Tech 2402 trips, try to identify and correct the problem before resetting the breakers with the back panel **Reset switches**. If the problem persists, refer the unit to a qualified technician.

4.4 Controls

The **Enable switch** is located on the front panel so you can easily turn the amplifier on and off. If you ever need to make any wiring or installation changes, don't forget to disconnect the power cord. The six steps listed next should be followed whenever you turn on the amplifier:

1. Turn down the level of your audio source. For example, set your master mixer's volume to $-\infty$.
2. Turn down the level controls of the amplifier (if they are not already down).
3. Turn on the Enable switch. The Enable indicator

beside the switch should glow. During the four second mute delay which immediately follows, the Signal/IOC indicators will flash unpredictably and the ODEP LEDs will stay off. After the mute delay, the ODEP indicators should come on with full brilliance and the Signal/IOC indicators should function normally (remain off if no signal is present; flash if a signal is present). Remember, the Channel 2 Signal/IOC indicator will remain on if the amplifier is in Parallel-Mono mode.

4. After the mute delay, turn up the level of your audio source to the maximum desired level.
5. Turn up the level controls of the amplifier until the maximum desired sound level is achieved.
6. Turn down the level of your audio source to its normal range.

For ease of use, the **level controls** are also located on the front panel. Each control has 31 detents for accurate repeatability. To prevent tampering with these controls, the Level Control Security Kit is available (see Section 8.3). *Note: In Bridge-Mono and Parallel-Mono modes, turn down the Channel 2 level control and only use the Channel 1 control.*

The **input sensitivity switch** is located inside the back panel of the amplifier. It is factory-set to 0.775 volts for standard 1-kHz power into 8 ohms. It can be switched either to 1.4 volts for standard 1-kHz power output, or to a fixed voltage gain of 26 dB. When set to 26 dB gain, the input sensitivity is 2.2 volts for the Macro-Tech 602, 2.6 volts for the Macro-Tech 1202 and 3.1 volts for the Macro-Tech 2402. *Note: Factory setting for international models is 1.4V.*

How to change the input sensitivity:

1. Turn off the amplifier and disconnect its power cord

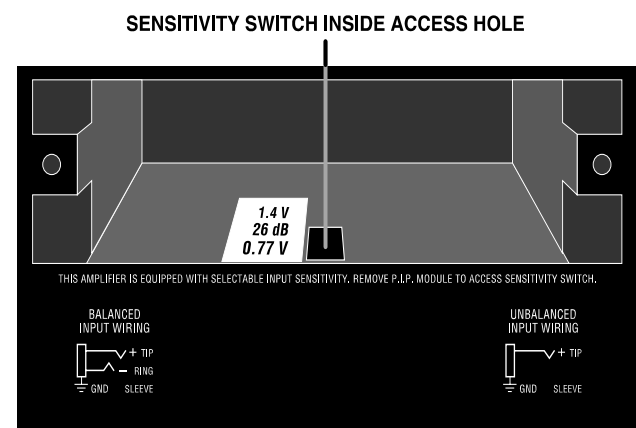

Fig. 4.3 Input Sensitivity and Ground Lift Switches

from the AC mains power receptacle.

2. Remove the PIP module (two screws).
3. Locate the sensitivity switch access hole inside the chassis opening as shown in Figure 4.3. It is located just above the phone jack inputs.
4. Set the switch to the desired position noted on the label for the access hole. The position toward the front panel sets the sensitivity to 1.4 volts for standard 1-kHz power, the middle position provides 26 dB gain, and the back position sets the sensitivity to 0.775 volts for standard 1-kHz power.
5. Replace the PIP module and reconnect the power to the amplifier.

The Macro-Tech 2402 has back panel **Reset switches** that are used to reset the breakers that protect the high-voltage power supplies from overload. If a breaker trips, the IOC indicator for the affected channel will turn on (see Figure 4.2).

4.5 Filter Cleaning

Dust filters are provided on the air intakes to the cooling system (see Figure 2.1). If these filters become clogged, the unit will not cool as efficiently as it should and may produce output levels that are lower than normal due to high heat sink temperature.

To clean, remove each of the filter elements by gently pulling them away from the front panel. Clean with mild dishwashing detergent and warm water. Replacement filters may be ordered from the factory.

Dust filters are not 100% efficient—depending on the local environment, the internal heat sinks of the amplifier will benefit from periodic cleaning by a qualified technician. Internal cleaning information is available from our Technical Support Group.

5 Technical Information

5.1 Overview

Your Macro-Tech amplifier incorporates several advanced technological features including real-time computer simulation of output transistor stress, low-stress output stages, an advanced heat sink embodiment and the PIP2 (Programmable Input Processor) expansion system.

Custom circuitry is incorporated to limit temperature and current to safe levels, making it highly reliable and tolerant of faults. Unlike many lesser amplifiers, it can operate at its voltage and current limits without self-destructing.

Real-time computer simulation is used to create an analogue of the junction temperature of the output transistors (hereafter referred to as “output devices”). Current is limited only when the device temperature becomes excessive (and by the minimum amount required). This patented approach is called Output Device Emulation Protection (or ODEP). It maximizes the available output power and protects against overheating—the major cause of device failure.

The amplifier is protected from all common hazards that plague high-power amplifiers including shorted, open or mismatched loads; overloaded power supplies, excessive temperature, chain-destruction phenomena, input overload and high-frequency blowups. The unit protects loudspeakers from input and output DC, as well as turn-on and turn-off transients.

The four-quadrant topology used in a Macro-Tech’s grounded output stages is called the Grounded Bridge. This patented topology makes full use of the power supplies providing peak-to-peak voltages to the load that are twice the voltage seen by the output devices (see Figure 5.1).

As its name suggests, the Grounded Bridge topology is referenced to ground. Composite devices are constructed to function as gigantic NPN and PNP devices to handle currents which exceed the limits of available devices. Each output stage has two composite NPN devices and two composite PNP devices.

The devices connected to the load are referred to as “high-side NPN and PNP” and the devices connected to ground are referred to as “low-side NPN and PNP.” Positive current is delivered to the load by increasing conductance simultaneously in the high-side NPN and low-side PNP stage, while synchronously decreasing conductance of the high-side PNP and low-side NPN.

The two channels may be used together to double the voltage (Bridge-Mono) or the current (Parallel-Mono) presented to the load. This feature gives you flexibility to maximize the power available to the load.

A wide bandwidth, multiloop design is used for state-of-the-art compensation. This produces ideal behavior and results in ultra-low distortion values.

Aluminum extrusions have been widely used for heat sinks in power amplifiers due to their low cost and reasonable performance. However, measured on a watts-per-pound or watts-per-volume basis, the extrusion technology doesn’t perform nearly as well as the heat sink technology developed for Macro-Tech amplifiers.

Our heat sinks are fabricated from custom convoluted fin stock that provides an extremely high ratio of area to volume, or area to weight. All power devices are mounted directly to massive heat spreaders that are electrically at the Vcc potential. Electrifying the heat spreaders improves thermal performance by eliminating the insulating interface underneath the power devices. The chassis itself is even used as part of the thermal circuit to maximize utilization of the available cooling resources.

5.2 Circuit Theory

Each channel is powered by its own power transformer T100 or T200. Both channels share a common low-voltage transformer TF-1. The secondary output of T100 is full-wave rectified by D109 and is filtered by a large computer-grade capacitor. D104 through D107 provide boosted voltage to power LVAs and predrivers. A thermal switch embedded in each transformer protects it from overheating.

The low-voltage transformer output is rectified by diodes D1, D2, D3 and D4 to generate an unregulated 24 volts. Monolithic regulators U1 and U2 provide a regulated ± 15 volts.

5.2.1 Stereo Operation

For simplicity, the discussion of Stereo operation will refer to one channel only. Mono operation will be discussed later.

Please refer to the block diagram in Figure 5.1 and the schematics provided at the back of this manual.

The input signal at the phone jack passes directly into the balanced gain stage (U104-C and U104-D). When the PIP module is used, the input signal first passes through the PIP’s circuitry and then to the balanced gain stage.

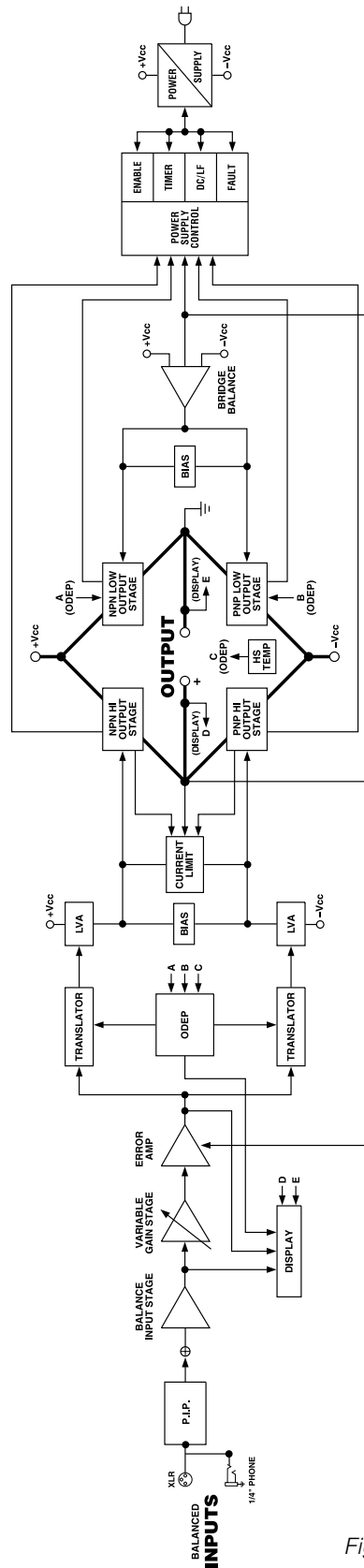

ONLY ONE CHANNEL SHOWN

Fig. 5.1 Circuit Block Diagram

The balanced gain stage (U104-C and U104-D) causes balanced to single-ended conversion using a difference amplifier. From there, gain can be controlled with a potentiometer. The error amp (U104-A) amplifies the difference between the output signal and the input signal from the gain pot, and drives the voltage translator stage.

From the error amp U104-A, the voltage translator stage channels the signal to the Last Voltage Amplifiers (LVAs) depending on the signal polarity. The +LVA (Q104 and Q105) and the -LVA (Q110 and Q111), with their push-pull effect through the bias servo Q318, drive the fully complementary output stage.

The bias servo Q318 is thermally coupled to the heat sink, and sets the quiescent bias current in the output stage to lower the distortion in the crossover region of the output signal. Depending on the polarity of the output signal, D301, D302, D303 and D304 are used to remove the charge on the unused portion of the output stage.

With the voltage swing provided by the LVAs, the signal then gains current amplification through the Darlington emitter-follower output stage.

The bridge-balanced circuit (U104-B) receives a signal from the output of the amplifier, and differences it with the signal at the Vcc supply. The bridge-balanced circuit then develops a voltage to drive the bridge-balanced output stage. This results in the Vcc supply having exactly one half of the output voltage added to their quiescent voltage. D309, D310, D311 and a trimmer resistor set the quiescent current point for the bridge-balanced output stage.

The protection mechanisms that affect the signal path are implemented to protect the amplifier under real-world conditions. These conditions are high instantaneous current, excessive temperature, and output device operation outside safe conditions.

Q107 and Q108 sense current in the output stage and act as a conventional current limiter. When current at any one instant exceeds the design criteria, the limiters remove the drive from the LVAs, thus limiting current in the output stage to a safe level.

To further protect the output stages, the patented ODEP circuitry is used. It produces an analog output proportional to the always-changing *safe operating area* of the output transistor. This output controls the translator stage previously mentioned, removing any further drive that may exceed the *safe operating area* of the output stage.

Thermal sensor S100 gives the ODEP circuits vital information on the operating temperature of the heat sink on which the output devices are mounted.

Should the amplifier fail in such a way that would cause DC across the output leads, the DC protection circuit senses this on the negative feedback loop and shuts down the power supply until the DC is removed.

5.2.2 Bridge-Mono Operation

By setting the back panel stereo/mono switch to Bridge-Mono, the user can convert the Macro-Tech into a bridged, single-channel amplifier. With a signal applied to the Channel 1 input jack and the load connected across the red (+) back panel 5-way binding posts, twice the voltage can be output.

The Channel 1 output feeds the Channel 2 error amp U204-A. Because there is a net inversion, the channel 2 output is out of polarity with Channel 1. This produces twice as much voltage across the load. Each of the channel's protection mechanisms work independently if a fault occurs.

5.2.3 Parallel-Mono Operation

With the stereo/mono switch set to Parallel-Mono, the output of Channel 2 is paralleled with the output of Channel 1. A suitable jumper capable of handling high current levels must be connected across the red (+) 5-way binding posts to gain the benefits of this mode of operation.

The signal path for Channel 1 is the same as previously discussed, except Channel 1 also drives the output stage of Channel 2. The Channel 2 balanced input, error amp, translators and LVAs are disconnected and no longer control the Channel 2 output stage. Disconnecting the front-end stages from the Channel 2 output causes the Channel 2 IOC circuit to note that the input waveform (which is not present) does not match the output waveform (which is driven by the Channel 1 input signal). This activates the Channel 2 IOC indicator any time the amplifier is switched to Parallel-Mono. The Channel 2 output stage and protection mechanisms are also coupled through S1 and function as one.

In Parallel-Mono mode, twice the current of one channel alone can be obtained. Because the Channel 2 ODEP circuit is coupled through S1, this gives added protection if a fault occurs in the Channel 2 output stage. The ODEP circuit of Channel 2 will limit the output of both output stages by removing the drive from the Channel 1 translator stages.

6 Specifications

The following applies to units in Stereo mode with 8-ohm loads and an input sensitivity of 26 dB gain unless otherwise specified.

Standard 1 kHz Power: refers to maximum average power in watts at 1 kHz with 0.1% THD.

Full Bandwidth Power: refers to maximum average power in watts from 20 Hz to 20 kHz with 0.1% THD.

120 VAC, 60 Hz Units: refers to amplifiers with dedicated transformers for 120 VAC, 60 Hz power mains.

International Units: refers to amplifiers with special multi-tap transformers that are configurable for several AC mains voltages and line frequencies (some are labeled 602, 1202 and 2402).

Performance

Frequency Response: ± 0.1 dB from 20 Hz to 20 kHz at 1 watt (see Figure 6.7).

Phase Response: ± 10 degrees from 10 Hz to 20 kHz at 1 watt (see Figure 6.10).

Signal-to-Noise Ratio, A-weighted: Better than 105 dB below rated power. Better than 100 dB below full bandwidth power.

Total Harmonic Distortion (THD): Less than 0.05% at full bandwidth power from 20 Hz to 1 kHz increasing linearly to 0.1% at 20 kHz.

Intermodulation Distortion (IMD): (60 Hz, 7 kHz) Less than 0.05% from 163 milliwatts to full bandwidth power.

Damping Factor: Greater than 1,000 from 10 Hz to 400 Hz (see Figure 6.8).

Crosstalk: See Figures 6.11, 6.12 and 6.13.

Slew Rate: Greater than 13 volts per microsecond.

Voltage Gain: 20:1 $\pm 3\%$ or 26 dB ± 0.25 dB at the maximum level setting (also see Section 4.4).

Macro-Tech 602: 54:1 $\pm 12\%$ or 35 dB ± 0.5 dB at 0.775 volt sensitivity; 30:1 $\pm 12\%$ or 30 dB ± 0.5 dB at 1.4 volt sensitivity.

Macro-Tech 1202: 64:1 $\pm 12\%$ or 36 dB ± 0.5 dB at 0.775 volt sensitivity; 36:1 $\pm 12\%$ or 31 dB ± 0.5 dB at 1.4 volt sensitivity.

Macro-Tech 2402: 83:1 $\pm 12\%$ or 38 dB ± 0.5 dB at 0.775 volt sensitivity; 46:1 $\pm 12\%$ or 33 dB ± 0.5 dB at 1.4 volt sensitivity.

Power

Output Power: The following are guaranteed minimums for standard 1 kHz power from 120 VAC, 60 Hz North American units. For more information or specs on international units, see the power matrices that follow.

Macro-Tech 602

Stereo mode (both channels driven):

- 400 watts into 2 ohms.
- 325 watts into 4 ohms.
- 220 watts into 8 ohms.

Bridge-Mono mode:

- 750 watts into 4 ohms.
- 655 watts into 8 ohms.
- 450 watts into 16 ohms.

Parallel-Mono mode:

- 700 watts into 1 ohm.
- 665 watts into 2 ohms.
- 450 watts into 4 ohms.

Macro-Tech 1202

Stereo mode (both channels driven):

- 675 watts into 2 ohms.
- 480 watts into 4 ohms.
- 310 watts into 8 ohms.

Bridge-Mono mode:

- 1300 watts into 4 ohms.
- 970 watts into 8 ohms.
- 620 watts into 16 ohms.

Parallel-Mono mode:

- 1300 watts into 1 ohm.
- 965 watts into 2 ohms.
- 620 watts into 4 ohms.

Macro-Tech 2402

Stereo mode (both channels driven):

- 1050 watts into 2 ohms.
- 800 watts into 4 ohms.
- 520 watts into 8 ohms.

Bridge-Mono mode:

- 2070 watts into 4 ohms.
- 1585 watts into 8 ohms.
- 1035 watts into 16 ohms.

Parallel-Mono mode:

- 2080 watts into 1 ohm.
- 1605 watts into 2 ohms.
- 1035 watts into 4 ohms.

Load Impedance: Safe with all types of loads. Rated for 2 to 16 ohms in Stereo, 4 to 16 ohms in Bridge-Mono and 1 to 4 ohms in Parallel-Mono mode.

Required AC Mains: 50/60 Hz; 100, 120, 220 and 240 VAC ($\pm 10\%$) units are available. All draw 100 watts or less at idle. Current, voltage and frequency requirements are provided on the unit's back panel (also see Section 7).

Amplifiers don't create energy. The AC mains voltage and current must be sufficient to deliver the power you expect.

Controls

Enable: A front panel push button used to turn the amplifier on and off.

Level: A front panel rotary control for each channel with 31 detents used to control the output level.

Stereo/Mono: A three-position back panel switch used to select Stereo, Bridge-Mono or Parallel-Mono mode.

Sensitivity: A three-position switch inside the PIP compartment used to select the input sensitivity for both channels: 0.775 volts or 1.4 volts for standard 1 kHz power, or a 26 dB voltage gain.

Reset (Macro-Tech 2402 only): A back panel push button for each channel used to reset the circuit breaker that protects each power supply.

Indicators

Enable: This amber front panel indicator shows the on/off status of the low-voltage power supply.

Signal/IOC: Each channel has a green front panel indicator that flashes to show amplifier output. If a channel's output waveform differs from its input by 0.05% or more, the indicator flashes *brightly* to show distortion. This function provides *proof of distortion-free performance*. In Parallel-Mono mode, the Channel 2 light stays on (see Section 4.2).

ODEP: Each channel has an amber front panel indicator that shows thermal-dynamic energy reserve. Normally, each ODEP indicator is lit to show available reserve energy. In the rare event that a channel has no reserve, its indicator will dim in proportion to ODEP limiting. An ODEP indicator may also turn off under other conditions (see Section 4.2).

Input/Output

Input Connector: Two balanced 1/4-inch phone jacks on the back panel and two balanced three-pin female XLR connectors on the factory-installed PIP2-FXQ (see Section 8 for information on optional PIP modules).

Input Impedance: Nominally 20 k ohms, balanced. Nominally 10 k ohms, unbalanced.

Input Sensitivity: Settings include 0.775 volts or 1.4 volts for standard 1 kHz power, or a 26 dB voltage gain (see Section 4.4 for more information).

Output Connectors: Two sets of color-coded 5-way binding posts (for banana plugs, spade lugs or bare wire).

Output Impedance: Less than 10 milliohms in series with less than 2 microhenries (see Figure 6.9).

DC Output Offset: (Shorted input) ± 10 millivolts.

Output Signal

Stereo: Unbalanced, two-channel.

Bridge-Mono: Balanced, single-channel. Channel 1 controls are active; Channel 2 should not be used.

Parallel-Mono: Unbalanced, single-channel. Channel 1 controls are active; Channel 2 controls are bypassed.

Protection

Macro-Tech amplifiers are protected against shorted, open or mismatched loads; overloaded power supplies; excessive temperature, chain destruction phenomena, input overload damage and high-frequency blowups. They also protect loudspeakers from input/output DC and turn-on/turn-off transients.

If unreasonable operating conditions occur, the patented ODEP circuitry will proportionally limit the drive level to protect the output transistor stages, particularly in the case of elevated temperature. Transformer overheating will result in a temporary shutdown of the affected channel; when it has cooled to a safe temperature, the transformer will automatically reset itself. Controlled slew-rate voltage amplifiers prevent RF burnouts. And input overload protection is provided by current-limiting resistance at the input. Refer to Section 4.3.

Turn On: Four-second delay with no dangerous transients. Contact Crown's Technical Support Group to change the turn-on delay time.

Construction

Steel chassis with durable black finish, aluminum front panel with Lexan overlay, and specially designed flow-through ventilation from front to side panels.

Cooling: Internal heat sinks with forced-air cooling for rapid, uniform heat dissipation.

Dimensions: Standard 19-inch (48.3-cm) rack mount width (EIA RS-310-B), 3.5-inch (8.9-cm) height, 16 inch (40.6-cm) depth behind the mounting surface and 2.5-inch (6.3-cm) protrusion in front of the mounting surface.

Approximate Weight: Center of gravity is 6 inches (15.2 cm) behind front mounting surface.

120 VAC, 60 Hz Units:

Macro-Tech 602: 39 pounds, 9 ounces (17.9 kg) net; 44 pounds (19.9 kg) shipping weight.

Macro-Tech 1202: 44 pounds, 1 ounce (20.0 kg) net; 47 pounds (21.3 kg) shipping weight.

Macro-Tech 2402: 51 pounds, 12 ounces (23.5 kg) net; 65 pounds (29.5 kg) shipping weight.

International Units:

Macro-Tech 602: 41 pounds, 15 ounces (19.0 kg) net; 46 pounds (20.9 kg) shipping weight.

Macro-Tech 1202: 42 pounds, 12 ounces (19.4 kg) net; 46 pounds, 13 ounces (21.3 kg) shipping weight.

Macro-Tech 2402: 48 pounds, 15 ounces (22.2 kg) net; 57 pounds, 6 ounces (26.0 kg) shipping weight.

Crown specifications are guaranteed for three years.

In an effort to provide you with as much information as possible about the high power-producing capabilities of your amplifier, we have created the following power matrices.

Minimum Guaranteed Power Specifications

Crown's minimum power specifications represent the absolute smallest amount of output power you can expect from your amplifier when it is driven to full output under the given conditions. Some spaces in each matrix may be left blank because the same guarantee is not provided for those conditions—however, your amplifier will perform well under all conditions listed in each matrix.

When measuring power, 0.1% THD appears to be the industry standard for distortion. Two of the maximum average power specifications shown in each minimum power matrix are measured at 0.1% THD so you can easily compare Crown specifications to those of other manufacturers. But this high level of distortion actually allows for some clipping which is undesirable. Because of this, a maximum average power spec at 0.05% THD is included in each minimum power matrix which represents non-clipped conditions. Although most manufacturers do not give you power specifications at 0.05% THD, we encourage them to provide these specifications so you will have a more realistic representation of the way amplifiers should be used in the real world—without a clipped output signal.

Many manufacturers publish power specs with a tolerance of ± 1 dB or worse. This means their amplifier can deviate more than 20% in output! A 100-watt amplifier would meet their specification if it only produced 79.4 watts. Other manufacturers qualify their specs by saying they are "typical," "subject to manufacturing tolerances," "single channel driven" or that they are specified with "fuses bypassed." Each of these statements effectively removes any performance guarantee. In fact, some manufacturers use these tactics to generate large power numbers, and they don't even print a disclaimer. We take a different approach at Crown—our amplifiers are *guaranteed* to meet or exceed their specifications for three years. Further, because our published specs are set below our "in-house" measurements, you can expect every Crown amplifier to exceed its published minimum power specs. We believe you should get what you pay for.

Macro-Tech 602 – Minimum Guaranteed Power (Watts)							
AC Mains	Stereo-Mono Mode	Load (Ohms)	Maximum Average			FTC Continuous Average	
			At 0.1% THD (See note 1)	At 0.1% THD (See note 2)	At 0.05% THD (See note 3)	At 0.1% THD (See note 4)	
			1 kHz	20Hz-20kHz	1 kHz	1 kHz	20Hz-20kHz
120 VAC, 60 Hz Units	Stereo (both channels driven)	2	400	335	395		
		4	325	300	325	320	285
		8	225	210	220	220	210
	Bridge-Mono (balanced output)	4	750	650	745		
		8	655	605	650	645	570
		16	450	425	445	450	420
	Parallel-Mono	1	700		695		
		2	665		660	635	
		4	450		450	450	
International Units	Stereo (both channels driven)	2			375		
		4	335	305	330	320	285
		8		220	230	230	215
	Bridge-Mono (balanced output)	4	730		725		
		8		625	670	645	565
		16	465	440	465	465	430
	Parallel-Mono	1			675		
		2	665		665	645	
		4			455	455	

Minimum Power Notes:

All minimum power specifications are based on 0.1% regulated AC mains and an ambient room temperature of 70° F (21° C). International units with multi-tap transformers are specified for the worst-case transformer tap (normally 100 VAC, 50 Hz). The standard EIA power measurement (RS-490) is not identified here because it is identical to the FTC Continuous Average Power specification.

1. A 1-kHz sine wave is presented to the amplifier and the output monitored for nonlinear distortion. The level is increased until the THD reaches 0.1%. At this level the average power per channel is reported.
2. A sine wave is presented to the amplifier over the range from 20 Hz to 20 kHz and the output monitored for nonlinear distortion. The level at each frequency is increased until the THD reaches 0.1%. At this level the average power per channel is reported.
3. A 1-kHz sine wave is presented to the amplifier and the output monitored for nonlinear distortion. The level is increased until the THD reaches 0.05%. At this level the average power per channel is reported.
4. Continuous power in the context of Federal Trade Commission testing is understood to be a minimum of five minutes of operation. Harmonic distortion is measured as the RMS sum total and given as a percentage of the fundamental output voltage. This applies for all wattages greater than 0.25 watts.

Fig. 6.1 Macro-Tech 602 Minimum Power Matrix

Macro-Tech 1202 – Minimum Guaranteed Power (Watts)							
AC Mains	Stereo-Mono Mode	Load (Ohms)	Maximum Average			FTC Continuous Average	
			At 0.1% THD (See note 1)	At 0.1% THD (See note 2)	At 0.05% THD (See note 3)	At 0.1% THD (See note 4)	
			1 kHz	20Hz-20kHz	1 kHz	1 kHz	20Hz-20kHz
120 VAC, 60 Hz Units	Stereo (both channels driven)	2	675	585	660		
		4	480	450	480	475	425
		8	310	295	305	305	295
	Bridge-Mono (balanced output)	4	1300	1130	1285		
		8	970	895	960	960	850
		16	620	590	615	620	585
	Parallel-Mono	1	1300		1290		
		2	965		960	950	
		4	620		615	610	
International Units	Stereo (both channels driven)	2		455	515		
		4	420	385	415	410	365
		8		275	285	280	265
	Bridge-Mono (balanced output)	4	1045	920	1030		
		8		780	840	830	730
		16	570	540	565	570	535
	Parallel-Mono	1			1040		
		2	845		845	820	
		4			570	565	

Fig. 6.2 Macro-Tech 1202 Minimum Power Matrix

Macro-Tech 2402 – Minimum Guaranteed Power (Watts)							
AC Mains	Stereo-Mono Mode	Load (Ohms)	Maximum Average			FTC Continuous Average	
			At 0.1% THD (See note 1)	At 0.1% THD (See note 2)	At 0.05% THD (See note 3)	At 0.1% THD (See note 4)	
			1 kHz	20Hz-20kHz	1 kHz	1 kHz	20Hz-20kHz
120 VAC, 60 Hz Units	Stereo (both channels driven)	2	1050	850	1025		
		4	800	750	785	770	685
		8	520	505	510	505	495
	Bridge-Mono (balanced output)	4	2070	1670	2030		
		8	1585	1485	1565	1530	1355
		16	1035	1000	1020	1005	955
	Parallel-Mono	1	2080		2050		
		2	1605		1590	1470	
		4	1035		1025	1005	
International Units	Stereo (both channels driven)	2			875		
		4	745	715	735	690	660
		8		500	510	505	500
	Bridge-Mono (balanced output)	4	1775		1735		
		8		1420	1475	1395	1320
		16	1030	1000	1020	1010	980
	Parallel-Mono	1			1750		
		2	1470		1460	1400	
		4			1010	1000	

Fig. 6.3 Macro-Tech 2402 Minimum Power Matrix

Maximum Power Specifications

Crown's maximum power specifications represent the largest amount of output power you can expect from your amplifier when it is driven to full output under the given conditions. These specifications can be used to prevent loudspeaker and hearing damage.

The maximum power matrices include specifications for single cycle and 40 millisecond burst sine waves. Burst signals act like large transient peaks that are present in common source signals. Loudspeakers can respond to a single cycle burst, so the single cycle burst specifications should be used to help you protect your loudspeakers. In contrast, a 40 millisecond burst represents the typical response time of the human ear. Your ear will not respond to the entire dynamic change of a burst that lasts less than 40 milliseconds.

The burst power specifications are provided at 0.05% THD which is a practical low-distortion condition. Operating the amplifier at levels higher than 0.05% THD can result in output power levels that are higher than those listed in the maximum power matrices.

Macro-Tech 602 – Maximum Power (Watts)										
AC Mains	Stereo-Mono Mode	Load (Ohms)	Single Cycle Tone Burst At less than 0.05% THD (See note 1)				40 Millisecond Tone Burst At 0.05% THD (See note 2)			
			20 Hz	50 Hz	1 kHz	7 kHz	50 Hz	1 kHz	7 kHz	
120 VAC, 60 Hz Units	Stereo (both channels driven)	2	460	460	475	495	460	430	455	
		4	350	430	575	560	375	340	355	
		8	255	280	325	320	245	235	245	
	Bridge-Mono (balanced output)	4	820	910	930	940	910	855	895	
		8	700	860	1165	1130	750	685	710	
		16	510	565	655	640	510	465	485	
	Parallel-Mono	1	905	920	940	970	920	860	890	
		2	765	865	1155	1120	750	690	710	
		4	520	560	650	635	510	465	485	
International Units	Stereo (both channels driven)	2		495	505	515	490	460	490	
		4		375	475	615	605	415	370	385
		8			310	350	345	270	250	260
	Bridge-Mono (balanced output)	4		945	970	985	990	970	915	960
		8			950	1240	1210	825	730	770
		16		520	620	700	680	545	500	525
	Parallel-Mono	1			915	930	970	915	895	940
		2		740	960	1230	1225	845	735	765
		4			610	700	675	540	505	530

Maximum Power Notes:

All maximum power specifications are based on 0.1% regulated AC mains and an ambient room temperature of 70° F (21° C). International units with multi-tap transformers are specified for the best-case transformer tap (normally 240 VAC, 60 Hz). Although it is an unusual condition, your amplifier can function well with AC mains voltages up to 10% over the specified line voltage. With overvoltage conditions, your amplifier may be capable of delivering instantaneous power levels up to 20% greater than the specifications in the matrix.

1. A single cycle sine wave is presented to the amplifier and monitored for nonlinear distortion. The average power during the burst is reported. Loudspeakers must be able to withstand this level if they are to be safely used with this amplifier.
2. A 40-millisecond sine wave burst (10 percent duty cycle) is presented to the amplifier and monitored for nonlinear distortion. The average power during the burst is reported. This power level is a measurement of the amplifier's maximum transient power that can be perceived by the human ear.

Fig. 6.4 Macro-Tech 602 Maximum Power Matrix

Macro-Tech 1202 – Maximum Power (Watts)									
AC Mains	Stereo-Mono Mode	Load (Ohms)	Single Cycle Tone Burst At less than 0.05% THD (See note 1)				40 Millisecond Tone Burst At 0.05% THD (See note 2)		
			20 Hz	50 Hz	1 kHz	7 kHz	50 Hz	1 kHz	7 kHz
120 VAC, 60 Hz Units	Stereo (both channels driven)	2	685	885	1050	1060	755	685	725
		4	515	620	770	750	535	500	525
		8	350	375	420	410	345	320	335
	Bridge-Mono (balanced output)	4	1475	1730	2025	1945	1475	1395	1395
		8	1030	1240	1585	1640	1120	1040	1120
		16	675	745	870	890	695	665	695
	Parallel-Mono	1	1325	1735	1980	2010	1495	1340	1405
		2	1010	1230	1515	1465	1060	980	1030
		4	690	750	830	810	675	630	660
International Units	Stereo (both channels driven)	2		850	1075	1090	755	640	680
		4	490	620	810	785	550	485	505
		8		385	440	425	350	320	335
	Bridge-Mono (balanced output)	4	1255	1650	2090	2120	1495	1265	1330
		8		1255	1615	1565	1105	980	1020
		16	655	765	880	850	695	640	670
	Parallel-Mono	1		1635	1980	1995	1485	1250	1315
		2	975	1250	1605	1555	1075	965	1005
		4		765	890	855	685	645	665

Fig. 6.5 Macro-Tech 1202 Maximum Power Matrix

Macro-Tech 2402 – Maximum Power (Watts)									
AC Mains	Stereo-Mono Mode	Load (Ohms)	Single Cycle Tone Burst At less than 0.05% THD (See note 1)				40 Millisecond Tone Burst At 0.05% THD (See note 2)		
			20 Hz	50 Hz	1 kHz	7 kHz	50 Hz	1 kHz	7 kHz
120 VAC, 60 Hz Units	Stereo (both channels driven)	2	1015	1405	1715	1675	1250	1090	1145
		4	780	965	1310	1270	860	795	830
		8	565	600	710	690	545	510	535
	Bridge-Mono (balanced output)	4	2010	2745	3380	3380	2465	2175	2265
		8	1590	1915	2610	2550	1775	1590	1660
		16	1120	1185	1420	1375	1085	1025	1065
	Parallel-Mono	1	1960	2780	3145	3045	2510	2145	2225
		2	1565	1955	2605	2505	1695	1580	1630
		4	1125	1185	1410	1365	1125	1020	1060
International Units	Stereo (both channels driven)	2		1485	1655	1680	1340	1080	1135
		4	835	1085	1515	1480	975	835	875
		8		690	825	800	625	565	585
	Bridge-Mono (balanced output)	4	2055	3000	3390	3335	2660	2140	2250
		8		2165	3055	2935	1950	1670	1740
		16	1165	1395	1675	1610	1245	1145	1190
	Parallel-Mono	1		2965	3065	3085	2645	2155	2235
		2	1665	2160	3040	2945	1940	1685	1735
		4		1375	1655	1600	1235	1125	1170

Fig. 6.6 Macro-Tech 2402 Maximum Power Matrix

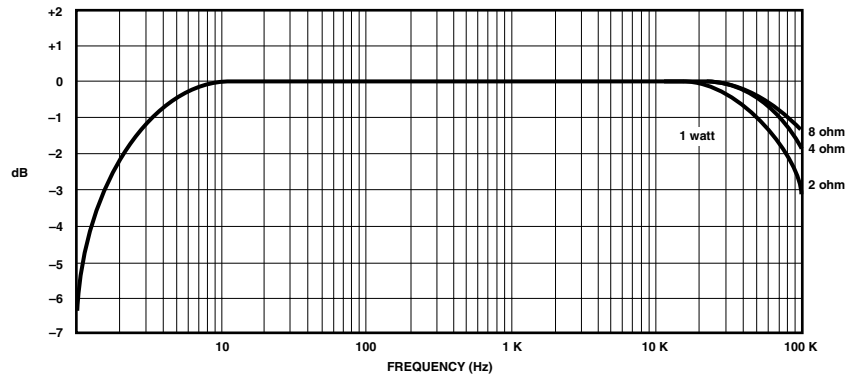

Fig. 6.7 Typical Frequency Response

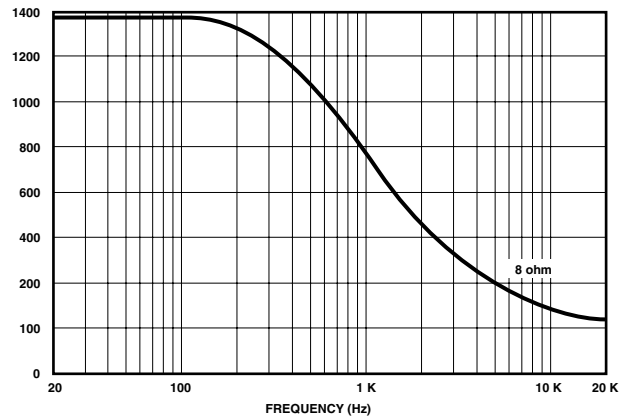

Fig. 6.8 Typical Damping Factor

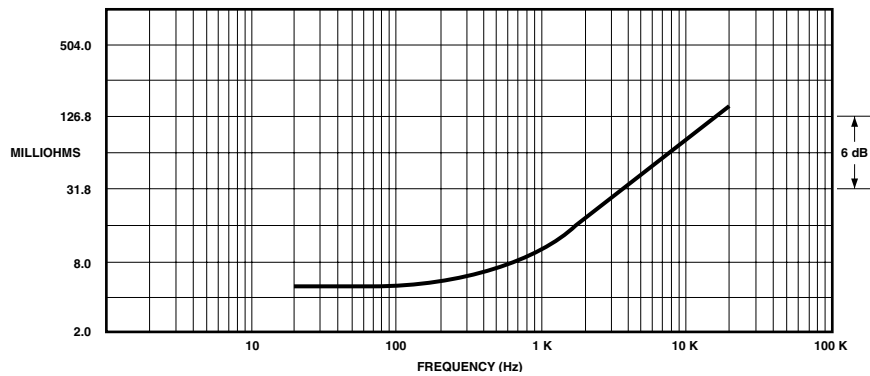

Fig. 6.9 Typical Output Impedance

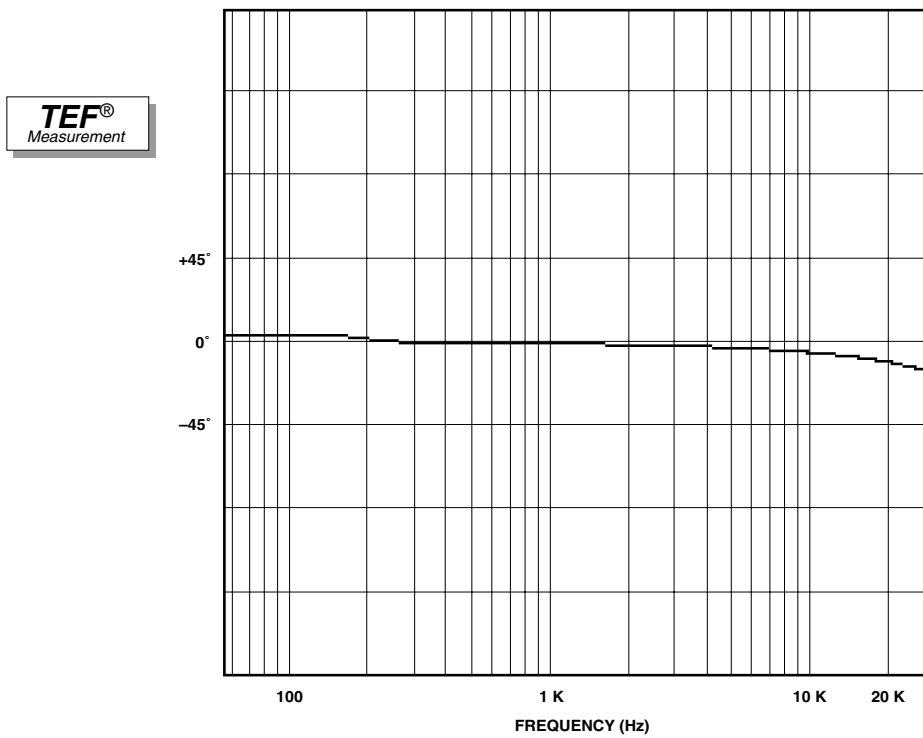

Fig. 6.10 Typical Phase Response

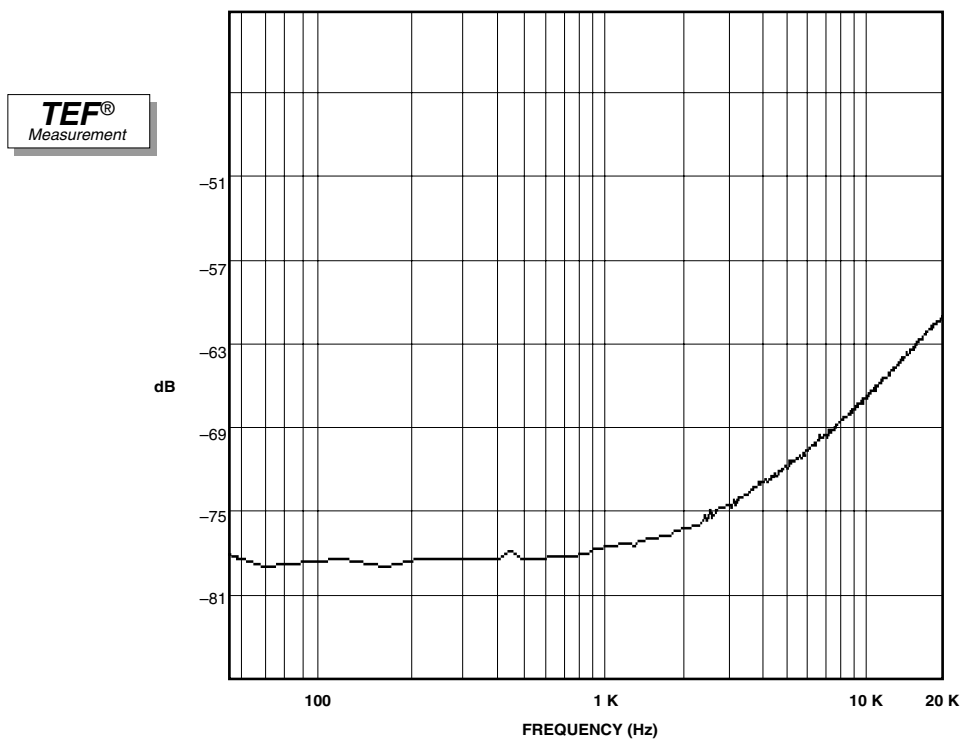

Fig. 6.11 Typical Crosstalk for the Macro-Tech 602

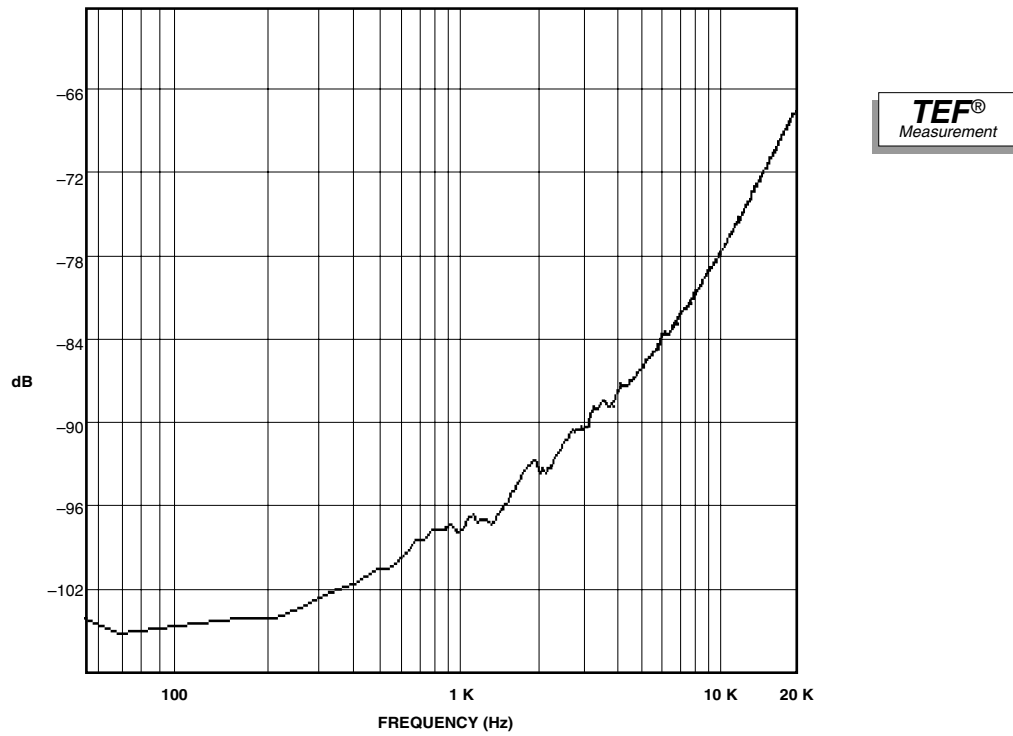

Fig. 6.12 Typical Crosstalk for the Macro-Tech 1202

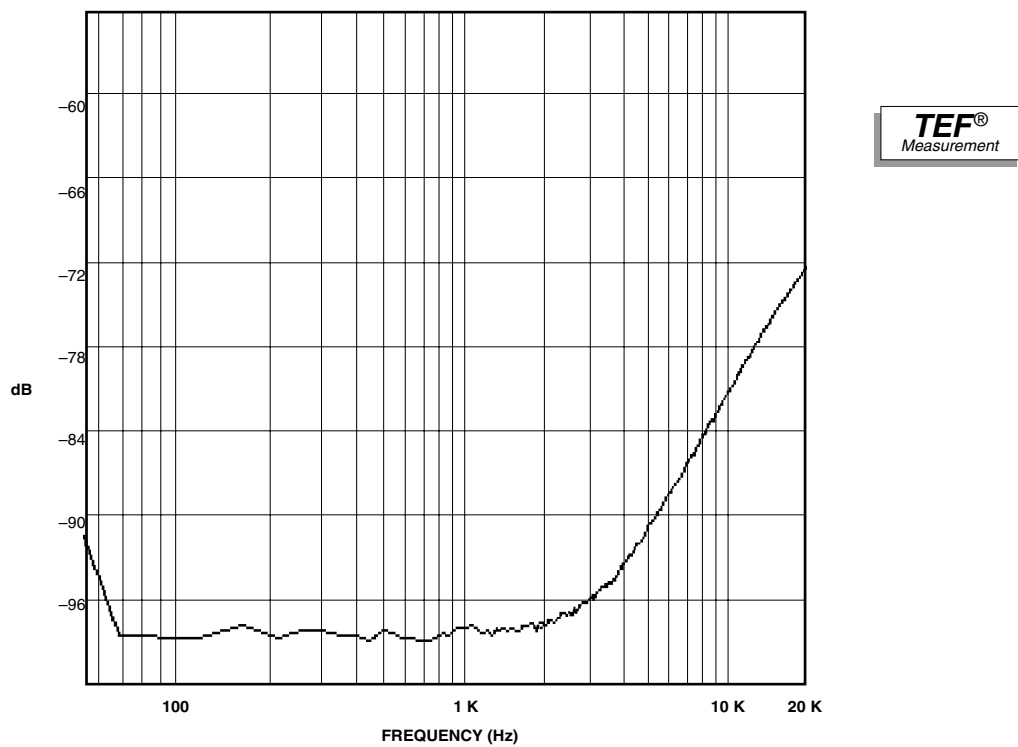

Fig. 6.13 Typical Crosstalk for the Macro-Tech 2402

7 AC Power Draw and Thermal Dissipation

This section provides detailed information about the amount of power and current drawn from the AC mains by the Macro-Tech 602, 1202 and 2402 amplifiers and the amount of heat produced under various conditions. The calculations presented here are intended to provide a realistic and reliable depiction of the amplifiers. The following assumptions or approximations were made:

- The amplifier's available channels are loaded and full power is being delivered.
- The amplifier efficiency at standard 1-kHz power is estimated to be 65%.
- Quiescent power draw is 90 watts (an almost negligible amount for full-power calculations).
- Quiescent thermal dissipation equals 105 btu/hr at 90 watts.
- The estimated duty cycles take into account the typical crest factor for each type of source material.
- Duty cycle of pink noise is 50%.
- Duty cycle of highly compressed rock 'n' roll mid-range is 40%.
- Duty cycle of rock 'n' roll is 30%.
- Duty cycle of background music is 20%.
- Duty cycle of continuous speech is 10%.
- Duty cycle of infrequent, short duration paging is 1%.

Here are the equations used to calculate the data presented in Figures 7.1 through 7.3:

$$\text{AC Mains Power Draw (watts)} = \frac{\text{Total output power with all channels driven (watts)} \times \text{Duty Cycle}}{\text{Amplifier Efficiency (.65)}} + \text{Quiescent Power Draw (watts)}$$

The quiescent power draw of 90 watts is a maximum value and includes power drawn by the fan. The following equation converts power draw in watts to current draw in amperes:

$$\text{Current Draw (amperes)} = \frac{\text{AC Mains Power Draw (watts)}}{\text{AC Mains Voltage} \times \text{Power Factor (.83)}}$$

The power factor of 0.83 is needed to compensate for the difference in phase between the AC mains voltage and current. The following equation is used to calculate thermal dissipation:

$$\text{Thermal Dissipation (btu/hr)} = \left(\frac{\text{Total output power with all channels driven (watts)} \times \text{Duty Cycle} \times .35}{\text{Amplifier Efficiency (.65)}} + \text{Quiescent Power Draw (watts)} \right) \times 3.415$$

The constant 0.35 is inefficiency (1.00–0.65) and the factor 3.415 converts watts to btu/hr. Thermal dissipation in btu is divided by the constant 3.968 to get kcal. If you plan to measure output power under real-world conditions, the following equation may also be helpful:

$$\text{Thermal Dissipation (btu/hr)} = \left(\frac{\text{Total measured output power from all channels (watts)} \times .35}{\text{Amplifier Efficiency (.65)}} + \text{Quiescent Power Draw (watts)} \right) \times 3.415$$

Macro-Tech 602

Duty Cycle	L O A D														
	8 Ohm Stereo				4 Ohm Stereo / 8 Ohm Bridge-Mono / 2 Ohm Parallel-Mono				2 Ohm Stereo / 4 Ohm Bridge-Mono / 1 Ohm Parallel-Mono						
	AC Mains Power Draw (Watts)	Current Draw (Amps)		Thermal Dissipation		AC Mains Power Draw (Watts)	Current Draw (Amps)		Thermal Dissipation		AC Mains Power Draw (Watts)	Current Draw (Amps)		Thermal Dissipation	
	100-120 V	220-240 V	btu/hr	kcal		100-120 V	220-240 V	btu/hr	kcal		100-120 V	220-240 V	btu/hr	kcal	
50%	450	4.5	2.3	740	185	615	6.1	3.1	930	235	720	7.2	3.6	1060	265
40%	380	3.8	1.9	655	165	510	5.1	2.6	805	205	595	6.0	3.0	910	230
30%	305	3.1	1.6	565	140	405	4.0	2.0	680	170	470	4.7	2.4	760	190
20%	235	2.4	1.2	480	120	300	3.0	1.5	560	140	340	3.4	1.7	610	155
10%	160	1.6	0.8	395	100	195	1.9	1.5	435	110	215	2.2	1.1	460	115

Fig. 7.1 Macro-Tech 602 Power Draw, Current Draw and Thermal Dissipation at Various Duty Cycles

Macro-Tech 1202

L O A D															
8 Ohm Stereo															
Duty Cycle	AC Mains Power Draw (Watts)	Current Draw (Amps)		Thermal Dissipation		AC Mains Power Draw (Watts)	Current Draw (Amps)		Thermal Dissipation		AC Mains Power Draw (Watts)	Current Draw (Amps)		Thermal Dissipation	
		100-120 V	220-240 V	btu/hr	kcal		100-120 V	220-240 V	btu/hr	kcal		100-120 V	220-240 V	btu/hr	kcal
		50%	580	5.8	2.9		895	225	850	8.5		4.3	1220	310	1165
40%	485	4.8	2.4	780	195	700	7.0	3.5	1035	260	950	9.5	4.8	1335	335
30%	385	3.9	2.0	660	165	545	5.5	2.8	855	215	735	7.4	3.7	1080	270
20%	285	2.9	1.5	545	135	395	3.9	2.0	670	170	520	5.2	2.6	820	205
10%	190	1.9	1.0	425	105	240	2.4	1.2	490	125	305	3.1	1.6	565	140

Fig. 7.2 Macro-Tech 1202 Power Draw, Current Draw and Thermal Dissipation at Various Duty Cycles

Macro-Tech 2402

L O A D															
8 Ohm Stereo															
Duty Cycle	AC Mains Power Draw (Watts)	Current Draw (Amps)		Thermal Dissipation		AC Mains Power Draw (Watts)	Current Draw (Amps)		Thermal Dissipation		AC Mains Power Draw (Watts)	Current Draw (Amps)		Thermal Dissipation	
		100-120 V	220-240 V	btu/hr	kcal		100-120 V	220-240 V	btu/hr	kcal		100-120 V	220-240 V	btu/hr	kcal
		50%	890	8.9	4.5		1265	320	1320	13.2		6.6	1780	450	1780
40%	730	7.3	3.7	1070	270	1075	10.8	5.4	1485	375	1445	14.4	7.2	1925	485
30%	570	5.7	2.9	880	220	830	8.3	4.2	1190	300	1105	11.1	5.6	1520	385
20%	410	4.1	2.1	690	175	580	5.8	2.9	895	225	765	7.7	3.9	1115	280
10%	250	2.5	1.3	500	125	335	3.4	1.7	600	150	430	4.3	2.2	710	180

Fig. 7.3 Macro-Tech 2402 Power Draw, Current Draw and Thermal Dissipation at Various Duty Cycles

8 Accessories

8.1 PIP and PIP2 Modules

One advantage of Crown PIP2 compatible amplifiers is the ability to customize them using PIP (Programmable Input Processor) and PIP2 modules. The PIPs shown here may be used in any Crown PIP2-compatible amplifier. PIPs carrying the PIP2 logo have been configured with an extended, PIP2-enhanced feature set.

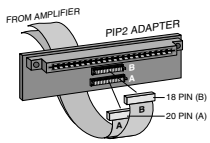

Fig. 8.1 PIP2 Adaptor Connection

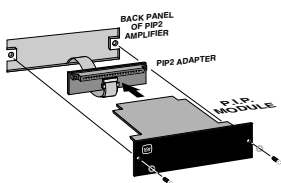

Fig. 8.2 Installing a PIP Module

The modules install easily: For PIP units featuring an edge-connector, first install the PIP2 adapter, then carefully slide the PIP card edge into the adapter's edge connector. Finally, insert the combined units into the amplifier and screw securely into place (see Figures 8.1 and 8.2).

For PIP2s featuring ribbon cable connectors, simply locate the two connectors on the underside of the PIP circuit board, then connect the two input ribbon cables coming from the amplifier. Both ribbon cables should run smoothly from the amplifier to the PIP card. Insert the PIP and attached cables into the PIP opening in the back of the amplifier, then screw securely into place (see Figure 8.3).

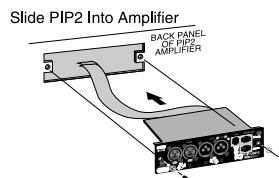
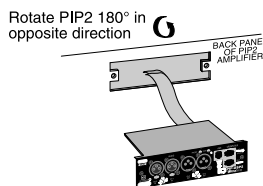
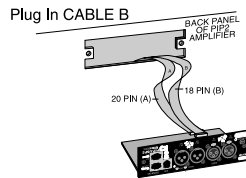
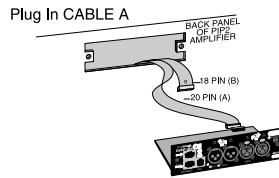
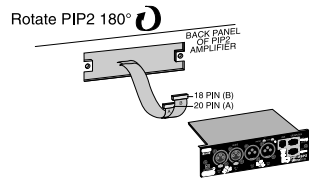
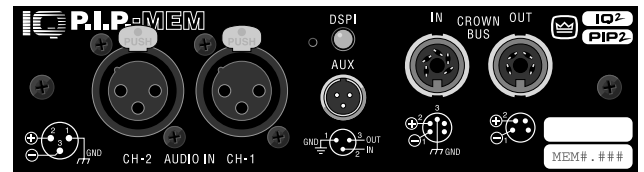

Fig. 8.3 Installing a PIP2 Module

For more information on these or other PIPs under development, contact your local dealer or Crown's Technical Support Group.



IQ-P.I.P.-DSP is an IQ System Programmable Input Processor with DSP (Digital Signal Processing) for PIP-compatible amplifiers. As a component of the IQ System, it connects the amplifier to the Crown Bus so the amplifier can be controlled and monitored. Its DSP capabilities enable it to be programmed with a variety of functions, such as filters and crossovers, signal delay, input compressor and output limiter, and a variety of other useful features similar to those included with the IQ-P.I.P.-SMT. Requires an IQ2 interface and a computer for initial setup.



IQ-P.I.P.-MEM Integrates Crown PIP-compatible amplifiers into Crown's IQ System. Each channel of each amplifier can be monitored and individually controlled from an inexpensive PC. A total of 15 functions can be either monitored or controlled. Memory backup is also incorporated in case of power failure. Requires an IQ2 interface and a computer for initial setup.

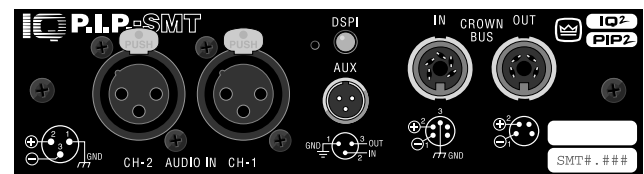

IQ-P.I.P.-SMT "Smart Amp" offers impressive new features unavailable elsewhere. The processing speed is substantially enhanced over other designs. A programmable power-supply gate conserves energy by shutting off the amplifier's high-power supplies until an audio signal is present. The user may define error-reporting conditions of the amplifier. There is much greater flexibility and thermal operational protection available, as well as a built-in smooth output limiter to discretely control maximum amplifier output. Requires an IQ2 interface and a computer for initial setup.



WARNING: Disconnect power to the amplifier when installing or removing a PIP module.

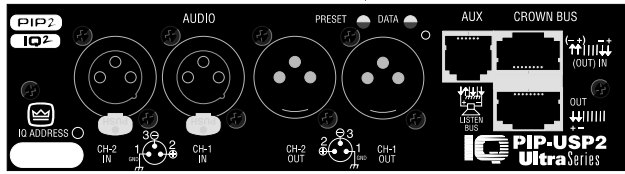

IQ-PIP-USP2 is an IQ2-series component. This means it supports Crown's UCODE protocol and requires an IQ System with an IQ2-compatible IQ interface. UCODE (universal code) enables users and third parties to develop custom software objects to control and monitor IQ2-compatible components like the IQ-PIP-USP2.

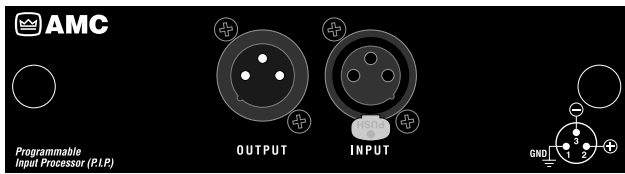

P.I.P.-AMCb combines many of the features found in the P.I.P.-XOV and P.I.P.-CLP to provide both a variable 4th-order Linkwitz-Riley crossover and an IOC-driven or variable-threshold signal-driven compressor. In addition, variable equalization networks provide for "constant-directivity" horn equalization and filter-assisted B6 vented bass box equalization. Bi-amping and tri-amping capabilities are provided via XLR connectors.

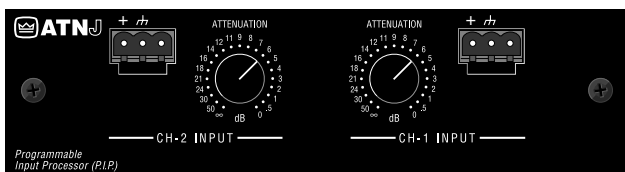

P.I.P.-ATNJ includes the features of the P.I.P.-FXT (balanced Jensen® 1:1 isolation transformers) and adds to each channel a 12-dB/octave RFI filter, a variable 18-dB/octave high-pass filter (to reduce bass/subsonic frequencies), and a 6-dB/octave 3-kHz shelving network for "constant-directivity" horn equalization. Special quick-connect barrier blocks are provided for inputs to each channel. Also adds a Jensen® 32-step precision attenuator to each channel.

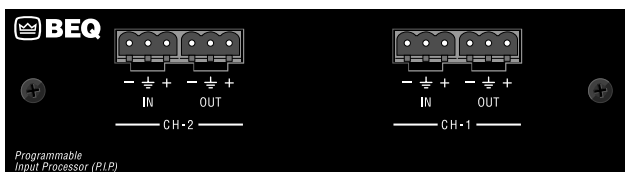

P.I.P.-BEQC adds many features of the Bose® Controllers to the input of your amplifier. Each channel includes a custom equalization network for Bose loudspeakers. Also included is a bass-cut (high-pass) filter for each channel. The equalization and bass-cut filters can be bypassed, if desired. Balanced inputs and "daisy-chain" outputs use

removable barrier block connectors for quick, solderless connections.

P.I.P.-BEQX Same as P.I.P.-BEQC but with XLR connectors.

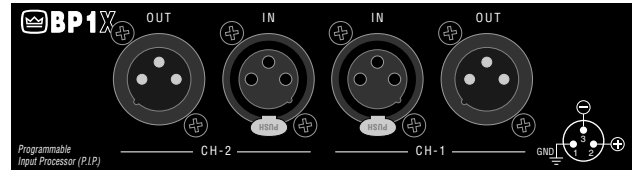

P.I.P.-BP1C The P.I.P.-BP1C is a versatile, stereo band-pass processor that plugs into any PIP-capable Crown amplifier. Each channel of the P.I.P.-BP1C is completely independent from the other and combines the functions of a low-pass filter, a high-pass filter, vented loudspeaker box equalization, horn equalization and compression. DIP switches and convenient jumper blocks make it easy to configure any of its powerful operating features. Uses removable barrier block, quick-disconnect connectors. **P.I.P.-BP1X** Same as the P.I.P.-BP1C but with XLR connectors.

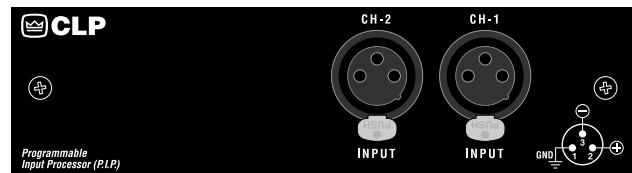

P.I.P.-CLP is designed to detect and prevent overload. The same error detecting circuit that is used to signal the IOC indicator is used to activate this error-driven compressor. It is not a typical signal-driven compressor, but a circuit to prevent any overload. It can yield up to 13 dB or additional signal safety margin without noticeable program change.

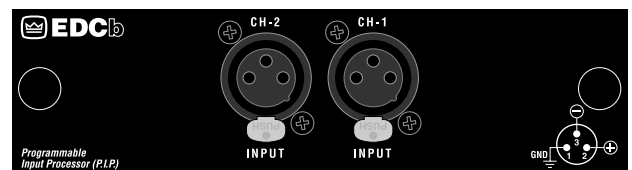

P.I.P.-EDCb State-of-the-art programmable error-driven and signal-driven compressor plus a variable high-pass filter for each channel. Fast or slow attach and release times can be set independently for each channel.

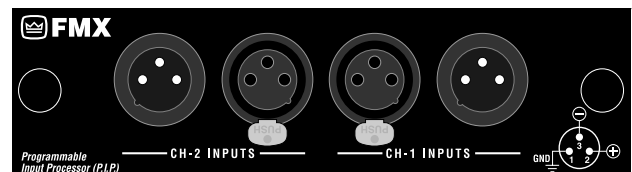

P.I.P.-FMX facilitates "daisy-chaining" several amplifier balanced inputs together. Female to male 3-pin XLR connectors are used to passively bridge the amplifier inputs.

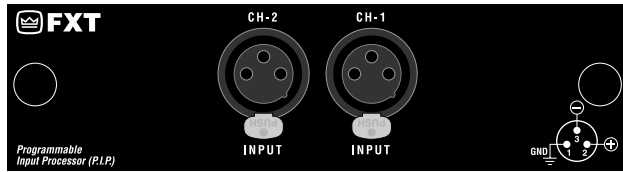

P.I.P.-FXT uses balanced 1:1 transformers to isolate the source from the inputs. It comes with balanced female 3-pin XLR connectors.

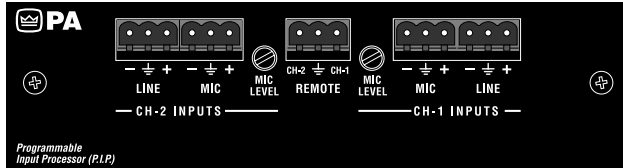

P.I.P.-PA permits the unique capability of adding one mic/line input directly to each channel of an amplifier. With phantom power for microphones, this mic/line input may be remotely switched from mic to line priorities.

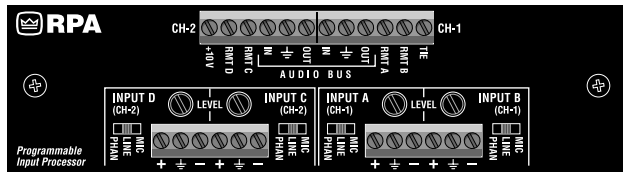

P.I.P.-RPA A phantom-power mixer that has four balanced mic or line inputs with voiceover capability and adjustable “duck” level, 84 dB of attenuation. A 10-volt DC source for remote control capability is provided. The P.I.P.-EXT (Part M44731-4), available from service, allows the P.I.P.-RPA and other PIP cards to be “extended” outside the amplifier for easy set up.

P.I.P.-RPAT has the same features as the P.I.P.-RPA but includes four input transformers.

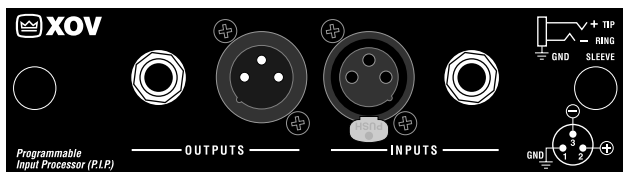

P.I.P.-XOV is a versatile, economical mono 12- or 18-dB/octave crossover/filter which offers bi-amping and tri-amping capability.

8.2 Cooling Fan Options

Every Macro-Tech amplifier has a built-in high-velocity fan that provides optimum cooling. Two optional replacement fan blades are available for special cooling requirements. Crown part C 6594-3 is a quieter, low-velocity fan blade that in many cases can provide adequate cooling. Crown part C 6593-5 is a reverse air-flow fan blade which changes the direction of the air flow in and out of the amplifier (not recommended for the Macro-Tech 2402). Important: The optional replacement fan blades should only be installed by a qualified technician.

8.3 Level Control Shaft Lock

A security accessory, the shaft lock can be used to secure your amplifier's level controls in situations where the front panel controls are subject to tampering. One is needed for each channel. They can be ordered through the Crown Service/Parts Department. For more information, contact your local Crown dealer or Crown's Technical Support Group.

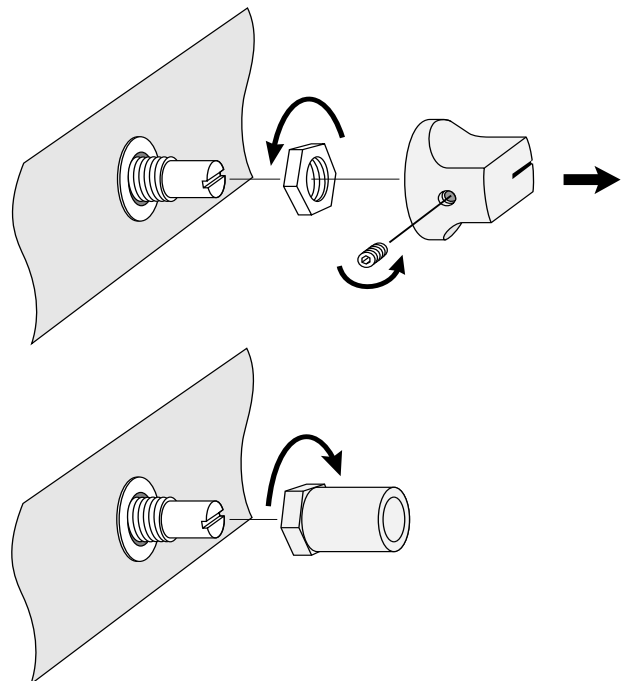

Fig. 8.4 Installing a Level Control Shaft Lock

9 Service

This unit has very sophisticated circuitry which should only be serviced by a fully trained technician. This is one reason why each unit bears the following label:



CAUTION: To prevent electric shock, do not remove covers. No user serviceable parts inside. Refer servicing to a qualified technician.

9.1 Worldwide Service

Service may be obtained from an authorized service center. (Contact your local Crown/Amcron representative or our office for a list of authorized service centers.) To obtain service, simply present the bill of sale as proof of purchase along with the defective unit to an authorized service center. They will handle the necessary paperwork and repair.

Remember to transport your unit in the original factory pack.

9.2 North American Service

Service may be obtained in one of two ways: from an authorized service center or from the factory. You may choose either. It is important that you have your copy of the bill of sale as your proof of purchase.

9.2.1 Service at a North American Service Center

This method usually saves the most time and effort. Simply present your bill of sale along with the defective unit to an authorized service center to obtain service. They will handle the necessary paperwork and repair. Remember to transport the unit in the original factory pack. A list of authorized service centers in your area can be obtained from our Technical Support Group.

9.2.2 Factory Service

To obtain factory service, fill out the **service information page** that follows and send it along with your proof of purchase and the defective unit to the Crown factory.

For warranty service, we will pay for ground shipping both ways in the United States. Contact Crown Factory Service or Technical Support to obtain prepaid shipping labels prior to sending the unit. Or, if you prefer, you may prepay the cost of shipping, and Crown will reimburse you. Send copies of the shipping receipts to Crown to receive reimbursement.

Your repaired unit will be returned via UPS ground. Please contact us if other arrangements are required.

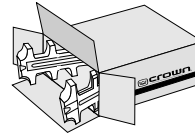

Always use the original factory pack to transport the unit.

Factory Service Shipping Instructions:

1. When sending a Crown product to the factory for service, be sure to fill out the service information form that follows and enclose it inside your unit's shipping pack. Do not send the service information form separately.
2. To ensure the safe transportation of your unit to the factory, ship it in an original factory packing container. If you don't have one, call or write Crown's Parts Department. With the exception of polyurethane or wooden crates, any other packing material will not be sufficient to withstand the stress of shipping. **Do not use loose, small size packing materials.**
3. Do not ship the unit in any kind of cabinet (wood or metal). Ignoring this warning may result in extensive damage to the unit and the cabinet. Accessories are not needed—do not send the instruction manual, cables and other hardware.

If you have any questions, please call or write the Crown Technical Support Group.

Crown Audio Customer Service

Technical Support / Factory Service
Plant 2 SW, 1718 W. Mishawaka Rd., Elkhart,
Indiana 46517 U.S.A.

Telephone: 219-294-8200
800-342-6939 (North America,
Puerto Rico, and Virgin Islands only)

Facsimile: 219-294-8301 (Technical Support)
219-294-8124 (Factory Service)

Fax Back: 219-293-9200 (North America only)
800-294-4094 (North America only)
219-294-8100 (International)

Internet: <http://www.crownaudio.com>

