

We've expanded our product offering to include a broad range of combustion solutions, industrial burners, and burner controls. Lesman is now a Honeywell Combustion Solutions Distributor. We can provide you with quick delivery, factory support, and up-to-date information on Honeywell flame safeguard, burner controls, and accessories. Lesman is also now an authorized distributor for Maxon valves and industrial burners, providing you a complete burner solution.

With the increased focus on emissions control, we've teamed up with vendors that have solutions to reduce NOx and environmental pollutants. If you're looking for an analyzer we don't carry, our partners at RAECO can help you out.

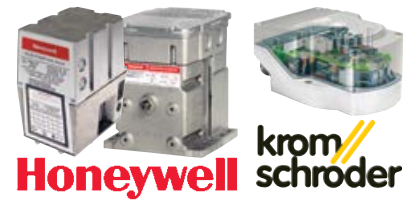

	Prices Start at	See Page
Actuators		
Honeywell ControlLinks™ Parallel-Position Actuators	\$339.30	263
Honeywell Modutrol IV Low-Torque Rotary Actuator Motors	\$979.50	285
Honeywell V4055 On-Off Gas Valve Actuators	\$565.72	281
Kromschroder IC20/IC40 Valve Actuators	\$412.00	286



Burner Control Systems		
Fireye Flame Monitor Burner Control System	\$1102.00	270
Fireye Industrial MB Multi-Burner Flame Safeguard System	\$2094.00	271
Honeywell 7800 Series Microprocessor-Based Burner Controls	\$605.07	264
Honeywell ControlLinks™ Integrated Combustion Panels	\$13207.36	259
Honeywell ControlLinks™ Linkageless Fuel Air Ratio Controls	\$876.18	262
Honeywell Delphi Boiler Control Systems	Call	260
Honeywell IRIS Signal Processors for Industrial Burners	\$1148.41	275
Honeywell RA890 Protectorelay® Electromechanical Primary Controls	\$2947.35	265
Kromschroder Flame Relays and Burner Control Modules	\$271.00	274
Maxon SMARTFIRE® Intelligent Combustion Control System	Call	261
Maxon SMARTLINK® Thermal Mass Flowmeter	Call	261



Combustion Efficiency Analyzers		
Honeywell ControlLinks™ Integrated Combustion Panels	\$13207.36	259
Honeywell Delphi Combustion Efficiency Panel	Call	260



Flame Detectors and Amplifier Modules		
Fireye Discrete Flame Scanners	\$137.00	273
Fireye Integrated Flame Scanners with Internal Flame Relay	\$1960.00	272
Honeywell R78 Series Flame Signal Amplifiers	\$282.88	266
Honeywell Flame Detectors	\$129.28	268
Honeywell IRIS Industrial Flame Detectors	\$1671.78	276
Kromschroder UVS10D2 Ultraviolet Flame Detector	\$190.00	274



Industrial Burners		
Maxon Burner Systems for Industrial Applications	Call	290



Looking for emissions and combustion efficiency analyzers? Our partners at RAECO have the latest in portable systems from Testo. See page 540 to 543.

Models also available to rent by the day, week, or month. Call 866-736-8347 and talk to the RAECO Rents team!



Prices in this catalog are current at the publication date, and are subject to change without notice. Some products may not be available in all Lesman markets or geographic areas.

Prices Start at See Page



Honeywell

Pressure Controls

Honeywell C437 Mercury-Free Pressure Limit Switches	\$345.70	288
Honeywell C6097 Safety Limit Switches	\$127.95	288
Honeywell L404F Pressuretrol® Operating Controls	\$202.78	288
Honeywell P7810C Pressuretrol® Line Voltage Pressure Controllers	\$608.46	263
Kromschroder DG Pressure Switches for Gas Applications	\$73.00	289



Temperature Controls and Sensors

Honeywell T631 Airswitch Controller	\$173.50	287
Honeywell T675A Remote Bulb Temperature Controller	\$184.92	287
Honeywell T775 Digital Temperature Controllers	\$447.57	287
Honeywell T6051 Line Voltage Thermostat	\$190.11	287



Valves

A-T Controls FM-Approved Ball Valves for Safety Shutoff	\$1420.00	282
ASCO Valve Co Safety Shutoff Solenoid Valves for Combustion Systems	\$75.00	278
Honeywell V5055 Gas Safety Shutoff Valves	\$365.70	281
Honeywell V51E Firing Rate Gas Valves	\$476.41	285
Kromschroder BV Butterfly Valves	\$230.00	286
Kromschroder VAS Valvario Solenoid Valves	\$249.00	280
Maxon Flow Control, Vent, and Safety Shutoff Valves	Call	284
Maxon SmartLink MRV Micro-Ratio Valves	Call	282



Burner Control Accessories

Honeywell Intermittent Ignition Pilot Control	\$191.04	288
Honeywell 7800 Series Burner Control Plug-In Modules	\$319.23	267
Honeywell Q7800 Wiring Subbases	\$43.65	265
Honeywell ST7800 Plug-In Purge Timer Cards	\$80.30	266
Kromschroder Ionization Pilots for Industrial Gas Burners	\$106.00	292

Prices in this catalog are current at the publication date, and are subject to change without notice. Some products may not be available in all Lesman markets or geographic areas.

Typical Single Burner Furnace with Flame Safety System

Call 800-953-7626 for help with any of these system components!

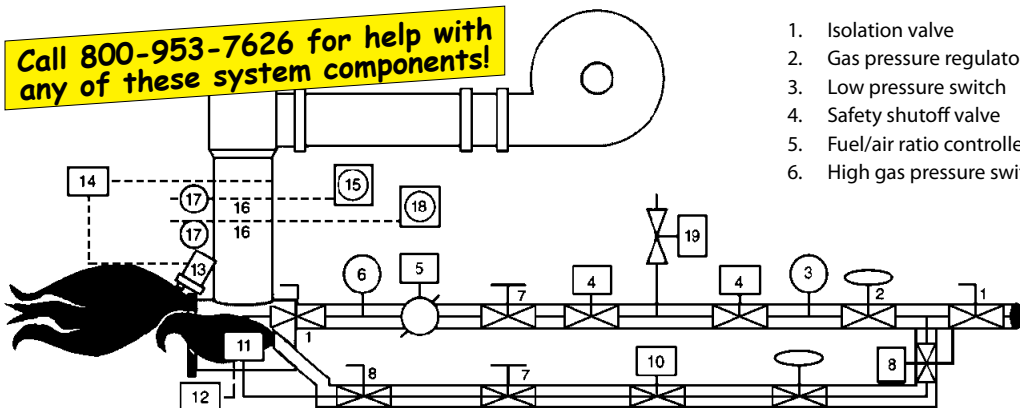

1. Isolation valve
2. Gas pressure regulator
3. Low pressure switch
4. Safety shutoff valve
5. Fuel/air ratio controller
6. High gas pressure switch
7. Test cock
8. Pilot gas cock
9. Pilot pressure regulator
10. Pilot solenoid valve (2 required)
11. Gas pilot burner assembly
12. Solid-state ignition transformer
13. Flame detector
14. Flame safeguard control
15. High temperature limit controller
16. Thermocouple leadwire
17. Thermocouple sensor
18. Temperature controller
19. Vent valve

Integrated Combustion Control Panels



Honeywell's engineered systems team has designed three completely integrated control panels to suit your combustion control needs. All three are pre-wired, pre-tested, and build in a certified UL 508 panel shop.

These heavy duty Hoffman™ panels are suitable for use in most environments and applications. They're ready to install, right out of the box, so installation time is minimal, and downtime is reduced.

Take advantage of special discounts on Honeywell integrated combustion control panels.

YP7999A1000 ControlLinks™ Fuel Air Ratio Control Panel

For reliable fuel air ratio control and energy savings in the boiler room.

Components: S7999B1000 panel display, R7999A1005 ControlLinks™ controller module, Q7999A1006 ControlLinks subbase.

ML7999A actuators must be ordered separately. See page 265.

Panel Specifications: 100-120 V, 50-60 Hz, 3 Amp electrical rating, NEMA 12 enclosure, fuel selector switch, alarm light, reset button, unit shutdown/emergency stop, automatic/manual switch, and a manual operation potentiometer

Model Selection Guide

Description	Catalog Number	Prices Start at
ControlLinks™ Fuel Air Ratio Control Panel	YP7999A1000	\$13207.36



YP7899A1002 ControlLinks™ Burner Management Panel

For single-fuel burner management with SIL3 capability and fuel air ratio control.

Components: S7999B1000 panel display, R7999A1005 ControlLinks™ controller module, Q7999A1006 ControlLinks subbase, RM7800L1087 relay module, Q7800 wiring subbase, S7810M Modbus™ module, and S7800A keyboard display module

ML7999A actuators, R78 flame amplifiers, ST7800 purge timer cards, and appropriate flame detectors must be ordered separately.

Panel Specifications: 100-120 V, 50-60 Hz, 3 Amp electrical rating, NEMA 12 enclosure, fuel selector switch, alarm light, reset button, unit shutdown/emergency stop, automatic/manual switch, and a manual operation potentiometer

Model Selection Guide

Description	Catalog Number	Prices Start at
ControlLinks™ Burner Management Panel	YP7899A1002	\$21697.81



YP7899C1000 Burner Management System Panel



Combines two industry standards into a complete integrated control panel: Honeywell's 7800 series burner controls with SIL3 capability and UDC controllers for reliable high limit and PID load control.

Components: S7999B1000 panel display, RM7800L1087 relay module, Q7800 wiring subbase, S7810M Modbus™ module, S7800A keyboard display module, and two UDC2500 controllers
R78 flame amplifiers, ST7800 purge timer cards, and appropriate flame detectors must be ordered separately.

Panel Specifications: 100-120 V, 50-60 Hz, 3 Amp electrical rating, NEMA 12 enclosure, fuel selector switch, alarm light, reset button, unit shutdown/emergency stop, automatic/manual switch, and a manual operation potentiometer

Model Selection Guide

Description	Catalog Number	Prices Start at
Burner Management System Panel	YP7899C1000	\$20282.74

Delphi Boiler Control System



Improve your boiler efficiency by upgrading your control system!

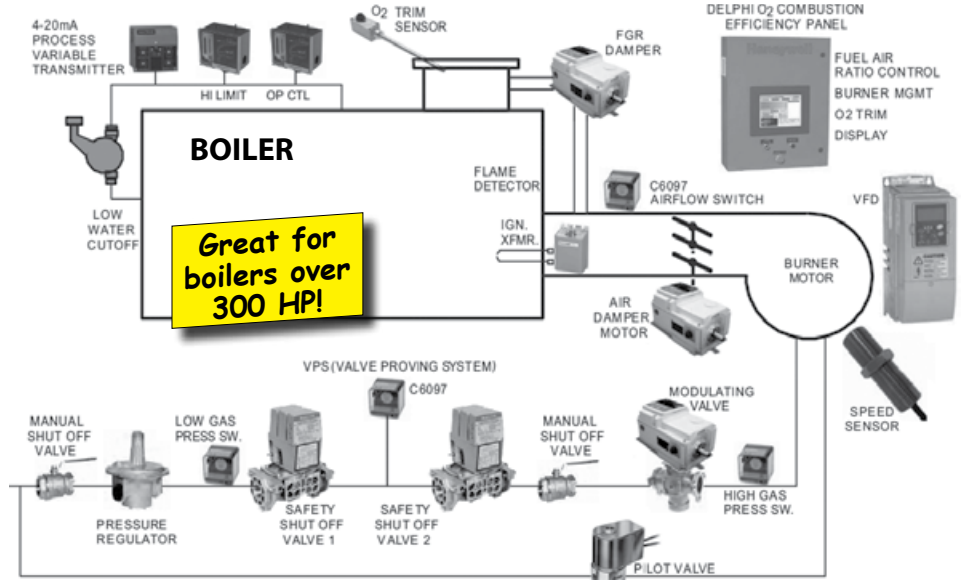

Features

- Packaged flame safeguard control and linkageless fuel/air ratio control with O₂ trim — for efficient boiler control
- Industrial panel PC with large 12" color touchscreen interface
- NEMA 12 enclosure with two filter kits, 4-20 mA sensor inputs
- Embedded software for setup, control and monitoring
- High accuracy O₂ sensor with quick response and open air calibration feature —no moving parts or replaceable filters
- Oxygen sense and trim capability — trim and sensor enable/disable, compensation for variable combustion air, separate O₂ setpoint at each 10% step of firing rate

Fuel/Air Ratio Control Features

- Variable frequency drive (VFD) control capability reduces fan energy costs
- Available actuators from 100 to 400 in lbs
- Firing rate/load control via temperature, pressure or manual operation
- Firing rate limiter algorithm helps prevent overshoot
- Ramp rate limiter algorithm helps prevent thermal shock
- Low fire hold capability via process variable
- Dedicated actuator and VFD channels with feedback

System Components

The Delphi Combustion Efficiency Panel YP900A1000 ships complete with the following components (pre-wired as required):

- RM7840L1075 programmable flame safeguard control with valve proving system (VPS) capability, includes wiring subbase and mounting kit Q7800A1005
- S7800A1142 keyboard display module for Modbus RTU communication, valve proving, and post-purge timer programming
- ABC900A1000 Hybrid Controller: Includes CPU30 control, power supply shield and resistor kits, 4-slot I/O rack and four I/O card: one each for analog input, analog output, digital input, and digital output
- MF020-1-LC3 high temperature oxygen sensor
- S900A1000 12" Panel Touchscreen with software
- LCZ460-30-ECC Hall effect zero speed sensor for variable frequency drive speed measurement
- SNDJ-CNT-G02-ECC tachometer with single channel, relay and 0/2-10 VDC output for VFD speed measurement
- Shunt resistor kits cable connectors, cable gland, compression fittings, power supplies for panel PC and sensors, frequency/noise filter/surge suppressor, and line conditioner, relays, fuses, Ethernet switch, and alarm on/off switch

The O₂ Sensor and Hall Effect Sensor require field wiring



Call Lesman for pricing on Delphi panels and other combustion efficiency components.

These components are required for the system to operate, and need to be purchased separately

- Amplifier for RM7840L (R78xx)
- Purge timer card for RM7840L (ST7800)
- Flame detector or electronic actuators – ML7999B or 2001 series HercuLine actuators
- NXS Variable frequency drive (optional)
- 4-20mA sensors (temperature, pressure) for PV/modulation/firing rate, stack temperature or other monitoring points

Note: Separate controls are required for the following functions: high limit, low limit, operating control, ignition transformer, fuel pressure limits, fuel temperature limits, low water cutoff controls, high water level control, combustion air proving switch, air atomization proving switch and other limits and interlocks as required by the application.

MAXON Combustion Control Systems

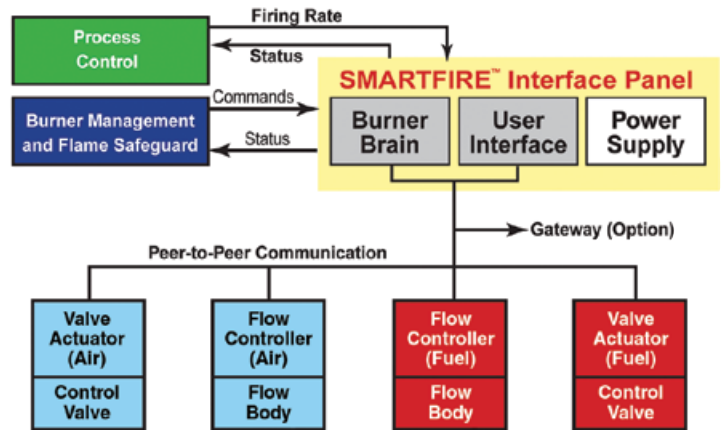

SMARTFIRE® Intelligent Combustion Control System

- Plug and play turnkey system for easy installation and setup
- Designed for harsh environments — includes NEMA 4X enclosures, high torque actuators, and all-digital field device communications
- Precise electronic control of air and fuel flow to the burner to maximize efficiency and minimize emissions simultaneously
- Maintains emissions or fuel efficiency over the entire operating range of the burner, not just at one burner setpoint
- Automatically compensates for changes in combustion or process conditions with full cross-limited ratio control, ensuring a highly repeatable heat source
- Integrates easily with all burner management systems, reducing engineering costs in retrofit applications
- Advanced diagnostics and troubleshooting provide real-time data about combustion and process system performance
- Redundant system safety checks built into intelligent components significantly reduces the risks associated with combustion system commissioning and maintenance neglect

- FM and CSA approved, and meets requirements of European EMC and low-voltage directives



- Remote monitoring gateway option reduces downtime, provides immediate off-site tech support over a phone line
- Maxon's SMARTFIRE® is an automated fuel/air ratio control system that provides precise thermal mass flow control of your critical burner systems. The flow control valve system is comprised of five components that integrate easily with a conventional burner management system and pipe train.

SMARTFIRE® provides precise electronic control of air and fuel flow to the burner, maintaining emissions or fuel efficiency over the entire operating range of the burner. It automatically compensates for changes in combustion or process conditions with full cross-limited ratio control, ensuring a highly repeatable heat source. SMARTFIRE® valves provide real-time information about combustion and process system performance, as well as optional data logging and remote monitoring. In most installations, SMARTFIRE® contributes to reduced fuel bills, emissions compliance, and maximized uptime on critical industrial heating equipment.

SMARTLINK® Thermal Mass Flowmeter

- Displays instantaneous standard rate and totalized flow without calculations
- Temperature compensation extends accuracy over wider ranges of fluid temperatures
- Redundant meter provides on-line self-checks for safe operation and fail-safe alarm output
- Monitors, displays, and outputs air/fuel ratio when two meters are electrically "linked"
- In-line flow body uses conditioning screens to reduce straight-run pipe requirements
- Large local display. No PC or other interface necessary for configuration and operation
- Fail-safe alarm, limit and analog outputs for easy integration into PLC or DCS systems
- FM approved for Class 1, Div 2 Groups A-D and Class 1, Zone 2, Group IIC

SMARTLINK® Meter is a highly accurate and repeatable mass flowmeter for monitoring fuel and air.

The meter uses a constant temperature differential technique with two matched, platinum RTDs in a rugged, stainless probe assembly. One RTD measures fluid temperature; an intelligent bridge circuit heats the second RTD element, maintaining a constant temperature differential above the temperature of the process fluid.

Based on the amount of power delivered to the heated element, the on-board microprocessor establishes a precise mass flow rate. The highly integrated sensor probe and electronic design permits fully automated factory calibration, providing every manufactured unit with out-of-the-box measurement accuracy.



Look for more information on Maxon combustion control systems, burners, and valve products online at Lesman.com

ControLinks™ Burner Control System

Honeywell

Honeywell ControLinks™ fuel air ratio control system helps you realize energy savings, increased turndown, reduced emissions, and system reliability in an easy-to-install, powerful, and cost-effective package.

Features

- Stand-alone control system designed for easy retrofits
- Dynamic safety checks: failsafe potentiometer check, anti-swap of actuators, and curve verification algorithms, relay test for limit control input/output (LCI-LCO) contact set
- Integrated shock protection algorithms: Water or stack temperature low fire hold, flue gas recirculation (FGR) hold, FGR and low-fire hold
- Controller LEDs: Power, alarm, motor 1, 2, 3, 4 for status, and fault code annunciation (60 possible)
- Two independent fuel profiles with or without FGR
- Programmable positioning for non-selected fuel actuator, standby, purge, light-off, or minimum/maximum modulation
- Up to four universal parallel positioning actuators: Combustion air, fuel 1, fuel 2, FGR/flexible usage
- Fourth channel actuator flexible usage: FR, secondary air control or modulating fuel valve
- Auto/manual firing rate input
- Seven to 24 points per profile curve with quick setup feature, providing minimum three-point profile curve
- Actuator CW/CCW switches for manually driving hub—useful for installation and service
- Actuator LED annunciation for unconfigured, configured, on-line, or faulty actuator states

For boilers and burners up to 300 HP!

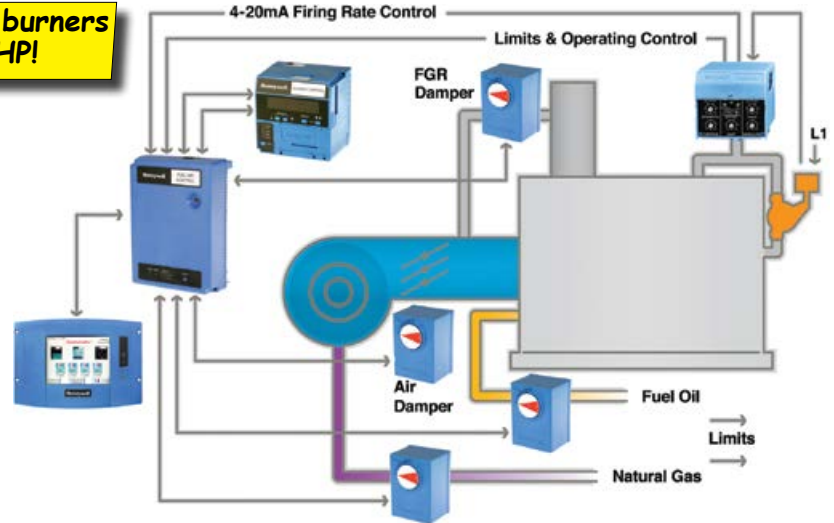

Typical boiler application with Honeywell ControLinks™ fuel ratio control system installed.

Honeywell ControLinks™ replaces the traditional single point modulation of a mechanical cam-and-linkage assembly that controls the relationship between fuel, airflow, and flue gas recirculation on a power burner. The linkageless fuel air ratio control provides more accuracy and efficiency in actuator positioning and burner firing, reducing your service requirements and downtime. It can be installed as part of a retrofit or a new burner application—anywhere increased efficiency is desired.

Up to four independently controlled universal parallel positioning actuators (UPPAs) are managed by the ControLinks controller, which responds to load and firing rate demands.

ControLinks can be used on single or combination fuel single burner applications, including power burners, boilers, process furnaces, ovens, smelting, kilns, paint drying booths, VOC burn-off, ceramics, make-up air heaters, or any full modulating burner.



R7999A ControLinks™ Fuel Air Controller

Uses the latest microprocessor technology to simultaneously control up to four actuators. Use with ML7999 actuators to replace mechanical cam-and-linkage assembly controlling the relationship between fuel, airflow, and flue gas recirculation (FGR) on a power burner.

Fast burner setup vial PC or laptop. Two independent fuel profiles with or without FGR. Programmable behaviors of all actuators during purge and standby. Programmable behavior of non-selected fuel actuator. Independent light off and minimum modulation positions. Auto/manual input and manual mode firing-rate input. Multipurpose communications port.

ZM7999A ControLinks™ configuration software tool lets you create burner modulation curves (profiles) for your burners, for safe and efficient operation at all points along the curve. Wizards step you through the commissioning process. Save files on your PC to use over again.

Complete System Requires: R7999 controller, Q7999 wiring subbase, ML7999 positioning actuator, and ZM7999 configuration software.

Model Selection Guide

Description	Catalog Number	Price
Fuel air ratio controller, 100-120 VAC, 50/60 Hz	R7999A1005	\$876.18
Field wiring terminal subbase for R7999A controller. Panel mount, NEMA 1 enclosure	Q7999A1006	111.41
ControLinks™ Windows-based configuration software for R7999A controllers	ZM7999A1006	422.04

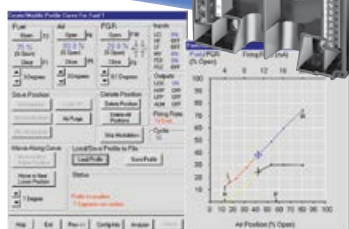

Learn more online at
[www.Lesman.com!](http://www.Lesman.com)



Call for adapter assemblies for connecting to shaft sizes other than 1/2".

ML7999 Universal Parallel-Positioning Actuators

ControlLinks™ actuators control the position of primary and secondary fuel valves, combustion air damper, and flue gas return dampers. UL, CSA, CE approved.

Vibration: 0.0 to 0.5g continuous

Environmental Conditions: Ambient Temperature: -40° to 140°F; Operating Temperature: -40° to 150°F; Operating Humidity: 5% to 95% RH, non-condensing



Model Selection Guide

Actuator Description and Function	Catalog Number	Price
Pulse-width modulating control of combustion air dampers, butterfly gas valves, oil modulation valves, and flue gas recirculation systems. Includes precise feedback potentiometer and integral power supply. Parallel-positioning actuator.	ML7999A2001	\$339.30
Provides 4-20 mA control input to control combustion air dampers and modulation valves. Includes precision drive shaft control and integral power supply capable of direct line voltage connection. Direct coupled actuator.	ML7999B1002	611.53



S7999B ControlLinks™ Configuration Display

Monitor up to 99 burner systems connected via Modbus. Each burner control, fuel/air ratio control, expanded annunciator or other Modbus devices present on the burner system can be viewed individually to determine its status.

Display: Color 3.5" x 4.6" touchscreen interface with screen saver, contrast and volume controls

Communications: Two RS-485 Modbus ports for monitoring up to 99 unique controls

Function: Allows setup and monitoring of R7999 ControlLinks controller, programmable expanded annunciator terminal remaining, and R7999 EEPROM backup and restore

Model Selection Guide



Description	Catalog Number	Price
Touchscreen display for ControlLinks™ system. 12 VDC input power	S7999B1000	\$1584.07



P7810C Pressuretrol® Controller

Line voltage pressure controller that eliminates the need for a controller and transmitter. One unit does on/off control, high limit and 4-20 mA modulation.

Accuracy: ±4.0% full scale output over operating temperature (32° to 140°F)



Model Selection Guide

Description	Catalog Number	Price
Solid State Pressuretrol® Controller with On/Off Control, Limit Control, and 4-20 mA Modulation. FM, CSA, UL Approvals.	P7810C1000	\$608.46
LED Indicators for Power, Call for Heat Function, and Lockout Status	P7810C1018	676.76
	P7810C1026	755.76
Siphon Loop with 1/4" NPT Threads for P7810C	209731A	113.06

ControlLinks™ Accessories

Looking for a portable combustion analyzer? See page 540 to 543. Available for sale or short-term rental!

Model Selection Guide

Description	Catalog Number	Price
ML7999 actuator shaft adapter for and 3/8" round or square valve shaft	201391	\$4.10
ML7999 actuator weatherproofing kit (1 corner stop, 2 gaskets)	32002935-001	23.56
ML7999 actuator 3/4" shaft adapter assembly	32003168-001	67.43
ML7999 actuator 5/8" shaft adapter assembly	32003168-002	67.19
ML7999 actuator 9/16" shaft adapter assembly	32003168-003	67.19
V51E mounting plate for 1.5" and 2" valves	32003396-001	55.17
V51E mounting plate for 2.5" 3", and 4" valves	32003396-002	60.06
R7999 3-pin electrical connector	32002515-001	11.77

Honeywell 7800 Series Burner Controls



Model	RM7840	RM7890	RM7895	RM7898
Control Type	Programming	On-Off Primary	On-Off Primary	On-Off Primary
Added Function	Selectable Pre-Purge Timing, Air Flow Check	Units Available with Valve Proving (VPS)	Selectable Pre-Purge Timing	Selectable Pre-Purge Timing, Shutter Drive, Programmable Post-Purge, Valve Proving
Required Components	Wiring Subbase, Flame Signal Amplifier, Purge Timer Card, Keyboard Display (for VPS)	Wiring Subbase, Flame Signal Amplifier, Purge Timer Card, Keyboard Display (for VPS)	Wiring Subbase, Flame Signal Amplifier, Purge Timer Card	Wiring Subbase, Flame Signal Amplifier, Plug-In Purge Timer Card, Keyboard Display (for VPS)

Upgrading to Honeywell 7800 enhanced burner controls

Enhanced 7800 models offer several added features at a lower price than the core 7800 burner control series.

- Expanded cycle counter
- Standard run/test switch
- Jumper for intermittent or interrupted pilot
- Valve proving functionality, and
- Pre-ignition interlock (for proof of closure)

Look for a * for enhanced model part numbers.

Enhanced > Legacy	RM7890 B1048	RM7897 A1002	RM7897 C1000	RM7898 A1000	RM7840 L1075	RM7800 L1087
RM7890A1015	•					
RM7890A1056	•					
RM7890B1014	•					
RM7895A1014		•		•		
RM7895C1012		•	•	•		
RM7897A1002				•		
RM7897C1000				•		
RM7840L1018					•	•
RM7800L1012					•	•

RM7840 Programming Control Unit for Forced-Air Burners



Programming control with valve proving for automatically fired gas-, oil-, coal-, or combination fuel single-burner applications.

- Interrupted pilot type
- Airflow check feature
- Valve proving feature tests valve seat integrity to detect a leak greater than 0.1% of burner input capacity
- Five LEDs provide sequence information. Power LED blinks fault code on Lockout.
- CSA, FM, and UL approved

Required components: Q7800 universal wiring subbase, R78 series flame signal amplifier, ST7800A plug-in purge timer cards, S7800A1142 keyboard display module for advanced diagnostics, and to set up valve proving



Model Selection Guide

Flame Establishing Period Pilot	Main	Interlocks	Catalog Number	Price
4 or 10 seconds	10, 15, or 30 seconds, or intermittent	Running and low-fire (LHL-LF)	RM7840G1022	\$2461.24
4 or 10 seconds	10 or 15 seconds	Lockout, low-fire and high-fire (LHL-LF&HF)	RM7840L1075*	2931.96

RM7890 On-Off Primary Control with Valve Proving for Forced-Air Burners



Microprocessor-based integrated primary burner control for automatically fired gas, oil, coal, or combination fuel single burner applications.

- Five LEDs for sequence information
- Valve proving feature tests valve seat integrity to detect a leak greater than 0.1% of burner input capacity
- Closed loop logic test, expanded safe-start check, internal hardware status monitoring and tamper-resistant timing and logic
- UL, CSA, FM, FCC approved

Required components: Q7800 universal wiring subbase, R78 series flame signal amplifier, S7800A1142 keyboard display module (shown) for advanced diagnostics and to set up valve proving



Model Selection Guide

Flame Establishing Period Pilot	Main	Pilot Type	Special Features	Catalog Number	Price
4 or 10 seconds	Intermittent	Intermittent		RM7890A1015	\$596.12
4 or 10 seconds	Intermittent	Intermittent	Shutter Drive Capability	RM7890B1030	607.61
4 or 10 seconds	Intermittent	Intermittent	Shutter Drive Capability	RM7890B1014	864.38
4 or 10 seconds	Intermittent	Intermittent	Valve Proving (VPS) Check Feature, Blinking LED Fault Annunciation	RM7890A1056	605.07
4 or 10 seconds	Intermittent	Intermittent	Shutter Drive Capability, VPS Check, Blinking LED Fault Annunciation	RM7890B1048*	634.90



RM7895 On-Off Primary Control Unit for Forced-Air Burners

Microprocessor-based integrated primary burner control for automatically fired gas, oil, or combination fuel single burner applications.



- On/off primary control with prepurge and airflow switch check
- Five LEDs for sequence information
- Optional local or remote annunciation of operation and fault information, remote reset capability
- Selectable relight or lockout on loss of flame

Required components: Q7800 universal wiring subbase, R78 series flame signal amplifier, ST7800 plug-in purge timer card



Model Selection Guide

Flame Establishing Period Pilot	Main	Pilot Type	Airflow Check	Delayed Main Valve	Interlocks	Catalog Number	Price
4 or 10 seconds	Intermittent	Intermittent	No	No	Selectable	L RM7895A1014*	\$795.05
4 or 10 seconds	Intermittent	Intermittent	Dynamic	No	Selectable	L RM7895B1013	795.05
4 or 10 seconds	10 Seconds	Interrupted	Dynamic	Yes	Selectable	RM7895D1011	998.91
4 or 10 seconds	10 Seconds	Interrupted	Dynamic	Yes	Selectable	RM7895C1012	998.91

RM7898 On-Off Primary Control Unit with Valve Proving



Microprocessor-based integrated primary burner control for automatically fired gas, oil, or combination fuel single burner applications.

- On/off primary control, programmable post purge and valve proving feature available through keyboard display module
- Five LEDs for sequence information, power LED blinks fault code on safety shutdown
- Airflow switch check and shutter drive output
- Selectable recycle or lockout on loss of airflow or flame
- Local or remote annunciation of operation and fault information

Required components: Q7800 universal wiring subbase, R78 series flame signal amplifier, ST7800 plug-in purge timer card, S7800A1142 keyboard display module



Model Selection Guide

Flame Establishing Period Pilot	Main	Pilot Type	Special Features	Catalog Number	Price
4 or 10 seconds	Intermittent or 10 seconds	Selectable	Shutter drive output, programmable post purge, valve proving	L RM7898A1000*	\$791.43
4 or 10 seconds	Intermittent or 10 seconds	Selectable	Shutter drive output, programmable post purge, valve proving, plus early spark shutoff when flame is sensed	L RM7898A1018	791.43

Q7800A or B Wiring Subbases for RM7800 Burner Controls



Select either the panel-mount or burner-mount version of the Q7800A,B 22-terminal universal wiring subbase to mount your 7800 series relay. Both are fully compatible with all 7800 relay modules, so you can specify a wiring termination approach that meets your application requirements.



Model Selection Guide

Description	Catalog Number	Price
22 Terminal Universal Wiring Subbase		
Panel Mount	L Q7800A1005	\$43.65
Burner/Wall Mount	L Q7800B1003	43.65



RA890 Protectorelay® Electromechanical Primary Control

Non-programming primary control provides flame safeguard protection for industrial and commercial single or dual fuel burners. With SPDT alarm contacts.

Use with flame rods, rectifying photocells and C7012A,C Purple Peeper ultraviolet flame detectors. Recycles once after failure to re-establish pilot. No start if failure occurs in flame detector circuit.

Power Rating: 50 Hz: 8.5w, 17VA max.;
60 Hz: 7w, 13 VA max.

Ambient Temperature: -20° to 105°F

Model Selection Guide

Description	Safety Switch Timing	Flame Failure Response	Catalog Number	Price Each
Rectification-Type	15 Seconds	3.0 Seconds	RA890F1288	\$2947.42
Ultraviolet-Type	15 Seconds	3.0 Seconds	L RA890G1260	2947.35
Q270A Protectorelay® Mounting Subbase			Q270A1024	216.67



Compatible flame detectors on pages 268 and 269.

R78 Series Flame Signal Amplifier Modules

Honeywell



- Dynamic Ampli-Check™ or Self-Check rectification available, with safety shutdown on amplifier or system failure
- Flame signal strength 0.0 to 5.0 VDC
- Test jacks measure amplifier signal voltage
- UL, CSA, FM approved



Solid-state flame signal amplifiers detect the presence of flame in response to a signal from a rectifying, ultraviolet, or infrared flame detector.

Dynamic Ampli-Check™ circuitry tests flame amplifier during burner operation; 7800 series relay module locks out on safety shutdown with amplifier failure.

Dynamic Self-Check Rectification Amplifier and Dynamic Self-Check Ultraviolet Amplifier test electronic components in the flame detection system 10 to 12 times per minute. The 7800 series relay module locks out on safety shutdown with flame detection system failure.

R7849A flame detectors should be used only on burners that cycle on and off at least once every 24 hours. Appliances with burners that remain on for 24 hours or longer should use ultraviolet flame detection systems (C7012E/F detector and R7847C amplifier or C7076A detector and R7886A amplifier).

Model Selection Guide

Color Code	Type	Flame Failure Response Time	Self-Checking	Compatible Flame Sensors	Catalog Number	Price
Rectification-Type Flame Amplifiers, Green						
Green	Rectification	3.0 Seconds	Dynamic	C7024E, F Flame Detector	R7824C1002	\$709.04
Green	Rectification	0.8 or 1.0 Second	Standard	Gas: Rectifying Flame Rods C7004/7005/7007/7008/7009, Q179	R7847A1025	282.88
Green	Rectification	2.0 or 3.0 Second	Standard	Gas: Rectifying Flame Rods C7004/7005/7007/7008/7009, Q179; Gas, Oil and Coal: Ultraviolet Flame Sensors C7012A, C	R7847A1033	282.88
Green	Rectification	0.8 or 1.0 Second	Standard	Gas: Rectifying Flame Rods C7004/7005/7007/7008/7009, Q179*	R7847A1074	282.88
Green	Rectification	2.0 or 3.0 Second	Standard	Gas: Rectifying Flame Rods C7004/7005/7007/7008/7009, Q179* Gas, Oil, and Coal: Ultraviolet Flame Sensors C012A, C	R7847A1082	282.88
Green	Rectification	0.8 or 1.0 Second	Ampli-Check	Gas: Rectifying Flame Rods C7004/7005/7007/7008/7009, Q179	R7847B1023	812.55
Green	Rectification	2.0 or 3.0 Second	Ampli-Check	Gas: Rectifying Flame Rods C7004/7005/7007/7008/7009, Q179 Gas, Oil, and Coal: Ultraviolet Flame Sensors C7012A, C	R7847B1031	812.55
Green	Rectification	0.8 or 1.0 Second	Ampli-Check	Gas: Rectifying Flame Rods C7004/7005/7007/7008/7009, Q179*	R7847B1064	812.55
Green	Rectification	2.0 or 3.0 Second	Dynamic	Gas, Oil, and Coal: Ultraviolet Flame Sensors C7012E, F	R7847C1005	615.54
Infrared-Type Flame Signal Amplifier, Red						
Red	Infrared	2.0 or 3.0 Second	Standard	Gas, Oil, and Coal: Infrared Lead Sulfide Flame Sensors C7015	R7848A1008	530.93
Red	Infrared	2.0 or 3.0 Second	Ampli-Check	Gas, Oil, and Coal: Infrared Lead Sulfide Flame Sensors C7015	R7848B1006	566.87
Ultraviolet-Type Flame Signal Amplifier, Purple						
Purple	UV	0.8 or 1.0 Second	Standard	Gas, Oil: Minipeeper C7027A, C7035A, C7044	R7849A1015	282.88
Purple	UV	2.0 or 3.0 Second	Standard	Gas, Oil: Minipeeper C7027A, C7035A, C7044	R7849A1023	282.88
Purple	UV	0.8 or 1.0 Second	Ampli-Check	Gas, Oil: Minipeeper C7027A, C7035A, C7044	R7849B1013	441.67
Purple	UV	2.0 or 3.0 Second	Ampli-Check	Gas, Oil: Minipeeper C7027A, C7035A, C7044	R7849B1021	441.67
Ultraviolet-Type Flame Signal Amplifier, Purple						
Purple	UV	2.0 or 3.0 Second	Dynamic	Gas, Oil, and Coal: Ultraviolet Flame Sensor C7061	R7861A1026	744.92
Purple	UV	0.8 or 1.0 Second	Dynamic	Gas, Oil, and Coal: Ultraviolet Flame Sensor C7061	R7861A1034	744.92

* Leadwire runs greater than 50 ft.

Don't see the timer card you need? Call Lesman.

ST7800A Plug-In Purge Timer Cards



Purge timers let you purge unburned fuels from the combustion chamber. The plug-in cards install easily into the 7800 series relay module. They are available in 15 timing ranges from 2 seconds to 30 minutes.

- Compatible with selected 7800 series relay modules.
- CSA, FM approved, UL recognized



Model Selection Guide

Description	Catalog Number	Price	Description	Catalog Number	Price	Description	Catalog Number	Price
2-Second Pre-Purge	R7800A1005	\$80.30	30-Second Pre-Purge	R7800A1039	\$80.30	2.5-Minute Pre-Purge	R7800A1070	\$80.30
7-Second Pre-Purge	ST7800A1013	80.30	60-Second Pre-Purge	ST7800A1054	80.30	4-Minute Pre-Purge	ST7800A1088	80.30
10-Second Pre-Purge	ST7800A1021	80.30	1.5-Minute Pre-Purge	ST7800A1062	80.30	6-Minute Pre-Purge	ST7800A1096	80.30

Burner Control Plug-In Accessory Modules

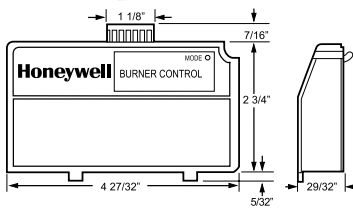

S7800A1142 Universal Keyboard Display Module

Provides current status of burner sequence, timing, hold, and lockout information plus selective or preemptive messages. Required for programming Valve Proving and Post Purge features on 7800 series relay modules.



- First-out annunciation and system diagnostics provided in 2-row by 20-column display
- Provides burner control data, remote reset, and report generation
- Local or remote operation, fault data
- UL listed, CSA certified, FM approved, FCC rated

Model Selection Guide

Description	Catalog Number	Price
Universal Keyboard Display	S7800A1142	\$624.16

S7810 and S7820 Modules

Add communication and control to your 7800 series relays

- All install directly on front of 7800 relay modules
- Communications interface for PCs or Modbus RTU networks
- Support for remote mounted keyboard display module
- Remote control, reset functions



Model Selection Guide

Description	Catalog Number	Price
Remote Reset Module: Provides remote reset by pushbutton at up to 1000 feet away	S7820A1007	\$273.18
Data ControlBus Module: Remote mounting for Keyboard Display Module, remote reset, and communication interface to PC	S7810A1009	319.23
Modbus Module: Remote mounting for Keyboard Display Module, remote reset and control, and communicates to Modbus RTU network as slave device	S7810M1003	234.89



S7830A1005 First-Out Expanded Annunciator Panel

Monitors the status of a series string of limit, control, and interlock contacts. It enhances fault and status messages of the 7800 series burner control.

- 26 LEDs — 22 LEDs to annunciate limits and interlocks, 4 LEDs to annunciate power, current status, first-out status, and system lockout
- Enhances keyboard display module sequence hold and lockout messages
- Connects to 7800 series control via RS-485
- UL listed, CSA, FM approved



Model Selection Guide

Description	Catalog Number	Price
First-Out Expanded Annunciator Connector for Keyboard Display	S7830A1005 203541	\$1084.20 56.41

QS460MMDS1000 Modbus RTU Gateway

Connects 7800 series relay modules and controls via DeviceNet Gateway to PLC systems. Compatible with 7800 controls, S7830 annunciator, and Controlinks systems.

- Moves data bidirectionally across devices with Modbus RTU, BACnet/IP, DeviceNet, Ethernet/IP, and Modbus TCP
- 10/100 Base-T Ethernet, DB9 and T-Strip5 connections for RS-232, RS-485, CAN/DeviceNet
- Requires S7810M1003 Modbus module for communication to Controlinks ratio control system or S7830 annunciator panel
- Embedded web server, so you can configure it easily via a browser
- DIN-rail mountable anodized aluminum enclosure, requires 24 VDC power supply

Model Selection Guide

Description	Catalog Number	Price
Gateway Module	QS460MMDS1000	\$882.00



Fast, easy connection to your PLC!

Flame Detectors

Honeywell



Model	C7008, C7009	Q340A	C7012 Purple Peeper®	C7027 Minipeeper®	C7035 Minipeeper®	C7061 Purple Peeper®	C7076
Detector Type	Flame Rod	Thermocouple	Rectification Ultraviolet	Ultraviolet	Ultraviolet	Ultraviolet	Ultraviolet
Burner Type	Gas-Fired	Gas-Fired	Coal, Gas, or Oil-Fired	Coal, Gas, or Oil-Fired	Coal, Gas, or Oil-Fired	Gas or Oil-Fired	Gas or Oil-Fired
Pilot Type	Intermittent or Standing	Intermittent or Standing	Intermittent or Interrupted	Intermittent or Interrupted	Intermittent or Interrupted	Intermittent or Interrupted	Intermittent or Interrupted
Unique Feature	100% Fail-Safe Operation	Low Cost Units for Process Applications	Dynamic Self-Check, Shutter	1/2" Sight Pipe Mount	1" Sight Pipe Mount	Dynamic Self-Check	Dynamic Self-Check, Adjustable Sensitivity
Flame Amplifier	R7247A,B, R7847A, B, R7257, R7289	Typically Connected via UDC	R7247C, R7847C, R7747C	R7249A,B, R7849A, B, R7749B, R7259, R7290	R7249A,B, R7849A,B, R7749B, R7259, R7290	R7861	R7476A1015, R7886A1001

C7008, C7009
Rectification Flame Rods

Kantal A-1 flame rod with sparkplug-type rod holder, threaded base, and snap-on cover.

100% fail-safe flame detection. For gas-fired systems and intermittent pilots only. Use with Honeywell flame safeguard controls that require rectification-type flame detectors. Can be used with or without cover and cut to desired length. Includes flame rod holder and Rajah electrical connector.

Approvals: UL, CSA, FM.



Model Selection Guide

Flame Rod Length	Holder Dimensions		Electrical Connection	Catalog Number	Price
	Length	Diameter			
12"	3-3/4"	7/8"	1/4" NPT Male	C7008A1174	\$210.25
24"	3-3/4"	7/8"	1/4" NPT Male	C7008A1182	312.12
4"	2-3/8"	3/8"	1/8" NPT Male	C7009A1009	129.28
12"	2-3/8"	3/8"	1/8" NPT Male	C7009A1025	172.20

Q340 Thermocouples for Gas-Fired Pilot Flame Detection

Premium long-life, durable 30mv thermocouples generate a thermoelectric current that senses a pilot flame on gas-fired heating systems.

For easy installation, the Q340A comes with a push-in clip, split nut, and an adapter assembly, plus a 11/32 male connector nut for Pilotstat® safety control power units.

Output: Normal: 26 to 32 mV; Lowest Acceptable: 18 mV; Turndown: 2 mV

Temperature Rating: 1400°F at hot junction, 780°F at cold junction

Replacement for: Robertshaw 1980, T45, T46, White Rogers HO series, Penn-Baso K15, K16, K19, 88D, ITT-General 2500 and 2600 series, and Jade TK5

Model Selection Guide

Lead Length	Catalog Number	Price
36" (914mm)	Q340A1090	13.03
48" (1219mm)	Q340A1108	14.42



C7076 UV Detector with Adjustable Sensitivity

Dual adjustable sensitivity with 400:1 dynamic range, for use with intermittent or interrupted pilots on gas- or oil-fired burners. Compatible with R7476A and R7886A dynamic self-check UV flame amplifiers. Closed-loop self-checking circuit ensures integrity of both amplifier and flame detector.

Call Lesman inside sales at 800-953-7626 for pricing and delivery.





Need a flame detector for mixed fuel applications? See page 276.



C7012 Purple Peeper® Solid-State UV Flame Detectors

120 VAC Solid-state UV flame detector with dynamic self-check, for coal-, gas-, or oil-fired burners. Can be used with intermittent or interrupted pilots. Compatible with R7247C, R7847C, and R7747C UV flame amplifiers on Honeywell RM7800 series relay modules.

Mounts horizontally, vertically, or at any angle in between. Provides quick electrical hookup with threaded conduit fitting and color-coded leadwires. Reduces nuisance shutdowns by wiring two in parallel.

Mounting: Mounting flange with NPT internal threads for attaching to sight pipe

Approvals: UL, CSA, FM.

Model Selection Guide

Mounting Size	Ambient Temp. Range	Shutter	Catalog Number	Price
Dynamic Self-Checking Ultraviolet Detector				
3/4" NPT	25° to 135°F	No	C7012A1145	\$2168.36
3/4" NPT	-20° to 125°F	Yes	C7012E1104	4485.13
1" NPT	-20° to 125°F	Yes	C7012E1112	4569.75
1" NPT	-20° to 125°F	Yes	C7012F1052*	8684.21

* Explosion-proof housing



C7027 Minipeeper® Ultraviolet Flame Detectors

Compact UV flame detectors for use on coal-, gas-, oil-fired or combination burners. Can be used with either intermittent or interrupted pilots. Compatible with R7248A/B, R7849A/B, R7749B, R7259, and R7290 solid-state UV flame amplifiers on Honeywell RM7800 series relay modules and controls.

Compact size allows for blast-tube mounting. Seals against pressures up to 5 psi when correctly installed. Wire in parallel for difficult sighting applications.

Mounting: 1/2" sight pipe with integral collar or 1/2" NPT threaded spud connector.

Dimensions: 1-1/8" diameter (with mounting nut), 3-7/8" length, 8-foot lead.

Electrical Connections: Two NEC Class 1 leadwires

Approvals: UL, CSA, FM.

Model Selection Guide

Ambient Temp. Range	Sight Pipe Mounting	Catalog Number	Price
-40° to 215°F	Integral nut	C7027A1031	\$197.12
-40° to 215°F	Integral nut*	C7027A1072	197.12
0° to 215°F	Integral nut	C7027A1023	177.80
0° to 215°F	Integral nut**	C7027A1049	177.80
0° to 215°F	Integral nut**	C7027A1080	221.00

* 1/2" NPT threaded spud connector

** Includes 136733 heat block and 390427B bushing



C7035 Minipeeper® Ultraviolet Flame Detectors

Compact ultraviolet flame detectors with field-replaceable UV sensing tubes. For use on coal-, gas-, oil-fired or combination burners. Can be used with either intermittent or interrupted pilots. Compatible with R7248A/B, R7849A/B, R7749B, R7259, and R7290 solid-state UV flame amplifiers on Honeywell RM7800 series relay modules and controls.

Shield protects sensing tube. Seals against pressures to 5PSI when correctly installed. Can be wired in parallel for difficult sighting applications.

Mounting: 1" sight pipe with integral collar

Dimensions: 1-1/2" diam, 4-1/8" length, 72" leads

Approvals: UL, CSA, FM.

Model Selection Guide

Description	Catalog Number	Price
0° to 215°F temperature range, 6' lead	C7035A1023	\$391.17
-40° to 250° F temperature range, 6' lead	C7035A1031	391.17
Replacement UV sensing tube for C7035	129464M	360.19

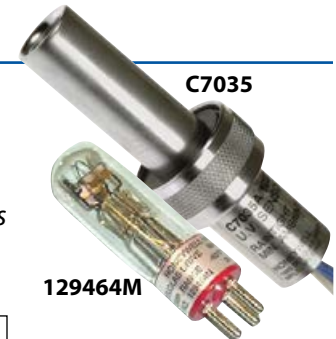

129464M



C7061 Purple Peeper® Solid-State UV Flame Detectors

Ultraviolet flame detector with dynamic self-check for gas-, or oil-fired burners. Can be used with intermittent or interrupted pilots. Compatible with R7861 dynamic self-check UV flame amplifiers on Honeywell RM7800 series relay modules.

Mounts horizontally, vertically, or at any angle in between. Reduces nuisance shutdowns by wiring two in parallel. Field-replaceable UV sensing tube and quartz viewing window.

Mounting: Mounting flange with 3/4" NPT internal threads

Dimensions: 5-1/4" diam. (with flange), 7-7/32" long, 96" leads

Approvals: UL, CSA, FM.



Model Selection Guide

Description	Catalog Number	Price
120 VAC, 3/4" NPT	C7061A1012	\$1676.47
120 VAC, 3/4" NPT*	C7061A1038	1701.81
UV Sensing Tube	129464N	400.79

* With Brad Harrison 41310 connector



129464N

Flame Monitor Series Burner Control System



Flame-Monitor Series

The Flame-Monitor Series provides the proper burner sequencing, ignition and flame monitoring protection on automatically ignited oil, gas and combination fuel burners. Interchangeable programmer and flame amplifier modules allow complete versatility in selecting control function.

The flame-monitor control uses the same wiring base as the Fireeye D-Series and C-Series Controls and is directly interchangeable with most models with out rewiring.

The Flame-Monitor control can be used with ultraviolet, AUTOCHECK® infrared, photocell, flame rod or self-check ultraviolet flame scanners. Special features include remote reset, remote display, expanded announcement of safety lockouts, programmability of safety interlock messages, and remote data communications capability.

The complete Flame-Monitor control consists of a chassis, display module, programmer, amplifier, scanner and a wiring base.

EP Programmer Module

The Fireeye EP Programmer Modules provide start-up programming, safe start check, and flame monitoring supervision. They ensure open damper high fire purge interlock, proof of low fire position and fuel valve end switch safety checks.

A running interlock circuit constantly monitors the limit switches, air flow switches and fuel pressure switches throughout the programmer. EP programmer modules will de-energize all fuel valve circuits within 4 seconds following a flame failure or at the end the pilot-trail-for-ignition period if no flame is detected.

EP programmers provide a Check-Run switch to stop the control in its firing sequence at any time (except MTFI) to aid in setup, start-up, and check out of the burner and its associated interlocks.

EP programmers offer the following functions: an increase of purge timing and air flow switch opened at the start of the operating cycle. EP programmers include an RJ45 style connector to interface with the ED510 display module. EP programmers store the burner cycle and on-time history, as well as lockout history (with burner cycle and burner hour time stamp).



ED510 Display Module

- LCD backlit display with 2 lines of 16 characters each
- 3-key keypad provides historical data from the burner, the last 6 lockout conditions (with burner cycle and burner hour time stamp)
- Mounts directly onto front face of programmers
- Continuous display of current burner status, including first out announcement in the event of a lockout condition
- Remote display capability using DIN-sized opening and remote mounting kit
- RJ style connector

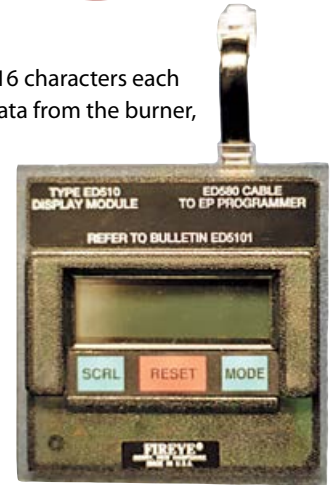

Flame Amplifier Module

Flame amplifier modules are used with the appropriate flame scanner to provide flame scanning capability. Fireeye offers ultraviolet amplifiers and flame rectification amplifiers for use with flame rods, photocells and auto-check infrared amplifiers.

Self-checking ultraviolet scanners and amplifiers should be used in applications where burner firing operation is continuous or where the burner is on for long periods of time without cycling.



Model Selection Guide

Component	Description	Catalog Number	Availability	Price
Chassis	120VAC Chassis with Mounting Screws and Dust Cover	E110	••••	\$1102.00
Program Module	30 Sec. Purge, 10/15 Sec. TFI, 4 Sec. FFRT, Non-Recycle Modulation	EP160	••••	1497.00
Display	2 Line x 16 Character LCD Display with Keypad	ED510	••••	776.00
Flame Scanner	Non Self-Checking Scanner, 3 Ft. Flexible Cable, 1/2" NPT Conn.	UV1A3	↓	206.00
	Non Self-Checking Scanner, 6 Ft. Flexible Cable, 1/2" NPT Conn.	UV1A6	↓	245.00
	Infrared Scanner, 8 Ft Shielded Cable with 90° Head	48PT2-9003	↓	325.00
	Ultraviolet Self-Checking Scanner 120 VAC Shutter, 1" NPT Thread	45UV5-1009	↓	1774.00
	12" Flame Rod for Gas Flames, 1/2" NPT Connection	69ND1-1000K4	↓	137.00
Amplifier Module	Standard Ultraviolet Amplifier	EUV1	•	585.00
	Autocheck Infrared Amplifier	E1R1	•	869.00
	Self-Check Ultraviolet Amplifier	EUVS4	•	984.00
	Flame Rectification Amplifier	ERT1	•	578.00
Wiring Base	Surface Mount	60-1386-2	••••	170.00
	Panel Mount	60-1466-2	••••	170.00

Looking for other Fireeye burner control systems?
 Call Lesman at
 800-953-7626.



For specifications on compatible flame scanners, see pages 272 and 273.



Industrial MB Series Multi-Burner Control Systems



The Fireye Multi-Burner Monitoring System controls the start-up sequence and monitors the flame of up to 20 individual gas, oil or combination gas/oil burners connected to a common valve train. Dynamic on-board diagnostics check for faulty relays, proof of valve closure, high and low fire switch interlocks, and shortened air switch. The MB is even able to specifically identify which burner caused the initial flame failure.

Plug-in flame sensor modules that can sense UV, UV self-check or flame rod provide for easy replacement on an individual basis. Configuration and startup time is reduced through use of on-board DIP switches, which also allow sequencing and timing functions.

The MB-600S chassis directly powers pilot and main gas valves and ignition transformers. The built-in blower output, purge timing, and modulation control let you add independent limits and a controller to create a complete combustion control system for furnace, oven or other multi-burner applications.



Specifications

- Number of Burners:** 20 max.
- Pilot Proving Time:** 7 seconds
- Purge Time:** 0 sec to 60 min
- Pilot Trial for Ignition:** 5, 10 or 15 seconds
- Flame Failure Response Time:** 3 (±0.5) seconds
- Valve Operation:** Simultaneous (all burners operate from one fuel train)
- Supply Voltage:** 120VAC, 50/60 Hz; *Power Consumption:* 25VA
- Temperature Rating:** -32° to 122°F (-36° to 50°C)
- Contact Ratings:** *Fan Motor:* 15 Amp Resistive; *Others:* 10 Amp Resistive



For specifications on compatible flame scanners, see pages 272 and 273.

Model Selection Guide

Description	Catalog Number	Price
Step 1: Select a Chassis for your Multiburner Control System		
Chassis	120VAC 50/60Hz, Motherboard, Relay Board, Logic Module, and Power Module. 4 Auxiliary Inputs, Purge Modulation, Valve Leak Testing	MB-600S \$2094.00
	120VAC 50/60Hz, Motherboard with RS-232 Communications, Relay Board, Logic Module, Power Module. 4 Auxiliary Inputs, Purge Modulation, Valve Leak Testing	MB-632S 2252.00
	120VAC 50/60Hz, Motherboard with RS-485 Communications, Relay Board, Logic Module, Power Module. 4 Auxiliary Inputs, Purge, Modulation, Valve Leak Testing	MB-685S 2252.00
Step 2: Select a Flame Sensor Module		
Sensor Module	Plug-In Flame Sensor Module, UV/FR Plastic Case with Mounting Screws	MB-600PF 419.00
Step 3: For Systems with More than 4 Burners, Select Expansion Board Modules and Cables		
Expansion Modules	Expansion Board for up to 4 Burners	MB-604E 407.00
	Expansion Board for up to 8 Burners	MB-608E 755.00
	6" Cable for Expansion Board	59-506-1 83.40
	36" Cable for Expansion Board	59-506-3 107.00
Step 4: Select Optional Remote Display and Cable		
Display	Remote Display with Keypad	MB510 530.00
	6 Ft. Cable for Remote Display	59-507-6 27.90
	10 Ft. Cable for Remote Display	59-507-10 41.90
Step 5: Select One Flame Scanner for Each Burner on Your System		
Scanners and Accessories	1/2" NPT Straight UV Scanner, 4 Ft. Flex Conduit, Insulated Nylon Coupling	UV7A4 231.00
	1/2" NPT UV Scanner, NEMA 4, 4 Ft. Flex Conduit, Insulated Nylon Coupling	UV7A4W 296.00
	1/2" NPT 90° UV Scanner, 6 Ft Shielded Cable	UV7R4 181.00
	1" NPT Self-Check Scanner	UV7SC 1194.00
	10 Ft Cable for UV7SC Self-Check Scanner	59-504-010 183.00
	Scanner Support, Max Temp 200°F	36-935 43.50
	Magnifying Lens Assembly	46-185 111.00
	Magnifying Lens	46-186 117.00
	Non-Magnifying Lens	46-187 35.00
1/2" NPTF Insulated Nylon Coupling	35-319 55.20	

Tip: If your system has between 4 and 8 burners, select 1 MB-604E module and a connecting cable. If your system has between 9 and 13 burners, select 1 MB-608E module and a connecting cable. For systems that have 14 to 20 burners, you can mix MB-604E and MB-608E modules to fit.

Fireye Integrated Flame Scanners



Comparing Fireye Integrated Flame Scanners

Fireye integrated flame scanners accurately detect the presence or absence of flame in a combustion chamber. Their advanced sensors and algorithms can discriminate the target burner from adjacent flames in the same combustion chambers, in all fuel types and burner configurations.

Use these integrated scanners to replace Fireye discrete scanner models 45UV5 (single burner applications) and 45RM4 (multi-burner applications), without the need for a separate flame amplifier or switch.



	Simplicity 65UV5	Phoenix 85UVF	Insight 95UVS2	Insight II 95DSS3
Detector Type	Ultraviolet	Ultraviolet	Ultraviolet, Infrared, or Both	Ultraviolet and Infrared
4-20 mA Output	One	One	One	Two
Flame Relay	SPDT (NO and NC)	SPST, Normally Open	SPST, Normally Open	Two SPDT (NO and NC)
Fault Relay	SPST, Normally Open	SPST, Normally Closed	SPST, Normally Closed	SPST, Normally Open
Enclosure	NEMA 4X/IP66	NEMA 4X/IP66	NEMA 4X/IP66	NEMA 4X/IP66
Environmental	Class I, Div 2, Groups A-D	Class I, Div 2, Class II, Div II, Class III	Class I, Div 2, Groups A-D, Class II, Div 2, Groups F-G	Class I, Div 2, Group A-D, Class II, Div 2, Groups F-G
Approvals	FM, UL c, CE	FM, UL c/us, CE, ATEX, CENELEC	FM, CSA, UL c/us	FM, UL c/us (SIL 3), CE, ATEX
Display	Internal LED for flame signal and fault indication	LEDs and four-button interface	Alphanumeric LED and four-button interface	Alphanumeric VFD display with five pushbuttons, or infrared transmitter version with wireless handheld communicator
Advanced Features			Autotune, 21 flame flicker frequencies, four selectable programmable setpoint files	Autotune, 21 flame flicker frequencies, four selectable programmable setpoint files, adjustable sensor gain
Diagnostics	Electromechanical self-checking shutter	Self-diagnostics and electronic self-checking	Electronic self-checking	Electronic self-checking
ON/OFF Threshold	Fixed	Automatically set	Adjustable	Independently adjustable (per relay)
Power	24 VDC	24 VDC	24 VDC	24 VDC



Fireye Insight II 95DSS3 Dual Sensor Flame Scanner

Fireye Insight II 95DSS3 is the first primary safety control to receive UL's SIL3 functional safety certification. Insight II scanners use advanced techniques to discriminate and integrate flame detection, amplification, safety determination, and flame switch functions into a single detection head.

Two independently adjustable flame relays can be set to operate from the ultraviolet sensor, the infrared sensor, or both. The Insight II also offers 21 choices of modulation frequency, adjustable sensor gain, adjustable flame relay ON/OFF thresholds, two 4-20 mA analog signal strength outputs, fault relay, four selectable programming files (for different fuels or firing rates), and automatic configuration capability with manual override.

The Insight II scanner can be purchased blind with a blank cover, with a two-line alphanumeric VFD display and five-button keypad, or with an infrared transmitter head that communicates wirelessly to a handheld remote communications tool.

Model Selection Guide

Description	Catalog Number	Price
Dual Ultraviolet and Infrared Flame Scanner	95DSS3-1	\$4099.00
Vacuum Fluorescent Display	95DISP-1	838.00
Wireless Display with Four LED Indicators	95WIDISP-2	595.00
Wireless Programmer for 95WIDISP-2	95WIHH-2	1011.00
Flame Scanner Mounting Flange, 1" NPT	60-2919-1	158.00
10' Cable Assembly	59-546-3	136.00
Flame Scanner Cooling Cover	60-2930-1	564.00
Windows Communication Software	FS95OW-1	1811.00



UL Certified to SIL3

NORMALLY AVAILABLE FROM STOCK

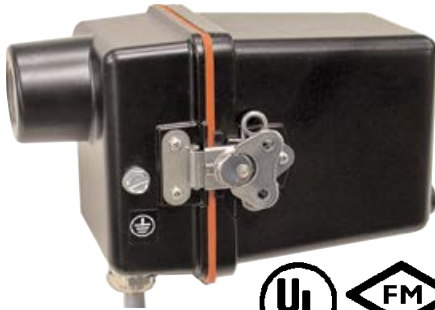

Fireye Simplicity 65UV5 Ultraviolet Scanner

The Fireye Simplicity scanner uses an ultraviolet tube-type sensor and an electromechanical self-checking shutter mechanism. It features an internal flame relay with a fixed ON/OFF threshold and a four-second flame failure response time.

The 65UV5 can be used to detect ultraviolet emissions from fossil fuel flames (natural gas, coke oven gas, propane, methane, butane, kerosene, light petroleum distillates and diesel fuels).

Model Selection Guide

Description	Catalog Number	Price
Simplicity Self-Checking Integrated Flame Scanner		
Ultraviolet Flame Scanner	65UV5-1004QD	\$1960.00
Replacement UV Tube	4-290-1	414.00
24 VDC Power Supply	60-2685-25	439.00
Heat Insulating Jacket	97-1051	753.00



Fireye Phoenix 85UVF Ultraviolet Flame Scanner

The Phoenix 85UVF flame scanner uses a solid state ultraviolet flame detection sensor, and an internal relay with automatically set ON/OFF thresholds, eliminating the need for a remote flame amplifier or flame switch.

The scanner interface includes a pushbutton keypad and LEDs that provide continuous indication of flame signal, flame relay status, scanner status, and selected operation mode.

Model Selection Guide

Description	Catalog Number	Price
Phoenix Self-Checking Integrated Ultraviolet Flame Scanner		
UV Flame Scanner	85UVF1-1QD	\$1571.00
UV Flame Scanner, ATEX and CE Approved	85UVF1-1CEX	2829.00
Mounting Flange for 85UVF1	35-318-1	70.00
10' Cable Assembly	59-546-3	136.00



Fireye Insight 95UVS2 Ultraviolet Flame Scanner

Fireye Insight 95UVS2 uses a solid state ultraviolet sensor and an internal relay with adjustable ON/OFF thresholds in gas applications.

At setup, the Insight determines the modulation frequency for the best flame ON/OFF discrimination. An eight-character alphanumeric LED display and a four-button keypad let you view operating parameters and select setpoints.





The S2 expanded model includes automatic programming with manual override, 21 choices of flame flicker frequency, and four selectable programmable files to store setpoints. Plus, it can communicate remotely using Fireye PC software.

Model Selection Guide

Description	Catalog Number	Price
Insight Solid State Integrated Ultraviolet Flame Scanner		
UV Flame Scanner with Quick Disconnect	95UVS2-1	\$4778.00
UV Flame Scanner, Quick Disconnect, ATEX	95UVS2-1CEX	6460.00
Mounting Flange for 95UVS2-1	60-2692	139.00
Mounting Flange for ATEX Scanner	129-168-1	153.00
Windows Communication Software	FS950W-1	1811.00
10' Cable Assembly	59-496-3	136.00

Fireye Discrete Flame Scanners

These models require flame amplifiers.

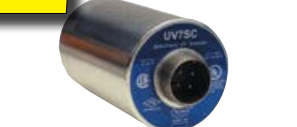
				
<p>UV1A Ultraviolet miniature non- self-checking scanners suitable for fuel gases and #2 oil. Non-replaceable tube. Mounting collar 1/2" NPT.</p>	<p>48PT2 Lead sulfide scanner. Designed to detect low frequency IR signals from gas or oil flames. Mounting collar is 1/2" NPT with straight or 90° mounts. 8 ft. flexible conduit. Replaceable sensor cell.</p>	<p>UV7A4 High sensitivity ultraviolet (UV) for monitoring gas or oil flames which cycle on and off frequently. UL listed, CSA certified, and FM approved.</p>	<p>UV7R4 90° 90° right angle ultraviolet flame scanner. High sensitivity ultraviolet (UV) for monitoring gas or oil flames which cycle on and off frequently. UL listed, CSA certified, and FM approved.</p>	<p>UV7SC Self-Check UV Self-check UV7SC Used for continuous gas or oil flames. Fused silica quartz lens, alloy housing with seals, long life push-pull electromagnetically driven photo shutter. Requires cable assembly 59-504-010.</p>

See pages 270 and 271 for compatible flame amplifiers and burner controls.



Flame Relays and Burner Control Units

Choosing the Right Kromschroder Burner Control



	IFS 110IM	IFD 258	BCU 370
Operating Time	< 24 Hours	< 24 Hours	> 24 Hours
Ignition Type	Direct	Direct	Direct or Pilot Burner
Signal Line Length	50M Max	75M Max	50M Max
Behavior at Flame Failure	Fault Lockout and/or Restart	Switchable: Fault Lockout or Restart	Programmable
Gas Valve Outputs	2	1	2
Prices Start at	\$543.00	\$440.00	\$713.00

IFS 110IM Burner Control Unit

Automatic burner control for ignition and control of gas burners in gas-firing installations of all types. Designed for high cycling frequency and long life.



- For use with flame rod or UV detector
- Performs flame simulation check before starting burner and after switching off
- Semiconductor output for ignition transformer — no switch contacts
- Remote reset, external fault indication
- Can be used for multi-burner control by adding flame relay IFW 15T

Model Selection Guide

Description	Pilot Flame Establishing Period	Catalog Number	Price
Burner control unit for intermittent pilots, FFRT 2 seconds, fault lockout and restart following flame failure			
IFS 110IMT-3/2/2N	3 seconds	84367700	\$543.00
IFS 110IMT-5/2/2N	5 seconds	84367710	543.00
IFS 110IMT-10/2/2N	10 seconds	84367720	543.00
Burner control unit for intermittent operation FFRT 2 seconds, restart following flame failure			
IFS 110IMT-W-3/2/2N	3 seconds	84367750	564.00
IFS 110IMT-W-5/2/2N	5 seconds	84367760	564.00
IFS 110IMT-W-10/2/2N	10 seconds	84367770	564.00



IFW 15T Flame Relay

- Add to an IFS 110 IM for use in multi-burner control applications
- Potential-free contacts
- Integrated ON lamp
- Lets your PLC know when flame is present



Model Selection Guide

Description	Catalog Number	Price
Flame relay. Use with IFS 110IM burner control for multi-burner apps.		
IFW 15T-N Flame Relay	84359100	\$271.00

BCU 370 Burner Control Unit

For controlling, igniting, and monitoring industrial forced draught burners of unlimited capacity in intermittent or continuous operation.



- Use with UV or ionization flame sensors
- Activates blower, positions butterfly valve, monitors gas and air pressure, and checks valves with external gas pressure switch (DGmax)
- Programmable by optical interface and BCSoft PC software



Model Selection Guide

Ignition	Function	Catalog Number	Price
Burner control unit for intermittent or continuous direct or pilot burner.			
None	DGMax pressure monitoring	88600861	\$713.00
None	Integrated tightness control	88600708	1015.00
Electronic	DGmax pressure monitoring	88600298	808.00
Electronic	Integrated tightness control	88600299	1123.00

UVS10D2 Ultraviolet Flame Detector

For monitoring gas burners of with or without fan, on hot-air furnaces, gas-fired boilers, industrial furnaces, and excess-gas flaring installations.

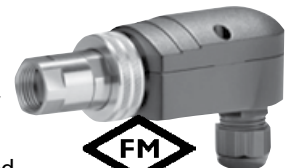

- Insensitive to sunlight, daylight, infrared radiation, and incandescent lamps
- Tube life expectancy 10,000 operating hours
- Protects against interruptions or short circuits in the flame signal line
- Rugged aluminum construction with integrated heat guard, 1/2" NPTF threaded collar and 6-foot leads

Model Selection Guide

Description	Catalog Number	Price
UVS 0D2 Ultraviolet Flame Detector	84315205	\$190.00
Ultraviolet Replacement Tube	74960445	113.00

Industrial Flame Monitoring for Continuous Burners



Honeywell IRIS 

Key Features

- Proportional 0/4-20mA flame signal output
- Flame and self-check relays
- Wide spectral response for hard-to-site applications
- Adjustable "Flame On" and "Flame Off" points
- Models for one, two, or three viewing heads, with independent configuration for each sensor
- Multiple flicker frequency settings prevent flame-out
- Compact UV and IR detectors ideal for pilot monitoring
- Viewing head temperature indication
- Electronic shutter for viewing head self-check
- Hazardous location viewing head models: Class I, Div 2, Groups A-D, T5 and T4A

**Flame safeguard controls with standard 4-20 mA output!
Multiple burners? Multiple fuels?
Changing fuels? Here's the solution!**

Honeywell's flame monitoring systems are ideal for applications in petroleum, petrochemical, pulp, paper, and metals processing industries. Their ability to discriminate in the toughest environments tailors them for industrial process, black liquor recovery, cogeneration or grate-fired builders, cement or lime kilns, Claus (H2S) reactors, thermal oxidizers, and gas turbines.





These industrial flame monitoring systems are uniquely suited for multiple burner applications, exotic fuels, hostile environments and burner types including combination, low NOx, opposed fired, hydrogen, duct, and register burners.

Learn more about combustion controls and flame safety with our free webinar recordings.
www.lesman.com/train/

Remote Configuration, Monitoring, and Diagnostics

You can easily interface multiple signal processors through FlameTools software for remote configuration, monitoring and diagnostics. The user-friendly graphical interface provides intuitive configuration options for settings and outputs. PC software provides access to:

- Flame strength in numeric, graphic, or spreadsheet format
- Simultaneous display of multiple devices and channels
- Configuration control with easy-to-use sliders
- Data logging, with the ability to save process details to spreadsheet
- Filter wizard that automatically saves and compares flame readings for all filter settings
- Ability to save configuration of connected devices to a spreadsheet
- Automatic device detection for serial ports

Finding the Right IRIS System for Your Application					
	<p>700 Single burner signal processor. One channel, two-digit numeric display, keypad, and status LEDs Outputs 0/4-20 mA scalable (non-isolated), Two SPST flame relays, One SPST self-check relay Power to detector</p>	<p>P222 Flare stack pilot monitoring signal processor One channel, four-digit alphanumeric display, keypad, and status LEDs Outputs 0/4-20 mA scalable, Two SPDT early indication, One SPDT delayed indication, Power to detector</p>	<p>P522 Multi-burner, multi-fuel signal processor Two-channel toggle, four-digit alphanumeric display, keypad, and status LEDs Outputs 0/4-20 mA scalable, Two SPDT flame relays, One SPDT self-check relay Power to detectors</p>	<p>P531 Multi-burner, multi-fuel signal processor Three channels with status LEDs Detachable programmer and keypad optional Outputs 0/4-20 mA scalable, 24 VDC @ 50 mA aux out, Six SPDT flame relays, One SPDT self-check relay, Three normally open alarm relays, Power to detectors</p>	<p>P532 Multi-burner, multi-fuel signal processor Three channels, three tri-color alphanumeric scrolling displays, keypad, and status LEDs Outputs 0/4-20 mA scalable, 24 VDC @ 50 mA aux out, Six SPDT flame relays, One SPDT self-check relay, Three normally-open alarm relays, Power to detectors</p>
Compatible Sensors	S700/S800	S256B	S55xBE	S700/S800/S55xBE	S700/S800/S55xBE

Industrial Flame Monitoring for Continuous Burners

Flare Stack Pilot Monitoring

Honeywell IRIS



P222 Watchdog Signal Processor and Viewing Head

One channel signal processor for UV flare stack monitoring, with mounting base, plug-in terminals, four-digit alphanumeric display, keypad, and status LEDs. Watchdog III UV flare stack viewing head with digital display, quick disconnect plug and 0-99 gain.

In many industries, EPA regulations require the monitoring of a stack's flame, or the pilot flame that ignites the gases, to avoid releasing unburned hydrocarbons into the atmosphere.

The Honeywell IRIS Watchdog III system monitors pilot and flare stack activity using an ultraviolet sensor. It provides continuous burner surveillance indicating the presence or absence of a flame at the flame tip, to help comply with state and federal EPA reporting regulations.

The P222 signal processor includes two independent relays, one for early response (adjustable from 1-60 seconds) to a flame loss, and the other for time-delayed response (adjustable between the early response time and 60 minutes) for a flame-out alarm. The signal processor pairs with the Honeywell IRIS S256B ultraviolet viewing head for a fully functional flare stack monitoring system.

Processor Outputs: 0/4-20 mA scalable, two SPDT early indication, one SPDT delayed indication, power detector

Programmed via: Keypad or FlameTools software

Processor Power: 85-265 VAC 50/60 Hz

Ambient Temperature Range:

Processor: 32° to 140°F;

Viewing Head: -40° to 140°F

Enclosure: Processor: NEMA 1;

Viewing Head: IP67, NEMA 4X

Approvals: CSA Special Acceptance

Model Selection Guide

Description	Catalog Number	Price
Flare Stack Signal Processor, AC	P222	\$4775.61
Flare Stack UV Viewing Head	S256B	6623.58
Cable with Braided Shield (per Ft)	C328	9.31

Scalable 4-20 mA output standard on all Iris flame signal processors!

700 Signal Processors for Single Burner Applications

One channel signal processor with DIN-rail mounting, plug-in terminals, two-digit numeric display, keypad, and status LEDs. NEMA 1 enclosure.

Outputs: 0/4-20 mA scalable, two SPDT flame relays, one SPDT self-check relay, power detectors

Programmed via: Keypad

Processor Power: 85-265 VAC 50/60 Hz or 22-26 VDC

Ambient Temperature Range: 32° to 140°F

Approvals: FM, CSA

Compatible Viewing Heads: One S700 or S800

Model Selection Guide

Description	Catalog Number	Price
Single Burner Signal Processor, AC	700ACSP	\$1356.71
Single Burner Signal Processor, DC	700DCSP	1148.41



S700/S800 Viewing Heads

Viewing head with quick disconnect plug and 15-ft cable, 1-9 gain selection

Enclosure: IP67, NEMA 4/4X with tightened connector and UV cable protection

Approvals: FM, CSA Class 1, Div 2, Groups A-D, T4A

Ambient Temperature Range: -40° to 185°F

Compatible Signal Processors: P531 and P532 series multi-burner processors, 700 series single burner processors

Model Selection Guide

Description	Catalog Number	Price
Aluminum housing over center latches		
Infrared Viewing Head	S702	\$1671.78
Ultraviolet Viewing Head	S706	1703.92
Stainless steel housing with friction twist lock		
Infrared Viewing Head	S802	\$1599.59
Ultraviolet Viewing Head	S806	1740.00
15' Cable with LED, Braided Shield	ASY782	612.00



Multi-Burner and Multi-Fuel Applications

P522 Signal Processors

Signal processor with mounting base, plug-in terminals, two channel toggle, four-digit alphanumeric display, keypad and status LEDs. NEMA 1 enclosure.

Outputs: 0/4-20 mA scalable, two SPDT flame relays, one SPDT self-check relay, power detectors

Programmed via: Keypad or FlameTools software

Processor Power: 85-265 VAC 50/60 Hz or 22-26 VDC

Approvals: FM, CSA

Ambient Temperature Range: 32° to 122°F

Compatible Viewing Heads: Two S55xBE models



Model Selection Guide

Description	Catalog Number	Price
Multi-burner Signal Processor, AC	P522AC	\$3426.70
Multi-burner Signal Processor, DC	P522DC	3426.70

P531 Signal Processors

Signal processor with mounting base, plug-in terminals, three channels and status LEDs. Compatible with RP532U detachable programmer/keypad. NEMA 1 enclosure.

Outputs: 0/4-20 mA scalable, 24 VDC@ 50 mA aux out, six SPDT flame relay, one SPDT self-check relay, three normally open alarm relays, power detectors

Programmed via: Detachable P532U1 program interface or FlameTools software

Processor Power: 85-265 VAC 50/60 Hz or 22-26 VDC

Ambient Temperature Range: FM: -40° to 140°F; CSA: 32° to 125°F

Approvals: FM, CSA

Compatible Viewing Heads: Two S55xBE and one S700 or S800



Keypad interface lets the RP531 function like the RP532.

Model Selection Guide

Description	Catalog Number	Price
Multi-burner Signal Processor, AC	P531AC	\$3324.62
Multi-burner Signal Processor, DC	P531DC	2835.28
Keypad/Programming Interface	P532UI	#VALUE!

P532 Signal Processors

Signal processor with mounting base, plug-in terminals, three channels, three tri-color alphanumeric scrolling displays, keypad, and status LEDs. NEMA 1 enclosure.

Outputs: 0/4-20 mA scalable, 24 VDC@ 50 mA aux out, six SPDT flame relay, one SPDT self-check relay, three normally open alarm relays, power detectors

Programmed via: Keypad or FlameTools software

Processor Power: 85-265 VAC 50/60 Hz or 22-26 VDC

Ambient Temperature Range: FM: -40° to 140°F; CSA: 32° to 125°F

Approvals: FM, CSA

Compatible Viewing Heads: Two S55xB and one S700 or S800



Model Selection Guide

Description	Catalog Number	Price
Multi-burner Signal Processor, AC	P532AC	\$4788.77
Multi-burner Signal Processor, DC	P532DC	4431.33

S55xBE Viewing Heads with Digital Displays

Viewing head with digital display(s), quick disconnect plug, IR high pass filter and 0-699 gain selections, 0-99 UV gain selection

Enclosure: IP67, NEMA 4X

Approvals: CSA: Class 1, Div 2, Groups A-D, T5; FM

Ambient Temperature Range: -40° to 122°F

Color Code: UV and IR: White; IR: Red; UV: Blue

Compatible Signal Processors: P522, P531, and P532 series multi-burner processors



Model Selection Guide

Description	Catalog Number	Price
Ultraviolet/Infrared Viewing Head	S550BE	\$4048.92
Infrared Viewing Head	S552BE	3165.33
Ultraviolet Viewing Head	S556BE	3660.18
Cable with Braided Shield (per Ft)	C328	9.31

ASCO® Solenoid Valves for Combustion Systems

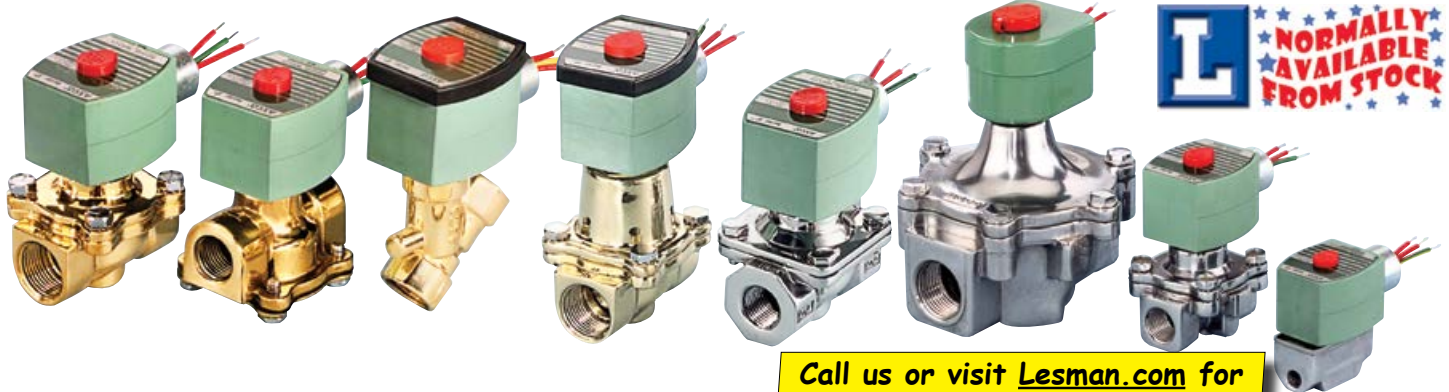

Comparing ASCO Combustion Valves



	8030	8040	8210	8214	8215	8262
Valve Parts In Contact with Fluids	Brass body 305 SS core tube NBR seals/disc 430F SS core/plugnut Copper shading coil 302 SS springs	Aluminum body 305 SS core tube NBR seals/disc 430F SS core/plugnut Copper shading coil 302 SS springs Zinc-plated steel pipe plug	Brass body 305 SS core tube NBR seals/disc 430F SS core/plugnut Copper shading coil	Aluminum body 305 SS core tube NBR seals/disc 430F SS core/plugnut Copper shading coil 302 SS springs Zinc-plated steel pipe plug	Aluminum body 305 SS core tube NBR seals/disc/ diaphragm 430F SS core/plugnut 302 SS or 17-7 PH springs Copper shading coil CA core guide 305 SS core tube	Brass body 305 SS core tube NBR seals/disc 430F SS core/plugnut Copper shading coil Inconel 600 springs Acetal core guide PTFE rider ring
Approvals	UL, FM, CSA	UL, CSA, FM (3/8" to 3/4" only)	UL, FM, CSA	UL, FM, CSA	UL, CSA, FM (except 8215A090 and 8215A040)	UL, FM, CSA

Model Selection Guide

120 volts AC/60 Hz — All Valves Shown Here are Normally Closed (Closed when De-Energized), for Use in Fluids to Maximum Temperatures 125°F

Pipe Size	Orifice Size	Cv Flow Factor	Gas Capacity BTU/Hr	Operating Pressure Differential (PSI)		Watt Rating/ Class of Coil Insulation	Solenoid Valve		Repair Kit		Replacement Coil	
				Min.	Max.		Catalog Number	Price Each	Catalog Number	Price Each	Catalog Number	Price Each
Direct Acting Gas Shutoff Valves												
1/8"	5/16"	1	53,700	0	15	6.1/F	8040H006	\$75.00	318247	\$63.00	238210-032-D	\$92.00
1/4"	5/16"	1.1	59,000	0	15	10.1/F	8040H007	76.00	318247	63.00	238210-032-D	92.00
3/8"	3/8"	1.8	97,000	0	15	10.1/F	8030G068	186.00	306628	139.00	238610-032-D	102.00
1/2"	7/16"	2.8	151,000	0	8	10.1/F	8030G069	189.00	306629	155.00	238610-032-D	102.00
1/2"	3/4"	5.4	291,000	0	2	10.1/F	8040G022	182.00	306633	83.00	238610-032-D	102.00
3/4"	3/4"	9.5	512,000	0	2	10.1/F	8040G023	183.00	306633	83.00	238610-032-D	102.00
1"	1-5/8"	16.8	900,000	0	0.5	15.4/F	8040C004	185.00	304079	138.00	099257-001-D	134.00
Pilot Operated Gas Shutoff Valves												
3/8"	5/8"	2.8	150,000	0	50	10.1/F	8210G074	198.00	304076	160.00	238610-032-D	102.00
3/8"	3/4"	3.4	183,000	0	50	10.1/F	8215G010	193.00	302350	133.00	238610-032-D	102.00
1/2"	5/8"	3.6	193,000	0	50	10.1/F	8210G075	235.00	304076	160.00	238610-032-D	102.00
1/2"	3/4"	4.4	238,500	0	50	10.1/F	8215G020	193.00	302350	133.00	238610-032-D	102.00
3/4"	5/8"	5.0	295,000	0	50	10.1/F	8210G076	256.00	304076	160.00	238610-032-D	102.00
3/4"	3/4"	5.1	247,500	0	50	10.1/F	8215G030	204.00	302350	133.00	238610-032-D	102.00
1"	1-5/8"	21	1,119,000	0	25	15.4/F	8215B050	301.00	302352	245.00	099257-001-D	134.00
1-1/4"	1-5/8"	32	1,730,000	0	25	15.4/F	8215B060	301.00	302352	245.00	099257-001-D	134.00
1-1/2"	1-5/8"	35	1,900,000	0	25	15.4/F	8215B070	348.00	302352	245.00	099257-001-D	134.00
2"	2-3/32"	60	3,251,000	0	25	15.4/F	8215B080	513.00	302353	312.00	099257-001-D	134.00
2-1/2"	3"	117	5,821,000	0	5	28.2/F	8215A090	778.00	302354	481.00	206409-011-D	332.00
3"	3"	138	7,430,000	0	5	28.2/F	8215A040	998.00	302354	481.00	206409-011-D	332.00
Gas Shutoff Valves with Waterproof Enclosures												
3/8"	3/4"	3.4	183,000	0	5	17.1/F	8214G010	157.00	316233	130.00	238610-132-D	126.00
1/2"	3/4"	4.4	238,500	0	5	17.1/F	8214G020	157.00	316233	130.00	238610-132-D	126.00
3/4"	3/4"	5.1	247,500	0	5	17.1/F	8214G030	161.00	316233	130.00	238610-132-D	126.00

Looking for another ASCO solenoid valve? Call Lesman's solenoid valve specialists at 800-953-7626. We stock deep!

ASCO® 8214 Series 2-Way Gas Safety Shutoff Valves

Features

- FM approved as safety shutoff valve with visual indicator and proof-of-closure switch options (Suffix "VI" & "C")
- For on-off control of fuel gas in commercial and industrial gas burners
- Unique double disc design with overtravel provides redundant sealing for leak tight shutoff
- Zero differential piloted diaphragm
- Valves provided with 1/8" NPT upstream and downstream pipe taps with plugs for routine testing
- Optional flange adapters for ease of installation and service
- Modular design for flexibility to configure double solenoid gas train with a small footprint
- Low ambient operating temperature range — valves can be installed in frigid environments as low as -40° C/F



FM approved as safety shutoff valve when ordered with optional visual indication or proof-of-closure switch.

Specifications

Construction: Body: Aluminum; Seals and disc: NBR; Core tube: 305 stainless steel; Core guide: Acetal; Rider ring: PTFE; Core and plugnut: 430F SS; Springs: 302 SS; Shading coil: Copper; Pipe plug: Zinc-plated steel

Standard Voltages: 24, 120, 240 VAC, 60 Hz (or 110, 200 VAC, 50 Hz); 12, 24 VDC; Visual indicator and Proof-of-Closure switch only available on AC constructions

General Purpose Solenoid Enclosures: RedHat metal Type 1; General Purpose housing has a 7/8" diameter hole to accept standard conduit hubs or connectors. Add prefix JB to catalog number for a Junction Box construction with two 7/8" diameter knockouts. (i.e. JB8214 265)

Watertight Solenoid Enclosures: RedHat II molded epoxy Type 1, 2, 3, 3S, 4 and 4X combination. General Purpose and Watertight solenoid enclosures with 1/2" conduit hub as standard.

Valve Response Time: Opening Time: <1 second; Closing Time: <1 second

Approvals: UL Listed: Standard 429 "Electrically Operated Valves," Guide Y10Z, File MP618 Safety Shutoff Valves. FM Approved: Class 7400 "liquid and gas safety shutoff valves," when ordered with C, VI options. CSA Certified: Standard C22.2 No. 139 "Electrically Operated Valves," File 010381. Automatic Gas Valves Z21.21 (6.5), C/I, File 112872. 3) Automatic Gas Safety Shutoff Valves (3.9), File 112872.

Model Selection Guide

120 volts AC/60 Hz — Valves Shown Here are Normally Closed (Closed when De-Energized), For Use in Fluids to Maximum Temperatures 125°F

Pipe Size	Orifice Size	Cv Flow Factor	Gas Capacity BTU/Hr	Operating Pressure Differential (PSI)		Watt Rating/ Class of Coil Insulation	Solenoid Valve		Replacement Coil		
				Min.	Max.		Catalog Number	Price Each	Catalog Number	Price Each	
Two-Way, Normally Closed General Purpose Gas Valves (UL, CSA Approved as Safety Shutoff Valves)											
1 1/4"	2 3/32"	36	1,925,000	0	5	20/F	8214 265	\$347.00	099257-005-D	\$177.00	
1 1/2"	2 3/32"	45	2,406,000	0	5	20/F	8214 275	456.00	099257-005-D	177.00	
2	2/32"	55	2,940,500	0	5	20/F	8214 280	542.00	099257-005-D	177.00	
Two-Way, Normally Closed Watertight Gas Valves (UL, CSA Approved as Safety Shutoff Valves). Only available in AC voltages.											
1 1/4"	2 3/32"	36	1,925,000	0	5	20/F	8214G266	334.00	272610-132-D	132.00	
1 1/2"	2 3/32"	45	2,406,000	0	5	20/F	8214G276	439.00	272610-132-D	132.00	
2	2/32"	55	2,940,500	0	5	20/F	8214G281	521.00	272610-132-D	132.00	
Options and Accessories (For AC voltages only)			Visual indication of open/shut position (For FM-Approved safety shutoff valve)						Suffix VI	106.00	
			1 Amp proof of closure switch (For FM-Approved safety shutoff valve)						Suffix C	157.00	

Learn more at Lesman.com
Get ASCO specifications...

...Check Lesman and factory stock status and lead times...



...Find the right rebuild kit or replacement coil for your valve.

Solids Flow and Motion
Controllers and Programmers
Digital Indicators
Recorders and Data Acquisition
Combustion Safety and Efficiency
Process Valves



Valvario® VAS Safety Shut-Off Solenoid Valves

Normally closed solenoid valves. Safeguard and control air and gas supply to burners and appliances. For use in gas control and safety systems in all sectors of the iron, steel, glass, and ceramics industries, plus commercial heat generation in packaging, paper, and food industries.

- Modular design saves space and piping work
- Main gas valve, pilot valve, regulator and pressure switch are all available for direct "stack" mounting for one small modular footprint
- Changeable mounting plates make it easy to reduce input/output size and flange size. Reduces need for keeping multiple sizes in inventory
- Modular-mount mercury-free pressure switch has test port and <25% deadband
- Can be equipped with Proof of Closure visual indicator
- High flow rate and low pressure drop
- CSA, FM, CE approvals



Specifications

Inlet Pressure: (pe): 7 PSIG max

Non-Operational Pressure: FM approved: 10 PSIG; CSA approved: 5 PSIG

Flow Adjustment: Limits max flow between 20% and 100%. On VAS 1-3 sizes, the setting can be monitored on an indicator

Adjustment of Start Gas Rate: 0% to 70%

Opening Times: VAS/N quick opening: ≤1sec; VAS/L slow opening: up to 30 sec

Closing Time: <1 second

Ambient Temperature: -4° to 140°F

Safety Valve: Class A, Group 2, pursuant to EN 13611 and EN 161; FM research class 7410 and 7411, ANSI Z21.21, CSA 6.5

Materials: IP65 enclosure; Valve housing: Aluminum, Valve seal: NBR

Voltage: 120 VAC, 50/60 Hz

Current Consumption (at 68°F): Pickup: 1.8 amp; Holding: 0.3 amp

Switching Frequency: 5x per minute, except VAS 9: Once per minute

Switching Cycles: 0.1 amp: 500,000; 0.5 amp: 300,000; 1 amp: 200,000; 3 amp: 100,000

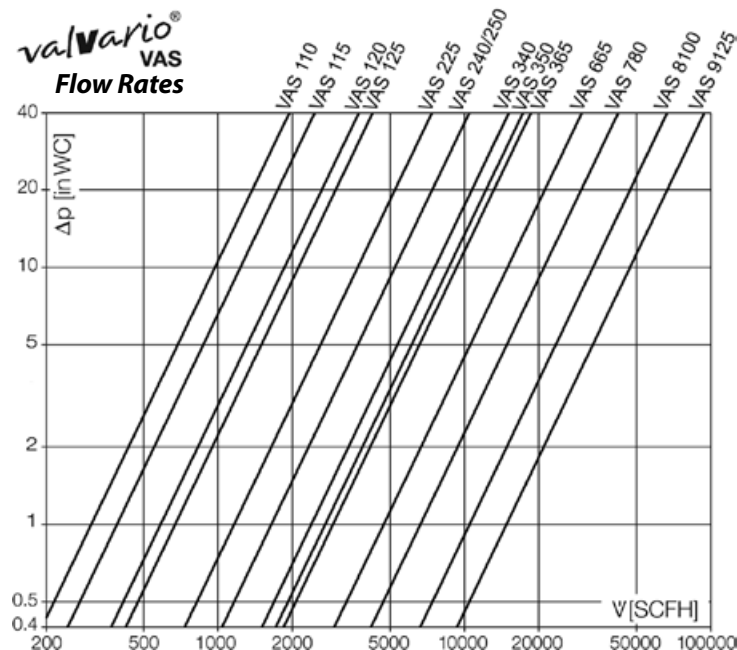

Model Selection Guide

Series	Valve Size	Inlet/Outlet Flange Size	Catalog Number	Price
Quick Opening, NPT Threaded Connection				
VAS 1T10N/NQ	1	3/8"	88001831	\$202.00
VAS 1T15N/NQ	1	1/2"	88001832	202.00
VAS 1T20N/NQ	1	3/4"	88001842	239.00
VAS 1T25N/NQ	1	1"	88001830	249.00
VAS 2T25N/NQ	2	1"	88001849	329.00
VAS 2T32N/NQ	2	1 1/4"	88001850	329.00
VAS 2T40N/NQ	2	1 1/2"	88001851	339.00
VAS 2T50N/NQ	2	2"	88001852	339.00
VAS 3T40N/NQ	3	1 1/2"	88001853	457.00
VAS 3T50N/NQ	3	2"	88001854	457.00
VAS 3T65N/NQ	3	2 1/2"	88001855	488.00
Slow Opening, NPT Threaded Connection				
VAS 1T10N/LQ	1	3/8"	88001856	249.00
VAS 1T15N/LQ	1	1/2"	88001857	249.00
VAS 1T20N/LQ	1	3/4"	88001858	285.00
VAS 1T25N/LQ	1	1"	88001859	295.00
VAS 2T25N/LQ	2	1"	88001860	372.00
VAS 2T32N/LQ	2	1 1/4"	88001861	372.00
VAS 2T40N/LQ	2	1 1/2"	88001862	381.00
VAS 2T50N/LQ	2	2"	88001863	381.00
VAS 3T40N/LQ	3	1 1/2"	88001864	494.00
VAS 3T50N/LQ	3	2"	88001865	494.00
VAS 3T65N/LQ	3	2 1/2"	88001869	523.00

Honeywell

Shutoff Valves and Actuators

V5055 Industrial Gas Safety Shutoff Valve



Safety shutoff valves used with V4055 fluid power actuators to control natural or LP gas flow to commercial and industrial burners. Mounts directly in gas supply line.

Temperature Range: -40°F to 150°F



Operating Differential: 5 PSI max with V4055A or D; 15 PSI max with V4055 B, E, F, or G models.

Includes: 1/4"–18 NPT upstream and downstream taps and plugs

Proof of Closure: V5055C valves have double seal and are used with V4055D and V4055E actuators to provide proof-of-closure switch and valve seal over-travel interlock

Approvals: FM, CSA, and UL

Model Selection Guide

Pipe Size	Capacity	Functions	Catalog Number	Price
Safety shutoff valves for use with V4055 valve actuators				
1.5" NPT	1717 cf/Hr – 48.6 m3/Hr	On/off safety shutoff	V5055A1020	\$365.70
3" NPT	4250 cf/Hr – 148 m3/Hr		V5055A1053	817.87
1.25" NPT	1406 cf/Hr – 39.8 m3/Hr	On/off safety shutoff, slow opening	 V5055B1010	321.98
1.5" NPT	1717 cf/Hr – 48.6 m3/Hr	On/off safety shutoff, proof of closure	 V5055C1059	735.48
2" NPT	3620 cf/Hr – 102.5 m3/Hr		V5055C1000	886.13
2.5" NPT	4250 cf/Hr – 120 m3/Hr		V5055C1018	1044.29

Picking the right V4055 actuator

After you've chosen your V5055 safety shutoff valve, you'll need a compatible V4055 actuator. If you selected a V5055A valve, order a V4055A actuator. If you selected a V5055C valve, you'll need a V4055D actuator.

From there, you have the option of choosing 13 second or 26 second timing, whether or not your actuator needs an internal auxiliary switch, and whether or not your process has a damper shaft.



V4055 On-Off Gas Valve Actuator

Use with Honeywell V5055 gas valves where smooth light off is important to control gas supply to industrial burners.

One second maximum closing time. Continuous display of valve position with a red (open) or yellow (closed) indicator. Provides final safety shutoff service when used with V5055 valves.

Temperature Range: -40° to 150°F





Operating Pressure: 5 psi maximum

Electrical Rating: 120 VAC, 60 Hz

Auxiliary Switch Contact Ratings: 9.8 AFL, 55.8 ALR, 1/2 hp

Proof of Closure Switch Contact Ratings (V4055D): 4.9 AFL, 29.4 ALR, 1/2 hp; 9.8 AFL, 58.8 ALR, 1/2 hp

Model Selection Guide

Timing (Open)	Internal Auxiliary Switch	Damper Shaft	Catalog Number	Price
On-Off Actuator, Use with V5055/V5097A,B Valve Bodies				
13 sec	Yes (90° Stroke)	No	V4055A1296	\$684.52
13 sec	No	Yes	 V4055A1098	611.04
13 sec	No	No	 V4055A1031	611.04
26 sec	No	Yes	V4055A1064	565.72
26 sec	No	No	V4055A1007	565.72
26 sec	No	No	V4055A1312*	1196.00
On-Off Actuator with Proof of Closure Switch, Use with V5055C/V5097C Valve Bodies				
13 sec	Yes	No	 V4055D1035	735.39
13 sec	No	Yes	 V4055D1019	661.86
13 sec	No	No	V4055D1043	661.86
26 sec	No	Yes	 V4055D1001	619.39

* NEMA 4 Enclosure

Looking for direct-acting or pilot gas shutoff valves or vent valves? See page 278.

Need an FM-approved safety shutoff valve with visual indication and proof of closure? See page 279!



FM-Approved Ball Valves for Safety Shut-Off

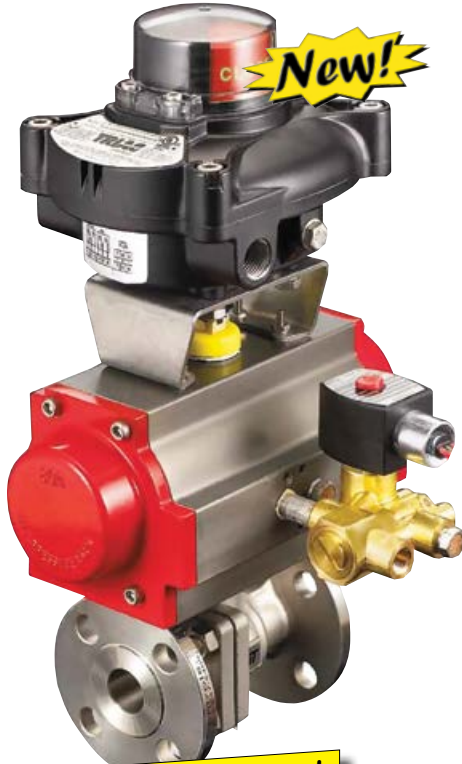

Call for pricing and delivery on Oxygen-cleaned valves

FM approved for use in applications that require protection for fuel-burning equipment per FM class 7400, 7420, and 7422. Available in threaded or ANSI flange design, in sizes from 1/4" to 6". Components include a spring-return automated ball valve, explosion-proof limit switch, and a solenoid pilot valve.

Assemblies feature the latest in quarter-turn automation and rack-and-pinion actuator design, for a marked improvement over older spring-diaphragm technology.

The actuator, combined with the superior valve seating and stem seal design, provides for reliable and consistent closure in a compact fuel gas safety shut-off system.

Features

- Pyramidal stem seal system
- 316 stainless steel or carbon steel bodies, reinforced Teflon seat
- Three-piece threaded or ANSI flanged connections
- Solenoids approved for waterproof and explosion-proof environments
- Two SPDT mechanical limit switch, 5 Amp, NEMA 4, 4X, 7, and 9

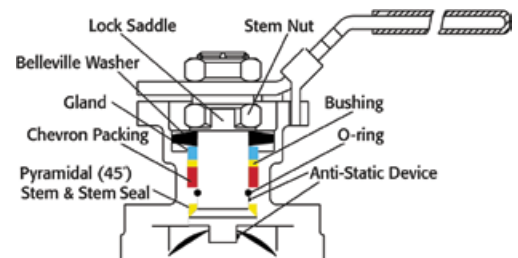

A-T Controls' patented Pyramidal stem seal system protects your valve against wear and leakage, and reduce your plant's fugitive emissions.

Specifications

Body: Choice of 316 stainless steel or carbon steel

Approvals: FM Class 7400, 7420, and 7400

Maximum Operating Pressure (depends on valve size): F88 (threaded) carbon steel: 1000 to 1450 PSI at 100°F; F88 stainless steel: 1000 to 1440 PSI at 100°F; F9D (flanged) carbon steel: 285 to 740 PSI at 100°F; F9D stainless steel: 275 to 720 PSI at 100°F

Limit Switch: Standard: Two SPDT mechanical switches, 5 Amp @ 125 VAC, NEMA 4, 4X, 7, and 9.

Optional: Two 5 Amp DPDT mechanical switches, two 1 Amp SPDT proximity switches, or two 5 Amp SPDT mechanical switches with 4-20 mA position transmitter

SMARTLINK® MRV Micro-Ratio Valve with Electronic Linkage



- Precise and repeatable flow control optimizes fuel efficiency, enables accurate temperature control and lowers burner emissions
- Synchronous control of up to four valves with conventional signal from your process controller
- Stores 22 point customized profile for each valve
- Standby, purge and light off positions can be defined independent of valve profiles
- UL and CE approved electronics and software for air-fuel ratio control
- FM approved as non-incendive for Class I, Div 2, Groups A-D, and T4; NEMA 4X standard actuator

Today's advanced industrial burner systems use advanced ratio control to minimize emissions while maximizing efficiency. Maxon SMARTLINK® MRV flow control valves provide that control and more.

An electronic parallel positioning system for air:fuel ratio control, SMARTLINK MRV is the industry standard in gas valves when operational reliability and precision are required. MAXON's complete SMARTLINK system includes up to four gas valves and a Control Interface Unit to electronically link the valves to your process controller. Each flow control valve is continuous duty and fully adjustable to 0.1% accuracy to provide dynamic control of burner ratios for optimal performance.

Dimensions: F88 Three-Piece Threaded Assembly

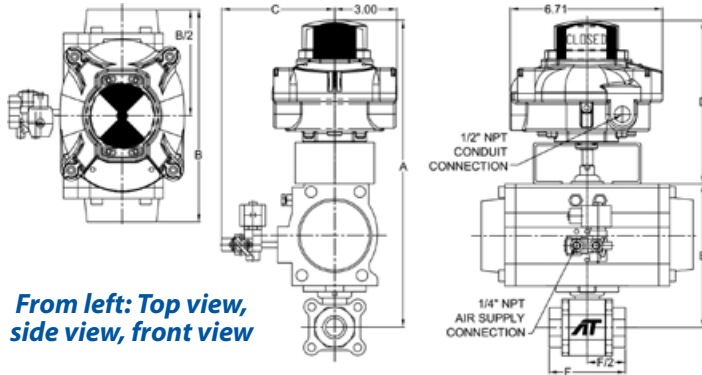

From left: Top view,
side view, front view

Dimensions: FD9 ANSI Flanged Assembly

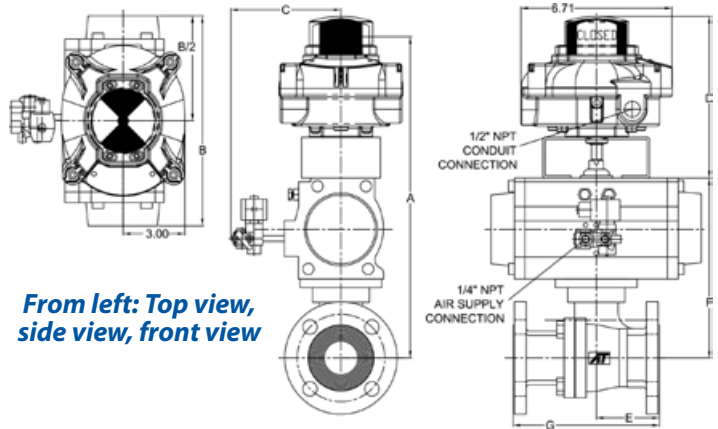

From left: Top view,
side view, front view

Model Selection Guide — Ball Valves with Gas Safety Shutoff Assembly

Valve Size	Valve Cv	Valve Dimensions			Actuator Dimensions			Carbon Steel Valve		Stainless Steel Valve	
		A	C	F	B	D	E	Catalog Number	Price	Catalog Number	Price
Model F88 FireSafe NACE, Three-Piece Full Port Ball Valve, Direct Mount Gas Safety Shutoff Assembly											
1/4"	7	12.14	6.60	2.95	8.00	7.05	5.09	SS-8C-TX-025-6AA	\$ 1420.00	SS-8S-TX-025-6AA	\$ 1432.00
3/8"	8	12.14	6.60	2.95	8.00	7.05	5.09	SS-8C-TX-038-6AA	1420.00	SS-8S-TX-038-6AA	1432.00
1/2"	15	12.14	6.60	2.85	8.00	7.05	5.09	SS-8C-TX-050-6AA	1437.00	SS-8S-TX-050-6AA	1440.00
3/4"	40	13.37	5.98	3.36	9.34	7.05	6.32	SS-8C-TX-075-6AA	1515.00	SS-8S-TX-075-6AA	1530.00
1"	70	13.85	5.98	4.25	9.34	7.05	6.80	SS-8C-TX-100-6AA	1583.00	SS-8S-TX-100-6AA	1584.00
1 1/4"	110	14.00	5.98	4.37	9.34	7.05	6.95	SS-8C-TX-125-6AA	1639.00	SS-8S-TX-125-6AA	1649.00
1 1/2"	250	15.04	6.22	5.01	10.92	7.05	7.99	SS-8C-TX-150-6AA	1867.00	SS-8S-TX-150-6AA	1880.00
2"	430	15.75	6.39	5.62	11.51	7.05	8.70	SS-8C-TX-200-6AA	2201.00	SS-8S-TX-200-6AA	2218.00
2 1/2"	600	17.51	6.85	7.28	13.92	7.05	10.46	SS-8C-TX-250-6AA	2547.00	SS-8S-TX-250-6AA	2633.00
3"	1100	17.51	6.85	8.07	13.92	7.05	10.81	SS-8C-TX-300-6AA	2892.00	SS-8S-TX-300-6AA	2999.00
4"	2200	19.67	7.20	9.45	15.20	7.48	12.19	SS-8C-TX-400-6AA	3410.00	SS-8S-TX-400-6AA	3573.00

Valve Size	Valve Cv	Valve Dimensions				Actuator Dimensions			Carbon Steel Valve		Stainless Steel Valve	
		A	C	E	G	B	D	F	Catalog Number	Price	Catalog Number	Price
Model FD9 Firesafe NACE, ANSI #150 Flanged Full Port Ball Valve Gas Safety Shutoff Assembly												
1/2"	15	12.32	6.60	1.84	4.26	8.00	7.05	5.27	SS-9C-FX-050-6AA	\$ 1500.00	SS-9S-FX-050-6AA	\$ 1535.00
3/4"	45	13.56	5.98	2.18	4.62	9.34	7.05	6.51	SS-9C-FX-075-6AA	1586.00	SS-9S-FX-075-6AA	1591.00
1"	85	13.85	5.98	2.21	5.00	9.34	7.05	6.80	SS-9C-FX-100-6AA	1644.00	SS-9S-FX-100-6AA	1649.00
1 1/2"	275	15.84	6.39	2.83	6.50	11.51	7.05	8.79	SS-9C-FX-150-6AA	1986.00	SS-9S-FX-150-6AA	2027.00
2"	460	16.13	6.39	3.38	7.02	11.51	7.05	9.08	SS-9C-FX-200-6AA	2147.00	SS-9S-FX-200-6AA	2205.00
2 1/2"	700	17.80	6.85	3.06	7.48	13.92	7.05	10.75	SS-9C-FX-250-6AA	2719.00	SS-9S-FX-250-6AA	2832.00
3"	1100	18.45	6.85	4.01	8.01	13.92	7.05	11.40	SS-9C-FX-300-6AA	3120.00	SS-9S-FX-300-6AA	3259.00
4"	2200	20.59	7.20	4.07	9.00	15.20	7.48	13.11	SS-9C-FX-400-6AA	4227.00	SS-9S-FX-400-6AA	4472.00
6"	5150	25.88	8.22	7.00	15.50	24.37	7.48	18.40	SS-9C-FX-600-6AA	7812.00	SS-9S-FX-600-6AA	8468.00

Model FD9 Firesafe NACE, ANSI #300 Flanged Full Port Ball Valve Gas Safety Shutoff Assembly												
1/2"	15	12.32	6.60	1.84	4.26	8.00	7.05	5.27	SS-9C-3X-050-6AA	1544.00	SS-9S-3X-050-6AA	1554.00
3/4"	45	13.56	5.98	2.18	4.62	9.34	7.05	6.51	SS-9C-3X-075-6AA	1670.00	SS-9S-3X-075-6AA	1682.00
1"	85	13.85	5.98	2.21	5.00	9.34	7.05	6.80	SS-9C-3X-100-6AA	1752.00	SS-9S-3X-100-6AA	1769.00
1 1/2"	275	15.84	6.39	2.83	6.50	11.51	7.05	8.79	SS-9C-3X-150-6AA	2189.00	SS-9S-3X-150-6AA	2261.00
2"	460	16.13	6.39	3.38	7.02	11.51	7.05	9.08	SS-9C-3X-200-6AA	2329.00	SS-9S-3X-200-6AA	2420.00
2 1/2"	700	17.80	6.85	3.06	7.48	13.92	7.05	10.75	SS-9C-3X-250-6AA	2982.00	SS-9S-3X-250-6AA	3129.00
3"	1100	18.45	6.85	4.01	8.01	13.92	7.05	11.40	SS-9C-3X-300-6AA	3535.00	SS-9S-3X-300-6AA	3747.00
4"	2200	20.59	7.20	4.07	9.00	15.20	7.48	13.11	SS-9C-3X-400-6AA	5104.00	SS-9S-3X-400-6AA	5434.00
6"	5150	25.88	8.22	7.00	15.50	24.37	7.48	18.40	SS-9C-3X-600-6AA	9273.00	SS-9S-3X-600-6AA	10113.00

Safety Shutoff and Vent Valves

5000 Series Electromechanical Valves for Oil and Gas

- 3/4" to 3" line sizes with threaded NPT process connection; Line pressures up to 125 PSIG
- Field-rotatable top assemblies in 90° increments to fit your application
- Actuators available with manual reset or automatic reset operators
- Visual position indication standard
- Overtravel position switches for open and closed position
- Electrically actuated valves with powerful closing spring provide closure in less than one second
- FM, CSA, UL, and CE approved; Available for non-incendive Class I, Div 2 areas; Full assessment to IEC 61508 as SIL 3 capable; Designed to meet Fluid Control Institute (FCI) 70-2 control valve standard for Class VI seat leakage



Model Selection Guide

5000 Series Gas Shutoff Valve: Normally closed automatic gas shutoff valve, cast iron body. Six-second timing. Trim: 400 series stainless steel seat, hardened ductile iron disc, PEEK follower ring. BUNA N o-rings/bumper, 115 VAC, 60 Hz, NEMA 4 enclosure.

Process Conn.	Valve Size	Cv	Operating ΔP Max.	Catalog Number	Price
One proof of open switch, one proof of closure switch.					
NPT Thread	0.75" (DN20)	19	125 PSIG	5 075SMA11-AA11-BB21A0	\$ 1639.99
	1" (DN25)	20	125 PSIG	5 100SMA11-AA11-BB21A0	1668.25
	1.25" (DN32)	45	100 PSIG	5 125SMA11-AA11-BB21A0	1678.40
	1.5" (DN40)	53	70 PSIG	F 150SMA11-AA11-BB21A0	1727.82
	2" (DN50)	86	70 PSIG	5 200SMA11-AA11-BB21A0	2041.00
	2.5" (DN65)	127	40 PSIG	F 250SMA11-AA11-BB21A0	2204.40
ANSI Flange	3" (DN80)	423	30 PSIG	F 300SMA11-AA11-BB21A0	2453.40
	2.5" (DN65)	304	50 PSIG	5 250CMA11-BA11-BB21A0	2754.99
	3" (DN80)	173	40 PSIG	5 300CMA11-BA11-BB21A0	3418.60
	4" (DN100)	490	40 PSIG	F 400CMA11-BA11-BB21A0	3561.70
Two proof of open switches, two proof of closure switches.					
NPT Thread	1.5" (DN40)	53	70 PSIG	F 150SMA11-AA11-BB22A0	1952.30
	2" (DN50)	86	70 PSIG	F 200SMA11-AA11-BB22A0	2265.60
	2.5" (DN65)	127	40 PSIG	F 250CMA11-AA11-BB22A0	3213.60
	3" (DN80)	423	30 PSIG	F 300CMA11-AA11-BB22A0	3390.90
ANSI Flange	4" (DN100)	490	40 PSIG	F 400CMA11-BA11-BB22A0	4020.40

Call for larger valves with high flow capacity or 12 second motor timing.

4700 General Purpose Electromechanical Valves

- Line sizes from 3/8" to 6" diam., Cv flow factors to 1230, line pressures to 600 PSIG
- Normally closed valves for quick, reliable shut-off of gas or oil lines; Normally open versions for vent or process purge lines
- Top assembly enclosures meet NEMA 1, 3, 3S, 4, and 12, CSA 2, 4, and 5; Also available with NEMA 4X trim
- Choice of manual reset or automatic reset motorized operators
- Minimal line pressure drops with straight-through flow swinging gate or rising stem valve bodies



NI Series Non-Incendive Electromechanical Valves

- Line sizes 3/4" to 6" diam., Cv flow factors to 765, and line pressures to 600 PSIG
- Top assembly enclosures meet NEMA 1, 3, 3S, 4, and 12; Available NEMA 4X trim
- Manual reset or automatic reset motorized operators available
- Sanctioned service valve approvals: FM, IRI for block, bleed, and vent systems; Valve bodies designed to ANSI standards
- FM approved for Class I, Div 2; Class II, Div 2; and Class III, Div 2; Meets non-incendive component criteria of NEC/NFPA 70-1996



Actionair® Air Actuated Valves

- Series 1000 shut-off valves: 3/4" to 6" rising stem bodies, normally closed actuators: CGA certified, FM approved for use with air, natural gas, LP gases, #1 and #2 fuel oils
- Series 2000 vent valves: 3/4" to 4" rising stem bodies, normally open actuators: CGA certified, FM approved for use with air, natural gas, LP gases, #1 and #2 fuel oils
- Series 3000 shut-off valves: 1/2" to 1-1/4" swinging gate bodies, normally closed actuators: FM approved for use with #1, #2, #4, and preheated #5 and #6 fuel oils
- Available Cv factors to 1230, and line pressures to 700 PSIG
- Two-color open/shut indicator for positive visual indication of valve's body position
- Meet NEMA 1, 2, 3, 3R, 4, and 12, CSA 2, 4, and 5; Designed to ASME/ANSI standards



Call for current pricing.

8000 Series Air Actuated Valves for Oil and Gas

- Available in 3/8" to 2" line sizes and line pressures up to 740 PSIG
- Pneumatically actuated valves with powerful closing spring for reliable operation
- Top mounted 360° open-shut visual position indication
- Cast iron and carbon steel body assemblies to handle general purpose or severe fluids
- Compact design with integral solenoid, quick exhaust and position switches
- FM, CSA approved safety shut-off valves; Hazardous location approved: Intrinsically Safe for Class I, Div. 1 (and ATEX Zone 2/22 when ordered with the ATEX IS solenoid); Non-Incendive for Class I, Div. 2; NACE-compliant trims available



Honeywell

Firing Rate Valves and Motors

V51E Butterfly Firing Rate Gas Valve

Provides modulating control of natural, manufactured, LP gases or air.

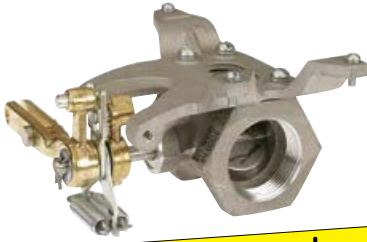

To complete your valve assembly select a Honeywell Modutrol actuator motor below.

Use in commercial and industrial installations where large amounts of gas must be closely controlled. Do not use as a safety shutoff valve. Use with modutrol motor and Q100 linkage kit. Includes strain release.

Temperature Range: 32° to 140°F

Pressure: Rating: 5 psi max.; Inlet/outlet pressure tapping: Two downstream 1/4" NPT taps

Material: Aluminum body

Approvals: UL



Model Selection Guide

Pipe Size	Capacity	Catalog Number	Price
1.5"	4200 cf/Hr – 118.9 m3/Hr	V51E1000	\$476.41
2"9	210 cf/Hr – 260.7 m3/Hr	V51E1018	530.59
2.5"	8390 cf/Hr – 199.8 m3/Hr	V51E1034	569.90
3"	14640 cf/Hr – 414.5 m3/Hr	V51E1059	600.52
Bracket for 2" valve/Modutrol motor		127413	174.29
Bracket for 2.5" valve/Modutrol motor		127415	209.31
Strain release assembly		49085B	263.50
Stop screws for stop bracket (2 reqd.)		80897BC/0021	3.02
Linkage kit V51 to M9484 Modutrol		Q100B1006	116.87

Modutrol IV Rotary Actuator Motors for Firing Rate Valves



These low torque rotary actuators are reversing, proportional motors used to drive burner firing rate valves, dampers, or auxiliary equipment.

Ambient Temperature: -40° to 150°F (-40° to 66°C)

Crankshaft: Double ended, 3/8" (9.5mm) square

Deadweight Load on Shaft: 200 lb (either end); 300 lb combined power and auxiliary shafts

Power Consumption: 18 W

Voltage: 24 VAC

Switch Ratings: 120 VAC: 7.2 AFL, 43.2 ARL, 40 VA pilot duty opposite contact; 240 VAC: 3.6 AFL, 21.6 ALR, 40 VA pilot duty opposite contact

Compatible Linkage: Q100B1006, connects Modutrol to V51E butterfly valve above.

Replaces: Retired models M941A, C, and D motors

Approvals: CSA, UL



More Honeywell Modutrol IV motors on page 338 and online. Visit www.Lesman.com/get/modutrol.php for series specifications and model selection guides.

Model Selection Guide

Stroke Timing		Torque Rating	Auxiliary Switches	Product Includes	Functional Replacement for These Obsolete Models	Catalog Number	Price
90°	160°						
Proportional-Reversing Motors to Drive Firing Rate Valves, 135 Ohm Input Signal, 90° to 160° Field-Adjustable Stroke, 24 VAC							
15 sec	30 sec	75 Lb-in	1	Tapped Shaft	M9484D1002, D1036, and E1116	M9484E1009	\$1166.88
30 sec	60 sec	150 Lb-in	0		M9484D1028, D1044, and D1051	M9484D1010	979.50
30 sec	60 sec	150 Lb-in	1		M9484E1090 and E4003	M9484E1017	1149.64
30 sec	60 sec	150 Lb-in	1	Motor Crank Arm, Ships in 90° Position	M9484E1025, E1041, E1058, E1066, M9484E1074, and E1082	M9484E1033	1153.56
30 sec	60 sec	150 Lb-in	2	Ships in 90° Position		M9484F1007	1207.48
30 sec	60 sec	150 Lb-in	2	Tapped Shaft, Ships in 90° Position		M9484F1031	1238.78



See 333-338.

Honeywell

Looking for motors for damper control?

Honeywell HercuLine 2000 Series Electric Actuators

- No-burnout motor, low power consumption
- Two end-of-travel electric limit switches standard
- Up to four additional SPDT auxiliary switches
- Optional manual handwheel
- Mounting plates adapt to Invensys (Barber-Colman) or Siemens (Landis & Staefa) mountings
- CSA, UL, CE certification, NEMA 4/IP67

Butterfly Valves and Actuators



Need a butterfly valve for flue gas or high temperature air flow rates? Call Lesman for pricing and availability.

BV Butterfly Valves

High accuracy valves for control of gas flow rates. Mount on IC 20 or IC 40 actuators to regulate flow rates for modulating or stage-controlled combustion systems.

- Low leakage rate and pressure loss
- Other models available for flue gas and high temperature air flow rates to 840°F. Call Lesman for details

Model Selection Guide

Model	Temperature Range	Bore Size	Nominal Diameter	Reduced Nominal Diam.	Compatible Actuator	Catalog Number	Price
Butterfly valve for continuous control of gas flow rates, ratio of 10:1. Maximum inlet pressure 7.25 PSI.							
BVG 40TW05	-4° to 140°F	Full	1 1/2"		IC 20 or IC 40	88300141	\$230.00
BVG 65TW05	-4° to 140°F	Full	2 1/2"		IC 20 or IC 40	88300143	263.00
BVG 50TW05	-4° to 140°F	Full	2"		IC 20 or IC 40	88300142	245.00
BVG 80TW05	-4° to 140°F	Full	3"		IC 20 or IC 40	88300144	302.00
BVG 100TW05	-4° to 140°F	Full	4"		IC 20 or IC 40	88300145	327.00
BVG 40/32TW05	-4° to 140°F	1X Reducing	1 1/2"	1 1/4"	IC 20 or IC 40	88300146	319.00
BVG 50/40TW05	-4° to 140°F	1X Reducing	2"	1 1/2"	IC 20 or IC 40	88300147	339.00
BVG 65/50TW05	-4° to 140°F	1X Reducing	2 1/2"	2"	IC 20 or IC 40	88300148	358.00
BVG 80/65TW05	-4° to 140°F	1X Reducing	3"	2 1/2"	IC 20 or IC 40	88300149	399.00
BVG 100/80TW05	-4° to 140°F	1X Reducing	4"	3"	IC 20 or IC 40	88300150	437.00
BVG 40/25TW05	-4° to 140°F	2X Reducing	1 1/2"	1"	IC 20 or IC 40	88300151	319.00
BVG 65/40TW05	-4° to 140°F	2X Reducing	2 1/2"	1 1/2"	IC 20 or IC 40	88300153	358.00
BVG 50/32TW05	-4° to 140°F	2X Reducing	2"	1 1/4"	IC 20 or IC 40	88300152	339.00
BVG 80/50TW05	-4° to 140°F	2X Reducing	3"	2"	IC 20 or IC 40	88300154	399.00
BVG 100/65TW05	-4° to 140°F	2X Reducing	4"	2 1/2"	IC 20 or IC 40	88300155	437.00



Compatible Valve Actuators for BV Butterfly Valves

Reversible gear motors to transmit rotary movements between 0° and 90°.

- IC 20 for basic applications with continuous or three-point step control, automatic/manual mode change-over for easy commissioning. IC 20..E is controlled by 0/4-20 mA or 0-10V signal
- IC 40 for complex applications with programmable functions for flexible adjustment to the process. Compatible with BCSoft for data monitoring, troubleshooting, and programming

Model Selection Guide

Description	Torque (Lb-in)	Run Time (Over 90° Stroke)	Controlling Signal	Catalog Number	Price
IC 20 Reversible gear motor, 120 VAC, 50/60 Hz					
IC 20-07Q2	22 Lb-in	7.5 seconds	Three-point step	88300062	\$412.00
IC 20-15Q3	26.5 Lb-in	15 seconds	Three-point step	88300063	412.00
IC 20-30Q3	26.5 Lb-in	30 seconds	Three-point step	88300064	412.00
IC 20-60Q3	26.5 Lb-in	60 seconds	Three-point step	74105715	403.00
IC 20-15Q3E	26.5 Lb-in	15 seconds	Continuous	88300079	888.00
IC 20-30Q3E	26.5 Lb-in	30 seconds	Continuous	88300080	888.00
IC 20-60Q3E	26.5 Lb-in	60 seconds	Continuous	88300081	888.00
Description	Torque (Lb-in)	Additional Input/Output Functions		Catalog Number	Price
IC 40 Reversible gear motor, 100-230 VAC, 50/60 Hz					
IC 40TA2	22 Lb-in	—		88300085	\$735.00
IC 40TA2A	22 Lb-in	4-20 mA input		88300088	788.00
IC 40TA2R10	22 Lb-in	1000Ω feedback potentiometer		88300084	836.00
IC 40TA2AR10	22 Lb-in	4-20 mA input and 1000Ω feedback potentiometer		88300241	886.00
IC 40TSA3	26.5 Lb-in	Safety closing function		88300091	892.00
IC 40TSA3A	26.5 Lb-in	Safety closing, 4-20 mA input		88300094	940.00
IC 40TSA3R10	26.5 Lb-in	Safety closing, 1000Ω feedback potentiometer		88300095	993.00
IC 40TSA3AR10	26.5 Lb-in	Safety closing, 4-20 mA input, 1000Ω feedback potentiometer		88300098	1038.00
				Loose (/B)	Assembled (/E)
IC 20/40 Attachment Set				74921671	\$69.00
IC 20/40 Adapter - Free Shaft End				74921676	63.00
IC 20/40 Adapter - Manual Adjustment				74921678	59.00
IC 20/40 Adapter - Square Shaft				74921674	63.00
IC 40 Accessory: Fastening Set IC-BV				74921082	7.80
				74921747	\$88.00
				74921677	82.00
				74921679	72.00
				74921675	82.00
				74921084	13.00

Temperature Controls and Sensors

T775 Digital Temperature Controller

Stand-alone electronic temperature controller with keypad and graphical digital display, capable of remote sensing and providing switched or proportional outputs.

Temperature: Operating Range: -40° to 140°F at 60 Hz, -40° to 125°F at 50 Hz; Setpoint Range: -40° to 284°F; Throttling Range: 1° to 150°F; Differential: 1°F to 150°F; Accuracy: ±1°F at 77°F

Approvals: UL Listed, CE Certified

Enclosure: NEMA 1, IP65 Rated



Model Selection Guide

Control Type	SPDT Relay Outputs	Analog Outputs	Floating Output	High/Low Limit Control	Catalog Number	Price
Remote Bulb Digital Temperature Controller with Two Sensor Inputs, One 5002159-001 Sensor Included.						
Standard	4	0	2	No	T775B2040	\$499.45
Modulating	2	Two 4-20 mA, 0-10 VDC, or 2-10 VDC	0	Yes	T775M2048	447.57
Encapsulated Platinum PTC Sensing Element with 6" Lead, for Use with T775 as Second Input					193987GA	180.67

T675A Remote Bulb Temperature Controller

Remote bulb thermostats regulate temperature of air or liquids in ducts, pipes, tanks, and boilers. Suitable for applications where the controller must be placed outside the sensing area.

Contact Ratings: T675A1136: 125 VA; T675A1565: 8.0 AFL, 48.0 ALR

Approvals: UL Listed, CSA Certified

Model Selection Guide

Setpoint Range	Differential Temperature	Max. Operating Temperature	Bulb Size	Contact Rating (120 VAC)	Catalog Number	Price
Remote (Copper) Bulb Temperature Controller with 20-Foot Capillary, 1 SPDT Relay Output						
0° to 100°F	1°F	125°F	1/2" x 4-3/16"	125 VA	T675A1136	\$184.92
55° to 175°F	3.6° to 12°F	200°F	1/2" x 3-9/16"	8.0 AFL, 48.0 ALR	T675A1565	203.42



T6051 Line Voltage Thermostat

Control fan coils, fans, motor starters, valves, contactors, and circulator motors in heating or cooling systems. Removable knob locks setpoint and prevents tampering.

Electrical Rating: 120/240 VAC, 50/60 Hz; Resistive Rating: 22A @ 120/240 VAC, 19A @ 277 VAC.

Inductive Current: 120V: 16.0 Amps heating, 8.0 Amps cooling; 240V: 8.0 Amps heating, 4.0 amps cooling

Model Selection Guide

Description	Catalog Number	Price
Line voltage thermostat with resistive rating, 125 VA pilot duty, 50° to 80°F range, UL listed	T6051A1016	\$190.11

Includes standard locking cover P/N 135535B. Can be mounted either vertically or horizontally on standard outlet box.



T631 Airswitch Controller

Provides line voltage control of cooling, heating or ventilating equipment in storage areas.

Sensing Element: Coiled copper tube

Enclosure: Red steel corrosion-resistant case

Approvals: UL listed; CSA certified

SPDT Snap Switch Rating: 2A @ 24 VAC; 7.4A @ 120 VAC; 3.7A @ 240 VAC



Model Selection Guide

Temperature Setpoint Range		Fixed Differential		Max. Ambient Temperature		Catalog Number	Price
°F	°C	°F	°C	°F	°C		
-10 - 100	-23 - 38	3.0	1.7	125	52	T631A1063	\$173.50
0 - 70	-18 - 21	3.0	1.7	125	52	T631A1030	174.27
35 - 100	2 - 38	2.0	1.1	120	49	T631A1006	174.27
35 - 100	2 - 38	3.5	1.9	120	50	T631A1113	182.18
70 - 140	21 - 60	2.0	1.1	150	66	T631A1022	181.94

Pilot Controls and Mechanical Safety Switches

C6097 Safety Limit Switches



Limit switches for positive or differential pressure systems to sense natural gas, liquid propane gas, or air. Removable clear cover protects scale plate and adjusting knob.

Temperature Range: -40° to 140°F

Switch Ratings: 3.0 AFL, 18.0 ALR, 5.0 Amp resistive. Can be wired to turn on alarms.

Model Selection Guide

Operating Range	Pressure Differential at Min. Setpoint	Max. Setpoint	Switch Operation	Mounting	Catalog Number	Price
Diaphragm-Actuated Safety Limit Switch, Brake on Pressure Fall, 1/8" NPT Internal Threaded Connection						
0.4" to 5" WC	0.16" WC	0.24" WC	Auto Recycle	1/4" NPT	C6097A1004	\$166.13
0.4" to 5" WC	0.6" WC	0.25" WC	Manual Reset	1/4" NPT	C6097A1095	156.04
3" to 21" WC	0.24" WC	0.48" WC	Auto Recycle	1/4" NPT	C6097A1053	127.95
12" to 60" WC	1.1" WC	2.4" WC	Auto Recycle	1/4" NPT	C6097A1079	138.09
Diaphragm-Actuated Safety Limit Switch, Break on Pressure Rise, 1/8" NPT Internal Threaded Connection						
3" to 21" WC	2.4" WC	4.2" WC	Manual Reset	1/4" NPT	C6097B1028	153.84
12" to 60" WC	10" WC	12" WC	Manual Reset	1/4" NPT	C6097B1002	166.10
1.5 to 7 PSI	1.1" WC	1.4" WC	Manual Reset	1/4" NPT	C6097B1051	181.06



L404F Pressuretrol® Controllers

Operating control with automatic limit protection for pressure systems. Use with steam, air, noncombustible gases, or fluids non-corrosive to pressure sensing element

Switching Action: SPDT snap-action switch to open or close a circuit on pressure rise

Connections: Pipe (main or high pressure): 1/4" NPT internal thread; Electrical: Screw terminals

Model Selection Guide

Operating Range	Sustained Pressure	Adjustable Differential	Sensor Element	Unit Includes	Catalog Number	Price
2 to 15 PSI	25 PSI max.	2 to 6 PSI	Stainless Steel Diaphragm	Siphon Loop	L404F1060	\$202.78
5 to 50 PSI	85 PSI max.	6 to 14 PSI	Stainless Steel Diaphragm	Ground Screw	L404F1375	205.98
10 to 150 PSI	225 PSI max.	10 to 22 PSI	Stainless Steel Diaphragm	—	L404F1102	222.73



C437 Mercury-Free Pressure Limit Switches

Safety shutoff, pressure, or differential pressure control in industrial gas systems.

Switch Action and Operation: SPST (Mercury-free), break on rise, Manual reset

Switch Contact Ratings: 120 VAC: 8/0 AFL, 48.0 ALR, 10 Amp resistive; 240 VAC: 5.1 AFL, 12.0 ALR, 2 Amp resistive

Pipe Connections: Main or High Pressure: 1/2" NPT internal thread; Vent or Low Pressure: 1/8" NPT internal thread

Materials: Sensor Element: Buna-N Diaphragm; Case: Diecast aluminum

Model Selection Guide

Operating Range	Sustained Pressure	Pressure Differential	Switch Operation	Upgrade from Mercury Switch	Catalog Number	Price
0.5 to 5 PSI	15 PSI max.	0.5 PSI, Subtractive	Manual Reset	C437D1013	C437D2011	\$345.70
1 to 10 PSI	30 PSI max.	1 PSI, Subtractive	Manual Reset	C437D1021	C437D2029	345.70
1" to 26" WC	5 PSI max.	1.75" WC, Additive	Manual Reset	C437E1004	C437E2002	345.70
0.5 to 5 PSI	15 PSI max.	0.5 PSI, Additive	Manual Reset	—	C437E2010	345.70



S8610U3009 Intermittent Pilot Ignition Control

Provides ignition sequence, flame monitoring, and safety shutoff for intermittent pilot ignition systems used on natural or LP gas-fired furnaces, boilers, and heating applications.

Electrical Rating: 24 V, 60 Hz; **Current Draw:** 1A pilot valve, 2A main valve; **Contact Rating:** 0.2A

Field Replacement: For most Honeywell, Robertshaw, Johnson, UTEC (HCS) intermittent pilot ignition modules

Model Selection Guide

Trial for Ignition	Configurable Pre-Purge	Catalog Number	Price
15- or 90-sec	0- or 30-sec	S8610U3009	\$191.04



Solids Flow and Motion

Controllers and Programmers

Digital Indicators

Recorders and Data Acquisition

Combustion Safety and Efficiency

Process Valves

**krom
schroder**



DG Pressure Switches

Monitors positive air and gas pressures, negative or differential air pressures in industrial and commercial applications.

- Accurate repeatable switching action with low hysteresis
- Die-cast aluminum alloy base, glass fiber-reinforced plastic switch housing, nitrile rubber diaphragm, and high-quality injection-molded plastic covers
- One normally open and one normally closed contact in each switch (5A resistive or 0.5A inductive)
- Automatic and manual reset models
- 8A quick-acting fuse for short circuit protection
- FM approved, cULus listed

Model Selection Guide

Model	Adjustable Range ("WC)	Connection	Catalog Number	Price
DG..T pressure switch with 110V control lamp (green) for positive, negative, and differential pressure, automatic reset				
DG 6T	0.2" to 2.4"	2 x 1/4" NPT	84447802	\$89.00
DG 10T	0.4" to 4"	2 x 1/4" NPT	84447812	89.00
DG 50T	1" to 20"	2 x 1/4" NPT	84447822	89.00
DG 150T	12" to 60"	2 x 1/4" NPT	84447832	89.00
DG 500T	40" to 200"	2 x 1/4" NPT	84447842	89.00
DG..HT pressure switch with manual reset, locks on pressure rise				
DG 10HT	0.4" to 4"	2 x 1/4" NPT	84447912	107.00
DG 50HT	1.0" to 20"	2 x 1/4" NPT	84447922	107.00
DG 150HT	12" to 60"	2 x 1/4" NPT	84447932	107.00
DG 500HT	40" to 200"	2 x 1/4" NPT	84447942	107.00
DG..NT pressure switch with manual reset, locks on pressure fall				
DG 10NT	0.4" to 4"	2 x 1/4" NPT	84447962	107.00
DG 50NT	1.0" to 20"	2 x 1/4" NPT	84447972	107.00
DG 150NT	12" to 60"	2 x 1/4" NPT	84447982	107.00
DG 500NT	40" to 200"	2 x 1/4" NPT	84447992	107.00

DG..VT Safety Limit Pressure Switches

Diaphragm-actuated safety limit switch controls rising or falling pressures that must not overshoot or undershoot a set limit value, and controls the minimum or maximum gas inlet pressure of a gas control line.

- For use with natural gas and air
- Die-cast aluminum base, glass-filled PBT switch housing, NBR diaphragm, and polycarbonate cover
- Available with Valvario mount for direct connection to Kromschroder modular valve trains
- Ambient temperatures 5° to 140°F
- 4-pin DIN/Amp plug wiring connector

Model Selection Guide

Description	Adjustable Range	Connection	Catalog Number	Price
DG pressure switch with 4-pin plug, socket, and 18" flexible leads				
DG 17VCT6-6W	0.8" to 6.8" WC	1/8 NPTM	84448040	\$73.00
DG 40VCT6-6W	2.0" to 16" WC	1/8 NPTM	84448840	73.00
DG 110VCT6-6W	12" to 44" WC	1/8 NPTM	84448440	73.00
DG 300VCT6-6W	40" to 120" WC	1/8 NPTM	84448940	73.00
DG 17VCT8-6W	0.8" to 6.8" WC	1/4" NPTM	84448090	73.00
DG 40VCT8-6W	2.0" to 16" WC	1/4" NPTM	84448890	73.00
DG 110VCT8-6W	12" to 44" WC	1/4" NPTM	84448490	73.00
DG 300VCT8-6W	40" to 120" WC	1/4" NPTM	84448990	73.00
DG 17/VCT1-6W	0.8" to 6.8" WC	Valvario	75454583	88.00
DG 40/VCT1-6W	2.0" to 16" WC	Valvario	74214174	88.00
DG 110/VCT1-6W	12" to 44" WC	Valvario	75454585	88.00
DG 300/VCT1-6W	40" to 120" WC	Valvario	75454586	88.00



RAECO rents portable combustible gas monitors and efficiency analyzers!

- Looking for portable combustible gas LEL monitors or combustion efficiency analyzers? Check with our partners at RAECO Rents!
- Rentals available on a daily, weekly, or monthly basis
- All parts, accessories, and software included in the rental kit
- Free round-trip UPS Ground shipping on any rental of a week or longer!

Ask us about the Testo 350 combustion efficiency analyzer. Learn more at RAECOrents.com.

Burner Systems for Industrial Applications



Finding the right Maxon burner for your application

	APX®	NP-LE AIRFLO®	CROSSFIRE®	TUBE-O-FLAME®	TUBE-O-THERM®	OVENPAK® LE	M-PAKT®	KINEMAX®	OVENPAK® 400	MEGAFIRE®	KINEDIZER® LE	OPTIMA™ SLS	UNI-RAD®
Heat Treating and Furnace Burners								✓			✓		✓
Low Emissions			✓			✓	✓				✓	✓	
Make-Up Air (Food or Spray Dryers, Food Processing)		✓	✓										
Oven Burners	✓					✓	✓		✓				
Oxidizers								✓			✓		
Paper Mill Dryers	✓		✓				✓		✓	✓		✓	
Pre-Heated Combustion Air			✓					✓	✓		✓		✓
Rotary Dryers and Kilns									✓	✓	✓		
Solution Heating and Finishing Systems	✓			✓	✓	✓	✓						
Steel Mills								✓			✓		✓

APX®

- Nozzle-mixing line burner for use with low pressure natural gas, propane and butane
- Single-piece aluminum extrusion body design eliminates leakage
- Cooler oven walls due to deeper penetration inside the oven (wall-mount); Independent of variable process air flows (in-duct)
- Corrosion-resistant main gas/air body and durable stainless steel mixing plates
- Up to 1.0 MMBtu/h per foot; Up to 40:1 turndown
- Packaged units up to 15 foot in length



TUBE-O-FLAME®

- Nozzle-mixing refractory-less burners for tube firing
- Burns any clean low-pressure fuel gas
- Increases heat transfer efficiencies with long swirling flame pattern
- Flange-mounted compact design for easy installation
- Low horsepower requirements reduce initial and operating costs
- Produces low levels of NOx in combustion products
- Generates less noise than open-port tube firing
- Capacities to 5 MMBtu/h; Up to 20:1 turndown



NP-LE AIRFLO®

- Designed for direct-fired make-up air and process applications
- Improved emissions over Maxon's earlier NP AIRFLO units, with significantly lower CO and NO2 levels
- Shorter flame length
- Available in low pressure version and corrosion-resistant materials
- Easily meets ANSI/CSA standards
- Up to 1 MMBtu/h per foot; Up to 30:1 turndown



TUBE-O-THERM®

- Burns natural gas, propane, or butane
- Burner-to-tube direct firing system allows uniform heat transfer, eliminates hot spots, and produces faster bring-up times
- Fires directly into small-bore immersion tubes
- Designed with integral low-horsepower blower to lower costs and save energy
- Wall- or tube-mount design for no-hassle installation and easy maintenance access
- UV flame scanner capability for all four sizes
- Capacities to 5.3 MMBtu/h



CROSSFIRE®

- Nozzle-mixing line burner for use with low pressure natural gas firing
- Extremely low emissions — Capable of NOx levels of 25 ppm and CO levels of 250 ppm at 3% O2
- Temperature uniformity to enhance product quality
- Also available in stainless steel housings or nickel-plated body
- Up to 2.5 MMBtu/h per foot; Up to 25:1 turndown



Look for more information on Maxon combustion control systems, burners, and valve products online at Lesman.com

OVENPAK® LE

- Burns any clean fuel gas, and operates on low gas supply pressures
- Provides clean combustion with low NOx and CO levels
- Compact burner design provides quick and easy installation
- Balanced pressure design and visible ignition action for easy commissioning, adjustment and maintenance
- Up to 6.5 MMBtu/h; Up to 100:1 turndown

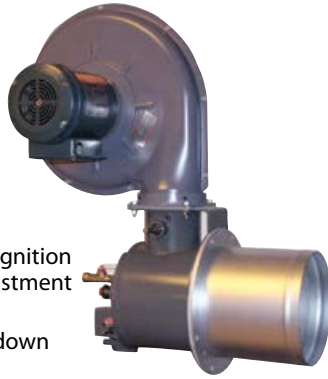

M-PAKT®

- Burns natural gas or propane
- Extremely low emissions — Capable of single-digit NOx and CO levels at 3% O2
- Flame contained almost entirely inside the discharge sleeve
- Durable steel outer construction with stainless steel internals
- Compact design with a variety of control methods
- Up to 8.4 MMBtu/h; Up to 13.5:1 turndown

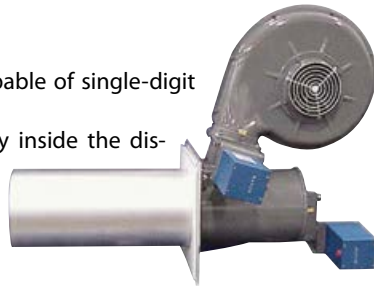

KINEMAX®

- Burns most clean low-pressure gaseous fuels or light oil; Can be used with oxygen-enriched combustion air
- Lower fuel consumption using preheated combustion air (up to 800°F)
- Operate on-ratio with excess fuel or excess oil to meet specific demands of your combustion process
- Exit velocities up to 275 ft/s to promote workload heat penetration and better furnace temperature uniformity
- Refractory block for chamber temperatures up to 3000°F
- Removable backplate gives easy access for inspection, maintenance
- Seven sizes, capacities to 8.4 MMBtu/h; Up to 48:1 turndown

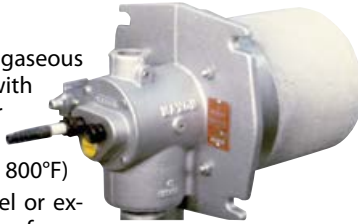

OVENPAK® 400

- Burns any clean fuel gas; Requires only low-pressure gas
- Fires into passing air streams
- Provides clean combustion with low NOx levels
- Simple field adjustment and maintenance
- Compact burner design provides quick and easy installation
- More than 90 different styles and sizes — including cost-effective external blower versions
- Capacities to 16.5 MMBtu/h; Greater than 40:1 turndown



MEGAFIRE®

- Provides clean burning of #2 oil, natural gas or propane; Fires gas, oil, or both simultaneously
- Inline blower version includes energy-efficient centaxial direct drive combustion air blower
- Quiet operation with exceptionally low horsepower requirement
- Nine different styles, three different sizes
- Capacities to 45 MMBtu/h; 10:1 turndown on #2 oil, 15:1 turndown on natural gas



KINEDIZER® LE

- Burns natural gas, propane, or other fuel gases
- Accepts preheated and vitiated combustion air
- Field-proven low emissions; State-of-the-art NOx firing, adjustable for application flexibility
- Rugged design for oxidizers, process heaters, kilns, furnaces, dryers, waste incineration, and other high-temperature applications
- Excellent stirring and mixing with medium velocity exhaust
- Six sizes, capacities up to 75 MMBtu/h; Up to 22:1 turndown, with the lowest NOx and excess air in the KINEDIZER® family!



OPTIMA™ SLS

- Fuel flexible with natural gas, propane, and butane capability
- Low NOx and CO production levels for extremely clean, reliable heat — and easy air permitting and environmental compliance
- Large capacity heat releases with a compact, robust flame geometry
- Intelligent ratio control for reliable operation, optimal fuel efficiency
- All steel and high temperature alloy construction for reduced weight, increased durability
- Configurable for dryers, air heaters, ovens, kilns, process heaters, paper machines, and a variety of industrial heating equipment
- Direct factory operational support with SMARTFIRE® control and communication gateway
- Five sizes, capacities to 93.5 MMBtu/h; Up to 17.8:1 turndown



UNI-RAD®

- Radiant tube burner for fuel gas inputs
- Suitable for use on pressure tubes, negative pressure tubes, and electrified radiant tubes
- Flame length adjustable by changing combustion air-to-ignition ratios — produces optimum tube temperature uniformity over a wide range of firing rates and preheated air temperatures
- Continuous plasma spark provides instantaneous ignition, so burner can operate from the DAT output of a PID control loop
- Can be used in conjunction with UV flame supervision equipment



**For application assistance, call Lesman at 800-953-7626,
or fill out the Maxon burner application datasheet at
www.lesman.com/datasheets/**

kromschroder



Pilots for Industrial Gas Burners

ZMI Ionization Pilot for Industrial Gas Burners

For automatic ignition and control of clean industrial gas burners. Compatible with Kromschroder IFS automatic burner controls, PFU760 and PFU780 burner controls, TZI and TGI ignition transformers.

- For all clean industrial gases
- Capacity: 16mm (0.63"): 2800–4800 BTU/Hr; 25mm (0.98"): 4000–11500 BTU/Hr
- One electrode for ignition and control

Construction: Flame tube: 25 CR/20NI; Housing: Aluminum; Electrode: Kanthal; Burner head: Ceramic

Ambient Temperature: 183° F max

Connections: Gas: 1/4" NPT; Air: 1/2" NPT

Pressure Range (Gas and Air): 4" to 20" WC (10 to 50 bar)

Model Selection Guide

Capacity	Burner Size	Tube Length	Catalog Number	Price
2800-4800 BTU/Hr	0.63"	5.9"	84230015	\$320.00
	0.63"	7.87"	84230025	320.00
	0.63"	11.81"	84230035	369.00
	0.63"	15.75"	84230045	417.00
	0.63"	19.69"	84230055	464.00
4000-11500 BTU/Hr	0.63"	23.62"	84230065	511.00
	0.98"	5.9"	84234015	426.00
	0.98"	7.87"	84234025	426.00
	0.98"	11.81"	84234035	478.00
	0.98"	15.75"	84234045	531.00
	0.98"	19.69"	84234055	583.00
	0.98"	23.62"	84234065	636.00

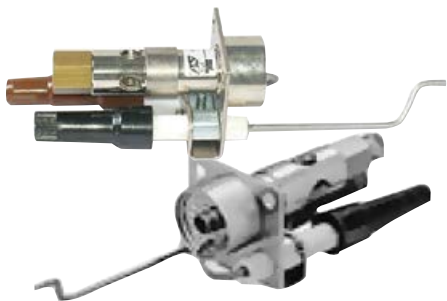

ZAI Ionization Pilot for Natural Gas Burners

For the safe ignition and flame protection of atmospheric burners. Compatible with Kromschroder IFS automatic burner controls, PFU760 and PFU780 burner controls.

- Capacity 3kW (approximately 2500 kCal/Hr)
- Direct ignition and ionization control
- Pilot burner with forced air supply

Construction: Ignition head and fixing plate: Galvanized steel; Ignition and ionization electrodes: Kanthal A-1; Plug connector: Brown (suppressed) for ignition electrode, black for flame rectification electrode

Ambient Temperature: 572° F max

Gas Connection: Cu-tube 8x1

Protective Grade: IP20

Model Selection Guide

Description	Catalog Number	Price
ZAI Ionization Pilot Burner	84228020	\$106.00
Heat-Resistant Protective Tube	35437010	74.00
Ionization Electrode	34472920	19.00
Ignition Electrode	34472941	21.00



ZKIH Ionization Pilot for Direct Ignition Burners

For the safe ignition and ionization control of gas burners. Compatible with Kromschroder IFS automatic burner controls and PF-19 burner control systems.

- Capacity 2–7kW
- Pilot burner with forced air supply
- Direct ignition and ionization control
- For natural gas, town gas, and LPG

Temperature: Ambient at flame conduit tube: 1832°F max; Ambient around burner nozzle: 932°F max; Gas/air temperature: 338°F max

Connections: Gas: 1/4" NPT; Air: 1/2" NPT

Orifice Insert: 0.09" diameter

Construction: Housing: AISI; Ignition/sensing electrodes: Kanthal A-1; Flame conduit/protection tubes: Heat-proof Cr-Ni steel

Pressure: Gas: 8" WC; Air: 16" WC

Flow Rate: Gas: 14 ft³/hr; Air: 140 ft³/hr

Model Selection Guide

	Burner Size	Tube Length	Catalog Number	Price
ZKIH Pilot Burner	5.9"	3.94"	84214010	\$350.00
	7.87"	3.94"	84214020	350.00
	11.81"	3.94"	84214030	416.00
	15.75"	3.94"	84214040	484.00
	19.69"	3.94"	84214050	439.00
NPT Adapter Set for ZKIH Burner			74923430	43.60