

AVIOM[®]

PRO64[®]
NETWORK MANAGER[™]

VERSION 3.0.3



User Guide

Notice of Rights

All rights reserved. No part of this document may be reproduced or transmitted in any form or by any means—electronic, mechanical, photocopy, recording, or otherwise—without written permission of Aviom, Inc.

Trademarks

Aviom, A-Net, the A-Net icon, Pro16, Pro64, AllFrame, m-control, and Virtual Data Cable are trademarks of Aviom, Inc. All other trademarks are the property of their respective owners.

Aviom products are protected by one or more of the following patents: 7,043,671; 7,301,966; 7,403,828; 7,523,362; 7,526,526; 7,787,580.

© 2012 Aviom, Inc. All rights reserved.
Information subject to change without notice.



Table of Contents

Notice of Rights	ii
Trademarks	ii
Welcome	1
Firmware Notice	2
Overview	3
What's New in Version 3.0	4
New in Version 3.0.2	4
Conventions Used in this Document	5
Installing Pro64 Network Manager	6
Computer Requirements	6
Start the Installation Process	7
Welcome Screens	7
Software License Agreement	8
Enter User Information	8
Choose the Installation Location	9
Install	9
Quitting the Installer	11
Updating or Removing the Application	11
What Gets Installed	12
Demo Projects	12
Pro64 Network Manager Interface	13
Pro64 Network Manager Windows	14
Workspace	14
Network Overview	15
Device Windows	16
Scene Manager Window	17
Audio Slot Manager Window	18
Virtual Data Cable Monitor Window	19
Event Log Window	19
Firmware Update Window	20

Firmware Updates	21
Software Notice	21
Update Requirements	21
USB-to-RS-232 Adapters	22
Hardware Setup For Firmware Updates	22
Communication Setup For Rack-Mount I/O Devices	22
Communication Setup For AllFrame I/O Devices	24
Communication Setup for the 6416Y2 Card	25
Front Panel DIP Switches	25
6416Y2 as Control Master	25
6416Y2 as a Slave Device	25
Circuit Board DIP Switches on the 6416Y2	26
After Updating 6416Y2 Firmware	27
Connecting to the Network for the First Time	28
About COM Ports	28
Firmware Update Utility Window	30
Progress Bars	31
If a Firmware Update Fails	31
Closing the Firmware Update Window.	32
Firmware Update Window Menus.	33
File Menu	33
Firmware Report	33
Update Options Menu.	33
Maintaining a Pro64 Network	35
Adding Devices to a Network While Online.	36
Online vs. Offline	37
Working Online	37
Working Offline	37
The Project	38
Project Contents	38
Saving a Project	38
The Project Structure.	39
Scenes vs. Device Presets	40
Project Compatibility.	41
Transitioning From Online to Offline	42
Transitioning From Offline to Online	42
Going Online With an Unsaved Project Open	42
Going Online With a Saved Project Open	44
When the Project Has Not Changed	44
When the Project Has Changed	45

Workspace Features	46
Workspace Status Bar	46
Online/Offline Status	46
Control Master	46
Network Mode	46
Clock Master	46
Clock	46
Clock Errors.	47
Sample Rate	47
Mute All	47
Workspace Window Commands	48
Workspace Menu Commands	49
File Menu	49
Network Menu	49
Tools Menu	50
Windows Menu	50
About the Open Windows List Contents	50
Help Menu	51
Network Overview Features	52
The Network Overview Interface	53
Changing Column Widths	53
Sorting the Network Overview	53
Status Column	53
LED Device Identify Feature	54
Front Panel Lock/Unlock	55
Device Column	56
Numeric ID	56
Control Master and Clock Master Indicators	57
Filtering the Network Overview	57
The Filter Dialog Box.	58
Location Column	58
User Labels	59
Input/Output Slot Range Displays	60
Filtering by Slot Range	60
Remote Control	60
Comments Field	60
Network Overview Menus.	61
File Menu	61
Network Report	61
Edit Menu.	62
View Menu	62

Device Menu	62
Device Window Features	63
Window Views	64
Fields in the Device Overview	64
User Label	64
Status Bar	65
Input/Output Grids	65
AllFrame I/O Grids	66
Slot Range	67
Activating Channels	68
Activating All Channels	68
Channel/Slot Conflicts	69
Deactivating Slots	70
Assigning Input Channels to the Matrix	70
Control Groups	71
Device-Specific Features	72
AllFrame	72
AllFrame C4dio Card Support	74
C4dio Sample Rate Converters.	75
AllFrame Standby Options	77
Standby From the Device Window	78
Standby From the F6 Front Panel	78
Standby From a Contact Closure	79
Hardware and Software Standby Together.	80
Standby and External Clocks.	80
AllFrame C4o Output Levels	81
Clearing AllFrame Output Level Settings	82
6416Y2 A-Net Interface Card	83
How DIP Switch #9 Works.	83
6416Y2 Status Icon	84
m-control	84
VDC Settings.	85
MY8 and MY16 Modes.	86
6416Y2 Output Slots	87
6416Y2 Card Stereo Links	88
Card Configuration Dialog Box	89
Card Mode	90
m-control	90
Pad Mode	90
Serial Interface.	91
Network Slots to be Remote Controlled.	91

ASI A-Net Systems Interface	92
MH10/MH10f Merger Hubs	93
6416dio Digital I/O Module	94
RCI Remote Control Interface.	95
Matrix Assignments	96
Clearing Matrix Assignments	97
Device Window Views	98
Inputs to Network View	98
Stereo Links	99
Linking/Unlinking Channel Pairs	99
Mic Preamp Channel Settings	100
Clearing Channel Settings	101
Outputs From Network View	101
Setting an Output Matrix Assignment	103
Direct Text Entry	104
Matrix Assignments on the ASI	105
ASI Outputs	106
ASI Matrix Views	108
Clearing Output Matrix Assignments	109
6416Y2 Card and ASI Outputs	110
The Inputs and Outputs View	111
Device Presets.	112
The Device Presets View.	113
Saving a Device Preset	113
Updating a Device Preset	114
Recalling a Device Preset	114
Clearing a Device Preset	114
Device Window Menus	115
File Menu	115
Edit Menu.	115
View Menu	116
Tools Menu.	116
Channel Settings Menu – Input Devices	117
Channel Settings Menu – Output Devices	118
Presets Menu	118
Audio Slot Manager	119
Slot Assignments View	120

Slots and I/O Routing View	121
Scene Manager	122
How Scenes Work	122
The Scene Manager Window	123
Scene Manager Features.	124
Number Column	124
Lock Column.	124
Scene Name Column.	124
Scene Valid Column	124
Scene Notes Column	124
Saving a Scene	125
Adding Scene Notes	125
Renaming a Scene	125
Recalling a Scene	126
Making Changes to Existing Scenes	126
Locking a Scene	126
Locking All Scenes	127
Clearing Scenes	127
Scene Compatibility	128
Working Online	128
Working Offline	128
Validating Scenes	129
Scene Manager Menus	130
File Menu	130
Edit Menu.	130
Scene Menu	131
Virtual Data Cable Monitor	132
The Virtual Data Cable Monitor Window	132
VDC Slots	133
VDC Type	133
RS-232/422 VDC	133
VDC Source.	134
VDC Compatible Devices	134
VDC Destination	134
Event Log Window	135
Saving Event Log Text	135
Troubleshooting	136

Appendix	138
RS-232 Cables and Pinout	138
RS-232 Connections.	138
Wiring a DB9 Crossover Cable	139
Index	140
SOFTWARE LICENSE AGREEMENT	148

PRO64[®] NETWORK MANAGER[™]

WELCOME

Version 3 of **Aviom Pro64[®] Network Manager[™]** is a software application designed to manage and configure Pro64 digital snakes and audio networks from a central location. Pro64 Network Manager simplifies system installation and device setup while at the same time unlocking flexibility not accessible from the front panel user interfaces. All Pro64 device are powered by A-Net[®], Aviom's proprietary audio distribution and networking technology that is designed specifically for the unique demands of data-intensive streaming audio.

Pro64 Network Manager connects to a Pro64 digital snake or audio network via RS-232 (or USB when connected to AllFrame Multi-modular I/O System[™] products) and makes use of the network's built-in Managed Mode to simplify tasks related to supporting and configuring Pro64 networks.

All network settings can be monitored, including channel activation and Slot assignment, internal/external clock source and sample rate, m-control[™], firmware versions and updates, Virtual Data Cables[™], and channel naming.

Pro64 Network Manager helps users track and allocate network resources more efficiently, speeds configuration of systems and I/O devices, and simplifies troubleshooting and network maintenance.

✓ **NOTE:** Manual Mode systems are not supported in this version of the application.

FIRMWARE NOTICE

Version 3.0 (and above) of the Pro64 Network Manager application introduces support for the C4dio card and external clocking options for the AllFrame Multi-Modular I/O System. All Pro64 devices must be updated to the most recent firmware (version 5.0 or higher) to be managed and controlled by the Pro64 Network Manager Version 3 software.

Use Pro64 Network Manager's built-in Firmware Update utility to update all devices in the Pro64 network before proceeding.

Pro64 devices with firmware version 4 and earlier (referred to in this document as v2.xx, 3.xx, and 4.xx) are only compatible with the firmware update utility in the Pro64 Network Manager application until they are updated to firmware version 5.0 or higher (referred to in this document as v5.xx). Settings on Pro64 devices running older firmware versions (v4.xx and before) cannot be controlled by this version of the Pro64 Network Manager software.

✓ **NOTE:** You cannot manage and control a network made up of Pro64 devices whose firmware is a mix of old and new firmware versions.

Updating firmware requires a direct RS-232 connection between the PC and the Pro64 network's Control Master device. Normally this is accomplished by connecting a null modem DB9 cable between the RS-232 jack on the computer and the Pro64 device. In the case of an F6 Modular I/O Frame (part of the AllFrame system), a USB connection is required if the F6 is used as the network's Control Master. Firmware updates take about 3-5 minutes per module. (See page 13.)

Computers lacking a serial port connection may require the use of a USB-to-RS-232 adapter to update non-AllFrame devices. See page 21 for complete update details.

OVERVIEW

The following is an overview of the steps required to start managing and controlling your Pro64 audio networking products with Pro64 Network Manager.

- Download the current version of the Pro64 Network Manager Version software installer from the Aviom website (www.Aviom.com).
- Install the Pro64 Network Manager application. (See page 7.)
- Connect the Pro64 network to the PC with a DB9 null modem cable, compatible USB-to-RS-232 adapter, or USB cable when using AllFrame devices. (See page 21.)
- Configure the network's Control Master so that it can communicate with the software. (See page 22.)
- Launch Pro64 Network Manager for the first time. (See page 28.)
- Update the firmware in any Pro64 devices that have outdated firmware installed. (See page 30.)
- When all firmware is updated, start managing the Pro64 network. (See page 13.)
- Explore the features and functions of Pro64 Network Manager including projects (page 37), the Network Overview (page 15), Device Windows (page 16), and the Scene Manager (page 122).

After installing the Pro64 Network Manager application you can choose to work offline with the included demo projects to become familiar with the features of Pro64 Network Manager prior to updating firmware and working online. See page 12 for additional information.

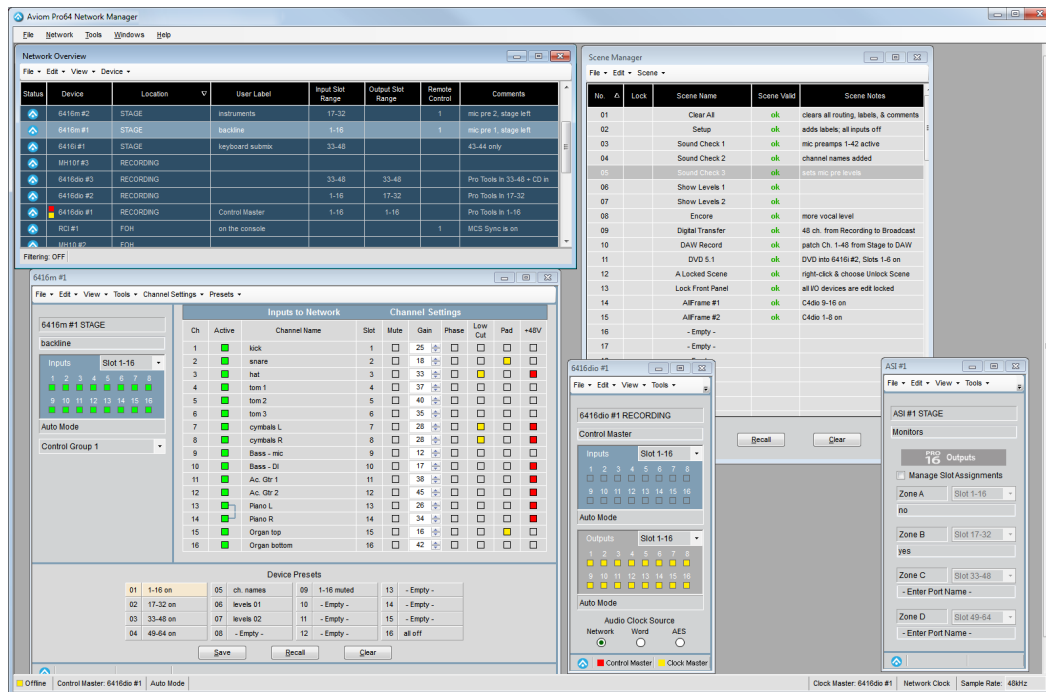

The Pro64 Network Manager workspace

What's New in Version 3.0

If your system is already running Version 2 of Pro64 Network Manager, the Version 3 release introduces the following new features and functionality:

- Hardware support for the C4dio card for the AllFrame—a firmware update to the AllFrame F6 is required to allow the cards to be recognized. See page 74.
- AllFrame devices now support external clocks (requires at least one C4dio card to be installed).
- External sync via Word Clock and AES3 clocks are supported when a C4dio card is installed in an AllFrame.
- Optional sample rate converters (SRC) are available when a C4dio card is installed in an AllFrame F6 allowing external devices with digital outputs such as CD players to be connected to a Pro64 network. See page 75.
- The AllFrame Device Window has new features that support C4dio cards installed in the F6 including Sample Rate Converters on/off switches and Audio Clock Source menu selection options.
- Standby Mode is now supported for AllFrame devices in the network. See page 77.
- Three methods of Standby for AllFrame devices are supported—software based using the Device Window in Pro64 Network Manager, from the AllFrame's dedicated front panel Standby momentary switch, and hardware-based using a contact closure connected to the Euroblock connector on the top panel of the AllFrame. See page 77.

Use the Firmware Update utility (found in the Tools menu of the main workspace) to update the firmware in your Pro64 devices to take advantage of the new hardware-related features.

New in Version 3.0.3

In addition to the Version 3.0 features described above, Version 3.0.2 is a maintenance update that introduces the following:

- Device Windows will no longer show multiple warning messages if resource conflicts exist when attempting to activate multiple Slots using the Activate All Input Channels command found in the Channel Settings menu. See page 68.
- A new Channel Activation Warning window has been added.
- Network Overview sorting issues have been resolved.

Conventions Used in this Document

This document supports Version 3 (and above) of the Aviom Pro64 Network Manger software; it will be referred to simply as **Pro64 Network Manager**.

This software revision requires that all Pro64 devices have firmware version 5.00 or higher installed in order to be used with this version of the software. Version 5 firmware and its variants will be referred to as **v5.xx**. Pro64 devices with older firmware versions installed cannot be used online with this version of the application. They will be referred to as **v2.xx**, **v3.xx**, and **v4.xx**.

An **ALLFRAME** refers to the assembled unit of an F6 Modular I/O Frame plus its installed I/O cards, including the C4m, C4o, and/or C4dio.

INSTALLING PRO64 NETWORK MANAGER

It is recommended that you quit all running Windows applications before starting the Aviom Pro64 Network Manager installation process.

Check the Aviom website (www.aviom.com) for the latest information about software and firmware updates and the complete line of Aviom Pro16® and Pro64® products.

Computer Requirements

The minimum computer system requirements for running the Aviom Pro64 Network Manager application are listed below.

Windows

- Intel® or AMD® processor — 1 gigahertz (GHz) or faster
- Intel, AMD, or 100% compatible motherboard & chipset
- Microsoft® Windows® XP with Service Pack 3 (SP3), or Windows 7
- 2 gigabyte (GB) RAM (32-bit systems) or 4 GB RAM (64-bit systems)
- 125 MB of free hard disk space for full installation
- VGA Video (1024 x 768) - 256 colors
- DirectX 9 graphics device with WDDM 1.0 or higher driver
- One available RS-232 port (or a USB port with a compatible USB-to-RS-232 adapter), or, for AllFrame devices, one available USB port
- The free Adobe Reader (or equivalent) is required to open the included User Guide from the help menu
- Microsoft .Net Framework 3.5

If your PC does not have the .NET Framework 3.5 components installed, an Internet connection may be required to download and install these required components from the Microsoft website.

Mac OS

There is no official support for Pro64 Network Manager running on Apple® Mac computers. Experiments with a Mac running the Windows OS and the third-party Parallels software have had positive results, but there is no guarantee of acceptable performance at this time. The system used for the Mac tests included:

- Intel®-based Apple Mac
- Parallels software (info available from the Apple website)
- Mac OS 10.4.6 or higher
- USB-to-RS-232 converter

Start the Installation Process

Before installing the software, disconnect the Pro64 network from the PC to avoid any conflicts with drivers installed by previous versions of the application. Locate the installer file, named “Pro64_Network_Manager_Installer.exe” and double-click it to begin the installation process. If an older version of Pro64 Network Manager is already installed on the computer, a dialog box will appear, stating that the currently installed version must be uninstalled before proceeding. Click **Yes** to continue the installation or click **No** to abort. Optionally you can choose to uninstall a previous version of Pro64 Network Manager by using the tools built into the Windows OS Control Panel.

During the install, most screens give the option of navigating back to the previous step to review settings or make changes before continuing. To do this, click the **BACK** button. (To exit the installer at any time prior to finishing, click the **CANCEL** button; no software components will be installed.)

Welcome Screens

When the Welcome screens appear, click **NEXT** to continue and install Pro64 Network Manager or click **CANCEL** to exit without running the installer.

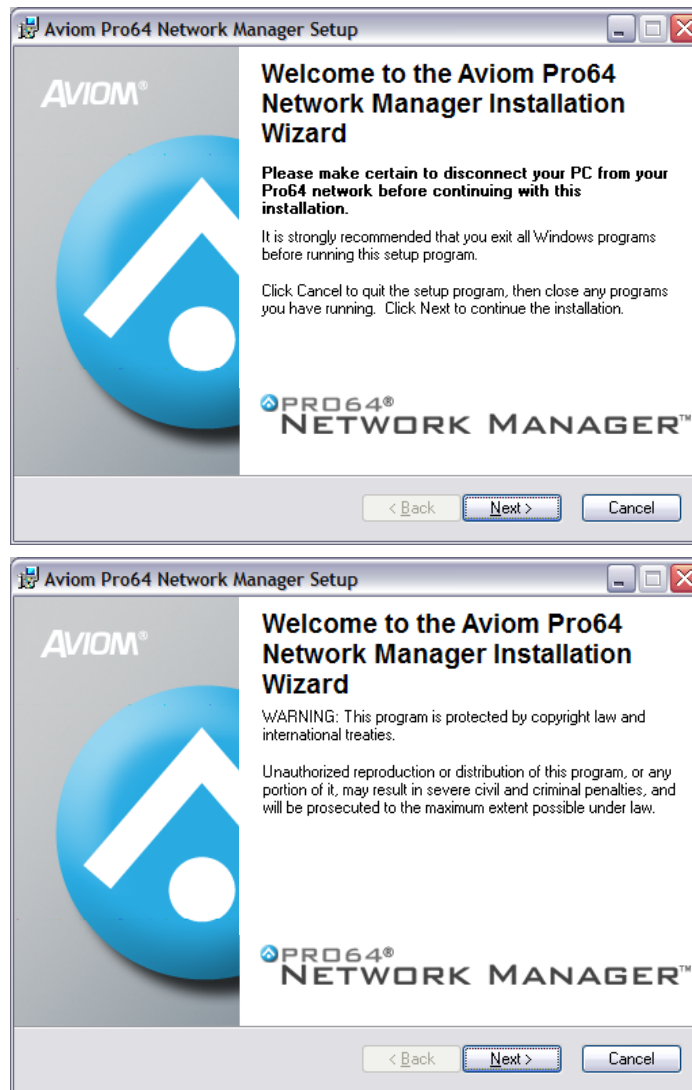

Click the **Next** button to continue the installation process.

Software License Agreement

When the Software License Agreement page appears, read the agreement completely, click the **I ACCEPT THE LICENSE AGREEMENT** radio button, and then click the **NEXT** button to continue the installation.

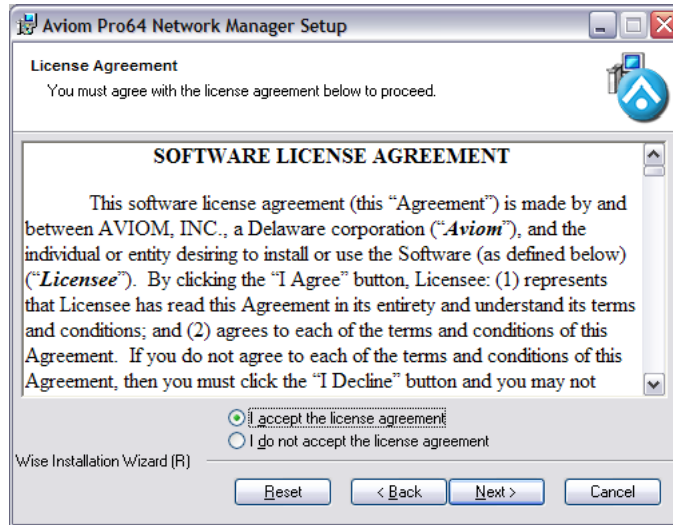

The Software License Agreement

If you do not accept the software license agreement the installer will exit without installing Aviom Pro64 Network Manager.

Following the license agreement the current ReadMe document will be displayed.

Enter User Information

You have the option of entering personalized information for the installation, including user and organization names. When installing on a computer that has multiple users, you have the option of having the Pro64 Network Manager software accessible to anyone or only to a specific user. Choose the option that best suits your needs and click its radio button. Click the **NEXT** button to continue the installation.

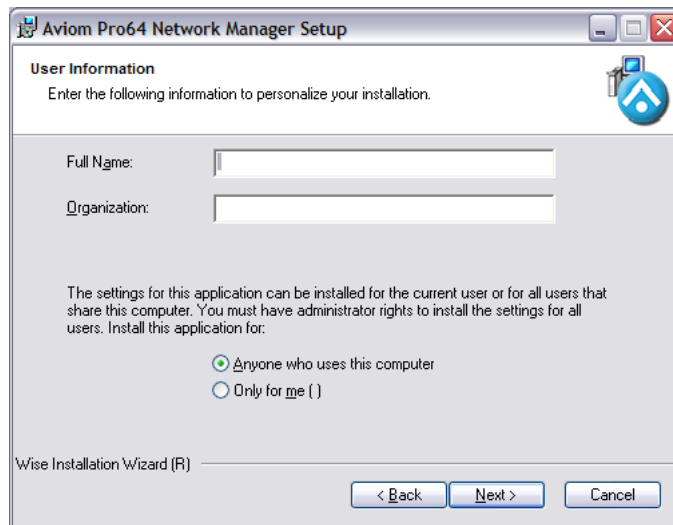

Enter user information

Choose the Installation Location

Select the hard drive and folder location on your computer where the Pro64 Network Manager software will be installed in the Destination Folder window. To install Pro64 Network Manager using the default location, simply click the **NEXT** button. To install to a different location, click the **BROWSE** button and navigate to and select the desired location. Click **NEXT** to continue.

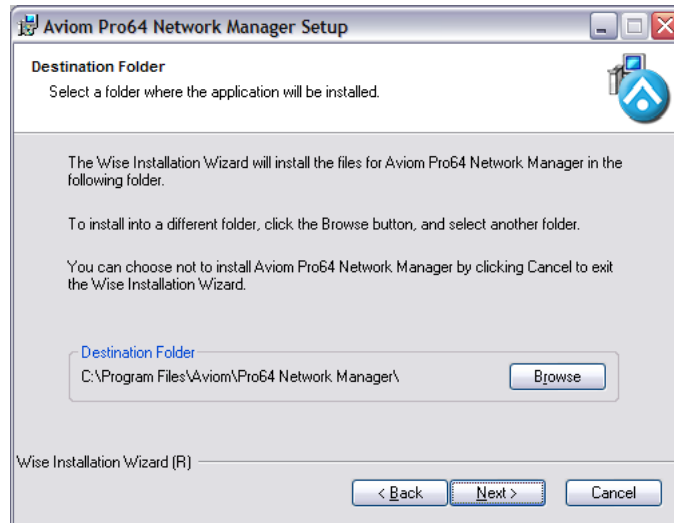

Click **Browse...** to install Pro64 Network Manager to a folder other than the default location.

Install

At this point, the installer has enough information to install the Pro64 Network Manager application and its supporting files. On the screen that follows, click **NEXT** to begin the installation. Click **BACK** to return to the previous screen to review settings, or click **CANCEL** to exit the installer.

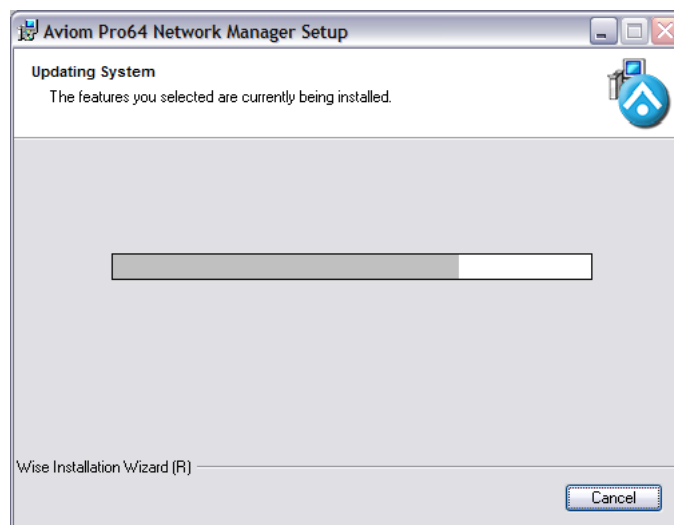

A progress bar is displayed during the installation process.

When the install has finished installing the application components, the following screen will be displayed. Click **FINISH** to complete the installation process.

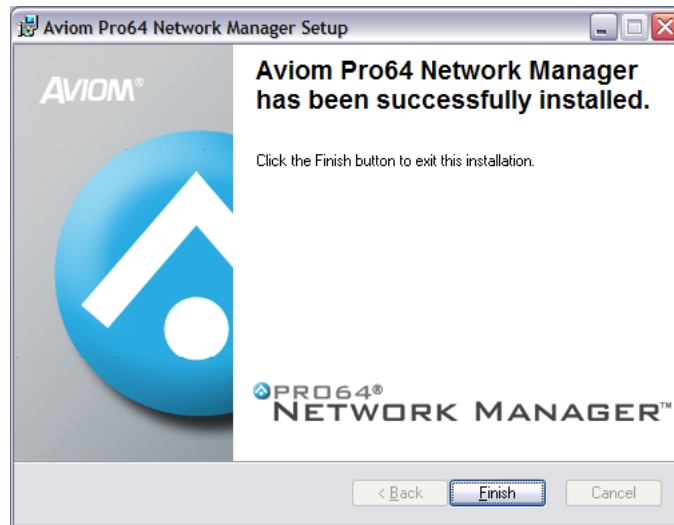

Click the **Finish** button to exit the installer.

The installer closes; Pro64 Network Manager is now ready to use (assuming that all required Microsoft updates and .NET Framework components are correctly installed).

Launch Pro64 Network Manager by double-clicking its icon or file name in the application folder, or by selecting **PRO64 NETWORK MANAGER** from within the Aviom folder in the All Programs section of the PC Start menu.

✓ **NOTE:** The Windows XP default location for the installation is
C:\Program Files\Aviom\Pro64 Network Manager\Pro64_Network_Manager.exe

The Windows 7 default location for the installation is
C:\Program Files (x86)\Aviom\Pro64 Network Manager\Pro64_Network_Manager.exe

Quitting the Installer

At any time before the installation of Pro64 Network Manager is complete, the user has the option of exiting the installer. Clicking the **CANCEL** button in one of the installer windows will stop the installation process. In the dialog box that appears after clicking Cancel, choose **EXIT SETUP** to stop the installer or click **RESUME** to continue the installation process.

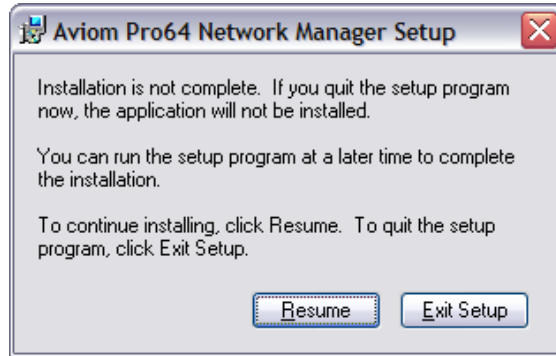

Clicking Cancel when running the installer opens this dialog box.

Updating or Removing the Application

When a new version of Pro64 Network Manager is available, the old version of the application will be removed automatically in the process of installing a new version.

If you want to manually remove Pro64 Network Manager, an uninstall shortcut is placed in the Pro64 Network Manager folder automatically during the initial installation. The utility can be accessed directly from the Aviom\Pro64 Network Manager folder created in the Programs Menu. Optionally, the application can be removed by using the standard Windows OS utilities found in the Windows OS Control Panel.

As a precaution, back up any files in the Pro64 Network Manager folder that you wish to save before proceeding with the uninstall and update procedure. The uninstall utility removes all program files, product-specific update files, application icons, log files, registry entries, and text files associated with Pro64 Network Manager. It does not delete any user-created files.

What Gets Installed

Pro64 Network Manager is installed by default into the following folder:
C:\Program Files\Aviom\Pro64 Network Manager (Windows XP) or
C:\Program Files (x86)\Aviom\Pro64 Network Manager (Windows 7).

Within the Pro64 Network Manager folder, which contains the application's resources, the following folders will be created.

- **Demo Projects** – allows you to learn the application and work with each type of Pro64 device without being connected to a network.
- **Device Update** – contains the current set of firmware update files (.upd) for all Pro64 devices
- **Documents** – documentation, licenses, and ReadMe files
- **FTDI USB Drivers** – a backup copy of the USB driver installer (required for AllFrame devices) in case the driver ever needs to be reinstalled

The Update Files folder found within the Device Update folder will contain the most recent firmware update files for all Pro64 hardware modules, one file per product. Pro64 Network Manager looks in this folder by default for firmware update files (with extension .upd) for your Pro64 devices.

The Documents folder contains the User Guide and any current ReadMe files. (The free Adobe Reader (or equivalent) is required to open the included User Guide from the help menu.)

✓ **NOTE:** Do not rearrange or move any of the files or folders created during the installation.

Demo Projects

The Pro64 Network Manager installation includes multiple demo projects. Use the demo projects to help you learn the application and its features as well as to explore the functions of Pro64 devices that are not currently in your network.

Demo Project 1 contains at least one of each Pro64 network device along with sample Scenes and Device Presets that show the versatility of both the Pro64 network and the Pro64 Network Manager application. Demo Project 2 contains only AllFrame devices with a variety of I/O card configurations. Demo Project 3 is smaller, with three AllFrame devices connected to a Yamaha console.

Experiment with recalling presets in the Device Window of a 6416m Mic Input Module, for example, to see its 16 channel strips change with a single mouse click.

To preserve the original demo project's settings as you learn the application use the **SAVE PROJECT As...** command found in the File menu to save a copy of the demo project with a different name before you begin editing.

✓ **NOTE:** The demo projects can be opened and edited in offline mode only unless the network you connect to has the exact same complement of Pro64 devices installed.

Pro64 NETWORK MANAGER INTERFACE

The main components of the Pro64 Network Manager user interface are indicated below.

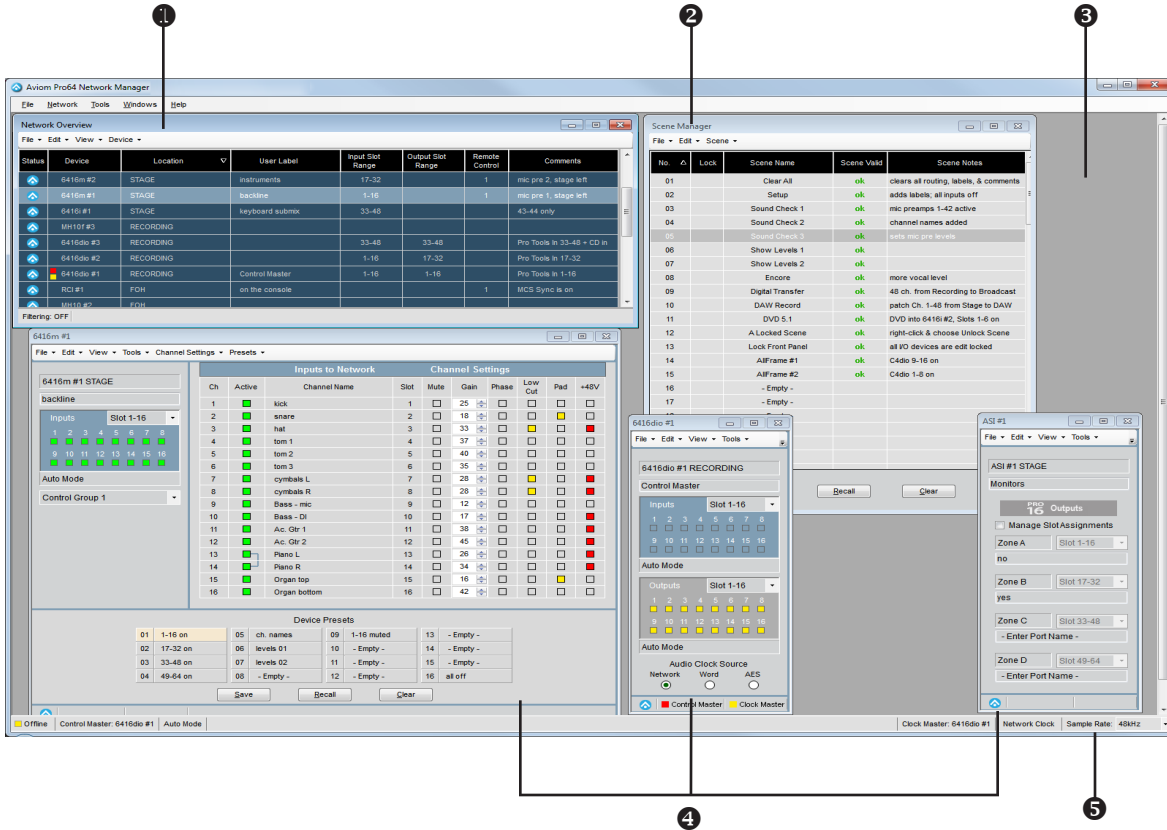

1	Network Overview	Lists all Pro64 devices and their properties
2	Scene Window	Save and recall up to 99 network scenes
3	Main Workspace	Holds all other application windows such as the Network Overview and Device Windows
4	Device Windows	Displays specific information for each type of Pro64 device
5	Status Bar	Displays online/offline status, network mode, sample rate, and clock info

PRO64 NETWORK MANAGER WINDOWS

The Pro64 Network Manager application consists of the following components:

- Application Workspace
- Network Overview
- Individual Device Windows
- Scene Manager Window
- Virtual Data Cable Manager Window
- Audio Slot Manager Window
- Event Log Window
- Firmware Update Window

The following section presents a brief overview of these components and the windows that make up the Pro64 Network Manager application. Each window, along with its features, menu items, and functions is described in detail in the sections that follow this overview.

Workspace

The Workspace is the general application window that holds all other windows such as the Network Overview and Device Windows. The workspace cannot be closed while the Pro64 Network Manager application is running. The workspace can be sized and positioned on the PC desktop by the user. Closing the main workspace window exits the application.



The empty main workspace before loading a project

The workspace will be blank when there is no project loaded or when the application is not connected online to a Pro64 network. See page 46 for additional information.

Network Overview

The Network Overview shows a list of all Pro64 devices in the current network and project along with Slot range properties and user-defined text fields. The Network Overview can be opened/closed and repositioned in the workspace, or resized as needed while the application is running. The information displayed in the Network Overview can be sorted by column type.

The Network Overview has a local menu bar containing functions that allow you to print a network report, filter devices and/or Slot ranges from the current view, etc. A Status Bar runs along the bottom edge of this window that displays information specific to the Network Overview such as filtering.

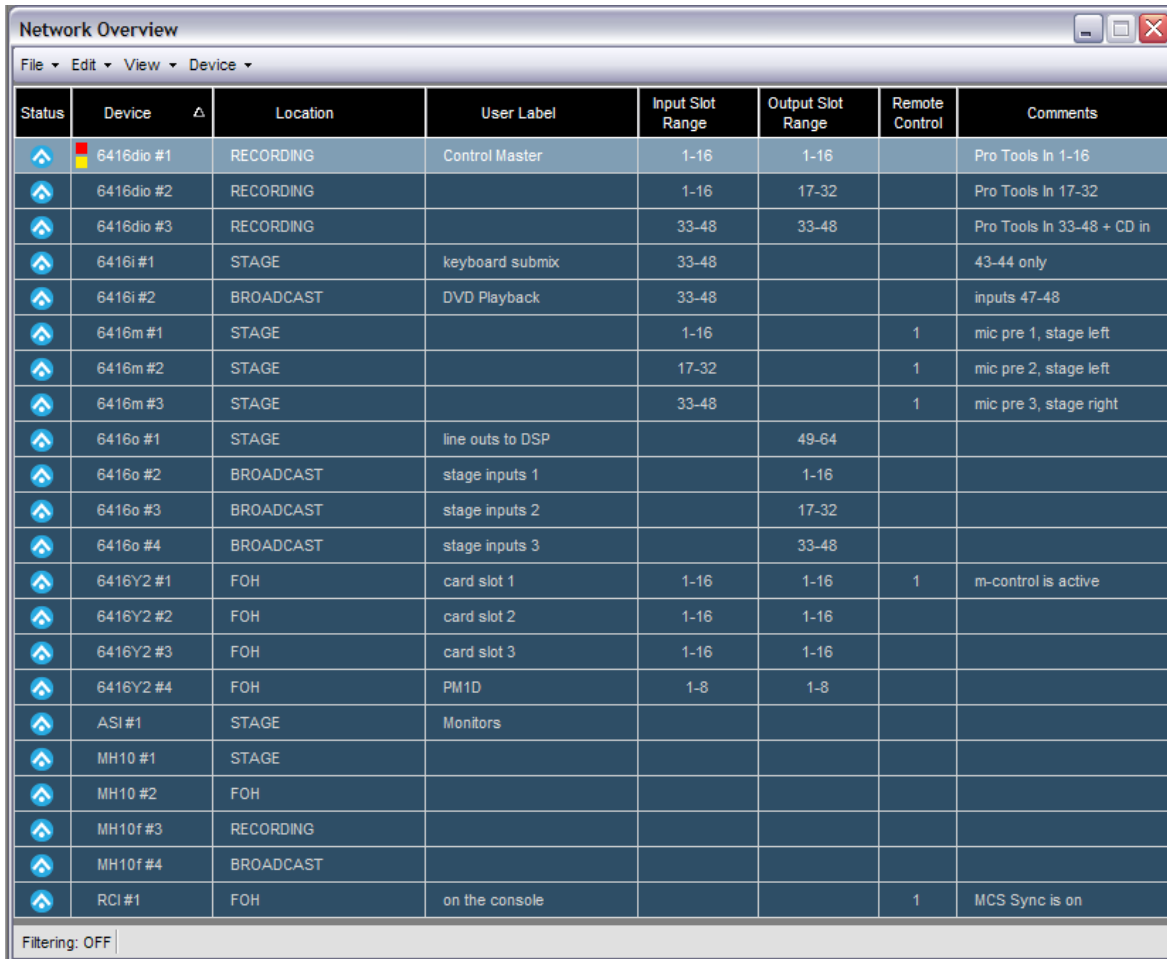

The screenshot shows a window titled "Network Overview" with a menu bar (File, Edit, View, Device) and a table of device configurations. The table has columns for Status, Device, Location, User Label, Input Slot Range, Output Slot Range, Remote Control, and Comments. The table contains 20 rows of data, including devices like 6416dio #1-3, 6416i #1-2, 6416m #1-3, 6416o #1-4, 6416Y2 #1-4, ASI #1, MH10 #1-4, and RCI #1.

Status	Device	Location	User Label	Input Slot Range	Output Slot Range	Remote Control	Comments
▲	6416dio #1	RECORDING	Control Master	1-16	1-16		Pro Tools In 1-16
▲	6416dio #2	RECORDING		1-16	17-32		Pro Tools In 17-32
▲	6416dio #3	RECORDING		33-48	33-48		Pro Tools In 33-48 + CD in
▲	6416i #1	STAGE	keyboard submix	33-48			43-44 only
▲	6416i #2	BROADCAST	DVD Playback	33-48			inputs 47-48
▲	6416m #1	STAGE		1-16		1	mic pre 1, stage left
▲	6416m #2	STAGE		17-32		1	mic pre 2, stage left
▲	6416m #3	STAGE		33-48		1	mic pre 3, stage right
▲	6416o #1	STAGE	line outs to DSP		49-64		
▲	6416o #2	BROADCAST	stage inputs 1		1-16		
▲	6416o #3	BROADCAST	stage inputs 2		17-32		
▲	6416o #4	BROADCAST	stage inputs 3		33-48		
▲	6416Y2 #1	FOH	card slot 1	1-16	1-16	1	m-control is active
▲	6416Y2 #2	FOH	card slot 2	1-16	1-16		
▲	6416Y2 #3	FOH	card slot 3	1-16	1-16		
▲	6416Y2 #4	FOH	PM1D	1-8	1-8		
▲	ASI #1	STAGE	Monitors				
▲	MH10 #1	STAGE					
▲	MH10 #2	FOH					
▲	MH10f #3	RECORDING					
▲	MH10f #4	BROADCAST					
▲	RCI #1	FOH	on the console			1	MCS Sync is on

Filtering: OFF

The Network Overview shows the entire network configuration at a glance.

Use the keyboard shortcut **CTRL+1** to open the Network Overview; it can also be opened by choosing **NETWORK OVERVIEW** from the Windows menu of the main workspace. See page 52 for additional information.

Device Windows

A Device Window displays specific information for each type of Pro64 device (6416m, 6416dio, AllFrame, MH10, ASI, etc.). Device Windows are used to manage and edit a device's settings such as Slot range, routing, channel activation, input channel names, as well as providing an interface for saving and recalling up to 16 device presets. Each Device Window contains multiple views designed specifically for that device.

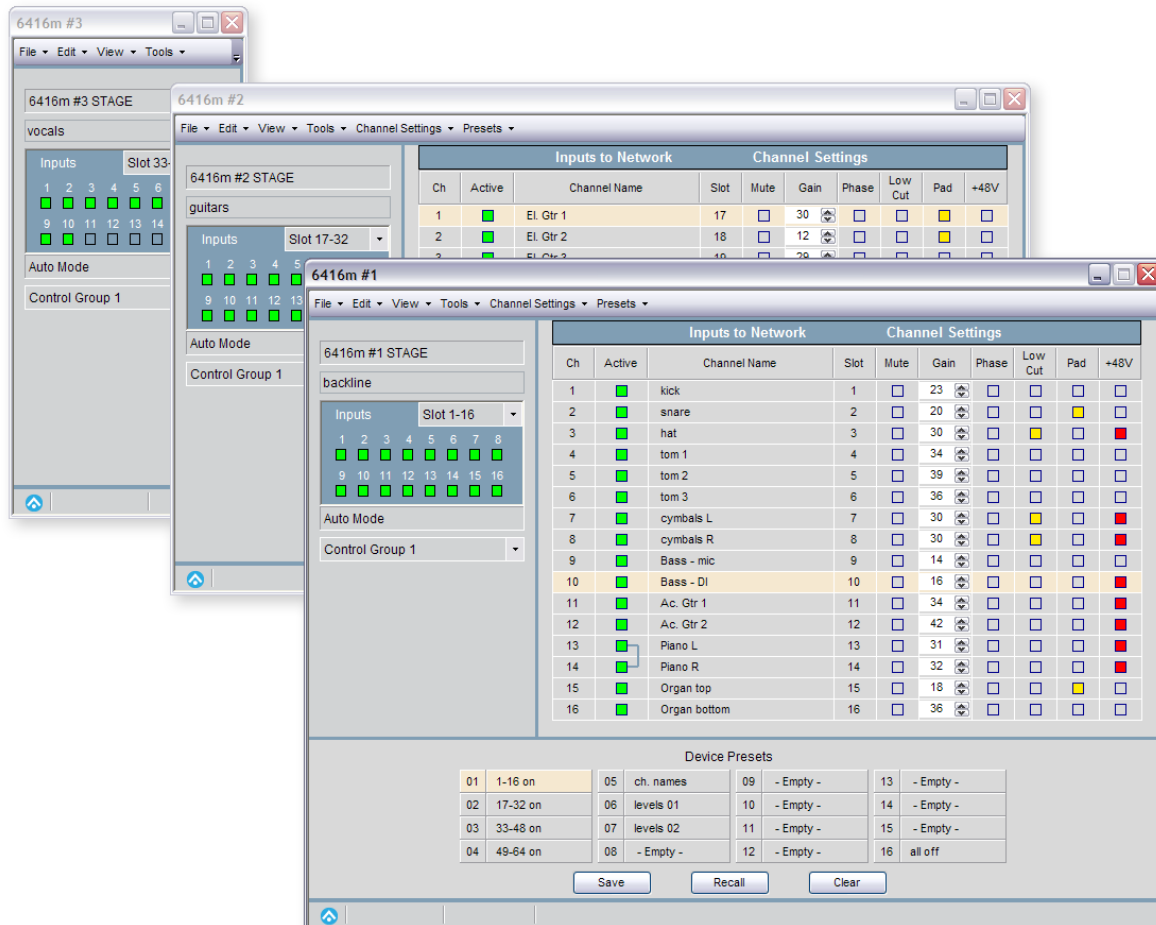

The Device Window offers multiple views of a Pro64 device's settings.

Multiple Device Windows may be open within the workspace, but only one view for a given Pro64 device may be open at a time. Device Windows have their own local menu bars containing items designed to control settings unique to that device; you can also print a report for each device. The Device Windows can be opened, closed, and repositioned in the workspace as needed.

Double-clicking a single device row in the Network Overview opens its Device Window. With a device highlighted in the Network Overview, using the keyboard shortcut **CTRL+D** also opens its Device Window. See page 63 for additional information.

Scene Manager Window

A Scene saves the configuration of everything in the Pro64 network—channel on/off settings, routing, input channel names, and so on. The Scene Manager Window allows the user to save, recall, name, and manage up to 99 Scenes stored within the current project. Scenes allow the user to reconfigure an entire Pro64 audio network from a central location, making setup changes for multiple devices for any type of production easy to manage.



The Scene Manager allows a user to create, save, and recall scenes that are part of a project.

Use the keyboard shortcut **CTRL+2** to open the Scene Manager. The window can also be opened by choosing **SCENE MANAGER** from the Windows menu of the main workspace. See page 122 for additional information about Scenes.

Audio Slot Manager Window

The Audio Slot Manager allow the user to view the I/O routings for an entire Pro64 network from a central location. Each network Slot can be examined individually, with the window displaying lists of all devices that have assignments to the same Slot. Activation of input and/or output devices can also be managed from this window.

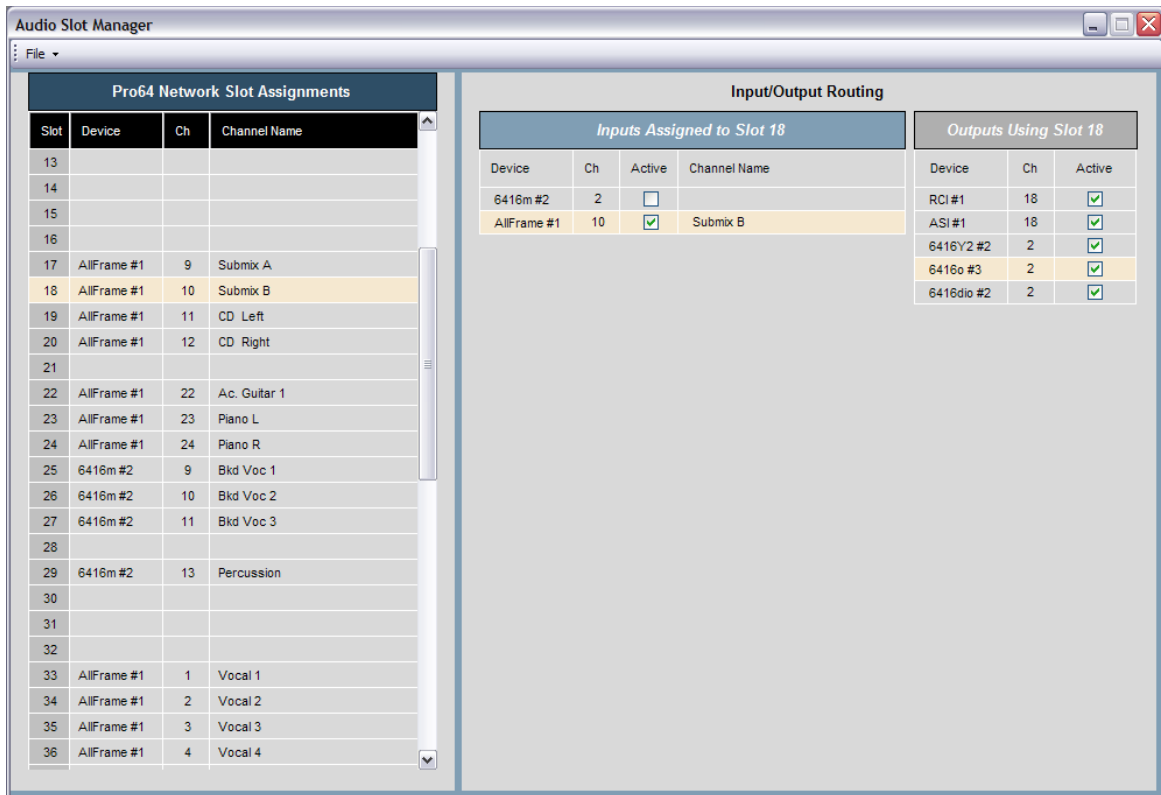

The Audio Slot Manager provides an overview of the routing of all network Slots in a project.

Use the keyboard shortcut **CTRL+4** to open the Audio Slot Manager. The window can also be opened by choosing **AUDIO SLOT MANAGER** from the Windows menu of the main workspace. See page 119 for additional information.

Virtual Data Cable Monitor Window

The Virtual Data Cable™ (VDC) Monitor window is used for viewing the routing of the 14 Virtual Data Cable Slots available in the network.

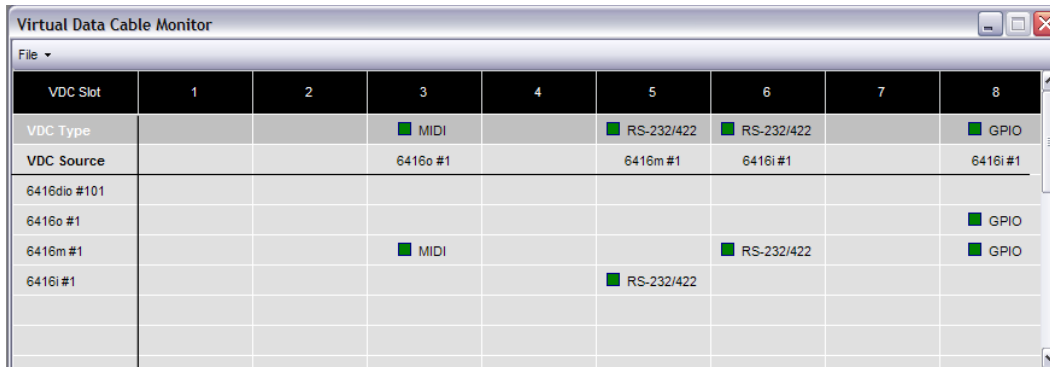

VDC Slot	1	2	3	4	5	6	7	8
VDC Type			■ MIDI		■ RS-232/422	■ RS-232/422		■ GPIO
VDC Source			6416o #1		6416m #1	6416i #1		6416i #1
6416dio #101								
6416o #1								■ GPIO
6416m #1			■ MIDI			■ RS-232/422		■ GPIO
6416i #1					■ RS-232/422			

The VDC window displays the status of the 14 Virtual Data Cable Slots.

To open the Virtual Data Cable Monitor use the keyboard shortcut **CTRL+3** or choose **VIRTUAL DATA CABLE MONITOR** from the Windows menu of the workspace. See page 132 for additional VDC information.

Event Log Window

The Event Log shows text relating to network activity, errors, etc. Its contents can be saved to disk and portions of the log text can be copied, pasted, etc. as needed. The Event Log captures up to 256 lines of messages to the computer's on-board RAM.

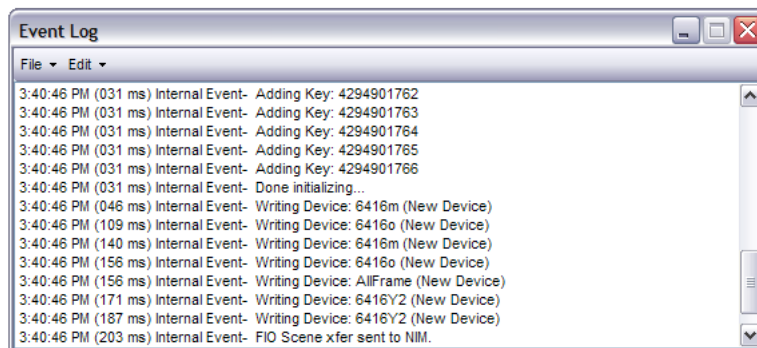

The Event Log can be positioned anywhere on screen as needed.

In the main workspace open the Event Log by choosing **EVENT LOG** from the Windows menu or by using the keyboard shortcut **CTRL+5**. The Event Log can be opened/closed, repositioned, or resized on screen as needed.

Text created by the Event Log must be saved by copying and pasting into a new desktop document if any portions of it need to be retained. See page 135 for additional information.

Firmware Update Window

The Firmware Update utility is accessed from the Tools menu in the main workspace when the application is online and connected to a Pro64 network. It shows a list of all Pro64 devices in the current network and allows their firmware to be updated.

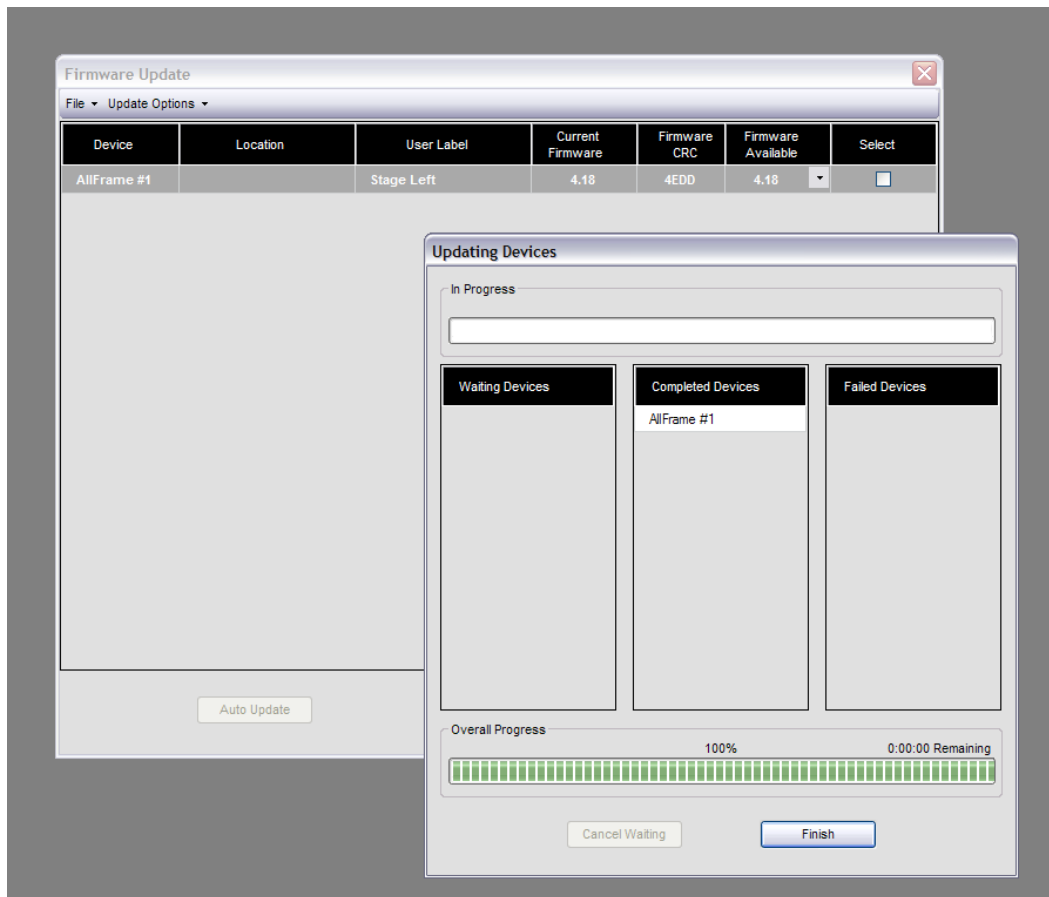

Firmware Update window and progress bars

The Firmware Update utility can also be used to roll back the firmware of any Pro64 device to any previous firmware version. See page 21 for additional information.

FIRMWARE UPDATES

Firmware is the embedded software that resides in each Pro64 device. Updating firmware can be done one device at a time or in a batch, as would happen when connecting a version 4.xx or prior network to **Pro64 Network Manager Version 3** for the first time. All Pro64 devices in a network should be updated to the most recent firmware to avoid compatibility issues.

The Firmware Update utility is contained within Pro64 Network Manager and runs in a separate window. During a firmware update (and as long as the Firmware Update window is open) you cannot edit or make any changes in the other windows of the Pro64 Network Manager application.

Software Notice

Pro64 Network Manager's Firmware Update utility replaces the Pro64 Update Tool software previously released for firmware management. The Pro64 Update Tool software is no longer supported.

If you need to maintain a group of older Pro64 device's firmware but do not need to control and manage your Pro64 network, you can still do firmware updates using Pro64 Network Manager without updating to v5.xx firmware. You will not have access to any of the other Pro64 Network Manager functionality until those devices are updated to v5.xx firmware.

✓ **NOTE:** Version 5.xx firmware is required to run Pro64 Network Manager Version 3 online. .

Update Requirements

For rack-mount I/O devices, such as the 6416m Mic Input Module, updating firmware requires a direct RS-232 connection between the computer and the Pro64 network's Control Master device. Normally this is accomplished by connecting a null modem DB9 cable between the RS-232 jacks on the computer and the Pro64 device. Firmware updates take 3-5 minutes per device to complete.

Computers lacking an integrated RS-232 COM port connection may require the use of a USB-to-RS-232 adapter. The adapter (sometimes called a USB-to-Serial adapter) operates as a bridge between a USB port and a standard RS-232 Serial COM port.

If an AllFrame device, such as the F6 Modular I/O Frame is used as the network's Control Master, a USB connection is required between the F6 and the computer. See page 24.

The Appendix section of this document contains wiring and pinout information for RS-232 and null modem cables. See page 138.

USB-to-RS-232 Adapters

The following USB-to-RS-232 Adapters have been tested by Aviom and found to work with the Pro64 Network Manager application:

- **Keyspan USB High Speed Serial Adapter** (Model USA-19HS) Run their utility software to determine the COM port that is in use.
- **Gigaware USB-A to Serial Cable** (Model 26-949) Easy to configure; readily available from Radio Shack© stores.
- **IOGEAR USB to Serial Converter Cable** (Model GUC232A) Must configure the device's baud rate and get its COM port info from within the Ports section of the Windows OS Device Manager; not well documented. Identifies itself as the ATEN USB to Serial Bridge.
- **CablesToGo 13in Port Authority USB Serial DB9 Cable** (Model 26886) Must configure the device's baud rate and get its COM port info from within the Ports section of Windows OS Device Manager; not well documented.

Hardware Setup For Firmware Updates

Follow the steps below to set up the computer and the Pro64 network prior to launching the Pro64 Network Manager application for the first time. If your network uses a **6416Y2 A-Net Interface Card*** or **AllFrame F6** as the Control Master, see the sections that follow for specific information about setting up these devices.

Communication Setup For Rack-Mount I/O Devices

To set up Pro64 rack-mount I/O devices such as the 6416m, 6416dio, and 6416o for updating:

- Connect an RS-232 serial cable (null modem) or properly configured USB-to-RS-232 adapter between the PC and the Pro64 network's Control Master device. You may need to configure the PC's COM port settings for some USB-to-RS-232 converters.
- Configure the Control Master device to communicate at 57.6k baud with 8 data bits, one stop bit, and no parity using the DIP switches found in the RS-232 section of the device's Virtual Data Cable™ (VDC) section of the rear panel as seen in the example below **.

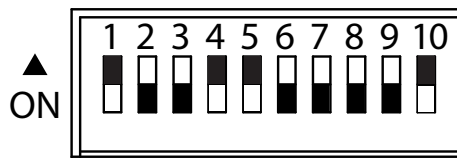

57.6k baud DIP switch settings (DIP switch handles are black)

- Disable any RS-232 or RS-422 Virtual Data Cables that are in use on the Control Master.
- On the front panel of the Control Master device, press the **MANAGED** button followed by the **ENTER** button. The Managed button will light yellow.
- At this point you are ready launch the Pro64 Network Manager application.

* If you are using the 6416Y2 A-Net Interface Card as the Control Master device, you can simplify the firmware update process by switching the Control Master function to a rack-mount Pro64 I/O device or AllFrame device temporarily.

** The 6416dio Digital I/O Module has a 12-position DIP switch on its rear panel; DIP switch #10 is still used to set the device as the Control Master for the network. Leave DIP switches 11 and 12 in the down position. (DIP switch #12 selects between RS-232 and RS-422 communication.)

✓ **NOTE:** The DIP switch settings described above must be used any time the firmware is updated or rolled back on a rack-mount I/O device used as the network's Control Master. Leave the DIP switches set as shown in the diagram above to simplify future updates.

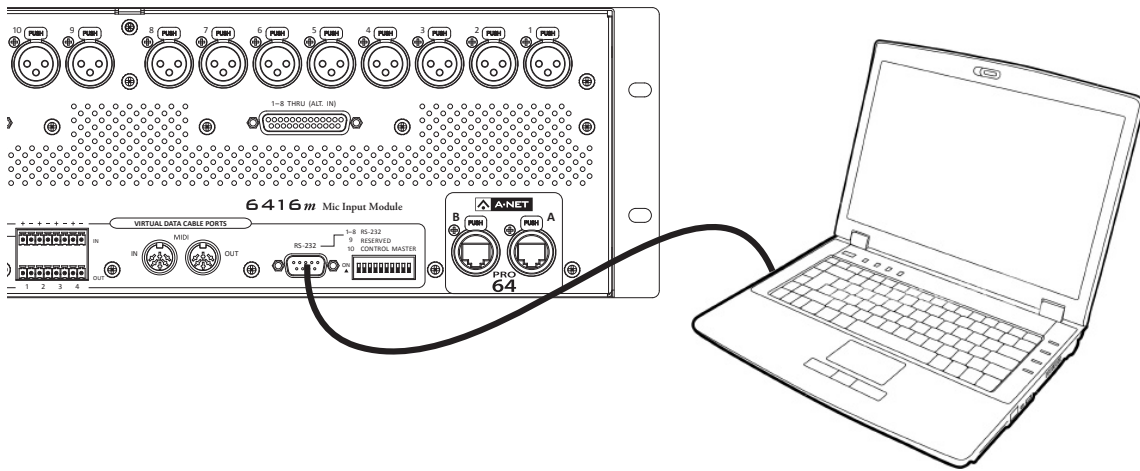

Connect the PC to the Control Master device with an RS-232 cable.

Communication Setup For AllFrame I/O Devices

AllFrame Modular I/O System devices such as the F6 Modular I/O Frame do not require the user to set a baud rate prior to starting firmware updates. When an AllFrame device such F6 is the Pro64 network's Control Master follow these steps to set up the device for firmware updates:

- Remove the control panel cover on the front of the F6.
- Make sure that the Control Master switch is in the up position.
- Connect a USB cable to the Type-B USB port on the F6.
- Connect the other end of the USB cable to the PC.
- Launch the Pro64 Network Manager application.

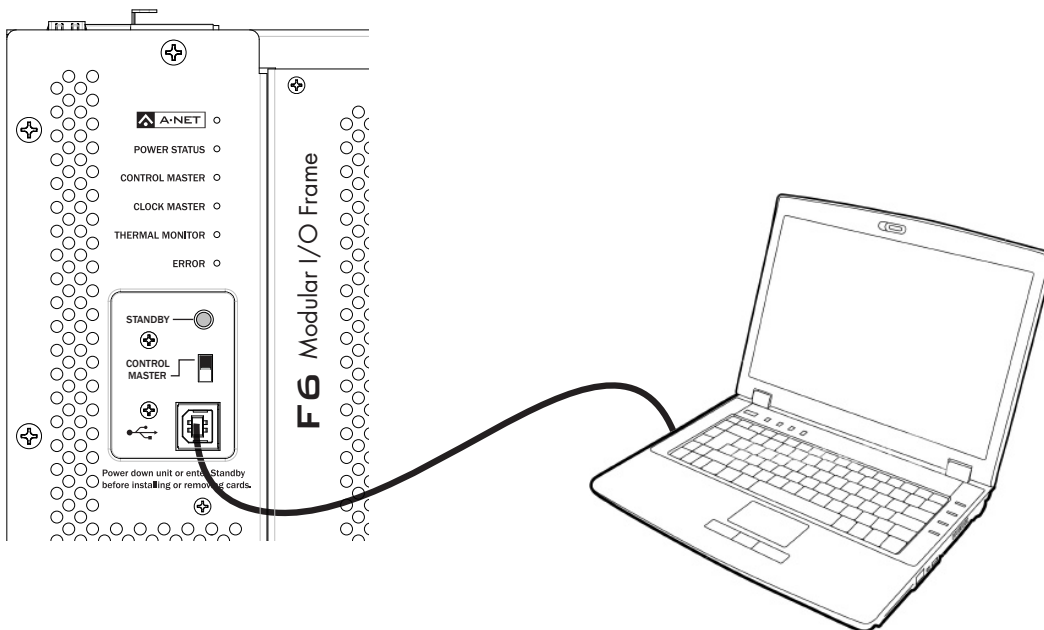

Connect the F6 to a PC using a USB cable when the F6 is the Control Master.

Communication Setup for the 6416Y2 Card

This section details the card settings required for updating firmware; they must be made on all the 6416Y2 cards in a network *before* being installed in a Yamaha host device and running Pro64 Network Manager for the first time. DIP switch settings are slightly different if the 6416Y2 card is the network's Control Master versus if it is a slave card.

Front Panel DIP Switches

On the front panel of the 6416Y2 card, the system lock (DIP switch #9) and m-control (DIP switch #10) functions need to be disabled during a firmware update. To do this set DIP switch #9 and #10 *up*—this is the 'off' position for switches in this DIP switch block. If the network contains multiple 6416Y2 cards, be sure to disable m-control on each card before starting the firmware update process. Choose the front-panel option that suits your application (the card is either the Control Master or a slave device), then move on to setting up the card's other DIP switches for the firmware update by following the steps in the section that follows.

6416Y2 as Control Master

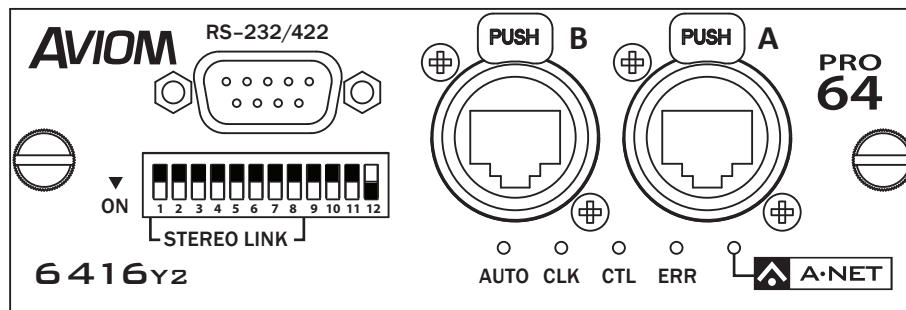

Front panel settings for a card set as Control Master; switch #12 down (DIP switch handles are black)

6416Y2 as a Slave Device

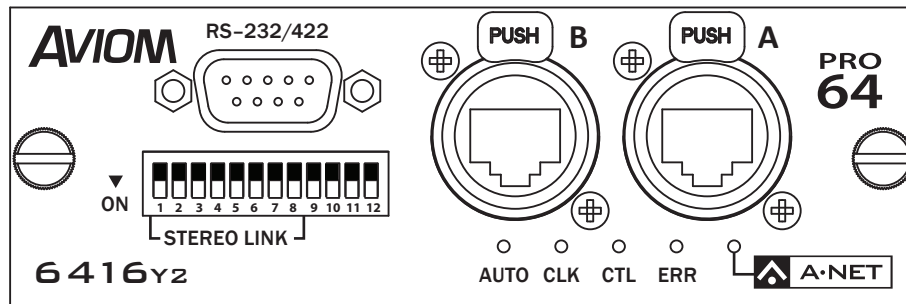

Front panel settings for a non-Control Master (slave) card; all DIP switches in the up position

Circuit Board DIP Switches on the 6416Y2

Before installing the 6416Y2 card in the Yamaha device, set up the card's DIP switches as follows so that the card's firmware can be updated:

1. Set DIP switch #1 in block SW8 in the down position—this sets the card to communicate via RS-232.
2. Set the card for Managed Mode by moving DIP switch #10 found in Switch Block 9 (SW9) to the up position.
3. In order to properly communicate with Pro64 Network Manager during a firmware update, all Virtual Data Cables on the 6416Y2 card need to be disabled. To do this, set DIP switches 2 through 7 found in Switch Block 8 (SW8) to the down position.
4. In Switch Block SW4, set switches 2, 5, and 8 to the up position—this sets the baud rate, stop bit, and parity for the RS-232 communication with the PC.

The MY Mode switch (SW8, #10) can be in either position; it is shown in the 16-channel MY16 Mode (up) in the diagrams.

DIP switches used for the Slot Transmit and Receive ranges (#5-8 in block SW9) can be ignored during the update process; they are shown in the down position in the diagrams that follow. Channel activation DIP switches found in DIP Switch Blocks SW1 and SW2 are also ignored during a firmware update. Those are also shown as off (down) in the diagram.

Once the DIP switches are set, the card can be installed in the Yamaha host device.

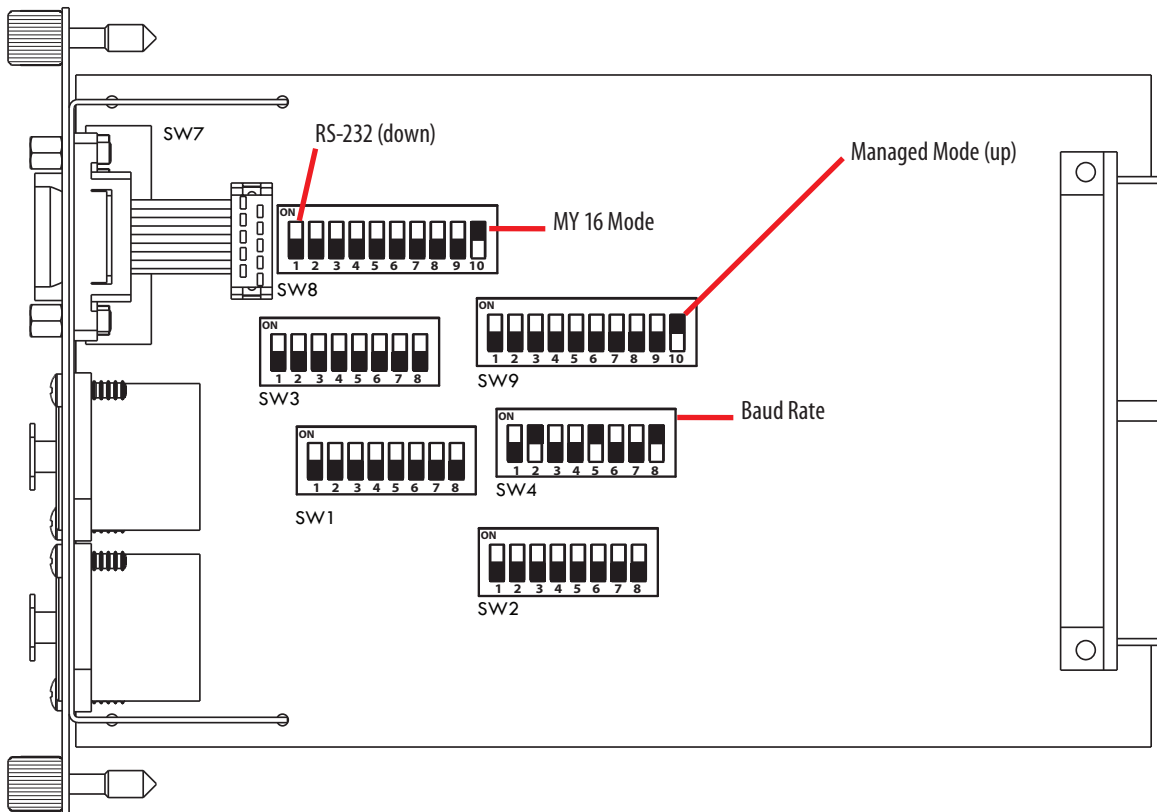

The 6416Y2 card ready for a firmware update (DIP switch handles are black)

After Updating 6416Y2 Firmware

Once new firmware is installed, DIP switch #9, found in DIP Switch Block 9 (SW9), is used to select between **Pro64 Network Manager enabled** (when up, the software controls all I/O routing and settings) or **DIP switch control** (when down, the card's onboard DIP switches control the I/O routing and settings on the 6416Y2 card). This switch needs to be in the *down* position for the initial firmware update from v2.xx, v3.xx, or v4.xx to version 5.xx.

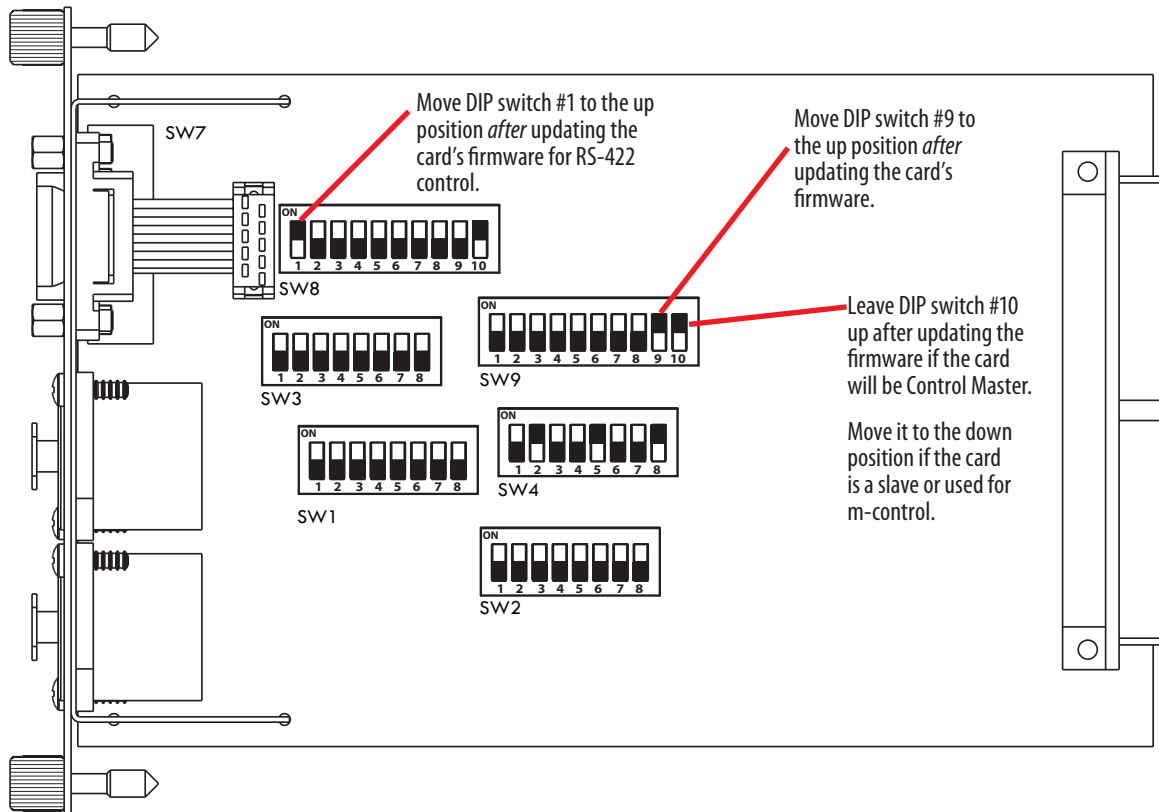

6416Y2 card is ready for control and management from Pro64 Network Manager after being updated.

Leave the Managed Mode DIP switch (#10 in block SW9) in the up position on a card set to be the network's Control Master. Move this switch to the down position if the card will be a slave. Remember that only one Pro64 device or 6416Y2 card can be the network's Control Master, so only one card can have its DIP switch #10 in block SW9 set to the up position.

If a 6416Y2 card is used as Control Master, it is not possible for that same card to send m-control information. The options are: (1) use a different 6416Y2 card for m-control or (2) use a different Pro64 device as the network's Control Master. Switch Block SW4, the baud rate settings, can be left set as shown to simplify future firmware updates. Additional information about the 6416Y2 card starts on page 83.

-
- ✓ **NOTE:** Once the 6416Y2 card's firmware has been updated, DIP switch #9 in DIP Switch Block 9 (SW9) needs to be placed in the *up* position to enable control from Pro64 Network Manager. Power down the Pro64 network and the host Yamaha devices and set all 6416Y2 cards in this manner; restart the Yamaha devices and the Pro64 network to continue.
-

Connecting to the Network for the First Time

Double-click the Pro64 Network Manager icon on the PC desktop, or select the application by name from the programs list in the Windows OS Start menu to launch the application.

Pro64 Network Manager starts in offline mode. To connect to the network, choose **WORK ONLINE...** from the Network menu of the main workspace. In the dialog box that opens, choose the computer COM port where your USB cable (for AllFrame devices), RS-232 null modem cable (or properly configured USB-to-RS-232 converter for rack-mount Pro64 I/O devices) is connected from the menu and then click **OK**. Pro64 Network Manager will then scan for a Pro64 network. Click the **CANCEL** button to continue working offline.

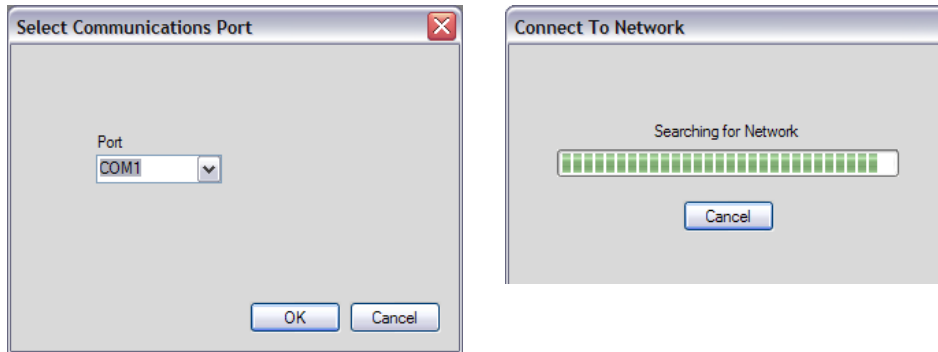

Choose the COM port and then click OK to connect online.

About COM Ports

If there is more than one serial port on your PC, each valid COM port will be selectable in the drop-down menu. You may need to configure the COM port settings from the Windows OS Device Manager.

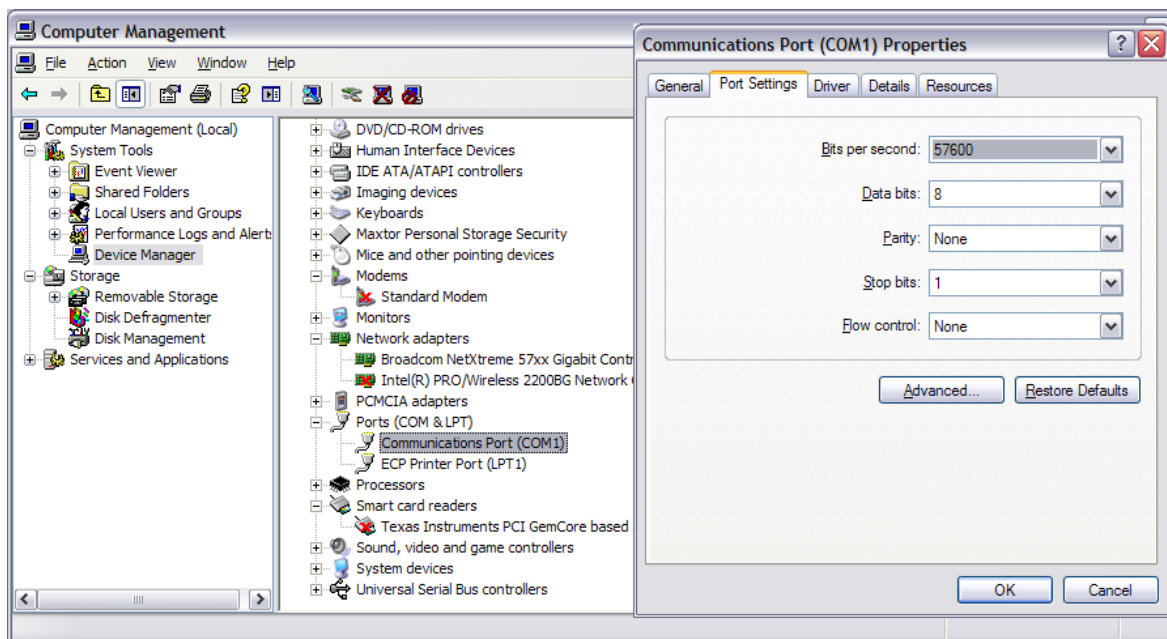

The Windows OS Device Manager and its COM port settings

When connecting to a Pro64 network running firmware versions older than v5.xx to Pro64 Network Manager Version 3 for the first time you will be prompted to update the firmware on all Pro64 devices before being allowed to control and manage the network.

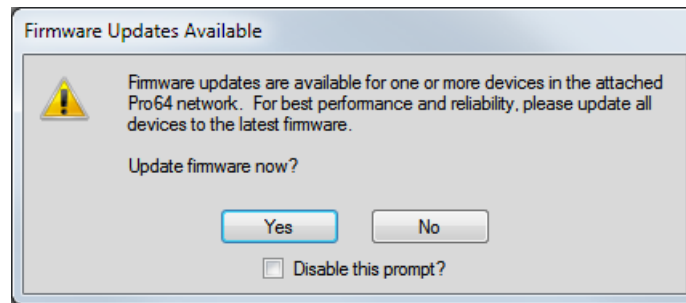

The firmware update warning

Click **YES** to open the Firmware Update window where you will be able to monitor the progress of the updates. Each Pro64 device takes approximately 3-5 minutes to update. (See the complete description that follows.) You can also use this option to view the current firmware revision of the devices in the network without automatically starting a firmware update.

To continue using Pro64 Network Manager without updating, click **No**; the application will transition to offline mode. You can then open and edit projects that have been saved to disk.

-
- ✓ **NOTE:** You cannot work online and view or manage a network with Pro64 Network Manager Version 3 until all connected Pro64 devices are running v5.xx firmware.
-

Firmware Update Utility Window

The components of the Firmware Update window are described below.



The firmware update window components

①	Pro64 device type, with numeric ID and location label
②	Current firmware version installed in the Pro64 device
③	Firmware checksum
④	Red indicates a new firmware version is available
⑤	Drop-down menu to select firmware versions
⑥	Select box; used for choosing which devices to update
⑦	Click a button to start updates or exit

Progress Bars

During the firmware update process, progress bars and an info window will be displayed. The Updating Devices window will show a list of all Pro64 devices that have been selected for updating. Devices will be listed in the **COMPLETED DEVICES** column once their firmware has been updated. If errors occur during the update process, the device's name will appear in the **FAILED DEVICES** column.

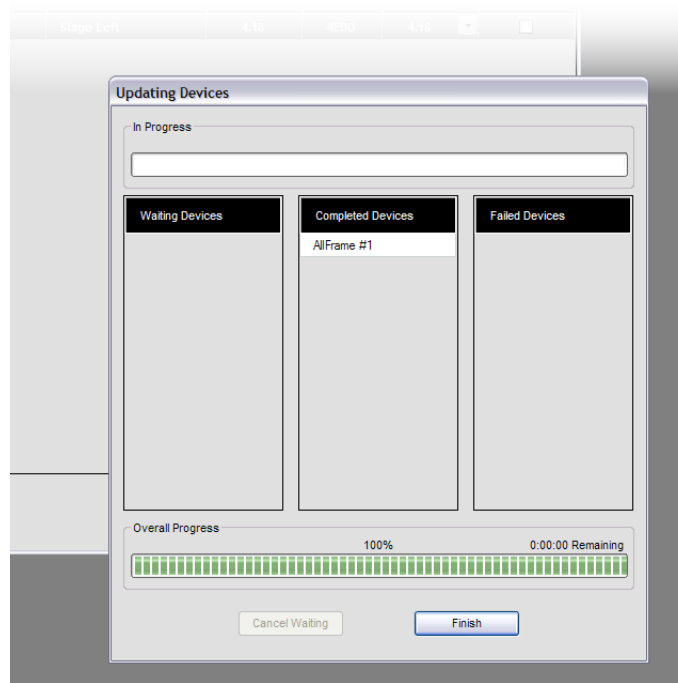

Firmware Update window progress information

To close the Updating Devices window, click the **FINISH** button once all firmware updates have been completed. To stop the update process for Pro64 devices that remain in the list, click the **CANCEL WAITING** button. Note that the firmware update in progress must be completed before you will be allowed to exit.

If a Firmware Update Fails

If a Pro64 device fails the update process, try one of the following solutions:

- Try a different null modem cable.
- Check the pinout on the RS-232 cable with a multimeter.
- Keep all RS-232 communication cables as short as possible.
- Try a different USB-to-RS-232 adapter.
- Use a different PC.
- Relocate the Pro64 device, making it closer to the Control Master.
- Minimize cable distance (including Cat-5 connections) between the Control Master and the device in question.

Closing the Firmware Update Window

Attempting to close the Firmware Update window while an update is in progress will cause a warning dialog box to appear. The dialog box shows information about the current Pro64 device being updated, and includes an estimate for the amount of time remaining for that firmware update to complete. It also includes an estimate of the time required to complete *all* scheduled firmware updates.

You cannot exit the firmware update utility or quit Pro64 Network Manager until at least the currently running firmware update is completed.

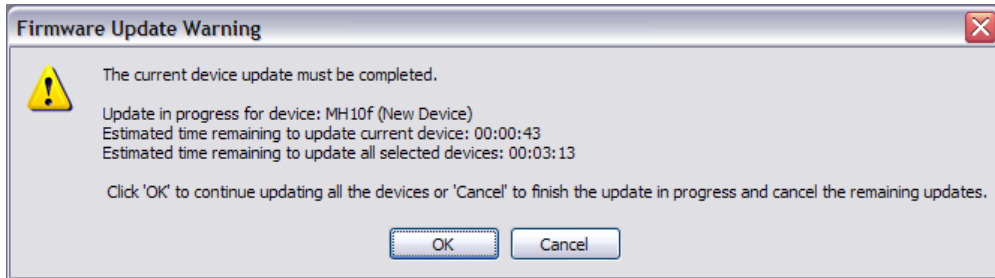

Stop one or more updates by clicking Cancel.

To exit the Firmware Update utility after the current update is completed and cancel all subsequent updates, click the **CANCEL** button in the dialog box. To continue the update process for all devices in the Remaining Updates list, click the **OK** button.

Firmware Update Window Menus

When the Firmware Update window is open the following menu commands are available:

File Menu

Print	Opens the standard Windows OS printer selection dialog box and allows you to print a report showing the current firmware versions for all devices in the network (shortcut - Ctrl+P)
Close Window	Closes the Firmware Update window (shortcut - Ctrl+W)

Firmware Report

Printing a firmware update report provides a written record of the network's current firmware revisions.

<p>Network Mode: Auto Clock Mode: Internal Network Sample Rate: 48kHz</p>				<p>Firmware Update Control Master: 6416dio Clock Master: 6416dio</p>	
Device	Location	Firmware Version	CRC	Bootloader Version	CRC
6416dio #1		3.42	F689	0.24	7B25
6416i #1	STAGE	3.42	7FBD	1.23	33F1
6416m #1	STAGE	3.42	A860	1.04	4B2E
6416o #1	FOH	3.42	7FBD	1.23	33F1
MH10f #1	FOH	3.42	B546	1.13	33C0
MH10f #2	FOH	3.42	C2C3	1.13	33C0

Sample content from a firmware report

Update Options Menu

Locate Update Files	Opens a dialog box that allows you to navigate the computer's hard disks to locate the folder where the firmware update files are stored. Use this to choose a firmware update folder other than the default.
Refresh Update Files	This command refreshes the Firmware Update window view and should be used if the devices in the network or the contents of the firmware update files folder changes while the Firmware Update window is open.
Use Default Update Files	Select this command to reset the location of the firmware updates files back to the default.

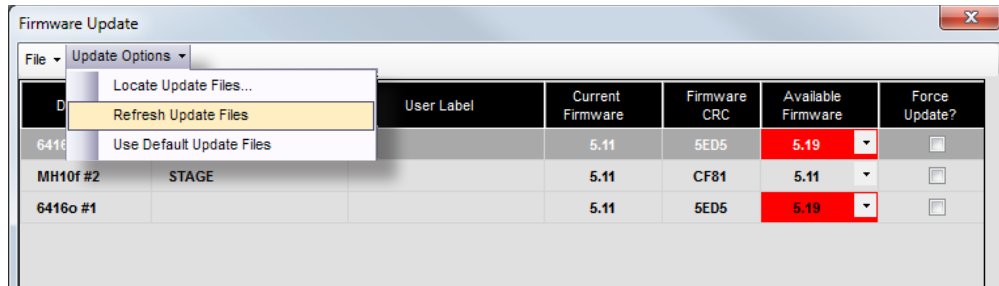

Commands in the Update Options menu

The default location for firmware update files is:

C:\Program Files\Aviom\Pro64 Network Manager\Device Update\Update Files or
 C:\Program Files (x86)\Aviom\Pro64 Network Manager\Device Update\Update Files

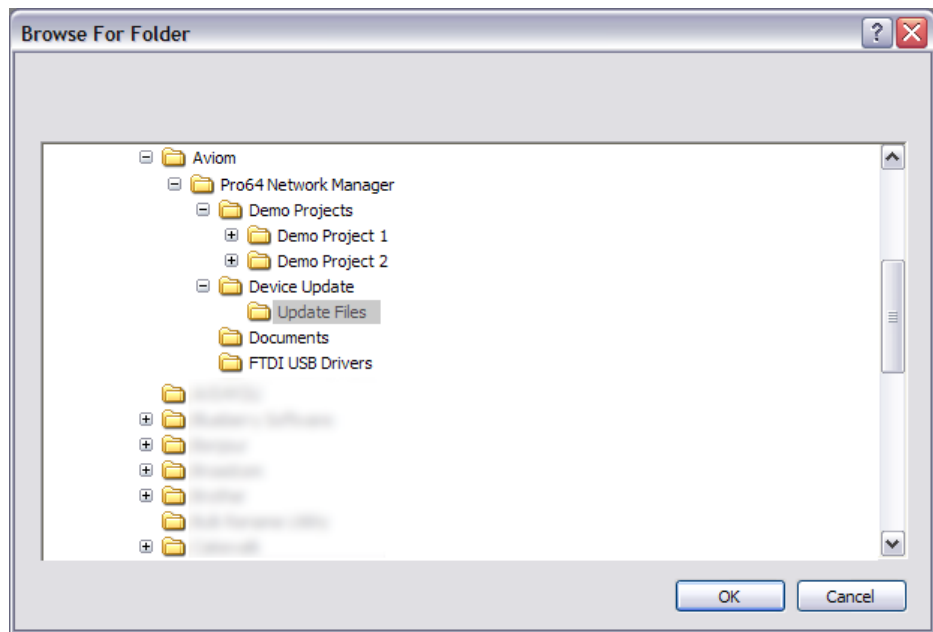

This screen shot shows the default location for device update files stored in the application's folder.

Maintaining a Pro64 Network

Once a Pro64 network is updated to the current version of the firmware to work with the Pro64 Network Manager software, you should periodically check for new firmware update files to keep your Pro64 products up to date. Updates are posted to the Aviom website. (See page 21 for additional update and firmware information.)

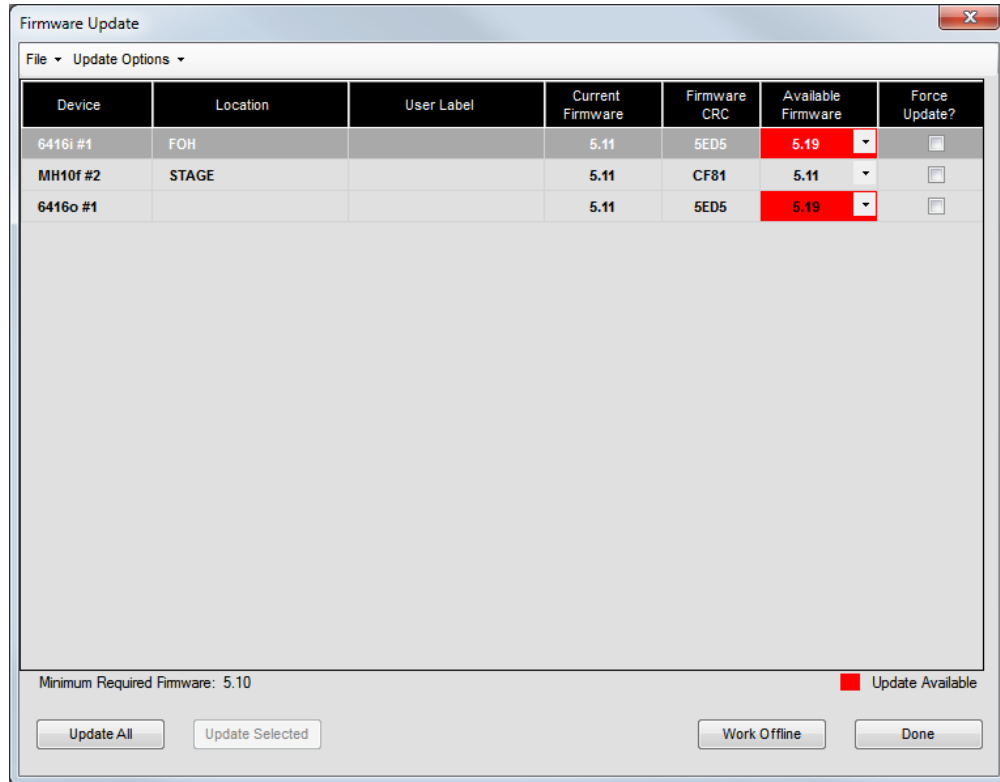

Pro64 devices with new firmware available are indicated in red.

Once new firmware files are downloaded and placed into the default firmware update file folder, any Pro64 devices that have new firmware available are indicated with red text when the Firmware Update window is opened. Remember that you must be working online to be able to open the Firmware Update window. Use the **UPDATE ALL** command found in the Update options menu to start the update process. Optionally, select individual devices to be updated by clicking in their **SELECT** boxes.

The default location for the firmware update files is:

C:\Program Files\Aviom\Pro64 Network Manager\Device Update\Update Files (Windows XP)

C:\Program Files (x86)\Aviom\Pro64 Network Manager\Device Update\Update Files (Windows 7)

-
- ✓ **NOTE:** If you download new firmware files from the Aviom website, be sure they are placed in the default Update Files folder so that they are automatically recognized by the Firmware Update utility when the window is opened. If updates files are stored in a different folder you will need to manually locate the firmware update files for each Pro64 device to be updated.
-

If 6416Y2 A-Net Interface Cards are part of the network, refer to the card-specific details on page 25 for information on how to set up the card and update its firmware.

Adding Devices to a Network While Online

Adding one or more devices running outdated firmware to a v5.xx network while online will require the devices with older firmware to be updated in order to retain control and management of the network using Pro64 Network Manager.

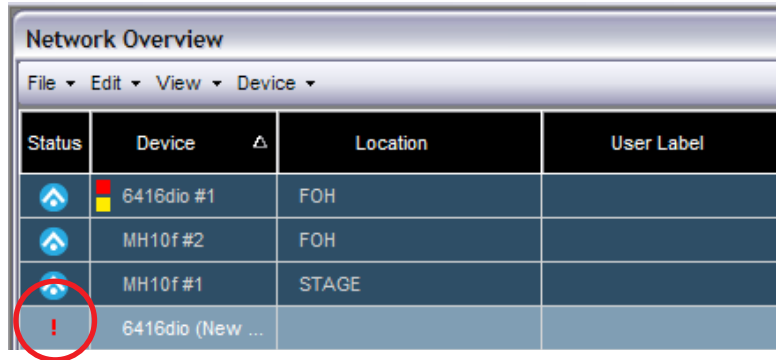

Status	Device	Location	User Label
Online	6416dio #1	FOH	
Online	MH10f #2	FOH	
Online	MH10f #1	STAGE	
Incompatible	6416dio (New ...)		

An outdated device has been added to the network.

In the Network Overview window, the Status column will indicate incompatible devices with a red exclamation point icon (!). Device Windows for any Pro64 devices that are not updated cannot be opened. Projects cannot be saved or edited while such devices are connected. A dialog box opens warning of the incompatibility. Click **OK** to continue; the network will switch to offline mode.

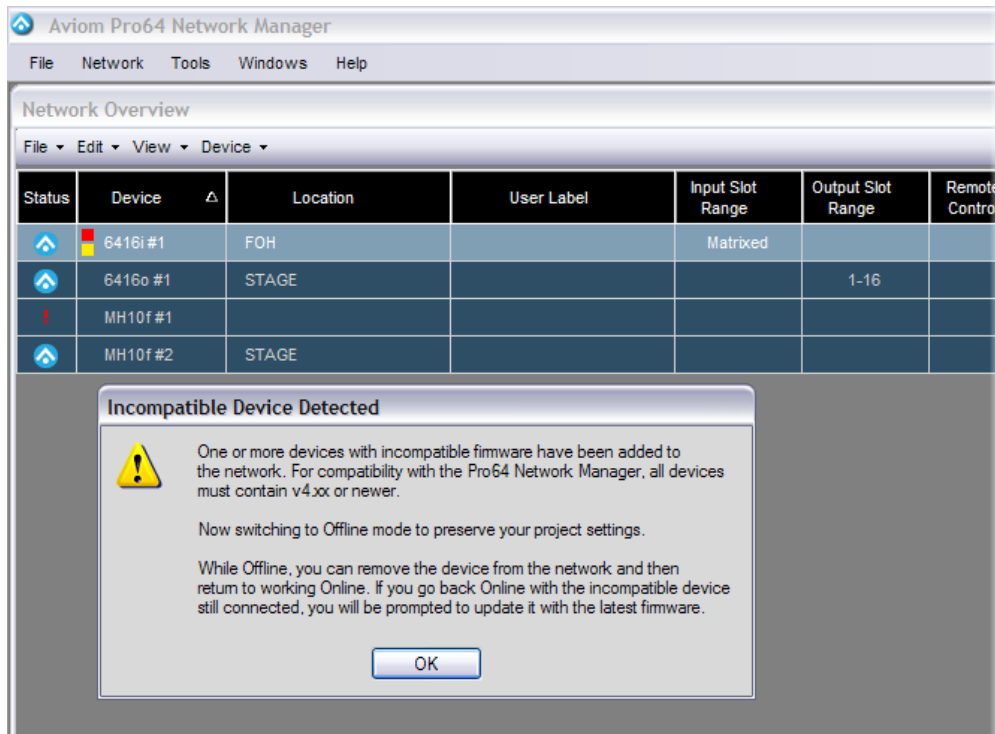

The network switches to offline mode when an incompatible device is added to the network.

To continue managing a Pro64 network online, you must either update each incompatible device or remove them from the network. Devices that have their firmware rolled back to previous firmware versions are no longer compatible with the online network and must be removed before continuing.

ONLINE VS. OFFLINE

Pro64 Network Manager provides two ways of working with the settings and information related to a Pro64 network—online and offline. The Network menu in the main workspace provides the commands needed to go between the two states.

Working Online

Working *online* means that Pro64 Network Manager is connected to a group of Pro64 devices via an RS-232 or USB connection with the network's Control Master, and that the user can monitor and change the settings in the network. Working online allows the user to make changes to the network I/O routing in real time, along with providing access to the Firmware Update utility. Settings can be saved in the form of a project (described below). The project brings with it the option of creating and saving network-wide Scenes and/or device-specific presets. See page 122 for information on the use of Scenes and see page 112 for complete information about using Device Presets.

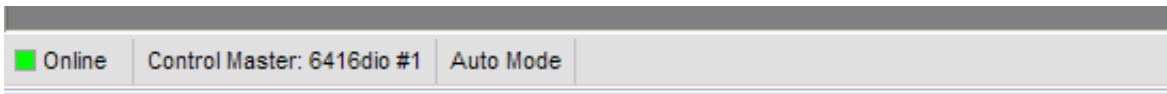

The status bar will show a green Online LED when connected to a Pro64 network.

Working Offline

Once a project has been created, it can be edited *offline* without requiring the Pro64 network to be connected to the PC. Most Pro64 Network Manager features and functions are available while working offline; the Firmware Update utility is unavailable since no Pro64 hardware exists while offline.

Projects that are edited offline can be loaded back into the Pro64 network by reconnecting to the Pro64 network as long as the physical makeup of the network hardware is the same.

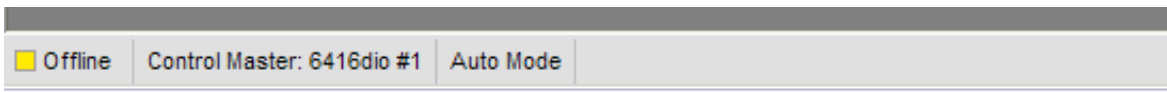

The status bar will show a yellow Offline LED when working without an active connection to a Pro64 network.

THE PROJECT

Pro64 Network Manager saves all information about the configuration of a network in a structure called a *project*. This includes:

- Quantity and type of all Pro64 devices in the network
- Active Slots on all I/O devices
- Input and output Slot routing, including matrix settings
- Sample rate
- Control Master device
- Clock Master device
- Clock source (Network, Word Clock, AES3)
- Active Virtual Data Cables (VDC)
- Device Numeric ID and Location labels
- Channel names
- Network Scenes
- Device Presets for each I/O device
- User-created text, comments, etc.
- Current open windows and their positions

Only one project can be open at a time while working with Pro64 Network Manager. New projects can be created while connected online to a Pro64 network or by using the **SAVE PROJECT As...** function with an existing project open while working offline. Projects saved to disk can be opened and edited offline at any time.

Project Contents

A project consists of a set of files and folders created as a group when you use the **SAVE PROJECT** command for the first time when no project is open while working online, or when either the **NEW PROJECT** or **SAVE PROJECT As..** command is used while an existing project is open. Projects can be stored in any convenient location on the computer's hard disk.

Saving a Project

When connected online to a Pro64 network, you can create and save a project by using the **SAVE PROJECT** command found in the File menu of the main workspace. The shortcut for this command is Ctrl+S.

After navigating to an appropriate folder, enter a name for the project in the dialog box's **FILE NAME** field and then click the **SAVE** button. Once a project has been created, you can create a new project using the same network configuration by using the **NEW PROJECT** command found in the File menu in the main workspace (the shortcut is Ctrl+N).

✓ **NOTE:** Do not move or rearrange the project's sub-folders or their contents.

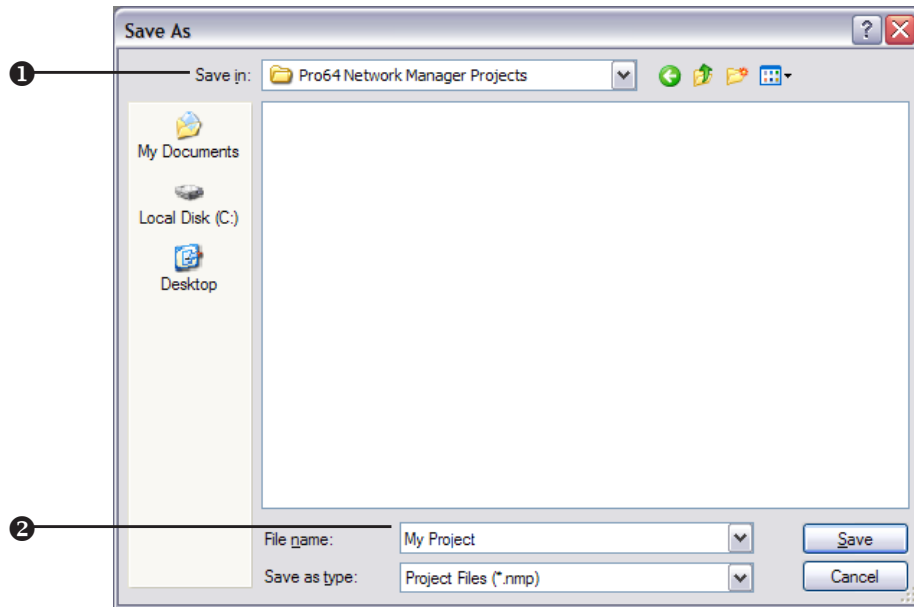

Create a project in any folder (1); name the project (2)

The newly saved project will include all current network I/O routing, text, and user-created settings. Once a project has been created and saved to disk, you have the option of creating Scenes and/or Device Presets that become part of the project.

The Project Structure

Each project is created in its own folder with a layout like the one shown below; it contains the project file itself as well as sub-folders for Project Settings, Project Scenes, and Device Presets. All Pro64 Network Manager projects use the .nmp file extension.

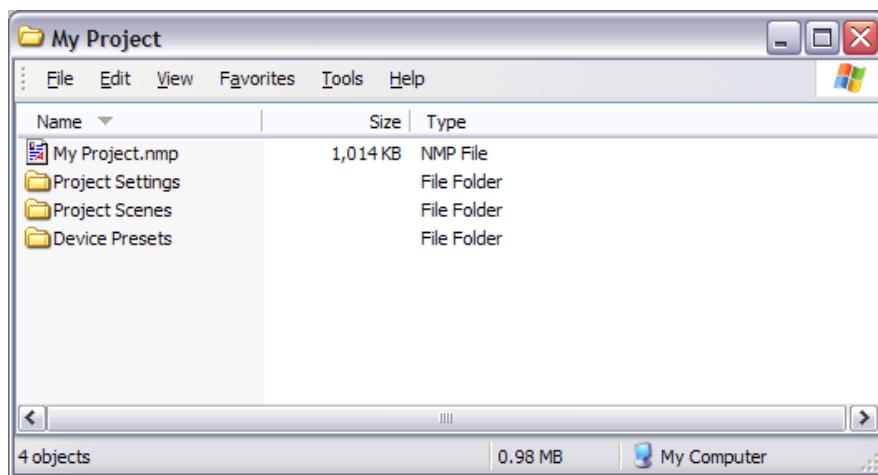

A project's folder structure

As you work with a project the application will create new Scene and Device Preset files as needed and store them in the sub-folders that were created with the project. When working with Scenes and Device Presets you will be prompted to confirm any operation that overwrites or deletes one of these files.

Scenes vs. Device Presets

A Device Preset saves the configuration of a single Pro64 I/O device and includes all channel names, channel and Slot input and/or output routing, etc., making them the ideal way to store commonly used settings for *one* device. Recalling a Device Preset will only affect the settings of the individual device. If recalling a Device Preset requests a network Slot resource that is already in use by another device, that request will be denied.

A Scene, on the other hand, stores the configuration of every device in the Pro64 network including the channel/Slot I/O routing for all devices, user labels and comments in the Network Overview, Virtual Data Cable settings, user-generated text, and notes for the Scenes themselves.

There is no requirement to create Device Presets or Scenes when working with a project.

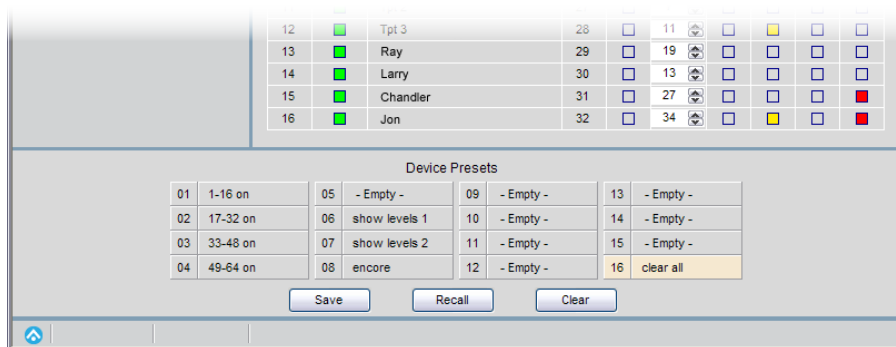

The Device Presets view for a 6416m

Scenes are a great way to simplify I/O management of a Pro64 network if you regularly use the same group of configurations—a digital transfer between Recording and Broadcast studios, a Stage to FOH digital snake with a monitor split, connecting the DAW to the Video Room, etc.

Each configuration saved as a Scene can be recalled quickly from within a project without the need to shut down the Pro64 Network Manager application or configure front-panel settings on the I/O modules.

-
- ✓ **NOTE** Scenes are designed to change the configuration of an entire audio network with a single click of the mouse. Depending on the makeup of the network and the length of cabling involved, it will take a short amount of time to load the new configuration, during which the network's audio will be muted. Pro64 Network Manager Scenes should not be confused with mixing console scenes and automation designed for seamless transitions in a real-time mixing environment.
-



The Scene Manager window

You can choose to work using any combination of the project file, Scenes, and Device Presets. Once a project has been created, all information about the current network is stored when the project is saved using the **SAVE PROJECT** command in the File menu of the main workspace.

Project Compatibility

Any projects saved to disk are checked for compatibility with the current network when they are opened while working online or when you attempt to transition from working offline to online.

It is important to remember that the quantity and type of the Pro64 devices in the network as well as the specific Pro64 devices set as Control Master and Clock Master are directly tied to the project when it is created. A saved project that has any of the above-described properties different from the current network can be opened *offline* for editing but cannot be loaded into the online Pro64 network until the networks match. In addition, remember that an AllFrame device's specific card configuration including the installed location and quantities of each card type is tied to the project.

The makeup of the network could be different for a number of reasons including devices not being powered up, the addition/deletion of Pro64 devices, damaged or missing cables, etc.

✓ **NOTE:** AllFrame devices are user configurable and as such must contain the exact complement of I/O cards which must be installed in the same card slots within the F6 in order to remain compatible.

Transitioning From Online to Offline

When connected online to a Pro64 network, you can break the active connection between the host computer and the Pro64 network by working offline. To change from online to offline operation, choose **WORK OFFLINE...** from the Network menu of the main workspace. The RS-232 or USB connection between the Control Master and the PC can be removed at this point if required, and the Pro64 network itself can be shut down if necessary.

Once offline, the settings in the current project can be edited as needed, and the project can be saved to disk as described above. New Scenes and Device Presets can be added to the project while working offline, as well. However, the makeup of the network cannot be changed. There is no way to remove a Pro64 device from the device list seen in the Network Overview. See page 53 for information on using the Network Overview.



Online operation shows a green LED and offline operation shows a yellow LED in the status bar.

Transitioning From Offline to Online

While Pro64 Network Manager is offline, there are different scenarios that will affect what happens when you attempt to transition from offline to online operation. The first is the easiest—there is no project open and the workspace is blank. Simply select the **WORK ONLINE...** command from the Network menu and connect to the network after selecting a COM port via the dialog box prompts that follow.

Pro64 Network Manager then scans the network and uploads all the settings from the Pro64 devices into a new workspace that you can control, edit, and save as a project.

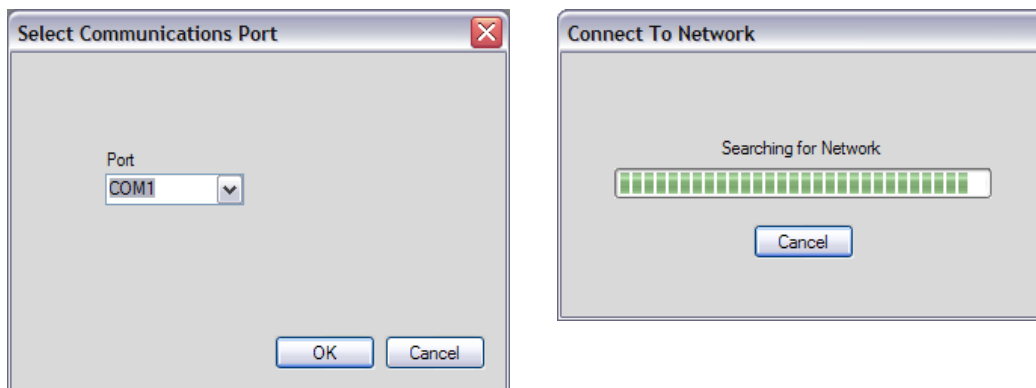

Choose the COM port and then click OK to connect online.

Going Online With an Unsaved Project Open

An unsaved project can be open offline, as would happen if you started working online first and then made the transition to offline without saving a project.

In this case the project must first be tested to check that it is compatible with the Pro64 network hardware that it is being connected to. (Remember, the Pro64 device list, Control Master device, and Clock Master device all must match.)

Choose **WORK ONLINE...** from the Network menu to start the transition process. The following illustrates the options that are available when transitioning from offline to online without having created a project first.

When **WORK ONLINE...** is selected from the Network menu, the following dialog box appears:

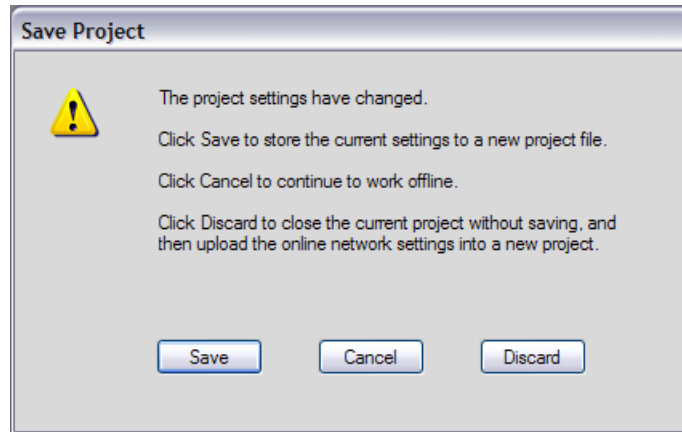

The transition dialog box

Click **CANCEL** to exit the dialog box and continue working offline.

Click the **SAVE** button to store the current settings to disk as a project. In the Save dialog box, navigate to an appropriate directory and then name and save the project.

Click **DISCARD** to close the project that is currently open without saving changes.

After using the Save or Discard options, the Connect to Network dialog boxes (as described previously) will appear. The network is now connected online.

If you selected the Save option in the previous dialog box, the project and its settings remain open. Since the settings from the offline project (channel activation, channel names, I/O routing, etc.) may be different from the actual settings of the online Pro64 hardware's front panels, you will be given the opportunity to choose which settings will be used—those from the offline project or those from the Pro64 hardware.

The following dialog box appears:

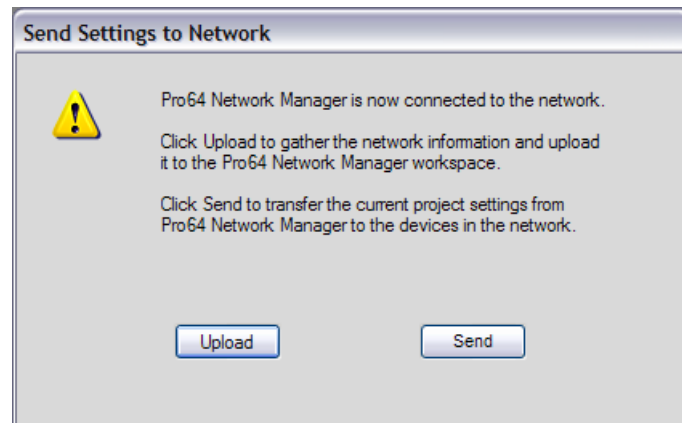

The Upload or Send dialog box

Two choices are available. Click **UPLOAD** to gather the settings from the Pro64 hardware devices *into* the project. The on-screen settings (channel activation, channel names, I/O routing, etc.) may change and will now exactly reflect the current state of the Pro64 hardware front panels. Immediately saving these settings as a Scene guarantees that you can always recall the exact configuration that gets uploaded.

The other option is to click the **SEND** button to transfer the settings from the current project into the Pro64 hardware devices.

Once one of these options has been selected, the network can be edited online as needed. The Pro64 network and Pro64 Network Manager are now in sync.

Going Online With a Saved Project Open

You can transition from online to offline operations as often as needed. If you start working online, save a project, and then transition to work offline, returning to online operation will behave as follows.

When the Project Has Not Changed

If nothing in the project has been edited and no windows have been repositioned, etc., when **WORK ONLINE...** is selected from the Network menu, the Connect to Network dialog boxes will appear. Select the appropriate COM port and click **OK** to continue. The network is now connected online.

Once connected online, the Send Settings to Network dialog box appears:

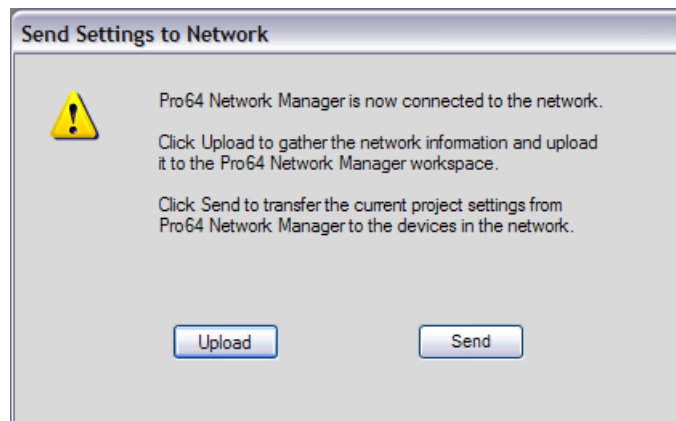

The Upload or Send dialog box

Two choices are available. Click **UPLOAD** to gather the settings from the Pro64 hardware devices into the project. The on-screen settings may change and will now exactly reflect the current state of the Pro64 hardware front panels. Immediately saving these settings as a Scene guarantees that you can always recall the exact configuration that gets uploaded.

The other option is to click the **SEND** button to transfer the settings from the current project into the Pro64 hardware devices.

When the Project Has Changed

When **WORK ONLINE...** is selected from the Network menu while working with a project but the project settings have changed, the following dialog box appears:

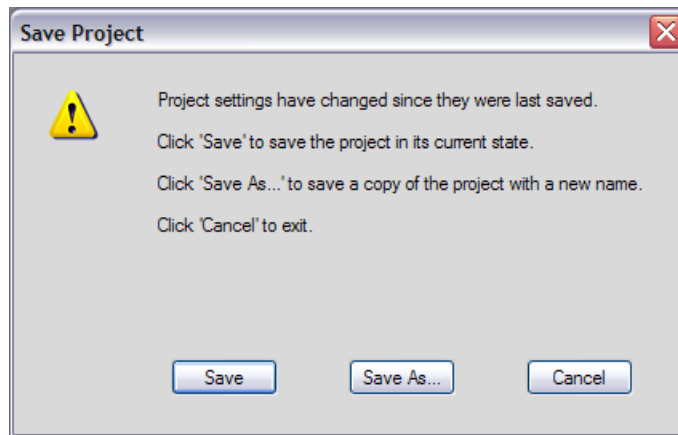

The Save Project dialog box

Click **SAVE** to update the current project files on disk. Click **SAVE AS...** to save a copy of the project with a different name. Click **CANCEL** to exit the dialog box and return to working offline.

As seen in the previous examples, the Send Settings to Network dialog box appears next. Click **UPLOAD** to gather the settings from the Pro64 hardware devices into the project or click the **SEND** button to transfer the settings from the current project into the Pro64 hardware devices.

WORKSPACE FEATURES

The workspace holds all other Pro64 Network Manager windows. The workspace can be sized and positioned on the PC desktop by the user. Closing the main workspace window exits the application.

Workspace Status Bar

The application's main Status Bar shows global information in a single row along the bottom of the workspace window. Included are online/offline status, network mode, sample rate, clock source, as well as Control Master and Clock Master info.

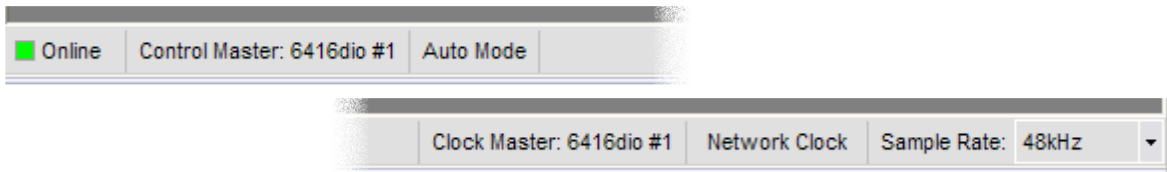

The workspace status bar runs along the bottom of the workspace.

Online/Offline Status

The first item in the Status Bar indicates the current network state—online or offline. When online (connected to a Pro64 network), a green icon with the text “Online” appears. When offline, the text reads “Offline” and a yellow icon is displayed.

Control Master

The Control Master section of the Status Bar is a read-only field that shows the type of Pro64 device currently set as the network's Control Master along with that device's numeric ID number.

Network Mode

This section of the status bar displays the network mode; currently Pro64 Network Manager supports only Auto Mode systems. This is a read-only field.

Clock Master

The network's Clock Master device and its numeric ID number are shown on the right side of the Status Bar; this is a read-only field.

Clock

The Clock section of the Status Bar indicates the type of clock being used by the network. This is a read-only field. Settings displayed here can include Network Clock (internal), or External Clock.

Clock Errors

If a clock error occurs while synced to an external clock source, the clock type field will display the error condition with red text as seen below.

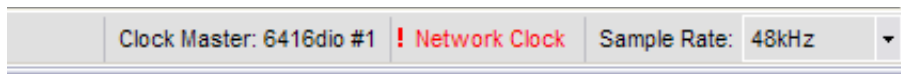

A clock error is indicated in red.

The network will continue to operate using its internal clock until the error is corrected and the external clock is restored, or until you intentionally reconfigure the Clock Master to use internal (Network) clock.

Sample Rate

The Sample Rate pop-up is a user-selectable field. Click on the arrow to open a list of the available network sample rates from 44.1 to 192kHz. You will be prompted to confirm a network-wide sample rate change as this can affect the make-up of the network itself and the total number of available Slots.

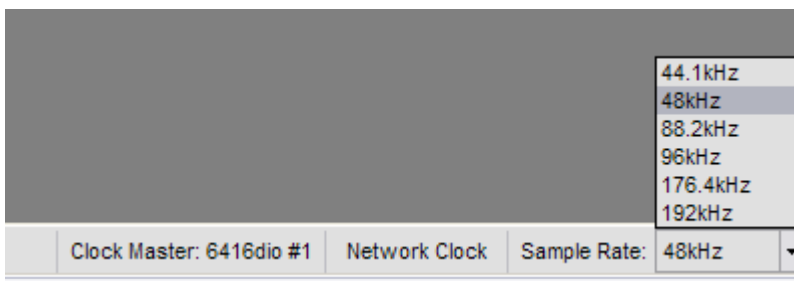

Sample Rate selection

-
- ✓ **NOTE:** Choosing a sample rate has an impact on the total number of Slots available for use in a network. See the documentation that came with your Pro64 devices for additional information.
-

Mute All

The Mute All command will temporarily mute all audio outputs while making changes to network hardware, positioning microphones, etc. When activated from the command in the Network menu of the workspace, **MUTE ALL** is shown in red in the status bar. The temporary Mute All state is not saved as part of the project. (Shortcut: Ctrl+Shift+1)



Mute All as seen in the status bar

-
- ✓ **NOTE:** The Mute All function is not available when working with a project offline.
-

Workspace Window Commands

Right-click the title bar of the workspace to open the standard (Windows OS) commands for resizing, minimizing, and closing the window.

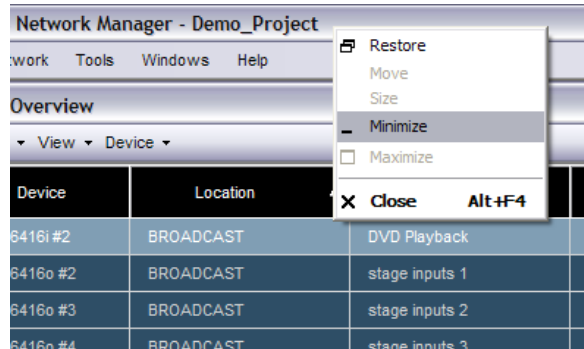

Right-click the title bar of the workspace to access the standard OS-level window commands.

The window management commands duplicate those found in the workspace window's upper right corner—Minimize, Maximize, and Close.



The standard window management commands

✓ **NOTE:** Using the Close command (or its keyboard shortcut Alt+F4) is the same as quitting the Pro64 Network Manager application.

Workspace Menu Commands

The menu commands found in the main workspace are described below.

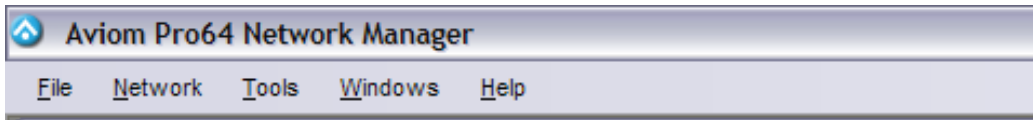

Workspace menus

File Menu

The File menu offers the following commands:

New Project	Opens a dialog box that allows you to navigate to a folder on your hard disk and choose a storage location and name for a new project. The new project is based on the current network configuration. All channels are deactivated and channel parameters are set to factory default conditions. Scenes and Device Presets are cleared. (shortcut - Ctrl+N)
Open Project	Opens a dialog box that allows you to navigate to a folder on your hard disk and choose a project to be opened (shortcut - Ctrl+O)
Save Project	Saves the current project (shortcut - Ctrl+S)
Save Project As...	Opens the Save dialog to allow you to save a copy of the current project with a different name (shortcut - Ctrl+Shift+S)
Close Project	Closes the current project; leaves the workspace open
Exit	Quits the Pro64 Network Manager application (shortcut - Alt+F4)

Network Menu

The Network menu commands control online/offline status.

Work Online...	Opens a dialog box that allows you to connect to a Pro64 network. Open projects are checked for compatibility with the online network.
Work Offline...	When connected to a Pro64 network that is being managed online, this command breaks the communication connection between the PC and the Pro64 hardware allowing you to make edits without being physically connected to the network.
Mute All	Use the Mute All command to temporarily mute all audio outputs. A red "Mute All" is shown in the workspace status bar while the outputs are muted. Repeat the command to return to normal operation. (shortcut - Ctrl+Shift+1) <i>This item is not available when working offline.</i>

Tools Menu

Use the Tools menu commands to access the Firmware Update utility and preferences.

Update Firmware...	Opens the Firmware Update utility <i>This item is not available when working offline.</i>
Preferences	Opens the Preferences dialog box

Windows Menu

The Windows menu provides shortcuts to the application's main windows.

Network Overview	Opens the Network Overview window (keyboard shortcut Ctrl+1)
Scene Manager	Opens the Scene Manager window (keyboard shortcut Ctrl+2)
Virtual Data Cable Monitor	Opens the Virtual Data Cable (VDC) Monitor window (keyboard shortcut Ctrl+3)
Audio Slot Manager	Opens the Audio Slot Manager window (keyboard shortcut Ctrl+4)
Event Log	Opens the Event Log window (keyboard shortcut Ctrl+5)
Close All	Closes all currently open windows but does not quit the Pro64 Network Manager application.
Open Windows List	This section of the menu lists all currently open windows; selecting a window from the list will bring it to the front for editing

About the Open Windows List Contents

The contents of the Open Windows List will change as you open and close the various windows that are part of the Pro64 Network Manager application. Selecting any of the numbered windows with the mouse (or typing the corresponding number on the PC keyboard once the menu is open) will select that window and bring it into focus.

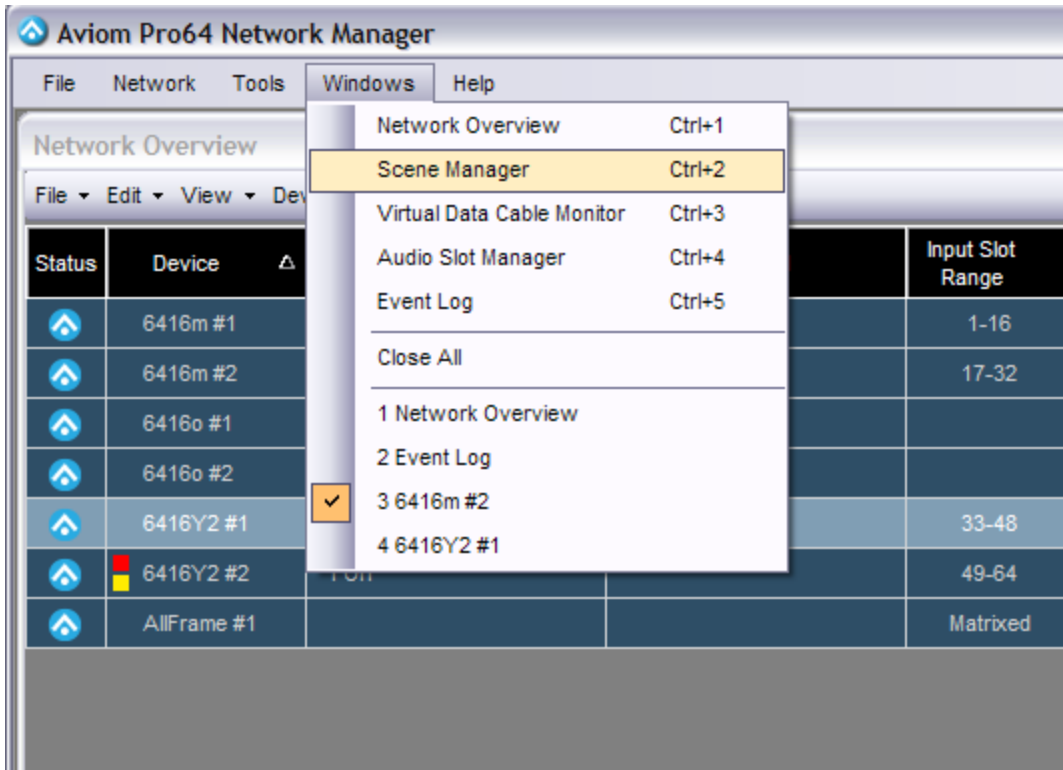

Items in the Windows menu

Help Menu

Application support is found in the Help menu.

Pro64 Network Manager Help	Opens the User Guide for the application; the document is in PDF format and requires Adobe Reader or equivalent
Online Support	Launches your browser and goes to the Aviom website support area
About Pro64 Network Manager	Opens a dialog box that shows the application version number and other support information.

NETWORK OVERVIEW FEATURES

The Network Overview contains the following information about the Pro64 network and its active devices: Information is arranged in table format in rows and columns. Open the Network Overview from the main workspace by choosing **NETWORK OVERVIEW** from the windows menu or by using the shortcut Ctrl+1.

The following information is displayed:

- Status – The blue A-Net icon signifies that a Pro64 device is active in the network
- Device Type – 6416m, MH10, ASI, etc.
- Device Numeric ID – Used to help identify multiple devices of the same type
- Location – A user-defined field based on where a Pro64 device is installed
- User Label – User editable text, 16 characters maximum
- Input Slot Range – The current Slot range setting for each input-capable Pro64 device
- Output Slot Range – The current Slot range for each output-capable Pro64 device
- Remote Control – Shows the Control Group setting for 6416m, RCI, and 6416Y2
- Comments – User-defined text, 256 characters maximum

The screenshot shows a window titled "Network Overview" with a menu bar (File, Edit, View, Device) and a table of device data. The table has 8 columns: Status, Device, Location, User Label, Input Slot Range, Output Slot Range, Remote Control, and Comments. The table contains 20 rows of data for various Pro64 devices.

Status	Device	Location	User Label	Input Slot Range	Output Slot Range	Remote Control	Comments
▲	6416dio #1	RECORDING	Control Master	1-16	1-16		Pro Tools In 1-16
▲	6416dio #2	RECORDING		1-16	17-32		Pro Tools In 17-32
▲	6416dio #3	RECORDING		33-48	33-48		Pro Tools In 33-48 + CD in
▲	6416i #1	STAGE	keyboard submix	33-48			43-44 only
▲	6416i #2	BROADCAST	DVD Playback	33-48			inputs 47-48
▲	6416m #1	STAGE		1-16		1	mic pre 1, stage left
▲	6416m #2	STAGE		17-32		1	mic pre 2, stage left
▲	6416m #3	STAGE		33-48		1	mic pre 3, stage right
▲	6416o #1	STAGE	line outs to DSP		49-64		
▲	6416o #2	BROADCAST	stage inputs 1		1-16		
▲	6416o #3	BROADCAST	stage inputs 2		17-32		
▲	6416o #4	BROADCAST	stage inputs 3		33-48		
▲	6416Y2 #1	FOH	card slot 1	1-16	1-16	1	m-control is active
▲	6416Y2 #2	FOH	card slot 2	1-16	1-16		
▲	6416Y2 #3	FOH	card slot 3	1-16	1-16		
▲	6416Y2 #4	FOH	PM1D	1-8	1-8		
▲	ASI #1	STAGE	Monitors				
▲	MH10 #1	STAGE					
▲	MH10 #2	FOH					
▲	MH10f #3	RECORDING					
▲	MH10f #4	BROADCAST					
▲	RCI #1	FOH	on the console			1	MCS Sync is on

Filtering: OFF

The Network Overview is arranged in columns and rows; data can be sorted by clicking the column headings.

THE NETWORK OVERVIEW INTERFACE

Pro64 devices in the Network Overview can be selected singly or in groups. Click any field in a row to highlight a device. Shift-click to select multiple devices consecutively, or Control-click to choose non-contiguous devices from the list.

The Network Overview window can be resized as needed while running the application. If the Network Overview is made smaller than the default size, scroll bars will appear to allow any row or column to be brought into focus. The Network Overview can be minimized by clicking the Minimize icon in the window's title bar.

Changing Column Widths

Columns in the Network Overview can be resized as needed. To change a column width, position the mouse cursor in the headings area between any two columns until a left/right arrow icon appears. Click and drag the separator to the desired width.

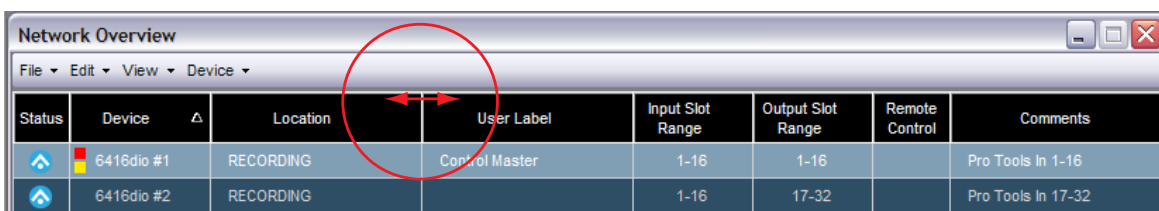

Status	Device	Location	User Label	Input Slot Range	Output Slot Range	Remote Control	Comments
	6416dio #1	RECORDING	Control Master	1-16	1-16		Pro Tools In 1-16
	6416dio #2	RECORDING		1-16	17-32		Pro Tools In 17-32

Click and drag the column separator to change the column width.

Sorting the Network Overview

Information displayed in the Network Overview can be sorted as needed by clicking the column headings. Sorting can be ascending or descending and the current sort selection will be indicated in the column heading with a triangle icon. The following columns can be sorted:

- Device
- Location
- User Label
- Input Slot Range
- Output Slot Range

Status Column

A blue A-Net icon appears in the Status column to indicate an active Pro64 device. A red exclamation point icon (!) will be displayed if a Pro64 device with old firmware is added to the network or if a device is unable to communicate with the network because of corrupt firmware, hardware failure, etc.

The Status column also holds special icons used for the front panel lock feature (see page 55) and the LED Device Identify function.

Network Overview			
File ▾ Edit ▾ View ▾ Device ▾			
Status	Device	Location	User Label
	6416dio #1	FOH	
	6416i #1	STAGE	
	AllFrame #1		
	6416o #346	FOH	
	MH10f #1		
	MH10f (New ...)		

Blue icons indicate active Pro64 device, the red exclamation point indicates a device that needs to be updated.

For 6416Y2 cards installed in Yamaha devices, a yellow A-Net icon is used to indicate a card in the network that is not set up for control from Pro64 Network Manager. See page 27. A gray Status icon is used to indicate Standby Mode for AllFrame devices.

LED Device Identify Feature

When working online with a Pro64 network, the LED Device Identify feature causes the front panel LEDs on a device to flash to help identify it, a function that is useful during system setup and firmware updates, especially when multiple devices of the same type are installed in the same location. The LED Device Identify feature is available from the Device menu or via a right-click on any row of the Network Overview.

To activate the LED Device Identify feature for one or more Pro64 devices, first select the device(s) in the Network Overview. Then do one of the following: choose **LED DEVICE IDENTIFY ON** from the Device menu or right click one of the selected rows and choose **LED DEVICE IDENTIFY ON** from the contextual menu.

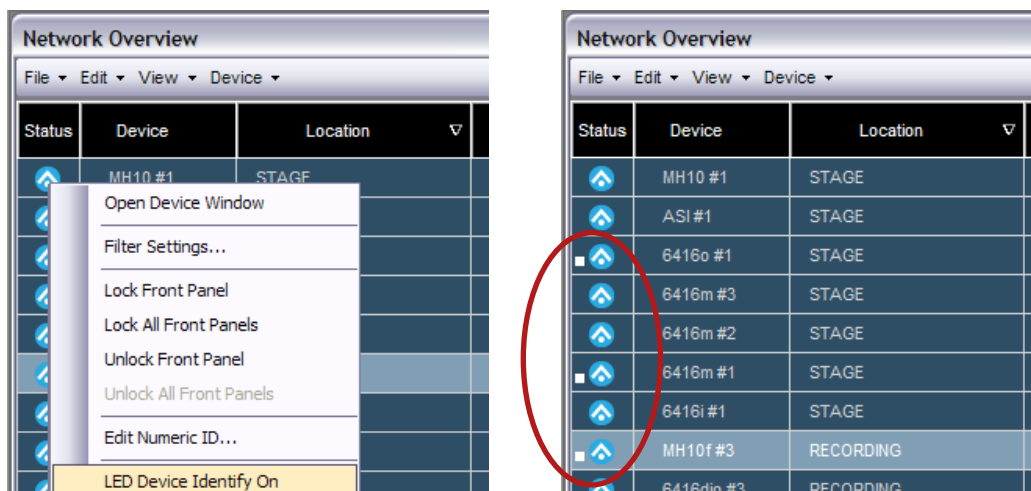

Right-click to access the menu (left). Three devices have their LED Device Identify function on (right).

When the LED Device Identify function is on, a white icon appears in the Status column of the Network Overview for the selected device.

To turn off the LED Device Identify feature for an individual Pro64 device, select the device in the Network Overview and then choose **LED DEVICE IDENTIFY OFF** after right-clicking in the device's row to select it. To clear all front panel flashing related to use of the LED Device Identify feature, right-click anywhere in the Network Overview and choose **ALL LED DEVICE IDENTIFY OFF** from the contextual menu.

Use the shortcut Ctrl+I to activate the LED Device Identify feature and Ctrl+Shift+I to clear it.

Front Panel Lock/Unlock

The front panel of each Pro64 I/O device in the current network can be locked from the Pro64 Network Manager application to prevent edits being made from the hardware's front panels. Devices can be locked individually or in groups.

The following Pro64 devices are capable of being locked:

- 6416i Input Module
- 6416o Output Module
- 6416m Mic Input Module
- 6416dio Digital I/O Module

To lock the front panel of a compatible device, select the device in the Network Overview and then choose **LOCK FRONT PANEL** from the Device menu. When a device's front panel is locked, a lock icon appears in the Status column of the Network Overview and in the status bar of its Device Window.

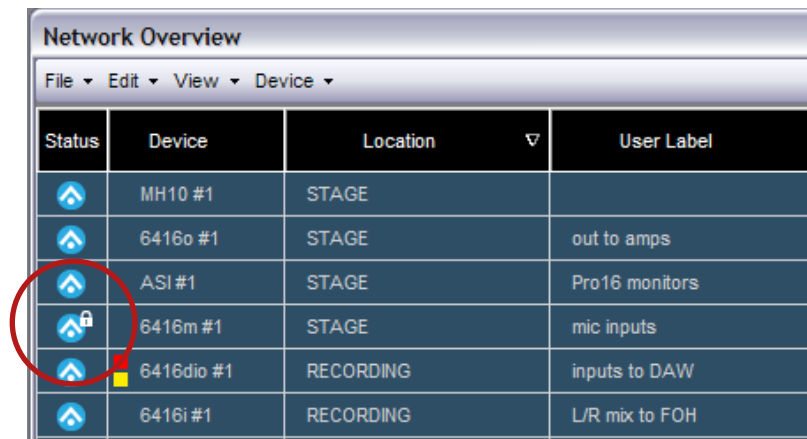

Status	Device	Location	User Label
⬆	MH10 #1	STAGE	
⬆	6416o #1	STAGE	out to amps
⬆	ASI #1	STAGE	Pro16 monitors
⬆🔒	6416m #1	STAGE	mic inputs
⬆	6416dio #1	RECORDING	inputs to DAW
⬆	6416i #1	RECORDING	L/R mix to FOH

The lock icon in the Status column indicates that a device is edit locked.

To lock more than one device, Shift-click or Control-click compatible device rows in the Network Overview to select them and then choose **LOCK FRONT PANEL** from the Device menu (keyboard shortcut Ctrl+L). Or, to lock all compatible devices without needing to select individual devices in the list first, simply choose **LOCK ALL FRONT PANELS** from the Device menu (or use the keyboard shortcut Ctrl+Alt+L).

To unlock one or more devices, select them in the Network Overview and then choose **UNLOCK FRONT PANEL** from the Device menu (or use Ctrl+Shift+L). To unlock all locked devices without needing to select individual items first, choose **UNLOCK ALL FRONT PANELS** from the Device menu (or use the keyboard shortcut Ctrl+Alt+Shift+L).

The lock/unlock commands are duplicated in the Network Overview's right-click contextual menu for convenience.

The following Pro64 devices have no Edit Lock control on their front panel interfaces and cannot be locked:

- 6416Y2 A-Net Interface Card for Yamaha®
- AllFrame
- MH10 and MH10f Merger Hubs
- ASI A-Net Systems Interface
- RCI Remote Control Interface

Device Column

The Device column lists all Pro64 devices in the network by type. Numbers can be appended to the device type when multiple devices of the same type are part of a network (6416m #1, 6416m #2, etc.) by changing the device's Numeric ID. Click the column heading to sort devices by type.

Numeric ID

Each Pro64 device in a network can be identified with a number (up to 3 digits). This unique ID is stored in the hardware itself and can only be changed from the Pro64 Network Manager application. When new Pro64 devices are added to a network they do not have a Numeric ID associated with them. In the Network Overview and Device Windows they are displayed as **(New Device)**.

Status	Device	Location
⬆	6416dio (New Device)	
⬆	6416i (New Device)	
⬆	6416m (New Device)	
⬆	6416o (New Device)	
⬆	6416Y2 (New Device)	

Devices without Numeric IDs are identified as New Device

To set (or change) a Numeric ID for a Pro64 device, select a device (6416m, 6416o, etc.) in the Network Overview and choose **EDIT NUMERIC ID...** from the Device menu or right-click on the row and choose the **EDIT NUMERIC ID...** command from the contextual menu.

⬆	6416m #1	1-16	1	mic pre 1, stage left
⬆	6416m #2	17-32	1	mic pre 2, stage left
⬆	6416m (New Device)	33-48	1	mic pre 3, stage right
⬆	6416o #1	line outs to DSP	49-64	
⬆	6416o #2		1-16	
⬆	6416o #3	BROADCAST	17-32	
⬆	6416o #4	BROADCAST	33-48	
⬆	6416Y2 #1	card slot 1	1-16	1-16

Right-click to access the Numeric ID menu item

In the Numeric ID dialog box enter a number from 1-999 and then click the **OK** button to close the dialog and apply the new ID number.

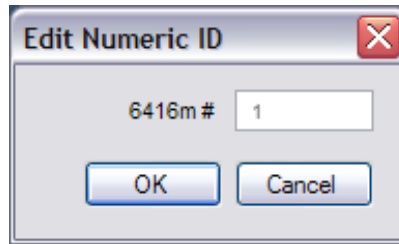



Enter numbers from 1-999

The Numeric ID is stored in the Pro64 device itself until changed, and retains the setting as new projects are created and edited.

-
- ✓ **NOTE:** Since the Numeric ID is stored in the hardware itself, it is possible to give two Pro64 devices the same Numeric ID. To avoid confusion when working with a network, it is suggested that each Pro64 device of the same type be given a unique Numeric ID.
-

Control Master and Clock Master Indicators

Two special icons are used to indicate the network's Control Master and Clock Master devices. A red square icon indicates the Control Master and a yellow square icon is used for the Clock Master.

Status	Device	Location	User Label
	6416dio #1	RECORDING	Control Master
	6416dio #2	RECORDING	

6416dio #1 is the network's Control Master and Clock Master.

The Control Master designation for a Pro64 device is set on the hardware itself and cannot be changed from within Pro64 Network Manager.

Filtering the Network Overview

Pro64 devices displayed in the Network Overview can be filtered from view if desired without affecting network operations. To filter the list, right-click anywhere on a device row and select **FILTER SETTINGS** from the contextual menu, or use the **FILTER SETTINGS...** command from the View menu (shortcut Ctrl+F) to open the Filter dialog box.

-
- ✓ **NOTE:** Filters do not affect the makeup of the Pro64 network or the allocation of network Slot resources.
-

The Network Overview's local Status Bar will read **FILTER ON** when any data type in the Network Overview is being filtered. The current filter settings are saved with the project.

The Filter Dialog Box

You can filter combinations of devices and Slot I/O ranges from a central location by using the controls in the filter dialog box, found in the View menu of the Network Overview. To access the filter, choose **FILTER SETTINGS...** from the View menu or right-click in the Network Overview and select the command from the contextual menu; the dialog box will open. (The keyboard shortcut is Ctrl+F)

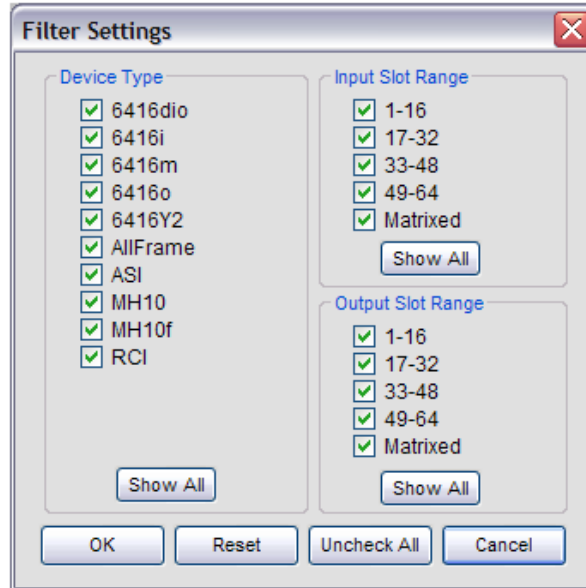

Set and clear filter combinations from the filter dialog box.

Device types can be shown or hidden using the check boxes; uncheck a device type to hide it. Input and output Slot ranges can also be filtered from view; uncheck any range to hide it. Each sub-section of the filter has its own Show All button that allows the filter to be reset quickly. Once the filters are applied to your liking, click the **OK** button to close the dialog box and activate the filter. Click the **CANCEL** button to exit without changing the filter settings.

The bottom of the filter dialog box also has two global filter commands. Click **RESET** to return each device type and Slot I/O range to the default (on) state. Use **UNCHECK ALL** to set all the check boxes to their off state, useful as a starting point when you want to create a filter with only a few parameters included.

Location Column

A Location is a user-defined text label in the Network Overview that is used to define where a device is installed in the current Pro64 network and aid in sorting and managing devices in large systems. Click the column heading to sort the network by Location.

Status	Device	Location
▲	6416dio #1	RECORDING
▲	6416dio #2	RECORDING
▲	6416dio #3	RECORDING
▲	6416i #1	STAGE
▲	6416i #2	BROADCAST
▲	6416m #1	STAGE
▲	6416m #2	STAGE
▲	6416m #3	STAGE
▲	6416o #1	STAGE
▲	6416o #2	BROADCAST

Sort by Location by clicking its column heading.

To add location text for a device, click in the Location field in the Network Overview for the desired device. When the text cursor appears, enter up to 16 characters of text. The Location label is stored in the Pro64 device and with the project.

Location information entered in this column is displayed in the other windows of Pro64 Network Manager such as the Device Windows.

User Labels

The User Label column in the Network Overview provides a user-defined text field (16 characters or less) for each Pro64 device in the network. Text can be entered in the Network Overview or from a Device Window. User Labels are stored in the Pro64 device and get saved with Scenes and the project.

Status	Device	Location	User Label
▲	6416dio #1	RECORDING	Control Master
▲	6416dio #2	RECORDING	
▲	6416dio #3	RECORDING	
▲	6416i #1	STAGE	keyboard submix
▲	6416i #2	BROADCAST	DVD Playback

Sort by the User Label by clicking its column heading.

Click in a User Label field in either the Network Overview or a Device Window to edit text; there is a 16-character maximum. Press the keyboard **ENTER** key or click elsewhere in the window to finish.

Input/Output Slot Range Displays

In the Network Overview, a pair of Slot Range columns show the current Slot range for each input- and output-capable Pro64 device. These are read-only fields. Slot ranges can be changed from the Device Window for each I/O device. Slot range information does not apply to network devices such as the MH10, MH10f, ASI, or RCI.

Valid input and output Slot Range settings (depending on the current sample rate) include:

- 1-16 (44.1/48kHz, 88.2/96kHz, and 176.4/192kHz)
- 17-32 (44.1/48kHz, and 88.2/96kHz)
- 33-48 44.1/48kHz)
- 49-64 (44.1/48kHz)
- Matrixed (44.1/48kHz, 88.2/96kHz, and 176.4/192kHz)

Click the input or output column heading to sort the Network Overview device list by Slot range.

Filtering by Slot Range

The Network Overview can be filtered by Slot range if desired. To filter the list by Slot range, choose **FILTER SETTINGS...** from the View menu. (See page 58.)

Remote Control

The Remote Control column of the Network Overview shows the Control Group setting for any device capable of using remote control (valid settings are 1-4 and off). This is a read-only field.

Comments Field

The Network Overview's Comments field is a user-defined text area that is stored with individual Scenes and with the project. Each Scene can recall a unique set of Comments as needed for an application.

To add a comment, click in the Comments field for any network device. When the text cursor appears enter text of up to 256 characters. (Comments are not stored in the Pro64 device.)

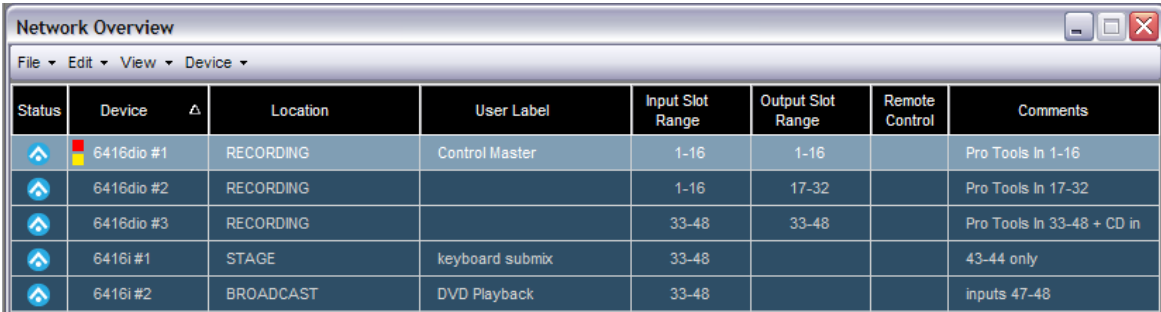

Status	Device	Location	User Label	Input Slot Range	Output Slot Range	Remote Control	Comments
▲	6416dio #1	RECORDING	Control Master	1-16	1-16		Pro Tools In 1-16
▲	6416dio #2	RECORDING		1-16	17-32		Pro Tools In 17-32
▲	6416dio #3	RECORDING		33-48	33-48		Pro Tools In 33-48 + CD in
▲	6416i #1	STAGE	keyboard submix	33-48			43-44 only
▲	6416i #2	BROADCAST	DVD Playback	33-48			inputs 47-48

Enter up to 256 characters in the Comments field.

Network Overview Menus

This section describes the menus and commands available in the Network Overview.

File Menu

The File menu offers the following commands:

Print...	Prints a report detailing the current network settings
Print Preview	Displays a preview of the information that will be printed in the Network Overview report
Close Window	Closes the Network Overview (shortcut - Ctrl+W)

To print a report containing all the information shown in the Network Overview, choose **PRINT...** from the File menu. The standard OS print dialog box will open, allowing you to select any connected printer and set page properties.

To view the report prior to printing select **PRINT PREVIEW** from the File menu.

Network Report

Print a network report from the Network Overview to create a record of the current state of the network including all devices, location names, user labels and comments, and channel/Slot ranges.

						Network Overview	
Network Mode: Auto		Clock Mode: Internal		Network Sample Rate: 48kHz		Control Master: 6416dio	
						Clock Master: 6416dio	
Device	Location	User Label	Slot Range		Remote Control	Comments	
			In	Out			
6416i #2	BROADCAST	DVD Playback	33-48			inputs 47-48	
6416o #2	BROADCAST	stage inputs 1		1-16			
6416o #3	BROADCAST	stage inputs 2		17-32			
6416o #4	BROADCAST	stage inputs 3		33-48			
MH10f #4	BROADCAST						
6416Y2 #1	FOH	card slot 1	1-16	1-16	1	m-control is active	
6416Y2 #2	FOH	card slot 2	1-16	1-16			
6416Y2 #3	FOH	card slot 3	1-16	1-16			
6416Y2 #4	FOH	PM1D	1-8	1-8			
MH10 #2	FOH						
RCI #1	FOH	on the console			1	MCS Sync is on	

A sample network report

To close the Network Overview, choose **CLOSE WINDOW** or use the keyboard shortcut Ctrl+W. The project remains open. To reopen the Network Overview, choose **NETWORK OVERVIEW** from the main workspace's Windows menu (or use the keyboard shortcut Ctrl+1).

Edit Menu

The Edit menu in the Network Overview offers the following commands that can be used when editing text labels and comments

Cut	Cuts the selected text (shortcut - Ctrl+X)
Copy	Copies the selected text to the clipboard (shortcut - Ctrl+C)
Paste	Pastes text that was copied to the clipboard (shortcut - Ctrl+V)
Undo	Undoes the last cut, clear, or paste operation (shortcut - Ctrl+Z)

These commands become active once you have entered a valid, editable text field.

View Menu

The View menu provides access to the Filter Settings... dialog box. (See page 58.)

Device Menu

The Network Overview's Device menu provides access to the LED Device Identify feature as well as the front panel lock/unlock feature. See page 54 for information on the LED Device Identify feature.

Open Device Window	Opens the Device Window for the selected Pro64 device (shortcut - Ctrl+D)
LED Device Identify On	Flashes the LEDs on the front panel of the selected Pro64 device to make it easy to identify; a white square icon is added to the Status column when the feature is on (shortcut - Ctrl+I)
LED Device Identify Off	Clears the selected device's front panel LED flashing when using the LED Device Identify function (shortcut - Ctrl+Shift +I)
All Device Identify Off	Clears the LED Device Identify flashing for all devices (shortcut - Ctrl+Alt+Shift +I)
Lock Front Panel	Locks the front panel of the selected Pro64 device; a lock icon is added to the Status column (shortcut - Ctrl+L)
Lock All Front Panels	Locks the front panel of the all Pro64 devices in the network; a lock icon is added to the Status column for each (shortcut - Ctrl+Alt+L)
Unlock Front Panel	Unlocks the front panel of the selected Pro64 device (shortcut - Ctrl+Shift +L)
Unlock All Front Panels	Unlocks the front panel of all Pro64 devices (shortcut - Ctrl+Alt+Shift +L)

•

DEVICE WINDOW FEATURES

A Device Window contains the unique settings for each type of Pro64 device. Most Device Windows have multiple views used to simplify managing data for a specific device type, along with a local menu bar used for accessing commands and features related to that device.

To open a Device Window, select a row in the Network Overview and then double click it.

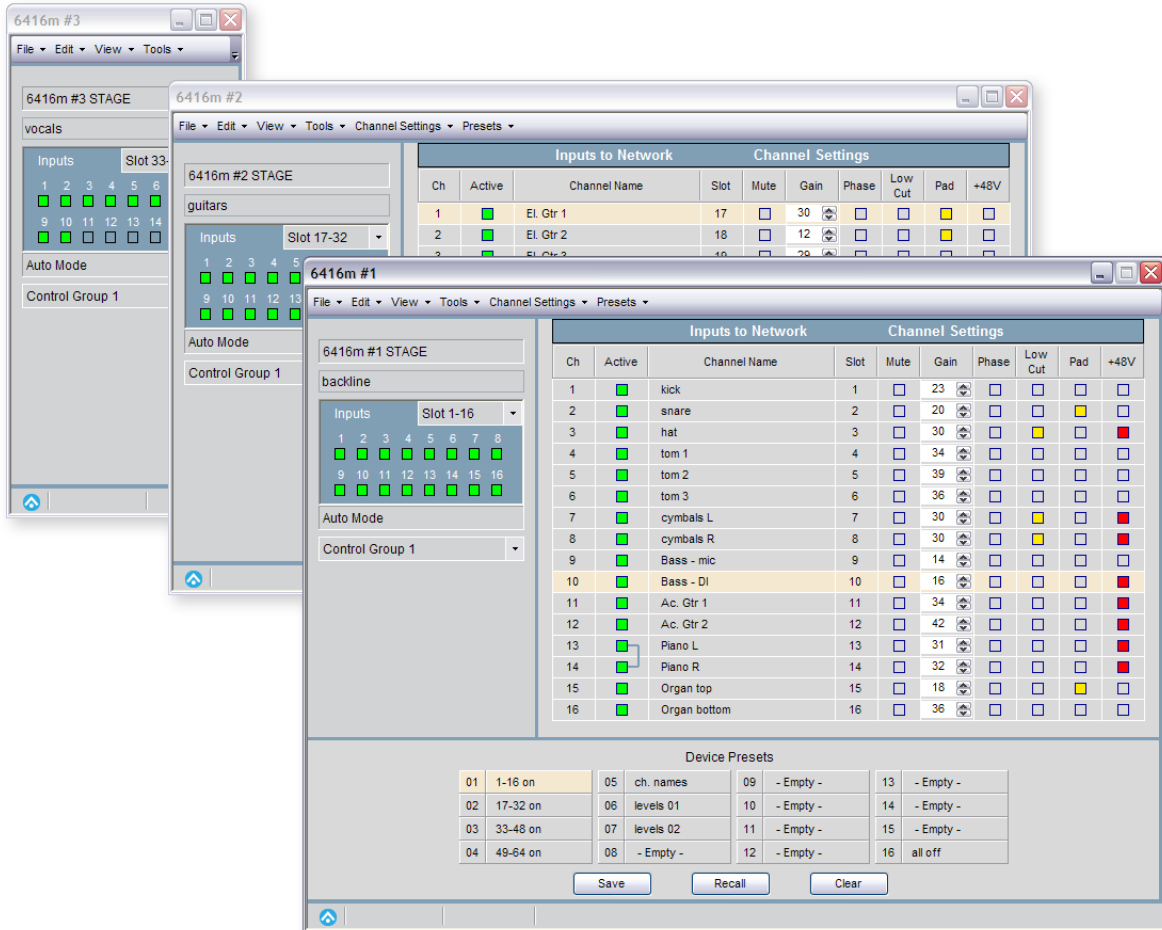

Device Windows showing the various views

A Device Window can also be opened by using the shortcut **CTRL+D** when a device's row is selected in the Network Overview.

Window Views

The following views are available for the Device Windows:

- **Device Overview** – the most compact view; available for all devices
- **Inputs to Network** – AllFrame, 6416i, 6416m, 6416dio, and 6416Y2 only
- **Outputs from Network** – AllFrame, 6416o, 6416dio, 6416Y2, and ASI only
- **Inputs and Outputs** – AllFrame, 6416dio and 6416Y2 only
- **Device Presets (Show All)** – AllFrame, 6416i, 6416o, 6416m, 6416dio, 6416Y2, and ASI
- **Port Names** – MH10/MH10f only

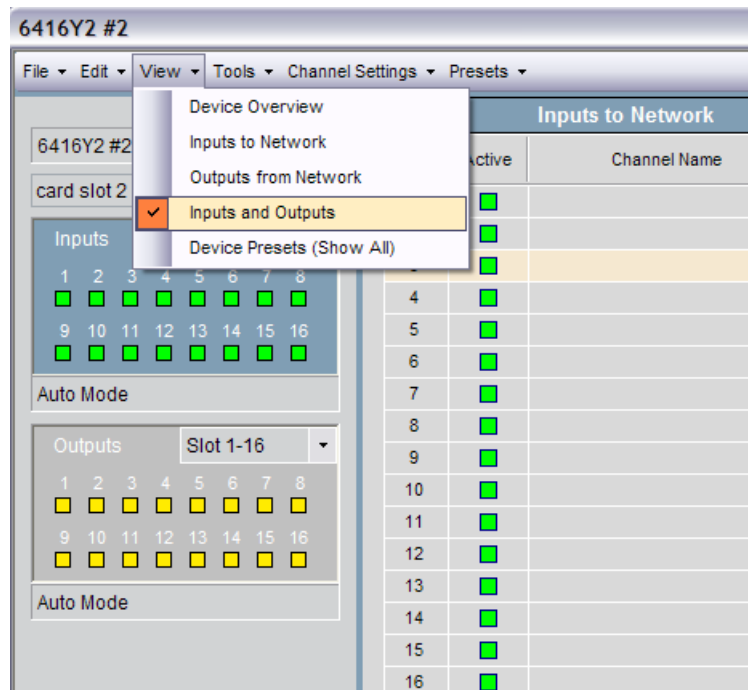

I/O modules have multiple views available.

Select the view you want to use from the device's View menu. The RCI device window does not require a View menu; all information is displayed in its overview.

Fields in the Device Overview

The device type, number, location, and user label are displayed at the top of each Device Overview. These fields are common to all device types and mirror the text seen in the Network Overview.

User Label

To change the User Label text, click in the label area. The text highlights; type in a new name to replace the existing text or use the cursor, arrow keys, backspace and delete keys to edit an existing text label. Changes to the User Label will be reflected immediately in the Network Overview.

Status Bar

Each Device Window contains a read-only status bar along its bottom edge. A copy of the A-Net status icon from the Network Overview will appear in the device window along with Control Master and Clock Master icons as needed.

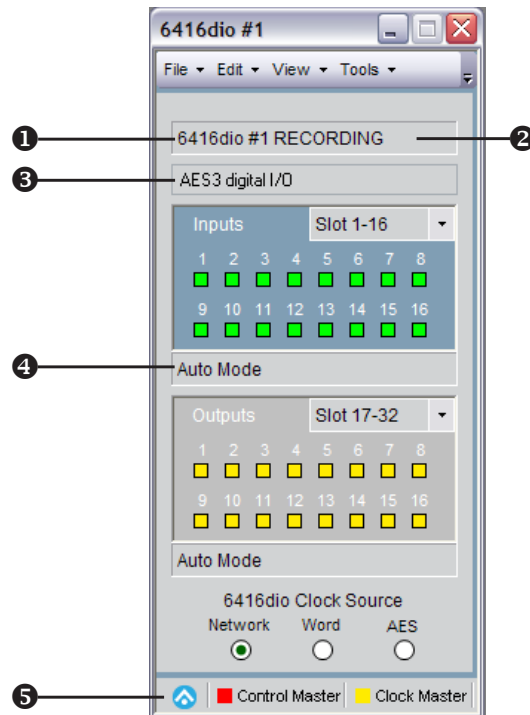

Device type and number (1), Location (2), User Label (3), network mode field (4), and status bar (5)

Input/Output Grids

Pro64 input- and output-capable devices will have I/O grids in their device windows. Bidirectional devices such as the AllFrame, 6416Y2 A-Net Interface Card and 6416dio Digital I/O Module will have both types. Exceptions are noted in the sections that follow.

The grids serve a twofold purpose—they provide a quick overview of channel and Slot use on each Pro64 device and they can be used to quickly activate channels and assign them to network Slots; simply click a channel to activate/deactivate it.

Inputs are displayed in green, outputs are yellow. The input and output channel grids are numbered 1-16, corresponding to the 16 physical connections on the rack-mount Pro64 I/O devices.



Input grid (left) and output grid (right) with Slot range drop down menus

AllFrame I/O Grids

AllFrame devices have slightly different I/O grid displays because their I/O hardware is user-configurable. The top section of the Device Window will show a table of the installed I/O cards, using letters corresponding to the card's installed location plus channel numbers on the card (A1-A4, D1-D4, etc.). Individual on/off switches are provided in the Input and Output grids based on the actual cards installed. Inputs or outputs that are not applicable to a certain card slot will be grayed out. The basic functionality of the I/O switches is the same as that for the rack-mounted Pro64 I/O devices: click to activate or deactivate a Slot.

-
- ✓ **NOTE:** An AllFrame device's inputs are not automatically assigned to network Slots; this must be done using the **Inputs to Network** view on a per-channel basis prior to activating an input.
-

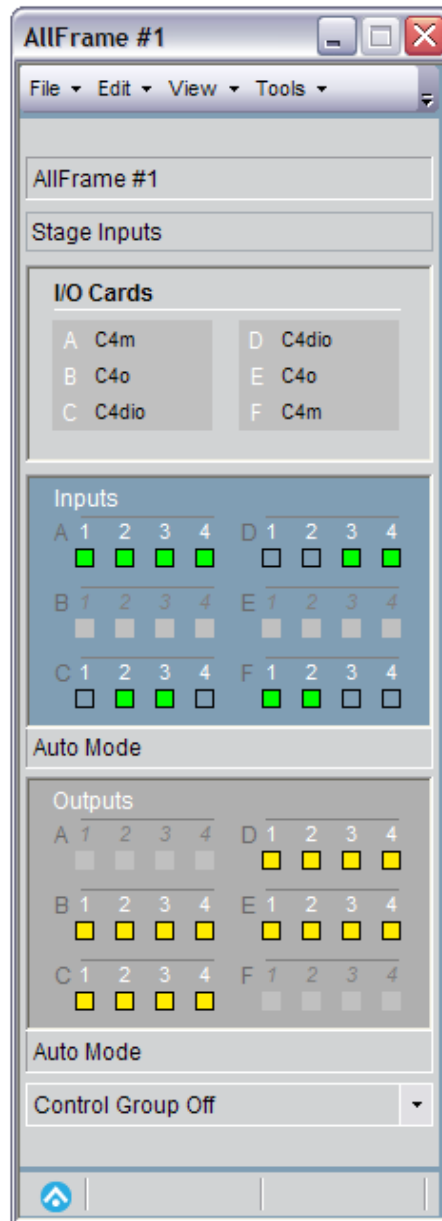

The Device Overview for an AllFrame device shows its installed cards as well as the current state of all I/O slots.

Slot Range

Within the Input/Output grid is a Slot range drop down menu (not available on AllFrame devices). This is used to assign a Pro64 device to either one of the four 16-channel Slot ranges used by the network or to the matrix. Available settings are Slot 1-16, Slot 17-32, Slot 33-48, Slot 49-64, or Matrixed.

Remember that the current network sample rate affects the total number of input Slots that are available to be activated (64 Slots at 44.1/48kHz; 32 Slots at 88.2/96kHz; 16 Slots at 176.4/192kHz).

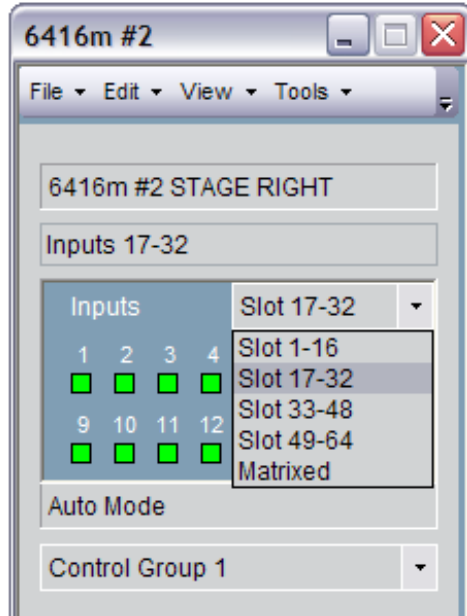

Choose a new Slot range from the drop down menu.

To change a Slot range setting, click in the drop down menu and select a new Slot range or Matrixed. You will be prompted to confirm the change. For input devices, all currently activated channels will be deactivated when a new 16-channel Slot range is selected to avoid conflicts with input Slots already active in the network on other Pro64 devices. Activating the matrix does not deactivate the Slot assignments.

Activating Channels

To assign a channel on a Pro64 input device to a network Slot, click the channel's on-screen **ACTIVE** button. Green Active LEDs appear in both the Device Overview and Inputs to Network views. The input channel and its corresponding network Slot now available to all output devices in the network

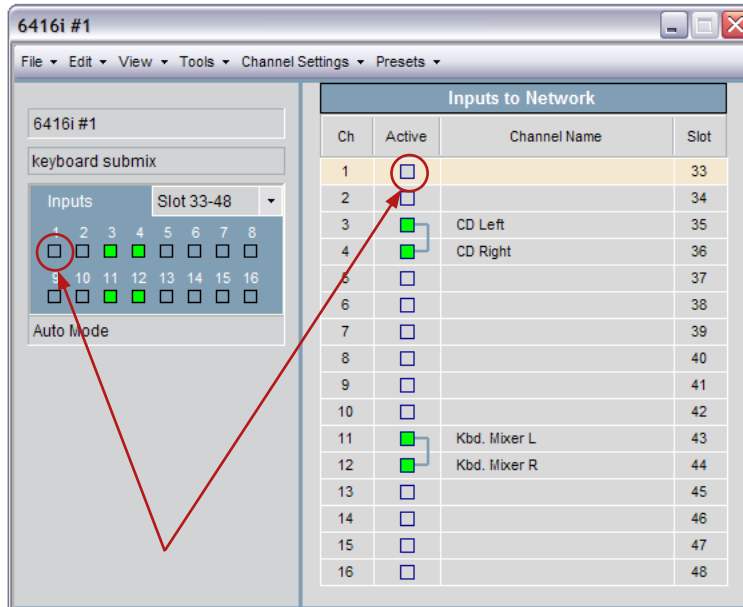

Click either Active LED to assign an input to a network Slot.

Activating All Channels

The Device Window's Channel Settings menu provides a shortcut command that can activate and assign all channels on an input device to the network. Choose **ACTIVATE ALL INPUT CHANNELS** from the menu; if any conflicts exist they will be reported in the Channel Activation Warning window.

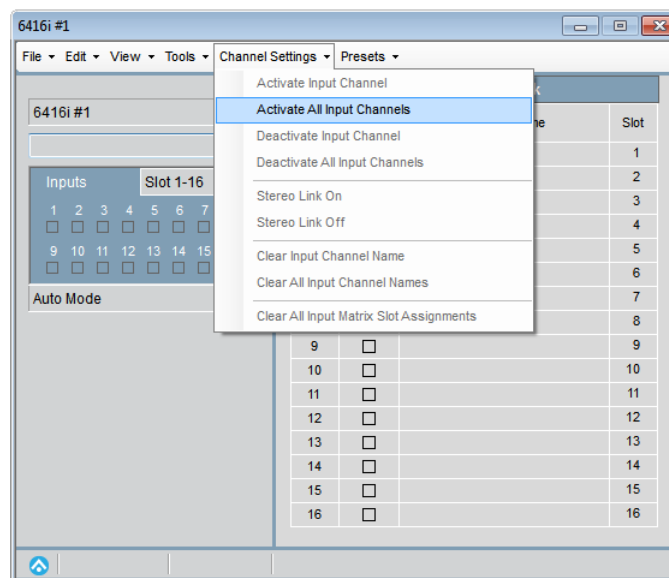

The Activate All Input Channels command in the Channel Settings menu

AllFrame devices are always assigned to the matrix and have no default channel routing. Before an AllFrame input channel can be activated and assigned to the network, it must be assigned to a network Slot first.

Channel/Slot Conflicts

If the assigned network Slot is currently in use by another Pro64 input device, the Channel Activation Warning window will appear to warn you of the resource conflict. Click **OK** to close the dialog box. To resolve the conflict, assign the input channel to an unused network Slot or change the assignment for the Slot in question on the device currently assigned to use it.

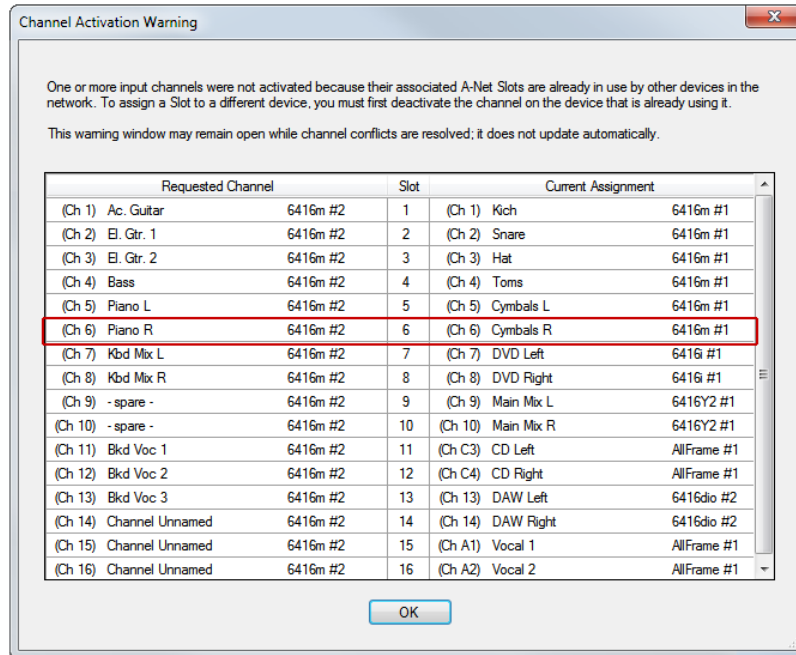

The Channel Activation Warning shows any resource allocation conflicts.

Information in the Channel Activation Warning window is displayed in rows and shows the requested input channel number, the channel name, the requesting Pro64 network device, the Slot where the conflict has occurred, and the channel number, name, and Pro64 device currently using the Slot in question.

The Channel Activation Warning window may remain open as resource conflicts are resolved, but will not update automatically. Resize the window as needed by using the grab bar in the lower right corner of the window.

Deactivating Slots

To deactivate an active Slot on an input device, click the green channel LED; the LED will turn off and the Slot resource is made available to other devices in the network.

There are no restrictions on output modules; their channels can be turned on/off at any time. No warning dialogs are required. The 6416Y2 Yamaha card is an exception; its outputs are always active.

Assigning Input Channels to the Matrix

The matrix capabilities of Pro64 Network Manager allow any input channel on a Pro64 device to be assigned to any network Slot, simplifying complex routings. To access the matrix functionality, a Pro64 device must first be set to **MATRIXED** in the Slot range drop down, found in its Device Window. (AllFrame devices have their inputs assigned to the matrix by default.)

Once a device has been set to Matrixed, the **Inputs to Network** view changes to reveal the routing options for each input channel on the device.

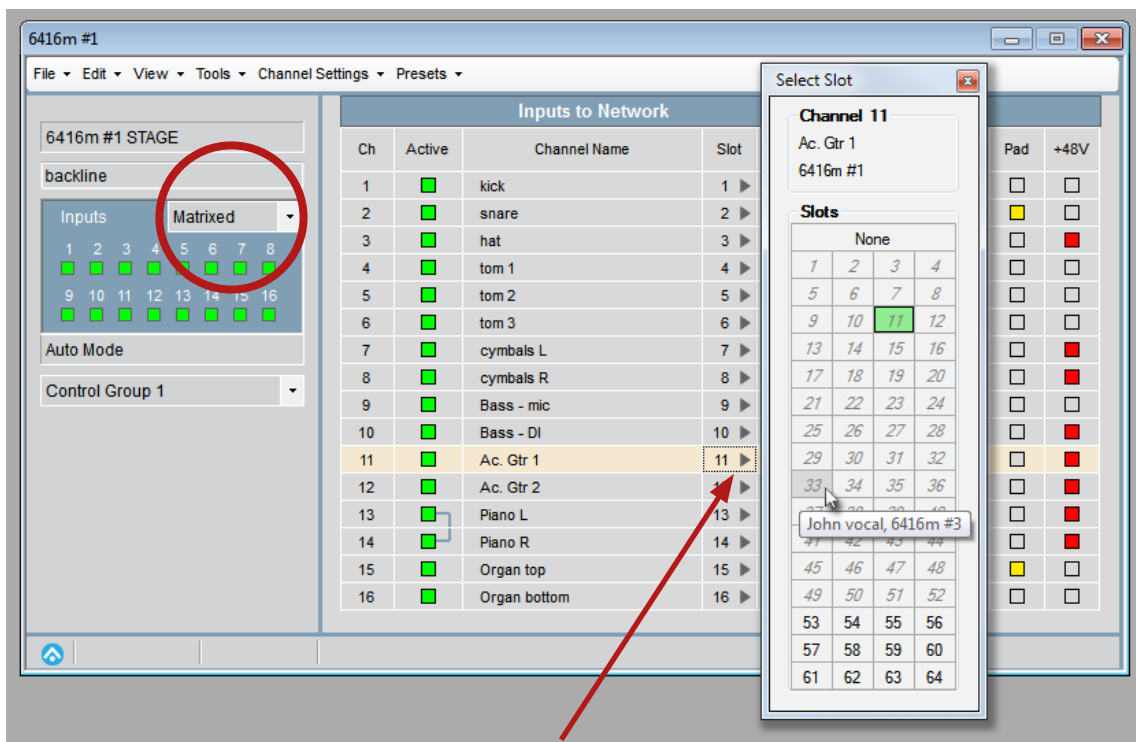

Once Matrixed is selected in the Slot range menu, clicking the arrow next to a Slot's current assignment will open the selection menu. Select a new Slot assignment by clicking its number.

In the Select Slot dialog box, the current Slot assignment is shown in green; available, unassigned Slots are displayed with standard text while Slots that are already active in the network are displayed in italics. The top of the Select Slot dialog box also offers the option of selecting no channel/Slot assignment, displayed as **NONE**. Hovering the cursor over a Slot number while the dialog box is open will show the Slot's channel name and source device (if applicable) or **SLOT AVAILABLE**.

Control Groups

For remote-controllable devices capable of belonging to a Control Group (6416m, AllFrame, RCI, and the 6416Y2 card when m-control™ is active), the Control Group drop down menu will appear in the Device Window. Select a Control Group from the drop down menu to change the Control Group for the device currently being edited; available settings are Control Groups 1-4 and 'Off'.

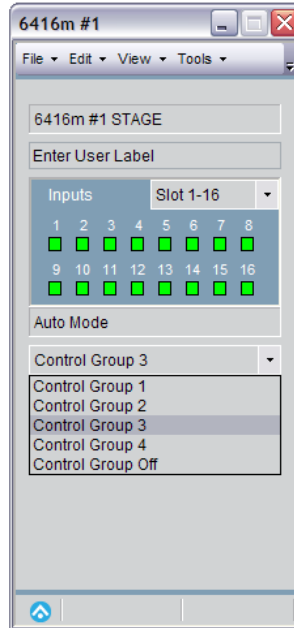

Control Group can be set to one of the four groups or 'off'.

✓ **NOTE:** The 6416Y2 A-Net Interface Card is always assigned to one of the four Control Groups when m-control is in use and has no 'off' setting available.

A device must be assigned to a Control Group to send or receive remote control information.

DEVICE-SPECIFIC FEATURES

In addition to the common features described previously, some of the Device Windows also contain device-specific features that are described below.

AllFrame

The Device Overview for the F6 Modular I/O Frame, which is part of the AllFrame Multi-Modular I/O System (displayed on screen simply as *AllFrame*) shows which optional I/O cards have been installed into each of its six card slots.

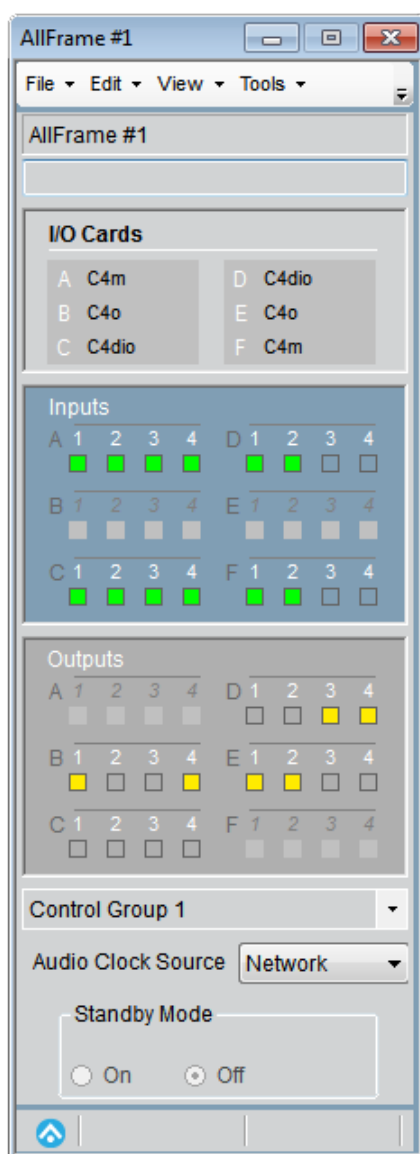

The AllFrame I/O Card table displays the installed cards for each AllFrame.

Cards are identified by letter, A through F, corresponding to the location in the F6 where the I/O card is installed. The input and output channels within an I/O card are numbered 1 through 4, and are displayed with the corresponding location's letter prefix (A1-A4, B1-B4, etc.) in the Device Window.



AllFrame I/O card locations are identified by letter.

AllFrame C4dio Card Support

When a C4dio Digital I/O Card is installed in an AllFrame, the AllFrame can use external clocks in the form of Word Clock or the clock embedded within a digital AES3 stream. Each C4dio card installed can be a clock source. To support this feature, the AllFrame Device Window has an Audio Clock Source drop-down menu with options that correspond to the C4dio cards and their installed locations.

Two clock options are available per C4dio card installed: Word and AES. In the drop-down menu the options are displayed in a list with the C4dio card's installed location (by letter, A-F) in the F6 hardware as seen below.

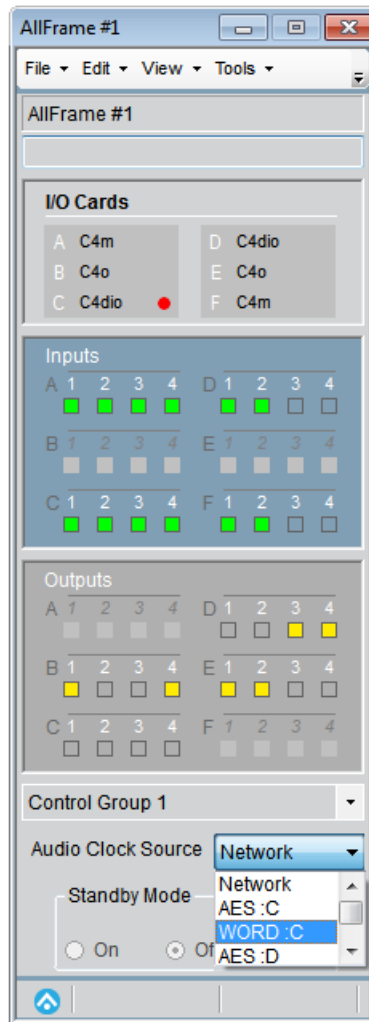

External clock options for a C4dio card installed into slot C of an F6

Choose the card and clock type from the list and then confirm the change in the dialog box that opens once a selection has been made. The network will lock to the external clock. If the external clock is not present, or fails while being used, the network switches automatically to its internal clock.

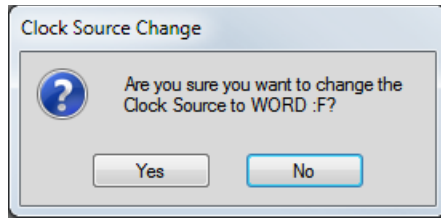

Clock change confirmation dialog box

When an external clock source is being used, the Device Overview for the AllFrame will display a red dot next to the C4dio card that is the clock source.

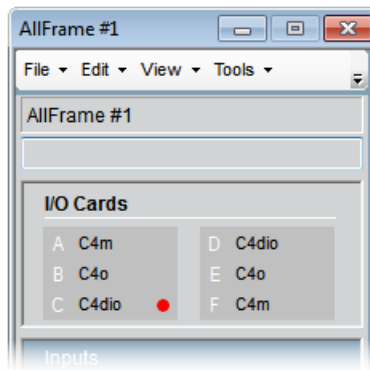

An external clock source is indicated by a red dot.

C4dio Sample Rate Converters.

The C4dio card includes sample rate converters (SRC) that allow external devices to be connected to a Pro64 network without clock artifacts caused by out-of-sync clocks. The sample rate converters operate in pairs and are on by default when a C4dio card is installed in an AllFrame.

The Inputs to Network view contains an SRC column that shows the state of the sample rate converters; a yellow square indicates that a sample rate converter pair is active. The on/off state of the sample rate converters save with device presets.

When the sample rate converters are active, a C4dio card cannot be used as an AES3 clock source. Attempting to activate AES as a clock source will result in a warning dialog box. Turn the sample rate converters off and try again.

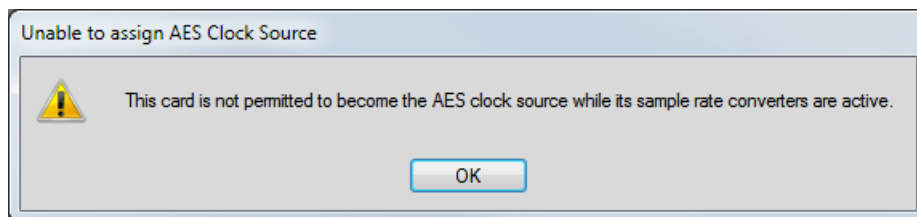

Sample rate converter warning

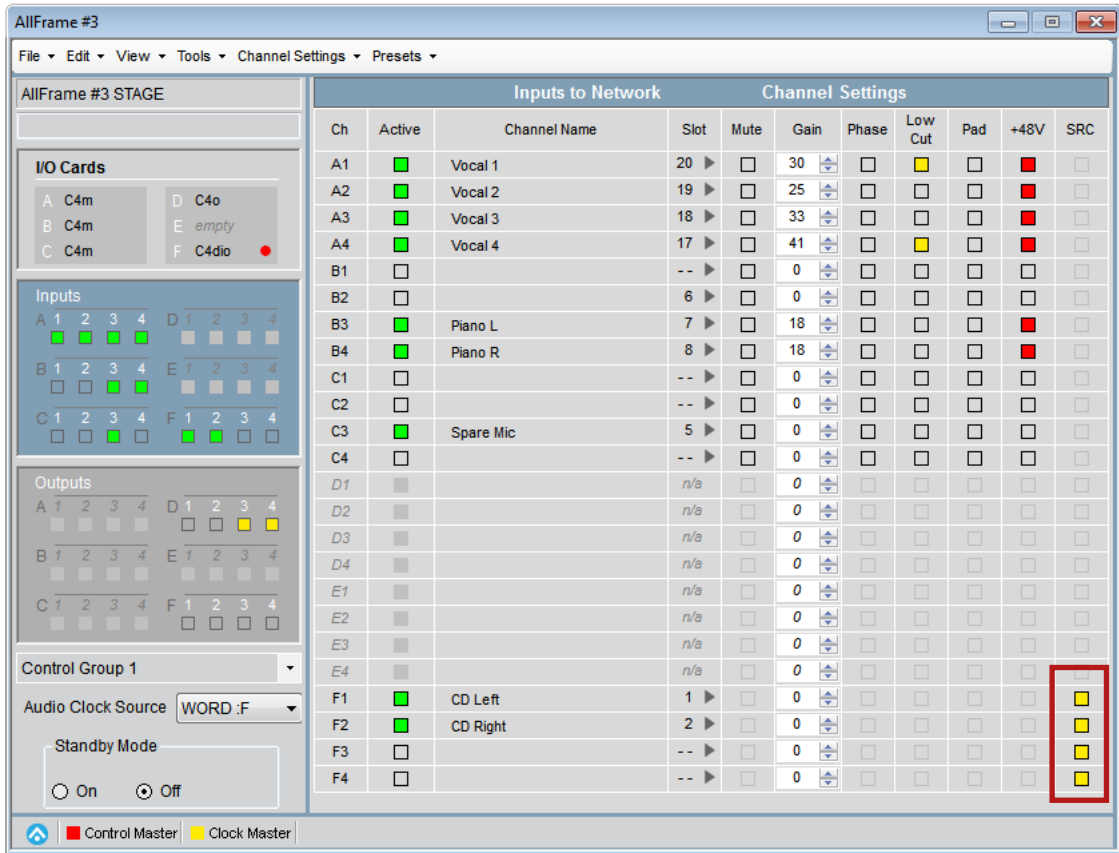

Sample rate converters on a C4dio card installed in slot F of an AllFrame

AllFrame Standby Options

AllFrame devices in a network can be placed into standby and remain on the network while I/O cards are changed. Three versions of standby are supported: software controlled from the AllFrame's Device Window, from the AllFrame hardware's front panel Standby momentary switch, or by using a wired contact closure connected to the Standby Euroblock connector on the top panel on the unit.

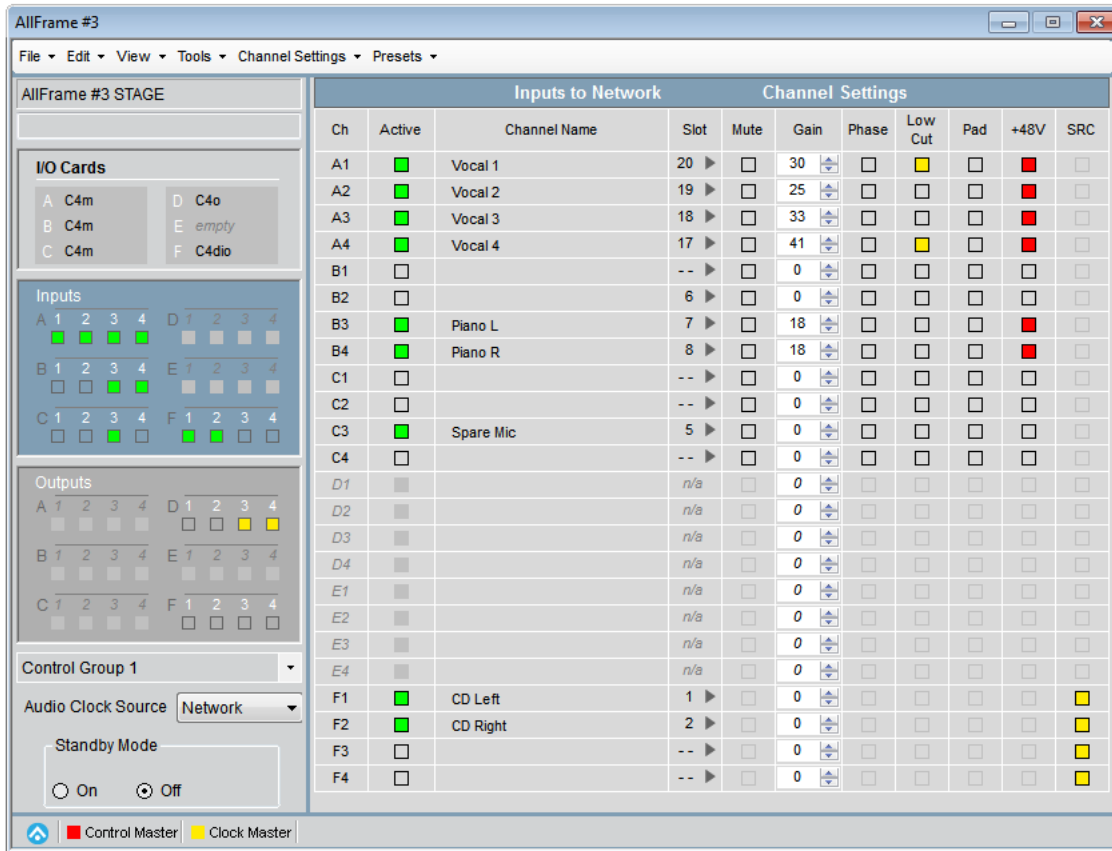

Standby information appears in the Device Window's Overview.

When an AllFrame is in standby its Status icon in the Network Overview will be displayed in gray. Changes to routing, mic preamp settings, output levels, etc., can still be made but will not be available until the AllFrame is out of standby.

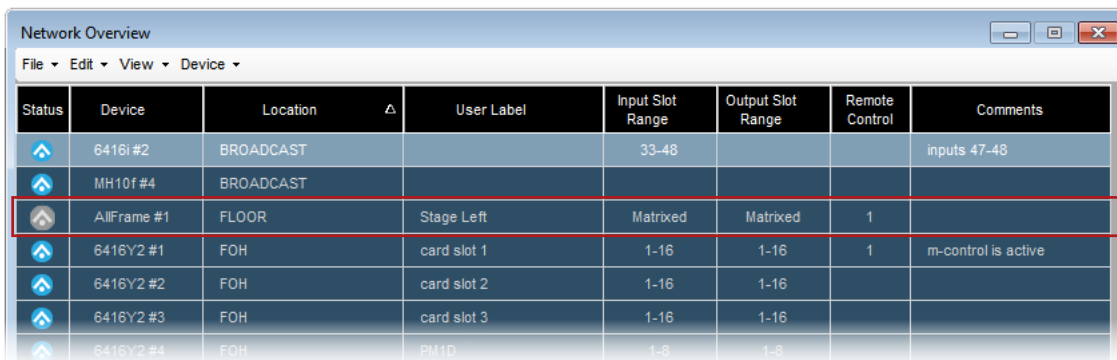

The AllFrame's Status icon in the Network Overview is gray when the device is in Standby.

Standby From the Device Window

To put the AllFrame in Standby from the Device Window while online, click the **On** button in the Standby Mode section of the Device Window. The On button lights and a yellow warning triangle icon appears. The AllFrame's I/O resources are disabled, but A-Net continues to flow for all network connections. The device's status icon in the Network Overview is gray while the AllFrame is in standby.

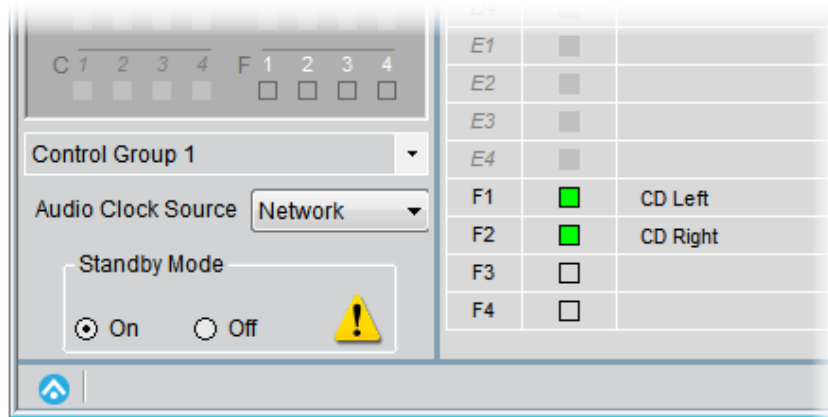

An AllFrame placed into Standby from the Device Window

While in standby, an AllFrame's I/O cards can be changed. However, if a saved project is open when the AllFrame I/O is changed, the AllFrame will no longer be compatible when it comes back online—its hardware complement is different.

To return the AllFrame to normal network operation, click the Standby Mode **Off** button. The AllFrame's I/O resources are again available to the network.

Standby From the F6 Front Panel

To place an AllFrame into Standby from the hardware's front panel, press the gray momentary **STANDBY** button found beneath the control panel cover plate. This action duplicates the functionality previously described for the activation of Standby Mode from within Pro64 Network Manager—the AllFrame's audio I/O resources are suspended and A-Net continues to flow for all connected network devices. I/O Cards in the F6 can be swapped as needed. To return the AllFrame to normal operation, press the gray **STANDBY** button or click the **Off** button in the AllFrame Device Window in the software.

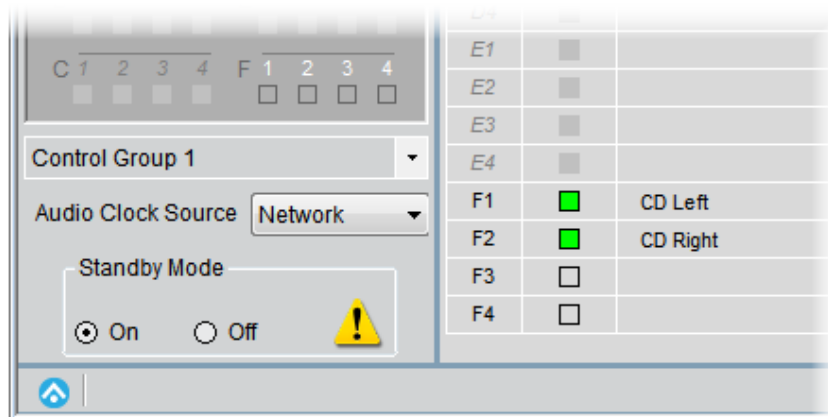

Pressing the gray front panel Standby switch performs the same function as using the software switch.

Standby From a Contact Closure

Standby Mode can also be activated by wiring a contact closure switch to the Standby Euroblock connector on the top panel of the F6 hardware. This allows a physical switch to trigger the standby state as might required if the AllFrame was built into an electrical enclosure with a door that was to be closed when the device was not in use. To differentiate this type of Standby behavior from that initiated by software or the momentary switch it is referred to as **Hardware Standby**.

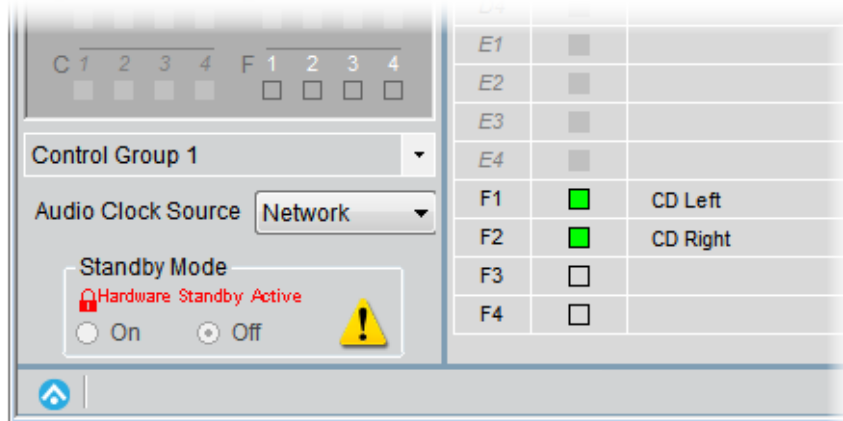

An AllFrame in hardware standby

When an AllFrame is placed into Standby Mode using a physical contact closure device, it will display a special lock icon in the Device Window that reads **HARDWARE STANDBY ACTIVE** in red along with the yellow warning triangle. (Notice that the Standby Mode's radio button remains set to **OFF** in this case.) Pro64 Network Manager cannot change this standby state. The contact closure must be opened manually to return the AllFrame to normal operation.

✓ **NOTE:** When an AllFrame is in Hardware Standby it cannot then be placed into software standby.

Hardware and Software Standby Together

Both types of Standby *can* be used simultaneously if the AllFrame enters the software version of Standby first. If while the AllFrame is in software Standby, a hardware contact closure is triggered on the same AllFrame device, both types of Standby will be in force. On screen in the Device Window, the Standby Mode **ON** radio button will be lit and the red **HARDWARE STANDBY ACTIVE** will also be on.

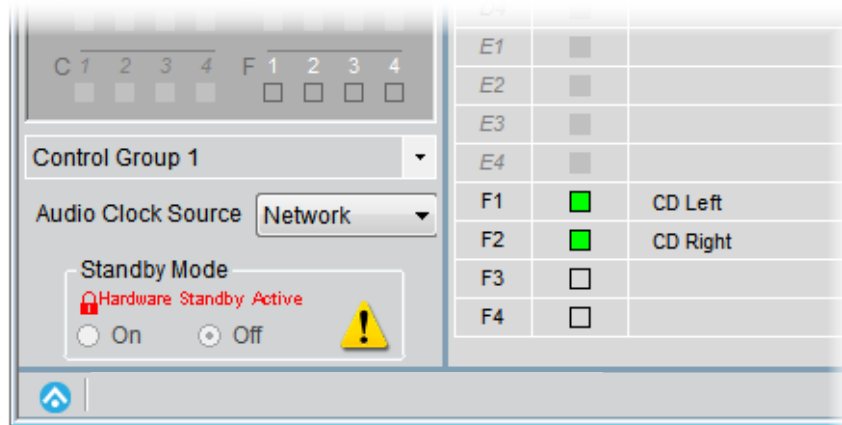

An AllFrame in hardware standby

To exit this state, the hardware contact closure needs to be opened manually (the software Standby will still be in force). Then, the software Standby can be disabled by either clicking the on-screen **OFF** button in the Device Window or pushing the gray **STANDBY** momentary switch on the AllFrame hardware.

Standby and External Clocks

When an AllFrame device is the network's Control Master and is set to use external AES or Word Clock, entering standby will force the clock source to be set to Network (internal) clock while the AllFrame is in standby. When the AllFrame comes out of standby the external clock will again be the network's clock source, as long as the C4dio card containing the clock connection is in the same physical location (slot A-F) in the AllFrame hardware *and* the external clock source is still connected.

AllFrame C4o Output Levels

The analog audio outputs on an AllFrame device with one or more C4o Analog Output Cards installed can be set to one of five levels: +28dBu, +24dBu, +18dBu, +4dBu, or Mic.

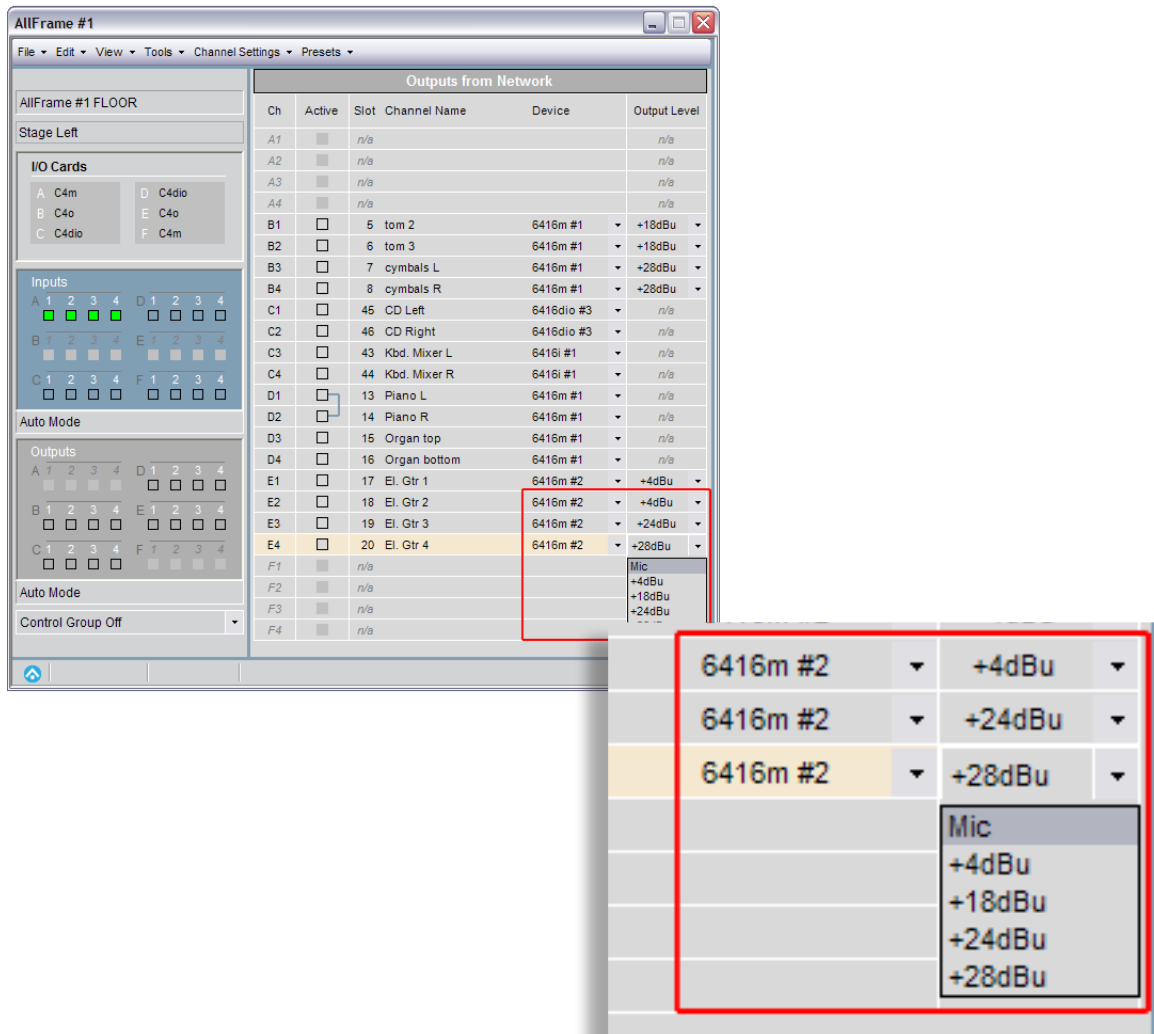

Use the drop-down menu to select an analog output level for a C4o output.

Click the drop-down menu arrow to reveal the output level choices for a channel. The output level settings save as part of a device preset, making presets ideal for recalling frequently used configurations for an AllFrame device. Output level settings also save as part of the network-wide Scenes. Save a project first before attempting to save a Scene or Device Preset.

Clearing AllFrame Output Level Settings

The Channel Settings menu contains two commands that can be used to clear AllFrame analog output level settings. Choose **CLEAR OUTPUT CHANNEL SETTINGS** to reset the selected channel back to its default, +24dBu. Use the **CLEAR ALL OUTPUT CHANNEL SETTINGS** command to set all analog outputs back to the default setting.

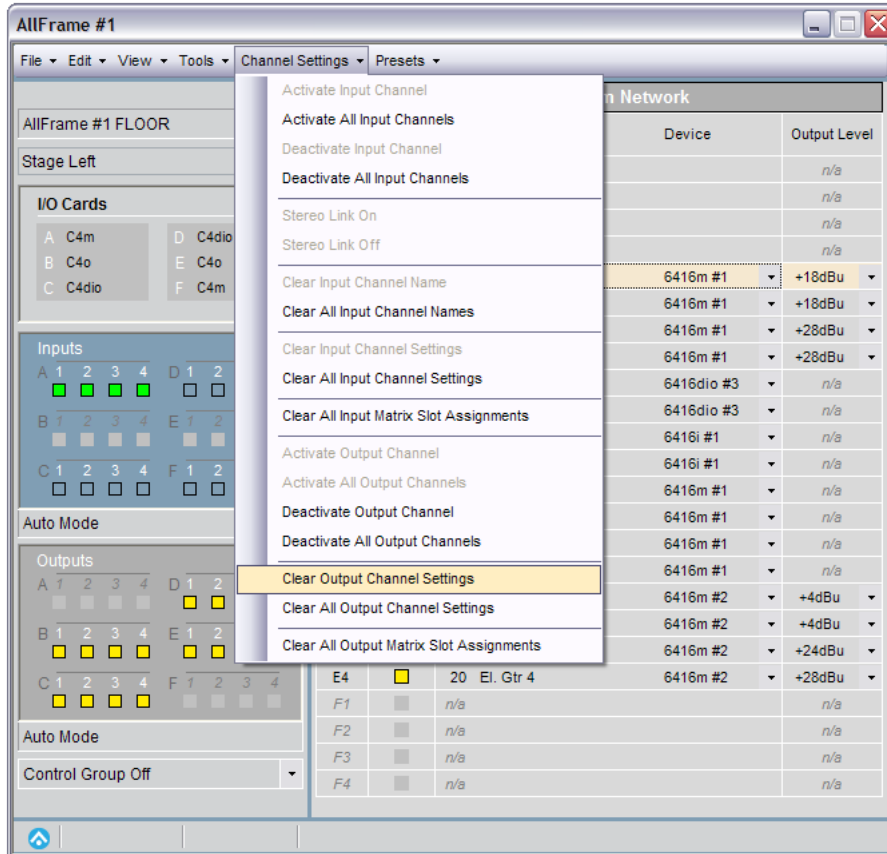

The Clear Output Channel Settings commands return analog outputs to the default +24dBu setting.

Save AllFrame output levels as part of a Device Preset or Scene to simplify device configuration and setup.

✓ **NOTE:** The output level reset commands are only available on AllFrame devices.

6416Y2 A-Net Interface Card

The 6416Y2 can be set up to follow the configuration of its onboard DIP switches or to use the configuration sent to it from the Pro64 Network Manager application. The programmed settings from Pro64 Network Manager are retained even after the PC is removed from the network.

To enable control of the 6416Y2 card via Pro64 Network Manager, set DIP switch #9 found in DIP Switch Block 9 (SW9) to the up position *after* its firmware has been updated. All 6416Y2 cards in the network must be set this way in order to be controllable from Pro64 Network Manager. (This switch must be in the down position for the firmware update.)

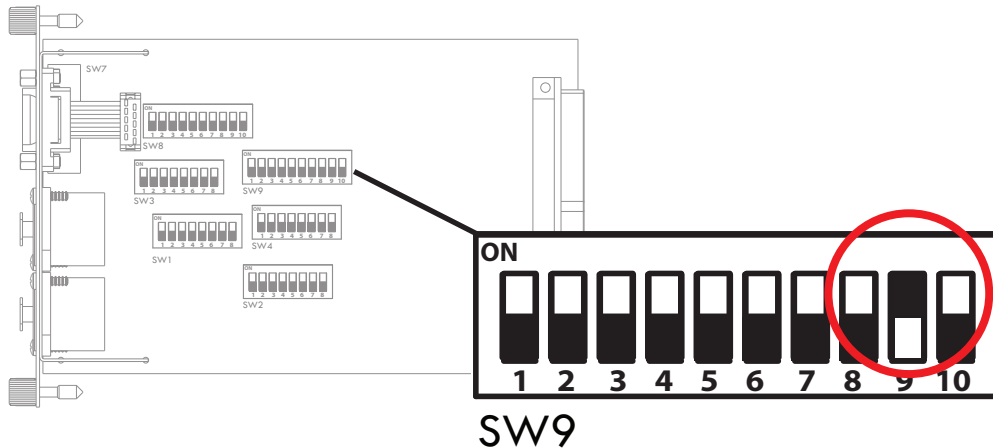

Detail view of block SW9 showing DIP switch #9 in the up position to enable Pro64 Network Manager control

Remember that if a 6416Y2 card is the network's Control Master, DIP switch #10 in block SW9 (Managed Mode on) must also be in the up position.

When DIP switch #9 in block SW9 is in the down position, the 6416Y2 card will use the settings from its onboard DIP switches and no changes from Pro64 Network Manager will be allowed. The 6416Y2 card will still appear as a valid Pro64 device in the Pro64 Network Manager windows while online, but no changes to any I/O routing, configuration settings, or text edits such as channel names will be allowed until DIP switch #9 in block SW9 is set to the up position.

How DIP Switch #9 Works





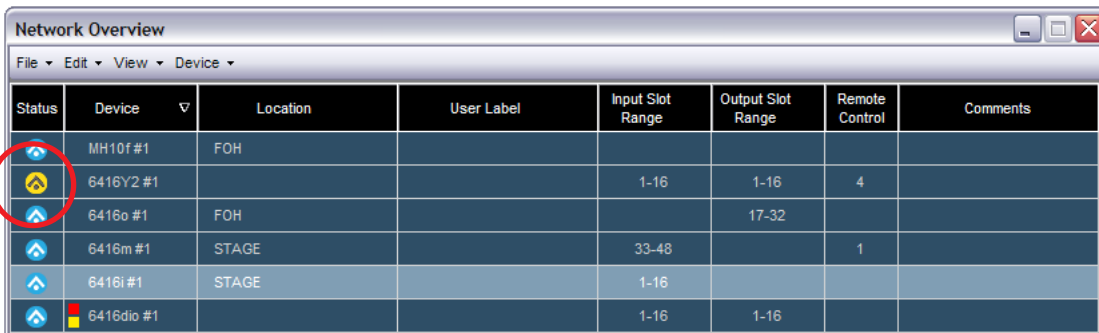

There is only one set of I/O routing parameters available for the 6416Y2 card at a time; DIP switch #9 chooses which set is used—the one programmed from Pro64 Network Manager or the one defined by the actual DIP switch settings on the card. Moving DIP switch #9 in block SW9 from the Pro64 Network Manager control enabled position (up) to local DIP switch control (down) will clear the programming performed from within Pro64 Network Manager until the switch is returned to the up position *and* the card (along with its Yamaha host device) is reconnected to the PC and the settings restored.

Saving a Device Preset will help assure that settings can always be restored to a 6416Y2 card. See page 112 for more information on using Device Presets.

6416Y2 Status Icon

In the Network Overview window the 6416Y2 card's Status column displays a blue A-Net icon to indicate that the card can be controlled. A non-controllable card will have a yellow A-Net status icon. The same status icon is seen in the card's Device Window.



Status	Device	Location	User Label	Input Slot Range	Output Slot Range	Remote Control	Comments
	MH10f #1	FOH					
	6416Y2 #1			1-16	1-16	4	
	6416o #1	FOH			17-32		
	6416m #1	STAGE		33-48		1	
	6416i #1	STAGE		1-16			
	6416dio #1			1-16	1-16		

The yellow icon indicates that the card is not controllable.

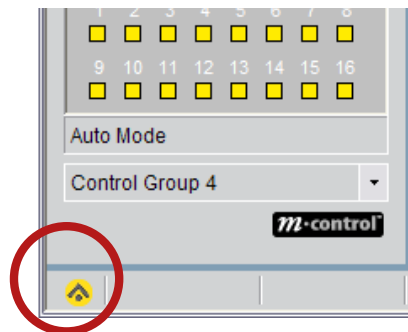

The yellow A-Net icon indicates a card that is not controllable.

m-control

Using m-control to provide remote preamp control from a Yamaha device requires the user to set DIP switch #10 on the card's front panel to the 'on' position (down) in order to activate the function; it cannot be activated from within the Pro64 Network Manager software. When m-control is activated for one or more 6416Y2 cards in the network a special icon will appear in the Device Window for each card. The card configuration dialog box for choosing m-control settings is available in the Tools menu of the card's Device Window. See page 89 for more information.

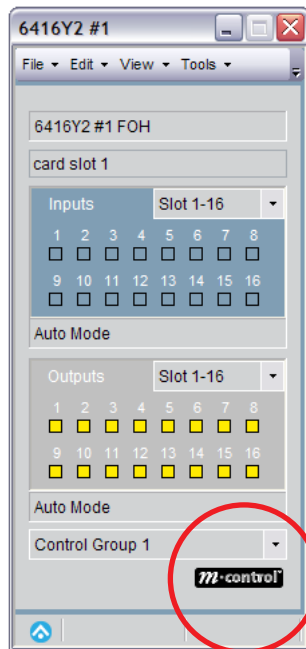

The m-control icon appears for any 6416Y2 card that has DIP switch #10 activated.

Install the 6416Y2 card into Yamaha MY slot #1 when using m-control.

A 6416Y2 card that is set to be the network's Control Master **cannot** also have m-control active. If the network has only one 6416Y2 card installed, there are two options: set a different Pro64 device as the Control Master or work without m-control enabled. In a network with multiple 6416Y2 cards installed, simply activate m-control on a card that is not the Control Master.

✓ **NOTE:** The m-control feature needs to be disabled during firmware updates.

VDC Settings

When a 6416Y2 card is used as the network's Control Master, no Virtual Data Cables can be assigned to that 6416Y2 card while the Pro64 Network Manager application is connected and actively managing the network.

MY8 and MY16 Modes

It is important to note that the choice to use the Yamaha MY8 or MY16 mode (8-channel versus 16-channel communication) must be set by the user via the 6416Y2 card's DIP switches before installing the card in a Yamaha host device; it cannot be controlled via software. Refer to the 6416Y2 card and Yamaha product's documentation for additional information about the use of the two MY modes.

In the 6416Y2 device windows, any 6416Y2 cards running in MY8 mode will have input and output channels 9-16 disabled as seen below.

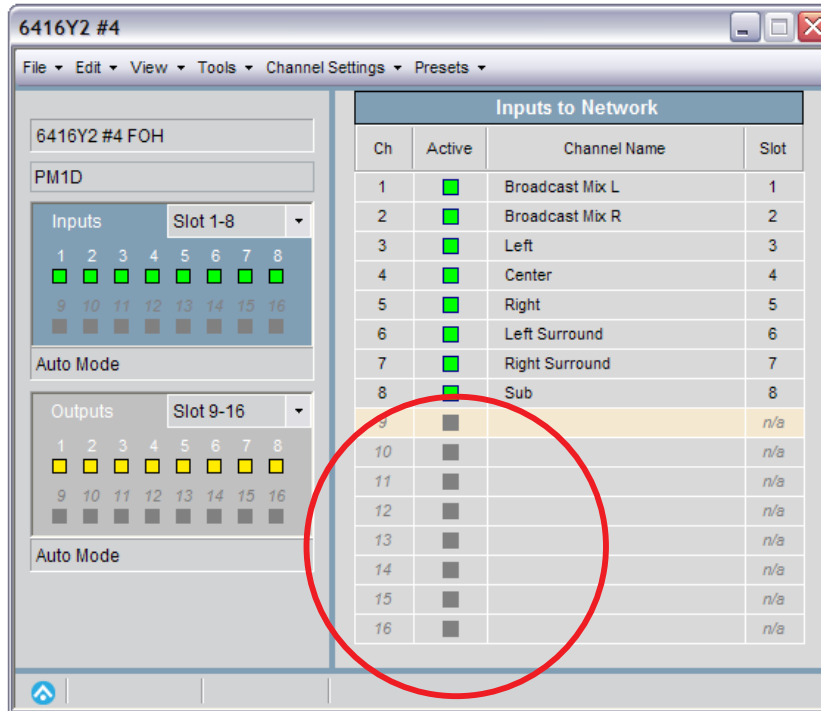

Channels 9-16 are disabled in MY8 mode.

6416Y2 Output Slots

Active Pro64 network Slots coming into a Yamaha device via a 6416Y2 card are always available to be output from the card to the Yamaha console. The Yamaha operator makes the choice to use a Pro64 network resource by patching one or more Pro64 network Slots into the Yamaha device for mixing and/or processing as needed. For this reason, the output Slots (as seen in all device views) for 6416Y2 cards in the network are always on; their yellow LEDs in the Device Window cannot be changed.

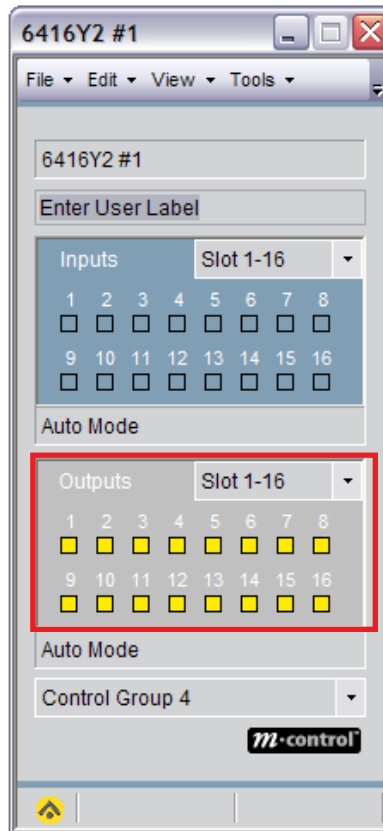

6416Y2 card output Slots are always on.

✓ **NOTE:** The 6416Y2 card's Device Window does not allow output channels to be turned off.

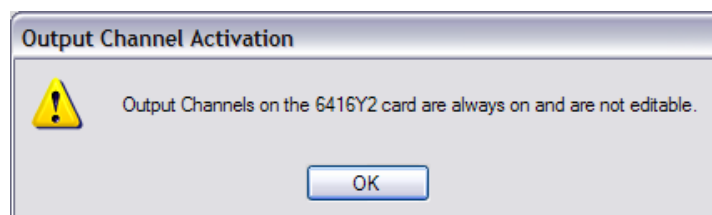

Clicking an output Slot on a 6416Y2 will cause this warning dialog box to appear.

6416Y2 Card Stereo Links

Pro64 Network Manager adds simplified programming for input modules capable of using stereo links. However, the 6416Y2 card uses physical DIP switches on its front panel for activating a stereo link for a channel pair. These switches are not software controllable.

In the 6416Y2 card's Device Window there are no software stereo link commands available (unlike other Pro64 input devices), but any active stereo links will be displayed. Changes to 6416Y2 channel pairs can be made at any time using the DIP switches on the front face of the card; the on-screen display will update immediately.

Inputs to Network			
Ch	Active	Channel Name	Slot
1	<input type="checkbox"/>		33
2	<input type="checkbox"/>		34
3	<input checked="" type="checkbox"/>	CD Left	35
4	<input checked="" type="checkbox"/>	CD Right	36
5	<input type="checkbox"/>		37
6	<input type="checkbox"/>		38
7	<input type="checkbox"/>		39
8	<input type="checkbox"/>		40
9	<input type="checkbox"/>		41
10	<input type="checkbox"/>		42
11	<input checked="" type="checkbox"/>	Kbd. Mixer L	43
12	<input checked="" type="checkbox"/>	Kbd. Mixer R	44
13	<input type="checkbox"/>		45
14	<input type="checkbox"/>		46
15	<input type="checkbox"/>		47
16	<input type="checkbox"/>		48

Stereo links are active on channels 3-4 and 11-12.

All channel activation rules still apply for stereo links on 6416Y2 cards—channels to be stereo linked must be an odd-even pair and both channels must be active in the network before a stereo link can be used.

The Status icon will be yellow if a 6416Y2 card is configured to use the settings from its internal DIP switches instead of those coming from the software; a card in this state cannot be edited or controlled. This status icon mirrors the one seen in the Network Overview.

Card Configuration Dialog Box

The Tools menu for the 6416Y2 Card's Device Window contains a shortcut to the Card Configuration dialog box. The settings here control the Pad Mode, Serial interface communication, and m-control channel/Slot options.

Card Configuration

Card Mode (Read-Only)

MY16 (16 Channels) MY8 (8 Channels)

The MY mode is set using DIP switch #10, found in block SW8. MY8 mode is required for use with the PM1D and 88.2/96kHz sample rates.

m-control (Read-Only)

On Off

Be sure to set DIP switch #10 on the front panel of the 6416Y2 card to activate m-control.

Pad Mode (m-control only)

Auto Pad

The pads on the Aviom preamps are automatically engaged and disengaged as console settings change, offering the widest range of gain settings (80dB total).

NOTE: Audio briefly mutes on the selected channel when the pad state changes.

Manual Pad

Pads on the Aviom preamps cannot be changed from the console and must be engaged manually from Pro64 Network Manager or an RC/MCS. The gain range is 0 to 55dB.

Serial Interface (m-control only)

Rear Panel (All devices except LS9; requires a DB9 serial cable)

Backplane (LS9 only)

Network Slots to be remote controlled (m-control only)

1 - 16

17 - 32

33 - 48

49 - 64

OK Cancel

The 6416Y2 Card Configuration options

Card Mode

The 6416Y2 card mode can be set to either MY16 or MY8. Yamaha's MY16 offers 16 channels at 44.1/48kHz while MY8 mode offers 8-channel operation, useful for Yamaha devices capable of using the 96kHz sample rate or when the card is used with the PM1D console. This field is read-only; the mode is set with DIP switch #10 in switch block SW8 on the card itself.

m-control

The m-control field in the Card Configuration dialog box is read-only; m-control can only be activated from the front panel of the 6416Y2 card by placing DIP switch #10 in the down position. Using m-control allows remote control of Pro64 preamp settings directly from the interface of supported Yamaha devices.

Pad Mode

When using m-control with Pro64 remote controllable mic preamps (as found in the 6416m and AllFrame) there are user-selectable options that control how the 24dB pad built into the remote preamps operate. Two choices are available: Auto Pad and Manual Pad.

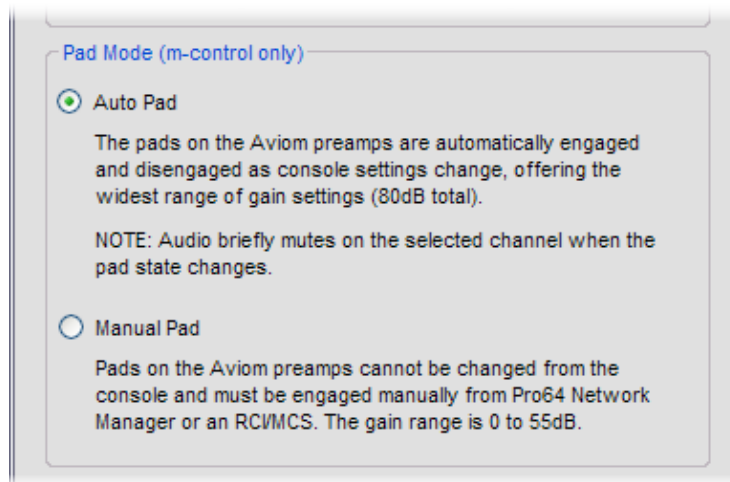

Pad Mode options in the Card Configuration dialog box

Choose **AUTO PAD** to allow the remote control commands coming from the Yamaha device to automatically turn the Pro64 mic preamp's pad on and off as needed. This mode provides the widest range of gain settings for both mic- and line-level audio sources by combining the 56dB range of the preamp with the 24dB pad for a total 80dB gain range. Note that the pad circuitry is in the analog domain for optimal audio fidelity. When the pad is engaged or disengaged on the Pro64 mic preamp, audio will mute briefly while the pad state is changed via relays to avoid unwanted noise in the audio system.

To separate the mic preamp gain from the pad, choose the **MANUAL PAD** setting. When using Manual Pad the preamp gain range is 56dB (displayed as 0 to +55 on Aviom devices). The 56dB range is mapped to the 73 available steps of the Yamaha control. The pad must be engaged or disengaged from the front panel of a 6416m, from an RCI/MCS, or from Pro64 Network Manager.

-
- ✓ **NOTE:** The on-screen display of gain in a Yamaha device is limited to the interface provided the operator by the Yamaha operating system; the numbers displayed on the Pro64 preamp and the Yamaha controller *will* be different but the actual values and resulting audio levels will be the same. Yamaha displays gain range relative to the signal strength of the channel's input, typically displayed as "+10" at the minimum and "-62" at the maximum range of a control's display.
-

Serial Interface

The Serial Interface field determines how the 6416Y2 card communicates with the Yamaha host device—either from the rear panel Remote jack of the host device via a DB9 serial cable, or from the Yamaha device's backplane connector (currently required for the LS9, M7CL-ES, and CL Series consoles).

Network Slots to be Remote Controlled

When m-control is being used, the 6416Y2 card can be set up to control any or all of the available mic preamps in the Pro64 network. Use the check boxes to select the group of Slots that should be controlled from the Yamaha device (1-16, 17-32, 33-48, and/or 49-64) in any combination.

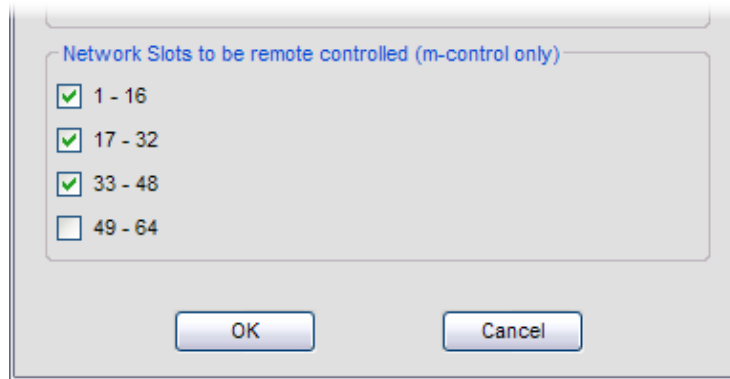

Select which mic preamps to control by clicking the check boxes.

-
- ✓ **NOTE:** When controlling remote preamps with m-control, remember that the Control Group setting must match on both the sending and receiving devices.
-

ASI A-Net Systems Interface

The ASI device window displays the available Pro16® A-Net outputs as four Zones, labeled A-D. The actual number of network Slots available to the four Pro16 Zones is based on the current network sample rate.

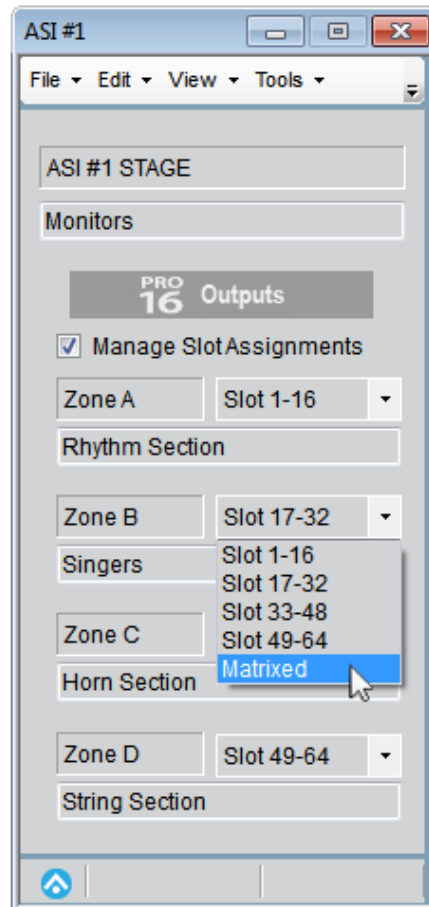

The four Pro16 A-Net ports on the ASI

MH10/MH10f Merger Hubs

The MH10 (and MH10f) device window shows the device's ten A-Net ports; any ports with an active Pro64 device connected are displayed with a solid color green icon. (The displayed port LEDs are read-only)

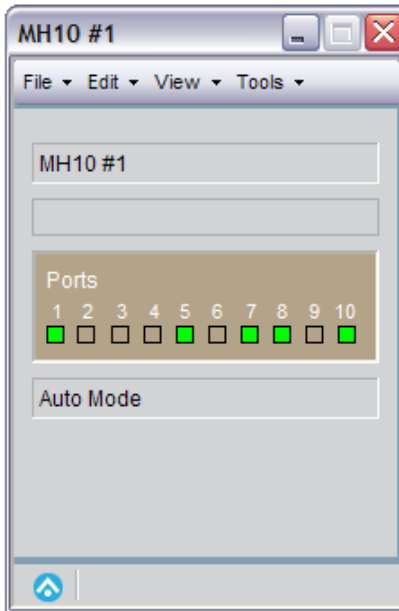

Pro64 A-Net ports on the MH10/MH10f

6416dio Digital I/O Module

The 6416dio Device Overview provides radio buttons for choosing a clock source. The choices are Network (internal), Word Clock, and AES3.

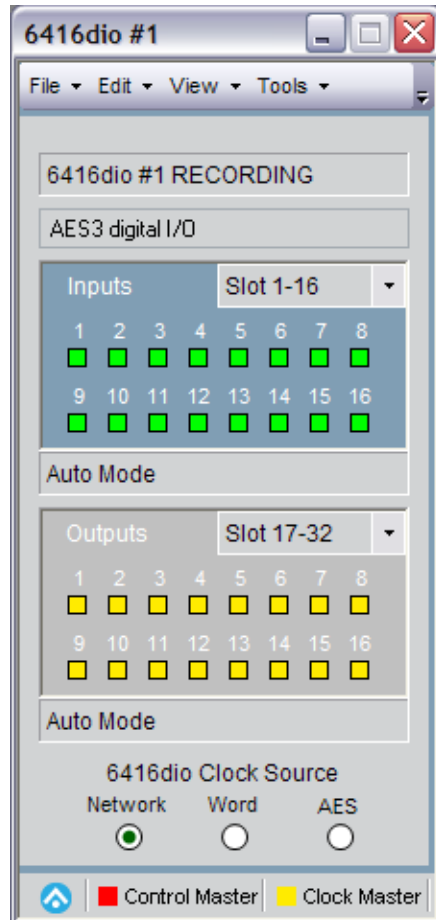

The 6416dio has radio buttons for selecting a clock source

If a clock error occurs (for example, if when using Word Clock, the clock source is disconnected) the 6416dio Clock Source radio buttons will display the error in red. (The network temporarily uses the internal clock until the external source becomes available.) Changing this setting will not have an effect on network clocking if this particular 6416dio device is not the Clock Master.

RCI Remote Control Interface

The RCI device window includes a selector for choosing an A-Net Slot to monitor through the RCI's built-in headphone and line-level output. Click the up/down arrows to scroll through and select Slots from 1-64 or Mute. (The actual available Slots are based on the current network sample rate.)

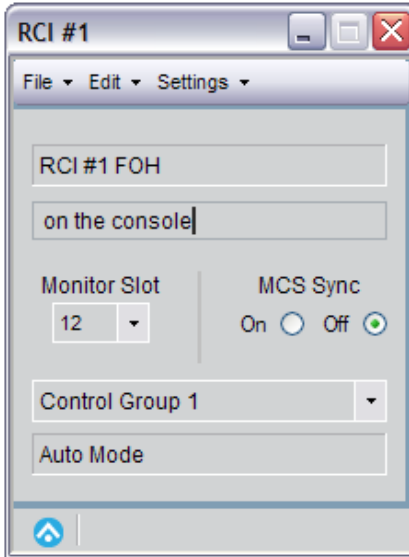

The RCI overview

A radio button in the RCI device overview chooses the RCI/MCS sync mode that determines how audio is routed to the RCI's line-level and headphone monitor output. With **MCS SYNC ON** the RCI follows Slot selection on the MCS or from the software. When using **MCS SYNC OFF** the user controls the monitor Slot selection manually from the RCI front panel (or the RCI's Device Window). When choosing this option, Slot selections from the MCS are ignored, allowing an important channel to remain in the monitors or headphones even while the engineer selects and makes changes to other Slots in the network.

MATRIX ASSIGNMENTS

When an input device is set to Matrixed (the default for an AllFrame device), the drop-down menu within the Inputs to Network view is used to set Slot assignments. Click the channel's Slot column to reveal the drop-down menu and begin the selection process.

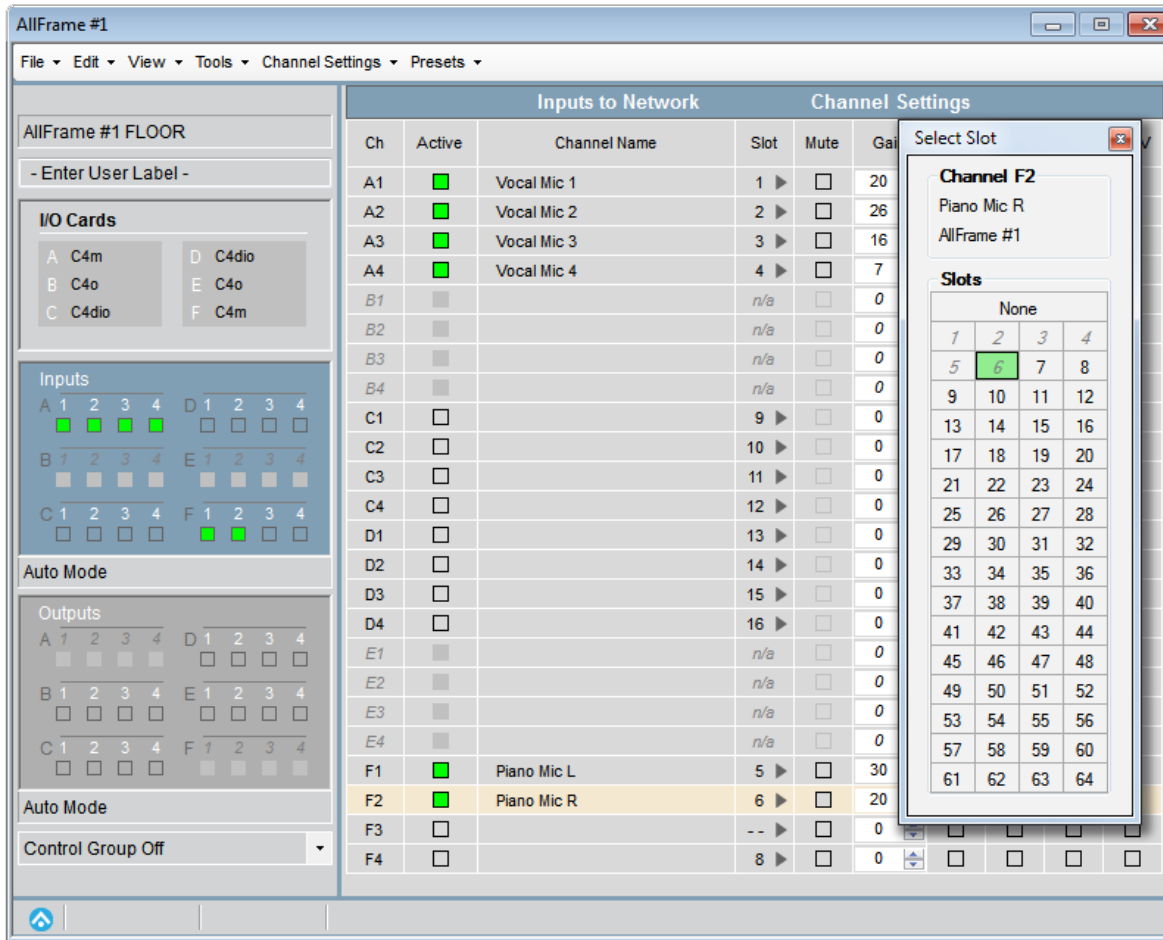

The AllFrame Inputs to Network view displaying the Slot selection dialog.

In the Slot number column, a double dash symbol (- -) indicates that the input channel is not assigned to a network Slot. The channel cannot be made active until a Slot assignment exists.

To make a matrix assignment, click on the arrow symbol in the Slot column for the channel to reveal the menu of available Slots (the actual numbers seen here is dependant on the current sample rate). Any network Slots that are already active in the network are displayed with italic text. Slots that are active elsewhere in the network *can* be assigned to an input channel on the current device but *cannot* be activated until the Slot is deactivated on the other Pro64 device. Only one matrix assignment to a given Slot per device is possible. Matrix assignments save with the project and can also be saved in Scenes and/ or Device Presets.

Clearing Matrix Assignments

To clear one input assignment, set the routing to None, a double dash, "--", will appear in the Slot column. To clear all of an input device's matrix routings, use the **CLEAR ALL MATRIX SLOT ASSIGNMENTS** command found in the Channel Settings menu. This command will set each input's Slot assignment column to read "--" to indicate that no valid Slot assignments exist. Active Slots will automatically be deactivated and their network resources available to other Pro64 deices.

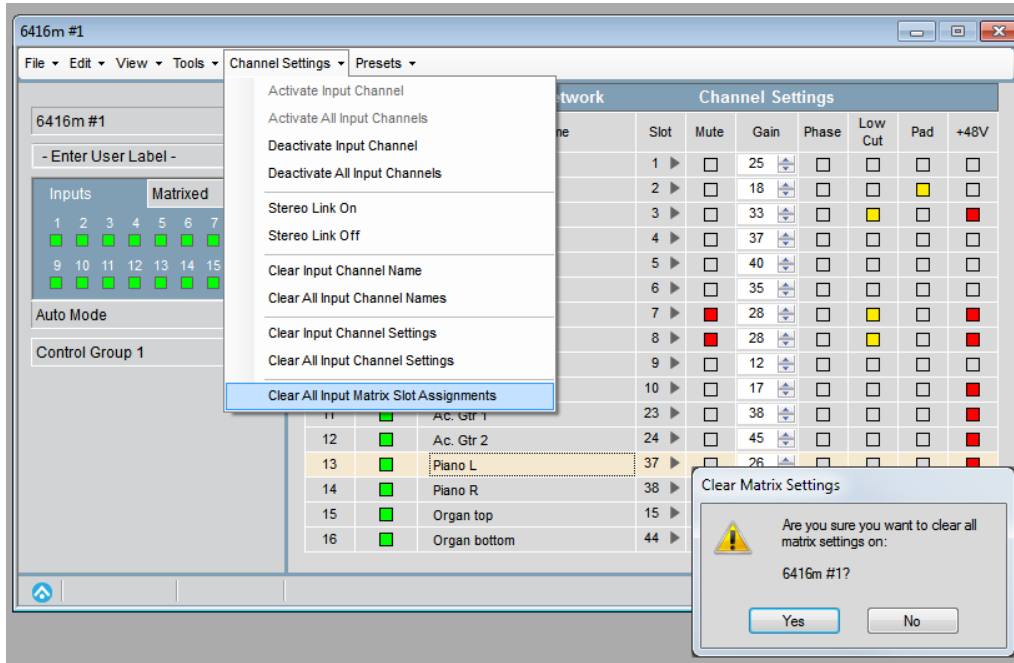

Reset all matrix assignments with one command.

DEVICE WINDOW VIEWS

In addition to the Device Overview features described above, most device windows have a View menu used to open and close the various views provided for the device. The options include:

- Device Overview (all devices)
- Inputs to Network (AllFrame, 6416i, 6416m, 6416Y2, and 6416dio)
- Outputs From Network (AllFrame, 6416o, 6416Y2, 6416dio, and ASI)
- Inputs and Outputs (AllFrame, 6416Y2 and 6416dio)
- Device Presets (AllFrame, 6416i, 6416m, 6416Y2, 6416o, 6416dio, and ASI)
- Port Names (MH10/MH10f only)

The RCI device window does not require a View menu; all information is displayed in the overview.

Inputs to Network View

The AllFrame, 6416i, 6416m, 6416Y2, and 6416dio share a common set of controls for managing inputs to the network. To open this view, choose **INPUTS TO NETWORK** from the View menu. The view will open, showing the available inputs and channel strip parameters for mic preamps (if applicable).

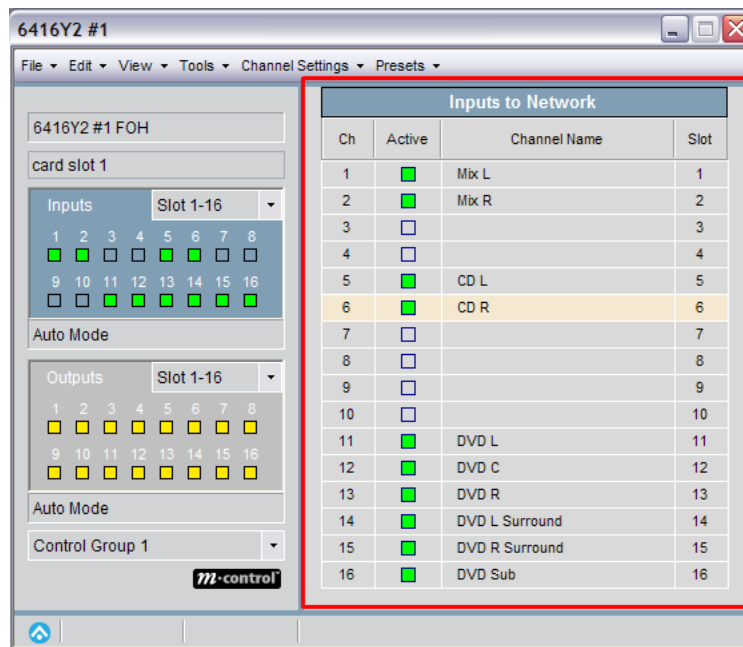

The Inputs to Network view

The first four columns of data displayed are common to all five devices. The **CH** column corresponds to the input channels on the Pro64 device; this is a read-only field. The **ACTIVE** column mirrors the channel grid seen in the device overview. To toggle a setting click a channel's **ACTIVE** box from either location. The Active box will light green if the channel is active on the network.

Text in the **CHANNEL NAME** field is user-defined. Click to edit the text; there is a 16-character maximum.

Text entered in this field is stored in the Pro64 device itself and is available throughout the network to all output-capable devices. Use the Edit menu's copy/paste commands as needed on user-defined text.

The **SLOT** column shows the network Slot to which an input module's channel is assigned. The text in this column is read-only when an input device is set to one of the four 16-channel input ranges. It is displayed as a drop-down menu when the matrix is active (this is the default view for AllFrame devices).

Stereo Links

To set a pair of input module channels to be stereo linked from Pro64 Network Manager, they need to follow the Pro64 network rules: the channels must be an odd-even pair *and* both channels must be active in the network.

Linking/Unlinking Channel Pairs

To link a pair of active channels, right-click in the Active column for either of the channels. In the menu, that appears choose **STEREO LINK ON**. To unlink a pair of channels right-click in the Active column for either of the channels and choose **STEREO LINK OFF** or deactivate one of the active Slots.

The 6416Y2 card is an exception—its stereo links are set manually using the DIP switches on its front panel. No software control of the link on/off function is available.

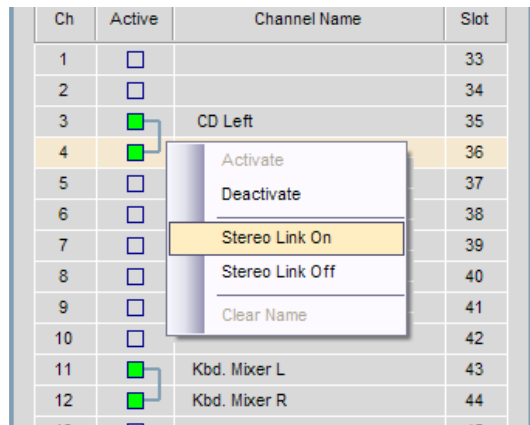

Ch	Active	Channel Name	Slot
1	<input type="checkbox"/>		33
2	<input type="checkbox"/>		34
3	<input checked="" type="checkbox"/>	CD Left	35
4	<input checked="" type="checkbox"/>		36
5	<input type="checkbox"/>		37
6	<input type="checkbox"/>		38
7	<input type="checkbox"/>		39
8	<input type="checkbox"/>		40
9	<input type="checkbox"/>		41
10	<input type="checkbox"/>		42
11	<input checked="" type="checkbox"/>	Kbd. Mixer L	43
12	<input checked="" type="checkbox"/>	Kbd. Mixer R	44

The screenshot shows a table with columns 'Ch', 'Active', 'Channel Name', and 'Slot'. A context menu is open over the 'Active' column of channel 4. The menu items are: 'Activate', 'Deactivate', 'Stereo Link On' (highlighted), 'Stereo Link Off', and 'Clear Name'. Channel 3 is 'CD Left' and channel 4 is active. Channel 11 is 'Kbd. Mixer L' and channel 12 is 'Kbd. Mixer R', both active.

The stereo link menu

For channels that are set as stereo pairs on an input module, a special bracket icon will appear in the Inputs to Network panel.

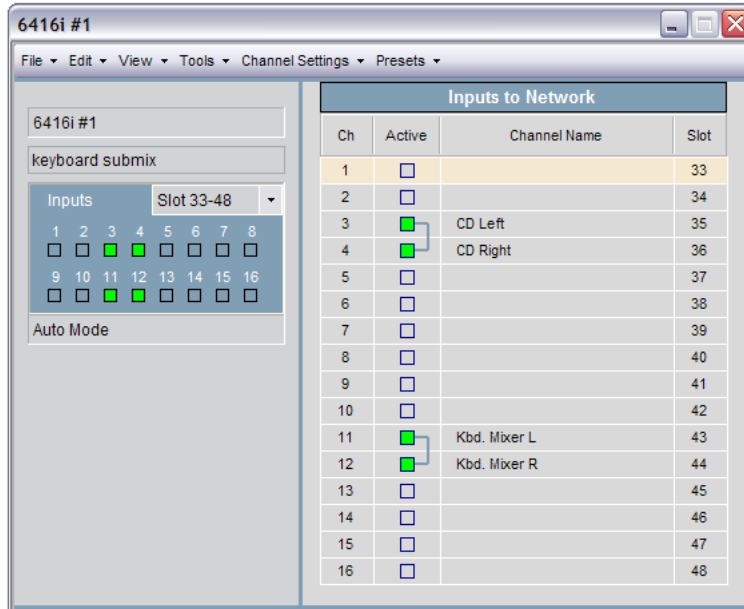

Stereo links are set on channels 3–4 and 11–12.

Mic Preamp Channel Settings

In addition to the input settings common to all Pro64 input devices, the Inputs to Network view for the AllFrame and 6416m display the channel strip parameters for the mic preamps: Mute, Gain, Phase, Low Cut filter, -24dB Pad, and +48V Phantom Power.

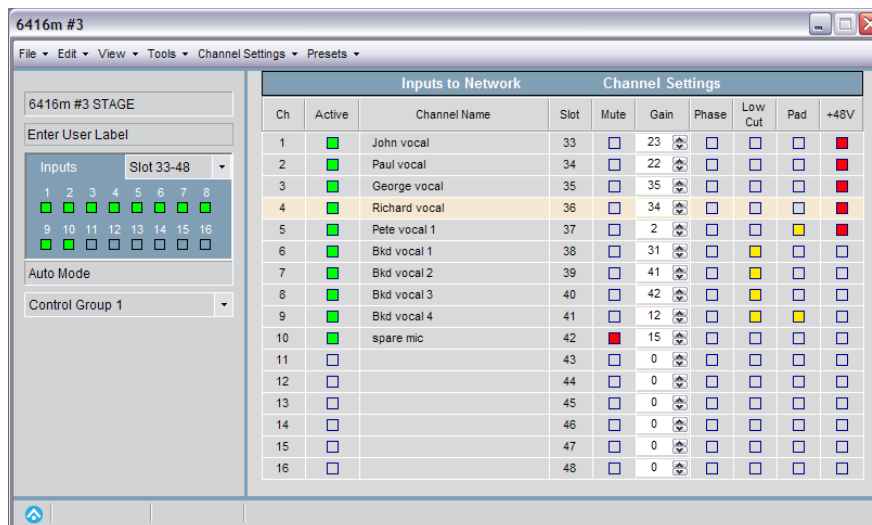

6416m channel strip settings in the input view

Click any button in the channel strip to toggle its status; to change mic preamp gain click the up/down arrows on screen or click in the numeric Gain field to edit gain values with the keyboard arrow keys or with text entry.

The 24dB Pad and +48V Phantom Power will require confirmation via a dialog box in Pro64 Network Manager. Click **Yes** to apply the change or **No** to cancel.

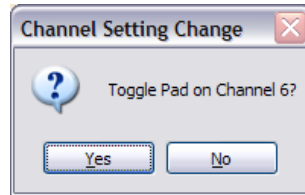

Confirmation is required for changes to +48V and Pad settings.

Any updates to mic preamp channel strip settings made from other controllers in the network (such as an RCI/MCS combination or a Yamaha device with a Pro64 A-Net card installed) will automatically update the on-screen settings.

Clearing Channel Settings

Two convenient functions are found in the Channel Settings menu that can simplify the editing of 6416m mic preamp parameters. Use the **CLEAR CHANNEL SETTINGS** command on a selected channel to reset a single preamp channel to the defaults. Or use the **CLEAR ALL CHANNEL SETTINGS** command to reset all 16 preamp channel strips at once. It is not necessary to select channels first when using this command.

Both Clear Channels settings commands require confirmation. Save a Device Preset before clearing the channel settings if you need to recall the current preamp settings at a later time.

Outputs From Network View

The AllFrame, 6416o, 6416Y2, and 6416dio each contain an **Outputs from Network** view that shows details about the active network Slots assigned to their outputs. The ASI A-Net System Interface also has an **Outputs from Network** view, but offers features designed to simplify routing Pro64 Slots to Pro16 devices such as A-16II Personal Mixers. See page 108.

As with an input device, the **Ch** column is related to the physical output channels available from the Pro64 device and is a read-only field. An AllFrame device shows the I/O card's installed location as well as the channel number on that card (displayed as A1-A4, B1-B4, etc.).

The **ACTIVE** column has yellow indicators that work as on/off switches for the audio assigned to the device's channels. Click any switch to toggle its state (see the exceptions starting on page 110 for the 6416Y2 card and ASI). Since the outputs from a Pro64 device do not alter the makeup of the Pro64 network's inputs, no confirmation dialogs are required; output channel status can be changed at any time.

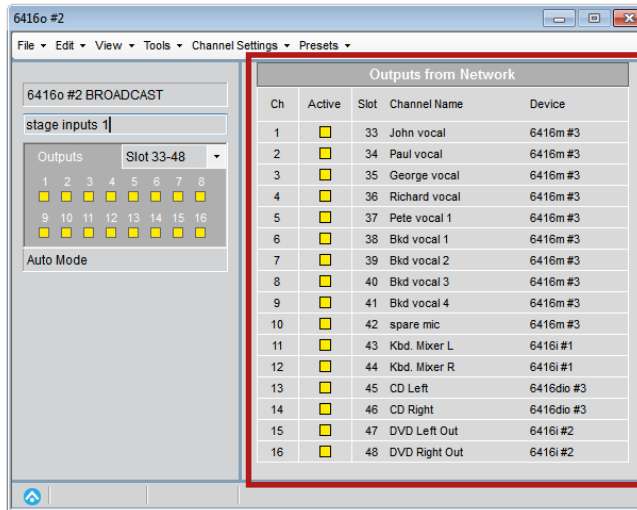

The Outputs from Network view for a 6416o

The **SLOT** field shows the network Slot currently assigned to each of the output channels on the device. Slot numbers seen here are directly related to the Slot range currently assigned in the Outputs grid of the device overview (Slots 1-16, 17-32, 33-48, 49-64 or Matrixed). Slot numbers are read-only until the device is set to **MATRIXED** using the Slot range pop-up in the overview.

The read-only **CHANNEL NAME** and **DEVICE** fields are also related to the device's currently selected output Slot range and will display each output channel's source name and its originating network device, updating immediately as changes are made in the network. Note that the Channel Name and Device field text will read "No Active Input" for channels that do not have an active Slot assigned somewhere in the network.

Setting an Output Matrix Assignment

For all non-AllFrame devices the first step in assigning a matrix output assignment is setting the output device to use the matrix. In the Slot range drop-down menu in the Device Overview, choose **MATRIXED** from the menu, then click **Yes** in the confirmation dialog box that appears. .

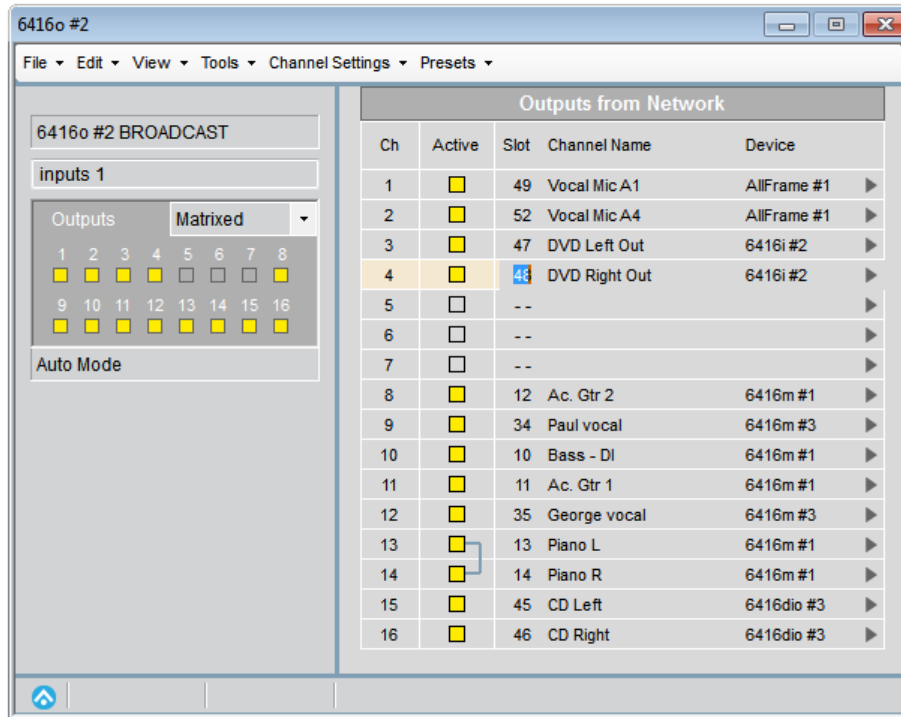

Setting an output device to Matrixed requires confirmation.

In the Outputs from Network view, the individual channel rows change to reveal a drop-down menu per channel. Unassigned channels read as **No ACTIVE INPUT**. Use the dialog box to select an output from the available sources active in the network. The sources are sorted in Slot order; the actual number of Slots available in this menu is determined by the current sample rate. Any number of outputs on a Pro64 device can be assigned to output the same network Slot. Matrix assignments save with the project and also with Scenes and Device Presets.

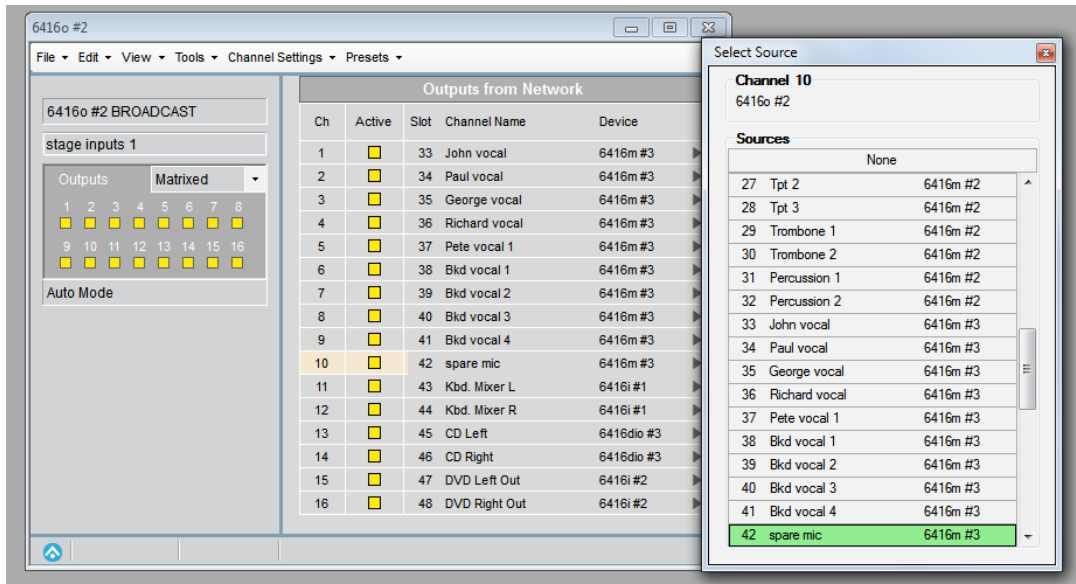

Select an output source from the menu to assign it.

Direct Text Entry

Another way to assign a matrix output Slot on a Pro64 device is via direct text entry. Once an output device is assigned to the matrix, clicking the Slot number in the Outputs From Network view will highlight its text. To change the routing assignment, type a new number on the keyboard. Optionally, use the keyboard's up/down arrow keys to scroll through all network Slots. Press the keyboard **ENTER** key when finished to accept the change.

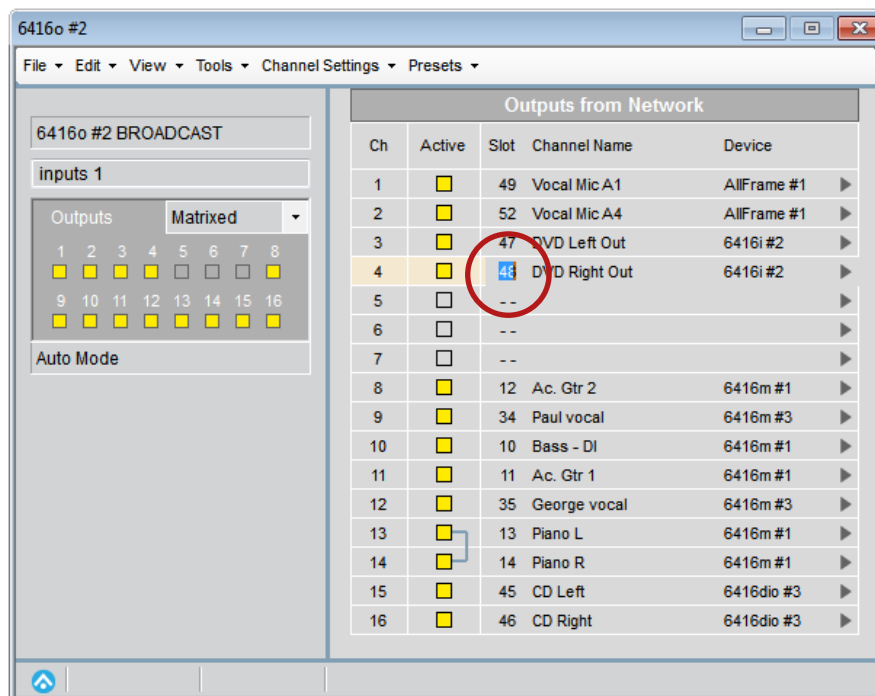

Type a new Slot assignment or scroll with the arrow keys to make a change.

Matrix Assignments on the ASI

The ASI A-Net Systems Interface allows Pro16 output devices such as the A-16II Personal Mixer to be connected to a Pro64 network. The ASI has four Pro16 outputs, labeled on the hardware in blocks of sixteen channels as 1-16, 17-32, 33-48, and 49-64. In its standard configuration, the ASI outputs the 64 Slots of a Pro64 network (at 44.1/48kHz) in sequential order. Adding matrix assignments to the ASI makes this device even more powerful.

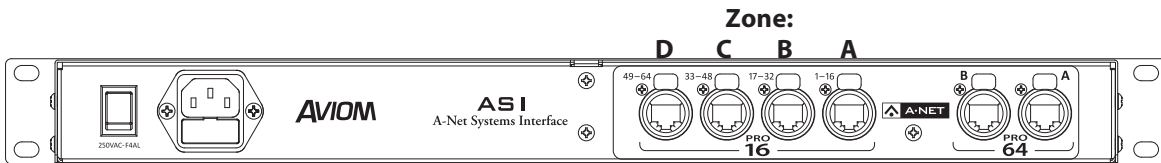
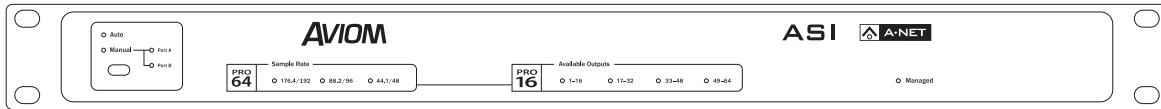

The ASI front and rear panel interfaces

Within the Pro64 Network Manager interface the four Pro16 outputs of the ASI are referred to as **ZONES**; the Zones are labeled A, B, C, and D. With the addition of matrix assignments the Pro16 outputs no longer need to be restricted to sequential blocks of 16 channels. Each ASI in the network can create four unique sets of outputs channels for on-stage monitoring with A-16II Personal Mixers using any Slots in the Pro64 network. Any number of ASI devices can be added to a Pro64 network to provide an unlimited number of custom programmable multi-zone monitor mix feeds.

Pro16 Outputs					Zone A (1-16)
Ch	Active	Slot	Channel Name	Device	
1	<input checked="" type="checkbox"/>	1	kick	6416m #1	▶
2	<input checked="" type="checkbox"/>	2	snare	6416m #1	▶
3	<input checked="" type="checkbox"/>	7	cymbals L	6416m #1	▶
4	<input checked="" type="checkbox"/>	8	cymbals R	6416m #1	▶
5	<input checked="" type="checkbox"/>	10	Bass - DI	6416m #1	▶
6	<input checked="" type="checkbox"/>	11	Ac. Gtr 1	6416m #1	▶
7	<input checked="" type="checkbox"/>	18	El. Gtr 2	6416m #2	▶
8	<input checked="" type="checkbox"/>	33	Vocal Mic A1	AllFrame #1	▶
9	<input checked="" type="checkbox"/>	34	Vocal Mic A2	AllFrame #1	▶
10	<input checked="" type="checkbox"/>	35	Vocal Mic A3	AllFrame #1	▶
11	<input checked="" type="checkbox"/>	36	Vocal Mic A4	AllFrame #1	▶
12	<input checked="" type="checkbox"/>	23	Sax 1	6416m #2	▶
13	<input checked="" type="checkbox"/>	41	Voc. Submix L	6416Y2 #3	▶
14	<input checked="" type="checkbox"/>	42	Voc. Submix R	6416Y2 #3	▶
15	<input checked="" type="checkbox"/>	59	Kbd. Mixer L	6416i #1	▶
16	<input checked="" type="checkbox"/>	60	Kbd. Mixer R	6416i #1	▶

Pro16 Outputs					Zone B (17-32)
Ch	Active	Slot	Channel Name	Device	
1	<input checked="" type="checkbox"/>	41	Voc. Submix L	6416Y2 #3	▶
2	<input checked="" type="checkbox"/>	42	Voc. Submix R	6416Y2 #3	▶
3	<input checked="" type="checkbox"/>	59	Kbd. Mixer L	6416i #1	▶
4	<input checked="" type="checkbox"/>	60	Kbd. Mixer R	6416i #1	▶
5	<input checked="" type="checkbox"/>	21	Harmonica mic	6416m #2	▶
6	<input checked="" type="checkbox"/>	22	Harmonica amp	6416m #2	▶
7	<input checked="" type="checkbox"/>	11	Ac. Gtr 1	6416m #1	▶
8	<input checked="" type="checkbox"/>	12	Ac. Gtr 2	6416m #1	▶
9	<input checked="" type="checkbox"/>	17	El. Gtr 1	6416m #2	▶
10	<input checked="" type="checkbox"/>	33	Vocal Mic A1	AllFrame #1	▶
11	<input checked="" type="checkbox"/>	34	Vocal Mic A2	AllFrame #1	▶
12	<input checked="" type="checkbox"/>	35	Vocal Mic A3	AllFrame #1	▶
13	<input checked="" type="checkbox"/>	36	Vocal Mic A4	AllFrame #1	▶
14	<input checked="" type="checkbox"/>	9	Bass - mic	6416m #1	▶
15	<input checked="" type="checkbox"/>	51	Drum Submix L	6416Y2 #3	▶
16	<input checked="" type="checkbox"/>	52	Drum Submix R	6416Y2 #3	▶

Two Zones of the ASI are shown with matrix assignments.

✓ **NOTE:** The outputs on an ASI cannot be turned off.

ASI Outputs

In Pro64 Network Manager the ASI defaults to having its four Pro16 outputs assigned in blocks of 16 channels. Zone A is automatically assigned to Slots 1-16, Zone B is assigned to Slots 17-32, Zone C is assigned to 33-48, and Zone D is assigned to 49-64. Changes can be made by opening the ASI Device Window.

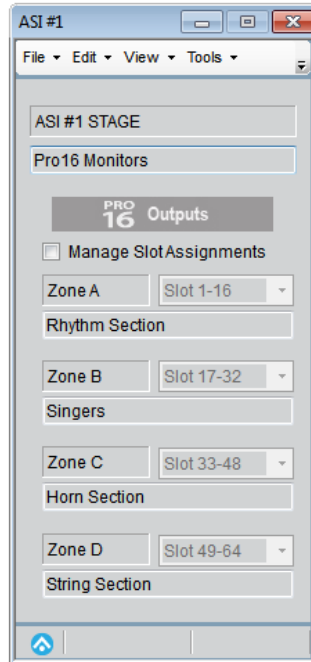

The default state for the ASI has all Zones set to four sequential blocks of 16 channels each.

To access the matrix functionality on the ASI, click the box marked **MANAGE SLOT ASSIGNMENTS** in the Device Window overview. Once checked, the Slot assignment drop-down menus in the overview become active. Each Zone can be assigned to one of five choices:

- Slot 1-16
- Slot 17-32
- Slot 33-48
- Slot 49-64
- Matrixed

To change the routing for a Zone, select one of the options and confirm the change by clicking **YES** in the dialog box that appears. Click **No** in the dialog box to cancel the operation.

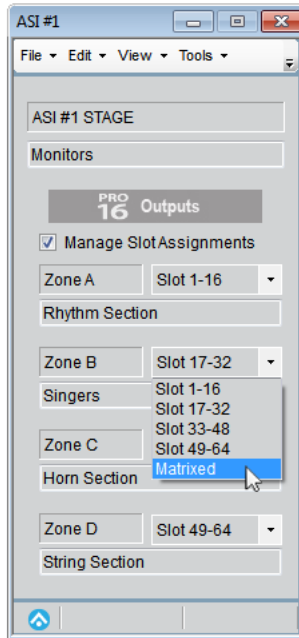

The default state for the ASI has all Zones set to sequential blocks of 16 channels each.

To return to the ASI to its original state, with its outputs assigned in order from 1-64 across the four Pro16 outputs, un-check the **MANAGE SLOT ASSIGNMENTS** check box in the Device Window. In the dialog box that appears, click **OK** to complete the change. Click **CANCEL** in the dialog box to leave the ASI in its managed state.

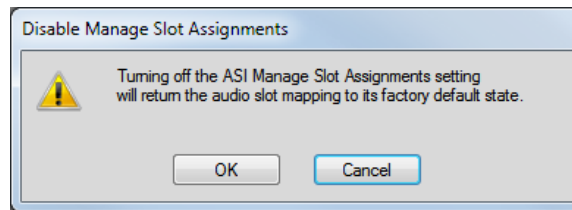

Clicking OK will reset the ASI to its default state.

ASI Matrix Views

The Outputs From Network view for the ASI shows two of the available Zones at all times. Each set of 16 outputs is labeled **Pro16 OUTPUTS** rather than **OUTPUTS FROM NETWORK** as seen on Pro64 output devices. Any of the four Zones can be shown by selecting a Zone name from the drop-down menu found at the top of each Pro16 Outputs section.

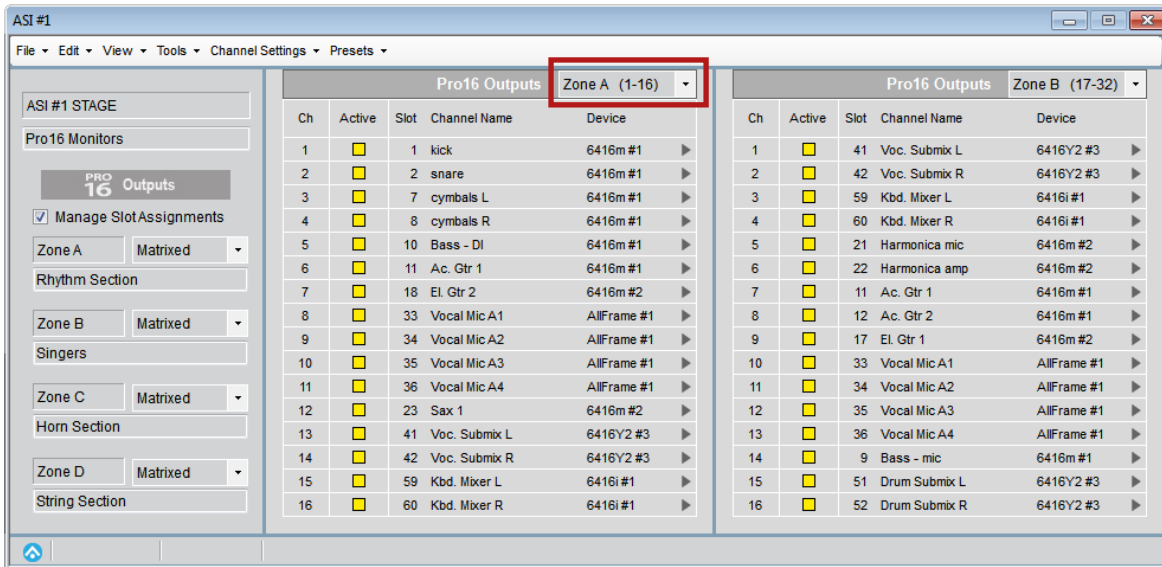

Two zones of Pro16 outputs are shown in each ASI Device Window. Select a Zone to view using the drop-down menu.

Changing the content sent to any channel in a Zone follows the same rules as outlined previously for Pro64 output devices. Click on the arrow in any channel's row and choose the Pro64 Slot to be output. Optionally, select the Slot number to highlight it and then type in the desired Slot number. Save frequently used Pro16 output assignments as Device Presets for easy recall.

Clearing Output Matrix Assignments

Output assignments can be cleared for any output-capable device that has been set to Matrixed. Choose **CLEAR ALL OUTPUT MATRIX ASSIGNMENTS** from the Channel Settings menu, and click **Yes** in the dialog box that appears. All output channels are set to no assignment, displayed as "--" in the Slot column of the Outputs from Network view.

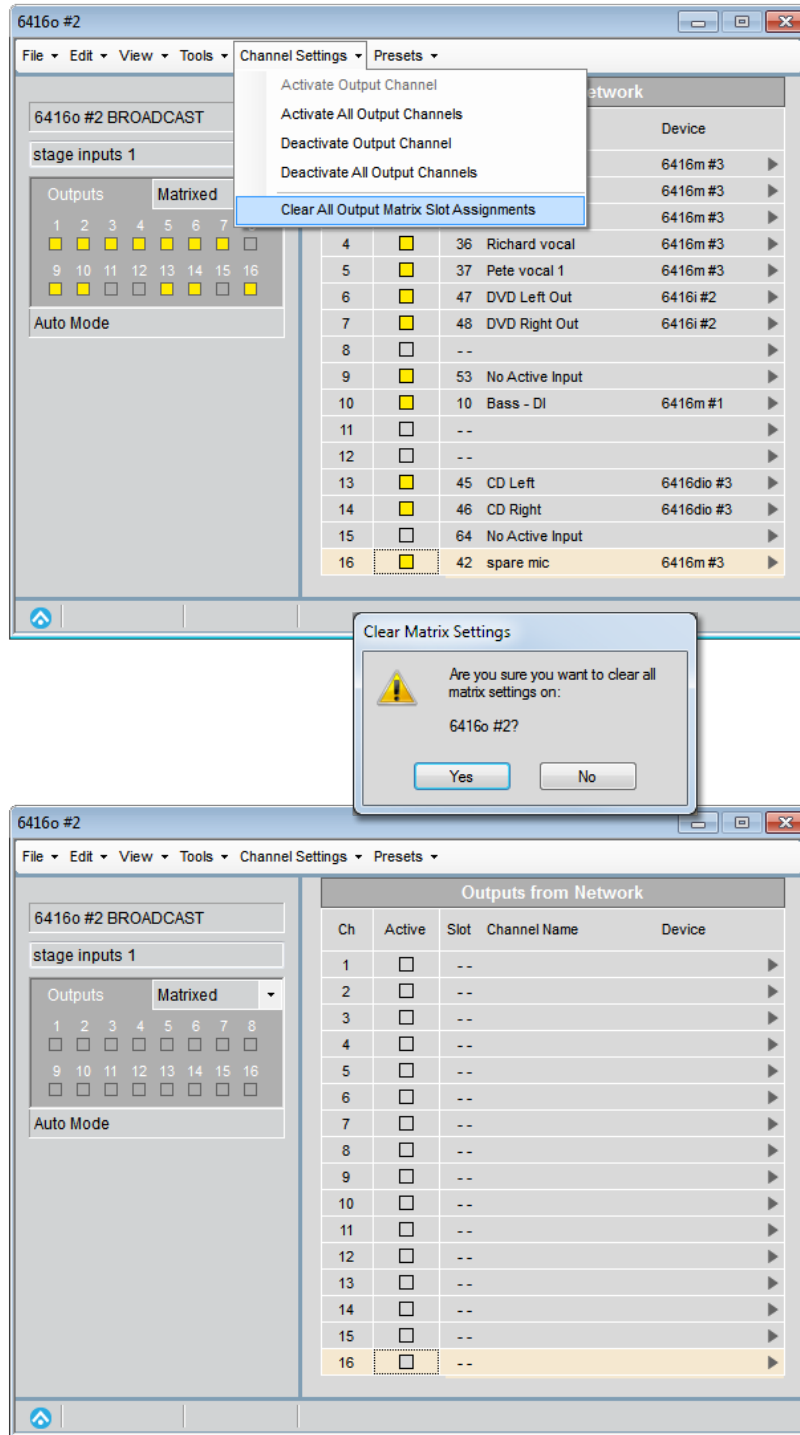

Matrix assignments are shown before and after being cleared.

6416Y2 Card and ASI Outputs

In its Device Window, the individual outputs from a 6416Y2 A-Net card cannot be turned off—the card does not have DIP switches on the circuit board that can support this functionality. Outputs from the 6416Y2 are always sent to the Yamaha console, where they can be routed to mixer faders as needed and turned on or off from the Yamaha console's user interface. Clicking the activation icons for a 6416Y2 card output will cause a warning dialog box to appear as a reminder.

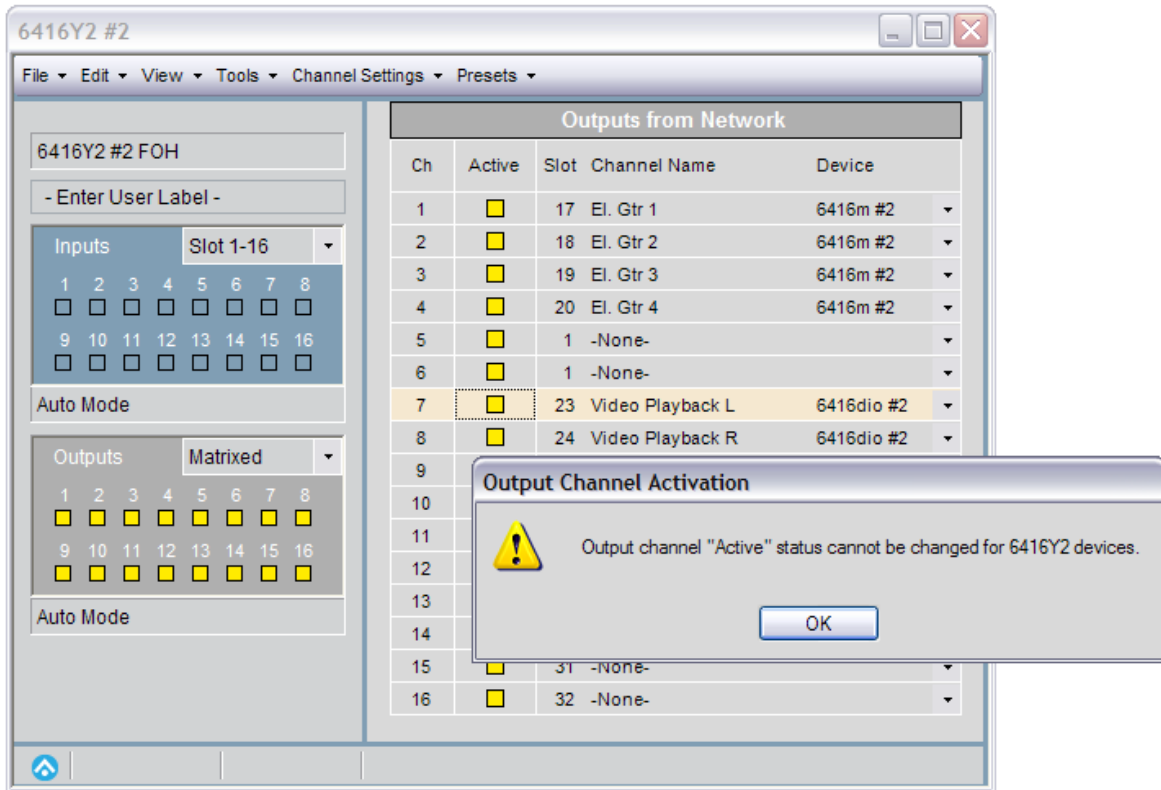

6416Y2 outputs are always active.

The same rules apply for the ASI A-Net Systems Interface—the ASI has outputs that cannot be turned off. Clicking an output's Active button in an ASI Device Window will result in a warning message.

The Inputs and Outputs View

The bidirectional AllFrame, 6416Y2 A-Net Interface Card and 6416dio Digital I/O Module each have a view that opens the Inputs to Network and Outputs from Network panels together. Select **INPUTS AND OUTPUTS** from the View menu to open it. The state of this window will save with the Project.



The Inputs and Outputs view for the 6416Y2 card

DEVICE PRESETS

Device Presets provide a simple way to save and recall settings for an individual Pro64 I/O device. Device Presets can be used to recall frequently used channel combinations, input channel names, matrix routings, etc. Note that Device Presets are not available on the MH10/MH10f, RCI, and ASI.

Device Presets are saved as part of a project; you will be prompted to create a project first if you attempt to create a preset when no project exists.

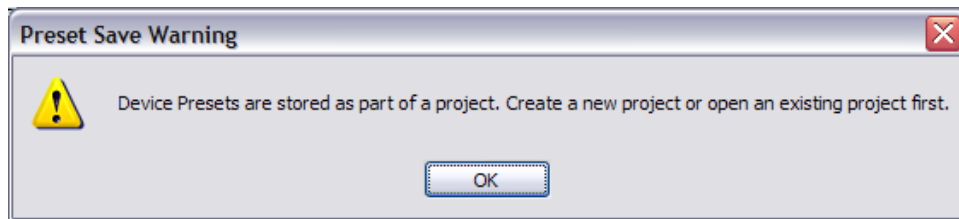

Device Presets are saved with a project.

A Device Preset stores the following information:

- Input and/or Output Slot range (1-16, 17-32, 33-48, or 49-64)
- Matrix on/off state
- Matrix channel/Slot routing
- Active Input channels assigned to network Slots for AllFrame, 6416i, 6416m, 6416Y2, and 6416dio
- Channel names for input devices for AllFrame, 6416i, 6416m, 6416Y2, and 6416dio
- Stereo Link status (input devices only)
- 6416m and AllFrame mic preamp parameters: Mute, Gain, Phase, Low Cut, Pad, and +48V phantom power
- Output channel on/off status for AllFrame, 6416o and 6416dio

✓ **NOTE:** Since the AllFrame hardware is user-configurable, it is important to understand that AllFrame Device Presets are linked to the specific configuration, type, and location of all I/O cards installed in the device. Moving or changing the quantities of the I/O cards in an AllFrame will cause saved device presets in a project to become invalid.

The Device Presets View

To display the Device Presets interface choose **DEVICE PRESETS (SHOW ALL)** from the View menu. By default, when the Device Presets are displayed all input and/or output panels for the current device will be shown. To hide the Device Presets, select any other view from the View menu. Undefined presets are marked as **- EMPTY -** in the presets list.

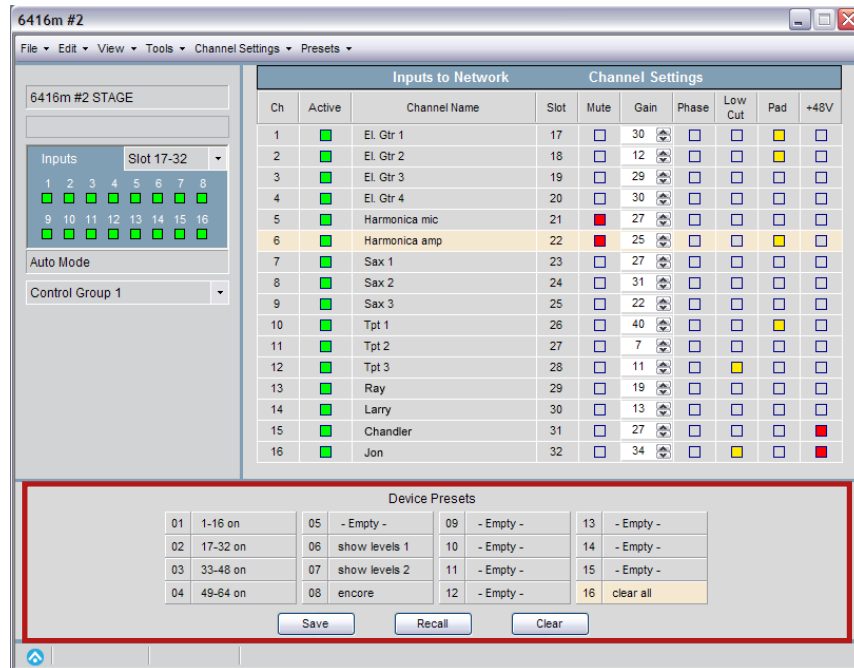

The Device Presets panel, shown in the 6416m device window

Saving a Device Preset

Up to 16 Device Presets can be saved per Pro64 I/O device. The presets are stored to disk along with other Pro64 Network Manager project settings. To save a Device Preset into one of the 16 locations, first configure the Pro64 device as required for your application. Next, click in one of the Device Preset locations until the text cursor appears. Give the Device Preset a name, up to 16 characters, and then click the **SAVE** button in the Device Preset panel or press the **ENTER** key on your keyboard. Confirm the save operation in the dialog box that appears.

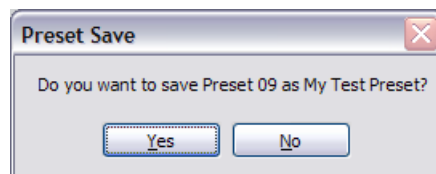

Confirm the save operation.

To use the default name for a preset, select a preset location and then click the **SAVE** button without typing in a preset name. The name will be filled in automatically (Preset 01, Preset 02, etc.) Presets can be renamed later as needed, see Updating a Device Preset below.

Updating a Device Preset

Once a Device Preset has been saved you can change its settings, rename it, and update it as often as needed. To update one of the 16 Device Presets with a newer version, select the preset in the Device Preset panel to highlight it, rename it if necessary, and then click the **SAVE** button in the Device Preset panel. You will be prompted to confirm the change before the preset is overwritten.

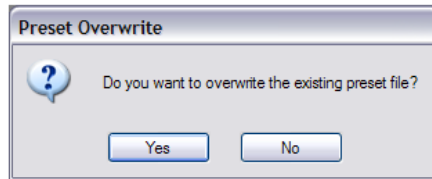

Confirm the change to an existing preset.

To change only the preset's name, click the preset's name field, select and enter any text to be changed, then press the keyboard **ENTER** key. Confirm the update in the dialog box that appears by clicking **Yes**.

Recalling a Device Preset

To recall a Device Preset that has been saved with the project, first select the preset to highlight it and then click the **RECALL** button in the Device Preset panel.

For input modules, if there are any Slot activation conflicts caused by the Device Preset recall, a warning dialog will alert you to the conflict.

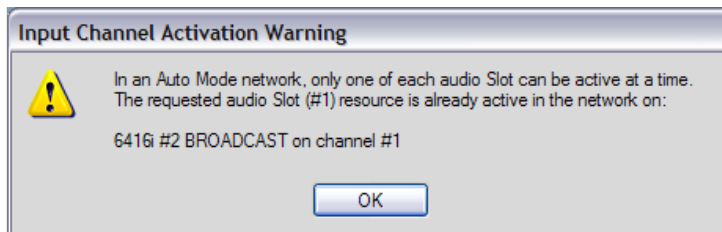

Conflict warning

Remember that only one input channel can occupy a network Slot at a time.

Clearing a Device Preset

To remove a Device Preset from the preset panel (which also removes it from the project and from disk), first select the preset to highlight it and then click the **CLEAR** button in the Device Preset panel.

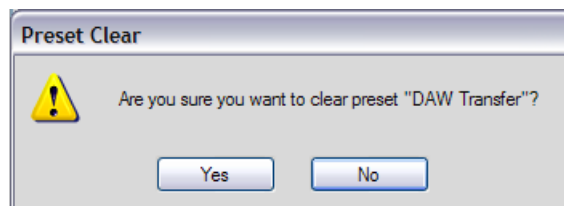

Clearing a preset requires confirmation.

Confirm the operation by clicking the **Yes** button. There is no undo. for this action

DEVICE WINDOW MENUS

Each Device Window has a set of menus along its top edge. The File and Edit menus are common to all Device Windows. Device-specific menu commands are noted below.

File Menu

The File menu contains the following commands:

Print Device Info...	Prints a report detailing the current device's settings
Print Preview	Displays a preview of the information that will be printed in the Device Info report
Close Window	Closes the current Device Window (shortcut - Ctrl+W)

Edit Menu

The Edit menu contains these text editing commands:

Cut	Cuts the selected text (shortcut - Ctrl+X)
Copy	Copies the selected text to the clipboard (shortcut - Ctrl+C)
Paste	Pastes text that was copied to the clipboard (shortcut - Ctrl+V)
Clear Text	Clears the selected text (shortcut - Del key)
Undo	Undoes the last cut, clear, or paste operation (shortcut - Ctrl+Z)

View Menu

Use the View menu to select a view for the currently selected Device Window. Not all views are available for every Pro64 device. Only one view of a device is available at a time.

Device Overview	Available for all devices; the most compact view
Inputs to Network	AllFrame, 6416i, 6416m, 6416dio, and 6416Y2 only
Outputs From Network	AllFrame, ASI, 6416o, 6416dio, and 6416Y2 only
Inputs and Outputs	AllFrame, 6416dio and 6416Y2 only
Device Presets (Show All)	AllFrame, ASI, 6416i, 6416o, 6416m, 6416dio, and 6416Y2 only
Port Names	MH10/MH10f only

Tools Menu

Lock or unlock the front panel of Pro64 I/O modules (6416i, 6416m, 6416dio, and 6416o only) using the commands in the Tools menu.

Lock Front Panel	Prevents front-panel editing for the selected I/O device. A lock icon will appear in the device's status bar.
Unlock Front Panel	Allows front-panel editing for the selected I/O device.
Card Configuration	6416Y2 card only – opens the Card Configuration dialog box where m-control, Serial Interface, and Pad mode settings can be changed.

Channel Settings Menu – Input Devices

The Channel Settings menu is available for I/O modules only (AllFrame, 6416i, 6416m, 6416Y2, 6416dio, and 6416o) and contains the commands listed below.

Input Module Settings (AllFrame, 6416i, 6416m, 6416Y2, and 6416dio)	
Activate Input Channel	Makes the selected channel active in the network and lights its green 'Active' LED.
Activate All Input Channels	Sets all channels of the current device as active in the network and lights their green 'Active' LEDs.
Deactivate Input Channel	Deactivates the selected channel, removing it from the network, and turns off its green 'Active' LED.
Deactivate All Input Channels	Deactivates all channels on the device, removing them from the network, and turns off all green 'Active' LEDs.
Stereo Link On	Activates a stereo link for a pair of adjacent channels.
Stereo Link Off	Clears the Stereo Link for the selected channels.
Clear Input Channel Name	Clears text from the Channel Name field.
Clear All Input Channel Names	Clears text from the Channel Name field of all 16 channels.
Clear Channel Settings	<i>AllFrame and 6416m only;</i> clears the channel strip parameters (Mute, Gain, Phase, Low Cut, Pad, +48V) for the selected channel.
Clear All Channel Settings	<i>AllFrame and 6416m only;</i> clears all channel strip parameters (Mute, Gain, Phase, Low Cut, Pad, +48V).
Clear All Input Matrix Slot Assignments	Resets an input device to the default routings.

✓ **NOTE** Activating one or more input channels on a Pro64 input module is subject to all Auto Mode network rules. Attempting to activate an input module's channel into a network Slot that is already in use by another input device will result in an error message.

Channel Settings Menu – Output Devices

Output Module Settings (AllFrame, 6416dio, and 6416o)	
Activate Output Channel	Makes the selected output channel active and lights its yellow 'Active' LED. <i>(Not available on ASI or 6416Y2 cards)</i>
Activate All Output Channels	Sets all output channels of the current device to active and lights their yellow 'Active' LEDs. <i>(Not available on ASI or 6416Y2 cards)</i>
Deactivate Output Channel	Deactivates the selected output channel and turns off its yellow 'Active' LED. <i>(Not available on ASI or 6416Y2 cards)</i>
Deactivate All Output Channels	Deactivates all output channels on the device and turns off all yellow 'Active' LEDs. <i>(Not available on ASI or 6416Y2 cards)</i>
Clear All Output Matrix Slot Assignments	Resets an output device to the default routings.

Presets Menu

The Presets menu is available for I/O devices only (AllFrame, ASI, 6416i, 6416m, 6416Y2, 6416dio, and 6416o) and contains the following commands:

Save Device Preset	Saves the current state of the Pro64 I/O device as a preset in the selected location (1-16); also used when updating existing presets.
Recall Device Preset	Recalls the currently selected preset for the device.
Clear Device Preset	Clears the currently selected preset and removes it from disk. There is no undo.
Clear All Device Presets	Clears all 16 presets and removes them from disk. There is no undo.

AUDIO SLOT MANAGER

The Audio Slot Manager allows the user to view the I/O routings for an entire Pro64 network from a central location, which is especially useful when a network has a large number of Pro64 I/O devices.

Use the Audio Slot Manager inspect any network Slot and get an easy-to-use overview of the Pro64 devices that have input and/or output assignments to the selected Slot. Two views are available: Slot Assignments and Slots and I/O Routing. Use the window's View menu to choose a view.



Audio Slot Manager Components

Audio Slot Manager Components	
1	Slot Assignments View
2	Input and Output Routing View
3	Slot numbers 1-64
4	Pro64 device supplying the input
5	Channel number on the source input device
6	Channel Name, from the source device
7	Inputs in the network assigned to the selected Slot
8	Active LED
9	Network outputs using the selected Slot
10	Scroll bars

Slot Assignments View

The Slot Assignments view shows the 64 network Slots as scrolling list. Information about the network's Slots is displayed in columns. The **SLOT** column shows the network Slots (maximum 64 Slots at 44.1/48kHz) by number. Scroll the list with the scroll bar handles on the right side of the window. The **DEVICE** column shows which Pro64 device is providing the input for each Slot (for example 6416m #1). The column marked **Ch** shows which input channel on that device is supplying the input to the network. The **CHANNEL NAME** column displays the user-entered channel name that was entered in the Device Window. A Slot with no assignment is shown blank. Click any row to select a Slot.

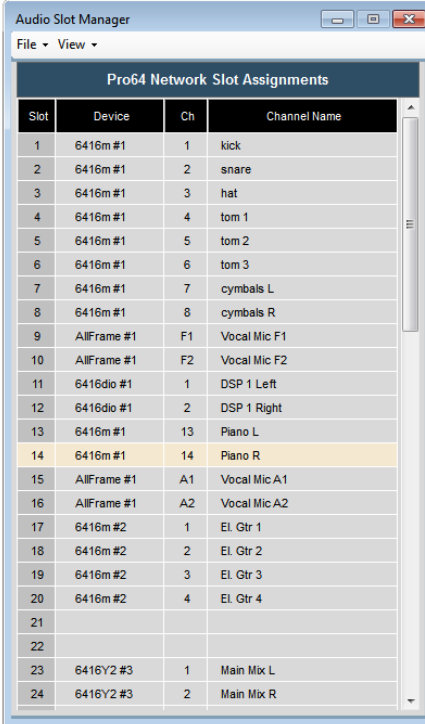

The screenshot shows the 'Audio Slot Manager' window with a menu bar (File, View) and a title bar. The main content is a table titled 'Pro64 Network Slot Assignments'. The table has four columns: Slot, Device, Ch, and Channel Name. The rows are numbered 1 through 24. Row 14 is highlighted in yellow. The table data is as follows:

Slot	Device	Ch	Channel Name
1	6416m #1	1	kick
2	6416m #1	2	snare
3	6416m #1	3	hat
4	6416m #1	4	tom 1
5	6416m #1	5	tom 2
6	6416m #1	6	tom 3
7	6416m #1	7	cymbals L
8	6416m #1	8	cymbals R
9	AllFrame #1	F1	Vocal Mic F1
10	AllFrame #1	F2	Vocal Mic F2
11	6416dio #1	1	DSP 1 Left
12	6416dio #1	2	DSP 1 Right
13	6416m #1	13	Piano L
14	6416m #1	14	Piano R
15	AllFrame #1	A1	Vocal Mic A1
16	AllFrame #1	A2	Vocal Mic A2
17	6416m #2	1	El. Gtr 1
18	6416m #2	2	El. Gtr 2
19	6416m #2	3	El. Gtr 3
20	6416m #2	4	El. Gtr 4
21			
22			
23	6416Y2 #3	1	Main Mix L
24	6416Y2 #3	2	Main Mix R

The Audio Slot Manager window displays all network resources as a list.

Information in this part of the window is read-only. Changes made to network Slot assignments or channel names from individual Device Windows or from the Slots and I/O Routing view of the Audio Slot Manager are instantly updated.

Slots and I/O Routing View

The default view for the Audio Slot Manager window shows both the **Slot Assignments** and the **Slots and I/O Routing** view. On the right side of the window, the routing for the selected Slot is divided into two sections, marked **INPUTS ASSIGNED TO SLOT x** and **OUTPUTS USING SLOT x** (where *x* is the Slot that was selected in the left side of the window, the Slot Assignments View).

The left side of the Slots and I/O Routing shows the network devices that have inputs assigned to the selected Slot and indicates which input is active with a green LED icon in its **ACTIVE** column. (Only one input can be active per network Slot.) To change the assignment to another device in the list, first disable the currently active device's input by clicking the green LED in its Active column. Then click the **ACTIVE LED** on a different device to assign it to the selected Slot. If the device you'd like to assign the Slot to is not displayed, open its Device Window from the Network Overview and make the assignment to the desired Slot there first. It will be added to the list of available inputs in the Slots and Routing view.

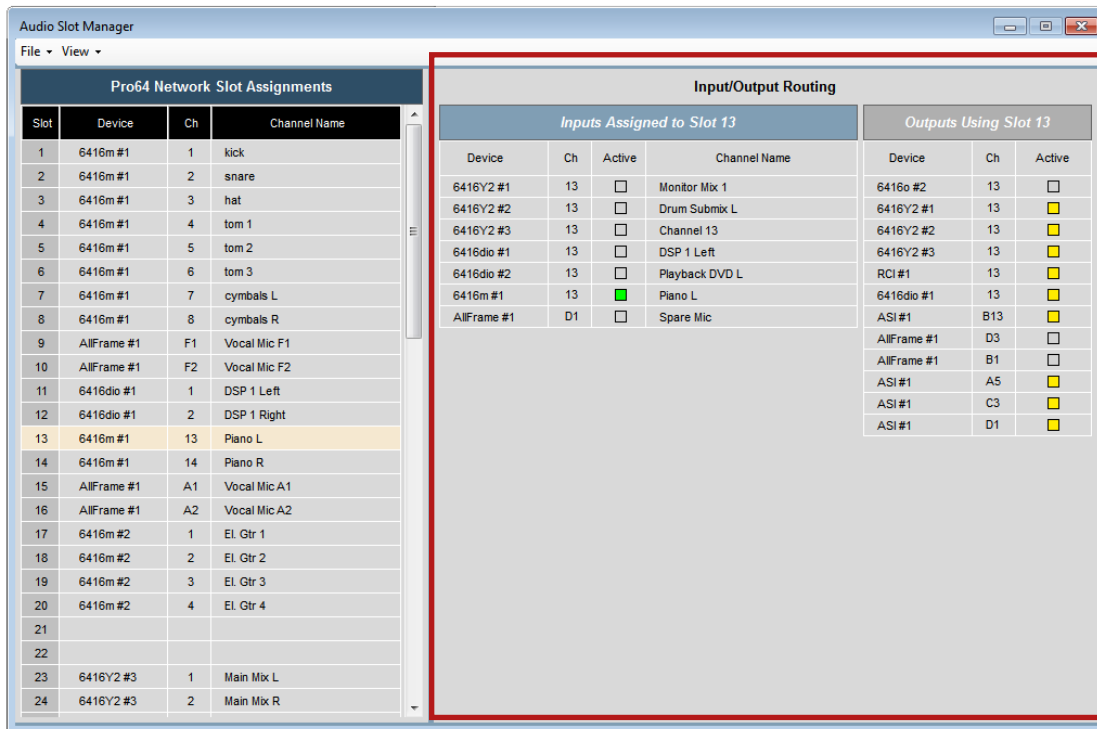

The Slots and I/O Routing view

The right side of the Slots and I/O Routing sections shows network devices that have an output assigned to use the selected input source. Any number of output devices can be assigned to use a network Slot, including multiple channels on the same device. Outputs that are active are indicated with a yellow LED in the **ACTIVE** column.

SCENE MANAGER

Within a project, Pro64 Network Manager can also save and recall complete network configurations in the form of a Scene, which can simplify I/O management of a Pro64 network. Up to 99 Scenes can be stored per project. Each configuration can be recalled quickly without the need to shut down the Pro64 Network Manager application, close the current project, or configure front-panel settings on I/O modules.

To open the Scene Manager window choose **SCENE MANAGER** from the Windows menu of the main workspace or use the keyboard shortcut Ctrl+2.

Scenes are an optional component of a Pro64 Network Manager project; there is no requirement to use Scenes once a project has been saved.

Information saved in a Scene includes:

- Type and quantity of all Pro64 devices in the network
- Active Slots on all I/O devices
- Slot routing and matrix settings
- Active Virtual Data Cables
- Channel names on all input devices
- User-created text, labels, comments, etc.
- Scene notes
- 6416dio and AllFrame clock source

Scenes do not save the following network-wide settings (these are saved in the project, except as noted):

- Sample Rate
- Control Master device
- Clock Master device
- Device Numeric ID and Location labels
- Port names for MH10 and MH10f
- Device Presets (managed individually for each I/O device)

✓ **NOTE:** The Scene Manager relies on the folder structure created by the project to manage its Scenes. Do not move or rearrange the project's sub-folders or their contents.

How Scenes Work

Scenes are designed to simplify the management and recall of network configurations and should not be confused with scenes as used in the context of a mixing console or digital audio workstation (DAW). **Scenes are not intended to provide seamless transitions between network configurations.** The time it takes for a Scene to load will vary, based on a variety of factors including the total number of Pro64 devices in use, the makeup of the network, and the cable distance between Pro64 devices for all Cat-5e and/or fiber optic cabling in the network.

✓ **NOTE:** Network outputs will mute briefly while Scenes are recalled as resources are reallocated to avoid noise or abrupt changes in level. This is normal behavior.

The Scene Manager Window

Components of the Scene Manager window are described below.



1	Number (No.) column for Scenes 1-99; sortable
2	Locked Scenes are indicated with a lock icon.
3	Scene Name; 16 characters maximum; sortable
4	Scene Valid indicates Scenes that are compatible with the current network hardware configuration with an OK icon. Incompatible Scenes show a red exclamation point ! symbol.
5	Scene Notes; user-defined text, up to 256 characters
6	Save, Recall, and Clear buttons for Scene operations

Scene Manager Features

The Scene Manager window consists of the Number, Lock, Scene Name, Scene Valid, and Scene Notes columns along with the window's menu bar and the Save, Recall, and Clear buttons.

Number Column

The Number column (abbreviated No.) lists the Scenes from 1-99. Sort the list by number by clicking in the column header. Scroll the window to see more Scenes.

Lock Column

When a Scene is locked, a lock icon is added to the column.

Scene Name Column

The Scene Name field holds user-created text, up to 16 characters per Scene. Sort the list by name by clicking in the column header.

Scene Valid Column

The Scene Valid column indicates Scenes that are usable within the current project with a green **OK** icon. If for any reason a Scene is missing or not compatible with the current project, a red exclamation point (!) will be displayed. Incompatible Scenes can not be loaded or edited.



No.	Lock	Scene Name	Scene Valid	Scene Notes
01		Setup	ok	all inputs off
02		Sound Check 1	ok	mic preamps 1-42 on
03		Sound Check 2	ok	channel names added
04		Sound Check 3	ok	sets mic pre levels
05		Show Levels 1	ok	
06		Show Levels 2	!	
07		Encore	ok	
08		DVD 5.1	ok	DVD into 6416i #2, Slots 1-6 on

Valid Scenes have a green OK icon; incompatible Scenes have a red exclamation point.

Scene Notes Column

The Scene Notes column holds user-created text, up to 256 characters per Scene.

Saving a Scene

Scenes are saved to disk within the Project Scenes folder found inside the project folder once a project has been saved. Scenes can be stored in any of the 99 locations in any order; available Scene locations are marked – **EMPTY** – in the Scene Name column.

10		DAW Record	ok	patch Ch. 1-48 from Stage to DAW
11	🔒	A Locked Scene	ok	right-click the Lock column
12		Clear All	ok	clears labels & comments
13		A New Scene		
14		- Empty -		

Clicking in an empty Scene field allows you to enter a name for the Scene.

To save a Scene, place the cursor in the **SCENE NAME** field of an empty Scene location. Once the cursor changes to the text entry tool, type in a name for the new Scene (16 characters maximum). Press the **ENTER** key on the PC keyboard.

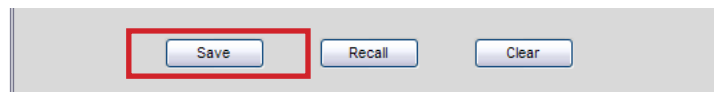

Click Save to store the Scene.

Confirm the save operation in the dialog box that appears by clicking **OK**; the Scene is stored to disk and is ready to use. Clicking **No** in the Save dialog box will exit and cancel the save operation. To save a Scene and use the default name (Scene 01, Scene 02, etc.), select an empty Scene row and then click the **SAVE** button or choose **SAVE SCENE** from the Scene menu. Confirm the save operation by clicking **OK**.

Adding Scene Notes

Use the Scene Notes field to store text information related to a Scene. Up to 256 characters can be entered. Once a Scene has been saved, you can enter Scene Notes text at any time. Text can be added to the Scene file without requiring the Scene to be re-saved, allowing you to add and edit notes for multiple Scenes without requiring them to be recalled first. Scene Note text is saved with the project.

To edit existing note text, click in the Scene Notes field for a Scene. When the text cursor appears, select all or part of the current text to change or delete. Use the Edit menu's **CUT**, **COPY**, and/or **PASTE** commands as needed. Press the keyboard **ENTER** key or click in another Scene row to complete the edit. The text is added to the Scene file without requiring the Scene to be re-saved. Scenes Notes cannot be added or edited if a Scene is locked. Remember to save the project after editing Scene Notes.

Use the Escape (**Esc**) key on the keyboard to exit the text entry mode without changing the existing text.

Renaming a Scene

Unlocked Scenes can be renamed at any time while a project is open. To change a Scene's name, click in the **SCENE NAME** field for the selected Scene. When the text cursor appears, change the name as needed. Press the keyboard **ENTER** key and then confirm the edit (click **Yes**) to complete the operation. The Scene name is changed and the Scene file is updated on disk; you do not need to re-save the Scene with the Save button to rename a Scene. Save the project after editing Scene names.

You can also use the Edit menu's **CUT**, **COPY**, and/or **PASTE** commands during renaming. Use the Escape (**Esc**) key on the keyboard to exit the text entry mode without changing the existing Scene name text.

Recalling a Scene

Once Scenes are saved to disk with a project they can be recalled as needed. To recall a Scene, click anywhere in the row of a valid Scene to select it; the row will be highlighted. Click the **RECALL** button in the Scene Manager window or choose **RECALL SCENE** from the Scene menu to recall the Scene.

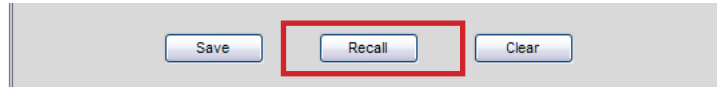

Select a Scene and click Recall.

✓ **NOTE:** Remember that audio will mute briefly while the network is reconfigured.

The time it takes to recall a Scene and reconfigure the network will vary and is based on the number of Pro64 devices, the distance between devices, and the device's relative location to the Control Master.

Making Changes to Existing Scenes

To edit and update an unlocked Scene that has already been saved, first make any changes to the Pro64 devices in the network that are required including I/O routing, channel names, Slot ranges, etc. Then select the Scene to be updated by clicking the appropriate row of the Scene Manager; the row will be highlighted. Click the **SAVE** button and then confirm the overwrite message in the dialog box that appears. The new configuration is stored to disk.

Clicking the **No** button in the dialog box will cancel to update operation and return you to the Scene Manager window.

✓ **NOTE:** Only unlocked Scenes can be updated.

Locking a Scene

To prevent changes from being made to a Scene, use the lock function. Locking a Scene prevents changes from being made to the Scene's contents, the Scene Name and Scene Notes fields, and also prevents the Scene from being deleted from disk when using any of the Clear commands. Locking a scene will not prevent it from being recalled.

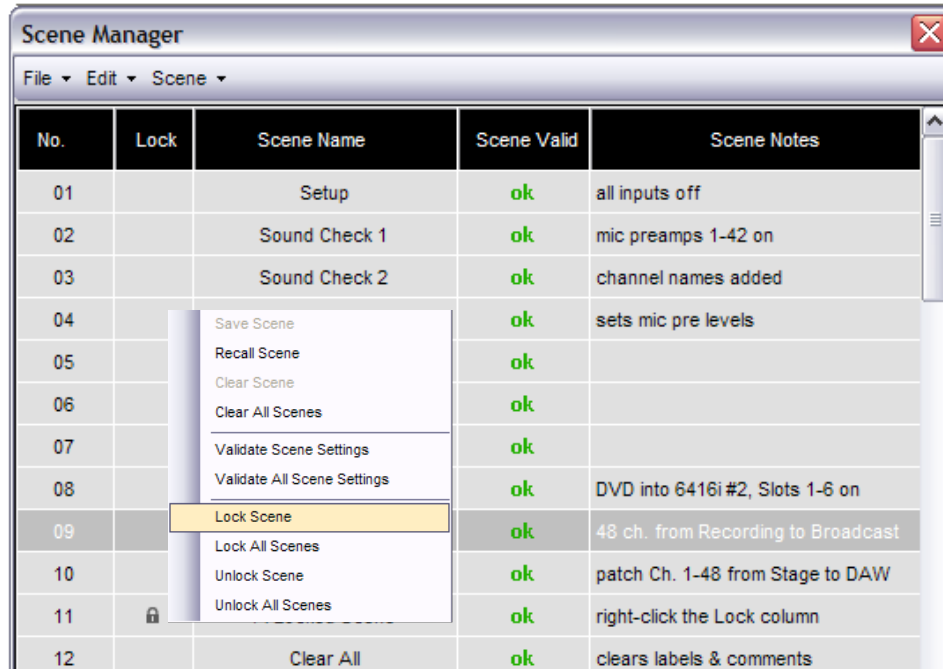

Lock a Scene by right-clicking in Scene row.

To lock a Scene, click a Scene row to highlight it. Right-click in the row to open the contextual menu. Choose **LOCK SCENE** from the menu that appears. A lock icon is added to the row. As an option, choose **LOCK SCENE** from the Scene Manager window's Scene menu.

To unlock a Scene, right-click on a selected Scene's Lock column and choose **UNLOCK SCENE** from the contextual menu or choose **UNLOCK SCENE** from the window's Scene menu.

Locking All Scenes

To lock all the Scenes in a project, use the **LOCK ALL SCENES** command found in the Scene menu as well as in the contextual menu. All Scenes will have the lock icon added to their rows. To unlock all currently locked Scenes use the **UNLOCK ALL SCENES** command. All Scenes are returned to their edit-ready state.

Empty Scenes cannot be locked.

Clearing Scenes

To remove one or more Scenes from a project, use the Clear command. First click a Scene row to highlight it. Click the **CLEAR** button and confirm the operation in the dialog box that appears by clicking **Yes**. The Scene file is removed from disk and the Scene row is returned to the default settings. Clicking **No** in the dialog box will cancel the clear operation.

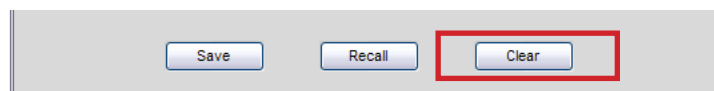

Remove a Scene from the project with the Clear button.

As an alternative, choose the **CLEAR SCENE** command from the Scene Manager window's Scene menu. There is no undo.

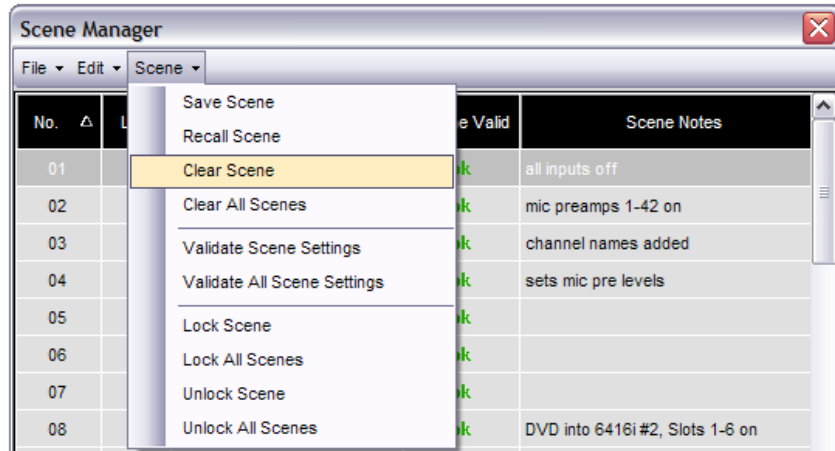

Use the commands in the Scene menu to delete Scenes from a project.

To clear all the Scenes in a project use the **CLEAR ALL SCENES** command found in the Scene menu. In the dialog box that appears click **Yes** to permanently erase all Scene files from disk and remove them from the project or click **No** to return to the Scene Manager window without deleting any of the Scene files. There is no undo possible when deleting all Scenes. Save the project after editing and clearing Scenes.

Scene Compatibility

To be used online with a Pro64 Network Manager project, a Scene needs to contain information that is compatible with the exact quantity and type of all Pro64 devices in the network. Changing the number of Pro64 devices in the network, for example from two 6416m to three 6416m mic preamps, will cause any Scenes created when only two 6416m preamps were in the network to be invalid when three 6416m preamps are connected. AllFrame I/O cards must be in the same slot (A-F) as when the Scene was saved in order to be valid.

Working Online

When a project is loaded while working online, every Scene in the project file is checked for compatibility. If the Scene is compatible it is marked in the Scene Valid column of the Scene Manager window with a green **OK** icon. This icon indicates that the Scene can be loaded into the current hardware configuration.

If a Scene is found to be incompatible it will be marked with a red exclamation point icon (!) in the Scene Valid column. Scenes can become invalid for a number of reasons including a change in the makeup of the network (a Pro64 device is not powered up, for example), a Scene being renamed or moved from the project folder, or a cable problem causing A-Net communication between devices to change or become intermittent.

Working Offline

When working offline, Scenes can be edited as needed; new Scenes can also be created without requiring a network connection. Scenes are only checked for compatibility when the network transitions from working offline to working online. As happens when a project is opened while already online, all valid Scenes are marked **OK** and any invalid Scenes will show (!) in the Scene Valid column.

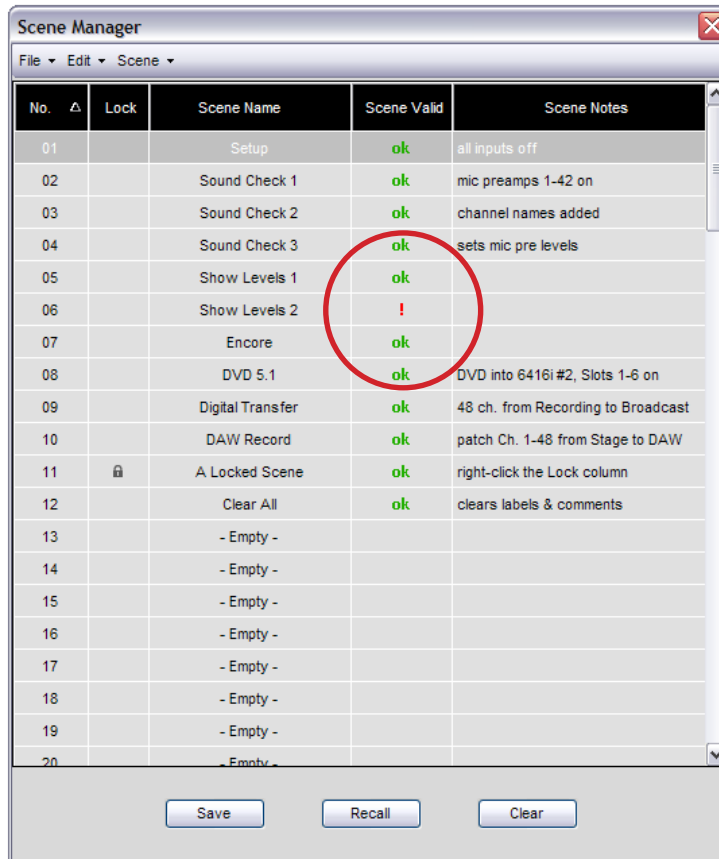

Valid scenes are marked in green, invalid ones in red.

Scenes in an online network that start out as valid will become invalid if a new Pro64 device is added to (or removed from) the network after the Scenes have been saved because the device count has changed.

Validating Scenes

There are two utility commands for checking Scenes within a project. Choose the **VALIDATE SCENE SETTINGS** command to re-scan a single selected Scene for compatibility with the current network or choose **VALIDATE ALL SCENE SETTINGS** to check all Scenes in the project. Any Scene whose compatibility has changed will have its status in the Scene Valid column updated

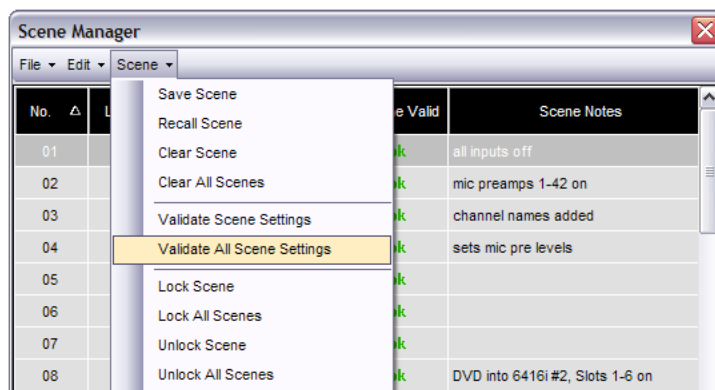

Validate Scene commands in the Scene menu

Scene Manager Menus

The Scene Manager menu commands are described below; they are also available by right-clicking in the Scene Manager window.

File Menu

The File menu contains the following command:

Close Window	Closes the Scene Manager window (shortcut - Ctrl+W)
---------------------	---

Edit Menu

The Edit menu contains the text editing commands described below. Note that the Edit menu's text editing commands only apply while actively editing text in the Scene Name and Scene Notes fields.

Undo	Undoes the last text-based cut, clear, or paste operation (shortcut - Ctrl+Z)
Redo	Resets text to the last cut, clear, or paste operation (shortcut - Ctrl+Shift+Z)
Cut	Cuts the selected text (shortcut - Ctrl+X)
Copy	Copies the selected text to the clipboard (shortcut - Ctrl+C)
Paste	Pastes text that was copied to the clipboard (shortcut - Ctrl+V)
Clear	Clears the selected text (shortcut - Del key)

Scene Menu

The Scene menu contains the commands used to manage a project's Scenes.

Save Scene	Saves a Scene in the currently selected location
Recall Scene	Recalls the currently selected Scene
Clear Scene	Clears the currently selected Scene, erasing the file from the project and the hard disk; there is no undo.
Clear All Scenes	Clears all Scenes, erasing the files from the project and the hard disk; there is no undo.
Validate Scene Settings	Check the currently selected Scene to verify that it is compatible with the current network configuration
Validate All Scene Settings	Checks all Scenes in the project to verify that they are compatible with the current network configuration
Lock Scene	Locks the currently selected Scene
Lock All Scenes	Locks all Scenes without requiring that they be selected first
Unlock Scene	Unlocks the currently selected Scene
Unlock All Scenes	Unlocks all Scenes without requiring that they be selected first

VIRTUAL DATA CABLE MONITOR

A Pro64 Network Manager project saves the configuration of all Virtual Data Cables (VDC) active in the network as part of a project. You can also use Scenes to recall different combinations of VDC assignments from within a single project if required.

The read-only Virtual Data Cable Monitor window provides an overview of the 14 available VDC Slots. Making changes to VDC settings and routing must be done from the front panels of the Pro64 devices.

To open the Virtual Data Cable Monitor window choose **VIRTUAL DATA CABLE MONITOR** from the Windows menu of the main workspace or use the keyboard shortcut Ctrl+3. Resize the window as needed; scroll bars appear automatically as the window is resized.

The Virtual Data Cable Monitor Window

Components of the Virtual Data Cable Monitor window are described below.

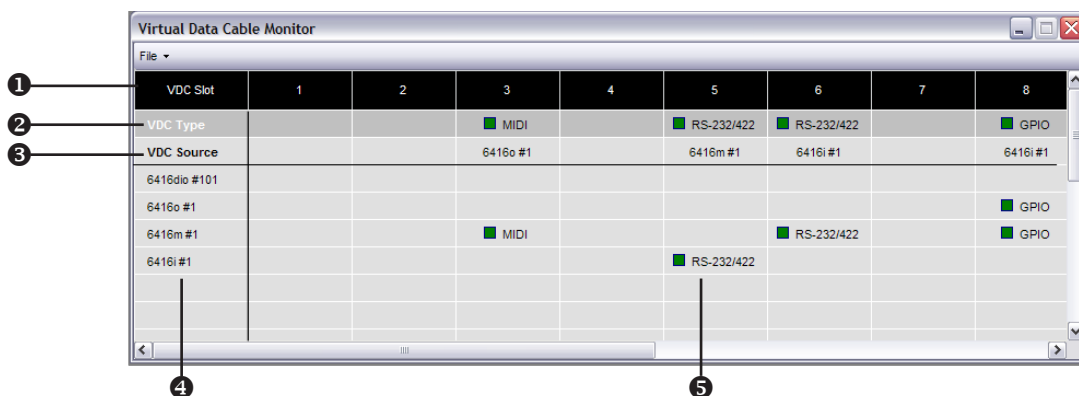

①	VDC Slots; each of the 14 columns lists the settings for one of the Virtual Data Cables
②	VDC Type; shows the type of Virtual Data Cable input that is active on the source device
③	VDC Source; the Pro64 device where the VDC input is connected
④	List of all VDC-compatible devices in the current network
⑤	VDC destination; shows the type of Virtual Data Cable being output from the Pro64 device

VDC Slots

The top row of the Virtual Data Cable Monitor window contains the 14 columns for the network's VDC Slots. Each column contains the routing information for one of the Virtual Data Cables.

VDC Type

When a Virtual Data Cable is activated from a Pro64 device, information about the VDC will be displayed in the VDC Type column. Valid entries include GPIO, MIDI, and RS-232/422.

An active VDC will show a yellow LED icon when only its input is activated. It will display a green LED icon when the input is connected to a valid output somewhere in the network.

VDC Slot	1	2	3	4	5	6	7	8
VDC Type			🟡 MIDI					🟢 GPIO
VDC Source			6416o #1					6416i #1
6416dio #101								
6416o #1								🟢 GPIO
6416m #1								🟢 GPIO
6416i #1								

VDC 3 has an incomplete MIDI connection; VDC 8 shows a GPIO connection with two outputs.

RS-232/422 VDC

When using RS-232 or RS-422 with a VDC, remember that these data types require a pair of Virtual Data Cables per connection—one for transmit, the other for receive. An incomplete RS-232 or RS-422 VDC will have yellow LED icons in two columns.

VDC Slot	1	2	3	4	5	6	7	8
VDC Type			🟢 MIDI			🟡 RS-232/422		🟢 GPIO
VDC Source			6416o #1			6416i #1		6416i #1
6416dio #101								
6416o #1								🟢 GPIO
6416m #1			🟢 MIDI					🟢 GPIO
6416i #1					🟡 RS-232/422			

Yellow icons indicate that VDC 5-6 has an RS-232/422 input on 6416i #1 but no output device has been selected.

VDC Source

The VDC Source row indicates the Pro64 device in the network where the active VDC input is located. This row will be blank for a VDC Slot until a VDC becomes active.

VDC Compatible Devices

The Pro64 devices in your network that are capable of using Virtual Data Cables will be listed along the left side of the Virtual Data Cable Monitor window. Compatible devices in this list can include:

- 6416i Line-Level Input Module
- 6416m Mic Input Module
- 6416o Output Module
- 6416dio Digital I/O Module
- 6416Y2 A-Net Interface Card

The AllFrame, ASI, RCI, MH10, and MH10f have no VDC ports and will not appear in this list, even if they are installed in the network.

VDC Destination

When an active VDC is being output from a Pro64 device, the output VDC will be shown in the VDC Destination row for each of the 14 VDC Slots.

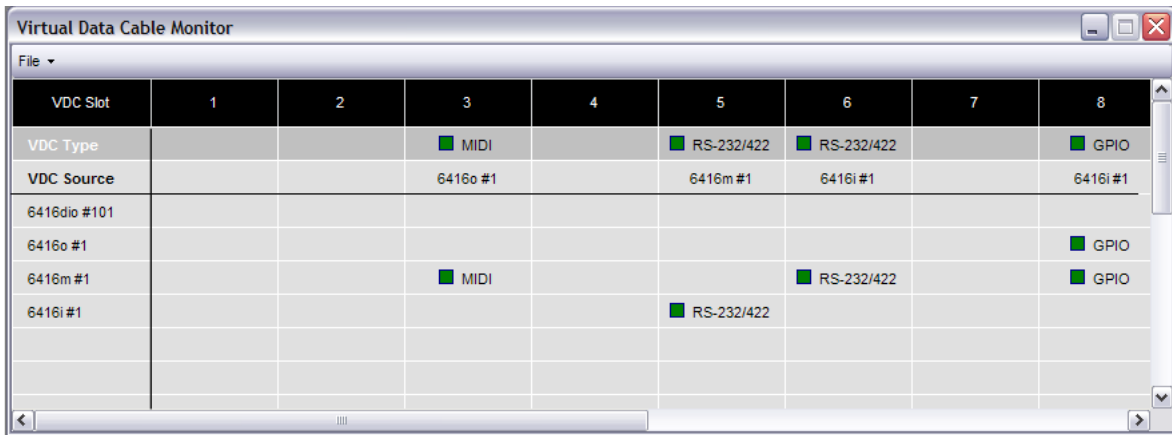

VDC Slot	1	2	3	4	5	6	7	8
VDC Type			■ MIDI		■ RS-232/422	■ RS-232/422		■ GPIO
VDC Source			6416o #1		6416m #1	6416i #1		6416i #1
6416dio #101								
6416o #1								■ GPIO
6416m #1			■ MIDI			■ RS-232/422		■ GPIO
6416i #1					■ RS-232/422			

Three different types of VDC connections are shown.

Note that multiple copies of GPIO and MIDI Virtual Data Cables can be output if required. RS-232 and RS-422 are handshaking protocols; only one input device and one output device can be active per connection. The Pro64 network is capable of distributing a maximum of seven such transmit/receive connection pairs.

EVENT LOG WINDOW

Pro64 Network Manager creates a log of application- and project-related events while you work. To open the Event Log window choose **EVENT LOG** from the Windows menu of the main workspace or use the keyboard shortcut Ctrl+4.

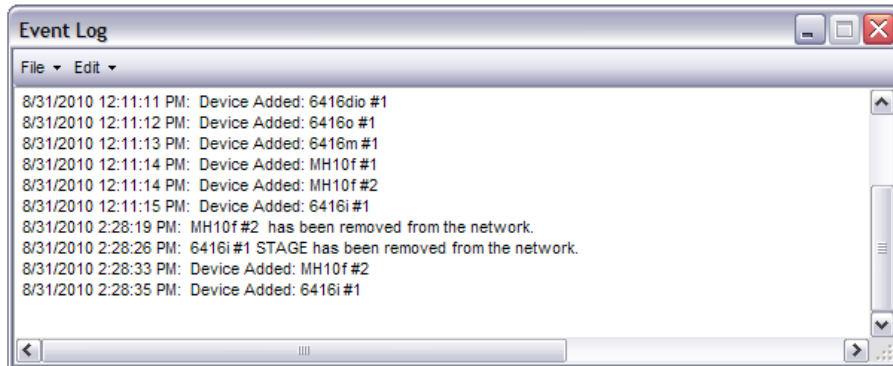

The Event Log window

The Event Log window can be resized as needed and positioned anywhere within the workspace.

Saving Event Log Text

To save text from the Event Log window, select the desired region of text and use the copy and paste commands to save it in a standard word processor document window or email.

TROUBLESHOOTING

The following section provides troubleshooting tips for the Pro64 Network Manager software.

Problem	Possible Solutions
AllFrame – I/O card not recognized	<ul style="list-style-type: none"> Update firmware on the F6
AllFrame – no audio	<ul style="list-style-type: none"> Check that the device is not in Standby Mode
Blue A-Net LED is blinking on some network devices' front panels	<ul style="list-style-type: none"> A blinking A-Net LED indicates a device whose firmware is out of date. Run the firmware update utility.
6416Y2 card – m-control is not working	<ul style="list-style-type: none"> The 6416Y2 card needs to be installed in MY expansion slot #1. Check the m-control source—Rear Panel or Backplane—in the Card Configuration window (found in the Tools menu of the 6416Y2 Device Window). Check that the network Slots to be remote controlled are activated in the Card Configuration window A single card cannot be the network Control Master and provide m-control. Set a different Pro64 device or another 6416Y2 card as Control Master. Check front panel DIP switch #10 on the 6416Y2; it should be down to activate m-control.
6416Y2 card – only 8 channels available at 44.1/48kHz	<ul style="list-style-type: none"> Check SW8, switch #10. Set it to up for 16-channel operation and down for 8-channel. For the PM1D, this is normal.
6416Y2 card – the Status icon is yellow instead of blue.	<ul style="list-style-type: none"> Power down the Yamaha host device and remove the 6416Y2 card. Check SW9, DIP switch #10. It must be up for PC control.
Network Overview – cannot see all the network's devices	<ul style="list-style-type: none"> Check that device filtering is not active; choose FILTER SETTINGS... from the View menu and click the RESET button.
Cannot update firmware on the Control Master device	<ul style="list-style-type: none"> Try temporarily using a different device as Control Master for the firmware update; return to the original configuration once the firmware has been successfully updated.
Firmware updates fails or does not complete for a device	<ul style="list-style-type: none"> Try moving the device closer to the Control Master, keeping all cables as short as possible. Try a different USB-to-RS-232 adapter.

Problem	Possible Solutions
<p>Pro64 Network Manager cannot communicate with the network</p>	<ul style="list-style-type: none"> ▪ Check the RS-232 cable and communication settings. ▪ Keep all RS-232 cables as short as possible. ▪ Incorrect RS-232 baud rate settings ▪ USB-to-RS-232 device is not set up properly ▪ Incorrect RS-232 cable; must be null modem and not a straight through cable ▪ Check the pinout of the RS-232 null modem cable using a multimeter.
<p>Pro64 Network Manager software is unstable or will not launch</p>	<ul style="list-style-type: none"> ▪ Check that the computer is running the proper version of the Windows OS—Windows XP with Service Pack 3 or Windows 7 ▪ Check that the computer has the correct Microsoft .NET Framework 3.5 components installed (available on the Microsoft website). ▪ Run the 'regedit' utility and search for NET FRAMEWORK SETUP to find the versions installed on your PC.

APPENDIX

RS-232 Cables and Pinout

Using an RS-232 device with a Pro64 device requires a female-to-female DB9 null modem cable (also referred to as a crossover cable).

The RS-232 jack found in the VDC section of a Pro64 device has the following pinout.

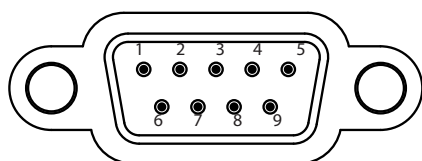

DB9 connector pinout on a Pro64 device

RS-232 Connections

The table below describes the pinout for the RS-232 connectors found on Pro64 devices.

Pin	Signal
1	Data Carrier Detect *
2	Received Data
3	Transmitted Data
4	Data Terminal Ready *
5	Signal Ground
6	Data Set Ready *
7	Request To Send *
8	Clear To Send *
9	Ring Indicator *

* *Not supported, no connect*

Wiring a DB9 Crossover Cable

The following table can be used to create a null modem (crossover) cable:

Crossover Cable	
Pin #	Pin #
1 and 6	4
2	3
3	2
4	1 and 6
5	5
7	8
8	7
Pin 9 - no connect	

Index

Symbols

- 24dB Pad 101
- +28dBu 81
- 48kHz 60
- +48V 100, 101, 112, 117
- 49-64 67
- 96kHz
 - 6416Y2 card 90
- 192kHz 60
- 6416dio Digital I/O Module 23, 55, 65, 94, 111, 116, 134
 - clock error 94
 - RS-422 23
- 6416i Line-Level Input Module 55, 116, 131, 134
- 6416m Mic Input Module 55, 71, 100, 116, 134
 - change gain 100
 - Clear Channel Settings 101
- 6416o Output Module 55, 134
- 6416Y2
 - Firmware Update 83
- 6416Y2 A-Net Interface Card 22, 56, 65, 70, 71, 83, 101, 116, 134
 - 96kHz 90
 - Card Configuration 89
 - Outputs From Network 111
 - stereo links 99
- 6416Y2 as a Slave Device 25
- 6416Y2 as Control Master 25
- 6416Y2 Card 23
 - channels 9-16 disabled 86
 - Control Master 83
 - DIP Switch 26
 - DIP switch control 27
 - firmware update 26
 - Front Panel DIP Switches 25
 - Managed Mode 27
 - Pro64 Network Manager enabled 27
 - Status Icon 83
 - Virtual Data Cable 85
- 6416Y2 card - 8 channels 136
- 6416Y2 Card Outputs 110
- 6416Y2 firmware update 35
- 6416Y2 outputs
 - yellow LED 87
- 6416Y2 Output Slots 87, 88
- .NET Framework 6, 137
- .nmp extension 39
- .upd extension 12

A

- A-16II Personal Mixer 105
 - Zones 105
- About Pro64 Network Manager 51
- activate a channel 68

- Activate All Input Channels 108, 117
- Activate All Output Channels 118
- Activate Input Channel 117
- Activate LED Device Identify 54
- Activate Output Channel 118
- Activating All Channels 68
- Activating Channels 68
- Active column 98, 99, 101
- Active LED 109, 118, 119
- Active Slot 122
- active VDC 134
- Adapter
 - RS-232 22
- Adobe Reader 12, 51
- AES3 74, 94
- AES3 clock 4, 75, 80
- AllFrame 2, 3, 21, 24, 56, 65, 70, 71, 72, 98, 99, 111, 116
 - I/O card 72, 112
 - Mic level 81
 - mic preamp 100
 - Output Level Settings 82
 - Outputs 101
 - Slot range 67
 - Standby 77
 - Standby Mode 4, 54
 - Standby momentary switch 77
 - USB driver 12
- AllFrame C4dio
 - sample rate converter 4
- AllFrame compatibility 41
- AllFrame I/O cards
 - Scene 128
- AllFrame I/O Grid 66
- AllFrame Multi-Modular I/O System 2
- AllFrame Output Levels 81
- Alt+F4 48
- analog audio output
 - AllFrame 81
- A-Net 78, 128
- A-Net icon 52, 53
 - blue 84
 - yellow 54, 84
- A-Net LED 136
- A-Net Slot
 - monitor 95
- A-Net status icon 65
- Apple 6
- application folders 12
- ASI 116
 - Device Preset 108
 - Manage Slot Assignments 106
 - Matrix Assignments 105
 - Port names 122
 - Pro16 Zone 92

- Zone 108
- ASI A-Net Systems Interface 56, 92, 110
- ASI Matrix View 108
- ASI Outputs 110
- Assigning Input Channels
 - Matrix 70
- Audio Clock Source 4
- Audio Clock Source menu 74
- audio output
 - mute 122, 126
- Audio Slot Manager 14, 18, 119
 - Slot Assignments View 120
- Auto Mode 46
- Auto Pad 90
- Aviom folder 12, 35

B

- baud rate 22, 26, 137
- blue A-Net icon 53
- bracket icon 99
- building
 - Elvis has left the 58

C

- C4dio
 - Sample Rate Converter 75
- C4dio card 4
 - sample rate converter 4
- C4dio Card 74
- C4o
 - Output Level Settings 82
- C4o Analog Output Card 81
- cable
 - DB9 null modem 21
- Cable
 - RS-232 138
- cable pinout 21
- cancel
 - Firmware Update 32
- Cancel Waiting button 31
- Card Configuration
 - 6416Y2 89
- Card Configuration window 136
- Card Mode 90
- cards
 - AllFrame I/O 41
- card slot 72
- change a Slot range 67
- change gain
 - 6416m 100
- Changing Column Widths
 - Network Overview 53
- Channel Activation Warning 68, 69
- Channel Name 98, 102, 112
- Channel Name column 120
- Channel Name field 117
- channel on/off 112

- channel pair
 - 6416Y2 card 88
- channels 9-16 disabled
 - 6416Y2 card 86
- Channel Settings, 6416m 100
- Channel Settings menu 68
- Channel Settings Menu 117, 118
- Channel/Slot Conflicts 69
- channel strip 100
- channel strip parameters 117
- Ch column 98, 101
- checksum 30
- choosing devices to update 30
- Clear 127
- Clear All Device Presets 118
- Clear All Input Channel Names 117
- Clear All Matrix Slot Assignments 97
- Clear All Output Channel Settings 82
- Clear All Output Matrix Assignments 109
- Clear All Scenes 128, 131
- Clear button 114
- Clear Channel Settings 101, 117
 - clear all 117
- Clear Device Preset 118
- Clearing a Device Preset 114
- Clear Input Channel Name 117
- Clear LED Device Identify 55
- Clear Matrix Assignments 97
- Clear Matrix Slot Assignments 117
- Clear Output Level Settings
 - AllFrame 82
- Clear Scene 131
- Clear Text 115, 117, 130
- Clock 46
- Clock Error 47, 94
 - 6416dio 94
- Clock Master 38, 41, 46, 57, 65, 122
- clock source 94
- Clock source 38, 122
- Clock Source 4
- Close All 50
- Close command 48
- Close Window 61, 115, 130
- CL Series 91
- comments 38, 122
- Comments 52, 60
- Communication Setup 22, 24
 - 6416Y2 25
- Compatibility 128
 - projects 41
 - Scene 129
- Compatible Devices
 - VDC 134
- Completed Devices 31
- COM port 21, 22, 28, 44
- Computer Requirements 6
- configuration 40, 122, 132
 - m-control 84
- conflict

- Slot activation 114
- Connecting For the First Time 28
- Connect to Network 43
- contact closure 4, 77, 79
- contextual menu 56
- Control Group 52, 60, 71, 91
- Control Master 2, 21, 24, 38, 41, 46, 57, 65, 122, 126, 136
 - 6416Y2 83
 - DIP switch 23
 - Managed 22
 - m-control 85
- Control Panel
 - Windows OS 11
- control panel cover 24
- Copy 62
- copy/paste text 62
- Crossover Cable 138
 - wiring 139
- Cut 62
- Cut, Copy, Paste
 - Scene 125

D

- DB9 2, 139
 - pinout 138
- DB9 cable 21
- DB9 serial cable 91
- Deactivate a channel 68
- Deactivate All Input Channels 117
- Deactivate All Output Channels 118
- Deactivate Input Channel 117
- Deactivate Output Channel 118
- Deactivating Channels 68
- Deactivating Slots 70
- default install location 10, 12
- default location
 - firmware update 35
- default name 113
- Demo Project 3, 12
- Device column 120
- Device Column 56
- Device field 102
- Device Identify 54, 62
- Device Manager
 - Windows OS 28
- Device Menu
 - Network Overview 62
- Device Number 52
- Device Overview 64, 89, 98, 116
- Device Preset 38, 39, 40, 41, 64, 83, 96, 98, 101, 112, 113, 118, 122
 - ASI 108
 - matrix assignments 103
 - output levels 81
 - rename 114
- Device Presets (Show All) 116
- Devices
 - filter 58

- devices in the network 122
- Device Type 30, 52
- Device Update 12
- Device Window 13, 14, 16, 63
 - 6416Y2 84, 87
 - User Label 59
- Device Window Menus 115
- Device Window Views 98
- digital audio workstation 122
- DIP switch 22, 25, 83, 136
 - 6416Y2 88, 90
 - 6416Y2 card 26
 - stereo link 99
- DIP switch control
 - 6416Y2 card 27
- disable m-control 25
- Disable RS-232
 - VDC 22
- Discard 43
- Documents folder 12
- double dash symbol 96, 97
- download 35
- drag 53
- Drivers 12

E

- editing projects
 - offline 38
- editing text
 - Scene 125
- edit lock 55, 116
- Edit Menu
 - Device Window 115, 130
 - Network Overview 62
- edit notes 125
- Edit Numeric ID... 56
- egg
 - Easter 100
- Empty 125
- Empty Scene 127
- Enter button 22
- error
 - Slot activation 114
- Escape key 125
- Euroblock
 - Standby 77, 79
- Euroblock connector 4
- Event Log 14, 19, 20, 50, 135
 - saving text 135
- exclamation point icon 36, 53
- Exit 46, 49
- exit Firmware Update 32
- Exit Setup 11
- external clock 4
- External Clock 46, 47, 74, 75, 80

F

- F6 Modular I/O Frame 2, 21, 24, 72
- Fab Four 104
- Failed Devices 31
- File Menu
 - Device Window 115, 130
 - Firmware Update 33
 - Network Overview 61
 - Workspace 49
- Filter
 - Device Type 57
 - Network Overview 57
 - reset 58
 - Slot Range 60
 - Uncheck All 58
- Filter Dialog Box 58
- Filter On 58
- Filter Settings 57, 58, 60, 62, 136
 - project 58
- Finish button 31
- Firmware 2, 5, 33
 - roll back 20, 35
- Firmware Report 33
- firmware roll back 36
- Firmware Update 14, 20, 21, 35
 - 6416Y2 26, 83
 - cancel 32
 - default location 35
 - m-control 85
 - Print report 33
 - time remaining 32
- Firmware Update Fails 31
- firmware update file 12
- Firmware Update Utility 29, 30
- Firmware Update Window
 - close 32
- firmware version 30
- folder 39, 122
 - project 38, 39
 - Scene, Device Preset 38
- folders 12
- Front Panel DIP Switches
 - 6416Y2 card 25
- front panel LED flashing 62
- Front Panel Lock 55
- FTDI USB Driver 12

G

- Gain 100, 112, 117
- gain range 90
- garden gnome 98
- gimme back
 - that filet o' fish 112
- GPIO 133, 134
- gray Status icon 75, 77
- green channel LED 70
- green LED icon 133

- green OK 124
- Grids 65

H

- Hardware Standby 79
- Hardware Standby Active 79, 80
- Help
 - mono, PMC 1255 51
- Help Menu
 - Workspace 51
- Hub 93

I

- ID 46
- in 38
- incompatible device 36
- Input Assignments 70
- input module
 - stereo link 99
- Input/Output Grids 65
- Inputs and Outputs 116
- Inputs Assigned to Slot 121
- Input Slot Range 52, 53
- Inputs to Network 64, 66, 68, 89, 98, 111, 116
- Installation Location 9
- Installing Pro64 Network Manager 6
- install location, default 12
- Internal Clock 46, 80, 94
- invalid Scene 128
- I/O Card 72
 - AllFrame 72, 112
- I/O Grid 65
 - AllFrame 66
- I/O routing 18, 119

L

- Labels 59
- LED Device Identify 54, 62
 - clear 55
- LED flashing
 - front panel 62
- LED icon 133
- License 8
- Link a Channel Pair 99
- Locate Update Files 33
- Location 30, 38, 52, 58, 59, 122
- Lock All Front Panels 55
- Lock All Scenes 127, 131
- Lock Column
 - Scene 124
- Locked Scene 123, 125, 126
- Lock Front Panel 55, 116
- lock icon 55, 116
- Locking a Scene 126
- Lock Scene 127, 131
- Lock/Unlock

- Front Panel 55
- Log 14, 19, 135
- Log file 50
- Low Cut 100, 112, 117
- LS9 console 91

M

- M7CL-ES 91
- Mac OS 6
- Maintaining a v3 Network 35
- Managed button 22
- Managed Mode 26
 - 6416Y2 26, 27
- Manage Slot Assignments 106, 107
- Manual Mode 1
- Manual Pad 90
- matrix 38, 69, 122
- Matrix 58, 60, 67, 70, 102, 103, 104, 112
- Matrix Assignment 96, 99, 103, 112
 - Clear 109
 - Output 103
- Matrix Assignments - ASI 105
- m-control 25, 27, 71, 84, 85, 89, 90, 91
 - Control Group 91
 - Control Master 85
 - during firmware updates 85
 - troubleshooting 136
- m-control configuration 84
- MCS 90
- MCS Sync 95
- Menu Commands
 - Workspace 49
- MH10 112
 - Port names 122
- MH10 Merger Hub 64, 93, 116
- MH10/MH10f Merger Hub 56
- Mic level
 - AllFrame 81
- Mic Preamp
 - AllFrame 100
 - channel strip settings 100
- mic preamp settings 112
 - clear all 101
- MIDI 133, 134
- momentary switch 4
- monitor
 - A-Net Slot 95
 - RCI 95
- multi-zone monitor mix 105
- mute 122, 126
 - audio output 122
- Mute 100, 112, 117
- Mute All 47, 49
- MY8 90
- MY8 mode 86
- MY8, MY16 mode 86
- MY16 90
- MY expansion slot 136

N

- name a Scene 125
- Net Framework Setup 137
- Network Clock 46, 80, 94
- network configuration 122
- Network menu 37
- Network Menu
 - Workspace 49
- Network outputs
 - mute 122
- Network Overview 13, 14, 36, 50, 52, 63
 - filter 57
 - User Label 59
- Network Overview Menus 61
- Network Report 61
- Network Slots
 - remote controlled 91
- Neutrik EtherCon. *See* EtherCon
- New Device 56
- new firmware available 30
- New Project 38, 49
- No Active Input 102, 103
- Notes
 - Scene 123
- null modem. *See* Crossover cable
- null modem cable 21, 28, 137
- Null modem cable 138, 139
- null modem DB9 cable 2
- Number Column
 - Scene 124
- Number (No.) column 123
- Numeric ID 30, 38, 46, 56, 57, 122

O

- Offline 36, 47, 49
 - editing projects 38
- Offline LED 37
- offline/online 28
- Offline to Online 41, 42
- OK 36, 69
- OK icon 123, 124, 128
- old firmware 5, 29
- On
 - Standby 78
- online 35, 36
- Online 49
- Online LED 37
- Online/Offline 128
- Online/Offline Status 46
- Online Support 51
- Online to Offline 42
- Online vs. Offline 37
- Open Project 49
- Open Windows List 50
- output level
 - AllFrame 81
- Output Levels

- AllFrame 81
- Output Level Settings 82
 - Clearing 82
- Output Matrix Assignment 103
 - Clear 109
- Output Module Settings 118
- Outputs From Network 64, 98, 101, 102, 116
 - 6416Y2 card 111
- Outputs from Network view 109
 - Matrix 103
- Output Slot Range 52, 53, 60
- Outputs Using Slot 121
- Overview 13, 15
- overwrite 40

P

- Pad 100, 101, 112, 117
- Pad Mode 90
- Parallels 6
- Paste 62
- PC
 - connecting 23
- PC control 136
- PC keyboard 50
- PDF 51
- Personal Mixer 105
- Phantom Power 100, 101, 112
- Phase 100, 112, 117
- pinout 21
- Pinout
 - RS-232 138
- PM1D 90, 136
- Port names
 - MH10, ASI 122
- Port Names 64, 98, 116
- preamp control 84
 - Control Group 91
- preamps 100
- Preferences 50
- preset
 - rename 114
- Presets 39, 112
- Presets Menu 118
- Print
 - Firmware Update 33
- print a report
 - Network Overview 61
- Print Device Info 61, 115
- Print Preview
 - Device Window 61, 115
 - Network Overview 61
- Pro16 6, 92, 105
- Pro16 Outputs 107, 108
- Pro16 Zone
 - ASI 92
- Pro64 6
- Pro64 network 40
- Pro64 Network Manager enabled

- 6416Y2 card 27
- Pro64 Network Manager folder 12
- Pro64 Update Tool 21
- Progress Bar 31
- project 42, 122, 131, 132
 - go online 42
 - window position 38
- Project 38, 42, 44, 45, 112
 - Filter Settings 58
 - save as 49
- Project Compatibility 41
- Project Scenes 39
- Project Scenes folder 125

Q

- quit 48
- Quitting the Installer 11

R

- RCI 64, 71, 90, 98
- RCI/MCS sync 95
- RCI Remote Control Interface 56, 95
- ReadMe 8
- Recall button 114
- Recall Device Preset 118
- Recalling a Device Preset 114
- Recalling a Scene 126
- recall time
 - Scene 122
- red dot 75
- red exclamation point 36, 53, 124
- red Mute All 49
- red square icon 57
- Refresh Update Files 33
- regedit 137
- Remaining Updates 32
- Remote Control 52, 60, 71, 90
- remote preamp control 84
- Removing the Application 11
- Rename a Device Preset 114
- Renaming a Scene 125
- Requirements 6
- Reset filter 58
- resource conflict 69
- roll back firmware 20, 36
- RS-232 2, 21, 22, 26, 42, 133, 134, 137
 - null modem cable 137
- RS-232 Cable 138
- RS-232 Connections 138
- RS-232 pinout 21
- RS-422 133, 134
 - 6416dio 23
- RTFM 1, 3

S

- sample rate 1

- Sample Rate 13, 46, 47, 60, 67, 92, 95, 103, 122
- sample rate converter
 - AllFrame C4dio 4
- Sample Rate Converter
 - C4dio 75
- Save button 114
- Save Device Preset 118
- Save Project 41, 49
- Save Scene 131
- Saving a Device Preset 113
- Saving a Project 38
- Saving a Scene 125
- Saving Event Log 135
- Scene 38, 39, 41, 81, 96
 - AllFrame I/O cards 128
 - Clear 127, 130
 - Clear All 128
 - compatibility 129
 - Cut, Copy, Paste 125
 - editing text 125
 - Lock 126
 - Lock All 127
 - matrix assignments 103
 - recall 126
 - recall time 122
 - red exclamation point 124
 - Renaming 125
 - transitions 122
 - update 126
 - Validate 130
 - Working Offline 128
 - Working Online 128
- Scene Compatibility 128
- Scene Manager 14, 17, 50, 122, 123, 124, 126, 127, 128
- Scene Manager Menus 130
- Scene Name 123
- Scene Name Column 124
- Scene Notes 123, 124, 125
- Scene Valid 123, 128
- Scene Valid Column 124
- Scene Window 13
- Select box 35
- Select Slot dialog box 70
- Send 44
- Send Settings to Network 44
- Serial Adapter 21
- serial cable 22
- Serial Interface 91
- serial port 2
- Service Pack 3
 - Windows XP 6
- Setup
 - RS-232 22, 24, 25
- shortcut 15, 16, 17, 18, 19, 47, 55
- Show All 58, 116
- Slot 38
 - VDC 19, 132
- Slot 1-16 67, 106
- Slot 17-32 67, 106
- Slot 33-48 67, 106
- Slot 49-64 106
- Slot activation conflict 114
- Slot Assignments 106, 119
 - clear 97
- Slot Assignments View
 - Audio Slot Manager 120
- Slot column 99, 120
- Slot field 102
- Slot Range 15, 52, 53, 60, 67, 112
 - change 67
 - Filter 58, 60
- Slots
 - 6416Y2 87, 88
 - VDC 132
- Slots and I/O Routing 119, 120
- Slots and I/O Routing View 121
- Slots available 47
- Software License 8
- Sort 53, 58
- SRC 4, 75
- Standby 80
 - AllFrame 77
 - Euroblock 79
 - F6 Front Panel 78
- Standby Euroblock
 - AllFrame 77
- Standby Mode 72, 78
 - AllFrame 4
- Standby Mode Off button 78
- Standby momentary switch
 - AllFrame 77
- Status 36
- Status Bar 13, 15, 16, 46, 58, 116
 - Device Window 65
 - red Mute All 49
 - Workspace 46
- Status column 84
- Status Column 53
- Status icon 52, 65, 136
 - 6416Y2 88
 - 6416Y2 card 83
 - gray 77
- Stereo Link 117
 - 6416Y2 88
- Stereo Link Off 99
- Stereo Link On 99
- Stereo Links 99
 - 6416Y2 99
- stereo pair 99
- SW8 26
- SW9
 - 6416Y2 26, 83
- Switch Block 9 83
- Sync
 - MCS 95

T

- Text entry 99
- the 41

- time remaining
 - Firmware Update 32
- time to update 29
- Tools menu 4
- Tools Menu 20, 116
 - Workspace 50
- Tools Menu - 6416Y2 Card 117
- transitions
 - Scene 122
- Transmit and Receive range
 - 6416Y2 26
- Troubleshooting 136

U

- Uncheck All
 - filter 58
- Undo 62, 115, 130
- uninstall 7
- Unlink a Channel Pair 99
- Unlock All Front Panels 55
- Unlock All Scenes 131
- Unlock Front Panel 55, 116
- Unlock Scene 127, 131
- Unsaved Project 42
- update 29
- Update All 29, 35
- update a Scene 126
- Update Firmware 2, 20, 50
- Update Options Menu 33
- Updating a Device Preset 114
- Updating Devices window 31
- UPD extension 12
- Upload 44
- USB 2, 3, 21, 42
- USB cable 24
- USB driver 12
- USB Serial Adapter 22
- USB-to-RS-232 2, 6, 21, 28, 31, 136, 137
- Use Default Update Files 33
- user-created files 11
- User Label 52, 59, 64, 65
 - Device Window 64

V

- v2.xx firmware 2, 36
- v3.xx firmware 36
- v5.xx firmware 2, 5, 21
- Validate All Scene Settings 131
- Validate Scene Settings 131
- Validating Scenes 129
- VDC 19, 22, 50, 132
 - Disable RS-232 22
 - RS-232 pinout 138
- VDC Compatible Devices 134
- VDC Destination 132, 134
- VDC Slot 132, 133
- VDC Source 132, 134
- VDC Type 132, 133

- version 3.0 2
- View
 - Device Window 64
- View Menu
 - Device Window 98, 116, 130
 - Network Overview 62
- Views 16, 64
 - Device Window 98
- Virtual Data Cable 14, 19, 22, 26, 38, 122
 - 6416Y2 85
- Virtual Data Cable Monitor 50, 132

W

- website 3
- What Gets Installed 12
- Window Commands 48
- window position
 - project 38
- Windows 7 10, 137
- Windows List 50
- Windows Menu
 - Workspace 50
- Windows OS 11
- Windows OS Control Panel 7
- Windows OS Device Manager 28
- Windows XP 10, 137
- Wiring a Crossover Cable 139
- Word Clock 4, 74, 80, 94
- Working Offline 37
 - Scene 128
- Working Online 37
 - Scene 128
- Work Offline 29, 42, 49
- Work Online 28, 42, 43, 45, 49
- Workspace 13, 14, 46
- Workspace Features 46
- Workspace Menu Commands 49
- Workspace Status Bar 46

Y

- Yamaha 26, 84, 90
- Yamaha device 56, 86, 87, 90
- yellow A-Net icon 54, 84
- yellow LED
 - 6416Y2 outputs 87
- yellow LED icon 133
- yellow square icon 57
- yellow Status icon
 - 6416Y2 88
- yellow warning triangle 78
- Yes
 - 114
- You
 - ...are here 41

Z

- Zone 105
 - ASI 92, 108

SOFTWARE LICENSE AGREEMENT

This software license agreement (this “Agreement”) is made by and between AVIOM, INC., a Delaware corporation (“*Aviom*”), and the individual or entity desiring to install or use the Software (as defined below) (“*Licensee*”). By clicking the “I Agree” button, Licensee: (1) represents that Licensee has read this Agreement in its entirety and understand its terms and conditions; and (2) agrees to each of the terms and conditions of this Agreement. If you do not agree to each of the terms and conditions of this Agreement, then you must click the “I Decline” button and you may not install or use the Software.

DEFINITIONS.

“*AVIOM PRODUCT*” SHALL MEAN THE PRODUCT OF AVIOM INTO WHICH THE FIRMWARE IS INTENDED TO BE INSTALLED.

(a) “*Firmware*” shall mean the firmware provided by Aviom that is intended to be installed into a specific product of Aviom.

(b) “*Installation Software*” shall mean the software provided by Aviom to enable Licensee to install the Firmware into the Aviom Product.

(c) “*Software*” shall mean both the Installation Software and the Firmware, collectively.

1. Grant of License. Subject to the terms and conditions of this Agreement, Aviom grants Licensee a limited, non-exclusive license to the object code version of the Software (the “*License*”). The License permits Licensee to install and use the Installation Software on a single workstation and use the Installation Software to flash the Firmware into the Aviom Product(s). The License also grants Licensee the right to use the Firmware on all Aviom Products owned by Licensee. Licensee may also use the documentation included with the Software, if any, (e.g. help files, release notes, and readme.txt files) (collectively, “*Documentation*”) as is reasonable and necessary for Licensee to use the Software.

2. Compensation. There is no charge for use of the Software by Licensee under the terms and conditions of this Agreement.

3. Ownership. Licensee acknowledges that: (a) the Software is and shall remain the exclusive property of Aviom and Aviom’s successors and assigns; (b) Licensee has no right or interest in the Software or the Documentation other than as expressly granted in this Agreement; (c) nothing in this Agreement shall be construed as a sale of the Software or the Documentation to Licensee; and (d) all intellectual property rights shall remain with Aviom and the Agreement shall not transfer any intellectual property rights in, or associated with, Software or the Documentation to Licensee.

4. Transfer of License; Copy Protection. Licensee may not rent, loan, transfer, sublicense, lease or otherwise distribute or operate all or any part of the Software to or for the benefit of any third party. Licensee may not assign all or any part of its rights or obligations under this Agreement without Aviom’s prior written consent and any attempt to the contrary will be void and a material breach of this Agreement. Aviom may withhold such consent in its sole discretion.

Other Restrictions. Licensee may not reverse engineer, decompile, disassemble, modify or create derivative works of all or any part of the Software or otherwise derive the source code to all or any part of the Software. Without limiting the generality of the foregoing, Licensee shall not use a debugging tool to examine, operate or alter all or any part of the Software or run all or any part of the Software through a disassembly or source extraction system of any kind or create any derivative work of all or any part of the Software. Licensee agrees that any information obtained in violation of the restrictions as set forth in this Section 6 will be Confidential Information automatically and irrevocably deemed assigned to and owned exclusively by

Aviom. Licensee will ensure that all marks, notices or legends pertaining to the origin, identity or ownership of the Software or the Documentation remain intact and clearly legible. Notwithstanding anything contained in this Agreement to the contrary, if Licensee is located in the European Union and Licensee determines that access to the source code to the Software is necessary to achieve interoperability of the Software with other programs, then Licensee may reverse engineer the Software provided that: (a) Aviom has not already made available to Licensee the information necessary to achieve interoperability; and (b) Licensee limits its reverse engineering activities to those parts of the Software which are necessary to achieve interoperability with such programs.

Copyright.

(a) The Software and the Documentation contain proprietary material of Aviom and/or material that other software and/or information suppliers have licensed to Aviom for use in the Software. This material is protected by copyright and other laws respecting proprietary rights. Aviom and/or its licensors retain all rights in the Software and the Documentation, including (without limitation) all copyright and other proprietary rights worldwide in all media. Licensee may not use all or any part of the Software or the Documentation except as expressly permitted under this Agreement and under U.S. and/or other applicable copyright laws.

(b) While Licensee may make a reasonable number of copies of the Software and the Documentation solely for archival/back-up purposes, no part of the Software or the Documentation may be used, reproduced or duplicated in any medium or format beyond the express terms of this Agreement without prior written authorization from Aviom. Any use or reproduction not authorized by this Agreement is prohibited and shall immediately terminate this Agreement.

(c) Licensee acknowledges that the Software and the licensed materials therein are highly proprietary in nature and that unauthorized copying, transfer or use may cause Aviom irreparable injury that cannot be adequately compensated for by means of monetary damages. Licensee agrees that any breach of this Agreement by Licensee may be enforced by Aviom by means of equitable relief (including, but not limited to, injunctive relief) without the necessity of posting any bonds in addition to any other available rights and remedies.

5. Termination.

(a) Termination. If Licensee: (i) makes or distributes, or fails to prevent others in its control from making or distributing, copies of the Software or the Documentation (except as expressly permitted by this Agreement) or modifications or derivations thereof; or (ii) breaches any provision of this Agreement, then this Agreement shall terminate automatically.

Effect of Termination. Upon any termination of this Agreement, Licensee shall: (i) immediately discontinue use of the Software and the Documentation; (ii) remove the Installation Software and the Documentation from all of Licensee's workstations; and (iii) delete and destroy all copies of the Software and the Documentation in its possession or control. Sections 4, 5, 6, 7, 8(b) and 9 through 12 shall survive the termination or expiration of this Agreement for any reason in accordance with their respective terms.

6. Disclaimer of Warranties. AVIOM LICENSES AND PROVIDES THE SOFTWARE AND THE DOCUMENTATION TO LICENSEE ON AN "AS-IS" BASIS. AVIOM HEREBY DISCLAIMS ANY AND ALL WARRANTIES AND CONDITIONS WITH REGARD TO THE SOFTWARE AND THE DOCUMENTATION, INCLUDING, BUT NOT LIMITED TO, ALL IMPLIED WARRANTIES AND CONDITIONS OF MERCHANTABILITY, FITNESS FOR A PARTICULAR PURPOSE, ACCURACY, TITLE AND NON-INFRINGEMENT.

7. Limitations of Liability.

(a) General. IN NO EVENT WILL AVIOM BE LIABLE FOR DAMAGES ARISING OUT OF THE USE OR LICENSING OF THE SOFTWARE OR THE DOCUMENTATION OR ARISING

UNDER THIS AGREEMENT, WHETHER IN TORT, CONTRACT OR OTHERWISE, TO LICENSEE OR ANY OTHER PERSON OR ENTITY INCLUDING ANY DAMAGES CAUSED TO AVIOM PRODUCTS FROM USE OF ALL OR ANY PART OF THE SOFTWARE.

(b) Consequential Damages, Etc. AVIOM SHALL IN NO EVENT BE LIABLE TO LICENSEE OR ANY OTHER PERSON OR ENTITY FOR ANY LOST PROFITS, OR CONSEQUENTIAL, INCIDENTAL, INDIRECT, PUNITIVE, SPECIAL, OR SIMILAR DAMAGES, INCLUDING, WITHOUT LIMITATION, DAMAGES FOR LOSS OF DATA, DAMAGES TO HARDWARE INCLUDING BUT NOT LIMITED TO AVIOM PRODUCTS, IMPAIRMENT OR LOSS OF GOODWILL, WORK STOPPAGE, COMPUTER FAILURE OR MALFUNCTION, AVIOM PRODUCT FAILURE OR MALFUNCTION, LOSS OF WORK PRODUCT, OR ANY AND ALL OTHER COMMERCIAL DAMAGES OR LOSSES, DIRECT OR INDIRECT, WHETHER IN TORT, CONTRACT, OR OTHERWISE, EVEN IF ADVISED OF THE POSSIBILITY OF SUCH DAMAGES.

(c) THE LIMITATIONS OF LIABILITY SET FORTH IN THIS SECTION (I) REFLECT AN ALLOCATION OF RISK GIVEN THE AMOUNTS PAYABLE UNDER THIS AGREEMENT AND (II) SHALL REMAIN FULLY OPERATIVE EVEN IF THE LIMITED REMEDY SET FORTH IN THE AGREEMENT FAILS OF ITS ESSENTIAL PURPOSE OR IS OTHERWISE HELD TO BE UNENFORCEABLE.

8. Export Regulations. The transfer of technology across national boundaries is regulated by the U.S. Government. Licensee agrees that Licensee shall not: (a) acquire, ship, transport, export or re-export the Software, directly or indirectly, into any country in violation of any applicable law (including, but not limited to, the United States Export Administration Act and the regulations promulgated thereunder); or (b) use the Software for any purpose prohibited by such laws.

9. Miscellaneous.

(a) Governing law; Jurisdiction. The validity, interpretation, rights and obligations of the parties and any dispute arising under this Agreement shall be governed by the laws of the Commonwealth of Pennsylvania applicable to contracts between residents of Pennsylvania and wholly performed in Pennsylvania. Neither the United Nations Convention on the International Sale of Goods, the 1974 Convention on the Limitation Period in the International Sale of Goods, nor any amendment or protocol to either of the foregoing shall apply to this Agreement or the activities undertaken under or in respect of this Agreement. The state and federal courts with jurisdiction over Chester County, Pennsylvania shall have exclusive jurisdiction over any case, controversy or dispute concerning this Agreement or its performance or the Software; provided that Aviom may seek injunctive relief in any court of competent jurisdiction.

(b) Severability. If any provision of this Agreement shall be determined to be void, invalid, unenforceable or illegal for any reason, then the validity and enforceability of all the remaining provisions hereof shall not be affected thereby.

(c) Failure to Exercise Rights. The failure of either party to exercise any of its rights under this Agreement for a breach thereof shall not be deemed to be a waiver of those rights or a waiver of any subsequent breach of the same or any other provision.

(d) Titles. The titles of the Sections of this Agreement are for convenience only and do not in any way limit or amplify the terms and conditions of this Agreement.

(e) Entire Agreement. This Agreement constitutes the entire understanding between the parties with respect to the subject matter of this Agreement and supersedes any and all prior and contemporaneous understandings, statements, warranties, representations and agreements, both oral and written, relating thereto. This Agreement cannot be modified except in a writing signed by the party against whom enforcement is sought.

PRO 64[®]

AVIOM[®]

1157 Phoenixville Pike, Suite 201 • West Chester, PA 19380
Voice: +1 610.738.9005 • Fax: +1 610.738.9950 • www.Aviom.com