

Dell Embedded Box PC



5000

Installation and Operation Manual

Computer Model: Dell Embedded Box PC 5000
Regulatory Model: N01PC
Regulatory Type: N01PC001



Notes, cautions, and warnings

-  **NOTE:** A NOTE indicates important information that helps you make better use of your product.
-  **CAUTION:** A CAUTION indicates either potential damage to hardware or loss of data and tells you how to avoid the problem.
-  **WARNING:** A WARNING indicates a potential for property damage, personal injury, or death.

Copyright © 2016 Dell Inc. or its subsidiaries. All rights reserved. Dell, EMC, and other trademarks are trademarks of Dell Inc. or its subsidiaries. Other trademarks may be trademarks of their respective owners.

2016 - 11

Rev. A00

Contents

1 Overview	5
2 Features	6
Top view	6
CANbus connector mapping	7
VGA connector mapping	7
12-26V DC power port (barrel connector)	8
+12-26V DC power connector	8
Bottom view	9
GPIO-in connector mapping	10
GPIO-out connector mapping	10
RS232 connector mapping	11
RS422 connector mapping	11
RS485 connector mapping	11
3 Setting up the Embedded Box PC	13
Mounting the Embedded Box PC on the wall	15
4 Setting up your operating system	17
Ubuntu Desktop	17
Reinstalling Ubuntu Desktop	17
Restoring Ubuntu Desktop	18
Restoring Ubuntu Desktop on the Embedded Box PC from the recovery USB flash drive	18
Creating the bootable USB flash drive	18
Creating the recovery USB flash drive	18
Reinstalling Ubuntu Desktop	18
Windows OS	19
Windows 7 Professional SP1	19
Windows 7 Professional for Embedded Systems SP1	22
Windows Embedded Standard 7 P/E	24
Windows 10 Professional	26
Windows 10 IoT Enterprise LTSB 2015	28
Recommended drivers and applications for Embedded Box PC	31
5 Specifications	34
6 Activating your mobile broadband service	37
7 Setting up the ZigBee dongle	38
8 Display options	39



9 Connector kits.....	40
Remote power connector.....	40
12-26V DC power connector.....	40
GPIO-in connector.....	40
GPIO-out connector.....	41
10 Contacting Dell.....	42



Overview

The Embedded Box PC 5000 enables you to connect your devices (wired or wireless) to network-enabled devices and manage them remotely in your existing network ecosystem. It enables you to connect with devices used in process and discrete manufacturing, fleet management, kiosks, digital signage, surveillance, and automated retail solutions. It can be either mounted on the wall using the Dell approved wall mount kits or placed on a flat surface. It supports Windows 7 Professional SP1 64-bit, Windows 7 Professional for Embedded Systems SP1 64-Bit, Windows Embedded Standard 7 P/E 64-bit, Windows 10 Professional 64-bit, Windows 10 IoT Enterprise LTSC 2015 64-bit, and Ubuntu Desktop 16.04 operating systems.



Features

Top view

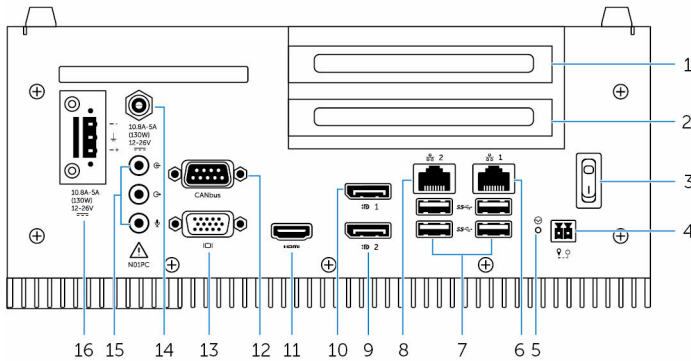

Features

1	PCI slot one	Install a PCI card or a PCIe card and PCIe riser card. Maximum supported card size: Height 111.15 mm (4.38 inches), length 167.65 mm (6.6 inches)
2	PCIe (x16) slot or PCI slot two	Install a PCIe card or a PCI card and PCI riser card. Maximum supported card size: Height 111.15 mm (4.38 inches), length 167.65 mm (6.6 inches)
3	Power switch	Turn on or off the Embedded Box PC.
4	Remote power switch ¹	Install a remote power switch.
5	Hard reset	Using a pin, press the button located in the pin hole to restart the Embedded Box PC.
6	Network port one	Connect an Ethernet (RJ45) cable for network access. Provides data transfer speeds up to 10/100/1000 Mbps.
7	USB 3.0 ports (4)	Connect USB enabled devices. Provides data transfer speeds up to 5 Gbps.
8	Network port two	Connect an Ethernet (RJ45) cable for network access. Provides data transfer speeds up to 10/100/1000 Mbps.
9	DisplayPort two	Connect a monitor or another DisplayPort enabled device. Provides video and audio output.
10	DisplayPort one	Connect a monitor or another DisplayPort enabled device. Provides video and audio output.



NOTE: For more information about the display options, see [Display Options](#).



NOTE: For more information about the display options, see [Display Options](#).

Features

11	HDMI port	Connect a monitor or another HDMI-in enabled device. Provides video and audio output.
12	CANbus port (optional)	Connect to a CANbus port enabled device or dongles. For more information, see CANbus connector mapping .
13	VGA port	Connect a monitor or another VGA enabled device. Provides video output. For more information, see VGA connector mapping .
14	12-26V DC power port (barrel connector)	Connect a 12-26V DC power cable for supplying power to your Embedded Box PC. For more information, see 12-26V DC power port (barrel connector) .
15	Audio ports (3)	Connect a speaker, a headphone, a microphone, or a headset (headphone and microphone combo). NOTE: Connect the headset to the Line Out port.
16	+12-26V DC power connector	Connect a 12-26V DC power connector for supplying power to your Embedded Box PC. For more information, see +12-26V DC power connector .

1 Connections made to these ports must use SELV circuits and the wire (26 AWG-18 AWG) must have Double Insulation (DI) or Reinforced Insulation (RI) to protect it from all hazardous voltages. Torque the screws at 2.88 kg-cm (2.5 lb-in) to secure the wire to the connector.

CANbus connector mapping

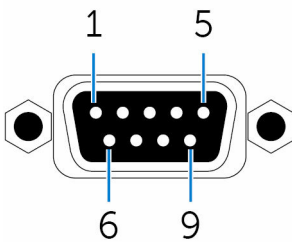

Pin	Signal	Pin	Signal
1	NC	6	NC
2	CAN_L	7	CAN_H
3	GND	8	NC
4	NC	9	NC
5	NC		

VGA connector mapping

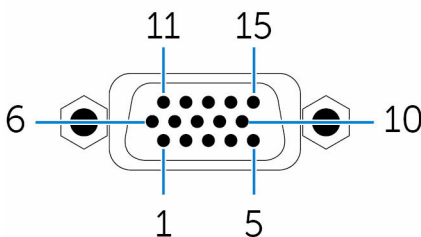

Pin	Signal	Pin	Signal	Pin	Signal
1	RED	6	GND	11	NC
2	GREEN	7	GND	12	DDCDAT
3	BLUE	8	GND	13	HSYNC
4	NC	9	+5V	14	VSYS
5	GND	10	GND	15	DDCCLK

12-26V DC power port (barrel connector)

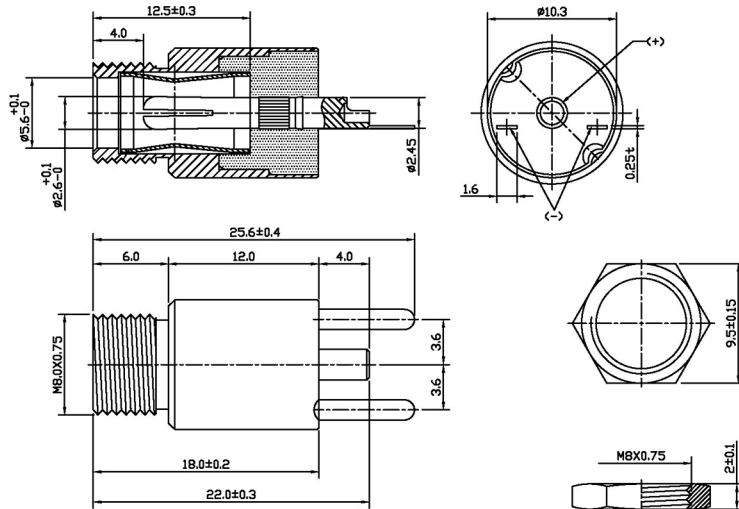

+12-26V DC power connector

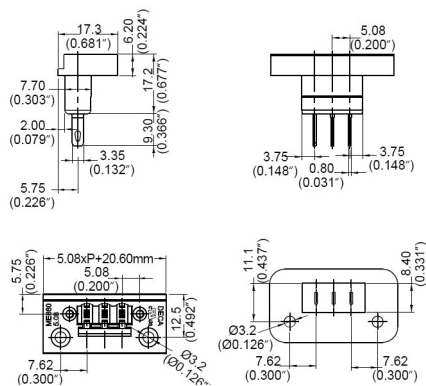

Bottom view

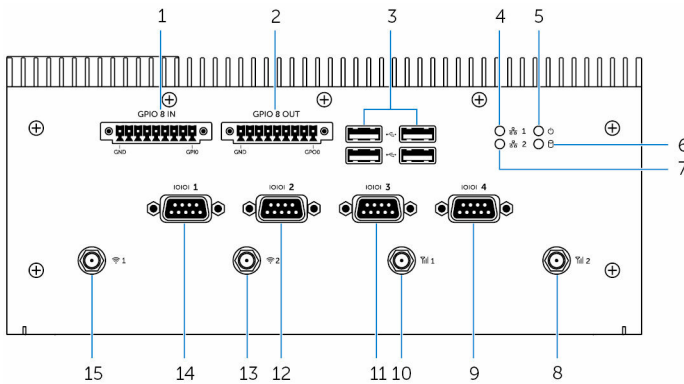

Features

1	GPIO-in 8-pin port ^{1, 2, 4}	Connect to a GPIO-out enabled device or dongle. For more information, see GPIO-in connector mapping .
2	GPIO-out 8-pin port ^{2, 3, 4}	Connect to a GPIO-in enabled device or dongle. For more information, see GPIO-out connector mapping .
3	USB 2.0 ports (4)	Connect USB enabled devices. Provides data transfer speeds up to 480 Mbps.
4	Network status light one	Indicates the network activity of network port one.
5	Power status light	Indicates the power-state of the Embedded Box PC.
6	Hard-drive activity light	Turns on when the Embedded Box PC reads from or writes to the internal storage device.
7	Network status light two	Indicates the network activity of the network port two.
8	Mobile broadband antenna port two	Connect a mobile broadband antenna to increase the range and strength of the mobile broadband signals.
9	RS232/RS422/RS485 port four (configurable in the BIOS)	Connect an RS232/RS422/RS485 cable to the Embedded Box PC. For more information, see RS232/RS422/RS485 connector mapping.
10	Mobile broadband antenna port one	Connect a mobile broadband antenna to increase the range and strength of mobile broadband signals.
11	RS232/RS422/RS485 port three (configurable in the BIOS)	Connect an RS232/RS422/RS485 cable to the Embedded Box PC. For more information, see RS232/RS422/RS485 connector mapping.
12	RS232/RS422/RS485 port two (configurable in the BIOS)	Connect an RS232/RS422/RS485 cable to the Embedded Box PC. For more information, see RS232/RS422/RS485 connector mapping.
13	Wireless antenna port two	Connect a wireless antenna to increase the range and strength of wireless signals.
14	RS232/RS422/RS485 port one (configurable in the BIOS)	Connect an RS232/RS422/RS485 cable to the Embedded Box PC. For more information, see RS232/RS422/RS485 connector mapping.
15	Wireless antenna port one	Connect a wireless antenna to increase the range and strength of wireless signals.

¹ The GPIO-in port has 9 pins. Pin labels are GND and GP10 through GP17.

Features

2 Connections made to these ports must use SELV circuits and the wire (26 AWG-18 AWG) must have Double Insulation (DI) or Reinforced Insulation (RI) to protect it from all hazardous voltages. Torque the screws at 2.88 kg-cm (2.5 lb-in) to secure the wire to the connector.

3 The GPIO-in port has 9 pins. Pin labels are GND and GP00 through GP07.

4 Connections made to the GPIO-in/out port must use SELV circuits (30 Vmax) and must be protected by Double/Reinforced Insulation (DI)/(RI) from all hazardous voltages.

GPIO-in connector mapping



Pin	Signal	Pin	Signal
1	GPI0	6	GPI5
2	GPI1	7	GPI6
3	GPI2	8	GPI7
4	GPI3	9	GND
5	GPI4		

GPIO-out connector mapping



Pin	Signal	Pin	Signal
1	GPO0	6	GPO5
2	GPO1	7	GPO6
3	GPO2	8	GPO7
4	GPO3	9	GND
5	GPO4		

RS232 connector mapping

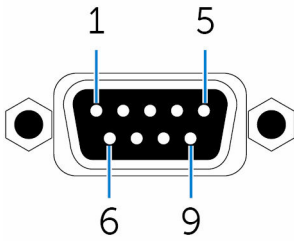

Pin	Signal	Pin	Signal
1	DCD	6	DSR
2	RXD	7	RTS
3	TXD	8	CTS
4	DTR	9	RI
5	GND		

RS422 connector mapping

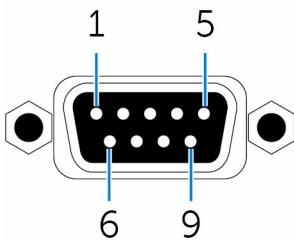

Pin	Signal	Pin	Signal
1	TX-	6	NC
2	TX+	7	NC
3	RX+	8	NC
4	RX-	9	NC
5	GND		



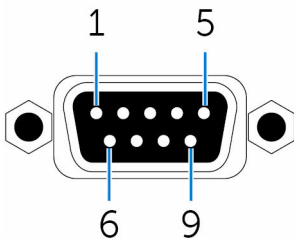









RS485 connector mapping



Pin	Signal	Pin	Signal
1	DATA-	6	NC
2	DATA+	7	NC

Pin	Signal	Pin	Signal
3	NC	8	NC
4	NC	9	NC
5	GND		

Setting up the Embedded Box PC

-  **WARNING:** During the installation of the Embedded Box PC, the responsible party or integrator must use the power adapter provided with the Embedded Box PC, or connect to a 12-26 VDC separate power source already present as part of the clients installation. Always ensure that the available power source matches the required input power of the Embedded Box PC. Check the input power markings next to power connector(s) before making connections.
-  **WARNING:** Before you begin any of the procedures in this section, read the safety information that shipped with your Embedded Box PC. For additional best practices information, go to www.dell.com/regulatory_compliance.
-  **WARNING:** To ensure that the protection provided by the Embedded Box PC is not impaired, do not use or install the Embedded Box PC in any manner other than what is specified in this manual.
-  **WARNING:** To provide additional power connections to the main network, use cables appropriate for the load currents such as, 3-core cable rated 15 A at 90°C (194°F) minimum, which conform to either IEC 60227 or IEC 60245. The Embedded Box PC accepts cables from 0.8 mm to 2.5 mm (18 AWG to 14 AWG).
-  **WARNING:** The symbol  indicates hot surface or adjacent hot surface that can obtain temperature during normal use that can cause a burn. Allow equipment to cool off or use protective gloves when handling to reduce risk of a burn.
-  **WARNING:** This product is designed for specific applications and must be installed by qualified personnel with RF and regulatory related knowledge. The general user must not attempt to install or change the setting.
-  **WARNING:** Before installation, the two power inputs (Terminal Block or Power Jack) must be protected by 20 A fuses or circuit-breakers, which are over current protection devices in front of the Embedded Box PC.
-  **WARNING:** The product shall be installed at a location where the radiating antenna is kept 20 cm away from nearby persons in its normal operating condition to meet regulatory RF exposure requirements.
-  **WARNING:** Use only the antenna(s), which are approved by Dell.
-  **WARNING:** Connect a certified SELV power to either Phoenix connector or the Barrel connector only. The connection of two power sources may damage equipment and present risk of fire.
-  **WARNING:** If your equipment or accessories are provided with a detachable main supply cord set and has to be replaced, ensure that the replacement cord set has an adequate voltage, current, and temperature rating for the country where the equipment is installed. The cord set must comply to the local safety code, regulations, and law.

1. Install the Embedded Box PC on a vertical surface like a wall using [wall-mount brackets](#) or in a panel box.
2. Connect to your network in one of the following methods:
 - Connect the network cable.

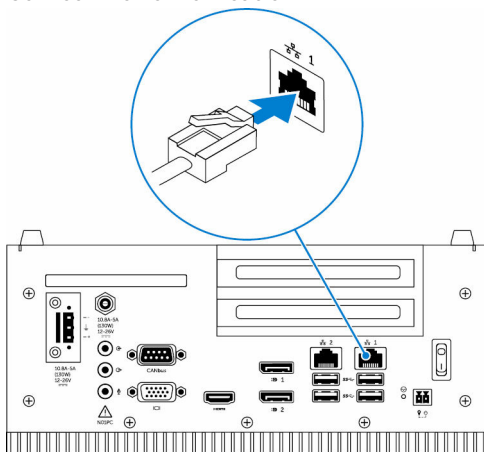

- Install the wireless antenna (WLAN 1 and WLAN 2) to enable the wireless connection.

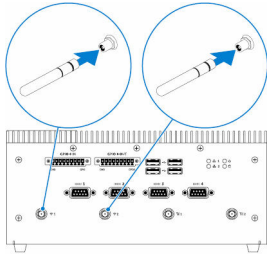

- Install the mobile broadband antenna (WWAN 1 and WWAN 2) to enable the mobile broadband connection.

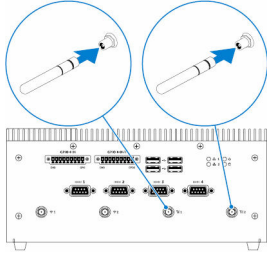

NOTE: For more information on connecting the wireless antenna to Dell Embedded Box PC, see the documentation that is shipped with the wireless antenna.

NOTE: For more information about installing the WWAN card in the Embedded Box PC, see the *Embedded Box PC Service Manual* at www.dell.com/support.

NOTE: Peripherals such as the wireless antenna, keyboard, and mouse are sold separately.

3. Connect devices using the I/O ports on your Embedded Box PC.
4. Connect the Embedded Box PC to the power source in one of the following methods:
 - Connect the power adapter and tighten the sleeves on the adapter pin to secure it to the Embedded Box PC.

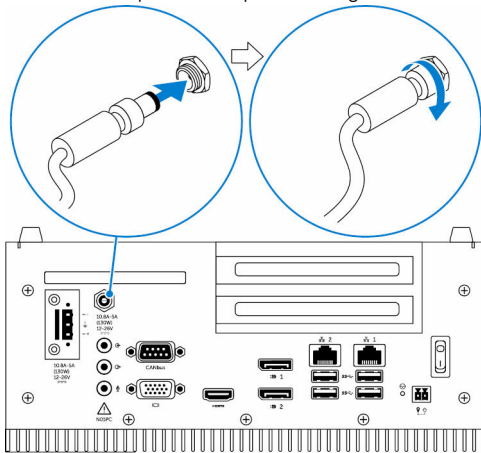

- Connect the power terminal block to the adapter port and torque the screws at 5.07 kilograms-centimeter (4.4 pounds-inch) to secure it to the Embedded Box PC.

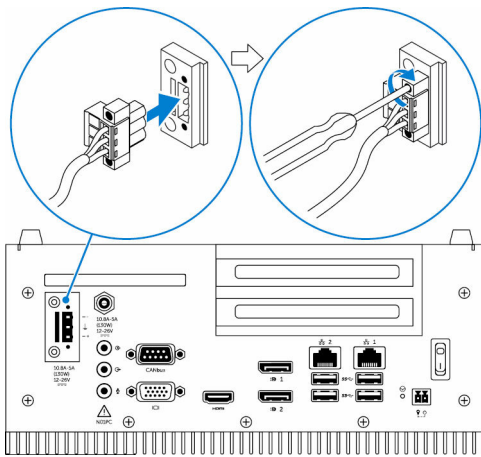

5. Turn on the Embedded Box PC and complete the operating system setup.

Mounting the Embedded Box PC on the wall

Mount the Embedded Box PC on a wall by using the mounting brackets.

NOTE: The Embedded Box PC is shipped with only those screws that are required for securing the two mounting brackets to the back of the Embedded Box PC.

1. Secure the two mounting brackets to the back of the Embedded Box PC by using eight M3x8 screws.

NOTE: Torque the screws at 3 to 3.4 kilograms-centimeter (2.6 to 3.0 pounds-inch).

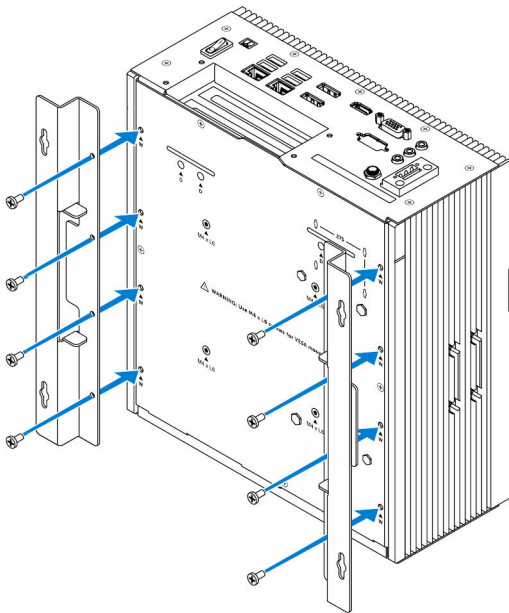

2. Drill four holes in the wall that correspond to the holes on the mounting bracket.
3. Place the Embedded Box PC against the wall and align the holes on the mounting brackets with the holes on the wall.

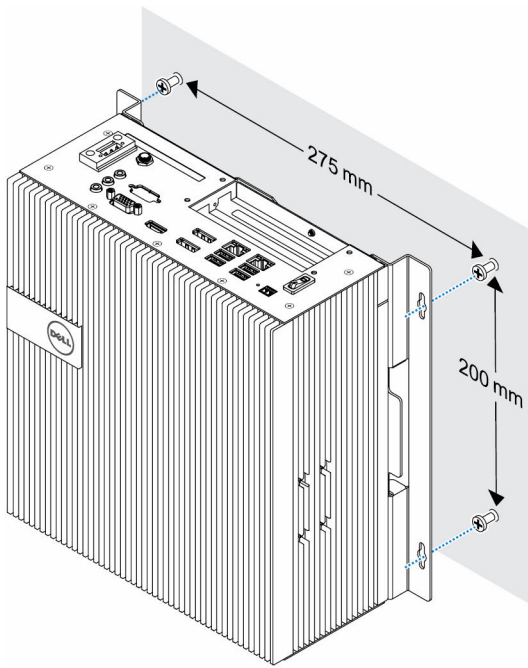

4. Secure the Embedded Box PC to the wall.

 **NOTE:** Torque the screws (M4x6) at 5 to 5.4 kilograms-centimeter (4.3 to 4.7 pounds-inch).

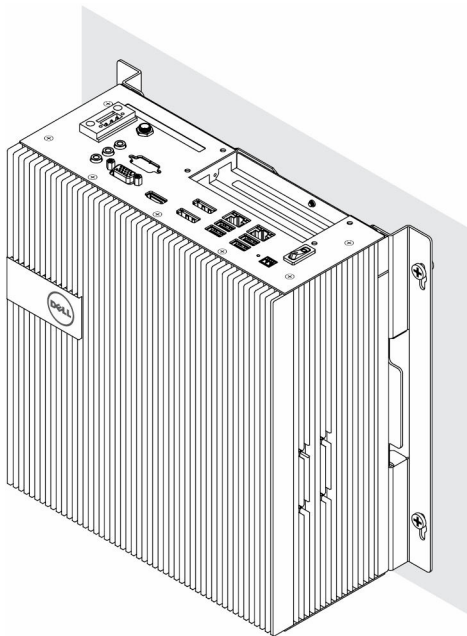

Setting up your operating system

 **WARNING:** To prevent operating system corruption from sudden power loss, use the operating system to gracefully shut down the Embedded Box PC.

The Embedded Box PC is shipped with one of the following operating systems:

- Windows 7 Professional SP1 64-bit
- Windows 7 Professional for Embedded Systems SP1 64-Bit
- Windows Embedded Standard 7 P 64-bit
- Windows Embedded Standard 7 E 64-bit
- Windows 10 Professional 64-bit
- Windows 10 IoT Enterprise LTSB 2015 64-bit
- Ubuntu Desktop 16.04

 **NOTE:** For more information about Windows operating systems, see msdn.microsoft.com.

 **NOTE:** For more information about Ubuntu Desktop operating system, see www.ubuntu.com/desktop.

Ubuntu Desktop

Reinstalling Ubuntu Desktop

Before reinstalling Ubuntu Desktop, ensure the following:

- Connect a keyboard, mouse, and monitor to the Embedded Box PC, or connect to the Embedded Box PC through a KVM session, Dell Wyse Cloud Client Manager (CCM), or Dell Command | Monitor (DCM).
- Create a [bootable USB flash drive](#).

 **NOTE:** For more information about using the CCM, see the CCM documentation available at www.cloudclientmanager.com.

 **NOTE:** For more information about using the DCM, see the DCM documentation available at www.dell.com/clientssystemsmangement.

 **NOTE:** Dell recommends that you create a [recovery USB flash drive](#) before installing Ubuntu Desktop for the first time.

Follow these steps to reinstall Ubuntu Desktop:

1. Insert the bootable Ubuntu Desktop USB flash drive.
2. Turn on the Embedded Box PC.
3. Press F12 to access the boot menu.
4. Enable **UEFI boot mode** in System Setup and boot from the Ubuntu Desktop USB flash drive.
5. Select **Dell recovery** to start the Ubuntu Desktop installation.
6. Select the drive onto which you want to install the Ubuntu Desktop operating system.
7. After the installation is complete, restart the Embedded Box PC.
8. Follow the instructions on the screen to configure the **Language, License Agreement, Location, Keyboard Layout, and User name/password** settings.



The Embedded Box PC restarts to boot Ubuntu Desktop successfully.

Restoring Ubuntu Desktop

You can restore Ubuntu Desktop on the Embedded Box PC to a new condition if you encounter any of the following situations:

- You are unable to start Ubuntu Desktop
- The Ubuntu Desktop operating system is damaged

Before restoring, create a recovery USB flash drive with the backup image.

Restoring Ubuntu Desktop on the Embedded Box PC from the recovery USB flash drive

1. Insert the recovery USB flash drive into the Embedded Box PC.
2. Turn on the Embedded Box PC.
3. Press F12 to access the boot menu.
4. Enable **UEFI boot mode** in System Setup and boot from the Ubuntu Desktop USB flash drive.
5. Select **Dell recovery** to start Ubuntu Desktop recovery.
6. Select the disk onto which you want to install the Ubuntu Desktop operating system.
7. After the installation is complete, restart the Embedded Box PC.
8. Follow the instructions on the screen to complete the **Language, License Agreement, Location, Keyboard Layout, and User name/Password** settings.

The Embedded Box PC restarts to boot Ubuntu Desktop successfully.

Creating the bootable USB flash drive

1. Download the Ubuntu Desktop ISO image from www.ubuntu.com/download/desktop.
2. Follow the instructions provided at www.ubuntu.com/download/desktop/create-a-usb-stick-on-windows.
3. Reinstall the Ubuntu Desktop operating system from the bootable USB flash drive.

Creating the recovery USB flash drive

Create a recovery disk when installing Ubuntu Desktop for the first time.

1. Turn on the Embedded Box PC.
2. Follow the instructions on the screen when you start the Embedded Box PC for the first time.
3. Select **Language**, and click **Continue**.
4. Agree to the license agreement, and click **Continue**.
5. Select a location, and click **Continue**.
6. Select the keyboard layout, and click **Continue**.
7. Enter the user name and password, and then click **Continue**.
8. Insert a USB flash drive with 2 GB or more space to create the recovery USB flash drive, and then click **Continue**.
9. To create a startup disk, select **USB stick user plugged**, and then click **Make Startup Disk**.

The recovery USB flash drive is created.

Reinstalling Ubuntu Desktop

Before reinstalling Ubuntu Desktop, ensure the following:

- Connect a keyboard, mouse, and monitor to the Embedded Box PC, or connect to the Embedded Box PC through a KVM session, Dell Wyse Cloud Client Manager (CCM), or Dell Command | Monitor (DCM).
- Create a [bootable USB flash drive](#).

 **NOTE:** For more information about using the CCM, see the CCM documentation available at www.cloudclientmanager.com.

 **NOTE:** For more information about using the DCM, see the DCM documentation available at www.dell.com/clientsystemsmangement.

 **NOTE:** Dell recommends that you create a [recovery USB flash drive](#) before installing Ubuntu Desktop for the first time.

Follow these steps to reinstall Ubuntu Desktop:

1. Insert the bootable Ubuntu Desktop USB flash drive.
2. Turn on the Embedded Box PC.
3. Press F12 to access the boot menu.
4. Enable **UEFI boot mode** in System Setup and boot from the Ubuntu Desktop USB flash drive.
5. Select **Dell recovery** to start the Ubuntu Desktop installation.
6. Select the drive onto which you want to install the Ubuntu Desktop operating system.
7. After the installation is complete, restart the Embedded Box PC.
8. Follow the instructions on the screen to configure the **Language, License Agreement, Location, Keyboard Layout, and User name/password** settings.
The Embedded Box PC restarts to boot Ubuntu Desktop successfully.

Windows OS

Windows 7 Professional SP1

Overview

The Embedded Box PC is shipped with Windows 7 Professional SP1. For more information, see <https://support.microsoft.com/en-us>.

Boot up and log in

Before configuring the Windows 7 Professional SP1, connect a keyboard, mouse, and monitor to the Embedded Box PC. Turn on the Embedded Box PC to boot into Windows.

1. Select regional settings.
2. Create a user account.
3. Read and agree to applicable End User Licence Agreements.
4. Select your preferred settings.

 **NOTE:** Connect to a wireless network if available.

Restoring Windows 7 Professional SP1

You can restore Windows 7 Professional SP1 on the Embedded Box PC by using the recovery OS image on the boot partition, which resets the run-time image back to the factory image.

Connect a keyboard, mouse, and monitor to the Embedded Box PC. Boot to the recovery environment by following these steps:

1. Turn off your computer.
2. Turn on the Embedded Box PC.
3. When the Dell logo appears on the screen, press F8 several times to open the **Advanced Boot Options** menu.
4. Use the arrow keys to select **Repair Your Computer** and press **Enter**.
5. From the **System Recovery Options** menu, select a keyboard layout, and then click **Next**.
6. On the next screen, log in as a local user or the Administrator.
7. From the **Recovery options** menu, select **Factory Image Restore**.
8. Click **Next** to open the **Confirm Data Deletion** menu.
9. Select the **Yes, reformat hard drive and restore system software to factory condition** check box and click **Next**.



10. After the restore operation is complete, click **Finish** to restart the computer.

Windows 7 Professional SP1 basic functions

BIOS update

BIOS updates for the Embedded Box PC may be downloaded from dell.com/support. The download includes an executable that may be ran from the local machine.

Watchdog Timer

The Watchdog Timer for Windows 7 Professional SP1 is controlled via a BIOS setting. Enter the BIOS during boot by pressing F2. The Watchdog Timer is enabled and disabled under the BIOS setting **Watchdog Timer**.

TPM support

Windows 7 Professional SP1 supports TPM 1.2. For more information about TPM resources, see [https://technet.microsoft.com/en-us/library/cc749022\(v=ws.10\).aspx](https://technet.microsoft.com/en-us/library/cc749022(v=ws.10).aspx).

System shutdown

Click **Start**, and then click **Shut down** to shut down the Embedded Box PC.

System restart

Click **Start**, and click the arrow next to **Shut down**, and then click **Restart** to restart the Embedded Box PC.

LAN network configuration

1. Click **Start** and type `Network` in the search box.
2. Click **Network and Sharing Center** from the search result.
The **Network and Sharing Center** window appears.
3. From the left panel, click **Change adapter settings**.

WLAN network configuration

1. Click **Start** and type `Network` in the search box.
2. Click **Network and Sharing Center** from the search result.
The **Network and Sharing Center** window appears.
3. From the left panel, click **Change adapter settings**.

Bluetooth configuration

1. Click **Start** and type `Bluetooth` in the search box.
2. Click **Change Bluetooth settings** from the search result.
The **Bluetooth Settings** dialog box appears.

DW5580 network configuration

Follow the *Service Manual* to install and configure the DW5580 module and the corresponding carrier SIM card for the system. Once the module and the SIM card are installed, follow these steps to connect and disconnect from WWAN.

1. Click **Start** and type `Network` in the search box.
2. Click **Network and Sharing Center** from the search result.
The **Network and Sharing Center** window appears.
3. From the left panel, click **Change adapter settings**.
4. Locate the required WWAN connection.
5. Right-click the WWAN connection, and then select **Connect** or **Disconnect** to connect to or disconnect from the WWAN adapter, respectively.

Common port mappings on Embedded Box PC 5000 with Windows 7 Professional SP1

Serial port mapping

The following table shows the serial port mapping at the bottom of the Embedded Box PC 5000 with the Dell factory installed Windows 7 Professional SP1 OS image.

Table 1. Serial port mapping

Number	Port type	Connector	Device node
1	RS232/422/485	DB9	COM1
2	RS232/422/485	DB9	COM2
3	RS232/422/485	DB9	COM3
4	RS232/422/485	DB9	COM4

Embedded Box PC 5000 GPIO module In/Out mapping

The GPIOs ports on the Embedded Box PC and Nuvoton NCT6793D uses index/data pair of CPU I/O addresses 2Eh/2Fh to access NCT6793D.

GPIO 8 Out pin# to NCT6793D pin# map:

0 to 121 (GP00)

1 to 122 (GP01)

2 to 123 (GP02)

3 to 2 (GP03)

4 to 3 (GP04)

5 to 4 (GP05)

6 to 5 (GP06)

7 to 6 (GP07)

8 is GND

GPIO 8 In pin# to NCT6793D pin# map:

0 to 50 (GP60)

1 to 49 (GP61)

2 to 48 (GP62)

3 to 47 (GP63)

4 to 45 (GP64)

5 to 44 (GP65)

6 to 43 (GP66)

7 to 42 (GP67)

8 is GND

Embedded Box PC 5000 I/O module PCIe expansion mapping

The PCIe slots on the expansion module if the top side of the Embedded Box PC are driven directly from the host PCIe bus. Since it is generic PCIe expansion, there are no PCIe device-specific drivers integrated into the Windows 7 Professional SP1 OS image. If



there is specific PCIe card used on this slot, contact the vendor of that PCIe card to verify if they have Windows 7 Professional SP1 drivers.

Windows 7 Professional for Embedded Systems SP1

Overview

The Embedded Box PC is shipped with Windows 7 Professional for Embedded Systems. For more information, see <https://www.microsoft.com/windowseembedded/en-us/windows-embedded-enterprise-7.aspx>.

Boot up and log in

Before configuring the Windows 7 Professional for Embedded Systems, connect a keyboard, mouse, and monitor to the Embedded Box PC. Turn on the Embedded Box PC to boot into Windows.

1. Select regional settings.
2. Create a user account.
3. Read and agree to applicable End User Licence Agreements.
4. Select your preferred settings.

 **NOTE: Connect to a wireless network if available.**

Windows 7 Professional for Embedded Systems basic functions

Watchdog Timer

The Watchdog Timer for Windows 7 Professional for Embedded Systems is controlled via a BIOS setting. Enter the BIOS during boot by pressing F2. The Watchdog Timer is enabled and disabled under the BIOS setting **Watchdog Timer**.

TPM support

Windows 7 Professional for Embedded Systems supports TPM 1.2. For more information about TPM resources, see [https://technet.microsoft.com/en-us/library/cc749022\(v=ws.10\).aspx](https://technet.microsoft.com/en-us/library/cc749022(v=ws.10).aspx).

System shutdown

Click **Start**, and then click **Shut down** to shut down the Embedded Box PC.

System restart

Click **Start**, and click the arrow next to **Shut down**, and then click **Restart** to restart the Embedded Box PC.

LAN network configuration

1. Click **Start** and type `Network` in the search box.
2. Click **Network and Sharing Center** from the search result.
The **Network and Sharing Center** window appears.
3. From the left panel, click **Change adapter settings**.

WLAN network configuration

1. Click **Start** and type `Network` in the search box.
2. Click **Network and Sharing Center** from the search result.
The **Network and Sharing Center** window appears.
3. From the left panel, click **Change adapter settings**.

Bluetooth configuration

1. Click **Start** and type `Bluetooth` in the search box.
2. Click **Change Bluetooth settings** from the search result.
The **Bluetooth Settings** dialog box appears.

DW5580 network configuration

Follow the *Service Manual* to install and configure the DW5580 module and the corresponding carrier SIM card for the system. Once the module and the SIM card are installed, follow these steps to connect and disconnect from WWAN.

1. Click **Start** and type `Network` in the search box.
2. Click **Network and Sharing Center** from the search result.
The **Network and Sharing Center** window appears.
3. From the left panel, click **Change adapter settings**.
4. Locate the required WWAN connection.
5. Right-click the WWAN connection, and then select **Connect** or **Disconnect** to connect to or disconnect from the WWAN adapter, respectively.

Common port mappings on Embedded Box PC 5000 with Windows 7 Professional for Embedded Systems

Serial port mapping

The following table shows the serial port mapping at the bottom of the Embedded Box PC 5000 with Windows 7 Professional for Embedded Systems OS image.

Table 2. Serial port mapping

Number	Port type	Connector	Device node
1	RS232/422/485	DB9	COM1
2	RS232/422/485	DB9	COM2
3	RS232/422/485	DB9	COM3
4	RS232/422/485	DB9	COM4

Embedded Box PC 5000 GPIO module In/Out mapping

The GPIOs ports on the Embedded Box PC and Nuvoton NCT6793D uses index/data pair of CPU I/O addresses 2Eh/2Fh to access NCT6793D.

GPIO 8 Out pin# to NCT6793D pin# map:

0 to 121 (GP00)

1 to 122 (GP01)

2 to 123 (GP02)

3 to 2 (GP03)

4 to 3 (GP04)

5 to 4 (GP05)

6 to 5 (GP06)

7 to 6 (GP07)

8 is GND

GPIO 8 In pin# to NCT6793D pin# map:

0 to 50 (GP60)

1 to 49 (GP61)

2 to 48 (GP62)



3 to 47 (GP63)

4 to 45 (GP64)

5 to 44 (GP65)

6 to 43 (GP66)

7 to 42 (GP67)

8 is GND

Embedded Box PC 5000 I/O module PCIe expansion mapping

The PCIe slots on the expansion module if the top side of the Embedded Box PC are driven directly from the host PCIe bus. Since it is generic PCIe expansion, there are no PCIe device-specific drivers integrated into the Windows 7 Professional for Embedded Systems OS image. If there is specific PCIe card used on this slot, contact the vendor of that PCIe card to verify if they have Windows 7 Professional for Embedded Systems drivers.

Windows Embedded Standard 7 P/E

Overview

The Embedded Box PC is shipped with Windows Embedded Standard 7 P/E. For more information on Windows 7 operating system, see <https://support.microsoft.com/en-us>.

Boot up and login

Before configuring the Windows Embedded Standard 7 P/E, connect a keyboard, mouse, and monitor to the Embedded Box PC.

1. Turn on the Embedded Box PC and login to Windows Embedded Standard 7 P/E.
2. Select regional settings.
3. Create a **User Account**.
4. Read and accept the EULA.
5. Select your preferred settings.

 **NOTE: Connect to a wireless network if available.**

Windows Embedded Standard 7 P/E. basic functions

BIOS update

Download the latest BIOS version from www.dell.com/support. Run the executable in the download package from the local machine.

Watchdog timer

The watchdog timer for Windows Embedded Standard 7 P/E. is enabled and disabled through the BIOS.

TPM support

Windows Embedded Standard 7 P/E. supports TPM 1.2. For more information, see <https://technet.microsoft.com/en-us/library/cc749022.aspx>.

System shutdown

Click the Start icon, then click **Shut down** to shut down the Embedded Box PC.

System restart

Click the Start icon, then click right-arrow next to the **Shut down** button and click **Restart**.

Configuring LAN/WLAN network

1. Click the Start icon then search for Network.
2. Open **Network and Sharing Center**.
3. Click **Change adapter settings** on the left panel.

to configure the LAN on the Embedded Box PC.

Configuring Bluetooth

1. Click the Start icon then search for Bluetooth.
2. Click **Change Bluetooth settings** .

Configuring WWAN (DW5580) network

 **NOTE:** For instruction on installing the WWAN card and SIM card, see the *Service manual* for your system at www.dell.com/support. After installing the WWAN module and SIM card:

1. Click the Start icon then search for Network.
2. Open **Network and Sharing Center**.
3. Click **Change adapter settings** on the left panel.
4. Locate the WWAN connection and select the entry to connect (or disconnect) to the WWAN module.

Common port mappings

Serial port mapping

The table lists the serial port mapping on the Embedded Box PC 5000, with the Dell factory installed Windows Embedded Standard 7 P/E OS.

Table 3. Serial port mapping

Serial port number	Port type	Connector	Device Node
1	RS232/422/485	DB9	COM1
2	RS232/422/485	DB9	COM2
3	RS232/422/485	DB9	COM3
4	RS232/422/485	DB9	COM4

Embedded Box PC 5000 GPIO In/Out mapping

The GPIOs ports on the Embedded Box PC and Nuvoton NCT6793D uses index/data pair of processor I/O Addresses 2Eh/2Fh to access NCT6793D.

GPIO 8 Out pin# to NCT6793D pin# map:

0 to 121 (GP00)

1 to 122 (GP01)

2 to 123 (GP02)

3 to 2 (GP03)

4 to 3 (GP04)

5 to 4 (GP05)

6 to 5 (GP06)

7 to 6 (GP07)



8 is GND

GPIO 8 In pin# to NCT6793D pin# map:

0 to 50 (GP60)

1 to 49 (GP61)

2 to 48 (GP62)

3 to 47 (GP63)

4 to 45 (GP64)

5 to 44 (GP65)

6 to 43 (GP66)

7 to 42 (GP67)

8 is GND

Embedded Box PC 5000 IO Module PCIe expansion mapping

The PCIe slots on the Embedded Box PC are driven directly from the host PCIe bus. Since it is a generic PCIe expansion, there are no PCIe device-specific drivers integrated into the Windows Embedded Standard 7 P/E OS image. If there is a specific PCIe card used on this slot, contact the Vendor of that PCIe card to verify if they have Windows Embedded Standard 7 P/E drivers.

Windows 10 Professional

Overview

The Embedded Box PC is shipped with Windows 10 Pro. For more information on Windows 10 operating system, see <https://support.microsoft.com/en-us>.

Boot up and login

Before configuring the Windows 10 Pro, connect a keyboard, mouse, and monitor to the Embedded Box PC.

1. Turn on the Embedded Box PC and login to Windows Pro.
2. Select regional settings.
3. Read and accept the EULA.
4. Create a **User Account**.
5. Select your preferred settings.

 **NOTE: Connect to a wireless network if available.**

Restoring Windows 10 Pro

Using the recovery OS image on the Boot partition, restore Windows 10 Pro on the Embedded Box PC to the factory image.

Before starting the Windows 10 Pro restore process, connect a keyboard, mouse, and monitor to the Embedded Box PC:

1. Boot to the desktop.
2. Click the start icon and power icon.
3. Press and hold the Shift key and click **Restart**.
The system will Boot into the recovery console.
4. Select **Troubleshoot**.
5. Select **Factory Image Restore**.

6. Select **Next**.
Wait until the default factory image is installed on the system.
7. Select **Finish**.

Windows 10 Pro basic functions

BIOS update

Download the latest BIOS version from www.dell.com/support. Run the executable in the download package from the local machine.

Watchdog timer

The watchdog timer for Windows 10 Pro is enabled and disabled through the BIOS.

TPM support

Windows 10 Pro supports TPM 2.0. For more information, see <https://technet.microsoft.com/en-us/library/cc749022.aspx>.

System shutdown

Click the start icon then the power icon. Click **Shut down** to shut down the Embedded Box PC.

System restart

Click the start icon then the power icon. Click **Restart** to restart the Embedded Box PC.

LAN network

Click the Start icon then the settings icon. Click **Network & Internet** to configure the LAN on the Embedded Box PC.

Configuring WLAN network

Click the Start icon then the settings icon. Click **Devices** and the **Bluetooth** to configure the wireless devices on the Embedded Box PC.

Configuring WWAN (DW5580) network

 **NOTE:** For instruction on installing the WWAN card and SIM card, see the *Service manual* for your system at www.dell.com/support. After installing the WWAN module and SIM card:

1. Click the Start icon then the settings icon.
2. Click **Network & Internet**.
3. Locate the WWAN connection in the Wi-Fi section and connect (or disconnect) the WWAN module.

Common port mappings

Serial port mapping

The table lists the serial port mapping on the Embedded Box PC 5000 and the multifunction port cable, with the Dell factory installed Windows 10 Pro OS.

Table 4. Serial port mapping

Serial port number	Port type	Connector	Device Node
1	RS232/422/485	DB9	COM1
2	RS232/422/485	DB9	COM2
3	RS232/422/485	DB9	COM3
4	RS232/422/485	DB9	COM4

Embedded Box PC 5000 GPIO In/Out mapping

The GPIOs ports on the Embedded Box PC and Nuvoton NCT6793D uses index/data pair of processor I/O Addresses 2Eh/2Fh to access NCT6793D.



GPIO 8 Out pin# to NCT6793D pin# map:

0 to 121 (GP00)

1 to 122 (GP01)

2 to 123 (GP02)

3 to 2 (GP03)

4 to 3 (GP04)

5 to 4 (GP05)

6 to 5 (GP06)

7 to 6 (GP07)

8 is GND

GPIO 8 In pin# to NCT6793D pin# map:

0 to 50 (GP60)

1 to 49 (GP61)

2 to 48 (GP62)

3 to 47 (GP63)

4 to 45 (GP64)

5 to 44 (GP65)

6 to 43 (GP66)

7 to 42 (GP67)

8 is GND

Embedded Box PC 5000 IO Module PCIe expansion mapping

The PCIe slots on the Embedded Box PC are driven directly from the host PCIe bus. Since it is a generic PCIe expansion, there are no PCIe device-specific drivers integrated into the Windows 10 Pro OS image. If there is a specific PCIe card used on this slot, contact the Vendor of that PCIe card to verify if they have Windows 10 Pro drivers.

Windows 10 IoT Enterprise LTSB 2015

Overview

The Embedded Box PC is shipped with Windows 10 IoT Enterprise LTSB 2015. For more information on Windows operating system, see <https://support.microsoft.com/en-us>.

Boot up and login

Before configuring the Windows 10 IoT Enterprise LTSB 2015, connect a keyboard, mouse, and monitor to the Embedded Box PC.

1. Turn on the Embedded Box PC and login to Windows.
2. Select regional settings.
3. Select your preferred settings.

4. Create a **User Account**.

 **NOTE: Connect to a wireless network if available.**

Restoring Windows 10 IoT Enterprise LTSB 2015

Using the recovery OS image on the Boot partition, restore Windows 10 IoT Enterprise LTSB 2015 on the Embedded Box PC to the factory image.

Before starting the Windows 10 IoT Enterprise LTSB 2015 restore process, connect a keyboard, mouse, and monitor to the Embedded Box PC:

1. Boot to the desktop.
2. Click the start icon and power icon.
3. Press and hold the Shift key and click **Restart**.
The system will Boot into the recovery console.
4. Select **Troubleshoot**.
5. Select **Factory Image Restore**.
6. Select **Next**.
Wait until the default factory image is installed on the system.
7. Select **Finish**.

Windows Windows 10 IoT Enterprise LTSB 2015 basic functions

BIOS update

Download the latest BIOS version from www.dell.com/support. Run the executable in the download package from the local machine.

Watchdog timer

The watchdog timer for Windows 10 IoT Enterprise LTSB 2015 is enabled and disabled through the BIOS.

TPM support

Windows 10 IoT Enterprise LTSB 2015 supports TPM 2.0. For more information, see <https://technet.microsoft.com/en-us/library/cc749022.aspx>.

System shutdown

Click the start icon then the power icon. Click **Shut down** to shut down the Embedded Box PC.

System restart

Click the start icon then the power icon. Click **Restart** to restart the Embedded Box PC.

LAN network

Click the Start icon then the settings icon. Click **Network & Internet** to configure the LAN on the Embedded Box PC.

Configuring WLAN network

Click the Start icon then the settings icon. Click **Devices** and the **Bluetooth** to configure the wireless devices on the Embedded Box PC.

Configuring WWAN (DW5580) network

 **NOTE: For instruction on installing the WWAN card and SIM card, see the *Service manual* for your system at www.dell.com/support. After installing the WWAN module and SIM card:**

1. Click the Start icon then the settings icon.
2. Click **Network & Internet**.
3. Locate the WWAN connection in the Wi-Fi section and connect (or disconnect) the WWAN module.



Common port mappings

Serial port mapping

The table lists the serial port mapping on the Embedded Box PC 5000 and the multifunction port cable, with the Dell factory installed Windows 10 IoT Enterprise LTSB 2015.

Table 5. Serial port mapping

Serial port number	Port type	Connector	Device Node
1	RS232/422/485	DB9	COM1
2	RS232/422/485	DB9	COM2
3	RS232/422/485	DB9	COM3
4	RS232/422/485	DB9	COM4

Embedded Box PC 5000 GPIO In/Out mapping

The GPIOs ports on the Embedded Box PC and Nuvoton NCT6793D uses index/data pair of processor I/O Addresses 2Eh/2Fh to access NCT6793D.

GPIO 8 Out pin# to NCT6793D pin# map:

0 to 121 (GP00)

1 to 122 (GP01)

2 to 123 (GP02)

3 to 2 (GP03)

4 to 3 (GP04)

5 to 4 (GP05)

6 to 5 (GP06)

7 to 6 (GP07)

8 is GND

GPIO 8 In pin# to NCT6793D pin# map:

0 to 50 (GP60)

1 to 49 (GP61)

2 to 48 (GP02)

3 to 47 (GP63)

4 to 45 (GP64)

5 to 44 (GP65)

6 to 43 (GP66)

7 to 42 (GP67)

8 is GND

Embedded Box PC 5000 IO Module PCIe expansion mapping

The PCIe slots on the Embedded Box PC are driven directly from the host PCIe bus. Since it is a generic PCIe expansion, there are no PCIe device-specific drivers integrated into the Windows 10 IoT Enterprise LTSB 2015 OS image. If there is a specific PCIe card used on this slot, contact the Vendor of that PCIe card to verify if they have Windows 10 IoT Enterprise LTSB 2015 drivers.

Recommended drivers and applications for Embedded Box PC

Dell recommends installing the drivers and applications required for the Embedded Box PC from www.dell.com/support in the following sequence:

1. Intel Mobile Chipset Software Installation Utility
2. Critical Microsoft Quick Fix Engineering (QFE)
3. Intel Rapid Storage Technology
4. Graphics
5. Intel Management Technology
6. Audio
7. Integrated wired Network Adapter
8. Wireless Local Network Adapters and Bluetooth
9. USB 3.0
10. ZigBee
11. CANbus

Intel Mobile Chipset Software Installation Utility

1. Go to www.dell.com/support.
2. Click **Product support**, enter the Service Tag of the Embedded Box PC, and then click **Submit**.
 **NOTE: If you do not have the Service Tag, use the auto-detect feature or manually browse for the Embedded Box PC model.**
3. Click **Drivers & downloads** → **Find it myself**.
4. Scroll down the page and expand **Chipset**.
5. Click **Download** to download the Intel Mobile Chipset Software Installation Utility.
6. After the download is complete, navigate to the folder where you saved the chipset driver file.
7. Double-click the chipset driver file icon and follow the instructions on the screen.

Critical Microsoft QFEs

Dell recommends installing all the latest available fixes specific to Embedded Box PC through **Windows Update** or from www.microsoft.com.

Intel Rapid Storage Technology

The Intel Rapid Storage Technology (IRST) driver must be installed in AHCI or RAID mode. The Intel IRST application must also be installed.

The SATA operation modes are configured in the BIOS. If the SATA mode is configured in AHCI or RAID mode, the IRST driver must be installed during the initial operating system installation stages. The IRST driver is only available from Dell.

1. Go to www.dell.com/support.
2. Click **Product support**, enter the Service Tag of the Embedded Box PC, and then click **Submit**.
 **NOTE: If you do not have the Service Tag, use the auto-detect feature or manually browse for the Embedded Box PC model.**
3. Click **Drivers & downloads** → **Find it myself**.
4. Scroll down the page and expand **Serial ATA**.



5. Click **Download** to download the Dell IRST driver file.
6. After the download is complete, navigate to the folder where you saved the Dell IRST driver file.
7. Double-click the Dell IRSTdriver file icon and follow the instructions on the screen.

Graphics

1. Go to www.dell.com/support.
2. Click **Product support**, enter the Service Tag of the Embedded Box PC, and then click **Submit**.
 **NOTE: If you do not have the Service Tag, use the auto-detect feature or manually browse for the Embedded Box PC model.**
3. Click **Drivers & downloads** → **Find it myself**.
4. Scroll down the page and expand **Video**.
5. Click **Download** to download the graphics driver file.
6. After the download is complete, navigate to the folder where you saved the graphics driver file.
7. Double-click the graphics driver file icon and follow the instructions on the screen.

Intel Management Technology

1. Go to www.dell.com/support.
2. Click **Product support**, enter the Service Tag of the Embedded Box PC, and then click **Submit**.
 **NOTE: If you do not have the Service Tag, use the auto-detect feature or manually browse for the Embedded Box PC model.**
3. Click **Drivers & downloads** → **Find it myself**.
4. Scroll down the page and expand **Chipset**.
5. Click **Download** to download the Intel Management Engine Component Installer and Intel Serial I/O driver.
6. After the download is complete, navigate to the folder where you saved the driver files.
7. Double-click the driver file icons and follow the instructions on the screen.

Audio

1. Go to www.dell.com/support.
2. Click **Product support**, enter the Service Tag of the Embedded Box PC, and then click **Submit**.
 **NOTE: If you do not have the Service Tag, use the auto-detect feature or manually browse for the Embedded Box PC model.**
3. Click **Drivers & downloads** → **Find it myself**.
4. Scroll down the page and expand **Audio**.
5. Click **Download** to download the HD Audio driver.
6. After the download is complete, navigate to the folder where you saved the HD Audio driver file.
7. Double-click the HD Audio driver file icon and follow the instructions on the screen.

Integrated wired Network Adapter

1. Go to www.dell.com/support.
2. Click **Product support**, enter the Service Tag of the Embedded Box PC, and then click **Submit**.
 **NOTE: If you do not have the Service Tag, use the auto-detect feature or manually browse for the Embedded Box PC model.**
3. Click **Drivers & downloads** → **Find it myself**.
4. Scroll down the page and expand **Network**.
5. Click **Download** to download the LAN driver.
6. After the download is complete, navigate to the folder where you saved the LAN driver file.
7. Double-click the LAN driver file icon and follow the instructions on the screen.

 **NOTE: Enable the Windows Update and connect to Internet after installing the Integrated Wired Network Controller driver.**

Wireless Local Network Adapters and Bluetooth

1. Go to www.dell.com/support.
2. Click **Product support**, enter the Service Tag of the Embedded Box PC, and then click **Submit**.

 **NOTE: If you do not have the Service Tag, use the auto-detect feature or manually browse for the Embedded Box PC model.**

3. Click **Drivers & downloads** → **Find it myself**.
4. Scroll down the page and expand **Network**.
5. Click **Download** to download the Wireless LAN and Bluetooth device drivers.
6. After the download is complete, navigate to the folder where you saved the driver files.
7. Double-click the driver file icons and follow the instructions on the screen.

USB 3.0

1. Go to www.dell.com/support.
2. Click **Product support**, enter the Service Tag of the Embedded Box PC, and then click **Submit**.

 **NOTE: If you do not have the Service Tag, use the auto-detect feature or manually browse for the Embedded Box PC model.**

3. Click **Drivers & downloads** → **Find it myself**.
4. Scroll down the page and expand **Chipset**.
5. Click **Download** to download the USB 3.0 driver.
6. After the download is complete, navigate to the folder where you saved the USB 3.0 driver file.
7. Double-click the USB 3.0 driver file icon and follow the instructions on the screen.

ZigBee

1. Go to www.dell.com/support.
2. Click **Product support**, enter the Service Tag of the Embedded Box PC, and then click **Submit**.

 **NOTE: If you do not have the Service Tag, use the auto-detect feature or manually browse for the Embedded Box PC model.**

3. Click **Drivers & downloads** → **Find it myself**.
4. Scroll down the page and expand **Network**.
5. Click **Download** to download the ZigBee 3.0 driver.
6. After the download is complete, navigate to the folder where you saved the ZigBee 3.0 driver file.
7. Double-click the ZigBee 3.0 driver file icon and follow the instructions on the screen.

CANbus

1. Go to www.dell.com/support.
2. Click **Product support**, enter the Service Tag of the Embedded Box PC, and then click **Submit**.

 **NOTE: If you do not have the Service Tag, use the auto-detect feature or manually browse for the Embedded Box PC model.**

3. Click **Drivers & downloads** → **Find it myself**.
4. Scroll down the page and expand **Chipset**.
5. Click **Download** to download the CANbus driver.
6. After the download is complete, navigate to the folder where you saved the CANbus driver file.
7. Double-click the CANbus driver file icon and follow the instructions on the screen.



Specifications

Dimension and weight

Width	246 mm (9.69 in)
Depth	270 mm (10.63 in)
Height	107.20 mm (4.22 in)
Weight	5.80 kg (12.80 lb)

System information

Model number	Dell Embedded Box PC 5000
Processor	<ul style="list-style-type: none"> • Intel Celeron G3900E • Intel Core i3-6100E • Intel Core i5-6440EQ • Intel Core i7-6820EQ



NOTE: Depending on workload, Intel 4th generation Core i7 configurations could throttle in operating environments above 35°C (95°F).

Operating systems supported	<ul style="list-style-type: none"> • Windows 7 Professional SP1 64-bit • Windows 7 Professional for Embedded Systems SP1 64-Bit • Windows Embedded Standard 7 P 64-bit • Windows Embedded Standard 7 E 64-bit • Windows 10 Professional 64-bit • Windows 10 IoT Enterprise LTSC 2015 64-bit • Ubuntu Desktop 16.04
-----------------------------	---

Storage

Storage devices supported	<ul style="list-style-type: none"> • Two 2.5-inch SATA hard drive • Two M.2 solid-state drive with interposer • One 2.5-inch SATA hard drive + one M.2 solid-state drive with interposer
---------------------------	---

Memory

Slots	2 DIMM slots (maximum 16 GB per slot)
Type	DDR4
Speed	2133 MHz
Configurations supported	<ul style="list-style-type: none"> • 4 GB • 8 GB • 16 GB • 32 GB

Ports and connectors

Audio/video	<ul style="list-style-type: none">• One HDMI port• One VGA port• Two DisplayPort• One line-in port• One line-out port• One microphone port
-------------	---

 **NOTE: For more information about the display options, see [Display Options](#).**

Network	<ul style="list-style-type: none">• Two RJ45 ports• Two wireless ports• Two mobile broadband antenna ports
I/O port	<ul style="list-style-type: none">• One CANbus port (optional)• Four RS232/RS422/RS485 ports• GPIO 16-bit
USB	<ul style="list-style-type: none">• Four USB 3.0 ports• Four USB 2.0 ports

Communications

WiFi	Dual-band 802.11b/g/n/ac
Bluetooth	Bluetooth 4.1 LE

Power requirements

Phoenix connector input voltage/current	12 VDC/10.80 A-26 VDC/5 A
Power input voltage/current	12 VDC/10.80 A-26 VDC/5 A



WARNING: Connect a certified SELV power to either Phoenix connector or the Barrel connector only. The connection of two power sources may damage equipment and present risk of fire.

RTC coin-cell battery (lithium ion)

Type	CR-2032H	BR-2032	Others
Manufacturer	<ul style="list-style-type: none">• Hitachi Ltd.• Maxell Ltd.	Panasonic Corp.	Varies depending on the battery type
Maximum abnormal charging rate:			
Voltage	3 V	3 V	3 V
Current	10 mA	10 mA	10 mA
Standard	UL1642	UL1642	UL1642
Approval	UL (MH12568)	UL (MH12210)	UL (MHxxxxx)

Environmental requirements

Temperature range:	
Operating: Hard drive	0°C to 40°C (32°F to 104°F)



Environmental requirements

Operating: Solid-state drive	0°C to 50°C (32°F to 122°F)
Non-operating	-40°C to 65°C (-40°F to 149°F)
Relative humidity (maximum):	
Operating	10% to 90% (non-condensing)
Non-operating	5% to 95% (non-condensing)
Altitude (maximum, unpressurized):	
Operating	-15.20 m to 5000 m (-50 ft to 16,404 ft)
Storage	-15.20 m to 10,668 m (Sea level to 35,000 ft)
IP level	IP 30

Activating your mobile broadband service

 **NOTE:** For more information about installing the SIM card, see the Embedded Box PC Service Manual at www.dell.com/support.

1. Turn on the Embedded Box PC.
2. Follow these steps to connect to the mobile broadband network:

 **NOTE:** To activate your mobile broadband service, contact your service provider with the following information:

Windows OS

- a. From the task bar select the Network icon and then select **Cellular**.
The **Cellular** page is displayed.
- b. Select your **Mobile Broadband Carrier** to expand the options.
- c. Select **Advanced Options**.
The options are displayed.
- d. Make a note of the **International Mobile Equipment Identity (IMEI)** and the **Integrated Circuit Card Identifier (ICCID)**.

Ubuntu OS

Open a **Terminal** window.

- a. Go to super user mode by entering: `$sudo su -`
- b. Configure the Mobile Broadband connection profile:

```
#nmcli con add type gsm ifname ttyACM3 con-name <connection name> apn <apn> user <user name> password <password>
```

- c. Connect to the mobile network: `#nmcli con up <connection name>`

To disconnect from the mobile network: `#nmcli con down <connection name>`.

Setting up the ZigBee dongle

1. Shut down the Embedded Box PC.
2. Connect the ZigBee dongle to any external USB port on the Embedded Box PC.

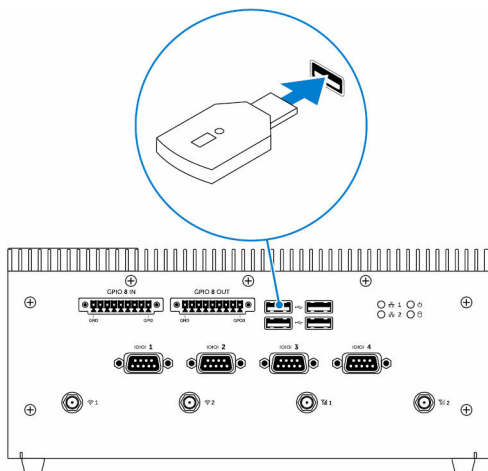

3. Turn on the Embedded Box PC and complete the setup.

 **NOTE:** For ZigBee development information, see the SiLabs developer website at www.silabs.com or contact the network system's application provider.

Display options

Embedded Box PC consists of the following video connectors:

- VGA
- HDMI
- DisplayPort 1 (DP1)
- DisplayPort 2 (DP2)

The Embedded Box PC supports up to three simultaneous connections. The enabled ports are:

- HDMI, DP1, and VGA (default)
- HDMI, DP1, and DP2

Video output is always supported on HDMI and DP1 connectors. You can switch the display output between the VGA port and the DP2 port in the BIOS.

 **NOTE: Video output availability depends on the operating system support and configuration.**

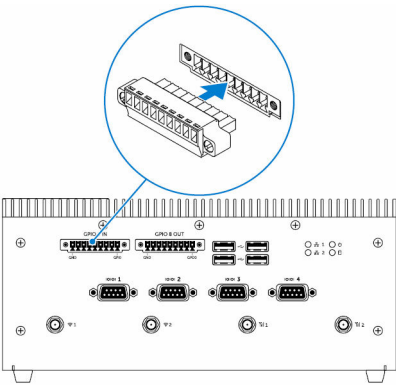

GPIO-out connector

Use the GPIO-out connector to connect the GPIO-in enabled devices or dongles.

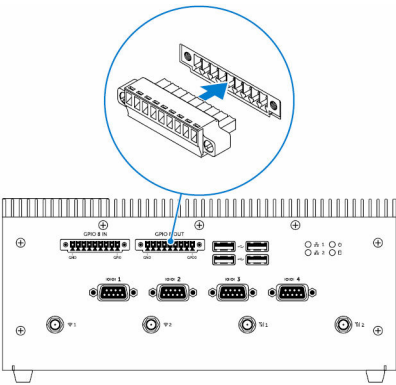

Contacting Dell

To contact Dell for sales, technical assistance, or customer service issues:

1. Go to www.dell.com/contactdell.
2. Verify your country or region in the drop-down list at the bottom of the page.
3. Select the appropriate service or support link based on your requirement or choose the method of contacting Dell that is convenient for you.

Dell provides several online and telephone-based support and service options. Availability varies by country and product, and some services may not be available in your area.

 **NOTE: If you do not have an active internet connection, you can find contact information on your purchase invoice, packing slip, bill, or Dell product catalog.**