

The TC-2F

Time Control Module

For the Sensiscan 2000 Fire Alarm Control Panels

Table of Contents

	Page
Section One: General Information	4
Section Two: Inventory	7
Section Three: Installation	9
Installation Outline	9
Mounting Optional Expanders	9
Installation	10
Harness Connections	10
Power Configurations for the TC-2F	11
Section Four: Evacuation Applications	13
TC-2F Pre-Signal/Dual Coded Evacuation Circuits	13
Notification Appliance Circuits on the ICE-4F	14
Programming the TC-2F for Evacuation	15
Programming the Delay Timer for Evacuation	15
Delay Timer Operation (in Evacuation)	17
Section Five: Releasing Applications	19
Releasing Service Connections on the TC-2F	19
Releasing Service Connections on the ICE-4F	20
Wiring the CRE-4F Control Relay Expander	21
Programming the TC-2F for Releasing	22
Programming the Delay Timer for Releasing	24
Delay Timer Operation (Releasing)	25
Releasing Service Controls	26
Slide-In Labels for the TC-2F	<i>Inside the back cover</i>

Section One: General Information



The TC-2F Module may be field-programmed to operate in one of five different modes:

Pre-Signal Evacuation

For Pre-Signal application, where allowed by Authority Having Jurisdiction (AHJ), the TC-2F provides:

- * Two Evacuation audible circuits
- * Pre-Signal Alert audible circuit
- * Alert Hold circuit
- * Programmable timer with display



Pre-Signal Operation

Initiating zone has activated both Alert Enable 1 and Alert Enable 2.		The Alert audible circuit will pulse the audible circuits at 20 PPM and the timer will begin to count down.
If the "HOLD ON ALERT" circuit is activated....		...the Alert audible circuit will continue to pulse at 20 PPM. The timer will hold at ten seconds.
The time delay has counted down to zero (General Evacuation LED flashes).		The Alert audible and the two General Evacuation Notification Appliance Circuits will turn on steady.

Dual-Coded Evacuation

Similar to Pre-Signal Evacuation with the exception that all three audible circuits activate simultaneously with an alert tone at the start of the time delay, followed by a different evacuation code after time out.

Dual-Coded Operation





Initiating zone has activated both Alert Enable 1 and Alert Enable 2.		All three audible circuits will pulse the at 20 PPM and the timer will begin to count down.
If the "HOLD ON ALERT" circuit is activated....		...all three audible circuits will continue to pulse at 20 PPM. The timer will hold at 10 seconds.
The time delay has counted down to zero (General Evacuation LED flashes).		All three audible circuits will pulse a TEMPORAL 3-3-3 code.

Standard Release

For Halon and other agent-releasing applications.

- Two supervised releasing circuits
- Warning Bell circuit
- Supervised Abort circuit
- Cross-zone capability
- LED display of time remaining, Abort and Release





Standard Releasing Operation

Initiating circuit activates either Enable 1 or Enable 2.	 No action taken by the TC-2F (Notification Appliance Circuit on the CPU may be programmed to sound on first alarm).
Initiating circuits activate both Enable 1 and Enable 2.	 The Warning Bell circuit will sound steady and the timer will begin to count down.
If the "ABORT" circuit is activated (non-latching).....	 ...the Warning Bell circuit continues to sound steady. The timer stops and holds at 5 seconds until release.
If the "ABORT" circuit is not active, or has been disengaged, the time delay will count down to zero (the Release LED flashes).	 The Warning Bell circuit continues to sound steady and both releasing circuits are activated

Triple-Coded Release

All functions of Standard Release, with a coded warning audible circuit to indicate first zone in alarm, second zone in alarm and release.

Triple-Coded Releasing Operation

First initiating circuit activates either Enable 1 or Enable 2.	 No action taken by the TC-2F (Note: Notification Appliance Circuit on the CPU may be programmed to sound first alarm).
Initiating circuits activate both Enable 1 and Enable 2.	 The Warning Bell circuit will sound steady and the timer will begin to count down.
If the "ABORT" circuit is activated (non-latching).....	 ...the Warning Bell circuit continues to sound steady. The timer stops and holds at 5 seconds until release.
If the "ABORT" circuit is not active, or has been disengaged, the time delay will count down to zero (the Release LED will flash).	 The Warning Bell circuit continues to sound steady and releasing circuits are activated.

IRI Release

All functions of Triple-Coded Release, except abort commands are accepted only if they occur before initiation of the second zone into alarm.

IRI Releasing Operation

First initiating circuit activates Enable 1.	☞	The Warning Bell circuit will pulse the audible at 20 PPM.
Second initiating circuit activate both Enable 1 and Enable 2	☞	The Warning Bell circuit will pulse at 110 PPM and the timer will begin to count down.
If the "ABORT" circuit is activated (non-latching)...	☞	...then the Warning Bell circuit will pulse at 20 PPM. The timer will stop and hold at 5 seconds until release.
If the "ABORT" circuit is not active, or has been disengaged, the time delay will count down to zero (Release LED will flash).	☞	The Warning Bell circuit will sound steady and releasing circuits are activated.

Application Notes:

1) Selection of operating mode is done using the *System Coded Circuit* and *March Time/Temporal* programming selections. Care must be taken to ensure that program selections do not conflict with other controlled outputs within the fire alarm control system.

2) More than one TC-2F may be installed in a control panel, but all TC-2F modules must be programmed for the same type of operation (Standard Release, Triple-Coded Release, IRI Release, etc).

3) Care must be taken to ensure that adequate power is provided for output circuits, particularly release circuits which require *regulated* power.

About this Manual

This document contains information specific to the TC-2F. Before installing, you should be familiar with the installation manual for the respective fire alarm control panel:

The Sensiscan 2000 Installation, Operation, and Programming Manual, Document 15017.

TC-2F Power Requirements

Standby Current: 0.007 amps Alarm Current: 0.072 amps

Refer to the respective fire alarm control panel manual for calculation of primary and secondary power requirements for the TC-2F.

Section Two: Inventory

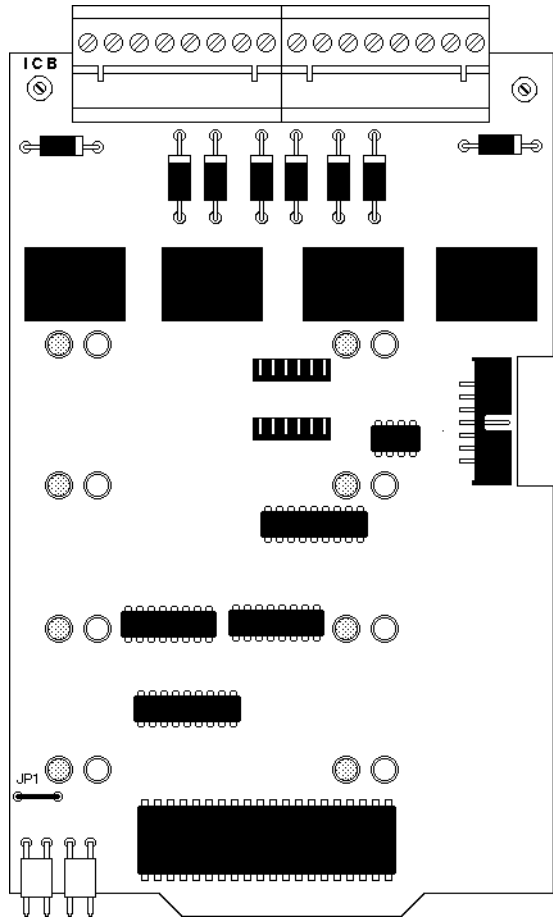

The TC-2F Time Control Module features removable terminal blocks that ease installation and servicing. Provided with the module are two harnesses for connection to the source of power. Also included are four End-of-Line resistors and four 4.7K Dummy Load resistors.



**4.7K 1/2-watt
ELR (71252)**



**4.7K 1/2-watt
Dummy Load
Resistor (71245)**

TC-2F



AVPS-24F Bell Power Harness (71091)



CPU Bell Power Harness (71093)

Optional Equipment for the TC-2F Time Control Module

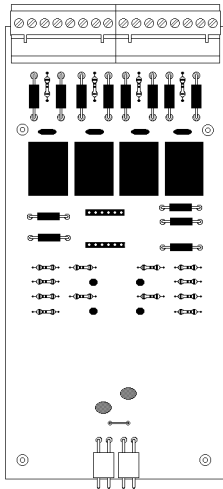

ICE-4F Indicating Circuit Expander

The ICE-4F provides the TC-2F with up to four additional releasing coil circuits or four Notification Appliance Circuits. Use only UL-listed releasing devices rated for 24 VDC. The expander plugs into the back of the TC-2F. An Auxiliary Bell Power Harness (below) is provided with each expander.



Note: The addition of an ICE-4F will allow a total of six releasing circuits from a single TC-2F/ICE-4F combination. Carefully check the current draw required if this number of releasing circuits is to be employed and ensure that an adequate supply is provided.

CRE-4F Control Relay Expander

The CRE-4F provides four Form-C relays that will operate on release. Contacts are rated for 5 amps @ 125 VAC (resistive) or 28 VDC (resistive). The expander plugs into the back of the TC-2F.

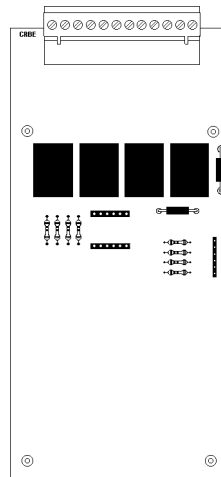

Section Three: Installation

Installation Outline

- If an optional ICE-4F or CRE-4F is to be used, mount the expander board to the TC-2F as illustrated in Figure 3-1.
- Mount the TC-2F assembly into the CHS-4F Chassis as illustrated in Figure 3-2.
- Connect the 1st Row or Expander Row Ribbon Cable from the system's CPU module to the TC-2F as illustrated in Figure 3-3.
- For connection of Notification Appliance power or releasing solenoid power to the TC-2F (using power harnesses), refer to Figure 3-3.
- Field wire the TC-2F circuits and program the CPU as outlined in Section Four (Evacuation Applications) or Section Five (Releasing Applications).

Figure 3-1: Mounting an Optional ICE-4F or CRE-4F Expander

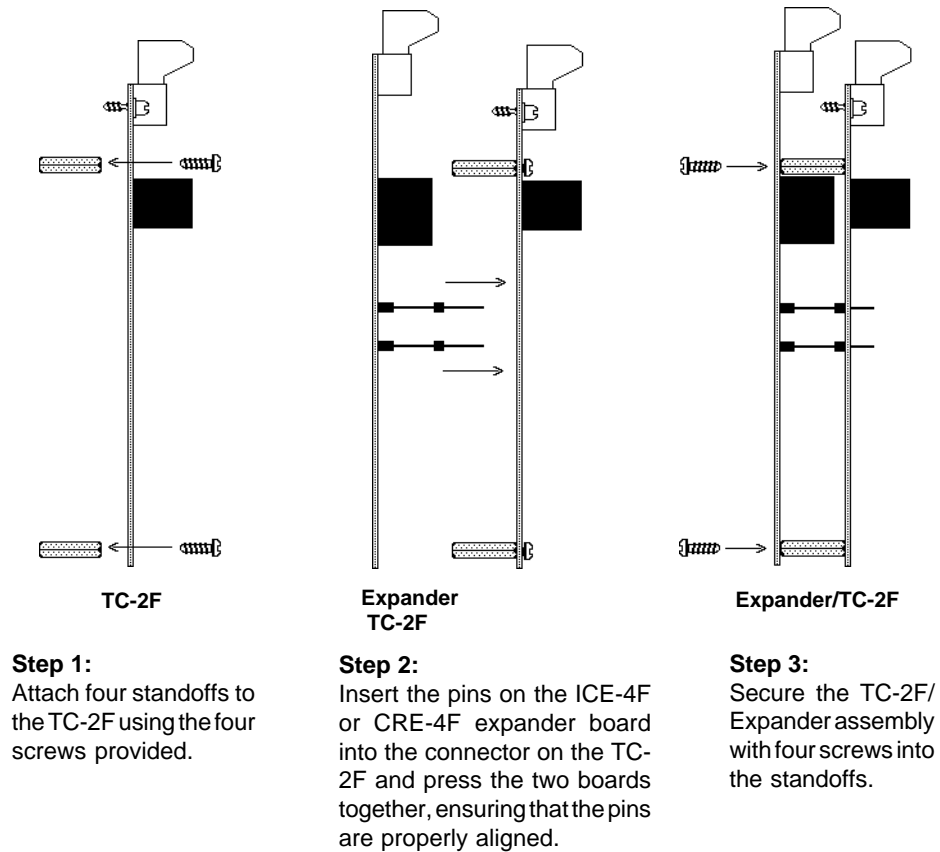
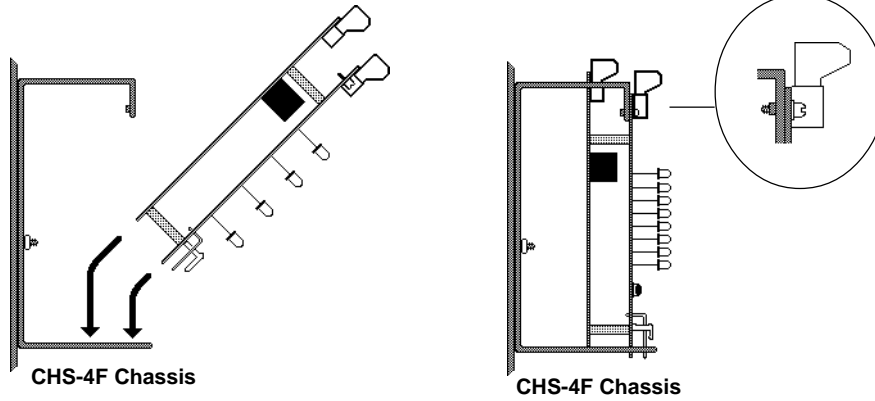

Figure 3-2: Installation



Step 1:
Angle the TC-2F assembly into the CHS-4F Chassis so that the upper board edge slips into the slot on the bottom rail of the chassis.

Step 2:
Push the upper end of the TC-2F assembly into the chassis and secure with the two captive module screws. Straighten LEDs so that they extend from the TC-2F at a 90-degree angle.

Figure 3-3: Harness Connections

1) If power for the TC-2F (or the ICE-4F) is to come from an MPS, connect Power Harness 71093 from J5 on the TC-2F to the power supply. If the AVPS-24F is to be used, connect Power Harness 71091 from J5 to P3 on the AVPS-24F. If the TC-2F is to share power with another module, connect Power Harness 71091 from J6 on that module to J5 on the TC-2F. For various supply configurations for the TC-2F, see the next page.

2) Connect the 1st Row Ribbon from the CPU module to the TC-2F as illustrated.

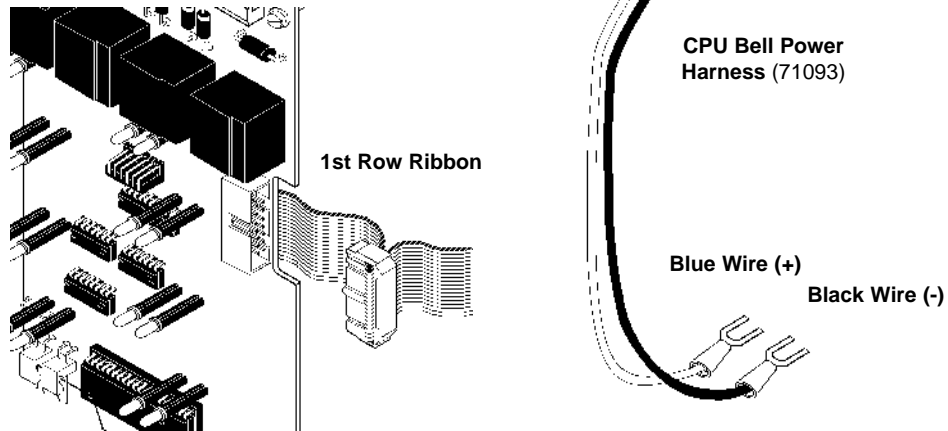

Powering for Pre-Signal or Dual-Code Evacuation

When used for Pre-Signal or Dual-Code Evacuation, the TC-2F/ICE-4F does not require that the 24 VDC power be regulated, but it must be power-limited. This power can be supplied by Notification Appliance power from the MPS-24BRBF, or special application power from the AVPS-24F. Refer to the Device Compatibility Document, for a list of compatible, UL listed Notification Appliances. **Note:** The illustrations below assume that no other Notification Appliance power is drawn from MPS or AVPS-24F. If this is not the case, reduce the maximum current that can be supplied to the TC-2F/ICE-4F appropriately.

MPS-24BRBF: 2.0 amps max. Connect to TB2 Terminals 3 (+) and 4 (-). **CAUTION:** The +24 VDC provided on TB2 Terminal 3 is power-limited only when used with the minus return on TB2 Terminal 4. *Do not use the minus return on TB2 Terminal 2 with the +24 VDC power on TB2 Terminal 3.*

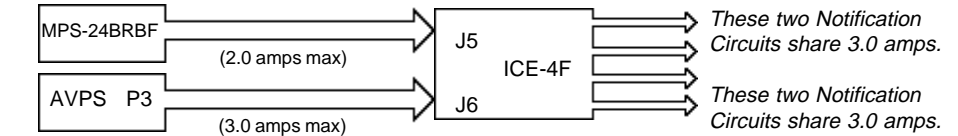
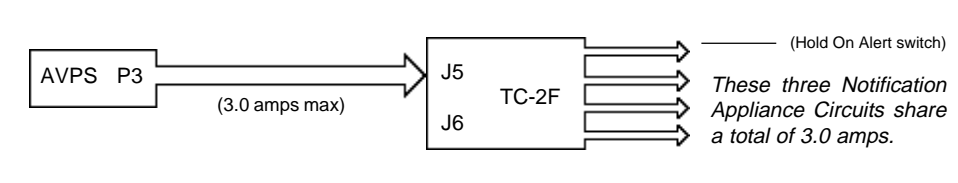
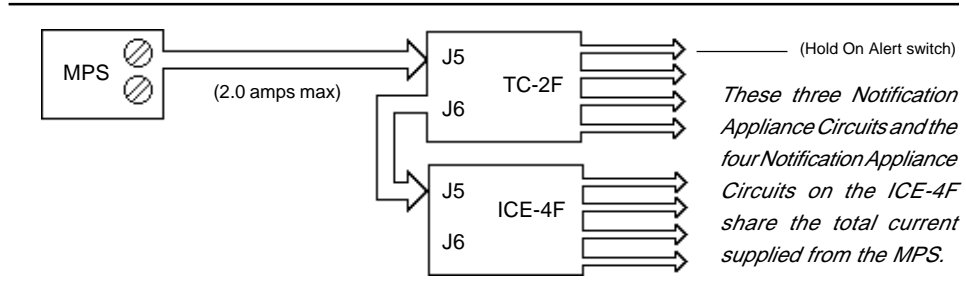
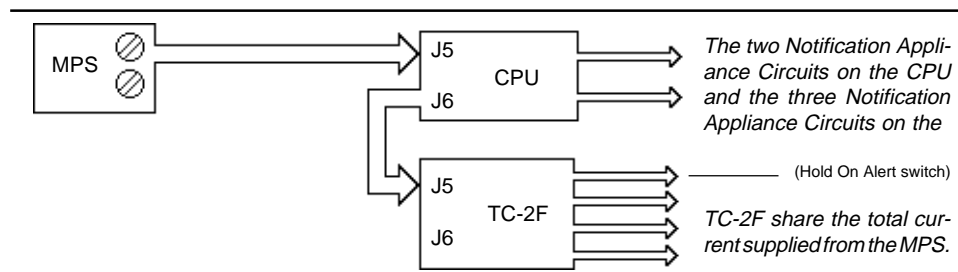

IMPORTANT:
Cut jumper JP1 when supplying the TC-2F or ICE-4F with two different power sources.

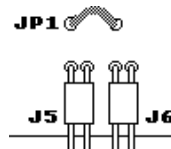

Powering the TC-2F for Releasing Service

The TC-2F must be supplied with regulated 24 VDC power for compatibility with listed 24V release solenoids. **Note:** The illustration below assumes that no other power is drawn from the regulated output of the MPS. If this is not the case, reduce the maximum current that can be supplied to the TC-2F appropriately.

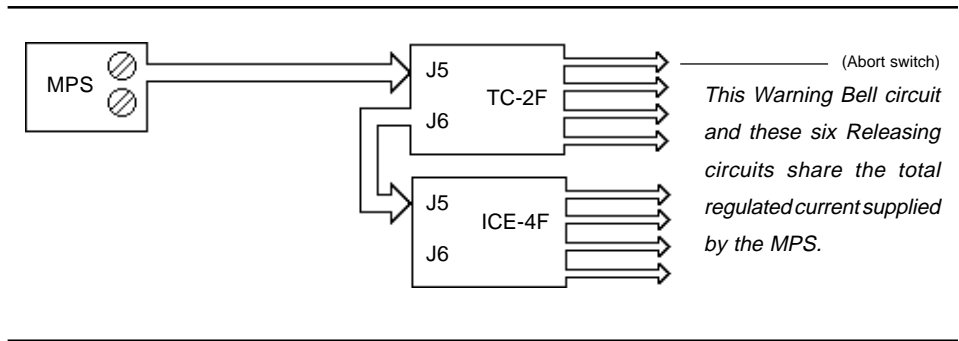
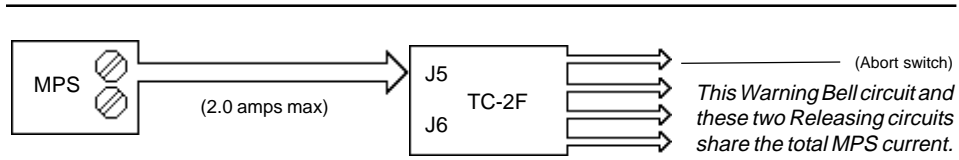

Section Four: Evacuation Applications

Pre-Signal and Dual-Coded Evacuation Circuits

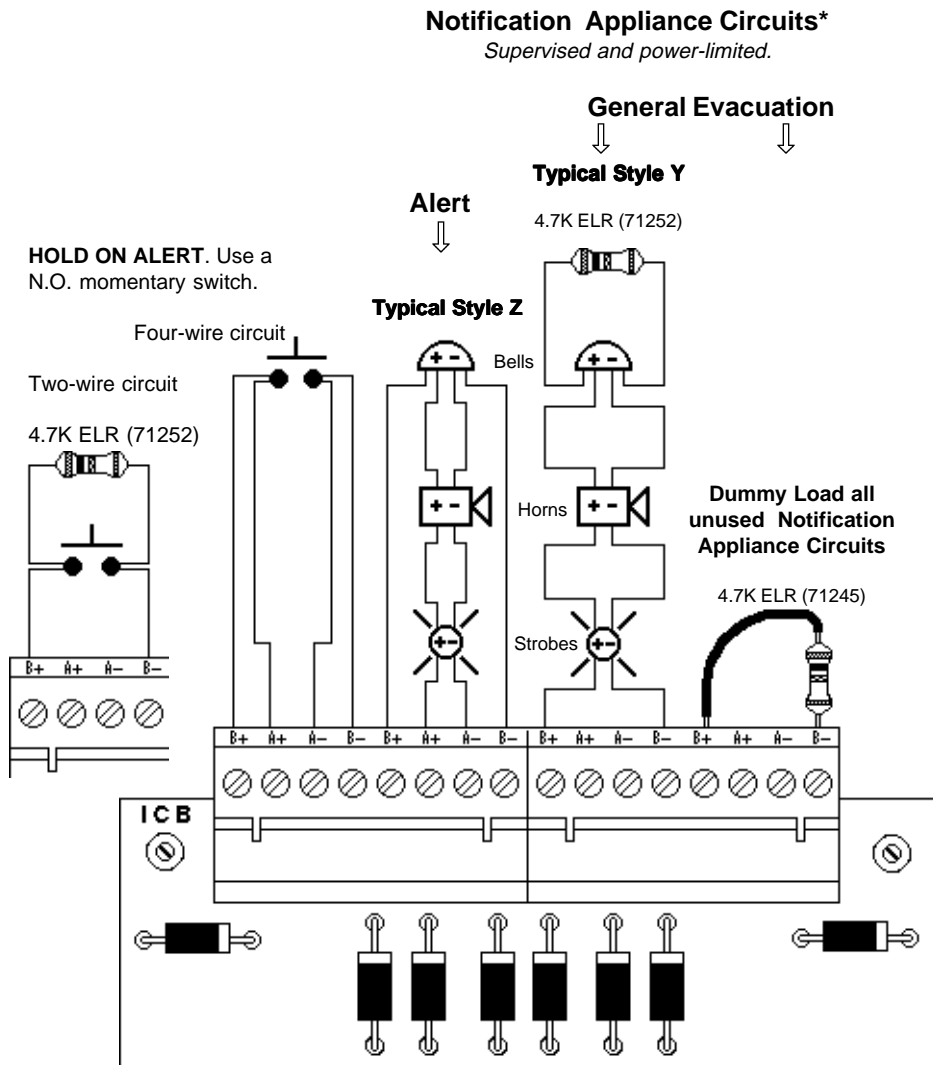

* See the Device Compatibility Document, 15384, for compatible Notification Appliances. Maximum current per circuit is 3.0 amps, subject to the limitations of the bell power supply. Notification Appliance Circuits can be wired Style Y or Style Z.

Optional ICE-4F Notification Appliance Circuits

For Pre-Signal and Dual-Coded applications, the Notification Appliance Circuits located on the ICE-4F will activate under general evacuation when the time delay has counted down to zero.

General Evacuation Notification Appliance Circuits* *Supervised and power-limited.*

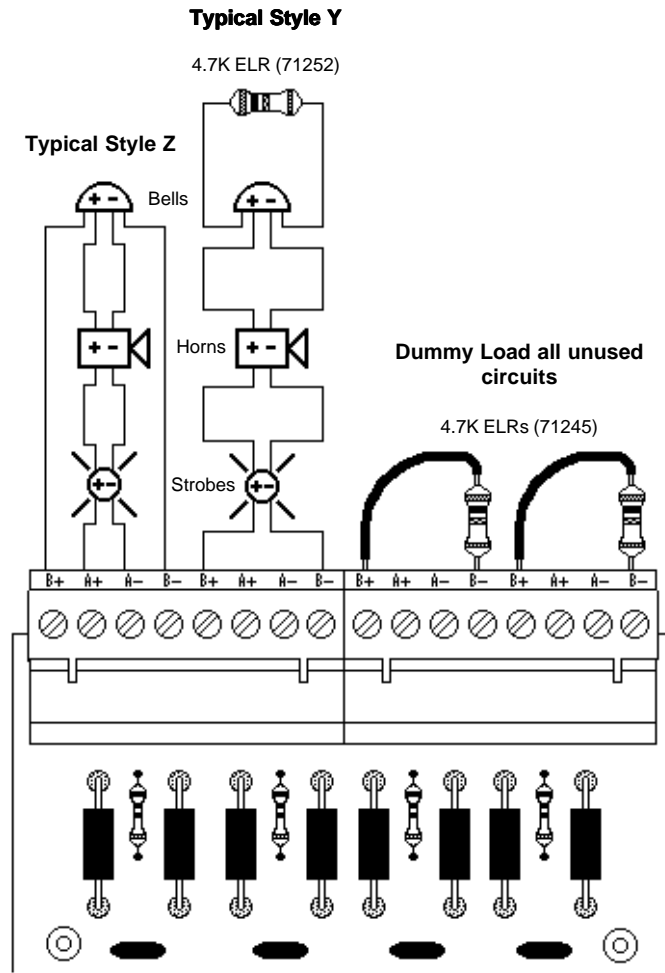

ICE-4F Indicating Circuit Expander

* See the Device Compatibility Document, 15384, for compatible Notification Appliances. Maximum current per circuit is 3.0 amps, subject to the limitations of the bell power supply. Notification Appliance Circuits can be wired Style Y or Style Z.

Programming the TC-2F for Evacuation Service

This section contains programming information specific to the TC-2F for Pre-Signal and Dual Coded application. For general information on programming the fire alarm control panel, refer to the respective programming manual. **Note:** The programming key must be inserted into the CPU before continuing.

Reconfigure

The system must be reconfigured any time a new module is installed. Enter 1 2 3 - 1 2 3 1. (the reconfiguration password). All green LEDs on the TC-2F should light if the module has been installed correctly. Press ESCAPE to confirm system configuration.

Programming

The TC-2F can be programmed at the same time as the rest of the control panel or separately. Specifically, the programming steps that involve the TC-2F are as follows:

CODED CIRCUIT

CODE TYPE

**I/O MAP
(and Delay Timer)**

Push the FUNCTION SELECT switch repeatedly until the CODED CIRCUIT LED illuminates steadily.

Continue on with CPU programming for the TC-2F as outlined in the *Programming Pre-Signal Evacuation* or *Programming Dual-Coded Evacuation* sections

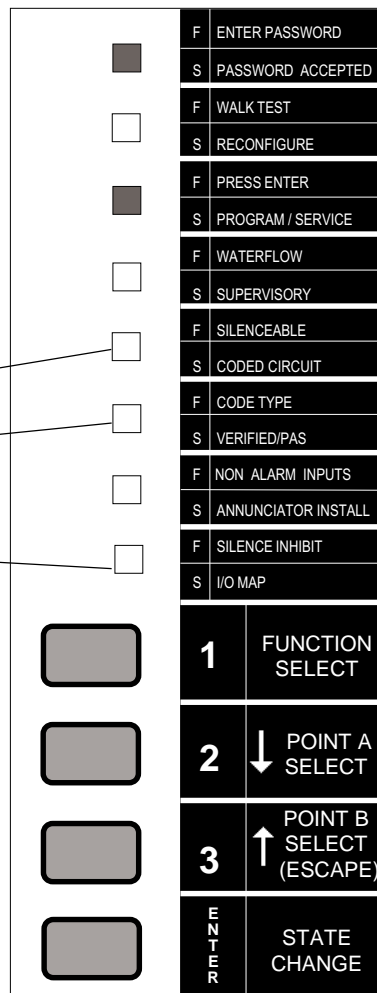

Programming Pre-Signal Evacuation

CODED CIRCUIT

Select both ENABLE A and ENABLE B for CODED CIRCUIT. *Do not select any of the four time selections for coded circuits.*

CODE TYPE

Temporal code must be selected for CODE TYPE. When the CODE TYPE LED is flashing, set the green LED on Notification Appliance Circuit 1 for flashing.

I/O MAP

Map all initiating circuits to both ENABLE 1 and ENABLE 2 on the TC-2F module. Each circuit must also be mapped into the same desired time delay.

Programming Dual-Coded Evacuation

CODED CIRCUIT

Select both ENABLE A and ENABLE B for coded circuits. Also program the four time selections for coded circuits.

CODE TYPE

Temporal code must be selected for Code Type. When the Code Type LED is flashing, set the green LED on Notification Appliance Circuit 1 for flashing.

I/O MAP

Map all initiating circuits to both ENABLE 1 and ENABLE 2 on the TC-2F module. Each circuit must also be mapped to the same desired time delay.

Programming the Delay Timer for Evacuation Service

During I/O Mapping, a delay timer setting can be programmed. For evacuation service, the settings range from 4 minutes to 30 seconds, but are cumulative (can be added together for a maximum delay of 7 minutes and 30 seconds).

Use the **POINT SELECT** switches to move the programming pointer to one of the time delay points on the TC-2F.

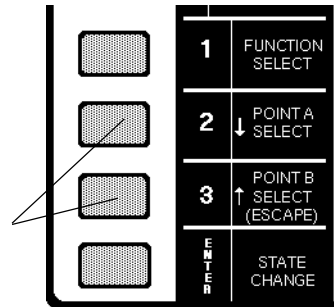

Use the **STATE CHANGE** switch to turn the green LED for that point on (selected) or off (deselected).



Use the **POINT SELECT** switches to move to each point for selection or deselection.

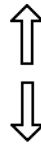

When the desired time delay has been set, continue on with I/O Mapping.



The LED arrangement above illustrates a time delay setting of 5 minutes (4 MINUTES and 1 MINUTE).

Delay Timer Operation (Evacuation service)

After the TC-2F has been activated by an alarm; the green LEDs will flash indicating how much time is remaining.

Example: A 5-minute, 30-second time delay will start by flashing the 4 minute, 1 minute and 30 second LEDs. After the timer has counted 30 seconds, only the 4 minute and 1 minute LEDs will flash. This will continue until the timer has reached 10 seconds. The 30 seconds LED will start to flash at twice the normal rate during the last 10 seconds. Then the GENERAL EVACUATION LED will flash.

If the HOLD ON ALERT switch has been activated, the timer will continue to count down until 10 seconds remain. The timer will stop and wait until the hold switch is deactivated, as which time the timer will count down to zero.



Pre-Signal/Dual-Coded Evacuation application at a countdown of 1 minute and 30 seconds.

Time settings for releasing modes are different than the values shown above.

Section Five: Releasing Applications

Releasing Service Field Connections

When power-limited and nonpower-limited circuits are used, skip a set of outputs between the power-limited and nonpower-limited circuits as shown in the figure below.

Typical ABORT circuit. Use a momentary normally open switch. Power-limited circuit.

Typical Style Z Warning Bell circuit. Power-limited circuit

Releasing Devices. Use only UL listed releasing devices rated for 24 VDC. Nonpower-limited. Maximum of one device per circuit.**

Note: Do not program an abort switch for Preaction or Deluge systems.

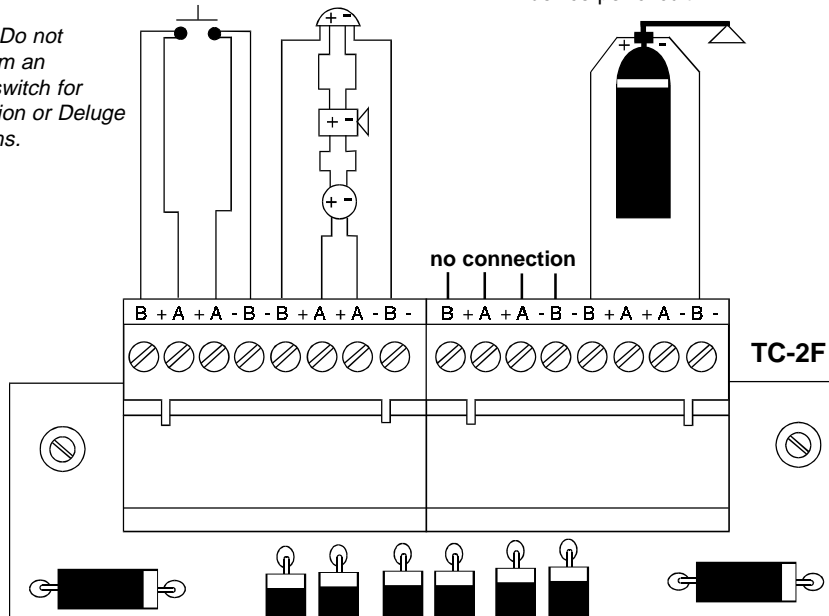

Typical Wiring Diagram for Mixed Power-limited and Nonpower-limited

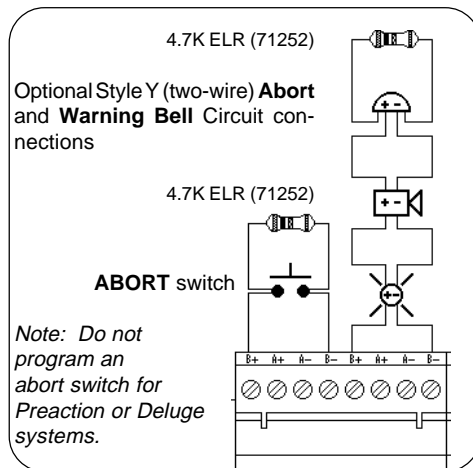

* See the Device Compatibility Document for compatible Notification Appliances. Maximum of 3 amps per circuit, subject to the limitations of the power supply.

** Releasing devices wired Style "Y" only.

* All circuits are supervised and power limited.

* Factory Mutual requires 90 hours of standby power and Style D (Class A) wiring on all Initiating Device Circuits in Pre-Action or Deluge systems.

* Wiring must be configured to maintain a minimum voltage of 20.4V on release circuits. Calculation of maximum allowable resistance:

$$R_{max} = \frac{20.6V - 20.4V}{I_s}$$

Where:

R_{max} = maximum allowable resistance of wiring
 I_s = solenoid current

Optional ICE-4F Releasing Circuit Connections

The ICE-4F will allow up to six supervised releasing coil circuits to be controlled by a TC-2F. Use only UL listed releasing devices rated for 24 VDC. Maximum of one device per circuit. Care must be taken to ensure that adequate power is provided for the releasing circuits, which require regulated power. Maximum current per circuit is 3 amps, subject to the limitations of the power supply.

Typical Style Y Releasing Circuits *Supervised*

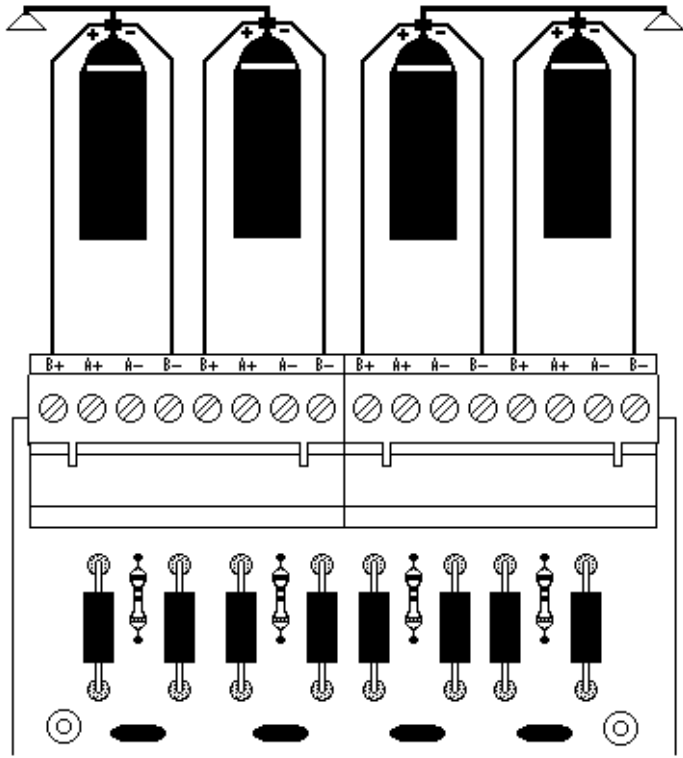

*** Deluge/Pre-Action Release:** When using this configuration for Deluge and/or Pre-Action Services, wiring must be configured to maintain a minimum voltage of 20.4VDC on release circuits. Calculation of maximum allowable resistance:

$$R_{\text{max}} = \frac{20.6\text{V} - 20.4\text{V}}{I_s} \quad \text{where:} \quad R_{\text{max}} = \text{maximum allowable resistance of wiring}$$

$$I_s = \text{solenoid current}$$

* Factory Mutual requires 90 hours of standby power and Style D (Class A) wiring on all Initiating Device Circuits. *Do not program an abort switch for this application. * For NFPA 13 and 15 applications, the soak timer must be disabled. *For NFPA 16 applications, the soak timer may be set to 10 or 15 minutes. *For UL Listed and FM approved Solenoid Release Valves, see the Device Compatibility Document.

Optional CRE-4F Relay Expander

The four output relays on the CRE-4F Control Relay Expander will operate on Release.

Field Wiring the CRE-4F

If using a mix of power-limited and nonpower-limited circuits, maintain a minimum of 0.25" spacing between power-limited and nonpower-limited wiring and exit the enclosure from different knockouts.

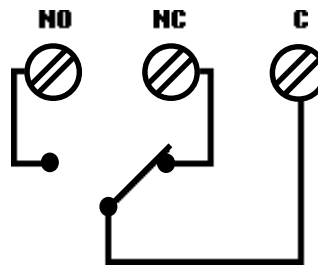
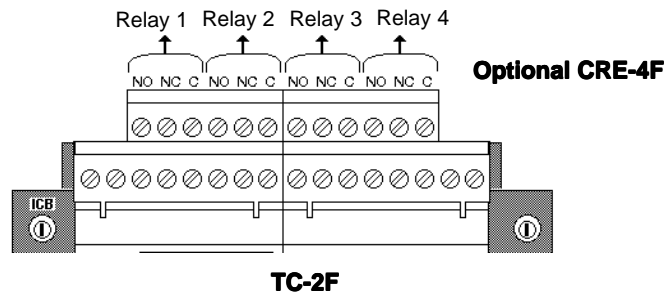

Typical Relay in Standby Position

The contacts are rated for 5 amps @ 120VAC or 28VDC (resistive).

Programming the TC-2F for Releasing Service

This section contains programming information specific to the TC-2F for releasing applications. For general information on programming the fire alarm control panel, refer to the respective programming manual. **Note:** The programming key must be inserted into the CPU before continuing.

Reconfigure

The system must be reconfigured any time a new module is installed. Enter 1 2 3 - 1 2 3 1. (the Reconfiguration password). All green LEDs on the TC-2F should light if the module has been installed correctly. Press ESCAPE to confirm system configuration.

Programming

The TC-2F can be programmed at the same time as the rest of the control panel or separately. Specifically, the programming steps that involve the TC-2F are as follows:

SILENCEABLE/CODED CIRCUIT

CODE TYPE

I/O MAP
(and Delay Timer)

Push the FUNCTION SELECT switch repeatedly until the CODED CIRCUIT LED flashes.

Continue on with CPU programming for the TC-2F as outlined in the *Programming Standard Release*, *Programming Triple Coded Release*, or *Programming IRI Release* sections.

<input checked="" type="checkbox"/>	F	ENTER PASSWORD
<input type="checkbox"/>	S	PASSWORD ACCEPTED
<input type="checkbox"/>	F	WALK TEST
<input type="checkbox"/>	S	RECONFIGURE
<input type="checkbox"/>	F	PRESS ENTER
<input type="checkbox"/>	S	PROGRAM / SERVICE
<input type="checkbox"/>	F	WATERFLOW
<input type="checkbox"/>	S	SUPERVISORY
<input type="checkbox"/>	F	SILENCEABLE
<input type="checkbox"/>	S	CODED CIRCUIT
<input type="checkbox"/>	F	CODE TYPE
<input type="checkbox"/>	S	VERIFIED/PAS
<input type="checkbox"/>	F	NON ALARM INPUTS
<input type="checkbox"/>	S	ANNUNCIATOR INSTALL
<input type="checkbox"/>	F	SILENCE INHIBIT
<input type="checkbox"/>	S	I/O MAP
<input type="checkbox"/>	1	FUNCTION SELECT
<input type="checkbox"/>	2	↓ POINT A SELECT
<input type="checkbox"/>	3	↑ POINT B SELECT (ESCAPE)
<input type="checkbox"/>	E N T R Y	STATE CHANGE

Programming Standard Releasing Service

SILENCEABLE

Select all eight of the TC-2F circuits as non-silenceable.

CODED CIRCUIT

Do not select any TC-2F circuits as coded circuits.

I/O MAP

For cross zone operation, map the first zone to ENABLE 1 and to the desired time delay. Map zone 2 to ENABLE 2 and to the same time delay. For single zone release, map initiating circuit to both Enables 1 and 2, and to the desired time delay.

Programming Triple-Coded Releasing

SILENCEABLE

Select all eight of the TC-2F circuits as non-silenceable.

CODED CIRCUITS

Select ENABLE 1 and ENABLE 2 for coded circuits. Do not select any of the time selects for coded circuits.

CODE TYPE

Select March Time Code for CODE TYPE.

I/O MAP

For cross zone operation, map the first zone to ENABLE 1 and to the desired time delay. Map zone 2 to ENABLE 2 and to the same time delay. For single zone release, map initiating circuit to both Enables 1 and 2, and to the desired time delay.

Programming IRI Releasing

SILENCEABLE

Select all eight of the TC-2F circuits as non-silenceable.

CODED CIRCUIT

Select ENABLE 1 for coded circuits. *Do not select ENABLE 2 or any of the time selects for coded circuits.*

CODE TYPE

Select March Time Code for CODE TYPE.

I/O MAP

For cross zone operation, map first zone to ENABLE 1 and to the desired time delay. Map zone 2 to ENABLE 2 and to the same time delay as zone 1. For single zone release, map initiating circuit to both Enable 1 and 2, and to desired time delay.

Programming the Delay Timer for Releasing Service

Note: Releasing service applications cannot employ a time delay greater than 1 minute! When the IRI Abort feature is used, time delay can only be set for 15 seconds.

During I/O Mapping, a delay timer setting can be programmed. For releasing service, the settings range from 1 minute to 15 seconds, but are cumulative (can be added together as long as the maximum delay is no more than 1 minute).

Use the **POINT SELECT** switches to move the programming pointer to one of the time delay points on the TC-2F.

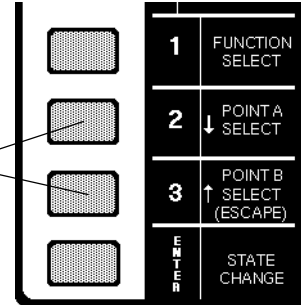

Use the **STATE CHANGE** switch to turn the green LED for that point on (selected) or off (deselected).

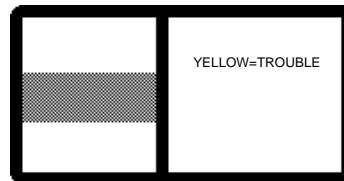

Use the **POINT SELECT** switches to move to each point for selection or deselection.

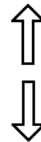

When the desired time delay has been set, continue on with I/O Mapping.



The LED arrangement above illustrates a time delay setting of 45 seconds (30 SECONDS+15 SECONDS).

Delay Timer Operation (Releasing service)

The programmable time delay has an operating range from 1 minute to 15 seconds.

After the TC-2F has been activated by an alarm; the green LEDs will flash, indicating how much time is remaining.

Example: A 45-second time delay will start by flashing the 30 second LED. After the timer has counted 30 seconds, only the 15 seconds LED will flash. This will continue until the timer has reached 10 seconds. The 15 seconds LED will start to flash at twice the normal rate during the last 10 seconds. Then the RELEASE LED will flash.

If the ABORT switch has been activated, the timer will continue to count down until 5 seconds remain. The timer will stop and wait until the ABORT switch is deactivated, as which time the timer will count down to zero.

Sensiscan 2000 Dress Panel

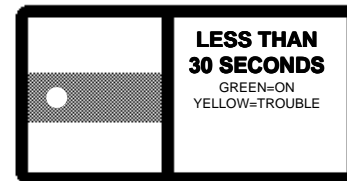

Releasing application at a countdown of 45 seconds.

Releasing Service Controls

When **ABORT** is activated the time delay will continue to function until the countdown reaches five seconds. When the abort is deactivated, the timer will count 5 seconds, then release.

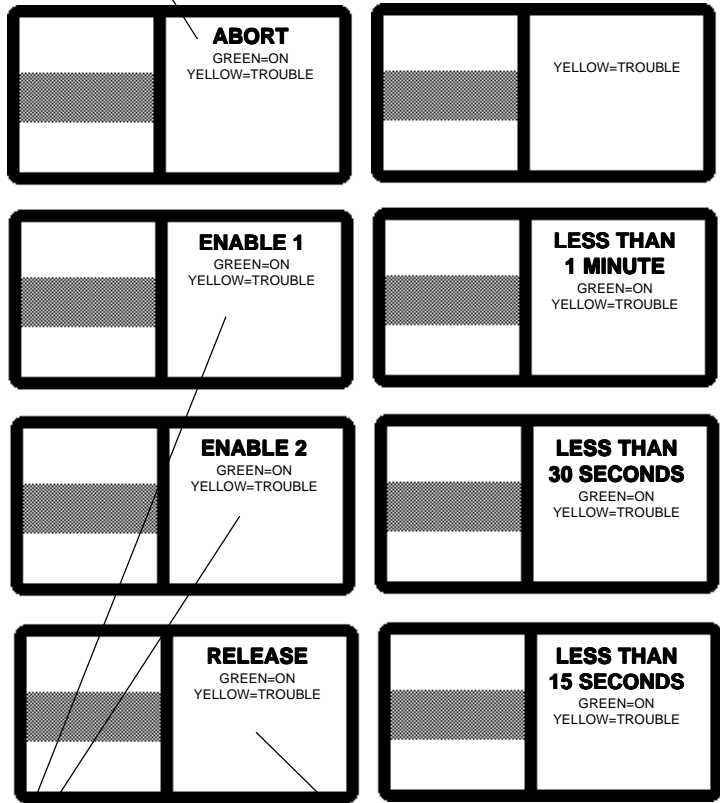

ENABLE 1 and **ENABLE 2** are the cross-zone inputs to activate the time delay (see field programming for complete details). A single zone release can be accomplished by mapping an initiating circuit to both Enable 1 and Enable 2.

Activating **RELEASE** will cancel any remaining time delay or abort action. The release circuits will activate after a five second delay. Manual release may be operated from any initiating circuit mapped into this point.

Slide-In Labels for the TC-2F

Remove this page from the manual and careful cut along the dotted line for TC-2F labels. Custom information may be typed onto these labels in the window space provided. Insert labels into the slots on the panel door.

Pre-Signal/Dual Coded Evacuation Labels

Releasing Service Labels

Left-side	Right-side	Left-side	Right-side
HOLD ON ALERT <small>GREEN=ON YELLOW=TROUBLE</small>	LESS THAN 4 MINUTES <small>GREEN=ON YELLOW=TROUBLE</small>	ABORT <small>GREEN=ON YELLOW=TROUBLE</small>	<small>YELLOW=TROUBLE</small>
ALERT ENABLE 1 <small>GREEN=ON YELLOW=TROUBLE</small>	LESS THAN 2 MINUTES <small>GREEN=ON YELLOW=TROUBLE</small>	ENABLE 1 <small>GREEN=ON YELLOW=TROUBLE</small>	LESS THAN 1 MINUTE <small>GREEN=ON YELLOW=TROUBLE</small>
ALERT ENABLE 2 <small>GREEN=ON YELLOW=TROUBLE</small>	LESS THAN 1 MINUTE <small>GREEN=ON YELLOW=TROUBLE</small>	ENABLE 2 <small>GREEN=ON YELLOW=TROUBLE</small>	LESS THAN 30 SECONDS <small>GREEN=ON YELLOW=TROUBLE</small>
GENERAL EVACUATION <small>GREEN=ON YELLOW=TROUBLE</small>	LESS THAN 30 SECONDS <small>GREEN=ON YELLOW=TROUBLE</small>	RELEASE <small>GREEN=ON YELLOW=TROUBLE</small>	LESS THAN 15 SECONDS <small>GREEN=ON YELLOW=TROUBLE</small>

Type appropriate information into label windows above before cutting these labels from the page.