



User's Manual

Version 5.2

Remote Account Manager for Windows

DoorKing, Inc.
120 Glasgow Avenue
Inglewood, California 90301

U.S.A.

Phone: 310-645-0023

Fax: 310-641-1586

www.doorking.com

NOTICE

DOORKING INC. reserves the right to make changes in the product described in this manual at any time and without notice or obligation of DoorKing Inc. to notify any persons of any such revisions or changes. Additionally, DoorKing Inc. makes no representations or warranties with respect to this manual. This manual is copyrighted, all rights reserved. No portion of this manual may be copied, reproduced, translated, or reduced to any electronic medium without prior written consent from DoorKing Inc.

Companies, apartment complexes, names, and data used in the examples in this manual are fictitious unless otherwise noted.

END-USER LICENSE AGREEMENT FOR DOORKING SOFTWARE

IMPORTANT – READ CAREFULLY: This DoorKing End-User License Agreement (EULA) is a legal agreement between you (either an individual or entity) and DoorKing, Inc. for DoorKing software products which includes computer software programs and may include associated media, printed materials or other electronic documentation (SOFTWARE PRODUCT). By installing, copying, or otherwise using the SOFTWARE PRODUCT, you agree to be bound by the terms of this EULA. If you do not agree to the terms of this EULA, do not install or use the SOFTWARE PRODUCT.

SOFTWARE PRODUCT LICENSE

- The SOFTWARE PRODUCT is protected by copyright laws and international copyright treaties, as well as other intellectual property laws and treaties. The SOFTWARE PRODUCT is licensed, not sold.
- DOORKING, Inc. licenses the DoorKing SOFTWARE PRODUCT for your use only. You assume all responsibility for the installation, operation and results. You may create copies of the SOFTWARE PROGRAM. You may not copy the printed materials or other electronic documentation accompanying the SOFTWARE PRODUCT.
- You may not reverse engineer, disassemble or decompile the SOFTWARE PRODUCT nor copy its features or methods of operation for use in any other program. You recognize that DoorKing's source code, data, features and methods of operation are trade secrets belonging to DoorKing.
- You may permanently transfer all of your rights under this EULA, provided you retain no copies, you transfer all of the SOFTWARE PRODUCT (including the media and printed materials) and the recipient agrees to the terms of this EULA.
- Without prejudice to any other rights, DoorKing may terminate this EULA if you fail to comply with the terms and conditions of this EULA. In such event, you must destroy all copies of the SOFTWARE PRODUCT and all of its component parts.

LIMITED WARRANTY

DOORKING, INC. warrants that the SOFTWARE PRODUCT will perform substantially in accordance with the accompanying written materials for a period of ninety (90) days from the date of receipt.

DOORKING, INC. warrants the diskettes on which on which the software is recorded to be free from defects in materials and faulty workmanship under normal use for a period of ninety (90) days after the date of the original purchase. If during this 90 day period a defect in the diskette should occur, the diskette may be returned for replacement without charge through your authorized DoorKing dealer. Your sole remedy in the event of a defect in a diskette is limited to replacement of the diskette as provided above. This remedy is your exclusive remedy for breach of this warranty. It gives you certain rights and you may have other rights which vary from state to state.

EXCEPT FOR THE EXPRESS WARRANTY ABOVE, THE DOORKING REMOTE ACCOUNT MANAGER (PRODUCT) IS PROVIDED ON AN "AS IS" BASIS, WITHOUT ANY OTHER WARRANTIES, OR CONDITIONS, EXPRESS OR IMPLIED, INCLUDING BUT NOT LIMITED TO WARRANTIES OF MERCHANTABILITY, MERCHANTABILITY OR FITNESS FOR A PARTICULAR PURPOSE, OR THOSE ARISING BY LAW, STATUTE, USAGE OF TRADE OR COURSE OF DEALING. THE ENTIRE RISK AS TO THE RESULTS AND PERFORMANCE OF THE PRODUCT IS ASSUMED BY YOU. NEITHER WE NOR OUR DEALERS OR DISTRIBUTORS SHALL HAVE ANY LIABILITY TO YOU OR ANY OTHER PERSON OR ENTITY FOR ANY INDIRECT, INCIDENTAL, SPECIAL OR CONSEQUENTIAL DAMAGES WHATSOEVER, INCLUDING BUT NOT LIMITED TO LOSS OF REVENUE OR PROFIT, LOST OR DAMAGED DATA OR OTHER COMMERCIAL OR ECONOMIC LOSS, EVEN IF WE HAVE BEEN ADVISED OF THE POSSIBILITY OF SUCH DAMAGES OR THEY ARE FORESEEABLE; OR FOR CLAIMS BY A THIRD PARTY. OUR MAXIMUM AGGREGATE LIABILITY TO YOU, AND THAT OF OUR DEALERS AND DISTRIBUTORS SHALL NOT EXCEED THE AMOUNT PAID BY YOU FOR THE PRODUCT. THE LIMITATIONS IN THIS SECTION SHALL APPLY WHETHER OR NOT THE ALLEGED BREACH OR DEFAULT IS A BREACH OF A FUNDAMENTAL CONDITION OR TERM, OR A FUNDAMENTAL BREACH. SOME STATES / COUNTRIES DO NOT ALLOW THE EXCLUSION OR LIMITATION OF LIABILITY FOR CONSEQUENTIAL OR INCIDENTAL DAMAGES SO THE ABOVE LIMITATIONS MAY NOT APPLY TO YOU.

TABLE OF CONTENTS

Section 1 – Introduction

1.1	Installation Guidelines – All Systems.....	7
Getting Started		
1.2.1	Windows 95, 98, ME, 2000 or XP Install	8
1.2.2	Windows 3.1 Install	8
1.2.3	Read First.....	9
1.2.4	File Information.....	9
1.2.5	Security Levels	10
1.2.6	Elevator Control.....	10
1.2.7	Hold Open Time Zones	10
1.2.8	Transactions.....	11
1.2.9	Password.....	11
1.2.10	Port Configuration	11
1.2.11	Clock Setting	11
1.2.12	Prior to Programming	12
1.2.13	Start the Program	12
1.2.14	Series Column.....	12

Section 2 – Account Management

2.1	Account Information.....	13
2.1.1	Creating a New Account.....	14
2.1.2	Editing Account Information	15
2.1.3	Deleting Accounts	15
2.2	Share Information Feature.....	16
2.3	Communication Port Configuration.....	17
2.4	Password.....	17

Section 3 – System Management

3.1	Entry Panel Programming	19
3.1.1	Entry Panel Setup	20
3.1.2	Communication Setup	20
3.1.3	Tone Open Numbers.....	20
3.1.4	Entry Codes.....	21
3.1.5	Miscellaneous Setup Items	22
3.1.6	System Message.....	22
3.2	Relay Numbering and Control	23
3.2.1	Labeling Relays with Tracker Disabled	24
3.2.2	Labeling Relays with Tracker Enabled	25
3.3	Relay Hold Open Time Zone Programming	
3.3.1	Creating Relay Hold Time Zones	26
3.3.2	Applying Relay Hold Time Zones	27
3.4	Security Levels	28
3.4.1	Planning Security Levels.....	29
3.4.2	Creating Security Levels	30
3.5	Device Association	
3.5.1	Device Association	32
3.5.2	Mass Enable.....	33
3.6	Elevator Control	
3.6.1	Planning Elevator Control / Security Levels	34
3.6.2	Programming the Relay / Elevator Control Table.....	35
3.6.3	Programming Security Levels with Elevator Control	36

Section 4 – Database Management

4.1	User (Resident) Information	41
4.1.1	Adding Resident (User) Information	42
4.2	Assigning Device Codes	44
4.3	Elevator Reference	
4.3.1	Programming the Elevator Reference Table	45
4.3.2	Assigning Elevator Reference to Residents	46

Section 5 – Data Transfer / Reports

5.1	Transfer Now	
5.1.1	Send Data Now	47
5.1.2	Receiving Data Now	48
5.1.3	Receiving Transactions	49
5.2	Scheduled Transfers	
5.2.1	Scheduling Transfers	50
5.3	Viewing / Reporting Transactions	
5.3.1	Viewing Transactions	51
5.3.2	Creating Reports	53
5.4	Exporting / Importing Database Files	
5.4.1	Exporting Data	54
5.4.2	Importing Data in CSV Format (Microsoft Excel)	55
5.4.3	Main Frame Import	57

Section 6 – Appendix

6.1	Upgrading from DOS Version Software	61
6.1.1	Hidden Names	61
6.2	Using V. 2.0, 2.1 or 3.0 Accounts with V. 5.2 Software	
6.2.1	Upgrading Software	62
6.2.2	Upgrading Hardware and Software	62
6.3	Backup and Restore	62
6.4	Transferring and Saving	
6.4.1	Transferring or Saving the DoorKing Program	63
6.4.2	Saving and Transferring Resident Files	64
6.5	Trouble Shooting	
6.5.1	Modem	65
6.5.2	Entry System	65
6.5.3	Phone Line	65
6.5.4	Date / Time	65
6.5.5	Computer System Information Form	66
6.5.6	Error Messages	67
6.6	Glossary	68
6.7	Preprogramming Information	
6.7.1	Access Systems	70
6.7.2	Circuit Board Series Selection	70
6.7.3	Hardware Revisions	71
6.7.4	Tracker Expansion	71
6.8	Preprogramming Requirements	72
	Security Level Planning Guide	73

SECTION 1 - INTRODUCTION

The DoorKing Remote Account Manager for Windows is a powerful, flexible and easy to use computer program that allows you to manage access control for residents and their guest in a variety of controlled access applications including apartment complexes, gated communities, apartment and condominium building's, college dormitories, office buildings, factories, industrial sites, etc. Use this program with the DKS models 1803PC, 1815 and 1817 Telephone Entry and Access Control Systems, and with the model 1818 Multi Door Card Access System. Communication to the access system can be by modem or RS-232 protocol.

This software program will allow you to program and manage up to 100 different 1803PC, 1815, 1817 or 1818 systems (called accounts), each with up to 16 different controlled access points each using a variety of control technologies (Card, RFID, PIN, etc.) for up to 3000 individuals, and can accommodate up to 8000 unique device (Card, RFID, PIN) codes. You can also manage guest and resident elevator usage for each account for up to four (4) elevators serving up to 64 floors each for those applications where elevator control is a necessity.

For accountability purposes, each system will store the last 8000 events in a history buffer, which can then be transferred to the PC for permanent storage and reporting. The software report generator allows you to sort and customize the report to a variety of different parameters. Reports include the resident name, time, date, entry location, device number used, if access was granted or denied, and more. In addition to the standard access control reports, the software will also generate Gate Tracker™ reports for vehicular gate operators that have Gate Tracker™ capability. Gate Tracker™ will provide data on gate operator functions and can be used as a maintenance and troubleshooting tool. Gate Tracker™ reports include time and date of power outages, shorted inputs, loop detector problems, attempted forced entries, if any obstructions where encountered (gate hit something), gate cycle count, etc.

1.1 INSTALLATION GUIDELINES – ALL SYSTEMS

The new features listed below apply only to version 5.2 of this software and to the 1815, 1817, and 1818 systems which utilize the 1840, 1841 and 1842 control boards, REVISION D and higher; and the 1803PC system with the 1844 control board.

- Adds export capability in CSV format that can be used in spreadsheet programs such as Microsoft Excel.
- Adds import capability from spreadsheet programs such as Microsoft Excel.
- Adds import capability from main frame computer systems using single comma delimited text files.
- Scheduled data transfer with repeat function.
- Generate transaction reports across several accounts.
- Backup and restore feature.
- Diagnostics – for use with a DKS technician only.
- Summary log files.

1.2 GETTING STARTED

Here is what you need to install and use the DoorKing Remote Account Manager for Windows.

- A PC running Windows XP, Windows 2000, Windows 98, Windows 95, or Windows 3.1.
- A 486 processor (recommend a Pentium processor).
- 8 Megabytes of RAM memory (recommend 16 Megabytes).
- A mouse.
- A Hayes compatible modem on COM 1 or COM 2.
- A CD Drive.
- The DoorKing Remote Account Manager Software.

NOTE: This software program is not designed to operate in a network environment.

Some Gateway 2000 computers with an internal modem will not communicate with the 1803PC, 1815, 1817, or 1818 systems. If you have difficulty with this computer, you will need to replace the internal modem with either an external modem or a different make internal modem.

If you have downloaded the software from our internet site, double-click the DKSETUP.EXE file (look in the Downloaded Program Files folder, which is found under the Windows folder) and follow the on-screen instructions to install the software.

1.2.1 WINDOWS 95, 98, ME, 2000 or XP INSTALL

Stop all running programs. Insert the DKS CD in the CD drive. If the setup program does not start automatically, follow the steps below.

1. Select RUN.
2. Enter: E:DKSETUP (use the letter of your CD drive) in the command line and then click OK.
3. Follow the on screen instructions.

1.2.2 WINDOWS 3.1 INSTALL

Stop all running programs. Insert the DKS CD in the CD drive.

1. From the MAIN GROUP, click on the FILE MANAGER.
2. Click RUN.
3. Enter: E:DKSETUP (use the letter of your CD drive) in the command line and then click OK.
4. Follow the on screen instructions.

1.2.3 READ FIRST

The version 5.2 software was designed to be "backward" integrated, meaning that this software can be used to program earlier versions of our telephone entry and access control systems. Prior to creating a new account, you will be prompted to choose the "series" number and revision level of the circuit board in the entry system that you are going to program. Refer to section 6.7.2 for more information on the circuit board series number.

This software program is designed to work with DKS 1803PC, 1815, 1817 and 1818 systems only. Some earlier versions of the these systems do not have all of the capabilities described in this manual. This includes transactions, time zones, alternate area codes, relay 0 (third relay) operation, RS-232 communications, security levels and elevator control. If you attempt to use these features with circuit boards that do not have the capability to support the feature, a "version" error message will appear on your computer screen when you attempt to transfer the data to the entry system. If this happens, you need to disable the offending feature by turning it off before attempting to resend the data. Refer to section 6.7.3 for more information.

The information in this manual describes the use of the DoorKing Remote Account Manager for Windows only. For information relating to the installation of the 1803PC, 1815, 1817, or 1818 systems, refer to the respective installation and maintenance manual shipped with the system. For information relating to the Tracker™ expansion boards, refer to the separate manual for these boards. For information about the elevator control board, refer to the Elevator Control Installation manual.

1.2.4 FILE INFORMATION

When you installed the DoorKing Remote Account Manager, the software automatically created a folder (directory) named DKW52. Each account that you establish creates a sub-folder (sub-directory) under the DKW52 folder starting with ACCT00. The respective account files are then stored under the account sub-folder.

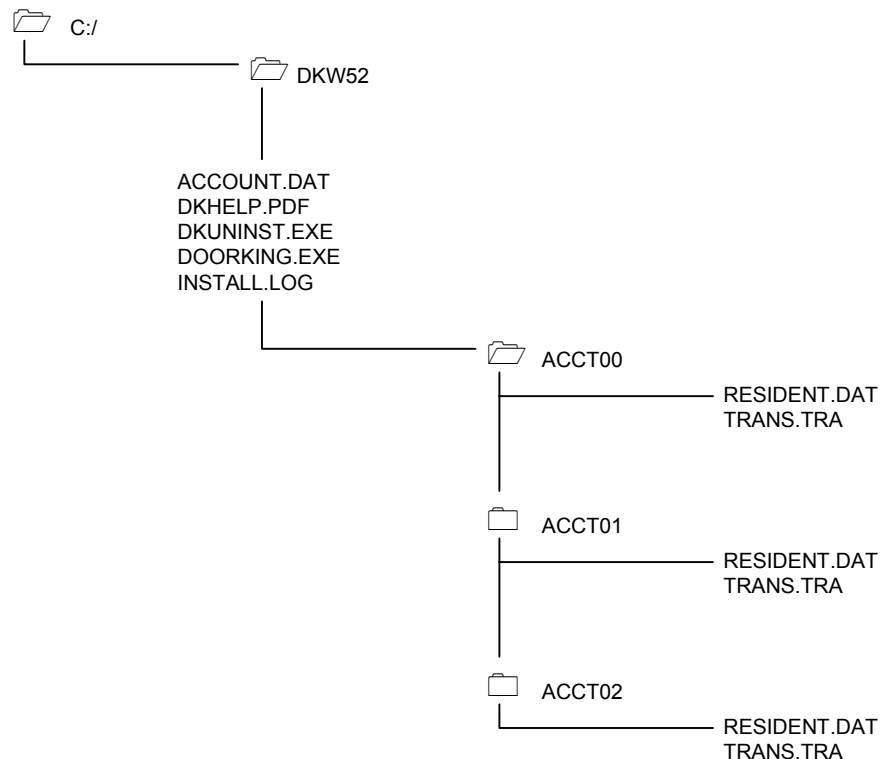

1.2.5 SECURITY LEVELS

Security levels allow you to set individual door/gate access times for residents using a weigand device (Card, RFID, PIN, etc.). An example of this would be a gated apartment community that has a vehicular entry gate, a pedestrian access gate, a pool gate, a laundry room door, tennis court gate, office door, etc., where entry is controlled by a card reader. Security levels can be created that would allow residents access through the vehicular entry gate and pedestrian access gate 24 hours a day, 7 days a week, access to the pool and tennis court from 9:00 AM - 10:00 PM 7 days a week, access to the laundry room 7:00 am - 11:00 PM 7 days a week, and access to the office 9:00 AM - 6:00 PM Monday through Friday only.

Security levels are not assigned to the access control device. They are assigned to the individual user. In this manner, different security levels can be created allowing different access times to different users through a single access point. For example, this could be applicable in a controlled office (or factory) environment where different employees have different working hours.

There are 31 security levels available in the software program. The first two (Security Level 00 and 01) are factory set and are not programmable. Security Level 00 (SL00) will deny access at all controlled access locations to the user(s) that it is assigned to. An example of using SL00 would be a tenant in an apartment building who has been evicted and is no longer allowed entry to the building or any other controlled access point within the building. Security Level 01 (SL01) is the opposite of SL00, and will allow access to users that it is assigned to 24 hours a day, 7 days a week. An example of using SL01 would be for management or maintenance personnel who need to have full access to ALL locations at ALL times.

The remaining 29 security levels (SL02 - SL30) allow you to setup four different time zones for each level, and allow you to select the controlled access point(s) that it applies to. In the example given in paragraph 1 above, four different time zones were created under a single security level, and then the controlled entry point(s) that the time zone applies to were selected. The security level was then assigned to the individual residents.

1.2.6 ELEVATOR CONTROL

The elevator control feature determines which elevator(s) in a building a guest or resident will be allowed to use, and to which floor(s) the resident or guest will be allowed to go to, under certain controlled access conditions. In its most common use, when a resident grants access to a guest in a high rise apartment building, the system will call the designated elevator(s) to the ground floor, and then only the floor button that the resident resides on will be active in the elevator(s). This prevents the guest from accessing other than the designated elevator(s), or from going to unauthorized floors.

Elevator control can also be applied to residents to control which elevator(s) they can use and to which floor(s) they are allowed access too. In this application, a card reader is installed inside the elevator(s) car. When the resident enters the elevator, they must use their access card to "turn on" the elevator buttons. The buttons that will be turned on are set in the software. Security levels can also be applied in this application. As an example, suppose a resident lives in a high-rise apartment building. On the 20th floor of this building is a workout room that is only open 7 days a week from 6:00 AM to 11:00 PM only. Elevator control and security level control can be employed to allow residents access via the elevator to the workout room at the designated days and times only.

1.2.7 HOLD OPEN TIME ZONES

Up to eight different time zones can be created to "Hold Open" the door or gate at a controlled access point. An example of using this feature would be to hold open a vehicular access gate during "rush hour" traffic, unlock an office door during normal working hours, etc. Hold open time zones can be applied individually, or in any combination to each controlled access point(s).

1.2.8 TRANSACTIONS

Transactions are automatically saved each time that they are received from the 1803PC, 1815, 1817, or 1818. Each time transactions are received, the software will automatically create a file name for them starting with TRANS00. The file number will increase sequentially to a maximum TRANS99. When 99 files have been created, prior to receiving the next transaction file, the software will overwrite the old TRANS00 file with the new transaction information and will delete file TRANS01. The next transaction file that is received will be stored in the now empty TRANS01 file and the information in TRANS02 will be deleted to make room for the next transaction file. This sequence repeats itself sequentially.

Transactions are stored under their respective account sub-folders. This prevents transactions from one account being mixed up with transactions from another account. Each account can therefore have up to 99 transaction files stored as described above.

1.2.9 PASSWORD

When you start the DoorKing Remote Account Manager for Windows the first time, a password window will appear. Since you have not yet entered a password, simply click OK or press enter to continue.

To change your password (or enter a new one for the first time), click the PASSWORD button on the accounts screen. The change password window will appear. You will need to enter the old password once, and then enter the new password twice. Be sure to make your password something that is familiar to you so that you do not forget it. The password that you enter can be alpha-numeric and is case sensitive.

1.2.10 PORT CONFIGURATION

When the DoorKing Remote Account Manager is installed, the software will automatically set the modem to operate under COM 2, 2400 Baud rate, and will install a set-up string that is common to most modems. If your modem is installed on another com port, or if you need to enter any special set-up strings, click the CONFIG PORTS button on the accounts screen. The port configuration window will appear and allow you to make the necessary adjustments. There is also an auto-config button that will set up the software to respond to your modem installation. Make sure that the modem in the computer is working properly by connecting with America On Line, Earthlink or any other of the on line services.

1.2.11 CLOCK SETTING

Each time contact is made with the entry system from the computer, the clock / calendar in the entry system is automatically updated to match the clock information from your PC. Be sure that your computers clock / calendar is set to the correct time and date.

1.2.12 PRIOR TO PROGRAMMING

The DoorKing Remote Account Manager can manage up to 100 separate accounts. By definition, an "account" is any 1803PC, 1815, 1817, or 1818 system that you are going to program with this software. Each unit must have a unique account name set-up for it, even if the unit is sharing the phone line with another DoorKing system. If this is the case, you must be sure that the master codes of each unit sharing the line are set differently. You must also set the software for multiple systems sharing a line by going to the SYSTEM INFO screen and clicking the YES button next to the multiple systems line.

The following system parameters cannot be set with the software. These parameters must be set and programmed into the system from the system keypad, or they are factory set limits or features which cannot be changed remotely. The entry system should be tested to be sure that it is operating properly. It is very important that the phone line connected to the entry system is free of any hum, noise, or other interference that could cause modem communication problems. Refer to the installation and maintenance manual that was included with the 1803PC, 1815, 1817, or 1818 system to program the following parameters.

1. The system Master Code.
2. Single or multiple systems sharing the same phone line.
3. Match the memory size of the chips sent with the unit. The memory size cannot be set from the software program.
4. MemPLUS (cards) chips must be installed to enable the cards, transmitter, key code, time zones, Tracker™ expansion, security levels and elevator control features. Click MemPLUS button ON if MemPLUS chips are installed, otherwise leave OFF.
5. Determine which control board is installed in your entry system (see 6.7.3).

1.2.13 START THE PROGRAM

Follow these steps when starting the DoorKing Remote Account Manager for Windows program for the first time.

1. Double click the DoorKing icon to start the program.
2. **When the password window appears, just click OK or press enter.** Since this is the first time that you have started the program, no password has yet been programmed so simply clicking OK or pressing enter will let you into the program.

The account screen is the main screen that you come to after entering the program. This is where most of your work will be done after you have set-up your account(s), programmed your system information and entered your resident data. From the account screen, you will be able to program the entry system, receive information from the remote system, and receive transactions to your PC.

To use the DoorKing Remote Account Manager to program your entry systems, you will perform the following three basic steps.

1. Create an account for the access system (ACCOUNT SCREEN).
2. Enter the access system information (SYSTEM INFO SCREEN).
3. Enter the resident (user) data (RESIDENT DATA SCREEN).

1.2.14 SERIES COLUMN

The last column on the account screen is the SERIES column and is indicated by the letter S. This column will indicate either "40", "4E", or "50" depending on which series control board is selected when the account is created.

SECTION 2 – ACCOUNT MANAGEMENT

To begin using the DoorKing Remote Account Manager to program your 1803PC, 1815, 1817, or 1818 systems, you must first create an ACCOUNT under which all the relevant account information (resident user data, transaction files, etc.) will be stored.

By definition, an ACCOUNT must be created for every 1803PC, 1815, 1817 or 1818 system that will be programmed with the Remote Account Manager software (up to 100 accounts can be managed with this software). Two or more units cannot share the same account name, even if they are sharing the same phone line. However, different accounts may share a common resident database (Section 2.2).

2.1 ACCOUNT INFORMATION

1. Start the Remote Account Manager software program. While the program is loading, a DoorKing logo will appear on your screen.
2. Once the program has loaded, the password window will appear. Enter your password to proceed. NOTE: The first time you start the program, simply click OK.
3. The ACCOUNT screen will appear on your screen.

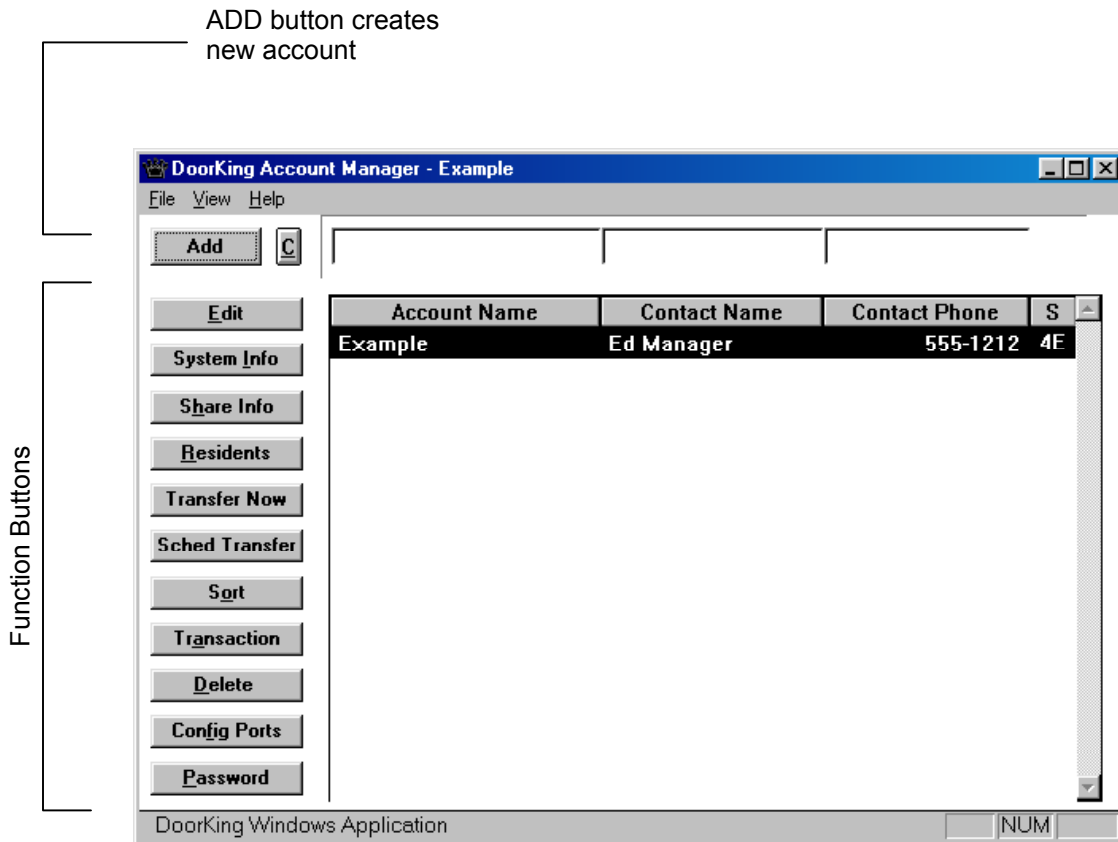

Figure 1

2.1.1 CREATING A NEW ACCOUNT

1. With the ACCOUNT INFORMATION screen displayed, click your mouse in the contact name field on the edit line.
2. Enter the required information in the account name, contact name and contact phone fields (Figure 2).
3. Click the ADD button.

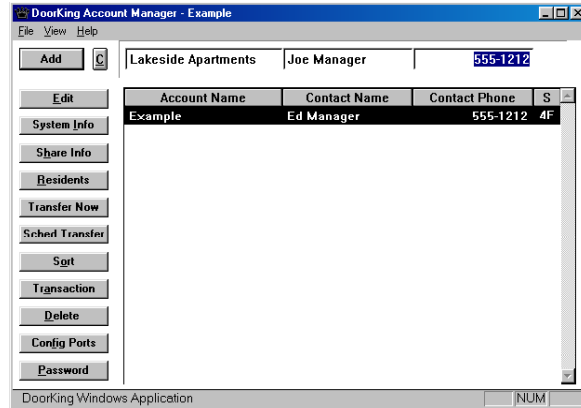

Figure 2

4. The Control Board Selection window will pop up (Figure 3). You must click the button for the type of control board installed in the system that you are going to program (refer to 6.7.2, Board Series Selection). After selecting the series control board in your access system, click OK.

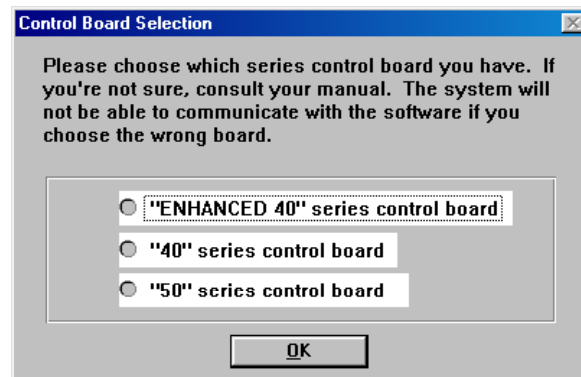

Figure 3

5. An advisory window (Figure 4) will appear asking you if you are sure of your selection. Click OK to proceed or click NO to go back to the previous window.

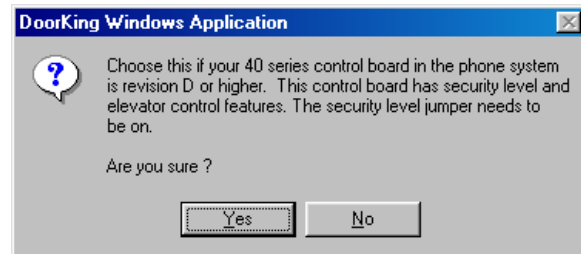

Figure 4

6. Clicking OK in step 5 creates your new account. The account information that was entered in step 2 will move down to the main body of the account screen (Figure 5).
7. Repeat steps 1-6 to create up to 99 additional accounts.
8. If more than one account is displayed on the screen, click the SORT button to list the accounts in alphabetical order.

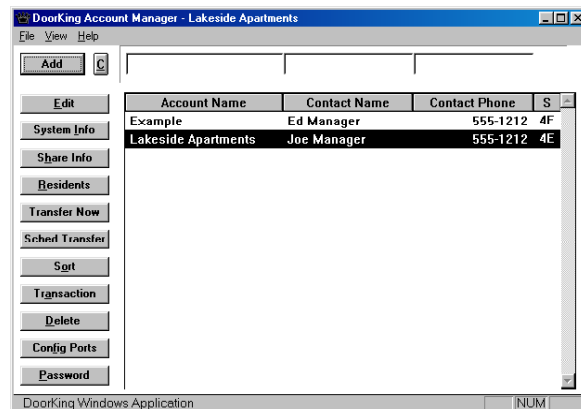

Figure 5

2.1.2 EDITING ACCOUNT INFORMATION

1. Click on the account that you want to edit and click the EDIT button. The account information will appear in the EDIT fields (Figure 6).
2. Make any changes necessary in the account name, contact name and contact phone number fields.
3. To accept the changes just made, click the EDIT button. To disregard the changes made, click the STOP EDIT button. The changed account information will appear in the main body.

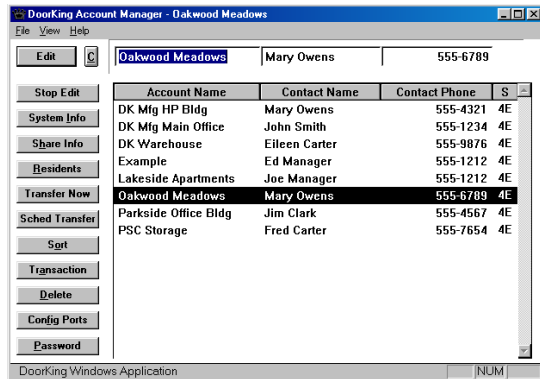

Figure 6

NOTE: This edit function changes only the account name and contact information. It does nothing to change any of the resident, system, time zone, security level, etc. information associated with the account.

2.1.3 DELETING ACCOUNTS

1. Click on the account that you want to delete to highlight it.
2. Click the DELETE button.
3. A warning will appear asking if you are sure that you want to proceed.
4. Click OK to delete the account or click NO to return to the account screen without deleting the account.

WARNING: When you delete an account, all the system information and resident data contained in the account folder (sub-directory) will also be deleted. Prior to deleting the account, you may want to copy the account data onto a floppy disk. This will enable you to restore the resident data easily if it becomes necessary at a later date to re-establish the account.

To copy the data, you can use Windows Explorer to copy the information in the account folder to the floppy disk. Refer to your Windows User's Manual for instructions on copying files and see section 6.4.2.

You can also use the BACKUP command. Refer to section 6.3.1.

2.2 SHARE INFORMATION FEATURE

The SHARE INFO feature allows more than one "account" to share its resident database with other accounts. The share info feature is useful in applications where there is more than one entry point and the entry points will all have identical resident data. For example, if an apartment complex had a front and rear entry door (or gate), and an 1803PC, 1815, 1817, or 1818 system was installed on each entry point, the share info feature lets you use and maintain a single resident database for both entry locations. It is still necessary to send the data to each entry system individually, even if the systems are sharing the same phone line. **Accounts that share resident information must have the same board series, memory, and must have the same number of digits in the directory code as the primary account.**

1. From the accounts screen, click the account name that is the primary account, then click the SHARE INFO button. The share info screen will appear with the primary account listed in the accounts group (Figure 7). In the example, DK Mfg Main Office was selected as the primary account. Notice that this account name is shown as the primary account in the upper right hand corner of the share information window, and that this account is listed in the "Accounts In Group" window on the right side of the screen. To change the primary account, click the arrow button on the primary account window, then scroll up or down and select a new primary account.

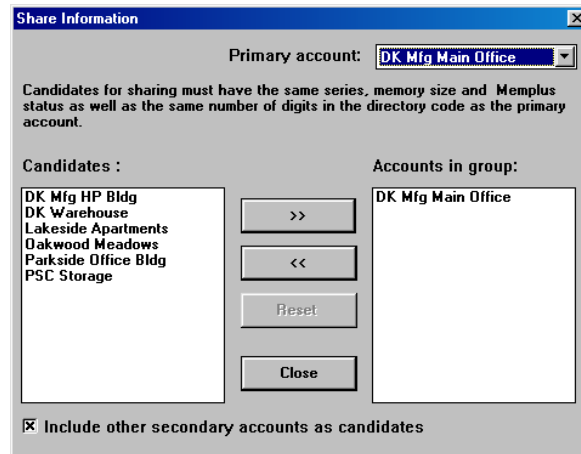

Figure 7

2. From the candidates list, click the account that you want to share the primary account resident data base with, and then click the right (>>) button to place the account in the accounts group. In the example, DK Mfg HP Bldg and DK Warehouse have been placed in the "Accounts In Group" window (Figure 8). These accounts will now share the resident database associated with the primary account - DK Mfg Main Office.

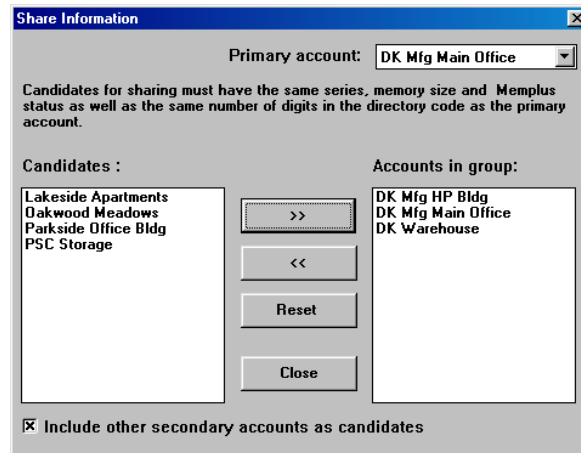

Figure 8

3. Select other candidate accounts as required. When complete, click the CLOSE button.
4. To remove an account from the Accounts In Group, click on the account you want removed, and then click the << arrow button. This will lace the account back in the candidates list and it will no longer share the resident data with the primary account.
5. When a candidate account is selected to share information with a primary account, the account is removed from the candidate list, even if a different primary account is chosen, unless the "Include Other Secondary Accounts As Candidates" button is turned ON (X appears in the button window).

2.3 COMMUNICATION PORT CONFIGURATION

When you installed the DoorKing Remote Account Manager for Windows software on your computer, the software automatically checked your modem and configured itself with a modem setup string that is common to most modems. The port configuration window is provided only if you need to enter any special modem setup strings that may be applicable to your modem (refer to the manual that came with your modem).

NOTE: Typically, you will not need to make any adjustments to your port configuration, and therefore no changes need to be made. You should only make adjustments in these settings if you are experiencing problems in communicating with the entry system.

1. Click the CONFIG PORTS button on the accounts screen. The port configuration window will appear (Figure 9).
2. Make the adjustments to the port setup as required (refer to your modem manual) or click the Auto Config Modem button.
3. Click OK to proceed with the changes or click CANCEL to return to the accounts screen without any changes being made.

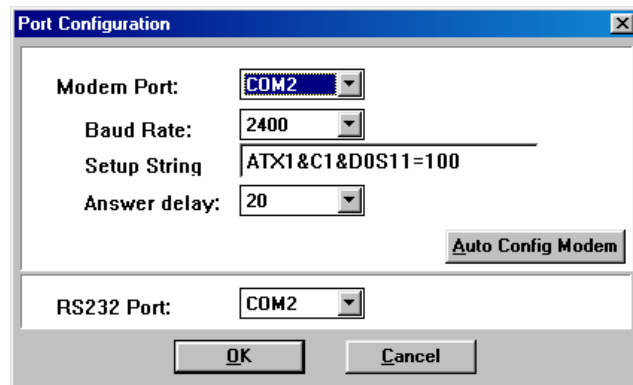

Figure 9

2.4 PASSWORD

This programming sequence allows you to change the password that starts the Remote Account Manager software.

1. Click the PASSWORD button on the accounts screen. The Change Password window will appear (Figure 10).
2. Enter your current password in the first line.
3. Enter the new password in the second line.
4. Confirm the new password in the third line.
5. Click OK to set the new password, or click CANCEL to return to the accounts screen without changing the password.



Figure 10

SECTION 3 – SYSTEM MANAGEMENT

Once an account(s) has been created, the access control system information must be programmed. This information includes setting the entry system parameters, labeling the system relays for each entry point, mass enabling device (card, transmitter, etc.) codes, creating security levels and time zones, creating hold open times, and programming the elevator control parameters if elevator control is used.

The control board series that was chosen when you first created an account (2.1.1, Figure 3) will affect how the entry panel is programmed. This chapter and the illustrations in it, addresses programming an entry panel with a 40 Series Enhanced control board. Many of the steps will be identical for all series (40 Enhanced, 40 and 50) control boards, however the screen layouts and screen look will vary depending on which series was chosen when the account was created.

3.1 ENTRY PANEL PROGRAMMING

The first step in system management is to program the entry panel system parameters. The entry panel can be a model 1803PC, 1815, 1817 or 1818 depending on your specific needs. The Remote Account Manager software is designed to address all of these entry panels, therefore some programming steps will be slightly different for the different panels.

1. On the account screen, select the account that you want to program the system information for by clicking on the account name.
2. Once the account name is high lighted, click the SYSTEM INFO button. The System information window will appear (Figure 11).

The screenshot shows the 'DoorKing Account Manager - Lakeside Apartments' window. The interface includes a menu bar (File, View, Help) and a sidebar with buttons for Accounts, Relays, Hold Open, Device Enable, Sys Message, Security Level, Relay/Elevator, and Elevator Ref. The main area contains various configuration fields:

- Master Code:** 9999
- System Memory:** 25
- Talk Time(min:sec):** 1:00
- Num Of Digits In Dir Code:** 3
- System Phone:** (empty field)
- Communication:** Modem
- MemPLUS
- Multiple Systems

Relay	Tone Open Numbers				Other Relay Options		
	Momentary	Hold	Release	Hold 1 Hr	Postal Switch	Rotary 9 Momentary	Entry Code Range
0	-	-	-	-	<input type="checkbox"/>	<input type="checkbox"/>	- -
1	9	8	7	6	<input checked="" type="checkbox"/>	<input checked="" type="checkbox"/>	0000 - 9999 (divide)
2	5	4	3	2	<input type="checkbox"/>	<input type="checkbox"/>	- -

- Transactions
- Interface With 1816
- Tracker
- Dial Type:** Tone
- Resident Info Directory:** ACCT01
- Other Info Directory:** ACCT01

DoorKing Windows Application NUM

Figure 11

3.1.1 ENTRY PANEL SETUP

1. Enter the four-digit MASTER CODE in the field provided. **The master code entered here must match the four-digit master code that has been programmed into the entry panel.**
2. Select the SYSTEM MEMORY. **The system memory must match the memory size of the chips installed in the entry panel.**
3. Set the system TALK TIME.
4. Set the DIRECTORY CODE DIGITS. *NOTE: This field not available with 50 series control boards.*

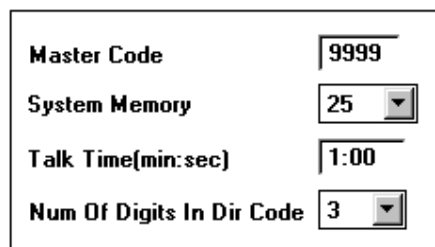

Master Code	9999
System Memory	25
Talk Time(min:sec)	1:00
Num Of Digits In Dir Code	3

Figure 12

3.1.2 COMMUNICATION SETUP

1. Enter the SYSTEM PHONE number in the field provided. Include the area code if 10-digit dialing is required in your area. *NOTE: This field is optional if RS-232 communication will be used.*
2. Select either modem or RS-232 communication. *NOTE: This field is not available with 50 series control boards. (Diagnostics is used only when you are talking with a DKS technician on the telephone).*
3. Click the MemPLUS button only if MemPLUS chips are installed in the entry panel. Refer to the Owner's Manual that came with the entry panel on how to identify MemPLUS chips. *NOTE: MemPLUS chips are required if card readers, RF transmitters, Tracker™ expansion boards, security levels or elevator control will be used with this system.*
4. Click the MULTIPLE SYSTEMS button only if this entry panel is sharing a phone line with another entry panel. *NOTE: This must match what the entry panel has been programmed for - either single or multiple systems sharing the same line.*

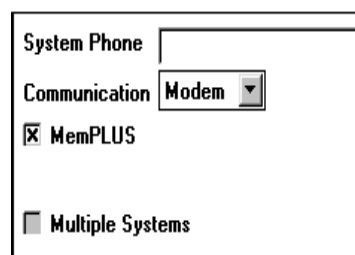

System Phone	
Communication	Modem
<input checked="" type="checkbox"/> MemPLUS	
<input type="checkbox"/> Multiple Systems	

Figure 13

3.1.3 TONE OPEN NUMBERS

Tone open numbers are the numbers that the entry panel will respond to and will cause the programmed relay action that the tone number was set for. Tone open numbers can be set to activate a single relay or any combination of relays. Each relay has four tone open number fields that can be set, however when a call is made to a resident, the resident can only momentarily activate the relay - the system will not respond to other tone open numbers from a resident.

The other three tone open number fields (Hold, Release, Hold 1 Hr.) are functions designed for the system administrator and will cause the relay(s) in the entry panel to respond to the programmed command. To use these functions, the system administrator calls the entry panel via a touch-tone telephone, and then enters a series of numbers to cause the desired relay action (Refer to the Owner's Manual that came with the entry panel for instructions on using this feature).

The 1818 Entry Panel does not have RELAY 0 capability. Leave all Relay 0 fields blank if programming an 1818 entry panel. Series 50 control boards do not have Relay 0 capability, and only Relay 1 tone open numbers are programmable. The postal input and rotary dial 9 functions on 50 series control boards are not programmable. These functions will always activate Relay 1 in the 50 series control board.

1803PC, 1815, 1817 ENTRY PANELS

If Tracker™ expansion boards are used with the 1803PC, 1815 or 1817 entry panels, set the tone open number(s), postal switch and rotary dial 9 inputs to activate RELAY 0. Relay 1 and Relay 2 are used as Tracker™ board command relays in this configuration.

1818 ENTRY PANELS

Generally, tone open numbers do not need to be set when using the 1818 entry panel because this panel is not designed for any voice communication requirements. However, it may be desirable to program tone open numbers for Relays 1 and 2 (there is no Relay 0 in the 1818, leave these fields blank) so that the system administrator can unlock doors (or open gates) under abnormal situations. For example, if a tone number is entered in the HOLD and RELEASE fields for Relays 1 and 2, a system administrator could use this function to command ALL doors and gates connected to the system to unlock (or open) in an emergency situation by calling the 1818 from a touch-tone telephone and entering the hold open tone command. This function requires that a CO telephone line be connected to the 1818 system for communication. This function is not available if RS232 is the only means of communicating with the 1818 system.

Relay	Tone Open Numbers				Other Relay Options		
	Momentary	Hold	Release	Hold 1 Hr	Postal Switch	Rotary 9 Momentary	Entry Code Range
0	<input type="text"/>	<input type="text"/>	<input type="text"/>	<input type="text"/>	<input type="checkbox"/>	<input type="checkbox"/>	<input type="text"/> - <input type="text"/>
1	<input type="text" value="9"/>	<input type="text" value="8"/>	<input type="text" value="7"/>	<input type="text" value="6"/>	<input checked="" type="checkbox"/>	<input checked="" type="checkbox"/>	<input type="text" value="0000"/> - <input type="text" value="9999"/> (divide)
2	<input type="text" value="5"/>	<input type="text" value="4"/>	<input type="text" value="3"/>	<input type="text" value="2"/>	<input type="checkbox"/>	<input type="checkbox"/>	<input type="text"/> - <input type="text"/>

Figure 14

1. Enter the tone open number for each relay under the desired function for that relay. If a function is not desired, leave it blank. *NOTE: 50 series control boards - only Relay 1 tone open numbers can be set.*
2. Select which relay(s) will activate when the postal switch is activated and when the entry panel detects a rotary dial 9. This field not available with 50 series control boards.

3.1.4 ENTRY CODES

Do not confuse four-digit ENTRY CODES with five-digit PIN codes. An ENTRY CODE is a four-digit number assigned to an individual and is entered in the entry code field on the resident information screen. Entry codes will activate the relay on the entry panel control board that it is programmed for when the code is entered on the entry panel keypad only. PIN (Personnel Identification Number) CODES are five-digit codes that are assigned to an individual and are entered in the device code field on the resident information screen. The relay that the PIN code will activate is determined by which weigand input the PIN keypad is connected to and security level programming.

1. If entry codes are used, lower and upper ranges can be programmed which will cause the entry code to activate the desired relay(s). *NOTE: Entry code ranges may overlap allowing one entry code to activate any combination of relays.*
2. Enter the lower and upper boundary four digit entry code number for each relay. This field not available with 50 series control boards.

3.1.5 MISCELLANEOUS SETUP ITEMS

1. Click the TRANSACTIONS button if transactions are to be stored in the entry system panel. The panel can store a maximum of 8000 events in the transaction buffer.
2. Click the INTERFACE WITH 1816 button only if the entry panel is connected to a DoorKing Model 1816 Telephone Intercom System.
3. Click the TRACKER button only if Tracker™ expansion boards are connected to the entry panel weigand input(s). This button must be turned ON even if a single Tracker™ board is used.
4. Set the DIAL TYPE to TONE for most installations. Use the rotary dial type only if the phone line connected to the entry panel is a rotary dial phone line. *NOTE: Typically, this is always set to TONE.*
5. The RESIDENT INFO DIRECTORY field identifies the file name that the resident information will be stored under for the current account. This field cannot be changed and is shown for information purposes only.
6. The OTHER INFO DIRECTORY field identifies the resident file name of the primary account. The information in this field will be the same as the resident info directory field, unless this account is sharing the resident database with another account. This field cannot be changed and is shown for information purposes only.

<input checked="" type="checkbox"/> Transactions <input type="checkbox"/> Interface With 1816 <input type="checkbox"/> Tracker	Dial Type: <input type="text" value="Tone"/>
	Resident Info Directory: <input type="text" value="ACCT02"/>
	Other Info Directory: <input type="text" value="ACCT02"/>

Figure 15

3.1.6 SYSTEM MESSAGE

This section applies to the 1815 and 1817 entry panels only. Skip this section if you are programming the 1803PC or 1818 entry panel.

1. Click the SYS MESSAGE button on the System Information Screen. The Message and Instructions window will appear (Figure 16). *NOTE: Only the System Message is programmable on 50 SERIES boards, therefore the field for programming the instruction message will not appear.*
2. Click either 1815 or 1817 to match the entry panel you are programming.
3. Enter the desired messages. The System Message has a maximum of 48 characters, while the Instruction Message has a maximum of 54 characters. Spaces count as a character.

Figure 16

3.2 RELAY NUMBERING AND CONTROL

The model 1803PC, 1815 and 1817 telephone entry systems each have three relays (Relay 0, 1, and 2) on the control board while the 1818 access control system has two (Relay 1, 2) relays. When Tracker™ boards are added to the system, the output relay on the Tracker™ boards are listed in the software sequentially, beginning with relay 3 (Relays 0, 1 and 2 are on the main control board).

When Tracker™ boards are used to expand the access control system, relays 1 and 2 are used as Tracker™ Command (Cmd) relays with Relay 2 commanding Tracker™ boards 1-8 (system relays 3-10) and Relay 1 commanding Tracker™ boards 9-16 (system relays 11-18). Refer to Figure 17.

1803PC, 1815 and 1817 SYSTEMS ONLY

If both Relay 1 and Relay 2 are used to control Tracker™ boards, Relay 0 is used as the Primary Relay that will open a visitor door or gate when the resident pushes "9" on their telephone. Refer to section 3.1.3.

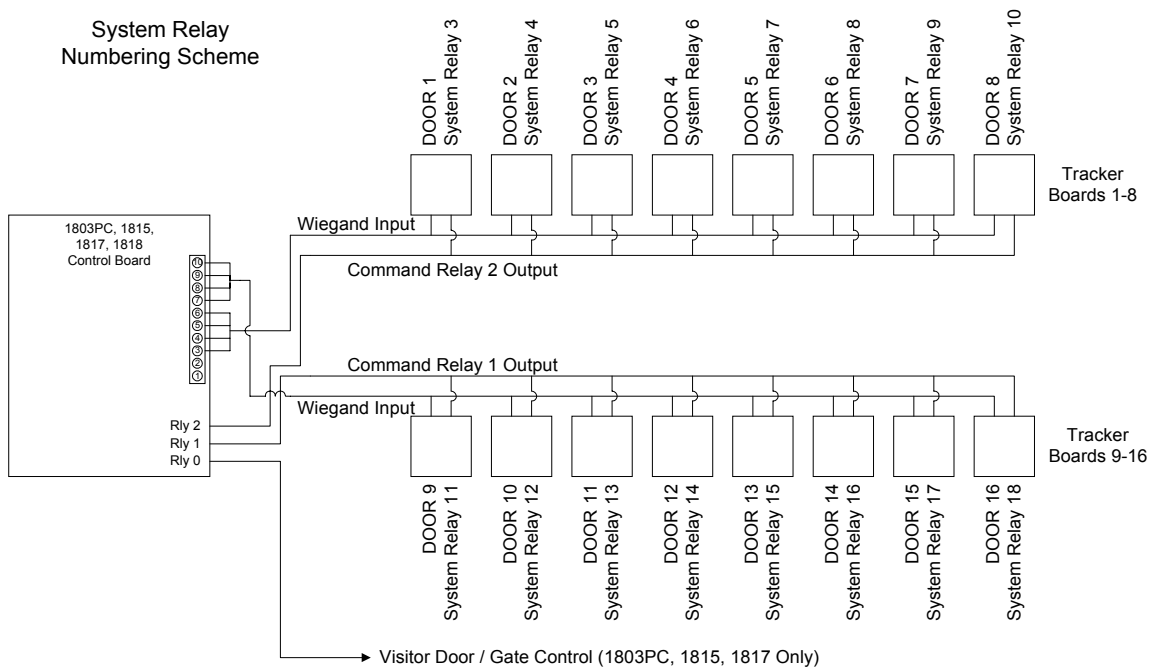

Figure 17

3.2.1 LABELING RELAYS WITH TRACKER DISABLED

Click the RELAYS button on the system screen to bring up the relays screen. The relay screen is where the output relays of the telephone entry system can be labeled, where you will set the relay strike time for the relays, and where you can enable the "Hold Open During Modeming" command.

NOTE: The "Hold Open During Modeming" command is not active if RS-232 communication is being used.

Use the following instructions if the TRACKER button (System Info Screen) is not checked. If the TRACKER button is checked, go to section 3.2.2.

1. From the SYSTEM INFO screen, click the RELAYS button. The relay information screen will appear (Figure 18).
2. Clicking the "Hold Open During Modeming" button activates the relay during the data transfer, and then deactivates it when the data transfer is complete. This will cause your gate or door to remain open during the data transfer. If this is not desirable, do not activate this feature. The weigand input devices (cards, transmitters, etc.) remain operational during the data transfer. *NOTE: This feature is not active when using RS-232 communications.*
3. Click in the name field, then enter a name for the relay. This is the name that will appear on the transaction reports, for example: "Main Gate" or "Side Gate". The maximum characters that can be entered in this field is 12 (Figure 19).
4. Click the time field and enter the time in seconds that the relay is to be activated.
5. When complete with this screen, click OK to return to the System Info screen.
6. Click the RESET button to change the relay options to the default settings.
7. Clicking the CANCEL button will reset this screen to the previous settings and return you to the System Info screen.

NOTE: Relay 0 is not used with the 1818 system. Leave this field blank if the account that you are programming is an 1818 unit.

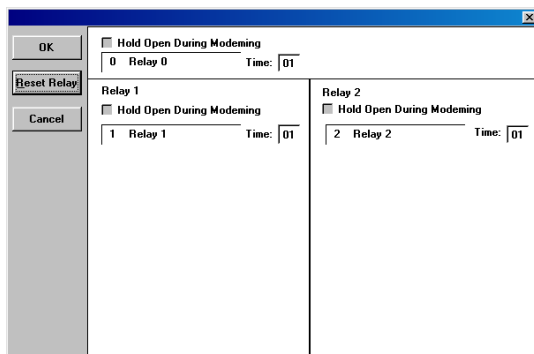

Figure 18

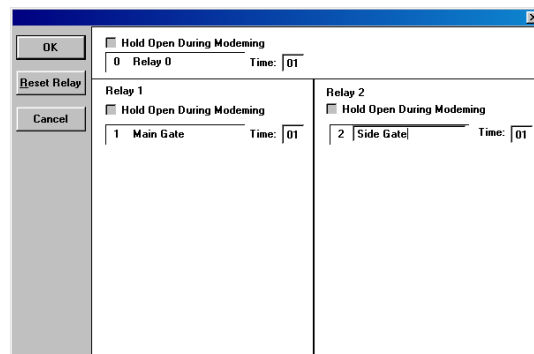

Figure 19

3.2.2 LABELING RELAYS WITH TRACKER ENABLED

Click the RELAYS button on the system screen to bring up the relays screen. The relay screen is where the output relays of the telephone entry system can be labeled, where you will set the relay strike time for the command relays, and where you can enable the "Hold Open During Modeming" command.

NOTE: The "Hold Open During Modeming" command is not active if RS-232 communication is being used.

Use the following instructions if the TRACKER button (System Info Screen) is checked. If the TRACKER option is not checked, refer to section 3.2.1.

1. From the SYSTEM INFO screen, click the RELAYS button.
2. Click "Additional Relays For Tracker 2" button to enable system relays 3-10 (see Figure 20).
3. Click "Additional Relays For Tracker 1" button to enable system relays 11-18 (see Figure 21).
4. Click "Hold Open During Modeming" (not active if RS-232 communication is used) to activate the respective relays during the data transfer. This will activate ALL respective tracker board relays during modeming, which will unlock all doors (gates) during this process. If this is not desirable, do not turn this feature on. HINT: All weigand input devices (cards, transmitters, etc.) remain operational during the data transfer.
5. Click in the name field, then enter a name for each relay. This is the name that will appear on the transaction reports, for example: "Main Gate" or "Rear Gate". The maximum characters that can be entered in this field is 12.
6. The default relay strike time for system relays 1 and 2 (labeled Cmd 11-18 and Cmd 3-10 respectively in fig 21) is 00 seconds. The individual relay strike times are set at the Tracker™ boards.
7. When complete with this screen, click the OK button to save the changes made and to return to the System Info screen. To return to the System Info screen without saving any changes, click the CANCEL button.
8. Click the RESET button to change the relay options to the default settings.

NOTE: Relay 0 is not used with the 1818 system. Leave this field blank if the account that you are programming is an 1818 unit.

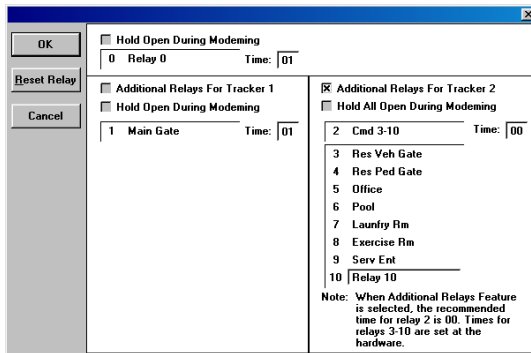

Figure 20

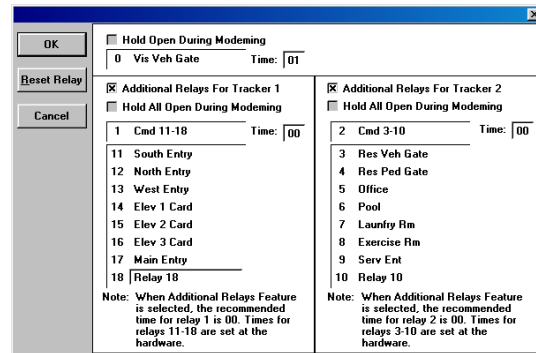

Figure 21

3.3 RELAY HOLD OPEN TIME ZONE PROGRAMMING

Up to eight (8) relay hold time zones can be created in the software. After the time zones have been created, they can then be applied as needed to the system relay(s) that you chose.

NOTE: The time zones applied to the Tracker™ board relays (system relays 3-18) are only accurate to 5 minutes.

IMPORTANT: Earlier versions of the software can only time zone relays 0, 1 and 2, and only have two (2) time zones available per relay. The time zones referenced in this section apply only to 30 Series and ENHANCED 40 Series boards and software versions 5.0 and higher.

3.3.1 CREATING RELAY HOLD TIME ZONES

Click the HOLD OPEN button on the System Info screen to bring up the Relay Hold Open Times screen (Figure 22).

1. Enter a Begin Time and an End Time for the first time zone.
2. Click the day(s) of the week that the time zone is to be active (an X will appear in the box).
3. Repeat the above to create up to seven additional time zones. NOTE: Time Zones may overlap.
4. Click CANCEL to return to the System Info screen without saving the time zones, or click the CLEAR button to reset the table and start over.
5. Go to Section 3.3.2 to apply the time zones to the desired system relays, or click OK to save the time zones and return to the System Info screen without applying the time zones to any relay.

Relay Hold Open Times							Relay Number													
	BEGIN TIME	END TIME	S	M	T	W	T	F	S	0	1	2	3	4	5	6	7	8	9	10
1	06:00 AM	08:00 AM	<input type="checkbox"/>	<input checked="" type="checkbox"/>	<input checked="" type="checkbox"/>	<input checked="" type="checkbox"/>	<input checked="" type="checkbox"/>	<input checked="" type="checkbox"/>	<input type="checkbox"/>	<input type="checkbox"/>	<input type="checkbox"/>	<input type="checkbox"/>	<input type="checkbox"/>	<input type="checkbox"/>	<input type="checkbox"/>	<input type="checkbox"/>	<input type="checkbox"/>	<input type="checkbox"/>	<input type="checkbox"/>	<input type="checkbox"/>
2	08:00 AM	08:00 PM	<input checked="" type="checkbox"/>	<input type="checkbox"/>	<input type="checkbox"/>	<input type="checkbox"/>	<input type="checkbox"/>	<input type="checkbox"/>	<input checked="" type="checkbox"/>	<input type="checkbox"/>	<input type="checkbox"/>	<input type="checkbox"/>	<input type="checkbox"/>	<input type="checkbox"/>	<input type="checkbox"/>	<input type="checkbox"/>	<input type="checkbox"/>	<input type="checkbox"/>	<input type="checkbox"/>	<input type="checkbox"/>
3	09:00 AM	05:00 PM	<input type="checkbox"/>	<input checked="" type="checkbox"/>	<input checked="" type="checkbox"/>	<input checked="" type="checkbox"/>	<input checked="" type="checkbox"/>	<input checked="" type="checkbox"/>	<input type="checkbox"/>	<input type="checkbox"/>	<input type="checkbox"/>	<input type="checkbox"/>	<input type="checkbox"/>	<input type="checkbox"/>	<input type="checkbox"/>	<input type="checkbox"/>	<input type="checkbox"/>	<input type="checkbox"/>	<input type="checkbox"/>	<input type="checkbox"/>
4	07:00 AM	05:00 PM	<input type="checkbox"/>	<input checked="" type="checkbox"/>	<input checked="" type="checkbox"/>	<input checked="" type="checkbox"/>	<input checked="" type="checkbox"/>	<input checked="" type="checkbox"/>	<input checked="" type="checkbox"/>	<input type="checkbox"/>	<input type="checkbox"/>	<input type="checkbox"/>	<input type="checkbox"/>	<input type="checkbox"/>	<input type="checkbox"/>	<input type="checkbox"/>	<input type="checkbox"/>	<input type="checkbox"/>	<input type="checkbox"/>	<input type="checkbox"/>
5	00:00 AM	00:00 AM	<input type="checkbox"/>	<input type="checkbox"/>	<input type="checkbox"/>	<input type="checkbox"/>	<input type="checkbox"/>	<input type="checkbox"/>	<input type="checkbox"/>	<input type="checkbox"/>	<input type="checkbox"/>	<input type="checkbox"/>	<input type="checkbox"/>	<input type="checkbox"/>	<input type="checkbox"/>	<input type="checkbox"/>	<input type="checkbox"/>	<input type="checkbox"/>	<input type="checkbox"/>	<input type="checkbox"/>
6	00:00 AM	00:00 AM	<input type="checkbox"/>	<input type="checkbox"/>	<input type="checkbox"/>	<input type="checkbox"/>	<input type="checkbox"/>	<input type="checkbox"/>	<input type="checkbox"/>	<input type="checkbox"/>	<input type="checkbox"/>	<input type="checkbox"/>	<input type="checkbox"/>	<input type="checkbox"/>	<input type="checkbox"/>	<input type="checkbox"/>	<input type="checkbox"/>	<input type="checkbox"/>	<input type="checkbox"/>	<input type="checkbox"/>
7	00:00 AM	00:00 AM	<input type="checkbox"/>	<input type="checkbox"/>	<input type="checkbox"/>	<input type="checkbox"/>	<input type="checkbox"/>	<input type="checkbox"/>	<input type="checkbox"/>	<input type="checkbox"/>	<input type="checkbox"/>	<input type="checkbox"/>	<input type="checkbox"/>	<input type="checkbox"/>	<input type="checkbox"/>	<input type="checkbox"/>	<input type="checkbox"/>	<input type="checkbox"/>	<input type="checkbox"/>	<input type="checkbox"/>
8	00:00 AM	00:00 AM	<input type="checkbox"/>	<input type="checkbox"/>	<input type="checkbox"/>	<input type="checkbox"/>	<input type="checkbox"/>	<input type="checkbox"/>	<input type="checkbox"/>	<input type="checkbox"/>	<input type="checkbox"/>	<input type="checkbox"/>	<input type="checkbox"/>	<input type="checkbox"/>	<input type="checkbox"/>	<input type="checkbox"/>	<input type="checkbox"/>	<input type="checkbox"/>	<input type="checkbox"/>	<input type="checkbox"/>

Figure 22

3.3.2 APPLYING RELAY HOLD TIME ZONES

Once the required time zones are created, you can then apply them to the system relay(s) that you want to operate under the time zone.

1. Click the relay(s) next to the time zone that you want to apply the time zone to. An X will appear in the box (Figure 23).
2. Use the scroll button under the relay number table to access system relays 11-18.
3. Click OK to save the time zones and return to the System Info screen.
4. Click CANCEL to return to the System Info screen without saving any changes.
5. Click CLEAR to clear all time zones.

In the example below, four time zones have been created. Refereeing back to Figure 21 on page 27, Relay 3 has been labeled Res Veh Gate (Resident Vehicle Gate). Time zones 1 and 2 have been applied to Relay 3, which means that on Monday through Friday, the resident vehicular gate will automatically open at 6:00 AM and remain open until 8:00 PM. On Saturday and Sunday, this gate will open at 8:00 AM and remain open until 8:00 PM.

Again refereeing back to Figure 21 on page 27, Relay 5 has been labeled Office. Time zone 3 has been applied to Relay 5, which means that the office door will unlock at 9:00 AM and remain unlocked until 5:00 PM Monday through Friday. This door will remain locked on the weekends.

Relay 9 is labeled the Serv Ent (Service Entrance). Time zone 4 has been created and applied to this entry only (relay 9) meaning that this door will open at 7:00 Am and relock at 5:00 PM Monday through Friday, and will remain locked on the weekends.

Relay Hold Open Times				Relay Number																
	BEGIN TIME	END TIME	S	M	T	W	T	F	S	0	1	2	3	4	5	6	7	8	9	10
1	06:00 AM	08:00 AM	<input type="checkbox"/>	<input checked="" type="checkbox"/>	<input checked="" type="checkbox"/>	<input checked="" type="checkbox"/>	<input checked="" type="checkbox"/>	<input checked="" type="checkbox"/>	<input checked="" type="checkbox"/>	<input type="checkbox"/>	<input type="checkbox"/>	<input type="checkbox"/>	<input type="checkbox"/>	<input checked="" type="checkbox"/>	<input type="checkbox"/>	<input type="checkbox"/>	<input type="checkbox"/>	<input type="checkbox"/>	<input type="checkbox"/>	<input type="checkbox"/>
2	08:00 AM	08:00 PM	<input checked="" type="checkbox"/>	<input type="checkbox"/>	<input type="checkbox"/>	<input type="checkbox"/>	<input type="checkbox"/>	<input type="checkbox"/>	<input checked="" type="checkbox"/>	<input type="checkbox"/>	<input type="checkbox"/>	<input type="checkbox"/>	<input checked="" type="checkbox"/>	<input type="checkbox"/>	<input type="checkbox"/>	<input type="checkbox"/>	<input type="checkbox"/>	<input type="checkbox"/>	<input type="checkbox"/>	<input type="checkbox"/>
3	09:00 AM	05:00 PM	<input type="checkbox"/>	<input checked="" type="checkbox"/>	<input checked="" type="checkbox"/>	<input checked="" type="checkbox"/>	<input checked="" type="checkbox"/>	<input checked="" type="checkbox"/>	<input checked="" type="checkbox"/>	<input type="checkbox"/>	<input type="checkbox"/>	<input type="checkbox"/>	<input type="checkbox"/>	<input type="checkbox"/>	<input checked="" type="checkbox"/>	<input type="checkbox"/>	<input type="checkbox"/>	<input type="checkbox"/>	<input type="checkbox"/>	<input type="checkbox"/>
4	07:00 AM	05:00 PM	<input type="checkbox"/>	<input checked="" type="checkbox"/>	<input checked="" type="checkbox"/>	<input checked="" type="checkbox"/>	<input checked="" type="checkbox"/>	<input checked="" type="checkbox"/>	<input checked="" type="checkbox"/>	<input type="checkbox"/>	<input type="checkbox"/>	<input type="checkbox"/>	<input type="checkbox"/>	<input type="checkbox"/>	<input type="checkbox"/>	<input type="checkbox"/>	<input type="checkbox"/>	<input type="checkbox"/>	<input checked="" type="checkbox"/>	<input type="checkbox"/>
5	00:00 AM	00:00 AM	<input type="checkbox"/>	<input type="checkbox"/>	<input type="checkbox"/>	<input type="checkbox"/>	<input type="checkbox"/>	<input type="checkbox"/>	<input type="checkbox"/>	<input type="checkbox"/>	<input type="checkbox"/>	<input type="checkbox"/>	<input type="checkbox"/>	<input type="checkbox"/>	<input type="checkbox"/>	<input type="checkbox"/>	<input type="checkbox"/>	<input type="checkbox"/>	<input type="checkbox"/>	<input type="checkbox"/>
6	00:00 AM	00:00 AM	<input type="checkbox"/>	<input type="checkbox"/>	<input type="checkbox"/>	<input type="checkbox"/>	<input type="checkbox"/>	<input type="checkbox"/>	<input type="checkbox"/>	<input type="checkbox"/>	<input type="checkbox"/>	<input type="checkbox"/>	<input type="checkbox"/>	<input type="checkbox"/>	<input type="checkbox"/>	<input type="checkbox"/>	<input type="checkbox"/>	<input type="checkbox"/>	<input type="checkbox"/>	<input type="checkbox"/>
7	00:00 AM	00:00 AM	<input type="checkbox"/>	<input type="checkbox"/>	<input type="checkbox"/>	<input type="checkbox"/>	<input type="checkbox"/>	<input type="checkbox"/>	<input type="checkbox"/>	<input type="checkbox"/>	<input type="checkbox"/>	<input type="checkbox"/>	<input type="checkbox"/>	<input type="checkbox"/>	<input type="checkbox"/>	<input type="checkbox"/>	<input type="checkbox"/>	<input type="checkbox"/>	<input type="checkbox"/>	<input type="checkbox"/>
8	00:00 AM	00:00 AM	<input type="checkbox"/>	<input type="checkbox"/>	<input type="checkbox"/>	<input type="checkbox"/>	<input type="checkbox"/>	<input type="checkbox"/>	<input type="checkbox"/>	<input type="checkbox"/>	<input type="checkbox"/>	<input type="checkbox"/>	<input type="checkbox"/>	<input type="checkbox"/>	<input type="checkbox"/>	<input type="checkbox"/>	<input type="checkbox"/>	<input type="checkbox"/>	<input type="checkbox"/>	<input type="checkbox"/>

Figure 23

3.4 SECURITY LEVELS

Security Levels (SL) allow you to control individual access through the controlled entry points by persons using a weigand device (card, transmitter, PIN, etc.). As an example of this, a plant manager may have 24 hour, seven day a week access into the plant, but individual workers will only be granted access depending on which shift that they work. It is also possible to allow a person 24 hour a day access at one entry point, but limit their access at another entry point. This is possible because each security level can have up to four different time zones created.

Individuals can only be assigned a single security level (see sect 4), however there are 31 different security levels available. The first two security levels are factory set and cannot be changed. SL00 disables all devices (cards, transmitters, etc.) assigned to an individual. An example of using SL00 would be for an individual who has been evicted from an apartment, or an employee who has been fired from a job, and they are no longer granted access at any entry point. In effect, SL00 "turns off" all devices assigned to that individual. The opposite of SL00 is SL01, which enables all devices assigned to an individual on a 24 hour a day, 7 day a week basis. An example of using SL01 would be for management or maintenance personnel who need access at all entry points at all times.

The remaining 29 Security Levels (SL02 - SL30) can each have up to four (4) Time Zones (TZ) created within them allowing up to 116 different time zone combinations.

Leave the FLOORS buttons (1-64) blank when elevator control is not being used. If elevator control is in use, refer to Section 3.6 for additional programming information.

IMPORTANT: This section applies to ENHANCED 1840, 1841 (Rev D and higher), and 1844 (Rev A and higher) control boards only. Security levels are not available with earlier board revisions or with earlier versions of the software.

Security Level 02, Time Zone 1

Security Level: 00 Device always Disabled
 Security Level: 01 Device always Enabled
 Security Level: 02 Time Zones: TZ1 TZ2 TZ3 TZ4

Time: BEGIN TIME END TIME S M T W T F S
 00:00 AM 00:00 AM

Relays: 0 1 2 3 4 5 6 7 8 9 10 11 12 13 14 15 16 17 18

* To change the floor name, double-click on it

Floors: 1 2 3 4 5 6 7 8 9 10 11 12 13 14 15 16

17 18 19 20 21 22 23 24 25 26 27 28 29 30 31 32

33 34 35 36 37 38 39 40 41 42 43 44 45 46 47 48

49 50 51 52 53 54 55 56 57 58 59 60 61 62 63 64

OK
 Cancel
 View Active SLs
 Relays
 Relay/Elevator
 Clear Time Zone

Figure 24

3.4.1 PLANNING SECURITY LEVELS

Successful use of security levels (SL) begins with determining who the system users are going to be and what access control restrictions will be placed on them. Keep in mind that only one security level can be assigned to an individual user of the system, therefore the security level created for them must address all of the users access needs. The example below gives you an idea of some of the things to consider as you plan your security levels and access control requirements. The hypothetical access system described below controls access to the following; separate visitor and resident vehicular gates, a resident pedestrian gate, a service entrance vehicular gate, a South entrance vehicular gate, a pool gate, a laundry room, an exercise room and the management office. Elevator control is not in use with this hypothetical access system (see section 3.6 for elevator control).

Refer to the instructions and diagrams in Section 3.4.2 for instructions on how the Security Levels described below were created.

In a typical gated community or apartment building, residents must have a security level that allows them access to their homes 24 hours a day, 7 days a week, but restricts them from gaining access to areas that are closed at certain times of the day - the office or pool for instance. In this case, we cannot use SL01 because this security level allows access 24 hours a day at all controlled access points.

The answer to this problem is to create a security level (start with SL02) with time zone 1 (TZ1) set for 24 hour a day, 7 day a week access. You then apply this first time zone to the relays that control the main entry gate or main entry door (relay 3), any pedestrian gates (relay 4), rear entrances (relay 11), etc. Once you have created the first time zone (TZ1) within the first security level (SL02) and applied this TZ to the relays that control the access points where 24 hour a day, 7 day a week access is to be granted (fig 25), you can then use the next three time zones (TZ2, TZ3, TZ4) within the security level (SL02) to restrict the users access to other access points.

Let's next consider access to the pool, laundry and exercise room areas. Time zone 2 (TZ2) is set to allow access from 8:00 AM to 10:00 PM seven days a week. This time zone is then applied to the relays (relays 6, 7, 8) that control access to the pool, laundry and exercise room areas (fig 26). The next area is access to the management office. TZ3 is set to allow access from 9:00 AM to 5:00 PM, Monday through Saturday only (the office is closed on Sundays) and then applied to relay 5 that controls access to the office (fig 27). In this example, TZ4 is not used at this time. You have now created a security level (SL02) with three different time zones that allow entry at all times through the main gate(s) and/or door(s), and restricts access to certain times of the day for the pool, laundry, and exercise room, and limits access to the office area to six days a week at certain times only.

Next create another security level (SL03) for the landscape and pool service companies. In this example application, these vendors are allowed access to the property at the service entrance Monday through Friday, 8:00 AM to 5:00 PM only. In SL03, TZ1 is set for these times and applied to the respective relays (relays 6, 9). Vendors are now limited in the days and times that they can gain entry to the property, and must use the service entry (fig 28). It is possible to create security levels for each vendor to restrict them to access on certain days of the week only, and to restrict access to their respective area of concern only. The problem with the security level created in the first part of this paragraph is that it will allow all vendors access to all areas within the time limits of the security level. For example, the laundry service vendor needs access only to the laundry room, not to the pool or exercise rooms. In this case, SL04 has been created with TZ1 set from 8:00 AM to 5:00 PM, and applied to relays 7 and 9 which control access to the service entry gate and laundry room only (fig 29).

Another security level (SL05) is created for the office personnel to allow them access to the office (relay 5). The office is open from 9:00 AM to 5:00 PM, however access will be allowed to these persons from 7:00 AM to 6:00 PM (fig 30) Monday through Friday only. A second time zone (TZ2) has been created within this security level to restrict office personnel to use the South entry only (relay 11) and to grant access to the pool, laundry and exercise areas one hour before and after these common areas open (fig 31).

Office managers, the resident property manager, and maintenance personnel are assigned SL01, which will allow these users access to all entry points at all times.

3.4.2 CREATING SECURITY LEVELS

Using security levels requires two basic programming steps. The first step is to plan and create the individual security level(s) required and then apply them to the individual entry points (relays). Refer to the Security Level Planning Chart in the back of this manual to see how Security Level 02 was first planned. The second step is to assign the security level to the individual users of the system. This second step is accomplished in Section 4 - Data Base Management.

PROGRAMMING SECURITY LEVEL 02

1. From the System Info screen, click the SECURITY LEVEL button to access the security level screen.
2. Click the Security Level pull down menu down arrow button to select which security level you want to create. If you are creating the first security level, we suggest that you start with SL02.
3. Click TZ1 to set begin and end times for the first time zone in this security level.
4. Click the begin time and enter the time desired. Likewise, click the end time and enter the end time desired.
5. Select the days of the week for this time zone (an X will appear in the box when the day is selected).
6. Select the relays that you want this security level to apply to. *NOTE: Clicking the RELAYS button will cause the Relays screen to appear (see figure 21). This is where you "named" the relays (pg. 25). From here you can determine which relays you want this security level to control. Click CANCEL to return to the Security Level screen.*
7. Click TZ2 to set up begin and end times, days of the week, and the relays that this time zone is to be applied to.
8. Repeat step 7 to set up time zones 3 (TZ3) and 4 (TZ4).

NOTE: The FLOORS buttons are left blank when elevator control is not used. See section 3.6 for additional programming instructions when using elevator control.

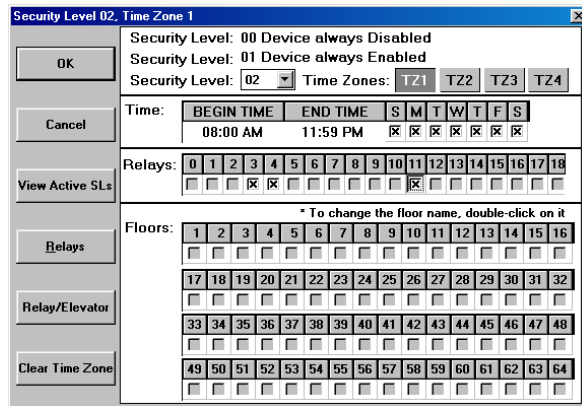

Figure 25

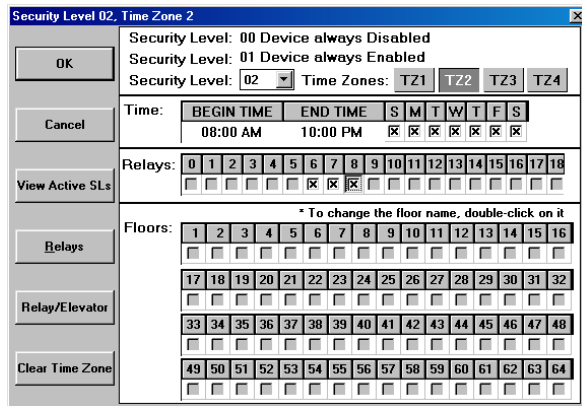

Figure 26

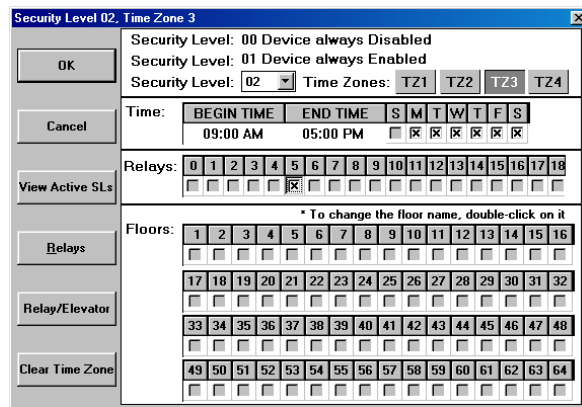

Figure 27

PROGRAMMING ADDITIONAL SECURITY LEVELS

9. Click the Security Level pull down menu down arrow button to select the next security level you want to create.
10. Enter the begin and end times for TZ1, select the days of the week for this time zone and select the relays that this time zone will be applied to.
11. Click TZ2 and enter the begin and end times for TZ2, select the days of the week for this time zone and select the relays that this time zone will be applied to.
12. Click TZ3 and enter the begin and end times for TZ3, select the days of the week for this time zone and select the relays that this time zone will be applied to.
13. Click TZ4 and enter the begin and end times for TZ4, select the days of the week for this time zone and select the relays that this time zone will be applied to.
14. Repeat steps 9-13 to create additional security levels.

To view all the security levels that have been created, click the VIEW ACTIVE SL button. Click the DONE button to return to the Security Level window.

Click the CLEAR TIME ZONE button to reset the time zones in the current window.

Click OK to return to the SYSTEM INFO screen.

NOTE: The RELAY/ELEVATOR button is used with elevator control only. If Elevator control is in use, see section 3.6 for additional programming instructions.

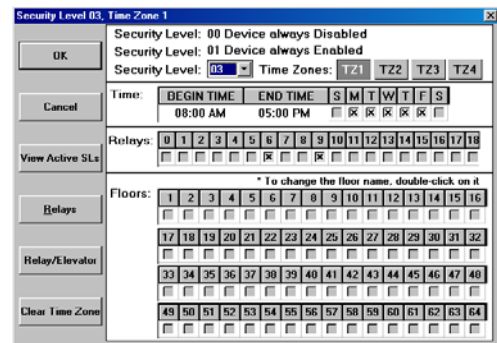

Figure 28

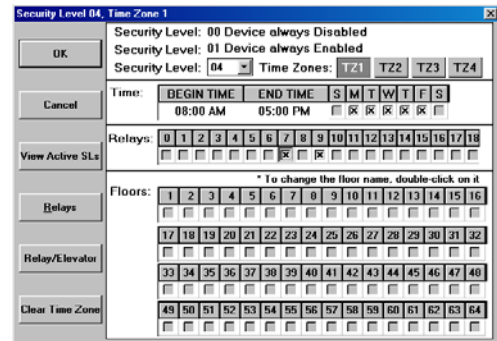

Figure 29

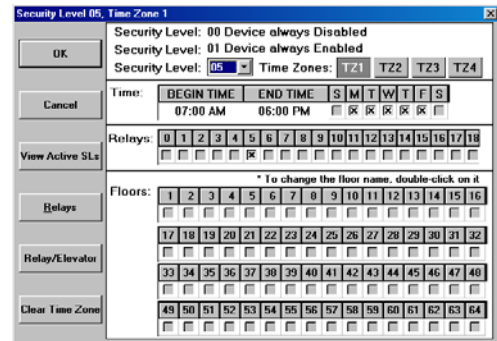

Figure 30

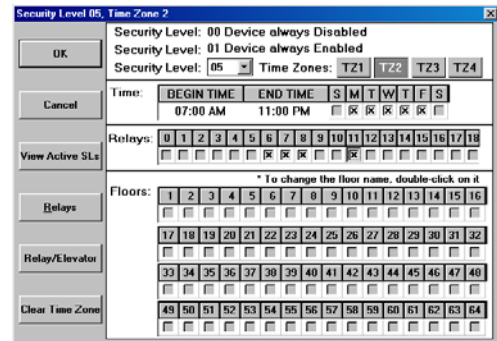

Figure 31

3.5 DEVICE ASSOCIATION

The DEVICE ASSOCIATION function allows you to associate the names of a card, transmitter, or other 26-bit weigand devices connected to the system with certain code numbers restricted to that device. For example, if an entry system is using a combination of card readers and RF transmitters, this feature allows you to name a range of codes associated with each device. This function will also allow you to "mass enable" (turn on) a specified range of codes at one time.

NOTE: Device association simply associates a range of "device" codes with a device name that you create.

3.5.1 DEVICE ASSOCIATION

1. From the SYSTEM INFO screen, click the DEVICE ENABLE button. The default Device Association window will appear (fig 32).
2. Click the "Device Name" field and enter a name for the device (12 characters max).
3. Click the "From" field and enter the beginning device number. Click the "To" field and enter the ending device number.
4. Repeat steps 2 and 3 to enter additional device names and ranges.
5. Click the OK button (or press ENTER) when complete or click the "Mass Enable" arrow next to the device codes that you want to activate (see 3.5.2).

In the example in figure 33, a combination of access cards, MicroPLUS™ transmitters, and personal identification numbers (PINs) have been used for access control purposes. Device names are a maximum of 12 characters. In this example, access cards have been labeled "Cards", MicroPLUS™ transmitters have been labeled "Trans", and PIN codes have been labeled "PIN". Notice also that three different sets of cards have been issued, each with their own unique range of codes. The labels "Cards," "Trans" and "PIN" will be used in the transaction log anytime a device within the respective ranges is used. In addition, the first letter of the device name will show on the resident screen under the T (type) field to identify the type of device.

IMPORTANT: These steps do not activate (or turn on) any device codes. Device association only "labels" a range of device codes. To activate (turn on) these devices, go to section 3.5.2. Device codes must be entered as a 5-digit number between 00001 and 65407. The system allows a maximum of 8000 device codes, therefore you simply cannot "mass enable" codes 00001 through 65407 as this exceeds the maximum amount of device codes allowed.

Device Name	From	To	Mass Enable
Cards	00000	65407	▼
			▼
			▼
			▼
			▼
			▼
			▼
			▼
			▼
			▼

Figure 32

Device Name	From	To	Mass Enable
Cards	01000	01999	▼
Trans	00100	00199	▼
PIN	42000	42100	▼
Cards	02500	03000	▼
Cards	05000	05100	▼
			▼
			▼
			▼
			▼
			▼

Figure 33

3.5.2 MASS ENABLE

The MASS ENABLE function allows you to activate (turn on) a range of device codes at one time. This allows resident managers or access system administrators to activate a group of cards (or transmitters or PINs) prior to the devices being issued or any users being entered in the database. Once the user(s) is entered in the database, the manager can select the card (or transmitter, or PIN) and assign it to the user. See section 4.2 for programming instructions on assigning "mass enabled" codes to system users.

1. Click the DEVICE ENABLE button on the System Info screen to bring up the Device Association pop-up window.
2. Click the DOWN ARROW to the right of the device that you want to mass enable. The Mass Enable window pops up.
3. Enter the range of codes that you want to mass enable and enter a Security Level for this range if desired (fig. 34). *NOTE: Entering the security level is optional. If the security level is left blank, the software will automatically assign security level 01 to the device codes. Keep in mind that when you assign (see 4.2) a device code to a user in the database, the security level will automatically change to that of the security level assigned to the user.*
4. Click the ENABLE button. The codes will now be turned on and the range that you entered in step 3 will move to the field below (fig. 35).
5. Repeat steps 2 through 4 to mass enable other device codes.
6. To reverse this process, select the device codes that have been mass enabled by clicking on them, then click EDIT to change the devices codes that are mass enabled or click DELETE to deactivate the device codes that have been mass enabled.
7. Click the CLOSE button to close the mass enable window.

In the example in figure 35, device codes 01000 through 01999 have all been "Mass Enabled" and placed in security level 2 (SL02). From the device association window (fig. 33) we know that these device codes represent access cards.

Once the device codes have been mass enabled, they are active (turned on) and ready to be "assigned" to a system user. Refer to section 4.2 for instructions on assigning device codes to the system users.

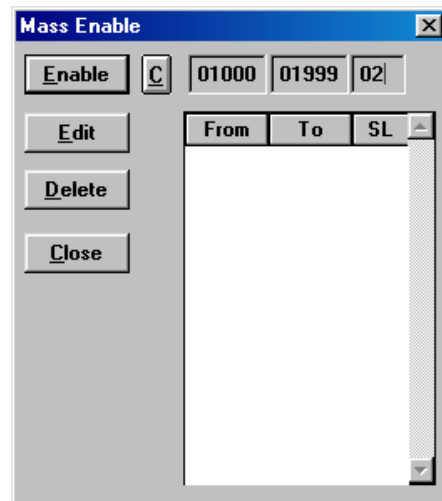

Figure 34

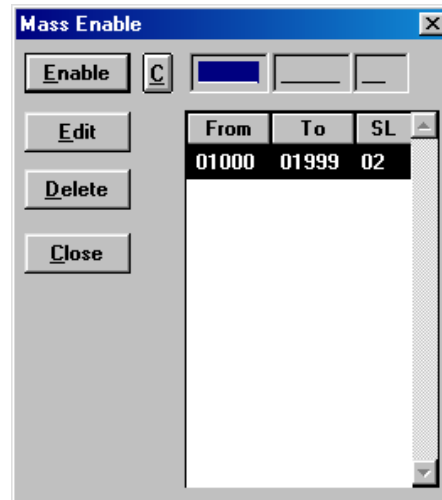

Figure 35

3.6 ELEVATOR / FLOOR CONTROL

The elevator control feature is typically used in high-rise apartment buildings or office buildings and is designed to limit which elevator(s) and which floor(s) a person is allowed access to. This control can be applied to building residents and to visitors that have been granted access by a resident. In its most common use, when a resident grants access to a visitor, the system will call the designated elevator(s) to the ground floor, and then only the floor button that the resident resides on will be active in the elevator(s). This prevents the visitor from accessing other than the designated elevator(s), or from going to unauthorized floors. Elevator restrictions for visitors are programmed in Section 4.1.1.

Elevator control can also be applied to residents to control which elevator(s) they can use and to which floor(s) they are allowed access. In this application, a card reader is installed inside the elevator(s) car. When the resident enters the elevator, they must use their access card to "turn on" the elevator buttons. The buttons that will be turned on are set in the software. Security levels can also be applied to elevator control, however the SL01 security level does not affect elevator control and will not grant unrestricted access to all floors in a building that uses elevator control. Therefore, if it is necessary to allow certain personnel unrestricted access to the elevators and floor numbers, a security level should be created for this requirement (see SL06, page 37). Elevator restrictions for system users are programmed in sections 3.6.2.

NOTE: Elevator control is only available with ENHANCED SERIES 40 boards and requires the installation of the 2348 Elevator Control board(s). This software and hardware will control a maximum of four (4) elevators with each elevator serving up to 64 floors.

3.6.1 PLANNING ELEVATOR CONTROL / SECURITY LEVELS

Refer to the instructions and diagrams in Section 3.6.3 for instructions on how Security Levels and Elevator Control has been used to meet the criteria in the following hypothetical building.

The following example assumes that access control is used in a high-rise apartment building with four elevators. Floors 2 through 4 in this building are reserved for private business. On the 20th floor of this building is a exercise room that is open from 6:00 AM to 11:00 PM, seven days a week, but access is restricted to only those residents that pay a monthly fee for the use of the facility. There is a main entry door where the private business employees, building residents and guests have access. System users (building residents and business employees) use a card to gain access to the building while visitors will use a telephone entry system to communicate with the person they wish to visit. A rear entry door is reserved for residents and service personnel only and access is controlled at this entry with a card reader only. Elevator control is used in this application and each of the four elevators has a card reader installed in the elevator car.

The building residents are to be granted access 24 hours a day, seven days a week at the main and rear entry. They will be allowed to use any of the four elevators, but will not have elevator access to the business floors (2, 3, 4). The exercise room in this building is open to residents seven days a week, but the hours are restricted from 6:00 AM to 11:00 PM., and only those residents that have paid a monthly user fee will be granted access to this area. Visitors will only be allowed access to the floor that the person they are visiting lives on, or to the floor that the office they are visiting is located on, and they (visitors) can only use elevators 1 or 2. The business employees are granted access only at the main entry door, Monday through Saturday from 6:00 AM to 8:00 PM. These business employees are restricted to floors 2, 3 and 4 using elevators 1 and 2 only. The business managers are granted access 24 hours a day, seven days a week, but are restricted to floors 2, 3 and 4 only via elevators 1 and 2 only. Building maintenance personnel and management personnel are granted access 24 hours a day, seven days a week at all controlled entry points and can use any of the four elevators and are not restricted to any floors.

IDENTIFY THE SYSTEM RELAYS

The first step is to identify the system relays that will be used and to name them (refer to 3.2.2). System relay 1 will be used to control the main entry door and is labeled "Main Entry." System relay 2 becomes the command relay for the Tracker™ expansion boards used in this application and is labeled Cmd 3-10. System relay 3 is the card reader on the rear entry and is labeled "Rear Entry." System relay 4 is the card reader that allows access to the exercise room (Exercise Rm) and system relays 5, 6, 7 and 8 are the card readers installed in elevators 1 through 4 respectively (fig. 36).

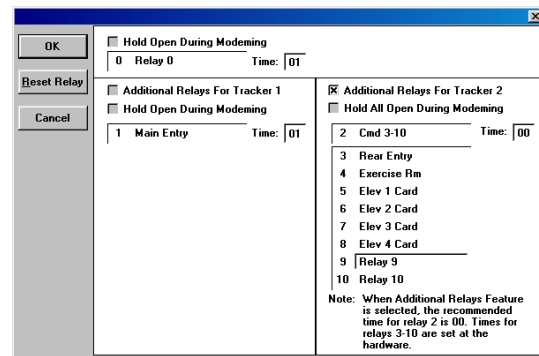

Figure 36

3.6.2 PROGRAMMING THE RELAY / ELEVATOR CONTROL TABLE

Programming elevator control for the system users (the building residents and business employees) consist of two steps (elevator control for visitors is programmed in Section 4.1.1). The first step is to program the Relay / Elevator Table. This table tells the access system which system relay controls which elevator and sends this information to the elevator control board. As identified in figure 36, system relay 5 is activated by the card reader in elevator 1, system relay 6 by the card reader in elevator 2, system relay 7 by the card reader in elevator 3, and system relay 8 by the card reader in elevator 4.

The second step will be to program the appropriate security levels needed to control access as described in our hypothetical application. Besides restricting access to certain days and times and certain access locations, these security levels will also restrict users to certain floors and determine which elevators they can use.

PROGRAMMING THE RELAY / ELEVATOR TABLE

1. Click the RELAY / ELEVATOR button on the System Info screen. The Relay / Elevator Table window will appear.
2. The system relay numbers are listed on the left side of the table. Use the scroll button to scroll up or down to view all the system relay numbers. The elevator numbers (1-8) are listed across the top of the table. **Although eight elevators are listed, you can only check a maximum of four (4) elevators at one time.**
3. Click the box under the elevator number that the corresponding system relay is to control. In this example, elevator 1 is controlled by system relay 5, elevator 2 by relay 6, elevator 3 by relay 7, and elevator 4 by relay 8 (fig. 37).
4. Click OK to set the table, click CLEAR to start over, or click CANCEL to return to the system info screen without saving any changes to the Relay / Elevator Table.

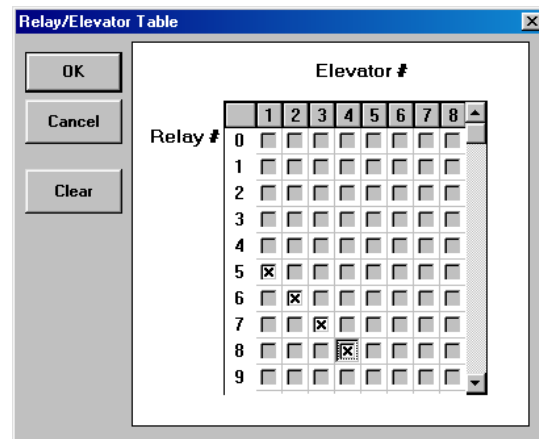

Figure 37

3.6.3 PROGRAMMING SECURITY LEVELS WITH ELEVATOR CONTROL

The first step is to identify the different security levels required to control access as described in our hypothetical building, and then to program these levels into the software program. Refer to Section 3.4 for more information on programming security levels.

SL02

This security level is created to allow building residents 24 hour a day, seven days a week access into the building (TZ1) either through the main entry (relay 1) or the rear entry (relay 3). It also allows them to use elevators 1, 2, 3 or 4 at any time (relays 5, 6, 7 and 8), and allows them to access floors 5 through 19 (note that floors 5-19 are activated). Floor 20 is not included in TZ1 because access to the exercise room (relay 4) is not available 24 hours a day (fig 38). TZ2 is created to allow residents with exercise room privileges access to the exercise room (relay 4) and allows them to gain access to the 20th floor by any of the elevators during the times defined by TZ2 (fig 39).

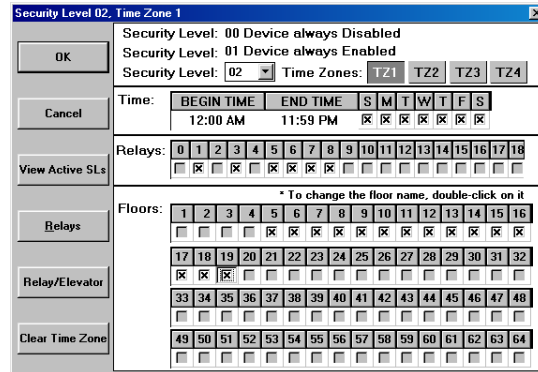

Figure 38

SL03

SL03-TZ1 is identical to SL02-TZ1, but SL03 does not have any other additional time zones. This security level was created to allow residents without exercise room privileges access to the building and all floors with the exception of the exercise room and floor 20 (fig 40).

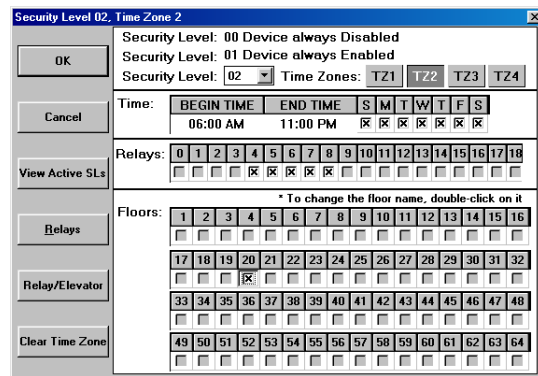

Figure 39

NOTE: You cannot simply assign SL02 to the residents who do not have exercise room privileges, even though SL02-TZ1 is identical to the SL03 security level. Remember, SL02-TZ2 allows access to this restricted area. Assigning SL02 to these residents will give them access to this area!

The two security levels created here meet all the access control requirements and restrictions for the building residents as described in 3.6.1. Additional security levels now need to be created to meet the access control and access restriction requirements for the businesses located on floors 2, 3 and 4.

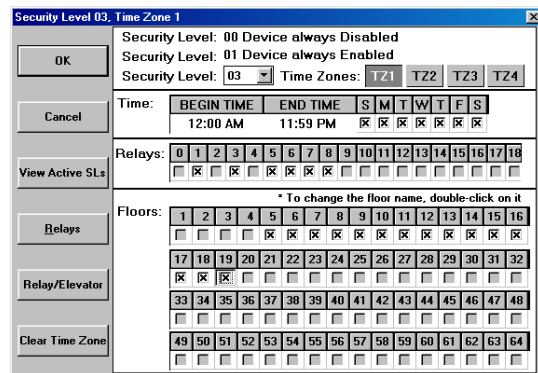

Figure 40

SL04

This security level will be assigned to the employees who work at the businesses located on floors 2, 3 and 4. Access is limited to the main entry only (relay 1) Monday through Saturday, 6:00 AM to 8:00 PM. This security level allows the use of elevators 1 and 2 only, and restricts access to floors 2, 3 and 4 only (fig 41).

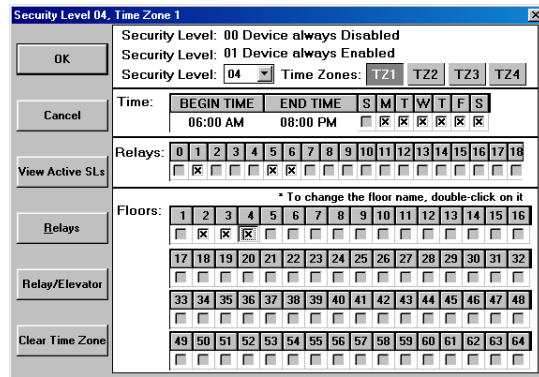

Figure 41

SL05

SL05 allows business managers access to their offices 24 hours a day, seven days a week through the main entry only. Access is restricted to the main entry, and the managers can only use elevators 1 or 2 (fig 42).

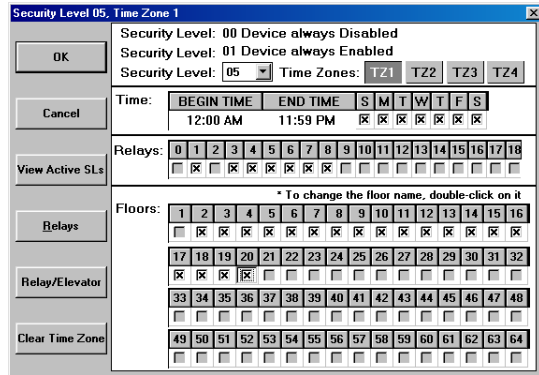

Figure 42

SL06

The other criteria defined in our hypothetical building was that the building owners and maintenance personnel are to be allowed access 24 hours a day, seven days a week at any entrance, and are permitted to use any of the elevators. Since SL01 does not address the elevator control boards, SL06 is created to allow access to these persons under the conditions stated (fig 43).

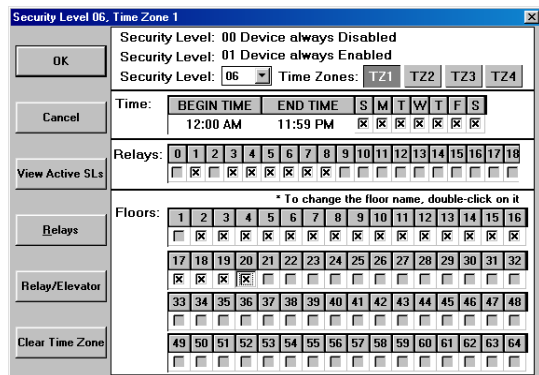

Figure 43

VISITOR FLOOR CONTROL

The next access control criteria to meet in this application is to restrict access for visitors. When a visitor is granted access to the building, they will be allowed access only to the floor that the person they are visiting resides on. Further restrictions can limit the visitor as to which elevator(s) they may use. For example, assume Mr. Smith is visiting Mr. Jones who lives on the 10th floor of our building. When Mr. Jones grants access to Mr. Smith by pressing 9 on his telephone, the system will "turn on" only the 10th floor button in the elevator(s). Mr. Smith will not have access to any other floor.

This floor control programming is set in the data base management section. For information on programming this elevator floor control for visitors, see Section 4.1.1.

SL02
Assigned to residents with exercise room privileges.

TZ1 in this security level provides access 24 hours a day, 7 days a week through the main and rear entry doors, and allows them to use any of the four elevators to access floors 5 through 19.

TZ2 in this security level allows these residents access to the exercise room and access to floor 20 via any of the elevators from 6:00 AM to 11:00 PM, 7 days a week.

SL03
Assigned to residents without exercise room privileges.

TZ1 in this security level provides access 24 hours a day, 7 days a week through the main and rear entry doors, and allows them to use any of the four elevators to access floors 5 through 19 only.

SL04
Assigned to private business employees.

TZ1 in this security level provides access Monday through Saturday, 6:00 AM to 8:00 PM through the main entry door only, and restricts them to elevators 1 and 2 to access floors 2, 3 and 4 only.

SL05
Assigned to private business managers.

TZ1 in this security level provides access 24 hours a day, 7 days a week through the main entry door only, and restricts them to elevators 1 and 2 to access floors 2, 3 and 4 only.

SL06
Assigned to building owners, maintenance personnel.

TZ1 in this security level provides access 24 hours a day, 7 days a week at all entry locations with no elevator or floor restrictions.

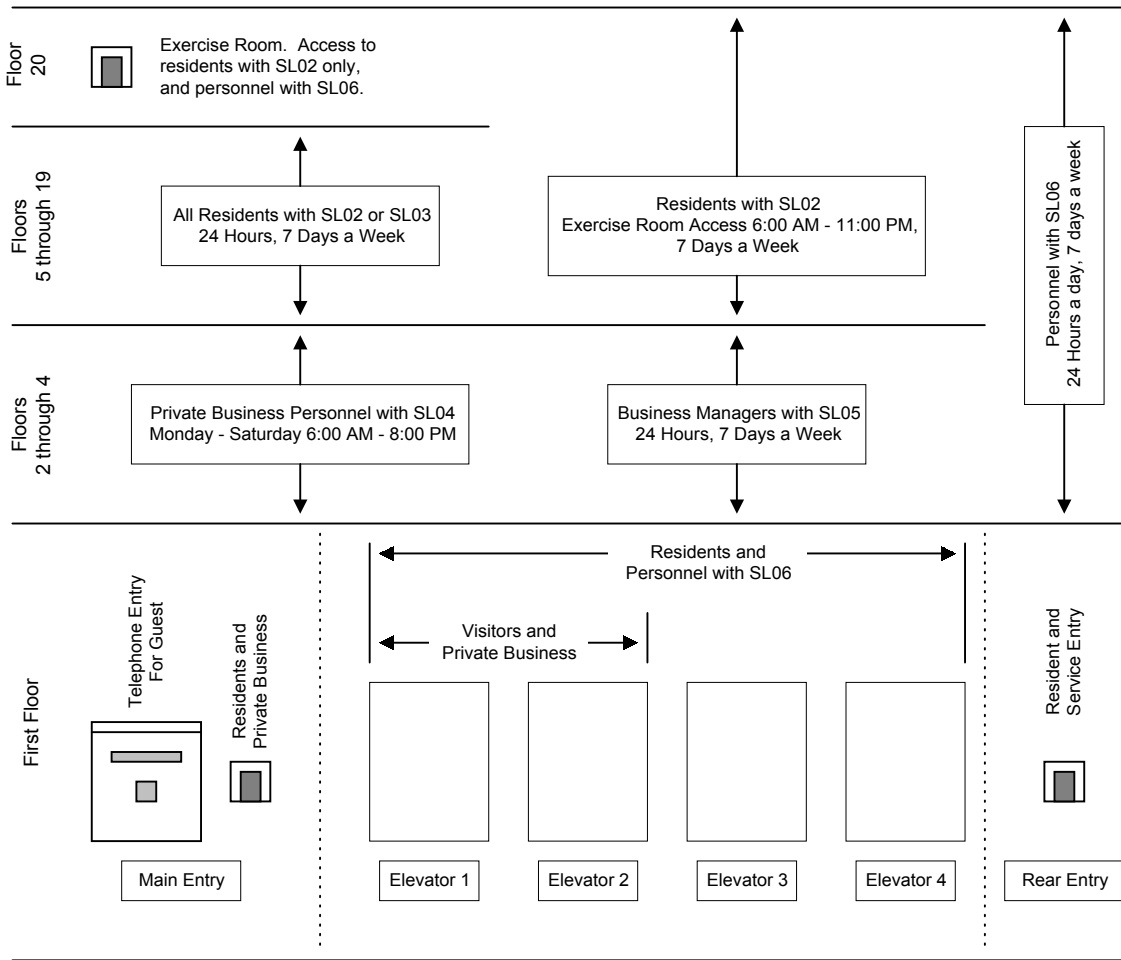

SECTION 4 – DATABASE MANAGMENT

Once the account(s) has been created (chapter 2) and the system operating parameters have been set (chapter 3), the access control system user database must be programmed. This information includes entering all the users (residents) names, phone numbers, assigning directory codes, assigning four digit entry codes if used, assigning a security level to the user, assigning a device code(s) (card, transmitter or PIN) to the user, and setting floor restrictions for visitors if elevator control is in use.

The control board series that was chosen when you first created an account (Chapter 2) will affect how the user database is programmed. This chapter and the illustrations in it address programming an entry panel with a 40 Series Enhanced control board. Many of the steps will be identical for all series (40 Enhanced, 40 and 50) control boards, however the screen layouts and screen look will vary depending on which series was chosen when the account was created.

4.1 USER (RESIDENT) INFORMATION

1. From the Accounts Screen, click on the account that you are going to input the user data for.
2. Click the RESIDENTS button.
3. The User (Resident) information screen will appear (fig 44).

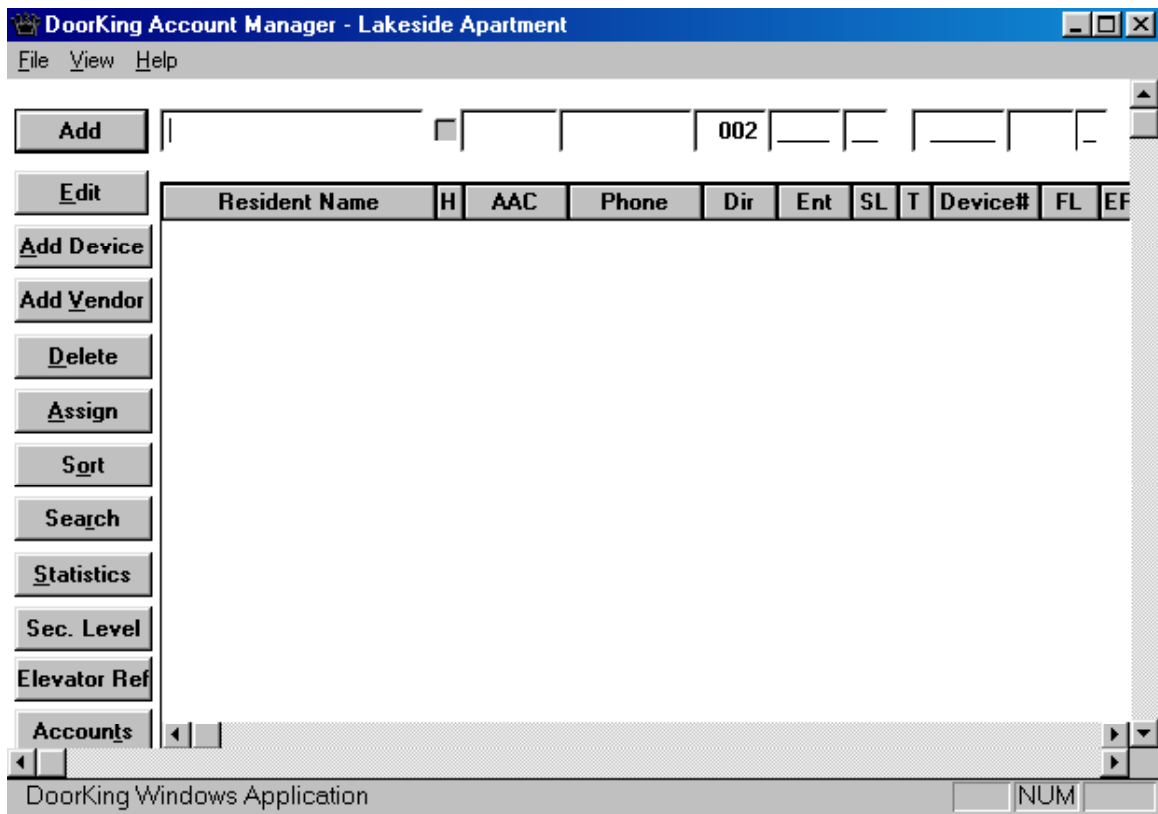

Figure 44

4.1.1 ADDING RESIDENT (USER) INFORMATION

Resident information is entered into the database using the **EDIT LINE** above the database field.

1. Enter the resident (user) name in the name field.
2. Click the H (Hide) button if this name is NOT to be displayed on the electronic directory. (Not applicable if programming is for the 1803PC or 1818 system).
3. Enter a 3-digit Alternate Area Code (AAC) if 10-digit dialing is necessary, or enter a 4-digit AAC (1+area code) for any long distance dialing requirements. The maximum AACs than can be used with this system is 10.
4. Enter the resident phone number. (Optional if programming an 1818 system).
5. The directory code is filled automatically by the software, or you can enter your own directory code. The directory code length (1, 2, 3 or 4 digits) was set in Chapter 3. The directory code will increase sequentially as you add new names. *NOTE: We suggest that you start with directory code 2, 02, 002 or 0002 (the number of digits is determined by the setting you chose in Chapter 3). The reason for this is that the first two directory codes (000 and 001, as a three digit example) have their talk time factory set for the maximum and this setting cannot be changed. You should use these directory codes when programming a manager's office or an emergency number.*
6. Enter a 4-digit entry code (optional) assigned to this user. *NOTE: An entry code is an access code that the user enters on the entry system keypad to gain access at the entry point defined by the entry code range numbers and relays. (Entry codes are not used with the 1818 system because this system does not have a keypad accessible by the users.) Do not confuse 4-digit entry codes with 5-digit PINs (Personnel Identification Number). PINs are entered on a keypad that sends the data to the system via weigand output and treated in the system like card and transmitter codes.*
7. Enter the 2-digit Security Level assigned to this user. The default SL is 01. *NOTE: To view the security levels created in Chapter 3, click the SEC. LEVEL button.*
8. The T field stands for "Type". This field is automatically set by the software which will enter the first letter of the "type" of device you created in the Device Association window in Chapter 3. For example, if device code 01000 was labeled as a "Card" in the Device Association window, a "C" will appear in this field if this device code is assigned to a resident.
9. Enter the 5-digit device code in the Device field. *NOTE: If the "Mass Enable" feature was used to activate a range of device codes, leave this field blank. After entering all of the user information in the database, you can then use the ASSIGN button to assign the device codes to the users you chose. See 4.2 for more information. Device code numbers must be between 00001 and 65407 with a maximum of 8000 codes allowed.*
10. If elevator control will be used with this access system, enter the floor number in the FL field that the resident (user) resides on.
11. Enter the Elevator Reference number in the ER field if elevator control is used. The default ER is 1. See 4.3 for more information on setting the Elevator Reference.
12. Click the ADD button (or press ENTER). A "Notes" window will appear that will allow you to enter up to 80 characters in the notes field.
13. Click OK (or press ENTER) to enter the current information and create a record in the database for this user. This will clear the EDIT LINE and allow you to start on the next record.

- A. The resident (user) information is entered on the EDIT LINE (fig 45).
- B. Any notes that are necessary are entered in the notes field (fig 46). The notes field is accessible by using the scroll arrow and scrolling the page to the right.
- C. When all the resident information is entered, click the SORT button to list the residents alphabetically (fig 47). *NOTE: The SORT button will allow you to sort the data by several different means. However, the user data is always saved alphabetically in the software.*

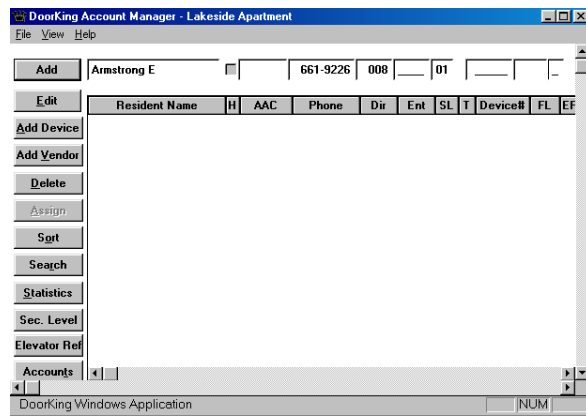

Figure 45

EDIT INFORMATION

1. Click on the user name that needs editing, then click the EDIT button. The information will shift to the EDIT LINE.
2. Make the necessary changes, then click the EDIT button. The notes window will appear allowing you to make any necessary changes to the notes field.
3. Select another user to edit, or click STOP EDIT.

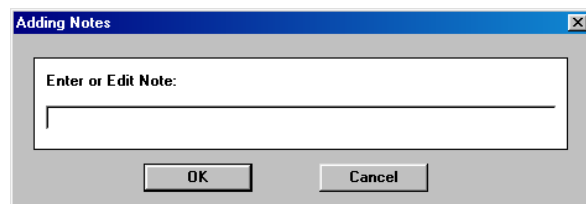

Figure 46

ADD VENDOR

1. Vendor information is entered into the data base in the same manner as are the system users with the exception that vendors do not have a phone number field.

SEARCH

1. Use the SEARCH button to search on any of the fields on the resident information screen to locate specific information or a specific user.

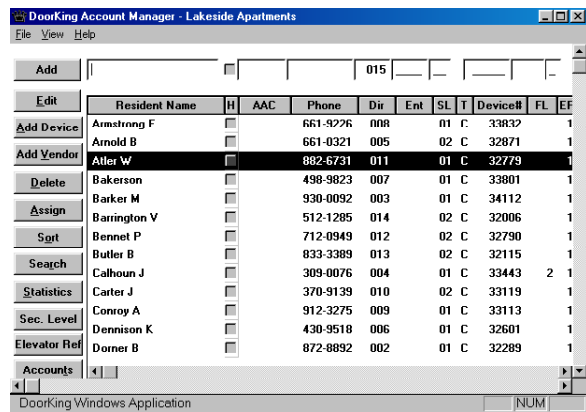

Figure 47

STATISTICS

1. Click the STATISTICS button to determine how many user are currently programmed into the data base, the number of Directory Codes used, how many Mass Enabled devices are currently programmed, etc.

Notice in the examples above that the device codes have not yet been assigned to the individual users. Device codes may be entered when the user information is being entered, or if the MASS ENABLE (3.5.2) feature was used to activate a range of device codes, these devices can now be ASSIGNED to the individual users. Refer to Section 4.2.

4.2 ASSIGNING DEVICE CODES

To use the Assign feature, device codes must be Mass Enabled (3.5.2).

1. Click the user (resident or vendor) that you are going to assign a device (card, transmitter, PIN) code to. The user record should be highlighted (fig 48).
2. Click the ASSIGN button. The Assign Device Number window will appear (fig 49).
3. Select a device number by clicking on it. NOTE: More than one device can be selected by dragging the mouse pointer over the number of device codes that are to be assigned to the resident in step 1.
4. Click the ASSIGN button to assign the device codes to the user.
5. Select the next user in the Resident Info screen. Note: You do not have to close the assign window.
6. Repeat steps 3 and 4 to assign devices to the other system users (fig 50).
7. When complete, click the CLOSE button to close the Assign window.

NOTE: The device that is assigned will assume the Security Level of the user. For example, if you assign a device code with a security level of 02 to a user who has security level 03 assigned to him, then the device will automatically assume security level 03 when it is assigned to this user.

Resident Name	H	AAC	Phone	Dir	Ent	SL	T	Device#	FL	EF
Armstrong F	<input type="checkbox"/>		661-9226	008		01	C	33832		1
Arnold B	<input type="checkbox"/>		661-0321	005		02	C	32871		1
Atter W	<input type="checkbox"/>		882-6731	011		01	C	32779		1
Bakerson	<input type="checkbox"/>		498-9823	007		01	C	33801		1
Barker M	<input type="checkbox"/>		930-0092	003		01	C	34112		1
Barrington V	<input type="checkbox"/>		512-1285	014		02	C	32006		1
Bennet P	<input type="checkbox"/>		712-0949	012		02	C	32790		1
Butler B	<input type="checkbox"/>		833-3389	013		02	C	32115		1
Calhoun J	<input type="checkbox"/>		309-0076	004		01	C	33443	2	1
Carter J	<input type="checkbox"/>		370-9139	010		02	C	33119		1
Conroy A	<input type="checkbox"/>		912-3275	009		01	C	33113		1
Dennison K	<input type="checkbox"/>		430-9518	006		01	C	32601		1
Dorner B	<input type="checkbox"/>		872-8892	002		01	C	32289		1

Figure 48

T	Device #	SL
C	00000	01
C	00001	01
C	00002	01
C	00003	01
C	00004	01
C	00005	01
C	00007	01
C	00008	01
C	00009	01
C	00012	01

Figure 49

Resident Name	H	AAC	Phone	Dir	Ent	SL	T	Device#	FL	EF
Armstrong F	<input type="checkbox"/>		661-9226	008		01	C	33832		1
Arnold B	<input type="checkbox"/>		661-0321	005		02	C	32871		1
								C 00006		
								C 00010		
								C 00011		
Atter W	<input type="checkbox"/>		882-6731	011		01	C	32779		1
Bakerson	<input type="checkbox"/>		498-9823	007		01	C	33801		1
Barker M	<input type="checkbox"/>		930-0092	003		01	C	34112		1
Barrington V	<input type="checkbox"/>		512-1285	014		02	C	32006		1
Bennet P	<input type="checkbox"/>		712-0949	012		02	C	32790		1
Butler B	<input type="checkbox"/>		833-3389	013		02	C	32115		1
Calhoun J	<input type="checkbox"/>		309-0076	004		01	C	33443	2	1
Carter J	<input type="checkbox"/>		370-9139	010		02	C	33119		1
Conroy A	<input type="checkbox"/>		912-3275	009		01	C	33113		1
Dennison K	<input type="checkbox"/>		430-9518	006		01	C	32601		1
Dorner B	<input type="checkbox"/>		872-8892	002		01	C	32289		1

Figure 50

4.3 ELEVATOR REFERENCE

The Elevator Reference table is part of the elevator control feature that is typically used in high rise apartments or office buildings and is designed to limit which elevator(s) and to which floor a visitor is allowed access to after being admitted by a resident. To use the elevator control for visitor access, the resident must have their floor number entered in the FLOOR (FL) field on the Resident Info screen. This tells the system which floor the visitor will be allowed access to.

The Elevator Reference table sets which elevator(s) the visitor is allowed to use and sets a time limit as to how long the floor button will be active after access has been granted. Up to eight (8) Elevator References (ER) can be programmed for greater flexibility. Typically, you will need only a single ER.

NOTE: Elevator control is only available with 30 Series and ENHANCED SERIES 40 boards and requires the installation of the 2348 Elevator Control board(s). This software and hardware will control a maximum of four (4) elevators with each elevator serving up to 64 floors.

4.3.1 PROGRAM THE ELEVATOR REFERENCE (ER) TABLE

Refer to Figure 51 for the following steps.

1. From the Resident Info screen, click the ELEVATOR REFERENCE button. The Elevator Reference Table window will appear (fig 51). The elevator numbers are listed across the first row while the elevator reference number is listed in the first column.
2. Start with ER1. Select which elevator(s) ER1 will be applied to. In figure 4.3.1, ER1 is applied to elevators 1 and 2, which means that visitors of residents with 1 programmed in the ER field are limited to using elevators 1 and 2 only.
3. Set the time that the elevator floor button will be active. When a resident grants a visitor access, the system will "turn on" the floor button that the resident lives on in the elevators designated in step 2. The floor button will be active for the amount of time that you set here. If the elevator is not at the ground (first floor) level, the system will "call" the elevator to this level, and then start the timer after it reaches this level. In figure 51, the time for ER1 is set to 2 minutes.

	Elevator Number								Time
ER	1	2	3	4	5	6	7	8	(min:sec)
1	<input checked="" type="checkbox"/>	<input checked="" type="checkbox"/>	<input type="checkbox"/>	<input type="checkbox"/>	<input type="checkbox"/>	<input type="checkbox"/>	<input type="checkbox"/>	<input type="checkbox"/>	2:00
2	<input type="checkbox"/>	<input type="checkbox"/>	<input type="checkbox"/>	<input type="checkbox"/>	<input type="checkbox"/>	<input type="checkbox"/>	<input type="checkbox"/>	<input type="checkbox"/>	1:00
3	<input type="checkbox"/>	<input type="checkbox"/>	<input type="checkbox"/>	<input type="checkbox"/>	<input type="checkbox"/>	<input type="checkbox"/>	<input type="checkbox"/>	<input type="checkbox"/>	1:00
4	<input type="checkbox"/>	<input type="checkbox"/>	<input type="checkbox"/>	<input type="checkbox"/>	<input type="checkbox"/>	<input type="checkbox"/>	<input type="checkbox"/>	<input type="checkbox"/>	1:00
5	<input type="checkbox"/>	<input type="checkbox"/>	<input type="checkbox"/>	<input type="checkbox"/>	<input type="checkbox"/>	<input type="checkbox"/>	<input type="checkbox"/>	<input type="checkbox"/>	1:00
6	<input type="checkbox"/>	<input type="checkbox"/>	<input type="checkbox"/>	<input type="checkbox"/>	<input type="checkbox"/>	<input type="checkbox"/>	<input type="checkbox"/>	<input type="checkbox"/>	1:00
7	<input type="checkbox"/>	<input type="checkbox"/>	<input type="checkbox"/>	<input type="checkbox"/>	<input type="checkbox"/>	<input type="checkbox"/>	<input type="checkbox"/>	<input type="checkbox"/>	1:00
8	<input type="checkbox"/>	<input type="checkbox"/>	<input type="checkbox"/>	<input type="checkbox"/>	<input type="checkbox"/>	<input type="checkbox"/>	<input type="checkbox"/>	<input type="checkbox"/>	1:00

Figure 51

EXAMPLE: In our hypothetical building, Mr. Bernard lives on the 11th floor of the building. His elevator reference was set to 1 on the Resident Information screen (4.3.2). When Mr. Bernard grants a visitor access, that visitor can only use elevators 1 or 2, and they must activate the button for floor 11 (the only button that will work) within two minutes after the elevator reaches the ground floor (fig 51). If the elevator was already at the ground floor, the visitor will have two minutes to activate the button from the time they entered the building.

NOTE: Although the Elevator Reference Table has eight (8) elevator columns, only four (4) elevators can be set in this table.

4.3.2 ASSIGNING ELEVATOR REFERENCE TO RESIDENTS

After the Elevator Reference Table is complete, an elevator reference number must be assigned to each resident using the elevator control feature. This is set on the Resident Information Screen.

1. On the Resident Information Screen, click the resident that you are going to set an Elevator Reference (ER) number for. The resident should be highlighted.
2. Click the EDIT button. In the EDIT LINE enter the Elevator Reference number and click the EDIT button (or press ENTER). *NOTE: You should also enter the floor number in the FL field that the resident lives on if you have not done so already.*
3. Repeat steps 1 and 2 to set the ER for other the other residents.

The screenshot shows the 'DoorKing Account Manager - Lakeside Apartments' window. It features a menu bar (File, View, Help) and a toolbar with buttons for Add, Edit, Add Device, Add Vendor, Delete, Assign, Sort, Search, Statistics, Sec. Level, Elevator Ref, and Accounts. Below the toolbar is a data table with the following columns: Resident Name, AAC, Phone, Dir, Ent, SL, T, Device#, FL, and EF. The 'Dorner B' row is highlighted in black. The 'Elevator Ref' field is currently empty.

Resident Name	AAC	Phone	Dir	Ent	SL	T	Device#	FL	EF
Armstrong E		661-9226	008		01	C	33832	4	1
Arnold B		661-0321	005		02	C	32871	5	2
Atler W		882-6731	011		01	C	32779	7	2
Bakerson		498-9823	007		01	C	33801	2	1
Barker M		930-0092	003		01	C	34112	6	1
Barrington V		512-1285	014		02	C	32006	12	2
Bennet P		712-0949	012		02	C	32790	6	1
Butler B		833-3389	013		02	C	32115	11	2
Calhoun J		309-0076	004		01	C	33443	2	1
Carter J		370-9139	010		02	C	33119	12	2
Conroy A		912-3275	009		01	C	33113	9	1
Dennison K		430-9518	006		01	C	32601	7	1
Dorner B		872-8892	002		01	C	32289	4	2

Figure 52

CHAPTER 5 - DATA TRANSFER / REPORTS

There are two methods of data transfer that can be performed when communicating with the 1803PC, 1815, 1817, or 1818 entry system using the DoorKing Remote Account Manager for Windows: Transfer Now and Scheduled Transfer.

Version 5.2 Notes:

The **SEND DATA**, **RECEIVE DATA** and **RECEIVE TRANSACTIONS** buttons are replaced with the **TRANSFER NOW** button in V 5.2. Section 5.4, Exporting / Importing Database Files applies only to version 5.2.

5.1 TRANSFER NOW

The **TRANSFER NOW** button on the account screen provides you with three choices of immediate data transfer: Send Data Now; Receive Data Now and Receive Transactions Now. Data transfer can take up to 12 minutes (up to 3 minutes if using RS-232) depending on the size of the file that you are sending. The send all data function is normally used during the initial programming of the entry system to load the entire database.

NOTE: Before sending data, be sure that the date and time are correctly set on your computer. If the date and time are set incorrectly, all transaction reports will be stored in the system with the incorrect date and time.

5.1.1 SEND DATA NOW

1. From the account screen, click the **TRANSFER NOW** button and select Send Data Now.
2. Select the account(s) that you are sending data to (fig 53) by checking Send All (sends all data) or Send Chg (sends changes only).
3. Click **OK** to send the data or **Cancel** to cancel the action.

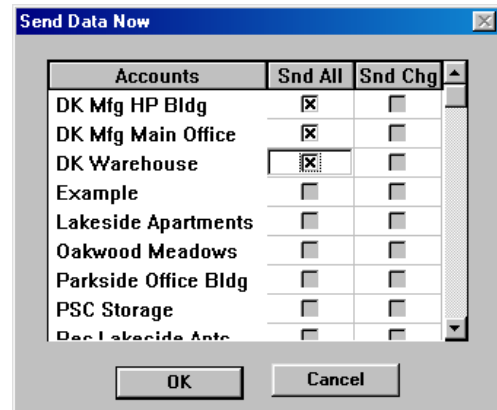

Figure 53

5.1.2 RECEIVING DATA NOW

The receive data feature is basically the opposite of the send all data feature. Instead of the computer sending data to the entry system, the entry system sends the data to the computer to update the computer files. This feature is useful for auditing or trouble shooting purposes.

Caution should be used when using this feature because your resident files will be updated with the information stored in the entry system. We recommend that you create a new **"receive account"** to receive the information into. This will keep the received files separate from the original account files. After viewing the information received, you could then delete these files or use these files by simply deleting the original account and then renaming the "receive account" to the proper account name.

Before using the receive data feature, you must be sure that your "receive account" system information matches the system information of the entry system that you are going to receive data from. This includes the master code, memory size, card usage, entry system phone number, and single or multiple systems on the phone line.

1. From the accounts screen, click on the account that you are going to receive data from. This should be the new "receive" account that you created. The account should be highlighted (see fig 54).
2. Click the TRANSFER NOW button and select Receive Data Now. A window will appear warning you that existing account information will be overwritten and will give you the option to continue or abort. If you have not created a new "receive data" account, we suggest that you do so before continuing, otherwise click the YES button.
3. Once you click the Yes button, the Receive Data window will appear and the software will initiate communications. Click the MINIMIZE button during the data transfer to allow you to continue with other work on your computer while the data transfer is taking place. Do not exit the DoorKing program during a data transfer (sending or receiving), otherwise the transfer will stop and your data will be incomplete.

NOTE: Hidden resident names and vendor names will not be received from 50 Series boards.

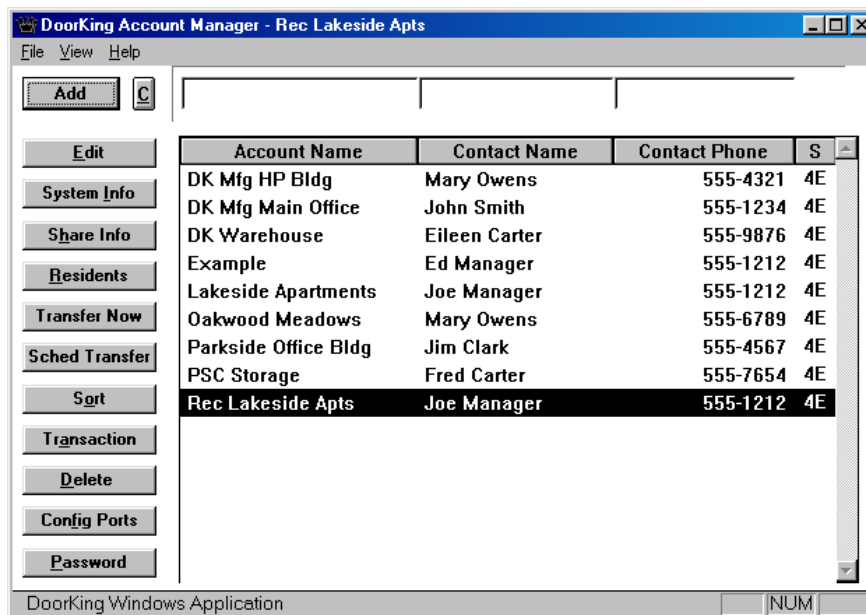

Figure 54

5.1.3 RECEIVING TRANSACTIONS

The 1803PC, 1815, 1817, or 1818 entry systems store all activity in a history buffer which is then downloaded to the PC for auditing, analysis, and record keeping. The history buffer in these units will store up to 8000 (40 Series) or 5000 (50 Series) events which include the date, time, resident name, if access was by telephone entry, entry code, postal, or card / transmitter and which code number was used. The system will also report if access was granted or denied. If the access control system includes gate operators with Gate Tracker™ reporting capability, these transactions are also received during the transaction data transfer.

A new transaction file is created each time the history buffer in the entry system is received by the PC. Transactions files are checked so that duplicate information is not received. For example, suppose that there were 100 events in the history buffer when you did an initial receive transactions function. A file named TRANS.00 will have been created under the account sub-directory. This file will contain the first 100 transactions. Now suppose a week later you perform another transaction function. This time there are a total of 250 events in the history buffer, the first 100 and 150 new ones. Only the last 150 events will be received, the previous 100 events will not be received because they are already stored in the first transaction file. Only the newest 150 events will be stored in transaction file TRANS.01.

1. From the accounts screen, click the TRANSFER NOW button and select RECEIVE TRANSACTIONS NOW.
2. Select which account(s) that you want to receive transactions from (fig 55).
3. Click OK to proceed or click CANCEL to cancel the action.

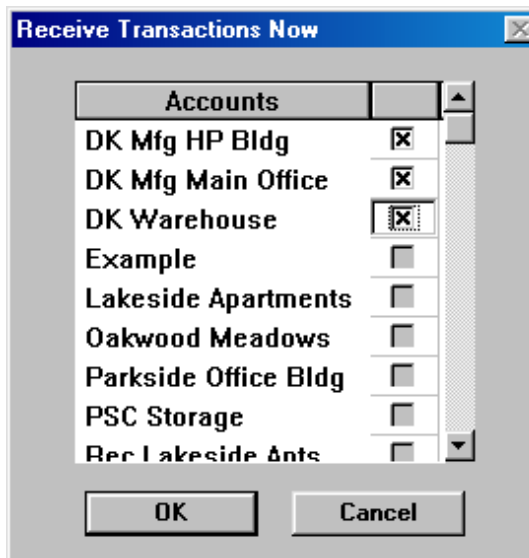

Figure 55

5.2 SCHEDULED TRANSFERS

With the DoorKing Remote Account Manager software release 5.2 you can set up sophisticated schedules to send data or receive transactions.

5.2.1 Scheduling Transfers

1. From the ACCOUNTS screen, click the SCHED TRANSFER button. The scheduled transfer window appears.
2. Create your transfer schedule(s). When complete, click the ACCOUNTS button.

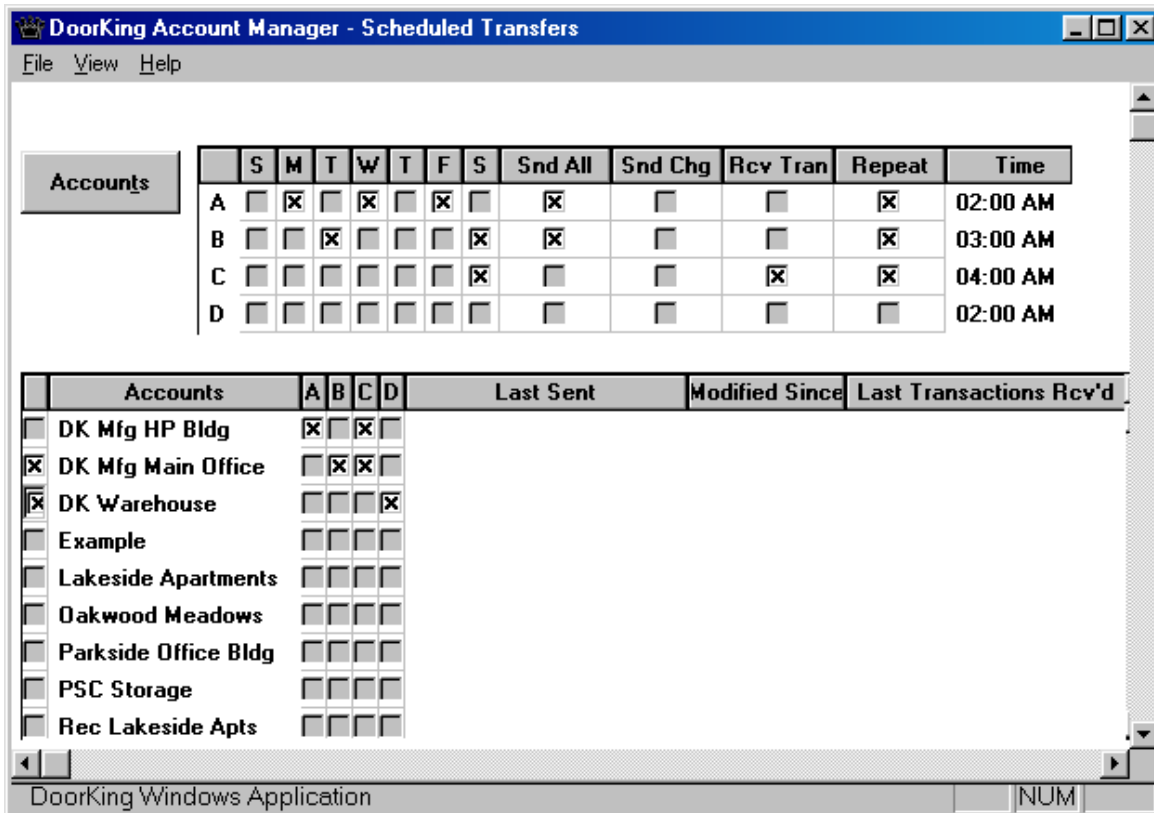

There are 4 schedules you can set up, A, B, C and D. In this example schedule A is set up to Send All data on Mondays, Wednesdays and Fridays at 2:00am. And since the repeat box is checked, this schedule will repeat every week. Similarly, schedule B sends all data every Tuesday at 3:00am and will repeat. Schedule C is set up to receive transactions once a week on Saturdays at 4:00am. Schedule D is not set up at this time.

The lower part of the screen shows all of your accounts from the account screen. The far left check box is to enable or disable schedules for your accounts. The A, B, C and D columns allow you to assign schedules to accounts. So you can see that DK Mfg HP Bldg has schedules A and C assigned to it but no automatic data transfers will occur since the far left enable box is not checked. The account DK Mfg Main Office however, has schedules B and C assigned to it and the automatic data transfers will occur since the far left enable box is checked. The DK Warehouse account will automatically receive transactions on Saturdays at 2:00 AM. Information next to each account provides details on the last successful send, if the account has been modified since this send, and information when the last transactions were received.

5.3 VIEWING / REPORTING TRANSACTIONS

After you have received the transactions from the entry system, you can then view the transaction file on your computer, print the transaction file, or create a report with specific information.

5.3.1 VIEWING TRANSACTIONS

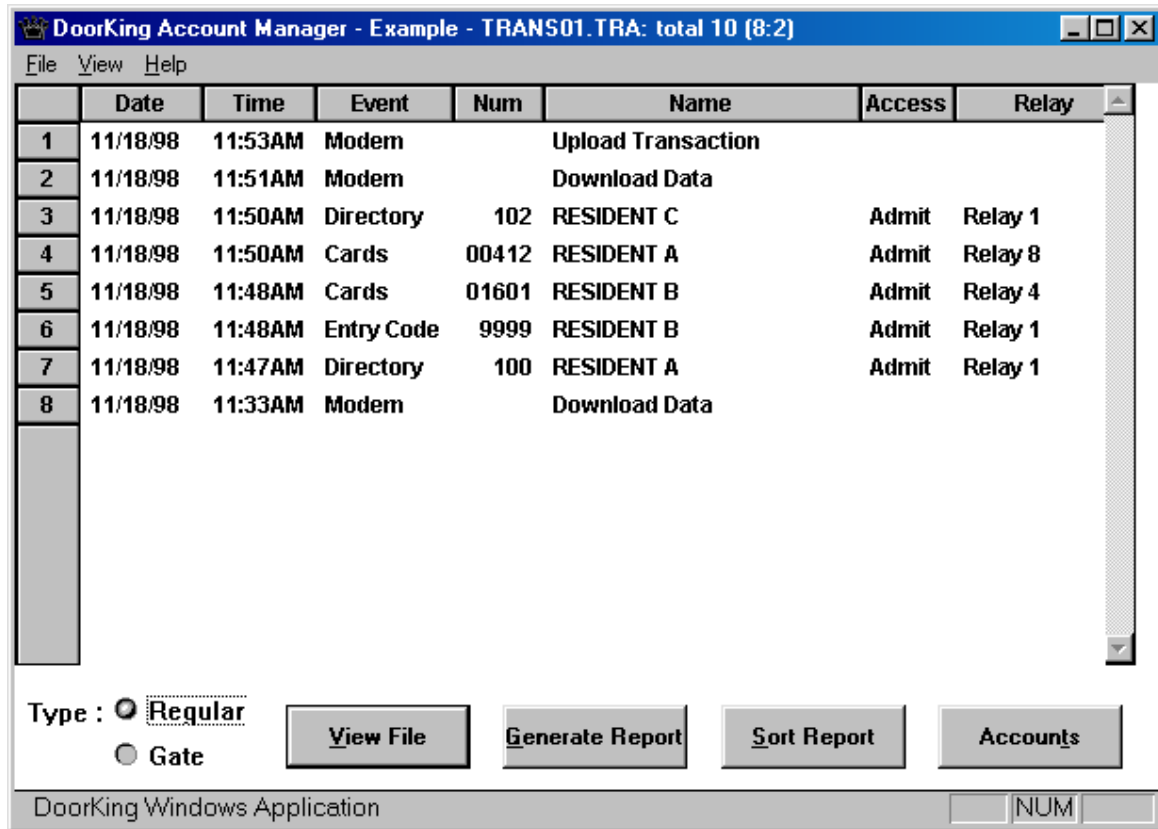

Figure 56

1. From the accounts screen, click on the account that you want to view transactions for. The account should be highlighted.
2. Click the TRANSACTION button. The transaction screen (fig 56) will appear and the last transaction file received will be displayed. (If there are no transaction files, an empty transaction screen will appear.)
3. The transactions can be sorted by any field (You must first "generate" a report before it can be sorted. See 5.3.2) Click the SORT REPORT button to display the Sort report window (fig 57). Enter the sorting parameters that you need.

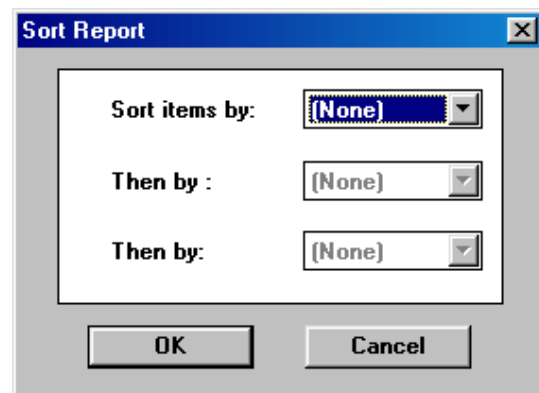

Figure 57

4. To view the standard transactions, click the REGULAR button. To view the Gate Tracker™ transactions, click the GATE button.
5. To view other transaction files, click the VIEW FILE button. The Open file window (fig 58) will appear on the transaction screen. Select the transaction file that you want to view by clicking the file then clicking OK. The transactions for the file that you selected will appear on your screen. Transaction files have a .TRA extension. *NOTE: If you want to view all transactions files, click the GENERATE REPORT button. When the report generator window appears, simply click the OK button without entering any report parameters. This will cause all transaction files to be displayed in chronological order.*
6. To print the current file, click FILE and then PRINT from the pull down menu. To return to the accounts screen, click the ACCOUNTS button.

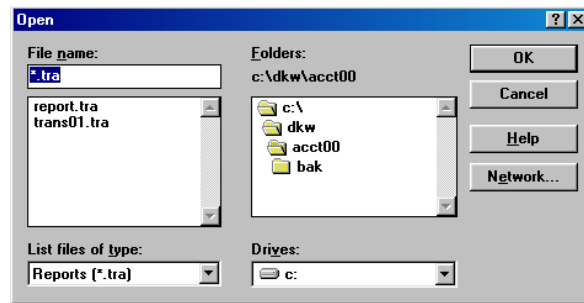
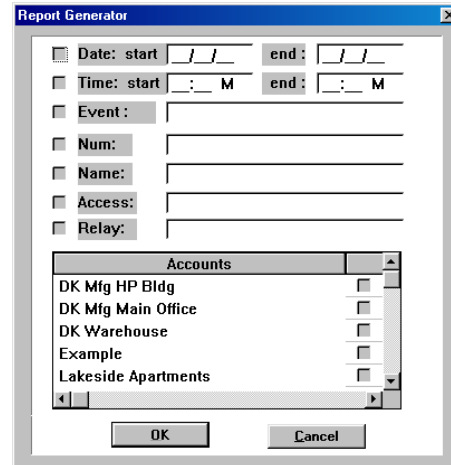

Figure 58

5.3.2 CREATING REPORTS

Once you have received transactions from the entry system and have opened a specific transaction file, the report writer feature lets you set certain parameters to generate specific transaction file reports. For example, you can create a report for a specific date only, or between certain times only, or for a particular resident only.

1. After the transaction file is opened and displayed on your screen, click the GENERATE REPORT button. The report generator window will appear in the transaction screen (fig 59).
2. Reports can be generated by specifying the date, time, name, etc., or by any combination of these parameters. Click the button next to the item(s) that you are going to use to set your report parameters. An X should appear in the button.
3. Reports can be generated across several accounts. Click the box next to the account(s) that you want to generate a report for.
4. Enter the specific information, or any known part and click OK.
5. Your report will be generated allowing you to view it on the screen or print it on your printer.
6. Click the CANCEL button to cancel the report.



The screenshot shows the 'Report Generator' dialog box. It has several input fields for Date, Time, Event, Num, Name, Access, and Relay, each with a checkbox. Below these is a list of accounts: DK Mfg HP Bldg, DK Mfg Main Office, DK Warehouse, Example, and Lakeside Apartments. Each account has a checkbox to its right. At the bottom are 'OK' and 'Cancel' buttons.

Figure 59

In the sample in figure 60, a report has been requested for all Card Reader events with users Admitted at the Main Entry between the hours of 9:00 and 10:00 AM for the week beginning September 23, 2002 and ending September 27, 2002. The report will be generated for the three accounts selected.

NOTE: When you request a report, the report will be generated across all transaction files, not just the file displayed on the screen.

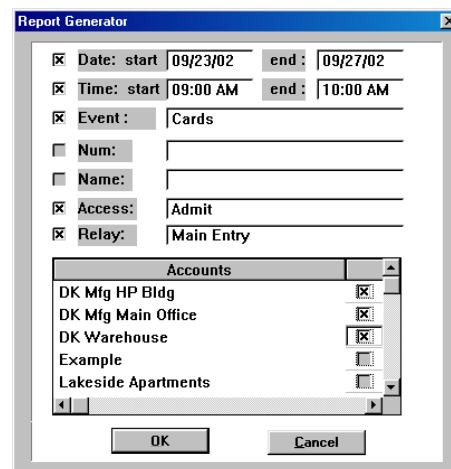

The screenshot shows the 'Report Generator' dialog box with the following settings: Date: start 09/23/02, end 09/27/02; Time: start 09:00 AM, end 10:00 AM; Event: Cards; Access: Admit; Relay: Main Entry. In the Accounts list, checkboxes are checked for DK Mfg HP Bldg, DK Mfg Main Office, and DK Warehouse. 'OK' and 'Cancel' buttons are at the bottom.

Figure 60

5.4 EXPORTING / IMPORTING DATABASE FILES

DoorKing's Remote Account Manager software version 5.2 has import / export functions that can be used to get resident data into and out of the DoorKing database.

The Export function exports the database in the popular CVS (comma separated values) file format. This file format is easily read by many common spreadsheet programs, such as Microsoft Excel.

The import function recognizes two file formats. One format is CSV that many spreadsheet programs, such as Microsoft Excel, can generate. This makes it very easy to import data into a DoorKing Account from a spreadsheet. The other import format is only intended for users who have in house programmers. This format was originally designed for dealing with a large college database where an on site programmer wrote a program to extract data from a mainframe in a format we specified. This is not intended for most users. See the Main Frame Import section of this manual.

5.4.1 Exporting Data

1. From the ACCOUNT SCREEN, click the FILE menu and then click EXPORT. The export window will appear.
2. Create a file name being sure to include the extension **.CSV**. This file will be saved in the current DoorKing folder, or you can save it in any folder on your hard drive that you choose. In this example, the file will be saved in the DKW52 folder with the file name Lakeside.CSV.
3. Check the account that you want to export data for.
4. Click OK or Cancel.

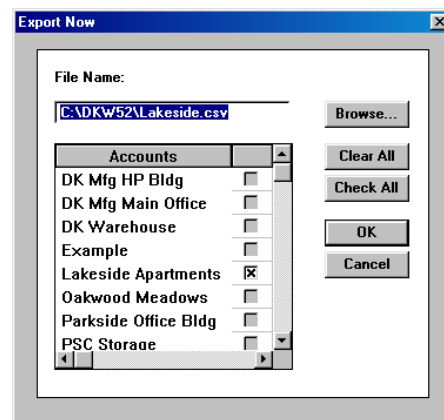

The resident file for the account Lakeside Apartments has now been exported to a file named Lakeside.csv. If you have Microsoft Excel, the file will automatically load into the excel spreadsheet when you open it from excel. Note the extra ACCOUNT column. This has the account name in this column. If another account had been included in the export file from the Export Now screen, you would have seen that account name in the account column with resident data next to it. Also note the VENDOR column. This simply has an 'N' if this line was is a resident, or a 'Y' if this line is a vendor. Note also that the 'T' column did not export. This is because the 'type' of device is determined by the Device Enable screen on the System Info screen. It's not data that the user types in or exports or imports.

	A	B	C	D	E	F	G	H	I	J	K	L	M	N	O
	ACCOUNT	NAME	H	AAC	PHONE	DIR	ENT	SL	DEVICE#	FL	ER	NOTES	VENDOR		
1	Lakeside	/Armstrong	N		661-9226		8		1	33832		1	N		
2	Lakeside	/Arnold	B	N	661-0321		5		2	32871		1	N		
3	Lakeside	/Atler	W	N	882-6731		11		1	32779		1	N		
4	Lakeside	/Bakerson	N		498-9823		7		1	33801		1	N		
5	Lakeside	/Barker	M	N	930-0092		3		1	34112		1	N		
6	Lakeside	/Barrington	N		512-1285		14		2	32006		1	N		
7	Lakeside	/Bennet	P	N	712-0949		12		1	32790		1	N		
8	Lakeside	/Butler	B	N	833-3389		13		2	32115		1	N		
9	Lakeside	/Calhoun	J	N	309-0076		4		1	33443	2	1	N		
10	Lakeside	/Carter	J	N	370-9139		10		2	33119		1	N		
11	Lakeside	/Conroy	A	N	912-3275		9		1	33113		1	N		
12	Lakeside	/Dennis	I	N	430-9518		6		1	32601		1	N		

5.4.2 Importing Data in CSV Format (Microsoft Excel)

The import process allows the user to import the resident data from a comma separated value (CSV) text file rather than keying in individual residents in the DoorKing Remote Account Manager program. The import file may contain more than one account. The import file is generated from a program such as Microsoft Excel that is capable of saving a file in .CSV format.

Before the import process can begin, you must set up the account(s) in the DoorKing Remote Account Manager program in the normal fashion. The account name(s) must match the account name(s) in the import file and is case sensitive. Details of the import file are described later in this section. The control board selection must be an **ENHANCED 40** series control board and you must have this control board installed in the entry system.

The fields on the System Information screen (see 3.1) that need to be set correctly for the import process are: **System Memory, Num of Digits In Dir Code, MemPLUS and Transactions**. Be careful – the fields described above depend on the specific phone model and features you bought. You won't be able to send or receive data between your PC and your phone system if these fields are not set up correctly.

1. Set up an ACCOUNT in the Remote Account Manager program that you want to import data to. Be sure the required fields are set correctly as described in the above paragraph.
2. From the ACCOUNT SCREEN, click the FILE menu, select IMPORT and then choose IMPORT NOW or SCHEDULED IMPORT. The selected import window will appear.
3. Type in a path name or use the BROWSE button to locate the file you want to import (this is the file you have created in Microsoft Excel and saved in the CSV format).
- 3a. If you selected SCHEDULED IMPORT in step 2, click the days of the week and enter the time that you want the import to be performed. Check the REPEAT square if the schedule is to repeat on a weekly basis. You must also check the Enable Schedule box to initiate the schedule that you created.
4. Check the CSV Format box (Main Frame Format is for special purposes only and is described in 5.4.3).
5. Check INITIALIZE if this is the first time that you are importing the file to the Remote Account Manager program, or check UPDATE if you have made changes to a file that has already been imported to the Remote Account Manager program. Note: if this is the first time that you are importing a file, then update and initialize will do the same thing – import the file.
6. Check SINGLE ACCOUNT if you are importing data for a single account, or check MULTIPLE ACCOUNTS if you are importing data to two or more accounts. If you are importing to a single account, select the account from the drop down list. If you are importing to multiple accounts, the account name must be present in the import file that you created in Excel (column A – Account).
7. Click OK and the import will perform immediately or later if scheduled.

Import Now

File Name: C:\ADKW52\LAKE SIDE.CSV Browse...

File Format:
 CSV Format Main Frame Format

Import
 Update Initialize

Account Selection:
 Single Account Multiple Account:
Lakeside Apartments

OK Cancel

Import Schedule

File Name: C:\ADKW52\LAKE SIDE.CSV Browse...

S	M	T	W	T	F	S	Repeat	Time
<input type="checkbox"/>	<input type="checkbox"/>	<input type="checkbox"/>	<input checked="" type="checkbox"/>	<input type="checkbox"/>	<input type="checkbox"/>	<input type="checkbox"/>	<input checked="" type="checkbox"/>	02:00 AM

Enable the schedule

File Format:
 CSV Format Main Frame Format

Import
 Update Initialize

Account Selection:
 Single Account Multiple Account:
Lakeside Apartments

OK Cancel

Below is the Lakeside.csv file opened with Microsoft Excel. This is the file we imported into the DoorKing Remote Account Manager program. Note the column headings here. You need to use these column headings so the DoorKing import program can recognize the data. Notice that it's not necessary to have a 'T' or type column since the type of device is determined by the Device Enable screen on the System Info screen.

	A	B	C	D	E	F	G	H	I	J	K	L	M	N	O
1	ACCOUNT	NAME	H	AAC	PHONE	DIR	ENT	SL	DEVICE#	FL	ER	NOTES	VENDOR		
2	Lakeside /	Armstrong	N		661-9226		8		1	33832		1	N		
3	Lakeside /	Arnold B	N		661-0321		5		2	32871		1	N		
4	Lakeside /	Atler W	N		882-6731		11		1	32779		1	N		
5	Lakeside /	Bakerson	N		498-9823		7		1	33801		1	N		
6	Lakeside /	Barker M	N		930-0092		3		1	34112		1	N		
7	Lakeside /	Barrington	N		512-1285		14		2	32006		1	N		
8	Lakeside /	Bennet P	N		712-0949		12		2	32790		1	N		
9	Lakeside /	Butler B	N		833-3389		13		2	32115		1	N		
10	Lakeside /	Calhoun J	N		309-0076		4		1	33443	2	1	N		
11	Lakeside /	Carter J	N		370-9139		10		2	33119		1	N		
12	Lakeside /	Conroy A	N		912-3275		9		1	33113		1	N		
13	Lakeside /	Dennison I	N		430-9518		6		1	32601		1	N		

The ACCOUNT column in the Excel spreadsheet put all of the residents in the Lakeside Apartments account in the DoorKing database. Different account names in this column would have directed the data on that line to the account in the Remote Account Manager program with the same name. The 'N' in the VENDOR column of the Excel spreadsheet made all of the entries residents. A 'Y' would make the data on that line a vendor. You can see the notes for the residents by scrolling to the right as you normally do in the DoorKing Remote Account Manager program.

HINT: To easily setup the proper columns in the spreadsheet program, create an account in the Remote Account Manager program and EXPORT it to Excel (5.4.2). You do not need to enter any resident data – just export the “empty” account. When you open it in the spreadsheet program, the columns will be setup and you need only to enter the resident data. You can also create columns of your own choice (address, for example). When importing the file to the DoorKing program, these columns are simply ignored.

The import process checks for errors in the data just as if you were entering them in manually from the resident screen. For example, you cannot import device data if you do not have MemPLUS checked on the System Info screen. If you encounter errors, a message is displayed informing you that error details can be found in the summary or events.log file by pulling down the file menu in the upper left hand corner. It is important that you understand the data restrictions for residents. See the DoorKing Account Manager manual.

Important .CSV information

In the above Excel file example, you can see that all the columns of DoorKing data were present and were being maintained in Excel. If other columns of data were in the Excel spread sheet that did not pertain to the DoorKing database, they would have been ignored. If you're maintaining all columns of data from Excel or some other program and always importing all the data and all the columns, that makes this import process fairly simple. You can choose 'Initiate' every time you import, and all the data in the DoorKing account will be replaced with the data from your import file.

However, you may not want to import all the columns of DoorKing data. Perhaps you have some other application program where only the data you want to import to the DoorKing database is the name and phone number. In that case, the initial time you import, only the NAME and PHONE columns would be imported and the DoorKing import program would generate the directory codes for you. The next time you import, choose the Update option and new names in the import file would be added to the DoorKing database. You'll get a message pointing out the names that are still in the DoorKing database, but no longer in the import file. It would be up to you at that point to remove them from the DoorKing database. You could at that point enter in device numbers, etc, into the resident screen. But be careful here. **If at some later time you want to import device numbers, the device numbers that you've been maintaining in the DoorKing database will be replaced with the imported data.** Messages will warn you that you've not imported this column of data before and this new data will replace this column of data in the DoorKing database. Just be aware of where you are maintaining what types of data. If you've maintaining device numbers from the DoorKing database, just always maintain them from there. If you've using Excel to maintain all columns of data for DoorKing and whatever other application you're using, just keep maintaining it in that fashion.

5.4.3 Main Frame Import

This import process allows the user to import the resident data from a single comma delimited text file rather than keying in individual residents in the DoorKing Account Manager program. The import file may contain more than one account. **This import file format is non-standard and is intended only for those who have in-house programmers who can write a program to extract data from a large database and put the data into this non-standard format.** Most users will want to use the CSV – Excel Import that is intended for PC users.

Before the import process can begin, you must set up the account(s) in the DoorKing Remote Account Manager program in the normal fashion. The account name(s) must match the account name(s) in the import file and is case sensitive. Details of the import file are described later in this section. The control board selection must be an **ENHANCED 40** series control board and you must have this control board installed in the entry system.

The fields on the System Information screen (see 3.1) that need to be set correctly for the import process are: **System Memory, Num of Digits In Dir Code, MemPLUS and Transactions.** Be careful – the fields described above depend on the specific phone model and features you bought. You won't be able to send or receive data between your PC and your phone system if these fields are not set up correctly.

1. Set up an ACCOUNT in the Remote Account Manager program that you want to import data to. Be sure the required fields are set correctly as described in the above paragraph.
2. From the ACCOUNT SCREEN, click the FILE menu, select IMPORT and then choose IMPORT NOW or SCHEDULED IMPORT. The selected import window will appear.
3. Type in a path name or use the BROWSE button to locate the file you want to import (this is the file you have created in a single comma delimited text file format).
- 3a. If you selected SCHEDULED IMPORT in step 2, click the days of the week and enter the time that you want the import to be performed. Check the REPEAT square if the schedule is to repeat on a weekly basis. You must also check the Enable Schedule box to initiate the schedule that you created.
4. Check the Main Frame Format box (CSV Format is intended for PC users and is described in 5.4.2). The Update, Initialize and Account Selection options are for CSV format only and will be grayed out.
5. Click OK and the import will perform immediately or later if scheduled.

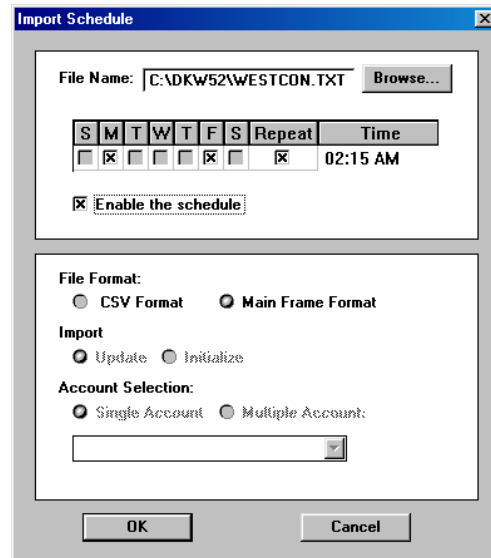
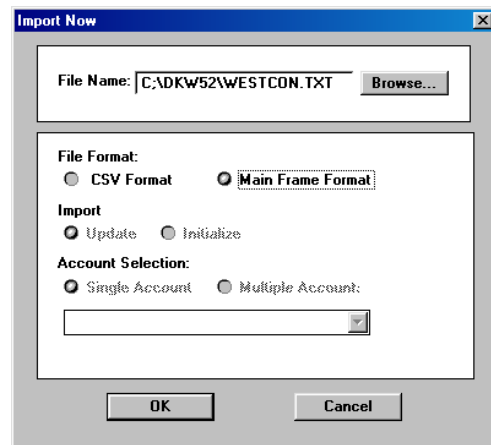

Below is the WestCon.txt file from the above example opened with Notepad. Note that the non-printable carriage return and line feed characters are present at the end of each line. You must put these characters in your import file. During the import process, the import program will check for errors just as if you were entering the data manually at the screen. For example, you cannot import device data if MemPLUS is not checked on the system Info screen. If the import process encounters errors, a message is displayed informing you that error details can be found in the summary or events.log file by pulling down the file menu in the upper left hand corner. It is important that you understand the restrictions of the data on the resident screen.

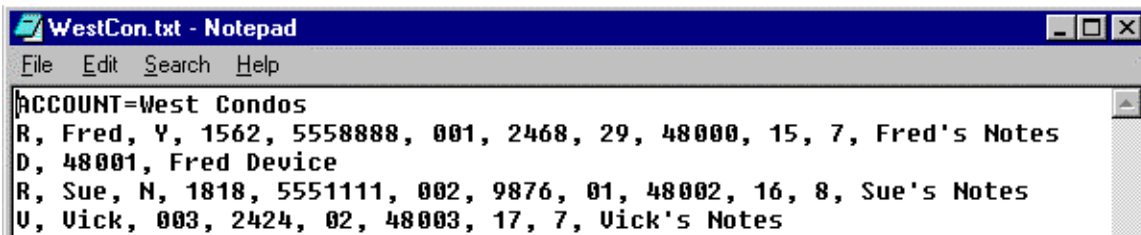

There are a few keywords and they must be capitalized:

- ACCOUNT= account name (up to 20 printable ASCII characters except comma)
- R signifies a Resident Record
- V signifies a Vendor Record
- D signifies additional devices for the previous resident or vendor
- Y when in 3rd field of an R type record means 'Hide'
- N when in 3rd field of an R type record means 'Do Not Hide'

The columns of data in the DoorKing resident screen are delimited by a comma. The only required fields for a resident or vendor record besides 'R' or 'V' is the directory code. So R, , , , , 001, , , , , and V, , 003, , , , , are legal records in an import file. The only required field for an additional device record besides 'D' is the device number itself. So D, 65000, is a legal additional device record. Data left out will use the same defaults as if you were manually entering in data on the resident screen. Notice that a resident record always has 11 commas, vendor record always has 8 commas and a device record always has 2 commas separating the data.

Below shows how the data looks after it's been imported to the DoorKing Account Manager software program.

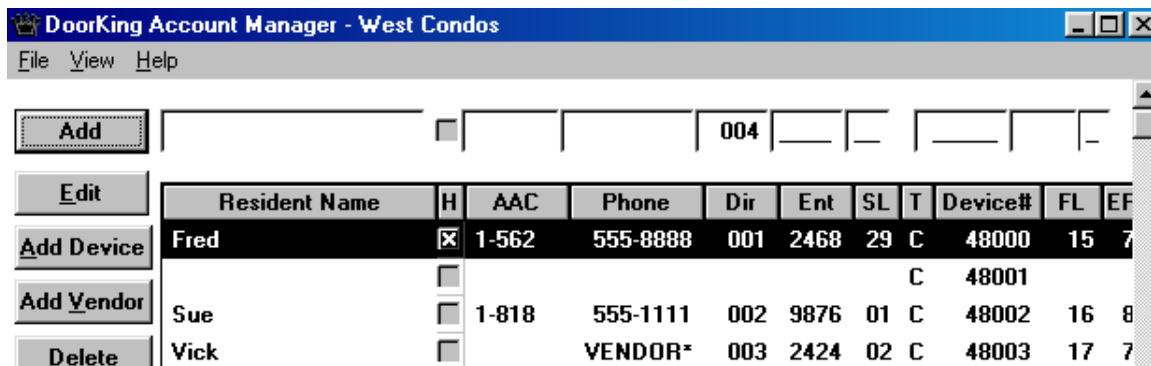

Notice that the T column was not imported. Data in this column is determined by the Device Enable screen found on the System Info screen. By scrolling to the right, you can see the notes.

CHAPTER 6 – APPENDIX

If you are currently using the DOS version of the DoorKing Remote Account Manager, there is no direct conversion or upgrade of the DOS program or files to the Windows version. However, this does not mean that you cannot program your entry system with the Windows version, nor does it mean that you cannot easily create all your resident files without having to re-enter all resident information. Follow the simple guidelines below to create your Windows version files for your entry system. *NOTE: The upgrade instructions below apply only to entry systems with "50 Series" control boards.*

6.1 UPGRADING FROM DOS VERSION SOFTWARE

1. Install the DoorKing Remote Account Manager for Windows on your computer as described on page 2. Installing the Windows version of the program will not affect the operation or the associated files of the DOS version.
2. Create a new account (Chapter 2) to receive the entry system information into. **When prompted for a 50 Series or 40 Series control board, you must select "50 Series." There is no conversion of DOS or "50 Series" files to the "40 Series" file format.** When entering the system information for the new account, be sure to match the master code, memory size, card usage, system phone number, and multiple systems usage to the existing entry system. This information can be obtained by checking the System Information Screen in the DOS version of the program.
3. From the accounts screen, click the Receive Data button (page 44) to receive the information stored in the entry system to the new account that you created. When the data transfer is complete, you will be up and running with the Windows version of the DoorKing Remote Account Manager!
4. After your data has been transferred from the entry system to your Windows account files, you will need to enter the vendor names (if any) on the resident screen in the Windows program. This is necessary because vendor names are not received by the computer when a receive data function is performed. Vendor names can be obtained by checking the Resident Information Screen in the DOS version of the program.

6.1.1 HIDDEN NAMES

If any of the resident names in the DOS version were hidden using the hide feature, the data associated with the hidden names will not be received by your computer using the Receive Data function. You will have to re-enter the information for these residents. If you have a large number of resident names that are hidden using the hide feature, it may be beneficial to first un-hide these names and send the new information to the entry system before receiving the data in the Windows account files.

1. In the DOS version, go to the Resident Information screen and un-hide any resident names that are currently hidden. Be sure to save (F7) these changes.
2. Send the new data to the entry system.
3. From the Windows version, receive the data into the new account created in the Windows version as described above.
4. In the Windows version, hide the residents that do not want their names to appear in the electronic directory (Chapter 4).
5. Send the new data (with the hidden names) to the entry system.

Remember, vendor names and resident names with the hide feature turned on are not received by the PC when performing a receive data function. All other information is received.

6.2 USING V. 2.0, 2.1 OR 3.0 ACCOUNTS WITH V. 5.2 SOFTWARE

Prior to installing the version 5.2 software, you should backup any current account information (see section 6.4). Install the version 5.2 software on your computer as described on page 10 of this manual. If you have the earlier version of the Remote Account Manager software already installed, the installation program will detect this program and will ask if you want the files running under the old program to run under the new program. We suggest that you click the YES button when prompted to do so.

6.2.1 UPGRADING SOFTWARE

If you are currently using the DoorKing Remote Account Manager for Windows, version 2.0, 2.1 or 3.0, to manage your entry system with a "50 Series" board, the account created with one of these earlier versions of the software can be used with the version 5.2 software. The account and the files associated with it will be read by the version 5.2 software as a "50 Series" account.

6.2.2 UPGRADING HARDWARE AND SOFTWARE

If your DoorKing access system (1815, 1817 or 1818) hardware is being upgraded from a "50 Series" control board to a "40 Series" control board, there is no direct conversion of the data from a "50 Series" format to the "40 Series" format. This means that all data stored under the old format cannot be transferred to the new format and will have to be entered into the 5.2 software as if you are programming a brand new account.

6.3 BACKUP and RESTORE

The backup and restore features allow you to keep a copy of all the account and resident file information so that this information can be easily restored or transferred to a different computer. We recommend doing a backup after you have created your account and entered your resident information. You should also do a backup each time that you make changes to your account(s).

6.3.1 Backup

1. Click the FILE menu and choose BACKUP.
2. Select the destination folder that the account and resident file information will be copied to.
3. Click OK.

6.3.2 Restore

1. Click the FILE menu and choose RESTORE.
2. Select the folder from where your backup was copied.
3. Click OK.

6.4 TRANSFERRING AND SAVING

NOTE: You cannot transfer the files from a Windows 95 computer to a Windows 98, ME, 2000 or XP computer using the steps described under 6.4.1 because a Widgets.dll error will occur. Follow the steps in 6.4.2 on the next page in order to transfer or save files from a Windows 95 to Windows 98, ME, 2000 or XP computer.

6.4.1 TRANSFERRING OR SAVING THE DOORKING PROGRAM

1. Insert a blank 3-½ inch floppy disk into your computer.
2. Click Start, go to Programs, and click Windows Explorer.
3. On the left-hand side of the screen you will see your C: Drive. Under your C: Drive you will see a folder that says DKW52. Right click on the DKW52 folder and a drop-down menu appears.
4. Click copy.
5. There is a scrollbar in the middle of the screen. Use the scrollbar to scroll up until you see 3-½ Floppy A: on the left-hand side of the screen.
6. Right click on 3-½ Floppy A: and drop down menu will appear.
7. Click paste. **The computer may ask you to insert another disk to continue copying the files if the floppy disk is full of information. Stop at this point and follow the steps in Method 2 for saving or transferring files. The program will not copy correctly if you insert the next disk. If the disk copies the full program with no error messages, proceed to step 8.**
8. Go to the Windows Explorer on your other computer system or the computer for restoring the DoorKing program.
9. Highlight 3-½ Floppy A:
10. On the right side of the screen, you will see the DKW52 folder. Click and drag the DKW52 folder and drop it on the C: Drive on the left side of the screen.
11. Once the transferring is complete, DKW52 will appear underneath the C: Drive. Highlight DKW52.
12. On the right side of the screen, you will see DoorKing or DoorKing.exe. Right click on DoorKing and a drop-down window appears.
13. Click Create Shortcut.
14. A DoorKing Shortcut will now appear at the bottom of right side of the screen. Click, drag, and drop the DoorKing Shortcut onto "Desktop" on the left side of the screen. You have completed the process.

6.4.2 SAVING AND TRANSFERRING RESIDENT FILES

1. From the DoorKing program, highlight your Account and click System Info.
2. On the System Info Screen, take note of your Resident Info Directory number (ex: ACCT00, ACCT01, etc.).
3. Click Start, go to Programs, and click Windows Explorer.
4. On the left side of the screen in the Windows Explorer you will see C: Drive. Underneath the C: Drive you will see a folder that says DKW52. Click the + sign just to the left of the DKW52 folder.
5. Below the DKW52 folder will be another folder showing ACCT00, ACCT01, ACCT02, etc. Highlight the folder with your Resident Info Directory Account number.
6. On the right side of the screen, files appear. Locate the file that says Residents or Resident.dat and highlight it.
7. Right click on Resident and a drop-down window appears. Click copy.
8. Insert a blank 3-½ inch floppy disk into your computer. Use the scrollbar in the middle of the screen and scroll up until you see 3-½ Floppy A: on the left side of the screen.
9. Right click on 3-½ Floppy A: and a drop-down menu appears. Click paste and the Resident file will transfer to the floppy disk.
10. If you are transferring the files to a different computer, make sure that the DoorKing Software is already installed on that computer and that an Account with all of the appropriate System Information has been created. Note what your Resident Info Directory number is. If you are installing the saved file from a Floppy Disk, go to the DoorKing Program and highlight your DoorKing Account and click System Info. Note what your Resident Info Directory Number is.
11. Go to the Windows Explorer and locate the DKW52 folder on the left side of the screen under the C: Drive. Click the + sign just to the left of the DKW folder.
12. Locate the correct Resident Info Directory ACCT number where the file will be transferred.
13. Insert the floppy disk with the saved file on it into the computer. Use the scrollbar in the middle of the screen and scroll up until you see 3-½ Floppy A: Highlight 3-½ Floppy.
14. On the right side of the screen, you will see the Resident.dat file that was previously saved. Click, drag, and drop the Resident file from the right side of the screen into the appropriate ACCT folder under the DKW52 folder on the left side of the screen.
15. A screen will appear asking you "Would you like to replace the existing file" (Win 95) or "This folder already contains a file named Resident." (Win 98, ME, 2000, XP). Click "Yes" and the sequence will be complete.

6.5 TROUBLE SHOOTING

If you experience problems with the DoorKing Remote Account Manager for Windows, a problem may exist in your modem, at the telephone entry system, or with the phone line. Before calling your DoorKing dealer or DoorKing directly for assistance, check the following items and be sure to complete the information sheet so that we can properly assist you.

6.5.1 MODEM

1. Be sure that your modem is working correctly. Check modem communications with an on line service provider such as America On Line or Earthlink.
2. If your modem is external, make sure it is turned on.
3. Make sure the correct COM port is selected. When running Microsoft Windows, chances are you have a mouse connected to COM1. Your modem should be connected to COM2. The COM port that your modem is connected to, and the IRQ setting, can be determined from the Windows software.
4. If running Windows, use the Windows Add New Hardware command to locate your modem.
5. If the software is reporting many re-tries when sending blocks of information (mismatch received, resending data block), you might have experienced noise on the phone line. Try resending the data. The phone company routes calls differently each time you call.
6. Refer to the manual that came with your modem for additional modem trouble shooting guidelines.

6.5.2 ENTRY SYSTEM

1. Be sure that the entry system (1803PC, 1815, 1817, or 1818) is working correctly. Call the phone number that the entry system is installed on. After two rings, there should be silence indicating that the entry system has answered and is waiting for information to be received.
2. If the entry system does not answer, check to be sure that the ring pin is installed on the entry system control board. Check to be sure that the phone number is correct.
3. Refer to the installation and maintenance manual that came with the entry system for additional entry system trouble shooting information.

6.5.3 PHONE LINE

1. Have the installer check the phone line for any hum or noise. Any hum or noise can disrupt modem communications. Disconnect the phone line from the entry system and connect a telephone test set to the phone line. If the line is noisy or there is any hum on the line, this will have to be corrected before the entry system will be able to communicate with your computer.

6.5.4 DATE / TIME

1. The date and time are set in the entry system from your computer each time contact is made with the entry system via modem. If your computers date and time are set incorrectly, then all transaction events stored in the system history buffer will reflect this incorrect data.

6.5.5 COMPUTER / SYSTEM INFORMATION

If you need to contact your installing dealer or DoorKing for assistance with the DoorKing Remote Account Manager software, you must have all of the following information available so that we can assist you.

Your Computer (Make / Model) _____

Your Modem (Make / Model) _____

Comm Port _____

Entry System (1803PC, 1815, 1817, 1818) _____

Circuit Board Series (1840 or 1850) _____

Serial No. / Rev _____

Master Code _____

Memory Size _____

Directory Code Digits (1-2-3-4) _____

MemPLUS (Yes / No) _____

System Phone No. & Area Code _____

Talk Time _____

Modem or RS232 Communication _____

Multiple Systems (Yes / No) _____

Relay 0 Tone Numbers

(Momentary / Hold / Release / Hold 1 Hr.) _____

Relay 0 Options

(Postal Activate / Rotary 9 Activate) _____

Entry Code Range _____

Relay 1 Tone Numbers

(Momentary / Hold / Release / Hold 1 Hr.) _____

Relay 1 Options

(Postal Activate / Rotary 9 Activate) _____

Entry Code Range _____

Relay 2 Tone Numbers

(Momentary / Hold / Release / Hold 1 Hr.) _____

Relay 2 Options

(Postal Activate / Rotary 9 Activate) _____

Entry Code Range _____

Transactions Enabled (Yes / No) _____

Interface with 1816 System (Yes / No) _____

Dial Type (Tone / Rotary) _____

Tracker Expansion Boards Used (Yes / No) _____

How Many? _____

Elevator Control Boards Used (Yes / No) _____

How Many? _____

6.5.6 ERROR MESSAGES

These are some of the most common error messages that you may receive when attempting to send (or receive) data and the remedy to fix the errors. There are other error messages that you can receive when entering data in the different screens, many of which are self-explanatory. For example, DUPLICATE CARDS or DUPLICATE DIR CODES error messages alert you to the fact that you have duplicate entries in these respective fields. You can correct these errors as you enter the data.

CARD MISMATCH - You are attempting to send MemPLUS (cards) EEPROM chip information to an entry system that does not have MemPLUS (cards) chips installed. You must either replace the standard memory chips in the entry system with MemPLUS (cards) chips or turn off the MemPLUS option on the system information screen.

CHECK SUM MISMATCH - Check sum mismatch is typically caused by static or hum on the phone line. The software will retry several times to communicate with the entry system, but will eventually terminate modem communications if clear data cannot be sent and received. If this happens, you might try to re-establish communication with the entry system since the phone company routes calls differently each time a call is placed. If the problem persists, the phone line at the entry system will need to be checked.

MASTER CODE MISMATCH - The master code that you entered in the system information screen does not match the master code that is programmed into the entry system. Either re-enter the master code in the system information screen to the correct one, or reprogram the master code at the entry system to match the master code entered in the system information screen.

MEMORY MISMATCH - The memory size selected in the system information screen does not match the memory size of the chips installed in the entry system. Reset the memory size in the system information screen to match the memory chips installed in the entry system.

MODEM INITIALIZATION FAILED - This indicates a problem with your modem or the modem setup. Check to be sure that the COM port selected for the modem is correct. If using an external modem, be sure that it is turned on. Click the CONFIG PORTS button on the accounts screen, then click the AUTO CONFIG button. This should correct any modem setup errors, but will not correct any problems with the modem itself.

NO CONNECT - Multiple systems selected in the system information screen does not match the multiple system programming in the entry system. If the multiple system button is turned on, turn it off. If it is turned off, turn it on. This error message can also be caused by a bad phone line, modem, or other external factors than may affect the data transfer.

VERSION ERROR - The entry system that you are attempting to up load data to is an earlier version that does not support transactions or time zone functions. Turn the transaction and time zone functions off in the system information screen, otherwise the entry system must be upgraded with a current revision board.

6.6 GLOSSARY

ACCOUNT - When using the DoorKing Remote Account Manager Software for Windows, an account is any single entry system (1803PC, 1815, 1817, 1818) installed in the field. Each installed system should be given its own unique name to differentiate it from other systems.

ACCOUNT SCREEN - The screen where accounts are created and maintained. The account screen is the primary screen from which most of the functions of the program are carried out. This includes sending and receiving data, receiving transactions, and establishing time zones.

ALTERNATE AREA CODE - The alternate area code is entered on the system information screen as a three digit (area code) or four digit (1+ the area code) number. The alternate area code is used when the entry system is required to use a 10 or 11 digit number to call certain residents. This may be required with the local phone companies "over laying" area codes in certain parts of the country.

BUFFER - Buffer refers to the RAM storage in the entry system where all access attempts are recorded and stored. The buffer can be received to the PC for storage on the computers hard disk and for creating and printing transaction reports. Buffer is also referred to as history buffer, event buffer, transaction buffer.

DEVICES - Refers to an access control devices that allow the holder access provided that the device number is programmed into and activated by the software. Device numbers are five digits in length. Devices are typically access cards or RF transmitters, however, most 26 bit weigand devices can be supported to control access.

DIAL TYPE - Normally, tone dial type will be selected on the system information screen. This causes the entry system to call out by using DTMF tones. Some older applications may still use rotary style phone lines. Set the system to rotary if this is the case.

DIRECTORY CODE - A code number that a particular residents data (phone number, name, entry code number, card number) is stored under. It is also the number that a guest will enter on the entry system keypad to cause the system to dial that particular residents phone number.

DIRECTORY NAME - Automatically created by the software. This is the account sub-directory under which all the pertinent account information is stored. Normally, you do not need to make any changes to the account directory selection when a new account is established. However, if two or more entry systems are going to share the same resident file information, you can choose the same directory name which would eliminate the need to create separate resident files for each entry system.

DIVIDE NUMBER - A four digit number that is entered in the system information screen. The divide number allows entry codes to activate either relay, 1 or 2. Entry code equal to or less than the divide number will activate relay 1. Entry codes greater than the divide number will activate relay 2.

DOS - Disk Operating System

DTMF - Dual Tone Multi Frequency. Basically, DTMF is phone company lingo for the tones that are heard when you press the buttons on your telephone.

EEPROM - Electrically Erasable Programmable Read Only Memory. This type memory does not lose the information stored in it when power is removed. This is the type of memory used in the 1803PC, 1815, 1817, and 1818 systems.

ELEVATOR CONTROL - Limits system users as to which elevators can be used and to which floors they may have access to. Also limits the elevators that can be used by a visitor, and limits them to access only the floor (via the levator) that the person who granted them access resides on.

ENTRY CODES - A four-digit number that when entered on the entry system keypad (preceded by the # sign) causes one of the relays in the entry system to activate for its programmed strike time.

ENTRY CODE RANGES - A range of four-digit numbers with upper and lower boundaries. Ranges are applied to relay 0, relay 1 and relay 2. When a four-digit entry code is entered on the system keypad, the range that the entry code falls into will cause the respective relay(s) to activate.

MASTER CODE - The master code is a four digit number that provides programming security. You must know the system master code to perform any programming. The master code can only be set at the entry system. If you attempt to send information to the entry system with an incorrect master code, a MASTER CODE MIS-MATCH ERROR message will appear on your computer screen and the modem will be disconnected.

MULTIPLE SYSTEMS - Multiple systems is a term used when two or more entry systems are sharing the same phone line. If a single system is on a single phone line, multiple systems is set to NO. If two or more systems are connected to the same phone line, multiple systems is set to YES. Multiple systems programming can only be set at the entry system. You must match the multiple systems programming on the system information screen. If this programming parameter is not set correctly, a NO CONNECT ERROR message will be received on your computer screen.

PIN CODES - Personal Identification Number that is assigned to a system user. A five-digit code entered on a digital keypad that outputs the code to the access system in weigand format. PIN codes are treated by the system in the same way as card and transmitter codes are processed and treated.

RAM - Random Access Memory. Memory that will lose information stored in it if power is removed.

RELAY TIME - Relay time (also called strike time) is the amount of time that the relay will activate after a momentary open command is received by the system. Typical relay strike times are 1 second to activate a gate operator and five or more seconds to release an electric door strike or magnetic lock.

RESIDENT SCREEN - The resident screen is accessed from the accounts screen. This is where all the resident information is entered into the program. This information includes the resident name, directory code, phone number, entry code number, and any card or transmitter number if these devices are used.

SECURITY LEVEL - Restricts access at the different entry locations to certain times and days depending on the security level assigned to the individual user.

SYSTEM INFORMATION and SYSTEM MESSAGE - The user programmable message that scrolls from right to left on the 1815 system, or which is displayed on the 1817 system screens. There are now two parts to the user programmable message. The system message precedes the system information message in the 1815 system. In the 1817 system, the system message is displayed on the top screen while the system information message is displayed on the bottom screen. The system message can be up to 48 alphanumeric characters long (spaces count as a character) and the information message can be up to 52 characters long. Clicking the reset buttons resets the messages to the factory default.

SYSTEM MEMORY - System memory refers to the EEPROM chips installed in the entry system and refers to the number of individual resident telephone numbers (and therefore the capacity of the system) that can be stored in the entry system. EEPROM chips are also specified as being MemPLUS or not. Chips that are not MemPLUS do not have the storage capacity to store any device (card or transmitter) codes. When programming the system memory on the system information screen, the memory capacity selected, and MemPLUS usage must match the memory chips in the entry system. If you attempt to send information to the entry system with an incorrect memory size selected, or improper MemPLUS usage selected, a MEMORY SIZE ERROR, or CARD ENABLE ERROR message will appear on your computer screen and the modem will be disconnected.

SYSTEM PHONE - This refers to the phone number of the central office (C.O.) phone line attached to the entry system. This phone number is entered in the system information screen and is typically a local number. However, management companies with complexes out of the local area can enter an 11 digit long distance number in this programming area.

SYSTEM SCREEN - The system screen is accessed from the accounts screen. This is where all the system operating parameters are entered into the program. The following parameters cannot be set from the system screen, they must match the entry system parameters. 1) master code, 2) system memory, 3) MemPLUS 4) multiple systems.

TALK TIME - The talk time is the maximum amount of time that the entry system will allow communication to a resident to take place. The talk time clock starts timing after the system has dialed the resident phone number, not when the resident picks up their phone. Talk time is typically set between 30 seconds and 1 minute since the time required to identify the guest and press the tone open number is usually short.

TONE NUMBERS - The tone numbers are the numbers that the resident will press on their touch tone telephone to grant or deny a visitor access when a call has been placed to them from the entry system. Typically, the number 9 is used to grant access and the number 4 is used to deny access, although these numbers can be programmed to any number desired. In addition to these two-tone numbers, managers can also program a "hold" tone number and a "hold 1 hour" tone number. These numbers would be for management use only and would allow a manager to call the entry system and command it to open the door or gate and hold it open until the manager calls back to release the door or gate. As an alternative, the hold 1 hour command would automatically release the door or gate after one hour. See the system installation and maintenance manual for more information on tone numbers.

TRACKER™ - An optional feature that expands the 1803PC, 1815, 1817 and 1818 systems to control up to 16 doors/gates. Tracker™ expansion boards are required.

TRANSACTIONS - Transactions are stored in the entry system buffer, then received to the PC. These events are date and time stamped. The event log is stored in RAM memory in the entry system until it is down loaded to the PC. There are two types of transactions stored in the history buffer - regular and gate. Regular transactions are events generated by persons using the entry system. Gate transactions are gate operator events reporting to the system from the Gate Tracker, reporting device.

VENDOR - A vendor is a listing on the resident information screen that is assigned an entry code, device code only, and security level only. Vendor codes are typically assigned to maintenance personnel, utility companies, service companies, etc.

"40" SERIES - Refers 1840, 1841, 1842 and 1844 circuit boards.

"40" SERIES ENHANCED - Enhanced boards are identified by Revision level D or higher on the 1840, 1841 and 1842 circuit boards. All 1844 circuit boards are "enhanced." The enhanced boards allow for the creation of security levels and elevator control in the software.

"50" SERIES - Refers to the circuit boards in the entry system using the model numbers 1852, 1853, 1854, 1855, 1856, 1857.

6.7 PREPROGRAMMING INFORMATION

6.7.1 ACCESS SYSTEMS

This software program can be used to program DoorKing 1803PC, 1815, 1817, and 1818 telephone entry and access control systems only. Version 4.0, 4.1, 5.0, 5.1 or 5.2 software must be used to program these systems which utilize the 1840, 1841, 1842 and 1844 ("40" series) control boards, REV C or earlier. Version 5.0, 5.1 or 5.2 software must be used to program these systems with REV D (Enhanced 40 Series) boards or later (except 1844). Earlier versions of this software program (1.0, 2.0, 2.1, 3.0) cannot be used to program entry systems with "40" series boards. Version 4.0, 4.1, 5.0, 5.1 or 5.2 can be used to program systems that utilize the 1852, 1853, 1854, 1855, 1856, or 1857 ("50" series) control boards.

6.7.2 BOARD SERIES SELECTION

Because of the different formatting schemes used in the different control boards, you will be prompted to select a "50 Series", "40 Series" or "ENHANCED 40 Series" control board when you first create your account. If you are programming a system with a 50 series board (1852, 1853, etc.), click the 50 Series button. If you are programming a system with a 40 series board REV C or lower, click the 40 series button. If you are programming a system with a 40 series board REV D or higher, click the ENHANCED 40 series button. NOTE: The security level shorting bar must be installed on the hardware to program REV D or higher boards (40 series boards only). Refer to the system installation manual.

It is very important that you select the correct board series, otherwise communication to the entry system will fail and all data entered in the account will have to be re-entered. We strongly suggest that you know the control board series and revision level before proceeding with any data entry. Check with your installing dealer, or you can simply open the entry system faceplate to check the control board to see which series you have. Look for a small white tag that will have the information you need printed on it.

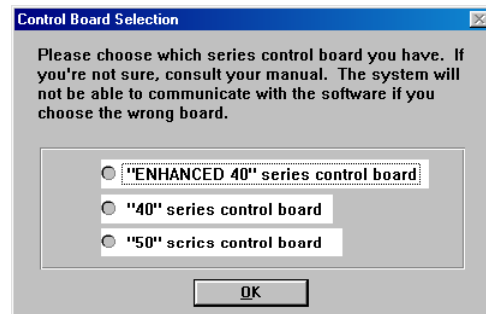

If you do not know which circuit board is in your entry system, select "ENHANCED 40 series" when prompted, to create your account. After entering the necessary information in the system screen, enter information for a single resident in the resident screen, and then send the data to the entry system. If the correct series was selected, the entry system will communicate with your PC and the data will be sent. After the data is sent, you can then enter the remaining resident information. If the incorrect series was selected, communication with the entry system will fail. You should then delete this account and re-create it selecting the correct series.

IMPORTANT! Resident information cannot be transferred or reformatted from the earlier versions of the software to version 4.1, 5.0, 5.1 or 5.2 (or vice-versa) once it has been entered in the resident information screen. If you create your account by guessing which series control board that you are dealing with and then enter all the resident information, you will have to re-enter all this information if you guess wrong! This is why we suggest the performing the test in the preceding paragraph if you do not know which series control board you have. This will eliminate the task of re-entering all data if the wrong selection was made when the account was created.

6.7.3 HARDWARE REVISIONS

Some of the earlier model 1803PC, 1815, 1817 and 1818 systems do not have all of the features and capabilities that have been added to the systems over the years. The features that the systems have are dependent on the circuit board installed in the system and the revision level of the circuit board. The chart below will assist you in determining exactly what features your system has.

Circuit Board	Used On	Transactions	Device Codes	Time Zones	Tracker	Area Codes	RS232	Control Relays	Security Levels	Elevator Control
1852	1815	5000	2000	Rev P Higher	No	5 Rev S	No	2	No	No
1853	1817	5000	2000	Rev F Higher	No	5 Rev H	No	2	No	No
1854	1818	5000	2000	Rev C Higher	No	N/A	No	2	No	No
1855	1815	500	6000	Yes	Yes	5	No	2	No	No
1856	1817	5000	6000	Yes	Yes	5	No	2	No	No
1857	1818	5000	600	Yes	Yes	N/A	No	2	No	No
1840	1815	8000	8000	Yes	Yes	10	Rev C Higher	3	Rev D Higher	Rev D Higher
1841	1817	8000	8000	Yes	Yes	10	Rev C Higher	3	Rev D Higher	Rev D Higher
1842	1818	8000	8000	Yes	Yes	N/A	Rev C Higher	3	Rev D Higher	Rev D Higher
1844	1803PC	8000	8000	Yes	Yes	10	Yes	3	Yes	Yes

6.7.4 TRACKER™ EXPANSION

Tracker™ refers to optional expansion boards (p/n 2351-010) that allows the entry system to control up to 16 access locations. Tracker™ boards also perform other functions such as reporting door ajar or forced entry conditions, activating building and local alarms, and providing request to exit inputs to the system. If Tracker™ boards are to be utilized with the security level feature in this software package, be sure that the Tracker™ boards being utilized are REV D or higher.

Tracker™ boards can also be used for DoorKing's Gate Tracker™ reporting feature which reports gate operator activity to the access system. To utilize Gate Tracker™, the gate operator must be equipped with a circuit board that has Gate Tracker™ outputs. The chart below will help you to determine if your gate operator has this feature. For more information on the full features of the Tracker™ expansion boards, refer to the Tracker™ Installation Manual.

Gate Operator Models	Circuit Board Number
601, 601, 605, 610, 615, 620, 625	4501-010 Rev R or Higher
910, 915, 920, 1100	4601-010 Rev J or Higher
1601, 1602	1601-010 Rev Q or Higher
6050, 6100, 6300	4502-010
9100, 9150	4602-010
1150, 9200, 9300	4402-010

6.8 PREPROGRAMMING REQUIREMENTS

Prior to programming the telephone entry / access control system with the DoorKing Remote Account Manager for Windows, you must have the following information. The system MASTER CODE and single / multiple line sharing functions must be programmed into the access system at the access system keypad. You must also know what type of memory chips are installed in your unit (Standard or MemPLUS), and the memory level that the chip is capable of. Refer to the Owner's Manual that was included with the access system for additional information on these operating parameters.

Circuit Board Information Circle One			Master Code	Memory Size Circle One		Memory Type	Single Multiple
50 Series	40 Series Rev C or Lower	40 Series Enhanced	Record Code	50 Series	40 Series	Circle One	Circle One
1852-010 1853-010 1854-010 1855-010 1856-010 1857-010	1840-010 1841-010 1842-010	1840-010 1841-010 1842-010 1844-010		20 52 116 250 500 988	25 75 125 250 500 1000 2000 3000	Standard or MemPLUS	Single Multiple

VERSION 5.2

Version 5.2 software will communicate with older telephone entry systems, which the software refers to as "Series 50", and the newer telephone entry systems that the software refers to as "Series 40" and "Series 40 Enhanced" (see chart below). The instruction that you will follow is dependent on your selection the series control board that you select when you first create an account. For example, if account "A" uses an older telephone entry system with an 1855 control board, you will select "50 Series" when you create this account and follow the instructions in this manual labeled "50 Series." If account "B" uses a new system with an 1840 control board, Rev D, you will select "40 Series Enhanced" when you create this account and follow the instructions in this manual labeled "40 Series Enhanced." The instructions in many parts of this manual are identical for all versions of the software.

Feature	50 Series	40 Series	40 Series Enhanced
Program these boards	1852, 1853, 1854, 1855, 1856, 1857	1840, 1841, 1842 Rev C & Lower	1840, 1841, 1842 Rev D & Higher and 1844
Memory size available	20, 52, 116, 250, 500, 988	25, 75, 125, 250, 500, 1000, 2000, 3000	25, 75, 125, 250, 500, 1000, 2000, 3000
Maximum transactions	5000	8000	8000
Maximum device codes	6000	8000	8000
Area codes	5	10	10
Directory digits	3 – Non-programmable	1-2-3 or 4, Programmable	1-2-3 or 4, Programmable
Entry code ranges	No	Rev C only	Yes
Entry code divide number	No	Rev A & B only	No
Tone open numbers are programmable for these relays	Programmable for relay 1 only	Relay 1 only, Rev A & B Relay 0, 1 & 2, Rev C only	Relay 0, 1 & 2
Postal switch programming	Activates relay 1 only	Relay 1 only, Rev A & B Relay 0, 1 or 2, Rev C	Relay 0, 1 or 2
RS-232 communication	No	Rev C only	Yes
Programmable instruction message	No	Yes	Yes
Security levels	No	No	Yes
Elevator control	No	No	Yes

SECURITY LEVEL PLANNING GUIDE

The sample below was used to create security level 02 as described in Section 3.4.2. Use the guides on the following pages to simplify planning and organizing your different security levels before starting to program the different levels in the software.

1. Name ALL relays that the system will control. Remember that the software program will only allow you to enter 12 characters in the relay name field, so you may have to abbreviate in some cases.
2. Complete a chart for EACH security level that needs to be created. Copy the blank charts if necessary. You can create up to 29 security levels starting with level 02. Security levels 00 (always deny access) and 01 (always grant access) are not programmable.

Relay 0: Visitor Vehicular Gate
(1803PC, 1815, 1817 Only)

Relay 1: Tracker Command

Tracker Command

Relay 11: South Entry

Relay 12: North Entry

Relay 13: West Entry

Relay 14: Elevator 1 Card

Relay 15: Elevator 2 Card

Relay 16: Elevator 3 Card

Relay 17: Elevator 4 Card

Relay 18: _____

Relay 2: Tracker Command

Tracker Command

Relay 3: Resident Vehicular Gate

Relay 4: Resident Pedestrian Gate

Relay 5: Office

Relay 6: Pool

Relay 7: Laundry Room

Relay 8: Exercise Room

Relay 9: Service Entrance

Relay 10: _____

SECURITY LEVEL <u>2</u>		DAYS							RELAYS																			
Time Zone	Start Time - Stop Time	S	M	T	W	T	F	S	0	1	2	3	4	5	6	7	8	9	10	11	12	13	14	15	16	17	18	
1	12:00 AM - 11:59 PM	X	X	X	X	X	X	X				X	X							X								
2	8:00 AM - 10:00 PM	X	X	X	X	X	X	X							X	X	X											
3	9:00 AM - 5:00 PM		X	X	X	X	X	X						X														
4																												

Label each relay in the system. If relay 1 or relay 2 is used to control Tracker expansion boards, we suggest that you label these relays "Tracker Command." This can be abbreviated in the software as Tracker Cmd.

If both relay 1 and relay 2 are used as Tracker Command relays, then relay 0 becomes the controlling relay for visitor entry, otherwise relay 0 is typically not used.

Relay 0: _____
(1803PC, 1815, 1817 Only)

Relay 1: _____

Relay 11: _____

Relay 12: _____

Relay 13: _____

Relay 14: _____

Relay 15: _____

Relay 16: _____

Relay 17: _____

Relay 18: _____

Tracker Command

Relay 2: _____

Relay 3: _____

Relay 4: _____

Relay 5: _____

Relay 6: _____

Relay 7: _____

Relay 8: _____

Relay 9: _____

Relay 10: _____

Tracker Command

SECURITY LEVEL _____		DAYS							RELAYS																			
Time Zone	Start Time - Stop Time	S	M	T	W	T	F	S	0	1	2	3	4	5	6	7	8	9	10	11	12	13	14	15	16	17	18	
1		<input type="checkbox"/>	<input type="checkbox"/>	<input type="checkbox"/>	<input type="checkbox"/>	<input type="checkbox"/>	<input type="checkbox"/>	<input type="checkbox"/>	<input type="checkbox"/>	<input type="checkbox"/>	<input type="checkbox"/>	<input type="checkbox"/>	<input type="checkbox"/>	<input type="checkbox"/>	<input type="checkbox"/>	<input type="checkbox"/>	<input type="checkbox"/>	<input type="checkbox"/>	<input type="checkbox"/>	<input type="checkbox"/>	<input type="checkbox"/>	<input type="checkbox"/>	<input type="checkbox"/>	<input type="checkbox"/>	<input type="checkbox"/>	<input type="checkbox"/>	<input type="checkbox"/>	<input type="checkbox"/>
2		<input type="checkbox"/>	<input type="checkbox"/>	<input type="checkbox"/>	<input type="checkbox"/>	<input type="checkbox"/>	<input type="checkbox"/>	<input type="checkbox"/>	<input type="checkbox"/>	<input type="checkbox"/>	<input type="checkbox"/>	<input type="checkbox"/>	<input type="checkbox"/>	<input type="checkbox"/>	<input type="checkbox"/>	<input type="checkbox"/>	<input type="checkbox"/>	<input type="checkbox"/>	<input type="checkbox"/>	<input type="checkbox"/>	<input type="checkbox"/>	<input type="checkbox"/>	<input type="checkbox"/>	<input type="checkbox"/>	<input type="checkbox"/>	<input type="checkbox"/>	<input type="checkbox"/>	<input type="checkbox"/>
3		<input type="checkbox"/>	<input type="checkbox"/>	<input type="checkbox"/>	<input type="checkbox"/>	<input type="checkbox"/>	<input type="checkbox"/>	<input type="checkbox"/>	<input type="checkbox"/>	<input type="checkbox"/>	<input type="checkbox"/>	<input type="checkbox"/>	<input type="checkbox"/>	<input type="checkbox"/>	<input type="checkbox"/>	<input type="checkbox"/>	<input type="checkbox"/>	<input type="checkbox"/>	<input type="checkbox"/>	<input type="checkbox"/>	<input type="checkbox"/>	<input type="checkbox"/>	<input type="checkbox"/>	<input type="checkbox"/>	<input type="checkbox"/>	<input type="checkbox"/>	<input type="checkbox"/>	<input type="checkbox"/>
4		<input type="checkbox"/>	<input type="checkbox"/>	<input type="checkbox"/>	<input type="checkbox"/>	<input type="checkbox"/>	<input type="checkbox"/>	<input type="checkbox"/>	<input type="checkbox"/>	<input type="checkbox"/>	<input type="checkbox"/>	<input type="checkbox"/>	<input type="checkbox"/>	<input type="checkbox"/>	<input type="checkbox"/>	<input type="checkbox"/>	<input type="checkbox"/>	<input type="checkbox"/>	<input type="checkbox"/>	<input type="checkbox"/>	<input type="checkbox"/>	<input type="checkbox"/>	<input type="checkbox"/>	<input type="checkbox"/>	<input type="checkbox"/>	<input type="checkbox"/>	<input type="checkbox"/>	<input type="checkbox"/>

SECURITY LEVEL _____		DAYS							RELAYS																		
Time Zone	Start Time - Stop Time	S	M	T	W	T	F	S	0	1	2	3	4	5	6	7	8	9	10	11	12	13	14	15	16	17	18
1		<input type="checkbox"/>	<input type="checkbox"/>	<input type="checkbox"/>	<input type="checkbox"/>	<input type="checkbox"/>	<input type="checkbox"/>	<input type="checkbox"/>	<input type="checkbox"/>	<input type="checkbox"/>	<input type="checkbox"/>	<input type="checkbox"/>	<input type="checkbox"/>	<input type="checkbox"/>	<input type="checkbox"/>	<input type="checkbox"/>	<input type="checkbox"/>	<input type="checkbox"/>	<input type="checkbox"/>	<input type="checkbox"/>	<input type="checkbox"/>	<input type="checkbox"/>	<input type="checkbox"/>	<input type="checkbox"/>	<input type="checkbox"/>	<input type="checkbox"/>	<input type="checkbox"/>
2		<input type="checkbox"/>	<input type="checkbox"/>	<input type="checkbox"/>	<input type="checkbox"/>	<input type="checkbox"/>	<input type="checkbox"/>	<input type="checkbox"/>	<input type="checkbox"/>	<input type="checkbox"/>	<input type="checkbox"/>	<input type="checkbox"/>	<input type="checkbox"/>	<input type="checkbox"/>	<input type="checkbox"/>	<input type="checkbox"/>	<input type="checkbox"/>	<input type="checkbox"/>	<input type="checkbox"/>	<input type="checkbox"/>	<input type="checkbox"/>	<input type="checkbox"/>	<input type="checkbox"/>	<input type="checkbox"/>	<input type="checkbox"/>	<input type="checkbox"/>	<input type="checkbox"/>
3		<input type="checkbox"/>	<input type="checkbox"/>	<input type="checkbox"/>	<input type="checkbox"/>	<input type="checkbox"/>	<input type="checkbox"/>	<input type="checkbox"/>	<input type="checkbox"/>	<input type="checkbox"/>	<input type="checkbox"/>	<input type="checkbox"/>	<input type="checkbox"/>	<input type="checkbox"/>	<input type="checkbox"/>	<input type="checkbox"/>	<input type="checkbox"/>	<input type="checkbox"/>	<input type="checkbox"/>	<input type="checkbox"/>	<input type="checkbox"/>	<input type="checkbox"/>	<input type="checkbox"/>	<input type="checkbox"/>	<input type="checkbox"/>	<input type="checkbox"/>	<input type="checkbox"/>
4		<input type="checkbox"/>	<input type="checkbox"/>	<input type="checkbox"/>	<input type="checkbox"/>	<input type="checkbox"/>	<input type="checkbox"/>	<input type="checkbox"/>	<input type="checkbox"/>	<input type="checkbox"/>	<input type="checkbox"/>	<input type="checkbox"/>	<input type="checkbox"/>	<input type="checkbox"/>	<input type="checkbox"/>	<input type="checkbox"/>	<input type="checkbox"/>	<input type="checkbox"/>	<input type="checkbox"/>	<input type="checkbox"/>	<input type="checkbox"/>	<input type="checkbox"/>	<input type="checkbox"/>	<input type="checkbox"/>	<input type="checkbox"/>	<input type="checkbox"/>	<input type="checkbox"/>

SECURITY LEVEL _____		DAYS							RELAYS																		
Time Zone	Start Time - Stop Time	S	M	T	W	T	F	S	0	1	2	3	4	5	6	7	8	9	10	11	12	13	14	15	16	17	18
1		<input type="checkbox"/>	<input type="checkbox"/>	<input type="checkbox"/>	<input type="checkbox"/>	<input type="checkbox"/>	<input type="checkbox"/>	<input type="checkbox"/>	<input type="checkbox"/>	<input type="checkbox"/>	<input type="checkbox"/>	<input type="checkbox"/>	<input type="checkbox"/>	<input type="checkbox"/>	<input type="checkbox"/>	<input type="checkbox"/>	<input type="checkbox"/>	<input type="checkbox"/>	<input type="checkbox"/>	<input type="checkbox"/>	<input type="checkbox"/>	<input type="checkbox"/>	<input type="checkbox"/>	<input type="checkbox"/>	<input type="checkbox"/>	<input type="checkbox"/>	<input type="checkbox"/>
2		<input type="checkbox"/>	<input type="checkbox"/>	<input type="checkbox"/>	<input type="checkbox"/>	<input type="checkbox"/>	<input type="checkbox"/>	<input type="checkbox"/>	<input type="checkbox"/>	<input type="checkbox"/>	<input type="checkbox"/>	<input type="checkbox"/>	<input type="checkbox"/>	<input type="checkbox"/>	<input type="checkbox"/>	<input type="checkbox"/>	<input type="checkbox"/>	<input type="checkbox"/>	<input type="checkbox"/>	<input type="checkbox"/>	<input type="checkbox"/>	<input type="checkbox"/>	<input type="checkbox"/>	<input type="checkbox"/>	<input type="checkbox"/>	<input type="checkbox"/>	
3		<input type="checkbox"/>	<input type="checkbox"/>	<input type="checkbox"/>	<input type="checkbox"/>	<input type="checkbox"/>	<input type="checkbox"/>	<input type="checkbox"/>	<input type="checkbox"/>	<input type="checkbox"/>	<input type="checkbox"/>	<input type="checkbox"/>	<input type="checkbox"/>	<input type="checkbox"/>	<input type="checkbox"/>	<input type="checkbox"/>	<input type="checkbox"/>	<input type="checkbox"/>	<input type="checkbox"/>	<input type="checkbox"/>	<input type="checkbox"/>	<input type="checkbox"/>	<input type="checkbox"/>	<input type="checkbox"/>	<input type="checkbox"/>	<input type="checkbox"/>	
4		<input type="checkbox"/>	<input type="checkbox"/>	<input type="checkbox"/>	<input type="checkbox"/>	<input type="checkbox"/>	<input type="checkbox"/>	<input type="checkbox"/>	<input type="checkbox"/>	<input type="checkbox"/>	<input type="checkbox"/>	<input type="checkbox"/>	<input type="checkbox"/>	<input type="checkbox"/>	<input type="checkbox"/>	<input type="checkbox"/>	<input type="checkbox"/>	<input type="checkbox"/>	<input type="checkbox"/>	<input type="checkbox"/>	<input type="checkbox"/>	<input type="checkbox"/>	<input type="checkbox"/>	<input type="checkbox"/>	<input type="checkbox"/>	<input type="checkbox"/>	

SECURITY LEVEL _____		DAYS							RELAYS																		
Time Zone	Start Time - Stop Time	S	M	T	W	T	F	S	0	1	2	3	4	5	6	7	8	9	10	11	12	13	14	15	16	17	18
1		<input type="checkbox"/>	<input type="checkbox"/>	<input type="checkbox"/>	<input type="checkbox"/>	<input type="checkbox"/>	<input type="checkbox"/>	<input type="checkbox"/>	<input type="checkbox"/>	<input type="checkbox"/>	<input type="checkbox"/>	<input type="checkbox"/>	<input type="checkbox"/>	<input type="checkbox"/>	<input type="checkbox"/>	<input type="checkbox"/>	<input type="checkbox"/>	<input type="checkbox"/>	<input type="checkbox"/>	<input type="checkbox"/>	<input type="checkbox"/>	<input type="checkbox"/>	<input type="checkbox"/>	<input type="checkbox"/>	<input type="checkbox"/>	<input type="checkbox"/>	
2		<input type="checkbox"/>	<input type="checkbox"/>	<input type="checkbox"/>	<input type="checkbox"/>	<input type="checkbox"/>	<input type="checkbox"/>	<input type="checkbox"/>	<input type="checkbox"/>	<input type="checkbox"/>	<input type="checkbox"/>	<input type="checkbox"/>	<input type="checkbox"/>	<input type="checkbox"/>	<input type="checkbox"/>	<input type="checkbox"/>	<input type="checkbox"/>	<input type="checkbox"/>	<input type="checkbox"/>	<input type="checkbox"/>	<input type="checkbox"/>	<input type="checkbox"/>	<input type="checkbox"/>	<input type="checkbox"/>	<input type="checkbox"/>	<input type="checkbox"/>	
3		<input type="checkbox"/>	<input type="checkbox"/>	<input type="checkbox"/>	<input type="checkbox"/>	<input type="checkbox"/>	<input type="checkbox"/>	<input type="checkbox"/>	<input type="checkbox"/>	<input type="checkbox"/>	<input type="checkbox"/>	<input type="checkbox"/>	<input type="checkbox"/>	<input type="checkbox"/>	<input type="checkbox"/>	<input type="checkbox"/>	<input type="checkbox"/>	<input type="checkbox"/>	<input type="checkbox"/>	<input type="checkbox"/>	<input type="checkbox"/>	<input type="checkbox"/>	<input type="checkbox"/>	<input type="checkbox"/>	<input type="checkbox"/>	<input type="checkbox"/>	
4		<input type="checkbox"/>	<input type="checkbox"/>	<input type="checkbox"/>	<input type="checkbox"/>	<input type="checkbox"/>	<input type="checkbox"/>	<input type="checkbox"/>	<input type="checkbox"/>	<input type="checkbox"/>	<input type="checkbox"/>	<input type="checkbox"/>	<input type="checkbox"/>	<input type="checkbox"/>	<input type="checkbox"/>	<input type="checkbox"/>	<input type="checkbox"/>	<input type="checkbox"/>	<input type="checkbox"/>	<input type="checkbox"/>	<input type="checkbox"/>	<input type="checkbox"/>	<input type="checkbox"/>	<input type="checkbox"/>	<input type="checkbox"/>	<input type="checkbox"/>	

SECURITY LEVEL _____		DAYS							RELAYS																		
Time Zone	Start Time - Stop Time	S	M	T	W	T	F	S	0	1	2	3	4	5	6	7	8	9	10	11	12	13	14	15	16	17	18
1		<input type="checkbox"/>	<input type="checkbox"/>	<input type="checkbox"/>	<input type="checkbox"/>	<input type="checkbox"/>	<input type="checkbox"/>	<input type="checkbox"/>	<input type="checkbox"/>	<input type="checkbox"/>	<input type="checkbox"/>	<input type="checkbox"/>	<input type="checkbox"/>	<input type="checkbox"/>	<input type="checkbox"/>	<input type="checkbox"/>	<input type="checkbox"/>	<input type="checkbox"/>	<input type="checkbox"/>	<input type="checkbox"/>	<input type="checkbox"/>	<input type="checkbox"/>	<input type="checkbox"/>	<input type="checkbox"/>	<input type="checkbox"/>	<input type="checkbox"/>	
2		<input type="checkbox"/>	<input type="checkbox"/>	<input type="checkbox"/>	<input type="checkbox"/>	<input type="checkbox"/>	<input type="checkbox"/>	<input type="checkbox"/>	<input type="checkbox"/>	<input type="checkbox"/>	<input type="checkbox"/>	<input type="checkbox"/>	<input type="checkbox"/>	<input type="checkbox"/>	<input type="checkbox"/>	<input type="checkbox"/>	<input type="checkbox"/>	<input type="checkbox"/>	<input type="checkbox"/>	<input type="checkbox"/>	<input type="checkbox"/>	<input type="checkbox"/>	<input type="checkbox"/>	<input type="checkbox"/>	<input type="checkbox"/>	<input type="checkbox"/>	
3		<input type="checkbox"/>	<input type="checkbox"/>	<input type="checkbox"/>	<input type="checkbox"/>	<input type="checkbox"/>	<input type="checkbox"/>	<input type="checkbox"/>	<input type="checkbox"/>	<input type="checkbox"/>	<input type="checkbox"/>	<input type="checkbox"/>	<input type="checkbox"/>	<input type="checkbox"/>	<input type="checkbox"/>	<input type="checkbox"/>	<input type="checkbox"/>	<input type="checkbox"/>	<input type="checkbox"/>	<input type="checkbox"/>	<input type="checkbox"/>	<input type="checkbox"/>	<input type="checkbox"/>	<input type="checkbox"/>	<input type="checkbox"/>	<input type="checkbox"/>	
4		<input type="checkbox"/>	<input type="checkbox"/>	<input type="checkbox"/>	<input type="checkbox"/>	<input type="checkbox"/>	<input type="checkbox"/>	<input type="checkbox"/>	<input type="checkbox"/>	<input type="checkbox"/>	<input type="checkbox"/>	<input type="checkbox"/>	<input type="checkbox"/>	<input type="checkbox"/>	<input type="checkbox"/>	<input type="checkbox"/>	<input type="checkbox"/>	<input type="checkbox"/>	<input type="checkbox"/>	<input type="checkbox"/>	<input type="checkbox"/>	<input type="checkbox"/>	<input type="checkbox"/>	<input type="checkbox"/>	<input type="checkbox"/>	<input type="checkbox"/>	

SECURITY LEVEL _____		DAYS							RELAYS																		
Time Zone	Start Time - Stop Time	S	M	T	W	T	F	S	0	1	2	3	4	5	6	7	8	9	10	11	12	13	14	15	16	17	18
1		<input type="checkbox"/>	<input type="checkbox"/>	<input type="checkbox"/>	<input type="checkbox"/>	<input type="checkbox"/>	<input type="checkbox"/>	<input type="checkbox"/>	<input type="checkbox"/>	<input type="checkbox"/>	<input type="checkbox"/>	<input type="checkbox"/>	<input type="checkbox"/>	<input type="checkbox"/>	<input type="checkbox"/>	<input type="checkbox"/>	<input type="checkbox"/>	<input type="checkbox"/>	<input type="checkbox"/>	<input type="checkbox"/>	<input type="checkbox"/>	<input type="checkbox"/>	<input type="checkbox"/>	<input type="checkbox"/>	<input type="checkbox"/>	<input type="checkbox"/>	
2		<input type="checkbox"/>	<input type="checkbox"/>	<input type="checkbox"/>	<input type="checkbox"/>	<input type="checkbox"/>	<input type="checkbox"/>	<input type="checkbox"/>	<input type="checkbox"/>	<input type="checkbox"/>	<input type="checkbox"/>	<input type="checkbox"/>	<input type="checkbox"/>	<input type="checkbox"/>	<input type="checkbox"/>	<input type="checkbox"/>	<input type="checkbox"/>	<input type="checkbox"/>	<input type="checkbox"/>	<input type="checkbox"/>	<input type="checkbox"/>	<input type="checkbox"/>	<input type="checkbox"/>	<input type="checkbox"/>	<input type="checkbox"/>	<input type="checkbox"/>	
3		<input type="checkbox"/>	<input type="checkbox"/>	<input type="checkbox"/>	<input type="checkbox"/>	<input type="checkbox"/>	<input type="checkbox"/>	<input type="checkbox"/>	<input type="checkbox"/>	<input type="checkbox"/>	<input type="checkbox"/>	<input type="checkbox"/>	<input type="checkbox"/>	<input type="checkbox"/>	<input type="checkbox"/>	<input type="checkbox"/>	<input type="checkbox"/>	<input type="checkbox"/>	<input type="checkbox"/>	<input type="checkbox"/>	<input type="checkbox"/>	<input type="checkbox"/>	<input type="checkbox"/>	<input type="checkbox"/>	<input type="checkbox"/>	<input type="checkbox"/>	
4		<input type="checkbox"/>	<input type="checkbox"/>	<input type="checkbox"/>	<input type="checkbox"/>	<input type="checkbox"/>	<input type="checkbox"/>	<input type="checkbox"/>	<input type="checkbox"/>	<input type="checkbox"/>	<input type="checkbox"/>	<input type="checkbox"/>	<input type="checkbox"/>	<input type="checkbox"/>	<input type="checkbox"/>	<input type="checkbox"/>	<input type="checkbox"/>	<input type="checkbox"/>	<input type="checkbox"/>	<input type="checkbox"/>	<input type="checkbox"/>	<input type="checkbox"/>	<input type="checkbox"/>	<input type="checkbox"/>	<input type="checkbox"/>	<input type="checkbox"/>	

SECURITY LEVEL _____		DAYS							RELAYS																		
Time Zone	Start Time - Stop Time	S	M	T	W	T	F	S	0	1	2	3	4	5	6	7	8	9	10	11	12	13	14	15	16	17	18
1		<input type="checkbox"/>	<input type="checkbox"/>	<input type="checkbox"/>	<input type="checkbox"/>	<input type="checkbox"/>	<input type="checkbox"/>	<input type="checkbox"/>	<input type="checkbox"/>	<input type="checkbox"/>	<input type="checkbox"/>	<input type="checkbox"/>	<input type="checkbox"/>	<input type="checkbox"/>	<input type="checkbox"/>	<input type="checkbox"/>	<input type="checkbox"/>	<input type="checkbox"/>	<input type="checkbox"/>	<input type="checkbox"/>	<input type="checkbox"/>	<input type="checkbox"/>	<input type="checkbox"/>	<input type="checkbox"/>	<input type="checkbox"/>	<input type="checkbox"/>	
2		<input type="checkbox"/>	<input type="checkbox"/>	<input type="checkbox"/>	<input type="checkbox"/>	<input type="checkbox"/>	<input type="checkbox"/>	<input type="checkbox"/>	<input type="checkbox"/>	<input type="checkbox"/>	<input type="checkbox"/>	<input type="checkbox"/>	<input type="checkbox"/>	<input type="checkbox"/>	<input type="checkbox"/>	<input type="checkbox"/>	<input type="checkbox"/>	<input type="checkbox"/>	<input type="checkbox"/>	<input type="checkbox"/>	<input type="checkbox"/>	<input type="checkbox"/>	<input type="checkbox"/>	<input type="checkbox"/>	<input type="checkbox"/>	<input type="checkbox"/>	
3		<input type="checkbox"/>	<input type="checkbox"/>	<input type="checkbox"/>	<input type="checkbox"/>	<input type="checkbox"/>	<input type="checkbox"/>	<input type="checkbox"/>	<input type="checkbox"/>	<input type="checkbox"/>	<input type="checkbox"/>	<input type="checkbox"/>	<input type="checkbox"/>	<input type="checkbox"/>	<input type="checkbox"/>	<input type="checkbox"/>	<input type="checkbox"/>	<input type="checkbox"/>	<input type="checkbox"/>	<input type="checkbox"/>	<input type="checkbox"/>	<input type="checkbox"/>	<input type="checkbox"/>	<input type="checkbox"/>	<input type="checkbox"/>	<input type="checkbox"/>	
4		<input type="checkbox"/>	<input type="checkbox"/>	<input type="checkbox"/>	<input type="checkbox"/>	<input type="checkbox"/>	<input type="checkbox"/>	<input type="checkbox"/>	<input type="checkbox"/>	<input type="checkbox"/>	<input type="checkbox"/>	<input type="checkbox"/>	<input type="checkbox"/>	<input type="checkbox"/>	<input type="checkbox"/>	<input type="checkbox"/>	<input type="checkbox"/>	<input type="checkbox"/>	<input type="checkbox"/>	<input type="checkbox"/>	<input type="checkbox"/>	<input type="checkbox"/>	<input type="checkbox"/>	<input type="checkbox"/>	<input type="checkbox"/>	<input type="checkbox"/>	

SECURITY LEVEL _____		DAYS							RELAYS																			
Time Zone	Start Time - Stop Time	S	M	T	W	T	F	S	0	1	2	3	4	5	6	7	8	9	10	11	12	13	14	15	16	17	18	
1		<input type="checkbox"/>	<input type="checkbox"/>	<input type="checkbox"/>	<input type="checkbox"/>	<input type="checkbox"/>	<input type="checkbox"/>	<input type="checkbox"/>	<input type="checkbox"/>	<input type="checkbox"/>	<input type="checkbox"/>	<input type="checkbox"/>	<input type="checkbox"/>	<input type="checkbox"/>	<input type="checkbox"/>	<input type="checkbox"/>	<input type="checkbox"/>	<input type="checkbox"/>	<input type="checkbox"/>	<input type="checkbox"/>	<input type="checkbox"/>	<input type="checkbox"/>	<input type="checkbox"/>	<input type="checkbox"/>	<input type="checkbox"/>	<input type="checkbox"/>	<input type="checkbox"/>	<input type="checkbox"/>
2		<input type="checkbox"/>	<input type="checkbox"/>	<input type="checkbox"/>	<input type="checkbox"/>	<input type="checkbox"/>	<input type="checkbox"/>	<input type="checkbox"/>	<input type="checkbox"/>	<input type="checkbox"/>	<input type="checkbox"/>	<input type="checkbox"/>	<input type="checkbox"/>	<input type="checkbox"/>	<input type="checkbox"/>	<input type="checkbox"/>	<input type="checkbox"/>	<input type="checkbox"/>	<input type="checkbox"/>	<input type="checkbox"/>	<input type="checkbox"/>	<input type="checkbox"/>	<input type="checkbox"/>	<input type="checkbox"/>	<input type="checkbox"/>	<input type="checkbox"/>	<input type="checkbox"/>	<input type="checkbox"/>
3		<input type="checkbox"/>	<input type="checkbox"/>	<input type="checkbox"/>	<input type="checkbox"/>	<input type="checkbox"/>	<input type="checkbox"/>	<input type="checkbox"/>	<input type="checkbox"/>	<input type="checkbox"/>	<input type="checkbox"/>	<input type="checkbox"/>	<input type="checkbox"/>	<input type="checkbox"/>	<input type="checkbox"/>	<input type="checkbox"/>	<input type="checkbox"/>	<input type="checkbox"/>	<input type="checkbox"/>	<input type="checkbox"/>	<input type="checkbox"/>	<input type="checkbox"/>	<input type="checkbox"/>	<input type="checkbox"/>	<input type="checkbox"/>	<input type="checkbox"/>	<input type="checkbox"/>	<input type="checkbox"/>
4		<input type="checkbox"/>	<input type="checkbox"/>	<input type="checkbox"/>	<input type="checkbox"/>	<input type="checkbox"/>	<input type="checkbox"/>	<input type="checkbox"/>	<input type="checkbox"/>	<input type="checkbox"/>	<input type="checkbox"/>	<input type="checkbox"/>	<input type="checkbox"/>	<input type="checkbox"/>	<input type="checkbox"/>	<input type="checkbox"/>	<input type="checkbox"/>	<input type="checkbox"/>	<input type="checkbox"/>	<input type="checkbox"/>	<input type="checkbox"/>	<input type="checkbox"/>	<input type="checkbox"/>	<input type="checkbox"/>	<input type="checkbox"/>	<input type="checkbox"/>	<input type="checkbox"/>	<input type="checkbox"/>

SECURITY LEVEL _____		DAYS							RELAYS																			
Time Zone	Start Time - Stop Time	S	M	T	W	T	F	S	0	1	2	3	4	5	6	7	8	9	10	11	12	13	14	15	16	17	18	
1		<input type="checkbox"/>	<input type="checkbox"/>	<input type="checkbox"/>	<input type="checkbox"/>	<input type="checkbox"/>	<input type="checkbox"/>	<input type="checkbox"/>	<input type="checkbox"/>	<input type="checkbox"/>	<input type="checkbox"/>	<input type="checkbox"/>	<input type="checkbox"/>	<input type="checkbox"/>	<input type="checkbox"/>	<input type="checkbox"/>	<input type="checkbox"/>	<input type="checkbox"/>	<input type="checkbox"/>	<input type="checkbox"/>	<input type="checkbox"/>	<input type="checkbox"/>	<input type="checkbox"/>	<input type="checkbox"/>	<input type="checkbox"/>	<input type="checkbox"/>	<input type="checkbox"/>	<input type="checkbox"/>
2		<input type="checkbox"/>	<input type="checkbox"/>	<input type="checkbox"/>	<input type="checkbox"/>	<input type="checkbox"/>	<input type="checkbox"/>	<input type="checkbox"/>	<input type="checkbox"/>	<input type="checkbox"/>	<input type="checkbox"/>	<input type="checkbox"/>	<input type="checkbox"/>	<input type="checkbox"/>	<input type="checkbox"/>	<input type="checkbox"/>	<input type="checkbox"/>	<input type="checkbox"/>	<input type="checkbox"/>	<input type="checkbox"/>	<input type="checkbox"/>	<input type="checkbox"/>	<input type="checkbox"/>	<input type="checkbox"/>	<input type="checkbox"/>	<input type="checkbox"/>	<input type="checkbox"/>	<input type="checkbox"/>
3		<input type="checkbox"/>	<input type="checkbox"/>	<input type="checkbox"/>	<input type="checkbox"/>	<input type="checkbox"/>	<input type="checkbox"/>	<input type="checkbox"/>	<input type="checkbox"/>	<input type="checkbox"/>	<input type="checkbox"/>	<input type="checkbox"/>	<input type="checkbox"/>	<input type="checkbox"/>	<input type="checkbox"/>	<input type="checkbox"/>	<input type="checkbox"/>	<input type="checkbox"/>	<input type="checkbox"/>	<input type="checkbox"/>	<input type="checkbox"/>	<input type="checkbox"/>	<input type="checkbox"/>	<input type="checkbox"/>	<input type="checkbox"/>	<input type="checkbox"/>	<input type="checkbox"/>	<input type="checkbox"/>
4		<input type="checkbox"/>	<input type="checkbox"/>	<input type="checkbox"/>	<input type="checkbox"/>	<input type="checkbox"/>	<input type="checkbox"/>	<input type="checkbox"/>	<input type="checkbox"/>	<input type="checkbox"/>	<input type="checkbox"/>	<input type="checkbox"/>	<input type="checkbox"/>	<input type="checkbox"/>	<input type="checkbox"/>	<input type="checkbox"/>	<input type="checkbox"/>	<input type="checkbox"/>	<input type="checkbox"/>	<input type="checkbox"/>	<input type="checkbox"/>	<input type="checkbox"/>	<input type="checkbox"/>	<input type="checkbox"/>	<input type="checkbox"/>	<input type="checkbox"/>	<input type="checkbox"/>	<input type="checkbox"/>

SECURITY LEVEL _____		DAYS							RELAYS																			
Time Zone	Start Time - Stop Time	S	M	T	W	T	F	S	0	1	2	3	4	5	6	7	8	9	10	11	12	13	14	15	16	17	18	
1		<input type="checkbox"/>	<input type="checkbox"/>	<input type="checkbox"/>	<input type="checkbox"/>	<input type="checkbox"/>	<input type="checkbox"/>	<input type="checkbox"/>	<input type="checkbox"/>	<input type="checkbox"/>	<input type="checkbox"/>	<input type="checkbox"/>	<input type="checkbox"/>	<input type="checkbox"/>	<input type="checkbox"/>	<input type="checkbox"/>	<input type="checkbox"/>	<input type="checkbox"/>	<input type="checkbox"/>	<input type="checkbox"/>	<input type="checkbox"/>	<input type="checkbox"/>	<input type="checkbox"/>	<input type="checkbox"/>	<input type="checkbox"/>	<input type="checkbox"/>	<input type="checkbox"/>	<input type="checkbox"/>
2		<input type="checkbox"/>	<input type="checkbox"/>	<input type="checkbox"/>	<input type="checkbox"/>	<input type="checkbox"/>	<input type="checkbox"/>	<input type="checkbox"/>	<input type="checkbox"/>	<input type="checkbox"/>	<input type="checkbox"/>	<input type="checkbox"/>	<input type="checkbox"/>	<input type="checkbox"/>	<input type="checkbox"/>	<input type="checkbox"/>	<input type="checkbox"/>	<input type="checkbox"/>	<input type="checkbox"/>	<input type="checkbox"/>	<input type="checkbox"/>	<input type="checkbox"/>	<input type="checkbox"/>	<input type="checkbox"/>	<input type="checkbox"/>	<input type="checkbox"/>	<input type="checkbox"/>	<input type="checkbox"/>
3		<input type="checkbox"/>	<input type="checkbox"/>	<input type="checkbox"/>	<input type="checkbox"/>	<input type="checkbox"/>	<input type="checkbox"/>	<input type="checkbox"/>	<input type="checkbox"/>	<input type="checkbox"/>	<input type="checkbox"/>	<input type="checkbox"/>	<input type="checkbox"/>	<input type="checkbox"/>	<input type="checkbox"/>	<input type="checkbox"/>	<input type="checkbox"/>	<input type="checkbox"/>	<input type="checkbox"/>	<input type="checkbox"/>	<input type="checkbox"/>	<input type="checkbox"/>	<input type="checkbox"/>	<input type="checkbox"/>	<input type="checkbox"/>	<input type="checkbox"/>	<input type="checkbox"/>	<input type="checkbox"/>
4		<input type="checkbox"/>	<input type="checkbox"/>	<input type="checkbox"/>	<input type="checkbox"/>	<input type="checkbox"/>	<input type="checkbox"/>	<input type="checkbox"/>	<input type="checkbox"/>	<input type="checkbox"/>	<input type="checkbox"/>	<input type="checkbox"/>	<input type="checkbox"/>	<input type="checkbox"/>	<input type="checkbox"/>	<input type="checkbox"/>	<input type="checkbox"/>	<input type="checkbox"/>	<input type="checkbox"/>	<input type="checkbox"/>	<input type="checkbox"/>	<input type="checkbox"/>	<input type="checkbox"/>	<input type="checkbox"/>	<input type="checkbox"/>	<input type="checkbox"/>	<input type="checkbox"/>	<input type="checkbox"/>

SECURITY LEVEL _____		DAYS							RELAYS																			
Time Zone	Start Time - Stop Time	S	M	T	W	T	F	S	0	1	2	3	4	5	6	7	8	9	10	11	12	13	14	15	16	17	18	
1		<input type="checkbox"/>	<input type="checkbox"/>	<input type="checkbox"/>	<input type="checkbox"/>	<input type="checkbox"/>	<input type="checkbox"/>	<input type="checkbox"/>	<input type="checkbox"/>	<input type="checkbox"/>	<input type="checkbox"/>	<input type="checkbox"/>	<input type="checkbox"/>	<input type="checkbox"/>	<input type="checkbox"/>	<input type="checkbox"/>	<input type="checkbox"/>	<input type="checkbox"/>	<input type="checkbox"/>	<input type="checkbox"/>	<input type="checkbox"/>	<input type="checkbox"/>	<input type="checkbox"/>	<input type="checkbox"/>	<input type="checkbox"/>	<input type="checkbox"/>	<input type="checkbox"/>	<input type="checkbox"/>
2		<input type="checkbox"/>	<input type="checkbox"/>	<input type="checkbox"/>	<input type="checkbox"/>	<input type="checkbox"/>	<input type="checkbox"/>	<input type="checkbox"/>	<input type="checkbox"/>	<input type="checkbox"/>	<input type="checkbox"/>	<input type="checkbox"/>	<input type="checkbox"/>	<input type="checkbox"/>	<input type="checkbox"/>	<input type="checkbox"/>	<input type="checkbox"/>	<input type="checkbox"/>	<input type="checkbox"/>	<input type="checkbox"/>	<input type="checkbox"/>	<input type="checkbox"/>	<input type="checkbox"/>	<input type="checkbox"/>	<input type="checkbox"/>	<input type="checkbox"/>	<input type="checkbox"/>	<input type="checkbox"/>
3		<input type="checkbox"/>	<input type="checkbox"/>	<input type="checkbox"/>	<input type="checkbox"/>	<input type="checkbox"/>	<input type="checkbox"/>	<input type="checkbox"/>	<input type="checkbox"/>	<input type="checkbox"/>	<input type="checkbox"/>	<input type="checkbox"/>	<input type="checkbox"/>	<input type="checkbox"/>	<input type="checkbox"/>	<input type="checkbox"/>	<input type="checkbox"/>	<input type="checkbox"/>	<input type="checkbox"/>	<input type="checkbox"/>	<input type="checkbox"/>	<input type="checkbox"/>	<input type="checkbox"/>	<input type="checkbox"/>	<input type="checkbox"/>	<input type="checkbox"/>	<input type="checkbox"/>	<input type="checkbox"/>
4		<input type="checkbox"/>	<input type="checkbox"/>	<input type="checkbox"/>	<input type="checkbox"/>	<input type="checkbox"/>	<input type="checkbox"/>	<input type="checkbox"/>	<input type="checkbox"/>	<input type="checkbox"/>	<input type="checkbox"/>	<input type="checkbox"/>	<input type="checkbox"/>	<input type="checkbox"/>	<input type="checkbox"/>	<input type="checkbox"/>	<input type="checkbox"/>	<input type="checkbox"/>	<input type="checkbox"/>	<input type="checkbox"/>	<input type="checkbox"/>	<input type="checkbox"/>	<input type="checkbox"/>	<input type="checkbox"/>	<input type="checkbox"/>	<input type="checkbox"/>	<input type="checkbox"/>	<input type="checkbox"/>

SECURITY LEVEL _____		DAYS							RELAYS																			
Time Zone	Start Time - Stop Time	S	M	T	W	T	F	S	0	1	2	3	4	5	6	7	8	9	10	11	12	13	14	15	16	17	18	
1		<input type="checkbox"/>	<input type="checkbox"/>	<input type="checkbox"/>	<input type="checkbox"/>	<input type="checkbox"/>	<input type="checkbox"/>	<input type="checkbox"/>	<input type="checkbox"/>	<input type="checkbox"/>	<input type="checkbox"/>	<input type="checkbox"/>	<input type="checkbox"/>	<input type="checkbox"/>	<input type="checkbox"/>	<input type="checkbox"/>	<input type="checkbox"/>	<input type="checkbox"/>	<input type="checkbox"/>	<input type="checkbox"/>	<input type="checkbox"/>	<input type="checkbox"/>	<input type="checkbox"/>	<input type="checkbox"/>	<input type="checkbox"/>	<input type="checkbox"/>	<input type="checkbox"/>	<input type="checkbox"/>
2		<input type="checkbox"/>	<input type="checkbox"/>	<input type="checkbox"/>	<input type="checkbox"/>	<input type="checkbox"/>	<input type="checkbox"/>	<input type="checkbox"/>	<input type="checkbox"/>	<input type="checkbox"/>	<input type="checkbox"/>	<input type="checkbox"/>	<input type="checkbox"/>	<input type="checkbox"/>	<input type="checkbox"/>	<input type="checkbox"/>	<input type="checkbox"/>	<input type="checkbox"/>	<input type="checkbox"/>	<input type="checkbox"/>	<input type="checkbox"/>	<input type="checkbox"/>	<input type="checkbox"/>	<input type="checkbox"/>	<input type="checkbox"/>	<input type="checkbox"/>	<input type="checkbox"/>	<input type="checkbox"/>
3		<input type="checkbox"/>	<input type="checkbox"/>	<input type="checkbox"/>	<input type="checkbox"/>	<input type="checkbox"/>	<input type="checkbox"/>	<input type="checkbox"/>	<input type="checkbox"/>	<input type="checkbox"/>	<input type="checkbox"/>	<input type="checkbox"/>	<input type="checkbox"/>	<input type="checkbox"/>	<input type="checkbox"/>	<input type="checkbox"/>	<input type="checkbox"/>	<input type="checkbox"/>	<input type="checkbox"/>	<input type="checkbox"/>	<input type="checkbox"/>	<input type="checkbox"/>	<input type="checkbox"/>	<input type="checkbox"/>	<input type="checkbox"/>	<input type="checkbox"/>	<input type="checkbox"/>	<input type="checkbox"/>
4		<input type="checkbox"/>	<input type="checkbox"/>	<input type="checkbox"/>	<input type="checkbox"/>	<input type="checkbox"/>	<input type="checkbox"/>	<input type="checkbox"/>	<input type="checkbox"/>	<input type="checkbox"/>	<input type="checkbox"/>	<input type="checkbox"/>	<input type="checkbox"/>	<input type="checkbox"/>	<input type="checkbox"/>	<input type="checkbox"/>	<input type="checkbox"/>	<input type="checkbox"/>	<input type="checkbox"/>	<input type="checkbox"/>	<input type="checkbox"/>	<input type="checkbox"/>	<input type="checkbox"/>	<input type="checkbox"/>	<input type="checkbox"/>	<input type="checkbox"/>	<input type="checkbox"/>	<input type="checkbox"/>

SECURITY LEVEL _____		DAYS							RELAYS																		
Time Zone	Start Time - Stop Time	S	M	T	W	T	F	S	0	1	2	3	4	5	6	7	8	9	10	11	12	13	14	15	16	17	18
1		<input type="checkbox"/>	<input type="checkbox"/>	<input type="checkbox"/>	<input type="checkbox"/>	<input type="checkbox"/>	<input type="checkbox"/>	<input type="checkbox"/>	<input type="checkbox"/>	<input type="checkbox"/>	<input type="checkbox"/>	<input type="checkbox"/>	<input type="checkbox"/>	<input type="checkbox"/>	<input type="checkbox"/>	<input type="checkbox"/>	<input type="checkbox"/>	<input type="checkbox"/>	<input type="checkbox"/>	<input type="checkbox"/>	<input type="checkbox"/>	<input type="checkbox"/>	<input type="checkbox"/>	<input type="checkbox"/>	<input type="checkbox"/>	<input type="checkbox"/>	<input type="checkbox"/>
2		<input type="checkbox"/>	<input type="checkbox"/>	<input type="checkbox"/>	<input type="checkbox"/>	<input type="checkbox"/>	<input type="checkbox"/>	<input type="checkbox"/>	<input type="checkbox"/>	<input type="checkbox"/>	<input type="checkbox"/>	<input type="checkbox"/>	<input type="checkbox"/>	<input type="checkbox"/>	<input type="checkbox"/>	<input type="checkbox"/>	<input type="checkbox"/>	<input type="checkbox"/>	<input type="checkbox"/>	<input type="checkbox"/>	<input type="checkbox"/>	<input type="checkbox"/>	<input type="checkbox"/>	<input type="checkbox"/>	<input type="checkbox"/>	<input type="checkbox"/>	
3		<input type="checkbox"/>	<input type="checkbox"/>	<input type="checkbox"/>	<input type="checkbox"/>	<input type="checkbox"/>	<input type="checkbox"/>	<input type="checkbox"/>	<input type="checkbox"/>	<input type="checkbox"/>	<input type="checkbox"/>	<input type="checkbox"/>	<input type="checkbox"/>	<input type="checkbox"/>	<input type="checkbox"/>	<input type="checkbox"/>	<input type="checkbox"/>	<input type="checkbox"/>	<input type="checkbox"/>	<input type="checkbox"/>	<input type="checkbox"/>	<input type="checkbox"/>	<input type="checkbox"/>	<input type="checkbox"/>	<input type="checkbox"/>	<input type="checkbox"/>	
4		<input type="checkbox"/>	<input type="checkbox"/>	<input type="checkbox"/>	<input type="checkbox"/>	<input type="checkbox"/>	<input type="checkbox"/>	<input type="checkbox"/>	<input type="checkbox"/>	<input type="checkbox"/>	<input type="checkbox"/>	<input type="checkbox"/>	<input type="checkbox"/>	<input type="checkbox"/>	<input type="checkbox"/>	<input type="checkbox"/>	<input type="checkbox"/>	<input type="checkbox"/>	<input type="checkbox"/>	<input type="checkbox"/>	<input type="checkbox"/>	<input type="checkbox"/>	<input type="checkbox"/>	<input type="checkbox"/>	<input type="checkbox"/>	<input type="checkbox"/>	

SECURITY LEVEL _____		DAYS							RELAYS																		
Time Zone	Start Time - Stop Time	S	M	T	W	T	F	S	0	1	2	3	4	5	6	7	8	9	10	11	12	13	14	15	16	17	18
1		<input type="checkbox"/>	<input type="checkbox"/>	<input type="checkbox"/>	<input type="checkbox"/>	<input type="checkbox"/>	<input type="checkbox"/>	<input type="checkbox"/>	<input type="checkbox"/>	<input type="checkbox"/>	<input type="checkbox"/>	<input type="checkbox"/>	<input type="checkbox"/>	<input type="checkbox"/>	<input type="checkbox"/>	<input type="checkbox"/>	<input type="checkbox"/>	<input type="checkbox"/>	<input type="checkbox"/>	<input type="checkbox"/>	<input type="checkbox"/>	<input type="checkbox"/>	<input type="checkbox"/>	<input type="checkbox"/>	<input type="checkbox"/>	<input type="checkbox"/>	
2		<input type="checkbox"/>	<input type="checkbox"/>	<input type="checkbox"/>	<input type="checkbox"/>	<input type="checkbox"/>	<input type="checkbox"/>	<input type="checkbox"/>	<input type="checkbox"/>	<input type="checkbox"/>	<input type="checkbox"/>	<input type="checkbox"/>	<input type="checkbox"/>	<input type="checkbox"/>	<input type="checkbox"/>	<input type="checkbox"/>	<input type="checkbox"/>	<input type="checkbox"/>	<input type="checkbox"/>	<input type="checkbox"/>	<input type="checkbox"/>	<input type="checkbox"/>	<input type="checkbox"/>	<input type="checkbox"/>	<input type="checkbox"/>	<input type="checkbox"/>	
3		<input type="checkbox"/>	<input type="checkbox"/>	<input type="checkbox"/>	<input type="checkbox"/>	<input type="checkbox"/>	<input type="checkbox"/>	<input type="checkbox"/>	<input type="checkbox"/>	<input type="checkbox"/>	<input type="checkbox"/>	<input type="checkbox"/>	<input type="checkbox"/>	<input type="checkbox"/>	<input type="checkbox"/>	<input type="checkbox"/>	<input type="checkbox"/>	<input type="checkbox"/>	<input type="checkbox"/>	<input type="checkbox"/>	<input type="checkbox"/>	<input type="checkbox"/>	<input type="checkbox"/>	<input type="checkbox"/>	<input type="checkbox"/>	<input type="checkbox"/>	
4		<input type="checkbox"/>	<input type="checkbox"/>	<input type="checkbox"/>	<input type="checkbox"/>	<input type="checkbox"/>	<input type="checkbox"/>	<input type="checkbox"/>	<input type="checkbox"/>	<input type="checkbox"/>	<input type="checkbox"/>	<input type="checkbox"/>	<input type="checkbox"/>	<input type="checkbox"/>	<input type="checkbox"/>	<input type="checkbox"/>	<input type="checkbox"/>	<input type="checkbox"/>	<input type="checkbox"/>	<input type="checkbox"/>	<input type="checkbox"/>	<input type="checkbox"/>	<input type="checkbox"/>	<input type="checkbox"/>	<input type="checkbox"/>	<input type="checkbox"/>	

SECURITY LEVEL _____		DAYS							RELAYS																		
Time Zone	Start Time - Stop Time	S	M	T	W	T	F	S	0	1	2	3	4	5	6	7	8	9	10	11	12	13	14	15	16	17	18
1		<input type="checkbox"/>	<input type="checkbox"/>	<input type="checkbox"/>	<input type="checkbox"/>	<input type="checkbox"/>	<input type="checkbox"/>	<input type="checkbox"/>	<input type="checkbox"/>	<input type="checkbox"/>	<input type="checkbox"/>	<input type="checkbox"/>	<input type="checkbox"/>	<input type="checkbox"/>	<input type="checkbox"/>	<input type="checkbox"/>	<input type="checkbox"/>	<input type="checkbox"/>	<input type="checkbox"/>	<input type="checkbox"/>	<input type="checkbox"/>	<input type="checkbox"/>	<input type="checkbox"/>	<input type="checkbox"/>	<input type="checkbox"/>	<input type="checkbox"/>	
2		<input type="checkbox"/>	<input type="checkbox"/>	<input type="checkbox"/>	<input type="checkbox"/>	<input type="checkbox"/>	<input type="checkbox"/>	<input type="checkbox"/>	<input type="checkbox"/>	<input type="checkbox"/>	<input type="checkbox"/>	<input type="checkbox"/>	<input type="checkbox"/>	<input type="checkbox"/>	<input type="checkbox"/>	<input type="checkbox"/>	<input type="checkbox"/>	<input type="checkbox"/>	<input type="checkbox"/>	<input type="checkbox"/>	<input type="checkbox"/>	<input type="checkbox"/>	<input type="checkbox"/>	<input type="checkbox"/>	<input type="checkbox"/>	<input type="checkbox"/>	
3		<input type="checkbox"/>	<input type="checkbox"/>	<input type="checkbox"/>	<input type="checkbox"/>	<input type="checkbox"/>	<input type="checkbox"/>	<input type="checkbox"/>	<input type="checkbox"/>	<input type="checkbox"/>	<input type="checkbox"/>	<input type="checkbox"/>	<input type="checkbox"/>	<input type="checkbox"/>	<input type="checkbox"/>	<input type="checkbox"/>	<input type="checkbox"/>	<input type="checkbox"/>	<input type="checkbox"/>	<input type="checkbox"/>	<input type="checkbox"/>	<input type="checkbox"/>	<input type="checkbox"/>	<input type="checkbox"/>	<input type="checkbox"/>	<input type="checkbox"/>	
4		<input type="checkbox"/>	<input type="checkbox"/>	<input type="checkbox"/>	<input type="checkbox"/>	<input type="checkbox"/>	<input type="checkbox"/>	<input type="checkbox"/>	<input type="checkbox"/>	<input type="checkbox"/>	<input type="checkbox"/>	<input type="checkbox"/>	<input type="checkbox"/>	<input type="checkbox"/>	<input type="checkbox"/>	<input type="checkbox"/>	<input type="checkbox"/>	<input type="checkbox"/>	<input type="checkbox"/>	<input type="checkbox"/>	<input type="checkbox"/>	<input type="checkbox"/>	<input type="checkbox"/>	<input type="checkbox"/>	<input type="checkbox"/>	<input type="checkbox"/>	

SECURITY LEVEL _____		DAYS							RELAYS																		
Time Zone	Start Time - Stop Time	S	M	T	W	T	F	S	0	1	2	3	4	5	6	7	8	9	10	11	12	13	14	15	16	17	18
1		<input type="checkbox"/>	<input type="checkbox"/>	<input type="checkbox"/>	<input type="checkbox"/>	<input type="checkbox"/>	<input type="checkbox"/>	<input type="checkbox"/>	<input type="checkbox"/>	<input type="checkbox"/>	<input type="checkbox"/>	<input type="checkbox"/>	<input type="checkbox"/>	<input type="checkbox"/>	<input type="checkbox"/>	<input type="checkbox"/>	<input type="checkbox"/>	<input type="checkbox"/>	<input type="checkbox"/>	<input type="checkbox"/>	<input type="checkbox"/>	<input type="checkbox"/>	<input type="checkbox"/>	<input type="checkbox"/>	<input type="checkbox"/>	<input type="checkbox"/>	
2		<input type="checkbox"/>	<input type="checkbox"/>	<input type="checkbox"/>	<input type="checkbox"/>	<input type="checkbox"/>	<input type="checkbox"/>	<input type="checkbox"/>	<input type="checkbox"/>	<input type="checkbox"/>	<input type="checkbox"/>	<input type="checkbox"/>	<input type="checkbox"/>	<input type="checkbox"/>	<input type="checkbox"/>	<input type="checkbox"/>	<input type="checkbox"/>	<input type="checkbox"/>	<input type="checkbox"/>	<input type="checkbox"/>	<input type="checkbox"/>	<input type="checkbox"/>	<input type="checkbox"/>	<input type="checkbox"/>	<input type="checkbox"/>	<input type="checkbox"/>	
3		<input type="checkbox"/>	<input type="checkbox"/>	<input type="checkbox"/>	<input type="checkbox"/>	<input type="checkbox"/>	<input type="checkbox"/>	<input type="checkbox"/>	<input type="checkbox"/>	<input type="checkbox"/>	<input type="checkbox"/>	<input type="checkbox"/>	<input type="checkbox"/>	<input type="checkbox"/>	<input type="checkbox"/>	<input type="checkbox"/>	<input type="checkbox"/>	<input type="checkbox"/>	<input type="checkbox"/>	<input type="checkbox"/>	<input type="checkbox"/>	<input type="checkbox"/>	<input type="checkbox"/>	<input type="checkbox"/>	<input type="checkbox"/>	<input type="checkbox"/>	
4		<input type="checkbox"/>	<input type="checkbox"/>	<input type="checkbox"/>	<input type="checkbox"/>	<input type="checkbox"/>	<input type="checkbox"/>	<input type="checkbox"/>	<input type="checkbox"/>	<input type="checkbox"/>	<input type="checkbox"/>	<input type="checkbox"/>	<input type="checkbox"/>	<input type="checkbox"/>	<input type="checkbox"/>	<input type="checkbox"/>	<input type="checkbox"/>	<input type="checkbox"/>	<input type="checkbox"/>	<input type="checkbox"/>	<input type="checkbox"/>	<input type="checkbox"/>	<input type="checkbox"/>	<input type="checkbox"/>	<input type="checkbox"/>	<input type="checkbox"/>	

SECURITY LEVEL _____		DAYS							RELAYS																		
Time Zone	Start Time - Stop Time	S	M	T	W	T	F	S	0	1	2	3	4	5	6	7	8	9	10	11	12	13	14	15	16	17	18
1		<input type="checkbox"/>	<input type="checkbox"/>	<input type="checkbox"/>	<input type="checkbox"/>	<input type="checkbox"/>	<input type="checkbox"/>	<input type="checkbox"/>	<input type="checkbox"/>	<input type="checkbox"/>	<input type="checkbox"/>	<input type="checkbox"/>	<input type="checkbox"/>	<input type="checkbox"/>	<input type="checkbox"/>	<input type="checkbox"/>	<input type="checkbox"/>	<input type="checkbox"/>	<input type="checkbox"/>	<input type="checkbox"/>	<input type="checkbox"/>	<input type="checkbox"/>	<input type="checkbox"/>	<input type="checkbox"/>	<input type="checkbox"/>	<input type="checkbox"/>	
2		<input type="checkbox"/>	<input type="checkbox"/>	<input type="checkbox"/>	<input type="checkbox"/>	<input type="checkbox"/>	<input type="checkbox"/>	<input type="checkbox"/>	<input type="checkbox"/>	<input type="checkbox"/>	<input type="checkbox"/>	<input type="checkbox"/>	<input type="checkbox"/>	<input type="checkbox"/>	<input type="checkbox"/>	<input type="checkbox"/>	<input type="checkbox"/>	<input type="checkbox"/>	<input type="checkbox"/>	<input type="checkbox"/>	<input type="checkbox"/>	<input type="checkbox"/>	<input type="checkbox"/>	<input type="checkbox"/>	<input type="checkbox"/>	<input type="checkbox"/>	
3		<input type="checkbox"/>	<input type="checkbox"/>	<input type="checkbox"/>	<input type="checkbox"/>	<input type="checkbox"/>	<input type="checkbox"/>	<input type="checkbox"/>	<input type="checkbox"/>	<input type="checkbox"/>	<input type="checkbox"/>	<input type="checkbox"/>	<input type="checkbox"/>	<input type="checkbox"/>	<input type="checkbox"/>	<input type="checkbox"/>	<input type="checkbox"/>	<input type="checkbox"/>	<input type="checkbox"/>	<input type="checkbox"/>	<input type="checkbox"/>	<input type="checkbox"/>	<input type="checkbox"/>	<input type="checkbox"/>	<input type="checkbox"/>	<input type="checkbox"/>	
4		<input type="checkbox"/>	<input type="checkbox"/>	<input type="checkbox"/>	<input type="checkbox"/>	<input type="checkbox"/>	<input type="checkbox"/>	<input type="checkbox"/>	<input type="checkbox"/>	<input type="checkbox"/>	<input type="checkbox"/>	<input type="checkbox"/>	<input type="checkbox"/>	<input type="checkbox"/>	<input type="checkbox"/>	<input type="checkbox"/>	<input type="checkbox"/>	<input type="checkbox"/>	<input type="checkbox"/>	<input type="checkbox"/>	<input type="checkbox"/>	<input type="checkbox"/>	<input type="checkbox"/>	<input type="checkbox"/>	<input type="checkbox"/>	<input type="checkbox"/>	