

Relays Optocouplers R600 Series





Relays and optocouplers R600 series



Summary

R600 interfaces

Description	3
-------------------	---

Relay interfaces

Selection guide	6
R600 relay modules	7

Optocouplers interfaces

Selection guide	12
R600 optocoupler modules	13

Accessories	17
-------------------	----

Marking	18
---------------	----

Index	19
-------------	----

Applications

R600

NEW RANGE

In present automatic processes, the control device includes a computer or a PLC linked to the process with a lot of wires connecting to sensors or actuators.

These performing processors in their own activity are environmental interferences and overvoltages much sensitive.

Moreover, their action field is often limited in voltage and current of 24 V DC / 100 mA.

In order to fit voltage/current together with galvanic insulation, interface is necessary through devices providing these functions plus transmission of input/output logic signals.

The R600 range of relays and optocouplers makes it possible. These devices provide many voltage and current adjustments (5 to 400 V / 1 mA to 12 A) and input/output insulation from 2 to 4 kV.

The ABB solution

ABB uses Entelec's know-how for providing a full range of automatic process products.

The new R600 range of relays and optocouplers is the solution for all your applications. It provides a wide panel of relay and optocoupler products with many functions.



Relay range

- Input voltage :
from 5 to 250 V AC/DC
- Voltage switching range :
from 5 to 250 V AC/DC
- Current switching range :
from 1 mA to 12 A
- Leakage current and overvoltage protection
- Relay coil forcing switch

Optocoupler range

- Input voltage :
from 5 to 250 V AC/DC
- Voltage switching range :
from 5 to 58 V DC,
from 20 to 400 V AC
- Current switching range :
from 1 mA to 5 A
- Overvoltage protection



EASY MARKING

Box function with markers type RC610
Wire connection with markers type RC65
Electrical schematic of the block on the side of the block

Type RC610



Type RC65

MANUAL OR AUTOMATIC FUNCTIONING

Micro-Switch allowing forcing of the coil input to 0 or 1 for interventions in equipments.

Two possibilities:

- With a visible switch located on front side. (Fig. 1)
- With a secure switch (Fig. 2) after access hatch opening (Fig. 3)

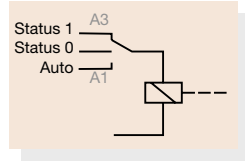

(Fig. 1)



(Fig. 3)



(Fig. 2)



FUNCTIONING STATUS

Functioning display through a green Led.

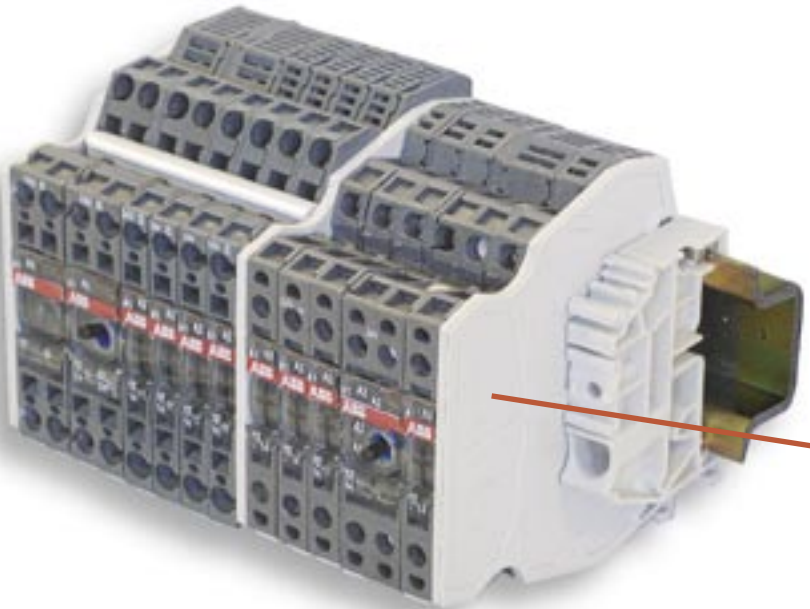

JUMPER BAR

Same jumper bar for «Screw clamp» or «Spring clamp» technologies. Independent of wire clamp and snap on held in place. Use of end sections is required to preserve IP20 protection.



DISTRIBUTION BLOCK

«Screw clamp» or «Spring clamp» technologies. With protection connected to the rail.

For polarity distribution on demand : coils and/or contacts.



MESUREMENTS - TESTS

Holes for holding DIA. 2 mm test plugs of the measurement apparatus in position.



EASY WIRING

DIA. 3,5 mm screwdriver self-gripped into spring





ABB PROVIDES A FULL SOLUTION FROM SENSOR TO MOTOR

SAVING

CONTACT LIFE INCREASED

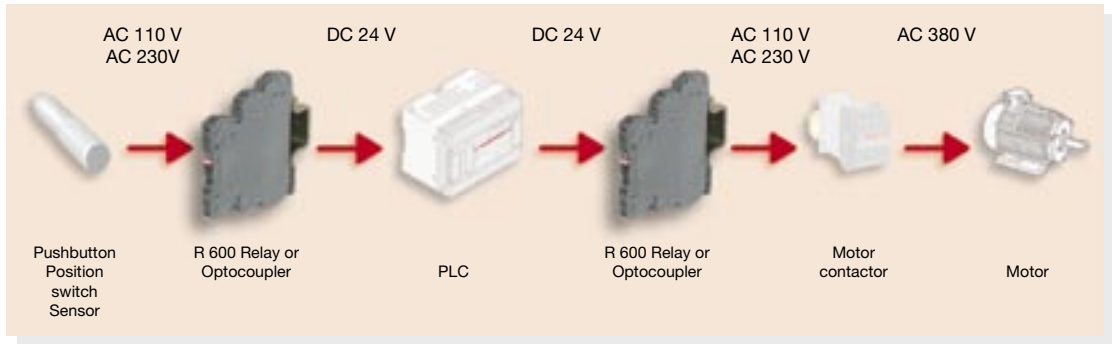
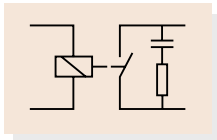

Contact protection through RC circuit

DIMENSIONS

Compact block in «spring clamp» or «screw clamp» versions with 6 mm and 12 mm spacings.

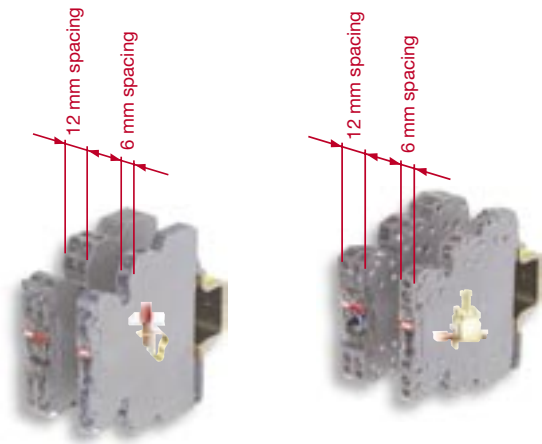
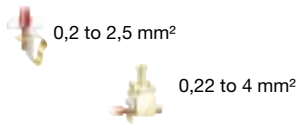

ONLY ONE PART NUMBER AC/

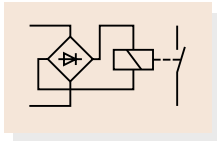

SAFETY

SEPARATION AND IDENTIFICATION OF SEVERAL VOLTAGES

Separator end sections.

IP20 PROTECTION

NO DISTURBANCE PRODUCTION

Choice of high quality electronic components to reduce leakage currents (< 50 µA).

IMMUNITY

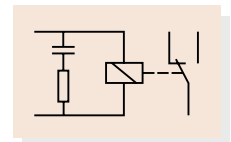

Leakage current protection

ACCORDANCE TO STANDARDS :



PERFORMANCES

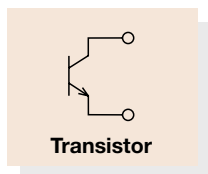
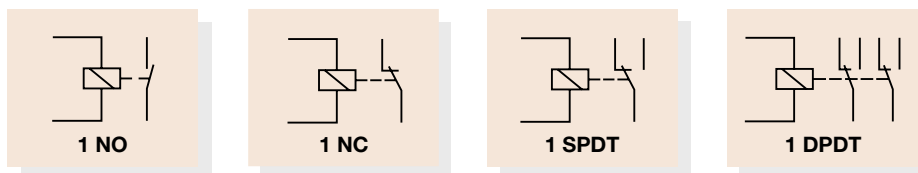

Transistor

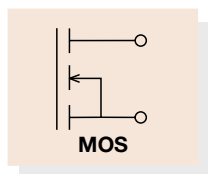

MOS

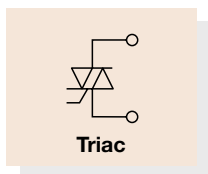

Triac

ADAPTABILITY TO ANY APPLICATION TYPE

THE PLUS IN OUR PERFORMANCES

- Triac output 400 VAC (50 Hz / 60 Hz)
- Relay output 12 A in 12 mm spacing
- 100 part numbers
- Screw clamp or spring clamp connections

Selection guide R600 Relay modules



RB..... = screw clamp



RBR..... = spring clamp



Input / Output	5 V DC	12 V DC	24 VAC/DC 50 / 60 Hz	48-60 V AC/DC 50 / 60 Hz	115 V AC/DC 50 / 60 Hz	230 V AC/DC 50 / 60 Hz
10 mA / 6 A 			RB 111 A 24 V AC/DC 1SNA 645 014 R2700 spacing : 6 mm RBR 111 A 24 V AC/DC 1SNA 645 514 R2100 spacing : 6 mm	RB 111 A 48-60 V AC/DC 1SNA 645 015 R2000 spacing : 6 mm RBR 111 A 48-60 V AC/DC 1SNA 645 515 R2200 spacing : 6 mm	RB 111 A 115 V AC/DC 1SNA 645 016 R2100 spacing : 6 mm RBR 111 A 115 V AC/DC 1SNA 645 516 R2300 spacing : 6 mm	RB 111 A 230 V AC/DC 1SNA 645 017 R2200 spacing : 6 mm RBR 111 A 230 V AC/DC 1SNA 645 517 R2400 spacing : 6 mm
10 mA / 6 A 			RB 111 AI 24 V AC/DC 1SNA 645 063 R0000 spacing : 6 mm RBR 111 AI 24 V AC/DC 1SNA 645 563 R0200 spacing : 6 mm			
10 mA / 6 A 			RB 111 AR 24 V AC/DC 1SNA 645 018 R0300 spacing : 12 mm RBR 111 AR 24 V AC/DC 1SNA 645 518 R0500 spacing : 12 mm			
10 mA / 6 A 			RB 101 AR 24 V AC/DC 1SNA 645 019 R0400 spacing : 12 mm RBR 101 AR 24 V AC/DC 1SNA 645 519 R0600 spacing : 12 mm			
10 mA / 6 A 	RB 121 5 V DC 1SNA 645 034 R2300 spacing : 6 mm RBR 121 5 V DC 1SNA 645 534 R2500 spacing : 6 mm	RB 121 12 V DC 1SNA 645 035 R2400 spacing : 6 mm RBR 121 12 V DC 1SNA 645 535 R2600 spacing : 6 mm	RB 121 A 24 V AC/DC 1SNA 645 001 R0300 spacing : 6 mm RBR 121 A 24 V AC/DC 1SNA 645 501 R0500 spacing : 6 mm	RB 121 A 48-60 V AC/DC 1SNA 645 002 R0400 spacing : 6 mm RBR 121 A 48-60 V AC/DC 1SNA 645 502 R0600 spacing : 6 mm	RB 121 A 115 V AC/DC 1SNA 645 003 R0500 spacing : 6 mm RBR 121 A 115 V AC/DC 1SNA 645 503 R0700 spacing : 6 mm	RB 121 A 230 V AC/DC 1SNA 645 004 R0400 spacing : 6 mm RBR 121 A 230 V AC/DC 1SNA 645 504 R0000 spacing : 6 mm
1 mA / 6 A 	RB 121 5 V DC 1SNA 645 036 R2500 spacing : 6 mm RBR 121 5 V DC 1SNA 645 536 R2700 spacing : 6 mm	RB 121 12 V DC 1SNA 645 037 R2700 spacing : 6 mm RBR 121 12 V DC 1SNA 645 537 R2000 spacing : 6 mm	RB 121 A 24 V AC/DC 1SNA 645 005 R0700 spacing : 6 mm RBR 121 A 24 V AC/DC 1SNA 645 505 R0100 spacing : 6 mm	RB 121 A 48-60 V AC/DC 1SNA 645 006 R0000 spacing : 6 mm RBR 121 A 48-60 V AC/DC 1SNA 645 506 R0200 spacing : 6 mm	RB 121 A 115 V AC/DC 1SNA 645 007 R0100 spacing : 6 mm RBR 121 A 115 V AC/DC 1SNA 645 507 R0300 spacing : 6 mm	RB 121 A 230 V AC/DC 1SNA 645 008 R1200 spacing : 6 mm RBR 121 A 230 V AC/DC 1SNA 645 508 R1400 spacing : 6 mm
10 mA / 6 A 			RB 121 AI 24 V AC/DC 1SNA 645 032 R2100 spacing : 12 mm RBR 121 AI 24 V AC/DC 1SNA 645 532 R2300 spacing : 12 mm			
1 mA / 6 A 			RB 121 AI 24 V AC/DC 1SNA 645 033 R2200 spacing : 12 mm RBR 121 AI 24 V AC/DC 1SNA 645 533 R2400 spacing : 12 mm			
10 mA / 6 A 			RB 121 AI 24 V AC/DC 1SNA 645 009 R1300 spacing : 12 mm RBR 121 AI 24 V AC/DC 1SNA 645 509 R1500 spacing : 12 mm			
1 mA / 6 A 			RB 121 AI 24 V AC/DC 1SNA 645 010 R0700 spacing : 12 mm RBR 121 AI 24 V AC/DC 1SNA 645 510 R0100 spacing : 12 mm			
10 mA / 6 A 					RB 121 AR 115 V AC/DC 1SNA 645 046 R0700 spacing : 12 mm RBR 121 AR 115 V AC/DC 1SNA 645 546 R0100 spacing : 12 mm	RB 121 AR 230 V AC/DC 1SNA 645 011 R2500 spacing : 12 mm RBR 121 AR 230 V AC/DC 1SNA 645 511 R2600 spacing : 12 mm
1 mA / 6 A 			RB 122 A 24 V AC/DC 1SNA 645 012 R2500 spacing : 12 mm RBR 122 A 24 V AC/DC 1SNA 645 512 R2700 spacing : 12 mm	RB 122 A 48-60 V AC/DC 1SNA 645 040 R1500 spacing : 12 mm RBR 122 A 48-60 V AC/DC 1SNA 645 540 R1700 spacing : 12 mm	RB 122 A 115 V AC/DC 1SNA 645 041 R0200 spacing : 12 mm RBR 122 A 115 V AC/DC 1SNA 645 541 R0400 spacing : 12 mm	RB 122 A 230 V AC/DC 1SNA 645 013 R2600 spacing : 12 mm RBR 122 A 230 V AC/DC 1SNA 645 513 R2000 spacing : 12 mm

Relay Interfaces

Relay modules R600

DIN 3



RB...111.../RB...101... - 2,5 mm² blocks - 6 mm .236" or 12 mm .472" spacing

Characteristics

Relay characteristics COIL	RB...111A					RB...111AI	RB...111AR	RB...101AR
	24 VAC/DC	48 VAC/DC	60 VAC/DC	115 VAC/DC	230 VAC/DC	24 VAC/DC	24 VAC/DC	24 VAC/DC
Rated voltage +20%, -15% on DC ; +10%, -10% on AC	24 VAC/DC	48 VAC/DC	60 VAC/DC	115 VAC/DC	±10% on AC +10% -15% on DC 230 VAC/DC	24 VAC/DC	24 VAC/DC	24 VAC/DC
Frequency	50 / 60 Hz	50 / 60 Hz	50 / 60 Hz	50 / 60 Hz	50 / 60 Hz	50 / 60 Hz	50 / 60 Hz	50 / 60 Hz
Power	0,24 W	0,34 W	0,54 W	0,46 W	0,8 W	0,24 W	0,24 W	0,24 W
Rated current	10 mA	7 mA	9 mA	4 mA	3,5 mA	10 mA	10 mA	10 mA
Drop-out voltage at 20°C	4,5 V	8 V	8 V	17 V	27 V	4,5 V	4,5 V	4,5 V
Status device	green LED							
CONTACT								
Type	1 NO					1 NO + RC		1 NC + RC
Voltage switching range min./max.	12 V / 250 V AC							
Current switching range min./max.	10 mA / 6 A							
Load switching range	0,6 VA / 1500 VA (ohmic load) 0,6 W / 140 W							
Number of on-load operations	10 ⁵ on AC15							
Number of off-load operations	10 ⁷							
Operating speed	F 5 ms	5 ms	5 ms	6 ms	7 ms	5 ms	5 ms	5 ms
	O 8 ms	8 ms	8 ms	15 ms	15 ms	8 ms	8 ms	8 ms
Bounce	1,2 ms							
Insulation coil / contact	4000 V RMS							
Resistance to shock coil / contact	4000 V RMS							
Insulation contact / contact	1000 V RMS							
Ambient temperature storage	-40°C to +80°C							
operating	-20°C to +70°C (1)							
Other characteristics								
Body material	grey				Screw clamp UL 94 V0		Spring clamp UL 94 V0	
Wire	Solid wire				0,2 - 4 mm ² / 24 - 12 AWG		0,2 - 2,5 mm ² / 24 - 12 AWG	
size	Stranded wire				0,22 - 2,5 mm ² / 24 - 12 AWG		0,22 - 2,5 mm ² / 24 - 12 AWG	
Rated wire size					2,5 mm ² / 12 AWG		2,5 mm ² / 12 AWG	
Wire stripping length					9 mm .354"		9 mm .354"	
Recommended screwdriver					3,5 mm .137"		3,5 mm .137"	
Protection					IP20 NEMA1		IP20 NEMA1	
Recommended torque					0,4 - 0,6 Nm 3.5 - 5.3 lb.in		0,4 - 0,6 Nm 3.5 - 5.3 lb.in	
Approvals								

Reference standards CEI 947-7-1 / CEI 947-1 / CEI 1131-2 (in relevant parts) / CEI 60664-1 / CEM : IRC 1000-4-2, 3, 4, 5, 6.

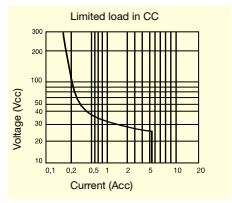

(1) Over 55°C, blocks have to be mounted on horizontal rail with 10 mm spacing between each block. For vertical rail mounting use temperature is 15°C less decreased.

	DC12	AC12	DC13	AC15
24 V	6 A	6 A	1 A	3 A
110/120 V	0,3 A	6 A	0,2 A	3 A
220/230 V	0,2 A	6 A	0,1 A	3 A

Order codes

Description	Type	Order P/N	Packaging	Weight kg
Screw clamp relay module 6 mm spacing	RB 111 A-24VAC/DC	1SNA 645 014 R2700	10	0,02
Screw clamp relay module 6 mm spacing	RB 111 A-48-60VAC/DC	1SNA 645 015 R2000	10	0,02
Screw clamp relay module 6 mm spacing	RB 111 A-115VAC/DC	1SNA 645 016 R2100	10	0,02
Screw clamp relay module 6 mm spacing	RB 111 A-230VAC/DC	1SNA 645 017 R2200	10	0,02
Screw cl. relay mod. with switch 6 mm sp.	RB 111 AI-24VAC/DC	1SNA 645 063 F0000	10	0,02
Screw cl. relay mod. w/contact protection 12 mm sp.	RB 111 AR-24VAC/DC	1SNA 645 018 F0300	5	0,03
Screw cl. relay mod. w/contact protection 12 mm sp.	RB 101 AR-24VAC/DC	1SNA 645 019 F0400	5	0,03
Spring clamp relay module 6 mm spacing	RBR 111 A-24VAC/DC	1SNA 645 514 R2100	10	0,02
Spring clamp relay module 6 mm spacing	RBR 111 A-48-60VAC/DC	1SNA 645 515 R2200	10	0,02
Spring clamp relay module 6 mm spacing	RBR 111 A-115VAC/DC	1SNA 645 516 R2300	10	0,02
Spring clamp relay module 6 mm spacing	RBR 111 A-230VAC/DC	1SNA 645 517 R2400	10	0,02
Spring cl. relay mod. with switch 6 mm sp.	RBR 111 AI-24VAC/DC	1SNA 645 563 F0200	10	0,02
Spring cl. relay mod. w/contact protection 12 mm sp.	RBR 111 AR-24VAC/DC	1SNA 645 518 F0500	5	0,03
Spring cl. relay mod. w/contact protection 12 mm sp.	RBR 101 AR-24VAC/DC	1SNA 645 519 F0600	5	0,03

Accessories

End section	BADH V0	1SNA 116 900 F2700	50	
	BADL V0	1SNA 399 903 F0200	50	
	BAM2 V0	1SNA 399 967 F0100	50	
Separator end section	SC 612	1SNA 290 474 F0200	10	
Divisible shunt 10 poles	BJ 612-10	1SNA 290 488 F0100	10	
Divisible shunt 70 poles	BJ 612-70	1SNA 290 489 F0200	10	
Screw clamp distribution block sp. 12 mm	D4/12-3A-3A	1SNA 645 031 F2000	5	
Spring clamp distribution block sp. 12 mm	D4/12-3L-3L	1SNA 645 531 F2200	5	
Test plug DIA. 2 mm	FC2	1SNA 007 865 F2600	10	
Marking method	RC65 RC610	see marking		

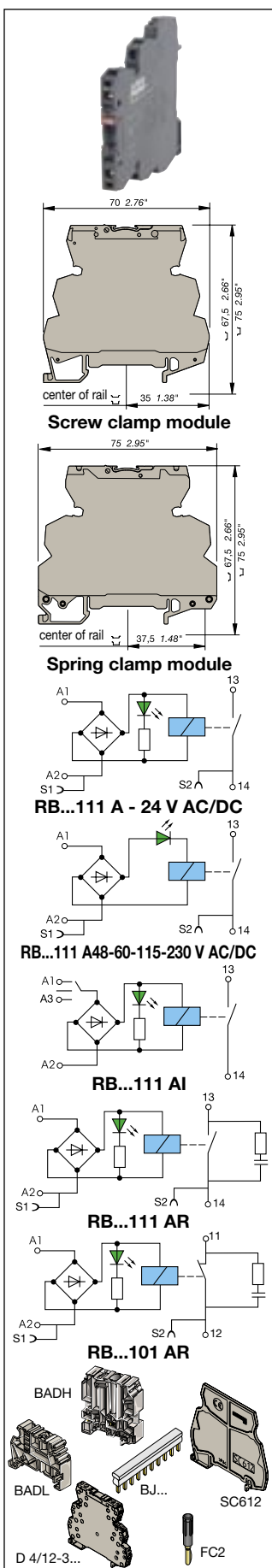

Relay Interfaces

Relay modules R600 ┌ DIN 3



RB...121... - 2,5 mm² blocks - 6 mm .236" spacing

Characteristics

Relay characteristics COIL	RB...121		RB...121A				
	Rated voltage +20%, -15% on DC ; +10%, -10% on AC	5 V DC	12 V DC	24 VAC/DC	48 V AC/DC	60 V AC/DC	115 V AC/DC
Frequency			50 / 60 Hz	50 / 60 Hz	50 / 60 Hz	50 / 60 Hz	50 / 60 Hz
Power	0,2 W	0,2 W	0,24 W	0,33 W	0,54 W	0,46 W	0,8 W
Rated current	40 mA	16 mA	10 mA	7 mA	9 mA	4 mA	3,5 mA
Drop-out voltage at 20°C	1,2 V	2,2 V	4,5 V	8 V	8 V	17 V	27 V
Status device	green LED						

CONTACT

Type	1 SPDT						
Voltage switching range min./max.	12 V / 250 V AC						
Current switching range min./max.	10 mA / 6 A						
Load switching range	0,6 VA / 1500 VA (ohmic load)						
AC1 min. / max.	0,6 W / 140 W						
DC1 min. / max.	10 ⁵ on AC15						
Number of on-load operations	10 ⁷						
Number of off-load operations	10 ⁷						
Operating speed	F	5 ms	5 ms	5 ms	5 ms	6 ms	7 ms
	O	8 ms	8 ms	8 ms	8 ms	15 ms	16 ms
Bounce	1,2 ms						
Insulation coil / contact	4000 V RMS						
Resistance to shock coil / contact	4000 V RMS						
Insulation contact / contact	1000 V RMS						
Ambient temperature storage	-40°C to +80°C						
operating	-20°C to +70°C (1)						

Other characteristics

	Screw clamp	Spring clamp
Body material	grey <input type="checkbox"/>	UL 94 V0
Wire	Solid wire	UL 94 V0
size	0,2 - 4 mm ² / 24 - 12 AWG	0,2 - 2,5 mm ² / 24 - 12 AWG
Stranded wire	0,22 - 2,5 mm ² / 24 - 12 AWG	0,22 - 2,5 mm ² / 24 - 12 AWG
Rated wire size	2,5 mm ² / 12 AWG	2,5 mm ² / 12 AWG
Wire stripping length	9 mm .354"	9 mm .354"
Recommended screwdriver	3,5 mm .137"	3,5 mm .137"
Protection	IP20 NEMA1	IP20 NEMA1
Recommended torque	0,4 - 0,6 Nm 3,5 - 5,3 lb.in	0,4 - 0,6 Nm 3,5 - 5,3 lb.in

Approvals

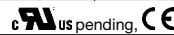

Reference standards CEI 947-7-1 / CEI 947-1 / CEI 1131-2 (in relevant parts) / CEI 60664-1 / CEM : IRC 1000-4-2, 3, 4, 5, 6.

(1) Over 55°C, blocks have to be mounted on horizontal rail with 10 mm spacing between each block. For vertical rail mounting use temperature is 15°C less decreased.

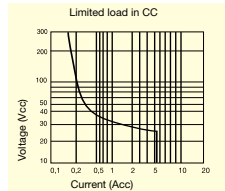

	DC12	AC12	DC13	AC15
24 V	6 A	6 A	1 A	3 A
110/120 V	0,3 A	6 A	0,2 A	3 A
220/230 V	0,2 A	6 A	0,1 A	3 A

Order codes

Description	Type	Order P/N	Packaging	Weight
Screw clamp relay module	RB 121-5VDC	1SNA 645 034 R2300	10	0,02
Screw clamp relay module	RB 121-12VDC	1SNA 645 035 R2400	10	0,02
Screw clamp relay module	RB 121 A-24VAC/DC	1SNA 645 001 R0300	10	0,02
Screw clamp relay module	RB 121 A-48-60VAC/DC	1SNA 645 002 R0400	10	0,02
Screw clamp relay module	RB 121 A-115VAC/DC	1SNA 645 003 R0500	10	0,02
Screw clamp relay module	RB 121 A-230VAC/DC	1SNA 645 004 R0400	10	0,02
Spring clamp relay module	RBR 121-5VDC	1SNA 645 534 R2500	10	0,02
Spring clamp relay module	RBR 121-12VDC	1SNA 645 535 R2600	10	0,02
Spring clamp relay module	RBR 121 A-24VAC/DC	1SNA 645 501 R0500	10	0,02
Spring clamp relay module	RBR 121 A-48-60VAC/DC	1SNA 645 502 R0600	10	0,02
Spring clamp relay module	RBR 121 A-115VAC/DC	1SNA 645 503 R0700	10	0,02
Spring clamp relay module	RBR 121 A-230VAC/DC	1SNA 645 504 R0000	10	0,02

Accessories

End section	BADH V0	1SNA 116 900 R2700	50
	BADL V0	1SNA 399 903 R0200	50
	BAM2 V0	1SNA 399 967 R0100	50
Separator end section	SC 612	1SNA 290 474 R0200	10
Divisible shunt 10 poles	BJ 612-10	1SNA 290 488 R0100	10
	BJ 612-70	1SNA 290 489 R0200	10
Screw clamp distribution block sp. 12 mm	D4/12-3A-3A	1SNA 645 031 R2000	5
Spring clamp distribution block sp. 12 mm	D4/12-3L-3L	1SNA 645 531 R2200	5
Test plug DIA. 2 mm	FC2	1SNA 007 865 R2600	10
Marking method	RC65 RC610	see marking	

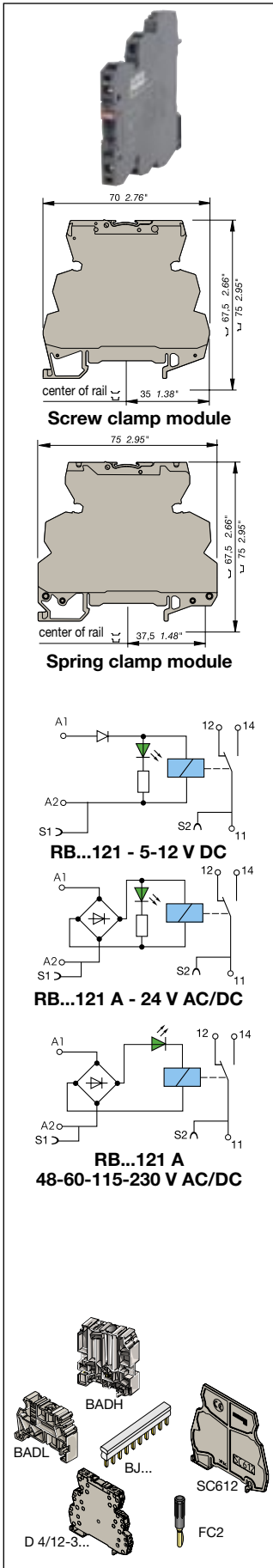

Relay Interfaces

Relay modules R600

DIN 3



RB...121... - 2,5 mm² blocks - 6 mm .236" spacing

Characteristics

Relay characteristics COIL	RB...121		RB...121A				
	Rated voltage +20%, -15% on DC ; +10%, -10% on AC	5 V DC	12 V DC	24 VAC/DC	48 V AC/DC	60 V AC/DC	115 V AC/DC
Frequency			50 / 60 Hz	50 / 60 Hz	50 / 60 Hz	50 / 60 Hz	50 / 60 Hz
Power	0,2 W	0,2 W	0,24 W	0,33 W	0,54 W	0,46 W	0,8 W
Rated current	40 mA	16 mA	10 mA	7 mA	9 mA	4 mA	3,5 mA
Drop-out voltage at 20°C	1,2 V	2,2 V	4,5 V	8 V	8 V	17 V	27 V
Status device	green LED						
CONTACT							
Type	1 SPDT						
Voltage switching range min./max.	5 V / 250 V AC						
Current switching range min./max.	1 mA / 6 A						
Load switching range	0,05 VA / 1500 VA (ohmic load) 0,05 W / 140 W						
Number of on-load operations	10 ⁵ on AC15						
Number of off-load operations	10 ⁷						
Operating speed	F 5 ms	5 ms	5 ms	5 ms	5 ms	6 ms	7 ms
	O 8 ms	8 ms	8 ms	8 ms	8 ms	15 ms	16 ms
Bounce	1,2 ms						
Insulation coil / contact	4000 V RMS						
Resistance to shock coil / contact	4000 V RMS						
Insulation contact / contact	1000 V RMS						
Ambient temperature storage	-40°C to +80°C						
operating	-20°C to +70°C (1)						
Other characteristics							
Body material	grey <input type="checkbox"/>			Screw clamp UL 94 V0		Spring clamp UL 94 V0	
Wire	Solid wire		0,2 - 4 mm ² / 24 - 12 AWG		0,2 - 2,5 mm ² / 24 - 12 AWG		
size	Stranded wire		0,22 - 2,5 mm ² / 24 - 12 AWG		0,22 - 2,5 mm ² / 24 - 12 AWG		
Rated wire size			2,5 mm ² / 12 AWG		2,5 mm ² / 12 AWG		
Wire stripping length			9 mm .354"		9 mm .354"		
Recommended screwdriver			3,5 mm .137"		3,5 mm .137"		
Protection			IP20 NEMA1		IP20 NEMA1		
Recommended torque			0,4 - 0,6 Nm 3.5 - 5.3 lb.in		0,4 - 0,6 Nm 3.5 - 5.3 lb.in		
Approvals	us pending,						
Reference standards	CEI 947-7-1 / CEI 947-1 / CEI 1131-2 (in relevant parts) / CEI 60664-1 / CEM : IRC 1000-4-2, 3, 4, 5, 6.						

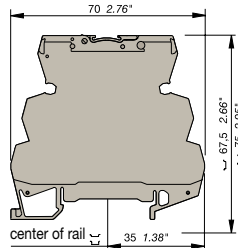

Screw clamp module

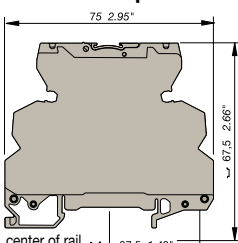

Spring clamp module

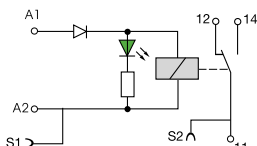

RB...121 - 5-12 V DC

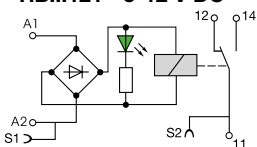

RB...121 A - 24 V AC/DC

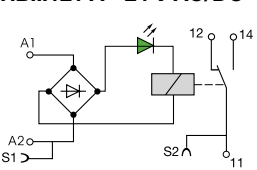

RB...121 A 48-60-115-230 V AC/DC

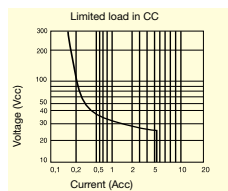

(1) Over 55°C, blocks have to be mounted on horizontal rail with 10 mm spacing between each block. For vertical rail mounting use temperature is 15°C less decreased.

	DC12	AC12	DC13	AC15
24 V	6 A	6 A	1 A	3 A
110/120 V	0,3 A	6 A	0,2 A	3 A
220/230 V	0,2 A	6 A	0,1 A	3 A

Order codes

Description	Type	Order P/N	Packaging	Weight
Screw clamp relay module low level contact	RB 121-5VDC	1SNA 645 036 R2500	10	0,02
Screw clamp relay module low level contact	RB 121-12VDC	1SNA 645 037 R2600	10	0,02
Screw clamp relay module low level contact	RB 121 A-24VAC/DC	1SNA 645 005 R0700	10	0,02
Screw clamp relay module low level contact	RB 121 A-48-60VAC/DC	1SNA 645 006 F0000	10	0,02
Screw clamp relay module low level contact	RB 121 A-115VAC/DC	1SNA 645 007 R0100	10	0,02
Screw clamp relay module low level contact	RB 121 A-230VAC/DC	1SNA 645 008 R1200	10	0,02
Spring clamp relay module low level contact	RBR 121-5VDC	1SNA 645 536 F2700	10	0,02
Spring clamp relay module low level contact	RBR 121-12VDC	1SNA 645 537 F2000	10	0,02
Spring clamp relay module low level contact	RBR 121 A-24VAC/DC	1SNA 645 505 F0100	10	0,02
Spring clamp relay module low level contact	RBR 121 A-48-60VAC/DC	1SNA 645 506 F0200	10	0,02
Spring clamp relay module low level contact	RBR 121 A-115VAC/DC	1SNA 645 507 F0300	10	0,02
Spring clamp relay module low level contact	RBR 121 A-230VAC/DC	1SNA 645 508 R1400	10	0,02

Accessories

End section	BADH V0	1SNA 116 900 F2700	50
	BADL V0	1SNA 399 903 R0200	50
	BAM2 V0	1SNA 399 967 F0100	50
Separator end section	SC 612	1SNA 290 474 F0200	10
Divisible shunt 10 poles	BJ 612-10	1SNA 290 488 F0100	10
	BJ 612-70	1SNA 290 489 F0200	10
Screw clamp distribution block sp. 12 mm	D4/12-3A-3A	1SNA 645 031 F2000	5
Spring clamp distribution block sp. 12 mm	D4/12-3L-3L	1SNA 645 531 F2200	5
Test plug DIA. 2 mm	FC2	1SNA 007 865 F2600	10
Marking method	RC65 RC610	see marking	

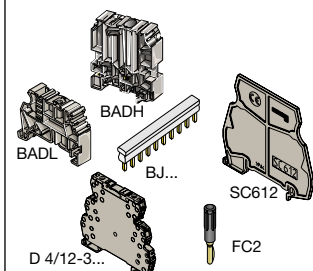

Relay Interfaces

Relay modules R600  DIN 3



RB...121 A... - 2,5 mm² blocks - 12 mm .472" spacing

Characteristics

Relay characteristics	RB...121 AR			RB...121 AI		
	COIL					
Rated voltage +20%, -15% on DC ; +10%, -10% on AC	115 V AC/DC	±10% on AC +10% -15% on DC 230 V AC/DC	24 V AC/DC	24 V AC/DC	24 V AC/DC	24 V AC/DC
Frequency	50 / 60 Hz	50 / 60 Hz	50 / 60 Hz	50 / 60 Hz	50 / 60 Hz	50 / 60 Hz
Power	2 W	2,8 W	0,24 W	0,24 W	0,24 W	0,24 W
Rated current	18 mA	12 mA	10 mA	10 mA	10 mA	10 mA
Drop-out voltage at 20°C	17 V	27 V	4,5 V	4,5 V	4,5 V	4,5 V
Status device	green LED			green LED		
CONTACT						
Type	1 SPDT			1 SPDT		
Voltage switching range min./max.	12 V / 250 V			5 V / 250 V		
Current switching range min./max.	10 mA / 6 A			1 mA / 6 A		
Load switching range	0,6 VA / 1500 VA (ohmic load) 0,6 W / 140 W			0,05 VA/1500 VA (ohmic load) 0,05 W / 140 W		
Number of on-load operations	10 ⁵ on AC15			10 ⁵ on AC15		
Number of off-load operations	10 ⁷			10 ⁷		
Operating speed	F 6 ms	7 ms	5 ms	5 ms	5 ms	5 ms
	O 15 ms	16 ms	8 ms	8 ms	8 ms	8 ms
Bounce				4000 V RMS		
Insulation coil / contact				4000 V RMS		
Resistance to shock coil / contact				1000 V RMS		
Insulation contact / contact				-40°C to +80°C		
Ambient temperature storage				-20°C to +70°C (1)		
Ambient temperature operating						
Other characteristics	Screw clamp UL 94 V0			Spring clamp UL 94 V0		
Body material	grey <input type="checkbox"/>					
Wire	Solid wire			Solid wire		
Wire size	0,2 - 4 mm ² / 24 - 12 AWG			0,2 - 2,5 mm ² / 24 - 12 AWG		
Stranded wire	0,22 - 2,5 mm ² / 24 - 12 AWG			0,22 - 2,5 mm ² / 24 - 12 AWG		
Rated wire size	2,5 mm ² / 12 AWG			2,5 mm ² / 12 AWG		
Wire stripping length	9 mm .354"			9 mm .354"		
Recommended screwdriver	3,5 mm .137"			3,5 mm .137"		
Protection	IP20 NEMA1			IP20 NEMA1		
Recommended torque	0,4 - 0,6 Nm 3.5 - 5.3 lb.in			0,4 - 0,6 Nm 3.5 - 5.3 lb.in		
Approvals				us pending, CE		
Reference standards	CEI 947-7-1 / CEI 947-1 / CEI 1131-2 (in relevant parts) / CEI 60664-1 / CEM : IRC 1000-4-2, 3, 4, 5, 6.					

(1) Over 55°C, blocks have to be mounted on horizontal rail with 10 mm spacing between each block. For vertical rail mounting use temperature is 15°C less decreased.

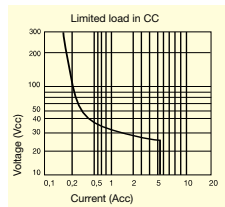

	DC12	AC12	DC13	AC15
24 V	6 A	6 A	1 A	3 A
110/120 V	0,3 A	6 A	0,2 A	3 A
220/230 V	0,2 A	6 A	0,1 A	3 A

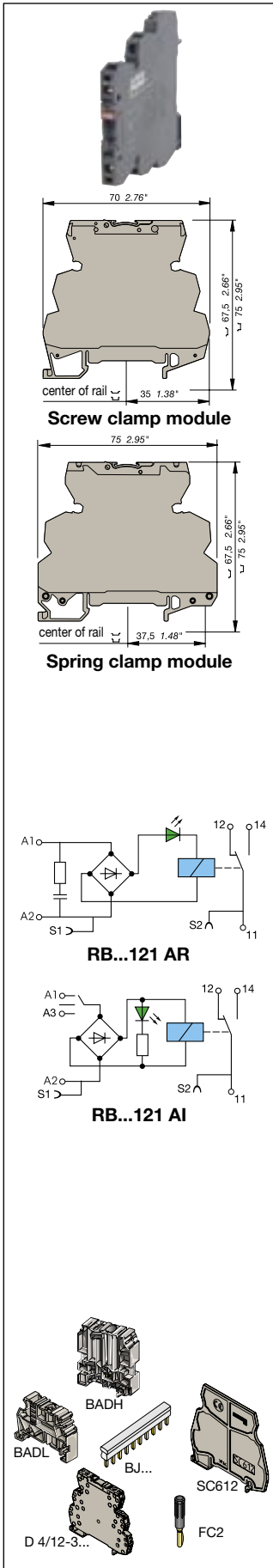

Order codes

Description	Type	Order P/N	Packaging	Weight
Screw cl. relay module w/leakage current protection	RB 121 AR-115VAC/DC	1SNA 645 046 R0700	5	0,03 kg
Screw cl. relay module w/leakage current protection	RB 121 AR-230VAC/DC	1SNA 645 011 R2400	5	0,03 kg
Screw clamp relay module with switch	RB 121 AI-24VAC/DC	1SNA 645 032 R2100	5	0,03 kg
Screw clamp relay module with safety switch	RB 121 AI-24VAC/DC	1SNA 645 009 R1300	5	0,03 kg
Screw clamp relay module low level w/switch	RB 121 AI-24VAC/DC	1SNA 645 033 R2200	5	0,03 kg
Screw clamp relay module low level w/safety switch	RB 121 AI-24VAC/DC	1SNA 645 010 R0700	5	0,03 kg
Spring cl. relay module w/leakage current protection	RBR 121 AR-115VAC/DC	1SNA 645 546 R0100	5	0,03 kg
Spring cl. relay module w/leakage current protection	RBR 121 AR-230VAC/DC	1SNA 645 511 R2600	5	0,03 kg
Spring clamp relay module with switch	RBR 121 AI-24VAC/DC	1SNA 645 532 R2300	5	0,03 kg
Spring clamp relay module with safety switch	RBR 121 AI-24VAC/DC	1SNA 645 509 R1500	5	0,03 kg
Spring clamp relay module low level w/switch	RBR 121 AI-24VAC/DC	1SNA 645 533 R2400	5	0,03 kg
Spring clamp relay module low level w/safety switch	RBR 121 AI-24VAC/DC	1SNA 645 510 R0100	5	0,03 kg

Accessories

End section	BADH V0	1SNA 116 900 R2700	50
	BADL V0	1SNA 399 903 R0200	50
	BAM2 V0	1SNA 399 967 R0100	50
Separator end section	SC 612	1SNA 290 474 R0200	10
Divisible shunt 10 poles	BJ 612-10	1SNA 290 488 R0100	10
	BJ 612-70	1SNA 290 489 R0200	10
Screw clamp distribution block sp. 12 mm	D4/12-3A-3A	1SNA 645 031 R2000	5
Spring clamp distribution block sp. 12 mm	D4/12-3L-3L	1SNA 645 531 R2200	5
Test plug DIA. 2 mm	FC2	1SNA 007 865 R2600	10
Marking method	RC65 RC610	see marking	

Relay Interfaces

Relay modules R600

DIN 3



RB...122A - 2,5 mm² blocks - 12 mm .472" spacing

Characteristics

Relay characteristics		RB...122A				
COIL						
Rated voltage +20%, -15% on DC ; +10%, -10% on AC		24 V AC/DC	48 V AC/DC	60 V AC/DC	115 V AC/DC	±10% on AC +10% -15% on DC 230 V AC/DC
Frequency		50 / 60 Hz	50 / 60 Hz	50 / 60 Hz	50 / 60 Hz	50 / 60 Hz
Power		0,48 W	0,62 W	0,96 W	0,58 W	1,15 W
Rated current		20 mA	13 mA	16 mA	5 mA	5 mA
Drop-out voltage at 20°C		5,4 V	8,8 V	8,8 V	20 V	10 V
Status device		green LED				
CONTACT						
Type		1 DPDT				
Voltage switching range min./max.		5 V / 250 V DC - 250 V AC				
Current switching range min./max.		1 mA / 6 A				
Load switching range		5 mVA / 1500 VA 5 mW / 192 W				
AC1 min. / max.						
DC1 min. / max.						
Number of on-load operations		10 ⁵				
Number of off-load operations		2 x 10 ⁷				
Operating speed						
	F	6 ms	10 ms	10 ms	6 ms	6 ms
	O	10 ms	14 ms	14 ms	15 ms	15 ms
Bounce		1 ms				
Insulation coil / contact		4000 V RMS				
Resistance to shock coil / contact		4000 V RMS				
Insulation contact / contact		3500 V RMS				
Ambient temperature storage		-40°C to +80°C				
operating		-20°C to +70°C (1)				
Other characteristics		Screw clamp		Spring clamp		
Body material	grey <input type="checkbox"/>	UL 94 V0		UL 94 V0		
Wire	Solid wire	0,2 - 4 mm ² / 24 - 12 AWG		0,2 - 2,5 mm ² / 24 - 12 AWG		
size	Stranded wire	0,22 - 2,5 mm ² / 24 - 12 AWG		0,22 - 2,5 mm ² / 24 - 12 AWG		
Rated wire size		2,5 mm ² / 12 AWG		2,5 mm ² / 12 AWG		
Wire stripping length		9 mm .354"		9 mm .354"		
Recommended screwdriver		3,5 mm .137"		3,5 mm .137"		
Protection		IP20 NEMA1		IP20 NEMA1		
Recommended torque		0,4 - 0,6 Nm	3,5 - 5,3 lb.in	0,4 - 0,6 Nm	3,5 - 5,3 lb.in	
Approvals		cULus pending, CE				

Reference standards CEI 947-1 / CEI 947-2 / CEI 1131-2 (in relevant parts) / CEI 60664-1 / CEM : IRC 1000-4-2, 3, 4, 5, 6.

(1) Over 55°C, blocks have to be mounted on horizontal rail with 10 mm spacing between each block. For vertical rail mounting use temperature is 15°C less decreased.

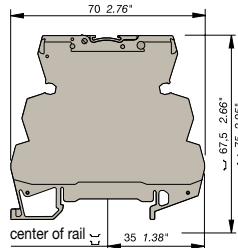

Screw clamp module

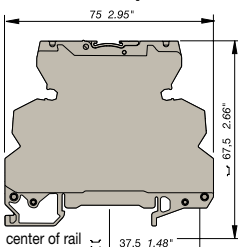

Spring clamp module

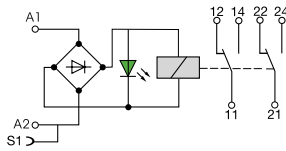

RB...122 A
24-48-60 V AC/DC

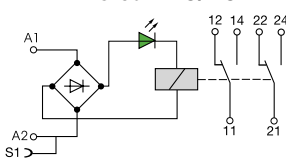

RB...122 A
115-230 V AC/DC

Order codes

Description	Type	Order P/N	Packaging	Weight
Screw clamp relay module	RB 122 A-24VAC/DC	1SNA 645 012 R2500	5	0,03
Screw clamp relay module	RB 122 A-48-60VAC/DC	1SNA 645 040 R1500	5	0,03
Screw clamp relay module	RB 122 A-115VAC/DC	1SNA 645 041 R0200	5	0,03
Screw clamp relay module	RB 122 A-230VAC/DC	1SNA 645 013 R2600	5	0,03
Spring clamp relay module	RBR 122 A-24VAC/DC	1SNA 645 512 R2700	5	0,03
Spring clamp relay module	RBR 122 A-48-60VAC/DC	1SNA 645 540 R1700	5	0,03
Spring clamp relay module	RBR 122 A-115VAC/DC	1SNA 645 541 R0400	5	0,03
Spring clamp relay module	RBR 122 A-230VAC/DC	1SNA 645 513 R2000	5	0,03

Accessories

End section	BADH V0	1SNA 116 900 R2700	50
	BADL V0	1SNA 399 903 R0200	50
	BAM2 V0	1SNA 399 967 R0100	50
Separator end section	SC 612	1SNA 290 474 R0200	10
Divisible shunt 10 poles	BJ 612-10	1SNA 290 488 R0100	10
	BJ 612-70	1SNA 290 489 R0200	10
Screw clamp distribution block sp. 12 mm	D4/12-3A-3A	1SNA 645 031 R2000	5
Spring clamp distribution block sp. 12 mm	D4/12-3L-3L	1SNA 645 531 R2200	5
Test plug DIA. 2 mm	FC2	1SNA 007 865 R2600	10
Marking method	RC65		
	RC610	see marking	

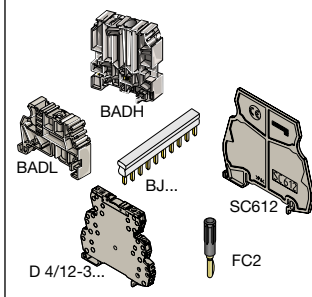

Selection guide R600 Optocoupler modules



OB..... = screw clamp



OBR..... = spring clamp



Output \ Input	5-12 V DC	24 V DC	24 VAC/DC 50 / 60 Hz	48-60 V AC/DC 50 / 60 Hz	115 V AC/DC 50 / 60 Hz	115-230 V AC/DC 50 / 60 Hz	230 V AC/DC 50 / 60 Hz
100 mA 4,5 to 58 V DC 	OBIC 0100 5-12 V DC 1SNA 645 047 R0000 spacing : 6 mm	OBIC 0100 24 V DC 1SNA 645 021 R2600 spacing : 6 mm		OBIC 0100 48-60 V AC/DC 1SNA 645 049 R1200 spacing : 6 mm		OBIC 0100 115-230 V AC/DC 1SNA 645 022 R2700 spacing : 6 mm	
	OBIC 0100 5-12 V DC 1SNA 645 547 R0200 spacing : 6 mm	OBIC 0100 24 V DC 1SNA 645 521 R2000 spacing : 6 mm		OBIC 0100 48-60 V AC/DC 1SNA 645 549 R1400 spacing : 6 mm		OBIC 0100 115-230 V AC/DC 1SNA 645 522 R2100 spacing : 6 mm	
2 A 4,5 to 58 V DC 	OBOC 1000 5-12 V DC 1SNA 645 050 R1700 spacing : 6 mm	OBOC 1000 24 V DC 1SNA 645 051 R0400 spacing : 6 mm	OBOC 1500 24 V AC/DC 1SNA 645 025 R2200 spacing : 6 mm	OBOC 1000 48-60 V AC/DC 1SNA 645 053 R0600 spacing : 6 mm	OBOC 1000 115 V AC/DC 1SNA 645 054 R0700 spacing : 6 mm		OBOC 1000 230 V AC/DC 1SNA 645 026 R2300 spacing : 6 mm
	OBOC 1000 5-12 V DC 1SNA 645 550 R1100 spacing : 6 mm	OBOC 1000 24 V DC 1SNA 645 551 R0600 spacing : 6 mm	OBOC 1500 24 V AC/DC 1SNA 645 525 R2400 spacing : 6 mm	OBOC 1000 48-60 V AC/DC 1SNA 645 553 R0000 spacing : 6 mm	OBOC 1000 115 V AC/DC 1SNA 645 554 R0100 spacing : 6 mm		OBOC 1000 230 V AC/DC 1SNA 645 526 R2500 spacing : 6 mm
5 A 4,5 to 58 V DC 		OBOC 5000 24 V DC 1SNA 645 024 R2100 spacing : 6 mm			OBOC 5000 115 V AC/DC 1SNA 645 058 R1300 spacing : 6 mm		OBOC 5000 230 V AC/DC 1SNA 645 059 R1400 spacing : 6 mm
		OBOC 5000 24 V DC 1SNA 645 524 R2300 spacing : 6 mm			OBOC 5000 115 V AC/DC 1SNA 645 558 R1500 spacing : 6 mm		OBOC 5000 230 V AC/DC 1SNA 645 559 R1600 spacing : 6 mm
1 A 24 to 400 V AC 50 / 60 Hz 		OBOA 1000 24 V DC 1SNA 645 027 R2400 spacing : 6 mm		OBOA 1000 48-60 V AC/DC 1SNA 645 061 R0600 spacing : 6 mm	OBOA 1000 115 V AC/DC 1SNA 645 062 R0700 spacing : 6 mm		OBOA 1000 230 V AC/DC 1SNA 645 028 R0500 spacing : 6 mm
		OBOA 1000 24 V DC 1SNA 645 527 R2600 spacing : 6 mm		OBOA 1000 48-60 V AC/DC 1SNA 645 561 R0000 spacing : 6 mm	OBOA 1000 115 V AC/DC 1SNA 645 562 R0100 spacing : 6 mm		OBOA 1000 230 V AC/DC 1SNA 645 528 R0700 spacing : 6 mm
2 A 10 to 230 VAC 50 / 60 Hz 			OBOA 2000 24 V AC/DC 1SNA 645 029 R0600 spacing : 6 mm				
			OBOA 2000 24 V AC/DC 1SNA 645 529 R0000 spacing : 6 mm				

Electronic Interfaces

R600 optocoupler modules

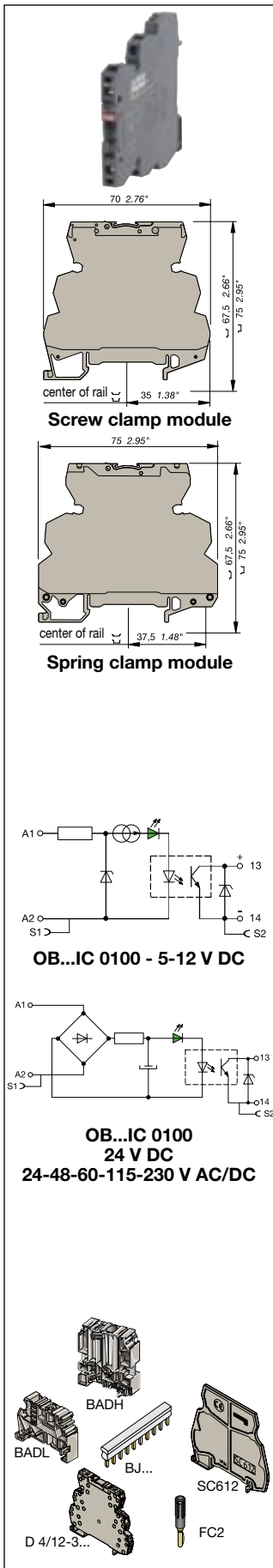

OB...IC 0100 - 2,5 mm² blocks - 6 mm .236" spacing

Characteristics

Opto. characteristics	OB...IC 0100																	
	INPUT		5 V DC - 12 V DC		24 V DC		48 V AC/DC		60 V AC/DC		115 V AC/DC		230 V AC/DC					
Input voltage +20% -15% on DC, +10% -10% on AC			5 V DC - 12 V DC		24 V DC		48 V AC/DC		60 V AC/DC		115 V AC/DC		230 V AC/DC					
Frequency			50 / 60 Hz		50 / 60 Hz		50 / 60 Hz		50 / 60 Hz		50 / 60 Hz		50 / 60 Hz					
Input current	5 mA 9 mA		4 mA		4 mA		5 mA		5 mA		5 mA		5 mA					
Pull-in voltage at I _s =100%	4 V 4 V		15 V		25 V		25 V		25 V		25 V		25 V					
Switching time C / O	10 μs / 500 μs		10 μs / 500 μs		5 ms / 20 ms		20 Hz											
Operating frequency	1000 Hz		1000 Hz															
Permissible leakage current	0,9 mA		1 mA		0,9 mA													
OUTPUT																		
Output voltage	4,5 to 58 VDC																	
Output current min.	1 mA																	
Output current max.	100 mA																	
Output leakage current at U _{max}	< 50 μA																	
Residual voltage at I _{max} and U rated	typical 1 V max. 1,3 V																	
Frequency on inductive load	20 Hz																	
Isolation Input / Output	2500 V RMS																	
TEMPERATURE																		
Ambient temperature storage	-40°C to +80°C																	
operating	-20°C to +70°C (1)																	
Other characteristics																		
Body material	grey <input type="checkbox"/> UL 94 V0						Screw clamp						Spring clamp					
Wire size	Solid wire 0,2 - 4 mm ² / 24 - 12 AWG						0,22 - 2,5 mm ² / 24 - 12 AWG						0,22 - 2,5 mm ² / 24 - 12 AWG					
Stranded wire	2,5 mm ² / 12 AWG						2,5 mm ² / 12 AWG						2,5 mm ² / 12 AWG					
Rated wire size	2,5 mm ² / 12 AWG						2,5 mm ² / 12 AWG						2,5 mm ² / 12 AWG					
Wire stripping length	9 mm .354"						9 mm .354"						9 mm .354"					
Recommended screwdriver	3,5 mm .137"						3,5 mm .137"						3,5 mm .137"					
Protection	IP20 NEMA1						IP20 NEMA1						IP20 NEMA1					
Recommended torque	0,4 - 0,6 Nm 3.5 - 5.3 lb.in						0,4 - 0,6 Nm 3.5 - 5.3 lb.in						0,4 - 0,6 Nm 3.5 - 5.3 lb.in					
Approvals																		
Reference standards	CEI 947-7-1 / CEI 947-1 / CEI 1131-2 (in relevant parts) / CEI 60664-1 / CEM : IRC 1000-4-2, 3, 4, 5, 6.																	

(1) Over 55°C, blocks have to be mounted on horizontal rail with 10 mm spacing between each block. For vertical rail mounting use temperature is 15°C less decreased.

Order codes

Description	Type	Order P/N	Packaging	Weight
Screw clamp optocoupler module 100 mA/DC	OBIC 0100-5-12VDC	1SNA 645 047 R0000	10	0,02
Screw clamp optocoupler module 100 mA/DC	OBIC 0100-24VDC	1SNA 645 021 R2600	10	0,02
Screw clamp optocoupler module 100 mA/DC	OBIC 0100-48-60VAC/DC	1SNA 645 049 R1200	10	0,02
Screw clamp optocoupler module 100 mA/DC	OBIC 0100-115-230VAC/DC	1SNA 645 022 R2700	10	0,02
Spring clamp optocoupler module 100 mA/DC	OBRIC 0100-5-12VDC	1SNA 645 547 R0200	10	0,02
Spring clamp optocoupler module 100 mA/DC	OBRIC 0100-24VDC	1SNA 645 521 R2000	10	0,02
Spring clamp optocoupler module 100 mA/DC	OBRIC 0100-48-60VAC/DC	1SNA 645 549 R1400	10	0,02
Spring clamp optocoupler module 100 mA/DC	OBRIC 0100-115-230VAC/DC	1SNA 645 522 R2100	10	0,02

Accessories

End section	BADH V0	1SNA 116 900 R2700	50
	BADL V0	1SNA 399 903 R0200	50
	BAM2 V0	1SNA 399 967 R0100	50
Separator end section	SC 612	1SNA 290 474 R0200	10
Divisible shunt 10 poles	BJ 612-10	1SNA 290 488 R0100	10
	BJ 612-70	1SNA 290 489 R0200	10
Screw clamp distribution block sp. 12 mm	D4/12-3A-3A	1SNA 645 031 R2000	5
Spring clamp distribution block sp. 12 mm	D4/12-3L-3L	1SNA 645 531 R2200	5
Test plug DIA. 2 mm	FC2	1SNA 007 865 R2600	10
Marking method	RC65 RC610	see marking	

Electronic Interfaces

R600 optocoupler modules



OB...OC 1... - 2,5 mm² blocks - 6 mm .236" spacing

Characteristics

Opto. characteristics	OB...OC 1000		OB...OC 1500	OB...OC 1000				
	INPUT	5 V DC - 12 V DC		24 V DC	24 V AC/DC	48 V AC/DC	60 V AC/DC	115 V AC/DC
Input voltage +20% -15% on DC, +10% -10% on AC	5 mA 9 mA		5,4 mA	50 / 60 Hz	50 / 60 Hz	50 / 60 Hz	50 / 60 Hz	50 / 60 Hz
Frequency	4 V		12 V	6,3 mA	4 mA	5,1 mA	4,2 mA	4 mA
Input current	2000 Hz		1000 Hz	15 V	27 V	27 V	50 V	80 V
Pull-in voltage at I _s =100%	15 μs / 250 μs		30 μs/400 μs	1 ms/7 ms	5 ms/20 ms	5 ms/20 ms	500 μs/10 ms	1 ms / 15 ms
Switching time C / O	2000 Hz		1000 Hz	60 Hz	20 Hz	20 Hz	50 Hz	35 Hz
Operating frequency	1 mA		0,8 mA	0,9 mA	1 mA	1 mA	0,3 mA	0,3 mA
Permissible leakage current								
OUTPUT				4,5 to 58 VDC				
Output voltage				1 mA				
Output current min.				2 A				
Output current max.								
Output leakage current at U _{max} .				< 50 μA				
Residual voltage at I max and U rated				0,1 V				
Frequency on inductive load				0,5 V				
Isolation Input / Output				2500 V RMS				
TEMPERATURE								
Ambient temperature storage				-40°C to +80°C				
operating				-20°C to +70°C (1)				
Other characteristics				Screw clamp		Spring clamp		
Body material	grey <input type="checkbox"/>			UL 94 V0		UL 94 V0		
Wire	Solid wire			0,2 - 4 mm ² / 24 - 12 AWG		0,2 - 2,5 mm ² / 24 - 12 AWG		
size	Stranded wire			0,22 - 2,5 mm ² / 24 - 12 AWG		0,22 - 2,5 mm ² / 24 - 12 AWG		
Rated wire size				2,5 mm ² / 12 AWG		2,5 mm ² / 12 AWG		
Wire stripping length				9 mm .354"		9 mm .354"		
Recommended screwdriver				3,5 mm .137"		3,5 mm .137"		
Protection				IP20 NEMA1		IP20 NEMA1		
Recommended torque				0,4 - 0,6 Nm 3.5 - 5.3 lb.in		0,4 - 0,6 Nm 3.5 - 5.3 lb.in		
Approvals				us pending, CE				
Reference standards				CEI 947-7-1 / CEI 947-1 / CEI 1131-2 (in relevant parts) / CEI 60664-1 / CEM : IRC 1000-4-2, 3, 4, 5, 6.				

(1) Over 55°C, blocks have to be mounted on horizontal rail with 10 mm spacing between each block. For vertical rail mounting use temperature is 15°C less decreased.

Screw clamp module
70 2.76"
67,5 2.66"
75 2.95"
center of rail 35 1.38"

Spring clamp module
75 2.95"
67,5 2.66"
75 2.95"
center of rail 37,5 1.48"

OB...OC 1000 - 5-12-24 V DC

OB...OC 1500 - 24 V AC/DC
OB...OC 1000
48-60-115-230 V AC/DC

Order codes

Description	Type	Order P/N	Packaging	Weight
Screw clamp optocoupler module 1 A/DC	OBOC 1000-5-12VDC	1SNA 645 050 R1700	10	0,02
Screw clamp optocoupler module 1 A/DC	OBOC 1000-24VDC	1SNA 645 051 R0400	10	0,02
Screw clamp optocoupler module 1,5 A/DC	OBOC 1500-24VAC/DC	1SNA 645 025 R2200	10	0,02
Screw clamp optocoupler module 1 A/DC	OBOC 1000-48-60VAC/DC	1SNA 645 053 R0600	10	0,02
Screw clamp optocoupler module 1 A/DC	OBOC 1000-115VAC/DC	1SNA 645 054 R0700	10	0,02
Screw clamp optocoupler module 1 A/DC	OBOC 1000-230VAC/DC	1SNA 645 026 R2300	10	0,02
Spring clamp optocoupler module 1 A/DC	OBROC 1000-5-12VDC	1SNA 645 550 R1100	10	0,02
Spring clamp optocoupler module 1 A/DC	OBROC 1000-24VDC	1SNA 645 551 R0600	10	0,02
Spring clamp optocoupler module 1,5 A/DC	OBROC 1500-24VAC/DC	1SNA 645 525 R2400	10	0,02
Spring clamp optocoupler module 1 A/DC	OBROC 1000-48-60VAC/DC	1SNA 645 553 R0000	10	0,02
Spring clamp optocoupler module 1 A/DC	OBROC 1000-115VAC/DC	1SNA 645 554 R0100	10	0,02
Spring clamp optocoupler module 1 A/DC	OBROC 1000-230VAC/DC	1SNA 645 526 R2500	10	0,02

Accessories

End section	BADH V0	1SNA 116 900 R2700	50
	BADL V0	1SNA 399 903 R0200	50
	BAM2 V0	1SNA 399 967 R0100	50
Separator end section	SC 612	1SNA 290 474 R0200	10
Divisible shunt 10 poles	BJ 612-10	1SNA 290 488 R0100	10
	BJ 612-70	1SNA 290 489 R0200	10
Screw clamp distribution block sp. 12 mm	D4/12-3A-3A	1SNA 645 031 R2000	5
Spring clamp distribution block sp. 12 mm	D4/12-3L-3L	1SNA 645 531 R2200	5
Test plug DIA. 2 mm	FC2	1SNA 007 865 R2600	10
Marking method	RC65 RC610	see marking	

Electronic Interfaces

R600 optocoupler modules

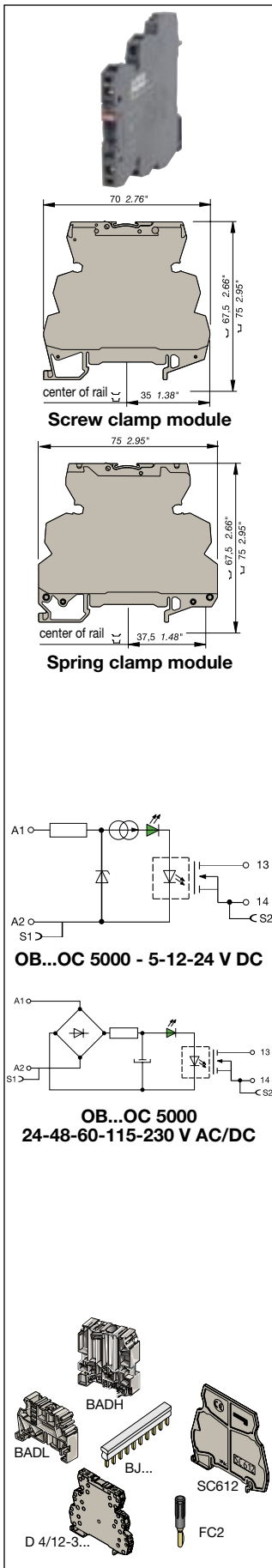

OB...OC 5000 - 2,5 mm² blocks - 6 mm .236" spacing

Characteristics

Opto. characteristics	OB...OC 5000			
	24 V DC	115 V AC/DC	230 V AC/DC	
INPUT				
Input voltage +20% -15% on DC, +10% -10% on AC	24 V DC	115 V AC/DC	230 V AC/DC	
Frequency		50 / 60 Hz	50 / 60 Hz	
Input current	5,4 mA	4,2 mA	4 mA	
Pull-in voltage at I _s =100%	12 V	50 V	80 V	
Switching time C / O	30 μs/400 μs	500 μs/10 ms	1 ms / 15 ms	
Operating frequency	1000 Hz	50 Hz	35 Hz	
Permissible leakage current	0,8 mA	0,3 mA	0,3 mA	

OUTPUT	
Output voltage	4,5 to 58 VDC
Output current min.	1 mA
Output current max.	5 A
Output leakage current at U _{max} .	< 50 μA
Residual voltage at I _{max} and U rated	0,1 V
Frequency on inductive load	0,5 V
Isolation Input / Output	2500 V RMS

TEMPERATURE	
Ambient temperature storage	-40°C to +80°C
operating	-20°C to +70°C (1)

Other characteristics	Screw clamp	Spring clamp
	Body material	grey <input type="checkbox"/> UL 94 V0
Wire size	Solid wire 0,2 - 4 mm ² / 24 - 12 AWG	0,2 - 2,5 mm ² / 24 - 12 AWG
Stranded wire	0,22 - 2,5 mm ² / 24 - 12 AWG	0,22 - 2,5 mm ² / 24 - 12 AWG
Rated wire size	2,5 mm ² / 12 AWG	2,5 mm ² / 12 AWG
Wire stripping length	9 mm .354"	9 mm .354"
Recommended screwdriver	3,5 mm .137"	3,5 mm .137"
Protection	IP20 NEMA1	IP20 NEMA1
Recommended torque	0,4 - 0,6 Nm 3.5 - 5.3 lb.in	0,4 - 0,6 Nm 3.5 - 5.3 lb.in

Approvals CE

Reference standards CEI 947-7-1 / CEI 947-1 / CEI 1131-2 (in relevant parts) / CEI 60664-1 / CEM : IRC 1000-4-2, 3, 4, 5, 6.

(1) Over 55°C, blocks have to be mounted on horizontal rail with 10 mm spacing between each block. For vertical rail mounting use temperature is 15°C less decreased.

Order codes

Description	Type	Order P/N	Packaging	Weight
			kg	kg
Screw clamp optocoupler module 5 A/DC	OB0C 5000-24VDC	1SNA 645 024 R2100	10	0,02
Screw clamp optocoupler module 5 A/DC	OB0C 5000-115VAC/DC	1SNA 645 058 R1300	10	0,02
Screw clamp optocoupler module 5 A/DC	OB0C 5000-230VAC/DC	1SNA 645 059 R1400	10	0,02
Spring clamp optocoupler module 5 A/DC	OB0C 5000-24VDC	1SNA 645 524 R2300	10	0,02
Spring clamp optocoupler module 5 A/DC	OB0C 5000-115VAC/DC	1SNA 645 558 R1500	10	0,02
Spring clamp optocoupler module 5 A/DC	OB0C 5000-230VAC/DC	1SNA 645 559 R1600	10	0,02

Accessories

End section	BADH V0	1SNA 116 900 R2700	50
	BADL V0	1SNA 399 903 R0200	50
	BAM2 V0	1SNA 399 967 R0100	50
Separator end section	SC 612	1SNA 290 474 R0200	10
Divisible shunt 10 poles	BJ 612-10	1SNA 290 488 R0100	10
	BJ 612-70	1SNA 290 489 R0200	10
Screw clamp distribution block sp. 12 mm	D4/12-3A-3A	1SNA 645 031 R2000	5
Spring clamp distribution block sp. 12 mm	D4/12-3L-3L	1SNA 645 531 R2200	5
Test plug DIA. 2 mm	FC2	1SNA 007 865 R2600	10
Marking method	RC65 RC610	see marking	

Electronic Interfaces

R600 optocoupler modules

┌ DIN 3



OB...OA 1000 / OB...OA 2000 - 2.5 mm² blocks - 6 or 12 mm spacing

Characteristics

Opto. characteristics	OB...OA 1000						OB...OA 2000
	24 V DC	48 V AC/DC	60 V AC/DC	115 V AC/DC	230 V AC/DC	24 V DC	
INPUT							
Input voltage +20% -15% on DC, +10% -10% on AC	24 V DC	48 V AC/DC	60 V AC/DC	115 V AC/DC	230 V AC/DC	24 V DC	
Frequency		50 / 60 Hz	50 / 60 Hz	50 / 60 Hz	50 / 60 Hz		
Input current	3,6 mA	4,3 mA	5,5 mA	4,15 mA	4,6 mA	3,6 mA	
Pull-in voltage at Is=100%	14 V	15 V	18 V	60 V	135 V	14 V	
Switching time C / O	150 µs/1ms	3 ms / 30 ms		2,2 ms/18 ms	2,5 ms/25 ms	150 µs/1ms	
Operating frequency	500 Hz	20 Hz	25 Hz	20 Hz	20 Hz	500 Hz	
Permissible leakage current	1 mA	1 mA	1 mA	1 mA	1 mA	1 mA	
OUTPUT							
Output voltage		24 to 400 V AC					10to230VAC
Frequency		50 / 60 Hz					50 / 60 Hz
Output current min.		25 mA					25 mA
Output current max.		1 A					2 A
Output leakage current at Umax.		< 0,5 mA					
Residual voltage at I max and U rated		1 V					
		1,6 V					
Frequency on inductive load		2500 V RMS					
Isolation Input / Output		2500 V RMS					
TEMPERATURE							
Ambient temperature storage		- 40°C to + 80°C					
operating		-20°C to +70°C (1)					
Other characteristics		Screw clamp		Spring clamp			
Body material	grey	UL 94 V0		UL 94 V0			
Wire Solid wire		0,2 - 4 mm ² / 24 - 12 AWG		0,2 - 2,5 mm ² / 24 - 12 AWG			
size Stranded wire		0,22 - 2,5 mm ² / 24 - 12 AWG		0,22 - 2,5 mm ² / 24 - 12 AWG			
Rated wire size		2,5 mm ² / 12 AWG		2,5 mm ² / 12 AWG			
Wire stripping length		9 mm .354"		9 mm .354"			
Recommended screwdriver		3,5 mm .137"		3,5 mm .137"			
Protection		IP20 NEMA1		IP20 NEMA1			
Recommended torque		0,4 - 0,6 Nm 3.5 - 5.3 lb.in		0,4 - 0,6 Nm 3.5 - 5.3 lb.in			
Approvals		us pending, CE					
Reference standards		CEI 947-7-1 / CEI 947-1 / CEI 1131-2 (in relevant parts) / CEI 60664-1 / CEM : IRC 1000-4-2, 3, 4, 5, 6.					

(1) Over 55°C, blocks have to be mounted on horizontal rail with 10 mm spacing between each block. For vertical rail mounting use temperature is 15°C less decreased.

Screw clamp module
70 2.76"
67.5 2.66"
75 2.95"
center of rail 35 1.38"

Spring clamp module
75 2.95"
67.5 2.66"
center of rail 37.5 1.48"

OB...OA 1000 - 5-12-24 V DC

OB...OA 1000 24-48-115-230 V AC/DC
OB...OA 2000 - 24 V AC/DC

Accessories: BADH, BADL, BJ..., SC612, D 4/12-3..., FC2

Order codes

Description	Type	Order P/N	Packaging	Weight kg
Screw opto. 1 A/AC	OBOA 1000-24VDC	1SNA 645 027 R2400	10	0,03
Screw opto. 1 A/AC	OBOA 1000-48-60VAC/DC	1SNA 645 061 R0600	10	0,03
Screw opto. 1 A/AC	OBOA 1000-115VAC/DC	1SNA 645 062 R0700	10	0,03
Screw opto. 1 A/AC	OBOA 1000-230VAC/DC	1SNA 645 028 R0500	10	0,03
Screw opto. 2 A/AC - 12 mm spacing	OBOA 2000-24VDC	1SNA 645 029 R0600	5	0,03
Spring opto. 1 A/AC	OBROA 1000-24VDC	1SNA 645 527 R2600	10	0,03
Spring opto. 1 A/AC	OBROA 1000-48-60VAC/DC	1SNA 645 561 R0000	10	0,03
Spring opto. 1 A/AC	OBROA 1000-115VAC/DC	1SNA 645 562 R0100	10	0,03
Spring opto. 1 A/AC	OBROA 1000-230VAC/DC	1SNA 645 528 R0700	10	0,03
Spring opto. 2 A/AC - 12 mm spacing	OBROA 2000-24VAC/DC	1SNA 645 529 R0000	5	0,03

Accessories

End section	BADH V0	1SNA 116 900 R2700	50
	BADL V0	1SNA 399 903 R0200	50
	BAM2 V0	1SNA 399 967 R0100	50
Separator end section	SC 612	1SNA 290 474 R0200	10
Divisible shunt 10 poles	BJ 612-10	1SNA 290 488 R0100	10
	BJ 612-70	1SNA 290 489 R0200	10
Screw clamp distribution block sp. 12 mm	D4/12-3A-3A	1SNA 645 031 R2000	5
Spring clamp distribution block sp. 12 mm	D4/12-3L-3L	1SNA 645 531 R2200	5
Test plug DIA. 2 mm	FC2	1SNA 007 865 R2600	10
Marking method	RC65 RC610	see marking	

Accessories

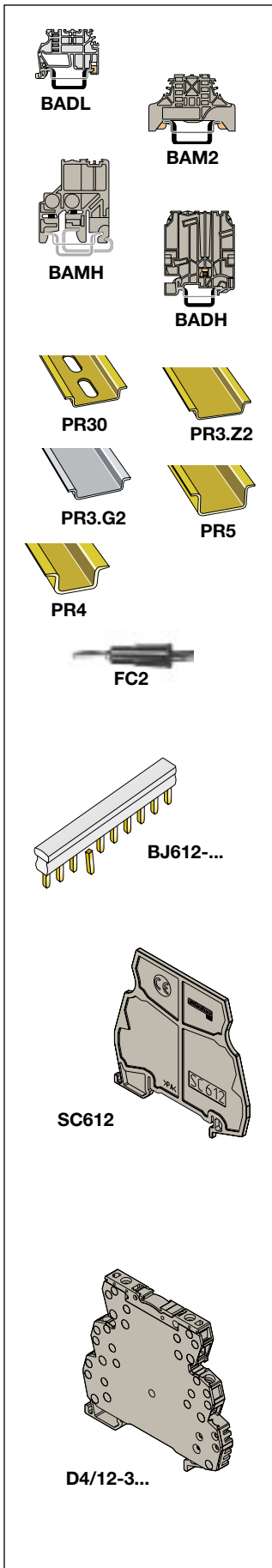

End stops

The end stops are mounted at the extremity of the terminal board assembly, giving additional support to the terminal blocks as markers. For various types of marking, refer to the marker section.

Description	Type	Order P/N	Packaging Weight kg
End stop DIN 3			
grey V0	BADL 9 mm	1SNA 399 903 R0200	50
End stop with screws DIN 3			
grey V0	BAM2 V0 10 mm	1SNA 399 967 R0100	50
grey V2	BAM2 10 mm	1SNA 206 351 R1600	50
beige V0	BAM2 V0 10 mm	1SNA 296 351 R0000	50
High end stop with screws DIN 1 and DIN 3			
grey	BAMH 9,1 mm	1SNA 114 836 R0000	50
beige V0	BAMH V0 9,1 mm	1SNA 194 836 R0100	50
High end stop with screws DIN 3			
grey	BADH 12 mm	1SNA 116 900 R2700	50

Mounting rails

Symmetrical zinc bichromate plated steel prepunched rail	PR30 2 m	1SNA 173 220 R0500	1
Symmetrical zinc bichromate plated steel rail	PR3.Z2 2 m	1SNA 174 300 R1700	1
White, symmetrical passivated galvanized steel rail	PR3.G2 2 m	1SNA 164 800 R0300	1
Symmetrical zinc bichromate plated steel rail	PR5 2 m	1SNA 168 700 R2200	1
Symmetrical zinc bichromate plated steel rail	PR4 2 m	1SNA 168 500 R1200	1

Test devices

Test plug DIA. 2 mm	FC2	1SNA 007 865 R2600	10
---------------------	-----	--------------------	----

Assembled jumper bar

This accessory permits electrical connection between 2 to 70 blocks with 6 mm spacing placed side by side. It can be used with screw clamp or spring clamp blocks with 6 mm or 12 mm spacing.

Interconnection of blocks not placed side by side is possible if teeth of the jumper bar have been cut in front of the blocks not to be connected. These teeth can be removed using pliers.

Use of separator end sections before and after the jumper bar is required to preserve IP20 protection of the assembly.

Assembled jumper bar 10 poles - 24 A	BJ612-10	1SNA 290 488 R0100	10
Assembled jumper bar 70 poles - 24 A	BJ612-70	1SNA 290 489 R0200	10

Separator end section

Directly mounted on the rail beside the block, it permits to identify and make electrical insulation of product groups using jumper bars. Dimensions are the same as screw clamp blocks : width 70 mm and height on rail 67,5 mm with 2 mm spacing.

Separator end section	SC612	1SNA 290 474 R0200	10
-----------------------	-------	--------------------	----

Distribution block

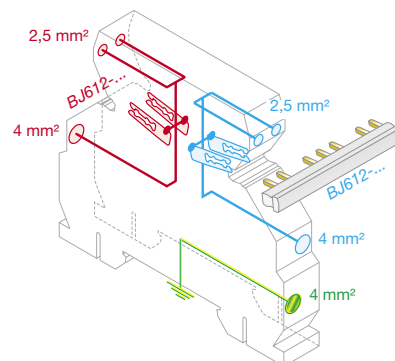

This terminal block with BJ612-... jumper bars permits 2 polarities distribution (*PCL side and process side*) thanks to two separate circuits, each of them including :

- one 4 mm² input,
- two 2,5 mm² outputs
- one double output for jumper bar BJ612-...

It permits also the connection of ground to the rail though a 4 mm² input.

Rated voltage : 250 VAC-DC
 Rated current : 32 A (4 mm²) - 16 A (2,5 mm²)
 Recommended torque : 0,4 - 0,6 Nm

Screw clamp distribution block sp. 12 mm	D4/12-3A-3A	1SNA 645 031 R2000	5
Spring clamp distribution block sp. 12 mm	D4/12-3L-3L	1SNA 645 531 R2200	5

Marking

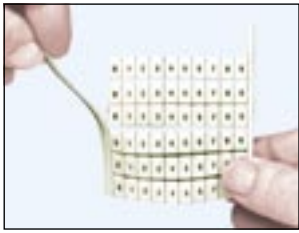

1

Remove one of the side bands of the

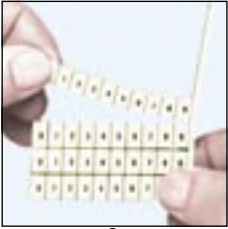

2

Separate the chosen strip from the rest of the card.

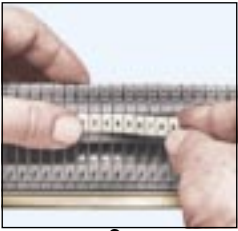

3

Press the first marker in place, hold it and slide your thumb on the rest of the strip.

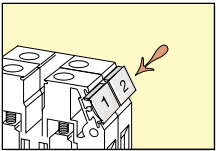

Horizontal marking

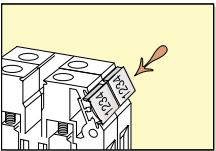

Vertical marking



Refillable box of 100 cards of 18 RC markers

Marking for Interface Modules

Selection table

Markers for modules :	RC610	RC55	RC65
R500	⊘	●	⊘
R600	●	POSSIBLE	●
R900	⊘	●	⊘
R910	●	POSSIBLE	●
R1800	⊘	●	⊘

Possible mounting : POSSIBLE

Recommended mounting : ●

Impossible mounting : ⊘

Marking for terminal blocks

Standard RC marker cards

Marker sizes	(x) = Nb of cards in 5 mm spacing kit			(x) = Nb of cards in 6 mm spacing kit		
	RC55	RC65	RC610	RC55	RC65	RC610
Blank cards	1SNA 230 000 R1200	1SNA 232 000 R0000	1SNA 233 000 R0100			
Horizontal marking						
10 strips from 1 to 10	1SNA 230 002 R0000 (5)	1SNA 232 002 R2600 (5)	1SNA 233 002 R2700 (25)			
10 strips from 11 to 20	1SNA 230 003 R0100 (2)	1SNA 232 003 R2700 (2)	1SNA 233 003 R2000 (10)			
10 strips from 21 to 30	1SNA 230 004 R0200	1SNA 232 004 R2000	1SNA 233 004 R2100 (6)			
10 strips from 31 to 40	1SNA 230 005 R0300	1SNA 232 005 R2100	1SNA 233 005 R2200 (4)			
10 strips from 41 to 50	1SNA 230 006 R0400	1SNA 232 006 R2200	1SNA 233 006 R2300 (3)			
10 strips from 51 to 60	1SNA 230 007 R0500	1SNA 232 007 R2300	1SNA 233 007 R2400 (2)			
10 strips from 61 to 70	1SNA 230 008 R1600	1SNA 232 008 R0400	1SNA 233 008 R0500 (2)			
From 1 to 100	1SNA 230 030 R0700 (2)	1SNA 232 030 R2500 (2)	1SNA 233 030 R2600 (15)			
From 101 to 200	1SNA 230 031 R2400	1SNA 232 031 R1200	1SNA 233 031 R1300 (2)			
20 times L1-L2-L3-N-PE	1SNA 230 131 R2500	1SNA 232 131 R1300	1SNA 233 131 R1400 (2)			
Vertical marking						
10 strips from 1 to 10	1SNA 230 041 R0600	1SNA 232 041 R2400	1SNA 233 041 R2500 (5)			
10 strips from 11 to 20	1SNA 230 042 R0700	1SNA 232 042 R2500	1SNA 233 042 R2600 (3)			
10 strips from 21 to 30	1SNA 230 043 R0000	1SNA 232 043 R2600	1SNA 233 043 R2700 (2)			
10 strips from 31 to 40	1SNA 230 044 R0100	1SNA 232 044 R2700	1SNA 233 044 R2000 (2)			
From 1 to 100	1SNA 230 060 R1500	1SNA 232 060 R0300	1SNA 233 060 R0400 (8)			

Marking kit RC 5 mm spacing or 6 mm spacing

Box with 100 cards with 18 various part numbers (see table next page)

Description	Type	Order P/N	Packaging Weight kg
Box with 100 cards RC 5 mm spacing		1SNA 400 085 R2700	1
Refill for box RC 5 mm		1SNA 400 145 R0700	1
Box with 100 cards RC 6 mm spacing		1SNA 400 084 R2600	1
Refill for box RC 6 mm		1SNA 400 144 R0600	1

Numerical index

Part Numbers	Pages	Part Numbers	Pages	Part Numbers	Pages	Part Numbers	Pages	Part Numbers	Pages
1SNA 007 865 R2600	17	1SNA 645 012 R2500	11	1SNA 645 548 R1300	13				
1SNA 114 836 R0000	17	1SNA 645 013 R2600	11	1SNA 645 549 R1400	13				
1SNA 116 900 R2700	17	1SNA 645 014 R2700	7	1SNA 645 550 R1100	14				
1SNA 164 800 R0300	17	1SNA 645 015 R2000	7	1SNA 645 551 R0600	14				
1SNA 168 500 R1200	17	1SNA 645 016 R2100	7	1SNA 645 553 R0000	14				
1SNA 168 700 R2200	17	1SNA 645 017 R2200	7	1SNA 645 554 R0100	14				
1SNA 173 220 R0500	17	1SNA 645 018 R0300	7	1SNA 645 558 R1500	15				
1SNA 174 300 R1700	17	1SNA 645 019 R0400	7	1SNA 645 559 R1600	15				
1SNA 194 836 R0100	17	1SNA 645 021 R2600	13	1SNA 645 560 R1300	16				
1SNA 206 351 R1600	17	1SNA 645 022 R2700	13	1SNA 645 561 R0000	16				
1SNA 230 000 R1200	18	1SNA 645 024 R2100	15	1SNA 645 562 R0100	16				
1SNA 230 002 R0000	18	1SNA 645 025 R2200	14	1SNA 645 563 R0200	7				
1SNA 230 003 R0100	18	1SNA 645 026 R2300	14						
1SNA 230 004 R0200	18	1SNA 645 027 R2400	16						
1SNA 230 005 R0300	18	1SNA 645 028 R0500	16						
1SNA 230 006 R0400	18	1SNA 645 029 R0600	16						
1SNA 230 007 R0500	18	1SNA 645 031 R2000	7						
1SNA 230 008 R1600	18	1SNA 645 032 R2100	10						
1SNA 230 030 R0700	18	1SNA 645 033 R2200	10						
1SNA 230 031 R2400	18	1SNA 645 034 R2300	8						
1SNA 230 041 R0600	18	1SNA 645 035 R2400	8						
1SNA 230 042 R0700	18	1SNA 645 036 R2500	9						
1SNA 230 043 R0000	18	1SNA 645 037 R2600	9						
1SNA 230 044 R0100	18	1SNA 645 040 R1500	11						
1SNA 230 060 R1500	18	1SNA 645 041 R0200	11						
1SNA 230 131 R2500	18	1SNA 645 046 R0700	10						
1SNA 232 000 R0000	18	1SNA 645 047 R0000	13						
1SNA 232 002 R2600	18	1SNA 645 048 R1100	13						
1SNA 232 003 R2700	18	1SNA 645 049 R1200	13						
1SNA 232 004 R2000	18	1SNA 645 050 R1700	14						
1SNA 232 005 R2100	18	1SNA 645 051 R0400	14						
1SNA 232 006 R2200	18	1SNA 645 053 R0600	14						
1SNA 232 007 R2300	18	1SNA 645 054 R0700	14						
1SNA 232 008 R0400	18	1SNA 645 055 R0000	15						
1SNA 232 030 R2500	18	1SNA 645 057 R0200	15						
1SNA 232 031 R1200	18	1SNA 645 058 R1300	15						
1SNA 232 041 R2400	18	1SNA 645 059 R1400	15						
1SNA 232 042 R2500	18	1SNA 645 061 R0600	16						
1SNA 232 043 R2600	18	1SNA 645 062 R0700	16						
1SNA 232 044 R2700	18	1SNA 645 063 R0000	7						
1SNA 232 060 R0300	18	1SNA 645 501 R0500	8						
1SNA 232 131 R1300	18	1SNA 645 502 R0600	8						
1SNA 233 000 R0100	18	1SNA 645 503 R0700	8						
1SNA 233 002 R2700	18	1SNA 645 504 R0000	8						
1SNA 233 003 R2000	18	1SNA 645 505 R0100	9						
1SNA 233 004 R2100	18	1SNA 645 506 R0200	9						
1SNA 233 005 R2200	18	1SNA 645 507 R0300	9						
1SNA 233 006 R2300	18	1SNA 645 508 R1400	9						
1SNA 233 007 R2400	18	1SNA 645 509 R1500	10						
1SNA 233 008 R0500	18	1SNA 645 510 R0100	10						
1SNA 233 030 R2600	18	1SNA 645 511 R2600	10						
1SNA 233 031 R1300	18	1SNA 645 512 R2700	11						
1SNA 233 041 R2500	18	1SNA 645 513 R2000	11						
1SNA 233 042 R2600	18	1SNA 645 514 R2100	7						
1SNA 233 043 R2700	18	1SNA 645 515 R2200	7						
1SNA 233 044 R2000	18	1SNA 645 516 R2300	7						
1SNA 233 060 R0400	18	1SNA 645 517 R2400	7						
1SNA 233 131 R1400	18	1SNA 645 518 R0500	7						
1SNA 290 474 R0200	17	1SNA 645 519 R0600	7						
1SNA 290 488 R0100	17	1SNA 645 521 R2000	13						
1SNA 290 489 R0200	17	1SNA 645 522 R2100	13						
1SNA 296 351 R0000	17	1SNA 645 524 R2300	15						
1SNA 399 903 R0200	17	1SNA 645 525 R2400	14						
1SNA 399 967 R0100	17	1SNA 645 526 R2500	14						
1SNA 400 084 R2600	18	1SNA 645 527 R2600	16						
1SNA 400 085 R2700	18	1SNA 645 528 R0700	16						
1SNA 400 144 R0600	18	1SNA 645 529 R0000	16						
1SNA 400 145 R0700	18	1SNA 645 530 R0500	16						
1SNA 645 001 R0300	8	1SNA 645 531 R2200	17						
1SNA 645 002 R0400	8	1SNA 645 532 R2300	10						
1SNA 645 003 R0500	8	1SNA 645 533 R2400	10						
1SNA 645 004 R0400	8	1SNA 645 534 R2500	8						
1SNA 645 005 R0700	9	1SNA 645 535 R2600	8						
1SNA 645 006 R0000	9	1SNA 645 536 R2700	9						
1SNA 645 007 R0100	9	1SNA 645 537 R2000	9						
1SNA 645 008 R1200	9	1SNA 645 540 R1700	11						
1SNA 645 009 R1300	10	1SNA 645 541 R0400	11						
1SNA 645 010 R0700	10	1SNA 645 546 R0100	10						
1SNA 645 011 R2400	10	1SNA 645 547 R0200	13						



**ABB Entrelec
Export Department**

10 rue Ampère Z.I. - B.P. 114
F - 69685 Chassieu cedex / France
Tel. : +33 (0) 4 7222 1722
Fax. : +33 (0) 4 7222 1935

As part of its on-going product improvement, ABB reserves the right to modify the characteristics or the products described in this document. The information given is not-contractual. For further details please contact the ABB company marketing these products in your country.

Publication
N° : TSNC 117.002.C0200
Imprimé en France (V+Y.05:2005-IBF)