

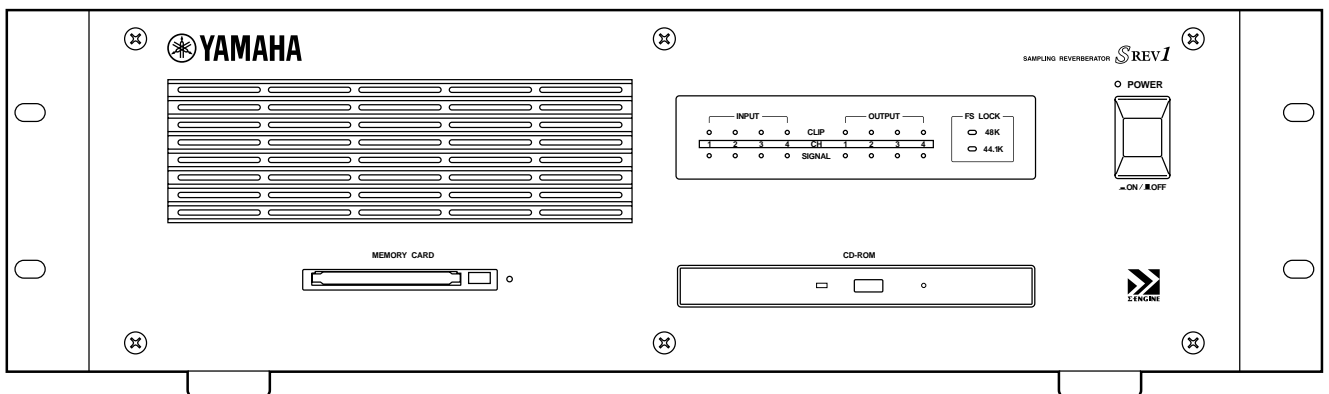

## SAMPLING REVERBERATOR

# SREV1

## Owner's Manual



Keep This Manual For Future Reference.



## FCC INFORMATION (U.S.A.)

1. **IMPORTANT NOTICE: DO NOT MODIFY THIS UNIT!** This product, when installed as indicated in the instructions contained in this manual, meets FCC requirements. Modifications not expressly approved by Yamaha may void your authority, granted by the FCC, to use the product.
2. **IMPORTANT:** When connecting this product to accessories and/or another product use only high quality shielded cables. Cable/s supplied with this product **MUST** be used. Follow all installation instructions. Failure to follow instructions could void your FCC authorization to use this product in the USA.
3. **NOTE:** This product has been tested and found to comply with the requirements listed in FCC Regulations, Part 15 for Class "B" digital devices. Compliance with these requirements provides a reasonable level of assurance that your use of this product in a residential environment will not result in harmful interference with other electronic devices. This equipment generates/uses radio frequencies and, if not installed and used according to the instructions found in the users manual, may cause interference harmful to the operation of other electronic devices. Compliance with FCC regulations does not guarantee that interference will not occur in all installations. If this product is found to be the source of interference, which can be determined by turning the unit "OFF" and "ON", please try to eliminate the problem by using one of the following measures: Relocate either this product or the device that is being affected by the interference. Utilize power outlets that are on different branch (circuit breaker or fuse) circuits or install AC line filter/s. In the case of radio or TV interference, relocate/reorient the antenna. If the antenna lead-in is 300 ohm ribbon lead, change the lead-in to coaxial type cable. If these corrective measures do not produce satisfactory results, please contact the local retailer authorized to distribute this type of product. If you can not locate the appropriate retailer, please contact Yamaha Corporation of America, Electronic Service Division, 6600 Orangethorpe Ave, Buena Park, CA 90620

The above statements apply **ONLY** to those products distributed by Yamaha Corporation of America or its subsidiaries.

**WARNING: THIS APPARATUS MUST BE EARTHED**

### IMPORTANT

THE WIRES IN THIS MAINS LEAD ARE COLOURED IN ACCORDANCE WITH THE FOLLOWING CODE:

GREEN-AND-YELLOW :	EARTH
BLUE :	NEUTRAL
BROWN :	LIVE

As the colours of the wires in the mains lead of this apparatus may not correspond with the coloured markings identifying the terminals in your plug, proceed as follows:

The wire which is coloured GREEN and YELLOW must be connected to the terminal in the plug which is marked by the letter E or by the safety earth symbol  $\perp$  or coloured GREEN and YELLOW.

The wire which is coloured BLUE must be connected to the terminal which is marked with the letter N or coloured BLACK.

The wire which is coloured BROWN must be connected to the terminal which is marked with the letter L or coloured RED.

\* This applies only to products distributed by YAMAHA KEMBLE MUSIC (U.K.) LTD.

### ADVARSEL!

Lithiumbatteri—Eksplodingsfare ved fejlagtig håndtering. Udskiftning må kun ske med batteri af samme fabrikat og type. Levér det brugte batteri tilbage til leverandoren.

### VARNING

Explosionsfara vid felaktigt batteribyte. Använd samma batterityp eller en ekvivalent typ som rekommenderas av apparattillverkaren. Kassera använt batteri enligt fabrikantens instruktion.

### VAROITUS

Paristo voi räjähtää, jos se on virheellisesti asennettu. Vaihda paristo ainoastaan laitevalmistajan suosittelemaan tyyppiin. Hävitä käytetty paristo valmistajan ohjeiden mukaisesti.

### Laser Diode Properties

- \* Material : GaAlAs
  - \* Wavelength : 765–815nm
  - \* Emission Duration : Continuous
  - \* Laser Output Power : Less than 0.22mW
- (Note) Laser output is measured at a distance of 20cm from the object lens on the optical pick-up head.

CLASS 1 LASER PRODUCT  
LASER KLASSE 1 PRODUKT  
LUOKAN 1 LASERLAITE  
KLASS 1 LASERAPPARAT

This unit is classified as a Class 1 laser product. This label is located on the rear panel.

Klassmärkning för Finland.

### CAUTION

USE OF CONTROLS OR ADJUSTMENTS OR PERFORMANCE OF PROCEDURES OTHER THAN THOSE SPECIFIED HEREIN MAY RESULT IN HAZARDOUS RADIATION EXPOSURE.

### ATTENTION

TOUTE MANIPULATION DES COMMANDES, TOUT RÉGLAGE OU TOUTE UTILISATION AUTRES QUE CEUX SPÉCIFIÉS DANS CE MANUEL POURRAIENT ENTRAÎNER UNE EXPOSITION DANGEREUSE AUX RADIATIONS.

### VORSICHT

DIE VERWENDUNG DER BEDIENELEMENTE UND EINSTELLFUNKTIONEN BZW. DAS AUSFÜHREN VON HANDLUNGEN IN EINER NICHT AUSDRÜCKLICH IN DIESER ANLEITUNG ERWAHNTEN WEISE KÖNNEN ZU EINER GESUNDHEITSSCHADLICHEN BESTRAHLUNG FÜHREN.

### PRECAUCIÓN

EL USO DE CONTROLES, AJUSTES O LA APLICACIÓN DE PROCEDIMIENTOS DISTINTOS A LOS DESCRITOS EN ESTE MANUAL, PUEDE OCASIONAR UNA EXPOSICIÓN A RADIACIÓN PELIGROSA.

---

# Important Information

---

## Read the following before using the SREV1

### Warnings

- Do not subject the unit to extreme temperatures, humidity, direct sunlight, or dust, which could be a potential fire or electrical shock hazard.
- Do not allow water to enter the unit or allow it to get wet. Fire or electrical shock may result.
- Connect the power cord or AC adapter only to an AC outlet of the type stated in this *Owner's Manual* or as marked on the unit. Failure to do so is a fire and electrical shock hazard.
- Hold the power-cord plug or AC adapter when disconnecting from an AC outlet. Never pull the cord. A power cord damaged through pulling is a potential fire and electrical shock hazard.
- Do not touch the power plug or AC adapter with wet hands. Doing so is a potential electrical shock hazard.
- Do not place heavy objects, including the unit, on top of the power cord. A damaged power cord is a fire and electrical shock hazard. In particular, be careful not to place heavy objects on a power cord covered by a carpet.
- Do not place a container with liquid or small metal objects on top of this unit. Liquid or metal objects inside this unit are a fire and electrical shock hazard.
- Do not scratch, bend, twist, pull, or heat the power cord. A damaged power cord is a fire and electrical shock hazard.
- If the power cord is damaged (e.g., cut or a bare wire is exposed), ask your dealer for a replacement. Using the unit with a damaged power cord is a fire and electrical shock hazard.
- Do not plug several pieces of equipment into the same AC outlet. This may overload the AC outlet, and could be a fire or electrical shock hazard. It may also affect the performance of some equipment.
- If you notice any abnormality, such as smoke, odor, or noise, or if a foreign object or liquid gets inside the unit, turn it off immediately. Remove the power cord or AC adapter from the AC outlet and consult your dealer for repair. Using a unit in this condition is a fire and electrical shock hazard.
- Do not place small objects on top of the unit. Metal objects falling inside is a fire and electrical shock hazard.
- If a foreign object or water gets inside the unit, turn it off immediately. Remove the power cord or AC adapter from the AC outlet and consult your dealer for repair. Using a unit in this condition is a potential fire and electrical shock hazard.
- If the unit is dropped or the cabinet damaged, turn off the power, remove the power plug or AC adapter from the AC outlet, and contact your dealer. If you continue using the unit without heeding this instruction, fire or electrical shock may result.
- Do not remove the unit covers. You could receive an electrical shock. If you think internal inspection, maintenance, or repair is necessary, contact your dealer.
- Do not attempt to modify the unit. This is a potential fire and electrical shock hazard.

- Do not block the front panel air inlet, ventilation slots, or fan outlets. Doing so is a potential fire hazard.

## Cautions

- Allow enough free space around the SREV1 for normal ventilation. This should be 20 cm behind, 10 cm at the sides, and 30 cm above. These distances should also be adopted when rack-mounting the SREV1. If the SREV1 is mounted in a portable rack case, keep the rear of the case open when using the SREV1 so as not to obstruct the flow of air from the two cooling fans. If the airflow is not adequate, the SREV1 will heat up inside and may cause a fire. Do not mount the SREV1 above equipment that produces a lot of heat, such as a power amplifier.
- Turn off all audio equipment when connecting to the unit, and use only cables of the type specified in this *Owner's Manual*.
- If you plan not to use the unit for a long period of time, remove the power cord or AC adapter from the AC outlet. Leaving the unit connected is a potential fire hazard.
- Do not use benzene, thinner, cleaning detergent, or a chemical cloth to clean the unit. Use only a soft, dry cloth.
- If the unit is stored in a cold place (e.g., overnight in a car), and then moved to a warmer environment, or if the temperature rises sharply, condensation may form inside the unit, which may affect performance. In this case, the unit should be allowed to acclimatize for about one hour before use.
- When the wordclock is changed on the wordclock master device, noise may occur from the SREV1's outputs, especially if an MY8-AT I/O card is installed, so turn down your power amps beforehand, otherwise any connected speakers may be damaged.
- If the RC-SREV1 displays the message "LOW BATTERY" when you turn on the unit, ask your Yamaha dealer to replace the internal battery as soon as possible. The unit will still work, but data other than backed up data will be lost. We recommend that you save this data to a PC Card before replacing the battery.
- For electrical safety reasons, it's important that the SREV1 is grounded properly. The supplied power cord has a three-pin plug, and if the ground terminal of the AC outlet is grounded, then the SREV1 will be grounded sufficiently through the power cord. If the AC outlet does not provide a suitable ground, however, a ground connection should be made to the dedicated grounding screw.

## Handling CD-ROMs

- Use only discs of the type specified in this *Owner's Manual*.
- The CD-ROM drive is for use with data discs only. Never insert audio CDs.
- Store discs in a place free from extreme temperatures, humidity, dust, and dirt.
- Always store discs in their cases.
- When handling discs, be careful not to touch the surface. Hold discs by the edge. Fingerprints, smudges, scratches, or dirt can affect performance.
- Be careful not to scratch the labeled side of the disc. Even scratches on that side can affect performance.
- Fingerprints and dust should be removed by wiping gently from the center of the disc towards the disc edge, using a soft, dry cloth. Never wipe in a circular motion and never rub a disc hard with a dry cloth.
- For stubborn stains and dirt, use a cleaning kit designed specifically for use with CDs. Do not use benzene, thinner, cleaning detergent, or a chemical cloth.
- For disc marking, use only pens specifically designed for writing on CDs and write only on the designated area. Do not attach a label to a disc.
- If a disc is stored in a cold place (e.g., overnight in a car), and then moved to a warmer environment, or if the temperature rises sharply, condensation may form on the disc surface, which may affect performance. In this case, the disc should be allowed to acclimatize for about one hour before use.
- Do not under any circumstances attempt to use discs that are cracked or warped. Doing so may seriously damage the unit.

## Handling PC Cards

- Use only PC Cards of the type specified in this *Owner's Manual*.
- Some PC Cards and PC Card adapters cannot be used with the SREV1.
- Do not eject a PC Card while the activity indicator is lit. Doing so may cause data loss.
- Store PC Cards in a place free from extreme temperatures, humidity, dust, and dirt.
- Always store PC Cards in their cases.

## Precautions for Transportation

During transportation, keep the CD-ROM door shut with tape, or a pad, or the like.

- When using tape, use tape that adheres well to the front panel.
- When using a pad, use a pad stiff enough that the elasticity holds the tray in place.

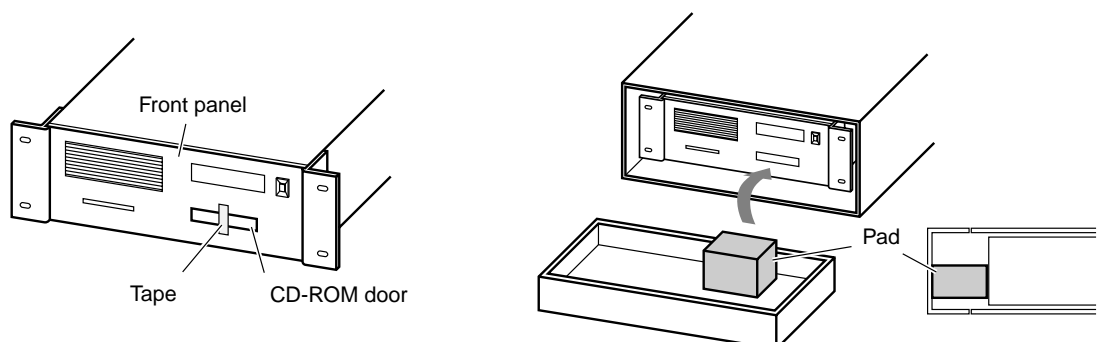

## Interference

The SREV1 uses high-frequency digital circuits that may cause interference on radio and television equipment located nearby. If interference is a problem, relocate the affected equipment.

## SREV1 Exclusion of Certain Responsibility

Manufacturer, importer, or dealer shall not be liable for any incidental damages including personal injury or any other damages caused by improper use or operation of the SREV1.

## Package Contents

The SREV1 package contains the following items:

- SREV1 Sampling Reverberator
- CD-ROM containing preset reverb programs and SREV1 utilities
- Power cord
- This *Owner's Manual*

Contact your Yamaha dealer if something is missing.

## Optional Extras

- RC-SREV1 Remote Controller
- DB-SREV1 DSP Expansion Board

## Trademarks

ADAT MultiChannel Optical Digital Interface is a trademark and ADAT and Alesis are registered trademarks of Alesis Corporation. Intel and Pentium are registered trademarks and MMX is a trademark of Intel Corporation. PCMCIA is a registered trademark of the Personal Computer Memory Card International Association. Tascam Digital Interface is a trademark and Tascam and Teac are registered trademarks of Teac Corporation. Windows is a trademark of Microsoft Corporation. Yamaha is a trademark of Yamaha Corporation. All other trademarks are the property of their respective holders and are hereby acknowledged.

## Copyright

No part of the SREV1, its software, including the supplied impulse-response data, or this *Owner's Manual* may be reproduced or distributed in any form or by any means without the prior written authorization of Yamaha Corporation. Using the supplied impulse-response data with equipment other than the SREV1, or obtaining the data by sampling or any other means, is strictly prohibited.

© 2000 Yamaha Corporation. All rights reserved.

## Yamaha Web Site

Information about the SREV1, related products, and other Yamaha professional audio equipment is available on the Yamaha Professional Audio Web site at:  
<<http://www.yamaha.co.jp/product/proaudio/homeenglish/>>.

---

## About this Manual

This *Owner's Manual* covers both the SREV1 Sampling Reverberator and the optional RC-SREV1 Remote Controller. (The SREV1 software manuals are on the CD-ROM.)

All the information you need in order to operate the SREV1 Sampling Reverberator and the optional RC-SREV1 Remote Controller is contained in this manual. Use the table of contents to familiarize yourself with its organization and locate topics, and use the index to locate specific information. A glossary of SREV1-related jargon is provided on page 93.

## Installing the SREV1

When mounting the SREV1 in a rack, remove its feet and leave adequate ventilation space all around (at least 20 cm of free space behind). If the SREV1 is mounted in a portable rack case, keep the rear of the case open when using the SREV1 so as not to obstruct the flow of air from the two cooling fans. Do not mount the SREV1 above equipment that produces a lot of heat, such as a power amplifier.

## Conventions Used in this Manual

In this manual, the SREV1 Sampling Reverberator, the optional RC-SREV1 Remote Controller, and the SREV1 software are referred to as the “SREV1,” “RC-SREV1,” and “SREV1 software” respectively.

The RC-SREV1 features two types of button: physical buttons that you can press (e.g., ENTER and UTILITY) and buttons that appear on the RC-SREV1 display pages. References to physical buttons are enclosed in square brackets, such as “press the [ENTER] button.” References to page buttons are not emphasized, for example, select the WCLK IN button.

Generally there are three versions of each RC-SREV1 display page, one for each mode: 2-channel, 4-channel, and 2-channel x2. If relevant to the task being explained, all three pages are shown. If the item being discussed is the same regardless of which mode is selected, then only one page is shown.

“PC” refers to an IBM PC-compatible computer running a Windows operating system.

**NEDERLAND**

- Dit apparaat bevat een lithium batterij voor geheugen back-up.
- Raadpleeg uw leverancier over de verwijdering van de batterij op het moment dat u het apparaat aan het einde van de levensduur afdankt of de volgende Yamaha Service Afdeling:  
Yamaha Music Nederland Service Afdeling  
Kanaalweg 18-G, 3526 KL UTRECHT  
Tel. 030-2828425
- Gooi de batterij niet weg, maar lever hem in als KCA.

**THE NETHERLANDS**

- This apparatus contains a lithium battery for memory back-up.
- For the removal of the battery at the moment of the disposal at the end of the service life please consult your retailer or Yamaha Service Center as follows:  
Yamaha Music Nederland Service Center  
Address: Kanaalweg 18-G, 3526 KL  
UTRECHT  
Tel: 030-2828425
- Do not throw away the battery. Instead, hand it in as small chemical waste.



---

# Contents

---

<b>1</b>	<b>Welcome</b>	<b>1</b>
	Welcome to the SREV1	2
	The SREV1 in a Nutshell	2
	SREV1 Features	4
	SREV1 Basics	6
	SREV1 Block Diagram	10
<b>2</b>	<b>Touring the SREV1 &amp; RC-SREV1</b>	<b>11</b>
	SREV1 Front Panel	12
	SREV1 Rear Panel	14
	RC-SREV1 Control Surface	16
	RC-SREV1 Display	18
	RC-SREV1 Rear Panel	20
<b>3</b>	<b>Getting Started</b>	<b>21</b>
	First Steps	22
	Connecting the RC-SREV1 Remote Controller	22
	Hookup Examples	23
	Connecting the Power Cord	26
	Turning On & Off the SREV1	26
	Turning On & Off the RC-SREV1	26
	Using an Optional RC-SREV1 AC Adapter	27
	Adjusting the RC-SREV1 Brightness & Contrast	27
	Using CD-ROMs	28
	Using PC Cards	29
<b>4</b>	<b>Basic Operation</b>	<b>31</b>
	SREV1 Startup	32
	RC-SREV1 Startup	32
	About the Internal Operations at Startup	33
	Selecting Reverb Modes	34
	Assigning Inputs	35
	Setting Input & Output Levels	36
	Metering	37
	Setting the Meter Mode	39
	Using Peak Hold	39
	Bypassing the SREV1	40
	Setting the Bypass Mode	40
	Using the Title Edit dialog Box	41
	Working with Quick Memories	42
	Working with the Library	45
	Working with Projects	48
<b>5</b>	<b>Editing Programs</b>	<b>51</b>
	Main 1 Parameters	52
	Main 2 Parameters	54
	Fine Reverb Parameters	56
	Pre EQ	57
	Post EQ	59
	Loading Impulse-Response Data	61

<b>6</b>	<b>Multiple SREV1s</b> .....	<b>63</b>
	About Multiple SREV1s .....	64
	Connections .....	64
	Multiple-unit Hookup with the RC-SREV1 .....	64
	Multiple-unit Operating Notes .....	65
	Selecting SREV1s from the RC-SREV1 .....	65
<b>7</b>	<b>MIDI</b> .....	<b>67</b>
	MIDI & the SREV1 .....	68
	MIDI Ports .....	68
	MIDI Pages .....	69
	Setting the MIDI Receive Channels .....	69
	Assigning Quick Memory Programs to Program Changes .....	70
	Assigning Parameters to Control Changes .....	71
<b>8</b>	<b>Wordclocks</b> .....	<b>73</b>
	Wordclocks & the SREV1 .....	74
	Wordclock Connections .....	74
	Selecting the Wordclock Source .....	75
	Wordclock Hookup Examples .....	78
<b>9</b>	<b>I/O Options</b> .....	<b>81</b>
	I/O Options & the SREV1 .....	82
	Available I/O Cards .....	82
	Choosing I/O Cards .....	83
	Installing I/O Cards .....	84
	<b>Troubleshooting</b> .....	<b>85</b>
	<b>Appendix</b> .....	<b>87</b>
	Error Messages .....	87
	Confirmation Messages .....	88
	General Messages .....	89
	General Specifications .....	90
	Digital Input Specifications .....	91
	Digital Output Specifications .....	91
	Control I/O Specifications .....	91
	Remote Cable Wiring Diagram .....	91
	Dimensions .....	92
	<b>Glossary</b> .....	<b>93</b>
	<b>Index</b> .....	<b>95</b>
	<b>MIDI Implementation Chart</b>	

# Welcome

---



## In this chapter...

Welcome to the SREV1 .....	2
The SREV1 in a Nutshell .....	2
SREV1 Features .....	4
SREV1 Basics .....	6
SREV1 Block Diagram .....	10

## Welcome to the SREV1

Thank you for choosing the Yamaha SREV1 Sampling Reverberator.

Unlike conventional digital reverberators, which synthesize reverberation using contrived signal-processing algorithms, the new SREV1 Sampling Reverberator from Yamaha employs digital convolution processing to impose an acoustic “fingerprint” of a previously measured environment onto any audio signal, faithfully recreating the original reverberation, with accurate reflection detail identical to that produced had the sound been heard in that environment. The SREV1 is perfect for recording studios, audio post, broadcast, concert halls, theaters, or anyone looking for superb quality reverb that sounds just like the real thing, with the option to sample the reverberation characteristics of any location for use back in the studio.

## The SREV1 in a Nutshell

Sonic “fingerprints” are produced by measuring the impulse response (i.e., acoustic characteristics) of an environment, which involves “blasting out” time-stretched pulses through an accurate speaker system and recording the results via carefully placed microphones. The resultant impulse-response data can then be used by the SREV1 to convolve the captured acoustic characteristics onto any audio signal.

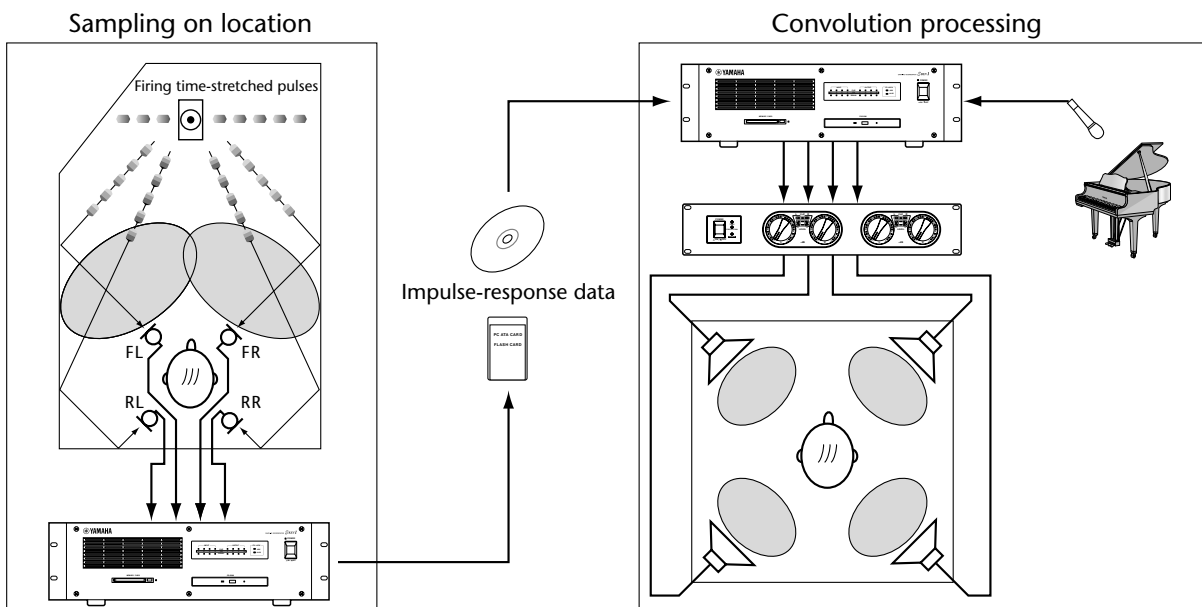

In addition to stereo reverb (2-channel mode), the SREV1 offers four-channel processing for surround reverb (4-channel mode). Alternatively, the SREV1 can be configured as two fully independent reverberators (2-channel x2 mode), each with its own inputs, outputs, and program settings.

Thirty-two of Yamaha’s new convolution chips provide the necessary “horsepower” for real-time convolution of up to 5.46 seconds per channel (2-channel mode), 2.73 seconds per channel (4-channel or 2-channel x2 mode). Featuring an additional 32 convolution chips, the optional DB-SREV1 DSP Expansion Board doubles the available convolution time to a maximum of 10.92 seconds per channel (2-channel mode), 5.46 seconds per channel (4-channel or 2-channel x2 mode).

Measured impulse response data is combined with variable parameters such as reverb time and initial delay to form reverb *programs*, which can be stored in special *Quick*

*memories* or the Internal Card or PC Card. Up to six programs can be stored in Quick memory in 2-channel or 4-channel mode; 12 in 2-channel x2 mode. Programs in Quick memory can be recalled instantly via the optional RC-SREV1 Remote Controller or MIDI Program Changes.

Projects, which contain all the Quick memory programs and the current program settings, provide a convenient way to manage programs and settings for each job. Projects can be stored on the Internal Card or PC Card.

The PC Card slot is fully compatible with the PC Card ATA specification and supports the FAT16 file system. The CD-ROM drive supports the ISO9660 Level 2 format. Both the PC Card and CD-ROM format is compatible with Windows.

The supplied CD-ROM contains preset reverb programs of famous venues from around the world, and a CD-ROM library is planned for future release. The preset programs on the supplied CD-ROM are loaded into the Internal Card at the factory.

Program editing is handled at two levels: Main parameters and Fine parameters. With Main parameter editing, channel parameters, such as reverb time, initial delay, reverb balance, EQ, etc., are grouped, so that, for example, the reverb time of all channels can be set simultaneously. Fine parameter editing adds pre-convolution 4-band PEQ, post-convolution 4-band PEQ, and impulse-response data loading. Reverb parameters can be edited individually or grouped. Reverb balance and reverb level parameters for each channel can be controlled individually via MIDI Control Changes.

Two AES/EBU inputs and outputs (providing 4 channels) are built in and two mini YGDAI (Yamaha General Digital Audio Interface) slots offer various analog and digital I/O options (AES/EBU, ADAT, Tascam). Inputs can be assigned to channels individually, allowing various input/output configurations. In 2-channel mode, for example, a single input can be assigned to both channels (left and right) for mono in/stereo out operation, or an individual input can be assigned to each channel for true stereo in/stereo out operation.

Superb sonic performance is provided by Yamaha's new convolution chip, 24-bit I/O, 32-bit internal signal processing, and 48 kHz internal wordclock. External wordclocks of 44.1 kHz and 48 kHz are supported and can be sourced via the dedicated BNC wordclock input, AES/EBU inputs, or card slot inputs.

Up to four SREV1s can be controlled using the optional RC-SREV1 Remote Controller, which features a large 320 x 240 dot graphical display, with fluorescent backlight and adjustable brightness and contrast, four motorized faders for parameter editing, and input and output clip indicators. Power is supplied by the SREV1.

## SREV1 Features

### Sonic Performance

- 32 Yamaha convolution chips
- 24-bit I/O and 32-bit internal processing
- 48 kHz internal wordclock
- 44.1 kHz or 48 kHz external wordclock

### Reverb Modes & Convolution Times

- 2-channel (stereo), 4-channel (surround), and 2-channel x2 (A and B) reverb modes
- Maximum convolution time of 5.46 seconds per channel (2-channel mode), 2.73 seconds per channel (4-channel mode or 2-channel x2 mode)
- Featuring an additional 32 convolution chips, the optional DB-SREV1 DSP Expansion Board doubles the available convolution time to a maximum of 10.92 seconds per channel (2-channel mode), 5.46 seconds per channel (4-channel or 2-channel x2 mode)

### Programs & Projects

- Programs combine impulse-response data with variable parameters such as reverb time, initial delay, EQ, and more
- Quick memories hold six instantly recallable programs (2-channel or 4-channel mode); 12 programs (2-channel x2 mode)
- Quick memory programs can be recalled via MIDI
- Projects provide a convenient way to manage programs for each job
- Programs and projects can be saved on the Internal Card or PC Card

### Storage

- PC Card slot fully compatible with the PC Card ATA specification and supports the FAT16 file system
- CD-ROM drive supports ISO9660 Level 2 format
- PC Card and CD-ROM formats compatible with Windows

### Editing

- Basic editing includes reverb time, initial delay, and reverb balance
- Advanced editing includes basic parameters plus pre-convolution 4-band PEQ, post-convolution 4-band PEQ, and impulse-response data loading for each channel
- Reverb balance and level parameters can be controlled via MIDI

## Flexible I/O

- Two AES/EBU format inputs and outputs (providing 4 channels)
- Two mini YGDAI (Yamaha General Digital Audio Interface) slots
- Optional mini YGDAI cards offer a variety of analog and digital I/O configurations, with support for all the popular digital audio interconnect formats, including AES/EBU, ADAT, and Tascam

## Optional RC-SREV1 Remote Controller

- Control up to four SREV1s
- Large 320 x 240 dot display, with fluorescent backlight and adjustable brightness and contrast
- Four motorized faders, data wheel, and INC/DEC buttons for parameter editing
- Input and output signal clip indicators
- Power supplied by the SREV1 (DC IN connector for use with optional AC adapter and custom remote cables)

## Others

- Yamaha CD-ROM library of famous venues from around the world
- SERIAL ports for multiple-unit operation
- MIDI IN and OUT ports
- BNC wordclock input
- 3U rack space

## SREV1 Basics

### Reverb Modes

The SREV1 offers three Reverb modes: 2-channel, 4-channel, and 2-channel x2. In 2-channel mode, the SREV1 functions as a stereo reverb processor. Use this mode if all you require is stereo outputs, as it offers the maximum convolution time per channel. In 4-channel mode, the SREV1 offers 4-channel processing for surround reverb. In 2-channel x2 mode, the SREV1 functions as two independent stereo reverb processors (A and B).

See page 34 for information on selecting Reverb modes.

The onboard AES/EBU inputs and mini YGDAI slot inputs can be freely assigned to channels. See “Assigning Inputs” on page 35 for more information.

### Convolution Times

The following table shows the maximum convolution time available per channel for each mode with and without the optional DB-SREV1 DSP Expansion Board installed.

Mode	Maximum Convolution Time per Channel ( $F_s = 48$ kHz)	
	Base System	with DSP Expansion Board (DB-SREV1)
2-channel	5.46 sec	10.92 sec
4-channel	2.73 sec	5.46 sec
2-channel x2	2.73 sec	5.46 sec

Convolution time is not the same as reverb time. Reverb time is the time it takes the reverb to decay to  $-60$  dB, and more convolution is required to provide reverberation to  $-90$  dB or  $-120$  dB, so the convolution time must be between 1.5 and 2 times more than the reverb time.

### Impulse-Response Data

Impulse-response data contains the impulse-response information (i.e., acoustic characteristics) of a measured environment. Preset programs come with their own impulse-response data. Each channel of a program is assigned impulse-response data, as shown below, and data can be loaded for channels individually on the Data Load pages. See “Loading Impulse-Response Data” on page 61 for more information. The impulse-response data for the preset programs is loaded into the Internal Card at the factory. It’s also on the supplied CD-ROM.

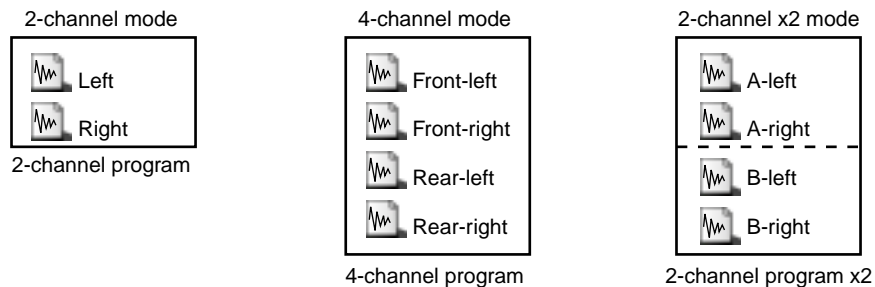



## Programs

There are two types of reverb program: 2-channel and 4-channel. Two-channel programs are for use with 2-channel mode and 2-channel x2 mode, while 4-channel programs are for use only with 4-channel mode. In 2-channel mode, 4-channel programs do not appear in the program lists and vice versa. The preset programs on the supplied CD-ROM are loaded into the Internal Card at the factory. User programs can be stored in the Quick memories, Internal Card or PC Card, where they can be write-protected.

## Projects

Projects contain all the Quick memory programs and the current program settings and free you to leave a project and come back to it at any time. Projects can be saved to the Internal Card or PC Card, where they can be write-protected.

There are three types of project: 2-channel, 4-channel, and 2-channel x2. Each project type is available only when the corresponding mode is selected. You can't, for example, select a 2-channel project in 4-channel mode. Projects are managed on the Project pages. See "Working with Projects" on page 48 for more information.

## Quick Memories

Quick memories are special memories for storing programs. Unlike programs on the Internal Card, PC Cards, and CD-ROMs, which take time to load, Quick memory programs can be recalled instantly. There are six Quick memories available in 2-channel or 4-channel mode; 12 in 2-channel x2 mode. Quick memories are managed on the Program pages. See "Working with Quick Memories" on page 42 for more information.

## Drives

Programs, projects, and impulse-response data can be loaded from the following drives: Internal Card, PC Card, or CD-ROM. The number of programs that can be stored on each drive depends on its capacity and the size of the associated impulse-response data. Programs and drives are managed on the Library pages. See “Working with the Library” on page 45 for more information.

The following diagram shows how programs and projects can be transferred to and from the drives and Quick memories, and impulse-response data transferred from the drives.

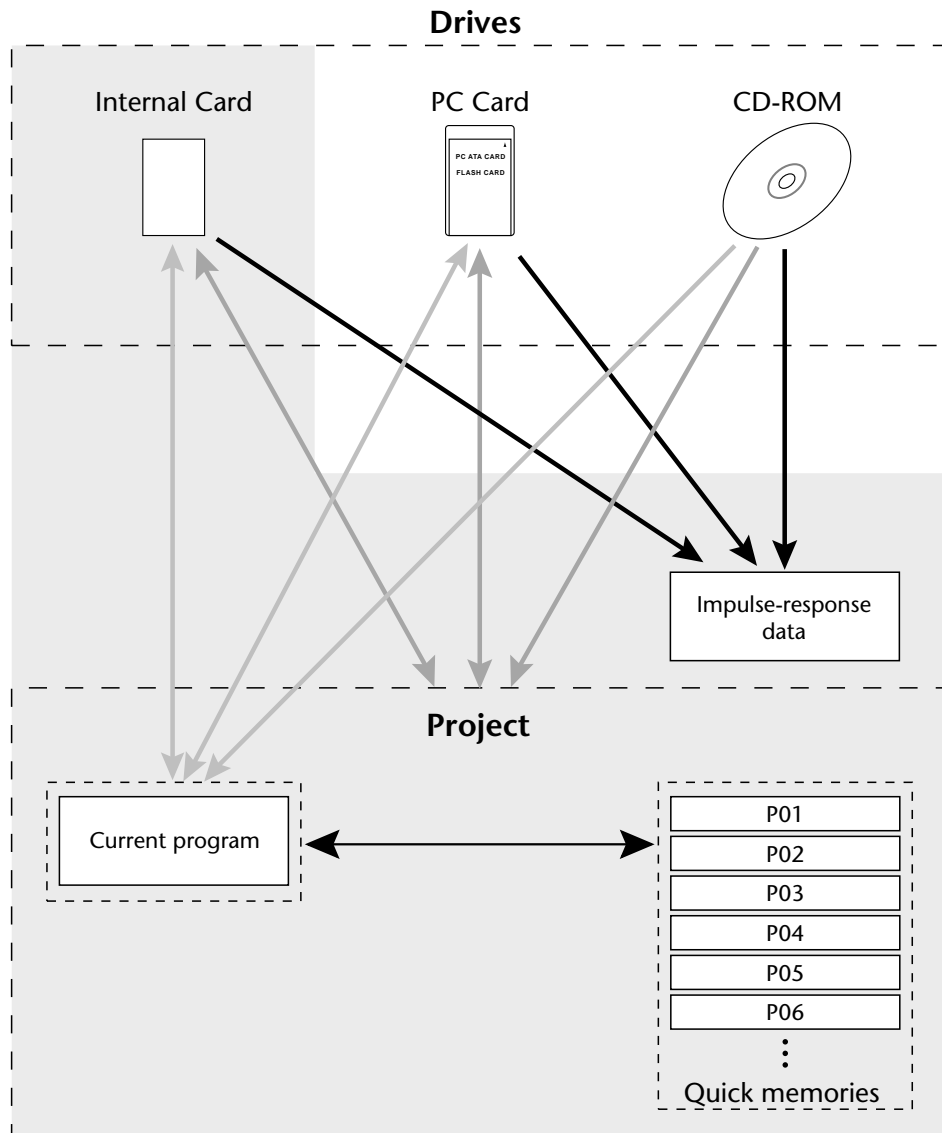

- See the Program pages for Quick memory store/recall operations
- See the Library pages for program and drive save/load operations
- See the Project pages for project and drive save/load operations
- See the Data Load pages for impulse-response data loading

## File Types

The SREV1 uses several file extensions to identify file types. Although these extensions do not generally appear on the RC-SREV1 pages, they may come in useful when checking the contents of a PC Card or CD-ROM on your PC.

File Extension	File Type
TM4	Impulse-response data (Yamaha original format)
TMC	Compressed and encrypted impulse-response data (Yamaha original format)
SP2	2-channel program
SP4	4-channel program
2CH	2-channel mode project
4CH	4-channel mode project
2X2	2-channel x2 mode project

## Parameters

SREV1 program parameters, such as reverb time, initial delay, an EQ, are stored within each program. Saved parameters include: reverb time, initial delay, reverb balance, reverb level, pre EQ, post EQ, and impulse-response data names.

Other parameters, including reverb mode, wordclock source, I/O select, I/O level, and MIDI settings, are not stored within each program, but they are stored in the SREV1's battery-backed memory.

## Output Assignments

The following table shows the fixed output assignments for each mode.

Mode	Channel	Outputs																									
		AES1		AES2		SLOT1								SLOT2													
		1	2	1	2	1	2	3	4	5	6	7	8	1	2	3	4	5	6	7	8						
2-channel	Left	•				•										•											
	Right		•				•										•										
4-channel	Front-left	•				•										•											
	Front-right		•				•										•										
	Rear-left			•				•										•									
	Rear-right				•				•										•								
2-channel x2	A-left	•				•										•											
	A-right		•				•										•										
	B-left			•				•										•									
	B-right				•				•										•								

# SREV1 Block Diagram

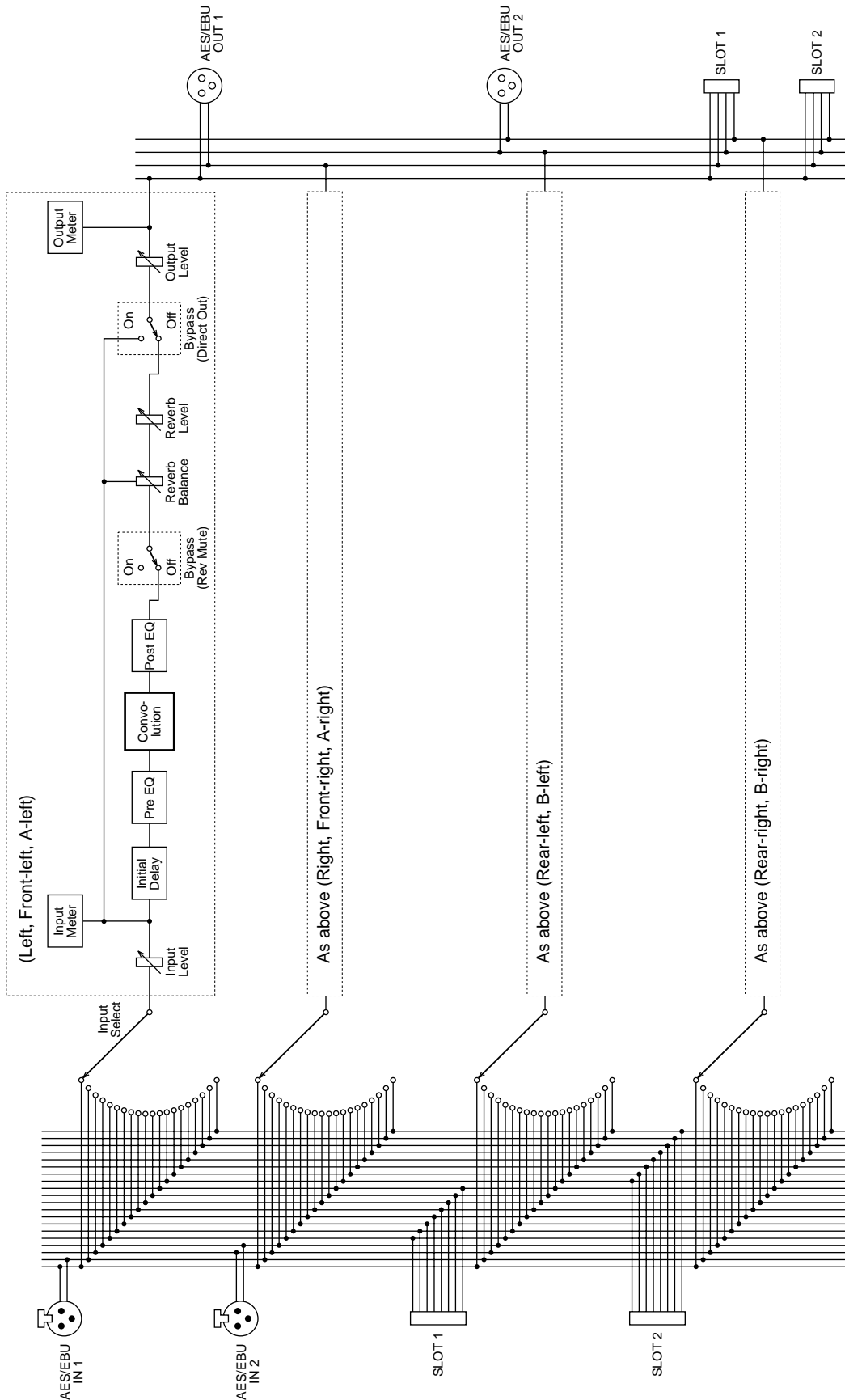

# Touring the SREV1 & RC-SREV1

---

# 2

## In this chapter...

SREV1 Front Panel .....	12
SREV1 Rear Panel .....	14
RC-SREV1 Control Surface .....	16
RC-SREV1 Display .....	18
RC-SREV1 Rear Panel .....	20

## SREV1 Front Panel

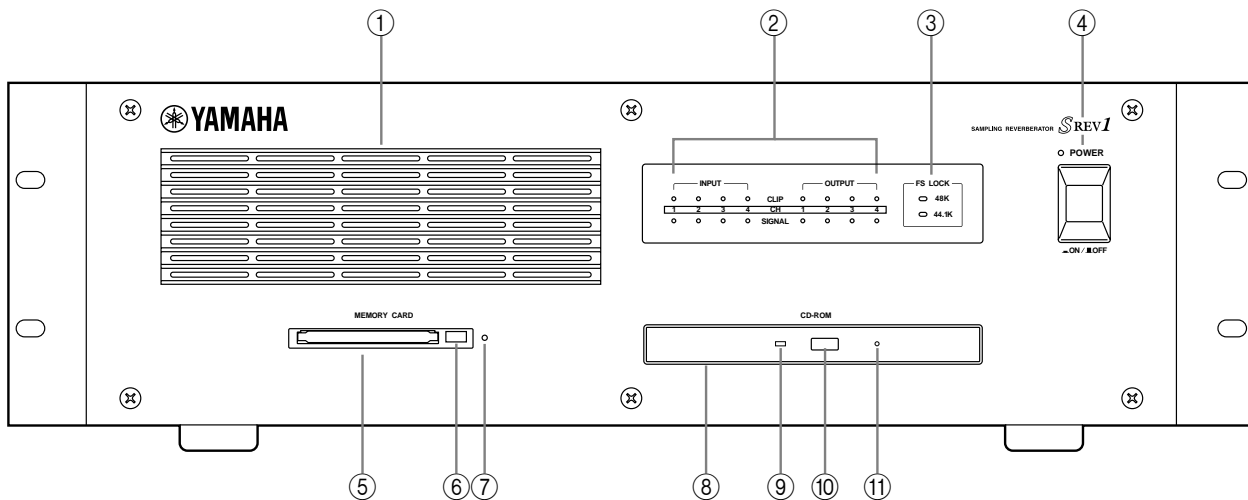

- ① **Air Inlet**  
The two internal cooling fans draw air into the SREV1 through this inlet. If the airflow is restricted, the SREV1 may overheat, so make sure that it's not blocked.
- ② **INPUT and OUTPUT signal indicators**  
The INPUT and OUTPUT signal level indicators consist of SIGNAL and CLIP indicators for each channel. The SIGNAL indicators light up when a signal is 34 dB below clipping and are intended to show the presence of a signal, while the CLIP indicators light up when a signal is actually clipping. See “Metering” on page 37 for more information.
- ③ **FS LOCK indicators**  
These indicators show the sampling rate—48 kHz or 44.1 kHz—and whether or not the SREV1 is locked to the selected wordclock source. See “Selecting the Wordclock Source” on page 75 for more information.
- ④ **POWER switch & indicator**  
This switch is used to turn on the power to the SREV1. The POWER indicator lights up when the SREV1 is turned on. See “Turning On & Off the SREV1” on page 26 for more information.
- ⑤ **MEMORY CARD slot**  
PC Cards can be inserted here for loading and saving programs, projects, or impulse-response data. See “Using PC Cards” on page 29 for more information.
- ⑥ **Memory card eject button**  
This button is used to eject PC Cards. See “Using PC Cards” on page 29 for more information.
- ⑦ **Memory card activity indicator**  
This indicator lights up when the inserted PC Card is being written or read. See “Using PC Cards” on page 29 for more information.

- ⑧ **CD-ROM drive**  
The supplied CD-ROM, containing reverb programs, projects, and impulse-response data, can be inserted here. See “Using CD-ROMs” on page 28 for more information.
- ⑨ **Disc activity indicator**  
This indicator lights up when the inserted CD-ROM is being read. See “Using CD-ROMs” on page 28 for more information.
- ⑩ **CD-ROM eject button**  
This button is used to eject CD-ROMs. See “Using CD-ROMs” on page 28 for more information.
- ⑪ **Emergency disc eject hole**  
This hole is used to manually eject CD-ROMs that cannot be ejected in the normal way. Use a pin-like tool of 2 mm or less in diameter, insert it into the hole and push gently. (A straightened paper clip makes an ideal tool.) Note that this technique should only be used as a last resort. Frequent use may lead to malfunction.

## SREV1 Rear Panel

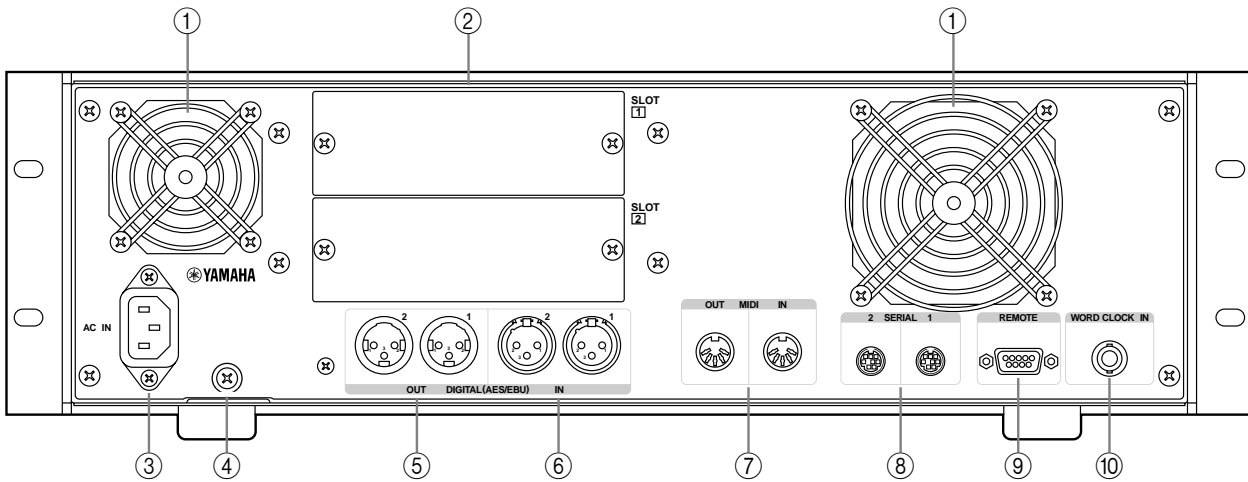

- ① Cooling fan outlets**  
 The two cooling fans expel air out through these outlets. If the airflow is restricted, the SREV1 may overheat, so make sure these outlets are not blocked.
- ② SLOTS 1 & 2**  
 These two slots are for use with optional mini YGDAI cards, offering a variety of analog and digital I/O options. See “I/O Options” on page 81 for more information. Slot inputs can be freely assigned to channels. See “Assigning Inputs” on page 35 for more information.
- ③ AC IN connector**  
 This connector is used to connect the SREV1 to a suitable AC outlet by using the supplied power cord. See “Connecting the Power Cord” on page 26 for more information.
- ④ Grounding screw**  
 For safety reasons, it’s important that the SREV1 is grounded properly. The supplied power cord has a three-pin plug, and if the ground terminal of the AC outlet is grounded, then the SREV1 will be grounded sufficiently through the power cord. If the AC outlet does not provide a suitable ground, however, a ground connection should be made to this grounding screw. Grounding is also an effective method for eliminating hum, interference, and other noise.
- ⑤ DIGITAL OUT (AES/EBU) connectors**  
 These two XLR-3-32-type connectors (AES1 and AES2) transmit up to four output signals, two per connection, as AES/EBU format digital audio. Output to channel assignments are fixed. See “Output Assignments” on page 9 for more information. Use only dedicated AES/EBU connecting cables (110Ω).
- ⑥ DIGITAL IN (AES/EBU) connectors**  
 These two XLR-3-31-type connectors (AES1 and AES2) receive up to four input signals, two per connection, as AES/EBU format digital audio. AES/EBU inputs can be freely assigned to channels. See “Assigning Inputs” on page 35 for more information. Use only dedicated AES/EBU connecting cables (110Ω).



⑦ **MIDI IN & OUT ports**

These standard MIDI IN and OUT ports are used to connect the SREV1 to other MIDI equipment for remote operation using MIDI Program Change and Control Change messages. See “MIDI & the SREV1” on page 68 for more information.

⑧ **SERIAL 1 & 2 ports**

These 8-pin mini DIN connectors are used to connect up to four SREV1s in a multiple-unit system. See “Multiple SREV1s” on page 63 for more information.

⑨ **REMOTE port**

This 9-pin D-sub connector is used to connect the RC-SREV1. See “Connecting the RC-SREV1 Remote Controller” on page 22 for more information.

⑩ **WORD CLOCK IN connector**

This BNC connector can be used to receive an external wordclock signal. See “Word-clock Connections” on page 74 for more information.

## RC-SREV1 Control Surface

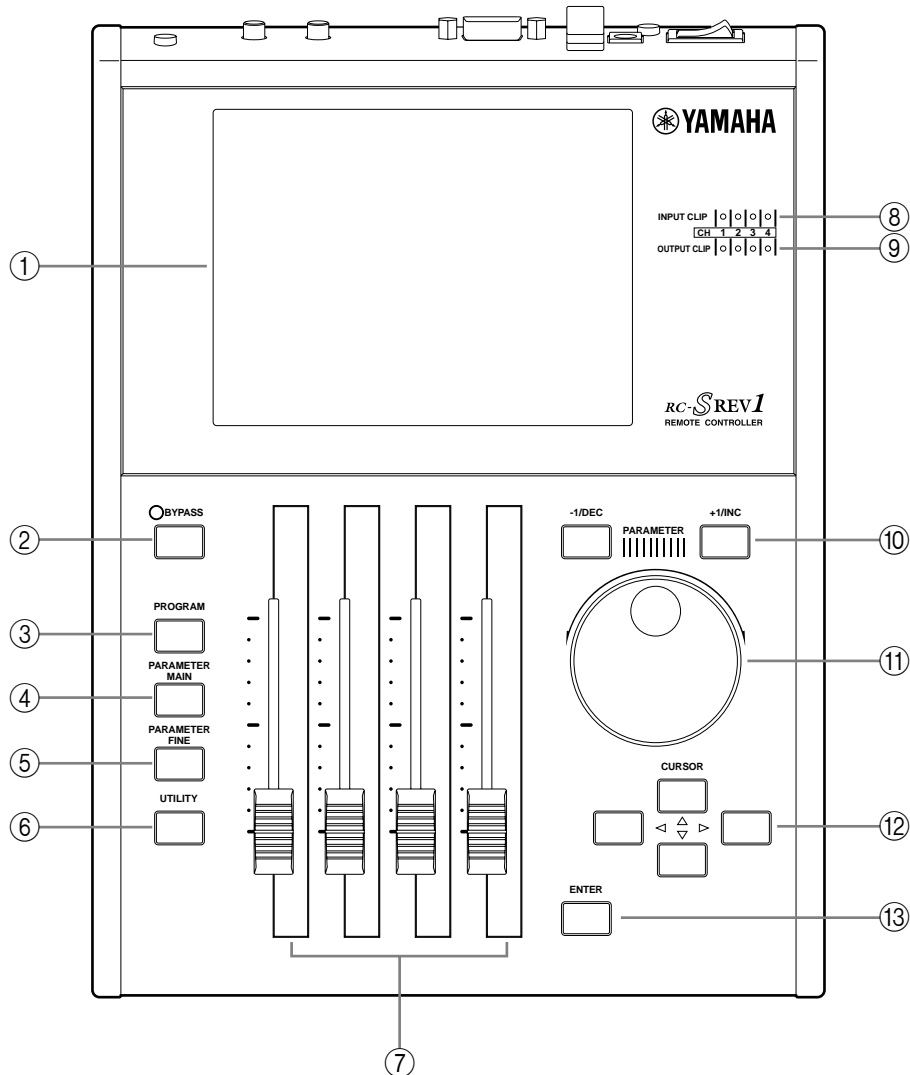

- ① **Display**  
See “RC-SREV1 Display” on page 18 for more information.
- ② **BYPASS button & indicator**  
This button is used to bypass the SREV1. The BYPASS indicator lights up when the SREV1 is bypassed. See “Bypassing the SREV1” on page 40 for more information.
- ③ **PROGRAM button**  
This button selects the Program, Library, and Project pages.
- ④ **PARAMETER MAIN button**  
This button selects the Main 1 and Main 2 pages.
- ⑤ **PARAMETER FINE button**  
This button selects the Rev, Pre EQ, and Post EQ pages.
- ⑥ **UTILITY button**  
This button selects the Setup, DIO, Meter I/O, and MIDI pages.

- 
- ⑦ **Motorized faders**

These four 60-mm motorized faders are for adjusting parameter values and input and output levels.
  - ⑧ **INPUT CLIP indicators**

There are four INPUT CLIP indicators, one for each channel, which light up when the corresponding channel's input signal is clipping.
  - ⑨ **OUTPUT CLIP indicators**

There are four OUTPUT CLIP indicators, one for each channel, which light up when the corresponding channel's output signal is clipping.
  - ⑩ **-1/DEC & +1/INC buttons**

These buttons work in parallel with the DATA wheel and are used for selecting programs or projects and setting parameter values. Use the [-1/DEC] button to decrease a value; the [+1/INC] button to increase it.
  - ⑪ **DATA wheel**

This wheel is used for selecting programs or projects and setting parameter values. Turn it clockwise to increase a value; counterclockwise to decrease it.
  - ⑫ **Cursor buttons ( ◀ / ▶ / ▲ / ▼ )**

These buttons are used to maneuver the cursor around the display pages in order to select buttons and parameters. The left ( ◀ ) button moves the cursor to the left; the right ( ▶ ) button moves it to the right; the up ( ▲ ) button moves it up; the down ( ▼ ) button moves it down.
  - ⑬ **ENTER button**

This button is used to execute functions and set options and parameters.

## RC-SREV1 Display

This large 320 x 240 dot display, with fluorescent backlight and adjustable brightness and contrast controls, displays the various program, parameter, and utility pages, system status, and signal level meters. As well as showing parameter values numerically, reverb and EQ parameters are displayed graphically, so you can see settings at a glance.

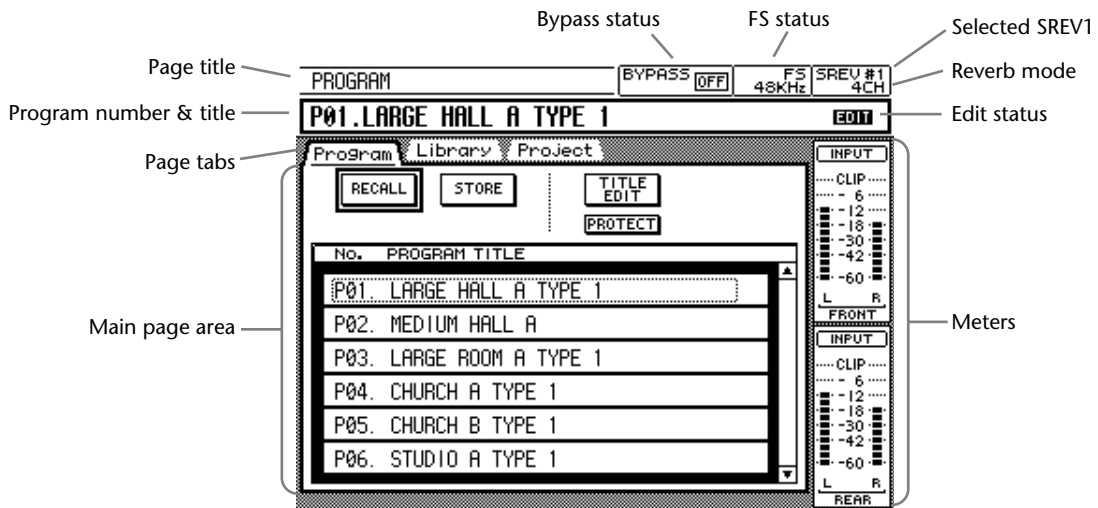

**Page title**—This is the title of the currently selected page.

**Program number & title**—This is the number and title of the current program. In 2-channel x2 mode, two numbers and titles are displayed, one for program A, the other for program B. Program numbers appear only when programs are recalled or stored in Quick memory. They do not appear when programs are loaded from a drive (i.e., Internal Card, PC Card, or CD-ROM).

**Page tabs**—Pages are grouped as program, parameter main, parameter fine, and utility, and these tabs show the titles of the pages available in each group.

**Main page area**—The various program, parameter, and utility pages appear here.

**Bypass status**—The status of the Bypass function appears here: ON (SREV1 bypassed) or OFF. See “Bypassing the SREV1” on page 40 for more information.

**FS status**—The SREV1 sampling rate is displayed here—48 kHz or 44.1 kHz—and whether or not it’s locked to the selected wordclock source—LOCK or UNLOCK. See “Selecting the Wordclock Source” on page 75 for more information.

**Selected SREV1**—This is the SREV1 currently selected for control from the RC-SREV1. See “Selecting SREV1s from the RC-SREV1” on page 65 for more information.

**Reverb mode**—This is the current Reverb mode: 2CH, 4CH, or 2CHX2.

**Edit status**—The Edit status indicator shows whether or not the current reverb program has been edited since it was recalled. If it has, the word “EDIT” appears (the letter “E” appears in 2-channel x2 mode).

**Meters**—In 2-channel mode, input and output meters for the left and right channels are displayed here. In 4-channel mode, meters for the front-left, front-right, rear-left, and rear-right channels are displayed. In 2-channel x2 mode, meters for the A-left, A-right, B-left, and B-right channels are displayed. For the 4-channel and 2-channel x2 modes, you can choose to display input or output meters. See “Metering” on page 37 for more information.

**Fader status**—The status of each fader appears along the bottom of the display. For pages selected with the [PARAMETER MAIN] button, the names of the parameters assigned to the faders appear, and for pages selected with the [PARAMETER FINE] button, the channel names appear, as shown below.

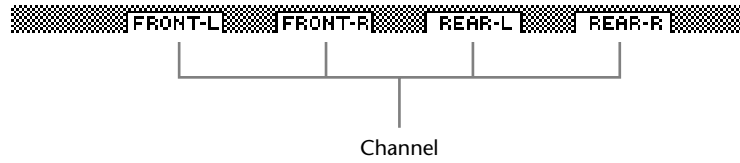
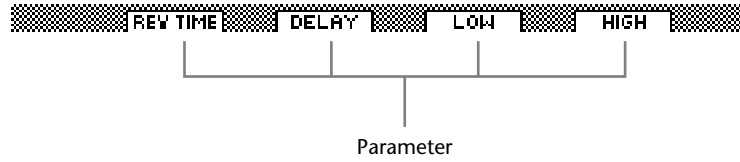

## RC-SREV1 Rear Panel

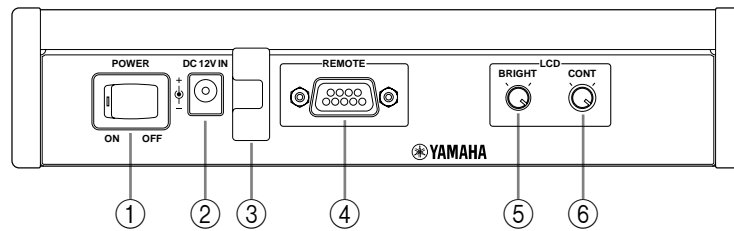

- ① **POWER switch**

This switch is used to turn on the power to the RC-SREV1. Power is supplied by the SREV1 via the remote cable, or an optional AC adapter. See “Turning On & Off the RC-SREV1” on page 26 for more information.
- ② **DC 12V IN connector**

An optional AC adapter can be connected here (necessary when a custom-made remote cable is used). See “Using an Optional RC-SREV1 AC Adapter” on page 27 for more information.
- ③ **Adapter cable clip**

This clip is used to secure the optional AC adapter’s cable in order to prevent accidental disconnection. See “Using an Optional RC-SREV1 AC Adapter” on page 27 for more information.
- ④ **REMOTE port**

This 9-pin D-sub connector is used to connect the RC-SREV1 to the SREV1 with the remote cable supplied with the RC-SREV1. See “Connecting the RC-SREV1 Remote Controller” on page 22 for more information.
- ⑤ **BRIGHT control**

This control is used to adjust the brightness of the display. See “Adjusting the RC-SREV1 Brightness & Contrast” on page 27 for more information.
- ⑥ **CONT control**

This control is used to adjust the contrast of the display. See “Adjusting the RC-SREV1 Brightness & Contrast” on page 27 for more information.

# Getting Started

---

# 3

## In this chapter...

First Steps .....	22
Connecting the RC-SREV1 Remote Controller .....	22
Hookup Examples .....	23
Connecting the Power Cord .....	26
Turning On & Off the SREV1 .....	26
Turning On & Off the RC-SREV1 .....	26
Using an Optional RC-SREV1 AC Adapter .....	27
Adjusting the RC-SREV1 Brightness & Contrast .....	27
Using CD-ROMs .....	28
Using PC Cards .....	29

## First Steps

Here's how to get up and running with the SREV1.

- 1 Familiarize yourself with the SREV1 and RC-SREV1.  
See “Touring the SREV1 & RC-SREV1” on page 11.
- 2 Install any mini YGDAI I/O cards.  
See “I/O Options” on page 81.
- 3 Connect the RC-SREV1.  
See “Connecting the RC-SREV1 Remote Controller” below.
- 4 Connect your audio equipment to the inputs and outputs.  
See “Hookup Examples” on page 23.
- 5 Connect the power cord and turn on the SREV1.  
See “Connecting the Power Cord” on page 26 and “Turning On & Off the SREV1” on page 26.
- 6 Turn on the RC-SREV1 and Adjust the brightness and contrast.  
See “Turning On & Off the RC-SREV1” on page 26 and “Adjusting the RC-SREV1 Brightness & Contrast” on page 27.

The SREV1 is now ready for use.

## Connecting the RC-SREV1 Remote Controller

The RC-SREV1 should be connected to the SREV1 using the supplied 9-pin D-sub remote cable, as shown below. In addition to control signals, the cable carries power for the RC-SREV1, so make sure it's attached securely.

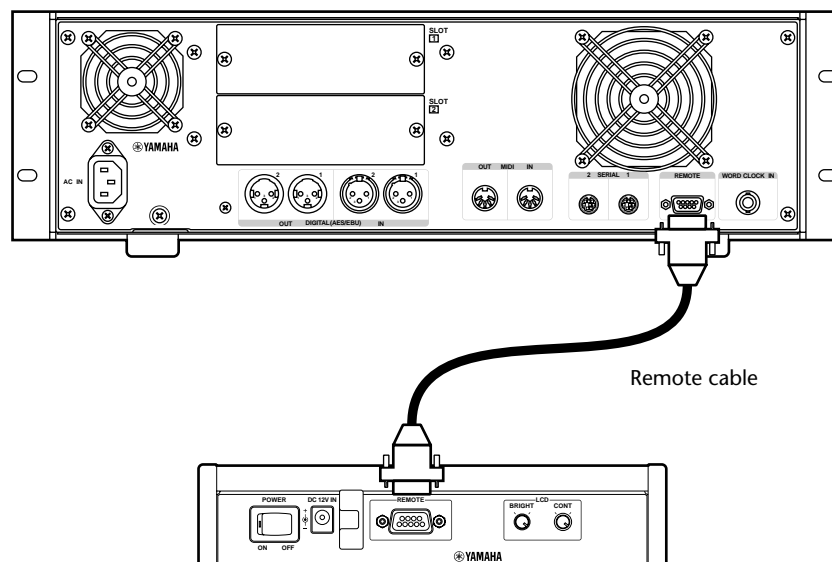



## Hookup Examples

This section contains several hookup examples for both digital and analog I/O.

### Two-channel AES/EBU I/O

This example shows how a digital mixer with AES/EBU format I/O can be connected to the SREV1's onboard AES/EBU I/O for two-channel operation. The input feed can be used to carry one or two digital-audio signals, allowing either 1 in/2 out or 2 in/2 out operation.

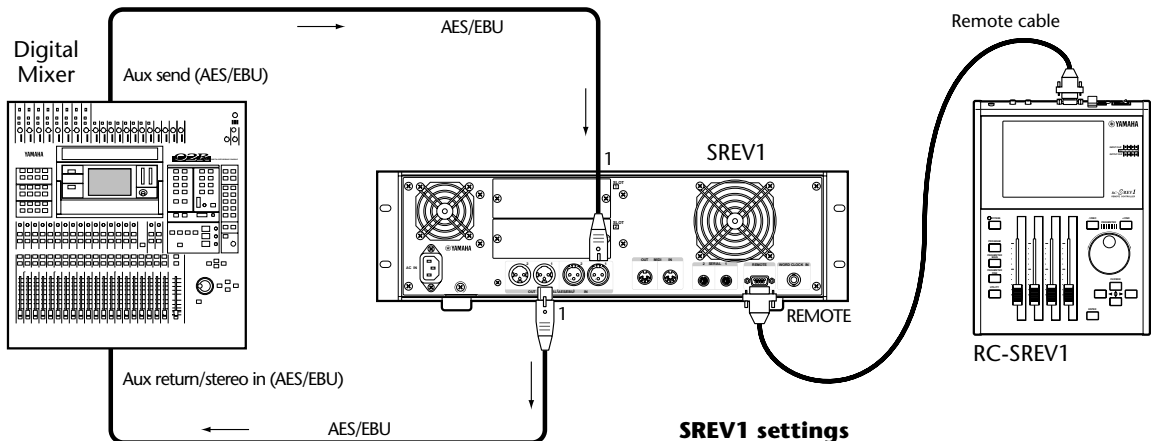

#### SREV1 settings

Reverb mode: 2-channel  
Input assignment: AES1 (1–2)  
Wordclock source: AES/EBU 1

### Four-channel AES/EBU I/O

This example shows how a digital mixer with AES/EBU format I/O can be connected to the SREV1's onboard AES/EBU I/O for four-channel operation. Each input feed can be used to carry one or two digital-audio signals, four signals in total, allowing 1 in/4 out, 2 in/4 out, 4 in/4 out operation (4-channel mode), or 1 in/2 out x2 or 2 in/2 out x2 operation (2-channel x2 mode).

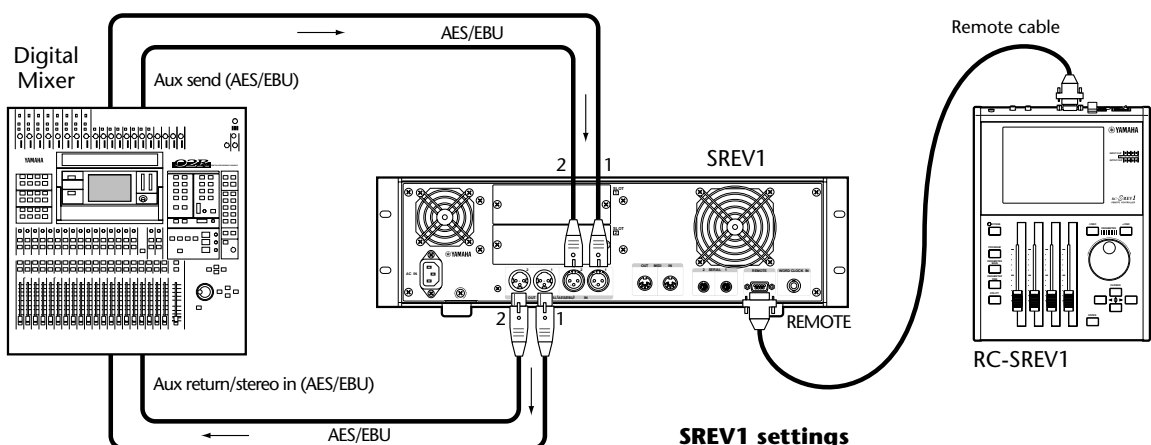

#### SREV1 settings

Reverb mode: 4-channel or 2-channel x2  
Input assignment: AES1 (1–2), AES2 (1–2)  
Wordclock source: AES/EBU 1

### Optional I/O Card Digital I/O

This example shows how a digital mixer with an AES/EBU connector can be connected to the SREV1 by using optional AES/EBU cards (MY8-AE). Up to four digital-audio input and output signals can be carried, allowing virtually any input/output configuration (e.g., 1 in/2 out, 2 in/4 out, 2 in/2 out x2, and so on).

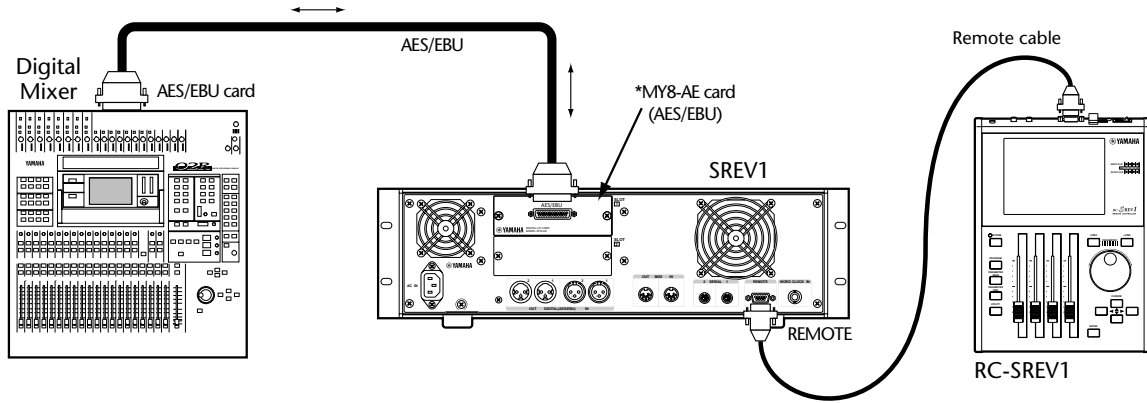

\*Alternatives:  
MY8-AT (ADAT format)  
MY8-TD (Tascam format)

**SREV1 settings**

Reverb mode: 2-channel, 4-channel, or 2-channel x2  
Input assignment: SLOT1 (1–8)  
Wordclock source: MY8-AE 1/2

### Two-channel Analog I/O

This example shows how an analog mixer, or digital mixer with analog I/O, can be connected to the SREV1 by using optional A/D and D/A I/O cards (MY4-AD and MY4-DA) for two-channel operation. One or two analog audio signals can be input and output, allowing 1 in/2 out or 2 in/2 out operation.

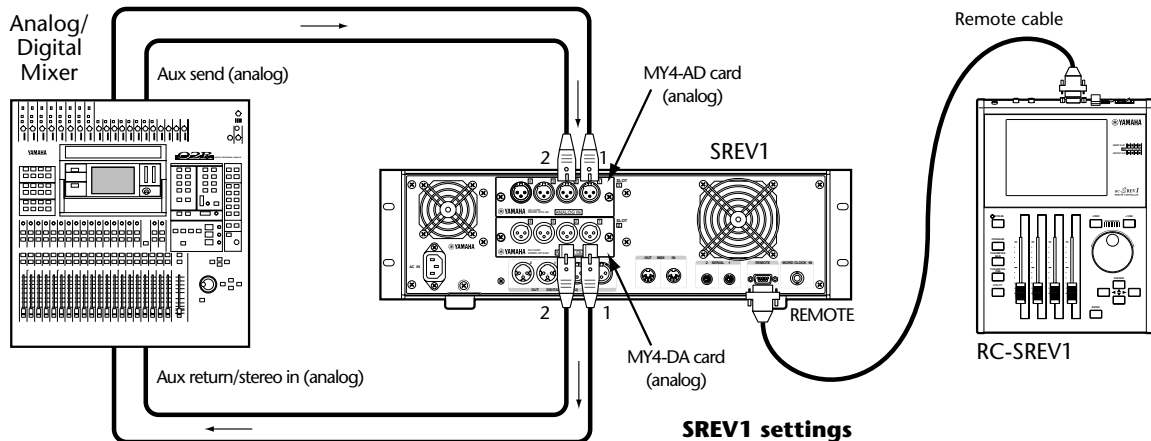

**SREV1 settings**

Reverb mode: 2-channel  
Input assignment: SLOT1 (1–2)  
Wordclock source: INT 48K

## Four-channel Analog I/O

This example shows how an analog mixer, or digital mixer with analog I/O, can be connected to the SREV1 by using optional A/D and D/A I/O cards (MY4-AD and MY4-DA) for four-channel operation. Between one and four channels can be used, allowing 1 in/4 out, 2 in/4 out, 4 in/4 out (4-channel mode), or 1 in/2 out x2 or 2 in/2 out x2 (2-channel x2 mode).

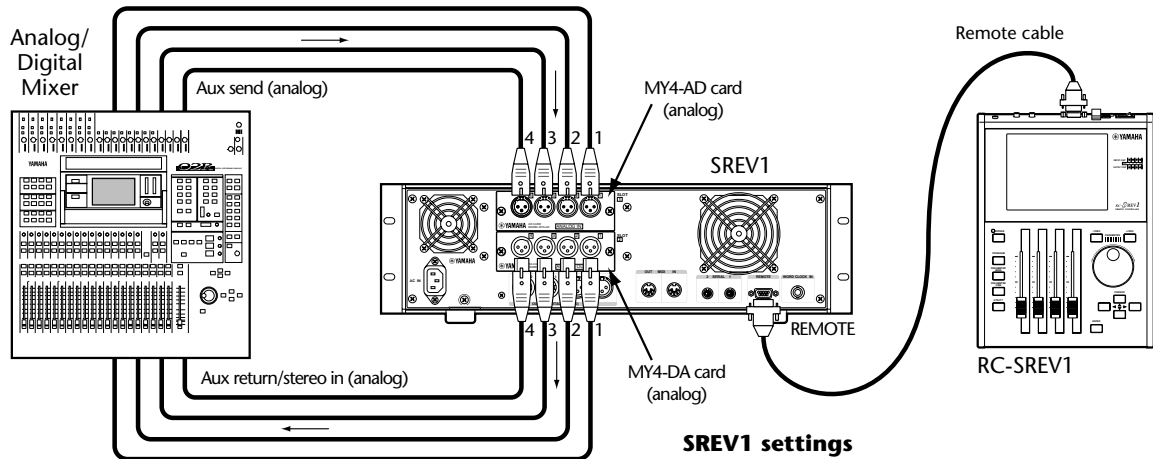

### SREV1 settings

Reverb mode: 4-channel or 2-channel x2  
 Input assignment: SLOT1 (1–4)  
 Wordclock source: INT 48K

## Connecting the Power Cord

**Warning:** Turn off all equipment before making any power connections.

Connect the socket-end of the supplied power cord to the AC IN socket on the rear panel of the SREV1. Connect the plug-end to a suitable AC wall outlet, one that conforms to the power supply requirements stated on the SREV1 rear panel.

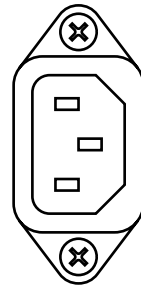

## Turning On & Off the SREV1

To prevent loud clicks and thumps in your speakers, turn on your audio equipment in the following order (reverse this order when turning off)—sound sources, SREV1, RC-SREV1, recorder, mixer, monitoring power amplifiers.

- 1 To turn on the SREV1, press the [POWER] switch.

The POWER indicator lights up.

See “SREV1 Startup” on page 32 and “About the Internal Operations at Startup” on page 33 for more information.

- 2 To turn off the SREV1, press the [POWER] switch again.

The POWER indicator goes out.

○ POWER

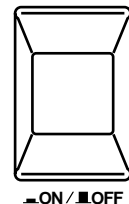

○ ON / ■ OFF

## Turning On & Off the RC-SREV1

*Note: In general, set the RC-SREV1 POWER switch to the ON position and use the SREV1 POWER switch to turn on and off the system. When using a custom-made remote cable, and an optional AC adapter, if the RC-SREV1 is turned on before the SREV1, the SREV1 must be turned on within 50 seconds. During this time the message “COULD NOT COMMUNICATE WITH SREV1. CHECK THE CABLE CONNECTION AND SREV1’S POWER. THEN TURN ON RC-SREV1 AGAIN.” appears. Therefore, turn on the RC-SREV1 after the SREV1.*

- 1 To turn on the RC-SREV1, set its [POWER] switch to the ON position.

The startup screen appears, and after communication is established between the SREV1 and RC-SREV1, the Program page appears.

See “RC-SREV1 Startup” on page 32 for more information.

- 2 To turn off the RC-SREV1, set its [POWER] switch to the OFF position.

The RC-SREV1 receives its power from the SREV1 via the remote cable, so if it doesn’t come on, make sure that the remote cable is connected properly and that the SREV1 is turned on.

POWER

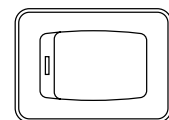

○ ON    ■ OFF

## Using an Optional RC-SREV1 AC Adapter

The remote cable, which carries power from the SREV1 to the RC-SREV1, is 20 meters in length. Since the power loss in longer cables would be too great, an optional Yamaha PA-6 AC power supply adapter (12 V DC) is required to power the RC-SREV1 when using remote cables over 20 meters in length. A wiring diagram for making custom remote cables is available on page 91. See your Yamaha dealer for more information.

The optional Yamaha PA-6 AC power supply adapter should be connected to the DC 12V IN connector on the rear of the RC-SREV1.

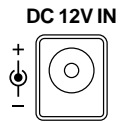

Loop the AC adapter cable around cable clip, shown here, to prevent accidental disconnection.

*Warning: Use only the Yamaha PA-6 AC power supply adapter with the RC-SREV1. Using any other AC adapter may cause a fault, leading to a buildup of heat, fire, or an electrical shock hazard.*

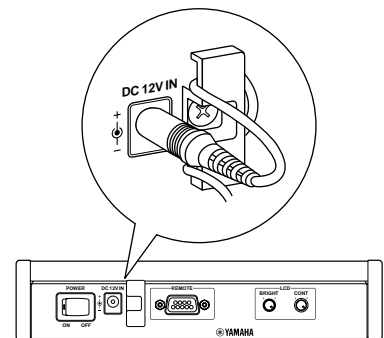

## Adjusting the RC-SREV1 Brightness & Contrast

Both the brightness and contrast of the RC-SREV1 display can be adjusted to suit your working environment or personal preference.

- 1 Use the CONT control to set the display contrast.  
Contrast adjusts the balance between pixels that are on and those that are off.
- 2 Use the BRIGHT control to set the display brightness.  
Brightness adjusts the strength of the display's backlight.

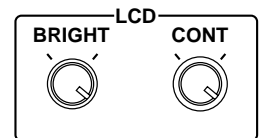

## Using CD-ROMs

The SREV1 can load programs, projects, and impulse-response data files stored on ISO9660 Level 2 format CD-ROMs, which are also supported by Windows.

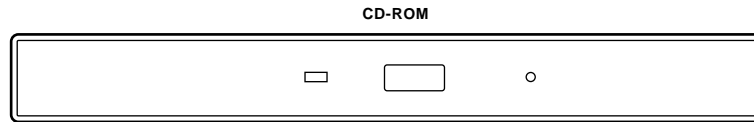

### Inserting & Ejecting CD-ROMs

CD-ROMs can only be inserted and ejected while the SREV1 is turned on.

- 1 Press the CD-ROM eject button, and when the disc tray appears, pull it out.
- 2 With the labeled-side facing up, carefully fit the disc onto the central spindle. (The disc sits flat when it's in correctly.)
- 3 Push the disc tray fully into the SREV1 to close it.

When a CD-ROM is being read, the activity indicator lights up.

The SREV1 takes between 20 and 30 seconds to recognize a CD-ROM after it's inserted.

- 4 To eject a CD-ROM, press the eject button.
- 5 When the disc tray appears, pull it out, remove the disc, and then push the tray back into the SREV1 in order to close it.

Always store CD-ROMs in their cases.

## Using PC Cards

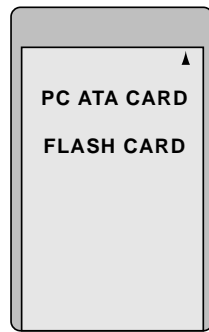

The SREV1 can store programs, projects, and impulse-response

data on standard PC Cards (PCMCIA). The SREV1 supports the PC Card ATA specification and the FAT16 file system, which is also supported by Windows. Use PCMCIA flash ATA cards (Type II) or CompactFlash cards with a PC Card adapter.

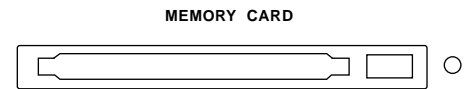

### Inserting & Ejecting PC Cards

- 1 Insert the PC Card face up into the MEMORY CARD slot and push it in all the way. (The eject button sticks out all the way when the card is fully inserted.)

The PC Card should be recognized and available for use in a few seconds.

Although rare, in some cases the PC Card may not be recognized. If this happens, try reinserting the card. If it's not recognized after several tries, contact your Yamaha dealer.

When a card is being written or read, the activity indicator lights up. Do not eject the card, or turn off the power while this indicator is lit.

- 2 To eject a card, make sure that the activity indicator is not lit, and then press the eject button.

The card ejects.

- 3 Remove the card from the slot.

When using a compact card with an adapter, pull the adapter to remove the card from the slot. Pulling only the card may damage it.

The speed at which data can be written and read on a PC Card depends on its type.

Always store PC Cards in their cases.

---

# Basic Operation

---

# 4

## In this chapter...

SREV1 Startup .....	32
RC-SREV1 Startup .....	32
About the Internal Operations at Startup .....	33
Selecting Reverb Modes .....	34
Assigning Inputs .....	35
Setting Input & Output Levels .....	36
Metering .....	37
Setting the Meter Mode .....	39
Using Peak Hold .....	39
Bypassing the SREV1 .....	40
Setting the Bypass Mode .....	40
Using the Title Edit dialog Box .....	41
Working with Quick Memories .....	42
Working with the Library .....	45
Working with Projects .....	48



## SREV1 Startup

When the SREV1 is turned on, its INPUT and OUTPUT signal indicators light up in sequence. During this time, the SREV1 loads impulse-response data for the current program and the programs in Quick memory from the Internal Card, and, if necessary, from the PC Card or CD-ROM. At this time, the SREV1 cannot be used. After about 30 seconds, when the necessary impulse-response data has been loaded, the CLIP and SIGNAL indicators go out and the SREV1 is ready for use.

Note that the startup time will be different if the current program or the programs in Quick memory are on PC Card or CD-ROM.

If the SREV1 does not output any sound, check your audio connections, and the input assignments. See “Assigning Inputs” on page 35 for more information.

## RC-SREV1 Startup

In Principle, the RC-SREV1 should be started up after the SREV1 has completed its startup. However, when the RC-SREV1 is connected to one SREV1 using the supplied remote cable, and that SREV1 is supplying power to the RC-SREV1, so long as the RC-SREV1 POWER switch is set to the ON position, the RC-SREV1 will be turned on at the same time as the SREV1 is turned on, and the RC-SREV1 will startup normally. If, however, you are using multiple SREV1s, connected together using serial cables, make sure that all SREV1s have completed startup before turning on the RC-SREV1.

When the RC-SREV1 is turned on, startup screen 1 appears for one second. Then startup screen 2 appears with an animated waveform moving from left to right. During this time, the RC-SREV1 receives necessary operating information from the SREV1 via the serial cable. When all the information has been received, the Program page appears.

When the RC-SREV1 is turned on after the SREV1 has completed its startup, the above procedure takes 15 seconds.

When the RC-SREV1 is turned on at the same time as the SREV1, it takes 45 seconds to start up, although the actual time will depend on the time it takes the SREV1 to start up.

If there is no animation on startup screen 2, there may be a communication error between the SREV1 and RC-SREV1. In this case, turn off both units and check the remote cable connections, also check for breaks in the cable.

*Startup screen 1*

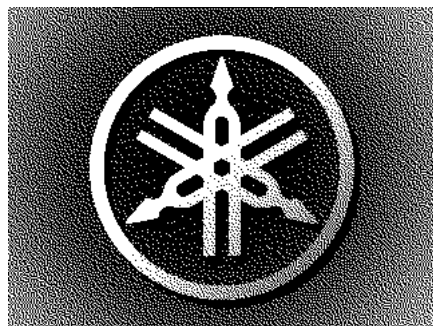

*Startup screen 2*



## About the Internal Operations at Startup

During startup, the SREV1 loads the necessary programs into the current and Quick program memories in order to restore the SREV1 to the same state it was in before it was last turned off. If any of these programs were previously loaded from a PC Card or CD-ROM and then stored to a Quick memory, the same PC Card or CD-ROM will be required to restore the contents of the Quick memories. In this case, be sure to insert the necessary PC Card or CD-ROM before starting the SREV1. Although the SREV1's battery-backed memory stores the titles of the current and Quick memory programs, it does not store the actual program or impulse-response data, so this must be loaded each time the SREV1 is started.

If a necessary PC Card or CD-ROM is not inserted, the message "DATA FILE NOT FOUND! INSERT PCMCIA CARD" or "DATA FILE NOT FOUND! INSERT CD-ROM DISC" appears once the RC-SREV1 has completed startup. In this case, insert the necessary PC Card or CD-ROM and try loading again.

Note that the above information regarding necessary PC Cards and CD-ROMs also applies to changing the Reverb mode and loading projects.

## Selecting Reverb Modes

This section explains how to select the 2-channel, 4-channel, and 2-channel x2 Reverb modes. See page 6 for more information about each mode.

- 1 Use the [UTILITY] button to locate the Setup page shown below.

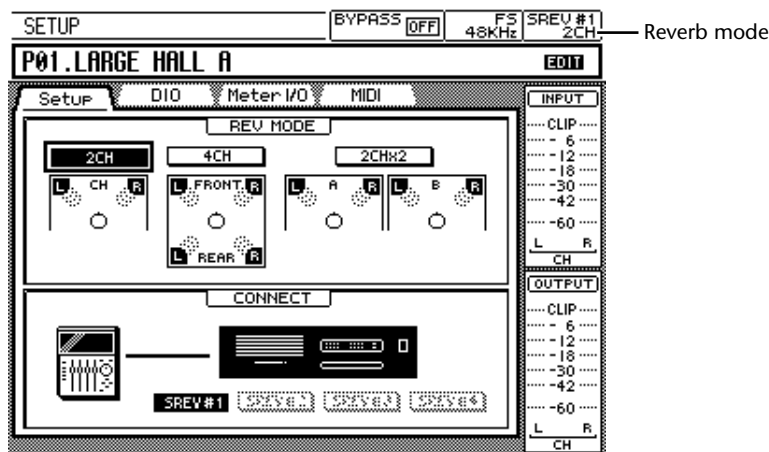

- 2 Use the cursor buttons to select the 2CH, 4CH, or 2CHx2 button in the REV MODE section of the page.
- 3 Press the [ENTER] button.  
A confirmation message appears.
- 4 Select YES to continue, or select NO to cancel the operation.
- 5 Press the [ENTER] button.

While the SREVE1 switches to the selected Reverb mode, the RC-SREVE1 displays the message “SETTING REV MODE...” and the SREVE1 INPUT and OUTPUT signal indicators light up in sequence.

*Note: Do not insert or eject a PC Card or CD-ROM while the SREVE1 is changing Reverb modes.*

Once the mode has been set, the mode title appears in the Reverb mode section of the display, the Program page is selected, and the cursor appears at the same position it does when the power is turned on.

The SREVE1 switches to the selected mode, the mode title appears in the Reverb mode section of the display, and the Program page is selected.

The SREVE1 stores all program parameters when the mode is changed, so when you return to a mode, the previous settings are restored.

# Assigning Inputs

This section explains how to assign the AES/EBU inputs and slot inputs to channels. When a four input I/O card, such as the MY4-AD, is installed, only the first four inputs of that slot are available.

- 1 Use the [UTILITY] button to locate the DIO page.

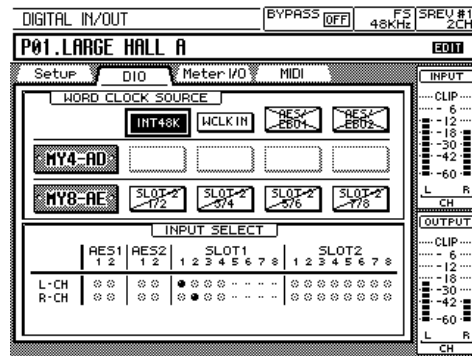

2-ch mode

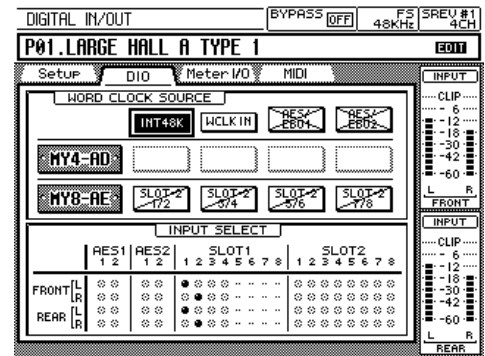

4-ch mode

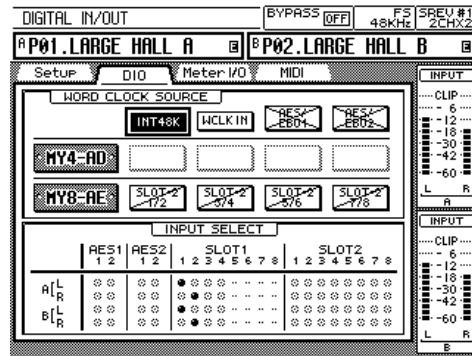

2-ch x2 mode

- 2 Use the cursor buttons to select the dots in the INPUT SELECT section of the page.  
A dotted circle indicates that an input is assignable; two dots indicate that an input is unavailable.
- 3 Press the [ENTER] button to assign an input to a channel.  
The input is assigned to the channel and the dotted circle changes to a solid dot.

## Setting Input & Output Levels

Input and output signal levels can be set on two different pages: Main 2 page or Meter I/O page. On the Main 2 page, levels are adjusted for all channels simultaneously as a group, while on the Meter I/O page, they can be adjusted for each channel individually. This section explains how to adjust input and output levels on the Meter I/O page. See page 54 for information on the Main 2 page.

- 1 Use the [UTILITY] button to locate the Meter I/O page.

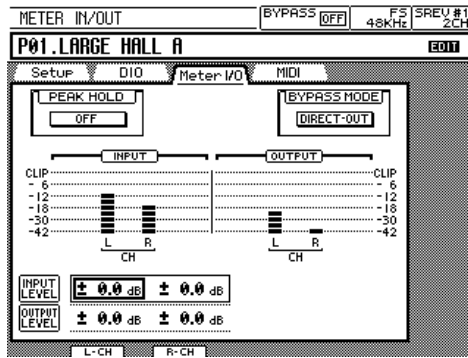

2-ch mode

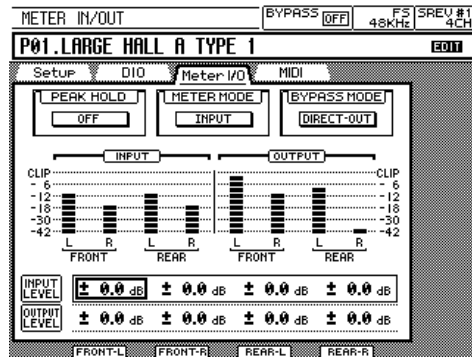

4-ch mode

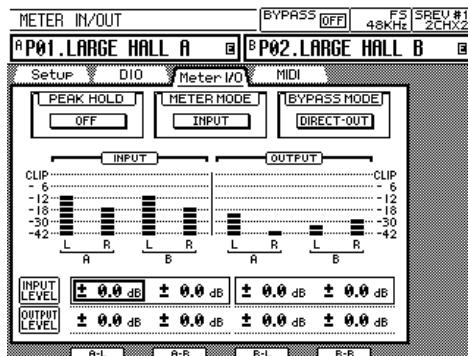

2-ch x2 mode

- 2 Use the cursor buttons to select the INPUT LEVEL and OUTPUT LEVEL parameters for each channel.
- 3 Use the faders to set the levels.

The DATA wheel or [-1/DEC] and [+1/INC] buttons can also be used to set levels in 0.1 dB steps.

The input and output levels can be set from  $-\infty$ , -72.0 dB to +6.0 dB in steps of 0.1 dB.

# Metering

Input and output signal levels can be metered in several places: the 14-segment meters on the RC-SREV1 display pages, the 11-segment meters on the Meter I/O page, the SIGNAL and CLIP indicators on the SREV1, and the CLIP indicators on the RC-SREV1. The Peak Hold function works with all of these meters. See “Using Peak Hold” on page 39 for more information.

## 14-segment Meters

Input and output signal levels can be metered by using the 14-segment meters that appear on most RC-SREV1 display pages. In 2-channel mode, input and output signal levels can be metered simultaneously. In 4-channel or 2-channel x2 mode, however, either the input or output levels can be metered, not both simultaneously. See “Setting the Meter Mode” on page 39 for more information.

The 14-segment LCD meters have the following resolution: CLIP / -3dB / -6dB / -9dB / -12dB / -15dB / -18dB / -24dB / -30dB / -36dB / -42dB / -48dB / -54dB / -60dB.

The following table shows how the input and output meters appear in each mode.

Mode	2-channel	4-channel		2-channel x2	
Meter					
I/O	INPUT & OUTPUT	INPUT	OUTPUT	INPUT	OUTPUT
		Use the METER MODE option on the Meter I/O page to switch between OUTPUT and INPUT (see page 39).			
Channels	Left, right	Front-left, front-right, rear-left, rear-right		A-left, A-right, B-left, B-right	

## Meter I/O Page

Input and output signal levels for all channels can be metered by using the 11-segment meters on the Meter I/O pages shown below, which are located by using the [UTILITY] button.

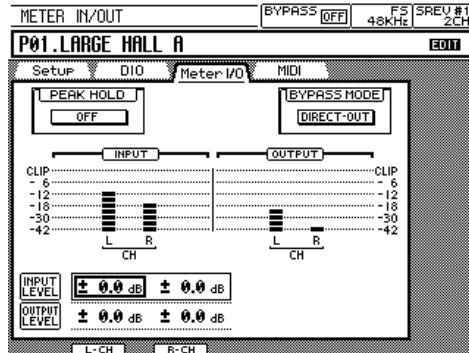

2-ch mode

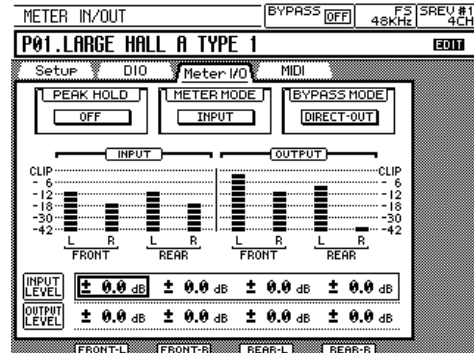

4-ch mode

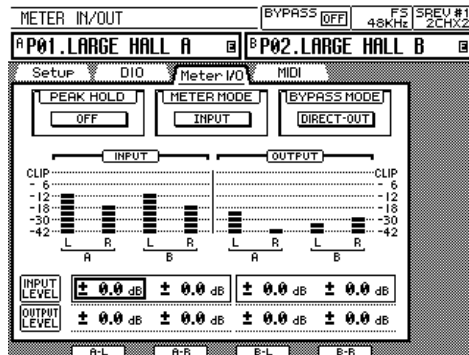

2-ch x2 mode

The 11-segment LCD meters have the following resolution:

CLIP, -3 dB, -6dB, -9 dB, -12dB, -15 dB, -18dB, -24 dB, -30dB, -36 dB, -42dB

## SREV1 SIGNAL and CLIP indicators

Input and output signal levels for each channel can be metered by using the SIGNAL and CLIP indicators on the SREV1 front panel. The SIGNAL indicators light up when the signal is 34 dB below clipping and are intended to show the presence of a signal, while the CLIP indicators light up when the signal is actually clipping.

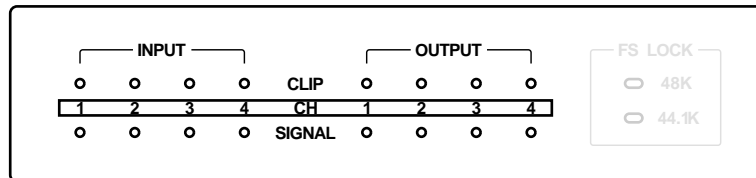

## RC-SREV1 CLIP indicators

Input and output signal levels for each channel can be metered for clipping by using the CLIP indicators on the RC-SREV1. These indicators light up when a signal is clipping.

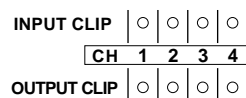

## Setting the Meter Mode

In 4-channel or 2-channel x2 mode, the 14-segment meters that appear on most RC-SREV1 display pages can be set to display either input or output signal levels by using the METER MODE option.

In 2-channel mode, meters for both the inputs and outputs (left and right) are always displayed, so the METER MODE option is not available when this mode is selected.

- 1 Use the [UTILITY] button to locate the Meter I/O page.

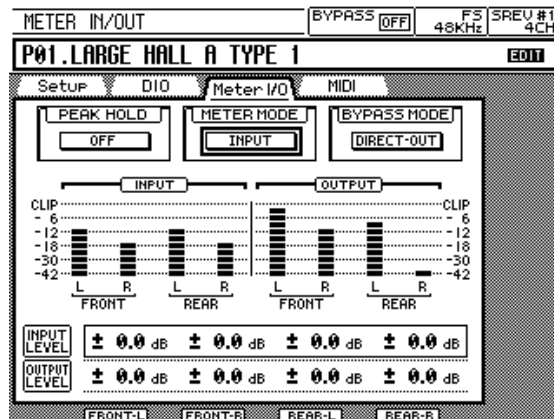

- 2 Use the cursor buttons to select the METER MODE button.
- 3 Use the [ENTER] button to toggle between INPUT and OUTPUT mode.  
The 14-segment meters are set accordingly.

## Using Peak Hold

By keeping the highest lit segment of each meter illuminated, the Peak Hold function offers a convenient way to check for signal peaks. In addition to the meters on the RC-SREV1 display pages, the Peak Hold function also works with the dedicated CLIP indicators on the SREV1 and RC-SREV1.

- 1 Use the [UTILITY] button to locate the Meter I/O page.

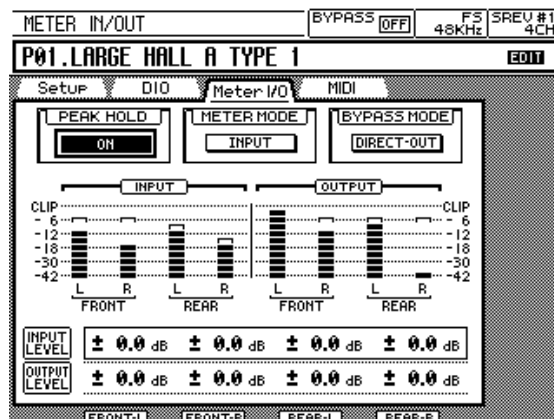



- 2 Use the cursor buttons to select the PEAK HOLD button.
- 3 Use the [ENTER] button to toggle between OFF and ON.  
The Peak Hold function is set accordingly.  
To reset the Peak Hold function, turn it off and then back on again.

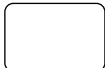

## Bypassing the SREV1

The SREV1 can be bypassed by using the [BYPASS] button. When the bypass function is on, the BYPASS indicator lights up and the word “ON” appears in the BYPASS area of the display, as shown below.

Bypass	BYPASS Button	Display	SREV1
Off	<input type="radio"/> BYPASS 	<b>BYPASS OFF</b>	Normal operation
On	<input checked="" type="radio"/> BYPASS 	<b>BYPASS ON</b>	Bypassed <sup>1</sup>

1. Depends on the Bypass mode: Direct-out/Rev-mute. See below.

## Setting the Bypass Mode

The Bypass function can be set so that it bypasses all processing (Direct-out) or just mutes the reverb processing (Rev-mute), in which case output signals are still affected by the Reverb Balance and Reverb Level parameters.

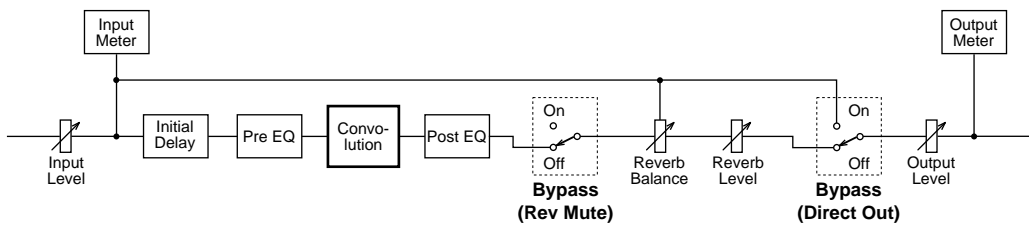

- 1 Use the [UTILITY] button to locate the Meter I/O page.

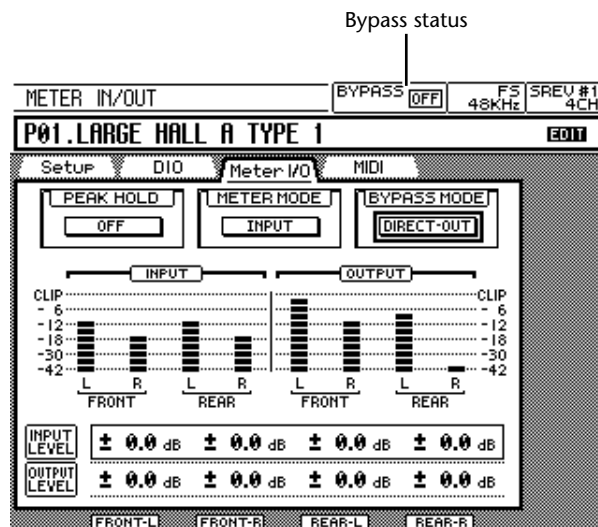

- 2 Use the cursor buttons to select the BYPASS MODE button.
- 3 Use the [ENTER] button to toggle between DIRECT-OUT and REV-MUTE.  
The Bypass mode is set accordingly.

## Using the Title Edit dialog Box

The Title Edit dialog box is used to title programs and projects, and it appears automatically when saving programs or projects, or when editing the titles of existing programs or projects. Titles can contain up to 27 characters, and both uppercase and lowercase letters and the plus (+) and minus (–) symbols are available.

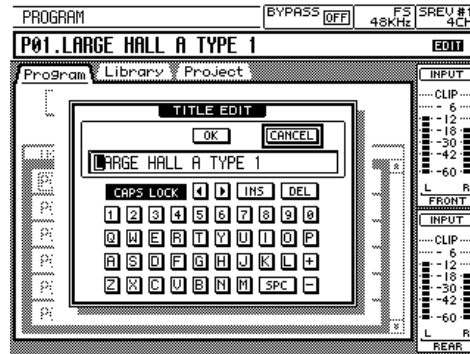

*Uppercase*

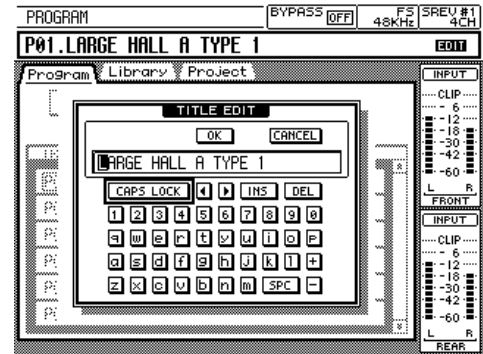

*Lowercase*

Use the DATA wheel or [–1/DEC] and [+1/INC] buttons to move the cursor within the title.

Use the CAPS LOCK button to access the lowercase and uppercase letters.

To enter a character, use the cursor buttons to select it, and then press the [ENTER] button. The selected character is inserted into the title at the cursor position and the cursor automatically moves one place to the right.

Use the SPC button to enter a space at the cursor position.

Use the INS button to insert a space at the cursor position and move the subsequent characters to the right. Characters that are moved beyond the right-hand side of the title window are lost.

Use the DEL button to delete the character at the cursor position and move subsequent characters to the left.

When you've finished editing, select the OK button and then press the [ENTER] button. (The message "CHANGING TITLE..." appears as the title is changed.) To cancel the operation, select the CANCEL button and then press the [ENTER] button.

## Working with Quick Memories

This section explains how to recall, store, title, and protect programs in Quick memory. All these operations are carried out on the Program pages shown below. In 2-channel x2 mode, two Program pages are available: Program-A and Program-B. There are six Quick memories available in 2-channel or 4-channel mode (P01–P06); 12 in 2-channel x2 mode (P01–P12). In the program list, a dotted box highlights the selected program.

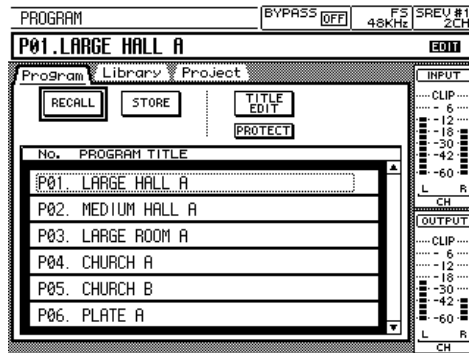

2-ch mode

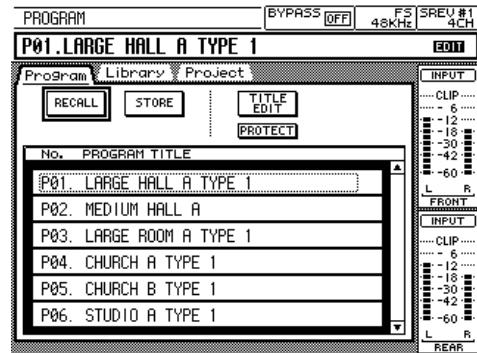

4-ch mode

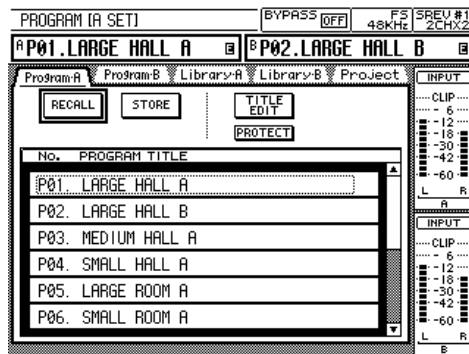

2-ch x2 mode—A

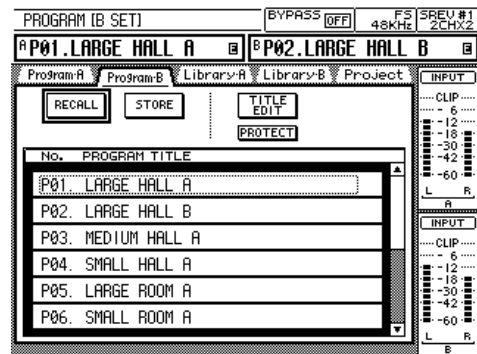

2-ch x2 mode—B

### Recalling Programs

Programs stored in Quick memories can be recalled instantly. The recalled program becomes the current program.

- 1 Use the [PROGRAM] button to locate the Program page.
- 2 Use the DATA wheel or the [-1/DEC] and [+1/INC] buttons to select a program from the list.
- 3 Use the cursor buttons to select the RECALL button, and then press [ENTER].

If the current program contains unsaved changes, a warning message appears. Select YES to discard the changes and recall the selected program, or select NO to cancel the operation.

The selected program is recalled and its number and title appear on the display.

In 2-channel x2 mode, when a program is recalled for reverberator A, reverberator B is muted, unless the optional DB-SREV1 Expansion Board is installed.

---

## Storing Programs

The current program can be stored to any Quick memory.

- 1 Use the [PROGRAM] button to locate the Program page.
- 2 Use the DATA wheel or the [-1/DEC] and [+1/INC] buttons to select a Quick memory.

Programs cannot be stored to Quick memories containing write-protected programs.

- 3 Use the cursor buttons to select the STORE button, and then press [ENTER].  
The Title Edit dialog box appears.

- 4 Enter a title.

See “Using the Title Edit dialog Box” on page 41 for more information.

- 5 Use the cursor buttons to select the OK button, and then press [ENTER].

(To cancel the operation, select the CANCEL button and then press [ENTER].)

The current program is stored to the selected Quick memory, and the Edit status indicator disappears (see page 18).

## Editing Program Titles

The titles of programs already stored in the Quick memories can be edited as follows.

- 1 Use the [PROGRAM] button to locate the Program page.
- 2 Use the DATA wheel or the [-1/DEC] and [+1/INC] buttons to select a program.

The titles of write-protected programs cannot be edited.

- 3 Use the cursor buttons to select the TITLE EDIT button, and then press [ENTER].

The Title Edit dialog box appears.

- 4 Edit the title.

See “Using the Title Edit dialog Box” on page 41 for more information.

- 5 Use the cursor buttons to select the OK button, and then press [ENTER].

(To cancel the operation, select the CANCEL button and then press [ENTER].)

Note that the “CHANGING TITLE...” message does not appear in this case.

The new title is stored.

## Protecting Quick Memory Programs

Quick memory programs can be write-protected to prevent accidental overwriting.

- 1 Use the [PROGRAM] button to locate the Program page.
- 2 Use the DATA wheel or the [-1/DEC] and [+1/INC] buttons to select a program.
- 3 Use the cursor buttons to select the PROTECT button, and then press [ENTER].  
The Protect icon (Ⓔ) appears to the right of the program's title.
- 4 Press the [ENTER] button again to unprotect the program.  
The Protect icon disappears.

## Working with the Library

This section explains how to load, save, title, protect, and delete programs from the Internal Card, PC Card, and CD-ROM. These operations are carried out on the Library pages shown below. In 2-channel x2 mode, two Library pages are available: Library-A and Library-B. In the program list, a dotted box highlights the selected program. In the DRIVE section of the page, INTERNAL is the Internal Card, CD-ROM is the CD-ROM drive, and PCMCIA is the PC Card.

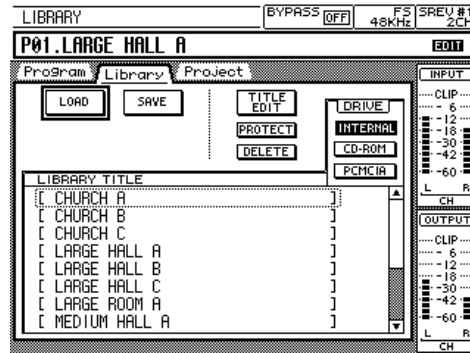

2-ch mode

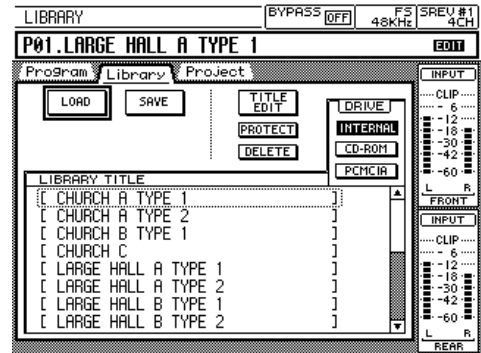

4-ch mode

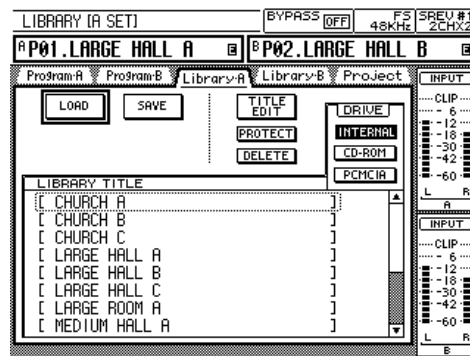

2-ch x2 mode—A

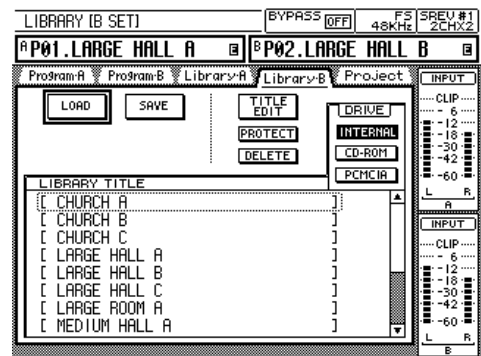

2-ch x2 mode—B

### Loading Programs from the Library

Programs can be loaded from the following drives: Internal Card, PC Card, or CD-ROM. The loaded program becomes the current program. The preset programs on the supplied CD-ROM are loaded into the Internal Card at the factory.

- 1 Use the [PROGRAM] button to locate the Library page.
- 2 Use the cursor buttons to select a drive button, and then press [ENTER] to make it the active drive.  
The programs stored on the active drive appear in the program list.
- 3 Use the DATA wheel or the [-1/DEC] and [+1/INC] buttons to select a program from the list.
- 4 Use the cursor buttons to select the LOAD button, and then press [ENTER].

If the current program contains unsaved changes, a warning message appears. Select YES to discard the changes and load the selected program, or select NO to cancel the operation.

The selected program, and its impulse-response data, is loaded and its title appears on the display.

Note that unlike the Quick memory programs, which load instantly, programs stored on the drives take time to load, depending on the size of the associated impulse-response data and the speed of the drive.

In 2-channel x2 mode, when a program is loaded for reverberator A, reverberator B is muted, unless the optional DB-SREV1 Expansion Board is installed.

## Saving Programs in the Library

The current program can be saved to the following drives: Internal Card or PC Card.

- 1 Use the [PROGRAM] button to locate the Library page.
- 2 Use the cursor buttons to select a drive button, and then press [ENTER] to make it the active drive.

The programs stored on the active drive appear in the program list.

- 3 Use the cursor buttons to select the SAVE button, and then press [ENTER].  
The Title Edit dialog box appears.

- 4 Enter a title.

See “Using the Title Edit dialog Box” on page 41 for more information.

- 5 Use the cursor buttons to select the OK button, and then press [ENTER].

(To cancel the operation, select the CANCEL button and then press [ENTER].)

If a program with the same title already exists, a confirmation dialog box appears. Select YES to overwrite the existing program, or select NO to cancel the operation. Note that if the existing program is write-protected, it cannot be overwritten.

The current program, and its impulse-response data, is saved to the selected drive, and the Edit status indicator disappears (see page 18).

## Editing Program Titles in the Library

The titles of programs stored on the following drives can be edited: Internal Card or PC Card.

- 1 Use the [PROGRAM] button to locate the Library page.
- 2 Use the cursor buttons to select a drive button, and then press [ENTER] to make it the active drive.

The programs stored on the active drive appear in the program list.

- 3 Use the DATA wheel or the [-1/DEC] and [+1/INC] buttons to select a program.

The titles of write-protected programs cannot be edited.

- 4 Use the cursor buttons to select the TITLE EDIT button, and then press [ENTER].

The Title Edit dialog box appears.

- 5 Edit the title.

See “Using the Title Edit dialog Box” on page 41 for more information.

- 6 Use the cursor buttons to select the OK button, and then press [ENTER].

(To cancel the operation, select the CANCEL button and then press [ENTER].)

The new title is saved.

---

## Protecting Library Programs

Programs stored on the following drives can be write-protected to prevent accidental deletion: Internal Card or PC Card.

- 1 Use the [PROGRAM] button to locate the Library page.
- 2 Use the cursor buttons to select a drive button, and then press [ENTER] to make it the active drive.  
The programs stored on the active drive appear in the program list.
- 3 Use the DATA wheel or the [-1/DEC] and [+1/INC] buttons to select a program.
- 4 Use the cursor buttons to select the PROTECT button, and then press [ENTER].  
The Protect icon (P) appears to the right of the program's title.
- 5 Press the [ENTER] button again to unprotect the program.  
The Protect icon disappears.

## Deleting Library Programs

Programs stored on the following drives can be deleted: Internal Card or PC Card. The preset programs loaded into the Internal Card at the factory are also available on the supplied CD-ROM.

- 1 Use the [PROGRAM] button to locate the Library page.
- 2 Use the cursor buttons to select a drive button, and then press [ENTER] to make it the active drive.  
The programs stored on the active drive appear in the program list.
- 3 Use the DATA wheel or the [-1/DEC] and [+1/INC] buttons to select a program.
- 4 Use the cursor buttons to select the DELETE button, and then press [ENTER].  
A confirmation dialog box appears. Select YES to delete the program, or select NO to cancel the operation. Note that if the program is write-protected, it cannot be deleted.  
The program, and its impulse-response data, is deleted and disappears from the list. If the impulse-response data is required by another program, it's not deleted.



## Working with Projects

This section explains how to load, save, title, protect, and delete projects from the Internal, PC Card, and CD-ROM drives. All these operations are carried out on the Project pages shown below. In the project list, a dotted box highlights the selected project. See page 7 for more information about projects.

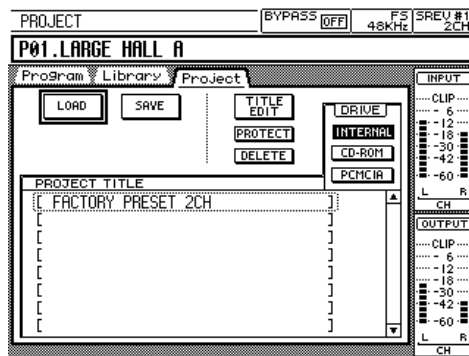

2-ch mode

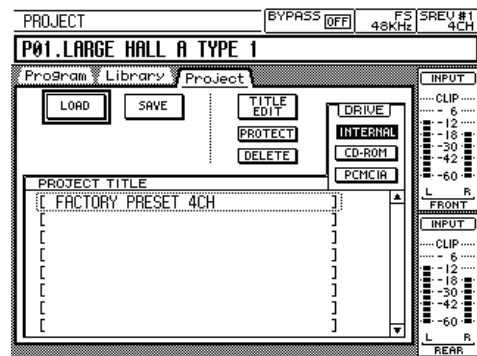

4-ch mode

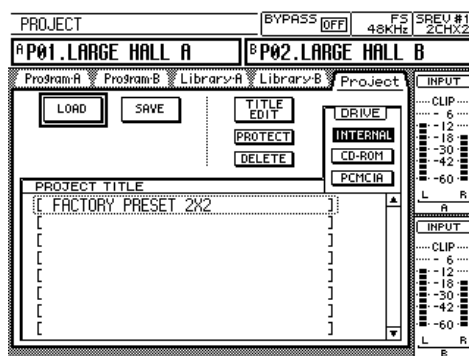

2-ch x2 mode

### Loading Projects

Projects can be loaded from the following drives: Internal Card, PC Card, or CD-ROM.

- 1 Use the [PROGRAM] button to locate the Project page.
- 2 Use the cursor buttons to select a drive button, and then press [ENTER] to make it the active drive.

The projects stored on the active drive appear in the project list.

- 3 Use the DATA wheel or the [-1/DEC] and [+1/INC] buttons to select a project from the list.
- 4 Use the cursor buttons to select the LOAD button, and then press [ENTER].

A confirmation message appears. Select YES to load the project, or select NO to cancel the operation.

The message “LOADING PROJECT...” appears while the selected project and its programs are loaded. The Program page appears when loading, which takes about 30 seconds, is complete.

---

## Saving Projects

Projects, which consist of all the Quick memory programs and the current program settings, can be saved to the following drives: Internal Card or PC Card.

- 1 Use the [PROGRAM] button to locate the Project page.
- 2 Use the cursor buttons to select a drive button, and then press [ENTER] to make it the active drive.

The projects already stored on the active drive appear in the project list.

- 3 Use the cursor buttons to select the SAVE button, and then press [ENTER].  
The Title Edit dialog box appears.

- 4 Enter a title.

See “Using the Title Edit dialog Box” on page 41 for more information.

- 5 Use the cursor buttons to select the OK button, and then press [ENTER].  
(To cancel the operation, select the CANCEL button and then press [ENTER].)

If a project with the same title already exists, a confirmation dialog box appears. Select YES to overwrite the existing project, or select NO to cancel the operation. Note that if the existing project is write-protected it cannot be overwritten.

The project is saved to the selected drive.

## Editing Project Titles

The titles of projects stored on the following drives can be edited: Internal Card or PC Card.

- 1 Use the [PROGRAM] button to locate the Project page.
- 2 Use the cursor buttons to select a drive button, and then press [ENTER] to make it the active drive.

The projects stored on the active drive appear in the project list.

- 3 Use the DATA wheel or the [-1/DEC] and [+1/INC] buttons to select a project.  
The titles of write-protected projects cannot be edited.

- 4 Use the cursor buttons to select the TITLE EDIT button, and then press [ENTER].

The Title Edit dialog box appears.

- 5 Edit the title.

See “Using the Title Edit dialog Box” on page 41 for more information.

- 6 Use the cursor buttons to select the OK button, and then press [ENTER].  
(To cancel the operation, select the CANCEL button and then press [ENTER].)

The new title is saved.

## Protecting Projects

Projects stored on the following drives can be write-protected to prevent accidental deletion: Internal Card or PC Card.

- 1 Use the [PROGRAM] button to locate the Project page.
- 2 Use the cursor buttons to select a drive button, and then press [ENTER] to make it the active drive.  
The projects stored on the active drive appear in the project list.
- 3 Use the DATA wheel or the [-1/DEC] and [+1/INC] buttons to select a project.
- 4 Use the cursor buttons to select the PROTECT button, and then press [ENTER].  
The Protect icon (E) appears to the right of the project's title.
- 5 Press the [ENTER] button again to unprotect the project.  
The Protect icon disappears.

## Deleting Projects

Projects stored on the following drives can be deleted: Internal Card or PC Card.

- 1 Use the [PROGRAM] button to locate the Project page.
- 2 Use the cursor buttons to select a drive button, and then press [ENTER] to make it the active drive.  
The projects stored on the active drive appear in the project list.
- 3 Use the DATA wheel or the [-1/DEC] and [+1/INC] buttons to select a project.
- 4 Use the cursor buttons to select the DELETE button, and then press [ENTER].  
A confirmation dialog box appears. Select YES to delete the project, or select NO to cancel the operation. Note that if the project is write-protected, it cannot be deleted.  
The selected project is deleted and disappears from the list.

# Editing Programs

---

# 5



## In this chapter...

Main 1 Parameters .....	52
Main 2 Parameters .....	54
Fine Reverb Parameters .....	56
Pre EQ .....	57
Post EQ .....	59
Loading Impulse-Response Data .....	61

## Main 1 Parameters

Basic parameters, including Reverb Time, Initial Delay, Pre EQ Low Gain, and Pre EQ High Gain, can be adjusted on the Main 1 pages. In 2-channel x2 mode, two Main 1 pages are available: Main1-A and Main1-B. Channels are grouped, so adjusting, say, the Reverb Time parameter, adjusts the reverb time of all channels simultaneously. In 2-channel x2 mode, A and B parameters are grouped independently. These parameters can be adjusted for each channel individually on the Fine parameter pages. See page 56 and page 57 for more information.

The graphs and parameter values of only one channel are displayed at a time. You can choose which channel by using the buttons in the DISPLAY CHANNEL section of the page. Below that section is the REV graph, which displays the reverb parameter settings graphically, and the PRE-EQ graph, which displays the Pre EQ settings graphically. If the EQ is turned off on the Pre EQ page (see page 57), the EQ graph appears shaded.

The Main 1 pages for each mode are shown below.

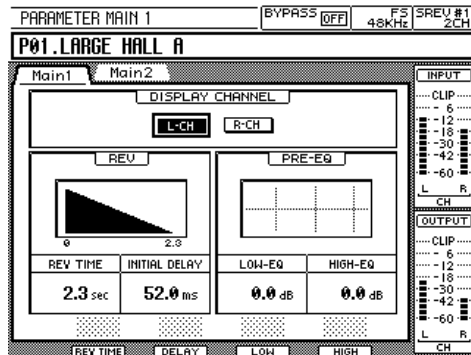

2-ch mode

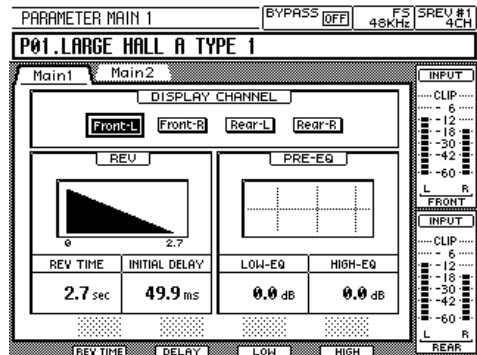

4-ch mode

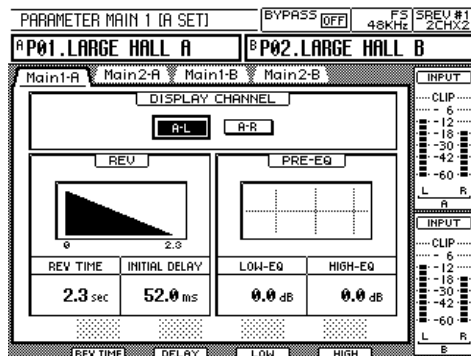

2-ch x2 mode—A

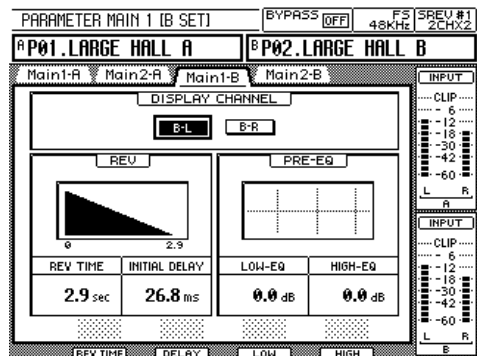

2-ch x2 mode—B

- 1 Use the [PARAMETER MAIN] button to locate the Main 1 page.
- 2 Use the cursor buttons to select a channel button in the DISPLAY CHANNEL section, and then press the [ENTER] button to make it the active display channel.

The button of the active display channel appears highlighted.

- 3 Use the cursor buttons to select the REV TIME, INITIAL DELAY, LOW-EQ, or HIGH-EQ parameter.
- 4 Use the faders, DATA wheel, or [-1/DEC] and [+1/INC] buttons to adjust the selected parameter.

Note that since adjustments to the REV TIME parameter do not take effect immediately, there is a small delay between adjusting the reverb time by using, for example, a fader and the new reverb time being applied.

The parameter ranges are as follows.

Parameter	Range	Steps	Description
REV TIME	0.3– <sup>1</sup>	0.1 sec	Reverb time
INITIAL DELAY	0.1–500.0 ms	0.1 ms	Initial delay time
LOW-EQ	–18.0 dB to +18.0 dB	0.1 dB	Pre EQ low gain
HIGH-EQ	–18.0 dB to +18.0 dB	0.1 dB	Pre EQ high gain

1. Actual maximum reverb time depends on the impulse-response data.

The following waveforms show the reverb produced by a snare drum with reverb times of 500 milliseconds and 2.0 seconds. Initial delay is 0.1 milliseconds; reverb balance is 100%. The third waveform shows how reflections can be delayed by using the Initial Delay parameter. Here the reverb time is 2.0 seconds; initial delay is 200 ms (exaggerated for illustration clarity); and the reverb balance is 50%.

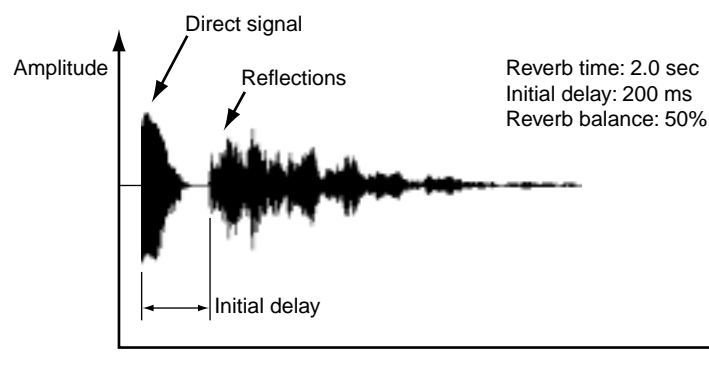
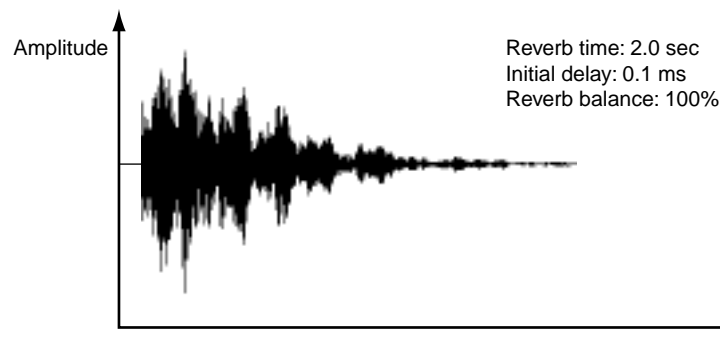
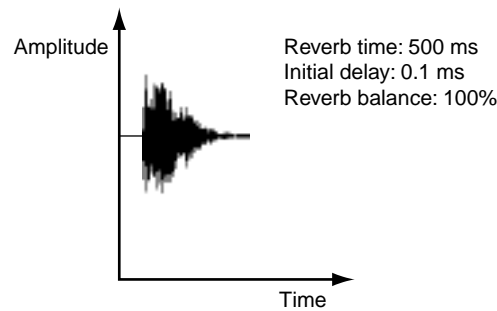

## Main 2 Parameters

Basic parameters, including Reverb Balance, Input Level, Output Level, and Pre EQ HPF frequency, can be adjusted on the Main 2 pages. In 2-channel x2 mode, two Main 2 pages are available: Main2-A and Main2-B. Channels are grouped, so adjusting, say, the Reverb Balance parameter, adjusts the reverb balance of all channels simultaneously. In 2-channel x2 mode, A and B parameters are grouped independently. These parameters can be adjusted for each channel individually on the Fine parameter pages. See page 56 and page 57 for more information.

The graphs and parameter values of only one channel are displayed at a time. You can choose which channel by using the buttons in the DISPLAY CHANNEL section of the page. Below that section is the REV graph, which displays the reverb parameter settings graphically, and the PRE-EQ graph, which displays the Pre EQ settings graphically. If the EQ is turned off on the Pre EQ page (see page 57), the EQ graph appears shaded. Likewise, if the HPF filter type parameter is set to THRU on the Pre EQ page, that also appears shaded.

The Main 2 pages for each mode are shown below.

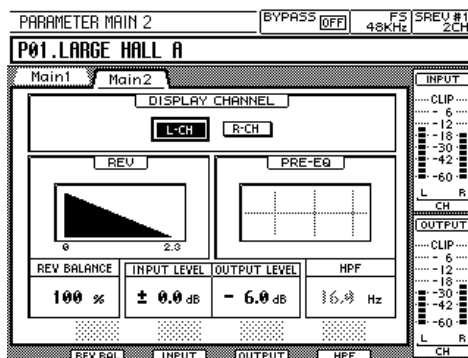

2-ch mode

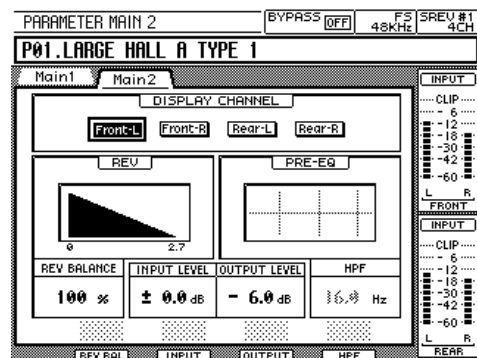

4-ch mode

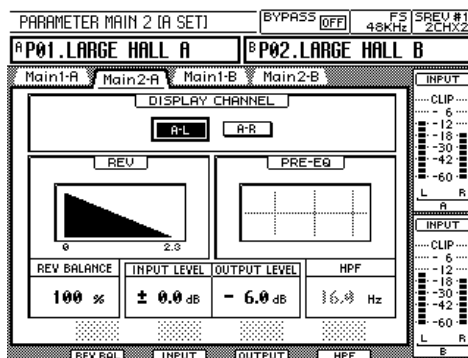

2-ch x2 mode—A

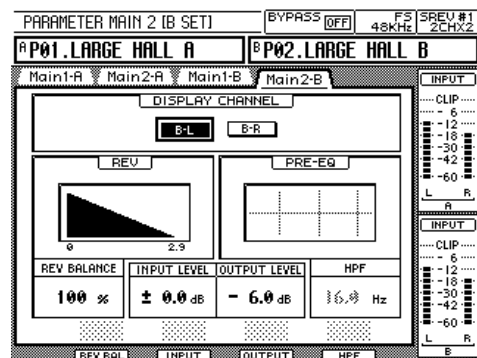

2-ch x2 mode—B

- 1 Use the [PARAMETER MAIN] button to locate the Main 2 page.
- 2 Use the cursor buttons to select a channel button in the DISPLAY CHANNEL section, and then press the [ENTER] button to make it the active display channel.

The button of the active display channel appears highlighted.

- 3 Use the cursor buttons to select the REV BALANCE, INPUT LEVEL, OUTPUT LEVEL, or HPF parameter.
- 4 Use the faders, DATA wheel, or [-1/DEC] and [+1/INC] buttons to adjust the selected parameter.

The parameter ranges are as follows.

Parameter	Range	Steps	Description
REV BALANCE	0–100%	1%	Balance between reverb and dry signals. 0% = all dry, 100% = all reverb.
INPUT LEVEL	$-\infty$ , -72.0 dB to +6.0 dB	0.1 dB	Input level
OUTPUT LEVEL	$-\infty$ , -72.0 dB to +6.0 dB	0.1 dB	Output level
HPF	16.0 Hz–23.6 kHz	1/12 oct	Pre EQ HPF frequency

### Reverb Balance

The following waveforms illustrate the effect of the Reverb Balance parameter. The sound source is a snare drum

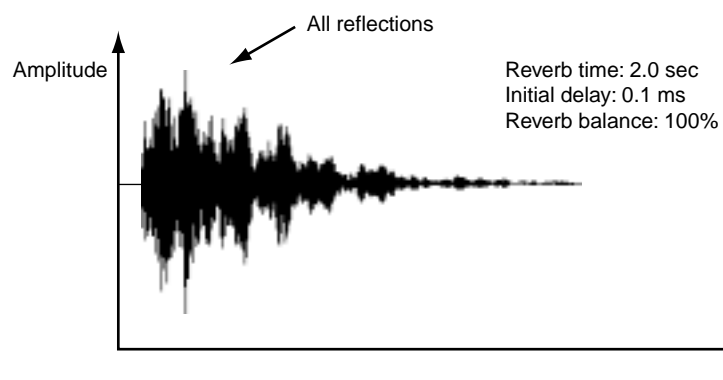
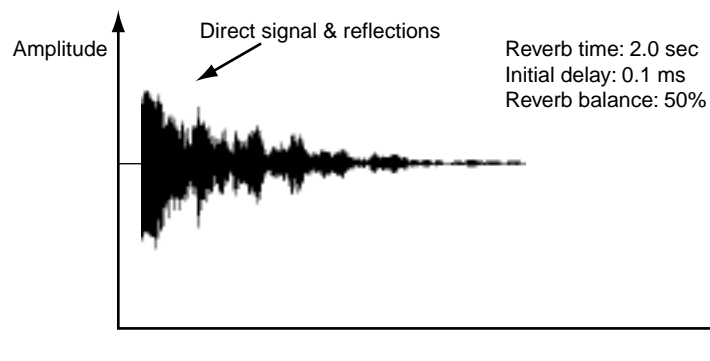
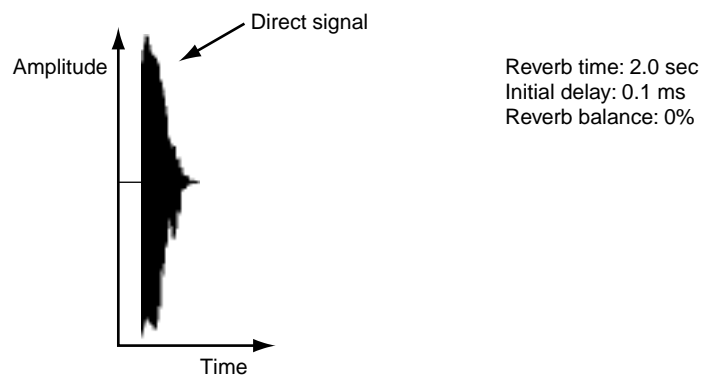



## Fine Reverb Parameters

Reverb Time, Initial Delay, Reverb Balance, and Reverb Level parameters can be adjusted for each channel individually on the Rev page, although there is an option to group them. In addition to numeric values, settings are displayed graphically.

The Rev pages for each mode are shown below.

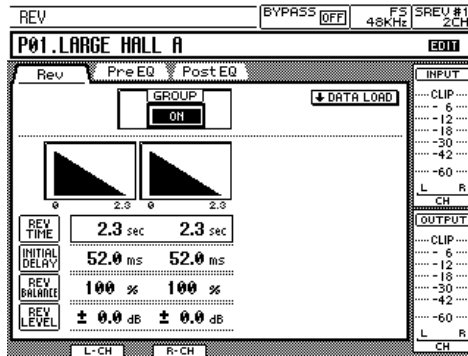

2-ch mode

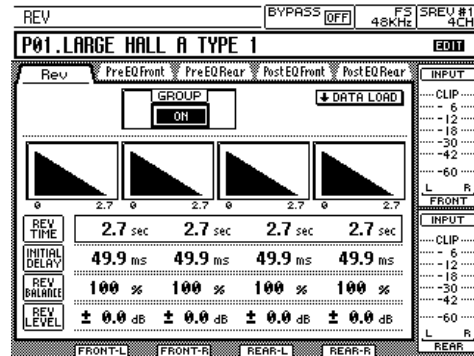

4-ch mode

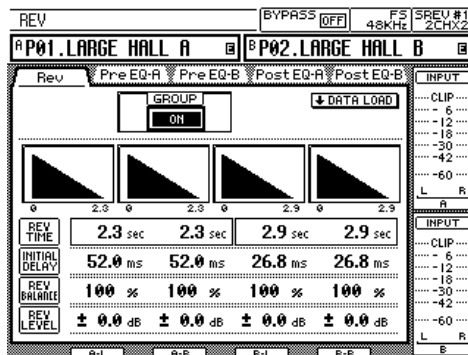

2-ch x2 mode

- 1 Use the [PARAMETER FINE] button to locate the Rev page.  
Use the ON/OFF button in the GROUP section to group and ungroup the channels. When set to ON, all channels are adjusted simultaneously. When set to OFF, channels can be adjusted individually.
- 2 Use the cursor buttons to select the REV TIME, INITIAL DELAY, REV BALANCE, or REV LEVEL parameter.
- 3 Use the faders, DATA wheel, or [-1/DEC] and [+1/INC] buttons to adjust the selected parameter.

Note that since adjustments to the REV TIME parameter do not take effect immediately, there is a small delay between adjusting the reverb time by using, for example, a fader and the new reverb time being applied, especially when channels are grouped.

The parameter ranges are as follows.

Parameter	Range	Steps	Description
REV TIME	0.3– <sup>1</sup>	0.1 sec	Reverb time
INITIAL DELAY	0.1–500.0 ms	0.1 ms	Delay before reverb starts
REV BALANCE	0–100%	1%	Balance between reverb and dry signals. 0% = all dry, 100% = all reverb.
REV LEVEL	–∞, –72 dB to +6.0 dB	0.1 dB	Reverb level

1. Actual maximum reverb time depends on the impulse-response data.

## Pre EQ

The pre-convolution EQ consists of a variable frequency HPF and fully parametric 3-band EQ. Parameters can be adjusted for each channel individually on the Pre EQ pages. In 4-channel mode, two Pre EQ pages are available: Pre EQ Front and Pre EQ Rear. Likewise, in 2-channel x2 mode, with Pre EQ-A and Pre EQ-B pages. In addition to numeric values, EQ settings are displayed graphically. Inactive parameters appear shaded. Q, for example, is not active when, say, the HIGH band is set to H.SHELF. The Pre EQ pages for each mode are shown below.

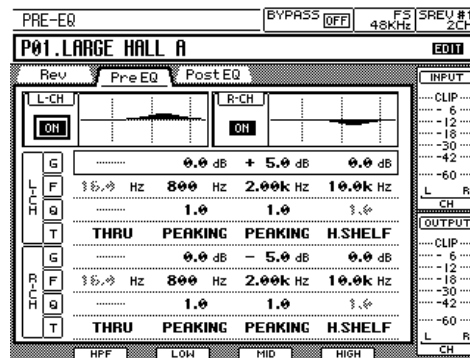

2-ch mode

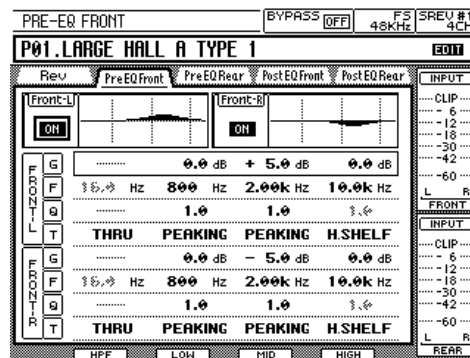

4-ch mode—Front

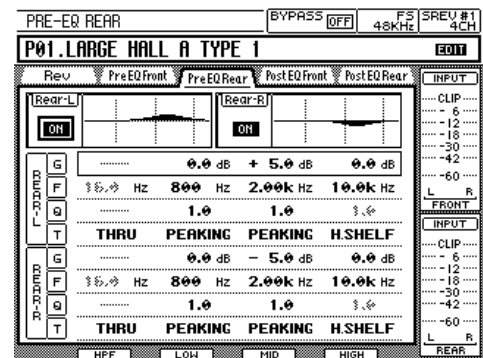

4-ch mode—Rear

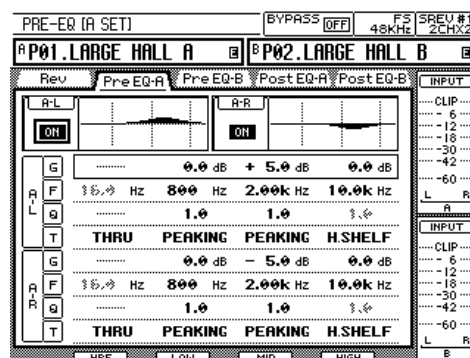

2-ch x2 mode—A

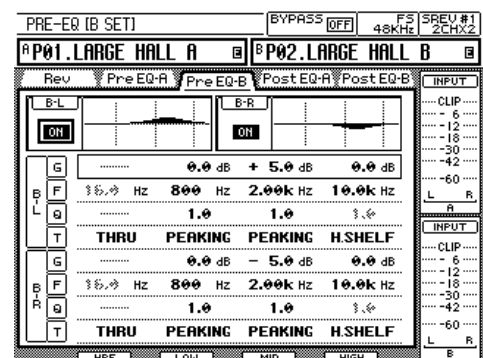

2-ch x2 mode—B

Note that the LOW band gain and HIGH band gain parameters can also be adjusted on the Main 1 page (see page 52). Likewise, the HPF frequency parameter can also be adjusted on the Main 2 page (see page 54). On these pages, however, the channels are grouped.

- 1 Use the [PARAMETER FINE] button to locate the Pre EQ page.

Use the ON/OFF button next to each EQ graph to turn on and off the Pre EQ for each channel. Note that these buttons also turn on and off the LOW band and HIGH band parameters on the Main 1 page.

- 2 Use the cursor buttons to select the G (gain), F (frequency), Q (width), or T (Filter Type) parameter.
- 3 Use the faders, DATA wheel, or [-1/DEC] and [+1/INC] buttons to adjust the selected parameter.

The parameter ranges are as follows.

Parameter	HPF	LOW <sup>1</sup>	MID <sup>2</sup>	HIGH <sup>3</sup>
Gain (G)	—	-18 dB to +18 dB (0.1 dB steps)		
Frequency (F)	16.0 Hz–23.6 kHz (1/12 oct steps)			
Q	—	10.0–0.10		
Filter Type (T)	THRU <sup>4</sup> , HPF	PEAKING, L.SHELF	PEAKING	PEAKING, H.SHELF, LPE, THRU <sup>5</sup>

1. Can be used as a peaking EQ (10–0.10) or low shelving EQ (L.SHELF).
2. Peaking EQ.
3. Can be used as a peaking EQ (10–0.10), high shelving EQ (H.SHELF), or low pass filter (LPE).
4. The HPF is bypassed when set to THRU.
5. The HIGH band is bypassed when set to THRU.

Note that when the HPF is set to THRU, the HPF parameter on the Main 2 page is inactive.

# Post EQ

The post-convolution EQ consists of a fully parametric 4-band EQ. Parameters can be adjusted for each channel individually on the Post EQ page. In 4-channel mode, two Post EQ pages are available: Post EQ Front and Post EQ Rear. Likewise, in 2-channel x2 mode, with Post EQ-A and Post EQ-B pages. In addition to numeric values, EQ settings are displayed graphically. Inactive parameters appear shaded. Q, for example, is not active when, say, the HIGH band is set to H.SHELF.

The Post EQ pages for each mode are shown below.

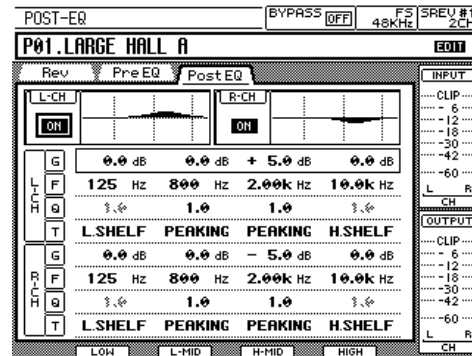

2-ch mode

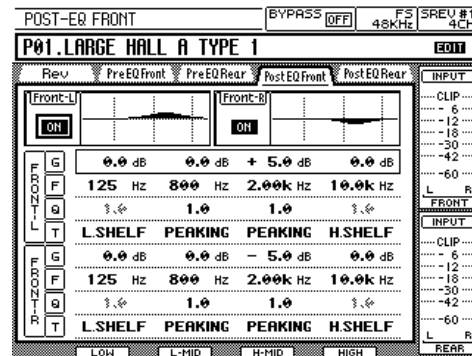

4-ch mode—Front

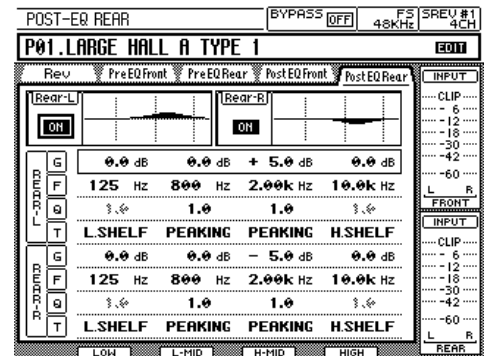

4-ch mode—Rear

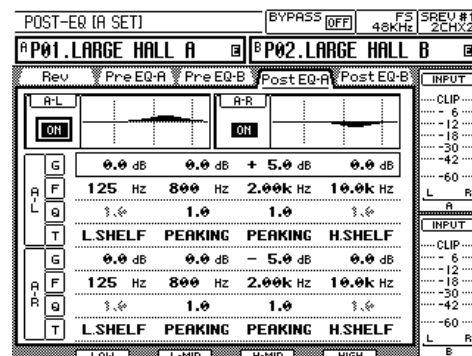

2-ch x2 mode—A

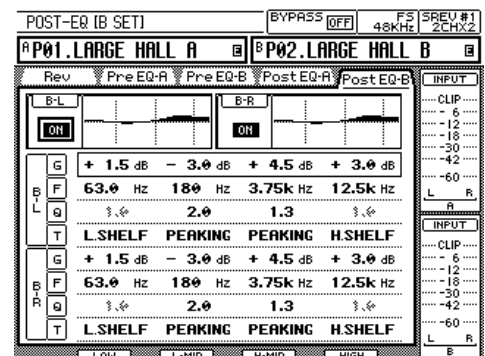

2-ch x2 mode—B

- 1 Use the [PARAMETER FINE] button to locate the Post EQ page.  
Use the ON/OFF button next to each EQ graph to turn on and off the Post EQ for each channel.
- 2 Use the cursor buttons to select the G (gain), F (frequency), Q (width) or T (Filter Type) parameter.

- 3 Use the faders, DATA wheel, or [-1/DEC] and [+1/INC] buttons to adjust the selected parameter.

The parameter ranges are as follows.

Parameter	LOW <sup>1</sup>	L-MID <sup>2</sup>	H-MID <sup>3</sup>	HIGH <sup>4</sup>
Gain (G)	-18 dB to +18 dB (0.1 dB steps)			
Frequency (F)	16.0 Hz–23.6 kHz (1/12 oct steps)			
Q	10.0–0.10			
Filter Type (T)	PEAKING, L.SHELF, HPF, THRU <sup>5</sup>	PEAKING	PEAKING	PEAKING, H.SHELF, LPF, THRU <sup>6</sup>

1. Can be used as a peaking EQ (10–0.10), low shelving EQ (L.SHELF), or high pass filter (HPF).
2. Peaking EQ.
3. Peaking EQ.
4. Can be used as a peaking EQ (10–0.10), high shelving EQ (H.SHELF), or low pass filter (LPF).
5. The HPF and LPF are bypassed when set to THRU.
6. The HIGH band is bypassed when set to THRU.

## Loading Impulse-Response Data

This section explains how to load impulse-response data for each channel of the current program from the Internal Card, PC Card, CD-ROM drive. Impulse response data stored in the following formats can be loaded: TM4 or TMC. See “File Types” on page 9 for more information. In the impulse-response file list, a dotted box highlights the selected file. The Protect icon (Ⓕ) appears to the right of write-protected files. In the DRIVE section of the page, INTERNAL is the Internal Card, CD-ROM is the CD-ROM drive, and PCMCIA is the PC Card.

The Data Load pages for each mode are shown below.

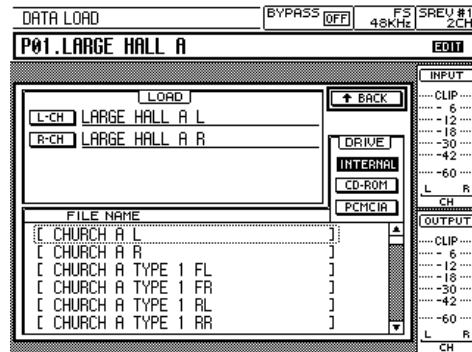

2-ch mode

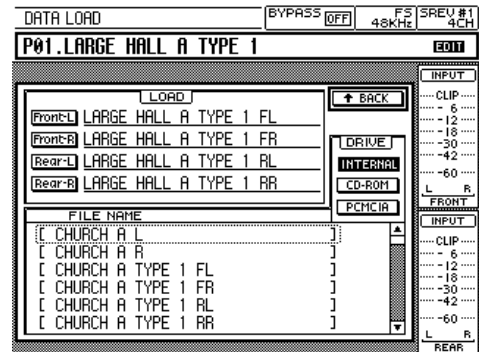

4-ch mode

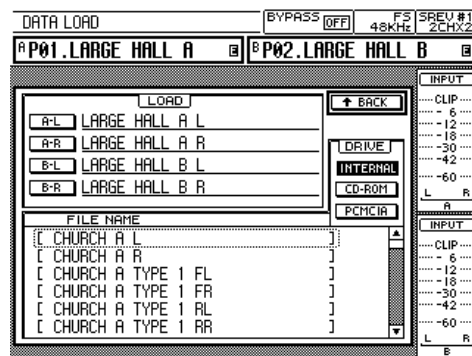

2-ch x2 mode

- 1 Use the [PARAMETER FINE] button to locate the Rev page.
- 2 Select the DATA LOAD button, and then press [ENTER].  
The Data Load page appears.
- 3 Use the cursor buttons to select a drive button, and then press [ENTER] to make it the active drive.  
The impulse-response data stored on the active drive appear in the file list.
- 4 Use the DATA wheel or the [-1/DEC] and [+1/INC] buttons to select a file from the list.
- 5 Use the cursor buttons to select the channel to which you want to load the impulse-response data, and then press [ENTER].  
A warning message appears. Select YES to load the selected file, or select NO to cancel the operation.  
The selected impulse-response data is loaded.
- 6 To return to the Rev page, select the BACK button, and then press [ENTER].  
The Rev page appears.

Impulse-response data (TM4 format) created by using IRSampler, the impulse-response sampling software, or IREdit, the impulse-response editing software, can be loaded into the SREV1 from a PC Card. The RC-SREV1 looks for impulse-response data stored in the “\yamaha\srev\data” folder of the PC Card, so you need to make a new folder called “data” in “x:\yamaha\srev\” and then copy your impulse-response data into it. (Note that “x” refers to the letter assigned to your PC Card while it’s inserted in your PC.)

The 2-channel (SP2) and 4-channel (SP4) programs that you create are stored in the “\yamaha\srev\prog” folder, and 2-channel, 4-channel, and 2-channel x2 projects are stored in the “\yamaha\srev\proj” folder. When you copy or move any of these files to another PC Card by using your PC, be sure to use the same folder organization and naming, otherwise, the SREV1 will not be able to find the files.

Note that the SREV1 can only list up to 128 files in a folder, so do not put any more files than that into a folder. If you do have more than 128 files in a folder, the SREV1 lists the first 128 files copied to the folder in alphabetical order.

# Multiple SREV1s

---

# 6



## In this chapter...

About Multiple SREV1s .....	64
Connections .....	64
Multiple-unit Operating Notes .....	65
Selecting SREV1s from the RC-SREV1 .....	65
Multiple-unit Hookup with the RC-SREV1 .....	64



## About Multiple SREV1s

Up to four SREV1s can be controlled from a single RC-SREV1.

## Connections

Multiple SREV1s are connected together in a daisy-chain fashion using the SERIAL ports shown here. Connections between units are made using serial cables, which are available from your Yamaha dealer.

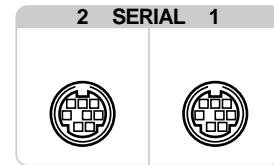

## Multiple-unit Hookup with the RC-SREV1

The following example shows how up to four SREV1s can be connected together in a daisy-chain fashion for control from an RC-SREV1. The SREV1 connected to the RC-SREV1 is automatically assigned ID #1, and the other SREV1s are assigned IDs in order of connection, as shown.

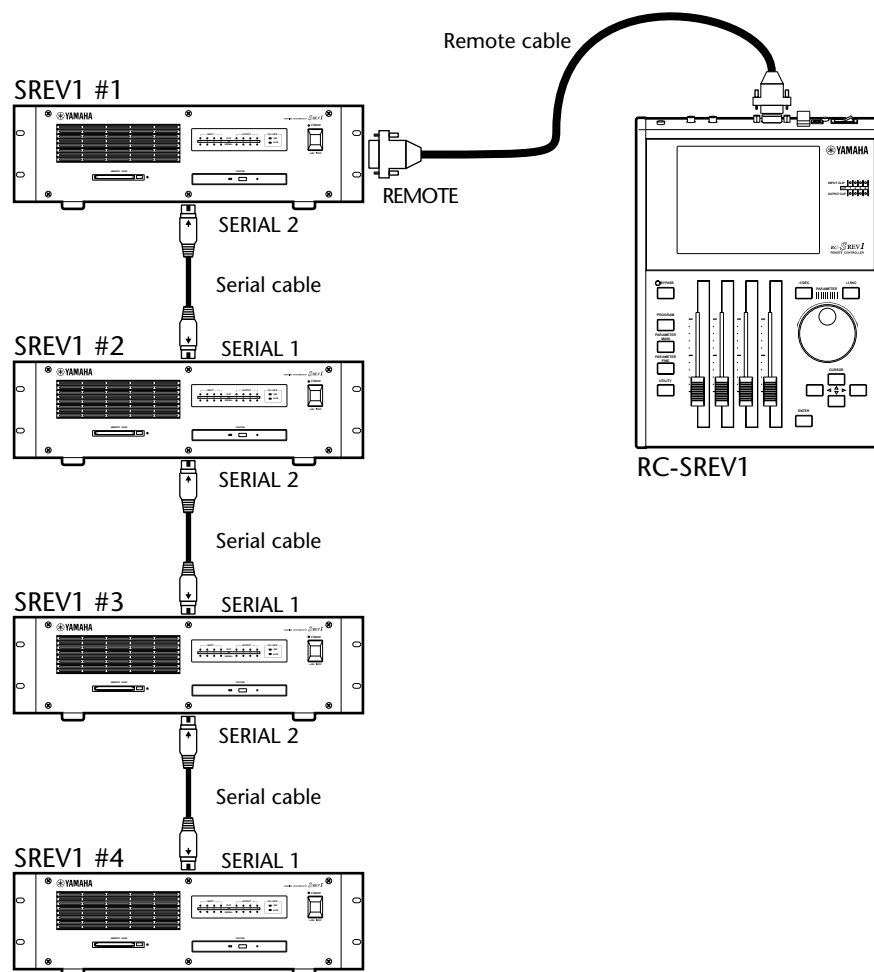

## Multiple-unit Operating Notes

- The RC-SREV1 should be connected to SREV1 #1.
- Connect the SREV1s together by using serial cables.
- Turn on the SREV1s first, and then the RC-SREV1.
- Do not connect or disconnect any serial cables while the system is up and running.
- Do not turn off any of the SREV1s while the system is up and running.

## Selecting SREV1s from the RC-SREV1

This section explains how to select the SREV1 to be controlled from the RC-SREV1.

- 1 Use the [UTILITY] button to locate the Setup page shown below.

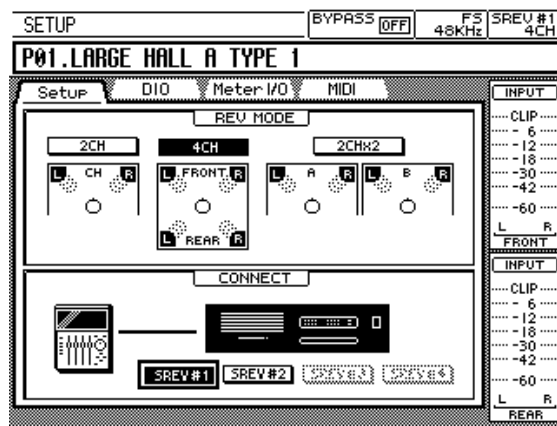

- 2 Use the cursor buttons to select the SREV #1, SREV #2, SREV #3, or SREV #4 button in the CONNECT section of the page.

The button of the currently selected SREV1 appears highlighted. The buttons of unconnected SREV1s appear shaded.

- 3 Press the [ENTER] button.  
A confirmation message appears.
- 4 Select YES to continue, or select NO to cancel the operation.
- 5 Press the [ENTER] button.

The RC-SREV1 retrieves system information such as Reverb mode, and wordclock source from the selected SREV1, and then updates its display. The number of the selected SREV1 appears in the top-right corner of the display (see page 18).

# MIDI

---

# 7

## In this chapter...

MIDI & the SREV1 .....	68
MIDI Ports .....	68
MIDI Pages .....	69
Setting the MIDI Receive Channels .....	69
Assigning Quick Memory Programs to Program Changes .....	70
Assigning Parameters to Control Changes .....	71

## MIDI & the SREV1

The SREV1 supports the following MIDI messages:

- Program Changes to recall up to 12 Quick memory programs
- Control Changes for Reverb Balance and Reverb Level control

These MIDI messages are not transmitted when actions are performed on RC-SREV1.

Quick memory programs can be assigned to MIDI Program Changes and then recalled remotely from other MIDI equipment. When a Program Change message is received, the program stored in the assigned Quick memory is recalled. See “Assigning Quick Memory Programs to Program Changes” on page 70 for more information.

The Reverb Balance and Reverb Level parameters for each channel can be assigned to MIDI Control Changes and then controlled remotely from other MIDI equipment. When a Control Change message is received, the assigned parameter is controlled. See “Assigning Parameters to Control Changes” on page 71 for more information.

The SREV1 can be set to receive Program Change and Control Change messages on any MIDI Channel from 1 through 16, and in 2-channel x2 mode, individual MIDI Channels can be set for A and B. See “Setting the MIDI Receive Channels” on page 69 for more information.

*Note: Do not control the SREV1 by using MIDI messages and the RC-SREV1 simultaneously.*

## MIDI Ports

The MIDI IN and OUT ports are used to transmit and receive MIDI messages. The MIDI IN port receives messages, while the MIDI OUT port currently echoes the messages received at the MIDI IN port, essentially like a MIDI THRU port.

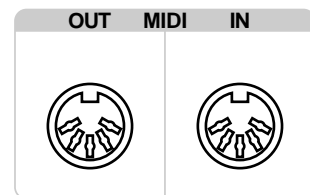

## MIDI Pages

MIDI settings are made on the MIDI pages shown below.

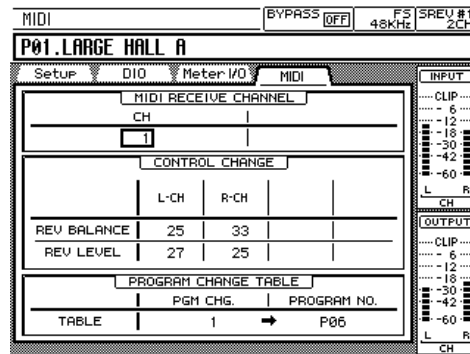

2-ch mode

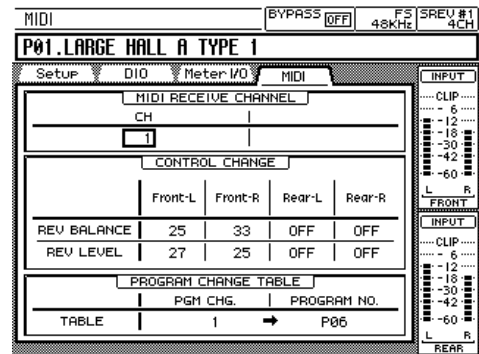

4-ch mode

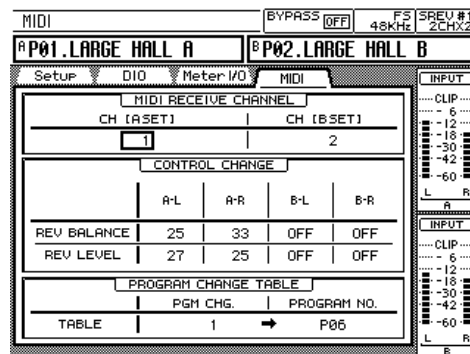

2-ch x2 mode

## Setting the MIDI Receive Channels

The MIDI Channel used to receive MIDI Program Change and Control Change messages is set on the MIDI page. There are two MIDI Channel settings in 2-channel x2 mode, one for A and one for B.

- 1 Use the [UTILITY] button to locate the MIDI page.
- 2 Use the cursor buttons to select the CH parameter in the MIDI RECEIVE CHANNEL section of the page.
- 3 Use the DATA wheel or [-1/DEC] and [+1/INC] buttons to select a MIDI Channel from 1 through 16 or OFF.

When OFF is selected, the SREV1 ignores received MIDI messages.

## Assigning Quick Memory Programs to Program Changes

Quick memory programs P01 through P06 (2-channel or 4-channel mode), P01–P12 (2-channel x2 mode) can be assigned to Program Changes 1 through 128.

- 1 Use the [UTILITY] button to locate the MIDI page.
- 2 Use the cursor buttons to select the PGM CHG. parameter in the PROGRAM CHANGE TABLE section of the page.
- 3 Use the DATA wheel or [–1/DEC] and [+1/INC] buttons to assign a Program Change from 1 through 128 to the selected Quick memory program.
- 4 Use the cursor buttons to select the PROGRAM NO. parameter in the PROGRAM CHANGE TABLE section of the page.
- 5 Use the DATA wheel or [–1/DEC] and [+1/INC] buttons to select a Quick memory program from P01 through P12, or “---” for no assignment.

Quick memory program number assignments P07 through P12 are active only in 2-channel x2 mode. In 2-channel and 4-channel mode, they are ignored.

When a Program Change message is received, the program stored in the assigned Quick memory is recalled along with the necessary impulse-response data, and the program’s number and title appear on the display, and the Edit indicator, if displayed, disappears.

The following illustration shows the type of MIDI equipment that can be used with the SREV1 for remote Quick memory program recall using Program Change messages.

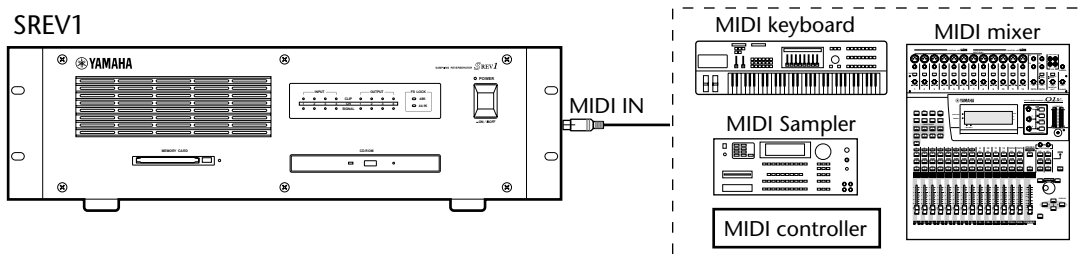

## Assigning Parameters to Control Changes

Reverb Balance and Reverb Level parameters for each channel can be assigned to MIDI Control Changes 0 through 95.

- 1 Use the [UTILITY] button to locate the MIDI page.
- 2 Use the cursor buttons to select the REV BALANCE or REV LEVEL assignments in the CONTROL CHANGE section of the page.  
In 2-channel mode, these are L-CH and R-CH. In 4-channel mode, Front-L, Front-R, Rear-L, and Rear-R. And in 2-channel x2 mode, A-L, A-R, B-L, and B-R.
- 3 Use the DATA wheel or [-1/DEC] and [+1/INC] buttons to assign a Control Change to OFF or 0 through 95.

When a Control Change message is received, the assigned parameter is controlled. If the Rev page is selected, you can see the parameter value update, and if the parameter is the currently selected parameter, then the corresponding fader moves as well.

If a Control Change is assigned to more than one parameter, all the assigned parameters are controlled when that Control Change is received.

Since Control Changes are assigned to channels individually, they are not affected by the GROUP button on the Rev page. Even if channels are grouped, only the assigned channel parameter is controlled when a Control Change message is received.

If a page selected by using the [PARAMETER FINE] button is displayed when a Control Change message is received, the corresponding fader moves and the graph and parameter values change, causing the Edit status indicator to appear.

If a page selected by using the [PARAMETER MAIN] button is displayed when a Control Change message is received, the corresponding fader, graph, and parameter value do not change. Only the Edit status indicator appears. To update the fader, graph, and parameter value, select another page, then select the previous page again.

The following illustration shows the type of MIDI equipment that can be used with the SREV1 for remote parameter control using Control Change messages.

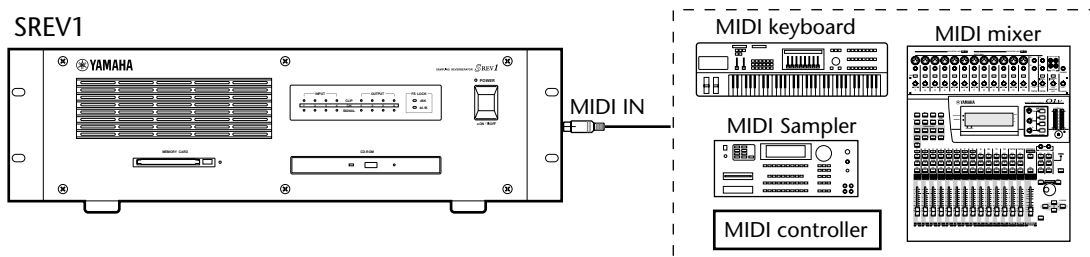

# Wordclocks

---

# 8

**In this chapter...**

Wordclocks & the SREV1 .....	74
Wordclock Connections .....	74
Selecting the Wordclock Source .....	75
Wordclock Hookup Examples .....	78



## Wordclocks & the SREV1

Unlike analog audio equipment, digital audio equipment must be synchronized when digital audio signals are transferred from one device to another, otherwise, signals may not be received correctly and audible noise, glitches, or clicks may occur. Synchronization is achieved using what's called a *wordclock*, which is a clock signal for synchronizing all the digital audio signals in a system. Note that wordclocks are not the same as SMPTE/EBU timecode or MIDI timecode, which are typically used to synchronize tape machines, MIDI sequencers, and so on. Wordclock synchronization refers to the synchronization of the digital audio processing circuits inside each digital audio device.

In a typical digital audio system, one device operates as the wordclock master, and the other devices operate as wordclock slaves, synchronizing to the wordclock master. Wordclock signals can be distributed via dedicated cables, typically BNC cables, or derived from digital audio connections, such as AES/EBU.

If you're connecting to the SREV1 using only analog inputs and outputs, no special wordclock settings are required, and the SREV1 can be set to use its own internally generated wordclock. If you're connecting other equipment digitally, however, you must decide which device to use as the wordclock master and which devices to use as slaves.

The SREV1 can be used as a 48 kHz wordclock master, or slaved to an external wordclock source of 44.1 kHz or 48 kHz. It can receive an external wordclock signal via an AES/EBU input, SLOT input, or the BNC WORD CLOCK IN connector.

In a system where all devices share a common wordclock, it's important that all devices be turned on even if they're not being used. Turn on the wordclock master first, and then the slaves. When shutting down the system, turn off the slaves first, and then the master. Before use, make sure that the wordclock slaves are correctly locked to the wordclock master. Most devices have front panel indicators, similar to the FS LOCK indicators on the SREV1, to show when they are wordclock locked. Refer to the relevant owner's manuals for more information.

When the wordclock source is changed, lower the volume of your system just in case a device becomes unlocked and outputs any unpleasant noises.

## Wordclock Connections

The WORD CLOCK IN BNC connector is used to receive wordclock signals from other digital audio equipment. When the wordclock source is set to WCLK IN, the SREV1 locks to the wordclock signal received at the WORD CLOCK IN connector.

See “Wordclock Hookup Examples” on page 78 for more information.

The WORD CLOCK IN is auto-terminating.

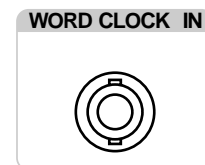

An external wordclock can also be sourced from an AES/EBU input or the slot input of a digital I/O card.

## Selecting the Wordclock Source

*Note: When the wordclock source is changed on the wordclock master device, noise may occur from the SREV1's outputs, especially if an MY8-AT I/O card is installed, so turn down your power amps beforehand, otherwise any connected speakers may be damaged.*

- 1 Use the [UTILITY] button to locate the DIO page shown below.

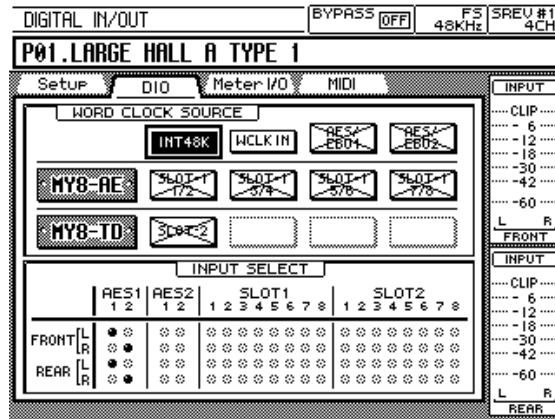

- 2 Use the cursor buttons to select a source.  
The button for the currently selected source appears highlighted.  
The following wordclock sources can be selected.

Condition	Source	Description
Always available	INT 48K	Internal 48 kHz wordclock (default setting)
When lockable external wordclock present	WCLK IN	External wordclock via the BNC WORD CLOCK IN
	AES/EBU1	External wordclock via the AES/EBU IN 1
	AES/EBU2	External wordclock via the AES/EBU IN 2
AES/EBU I/O card installed (MY8-AE) & lockable wordclock present	SLOT x 1/2	External wordclock via slot x, input pair 1/2
	SLOT x 3/4	External wordclock via slot x, input pair 3/4
	SLOT x 5/6	External wordclock via slot x, input pair 5/6
	SLOT x 7/8	External wordclock via slot x, input pair 7/8
ADAT or Tascam I/O card installed (MY8-AT, MY8-TD) & lockable wordclock present	SLOT x	External wordclock via slot x



This button indicates that a wordclock signal is present and that it's at the same frequency as the currently selected source. This source can be selected.



This button indicates that although a wordclock signal is present, it's not at the same frequency as the currently selected source. This source can be selected.



This button indicates that no wordclock signal is present. This source cannot be selected.





The button of the selected source appears highlighted, as shown here.

3 Press the [ENTER] button to activate the selected source.





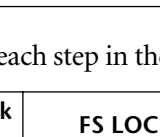
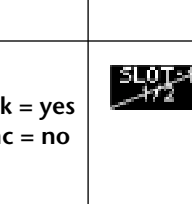
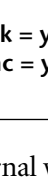
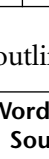

The SREV1 checks the selected source to see if a usable wordclock signal is available. If such a signal exists, the SREV1 locks to it and the corresponding FS LOCK indicator, 44.1 kHz or 48 kHz, lights up.

If a usable wordclock signal is not found, the SREV1 will not operate and the FS LOCK indicators flash, as shown in the following table. In this situation, you must select another wordclock source or correct the external wordclock source. This condition also occurs if a previously selected external wordclock source is disconnected, the device supplying it is turned off, or the external wordclock is neither 48 kHz nor 44.1 kHz.

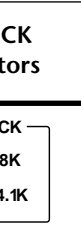
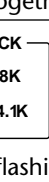
The following table shows the indicator status when the SREV1 is synced and locked to its internal wordclock or an external source.

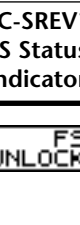
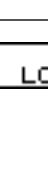

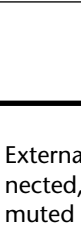
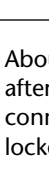
Condition	Wordclock Source Button	FS LOCK Indicators	RC-SREV1 FS Status Indicator
Internal wordclock Lock = yes Sync = yes			
External wordclock Lock = yes Sync = yes			

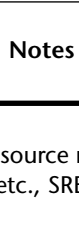
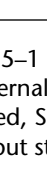
The following table outlines each step in the transition from wordclock unlock to lock.

Step	Condition	Wordclock Source Button	FS LOCK Indicators	RC-SREV1 FS Status Indicator	Notes
1	Lock = no Sync = no		 Flashing together		External source not connected, etc., SREV1 muted
2	Lock = yes Sync = no		 Alternate flashing		About 0.5–1 second after external source connected, SREV1 locked, but still muted
3	Lock = yes Sync = no				After about 0.5–1 second, the wordclock frequency is established and the SREV1 unmuted
4	Lock = yes Sync = yes				After about 2–3 seconds, synchronization is established and the SREV1 is ready for use

If the external wordclock frequency is neither 44.1 kHz nor 48 kHz (for example, it's 32 kHz), the transition from unlock to lock will stop at step 2 and the SREV1 outputs will remain muted.

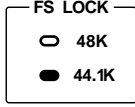
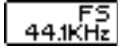
The following table outlines each step in the transition from wordclock lock to unlock.

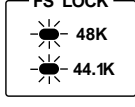
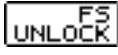
Step	Condition	Wordclock Source Button	FS LOCK Indicators	RC-SREV1 FS Status Indicator	Notes
1	Lock = yes Sync = yes				Normal condition
2	Lock = no Sync = no		 Flashing together		External source disconnected, etc., SREV1 muted

The INT 48K and WCLK IN buttons do not indicate whether or not the wordclock is locked or synchronized and never appear with diagonal lines through them. You can check the lock status of these sources by using the SREV1's FS LOCK indicator, or the RC-SREV1's FS status indicator.

If a previously selected wordclock source is no longer available, for example, when an I/O card is removed, the wordclock source button appears shaded. In this case, select another wordclock source in order to use the SREV1.

# Wordclock Hookup Examples

The following diagram shows the three different ways in which an external wordclock can be fed to the SREV1: AES/EBU input, slot input, or WORD CLOCK IN.

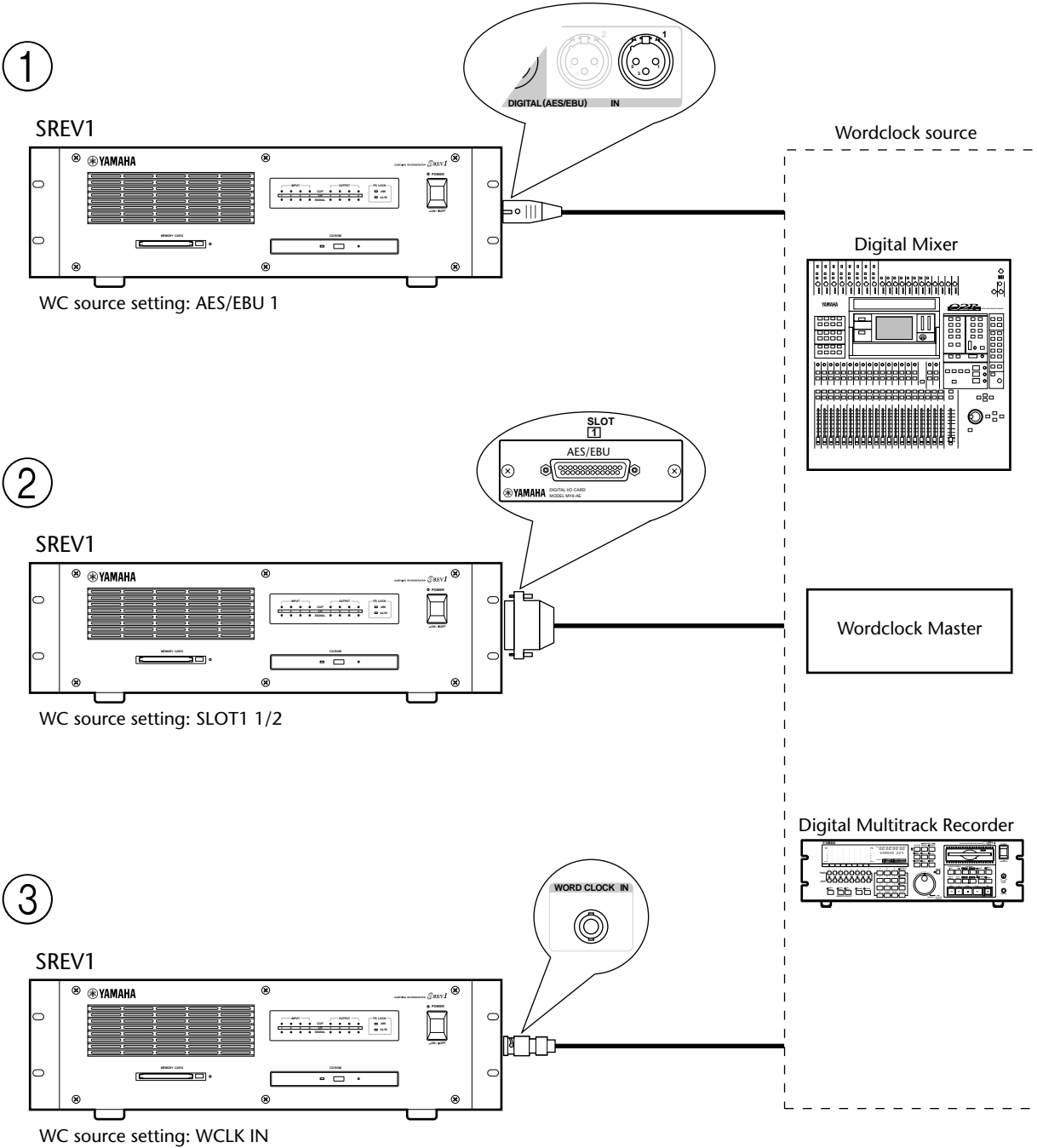

The following diagram shows how a wordclock signal can be distributed by using coaxial BNC cables in a multiple-SREV1 system.

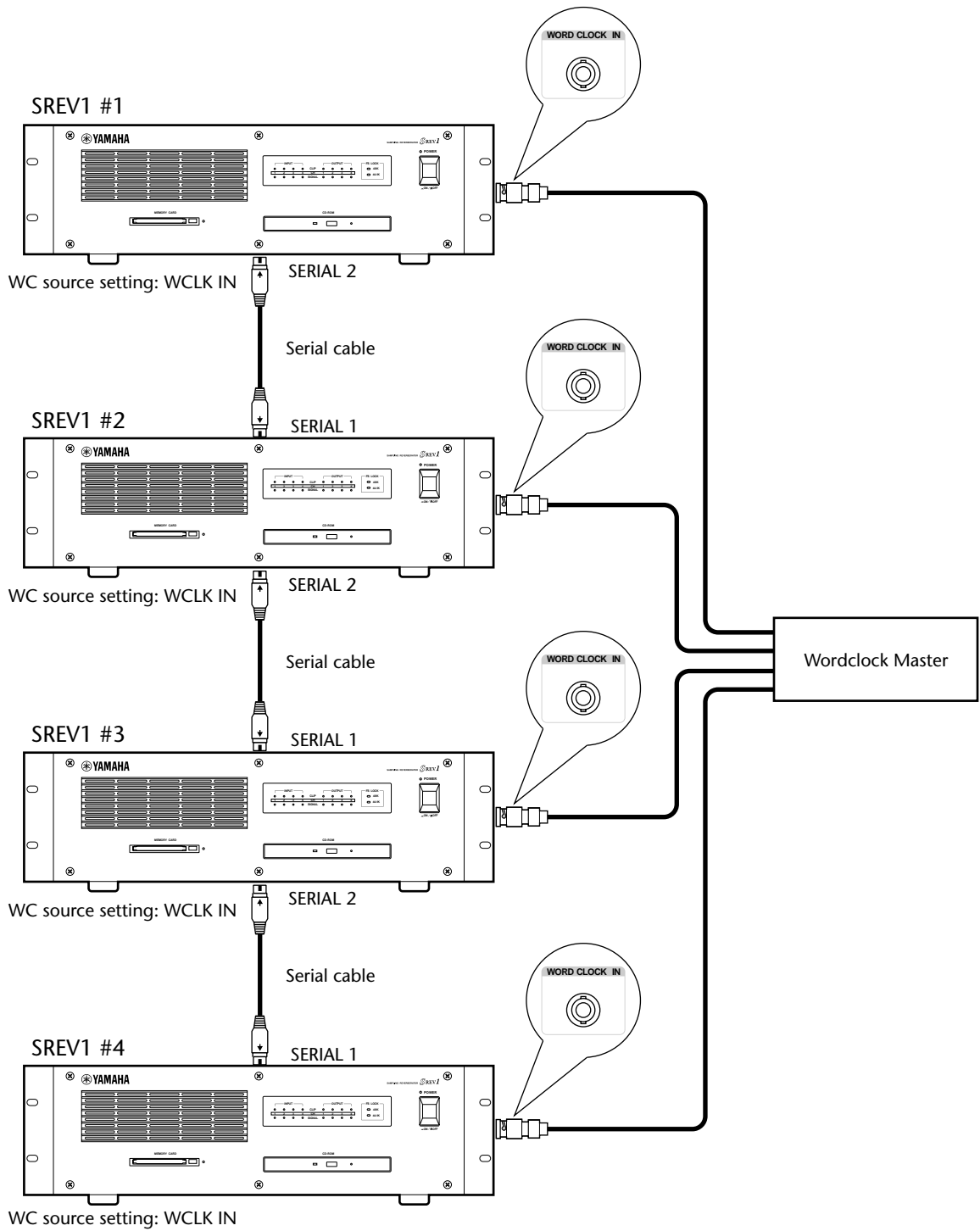

# I/O Options

---

# 9

## In this chapter...

I/O Options & the SREV1 .....	82
Available I/O Cards .....	82
Choosing I/O Cards .....	83
Installing I/O Cards .....	84

## I/O Options & the SREV1

In addition to the two AES/EBU inputs and outputs, the SREV1 features two mini YGDAI (Yamaha General Digital Audio Interface) slots for use with optional I/O cards, which offer several analog I/O options and digital I/O interfaces in all the popular digital audio interconnect formats, including AES/EBU, ADAT, and Tascam.

The Yamaha AW4416 Audio Workstation, 01V Digital Mixing Console, D24 Digital Multitrack Recorder, DME32 Digital Mixing Engine, AD824 AD Converter, and DA824 DA Converter also use mini YGDAI I/O cards. Note that the “CD” series of YGDAI cards used by the Yamaha 02R Digital Recording Console and 03D Digital Mixing Console are not interchangeable with mini YGDAI cards.

Slot inputs can be freely assigned to SREV1 channels. See “Assigning Inputs” on page 35 for more information. Channel-to-slot output assignments are fixed. See “Output Assignments” on page 9 for more information.

## Available I/O Cards

The following mini YGDAI cards are currently available. See the Yamaha Professional Audio Web site at the following URL for up-to-date news on mini YGDAI cards: <http://www.yamaha.co.jp/product/proaudio/homeenglish/>.

### **MY8-AD: 8 Analog Inputs**

The MY8-AD card provides eight electronically balanced analog inputs via phone jack connectors, with 20-bit 128-times oversampling A/D converters.

### **MY4-AD: 4 Analog Inputs**

The MY4-AD card provides four electronically balanced analog inputs via female XLR connectors, with 24-bit 128-times oversampling A/D converters.

### **MY4-DA: 4 Analog Outputs**

The MY4-DA card provides four electronically balanced analog outputs via male XLR connectors, with 20-bit 128-times oversampling D/A converters.

### **MY8-AT: ADAT**

The MY8-AT card provides ADAT format digital I/O via two MultiChannel Optical Digital Interface connectors, and supports 16-, 20-, and 24-bit wordlengths.

### **MY8-AE: AES/EBU**

The MY8-AE card provides AES/EBU format digital I/O via a 25-pin D-sub connector, and supports 16-, 20-, and 24-bit wordlengths.

### **MY8-TD: Tascam**

The MY8-TD card provides Tascam format digital I/O via a 25-pin D-sub connector, and supports 16-, 20-, and 24-bit wordlengths. A BNC connector is provided for word-clock output.

MY8-TD cards feature a device selector switch (EXT: 88/INT: 38) that should be set to match the device being connected. This should be set to “EXT: 88” when connecting a Tascam DA-88, or “INT: 38” when connecting a Tascam DA-38 or other digital audio device.



Specifications for the currently available I/O cards are as follows.

Card	Format	In	Out	A/D	D/A	Wordlength	Connectors
MY8-AD	Analog input	8	—	20-bit, 128 times	—	—	Phone jack (balanced) x8
MY4-AD	Analog input	4	—	24-bit, 128 times	—	—	XLR-3-31 type (balanced) x4
MY4-DA	Analog output	—	4	—	20-bit, 128 times	—	XLR-3-32 type (balanced) x4
MY8-AT	ADAT	8	8	—	—	16, 20, 24	Optical x2
MY8-AE	AES/EBU	8	8	—	—	16, 20, 24	25-pin D-sub (cable not included)
MY8-TD	Tascam	8	8	—	—	16, 20, 24	25-pin D-sub BNC wordclock output

As these specifications show, analog I/O cards offer either inputs or outputs, while digital I/O cards offer both inputs and outputs.

When an I/O card not listed above, for example, a future addition to the mini YGDAI series, is installed, the message “UNKNOWN CARD” appears.

## Choosing I/O Cards

For analog I/O with XLR-type connectors, an MY4-AD card could be installed in, say, SLOT 1, and an MY4-DA card in SLOT 2, although it makes no difference which card is installed in each slot.

To connect the SREV1 to other digital audio equipment, you must determine which digital interconnect format—AES/EBU, ADAT, or Tascam—the other equipment supports, and then install the necessary I/O cards.

The following table shows which cards to use when connecting the SREV1 to other Yamaha digital audio products. Each product can be connected by using the AES/EBU, ADAT, or Tascam interface format.

Unit	Max. # of Cards	Format	Card for Other Unit	Card for SREV1
AW4416	2	ADAT	MY8-AT	MY8-AT
		Tascam	MY8-TD	MY8-TD
		AES/EBU	MY8-AE	MY8-AE
AD824	1	As above		
DA824	1	As above		
DME32	4	As above		
D24	4	As above		
01V	1	As above		
02R	4 single or 2 double	ADAT	CD8-AT	MY8-AT
		Tascam	CD8-TDII	MY8-TD
		AES/EBU	CD8-AE or CD8-AE-S	MY8-AE
03D	1	As above		

An external wordclock can be sourced via digital I/O cards. See “Selecting the Wordclock Source” on page 75 for more information.

Using ADAT I/O cards in certain devices can cause wordclock-lock problems, so it’s recommend that you source wordclock signals via I/O cards of another format.

See your Yamaha dealer for more information.

## Installing I/O Cards

This section explains how to install mini YGDAI cards in the SREV1.

- 1 Turn off the SREV1.
- 2 Undo the two fixing screws and remove the slot cover, as shown below.

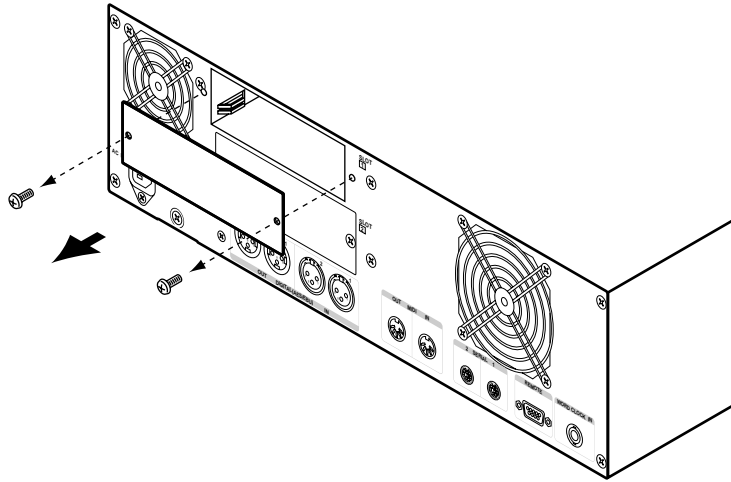

Keep the cover and fixing screws in a safe place for future use.

- 3 Insert the card between the guide rails and slide it all the way into the slot, as shown below. You may have to push firmly to plug the card into the SREV1 connector.

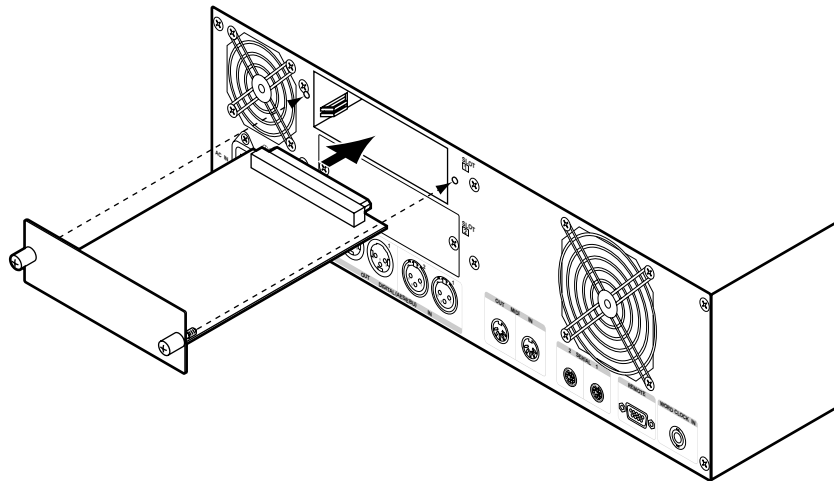

- 4 Secure the card using the attached thumbscrews. Do not leave the thumbscrews loose, as the card will not be grounded correctly.

You can check the type of I/O card installed in each slot, and assign slot inputs to channels on the DIO page. See “Assigning Inputs” on page 35 for more information.

# Troubleshooting

Symptom	Advice
<b>Cannot turn on the SREV1.</b>	Make sure that the power cord is connected properly to a suitable AC wall outlet and the SREV1. See "Connecting the Power Cord" on page 26 for more information.
	Make sure that the SREV1 POWER switch is set to ON. See "Turning On & Off the SREV1" on page 26 for more information.
	If you still cannot turn on the SREV1, contact your Yamaha dealer.
<b>The POWER indicator lights up when the SREV1 is turned on, but the INPUT and OUTPUT indicators flash alternately.</b>	Contact your Yamaha dealer.
<b>Cannot turn on the RC-SREV1.</b>	Make sure that the remote cable is connected between the SREV1 and RC-SREV1 properly. See "Connecting the RC-SREV1 Remote Controller" on page 22.
	Make sure that the RC-SREV1 POWER switch is in the ON position. See "Turning On & Off the RC-SREV1" on page 26 for more information.
<b>The FS LOCK indicators flash alternately.</b>	The SREV1 is locked but not synchronized to the external wordclock source. See "Selecting the Wordclock Source" on page 75 for more information.
<b>The FS LOCK indicators flash together.</b>	The SREV1 is neither locked nor synchronized to the external wordclock source. See "Selecting the Wordclock Source" on page 75 for more information.
<b>The FS status section of the RC-SREV1 display shows "UNLOCK".</b>	The SREV1 is neither locked nor synchronized to the external wordclock source. See "Selecting the Wordclock Source" on page 75 for more information.
<b>Connected an input signal but there's no output.</b>	If you're using slot inputs, make sure the I/O cards are installed properly and secured using the thumbscrews. See "Installing I/O Cards" on page 84.
	Make sure the input is assigned to the proper channel. See "Assigning Inputs" on page 35 for more information.
	Use the level meters to help trace the signal. See "Metering" on page 37 for more information.
	Check the channel's input and output level settings. See "Setting Input & Output Levels" on page 36 for more information.
	Is the Bypass mode is set to REV-MUTE, the reverb balance set to 100%, and the reverb level set to $-\infty$ ?
	Are you connected to the correct outputs? See "Output Assignments" on page 9 for more information.
<b>Can't hear any reverb.</b>	Is the SREV1 bypassed. See "Bypassing the SREV1" on page 40 for more information.
	Make sure that the Reverb Balance parameter is not set to 0%. See "Main 2 Parameters" on page 54 and "Fine Reverb Parameters" on page 56 for more information.
	Make sure that the Reverb Level parameter is not set to 0 dB. See "Fine Reverb Parameters" on page 56 for more information.
<b>Recalled a program but only its title is displayed, no program number.</b>	Probably because the program was recalled from a drive. Program numbers (P01–P12) are displayed only when programs are recalled from the Quick memories. See "RC-SREV1 Display" on page 18 for more information.

Symptom	Advice
Cannot store a Quick memory program.	Is the selected Quick memory write-protected? See "Protecting Quick Memory Programs" on page 44 for more information.
Cannot list the programs, projects, or impulse response data files on a PC Card.	Make sure the PC Card is fully inserted. See "Using PC Cards" on page 29 for more information.
Cannot list the programs, projects, or impulse response data files on a CD-ROM.	Make sure the CD-ROM is inserted correctly. See "Using CD-ROMs" on page 28 for more information.
A program is being recalled unknowingly.	Is the program assigned to a MIDI Program Change and being recalled by external MIDI messages? See "Assigning Quick Memory Programs to Program Changes" on page 70.
A parameter is being adjusted unknowingly.	Is the parameter assigned to a MIDI Control Change and responding to external MIDI messages? See "Assigning Parameters to Control Changes" on page 71.
Cannot receive MIDI messages.	Check the MIDI connections.
	Make sure the connected MIDI device is turned on and set to transmit on the correct MIDI Channels.
	Check the MIDI settings on the RC-SREV1. See "Setting the MIDI Receive Channels" on page 69.
MIDI Program Change messages do not recall programs.	Make sure that the SREV1 is set to receive Program Change messages on the correct channel. See "Setting the MIDI Receive Channels" on page 69.
	Check that the Program Change being transmitted is assigned to a Quick memory program. See "Assigning Quick Memory Programs to Program Changes" on page 70.
MIDI Control Change messages do not control parameters.	Make sure that the SREV1 is set to receive Control Change messages on the correct channel. See "Setting the MIDI Receive Channels" on page 69.
	Check that the Control Change being transmitted is assigned to a parameter. See "Assigning Parameters to Control Changes" on page 71.
Several parameters are adjusted when a Control Change message is received.	If a Control Change is assigned to more than one parameter, all of those parameters are adjusted when that Control Change is received. See "Assigning Parameters to Control Changes" on page 71 for more information.
Noise occurs from the outputs when the wordclock is changed on the wordclock master device.	This is normal, although it's more likely to occur if an MY8-AT I/O card is installed. To eliminate the risk of speaker damage, turn down your power amps beforehand.
Cannot eject a CD-ROM.	Use the emergency disc eject hole. See "SREV1 Front Panel" on page 12 for more information.

# Appendix

## Error Messages

Message	Reason	Solution
<b>VERSION MISMATCH. PUSH ANY KEY TO DOWNLOAD.</b>	The software versions of the SREV1 and RC-SREV1 do not match.	Press any button to download the necessary software from the SREV1 to the RC-SREV1 in order to match the software versions.
<b>COMMUNICATION TIMEOUT.</b>	Communication with the SREV1 failed.	Turn off both the SREV1 and RC-SREV1 and check the remote cable connections, also check for breaks in the cable.
<b>WRITE PROTECTED.</b>	A write protected Quick memory, program, or project was selected.	Turn off the protection in order to store or edit the title. The CD-ROM is always write protected.
<b>INSERT MEDIA.</b>	No media inserted.	Insert the necessary media. Note that it takes the SREV1 between 20 and 30 seconds to recognize CD-ROMs.
<b>TITLE IS EMPTY!</b>	No title has been entered or only spaces.	Enter some characters for the title.
<b>!!! LOW BATTERY !!!</b>	The SREV1's internal backup battery is getting low.	Ask your Yamaha dealer to change the battery as soon as possible.
<b>!!! NO BATTERY !!! RESTORED FROM BACKUP.</b>	The SREV1's internal backup battery is flat and the contents of the battery-backed memory were lost. The contents were restored from the backup file on the Internal card.	Ask your Yamaha dealer to change the battery as soon as possible.
<b>DATA FILE NOT FOUND! INSERT PCMCIA CARD.</b>	When the SREV1 was restarted, the Reverb mode changed, or a project loaded, the programs were loaded from the PC Card but the necessary impulse-response data could not be found.	Insert the PC Card containing the necessary impulse-response data.
<b>DATA FILE NOT FOUND! INSERT CD-ROM DISC.</b>	When the SREV1 was restarted, the Reverb mode changed, or a project loaded, the programs were loaded from the CD-ROM but the necessary impulse-response data could not be found.	Insert the CD-ROM containing the necessary impulse-response data.
<b>EMPTY DATA! SOME DATA ISN'T LOADED. CAN'T SAVE THIS PROGRAM.</b>	The impulse-response data for the program was not loaded.	Load the necessary impulse-response data, or load the program again.
<b>NO SUFFICIENT SPACE! CAN'T SAVE THIS PROGRAM.</b>	The program cannot be stored due to lack of space on the PC Card or Internal card.	Insert another PC Card, or delete some unnecessary programs in order to free some space.
<b>DESTINATION WRITE PROTECTED!</b>	You tried to edit the title of a program or project on the Library page, but the destination file is write protected.	Use another title, or turn off the write protection.
<b>COULD NOT COMMUNICATE WITH SREV1. CHECK THE CABLE CONNECTION AND SREV1'S POWER, THEN TURN ON RC-SREV1 AGAIN.</b>	Communication between the SREV1 and RC-SREV1 failed during startup.	<p>If the RC-SREV1 is powered by an optional AC adapter, make sure that the SREV1 is turned on.</p> <p>Turn off both the SREV1 and RC-SREV1 and check the remote cable connections, also check for breaks in the cable.</p>

## Confirmation Messages

Message	Condition	Solution
<b>CURRENT IS EDITED. RECALL PROGRAM OK?</b>	Appears when you recall a program from the Quick memory page, but the current program contains unsaved changes.	To discard the current program's unsaved changes and recall the program, press OK. To cancel the operation, press CANCEL.
<b>CURRENT IS EDITED, LOAD LIBRARY OK?</b>	Appears when you recall a program from the Library page, but the current program contains unsaved changes.	To discard the current program's unsaved changes and load the program, press OK. To cancel the operation, press CANCEL.
<b>SAME LIBRARY EXISTS! OVERWRITE OK?</b>	Appears when you save the current program on the Library page, but a program with the same title already exists.	To save and overwrite the existing program, press OK. To cancel the operation, press CANCEL.
	Appears when you edit the title of the selected program on the Library page, but a program with the same title already exists.	To overwrite the existing program, press OK. To cancel the operation, press CANCEL.
<b>DELETE LIBRARY OK?</b>	Appears when you delete the selected program on the Library page.	Press OK to delete the selected program. To cancel the operation, press CANCEL.
<b>CURRENT IS EDITED. LOAD PROJECT OK?</b>	Appears when you recall a project from the Project page, but the current program contains unsaved changes.	To discard the current program's unsaved changes and load the project, press OK. To cancel the operation, press CANCEL.
<b>SAME PROJECT EXISTS! OVERWRITE OK?</b>	Appears when you save a project on the Project page, but a program with the same title already exists.	To save and overwrite the existing program, press OK. To cancel the operation, press CANCEL.
	Appears when you edit the title of the selected project on the Project page, but a program with the same title already exists.	To save and overwrite the existing program, press OK. To cancel the operation, press CANCEL.
<b>DELETE PROJECT OK?</b>	Appears when you delete the selected project on the Project page.	Press OK to delete the selected program. To cancel the operation, press CANCEL.
<b>LOAD DATA OK?</b>	Appears when you load the selected impulse-response data from the Data Load page.	Press OK to load the selected impulse-response data. To cancel the operation, press CANCEL.
<b>CHANGE REV MODE OK?</b>	Appears when you select a different Reverb mode on the Setup page.	Press OK to switch to the Reverb mode. To cancel the operation, press CANCEL.

## General Messages

Message	Meaning
INITIALIZING...	The RC-SREV1's internal information is being updated.
SETTING REV MODE...	The Reverb mode is being changed.
RECALLING PROGRAM...	A Quick memory program is being recalled on the Program page.
STORING PROGRAM...	The current program is being stored to the selected Quick memory.
LOADING LIBRARY...	The selected program is being loaded on the Library page.
SAVING LIBRARY...	The current program is being saved on the Library page.
CHANGING TITLE...	The title of the selected program is being changed on the Library page.
DELETING LIBRARY...	The selected program is being deleted on the Library page.
CHANGING PROTECT MODE...	The protection setting of the selected program is being changed on the Library page.
DOWNLOADING FILE LIST...	The program list is being downloaded from the selected drive on the Library page.
LOADING DATA...	The selected impulse-response data is being loaded on the Data Load page.
DOWNLOADING FILE LIST...	The impulse-response data list is being downloaded from the selected drive on the Library page.
LOADING PROJECT...	The selected project is being loaded on the Project page.
SAVING PROJECT...	The selected project is being saved on the Project page.
CHANGING TITLE...	The title of the selected project is being changed on the Project page.
DELETING PROJECT...	The selected project is being deleted on the Project page.
CHANGING PROTECT MODE...	The protection setting of the selected project is being changed on the Project page.
DOWNLOADING FILE LIST...	The project list is being downloaded from the selected drive on the Project page.

## General Specifications

<b>Sampling rate</b>	<b>Internal</b>	48 kHz
	<b>External</b>	44.1 kHz or 48 kHz
<b>Internal processing</b>		32 bit
<b>Program Memories</b>	<b>2-channel, 4-channel mode</b>	6 (P01–P06)
	<b>2-channel x2 mode</b>	12 (P01–P12)
<b>Indicators</b>	<b>INPUT</b>	SIGNAL x4 (–34 dB), CLIP x4
	<b>OUTPUT</b>	SIGNAL x4 (–34 dB), CLIP x4
	<b>FS LOCK</b>	48K, 44.1K
	<b>Others</b>	POWER, PC Card, CD-ROM
<b>PC Card slot</b>		PCMCIA (Type II), PC Card ATA spec, FAT16
<b>CD-ROM drive</b>		ISO9660 Level 2 format
<b>Cooling fan</b>		x2
<b>Power requirements</b>		U.S.A. & Canada 120 V AC, 60 Hz Europe 230 V AC, 50 Hz
<b>Power consumption</b>		120 W
<b>Dimensions (W × H × D)</b>		480 × 141.7 × 451.8 mm (18.9 × 5.6 × 17.8 inches)
<b>Weight</b>		11.5 kg (25.3 lbs)
<b>Free-air operating temperature</b>		5° C to 40° C (41° F to 104° F)
<b>Power cord length</b>		2.5 m
<b>Supplied accessories</b>		Power cord, CD-ROM (Reverb programs, data), Owner's Manual
<b>Options</b>		RC-SREV1, DB-SREV1, MY8-AD, MY4-AD, MY4-DA, MY8-AT, MY8-AE, MY8-TD



## Digital Input Specifications

Connection	Format	Data Length	Level	Connector
DIGITAL IN 1, 2	AES/EBU	24 bit	RS-422	XLR-3-31 type <sup>1</sup>

1. XLR-3-31 type connectors are balanced (pin 1–ground, pin 2–hot (+), and pin 3–cold (-)).

## Digital Output Specifications

Connection	Format	Data Length	Level	Connector
DIGITAL OUT 1, 2	AES/EBU <sup>1</sup>	24 bit	RS-422	XLR-3-32 type <sup>2</sup>

1. Channel status:  
 Type: 2 audio channels.  
 Sampling rate: depends on internal configuration.
2. XLR-3-32 type connectors are balanced (pin 1–ground, pin 2–hot (+), and pin 3–cold (-)).

## Control I/O Specifications

Connection	Format	Level	Connector
SERIAL 1, 2	—	RS-422	8-pin mini DIN
MIDI IN	MIDI	—	5-pin DIN
MIDI OUT	MIDI	—	5-pin DIN
WORD CLOCK IN	—	TTL 75Ω	BNC
REMOTE	—	RS-422	9-pin D-sub (female)
SLOT (x2)	mini YGDAI	—	—

## Remote Cable Wiring Diagram

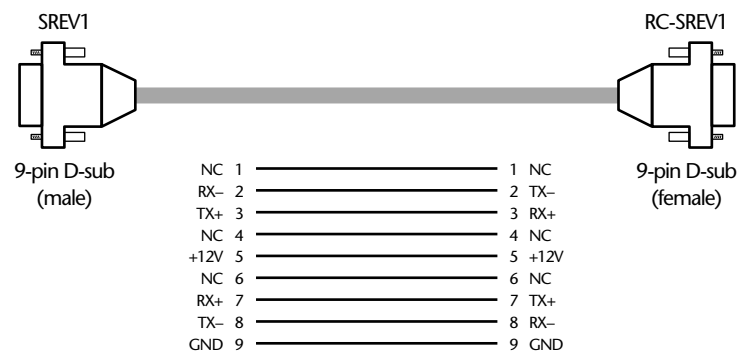

Note that if the resistance of the +12V or GND line between the two connectors is more than 1.5Ω, the optional Yamaha PA-6 AC adapter should be used to power the RC-SREV1.

Note also that the screws used to secure the D-sub connectors to the SREV1 and RC-SREV1 must be metric. Readily available D-sub connectors typically come with securing screws with an imperial thread, which cannot be used. The securing screws on the D-sub connectors on the supplied remote cable are metric.

# Dimensions

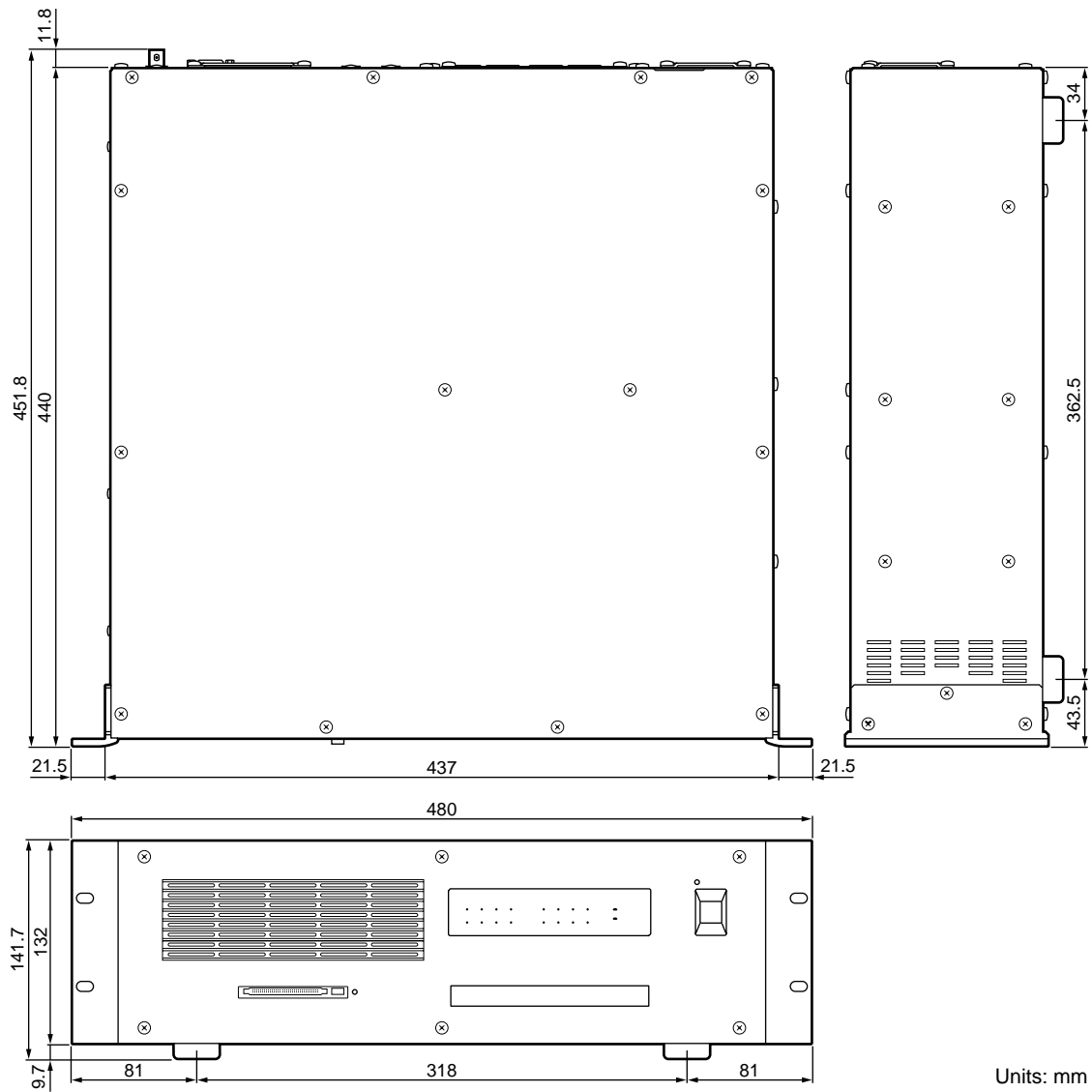

Specifications and external appearance subject to change without notice.

For European Model

Purchaser/User Information specified in EN55103-1 and EN55103-2.

Inrush Current: 70A

Conformed Environment: E1, E2, E3 and E4

---

# Glossary

---

**2-channel mode**—In this mode the SREV1 functions as a stereo processor.

**4-channel mode**—In this mode the SREV1 functions as a 4-channel surround processor.

**2-channel x2 mode**—In this mode the SREV1 functions as two independent stereo processors (A and B).

**ADAT interconnect format**—The digital audio interconnect format typically found on ADAT-compatible digital audio equipment. Eight channels of digital audio are carried per fiber-optic connection using Toslink connectors.

**AES/EBU interconnect format**—The digital audio interconnect format, established by the AES (Audio Engineering Society) and EBU (European Broadcasting Union), for transferring digital audio data between professional digital audio equipment. Two channels of digital audio (left/odd and right/even) are carried per balanced line.

**CD-ROM (Compact Disc Read Only Memory)**—The compact disc format for data storage. Defined in the Yellow Book.

**Control Change**—A type of MIDI message offering real-time parameter control. Typical Control Changes include Modulation, Volume, Pan, and Portamento.

**Convolution**—The digital audio process of imposing the characteristics of one signal onto another signal. The SREV1 convolves an acoustic “fingerprint” of a previously measured environment onto an audio signal, faithfully recreating the original reverberation, with accurate reflection detail identical to that produced had the sound been heard in that environment.

**Convolution time**—Convolution time is not the same as reverb time. Reverb time is the time it takes the reverberation to decay by –60 dB, and more convolution is required to provide reverberation down to –90 dB or –120 dB, so the convolution time must be between 1.5 and 2 times more than the reverb time.

**DIO**—Abbreviation for “digital input and output.”

**Drives**—Programs, projects, and impulse-response data can be stored on the following drives: Internal Card, PC Card, or CD-ROM. (The Internal Card is compact flash memory.)

**FAT16**—The FAT (File Allocation Table) system, developed by Microsoft and supported by MS-DOS and most Windows operating systems, is essentially a database that records where files are stored on hard disks and other storage media. FAT12 is the original 12-bit version. FAT16 is the 16-bit version, since superseded by the 32-bit version, FAT32, which supports larger storage devices.

**FS**—Abbreviation for “sampling frequency.”

**Impulse response**—The sound pressure measured at a sensor position set against the time of an acoustic pulse “fired” from the source position. In other words, an environment’s acoustical response.

**Initial delay**—The delay before the reverb reflections start.

**ISO9660 Level 2**—A standard format for storing files and directories on a CD-ROM. Conforming discs can be read by Macintosh, Windows, UNIX, and other systems.

**Library**—The place used to load, save, title, protect, and delete programs from the Internal Card, PC Card, and CD-ROM.

**MIDI (Musical Instrument Digital Interface)**—The standard digital interface for controlling electronic musical systems and audio equipment.

**mini YGDAI (Yamaha General Digital Audio Interface)**—The second-generation YGDAI interface system used on the 01V Digital Mixing Console, D24 Digital Multitrack Recorder, DME32 Digital Mixing Engine, and SREV1.

**PC Card**—A small, credit card-sized device for use with personal computers and other electronic devices. PC Cards come in three thicknesses, the thinnest being Type I, which is typically used for RAM or ROM memory. Type II cards, which are slightly thicker, may contain, for example, a fax/modem, while Type III cards are thick enough to contain a hard disk drive.

**PCMCIA (Personal Computer Memory Card International Association)**—The organization responsible for the development of the PC Card standard.

**Peaking**—A type of EQ circuit used to cut and boost a band of frequencies, producing a mountain-peak type response. The width of the band is called the Q. Middle-band EQ is usually of the peaking type. *Compare with* Shelving.

**PEQ**—Abbreviation for “parametric EQ.”

**Program**—Measured impulse response data is combined with variable parameters such as reverb time and initial delay to form reverb programs. Preset programs are supplied on CD-ROM. User programs can be stored in the Quick memories, Internal Card or PC Card.

**Program Change**—A type of MIDI message for recalling programs.

**Project**—A Project contains all the Quick memory programs and the current program settings. Projects can be stored on the Internal Card or PC Card.

**Q**—The unit used to express a filter’s width. High values imply a narrow frequency band, low values, a wide frequency band.

**Quick memory**—Quick memories are special memories for storing programs. Unlike programs stored on the Internal Card, PC Card, or CD-ROM, which take time to load, Quick memory programs can be recalled instantly.

**Reverb mode**—The SREV1 offers three modes of operation: 2-channel, 4-channel, and 2-channel x2. In 2-channel mode, the SREV1 functions as a stereo processor. In 4-channel mode, the SREV1 offers 4-channel surround processing. In 2-channel x2 mode, the SREV1 functions as two independent stereo processors (A and B).

**Reverb time**—The time it takes the reverberation to decay by –60 dB. *See also* Convolution time.

**RS-232C**—An interface for connecting serial devices, offering a transmission distance of approximately 15 meters, typically using 9- or 25-pin D-Sub connectors.

**RS-422**—A balanced interface for connecting serial devices, offering a transmission distance of approximately 1 kilometer, higher data rates, and greater immunity to interference than RS-232C.

**Shelving**—A type of EQ circuit used to cut and boost frequencies above or below a set frequency. It produces a shelf-looking response curve. High and low EQs are usually of the shelving type. *Contrast with* Peaking.

**Tascam TDIF-1 interconnect format**—The Tascam Digital InterFace audio interconnect format typically found on Tascam TDIF-1-compatible digital audio equipment. TDIF-1 is a bidirectional, 8-channel format, which uses 25-pin D-sub connectors.

**Wordclock**—A clock signal used to synchronize the data processing circuits of devices digital audio equipment.

**YGDAI (Yamaha General Digital Audio Interface)**—Yamaha digital audio interface system offering a range of analog and digital input and output options for Yamaha digital audio equipment, including AES/EBU, ADAT, and Tascam DIO.

# Index

## Symbols

- 1/DEC button 17
- +1/INC button 17

## Numerics

- 2CH
  - file types 9
- 2-channel mode
  - analog hookup example 24
  - convolution time 6
  - definition 93
  - digital hookup example 23
  - file types 9
  - I/O configurations 6
  - output assignments 9
  - selecting 34
- 2-channel x2 mode
  - analog hookup example 25
  - convolution time 6
  - definition 93
  - digital hookup example 23
  - file types 9
  - I/O configurations 6
  - output assignments 9
  - selecting 34
- 2X2
  - file types 9
- 4CH
  - file types 9
- 4-channel mode
  - analog hookup example 25
  - convolution time 6
  - definition 93
  - digital hookup example 23
  - file types 9
  - I/O configurations 6
  - output assignments 9
  - selecting 34

## A

- AC adapter
  - cable clip 20
  - using 27
- AC IN connector
  - about 14
  - using 26
- Activity indicator
  - CD-ROM 13
  - PC Card 12
- ADAT format
  - definition 93
  - I/O cards 82

- AES/EBU format
  - definition 93
  - I/O cards 82
- AES/EBU IN
  - assigning 35
  - hookup examples 23
- AES/EBU OUT
  - channel assignments 9
  - hookup examples 23
- AIFF
  - file types 9
- Air inlet 12
- Analog hookup examples 24
- Analog I/O 82
- Arrow buttons 17
- Assigning
  - inputs 35
  - parameters to Control Changes 71
  - quick memory programs to Program Changes 70
- ATA card, see PC Card

## B

- Block diagram 10
- BRIGHT control
  - about 20
  - using 27
- Brightness, RC-SREV1 display 27
- Bypass
  - mode setting 40
  - status 18
  - using 40
- BYPASS button & indicator
  - about 16
  - using 40

## C

- Cable clip 20
- Caps lock
- Cautions ii
- CD-ROM
  - definition 93
  - drive 13
  - Emergency disc eject hole 13
  - handling iii
  - loading impulse-response data 61
  - loading programs 45
  - loading projects 48
  - operation diagram 8
  - using 28
- CLIP indicator
  - RC-SREV1 17
  - SREV1 12
- CompactFlash 29

- Configurations, I/O 6
- Connecting
  - external wordclock 74
  - hookup examples 23
  - MIDI 68
  - multiple SREV1s 64
  - power cord 26
  - RC-SREV1 22
- Connection examples 23
- CONT control
  - about 20
  - using 27
- Contrast, RC-SREV1 display 27
- Control Changes
  - assigning parameters 71
  - definition 93
- Convolution
  - available times 6
  - definition 93
- Cooling fans 14
- Cursor buttons 17

## D

- Data load page 61
  - DATA wheel 17
  - DB-SREV1 DSP Expansion Board 6
  - DC 12V IN
    - connector 20
    - using 27
  - DEC button 17
  - Deleting
    - library programs 47
    - projects 50
  - Dial, PARAMETER wheel 17
  - DIGITAL (AES/EBU) IN 14
  - DIGITAL (AES/EBU) OUT 14
  - Digital hookup examples 23
  - DIO page 75
  - Direct-out, bypass mode 40
  - Display
    - about 18
    - brightness 27
    - contrast 27
  - Drives
    - about 8
    - definition 93
    - loading programs 45
    - loading projects 48
    - operation diagram 8
    - saving programs 46
    - saving projects 49
- ## E
- Edit buffer
    - operation diagram 8
  - Edit status indicator 18

Editing  
 fine post EQ parameters 59  
 fine pre EQ parameters 57  
 fine reverb parameters 56  
 library program titles 46  
 Main 1 parameters 52  
 Main 2 parameters 54  
 programs 51  
 project titles 49  
 quick memory program titles 43

Eject button  
 CD-ROM 13  
 PC Card 12

Ejecting  
 CD-ROM 28  
 PC Card 29

Emergency disc eject hole 13

ENTER button 17

EQ  
 post EQ 59  
 pre EQ 57

Extensions, SREV1 files 9

External wordclock 75

## F

Fader status 19

FAT16  
 definition 93  
 PC Cards 29

Files types 9

Fine parameters  
 post EQ 59  
 pre EQ 57  
 reverb 56

Frequency  
 post EQ 59  
 pre EQ 57  
 wordclock 75

Front panel 12

FS LOCK indicators 12

FS status 18

FS, definition 93

## G

Gain  
 post EQ 59  
 pre EQ 57

Getting started 21

Grounding screw 14

## H

H.shelf  
 post EQ 59  
 pre EQ 57

High  
 post EQ 59

pre EQ 57

High EQ  
 fine editing 57  
 Main 1, grouped 52

High-mid EQ 59

Home page on the web iv

Hookup examples  
 analog & digital I/O 23  
 multiple SREV1s 64  
 wordclock 78

HPF  
 Main 2, grouped 54  
 post EQ 59  
 pre EQ 57

## I

I/O cards  
 about 82  
 available 82  
 choosing 83  
 hookup example 24  
 installing 84  
 specifications 83  
 wordclock source 75

Impulse-response data  
 about 6  
 definition 93  
 loading 61

INC button 17

Indicators  
 BYPASS 16  
 CD-ROM activity 13  
 FS LOCK 12  
 INPUT 12  
 INPUT CLIP 17  
 OUTPUT 12  
 OUTPUT CLIP 17  
 PC Card activity 12  
 POWER 12

Initial delay  
 fine editing 56  
 Main 1, grouped 52

INPUT CLIP indicator  
 RC-SREV1 17  
 SREV1 12

Input level  
 fine setting 36  
 Main 1, grouped 54

Input/output configurations 6

Inputs  
 assigning 35  
 DIGITAL AES/EBU IN 14  
 I/O cards 82  
 setting levels 36

Inserting  
 CD-ROM 28  
 PC Card 29

Installing I/O cards 84

Internal Card  
 loading impulse-response data 61  
 loading programs 45  
 loading projects 48  
 operation diagram 8  
 saving programs 46  
 saving projects 49

Internal wordclock 75

Internet web site iv

ISO9660  
 CD-ROM 28  
 definition 93

## L

L.shelf  
 post EQ 59  
 pre EQ 57

LCD brightness & contrast 27

Levels, setting 36

Library  
 about 8  
 deleting library programs 47  
 editing library program titles 46  
 loading programs 45  
 operation diagram 8  
 protecting programs 47  
 saving programs 46  
 saving projects 49  
 working with 45

Library page 45

Loading  
 impulse-response data 61  
 programs from the library 45  
 projects 48

Lock, wordclock 75

Low  
 post EQ 59  
 pre EQ 57

Low EQ  
 fine editing 57  
 Main 1, grouped 52

Lowercase, titling

Low-mid EQ 59

LPF  
 post EQ 59  
 pre EQ 57

## M

Main 1  
 page 52  
 parameter editing 52

Main 2  
 page 54  
 parameter editing 54

Main page area 18  
 Mains lead 26  
 MEMORY CARD slot  
   about 12  
   using 29  
 Memory Stick 29  
 Meter I/O page 36, 38, 39, 40  
 Meter mode, setting 39  
 Meters  
   about 18  
   mode setting 39  
   peak hold 39  
   using 37  
 Microdrive 29  
 MIDI  
   about 68  
   assigning parameters to Control Changes 71  
   assigning quick memory programs to Program Changes 70  
   definition 93  
   implementation chart 99  
   IN & OUT ports, about 15  
   MIDI IN port 68  
   MIDI OUT port 68  
   receive channels 69  
 MIDI page 69  
 mini YGDAI  
   card specifications 83  
   cards 82  
   definition 94  
 Modes, see Reverb modes  
 Motorized faders 17  
 Multiple SREV1s  
   about 64  
   hookup examples 64  
   operating notes 65  
   selecting 65  
   serial connectors 64  
 MY cards 82

## N

Naming, see titling

## O

OUTPUT CLIP indicator  
   RC-SREV1 17  
   SREV1 12  
 Output level  
   fine setting 36  
   Main 2, grouped 54  
 Outputs  
   assignments 9  
   DIGITAL AES/EBU OUT 14  
   I/O cards 82

setting levels 36  
 Owner's manual  
   about v  
   conventions used v

## P

PA-6, optional AC adapter 27  
 Page tabs 18  
 Page title 18  
 PARAMETER FINE button 16  
 PARAMETER MAIN button 16  
 Parameters 9  
 PC Card  
   definition 94  
   handling iii  
   loading impulse-response data 61  
   loading programs 45  
   loading projects 48  
   operation diagram 8  
   saving programs 46  
   saving projects 49  
   using 29  
 PCMCIA  
   definition 94  
   See also PC Card  
 Peak hold, using 39  
 Peaking  
   definition 94  
   post EQ 59  
   pre EQ 57  
 PEQ, definition 94  
 Ports  
   MIDI 15  
   REMOTE 15  
   SERIAL 15  
 Post EQ 59  
 Post EQ page 59  
 Power cord 26  
 POWER switch (RC-SREV1)  
   about 20  
   using 26  
 POWER switch (SREV1)  
   about 12  
   using 26  
 Powering up the RC-SREV1 26  
 Powering up the SREV1 26  
 Pre EQ 57  
 Pre EQ page 57  
 PROGRAM button 16  
 Program Changes  
   assigning quick memory programs 70  
   definition 94  
 Program number & title 18  
 Program page 42  
 Programs

about 7  
 assigning Program Changes 70  
 definition 94  
 deleting library programs 47  
 editing 51  
 editing library program titles 46  
 editing quick memory program titles 43  
 loading from the library 45  
 parameters 9  
 protecting library programs 47  
 protecting quick memory programs 44  
 recalling from quick memories 42  
 saving in the library 46  
 storing in quick memories 43  
 Project page 48  
 Projects  
   about 7  
   deleting 50  
   editing project titles 49  
   loading 48  
   protecting projects 50  
   saving 49  
   working with 48  
 Protecting  
   library programs 47  
   projects 50  
   quick memory programs 44

## Q

Q  
 definition 94  
 post EQ 59  
 pre EQ 57  
 Quick memories  
   about 7  
   assigning Program Changes 70  
   definition 94  
   recalling programs 42  
   storing programs 43  
   working with 42

## R

RC-SREV1  
   connecting 22  
   control surface 16  
   display 18  
   optional AC adapter 27  
   rear panel 20  
   selecting SREV1s 65  
   turning on and off 26  
 Rear panel  
   RC-SREV1 20  
   SREV1 14

Recalling, quick memories 42  
 Receive channels, MIDI 69  
 Remote controller, see RC-SREV1  
 REMOTE port  
   connecting 22  
   RC-SREV1 20  
   SREV1 15  
 Rev page 56  
 Reverb balance  
   assigning Control Changes 71  
   fine editing 56  
   Main 1, grouped 54  
 Reverb level  
   assigning Control Changes 71  
   fine editing 56  
 Reverb modes  
   about 6  
   convolution times 6  
   definition 94  
   display 18  
   selecting 34  
 Reverb time 6  
   fine editing 56  
   Main 1, grouped 52  
 Rev-mute, bypass mode 40  
 Routing inputs, see Assigning inputs  
 RS-422  
   definition 94  
   SERIAL ports 64

## S

Saving  
   programs in the library 46  
   projects 49  
 Selected SREV1 18  
 Selecting  
   inputs 35  
   reverb modes 34  
   SREV1s from the RC-SREV1 65  
   wordclock source 75  
 SERIAL ports  
   about 15  
 Setting  
   bypass mode 40  
   input & output levels 36  
   meter mode 39  
   MIDI receive channels 69  
 Setup page 34, 65  
 Shelving, definition 94  
 SIGNAL indicator 12  
 Slots  
   assigning inputs 35  
   card options 82  
   card specifications 83  
   choosing cards 83  
   installing I/O cards 84  
   output assignments 9

SmartMedia 29  
 SP2  
   file types 9  
 SP4  
   file types 9  
 Specifications  
   I/O cards 83  
 SREV1  
   block diagram 10  
   bypassing 40  
   features 4  
   front panel 12  
   in a nutshell 2  
   installation v  
   rear panel 14  
   turning on and off 26  
 Startup  
   internal operations 33  
   RC-SREV1 32  
   SREV1 32  
 Storing, quick memories 43  
 Switching on the RC-SREV1 26  
 Switching on the SREV1 26  
 Sync, wordclock 75  
 System examples 23  
 System parameters 9

## T

Tabs 18  
 Tascam TDIF-1 format  
   definition 94  
   I/O cards 82  
 Termination, wordclock 74  
 Thru  
   post EQ 59  
   pre EQ 57  
 Title edit dialog box 41  
 Titling  
   edit dialog box 41  
   editing library program titles 46  
   editing project titles 49  
   editing quick memory program  
   titles 43  
 TM4  
   file types 9  
 TMC  
   file types 9  
 Troubleshooting 85  
 Turning on the RC-SREV1 26  
 Turning on the SREV1 26  
 Type  
   post EQ 59  
   pre EQ 57

## U

Unlock, wordclock 75

Unsync, wordclock 75  
 Uppercase, titling  
 UTILITY button 16

## V

Vent 12

## W

Warnings i  
 WAV  
   file types 9  
 Web site iv  
 Wheel, PARAMETER 17  
 WORD CLOCK IN  
   about 15  
   using 74  
 Wordclocks  
   about 74  
   definition 94  
   hookup examples 78  
   selecting 75  
   WORD CLOCK IN 74

## Y

Yamaha web site iv  
 YGDAI  
   card specifications 83  
   cards 82  
   definition 94



Function...		Transmitted	Recognized	Remarks
Basic Channel	Default Changed	1-16 1-16	1-16 1-16	Memorized
Mode	Default Messages Altered	X X *****	OMNI OFF/OMNI ON X X	Memorized
Note Number	True Voice	X *****	X X	
Velocity	Note On Note Off	X X	X X	
After Touch	Keys Ch's	X X	X X	
Pitch bend		X	X	
Control Change	0-95	X	0	Assignable
Prog Change	:True#	X *****	X X	Assignable
System Exclusive		X	X	Parameter Change
System Common	:Song Pos :Song Sel :Tune	X X X	X X X	
System Real Time	:Clock :Commands	X X	X X	
Aux Messages	:Local ON/OFF :All Notes OFF :Active Sense :Reset	X X X X	X X X X	
Notes				

Mode 1: OMNI ON, POLY  
Mode 3: OMNI OFF, POLY

Mode 2: OMNI ON, MONO  
Mode 4: OMNI OFF, MONO

O: Yes  
X: No

