

Voice Gateway &
Pocket Voice Gateway
H.323 and MGCP Protocols

User's Manual

USER'S NOTICE

No part of this manual, including the products and software described in it, may be reproduced, transmitted, transcribed, stored in a retrieval system, or translated into any language in any form or by any means, except documentation kept by the purchaser for backup purposes, without the express written permission of THE MANUFACTURER.

THE MANUFACTURER PROVIDES THIS MANUAL "AS IS" WITHOUT WARRANTY OF ANY KIND, EITHER EXPRESS OR IMPLIED, INCLUDING BUT NOT LIMITED TO THE IMPLIED WARRANTIES OR CONDITIONS OF MERCHANTABILITY OR FITNESS FOR A PARTICULAR PURPOSE. IN NO EVENT SHALL THE MANUFACTURER, ITS DIRECTORS, OFFICERS, EMPLOYEES OR AGENTS BE LIABLE FOR ANY INDIRECT, SPECIAL, INCIDENTAL, OR CONSEQUENTIAL DAMAGES (INCLUDING DAMAGES FOR LOSS OF PROFITS, LOSS OF BUSINESS, LOSS OF USE OR DATA, INTERRUPTION OF BUSINESS AND THE LIKE), EVEN IF THE MANUFACTURER HAS BEEN ADVISED OF THE POSSIBILITY OF SUCH DAMAGES ARISING FROM ANY DEFECT OR ERROR IN THIS MANUAL OR PRODUCT.

Product warranty or service will not be extended if: (1) the product is repaired, modified or altered, unless such repair, modification or alteration is authorized in writing by THE MANUFACTURER; or (2) the serial number of the product is defaced or missing.

Products and corporate names appearing in this manual may or may not be registered trademarks or copyrights of their respective companies, and are used only for identification or explanation and to the owners' benefit, without intent to infringe.

The product name and revision number are both printed on the product itself. Manual revisions are released for each product design represented by the digit before and after the period of the manual revision number. Manual updates are represented by the third digit in the manual revision number.

For previous or updated manuals, BIOS, drivers, or product release information, contact THE MANUFACTURER.

SPECIFICATIONS AND INFORMATION CONTAINED IN THIS MANUAL ARE FURNISHED FOR INFORMATIONAL USE ONLY, AND ARE SUBJECT TO CHANGE AT ANY TIME WITHOUT NOTICE, AND SHOULD NOT BE CONSTRUED AS A COMMITMENT BY THE MANUFACTURER. THE MANUFACTURER ASSUMES NO RESPONSIBILITY OR LIABILITY FOR ANY ERRORS OR INACCURACIES THAT MAY APPEAR IN THIS MANUAL, INCLUDING THE PRODUCTS AND SOFTWARE DESCRIBED IN IT.

Copyright © 2001 All Rights Reserved.

Product Name: **Voice Gateway / Pocket Voice Gateway**
Manual Revision: **1.00 E790**
Release Date: **Aug 2001**

CONTACT INFORMATION

CONTENTS

1. Introduction	7
1.1. How to make calls to Internet phones	7
1.2. How to make calls to PSTN phones	7
1.3. Item Checklist	7
2. Features	8
2.1. Voice Gateway Features	8
2.2. Pocket Voice Gateway Features	9
3. Specifications	10
3.1. Model Specifications and Comparison	10
4. Installation	11
4.1. Understanding the Voice Gateway	11
4.1.1 Front Panel LED Descriptions	11
4.1.2. Rear Panel Descriptions	12
4.2. Connecting the Voice Gateway	14
5. System Configuration	15
5.1. Console Control	15
5.1.1 PIN Definition of RJ-45 type UART	15
5.1.2. COM Port Configurations	16
5.1.3. Access Console Control	17
5.1.4. Console Command Set	18
5.2. Telnet Control	27
5.2.1. Establish Connection	27
5.3. Web (HTTP) Console	27
5.3.1. System Info (VoIP MISC)	28
5.3.2. H.323 Info	30
5.3.3. MGCP Info	32
5.4. Keypad Control	34
5.4.1. Basic Commands	34
5.4.2. Supplemental Services Commands	36

CONTENTS

6. Software Upgrade	37
6.1. Through the User Console Interface	37
6.2. Through the HTTP Web Console	40
7. System Operation	44
7.1 H.323 Notes	44
7.2 MGCP Notes	45
7.3 Application Examples	45
7.4 VoIP Voice Gateway to VoIP Networks	48
7.5 VoIP Voice Gateway to VoIP Networks with PSTN line	49

FCC & DOC COMPLIANCE

This device complies with FCC Rules Part 15. Operation is subject to the following two conditions:

- This device may not cause harmful interference, and
- This device must accept any interference received, including interference that may cause undesired operation.

This equipment has been tested and found to comply with the limits for a Class B digital device, pursuant to Part 15 of the FCC Rules. These limits are designed to provide reasonable protection against harmful interference in a residential installation. This equipment generates, uses and can radiate radio frequency energy and, if not installed and used in accordance with manufacturer's instructions, may cause harmful interference to radio communications. However, there is no guarantee that interference will not occur in a particular installation. If this equipment does cause harmful interference to radio or television reception, which can be determined by turning the equipment off and on, the user is encouraged to try to correct the interference by one or more of the following measures:

- Reorient or relocate the receiving antenna.
- Increase the separation between the equipment and receiver.
- Connect the equipment to an outlet on a circuit different from that to which the receiver is connected.
- Consult the dealer or an experienced radio/TV technician for help.

WARNING! Any changes or modifications to this product not expressly approved by the manufacturer could void any assurances of safety or performance and could result in violation of Part 15 of the FCC Rules.

1. Introduction

Thank you for purchasing an Voice Gateway / Pocket Voice Gateway. The Voice Gateway / Pocket Voice Gateway, like the rest of the VoIP voice gateway products offers the highest performance and interoperability capabilities in a Voice over Internet Protocol (VoIP) environment for residential and small business users. With VoIP technology, users can dial with a VoIP phone to all over the world at a very low cost or even no cost.

This new “VoIP voice gateway” not only provides a compact integration of technology but also opens the gate to the Internet for traditional Plain Old Telephone Service (POTS). By connecting the Voice Gateway / Pocket Voice Gateway to a broadband data network, such as a cable modem or xDSL modem, high quality telephony service though the Internet can easily be attained.

With high compression rates and well-engineered VoIP voice gateway jitter control system, the Voice Gateway / Pocket Voice Gateway can also provide smooth and high quality telephone service even on an original narrowband network, such as ISDN.

1.1. How to make calls to Internet phones

If you have already an Internet Service account from your local ISP, you can use this service to provide VoIP Telephone Service by VoIP voice gateway. Make sure that your ISP’s firewall allows VoIP services (H.323 or MGCP).

1.2. How to make calls to PSTN phones

As well as free telephony service by VoIP technology of VoIP products, you can subscribe to an Internet Telephony Service Account from your ITSP, then you can let your Voice Gateway / Pocket Voice Gateway to provide telephony service to PSTN.

NOTES: The Media Access Control (MAC) address (printed on a label on the bottom of the voice gateway) is needed for your local ISP/ ITSP to configure your subscription. Have this number ready before you contact your local ITSP.

1.3. Item Checklist

Check that your package is complete. If you discover damaged or missing items, please contact your retailer.

- Voice Gateway / Pocket Voice Gateway
- AC Power adapter
- Ethernet cable (RJ-45, Category 5)
- UART RJ-45 Console Cable
- This User’s Manual

2. Features

2.1. Voice Gateway Features

Supports

- G.711/G.723.1/G.729A voice compression algorithm
- Multiple VoIP protocols: H.323, H.225.0, Q.931, H.245, RTP/RTCP, H.450*, H.235*, MGCP 1.0: MGCP, SDP, RTP/RTCP
- Multiple UI/GUI for management and configuration: Web Console, Telnet, Console, Phone Set, SNMP.
- Voice: DTMF detection and generation, G.168 compliant echo canceller, silence detection (VAD) and CNG, Call Progress and User Tone Generation, Caller ID (optional), FoIP supporting T.30 & T.38 Fax Relay (optional)
- Telephony Supplemental services: Inner Conference Call, Speed Dial, Redial, Call Back, Distinct Ring, Call waiting*, Call Holding*, and Call Forwarding*
- Supports multiple languages for phone set configuration (phone number report & speed dial), voice record & playback*, and voice mail*

Provides

- Two 10/100 Base-T Fast Ethernet RJ-45 interfaces — WAN & LAN
- One UART RJ-45 connector console interface
- One or four RJ-11 POTS interfaces, FXS and FXO available
 - FXS only: 2 or 4 FXS port
 - FXO/FXS: 1 FXO i/f and 1 or 3 FXS port
 - FXO only: 2 or 4 FXO port

2. Features

2.2. Pocket Voice Gateway Features

Support

- G.711/G.723.1/G.729A# voice compression algorithm
- Multiple VoIP protocols: H.323, H.225.0, Q.931, H.245, RTP/RTCP, H.450*, H.235*, MGCP 1.0: MGCP, SDP, RTP/RTCP
- Multiple UI/GUI for management and configuration: Web Console, Telnet, Console, Phone Set, SNMP.
- Voice: DTMF detection and generation, G.168 compliant echo canceller, silence detection (VAD) and CNG, Call Progress and User Tone Generation, Caller ID (optional), FoIP supporting T.30 & T.38 Fax Relay (optional)
- Telephony Supplemental services: Inner Conference Call, Speed Dial, Redial, Call Back, Distinct Ring, Call waiting*, Call Holding*, and Call Forwarding*
- Supports multiple languages for phone set configuration (phone number report & speed dial), voice record & playback*, and voice mail*

Provides

- Provide one 10/100 Base-T Fast Ethernet RJ-45 interface
- Provide one UART RJ-45 connector console interface
- Provide one RJ-11 POTS interfaces, FXS and FXO available
FXS: 1 FXS port
FXO: 1 FXO port

3. Specifications

3.1. Model Specifications and Comparison

Description	Voice Gateway			Pocket Voice Gateway	
Models:	FXS only	FXO/FSX	FXO only	FXS	FXO
Tel Interface:	2 or 4 RJ-11 POTS interface			1 RJ-11 POTS Interface	
FxS Ports:	2 or 4	1 or 3	0	1	0
FxO Ports:	0	1	2 or 4	0	1
CPE Interface:	LAN: 10/100 Base-T Ethernet (RJ45) WAN: 10/100 Base-T Ethernet Crossover			WAN: 10/100 Base-T Ethernet Crossover USB*	
Console:	UART RJ45 Serial Interface				
VoIP Protocols:	MGCP or H.323 Selectable with RTP/FTCP Transmission				
Voice Compression:	G.711 (a-law / μ -law), G.723.1 (5.3kbps / 6.3kbps), G729A				
Voice Features:	DTMF Detect / Generate, G.168 Compliant Echo Canceller, Silence Detection, (VAD) and CNG, Call Progress Tone Generation, User Defined Tone Generation, Caller ID*, T.38 Fax Relay*			DTMF Detect / Generate, Echo Cancellation, Silence Detection (VAD), Call Progress, Tone Generation	
Tel Supp Services:	Inner Conference Call, Speed Dial, Redial, Call Back, Distinctive Ring, Call Waiting*, Call Holding*, and Call Forwarding*				
Configuration:	Console Telnet Web Console, Keypad, SNMP				
Power Adapter:	+5V, -24V, -56V, -5V			+12V 2.5A	

*optional features

4. Installation

4.1. Understanding the Voice Gateway

4.1.1 Front Panel LED Descriptions

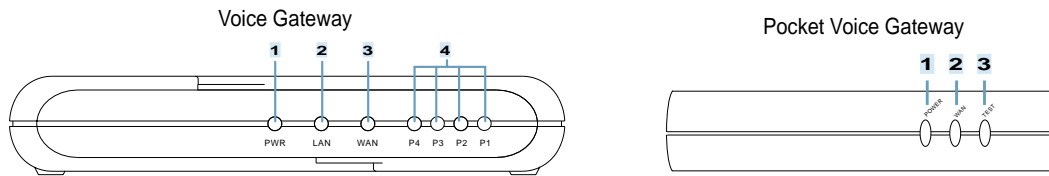

Voice Gateway

LED	State	Description
1. PWR	On	Voice Gateway is power ON
	Off	Voice Gateway is power Off
2. LAN	On	LAN port is linked with other device
	Flashing	Data is transmitting
	Off	No network connectivity on this port
3. WAN	On	WAN port is linked with other device
	Flashing	Data is transmitting
	Off	No network connectivity on this port
4. P4–P1	Off	Telephone Set is On-Hook or Line is not enabled
	On	Telephone Set is Off-Hook
	Flashing	Ring Indication

NOTE: System initialization will turn the LED ON for a few sec.

Pocket Voice Gateway

LED	State	Description
1. PWR	On	Voice Gateway is power ON
	Off	Voice Gateway is power Off
2. LAN	On	LAN port is linked with other device
	Flashing	Data is transmitting
	Off	No network connectivity on this port
3. LINE/ PHONE	Off	Telephone Set is On-Hook or Line is not enabled
	On	Telephone Set is Off-Hook
	Flashing	Ring Indication

NOTE: System initialization will turn the LED ON for a few sec.

4. Installation

4.1.2. Rear Panel Descriptions

Voice Gateway

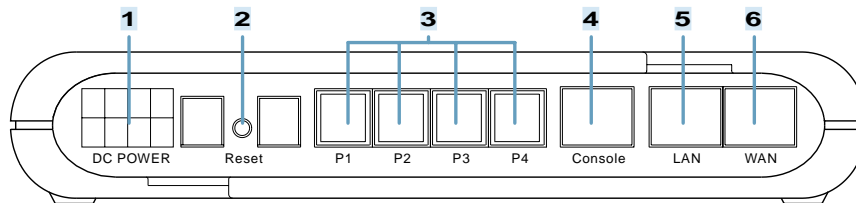

1. DC Multiple-voltage Power Input Jack

The provided power adapter converts AC power to multiple-voltage DC power for use with this jack. Power supplied through this jack will supply power to the voice gateway

2. Reset

The reset button, when pressed, resets the voice gateway without the need to unplug the power cord.

3. P1 - P4 (Phone Lines)

These ports are connected to either telephone sets or telco's telephone line depending to different models:

FXS only model: P1-P4 are connecting to telephone sets

FXO/FXS model: Line is connecting to telco's telephone line while P2-P4 are connecting to telephone sets.

FXO only model: L1-L4 are connecting to telco's telephone line.

4. CONSOLE

The RJ45 port supports the RS232 terminal interface for voice gateway management

5. LAN (optional)

The LAN port supports 10/100Base-T networks. This port allows your PC to be connected to the voice gateway through a CAT.5 twisted pair Ethernet cable.

6. WAN

The WAN port supports 10/100Base-T networks. This port (built with crossover) allows your voice gateway to be connected to an Internet Access device, e.g. router, cable modem, ADSL modem, through a CAT.5 twisted pair Ethernet cable.

4. Installation

Pocket Voice Gateway

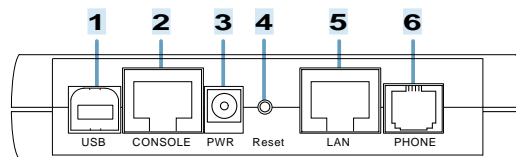

1. USB (optional)

The optional USB port allows the pocket voice gateway to be connected to your computer through the USB interface

2. CONSOLE

The RJ45 port supports the RS232 terminal interface for voice gateway management

3. DC +12V/1.25A Power Input Jack

The provided power adapter converts AC power to DC power for use with this jack. Power supplied through this jack will supply power to the pocket voice gateway.

4. Reset

The reset button, when pressed, resets the voice gateway without the need to unplug the power cord.

5. LAN

The LAN port supports 10/100Base-T networks. This port allows your PC to be connected to the voice gateway through a CAT.5 twisted pair Ethernet cable. The RJ45 port supports the RS232 terminal interface for pocket voice gateway management

6. PHONE (LINE)

This port is connected to either a telephone set or telco's telephone line depending to different models:

FXS model: connecting to telephone sets (PHONE)

FXO model: connecting to telco's telephone line (LINE)

4. Installation

4.2. Connecting the Voice Gateway

To avoid overheating problems, allow at least 3 centimeters (one inch) spacing between the ventilation holes and any object to either side of the unit. Avoid any obstructions on the top of the unit. The top of the unit should be at least 5 centimeters (two inches) from any obstruction. Connect the voice gateway using the following steps:

1. Connect the Ethernet Cable from the WAN port of voice gateway to the Internet access port. This Internet access port is a 10/100 BaseT connection on a router, switch, or broadband devices, such as cable modem or ADSL modem.
2. Connect the 10/100BaseT cable (RJ-45) from your computer to the LAN port connector on the voice gateway rear panel (optional).
3. Connect the telephone line from your telephone to the P1–P4 (RJ-11) connector on the rear panel.
4. Connect the AC adapter to multi-voltage input jack on the voice gateway rear panel. Then plug the AC adapter to a wall electrical outlet.

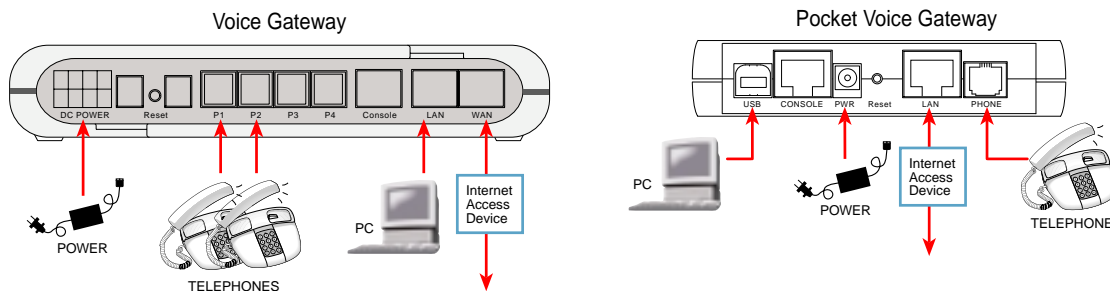

5. System Configuration

The Voice Gateway / Pocket Voice Gateway can be configured in many ways such as using telnet, Web browser, telephone keypad, or SNMP control. Although there are many VoIP protocols, Voice Gateway currently supports H.323 protocol and MGCP protocol.

For H.323 protocol, it can support both version 2 and version 3.

For MGCP protocol, Voice Gateway can support most major profiles to achieve maximum interoperability. This includes RFC standard profile (RFC 2705, MGCP 1.0), NCS standard profile (for Packet Cable, NCS 1.0), and some proprietary profile (MGCP 0.1, NCS 1.0).

The following sections describe all methods for controlling Voice Gateway.

5.1. Console Control

This section describes how to set up the different operation modes or monitor the performance of the Voice Gateway using the User Mode Console.

5.1.1 PIN Definition of RJ-45 type UART

PIN	Signal
1	NC
2	NC
3	TXD
4	GND
5	GND
6	RXD
7	NC
8	NC

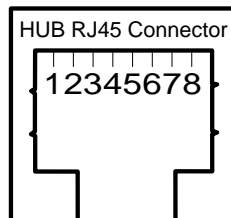

5. System Configuration

5.1.2. COM Port Configurations

To access the user console, use the console cable to connect the Console port on the Voice Gateway to your PC's empty COM port. Open a VT100 terminal emulation program such as Windows' HyperTerminal to configure the COM port. (The setup under HyperTerminal is given as an example below.)

In Windows, click **Start, Programs, Accessories, Communications**, and then select **HyperTerminal**. When the HyperTerminal window appears, double click the HyperTerminal icon to run it. If you cannot find it, add the program using **Add/Remove Programs** in Control Panel.

1. When HyperTerminal is started, you will be prompted to establish a new connection. Follow the on-screen instruction.

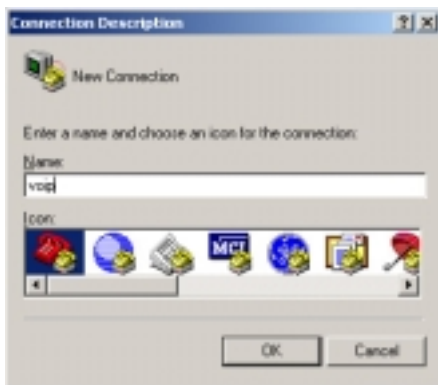

2. A user console connection do not require dial-up information. Simply choose the COM port that you are using and then click OK.



3. Configure the COM port as shown below. You are now ready to configure the operation mode.

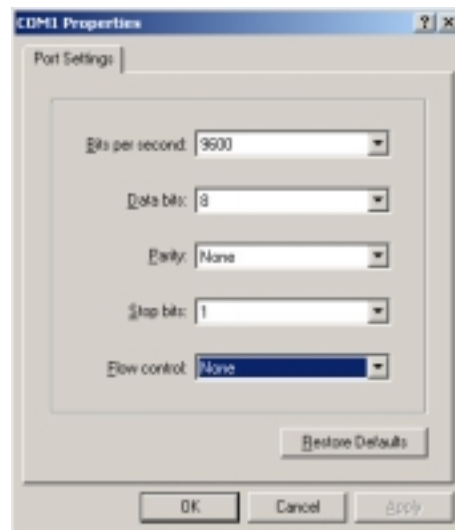

Recommended COM Port Settings:

Bit Rate: 9600 bps
Data Bits: 8
Parity Check: None
Stop Bit: 1
Flow Control: None

5. System Configuration

5.1.3. Access Console Control

In order to configure the voice gateway, press [CTRL D] to enter the console control mode. To protect the system settings, a username “voip” and a password is required. The factory password is the last 6 digits of the Ethernet MAC address. For example, if the MAC address of the voice gateway is 00:E0:18:F0:00:36, then the default password is f00036. (The default password is in lower case) Use the command “passwd” to change the password.

To reset the Voice Gateway to the above default values, press [CTRL O R] during system bootup while attached using the console cable.

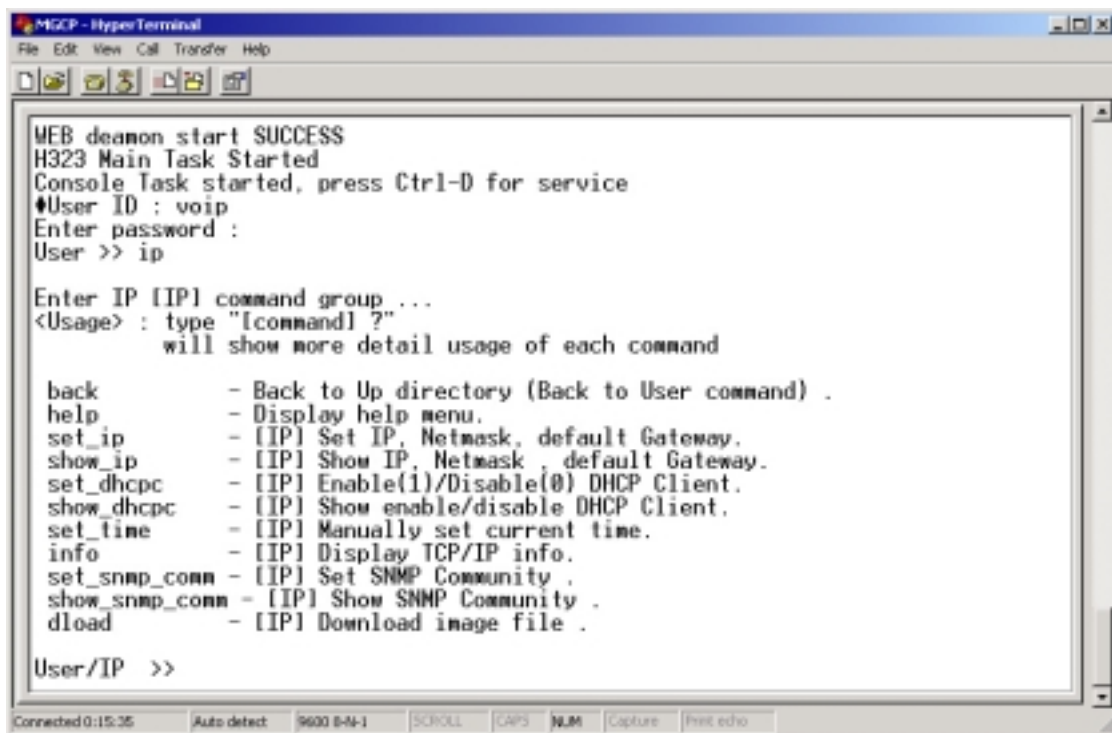

```
MGCP - HyperTerminal
File Edit View Call Transfer Help

WEB daemon start SUCCESS
H323 Main Task Started
Console Task started, press Ctrl-D for service
#User ID : voip
Enter password :
User >> ip

Enter IP [IP] command group ...
<Usage> : type "[command] ?"
          will show more detail usage of each command

back      - Back to Up directory (Back to User command) .
help      - Display help menu.
set_ip    - [IP] Set IP, Netmask, default Gateway.
show_ip   - [IP] Show IP, Netmask, default Gateway.
set_dhcp  - [IP] Enable(1)/Disable(0) DHCP Client.
show_dhcp - [IP] Show enable/disable DHCP Client.
set_time  - [IP] Manually set current time.
info      - [IP] Display TCP/IP info.
set_snmp  - [IP] Set SNMP Community .
show_snmp - [IP] Show SNMP Community .
dload     - [IP] Download image file .

User/IP >>
```

Connected 0:15:25 | Auto detect | 9600 B-4-1 | SCROLL | CAPS | NUM | Capture | Print echo

5. System Configuration

5.1.4. Console Command Set

1. System Commands

h323 (valid only on H.323 Client)

Enter H.323 Client [H323] Command Group.

help

Display the help menu. It lists all available commands in the current command group.

ip

Enter TCP/IP [IP] Command Group.

info

Display all information. It shows all information about the Voice Gateway/Pocket Voice Gateway, including hardware and software version, Internet configuration, and run-time status.

mg (valid only on MGCP Client)

Enter MGCP Client [MG] Command Group.

ping

Send ICMP echo request. Use this command to detect the connectivity with other Internet devices.

quit

Quit console command mode.

reboot

Reboot the system.

tel

Enter Telephony [TEL] Command Group.

2. Telephony Commands [TEL]

back

Return Root Command Group.

help

Display help menu. It lists all available commands in the current command group.

info

Display Telephony information.

set_sd_line

<Usage>: *set_sd_line* [line]

Input up to 8 Speed Dial entries SD(2~9) of a line.

line: Specify the line number of configuration.

[option]

? Display this help.

[prompt]

speed dial phone: max. 19 digits

5. System Configuration

speed dial Ring: [0] normal / [1] fast / [2] slow

[example]

```
set_sd_line 1
```

Input all SD(2~9) entries of Line 1.

Follow the prompt to fill in the phone number and select the ring type.

[Tips]

If you want to clear any SD entries, type “NULL” in [speed dial phone].

If you skip the rest of the SD entries, type “s” in [speed dial phone].

set_sd

<Usage>: *set_sd* [line] [SetNum] [phone] [ring]

Input one Speed Dial entry to a line.

line: Specify the line number of configuration.

SetNum: Specify the entry number of SD(2~9)

phone: Max. 19 digits

ring: [0] normal / [1] fast / [2] slow

[example]

```
set_sd 1 2 12345678 0
```

set up Line 1, SD(2), phone: 12345678, ring: normal

```
set_sd 1 2 NULL 0
```

clear SD(2) entry of Line 1.

show_sd

<Usage>: *show_sd* [option]

Show all Speed Dial entries in all lines

[option]

? Display this help.

set_country

<Usage> : *set_country* [option]

Select the country of location to generate a suitable tone signal.

[option]

? Display this help

set_ring

<Usage> : *set_ring*

Set up the ring cadence.

Follow the prompt to assign the ring on/off duration

[option]

? Display this help

[prompt]

on_duration - assign the on duration (unit : ms)

off_duration - assign the off duration (unit : ms)

5. System Configuration

show_ring

<Usage> : *show_ring*

Show the ring cadence.

[option]

? Display this help

set_buffer

<Usage> : *set_buffer* [option]

Set jitter buffer size.

[option]

? Display this help

set_gain

<Usage> : *set_gain*

Use this command to set gain control

[option]

? Display this help.

set_idt

<Usage> : *set_idt*

Use this command to set inter-digit time

[option]

? Display this help.

[prompt]

inter-digit time - assign the inter-digit time.

set_rbt

<Usage> : *set_rbt*

Use this command to enable/disable pseudo ring back tone

[option]

? Display this help.

[prompt]

Enable/Disable pseudo ring back tone

set_echocncl

<Usage> : *set_echocncl*

Use this command to enable/disable echo cancellation

[option]

? Display this help.

[prompt]

Enable/Disable echo cancellation

3. Internet Protocols Commands [IP]

help

Display help menu. It lists all available commands in the current command group.

5. System Configuration

back

Return root command group.

info

Display TCP/IP information.

set_ip

<Usage> : *set_ip* [option] [IP] [Netmask] [Default Gateway]

Set up the IP address, subnet mask, and default gateway of the voice gateway.

Type “set_ip” command, then, follow the prompt to complete the setting.

Type “set_ip” command and the parameters of IP address, subnet mask, and default gateway in one command line

[option]

? Display this help

This command is only valid in Disable DHCP status, and you can use “show_dhcpc” command to read current DHCP status.

show_ip

<Usage> : *show_ip* [option]

Show current IP , Netmask , Default Gateway

[option]

? Display this help

set_dhcpc

<Usage> : *set_dhcpc* [option] | [0|1]

Disable/enable the DHCP client

Disable DHCP client – use assigned static IP

Enable DHCP client – obtain IP automatically from DHCP server

[option]

? Display this help.

show_dhcpc

<Usage:> *show_dhcpc* [option]

Show the current status of DHCP client

Enabled -> obtain IP automatically from DHCP server

Disabled -> use assigned static IP

[option]

? Display this help.

set_time

<Usage> : *set_time* [option] | [yy-mm-dd] [hh:mm:ss]

Set up current time of day.

yy-mm-dd Year (A.D.), month (1-12), and day (1-31).

hh:mm:ss Hour (0-23), minute (0-59), and second (0-59).

[option]

? Display this help.

5. System Configuration

set_snmp_comm

<Usage> : *set_snmp_comm* [option]

Set up SNMP community for SNMP Get(Read)/Set(Write).

[option]

? Display this help

show_snmp_comm

<Usage> : *show_snmp_comm* [option]

Show SNMP Get(Read)/Set(Write) community .

[option]

? Display this help

dload

<Usage> : *dload* [option]

Download image file from TFTP Server.

Follow the prompt to assign the TFTP Server IP and download image file name then start to download the image file.

[option]

? Display this help

[prompt]

TFTP Server IP - assign the TFTP Server IP

Download image file name - assign the download image file name

4. H.323 Commands [H323]

(Valid only on H.323 client)

help

Display help menu. It lists all available commands in the current command group.

back

Return root command group.

info

Display H.323 protocol information

set_codec

<Usage> : *set_codec*

Use this command to set the preferred audio codec

[option]

? Display this help.

[prompt]

codec choose the preferred audio codec

silence choose to enable/disable the silence suppression function.

set_phno

<Usage> : *set_phno*

5. System Configuration

Use this command to set up the phone number for each line

[option]

? Display this help.

[prompt]

phone number - enter the phone number for each line

set_h323id

<Usage> : *set_h323id*

Use this command to setup the h323 id

[option]

? Display this help.

[prompt]

h323_id enter the h323 id

set_gk

<Usage> : *set_gk*

Use this command to enable/disable gatekeeper functionality

[option]

? Display this help.

[prompt]

Gatekeeper Enable this function to register with a gatekeeper

DNS Enable this only if your DNS server provides gatekeeper information.

Auto Discovery Enable this to auto-discovery the gatekeeper.

H.323 GK IPInput static gatekeeper IP address if AutoDiscovery is turned off.

set_altgk

<Usage> : *set_altgk*

Use this command to setup alternate gatekeeper

[option]

? Display this help.

[prompt]

No use this number to index the table.

IP define the IP address corresponding to this gatekeeper.

set_fs

<Usage> : *set_fs*

Use this command to enable/disable fast start functionality

[option]

? Display this help.

[prompt]

fast-start enable this to use the fast start function defined in H.323.

set_gw

<Usage> : *set_gw*

Use this command to enable/disable gateway support

5. System Configuration

[option]

? Display this help.

[prompt]

Enter a Gateway IP if an H.323 Gateway is present to support phone number/IP translation.

set_maptab

<Usage> : *set_maptab*

Use this command to setup the mapping table content

[option]

? Display this help.

[prompt]

No use this number to index the table.

Phone assign a phone number.

IP define the IP address corresponding to the phone number.

set_ac

<Usage> : *set_ac*

Use this command to enable/disable the function of auto insertion of the area code

[option]

? Display this help.

[prompt]

Area-Code enter the area code here to enable auto insertion.

set_nat

<Usage> : *set_nat*

Use this command to set no answer time

[option]

? Display this help.

[prompt]

nat set no answer time

set_shp

<Usage> : *set_shp*

Use this command to enable/disable sharp flag '#' support (end of phone no)

[option]

? Display this help.

[prompt]

shp Enable/Disable sharp flag '#' support

set_autoswitch

<Usage> : *set_autoswitch*

Use this command to enable/disable auto-switch support

[option]

? Display this help.

[prompt]

Enable/Disable auto-switch support

5. System Configuration

set_dtmfrelay

<Usage> : *set_dtmfrelay*

Use this command to select a DTMF rely protocol

5. MGCP Commands [MG]

(Valid only on MGCP client)

info

This will show all information of MGCP gateway setting. It includes Profile ID, Call agent information, Endpoint information..

restart

This will restart the MGCP gateway. It will re-activate using the parameter stored in the system

help

Display help menu.

back

Return root command group.

set_profile

<Usage> : *set_profile* [number] | [option]

number Set up MGCP profile, there are three basic profiles :

RFC 2705

NCS

MGCP 0.1 NCS 1.0 (CLARENT)

[option]

? Display this help.

After changing MGCP profile MG will automatically restart.

show_profile

<Usage> : *show_profile* [option]

Show MGCP profile detail.

[option]

? Display this help.

all Show all profile.

set_ca

<Usage> : *set_ca* [option]

Set up Call Agent (CA) information of MG.

Follow the prompt to complete the setting.

[option]

? Display this help

[prompt]

localname The local name of CA, max 32 characters allowed. This value is optional. e.g. CA1.

Type "NULL" to clear.

5. System Configuration

Domain | IP The Domain name or IP of the CA. e.g. “1.2.3.4” or “yourCA.company.com”.
If Domain name is used, use “set_dns” to set up DNS. Type “NULL” to clear the entry. Max 100 characters.

Port The port number of CA, 1024 ~ 65535, usually 2427 or 2727.

After setting CA information, MG will automatically restart.

show_ca

<Usage> : *show_ca* [option]

Show the CA information of MG and current NotifiedEntity of all endpoints.

[option]

? Display this help

set_gwname

<Usage> : *set_gwname* [option]

Set MG’s DomainName. epX@DomainName is name of endpoint X of this MGCP Gateway

Follow the prompt to complete the setting.

[option]

? Display this help

[prompt]

DomainName Max 50 characters allowed.

Type “NULL” to use default domain name ‘V’+MAC.

After setting Domain Name, MG will automatically restart.

show_gwname

<Usage> : *show_gwname* [option]

Show MG’s Domain Name

[option]

? Display this help

set_dns

<Usage> : *set_dns* [option]

Set a DNS Server IP of MG.

If CA is given in Domain Name, this value must be set.

Follow the prompt to complete the setting.

[option]

? Display this help

[prompt]

DNS Server IP Type “NULL” to clear DNS Server IP.

show_dns

<Usage> : *show_dns* [option]

Show DNS Server IP of MG

[option]

? Display this help

5. System Configuration

5.2. Telnet Control

The Voice Gateway can be controlled by Telnet applications. This capability is disabled when the voice gateway is already controlled from the console. Users may access all console commands using Telnet.

5.2.1. Establish Connection

Telnet can be used to enter the console control mode. The parameters of the factory default are shown below. The default values using Telnet are:

IP Address = 192.168.100.100
Netmask = 255.255.255.0
Default Gateway = 192.168.100.254

You have to also enter a username (default “voip”) and password while you use Telnet to connect to the system. The default password using Telnet is the same as the console control input (last 6 lowercase characters of the Ethernet MAC address). The console mode using the console cable has a higher priority than using Telnet. Therefore, the Telnet user cannot enter control mode while another computer has control through the console port. If a current Telnet session is active, it will be disconnected when a connection is started through the console port. Except priority levels, there are no differences in commands when accessing through Telnet or the console port.

5.3. Web (HTTP) Console

Users can use browsers to setup or show the information of the voice gateway. For example, they can use Internet Explorer to configure the telephone number of VoIP phone. The IP address of the Web console is the same as the IP address used by Telnet.



The web page is divided into several frames, each of which is related to a VoIP module. It includes system settings, H.323 or MGCP settings, and About. Users can follow the procedures listed below to set up Voice Gateway.

5. System Configuration

5.3.1. System Info (VoIP MISC)

5.3.1.1. System Status

The screenshot shows a web browser window displaying the VoIP MISC status page. The browser title is "VoIP Product - Voice Gateway - Microsoft Internet Explorer". The address bar shows "http://192.168.100.100". The page has a blue sidebar with links for "VoIP MISC", "H.323", and "About". The main content area has a blue header "VoIP MISC" with sub-links for "Configuration" and "Status". Below this is a green header "VoIP MISC Info" containing a table with system parameters.

VoIP MISC Info			
Port Status	[1] ok, [2] ok, [3] ok, [4] ok		
IP	192.168.100.100	Netmask	255.255.255.0
Default Router	192.168.100.254	DHCP Client	Disable

Below the system info are four sections, each with a green header and a table showing phone line configurations. All lines show "Normal" status for all phones.

1 Line (phone) Show Config

Phone	Ring	Phone	Ring
1	Normal	2	Normal
3	Normal	4	Normal
5	Normal	6	Normal
7	Normal	8	Normal

2 Line (phone) Show Config

Phone	Ring	Phone	Ring
1	Normal	2	Normal
3	Normal	4	Normal
5	Normal	6	Normal
7	Normal	8	Normal

3 Line (phone) Show Config

Phone	Ring	Phone	Ring
1	Normal	2	Normal
3	Normal	4	Normal
5	Normal	6	Normal
7	Normal	8	Normal

4 Line (phone) Show Config

Phone	Ring	Phone	Ring
1	Normal	2	Normal
3	Normal	4	Normal
5	Normal	6	Normal
7	Normal	8	Normal

5. System Configuration

5.3.1.2. System Configuration

The screenshot shows a web browser window titled "VoIP Product - Voice Gateway - Microsoft Internet Explorer" with the address bar showing "http://192.168.100.100". The page content is organized into several sections:

- VoIP MISC Info:** A navigation bar with links for "Configuration (1st Line)", "2nd Line (Phone) Configuration", "3rd Line (Phone) Configuration", "4th Line (Phone) Configuration", and "Status".
- VoIP MISC Configuration:** A section with a green header containing:
 - DHCP Client: enable disable. Buttons:
 - IP: Netmask: Default Router: Buttons:
 - Text: "After you change/set the above value. Please wait the Voice Gateway restart, then re-connect to the Voice Gateway."
- VoIP Software Upgrade:** A section with a green header containing:
 - TFTP Server IP: Image File Name: Button:
 - Text: "Press 'Download' button to download image file to this Voice Gateway !"
- 1st Line (Phone) Configuration:** A section with a green header containing a table for configuring 8 phone lines. Each line has a number input field and a "Ring" dropdown menu set to "Normal". Buttons:

5. System Configuration

5.3.2. H.323 Info

5.3.2.1. H.323 Status

The screenshot shows a web browser window titled "VoIP Product - Voice Gateway - Microsoft Internet Explorer". The address bar shows "http://192.168.330.100/". The page content is organized as follows:

- Left Navigation Panel:** Contains links for "VoIP MISC", "H.323", and "About".
- H.323 Info Section:** A blue header with two tabs: "Configuration" (selected) and "Status".
- H.323 Per-port and Codec Info Table:**

Phone	Tel.No.	H323 ID
0		
1		
2		
3		
- H.323 General Info Table:**

Gatekeeper	Gatekeeper IP	DNS IP	Fast Start	Auto-Ins Area Code	Area Code
Disable	0.0.0.0	0.0.0.0	Disable	Disable	
- H.323 Voice Related Info Table:**

Preferred Codec	Silence Suppression	DTMF Relay
G7231	Enable	In-Band
- Alternate gatekeeper Info Form:**

IP Address

- Private Mapping table Info Table:**

Phone Number	IP Address
--------------	------------

6. System Configuration

5.3.2.1. H.323 Configuration

The screenshot displays the configuration interface for a VoIP Product - Voice Gateway. The browser window shows the URL 'http://192.168.100.100/'. The page is organized into several sections:

- H.323 Info:** Contains 'Configuration' and 'Status' tabs.
- H.323 Per-part Configuration:** A table with columns for H323 ID, E164, and H323 ID. It includes radio buttons for 'enable' and 'disable' and 'Set'/'Reset' buttons.
- H.323 General Configuration:** A table with columns for Gatekeeper, Gatekeeper IP, DSS IP, Fast Start, Admin Area Code, and Area Code. It includes radio buttons for 'enable' and 'disable' and 'Set'/'Reset' buttons.
- Voice Related Configuration:** A table with columns for Protocol Codec, Silence Suppression, and DTMF Edge. It includes radio buttons for 'enable' and 'disable' and 'Set'/'Reset' buttons.
- Alternate gatekeeper Configuration:** A table with columns for IP Address and a list of IP addresses. It includes 'Set'/'Reset' buttons.
- Private mapping table Configuration:** A table with columns for Phone number and IP address. It includes 'Set'/'Reset' buttons.

6. System Configuration

5.3.3. MGCP Info

5.3.3.1 MGCP Status

The screenshot shows a web browser window titled "VoIP Product - Voice Gateway - Microsoft Internet Explorer". The address bar shows "http://192.168.180.100". The page content is as follows:

MGCP GATEWAY

Configuration | Status

Endpoint Info

GW status : OK

Name	Status	NotifiedEntry
ahn1@V00E018F0F0	Searching CA.	0
ahn2@V00E018F0F0	Searching CA.	0
ahn3@V00E018F0F0	Searching CA.	0
ahn4@V00E018F0F0	Searching CA.	0

MGCP Gateway Info

Gateway Name (Domain Name)		V00E018F0F0
CA	Local Name	
	Domain or IP	
	Port	2427
Domain Name Server (IP)		

Profile Info

ID : 1	Name : DEFAULT1	Protocol : MGCP 1.0 (RFC 2705)
--------	-----------------	--------------------------------

6. System Configuration

5.3.3.2 MGCP Configuration

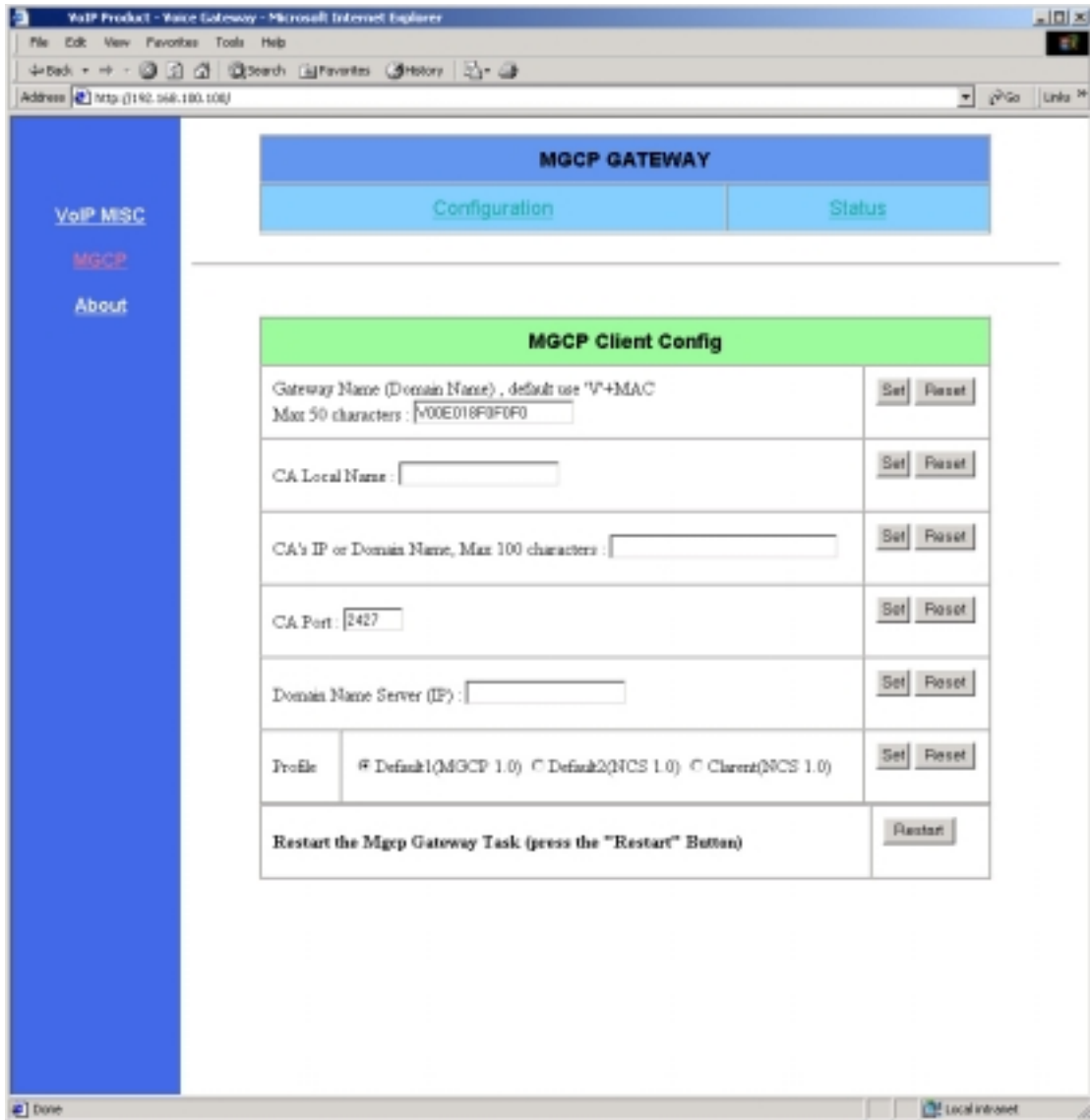

5. System Configuration

5.4. Keypad Control

Voice Gateway / Pocket Voice Gateway can be controlled using the keypad on the telephone set. Users can press special codes to set up the gateway. The control codes are listed below:

5.4.1. Basic Commands

1. Set Speed Dial

(Do) [1] (Do) [2–9 phone ID] (Do) [phone NO./IP][#] (Do) [0–2 :Ring Type] (Do----)

- When input IP, use * key to identify . (dot).
- Ring Type : 0 (Normal), 1(Fast), 2(Slow)
- Each phone can set 8 speed dial numbers

2. Read Speed Dial

(Do) [2] (Do) [2–9 phone ID] (phone number will be spoken) (Do)

- You can repeat this operation to hear all telephone setting.

3. DHCP

Enable: ## (Do) [3] (Do) [1 to enable] (Do----)

Disable: ## (Do) [3] (Do) [0 to disable] (Do) then

[1] (Do) [press IP][#], or

[2] (Do) [press netmask][#], or

[3] (Do) [press default gateway][#], or

[#](Do----)

- If you make an entry error, press # to finish, and repeat any DHCP entry.
- If the parameter is changed, system will reboot (Voice Gateway Reboots Automatically)

(Do): Short Tone Sound

(Do----): Long Tone Sound

5. System Configuration

4. MGCP

(Do) [4] (Do) then
[1] (Do) [press CAIP] [#] (Do), or
[2] (Do) [press CAPort] [#] (Do), or
[3] (Do) [press dnsIP] [#] (Do), or
[4] (Do) [1–3 to set ProfileID] (Do), or
[#] (Do----) (# indicate finish setting)

- CAIP = Call Agent IP address
- If the IP or Port parameter is changed, MG module will be restarted.
- Supported Profile ID: 1=MGCP 1.0 (RFC2705), 2=NCS 1.0 (Packet Cable), 3=Clarent (NCS1.0 MGCP 0.1)

5. H323

(Do) [5] (Do) then
[1] (Do) [1] (Do) [press phone] [#] (Do), or [2] [phone number will be spoken] (Do), or
[2] (Do) [0 , set GK not exist] (Do), or [1, set GK exist] (Do) [press GKIP] [#] (Do)
[3] (Do) [0/1 to set fastStart] (Do), or
[4] (Do) [press dnsIP] [#] (Do), or
[5] (Do) [0/1 to set AutoDiscovery] (Do), or
[6] (Do) [0, set GW not exist] (Do), or [1, set GW exist] (Do) [press GWIP] [#] (Do)
[#] (Do----)(# indicate finish setting)

6. Restore Factory Defaults

##*9 [1 to confirm]

(Do): Short Tone Sound
(Do----): Long Tone Sound

5. System Configuration

5.4.2. Supplemental Services Commands

Currently, the VoIP products of support the following basic supplemental services.

Automatic Callback (66)**

Automatic Callback allows a subscriber to initiate a call set up to the last directory number that was dialed from the subscriber's line so that the number is dialed automatically without the subscriber having to redial.

Automatic Redial (69)**

Automatic Recall allows a subscriber to automatically call back the last number that called the subscriber's directory number, whether the subscriber answered the call or not. To activate the AR feature, the subscriber needs to go off hook, waits for a dial tone, and dials a feature activation code (**69).

Speed Calling (74 + one digit (2 – 9))**

Speed calling permits the subscriber to dial selected directory numbers using fewer digits than normally required. This is accomplished through the assignment of one-digit code to frequently called directory number. Subscribers are allowed to assign eight directory numbers to the Speed Calling List (2 through 9).

Distinctive Ringing (61)**

Distinctive Ringing allows the subscriber to manage incoming calls by designating special directory numbers that may be identified using distinctive ringing patterns. Currently the VoIP gateway supports Fast/Normal/Slow Ringing. The Ring On/Off Patterns are On-1s, Off-1s (Fast mode)/On-2s, Off-1s (Normal Mode)/On-1s, Off-2s (Slot Mode).

Inner Conference Call (1-4)**

The VoIP products of with multiple phones can support an extra service for inner phones conference. Each user under the same Voice Gateway can call each other without any Internet connectivity. For example, the user in the phone 1 can dial ***3 to the user in the phone 3 directly.

6. Software Upgrade

Voice Gateway / Pocket Voice Gateway are software upgradable. Users may download the latest software from our web site and upgrade the voice gateway. Besides, users may switch between H.323 protocol and MGCP protocol by using different software image files.

Voice Gateways provide two interfaces for software upgrades, RS232 User Console Interface and HTTP Web Console Interface. This section will describe the step-by-step software upgrade procedures of both interfaces.

6.1. Through the User Console Interface

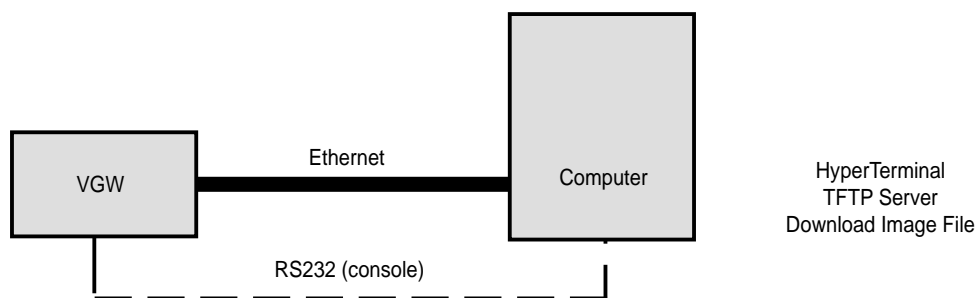

1. Save the upgrade software image file to your hard drive.
2. Make sure the modem is connected to your computer through the Ethernet interface and the Console port on the modem is connected to your computer's COM port.

6. Software Upgrade

3. Run a TFTP server program. Example: Cisco TftpServer (TFTPServer1-1-980730.exe) from: <http://www.cisco.com/pcgi-bin/tablebuild.pl/tftp>

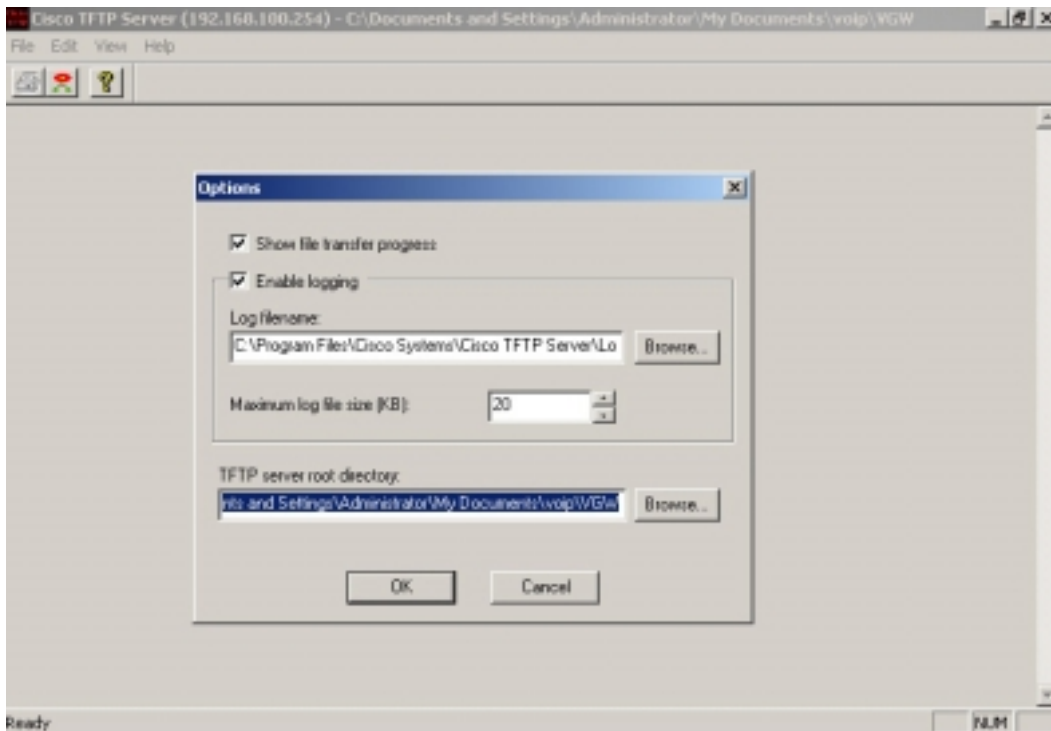

4. Turn on the hyperterminal user console. Refer to 5.1.2 “COM Port Configuration”.
5. Type “ip” under the “User >>” prompt to enter the IP directory.
6. Type “dload” command under the IP directory to upgrade the voice gateway. The IP address of the TFTP Server and the file name of the new software are required.
7. Voice gateway will reboot automatically after image downloaded, and the new user console will be launched.

6. Software Upgrade

```
MGCP - Hyperterminal
File Edit View Call Transfer Help
[Icons]

WEB daemon start SUCCESS
H323 Main Task Started
Console Task started, press Ctrl-D for service
#User ID : voip
Enter password :
User >> ip

Enter IP IIP1 command group ...
(Usage) : type "icommand ?"
          will show more detail usage of each command

back      - Back to Up directory (Back to User command) .
help      - Display help menu.
set_ip    - [IP] Set IP, Netmask, default Gateway.
show_ip   - [IP] Show IP, Netmask, default Gateway.
set_dhcp  - [IP] Enable(1)/Disable(0) DHCP Client.
show_dhcp - [IP] Show enable/disable DHCP Client.
set_time  - [IP] Manually set current time.
info      - [IP] Display TCP/IP info.
set_snmp  - [IP] Set SNMP Community .
show_snmp - [IP] Show SNMP Community .
dload     - [IP] Download image file .

User/IP >> dload
Download image from TFTP Server IP : [192.168.100.254] [192.168.100.1]
Download image name : [avg600kba_h323_1_4b3.bin]
Start Download File Now? [Y]
Start downloading avg600kba_h323_1_4b3.bin
From TFTP Server: 192.168.100.1 to Voice Gateway: 192.168.100.100
User/IP >>.....
TFTP download completed.
Performing MD5 digest check ...
Correct digest!

Upgrade app:
Erasing 8 blocks
.....
Correct digest!

Upgrade app:
Erasing 8 blocks
.....
Programming flash...
Total(bytes): 475004
Now (bytes): 475004
Succeed.

Resetting to start this code...
SysUpTime: 0 days 00:04:14

Default Mac Phy at 32

Voice Gateway Bootloader VGM 1.2i
Build Date: 2001/05/24 16:49:03
Flash ID 449 detected, Using structure 2
press ctrl-d to enter bldr ...
decompressing...
Gzip decompress

Voice Gateway Bootloader VGM 1.2i
Build Date: 2001/05/24 16:49:03
Flash ID 449 detected, Using structure 2
press ctrl-d to enter bldr ...
decompressing...
Gzip decompress
starting...

VoIP Voice Gateway using H.323
Hardware Version: VGM 1.20 , Software Version: 1.4b3

Set IP address to: 192.168.100.100
Set Subnet Mask to: 255.255.255.0
Set Default Gateway to: 192.168.100.254
SNMP Agent Listener Started!!
Telnet-Send daemon start SUCCESS
TELNET daemon start SUCCESS
Telnet-Recv daemon start SUCCESS
WEB daemon start SUCCESS
H323 Main Task Started
Console Task started, press Ctrl-D for service
-
```

6. Software Upgrade

6.2. Through the HTTP Web Console

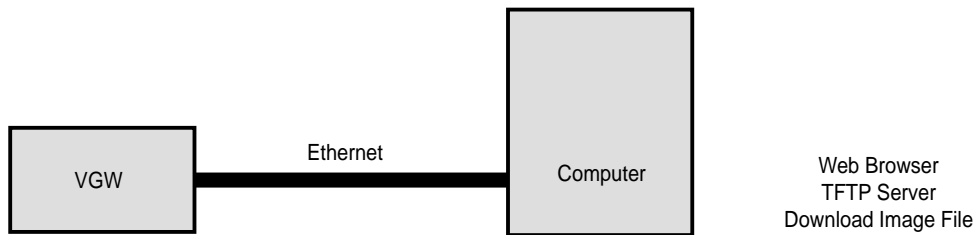

1. Save the upgrade software image file to your hard drive.
2. Make sure the modem is connected to your computer through the Ethernet .
3. Run a TFTP server program. Example: Cisco TftpServer (TFTPServer1-1-980730.exe) from: <http://www.cisco.com/cgi-bin/tablebuild.pl/tftp>

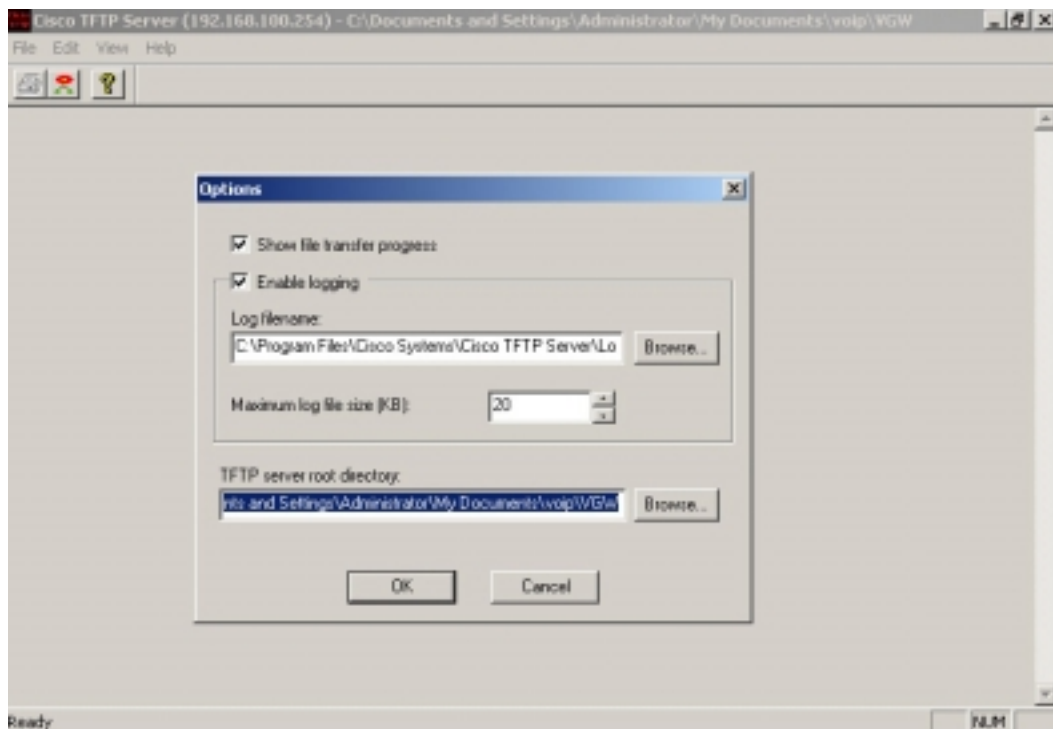

6. Software Upgrade

- 4. Power ON the voice gateway.
- 5. Run a web browser program. Example: Microsoft IE 5.0. The factory default network settings are:

IP: 192.168.100.100

Subnet mask: 255.255.255.0

Default gateway: 192.168.100.254

Type: <http://192.168.100.100/> to enter the web console



- 6. User need to login to access the web console. The factory default user name and password are:

Login name: voip

Password: The last 6 digits of the MAC address



6. Software Upgrade

7. In the web console, click on <VoIP MISC> in the left column, then select <Configuration> on the top command bar.



8. Click on the “Download” button to start downloading the new software. You can click “See the download result” to see the real time downloading status.

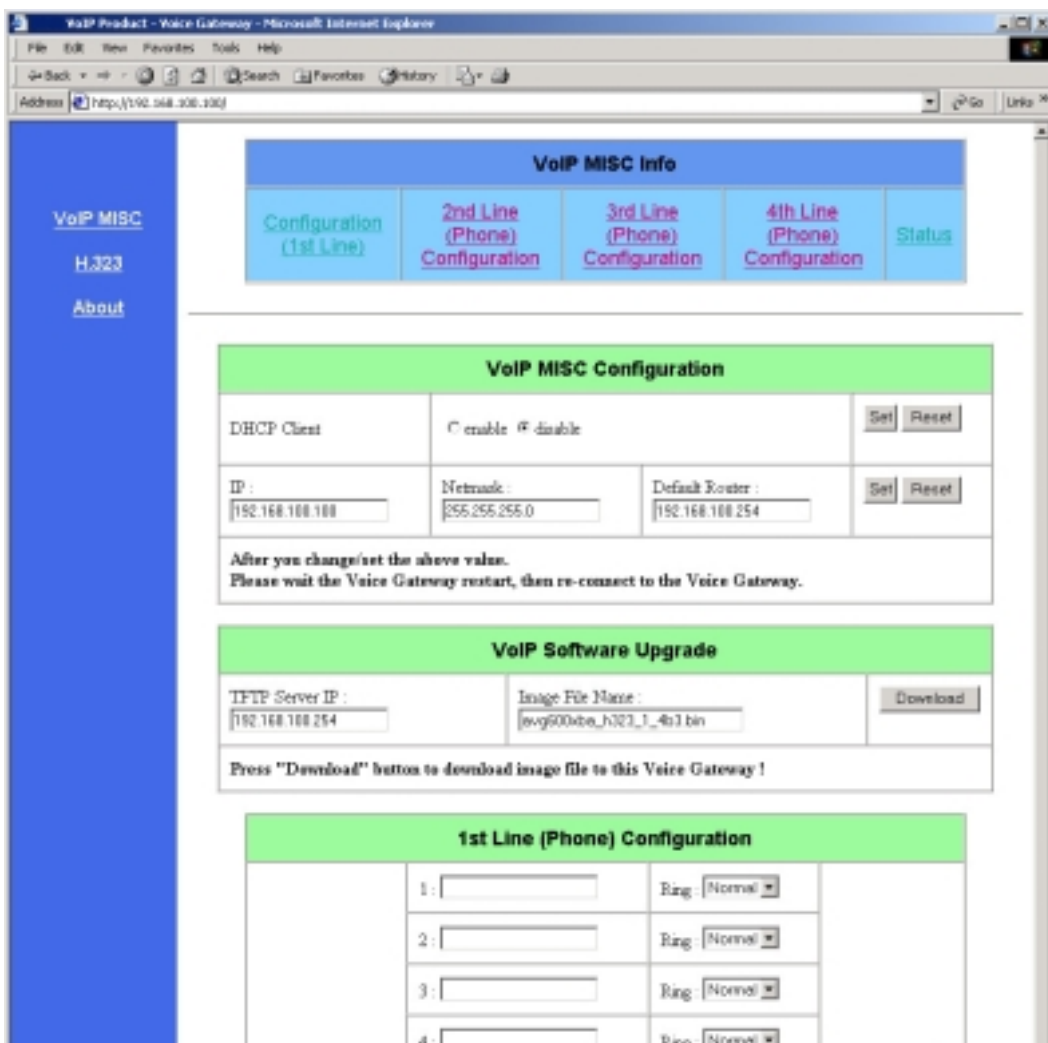

6. Software Upgrade

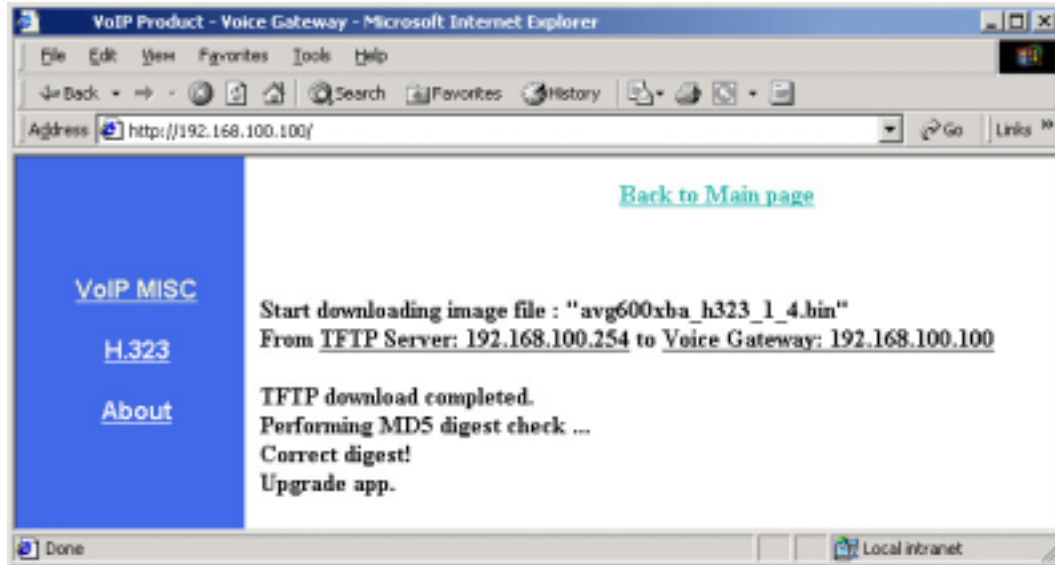

9. After downloading the new software successfully, the voice gateway will reboot automatically and the link will be disconnected. User may refresh the display and find the upgraded web console interface.

7. System Operation

Voice Gateway / Pocket Voice Gateway products can be operated in two modes: H.323 voice gateway and MGCP voice gateway. The system requirements are different in H.323 and MGCP environments.

7.1 H.323 Notes

H.323 is a peer-to-peer connection protocol for VoIP. In an H.323 environment, you can make a phone call to the destination directly, or through an H.323 gatekeeper and/or a trunk gateway. Then, you can make a phone call by either an IP address or a telephone number (E.164 number). Therefore, in our configuration, users have to setup the strategy to make a phone call. The criterion follows the rule:

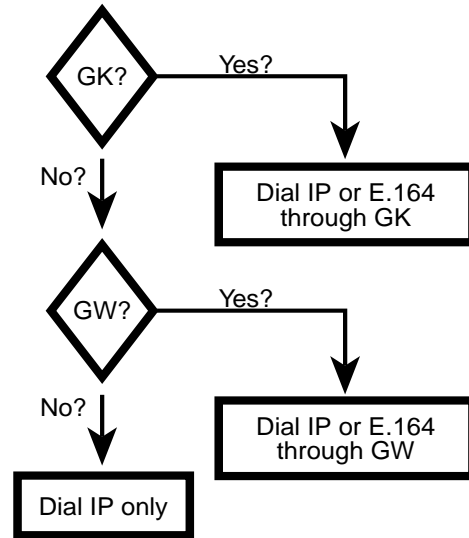

Make an H.323 phone call to other H.323 VoIP terminal (if H.323 firmware exists)

1. Call to pure VoIP (non-E.164 telephone) terminal
 - a. Pick up phone. After hearing a dial tone, dial the IP address of the peer terminal. Here you have to use star (*) as dot (.), and then press hash (#) to end. For example, if the IP address of the peer terminal is 192.168.100.2 then you have to press 192*168*100*2#
2. Call to E.164-addressed telephone terminal
 - a. In this environment, you have to connect to an H.323 Gatekeeper or Gateway to support E.164 address or IP Address.
 - b. You can use one of the user interfaces to configure the IP address of the H.323 Gatekeeper or Gateway. Refer to Chapter 5 for the configuration interface.

After you setup the IP address of the Gatekeeper and phone number of each line, you can dial to the peer terminal as in a standard telephone. For example, if you want to dial to 7123456 then you just press 7123456# to make this phone call.

7. System Operation

7.2 MGCP Notes

MGCP is a client-server connection protocol of VoIP technology. In an MGCP environment, it is compulsory for a server (named Call Agent or Call Manager) to manage and control all MGCP clients. Different Call Agents may employ different MGCP profiles, which define the procedures and parameters of a VoIP phone call.

Voice Gateway / Pocket Voice Gateway can support RFC standard profiles (RFC2705, MGCP 1.0), NCS standard profile (Packet Cable), and some proprietary profile (MGCP 0.1, NCS 1.0).

While the operator will set up the call agent with IP phone information, users have to set up the Voice Gateway with a valid IP address, the IP address (or domain name) of the Call Agents, and the corresponding MGCP profile.

In an MGCP environment, all clients need to use E.164 number to start the connection. The mapping of an E.164 number and IP address is handled by the MGCP Call Agent, then a user can call a peer VoIP terminal by the E.164 number. You can simply make a phone call as in standard telephones. For example, if you want to dial to 7123456 , you press 7123456 to make the phone call.

7.3 Application Examples

The voice gateways can be configured to perform many roles to support various demands from customers. Here, it presents some application examples for customer to know how to configure the voice gateway.

7.3.1 VoIP Voice Gateway to VoIP Networks using IP address

The first simple example shows the use of the Ethernet WAN port to connect to a VoIP network. The other LAN port connects to another computer. One or more telephone directly connects to the FXS interfaces (P1, P2 ... or Phone). This example provides you simple VoIP phone to another VoIP phone (VoIP to VoIP).

7. System Operation

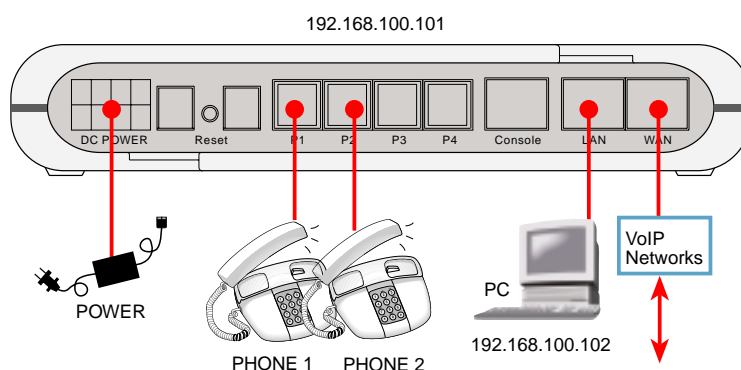

You can check the following items to make sure your configuration setting is correct. If you cannot have the correct result, please check the User Menu to see more details about system setting. Or you can connect to our customers support to inquire the setting.

- a. Use inner conference call to make phone call between each phones on the voice gateway:
 - Pick up one of telephone set, you will hear the dial tone.
 - Then dial ***1 to ***4 (for 4 ports) to make phone call to another one.
 - If the one is on-hook, voice gateway will ring the telephone. Pick up the phone, then the phone call establish well.
 - If the one is already in use then you will hear busy tone.
- b. Make the VoIP phone to VoIP Networks
 - Pick up one of telephone set, you will hear the dial tone.
 - Then the IP address of called party. For example, if you want to dial VoIP phone to 192.168.100.102, you have to dial 192*168*100*102#.
 - If called party is available then you will hear ring back tone. And if he accept the call, the phone call establish well.
 - If the one is already in use then you will hear busy tone.
- c. For H.323 phone in this case, you cannot dial E.164 telephone number (the traditional telephone number, like the one as your cell phone). And for multiple ports voice gateway, you cannot make VoIP phone to specified port. For example, you cannot dial to P2 directly without any setting. The P2 will receive the call only when P1 is already in use. But you can use other port (P2, P3, P4) to dial out without any limitations.
- d. For MGCP phone, you need Call Agent to control the MGCP phone. Therefore, you cannot dial IP address in this example.

7. System Operation

7.3.2 VoIP Voice Gateway to VoIP Networks using E.164 telephone number without VoIP Server

Since there are some limitations in the first example, our Voice Gateway supports another features to provide E.164 numbers' call without server. If another party (caller/called) of VoIP phone can support this feature also, then the both parties can use this function to dial the VoIP phone as the traditional telephone servers. Please refer to user menu to setup the H.323 telephone number mapping (show_maptab and set_map_tab commands in H.323 command directory)

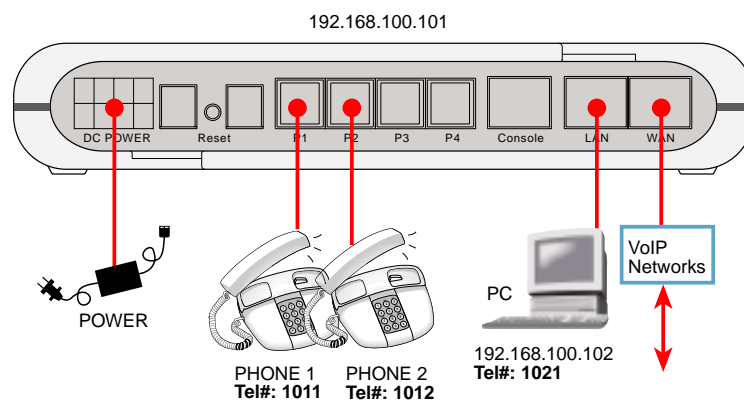

- a. This example can support all features in the previous example. It means you can dial VoIP phone using IP address and E.164 number co-existed.
- b. You have to configure the mapping table according above in both caller/called parties. For example, you have already setup the following mapping table:

<u>Index</u>	<u>Telephone</u>	<u>IP Address</u>
0	1011	192.168.100.101
1	1012	192.168.100.101
2	1013	192.168.100.101
3	1014	192.168.100.101
4	1021	192.168.100.102

- c. From another VoIP phone, you can dial 1012# to make the phone call to the second port of Voice Gateway. You can dial to second port directly even port one is also available for the call.
- d. Here, we mention again. For MGCP phone, it needs Call Agent to control it. Therefore, you cannot dial VoIP phone to others. The voice gateway can support inner conference call only without controlling from Call Agent.

7. System Operation

7.3.3 VoIP Voice Gateway to VoIP Networks controlled by VoIP Server

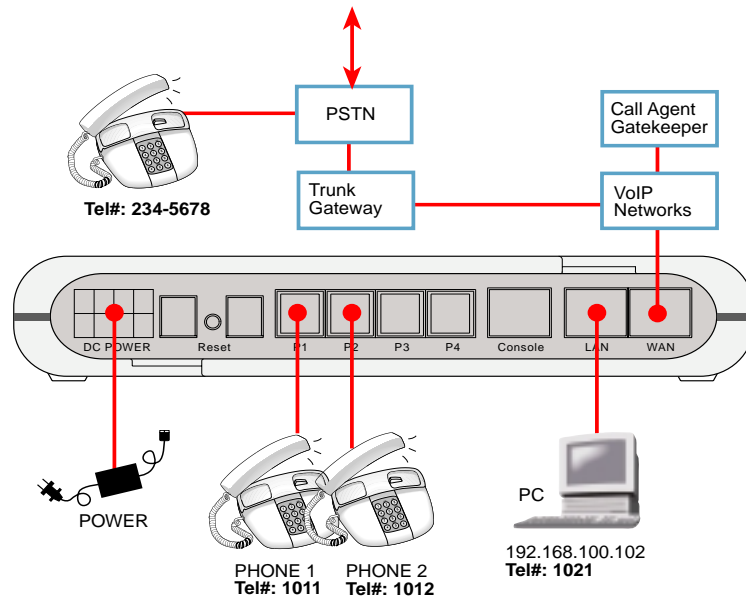

In order to dial out to PSTN world, the VoIP system has to connect to trunk gateway to PSTN controlled by VoIP Server. For example, you have to connect to Call Agent or Gatekeeper. Then you can dial to PSTN using VoIP phone.

- You have to setup the VoIP phone is controlled by Sever first in this example.
- For H.323, you have to enable Gatekeeper function in the H.323 command directory. And setup the IP address of Gatekeeper. Some vendor's trunk gateway supports E.164 numbering function but does not support Gatekeeper functionality, please enable trunk gateway and disable Gatekeeper in H.323 command directory.
- For H.323, the voice gateway has to setup the telephone number itself. Please use the `set_phno` command in H.323 command directory to set them.
- For MGCP, you have to setup the IP address of Call Agent. Then you have to setup the DNS name of the voice gateway. The similar setting have to support in setting of Call Agent. Then the voice gateway can make phone call well.
- If the voice gateway cannot connect to server well, you still can use the function of inner conference call. So, you can hear the dial tone also while you pick up the phone. By the way, if you want to dial out, you will hear busy tone since it cannot connect to VoIP server.
- For H.323, you can also dial to VoIP phone using IP address without connecting to VoIP server.

7. System Operation

7.3.4 VoIP Voice Gateway to VoIP Networks with PSTN line

The voice gateway of also support FXO interface to PSTN world directly. Three models of voice gateway support this function. AVG6001BA and AVG6001BD support one FXO interface. AVG6004BA support four FXO interfaces. Here is the example to support PSTN line and you can dial to traditional phone using our VoIP voice gateway.

Due to the variety of telephony specification, the FXO interface of voice gateway has to commit the specification very well. For example, you have to setup the call progressive tone of the PSTN line from Telephone companies or PBX. Please contact to our Technical Service to inquire the details specification of PSTN line in different countries and different PBX.

- The function of P2 (or P3 and P4 in 4 ports model) is as same as all the examples above.
- To provide PSTN backup functionality, you can use inner conference call to make a PSTN phone out. Just dial ***1, you can hear the second tone. Then you can dial the E.164 telephone number to real PSTN world. User can also configure the PSTN line port using E.164 number, for example 1011. Then after all other VoIP phone dial to 1011, the second tone can be hear. Then user can also dial the telephone number to PSTN world. Here, this voice gateway can be treated as a translation (so called gateway) between VoIP phone and PSTN phone.
- Vice verse, the user at PSTN world can dial to this PSTN line. After second ring, the voice gateway will pick up the phone and send the second dial tone again. Then user can also dial to VoIP phone using IP address or E.164 telephone number that is described in previous section.

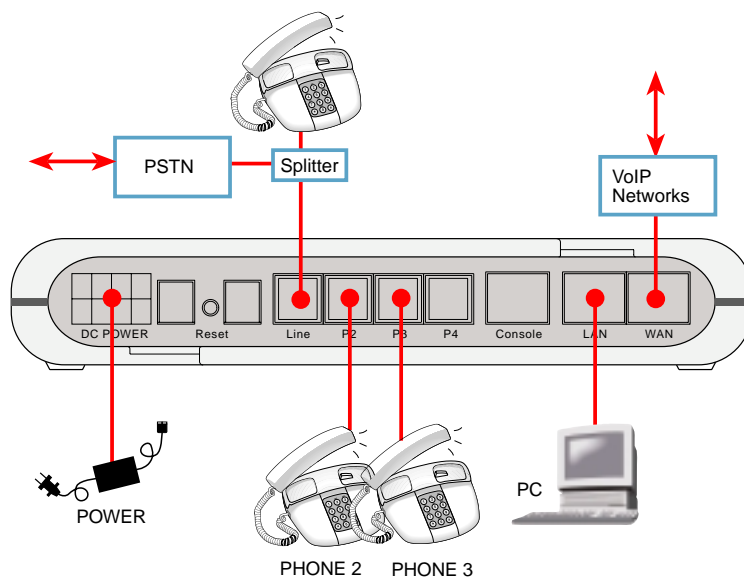

(This page was intentionally left blank.)