

Table of contents

Introduction	4
Congratulations	4
Safety and environment protection	5
Symbol glossary	8
Instrument cluster	10
Warning and control lights	10
Gauges	14
Entertainment systems	18
AM/FM stereo cassette (CD changer compatible)	18
AM/FM stereo with CD	30
Rear seat controls	39
CD changer	42
Climate controls	47
Manual heating and air conditioning	47
Electronic automatic temperature control	50
Lights	59
Headlamps	59
Bulb replacement	62
Driver controls	69
Steering wheel adjustment	71
Power windows	79
Mirrors	80
Locks and security	95
Keys	95
Locks	95
Anti-theft system	96

Table of contents

Seating and safety restraints 108

Seating	108
Safety restraints	120
Air bags	132
Child restraints	140

Driving 150

Starting	150
Brakes	154
Transmission operation	161
Vehicle loading	177
Trailer towing	180
Recreational towing	185

Roadside emergencies 186

Hazard flasher switch	187
Fuses and relays	189
Changing tires	196
Jump starting	202
Wrecker towing	207

Customer assistance 208

The dispute settlement board	211
Utilizing the mediation/arbitration	214
Getting assistance outside the U.S. and Canada	214
Ordering additional owner's literature	215
Reporting safety defects (U.S. only)	217

Cleaning 218

Cleaning your vehicle	218
Underbody preservation	223

Table of contents

Maintenance and specifications	225
Hood	226
Engine compartment	227
Engine oil	228
Battery	231
Fuel information	240
Air filter(s)	254
Part numbers	259
Refill capacities	260
Lubricant specifications	263
Engine data	265
Vehicle dimensions	266
Accessories	269
Index	273

All rights reserved. Reproduction by any means, electronic or mechanical including photocopying, recording or by any information storage and retrieval system or translation in whole or part is not permitted without written authorization from Ford Motor Company. Ford may change the contents without notice and without incurring obligation.

Copyright © 2001 Ford Motor Company

Introduction

The following warning may be required by California law:

CALIFORNIA Proposition 65 Warning



WARNING: Engine exhaust, some of its constituents, and certain vehicle components contain or emit chemicals known to the State of California to cause cancer and birth defects or other reproductive harm. In addition, certain fluids contained in vehicles and certain products of component wear contain or emit chemicals known to the State of California to cause cancer and birth defects or other reproductive harm.

CONGRATULATIONS

Congratulations on acquiring your new Ford. Please take the time to get well acquainted with your vehicle by reading this handbook. The more you know and understand about your vehicle the greater the safety and pleasure you will derive from driving it.

For more information on Ford Motor Company and its products visit the following website:

In the United States: www.ford.com

In Canada: www.ford.ca

In Australia: www.ford.com.au

In Mexico: www.ford.com.mx

Additional owner information is given in separate publications.



This Owner's Guide describes every option and model variant available and therefore some of the items covered may not apply to your particular vehicle. Furthermore, due to printing cycles it may describe options before they are generally available.



Remember to pass on the Owner's Guide when reselling the vehicle. It is an integral part of the vehicle.



Fuel pump shut-off switch In the event of an accident the safety switch will automatically cut off the fuel supply to the engine. The switch can also be activated through sudden vibration (e.g. collision when parking). To reset the switch, refer to the *Fuel pump shut-off switch* in the *Roadside emergencies* chapter.

SAFETY AND ENVIRONMENT PROTECTION



Warning symbols in this guide

How can you reduce the risk of personal injury and prevent possible damage to others, your vehicle and its equipment? In this guide, answers to such questions are contained in comments highlighted by the warning triangle symbol. These comments should be read and observed.



Warning symbols on your vehicle

When you see this symbol, it is imperative that you consult the relevant section of this guide before touching or attempting adjustment of any kind.



Protecting the environment

We must all play our part in protecting the environment. Correct vehicle usage and the authorized disposal of waste cleaning and lubrication materials are significant steps towards this aim. Information in this respect is highlighted in this guide with the tree symbol.



BREAKING-IN YOUR VEHICLE

There are no particular guidelines for breaking-in your vehicle. During the first 1 600 km (1 000 miles) of driving, vary speeds frequently. This is recommended to give the moving parts a chance to break in.

Introduction

SPECIAL NOTICES

Emission warranty

The New Vehicle Limited Warranty includes Bumper-to-Bumper Coverage, Safety Restraint Coverage, Corrosion Coverage, and 7.3L Power Stroke Diesel Engine Coverage. In addition, your vehicle is eligible for Emissions Defect and Emissions Performance Warranties. For a detailed description of what is covered and what is not covered, refer to the *Warranty Guide* that is provided to you along with your Owner's Guide.

Special instructions

For your safety, your vehicle is fitted with sophisticated electronic controls.



By operating other electronic equipment (e.g. mobile telephone without exterior aerial) electromagnetic fields can occur which can cause malfunctions of the vehicle electronics. Therefore you should observe the instructions of the equipment manufacturers.



Please read the section *Air bag* in the *Seating and safety restraints* chapter. Failure to follow the specific warnings and instructions could result in personal injury.



Rear facing child or baby seats should **NEVER** be used in front of a passenger side air bag.

Using your vehicle with a snowplow



Do not use this vehicle for snowplowing.

Using your vehicle as an ambulance



Do not use this vehicle as an ambulance.

Your vehicle is not equipped with the Ford Ambulance Preparation Package.

Notice to owners of pickup trucks and utility type vehicles



Utility vehicles have a significantly higher rollover rate than other types of vehicles.

Before you drive your vehicle, please read this Owner's Guide carefully. Your vehicle is not a passenger car. As with other vehicles of this type, failure to operate this vehicle correctly may result in loss of control or an accident.











Introduction

These are some of the symbols you may see on your vehicle.

Vehicle Symbol Glossary

Safety Alert		See Owner's Guide	
Fasten Safety Belt		Air Bag-Front	
Air Bag-Side		Child Seat	
Child Seat Installation Warning		Child Seat Tether Anchorage	
Brake System		Anti-Lock Brake System	
Brake Fluid - Non-Petroleum Based		Traction Control	
Master Lighting Switch		Hazard Warning Flasher	
Fog Lamps-Front		Fuse Compartment	
Fuel Pump Reset		Windshield Wash/Wipe	
Windshield Defrost/Demist		Rear Window Defrost/Demist	
Power Windows Front/Rear		Power Window Lockout	

Vehicle Symbol Glossary

Child Safety Door Lock/Unlock		Interior Luggage Compartment Release Symbol	
Panic Alarm		Engine Oil	
Engine Coolant		Engine Coolant Temperature	
Do Not Open When Hot		Battery	
Avoid Smoking, Flames, or Sparks		Battery Acid	
Explosive Gas		Fan Warning	
Power Steering Fluid		Maintain Correct Fluid Level	
Emission System		Engine Air Filter	
Passenger Compartment Air Filter		Jack	
Check fuel cap		Low tire warning	

Instrument cluster

WARNING LIGHTS AND CHIMES

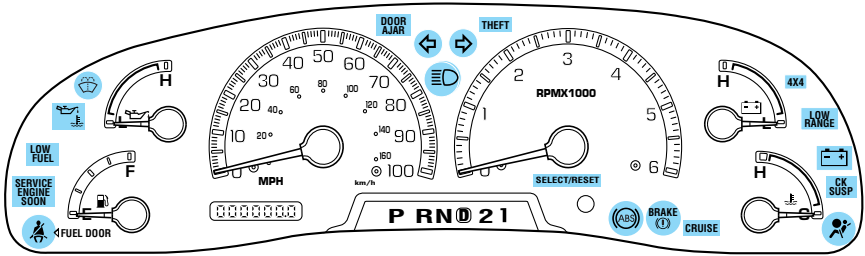

Warning lights and gauges can alert you to a vehicle condition that may become serious enough to cause expensive repairs. A warning light may illuminate when a problem exists with one of your vehicle's functions. Many lights will illuminate when you start your vehicle to make sure the bulb works. **If any light remains on after starting the vehicle, have the respective system inspected immediately.**

Service engine soon

Illuminates briefly to ensure the system is functional. If it comes on after the engine is started, one of the engine's emission control systems may be malfunctioning. The light may illuminate without a driveability concern being noted. The vehicle will usually be drivable and will not require towing.

**SERVICE
ENGINE
SOON**

Light turns on solid:

Temporary malfunctions may cause the light to illuminate. Examples are:

1. The vehicle has run out of fuel.
2. Poor fuel quality or water in the fuel.
3. The fuel cap may not have been properly installed and securely tightened.

These temporary malfunctions can be corrected by filling the fuel tank with high quality fuel of the recommended octane and/or properly installing and securely tightening the fuel cap. After three driving cycles without these or any other temporary malfunctions present, the light should turn off. (A driving cycle consists of a cold engine startup followed by mixed city/highway driving.) No additional vehicle service is required.

Instrument cluster

If the light remains on, have your vehicle serviced at the first available opportunity.

Light is blinking:

Engine misfire is occurring which could damage your catalytic converter. You should drive in a moderate fashion (avoid heavy acceleration and deceleration) and have your vehicle serviced at the first available opportunity.



Under engine misfire conditions, excessive exhaust temperatures could damage the catalytic converter, the fuel system, interior floor coverings or other vehicle components, possibly causing a fire.

Brake system warning

Illuminates if the parking brake is engaged. Also momentarily illuminates at start up to ensure the circuit is functional. If the brake warning lamp does not illuminate at these times, or illuminates after releasing the parking brake, seek service immediately. Refer to *Brakes* in the *Driving* chapter for more information.

BRAKE



Anti-lock brake system (ABS)

Momentarily illuminates at start up to ensure the circuit is functional. If the light does not illuminate, remains on or continues to flash, the ABS needs to be serviced (refer to *Brakes* in the *Driving* chapter for more information). With the ABS light on, the ABS is disabled and normal braking is still functional.



Safety belt

Illuminates to remind you to fasten your safety belts. For more information, refer to the *Seating and safety restraints* chapter.



Instrument cluster

Air bag readiness

Illuminates to confirm that the air bags (front or side) are operational. If the light fails to illuminate, continues to flash or remains on, have the system serviced immediately.



Charging system

Illuminates when the battery is not charging properly.

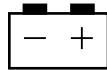

Check air suspension

Illuminates momentarily when the ignition is turned to the ON position and the engine is OFF. The light also illuminates when the air suspension switch is turned OFF or the air suspension system requires servicing. For information on the air suspension system, refer to the *Driving* chapter.



Low fuel

Illuminates when the fuel level in the fuel tank is at, or near, empty (refer to *Fuel gauge* in this chapter for more information).



Low washer fluid

Illuminates when the windshield washer fluid is low.



Speed control

Illuminates when the speed control is activated.



Oil pressure/Engine coolant

Illuminates when the engine coolant temperature is above the normal range or the engine oil pressure is below normal range. Check the engine oil and coolant level refer to *Adding engine oil* and *Adding coolant* in the *Maintenance and specifications* chapter.

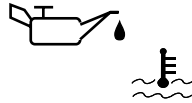

Turn signals

Illuminates when the turn signals or the hazard lights are turned on. If the lights stay on continuously or flash faster, check for a burned-out bulb.



High beams

Illuminates when the high beam headlamps are turned on.



Door ajar

Illuminates when any door is open (or not fully closed).

**DOOR
AJAR**

SecuriLock™ anti-theft system

Illuminates when the anti-theft alarm system is armed. If the light fails to illuminate, continues to flash or remains on, have the system serviced.

THEFT

Refer to *SecuriLock™ passive anti-theft system* in the *Locks and Security* chapter.

Instrument cluster

Four wheel drive low (if equipped)

Illuminates when four-wheel drive low is engaged. If the light continues to flash have the system serviced.

LOW RANGE

Four wheel drive indicator (if equipped)

Illuminates when the four-wheel drive is engaged. If the light continues to flash have the system serviced.

4x4

Safety belt warning chime

Sounds to remind you to fasten your safety belts.

BeltMinder chime

Sounds intermittently to remind you to fasten your safety belts.

Supplemental restraint system (SRS) warning chime

Sounds when a malfunction in the supplemental restraint system (front or side airbags) has been detected. Have the supplemental restraint system inspected immediately.

Headlamps on warning chime

Sounds when the headlamps or parking lamps are on, the key is removed from the ignition and the driver's door is opened.

Key-in-ignition warning chime

Sounds when the key is left in the ignition and the driver's door is opened.

GAUGES

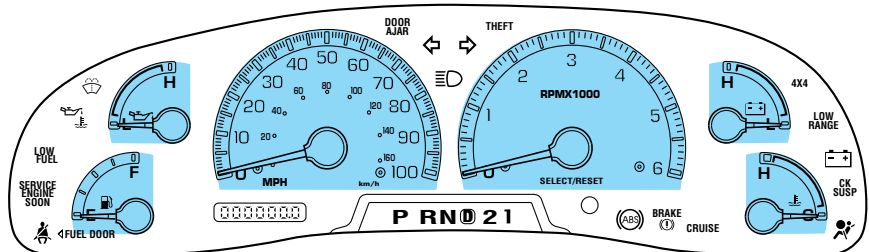

Instrument cluster

Engine coolant temperature gauge

Indicates the temperature of the engine coolant. At normal operating temperature, the needle remains within the normal area (the area between the “H” and “C”). If it enters the red section, the engine is overheating. Stop the vehicle as soon as safely possible, switch off the engine immediately and let the engine cool. Refer to *Engine coolant* in the *Maintenance and specifications* chapter.

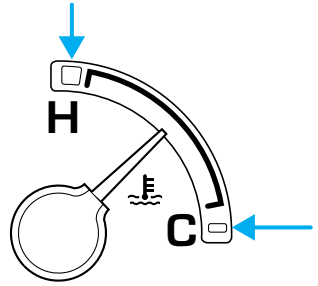

Never remove the coolant reservoir cap while the engine is running or hot. Steam and scalding liquid from a hot cooling system can burn you badly.

This gauge indicates the temperature of the engine coolant, not the coolant level. If the coolant is not at its proper level the gauge indication will not be accurate. If the gauge enters the red section, the oil pressure/engine coolant and *Check Engine/Service Engine Soon* indicators illuminate, refer to *What you should know about fail-safe cooling* in the *Maintenance and specifications* chapter.

Engine oil pressure gauge

Indicates engine oil pressure. At normal operating temperature, the needle will be in the normal range (the area between the “L” and “H”); if the needle goes below the normal range, stop the vehicle as soon as safely possible and switch off the engine immediately. Check the oil level. Add oil if needed (refer to *Engine oil* in the *Maintenance and specifications* chapter). If the oil level is correct, have your vehicle checked at your dealership or by a qualified technician.

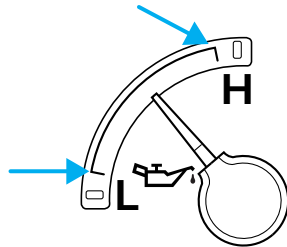

Instrument cluster

Battery voltage gauge

Indicates battery voltage. If the pointer moves and stays outside the normal operating range (as indicated by the arrows), have the vehicle's electrical system checked as soon as possible.

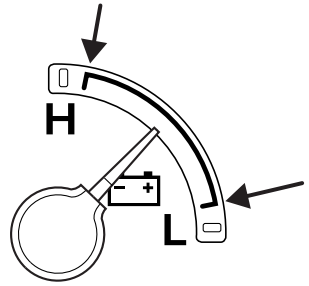

Fuel gauge

Displays approximately how much fuel is in the fuel tank. The fuel gauge may vary slightly when the vehicle is in motion or on a grade.

When refueling the vehicle from empty indication, the amount of fuel that can be added will be less than the advertised capacity due to the reserve fuel.

A minimum of 22.2 L (six gallons) must be added or removed from the fuel tank in order for the gauge to instantaneously update. If less than six gallons is the change, the gauge will take between five to twenty minutes to update.

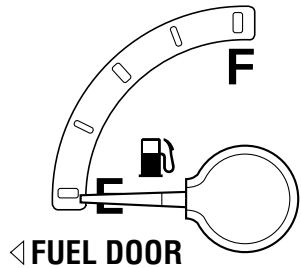

Speedometer

Indicates the current vehicle speed.

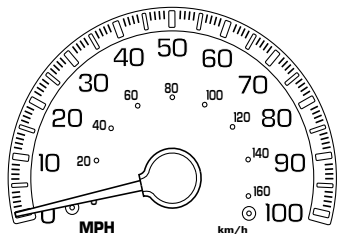

Instrument cluster

Odometer

Registers the total kilometers (miles) of the vehicle.



Trip odometer

Registers the kilometers (miles) of individual journeys. Press and release the reset button until a “T” appears in the display (this represents the trip mode). Press and hold the button for three seconds to reset.



Tachometer

Indicates the engine speed in revolutions per minute.

Driving with your tachometer pointer continuously at the top of the scale may damage the engine.

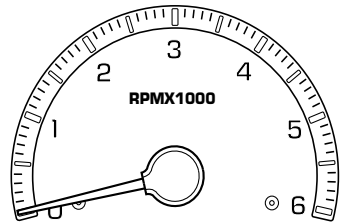

Entertainment systems

PREMIUM AM/FM STEREO/CASSETTE (CD CHANGER COMPATIBLE)

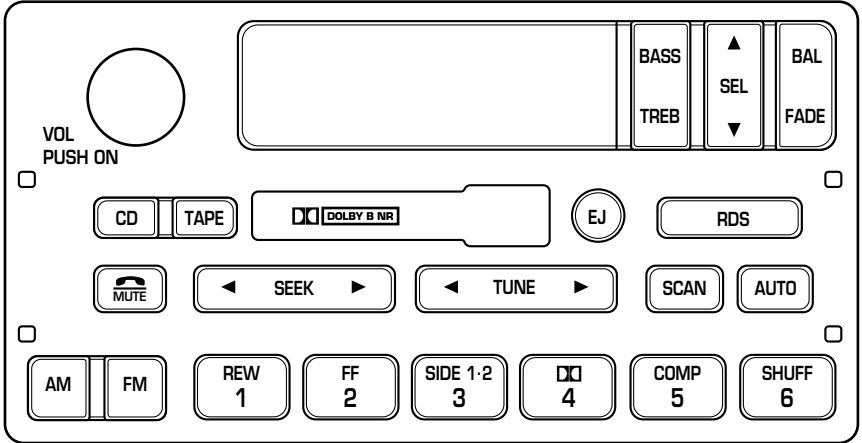

AUDIOPHILE AM/FM STEREO/CASSETTE (CD CHANGER COMPATIBLE)

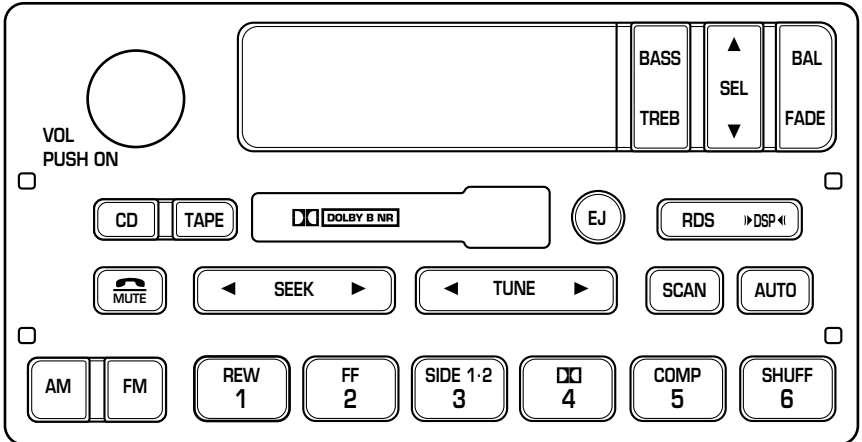

Entertainment systems

Your audio system is equipped with selective lighting, a unique lighting strategy. This lighting feature is operable when the headlamps are illuminated. During the operation of any selected mode, lighting for the individual function controls will either illuminate or turn off. Those controls which have a function for the specific mode of operation selected will be lit, while the controls which have no function for that mode will be turned off.

Volume/power control

Press the control to turn the audio system on or off.

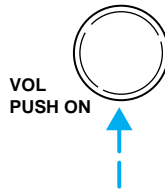

Turn the control to raise or lower volume.

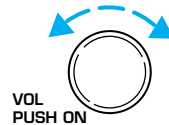

If the volume is set above a certain level and the ignition is turned off, the volume will come back on at a “nominal” listening level when the ignition switch is turned back on.

Speed sensitive volume (if equipped)

With this feature, radio volume automatically changes slightly with vehicle speed to compensate for road and wind noise.

The recommended level for speed sensitive volume is from level 1 through level 3. Level 0 turns the speed sensitive volume off and level 7 is the maximum setting.

With the radio on, press and hold the volume control for five seconds, until the display reads SPEED VOL, then press:

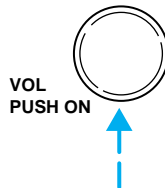

Entertainment systems

- ▲ to increase volume compensation
- ▼ to decrease or shut off the volume compensation

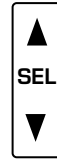

Bass adjust

The bass adjust control allows you to increase or decrease the audio system's bass output.

Press the BASS control. Use the SEL control to increase or decrease the amount of bass.

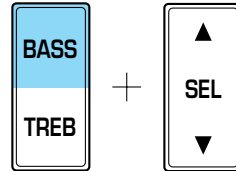

Treble adjust

The treble adjust control allows you to increase or decrease the audio system's treble output.

Press the TREB control. Use the SEL control to increase or decrease the amount of treble.

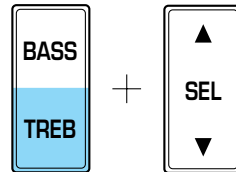

Speaker balance adjust

Speaker sound distribution can be adjusted between the right and left speakers.

Press the BAL control. Use the SEL control to adjust the sound between the speakers.

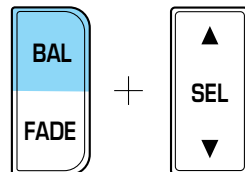

Speaker fade adjust

Speaker sound can be adjusted between the front and rear speakers.

Press the FADE control. Use the SEL control to adjust the sound between the front and rear speakers.

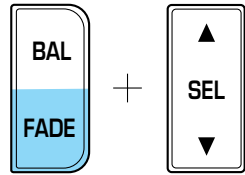

Seek function

The seek function control works in radio, tape or CD mode (if equipped).

Seek function in radio mode

- Press ◀ to find the next listenable station down the frequency band.
- Press ▶ to find the next listenable station up the frequency band.



Seek function in tape mode

- Press ◀ to listen to the previous selection on the tape or return to the beginning of the current selection.
- Press ▶ to listen to the next selection on the tape.



Seek function for CD changer

- Press ◀ to seek to the previous track of the current disc. If a selection has been playing for three seconds or more and you press ◀, the CD changer will replay that selection from the beginning.
- Press ▶ to seek forward to the next track of the current disc. After the last track has been completed, the first track of the current disc will automatically replay.



Entertainment systems

Scan function

The scan function works in radio, tape or CD mode (if equipped).



Scan function in radio mode

Press the SCAN control to activate scan mode and to hear a brief sampling of all listenable stations on the frequency band.

Press the SCAN control again to disengage scan mode.

Scan function in tape mode

Press the SCAN control to hear a short sampling of all selections on the tape. The tape will scan in a forward direction. At the end of the tape's first side, direction automatically reverses to the opposite side of the tape.

To stop on a particular selection, press the SCAN control again.

Scan function in CD mode

Press the SCAN control to hear a short sampling of all selections on the CD. The CD will scan in a forward direction, wrapping back to the first track at the end of the CD.

To stop on a particular selection, press the control again.

AM/FM select

The AM/FM select control works in radio, tape and CD modes (if equipped).

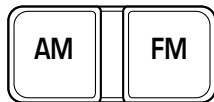

AM/FM select in radio mode

The AM/FM control allows you to select AM or FM frequency bands.

Press the control to toggle between AM, FM1 or FM2 memory preset stations.

AM/FM select in tape mode

Press this control to stop tape play and begin radio play.

AM/FM select in CD mode

Press this control to stop CD play and begin radio play.

Radio station memory preset

The radio is equipped with six station memory preset controls. These controls can be used to select up to six preset AM stations and twelve FM stations (six in FM1 and six in FM2).

Setting memory preset stations

1. Select the frequency band with the AM/FM select control.
2. Select a station. Refer to *Tune adjust* or *Seek function* for more information on selecting a station.
3. Press and hold a memory preset control until the sound returns, indicating the station is held in memory on the control you selected.



Autoset memory preset

Autoset allows you to set strong radio stations without losing your original manually set preset stations. This feature is helpful on trips when you travel between cities with different radio stations.

Starting autoset memory preset

1. Select a frequency using the AM/FM select controls.
2. Press the AUTO control.
3. When the first six strong stations are filled, the station stored in memory preset control 1 will start playing.



If there are less than six strong stations available on the frequency band, the remaining memory preset controls will all store the last strong station available.

To deactivate autoset and return to your audio system's manually set memory stations, press the control again.

Entertainment systems

Setting the clock with radio data system (RDS) feature

Press the RDS control until SELECT HOUR or SELECT MINS is displayed.



Use the SEL control to manually set the time.

- Press ▲ to increase hours/minutes.
- Press ▼ to decrease hours/minutes.

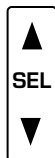

Tune adjust

The tune control works in radio or CD mode (if equipped).

Tune adjust in radio mode

- Press ◀ to move to the next frequency down the band (whether or not a listenable station is located there). Hold the control to move through the frequencies quickly.
- Press ▶ to move to the next frequency up the band (whether or not a listenable station is located there). Hold for quick movement.

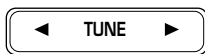

Tune adjust for CD changer

- Press ◀ to select the previous disc in the CD changer. (Play will begin on the first track of the disc unless the CD changer is in shuffle mode.) Refer to *Shuffle feature* for more information. Hold the control to continue reversing through the discs.
- Press ▶ to select the next disc in the CD changer. Hold the control to fast-forward through the remaining discs.



Tape/CD select

- To begin tape play (with a tape loaded into the audio system) while in the radio or CD mode, press the TAPE control. Press the button during rewind or fast forward to stop the rewind or fast forward function.



- To begin CD play (if equipped with CD changer), ensure that the CDs are loaded. Press the CD control. The first track of the disc will begin playing. After that, CD play will begin where it stopped last.



Do not insert any promotional (odd shaped or sized) discs, or discs with removable labels into the CD player as jamming may occur.

Rewind

The rewind control works in tape and CD modes.

- In tape mode, radio play will continue until rewind is stopped (with the TAPE control) or the beginning of the tape is reached.
- In CD mode, pressing the REW control for less than three seconds results in slow rewind. Pressing the control for more than three seconds results in fast rewind.



Fast forward

The fast forward control works in tape and CD modes (if equipped).

- In the tape mode, tape direction will automatically reverse when the end of the tape is reached.
- In CD mode, pressing the control for less than three seconds results in slow forward action. Pressing the control for more than three seconds results in fast forward action.



Entertainment systems

Tape direction select

Press SIDE 1-2 to play the alternate side of a tape.

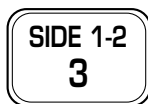

Eject function

Press the control to stop and eject a tape.



Dolby® noise reduction

Dolby® noise reduction operates only in tape mode. Dolby® noise reduction reduces the amount of hiss and static during tape playback.

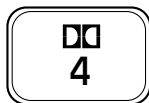

Press the  control to activate (and deactivate) Dolby® noise reduction.

The Dolby® noise reduction system is manufactured under license from Dolby Laboratories Licensing Corporation. Dolby® and the double-D symbol are registered trademarks of Dolby® Laboratories Licensing Corporation.

Compression feature

Compression adjust brings soft and loud CD passages together for a more consistent listening level.



Press the COMP control to activate and deactivate compression adjust.

The effect of the feature varies with the music content.

Entertainment systems

Shuffle feature

The shuffle feature operates in CD mode and plays all tracks on the current disc in random order. If equipped with the CD changer, the shuffle feature continues to the next disc after all tracks are played.



Press the SHUFFLE control to start this feature. Random order play will continue until the SHUFFLE control is pressed again.

Mute mode

Press the control to mute the playing media. Press the control again to return to the playing media.



Radio data system (RDS) feature

This feature allows your audio system to receive station identification or program type from RDS-equipped FM radio stations.

The Federal Communications Commission (FCC) and the Canadian Radio and Telecommunications Commission (CRTC) recommend FM radio broadcasters to use RDS technology to transmit information. FM radio stations are independently operated and individually elect to use RDS technology to transmit station ID and program type as desired.

Press the RDS control until RDS ON or RDS OFF appears in the display.



Use the SEL control to enable (ON) or disable (OFF) the feature. With the RDS activated, press the SEL control to scroll through the following selections:

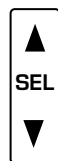

Traffic

- Press the RDS control until TRAFFIC is displayed.



Entertainment systems

- Use the SEL control to select ON or OFF. With the feature on, use the SEEK or SCAN control to find a radio station broadcasting a traffic report (if it is broadcasting RDS data).

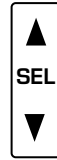

Traffic information is not available in most U.S. markets.

Program type

- Press the RDS control until the FIND program type is displayed.
- Use the SEL control to select the program type. With the feature on, use the SEEK or SCAN control to find the desired program type from the following selections:



- Classic
- Country
- Info
- Jazz
- Oldies
- R & B
- Religious
- Rock
- Soft
- Top 40

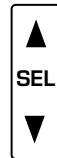

Show

- With RDS activated, press the RDS control until SHOW is displayed.



Entertainment systems

- Use the SEL control to select TYPE (the display shows the program type), NAME (the display shows the call letters of the station) or NONE.

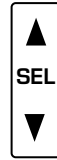

Digital signal processing (if equipped)

The digital signal processing (DSP) feature allows you to change the signal mode to suit your listening tastes.



These effects will change the sound quality and may need to be adjusted based upon the program material to suit your listening needs.

Press the control to turn the feature on or off.

Use the SEL control to select the desired signal mode (the selected mode will appear in the display). The following signal modes can be selected:

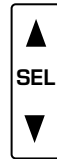

- JAZZ CLUB—jazz club with clearly reflected sounds.
- HALL—rectangular concert hall capacity of about 2 000
- CHURCH—church with a high vault.
- STADIUM—outdoor stadium with a capacity of about 30 000.
- NEWS—"voice-only" type of sound with a limited audio band.

Press the DSP control until one of the following appears:



- ALL SEATS
- DRIVER SEAT
- REAR SEATS

Entertainment systems

Use the SELECT control to change the equalization to the desired mode.

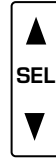

PREMIUM AM/FM STEREO/SINGLE CD RADIO

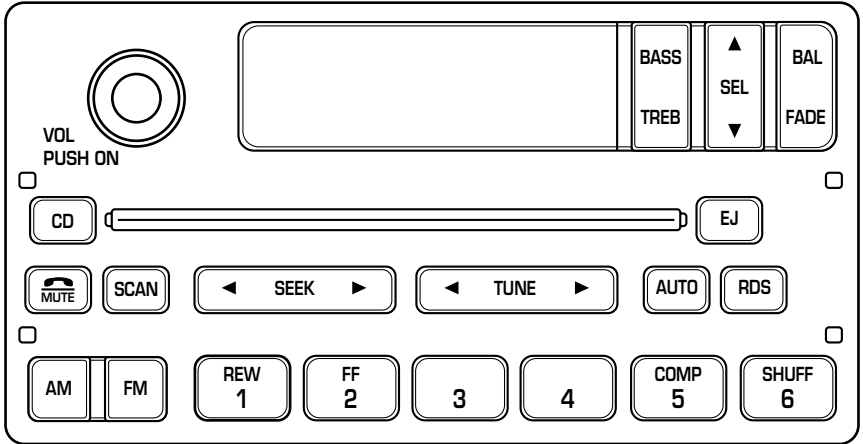

Your audio system is equipped with selective lighting, a unique lighting strategy. This lighting feature is operable when the headlamps are illuminated. During the operation of any selected mode, lighting for the individual function controls will either illuminate or turn off. Those controls which have a function for the specific mode of operation selected will be lit, while the controls which have no function for that mode will be turned off.

Entertainment systems

Volume/power control

Press the control to turn the audio system on or off.

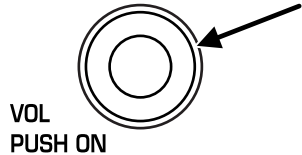

Turn the control to raise or lower volume.

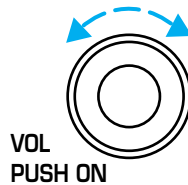

If the volume is set above a certain level and the ignition is turned off, the volume will come back on at a “nominal” listening level when the ignition switch is turned back on.

Speed sensitive volume (if equipped)

With this feature, radio volume changes automatically and slightly with vehicle speed to compensate for road and wind noise.

The recommended level for speed sensitive volume is from level 1 through level 3. Level 0 turns the speed sensitive volume off and level 7 is the maximum setting.

With the radio on, press and hold the volume control for five seconds, then press:

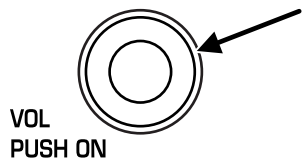

Entertainment systems

- ▲ to increase volume compensation
- ▼ to decrease or shut off the volume compensation

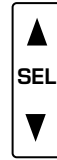

Bass adjust

The bass adjust control allows you to increase or decrease the audio system's bass output.

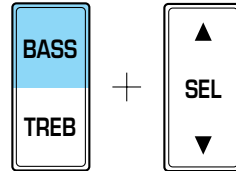

Treble adjust

The treble adjust control allows you to increase or decrease the audio system's treble output.

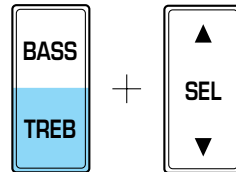

Speaker balance adjust

Speaker sound distribution can be adjusted between the right and left speakers.

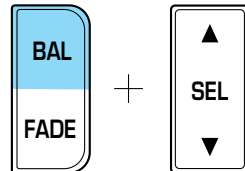

Speaker fade adjust

Speaker sound can be adjusted between the front and rear speakers.

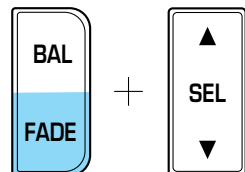

Seek function

The seek function control works in radio, CD and CD changer mode (if equipped).

Seek function in radio mode

- Press ◀ to find the next listenable station down the frequency band.
- Press ▶ to find the next listenable station up the frequency band.



Seek function for CD or CD changer (if equipped)

- Press ◀ to seek to the previous track of the current disc. If a selection has been playing for three seconds or more and you press ◀, the CD changer will replay that selection from the beginning.
- Press ▶ to seek forward to the next track of the current disc. After the last track has been completed, the first track of the current disc will automatically replay.



Scan function

The scan function works in radio, CD and CD changer mode (if equipped).



Scan function in radio mode

Press the SCAN control to hear a brief sampling of all listenable stations on the frequency band. Press the SCAN control again to stop the scan mode.

Scan function in CD mode

Press the SCAN control to hear a short sampling of all selections on the CD (The CD scans in a forward direction, wrapping back to the first track at the end of the CD.). To stop on a particular selection, press the control again.

Entertainment systems

AM/FM select

The AM/FM select control works in radio, tape and CD changer modes (if equipped).

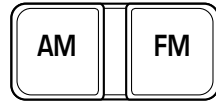

AM/FM select in radio mode

This control allows you to select AM or FM frequency bands. Press the control to switch between AM, FM1 or FM2 memory preset stations.

AM/FM select in CD or CD changer mode (if equipped)

Press this control to stop CD play and begin radio play.

Radio station memory preset

The radio is equipped with six station memory preset controls. These controls can be used to select up to six preset AM stations and twelve FM stations (six in FM1 and six in FM2).

Setting memory preset stations

1. Select the frequency band with the AM/FM select control.
2. Select a station. Refer to *Tune adjust* or *Seek function* for more information on selecting a station.
3. Press and hold a memory preset control until the sound returns, indicating the station is held in memory on the control you selected.



Autoset memory preset

Autoset allows you to set strong radio stations without losing your original manually set preset stations. This feature is helpful on trips when you travel between cities with different radio stations.

Entertainment systems

Starting autose memory preset

1. Select a frequency using the AM/FM select controls.
2. Press the AUTO control.
3. When the first six strong stations are filled, the station stored in memory preset control 1 will start playing.



If there are less than six strong stations available on the frequency band, the remaining memory preset controls will all store the last strong station available.

To deactivate autose and return to your audio system's manually set memory stations, press the AUTO control again.

Setting the clock

Press the RDS control until SELECT HOUR or SELECT MINS is displayed.



Use the SEL control to manually set the time.

- Press ▲ to increase hours/minutes.
- Press ▼ to decrease hours/minutes.



Tune adjust

The tune control works in radio or CD changer mode (if equipped).

Tune adjust in radio mode

- Press ◀ to move to the next frequency down the band (whether or not a listenable station is located there). Hold the control to move through the frequencies quickly.
- Press ▶ to move to the next frequency up the band (whether or not a listenable station is located there). Hold for quick movement.



Entertainment systems

Tune adjust for CD changer

- Press ◀ to select the previous disc in the CD changer. (Play will begin on the first track of the disc unless the CD changer is in shuffle mode.) Refer to *Shuffle feature* for more information. Hold the control to continue reversing through the disc.
- Press ▶ to select the next disc in the CD changer. Hold the control to fast-forward through the remaining discs.



CD select

To begin CD play (if CD[s] are loaded), press the CD control. The first track of the disc will begin playing. After that, CD play will begin where it stopped last. Press the CD control again to toggle between CD and CD changer mode (if equipped).

Do not insert any promotional (odd shaped or sized) discs, or discs with removable labels into the CD player as jamming may occur.

Rewind

The rewind control works in CD mode.

- In CD mode, pressing the REW control for less than three seconds results in slow rewind. Pressing the control for more than three seconds results in fast rewind.



Fast forward

The fast forward control works in CD mode.

- In CD mode, pressing the control for less than three seconds results in slow forward action. Pressing the control for more than three seconds results in fast forward action.



Eject function

Press the control to stop and eject a CD.



Entertainment systems

Compression feature (if equipped)

Compression adjust brings soft and loud CD passages together for a more consistent listening level.

Press the COMP control to activate and deactivate compression adjust.



Shuffle feature (if equipped)

The shuffle feature operates in CD changer mode and plays all tracks on the current disc in random order. The shuffle feature continues to the next disc after all tracks are played.

Press the SHUFFLE control to start this feature. Random order play will continue until the SHUFFLE control is pressed again.



Mute mode

Press the control to mute the playing media. Press the control again to return to the playing media.



Radio data system (RDS) feature

This feature allows your audio system to receive station identification or program type from RDS-equipped FM radio station.



The Federal Communications Commission (FCC) and the Canadian Radio and Telecommunications Commission (CRTC) recommend FM radio broadcasters to use RDS technology to transmit information. FM radio stations are independently operated and individually elect to use RDS technology to transmit station ID and program type as desired.

Press the RDS control until RDS ON or RDS OFF appear in the display. Use the SEL control to enable (ON) or disable (OFF) the feature. Once activated, you can choose from the following items:

Entertainment systems

Traffic

- Press the RDS control until TRAFFIC is displayed.
- Use the SEL control to select ON or OFF. With the feature on, use the SEEK or SCAN control to find a radio station broadcasting a traffic report (if it is broadcasting RDS data).

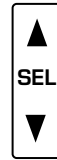

Program type

- Press the RDS control until FIND program type is displayed.
- Use the SEL control to select the program type. With the feature on, use the SEEK or SCAN control to find the desired program type from the following selections:
- Classic
- Country
- Info
- Jazz
- Oldies
- R & B
- Religious
- Rock
- Soft
- Top 40

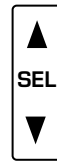

Entertainment systems

Show

- With RDS activated, press the RDS control until SHOW is displayed.
- Use the SEL control to select TYPE, NAME or NONE.

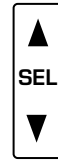

REAR SEAT CONTROLS (IF EQUIPPED)

The Personal Audio System, allows front and middle seat passengers to listen to different media sources (radio, cassette or CD) simultaneously. However, the front and middle-seat passengers cannot listen to two different radio stations at the same time.

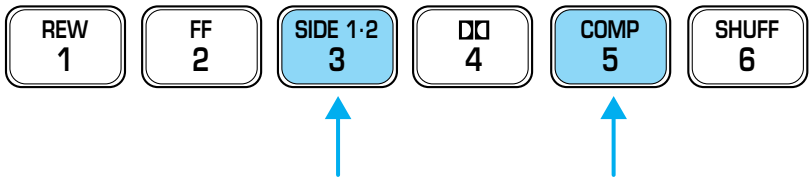
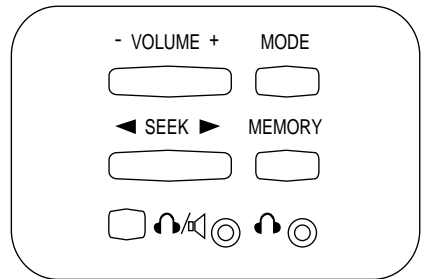

To turn on the rear seat controls, press the memory preset controls 3 and 5 at the same time. The  will appear in the display.

Pressing 3 and 5 at the same time again will turn the rear seat controls off.

If there is a discrepancy between the rear seat and the front audio controls, (such as both trying to listen to the same playing media), the front audio system will receive the desired selection.

Entertainment systems

To activate the Personal Audio System, press the speaker/headphone control. Press the MODE control to change audio sources (for headphone mode only). Use the SEEK, VOLUME and MEMORY controls to make adjustments to the playing media.

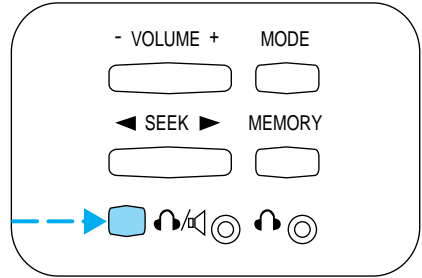

ADJUSTING THE VOLUME

Press the + control to increase volume.

Press the - control to decrease volume.

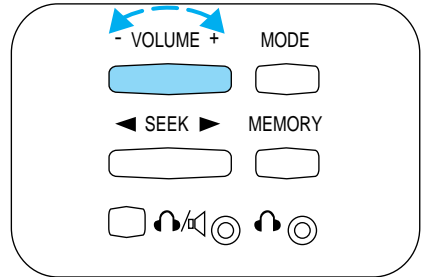

From the rear seat controls, volume control can be set no higher than the current radio setting unless the speakers are turned off. Refer to *Turning the rear speakers on and off*.

TURNING THE REAR SPEAKERS ON AND OFF

Press to turn the rear speakers on or off.

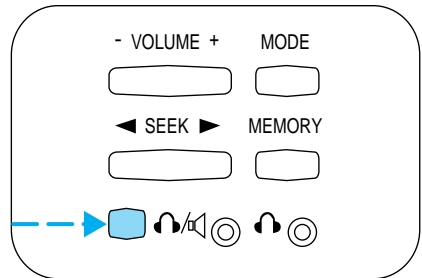

Entertainment systems

USING HEADPHONES/PERSONAL AUDIO SYSTEM

Plug a 3.5 mm headphone (not included) into the  jack. Press the speaker on/off control to operate the headphones. DUAL PLAY illuminates in the radio display and the fade control is disabled.

The rear speakers will cut out once the speaker on/off control is pressed. The front speaker will remain playing for the front passengers. Press the control again to deactivate the headphones (Personal Audio System). SINGLE PLAY illuminates in the radio display and the fade control is enabled.

For the Personal Audio System to be enabled, the rear seat controls must be active and  illuminated in the radio display.

MODE SELECT

Push the MODE control to toggle between AM, FM1, FM2, tape, CD or CD changer (if equipped). If in the Personal Audio System mode, SHARED illuminates in the radio display when the front and rear modes are set to the same media.

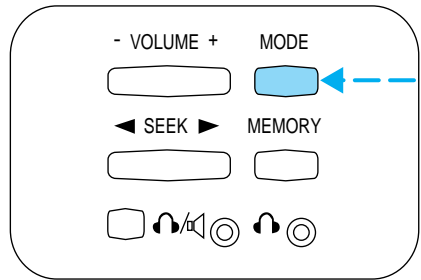

MEMORY PRESET CONTROL

Push the MEMORY control successively to allow rear seat passengers to scroll through the 6 memory presets in AM, FM1 or FM2.

Push the MEMORY control in CD changer mode (if equipped) to advance to the next disc.

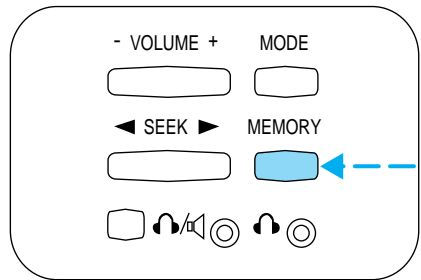

Entertainment systems

SEEK FUNCTION

- In radio mode, press ◀ to find the next listenable station down the frequency band.
- In radio mode, press ▶ to find the next listenable station up the frequency band.
- In tape mode, use the SEEK function to access the next ▶ or previous ◀ selection.
- In CD mode (if equipped), use the SEEK function to access the next ▶ or previous ◀ selection.

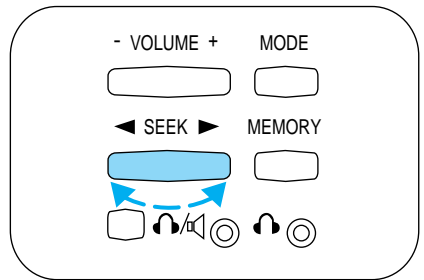

CD CHANGER (IF EQUIPPED)

Your CD changer is located in the center console.

Slide the door to access the CD changer magazine.

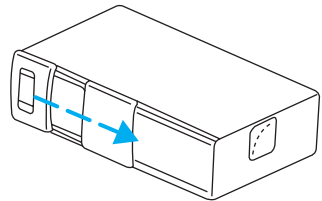

Press ▲ to eject the magazine.

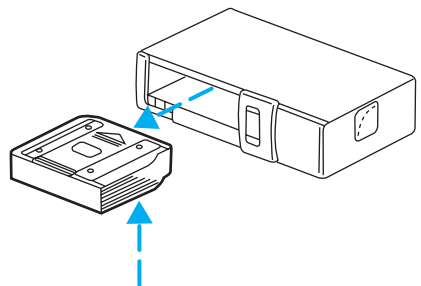

Entertainment systems

1. Pull the lever to remove a CD tray from the magazine.

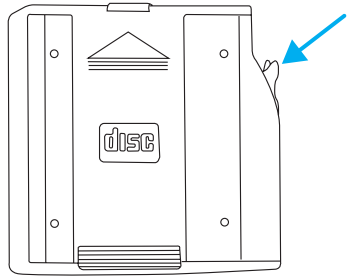

2. Insert one disc into each CD tray of the magazine (up to 6 discs). Ensure that the label side is facing up.

If you pull too hard on the disc holder, the disc holder may come completely out of the magazine. If this happens, reinsert the disc holder back into the magazine.

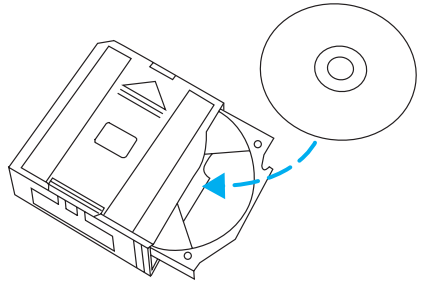

3. Insert each CD tray, with the disc loaded, all the way into the CD magazine.

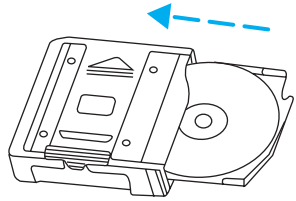

4. Insert the CD magazine into the changer.

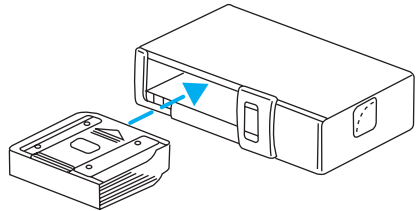

Entertainment systems

5. Slide the door to the left to close.

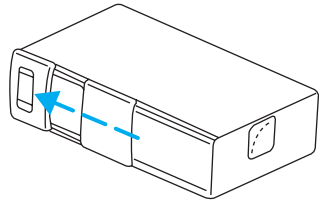

Use only compact discs containing this mark.



The magazine does not need to be full for the changer to operate.

Radio power must be turned on to play the CDs in the changer. The magazine may be stored in the glove compartment when not being used.

The CD magazine may be inserted or ejected with the radio power off.

Keep the CD changer door closed. Coins and foreign objects will damage the CD player and void your audio system warranty.

Do not insert any promotional (odd shaped or sized) discs, or discs with removable labels into the CD player as jamming may occur.

TROUBLESHOOTING THE CD CHANGER (IF EQUIPPED)



The laser beam used in the compact disc player is harmful to the eyes. Do not attempt to disassemble the case.

If sound skips:

- You may be traveling on a rough road, playing badly scratched discs or the disc may be dirty. Skipping will not scratch the discs or damage the player.

If your changer does not work, it may be that:

- A disc is already loaded where you want to insert a disc.
- The disc is inserted with the label surface downward.
- The disc is dusty or defective.
- A disc with format and dimensions not within industry standards is inserted.

Entertainment systems

CLEANING COMPACT DISCS

Inspect all discs for contamination before playing. If necessary, clean discs only with an approved CD cleaner and wipe from the center out to the edge. Do not use circular motion.

CD AND CD CHANGER CARE

- Handle discs by their edges only. Never touch the playing surface.
- Do not expose discs to direct sunlight or heat sources for extended periods of time.
- Do not insert more than one disc into each slot of the CD changer magazine.

Do not insert any promotional (odd shaped or sized) discs, or discs with removable labels into the CD player as jamming may occur.

CLEANING CASSETTE PLAYER (IF EQUIPPED)

Clean the tape player head with a cassette cleaning cartridge after 10 to 12 hours of play in order to maintain the best sound and operation.

CASSETTE AND CASSETTE PLAYER CARE

- Use only cassettes that are 90 minutes long or less.
- Do not expose tapes to direct sunlight, high humidity, extreme heat or extreme cold. Allow tapes that may have been exposed to extreme temperatures to reach a moderate temperature before playing.
- Tighten very loose tapes by inserting a finger or pencil into the hole and turning the hub.
- Remove loose labels before inserting tapes.
- Do not leave tapes in the cassette player for a long time when not being played.

Entertainment systems

RADIO FREQUENCY INFORMATION

The Federal Communications Commission (FCC) and the Canadian Radio and Telecommunications Commission (CRTC) establish the frequencies AM and FM stations may use for their broadcasts. Allowable frequencies are:

AM 530, 540–1600, 1610 kHz

FM 87.7, 87.9–107.7, 107.9 MHz

Not all frequencies are used in a given area.

RADIO RECEPTION FACTORS

Three factors can affect radio reception:

- **Distance/strength.** The further an FM signal travels, the weaker it is. The listenable range of the average FM station is approximately 40 km (24 miles). This range can be affected by “signal modulation.” Signal modulation is a process radio stations use to increase their strength/volume relative to other stations.
- **Terrain.** Hills, mountains and tall buildings between your vehicle’s antenna and the radio station signal can cause FM reception problems. Static can be caused on AM stations by power lines, electric fences, traffic lights and thunderstorms. Moving away from an interfering structure (out of its “shadow”) returns your reception to normal.
- **Station overload.** Weak signals are sometimes captured by stronger signals when you pass a broadcast tower. A stronger signal may temporarily overtake a weaker signal and play while the weak station frequency is displayed.

The audio system automatically switches to single channel reception if it will improve the reception of a station normally received in stereo.

AUDIO SYSTEM WARRANTIES AND SERVICE

Refer to the *Warranty Guide* for audio system warranty information.

If service is necessary, see your dealer or a qualified technician.

MANUAL HEATING AND AIR CONDITIONING SYSTEM (IF EQUIPPED)



Fan speed control

Controls the volume of air circulated in the vehicle.

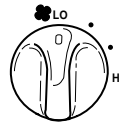

Temperature control knob

Controls the temperature of the airflow inside the vehicle.



Mode Selector Control

Controls the direction of the airflow to the inside of the vehicle.

The air conditioning compressor can operate in all modes except PANEL and FLOOR. However, the air conditioning will only function if the outside temperature is about 6°C (43°F) or higher.

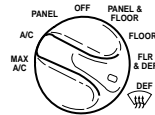

Since the air conditioner removes considerable moisture from the air during operation, it is normal if clear water drips on the ground under the air conditioner drain while the system is working and even after you have stopped the vehicle.

- **MAX A/C** – Uses recirculated air to cool the vehicle. MAX A/C is noisier than A/C but more economical and will cool the inside of the vehicle faster. Airflow will be from the instrument panel registers. This mode can also be used to prevent undesirable odors from entering the vehicle.

Climate controls

- A/C – Uses outside air to cool the vehicle. It is quieter than MAX A/C but not as economical. Airflow will be from the instrument panel registers.
- PANEL – Distributes outside air through the instrument panel registers. However, the air will not be cooled below the outside temperature because the air conditioning does not operate in this mode.
- OFF – Outside air is shut out and the fan will not operate. For short periods of time only, use this mode to prevent undesirable odors from entering the vehicle.
- PANEL & FLOOR – Distributes outside air through the instrument panel registers and the floor ducts. Heating and air conditioning capabilities are provided in this mode. For added customer comfort, when the temperature control knob is anywhere in between the full hot and full cold positions, the air distributed through the floor ducts will be slightly warmer than the air sent to the instrument panel registers.
- FLOOR – Allows for maximum heating by distributing outside air through the floor ducts. However, the air will not be cooled below the outside temperature because the air conditioning does not operate in this mode.
- FLR & DEF – Distributes outside air through the windshield defroster ducts and the floor ducts. Heating and air conditioning capabilities are provided in this mode. For added customer comfort, the air distributed through the floor ducts will be slightly warmer than the air sent to the windshield defroster ducts. If the temperature is about 6°C (43°F) or higher, the air conditioner will automatically dehumidify the air to reduce fogging.
- DEF  – Distributes outside air through the windshield defroster ducts. It can be used to clear ice or fog from the windshield. If the temperature is about 6°C (43°F) or higher, the air conditioner will automatically dehumidify the air to reduce fogging.

Operating tips

- In humid weather conditions, place the climate control system in Defrost mode before driving. This will reduce fogging on your windshield. Once the windshield has been cleared, operate the climate control system as desired.

Climate controls

- To reduce humidity buildup inside the vehicle in cold weather conditions, don't drive with the climate control system in the OFF or MAX A/C position.
- To reduce humidity buildup inside the vehicle in warm weather conditions, don't drive with the climate control system in the OFF position.
- Under normal weather conditions, your vehicle's climate control system should be left in any position other than the MAX A/C or OFF when the vehicle is parked. This allows the vehicle to "breathe" through the outside air inlet duct.
- Under snowy or dirty weather conditions, your vehicle's climate control system should be left in the OFF position when the vehicle is parked. This allows the climate control system to be free from contamination of outside pollutants.
- If your vehicle has been parked with the windows closed during warm weather conditions, the air conditioner will perform more efficiently in cooling the vehicle if driven for two or three minutes with the windows open. This will force most of the hot, stale air out of the vehicle. Once the vehicle has been "aired out", operate the climate control system as desired.
- Do not put objects under the front seat which may interfere with the airflow to the rear seats (if equipped).
- Remove any snow, ice or leaves from the air intake area (at the bottom of the windshield and underneath the hood).
- Do not place objects over the defroster outlets. These objects can block airflow and reduce visibility through your windshield. Avoid placing small objects on top of the instrument panel. These objects may fall down into the defroster outlets and block airflow, in addition to, damaging the climate control system.

To aid in side window defogging/demisting in cold weather conditions:

1. Select the position that distributes air through the Panel and Floor.
2. Set the temperature control to full heat.
3. Set the fan speed to full fan.
4. Direct the outer panel vents towards the side windows.
5. To increase airflow to the outer panel vents, close the central panel vents.

Climate controls



Do not place objects on top of the instrument panel as these objects may become projectiles in a collision or sudden stop.

ELECTRONIC AUTOMATIC TEMPERATURE CONTROL (EATC) SYSTEM (IF EQUIPPED)

The EATC system will maintain a selected temperature and automatically control airflow. You can override automatic operation with any of the override controls, the fan speed control or the steering wheel controls (if equipped).

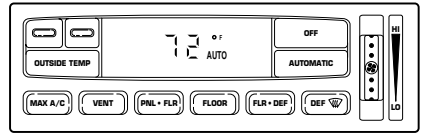

Turning the EATC on

Press AUTOMATIC, any of the override controls or the fan speed control. The EATC will only operate when the vehicle is running.

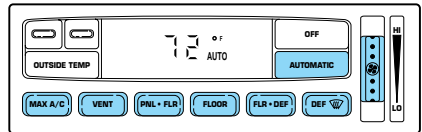

Turning the EATC system off

Press OFF. The outside temperature function will continue to operate until the ignition is turned off.

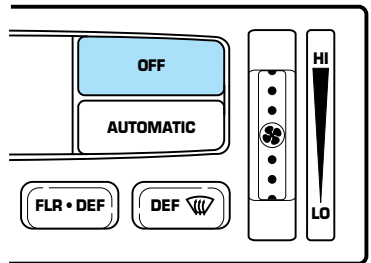

Automatic operation

Press AUTOMATIC and select the desired temperature. The selected temperature and the word AUTO will appear in the display window. The EATC system will either heat or cool to achieve the selected temperature. The system will automatically determine fan speed, airflow location and if outside air or recirculated air is required. Fan speed remains automatic unless the fan speed thumbwheel is turned or the steering wheel fan speed control (if equipped) is pressed.

Climate controls

When in AUTOMATIC and weather conditions require heat, air will be sent to the floor. However, if the engine is not warm enough to provide heat, the fan will be at a low speed and the air will be directed to the windshield. In approximately 3½ minutes or less, the fan speed will start to increase and the airflow location will change to the floor area.

If unusual conditions exist (i.e.-window fogging, etc.), the manual override controls allow you to select airflow locations and the fan control allows you to adjust fan speed as necessary.

Temperature selection

The display window indicates the selected temperature, function (AUTO or one of the override controls) and manual control of fan speed () if automatic fan speed is not desired.

To control the temperature, select any temperature between 18°C (65°F) and 29°C (85°F) by pressing the blue (cooler) or red (warmer) buttons.

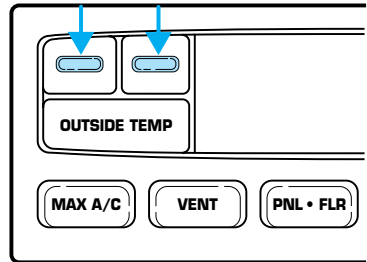

For continuous maximum cooling, push the blue button until 16°C (60°F) is shown in the display window. The EATC will continue maximum cooling (disregarding the displayed temperature) until a warmer temperature is selected by pressing the red control.

For continuous maximum heating, push the red button until 32°C (90°F) is shown in the display window. The EATC will continue maximum heating (disregarding the displayed temperature) until a cooler temperature is selected by pressing the blue control.

Climate controls

Temperature conversion

Press MAX A/C and DEF  at the same time (for one second) to switch between Fahrenheit and Celsius.

The English/Metric (E/M) control on the trip computer and message center (if equipped) will not change temperature display.

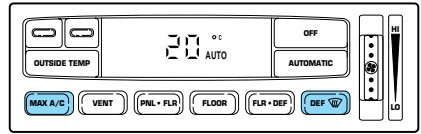

Fan speed ()

When AUTOMATIC is pressed, fan speed is adjusted automatically for existing conditions. You can override fan speed at any time. To control fan speed manually, use the thumbwheel to cancel automatic fan speed operation. Rotate the thumbwheel or press the steering wheel controls (if equipped) up for higher fan speed or down for lower fan speed.

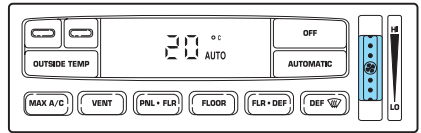

The display will show  to indicate manual fan operation.



To return to automatic fan operation, press AUTOMATIC.

Manual override controls

The manual override controls allow you to determine where airflow is directed. To return to full automatic control, press AUTOMATIC.

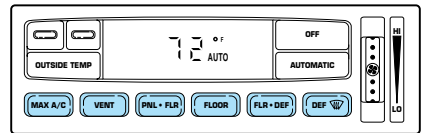

The air conditioning compressor can operate in all modes except FLOOR and VENT. It will also operate only when required when AUTOMATIC has been selected. However, the air conditioning will only function if the outside temperature is about 6°C (43°F) or higher.

Since the air conditioner removes considerable moisture from the air during operation, it is normal if clear water drips on the ground under the air conditioner drain while the system is working and even after you have stopped the vehicle.

Climate controls

- MAX A/C-Uses recirculated air to cool the vehicle. The temperature will display 16°C (60°F). To exit, press AUTOMATIC or any other override controls. MAX A/C is louder than normal A/C but more economical and will cool the inside of the vehicle faster. Airflow is from the instrument panel registers. This mode can also be used to prevent undesirable odors from entering the vehicle.
- VENT-Distributes outside air through the instrument panel registers. However, the air cannot be cooled below the outside temperature because the air conditioning does not operate in this mode.
- PNL•FLR-Distributes outside air through the instrument panel registers and the floor ducts. Heating and air conditioning capabilities are provided in this mode. The air will be heated or cooled based on the temperature selection. For added customer comfort, the air distributed through the floor ducts will be slightly warmer than the air sent to the instrument panel registers.
- FLOOR-Distributes outside air through the floor ducts. However, the air cannot be cooled below the outside temperature because the air conditioning does not operate in this mode.
- FLR•DEF-Distributes outside air through the windshield defroster ducts and the floor ducts. Heating and air conditioning capabilities are provided in this mode. The air will be heated or cooled based on the temperature selection. For added customer comfort, the air distributed through the floor ducts will be slightly warmer than the air sent to the windshield defroster ducts. If the temperature is about 6°C (43°F) or higher, the air conditioner will automatically dehumidify the air to reduce fogging.
- DEF  -Distributes outside air through the windshield defroster ducts. It can be used to clear ice or fog from the windshield. If the outside air temperature is about 6°C (43°F) or higher, the air conditioner will automatically dehumidify the air to reduce fogging.
- OFF-Outside air is shut out and the fan will not operate. For short periods of time only, use this mode to reduce undesirable odors from entering the vehicle.

Climate controls

Displaying outside temperature

Press **OUTSIDE TEMP** to display the outside air temperature. It will be displayed until **OUTSIDE TEMP** is pressed again.

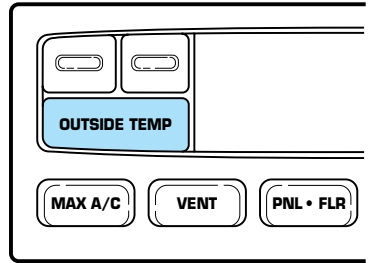

If the selected temperature is changed while the outside temperature is displayed, the new temperature will be displayed for four seconds after it is changed, then the outside temperature will return to the window.

If a manual override function is selected while the outside temperature is displayed, the new function will be displayed for four seconds after it is changed, then the outside temperature will return to the window along with the override selection.

The outside temperature reading is most accurate when the vehicle is moving. Higher readings may be obtained when the vehicle is not moving. The readings that you get may not agree with temperatures given on the radio due to differences in vehicle and station locations.

Operating tips

- In humid weather conditions, place the climate control system in DEF before driving. This will reduce fogging on your windshield. Once the windshield has been cleared, operate the climate control system as desired.
- To reduce humidity buildup inside the vehicle in cold weather conditions, don't drive with the climate control system in the OFF or MAX A/C position.
- To reduce humidity buildup inside the vehicle in warm weather conditions, don't drive with the climate control system in the OFF position.
- Under normal weather conditions, your vehicle's climate control system should be left in any position other than MAX A/C or OFF when the vehicle is parked. This allows the vehicle to "breathe" through the outside air inlet duct.

Climate controls

- Under snowy or dirty weather conditions, your vehicle's climate control system should be left in the OFF position when the vehicle is parked. This allows the climate control system to be free from contamination of outside pollutants.
- If your vehicle has been parked with the windows closed during warm weather conditions, the air conditioner will perform more efficiently in cooling the vehicle if driven for two or three minutes with the windows open. This will force most of the hot, stale air out of the vehicle. Once the vehicle has been "aired out", operate the climate control system as desired.
- Don't put objects under the front seat that will interfere with the airflow to the rear seats.
- Remove any snow, ice or leaves from the air intake area at the base of the windshield.
- Do not place objects over the defroster outlets. These objects can block airflow and reduce your ability to see through your windshield. Avoid placing small objects on top of the instrument panel. These objects may fall down into the defroster outlets and block airflow, in addition to damaging the climate control system.

To aid in side window defogging/demisting in cold weather conditions:

1. Select PNL • FLR
2. Set the temperature control to full heat
3. Set the fan speed control to HI
4. Direct the outer panel vents towards the side windows.

To increase airflow to the outer panel vents, close the central panel vents.



Do not place objects on top of the instrument panel, as these objects may become projectiles in a collision or sudden stop.

AUXILIARY A/C-HEATER CONTROLS (IF EQUIPPED)

Depending on your equipment package, your vehicle may be equipped with auxiliary A/C-heater controls. The auxiliary A/C-heater feature provides increased capacity to quickly heat or cool the vehicle. Besides the driver's control panel for the front seat occupants, the second row auxiliary A/C-heater controls allow the rear passengers to control the

Climate controls

temperature in the rear of the vehicle through a second control panel above the second row, or in the floor console.

If your vehicle is equipped with auxiliary A/C controls, they may be located in the floor console,

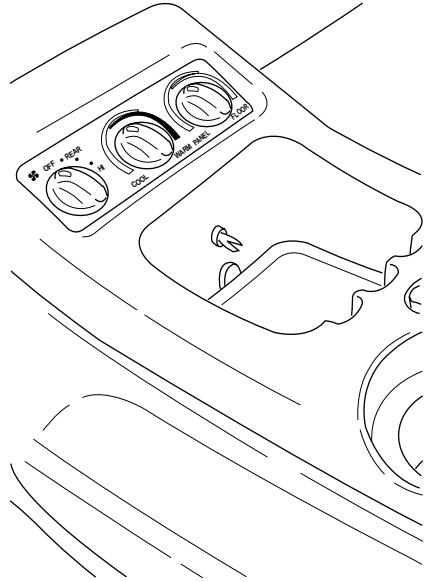

or located in the overhead console.

If your vehicle is equipped with a moon roof and a navigation system, you will not have a front auxiliary A/C- heater control console. All operation is obtained through the rear auxiliary A/C-heater control console.

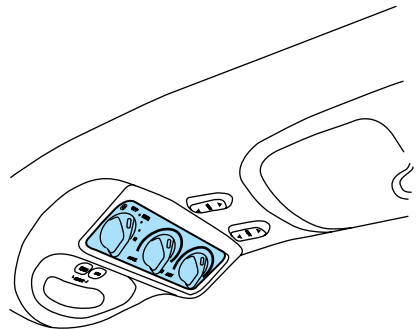

Climate controls

In order for the auxiliary A/C-heater controls (if equipped) to function, the driver's auxiliary A/C-heater control must be set to REAR, unless your vehicle is equipped with a moonroof and a navigation system.

In which case, the rear auxiliary A/C-heater control console serves as the main control for the auxiliary climate control system.

The instrument panel climate controls must be on in order for the auxiliary A/C-heater to operate.

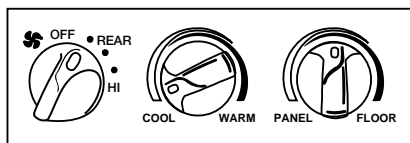

When the auxiliary A/C-heater control is set to FLOOR, airflow only occurs from the third row seat floor vent located in the driver's side rear quarter trim panel.

When the auxiliary A/C-heater control is set to PANEL, airflow occurs from the overhead 2nd and 3rd row vents.

Turn the fan speed control knob to the desired speed.



Turn the temperature control to the desired temperature.

You can get warm or cool air through either the overhead registers or floor vent by turning the auxiliary mode selector:

- Far left for airflow to the overhead registers.
- Far right for airflow to the rear floor vent.
- Anywhere between PANEL and FLOOR to vary airflow between the outlets.



Climate controls

REAR WINDOW DEFROSTER

The rear defroster control is located on the instrument panel.

Press the rear defroster control to clear the rear window of thin ice and fog.

- A small LED will illuminate when the rear defroster is activated.

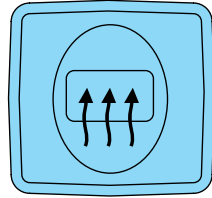

The ignition must be in the ON position to operate the rear window defroster.

The defroster turns off automatically after 10 minutes or when the ignition is turned to the OFF position. To manually turn off the defroster before 10 minutes have passed, push the control again.

HEADLAMP CONTROL ☀️

Rotate the headlamp control to the first position to turn on the parking lamps. Rotate to the second position to also turn on the headlamps.

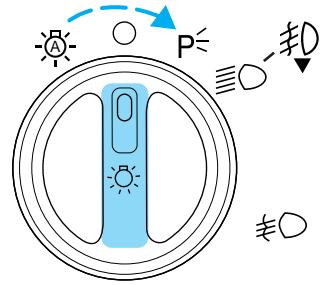

Foglamp control (if equipped) ☁️

The headlamp control also operates the foglamps. The foglamps can be turned on only when the headlamp control is in the ☁️ position and the high beams are not turned on.

Pull headlamp control towards you to turn foglamps on. The foglamp indicator light ☁️ will illuminate.

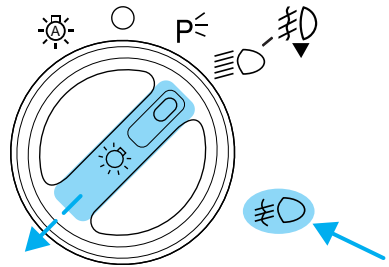

Autolamp control 🌙

The autolamp system provides light sensitive automatic on-off control of the exterior lights normally controlled by the headlamp control.

The autolamp system also keeps the lights on for approximately 20 seconds after the ignition switch is turned to OFF.

- To turn autolamps on, rotate the control counterclockwise.
- To turn autolamps off, rotate the control clockwise to OFF.
- Foglamps are not controlled by the autolamps. In order to turn on the foglamps, you must turn the lamp switch to the ☁️ position and pull toward you for foglamps.

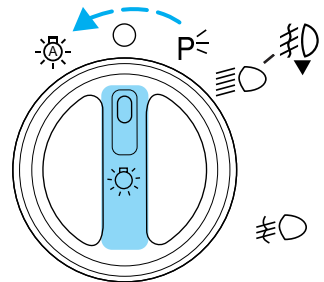

Lights

Daytime running lamps (DRL) (if equipped)

Turns the headlamps on with a reduced output. To activate:

- the ignition must be in the ON position and
- the headlamp control is in the OFF or Parking lamps position.



Always remember to turn on your headlamps at dusk or during inclement weather. The Daytime Running Lamp (DRL) system does not activate with your tail lamps and generally may not provide adequate lighting during these conditions. Failure to activate your headlamps under these conditions may result in a collision.

High beams

- Push forward to activate.
- Pull toward you to deactivate.

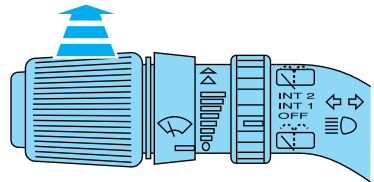

Flash to pass

Pull toward you to activate and release to deactivate.

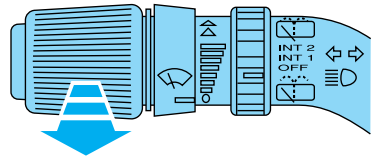

PANEL DIMMER CONTROL

Use to adjust the brightness of the instrument panel during headlamp and parklamp operation.

- Rotate up to brighten.
- Rotate down to dim.
- Rotate to full up position (past detent) to turn on interior lamps.
- Rotate to full down position (past detent) to turn off interior lamps.

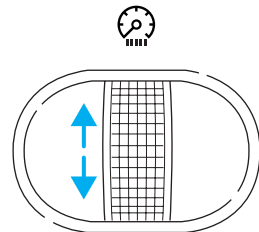

AIMING THE HEADLAMPS

The headlamps on your vehicle are properly aimed at the assembly plant. If your vehicle has been in an accident the alignment of your headlamps should be checked by a qualified service technician.

TURN SIGNAL CONTROL ⇐⇒

- Push down to activate the left turn signal.
- Push up to activate the right turn signal.

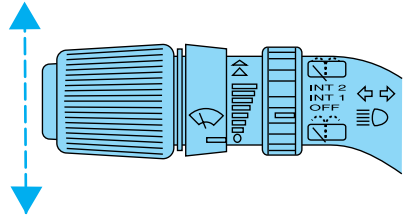

INTERIOR LAMPS

Map lamps

With trip computer

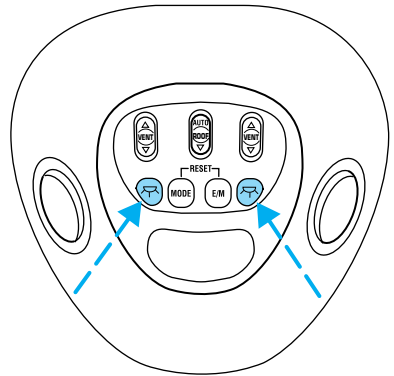

Lights

Without trip computer

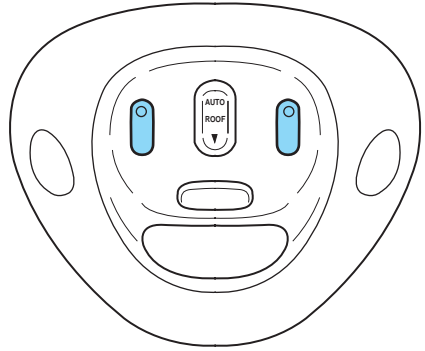

To turn on the map lamps, press the control next to each lamp.

Rear dome lamp

The dome lamp lights when:

- any door is opened.
- the instrument panel dimmer switch is held up until the courtesy lamps come on.
- any of the remote entry controls are pressed and the ignition is OFF.

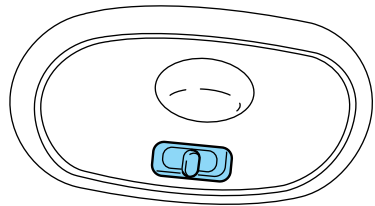

With the ignition key in the ACC or ON position, the rear dome lamp can be turned ON or OFF by sliding the control.

BULBS

Replacing exterior bulbs

Check the operation of the following lamps frequently:

- Headlamps
- Foglamps
- High-mount brakelamp
- Brakelamps
- Parking lamps
- Turn signals

- License plate lamp
- Tail lamps
- Back-up lamps

Do not remove lamp bulbs unless they can be replaced immediately with new ones. If a bulb is removed for an extended period of time, contaminants may enter the lamp housings and affect lamp performance.

Using the right bulbs

Replacement bulbs are specified in the chart below. Headlamp bulbs must be marked with an authorized “D.O.T.” for North America and an “E” for Europe to assure lamp performance, light brightness and pattern and safe visibility. The correct bulbs will not damage the lamp assembly or void the lamp assembly warranty and will provide quality bulb burn time.

Function	Number of bulbs	Trade number
Headlamps (low-beam)	2	9006
Headlamps (high-beam)	2	9005
Front park/turn lamps	2	3457 K
Foglamps	2	899
Dome/map lamps	2	579
Turn/tail/brake lamps	2	3157
Liftgate lamp	2	916
Backup lamp	2	3156
License lamp	2	168
High-mount brake lamp	1	W5W
Running board lamp (if equipped)	2	168
All replacement bulbs are clear in color except where noted.		
To replace all instrument panel lights - see your dealer		

Lights

Replacing the interior bulbs

Check the operation of the following interior bulbs frequently:

- interior overhead lamp
- map lamp

For bulb replacement, see a dealer or qualified technician.

Map lamps

To change the map lamp bulbs:

1. Use a small screwdriver to remove the map lamp lens.
2. To remove the old bulb, twist $\frac{1}{4}$ turn and pull it out.
3. Twist in a new bulb.
4. Align and press the map lamp lens back on and test the lamp operation.

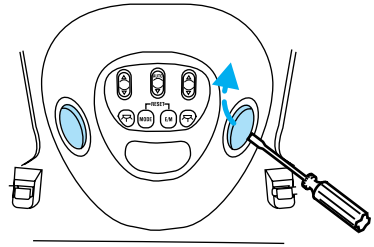

Replacing headlamp bulbs

1. Make sure that the headlamp control is in the OFF position.
2. Open the hood.
3. At the back of the headlamp, pull clips rearward and up to release the headlamp assembly.
4. Slide headlamp assembly forward and off of guide ribs to expose the back of the bulb and wiring connector.

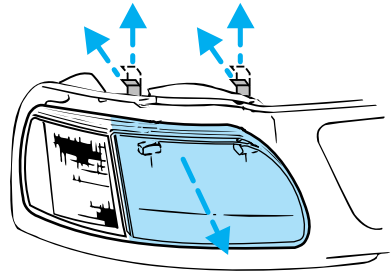

5. Disconnect the electrical connector from the bulb by pulling rearward.
6. Remove bulb retainer ring by turning it counterclockwise, then slide the ring off the plastic base.
7. Without turning, carefully pull bulb assembly out of headlamp assembly.

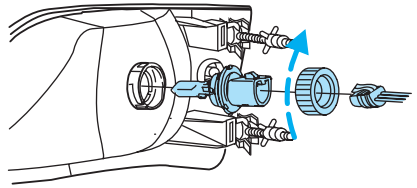

Handle a halogen headlamp bulb carefully and keep out of children's reach. Grasp the bulb only by its plastic base and do not touch the glass. The oil from your hand could cause the bulb to break the next time the headlamps are operated.

8. Insert the glass end of the new bulb into the headlamp assembly. When the grooves in the plastic base are aligned, push the bulb into the lamp assembly until the plastic base contacts the rear of the lamp assembly.
9. Install bulb retaining ring over the plastic base and lock the ring into the socket by turning it clockwise until you feel a "stop."
10. Connect the electrical connector into the plastic base until it "snaps."
11. Straighten alignment pins, making them parallel with the outer edges of the attachment standoff.
12. Carefully insert the headlamp assembly into the vehicle making sure the alignment pins are inserted into the proper holes and into the guide ribs.
13. Hold the headlamp assembly snugly against the vehicle and push down on the clips to lock the lamp into place.

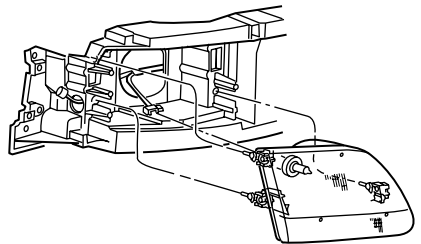

Lights

Replacing front parking lamp/turn signal bulbs

1. Make sure that the headlamp control is in the OFF position.
2. Open the hood.
3. Remove the screw and lamp assembly from the vehicle.
4. Rotate the bulb socket counterclockwise and remove from the lamp assembly.
5. Carefully pull the bulb out of the socket and push in the new bulb.
6. Install the bulb socket into the lamp assembly and rotate clockwise.
7. Install parking lamp assembly on vehicle.
8. Push gently until parking lamp assembly seats.
9. Install screw on the lamp assembly.

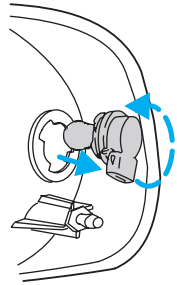

Replacing tail lamp/backup lamp bulbs

The tail lamp/backup lamp bulbs are located in the same portion of the tail lamp assembly, one just below the other. Follow the same steps to replace either bulb:

1. Open the liftgate to expose the lamp assembly screws.
2. Remove the two screws from the lamp assembly.
3. Carefully pry the lamp assembly away from the vehicle to expose the bulb sockets.
4. Rotate the bulb socket counterclockwise and remove from lamp assembly.
5. Pull bulb straight out of socket and push in the new bulb.
6. Install the bulb socket into the lamp assembly and rotate clockwise.
7. Carefully install the tail lamp assembly on the vehicle snapping the three retaining tabs into place.
8. Secure the lamp assembly with two screws.

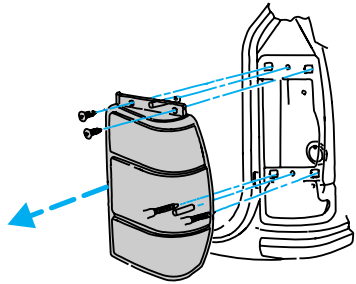

Replacing foglamp bulbs

1. Remove the bulb socket from the foglamp by turning counterclockwise.
2. Disconnect the electrical connector from the foglamp bulb.
3. Connect the new foglamp bulb to the electrical connector.
4. Install the bulb socket in the foglamp turning clockwise.

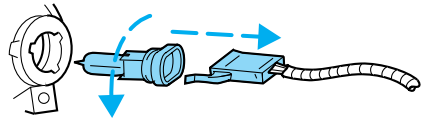

Replacing running board lamp bulbs

For bulb replacement, see a dealer or qualified technician.

High-mount brakelamp

To change the high-mount brakelamp bulbs:

1. Remove the four screws from the high-mount brakelamp assembly.
2. Carefully pull the lamp assembly away from the vehicle to access the bulbs.
3. Remove the bulb socket by turning counterclockwise and a careful pull.
4. Pull the bulb straight out of the socket and push in the new bulb.
5. Replace the bulbs as needed and install the high-mount brakelamp assembly.

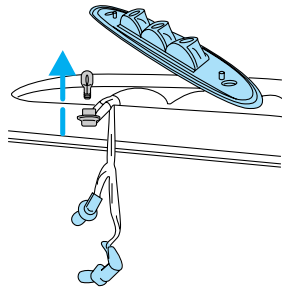
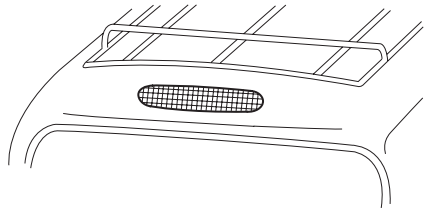

Lights

Replacing license plate lamp bulbs

The license plate bulbs are located behind the rear bumper. To change the license plate lamp bulbs:

1. Reach behind the rear bumper to locate the bulb.
2. Twist the bulb socket counterclockwise and carefully pull to remove it from the lamp assembly.
3. Pull out the old bulb from the socket and push in the new bulb.
4. Install the bulb socket in lamp assembly by turning it clockwise.

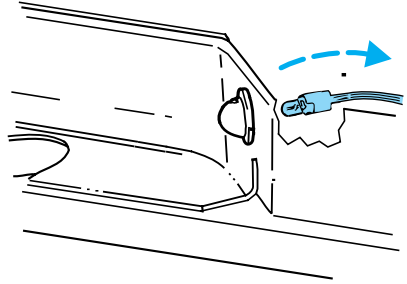

WINDSHIELD WIPER/WASHER CONTROLS

Rotate the windshield wiper control to the desired interval, low or high speed position.

The bars of varying length are for intermittent wipers. When in this position rotate the control upward for fast intervals and downward for slow intervals.

Push (tap) the end of the stalk briefly for a single swipe (no wash). Push and hold for three swipes with wash. Push and hold for a longer wash (up to ten seconds).

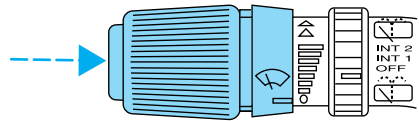
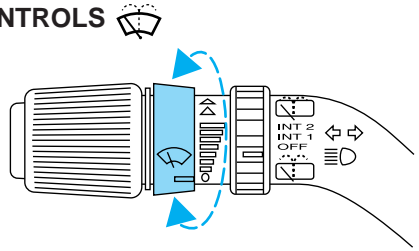

Rear window wiper/washer controls

For rear wiper operation, rotate the rear window wiper and washer control to the desired position. Select:

INT 1 — 3.5 second interval rear wiper.

INT 2 — 10.5 second interval rear wiper.

OFF — Rear wiper and washer off.

For rear wash cycle, rotate (and hold as desired) the rear wiper/washer control to either  position.

From either position, the control will automatically return to the INT2 or OFF position.

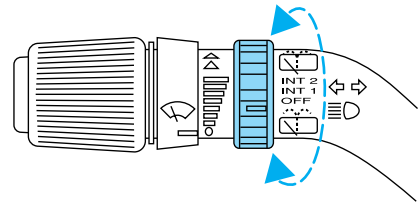

Speed dependent wipers

When the windshield wiper control is set on the intermittent settings, speed-sensitive front wipers automatically adjust as the vehicle's speed changes.

Driver controls

Windshield wiper blades

Check the wiper blades at least twice a year or when they seem less effective. Substances such as tree sap and some hot wax treatments used by commercial car washes reduce the effectiveness of wiper blades.

Checking the wiper blades

If the wiper blades do not wipe properly, clean both the windshield and wiper blades using undiluted windshield wiper solution or a mild detergent. Rinse thoroughly with clean water. To avoid damaging the blades, do not use fuel, kerosene, paint thinner or other solvents.

Changing the wiper blades

To replace the wiper blades:

1. Pull the wiper arm away from the windshield and lock into the service position.
2. Turn the blade at an angle from the wiper arm. Push the lock pin manually to release the blade and pull the wiper blade down toward the windshield to remove it from the arm.
3. Attach the new wiper to the wiper arm and press it into place until a click is heard.

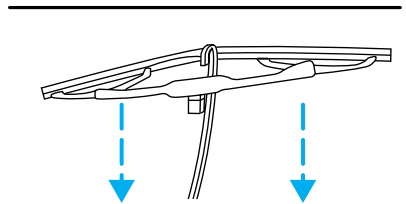
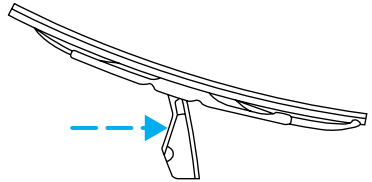

Rear window wiper blades

Refer to *Windshield wiper blades* in this section for more information on rear wiper blades.

TILT STEERING

Pull the tilt steering control toward you to move the steering wheel up or down. Hold the control while adjusting the wheel to the desired position, then release the control.

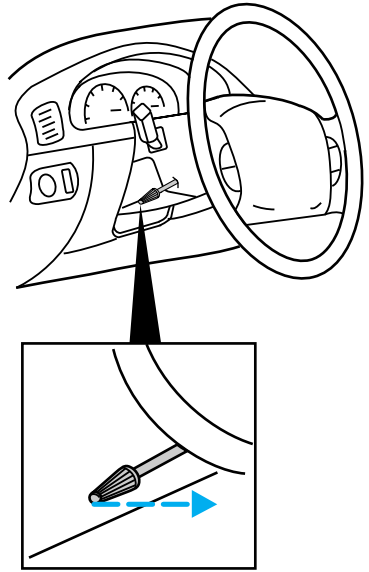

Never adjust the steering wheel when the vehicle is moving.

ILLUMINATED VISOR MIRROR (IF EQUIPPED)

To turn on the visor mirror lamps, lift the mirror cover open.

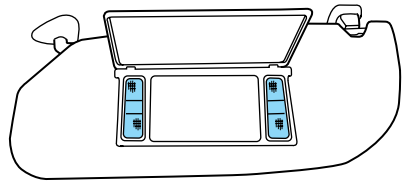

OVERHEAD CONSOLE

The appearance of your vehicle's overhead console will vary according to your option package.

Driver controls

Forward storage bin (if equipped)

Press the release control to open the storage compartment. The door will open slightly and can be moved to full open.

The storage compartment may be used to secure sunglasses or a similar object.

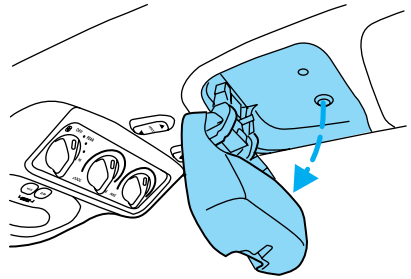

Installing a garage door opener (if equipped)

The storage compartment can be converted to accommodate a variety of aftermarket garage door openers:

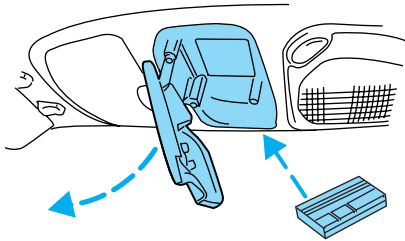

- Place Velcro hook onto back side of aftermarket transmitter opposite of actuator control.
- Place transmitter into storage compartment, control down.
- Place the provided height adaptors onto the back of the storage bin door as needed.
- Press the storage compartment door to activate the transmitter.

One-touch moon roof (if equipped) With trip computer

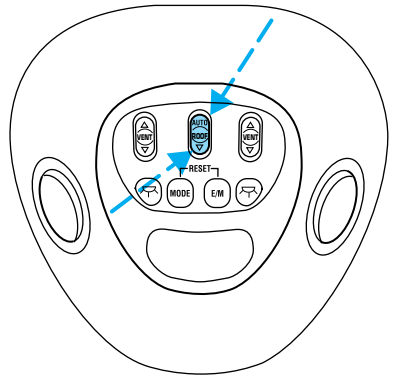

Without trip computer

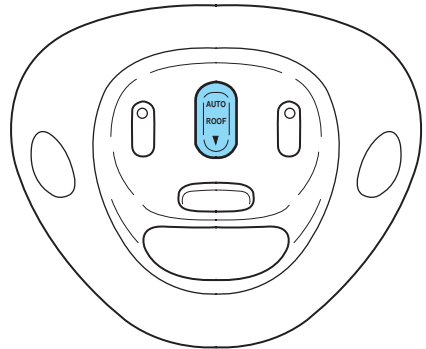

- Press and release the rear portion of the moon roof control to open.
- Press and hold (as desired) the front portion of the moon roof control to close.
- To halt motion at any point during one-touch opening, press the control a second time.
- The moon roof has a sliding shade that can be manually opened or closed when the glass panel is shut.
- To close the shade, pull it toward the front of the vehicle.



Do not let children play with the moon roof. They may seriously hurt themselves.

Driver controls

Trip computer

For information on the trip computer, refer to *Trip computer* this chapter.

Electronic compass (if equipped)

The compass reading may be affected when you drive near large buildings, bridges, power lines and powerful broadcast antennas. Magnetic or metallic objects placed in, on or near the vehicle may also affect compass accuracy.

Usually, when something affects the compass readings, the compass will correct itself after a few days of operating your vehicle in normal conditions. If the compass still appears to be inaccurate, a manual calibration may be necessary. Refer to *Compass calibration adjustment*.

Most geographic areas (zones) have a magnetic north compass point that varies slightly from the northerly direction on maps. This variation is four degrees between adjacent zones and will become noticeable as the vehicle crosses multiple zones. A correct zone setting will eliminate this error. Refer to *Compass zone adjustment*.

Electronic compass/temperature display (without trip computer)

Outside air temperature

The temperature display can be turned off and on by pressing the SELECT control on the overhead console. The temperature can be displayed in Centigrade or Fahrenheit by pressing the SELECT control.

If the outside temperature falls below 3°C (38°F), the display will alternate from “ICE” to the outside temperature at a two second rate for one minute.

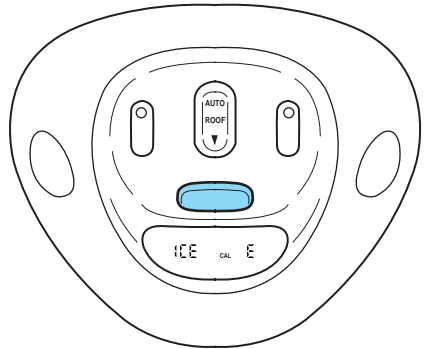

Compass zone adjustment

1. Determine which magnetic zone you are in for your geographic location by referring to the zone map.

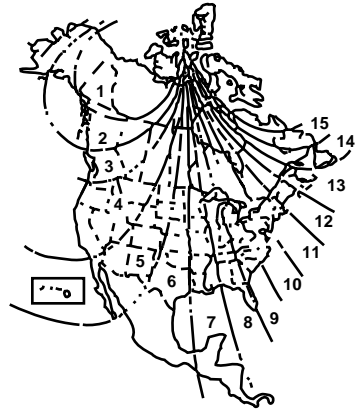

With trip computer

2. Locate the compass module mounted on the center rear view mirror post.

3. Turn ignition to the ON position.

4. Press and hold the RESET button on top of the compass module until the message display in the trip computer shows the current zone setting.

5. Release the RESET button.

6. Press the RESET button until the correct zone is displayed on the trip computer.

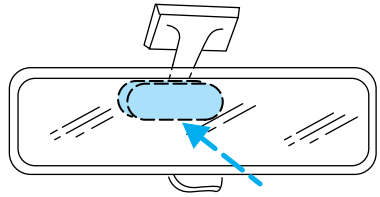

Driver controls

Without trip computer

1. Press and hold the SELECT control until VAR appears in the display, then release. The display should show the current zone number.
2. Press the SELECT control until the desired zone number appears. The display will flash and then return to normal operation. The zone is now updated.

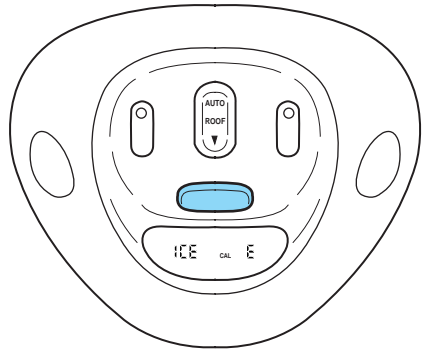

Compass calibration adjustment

Perform this adjustment in an open area free from steel structures and high voltage lines.

For optimum calibration, turn off all electrical accessories (heater/air conditioning, wipers, etc.) and make sure all vehicle doors are shut.

1. Start the vehicle.

With trip computer

2. Press and hold the RESET button on the compass module until CAL indicator is displayed in the trip computer.
3. Release pressure from the RESET button.
4. Slowly drive the vehicle in a circle (less than 5 km/h [3 mph]) until the CAL indicator turns off. This will take three to five circles to complete calibration.
5. The compass is now calibrated.

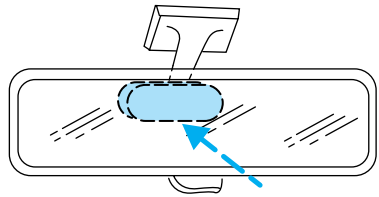

Driver controls

Without trip computer

1. Press and hold the SELECT control until CAL appears in the display (approximately eight seconds) and release.
2. Drive the vehicle slowly (less than 5 km/h [3 mph]) in circles until CAL indicator turns off in about 2–3 complete circles.
3. The compass is now calibrated.

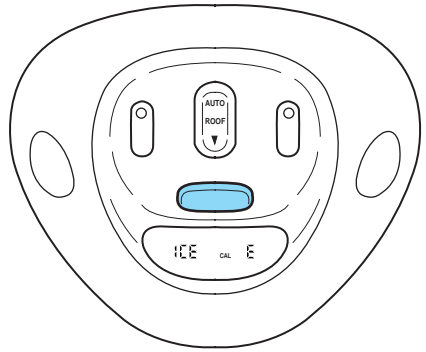

Power quarter rear windows (if equipped)

- Without a moon roof

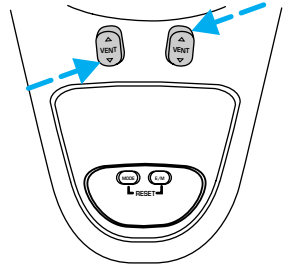

- With a moon roof

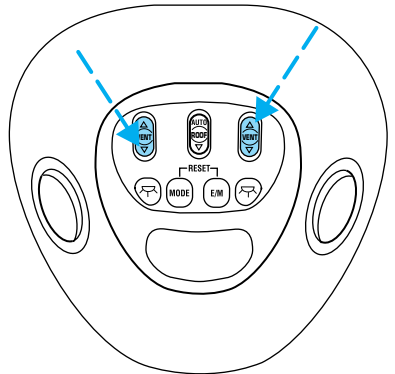

Driver controls

Press the ▲ portion of the VENT control to open the power rear quarter windows.

Press the ▼ portion of the VENT control to close the power rear quarter windows.

AUXILIARY POWER POINT 12V

Power outlets are designed for accessory plugs only. Do not hang any type of accessory or accessory bracket from the plug. Improper use of the power outlet can cause damage not covered by your warranty.

The auxiliary power point is located on the instrument panel.

Do not plug optional electrical accessories into the cigarette lighter. Use the power point.

Power outlets are designed for accessory plugs only. Do not hang any type of accessory or accessory bracket from the plug. Improper use of the power outlet can cause damage not covered by your warranty.

A second auxiliary power point is located on the lower rear side of the console. The power point is accessible from the rear seats.

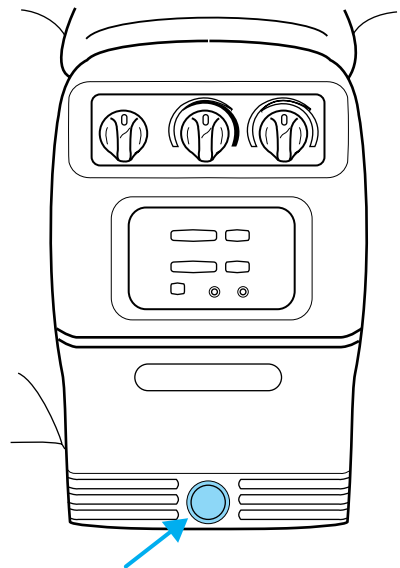
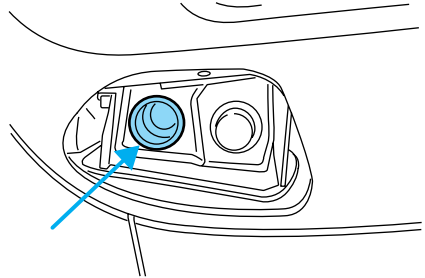

POWER WINDOWS

Press and hold the rocker switches to open and close windows.

- Press the top portion of the rocker switch to close.

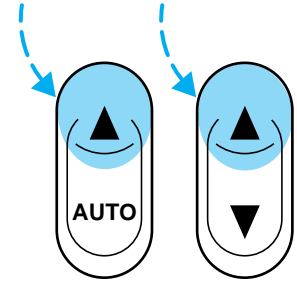

- Press the bottom portion of the rocker switch to open.

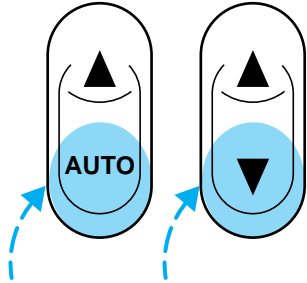

One touch down

- Press AUTO completely down and release quickly. The driver's window will open fully. Depress again to stop window operation.

One touch down can be deactivated during operation by pushing down on the top part of the driver power window control.

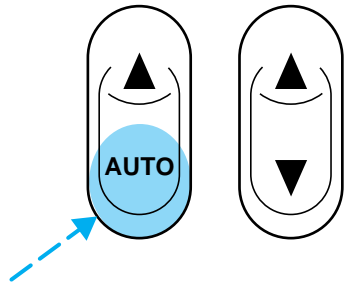

Driver controls

Window lock

The window lock feature allows only the driver to operate the power windows.

To lock out all the window controls except for the driver's press the left side of the control. Press the right side to restore the window controls.

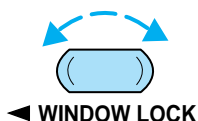

Accessory delay

With accessory delay, the window switches may be used for up to ten minutes after the ignition switch is turned to the OFF position or until any door is opened.

MIRRORS

Automatic dimming rear view mirrors (if equipped)

Your vehicle is equipped with an inside rear view mirror with an auto-dimming function. The electronic day/night mirror will change from the normal state to the non-glare state when bright lights (glare) reach the inside rear view mirror. When the inside rear view mirror detects bright light from in front of or behind the vehicle, the inside rear view mirror will automatically adjust (darken) to minimize glare.

Do not block the sensor on the backside of the inside rear view mirror since this may impair proper system performance.

Press the control to turn the mirror OFF or AUTO.

The mirror will automatically return to the normal state whenever the vehicle is placed in R

(Reverse)(when the mirror is on) to ensure a bright clear view when backing up.

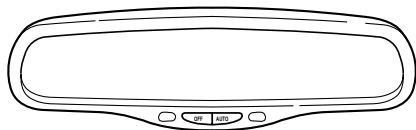

Power side view mirrors

The ignition can be in any position to adjust the power side view mirrors.

To adjust your mirrors:

Driver controls

1. Select L to adjust the left mirror or R to adjust the right mirror.

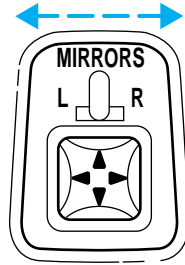

2. Move the control in the direction you wish to tilt the mirror.

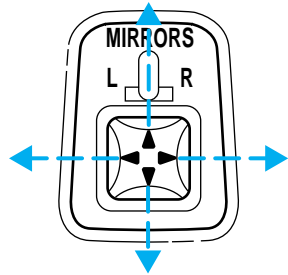

3. Return to the center position to lock mirrors in place.

4. Adjust spotter mirrors (if equipped) manually.

Heated outside mirrors (if equipped)

Both mirrors are heated automatically to remove ice, mist and fog when the rear window defrost is activated.

Do not remove ice from the mirrors with a scraper or attempt to readjust the mirror glass if it is frozen in place. These actions could cause damage to the glass and mirrors.

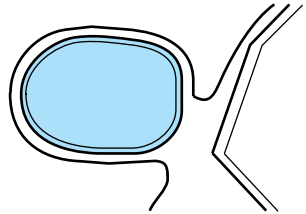

Driver controls

Signal mirrors (if equipped)

When the turn signal is activated, the outer portion of the appropriate mirror housing will blink red.

This provides an additional warning to other drivers that your vehicle is about to turn.

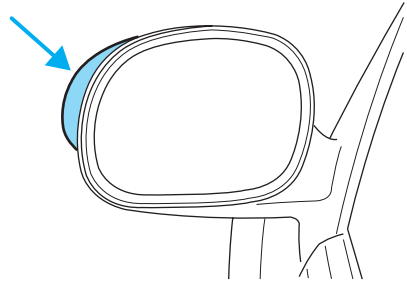

Fold-away mirrors

Pull the side mirrors in carefully when driving through a narrow space, like an automatic car wash.

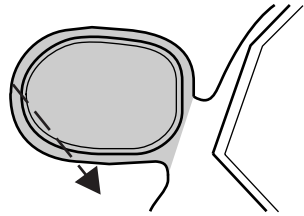

POWER ADJUSTABLE FOOT PEDALS

The accelerator and brake pedal should only be adjusted when the vehicle is stopped and the gearshift lever is in the P(Park) position.

Press and hold the rocker control to adjust accelerator and brake pedal toward you or away from you.

The adjustment allows for approximately 76 mm (3 inches) of maximum travel.

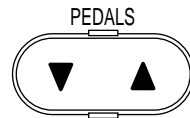

Never adjust the accelerator and brake pedal with feet on pedals or while the vehicle is moving.

SPEED CONTROL

To turn speed control on

- Press ON.

Vehicle speed cannot be controlled until the vehicle is traveling at or above 48 km/h (30 mph).

Do not shift the gearshift lever into N (Neutral) with the speed control on.

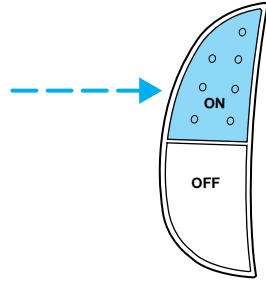

Do not use the speed control in heavy traffic or on roads that are winding, slippery, or unpaved.

To turn speed control off

- Press OFF or
- Turn off the vehicle ignition.

Once speed control is switched off, the previously programmed set speed will be erased.

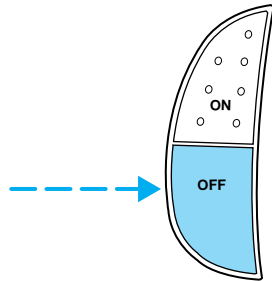

To set a speed

- Press SET ACCEL. For speed control to operate, the speed control must be ON and the vehicle speed must be greater than 48 km/h (30 mph).

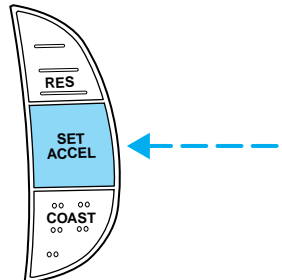

Driver controls

If you drive up or down a steep hill, your vehicle speed may vary momentarily slower or faster than the set speed. This is normal.

Speed control cannot reduce the vehicle speed if it increases above the set speed on a downhill. If your vehicle speed is faster than the set speed while driving on a downhill, you may want to shift to the next lower gear or apply the brakes to reduce your vehicle speed.

If your vehicle slows down more than 16 km/h (10 mph) below your set speed on an uphill, your speed control will disengage. This is normal. Pressing RES will re-engage it.



Do not use the speed control in heavy traffic or on roads that are winding, slippery, or unpaved.

To set a higher set speed

- Press and hold SET ACCEL. Release the control when the desired vehicle speed is reached or
- Press and release SET ACCEL to operate the Tap-Up function. Each press will increase the set speed by 1.6 km/h (1 mph) or
- Accelerate with your accelerator pedal. When the desired vehicle speed is reached, press and release SET ACCEL.

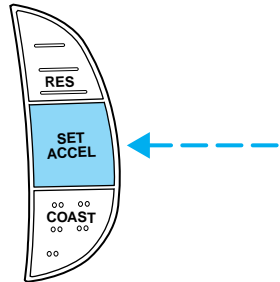

You can accelerate with the accelerator pedal at any time during speed control usage. Releasing the accelerator pedal will return your vehicle to the previously programmed set speed.

To set a lower set speed

- Press and hold COAST. Release the control when the desired speed is reached or
- Press and release COAST to operate the Tap-Down function. Each press will decrease the set speed by 1.6 km/h (1 mph) or
- Depress the brake pedal. When the desired vehicle speed is reached, press SET ACCEL.

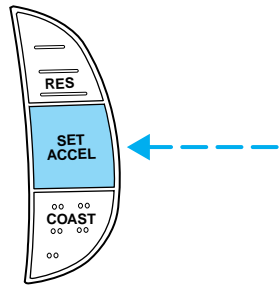
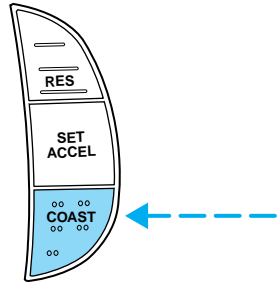

To disengage speed control

- Depress the brake pedal.
- Disengaging the speed control will not erase the previously programmed set speed.

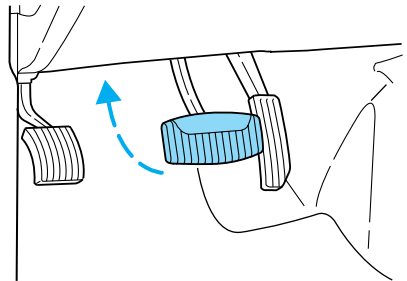

Driver controls

Pressing OFF will erase the previously programmed set speed.

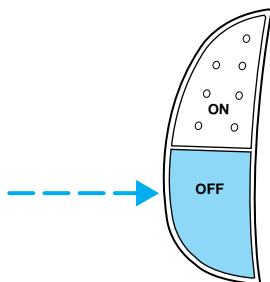

To return to a previously set speed

- Press RES. For RES to operate, the vehicle speed must be faster than 48 km/h (30 mph).

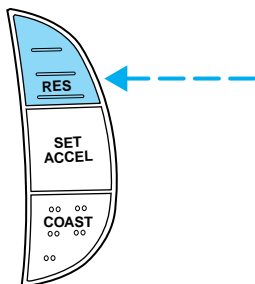

Indicator light

This light comes on when either the SET ACCEL or RES controls are pressed. The vehicle speed must be at or above 48 km/h (30 mph). It turns off when the speed control OFF control is pressed, the brake or clutch is applied, or the ignition is turned to the OFF position.

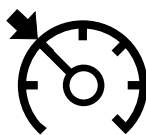

HOMELINK® UNIVERSAL TRANSCEIVER (IF EQUIPPED)

The HomeLink® Universal Transceiver, located on the driver's visor, provides a convenient way to replace up to three hand-held transmitters with a single built-in device. This feature will learn the radio frequency codes of most current transmitters to operate garage doors, entry gates, security systems, entry door locks, and home or office lighting.

Driver controls



When programming your HomeLink® Universal Transceiver, to a garage door or gate be sure that people and objects are out of the way to prevent potential harm or damage.

Do not use the HomeLink® Universal Transceiver with any garage door opener that lacks safety stop and reverse features as required by U.S. federal safety standards (this includes any garage door opener model manufactured before April 1, 1982). A garage door which cannot detect an object, signaling the door to stop and reverse, does not meet current U.S. federal safety standards. For more information on this matter, call toll-free: 1-800-355-3515 or on the Internet at **HomeLink.jci.com**.

Programming

Do not program the HomeLink® Universal Transceiver with the vehicle parked in the garage.

1. Prepare for programming the HomeLink® Universal Transceiver by erasing the three factory default codes by holding down the two outside buttons until the red light begins to flash after 20 seconds. Release both buttons.

2. Hold the end of your hand-held transmitter 5–14 cm (2–5 inches) away from the HomeLink® Universal

Transceiver surface (located on your visor) while keeping the red light in view.

3. Using both hands simultaneously press and hold the hand-held transmitter button and the desired HomeLink® button. Do not release the buttons until step 4 has been completed.

Some entry gates and garage door openers may require you to replace step 3 with the procedure in the “Canadian Programming” section.

4. The red light will flash slowly and then rapidly. Release both buttons when the red light flashes rapidly.

5. Follow steps 2 through 4 to program the remaining two buttons.

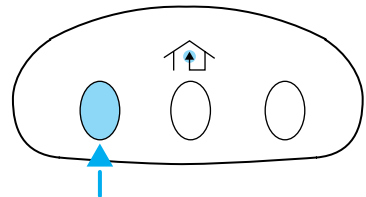
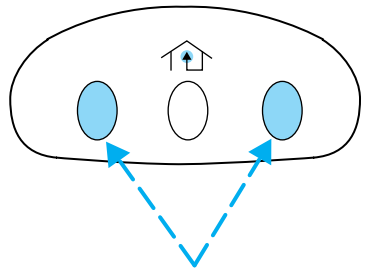

Driver controls

If you do not successfully program the HomeLink® Universal Transceiver after repeated attempts, refer to *Rolling code programming* which follows, or call toll-free customer assistance: 1-800-355-3515 or on the Internet at **HomeLink.jci.com**.

Canadian Programming

During programming, your hand-held transmitter may automatically stop transmitting after two seconds which may not be long enough to program the HomeLink® Universal Transceiver.

To program your hand-held transmitters:

- Continue to hold the button on the HomeLink® Universal Transceiver.
- Press and re-press the hand-held transmitter button every two seconds until the red light changes from a slow to a fast flash.

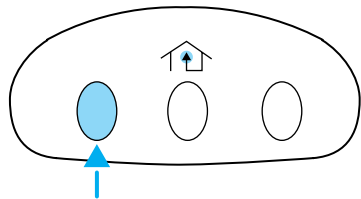

Operating the HomeLink® Universal Transceiver

Once programmed, the HomeLink® Universal Transceiver can be used in place of hand-held transmitters. To operate, simply press and release the appropriate HomeLink® button (the red light will illuminate, indicating the signal is being transmitted).

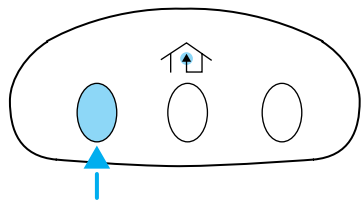

Rolling code programming

Rolling code garage door openers (or other rolling code devices) which are “code protected” and manufactured after 1996, may be determined by the following:

- Reference the device owner’s manual for verification
- The hand-held transmitter appears to program the HomeLink® Universal Transceiver but does not activate the device.
- Press and hold the trained HomeLink® button. The device has the rolling code feature if the indicator light flashes rapidly and then turns solid after two seconds.

After completing the “Programming” functions, follow these steps to train a garage door opener with the rolling code feature:

1. Locate the **training button** on the garage door motor head unit. Refer to the garage door opener manual or call 1-800-355-3515 or on the Internet at **HomeLink.jci.com**. if there is difficulty locating the training button.
2. Press the training button on the garage door motor head unit (which will activate the **“training” light**).
3. Press and release the programmed HomeLink® button. Press and release the HomeLink® button a *second time* to complete the training process. (Some garage door openers may require this procedure to be done a third time to complete the training.)

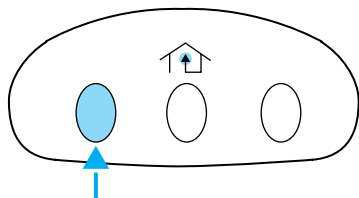

The 2nd or 3rd press from step 3 will activate the door. The HomeLink® Universal Transceiver has now been trained to the receiver. The remaining two buttons may now be programmed if this has not previously been done.

Erasing HomeLink® buttons

Individual buttons cannot be erased, however, to erase the three programmed buttons:

1. Hold down the two outside buttons until the red light begins to flash after 20 seconds.
2. Release both buttons.

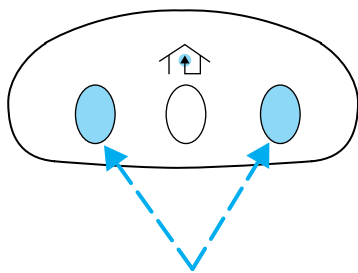

Reprogramming a single HomeLink® button

To program a device to HomeLink® using a HomeLink® button previously trained, follow these steps:

1. Press and hold the desired HomeLink® button. **Do NOT** release until **step 4** has been completed.

Driver controls

- When the indicator light begins to flash slowly (after 20 seconds), position the hand-held transmitter 5–14 cm (2 to 5 inches) away from the HomeLink® surface.
- Press and hold the hand-held transmitter button.
- The HomeLink® indicator light will flash, first slowly and then rapidly. When the indicator light begins to flash rapidly, release both buttons. The previous device has now been erased and the new device can be activated by pushing the HomeLink® button that has just been programmed.

TRIP COMPUTER (IF EQUIPPED)

The trip computer tells you about the condition of your vehicle through a constant monitor of vehicle systems. You may select display features on the trip computer for a display of status.

The appearance of your vehicle's trip computer may differ depending on your vehicle's option package, but the functions are the same.

The trip computer only works when the ignition is in the ON position. Trip computer features follow:

Selectable features

English/metric display

Press this control to change the trip computer display from metric to English units. Press again to change from English to metric units.

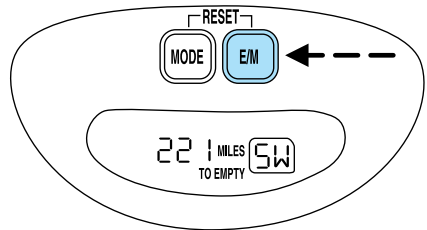

Mode control

Each press of the MODE control will display a different feature as follows:

Fuel range. This displays the approximate number of kilometers (miles) left to drive before the fuel tank is empty. The indicated distance to empty may be inaccurate:

- with sustained, drastic changes in fuel economy (such as trailer towing), but will eventually recover.
- if the vehicle is started while parked on an incline.
- if less than 27 liters (6 gallons) of fuel is added to the fuel tank.

The fuel range function will flash for 5 seconds when you have approximately the following distance you can drive before the fuel tank is empty:

- 80 km (50 miles)
- 40 km (25 miles)
- 16 km (10 miles)

Average fuel economy. The display will indicate the vehicle's average fuel economy in liters/100 km (or miles/gallon) since last reset.

- To reset the average fuel economy:
 1. Press the MODE control repeatedly until AVG F/ECON is displayed (no other display is resettable).
 2. Press the E/M and MODE controls simultaneously.

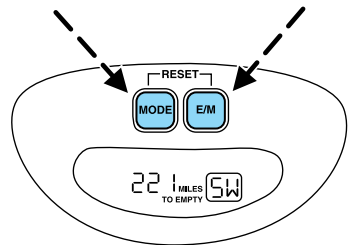
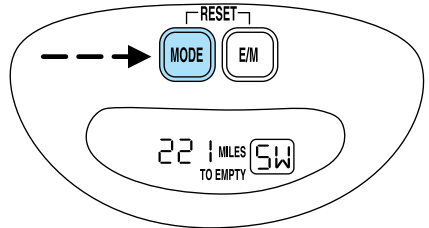

Compass display. Refer to *Electronic compass* in the *Controls and features* chapter for more information.

Off. In this mode the display will go blank indicating the system is off.

Driver controls

OVERDRIVE CONTROL

Activating overdrive

D (Overdrive) is the normal drive position for the best fuel economy. The overdrive function allows automatic upshifts and downshifts through all available gears.

Deactivating overdrive

Press the Transmission Control Switch (TCS) located on the end of the gearshift lever. The Transmission Control Indicator Light (TCIL) (the word OFF) will illuminate on the end of the gearshift lever. The transmission will operate in all gears except overdrive.

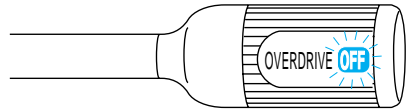

To return to normal overdrive mode, press the Transmission Control Switch again. The TCIL (the word OFF) will no longer be illuminated.

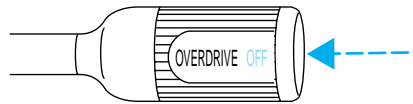

When you shut off and re-start your vehicle, the transmission will automatically return to normal **D** (Overdrive) mode.

For additional information about the gearshift lever and the transmission control switch operation refer to the *Automatic Transmission Operation* section of the *Driving* chapter.

CENTER CONSOLE

Your vehicle may be equipped with a variety of console features. These include:

- Utility compartment
- Cupholders
- Coin holder slots
- Compact disc changer (if equipped)
- Rear audio controls
- Power point



Use only soft cups in the cupholder. Hard objects can injure you in a collision.

Rear center console features (if equipped)

The rear center console incorporates the following features:

- utility compartment
- cupholders

POSITIVE RETENTION FLOOR MAT (IF EQUIPPED)

Position the floor mat so that the eyelet is over the pointed end of the retention post and rotate forward to lock in. Make sure that the mat does not interfere with the operation of the accelerator or the brake pedal.

To remove the floor mat, reverse the installation procedure.

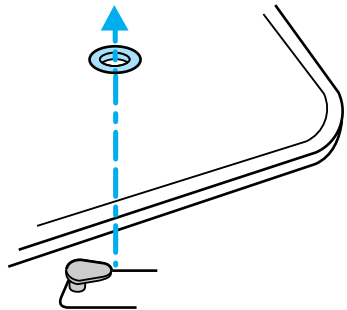

LIFTGATE

To open the rear window, turn the liftgate handle to the right.

To open the liftgate, turn the liftgate handle to the left.

- Do not open the liftgate or liftgate glass in a garage or other enclosed area with a low ceiling. If the liftgate glass is raised and the liftgate is also opened, both liftgate and glass could be damaged against a low ceiling.
- Do not leave the liftgate or liftgate glass open while driving. Doing so could cause serious damage to the liftgate and its components as well as allowing carbon monoxide to enter the vehicle.

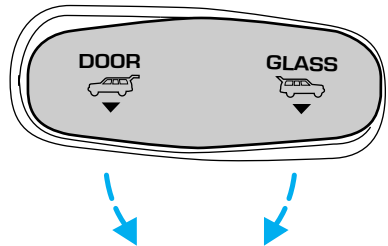

Driver controls



Make sure that the liftgate door and/or window are closed to prevent exhaust fumes from being drawn into the vehicle. This will also prevent passengers and cargo from falling out. If you must drive with the liftgate door or window open, keep the vents open so outside air comes into the vehicle.

LUGGAGE RACK (IF EQUIPPED)

The rear cross-bar can be adjusted to fit the item being carried. The front cross-bar does not move.

To adjust the luggage rack, push the adjustment lever forward (toward the front of the vehicle), then slide the cross-bar forward and lock the adjusting levers by pushing them down (toward the back of the vehicle). Pull the cross-bar rearward to ensure that it is locked in place.

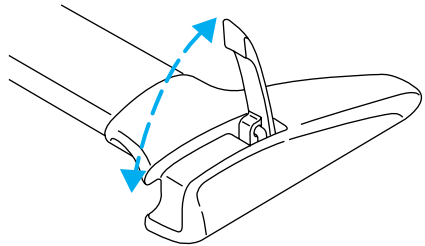

Load luggage at the front cross-bar and adjust the rear cross-bar as necessary.

- Do not exceed 90.7 kg (200 lb) of luggage if the weight is placed directly on the cross-bars.
- Do not exceed 68 kg (150 lb) if the weight is resting directly on the roof.

Use adjustable tie down loops to secure the load.

Locks and security

KEYS

The key operates all locks on your vehicle. In case of loss, replacement keys are available from your dealer.

You should always carry a second key with you in a safe place in case you require it in an emergency.

Refer to *SecuriLock™ Passive Anti-Theft System* for more information.

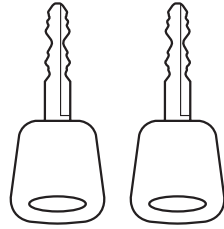

POWER DOOR LOCKS

If the door does not unlock when the U is pressed, see *Power door disable feature* in the *Remote entry section* in this chapter.

Press U to unlock all doors and L to lock all doors.

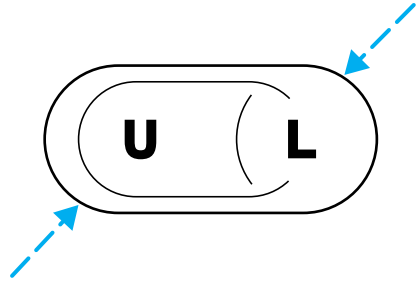

Childproof door locks

When these locks are set, the rear doors cannot be opened from the inside. The rear doors can be opened from the outside when the doors are unlocked.

The childproof locks are located on rear edge of each rear door and must be set separately for each door. Setting the lock for one door will not automatically set the lock for both doors.

Move lock control up to engage the childproof lock. Move control down to disengage childproof locks.

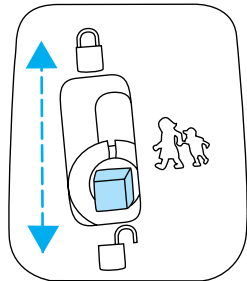

Locks and security

REMOTE ENTRY SYSTEM

This device complies with part 15 of the FCC rules and with RS-210 of Industry Canada. Operation is subject to the following two conditions: (1) This device may not cause harmful interference, and (2) This device must accept any interference received, including interference that may cause undesired operation.

Changes or modifications not expressly approved by the party responsible for compliance could void the user's authority to operate the equipment.

Your vehicle is equipped with a remote entry system which allows you to:

- unlock the vehicle doors without a key.
- lock all the vehicle doors without a key.
- activate the personal alarm.

The remote entry features only operate with the ignition in the LOCK position.

This system will disable the power door lock controls. These will not work until the vehicle is disarmed. Refer to *Power door locks* in the *Driver Controls* chapter for more information.

If there is any potential remote keyless entry problem with your vehicle, ensure **ALL key fobs** (remote entry transmitters) are brought to the dealership, to aid in troubleshooting.

Unlocking the doors

Press this control to unlock the driver door. The interior lamps and running board lamps (if equipped) will illuminate.

The memory mirrors/seat (if equipped) will also be moved to position 1, 2 or 3 depending upon which remote entry transmitter (1, 2 or 3) is used.

Press the control a second time within three seconds to unlock all doors.

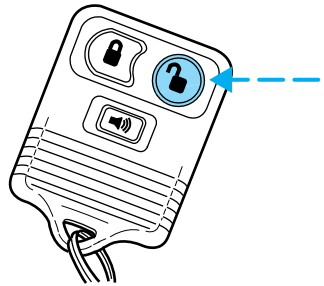

Locking the doors

Press this control to lock all doors. The doors will lock and the lamps will flash.

To confirm doors are closed and locked, press this control a second time within three seconds. The door(s) will lock again, the horn will chirp once and the lamps will flash.

If any of the doors are open or ajar, the horn will make two quick chirps, reminding you to properly close the doors.

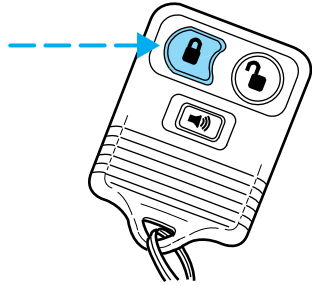

Power door lock disable feature

This feature will help protect your vehicle from unauthorized entry.

The UNLOCK function on the power door switch will not operate with the ignition OFF and twenty seconds after the doors are closed and electronically locked by the key fob, key pad, or power door switch (if pressed while the door was open).

The UNLOCK function will operate again after you unlock the vehicle using the key fob or key pad, turn the ignition to ON, or open the door from inside of the vehicle.

Deactivating/activating power door lock disable feature

1. Turn the ignition key to ON, then press the UNLOCK button 3 times.
2. Turn the ignition key to OFF, then press the UNLOCK button 3 times.
3. Turn the ignition key to ON, within five seconds press the LOCK button 2 times.

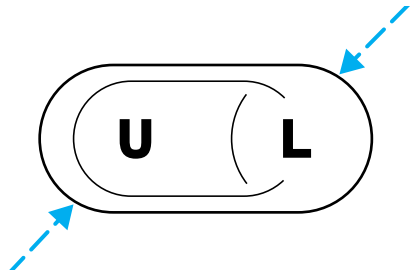

The user should receive 2 **horn chirps** to indicate the system has been disabled or 2 chirps followed by a honk to indicate the system has been enabled.

Pressing the power door LOCK button 2 times again will toggle the trim switch inhibit states.

Turn ignition to OFF to exit programming.

Locks and security

Sounding a panic alarm

Press this control to activate the alarm.

To deactivate the alarm, press the control again or turn the ignition to ACC or ON.

Panic alarm will only operate with the ignition in the OFF position.

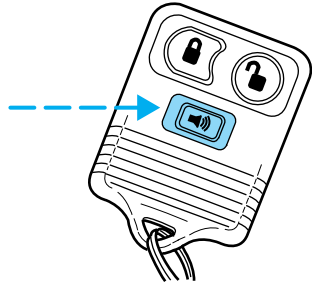

Replacing the battery

The remote transmitter is powered by one coin type three-volt lithium battery CR2032 or equivalent. Typical operating range will allow you to be up to 10 meters (33 feet) away from your vehicle. A decrease in operating range can be caused by:

- weather conditions
- nearby radio towers
- structures around the vehicle
- other vehicles parked next to the vehicle

To replace the battery:

1. Twist a thin coin between the two halves of the transmitter near the key ring. **DO NOT TAKE THE FRONT PART OF THE TRANSMITTER APART.**

2. Place the positive (+) side of new battery in the same orientation. Refer to the diagram inside the transmitter unit.

3. Snap the two halves back together.

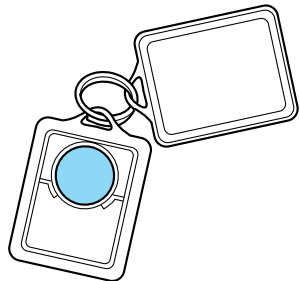

Replacement of the battery will **not** cause the remote transmitter to become deprogrammed from your vehicle. The remote transmitter should operate normally after battery replacement.

Replacing lost transmitters

If a remote transmitter has been lost and you would like to remove it from the vehicle's memory, or you would like to purchase additional remote transmitters and have them programmed to your vehicle:

- Take **all** your vehicle's transmitters to your dealer for programming, or
- Perform the programming procedure yourself

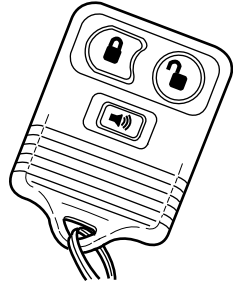

Programming remote transmitters

It is necessary to have **all** (maximum of four — original and/or new) of your remote transmitters available prior to beginning this procedure.

To program the transmitters yourself:

- Place the key in the ignition and turn from 2 (LOCK) to 3 (OFF) and cycle between 3 (OFF) and 4(ON) eight times in rapid succession (within 10 seconds) with the eighth turn ending in the 4 (ON) position. The doors will lock/unlock to confirm that programming mode has been entered.
- Within 20 seconds, program a remote transmitter by pressing any button on a transmitter. The doors will lock/unlock to confirm that the remote transmitter has been programmed. (If more than 20 seconds pass before pressing a remote transmitter button, the programming mode will exit and the procedure will have to be repeated.)
- Repeat the previous step to program additional remote transmitters. The doors will lock/unlock to confirm that each remote transmitter has been programmed.
- When you have completed programming the remote transmitters, turn the ignition to 3 (OFF). Again the doors will lock/unlock to confirm programming has been completed.

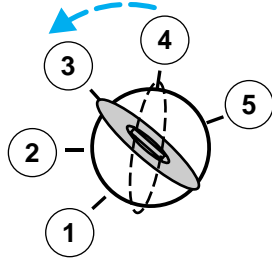

Locks and security

Illuminated entry

The illuminated entry system will turn on the interior lights when the remote transmitter unlock control is pressed.

The illuminated entry system will turn off the interior lights if the ignition switch is turned to the ON position, or if the remote transmitter lock control is pressed, or after 25 seconds of illumination.

The inside lights will not turn off if:

- they have been turned on with the dimmer control or
- any door is open

The battery save feature will turn off the interior lights 45 minutes after the last door is closed, even if the dimmer control is on.

Memory seat/mirrors/adjustable pedal feature (if equipped)

The memory feature allows automatic positioning of the driver seat, side mirrors and adjustable pedals to three programmable positions.

- To program position one, move the driver seat, both side mirrors, and adjustable pedals to the desired positions. Press the SET control. The SET control indicator light will briefly illuminate. While the light is illuminated, press control 1.
- To program position two, repeat the previous procedure using control 2.
- To program position three, repeat the previous procedure but press controls 1 and 2 simultaneously.

The memory feature also allows you to recall previously stored positions with your remote transmitter(s). Up to three remote transmitters can be activated to utilize the memory recall positions.

Press the memory feature control to move to the previously stored seat/mirror/adjustable pedal positions.

Activating/deactivating the memory feature on your remote transmitter

The memory feature from the remote transmitter can be turned off/on, however, the memory control buttons will continue to operate. Before following the procedure, make sure that the ignition is OFF and all doors and the liftgate window are closed. You must complete steps 1–7 within 30 seconds or the procedure will have to be repeated. If the procedure needs to be repeated, you must wait 30 seconds.

1. Turn the ignition key to ON.
2. Press the power door unlock control three times.
3. Turn the ignition key from ON to OFF.
4. Press the power door unlock control three times.
5. Turn the ignition back to ON. The horn will chirp.
6. Press the power door unlock control two times, then press the power lock control once. The horn will chirp twice if the memory feature was deactivated or three times (two short and one long) if the memory feature was activated.
7. Turn ignition to OFF. The horn will chirp once to confirm the procedure is complete.

Autolock (if equipped)

This feature automatically locks all vehicle doors when:

- all doors, liftgate and liftgate window are closed
- the engine is running
- you shift into any gear putting the vehicle in motion.

Relock

The autolock feature repeats when:

- any door, except the drivers, is opened then closed while the engine is running and
- you put the vehicle in motion.

Deactivating/activating the autolock feature

Before following the procedure, make sure that the ignition is OFF and all vehicle doors and the liftgate window are closed.

You must complete steps 1-7 within 30 seconds or the procedure will have to be repeated. If the procedure needs to be repeated, you must wait 30 seconds.

1. Turn the ignition key to ON.
2. Press the power door unlock control three times.
3. Turn the ignition key from ON to OFF.
4. Press the power door unlock control three times.
5. Turn the ignition back to ON. The horn will chirp.

Locks and security

6. Press the unlock control, then press the lock control. The horn will chirp once if autolock was deactivated or twice (one short and one long chirp) if autolock was activated.
7. Turn the ignition to OFF. The horn will chirp once to confirm the procedure is complete.

KEYLESS ENTRY SYSTEM

With the keyless entry keypad, you can:

- lock or unlock the vehicle doors without using the key.

Your vehicle has a factory set 5 digit code that operates the keyless entry system. You can also program your own 5 digit personal entry code. The factory-set code is located:

- on the owner's wallet card in the glove compartment
- taped to the computer module
- or at your dealer.

When pressing the controls on the keyless entry keypad, press the middle of the controls to ensure a good activation.

This system will disable the power door lock controls. These will not work until the vehicle is disarmed. Refer to *Power door locks* in the *Driver Controls* chapter for more information.

Programming your own personal entry code

To program your own code:

1. Enter factory set code (keypad will illuminate when pressed).
2. Press 1/2 control within five seconds of step 1.
3. Enter your personal 5 digit code. Enter each digit within five seconds of previous one.

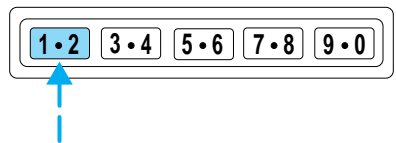

Do not set a code that includes five of the same number or presents them in sequential order. Thieves can easily figure out these types of codes.

Your personal code does not replace the permanent code that the dealership gave you. You can use either code to unlock your vehicle. If a second personal code is entered, the module will erase it in favor of the new code.

Locks and security

If you wish to erase your personal code, use the following instructions:

1. Enter factory set code.
2. Press 1/2 control within five seconds of step one.
3. Press 7/8 control and 9/0 control at the same time within five seconds of step 2.

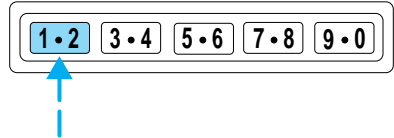

The system will now only respond to the factory set code.

Anti-scan feature

The keyless entry pad is disabled for 1 minute after 7 unsuccessful attempts at entering a valid key code. The keypad will flash during this 1 minute mode. However, the 7/8 and 9/0 controls will still lock the vehicle.

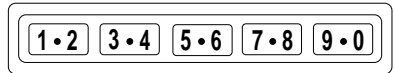

Anti-scan will be turned off after:

- one minute of keypad inactivity
- the keyfob UNLOCK button is pressed.
- the ignition is turned to the ON position

Unlocking the doors with the keyless entry system

To unlock the driver door, enter either the factory set code or the personal code (each digit must be pressed within five seconds of the prior digit). The interior lamps will also illuminate.

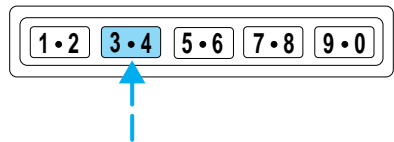

To unlock all doors, enter the factory set code or personal code (driver door unlocks) and press the 3/4 control within five seconds.

Locking the doors with the keyless entry system

It is not necessary to enter the factory or personal code prior to locking all doors. To lock the doors:

- Press the 7/8 control and the 9/0 control at the same time.

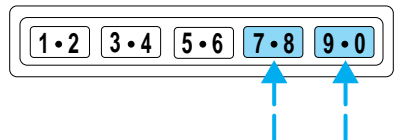

Locks and security

Activating/deactivating autolock with the keyless entry system

Before following the activation or deactivation procedures, make sure that the anti-theft system (if equipped) is not armed, ignition is off, and all vehicle doors and liftgate window are closed.

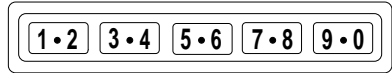

1. Enter 5 digit entry code
2. Press and hold 7/8 control
3. Press and release 3/4 control while holding 7/8 control
4. Release 7/8 control.

The horn will chirp once if autolock was deactivated or twice (one short and one long chirp) if autolock was activated.

To re-activate autolock, repeat steps 1–4.

SECURILOCK™ PASSIVE ANTI-THEFT SYSTEM

SecuriLock™ passive anti-theft system is an engine immobilization system. This system prevents the engine from being started unless a **coded key programmed to your vehicle** is used.

The SecuriLock™ passive anti-theft system is not compatible with non-Ford aftermarket remote start systems. Use of these systems may result in vehicle starting problems and a loss of security protection.

Automatic arming

The vehicle is armed immediately after switching the ignition to the 3 (OFF) position. The **THEFT** light in the instrument cluster will flash every two seconds when the vehicle is armed.

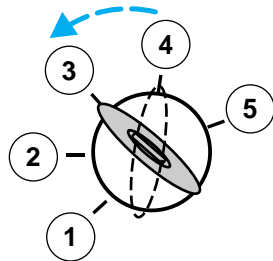

Automatic disarming

Switching the ignition to the 4 (ON) position with a **coded key** disarms the vehicle. The **THEFT** light will illuminate for three seconds and then go out. If the **THEFT** light stays on for an extended period of time or flashes rapidly, have the system serviced by your dealership or a qualified technician.

Key information

Your vehicle is supplied with **two coded keys**. Only a **coded key** will start your vehicle. Spare coded keys can be purchased from your dealership. Your dealership can program your key or you can “do it yourself”, refer to *Programming spare keys*.

Large metallic objects, electronic devices on the key chain that can be used to purchase gasoline or similar items, or a second key on the same key ring as the **coded key** may cause vehicle starting issues. If present, you need to keep these objects from touching the **coded key** while starting the engine. These objects and devices cannot damage the **coded key**, but can cause a momentary NO—START condition if they are too close to the key during engine start. If a problem occurs, turn ignition OFF and restart the engine with all other objects on the key ring held away from the ignition key. Check to make sure the **coded key** is an approved Lincoln **coded key**.

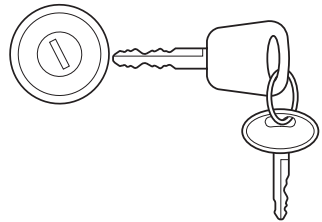
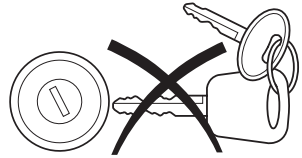
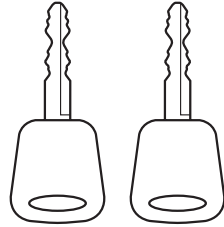

Locks and security

If your keys are lost or stolen you will need to do the following:

- Use your spare key to start the vehicle, or
- Have your vehicle towed to a dealership or locksmith. The key codes will need to be erased from your vehicle and new key codes will need to be re-coded.

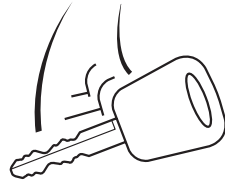

Replacing coded keys can be very costly and you may want to store an extra programmed key away from the vehicle in a safe place to prevent an unforeseen inconvenience.

The correct **coded key** must be used for your vehicle. The use of the wrong type of **coded key** may lead to a “NO-START” condition.

If an unprogrammed key is used in the ignition it will cause a “NO START” condition.

Programming spare keys

A maximum of eight keys can be coded to your vehicle. Only SecuriLock[™] keys can be used. To program a **coded key** yourself, you will need two previously programmed **coded keys** (keys that already operate your vehicle’s engine) and the new unprogrammed key(s) readily accessible for timely implementation of each step in the procedure.

If two previously programmed coded keys are not available, you must bring your vehicle to your dealership to have the spare coded key(s) programmed.

Please read and understand the entire procedure before you begin.

Locks and security

1. Insert the first previously programmed **coded key** into the ignition and turn the ignition from 3 (OFF) to 4 (ON) (maintain ignition in 4 (ON) for at least one second).

2. Turn ignition to 3 (OFF) then 2 (LOCK) and remove the first **coded key** from the ignition.

3. Within five seconds of removing the first **coded key**, insert the second previously programmed **coded key** into the ignition and turn the ignition from 3 (OFF) to 4 (ON) (maintain ignition in 4 (ON) for at least one second but no more than five seconds).

4. Turn the ignition to 3 (OFF) then 2 (LOCK) and remove the second **coded key** from the ignition.

5. Within 10 seconds of removing the second **coded key**, insert the new unprogrammed key (new key/valet key) into the ignition and turn the ignition from 3 (OFF) to 4 (ON) (maintain ignition in 4 (ON) for at least one second). This step will program your new key to a coded key.

6. To program additional new unprogrammed key(s), repeat this procedure from step 1.

If successful, the new coded key(s) will start the vehicle's engine and the theft indicator will illuminate for three seconds and then go out.

If not successful, the new coded key(s) will not start the vehicle's engine and the theft indicator will flash on and off and you may repeat steps 1 through 6. If failure repeats, bring your vehicle to your dealership to have the new spare key(s) programmed.

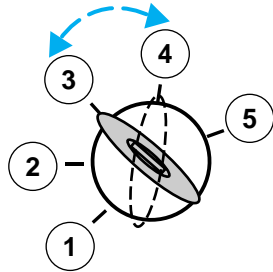

Seating and safety restraints

SEATING

Adjustable head restraints (if equipped)

Your vehicle's seats may be equipped with head restraints which are vertically adjustable. The purpose of these head restraints is to help limit head motion in the event of a rear collision. To properly adjust your head restraints, lift the head restraint so that it is located directly behind your head or as close to that position as possible. Refer to the following to raise and lower the head restraints.

The head restraints can be moved up and down.

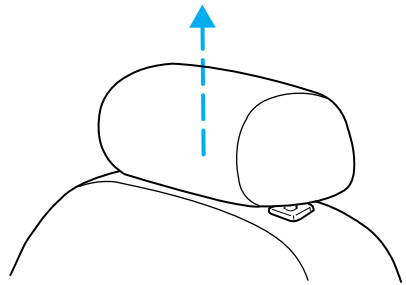

Adjusting the front manual seat



Never adjust the driver's seat or seatback when the vehicle is moving.



Do not pile cargo higher than the seatbacks to reduce the risk of injuring people in a collision or sudden stop.



Always drive and ride with your seatback upright and the lap belt snug and low across the hips.



Reclining the seatback can reduce the effectiveness of the seat's safety belt in the event of a collision.

Seating and safety restraints

Lift handle to move seat forward or backward.

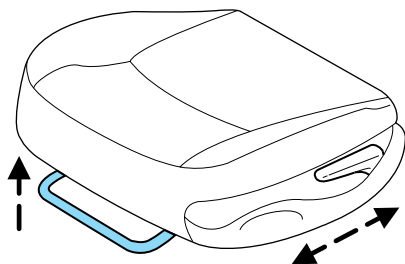

Pull lever up to adjust seatback.

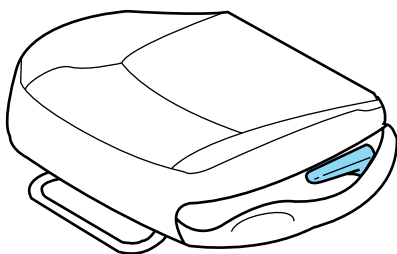

60/40 split bench seat (if equipped)

- Lift the release bar to move the seat forward or backward. Ensure the seat is retracted into place.
- Pull the seatback handle up to recline the seat.

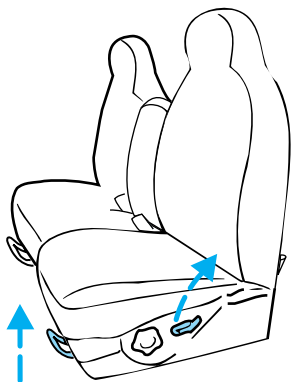

Seating and safety restraints

Using the armrest (if equipped)

Push the release control to move the armrest up or down.

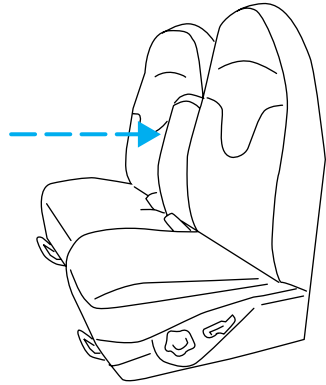

Using the manual lumbar support

Turn the lumbar support control toward the front of vehicle to move the lumbar support forward for more direct support.

Turn the lumbar support control toward the rear of vehicle to move the lumbar support back for less direct support.

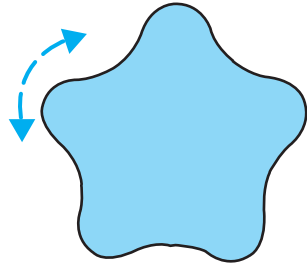

Adjusting the front power seat (if equipped)



Never adjust the driver's seat or seatback when the vehicle is moving.



Do not pile cargo higher than the seatbacks to avoid injuring people in a collision or sudden stop.



Always drive and ride with your seatback upright and the lap belt snug and low across the hips.

Seating and safety restraints



Reclining the seatback can reduce the effectiveness of the seat's safety belt in the event of a collision.

The control is located on the outboard side of the seat cushion.

Press to raise or lower the front portion of the seat cushion.

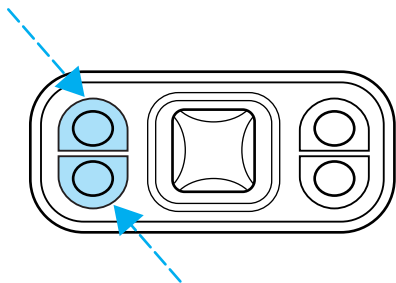

Press to raise or lower the rear portion of the seat cushion.

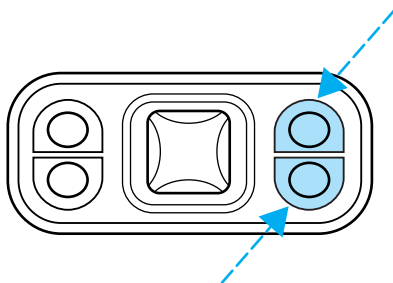

Press the control to move the seat forward, backward, up or down.

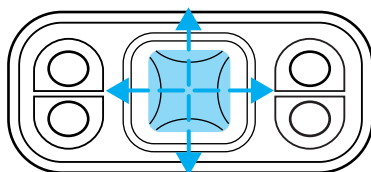

Seating and safety restraints

Memory seats/rearview mirrors/adjustable pedals (if equipped)

This system allows automatic positioning of the driver seat, outside rearview mirrors, and adjustable pedals to three programmable positions.

The memory seat control is located on the driver door.

- To program position one, move the driver seat to the desired position using the seat controls. Press the SET control. The SET control indicator light will briefly illuminate. While the light is illuminated, press control 1.
- To program position two, repeat the previous procedure using control 2.
- To program position three, repeat the previous procedure but press controls 1 and 2 simultaneously.

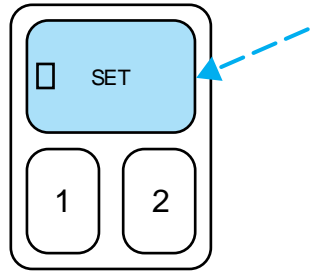

A position can only be recalled when the transmission gearshift is in Park. A memory seat position may be programmed at any time.

The memory seat positions are also recalled when you press your remote entry transmitter UNLOCK control.

To program the memory seat to remote entry transmitter, refer to *Remote entry system* in the *Locks and security* chapter.

Heated seats (if equipped)

To operate the heated seats:

- Push control to activate.
- Push again to deactivate.

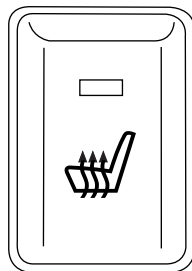

The indicator light on the control will illuminate when activated.

Seating and safety restraints

REAR SEATS

Adjustable head restraints

Your vehicle's seats may be equipped with head restraints which are vertically adjustable. The purpose of these head restraints is to help limit head motion in the event of a rear collision. To properly adjust your head restraints, lift the head restraint so that it is located directly behind your head or as close to that position as possible. Refer to the following to raise and lower the head restraints.

Push or pull the head rests to the desired position.

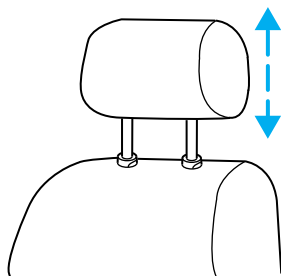

Rear folding bench seat (if equipped)

Folding down the rear seats

Ensure that the headrest is in the down position and no objects such as books, purses or briefcases are on the floor in front of the second row seats before folding them down.

Move front passenger seat forward so that the second row seat head rest clears the front seat.

1. Locate handle below the seat cushion near the bottom of the door side cushion that reads "FOLD FLAT OR RECLINE".
2. Lift the handle and push the seatback toward the front of the vehicle.

Seating and safety restraints

3. Press the green control on the seatback to release the closeout panel. Rotate the panel to closeout the space in the floor.
4. Once the second row seats are in the down position, the front seats may be readjusted.

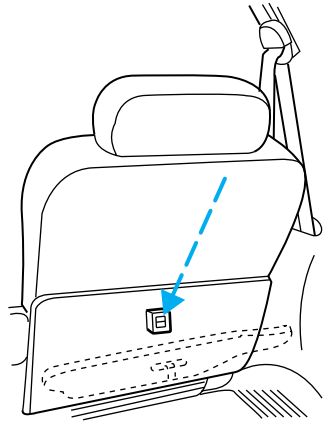

Returning the seat to upright



Always latch the vehicle seat to the floor, whether the seat is occupied or empty. If not latched, the seat may cause injury during a sudden stop.

1. Rotate the closeout panel onto the seatback and press the black control (adjacent to the green control) to lock.
2. Locate and lift the handle that reads “FOLD FLAT OR RECLINE”.
3. Pull on the seatback while lifting the handle to lift the seat into the upright position.

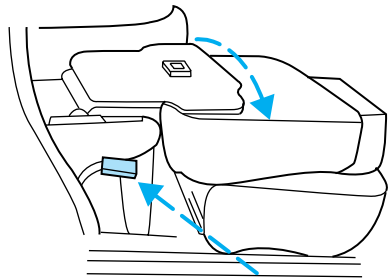

Seating and safety restraints

Reclining the seatback

Locate the lever at the bottom of the seatback that reads “FOLD FLAT OR RECLINE”. Pull the lever upwards to recline the seatback.

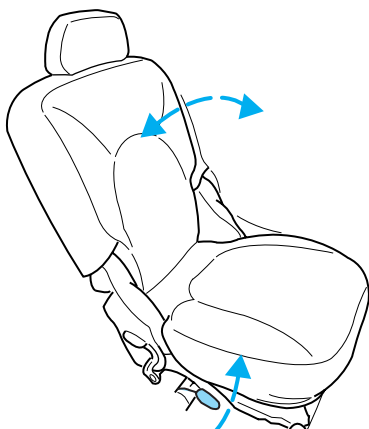

Third row seat

The third row seat is equipped with combination lap and shoulder belts in the outboard seating positions and a manual adjust tongue lap belt in the center seating position. For information on the proper operation of the safety restraints, refer to *Safety Restraints* in this chapter.

The third row seat may be removed from the vehicle for additional cargo space.

Accessing the third row seat

Your vehicle is equipped with an easy entry second row seat feature which allows ready access to the third row seat. You may enter the third row seat:

- through the passenger side rear door if your vehicle has a second row bench seat
- through either rear door if your vehicle has second row bucket seats

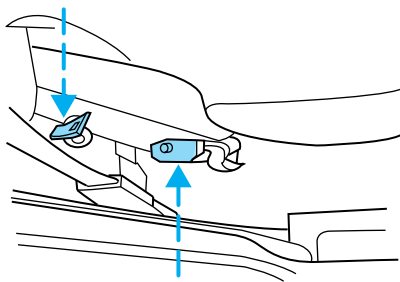

Ensure that the second row seat is in the upright position in order to achieve optimum access to the third row.

Seating and safety restraints

To minimize the risk of personal injury, the third row seat should not be left in the forward, stowed position while the vehicle is in motion. Please ensure that the seat is in the upright, fully latched position before putting the vehicle in motion.

1. Locate and lift seat control “3RD ROW ENTRY” to release seatback and cushion to flip toward the front seat.
2. After entering the seat, reverse this procedure; ensure that the latch tub and surrounding areas are clear.

Folding down the third row seat

Pull the seat release lever located on the lower right side of the seatback while pushing the seatback down into the seat cushion. The seatback will latch into place.

Pull the seat release lever to return the seatback into the upright seating position.

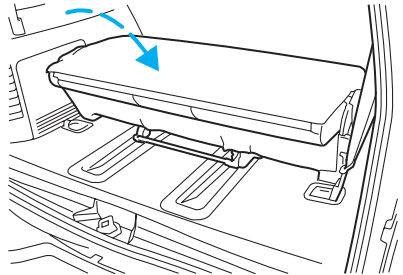

Removing the third row seat

From the rear of the vehicle, with the liftgate open:

1. Disengage the lap/shoulder belt from the floor by inserting a key or small screwdriver through the hole in the boot of the detachable anchor. Then, press the release button to separate the detachable anchor from the anchor tongue.

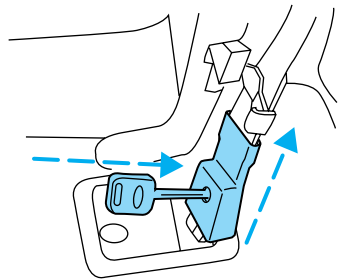

Seating and safety restraints

2. Before removing the seat, be sure that the detachable anchor tongue is stowed flat into the vehicle floor.

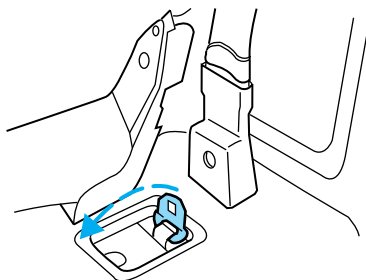

3. Use the black plastic clip (located just above the detachable anchor) to stow the loose seat belt.

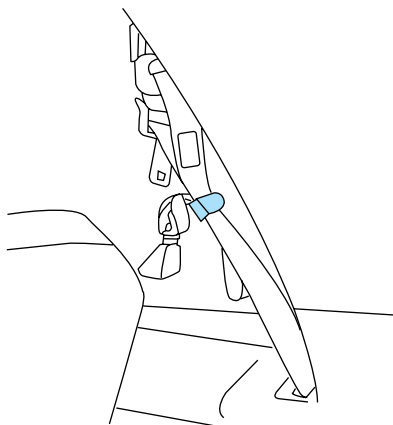

- Pull the seat release lever located on the lower right side of the seatback while pushing the seatback down into the seat cushion.
- The seatback will latch into place.

4. Lift the seat release bar located at the center of the seat near the floor to release the floor latches.

5. While pulling up on the release bar, lift the seat up and out of the floor tubs and roll seat rearward.

6. With assistance, lift the seat out of the vehicle.

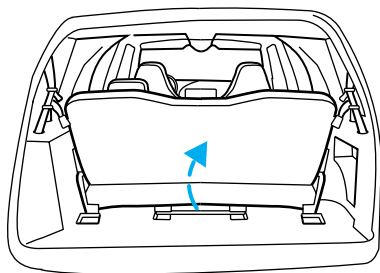

Seating and safety restraints

Installing the third row seat



Always latch the vehicle seat to the floor, whether the seat is occupied or empty. If not latched, the seat may cause injury during a sudden stop.



When reinstalling a rear seat in your vehicle it must be placed in its original position. Improper installation of the seat will prevent correct use of the safety belts and could increase the risk of injury. Refer to the warning label on the seat belt.

Before installing your third row seat, ensure that the detachable anchor tongues are stowed into the floor and the loose belts are stored out of the way. For proper latching, ensure that the floor tubs are clear of debris.

From the rear of the vehicle, with the liftgate open:

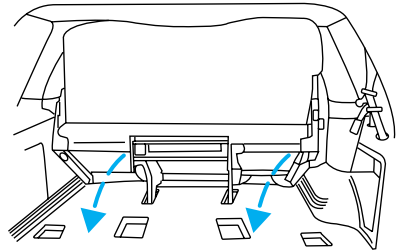

1. With assistance, lift the seat into the rear of the vehicle and position front rollers onto the track. By rolling the seat forward, guide the seat positioners over the front pins of the floor tubs.
2. Guide the positioners around each pin and lower the seat.
 - When the rear of the seat is 10–13 cm (4–5 in) above the rear pins, let the seat drop. This will ensure that the seat will properly latch into the floor.
3. Locate the seat belt anchor tongue in the plastic housing on the floor.
4. Disconnect the detachable anchor from its stowage location and connect it to the anchor tongue (making sure that the label on the detachable anchor is pointing toward the outside of the vehicle (left side) and that the belts are not twisted or jammed).

NOTE: Improper installation of the seat belt anchor will prevent correct use of the safety belt and could increase the risk or injury.

5. Insert the seat detachable anchor into detachable anchor tongue until you hear a “click” and feel the latch engage.
6. Push up on the seat to verify that it is latched into the floor.
7. Verify that the safety belts can move freely on either side of the seat.

Seating and safety restraints

3rd row tip/stow feature

The 3rd row seat has a tip/stow feature to increase cargo space without removing the seat from the vehicle.

To put seat in tip/stow position:

1. Pull the seat release lever located on the lower right side of the seatback while pushing the seatback down into the seat cushion.
2. The seatback will latch into place.

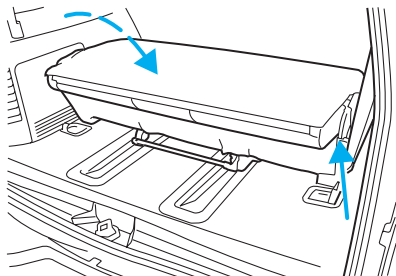

3. To release the rear floor latches of the 3rd row seat, lift the seat release bar located at the center of the seat near the floor to release the floor latches.
4. Lift back of seat up and hold.

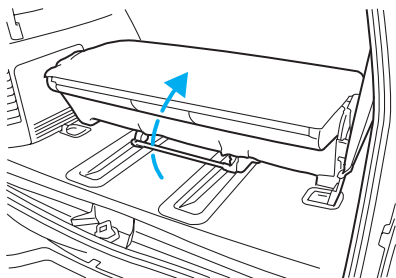

5. Lift latch up and out of floor tub to upright position using the strap on the latch.

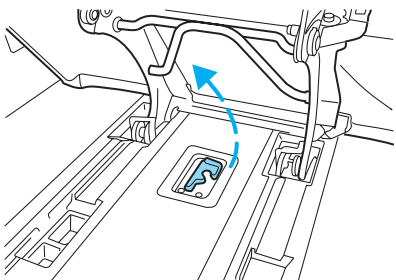

Seating and safety restraints

6. Pull down support bar and push into floor latch.

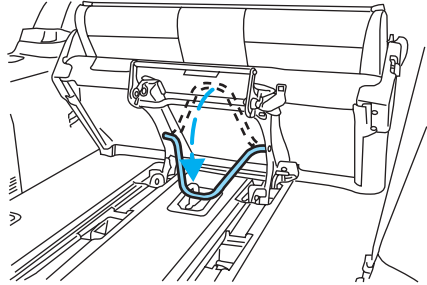

To return seat to seating position:

1. Hold seat and pull support bar from floor latch.
2. Rotate support bar up under seat.
3. Rotate floor latch down into floor tub.
4. Lower the seat. When the rear of the seat is 10–13 cm (4–5 in) above the rear pins, let the seat drop. This will ensure that the seat will properly latch into the floor.

SAFETY RESTRAINTS

Safety restraints precautions



Always drive and ride with your seatback upright and the lap belt snug and low across the hips.



To reduce the risk of injury, make sure children sit where they can be properly restrained.





Never let a passenger hold a child on his or her lap while the vehicle is moving. The passenger cannot protect the child from injury in a collision.





All occupants of the vehicle, including the driver, should always properly wear their safety belts, even when an air bag (SRS) is provided.

Seating and safety restraints

 It is extremely dangerous to ride in a cargo area, inside or outside of a vehicle. In a collision, people riding in these areas are more likely to be seriously injured or killed. Do not allow people to ride in any area of your vehicle that is not equipped with seats and safety belts. Be sure everyone in your vehicle is in a seat and using a safety belt properly.

 In a rollover crash, an unbelted person is significantly more likely to die than a person wearing a safety belt.

 Each seating position in your vehicle has a specific safety belt assembly which is made up of one buckle and one tongue that are designed to be used as a pair. 1) Use the shoulder belt on the outside shoulder only. Never wear the shoulder belt under the arm. 2) Never swing the safety belt around your neck over the inside shoulder. 3) Never use a single belt for more than one person.

 Always transport children 12 years old and under in the back seat and always properly use appropriate child restraints.

Combination lap and shoulder belts

1. Insert the belt tongue into the proper buckle (the buckle closest to the direction the tongue is coming from) until you hear a snap and feel it latch. Make sure the tongue is securely fastened in the buckle.

- Front seats

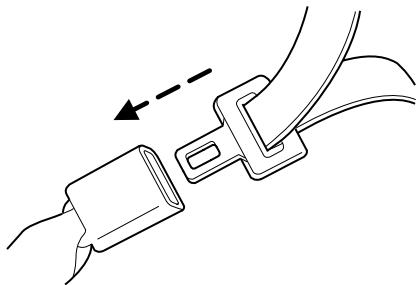

Seating and safety restraints

- Rear seats (if equipped)

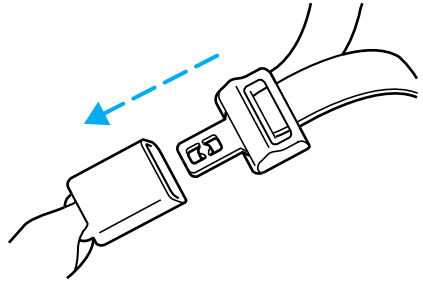

2. To unfasten, push the release button and remove the tongue from the buckle.

- Front seats

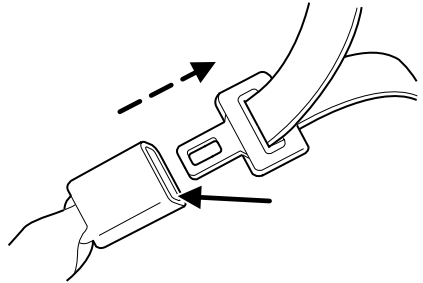

- Rear seats (if equipped)

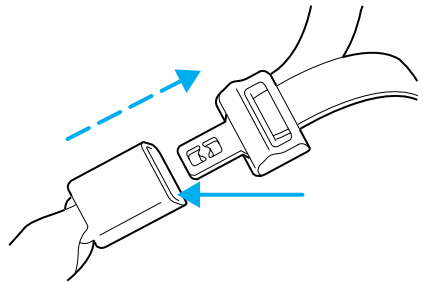

The front and rear outboard safety restraints in the vehicle are combination lap and shoulder belts. The front passenger and rear seat outboard safety belts have two types of locking modes described below:

Vehicle sensitive mode

The vehicle sensitive mode is the normal retractor mode, allowing free shoulder belt length adjustment to your movements and locking in

Seating and safety restraints

response to vehicle movement. For example, if the driver brakes suddenly or turns a corner sharply, or the vehicle receives an impact of approximately 8 km/h (5 mph) or more, the combination safety belts will lock to help reduce forward movement of the driver and passengers.

The safety belt system can also be made to lock manually by quickly pulling on the shoulder belt.

Automatic locking mode

In this mode, the shoulder belt is automatically pre-locked. The belt will still retract to remove any slack in the shoulder belt.

The automatic locking mode is not available on the driver safety belt.

When to use the automatic locking mode

- **Any time** a child safety seat is installed in a passenger front or outboard rear seating position (if equipped). Children 12 years old and under should be properly restrained in the rear seat whenever possible. Refer to *Safety Restraints for Children* or *Safety Seats for Children* later in this chapter.

How to use the automatic locking mode

1. Buckle the combination lap and shoulder belt.

- Front seats

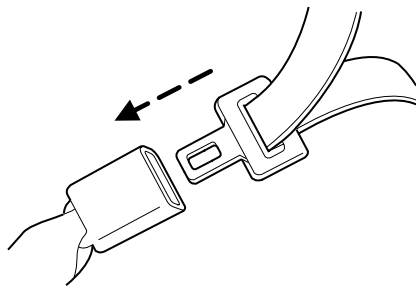

Seating and safety restraints

- Rear seats (if equipped)

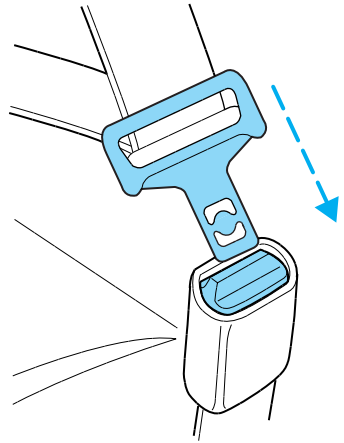

2. Grasp the shoulder portion and pull downward until the entire belt is extracted.



3. Allow the belt to retract. As the belt retracts, you will hear a clicking sound. This indicates the safety belt is now in the automatic locking mode.

How to disengage the automatic locking mode



Ford Motor Company recommends that all safety belt assemblies and attaching hardware should be inspected by a qualified technician after any collision. Safety belt assemblies not in use during a collision should also be inspected and replaced if either damage or improper operation is noted.

Seating and safety restraints

Disconnect the combination lap/shoulder belt and allow it to retract completely to disengage the automatic locking mode and activate the vehicle sensitive (emergency) locking mode.



After any vehicle collision, the front passenger outboard seat belt system must be checked by a qualified technician to verify that the “automatic locking retractor” feature for child seats is still functioning properly. In addition, all seat belts should be checked for proper function.



BELT AND RETRACTOR ASSEMBLY MUST BE REPLACED if the seat belt assembly “automatic locking retractor” feature or any other seat belt function is not operating properly when checked according to the procedures in Workshop Manual.



Failure to replace the Belt and Retractor assembly could increase the risk of injury in collisions.

Safety belt pretensioner

Your vehicle is equipped with safety belt pretensioners at the driver and front passenger seating positions.

The safety belt pretensioner is a device which removes excess webbing from the safety belt system. The safety belt pretensioner uses the same crash sensor system as the front air bag supplemental restraint system (SRS). When the safety belt pretensioner deploys, webbing from the lap and shoulder belt is tightened. The driver and front passenger seat belt system (including retractors, buckles and height adjusters) must be replaced if the vehicle is involved in a collision that results in deployment of front air bags and safety belt pretensioners. Refer to the *Safety belt maintenance* section in this chapter.



Failure to replace the safety belt assembly under the above conditions could result in severe personal injuries in the event of a collision.

Seating and safety restraints

Front and second row safety belt height adjustment

Your vehicle has safety belt height adjustments for the driver, front passenger and second row outboard passengers. Adjust the height of the shoulder belt so the belt rests across the middle of your shoulder.

To lower the shoulder belt height, push the button down and slide the height adjuster down. To raise the height of the shoulder belt, slide the height adjuster up. Pull down on the height adjuster to make sure it is locked in place.

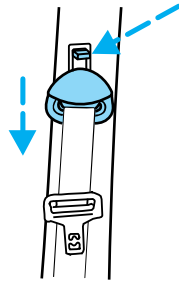

Position the shoulder belt height adjusters so that the belt rests across the middle of your shoulder. Failure to adjust the safety belt properly could reduce the effectiveness of the seat belt and increase the risk of injury in a collision.

Lap belts

Adjusting the lap belt



The lap belt should fit snugly and as low as possible around the hips, not across the waist.

Seating and safety restraints

• 1st row and 3rd row (if equipped) center seating positions

The lap belt does not adjust automatically.

Insert the tongue into the correct buckle (the buckle closest to the direction the tongue is coming from). To lengthen the belt, turn the tongue at a right angle to the belt and pull across your lap until it reaches the buckle. To tighten the belt, pull the loose end of the belt through the tongue until it fits snugly across the hips.

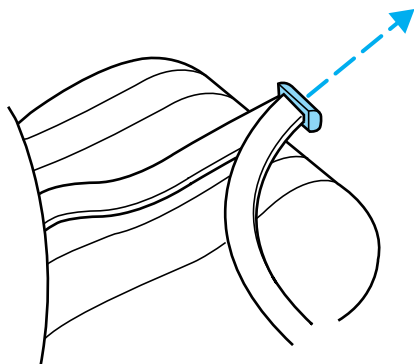

Shorten and fasten the belt when not in use.

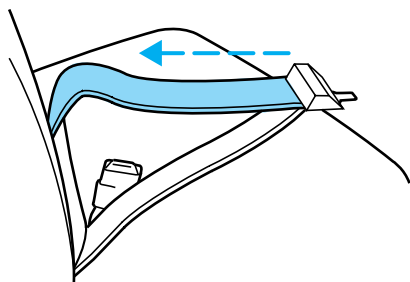

• 2nd row center seating position (if equipped)

The lap belt will adjust automatically. To fasten, grasp the tongue, and with a continuous motion, pull out enough webbing to buckle the tongue into the correct buckle. If you did not pull out enough webbing to reach the buckle, allow the tongue to retract fully before trying to pull it out again.

Safety belt warning light and indicator chime

The seat belt warning light illuminates in the instrument cluster and a chime sounds to remind the occupants to fasten their safety belts.

Seating and safety restraints

Conditions of operation

If...	Then...
The driver's safety belt is not buckled before the ignition switch is turned to the ON position...	The safety belt warning light illuminates 1-2 minutes and the warning chime sounds 4-8 seconds.
The driver's safety belt is buckled while the indicator light is illuminated and the warning chime is sounding...	The safety belt warning light and warning chime turn off.
The driver's safety belt is buckled before the ignition switch is turned to the ON position...	The safety belt warning light and indicator chime remain off.

BeltMinder (if equipped)

The BeltMinder feature is a supplemental warning to the safety belt warning function. This feature provides additional reminders to the driver that the driver's safety belt is unbuckled by intermittently sounding a chime and illuminating the safety belt warning lamp in the instrument cluster.

If...	Then...
The driver's safety belt is not buckled approximately 5 seconds after the safety belt warning light has turned off...	The BeltMinder feature is activated - the safety belt warning light illuminates and the warning chime sounds for 6 seconds every 30 seconds, repeating for approximately 5 minutes or until safety belt is buckled.
The driver's safety belt is buckled while the safety belt indicator light is illuminated and the safety belt warning chime is sounding...	The BeltMinder feature will not activate.
The driver's safety belt is buckled before the ignition switch is turned to the ON position...	The BeltMinder feature will not activate.

The purpose of the BeltMinder is to remind occasional wearers to wear safety belts all of the time.

Seating and safety restraints

The following are reasons most often given for not wearing safety belts:
(All statistics based on U.S. data)

Reasons given...	Consider...
"Crashes are rare events"	36 700 crashes occur every day. The more we drive, the more we are exposed to "rare" events, even for good drivers. <i>1 in 4 of us will be seriously injured in a crash during our lifetime.</i>
"I'm not going far"	3 of 4 fatal crashes occur within 25 miles of home.
"Belts are uncomfortable"	We design our safety belts to enhance comfort. If you are uncomfortable - try different positions for the safety belt upper anchorage and seatback which should be as upright as possible; this can improve comfort.
"I was in a hurry"	Prime time for an accident. BeltMinder reminds us to take a few seconds to buckle up.
"Seat belts don't work"	Safety belts , when used properly, reduce risk of death to front seat occupants by 45% in cars , and by 60% in light trucks .
"Traffic is light"	Nearly 1 of 2 deaths occur in single-vehicle crashes , many when no other vehicles are around.
"Belts wrinkle my clothes"	Possibly, but a serious crash can do much more than wrinkle your clothes, particularly if you are unbelted.
"The people I'm with don't wear belts"	Set the example, teen deaths occur 4 times more often in vehicles with TWO or MORE people. Children and younger brothers/sisters imitate behavior they see.
"I have an air bag"	Air bags offer greater protection when used with safety belts. Frontal airbags are not designed to inflate in rear and side crashes or rollovers.
"I'd rather be thrown clear"	Not a good idea. People who are ejected are 40 times more likely to DIE . Safety belts help prevent ejection, WE CAN'T "PICK OUR CRASH".



Do not sit on top of a buckled safety belt to avoid the Belt Minder chime. Sitting on the safety belt will increase the risk of injury in an accident. To disable (one-time) or deactivate the Belt Minder feature please follow the directions stated below.

Seating and safety restraints

One time disable

Any time the safety belt is buckled and then unbuckled during an ignition ON cycle, BeltMinder will be disabled for that ignition cycle only.

Deactivating/activating the BeltMinder feature

Read steps 1 - 9 thoroughly before proceeding with the deactivation/activation programming procedure.

The BeltMinder feature can be deactivated/activated by performing the following procedure:

Before following the procedure, make sure that:

- the parking brake is set
- the gearshift is in P (Park) (automatic transmission)
- the ignition switch is in the OFF position
- all vehicle doors are closed
- the driver's safety belt is unbuckled
- the parklamps/headlamps are in OFF position (If vehicle is equipped with Autolamps, this will not affect the procedure.)



To reduce the risk of injury, do not deactivate/activate the Belt Minder feature while driving the vehicle.

1. Turn the ignition switch to the RUN (or ON) position. (DO NOT START THE ENGINE)
2. Wait until the safety belt warning light turns off. (Approximately 1–2 minutes)
 - Steps 3–5 must be completed within 60 seconds or the procedure will have to be repeated.
3. Buckle then unbuckle the safety belt three times, ending with the safety belt unbuckled. This can be done before or during BeltMinder warning activation.
4. Turn on the parklamps/headlamps, turn off the parklamps/headlamps.
5. Buckle then unbuckle the safety belt three times, ending with the safety belt unbuckled.
 - After step 5 the safety belt warning light will be turned on for three seconds.

Seating and safety restraints

6. Within seven seconds of the safety belt warning light turning off, buckle then unbuckle the safety belt.
 - This will disable BeltMinder if it is currently enabled, or enable BeltMinder if it is currently disabled.
7. Confirmation of disabling BeltMinder is provided by flashing the safety belt warning light four times per second for three seconds.
8. Confirmation of enabling BeltMinder is provided by flashing the safety belt warning light four times per second for three seconds, followed by three seconds with the safety belt warning light off, then followed by flashing the safety belt warning light four times per second for three seconds again.
9. After receiving confirmation, the deactivation/activation procedure is complete.

Safety belt extension assembly

If the safety belt is too short when fully extended, there is a 20 cm (8 inch) safety belt extension assembly that can be added (part number 611C22). This assembly can be obtained from your dealer at no cost.

Use only extensions manufactured by the same supplier as the safety belt. Manufacturer identification is located at the end of the webbing on the label. Also, use the safety belt extension only if the safety belt is too short for you when fully extended. Do not use extensions to change the fit of the shoulder belt across the torso.

Safety belt maintenance

Inspect the safety belt systems periodically to make sure they work properly and are not damaged. Inspect the safety belts to make sure there are no nicks, tears or cuts. Replace if necessary. All safety belt assemblies, including retractors, buckles, front seat belt buckle assemblies, buckle support assemblies (slide bar-if equipped), shoulder belt height adjusters (if equipped), shoulder belt guide on seatback (if equipped), child safety seat tether bracket assemblies (if equipped), LATCH child seat tether anchors and lower anchors (if equipped), and attaching hardware, should be inspected after a collision. Ford Motor Company recommends that all safety belt assemblies used in vehicles involved in a collision be replaced. However, if the collision was minor and a qualified technician finds that the belts do not show damage and continue to operate properly, they do not need to be replaced. Safety belt assemblies not in use during a collision should also be inspected and replaced if either damage or improper operation is noted.

Seating and safety restraints



Failure to inspect and if necessary replace the safety belt assembly under the above conditions could result in severe personal injuries in the event of a collision.

Refer to *Cleaning and maintaining the safety belts* in the *Cleaning* chapter.

AIR BAG SUPPLEMENTAL RESTRAINT SYSTEM (SRS)

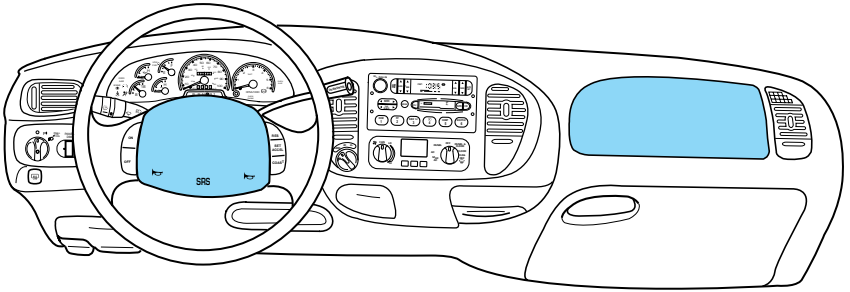

Your vehicle is equipped with a crash sensing and diagnostic module which records information about the air bag and sensor systems. In the event of a collision this module may save information related to the collision including information about the air bag system and impact severity. This information will assist Ford Motor Company in the servicing vehicle and helping to better understand real world collisions and further improve the safety of future vehicles.

Seating and safety restraints

Important supplemental restraint system (SRS) precautions

The supplemental restraint system is designed to work with the safety belt to help protect the driver and right front passenger from certain upper body injuries.

Air bags DO NOT inflate slowly or gently and the risk of injury from a deploying air bag is greatest close to the trim covering the air bag module.

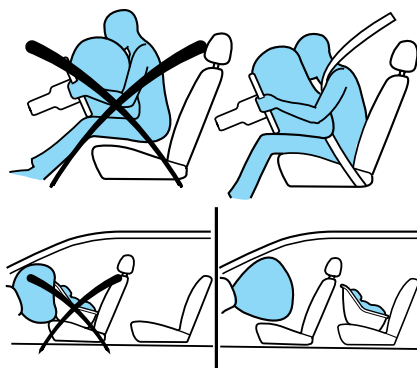

All occupants of the vehicle, including the driver, should always properly wear their safety belts, even when an air bag (SRS) is provided.



Always transport children 12 years old and under in the back seat and always properly use appropriate child restraints.



National Highway Traffic Safety Administration (NHTSA) recommends a minimum distance of at least 25 cm (10 inches) between an occupant's chest and the driver air bag module.



Never place your arm over the air bag module as a deploying air bag can result in serious arm fractures or other injuries.

Steps you can take to properly position yourself away from the air bag:

- Move your seat to the rear as far as you can while still reaching the pedals comfortably.
- Recline the seat slightly (one or two degrees) from the upright position.

Seating and safety restraints



Do not put anything on or over the air bag module. Placing objects on or over the air bag inflation area may cause those objects to be propelled by the air bag into your face and torso causing serious injury.



Do not attempt to service, repair, or modify the air bag supplemental restraint systems or its fuses. See your Ford or Lincoln Mercury dealer.



The front passenger air bag is not designed to offer protection to occupants in the center front seating position.



Modifications to the front end of the vehicle, including frame, bumper, front end body structure and tow hooks may affect the performance of the air bag sensors increasing the risk of injury. Do not modify the front end of the vehicle.



Additional equipment may affect the performance of the air bag sensors increasing the risk of injury. Please refer to the Body Builders Layout Book for instructions about the appropriate installation of additional equipment.

Seating and safety restraints

Children and air bags

For additional important safety information, read all information on safety restraints in this guide.

Children must always be properly restrained. Accident statistics suggest that children are safer when properly restrained in the rear seating positions than in the front seating position. Failure to follow these instructions may increase the risk of injury in a collision.

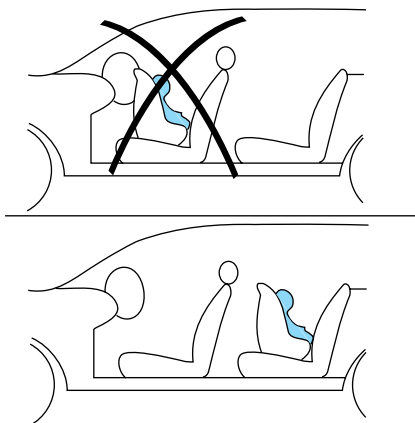

Air bags can kill or injure a child in a child seat.

NEVER place a rear-facing child seat in front of an active air bag. If you must use a forward-facing child seat in the front seat, move the seat all the way back.

How does the air bag supplemental restraint system work?

The air bag SRS is designed to activate when the vehicle sustains longitudinal deceleration sufficient to cause the sensors to close an electrical circuit that initiates air bag inflation.

The fact that the air bags did not inflate in a collision does not mean that something is wrong with the system. Rather, it means the forces were not of the type sufficient to cause activation. Air bags are designed to inflate in frontal and near-frontal collisions, not rollover, side-impact, or rear-impacts unless the collision causes sufficient longitudinal deceleration.

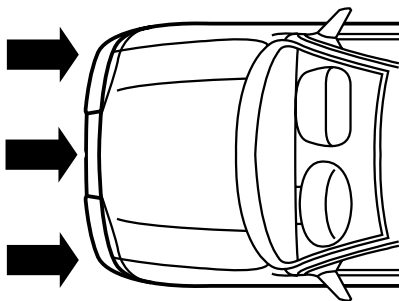

Seating and safety restraints

The air bags inflate and deflate rapidly upon activation. After air bag deployment, it is normal to notice a smoke-like, powdery residue or smell the burnt propellant. This may consist of cornstarch, talcum powder (to lubricate the bag) or sodium compounds (e.g., baking soda) that result from the combustion process that inflates the air bag. Small amounts of sodium hydroxide may be present which may irritate the skin and eyes, but none of the residue is toxic.



While the system is designed to help reduce serious injuries, contact with a deploying air bag may also cause abrasions, swelling or temporary hearing loss. Because air bags must inflate rapidly and with considerable force, there is the risk of death or serious injuries such as fractures, facial and eye injuries or internal injuries, particularly to occupants who are not properly restrained or are otherwise out of position at the time of air bag deployment. Thus, it is extremely important that occupants be properly restrained as far away from the air bag module as possible while maintaining vehicle control.



Several air bag system components get hot after inflation. Do not touch them after inflation.



If the air bag has deployed, **the air bag will not function again and must be replaced immediately.** If the air bag is not replaced, the unrepaired area will increase the risk of injury in a collision.

The SRS consists of:

- driver and passenger air bag modules (which include the inflators and air bags),
- one or more impact and safing sensors and diagnostic monitor (RCM),
- a readiness light and tone
- the electrical wiring which connects the components.

Seating and safety restraints

The RCM (restraints control module) monitors its own internal circuits and the supplemental air bag electrical system warning (including the impact sensors, the system wiring, the air bag system readiness light, the air bag back up power and the air bag ignitors).

Determining if the system is operational

The SRS uses a readiness light in the instrument cluster or a tone to indicate the condition of the system. Refer to *Air bag readiness* section in the *Instrument cluster* chapter. Routine maintenance of the air bag is not required.

A difficulty with the system is indicated by one or more of the following:

- The readiness light will either flash or stay lit.
- The readiness light will not illuminate immediately after ignition is turned on.
- A series of five beeps will be heard. The tone pattern will repeat periodically until the problem and/or light are repaired.



If any of these things happen, even intermittently, have the SRS serviced at your dealership or by a qualified technician immediately. Unless serviced, the system may not function properly in the event of a collision.

Side air bag system (if equipped)



Do not place objects or mount equipment on or near the air bag cover on the side of the seatbacks of the front seats or in front seat areas that may come into contact with a deploying air bag. Failure to follow these instructions may increase the risk of personal injury in the event of a collision.



Do not use accessory seat covers. The use of accessory seat covers may prevent the deployment of the side air bags and increase the risk of injury in an accident.



Do not lean your head on the door. The side air bag could injure you as it deploys from the side of the seatback.

Seating and safety restraints



Do not attempt to service, repair, or modify the air bag supplemental restraint system, its fuses or the seat cover on a seat containing an air bag. See your Ford or Lincoln Mercury dealer.



All occupants of the vehicle including the driver should always wear their safety belts even when an air bag SRS is provided.

How does the side air bag system work?

The side air bag system consists of the following:

- An inflatable nylon bag (air bag) with a gas generator concealed behind the outboard bolster of the driver and front passenger seatbacks.
- A special seat cover designed to allow airbag deployment.
- The same warning light, electronic control and diagnostic unit as used for the front air bags.
- Two crash sensors located under the outboard side of the front seats, attached to the floor.

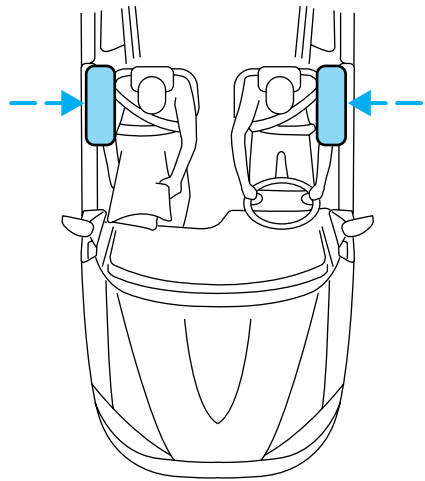

Side air bags, in combination with seat belts, can help reduce the risk of severe injuries in the event of a significant side impact collision.

The side air bags are fitted on the outboard side of the seatbacks of the front seats. In certain lateral collisions, the air bag on the side affected by the collision will be inflated, even if the respective seat is not occupied. The air bag was designed to inflate between the door panel and occupant to further enhance the protection provided occupants in side impact collisions.

The air bag SRS is designed to activate when the vehicle sustains lateral deceleration sufficient to cause the sensors to close an electrical circuit that initiates air bag inflation.

Seating and safety restraints

The fact that the air bags did not inflate in a collision does not mean that something is wrong with the system. Rather, it means the forces were not of the type sufficient to cause activation. Side air bags are designed to inflate in side-impact collisions, not roll-over, rear-impact, frontal or near-frontal collisions, unless the collision causes sufficient lateral deceleration.



Several air bag system components get hot after inflation. Do not touch them after inflation.



If the side air bag has deployed, **the air bag will not function again. The side air bag system (including the seat) must be inspected and serviced by a qualified technician in accordance with the vehicle service manual.** If the air bag is not replaced, the unrepaired area will increase the risk of injury in a collision.

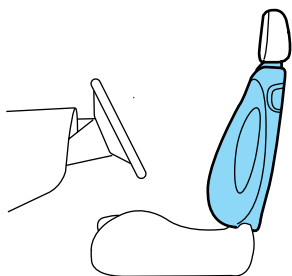

Determining if the system is operational

The SRS uses a readiness light in the instrument cluster or a tone to indicate the condition of the system. Refer to the *Air bag readiness* section in the *Instrumentation* chapter. Routine maintenance of the side air bag is not required.

A difficulty with the system is indicated by one or more of the following:

- The readiness light (same light as for front air bag system) will either flash or stay lit.
- The readiness light will not illuminate immediately after ignition is turned on.
- A series of five beeps will be heard. The tone pattern will repeat periodically until the problem and light are repaired.

If any of these things happen, even intermittently, have the SRS serviced at your dealership or by a qualified technician immediately. Unless serviced, the system may not function properly in the event of a collision.

Seating and safety restraints

Disposal of air bags and air bag equipped vehicles (including pretensioners)

For disposal of air bags or air bag equipped vehicles, see your local dealership or qualified technician. Air bags **MUST BE** disposed of by qualified personnel.

SAFETY RESTRAINTS FOR CHILDREN

See the following sections for directions on how to properly use safety restraints for children. Also see *Air bag supplemental restraint system (SRS)* in this chapter for special instructions about using air bags.

Important child restraint precautions

You are required by law to use safety restraints for children in the U.S. and Canada. If small children ride in your vehicle (generally children who are four years old or younger and who weigh 18 kg [40 lbs] or less), you must put them in safety seats made especially for children. Check your local and state or provincial laws for specific requirements regarding the safety of children in your vehicle.



Never let a passenger hold a child on his or her lap while the vehicle is moving. The passenger cannot protect the child from injury in a collision.

Always follow the instructions and warnings that come with any infant or child restraint you might use.

When possible, always place children under age 12 in the rear seat of your vehicle. Accident statistics suggest that children are safer when properly restrained in the rear seating positions than in the front seating position.

Children and safety belts

If the child is the proper size, restrain the child in a safety seat.

Children who are too large for child safety seats (as specified by your child safety seat manufacturer) should always wear safety belts.

Follow all the important safety restraint and air bag precautions that apply to adult passengers in your vehicle.

If the shoulder belt portion of a combination lap and shoulder belt can be positioned so it does not cross or rest in front of the child's face or neck, the child should wear the lap and shoulder belt. Moving the child closer to the center of the vehicle may help provide a good shoulder belt fit.

Seating and safety restraints



Do not leave children, unreliable adults, or pets unattended in your vehicle.

To improve the fit of lap and shoulder belts on children who have outgrown child safety seats, Ford recommends use of a belt-positioning booster seat that is labelled as conforming to all applicable Federal motor vehicle safety standards. Belt-positioning booster seats raise the child and provide a shorter, firmer seating cushion that encourages safer seating posture and better fit of lap and shoulder belts on the child.

A belt-positioning booster seat should be used if the shoulder belt rests in front of the child's face or neck, or if the lap belt does not fit snugly on both thighs, or if the thighs are too short to let the child sit all the way back on the seat cushion when the lower legs hang over the edge of the seat cushion. You may wish to discuss the special needs of your child with your pediatrician.

SAFETY SEATS FOR CHILDREN



Child and infant or child safety seats

Use a safety seat that is recommended for the size and weight of the child. Carefully follow all of the manufacturer's instructions with the safety seat you put in your vehicle. If you do not install and use the safety seat properly, the child may be injured in a sudden stop or collision.

Seating and safety restraints

When installing a child safety seat:

- Review and follow the information presented in the *Air Bag Supplemental Restraint System (SRS)* section in this chapter.
- Use the correct safety belt buckle for that seating position (the buckle closest to the direction the tongue is coming from).
- Insert the belt tongue into the proper buckle until you hear a snap and feel it latch. Make sure the tongue is securely fastened in the buckle.
- Keep the buckle release button pointing up and away from the safety seat, with the tongue between the child seat and the release button, to prevent accidental unbuckling.
- Place seat back in upright position.
- Put the safety belt in the automatic locking mode. Refer to *Automatic locking mode* (passenger side front and outboard rear seating positions) (if equipped) section in this chapter.

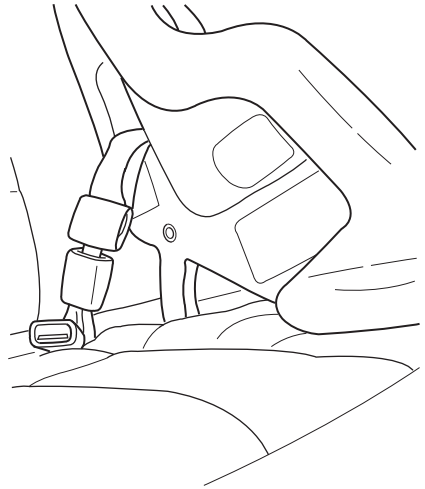

Ford recommends the use of a child safety seat having a top tether strap. Install the child safety seat in a seating position which is capable of providing a tether anchorage. For more information on top tether straps, refer to *Attaching child safety seats with tether straps*. in this chapter.



Carefully follow all of the manufacturer's instructions included with the safety seat you put in your vehicle. If you do not install and use the safety seat properly, the child may be injured in a sudden stop or collision.

Seating and safety restraints

Installing child safety seats in combination lap and shoulder belt seating positions



Air bags can kill or injure a child in a child seat. **NEVER** place a rear-facing child seat in front of an active air bag. If you must use a forward-facing child seat in the front seat, move the seat all the way back.

1. Position the child safety seat in a seat with a combination lap and shoulder belt.

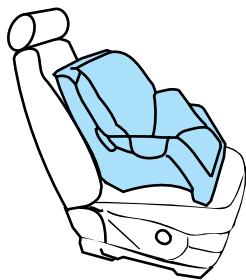

Children 12 and under should be properly restrained in the rear seat whenever possible.

2. Pull down on the shoulder belt and then grasp the shoulder belt and lap belt together.

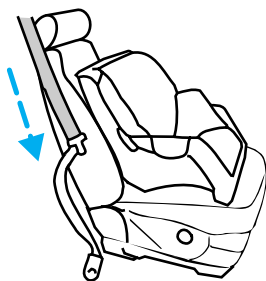

Seating and safety restraints

3. While holding the shoulder and lap belt portions together, route the tongue through the child seat according to the child seat manufacturer's instructions. Be sure the belt webbing is not twisted.

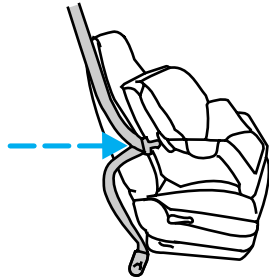

4. Insert the belt tongue into the proper buckle (the buckle closest to the direction the tongue is coming from) for that seating position until you hear a snap and feel the latch engage. Make sure the tongue is latched securely by pulling on it.

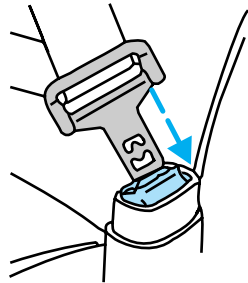

5. To put the retractor in the automatic locking mode, grasp the shoulder portion of the belt and pull downward until all of the belt is extracted and a click is heard.

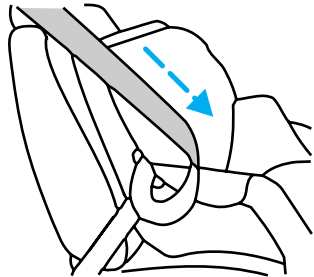

6. Allow the belt to retract. The belt will click as it retracts to indicate it is in the automatic locking mode.

Seating and safety restraints

7. Pull the lap belt portion across the child seat toward the buckle and pull up on the shoulder belt while pushing down with your knee on the child seat.

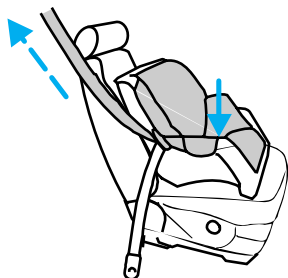

8. Allow the safety belt to retract to remove any slack in the belt.

9. Before placing the child in the seat, forcibly tilt the seat forward and back to make sure the seat is securely held in place. To check this, grab the seat at the belt path and attempt to move it side to side and forward and back. There should be no more than one inch of movement for proper installation.

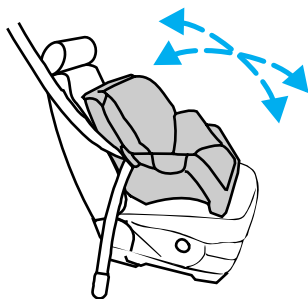

10. Try to pull the belt out of the retractor to make sure the retractor is in the automatic locking mode (you should not be able to pull more belt out). If the retractor is not locked, unbuckle the belt and repeat steps two through nine.

Check to make sure the child seat is properly secured before each use.

Installing child safety seat in the second row center seating position with an automatic locking retractor

1. Place the child safety seat in the center seating position.
2. In a continuous motion, pull out enough webbing from the retractor to route the tongue through the child seat.
3. While holding the webbing to prevent it from retracting, route the webbing through the child seat according to the child seat manufacturer's instructions. Be sure the belt webbing is not twisted.
4. Insert the tongue into the correct buckle for that seating position until you hear and feel the buckle engage. Make sure the buckle is latched securely by pulling on the webbing.

Seating and safety restraints

5. If you have not pulled out enough webbing to reach, allow the webbing to fully retract before attempting to pull it out again and repeat steps 2 through 4.
6. Pull the webbing through the child seat toward the buckle while pushing down with your knee on the child seat.
7. Allow the safety belt to retract to remove any slack in the belt. It will make a clicking noise while doing this.
8. Before placing the child in the seat, forcibly tilt the seat forward and back to make sure the seat is securely held in place.
9. Check to make sure the child seat is properly secured before each use.

Installing child safety seat in the third row center seating position (if equipped)

1. Place the child safety seat in the center seating position.
2. Route the tongue end through the child seat according to the child seat manufacturers instructions. If the tongue will not reach the buckle, lengthen the amount of belt by turning the tongue at a right angle to the belt and pulling on it until it reaches the buckle. Be sure the belt webbing is not twisted.
3. Insert the tongue into the correct buckle for that seating position (buckle closest to the direction the tongue is coming from) until you hear and feel the buckle engage. To tighten the belt, pull the loose end of the belt through the tongue until all the slack is removed from the belt. Make sure the buckle is latched securely by pulling on the webbing.
4. Before placing the child in the seat, forcibly tilt the seat forward and back to make sure the seat is securely held in place.
5. Check to make sure the child seat is properly secured before each use.

Attaching safety seats with tether straps

Most forward-facing child safety seats include a tether strap which goes over the back of the set and hooks to an anchoring point. Tether straps are available as an accessory for many older safety seats. Contact the manufacturer of your child safety seat for information about ordering a tether strap.

Seating and safety restraints

Tether anchorage hardware

All second row and one third row seating position have a fabric strap installed near the bottom of the rear face of the seatback. These straps have a loop at the top, and are to be used for child seat tether anchorages.

A tethered seat can be installed in the front passenger seat. Put the tether strap over the seatback and attach it to an anchor bracket.

Anchor brackets can be bolted to the rear edge of the front passenger seat cushion. The bolt holes are in the bottom of the rear edge of the front passenger seat cushion frame. The anchor bracket must be installed using the instructions provided with the kit.

Tether anchorage hardware kits (part number 613D74) including instructions, may be obtained at no charge from any Ford or Lincoln/Mercury dealer.



Tighten the anchor according to specifications. Otherwise, the safety seat may not be properly secured and the child may be injured in a sudden stop or collision.

Attaching child safety seats with tether straps

Most new forward-facing child safety seats include a tether strap which goes over the back of the seat and hooks to an anchoring point. Tether straps are available as an accessory for many older safety seats. Contact the manufacturer of your child seat for information about ordering a tether strap.

The rear seats of your vehicle are equipped with built-in tether strap anchors located behind the seats as described below.

The tether anchors in your vehicle are straps on the seatback.

Seating and safety restraints

The tether strap anchors in your vehicle are in the following positions (shown from top view):

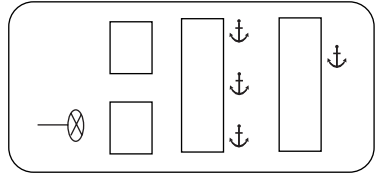

Attach the tether strap only to the appropriate tether anchor as shown. The tether strap may not work properly if attached somewhere other than the correct tether anchor.

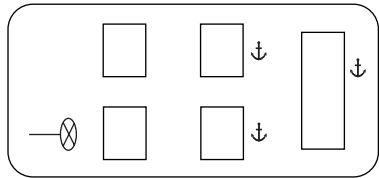

1. Position the child safety seat on the seat cushion.
2. Route the child safety seat tether strap over the back of the seat.

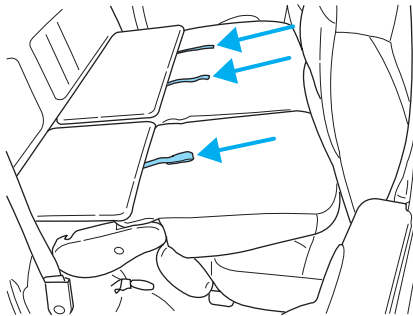

3. Locate the correct anchor for the selected seating position. (Shown with the seats folded down.)

Seating and safety restraints

- You may need to pull the seatback forward to access the tether anchors. Make sure the seat is locked in the upright position before installing the child seat. Refer to the *Folding Down The Rear Seats* section in this chapter for information on how to operate the rear seats.

4. Clip the tether strap to the anchor as shown.

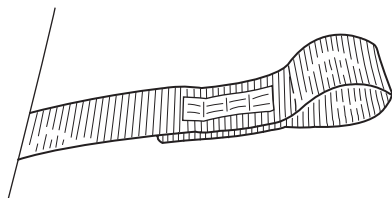

If the tether strap is clipped incorrectly, the child safety seat may not be retained properly in the event of a collision.

5. Refer to the *Installing child safety seats in combination lap and shoulder belt seating positions* section of this chapter for further instructions to secure the child safety seat.

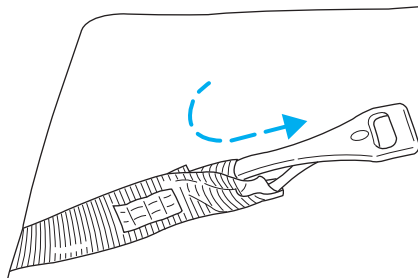

6. Tighten the child safety seat tether strap according to the manufacturer's instructions.



If the safety seat is not anchored properly, the risk of a child being injured in a collision greatly increases.

Driving

STARTING

Positions of the ignition

1. ACCESSORY, allows the electrical accessories such as the radio to operate while the engine is not running.
2. LOCK, locks the steering wheel, automatic transmission gearshift lever and allows key removal.
3. OFF, shuts off the engine and all accessories without locking the steering wheel.
4. ON, all electrical circuits operational. Warning lights illuminated. Key position when driving.
5. START, cranks the engine. Release the key as soon as the engine starts.

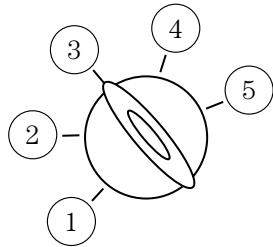

Preparing to start your vehicle

Engine starting is controlled by the powertrain control system. This system meets all Canadian Interference-Causing Equipment standard requirements regulating the impulse electrical field strength of radio noise.

When starting a fuel-injected engine, avoid pressing the accelerator before or during starting. Only use the accelerator when you have difficulty starting the engine. For more information on starting the vehicle, refer to *Starting the engine* in this chapter.



Extended idling at high engine speeds can produce very high temperatures in the engine and exhaust system, creating the risk of fire or other damage.



Do not park, idle, or drive your vehicle in dry grass or other dry ground cover. The emission system heats up the engine compartment and exhaust system, which can start a fire.



Do not start your vehicle in a closed garage or in other enclosed areas. Exhaust fumes can be toxic. Always open the garage door before you start the engine. See *Guarding against exhaust fumes* in this chapter for more instructions.



If you smell exhaust fumes inside your vehicle, have your dealer inspect your vehicle immediately. Do not drive if you smell exhaust fumes.

Important safety precautions

A computer system controls the engine's idle revolutions per minute (RPM). When the engine starts, the idle RPM runs faster to warm the engine. If the engine idle speed does not slow down automatically, have the vehicle checked. Do not allow the vehicle to idle for more than 10 minutes at the higher engine RPM.

Before starting the vehicle:

1. Make sure all vehicle occupants have buckled their safety belts. For more information on safety belts and their proper usage, refer to the *Seating and safety restraints* chapter.
2. Make sure the headlamps and vehicle accessories are off.
3. Make sure the gearshift is in P (Park).



Driving

4. Make sure the parking brake is set.

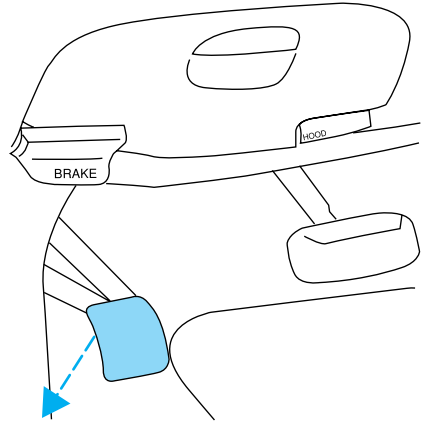

5. Turn the key to 4 (ON) without turning the key to 5 (START).

If there is difficulty in turning the key, firmly rotate the steering wheel left and right until the key turns freely. This condition may occur when:

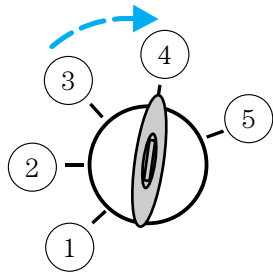

- front wheels are turned
- front wheel is against the curb
- steering wheel is turned when getting in or out of the vehicle

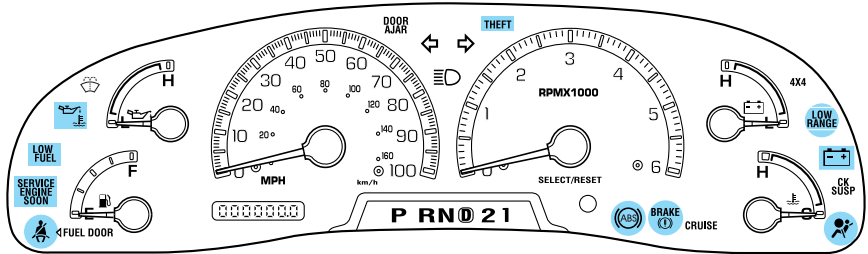

Make sure the corresponding lights illuminate or illuminate briefly. If a light fails to illuminate, have the vehicle serviced.

- If the driver's safety belt is fastened, the  light may not illuminate.

Starting the engine

Note: Whenever you start your vehicle, release the key as soon as the engine starts. Excessive cranking could damage the starter.

1. Turn the key to 5 (START) without pressing the accelerator pedal and release as soon as the engine starts. The key will return to 4 (ON).

2. If the temperature is above -12°C (10°F) and the engine does not start within five seconds on the first try, turn the key to OFF, wait 10 seconds and try again.

3. If the temperature is below -12°C (10°F) and the engine does not start in 15 seconds on the first try, turn the key OFF and wait 10 seconds and try again. If the engine does not start in two attempts, press the accelerator pedal all the way to floor and hold. Turn the key to START position.

4. When the engine starts, release the key, then release the accelerator pedal gradually as the engine speeds up.

5. After idling for a few seconds, apply the brake and release the parking brake.

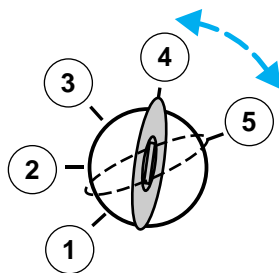

Using the engine block heater (if equipped)

An engine block heater warms the engine coolant, which improves starting, warms up the engine faster and allows the heater-defroster system to respond quickly. Use of an engine block heater is strongly recommended if you live in a region where temperatures reach -23°C (-10°F) or below.

For best results, plug the heater in at least three hours before starting the vehicle. Using the heater for longer than three hours will not harm the engine, so the heater can be plugged in the night before starting the vehicle.



To prevent electrical shock, do not use your heater with ungrounded electrical systems or two-pronged (cheater) adapters.

Driving

Guarding against exhaust fumes

Although odorless and colorless, carbon monoxide is present in exhaust fumes. Take precautions to avoid its dangerous effects.



If you ever smell exhaust fumes of any kind inside your vehicle, have your dealer inspect and fix your vehicle immediately. Do not drive if you smell exhaust fumes. These fumes are harmful and could kill you.

Have the exhaust and body ventilation systems checked whenever:

- the vehicle is raised for service
- the sound of the exhaust system changes
- the vehicle has been damaged in a collision



WARNING: Engine exhaust, some of its constituents, and certain vehicle components contain or emit chemicals known to the State of California to cause cancer and birth defects or other reproductive harm. In addition, certain fluids contained in vehicles and certain products of component wear contain or emit chemicals known to the State of California to cause cancer and birth defects or other reproductive harm.

Important ventilating information

If the engine is idling while the vehicle is stopped in an open area for long periods of time, open the windows at least 2.5 cm (one inch).

Adjust the heating or air conditioning (if equipped) to bring in fresh air.

Improve vehicle ventilation by keeping all air inlet vents clear of snow, leaves and other debris.

BRAKES

Your service brakes are self-adjusting. Refer to the scheduled maintenance guide for scheduled maintenance.

Occasional brake noise is normal and often does not indicate a performance concern with the vehicle's brake system. In normal operation, automotive brake systems may emit occasional or intermittent squeal or groan noises when the brakes are applied. Such noises are usually heard during the first few brake applications in the morning; however, they may be heard at any time while braking and can be aggravated by

environmental conditions such as cold, heat, moisture, road dust, salt or mud. If a “metal-to-metal,” “continuous grinding” or “continuous squeal” sound is present while braking, the brake linings may be worn-out and should be inspected by a qualified service technician.

Anti-lock brake system (ABS)

On vehicles equipped with an anti-lock braking system (ABS), a noise from the hydraulic pump motor and pulsation in the pedal may be observed during ABS braking events. Pedal pulsation coupled with noise while braking under panic conditions or on loose gravel, bumps, wet or snowy roads is normal and indicates proper functioning of the vehicle’s anti-lock brake system. The ABS performs a self-check after you start the engine and begin to drive away. A brief mechanical noise may be heard during this test. This is normal. If a malfunction is found, the ABS warning light will come on. If the vehicle has continuous vibration or shudder in the steering wheel while braking, the vehicle should be inspected by a qualified service technician.

The ABS operates by detecting the onset of wheel lockup during brake applications and compensates for this tendency. The wheels are prevented from locking even when the brakes are firmly applied. The accompanying illustration depicts the advantage of an ABS equipped vehicle (on bottom) to a non-ABS equipped vehicle (on top) during hard braking with loss of front braking traction.

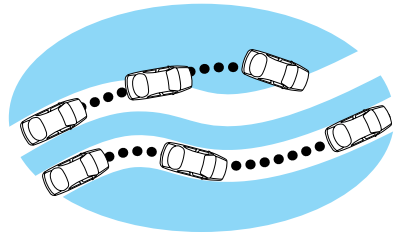

Using ABS

- In an emergency or when maximum efficiency from the four-wheel ABS is required, apply continuous force on the brake. The four wheel ABS will be activated immediately, thus allowing you to retain full steering control of your vehicle and, providing there is sufficient space, will enable you to avoid obstacles and bring the vehicle to a controlled stop.
- The anti-lock system does not decrease the time necessary to apply the brakes or always reduce stopping distance. Always leave enough room between your vehicle and the vehicle in front of you to stop.
- We recommend that you familiarize yourself with this braking technique. However, avoid taking any unnecessary risks.

Driving

ABS warning lamp (ABS)

The (ABS) warning lamp in the instrument cluster momentarily illuminates when the ignition is turned to the ON position. If the light does not illuminate momentarily at start up, remains on or continues to flash, the ABS needs to be serviced.

With the ABS light on, the anti-lock brake system is disabled and normal braking is still effective unless the brake warning light also remains illuminated with parking brake released. (If your brake warning lamp illuminates, have your vehicle serviced immediately.)

BRAKE
(!)

Parking brake (P)

Apply the parking brake whenever the vehicle is parked. To set the parking brake, press the parking brake pedal down until the pedal stops.

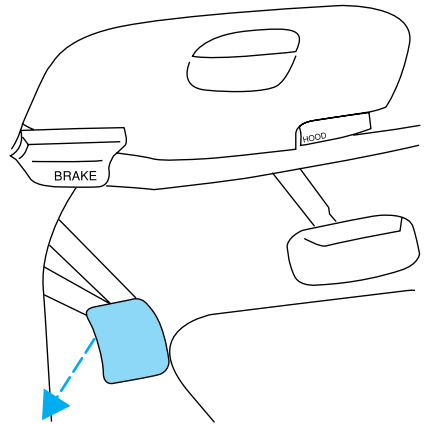

BRAKE
(!)

The BRAKE warning lamp in the instrument cluster illuminates and remains illuminated (when the ignition is turned ON) until the parking brake is released.



Always set the parking brake fully and make sure that the gearshift is securely latched in P (Park).

The parking brake is not recommended to stop a moving vehicle. However, if the normal brakes fail, the parking brake can be used to stop your vehicle in an emergency. Since the parking brake applies only the rear brakes, the vehicle's stopping distance will increase greatly and the handling of your vehicle will be adversely affected.

Pull the release lever to release the brake. Driving with the parking brake on will cause the brakes to wear out quickly and reduce fuel economy.

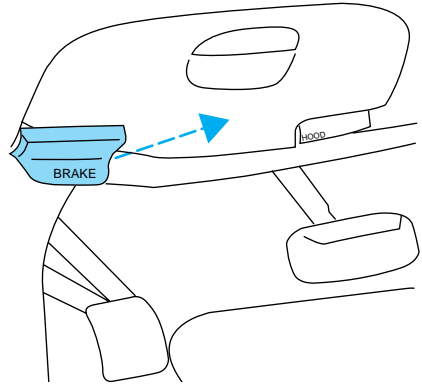

STEERING

Your vehicle is equipped with power steering. Power steering uses energy from the engine to help steer the vehicle.

To prevent damage to the power steering pump:

- Never hold the steering wheel to the extreme right or the extreme left for more than a few seconds when the engine is running.
- Do not operate the vehicle with a low power steering pump fluid level (below the MIN mark on the reservoir).

If the power steering system breaks down (or if the engine is turned off), you can steer the vehicle manually, but it takes more effort.

If the steering wanders or pulls, the condition could be caused by any of the following:

- underinflated tire(s) on any wheel(s)
- uneven vehicle loading
- high crown in center of road
- high crosswinds
- wheels out of alignment
- loose or worn suspension components

Driving

Speed sensitive steering

The steering in your vehicle is speed sensitive. At high speeds, steering assist will decrease to improve steering feel.

If the amount of effort required to steer your vehicle changes while driving at a constant vehicle speed, have the power steering system checked by your dealer or a qualified service technician.

AIR SUSPENSION SYSTEM (IF EQUIPPED)

The air suspension system is designed to improve ride, handling and general vehicle performance for static, on and off-road driving conditions.

- The load leveling feature of the air suspension automatically keeps the vehicle at a constant level if a load is added or removed from the vehicle.
- The height adjustment feature automatically controls the vehicle height over a range of approximately 5 cm (2 inches) based on vehicle speed, ignition position and selection of two or four-wheel drive modes.
- The air suspension automatically puts the vehicle at its lowest height when ignition is OFF to provide easy entry and exit. Whenever a door is opened (including the liftgate) the system memorizes and maintains the height of the vehicle until all doors are closed or until vehicle exceeds 16 km/h (10 mph).
- The air suspension system raises the vehicle to its normal ride position when the ignition is turned on, all doors are closed and the transmission is shifted into gear.
- In 4WD Low the air suspension system will not move to its lowest height. In 4WD Low, the air suspension system raises the vehicle above the normal ride height at speeds below 40 km/h (25 mph) to improve ground clearance. In 4WD Low, do not exceed 56 km/h (35 mph).
- When the vehicle is in motion, the air suspension system will adjust the vehicle's height according to ground clearance and speed to maximize ride comfort.
- It is normal to occasionally hear a buzz or clicking from the vehicle's air suspension system when the ignition is turned off. The system stays energized for 40 minutes after the ignition is turned off to compensate for any load changes made after the vehicle is parked.

The air suspension shut-off switch is located behind an access panel underneath the passenger side instrument panel.

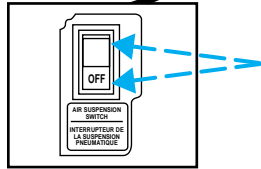
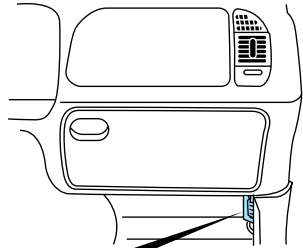

 On vehicles equipped with Air Suspension, turn OFF the Air Suspension switch prior to jacking, hoisting or towing your vehicle.

Normal vehicle operation does not require any action by the driver.

Check air suspension indicator light

The warning and indicator light CK SUSP illuminates when the air suspension switch is turned off or an air suspension system fault has been detected.

If the light is illuminated while driving and the air suspension system switch is not turned off, safely pull off the road at your earliest convenience. Turn the ignition switch from 4 (On) to 3 (Off) and 4 (On) again. If the warning light illuminates again, turn the air suspension switch off and have the vehicle serviced by a dealer or qualified service technician.

If the vehicle is loaded beyond the recommended maximum payload, the CK SUSP light may illuminate. To correct this condition, remove or redistribute the payload according to the recommended requirements and follow the procedure outlined above.

TRACTION-LOK AXLE (IF EQUIPPED)

This axle provides added traction on slippery surfaces, particularly when one wheel is on a poor traction surface. Under normal conditions, the Traction-Lok axle functions like a standard rear axle.

Extended use of other than the manufacturer's specified size tires on a Traction-Lok rear axle could result in a permanent reduction in effectiveness. This loss of effectiveness does not affect normal driving and should not be noticeable to the driver.

Driving



To avoid injury, never run the engine with one wheel off the ground, such as when changing a tire.

PREPARING TO DRIVE YOUR VEHICLE



Utility vehicles have a significantly higher rollover rate than other types of vehicles.



In a rollover crash, an unbelted person is significantly more likely to die than a person wearing a seat belt.

Your vehicle has special design and equipment features to make it capable of performing in a wide variety of circumstances. These special design features, such as larger tires and increased ground clearance, give the vehicle a higher center of gravity than a passenger car.



Vehicles with a higher center of gravity such as utility and four-wheel drive vehicles handle differently than vehicles with a lower center of gravity. Utility and four-wheel drive vehicles are **not** designed for cornering at speeds as high as passenger cars any more than low-slung sports cars are designed to perform satisfactorily under off-road conditions. Avoid sharp turns, excessive speed and abrupt maneuvers in these vehicles. Failure to drive cautiously could result in an increased risk of vehicle rollover, personal injury and death.



Loaded vehicles, with a higher center of gravity, may handle differently than unloaded vehicles. Extra precautions, such as slower speeds and increased stopping distance, should be taken when driving a heavily loaded vehicle.

Your vehicle has the capability to haul more cargo and people than most passenger cars. Depending upon the type and placement of the load, hauling people and cargo may raise the center of gravity of the vehicle. Use extra caution while becoming familiar with your vehicle. Know the capabilities and limitations of both you as a driver and your vehicle.

AUTOMATIC TRANSMISSION OPERATION

Brake-shift interlock

This vehicle is equipped with a brake-shift interlock feature that prevents the gearshift lever from being moved from P (Park) when the ignition is in the ON position unless brake pedal is depressed.

If you cannot move the gearshift lever out of P (Park) with ignition in the ON position and the brake pedal depressed:

1. Apply the parking brake, turn ignition key to LOCK, then remove the key.
2. Insert the key and turn it to OFF. **Apply the brake pedal and shift to N (Neutral).**
3. Start the vehicle.

If it is necessary to use the above procedure to move the gearshift lever, it is possible that a fuse has blown or the vehicle's brakelamps are not operating properly. Refer to *Fuses and relays* in the *Roadside emergencies* chapter.



Do not drive your vehicle until you verify that the brakelamps are working.

If your vehicle gets stuck in mud or snow it may be rocked out by shifting from forward and reverse gears, stopping between shifts, in a steady pattern. Press lightly on the accelerator in each gear.

Do not rock the vehicle if the engine is not at normal operating temperature or damage to the transmission may occur.

Do not rock the vehicle for more than a few minutes or damage to the transmission and tires may occur or the engine may overheat.



Always set the parking brake fully and make sure the gearshift is latched in P (Park). Turn off the ignition whenever you leave your vehicle.



If the parking brake is fully released, but the brake warning lamp remains illuminated, the brakes may not be working properly. See your dealer or a qualified service technician.

Driving

Driving with a 4–speed automatic transmission

Your vehicle's automatic transmission is equipped with a special shift strategy that insures maximum heater performance during cold weather operation.

When ambient temperature is -5°C (23°F) or below and the engine coolant temperature is below 38°C (100°F), light throttle upshifts may be slightly delayed. Once the engine coolant temperature reaches 71°C (160°F) the normal shift strategy will resume. This is normal operation and will not affect the function or the durability of the transmission.

If the normal shift strategy does not resume once the engine coolant temperature reaches the normal operating temperature, or if the downshifts and other throttle conditions do not function normally, see your dealer or a qualified service technician as soon as possible.

Understanding gearshift positions

To put your vehicle in gear, start the engine, depress the brake pedal, then move gearshift lever out of P (Park).



Hold the brake pedal down while you move the gearshift lever from P (Park) to another position. If you do not hold the brake pedal down, your vehicle may move unexpectedly and injure someone.

P (Park)

Always come to a complete stop before shifting into P (Park). Make sure the gearshift lever is securely latched in P (Park). This position locks the transmission and prevents the rear wheels from turning.



Always set the parking brake fully and make sure the gearshift lever is latched in P (Park). Turn off the ignition whenever you leave your vehicle.

R (Reverse)

With the gearshift lever in R (Reverse), the vehicle will move backward. Always come to a complete stop before shifting into and out of R (Reverse).



N (Neutral)

With the gearshift lever in N (Neutral), the vehicle can be started and is free to roll. Hold the brake pedal down while in this gear.



D (Overdrive)

The normal driving position for the best fuel economy. Transmission operates in gears one through four.



D (Overdrive) can be deactivated by pressing the transmission control switch (TCS) on the end of the gearshift lever.

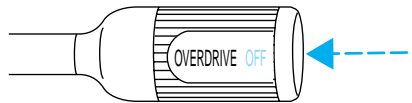

The transmission control indicator light (TCIL) (the word OFF) on the end of the gearshift lever will illuminate.

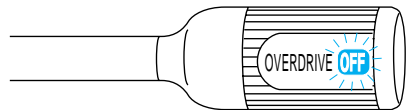

Drive – Not shown on the display. Activate by pressing the transmission control switch (TCS) on the end of the gearshift lever with the gearshift in the **D** position. The TCIL (the word OFF) will illuminate on the gearshift lever. Transmission operates in gears one through three. **D** (Drive) provides more engine braking than **D** (Overdrive) and is useful when:

- driving with a heavy load.
- towing a trailer up or down steep hills.
- additional engine downhill braking is desired. If towing a trailer, refer to *Driving while you tow* in the *Trailer towing* section.

To return to **D** (Overdrive) mode, press the transmission control switch (TCS). The TCIL (the word OFF) will no longer be illuminated.

Driving

Each time the vehicle is started, the transmission will automatically return to normal overdrive mode.

Every time the vehicle is shut off and restarted, you must press the transmission control switch to cancel overdrive operation if driving in overdrive is not desired.

2 (Second)

Use 2 (Second) to start-up on slippery roads or to provide additional engine braking on downgrades.



1 (First)

Use 1 (Low) to provide maximum engine braking on steep downgrades. Upshifts can be made by shifting to 2 (Second) or to **D** (Overdrive). Selecting 1 (Low) at higher speeds causes the transmission to shift to a lower gear, and will shift to 1 (Low) after vehicle decelerates to the proper speed.



Forced Downshifts

To gain acceleration in **D** (Overdrive) or Drive (O/D OFF) when passing another vehicle, push the accelerator to the floor. The transmission will downshift to the appropriate gear: third, second or first gear.

Shift strategy (4R100 automatic transmission)

To account for customer driving habits and conditions, your 4R100 automatic transmission electronically controls the shift quality by using an adaptive learning strategy. The adaptive learning strategy is maintained by power from the battery. When the battery is disconnected or a new battery is installed, the transmission must relearn its adaptive strategy. Optimal shifting will resume within a few hundred kilometers (miles) of operation.

If the shift quality does not improve within a few hundred kilometers (miles) of operation, or if the downshifts and other throttle conditions do not function normally, see your dealer or a qualified service technician as soon as possible.

REVERSE SENSING SYSTEM (IF EQUIPPED)

The reverse sensing system (RSS) sounds a tone to warn the driver of obstacles near the rear bumper when the reverse gear is selected.



To help avoid personal injury, please read and understand the limitations on the reverse sensing system described below.

Reverse sensing is only an assist for some (generally large and fixed) objects when moving in reverse on a flat surface at “parking speeds” of approximately 4.8 km/h (3 mph) or less. The weather may also affect the function of RSS. RSS may have reduced performance, or be activated in inclement weather. It is the driver’s responsibility for ensuring that their path is clear when operating the vehicle.



To help avoid personal injury, always use caution when in reverse and when using the reverse sensing system.



This system is not designed to prevent contact with small or moving objects. The system is designed to provide a warning to assist the driver in detecting large stationary objects to avoid damaging the vehicle. The system may not detect smaller objects, particularly those close to the ground.

The RSS will assist the driver in detecting certain objects while the vehicle slowly moves in reverse at speeds less than 4.8 km/h (3 mph). The RSS is not effective at speeds greater than 4.8 km/h (3 mph) and may not detect certain angular or moving objects.

Driving

The reverse sensing system detects obstacles within approximately 1.8 meters (5.9 ft.) of the rear bumper with a decreased coverage area at the outer corners of the bumper, (refer to the figures for approximate zone coverage areas). As you move closer to the obstacle, the rate of the tone increases. When the distance to the obstacle is less than 25.0 cm (10 in.), the tone will sound continuously. If the system detects a stationary or receding object further than 25.0 cm (10 in.) from the side of the vehicle, the tone will sound for only three seconds. Once the system detects an object approaching, the tone will sound again.

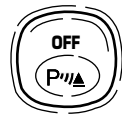
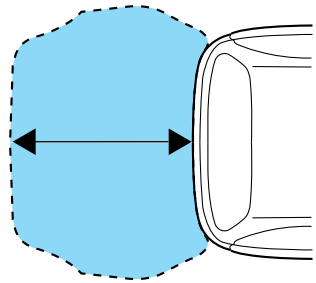
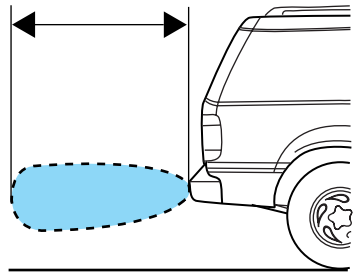

The reverse sensing system is automatically enabled when the gear selector is placed in R (Reverse) and the ignition is ON. A reverse sensing control allows the driver to disable the reverse sensing system only when the ignition is ON, and the gear selector is in R (Reverse).

The OFF indicator remains illuminated when the system is disabled. The system defaults to ON every time the reverse gear is selected. Press the control to disable or enable the system.

The indicator will remain illuminated to indicate a failure of the reverse sensing system.

Always keep the sensors (located on the rear bumper/fascia) free from dirt, snow and ice (do not clean the sensors with sharp objects). These elements may cause the system to operate inaccurately.

If the vehicle sustains damage to the rear bumper/fascia, leaving it misaligned or bent, the sensing zone may be altered causing inaccurate measurement of obstacles or false alarms.

FOUR-WHEEL DRIVE (4WD) OPERATION (IF EQUIPPED)



For important information regarding safe operation of this type of vehicle, see **Preparing to drive your vehicle** in this chapter.

When Four-wheel drive (4WD) is engaged, power is supplied to all four wheels through a transfer case. 4WD power can be selected when additional driving power is desired.

If equipped with the Electronic Shift 4WD System, and the instrument panel control is moved to 4WD Low while the vehicle is moving, the system will not engage and no damage will occur to the 4WD system. Before 4WD Low can be engaged, the vehicle must be at a complete stop with the brake pedal depressed and the transmission in N (Neutral).

4H or 4L operation is not recommended on dry pavement. Doing so could result in difficult disengagement of the transfer case, damage to the transfer case, increased tire wear, decreased fuel economy and difficulty turning.

Control-Trac automatic four-wheel drive system (if equipped)

Your 4x4 features the heavy-duty Control-Trac system which includes a computer-operated transfer case. This unique system is interactive with the road, continually monitoring and adjusting torque delivery to the front and rear wheels to optimize vehicle control.

Positions of the Control-Trac system

The Control-Trac A4WD system functions in three modes:

- **A4WD** position delivers power to the rear axle. If the rear wheels lose traction, power will be automatically delivered to the front axle to maintain traction throughout the slippery condition.
- **4H** position provides mechanically locked four-wheel drive power delivery to front and rear axles.
- **4L** position provides mechanically locked four-wheel drive when above average power at reduced speeds is required.

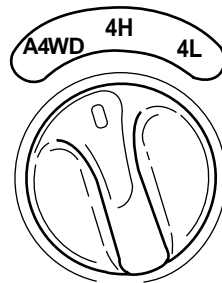

Driving



Utility and four-wheel drive vehicles are **not** designed for cornering at speeds as high as passenger cars any more than low-slung sports cars are designed to perform satisfactorily under off-road conditions. Avoid sharp turns or abrupt maneuvers in these vehicles.

Using the Control-Trac system

Shifting from A4WD to 4H

Move the 4WD control from A4WD to 4H at any forward speed up to 88 km/h (55 mph).

At temperatures below 0°C (32°F), shifts from A4WD to 4H should not be performed above 72 km/h (45 mph).

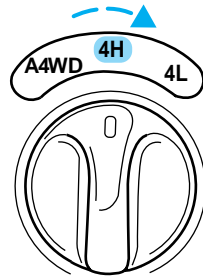

Shifting from 4H to 4L (and 4L to 4H)

1. Bring the vehicle to a stop.
2. Depress the brake.
3. Place the gearshift in N (Neutral).
4. Move the 4WD control to the 4H (or 4L) position.



Shifting to A4WD

Move the 4WD control back to A4WD at a stop or at speeds up to 88 km/h (55 mph).



Driving off-road with truck and utility vehicles

4WD vehicles are specially equipped for driving on sand, snow, mud and rough terrain and have operating characteristics that are somewhat different from conventional vehicles, both on and off the road.

How your vehicle differs from other vehicles

Truck and utility vehicles can differ from some other vehicles. Your vehicle may be higher to allow it to travel over rough terrain without getting hung up or damaging underbody components.

The differences that make your vehicle so versatile also make it handle differently than an ordinary passenger car.

Maintain steering wheel control at all times, especially in rough terrain. Since sudden changes in terrain can result in abrupt steering wheel motion, make sure you grip the steering wheel from the outside. Do not grip the spokes.

Drive cautiously to avoid vehicle damage from concealed objects such as rocks and stumps.

You should either know the terrain or examine maps of the area before driving. Map out your route before driving in the area. To maintain steering and braking control of your vehicle, you must have all four wheels on the ground and they must be rolling, not sliding or spinning.

Basic operating principles

- Do not use 4WD on dry, hard surfaced roads (except models equipped with Auto 4WD). This may damage the drivelines and axles.

Driving

- Drive slower in strong crosswinds which can affect the normal steering characteristics of your vehicle.
- Be extremely careful when driving on pavement made slippery by loose sand, water, gravel, snow or ice.

If your vehicle goes off the edge of the pavement

- If your vehicle goes off the edge of the pavement, slow down, but avoid severe brake application, Ease the vehicle back onto the pavement only after reducing your speed. Do not turn the steering wheel too sharply while returning to the road surface.
- It may be safer to stay on the apron or shoulder of the road and slow down gradually before returning to the pavement. You may lose control if you do not slow down or if you turn the steering wheel too sharply or abruptly.
- It often may be less risky to strike small inanimate objects, such as highway reflectors, with minor damage to your vehicle rather than attempt a sudden return to the pavement which could cause the vehicle to slide sideways out of control or roll over. Remember, your safety and the safety of others should be your primary concern.

If your vehicle gets stuck

If the vehicle is stuck it may be rocked out by shifting from forward and reverse gears, stopping between shifts, in a steady pattern. Press lightly on the accelerator in each gear.

Do not rock the vehicle for more than a few minutes or damage to the transmission and tires may occur or the engine may overheat.



Do not spin the wheels at over 56 km/h (35 mph). The tires may fail and injure a passenger or bystander.

Emergency maneuvers

- In an unavoidable emergency situation where a sudden sharp turn must be made, remember to avoid “over-driving” your vehicle, i.e., turn the steering wheel only as rapidly and as far as required to avoid the emergency. Excessive steering will result in less vehicle control, not more. Additionally, smooth variations of the accelerator and/or brake pedal pressure should be utilized if changes in vehicle speed are called for. Avoid abrupt steering, acceleration or braking. Use all available road surface to return the vehicle to a safe direction of travel.

- In the event of an emergency stop, avoid skidding the tires and do not attempt any sharp steering wheel movements.
- If the vehicle goes from one type of surface to another (i.e., from concrete to gravel) there will be a change in the way the vehicle responds to a maneuver (steering, acceleration or braking). Again, avoid these abrupt inputs.

Parking

On some 4WD vehicles, when the transfer case is in the N (Neutral) position, the engine and transmission are disconnected from the rest of the driveline. Therefore, the vehicle is free to roll even if the automatic transmission is in P (Park) or the manual transmission is in gear. Do not leave the vehicle unattended with the transfer case in N (Neutral) position. Always set the parking brake fully and turn off the ignition when leaving the vehicle.

4WD Systems (if equipped)

4WD (when you select the 4WD mode), uses all four wheels to power itself. This increases traction, enabling you to drive over terrain and road conditions that a conventional two-wheel drive vehicle can't.

Power is supplied to all four wheels through a transfer case. On 4WD vehicles, the transfer case allows you to select 4WD when necessary. Information on transfer case operation and shifting procedures can be found in the *Driving* chapter. Information on transfer case maintenance can be found in the *Maintenance and specifications* chapter. You should become thoroughly familiar with this information before you operate your vehicle.

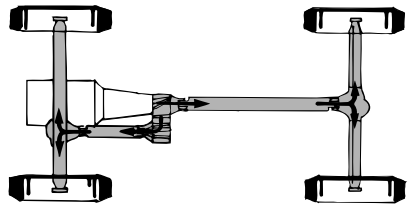

Normal characteristics

On some 4WD models, the initial shift from two-wheel drive to 4x4 while the vehicle is moving can cause some momentary clunk and ratcheting sounds. This is the front drivetrain coming up to speed and the automatic locking hubs engaging and is not cause for concern.

Driving

Sand

When driving over sand, try to keep all four wheels on the most solid area of the trail. Avoid reducing the tire pressures but shift to a lower gear and drive steadily through the terrain. Apply the accelerator slowly and avoid spinning the wheels.

If you must reduce the tire pressure for whatever reason in sand, make sure you re-inflate the tires as soon as possible.

Avoid excessive speed because vehicle momentum can work against you and cause the vehicle to become stuck to the point that assistance may be required from another vehicle. Remember, you may be able to back out the way you came if you proceed with caution.

Mud and water

If you must drive through high water, drive slowly. Traction or brake capability may be limited.

When driving through water, determine the depth; avoid water higher than the bottom of the hubs (if possible) and proceed slowly. If the ignition system gets wet, the vehicle may stall.

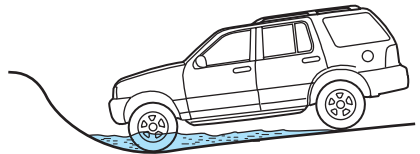

Once through water, always try the brakes. Wet brakes do not stop the vehicle as effectively as dry brakes. Drying can be improved by moving your vehicle slowly while applying light pressure on the brake pedal.

Be cautious of sudden changes in vehicle speed or direction when you are driving in mud. Even 4WD vehicles can lose traction in slick mud. As when you are driving over sand, apply the accelerator slowly and avoid spinning your wheels. If the vehicle does slide, steer in the direction of the slide until you regain control of the vehicle.

If the transmission, transfer case or front axle are submerged in water, their fluids should be checked and changed, if necessary.

Water intrusion into the transmission may damage the transmission.

If the front or rear axle is submerged in water, the axle lubricant should be replaced.

After driving through mud, clean off residue stuck to rotating driveshafts and tires. Excess mud stuck on tires and rotating driveshafts causes an imbalance that could damage drive components.

“Tread Lightly” is an educational program designed to increase public awareness of land-use regulations and responsibilities in our nation’s wilderness areas. Ford joins the U.S. Forest Service and the Bureau of Land Management in encouraging you to help preserve our national forest and other public and private lands by “treading lightly.”



Driving on hilly or sloping terrain

Although natural obstacles may make it necessary to travel diagonally up or down a hill or steep incline, you should always try to drive straight up or straight down. **Avoid driving crosswise or turning on steep slopes or hills.** A danger lies in losing traction, slipping sideways and possibly rolling over. Whenever driving on a hill, determine beforehand the route you will use. Do not drive over the crest of a hill without seeing what conditions are on the other side. Do not drive in reverse over a hill without the aid of an observer.

When climbing a steep slope or hill, start in a lower gear rather than downshifting to a lower gear from a higher gear once the ascent has started. This reduces strain on the engine and the possibility of stalling.

If you do stall out, do not try to turn around because you might roll over. It is better to back down to a safe location.

Apply just enough power to the wheels to climb the hill. Too much power will cause the tires to slip, spin or lose traction, resulting in loss of vehicle control.

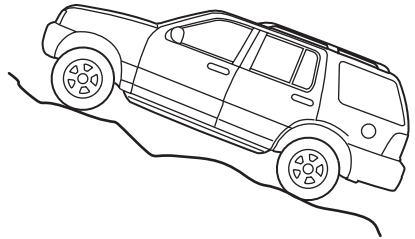

Driving

Descend a hill in the same gear you would use to climb up the hill to avoid excessive brake application and brake overheating. Do not descend in neutral, disengage overdrive or manually shift to a lower gear. When descending a steep hill, avoid sudden hard braking as you could lose control. When you brake hard, the front wheels can't turn and if they aren't turning, you won't be able to steer.

The front wheels have to be turning in order to steer the vehicle. Rapid pumping of the brake pedal will help you slow the vehicle and still maintain steering control.

If your vehicle has anti-lock brakes, apply the brakes steadily. Do not "pump" the brakes.

Driving on snow and ice

4WD vehicles have advantages over 2WD vehicles in snow and ice but can skid like any other vehicle.

Should you start to slide while driving on snowy or icy roads, turn the steering wheel in the direction of the slide until you regain control.

Avoid sudden applications of power and quick changes of direction on snow and ice. Apply the accelerator slowly and steadily when starting from a full stop.

Avoid sudden braking as well. Although a 4WD vehicle may accelerate better than a two-wheel drive vehicle in snow and ice, it won't stop any faster, because as in other vehicles, braking occurs at all four wheels. Do not become overconfident as to road conditions.

Make sure you allow sufficient distance between you and other vehicles for stopping as well as drive slower than usual and consider using one of the lower gears. In emergency stopping situations, avoid locking of the wheels. Use a "squeeze" technique, push on the brake pedal with a steadily increasing force which allows the wheels to brake yet continue to roll so that you may steer in the direction you want to travel. If you lock the wheels, release the brake pedal and repeat the squeeze technique. If your vehicle is equipped with a Four Wheel Anti-Lock Brake System (ABS), apply the brake steadily. Do not "pump" the brakes. Refer to the *Brakes* section of this chapter for additional

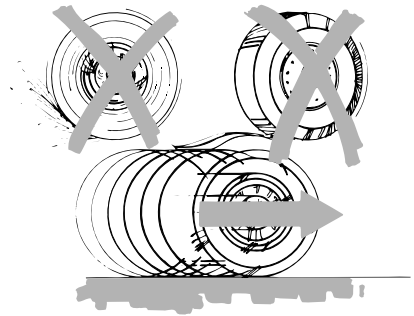

information on the operation of the anti-lock brake system.

Never drive with chains on the front tires of 4WD vehicles without also putting them on the rear tires. This could cause the rear to slide and swing around during braking.

Tires, Replacement Requirements

4WD vehicles are equipped with tires designed to provide for safe ride and handling capability.

Do not use a size and type of tire and wheel other than that originally provided by Ford because it can affect the safety and performance of your vehicle, which could lead to loss of vehicle control or roll over and serious injury. Make sure all tires and wheels on the vehicle are of the same size, type, tread design, brand and load-carrying capacity. If you have questions regarding tire replacement, see an authorized Ford or Lincoln/Mercury dealer.

If you nevertheless decide to equip your 4WD for off-road use with tires larger than what Ford recommends, you should not use these tires for highway driving.

If you use any tire/wheel combination not recommended by Ford, it may adversely affect vehicle handling and could cause steering, suspension, axle or transfer case failure.

Do not use “aftermarket lift kits” or other suspension modifications, whether or not they are used with larger tires and wheels.

These “aftermarket lift kits” could adversely affect the vehicle’s handling characteristics, which could lead to loss of vehicle control or roll over and serious injury.

Tires can be damaged during off-road use. For your safety, tires that are damaged should not be used for highway driving because they are more likely to blow out or fail.

You should carefully observe the recommended tire inflation pressure found on the safety compliance certification label attached to the left front door lock facing or door latch post pillar. Failure to follow tire pressure recommendations can adversely affect the way your vehicle handles. Do not exceed the Ford recommended pressure even if it is less than the maximum pressure allowed for the tire.

Driving

Each day before you drive, check your tires. If one looks lower than the others, use a tire gauge to check pressure of all tires, and adjust if required. Check tire pressure with a tire gauge every few weeks (including spare). Safe operation requires tires that are neither underinflated nor overloaded.

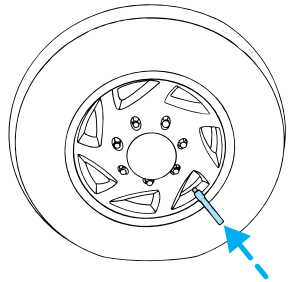

Periodically inspect the tire treads and remove stones, nails, glass or other objects that may be wedged in the tread grooves. Check for holes or cuts that may permit air leakage from the tire and make necessary repairs.

Inspect the tire side walls for cuts, bruises and other damage. If internal damage to the tire is suspected, have the tire demounted and inspected in case it needs to be repaired or replaced.

Maintenance and Modifications

The suspension and steering systems on your vehicle have been designed and tested to provide both reasonably safe, predictable performance whether loaded or empty and durable load carrying capability. For this reason, Ford strongly recommends that you do not make modifications such as adding or removing parts (such as lift kits or stabilizer bars) or by using replacement parts not equivalent to the original factory equipment.

Any modifications to a vehicle that raise the center of gravity can make it more likely the vehicle will roll over as a result of a loss of control. Ford recommends that caution be used with any vehicle equipped with a high load or device (such as ladder racks or pickup box cover).

Failure to maintain your vehicle properly may void the warranty, increase your repair cost, reduce vehicle performance and operational capabilities and adversely affect driver and passenger safety. Frequent inspection of vehicle chassis components is recommended if the vehicle is subjected to heavy off-road usage.

DRIVING THROUGH WATER

Do not drive quickly through standing water, especially if the depth is unknown. Traction or brake capability may be limited and if the ignition

system gets wet, your engine may stall. Water may also enter your engine's air intake and severely damage your engine.

If driving through deep or standing water is unavoidable, proceed very slowly. Never drive through water that is higher than the bottom of the hubs (for trucks) or the bottom of the wheel rims (for cars).

Once through the water, always try the brakes. Wet brakes do not stop the vehicle as effectively as dry brakes. Drying can be improved by moving your vehicle slowly while applying light pressure on the brake pedal.

Driving through deep water where the transmission vent tube is submerged may allow water into the transmission and cause internal transmission damage.

VEHICLE LOADING

Before loading a vehicle, familiarize yourself with the following terms:

- **Base Curb Weight:** Weight of the vehicle including any standard equipment, fluids, lubricants, etc. It does not include occupants or aftermarket equipment.
- **Payload:** Combined maximum allowable weight of cargo, occupants and optional equipment. The payload equals the gross vehicle weight rating minus base curb weight.
- **GVW (Gross Vehicle Weight):** Base curb weight plus payload weight. The GVW is not a limit or a specification.
- **GVWR (Gross Vehicle Weight Rating):** Maximum permissible total weight of the base vehicle, occupants, optional equipment and cargo. The GVWR is specific to each vehicle and is listed on the Safety Certification Label on the driver's door pillar.
- **GAWR (Gross Axle Weight Rating):** Carrying capacity for each axle system. The GAWR is specific to each vehicle and is listed on the Safety Certification Label on the driver's door pillar.
- **GCW (Gross Combined Weight):** The combined weight of the towing vehicle (including occupants and cargo) and the loaded trailer.
- **GCWR (Gross Combined Weight Rating):** Maximum permissible combined weight of towing vehicle (including occupants and cargo) and the loaded trailer
- **Maximum Trailer Weight Rating:** Maximum weight of a trailer the vehicle is permitted to tow. The maximum trailer weight rating is

Driving

determined by subtracting the vehicle curb weight for each engine/transmission combination, any required option weight for trailer towing and the weight of the driver from the GCWR for the towing vehicle.

- **Maximum Trailer Weight:** Maximum weight of a trailer the loaded vehicle (including occupants and cargo) is permitted to tow. It is determined by subtracting the weight of the loaded trailer towing vehicle from the GCWR for the towing vehicle.
- **Trailer Weight Range:** Specified weight range that the trailer must fall within that ranges from zero to the maximum trailer weight rating.

Remember to figure in the tongue load of your loaded trailer when figuring the total weight.



Do not exceed the GVWR or the GAWR specified on the certification label.

Do not use replacement tires with lower load carrying capacities than the originals because they may lower the vehicle's GVWR and GAWR limitations. Replacement tires with a higher limit than the originals do not increase the GVWR and GAWR limitations.

The Safety Certification Label, found on the driver's door pillar, lists several important vehicle weight rating limitations. Before adding any additional equipment, refer to these limitations. If you are adding weight to the front of your vehicle, (potentially including weight added to the cab), the weight added should not exceed the front axle reserve capacity (FARC). Additional frontal weight may be added to the front axle reserve capacity provided you limit your payload in other ways (i.e. restrict the number of occupants or amount of cargo carried).

Always ensure that the weight of occupants, cargo and equipment being carried is within the weight limitations that have been established for your vehicle including both gross vehicle weight and front and rear gross axle weight rating limits. Under no circumstance should these limitations be exceeded.



Exceeding any vehicle weight rating limitation could result in serious damage to the vehicle and/or personal injury.

Special loading instructions for owners of pickup trucks and utility-type vehicles



For important information regarding safe operation of this type of vehicle, see the **Preparing to drive your vehicle** section in this chapter.



Loaded vehicles, with a higher center of gravity, may handle differently than unloaded vehicles. Extra precautions, such as slower speeds and increased stopping distance, should be taken when driving a heavily loaded vehicle.

Your vehicle has the capability to haul more cargo and people than most passenger cars. Depending upon the type and placement of the load, hauling cargo and people may raise the center of gravity of the vehicle.

Calculating the load your vehicle can carry/tow

1. Use the appropriate maximum gross combined weight rating (GCWR) chart to find the maximum GCWR for your type engine and rear axle ratio.
2. Weigh your vehicle as you customarily operate the vehicle without cargo. To obtain correct weights, try taking your vehicle to a shipping company or an inspection station for trucks.
3. Subtract your loaded vehicle weight from the maximum GCWR on the following charts. This is the maximum trailer weight your vehicle can tow and must fall below the maximum shown under maximum trailer weight on the chart.

Driving

TRAILER TOWING

Trailer towing with your vehicle may require the use of a trailer tow option package.

Trailer towing puts additional loads on your vehicle's engine, transmission, axle, brakes, tires, and suspension. For your safety and to maximize vehicle performance, be sure to use the proper equipment while towing.

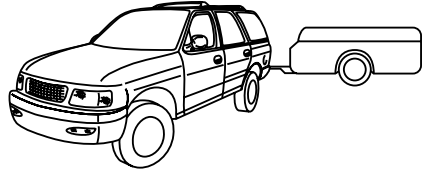

Follow these guidelines to ensure safe towing procedure:

- Stay within your vehicle's load limits. If exceeded, cargo should be removed from the trailer and/or the vehicle until all weights are within specified limits.
- Thoroughly prepare your vehicle for towing. Refer to *Preparing to tow* in this chapter.
- Use extra caution when driving while trailer towing. Refer to *Driving while you tow* in this chapter.
- Service your vehicle more frequently if you tow a trailer. Refer to the severe duty schedule in the scheduled maintenance guide.
- Do not tow a trailer until your vehicle has been driven at least 800 km (500 miles).
- Refer to the instructions included with towing accessories for the proper installation and adjustment specifications.

If your vehicle is equipped with the optional heavy duty trailer tow wiring, it is pre-wired for trailer towing. An electrical connector is provided under the instrument panel for installing a customer-supplied electric brake controller. Another electrical connector is provided at the hitch. This connector provides power to the trailer for taillamps, stop and turn lamps, back up lamps, battery charge, electric brakes (when a customer provided controller is installed) and ground. The kit included with your vehicle provides you with adaptors to attach the brake controller and convert the hitch connector for Class I trailer usage.

Engine	Rear axle ratio	Tire size - cm (inches)	Maximum GCWR - kg (lbs.)	Trailer weight range (0 - maximum) kg (lbs.)
4x2				
4.6L	3.31	40.6 (16)	4 990 (11 000)	0-2 676 (0-5 900)
4.6L	3.31	40.6 (17)	4 990 (11 000)	0-2 676 (0-5 900)
5.4L	3.31	40.6 (16)	5 443 (12 000)	0-3 084 (0-6 800)
5.4L	3.55	40.6 (16)	5 897 (13 000)	0-3 538 (0-7 800)
5.4L	3.55	43.2 (17)	5 897 (13 000)	0-3 538 (0-7 800)
5.4L	3.73	40.6 (16)	6 123 (13 500)	0-3 757 (0-8 300)
5.4L	3.73	43.2 (17)	6 124 (13 500)	0-3 765 (0-8 300)
4x4				
4.6L	3.55	40.6 (16)	5 216 (11 500)	0-2 722 (0-6 000)
4.6L	3.55	43.2 (17)	4 990 (11 000)	0-2 495 (5 500)
5.4L	3.31	40.6 (16)	5 443 (12 000)	0-2 903 (0-6 400)
5.4L	3.55	40.6 (16)	5 897 (13 000)	0-3 357 (0-7 400)
5.4L	3.55	43.2 (17)	5 760 (12 500)	0-3 130 (0-6 900)
Maximum frontal area of trailer is 5.6 square meters (60 square feet)				

Do not exceed the maximum loads listed on the Safety Compliance Certification label. For load specification terms found on the label, refer to *Vehicle loading* in this chapter. Remember to figure in the tongue load of your loaded trailer when figuring the total weight.



Towing trailers beyond the maximum recommended gross trailer weight exceeds the limit of the vehicle and could result in engine damage, transmission damage, structural damage, loss of control and personal injury.

Preparing to tow

Use the proper equipment for towing a trailer, and make sure it is properly attached to your vehicle. See your dealer or a reliable trailer dealer if you require assistance.

Driving

If your vehicle is not equipped with the factory heavy duty trailer tow option, auxiliary coolers are recommended for the automatic transmission system if you are planning on:

- traveling farther than 80 km (50 miles)
- towing in hilly terrain
- towing frequently

Hitches

Do not use hitches that clamp onto the vehicle's bumper or attach to the axle. You must distribute the load in your trailer so that 10%–15% of the total weight of the trailer is on the tongue.

Load equalizing hitch

When hooking up a trailer using a load equalizing hitch, always use the following procedure:

1. Park the unloaded vehicle on a level surface. With the ignition on and all doors closed, allow the vehicle to stand for several minutes so that it can level.
2. Turn the air suspension (if equipped) control to OFF.
3. Measure the height of a reference point on the front and rear bumpers at the center of the vehicle.
4. Attach the trailer to the vehicle and adjust the hitch equalizers so that the front bumper height is within 0–13 mm (0.5 in) of the reference point. After proper adjustment, the rear bumper should be no higher than in Step 3.
5. Turn the air suspension (if equipped) control to ON.



Adjusting an equalizing hitch so the rear bumper of the vehicle is lower or higher than it was unloaded will defeat the function of the load equalizing hitch and may cause unpredictable handling.

Safety chains

Always connect the trailer's safety chains to the frame or hook retainers of the vehicle hitch. To connect the trailer's safety chains, cross the chains under the trailer tongue and allow slack for turning corners.

If you use a rental trailer, follow the instructions that the rental agency gives to you.

Do not attach safety chains to the bumper.

Trailer brakes

Electric brakes and manual, automatic or surge-type trailer brakes are safe if installed properly and adjusted to the manufacturer's specifications. The trailer brakes must meet local and Federal regulations.



Do not connect a trailer's hydraulic brake system directly to your vehicle's brake system. Your vehicle may not have enough braking power and your chances of having a collision greatly increase.

The braking system of the tow vehicle is rated for operation at the GVWR not GCWR.

Trailer lamps

Trailer lamps are required on most towed vehicles. Make sure your trailer lamps conform to local and Federal regulations. See your dealer or trailer rental agency for proper instructions and equipment for hooking up trailer lamps.

Using a step bumper

The rear bumper is equipped with an integral hitch and requires only a ball with a 25.4 mm (one inch) shank diameter. The bumper has a 1 814 kg (4 000 lb.) trailer weight and 181 kg (400 lb.) tongue weight capability.

Use a frame-mounted weight distributing hitch for trailers over 1 814 kg (4 000 lb.).

Driving while you tow

When towing a trailer:

- Ensure that you turn off your speed control. The speed control may shut off automatically when you are towing on long, steep grades.
- Consult your local motor vehicle speed regulations for towing a trailer.
- Use a lower gear when towing up or down steep hills. This will eliminate excessive downshifting and upshifting for optimum fuel economy and transmission cooling.
- Anticipate stops and brake gradually.

Exceeding the GCWR rating may cause internal transmission damage and void your warranty coverage.

Driving

Servicing after towing

If you tow a trailer for long distances, your vehicle will require more frequent service intervals. Refer to your scheduled maintenance guide for more information.

Trailer towing tips

- Practice turning, stopping and backing up before starting on a trip to get the feel of the vehicle trailer combination. When turning, make wider turns so the trailer wheels will clear curbs and other obstacles.
- Allow more distance for stopping with a trailer attached.
- If you are driving down a long or steep hill, shift to a lower gear. Do not apply the brakes continuously, as they may overheat and become less effective.
- The trailer tongue weight should be 10% of the loaded trailer weight.
- After you have traveled 80 km (50 miles), thoroughly check your hitch, electrical connections and trailer wheel lug nuts.
- When stopped in traffic for long periods of time in hot weather, place the gearshift in P (Park) and increase idle speed. This aids engine cooling and air conditioner efficiency.
- Vehicles with trailers should not be parked on a grade. If you must park on a grade, place wheel chocks under the trailer's wheels.

Launching or retrieving a boat

When backing down a ramp during boat launching or retrieval:

- do not allow the static water level to rise above the bottom edge of the rear bumper and
- do not allow waves to break higher than 15 cm (6 inches) above the bottom edge of the rear bumper.

Exceeding these limits may allow water to enter critical vehicle components, adversely affecting driveability, emissions, reliability and causing internal transmission damage.

Replace the rear axle lubricant any time the axle has been submerged in water. Rear axle lubricant quantities are not to be checked or changed unless a leak is suspected or repair required.

Disconnect the wiring to the trailer before backing the trailer into the water. Reconnect the wiring to the trailer after the trailer is removed from the water.

RECREATIONAL TOWING (ALL WHEELS ON THE GROUND)

An example of recreational towing would be towing your vehicle behind a motorhome. Follow these guidelines if you have the need for recreational towing your vehicle with all four wheels on the ground. These guidelines are designed to ensure that your transmission is not damaged.

2WD vehicles (with automatic transmissions)

- Place the transmission in N (Neutral)
- Maximum speed is 56 km (35 mph)
- Maximum distance is 80 km (50 miles)

If a distance of 80 km (50 miles) or a speed of 56 km (35 mph) must be exceeded, the drive shaft will have to be removed before the vehicle is towed.

Ford recommends the driveshaft be removed/installed only by a qualified technician. See your local dealer for driveshaft removal/installation.

Improper removal/installation of the driveshaft can cause transmission fluid loss, damage to the driveshaft and internal transmission components.

4WD vehicles electronic shift transfer case (with automatic transmissions)

4x4 vehicles with electronic shift on the fly cannot be towed with any wheels on the ground.

Roadside emergencies

GETTING ROADSIDE ASSISTANCE

To fully assist if you should have a vehicle concern, Ford Motor Company offers a complimentary roadside assistance program. This program is separate from the New Vehicle Limited Warranty. The service is available:

- 24-hours, seven days a week
- for the Basic warranty period (Canada) or New Vehicle Limited Warranty period (U.S.) of three years or 60 000 km (36 000 miles), whichever comes first on Ford and Mercury vehicles, and four years or 80 000 km (50 000 miles) on Lincoln vehicles

Roadside assistance will cover:

- changing a flat tire
- jump-starts
- lock-out assistance
- limited fuel delivery*
- towing of your disabled vehicle to the nearest Ford Motor Company dealership, or your selling dealer if within 25 kms (15.5 miles) of the nearest Ford Motor Company dealership (one tow per disablement). Even non-warranty related tows, like accidents or getting stuck in the mud or snow, are covered (some exclusions apply, such as impound towing or repossession).

* Canadian customers refer to your *Roadside Assistance supplement* for exact fuel amounts.

USING ROADSIDE ASSISTANCE

Complete the roadside assistance identification card and place it in your wallet for quick reference. In the United States, this card is found in the Owner Guide portfolio in the glove compartment in Ford vehicles and is mailed to you if you own a Mercury or Lincoln. In Canada, the card is found in the Roadside Assistance book in the glove compartment.

U.S. Ford or Mercury vehicle customers who require roadside assistance, call 1-800-241-3673; Lincoln vehicle customers call 1-800-521-4140.

Canadian customers who require roadside assistance, call 1-800-665-2006.

If you need to arrange roadside assistance for yourself, Ford Motor Company will reimburse a reasonable amount. To obtain reimbursement information, U.S. Ford or Mercury vehicles customers call 1-800-241-3673; Lincoln vehicle customers call 1-800-521-4140.

Roadside emergencies

Canadian customers who need to obtain reimbursement information, call 1-800-665-2006.

ROADSIDE COVERAGE BEYOND BASIC WARRANTY

In the United States, you may purchase additional roadside assistance coverage beyond this period through the Ford Auto Club by contacting your Ford or Lincoln Mercury dealer.

Similarly in Canada, for uninterrupted Roadside Assistance coverage, you may purchase extended coverage prior to your Basic Warranty's Roadside Assistance expiring. For more information and enrollment, contact 1-877-294-2582 or visit our website at www.ford.ca.

HAZARD FLASHER

Use only in an emergency to warn traffic of vehicle breakdown, approaching danger, etc. The hazard flashers can be operated when the ignition is off.

- The hazard lights control is located on top of the steering column.
- Depress hazard lights control to activate all hazard flashers simultaneously.
- Depress control again to turn the flashers off.

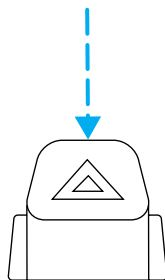

FUEL PUMP SHUT-OFF SWITCH FUEL RESET

The fuel pump shut-off switch is a device intended to stop the electric fuel pump when your vehicle has been involved in a substantial jolt.

After a collision, if the engine cranks but does not start, the fuel pump shut-off switch may have been activated.

Roadside emergencies

The fuel pump shut-off switch is located in the passenger's foot well, by the kick panel.

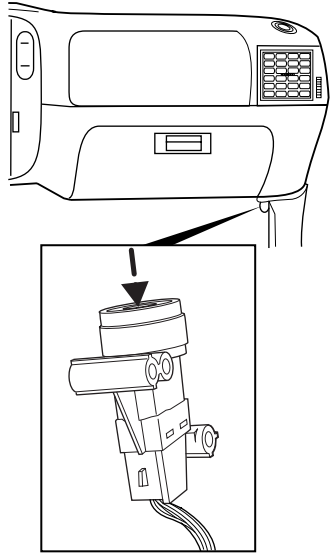

Use the following procedure to reset the fuel pump shut-off switch.

1. Turn the ignition to the OFF position.
2. Check the fuel system for leaks.
3. If no fuel leak is apparent, reset the fuel pump shut-off switch by pushing in on the reset button.
4. Turn the ignition to the ON position. Pause for a few seconds and return the key to the OFF position.
5. Make a further check for leaks in the fuel system.

FUSES AND RELAYS

Fuses

If electrical components in the vehicle are not working, a fuse may have blown. Blown fuses are identified by a broken wire within the fuse. Check the appropriate fuses before replacing any electrical components.

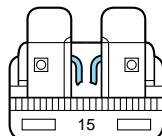

Note: Always replace a fuse with one that has the specified amperage rating. Using a fuse with a higher amperage rating can cause severe wire damage and could start a fire.

Standard fuse amperage rating and color

COLOR					
Fuse rating	Mini fuses	Standard fuses	Maxi fuses	Cartridge maxi fuses	Fuse link cartridge
2A	Grey	Grey	—	—	—
3A	Violet	Violet	—	—	—
4A	Pink	Pink	—	—	—
5A	Tan	Tan	—	—	—
7.5A	Brown	Brown	—	—	—
10A	Red	Red	—	—	—
15A	Blue	Blue	—	—	—
20A	Yellow	Yellow	Yellow	Blue	Blue
25A	Natural	Natural	—	—	—
30A	Green	Green	Green	Pink	Pink
40A	—	—	Orange	Green	Green
50A	—	—	Red	Red	Red
60A	—	—	Blue	—	Yellow
70A	—	—	Tan	—	Brown
80A	—	—	Natural	—	Black

Roadside emergencies

Passenger compartment fuse panel

The fuse panel is located below and to the left of the steering wheel by the brake pedal. Remove the panel cover to access the fuses.

To remove a fuse use the fuse puller tool provided on the fuse panel cover.

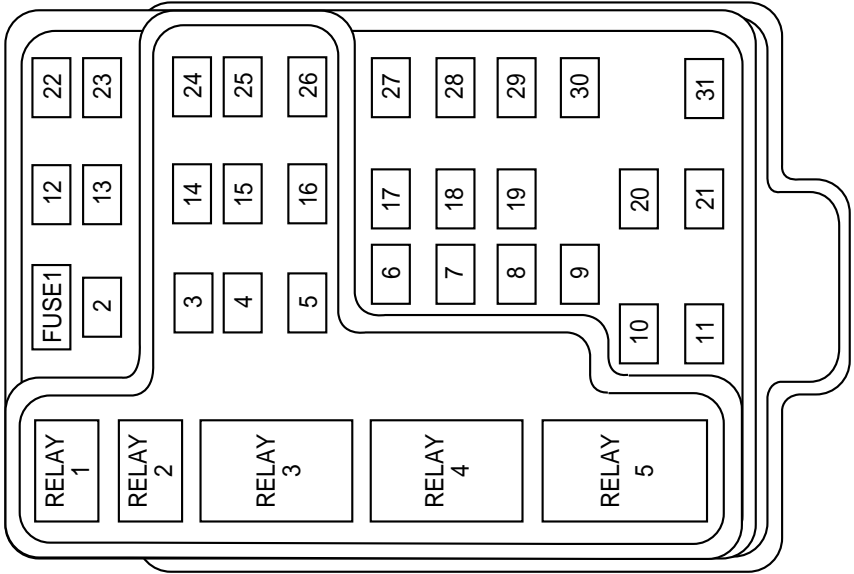

The fuses are coded as follows.

Fuse/Relay Location	Fuse Amp Rating	Passenger Compartment Fuse Panel Description
1	25A	Audio
2	5A	Overhead Trip Computer, Electronic Automatic Temperature Control (EATC), Powertrain Control Module (PCM), Cluster
3	20A	Cigar Lighter, OBD-II Scan Tool Connector
4	7.5A	Remote Entry Module, Mirrors, Memory Functions (Seats and Pedals)

Roadside emergencies

Fuse/Relay Location	Fuse Amp Rating	Passenger Compartment Fuse Panel Description
5	15A	Speed Control Module, Reverse Lamp, EVO Module, Climate Mode Switch (Front Blower Relay), Daytime Running Lamp Relay, Reverse Sensing System, Autolock, E/C Mirror
6	5A	Cluster, Overhead Trip Computer, Compass, Brake Shift Interlock Solenoid, Air Suspension Module, GEM Module, EVO Steering Sensor, Heated Mirror, Rear Defroster, Reverse Sensing System
7	5A	Aux A/C Blower Relay (via fuse 22)
8	5A	Radio, Remote Entry Module, GEM Module
9	—	Not Used
10	—	Not Used
11	30A	Front Washer Pump Relay, Wiper Run/Park Relay, Wiper Hi/LO Relay, Windshield Wiper Motor, Rear Washer Pump Relay
12	15A	Air Suspension Switch
13	20A	Stop Lamp Switch (Lamps), Turn/Hazard Flasher, Speed Control Module
14	15A	Rear Wipers, Running Board Lamps, Battery Saver Relay, Interior Lamp Relay, Accessory Delay Relay (Power Windows, Moonroof, Flip Windows)
15	5A	Stop Lamp Switch, (Speed Control, Brake Shift Interlock, ABS, PCM Module Inputs, Air Suspension Module, Autolock), GEM Module
16	20A	Headlamps (Hi Beams), Cluster (Hi Beam Indicator)
17	10A	Heated Mirrors, Heated Grid Switch Indicator
18	5A	Instrument Illumination (Dimmer Switch Power)
19	—	Not Used

Roadside emergencies

Fuse/Relay Location	Fuse Amp Rating	Passenger Compartment Fuse Panel Description
20	5A	Audio, Air Suspension Module, GEM Module, Memory Module
21	15A	Starter Relay, Fuse 20, Transmission Range Switch
22	10A	Air Bag Module, Intelligent Passenger Airbag Deactivation Module
23	10A	Aux A/C, Heated Seats, Trailer Tow Battery Charge, Turn/Hazard Flasher, 4x4 Clutch Relay, Overhead Console, E/C Mirror, 4 Wheel Anti-Lock Brake System (4WABS) Module
24	10A	EATC Module, EATC Blower Relay, Climate Control Switch Assembly, Feeds Fuse 7
25	—	Not Used
26	10A	Right Side Low Beam Headlamp
27	5A	Foglamp Relay and Foglamp Indicator
28	10A	Left Side Low Beam Headlamp
29	5A	Autolamp Module, Transmission Overdrive Control Switch
30	30A	Passive Anti Theft Transceiver, Cluster, Ignition Coils, Powertrain Control Module Relay
31	10A	Rear Integrated Control Panel (Audio), CD Player
Relay 1	—	Interior Lamp Relay
Relay 2	—	Battery Saver Relay
Relay 3	—	Rear Window Defroster Relay
Relay 4	—	One Touch Down Window Relay
Relay 5	—	ACC Delay Relay

Roadside emergencies

Power distribution box

The power distribution box is located in the engine compartment. The power distribution box contains high-current fuses that protect your vehicle's main electrical systems from overloads.

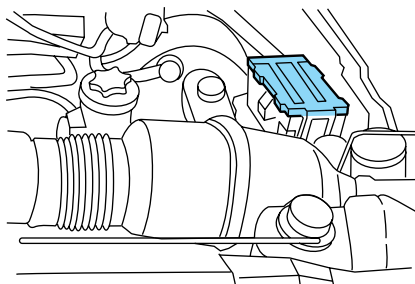

Always disconnect the battery before servicing high current fuses.



To reduce risk of electrical shock, always replace the cover to the Power Distribution Box before reconnecting the battery or refilling fluid reservoirs.

If the battery has been disconnected and reconnected, refer to the *Battery* section of the *Maintenance and specifications* chapter.

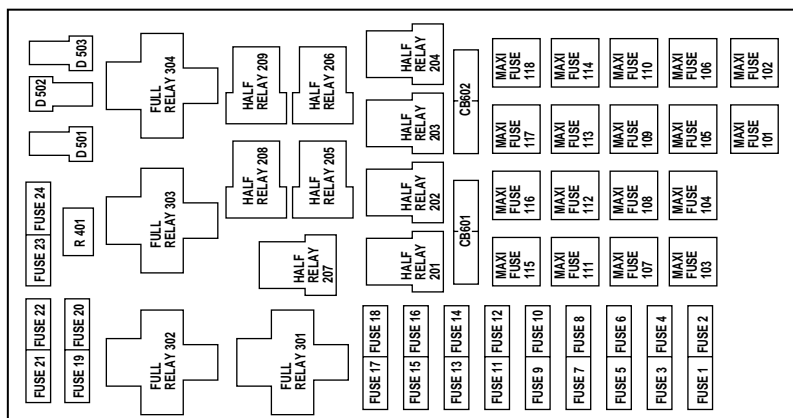

Roadside emergencies

The high-current fuses are coded as follows.

Fuse/Relay Location	Fuse Amp Rating	Power Distribution Box Description
1	20A *	Power Point
2	30A*	Powertrain Control Module
3	30A*	Headlamps/Autolamps
4	20A*	Console Powerpoint
5	20A*	Trailer Tow Backup/Park Lamps
6	15A*	Parklamps/Autolamps, Feeds Passenger Compartment Fuse 18
7	20A*	Horn
8	30A*	Power Door Locks
9	15A*	Daytime Running Lamps (DRL), Fog Lamps
10	20A*	Fuel Pump
11	20A*	Alternator Field
12	10A*	Rear Wipers
13	15A*	A/C Clutch
14	—	Not Used
15	10A*	Running Board Lamps
16	—	Not Used
17	10A*	Flip Windows
18	15A*	Powertrain Control Module, Fuel Injectors, Fuel Pump, Mass Air Flow Sensor
19	10A*	Trailer Tow Stop and Right Turn Lamp
20	10A*	Trailer Tow Stop and Left Turn Lamp
21	—	Not Used
22	—	Not Used
23	15A*	HEGO Sensors, Canister Vent, Automatic Transmission, CMS Sensor
24	—	Not Used
101	30A**	Trailer Tow Battery Charge
102	50A**	Four Wheel Antilock Brake Module
103	50A**	Junction Block Battery Feed

Roadside emergencies

Fuse/Relay Location	Fuse Amp Rating	Power Distribution Box Description
104	30A**	4x4 Shift Motor & Clutch
105	40A**	Climate Control Front Blower
106	—	Not Used
107	—	Not Used
108	30A**	Trailer Tow Electric Brake
109	50A**	Air Suspension Compressor
110	30A**	Heated Seats
111	40A**	Ignition Switch Battery Feed (Run/Start Circuit)
112	30A**	Drivers Power Seat, Adjustable Pedals, Memory Module
113	40A**	Ignition Switch Battery Feed (Run and Accessory Circuits)
114	30A**	Climate Control Auxiliary Blower
115	—	Not Used
116	40A**	Rear Window Defroster, Heated Mirrors
117	—	Not Used
118	—	Not Used
201	—	Trailer Tow Park Lamp Relay
202	—	Front Wiper Run/Park Relay
203	—	Trailer Tow Backup Lamp Relay
204	—	A/C Clutch Relay
205	—	Rear Wiper Down
206	—	Foglamp Relay
207	—	Front Washer Pump Relay
208	—	Rear Washer Pump Relay
209	—	Rear Wiper Up
301	—	Fuel Pump Relay
302	—	Trailer Tow Battery Charge Relay
303	—	Wiper Hi/Lo Relay
304	—	Powertrain Control Module Relay

Roadside emergencies

Fuse/Relay Location	Fuse Amp Rating	Power Distribution Box Description
401	—	Not Used
501	—	Powertrain Control Module Diode
502	—	A/C Clutch Diode
503	—	Not Used
601	30A	Delayed Accessory (Power Windows, Flip Windows, Moonroof)
602	—	Not Used
*Mini fuses **Maxi fuses		

Relays

Relays are located in the power distribution box and should be replaced by qualified technicians.

CHANGING THE TIRES

If you get a flat tire while driving, do not apply the brake heavily. Instead, gradually decrease your speed. Hold the steering wheel firmly and slowly move to a safe place on the side of the road.

Spare tire information

Your vehicle is equipped with a spare tire that may be used as a spare or a regular tire. The spare is identical to the other tires on your vehicle, although the wheel trim may not match.

Location of the spare tire and tools

The spare tire and tools for your vehicle are stowed in the following locations:

Item	Location
Spare tire	Under the vehicle, just forward of the rear bumper
Jack, wheel nut wrench, instructions	Behind the access panel located on the right rear quarter panel interior trim
Jack handle	On top of the radiator support at the front of the engine compartment

Roadside emergencies

Removing the jack handle

1. Open the hood.
2. Unsnap the end of the handle that is retained by the clip on the top of the windshield washer bottle.
3. Unsnap the shaft of the handle from the two retaining clips attached to the top of the radiator shroud.

Removing the jack and tools

1. Locate the access panel on the right rear quarter panel interior trim. Lift the two panel retaining clips and remove the panel.
2. Unsnap the wheel lug nut wrench and instructions from their retaining bracket.
3. Remove the jack by turning the thumbwheel counterclockwise to relieve tension against the stowage bracket.
4. If equipped with a two piece lug wrench, assemble the lug wrench as shown in the illustration.

- To assemble, screw the parts together. To disassemble, unscrew.

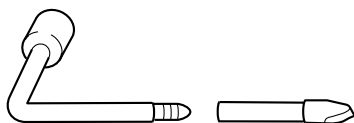

Removing the spare tire

1. Open the liftgate.
2. Twist counterclockwise and remove access plug (if equipped) from guide tube located just above the rear bumper.
3. Insert the straight end of the jack handle into the guide tube.

Forward motion will stop and resistance to turning will be felt when properly engaged.

4. Turn the handle counterclockwise until tire is lowered to the ground and the cable is slightly slack.
5. Remove the retainer from the spare tire.

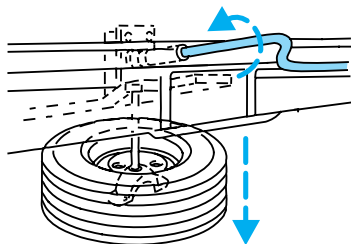

Roadside emergencies

Stowing the spare tire

1. Lay the tire on the ground with the outboard side facing up.
2. Install the retainer through the wheel center and slide the wheel under the vehicle.
3. Turn the spare handle clockwise until the tire is raised to its original position underneath the vehicle. The spare handle ratchets when the tire is raised to the stowed position. It will not allow you to overtighten.
4. Remove tools from the guide tube and install access plug, if removed.

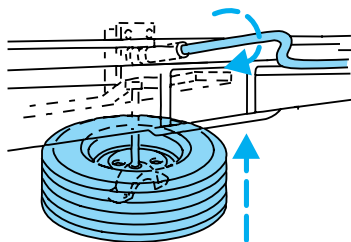

Tire change procedure

 To prevent the vehicle from moving when you change a tire, be sure the parking brake is set, then block (in both directions) the wheel that is diagonally opposite (other side and end of the vehicle) to the tire being changed.

 If the vehicle slips off the jack, you or someone else could be seriously injured.

 On vehicles equipped with Air Suspension, turn OFF the Air Suspension switch prior to jacking, hoisting or towing your vehicle.

Refer to the instruction sheet (located behind the interior trim access panel with the jack) for detailed tire change instructions.

Roadside emergencies

1. Park on a level surface, activate hazard flashers and set the parking brake.
2. Place gearshift lever in P (Park) and turn engine OFF.

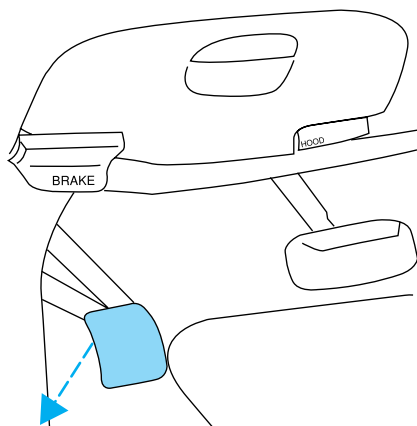

3. Block the diagonally opposite wheel.
4. Obtain the spare tire and jack from their storage locations.
5. Use the tip of the lug wrench to remove wheel trim.

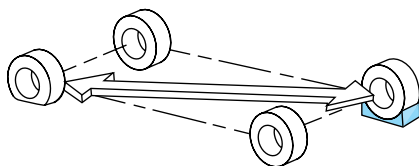

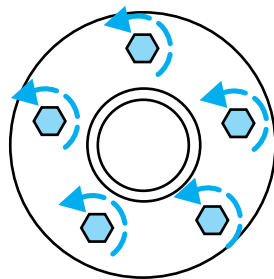

6. Loosen each wheel lug nut one-half turn counterclockwise but do not remove them until the wheel is raised off the ground.

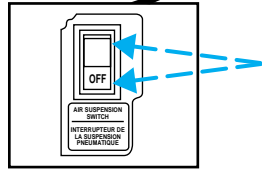
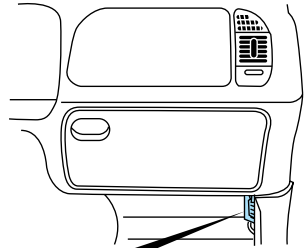

Roadside emergencies

7. Turn OFF the air suspension switch (if equipped).
8. Position the jack according to the following guides and turn the jack handle clockwise until the wheel is completely off the ground.



 When one of the rear wheels is off the ground, the transmission alone will not prevent the vehicle from moving or slipping off the jack, even if the transmission is in P (Park). To prevent the vehicle from moving when you change the tire, be sure that the parking brake is set and the diagonally opposite wheel is blocked. If the vehicle slips off the jack, someone could be seriously injured.

- Front (4x2)

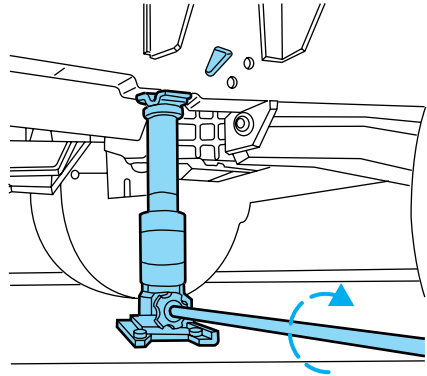

Roadside emergencies

- Front (4x4)

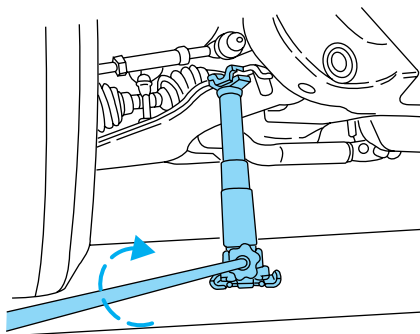

- Rear

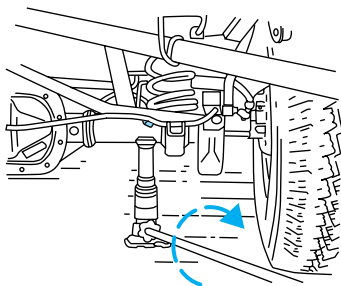

To lessen the risk of personal injury, do not put any part of your body under the vehicle while changing a tire. Do not start the engine when your vehicle is on the jack. The jack is only meant for changing the tire.

- **Never use the front or rear differential as a jacking point.**

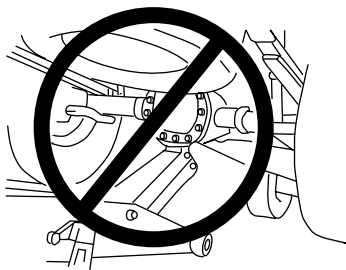

9. Remove the lug nuts with the lug wrench.

10. Replace the flat tire with the spare tire, making sure the valve stem is facing outward. Reinstall the lug nuts until the wheel is snug against the hub. Do not fully tighten the lug nuts until the wheel has been lowered.

11. Lower the wheel by turning the jack handle counterclockwise.

Roadside emergencies

12. Remove the jack and fully tighten the lug nuts in the order shown.

13. Put flat tire, jack and lug wrench away. Make sure the jack is fastened so it does not rattle when you drive.

14. Unblock the wheels.

15. Turn on the air suspension switch (if equipped).

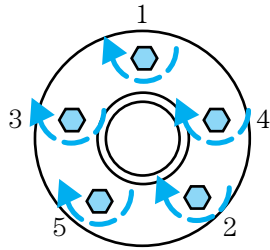

JUMP STARTING YOUR VEHICLE



The gases around the battery can explode if exposed to flames, sparks, or lit cigarettes. An explosion could result in injury or vehicle damage.



Batteries contain sulfuric acid which can burn skin, eyes, and clothing, if contacted.

Do not attempt to push-start your vehicle. Automatic transmissions do not have push-start capability; also, the catalytic converter may become damaged.

Preparing your vehicle

When the battery is disconnected or a new battery is installed, the transmission must relearn its adaptive strategy. As a result of this, the transmission may shift firmly. This operation is considered normal and will not affect function or durability of the transmission. Over time, the adaptive learning process will fully update transmission operation to its optimum shift feel.

1. **Use only a 12-volt supply to start your vehicle.**

2. Do not disconnect the battery of the disabled vehicle as this could damage the vehicle's electrical system.

3. Park the booster vehicle close to the hood of the disabled vehicle making sure the two vehicles **do not** touch. Set the parking brake on both vehicles and stay clear of the engine cooling fan and other moving parts.

Roadside emergencies

4. Check all battery terminals and remove any excessive corrosion before you attach the battery cables. Ensure that vent caps are tight and level.
5. Turn the heater fan on in both vehicles to protect any electrical surges. Turn all other accessories off.

Connecting the jumper cables

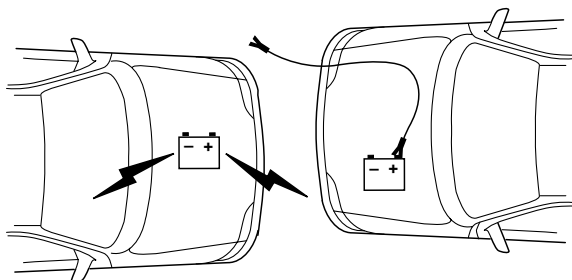

1. Connect the positive (+) booster cable to the positive (+) terminal of the discharged battery.

Note: In the illustrations, *lightning bolts* are used to designate the assisting (boosting) battery.

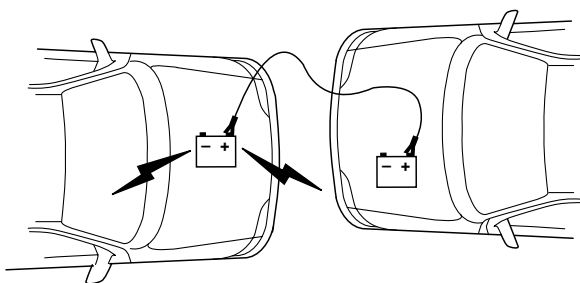

2. Connect the other end of the positive (+) cable to the positive (+) terminal of the assisting battery.

Roadside emergencies

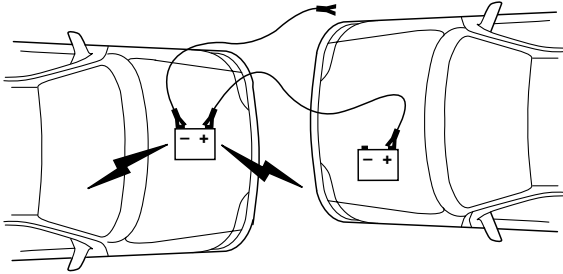

3. Connect the negative (-) cable to the negative (-) terminal of the assisting battery.

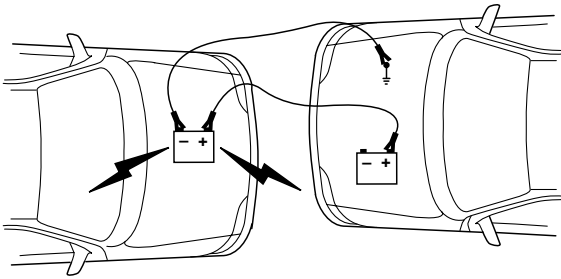

4. Make the final connection of the negative (-) cable to an exposed metal part of the stalled vehicle's engine, away from the battery and the carburetor/fuel injection system. **Do not** use fuel lines, engine rocker covers or the intake manifold as *grounding* points.



Do not connect the end of the second cable to the negative (-) terminal of the battery to be jumped. A spark may cause an explosion of the gases that surround the battery.

5. Ensure that the cables are clear of fan blades, belts, moving parts of both engines, or any fuel delivery system parts.

Jump starting

1. Start the engine of the booster vehicle and run the engine at moderately increased speed.
2. Start the engine of the disabled vehicle.

Roadside emergencies

3. Once the disabled vehicle has been started, run both engines for an additional three minutes before disconnecting the jumper cables.

Removing the jumper cables

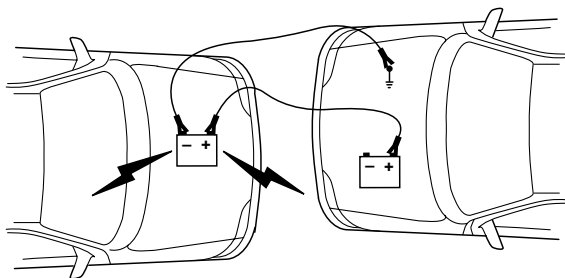

Remove the jumper cables in the reverse order that they were connected.

1. Remove the jumper cable from the *ground* metal surface.

Note: In the illustrations, *lightning bolts* are used to designate the assisting (boosting) battery.

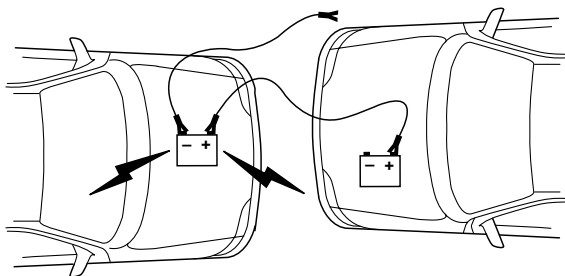

2. Remove the jumper cable on the negative (-) connection of the booster vehicle's battery.

Roadside emergencies

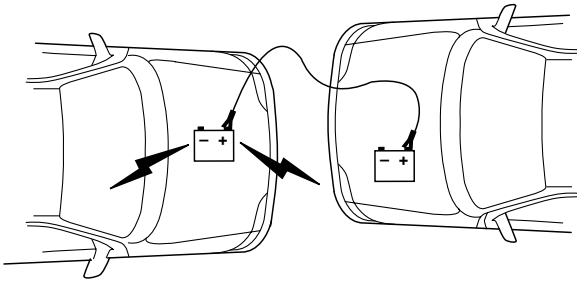

3. Remove the jumper cable from the positive (+) terminal of the booster vehicle's battery.

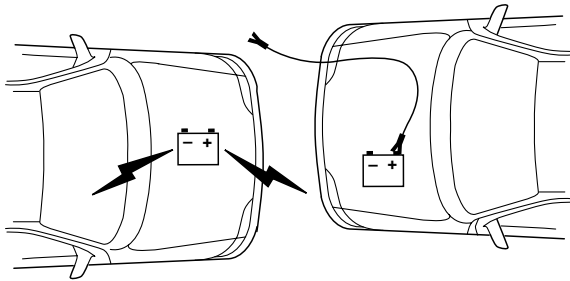

4. Remove the jumper cable from the positive (+) terminal of the disabled vehicle's battery.

After the disabled vehicle has been started and the jumper cables removed, allow it to idle for several minutes so the engine computer can *relearn* its idle conditions.

Roadside emergencies

WRECKER TOWING

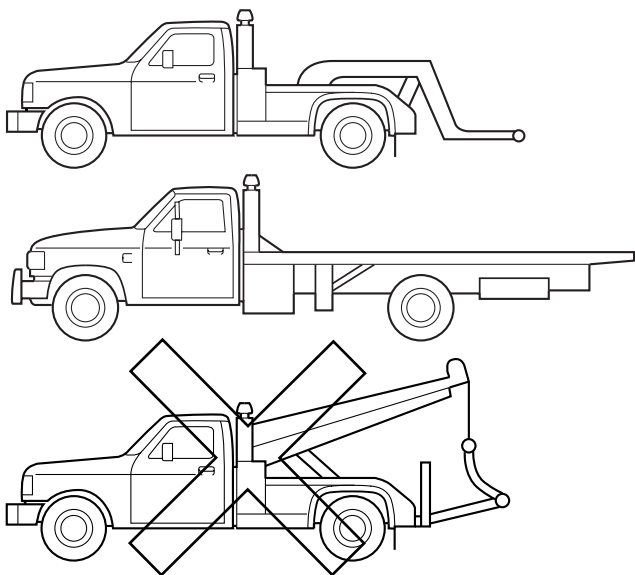

If you need to have your vehicle towed, contact a professional towing service or, if you are a member, your roadside assistance center.

It is recommended that your vehicle be towed with a wheel lift or flatbed equipment. Do not tow with a slingbelt. Ford Motor Company has not approved a slingbelt towing procedure.

If equipped with air suspension, the air suspension control must be turned to the OFF position.

On 4x2 vehicles, it is acceptable to tow the vehicle with the front wheels on the ground (without dollies) and the rear wheels off the ground.

On 4x4 vehicles, it is recommended that your vehicle be towed with a wheel lift and dollies or flatbed equipment with all the wheels off the ground.

If the vehicle is towed by other means or incorrectly, vehicle damage may occur.

Ford Motor Company provides a towing manual for all authorized tow truck operators. Have your tow truck operator refer to this manual for proper hook-up and towing procedures for your vehicle.

Customer assistance

GETTING THE SERVICES YOU NEED

At home

Ford Motor Company and Ford of Canada have authorized dealerships to service your vehicle. It is preferred that you return to the Ford dealer where your vehicle was purchased when warranty repairs are needed. However, you may also take your vehicle to another Ford Motor Company or Ford of Canada dealership authorized for warranty repairs. Certain warranty repairs require special training though, so not all dealers are authorized to perform all warranty repairs. That means that depending on the warranty repair needed, the vehicle may need to be taken to another dealer. If a particular dealership can not assist you, then contact the Customer Relationship Center.

If you have questions or concerns, or are unsatisfied with the service you are receiving, follow these steps:

1. Contact your Sales Representative or Service Advisor at your selling/servicing dealership.
2. If your inquiry or concern remains unresolved, contact the Sales Manager or Service Manager at the dealership.
3. If the inquiry or concern cannot be resolved at the dealership level, please contact the Ford Customer Relationship Center.

Away from home

If you own a Ford or Mercury vehicle and are away from home when your vehicle needs service, or if you need more help than the dealership could provide, after following the steps described above, contact the Ford Customer Relationship Center to find an authorized dealership to help you. In the United States:

Ford Motor Company
Customer Relationship Center
16800 Executive Plaza Drive
P.O. Box 6248
Dearborn, Michigan 48121
1-800-392-3673 (FORD)
(TDD for the hearing impaired: 1-800-232-5952)

Customer assistance

In Canada:
Customer Relationship Centre
Ford Motor Company of Canada, Limited
P.O. Box 2000
Oakville, Ontario L6J 5E4
1-800-565-3673 (FORD)

If you own a Lincoln vehicle and are away from home when your vehicle needs service, or if you need more help than the dealership could provide, after following the steps described above, contact the Ford Customer Relationship Center to find an authorized dealership to help you.

In the United States:
Ford Motor Company
Customer Relationship Center
16800 Executive Plaza Drive
P.O. Box 6248
Dearborn, Michigan 48121
1-800-521-4140
(TDD for the hearing impaired: 1-800-232-5952)

In Canada:
Customer Relationship Centre
Ford Motor Company of Canada, Limited
P.O. Box 2000
Oakville, Ontario L6J 5E4
1-800-565-3673 (FORD)

In order to help you service your Ford or Lincoln Mercury vehicle, please have the following information available when contacting a Customer Relationship Center:

- Your telephone number (home and business).
- The name of the dealer and the city where the dealership is located.
- The year and make of your vehicle.
- The date of vehicle purchase.
- The current odometer reading.
- The vehicle identification number (VIN).

If you still have a complaint involving a warranty dispute, you may wish to contact the Dispute Settlement Board (U.S.).

Customer assistance

In some states (in the U.S.) you must directly notify Ford in writing before pursuing remedies under your state's warranty laws. Ford is also allowed a final repair attempt in some states.

In the United States, a warranty dispute must be submitted to the Dispute Settlement Board before taking action under the Magnuson-Moss Warranty Act, or to the extent allowed by state law, before pursuing replacement or repurchase remedies provided by certain state laws. This dispute handling procedure is not required prior to enforcing state created rights or other rights which are independent of the Magnuson-Moss Warranty Act or state replacement or repurchase laws.

FORD EXTENDED SERVICE PLAN

You can get more protection for your new car or light truck by purchasing Ford Extended Service Plan (Ford ESP) coverage. Ford ESP is an optional service contract which is backed by Ford Motor Company or Ford Motor Service Company (in the U.S.) and Ford of Canada (in Canada). It provides the following:

- Benefits during the warranty period depending on the plan you purchase (such as: reimbursement for rentals; coverage for certain maintenance and wear items).
- Protection against covered repair costs after your Bumper-to-Bumper Warranty expires.

You may purchase Ford ESP from any participating Ford and Lincoln Mercury and Ford of Canada dealer. There are several plans available in various time, distance and deductible combinations which can be tailored to fit your own driving needs. Ford ESP also offers reimbursement benefits for towing and rental coverage.

When you buy Ford ESP, you receive Peace-of-Mind protection throughout the United States and Canada, provided by a network of more than 5,000 participating Ford or Lincoln Mercury and Ford of Canada dealers.

If you did not take advantage of the Ford Extended Service Plan at the time of purchasing your vehicle, you may still be eligible. Please contact your dealer for further information. Since this information is subject to change, please ask your dealer for complete details about Ford Extended Service Plan coverage options, or visit the Ford ESP website at www.ford-esp.com.

THE DISPUTE SETTLEMENT BOARD (U.S. ONLY)

The Dispute Settlement Board is:

- an independent, third-party arbitration program for warranty disputes
- available free to owners and lessees of qualifying Ford Motor Company vehicles

The Dispute Settlement Board may not be available in all states. Ford Motor Company reserves the right to change eligibility limitations, modify procedures and/or to discontinue this service without notice and without incurring obligations per applicable state law.

What kinds of cases does the Board review?

Unresolved warranty repair concerns or vehicle performance concerns as on Ford and Lincoln Mercury cars and Ford and Lincoln Mercury light trucks which are within the terms of any applicable written new vehicle warranty are eligible for review, except those involving:

- a non-Ford product
- a non-Ford dealership
- sales disputes between customer and dealer except those associated with warranty repairs or concerns with the vehicle's performance as designed
- a request for reimbursement of consequential expenses unless a service or product concern is being reviewed
- items not covered by the New Vehicle Limited Warranty (including maintenance and wear items)
- alleged personal injury/property damage claims
- cases currently in litigation
- vehicles not used primarily for family, personal or household purposes (except in states where the Dispute Settlement Board is required to review commercial vehicles)
- vehicles with non-U.S. warranties

Concerns are ineligible for review if the New Vehicle Limited Warranty has expired at receipt of your application and, in certain states eligibility is dependent upon the customer's possession of the vehicle.

Eligibility may differ according to state law. For example, see the unique brochures for California, West Virginia, Georgia and Wisconsin purchasers/lessees.

Customer assistance

Board membership

The Board consists of:

- three consumer representatives
- a Ford or Lincoln Mercury dealership representative

Consumer candidates for Board membership are recruited and trained by an independent consulting firm. The dealership Board member is chosen from Ford and Lincoln Mercury dealership management, recognized for their business leadership qualities.

What the Board needs

To have your case reviewed you must complete the application in the DSB brochure and mail it to the address provided on the application form. Some states will require you to use certified mail, with return receipt requested.

Your application is reviewed and, if it is determined to be eligible, you will receive an acknowledgment indicating:

- The file number assigned to your application.
- The toll-free phone number of the DSB's independent administrator.

Your dealership and a Ford Motor Company representative will then be asked to submit statements.

To properly review your case, the Board needs the following information:

- Legible copies of all documents and maintenance or repair orders relevant to the case.
- The year, make, model, and Vehicle Identification Number (VIN) listed on your vehicle ownership license.
- The date of repair(s) and mileage at the time of occurrence(s).
- The current mileage.
- The name of the dealer(s) who sold or serviced the vehicle.
- A brief description of your unresolved concern.
- A brief summary of the action taken by the dealer(s) and Ford Motor Company.
- The names (if known) of all the people you contacted at the dealership(s).
- A description of the action you expect to resolve your concern.

Customer assistance

You will receive a letter of explanation if your application does not qualify for Board review.

Oral presentations

If you would like to make an oral presentation, indicate YES to question 6 on the application. While it is your right to make an oral presentation before the Board, this is not a requirement and the Board will decide the case whether or not an oral presentation is made. An oral presentation may be requested by the Board as well.

Making a decision

Board members review all available information related to each complaint, including oral presentations, and arrive at a fair and impartial decision. Board review may be terminated at any time by either party.

Every effort is made to decide the case within 40 days of the date that all requested information is received by the Board. Since the Board generally meets once a month, it may take longer for the Board to consider some cases.

After a case is reviewed, the Board mails you a decision letter and a form on which to accept or reject the Board's decision. The decisions of the Board are binding on Ford (and, in some cases, on the dealer) but not on consumers who are free to pursue other remedies available to them under state or federal law.

To Request a DSB Brochure/Application

For a brochure/application, speak to your dealer or write/call to the Board at the following address/phone number:

Dispute Settlement Board
P.O. Box 5120
Southfield, MI 48086-5120
1-800-428-3718

You may also contact the North American Customer Relationship Center at 1-800-392-3673 (Ford), TDD for the hearing impaired: 1-800-232-5952 or by writing to the Center at the following address:

Ford Motor Company
Customer Relationship Center
16800 Executive Plaza Drive
P.O. Box 6248
Dearborn, Michigan 48121

Customer assistance

UTILIZING THE MEDIATION/ARBITRATION PROGRAM (CANADA ONLY)

In those cases where you continue to feel that the efforts by Ford and the dealer to resolve a factory-related vehicle service concern have been unsatisfactory, Ford of Canada participates in an impartial third party mediation/arbitration program administered by the Canadian Motor Vehicle Arbitration Plan (CAMVAP).

The CAMVAP program is a straight-forward and relatively speedy alternative to resolve a disagreement when all other efforts to produce a settlement have failed. This procedure is without cost to you and is designed to eliminate the need for lengthy and expensive legal proceedings.

In the CAMVAP program, impartial third-party arbitrators conduct hearings at mutually convenient times and places in an informal environment. These impartial arbitrators review the positions of the parties, make decisions and, when appropriate, render awards to resolve disputes. CAMVAP decisions are fast, fair, and final; the arbitrator's award is binding both to you and Ford of Canada.

CAMVAP services are available in all territories and provinces. For more information, without charge or obligation, call your CAMVAP Provincial Administrator directly at 1-800-207-0685.

GETTING ASSISTANCE OUTSIDE THE U.S. AND CANADA

Before exporting your vehicle to a foreign country, contact the appropriate foreign embassy or consulate. These officials can inform you of local vehicle registration regulations and where to find unleaded fuel.

If you cannot find unleaded fuel or can only get fuel with an anti-knock index lower than is recommended for your vehicle, contact a district or owner relations/customer relationship office.

The use of leaded fuel in your vehicle without proper conversion may damage the effectiveness of your emission control system and may cause engine knocking or serious engine damage. Ford Motor Company/Ford of Canada is not responsible for any damage caused by use of improper fuel.

In the United States, using leaded fuel may also result in difficulty importing your vehicle back into the U.S.

If your vehicle must be serviced while you are traveling or living in Central or South America, the Caribbean, or the Middle East, contact the nearest Ford dealership. If the dealership cannot help you, write or call:

Customer assistance

FORD MOTOR COMPANY
WORLDWIDE DIRECT MARKET OPERATIONS
1555 Fairlane Drive
Fairlane Business Park #3
Allen Park, Michigan 48101
U.S.A.
Telephone: (313) 594-4857
FAX: (313) 390-0804

If you are in another foreign country, contact the nearest Ford dealership. If the dealership employees cannot help you, they can direct you to the nearest Ford affiliate office.

If you buy your vehicle in North America and then relocate outside of the U.S. or Canada, register your vehicle identification number (VIN) and new address with Ford Motor Company Worldwide Direct Market Operations.

ORDERING ADDITIONAL OWNER'S LITERATURE

To order the publications in this portfolio, contact Helm, Incorporated at:
HELM, INCORPORATED
P.O. Box 07150
Detroit, Michigan 48207

Or call:

For a free publication catalog, order toll free: 1-800-782-4356

Monday-Friday 8:00 a.m. - 6:00 p.m. EST

(Items in this catalog may be purchased by credit card holders only.)

Obtaining a French owner's guide

French Owner's Guides can be obtained from your dealer or by writing to Ford Motor Company of Canada, Limited, Service Publications, P.O. Box 1580, Station B, Mississauga, Ontario L4Y 4G3.

IN CALIFORNIA (U.S. ONLY)

California Civil Code Section 1793.2(d) requires that, if a manufacturer or its representative is unable to repair a motor vehicle to conform to the vehicle's applicable express warranty after a reasonable number of attempts, the manufacturer shall be required to either replace the vehicle with one substantially identical or repurchase the vehicle and reimburse the buyer in an amount equal to the actual price paid or

Customer assistance

payable by the consumer (less a reasonable allowance for consumer use). The consumer has the right to choose whether to receive a refund or replacement vehicle.

California Civil Code Section 1793.22(b) presumes that the manufacturer has had a reasonable number of attempts to conform the vehicle to its applicable express warranties if, within the first 18 months of ownership of a new vehicle or the first 29 000 km (18 000 miles), whichever occurs first:

1. Two or more repair attempts are made on the same nonconformity likely to cause death or serious bodily injury OR
2. Four or more repair attempts are made on the same nonconformity (a defect or condition that substantially impairs the use, value or safety of the vehicle) OR
3. The vehicle is out of service for repair of nonconformities for a total of more than 30 calendar days (not necessarily all at one time)

In the case of 1 or 2 above, the consumer must also notify the manufacturer of the need for the repair of the nonconformity at the following address:

16800 Executive Plaza Drive
Mail Drop 3NE-B
Dearborn, MI 48126

REPORTING SAFETY DEFECTS (U.S. ONLY)

If you believe that your vehicle has a defect which could cause a crash, or could cause injury or death, you should immediately inform the National Highway Traffic Safety Administration (NHTSA) in addition to notifying Ford Motor Company.

Ford Motor Company

If NHTSA receives similar complaints, it may open an investigation, and if it finds that a safety defect exists in a group of vehicles, it may order a recall and remedy campaign. However, NHTSA cannot become involved in individual problems between you, your dealer or Ford Motor Company.

To contact NHTSA, you may either call the Auto Safety Hotline toll-free at 1-800-424-9393 (202-366-0123 in the Washington D.C. area) or write to:

NHTSA
U.S. Department of Transportation
400 Seventh Street
Washington, D.C. 20590

You can also obtain other information about motor vehicle safety from the Hotline.

Cleaning

WASHING THE EXTERIOR OF YOUR VEHICLE

Never wash a vehicle that is “hot to the touch” or during exposure to strong, direct sunlight. It is recommended that you wash your vehicle regularly with cool or lukewarm water and a neutral Ph shampoo, such as Detail Wash (ZC-3-A), which is available from your authorized Ford, Lincoln or Mercury dealer. Always use a clean sponge or carwash mitt with plenty of water for best results. Dry the vehicle with a chamois or soft terry cloth towel in order to eliminate water spotting.

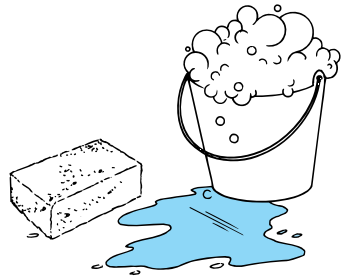

Never use strong household detergents or soap, such as dish washing or laundry liquid. These products can discolor and spot painted surfaces.

It is especially important to wash the vehicle regularly during winter months, as dirt and road salt are difficult to remove and do cause damage to the vehicle.

Items such as gasoline, diesel fuel, bird droppings and insect deposits should be washed and sponged off as soon as possible. Deposits not removed promptly can cause damage to the vehicle's paintwork and trim over time.

Remove any exterior accessories, such as antennas, before entering a car wash.

PROTECTING THE PAINT FINISH OF YOUR VEHICLE

Applying a polymer paint sealant to your vehicle on a regular basis will assist in reducing minor scratches and paint damage.

A typical paint sealant lasts approximately six months to a year, depending on local weather conditions and the cleaning soap that is used in washing the vehicle.

Do not use a wax that beads excessively.

Do not allow paint sealant to come in contact with any non-body (low-gloss black) colored trim, such as grained door handles, roof racks, bumpers, side moldings, mirror housings or the windshield cowl area. The paint sealant will “gray” or stain the parts over time.

REPAIRING PAINT CHIPS

Remove particles such as bird droppings, tree sap, insect deposits, tar spots, road salt and industrial fallout before repairing paint chips.

Minor scratches or paint damage from road debris may be repaired using the Ultra Touch Prep and Finishing Kit (F7AZ-19K507-BA), which is available at your authorized Ford, Lincoln or Mercury dealer. This kit contains:

- Lacquer Touch-Up Paint (ALBZ-19500-XXXXA)
- Exterior Acrylic Spray Lacquer (ALAZ-19500-XXXXA)

Please note that the part numbers (shown as XXXX above) will vary with your vehicle's specific coloring. **Carefully observe the application instructions on the products.**

CLEANING THE WHEEL RIMS AND COVERS

Aluminum wheel rims or covers are coated with a clearcoat paint finish.

Some automatic car washes may cause damage to the finish on your wheel rims or covers. Chemical-strength cleaners, or cleaning chemicals, in combination with brush agitation to remove brake dust and dirt, could wear away the clearcoat finish over time.

Do not use hydrofluoric acid-based or high caustic-based wheel cleaners, steel wool, fuels or strong household detergents for soiled wheel rims and covers.

Never apply any cleaning chemical to hot or warm wheel rims or covers.

Clean wheel rims and covers with Detail Wash (ZC-3-A), which is available from your authorized Ford, Lincoln or Mercury dealer. Spray cleaner on cool wheel rims or covers and allow to set for 2–5 minutes. Agitate the area with a sponge and rinse off with plenty of water.

Use Extra Strength Tar and Road Oil Removal (B7A-19520-AA), available from your authorized Ford, Lincoln or Mercury dealer, in order to remove tar and grease from wheel rims and covers.

CLEANING THE ENGINE

Engines are more efficient when they are clean because grease and dirt buildup keep the engine warmer than normal. When washing:

- The engine must be cool to the touch before spraying with water.

Cleaning

- **Never spray a hot engine with cold water, as damage to the engine block or engine components may occur.**
- Use caution when using a self-serve power washer (1000psi maximum pressure) to clean the engine, as the high-pressure fluid could penetrate the sealed parts and cause damage.
- **Never apply anything to any exposed belts in the engine compartment, including the belt dressing.**

For general cleaning of the engine and engine compartment, spray Engine Shampoo and Degreaser (F4AZ-19A536-A) on all parts that require cleaning and pressure rinse the area with cool water.

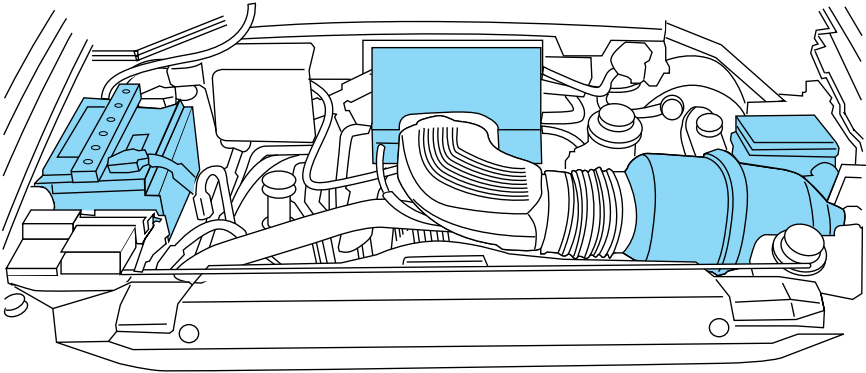

- Cover the highlighted areas to prevent water damage when cleaning the engine.
- **Never wash or rinse the engine while it is running; water in the running engine may cause internal damage.**

WASHING NON-PAINTED PLASTIC EXTERIOR PARTS

Use Detail Wash (ZC-3-A) for routine cleaning.

If tar or grease spots are present, clean with Extra Strength Tar and Road Oil Removal (B7A-19520-AA).

Use only approved products to clean plastic parts. These products are available from your authorized Ford, Lincoln or Mercury dealer.

WASHING THE EXTERIOR LAMPS

In order to avoid scratching the plastic lamps, do not use dry paper towels, non-approved chemical solvents or abrasive cleaners.

Use a soft cloth and a solution of Triple Clean (EOAZ-19526-AA), mixed properly with water, in order to remove bug residue. If tar or grease spots are present, clean with Extra Strength Tar and Road Oil Removal (B7A-19520-AA).

CLEANING THE WINDSHIELD, WIPER BLADES AND REAR WINDOW

If the wiper does not wipe properly, substances on the windshield, rear window or the wiper blades may be the cause. These may include hot wax treatments used by commercial car washes, tree sap, or other organic contamination.

Do not clean the windshield or rear window glass with abrasives, as they may cause scratches.

Do not use fuel, kerosene, or paint thinner to clean the windshield, rear window or the wiper blades as damage may occur.

Clean the outside of the windshield or rear window with a non-abrasive cleaner such as Ultra Clear Spray Glass Cleaner (E4AZ-19C507-AA), available from your authorized Ford, Lincoln or Mercury dealer. If after cleaning the glass surface, the water sheets from the glass (e.g., does not bead), then the window is clean.

The windshield, rear window and wiper blades should be cleaned regularly. Wiper blades can be cleaned with isopropyl (rubbing) alcohol or windshield washer solution. Be sure to replace wiper blades when they appear worn or do not function properly.

CLEANING THE INSTRUMENT PANEL

Clean the instrument panel with a damp cloth, then dry with a dry cloth. Avoid cleaners or polish that increase the gloss of the upper portion of the instrument panel. The dull finish in this area helps protect the driver from undesirable windshield reflection.

Cleaning



Do not use chemical solvents or strong detergents when cleaning the steering wheel or instrument panel to avoid contamination of the air bag system.

CLEANING THE INSTRUMENT CLUSTER LENS

Wipe the cluster area with a soft, damp cotton towel. Dry the area with a clean, dry towel.

CLEANING SEATS EQUIPPED WITH SIDE AIR BAGS

Remove dust and loose dirt with a vacuum cleaner. In order to remove stains and soil, clean with Extra Strength Upholstery Cleaner (E8AZ-19523-AA).

Never saturate the seat covers with any cleaning solution.



Do not use chemical solvents or strong detergents when cleaning the seat where the side air bag is mounted. Such products could contaminate the side air bag system and affect performance of the side air bag in a collision. The air bag may not function correctly and not provide injury reduction benefits.

CLEANING THE INTERIOR FABRIC, CARPETS AND CLOTH SEATS

Remove dust and loose dirt with a vacuum cleaner. Remove light stains and soil with Extra Strength Upholstery Cleaner (E8AZ-19523-AA).

Never saturate the seat covers with cleaning solution.

Do not use household cleaning products or glass cleaners, which can stain and discolor the fabric and affect the flame retardant abilities of the seat materials.

If grease or tar is present on the material, spot-clean the area first with Spot and Stain Remover (F3AZ-19521-WA). Follow up by recleaning the area with Extra Strength Upholstery Cleaner (E8AZ-19523-AA).

CLEANING LEATHER SEATS (IF EQUIPPED)

All Ford, Lincoln and Mercury vehicles with leather seating surfaces have a clear, protective coating over the leather.

To clean the leather seats, simply use a soft cloth with Deluxe Leather and Vinyl Cleaner (F2AZ-19521-WA). Dry the area with a soft cloth.

It is recommended that you use the Deluxe Leather Care Kit (F8AZ-19G253-AA), available from your authorized Ford, Lincoln or Mercury dealer. The mild cleaner and special pad available in the kit cleans the leather and maintains its natural beauty. For best results, follow the instructions printed on the cleaner label. Regular cleaning of your leather upholstery helps maintain its resiliency and color.

Do not use household cleaning products, alcohol solutions, solvents or cleaners intended for rubber, vinyl and plastics, or oil/petroleum-based leather conditioners. These products may cause premature wearing of the clear, protective coating.

CLEANING WOOD-TONE TRIM

Wipe stains with a clean, soft cloth and Ultra Clear Spray Glass Cleaner (E4AZ-19C507-AA). Dry the area by wiping with a dry, soft, clean cloth.

CLEANING THE INSIDE WINDOWS

Use Ultra Clear Spray Glass Cleaner (E4AZ-19C507-AA) for the inside windows if they become fogged.

To clean, use two lint-free, soft towels, folded into a pad-shape. Mist the glass completely with cleaner, and use one of the towels to evenly agitate the surface. Use the other towel to remove the residue.

CLEANING AND MAINTAINING THE SAFETY BELTS

Clean the safety belts with Extra Strength Upholstery Cleaner (E8AZ-19523-AA), available from your authorized Ford, Lincoln or Mercury dealer.

Do not use bleach, dye or any other solvent to clean the belts, as these actions may weaken the belt webbing.

UNDERBODY

Flush the complete underside of your vehicle frequently. Keep body and door drain holes free from packed dirt.

Cleaning

FORD, LINCOLN AND MERCURY CAR CARE PRODUCTS

Your Ford, Lincoln or Mercury dealer has many quality products available to clean your vehicle and protect its finishes. These quality products have been specifically engineered to fulfill your automotive needs; they are custom designed to complement the style and appearance of your vehicle. Each product is made from high quality materials that meet or exceed rigid specifications. For best results, use the following or products of equivalent quality:

Ford Custom Clearcoat Polish*

Ford Custom Silicone Gloss Polish

Ford Custom Vinyl Protectant* (not available in Canada)

Motorcraft Vinyl Conditioner (Canada only)

Ford Deluxe Leather and Vinyl Cleaner (not available in Canada)

Motorcraft Vinyl Cleaner (Canada only)

Ford Extra Strength Tar and Road Oil Remover* (not available in Canada)

Ford Extra Strength Upholstery Cleaner (not available in Canada)

Ford Custom Bright Metal Cleaner

Motorcraft Premium Car Wash Concentrate

Motorcraft Carlite Glass Cleaner (Canada only)

Ford Spot and Stain Remover*

Ford Super Premium Tire and Trim Dressing

Ford Triple Clean

Ford Ultra-Clear Spray Glass Cleaner (not available in Canada)

Ford Engine Shampoo and Degreaser

* May be sold with the Motorcraft name

Maintenance and specifications

SERVICE RECOMMENDATIONS

To help you service your vehicle:

- We highlight do-it-yourself items in the engine compartment for easy location.
- We provide a scheduled maintenance guide which makes tracking routine service easy.

If your vehicle requires professional service, your dealership can provide the necessary parts and service. Check your *Warranty Guide* to find out which parts and services are covered.

Use only recommended fuels, lubricants, fluids and service parts conforming to specifications. Motorcraft parts are designed and built to provide the best performance in your vehicle.

PRECAUTIONS WHEN SERVICING YOUR VEHICLE

Be especially careful when inspecting or servicing your vehicle.

- Do not work on a hot engine.
- When the engine is running, make sure that loose clothing, jewelry or long hair does not get caught up in moving parts.
- Do not work on a vehicle with the engine running in an enclosed space, unless you are sure you have enough ventilation.
- Keep all lit cigarettes, open flames and other lit material away from the battery and all fuel related parts.

If you disconnect the battery, the engine must “relearn” its idle conditions before your vehicle will drive properly, as explained in *Battery* in this chapter.

Maintenance and specifications

Working with the engine off

1. Set the parking brake and ensure the gearshift is securely latched in P (Park).
2. Turn off the engine and remove the key.
3. Block the wheels to prevent the vehicle from moving unexpectedly.

Working with the engine on

1. Set the parking brake and ensure the gearshift is securely latched in P (Park).
2. Block the wheels to prevent the vehicle from moving unexpectedly.

Note: Do not start your engine with the air cleaner removed and do not remove it while the engine is running.

OPENING THE HOOD

1. Inside the vehicle, pull the hood release handle located under the bottom of the instrument panel.
2. Go to the front of the vehicle and release the auxiliary latch that is located under the front center of the hood.
3. Lift the hood until the lift cylinders hold it open.

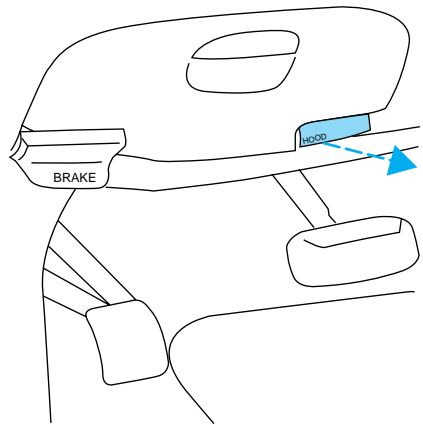

Maintenance and specifications

IDENTIFYING COMPONENTS IN THE ENGINE COMPARTMENT

4.6L V8 and 5.4L V8 engines

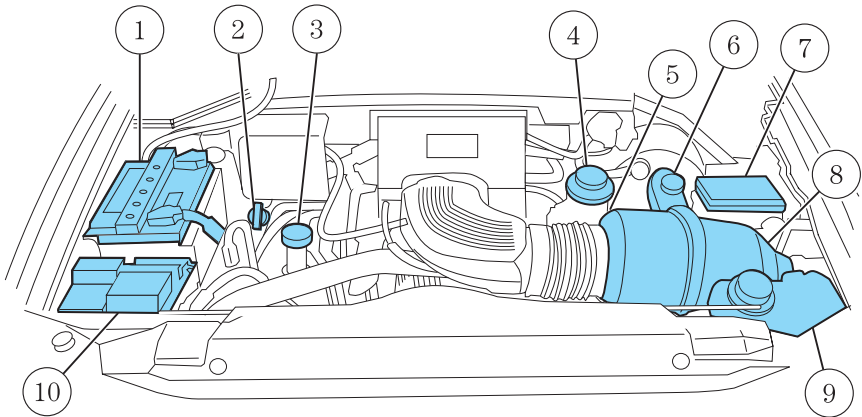

1. Battery
2. Automatic transmission fluid dipstick
3. Engine oil filler cap
4. Engine oil dipstick
5. Power steering fluid reservoir
6. Brake fluid reservoir
7. Power distribution box
8. Air filter assembly
9. Engine coolant reservoir
10. Windshield washer fluid reservoir

Maintenance and specifications

WINDSHIELD WASHER FLUID

Washer fluid

Check the washer fluid whenever you stop for fuel. The reservoir is highlighted with a  symbol.

If the level is low, add enough fluid to fill the reservoir. In very cold weather, do not fill the reservoir all the way.

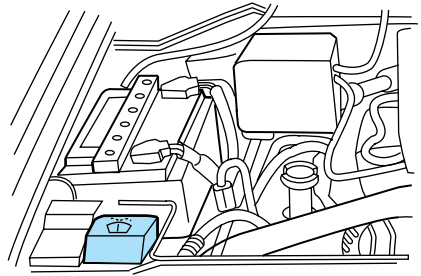

Only use a washer fluid that meets Ford specification ESR-M17P5-A. Refer to *Lubricant specifications* in this chapter.

State or local regulations on volatile organic compounds may restrict the use of methanol, a common windshield washer antifreeze additive. Washer fluids containing non-methanol antifreeze agents should be used only if they provide cold weather protection without damaging the vehicle's paint finish, wiper blades or washer system.

Note: Do not put washer fluid in the engine coolant reservoir. Washer fluid placed in the cooling system may harm engine and cooling system components.

Checking and adding washer fluid for the liftgate

Washer fluid for the liftgate is supplied by the same reservoir as the windshield.

ENGINE OIL

Checking the engine oil

Refer to the scheduled maintenance guide for the appropriate intervals for checking the engine oil.

1. Make sure the vehicle is on level ground.
2. Turn the engine off and wait a few minutes for the oil to drain into the oil pan.
3. Set the parking brake and ensure the gearshift is securely latched in P (Park).

Maintenance and specifications

4. Open the hood. Protect yourself from engine heat.
5. Locate and carefully remove the engine oil level indicator (dipstick).

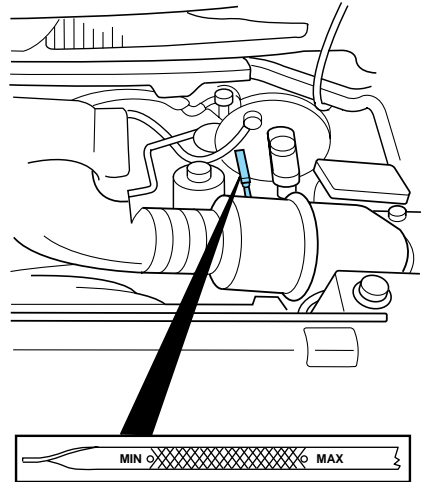

6. Wipe the indicator clean. Insert the indicator fully, then remove it again.
- If the oil level is **between the MIN and MAX marks**, the oil level is acceptable. **DO NOT ADD OIL.**
 - If the oil level is below the MIN mark, add enough oil to raise the level within the MIN-MAX range.

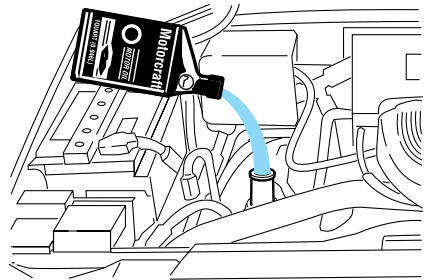

- Oil levels above the MAX mark may cause engine damage. Some oil must be removed from the engine by a service technician.
7. Put the indicator back in and ensure it is fully seated.

Maintenance and specifications

Adding engine oil

1. Check the engine oil. For instructions, refer to *Checking the engine oil* in this chapter.
2. If the engine oil level is not within the normal range, add only certified engine oil of the recommended viscosity. Remove the engine oil filler cap and use a funnel to pour the engine oil into the opening.
3. Recheck the engine oil level. Make sure the oil level is not above the MAX mark on the engine oil level indicator (dipstick).
4. Install the indicator and ensure it is fully seated.
5. Fully install the engine oil filler cap by turning the filler cap clockwise 1/4 of a turn until three clicks are heard or until the cap is fully seated.

To avoid possible oil loss, DO NOT operate the vehicle with the engine oil level indicator and/or the engine oil filler cap removed.

Engine oil and filter recommendations

Look for this certification trademark.

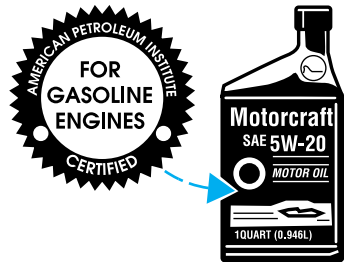

SAE 5W-20 engine oil is recommended.

Only use oils “Certified For Gasoline Engines” by the American Petroleum Institute (API). Use Motorcraft or an equivalent oil meeting Ford specification WSS-M2C153-H. **SAE 5W-20 oil provides optimum fuel economy and durability performance meeting all requirements for your vehicle’s engine.**

Do not use supplemental engine oil additives, oil treatments or engine treatments. They are unnecessary and could, under certain conditions, lead to engine damage which is not covered by your warranty.

Change your engine oil and filter according to the appropriate schedule listed in the scheduled maintenance guide.

Ford production and aftermarket (Motorcraft) oil filters are designed for added engine protection and long life. If a replacement oil filter is used

Maintenance and specifications

that does not meet Ford material and design specifications, start-up engine noises or knock may be experienced.

It is recommended you use the appropriate Motorcraft oil filter (or another brand meeting Ford specifications) for your engine application.

BATTERY

Your vehicle is equipped with a Motorcraft maintenance-free battery which normally does not require additional water during its life of service.

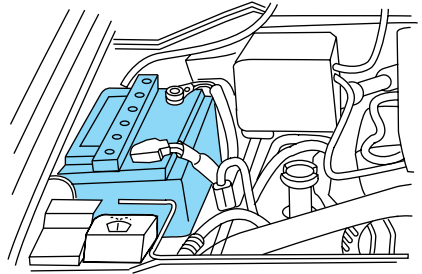

However, for severe usage or in high temperature climates, check the battery electrolyte level. Refer to the scheduled maintenance guide for the service interval schedules.

Keep the electrolyte level in each cell up to the “level indicator”. Do not overfill the battery cells.

If the electrolyte level in the battery is low, you can add plain tap water to the battery, as long as you do not use hard water (water with a high mineral or alkali content). If possible, however, try to only fill the battery cells with distilled water. If the battery needs water often, have the charging system checked.

If your battery has a cover/shield, make sure it is reinstalled after the battery has been cleaned or replaced.

For longer, trouble-free operation, keep the top of the battery clean and dry. Also, make certain the battery cables are always tightly fastened to the battery terminals.

If you see any corrosion on the battery or terminals, remove the cables from the terminals and clean with a wire brush. You can neutralize the acid with a solution of baking soda and water.

When the battery is disconnected or a new battery installed, the transmission must learn its adaptive strategy. As a result of this, the transmission may shift firmly. This operation is considered normal and will fully update transmission operation to its optimum shift feel.

Maintenance and specifications



Batteries normally produce explosive gases which can cause personal injury. Therefore, do not allow flames, sparks or lighted substances to come near the battery. When working near the battery, always shield your face and protect your eyes. Always provide proper ventilation.



When lifting a plastic-cased battery, excessive pressure on the end walls could cause acid to flow through the vent caps, resulting in personal injury and/or damage to the vehicle or battery. Lift the battery with a battery carrier or with your hands on opposite corners.



Keep batteries out of reach of children. Batteries contain sulfuric acid. Avoid contact with skin, eyes or clothing. Shield your eyes when working near the battery to protect against possible splashing of acid solution. In case of acid contact with skin or eyes, flush immediately with water for a minimum of 15 minutes and get prompt medical attention. If acid is swallowed, call a physician immediately.



Battery posts, terminals and related accessories contain lead and lead compounds. **Wash hands after handling.**

For information on transmission operation after the battery has been disconnected see “Shift strategy” in the driving section.

To account for customer driving habits and conditions, your automatic transmission (4R100) electronically controls the shift quality by using an adaptive learning strategy. The adaptive learning strategy is maintained by power from the battery. When the battery is disconnected or a new battery is installed, the transmission must relearn its adaptive strategy. Optimal shifting will resume within a few hundred kilometers (miles) of operation.

If the shift quality does not improve within a few hundred kilometers (miles) of operation, or if the downshifts and other throttle conditions do not function normally or after a long deceleration period, see your dealer or a qualified service technician as soon as possible.

Maintenance and specifications

Because your vehicle's engine is also electronically controlled by a computer, some control conditions are maintained by power from the battery. When the battery is disconnected or a new battery is installed, the engine must relearn its idle and fuel trim strategy for optimum driveability and performance. To begin this process:

1. With the vehicle at a complete stop, set the parking brake.
 2. Put the gearshift in P (Park), turn off all accessories and start the engine.
 3. Run the engine until it reaches normal operating temperature.
 4. Allow the engine to idle for at least one minute.
 5. Turn the A/C on and allow the engine to idle for at least one minute.
 6. With your foot on the brake pedal and with the A/C on, put the vehicle in D (Drive) and allow the engine to idle for at least one minute.
 7. Drive the vehicle to complete the relearning process.
- The vehicle may need to be driven 16 km (10 miles) or more to relearn the idle and fuel trim strategy.
 - **If you do not allow the engine to relearn its idle trim, the idle quality of your vehicle may be adversely affected until the idle trim is eventually relearned.**

If the battery has been disconnected or a new battery has been installed, the clock and the preset radio stations must be reset once the battery is reconnected.

- Always dispose of automotive batteries in a responsible manner. Follow your local authorized standards for disposal. Call your local authorized recycling center to find out more about recycling automotive batteries.

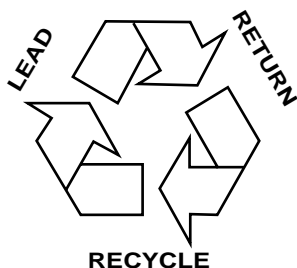

Maintenance and specifications

ENGINE COOLANT

Checking engine coolant

The concentration and level of engine coolant should be checked at the mileage intervals listed in the scheduled maintenance guide. The coolant concentration should be maintained at 50/50 coolant and water, which equates to a freeze point of -36°C (-34°F). Coolant concentration testing is possible with a hydrometer or antifreeze tester (such as the Rotunda Battery and Antifreeze Tester, 014-R1060). The level of coolant should be maintained at the “cold full” or “cold fill range” level in the coolant reservoir. If the level falls below, add coolant per the instructions in the *Adding Engine Coolant* section.

Your vehicle was factory-filled with a 50/50 engine coolant and water concentration. If the concentration of coolant falls below 40% or above 60%, the engine parts could become damaged or not work properly. **A 50-50 mixture of coolant and water provides the following:**

- **Freeze protection down to -36°C (-34°F).**
- **Boiling protection up to 129°C (265°F).**
- **Protection against rust and other forms of corrosion.**
- **Enables calibrated gauges to work properly.**

When the engine is cold, check the level of the engine coolant in the reservoir.

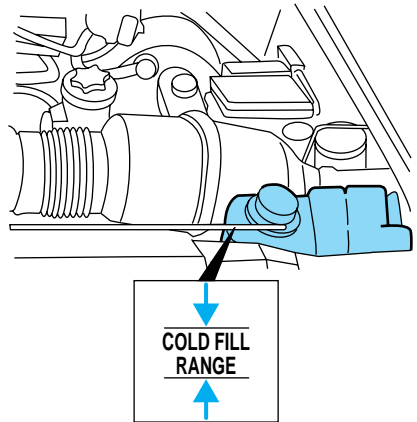

- The engine coolant should be at the “cold fill level” or within the “cold fill range” as listed on the engine coolant reservoir (depending upon application).

Maintenance and specifications

- Refer to the Scheduled Maintenance Guide for service interval schedules.
- Be sure to read and understand *Precautions when servicing your vehicle* in this chapter.

If the engine coolant has not been checked at the recommended interval, the engine coolant reservoir may become low or empty. If the reservoir is low or empty, add engine coolant to the reservoir. Refer to *Adding engine coolant* in this chapter.

Note: Automotive fluids are not interchangeable; do not use engine coolant, antifreeze or windshield washer fluid outside of its specified function and vehicle location.

Adding engine coolant

When adding coolant, make sure it is a 50/50 mixture of engine coolant and distilled water. Add the mixture to the coolant reservoir, **when the engine is cool**, until the appropriate fill level is obtained.



Do not add engine coolant when the engine is hot. Steam and scalding liquids released from a hot cooling system can burn you badly. Also, you can be burned if you spill coolant on hot engine parts.



Do not put engine coolant in the windshield washer fluid container. If sprayed on the windshield, engine coolant could make it difficult to see through the windshield.

The cooling system in your vehicle is filled with either green-colored Motorcraft Premium Engine Coolant meeting Ford specification ESE-M97B44-A or yellow-colored Motorcraft Premium Gold Engine Coolant meeting Ford Specification WSS-M97B51-A1. To determine your vehicle's coolant type (color), check your coolant reservoir.

- **Add Motorcraft Premium Engine Coolant (green-colored), VC-4-A (U.S.) or CXC-10 (Canada) or Motorcraft Premium Gold Engine Coolant (yellow-colored), VC-7-A, depending on the type of coolant originally equipped in your vehicle.** If you are unsure which type of coolant your vehicle requires, check your coolant reservoir or contact your local dealer.
- **Do not add/mix an orange-colored, extended life coolant such as Motorcraft Speciality Orange Engine Coolant, VC-2 (US) or CXC-209 (Canada), meeting Ford specification WSS-M97B44-D**

Maintenance and specifications

with the factory-filled coolant. Mixing Motorcraft Speciality Orange Engine Coolant or any orange-colored extended life product with your factory filled coolant can result in degraded corrosion protection.

- A large amount of water without engine coolant may be added, in case of emergency, to reach a vehicle service location. In this instance, the cooling system must be drained and refilled with a 50/50 mixture of engine coolant and distilled water as soon as possible. Water alone (without engine coolant) can cause engine damage from corrosion, overheating or freezing.
- **Do not use alcohol, methanol or brine or any engine coolants mixed with alcohol or methanol antifreeze (coolant).** Alcohol and other liquids can cause engine damage from overheating or freezing.
- **Do not add extra inhibitors or additives to the coolant.** These can be harmful and compromise the corrosion protection of the engine coolant.
- **Do not mix with recycled coolant unless from a Ford-approved recycling process (see *Use of Recycled Engine Coolant section*).**

For vehicles with overflow coolant systems with a non-pressurized cap on the coolant recovery system, add coolant to the coolant recovery reservoir when the engine is cool. Add the proper mixture of coolant and water to the “cold full” level. For all other vehicles, which have a coolant degas system with a pressurized cap, or if it is necessary to remove the coolant pressure relief cap on the radiator of a vehicle with an overflow system, follow these steps to add engine coolant.



To avoid personal injury, make sure the engine is cool before unscrewing the coolant pressure relief cap. The cooling system is under pressure; steam and hot liquid can come out forcefully when the cap is loosened slightly.

1. Before you begin, turn the engine off and let it cool.
2. When the engine is cool, wrap a thick cloth around the coolant pressure relief cap on the coolant reservoir (an opaque plastic bottle). Slowly turn cap counterclockwise (left) until pressure begins to release.
3. Step back while the pressure releases.
4. When you are sure that all the pressure has been released, use the cloth to turn it counterclockwise and remove the cap.

Maintenance and specifications

5. Fill the coolant reservoir slowly with the proper coolant mixture (see above), to within the “cold fill range” or the “cold full” level on the reservoir. If you removed the radiator cap in an overflow system, fill the radiator until the coolant is visible and radiator is almost full.
6. Replace the cap. Turn until tightly installed. (Cap must be tightly installed to prevent coolant loss.)

After any coolant has been added, check the coolant concentration see Checking Engine Coolant section). If the concentration is not 50/50 (protection to $-34^{\circ}\text{ F}/-36^{\circ}\text{ C}$), drain some coolant and adjust the concentration. It may take several drains and additions to obtain a 50/50 coolant concentration.

Whenever coolant has been added, the coolant level in the coolant reservoir should be checked the next few times you drive the vehicle. If necessary, add enough 50/50 concentration of engine coolant and distilled water to bring the liquid level to the proper level.

If you have to add more than 1.0 liter (1.0 quart) of engine coolant per month, have your dealer check the engine cooling system. Your cooling system may have a leak. Operating an engine with a low level of coolant can result in engine overheating and possible engine damage.

Recycled engine coolant

Ford Motor Company recommends the use of a recycled engine coolant produced by Ford-approved processes in vehicles originally equipped with Motorcraft Premium Engine Coolant (green-colored). However, not all coolant recycling processes produce coolant that meets Ford specification ESE-M97B44-A. Use of such coolant may harm the engine and cooling system components.

Ford Motor Company does NOT recommend the use of recycled engine coolant in vehicles originally equipped with Motorcraft Premium Gold Engine Coolant since a Ford-approved recycling process is not yet available.



Used engine coolant should be disposed of in an appropriate manner. Follow your community's regulations and standards for recycling and disposing of automotive fluids.

Coolant refill capacity

To find out how much fluid your vehicle's cooling system can hold, refer to *Refill capacities* in this chapter.

Maintenance and specifications

Fill your engine coolant reservoir as outlined in *Adding engine coolant* in this chapter.

Severe climates

If you drive in extremely cold climates (less than -36°C [-34°F):

- **It may be necessary to increase the coolant concentration above 50%.**
- **NEVER increase the coolant concentration above 60%.**
- **Increased engine coolant concentrations above 60% will decrease the overheat protection characteristics of the engine coolant and may cause engine damage.**
- **Refer to the chart on the coolant container to ensure the coolant concentration in your vehicle will provide adequate freeze protection at the temperatures in which you drive in the winter months.**

If you drive in extremely hot climates:

- **It is still necessary to maintain the coolant concentration above 40%.**
- **NEVER decrease the coolant concentration below 40%.**
- **Decreased engine coolant concentrations below 40% will decrease the corrosion protection characteristics of the engine coolant and may cause engine damage.**
- **Decreased engine coolant concentrations below 40% will decrease the freeze protection characteristics of the engine coolant and may cause engine damage.**
- **Refer to the chart on the coolant container to ensure the coolant concentration in your vehicle will provide adequate protection at the temperatures in which you drive.**

Vehicles driven year-round in non-extreme climates should use a 50/50 mixture of engine coolant and distilled water for optimum cooling system and engine protection.



What you should know about fail-safe cooling

If the engine coolant supply is depleted, this feature allows the vehicle to be driven temporarily before incremental component damage is incurred. The “fail-safe” distance depends on ambient temperatures, vehicle load and terrain.

Maintenance and specifications

How fail-safe cooling works

If the engine begins to overheat:

- The engine coolant temperature gauge will move to the red (hot) area.
- The  and the  symbol will illuminate.
- The *Service Engine Soon* indicator light will illuminate.

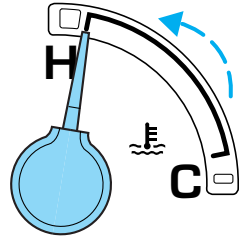

If the engine reaches a preset over-temperature condition, the engine will automatically switch to alternating cylinder operation. Each disabled cylinder acts as an air pump and cools the engine.

When this occurs the vehicle will still operate. However:

- The engine power will be limited.
- The air conditioning system will be disabled.

Continued operation will increase the engine temperature:

- The engine will completely shut down.
- Steering and braking effort will increase.

Once the engine temperature cools, the engine can be re-started. Take your vehicle to a service facility as soon as possible to minimize engine damage.

When fail-safe mode is activated

You have limited engine power when in the fail-safe mode, so drive the vehicle with caution. The vehicle will not be able to maintain high speed operation and the engine will run rough. Remember that the engine is capable of completely shutting down automatically to prevent engine damage, therefore:

1. Pull off the road as soon as safely possible and turn off the engine.
2. Arrange for the vehicle to be taken to a service facility.
3. If this is not possible, wait a short period for the engine to cool.
4. Check the coolant level and replenish if low.



Never remove the coolant reservoir cap while the engine is running or hot.

Maintenance and specifications

5. Restart the engine and take your vehicle to a service facility.

Driving the vehicle without repairing the engine problem increases the chance of engine damage. Take your vehicle to a service facility as soon as possible.

WHAT YOU SHOULD KNOW ABOUT AUTOMOTIVE FUELS

Important safety precautions



Do not overfill the fuel tank. The pressure in an overfilled tank may cause leakage and lead to fuel spray and fire.



The fuel system may be under pressure. If the fuel filler cap is venting vapor or if you hear a hissing sound, wait until it stops before completely removing the fuel filler cap. Otherwise, fuel may spray out and injure you or others.



If you do not use the proper fuel filler cap, excessive pressure or vacuum in the fuel tank may damage the fuel system or cause the fuel cap to disengage in a collision, which may result in possible personal injury.



Automotive fuels can cause serious injury or death if misused or mishandled.



Gasoline may contain benzene, which is a cancer-causing agent.

Maintenance and specifications

Observe the following guidelines when handling automotive fuel:

- Extinguish all smoking materials and any open flames before fueling your vehicle.
- Always turn off the vehicle before fueling.
- Automotive fuels can be harmful or fatal if swallowed. Fuel such as gasoline is highly toxic and if swallowed can cause death or permanent injury. If fuel is swallowed, call a physician immediately, even if no symptoms are immediately apparent. The toxic effects of fuel may not be visible for hours.
- Avoid inhaling fuel vapors. Inhaling too much fuel vapor of any kind can lead to eye and respiratory tract irritation. In severe cases, excessive or prolonged breathing of fuel vapor can cause serious illness and permanent injury.
- Avoid getting fuel liquid in your eyes. If fuel is splashed in the eyes, remove contact lenses (if worn), flush with water for 15 minutes and seek medical attention. Failure to seek proper medical attention could lead to permanent injury.
- Fuels can also be harmful if absorbed through the skin. If fuel is splashed on the skin and/or clothing, promptly remove contaminated clothing and wash skin thoroughly with soap and water. Repeated or prolonged skin contact with fuel liquid or vapor causes skin irritation.
- Be particularly careful if you are taking “Antabuse” or other forms of disulfiram for the treatment of alcoholism. Breathing gasoline vapors, or skin contact could cause an adverse reaction. In sensitive individuals, serious personal injury or sickness may result. If fuel is splashed on the skin, promptly wash skin thoroughly with soap and water. Consult a physician immediately if you experience an adverse reaction.

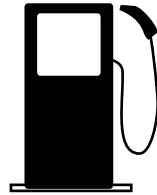

When refueling always shut the engine off and never allow sparks or open flames near the filler neck. Never smoke while refueling. Fuel vapor is extremely hazardous under certain conditions. Care should be taken to avoid inhaling excess fumes.

Maintenance and specifications



The flow of fuel through a fuel pump nozzle can produce static electricity, which can cause a fire if fuel is pumped into an ungrounded fuel container.

Use the following guidelines to avoid static build-up when filling an ungrounded fuel container:

- Place approved fuel container on the ground.
- DO NOT fill a fuel container while it is in the vehicle (including the cargo area).
- Keep the fuel pump nozzle in contact with the fuel container while filling.
- DO NOT use a device that would hold the fuel pump handle in the fill position.

Fuel Filler Cap

Your fuel tank filler cap has an indexed design with a 1/8 turn on/off feature.

When fueling your vehicle:

1. Turn the engine off.
2. Carefully turn the filler cap counterclockwise 1/8 of a turn until it stops.
3. Pull to remove the cap from the fuel filler pipe.
4. To install the cap, align the tabs on the cap with the notches on the filler pipe.
5. Turn the filler cap clockwise 1/8 of a turn until it stops.

If the “Service Engine Soon/Check Engine” indicator comes on and stays on after you start the engine, the fuel filler cap may not be properly installed. Turn off the engine, remove the fuel filler cap, align the cap properly and reinstall it.

If you must replace the fuel filler cap, replace it with a fuel filler cap that is designed for your vehicle. The customer warranty may be void for any damage to the fuel tank or fuel system if the correct genuine Ford or Motorcraft fuel filler cap is not used.

Maintenance and specifications



The fuel system may be under pressure. If the fuel filler cap is venting vapor or if you hear a hissing sound, wait until it stops before completely removing the fuel filler cap. Otherwise, fuel may spray out and injure you or others.



If you do not use the proper fuel filler cap, excessive pressure or vacuum in the fuel tank may damage the fuel system or cause the fuel cap to disengage in a collision, which may result in possible personal injury.

Choosing the right fuel

Use only UNLEADED FUEL. The use of leaded fuel is prohibited by law and could damage your vehicle.

Do not use fuel containing methanol. It can damage critical fuel system components.

Your vehicle was not designed to use fuel or fuel additives with metallic compounds, including manganese-based compounds containing MMT.

Repairs to correct the effects of using a fuel for which your vehicle was not designed may not be covered by your warranty.

Octane recommendations

Your vehicle is designed to use “Regular” unleaded gasoline with pump $(R+M)/2$ octane rating of 87.

We do not recommend the use of gasolines labeled as “Regular” that are sold with octane ratings of 86 or lower in high altitude areas.

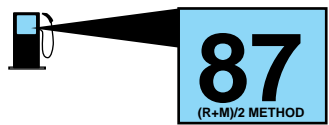

Do not be concerned if your engine sometimes knocks lightly. However, if it knocks heavily under most driving conditions while you are using fuel with the recommended octane rating, see your dealer or a qualified service technician to prevent any engine damage.

Fuel quality

If you are experiencing starting, rough idle or hesitation driveability problems during a cold start, try a different brand of “Regular” unleaded gasoline. “Premium” unleaded gasoline is not recommended (particularly in the United States) because it may cause these problems to become

Maintenance and specifications

more pronounced. If the problems persist, see your dealer or a qualified service technician.

It should not be necessary to add any aftermarket products to your fuel tank if you continue to use high quality fuel of the recommended octane rating. Aftermarket products could cause damage to the fuel system. Repairs to correct the effects of using an aftermarket product in your fuel may not be covered by your warranty.

Many of the world's automakers issued the World-wide Fuel Charter that recommends gasoline specifications to provide improved performance and emission control system protection for your vehicle. Gasolines that meet the World-wide Fuel Charter should be used when available. Ask your fuel supplier about gasolines that meet the World-wide Fuel Charter. In Canada, look for fuels that display the **Auto Makers' Choice**™ logo.



Cleaner air

Ford endorses the use of reformulated “cleaner-burning” gasolines to improve air quality.

Running out of fuel

Avoid running out of fuel because this situation may have an adverse affect on powertrain components.

If you have run out of fuel:

- You may need to cycle the ignition from OFF to ON several times after refueling, to allow the fuel system to pump the fuel from the tank to the engine.
- Your “Service Engine Soon” indicator may come on. For more information on the “Service Engine Soon” indicator, refer to the *Instrument Cluster* chapter.

Fuel Filter

For fuel filter replacement, see your dealer or a qualified service technician. Refer to the scheduled maintenance guide for the appropriate intervals for changing the fuel filter.

Maintenance and specifications

Replace the fuel filter with an authorized Motorcraft part. The customer warranty may be void for any damage to the fuel system if an authorized Motorcraft fuel filter is not used.

ESSENTIALS OF GOOD FUEL ECONOMY

Measuring techniques

Your best source of information about actual fuel economy is you, the driver. You must gather information as accurately and consistently as possible. Fuel expense, frequency of fillups or fuel gauge readings are NOT accurate as a measure of fuel economy. We do not recommend taking fuel economy measurements during the first 1 600 km (1 000 miles) of driving (engine break-in period). You will get a more accurate measurement after 3 000 km–5 000 km (2 000 miles–3 000 miles).

Filling the tank

The advertised fuel capacity of the fuel tank on your vehicle is equal to the rated refill capacity of the fuel tank as listed in the *Refill capacities* section of this chapter.

The advertised capacity is the amount of the indicated capacity and the empty reserve combined. Indicated capacity is the difference in the amount of fuel in a full tank and a tank when the fuel gauge indicates empty. Empty reserve is the small amount of fuel remaining in the fuel tank after the fuel gauge indicates empty.

The amount of usable fuel in the empty reserve varies and should not be relied upon to increase driving range. When refueling your vehicle after the fuel gauge indicates empty, you might not be able to refuel the full amount of the advertised capacity of the fuel tank due to the empty reserve still present in the tank.

For consistent results when filling the fuel tank:

- Turn the engine/ignition switch to the off position prior to refueling, an error in the reading will result if the engine is left running.
- Use the same filling rate setting (low — medium — high) each time the tank is filled.
- Allow no more than 2 automatic click-offs when filling.
- Always use fuel with the recommended octane rating.
- Use a known quality gasoline, preferably a national brand.

Maintenance and specifications

- Use the same side of the same pump and have the vehicle facing the same direction each time you fill up.
- Have the vehicle loading and distribution the same every time.

Your results will be most accurate if your filling method is consistent.

Calculating fuel economy

1. Fill the fuel tank completely and record the initial odometer reading (in kilometers or miles).
2. Each time you fill the tank, record the amount of fuel added (in liters or gallons).
3. After at least three to five tank fill-ups, fill the fuel tank and record the current odometer reading.
4. Subtract your initial odometer reading from the current odometer reading.
5. Follow one of the simple calculations in order to determine fuel economy:

Multiply liters used by 100, then divide by total kilometers traveled.

Divide total miles traveled by total gallons used.

Keep a record for at least one month and record the type of driving (city or highway). This will provide an accurate estimate of the vehicle's fuel economy under current driving conditions. Additionally, keeping records during summer and winter will show how temperature impacts fuel economy. In general, lower temperatures give lower fuel economy.

Driving style — good driving and fuel economy habits

Give consideration to the lists that follow and you may be able to change a number of variables and improve your fuel economy.

Habits

- Smooth, moderate operation can yield up to 10% savings in fuel.
- Steady speeds without stopping will usually give the best fuel economy.
- Idling for long periods of time (greater than one minute) may waste fuel.
- Anticipate stopping; slowing down may eliminate the need to stop.

Maintenance and specifications

- Sudden or hard accelerations may reduce fuel economy.
- Slow down gradually.
- Driving at reasonable speeds (traveling at 88 km/h [55 mph] uses 15% less fuel than traveling at 105 km/h [65 mph]).
- Revving the engine before turning it off may reduce fuel economy.
- Using the air conditioner or defroster may reduce fuel economy.
- You may want to turn off the speed control in hilly terrain if unnecessary shifting between third and fourth gear occurs. Unnecessary shifting of this type could result in reduced fuel economy.
- Warming up a vehicle on cold mornings is not required and may reduce fuel economy.
- Resting your foot on the brake pedal while driving may reduce fuel economy.
- Combine errands and minimize stop-and-go driving.

Maintenance

- Keep tires properly inflated and use only recommended size.
- Operating a vehicle with the wheels out of alignment will reduce fuel economy.
- Use recommended engine oil. Refer to *Lubricant specifications* in this chapter.
- Perform all regularly scheduled maintenance items. Follow the recommended maintenance schedule and owner maintenance checks found in your vehicle scheduled maintenance guide.

Conditions

- Heavily loading a vehicle or towing a trailer may reduce fuel economy at any speed.
- Carrying unnecessary weight may reduce fuel economy (approximately 0.4 km/L [1 mpg] is lost for every 180 kg [400 lb] of weight carried).
- Adding certain accessories to your vehicle (for example bug deflectors, rollbars/light bars, running boards, ski/luggage racks) may reduce fuel economy.
- Using fuel blended with alcohol may lower fuel economy.

Maintenance and specifications

- Fuel economy may decrease with lower temperatures during the first 12–16 km (8–10 miles) of driving.
- Driving on flat terrain offers improved fuel economy as compared to driving on hilly terrain.
- Transmissions give their best fuel economy when operated in the top cruise gear and with steady pressure on the gas pedal.
- Four-wheel-drive operation (if equipped) is less fuel efficient than two-wheel-drive operation.
- Close windows for high speed driving.

EPA window sticker

Every new vehicle should have the EPA window sticker. Contact your dealer if the window sticker is not supplied with your vehicle. The EPA window sticker should be your guide for the fuel economy comparisons with other vehicles.

It is important to note the box in the lower left corner of the window sticker. These numbers represent the Range of L/100 km (MPG) expected on the vehicle under optimum conditions. Your fuel economy may vary depending upon the method of operation and conditions.

EMISSION CONTROL SYSTEM

Your vehicle is equipped with various emission control components and a catalytic converter which will enable your vehicle to comply with applicable exhaust emission standards. To make sure that the catalytic converter and other emission control components continue to work properly:

- Use only the specified fuel listed.
- Avoid running out of fuel.
- Do not turn off the ignition while your vehicle is moving, especially at high speeds.
- Have the items listed in your scheduled maintenance guide performed according to the specified schedule.

The scheduled maintenance items listed in the scheduled maintenance guide are essential to the life and performance of your vehicle and to its emissions system.

If other than Ford, Motorcraft or Ford-authorized parts are used for maintenance replacements or for service of components affecting

Maintenance and specifications

emission control, such non-Ford parts should be equivalent to genuine Ford Motor Company parts in performance and durability.



Do not park, idle, or drive your vehicle in dry grass or other dry ground cover. The emission system heats up the engine compartment and exhaust system, which can start a fire.

Illumination of the “Check Engine” light, charging system warning light or the temperature warning light, fluid leaks, strange odors, smoke or loss of engine power, could indicate that the emission control system is not working properly.



Exhaust leaks may result in entry of harmful and potentially lethal fumes into the passenger compartment.

Do not make any unauthorized changes to your vehicle or engine. By law, vehicle owners and anyone who manufactures, repairs, services, sells, leases, trades vehicles, or supervises a fleet of vehicles are not permitted to intentionally remove an emission control device or prevent it from working. Information about your vehicle’s emission system is on the Vehicle Emission Control Information Decal located on or near the engine. This decal identifies engine displacement and gives some tune up specifications.

Please consult your *Warranty Guide* for complete emission warranty information.

Readiness for Inspection/Maintenance (I/M) testing

In some localities, it may be a legal requirement to pass an I/M test of the on-board diagnostics system. If your “Check Engine/Service Engine Soon” light is on, refer to the description in the *Warning lights and chimes* section of the *Instrument Cluster* chapter. Your vehicle may not pass the I/M test with the “Check Engine/Service Engine Soon” light on.

If the vehicle’s powertrain system or its battery has just been serviced, the on-board diagnostics system is reset to a “not ready for I/M test” condition. To ready the on-board diagnostics system for I/M testing, a minimum of 30 minutes of city and highway driving is necessary as described below:

- First, at least 10 minutes of driving on an expressway or highway.
- Next, at least 20 minutes driving in stop-and-go, city-type traffic with at least four idle periods.

Maintenance and specifications

Allow the vehicle to sit for at least eight hours without starting the engine. Then, start the engine and complete the above driving cycle. The engine must warm up to its normal operating temperature. Once started, do not turn off the engine until the above driving cycle is complete.

CHECKING AND ADDING POWER STEERING FLUID

Check the power steering fluid. Refer to the scheduled maintenance guide for the service interval schedules. If adding fluid is necessary, use only Ford Premium Power Steering Fluid.

1. Start the engine and let it run until it reaches normal operating temperature (the engine coolant temperature gauge indicator will be near the center of the normal area between H and C).

2. While the engine idles, turn the steering wheel left and right several times.

3. Turn the engine off.

4. Check the fluid level in the reservoir. It should be between the MIN and MAX lines. Do not add fluid if the level is in this range.

5. If the fluid is low, add fluid in small amounts, continuously checking the level until it reaches the range between the MIN and MAX lines. Be sure to put the cap back on the reservoir.

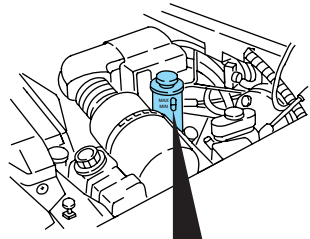
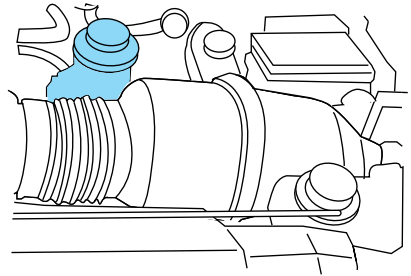

Maintenance and specifications

BRAKE FLUID (⚠)

Checking and adding brake fluid

Brake fluid should be checked and refilled as needed. Refer to the scheduled maintenance guide for the service interval schedules.

1. Clean the reservoir cap before removal to prevent dirt or water from entering the reservoir.

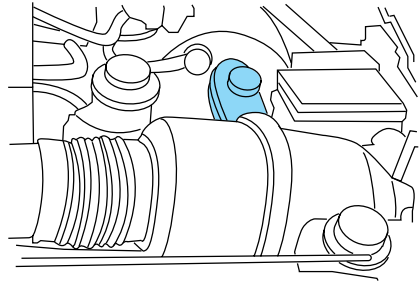

2. Visually inspect the fluid level.

3. If necessary, add brake fluid from a clean un-opened container until the level reaches MAX. Do not fill above this line.

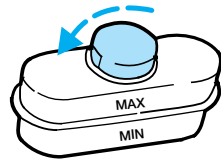

4. Use only a DOT 3 brake fluid certified to meet Ford specification ESA-M6C25-A. Refer to *Lubricant specifications* in this chapter.



Brake fluid is toxic. If brake fluid contacts the eyes, flush eyes with running water for 15 minutes. Seek medical attention if irritation persists. If taken internally, drink water and induce vomiting. Seek medical attention immediately.



If you use a brake fluid that is not DOT 3, you will cause permanent damage to your brakes.



Do not let the fluid level in the reservoir for the master cylinder fall below the MIN mark. If master cylinder runs dry, this may cause the brakes to fail.

Maintenance and specifications

TRANSMISSION FLUID

Checking automatic transmission fluid

Refer to your scheduled maintenance guide for scheduled intervals for fluid checks and changes. Your transmission does not consume fluid. However, the fluid level should be checked if the transmission is not working properly, i.e., if the transmission slips or shifts slowly or if you notice some sign of fluid leakage.

Automatic transmission fluid expands when warmed. To obtain an accurate fluid check, drive the vehicle until it is at normal operating temperature (approximately 30 km [20 miles]). If your vehicle has been operated for an extended period at high speeds, in city traffic during hot weather or pulling a trailer, the vehicle should be turned off for about 30 minutes to allow fluid to cool before checking.

1. Drive the vehicle 30 km (20 miles) or until it reaches normal operating temperature.
2. Park the vehicle on a level surface and engage the parking brake.
3. With the parking brake engaged and your foot on the brake pedal, start the engine and move the gearshift lever through all of the gear ranges. Allow sufficient time for each gear to engage.
4. Latch the gearshift lever in P (Park) and leave the engine running.
5. Remove the dipstick, wiping it clean with a clean, dry lint free rag. If necessary, refer to *Identifying components in the engine compartment* in this chapter for the location of the dipstick.
6. Install the dipstick making sure it is fully seated in the filler tube.
7. Remove the dipstick and inspect the fluid level. The fluid should be in the designated area for normal operating temperature or ambient temperature.

Low fluid level

Do not drive the vehicle if the fluid level is at the bottom of the dipstick and the ambient temperature is above 10°C (50°F).



Correct fluid level

The transmission fluid should be checked at normal operating temperature 66°C-77°C (150°F-170°F) on a level surface. The normal

Maintenance and specifications

operating temperature can be reached after approximately 30 km (20 miles) of driving.

You can check the fluid without driving if the ambient temperature is above 10°C (50°F). However, if fluid is added at this time, an overfill condition could result when the vehicle reaches normal operating temperature.

The transmission fluid should be in this range if at normal operating temperature (66°C-77°C [150°F-170°F]).

The transmission fluid should be in this range if at ambient temperature (10°C-35°C [50°F-95°F]).



High fluid level

Fluid levels above the safe range may result in transmission failure. An overfill condition of transmission fluid may cause shift and/or engagement concerns and/or possible damage.

High fluid levels can be caused by an overheating condition.



Adjusting automatic transmission fluid levels

Before adding any fluid, make sure the correct type is used. The type of fluid used is normally indicated on the dipstick and also in the *Lubricant specifications* section in this chapter.

Use of a non-approved automatic transmission fluid may cause internal transmission component damage.

If necessary, add fluid in 250 mL (1/2 pint) increments through the filler tube until the level is correct.

If an overfill occurs, excess fluid should be removed by a qualified technician.

An overfill condition of transmission fluid may cause shift and/or engagement concerns and/or possible damage.



Maintenance and specifications

DRIVELINE UNIVERSAL JOINT AND SLIP YOKE

Your vehicle may be equipped with universal joints that require lubrication. Refer to the scheduled maintenance guide for maintenance intervals. If the original universal joints are replaced with universal joints equipped with grease fittings, lubrication will also be necessary.

AIR FILTER MAINTENANCE

Refer to the scheduled maintenance guide for the appropriate intervals for changing the air filter element.

When changing the air filter element, use only the Motorcraft air filter element listed. Refer to *Motorcraft Part Numbers*.

Note: Do not start your engine with the air cleaner removed and do not remove it while the engine is running.

Changing the air filter element

1. Loosen the clamp that secures the air inlet tube to the engine air filter cover and disconnect the tube from the cover.

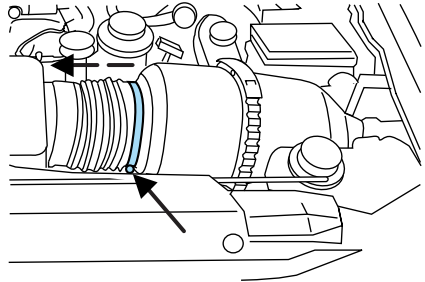

2. Loosen the clamp that secures the air filter cover to the air filter housing and carefully separate the cover from housing.

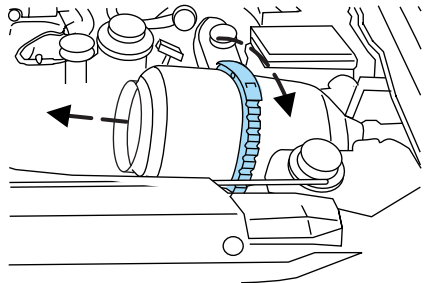

Maintenance and specifications

3. Remove the air filter element from the air filter housing.

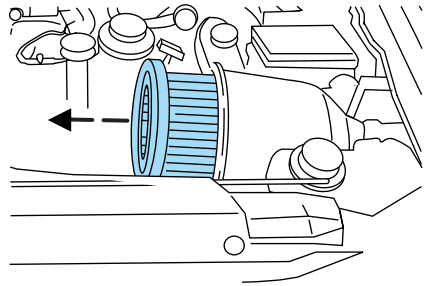

4. Install a new air filter element. Be careful not to crimp the filter element edges between the air filter housing and cover. This could cause filter damage and allow unmetered air to enter the engine if not properly seated.
5. Replace the air filter cover and secure the clamp.
6. Replace the air inlet tube and secure the clamp.

INFORMATION ABOUT UNIFORM TIRE QUALITY GRADING

New vehicles are fitted with tires that have a rating on them called Tire Quality Grades. The Quality grades can be found where applicable on the tire sidewall between tread shoulder and maximum section width. For example:

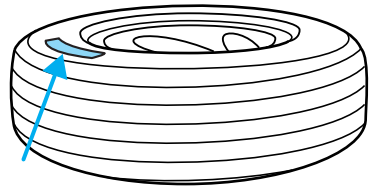

• **Treadwear 200 Traction AA Temperature A**

These Tire Quality Grades are determined by standards that the United States Department of Transportation has set.

Tire Quality Grades apply to new pneumatic tires for use on passenger cars. They do not apply to deep tread, winter-type snow tires, space-saver or temporary use spare tires, tires with nominal rim diameters of 10 to 12 inches or limited production tires as defined in Title 49 Code of Federal Regulations Part 575.104(c)(2).

U.S. Department of Transportation-Tire quality grades: The U.S. Department of Transportation requires Ford to give you the following information about tire grades exactly as the government has written it.

Maintenance and specifications

Treadwear

The treadwear grade is a comparative rating based on the wear rate of the tire when tested under controlled conditions on a specified government test course. For example, a tire graded 150 would wear one and one-half (1 1/2) times as well on the government course as a tire graded 100. The relative performance of tires depends upon the actual conditions of their use, however, and may depart significantly from the norm due to variations in driving habits, service practices, and differences in road characteristics and climate.

Traction AA A B C

The traction grades, from highest to lowest are AA, A, B, and C. The grades represent the tire's ability to stop on wet pavement as measured under controlled conditions on specified government test surfaces of asphalt and concrete. A tire marked C may have poor traction performance.



The traction grade assigned to this tire is based on straight-ahead braking traction tests, and does not include acceleration, cornering, hydroplaning or peak traction characteristics.

Temperature A B C

The temperature grades are A (the highest), B, and C, representing the tire's resistance to the generation of heat and its ability to dissipate heat when tested under controlled conditions on a specified indoor laboratory test wheel. Sustained high temperature can cause the material of the tire to degenerate and reduce tire life, and excessive temperature can lead to sudden tire failure. The grade C corresponds to a level of performance which all passenger car tires must meet under the Federal Motor Vehicle Safety Standard No. 109. Grades B and A represent higher levels of performance on the laboratory test wheel than the minimum required by law.



The temperature grade for this tire is established for a tire that is properly inflated and not overloaded. Excessive speed, underinflation, or excessive loading, either separately or in combination, can cause heat buildup and possible tire failure.

Maintenance and specifications

SERVICING YOUR TIRES

Checking the tire pressure

- Use an accurate tire pressure gauge.
- Check the tire pressure when tires are cold, after the vehicle has been parked for at least one hour or has been driven less than 5 km (3 miles).
- Adjust tire pressure to recommended specifications found on the Certification Label. Tire pressure information can also be found on the Tire Information label located on the inside of the fuel filler door.



Improperly inflated tires can affect vehicle handling and can fail suddenly, possibly resulting in loss of vehicle control.

Tire rotation

Because your vehicle's tires perform different jobs, they often wear differently. To make sure your tires wear evenly and last longer, rotate them as indicated in the scheduled maintenance guide. If you notice that the tires wear unevenly, have them checked.

- Four tire rotation

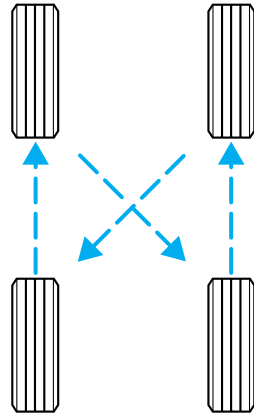

Maintenance and specifications

Replacing the tires

Replace the tires when the wear band is visible through the tire treads.

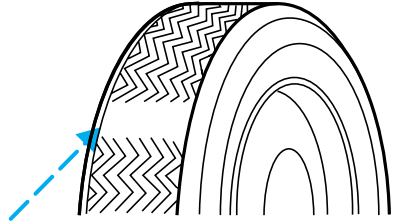

When replacing full size tires, never mix radial bias-belted, or bias-type tires. Use only the tire sizes that are listed on the Certification Label. Make sure that all tires are the same size, speed rating, and load-carrying capacity. Use only the tire combinations recommended on the label. If you do not follow these precautions, your vehicle may not drive properly and safely.



Make sure that all replacement tires are of the same size, type, load-carrying capacity and tread design (e.g., “All Terrain”, etc.), as originally offered by Ford.



Do not replace your tires with “high performance” tires or larger size tires.



Failure to follow these precautions may adversely affect the handling of the vehicle and make it easier for the driver to lose control and roll over.

Tires that are larger or smaller than your vehicle’s original tires may also affect the accuracy of your speedometer.

Maintenance and specifications

SNOW TIRES AND CHAINS



Snow tires must be the same size and grade as the tires you currently have on your vehicle.

The tires on your vehicle have all weather treads to provide traction in rain and snow. However, in some climates, you may need to use snow tires and chains.

Follow these guidelines when using snow tires and chains:

- Use only cable type chains offered by Ford as an accessory or equivalent. SAE class “S” or other conventional link type chains may contact and cause damage to the vehicle’s wheel house and/or body.
- Install chains securely, verifying that the chains do not touch any wiring, brake lines or fuel lines.
- Drive cautiously. If you hear the chains rub or bang against your vehicle, stop and re-tighten the chains. If this does not work, remove the chains to prevent damage to your vehicle.
- If possible, avoid fully loading your vehicle.
- Remove the tire chains when they are no longer needed. Do not use tire chains on dry roads.
- The suspension insulation and bumpers will help prevent vehicle damage. Do not remove these components from your vehicle when using snow tires and chains.
- Do not exceed 48 km/h (30 mph) with tire chains on your vehicle.

MOTORCRAFT PART NUMBERS

Component	4.6L V8 engine	5.4L V8 engine
Air filter element	FA-1634	FA-1634
Battery	BTX-65-650	BTX-65-650
Fuel filter	FG-986B	FG-986B
Oil filter	FL-820-S	FL-820-S
PCV valve	EV-233	EV-233
Spark plugs*	AWSF-32P	AWSF-22W

* Refer to Vehicle Emissions Control Information (VECI) decal for spark plug gap information.

Maintenance and specifications

REFILL CAPACITIES

Fluid	Ford Part Name	Application	Capacity
Brake fluid	High Performance DOT 3 Motor Vehicle Brake Fluid	All	Fill to line on reservoir
Engine oil (includes filter change)	Motorcraft SAE 5W-20 Super Premium Motor Oil	All	5.7L (6.0 quarts)
Fuel tank	N/A	4X2 with standard suspension	98.6L (26.0 gallons)
		4X4 and 4X2 with rear load level suspension	113.6L (30.0 gallons)
Power steering fluid	Motorcraft MERCON® ATF	All	Fill to line on reservoir
Transmission fluid ¹	Motorcraft MERCON®V ATF	4R70W	13.1L (13.9 quarts) ²
	Motorcraft MERCON® ATF	4R100 (4x2)	15.0L (15.9 quarts) ²
		4R100 (4x4)	15.5L (16.4 quarts) ²
Transfer case fluid	Motorcraft MERCON® ATF	4x4 vehicles	1.9L (2.0 quarts)

Maintenance and specifications

Fluid	Ford Part Name	Application	Capacity
Engine coolant ³	Motorcraft Premium Engine Coolant (green-colored) or Motorcraft Premium Gold Engine Coolant (yellow-colored)	4.6L V8 engine with 1 row radiator	20.5 L (21.7 quarts)
		4.6L V8 engine with 2 row radiator	21.8L (23.0 quarts)
		5.4L V8 engine with 1 row radiator	22.6L (23.9 quarts)
		5.4L V8 engine with 2 row radiator	24.1L (25.5 quarts)
		4.6L V8 engine with 1 row radiator and aux rear heat	21.7L (22.9 quarts)
		4.6L V8 engine with 2 row radiator and aux rear heat	23.5L (24.8 quarts)
		5.4L V8 engine with 1 row radiator and aux rear heat	24.9L (26.3 quarts)
		5.4L V8 engine with 2 row radiator and aux rear heat	26.4L (27.9 quarts)
Front axle lubricant	Motorcraft SAE 75W-90 Premium 4x4 Front Axle Lubricant	4x4 vehicles	1.8-2.0L (3.5-3.7 pints)
Rear axle lubricant ⁴	Motorcraft SAE 75W-140 Synthetic Rear Axle Lubricant	All	2.9-3.1L (5.5-5.8 pints)

Maintenance and specifications

Fluid	Ford Part Name	Application	Capacity
Windshield washer fluid	Ultra-Clear Windshield Washer Concentrate	All	4.1L (4.5 quarts)

¹Ensure the correct automatic transmission fluid is used. Transmission fluid requirements are indicated on the dipstick or on the dipstick handle. Check the container to verify the fluid being added is of the correct type. Refer to your scheduled maintenance guide to determine the correct service interval.

Some transmission fluids may be labeled as dual usage, such as MERCON® and MERCON® V. These dual usage fluids are not to be used in an automatic transmission that requires use of the MERCON® type fluid. However, these dual usage fluids may be used in transmissions that require the MERCON® V type fluid.

MERCON® and MERCON® V type fluids are not interchangeable. DO NOT mix MERCON® and MERCON® V. Use of a transmission fluid that indicates dual usage (MERCON® and MERCON® V) in an automatic transmission application requiring MERCON® may cause transmission damage. Use of any fluid other than the recommended fluid may cause transmission damage.

²Indicates only approximate dry-fill capacity. Some applications may vary based on cooler size and if equipped with an in-tank cooler. The amount of transmission fluid and fluid level should be set by the indication on the dipstick's normal operating range.

³Add the coolant type originally equipped in your vehicle.

⁴Your vehicle's rear axle is filled with a synthetic rear axle lubricant and is considered lubricated for life. These lubricants are not to be checked or changed unless a leak is suspected, service is required or the axle has been submerged in water. The axle lubricant should be changed any time the axle has been submerged in water. Add 118 ml (4 oz.) of Additive Friction Modifier C8AZ-19B546-A or equivalent meeting Ford specification EST-M2C118-A for complete refill of Traction-Lok axles.

Service refill capacities are determined by filling the rear axle 6 mm to 14 mm (1/4 inch to 9/16 inch) below the bottom of the filler hole.

Maintenance and specifications

LUBRICANT SPECIFICATIONS

Item	Ford part name	Ford part number	Ford specification
Hinges, latches, striker plates and rotors, seat tracks, fuel filler door hinge and spring	Multi-Purpose Grease	DOAZ-19584-AA or F5AZ-19G209-AA	ESB-M1C93-B or ESR-M1C159-A
Lock cylinders, swing-away spare tire carrier padlock	Penetrating and Lock Lubricant	Motorcraft XL-1	none
Brake fluid	High Performance DOT 3 Motor Vehicle Brake Fluid	C6AZ-19542-AB	ESA-M6C25-A and DOT 3
Driveshaft, slip spline, double Cardan joint center ball	Premium Long Life Grease	XG-1-K or XG-1-C or XG-1-T	ESA-M1C75-B
Engine coolant	Motorcraft Premium Engine Coolant (green-colored)	VC-4-A (US) or CXC-10 (Canada)	ESE-M97B44-A
	Motorcraft Premium Gold Engin Coolant (yellow-colored)	VC-7-A	WSS-M97B51-A1
Engine oil	Motorcraft SAE 5W20 Super Premium Motor Oil	XO-5W20-QSP	WSS-M2C153-H with API Certification Mark

Maintenance and specifications

Item	Ford part name	Ford part number	Ford specification
4x4 front wheel bearings, 4x4 spindle needle bearings, spindle thrust bearings & front drive axle u-joint/slip spline	High Temperature 4x4 Front Axle & Wheel Bearing Grease	E8TZ-19590-A	ESA-M1C198-A
Automatic transmission (4R100) ¹	Motorcraft MERCON® ATF	XT-2-QDX	MERCON®
Automatic transmission (4R70W) ¹	Motorcraft MERCON®V ATF	XT-5-QM	MERCON®V
Power steering fluid	Motorcraft MERCON® ATF	XT-2-QDX	MERCON®
Rear axle ²	Motorcraft SAE 75W-140 High Performance Synthetic Rear Axle Lube	F1TZ-19580-B	WSL-M2C192-A
Front axle (4X4)	Motorcraft SAE 75W-90 Premium 4x4 Front Axle Lubricant	XY-75W90-TQL	WSP-M2C201-A
Transfer case (4X4)	Motorcraft MERCON® ATF	XT-2-QDX	MERCON®
Windshield washer fluid	Ultra-clear Windshield Washer Concentrate	C9AZ-19550-AC	ESR-M17P5-A

¹Ensure the correct automatic transmission fluid is used. Transmission fluid requirements are indicated on the dipstick or on the dipstick handle. Check the container to verify the fluid being added is of the correct type. Refer to your scheduled maintenance guide to determine the correct service interval.

Maintenance and specifications

Some transmission fluids may be labeled as dual usage, such as MERCON® and MERCON® V. These dual usage fluids are not to be used in an automatic transmission that requires use of the MERCON® type fluid. However, these dual usage fluids may be used in transmissions that require the MERCON® V type fluid.

MERCON® and MERCON® V type fluids are not interchangeable. DO NOT mix MERCON® and MERCON® V. Use of a transmission fluid that indicates dual usage (MERCON® and MERCON® V) in an automatic transmission application requiring MERCON® may cause transmission damage. Use of any fluid other than the recommended fluid may cause transmission damage.

² Add 118 ml (4 oz.) of Additive Friction Modifier C8AZ-19B546-A or equivalent meeting Ford specification EST-M2C118-A for complete refill of Ford Traction-Lok rear axles.

ENGINE DATA

Engine	4.6L V8 engine	5.4L V8 engine
Cubic inches	281	330
Required fuel	87 octane	87 octane
Firing order	1-3-7-2-6-5-4-8	1-3-7-2-6-5-4-8
Spark plug gap	1.3-1.4 mm (0.052-0.056 inch)	1.3-1.4 mm (0.052-0.056 inch)
Ignition system	Coil on plug	Coil on plug
Compression ratio	9.37:1	9.0:1

Maintenance and specifications

VEHICLE DIMENSIONS

Vehicle dimensions	4x2 mm (in)	4x4 mm (in)
(1) Overall length	5 196.0 (204.6)	5 196.0 (204.6)
(2) Vehicle width	2 000.0 (78.7) ¹	2 000.0 (78.7) ¹
*width including mirrors	2 293 (90.3)	2 293 (90.3)
*with optional running boards	2 071 (81.5)	2 071 (81.5)
(3) Overall height ²	1 943.0 (76.5)	1 992.0 (78.4)
(4) Wheelbase	3 023.0 (119.0)	3 023.0 (119.0)
(5) Track - Front	1 661.0 (65.4)	1 661.0 (65.4)
(5) Track - Rear	1 663.0 (65.5)	1 663.0 (65.5)

¹ Vehicle width, including mirrors: 2 293.0 mm (90.3 in)

² Vehicle equipped with 16" tires and base suspension

Maintenance and specifications

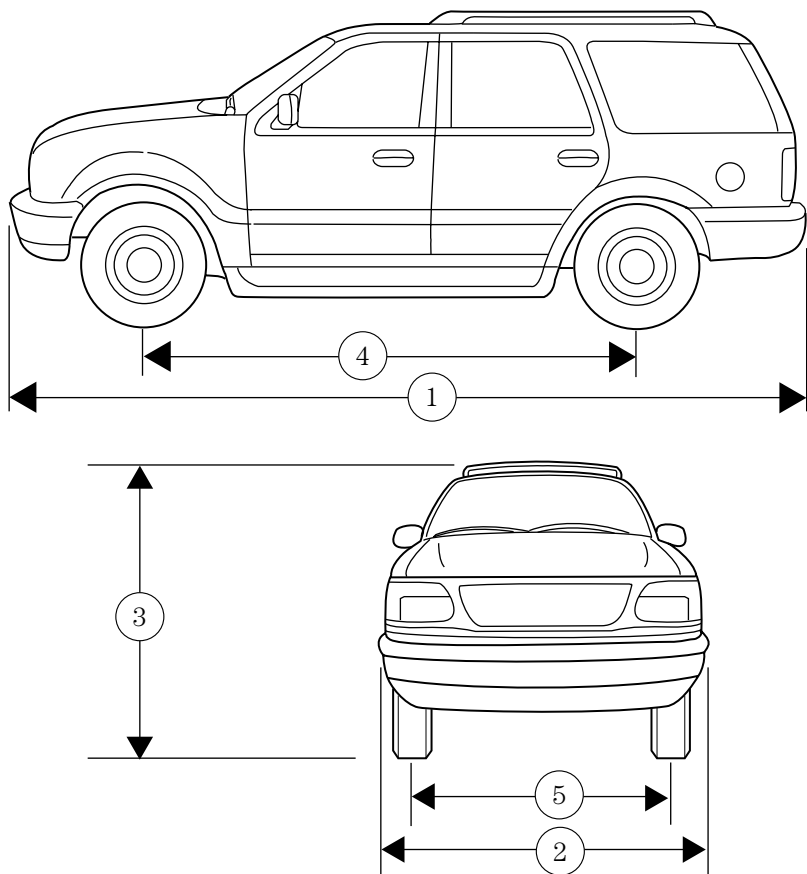

Maintenance and specifications

IDENTIFYING YOUR VEHICLE

Certification label

The National Highway Traffic Safety Administration Regulations require that a Certification label be affixed to a vehicle and prescribe where the Certification label may be located. The Certification label is located on the front door latch pillar on the driver's side.

MFD. BY FORD MOTOR CO. IN U.S.A.	
DATE: XXXXX	GVWR: XXXXX LB/ XXXXX KG
FGAWR: XXXXXX/XXXXXX	RGAWR: XXXXXX/XXXXXX
THIS VEHICLE CONFORMS TO ALL APPLICABLE FEDERAL MOTOR VEHICLE SAFETY STANDARDS IN EFFECT ON THE DATE OF MANUFACTURE SHOWN ABOVE.	
VIN: XXXXXXXXXXXXXXXXX	TYPE: XXXXXXXXXXXXXXXXX
	
MAXIMUM LOAD=OCCUPANTS + LUGGAGE=XXXXK/XXXXLB	
OCCUPANTS: X TOTAL X FR X 2ND X RR OCCUPANTS LUGGAGE	
XX XXXKG/XXXXLB	
TIRE: XXXX/XXXX XXX X XXXKG/XXXXLB	
PRESSURE (FR) XXX kPa/ XX PSI COLD	
PRESSURE (RR) XXX kPa/ XX PSI COLD	
<small>TRAILER TOWING - SEE OWNER GUIDE</small>	
EXT PNT: XXXXXX XXXXXX	RC: XX DSO: XXXX F0000
BAR INT TR TP/PS R AXLE TR SPR T0000	
X XX XXX X XX X XXXX	
UTC VFOHT-15294A10-GA	

Vehicle identification number

The vehicle identification number is attached to a metal tag and is located on the driver side instrument panel. (Please note that in the graphic XXXX is representative of your vehicle identification number.)

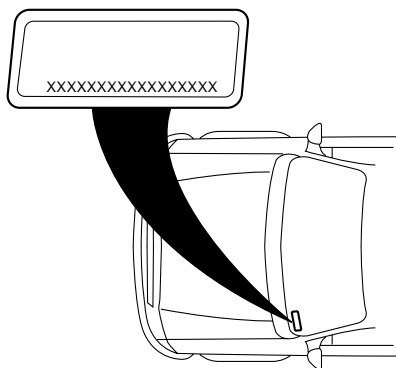

Engine number

The engine number (the last eight numbers of the vehicle identification number) is stamped on the engine block and transmission.

FORD ACCESSORIES FOR YOUR VEHICLE

A wide selection of genuine Ford accessories are available for your vehicle through your local authorized Ford, Lincoln, Mercury or Ford of Canada dealer. These quality accessories have been specifically engineered to fulfill your automotive needs; they are custom designed to complement the style and aerodynamic appearance of your vehicle. In addition, each accessory is made from high quality materials and meets or exceeds Ford's rigorous engineering and safety specifications. Ford Motor Company will repair or replace any properly dealer-installed Ford accessory found to be defective in factory-supplied materials or workmanship during the warranty period, as well as any component damaged by the defective accessory. The accessory will be warranted for whichever provides you the greatest benefit:

- 12 months or 20 000 km (12 000 miles) (whichever occurs first), or
- The remainder of your new vehicle limited warranty.

This means that genuine Ford accessories purchased along with your new vehicle and installed by the dealer are covered for the full length of your New Vehicle's Limited Warranty — 3 years or 60 000 km (36 000 miles) (whichever occurs first). Contact your dealer for details and a copy of the warranty.

Not all accessories are available for all models.

Vehicle Security

Styled wheel protector locks

Vehicle security systems

Comfort and convenience

Battery warmer

Cabin air filter

Cargo nets

Cargo organizers

Cargo storage box

Cargo trays

Carpeted cargo mat

Dash trim (wood grain)

Engine block heaters

Tire step

Accessories

Travel equipment

- Auto headlamps with DRL
- Bike rack
- Bumper mount bike carrier
- Canoe carrier
- Cell phone holder
- Daytime running lights (DRL)
- Factory luggage rack adaptors
- Fog lights
- Framed luggage covers
- Heavy-duty battery
- Kayak carrier
- Luggage/cargo basket
- Removable luggage rack (Track rider bars)
- Removable luggage rack adapters
- Running boards (Molded and tubular)
- Seatback organizer
- Ski/snowboard carrier
- Snow traction cables
- Soft luggage cover
- Towing mirrors (Removable and permanent)
- Trailer hitch (Class III)
- Trailer hitch bars and balls
- Trailer hitch wiring adaptor

Protection and appearance equipment

- Air bag anti-theft locks
- Cargo liners, interior
- Carpet floor mats
- Door edge guards
- Fender flares

Flat splash guards
Front end covers (full and sport)
Hood deflectors
Inside mirror with compass display
Inside mirror with compass and temperature display
Leather steering wheel
Locking gas cap
Molded splash guards
Molded vinyl floor mats
Moonroof deflector
Outside signal mirror (requires power mirrors)
Rear air deflectors
Side window air deflectors
Spare tire lock
Truck cover
Underbody security lighting
Carpeted floor mats
Wheels

Accessories

For maximum vehicle performance, keep the following information in mind when adding accessories or equipment to your vehicle:

- When adding accessories, equipment, passengers and luggage to your vehicle, do not exceed the total weight capacity of the vehicle or of the front or rear axle (GVWR or GAWR as indicated on the Safety compliance certification label). Consult your dealer for specific weight information.
- The Federal Communications Commission (FCC) and Canadian Radio Telecommunications Commission (CRTC) regulate the use of mobile communications systems - such as two-way radios, telephones and theft alarms - that are equipped with radio transmitters. Any such equipment installed in your vehicle should comply with FCC or CRTC regulations and should be installed only by a qualified service technician.
- Mobile communications systems may harm the operation of your vehicle, particularly if they are not properly designed for automotive use or are not properly installed. When operated, such systems may cause the engine to stumble or stall or cause the transmission to be damaged or operate improperly. In addition, such systems may be damaged or their performance may be affected by operating your vehicle. (Citizens band [CB] transceivers, garage door openers and other transmitters with outputs of five watts or less will not ordinarily affect your vehicle's operation.)
- Ford cannot assume responsibility for any adverse effects or damage that may result from the use of such equipment.

- A**
- Accessory delay80
 - Air bag supplemental restraint system132–133, 137
 - and child safety seats135
 - description133, 137
 - disposal140
 - driver air bag135, 138
 - indicator light12, 137, 139
 - operation135, 138
 - passenger air bag135, 138
 - side air bag137
 - Air cleaner filter254, 259
 - Air conditioning50
 - auxiliary heater and air conditioner55
 - manual heating and air conditioning system47
 - Air suspension158
 - description158
 - warning light12
 - Ambulance packages7
 - Antifreeze (see Engine coolant)234
 - Anti-lock brake system (see Brakes)155
 - Anti-theft system
 - warning light13
 - Armrests110
 - Automatic transmission
 - driving an automatic overdrive162
 - fluid, adding252
 - fluid, checking252
 - fluid, refill capacities260
 - fluid, specification265
 - Auxiliary power point78
 - Axle
 - lubricant specifications ..263, 265
 - refill capacities260
 - traction lok159
- B**
- Battery231
 - acid, treating emergencies231
 - charging system
 - warning light12
 - jumping a disabled battery ...202
 - maintenance-free231
 - replacement, specifications ...259
 - servicing231
 - voltage gauge16
 - Belt minder128
 - Brakes154
 - anti-lock155
 - anti-lock brake system (ABS)
 - warning light11, 156
 - brake warning light11
 - fluid, checking and adding251
 - fluid, refill capacities260
 - fluid, specifications263, 265
 - lubricant specifications ..263, 265
 - parking156
 - pedals (see Power adjustable foot pedals)82
 - shift interlock161
 - Break-in period5
- C**
- Capacities for refilling fluids260
 - Cassette tape player18
 - CD changer42
 - Certification Label268

Index

- Child safety restraints140
 - child safety belts140
 - Child safety seats141
 - attaching with
 - tether straps146–147
 - in front seat143
 - in rear seat143, 145–146
 - Cleaning your vehicle
 - engine compartment219
 - exterior223
 - instrument cluster lens222
 - instrument panel221
 - interior222
 - plastic parts220–221
 - safety belts223
 - washing218
 - waxing218
 - wheels219
 - windows223
 - wiper blades221
 - woodtone trim223
 - Clock24, 35
 - Compass, electronic74, 80
 - calibration76
 - set zone adjustment75
 - Console92
 - overhead71–72, 77
 - rear93
 - Controls
 - power seat110
 - Coolant
 - checking and adding234
 - refill capacities237, 260
 - specifications263, 265
 - Cruise control
(see Speed control)83
 - Customer Assistance186
 - Ford accessories
for your vehicle224
 - Ford Extended
Service Plan210
 - Getting assistance outside
the U.S. and Canada214
 - Getting roadside assistance ...186
 - Getting the
service you need208
 - Ordering additional
owner's literature215
 - The Dispute
Settlement Board211
 - Utilizing the Mediation/
Arbitration Program214
- ## D
- Daytime running lamps
(see Lamps)60
 - Defrost
 - rear window58
 - Dipstick
 - automatic
 - transmission fluid252
 - engine oil228
 - Doors
 - door ajar warning13
 - lubricant specifications263
 - Driveline universal joint
and slip yoke254
 - Driving under special
conditions170, 173
 - sand172
 - snow and ice174
 - through water172, 176

- E**
- Emergencies, roadside
 - jump-starting202
 - Emission control system248
 - Engine265–266
 - check engine/
 - service engine soon light10
 - cleaning219
 - coolant234
 - fail-safe coolant238
 - idle speed control231
 - lubrication
 - specifications263, 265
 - refill capacities260
 - service points227
 - starting after a collision187
 - Engine block heater153
 - Engine oil228
 - change oil soon warning,
 - message center228
 - checking and adding228
 - dipstick228
 - filter, specifications230, 259
 - recommendations230
 - refill capacities260
 - specifications263, 265
 - Exhaust fumes154
- F**
- Fail safe cooling238
 - Floor mats93
 - Fluid capacities260
 - Foglamps59
 - Four-Wheel Drive
 - vehicles14, 167
 - control trac167
 - description167
 - driving off road169
 - electronic shift168
 - indicator light14
 - preparing to
 - drive your vehicle160
 - Fuel240
 - calculating fuel economy245
 - cap242
 - capacity260
 - choosing the right fuel243
 - comparisons with EPA fuel
 - economy estimates248
 - detergent in fuel244
 - filling your vehicle
 - with fuel240, 242, 245
 - filter, specifications244, 259
 - fuel pump shut-off switch187
 - gauge16
 - improving fuel economy245
 - low fuel warning light12
 - octane rating243, 265–266
 - quality243
 - running out of fuel244
 - safety information relating
 - to automotive fuels240
 - Fuses189–190
- G**
- Garage door opener72, 86
 - Gas cap (see Fuel cap)242
 - Gas mileage
 - (see Fuel economy)245
 - Gauges14
 - battery voltage gauge16
 - engine coolant
 - temperature gauge15
 - engine oil pressure gauge15
 - fuel gauge16

Index

- odometer17
- speedometer16
- tachometer17
- trip odometer17
- GAWR
(Gross Axle Weight Rating)177
 - calculating179
 - definition177
 - driving with a heavy load177
 - location177
- GVWR (Gross
Vehicle Weight Rating)177
 - calculating177, 179
 - definition177
 - driving with a heavy load177
 - location177
- H**
 - Hazard flashers187
 - Head restraints108, 113
 - Headlamps59
 - aiming61
 - autolamp system59
 - bulb specifications63
 - daytime running lights60
 - flash to pass60
 - high beam13, 60
 - replacing bulbs64
 - turning on and off59
 - warning chime14
 - Heating50
 - heating and
air conditioning system47
 - HomeLink universal
transceiver (see
Garage door opener)86–89
 - Hood226
- I**
 - Ignition150, 265–266
 - Infant seats
(see Safety seats)141
 - Inspection/
maintenance (I/M) testing249
 - Instrument panel
 - cleaning221
 - cluster10, 222
 - lighting up
 - panel and interior60
- J**
 - Jack196
 - positioning196
 - storage196
 - Jump-starting your vehicle202
- K**
 - Keyless entry system
 - autolock101
 - locking and unlocking doors ..103
 - programming entry code102
 - Keys104–106
 - key in ignition chime14
 - positions of the ignition150
- L**
 - Lamps
 - autolamp system59
 - bulb replacement
 - specifications chart63
 - cargo lamps60
 - daytime running light60
 - fog lamps59
 - headlamps59

headlamps, flash to pass	60
instrument panel, dimming	60
interior lamps	61–62, 64
replacing bulbs	62, 64, 66–68
Lane change indicator (see Turn signal)	61
Liftgate	93
Lights, warning and indicator	10
air bag	12
air suspension	159
anti-lock brakes (ABS)	11, 156
anti-theft	13
brake	11
charging system	12
check coolant	13
cruise indicator	12
door ajar	13
engine oil pressure	13
high beam	13
low fuel	12
low washer fluid	12
safety belt	11
service engine soon	10
speed control	86
turn signal indicator	13
Load limits	177
GAWR	177
GVWR	177
trailer towing	177
Loading instructions	179
Locks	
autolock	101
childproof	95
doors	95
Lubricant specifications ...	263, 265
Lumbar support, seats	110

M

Message center	74, 90
english/metric button	90
menu button	91
Mirrors	71
automatic dimming rearview mirror	80
fold away	82
heated	81
programmable memory	100
side view mirrors (power)	80
Moon roof	73
Motorcraft parts	244, 259

O

Octane rating	243
Odometer	17
Oil (see Engine oil)	228
Overdrive	92

P

Panic alarm feature, remote entry system	98
Parking brake	156
Parts (see Motorcraft parts)	259
Pedals (see Power adjustable foot pedals)	82
Power distribution box (see Fuses)	193
Power door locks	95, 101
Power steering	157–158
fluid, checking and adding	250
fluid, refill capacity	260
fluid, specifications	263, 265

Index

Preparing to drive
your vehicle160

R

Rear window defroster58

Relays189, 196

Remote entry system96, 98

illuminated entry100

locking/unlocking doors95–97

panic alarm98

replacement/additional

transmitters99

replacing the batteries98

Reverse sensing system165

Roof rack94

S

Safety belts (see Safety
restraints)14, 120–124, 126

Safety defects, reporting217

Safety restraints120–126

belt minder128

cleaning the

safety belts131, 223

extension assembly131

for adults121–124

for children140

lap belt126

warning light

and chime11, 14, 127–128

Safety seats for children141

Seat belts

(see Safety restraints)120

Seats108

child safety seats141

cleaning222

memory seat100, 112

SecuriLock passive

anti-theft system104–106

Servicing your vehicle225

Snowplowing7

Spark plugs,

specifications259, 265–266

Special notice

ambulance conversions7

utility-type vehicles7

Specification chart,

lubricants263, 265

Speed control83

Speedometer16

Starting

your vehicle150–151, 153

jump starting202

Steering

speed sensitive158

Steering wheel

controls71, 83

tilting71

T

Tachometer17

Tires196, 255–257

changing196, 198

checking the pressure257

replacing258

rotating257

snow tires and chains259

tire grades256

treadwear256

Towing180

recreational towing185

trailer towing180

wrecker	207
Traction-lok rear axle	159
Transmission	161
fluid, checking and adding (automatic)	252
fluid, refill capacities	260
lubricant specifications	263, 265
Trip odometer	17
Turn signal	13, 61
V	
Vehicle dimensions	266
Vehicle Identification Number (VIN)	268
Vehicle loading	177
Ventilating your vehicle	154

W	
Warning chimes	14
Warning lights (see Lights)	10
Washer fluid	228
Water, Driving through	176
Windows	
power	79
rear wiper/washer	69
Windshield washer fluid and wipers	
checking and adding fluid	228
checking and cleaning	70
liftgate reservoir	228
operation	69
replacing wiper blades	70
Wrecker towing	207

