

TABLE OF CONTENTS

SECTION		PAGE
1	INTRODUCTION	3
2	THINGS TO KNOW BEFORE STARTING YOUR VEHICLE	11
3	UNDERSTANDING THE FEATURES OF YOUR VEHICLE	79
4	UNDERSTANDING YOUR INSTRUMENT PANEL	185
5	STARTING AND OPERATING	247
6	WHAT TO DO IN EMERGENCIES	335
7	MAINTAINING YOUR VEHICLE	347
8	MAINTENANCE SCHEDULES	401
9	IF YOU NEED CONSUMER ASSISTANCE	425
10	INDEX	433

INTRODUCTION

CONTENTS

■ Introduction	4	■ Warnings And Cautions	9
□ Roll Over Warning	5	■ Vehicle Identification Number	9
■ How To Use This Manual	7	■ Vehicle Modifications / Alterations	9

4 INTRODUCTION

INTRODUCTION

This is a specialized utility vehicle designed for both on-road and off-road use. It can go places and perform tasks for which conventional two-wheel drive enclosed vehicles were not intended. It handles and maneuvers differently from many passenger cars both on-road and off-road, so take time to become familiar with your vehicle.

Before you start to drive this vehicle, read the Owner's Manual. Be sure you are familiar with all vehicle controls, particularly those used for braking, steering, transmission, and transfer case shifting. Learn how your vehicle handles on different road surfaces. Your driving skills will improve with experience. When driving off-road or working the vehicle, don't overload the vehicle or expect the vehicle to overcome the natural laws of physics. Always observe federal, state, provincial and local laws wherever you drive.

As with other vehicles of this type, failure to operate this vehicle correctly may result in loss of control or an accident. Be sure to read "On-Road/Off-Road Driving Tips" in this manual.



WARNING!

Never leave children alone in a vehicle. Leaving children in a vehicle unattended is dangerous for a number of reasons. A child or others could be seriously or fatally injured. Do not leave the keys in the ignition. A child could operate power windows, other controls, or move the vehicle.

Roll Over Warning

Utility vehicles have a significantly higher roll over rate than other types of vehicles. This vehicle has a higher ground clearance, higher center of gravity, and narrower track than many passenger cars. It is capable of performing better in a wide variety of off-road applications. Driven in an unsafe manner, all vehicles can be caused to go out of control. Because of the higher center of gravity and the narrower track, if this vehicle is out of control it may roll over when some other vehicles may not.

Do not attempt sharp turns or abrupt maneuvers or other unsafe driving actions that can cause loss of vehicle control. Failure to operate this vehicle safely may result in an accident, roll over of the vehicle and serious injury or death. Because of its open-body construction, your vehicle offers less protection than closed vehicles in the event of an accident.

<p>▲ WARNING EVEN WITH ADVANCED AIR BAGS</p>  <ul style="list-style-type: none"> • CHILDREN CAN BE KILLED OR SERIOUSLY INJURED BY THE AIR BAG. • THE BACK SEAT IS THE SAFEST PLACE FOR CHILDREN. • NEVER PUT A REAR-FACING CHILD SEAT IN THE FRONT. • ALWAYS USE SEAT BELTS AND CHILD RESTRAINTS. • SEE OWNER'S MANUAL FOR MORE INFORMATION ABOUT AIR BAGS. 	<p>▲ WARNING HIGHER ROLLOVER RISK</p>  <ul style="list-style-type: none"> • AVOID ABRUPT MANEUVERS AND EXCESSIVE SPEED. • ALWAYS BUCKLE UP. • SEE OWNER'S MANUAL FOR FURTHER INFORMATION.
<p>▲ MISE EN GARDE MÊME AVEC DES SACS GONFLABLES PERFECTIONNÉS</p> <ul style="list-style-type: none"> • LES ENFANTS PEUVENT ÊTRE TUÉS OU GRAVEMENT BLESSÉS PAR UN SAC GONFLABLE. • LA BANQUETTE ARRIÈRE EST LA PLACE LA PLUS SÛRE POUR LES ENFANTS. • NE JAMAIS PLACER UN SIÈGE POUR ENFANT ORIENTÉ VERS L'ARRIÈRE À L'AVANT DU VÉHICULE. • UTILISEZ TOUJOURS LA CEINTURE DE SÉCURITÉ ET LE SYSTÈME DE RETENUE POUR ENFANT. • CONSULTEZ LE GUIDE DE L'AUTOMOBILISTE POUR OBTENIR PLUS DE RENSEIGNEMENTS SUR LES SACS GONFLABLES. 	<p>▲ MISE EN GARDE PLUS GRAND RISQUE DE CAPOTAGE</p> <ul style="list-style-type: none"> • ÉVITER LES MANŒUVRES ABRUPTES ET LA VITESSE EXCESSIVE. • PORTER TOUJOURS LES CEINTURES DE SÉCURITÉ. • CONSULTEZ LE GUIDE DE L'AUTOMOBILISTE POUR DE PLUS AMPLES RENSEIGNEMENTS.
<p>▲ ADVERTENCIA AUN CON SISTEMAS AVANZADOS DE BOLSA DE AIRE</p> <ul style="list-style-type: none"> • LA BOLSA DE AIRE PUEDE CAUSAR SERIOS DAÑOS O LA MUERTE A LOS NIÑOS. • EL ASIENTO DE ATRÁS ES EL LUGAR MÁS SEGURO PARA LOS NIÑOS. • NUNCA PONGA UN ASIENTO DE NIÑO CON LA CARA HACIA ATRÁS EN EL ASIENTO DELANTERO. • SIEMPRE USE LOS CINTURONES DE SEGURIDAD Y SISTEMAS DE SEGURIDAD PARA NIÑOS. • PARA MÁS INFORMACIÓN SOBRE BOLSA DE AIRE, CONSULTE EL MANUAL DEL PROPIETARIO. 	<p>▲ ADVERTENCIA ALTO RIESGO DE VOLCAMIENTO</p> <ul style="list-style-type: none"> • EVITE MANIOBRAS ABRUPTAS Y VELOCIDAD EXCESIVA. • USE SIEMPRE EL CINTURÓN DE SEGURIDAD. • PARA MÁS INFORMACIÓN VER MANUAL DEL PROPIETARIO.

819128e1

Failure to use driver and passenger seat belts provided is a major cause of severe or fatal injury. In fact, the U.S. government notes that the universal use of existing seat belts could cut the highway death toll by 10,000 or more each year, and could reduce disabling injuries by 2

6 INTRODUCTION

million annually. In a roll over crash, an unbelted person is significantly more likely to die than a person wearing a seat belt. Always buckle up.

Although your vehicle may be equipped with a soft top or optional hard top to give the occupants protection from the weather, these tops do not offer structural protection in the event of an accident and do not change the open-body characteristic of the vehicle. Even though your vehicle has a sport bar and side bars for some extra protection, it is a truly open vehicle—there is no structural integrated top and it has low sides and a folding windshield. Many of these vehicles do not have fully enclosed hard doors.

Operating this vehicle at excessive speeds or while intoxicated may result in loss of control, collision with other vehicles or objects, going off the road, or overturning, any of which may lead to serious injury or death. Also, **failure to use standard seat belts** subjects the

driver and passengers to a greater risk of being thrown out of an open-body vehicle than out of a closed vehicle in an accident which can result in injury or death.

This manual has been prepared with the assistance of service and engineering specialists to acquaint you with the operation and maintenance of your new vehicle. It is supplemented by a Warranty Information Booklet and various customer oriented documents. You are urged to read these publications carefully. Following the instructions and recommendations in this manual will help assure safe and enjoyable operation of your vehicle.

NOTE: After you read the manual, it should be stored in the vehicle for convenient reference and remain with the vehicle when sold so that the new owner will be aware of all safety warnings.

When it comes to service, remember that your authorized dealer knows your vehicle best, has the factory-trained technicians and genuine Mopar® parts, and is interested in your satisfaction.

WARNING!

Engine exhaust, some of its constituents, and certain vehicle components contain or emit chemicals known to the State of California to cause cancer and birth defects or other reproductive harm. In addition, certain fluids contained in vehicles and certain products of component wear contain or emit chemicals known to the State of California to cause cancer and birth defects or other reproductive harm.















































































HOW TO USE THIS MANUAL

Consult the table of contents to determine which section contains the information you desire.

The detailed index, at the rear of this manual, contains a complete listing of all subjects.

Consult the following table for a description of the symbols that may be used on your vehicle or throughout this owner's manual:

8 INTRODUCTION

											
WATER IN FUEL	REAR WINDOW WIPER INTERMITTENT	WINDSHIELD WIPER INTERMITTENT	EXTERIOR BULB FAILURE	HIGH BEAM	TURN SIGNALS	UPPER AIR OUTLET	HEATED SEAT LOW	DOOR LOCK	ADJUSTABLE PEDALS	ELECTRONIC SPEED CONTROL	ELECTRONIC STABILITY PROGRAM / BRAKE ASSIST SYSTEM
											
FUEL	REAR WINDOW INTERMITTENT WIPER	WINDSHIELD WASHER	MASTER LIGHTING SWITCH	LOW BEAM	KEY ACTIVATE (POWER OUTLET)	UPPER AND LOWER AIR OUTLET	HEATED SEAT HIGH	WINDOW LIFT	TIRE PRESSURE MONITOR	HILL DESCENT CONTROL	BRAKE SYSTEM WARNING PARKING BRAKE
											
FUEL FILL SIDE	REAR WINDOW WASHER	WINDSHIELD WASHER FLUID LEVEL	DOME LIGHT	FRONT FOG LIGHT	HOOD RELEASE	LOWER AIR OUTLET	RECIRCULATION	CONVERTIBLE 4 WINDOW DOWN	TRACTION CONTROL	AWD!	FAILURE OF ANTI-LOCK BRAKING SYSTEM
											
ENGINE OIL	REAR WINDOW DEFROST	WINDSHIELD, ELECTRICALLY HEATED	PARK LIGHTS	REAR FOG LAMP	LIFTGATE RELEASE AND LIFTGATE OPEN	DEFROST AND LOWER AIR OUTLET	VENTILATING FAN	WINDOW LOCK	ELECTRONIC THROTTLE CONTROL	4WD!	BRAKE SYSTEM WARNING PARKING BRAKE
											
BATTERY CHARGING	HEATED MIRROR	WINDSHIELD DEFROST	INSTRUMENT PANEL ILLUMINATION	SEAT BELT	SLIDING DOOR	TRUNK / DECK RELEASE	AIR CONDITIONING	CHILD SEAT TETHER ANCHOR	VOICE RECOGNITION BUTTON	WARNING	
											
GLOW PLUG	POWER STEERING FLUID	WINDSHIELD WIPER AND WASHER	SIDE AIRBAG	AIRBAG	SLIDING DOOR	EMERGENCY RELEASE HANDLE	LIGHTER	LOWER ANCHORS AND TETHER FOR CHILDREN (LATCH)	UCONNECT™ BUTTON	HAZARD	
											
MALFUNCTION INDICATOR LIGHT	TRANS OIL TEMP	ENGINE COOLANT TEMPERATURE	SRS AIRBAG	PASSENGER AIRBAG OFF	DOOR AJAR	CONVERTIBLE TOP DOWN	CONVERTIBLE TOP UP	HORN	SEE OWNER'S MANUAL ISD		

8191e970

WARNINGS AND CAUTIONS

This manual contains **WARNINGS** against operating procedures which could result in an accident or bodily injury. It also contains **CAUTIONS** against procedures which could result in damage to your vehicle. If you do not read this entire manual you may miss important information. Observe all Warnings and Cautions.

VEHICLE IDENTIFICATION NUMBER

The vehicle identification number (VIN) is found on a stamped plate located on the left front corner of the instrument panel pad, visible from outside of vehicle through windshield. This number also appears on the Automobile Information Disclosure Label affixed to a window on your vehicle. Save this label for a convenient record of your vehicle identification number and optional equipment.

NOTE: It is illegal to remove the VIN plate.

VEHICLE MODIFICATIONS / ALTERATIONS**WARNING!**

Any modifications or alterations to this vehicle could seriously affect its roadworthiness and safety and may lead to an accident resulting in serious injury or death.

THINGS TO KNOW BEFORE STARTING YOUR VEHICLE

CONTENTS

■ A Word About Your Keys14	□ Customer Key Programming18
□ Ignition Key Removal14	□ General Information18
□ Key-In-Ignition Reminder15	■ Security Alarm System — If Equipped19
■ Steering Wheel Lock — If Equipped15	□ To Set The Alarm19
□ To Manually Lock The Steering Wheel15	□ To Disarm The System19
□ To Release The Steering Wheel Lock16	■ Illuminated Entry20
■ Sentry Key Immobilizer System16	■ Remote Keyless Entry — If Equipped20
□ Important Note About Service17	□ To Unlock The Doors And Swing Gate21
□ Replacement Keys17	□ To Lock The Doors And Swing Gate21

12 THINGS TO KNOW BEFORE STARTING YOUR VEHICLE

□ Using The Panic Alarm22	□ Wind Buffeting34
□ To Turn Off “Flash Lights With Lock”22	■ Rear Swing Gate34
□ Programming Additional Transmitters23	■ Occupant Restraints36
□ General Information24	□ Lap/Shoulder Belts37
□ Battery Replacement25	□ Rear Center Lap/Shoulder Belt Retractor Lock-Out42
■ Doors25	□ Adjustable Upper Shoulder Belt Anchorage43
□ Front Door Removal26	□ Seat Belt Pretensioners43
□ Rear Door Removal (4 Door Models)27	□ Enhanced Seat Belt Use Reminder System (BeltAlert)44
■ Door Locks29	□ Seat Belts And Pregnant Women45
□ Manual Door Locks30	□ Seat Belt Extender46
□ Power Door Locks — If Equipped31	□ Driver And Front Passenger Supplemental Restraint Systems (SRS)46
■ Windows32		
□ Power Windows — If Equipped32		

	THINGS TO KNOW BEFORE STARTING YOUR VEHICLE	13
□ Child Restraint	□ Safety Checks You Should Make Inside The Vehicle63 .77
■ Engine Break-In Recommendations	□ Safety Checks You Should Make Outside The Vehicle75 .77
■ Safety Tips76
□ Exhaust Gas76

A WORD ABOUT YOUR KEYS

The keys for your new vehicle are enclosed in a plastic bag with the key code number on it. If you received your keys without the bag, ask your dealer to give you the number. The key code can also be obtained by the dealer from your vehicle invoice.

Ignition Key Removal

Manual Transmission

Turn the ignition switch to the ACC position, push the key and cylinder inward, rotate the key to the LOCK position, and remove the key.

Automatic Transmission — If Equipped

Place the shift lever in P (Park). Turn the ignition switch to the ACC position, push the key and cylinder inward, rotate the key to the LOCK position, and remove the key.

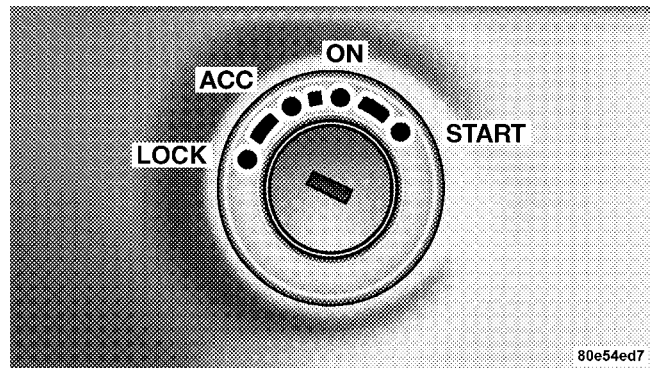

Ignition Key Positions

WARNING!

Leaving children in a vehicle unattended is dangerous for a number of reasons. A child or others could be injured. Children should be warned not to touch the parking brake, brake pedal, or the gear selector lever. Do not leave the keys in the ignition. A child could operate power windows, other controls, or move the vehicle.

CAUTION!

An unlocked vehicle is an invitation to thieves. Always remove the key from the ignition, and lock all doors when leaving the vehicle unattended.

Key-In-Ignition Reminder

Opening the driver's door when the key is in the ignition, sounds a signal to remind you to remove the key.

STEERING WHEEL LOCK — IF EQUIPPED

Your vehicle may be equipped with a passive steering wheel lock (manual transmission only). This lock prevents steering the vehicle without the ignition key. If the steering wheel is moved a half turn in either direction and the key is not in the ignition, the steering wheel will lock.

To Manually Lock the Steering Wheel

With the engine running, rotate the steering wheel 1/2 revolution from straight ahead position, turn off the engine and remove the key. Rotate the steering wheel slightly in both directions until the lock engages.

To Release the Steering Wheel Lock

Insert the key in the ignition and turn the wheel slightly to the right or left to disengage the lock.

NOTE: If you turned the wheel to the right to engage the lock, you must turn the wheel slightly to the right to disengage it. If you turned the wheel to the left to engage the lock, turn the wheel slightly to the left to disengage it.

SENTRY KEY IMMOBILIZER SYSTEM

The Sentry Key Immobilizer System (SKIM) prevents unauthorized operation of the vehicle by disabling the engine. The system will shut the engine down after 2 seconds of running if an invalid key is used to start the vehicle. This system utilizes ignition keys which have an electronic chip (transponder) embedded into them. Only keys that have been programmed to the vehicle can be used to start and operate the vehicle for longer than the 2 second validation time period.

The Sentry Key Immobilizer System does not need to be armed or activated. Operation of the system is automatic regardless of whether or not the vehicle is locked or unlocked. During normal operation, the "Security Alarm System Indicator Light" will come on for 3 seconds immediately after the ignition switch is turned on for a bulb check. Afterwards, if the bulb remains on, this indicates a malfunction in the electronics. If the bulb begins to flash immediately after the ignition switch is turned on, this indicates that an invalid key is being used to start the vehicle. Both of these conditions will result in the engine being shut down after 2 seconds of running. Keep in mind that a key which has not been programmed is also considered an invalid key even if it is cut to fit the ignition for that vehicle.

If the "Security Alarm System Indicator Light" comes on during normal vehicle operation (it has been running for

longer than 10 seconds) a fault has been detected in the electronics and the vehicle should be serviced as soon as possible.

NOTE:

- The Sentry Key Immobilizer System is not compatible with remote starting systems. Use of these systems may result in vehicle starting problems and loss of security protection.
- Mobil Speedpass™, additional Sentry Keys, or any other transponder equipped components on the same keychain will not cause a key-related (Transponder) fault unless the additional part is **physically held against the ignition key** being used when starting the vehicle. Also, cell phones, pagers, or other RF electronics will not cause interference with this system.

All of the keys provided with your new vehicle have been programmed to the vehicle electronics.

Important Note About Service

A four digit PIN number is needed to service the Sentry Key Immobilizer System. This number can be obtained from your authorized dealer. However, this number can also be found on your customer invoice that you were given upon receipt of your vehicle.

Replacement Keys

NOTE: Only keys that have been programmed to the vehicle electronics can be used to start the vehicle. Once a Sentry Key has been programmed to a vehicle, it cannot be programmed to any other vehicle.

At the time of purchase, the original owner is provided with a four digit PIN number. This number is required for dealer replacement of keys. Duplication of keys may be performed at an authorized dealer or by using the Customer Key Programming procedure. This procedure

18 THINGS TO KNOW BEFORE STARTING YOUR VEHICLE

consists of programming a blank key to the vehicle electronics. A blank key is one which has never been programmed.

NOTE: When having the Sentry Key System serviced, bring all vehicle keys to the dealer.

Customer Key Programming

You can program new keys to the system if you have two valid keys by doing the following:

1. Cut the additional Sentry Key Transponder blank(s) to match the ignition switch lock cylinder key code.
2. Insert the first valid key into the ignition switch and turn the ignition switch ON for at least 3 seconds but no longer than 15 seconds. Turn the ignition switch OFF and remove the first key.
3. Insert the second valid key and turn the ignition switch ON within 15 seconds. After ten seconds, a chime

will sound and the "Security Alarm System Indicator Light" will begin to flash. Turn the ignition switch OFF and remove the second key.

4. Insert a blank Sentry Key into the ignition switch and turn the ignition switch ON within 60 seconds. After 10 seconds, a single chime will sound. The "Security Alarm System Indicator Light" will stop flashing, turn on for 3 seconds; then turn off.

The new Sentry Key has been programmed. Repeat this process to program up to a total of 8 keys.

General Information

The Sentry Key Immobilizer System complies with FCC rules part 15 and with RSS-210 of Industry Canada. Operation is subject to the following two conditions:

1. This device may not cause harmful interference.

2. This device must accept any interference that may be received, including interference that may cause undesired operation.

SECURITY ALARM SYSTEM — IF EQUIPPED

This system monitors the vehicle doors, swing gate, and ignition for unauthorized operation. When the alarm is activated, the system provides both audible and visual signals. The horn, headlights, and tail lights will sound/flash repeatedly for three minutes. If disturbance is still present (driver's door, passenger door, other doors, ignition) after three minutes, the headlights and tail lights will flash for an additional 15 minutes.

NOTE: The "Panic" and "Security" alarms are quite different. Please take a moment to activate the "Panic" and the "Security" modes to hear the differences in the horn. In case one should go off in the future, you will need to know which mode has been activated in order to deactivate it.

To Set the Alarm

The alarm will set when you use the remote keyless entry transmitter to lock the doors and swing gate or when you use the power door lock switch while the door is open. After all the doors are locked and closed, the "Sentry Key/Security Alarm Indicator Light" (located in the instrument cluster) will flash rapidly for about 16 seconds to signal that the system is arming. During this 16 second arming period, opening any door or the swing gate will cancel the arming. If the system successfully arms, the "Sentry Key/Security Alarm Indicator Light" will flash at a slower rate to indicate the alarm is set.

To Disarm the System

To disarm the system, you will need to press the "Unlock" button on the remote keyless entry transmitter or turn the ignition key to the RUN position. If something has triggered the system in your absence, the horn will sound three times when you unlock the doors. Check the vehicle for tampering.

The Security Alarm System is designed to protect your vehicle; however, you can create conditions where the system will arm unexpectedly. If you remain in the vehicle and lock the doors with the transmitter, once the system is armed (after 16 seconds), when you pull the door handle to exit the alarm will sound. If this occurs, press the "Unlock" button on the remote keyless entry transmitter to disarm the system. You may also accidentally disarm the system by unlocking the driver's door with the key and then locking it. The door will be locked but the Security Alarm will not arm.

ILLUMINATED ENTRY

The interior lights will come on when you open any door.

The lights will remain on after all of the doors are closed, and then fade to off or they will immediately fade to off once the ignition switch is turned on.

REMOTE KEYLESS ENTRY — IF EQUIPPED

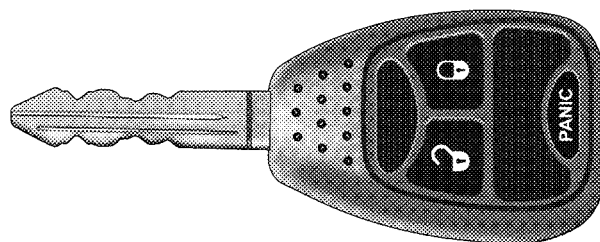

8163e6a8

Three Button Transmitter

This system allows you to lock or unlock the doors and swing gate or activate the panic alarm from distances a maximum of 66 feet (20 meters) using a hand held radio transmitter. The transmitter need not be pointed at the vehicle to activate the system.

NOTE: The line of transmission must not be blocked with metal objects.

To Unlock the Doors and Swing Gate

Press and release the “Unlock” button on the key fob once to unlock only the driver’s door or twice to unlock all the doors and swing gate. When the “Unlock” button is pressed, the illuminated entry will initiate, and the parking lights will flash on twice.

The system can be programmed to unlock all the doors upon the first “Unlock” button press by using the following procedure:

1. Press and hold the “Lock” button on a programmed key fob.
2. Continue to hold the “Lock” button at least 4 seconds, but not longer than 10 seconds, then press and hold the “Unlock” button.
3. Release both buttons at the same time.

4. Test the feature while outside of the vehicle, by pressing the “Lock/Unlock” button on the keyfob.

NOTE: Pressing the “Lock” button on the keyfob while you are inside the vehicle will activate the Security Alarm. Opening a door with the Security Alarm activated will cause the alarm to sound. Press the “Unlock” button to deactivate the Security Alarm.

5. If the desired programming was not achieved or to reactivate this feature, repeat the above steps.

To Lock the Doors and Swing Gate

Press and release the “Lock” button on the transmitter to lock all doors. The turn signal lights will flash and the horn will chirp once to acknowledge the lock signal. If desired, the “Sound Horn On Lock” feature can be turned on or off by performing the following steps:

1. Press the “Lock” button for 4 to 10 seconds.

2. While the “Lock” button is pressed (after 4 seconds), press the PANIC button. Release both buttons.

The “Sound Horn On Lock” feature can be reactivated by repeating this procedure.

Using The Panic Alarm

To turn the panic alarm feature ON or OFF, press and hold the PANIC button on the transmitter for at least one second and release. When the panic alarm is on, the headlights and park lights will flash, the horn will pulse on and off and the interior lights will turn on.

The panic alarm will stay on for 3 minutes unless you turn it off by pressing the PANIC button a second time or if the vehicle speed is 5 mph (8 km/h) or greater.

NOTE: When you turn off the panic alarm by pressing the PANIC button a second time, you may have to be closer to the vehicle due to the radio frequency noises of the system.

To Turn Off “Flash Lights With Lock”

NOTE: The Flash Lights With Lock feature can be turned on or off by performing the following steps:

1. Press the “Unlock” button for 4 to 10 seconds.
2. While the “Unlock” button is pressed, (after 4 seconds) press the “Lock” button. Release both buttons.
3. Test the flash lamps with LOCK feature while outside of the vehicle, by pressing the “Lock” button on the key fob with the ignition in the LOCK position, and the key removed.

NOTE: Pressing the “Lock” button on the key fob, while you are in the vehicle, will activate the Security Alarm. Opening a door with the Security Alarm activated will cause the alarm to sound. Press the “Unlock” button to deactivate the Security Alarm.

The “Flash Lights On Lock/Unlock” feature can be reactivated by repeating this procedure.

Programming Additional Transmitters

Vehicles will be shipped from the assembly plants with two key fob transmitters programmed only for that vehicle. A total of eight fobs can be programmed for your vehicle. Additional fobs can be programmed to your vehicle through the use of a currently programmed fob.

NOTE: When entering program mode using that fob, all other programmed fobs will be erased and you will have to reprogram them for your vehicle.

Use the Following procedure to program additional key fobs if the vehicle is not equipped with Sentry Key:

1. Enter your vehicle and close all doors.
2. Fasten your seat belt (Fastening the seatbelt will cancel any chiming that may confuse you during this programming procedure).
3. Place the key into the ignition.
4. Turn the ignition to the ON position (**Do not start the engine**).
5. Press and hold the “Unlock” button on the key fob.
6. After holding the “Unlock” button for four seconds, also press the PANIC button within 6 seconds.
7. When a single chime is heard release both buttons. The chime is an indication that you have successfully entered program mode. All fobs that are to be programmed must be done so within 60 seconds of when the chime was heard.
8. Using the fob to be programmed, press and release both the “Lock” and “Unlock” buttons, simultaneously.
9. A single chime will be heard.
10. Within four seconds of hearing the chime, press and release the “Unlock” button on the fob.

24 THINGS TO KNOW BEFORE STARTING YOUR VEHICLE

11. A single chime will be heard.
12. Repeat steps 8 through 10 to program up to six additional fobs.
13. Turn the ignition to the OFF position.
14. Your vehicle will remain in program mode up to 60 seconds from when the original chime was heard. After 60 seconds, all programmed fobs function normally.

NOTE: If you do not have a programmed transmitter, contact your dealer for details.

General Information

This device complies with part 15 of FCC rules and with RS-210 of Industry Canada. Operation is subject to the following conditions:

1. This device may not cause harmful interference.

2. This device must accept any interference that may be received including interference that may cause undesired operation.

NOTE: Changes or modifications not expressly approved by the party responsible for compliance could void the user's authority to operate the equipment.

If your Remote Lock Control fails to operate from a normal distance, check for these two conditions.

1. Weak batteries in transmitter. The expected life of batteries is five years.
2. Closeness to a radio transmitter such as a radio station tower, airport transmitter, military base, and some mobile or CB radios.

Battery Replacement

The recommended replacement battery is CR2032.

1. If the key fob is equipped with a screw, remove the screw. With the transmitter buttons facing down, use a flat blade (screw driver) to pry the two halves of the transmitter apart. Use **extreme care** not to damage the seal or internal components.

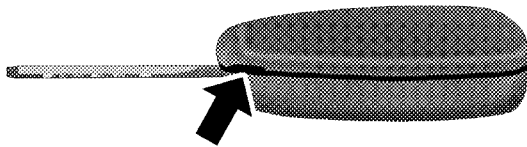

81182c72

Separating Transmitter Halves

2. Remove and replace the batteries. Avoid touching the new batteries with your fingers. Skin oils may cause battery deterioration. If you touch a battery, clean it with rubbing alcohol.

3. To assemble the transmitter case, snap the two halves together.

NOTE: If the key fob is equipped with a screw, reinstall and tighten the screw until snug.

DOORS

The vacuum fluorescent (VF) display located in the odometer area displays the word "door" as an indication of a door ajar or door not completely closed. When the vehicle is not moving and the door is ajar or not completely closed, the VF display will show the word "door."

If any other active warnings including "GATE", "GAS-CAP", "NOFUSE", or "ESPOFF" are present, they will be

shown in the VF display and will also continue to cycle. If the vehicle is moving, three single chimes will occur (One chime for each complete display cycle (three cycles total). After this, the display will continue to cycle only (no chimes).

If the trip/reset button is pressed while the VF warnings are being displayed, the VF display will revert back to only displaying the odometer/trip odometer mileage.

Front Door Removal

1. Remove the hinge pin screws from the upper and lower outside hinges (using a #T50 Torx® head driver).

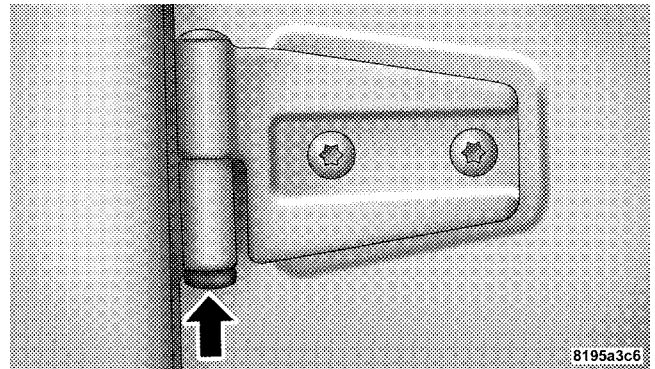

2. Unplug wiring harness connector under instrument panel.

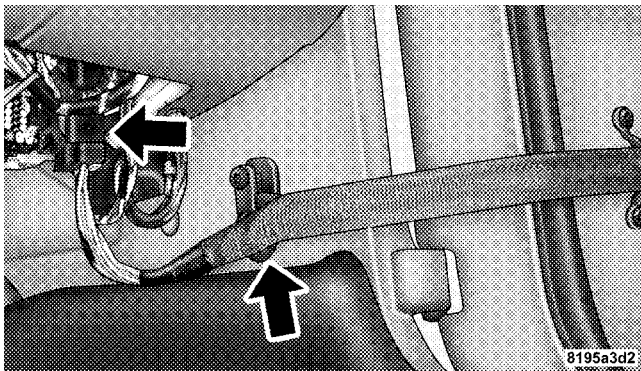

3. Unhook door strap from the body hook. Be careful not to allow door to swing fully open as mirror may damage paint.

4. With the door open, lift the door to clear hinge pins from their hinges, and remove door.

To reinstall the door(s), perform the above steps in the opposite order.

Rear Door Removal (4 Door Models)

2

1. Remove the hinge pin screws from the upper and lower outside hinges (using a #T50 Torx® head driver).

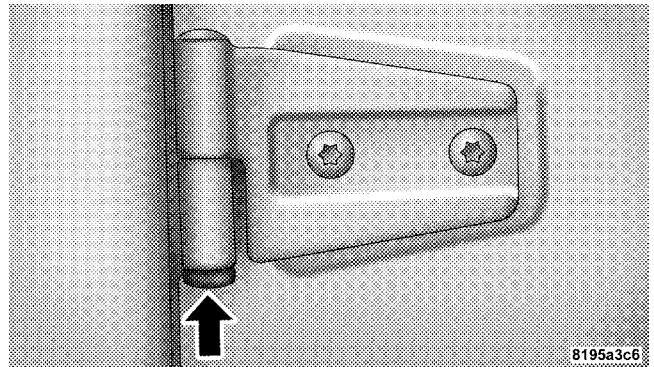

2. Slide front seat(s) fully forward.

28 THINGS TO KNOW BEFORE STARTING YOUR VEHICLE

3. Remove interior B-pillar trim access door at bottom of B-pillar.

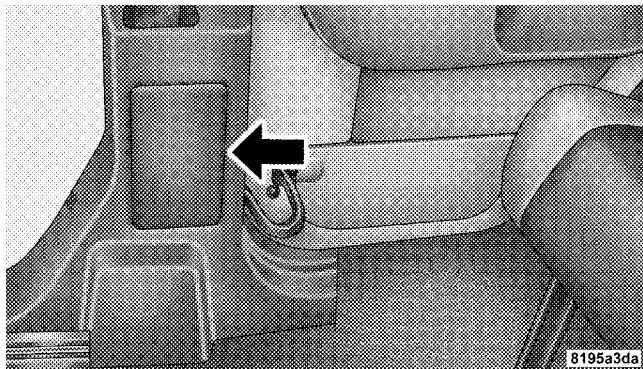

4. Unplug wiring harness connector.

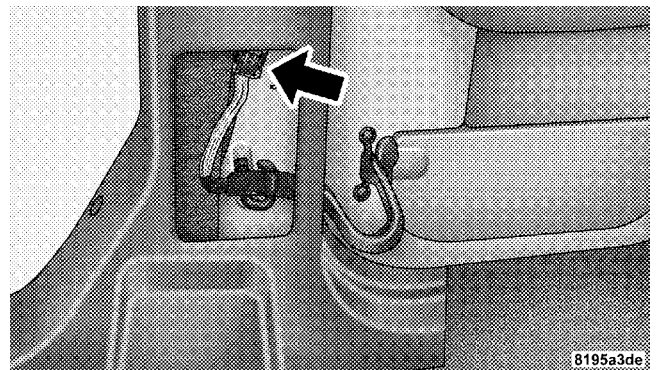

5. Unhook door strap from the body hook.

6. With the door open, lift the door to clear hinge pins from their hinges, and remove door.

To reinstall the door(s), perform the above steps in the opposite order.

DOOR LOCKS

The vacuum fluorescent (VF) display located in the odometer area displays the word “door” as an indication of a door ajar or door not completely closed. When the vehicle is not moving and the door is ajar or not completely closed, the VF display will show the word “door.”

If any other active warnings including “GATE”, “GAS-CAP”, “NOFUSE”, or “ESPOFF” are present, they will be shown in the VF display and will also continue to cycle. If the vehicle is moving, three single chimes will occur

(One chime for each complete display cycle (three cycles total). After this, the display will continue to cycle only (no chimes).

If the trip/reset button is pressed while the VF warnings are being displayed, the VF display will revert back to only displaying the odometer/trip odometer mileage.

NOTE: The ignition key that is used to start the vehicle is used to lock or unlock the doors, glove box, swing gate, and console storage.

Manual Door Locks

The front (2 Door Models) and rear doors (4 Door Models) are equipped with a rocker-type interior door lock. To lock a door when leaving your vehicle, press to the "Lock" position (flush) and close the door.

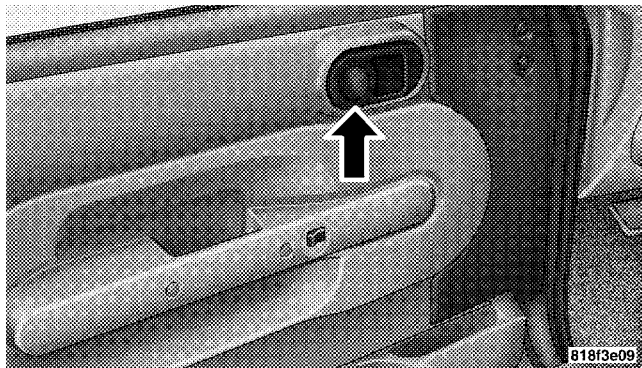

Manual Door Lock

WARNING!

- For personal security reasons and safety in an accident, lock the vehicle doors when you drive as well as when you park and leave the vehicle.
- Never leave children alone in a vehicle. Leaving children in a vehicle unattended is dangerous for a number of reasons. A child or others could be seriously or fatally injured. Do not leave the keys in the ignition. A child could operate power windows, other controls, or move the vehicle.

Power Door Locks — If Equipped

The door lock switch is located on each front door panel. Press the switch downward to lock the doors, and upward to unlock the doors.

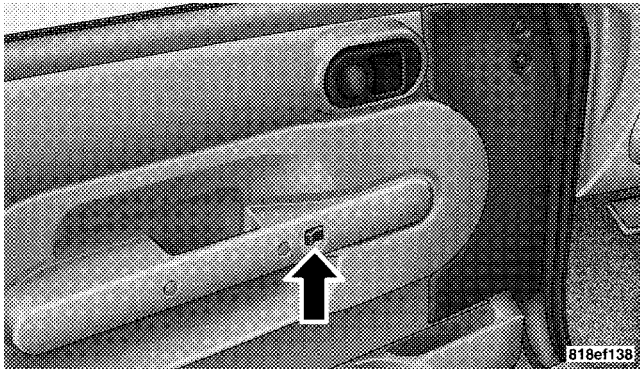

Power Door Lock Switch

WARNING!

- For personal security reasons and safety in an accident, lock the vehicle doors when you drive as well as when you park and leave the vehicle.
- Never leave children alone in a vehicle. Leaving children in a vehicle unattended is dangerous for a number of reasons. A child or others could be seriously or fatally injured. Do not leave the keys in the ignition. A child could operate power windows, other controls, or move the vehicle.

WINDOWS

Power Windows — If Equipped

The power window switches are located on the instrument panel center stack (below the radio). The top left switch controls the left front window and the top right switch controls the right front window. The lower left switch controls the left rear passenger window (4 door models), and the lower right switch controls the right rear passenger window (4 door models). The switches will continue to function for up to 10 minutes after the ignition key has been removed, or until a door is opened.

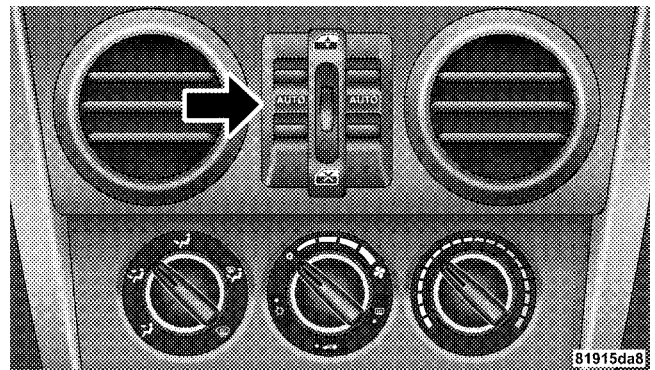

Power Window Switches

Auto Down

Both the driver and front passenger window switch has an “Auto Down” feature. Press the window switch past the first detent, release, and the window will go down

automatically. To cancel the “Auto Down” movement, operate the switch in either the up or down direction and release the switch.

To stop the window from going all the way down during the auto-down operation, pull up on the switch briefly.

To open the window part way, press to the first detent and release it when you want the window to stop.

The power window switches remain active for 10 minutes after the ignition has been turned off. Opening either front door will cancel this feature.

The rear passenger window switches (if equipped) are located on the back of the center floor console.

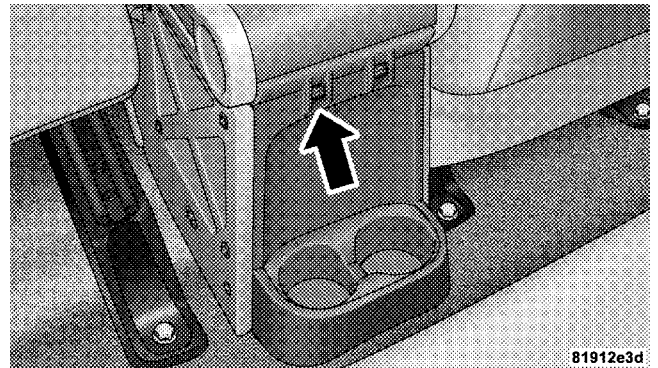

2

Rear Power Window Switches (4 Door)

Window Lockout Switch (4 Door Models Only)

The window lockout switch (located between the window switches) allows you to disable the rear window switches that are located on the back of the center floor

console. To disable the window controls, press the window lockout button downward. To enable the window controls, press the window lockout button upward.

Wind Buffeting

Wind buffeting can be described as the perception of pressure on the ears or a helicopter type sound in the ears. Your vehicle may exhibit wind buffeting with the windows down in certain open or partially open positions. This is a normal occurrence and can be minimized by adjusting window opening.

REAR SWING GATE

The vacuum fluorescent (VF) display located in the odometer area displays the word "gATE" as an indication of when the swing gate is not completely closed. When the vehicle is not moving, and the swing gate is not

completely closed, the VF display will show the word "gATE."

If any other active warnings are present, they will be shown in the VF display and will also continue to cycle. If the vehicle is moving, three single chimes will occur if the rear swing gate is open (one chime for each complete display cycle). After this, the VF display will continue to sequence only (no chimes).

If the trip/reset button is pressed while the VF warnings are being displayed, the VF display will revert back to only displaying the odometer/trip odometer mileage.

The swing gate can be unlocked using the remote keyless entry, or by activating the power door lock switches located on the front doors.

To open the swing gate, press the button on the gate handle.

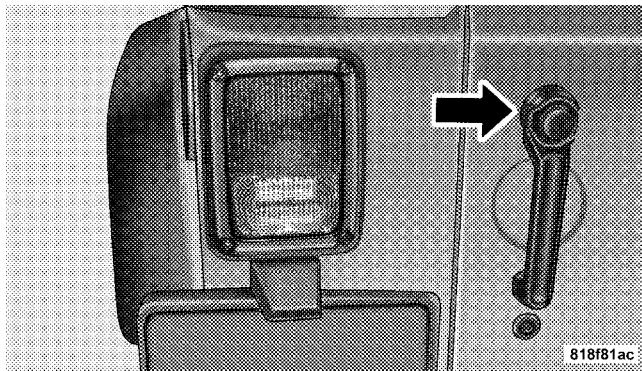

Gate Handle

NOTE: Close flip-up window before swing gate (hard top models only).

CAUTION!

Do not press on rear wiper blade when closing swing gate, as damage to the blade will result.

2

WARNING!

Driving with the flip-up window open can allow poisonous exhaust gases into your vehicle. You and your passengers could be injured by these fumes. Keep the flip-up window closed when you are operating the vehicle.

OCCUPANT RESTRAINTS

Some of the most important safety features in your vehicle are the restraint systems. These include the front and rear seat belts for the driver and all passengers, front airbags for both the driver and front passenger, and side airbags (if equipped) for both the driver and front passenger. If you will be carrying children too small for adult-size belts, your seat belts can also be used to hold infant and child restraint systems.

NOTE: The front airbags have a multi stage inflator design. This allows the airbag to have different rates of inflation that are based on collision severity.

Please pay close attention to the information in this section. It tells you how to use your restraint system properly to keep you and your passengers as safe as possible.

WARNING!

In a collision, you and your passengers can suffer injuries, including fatalities, if you are not properly buckled up. You can strike the interior of your vehicle or other passengers, or you can be thrown out of the vehicle. Always be sure you and others in your vehicle are buckled up properly.

Buckle up even though you are an excellent driver, even on short trips. Someone on the road may be a poor driver and cause a collision that includes you. This can happen far away from home or on your own street.

Research has shown that seat belts save lives, and that they can reduce the seriousness of injuries in a collision. Some of the worst injuries happen when people are thrown from the vehicle. Seat belts reduce the possibility of ejection and the risk of injury caused by striking the

inside of the vehicle. **Everyone** in a motor vehicle should be belted at all times to reduce or prevent injuries.

Lap/Shoulder Belts

All seating positions in your vehicle have combination lap/shoulder belts. The belt webbing retractor is designed to lock during very sudden stops or collisions. This feature allows the shoulder part of the belt to move freely with you under normal conditions. But in a collision, the belt will lock and reduce the risk of your striking the inside of the vehicle or being thrown out.

WARNING!

- It is extremely dangerous to ride in a cargo area, inside or outside of a vehicle. In a collision, people riding in these areas are more likely to be seriously injured or killed.
- Do not allow people to ride in any area of your vehicle that is not equipped with seats and seat belts.
- Be sure everyone in your vehicle is in a seat using a seat belt properly.

WARNING!

- **Wearing a seat belt incorrectly is dangerous. Seat belts are designed to go around the large bones of your body. These are the strongest parts of your body and take the forces of a collision the best. Wearing your belt in the wrong place could make your injuries in a collision much worse. You might suffer internal injuries, or you could even slide out of part of the belt. Follow these instructions to wear your seat belt safely and to keep your passengers safe, too.**
- **Two people should never be belted into a single seat belt. People belted together can crash into one another in an accident, hurting one another badly. Never use a lap/shoulder belt or a lap belt for more than one person, no matter what their size.**

Lap/Shoulder Belt Operating Instructions

1. Enter the vehicle and close the door. Sit back and adjust the seat.
2. The seat belt latch plate is above the back of the front seat, next to your arm in the rear seat. Grasp the latch plate and pull out the belt. Slide the latch plate up the webbing as far as necessary to allow the belt to go around your lap.

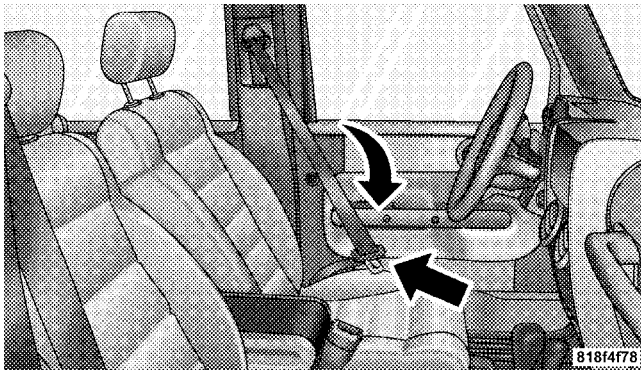

Latch Plate

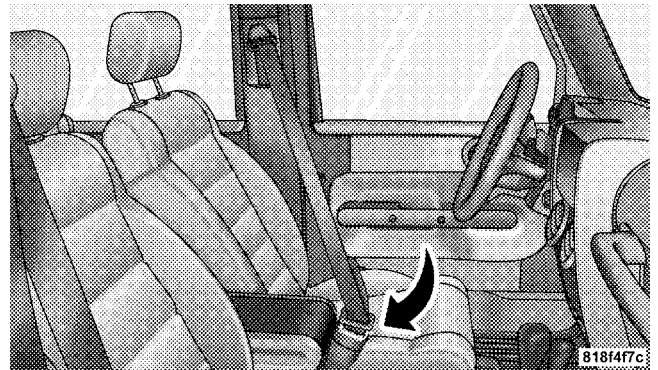

Latch Plate To Buckle

3. When the belt is long enough to fit, insert the latch plate into the buckle until you hear a "click."

WARNING!

A belt that is buckled into the wrong buckle will not protect you properly. The lap portion could ride too high on your body, possibly causing internal injuries. Always buckle your belt into the buckle nearest you.

A belt that is loose will not protect you as well. In a sudden stop you could move too far forward, increasing the possibility of injury. Wear your seat belt snugly.

A belt that is worn under your arm is very dangerous. Your body could strike the inside surfaces of the vehicle in a collision, increasing head and neck injury. A belt worn under the arm can cause internal injuries. Ribs aren't as strong as shoulder bones. Wear the belt over your shoulder so that the strongest bones will take the force in a collision.

A shoulder belt placed behind will not protect you from injury during a collision. You are more likely to hit your head in a collision if you do not wear your shoulder belt. The lap and shoulder belt are meant to be used together.

4. Position the lap belt across your thighs, below your abdomen. To remove slack in the lap belt portion, pull up on the shoulder belt. To loosen the lap belt if it is too tight, tilt the latch plate and pull on the lap belt. A snug belt reduces the risk of sliding under the belt in a collision.

NOTE: The "Seat Belt Indicator Light" will remain on until the driver's seat belt is buckled.

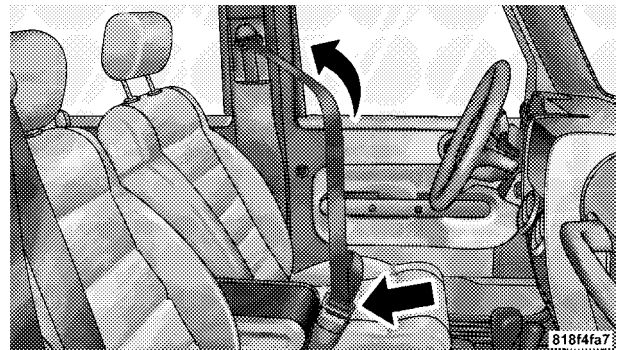

Removing Slack From Belt

WARNING!

A lap belt worn too high can increase the risk of internal injury in a collision. The belt forces won't be at the strong hip and pelvic bones, but across your abdomen. Always wear the lap belt as low as possible and keep it snug.

A twisted belt cannot do its job as well. In a collision it could even cut into you. Be sure the belt is straight. If you cannot straighten a belt in your vehicle, take it to your dealer and have it fixed.

5. Position the shoulder belt on your chest so that it is comfortable and not resting on your neck. The retractor will withdraw any slack in the belt.

6. To release the belt, push the red button on the buckle. The belt will automatically retract to its stowed position. If necessary, slide the latch plate down the webbing to allow the belt to retract fully.

WARNING!

A frayed or torn belt could rip apart in a collision and leave you with no protection. Inspect the belt system periodically, checking for cuts, frays, or loose parts. Damaged parts must be replaced immediately. Do not disassemble or modify the system. Seat belt assemblies must be replaced after a collision if they have been damaged (bent retractor, torn webbing, etc.).

Rear Center Lap/Shoulder Belt Retractor Lock-Out

This feature is designed to lock the retractor whenever the 60% rear seat back is not fully latched. This prevents someone from wearing the rear center lap/shoulder belt when the rear seat back is not fully latched.

NOTE:

- If the rear center lap/shoulder belt cannot be pulled out, check that the rear seat back is fully latched.
- If the rear seat back is properly latched and the rear center lap/shoulder belt still cannot be pulled out, the Automatic-Locking Retractor (ALR) system may be activated. To reset this feature you must let all of the belt webbing return into the retractor. You will not be able to pull out more webbing until all of the webbing has been returned back into the retractor.

WARNING!

The rear center lap/shoulder belt is equipped with a lock-out feature to ensure that the rear seat back is in the fully upright and locked position when occupied. If the rear seat back is not fully upright and locked and the rear center lap/shoulder belt can be pulled out of the retractor, the vehicle should immediately be taken to your dealer for service. Failure to follow this warning could result in serious or fatal injury.

Adjustable Upper Shoulder Belt Anchorage

In the front seat positions, the shoulder belt anchorage can be adjusted upward or downward to position the belt away from your neck. Push in on the anchorage near your outside shoulder and slide it up or down to reach the position that serves you best.

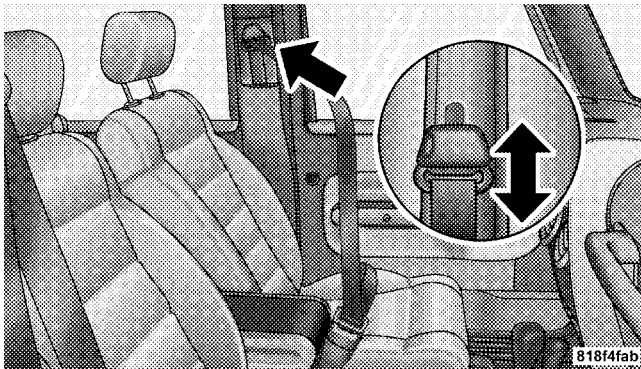

Adjusting Upper Shoulder Belt

WARNING!

Position the shoulder belt height adjusters so that the belt rests across the middle of your shoulder. Failure to adjust the safety belt properly could reduce the effectiveness of the seat belt and increase the risk of injury in a collision.

2

As a guide, if you are shorter than average, you will prefer a lower position, and if you are taller than average, you'll prefer a higher position. When you release the anchorage, try to move it up or down to make sure that it is locked in position.

Seat Belt Pretensioners

The driver and front passenger seat belts are equipped with a pretensioning device that is designed to remove any slack from the seat belt systems in the event of a collision. This device improves the performance of the

seat belt by assuring that the belt is tight around the occupant early in a collision. Pretensioners work for all size occupants, including those in child restraints.

NOTE: These devices are not a substitute for proper seat belt placement by the occupant. The seat belt must still be worn snugly and positioned properly.

The pretensioners are triggered by the Occupant Restraint Control (ORC) Module. Like the front airbags, the pretensioners are a single use item. After a collision that is severe enough to deploy the airbags and pretensioners, they must be replaced.

Enhanced Seat Belt Use Reminder System (BeltAlert)

If the driver or front passenger seat belt has not been buckled within 60 seconds of starting the vehicle and if the vehicle speed is greater than 5 mph (8 km/h), the Enhanced Warning System (BeltAlert) will alert the driver to buckle their seat belt. The driver should also

instruct all other occupants to buckle their seat belts. Once the warning is triggered, the Enhanced Warning System (BeltAlert) will continue to chime and flash the Seat Belt Warning Light for 96 seconds or until the driver or front passenger seat belt is buckled.

The Enhanced Warning System (BeltAlert) will be reactivated if the driver or front passenger seat belt is unbuckled for more than 10 seconds and the vehicle speed is greater than 5 mph (8 km/h).

The Enhanced Warning System (BeltAlert) can be enabled or disabled by your authorized dealer or by following these steps:

NOTE: The following steps must occur within the first 60 seconds of the ignition switch being turned to the ON or START position. The manufacturer does not recommend deactivating the Enhanced Warning System (BeltAlert).

1. Turn the ignition switch to the OFF position, and buckle the driver or front passenger seat belt.
2. Turn the ignition key to the ACCESSORY/RUN position (engine does not need to be running), and wait for the Seat Belt Warning Light to turn off.
3. Within 60 seconds of starting the vehicle, unbuckle and then re-buckle the driver or front passenger seat belt at least three times within 10 seconds, ending with the seat belt buckled.
4. Turn the ignition key to the OFF position. A single chime will sound to signify that you have successfully completed the programming.

The Enhanced Warning System (BeltAlert) can be reactivated by repeating this procedure.

NOTE: Although the Enhanced Warning System (BeltAlert) has been deactivated, the Seat Belt Warning Light will continue to illuminate while the driver's seat belt remains unfastened.

Seat Belts And Pregnant Women

We recommend that pregnant women use seat belts throughout their pregnancy. Keeping the mother safe is the best way to keep the baby safe.

Pregnant women should wear the lap part of the belt across the thighs and as snug across the hips as possible. Keep the belt low so that it does not come across the abdomen. That way the strong bones of the hips will take the force if there is a collision.

Seat Belt Extender

If a seat belt is too short, even when fully extended and when the adjustable upper shoulder belt anchorage (if equipped) is in its lowest position, your dealer can provide you with a seat belt extender. This extender should be used only if the existing belt is not long enough. When it is not required, remove the extender and store it.

WARNING!

Using a seat belt extender when not needed can increase the risk of injury in a collision. Only use when the seat belt is not long enough when it is worn low and snug, and in the recommended seating positions. Remove and stow the seat belt extender when not needed.

Driver And Front Passenger Supplemental Restraint Systems (SRS)

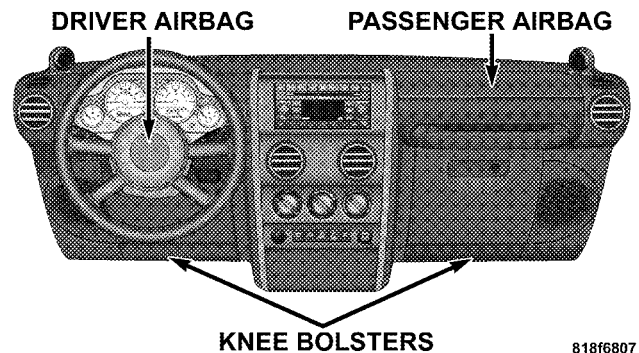

818f6807

Front Airbag Components

This vehicle has airbags for both the driver and right front passenger as a supplement to the seat belt restraint systems. The driver's front airbag is mounted in the steering wheel. The passenger side airbag is mounted in

the instrument panel, above the glove compartment. The words SRS/AIRBAG are embossed on the airbag covers.

NOTE: The front airbags are certified to the Federal regulations that allow less forceful deployment.

The front airbags have a multistage inflator design. This may allow the airbag to have different rates of inflation that are based on collision severity and occupant size. Also, the front passenger airbag is certified to the Federal regulations that define Occupant Classification (Refer to "Occupant Classification System" in this section).

If the vehicle is equipped with side airbags, they are located inside the driver and front passenger seats, and their covers are also labeled SRS/AIRBAG.

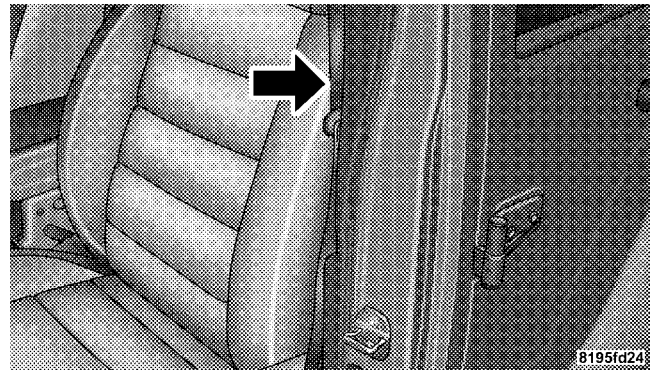

Side Airbag Location

NOTE: Airbag covers may not be obvious in the interior trim; but they will open to allow airbag deployment.

WARNING!

- Do not put anything on or around the front airbag covers or attempt to manually open them. You may damage the airbags and you could be injured because the airbags are no longer functional. These protective covers for the airbag cushions are designed to open only when the airbags are inflating.
- If your vehicle is equipped with side airbags, do not use accessory seat covers or place objects between you and the side airbags; the performance could be adversely affected and/or objects could be pushed into you, causing serious injury.
- If your vehicle is equipped with side airbags, do not attach cup holders or any other objects on or around the door. The inflating side airbag could drive the objects into occupants, causing serious injury.
- Do not cover or place items on the airbag covers. These items may cause serious injury during inflation.
- Do not store or place items under the front seats. You may damage the airbag wiring harnesses.

The front airbags have a multi stage inflator design. This allows the airbag to have different rates of inflation that are based on collision severity. Along with the seat belts, front airbags work with the instrument panel knee bolsters to provide improved protection for the driver and front passenger. Side airbags also work with seat belts to improve occupant protection.

The seat belts are designed to protect you in many types of collisions. The front airbags deploy in moderate to severe frontal collisions.

NOTE: The passenger front airbag may not deploy even when the driver front airbag has if the Occupant Classification System (refer to "Occupant Classification System" in this section) has determined the passenger seat is empty or is occupied by someone that is classified in the "small child" category.

If your vehicle is so equipped, the side airbag on the crash side of the vehicle is triggered in moderate to

severe side collisions. In certain types of collisions, both the front and side airbags may be triggered. But even in collisions where the airbags work, you need the seat belts to keep you in the right position for the airbags to protect you properly.

Here are some simple steps you can take to minimize the risk of harm from a deploying airbag.

1. Children 12 years and under should always ride buckled up in a rear seat.

Infants in rear facing child restraints should **NEVER** ride in the front seat of a vehicle with a passenger airbag. An airbag deployment could cause severe injury or death to infants in that position.

Children that are not big enough to properly wear the vehicle seat belt should be secured in the rear seat, in a child restraint or belt-positioning booster seat. Older

children who do not use child restraints or belt-positioning booster seats should ride properly buckled up in the rear seat. Never allow children to slide the shoulder belt behind them or under their arm.

If a child from 1 to 12 years old must ride in the front passenger seat because the vehicle is crowded, move the seat as far back as possible, and use the proper child restraint. See “Child Restraint” in this section.

You should read the instructions provided with your child restraint to make sure that you are using it properly.

2. All occupants should use their lap and shoulder belts properly.

3. The driver and front passenger seats should be moved back as far as practical to allow the front airbags room to inflate.

50 THINGS TO KNOW BEFORE STARTING YOUR VEHICLE

4. If your vehicle has side airbags, do not lean against the door, airbags will inflate forcefully into the space between you and the door.

5. If the airbag system in this vehicle needs to be modified to accommodate a disabled person, contact the Customer Center. Phone numbers are provided under "If You Need Assistance" in Section 9 of this manual.

WARNING!

- Relying on the airbags alone could lead to more severe injuries in a collision. The airbags work with your seat belt to restrain you properly. In some collisions the airbags won't deploy at all. Always wear your seat belts even though you have airbags.
- Being too close to the steering wheel or instrument panel during airbag deployment could cause serious injury. Airbags need room to inflate. Sit back, comfortably extending your arms to reach the steering wheel or instrument panel.
- If the vehicle has side airbags, they also need room to inflate. Do not lean against the door. Sit upright in the center of the seat.

Airbag System Components

The airbag system consists of the following:

- Occupant Restraint Control Module
- Airbag Warning Light
- Driver Airbag
- Passenger Airbag
- Front Seat Mounted Side Airbags (If Equipped)
- Steering Wheel and Column
- Instrument Panel
- Interconnecting Wiring
- Knee Impact Bolsters
- Front Acceleration Sensors
- Driver and Front Passenger Seat Belt Pretensioner

- Occupant Classification System (OCS) — Front Passenger Seat Only
 - Occupant Classification Module
 - Passenger Airbag Disable (PAD) Indicator Light
 - Weight Sensors

How The Airbag System Works

- The **Occupant Restraint Control (ORC) Module** determines if a frontal, or side collision is severe enough to require the front and/or side airbags to inflate. The front airbag inflators are designed to provide different rates of airbag inflation from direction provided by the ORC. The ORC may also modify the rate of inflation based on the occupant size provided by the Occupant Classification Module.

The ORC also monitors the readiness of the electronic parts of the system whenever the ignition switch is in

the START or ON positions. These include all of the items listed above except the knee bolster, the instrument panel, and the steering wheel and column. If the key is in the LOCK position, in the ACC position, or not in the ignition, the airbags are not on and will not inflate.



Also, the ORC turns on the “Airbag Warning Light” and “PAD Indicator Light” for 6 to 8 seconds for a self-check when the ignition is first turned on. After the self-check, the “Airbag Warning Light” will turn off. The “PAD Indicator Light” will function normally (Refer to “Passenger Airbag Disable (PAD) Indicator Light” in this section). If the ORC detects a malfunction in any part of the system, it turns on the “Airbag Warning Light” either momentarily or continuously. A single chime will sound if the light comes on again after initial start up.

WARNING!

Ignoring the “Airbag Warning Light” in your instrument panel could mean you won’t have the airbags to protect you in a collision. If the light does not come on, stays on after you start the vehicle, or if it comes on as you drive, have the airbag system checked right away.

- The **Occupant Classification System (OCS)** is part of a Federally regulated safety system required for this vehicle. It is designed to turn off the front passenger airbag in the unlikely event that a rear-facing infant seat is in the front passenger seat.

NOTE: Children 12 years and under should always ride buckled up in a rear seat in an appropriate child restraint.

- The **Passenger Airbag Disable (PAD) Indicator Light** (an amber light located in the lower switch bank) tells

the driver and front passenger when the front passenger airbag is turned off. The “PAD Indicator Light” illuminates the words “PASS AIR BAG OFF” to show that the passenger airbag will not inflate during a collision requiring airbags. When the right front passenger seat is empty or when very light objects are placed on the seat, the passenger airbag will not inflate even though the “PAD Indicator Light” is not illuminated.

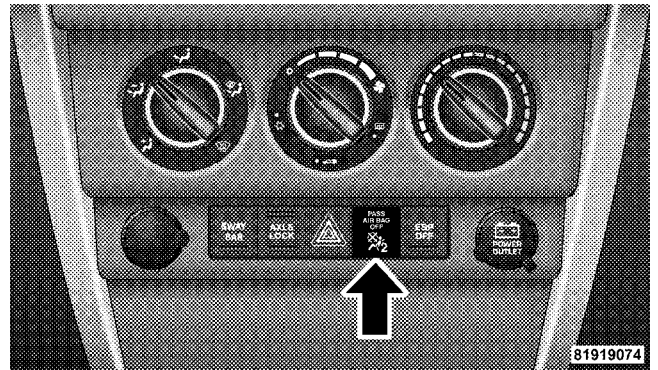

2

Indicator Light Location

The “PAD Indicator Light” should not be illuminated when teenagers, most children in a forward-facing child restraint or booster seats, most children that can properly wear the vehicle’s seat belt, and when an

54 THINGS TO KNOW BEFORE STARTING YOUR VEHICLE

adult passenger is properly seated in the front passenger seat. In this case, the airbag is ready to be inflated if a collision requiring an airbag occurs.

For almost all properly installed rear facing child restraints, the “PAD Indicator Light” will be illuminated indicating that the front passenger airbag is turned off and will not inflate. If the “PAD Indicator Light” is not illuminated, **DO NOT** assume the airbag is turned off and move the child restraint to the rear seat. A deploying passenger airbag can cause death or serious injury to a child in a rear facing infant seat.

NOTE: Even though this vehicle is equipped with an Occupant Classification System, children 12 years and under should always ride buckled up in a rear seat in an appropriate child restraint.

Front Passenger Seat Occupant	Passenger Airbag Disable (PAD) Indicator Light	Airbag Status
Adult	OFF	ON
Grocery Bags, Heavy Briefcases and Other Relatively Light Objects	ON	OFF
Empty or Very Small Objects	OFF*	OFF
* Since the system senses weight, some small objects will turn the PAD Indicator Light on.		

The OCS classifies an occupant using weight sensors mounted in the base of the front passenger seat. Any weight on the seat will be sensed by the system. Objects hanging on the seat or other passengers pushing down on the seat will also be sensed. The weight of an adult

will cause the system to turn the airbag on. In this case, the OCS has classified the occupant of the seat as an adult. An adult occupant needs to sit in a normal position (with their feet on or near the floor) in order to be properly classified. Reclining the seat back too far may change how an occupant is classified by the OCS.

Drivers and adult passengers should verify that the “PAD Indicator Light” is not illuminated when an adult is riding in the front passenger seat. If an adult occupant’s weight is transferred to another part of the vehicle (like the door or instrument panel), the weight sensors in the seat may not properly classify the occupant. Objects lodged under the seat or between the seat and the center console can prevent the occupant’s weight from being measured properly and may result in the occupant being improperly classified. Ensure that the front passenger seat back does not touch anything placed on the back seat

because this can also affect occupant classification. Also, if you fold down the rear seat check to be sure it doesn’t touch the front passenger seat.

If the front passenger seat is damaged in any way, it should only be serviced by an authorized dealer. If the seat is removed (or even if the seat attachment bolts are loosened or tightened in any way), take the vehicle to an authorized dealer.

If there is a fault present in the OCS, the “Airbag Warning Light” (a red light located in the center of the instrument cluster directly in front of the driver) will be turned on. This indicates that you should take the vehicle to an authorized dealer. The “Airbag Warning Light” is turned on whenever there is a fault that can affect the operation of the airbag system. If there is a fault present in the OCS, both the “PAD Indicator Light” and the “Airbag Warning Light” are illuminated to show that the passenger airbag is turned off until the fault is cleared. If an object is

lodged under the seat and interferes with operation of the weight sensors, a fault will occur which turns on both the "PAD Indicator Light" and the "Airbag Warning Light." Once the lodged object is removed, the fault will be automatically cleared after a short period of time.

- The **Driver and Passenger Airbag/Inflator Units** are located in the center of the steering wheel and the right side of the instrument panel. When the ORC detects a collision requiring the airbags, it signals the inflator units. A large quantity of nontoxic gas is generated to inflate the front airbags. Different airbag inflation rates are possible, based on collision severity and occupant size. The steering wheel hub trim cover and the upper right side of the instrument panel separate and fold out of the way as the bags inflate to their full size. The bags fully inflate in about 50–70 milliseconds. This is about half of the time it takes to blink your eyes. The bags then quickly deflate while helping to restrain the driver and front passenger.
- The **Occupant Classification Module (OCM)** is located beneath the front passenger seat. The OCM classifies the occupant into categories based on the measurements made by the seat weight sensors. The OCM communicates with the Occupant Restraint Control (ORC) Module. The ORC uses the occupant category to determine whether the front passenger airbag should be turned off. It also determines the rate of airbag inflation during a collision.
- Your vehicle has four **Weight Sensors** located between the seat and the floor pan. The weight sensors measure applied weight and transfers that information to the OCM.

The driver front airbag gas is vented through the vent holes in the sides of the airbag. The passenger front airbag gas is vented through the vent holes in the sides of the airbag. In this way, the airbags do not interfere with your control of the vehicle.

- The **Side Impact (SRS) Seat Mounted Side Airbags (If Equipped)** are designed to activate only in certain side collisions.

The ORC module determines if a side collision is severe enough to require the side airbags to inflate.

The ORC Module monitors the readiness of the electronic parts of the system whenever the ignition switch is in the START or ON positions. These include all of the items previously mentioned.

In moderate to severe side collisions, the side airbag inflator on the crash side of the vehicle is triggered, releasing a quantity of nontoxic gas. The inflating side airbag exits through the seat seam into the space between the occupant and the door. The side airbag moves at a very high speed and with such a high force, that it could injure you if you are not seated properly, or if items are positioned in the area where the side airbag inflates. This especially applies to children.

- The **Knee Impact Bolsters** help protect the knees of the driver and the front passenger, and position everyone for the best interaction with the front airbag.

The front passenger seat assembly contains critical components that affect the front passenger airbag deployment. Correctly functioning front passenger seat components are critical for the Occupant Classification System (OCS) to properly classify the front passenger and calculate the proper airbag deployment. Do not make any modifications to the front passenger seat components, assembly, or to the seat cover.

The following requirements must be strictly adhered to:

- Do not modify the front passenger seat assembly or components in any way.
- Do not modify the front seat center console or center position seat in any way.

58 THINGS TO KNOW BEFORE STARTING YOUR VEHICLE

- Do not use prior or future model year seat covers not designated for the specific model being repaired. Always use the correct seat cover specified for the vehicle.
- Do not replace the seat cover with an aftermarket seat cover.
- Do not add a secondary seat cover other than those approved by DaimlerChrysler/Mopar.
- At no time should any supplemental restraint system (SRS) component or SRS related component or fastener be modified or replaced with any part except those which are approved by DaimlerChrysler/Mopar.

WARNING!

Unapproved modifications or service procedures to the front passenger seat assembly, its related components, or seat cover may inadvertently change the airbag deployment in case of a frontal crash. This could result in death or serious injury to the front seat passenger if the vehicle is involved in an accident. A modified vehicle may not comply with required Federal Motor Vehicle Safety Standards (FMVSS).

If A Deployment Occurs

The airbag system is designed to deploy when the Occupant Restraint Control (ORC) Module detects a moderate-to-severe frontal collision, to help restrain the driver and front passenger, and then to immediately deflate.

NOTE: A frontal collision that is not severe enough to need airbag protection will not activate the system. This does not mean something is wrong with the airbag system.

If you do have a collision which deploys the airbags, any or all of the following may occur:

- The nylon airbag material may sometimes cause abrasions and/or skin reddening to the driver and front passenger as the airbags deploy and unfold. The abrasions are similar to friction rope burns or those you might get sliding along a carpet or gymnasium floor. They are not caused by contact with chemicals. They are not permanent and normally heal quickly. However, if you haven't healed significantly within a few days, or if you have any blistering, see your doctor immediately.
- As the airbags deflate you may see some smoke-like particles. The particles are a normal by-product of the

process that generates the nontoxic gas used for airbag inflation. These airborne particles may irritate the skin, eyes, nose, or throat. If you have skin or eye irritation, rinse the area with cool water. For nose or throat irritation, move to fresh air. If the irritation continues, see your doctor. If these particles settle on your clothing, follow the garment manufacturer's instructions for cleaning.

- It is not advisable to drive your vehicle after the airbags have deployed. If you are involved in another collision, the airbags will not be in place to protect you.

WARNING!

Deployed airbags and seat belt pretensioners cannot protect you in another collision. Have the airbags, seat belt pretensioner, and seat belt retractor assembly, replaced by an authorized dealer as soon as possible. Also, have the Occupant Classification System serviced as well.

Enhanced Accident Response Feature

If the airbags deploy after an impact and the electrical system remains functional, vehicles equipped with power door locks will unlock automatically. In addition, approximately 5 seconds after the vehicle has stopped moving, the interior lights will illuminate to aid visibility.

NOTE: The interior lights can only be deactivated if the key is removed from the ignition switch or the vehicle is driven.

Maintaining Your Airbag System**WARNING!**

- Modifications to any part of the airbag system could cause it to fail when you need it. You could be injured if the airbag system is not there to protect you. Do not modify the components or wiring, including adding any kind of badges or stickers to the steering wheel hub trim cover or the upper right side of the instrument panel. Do not modify the front bumper or vehicle body structure.
- Do not attempt to modify any part of your advanced airbag system. The airbag may inflate accidentally or may not function properly if modifications are made. Take your vehicle to an authorized dealer for any advanced airbag system service. If your seat including your trim cover and cushion needs to be serviced in any way (including removal or loosening/tightening of seat attachment bolts), take the vehicle to your authorized dealer. Only manufacturer approved seat accessories may be used. If it is necessary to modify an advanced airbag system for persons with disabilities, contact your authorized dealer.
- Do not place or hang any items such as add-on video players on the right front passenger seat back. The additional weight may cause the Occupant Classification System to be unable to correctly classify the right front occupant. This could allow the passenger frontal airbag to inflate when it is not desired.
- You need proper knee impact protection in a collision. Do not mount or locate any aftermarket equipment on or behind the knee bolsters.
- It is dangerous to try to repair any part of the airbag system yourself. Be sure to tell anyone who works on your vehicle that it has an airbag system.

Airbag Warning Light

You will want to have the airbag system ready to inflate for your protection in an impact. The airbag system is designed to be maintenance free. If any of the following occurs, have an authorized dealer service the system promptly:

- Does not come on during the 6 to 8 seconds after the ignition switch is first turned on.
- Remains on after the 6 to 8 second interval.
- Comes on for any period of time while driving.

Event Data Recorder (EDR)

In the event of an airbag deployment, your vehicle is designed to record up to 2-seconds of specific vehicle data parameters (see the following list) in the event data recorder prior to the moment of airbag deployment. Please note that such data are ONLY recorded if an airbag deploys, and are otherwise unavailable. In conjunction

with other data gathered during a complete accident investigation, the electronic data may be used by DaimlerChrysler Corporation and others to learn more about the possible causes of crashes and associated injuries in order to assess and improve vehicle performance. In addition to crash investigations initiated by DaimlerChrysler Corporation, such investigations may be requested by customers, insurance carriers, government officials, and professional crash researchers, such as those associated with universities, and with hospital and insurance organizations.

In the event that an investigation is undertaken by DaimlerChrysler Corporation (regardless of initiative), the company or its designated representative will first obtain permission of the appropriate custodial entity for the vehicle (usually the vehicle owner or lessee) before accessing the electronic data stored, unless ordered to download data by a court with legal jurisdiction (i.e., pursuant to a warrant). A copy of the data will be

provided to the custodial entity upon request. General data that does not identify particular vehicles or crashes may be released for incorporation in aggregate crash databases, such as those maintained by the US government and various states. Data of a potentially sensitive nature, such as would identify a particular driver, vehicle, or crash, will be treated confidentially. Confidential data will not be disclosed by DaimlerChrysler Corporation to any third party except when:

1. Used for research purposes, such as to match data with a particular crash record in an aggregate database, provided confidentiality of personal data is thereafter preserved
2. Used in defense of litigation involving a DaimlerChrysler Corporation product
3. Requested by police under a legal warrant
4. Otherwise required by law

Data Parameters that May Be Recorded:

- Diagnostic trouble code(s) and warning lamp status for electronically-controlled safety systems, including the airbag system
- Airbag disable lamp status (if equipped)
- "Time" of airbag deployment (in terms of ignition cycles and vehicle mileage)
- Airbag deployment level (if applicable)
- Seat belt status
- Brake status (service and parking brakes)
- Accelerator status (including vehicle speed)
- Engine control status (including engine speed)
- Cruise control status
- Traction/stability control status

Child Restraint

Everyone in your vehicle needs to be buckled up at all times — babies and children, too. Every state in the United States and all Canadian provinces require that small children ride in proper restraint systems. This is the law, and you can be prosecuted for ignoring it.

Children 12 years and under should ride properly buckled up in a rear seat, if available. According to crash statistics, children are safer when properly restrained in the rear seats, rather than in the front.

There are different sizes and types of restraints for children from newborn size to the child almost large enough for an adult safety belt. Always check the child seat owner's manual to ensure you have the correct seat for your child. Use the restraint that is correct for your child.

WARNING!

In a collision, an unrestrained child, even a tiny baby, can become a missile inside the vehicle. The force required to hold even an infant on your lap could become so great that you could not hold the child, no matter how strong you are. The child and others could be badly injured. Any child riding in your vehicle should be in a proper restraint for the child's size.

2

Infants and Child Restraints

- Safety experts recommend that children ride rearward-facing in the vehicle until they are at least one year old **and** weigh at least 20 lbs (9 kg). Two types of child restraints can be used rearward-facing: infant carriers and “convertible” child seats.

- The infant carrier is only used rearward-facing in the vehicle. It is recommended for children who weigh up to about 20 lbs (9 kg). “Convertible” child seats often have a higher weight limit in the rearward-facing direction than infant carriers do, so they can be used rearward-facing by children who weigh more than 20 lbs (9 kg) but are less than one year old. Both types of child restraints are held in the vehicle by the lap/shoulder belt or the LATCH child restraint anchorage system (Refer to LATCH — Child Seat Anchorage System in this section.)
- Rearward-facing child seats must **NEVER** be used in the front seat of a vehicle with the front passenger airbag unless the airbag is turned off. An airbag deployment could cause severe injury or death to infants in this position.

WARNING!

- **Improper installation can lead to failure of an infant or child restraint. It could come loose in a collision. The child could be badly injured or killed. Follow the manufacturer’s directions exactly when installing an infant or child restraint.**
- **A rearward facing infant restraint should only be used in a rear seat. A rearward facing infant restraint in the front seat may be struck by a deploying passenger airbag which may cause severe or fatal injury to the infant.**

Here are some tips for getting the most out of your child restraint:

- Before buying any restraint system, make sure that it has a label certifying that it meets all applicable Safety

Standards. The manufacturer also recommends that you try a child restraint in the vehicle seats where you will use it before you buy it.

- The restraint must be appropriate for your child's weight and height. Check the label on the restraint for weight and height limits.
- Carefully follow the instructions that come with the restraint. If you install the restraint improperly, it may not work when you need it.
- All seating positions (except for driver) have an automatic locking retractor identified by a distinctive label. The seat belts are designed to keep the lap portion tight around the child restraint so that it is not necessary to use a locking clip. For the seat belt with the automatic locking retractor, pull the belt from the retractor until there is enough to allow you to pass through the child restraint and slide the latch plate into the buckle. Then, pull the belt until it is fully

extracted from the retractor. Allow the belt to return to the retractor, pulling on the excess webbing to tighten the lap portion about the child restraint. For additional information, refer to "Automatic Locking Mode" earlier in this section.

- In the rear seat, you may have trouble tightening the lap/shoulder belt on the child restraint because the buckle or latch plate is too close to the belt path opening on the restraint. Disconnect the latch plate from the buckle and twist the short buckle-end belt several times to shorten it. Insert the latch plate into the buckle with the release button facing out.
- If the belt still cannot be tightened, or if pulling and pushing on the restraint loosens the belt, disconnect the latch plate from the buckle, turn the buckle around, and insert the latch plate into the buckle again. If you still cannot make the child restraint secure, try a different seating position.

- Buckle the child into the restraint exactly as the manufacturer's instructions tell you.
- When your child restraint is not in use, secure it in the vehicle with the seat belt or remove it from the vehicle. Do not leave it loose in the vehicle. In a sudden stop or collision, it could strike the occupants or seat backs and cause serious personal injury.

NOTE: For additional information refer to www.seatcheck.org or call 1-866-SEATCHECK.

Older Children and Child Restraints

Children who weigh more than 20 lbs (9 kg) and who are older than one year can ride forward-facing in the vehicle. Forward-facing child seats and convertible child seats used in the forward-facing direction, are for children who weigh 20 to 40 lbs (9 to 18 kg), and who are older than one year. These child seats are also held in the

vehicle by the lap/shoulder belt or the LATCH child restraint anchorage system (Refer to LATCH — Child Seat Anchorage System in this section.)

The belt-positioning booster seat is for children weighing more than 40 lbs (18 kg), but who are still too small to fit the vehicle's seat belts properly. If the child cannot sit with knees bent over the vehicle's seat cushion while the child's back is against the seat back, they should use a belt-positioning booster seat. The child and belt-positioning booster seat are held in the vehicle by the lap/shoulder belt.

Children Too Large for Booster Seats

Children who are large enough to wear the shoulder belt comfortably, and whose legs are long enough to bend over the front of the seat when their back is against the seat back, should use the lap/shoulder belt in a rear seat.

- Make sure that the child is upright in the seat.

- The lap portion should be low on the hips and as snug as possible.
- Check belt fit periodically. A child's squirming or slouching can move the belt out of position.
- If the shoulder belt contacts the face or neck, move the child closer to the center of the vehicle. Never allow a child to put the shoulder belt under an arm or behind their back.

Automatic-Locking Retractor (ALR)

To operate the switchable retractor, pull the belt from the retractor until there is enough to allow you to pass through the child restraint and slide the latch plate into the buckle. Then pull on the belt until it is all removed from the retractor. Allow the belt to return into the retractor, pulling on the excess webbing to tighten the lap portion about the child restraint. Follow the instructions of the child restraint manufacture.

NOTE: To reset this feature you must let all of the belt webbing return into the retractor. You will not be able to pull out more webbing until all of the webbing has been returned back into the retractor.

Installing the Child Restraint System

We urge that you carefully follow the directions of the manufacturer when installing your child restraint. Many, but not all, restraint systems will be equipped with separate straps on each side, with each having a hook or connector and a means for adjusting the tension in the strap. Forward-facing toddler restraints and some rearward-facing infant restraints will also be equipped with a tether strap with a hook and means for adjusting the tension in the strap.

In general, you will first loosen the adjusters on the lower and tether straps so that you can more easily attach the hook or connector to the lower and tether anchorages. The tether strap should be routed under the center of the

head restraint and attached to the tether anchor on the rear of the seat back. Then tighten all three straps as you push the child restraint rearward and downward into the seat.

Not all child restraint systems will be installed as we have described here. Again, carefully follow the instructions that come with the child restraint system.

NOTE: If your child restraint seat is not LATCH compatible, install the restraint using the vehicle seat belts.

WARNING!

An incorrectly anchored tether strap could lead to increased head motion and possible injury to the child. Use only the anchor position directly behind the child seat to secure a child restraint top tether strap.

LATCH — Child Seat Anchorage System (Lower Anchors and Tether for Children)

Your vehicle's rear seat is equipped with the child restraint anchorage system called LATCH. The LATCH system provides for the installation of the child restraint without using the vehicle's seat belts, instead securing the child restraint using lower anchorages and upper tether straps from the child restraint to the vehicle structure.

LATCH-compatible child restraint systems are now available. However, because the lower anchorages are to be introduced over a period of years, child restraint systems having attachments for those anchorages will continue to also have features for installation using the vehicle's seat belts. Child restraints having tether straps and hooks for connection to the top tether anchorages have been available for some time. For some older child restraints, many child restraint manufacturers offer add-on tether strap

kits or retro-fit kits. You are urged to take advantage of all the available attachments provided with your child restraint in any vehicle.

NOTE: When using the LATCH attaching system to install a child restraint, please ensure that all seat belts not being used for occupant restraints are stowed and out of reach of children. It is recommended that before installing the child restraint, buckle the seat belt so the seat belt is tucked behind the child restraint and out of reach. If the buckled seat belt interferes with the child restraint installation, instead of tucking the seat belt behind the child restraint, route the seat belt through the child restraint belt path and then buckle it. This should stow the seat belt out of the reach of an inquisitive child. Remind all children in the vehicle that the seat belts are not toys and should not be played with, and never leave your child unattended in the vehicle.

The rear seating positions have lower anchorages that are capable of accommodating LATCH-compatible child seats having flexible, webbing-mounted lower attachments. Child seats with fixed lower attachments must be installed in the outboard positions only. Regardless of the specific type of lower attachment, **NEVER** install LATCH-compatible child seats such that two seats share a common lower anchorage.

If you are installing LATCH-compatible child restraints in adjacent rear seating positions, you can use the LATCH anchors or the vehicle's seat belt for the outboard position, but you must use the vehicle's seat belt at the center position. If your child restraints are not LATCH-compatible, you can only install the child restraints using the vehicle's seat belts. Please refer to the next section for typical installation instructions.

Installing the LATCH-Compatible Child Restraint System

We urge that you carefully follow the directions of the manufacturer when installing your child restraint. Not all child restraint systems will be installed as described here. Again, carefully follow the installation instructions that were provided with the child restraint system.



The rear seat lower anchorages are round bars, located at the rear of the seat cushion where it meets the seat back, and are visible when you lean into the rear seat to install the child restraint. You will easily feel them if you run your finger along the intersection of the seatback and seat cushion surfaces.

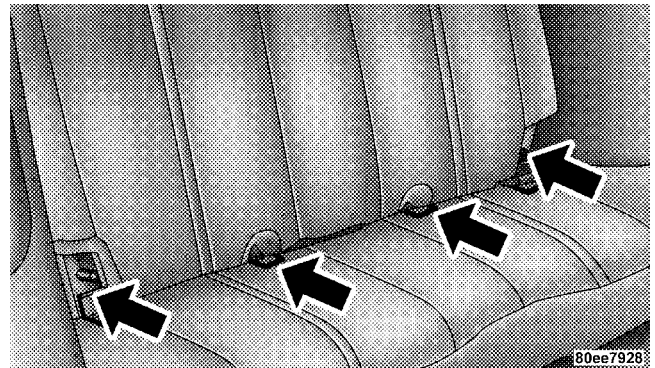

Latch Anchorages (2 Door Models)

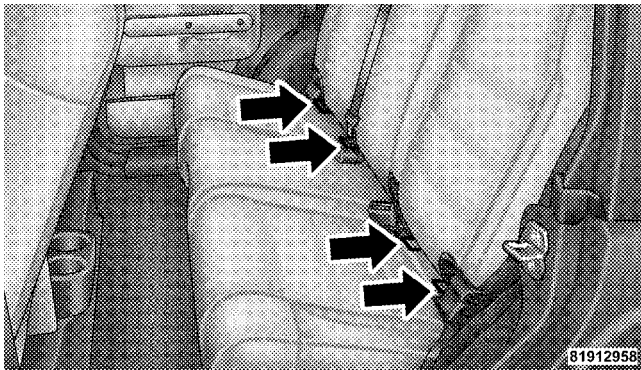

Latch Anchorages (4 Door Models)

In addition, there are tether strap anchorages behind each rear seating position located on the back of the seat.

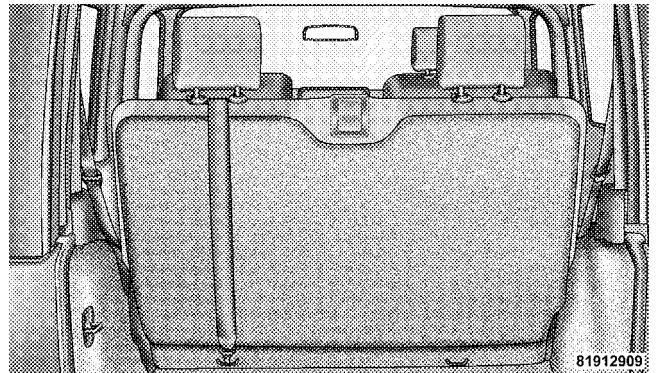

Tether Strap Mounting (2 Door Models)

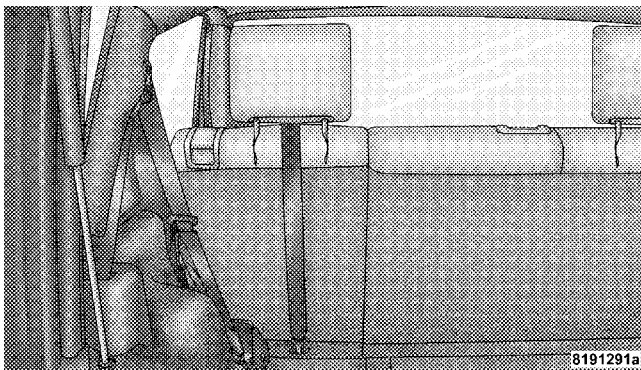

Tether Strap Mounting (4 Door Models)

Many, but not all restraint systems will be equipped with separate straps on each side, with each having a hook or connector for attachment to the lower anchorage and a means of adjusting the tension in the strap. Forward-facing toddler restraints and some rear-facing infant restraints will also be equipped with a tether strap, a

hook for attachment to the tether strap anchorage and a means of adjusting the tension of the strap.

You will first loosen the adjusters on the lower straps and on the tether strap so that you can more easily attach the hooks or connectors to the vehicle anchorages. Next attach the lower hooks or connectors over the top of the anchorage bars, pushing aside the seat cover material. Then, locate the tether anchorage directly behind the seat where you are placing the child restraint and attach the tether strap to the anchorage, being careful to route the tether strap to provide the most direct path between the anchor and the child restraint. Finally, tighten all three straps as you push the child restraint rearward and downward into the seat, removing slack in the straps according to the child restraint manufacturer's instructions.

WARNING!

Improper installation of a child restraint to the LATCH anchorages can lead to failure of an infant or child restraint. The child could be badly injured or killed. Follow the manufacturer's directions exactly when installing an infant or child restraint.

Installing Child Restraints Using the Vehicle Seat Belt

The passenger seat belts are equipped with automatic locking retractors, which are designed to keep the lap portion tight around the child restraint so that it is not necessary to use a locking clip. If the seat belt has a cinching latch plate, pulling up on the shoulder portion of the lap/shoulder belt will tighten the belt. Any seat belt system will loosen with time, so check the belt occasionally and pull it tight if necessary.

If the seat belt has a automatic locking retractor, it will have a distinctive label. Pull the belt from the retractor until there is enough to allow you to pass through the child restraint and slide the latch plate into the buckle. Then, pull the belt until it is all extracted from the retractor. Allow the belt to return to the retractor, pulling on the excess webbing to tighten the lap portion about the child restraint. Refer to "Automatic Locking Mode" earlier in this section.

In the rear seat, you may have trouble tightening the lap/shoulder belt on the child restraint because the buckle or latch plate is too close to the belt path opening on the restraint. Disconnect the latch plate from the buckle and twist the short buckle-end belt several times to shorten it. Insert the latch plate into the buckle with the release button facing out.

If the belt still can't be tightened, or if by pulling and pushing on the restraint loosens the belt, you may need

74 THINGS TO KNOW BEFORE STARTING YOUR VEHICLE

to do something more. Disconnect the latch plate from the buckle, turn the buckle around, and insert the latch plate into the buckle again. If you still can't make the child restraint secure, try a different seating position.

To attach a child restraint tether strap:

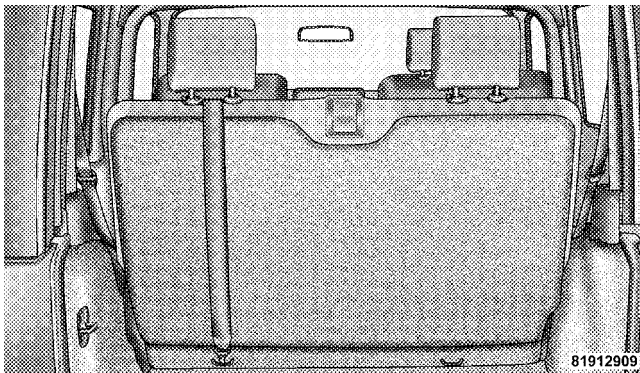

Tether Strap Mounting (2 Door Models)

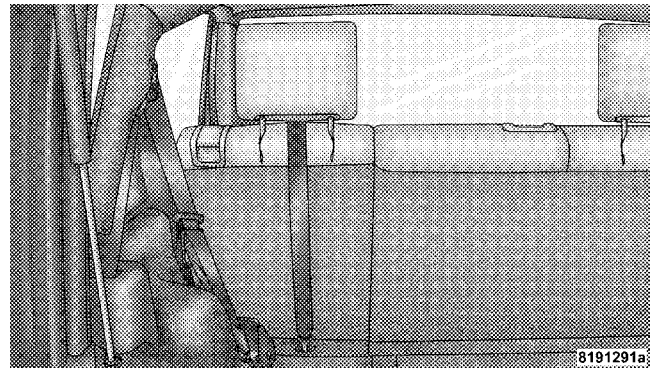

Tether Strap Mounting (4 Door Models)

Route the tether strap over the seat back and attach the hook to the tether anchor located on the back of the seat. For the outboard seating positions, route the tether under the head rest, and attach the hook to the tether anchor located on the back of the seat.

WARNING!

An incorrectly anchored tether strap could lead to increased head motion and possible injury to the child. Use only the anchor positions directly behind the child seat to secure a child restraint top tether strap.

Transporting Pets

Airbags deploying in the front seat could harm your pet. An unrestrained pet will be thrown about and possibly injured, or injure a passenger during panic braking or in a collision.

Pets should be restrained in the rear seat in pet harnesses or pet carriers that are secured by seat belts.

ENGINE BREAK-IN RECOMMENDATIONS

A long break-in period is not required for the engine in your new vehicle.

Drive moderately during the first 300 miles (500 km). After the initial 60 miles (100 km), speeds up to 50 or 55 mph (80 or 90 km/h) are desirable.

While cruising, brief full-throttle acceleration, within the limits of local traffic laws, contributes to a good break-in. Wide open throttle acceleration in low gear can be detrimental and should be avoided.

The engine oil installed in the engine at the factory is a high quality energy conserving type lubricant. Oil changes should be consistent with anticipated climate conditions under which vehicle operations will occur. The recommended viscosity and quality grades are shown in Section 7 of this manual. NON-DETERGENT OR STRAIGHT MINERAL OILS MUST NEVER BE USED.

A new engine may consume some oil during its first few thousand miles (kilometers) of operation. This should be considered as a normal part of the break-in and not interpreted as an indication of difficulty.

SAFETY TIPS

Exhaust Gas

WARNING!

Exhaust gases can injure or kill. They contain carbon monoxide (CO) which is colorless and odorless. Breathing it can make you unconscious and can eventually poison you. To avoid breathing (CO) follow the safety tips below.

- Do not inhale exhaust gases. They contain carbon monoxide, a colorless and odorless gas which can kill. Never run the engine in a closed area, such as a garage, and never sit in a parked vehicle with the engine running for an extended period. If the vehicle is stopped in an open area with engine running for more than a short period, adjust the ventilation system to force fresh, outside air into the vehicle.
- Guard against carbon monoxide with proper maintenance. Have the exhaust system inspected every time the vehicle is raised. Have any abnormal conditions repaired promptly. Until repaired, drive with all side windows fully open.
- Always run the climate control in panel or floor mode when driving with any windows open, even if only slightly, to help keep fresh air circulating inside vehicle. Otherwise poisonous gases could be drawn into the vehicle.
- On hardtop models, keep the tailgate window closed when driving your vehicle. On fabric top models, do not drive with the rear window curtain up unless the

side curtains are also open. This will prevent carbon monoxide and other poisonous exhaust gases from entering the vehicle.

Safety Checks You Should Make Inside The Vehicle

Seat Belts

Inspect the belt system periodically, checking for cuts, frays and loose parts. Damaged parts must be replaced immediately. Do not disassemble or modify the system.

Seat belt assemblies must be replaced after an accident if they have been damaged (bent retractor, torn webbing, etc.). If there is any question regarding belt or retractor condition, replace the belt.

Airbag Warning Light

The light should come on and remain on for 6 to 8 seconds as a indicator check when the ignition switch is first turned on. If the indicator is not lit during starting,

have it serviced. If the light stays on or comes on while driving, have the system checked by an authorized dealer.

Defrosters

Check operation by selecting the defrost mode and place the blower control on high speed. You should feel the air directed against the windshield.

Safety Checks You Should Make Outside The Vehicle

Tires

Examine tires for excessive tread wear or uneven wear patterns. Check for stones, nails, glass, or other objects lodged in the tread. Inspect for tread cuts or sidewall cracks. Check wheel nuts for tightness and tires (including spare) for proper pressure.

Lights

Have someone observe the operation of all exterior lights while you work the controls. Check turn signal and high beam indicator lights on the instrument panel.

Fluid Leaks

Check area under vehicle after overnight parking for fuel, coolant, oil, or other fluid leaks. Also, if gasoline fumes are detected, the cause should be located and corrected immediately.

UNDERSTANDING THE FEATURES OF YOUR VEHICLE

CONTENTS

■ Mirrors83	□ Head Restraints87
□ Inside Day/Night Mirror83	□ Fold And Tumble Rear Seat (2 Door Models)88
□ Outside Mirrors84	□ Removing The Rear Seat (2 Door Models)89
■ Seats85	□ Replacing The Rear Seat (2 Door Models)91
□ Front Seat Adjustment85	□ 60/40 Split Folding Rear Seat (4 Door Models)91
□ Manual Seat Height Adjustment — If Equipped86	□ To Raise The Rear Seat93
□ Front Seat Back Recline86	■ To Open And Close The Hood93
□ Front Passenger Easy Entry Seat (2 Door Models)87	■ Lights94

80 UNDERSTANDING THE FEATURES OF YOUR VEHICLE

□ Interior Lights94	□ Windshield Washers100
□ Multi-Function Control Lever96	□ Mist Feature100
□ Parking Lights, Instrument Panel Lights, And Headlights97	■ Tilt Steering Column101
□ Lights-On Reminder97	■ Electronic Speed Control — If Equipped102
□ Headlight Dimmer Switch97	□ To Activate102
□ Passing Light98	□ To Set At A Desired Speed103
□ Front Fog Lights — If Equipped98	□ To Deactivate103
□ Turn Signals98	□ To Resume Speed103
□ Daytime Running Lights — If Equipped99	□ To Vary The Speed Setting103
■ Windshield Wipers And Washers99	□ Manual Transmission104
□ Intermittent Wiper System99	□ To Accelerate For Passing104
□ Windshield Wiper Operation100	■ Electronic Brake Control System105
		□ ABS (Anti-Lock Brake System)105

<hr/>		UNDERSTANDING THE FEATURES OF YOUR VEHICLE 81	
□ TCS (Traction Control System)	106	□ Installing The Soft Top	120
□ BAS (Brake Assist System)	106	■ Freedom Top 3- Piece Modular Hard Top	123
□ ERM (Electronic Roll Mitigation)	107	□ Front Panel(s) Removal	124
□ ESP (Electronic Stability Program)	108	□ Front Panel(s) Installation	126
□ ESP/BAS Warning Lamp	113	□ Rear Panel Removal	126
■ Electrical Power Outlet	114	□ Rear Panel Installation	129
□ Electrical Outlet Use With Engine Off	115	■ Soft Top (2 Door Models)	130
■ Cup Holders	115	□ Folding Down The Soft Top	131
■ Storage	116	□ Putting Up The Soft Top	138
□ Console Storage Compartment	116	■ Soft Top (4 Door Models)	145
□ Rear Storage Compartment	117	□ Folding Down The Soft Top	146
■ Dual Top — If Equipped	118	□ Putting Up The Soft Top	155
□ Removing The Soft Top	118	■ Sunrider — 4 Door Models	163

82 UNDERSTANDING THE FEATURES OF YOUR VEHICLE

- Door Frame167
 - Door Frame Removal (2 Door Models)167
 - Door Frame Installation (2 Door Models)169
 - Door Frame Removal (4 Door Models)170
 - Door Frame Installation (4 Door Models)173
- Folding Windshield176
 - Lowering The Windshield And Removing Side Bars177
 - Raising The Windshield And Replacing Side Bars180
- Rear Window Features — Hard Top Only182
 - Rear Window Wiper/Washer — If Equipped ..182
 - Rear Window Defroster — If Equipped184

MIRRORS

Inside Day/Night Mirror

The mirror should be adjusted to center on the view through the rear window. A two-point pivot system allows for horizontal and vertical adjustment of the mirror.

Annoying headlight glare can be reduced by moving the small control under the mirror to the night position (toward rear of vehicle). The mirror should be adjusted while set in the day position (toward windshield).

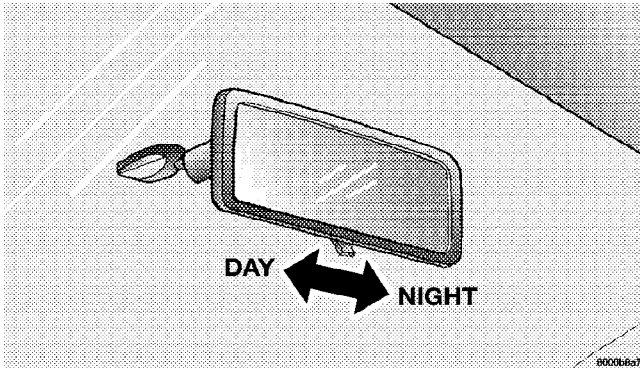

Adjusting Rearview Mirror

Outside Mirrors

To receive maximum benefit, adjust the outside mirror(s) to center on the adjacent lane of traffic with a slight overlap of the view obtained on the inside mirror.

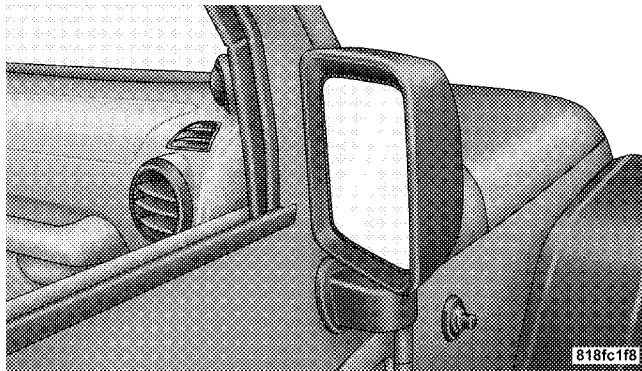

Outside Rear View Mirror

WARNING!

- Vehicles and other objects seen in the right side convex mirror will look smaller and farther away than they really are. Relying too much on your right side mirror could cause you to collide with another vehicle or other object.
- Use your inside mirror when judging the size or distance of a vehicle seen in the right side mirror.

SEATS**WARNING!**

Adjusting a seat while the vehicle is moving is dangerous. The sudden movement of the seat could cause you to lose control. The seat belt might not be properly adjusted and you could be injured. Adjust any seat only while the vehicle is parked.

Front Seat Adjustment

Move seat forward or rearward by lifting the lever. Be sure the latch engages fully.

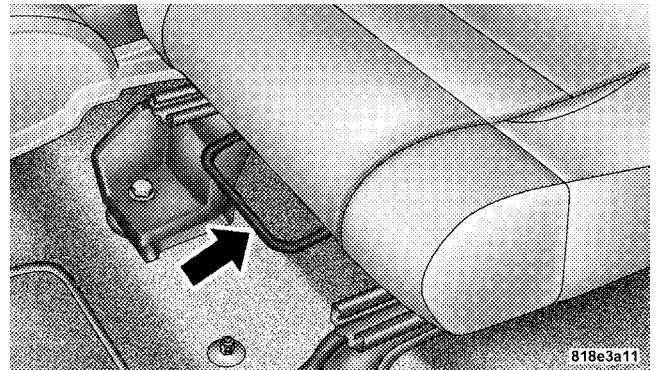
**Manual Seat Adjustment**

Manual Seat Height Adjustment — If Equipped

The driver's seat height can be raised or lowered, by using the ratcheting handle on the outboard side of the seat. Pull upward on the handle to raise the seat, push downward on the handle to lower the seat.

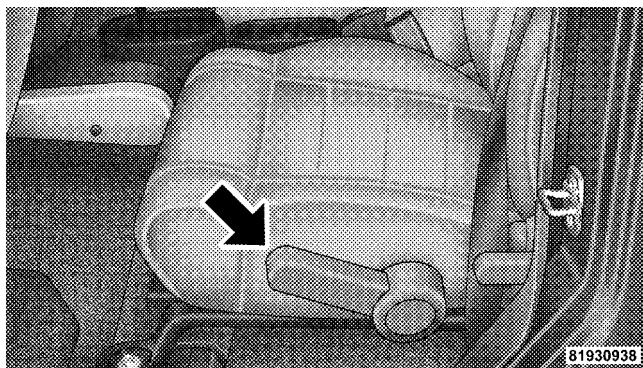

Seat Height Adjustment

Front Seat Back Recline

To recline:

1. Lean forward before lifting the handle, then lean back to the desired position and release the handle.

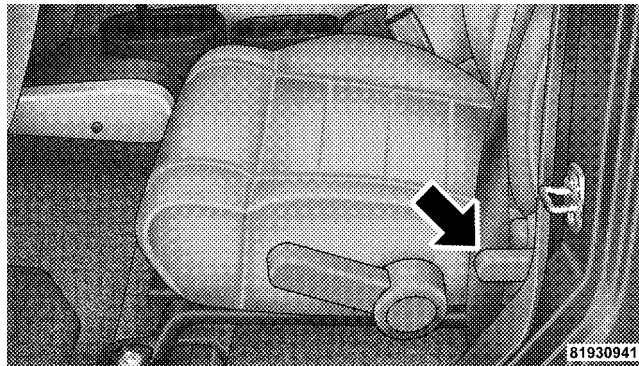

Recline Lever

2. Lift the handle to return the seatback to an upright position.

Front Passenger Easy Entry Seat (2 Door Models)

Push the lever on the seatback rearward (toward the rear of the vehicle) to tilt the entire seat forward.

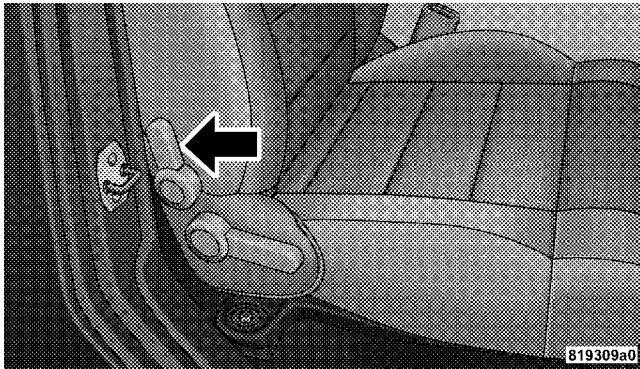

Easy Entry Lever

Head Restraints

Head restraints can reduce the risk of whiplash injury in the event of impact from the rear. Adjustable head restraints should be adjusted so that the upper edge is as high as practical. The front head restraints have a locking button that must be pushed inward to lower the head restraint. The restraints may be raised without pushing in the button. The rear head restraints are not adjustable.

3

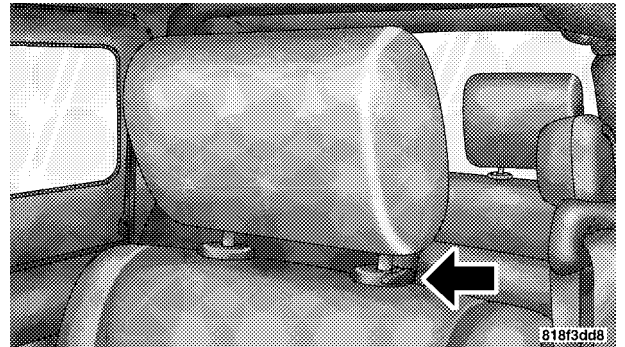

Adjustable Head Restraints

Fold And Tumble Rear Seat (2 Door Models)

NOTE: Prior to folding the rear seat, it may be necessary to reposition the front seats.

Also, be sure that the front seats are fully upright and positioned forward. This will allow the rear seat to fold down easily.

1. Lift the seatback release lever and fold seatback forward.

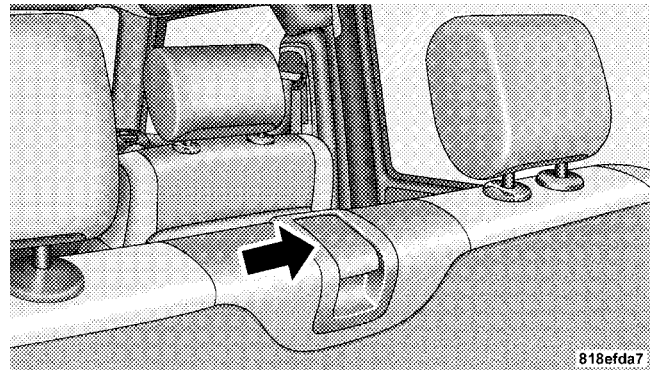

Rear Seat Release

2. Slowly flip the entire seat forward.

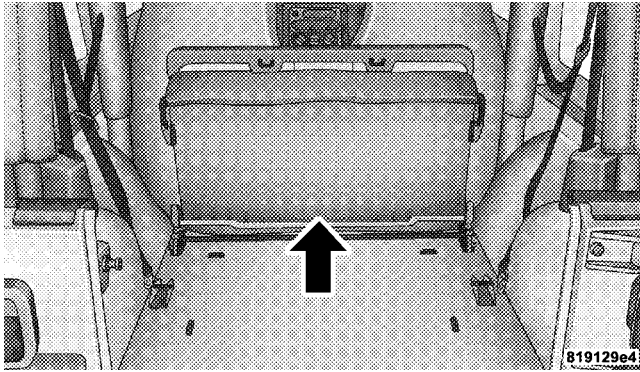

Folding Rear Seat

3. When completed, return seat to it's normal position.
4. Raise the rear seatback using the assist strap and firmly lock seat into position.

Removing the Rear Seat (2 Door Models)

WARNING!

- It is extremely dangerous to ride in a cargo area, inside or outside of a vehicle. In a collision people riding in these areas are more likely to be seriously injured or killed.
- Do not allow people to ride in any area of your vehicle that is not equipped with seats and seat belts.
- Be sure everyone in your vehicle is in a seat and using a seat belt properly.
- In a collision, you or others in your vehicle could be injured if seats are not properly latched to their floor attachments. Always be sure that the seats are fully latched.

90 UNDERSTANDING THE FEATURES OF YOUR VEHICLE

1. Remove the rear subwoofer (if equipped) mounting screws (3) using a #T30 Torx® head driver.

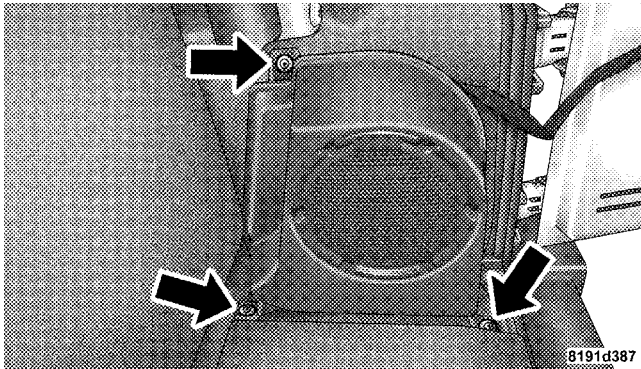

Subwoofer

2. Unplug electrical connector from rear subwoofer (if equipped).

3. Fold the rear seat forward following steps 1 through 3 under "Fold and Tumble Rear Seat" in this section.

4. Press down on release bar on each side, and pull seat out and away from lower bracket.

5. Remove seat from the vehicle.

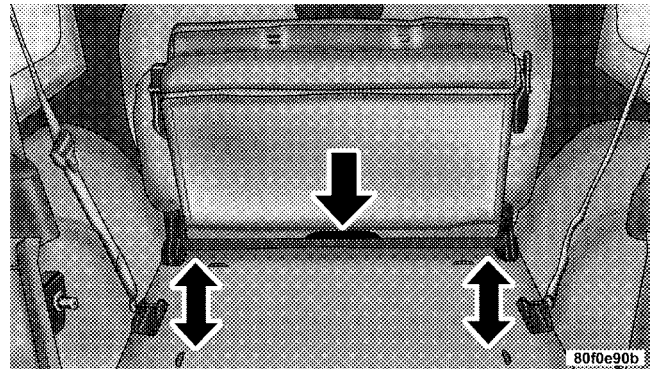

Release Bar Location

Replacing the Rear Seat (2 Door Models)

Reverse steps for removing the seat.

WARNING!
<ul style="list-style-type: none"> • To help protect against personal injury, passengers should not be seated in the rear cargo area with the rear seat folded down or removed from the vehicle. • The rear cargo space is intended for load carrying purposes only, not for passengers, who should sit in seats and use seat belts.

60/40 Split Folding Rear Seat (4 Door Models)

To provide additional storage area, each rear seat can be folded flat to allow for extended cargo space and still maintain some rear seating room.

NOTE: Prior to folding the rear seat, it may be necessary to reposition the front seat to its mid-track position.

Also, be sure that the front seats are fully upright and positioned forward. This will allow the rear seat to fold down easily.

WARNING!
<ul style="list-style-type: none"> • It is extremely dangerous to ride in a cargo area, inside or outside of a vehicle. In a collision, people riding in these areas are more likely to be seriously injured or killed. • Do not allow people to ride in any area of your vehicle that is not equipped with seats and seat belts. • Be sure everyone in your vehicle is in a seat and using a seat belt properly.

To Fold Down the Rear Seat

1. Locate the seatback release handle on the outboard top side of each rear seatback; lift up on the handle until the seatback releases. Fold the seatback completely forward.

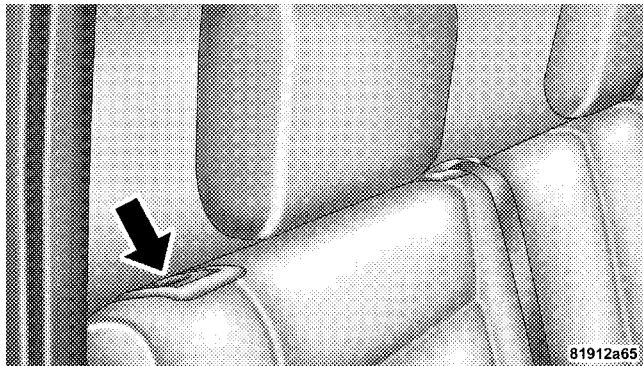

Rear Seat Release

NOTE: When lifting up on the release handle, the seatback will release easier if you do not pull forward on

the seatback; only lift up on the release handle until the seatback disengages, then fold the seat forward.

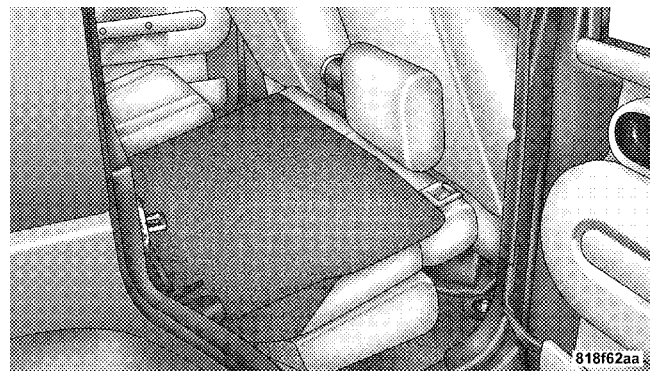

Folding Rear Seat

To Raise the Rear Seat

1. Raise the seatback and lock it into place. If interference from the cargo area prevents the seatback from fully locking, you will have difficulty returning the seat to its proper position.

NOTE: If the rear seatback is not fully latched, the center shoulder belt will not be able to be extended for use. If you cannot extend the center shoulder belt, please make sure your seatback is fully latched.

WARNING!

Be certain that the seatback is securely locked into position. If the seatback is not securely locked into position the seat will not provide the proper stability for child seats and/or passengers. An improperly latched seat could cause serious injury.

TO OPEN AND CLOSE THE HOOD

To open hood, first release both hood latches.

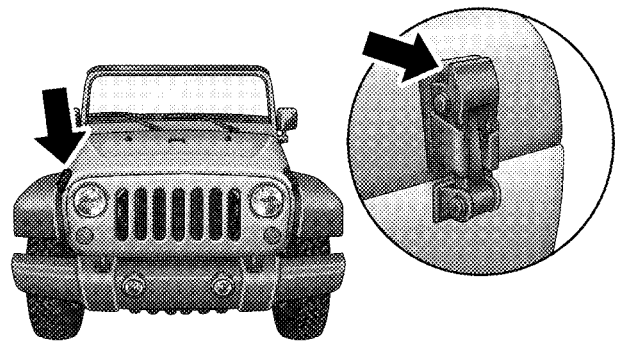

3

818f406e

Hood Latch

Next, locate handle in middle of the front end of the hood. Insert hand into gap between hood and top of grille, and push handle to the side to raise hood. You may

have to push down slightly on hood before pushing the handle. Insert the support rod into the slot on the hood panel.

To close the hood, remove the support rod from the hood panel and place it in the retaining clip. Lower the hood slowly. Secure both of the hood latches.

WARNING!

If the hood is not fully latched, it could fly up when the vehicle is moving and block your forward vision. Be sure all hood latches are latched fully before driving.

LIGHTS

Interior Lights

The overhead light comes on when a door is opened. It may also be turned on by rotating the control for the dimmer switch on the multi-function control lever fully upward.

The overhead light will automatically turn off in about 20 minutes if a door is left open or the dimmer control is left in the dome light position. Turn the ignition switch ON to restore the overhead light operation.

Cargo Lamp

Courtesy and dome lights are turned on when the front doors are opened, when the dimmer control (rotating wheel on the right side of the switch) is rotated to the upward detent position, or if equipped, when the "Unlock" button is pressed on the key fob.

Also, the rear cargo lamp may be operated by pressing the lens to turn it on. Press the lens again, to shut it off.

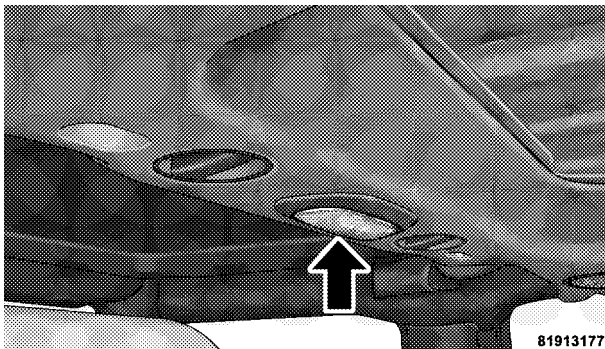

Cargo Lamp

81913177

When a door is open and the interior lights are on, rotating the dimmer control all the way down to the OFF detent will cause all the interior lights to go out. This is also known as the "Party" mode because it allows the doors to stay open for extended periods of time without discharging the vehicle's battery.

3

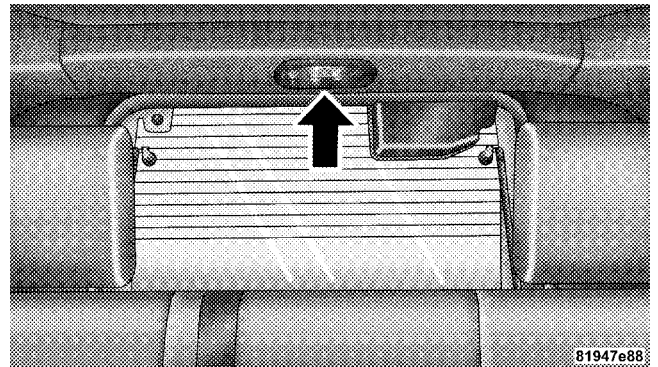

Rear Cargo Lamp (4 Door Only)

81947e88

Daytime Brightness Feature

Certain instrument panel components (odometer, radio display) can be illuminated at full brightness during the daytime. This can be helpful when driving with your headlights on during the daytime such as in a parade or a funeral procession. To activate this feature, rotate the left stalk one detent lower than the dome light.

Multi-Function Control Lever

The multi-function control lever controls the operation of the parking lights, headlights, headlight beam selection, passing light, fog lights, instrument panel light dimming, and turn signals.

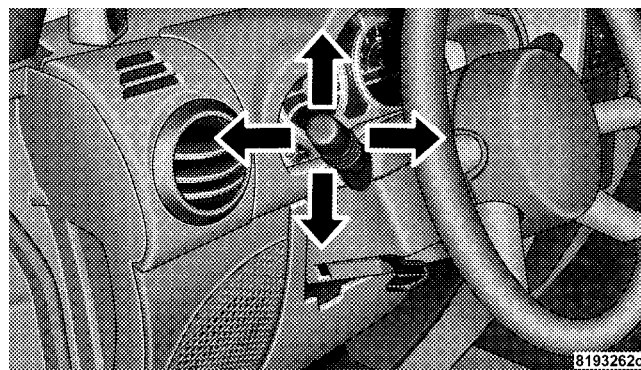

Multi-Function Control Lever

Parking Lights, Instrument Panel Lights, and Headlights

Turn the end of the multi-function control lever to the first detent for parking lights and instrument panel lights. Turn to the second detent for headlight operation.

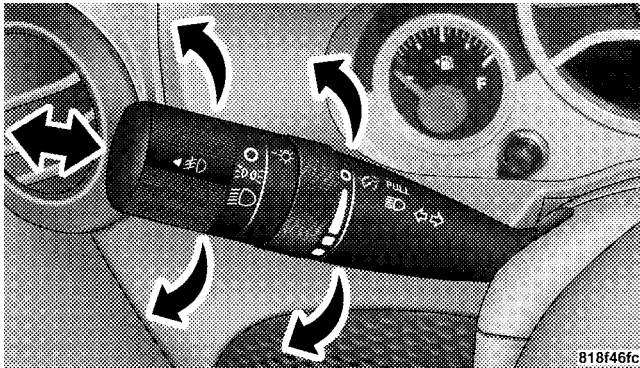

Headlight Switch

To change the brightness of the instrument panel lights, rotate the center portion of the multi-function control lever up or down.

NOTE: If the driver's door is left open, and the headlights or parking lights are left on, the "High Beam Indicator Light" will flash and a chime will sound.

Lights-On Reminder

If the headlights or parking lights are on after the ignition is turned off, a chime will sound when the driver's door is opened.

Headlight Dimmer Switch

Push the multi-function control lever away from you to switch the headlights to high beam. Pull the lever towards you to switch the headlights back to low beam.

Passing Light

You can signal another vehicle with your headlights by lightly pulling the multi-function control lever toward the steering wheel. This will cause the headlights to turn on at high beam and remain on until the lever is released.

Front Fog Lights — If Equipped

 The front fog light switch is in the multi-function control lever. To activate the front fog lights, turn on the parking or low beam headlights and pull out the end of the lever.

NOTE: The fog lights will only operate with the parking lights or the headlights on low beam. Selecting high beam headlights will turn off the fog lights.

Turn Signals

Move the multi-function control lever up or down and the arrows on each side of the instrument cluster flash to show proper operation of the front and rear turn signal lights. You can signal a lane change by moving the lever partially up or down without moving beyond the detent.

If either light remains on and does not flash, or there is a very fast flash rate, check for a defective outside light bulb. If an indicator fails to light when the lever is moved, it would suggest that the indicator bulb is defective.

NOTE: A tone will chime if the turn signals are left on for more than 1 mile (2 km).

Daytime Running Lights — If Equipped

The headlights come on at a low intensity level after the vehicle has been driven approximately 3 feet (1 meter). They will turn off when the vehicle is turned off or when the headlights are switched on.

WINDSHIELD WIPERS AND WASHERS**CAUTION!**

In cold weather, always turn off the wiper switch and allow the wipers to return to the park position before turning off the engine. If the wiper switch is left on and the wipers freeze to the windshield, damage to the wiper motor may occur when the vehicle is restarted.

Intermittent Wiper System

Use the intermittent wiper when weather conditions make a single wiping cycle, with a variable pause between cycles, desirable. Move the lever to the DELAY position, then select the delay interval by turning the end of the lever. The delay can be regulated from a maximum of approximately 18 seconds between cycles, to a cycle every second.

Windshield Wiper Operation

Move the lever upward to the second detent for LO speed wiper operation, or to the third detent for HI speed operation

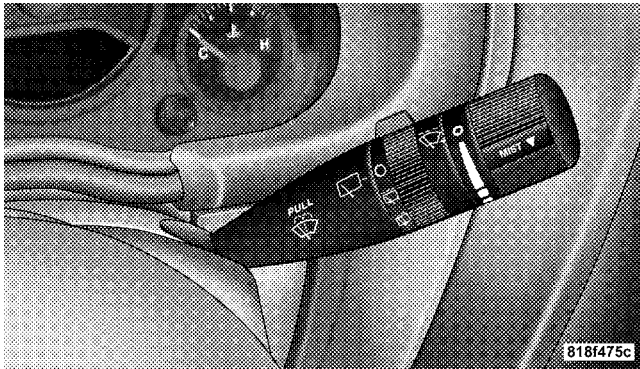

Windshield Wiper/Washer Switch

Windshield Washers

To use the washer, pull the lever toward you and hold while spray is desired. If the lever is pulled while in the delay range, the wiper will operate for two wipe cycles after the lever is released, and then resume the intermittent interval previously selected.

If the lever is pulled while in the OFF position, the wipers will operate for as long as the lever is held plus two wipe cycles, then turn OFF.

Mist Feature

Push down on the wiper lever to activate a single wipe to clear off road mist or spray from a passing vehicle. As long as the lever is held down, the wipers will continue to operate.

TILT STEERING COLUMN

To tilt the column, push down on the lever under the multi-function control lever and move the wheel up or down, as desired. Pull the lever back upwards to lock the column firmly in place.

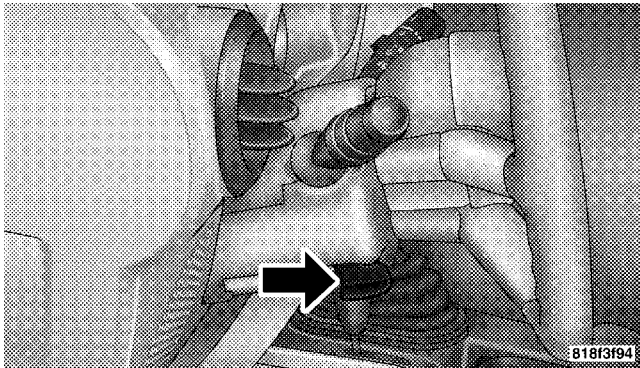

Tilt Steering Column

WARNING!

Tilting the steering column while the vehicle is moving is dangerous. Without a stable steering column, you could lose control of the vehicle and have an accident. Adjust the column only while the vehicle is stopped. Be sure it is locked before driving.

ELECTRONIC SPEED CONTROL — IF EQUIPPED

When engaged, this device takes over the accelerator operation at speeds greater than 35 mph (56 km/h). The speed control lever is located on the right side of the steering wheel.

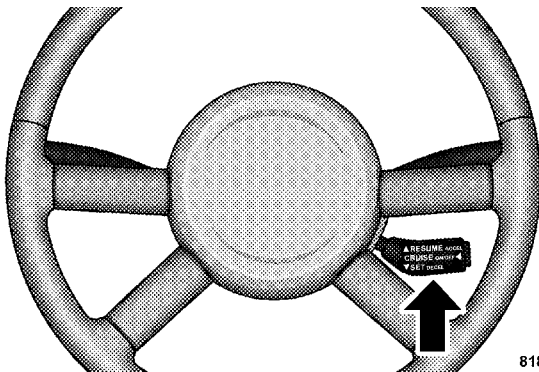

818f547e

Speed Control Switches

To Activate

Push the ON/OFF button. The CRUISE indicator in the instrument cluster will illuminate. To turn the system OFF, push the ON/OFF button a second time. The CRUISE indicator will turn off. The system should be turned OFF when not in use.

WARNING!

Leaving the Electronic Speed Control system on when not in use is dangerous. You could accidentally set the system or cause it to go faster than you want. You could lose control and have an accident. Always leave the system OFF when you are not using it.

To Set At A Desired Speed

When the vehicle has reached the desired speed, press down on the lever and release. Release the accelerator and the vehicle will operate at the selected speed.

NOTE: The vehicle should be traveling at a steady speed and on level ground before pressing the SET lever.

To Deactivate

A soft tap on the brake pedal, pulling the speed control lever towards you "CANCEL", or normal brake or clutch pressure while slowing the vehicle will deactivate speed control without erasing the set speed memory. Pressing the ON/OFF button or turning off the ignition switch erases the set speed memory.

To Resume Speed

To resume a previously set speed, push the "RESUME ACCEL" lever up and release. Resume can be used at any speed above 20 mph (32 km/h).

To Vary The Speed Setting

When the speed control is ON, speed can be increased by pushing up and holding "RESUME ACCEL". Release the lever when the desired speed is reached, and the new speed will be set.

Tapping "RESUME ACCEL" once will result in a 2 mph (3 km/h) speed increase. Each time the lever is tapped, speed increases so that tapping the lever three times will increase speed by 6 mph (10 km/h), etc.

To decrease speed while speed control is ON, push down and hold "SET DECEL". Release the lever when the desired speed is reached, and the new speed will be set.

Tapping the "SET DECEL" button once will result in a 1 mph (2 km/h) speed decrease. Each time the button is tapped, speed decreases.

Manual Transmission

Depressing the clutch pedal will disengage the speed control. A slight increase in engine RPM before the speed control disengages is normal.

Vehicles equipped with manual transmissions may need to be shifted into a lower gear to climb hills without speed loss.

WARNING!

Speed Control can be dangerous where the system can't maintain a constant speed. Your vehicle could go too fast for the conditions, and you could lose control. An accident could be the result. Don't use Speed Control in heavy traffic or on roads that are winding, icy, snow-covered, or slippery.

To Accelerate For Passing

Depress the accelerator as you would normally. When the pedal is released, the vehicle will return to the set speed.

Using Speed Control On Hills

NOTE: The speed control system maintains speed up and down hills. A slight speed change on moderate hills is normal.

On steep hills, a greater speed loss or gain and/or more frequent downshifts (auto transmission only) may occur so it may be preferable to drive without speed control.

ELECTRONIC BRAKE CONTROL SYSTEM

Your vehicle is equipped with an advanced electronic brake control system that includes ABS (Anti-Lock Brake System), TCS (Traction Control System), BAS (Brake Assist System), ERM (Electronic Roll Mitigation), and ESP (Electronic Stability Program). All five systems work together to enhance vehicle stability and control in various driving conditions, and are commonly referred to as ESP.

ABS (Anti-Lock Brake System)

This system aids the driver in maintaining vehicle control under adverse braking conditions. The system controls hydraulic brake pressure to prevent wheel lock-up and

help avoid skidding on slippery surfaces during braking. Refer to “Anti-Lock Brake System” in Section 5 of this manual for more information about ABS.

WARNING!

ABS (Anti-Lock Brake System) cannot prevent the natural laws of physics from acting on the vehicle, nor can it increase the traction afforded by prevailing road conditions. ABS cannot prevent accidents, including those resulting from excessive speed in turns, driving on very slippery surfaces, or hydroplaning. Only a safe, attentive, and skillful driver can prevent accidents. The capabilities of an ABS-equipped vehicle must never be exploited in a reckless or dangerous manner which could jeopardize the user’s safety or the safety of others.

TCS (Traction Control System)

This system monitors the amount of wheel spin of each of the driven wheels. If wheel spin is detected, brake pressure is applied to the slipping wheel(s) to provide enhanced acceleration and stability. A feature of the TCS system functions similar to a limited slip differential and controls the wheel spin across a driven axle. If one wheel on a driven axle is spinning faster than the other, the system will apply the brake of the spinning wheel. This will allow more engine torque to be applied to the wheel that is not spinning. This feature remains active even if TCS and ESP are in either the "Partial Off" or "Full Off" modes. Refer to "ESP (Electronic Stability Program)" in this section.

BAS (Brake Assist System)

The BAS is designed to optimize the vehicle's braking capability during emergency braking maneuvers. The system detects an emergency braking situation by sensing the rate and amount of brake application and then applies optimum pressure to the brakes. This can help reduce braking distances. The BAS complements the anti-lock brake system (ABS). Applying the brakes very quickly results in the best BAS assistance. To receive the benefit of the system, you must apply continuous braking pressure during the stopping sequence. Do not reduce brake pedal pressure unless braking is no longer desired. Once the brake pedal is released, the BAS is deactivated.

WARNING!

BAS (Brake Assist System) cannot prevent the natural laws of physics from acting on the vehicle, nor can it increase the traction afforded by prevailing road conditions. BAS cannot prevent accidents, including those resulting from excessive speed in turns, driving on very slippery surfaces, or hydroplaning. Only a safe, attentive, and skillful driver can prevent accidents. The capabilities of a BAS-equipped vehicle must never be exploited in a reckless or dangerous manner which could jeopardize the user's safety or the safety of others.

ERM (Electronic Roll Mitigation)

This system anticipates the potential for wheel lift by monitoring the driver's steering wheel input and the speed of the vehicle. When ERM determines that the rate of change of the steering wheel angle and vehicles speed are sufficient to potentially cause wheel lift, it applies the appropriate brake and may reduce engine power to lessen the chance that wheel lift will occur. ERM will only intervene during very severe or evasive driving maneuvers.

ERM can only reduce the chance of wheel lift occurring during severe or evasive driving maneuvers. It cannot prevent wheel lift due to other factors such as road conditions, leaving the roadway or striking objects or other vehicles.

NOTE: Anytime the ESP system is in the “Full Off” mode, ERM is disabled. Refer to ESP (Electronic Stability Program) for a complete explanation of the available ESP modes.

WARNING!

Many factors, such as vehicle loading, road conditions and driving conditions, influence the chance that wheel lift or rollover may occur. ERM cannot prevent all wheel lift or rollovers, especially those that involve leaving the roadway or striking objects or other vehicles. Only a safe, attentive, and skillful driver can prevent accidents. The capabilities of an ERM-equipped vehicle must never be exploited in a reckless or dangerous manner which could jeopardize the user’s safety or the safety of others.

ESP (Electronic Stability Program)

This system enhances directional control and stability of the vehicle under various driving conditions. ESP corrects for over/under steering of the vehicle by applying the brake of the appropriate wheel to assist in counteracting the over/under steer condition. Engine power may also be reduced to help the vehicle maintain the desired path.

ESP uses sensors in the vehicle to determine the vehicle path intended by the driver and compares it to the actual path of the vehicle. When the actual path does not match the intended path, ESP applies the brake of the appropriate wheel to assist in counteracting the oversteer or understeer condition.

- Oversteer - when the vehicle is turning more than appropriate for the steering wheel position.

- Understeer - when the vehicle is turning less than appropriate for the steering wheel position.

The "ESP/TCS Indicator Light" located in the instrument cluster, starts to flash as soon as the tires lose traction and the ESP system becomes active. The "ESP/TCS Indicator Light" also flashes when TCS is active. If the "ESP/TCS Indicator Light" begins to flash during acceleration, ease up on the accelerator and apply as little throttle as possible. Be sure to adapt your speed and driving to the prevailing road conditions.

WARNING!

ESP (Electronic Stability Program) cannot prevent the natural laws of physics from acting on the vehicle, nor can it increase the traction afforded by prevailing road conditions. ESP cannot prevent accidents, including those resulting from excessive speed in turns, driving on very slippery surfaces, or hydroplaning. Only a safe, attentive, and skillful driver can prevent accidents. The capabilities of an ESP-equipped vehicle must never be exploited in a reckless or dangerous manner which could jeopardize the user's safety or the safety of others.

The ESP system has 3 available operating modes in 4WD High Range. The system has 1 operating mode in 4WD Low Range. 2WD vehicles and 4WD vehicles in 2WD mode have 2 operating modes.

High Range (4WD Models) or 2WD Models***On***

This is the normal operating mode for ESP in 4WD high range and in 2WD vehicles. Whenever the vehicle is started or the transfer case (if equipped) is shifted from 4WD low range or neutral back to 4WD high range, the ESP system will be in this mode. This mode should be used for most all driving situations. ESP should only be turned to "Partial Off" or "Full Off" for specific reasons as noted below.

Partial Off

This mode is entered by momentarily depressing the "ESP Control Switch". When in "Partial Off" mode, the TCS portion of ESP has been disabled and the "ESP/TCS Indicator Light" will be illuminated. All other stability features of ESP function normally. This mode is intended to be used if the vehicle is in deep snow, sand, or gravel

conditions and more wheel spin than ESP would normally allow is required to gain traction. To turn ESP on again, momentarily depress the "ESP Control Switch". This will restore the normal "ESP On" mode of operation.

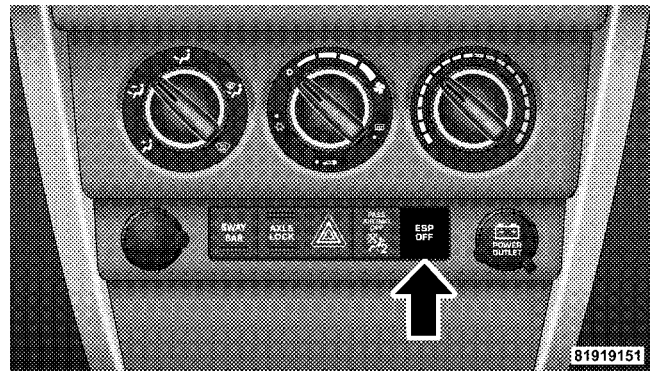
**ESP Control Switch**

NOTE: To improve the vehicle's traction when driving with snow chains, or starting off in deep snow, sand, or

gravel, it may be desirable to switch to the "Partial Off" mode by pressing the ESP switch. Once the situation requiring ESP to be switched to the "Partial Off" mode is overcome, turn ESP back on by momentarily depressing the "ESP Control Switch". This may be done while the vehicle is in motion.

ESP Off (4WD High Range Only)

This mode is intended for off-highway or off-road use when ESP stability features could inhibit vehicle maneuverability due to trail conditions. This mode is entered by depressing and holding the "ESP Control Switch" for 5 seconds when the vehicle is stopped and the engine is running. In this mode, all ESP and TCS stability features are turned off except for the "limited slip" feature described in the TCS section. After 5 seconds, a chime will sound, the "ESP/TCS Indicator Light" will illuminate, and the "ESP OFF" message will appear in the odometer. Refer to "Compass and Mini-Trip Computer — If Equipped" in Section 4 of this manual. To turn ESP on

again, momentarily depress the "ESP Control Switch". This will restore the normal "ESP On" mode of operation.

NOTE: The ESP system will change to "Partial Off" mode if the vehicle speed exceeds 40 mph (64 km/h). After the vehicle speed is reduced below 35 mph (56 km/h), the ESP system will return to "Full Off" mode.

NOTE: The "ESP OFF" message will display and the audible chime will sound when the gear selector is placed into the "P" (Park) position from any position other than "P" (Park), and then moved out of the "P" (Park) position. This will occur even if the message was previously cleared.

WARNING!

With the ESP switched off, the enhanced vehicle stability offered by ESP and ERM are unavailable. In an emergency evasive maneuver, the ESP and ERM systems will not engage to assist in maintaining stability. The "Full Off" ESP mode is intended for off-highway or off-road use only.

4WD Low Range**ESP Off**

This is the normal operating mode for ESP in 4WD low range. Whenever the vehicle is started in 4WD low range, or the transfer case (if equipped) is shifted from 4WD high range or neutral to 4WD low range, the ESP system will be in this mode. In 4WD low range, ESP and TCS, except for the "limited slip" feature described in the TCS section, are turned off until the vehicle reaches a speed of

40 mph (48 km/h). At 40 mph (48 km/h), the normal ESP stability function returns but TCS remains off. When the vehicle speed drops below 35 mph (40 km/h), the ESP system shuts off. ESP is off at low vehicle speeds in 4WD low range so that it will not interfere with off-road driving but ESP function returns to provide the stability feature at speeds above 40 mph (48 km/h). The "ESP/TCS Indicator Light" will always be illuminated in 4WD low range when ESP is off.

NOTE: The "ESP OFF" message will display and the audible chime will sound when the gear selector is placed into the "P" (Park) position from any position other than "P" (Park), and then moved out of the "P" (Park) position. This will occur even if the message was previously cleared.

WARNING!

With the ESP switched off, the enhanced vehicle stability offered by ESP and ERM are unavailable. In an emergency evasive maneuver, the ESP and ERM systems will not engage to assist in maintaining stability. The "Full Off" mode is intended for off-highway or off-road use only.

ESP/BAS Warning Lamp

**ESP
BAS** The malfunction indicator lamp for the ESP is combined with the BAS indicator. The yellow "ESP/BAS Warning Lamp" in the instrument cluster comes on when the ignition switch is turned to the "ON" position. It should go out with the engine running.

If the "ESP/BAS Warning Lamp" comes on continuously with the engine running, a malfunction has been detected

in either the ESP or the BAS system, or both. If this light remains on after several ignition cycles, and the vehicle has been driven several miles at speeds greater than 30 mph (48 km/h), see your authorized dealer as soon as possible to have the problem diagnosed and corrected.

NOTE:

- "The "ESP/BAS Warning Lamp" comes on momentarily each time the ignition switch is turned ON.
- Each time the ignition is turned ON, the ESP System will be ON even if it was turned off previously.
- The ESP Control System will make buzzing or clicking sounds when it is active. This is normal; the sounds will stop when ESP becomes inactive following the maneuver that caused the ESP activation.

ELECTRICAL POWER OUTLET

This vehicle has two auxiliary power outlets that can provide up to 20 Amps of current for accessories designed for use with the standard power outlet adapters. The outlet located in the lower portion of the instrument panel has a snap on plastic cap so that it can be covered when not in use. As a safety precaution, the outlet in the instrument panel only operates with the ignition switch ON. When the optional Cigar Lighter heating element is used, it heats when pushed in and pops out automatically when ready for use. **To preserve the heating element, do not hold the lighter in the heating position.**

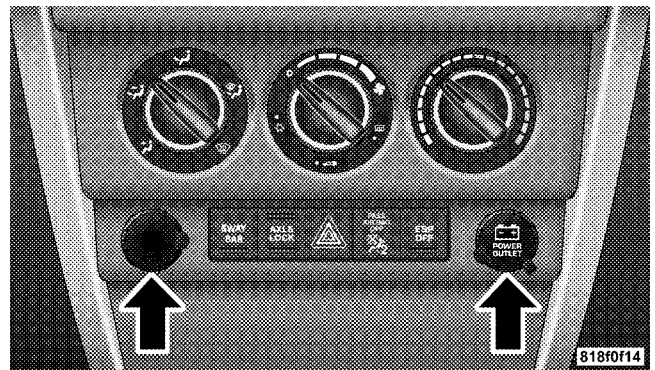

Power Outlets

Electrical Outlet Use With Engine Off**WARNING!**

- Many accessories that can be plugged in draw power from the vehicle's battery, even when not in use (i.e. cellular phones, etc.). Eventually, if plugged in long enough, the vehicle's battery will discharge sufficiently to degrade battery life and/or prevent engine starting.
- Accessories that draw higher power (i.e. coolers, vacuum cleaners, lights, etc.), will degrade the battery even more quickly. Only use these intermittently and with greater caution.
- After the use of high power draw accessories, or long periods of the vehicle not being started (with accessories still plugged in), the vehicle must be driven a sufficient length of time to allow the alternator to recharge the vehicle's battery.
- Power outlets are designed for accessory plugs only. Do not hang any type of accessory or accessory bracket from the plug.

CUP HOLDERS

In the center console there are two cup holders for the front seat passengers.

NOTE: The cup holder insert is removable from the console, for cleaning.

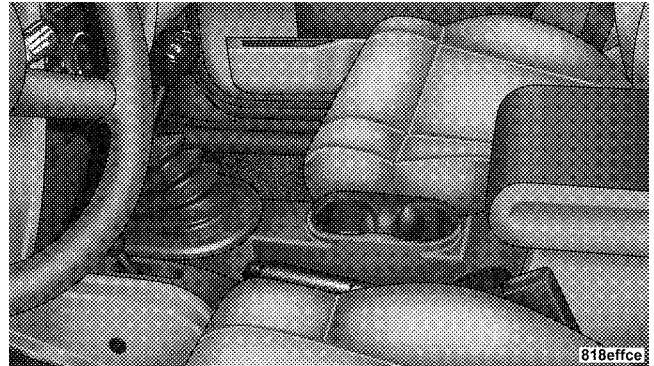

Front Cup Holders

The rear passengers have cup holders at the rear of the center console.

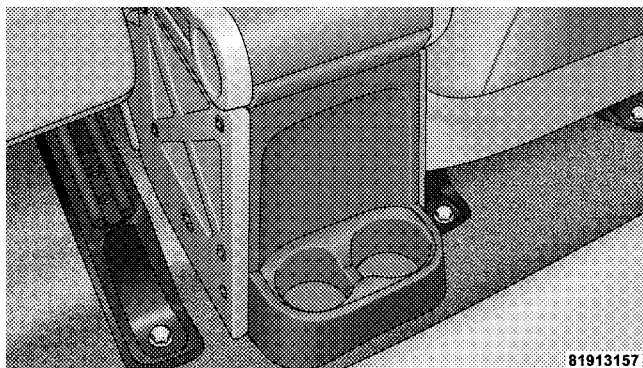

Rear Cup Holders

STORAGE

Console Storage Compartment

To lock or unlock, insert ignition key and turn. To open, press the latch and lift cover.

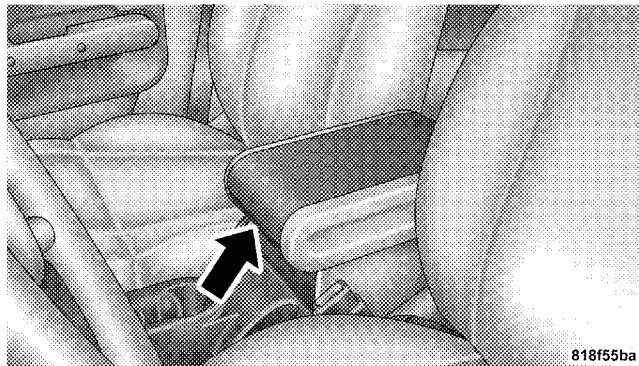

Center Console

Rear Storage Compartment

The rear storage compartment cover is held by a spring loaded latch. In order to remove the rear storage compartment cover, use the following procedure:

NOTE: The rear storage compartment latch should not be used as cargo tie-down.

1. Flip up pull loop so it is perpendicular (straight up) to the top surface of the tray.
2. Pull up on loop and twist 90 degrees, so it is parallel to the slotted hole in tray.

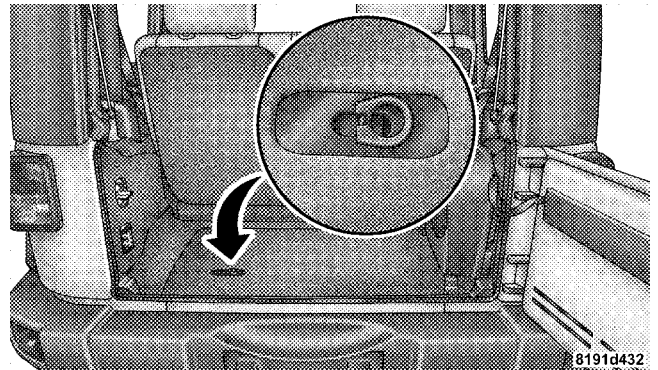

Rear Storage Cover

3. Open rear compartment cover.

DUAL TOP — IF EQUIPPED

If your vehicle is equipped with a Dual Top, **you must remove one of the tops from the vehicle. If the soft top is removed, the pivot brackets must also be removed from the sport bar.** The soft top was installed at the factory for shipping purposes only. **The soft top and the hard top are to be used independently.** Removal is mandatory to prevent any possible wear and tear on the soft top. Your vehicle warranty will not cover damage resulting from both tops remaining on the vehicle at the same time for extended periods of time.

Removing The Soft Top

1. Locate and remove the 2 boxes that contain the following items:

- Right and left door frames
- Door frame attachment knobs (4 for 2 door models, 6 for 4 door models)
- Right and left quarter windows
- Rear window
- Rear window roll up straps (2)
- Sunrider secure straps (2) (If Equipped)
- Rear swing gate brackets (2)

2. Remove the hard top. Refer to “Hard Top — Hard Top Removal” in this section.

3. Remove the soft top bow assembly pivot bracket screws (2 per side) using a #T30 Torx® head driver.

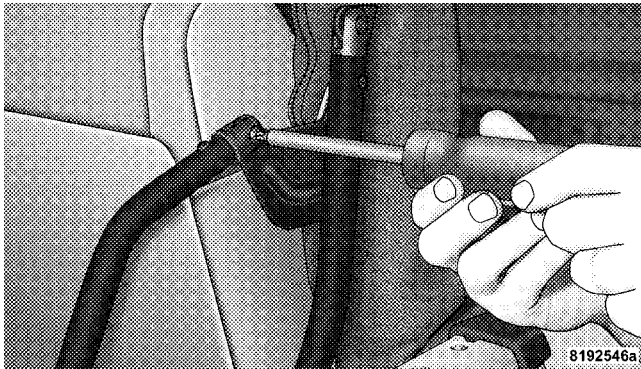

4. Using a rubber mallet, carefully tap the knuckles from the left and right metal pivot brackets. Remove the soft top from the vehicle and store in a clean, dry location.

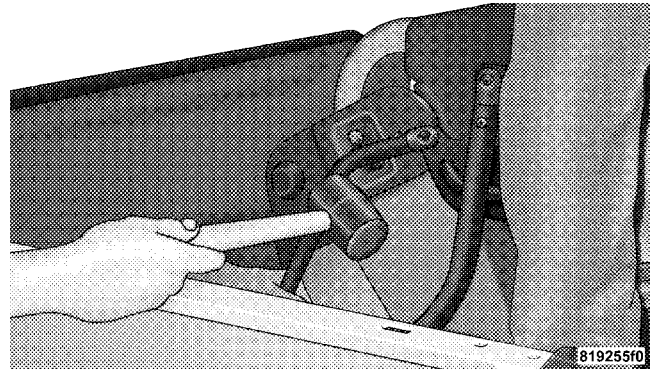

5. Unzip the zipper on the sport bar cover to expose the pivot brackets. Remove the brackets using a #T30 Torx® head driver. Recover and re-zip the sports bar cover. Store pivot brackets and screws in a safe place.

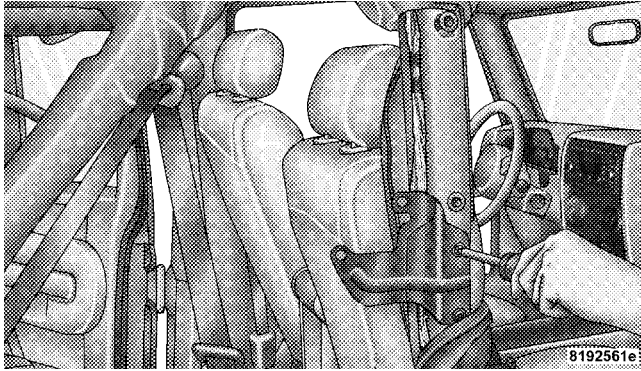

6. Reinstall the hard top. Refer to “Hard Top — Hard Top Installation” in this section.

Installing the Soft Top

NOTE: The following procedures are for first time set up only. For future soft top procedures, refer to “Soft Top” in this section.

1. Locate and remove the following items prior to hard top removal:

- Right and left door frames
- Door frame attachment knobs (4 for 2 door models, 6 for 4 door models)
- Right and left quarter windows
- Rear window

2. Remove the hard top. Refer to “Hard Top — Hard Top Removal” in this section.

3. Install the door frames. Refer to “Door Frame” in this section.

4. If the soft top has been removed, follow these steps to reinstall the soft top. If the soft top is on the vehicle, proceed to step #5.

a. If the pivot brackets have been removed, unzip the sport bar covers and attach the pivot brackets to the sports bar with the 4 screws that were removed using a #T30 Torx® head driver. Re-cover and re-zip sport bar covers.

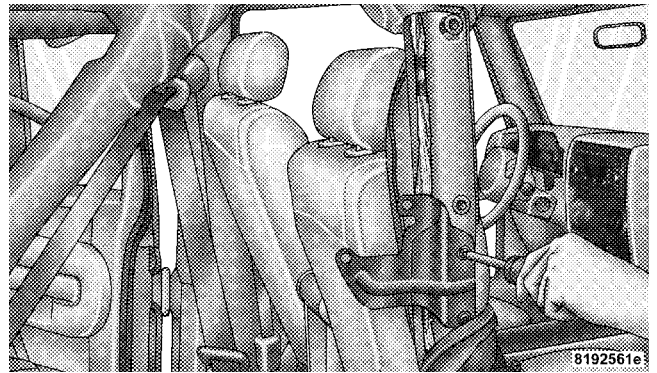

b. Lay the soft top into the rear of the vehicle with the bows pointing forward and the curved portion of the bows facing upward.

122 UNDERSTANDING THE FEATURES OF YOUR VEHICLE

c. Tap the knuckles on the side with a rubber mallet to reattach them to the metal pivot brackets.

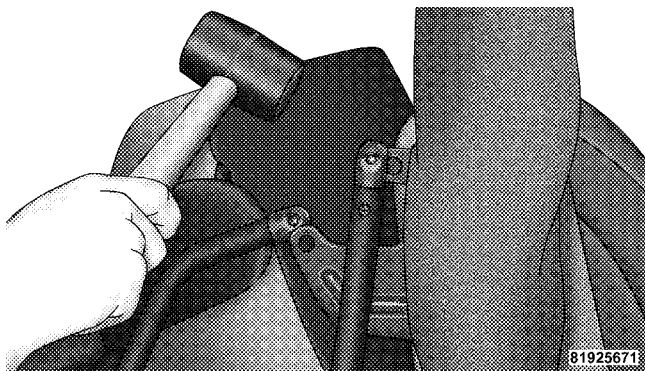

d. Screw the pivot screws back into place using a #T30 Torx® head driver. Secure them until they are snug being careful not to cross-thread the screws or over tighten.

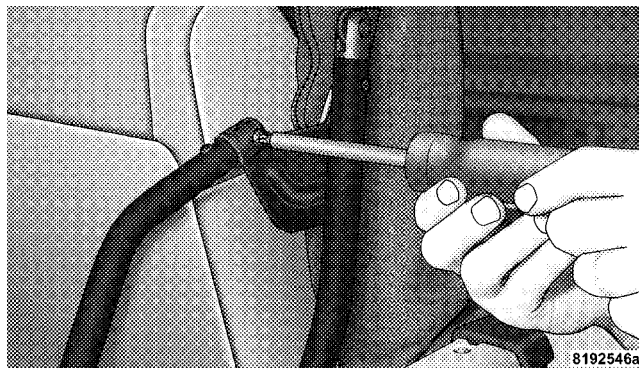

CAUTION!

Do not overtighten the screws. You can strip the screws if they are overtightened.

5. Unsnap and remove the black boot cover. This cover should be discarded. It was intended as a protective cover for shipping only.

NOTE: A visual instruction sheet is enclosed in the dual top wrap.

6. Remove the swing gate bar (black metal bar for bottom of rear window) located in the soft top and set aside.

NOTE: Be sure the wire harness in the right rear corner is not tangled in the soft top bows before you lift the top.

7. Put up the soft top. Refer to “Soft Top — Putting Up the Soft Top” in this section.

FREEDOM TOP 3-PIECE MODULAR HARD TOP

CAUTION!

- The hard top is not designed to carry any additional loads such as roof racks, spare tires, building, hunting, or camping supplies, and/or luggage, etc. Also, it was not designed as a structural member of the vehicle, and thus cannot properly carry any additional loads other than environmental (rain, snow, etc.).

CAUTION!

Do not move your vehicle until the top has been either fully attached to the windshield frame and bodyside, or fully removed.

Front Panel(s) Removal

NOTE: Left panel must be removed before removing right panel.

1. Fold down the sun visor, and move to the side.
2. Turn center dials (2) from center of roof panel.

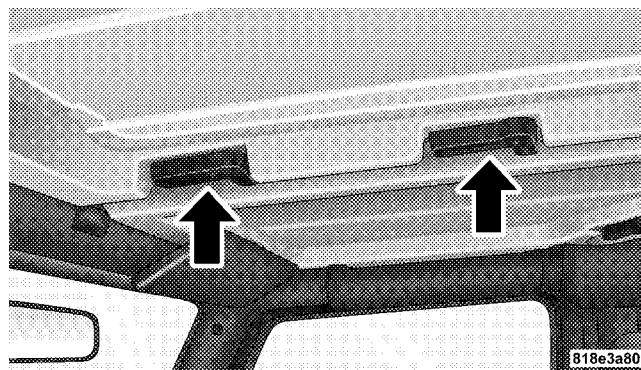

3. Turn rear dial (located above shoulder belt anchorage).

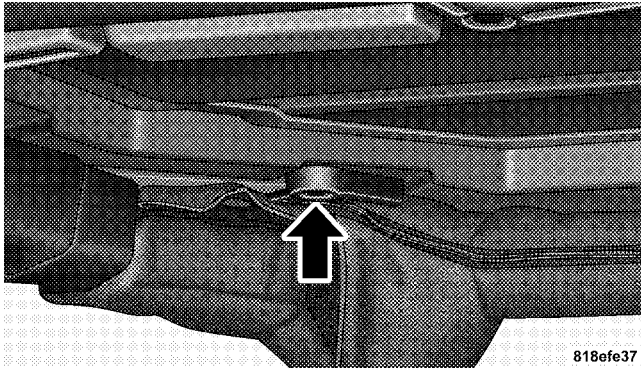

4. Turn rear fastener (knob) (located on overhead speaker bar assembly).

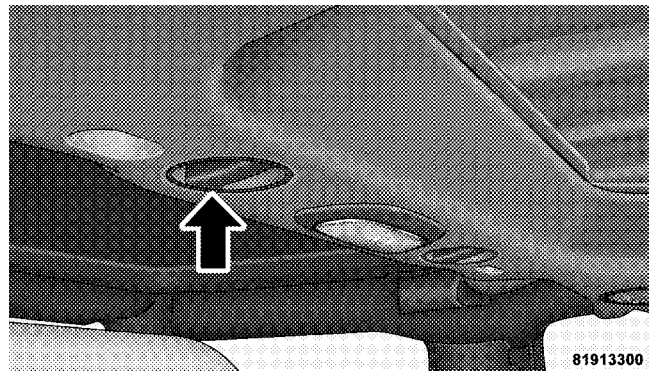

5. Unlatch the header panel latch located at the top of the windshield.

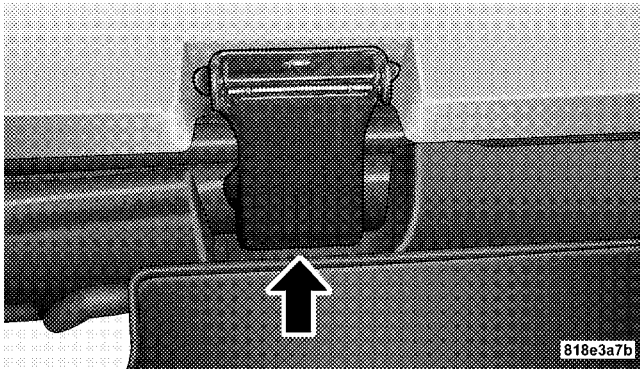

6. Remove panel.

To remove right panel, follow steps above except for step 2.

Front Panel(s) Installation

NOTE: The front panel (s) must be positioned properly to ensure sealing. Set the panels on the windshield frame so that there is no overhang. Also, make sure that the panels are sitting flush with the body.

1. Install right panel first, then the left panel.
2. Reinstall panel(s) using the same steps for removal in reverse order.

Rear Panel Removal

1. Remove both front panels. Refer to "Front Panel(s) Removal" in this section.
2. Unbolt the two (2) Torx® head screws which secure the hard top at the B-pillar using a #40 Torx® head driver.
3. Open both doors.

4. Unbolt the Torx® head screws (4 for 2 door models) (6 for 4 door models) which secure the hard top to the vehicle using a #40 Torx® head driver.
5. Open swing gate all the way to ensure clearance of the rear window glass. Lift rear window glass.

6. Locate the wiring harness at the rear left side corner of the vehicle.

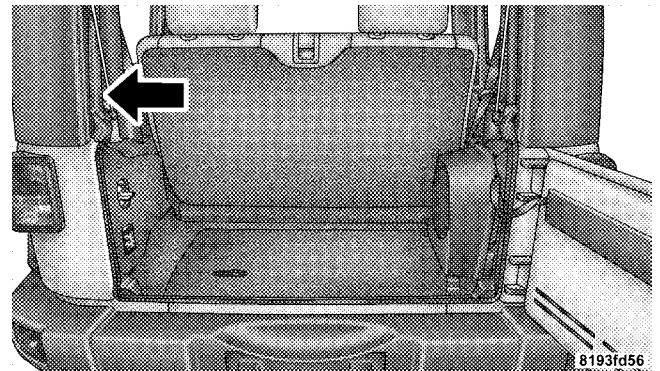
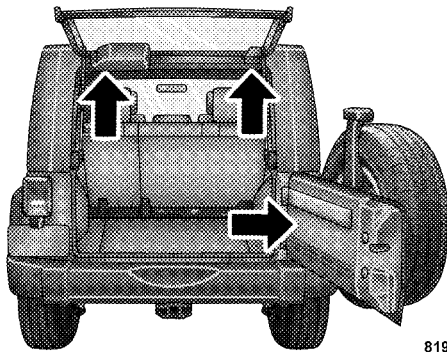

7. Disconnect the washer hose and install the tethered cap.

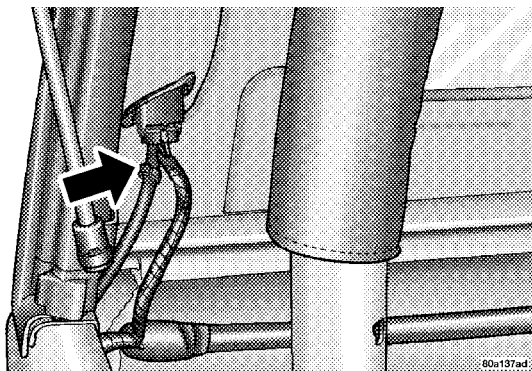

CAUTION!

Make sure storage cap is installed to prevent foreign materials from entering tube and clogging system.

8. Disconnect the wire harness from the hard top by pressing the tab at the side of the connector and pulling to disconnect.

NOTE: If the red latch on the connector is locked, push the red latch to the right until you can only see the latch on one end (right) of the connector. This will unlock connector tab, allowing the tab to be pressed down and enabling the harness to be disconnected from the hard top.

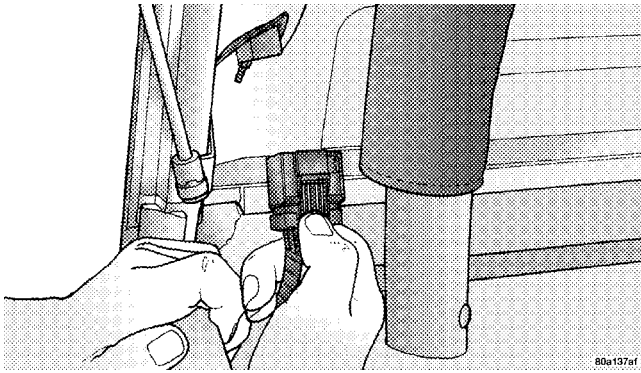

9. Remove the hard top from the vehicle. Place on a soft surface to prevent damage.

Rear Panel Installation

NOTE: If the door frames are installed from soft top usage, they must be removed prior to installation of the hard top.

1. Inspect the hard top seals for damage and replace if necessary.
2. Install the hard top using the same steps for removal in reverse order.

NOTE: The hard top must be positioned properly to ensure sealing. Also, make sure that the hard top is sitting flush with the body at the sides and check to ensure that there is a uniform gap between the lift glass and hard top.

SOFT TOP (2 DOOR MODELS)**CAUTION!**

- The soft top is not designed to carry any additional loads such as roof racks, spare tires, building, hunting, or camping supplies, and/or luggage, etc. Also, it was not designed as a structural member of the vehicle, and thus cannot properly carry any additional loads other than environmental (rain, snow, etc.).

If the temperature is below 72°F (24°C) and/or the top has been folded down for a period of time, the top will appear to have shrunk when you raise it, making it difficult to put up. This is caused by a natural contraction of the vinyl coating on the fabric top.

Place the vehicle in a warm area. Pull steadily on the top fabric. The vinyl will stretch back to its original size and the top can then be installed. **If temperature is 41°F (5°C) or below, do not attempt to put the top down or roll the rear or side curtains.**

CAUTION!

- Do not run a fabric top through an automatic car wash. Window scratches and wax build up may result.
- Do not lower the top when the temperature is below 41°F (5°C). Damage to the top may result.
- Do not move your vehicle until the top has been either fully attached to the windshield frame, or fully lowered.
- Do not lower the top with the windows installed. Window and top damage may occur.
- Refer to “Appearance Care for Fabric Top Models” in Section 7 of this manual. It contains important information on cleaning and caring for your vehicle’s fabric top.

WARNING!

- Do not drive vehicle with rear window curtain up unless side curtains are also removed. Dangerous exhaust gases could enter the vehicle causing harm to the driver and passengers.
- The fabric upper doors and fabric top are designed only for protection against the elements. Do not rely on them to contain occupants within the vehicle or to protect against injury during an accident. Remember, always wear seat belts.

Folding Down The Soft Top

NOTE: Clean side and rear windows before removal to assist in preventing scratching during removal of the soft top. If zippers are difficult to operate due to road dust,

132 UNDERSTANDING THE FEATURES OF YOUR VEHICLE

etc., clean them with a mild soap solution and a small brush. Cleaning products are available through your authorized dealer.

1. If your vehicle has half doors, remove each half door window by opening the door and lifting the half door window out.

NOTE: Stow half doors carefully outside of the vehicle, never inside to avoid scratches.

2. Place finger up into the rear of the plastic retainer and pull down rolling the retainer out of the door frame. Repeat this on the other side.

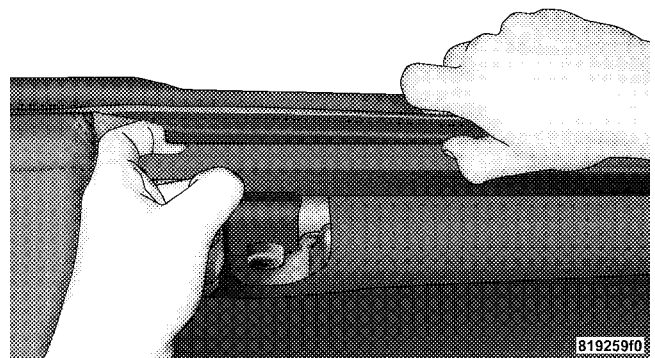

3. Unclip and move the sun visors to the side.

4. Release the header latches and leave the hooks in the loops on the windshield.

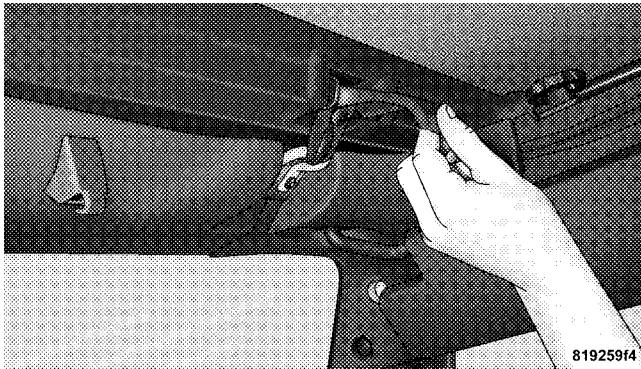

5. Open the swing gate.

6. Untuck the first three (3) inches of both sail panels, and pull the swing gate bar straight rearward out of the swing gate brackets (prior to unzipping the window).

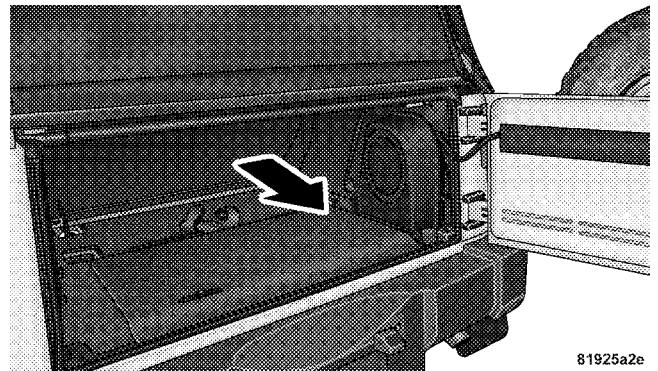

134 UNDERSTANDING THE FEATURES OF YOUR VEHICLE

- Unzip the rear window starting at the right lower corner of the window. Pull the zipper up, across the top and down to the left lower corner. **Zipper pulls will stay on the rear window.** Pull down on the rear window to disengage from the zipper on the top cover. Stow the windows carefully to avoid scratching.

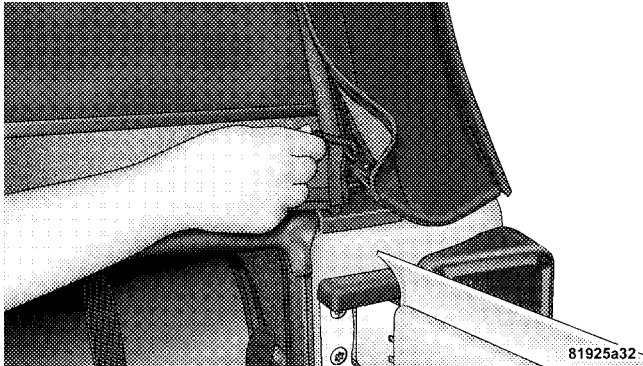

7. Undo the Velcro® that runs along the top and rear edge of the side window.
8. Beginning from the rear lower corner, completely unzip the window.

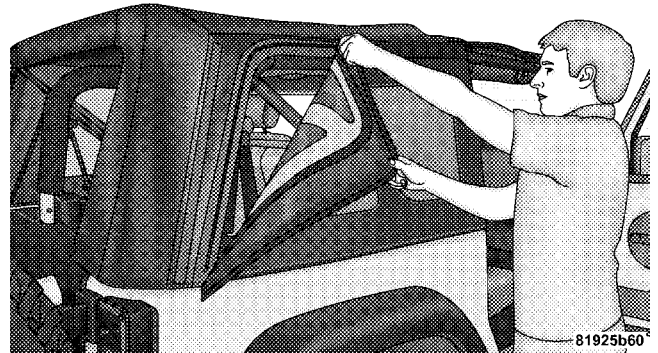

9. Once unzipped, remove from the door frame and from bodyside retainer. Repeat this step on the other side.

10. Remove the bottom retainers of the sail panels from the body side retainer at the rear corners of the vehicle.

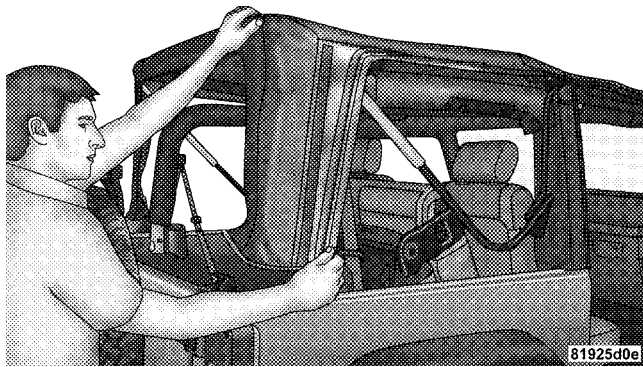

NOTE: It is helpful to pull down on the 3 bow.

11. As you begin to lower the top, fold the sail panels so that they rest on top of the soft top.

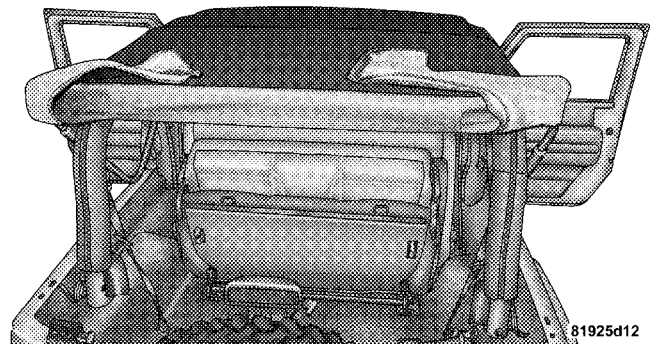

136 UNDERSTANDING THE FEATURES OF YOUR VEHICLE

12. The swing gate brackets do not need to be removed unless the hard top is being installed. To remove the swing gate brackets, pull the front side of clip forward and up to disengage from the bodyside retainer.

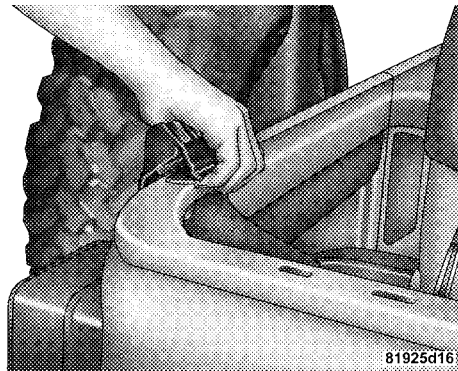

13. Completely release the latches from the loops on the windshield frame.

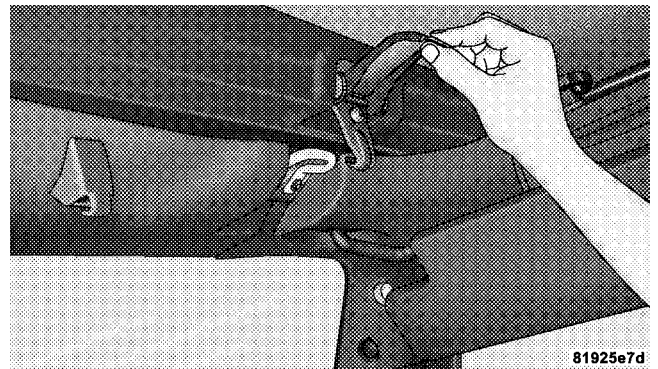

14. Grasp the side bow behind the header, lift the top, and fold toward the rear of the vehicle.

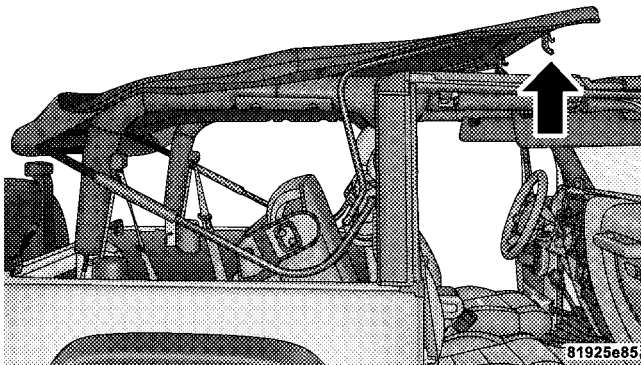

15. Tuck the fabric and the check straps between the bows and as far inward as possible. This will keep any portion of the top from flapping outside of the vehicle.

When the top is completely down, position the drip rails so they make a "v-shape", this prevents damage to the soft top material.

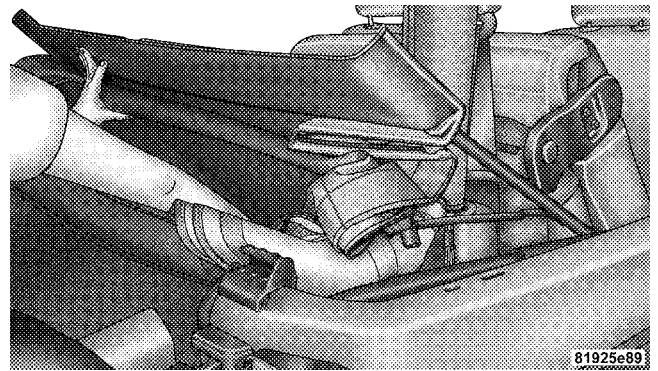

Putting Up The Soft Top

1. Unclip and move the sun visors to the side.
2. Standing on the side of the vehicle, lift the top by the side bow and the 2-bow (middle bow) up and over the sports bar until the header rests on the top of the windshield frame.

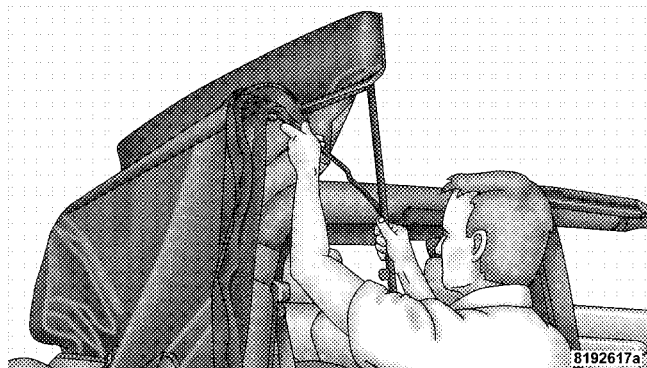

3. Before attaching the header latches, be sure the drip retainers above the door opening are not trapped between the top and the door frame.
4. Open the header latches and engage the hook on each side onto the windshield loops (do not close the latches).

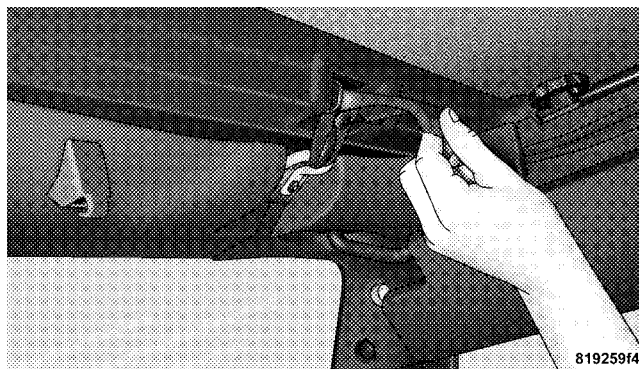

5. If the swing gate brackets were removed, install them by hooking the front edge on the body side retainer and rotate it downward until it snaps onto the rail. Ensure that the clips are properly located.

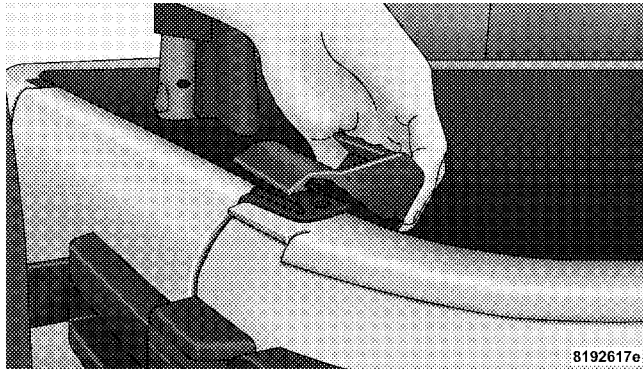

6. Move to the rear of the vehicle and gently pull the sail panels over the 3 bow.

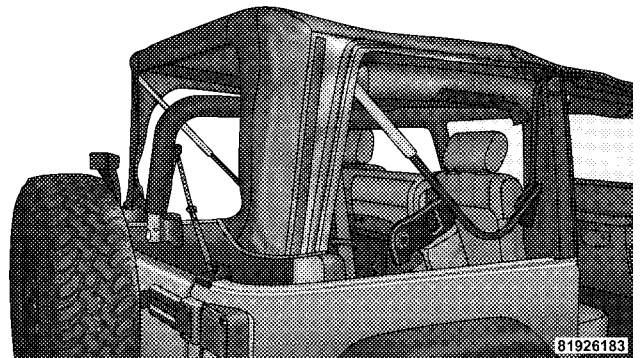

7. Tuck the sail panel retainers into the bodyside retainer. It may be necessary to pull down slightly at the top of the 3 bow to bring the retainers into place.

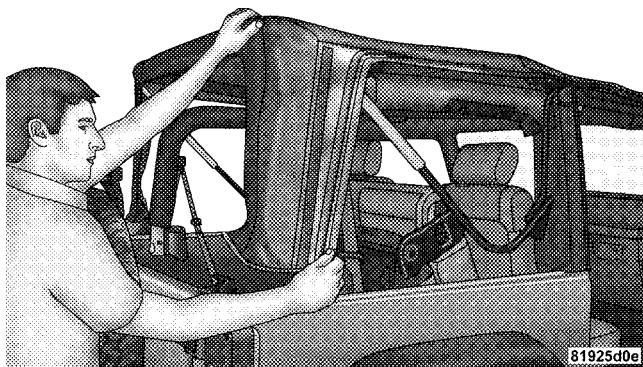

8. To install the quarter window, affix the upper rear corner of the window temporarily to the Velcro®. Start and zip the zipper only about 1 inch (2.5 cm). **At this time it is necessary to tuck in the door frame retainer.**

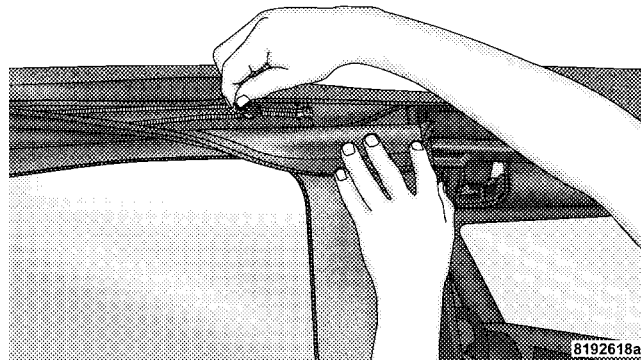

9. Tuck the front retainer into the door frame slot. Ensure that the retainer is fully rolled around and properly positioned into the door frame. Failure to do so will result in possible damage along with wind and water leaks.

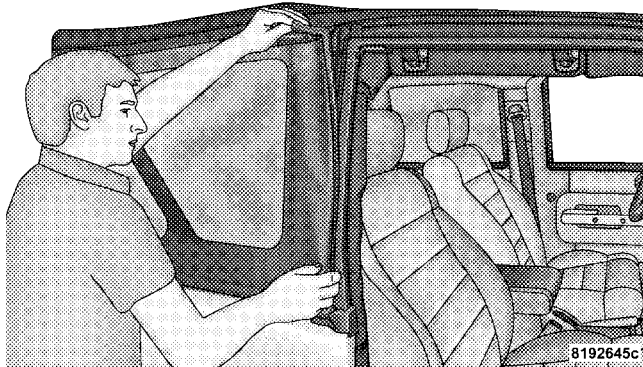

10. Continue zipping the window to the upper rear corner.

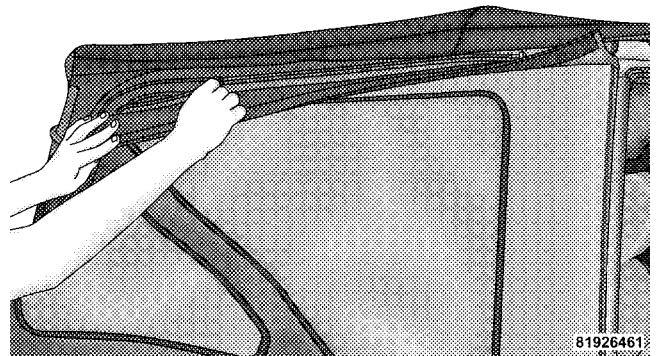

142 UNDERSTANDING THE FEATURES OF YOUR VEHICLE

11. Tuck the bottom retainer of the quarter window into the bottom retainer, beginning at the front and working to the rear of the vehicle. Finish zipping the window and attach the Velcro® along the top and rear of the window. Repeat this step for the other side.

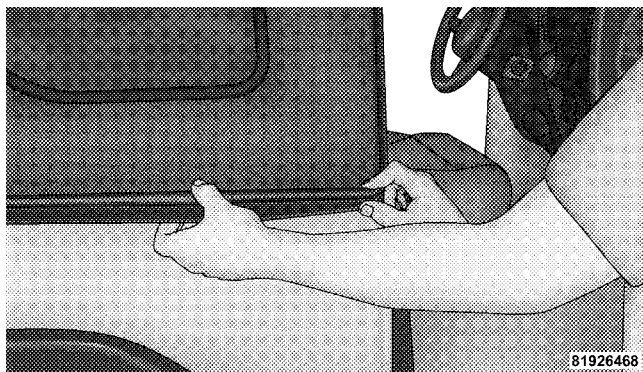

12. If the sail panel is fully installed, partially uninstall the sail panel near the swing gate opening so that the zipper can be accessed.

13. Locate the black swing gate bar. Slide the swing gate bar over the receiver at the bottom inside of the rear window, with the bulky seal away from you.

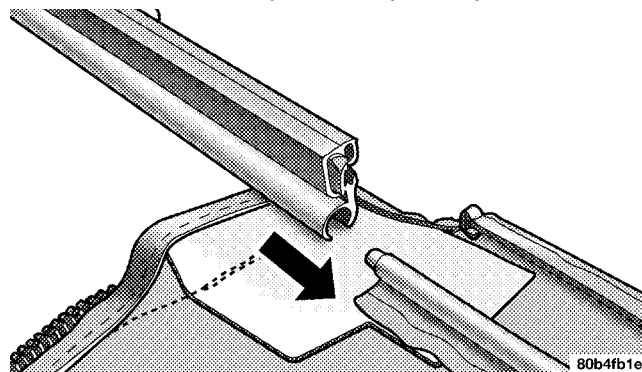

14. Install the rear window by starting both zipper ends at the lower left corner of the rear window opening. Ensure that the zippers are properly started and aligned before zipping to prevent damage.

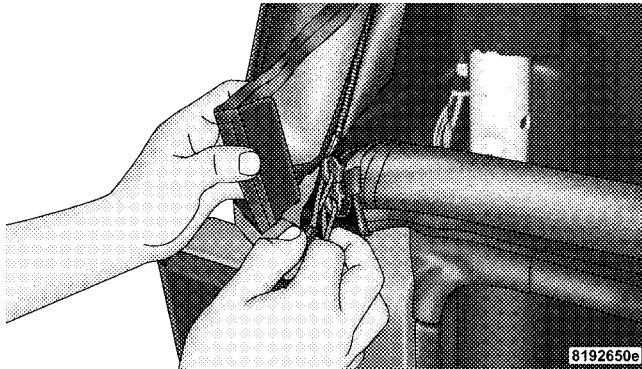

15. Run the zipper fully around to the right side of the window.

16. Finish installing the sail panels.

17. Grasp the swing gate bar and position it into the swing gate brackets.

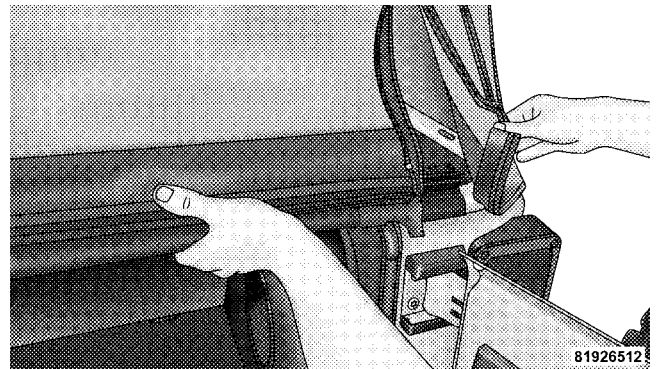

18. Apply downward pressure on the top corner of the rear soft top bow, and then completely tuck the sail panel into the bodyside retainer.

144 UNDERSTANDING THE FEATURES OF YOUR VEHICLE

19. Open the doors and tuck the plastic retainers into the door frame slots above the door opening. Start at the front and work toward the rear of the vehicle.

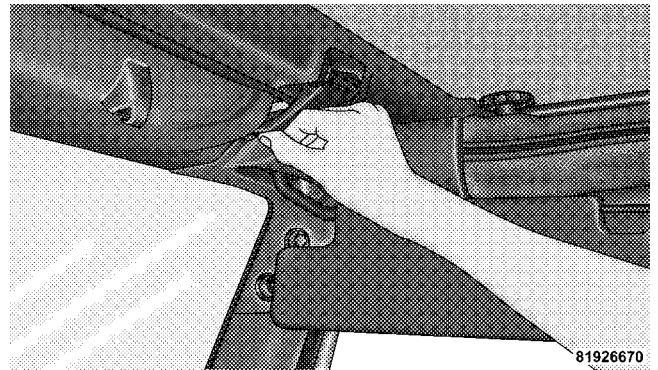
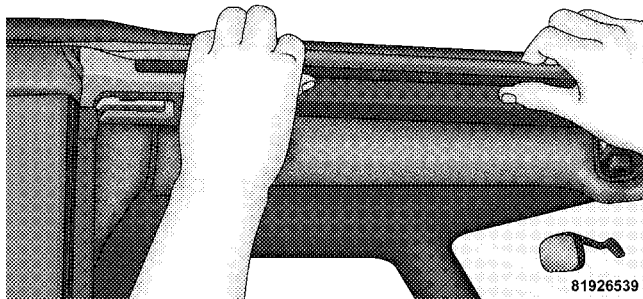

20. Close the header latches and return the sun visors to their secured position.

SOFT TOP (4 DOOR MODELS)**CAUTION!**

- The soft top is not designed to carry any additional loads such as roof racks, spare tires, building, hunting, or camping supplies, and/or luggage, etc. Also, it was not designed as a structural member of the vehicle, and thus cannot properly carry any additional loads other than environmental (rain, snow, etc.).

If the temperature is below 72°F (24°C) and/or the top has been folded down for a period of time, the top will appear to have shrunk when you raise it, making it difficult to put up. This is caused by a natural contraction of the vinyl coating on the fabric top.

Place the vehicle in a warm area. Pull steadily on the top fabric. The vinyl will stretch back to its original size and the top can then be snapped into place. **If temperature is 41°F (5°C) or below, do not attempt to put the top down or roll the rear or side curtains.**

CAUTION!

- Do not run a fabric top through an automatic car wash. Window scratches and wax build up may result.
- Do not lower the top when the temperature is below 41°F (5°C). Damage to the top may result.
- Do not lower the top when the windows are dirty. Grit may scratch the window.
- Do not move your vehicle until the top has been either fully attached to the windshield frame, or fully lowered.
- Do not lower the top with the windows installed. Window and top damage may occur.
- Refer to “Appearance Care for Fabric Top Models” in Section 7 of this manual. It contains important information on cleaning and caring for your vehicle’s fabric top.

WARNING!

- Do not drive vehicle with rear window curtain up unless side curtains are also open. Dangerous exhaust gases which can kill could enter the vehicle.
- The fabric upper doors and fabric top are designed only for protection against the elements. Do not rely on them to contain occupants within the vehicle or to protect against injury during an accident. Remember, always wear seat belts.

Folding Down The Soft Top

NOTE: Clean side and rear windows before removal to assist in preventing scratching during removal of the soft top. If zippers are difficult to operate due to road dust,

etc., clean them with a mild soap solution and a small brush. Cleaning products are available through your authorized dealer.

1. If your vehicle has half doors, remove each half door window by opening the door and lifting the half door window out.

NOTE: Stow half doors carefully outside of the vehicle, never inside to avoid scratches.

2. Above the front of the rear door, place finger up into the cut out in the plastic retainer and pull down rolling both the front and rear retainers out of the door frame. Repeat this on the other side.

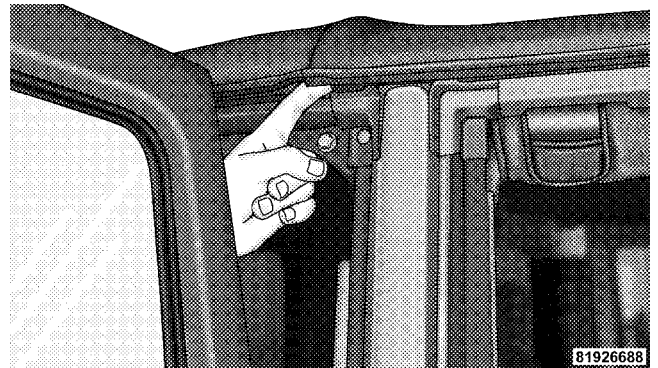

3. Unclip and move the sun visors to the side.

4. Release the header latches and hooks from the loops on the windshield frame.

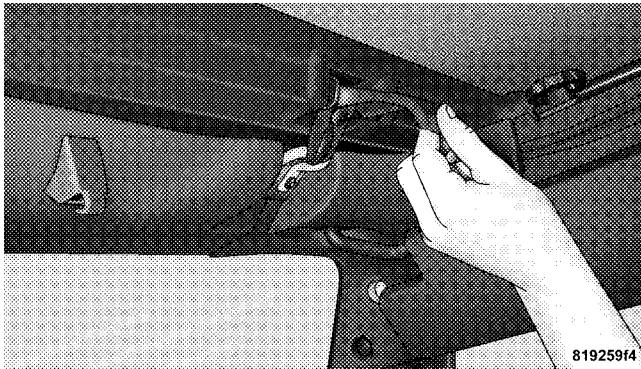

5. Open the swing gate.

6. Untuck the first three (3) inches of both sail panels, and pull the swing gate bar straight rearward out of the swing gate brackets (prior to unzipping the window).

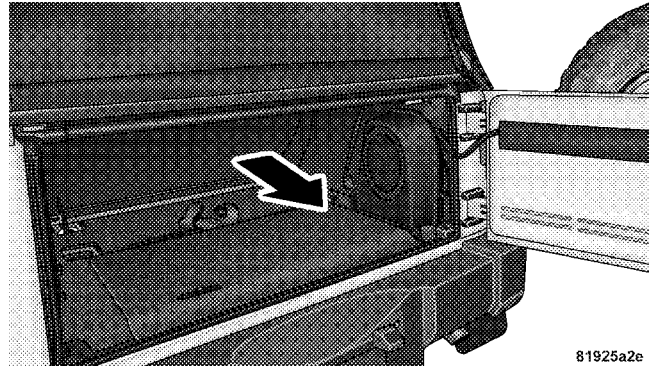

- Unzip the rear window starting at the right lower corner of the window. Pull the zipper up, across the top and down to the left lower corner. **Zipper pulls will stay on the rear window.** Pull down on the rear window to disengage from the zipper on the top cover. Stow the windows carefully to avoid scratching.

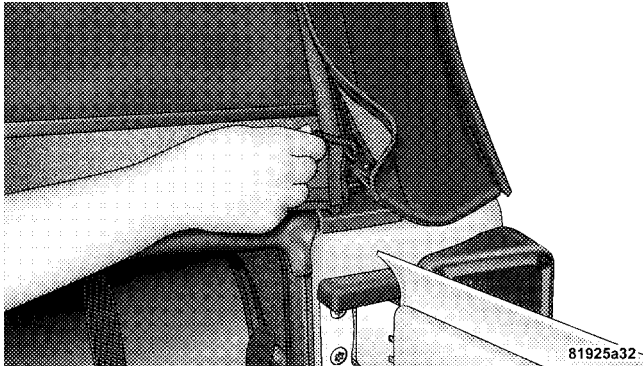

7. Undo the Velcro® that runs along the top and rear edge of the side window.
8. Beginning from the rear lower corner, completely unzip the window.

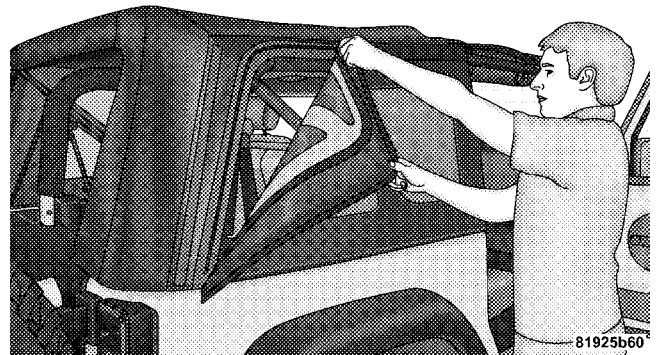

9. Once unzipped, remove from the door frame and from bodyside retainer. Repeat this step on the other side.

150 UNDERSTANDING THE FEATURES OF YOUR VEHICLE

10. Remove the bottom retainers of the sail panels from the body side retainer at the rear corners of the vehicle.

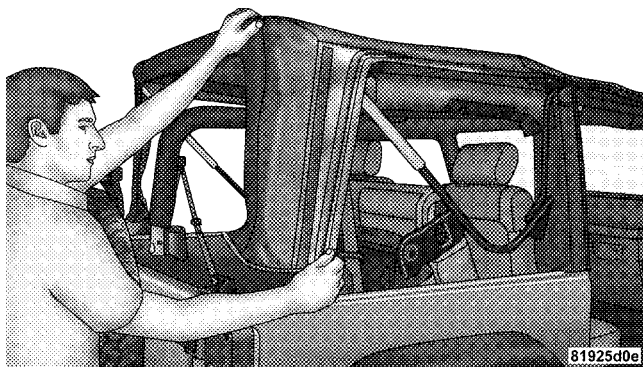

NOTE: It is helpful to pull down on the 4 bow.

11. Fold the sail panels so that they rest on top of the soft top.

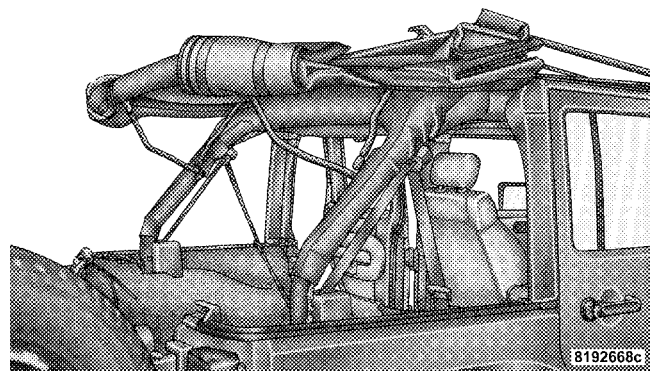

12. The swing gate brackets do not need to be removed unless the hard top is being installed. To remove the swing gate brackets, pull the front side of clip forward and up to disengage from the bodyside retainer.

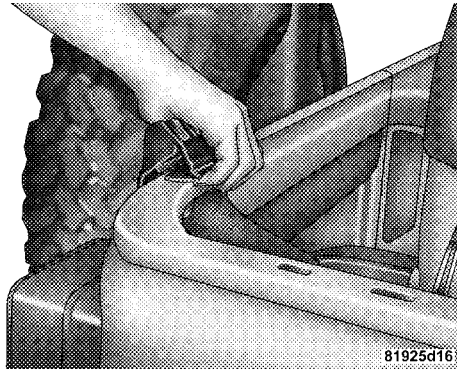

13. Grasp the front side bow behind the header, and lift the top.

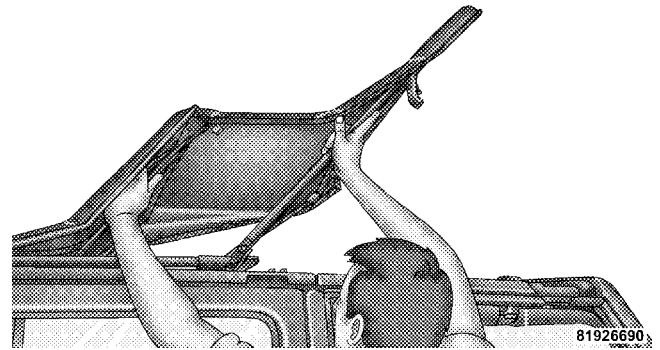

152 UNDERSTANDING THE FEATURES OF YOUR VEHICLE

14. Fold back the front section of the top, and gently rest the header on top of the rear portion of the deck.

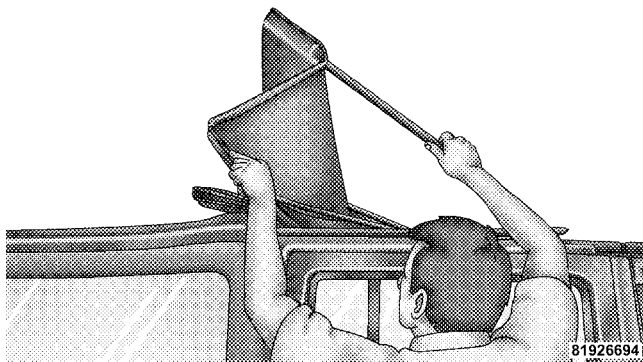

15. Fold the top material so that the plastic retainers form a "W" as shown. Enter the vehicle, and move the material into two folds.

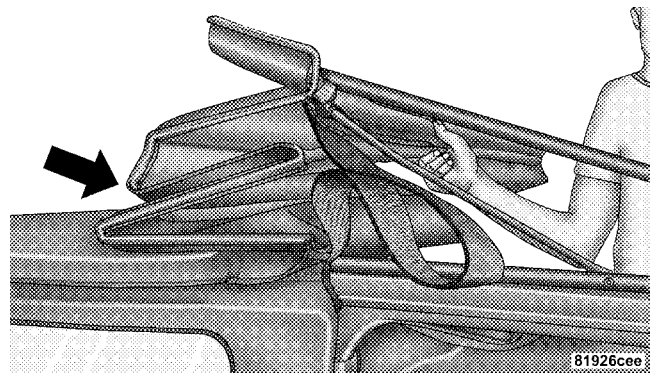

16. Release the side bows by pressing down on the latch above the front of the rear door. Push the top rearward to disengage. Repeat this step on the other side.

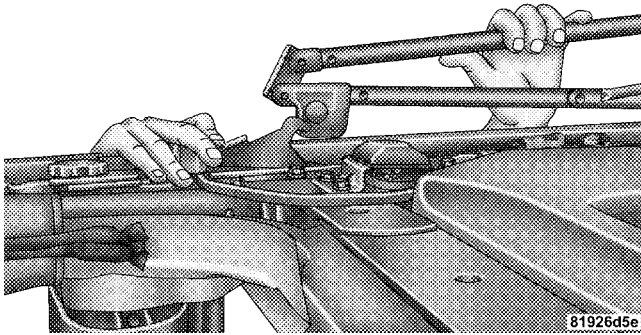

17. Grasp the folded side bows and slide the top along the door frame track to the rear door frame.

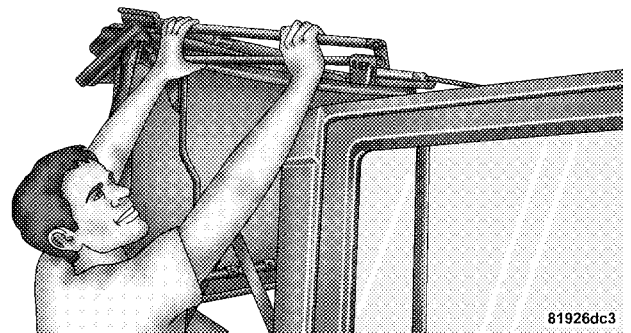

154 UNDERSTANDING THE FEATURES OF YOUR VEHICLE

18. Gently slide the side bows off the door frame track and lower the top down into the vehicle.

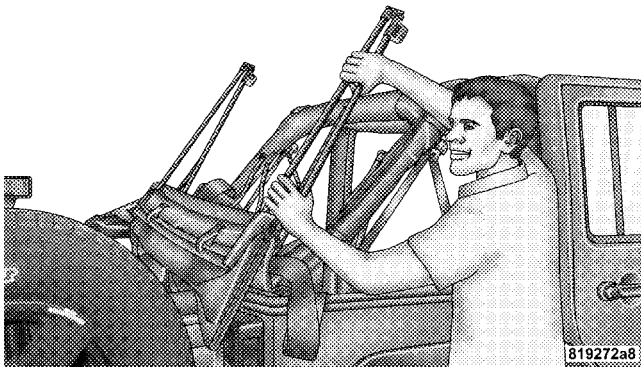

19. Tuck the fabric and the check straps between the bows as far inside as possible. This will keep any portion of the top from flapping outside of the vehicle.

20. Once the top is fully down, use the straps used to secure the top in the Sunrider position. Wrap the straps

around the side bows and through the slot on the bodyside retainer and Velcro® back onto itself. Ensure that the top is secure.

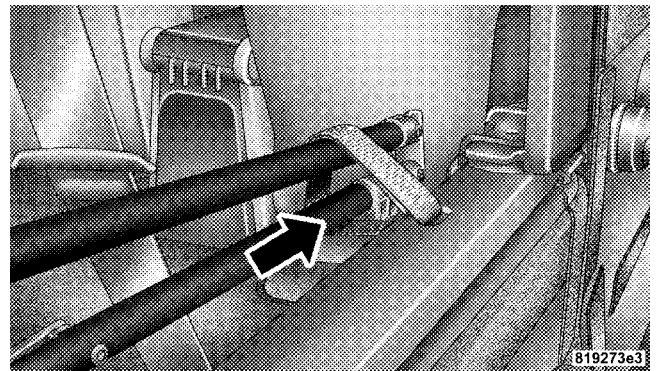

Putting Up The Soft Top

NOTE: Be extremely careful when putting up the soft top to prevent the doors from getting scratched. It may be helpful to open the rear doors.

1. Undo the straps used to secure the top in the down position and store in secure location.
2. Open the swing gate.
3. Grasp the folded side bows and lift to the top of the rear door frames.

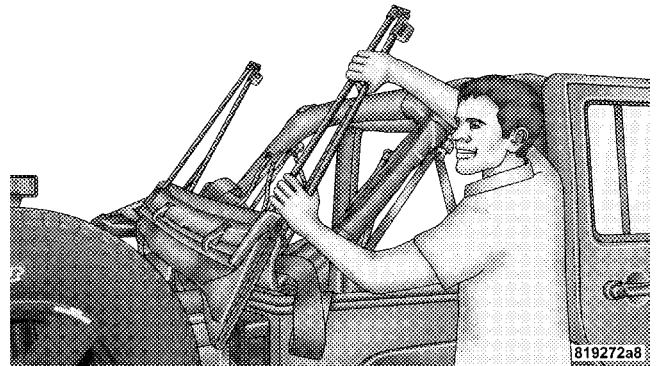

4. Engage the slider feature of the knuckles into the door frame tracks and slide the top forward.

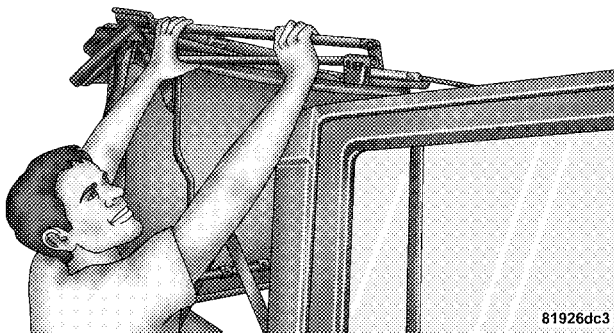

5. Ensure that the top locks into Sunrider locking mechanisms that are located above the front of the rear doors.

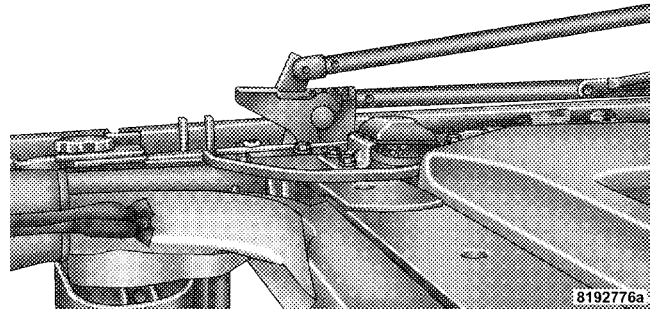

6. Unclip and move the sun visors to the side.

7. Standing on the side of the vehicle, lift the top by the side bow until it rests on the windshield frame.

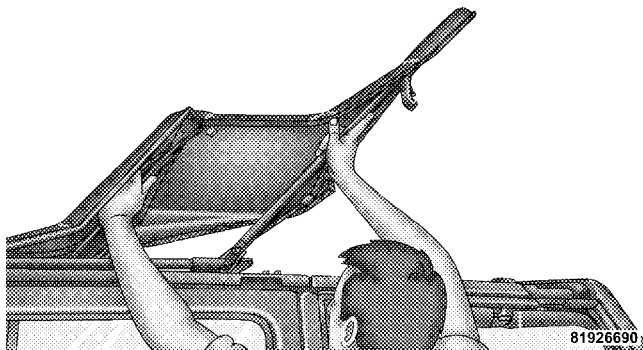

8. Before attaching the header latches, be sure the drip retainers above the door opening are not trapped between the top and the door frame.

9. Open the header latches and engage the hook on each side onto the windshield loops (do not close the latches).

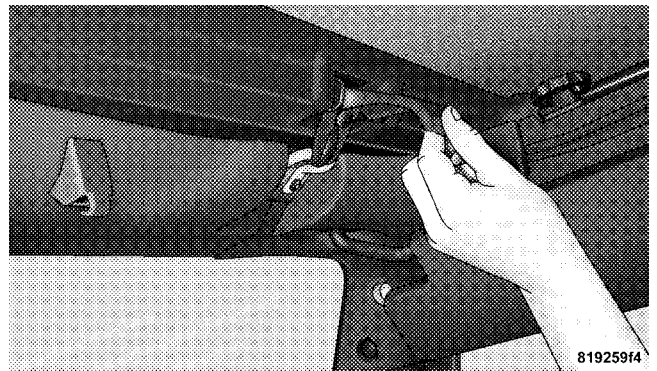

10. If the swing gate brackets were removed, install them by hooking the front edge on the body side retainer and rotate it downward until it snaps onto the rail. Ensure that the clips are properly located.

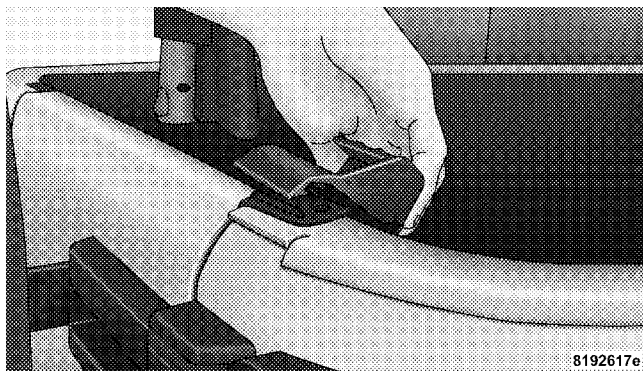

11. Move to the rear of the vehicle and gently pull the sail panels over the 4 bow.

12. Tuck the sail panel retainers into the bodyside retainer. It may be necessary to pull down slightly at the top of the 4 bow to bring the retainers into place.

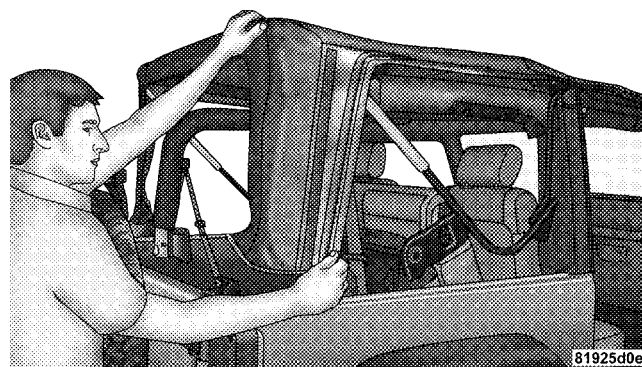

13. To install the quarter window, affix the upper rear corner of the window temporarily to the Velcro®. Start and zip the zipper only about 1 inch (2.5 cm). **At this time it is necessary to tuck in the door frame retainer.**

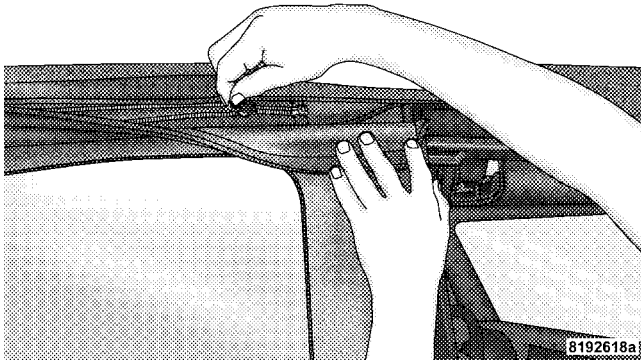

14. Tuck the front retainer into the door frame slot. Ensure that the retainer is fully rolled around and properly positioned into the door frame. Failure to do so will result in possible damage along with wind and water leaks.

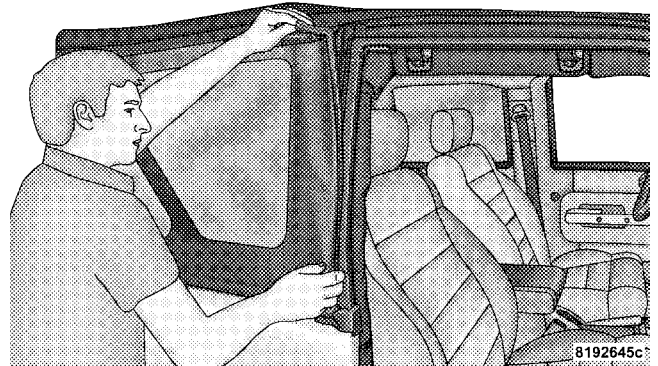

160 UNDERSTANDING THE FEATURES OF YOUR VEHICLE

15. Continue zipping the window to the upper rear corner.

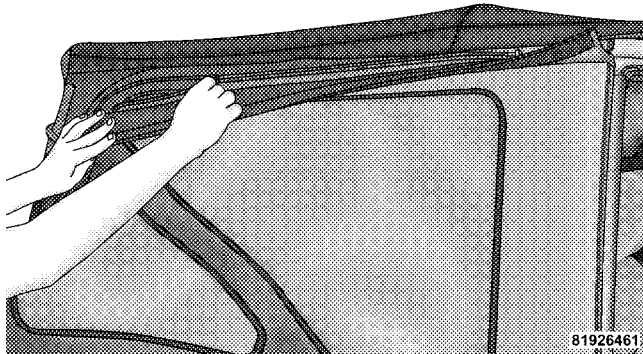

16. Tuck the bottom retainer of the quarter window into the bottom retainer, beginning at the front and working to the rear of the vehicle. Finish zipping the window and attach the Velcro® along the top and rear of the window. Repeat this step for the other side.

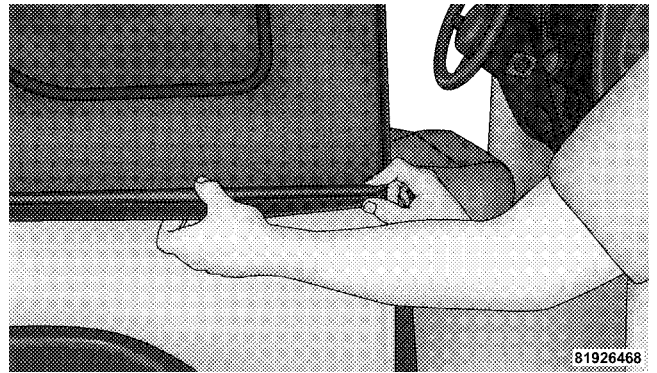

17. If the sail panel is fully installed, partially uninstall the sail panel near the swing gate opening so that the zipper can be accessed.

18. Locate the black swing gate bar. Slide the swing gate bar over the receiver at the bottom inside of the rear window, with the bulky seal away from you.

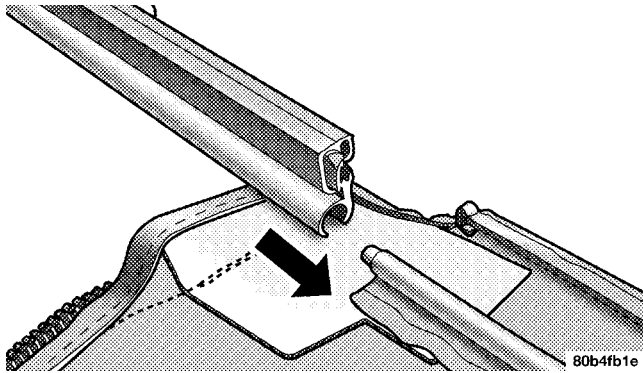

19. Install the rear window by starting both zipper ends at the lower left corner of the rear window opening. Ensure that the zippers are properly started and aligned before zipping to prevent damage.

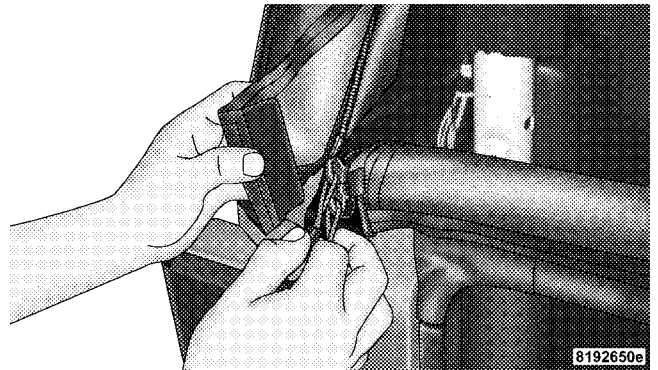

20. Run the first zipper fully around to the right side of the window.

21. Finish installing the sail panels.

162 UNDERSTANDING THE FEATURES OF YOUR VEHICLE

22. Grasp the swing gate bar and position it into the swing gate brackets.

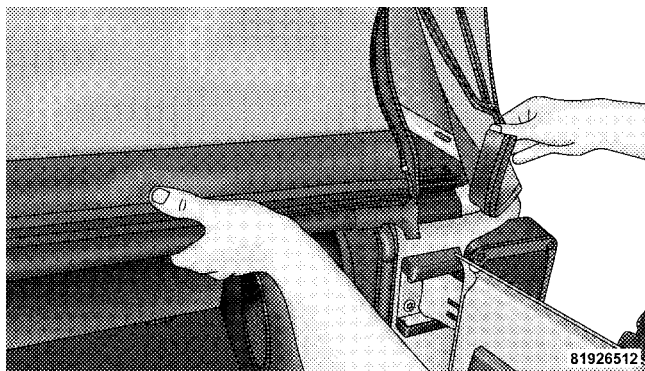

23. Completely tuck the sail panel into the bodyside retainer.

24. Open the doors and tuck the plastic retainers into the door frame slots above the door opening. Start at the front and work toward the rear of the vehicle.

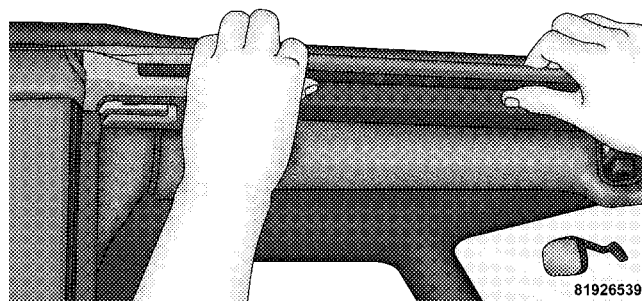

25. Ensure plastic retainer is tucked in properly at B-pillar not pinching seal.

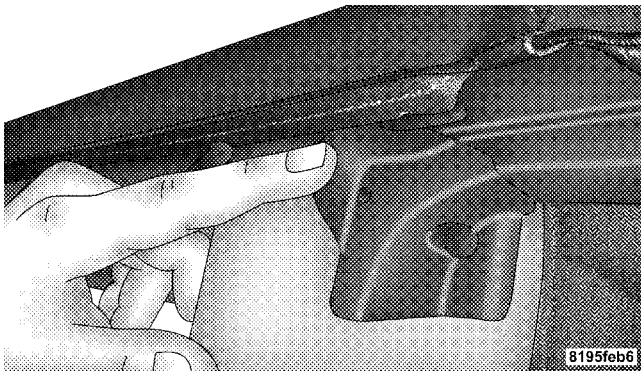

26. Close the header latches and return the sun visors to their secured position.

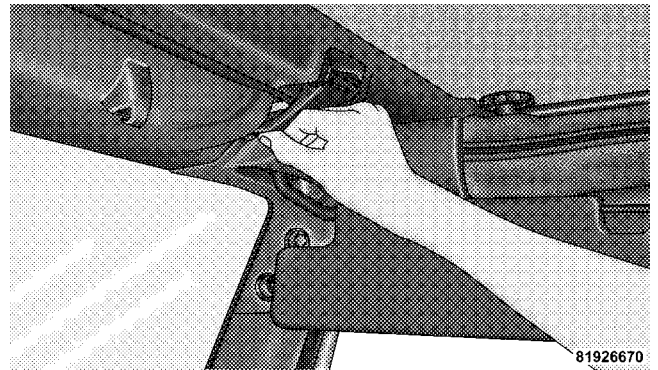

SUNRIDER — 4 DOOR MODELS

NOTE: If you are going to be driving faster than 40 mph (64 km/h) with the Sunrider feature open, it is recommended that you remove the rear window of the vehicle.

To Open

1. Above the front of the rear door, place finger up into the cut out in the plastic retainer and pull down rolling both the front and rear retainers out of the door frame. Repeat this on the other side.

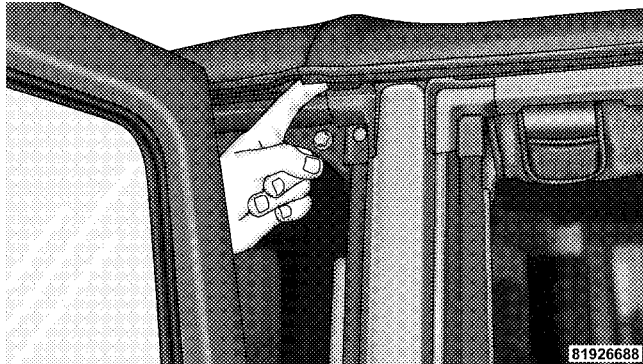

2. Unclip and move the sun visors to the side.

3. Release the header latches from the loops on the windshield frame.

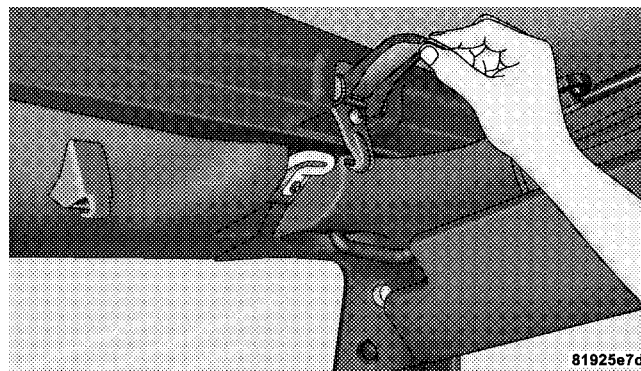

4. Grasp the front side bow behind the header, and lift the top.

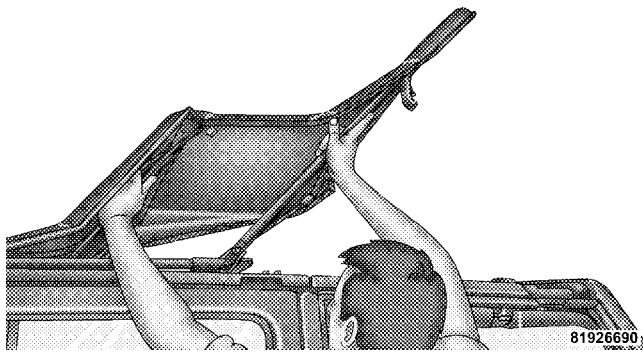

5. Fold back the front section of the top, and gently rest the header on top of the rear portion of the deck.

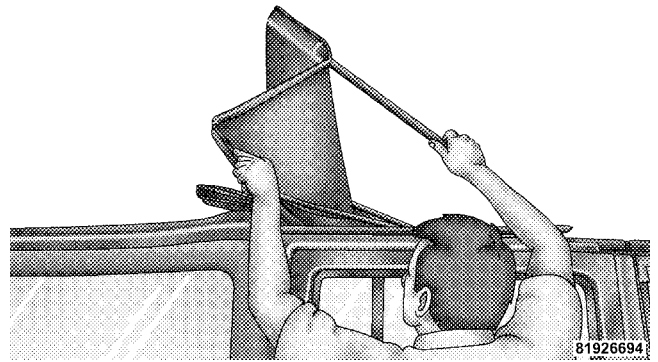

6. Fold the top material so that the plastic retainers form a "W" as shown. Enter the vehicle, and move the material into two folds. Ensure that the straps are securely stowed.

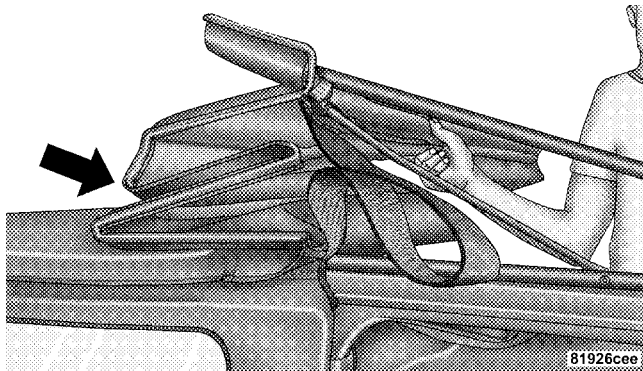

7. Secure the top by using the two (2) provided straps. Each strap will wrap around the side bow and Velcro® to itself, use one strap on each side of the vehicle.

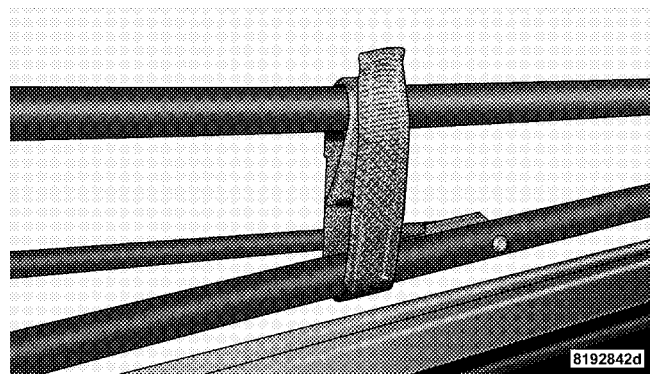

To Close

Perform the above steps in the opposite order.

DOOR FRAME**WARNING!**

Do not drive your vehicle on-pavement with the door frame removed as you lose the protection these structural elements can provide. This procedure is furnished for use during off-road operation only.

Door Frame Removal (2 Door Models)

1. Unscrew and remove the door frame attachment knobs (2 per side).

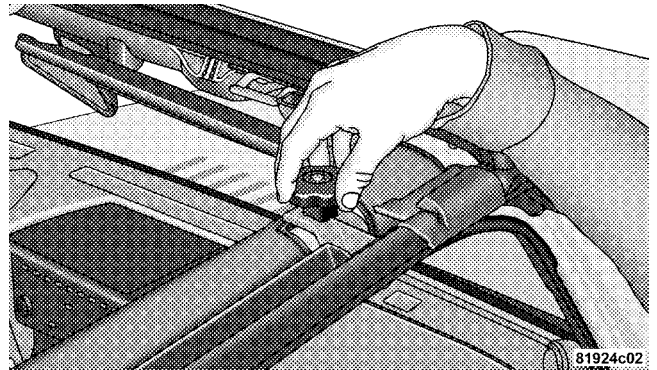

81924c02

WARNING!

Use both hands to remove the door frames. The door frames will fold and could cause injury if both hands are not used.

168 UNDERSTANDING THE FEATURES OF YOUR VEHICLE

2. Place one hand on the upper rear and one hand on the front of the door frame.
3. Pull the frame towards you with your rearward hand to remove the frame from the vehicle.

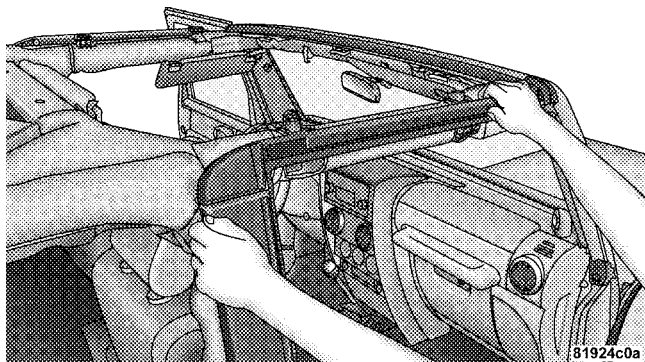

4. Screw the knobs back into the door frame and fold for storage. Store in a secure location.

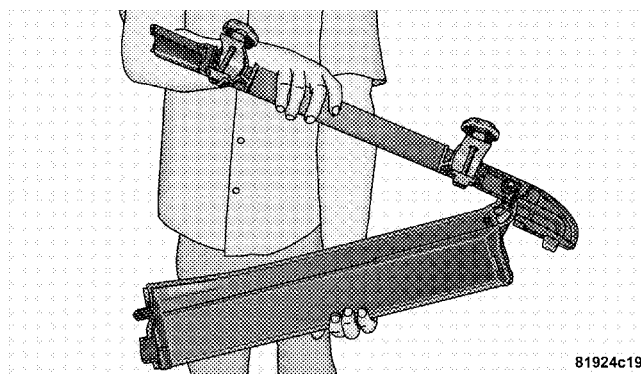

WARNING!

Never store the door frames in your vehicle. In an event of an accident, a loose door frame may cause personal injury. If removed, always store the door frames outside of the vehicle.

Door Frame Installation (2 Door Models)

1. Unfold door frame and unscrew thumbscrews.
2. Set the door frame pin into the hole on top of the body side, behind the door opening.

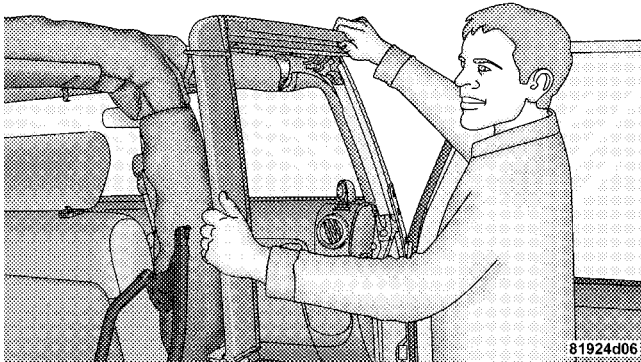

3. After the door frame pin has been set into the bodyside hole, carefully set the front of the door frame into the rubber seal at the top of the windshield.
4. Starting with the front of the door frame, clip it over the metal side bar and then clip the rear making sure that the material for the side bar covers is not pinched by the door frame.

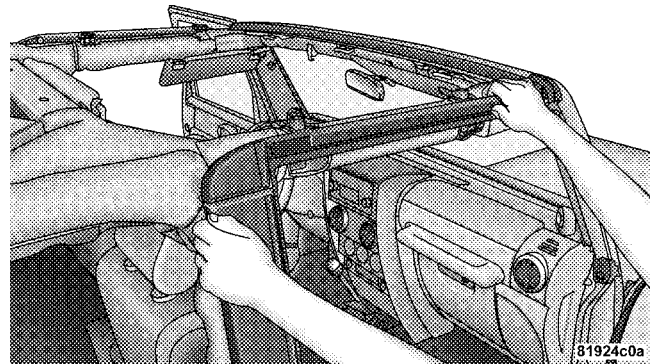

5. Starting with the front knob, screw in and tighten both knobs. Repeat on the other side.

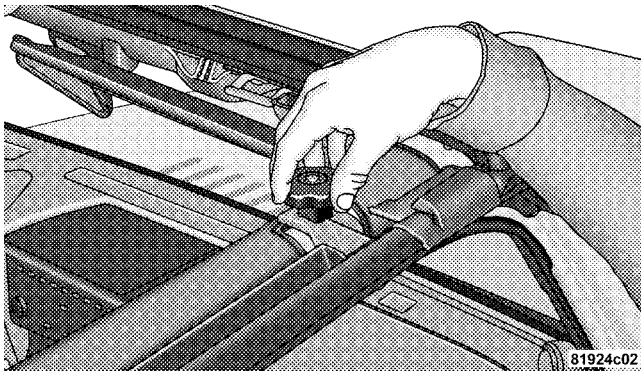

Door Frame Removal (4 Door Models)

1. Unscrew and remove the two (2) forward most door frame attachment knobs.

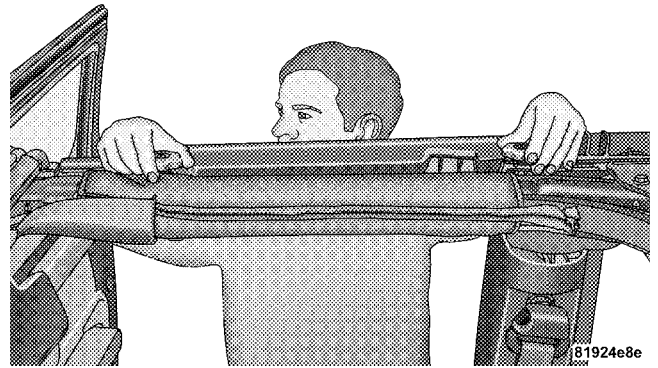

WARNING!

Use both hands to remove the door frames. The door frames will fold and could cause injury if both hands are not used.

2. Place one hand on the upper rear and one hand on the upper front of the front door frame.

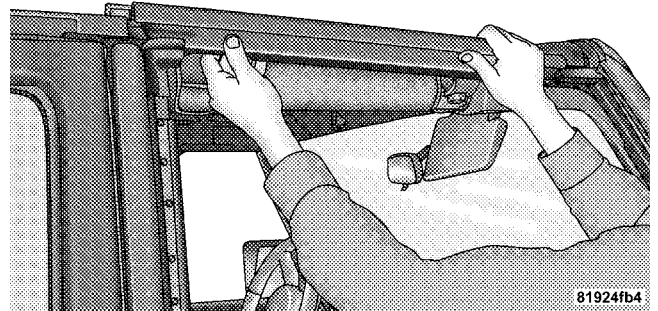
**3**

3. Pull the frame towards you with your front hand to remove the frame from the vehicle.

172 UNDERSTANDING THE FEATURES OF YOUR VEHICLE

4. Unscrew and remove the remaining door frame attachment knob on the rear door frame.

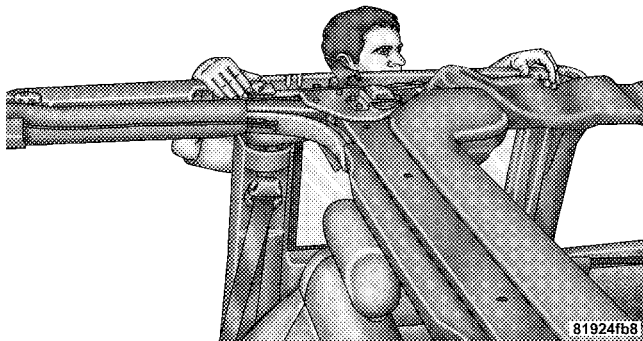

5. Place one hand on the upper rear and one hand on the upper front of the rear door frame. Pull the frame towards you with your rear hand to remove the frame from the vehicle.

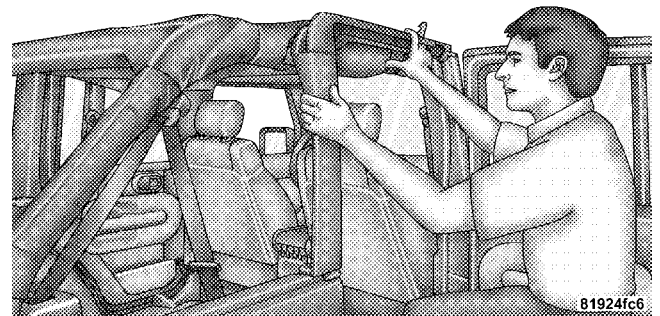

6. Screw the knob back into the door frame and fold for storage. Store in a secure location.

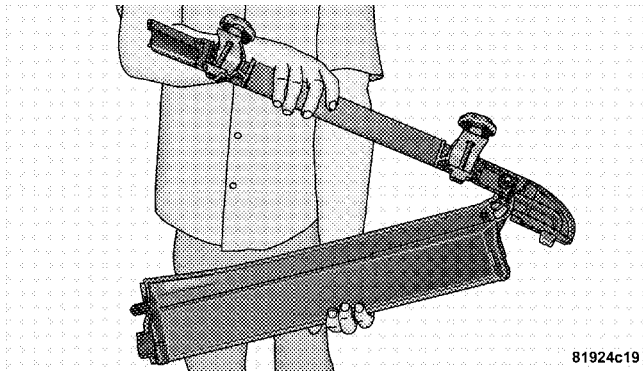

WARNING!

- Never store the door frames in your vehicle. In an event of an accident, a loose door frame may cause personal injury. If removed, always store the door frames outside of the vehicle.

3

Door Frame Installation (4 Door Models)

1. Install the rear door frame first.

174 UNDERSTANDING THE FEATURES OF YOUR VEHICLE

2. Set the door frame pin into the hole on top of the body side, just behind the rear door opening.

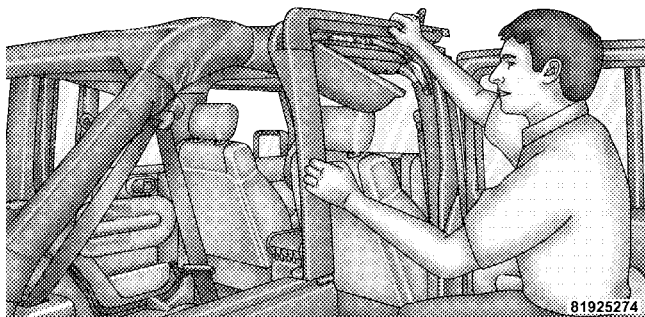

3. Position the top of the door frame against the metal sport bar and press onto the side bar making sure not to pinch the material of the sports bar covers and to ensure it is properly positioned on the seal above the front of the rear door.

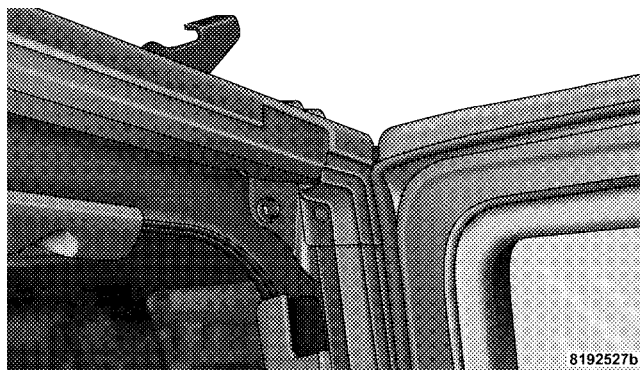

4. Loosely install the rear knob (long knob) to hold the door rail in position.

5. Carefully set the front of the front door frame in the rubber seal at the top of the windshield. Then, clip the front of the door rail over the side bar making sure that the material for the side bar cover is not pinched by the

door frame. Position the rear of the front door frame to lay on top of the front of the rear door frame.

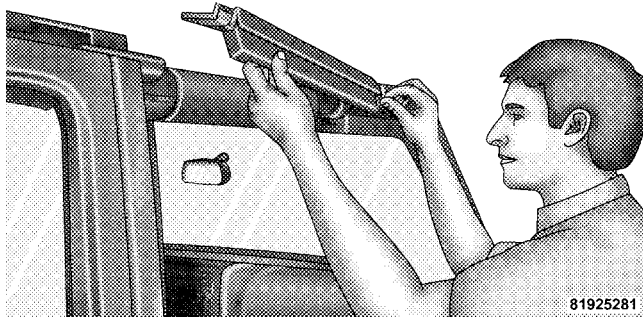

6. Loosely install both knobs beginning with the front knob (long knob). Then, install the middle knob (short knob) through the front and rear door frames and screw into the top of the b-pillar.

7. Tighten the front knob, then the rear most knob, and then the middle knob. Repeat this procedure for the other side.

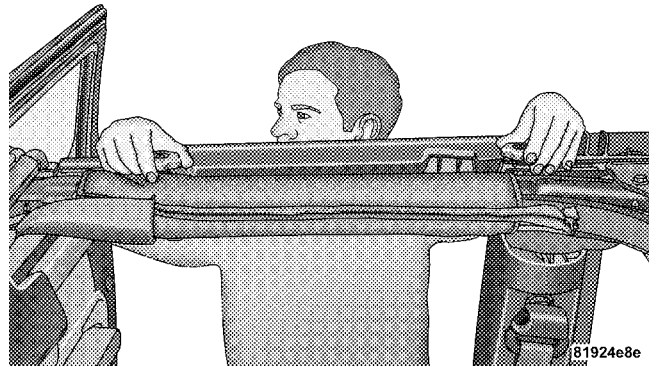

FOLDING WINDSHIELD

The fold down windshield and removable side bars on your vehicle are structural elements that can provide some protection in some accidents. The windshield also provides some protection against weather, road debris and intrusion of small branches and other objects.

Do not drive your vehicle on-road with the windshield down and the side bars removed as you lose the protection these structural elements can provide.

If required for certain off-road uses, the side bars can be removed and the windshield folded down. However, the protection afforded by these features is then lost. If you remove the side bars and fold down the windshield, drive slowly and cautiously. It is recommended that the speed of the vehicle be limited to 10 mph (16 km/h), with low range operation preferred, if you are driving off-road with the windshield folded down.

Raise the windshield and reinstall the side bars as soon as the task that required their removal is completed and before you return to on-road driving. Both you and your passenger should wear seat belts at all times, on-road and off-road, regardless of whether the windshield is raised or folded down.

Outside rear view mirrors are mounted on the doors. If you choose to remove the doors, see your authorized dealer for a replacement cowl-mounted outside mirror. Federal law requires outside mirrors on vehicles for on-road use.

WARNING!

Carefully follow these warnings to help protect against personal injury:

- Do not drive your vehicle on-road with the windshield down.
- Do not drive your vehicle unless the windshield is securely fastened, either up or down.
- Eye protection, such as goggles, should be worn at all times when the windshield is down.
- Be sure that you carefully follow the instructions for raising the windshield. Make sure that the folding windshield, windshield wipers, side bars, and all associated hardware and fasteners are correctly and tightly assembled before driving your vehicle. Failure to follow these instructions may prevent your vehicle from providing you and your passengers protection in some accidents.
- If you remove the doors, store them outside the vehicle. In the event of an accident, a loose door may cause personal injury.

Lowering the Windshield and Removing Side Bars

1. Lower the fabric top or remove the hard top following the instructions in this manual.

NOTE: To assist in properly reinstalling side bars, mark the original locations prior to removing.

2. Remove the 2 top hex bolts (13mm), and the 1 side hex bolt (13mm) visible through the trim (Do not remove plastic corner trim, sun visor bolts, or sport bar covering).

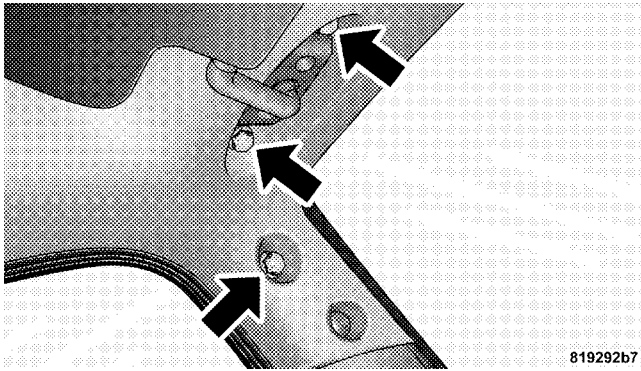

819292b7

3. Open sport bar Velcro covering.

4. Remove 1 hex bolt (13mm) visible through the plastic trim on bottom side of side bar, 1 hex bolt (13mm) on the side of the side bar, and 1 hex bolt (13mm) on top of the side bar.

NOTE: Pull side bar out horizontally when removing.

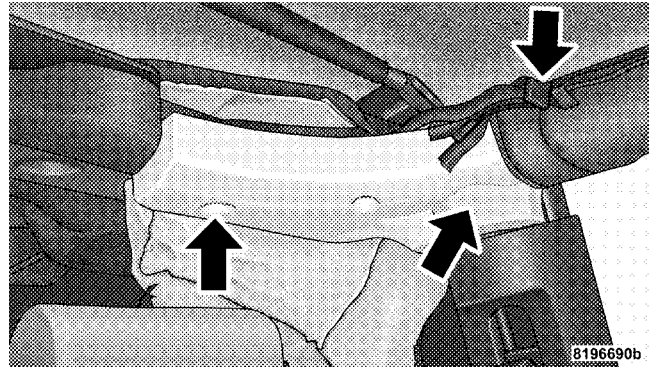

8196690b

CAUTION!

Do not remove the head impact foam from the side bars, as damage to the foam may result.

NOTE: Store all of the mounting bolts in their original threaded holes and tighten for safekeeping.

5. Remove side bar assembly, and reattach sport bar Velcro covering.

6. To safely store the side bars in your vehicle, use four cinch straps (available from your authorized dealer). Attach the straps through the slots located on the floor behind the folded rear seat at the front of the storage bin cover.

WARNING!

You or others could be injured if you carry the side bars loose in your vehicle. Remove the bars from the vehicle or securely store them as described or they may cause personal injury if an accident occurs. See your authorized dealer for the cinch straps.

7. Remove the windshield wiper arms by first pulling the wiper away from the windshield and out to the "lock" position. Unsnap the wiper arm nut caps, and remove retaining nuts. Lift the wiper arms off and store in center console or securely behind the rear seat.

8. Remove the lower windshield plates by removing the 6 black round headed Torx® head screws (using a #40 Torx® head driver) on each side of the base of the windshield.

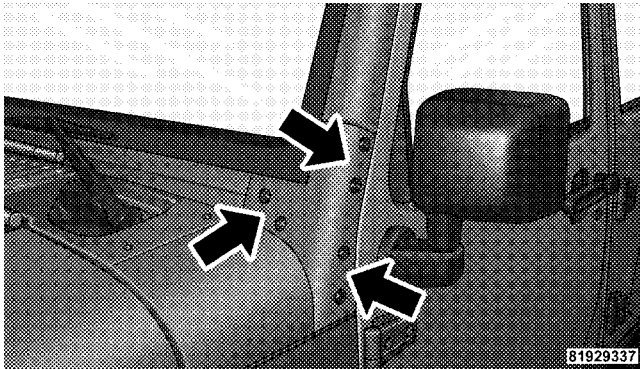

9. Lower the windshield gently until it contacts the rubber hood bumpers.

10. Secure the windshield by passing a cinch strap through the footman hoop on the center of the hood and on the center of the windshield frame. Tighten the strap to secure the windshield in place.

Raising The Windshield And Replacing Side Bars

1. Raise the windshield.

2. Loosely attach rear of side bar to sport bar. Refer to Step 4 of "Lowering Windshield and Removing Side Bars" earlier in this section.

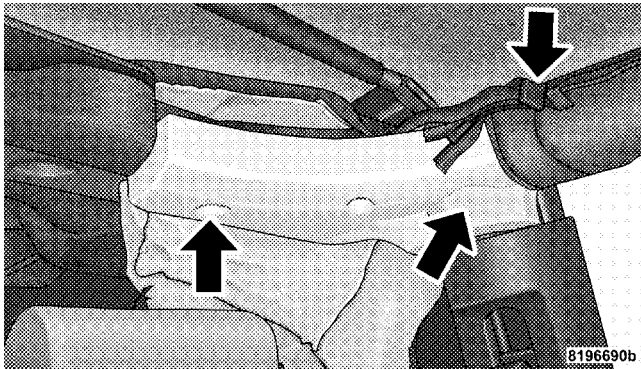

- Reattach sport bar Velcro covering.

3. Attach front of side bar to windshield frame.

- Install top two (2) hex bolts (13mm) first, then lower side hex bolt (13mm). Lower side bolt will not align until top two bolts are installed.

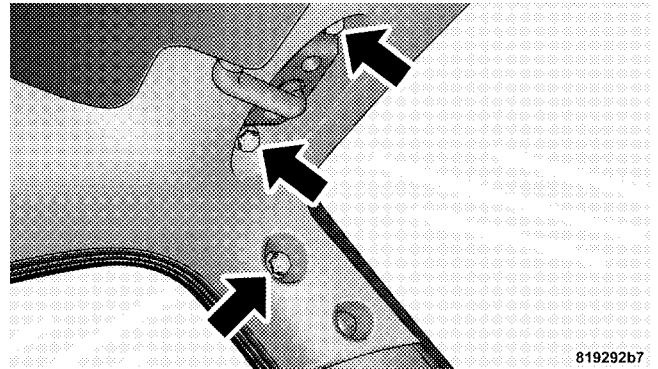

4. Tighten all side bar attachment bolts.

5. Install the lower windshield plates with the 6 black round headed Torx® head screws (using a #40 Torx® head driver) on each side of the base of the windshield.

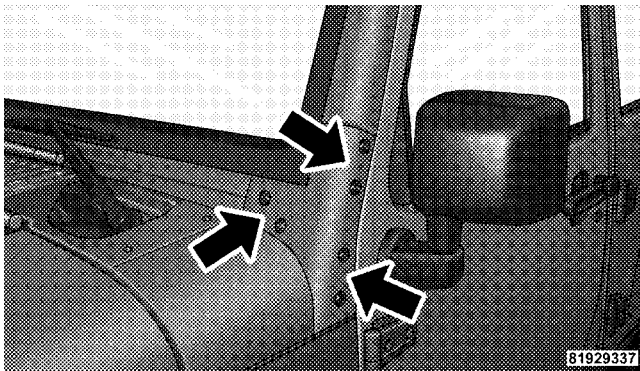

6. Reinstall wiper arms.

REAR WINDOW FEATURES — HARD TOP ONLY

Rear Window Wiper/Washer — If Equipped

A rotary ring switch on the control lever (located on the right side of the steering column), controls operation of the rear wiper/washer function. Rotating the center of the switch up to the “On” position will activate the wiper. Rotating the switch ring beyond the “On” or “Off” position will activate the rear washer. The wash pump will continue to operate as long as the lever or ring is engaged. Upon release, the wipers will cycle three times before returning to the set position.

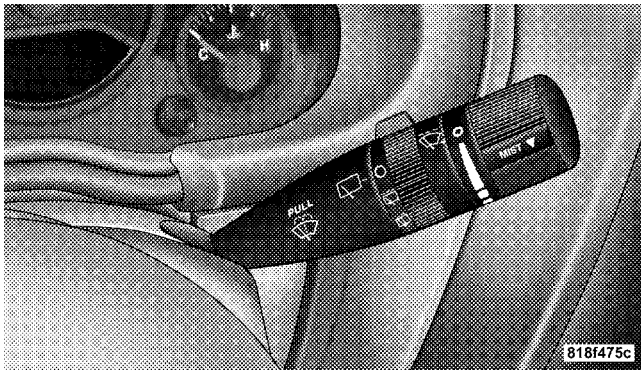

Windshield Wiper/Washer Switch

If the rear wiper is operating when the ignition is turned OFF, the wiper will automatically return to the "Park" position. When the vehicle is restarted, the wiper will resume function at whichever position the switch is set at.

If the swing gate flip-up window is open or the swing gate is open, connection to the rear window wiper is interrupted preventing activation of the rear wiper blade. When the swing gate flip-up window or the swing gate is closed, the rear wiper switch or the ignition switch needs to be turned OFF, and then to ON to restart the rear wiper.

NOTE: The rear swing gate will lock while the rear wiper is operating. The gate will stay locked until the wiper is turned off and the gate is unlocked (by key, lock switch, or key fob).

Adding Washer Fluid

The fluid reservoir for the windshield washers and the rear window washer is shared. It is located in the front of the engine compartment, and should be checked for fluid

level at regular intervals. Fill the reservoir with windshield washer solvent (not radiator antifreeze) and operate the system for a few seconds to flush out the residual water.

Rear Window Defroster — If Equipped

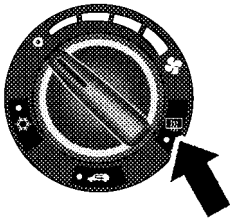

819179d2

The push-button is located on the bottom right side of the blower control knob. Press this button to turn on the rear window defroster, and the optional electric remote control heated mirrors. An amber light shows that the defroster is on.

The defroster will automatically turn off after about ten minutes. For five more minutes of operation, press the switch again. To prevent excessive battery drain, use the defroster only when the engine is operating.

CAUTION!

Use care when washing the inside of the rear window to prevent damage to heating elements. Use a soft cloth and a mild washing solution, wiping parallel to the heating elements. Also, keep all objects a safe distance from the window to prevent damaging the heating elements.

UNDERSTANDING YOUR INSTRUMENT PANEL

CONTENTS

■ Instrument Panel And Controls	188	□ Two Types Of Signals	203
■ Instrument Cluster	189	□ Electrical Disturbances	203
■ Instrument Cluster Description	190	□ AM Reception	203
■ Compass And Trip Computer — If Equipped . . .	198	□ FM Reception	204
□ Control Buttons	198	■ Sales Code REQ — AM/FM Stereo Radio And 6-Disc CD/DVD Changer (MP3/WMA Aux Jack)	204
□ Trip Conditions	199	□ Operating Instructions - Radio Mode	204
□ Compass Temperature Display	200	□ Operation Instructions - (Disc Mode For CD And MP3/WMA Audio Play, DVD-Video)	212
■ Radio General Information	203		
□ Radio Broadcast Signals	203		

186 UNDERSTANDING YOUR INSTRUMENT PANEL

□ Notes On Playing MP3/WMA Files	214	□ Operating Instructions — Satellite Radio	231
□ List Button (Disc Mode For MP3/WMA Play)	217	□ Clock Setting Procedure	231
□ Info Button (Disc Mode For MP3/WMA Play)	217	■ Satellite Radio — If Equipped	233
■ Sales Code RES — AM/FM Stereo Radio With CD Player (MP3 Aux Jack)	219	□ System Activation	233
□ Operating Instructions - Radio Mode	219	□ Electronic Serial Number/Sirius Identification Number (ENS/SID)	233
□ Operation Instructions - CD Mode For CD And MP3 Audio Play	224	□ Selecting Satellite Mode (RSC Radios)	234
□ Notes On Playing MP3 Files	227	□ Satellite Antenna	234
□ List Button (CD Mode For MP3 Play)	229	□ Reception Quality	234
□ Info Button (CD Mode For MP3 Play)	229	□ Operating Instructions - Satellite Mode	234
■ Sales Code RER — AM/FM/CD/DVD Radio With Navigation System — If Equipped	231	□ Operating Instructions - Hands Free Phone (If Equipped)	237
		□ Operating Instructions - Video Entertainment System (VES®) (If Equipped)	237

	UNDERSTANDING YOUR INSTRUMENT PANEL	187
■ CD/DVD Disc Maintenance		237
■ Radio Operation And Cellular Phones		237
■ Climate Controls		238
□ Manual Heater Only		238
	□ Manual Air Conditioning And Heating System — If Equipped	240
	□ Operating Tips	244

INSTRUMENT PANEL AND CONTROLS

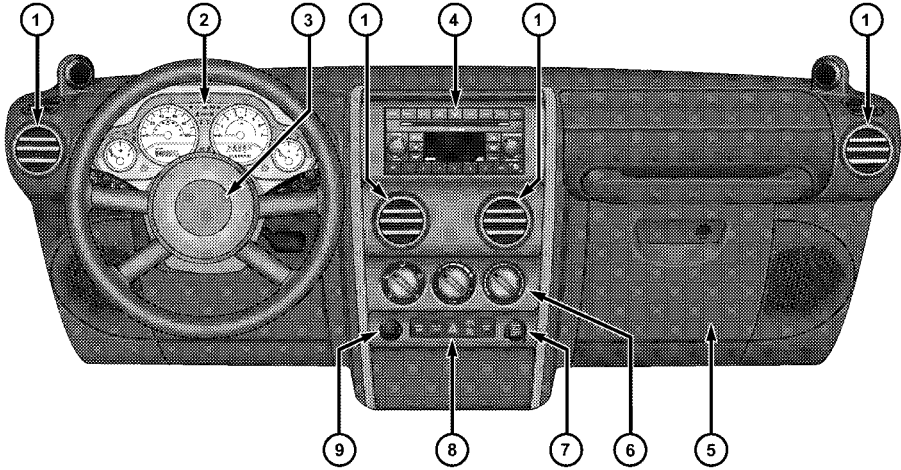

- 1. Air Outlet
- 2. Instrument Cluster
- 3. Horn

- 4. Radio
- 5. Glove Box
- 6. Climate Controls

- 7. Power Outlet
- 8. Lower Switch Bank
- 9. Auxiliary Power Outlet

INSTRUMENT CLUSTER

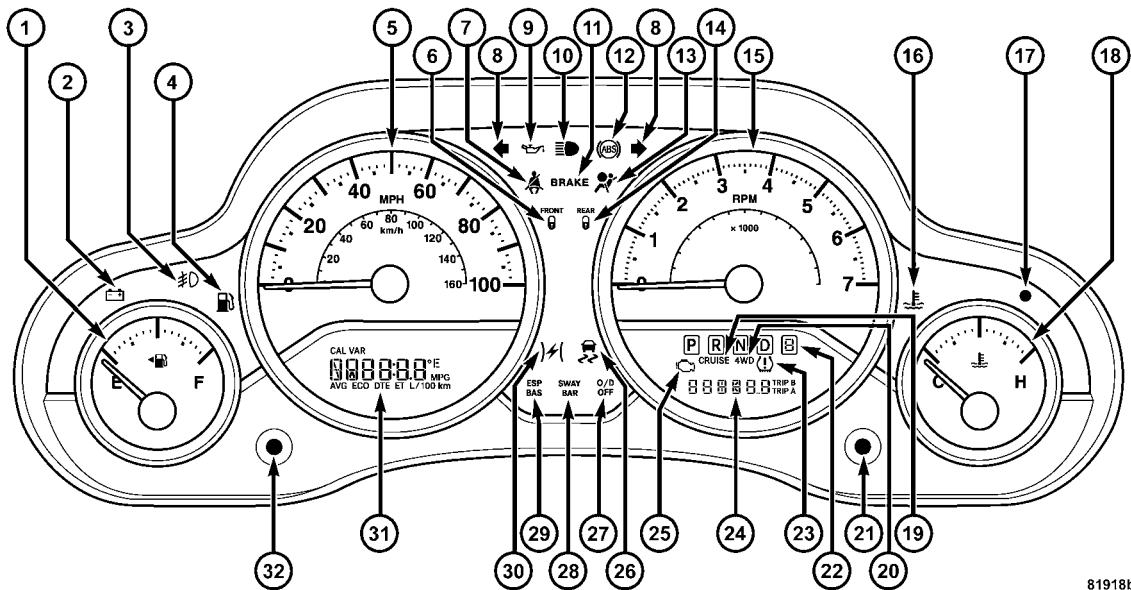

INSTRUMENT CLUSTER DESCRIPTION

Your vehicle is equipped with the instrument cluster described on the following pages.

1. Fuel Gauge

The pointer shows the level of fuel in the fuel tank. When the fuel gauge pointer initially moves to E, for your safety, approximately 2 U.S. Gallons (7.6L) of fuel remain.

NOTE: When the ignition switch is turned to OFF, the fuel gauge, voltmeter, oil pressure and temperature gauges may not show accurate readings. When the engine is not running, turn the ignition switch to ON to obtain accurate readings.

2. Charging System Warning Light

 This light shows the status of the electrical charging system. The light should come on for three seconds when the ignition is first turned ON. If the light comes back on immediately or comes on while driving, it means that there is a problem with the charging system

or the battery is low. Also, a chime will sound if the light comes back on. See your authorized dealer immediately.

3. Front Fog Light Indicator Light — If Equipped

 This light shows when the front fog lights are on.

4. Low Fuel Warning Light

 When the fuel level reaches approximately 2 U.S. Gallons (7.6L) this light will come on and remain on until fuel is added. The “Low Fuel Warning Light” may turn on and off again, especially during and after hard braking, accelerations, or turns. This occurs due to the shifting of the fuel in the tank.

5. Speedometer

Indicates vehicle speed.

6. Front Axle Lock Indicator Light — If Equipped

FRONT
 Indicates when the front axle lock has been activated.

7. Seat Belt Indicator Light

A warning chime and an indicator light will alert you to buckle the seat belts. When the belt is buckled, the chime will stop, but the light will stay on until it times out (about 6 seconds).

8. Turn Signal Indicator Lights

The arrows will flash with the exterior turn signals when the turn signal lever is operated. A tone will chime if the turn signals are left on for more than 1 mile (2 km).

9. Oil Pressure Warning Light

Shows low engine oil pressure. The light will come on and remain on when the ignition switch is turned from the OFF to the ON position, and the light will turn off after the engine is started. If the bulb does not come on, have the system checked by your authorized dealer.

If the warning light comes on and remains on while driving, stop the vehicle and shut off the engine. **DO NOT OPERATE THE VEHICLE UNTIL THE CAUSE IS CORRECTED.** Also, a single chime will sound.

10. High Beam Indicator Light

This light shows that the headlights are on high beam. Pull the turn signal lever towards the steering wheel to switch the headlights from high or low. If the driver's door is open, and the headlights or parklights are left on, the "High Beam Indicator Light" will flash and a chime will sound.

11. Brake Warning Light

BRAKE After ignition is turned on, illuminates to indicate function check at vehicle start-up. Indicates parking brake is applied. If the light stays on when the parking brake is off, it indicates a possible brake system fluid leak or low pressure level, **see your authorized dealer immediately.**

If the parking brake is applied and the vehicle is in motion, the red BRAKE warning light will “flash” and a chime will sound.

The operation of the BRAKE warning light can be checked by turning the ignition switch from the OFF position to the ON position. The light should illuminate for approximately two seconds. The light should then turn off unless the parking brake is applied or a brake fault is detected. If the light does not illuminate, have the light inspected by an authorized dealer.

12. Anti-Lock (ABS) Warning Light

 After ignition is turned on, illuminates to indicate function check at vehicle start-up. If light remains on after start-up or comes on and stays on at road speeds, it may indicate that the ABS has detected a malfunction or has become inoperative. The system reverts to standard non-anti-lock brakes.

If both the red BRAKE warning light and the amber ABS warning light are on, see your dealer immediately. Refer to “Anti-Lock Brake System” in Section 5 of this manual.

13. Airbag Warning Light



This indicator lights and remains lit for 6 to 8 seconds when the ignition is first turned on. If the light does not come on for 6 to 8 seconds, stays on or comes on while driving, have the airbag system checked by an authorized dealer.

14. Rear Axle Lock Indicator Light — If Equipped



Indicates when the rear axle lock has been activated.

15. Tachometer

Indicates the engine speed in revolutions per minute (RPM).

CAUTION!

Do not operate the engine with the tachometer pointer in the red area. Engine damage will occur.

16. Engine Coolant Temperature Warning Light

This light warns of an overheated engine condition. If the engine is critically hot, a warning chime will sound 10 times. After the chime turns off, the engine will still be critically hot until the light goes out.

17. Sentry Key/Security Alarm Indicator Light — If Equipped

Refer to “Sentry Key Immobilizer System” or “Vehicle Security Alarm” in Section 2 of this manual.

18. Coolant Temperature Gauge

Indicates engine coolant temperature. The red zone to the far right indicates possible overheating. Seek authorized service immediately if the

gauge operates in the red zone. In U.S. vehicles, temperature is indicated in degrees fahrenheit; in Canadian vehicles in degrees centigrade.

19. Cruise Indicator Light

CRUISE This light shows when the electronic speed control system is turned on.

20. 4WD Indicator Light — If Equipped

4WD This light alerts the driver that the vehicle is in the four-wheel drive mode, and the front and rear driveshafts are mechanically locked together forcing the front and rear wheels to rotate at the same speed.

21. Odometer/Trip Odometer Reset Button

Press this button to change the display from odometer to either of the two trip odometer settings. Trip A or Trip B will appear when in the trip odometer mode. Push in and hold the button for two seconds to reset the trip odometer to 0 miles or kilometers. The odometer must be in trip mode to reset.

22. *Transmission Range Indicator*

This display indicator shows the automatic transmission gear selection.

23. *Tire Pressure Monitoring Telltale Light — If Equipped*



Each tire, including the spare (if provided), should be checked monthly when cold and inflated to the inflation pressure recommended by the vehicle manufacturer on the vehicle placard or tire inflation pressure label. (If your vehicle has tires of a different size than the size indicated on the vehicle placard or tire inflation pressure label, you should determine the proper tire inflation pressure for those tires.)

As an added safety feature, your vehicle may be equipped with a tire pressure monitoring system (TPMS) that illuminates a low tire pressure telltale when one or

more of your tires is significantly under-inflated. Accordingly, when the low tire pressure telltale illuminates, you should stop and check your tires as soon as possible, and inflate them to the proper pressure. Driving on a significantly under-inflated tire causes the tire to overheat and can lead to tire failure. Under-inflation also reduces fuel efficiency and tire tread life, and may affect the vehicle's handling and stopping ability.

Please note that the TPMS is not a substitute for proper tire maintenance, and it is the driver's responsibility to maintain correct tire pressure, even if under-inflation has not reached the level to trigger illumination of the TPMS low tire pressure telltale.

The "Tire Pressure Monitoring Telltale Light" will illuminate in the instrument cluster, and an audible chime will be activated when one or more tire pressures is low. The "Tire Pressure Monitoring Telltale Light" will flash on

and off for 60 seconds when a system fault is detected. The flash cycle will repeat every ten minutes or until the fault condition is removed and reset.

CAUTION!

The TPMS has been optimized for the original equipment tires and wheels. TPMS pressures and warnings have been established for the tire size equipped on your vehicle. Undesirable system operation or sensor damage may result when using replacement equipment that is not of the same size, type, and/or style. After-market wheels can cause sensor damage. Do not use tire sealant from a can, or balance beads if your vehicle is equipped with a TPMS, as damage to the sensors may result.

24. Odometer/Trip Odometer

The odometer shows the total distance the vehicle has been driven.

U.S. federal regulations require that upon transfer of vehicle ownership, the seller certify to the purchaser the correct mileage that the vehicle has been driven. Therefore, if the odometer reading is changed during repair or replacement, be sure to keep a record of the reading before and after the service so the correct mileage can be determined.

25. Malfunction Indicator Light



This light is a part of an Onboard Diagnostic System called OBD II that monitors engine, and automatic transmission control systems. The light will illuminate when the ignition is in the ON position before engine start. If the bulb does not come on when turning the key from OFF to ON, have the condition checked promptly.

Certain conditions such as a loose or missing gas cap, poor quality fuel, etc. may illuminate the light after engine start. The vehicle should be serviced if the light

stays on through several typical driving styles. In most situations, the vehicle will drive normally and will not require towing.

When the engine is running, the “Malfunction Indicator Light” may flash to alert serious conditions that could lead to immediate loss of power or severe catalytic converter damage. The vehicle should be serviced as soon as possible if this occurs.

26. *Electronic Stability Program (ESP) Indicator Light/Traction Control System (TCS) Indicator Light*



This indicator light starts to flash as soon as the tires lose traction and the ESP system becomes active. The “ESP/TCS Indicator Light” also flashes when TCS is active. If the “ESP/TCS Indicator Light” begins to flash during acceleration, ease up on the accelerator and apply as little throttle as possible. Be sure to adapt your speed and driving to the prevailing road conditions. The “ESP/TCS Indicator Light” will flash any time the ESP or TCS is active and

helping to improve vehicle stability. If the “ESP/TCS Indicator Light” is on solid, the ESP system has been turned off by the driver or a temporary condition exists that will not allow full ESP function.

27. *O/D (Overdrive) Off Indicator Light*

O/D OFF This light will illuminate when the O/D OFF button has been selected. The O/D OFF button is located on the gear shift lever.

28. *Sway Bar Indicator Light — If Equipped*



This light will illuminate when the front sway bar is disconnected.

29. *Electronic Stability Program (ESP) Warning Light/Brake Assist System (BAS) Warning Light*



The ESP/BAS warning light in the instrument cluster comes on when the ignition switch is turned to the “ON” position. The light should go out with the engine running. If the ESP/BAS warning light comes on continuously with the

engine running, a malfunction has been detected in either the ESP or the BAS system. If this light stays illuminated, have the ESP and BAS checked at your authorized dealer as soon as possible. Refer to “Electronic Brake Control System” in Section 5 for more information.

30. Electronic Throttle Control (ETC) Warning Light — If Equipped

 This light informs you of a problem with the Electronic Throttle Control System. If a problem is detected while the engine is running, the light will either stay on or flash depending on the nature of the problem. Cycle the ignition key when the vehicle is safely and completely stopped and the gear selector is placed in the P (Park) position. The light should turn off. If the light remains on with the engine running, your vehicle will usually be drivable, however, see your dealer for service as soon as possible.

If the light continues to flash when the engine is running, immediate service is required and you may experience reduced performance, an elevated / rough idle, or engine stall and your vehicle may require towing. The light will come on when the ignition is first turned on and remain on briefly as a bulb check. If the light does not come on during starting, have the system checked by an authorized dealer.

31. Compass/Mini-Trip Computer Display — If Equipped

When the appropriate conditions exist, this display shows the Mini-Trip Computer messages. Refer to “Mini-Trip Computer” later in this section.

32. Compass/Mini-Trip Computer Button—If Equipped
Press this button to switch between the different functions.

COMPASS AND TRIP COMPUTER — IF EQUIPPED

This feature, located on the instrument cluster (speedometer and tachometer), displays information on outside temperature, compass direction, and trip information.

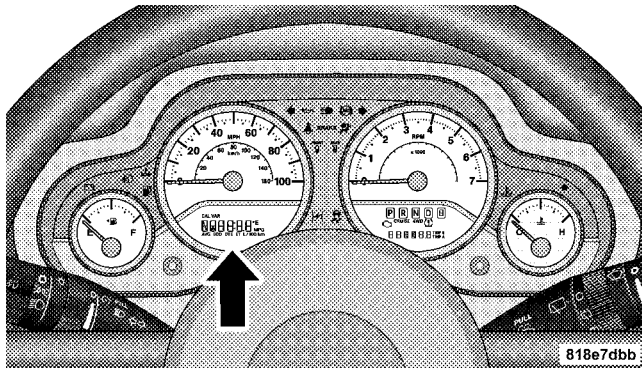

The compass/trip computer, when the appropriate conditions exist, will show the following messages in the odometer display:

- Door Ajar (door)
- Swing Gate Ajar (gATE)
- Loose Fuel Cap (gASCAP)
- IOD Fuse (noFUSE)
- ESP Off (ESPOFF)

These messages can be manually turned off by pressing the right button (on the instrument cluster).

Control Buttons

Press and release the left button (on the instrument cluster) to access the computer displays.

Press and hold the left button (on the instrument cluster) for 2 to 3 seconds to switch from English to Metric displays.

Reset

Press and hold the right button (on the instrument cluster) while function is being displayed to reset.

The following trip conditions can be reset:

- AVG ECO (changes to present fuel economy)
- ET

Trip Conditions**Average Fuel Economy (AVG ECO)**

This display shows the average fuel economy since the last reset.

Estimated Range (DTE)

This display shows the estimated distance that can be traveled with the fuel remaining in the tank. This estimated distance is based on the most recent trip information: $(\text{Average Fuel Economy}) \times (\text{Fuel Remaining})$

This display cannot be reset.

Elapsed Time (ET)

This display shows the accumulated ignition ON time since the last reset.

Trip Odometer (ODO)

This display shows the distance traveled since the last reset. Press and release the right button (on the instrument cluster) to switch from odometer, to trip A or trip B. Press and hold the right button while the odometer/trip odometer is displayed to reset.

Trip A

Shows the total distance traveled for trip A since the last reset.

Trip B

Shows the total distance traveled for trip B since the last reset.

Compass Temperature Display

This display provides the outside temperature and one of eight compass readings to indicate the direction the vehicle is facing.

WARNING!

Even if the display still reads a few degrees above 32°F (0°C), the road surface may be icy, particularly in woods or on bridges. Drive carefully under such conditions to prevent an accident and possible personal injury or property damage.

Compass Calibration

The Automatic Compass Calibration feature eliminates the need for the operator intervention under normal conditions. If the CAL indicator is lit, the compass needs to be calibrated. A good calibration requires a level surface and an environment free of large metal objects such as large buildings, bridges, underground cables, railroad tracks, etc.

Automatic Compass Calibration

The self-calibrating feature of the compass eliminates the need to calibrate the compass for normal conditions. During a short initial period, the compass may appear erratic and the CAL symbol will appear (blinking) on the display. After the vehicle has completed at least one complete circle under 5 mph (8 km/h) in an area free from large metal objects, calibration will be complete when the CAL symbol is extinguished.

After initial calibration, the compass will continue to automatically update this calibration whenever the vehicle is in motion.

Manual Compass Calibration

NOTE: Before attempting a manual compass calibration, the engine must be running and the transmission in the P (Park) position (if equipped).

Compass calibration can also be requested. To manually calibrate the compass, you must first enter the variance mode. Press the and hold the left button (located on the instrument cluster) for approximately 10 seconds to enter the variance mode, and release the button when the VAR symbol appears. The current variance value will also be displayed. Once in the variance mode, it is necessary to release the button, and then press and hold it again (approximately 10 seconds) until CAL is displayed (solid not blinking). Manual compass calibration has been initiated. Drive the vehicle slowly in one or more circles

under 5 mph (8 km/h) in an area free from large metal objects until the CAL symbol is extinguished.

When the CAL symbol no longer is displayed, the compass is calibrated and should display correct headings. Verify proper calibration by checking North (N), South (S), East (E), and West (W). If the compass does not appear accurate, repeat the calibration procedure in another area.

Compass Variance

Variance is the difference between magnetic North and geographic North. For proper compass function, the correct variance zone must be set.

Setting the Compass Variance

Refer to the variance map for the correct compass variance zone. To check the variance zone, the ignition must be on. Press and hold the left button (located on the instrument cluster) for approximately 10 seconds to enter the variance mode and release the button when the VAR

symbol appears. The current variance value will also be displayed. To change the zone, press the left button once to increment the zone. The default is Zone 8. After Zone 15, the values will wrap around to Zone 1. When the correct zone is displayed (per the Zone map) for the zone that the vehicle is located in, wait for about 5 seconds, then the trip computer will store the variance value in memory and the compass will resume normal operation.

NOTE: The US/Metric display will change from English to Metric or Metric to English before the VAR symbol appears, however, it will revert back to its original setting after programming the compass functions.

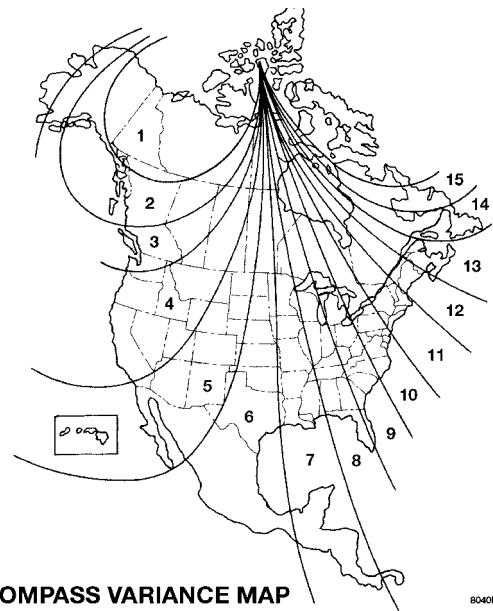

Outside Temperature

If the outside temperature is more than 131°F (55°C), the display will show 131°F (55°C). When the outside temperature is less than -40°F (-40°C), the display will show -40°F (-40°C).

RADIO GENERAL INFORMATION**Radio Broadcast Signals**

Your new radio will provide excellent reception under most operating conditions. Like any system, however, car radios have performance limitations, due to mobile operation and natural phenomena, which might lead you to believe your sound system is malfunctioning. To help you understand and save you concern about these “apparent” malfunctions, you must understand a point or two about the transmission and reception of radio signals.

Two Types of Signals

There are two basic types of radio signals... AM or Amplitude Modulation, in which the transmitted sound causes the amplitude, or height, of the radio waves to vary... and FM or Frequency Modulation, in which the frequency of the wave is varied to carry the sound.

Electrical Disturbances

Radio waves may pick up electrical disturbances during transmission. They mainly affect the wave amplitude, and thus remain a part of the AM reception. They interfere very little with the frequency variations that carry the FM signal.

AM Reception

AM sound is based on wave amplitude, so AM reception can be disrupted by such things as lightning, power lines and neon signs.

FM Reception

Because FM transmission is based on frequency variations, interference that consists of amplitude variations can be filtered out, leaving the reception relatively clear, which is the major feature of FM radio.

NOTE: The radio, steering wheel radio controls (if equipped), and 6 disc CD/DVD changer (if equipped) will remain active for up to 10 minutes after the ignition switch has been turned off. Opening a vehicle front door will cancel this feature.

SALES CODE REQ — AM/FM STEREO RADIO AND 6-DISC CD/DVD CHANGER (MP3/WMA AUX JACK)

NOTE: The radio sales code is located on the lower right side of your radio faceplate.

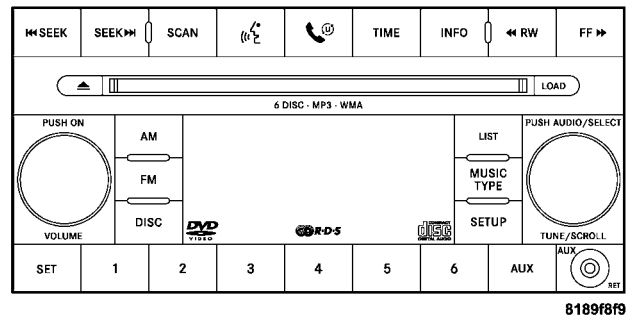

**REQ Radio
Operating Instructions - Radio Mode**

NOTE: The ignition switch must be in the ON or ACC position to operate the radio.

Power Switch/Volume Control (Rotary)

Press the ON/VOL control to turn the radio ON. Press the ON/VOL a second time to turn OFF the radio.

Electronic Volume Control

The electronic volume control turns continuously (360 degrees) in either direction without stopping. Turning the volume control to the right increases the volume and to the left decreases it.

When the audio system is turned on, the sound will be set at the same volume level as last played.

SEEK Buttons (Radio Mode)

Press and release the SEEK buttons to search for the next listenable station in AM/FM mode. Press the right switch to seek up and the left switch to seek down. The radio will remain tuned to the new station until you make another selection. Holding either button will bypass stations without stopping until you release it.

SCAN Button (Radio Mode)

Pressing the SCAN button causes the tuner to search for the next listenable station, in either AM, FM or Satellite (if equipped) frequencies, pausing for 5 seconds at each listenable station before continuing to the next. To stop the search, press SCAN a second time.

INFO Button (Radio Mode)

Press the INFO button for an RDS station (one with call letters displayed). The radio will return a Radio Text message broadcast from an FM station (FM mode only).

TIME Button

Press the TIME button and the time of day will be displayed. In AM or FM mode, pressing the TIME button will switch between the time and frequency displays.

Clock Setting Procedure

1. Press and hold the TIME button, until the hours blink.

2. Adjust the hours by turning the right side TUNE control knob.
3. After the hours are adjusted, press the right side TUNE control knob to set the minutes. The minutes will begin to blink.
4. Adjust the minutes using the right side TUNE control knob. Press the TUNE control knob to save time change.
5. To exit, press any button/knob or wait 5 seconds.

The clock can also be set by pressing the SETUP button and selecting the "SET HOME CLOCK" entry. Once in this display follow the above procedure, starting at step 2.

RW/FF (Radio Mode)

Pressing the rewind or fast forward button causes the tuner to search for the next frequency in the direction of the arrows. This feature operates in either AM, FM or Satellite (if equipped) frequencies.

TUNE Control (Radio Mode)

Turn the right side rotary control clockwise to increase or counter-clockwise to decrease the frequency.

Setting the Tone, Balance, and Fade

Press the rotary TUNE control knob and BASS will display. Turn the TUNE control knob to the right or left to increase or decrease the Bass tones.

Press the rotary TUNE control knob a second time and MID will display. Turn the TUNE control knob to the right or left to increase or decrease the Mid Range tones.

Press the rotary TUNE control knob a third time and TREBLE will display. Turn the TUNE control knob to the right or left to increase or decrease the Treble tones.

Press the rotary TUNE control knob a fourth time and BALANCE will display. Turn the TUNE control knob to the right or left to adjust the sound level from the right or left side speakers.

Press the rotary TUNE control knob a fifth time and FADE will display. Turn the TUNE control knob to the left or right to adjust the sound level between the front and rear speakers.

Press the rotary TUNE control knob again to exit setting tone, balance and fade.

MUSIC TYPE Button (Radio Mode)

Pressing this button once will turn on the Music Type mode for 5 seconds. Pressing the Music Type button or turning the TUNE control knob within 5 seconds will allow the program format type to be selected. Many radio stations do not currently broadcast Music Type information.

Toggle the Music Type button to select the following format types:

Program Type	16 Digit-Character Display
No program type or undefined	None
Adult Hits	Adlt Hit
Classical	Classicl
Classic Rock	Cls Rock
College	College
Country	Country
Foreign Language	Language
Information	Inform
Jazz	Jazz
News	News
Nostalgia	Nostalga
Oldies	Oldies
Personality	Persnlty
Public	Public
Rhythm and Blues	R & B

Program Type	16 Digit-Character Display
Religious Music	Rel Musc
Religious Talk	Rel Talk
Rock	Rock
Soft	Soft
Soft Rock	Soft Rck
Soft Rhythm and Blues	Soft R&B
Sports	Sports
Talk	Talk
Top 40	Top 40
Weather	Weather

By pressing the SEEK button when the Music Type icon is displayed, the radio will be tuned to the next frequency station with the same selected Music Type name. The Music Type function only operates when in the FM mode.

If a preset button is activated while in the Music Type (Program Type) mode, the Music Type mode will be exited and the radio will tune to the preset station.

SETUP Button

Pressing the SETUP button allows you to select between the following items:

NOTE: Use Tune Control Knob to scroll through the entries, and push Audio/Select button to select an entry and make changes.

- **DVD Enter** - When the disc is in DVD Menu mode, selecting DVD Enter will allow you to play the current highlighted selection. Use the remote control to scroll up and down the menu (If Equipped).
- **DISC Play/Pause** - You can toggle between playing the DVD or pausing the DVD, by pushing the SELECT button (If Equipped).



- **DVD Play Options** - Selecting the DVD Play Options will display the following:
 - Subtitle – Repeatedly Pressing SELECT will switch subtitles to different subtitle languages that are available on the disc (If Equipped).
 - Audio Stream – Repeatedly Pressing SELECT will switch to different audio languages (if supported on the disc) (If Equipped).
 - Angle – Repeatedly Pressing SELECT will change the viewing angle if it is supported by the DVD disc (If Equipped).
 - **VES Lock** - Locks out rear VES remote controls (If Equipped).
 - **VES CH1/CH2** - Allows the user to change mode of either the IR1 or IR2, wireless headphones, by pressing the Audio/Select button (If Equipped).
 - **Set Home Clock** - Pressing the SELECT button will allow user to set the clock. Turn TUNE control knob to adjust the hours then press and turn the TUNE control knob to adjust the minutes. Press the TUNE control knob again to save changes.
 - **Player Defaults** - Selecting this item will allow the user to scroll through the following items, and set defaults according to customer preference.
- NOTE:** The available selections for each of the above entries varies depending upon the disc.
- NOTE:** These selections can only be made while playing a DVD.
- **VES Power** - Allows you to turn VES ON and OFF (If Equipped).

Menu Language — If Equipped

Selecting this item will allow the user to choose the default startup DVD menu language (effective only if language supported by disc). If customer wishes to select

a language not listed, then scroll down and select "other". Enter the 4 digit country code using the TUNE control knob to scroll up and down to select the # and then push to select.

Audio Language — If Equipped

Selecting this item will allow the user to choose a default audio language (effective only if language supported by disc). If customer wishes to select a language not listed, then scroll down and select "other". Enter the country code using the TUNE control knob to scroll up and down to select the # and then push to select.

Subtitle Language — If Equipped

Selecting this item will allow the user to choose a default subtitle language (effective only if language supported by disc). If customer wishes to select a language not listed, then scroll down and select "other". Enter the

country code using the TUNE control knob to scroll up and down to select the # and then push to select.

Subtitles — If Equipped

Selecting this item will allow the user to choose between subtitle OFF or ON.

Audio DRC — If Equipped

Selecting this item will allow the user to limit maximum audio dynamic range - The default is set to "High" and under this setting, dialogues are played at 11 db higher than if the setting is "Normal."

Aspect Ratio — If Equipped

Selecting this item will allow the user to choose between wide screen, pan scan, and letter box.

AutoPlay — If Equipped

When this is set to ON and a DVD video is inserted, it will bypass the DVD menu screen and automatically play the movie. In some rare cases, the DVD player may not auto play the main title. In such cases, use the menu button on the remote control to select desired title to play.

NOTE: The user will have to set these defaults before loading a disc. If changes are made to these settings after a disc is loaded, changes will not be effective. Also, the defaults are effective only if the disc supports the customer preferred settings.

AM and FM Buttons (Radio Mode)

Press buttons to select AM or FM Modes.

SET Button (Radio Mode) — To Set the Push-Button Memory

When you are receiving a station that you wish to commit to push-button memory, press the SET button.

The symbol SET 1 will now show in the display window. Select the button (1-6) you wish to lock onto this station and press and release that button. If a button is not selected within 5 seconds after pressing the SET button, the station will continue to play but will not be stored into push-button memory.

You may add a second station to each push-button by repeating the above procedure with this exception: Press the SET button twice and SET 2 will show in the display window. Each button can be set for SET 1 and SET 2 in both AM and FM. This allows a total of 12 AM, 12 FM and 12 Satellite (if equipped) stations to be stored into push-button memory. The stations stored in SET 2 memory can be selected by pressing the push-button twice.

Every time a preset button is used a corresponding button number will be displayed.

Buttons 1 - 6 (Radio Mode)

These buttons tune the Radio to the stations that you commit to push-button memory (12 AM, 12 FM, and 12 Satellite (if equipped) stations).

DISC Button

Pressing the DISC button will allow you to switch from AM/FM modes to Disc modes.

Operation Instructions - (DISC MODE for CD and MP3/WMA Audio Play, DVD-VIDEO)

The radio DVD player and many DVD discs are coded by geographic region. These region codes must match in order for the disc to play. If the region code for the DVD disc does not match the region code for the radio DVD player, it will not play the disc. Customers may take their vehicle to a authorized dealer to change the region code of the player a maximum total of 5 times.

CAUTION!

The radio may shut down during extremely hot conditions. When this occurs, the radio will indicate "Disc Hot" and shut off until a safe temperature is reached. This shutdown is necessary to protect the optics of the DVD player and other radio internal components.

NOTE: The ignition switch must be in the ON or ACC position to operate the radio.

LOAD Button — Loading Compact Disc(s)

Press the LOAD button and the push-button with the corresponding number (1-6) where the CD is being loaded. The radio will display PLEASE WAIT and prompt when to INSERT DISC. After the radio displays "INSERT DISC," insert the CD into the player.

Radio display will show "LOADING DISC" when the disc is loading and "READING DISC" when the radio is reading the disc.

CAUTION!
<ul style="list-style-type: none"> • This CD player will accept 4 3/4 inch (12 cm) discs only. The use of other sized discs may damage the CD player mechanism.

Eject Button — Ejecting Compact Disc(s)



Press the eject button and the push-button with the corresponding number (1-6) where the CD was loaded and the disc will unload and move to the entrance for easy removal. Radio display will show "EJECTING DISC" when the disc is being ejected and prompt the user to remove the disc.

Press and hold the eject button for 5 seconds and all CDs will be ejected from the radio.

The disc can be ejected with the radio and ignition OFF.

SEEK Button (CD MODE)

Press the right SEEK button for the next selection on the CD. Press the left SEEK button to return to the beginning of the current selection, or return to the beginning of the previous selection if the CD is within the first second of the current selection. Pressing and holding the SEEK button will allow to scroll through tracks faster in CD, MP3/MWA modes.

SCAN Button (CD MODE)

Press the Scan button to scan through each track on the CD currently playing.

TIME Button (CD MODE)

Press this button to change the display from a large CD playing time display to a small CD playing time display.

RW/FF (CD MODE)

Press and hold FF (Fast Forward) and the CD player will begin to fast forward until FF is released or RW or another CD button is pressed. The RW (Reverse) button works in a similar manner.

AM or FM Button (CD MODE)

Switches the Radio to the Radio mode.

RND Button (Random Play Button) (CD MODE)

Press this button while the CD is playing to activate Random Play. This feature plays the selections on the compact disc in random order to provide an interesting change of pace.

Press the right SEEK button to move to the next randomly selected track.

Press the RND button a second time to stop Random Play.

Notes On Playing MP3/WMA Files

The radio can play MP3/WMA files, however, acceptable MP3/WMA file recording media and formats are limited. When writing MP3/WMA files, pay attention to the following restrictions.

Supported Media (Disc Types)

The MP3/WMA file recording media supported by the radio are CDDA, CD-R, CD-RW, MP3, WMA, DVD Video, DVD-R, DVD-RW, DVD+R, DVD+RW, and CDDA+MP3.

Supported Medium Formats (File Systems)

The medium formats supported by the radio are ISO 9660 Level 1 and Level 2 and includes the Joliet extension. When reading discs recorded using formats other than ISO 9660 Level 1 and Level 2, the radio may fail to read files properly and may be unable to play the file normally. UDF and Apple HFS formats are not supported.

The radio uses the following limits for file systems:

- Maximum number of directory levels: 8
- Maximum number of files: 255
- Maximum number of folders: 100
- Maximum number of characters in file/folder names:
 - Level 1: 12 (including a separator "." and a 3-character extension)
 - Level 2: 31 (including a separator "." and a 3-character extension)

Multisession disc formats are supported by the radio. Multisession discs may contain combinations of normal CD audio tracks and computer files (including MP3/WMA files). Discs created with an option such as "keep disc open after writing" are most likely multisession discs. The use of multisession for CD audio or MP3/WMA playback may result in longer disc loading times.

If a disc contain multi formats, such as CD audio and mp3/wma tracks, the radio will only play the mp3/wma tracks on that disc.

Supported MP3/WMA File Formats

The radio will recognize only files with the *.MP3/WMA extension as MP3/WMA files. Non-MP3/WMA files named with the *.MP3/WMA extension may cause playback problems. The radio is designed to recognize the file as an invalid MP3/WMA and will not play the file.

When using the MP3/WMA encoder to compress audio data to an MP3/WMA file, the bit rate and sampling frequencies in the following table are supported. In addition, variable bit rates (VBR) are also supported. The majority of MP3/WMA files use a 44.1 kHz sampling rate and a 192, 160, 128, 96 or VBR bit rates.

MPEG Specification	Sampling Frequency (kHz)	Bit rate (kbps)
MPEG-1 Audio Layer 3	48, 44.1, 32	320, 256, 224, 192, 160, 128, 112, 96, 80, 64, 56, 48
MPEG-2 Audio Layer 3	24, 22.05, 16	160, 128, 144, 112, 96, 80, 64, 56, 48
WMA Specification	Sampling Frequency (kHz)	Bit Rate (kbps)
WMA	44.1 and 48	48, 64, 96, 128, 160, 192 VBR

ID3 Tag information for artist, song title and album title are supported for version 1 ID3 tags. ID3 version 2 is not supported by the radios.

Playlist files are not supported. MP3 Pro files are not supported.

Playback of MP3/WMA Files

When a medium containing MP3/WMA data is loaded, the radio checks all files on the medium. If the medium contains a lot of folders or files, the radio will take more time to start playing the MP3/WMA files.

Loading times for playback of MP3/WMA files may be affected by the following:

- Media - CD-RW media may take longer to load than CD-R media
- Medium formats - Multisession discs may take longer to load than non-multisession discs
- Number of files and folders - Loading times will increase with more files and folders

To increase the speed of disc loading, it is recommended to use CD-R media and single-session discs. To create a single-session disc, enable the Disc at Once option before writing to the disc.

LIST Button (DISC Mode for MP3/WMA Play)

Pressing the LIST button will bring up a list of all folders on the disc. Scrolling up or down the list is done by turning the TUNE control knob. Selecting a folder by pressing the TUNE control knob will begin playing the files contained in that folder (or the next folder in sequence if the selection does not contain playable files).

The folder list will time out after 5 seconds.

INFO Button (DISC Mode for MP3/WMA Play)

Pressing the INFO button repeatedly will scroll through the following TAG information: Song Title, Artist, File Name, and Folder Name (if available).

Press the INFO button once more to return to "elapsed time" priority mode.

Press and hold the INFO button for 3 seconds or more and radio will display song titles for each file.

Press and hold the INFO button again for 3 seconds to return to "elapsed time" display.

Operation Instructions - Auxiliary Mode

The auxiliary (AUX) jack is an audio input jack, which allows the user to plug in a portable device such as an MP3/WMA player, cassette player or microphone and utilize the vehicle's audio system to amplify the source and play through the vehicle speakers.

Pushing the AUX button will change the mode to auxiliary device if the AUX jack is connected.

NOTE: The AUX device must be turned on and the device's volume set to proper level. If the AUX audio is not loud enough, turn the device's volume up. If the AUX audio sounds distorted, turn the device's volume down.

SEEK Button (Auxiliary Mode)

No function.

SCAN Button (Auxiliary Mode)

No function.

EJECT Button (Auxiliary Mode)



No function.

PSCAN Button (Auxiliary Mode)

No function.

TIME Button (Auxiliary Mode)

Press this button to change the display from elapsed playing time to time of day. The time of day will be displayed for 5 seconds.

RW/FF (Auxiliary Mode)

No function.

SET Button (Auxiliary Mode)

No function.

Operating Instructions - Hands Free Phone (If Equipped)

Refer to Hands Free Phone in Section 3 of the Owner's Manual.

Operating Instructions - Satellite Radio Mode (If Equipped)

Refer to the Satellite Radio section of the Owner's Manual.

Operating Instructions - Video Entertainment System (VES®) (If Equipped)

Refer to separate Video Entertainment System (VES®) Guide.

Dolby

Manufactured under licence from Dolby Laboratories. "Dolby" and the double-D symbol are trademarks of Dolby Laboratories.

Macrovision

This product incorporates copyright protection technology that is protected by U.S. patents and other intellectual property rights. Use of this copyright protection technology must be authorized by Macrovision, and is intended for home and other limited viewing uses only unless otherwise authorized by Macrovision. Reverse engineering or disassembly is prohibited

DTS

"DTS" and "DTS 2.0" are trademarks of Digital Theater Systems, Inc.

SALES CODE RES — AM/FM STEREO RADIO WITH CD PLAYER (MP3 AUX JACK)

NOTE: The radio sales code is located on the lower right side of your radio faceplate.

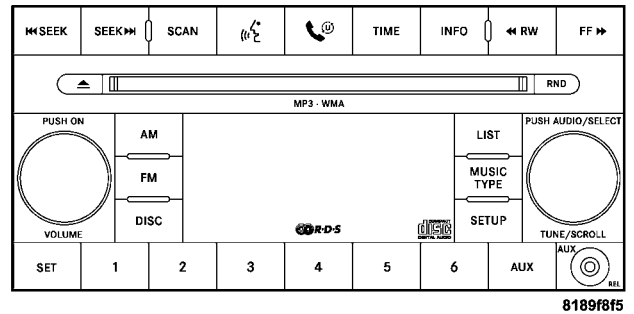

4

RES Radio

Operating Instructions - Radio Mode

NOTE: The ignition switch must be in the ON or ACC position to operate the radio.

Power Switch/Volume Control (Rotary)

Press the ON/VOLUME control knob to turn the radio on. Press the ON/VOLUME control knob a second time to turn the radio off.

Electronic Volume Control

The electronic volume control turns continuously (360 degrees) in either direction without stopping. Turning the ON/VOLUME control knob to the right increases the volume and to the left decreases it.

When the audio system is turned on, the sound will be set at the same volume level as last played.

SEEK Buttons

Press and release the SEEK buttons to search for the next listenable station in AM/FM mode. Press the right switch to seek up and the left switch to seek down. The radio will remain tuned to the new station until you make another selection. Holding either button will bypass stations without stopping until you release it.

SCAN Button

Pressing the SCAN button causes the tuner to search for the next listenable station, in either AM or FM frequencies, pausing for 5 seconds at each listenable station before continuing to the next. To stop the search, press SCAN a second time.

INFO Button

Press the INFO button for an RDS station (one with call letters displayed). The radio will return a Radio Text message broadcast from an FM station (FM mode only).

TIME Button

Press the TIME button and the time of day will be displayed. In AM or FM mode, pressing the TIME button will switch between the time and frequency displays.

Clock Setting Procedure

1. Press and hold the TIME button, until the hours blink.

2. Adjust the hours by turning the right side TUNE control knob.
3. After the hours are adjusted, press the right side TUNE control knob to set the minutes. The minutes will begin to blink.
4. Adjust the minutes using the right side TUNE control knob. Press the TUNE control knob to save time change.
5. To exit, press any button/knob or wait 5 seconds.

The clock can also be set by pressing the SETUP button, and selecting SET CLOCK. Once in this display follow the above procedure, starting at step 2.

RW/FF

Pressing the RW (Rewind) or FF (Fast Forward) buttons causes the tuner to search for the next frequency in the direction of the arrows. This feature operates in either AM or FM frequencies.

TUNE Control

Turn the right side rotary control clockwise to increase or counter-clockwise to decrease the frequency.

Setting the Tone, Balance, and Fade

Press the rotary TUNE control knob and BASS will display. Turn the TUNE control knob to the right or left to increase or decrease the Bass tones.

Press the rotary TUNE control knob a second time and MID will display. Turn the TUNE control knob to the right or left to increase or decrease the Mid Range tones.

Press the rotary TUNE control knob a third time and TREBLE will display. Turn the TUNE control knob to the right or left to increase or decrease the Treble tones.

Press the rotary TUNE control knob a fourth time and BALANCE will display. Turn the TUNE control knob to the right or left to adjust the sound level from the right or left side speakers.

222 UNDERSTANDING YOUR INSTRUMENT PANEL

Press the rotary TUNE control knob a fifth time and FADE will display. Turn the TUNE control knob to the left or right to adjust the sound level between the front and rear speakers.

Press the rotary TUNE control knob again to exit setting tone, balance and fade.

MUSIC TYPE Button

Pressing this button once will turn on the Music Type mode for 5 seconds. Pressing the Music Type button or turning the TUNE control knob within 5 seconds will allow the program format type to be selected. Many radio stations do not currently broadcast Music Type information.

Toggle the Music Type button to select the following format types:

Program Type	16 Digit-Character Display
No program type or undefined	None
Adult Hits	Adlt Hit
Classical	Classicl
Classic Rock	Cls Rock
College	College
Country	Country
Foreign Language	Language
Information	Inform
Jazz	Jazz
News	News
Nostalgia	Nostalga
Oldies	Oldies
Personality	Persnlty
Public	Public
Rhythm and Blues	R & B

Program Type	16 Digit-Character Display
Religious Music	Rel Musc
Religious Talk	Rel Talk
Rock	Rock
Soft	Soft
Soft Rock	Soft Rck
Soft Rhythm and Blues	Soft R&B
Sports	Sports
Talk	Talk
Top 40	Top 40
Weather	Weather

By pressing the SEEK button when the Music Type icon is displayed, the radio will be tuned to the next frequency station with the same selected Music Type name. The Music Type function only operates when in the FM mode.

If a preset button is activated while in the Music Type (Program Type) mode, the Music Type mode will be exited and the radio will tune to the preset station.

SETUP Button

Pressing the SETUP button allows you to select between the following items:

- **Set Clock** — Pressing the SELECT button will allow user to set the clock. Turn TUNE control knob to adjust the hours then press and turn the TUNE control knob to adjust the minutes. Press the TUNE control knob again to save changes.

4

AM and FM Buttons

Press buttons to select AM or FM Modes.

SET Button — To Set the Push-Button Memory

When you are receiving a station that you wish to commit to push-button memory, press the SET button. The symbol SET 1 will now show in the display window.

Select the button (1-6) you wish to lock onto this station and press and release that button. If a button is not selected within 5 seconds after pressing the SET button, the station will continue to play but will not be stored into push-button memory.

You may add a second station to each push-button by repeating the above procedure with this exception: Press the SET button twice and SET 2 will show in the display window. Each button can be set for SET 1 and SET 2 in both AM and FM. This allows a total of 12 AM and 12 FM stations to be stored into push-button memory. The stations stored in SET 2 memory can be selected by pressing the push-button twice.

Every time a preset button is used a corresponding button number will be displayed.

Buttons 1 - 6

These buttons tune the radio to the stations that you commit to push-button memory {12 AM and 12 FM stations}.

DISC Button

Pressing the DISC button will allow you to switch from AM/FM modes to Disc modes.

Operation Instructions - CD MODE for CD and MP3 Audio Play

NOTE: The ignition switch must be in the ON or ACC position to operate the radio.

NOTE: Note: This Radio is capable of playing compact discs (CD), recordable compact discs (CD-R), rewritable compact discs (CD-RW) compact discs with MP3 tracks and multisession compact discs with CD and MP3 tracks.

Inserting Compact Disc(s)

Gently insert one CD into the CD player with the CD label facing up. The CD will automatically be pulled into the CD Player and the CD icon will illuminate on the radio display. If a CD does not go into the slot more than an inch, a disc may already be loaded and must be ejected before a new disc can be loaded.

If you insert a disc with the ignition ON and the radio ON, the unit will switch from radio to CD mode and begin to play when you insert the disc. The display will show the disc number, the track number, and index time in minutes and seconds. Play will begin at the start of track 1.

CAUTION!

- This CD player will accept 4 3/4 inch (12 cm) discs only. The use of other sized discs may damage the CD player mechanism.
- Do not use adhesive labels. These labels can peel away and jam the player mechanism.
- RES is a single CD player. Do not attempt to insert a second CD if one is already loaded.
- Dual—media disc types (one side is a DVD, the other side is a CD) should not be used, and can cause damage to the player.

4

EJECT Button - Ejecting a CD

Press the EJECT button to eject the CD.



If you have ejected a disc and have not removed it within 10 seconds, it will be reloaded. If the CD is not removed, the radio will reinsert the CD but will not play it.

A disc can be ejected with the radio and ignition OFF.

NOTE: Ejecting with ignition OFF is not allowed on convertible or soft-top models (if equipped).

SEEK Button

Press the right SEEK button for the next selection on the CD. Press the left SEEK button to return to the beginning of the current selection, or return to the beginning of the previous selection if the CD is within the first second of the current selection. Pressing and holding the SEEK button will allow to scroll through tracks faster in CD, MP3 modes.

SCAN Button

Press the Scan button to scan through each track on the CD currently playing.

TIME Button

Press this button to change the display from a large CD playing time display to a small CD playing time display.

RW/FF

Press the RW button to stop the CD at the beginning of the current CD track/title.

Press and hold FF (Fast Forward) and the CD player will begin to fast forward until FF is released or RW or another CD button is pressed. The RW (Reverse) button works in a similar manner.

AM or FM Button

Switches the Radio to the Radio mode.

RND Button (Random Play Button)

Press this button while the CD is playing to activate Random Play. This feature plays the selections on the compact disc in random order to provide an interesting change of pace.

Press the right SEEK button to move to the next randomly selected track.

Press the RND button a second time to stop Random Play.

Notes On Playing MP3 Files

The radio can play MP3 files, however, acceptable MP3 file recording media and formats are limited. When writing MP3 files, pay attention to the following restrictions.

Supported Media (Disc Types)

The MP3 file recording media supported by the radio are CDDA, CD-R, CD-RW, MP3, and CDDA+MP3.

Supported Medium Formats (File Systems)

The medium formats supported by the radio are ISO 9660 Level 1 and Level 2 and includes the Joliet extension. When reading discs recorded using formats other than ISO 9660 Level 1 and Level 2, the radio may fail to read

files properly and may be unable to play the file normally. UDF and Apple HFS formats are not supported.

The radio uses the following limits for file systems:

- Maximum number of folder levels: 8
- Maximum number of files: 255
- Maximum number of folders (The radio display of file names and folder names is limited. For large numbers of files and/or folders, the radio may be unable to display the file name and folder name and will assign a number instead. With a maximum number of files, exceeding 20 folders will result in this display. With 200 files, exceeding 50 folders will result in this display.
- Maximum number of characters in file/folder names:
 - Level 1: 12 (including a separator "." and a 3-character extension)

- Level 2: 31 (including a separator "." and a 3-character extension)

Multisession disc formats are supported by the radio. Multisession discs may contain combinations of normal CD audio tracks and computer files (including MP3 files). Discs created with an option such as "keep disc open after writing" are most likely multisession discs. The use of multisession for CD audio or MP3 playback may result in longer disc loading times.

Supported MP3 File Formats

The radio will recognize only files with the *.MP3 extension as MP3 files. Non-MP3 files named with the *.MP3 extension may cause playback problems. The radio is designed to recognize the file as an invalid MP3 and will not play the file.

When using the MP3 encoder to compress audio data to an MP3 file, the bit rate and sampling frequencies in the following table are supported. In addition, variable bit

rates (VBR) are also supported. The majority of MP3 files use a 44.1 kHz sampling rate and a 192, 160, 128, 96 or VBR bit rates.

MPEG Specification	Sampling Frequency (kHz)	Bit Rate (kbps)
MPEG-1 Audio Layer 3	48, 44.1, 32	320, 256, 224, 192, 160, 128, 112, 96, 80, 64, 56, 48, 40, 32
MPEG-2 Audio Layer 3	24, 22.05, 16	160, 128, 144, 112, 96, 80, 64, 56, 48, 40, 32, 24, 16, 8

ID3 Tag information for artist, song title and album title are supported for version 1 ID3 tags. ID3 version 2 is not supported by the radios.

Playlist files are not supported. MP3 Pro files are not supported.

Playback of MP3 Files

When a medium containing MP3 data is loaded, the radio checks all files on the medium. If the medium contains a lot of folders or files, the radio will take more time to start playing the MP3 files.

Loading times for playback of MP3 files may be affected by the following:

- Media - CD-RW media may take longer to load than CD-R media
- Medium formats - Multisession discs may take longer to load than non-multisession discs
- Number of files and folders - Loading times will increase with more files and folders

To increase the speed of disc loading, it is recommended to use CD-R media and single-session discs. To create a single-session disc, enable the Disc at Once option before writing to the disc.

LIST Button (CD Mode for MP3 Play)

Pressing the LIST button will bring up a list of all folders on the disc. Scrolling up or down the list is done by turning the TUNE control knob. Selecting a folder by pressing the TUNE control knob will begin playing the files contained in that folder (or the next folder in sequence if the selection does not contain playable files).

The folder list will time out after 5 seconds.

INFO Button (CD Mode for MP3 Play)

Pressing the INFO button repeatedly will scroll through the following TAG information: Song Title, Artist, File Name, and Folder Name (if available).

Press the INFO button once more to return to "elapsed time" priority mode.

Press and hold the INFO button for 3 seconds or more and radio will display song titles for each file.

Press and hold the INFO button again for 3 seconds to return to "elapsed time" display.

Operation Instructions - Auxiliary Mode

The auxiliary (AUX) jack is an audio input jack, which allows the user to plug in a portable device such as an MP3 player, or cassette player, and utilize the vehicle's audio system to amplify the source and play through the vehicle speakers.

Pushing the AUX button will change the mode to auxiliary device if the AUX jack is connected.

NOTE: The AUX device must be turned on and the device's volume set to proper level. If the AUX audio is not loud enough, turn the device's volume up. If the AUX audio sounds distorted, turn the device's volume down.

TIME Button (Auxiliary Mode)

Press this button to change the display to time of day. The time of day will be displayed for 5 seconds (when ignition is off).

Operating Instructions - Hands Free Phone (If Equipped)

Refer to Hands Free Phone in Section 3 of the Owner's Manual.

Operating Instructions - Satellite Radio Mode (If Equipped)

Refer to the Satellite Radio section of the Owner's Manual.

Operating Instructions - Video Entertainment System (VES®) (If Equipped)

Refer to separate Video Entertainment System (VES®) Guide.

SALES CODE RER — AM/FM/CD/DVD RADIO WITH NAVIGATION SYSTEM — IF EQUIPPED

NOTE: The radio sales code is located on the lower right side of your radio faceplate.

Satellite Navigation Radio with CD Player with MP3 Capability (RER) - combines a Global-Positioning System-based navigation system with an integrated color screen to provide maps, turn identification, selection menus and instructions for selecting a variety of destinations and routes.

This radio has a hard drive. CD's can be ripped to the hard drive, and the map data comes loaded on the hard drive. Refer to your "Navigation User's Manual" for detailed operating instructions.

Operating Instructions — Satellite Radio

Refer to your "Navigation User's Manual" for detailed operating instructions.

Clock Setting Procedure

The GPS receiver used in this system is synchronized to the time data being transmitted by the GPS satellite. The satellites' clock is Greenwich Mean Time (GMT). This is the worldwide standard for time. This makes the system's clock very accurate once the appropriate time zone and daylight savings information is set.

To manually set the clock, change the time zone, or change daylight savings information, use a ball point pen or similar object to press the hour (H) or minute (M) buttons on the radio. The **Setup** screen appears.

Setting the Clock

1. Turn the ignition switch to the ON or ACC position. Using the tip of a ballpoint pen or similar object, press

either the H button on the faceplate to change the hour or the M button on the faceplate to change the minute.

2. The time setting will increase each time you press the button. Holding either button in will fast forward the setting.

3. If no changes are made within 5 seconds of accessing the **Setup** screen, the screen will time out and you will be taken to the last mode.

NOTE: To reset the clock, select the appropriate time zone and press ENTER. The clock will revert to the accurate time based on the time zone you selected.

Changing the Time Zone

1. Highlight "Clock Setup" and press ENTER.
2. AT the **Clock Setup** screen highlight the box next to "Time Zone" and press ENTER.

3. Highlight the appropriate time zone for you location and press ENTER to store your selection. Select "Done" when finished.

NOTE: When you are traveling and enter a new time zone, the cluck must be reset manually for the new zone.

Changing Daylight Savings Time

1. Highlight the box next to "Time" and press ENTER.
2. Select **Daylight Savings** when Daylight Savings Time is in effect or Select **Standard** if Daylight Savings Time is not being observed. press ENTER.
3. Select "Done" when finished.

Select "Done" to exit from the clock setting mode.

SATELLITE RADIO — IF EQUIPPED

Satellite radio uses direct satellite to receiver broadcasting technology to provide clear digital sound, coast to coast. The subscription service provider is Sirius™ Satellite Radio. This service offers up to 100 channels of music, sports, news, entertainment, and programming for children, directly from its satellites and broadcasting studios.

System Activation

Sirius Satellite Radio service is pre-activated, and you may begin listening immediately to the one year of SIRIUS audio service that is included with the factory-installed satellite radio system in your vehicle. Sirius will contact you to supply a welcome kit and to confirm subscription information, including the set up of your on-line listening account at no additional charge. For further information, call the toll-free number 888-539-7474, or visit the Sirius web site at www.sirius.com. Please have the following information available when changing your subscription:

1. The Electronic Serial Number/Sirius Identification Number (ESN/SID).
2. Credit card information.
3. Your Vehicle Identification Number.

Electronic Serial Number/Sirius Identification Number (ENS/SID)

The Electronic Serial Number/Sirius Identification Number is needed to activate your Sirius Satellite Radio system. To access the ESN/SID, refer to the following steps:

ESN/SID Access With RSC Radios

With the ignition switch in the ON/RUN or ACCESSORY position and the radio ON, press the SETUP button and scroll using the TUNE control knob until Sirius ID is selected. Press the TUNE control knob and the Sirius ID

number will be displayed. The Sirius ID number display will time out in 2 minutes. Press any button on the radio to exit this screen.

Selecting Satellite Mode (RSC Radios)

Press the SAT button until "SAT" appears in the display. A CD may remain in the radio while in the Satellite radio mode.

Satellite Antenna

To ensure optimum reception, do not place items on the roof around the rooftop antenna location or strap items to the trunk lid around the trunk lid antenna (if equipped). Metal objects placed within the line of sight of the antenna will cause decreased performance. Larger luggage items such as bikes should be placed as far rearward as possible, within the loading design of the rack. Do not place items directly on or above the antenna.

Reception Quality

Satellite reception may be interrupted due to one of the following reasons.

- The vehicle is parked in an underground parking structure or under a physical obstacle.
- Dense tree coverage may interrupt reception in the form of short audio mutes.
- Driving under wide bridges or along tall buildings can cause intermittent reception.
- Placing objects over or too close to the antenna can cause signal blockage.

Operating Instructions - Satellite Mode

NOTE: The ignition switch must be in the ON or ACC position to operate the radio.

SEEK Buttons

Press and release the SEEK buttons to search for the next channel in Satellite mode. Press the right switch to seek up and the left switch to seek down. The radio will remain tuned to the new channel until you make another selection. Holding either button will bypass channels without stopping until you release it.

SCAN Button

Pressing the SCAN button causes the tuner to search for the next channel, pausing for 8 seconds before continuing to the next. To stop the search, press SCAN a second time.

INFO Button

Pressing the INFO button will cycle between Artist, Song Title, and Composer (if available) information. Also, pressing and holding the INFO button for an additional 3 seconds will make the radio display the Song Title all of the time (press and hold again to return to normal display).

RW/FF

Pressing the RW (Rewind) or FF (Fast Forward) buttons causes the tuner to search for the next channel in the direction of the arrows.

TUNE Control (Rotary)

Turn the right side rotary control clockwise to increase or counter-clockwise to decrease the channel.

MUSIC TYPE Button

Pressing this button once will turn on the Music Type mode for 5 seconds. Pressing the MUSIC TYPE button or turning the TUNE control knob within 5 seconds will allow the program format type to be selected.

Toggle the MUSIC TYPE button again to select the music type.

By pressing the SEEK button when the Music Type function is active, the radio will be tuned to the next channel with the same selected Music Type name.

If a preset button is activated while in the Music Type (Program Type) mode, the Music Type mode will be exited and the radio will tune to the preset channel.

SETUP Button

Pressing the SETUP button allows you to select the following items:

- Display Sirius ID number — Press the SELECT button to display the Sirius ID number. This number is used to activate, deactivate, or change the Sirius subscription.

SET Button — To Set the Push-Button Memory

When you are receiving a channel that you wish to commit to push-button memory, press the SET button. The symbol SET 1 will now show in the display window. Select the button (1-6) you wish to lock onto this channel and press and release that button. If a button is not

selected within 5 seconds after pressing the SET button, the channel will continue to play but will not be stored into push-button memory.

You may add a second channel to each push-button by repeating the above procedure with this exception: Press the SET button twice and SET 2 will show in the display window. Each button can be set for SET 1 and SET 2. This allows a total of 12 Satellite channels to be stored into push-button memory. The channels stored in SET 2 memory can be selected by pressing the push-button twice.

Every time a preset button is used a corresponding button number will be displayed.

Buttons 1 - 6

These buttons tune the radio to the channels that you commit to push-button memory {12 Satellite stations}.

Operating Instructions - Hands Free Phone (If Equipped)

Refer to Hands Free Phone in Section 3 of the Owner's Manual.

Operating Instructions - Video Entertainment System (VES®) (If Equipped)

Refer to separate Video Entertainment System (VES®) Guide.

CD/DVD DISC MAINTENANCE

To keep the CD/DVD discs in good condition, take the following precautions:

1. Handle the disc by its edge; avoid touching the surface.
2. If the disc is stained, clean the surface with a soft cloth, wiping from center to edge.
3. Do not apply paper, paper CD labels, or tape to the disc; avoid scratching the disc.

4. Do not use solvents such as benzine, thinner, cleaners, or antistatic sprays.
5. Store the disc in its case after playing.
6. Do not expose the disc to direct sunlight.
7. Do not store the disc where temperatures may become too high.

RADIO OPERATION AND CELLULAR PHONES

Under certain conditions, the cellular phone being ON in your vehicle can cause erratic or noisy performance from your radio. This condition may be lessened or eliminated by relocating the cellular phone antenna. This condition is not harmful to the radio. If your radio performance does not satisfactorily "clear" by the repositioning of the antenna, it is recommended that the radio volume be turned down or off during cellular phone operation.

CLIMATE CONTROLS

Manual Heater Only

The controls for the heating/ventilation system in this vehicle consist of a series of rotary knobs. These comfort controls can be set to obtain desired interior conditions.

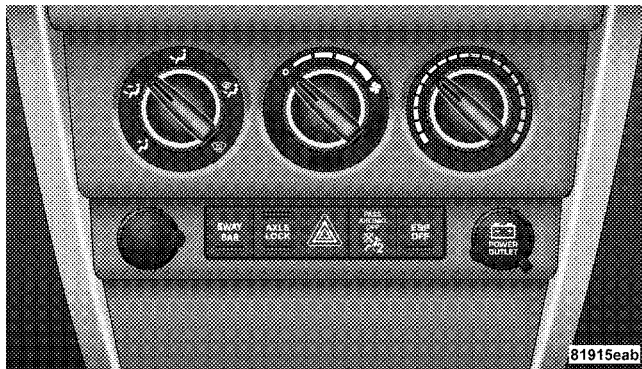

Manual Heater Control

Mode Control

The mode control (left rotary knob) allows you to choose from several patterns of air distribution. You can select either a primary mode, as identified by the symbols, or a blend of two of these modes. The closer the control is to a particular mode, the more air distribution you receive from that mode.

Panel

 Air is directed through the outlets in the instrument panel. These outlets can be adjusted to direct air flow.

Bi-Level

 Air is directed through the panel and floor outlets.

NOTE: There is a difference in temperature between the upper and lower outlets for added comfort. The warmer air goes to the floor outlets. This feature gives improved comfort during sunny but cool conditions.

Floor

 Air is directed through the floor outlets and side window demist outlets with a small amount through the defrost outlet.

Mix

 Air is directed through the floor, defrost and side window demist outlets. This setting works best in cold or snowy conditions that require extra heat at the windshield. This setting is good for maintaining comfort while reducing moisture on the windshield.

Defrost

 Air is directed through the windshield and side window demist outlets. Use this mode with maximum fan and temperature settings for best windshield and side window defrosting.

Blower Control

Use this control (center rotary knob) to regulate the amount of air forced through the system in any mode you select. The fan speed increases as you move the control to the right from the OFF position.

Temperature Control

Use this control (right rotary knob) to regulate the temperature of the air inside the passenger compartment. The blue area of the scale indicates cooler temperatures while the red area indicates warmer temperatures.

Manual Air Conditioning and Heating System — If Equipped

The controls for the heating/air conditioning and ventilation system in this vehicle consist of a series of rotary knobs. These comfort controls can be set to obtain desired interior conditions.

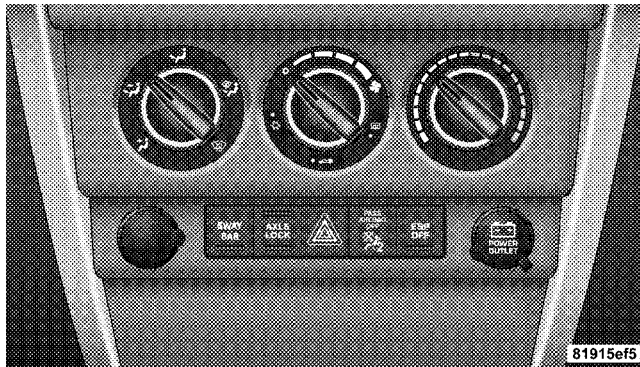

The instrument panel features four airflow registers. Two registers are located on the outer ends of the instrument panel and two are located in the center of the instrument panel. These registers can be closed to partially block airflow, and they can be adjusted to direct airflow where the occupant desires.

Mode Control

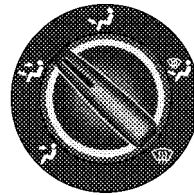

81915f2a

The mode control allows you to choose from several patterns of air distribution. You can select either a primary mode, as identified by the symbols, or a blend of two of these modes. The closer the control is to a particular mode, the more air distribution you receive from that mode.

Panel

 Air is directed through the outlets in the instrument panel. These outlets can be adjusted to direct air flow.

Bi-Level

 Air is directed through the panel and floor outlets.

NOTE: There is a difference in temperature between the upper and lower outlets for added comfort. The warmer air goes to the floor outlets. This feature gives improved comfort during sunny but cool conditions.

Floor

 Air is directed through the floor outlets and side window demist outlets with a small amount through the defrost outlet.

Mix

 Air is directed through the floor, defrost and side window demist outlets. This setting works best in cold or snowy conditions that require extra heat at the windshield. This setting is good for maintaining comfort while reducing moisture on the windshield.

Defrost

 Air is directed through the windshield and side window demist outlets. Use this mode with maximum fan and temperature settings for best windshield and side window defrosting.

NOTE: The air conditioning compressor operates in both Mix and Defrost or a blend of these modes even if the fan switch is not in the A/C position. This dehumidifies the air to help dry the windshield. To improve fuel economy, use these modes only when necessary.

Blower Control

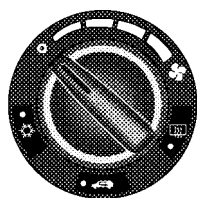

81915f88

Use this control to regulate the amount of air forced through the system in any mode you select. The fan speed increases as you move the control to the right from the OFF position.

Temperature Control

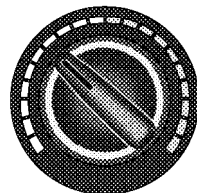

81915f92

Use this control to regulate the temperature of the air inside the passenger compartment. The blue area of the scale indicates cooler temperatures while the red area indicates warmer temperatures.

NOTE: If your air conditioning performance seems lower than expected, check the front of the A/C condenser: located in front of the radiator, for an accumulation of dirt or insects. Clean with a gentle water spray from behind the radiator and through the condenser. Fabric front fascia protectors may reduce air flow to the condenser, reducing air conditioning performance.

Circulation Control

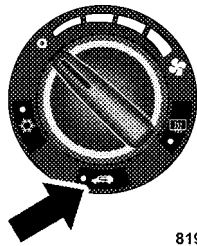

819160c4

Press this button to choose between outside air intake or recirculation of the air inside the vehicle. A lamp will illuminate when you are in "Recirculate" mode. Only use the "Recirculate" mode to temporarily block out any outside odors, smoke, or dust and to cool the interior rapidly upon

initial start up in very hot or humid weather.

NOTE: Continuous use of the "Recirculate" mode may make the inside air stuffy and window fogging may occur. Extended use of this mode is not recommended.

In cold or damp weather, the use of the "Recirculate" mode will cause windows to fog on the inside because of

moisture build up inside the vehicle. For maximum defogging, select the Outside Air position.

NOTE: The "Recirculate" mode will not operate in floor, mix or defrost modes.

Air Conditioning Operation

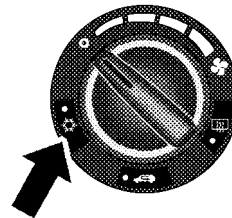

819160ac

Press this button to engage the air conditioning. A lamp will illuminate when the air conditioning system is engaged

4

NOTE: The air conditioning compressor will not engage until the engine has been running for about 10 seconds.

Operating Tips

Window Fogging

Windows will fog on the inside when the humidity inside the vehicle is high. This often occurs in mild or cool temperatures when it's rainy or humid. In most cases turning on the air-conditioning (pressing the snowflake button) will clear the fog. Adjust the temperature control, air direction and blower speed to maintain comfort.

As the temperature gets colder it may be necessary to direct air onto the windshield. Adjust the temperature control and blower speed to maintain comfort. Higher blower speeds will reduce fogging. Interior fogging on the windshield can be quickly removed by selecting the defrost mode.

Regular cleaning of the inside of the windows with a non-filming cleaning solution (vinegar and water works very well) will help prevent contaminants (cigarette

smoke, perfumes, etc.) from sticking to the windows. Contaminates increase the rate of window fogging.

Summer Operation

Air conditioned vehicles must be protected with a high quality antifreeze coolant during summer to provide proper corrosion protection and to raise the boiling point of the coolant for protection against overheating. A 50 % concentration is recommended. Refer to Fluids and Genuine Parts in Section 7 for the proper coolant type.

When using the air conditioner in extremely heavy traffic in hot weather especially when towing a trailer, additional engine cooling may be required. If this situation is encountered, operate the transmission in a lower gear to increase engine RPM, coolant flow and fan speed. When stopped in heavy traffic, it may be necessary to shift into N (Neutral) and depress the accelerator slightly for fast idle operation to increase coolant flow and fan speed.

Winter Operation

When operating the system during the winter months, make sure the air intake, located directly in front of the windshield, is free of ice, slush, snow, or other obstructions.

Vacation Storage

Anytime you store your vehicle, or keep it out of service (i.e. vacation) for two weeks or more, run the air conditioning system at idle for about five minutes in the fresh air and high blower setting. This will insure adequate system lubrication to minimize the possibility of compressor damage when the system is started again.

STARTING AND OPERATING

CONTENTS

■ Starting Procedures	251	■ Manual Transmission	255
□ Manual Transmission	251	□ 6-Speed Manual Transmission	255
□ Automatic Transmission	251	■ Automatic Transmission	258
□ Normal Starting	251	□ Shift Lock Manual Override	259
□ Extreme Cold Weather (Below -20°F Or -29°C)	252	□ Brake/Transmission Interlock System	260
□ If Engine Fails To Start	252	□ Automatic Transmission With Overdrive	261
□ After Starting	253	■ Four-Wheel Drive Operation (Command-Trac™ Or Rock-Trac™) — If Equipped	265
■ Engine Block Heater — If Equipped	254	□ Operating Instructions/Precautions	265

248 STARTING AND OPERATING

□ Shift Positions	267	□ Traction Downhill	278
□ Shifting Procedure	268	□ After Driving Off-Road	278
■ Trac-Lok™ Rear Axle — If Equipped	269	■ Parking Brake	279
■ Axle Lock (Tru-Lok™) — Rubicon Models	270	■ Anti-Lock Brake System	281
■ Rear Axle Lock — 4WD Non-Rubicon Models (If Equipped)	271	■ Power Steering	283
■ Electronic Sway Bar Disconnect — If Equipped	271	■ Tire Safety Information	284
■ On-Road Driving Tips	273	□ Tire Markings	284
■ Off-Road Driving Tips	274	□ Tire Identification Number (TIN)	288
□ When To Use 4L (Low) Range	275	□ Tire Loading And Tire Pressure	289
□ Driving Through Water	275	■ Tires — General Information	293
□ Driving In Snow, Mud And Sand	276	□ Tire Pressure	293
□ Hill Climbing	277	□ Tire Inflation Pressures	294
		□ Tire Pressures For High Speed Operation	296

□ Radial-Ply Tires	297	□ Reformulated Gasoline	307
□ Tire Spinning	297	□ Gasoline/Oxygenate Blends	307
□ Tread Wear Indicators	298	□ MMT In Gasoline	308
□ Life Of Tire	298	□ Materials Added To Fuel	308
□ Replacement Tires	299	□ Fuel System Cautions	308
□ Alignment And Balance	300	□ Carbon Monoxide Warnings	309
■ Tire Chains	300	■ Adding Fuel	310
■ Tire Rotation Recommendations	301	□ Fuel Filler Cap (Gas Cap)	310
■ Tire Pressure Monitor System (TPMS) — If Equipped	302	■ Vehicle Loading	313
□ Base System — If Equipped	303	□ Certification Label	313
□ General Information	306	■ Trailer Towing	315
■ Fuel Requirements	306	□ Common Towing Definitions	315
		□ Trailer Hitch Classification	319

250 STARTING AND OPERATING

□ Trailer Towing Weights (Maximum Trailer Weight Ratings)	320	■ Recreational Towing (Behind Motorhome, Etc.)	332
□ Trailer And Tongue Weight	324	□ Shifting Into Neutral (N)	332
□ Towing Requirements	325	□ Shifting Out Of Neutral (N)	333
□ Towing Tips	330		

STARTING PROCEDURES

Before starting your vehicle, adjust your seat, adjust both inside and outside mirrors, and fasten your seat belts.

WARNING!

Never leave children alone in a vehicle. Leaving children in a vehicle unattended is dangerous for a number of reasons. A child or others could be seriously or fatally injured. Do not leave the keys in the ignition. A child could operate power windows, other controls, or move the vehicle.

Manual Transmission

Apply the parking brake, place the gearshift control lever in N (Neutral) and depress the clutch pedal before starting vehicle. This vehicle is equipped with a clutch interlocking ignition system. It will not start unless the clutch pedal is pressed to the floor.

Automatic Transmission

Start the engine with the selector lever in the N (Neutral) or P (Park) position. Apply the brake before shifting to any driving range.

Normal Starting

Normal starting of either a cold or a warm engine is obtained without pumping or depressing the accelerator pedal. Turn the key to the START position and release when the engine starts. If the engine fails to start within 10 seconds, turn the key to the OFF position, wait 5 seconds, then repeat the normal starting procedure.

Tip Start Feature — Automatic Transmission Only

Do not press the accelerator. Turn the ignition key briefly to START position, and release it. The starter motor will continue to run, but will automatically disengage itself when the engine is running.

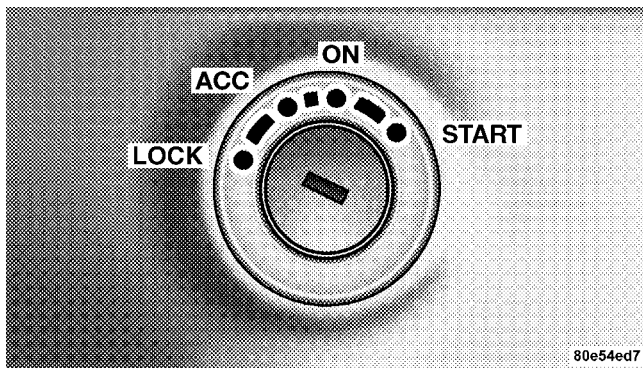

Ignition Key Positions

Extreme Cold Weather (below -20°F or -29°C)

To insure reliable starting at these temperatures, use of an externally powered electric engine block heater (available from your dealer) is recommended.

If Engine Fails to Start

If the engine fails to start after you have followed the “Normal Starting” or “Extreme Cold Weather” procedures, it may be flooded. Push the accelerator pedal all the way to the floor and hold it there while cranking the engine. This should clear any excess fuel in case the engine is flooded.

CAUTION!

To prevent damage to the starter, do not crank the engine for more than 15 seconds at a time. Wait 10 to 15 seconds before trying again.

WARNING!

Never pour fuel or other flammable liquids into the throttle body air inlet opening in an attempt to start the vehicle. This could result in a flash fire causing serious personal injury.

WARNING!

Do not attempt to push or tow your vehicle to get it started. Vehicles equipped with an automatic transmission cannot be started this way. Unburned fuel could enter the catalytic converter and once the engine has started, ignite and damage the converter and vehicle. If the vehicle has a discharged battery, booster cables may be used to obtain a start from a booster battery or the battery in another vehicle. This type of start can be dangerous if done improperly. Refer to Section 6 of this manual for proper jump starting procedures and follow them carefully.

If the engine has been flooded, it may start to run, but not have enough power to continue running when the key is released. If this occurs, continue cranking with the accelerator pedal pushed all the way to the floor. Release the accelerator pedal and the key once the engine is running smoothly.

If the engine shows no sign of starting after two 15 second periods of cranking with the accelerator pedal held to the floor, the "Normal Starting" or "Extreme Cold Weather" procedures should be repeated.

After Starting

The idle speed will automatically decrease as the engine warms up.

WARNING!

Never leave children alone in a vehicle. Leaving children in a vehicle unattended is dangerous for a number of reasons. A child or others could be seriously or fatally injured. Do not leave the keys in the ignition. A child could operate power windows, other controls, or move the vehicle.

WARNING!

Remember to disconnect the cord before driving. Damage to the 110-115 volt AC electrical cord could cause electrocution.

Use the heater when temperatures below 0°F (-18°C) are expected to last for several days.

ENGINE BLOCK HEATER — IF EQUIPPED

The engine block heater warms engine coolant and permits quicker starts in cold weather. Connect the cord to a standard 110-115 volt AC electrical outlet with a grounded, three wire extension cord. The engine block heater cord is found under the hood bundled in front of the battery tray.

MANUAL TRANSMISSION

6-Speed Manual Transmission

WARNING!

You or others could be injured if you leave the vehicle unattended without having the parking brake fully applied. The parking brake should always be applied when the driver is not in the vehicle, especially on an incline.

Follow the shift pattern on the gearshift knob.

NOTE: The backup lights will come on when your vehicle is in R (Reverse) gear and the ignition is in the ON position.

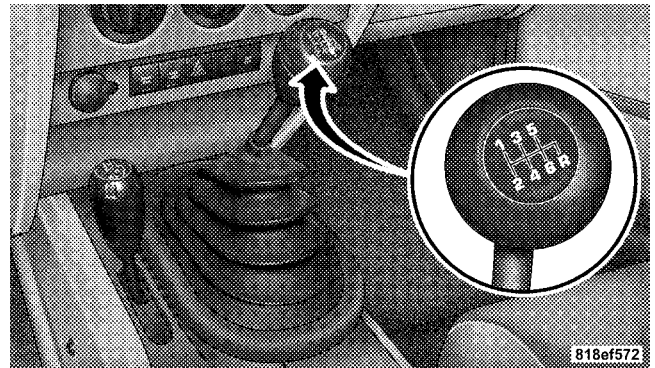

Manual Shift Controls

WARNING!

When parking your vehicle, always leave a manual transmission in first gear and apply the parking brake fully to guard against vehicle movement and possible injury or damage. Never use any gear as a substitute for the parking brake.

CAUTION!

To drive as safely as possible and to prolong the life of your manual transmission, follow these tips:

- Before shifting from a forward gear into reverse, or from reverse to a forward gear, stop vehicle completely. Otherwise, transmission damage may result.
- Do not operate at sustained high engine or road speeds in lower gears. Engine damage may result.
- Do not downshift into a low gear while traveling at too high a speed for that gear. Engine, clutch, or transmission damage may result.
- Do not rest your foot on the clutch pedal. This causes heat buildup and damages the clutch.
- When you slow down or go up a grade, downshift as speed requires or the engine may overheat.
- Never hold the vehicle stopped on a hill by using the clutch pedal. The clutch may be damaged.
- During cold weather, you may experience increased effort in shifting until the transmission fluid warms up. This is normal.
- Push in the clutch pedal completely when shifting. Otherwise, transmission or clutch damage may result.

- When “rocking” a stuck vehicle by shifting between a forward gear and reverse, do not spin wheels faster than 15 mph (24 km/h), or drivetrain damage may result.

Recommended Manual Transmission Shifting Speeds

The manufacturer recommends that you use the shift speeds listed in the chart below.

Manual Transmission Shift Speeds in MPH (KM/H)						
En- gine	Speeds	1 to 2	2 to 3	3 to 4	4 to 5	5 to 6
3.8L	Accel.	15 (24)	24 (39)	34 (55)	47 (76)	56 (90)
	Cruise	10 (16)	19 (31)	27 (43)	37 (60)	41 (66)

Recommended Manual Transmission Downshifting Speeds

To prevent clutch and transmission damage, your vehicle should be downshifted at speeds no greater than those listed in the chart below:

Manual Transmission Downshift Speeds in MPH (KM/H)					
Gear Selection	6th to 5th	5th to 4th	4th to 3rd	3rd to 2nd	2nd to 1st
Maximum Speed	88 (142)	71 (114)	51 (82)	33 (53)	20 (32)

CAUTION!

Failure to follow the recommended downshifting speeds may cause the engine to over speed and/or damage the clutch disc even if the clutch pedal is depressed.

AUTOMATIC TRANSMISSION**CAUTION!**

Damage to the transmission may occur if the following precautions are not observed:

- Shift into P (Park) only after the vehicle has come to a complete stop.
- Shift into or out of R (Reverse) only after the vehicle has come to a complete stop and the engine is at idle speed.
- Do not shift from R (Reverse), P (Park), or N (Neutral) into any forward gear when the engine is above idle speed.
- Before shifting into any gear, make sure your foot is firmly on the brake pedal.

WARNING!

It is dangerous to shift the selector lever out of P (Park) or N (Neutral) if the engine speed is higher than idle speed. If your foot is not firmly on the brake pedal, the vehicle could accelerate quickly forward or in reverse. You could lose control of the vehicle and hit someone or something. Only shift into gear when the engine is idling normally and when your foot is firmly on the brake pedal.

Shift Lock Manual Override

Your vehicle may be equipped with a shift lock manual override. The manual override may be used in the event

that the shift lever should fail to move from Park with the key in the ON position and the brake pedal depressed. To operate the shift lock manual override, perform the following steps:

1. Firmly set the parking brake.
2. Using a flat blade screwdriver, carefully remove the shift lock manual override cover which is located on the PRNDL bezel, in front of the P (Park) graphic.
3. Depress and maintain firm pressure on the service brake pedal.

4. Using the screwdriver, reach into the manual override opening. Press and hold the shift lock lever down.

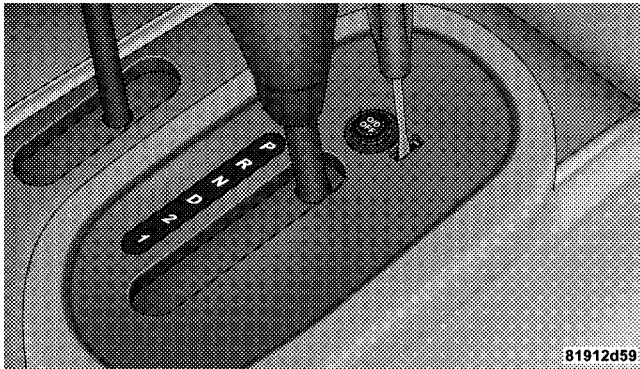

5. Depress the shifter release button and shift into N (Neutral).

6. The vehicle may then be started in N (Neutral).

Have your vehicle inspected by your local authorized dealer, if the shift lock manual override has been used.

Brake/Transmission Interlock System

This system prevents you from moving the gear shift out of P (Park) and into any gear unless the brake pedal is pressed. This system is active only while the ignition switch is in the ON position. Always depress the **brake pedal first**, before moving the gear selector out of P (Park).

Automatic Transmission with Overdrive

Shifting from D (Drive) to P (Park) or R (Reverse) (or from P or R to D) should be done only after the accelerator pedal is released and the vehicle is stopped. Be sure to keep your foot on the brake when moving the shift lever between these gears.

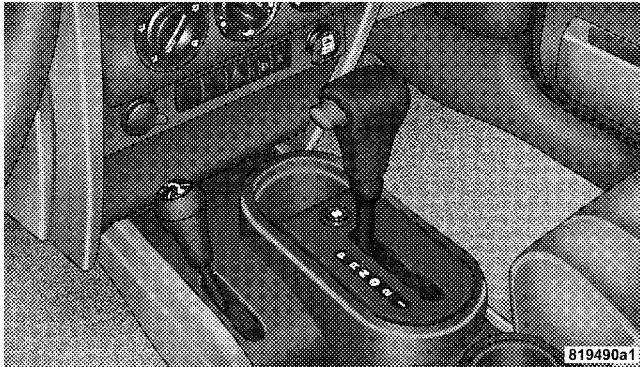

Automatic Shift Controls

Gear Ranges

DO NOT race the engine when shifting from P (Park) or N (Neutral) position into another gear range.

P (Park)

This gear position supplements the parking brake by locking the transmission. The engine can be started in this range. Never use P (Park) while the vehicle is in motion. Apply the parking brake when leaving the vehicle in this range. Always apply parking brake first, then place the selector in P (Park) position.

WARNING!

Never use P (Park) position as a substitute for the parking brake. Always apply parking brake fully when parked to guard against vehicle movement and possible injury or damage.

WARNING!

It is dangerous to shift the selector lever out of P (Park) or N (Neutral) if the engine speed is higher than idle speed. If your foot is not firmly on the brake pedal, the vehicle could accelerate quickly forward or in reverse. You could lose control of the vehicle and hit someone or something. Only shift into gear when the engine is idling normally and when your right foot is firmly on the brake pedal.

R (Reverse)

Use this range only after the vehicle has come to a complete stop.

N (Neutral)

Shift into N (Neutral) when the vehicle is standing for prolonged periods with the engine running. The engine may be started in this range. Set the parking brake if you must leave the vehicle.

NOTE: Towing the vehicle, coasting, or driving for any other reason with selector lever in N (Neutral) can result in severe transmission damage. Refer to "Recreational Towing" in Section 5 and "Towing a Disabled Vehicle" in Section 6 of this manual.

Overdrive (O/D)

For most city and highway driving. The transmission contains an electronically controlled Overdrive, and will automatically shift from D (Drive) to O/D (Overdrive) if the following conditions are present:

- The transmission selector is in D (Drive).
- The O/D OFF switch has not been activated.
- Vehicle speed is above approximately 30 mph (48 km/h).

When frequent transmission shifting occurs while using Overdrive, such as when operating the vehicle under heavy load conditions (for example, in hilly terrain,

strong head winds, or trailer towing), turning off overdrive will improve performance and extend transmission life by reducing excessive shifting and heat buildup.

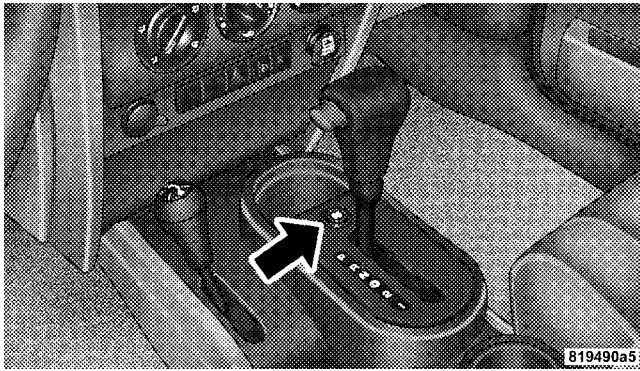

Overdrive Off Switch

Overdrive can be locked out by pressing the O/D OFF switch located on the center console. The O/D OFF indicator light (on the switch) will illuminate to show

that the switch has been activated. When the indicator light is on, Overdrive is locked out. Pressing the switch a second time restores the Overdrive function. The lockout feature is useful when towing a trailer or carrying a heavy load.

2 (Second)

For moderate grades and to assist braking on dry pavement or in mud and snow. Begins at a stop in low gear with automatic upshift to 2nd gear. Will not shift to 3rd.

1 (First)

For hard pulling at low speeds in mud, sand, snow, or on steep grades. Begins and stays in low gear with no upshift. Provides engine compression braking at low speeds.

WARNING!

Never use P (Park) position with an automatic transmission as a substitute for the parking brake. Always apply parking brake fully when parked to guard against vehicle movement and possible injury or damage.

CAUTION!

- Before moving the shift lever out of P (Park), you must turn the ignition from LOCK so the steering wheel and shift lever are released. Otherwise, damage to steering column or shifter could result.
- Never race the engine with the brakes on and the vehicle in gear, and never hold the vehicle on an incline without applying the brakes. These practices can overheat and damage the transmission.
- When “rocking” a stuck vehicle by moving between D (Drive) and R (Reverse), do not spin the wheels faster than 15 mph (24 km/h), or drivetrain damage may result.

Torque Converter Clutch

A feature designed to improve fuel economy has been added to the automatic transmission of this vehicle. A

clutch within the torque converter engages automatically at calibrated speeds. This may result in a slightly different feeling or response during normal operation in high gear. When the vehicle speed drops or during acceleration, the clutch automatically and smoothly disengages.

FOUR-WHEEL DRIVE OPERATION (COMMAND-TRAC™ OR ROCK-TRAC™) — IF EQUIPPED

Operating Instructions/Precautions

The transfer case provides four mode positions — two (rear) wheel drive high range, four wheel drive high range, neutral, and four wheel drive low range.

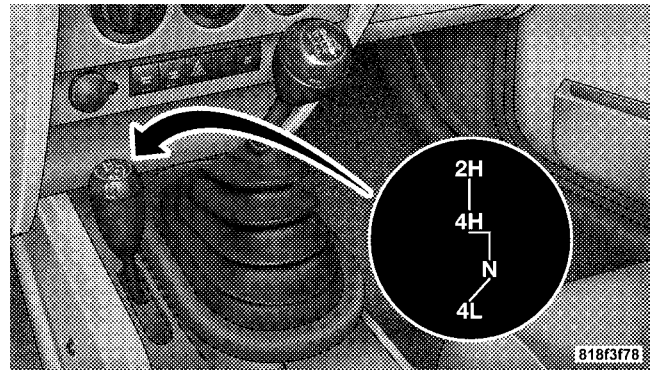

4WD Shift Controls

This transfer case is intended to be driven in the two wheel drive (2H) position for normal street and highway conditions such as dry hard surfaced roads.

In the events when additional traction is required, the transfer case 4H and 4L positions can be used to lock the front and rear driveshafts together and force the front

and rear wheels to rotate at the same speed. This is accomplished by simply moving the shift lever to these positions. The 4H and 4L positions are intended for loose, slippery road surfaces only. Driving in the 4H and 4L positions on dry hard surfaced roads may cause increased tire wear and damage to the driveline components.

The "4WD Indicator Light" (located in the instrument cluster) alerts the driver that the vehicle is in four wheel drive and that the front and rear driveshafts are locked together. This light illuminates when the transfer case is shifted into the 4H position.

NOTE: Do not attempt to make a shift while only the front or rear wheels are spinning. The transfer case is not equipped with a synchronizer and therefore the front and rear driveshafts speeds must be equal for the shift to take place. Shifting while only the front or rear wheels are spinning can cause damage to the transfer case.

When operating your vehicle in 4L, the engine speed is approximately three times (four times for Rubicon models) that of the 2H or 4H positions at a given road speed. Take care not to overspeed the engine.

Proper operation of four wheel drive vehicles depends on tires of equal size, type, and circumference on each wheel. Any difference will adversely affect shifting and cause damage to the transfer case.

Because four wheel drive provides improved traction, there is a tendency to exceed safe turning and stopping speeds. Do not go faster than road conditions permit.

WARNING!

You or others could be injured if you leave the vehicle unattended with the transfer case in the N (Neutral) position without first fully engaging the parking brake. The transfer case N (Neutral) position disengages both the front and rear driveshafts from the powertrain and will allow the vehicle to move regardless of the transmission position. The parking brake should always be applied when the driver is not in the vehicle.

Shift Positions

For additional information on the appropriate use of each transfer case mode position, see the information below:

2H Position

Rear Wheel Drive High Range — Normal street and highway driving. Dry hard surfaced roads.

4H Position

Four Wheel Drive High Range — Locks the front and rear driveshafts together. Forces the front and rear wheels to rotate at the same speed. Additional traction for loose, slippery road surfaces.

NOTE: This range should not be used during dry pavement operation.

The “4WD Indicator Light” (located in the instrument cluster) will illuminate when the transfer case is shifted into the 4H position.

N (Neutral) Position

Neutral — Disengages both the front and rear driveshafts from the powertrain. To be used for flat towing behind another vehicle. Refer to “Recreational Towing” in Section 5 of this manual.

4L Position

Four Wheel Drive Low Range — Locks the front and rear driveshafts together. Forces the front and rear wheels to rotate at the same speed. Additional traction and maximum pulling power for loose, slippery road surfaces only. Do not exceed 25 mph (40 km/h).

The “4WD Indicator Light” (located in the instrument cluster) will illuminate when the transfer case is shifted into the 4L position.

Shifting Procedure**2H to 4H or 4H to 2H**

Shifting between 2H and 4H can be made with the vehicle stopped or in motion. If the vehicle is in motion, shifts can be made up to 55 mph (88 km/h). With the vehicle in motion, the transfer case will engage/disengage faster if you momentarily release the accelerator pedal after completing the shift. Apply a constant force when shifting the transfer case lever.

4H to 4L or 4L to 4H

With the vehicle rolling at 2 to 3 mph (3 to 5 km/h), shift an automatic transmission to N (Neutral) or depress the clutch pedal on a manual transmission. While the vehicle is coasting at 2 to 3 mph (3 to 5 km/h), shift the transfer case lever firmly to the desired position. Do not pause in transfer case N (Neutral).

NOTE: Pausing in transfer case N (Neutral) in vehicles equipped with an automatic transmission may require shutting the engine OFF to avoid gear clash while completing the shift. If difficulty occurs, shift the automatic transmission to N (Neutral), hold foot on brake, and turn the engine OFF. Make shift to desired mode.

NOTE: Shifting into or out of 4L is possible with the vehicle completely stopped, however, difficulty may occur due to the mating teeth not being properly aligned. Several attempts may be required for clutch teeth alignment and shift completion to occur. The preferred

method is with the vehicle rolling at 2 to 3 mph (3 to 5 km/h). Avoid attempting to engage or disengage 4L with the vehicle moving faster than 2 to 3 mph (3 to 5 km/h).

WARNING!

Failure to engage a position completely can cause transfer case damage or loss of power and vehicle control. You could have an injury accident. Do not drive the vehicle unless the transfer case is fully engaged.

TRAC-LOK™ REAR AXLE — IF EQUIPPED

The Trac-Lok™ rear axle provides a constant driving force to both rear wheels and reduces wheel spin caused by the loss of traction at one driving wheel. If traction differs between the two rear wheels, the differential automatically proportions the usable torque by providing more torque to the wheel that has traction.

Trac-Lok™ is especially helpful during slippery driving conditions. With both rear wheels on a slippery surface, a slight application of the accelerator will supply maximum traction. When starting with only one rear wheel on an excessively slippery surface, slight application of the parking brake may be necessary to gain maximum traction.

WARNING!

On vehicles equipped with a limited-slip differential, never run the engine with one rear wheel off the ground. The vehicle may drive through the rear wheel remaining on the ground and cause you to lose control of your vehicle.

AXLE LOCK (TRU-LOK™) — RUBICON MODELS

The axle lock switch is located on the lower switch bank (below the climate controls).

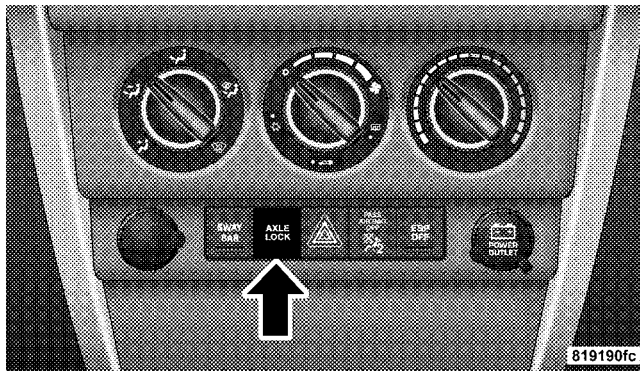

Axle Lock Switch

This feature will only activate when the following conditions are met:

- Key in ignition, vehicle in 4L (Low) range.

- Vehicle speed should be 10 mph (16 km/h) or less.

To activate the system, press the bottom of the switch once to lock the rear axle only (the “Rear Axle Lock Indicator Light” will illuminate), press the bottom of the switch again to lock the front axle (the “Front Axle Lock Indicator Light” will illuminate). Once the rear axle is locked, pressing the switch again will lock or unlock the front axle.

NOTE: The indicator lights will flash until the axles are fully locked or unlocked.

To unlock the axles, push the top of the switch.

Axle lock will disengage if the vehicle is taken out of 4L (Low) range, or the ignition switch is turned to the OFF position.

REAR AXLE LOCK — 4WD NON-RUBICON MODELS (IF EQUIPPED)

The rear axle lock switch is located on the lower switch bank (below the climate controls).

This feature will only activate when the following conditions are met:

- Key in ignition, vehicle in 4L (Low) range.
- Vehicle speed should be 10 mph (16 km/h) or less.

To activate the system, press the switch down to lock the rear axle (the “Rear Axle Lock Indicator Light” will illuminate), press the switch up to unlock the rear axle.

NOTE: The indicator lights will flash until the axle is fully locked or unlocked.

The rear axle lock will disengage if the vehicle is taken out of 4L (Low) range, or the ignition switch is turned to the OFF position.

ELECTRONIC SWAY BAR DISCONNECT — IF EQUIPPED

Your vehicle may be equipped with an electronic disconnecting stabilizer/sway bar. This system allows greater front suspension travel in off-road situations.

This system is controlled by the electronic control sway bar switch located on the lower switch bank (below the climate controls).

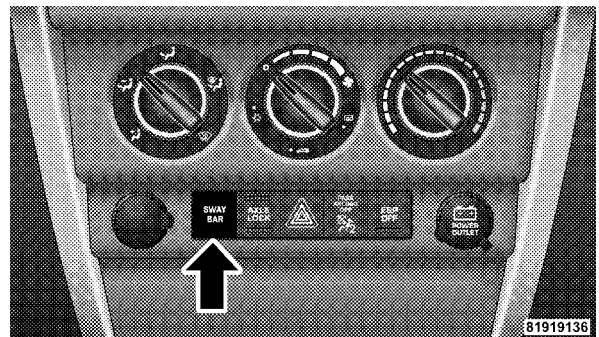

Sway Bar Switch

Press the sway bar switch to activate the system. Press the switch again to deactivate the system. The “Sway Bar Indicator Light” (located in the instrument cluster) will illuminate when the bar is disconnected. The “Sway Bar Indicator Light” will flash during activation transition, or when activation conditions are not met. The stabilizer/sway bar should remain in on-road mode during normal driving conditions.

WARNING!

Do not disconnect the stabilizer bar and drive on hard surfaced roads or at speeds above 18 mph (29 km/h), you may lose control of the vehicle, which could result in serious injury. The front stabilizer bar enhances vehicle stability and is necessary for maintaining control of the vehicle. The system monitors vehicle speed and will attempt to reconnect the stabilizer bar at speeds over 18 mph (29 km/h). This is indicated by a flashing or solid “Sway Bar Indicator Light.” Once vehicle speed is reduced below 14 mph (22 km/h), the system will once again attempt to return to off road mode.

To disconnect the stabilizer/sway bar, shift to either 4HI or 4LO (refer to “Four Wheel Drive Operation” in this section) and press the stabilizer/sway bar button to

obtain the off-road position. The amber indicator light will flash until the stabilizer/sway bar has been fully disconnected.

NOTE: The stabilizer/sway bar may be torque locked due to left and right suspension height differences. This condition is due to driving surface differences or vehicle loading. In order for the stabilizer/sway bar to disconnect/reconnect, the right and left halves of the bar must be aligned. This alignment may require that the vehicle be driven onto level ground or rocked from side to side.

To return to on-road mode, press the stabilizer/sway bar button again.

WARNING!

If the stabilizer/sway bar will not return to on-road mode, vehicle stability is greatly reduced. Do not attempt to drive vehicle over 18 mph (29 km/h). Driving faster than 18 mph (29 km/h) may cause loss of control of the vehicle, which could result in serious injury. Contact your local authorized dealer for assistance.

5

ON-ROAD DRIVING TIPS

Utility vehicles have higher ground clearance and a narrower track to make them capable of performing in a wide variety of off-road applications. Specific design characteristics give them a higher center of gravity than ordinary cars.

An advantage of the higher ground clearance is a better view of the road, allowing you to anticipate problems.

They are not designed for cornering at the same speeds as conventional 2-wheel drive vehicles any more than low-slung sports cars are designed to perform satisfactorily in off-road conditions. If at all possible, avoid sharp turns or abrupt maneuvers. As with other vehicles of this type, failure to operate this vehicle correctly may result in loss of control or vehicle rollover.

OFF-ROAD DRIVING TIPS

NOTE: Prior to off-road usage, the side step (if equipped) should be removed to prevent damage.

1. Remove two (2) nuts from bodyside.

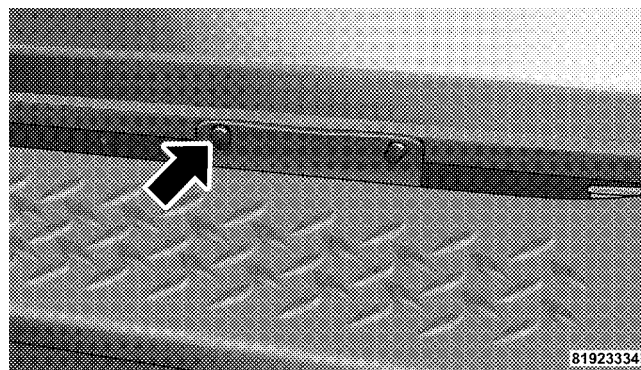

2. Remove one (1) bolt from underside of vehicle.

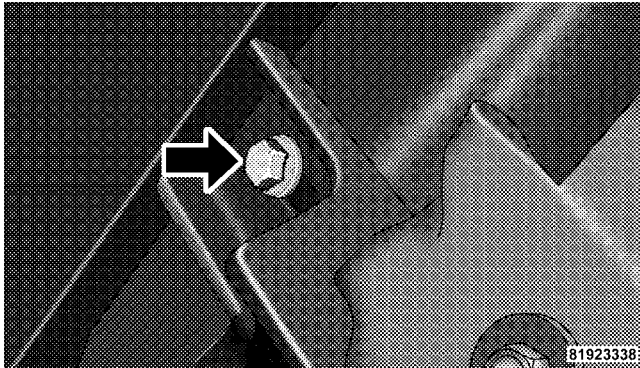

3. Remove side step assembly.

When To Use 4L (Low) Range

When off-road driving, shift to 4L (Low) for additional traction and control on slippery or difficult terrain, ascending or descending steep hills, and to increase low speed pulling power. This range should be limited to

extreme situations such as deep snow, mud, steep inclines, or sand where additional low speed pulling power is needed. Vehicle speeds in excess of 25 mph (40 km/h) should be avoided when in 4L (Low) range.

Driving Through Water

Although your vehicle is capable of driving through water, there are a number of precautions that must be considered before entering the water:

CAUTION!

When driving through water, do not exceed 5 mph (8 km/h). Always check water depth before entering as a precaution, and check all fluids afterward. Driving through water may cause damage that may not be covered by the new vehicle limited warranty.

Driving through water more than a few inches deep will require extra caution to ensure safety and prevent damage to your vehicle. If you must drive through water, try to determine the depth and the bottom condition (and location of any obstacles) prior to entering. Proceed with caution and maintain a steady controlled speed less than 5 mph (8 km/h) in deep water to minimize wave effects.

Flowing Water

If the water is swift flowing and rising (as in storm run-off) avoid crossing until the water level recedes and/or the flow rate is reduced. If you must cross flowing water avoid depths in excess of 9 inches. The flowing water can erode the streambed causing your vehicle to sink into deeper water. Determine exit point(s) that are downstream of your entry point to allow for drifting.

Standing Water

Avoid driving in standing water deeper than 20 inches, and reduce speed appropriately to minimize wave effects. Maximum speed in 20 inches of water is less than 5 mph (8 km/h).

Maintenance

After driving through deep water, inspect your vehicle fluids and lubricants (engine oil, transmission oil, axle, transfer case) to assure the fluids have not been contaminated. Contaminated fluid (milky, foamy in appearance) should be flushed/changed as soon as possible to prevent component damage.

Driving In Snow, Mud and Sand

In heavy snow, when pulling a load, or for additional control at slower speeds, shift the transmission to a low gear and shift the transfer case to 4L (Low) if necessary. Refer to "Four-Wheel Drive Operation" in this section.

Do not shift to a lower gear than necessary to maintain headway. Over-revving the engine can spin the wheels and traction will be lost.

Avoid abrupt downshifts on icy or slippery roads, because engine braking may cause skidding and loss of control.

Hill Climbing

NOTE: Before attempting to climb a hill, determine the conditions at the crest and/or on the other side.

Before climbing a steep hill, shift the transmission to a lower gear and shift the transfer case to 4L (Low). Use first gear and 4L (Low) for very steep hills.

If you stall or begin to lose headway while climbing a steep hill, allow your vehicle to come to a stop and immediately apply the brakes. Restart the engine and shift to R (Reverse). Back slowly down the hill allowing the compression braking of the engine to help regulate

your speed. If the brakes are required to control vehicle speed, apply them lightly and avoid locking or skidding the tires.

WARNING!

If the engine stalls or you lose headway or cannot make it to the top of a steep hill or grade, never attempt to turn around. To do so may result in tipping and rolling the vehicle. Always back carefully straight down a hill in R (Reverse) gear. Never back down a hill in N (Neutral) using only the brake.

Remember, never drive diagonally across a hill-always drive straight up or down.

If the wheels start to slip as you approach the crest of a hill, ease off the accelerator and maintain headway by

turning the front wheels slowly left and right. This may provide a fresh “bite” into the surface and will usually provide traction to complete the climb.

Traction Downhill

Shift the transmission into a low gear and the transfer case to 4L (Low) range. Let the vehicle go slowly down the hill with all four wheels turning against engine compression drag. This will permit you to control the vehicle speed and direction.

When descending mountains or hills, repeated braking can cause brake fade with loss of braking control. Avoid repeated heavy braking by downshifting the transmission whenever possible.

After Driving Off-Road

Off-road operation puts more stress on your vehicle than does most on-road driving. After going off-road it is always a good idea to check for damage. That way you can get any problems taken care of right away and have your vehicle ready when you need it.

- Completely inspect the underbody of your vehicle. Check tires, body structure, steering, suspension, and exhaust system for damage.
- Check threaded fasteners for looseness, particularly on the chassis, drivetrain components, steering, and suspension. Retighten them, if required, and torque to the values specified in the Service Manual.
- Check for accumulations of plants or brush. These things could be a fire hazard. They might hide damage to fuel lines, brake hoses, axle pinion seals, and propeller shafts.

- After extended operation in mud, sand, water, or similar dirty conditions, have brake rotors, wheels, brake linings, and axle yokes inspected and cleaned as soon as possible.

WARNING!

Abrasive material in any part of the brakes may cause excessive wear or unpredictable braking. You might not have full braking power when you need it to prevent an accident. If you have been operating your vehicle in dirty conditions, get your brakes checked and cleaned as necessary.

- If you experience unusual vibration after driving in mud, slush or similar conditions, check the wheels for impacted material. Impacted material can cause a wheel imbalance and freeing the wheels of it will correct the situation.

PARKING BRAKE

To set the parking brake, pull the lever up as firmly as possible. When the parking brake is applied with the ignition ON, the “Brake Warning Light” in the instrument cluster will light. To release the parking brake, pull up slightly, press the center button, then lower the lever completely.

NOTE: The instrument cluster “Brake Warning Light” indicates only that the parking brake is applied. You must be sure the parking brake is fully applied before leaving the vehicle.

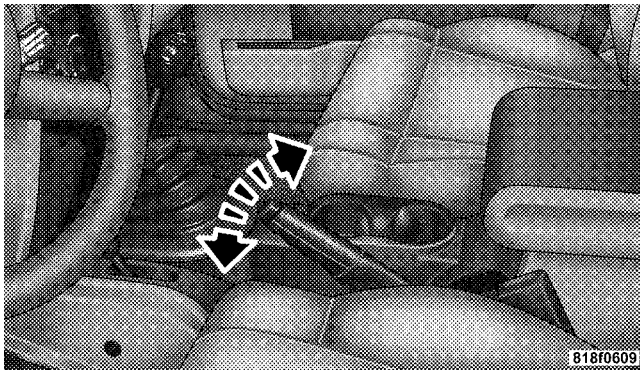

Parking Brake

Be sure the parking brake is firmly set when parked, and the gear shift lever is in the P (Park) position (automatic transmission) or R (Reverse) or 1st gear (manual transmission). When parking on a hill, you should apply the parking brake before placing the gear shift lever in P

(Park), otherwise the load on the transmission locking mechanism may make it difficult to move the selector out of P (Park).

WARNING!

- Always fully apply the parking brake when leaving your vehicle, or it may roll and cause damage or injury. Also, be certain to leave an automatic transmission in P (Park), a manual transmission in R (Reverse) or 1st gear. Failure to do so may allow the vehicle to roll and cause damage or injury.
- Never leave children alone in a vehicle. Leaving children in a vehicle unattended is dangerous for a number of reasons. A child or others could be seriously or fatally injured. Do not leave the keys in the ignition. A child could operate power windows, other controls, or move the vehicle.

When parking on a hill, turn the front wheels toward the curb on a downhill grade and away from the curb on an uphill grade.

The parking brake should always be applied whenever the driver is not in the vehicle.

ANTI-LOCK BRAKE SYSTEM

The Anti-Lock Brake System is designed to aid the driver in maintaining vehicle control under adverse braking conditions. The system operates with a separate computer to modulate hydraulic pressure to prevent wheel lock-up and help avoid skidding on slippery surfaces.

All vehicle wheels and tires must be the same size and type and tires must be properly inflated to produce accurate signals for the computer.

WARNING!

Significant over or under-inflation of tires, or mixing sizes of tires or wheels on the vehicle can lead to loss of braking effectiveness.

The Anti-Lock Brake System conducts a low speed self-test at about 12 mph (20 km/h). If for any reason, your foot is on the brake when the vehicle reaches 12 mph (20 km/h), this check will be delayed until 25 mph (40 km/h).

The Anti-Lock Brake System pump motor runs during the self-test and during an ABS stop to provide the regulated hydraulic pressure. The motor pump makes a low humming noise during operation, this is normal.

During off-road use, loss of traction can temporarily defeat the system and cause the warning light to illuminate. Turn the ignition OFF and ON again to restore Anti-Lock Brake System function.

WARNING!

Pumping of the Anti-Lock Brakes will diminish their effectiveness and may lead to an accident. Pumping makes the stopping distance longer. Just press firmly on your brake pedal when you need to slow down or stop.

WARNING!

- Anti-lock system (ABS) cannot prevent the natural laws of physics from acting on the vehicle, nor can it increase braking or steering efficiency beyond that afforded by the condition of the vehicle brakes and tires or the traction afforded.
- The ABS cannot prevent accidents, including those resulting from excessive speed in turns, following another vehicle too closely, or hydroplaning. Only a safe, attentive, and skillful driver can prevent accidents.
- The capabilities of an ABS equipped vehicle must never be exploited in a reckless or dangerous manner which could jeopardize the user's safety or the safety of others.

CAUTION!

The Anti-Lock Brake System is subject to possible detrimental effects of electronic interference caused by improperly installed aftermarket radios or telephones.

NOTE: During severe braking conditions, a pulsing sensation may occur and a clicking noise will be heard. This is normal, indicating that the Anti-Lock Brake System is functioning.

POWER STEERING

The standard power steering system will give you good vehicle response and increased ease of maneuverability in tight spaces. The system will provide mechanical steering capability if power assist is lost.

If for some reason the power assist is interrupted, it will still be possible to steer your vehicle. Under these conditions, you will observe a substantial increase in steering effort, especially at very low vehicle speeds and during parking maneuvers.

NOTE: Increased noise levels at the end of the steering wheel travel are considered normal and do not indicate that there is a problem with the power steering system.

Upon initial start-up in cold weather, the power steering pump may make noise for a short amount of time. This is due to the cold, thick fluid in the steering system. This noise should be considered normal, and does not in any way damage the steering system.

WARNING!

Continued operation with reduced power steering assist could pose a safety risk to yourself and others. Service should be obtained as soon as possible.

CAUTION!

Prolonged operation of the steering system at the end of the steering wheel travel will increase the steering fluid temperature and it should be avoided when possible. Damage to the power steering pump may occur.

TIRE SAFETY INFORMATION

Tire Markings

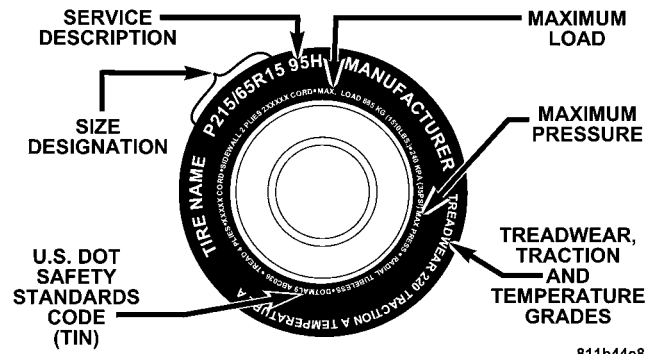

NOTE:

- P(Passenger)-Metric tire sizing is based on U.S. design standards. P-Metric tires have the letter "P" molded into the sidewall preceding the size designation. Example: P215/65R15 95H.
- European Metric tire sizing is based on European design standards. Tires designed to this standard have the tire size molded into the sidewall beginning with the section width. The letter "P" is absent from this tire size designation. Example: 215/65R15 96H
- LT(Light Truck)-Metric tire sizing is based on U.S. design standards. The size designation for LT-Metric tires is the same as for P-Metric tires except for the letters "LT" that are molded into the sidewall preceding the size designation. Example: LT235/85R16.
- Temporary Spare tires are high pressure compact spares designed for temporary emergency use only. Tires designed to this standard have the letter "T" molded into the sidewall preceding the size designation. Example: T145/80D18 103M.
- High Flotation tire sizing is based on U.S. design standards and begins with the tire diameter molded into the sidewall. Example: 31x10.5 R15 LT.

Tire Sizing Chart

EXAMPLE:
Size Designation: P = Passenger car tire size based on U.S. design standards "...blank..." = Passenger car tire based on European design standards LT = Light Truck tire based on U.S. design standards T = Temporary Spare tire 31 = Overall Diameter in Inches (in)
215 = Section Width in Millimeters (mm)
65 = Aspect Ratio in Percent (%) —Ratio of section height to section width of tire. 10.5 = Section Width in Inches (in)
R = Construction Code —"R" means Radial Construction. —"D" means Diagonal or Bias Construction.
15 = Rim Diameter in Inches (in)

EXAMPLE:**Service Description:**

95 = Load Index

—A numerical code associated with the maximum load a tire can carry.

H = Speed Symbol

—A symbol indicating the range of speeds at which a tire can carry a load corresponding to its load index under certain operating conditions.

—The maximum speed corresponding to the Speed Symbol should only be achieved under specified operating conditions. (ie. tire pressure, vehicle loading, road conditions and posted speed limits).

Load Identification:

"...blank..." = Absence of any text on sidewall of the tire indicates a Standard Load (SL) Tire

Extra Load (XL) = Extra Load (or Reinforced) Tire

Light Load = Light Load Tire

C,D,E = Load range associated with the maximum load a tire can carry at a specified pressure

Maximum Load — Maximum Load indicates the maximum load this tire is designed to carry.

Maximum Pressure — Maximum Pressure indicates the maximum permissible cold tire inflation pressure for this tire.

Tire Identification Number (TIN)

The TIN may be found on one or both sides of the tire however the date code may only be on one side. Tires with white sidewalls will have the full TIN including date code located on the white sidewall side of the tire.

Look for the TIN on the outboard side of black sidewall tires as mounted on the vehicle. If the TIN is not found on the outboard side then you will find it on the inboard side of the tire.

EXAMPLE:	
DOT MA L9 ABCD 0301	
DOT	= Department of Transportation —This symbol certifies that the tire is in compliance with the U.S. Department of Transportation tire safety standards, and is approved for highway use.
MA	= Code representing the tire manufacturing location.(2 digits)
L9	= Code representing the tire size.(2 digits)
ABCD	= Code used by tire manufacturer.(1 to 4 digits)
03	= Number representing the week in which the tire was manufactured.(2 digits) —03 means the 3rd week.
01	= Number representing the year in which the tire was manufactured.(2 digits) —01 means the year 2001. —Prior to July 2000, tire manufacturers were only required to have 1 number to represent the year in which the tire was manufactured. Example: 031 could represent the 3rd week of 1981 or 1991.

Tire Loading and Tire Pressure

Tire Placard Location

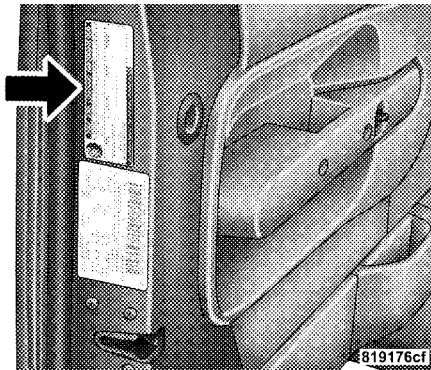

Tire Placard Location (2 Door Models)

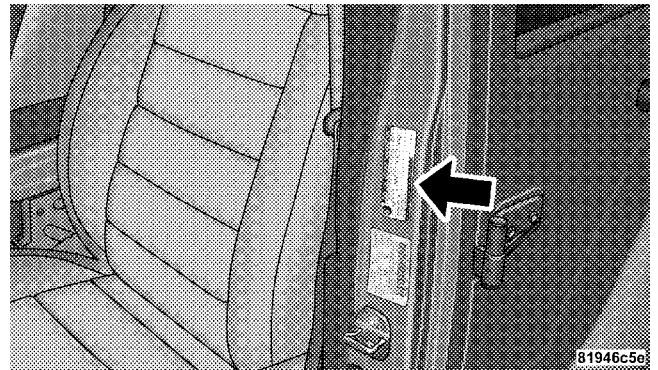

Tire Placard Location (4 Door Models)

Tire and Loading Information Placard

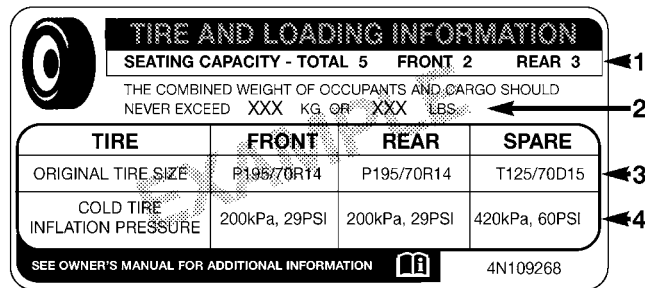

Tire and Loading Information

811b5a9a

This placard tells you important information about the,

- 1) number of people that can be carried in the vehicle
- 2) the total weight your vehicle can carry
- 3) the tire size designed for your vehicle
- 4) the cold tire inflation pressures for the front, rear and spare tires.

Loading

The vehicle maximum load on the tire must not exceed the load carrying capacity of the tire on your vehicle. You will not exceed the tire's load carrying capacity if you adhere to the loading conditions, tire size and cold tire inflation pressures specified on the Tire and Loading Information placard and the Vehicle Loading section of this manual.

NOTE: Under a maximum loaded vehicle condition, gross axle weight ratings (GAWR's) for the front and rear axles must not be exceeded. For further information on GAWR's, vehicle loading and trailer towing, see the Vehicle Loading section of this manual.

To determine the maximum loading conditions of your vehicle, locate the statement "The combined weight of occupants and cargo should never exceed XXX kg or XXX lbs." on the Tire and Loading Information placard. The

combined weight of occupants, cargo/luggage and trailer tongue weight (if applicable) should never exceed the weight referenced here.

Steps for Determining Correct Load Limit

1. Locate the statement "The combined weight of occupants and cargo should never exceed XXX pounds" on your vehicle's placard.
2. Determine the combined weight of the driver and passengers that will be riding in your vehicle.
3. Subtract the combined weight of the driver and passengers from XXX kilograms or XXX pounds.
4. The resulting figure equals the available amount of cargo and luggage load capacity. For example, if "XXX" amount equals 1400 lbs. and there will be five 150 lb. passengers in your vehicle, the amount of available cargo and luggage load capacity is 650 lb. (since $5 \times 150 = 750$, and $1400 - 750 = 650$ lb.)

5. Determine the combined weight of luggage and cargo being loaded on the vehicle. That weight may not safely exceed the available cargo and luggage load capacity calculated in step 4.

6. If your vehicle will be towing a trailer, load from your trailer will be transferred to your vehicle. Consult this manual to determine how this reduces the available cargo and luggage load capacity of your vehicle.

NOTE: The following table shows examples on how to calculate total load, cargo/luggage and towing capacities of your vehicle with varying seating configurations and number and size of occupants. This table is for illustration purposes only and may not be accurate for the seating and load carry capacity of your vehicle.

NOTE: For the following example the combined weight of occupants and cargo should never exceed 865 lbs. (392 Kg).

Occupants			Combined weight of occupants and cargo from Tire Placard	MINUS	Combined Occupant's weight	=	AVAILABLE Cargo/Luggage and Trailer Tongue Weight
TOTAL	FRONT	REAR					
<u>EXAMPLE 1</u>			865 lbs	minus	Occupant 1: 200 lbs Occupant 2: 130 lbs Occupant 3: 160 lbs Occupant 4: 100 lbs Occupant 5: 80 lbs TOTAL WEIGHT: 670 lbs	=	195 lbs
5	2	3					
<u>EXAMPLE 2</u>			865 lbs	minus	Occupant 1: 210 lbs Occupant 2: 180 lbs Occupant 3: 150 lbs TOTAL WEIGHT: 540 lbs	=	325 lbs
3	2	1					
<u>EXAMPLE 3</u>			865 lbs	minus	Occupant 1: 200 lbs Occupant 2: 200 lbs TOTAL WEIGHT: 400 lbs	=	465 lbs
2	2	0					

WARNING!

Overloading of your tires is dangerous. Overloading can cause tire failure, affect vehicle handling, and increase your stopping distance. Use tires of the recommended load capacity for your vehicle. Never overload them.

TIRES — GENERAL INFORMATION**Tire Pressure**

Proper tire inflation pressure is essential to the safe and satisfactory operation of your vehicle. Three primary areas are affected by improper tire pressure:

1. Safety—**WARNING!**

Improperly inflated tires are dangerous and can cause accidents.

- Under inflation increases tire flexing and can result in tire failure.
- Over inflation reduces a tire's ability to cushion shock. Objects on the road and chuck holes can cause damage that results in tire failure.
- Unequal tire pressures can cause steering problems. You could lose control of your vehicle.
- Overinflated or under inflated tires can affect vehicle handling and can fail suddenly, resulting in loss of vehicle control.
- Unequal tire pressures from one side of the vehicle to the other can cause the vehicle to drift to the right or left. Always drive with each tire properly inflated.

2. Economy—

Improper inflation pressures can cause uneven wear patterns to develop across the tire tread. These abnormal wear patterns will reduce tread life resulting in a need for earlier tire replacement. Under inflation also increases tire rolling resistance and results in higher fuel consumption.

3. Ride Comfort and Vehicle Stability—

Proper tire inflation contributes to a comfortable ride. Over inflation produces a jarring and uncomfortable ride.

Tire Inflation Pressures

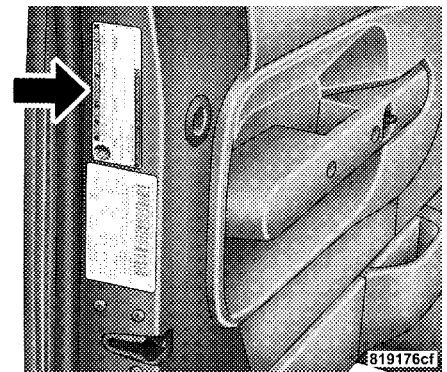

Tire Placard Location (2 Door Models)

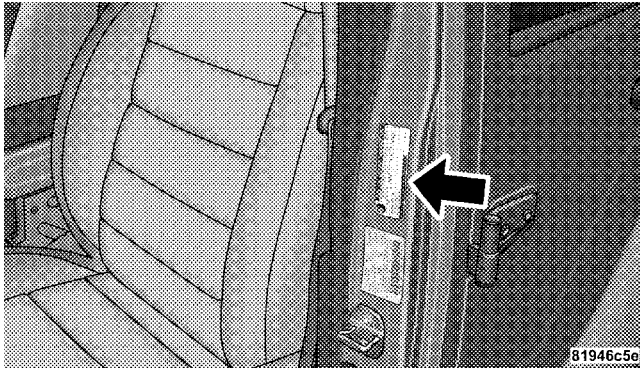

Tire Placard Location (4 Door Models)

The pressure should be checked and adjusted as well as inspecting for signs of tire wear or visible damage at least once a month. Use a good quality pocket-type gauge to check tire pressure. Do not make a visual judgement when determining proper inflation. Radial tires may look properly inflated even when they are under inflated.

CAUTION!

After inspecting or adjusting the tire pressure always reinstall the valve stem cap—if equipped. This will prevent moisture and dirt from entering the valve stem, which could damage the valve stem.

Inflation pressures specified on the placard are always “cold tire inflation pressure”. Cold tire inflation pressure is defined as the tire pressure after the vehicle has not been driven for at least 3 hours, or driven less than 1 mile (1 km) after a 3 hour period. The cold tire inflation pressure must not exceed the maximum inflation pressure molded into the tire side wall.

Check tire pressures more often if subject to a wide range of outdoor temperatures, as tire pressures vary with temperature changes.

Tire pressures change by approximately 1 psi (7 kPa) per 12° F (7° C) of air temperature change. Keep this in mind when checking tire pressure inside a garage especially in the winter.

Example: If garage temperature = 68° F (20° C) and the outside temperature = 32° F (0° C) then the cold tire inflation pressure should be increased by 3 psi (21 kPa), which equals 1 psi (7 kPa) for every 12° F (7° C) for this outside temperature condition.

Tire pressure may increase from 2 to 6 psi (13 to 40 kPa) during operation. DO NOT reduce this normal pressure build up or your tire pressure will be too low.

Tire Pressures for High Speed Operation

The manufacturer advocates driving at safe speeds within posted speed limits. Where speed limits or conditions are such that the vehicle can be driven at high speeds, maintaining correct tire inflation pressure is very important. Increased tire pressure and reduced vehicle

loading may be required for high speed vehicle operation. Refer to original equipment or an authorized tire dealer for recommended safe operating speeds, loading and cold tire inflation pressures.

WARNING!

High speed driving with your vehicle under load is dangerous. The added strain on your tires could cause them to fail. You could have a serious accident. Don't drive a vehicle loaded to maximum capacity at continuous speeds above 75 mph (120 km/h).

Radial-Ply Tires

WARNING!

Combining radial ply tires with other types of tires on your vehicle will cause your vehicle to handle poorly. The instability could cause an accident. Always use radial tires in sets of four. Never combine them with other types of tires.

Cuts and punctures in radial tires are repairable only in the tread area because of sidewall flexing. Consult your authorized dealer for radial tire repairs.

Tire Spinning

When stuck in mud, sand, snow, or ice conditions, do not spin your vehicle's wheels above 35 mph (55 km/h).

WARNING!

Fast spinning tires can be dangerous. Forces generated by excessive wheel speeds may cause tire damage or failure. A tire could explode and injure someone. Do not spin your vehicle's wheels faster than 35 mph (55 km/h) when you are stuck, and do not let anyone near a spinning wheel no matter what the speed.

Tread Wear Indicators

Tread wear indicators are in the original equipment tires to help you in determining when your tires should be replaced.

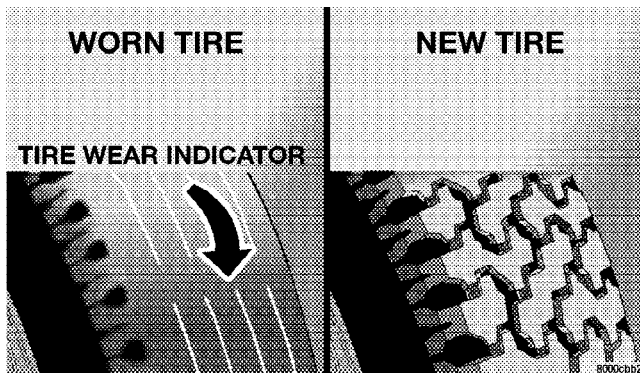

These indicators are molded into the bottom of the tread grooves and will appear as bands when the tread depth

becomes 1/16 inch (2 mm). When the indicators appear in 2 or more adjacent grooves, the tire should be replaced. Many states have laws requiring tire replacement at this point.

Life of Tire

The service life of a tire is dependent upon varying factors including but not limited to:

- Driving style
- Tire pressure
- Distance driven

WARNING!

Tires and spare tire should be replaced after six years, regardless of the remaining tread. Failure to follow this warning can result in sudden tire failure. You could lose control and have an accident resulting in serious injury or death.

Keep unmounted tires in a cool, dry place with as little exposure to light as possible. Protect tires from contact with oil, grease and gasoline.

Replacement Tires

The tires on your new vehicle provide a balance of many characteristics. They should be inspected regularly for wear and correct cold tire inflation pressure. The manufacturer strongly recommends that you use tires equivalent to the originals in size, quality and performance when replacement is needed (see the paragraph on tread wear indicators). Refer to the Tire and Loading Information placard for the size designation of your tire. The service description and load identification will be found on the original equipment tire. Failure to use equivalent replacement tires may adversely affect the safety, handling, and ride of your vehicle. We recommend that you contact your original equipment or an authorized tire dealer with any questions you may have on tire specifications or capability.

WARNING!

- Do not use a tire, wheel size or rating other than that specified for your vehicle. Some combinations of unapproved tires and wheels may change suspension dimensions and performance characteristics, resulting in changes to steering, handling, and braking of your vehicle. This can cause unpredictable handling and stress to steering and suspension components. You could lose control and have an accident resulting in serious injury or death. Use only the tire and wheel sizes with load ratings approved for your vehicle.
- Never use a tire with a smaller load index or capacity, other than what was originally equipped on your vehicle. Using a tire with a smaller load index could result in tire overloading and failure. You could lose control and have an accident.
- Failure to equip your vehicle with tires having adequate speed capability can result in sudden tire failure and loss of vehicle control.

CAUTION!

Replacing original tires with tires of a different size may result in false speedometer and odometer readings.

Alignment and Balance

Poor suspension alignment may result in:

- Fast tire wear.
- Uneven tire wear, such as feathering and one-sided wear.
- Vehicle pull to right or left.

Tires may also cause the vehicle to pull left or right. Alignment will not correct this problem. See your authorized dealer for proper diagnosis.

Improper alignment will not cause vehicle vibration. Vibration may be a result of tire and wheel out-of-balance. Proper balancing will reduce vibration and avoid tire cupping and spotty wear.

TIRE CHAINS

Install chains on rear tires only. Tire chains may be installed on all models except the Sahara and Rubicon. Follow these recommendations to guard against damage and excessive tire and chain wear:

- Use chains on P225/75R16 tires only. P245/75R16, P255/75R17, P255/70R18, and LT255/75R17 tires do not provide adequate clearance.
- Use SAE class "S" tire chains or traction devices only.
- Chains must be the proper size for the vehicle, as recommended by the chain manufacturer.
- Follow tire chain manufacturer's instructions for mounting chains.

- Install chains snugly and tighten after 6 mile (1 km) of driving.
- **Do not** exceed 30 mph (48 km/h).
- Drive cautiously, avoiding large bumps, potholes and extreme driving maneuvers.

TIRE ROTATION RECOMMENDATIONS

Tires on the front and rear axles of vehicles operate at different loads and perform different steering, handling, and braking functions. For these reasons, they wear at unequal rates, and develop irregular wear patterns.

These effects can be reduced by timely rotation of tires. The benefits of rotation are especially worthwhile with aggressive tread designs such as those on On/Off Road type tires. Rotation will increase tread life, help to maintain mud, snow, and wet traction levels, and contribute to a smooth, quiet ride.

Follow the recommended tire rotation frequency for your type of driving found in the “Maintenance Schedules” Section of this manual. More frequent rotation is permissible if desired. The reasons for any rapid or unusual wear should be corrected prior to rotation being performed.

The suggested rotation method is the “forward-cross” shown in the following diagram.

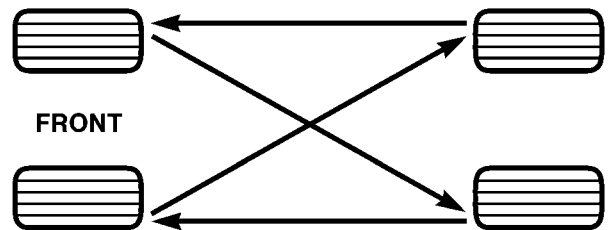

TIRE PRESSURE MONITOR SYSTEM (TPMS) — IF EQUIPPED

The Tire Pressure Monitoring System (TPMS) will warn the driver of a low tire pressure based on the vehicle recommended cold placard pressure.

The tire pressure will vary with temperature by about 1 psi (6.9 kPa) for every 12°F (6.5°C). This means that when the outside temperature decreases, the tire pressure will decrease. Tire pressure should always be set based on cold inflation tire pressure. This is defined as the tire pressure after a vehicle has not been driven for more than 3 hours - and in outside ambient temperature. Refer to the "Tires — General Information" in this section for information on how to properly inflate the vehicle's tires. The tire pressure will also increase as the vehicle is driven, this is normal and there should be no adjustment for this increased pressure.

The TPM System will warn the driver of a low tire pressure if the tire pressure falls below the low pressure warning threshold for any reason, including low temperature effects.

The TPM System will continue to warn the driver of low tire pressure as long as the condition exists, and will not turn off until the tire pressure is at or above recommended cold placard pressure. Once the low tire pressure warning has been illuminated, the tire pressure must be increased to the recommended cold placard pressure in order for the "Tire Pressure Monitoring Telltale Light" to be turned off. The system will automatically update and the "Tire Pressure Monitoring Telltale Light" will extinguish once the updated tire pressures have been received. The vehicle may need to be driven for up to 10 minutes above 15 mph (25 km/h) to receive this information.

For example, your vehicle may have a recommended cold (parked for more than 3 hours) air pressure of 35 psi

(241 kPa). If the ambient temperature is 65°F (18°C) and the measured tire pressure is 30 psi (207 kPa), a temperature drop to 20°F (-7°C) will decrease the tire pressure to approximately 26 psi (179 kPa). This tire pressure is sufficiently low enough to turn ON the “Tire Pressure Monitoring Telltale Light.” Driving the vehicle may cause the tire pressure to rise to approximately 30 psi (207 kPa), but the “Tire Pressure Monitoring Telltale Light” will still be ON. In this situation, the “Tire Pressure Monitoring Telltale Light” will turn OFF only after the tires have been inflated to the vehicle’s recommended cold placard pressure value.

Base System — If Equipped

The Tire Pressure Monitor System (TPMS) uses wireless technology with wheel rim mounted electronic sensors to monitor tire pressure levels. Sensors, mounted to each wheel as part of the valve stem, transmit tire pressure readings to the Receiver Module.

NOTE: It is particularly important, for you to check the tire pressure in all of your tires regularly and to maintain the proper pressure.

The Tire Pressure Monitor System (TPMS) consists of the following components:

- Receiver Module
- 4 Tire Pressure Monitoring Sensors
- Tire Pressure Monitoring Telltale Light

A tire pressure monitoring sensor is located in the spare wheel if the vehicle is equipped with a matching full size spare wheel and tire assembly. The matching full size spare tire can be used in place of any of the four road tires.



The “Tire Pressure Monitoring Telltale Light” will illuminate in the instrument cluster, and an audible chime will be activated when one or more of

the four active road tire pressures are low. The audible chime will sound once every ignition cycle for each condition that it detects. Should this occur, you should stop as soon as possible, check the inflation pressure of each tire on your vehicle, and inflate each tire to the pressure recommended by the vehicle manufacturer. The system will automatically update and the "Tire Pressure Monitoring Telltale Light" will extinguish once the updated tire pressures have been received. The vehicle may need to be driven for up to 10 minutes above 15 mph (25 km/h) to receive this information. A low spare tire will not cause the "Tire Pressure Monitoring Telltale Light" to illuminate or the chime to sound.

The "Tire Pressure Monitoring Telltale Light" will flash on and off for 60 seconds, and an audible chime will sound when a system fault is detected. The flash cycle will repeat every ten minutes, without an audible chime,

until the fault condition no longer exists. If the ignition key is cycled, this sequence will repeat, providing the system fault still exists.

NOTE: In the event that the matching full size spare tire is swapped with a low pressure road tire, the next ignition key cycle will still show the "Tire Pressure Monitoring Telltale Light" to be ON, and a chime to sound. Driving the vehicle for up to 10 minutes above 15 mph (25 kph) will turn OFF the "Tire Pressure Monitoring Telltale Light" as long as the spare tire or any other road tire(s) are not below the low pressure warning threshold.

CAUTION!

The TPMS has been optimized for the original equipment tires and wheels. TPMS pressures have been established for the tire size equipped on your vehicle. Undesirable system operation or sensor damage may result when using replacement equipment that is not of the same size, type, and/or style. After-market wheels can cause sensor damage. Do not use tire sealant from a can, or balance beads if your vehicle is equipped with a TPMS, as damage to the sensors may result.

CAUTION!

After inspecting or adjusting the tire pressure always reinstall the valve stem cap. This will prevent moisture and dirt from entering the valve stem, which could damage the wheel rim sensor.

NOTE:

- The TPMS is not intended to replace normal tire care and maintenance, nor to provide warning of a tire failure or condition.
- The TPMS should not be used as a tire pressure gauge while adjusting your tire pressure.
- Driving on a significantly under-inflated tire causes the tire to overheat and can lead to tire failure. Under-inflation also reduces fuel efficiency and tire tread life, and may affect the vehicle's handling and stopping ability.

- The TPMS is not a substitute for proper tire maintenance, and it is the driver’s responsibility to maintain correct tire pressure, even if under-inflation has not reached the level to trigger illumination of the “Tire Pressure Monitoring Telltale Light.”

General Information

This device complies with part 15 of the FCC rules and RSS 210 of Industry Canada. Operation is subject to the following conditions:

- This device may not cause harmful interference.
- This device must accept any interference received, including interference that may cause undesired operation.

The tire pressure sensors are covered under one of the following licenses:

United States KR5S120123
 Canada 2671-S120123

FUEL REQUIREMENTS



Your engine is designed to meet all emissions regulations and provide excellent fuel economy and performance when using high quality unleaded gasoline having an octane rating of 87. The use of premium gasoline is not recommended. The use of premium gasoline will provide no benefit over high quality regular gasoline, and in some circumstances may result in poorer performance.

Light spark knock at low engine speeds is not harmful to your engine. However, continued heavy spark knock at high speeds can cause damage and immediate service is required.

Poor quality gasoline can cause problems such as hard starting, stalling and hesitations. If you experience these symptoms, try another brand of gasoline before considering service for the vehicle.

Over 40 auto manufacturer's world wide have issued and endorsed consistent gasoline specifications (the World-wide Fuel Charter, WWFC) to define fuel properties necessary to deliver enhanced emissions, performance, and durability for your vehicle. The manufacturer recommends the use of gasoline that meets the WWFC specifications if they are available.

Reformulated Gasoline

Many areas of the country require the use of cleaner burning gasoline referred to as "Reformulated Gasoline."

Reformulated gasolines contains oxygenates, and are specifically blended to reduce vehicle emissions and improve air quality.

The manufacturer strongly supports the use of reformulated gasolines. Properly blended reformulated gasolines will provide excellent performance and durability for the engine and fuel system components.

Gasoline/Oxygenate Blends

Some fuel suppliers blend unleaded gasoline with oxygenates such as 10% ethanol, MTBE, and ETBE. Oxygenates are required in some areas of the country during the winter months to reduce carbon monoxide emissions. Fuels blended with these oxygenates may be used in your vehicle.

CAUTION!

DO NOT use gasolines containing Methanol or E85 Ethanol. Use of these blends may result in starting and driveability problems and may damage critical fuel system components.

Problems that result from using methanol/gasoline or E85 Ethanol blends are not the responsibility of the

manufacturer. While MTBE is an oxygenate made from Methanol, it does not have the negative effects of Methanol.

MMT In Gasoline

MMT is a manganese containing metallic additive that is blended into some gasoline to increase the octane number. Gasolines blended with MMT offer no performance advantage beyond gasolines of the same octane number without MMT. Gasolines blended with MMT have shown to reduce spark plug life and reduce emission system performance in some vehicles. The manufacturer recommends using gasolines without MMT. Since the MMT content of gasoline may not be indicated on the pump, you should ask your gasoline retailer whether or not his/her gasoline contains MMT.

It is even more important to look for gasolines without MMT in Canada, because MMT can be used at levels higher than those allowed in the United States.

MMT is prohibited in Federal and California reformulated gasolines.

Materials Added To Fuel

All gasoline sold in the United States is required to contain effective detergent additives. Use of additional detergents or other additives are not needed under normal conditions and would result in additional cost. Therefore you should not have to add anything to the fuel.

Fuel System Cautions

CAUTION!
Follow these guidelines to maintain your vehicle's performance:

- The use of leaded gasoline is prohibited by Federal law. Using leaded gasoline can impair engine performance, damage the emission control system.
- An out-of-tune engine, or certain fuel or ignition malfunctions, can cause the catalytic converter to overheat. If you notice a pungent burning odor or some light smoke, your engine may be out of tune or malfunctioning and may require immediate service. Contact your dealer for service assistance.
- The use of fuel additives which are now being sold as octane enhancers is not recommended. Most of these products contain high concentrations of methanol. Fuel system damage or vehicle performance problems resulting from the use of such fuels or additives is not the responsibility of the manufacturer.

NOTE: Intentional tampering with emissions control systems can result in civil penalties being assessed against you.

Carbon Monoxide Warnings

WARNING!

Carbon monoxide (CO) in exhaust gases is deadly. Follow the precautions below to prevent carbon monoxide poisoning:

- Do not inhale exhaust gases. They contain carbon monoxide, a colorless and odorless gas which can kill. Never run the engine in a closed area, such as a garage, and never sit in a parked vehicle with the engine running for an extended period. If the vehicle is stopped in an open area with the engine running for more than a short period, adjust the ventilation system to force fresh, outside air into the vehicle.
- Guard against carbon monoxide with proper maintenance. Have the exhaust system inspected every time

the vehicle is raised. Have any abnormal conditions repaired promptly. Until repaired, drive with all side windows fully open.

- Keep the swing gate closed when driving your vehicle to prevent carbon monoxide and other poisonous exhaust gases from entering the vehicle.

ADDING FUEL

Fuel Filler Cap (Gas Cap)

The gas cap is located on the driver's side of the vehicle. If the gas cap is lost or damaged, be sure the replacement cap is for use with this vehicle.

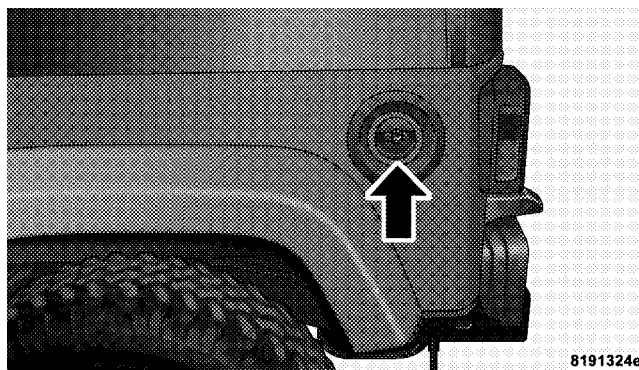

8191324e

Fuel Filler Cap

CAUTION!

Damage to the fuel system or emission control system could result from using an improper fuel cap (gas cap). A poorly fitting cap could let impurities into the fuel system. Also, a poorly fitting aftermarket cap can cause the MIL (Malfunction Indicator Light) to illuminate, due to fuel vapors escaping from the system.

CAUTION!

A poorly fitting gas cap may cause the Malfunction Indicator Light to turn on.

CAUTION!

To avoid fuel spillage and overfilling, do not “top off” the fuel tank after filling.

NOTE: When the fuel nozzle “clicks” or shuts off, the fuel tank is full.

WARNING!

- Never have any smoking materials lit in or near the vehicle when the gas cap is removed or the tank filled.
- Never add fuel when the engine is running. This is in violation of most state and federal fire regulations and will cause the malfunction indicator light to turn on.

NOTE: Tighten the gas cap about 1/4 turn until you hear one click. This is an indication that cap is properly tightened.

If the gas cap is not tighten properly, the Malfunction Indicator Light will come on. Be sure the gas cap is tightened every time the vehicle is refueled.

WARNING!
A fire may result if gasoline is pumped into a portable container that is inside of a vehicle. You could be burned. Always place gas containers on the ground while filling.

CAUTION!
Damage to the fuel system or emission control system could result from using an improper fuel tank filler cap (gas cap). A poorly fitting cap could let impurities into the fuel system.

WARNING!
<ul style="list-style-type: none">• Never add fuel when the engine is running.• Never have any smoking materials lit in or near the vehicle when the fuel cap is removed or the tank filled.

VEHICLE LOADING

Certification Label

As required by National Highway Traffic Safety Administration Regulations, your vehicle has a certification label affixed to the driver's side door or pillar.

This label contains the month and year of manufacture, Gross Vehicle Weight Rating (GVWR), Gross Axle Weight Rating (GAWR) front and rear, and Vehicle Identification Number (VIN). A Month-Day-Hour (MDH) number is included on this label and indicates the Month, Day and Hour of manufacture. The bar code that appears on the bottom of the label is your Vehicle Identification Number (VIN).

Gross Vehicle Weight Rating (GVWR)

The GVWR is the total permissible weight of your vehicle including driver, passengers, vehicle, options, trailer

tongue weight, and cargo. The label also specifies maximum capacities of front and rear axle systems (GAWR). Total load must be limited so GVWR and front and rear GAWR are not exceeded.

Payload

The payload of a vehicle is defined as the allowable load weight a truck can carry, including the weight of the driver, all passengers, options and cargo.

Gross Axle Weight Rating (GAWR)

The GAWR is the maximum permissible load on the front and rear axles. The load must be distributed in the cargo area so that the GAWR of each axle is not exceeded.

Each axle GAWR is determined by the components in the system with the lowest load carrying capacity (axle, springs, tires or wheels). Heavier axles or suspension components sometimes specified by purchasers for increased durability does not necessarily increase the vehicle's GVWR.

Tire Size

The tire size on the Label represents the actual tire size on your vehicle. Replacement tires must be equal to the load capacity of this tire size.

Rim Size

This is the rim size that is appropriate for the tire size listed.

Inflation Pressure

This is the cold tire inflation pressure for your vehicle for all loading conditions up to full GAWR.

Curb Weight

The curb weight of a vehicle is defined as the total weight of the vehicle with all fluids, including vehicle fuel, at full capacity conditions, and with no occupants or cargo loaded into the vehicle. The front and rear curb weight values are determined by weighing your vehicle on a commercial scale before any occupants or cargo are added.

Loading

The actual total weight and the weight of the front and rear of your vehicle at the ground can best be determined by weighing it when it is loaded and ready for operation.

The entire vehicle should first be weighed on a commercial scale to insure that the GVWR has not been exceeded. The weight on the front and rear of the vehicle should then be determined separately to be sure that the load is properly distributed over front and rear axle. Weighing the vehicle may show that the GAWR of either the front or rear axles has been exceeded but the total load is within the specified GVWR. If so, weight must be shifted from front to rear or rear to front as appropriate until the specified weight limitations are met. Store the heavier items down low and be sure that the weight is distributed equally. Stow all loose items securely before driving.

Improper weight distributions can have an adverse effect on the way your vehicle steers and handles and the way the brakes operate.

CAUTION!

Do not load your vehicle any heavier than the GVWR or the maximum front and rear GAWR. If you do, parts on your vehicle can break, or it can change the way your vehicle handles. This could cause you to lose control. Also overloading can shorten the life of your vehicle.

TRAILER TOWING

In this section you will find safety tips and information on limits to the type of towing you can reasonably do with your vehicle. Before towing a trailer carefully review this information to tow your load as efficiently and safely as possible.

To maintain warranty coverage, follow the requirements and recommendations in this manual concerning vehicles used for trailer towing.

Common Towing Definitions

The following trailer towing related definitions will assist you in understanding the following information:

Gross Vehicle Weight Rating (GVWR)

The GVWR is the total allowable weight of your vehicle. This includes driver, passengers, cargo and tongue weight. The total load must be limited so that you do not exceed the GVWR.

Gross Trailer Weight (GTW)

The gross trailer weight (GTW) is the weight of the trailer plus the weight of all cargo, consumables and equipment (permanent or temporary) loaded in or on the trailer in its "loaded and ready for operation" condition. The recommended way to measure GTW is to put your fully loaded trailer on a vehicle scale. The entire weight of the trailer must be supported by the scale.

Gross Combination Weight Rating (GCWR)

The gross combination weight rating (GCWR) is the total permissible weight of your vehicle and trailer when weighed in combination. (Note that GCWR ratings include a 150 lbs (68 kg) allowance for the presence of a driver).

Gross Axle Weight Rating (GAWR)

The GAWR is the maximum capacity of the front and rear axles. Distribute the load over the front and rear axles evenly. Make sure that you do not exceed either front or rear GAWR.

WARNING!

It is important that you do not exceed the maximum front or rear GAWR. A dangerous driving condition can result if either rating is exceeded. You could lose control of the vehicle and have an accident.

Tongue Weight (TW)

The downward force exerted on the hitch ball by the trailer. In most cases it should not be less than 10% or more than 15% of the trailer load. You must consider this as part of the load on your vehicle.

Frontal Area

The maximum height and maximum width of the front of a trailer.

Trailer Sway Control

The trailer sway control is a telescoping link that can be installed between the hitch receiver and the trailer tongue that typically provides adjustable friction associated with the telescoping motion to dampen any unwanted trailer swaying motions while traveling.

Weight-Carrying Hitch

A weight-carrying hitch supports the trailer tongue weight, just as if it were luggage located at a hitch ball or some other connecting point of the vehicle. These kind of hitches are the most popular on the market today and they're commonly used to tow small- and medium-sized trailers.

Weight-Distributing Hitch

A weight-distributing system works by applying leverage through spring (load) bars. They are typically used for heavier loads, to distribute trailer tongue weight to the tow vehicle's front axle and the trailer axle(s). When used in accordance with the manufacturers' directions, it provides for a more level ride, offering more consistent steering and brake control thereby enhancing towing safety. The addition of a friction/hydraulic sway control also dampens sway caused by traffic and crosswinds and contributes positively to tow vehicle and trailer stability. Trailer sway control and a weight distributing (load equalizing) hitch are recommended for heavier Tongue Weights (TW) and may be required depending on Vehicle and Trailer configuration/loading to comply with gross axle weight rating (GAWR) requirements.

WARNING!

An improperly adjusted Weight Distributing Hitch system may reduce handling, stability, braking performance, and could result in an accident.

Weight Distributing Systems may not be compatible with Surge Brake Couplers. Consult with your hitch and trailer manufacturer or a reputable Recreational Vehicle dealer for additional information.

EXAMPLE ONLY

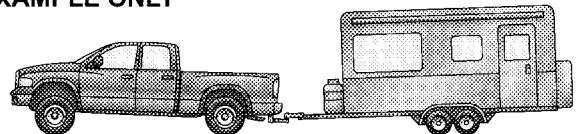

FIG. 1 WITHOUT WEIGHT DISTRIBUTION

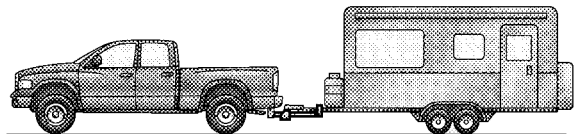

FIG. 2. WITH WEIGHT DISTRIBUTION

8181f965

Weight Distributing Hitch System

EXAMPLE ONLY

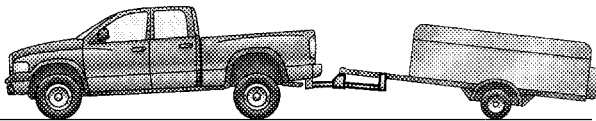

FIG. 3 IMPROPER ADJUSTMENT (INCORRECT)

8181f96f

Improper Adjustment of Weight Distributing System

Trailer Hitch Classification

The following chart provides the industry standard for the maximum trailer weight a given trailer hitch class can tow and should be used to assist you in selecting the correct trailer hitch for your intended towing condition. Refer to the Trailer Towing Weights (Maximum Trailer Weight Ratings) chart for the Max. GTW towable for your given drivetrain.

Trailer Hitch Classification	
Class	Max. GTW (Gross Trailer Wt.)
Class I - Light Duty	2,000 lbs (907 kg)
Class II - Medium Duty	3,500 lbs (1 587 kg)
Class III - Heavy Duty	5,000 lbs (2 268 kg)
Class IV - Extra Heavy Duty	10,000 lbs (4 540 kg)

All trailer hitches should be professionally installed on your vehicle.

Trailer Towing Weights (Maximum Trailer Weight Ratings)

The following chart provides the maximum trailer weight ratings towable for your given drivetrain.

Engine/ Transmission	Axle	Model	GCWR (Gross Combined Wt. Rating)	Frontal Area	Max. GTW (Gross Trailer Wt.)	Max. Tongue Wt. (See Note 1)
3.8L/ Manual	3.21	2 Door X Model (4WD)	4,910 lbs (2 227 kg)	25 sq. ft. (2.32 square meters)	1,000 lbs (453 kg)	100 lbs (45 kg)
3.8L/ Manual	4.10	2 Door X Model (4WD)	4,910 lbs (2 227 kg)	25 sq. ft. (2.32 square meters)	2,000 lbs (907 kg)	200 lbs (91 kg)
3.8L/ Automatic	4.10	2 Door X Model (4WD)	5,935 lbs (2 692 kg)	25 sq. ft. (2.32 square meters)	2,000 lbs (907 kg)	200 lbs (91 kg)
3.8L/ Manual	3.21	2 Door Sahara Model (4WD)	5,101 lbs (2 314 kg)	25 sq. ft. (2.32 square meters)	1,000 lbs (453 kg)	100 lbs (45 kg)

3.8L/ Manual	4.10	2 Door Sahara Model (4WD)	6,101 lbs (2 767 kg)	25 sq. ft. (2.32 square meters)	2,000 lbs (907 kg)	200 lbs (91 kg)
3.8L/ Automatic	4.10	2 Door Sahara Model (4WD)	6,126 lbs (2 779 kg)	25 sq. ft. (2.32 square meters)	2,000 lbs (907 kg)	200 lbs (91 kg)
3.8L/ Manual	4.10	2 Door Rubicon Model (4WD)	6,254 lbs (2 837 kg)	25 sq. ft. (2.32 square meters)	2,000 lbs (907 kg)	200 lbs (91 kg)
3.8L/ Automatic	4.10	2 Door Rubicon Model (4WD)	6,279 lbs (2 848 kg)	25 sq. ft. (2.32 square meters)	2,000 lbs (907 kg)	200 lbs (91 kg)
3.8L/ Manual	3.21	4 Door X Model (2WD)	5,014 lbs (2 274 kg)	32 sq. ft. (2.97 square meters)	1,000 lbs (453 kg)	100 lbs (45 kg)

322 STARTING AND OPERATING

3.8L/ Manual	4.10	4 Door X Model (2WD)	7,514 lbs (3 408 kg)	32 sq. ft. (2.97 square meters)	3,500 lbs (1 587 kg)	350 lbs (159 kg)
3.8L/ Automatic	4.10	4 Door X Model (2WD)	7,539 lbs (3 420 kg)	32 sq. ft. (2.97 square meters)	3,500 lbs (1 587 kg)	350 lbs (159 kg)
3.8L/ Manual	3.21	4 Door Sahara Model (2WD)	5,204 lbs (2 360 kg)	32 sq. ft. (2.97 square meters)	1,000 lbs (453 kg)	100 lbs (45 kg)
3.8L/ Manual	4.10	4 Door Sahara Model (2WD)	7,704 lbs (3 494 kg)	32 sq. ft. (2.97 square meters)	3,500 lbs (1 587 kg)	350 lbs (159 kg)
3.8L/ Automatic	4.10	4 Door Sahara Model (2WD)	7,729 lbs (3 506 kg)	32 sq. ft. (2.97 square meters)	3,500 lbs (1 587 kg)	350 lbs (159 kg)

3.8L/ Manual	3.21	4 Door X Model (4WD)	5,225 lbs (2 370 kg)	32 sq. ft. (2.97 square meters)	1,000 lbs (453 kg)	100 lbs (45 kg)
3.8L/ Manual	4.10	4 Door X Model (4WD)	7,725 lbs (3 504 kg)	32 sq. ft. (2.97 square meters)	3,500 lbs (1 587 kg)	350 lbs (159 kg)
3.8L/ Automatic	4.10	4 Door X Model (4WD)	7,750 lbs (3 515 kg)	32 sq. ft. (2.97 square meters)	3,500 lbs (1 587 kg)	350 lbs (159 kg)
3.8L/ Manual	3.21	4 Door Sahara Model (4WD)	5,419 lbs (2 458 kg)	32 sq. ft. (2.97 square meters)	1,000 lbs (453 kg)	100 lbs (45 kg)
3.8L/ Manual	4.10	4 Door Sahara Model (4WD)	7,919 lbs (3 592 kg)	32 sq. ft. (2.97 square meters)	3,500 lbs (1 587 kg)	350 lbs (159 kg)

324 STARTING AND OPERATING

3.8L/ Automatic	4.10	4 Door Sahara Model (4WD)	7,944 lbs (3 603 kg)	32 sq. ft. (2.97 square meters)	3,500 lbs (1 587 kg)	350 lbs (159 kg)
3.8L/ Manual	4.10	4 Door Rubicon Model (4WD)	7,965 lbs (3 613 kg)	32 sq. ft. (2.97 square meters)	3,500 lbs (1 587 kg)	350 lbs (159 kg)
3.8L/ Automatic	4.10	4 Door Rubicon Model (4WD)	7,990 lbs (3 624 kg)	32 sq. ft. (2.97 square meters)	3,500 lbs (1 587 kg)	350 lbs (159 kg)
Refer to local laws for maximum trailer towing speeds.						

NOTE: The trailer tongue weight must be considered as part of the combined weight of occupants and cargo, and should never exceed the weight referenced on the Tire and Loading Information placard. Refer to the Tire-Safety Information section in this manual.

Trailer and Tongue Weight

Always load a trailer with 60% to 65% of the weight in the front of the trailer. This places 10% to 15% of the Gross Trailer Weight (GTW) on the tow hitch of your vehicle. Loads balanced over the wheels or heavier in the rear can cause the trailer to sway **severely** side to side

which will cause loss of control of vehicle and trailer. Failure to load trailers heavier in front is the cause of many trailer accidents.

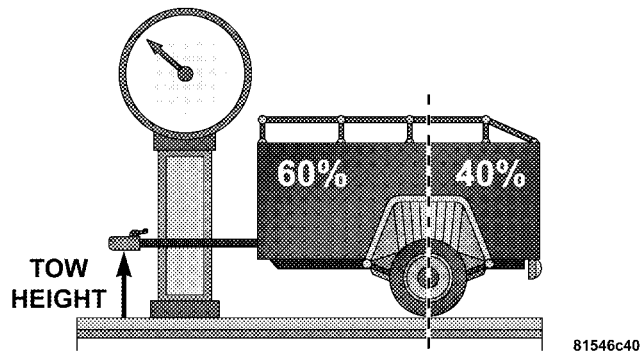

Consider the following items when computing the weight on the rear axle of the vehicle:

- The tongue weight of the trailer.

- The weight of any other type of cargo or equipment put in or on your vehicle.
- The weight of the driver and all passengers.

NOTE: Remember that everything put into or on the trailer adds to the load on your vehicle. Also, additional factory-installed options, or dealer-installed options, must be considered as part of the total load on your vehicle. Refer to the Tire and Loading Information placard in the Tire Safety Information section of this manual for the maximum combined weight of occupants and cargo for your vehicle.

Towing Requirements

To promote proper break-in of your new vehicle drivetrain components the following guidelines are recommended:

NOTE: Trailer towing requires special rear axle lubricant. Refer to “Fluids, Lubricants, and Genuine Parts” in Section 7 for more information.

CAUTION!

- Avoid towing a trailer for the first 500 miles (805 km) of vehicle operation. Doing so may damage your vehicle.

Perform the maintenance listed in Section 8 of this manual. When towing a trailer, never exceed the GAWR, or GCWR, ratings.

WARNING!

Improper towing can lead to an injury accident. Follow these guidelines to make your trailer towing as safe as possible:

Make certain that the load is secured in the trailer and will not shift during travel. When trailering cargo that is not fully secured, dynamic load shifts can occur that may be difficult for the driver to control. You could lose control of your vehicle and have an accident.

- When hauling cargo or towing a trailer, do not overload your vehicle or trailer. Overloading can cause a loss of control, poor performance or damage to brakes, axle, engine, transmission, steering, suspension, chassis structure or tires.

- Safety chains must always be used between your vehicle and trailer. Always connect the chains to the frame or hook retainers of the vehicle hitch. Cross the chains under the trailer tongue and allow enough slack for turning corners.
- Vehicles with trailers should not be parked on a grade. When parking, apply the parking brake on the tow vehicle. Put the tow vehicle automatic transmission in P (Park). With a manual transmission, shift the transmission into 1st gear. And with four-wheel-drive vehicles, make sure the transfer case is not in N (Neutral). Always, block or "chock" the trailer wheels.
- GCWR must not be exceeded.
- **Total weight must be distributed between the tow vehicle and the trailer such that the following four ratings are not exceeded:**

1. GVWR

2. GTW

3. GAWR

4. Tongue weight rating for the trailer hitch utilized (This requirement may limit the ability to always achieve the 10% to 15% range of tongue weight as a percentage of total trailer weight).

Towing Requirements — Tires

- Do not attempt to tow a trailer while using a compact spare tire.
- Proper tire inflation pressures are essential to the safe and satisfactory operation of your vehicle. Refer to the Tires—General Information section of this manual on Tire Pressures for proper tire inflation procedures.
- Also, check the trailer tires for proper tire inflation pressures before trailer usage.

- Check for signs of tire wear or visible tire damage before towing a trailer. Refer to the Tires–General Information section of this manual on Tread Wear Indicators for the proper inspection procedure.
- When replacing tires, refer to the Tires–General Information section of this manual on Replacement Tires for proper tire replacement procedures. Replacing tires with a higher load carrying capacity will not increase the vehicle’s GVWR and GAWR limits.

Towing Requirements — Trailer Brakes

- Do **not** interconnect the hydraulic brake system or vacuum system of your vehicle with that of the trailer. This could cause inadequate braking and possible personal injury.
- An electronically actuated trailer brake controller is required when towing a trailer with electronically

actuated brakes. When towing a trailer equipped with a hydraulic surge actuated brake system, an electronic brake controller is not required.

- Trailer brakes are recommended for trailers over 1,000 lbs (454 kg) and required for trailers in excess of 2,000 lbs (907 kg).

CAUTION!

If the trailer weighs more than 1,000 lbs (454 kg) loaded, it should have its own brakes and they should be of adequate capacity. Failure to do this could lead to accelerated brake lining wear, higher brake pedal effort, and longer stopping distances.

WARNING!

Do not connect trailer brakes to your vehicle's hydraulic brake lines. It can overload your brake system and cause it to fail. You might not have brakes when you need them and could have an accident.

Towing any trailer will increase your stopping distance. When towing you should allow for additional space between your vehicle and the vehicle in front of you. Failure to do so could result in an accident.

Towing Requirements — Trailer Lights & Wiring

Whenever you pull a trailer, regardless of the trailer size, stop lights and turn signals on the trailer are required for motoring safety.

The Trailer Tow Package may include a 4 and 7 pin wiring harness. Use a factory approved trailer harness and connector.

NOTE: Do not cut or splice wiring into the vehicles wiring harness.

The electrical connections are all complete to the vehicle but you must mate the harness to a trailer connector. Refer to the following illustrations.

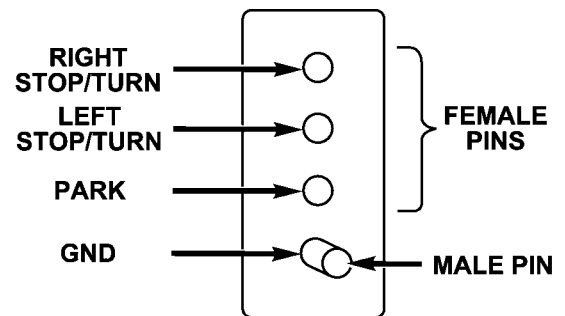

4 - Pin Connector

813262be

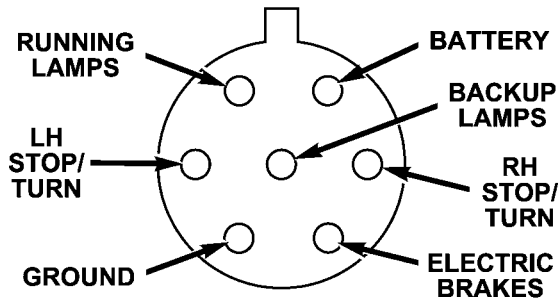

812634c6

7- Pin Connector

Towing Tips

Before setting out on a trip, practice turning, stopping and backing the trailer in an area away from heavy traffic.

If using a manual transmission vehicle for trailer towing, all starts must be in FIRST gear to avoid excessive clutch slippage.

Towing Tips — Automatic Transmission

The "D" range can be selected when towing. However, if frequent shifting occurs while in this range, the "3" range should be selected.

NOTE: Using the "3" range while operating the vehicle under heavy operating conditions will improve performance and extend transmission life by reducing excessive shifting and heat build up. This action will also provide better engine braking.

The automatic transmission fluid and filter should be changed if you REGULARLY tow a trailer for more than 45 minutes of continuous operation. See "Schedule B" in section 8 of this manual for transmission fluid change intervals.

NOTE: Check the automatic transmission fluid level before towing.

Towing Tips — O/D Off (If Equipped)

To reduce potential for automatic transmission overheating, turn the “O/D OFF” feature OFF when driving in hilly areas or shift the transmission to Drive position 2 on more severe grades. Refer to “Transmission Shifting” in this section.

Towing Tips — Electronic Speed Control (If Equipped)

- Don’t use in hilly terrain or with heavy loads.
- When using the speed control, if you experience speed drops greater than 10 mph (16 km/h), disengage until you can get back to cruising speed.
- Use speed control in flat terrain and with light loads to maximize fuel efficiency.

Towing Tips — Cooling System

To reduce potential for engine and transmission overheating, take the following actions:

– *Highway Driving*

Reduce speed.

– *Air Conditioning*

Turn off temporarily.

- refer to Cooling System Operating information in the Maintenance section of this manual for more information.

RECREATIONAL TOWING (BEHIND MOTORHOME, ETC.)**CAUTION!**

Front or rear wheel lifts should not be used. Internal damage to the transmission or transfer case will occur if a front or rear wheel lift is used when recreational towing.

NOTE: The transfer case must be shifted into N (Neutral) for recreational towing.

Shifting Into Neutral (N)

Use the following procedure to prepare your vehicle for recreational towing.

CAUTION!

It is necessary to follow these steps to be certain that the transfer case is fully in N (Neutral) before recreational towing to prevent damage to internal parts.

1. Depress brake pedal.
2. Shift automatic transmission into N (Neutral) or depress clutch pedal on manual transmission.
3. Shift transfer case lever into N (Neutral).
4. Start engine.
5. Shift automatic transmission into D (Drive) or manual transmission into gear.
6. Release brake pedal and ensure that there is no vehicle movement.

7. Shut the engine off and place the ignition key into the unlocked OFF position.
8. Shift automatic transmission into P (Park).
9. Apply parking brake.
10. Attach vehicle to the tow vehicle with tow bar.
11. Release parking brake.

CAUTION!

Damage to the transmission may occur if the transmission is shifted into P (Park) with the transfer case in N (Neutral) and the engine running. With the transfer case in N (Neutral) ensure that the engine is off prior to shifting the transmission into P (Park) (refer to steps 7 – 8 above).

Shifting Out Of Neutral (N)

Use the following procedure to prepare your vehicle for normal usage.

1. Shift automatic transmission into N (Neutral) or depress clutch pedal on manual transmission.
2. Shift transfer case lever into desired position.
3. Shift automatic transmission into D (Drive) or release clutch on manual transmissions.

NOTE: When shifting out of transfer case N (Neutral) on automatic transmission equipped vehicles, turning the engine off may be required to avoid gear clash.

WARNING!

You or others could be injured if you leave the vehicle unattended with the transfer case in the N (Neutral) position without first fully engaging the parking brake. The transfer case N (Neutral) position disengages both the front and rear driveshafts from the powertrain and will allow the vehicle to move despite the transmission position. The parking brake should always be applied when the driver is not in the vehicle.

CAUTION!

- Do not use a bumper mounted clamp-on tow bar on your vehicle. The bumper face bar will be damaged.

WHAT TO DO IN EMERGENCIES

CONTENTS

■ Hazard Warning Flashers336	□ Preparations For Jacking339
■ If Your Engine Overheats337	□ Jacking Instructions340
■ Jacking And Tire Changing338	■ Jump Starting342
□ Jack Location338	■ Emergency Tow Hooks — If Equipped344
□ Spare Tire Stowage339	■ Towing A Disabled Vehicle345

HAZARD WARNING FLASHERS

Your vehicle's hazard warning flasher is an emergency warning system. When you activate it, all front and rear directional signals will flash intermittently. Use it when your vehicle is disabled on or near the road. It warns other drivers to steer clear of you and your vehicle. This is an emergency warning system, not to be used when the vehicle is in motion.

To activate the warning flashers, press the button on the lower switch bank (below the climate controls). To turn the warning flashers off, press the button again.

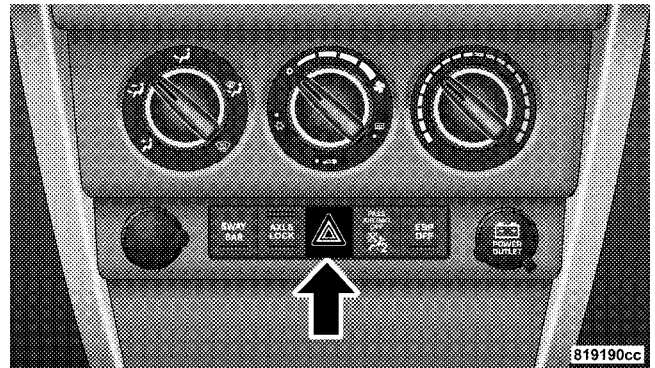

Hazard Warning Switch

NOTE: With extended use, the flasher may wear down your battery.

IF YOUR ENGINE OVERHEATS

In any of the following situations, you can reduce the potential for overheating by taking the appropriate action.

- On the highways — Slow down.
- In city traffic — While stopped, put transmission in N (Neutral), but do not increase engine idle speed.

NOTE: There are steps that you can take to slow down an impending overheat condition. If your air conditioner is on, turn it off. The air conditioning system adds heat to the engine cooling system and turning off the A/C removes this heat. You can also turn the Temperature Control to maximum heat, the Mode Control to floor, and the Fan Control to High. This allows the heater core to act as a supplement to the radiator and aids in removing heat from the engine cooling system.

CAUTION!

Driving with a hot cooling system could damage your vehicle. If the temperature gauge reads "H", pull over and stop the vehicle. Idle the vehicle with the air conditioner turned off until the pointer drops back into the normal range. If the pointer remains on the "H", and you hear continuous chimes, turn the engine off immediately, and call for service.

JACKING AND TIRE CHANGING**WARNING!**

- Getting under a jacked-up vehicle is dangerous. The vehicle could slip off the jack and fall on you. You could be crushed. Never get any part of your body under a vehicle that is on a jack. If you need to get under a raised vehicle, take it to a service center where it can be raised on a lift.
- The jack is designed to use as a tool for changing tires only. The jack should not be used to lift the vehicle for service purposes. The vehicle should be jacked on a firm level surface only. Avoid ice or slippery areas.

Jack Location

The jack and lug wrench are located in the rear storage compartment. Refer to "Storage" in Section 3 of this manual.

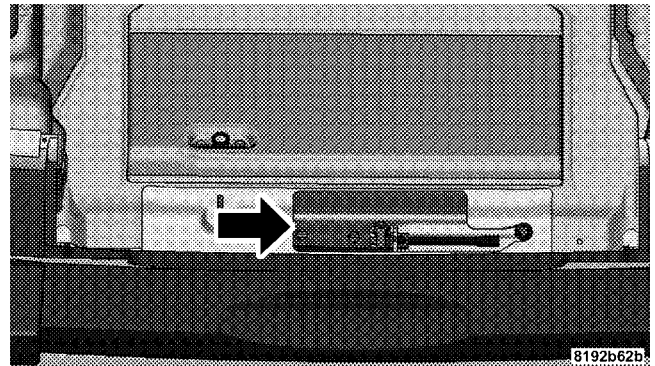

Jack Storage

Spare Tire Stowage

To remove the spare tire from the carrier, remove the tire cover, if equipped, and remove the lug nuts with the lug wrench turning them counterclockwise.

NOTE: If you have added aftermarket accessories to the spare tire mounted carrier, it cannot exceed a gross weight of 50 lbs (23 kg) including the weight of the spare tire.

Preparations For Jacking

Park on a firm level surface, avoid ice or slippery areas, **set the parking brake** and place automatic transmission in P (Park), or manual transmission in R (Reverse). Turn OFF the ignition.

WARNING!

Do not attempt to change a tire on the side of the vehicle close to moving traffic. Pull far enough off the road to avoid being hit when operating the jack or changing the wheel.

- Turn on the Hazard Warning Flasher.

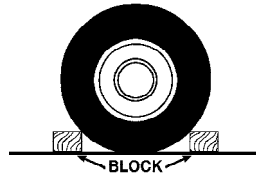

- Block both the front and rear of the wheel diagonally opposite of the jacking position. For example, if changing the right front tire, block the left rear wheel.
- Passengers should not remain in the vehicle when the vehicle is being jacked.

Jacking Instructions

1. Remove spare tire, jack and tools from stored location.
2. Loosen (but do not remove) the wheel lug nuts by turning them to the left one turn while the wheel is still on the ground.
3. Assemble the jack and jacking tools. Connect jack handle driver to extension, then to lug wrench.
4. Operate jack from the front or the rear of the vehicle. Place the jack under the axle tube, as shown. **Do not raise the vehicle until you are sure the jack is fully engaged.**

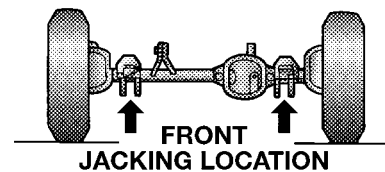
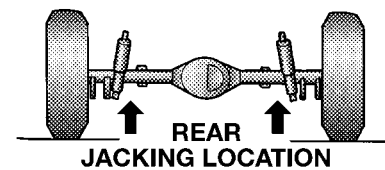

Jacking Locations

5. Raise the vehicle by turning the jack screw to the right. Raise the vehicle only until the tire just clears the surface and enough clearance is obtained to install the spare tire. Minimum tire lift provides maximum stability.

WARNING!

Raising the vehicle higher than necessary can make the vehicle less stable and cause an accident. It could slip off the jack and hurt someone near it. Raise the vehicle only enough to remove the tire.

6. Remove the lug nuts and wheel.

7. Position spare wheel/tire on vehicle and install lug nuts with cone-shaped end toward wheel. Lightly tighten

nuts clockwise. To avoid the risk of forcing the vehicle off the jack, do not tighten the nuts fully until the vehicle has been lowered.

8. Lower the vehicle by turning the jack screw to the left, and remove the jack and wheel blocks.

9. Finish tightening the lug nuts. Push down on the wrench while tightening for increased leverage. Alternate nuts until each nut has been tightened twice. Correct wheel nut tightness is 130 N·m (95 ft. lbs). If in doubt about the correct tightness, have them checked with a torque wrench by your authorized dealer or at a service station.

10. Remove jack assembly and wheel blocks.

WARNING!

A loose tire or jack, thrown forward in a collision or hard stop could endanger the occupants of the vehicle. Always stow the jack parts and the spare tire in the places provided.

11. Secure the tire, jack, and tools in their proper locations.

JUMP STARTING

If the vehicle has a discharged battery, booster cables may be used to obtain a start from a booster battery or the battery in another vehicle. This type of start can be dangerous if done improperly, so follow this procedure carefully.

WARNING!

Battery fluid is a corrosive acid solution; do not allow battery fluid to contact eyes, skin or clothing. Don't lean over battery when attaching clamps or allow the clamps to touch each other. If acid splashes in eyes or on skin, flush contaminated area immediately with large quantities of water.

A battery generates hydrogen gas which is flammable and explosive. Keep flame or spark away from the vent holes.

Do not use a booster battery or any other booster source that has a greater than 12 volt system, i.e. Do not use a 24 volt power source.

1. Remove all metal jewelry such as watch bands or bracelets which might make an unintended electrical contact.

2. Park the booster vehicle within cable reach but without letting the vehicles touch. Set the parking brake on both vehicles, place the automatic transmission in P (Park), or the manual transmission in N (Neutral), and turn the ignition OFF.
3. Turn off the heater, radio, and all unnecessary electrical loads.
4. Connect one end of a jumper cable to the positive terminal of the booster battery. Connect the other end of the same cable to the positive terminal of the discharged battery.

WARNING!

Do not permit vehicles to touch each other as this could establish a ground connection and personal injury could result.

5. Connect the other cable, first to the negative terminal of the booster battery and then to the engine of the vehicle with the discharged battery. Make sure you have a good contact on the engine.

WARNING!

- You should not try to start your vehicle by pushing or towing.
- Do not connect the cable to the negative post of the discharge battery. The resulting electrical spark could cause the battery to explode.
- During cold weather when temperatures are below freezing point, electrolyte in a discharged battery may freeze. Do not attempt jump starting because the battery could rupture or explode. The battery temperature must be brought up above freezing point before attempting jump start.

6. Start the engine in the vehicle which has the booster battery, let the engine idle a few minutes, then start the engine in the vehicle with the discharged battery.
7. When removing the jumper cables, reverse the above sequence exactly. Be careful of the moving belts and fan.

WARNING!

Any procedure other than above could result in:

1. Personal injury caused by electrolyte squirting out the battery vent;
2. Personal injury or property damage due to battery explosion;
3. Damage to charging system of booster vehicle or of immobilized vehicle.

EMERGENCY TOW HOOKS — IF EQUIPPED

If your vehicle is equipped with tow hooks, they are mounted in the front and the rear.

CAUTION!

Tow hooks are for emergency use only, to rescue a vehicle stranded off road. Do not use tow hooks for tow truck hookup or highway towing. You could damage your vehicle. Tow straps are recommended when towing the vehicle, chains may cause vehicle damage.

WARNING!

Stand clear of vehicles when pulling with tow hooks. Tow straps and chains may break, causing serious injury.

TOWING A DISABLED VEHICLE

The manufacturer recommends towing with all four wheels off the ground. Acceptable methods are to tow the vehicle on a flatbed or with one end of the vehicle raised and the other end on a towing dolly.

MAINTAINING YOUR VEHICLE

CONTENTS

■ Engine Compartment – 3.8L	350	□ Drive Belts — Check Condition And Tension	358
■ Onboard Diagnostic System — OBD II	351	□ Spark Plugs	358
□ Loose Fuel Filler Cap Message	351	□ Catalytic Converter	358
■ Emissions Inspection And Maintenance Programs	352	□ Crankcase Emission Control System	360
■ Replacement Parts	353	□ Fuel Filter	360
■ Dealer Service	354	□ Engine Air Cleaner Filter	361
■ Maintenance Procedures	354	□ Maintenance-Free Battery	361
□ Engine Oil	354	□ Air Conditioner Maintenance	362

348 MAINTAINING YOUR VEHICLE

□ Power Steering Fluid Check	363	□ Transfer Case	377
□ Driveline And Steering Component Lubrication	364	□ Front/Rear Axle Fluid	378
□ Body Lubrication	364	□ Appearance Care And Protection From Corrosion	379
□ Windshield Wiper Blades	365	■ Fuses (Totally Integrated Power Module)	385
□ Windshield Washers	365	■ Vehicle Storage	393
□ Exhaust System	366	■ Replacement Bulbs — If Equipped	393
□ Cooling System	366	■ Bulb Replacement	394
□ Hoses And Vacuum/Vapor Harnesses	371	□ Head Light	394
□ Brake System	372	□ Front Park/Turn Signal	395
□ Automatic Transmission	374	□ Front Side Marker	395
□ Hydraulic Clutch Fluid — Manual Transmission	376	□ Front Fog Light	396
□ Manual Transmission	376	□ Rear Tail, Stop, Turn Signal, And Back-Up Lights	396

□ Center High Mounted Stop Light (CHMSL) . . .	397	□ Engine	398
■ Fluid Capacities	397	□ Chassis	399
■ Fluids, Lubricants And Genuine Parts	398		

ENGINE COMPARTMENT – 3.8L

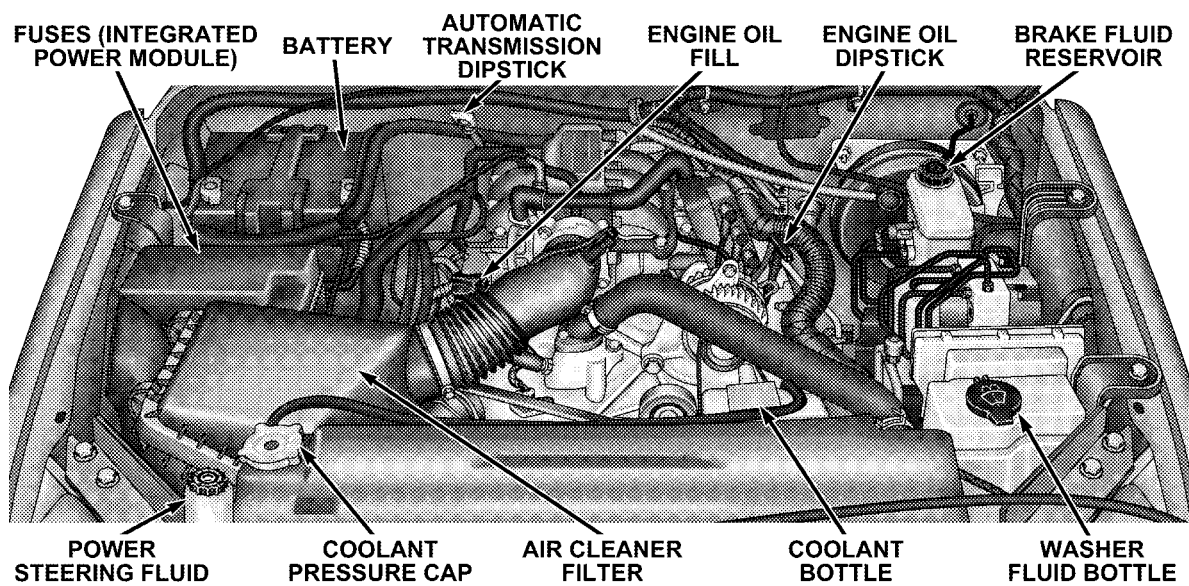

8191f0ee

ONBOARD DIAGNOSTIC SYSTEM — OBD II

Your vehicle is equipped with a sophisticated onboard diagnostic system called OBD II. This system monitors the performance of the emissions, engine, and automatic transmission control systems. When these systems are operating properly, your vehicle will provide excellent performance and fuel economy, as well as engine emissions well within current government regulations.

If any of these systems require service, the OBD II system will turn on the “Malfunction Indicator Light.” It will also store diagnostic codes and other information to assist your service technician in making repairs. Although your vehicle will usually be drivable and not need towing, see your dealer for service as soon as possible.

CAUTION!

- Prolonged driving with the “Malfunction Indicator Light” on could cause further damage to the emission control system. It could also affect fuel economy and driveability. The vehicle must be serviced before any emissions tests can be performed.
- If the “Malfunction Indicator Light” is flashing while the engine is running, severe catalytic converter damage and power loss will soon occur. Immediate service is required.

Loose Fuel Filler Cap Message

After fuel is added, the vehicle diagnostic system can determine if the fuel filler cap is loose, improperly installed, or damaged. A loose fuel filler cap message will be displayed in the instrument cluster. Tighten the gas

cap until a "clicking" sound is heard. This is an indication that the gas cap is properly tightened. Press the odometer reset button to turn the message off. If the problem persists, the message will appear the next time the vehicle is started. This might indicate a damaged cap. If the problem is detected twice in a row, the system will turn on the Malfunction Indicator Light (MIL). Resolving the problem will turn the MIL light off.

EMISSIONS INSPECTION AND MAINTENANCE PROGRAMS

In some localities, it may be a legal requirement to pass an inspection of your vehicle's emissions control system. Failure to pass could prevent vehicle registration.



For states, which have an I/M (Inspection and Maintenance) requirement, this check verifies the following: the MIL (Malfunction Indicator Lamp)

is functioning and is not on when the engine is running, and that the OBD (On Board Diagnostic) system is ready for testing.

Normally, the OBD system will be ready. The OBD system may **not** be ready if your vehicle was recently serviced, if you recently had a dead battery, or a battery replacement. If the OBD system should be determined not ready for the I/M test, your vehicle may fail the test.

Your vehicle has a simple ignition key actuated test, which you can use prior to going to the test station. To check if your vehicle's OBD system is ready, you must do the following:

1. Insert your ignition key into the ignition switch.
2. Turn the ignition to the ON position, but do not crank or start the engine.
3. If you crank or start the engine, you will have to start this test over.

4. As soon as you turn your key to the ON position, you will see your MIL symbol come on as part of a normal bulb check.

5. Approximately 15 seconds later, one of two things will happen:

- a. The MIL will flash for about 10 seconds and then return to being fully illuminated until you turn off the ignition key or start the engine. This means that your vehicle's OBD system is **not ready** and you should **not** proceed to the I/M station.
- b. The MIL will not flash at all and will remain fully illuminated until you turn off the ignition key or start the engine. This means that your vehicle's OBD system is **ready** and you can proceed to the I/M station.

If your OBD system is **not ready**, you should see your authorized dealer or repair facility. If your vehicle was recently serviced or had a battery failure or replacement,

you may need to do nothing more than drive your vehicle as you normally would in order for your OBD system to update. A recheck with the above test routine may then indicate that the system is now ready.

Regardless of whether your vehicle's OBD system is ready or not ready, if the MIL symbol is illuminated during normal vehicle operation, you should have your vehicle serviced before going to the I/M station. The I/M station can fail your vehicle because the MIL symbol is on with the engine running.

REPLACEMENT PARTS

Use of genuine Mopar® parts for normal/scheduled maintenance and repairs is highly recommended to insure the designed performance. Damage or failures caused by the use of non-Mopar® parts for maintenance and repairs will not be covered by the manufacturer's warranty.

DEALER SERVICE

Your dealer has the qualified service personnel, special tools, and equipment to perform all service operations in an expert manner. Service Manuals are available which include detailed service information for your vehicle. Refer to these manuals before attempting any procedure yourself.

NOTE: Intentional tampering with emissions control systems can result in civil penalties being assessed against you.

WARNING!

You can be badly injured working on or around a motor vehicle. Only do service work for which you have the knowledge and the proper equipment. If you have any doubt about your ability to perform a service job, take your vehicle to a competent mechanic.

MAINTENANCE PROCEDURES

The pages that follow contain the **required** maintenance services determined by the engineers who designed your vehicle.

Besides the maintenance items for which there are fixed maintenance intervals, there are other items that should operate satisfactorily without periodic maintenance. However, if a malfunction of these items does occur, it could adversely affect the engine or vehicle performance. These items should be inspected if a malfunction is observed or suspected.

Engine Oil**Checking Oil Level**

To assure proper lubrication of your vehicle's engine, the engine oil must be maintained at the correct level. The best time to check the engine oil level is about 5 minutes after a fully warmed up engine is shut off or before starting the engine after it has sat overnight.

Checking the oil while the vehicle is on level ground will improve the accuracy of the oil level readings. Always maintain the oil level within the SAFE zone on the dipstick. Adding one quart of oil when the reading is at the bottom of the SAFE zone will result in a reading at the top of the safe zone on these engines.

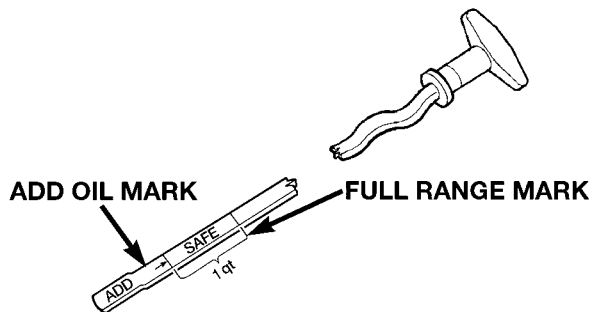

80c0715e

CAUTION!

Overfilling or underfilling the crankcase will cause aeration or loss of oil pressure. This could damage your engine.

Change Engine Oil

Road conditions as well as your kind of driving affect the interval at which your oil should be changed. Check the following to determine if any apply to you:

- Day or night temperatures are below 32°F (0°C)
- Stop and go driving
- Extensive engine idling
- Driving in dusty conditions
- Short trip driving of less than 10 miles (16.2 km)

- More than 50% of your driving is at sustained high speeds during hot weather, above 90°F (32°C)
- Taxi, Police, or delivery service (commercial service)
- Trailer towing
- Off-road or desert driving
- If equipped for and operating with E-85 (ethanol) fuel

If ANY of these apply to you, then change your engine oil at every interval shown in schedule “B” of the “Maintenance Schedules” section of this manual.

If none of these apply to you, then change your engine oil at every interval shown on schedule “A” of the “Maintenance Schedules” section of this manual

NOTE: Under no circumstances should oil change intervals exceed 6,000 miles (10 000 km) or 6 months whichever comes first.

Engine Oil Selection

For best performance and maximum protection for all engines under all types of operating conditions, the manufacturer recommends engine oils that are API Certified and meet the requirements of DaimlerChrysler Material Standard MS-6395.

American Petroleum Institute (API) Engine Oil Identification Symbol



This symbol means that the oil has been certified by the American Petroleum Institute (API). The manufacturer only recommends API Certified engine oils.

Engine Oil Viscosity (3.8L Engines)

SAE 5W-20 engine oil is recommended for all operating temperatures. This engine oil improves low temperature starting and vehicle fuel economy. Your engine oil filler cap shows the recommended engine oil viscosity for your vehicle.

Lubricants which do not have both, the engine oil certification mark and the correct SAE viscosity grade number should not be used.

Materials Added To Engine Oils

The manufacturer **strongly recommends** against the addition of any additives (other than leak detection dyes) to engine oil. Engine oil is an engineered product and its performance may be impaired by supplemental additives.

Disposing of Used Engine Oil

Care should be taken in disposing of used engine oil from your vehicle. Used oil, indiscriminately discarded, can

present a problem to the environment. Contact your authorized dealer, service station, or governmental agency for advice on how and where used oil can be safely discarded in your area.

Engine Oil Filter

The engine oil filter should be replaced at every engine oil change.

Engine Oil Filter Selection

All of the manufacturer's engines have a full-flow type disposable oil filter. Use a filter of this type for replacement. The quality of replacement filters varies considerably. Only high quality filters should be used to assure most efficient service. Mopar® engine oil filters are high quality oil filters and are recommended.

Drive Belts — Check Condition and Tension

Belt tension is controlled by means of an automatic tensioner. No belt tension adjustments are required. However, belt and belt tensioner condition should be inspected at the specified intervals, and replaced if required. See your authorized dealer for service.

At the mileage indicated in the appropriate “Maintenance Schedule”, all belts and tensioner should be checked for condition. Improper belt tension can cause belt slippage and failure.

Belts should be inspected for evidence of cuts, cracks, glazing, or frayed cords and replaced if there is indication of damage which could result in belt failure. Low generator belt tension can cause battery failure.

Also check belt routing to make sure there is no interference between the belts and other engine components.

Spark Plugs

Spark plugs must fire properly to assure engine performance and emission control. New plugs should be installed at the mileage specified in the appropriate maintenance chart. The entire set should be replaced if there is any malfunction due to a faulty spark plug.

Refer to the “Vehicle Emission Control Information” label in the engine compartment for spark plug information.

Catalytic Converter

The catalytic converter requires the use of unleaded fuel only. Leaded gasoline will destroy the effectiveness of the converter as an emission control device.

Under normal operating conditions, the catalytic converter will not require maintenance. However, it is important to keep the engine properly tuned to assure proper catalyst operation and prevent possible catalyst damage.

CAUTION!

Damage to the catalytic converter can result if your vehicle is not kept in proper operating condition. In the event of engine malfunction, particularly involving engine misfire or other apparent loss of performance, have your vehicle serviced promptly. Continued operation of your vehicle with a severe malfunction could cause the converter to overheat, resulting in possible damage to the converter and vehicle.

WARNING!

A hot exhaust system can start a fire if you park over materials that can burn. Such materials might be grass or leaves coming into contact with your exhaust system. Do not park or operate your vehicle in areas where your exhaust system can contact anything that can burn.

In unusual situations involving grossly malfunctioning engine operation, a scorching odor may suggest severe and abnormal catalyst overheating. If this occurs, stop the vehicle, turn off the engine and allow it to cool. Service, including a tune up to manufacturer's specifications, should be obtained immediately.

To minimize the possibility of catalytic converter damage:

- Do not shut off the engine or interrupt the ignition when the transmission is in gear and the vehicle is in motion.
- Do not try to start the engine by pushing or towing the vehicle.
- Do not idle the engine with any spark plug wires disconnected or removed, such as when diagnostic testing.
- Do not idle the engine for prolonged periods during very rough idle or malfunctioning operating conditions.
- Do not allow vehicle to run out of fuel.

NOTE: Intentional tampering with emissions control systems can result in civil penalties being assessed against you.

Crankcase Emission Control System

Proper operation of this system depends on freedom from sticking or plugging due to deposits. As vehicle mileage builds up, the PCV valve and passages may accumulate deposits. If a valve is not working properly, replace it with a new valve. **DO NOT ATTEMPT TO CLEAN THE OLD PCV VALVE!**

Check ventilation hose for indication of damage or plugging deposits. Replace if necessary.

Fuel Filter

A plugged fuel filter can cause hard starting or limit the speed at which a vehicle can be driven. Should an excessive amount of dirt accumulate in the fuel tank, frequent replacement of the fuel filter which is mounted in the fuel tank may be necessary.

Engine Air Cleaner Filter

Under normal driving conditions, replace the air filter at the intervals shown on "Maintenance Schedule A." If, however, you drive the vehicle frequently under dusty or severe conditions, the filter element should be inspected periodically and replaced if necessary at the intervals shown on "Maintenance Schedule B."

WARNING!



The air cleaner can provide protection in the case of engine backfire. Do not remove the air cleaner unless it is necessary for repair or maintenance. Make sure that no one is near the engine compartment before starting the vehicle with the air cleaner removed. Failure to do so can result in serious personal injury.

Maintenance-Free Battery

Your vehicle is equipped with a maintenance-free battery. You will never have to add water, nor is periodic maintenance required.

WARNING!

Battery posts, terminals, and related accessories contain lead and lead compounds. Always wash hands after handling the battery.

BATTERY CONDITION INDICATOR	O.K. TO JUMP START	 	DARKENED INDICATOR WITH GREEN DOT <ul style="list-style-type: none"> • BATTERY CHARGE OK • FLUID LEVEL OK DARKENED INDICATOR NO GREEN DOT <ul style="list-style-type: none"> • BATTERY CHARGE LOW • FLUID LEVEL OK
	DO NOT JUMP START		YELLOW OR BRIGHT INDICATOR <ul style="list-style-type: none"> • BATTERY CHARGE UNKNOWN • FLUID LEVEL LOW (CHARGE MAY STILL BE SUFFICIENT TO START YOUR CAR)

8000ebce

To determine the battery charge, check the battery test indicator (if equipped) on top of the battery. Refer to the illustration.

CAUTION!

It is essential when replacing the cables on the battery that the positive cable is attached to the positive post and the negative cable is attached to the negative post. Battery posts are marked (+) positive and negative (-) and identified on the battery case. Also, if a "fast charger" is used while battery is in the vehicle, disconnect both vehicle battery cables before connecting the charger to battery. Do not use a "fast charger" to provide starting voltage.

Air Conditioner Maintenance

For best possible performance, your air conditioner should be checked and serviced by an Authorized Dealer at the start of each warm season. This service should include cleaning of the condenser fins and a performance test. Drive belt tension should also be checked at this time.

WARNING!

- Use only refrigerants and compressor lubricants approved by the manufacturer for your air conditioning system. Some unapproved refrigerants are flammable and can explode, injuring you. Other unapproved refrigerants or lubricants can cause the system to fail, requiring costly repairs. Refer to Section 3 of the Warranty Information Book for additional warranty information.
- The air conditioning system contains refrigerant under high pressure. To avoid risk of personal injury or damage to the system, adding refrigerant or any repair requiring lines to be disconnected should be done by an experienced repairman.

Refrigerant Recovery and Recycling

R-134a Air Conditioning Refrigerant is a hydrofluorocarbon (HFC) that is endorsed by the Environmental Protection Agency and is an ozone-saving product. However, the manufacturer recommends that air conditioning service be performed by dealers or other service facilities using recovery and recycling equipment.

Power Steering Fluid Check

Checking the power steering fluid level at a defined service interval is not required. The fluid should only be checked if a leak is suspected, abnormal noises are apparent, and/or the system is not functioning as anticipated. Coordinate inspection efforts through a certified DaimlerChrysler Dealership."

WARNING!

Fluid level should be checked on a level surface with the engine off to prevent injury from moving parts, and to insure accurate fluid level reading. Do not overfill. Use only the manufacturer's recommended fluid.

If necessary, add fluid to restore to the proper indicated level. With a clean cloth, wipe any spilled fluid from all surfaces. Refer to Fluids, Lubricants, and Genuine Parts for correct fluid type.

NOTE: Upon initial start-up in cold weather, the power steering pump may make noise for a short period of time. This is due to the cold, thick fluid in the steering system. This noise should be considered normal, and does not in any way damage the steering system.

Driveline And Steering Component Lubrication

All driveline and steering components are sealed and do not require lubrication. Driveshafts are not serviceable.

Body Lubrication

Locks and all body pivot points, including such items as seat tracks, doors, tailgate and hood hinges, should be lubricated periodically to assure quiet, easy operation and to protect against rust and wear. Prior to the application of any lubricant, the parts concerned should be wiped clean to remove dust and grit; after lubricating excess oil and grease should be removed. Particular attention should also be given to hood latching components to insure proper function. When performing other underhood services, the hood latch, release mechanism and safety catch should be cleaned and lubricated.

The external lock cylinders should be lubricated twice a year, preferably in the fall and spring. Apply a small

amount of a high quality lubricant such as Mopar® Lock Cylinder Lubricant directly into the lock cylinder.

Windshield Wiper Blades

Clean the rubber edges of the wiper blades and the windshield periodically with a sponge or soft cloth and a mild non-abrasive cleaner. This will remove accumulations of salt or road film.

Operation of the wipers on dry glass for long periods may cause deterioration of the wiper blades. Always use washer fluid when using the wipers to remove salt or dirt from a dry windshield. Avoid using the wiper blades to remove frost or ice from the windshield. Keep the blade rubber out of contact with petroleum products such as engine oil, gasoline, etc.

Windshield Washers

The fluid reservoir in the engine compartment should be checked for fluid level at regular intervals. Fill the reservoir with windshield antifreeze (not radiator antifreeze) rated not to freeze at -25°F (-31°C). Operate the system for a few seconds to flush out the residual water.

WARNING!

Commercial windshield washer solvents are flammable. They could ignite and burn you. Care must be exercised when filling or working around the washer solution.

Exhaust System

The best protection against carbon monoxide entry into the vehicle body is a properly maintained engine exhaust system.

If you notice a change in the sound of the exhaust system; or if the exhaust fumes can be detected inside the vehicle; or when the underside or rear of the vehicle is damaged; have an authorized technician inspect the complete exhaust system and adjacent body areas for broken, damaged, deteriorated, or mispositioned parts. Open seams or loose connections could permit exhaust fumes to seep into the passenger compartment. In addition, inspect the exhaust system each time the vehicle is raised for lubrication or oil change. Replace as required.

Cooling System

WARNING!

You or others can be badly burned by hot antifreeze/coolant or steam from your radiator. If you see or hear steam coming from under the hood, don't open the hood until the radiator has had time to cool. Never try to open a cooling system pressure cap when the radiator or coolant bottle is hot.

Engine Coolant Checks

Check antifreeze/coolant protection every 12 months (before the onset of freezing weather, where applicable). If antifreeze/coolant is dirty or rusty in appearance, the system should be drained, flushed and refilled with fresh antifreeze/coolant. Check the front of the A/C condenser (if equipped) or radiator for any accumulation of bugs, leaves, etc. If dirty, clean by gently spraying water from a

garden hose vertically down the face of the A/C condenser (if equipped) or the back of the radiator core.

Check the engine cooling system hoses for brittle rubber, cracking, tears, cuts, and tightness of the connection at the coolant recovery bottle and radiator. Inspect the entire system for leaks.

With the engine at normal operating temperature (but not running), check the cooling system pressure cap for proper vacuum sealing by draining a small amount of antifreeze/coolant from the radiator drain cock. If the cap is sealing properly, the antifreeze/coolant will begin to drain from the coolant recovery bottle. **DO NOT REMOVE THE COOLANT PRESSURE CAP WHEN THE COOLING SYSTEM IS HOT.**

Cooling System — Drain, Flush, And Refill

At the intervals shown in the appropriate "Maintenance Schedule," the system should be drained, flushed, and refilled.

If the solution is dirty and contains a considerable amount of sediment, clean and flush with reliable cooling system cleaner. Follow with a thorough rinsing to remove all deposits and chemicals. Properly dispose of old antifreeze/coolant solution.

Discard old antifreeze/coolant solution according to recommended procedure.

Selection Of Engine Coolant

Use only the manufacturer's recommended antifreeze/coolant, refer to Fluids, Lubricants, and Genuine Parts for correct antifreeze/coolant type.

CAUTION!

- **Mixing of antifreeze/coolant other than the specified HOAT antifreeze/coolant may result in decreased corrosion protection and engine damage. If a non-HOAT antifreeze/coolant is introduced into the cooling system in an emergency, it should be replaced with the specified antifreeze/coolant as soon as possible.**
- **Do not use plain water alone or alcohol base antifreeze/coolant products. Do not use additional rust inhibitors or antirust products, as they may not be compatible with the antifreeze/coolant and may plug the radiator.**
- **This vehicle has not been designed for use with Propylene Glycol based antifreeze/coolant. Use of Propylene Glycol base antifreeze/coolant is not recommended.**

Adding Engine Coolant

Your vehicle has been built with an improved antifreeze/coolant that allows extended maintenance intervals. This antifreeze/coolant can be used up to 5 Years or 100,000 miles before replacement. To prevent reducing this extended maintenance period, it is important that you use the same antifreeze/coolant throughout the life of your vehicle. Please review these recommendations for using Hybrid Organic Additive Technology (HOAT) antifreeze/coolant.

When adding antifreeze/coolant, a minimum solution of 50% recommended Mopar Antifreeze/ Coolant 5 Year/ 100,000 Mile Formula HOAT (Hybrid Organic Additive Technology), or equivalent, in water should be used. Use higher concentrations (not to exceed 70%) if temperatures below -34°F (-37°C) are anticipated.

Use only high purity water such as distilled or deionized water when mixing the water/antifreeze (coolant) solution. The use of lower quality water will reduce the amount of corrosion protection in the engine cooling system.

Please note that it is the owner's responsibility to maintain the proper level of protection against freezing according to the temperatures occurring in the area where the vehicle is operated.

NOTE: Mixing antifreeze/coolant types will decrease the life of the antifreeze/coolant and will require more frequent antifreeze/coolant changes.

Cooling System Pressure Cap

The cap must be fully tightened to prevent loss of antifreeze/coolant, and to insure that antifreeze/coolant will return to the radiator from the coolant reserve tank.

The cap should be inspected and cleaned if there is any accumulation of foreign material on the sealing surfaces.

WARNING!

The warning words DO NOT OPEN HOT on the cooling system pressure cap are a safety precaution. Never add antifreeze/coolant when the engine is overheated. Do not loosen or remove the cap to cool an overheated engine. Heat causes pressure to build up in the cooling system. To prevent scalding or injury, do not remove the pressure cap while the system is hot or under pressure.

7

Disposal of Used Engine Coolant

Used ethylene glycol based antifreeze/coolant is a regulated substance requiring proper disposal. Check with your local authorities to determine the disposal rules for your community. To prevent ingestion by animals or

children, do not store ethylene glycol based antifreeze/coolant in open containers or allow it to remain in puddles on the ground. If ingested by a child, contact a physician immediately. Clean up any ground spills immediately.

Engine Coolant Level

The coolant bottle provides a quick visual method for determining that the coolant level is adequate. With the engine idling, and warm to normal operating temperature, the level of the antifreeze/coolant in the bottle should be between the ranges indicated on the bottle.

The radiator normally remains completely full, so there is not need to remove the radiator cap unless checking for antifreeze/coolant freeze point or replacing antifreeze/coolant. Advise your service attendant of this. As long as the engine operating temperature is satisfactory, the coolant bottle need only be checked once a month.

When additional antifreeze/coolant is needed to maintain the proper level, it should be added to the coolant bottle. Do not overfill.

Points To Remember

NOTE: When the vehicle is stopped after a few miles of operation, you may observe vapor coming from the front of the engine compartment. This is normally a result of moisture from rain, snow, or high humidity accumulating on the radiator and being vaporized when the thermostat opens, allowing hot antifreeze/coolant to enter the radiator.

If an examination of your engine compartment shows no evidence of radiator or hose leaks, the vehicle may be safely driven. The vapor will soon dissipate.

- Do not overfill the coolant bottle.
- Check antifreeze/coolant freeze point in the radiator and in the coolant recovery bottle. If antifreeze/

coolant needs to be added, contents of coolant recovery bottle must also be protected against freezing.

- If frequent antifreeze/coolant additions are required, or if the level in the recovery bottle does not drop when the engine cools, the cooling system should be pressure tested for leaks.
- Maintain antifreeze/coolant concentration at 50% HOAT antifreeze/coolant (minimum) and distilled water for proper corrosion protection of your engine which contains aluminum components.
- Make sure that the radiator and coolant recovery bottle hoses are not kinked or obstructed.
- Keep the front of the radiator clean. If your vehicle is equipped with air conditioning, keep the front of the condenser clean, also.
- Do not change the thermostat for summer or winter operation. If replacement is ever necessary, install

ONLY the correct type thermostat. Other designs may result in unsatisfactory cooling performance, poor gas mileage, and increased emissions.

Hoses and Vacuum/Vapor Harnesses

Inspect surfaces of hoses and nylon tubing for evidence of heat and mechanical damage. Hard or soft spots, brittle rubber, cracking, tears, cuts, abrasions, and excessive swelling indicate deterioration of the rubber.

Pay particular attention to the hoses nearest to high heat sources such as the exhaust manifold. Inspect hose routing to be sure hoses do not touch any heat source or moving component that may cause heat damage or mechanical wear.

Insure nylon tubing in these areas has not melted or collapsed. Inspect all hose connections such as clamps and couplings to make sure they are secure and no leaks

are present. Components should be replaced immediately if there is any evidence of degradation that could cause failure.

Brake System

In order to assure brake system performance, all brake system components should be inspected periodically. Refer to the appropriate "Maintenance Schedule" in Section 8 for suggested service intervals.

WARNING!

Riding the brakes can lead to brake failure and possibly an accident. Driving with your foot resting or riding on the brake pedal can result in abnormally high brake temperatures, excessive lining wear, and possible brake damage. You wouldn't have your full braking capacity in an emergency.

Brake and Power Steering System Hoses

When servicing the vehicle for scheduled maintenance, inspect surface of hoses for evidence of heat and mechanical damage. Hard and brittle rubber, cracking, tears, cuts, abrasion, and excessive swelling suggest deterioration of the rubber. Particular attention should be made to examining those hose surfaces nearest to high heat sources, such as the exhaust manifold.

Inspect all hose clamps and couplings to make sure they are secure and no leaks are present.

NOTE: Inspection of brake hoses should be done whenever the brake system is serviced and every engine oil change.

WARNING!

Worn brake hoses can burst and cause brake failure. You could have an accident. If you see any signs of cracking, scuffing, or worn spots, have the brake hoses replaced immediately.

Brake Master Cylinder

The fluid level in the master cylinder should be checked when performing under hood services, or immediately if the BRAKE warning light shows system failure

Be sure to clean the top of the master cylinder area before removing the cap. If necessary, add fluid to bring the fluid level up to the requirements described on the brake fluid reservoir. With disc brakes, fluid level can be expected to fall as the brake pads wear. Brake fluid level

should be checked when pads are replaced. However, low fluid level may be caused by a leak and a checkup may be needed.

Use only manufacturer's recommended brake fluid, refer to Fluids, Lubricants, and Genuine Parts for correct fluid type.

WARNING!

- **Use of a brake fluid that may have a lower initial boiling point or unidentified as to specification, may result in sudden brake failure during hard prolonged braking. You could have an accident.**
- **Overfilling the brake fluid reservoir can result in spilling brake fluid on hot engine parts and the brake fluid catching fire.**

Use only brake fluid that has been in a tightly closed container to avoid contamination from foreign matter. Do not allow petroleum base fluid to contaminate the brake fluid as seal damage will result.

Automatic Transmission

Selection of Lubricant

It is important that the proper lubricant is used in the transmission to assure optimum transmission performance. Use only manufacturer's recommended transmission fluid, refer to Fluids, Lubricants, and Genuine Parts for correct fluid type. It is important that the transmission fluid be maintained at the prescribed level using the recommended fluid.

CAUTION!

Using a transmission fluid other than the manufacturer's recommended fluid may cause deterioration in transmission shift quality and/or torque converter shudder. Using a transmission fluid other than the manufacturer's recommended fluid will result in more frequent fluid and filter changes. Refer to Fluids, Lubricants, and Genuine Parts for correct fluid type.

Fluid Level Check — 42RLE

NOTE: If equipped with a dipstick, use the following procedure. If your vehicle has a capped dipstick tube, it is sealed and should not be tampered with. Your authorized dealer has the proper tools to ensure that the fluid level is set properly.

Check the fluid level while the transmission is at normal operating temperature 180° F (82° C). This occurs after at least 15 mi (25 km) of driving. At normal operating temperature the fluid cannot be held comfortably between the fingertips.

To properly check the automatic transmission fluid level, the following procedure must be used:

1. Operate the engine at idle speed and normal operating temperature.
2. The vehicle must be on level ground.
3. Fully apply parking brake.
4. Place the gear selector momentarily in each gear position ending with the lever in P (Park).
5. Remove the dipstick, wipe it clean and reinsert it until seated.

6. Remove the dipstick again and note the fluid level on both sides. The fluid level should be between the HOT (upper) reference holes on the dipstick at normal operating temperature. Verify that a solid coating of oil is seen on both sides of the dipstick. If the fluid is low, add as required into the dipstick tube. **Do not overfill.** After adding any quantity of oil through the dipstick tube, wait a minimum of two (2) minutes for the oil to fully drain into the transmission before rechecking the fluid level.

NOTE: If it is necessary to check the transmission below the operating temperature, the fluid level should be between the two cold (lower) holes on the dipstick with the fluid at approximately 70° F (21° C) (room temperature). If the fluid level is correctly established at room temperature, it should be between the HOT (upper) reference holes when the transmission reaches 180° F (21° C). Remember it is best to check the level at the normal operating temperature.

CAUTION!

Be aware that if the fluid temperature is below 50° F (10° C), it may not register on the dipstick. Do not add fluid until the temperature is elevated enough to produce an accurate reading.

7. Check for leaks. Release the parking brake.

NOTE: To prevent dirt and water from entering the transmission after checking or replenishing fluid, make certain that the dipstick cap is properly reseated. It is normal for the dipstick cap to spring back slightly from its fully seated positions, as long as its seal remains engaged in the dipstick tube.

Special Additives

The manufacturer strongly recommends against the addition of any additives to the transmission. The only exception to this policy is the use of special dyes to aid in

detecting fluid leaks. The use of transmission sealers should be avoided as they may adversely affect seals.

Hydraulic Clutch Fluid — Manual Transmission

The clutch hydraulic system is a sealed maintenance free system. In the event of leakage or other malfunction, the system must be replaced.

Manual Transmission**Selection of Lubricant**

Use only manufacturer's recommended manual transmission fluid, refer to Fluids, Lubricants, and Genuine Parts for correct fluid type.

Fluid Level Check

Check the fluid level by removing the fill plug. The fluid level should be between the bottom of the fill hole and a point not more than 3/16" (4.76 mm) below the bottom of the hole.

Add fluid, if necessary, to maintain the proper level.

Frequency of Fluid Change

Under normal operating conditions, the fluid installed at the factory will give satisfactory lubrication for the life of the vehicle. Fluid changes are not necessary unless the lubricant has become contaminated with water. If contaminated with water, the fluid should be changed immediately.

Transfer Case

Fluid Level Check

The fluid level should be to the bottom edge of the fill hole (A) when the vehicle is in a level position.

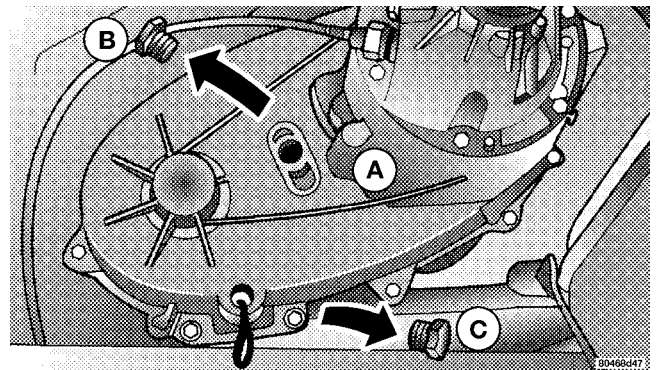

Adding Fluid

Fluid should be added only at filler hole until fluid begins to run out of the hole.

Drain

First remove fill plug (B), then drain plug (C). Recommended tightening torque for drain and fill plugs is 15–25 ft.lbs. (20–34 N·m).

CAUTION!

When replacing plugs, do not overtighten. You could damage them and cause them to leak.

Selection of Lubricant

Use only manufacturer's recommended fluid, refer to Fluids, Lubricants, and Genuine Parts for correct fluid type.

Front/Rear Axle Fluid**Fluid Level Check**

Lubricant should be at bottom edge of the oil fill hole.

Adding Fluid

Add lubricant only at the fill hole and only to the level specified above.

Selection of Lubricant

Use only manufacturer's recommended fluid, refer to Fluids, Lubricants, and Genuine Parts for correct fluid type.

Maintenance After Off-Road Driving

After extended operation in mud, sand or water, or similar dirty conditions, have your brake drums, brake linings, and axle joints inspected and cleaned as soon as possible. This will prevent any abrasive material from causing excessive wear or unpredictable braking action.

Following off-road usage, completely inspect the underbody of your vehicle. Check tires, body structure, steering, suspension and exhaust system for damage. Check threaded fasteners for looseness, particularly on the chassis, drivetrain components, steering and suspension. Retighten, if required, to torque values specified in the Service Manual. Also check for accumulations of vegetation or brush that could become a fire hazard, or conceal

damage to fuel lines, brake hoses, axle pinion seals, and propeller shafts. Check air conditioning drain tube on the lower dash wall in the engine compartment for mud or debris, and clean as required. A plugged tube will adversely affect air conditioning performance.

CAUTION!

Under frequent heavy-duty driving conditions, change all lubricants, and lubricate body components and steering linkage more often than in normal service to prevent excessive wear.

Appearance Care And Protection From Corrosion

Protection Of Body And Paint From Corrosion

Vehicle body care requirements vary according to geographic locations and usage. Chemicals that make roads passable in snow and ice, and those that are sprayed on

trees and road surfaces during other seasons, are highly corrosive to the metal in your vehicle. Outside parking, which exposes your vehicle to airborne contaminants, road surfaces on which the vehicle is operated, extreme hot or cold weather and other extreme conditions will have an adverse effect on paint, metal trim, and underbody protection.

The following maintenance recommendations will enable you to obtain maximum benefit from the corrosion resistance built into your vehicle.

What Causes Corrosion?

Corrosion is the result of deterioration or removal of paint and protective coatings from your vehicle.

The most common causes are:

- Road salt, dirt and moisture accumulation.
- Stone and gravel impact.

- Insects, tree sap and tar.
- Salt in the air near sea-coast localities.
- Atmospheric fallout/industrial pollutants.
- Bird droppings.

Washing

- Wash your vehicle regularly. Always wash your vehicle in the shade using Mopar® Car Wash or a mild car wash soap, and rinse the panels completely with clear water.
- If insects, tar, or other similar deposits have accumulated on your vehicle, use Mopar® Super Kleen Bug and Tar Remover to remove.
- Use Mopar® Cleaner Wax to remove road film, stains, and to protect your paint finish. Take care never to scratch the paint.

- Avoid using abrasive compounds and power buffing that may diminish the gloss or thin out the paint finish.

CAUTION!

Do not use abrasive or strong cleaning materials such as steel wool or scouring powder, which will scratch metal and painted surfaces.

Special Care

- If you drive on salted or dusty roads or if you drive near the ocean, hose off the undercarriage at least once a month.
- It is important that the drain holes in the lower edges of the doors, rocker panels and tailgate must be kept clear and open.

- If you detect any stone chips or scratches in the paint, touch them up immediately. The cost of such repairs is considered the responsibility of the owner.
- If your vehicle is damaged due to an accident or similar cause which destroys the paint and protective coating have your vehicle repaired as soon as possible. The cost of such repairs is considered the responsibility of the owner.
- If you carry special cargo such as chemicals, fertilizers, de-icer salt, etc., assure that such materials are well packaged and sealed.
- If a lot of driving is done on gravel roads, consider mud or stone shields behind each wheel.
- Use Mopar® Touch Up Paint on scratches or chips as soon as possible. Your authorized dealer has touch up paint to match the color of your vehicle.

Wheel and Wheel Trim Care

All wheels and wheel trim, especially aluminum and chrome plated wheels should be cleaned regularly with a mild soap and water to prevent corrosion. To remove heavy soil, use Mopar® Wheel Cleaner or select a non-abrasive, non-acidic cleaner. Do not use scouring pads, steel wool, a bristle brush or metal polishes. Only Mopar® cleaners are recommended. Do not use oven cleaner. Avoid automatic car washes that use acidic solutions or harsh brushes that may damage the wheels' protective finish.

YES Essentials® Fabric Cleaning Procedure – If Equipped

YES Essentials® seats may be cleaned in the following manner:

- Remove as much of the stain as possible by blotting with a clean, dry towel.
- Blot any remaining stain with a clean, damp towel.

- For tough stains, apply Mopar® Total Clean or a mild soap solution to a clean, damp cloth and remove stain. Use a fresh, damp towel to remove soap residue.
- For grease stains, apply Mopar® Multi-Purpose Cleaner to a clean, damp cloth and remove stain. Use a fresh, damp towel to remove soap residue.
- Do not use any solvents or protectants on Yes Essentials® products.

Interior Care

Use Mopar® Total Clean to clean fabric upholstery and carpeting.

Interior Trim should be cleaned starting with a damp cloth, a damp cloth with Mopar® Total Clean, then Mopar® Spot & Stain Remover if absolutely necessary. Do not use harsh cleaners or Armorall. Use Mopar® Total Clean to clean vinyl upholstery.

WARNING!

Do not use volatile solvents for cleaning purposes. Many are potentially flammable, and if used in closed areas they may cause respiratory harm.

Glass Surfaces

All glass surfaces should be cleaned on a regular basis with Mopar® Glass Cleaner or any commercial household-type glass cleaner. Never use an abrasive type cleaner. Use caution when cleaning inside rear windows equipped with electric defrosters. Do not use scrapers or other sharp instruments which may scratch the elements.

When cleaning the rear view mirror, spray cleaner on the towel or rag that you are using. Do not spray cleaner directly on the mirror.

Cleaning Plastic Instrument Cluster Lenses

The lenses in front of the instruments in this vehicle are molded in clear plastic. When cleaning the lenses, care must be taken to avoid scratching the plastic.

1. Clean with a wet soft rag. A mild soap solution may be used, but do not use high alcohol content or abrasive cleaners. If soap is used, wipe clean with a clean damp rag.
2. Dry with a soft tissue.

Seat Belt Maintenance

Do not bleach, dye or clean the belts with chemical solvents or abrasive cleaners. This will weaken the fabric. Sun damage will also weaken the fabric.

If the belts need cleaning, use Mopar® Total Clean, a mild soap solution, or lukewarm water. Do not remove the belts from the vehicle to wash them.

Replace the belts if they appear frayed or worn or if the buckles do not work properly.

Appearance Care For Fabric Top Models**CAUTION!**

To maintain the appearance of your vehicle's interior trim and top, follow these precautions:

- Avoid leaving your vehicle unattended with the top down, as exposure to sun or rain may damage interior trim.
- Do not use harsh cleaners or bleaching agents on top material, as damage may result.
- Do not allow any vinyl cleaner to run down and dry on the paint, leaving a streak.

- After cleaning your vehicle's fabric top, always make sure it is completely dry before lowering.
- Be especially careful when washing the windows by following the directions for "Care of Fabric Top Windows."

WASHING — Use Mopar® Car Wash or mild soap suds, lukewarm water, and a brush with soft bristles. If extra cleaning is required, use Mopar® Convertible Cloth Top Cleaner or a mild foaming cleaner on the entire top, but support top from underneath.

RINSING — Be sure to remove all trace of cleaner by rinsing the top thoroughly with clean water. Remember to allow the top to dry before lowering it.

Care Of Fabric Top Windows

CAUTION!

Your vehicle's fabric top has pliable plastic windows which can be scratched unless special care is taken by following these directions:

1. Never use a dry cloth to remove dust. Instead, **use a microfiber towel or soft cotton cloth moistened with cold or warm, clean water, and wipe across the window, not up and down.** Mopar® Jeep Soft Glass Window Cleaner will safely clean all plastic windows without scratching. Removes fine scratches to improve visibility and provide UV protection to help prevent yellowing.
2. When washing, **never use hot water** or anything stronger than a mild soap. Never use solvents such as alcohol or harsh cleaning agents.

3. Always rinse thoroughly with cold water, then wipe with a soft and slightly moist, clean cloth.

4. When removing frost, snow or ice, **never use a scraper or de-icing chemicals**. Use warm water only if you must clean the window quickly.

5. Debris (sand, mud/dirt, dust, or salt) from off-road driving will have a major impact on zipper operation. Even normal on-road driving and vehicle washing will eventually impact window zipper operation. To maintain ease of use of the window zippers, each window zipper should be cleaned and lubricated regularly. Use Mopar® Soft Top Zipper Cleaner and Lubricant to ease zipper operation. Before applying, make sure the zipper teeth are clear of sand, mud, and other materials. Clean both sides of the zipper, not just one side. Rinse both zipper halves with fresh water and allow to dry. Aggressively work the Mopar® Soft Top Zipper Cleaner and Lubricant

into the zipper teeth. If a stuck zipper slide is experienced, work the Mopar® Soft Top Zipper Cleaner and Lubricant into the zipper slide. Several applications may be required before the zipper comes free.

6. Never paste stickers, gummed labels or any tape to the windows. Adhesives are hard to remove and may damage the windows.

FUSES (TOTALLY INTEGRATED POWER MODULE)

The Totally Integrated Power Module (TIPM) is located in the engine compartment near the battery. This center contains cartridge fuses, mini fuses and relays. A label that identifies each component is printed on the inside of the cover.

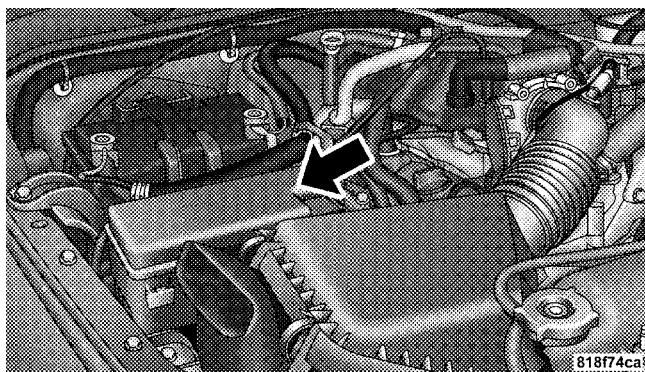

Integrated Power Module (TIPM)

Cavity	Cartridge Fuse	Mini Fuse	Description
J1	40 Amp Green		Power Folding Seat
J2	30 Amp Pink		Transfer Case/Pwr Liftgate Module

Cavity	Cartridge Fuse	Mini Fuse	Description
J3	40 Amp Green		Rear Door Module (RR DOOR NODE)
J4	25 Amp Natural		Driver Door Node
J5	25 Amp Natural		Passenger Door Node
J6	40 Amp Green		Anti-Lock Brake System (ABS) Pump/ESP
J7	30 Amp Pink		Anti-Lock Brake System (ABS) Valve/ESP
J8	40 Amp Green		Power Memory Seat
J9	40 Amp Green		PZEV Motor/Flex Fuel
J10	30 Amp Pink		Manual Tuning Valve/Hdlp Wash Relay

Cavity	Cartridge Fuse	Mini Fuse	Description
J11	30 Amp Pink		Sway Bar/ THATCHAM Lock- Unlock/Power Slid- ing Door Module
J13	60 Amp Yellow		Ignition Off Draw (IOD) — Main
J14	40 Amp Green		EBL (Rear Window Defogger)
J15	30 Amp Pink		Rear Blower
J17	40 Amp Green		Starter Solenoid
J18	20 Amp Yellow		Powertrain Control Module (PCM) Trans Range
J19	60 Amp Yellow		Radiator Fan

Cavity	Cartridge Fuse	Mini Fuse	Description
J20	30 Amp Pink		Front Wiper LO/HI
J21	20 Amp Yellow		Front/Rear Washer
J22	25 Amp Natural		Sunroof Module
M1		20 Amp Yellow	Center High Mounted Stop Light (CHMSL)/ Brake Switch
M2		20 Amp Yellow	Trailer Lighting
M3		20 Amp Yellow	Frnt/Rear Axle Lockers
M4		10 Amp Red	Trailer Tow
M5		25 Amp Natural	Inverter

Cavity	Cartridge Fuse	Mini Fuse	Description
M6		20 Amp Yellow	Power Outlet #1/Rain Sensor
M7		20 Amp Yellow	Power Outlet #2 (BATT/ACC SELECT)
M8		20 Amp Yellow	Front Heated Seat
M9		20 Amp Yellow	Rear Heated Seat
M10		20 Amp Yellow	Satellite Digital Audio Receiver (SDARS), RADIO, Antenna (ANT), Vanity Lamp (VANITY LP)
M11		10 Amp Red	(Ignition Off Draw) IOD-HVAC/MW SENSR

Cavity	Cartridge Fuse	Mini Fuse	Description
M12		30 Amp Green	Amplifier (AMP)
M13		20 Amp Yellow	Ignition Off Draw—Cabin Compartment Node (IOD-CCN), Wireless Control Module (WCM), SIREN, Clock Module (CLK MOD), Multi-Function Control Switch (MULTIFCTN SW)
M14		20 Amp Yellow	Trailer Tow (Export Only)

Cavity	Cartridge Fuse	Mini Fuse	Description
M15		20 Amp Yellow	COL MOD, IR SNS, Heater Ventilation, Air Conditioning/Automatic Temperature Control (HVAC/ATC), Rear View Mirror (RR VW MIR), Cabin Compartment Node (CCN), Transfer Case Switch (T-CASE SW), RUN/ST, Multi-Function Control Switch (MULTIFTCN SW), Tire Pressure Monitor (TPM), Glow Plug Module (GLW PLG MOD) — Export Diesel Only

Cavity	Cartridge Fuse	Mini Fuse	Description
M16		10 Amp Red	Occupant Restraint Controller/Occupant Classification Module (ORC/OCM)
M17		15 Amp Blue	Left Tail/License/Park Lamp (LT-TAIL/LIC/PRK LMP)
M18		15 Amp Blue	Right Tail/Park/Run Lamp (RT-TAIL/PRK/RUN LMP)
M19		25 Amp Natural	Auto Shut Down (ASD #1 and #2)

Cavity	Cartridge Fuse	Mini Fuse	Description
M20		15 Amp Blue	Cabin Compartment Node Interior Light (CCN INT LIGHT), Switch Bank (SW BANK), Steering Control Module (SCM)
M21		20 Amp Yellow	Auto Shut Down (ASD #3)
M22		10 Amp Red	Right Horn (RT HORN (HI/LOW)
M23		10 Amp Red	Left Horn (LT HORN (HI/LOW)
M24		25 Amp Natural	Rear Wiper (REAR WIPER)

Cavity	Cartridge Fuse	Mini Fuse	Description
M25		20 Amp Yellow	Fuel Pump (FUEL PUMP), Diesel Lift Pump (DSL LIFT PUMP) — Export Only
M26		10 Amp Red	Power Mirror Switch (PWR MIRR SW), Driver Window Switch (DRVR WIND SW)
M27		10 Amp Red	Ignition Switch (IGN SW), Window Module (WIN MOD)
M28		10 Amp Red	Next Generation Controller (NGC), Transmission Feed (TRANS FEED), J1962

Cavity	Cartridge Fuse	Mini Fuse	Description
M29		10 Amp Red	Occupant Classification Module (OCM)
M30		15 Amp Blue	Rear Wiper Module (RR WIPER MOD), Power Folding Mirror (PWR FOLD MIR)
M31		20 Amp Yellow	Back-Up Lamps (B/U LAMPS)
M32		10 Amp Red	Occupant Restraint Controller (ORC), TT EUROPE
M33		10 Amp Red	Next Generation Controller (NGC), Global Powertrain Engine Controller (GPEC)

Cavity	Cartridge Fuse	Mini Fuse	Description
M34		10 Amp Red	Park Assist (PRK ASST), Heater Ventilation, Air Conditioning Module (HVAC MOD), Headlamp Wash (HDLP WASH), Compass (COMPAS)
M35		10 Amp Red	Heated Mirrors
M36		20 Amp Yellow	LIGHTER OR PWR OUTLET, Underhood Lamp (UH LAMP)

Cavity	Cartridge Fuse	Mini Fuse	Description
M37		10 Amp Red	Anti-Lock Brake System (ABS), Electronic Stability Program (ESP), Stop Lamp Switch (STP LP SW), Fuel Pump Rly Hi Control
M38		25 Amp Natural	Lock/Unlock Motors (LOCK/UNLOCK MTRS)

CAUTION!

- When installing the Integrated Power Module cover, it is important to ensure the cover is properly positioned and fully latched. Failure to do so may allow water to get into the Integrated Power Module, and possibly result in a electrical system failure.
- When replacing a blown fuse, it is important to use only a fuse having the correct amperage rating. The use of a fuse with a rating other than indicated may result in a dangerous electrical system overload. If a properly rated fuse continues to blow, it indicates a problem in the circuit that must be corrected.

VEHICLE STORAGE

If you are leaving your vehicle dormant for more than 21 days you may want to take steps to protect your battery. You may:

- Remove Cartridge fuse #15 in the Power Distribution Center labeled Ignition-Off Draw (IOD).
- Store the removed IOD fuse in the Power Distribution Center location #11 labeled "IOD Storage."
- Or, disconnect the negative cable from the battery.
- Anytime you store your vehicle, or keep it out of service (i.e. vacation) for two weeks or more, run the air conditioning system at idle for about five minutes in the fresh air and high blower setting. This will insure adequate system lubrication to minimize the possibility of compressor damage when the system is started again.

REPLACEMENT BULBS — IF EQUIPPED

Interior Lights	Bulb Type
Auto. Trans. Indicator Light	658
Courtesy Lights, Under Dash (1).	906
Heater Control Lights (2)	194
Rocker Switch Indicator Light (Rear Window Defogger, and Rear Wash/Wipe)	**
Soundbar Dome Light	912

** Bulbs only available from authorized dealer.

Instrument Cluster	Bulb Type
Telltale (High Beam)	74
Illumination	103

Exterior Lights	Bulb Type
Backup Lights (2)	3157
Center High Mounted Stop Light (1)	L.E.D.
Fog Lights	9145
Front Park/Turn Lights (2)	3157
Front Side Marker Lights (2)	168
Headlights (2)	H13
Stop/Tail/Turn Lights (2)	3157
Underhood Light	561
License Light	194

NOTE: Numbers refer to commercial bulb types that can be purchased from your local authorized dealer.

If a bulb needs to be replaced, visit your authorized dealer or refer to the applicable Service Manual.

BULB REPLACEMENT

Head Light

1. Open hood and support using prop rod.
2. Remove the front grille. Turn the retainers along the top 1/4 turn counter-clockwise and remove.
3. Pull the bottom of the grille away starting at one side and working toward the other.
4. Turn both park and turn signal socket assemblies 1/4 turn counter-clockwise and remove.
5. Remove the four screws holding the metal retaining ring.
6. Remove the lamp from the collar.
7. Grasp the bulb and turn 1/4 turn counter-clockwise.
8. Pull the bulb from the housing.

9. Push connector locking tab to the unlock position.
10. Remove connector from bulb.
11. Push connector onto new bulb base, and push the connector locking tab to the lock position.

CAUTION!

Do not touch the new bulb with your fingers. Oil contamination will severely shorten bulb life. If the bulb comes in contact with any oily surface, clean the bulb with rubbing alcohol.

12. Reinstall bulb housing. Rotate the bulb 1/4 turn clockwise.

Front Park/Turn Signal

1. Remove the front grille. Turn the retainers along the top 1/4 turn counter-clockwise and remove.
2. Pull the bottom of the grille away starting at one side and working toward the other.
3. Turn the socket assembly 1/4 turn counter-clockwise and remove from housing. Pull the bulb straight from the socket to replace.

Front Side Marker

1. Reach under the front fender flare and locate the front side marker socket.
2. Turn the socket assembly counter-clockwise 1/3 turn and remove it from the housing. Pull the bulb straight from the socket to replace.

Front Fog Light

1. Locate the front fog lamp in the front fascia, and disconnect the electrical connector from underneath.
2. Turn the bulb 1/4 turn counter-clockwise.

CAUTION!

Do not touch the new bulb with your fingers. Oil contamination will severely shorten bulb life. If the bulb comes in contact with any oily surface, clean the bulb with rubbing alcohol.

Rear Tail, Stop, Turn Signal, and Back-Up Lights

1. Remove the two (2) inboard screws attaching the tail light housing to the body. **DO NOT REMOVE THE OUTER SCREWS AT ANY TIME.**

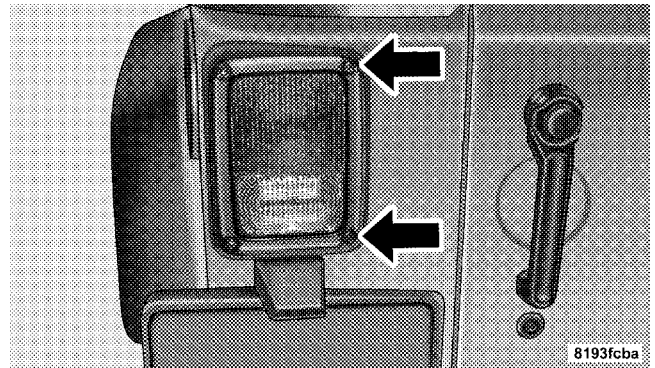

2. Separate the housing from the body by pushing the lamp inboard while pulling the lamp away from the body.
3. Rotate the appropriate socket 1/4 turn counter-clockwise, then remove it from the housing.
4. Pull the bulb straight from the socket to replace.

Center High Mounted Stop Light (CHMSL)

The stop lamp is mounted on a bracket that extends upward from the tailgate behind the spare tire. If service is needed, obtain the LED/Cover Assembly from your local authorized dealer.

1. Remove the spare tire.
2. Remove the four (4) screws holding the lens/cover in place on the spare tire carrier.
3. Disconnect the wire harness from the back of the LED cover.

FLUID CAPACITIES

	U.S.	Metric
Fuel (Approximate) — 2 Door Models	18.5 Gallons	70 Liters
Fuel (Approximate) — 4 Door Models	21.5 Gallons	79 Liters
Engine Oil with Filter		
3.8 Liter Engine (SAE 5W-20, API Certified Engine Oil)	6 Qts	5.7 Liters
Cooling System *		
3.8 Liter Engine (Mopar® Antifreeze/Engine Coolant 5 Year/100,000 Mile Formula)	13 Qts	12 Liters

* Includes heater and coolant recovery bottle filled to MAX level.

FLUIDS, LUBRICANTS AND GENUINE PARTS**Engine**

Component	Fluid, Lubricant, or Genuine Part
Engine Coolant	Mopar® Antifreeze/Coolant 5 Year/100,000 Mile Formula HOAT (Hybrid Organic Additive Technology)
Engine Oil	API Certified SAE 5W-20 Engine Oil is recommended. Meets the requirements of DaimlerChrysler Material Standard MS-6395.
Spark Plugs	Refer to the Vehicle Emission Control Information label in the engine compartment.
Oil Filter (3.8L Engine)	Mopar® Oil Filter (P/N 04105409AC)
Fuel Selection	87 Octane

Chassis

Component	Fluid, Lubricant, or Genuine Part
Automatic Transmission	Mopar® ATF+4 Automatic Transmission Fluid
Manual Transmission	Mopar® Manual Transmission Lubricant or equivalent (meeting the requirements of DaimlerChrysler Material Standard MS-9224)
Transfer Case	Mopar® ATF+4 Automatic Transmission Fluid or equivalent.
Axle Differential (Front)	Mopar® Gear & Axle Lubricant (SAE 80W-90) (API GL-5) or equivalent.
Axle Differential (Rear)	198 RBI (Model 35) and 226 RBI (Model 44) - Mopar® Gear & Axle Lubricant (SAE 80W-90) (API GL-5) or equivalent. For trailer towing, use Mopar® Synthetic Gear & Axle Lubricant (SAE 75W-140) or equivalent. Models equipped with Trac-Lok require an additive.
Brake Master Cylinder	Mopar® DOT 3 Brake Fluid, SAE J1703 should be used. If DOT 3, SAE J1703 brake fluid is not available, then DOT 4 is acceptable. Use only recommended brake fluids.
Power Steering Reservoir	Mopar® ATF+4 Automatic Transmission Fluid

MAINTENANCE SCHEDULES

CONTENTS

■ Emission Control System Maintenance	402	□ Schedule "B"	405
■ Maintenance Schedules	402	□ Schedule "A"	417

EMISSION CONTROL SYSTEM MAINTENANCE

The “Scheduled” maintenance services, listed in **bold type** must be done at the times or mileages specified to assure the continued proper functioning of the emission control system. These, and all other maintenance services included in this manual, should be done to provide best vehicle performance and reliability. More frequent maintenance may be needed for vehicles in severe operating conditions such as dusty areas and very short trip driving.

Inspection and service also should be done any time a malfunction is suspected.

NOTE: Maintenance, replacement, or repair of the emission control devices and systems on your vehicle may be performed by any automotive repair establishment or individual using any automotive part, which has been certified pursuant to U.S. EPA or, in the State of California, California Air Resources Board regulations.

MAINTENANCE SCHEDULES

There are two maintenance schedules that show the **required** service for your vehicle.

First is Schedule “**B**”. It is for vehicles that are operated under the conditions that are listed below and at the beginning of the schedule.

- Day or night temperatures are below 32°F (0°C)
- Stop and go driving
- Excessive engine idling
- Driving in dusty conditions
- Short trips of less than 10 miles (16.2 km)
- More than 50% of your driving is at sustained high speeds during hot weather, above 90°F (32°C)
- Trailer towing
- Taxi, police, or delivery service (commercial service)

- Off-road or desert driving

NOTE: If **ANY** of these apply to you then change your engine oil every 3,000 miles (5 000 km) or 3 months, whichever comes first and follow "Schedule B" of the "Maintenance Schedules" section of this manual.

NOTE: If **ANY** of these apply to you then flush and replace your engine coolant/anti-freeze every 102,000 miles (164 000 km) or 60 months, whichever comes first, and follow "Schedule B" of the "Maintenance Schedules" section of this manual.

NOTE: Most vehicles are operated under the conditions listed for Schedule "B."

Second is Schedule "A". It is for vehicles that are not operated under any of the conditions listed under Schedule "B."

Use the schedule that best describes your driving conditions. Where time and mileage are listed, follow the interval that occurs first.

CAUTION!

Failure to perform the required maintenance items may result in damage to the vehicle.

At Each Stop for Fuel

- Check the engine oil level about 5 minutes after a fully warmed engine is shut off. Checking the oil level while the vehicle is on level ground will improve the accuracy of the oil level reading. Add oil only when the level is at or below the ADD or MIN mark.
- Check the windshield washer solvent, add as required.

404 MAINTENANCE SCHEDULES

Once a Month

- Check the tire pressure and look for unusual wear or damage.
- Inspect the battery and clean and tighten the terminals as required.
- Check the fluid levels of the coolant reservoir, brake master cylinder, and transmission, and add as needed.
- Check all lights and all other electrical items for correct operation.

At Each Oil Change

- Change the engine oil filter.
- Inspect the exhaust system.
- Inspect brake hoses.
- Check the coolant level, hoses, and clamps.
- After completion of off-road operation, the underside of the vehicle should be thoroughly inspected. Examine threaded fasteners for looseness.

Schedule "B"

Follow this schedule if you usually operate your vehicle under one or more of the following conditions.

- Day or night temperatures are below 32°F (0°C)
- Stop and go driving
- Excessive engine idling
- Driving in dusty conditions
- Short trips of less than 10 miles (16.2 km)
- More than 50% of your driving is at sustained high speeds during hot weather, above 90°F (32°C)
- Trailer towing
- Taxi, police, or delivery service (commercial service)

- Off-road or desert driving
- **If equipped for and operated with E-85 (ethanol) fuel.**

NOTE: If **ANY** of these apply to you then change your engine oil every 3,000 miles (5 000 km) or 3 months, whichever comes first and follow "Schedule B" of the "Maintenance Schedules" section of this manual.

NOTE: If **ANY** of these apply to you then flush and replace your engine coolant/anti-freeze every 102,000 miles (164 000 km) or 60 months, whichever comes first, and follow "Schedule B" of the "Maintenance Schedules" section of this manual.

406 SCHEDULE "B"

Miles (Kilometers)	3,000 (5 000)	6,000 (10 000)	9,000 (14 000)	12,000 (19 000)	15,000 (24 000)
Change the engine oil and engine oil filter, if not replaced at 3 months.	X	X	X	X	X
Rotate the tires.		X		X	
Inspect the engine air filter element, replace if necessary.					X
Inspect the brake linings.				X	
Drain and refill the front and rear axle fluid.					X
Inspect the transfer case fluid, add if necessary.					X
Clean and lubricate soft top zippers (if equipped).	X	X	X	X	X

Miles (Kilometers)	18,000 (29 000)	21,000 (34 000)	24,000 (39 000)	27,000 (43 000)	30,000 (48 000)
Change the engine oil and engine oil filter, if not replaced at 3 months.	X	X	X	X	X
Rotate the tires.	X		X		X
Inspect the engine air filter element, replace if necessary.					X
Inspect the PCV Valve, and replace if necessary. ◇					X
Inspect the brake linings.			X		
Drain and refill the front and rear axle fluid.					X
Inspect the manual transmission fluid, add as necessary.					X
Inspect the transfer case fluid, add if necessary.					X
Clean and lubricate soft top zippers (if equipped).	X	X	X	X	X

408 SCHEDULE "B"

Miles (Kilometers)	33,000 (53 000)	36,000 (58 000)	39,000 (63 000)	42,000 (68 000)	45,000 (72 000)
Change the engine oil and engine oil filter, if not replaced at 3 months.	X	X	X	X	X
Rotate the tires.		X		X	
Inspect the engine air filter element, replace if necessary.					X
Inspect the brake linings.		X			
Drain and refill the front and rear axle fluid.					X
Inspect the transfer case fluid, add if necessary.					X
Inspect the drive belt, and replace as needed.					X
Clean and lubricate soft top zippers (if equipped).	X	X	X	X	X

Miles (Kilometers)	48,000 (77 000)	51,000 (82 000)	54,000 (87 000)	57,000 (92 000)	60,000 (97 000)
Change the engine oil and engine oil filter, if not replaced at 3 months.	X	X	X	X	X
Rotate the tires.	X		X		X
Inspect the engine air filter element, replace if necessary.					X
Inspect the PCV Valve, and replace if necessary. ◇					X
Inspect the brake linings.	X				X
Drain and refill the front and rear axle fluid.					X
Inspect manual transmission fluid, add as necessary.					X
Drain and refill the automatic transmission fluid. Replace main sump filter and spin-on cooler return filter (if equipped). ‡					X
Inspect the drive belt, and replace as needed. Not required if belt was previously.					X
Drain and refill the transfer case fluid.					X
Flush and replace the engine coolant/anti-freeze.					X
Clean and lubricate soft top zippers (if equipped).	X	X	X	X	X

410 SCHEDULE "B"

Miles (Kilometers)	63,000 (101 000)	66,000 (106 000)	69,000 (111 000)	72,000 (116 000)	75,000 (121 000)
Change the engine oil and engine oil filter, if not replaced at 3 months.	X	X	X	X	X
Rotate the tires.		X		X	
Inspect the engine air filter element, replace if necessary.					X
Inspect the brake linings.				X	
Inspect the transfer case fluid, add if necessary.					X
Drain and refill the front and rear axle fluid.					X
Inspect the drive belt, and replace as needed. Not required if belt was previously replaced.					X
Clean and lubricate soft top zippers (if equipped).	X	X	X	X	X

Miles (Kilometers)	78,000 (126 000)	81,000 (130 000)	84,000 (135 000)	87,000 (140 000)	90,000 (145 000)
Change the engine oil and engine oil filter, if not replaced at 3 months.	X	X	X	X	X
Rotate the tires.	X		X		X
Inspect the engine air filter element, replace if necessary.					X
Inspect the PCV Valve, and replace if necessary. ◇					X
Inspect the brake linings.			X		
Drain and refill the front and rear axle fluid.					X
Inspect the drive belt, and replace as needed. Not required if belt was previously replaced.					X
Inspect the manual transmission fluid, add as necessary.					X
Inspect the transfer case fluid, add if necessary.					X
Clean and lubricate soft top zippers (if equipped).	X	X	X	X	X

412 SCHEDULE "B"

Miles (Kilometers)	93,000 (150 000)	96,000 (154 000)	99,000 (159 000)	102,000 (164 000)	105,000 (169 000)
Change the engine oil and engine oil filter, if not replaced at 3 months.	X	X	X	X	X
Rotate the tires.		X		X	
Inspect the engine air filter element, replace if necessary.					X
Replace the spark plugs.			X		
Replace the ignition cables.			X		
Inspect the brake linings.		X			
Drain and refill the front and rear axle fluid.					X
Inspect the transfer case fluid, add if necessary.					X
Inspect the drive belt, and replace as needed. Not required if belt was previously replaced.					X
Flush and replace the engine coolant/anti-freeze, if not done at 60,000 miles (96 000 km).				X	
Clean and lubricate soft top zippers (if equipped).	X	X	X	X	X

Miles (Kilometers)	108,000 (174 000)	111,000 (179 000)	114,000 (183 000)	117,000 (188 000)	120,000 (193 000)
Change the engine oil and engine oil filter, if not replaced at 3 months.	X	X	X	X	X
Rotate the tires.	X		X		X
Inspect the engine air filter element, replace if necessary.					X
Inspect the PCV Valve, and replace if necessary. ◇					X
Inspect the brake linings.	X				X
Drain and refill the front and rear axle fluid.					X
Inspect the manual transmission fluid, add as necessary.					X
Drain and refill the automatic transmission fluid. Replace main sump filter and spin-on cooler return filter (if equipped). ‡					X
Inspect the drive belt, and replace as needed. Not required if belt was previously replaced.					X
Drain and refill the transfer case fluid.					X
Flush and replace the engine coolant/anti-freeze, if not replaced at 102,000 miles (164 000 km).					X
Clean and lubricate soft top zippers (if equipped).	X	X	X	X	X

414 SCHEDULE "B"

Miles (Kilometers)	123,000 (198 000)	126,000 (203 000)	129,000 (208 000)	132,000 (212 000)	135,000 (217 000)
Change the engine oil and engine oil filter, if not replaced at 3 months.	X	X	X	X	X
Rotate the tires.		X		X	
Inspect the engine air filter element, replace if necessary.					X
Inspect the brake linings.				X	
Drain and refill the front and rear axle fluid.					X
Inspect the transfer case fluid, add if necessary.					X
Inspect the drive belt, and replace as needed. Not required if belt was previously replaced.					X
Clean and lubricate soft top zippers (if equipped).	X	X	X	X	X

Miles (Kilometers)	138,000 (222 000)	141,000 (227 000)	144,000 (232 000)	147,000 (237 000)	150,000 (241 000)
Change the engine oil and engine oil filter, if not replaced at 3 months.	X	X	X	X	X
Rotate the tires.		X		X	
Inspect the engine air filter element, replace if necessary.					X
Inspect the PCV Valve, and replace if necessary. ◇					X
Inspect the brake linings.			X		
Drain and refill the front and rear axle fluid.					X
Inspect the manual transmission fluid, add as necessary.					X
Inspect the transfer case fluid, add if necessary.					X
Inspect the drive belt, and replace as needed. Not required if belt was previously replaced.					X
Flush and replace the engine coolant/anti-freeze, if not done at 120,000 miles (193 000 km).					X
Clean and lubricate soft top zippers (if equipped).	X	X	X	X	X

416 SCHEDULE "B"

Inspection and service should also be performed anytime a malfunction is observed or suspected. Retain all receipts.

† Applies only if vehicle is used for frequent trailer towing or fleet/commercial service.

◇ This maintenance is recommended by the manufacturer to the owner, but is not required to maintain emissions warranty.

‡Off-highway operation, trailer towing, taxi, limousine, bus, snow plowing, or other types of commercial service or prolonged operation with heavy loading, especially in hot weather, require front and rear axle service indicated with a ‡ in Schedule "B". Perform these services if the vehicle is usually operated under these conditions.

Schedule "A"

Miles (Kilometers) [Months]	6,000 (10 000) [6]	12,000 (19 000) [12]	18,000 (29 000) [18]	24,000 (39 000) [24]	30,000 (48 000) [30]
Change the engine oil and engine oil filter.	X	X	X	X	X
Rotate the tires.	X	X	X	X	X
Inspect the engine air filter element, and replace if necessary.					X
Inspect the brake linings.			X		
Inspect the manual transmission fluid, add as necessary.					X
Inspect the transfer case fluid, add as necessary.					X
Clean and lubricate soft top zippers (if equipped).	X	X	X	X	X

418 SCHEDULE "A"

Miles (Kilometers) [Months]	36,000 (58 000) [36]	42,000 (68 000) [42]	48,000 (77 000) [48]	54, 000 (87 000) [54]
Change the engine oil and engine oil filter.	X	X	X	X
Rotate the tires.	X	X	X	X
Inspect the brake linings.	X			X
Clean and lubricate soft top zippers (if equipped).	X	X	X	X

Miles (Kilometers) [Months]	60,000 (97 000) [60]	66,000 (106 000) [66]	72,000 (116 000) [72]	78,000 (126 000) [78]
Change the engine oil and engine oil filter.	X	X	X	X
Rotate the tires.	X	X	X	X
Inspect the engine air filter element, and replace if necessary.	X			
Inspect the PCV Valve, and replace if necessary. ◇	X			
Inspect the brake linings.			X	
Inspect the drive belt, and replace as needed.	X			
Inspect the drive belt, and replace as needed. Not required if belt was previously replaced.			X	
Flush and replace the engine coolant/anti-freeze. Where both time and mileage are indicated, follow the interval which occurs first.	X			
Inspect the manual transmission fluid, add as necessary.	X			
Inspect transfer case fluid, add as necessary.	X			
Clean and lubricate soft top zippers (if equipped).	X	X	X	X

420 SCHEDULE "A"

Miles (Kilometers) [Months]	84,000 (135 000) [84]	90,000 (145 000) [90]	96,000 (154 000) [96]	102, 000 (164 000) [102]
Change the engine oil and engine oil filter.	X	X	X	X
Rotate the tires.	X	X	X	X
Inspect the engine air filter element, and replace if necessary.		X		
Inspect the PCV Valve, and replace if necessary. ◇		X		
Replace the spark plugs.			X	
Replace the ignition cables.			X	
Inspect the brake linings.		X		
Inspect the drive belt, and replace as needed. Not required if previously replaced.		X		X
Flush and replace the engine coolant/anti-freeze if not done at 60 months.				X
Inspect the manual transmission fluid, add as necessary.		X		
Inspect the transfer case fluid, add as necessary.		X		
Clean and lubricate soft top zippers (if equipped).	X	X	X	X

Miles (Kilometers) [Months]	108,000 (174 000) [108]	114,000 (183 000) [114]	120,000 (193 000) [120]	126,000 (203 000) [126]
Change the engine oil and engine oil filter.	X	X	X	X
Rotate the tires.	X	X	X	X
Inspect the engine air filter element, and replace if necessary.			X	
Inspect the PCV Valve, and replace if necessary. ◇			X	
Inspect the brake linings.	X			
Inspect the drive belt, and replace as needed. Not required if previously replaced.			X	
Inspect the manual transmission fluid, add as necessary.			X	
Drain and refill the transfer case fluid.			X	
Flush and replace the engine coolant/anti-freeze, if not done at 102,000 miles (164 000 km).			X	
Clean and lubricate soft top zippers (if equipped).	X	X	X	X

422 SCHEDULE "A"

Miles (Kilometers) [Months]	132,000 (212 000) [132]	138,000 (222 000) [138]	144,000 (232 000) [144]	150,000 (241 000) [150]
Change the engine oil and engine oil filter.	X	X	X	X
Rotate the tires.	X	X	X	X
Inspect the engine air filter element, and replace if necessary.				X
Inspect the PCV Valve, and replace if necessary. ◇				X
Inspect the brake linings.	X			
Inspect the drive belt, and replace as needed. Not required if previously replaced.		X		X
Inspect the manual transmission fluid, add as necessary.				X
Inspect the transfer case fluid, add as necessary.				X
Flush and replace the engine coolant/anti-freeze, if not done at 120,000 miles (193 000 km).				X
Clean and lubricate soft top zippers (if equipped).	X	X	X	X

Inspection and service should also be performed anytime a malfunction is observed or suspected. Retain all receipts.

◇ This maintenance is recommended by the manufacturer to the owner, but is not required to maintain emissions warranty.

IF YOU NEED CONSUMER ASSISTANCE

CONTENTS

■ Suggestions For Obtaining Service For Your Vehicle	426	■ Reporting Safety Defects	429
□ Prepare For The Appointment	426	□ In Canada	429
□ Prepare A List	426	■ Publication Order Forms	430
□ Be Reasonable With Requests	426	■ Department Of Transportation Uniform Tire Quality Grades	431
■ If You Need Assistance	426	□ Treadwear	431
■ Warranty Information (U.S. Vehicles Only)	429	□ Traction Grades	431
■ Mopar® Parts	429	□ Temperature Grades	432

SUGGESTIONS FOR OBTAINING SERVICE FOR YOUR VEHICLE**Prepare For The Appointment**

If you're having warranty work done, be sure to have the right papers with you. Take your warranty folder. All work to be performed may not be covered by the warranty, discuss additional charges with the service manager. Keep a maintenance log of your vehicle's service history. This can often provide a clue to the current problem.

Prepare A List

Make a written list of your vehicle's problems or the specific work you want done. If you've had an accident, or work done that is not on your maintenance log, let the service advisor know.

Be Reasonable With Requests

If you list a number of items, and you must have your vehicle by the end of the day, discuss the situation with the service advisor and list the items in order of priority. At many dealers you may obtain a rental vehicle at a minimal daily charge. If you need a rental, it is advisable to make these arrangements when you call for an appointment.

IF YOU NEED ASSISTANCE

The manufacturer and its dealers are vitally interested in your satisfaction. We want you to be happy with our products and services.

Warranty service must be done by an authorized Chrysler, Dodge, or Jeep dealer. We strongly recommend that you take your vehicle to your selling dealer. They know you and your vehicle best, and are most concerned that you get prompt and high quality service. The manufacturer's dealers have the facilities, factory-trained

technicians, special tools, and the latest information to assure your vehicle is fixed correctly and in a timely manner.

This is why you should always talk to your dealer's service manager first. Most matters can be resolved with this process.

- If for some reason you are still not satisfied, talk to the general manager or owner of the dealership. They want to know if you need assistance.
- If your dealership is unable to resolve the concern, you may contact the Manufacturer's Customer Center.

Any communication to the Manufacturer's Customer Center should include the following information:

- Owner's name and address
- Owner's telephone number (home and office)
- Dealership name

- Vehicle identification number
- Vehicle delivery date and mileage

DaimlerChrysler Motors Corporation Customer Center

P.O. Box 21-8004
 Auburn Hills, MI 48321-8004
 Phone: (800) 992-1997

DaimlerChrysler Canada Inc. Customer Center

P.O. Box 1621
 Windsor, Ontario N9A 4H6
 Phone —(800) 465-2001

In Mexico contact:

Av. Prolongacion Paseo de la Reforma, 1240
 Sante Fe C.P. 05109
 Mexico, D. F.
 In Mexico (915) 729-1248 or 729-1240
 Outside Mexico (525) 729-1248 or 729-1240

Customer Assistance For The Hearing Or Speech Impaired (TDD/TTY)

To assist customers who have hearing difficulties, the manufacturer has installed special TDD (Telecommunication Devices for the Deaf) equipment at its Customer Center. Any hearing or speech impaired customer who has access to a TDD or a conventional teletypewriter (TTY) in the United States can communicate with the manufacturer by dialing 1-800-380-CHRY.

Service Contract

You may have purchased a service contract for your vehicle to help protect you from the high cost of unexpected repairs after your manufacturer's new vehicle limited warranty expires. The manufacturer stands behind only the manufacturer's Service Contracts. If you purchased a manufacturer's Service Contract, you will receive Plan Provisions and an Owner Identification Card in the mail within three weeks of your vehicle delivery date. If you have any questions about your service

contract, call the manufacturer's Service Contract National Customer Hotline at 1-800-521-9922.

The manufacturer will not stand behind any service contract that is not the manufacturer's Service Contract. It is not responsible for any service contract other than the manufacturer's Service Contract. If you purchased a service contract that is not a manufacturer's Service Contract, and you require service after your manufacturer's new vehicle limited warranty expires, please refer to your contract documents, and contact the person listed in those documents.

We appreciate that you have made a major investment when you purchased your new vehicle. Your dealer has also made a major investment in facilities, tools, and training to assure that you are absolutely delighted with your ownership experience. You'll be pleased with their sincere efforts to resolve any warranty issues or related concerns.

WARRANTY INFORMATION (U.S. Vehicles Only)

See the Warranty Information Booklet for the terms and provisions of DaimlerChrysler's warranties applicable to this vehicle.

MOPAR® PARTS

Mopar® fluids, lubricants, parts, and accessories are available from your dealer. They will help you keep your vehicle operating at its best.

REPORTING SAFETY DEFECTS

In the 50 United States and Washington D.C.: If you believe that your vehicle has a defect, which could cause a crash or cause injury or death, you should immediately inform the National Highway Traffic Safety Administration (NHTSA) in addition to notifying the manufacturer.

If NHTSA receives similar complaints, it may open an investigation, and if it finds that a safety defect exists in a group of vehicles, it may order a recall and remedy

campaign. However, NHTSA cannot become involved in individual problems between you, your dealer, and the manufacturer.

To contact NHTSA, you may either call the Auto Safety Hotline toll free at 1-888-327-4236 (TTY: 1-800-424-9153), or go to <http://www.NHTSA.gov>. or write to: NHTSA, U.S. Dept. of Transportation, Washington DC 20590. You can also obtain other information about motor vehicle safety from the Hotline.

In Canada:

If you believe that your vehicle has a safety defect, you should contact the Customer Service Department immediately. Canadian customers who wish to report a safety defect to the Canadian government should write to Transport Canada, Motor Vehicle Defect Investigations and Recalls, 2780 Sheffield Road, Ottawa, Ontario K1B 3V9.

PUBLICATION ORDER FORMS

To order the following manuals, you may use either the website or the phone numbers listed below. Visa, Mastercard, American Express, and Discover orders are accepted. If you prefer mailing your payment, please call for an order form.

NOTE: A street address is required when ordering manuals. (No P.O. Boxes).

- *Service Manuals.*

These comprehensive service manuals provide the information that students and professional technicians need in diagnosing/troubleshooting, problem solving, maintaining, servicing, and repairing DaimlerChrysler Corporation vehicles. A complete working knowledge of the vehicle, system, and/or components is written in straightforward language with illustrations, diagrams, and charts.

- *Diagnostic Procedure Manuals.*

Filled with diagrams, charts and detailed illustrations, these practical manuals make it easy for students and technicians to find and fix problems on computer-controlled vehicle systems and features. They show exactly how to find and correct problems the first time, using step-by-step troubleshooting and driveability procedures, proven diagnostic tests and a complete list of all tools and equipment.

- *Owner's Manuals.*

These manuals have been prepared with the assistance of service and engineering specialists to acquaint you with specific Chrysler group vehicles. Included are starting, operating, emergency and maintenance procedures as well as specifications, capabilities and safety tips.

Call Toll Free at:

- 1-800-890-4038 (U.S.)
- 1-800-387-1143 (Canada)

Or

Visit us on the World Wide Web at:

- www.techauthority.daimlerchrysler.com
- www.daimlerchrysler.ca/manuals

DEPARTMENT OF TRANSPORTATION UNIFORM TIRE QUALITY GRADES

The following describes the tire grading categories established by the National Highway Traffic Safety Administration. The specific grade rating assigned by the tire's manufacturer in each category is shown on the sidewall of the tires on your car.

All Passenger Car Tires Must Conform to Federal Safety Requirements in Addition to These Grades.

Treadwear

The treadwear grade is a comparative rating based on the wear rate of the tire when tested under controlled conditions on a specified government test course. For example, a tire graded 150 would wear one and a half (1 1/2) times as well on the government course as a tire graded 100. The relative performance of tires depends upon the actual conditions of their use, however, and may depart significantly from the norm due to variations in driving habits, service practices and differences in road characteristics and climate.

Traction Grades

The traction grades, from highest to lowest, are AA, A, B, and C. Those grades represent the tire's ability to stop on wet pavement as measured under controlled conditions

on specified government test surfaces of asphalt and concrete. A tire marked C may have poor traction performance.

WARNING!

The traction grade assigned to this tire is based on straight-ahead braking traction tests, and does not include acceleration, cornering, hydroplaning, or peak traction characteristics.

Temperature Grades

The temperature grades are A (the highest), B, and C, representing the tire's resistance to the generation of heat and its ability to dissipate heat when tested under controlled conditions on a specified indoor laboratory test wheel. Sustained high temperature can cause the material of the tire to degenerate and reduce tire life, and excessive temperature can lead to sudden tire failure. The

grade C corresponds to a level of performance which all passenger car tires must meet under the Federal Motor Vehicle Safety Standard No. 109. Grades B and A represent higher levels of performance on the laboratory test wheel than the minimum required by law.

WARNING!

The temperature grade for this tire is established for a tire that is properly inflated and not overloaded. Excessive speed, under inflation, or excessive loading, either separately or in combination, can cause heat buildup and possible tire failure.

INDEX

- ABS (Anti-Lock Brake System) 192,281
Adding Fuel 310
Adding Washer Fluid 183
Air Cleaner, Engine (Engine Air Cleaner Filter) . . . 361
Air Conditioner Maintenance 362
Air Conditioning 240,243
Air Conditioning Controls 243
Air Conditioning, Operating Tips 244
Air Conditioning Refrigerant 363
Air Conditioning System 243
Air Filter 361
Air Pressure, Tires 294
Airbag 46
Airbag Deployment 58
Airbag Light 61,192
Airbag Maintenance 60
Airbag, Side 57
Alarm (Security Alarm) 19
Alignment and Balance 300
Alterations/Modifications, Vehicle 9
Antenna, Satellite Radio 234
Antifreeze (Engine Coolant) 397
Anti-Lock Brake System (ABS) 105,281
Anti-Lock Warning Light 192
Appearance Care 379
Arming Theft System (Security Alarm) 19
Auto Down Power Windows 32
Automatic Transmission 374
 Fluid and Filter Changes 374
 Fluid Level Check 374
 Fluid Type 374
 Gear Ranges 261
 Shifting 261
 Special Additives 376
 Torque Converter 264
Auxiliary Electrical Outlet (Power Outlet) 114
Auxiliary Power Outlet 114
Axle Lock 270,271

Battery	361	Capacities, Fluid	397
Emergency Starting	342	Caps, Filler	
Keyless Transmitter Replacement (RKE)	25	Fuel	310
Belts, Drive	358	Power Steering	363
Belts, Seat	37	Car Washes	380
Body Mechanism Lubrication	364	Carbon Monoxide Warning	309
Brake Assist System	106	Cargo Light	95
Brake Assist Warning Light	196	Catalytic Converter	358
Brake Control System, Electronic	105	Caution, Exhaust Gas	76
Brake System	372	CD (Compact Disc) Player Maintenance	237
Anti-Lock (ABS)	105,281	Cellular Phone	237
Hoses	372	Center High Mounted Stop Light	397
Master Cylinder	373	Certification Label	313
Parking	279	Chains, Tire	300
Warning Light	191	Changing A Flat Tire	338
Brake/Transmission Interlock	260	Charging System Light	190
Break-In Recommendations, New Vehicle	75	Chart, Tire Sizing	285
Bulb Replacement	393,394	Check Engine Light (Malfunction Indicator Light)	195,352

Child Restraint	63,70,73	Points to Remember	370
Child Restraint Tether Anchors	68,70	Pressure Cap	369
Child Seat	67	Selection of Coolant (Antifreeze)	367,397
Climate Control	238	Temperature Gauge	193
Clock	205,220,231	Corrosion Protection	379
Compact Disc (CD) Maintenance	237	Crankcase Emission Control System	360
Compass	198	Cruise Light	193
Compass Calibration	200	Cup Holder	115
Console	116	Customer Assistance	426
Console, Floor	116		
Contract, Service	428	Data Recorder, Event	61
Converter, Catalytic	358	Daytime Running Lights	99
Cooling System	366	Dealer Service	354
Adding Coolant (Antifreeze)	368	Defroster, Rear Window	184
Coolant Capacity	397	Defroster, Windshield	239,241
Coolant Level	370	Delay (Intermittent) Wipers	99
Disposal of Used Coolant	369	Diagnostic System, Onboard	351
Drain, Flush, and Refill	367	Dimmer Switch, Headlight	97
Inspection	366		

Dipsticks		Electronic Speed Control (Cruise Control)	102
Oil (Engine)	354	Electronic Stability Program (ESP)	108
Disabled Vehicle Towing	345	Electronic Throttle Control Warning Light	197
Disarming, Theft System	19	Electronic Vehicle Information Center (EVIC)	197
Disposal		Emergency Brake	279
Engine Oil	357	Emergency, In Case of	
Used Coolant (Antifreeze)	369	Brake Warning Light	191
Door Locks	29,30	Coolant Temperature Gauge	193
Doors	25	Hazard Warning Flasher	336
Drive Belts	358	Jacking	338
Driver's Seat Back Tilt	86	Jump Starting	342
Driving	273	Tow Hooks	344
Off-Pavement	274	Emission Control System Maintenance	352,402
Off-Road	274	Engine	
Dual Top	118	Air Cleaner	361
Electrical Outlet, Auxiliary (Power Outlet)	114	Block Heater	254
Electrical Power Outlets	114	Break-In Recommendations	75
Electronic Brake Control System	105	Compartment	350
		Compartment Identification	350

Exhaust Gas Caution	76,309	Extender, Seat Belt	46
Fails to Start	252	Exterior Finish Care	380
Flooded, Starting	252	Fabric Care	381,382,383
Fuel Requirements	306,397	Fabric Top	383
Jump Starting	342	Filters	
Oil	354,397	Air Cleaner	361
Oil Disposal	357	Engine Fuel	360
Oil Filter	357	Engine Oil	357
Oil Selection	397	Finish Care	380
Overheating	337	Flashers	
Starting	251	Hazard Warning	336
Temperature Gauge	193	Turn Signal	191,395,396
Engine Oil Viscosity	357	Flooded Engine Starting	252
Engine Oil Viscosity Chart	357	Fluid Capacities	397
Enhanced Accident Response Feature	60	Fluid Level Checks	378
Entry System, Illuminated	20	Automatic Transmission	374
Event Data Recorder	61	Engine Oil	354
Exhaust Gas Caution	76,309	Manual Transmission	376
Exhaust System	366		

Power Steering	363	Requirements	397
Fluids, Lubricants and Genuine Parts	398	Tank Capacity	397
Fog Light Service	396	Fuel System Caution	308,311,312
Fog Lights	98,396	Fuses	385
Fold and Tumble Rear Seat	88	Gas Cap (Fuel Filler Cap)	310,351
Folding Rear Seat	91	Gasoline (Fuel)	306
Folding Windshield	176	Gasoline, Reformulated	307
Four Wheel Drive	265	Gasoline/Oxygenate Blends	307
Shifting	267	Gauges	
Four Wheel Drive Operation	265	Coolant Temperature	193
Four-Way Hazard Flasher	336	Fuel	190
Front Axle (Differential)	378	Odometer	195
Fuel	306	Speedometer	190
Filler Cap (Gas Cap)	310	Tachometer	192
Filter	360	Gear Ranges	257,261
Gasoline	306	General Information	306
Gauge	190	Glass Cleaning	382
Materials Added	308	Gross Axle Weight Rating	316
Octane Rating	306		

Gross Vehicle Weight Rating	315	Holder, Cup	115
GVWR	313	Hood Release	93
Hard Top	123	Hoses	371,372
Hard Top, Modular	123	Hydraulic Clutch Fluid	376
Hard Top Removal	126	Ignition	14
Hazard Warning Flasher	336	Key	14
Head Restraints	87	Ignition Key Removal	14
Head Rests	87	Illuminated Entry	20
Headlights		Infant Restraint	63
Bulb Replacement	394	Inflation Pressure Tires	294
Dimmer Switch	97	Inside Rearview Mirror	83
Replacing	394	Instrument Cluster	189
Switch	97	Instrument Panel and Controls	188
Heater	238	Instrument Panel Lens Cleaning	383
Heater, Engine Block	254	Integrated Power Module (Fuses)	385
High Beam Indicator	191	Interior Appearance Care	382
Hitches		Interior Lights	94
Trailer Towing	319	Intermittent Wipers (Delay Wipers)	99

Introduction	4	Lead Free Gasoline	306
Jack Location	338	Lights	94
Jack Operation	338,340	Airbag	61,192
Jacking Instructions	340	Anti-Lock	192
Jump Starting	342	Anti-Lock Warning	192
Key, Programming	18	Back-Up	396
Key, Replacement	17	Brake Assist Warning	113,196
Key, Sentry (Immobilizer)	16	Brake Warning	191
Key-In Reminder	15	Bulb Replacement	394
Keyless Entry System	20	Cargo	95
Keys	14	Center Mounted Stop	397
Lane Change and Turn Signals	191	Check Engine (Malfunction Indicator)	195
Lap Belts	37	Cruise	193
Lap/Shoulder Belts	37	Daytime Running	99
LATCH (Lower Anchors and Tether for CHildren)	68,70	Dimmer Switch, Headlight	97
		Electronic Stability Program (ESP) Indicator	113,196
		Electronic Throttle Control Warning	197
		Engine Temperature Warning	193

Fog	98,396	Tire Pressure Monitoring (TPMS)	194
Hazard Warning Flasher	336	Traction Control	196
Headlight Switch	97	Turn Signal	98,191,395,396
Headlights	394	Warning (Instrument Cluster Description)	190
High Beam	191	Loading Vehicle	313
High Beam Indicator	191	Tires	289
Instrument Cluster	97	Locking Axle	270,271
Interior	94	Locks	
Lights On Reminder	97	Door	29,30
Low Fuel	190	Power Door	31
Low Tire	194	Steering Wheel	15
Oil Pressure	191	Lower Anchors and Tether	
Passing	98	for CHildren (LATCH)	68,70
Rear Servicing	396	Lubrication, Body	364
Rear Tail	396	Maintenance Free Battery	361
Seat Belt Reminder	191	Maintenance Procedures	354
Sentry Key	193	Maintenance Schedule	402
Service	394	Schedule "A"	417
Side Marker	396		

Schedule "B"	405	Navigation Radio	231
Maintenance Schedules	402	Navigation System	231
Malfunction Indicator Light (Check Engine)	195,352	New Vehicle Break-In Period	75
Manual, Service	430	Occupant Restraints	36
Manual Transmission	255,376	Octane Rating, Gasoline (Fuel)	306
Fluid Level Check	376	Odometer	195,197
Lubricant Selection	376	Trip	193,195,197
Shift Speeds	257	Off-Pavement Driving (Off-Road)	274
Master Cylinder (Brakes)	373	Off-Road Driving (Off-Pavement)	274
Mini-Trip Computer	198	Oil, Engine	354
Mirrors	83	Capacity	397
Outside	84	Dipstick	354
Rearview	83	Filter	357
Modifications/Alterations, Vehicle	9	Identification Logo	356
Modular Hard Top	123	Materials Added to	357
Monitor, Tire Pressure System	302	Pressure Warning Light	191
Mopar Parts	353,429	Recommendation	356,397
Multi-Function Control Lever	96	Viscosity	357,397

Oil Pressure Light	191	Windows	32
Onboard Diagnostic System	351,352	Pregnant Women and Seat Belts	45
Outside Rearview Mirrors	84	Preparation for Jacking	339
Overheating, Engine	337	Pretensioners	
Owner's Manual (Operator Manual)	430	Seat Belts	43
		Programming Transmitters	
Paint Care	379	(Remote Keyless Entry)	23
Paint Damage	379		
Panic Alarm	22	Radial Ply Tires	297
Parking Brake	279	Radio Broadcast Signals	203
Passing Light	98	Radio, Navigation	231
PCV Valve	360	Radio Operation	237
Pets	75	Radio, Satellite	231,233
Placard, Tire and Loading Information	290	Rear Axle (Differential)	378
Polishing and Waxing	380	Rear Swing Gate	34
Power		Rear Window Defroster	184
Distribution Center (Fuses)	385	Rear Window Features	182
Door Locks	31	Rear Wiper/Washer	182
Steering	283,363	Rearview Mirrors	83
		Recorder, Event Data	61

Recreational Towing	332	Safety Checks Inside Vehicle	77
Shifting into Transfer Case Neutral (N)	332	Safety Checks Outside Vehicle	77
Shifting out of Transfer Case Neutral (N)	333	Safety Defects, Reporting	429
Reformulated Gasoline	307	Safety Information, Tire	284
Refrigerant	363	Safety Tips	76
Release, Hood	93	Satellite Radio	231,233
Reminder, Lights On	97	Satellite Radio Antenna	234
Reminder, Seat Belt	44	Schedule, Maintenance	402
Remote Control		Seat Belt Reminder	44
Door Locks	20	Seat Belts	37
Remote Keyless Entry (RKE)	20	Adjustable Upper Shoulder Anchorage	43
Replacement Bulbs	393	And Pregnant Women	45
Replacement Parts	353	Child Restraint	63,73
Replacement Tires	299	Extender	46
Reporting Safety Defects	429	Front Seat	37
Restraint, Head	87	Maintenance	383
Restraints, Child	63,67	Pretensioners	43
Restraints, Occupant	36	Reminder	191
Rotation, Tires	301	Seats	85

Adjustment	85	Setting the Clock	205,220,231
Cleaning	381	Shift Lock Manual Override	259
Easy Entry	87	Shift Speeds, Manual Transmission	257
Fold and Tumble Rear	88	Shifting	258
Head Restraints	87	Automatic Transmission	261
Height Adjustment	86	Manual Transmission	255
Rear Folding	91	Shoulder Belt Upper Anchorage	43
Removal	89,91	Shoulder Belts	37
Seatback Release	86	Side Airbag	57
Tilting	86	Signals, Turn	98,191,395,396
Security Against Theft	19	Snow Chains (Tire Chains)	300
Security Alarm (Theft Alarm)	19	Soft Top	130,145
Selection of Oil	356	Spare Tire	339
Sentry Key (Immobilizer)	16	Spark Plugs	358
Sentry Key Programming	18	Specifications	
Sentry Key Replacement	17	Fuel (Gasoline)	306
Service Assistance	426	Oil	356
Service Contract	428	Speed Control (Cruise Control)	102
Service Manuals	430	Speedometer	190

Starting	251	System, Navigation	231
Automatic Transmission	251	Tachometer	192
Cold Weather	252	Temperature Gauge, Engine Coolant	193
Engine Block Heater	254	Tether Anchor, Child Restraint	68
Engine Fails to Start	252	Theft System Arming	19
Manual Transmission	251	Theft System Disarming	19
Steering		Tilt Steering Column	101
Power	283,363	Tip Start	252
Tilt Column	101	Tire and Loading Information Placard	289,290
Wheel Lock	15	Tire Identification Number (TIN)	288
Wheel, Tilt	101	Tire Markings	284
Storage	116,393	Tire Safety Information	284
Storage, Behind the Seat	117	Tires	293,431
Storage, Vehicle	245,393	Air Pressure	294
Storing Your Vehicle	393	Alignment and Balance	300
Sunrider	163	Chains	300
Supplemental Restraint System - Airbag	46	Changing	338
Sway Bar Disconnect, Electronic	271	General Information	293
Swing Gate, Rear	34		

High Speed	296	Towing	315,345
Inflation Pressures	294	Disabled Vehicle	345
Jacking	338,340	Guide	320
Load Capacity	289,290	Recreational	332
Pressure Monitor System (TPMS)	302	Weight	320
Pressure Warning Light	194	Trac-Lok Rear Axle	269
Quality Grading	431	Traction Control	106
Radial	297	Traction Control Light	196
Replacement	299	Trailer Towing	315
Rotation	301	Cooling System Tips	331
Safety	284	Hitches	306,319
Sizes	285	Minimum Requirements	325
Spare Tire	339	Trailer and Tongue Weight	324
Spinning	297	Wiring	329
Tread Wear Indicators	298	Trailer Towing Guide	320
To Open Hood	93	Trailer Weight	320
Tongue Weight/Trailer Weight	324	Transfer Case	377
Torque Converter Clutch	264	Four-Wheel-Drive Operation	265
Tow Hooks, Emergency	344	Maintenance	377

Transmission		Vacuum/Vapor Harnesses	371
Automatic	261	Vehicle Identification Number (VIN)	9
Maintenance	374,376	Vehicle Loading	290,313
Manual	255	Vehicle Modifications/Alterations	9
Range Indicator	194	Vehicle Storage	245,393
Shifting	258	Viscosity, Engine Oil	357
Transmitter Battery Service		Warning Flasher, Hazard	336
(Remote Keyless Entry)	25	Warning Lights	
Transmitter Programming		(Instrument Cluster Description)	190
(Remote Keyless Entry)	23	Warnings and Cautions	9
Transporting Pets	75	Warranty Information	429
Tread Wear Indicators	298	Washer, Adding Fluid	183
Trip Computer	198	Washers, Windshield	365
Trip Odometer	195	Waxing and Polishing	380
Trip Odometer Reset Button	193	Wheel Alignment and Balance	300
Turn Signals	98,191,395,396	Wheel and Wheel Trim	381
Uniform Tire Quality Grades	431	Wheel and Wheel Trim Care	381
Upholstery Care	382	Wheel Mounting	341

450 INDEX

Wind Buffeting	34	Fluid	365
Window Fogging	244	Windshield Wiper Blades	365
Windows	32	Windshield Wipers	99
Power	32	Wiper, Rear	182
Windshield, Folding	176	YES Essentials® Fabric Cleaning Procedure	381
Windshield Washers	99,365		

