

DISC MOWER BLADES

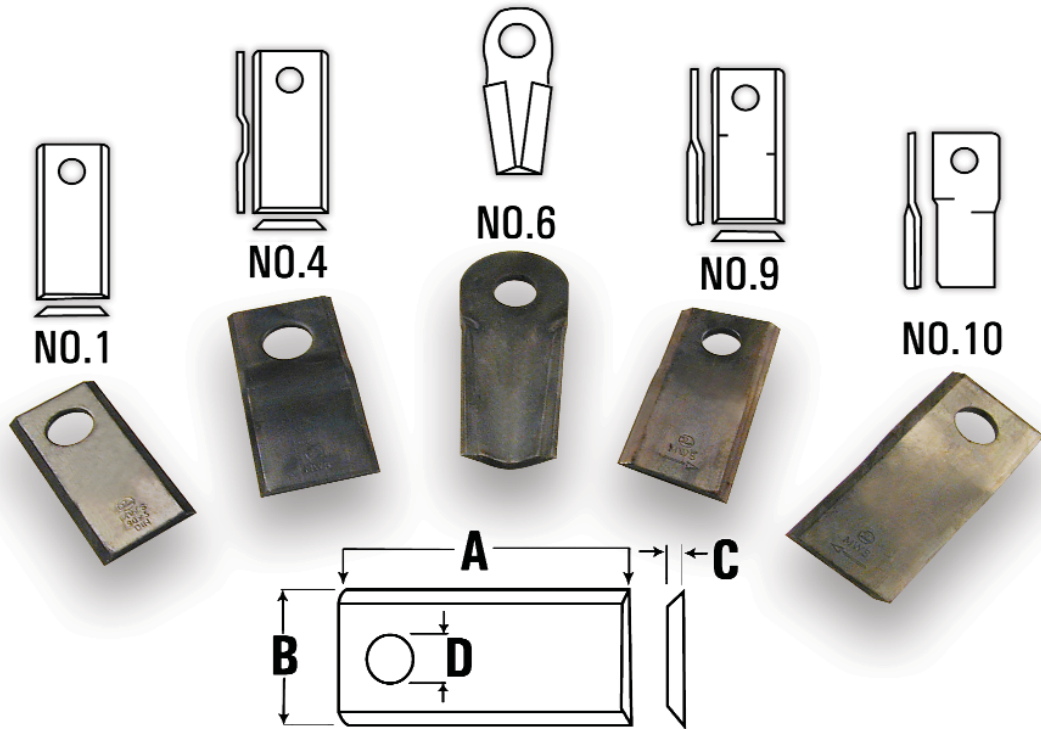

Agriquip

PART	TYPE	LENGTH	WIDTH	THICKNESS	HOLE DIA.
A-05889921	10 LH	3.937" / 100mm	1.85" / 47mm	.157" / 4mm	.826" / 21mm
For Models: ALL CM SERIES					
A-05870021	10 RH	3.937" / 100mm	1.85" / 47mm	.157" / 4mm	.826" / 21mm
For Models: ALL CM SERIES					

BUSH HOG

PART	TYPE	LENGTH	WIDTH	THICKNESS	HOLE DIA.
A-526215BH	10 RH	4.724" / 120mm	1.890" / 48mm	.157" / 4mm	.728" / 18.5mm
For Models: DM18, DM19, DM7, DM8, DM9, HM5, HM7, HM8					
A-526216BH	10 LH	4.724" / 120mm	1.890" / 48mm	.157" / 4mm	.728" / 18.5mm
For Models: DM18, DM19, DM7, DM8, DM9, HM5, HM7, HM8					
A-527748BH	9 RH	4.750" / 121mm	2.000" / 50.8mm	.157" / 4mm	.889" / 22.6mm
For Models: DM180, DM190, DM70, DM80, DM90					
A-527749BH	9 LH	4.750" / 121mm	2.000" / 50.8mm	.157" / 4mm	.889" / 22.6mm
For Models: DM180, DM190, DM70, DM80, DM90					
A-527747BH	10 RH	4.750" / 121mm	2.000" / 50.8mm	.157" / 4mm	.889" / 22.6mm
For Models: DM5406, DM5407, DM5408, DM5409					
A-527746BH	10 LH	4.750" / 121mm	2.000" / 50.8mm	.157" / 4mm	.889" / 22.6mm
For Models: DM5406, DM5407, DM5408, DM5409					

CASE-IH

PART	TYPE	LENGTH	WIDTH	THICKNESS	HOLE DIA.
A-700712888	9 RH	4.213" / 107mm	1.772" / 45mm	.157" / 4mm	.716" / 18.2mm
For Models: 8309, 8312, 8315, 8850					
A-700712889	9 LH	4.213" / 107mm	1.772" / 45mm	.157" / 4mm	.716" / 18.2mm
For Models: 8309, 8312, 8315, 8350					
A-700711857	10 RH	4.213" / 107 MM	1.890" / 48 MM	.157" / 4 MM	.728" / 18.5 MM
For Models: 8309, 8312, 8315, 8850					
A-700711858	10 LH	4.213" / 107 MM	1.890" / 48 MM	.157" / 4 MM	.728" / 18.5 MM
For Models: 8309, 8312, 8315, 8850					
A-3164894R3		3.78" / 96mm	1.57" / 40mm	.14" / 3.5mm	.75" / 19mm
For Models: 3104, 3106					
A-ZA113384A1	9 RH	4.750" / 121MM	2.000" / 50.8 MM	.157" / 4 MM	.889" / 22.6 MM
For Models: (3204, 3205, 3206, 3309 ALL W/ Heavy Duty Disc)					

DISC MOWER BLADES

A-ZA113385A1	9 LH	4.750" / 121 MM	2.000" / 50.8 MM	.157" / 4 MM	.889" / 22.6 MM
For Models: (3204, 3205, 3206, 3309 ALL W/ Heavy Duty Disc)					
A-ZA526215	10 RH	4.725" / 120 MM	1.890" / 48 MM	.157" / 4 MM	.728" / 18.5 MM
For Models: (3204, 3205, 3206, 3209 ALL W/ Standard Disc)					
A-ZA526216	10 LH	4.724" / 120 MM	1.890" / 48 MM	.157" / 4 MM	.728" / 18.5 MM
For Models: (3204, 3205, 3206, 3209 ALL W/ Standard Disc)					

CLAAS

PART	TYPE	LENGTH	WIDTH	THICKNESS	HOLE DIA.
A-9775160	1	3.543" / 90mm	1.575" / 40mm	.118" / 3mm	.748" / 19mm
For Models: DISC MOWER - CHECK DIM.					
A-9781860	1	3.779" / 96mm	1.575" / 40mm	.118" / 3mm	.748" / 19mm
For Models: DISC MOWER - CHECK DIM.					
A-9041777	10 LH	3.7" / 94mm	1.57" / 40mm	.12" / 3mm	.75" / 19mm
For Models: CORTO 290F, WM165, WM185, WM210, WM31F					
A-9041787	10 RH	3.7" / 94mm	1.57" / 40mm	.12" / 3mm	.75" / 19mm
For Models: CORTO 290F, WM165, WM185, WM210, WM31F					
A-9782414	9	3.78" / 96mm	1.57" / 40mm	.12" / 3mm	.75" / 19mm
For Models: SEVERAL					

FELLA

PART	TYPE	LENGTH	WIDTH	THICKNESS	HOLE DIA.
A-116948	1	3.35" / 85mm	1.61" / 41mm	.17" / 4.3mm	.77" / 19.5mm
For Models: FKM2, FKM2H, FKM80					
A-116954	1	3.779" / 96mm	1.575" / 40mm	.118" / 3mm	.748" / 19mm
For Models: KM20, KM22					
A-121713	10 RH	3.858" / 98mm	1.890" / 48mm	.157" / 4mm	.748" / 19mm
For Models: (SM165, SM240 ALL <1989)					
A-121712	10 LH	3.858" / 98mm	1.890" / 48mm	.157" / 4mm	.748" / 19mm
For Models: (SM165, SM240 ALL <1989), SM215 <7/1990					
A-122330	10 RH	4.173" / 106mm	1.890" / 48mm	.157" / 4mm	.748" / 19mm
For Models: (SM165, SM206, SM215, SM216, SM240 ALL 1990>)					
A-122329	10 LH	4.173" / 106mm	1.890" / 48mm	.157" / 4mm	.748" / 19mm
For Models: (SM165, SM206, SM215, SM216, SM240 ALL 1990>)					
A-111725	10 RH	4.274" / 120mm	1.890" / 48mm	.157" / 4mm	.728" / 18.5mm
For Models: SM240					
A-111724	10 LH	4.724" / 120mm	1.890" / 48mm	.157" / 4mm	.728" / 18.5mm
For Models: SM240					
A-477741	1	3.543" / 90mm	1.575" / 40mm	.118" / 3mm	.748" / 19mm
For Models: DISC MOWER - CHECK DIM.					

FAHR

PART	TYPE	LENGTH	WIDTH	THICKNESS	HOLE DIA.
A-110190102820	1	3.267" / 83mm	1.575" / 40mm	.118" / 3mm	.748" / 19mm
For Models: SEVERAL					
A-1101203011500	1	3.779" / 96mm	1.575" / 40mm	.118" / 3mm	.748" / 19mm
For Models: KM2.17, KM2.19, KM2.33, KM20, KM22, KM24, KM25					
A-06561542	9	3.78" / 96mm	1.57" / 40mm	.12" / 3mm	.75" / 19mm
For Models: KM2.17, KM2.19, KM2.33, KM20, KM22, KM24, KM25					
A-1101701015300	1	3.779" / 96mm	1.575" / 40mm	.118" / 3mm	.748" / 19mm
For Models: KM20, KM22, KM24, KM25					
A-1101901027120	1	3.543" / 90mm	1.575" / 40mm	.118" / 3mm	.748" / 149mm
For Models: KM20, KM22					
A-06561547	9 LH	3.78" / 96mm	1.61" / 41mm	.12" / 3mm	.75" / 19mm
For Models: KM2.27					
A-06561546	9 RH	3.78" / 96mm	1.61" / 41mm	.12" / 3mm	.75" / 19mm
For Models: KM2.27					
A-1101901028200	1	3.267" / 83mm	1.575" / 40mm	.118" / 3mm	.748" / 19mm
For Models: DISC MOWER - CHECK DIM.					

FARENDLOSE

PART	TYPE	LENGTH	WIDTH	THICKNESS	HOLE DIA.
A-011069	1	3.897" / 99mm	1.575" / 40mm	.118" / 3mm	.748" / 19mm
For Models: DISC MOWER - CHECK DIM.					

DISC MOWER BLADES

Fort

PART	TYPE	LENGTH	WIDTH	THICKNESS	HOLE DIA.
A-40490006	9 LH	3.86" / 98mm	1.77" / 45mm	.14" / 3.5mm	.65" / 16.5mm
For Models: (DISC MOWER: SEVERAL)					
A-40490005	9 RH	3.86" / 98mm	1.77" / 45mm	.14" / 3.5mm	.65" / 16.5mm
For Models: (DISC MOWER: SEVERAL)					

Freundahl (JF)

PART	TYPE	LENGTH	WIDTH	THICKNESS	HOLE DIA.
A-13800001	9	3.7" / 94mm	1.97" / 50mm	.16" / 4mm	.79"x.94" / 20x24mm
For Models: JF-245					
A-13800005	1	3.7" / 94mm	1.57" / 40mm	.16" / 4mm	.75" / 19mm
For Models: JF-1900					
A-13800002	9	3.7" / 94mm	1.97" / 50mm	.16" / 4mm	.79"x.94" / 20x24mm
For Models: SEVERAL					
A-13800003	9	3.7" / 94mm	1.97" / 50mm	.16" / 4mm	.79"x.94" / 20x24mm
For Models: SEVERAL					
A-13800004		4.33" / 110mm	1.97" / 50mm	.16" / 4mm	.81" / 20.5mm
For Models: SEVERAL					
A-13800006	9 LH	3.7" / 94mm	1.65" / 42mm	.16" / 4mm	.75" / 19mm
For Models: SEVERAL					
A-13800007	9 RH	3.7" / 94mm	1.65" / 42mm	.16" / 4mm	.75" / 19mm
For Models: SEVERAL					
A-13800013	1 HVDTY	3.543" / 90mm	1.772" / 45mm	.157" / 4mm	.807"x.946" / 20.54x24.3mm
For Models: SEVERAL					

GEHL

PART	TYPE	LENGTH	WIDTH	THICKNESS	HOLE DIA.
A-125446	9 RH	4.843" / 123 MM	1.772" / 45 MM	.160" / 4 MM	.716" / 18.2 MM
For Models: 162 W/ HD Disc, 165, 2340, 2360					
A-125447	9 LH	4.843" / 123 MM	1.772" / 45 MM	.157" / 4 MM	.716" / 18.2 MM
For Models: 162 W/ HD Disc, 165, 2340, 2360					
A-613727	9 RH	3.740" / 95 MM	1.772" / 45 MM	.139" / 3.5 MM	.640" / 16.25 MM
For Models: 162 W/ Standard Disc					
A-613728	9 LH	3.740" / 95 MM	1.772" / 45 MM	.139" / 3.5 MM	.640" / 16.25 MM
For Models: 162 W/ Standard Disc					
A-113269	9 RH	4.213" / 107 MM	1.772" / 45 MM	.157" / 4 MM	.716" / 18.2 MM
For Models: 1162, 1165, 2345, 2365					
A-113268	9 LH	4.213" / 107 Mm	1.772" / 45 MM	.157" / 4 MM	.728" / 18.5 MM
For Models: 1162, 1165, 2345, 2365					
A-604659	10 RH	4.724" / 120mm	1.890" / 48mm	.157" / 4mm	.728" / 18.5mm
For Models: 2310, 2330 SN <2226, DC1080, DC2350, DM140, DM160					
A-604658	10 LH	4.724" / 120mm	1.890" / 48mm	.157" / 4mm	.728" / 18.5mm
For Models: 2310, 2330 SN <2226, DC1080, DC2350, DM140, DM160					
A-612635	10 RH	4.213" / 107 MM	1.890" / 48 MM	.157" / 4 MM	.728" / 18.5 MM
For Models: 2330 SN 2226>					
A-612634	10 LH	4.213" / 107 MM	1.890" / 48 MM	.157" / 4 MM	.728" / 18.5 MM
For Models: 2330 SN 2226>					
A-126744	N/A	5.197" / 132mm	1.968" / 50mm	.157" / 4mm	.718" / 18.25mm
For Models: 2340, 2360					

HESSTON

PART	TYPE	LENGTH	WIDTH	THICKNESS	HOLE DIA.
A-DM304	9 RH	3.858" / 98mm	1.575" / 40mm	.157" / 4mm	.640" / 16.25mm
For Models: 1030, 1040, 1050, 1060					
A-DM303	9 LH	3.858" / 98mm	1.575" / 40mm	.157" / 4mm	.640" / 16.25mm
For Models: 1030, 1040, 1050, 1060					
A-6616924	1 RH	4.134" / 105mm	1.850" / 47mm	.118" / 3mm	.827" / 21mm
For Models: 1180					
A-748095	4 LH	4.134" / 105mm	1.850" / 47mm	.118" / 3mm	.827" / 21mm
For Models: 1180					
A-700712888	9 RH	4.213" / 107mm	1.772" / 45mm	.157" / 4mm	.716" / 18.2mm
For Models: 1320, 1340					

DISC MOWER BLADES

A-700711857	10 RH	4.213" / 107 MM	1.890" / 48 MM	.157" / 4 MM	.728" / 18.5 MM
For Models: 1320, 1340					
A-700711858	10 LH	4.213" / 107 MM	1.890" / 48 MM	.157" / 4 MM	.728" / 18.5 MM
For Models: 1320, 1340					
A-700712889	9 LH	4.213" / 107mm	1.772" / 45mm	.157" / 4mm	.716" / 18.2mm
For Models: 1320, 1340, 1360, 1365, 8500					
A-784095	4	4.134" / 105mm	1.850" / 47mm	.118" / 3mm	.827" / 21mm
For Models: (DISC MOWERS: SEVERAL)					

JOHN DEERE

PART	TYPE	LENGTH	WIDTH	THICKNESS	HOLE DIA.
A-CC19333	9 RH	3.600"	1.575"	.118"	.639"
For Models: 1314, 1315					
A-CC19336	9 LH	3.600"	1.575"	.118"	.639"
For Models: 1314, 1315					
A-CC20501	9 RH	3.740" / 95mm	1.772" / 45mm	.139" / 3.5mm	.640" / 16.25mm
For Models: 1314, 1315, 1320, 1326, 1327, 240, 260					
A-CC20500	9 LH	3.740" / 95mm	1.772" / 45mm	.139" / 3.5mm	.640" / 16.25mm
For Models: 1314, 1315, 1320, 1326, 1327, 240, 260					
A-CC21781	9 RH	4.843" / 123mm	1.772" / 45mm	.157" / 4mm	.716" / 18.2mm
For Models: 1326, 1327, 265 S/N 150001->, 270, 275 S/N 152001->					
A-CC21780	9 LH	4.843" / 123mm	1.772" / 45mm	.157" / 4mm	.716" / 18.2mm
For Models: 1326, 1327, 265 S/N 150001->, 270, 275 S/N 152001->					
A-CC26780	9 LH	4.213" / 107mm	1.772" / 45mm	.157" / 4mm	.716" / 18.2mm
For Models: 1350, 1360, 1460, 1470, 910, 920, 930					
A-CC26781	9 RH	4.213" / 107mm	1.772" / 45mm	.157" / 4mm	.716" / 18.2mm
For Models: 1350, 1360, 1460, 1470, 910, 920, 930					

JF

PART	TYPE	LENGTH	WIDTH	THICKNESS	HOLE DIA.
A-2220101B	1	3.543" / 90mm	1.772" / 45mm	.157" / 4mm	.807" - .946" / 20.5mm - 24.3mm
For Models: SEVERAL					

KRONE

PART	TYPE	LENGTH	WIDTH	THICKNESS	HOLE DIA.
A-1466900	10	3.779" / 96mm	1.890" / 48mm	.157" / 4mm	.748" / 19mm
For Models: 202, 242, 282, AM167					
A-1466910	10	3.779" / 96mm	1.890" / 48mm	.157" / 4mm	.748" / 19mm
For Models: 202, 242, 282, AM167					
A-41474191	10 LH	3.701" / 94mm	1.575" / 40mm	.118" / 3mm	.748" / 19mm
For Models: 240, 241, 281					
A-1473025	10	3.701" / 94mm	1.575" / 40mm	.118" / 3mm	.748" / 19mm
For Models: 240, 241, 281 S/N <-5549					
A-1474195	10	3.701" / 94mm	1.575" / 40mm	.118" / 3mm	.748" / 19mm
For Models: 240, 241, 281 S/N <-5549					
A-13712427	1	3.779" / 96mm	1.575" / 40mm	.118" / 3mm	.748" / 19mm
For Models: DISC MOWER - CHECK DIM.					
A-13722427	1	3.267" / 83mm	1.575" / 40mm	.118" / 3mm	.748" / 19mm
For Models: DISC MOWER - CHECK DIM.					
A-41410710	1	3.543" / 90mm	1.575" / 40mm	.118" / 3mm	.748" / 19mm
For Models: DISC MOWER - CHECK DIM.					
A-1466911	10 RH	3.779" / 96mm	1.890" / 50.4mm	.157" / 4mm	.748" / 19mm
For Models: AM167, AM202, AM242, AM282					
A-1466901	10 LH	3.779" / 96mm	1.890" / 50.4mm	.157" / 4mm	.748" / 19mm
For Models: AM167, AM202, AM242, AM282					
A-139889		4.409"	1.890"	.157"	.748"
For Models: 323 Shaft Drive					
A-139888		4.409"	1.890"	.157"	.748"
For Models: 323 Shaft Drive					
A-1446901	10 LH	3.78" / 96mm	1.93" / 49mm	.16" / 4mm	.75" / 19mm
For Models: (DISC MOWER: SEVERAL)					
A-1446911	10 RH	3.78" / 96mm	1.93" / 49mm	.16" / 4mm	.75" / 19mm
For Models: (DISC MOWER: SEVERAL)					

DISC MOWER BLADES

A-1458691	10 LH	3.66" / 93mm	1.85" / 47mm	.12" / 3mm	.75" / 19mm
For Models: (DISC MOWER: SEVERAL)					
A-1458681	10 RH	3.66" / 93mm	1.85" / 47mm	.12" / 3mm	.75" / 19mm
For Models: (DISC MOWER: SEVERAL)					

KUHN

PART	TYPE	LENGTH	WIDTH	THICKNESS	HOLE DIA.
A-55903310	9 RH	4.213" / 107mm	1.772" / 45mm	.157" / 4mm	.716" / 18.2mm
For Models: FC250, FC300, FC350, GMD400, GMD500, GMD600, GMD700, FC200 <1988, FC240, FC280					
A-55903210	9 LH	4.213" / 107mm	1.772" / 45mm	.157" / 4mm	.716" / 18.2mm
For Models: FC250, FC300, FC350, GMD400, GMD500, GMD600, GMD700					
A-56150000	1	3.779" / 96mm	1.575" / 40mm	.118" / 3mm	.640" / 16.25mm
For Models: GMD44, GMD55, GMD66					
A-56151310	9 RH	3.740" / 95mm	1.772" / 45mm	.139" / 3.5mm	.640" / 16.25mm
For Models: (GMD44, GMD55, GMD66, GMD77 ALL W/ Standard Disc)					
A-56151210	9 LH	3.740" / 95mm	1.772" / 45mm	.139" / 3.5mm	.640" / 16.25mm
For Models: (GMD44, GMD55, GMD66, GMD77 ALL W/ Standard Disc)					
A-56151100	9	3.425" / 87mm	1.575" / 40mm	.118" / 3mm	.640" / 16.25mm
For Models: (GMD44HD, GMD55HD, GMD77HD ALL W/ Heavy Duty Disc)					
A-56151200	9 LH	3.661" / 93mm	1.575" / 40mm	.118" / 3mm	.640" / 16.25mm
For Models: (GMD44HD, GMD55HD, GMD77HD, GMD66HD ALL W/ Heavy Duty Disc)					
A-56151300	9 RH	3.661" / 93mm	1.575" / 40mm	.118" / 3mm	.640" / 16.25mm
For Models: (GMD44HD, GMD55HD, GMD66HD, GMD77HD ALL W/ Heavy Duty Disc)					
A-56451200	9 RH	4.843" / 123mm	1.772" / 45mm	.157" / 4mm	.716" / 18.2mm
For Models: (GMD44HD, GMD55HD, GMD66HD, GMD77HD ALL W/ HD Disc)					
A-56451300	9 RH	4.843" / 123mm	1.772" / 45mm	.157" / 4mm	.716" / 18.2mm
For Models: (GMD44HD, GMD55HD, GMD66HD, GMD77HD ALL W/ HD Disc)					
A-56451210	9	4.843" / 123mm	1.772" / 45mm	.160" / 4mm	.716" / 18.2mm
For Models: (GMD44HD, GMD55HD, GMD66HD, GMD77HD ALL W/ HD Disc)					
A-56450000	6	5.039" / 128mm	1.968" / 50mm	.728" - .807" / 18.5mm - 20.5mm.728" - .807" / 18.5mm - 20.5mm	
For Models: DISC MOWER - CHECK DIM.					
A-56110300	6	5.039" / 128mm	1.968" / 50mm	.807" - .905" / 20.5mm - 23mm.807" - .905" / 20.5mm - 23mm	
For Models: DISC MOWER - CHECK DIM.					
A-55906000	9 LH	4.566" / 116mm	1.772" / 45mm	.716" / 18.2mm	.716" / 18.2mm
For Models: DISC MOWER - CHECK DIM.					
A-56450002	6	5.12" / 130mm	1.97" / 50mm	.16" / 4mm	.73x.81" / 18.5x20.5mm
For Models: (DISC MOWER: SEVERAL)					
A-55906100	9 RH	4.566" / 116mm	1.772" / 45mm	.716" / 18.2mm	.716" / 18.2mm
For Models: DISC MOWER - CHECK DIM.					

LONG

PART	TYPE	LENGTH	WIDTH	THICKNESS	HOLE DIA.
A-AMI11103	9 LH	3.78" / 96mm	1.61" / 41mm	.12" / 3mm	.75" / 19mm
For Models: 2007, 2008, 2009					
A-AMI11104	9 RH	3.78" / 96mm	1.61" / 41mm	.12" / 3mm	.75" / 19mm
For Models: 2007, 2008, 2009					
A-BCS31192R	10 RH	3.71" / 94mm	1.89" / 48mm	.16" / 4mm	.75" / 19mm
For Models: 2084, 2096					
A-BCS31193L	10 LH	3.71" / 94mm	1.89" / 48mm	.16" / 4mm	.75" / 19mm
For Models: 2084, 2096					

LELY

PART	TYPE	LENGTH	WIDTH	THICKNESS	HOLE DIA.
A-4120114730	10 LH	4.724" / 120mm	1.890" / 48mm	.157" / 4mm	.728" / 18.5mm
For Models: 165, 205, 240, 280, 320					
A-4120114740	10 RH	4.724" / 120mm	1.890" / 48mm	.157" / 4mm	.728" / 18.5mm
For Models: 165, 205, 240, 280, 320					

M & W

PART	TYPE	LENGTH	WIDTH	THICKNESS	HOLE DIA.
A-3238725	10 RH	3.94" / 100mm	1.77" / 45mm	.16" / 4mm	.79" / 20mm
For Models: HC5, HC6, HC7					
A-3238726	10 LH	3.94" / 100mm	1.77" / 45mm	.16" / 4mm	.79" / 20mm
For Models: HC5, HC6, HC7					

DISC MOWER BLADES

Marangon

PART	TYPE	LENGTH	WIDTH	THICKNESS	HOLE DIA.
A-05869921	10	3.937" / 100mm	1.85" / 47mm	.157" / 4mm	.826" / 21mm
For Models: (DISC MOWER: SEVERAL)					
A-05870021	10 RH	3.937" / 100mm	1.85" / 47mm	.157" / 4mm	.826" / 21mm
For Models: SEVERAL					

MASSEY FERGUSON

PART	TYPE	LENGTH	WIDTH	THICKNESS	HOLE DIA.
A-3730224M1	10 RH	4.724" / 120 MM	1.890" / 48 MM	.157" / 4 MM	.728" / 18.5 MM
For Models: 125					
A-3730223M1	10 LH	4.213" / 107 MM	1.890" / 48 MM	.157" / 4 MM	.728" / 18.5 MM
For Models: 125					
A-3730225M1	10 LH	4.724" / 120 MM	1.890" / 48 MM	.157" / 4 MM	.728" / 18.5 MM
For Models: 127					
A-3730226M1	10 RH	4.725" / 120 MM	1.890" / 48 MM	.157" / 4 MM	.728" / 18.5 MM
For Models: 127					

Mortl

PART	TYPE	LENGTH	WIDTH	THICKNESS	HOLE DIA.
A-6553L1	9 LH	3.86" / 98mm	1.85" / 47mm	.12" / 3mm	.91" / 23mm
For Models: SEVERAL					
A-6553R1	9 RH	3.86" / 98mm	1.85" / 47mm	.12" / 3mm	.91" / 23mm
For Models: SEVERAL					
A-T673L	10 LH	3.86" / 98mm	1.85" / 47mm	.12" / 3mm	.91" / 23mm
For Models: SEVERAL					
A-T673R	10 RH	3.86" / 98mm	1.85" / 47mm	.12" / 3mm	.91" / 23mm
For Models: SEVERAL					

NEW HOLLAND

PART	TYPE	LENGTH	WIDTH	THICKNESS	HOLE DIA.
A-853819	9 RH	4.213" / 107mm	1.772" / 45mm	.157" / 4mm	.728" / 18.5mm
For Models: 408, 411 SN 711816>, 412, 415					
A-853820	9 LH	4.213" / 107mm	1.772" / 45mm	.157" / 4mm	.728" / 18.5mm
For Models: 408, 411, 412, 415					
A-785609	9 RH	4.566" / 116mm	1.772" / 45mm	.716" / 18.2mm	.716" / 18.2mm
For Models: 411 S/N <-711815					
A-785608	9 LH	4.566" / 116mm	1.772" / 45mm	.716" / 18.2mm	.716" / 18.2mm
For Models: 411 S/N <-711815					
A-274097	9 RH	3.661" / 93mm	1.575" / 40mm	.120" / 3mm	.640" / 16.25mm
For Models: 442 SN < Z4750, 452, 462 SN < Z1643					
A-274096	9 LH	3.661" / 93mm	1.575" / 40mm	.120" / 3mm	.640" / 16.25mm
For Models: 442 SN < Z4750, 452, 462 SN < Z1643					
A-274230	1	3.779" / 96mm	1.575" / 40mm	.120" / 3mm	.640" / 16.25mm
For Models: 442, 462					
A-697551	6	5.039" / 128mm	1.968" / 50mm	.160" / 4mm	.807" - .905" / 20.5mm - 23mm
For Models: 442, 462					
A-766727	9 RH	3.740" / 95mm	1.772" / 45mm	.140" / 3.6mm	.640" / 16.25mm
For Models: (442, 452, 462 ALL W/ Standard Disc)					
A-766726	9 LH	3.740" / 95mm	1.772" / 45mm	.140" / 3.6mm	.640" / 16.25mm
For Models: (442, 452, 462 ALL W/ Standard Disc)					
A-784221	9 RH	4.843" / 123mm	1.772" / 45mm	.160" / 4mm	.716" / 18.2mm
For Models: (442, 452, 462, 463, 465 ALL W/ Heavy Duty Disc)					
A-784220	9 LH	4.843" / 123mm	1.772" / 45mm	.160" / 4mm	.716" / 18.2mm
For Models: (442, 452, 462, 463, 465 ALL W/ Heavy Duty Disc)					

NEW IDEA

PART	TYPE	LENGTH	WIDTH	THICKNESS	HOLE DIA.
A-526216NI	10 LH	4.724" / 120 MM	1.890" / 48 MM	.157" / 4 MM	.728" / 18.5 MM
For Models: 526, 527, 528, (5209, 5212 ALL SN 9756-16012), (5406, 5407, 5408, 5409 ALL SN 1001159-1007480)					
A-527746NI	10 RH	4.750" / 121mm	2.000" / 50.8mm	.889" / 22.6mm	.889" / 22.6mm
For Models: (5209, 5212 ALL SN 16013>), 5312, (5406, 5407, 5408, 5410 ALL SN 1007482>)					
A-527747NI	10 LH	4.750" / 121mm	2.000" / 50.8mm	.889" / 22.6mm	.889" / 22.6mm
For Models: (5209, 5212 ALL SN 16013>), 5312, (5406, 5407, 5408, 5410 ALL SN 1007482>)					

DISC MOWER BLADES

A-527748NI	9 RH	4.750" / 121 MM	2.000" / 50.8 MM	.157" / 4 MM	.889" / 22.6 MM
For Models: (5209, 5212 ALL SN 16013>), 5406, 5407, 5410					
A-526215NI	10 RH	4.724" / 120 MM	1.890" / 48 MM	.157" / 4 MM	.728" / 18.5 MM
For Models: (5209, 5212 ALL SN 9756-16012), 526, 527, 528, (5406, 5407, 5408, 5409 ALL SN 1001159-1007480)					
A-527749NI	9 LH	4.750" / 121 MM	2.000" / 50.8 MM	.157" / 4 MM	.889" / 22.6 MM
For Models: 5406, 5407, 5410, (5209, 5212 ALL SN 16013>)					

NIEMEYER

PART	TYPE	LENGTH	WIDTH	THICKNESS	HOLE DIA.
A-1448261	10 RH	3.543" / 90mm	1.937" / 49mm	.157" / 4mm	.748" / 19mm
For Models: DISC MOWER - CHECK DIM.					
A-1448251	10 LH	3.543" / 90mm	1.937" / 49mm	.157" / 4mm	.748" / 19mm
For Models: DISC MOWER - CHECK DIM.					
A-41473021	10 RH	3.701" / 94mm	1.575" / 40mm	.118" / 3mm	.748" / 19mm
For Models: DISC MOWER - CHECK DIM.					

Reese

PART	TYPE	LENGTH	WIDTH	THICKNESS	HOLE DIA.
A-UFO141	9	4.02" / 102mm	1.77" / 45mm	.16" / 4mm	.68" / 17.25mm
For Models: (DISC MOWER: SEVERAL)					

RHINO

PART	TYPE	LENGTH	WIDTH	THICKNESS	HOLE DIA.
A-65948	9 LH	4.343" / 110mm	1.850" / 47mm	.118" / 3mm	.827" / 21mm
For Models: SEVERAL					
A-65947	9 RH	4.343" / 110mm	1.850" / 47mm	.118" / 3mm	.827" / 21mm
For Models: SEVERAL					

SITREX

PART	TYPE	LENGTH	WIDTH	THICKNESS	HOLE DIA.
A-21009431	9 RH	3.740" / 95 MM	1.772" / 45 MM	.139" / 3.5 MM	.640" / 16.25 MM
For Models: SEVERAL Check Dimensions					
A-21009432	9 LH	3.740"	1.772"	.139"	.640"
For Models: SEVERAL Check Dimensions					

SCHMITZ

PART	TYPE	LENGTH	WIDTH	THICKNESS	HOLE DIA.
A-1002268	1	3.779" / 96 MM	1.575" / 40 MM	.118" / 3 MM	.748" / 19 MM
For Models: SEVERAL Check Dimensions					

TAARUP

PART	TYPE	LENGTH	WIDTH	THICKNESS	HOLE DIA.
A-56110300	6	5.039" / 128mm	1.968" / 50mm	.807" - .905" / 20.5mm - 23mm.807" - .905" / 20.5mm - 23mm	
For Models: 204, 205, 206					
A-16530208	6	5.039" / 128mm	1.968" / 50mm	.157" / 4mm .728" - .807" / 18.5mm - 20.5mm	
For Models: 204, 205, 206					
A-58372000	1	4.291" / 107mm	1.575" / 40mm	.118" / 3mm	.807" / 20.5mm
For Models: DISC MOWER - CHECK DIM.					
A-90261560	10 RH	4.213" / 107mm	1.890" / 48mm	.157" / 4mm	.728" / 18.5mm
For Models: DISC MOWER - CHECK DIM.					
A-90261559	10 LH	4.213" / 107mm	1.890" / 48mm	.157" / 4mm	.728" / 18.5mm
For Models: SEVERAL Check Dimensions					
A-56110400	9 LH	4.96" / 126mm	1.89" / 48mm	.16" / 23mm	.81x.91" / 20.5x23mm
For Models: (DISC MOWER: SEVERAL)					
A-56110900	9 RH	4.96" / 126mm	1.89" / 48mm	.16" / 23mm	.81x.91" / 20.5x23mm
For Models: (DISC MOWER: SEVERAL)					

TAS

PART	TYPE	LENGTH	WIDTH	THICKNESS	HOLE DIA.
A-121712	10 LH	3.858" / 98mm	1.890" / 48mm	.157" / 4mm	.748" / 19mm
For Models: (DISC MOWERS: SEVERAL)					
A-121713	10 RH	3.858" / 98mm	1.890" / 48mm	.157" / 4mm	.748" / 19mm
For Models: (DISC MOWERS: SEVERAL)					

DISC MOWER BLADES

VICON

PART	TYPE	LENGTH	WIDTH	THICKNESS	HOLE DIA.
A-90261560	10 RH	4.213" / 107mm	1.890" / 48mm	.157" / 4mm	.728" / 18.5mm
For Models: AM2800, CM216, CM217, CM2200, DMP2800, KM281 Late Model W/ 3 Blades Per Disc, GMR2800, KM216, KM391CP, OM216, OM281					
A-90261559	10 LH	4.213" / 107mm	1.890" / 48mm	.157" / 4mm	.728" / 18.5mm
For Models: AM2800, CM216, CM217, CM2200, DMP2800, KM281 Late Model W/ 3 Blades Per Disc, GMR2800, KM391CP, OM216, OM281					
A-58699	10 LH TWST	4.724" / 120mm	1.890" / 48mm	.157" / 4mm	.728" / 18.5mm
For Models: AM3200, CM165, CM167, CM1700, CM240, CM2400, CM247, DMP2400, DMP3200, KM240, KM241, KM281 Early Model W/ 2 Blades Per Disc, KM321					
A-58700	10 RH TWST	4.724" / 120mm	1.890" / 48mm	.157" / 4mm	.728" / 18.5mm
For Models: AM3200, CM165, CM167, CM1700, CM240, CM2400, CM247, CMP3200, DMP2400, KM240, KM241, KM281 Early Models W/ 2 Blades Per Disc, KM321					
A-90258699	10 LH	4.724" / 120 MM	1.890" / 48 MM	.157" / 4 MM	.728" / 18.5 MM
For Models: CM165, CM167, CM240, CM247, GMR2400, GMR3200, KM165, KM240, KM241, KM321, OM165, OM241					
A-90258700	10 RH	4.724" / 120 MM	1.890" / 48 MM	.157" / 4 MM	.728" / 18.5 MM
For Models: CM165, CM167, CM240, CM247, GMR2400, GMR3200, KM165, KM240, KM241, KM321, OM165, OM241					

VERMEER

PART	TYPE	LENGTH	WIDTH	THICKNESS	HOLE DIA.
A-CM120	4	4.134" / 105mm	1.850" / 47mm	.118" / 3mm	.827" / 21mm
For Models: SEVERAL Check Dimensions					
A-MT452S	1	3.779" / 96 MM	1.575" / 40 MM	.118" / 3 MM	.748" / 19 MM
For Models: SEVERAL Check Dimensions					
A-MT52	1	3.543" / 90mm	1.575" / 40mm	.118" / 3mm	.748" / 19mm
For Models: SEVERAL					

WELGER

PART	TYPE	LENGTH	WIDTH	THICKNESS	HOLE DIA.
A-0982150100	1	3.543" / 90mm	1.575" / 40mm	N/A	.748" / 19mm
For Models: DISC MOWER - CHECK DIM.					

ZWEEGER

PART	TYPE	LENGTH	WIDTH	THICKNESS	HOLE DIA.
A-CM15	1	4.134" / 105mm	1.850" / 47mm	.118" / 3mm	.827" / 21mm
For Models: 135, 164, 166, 167, 168, 170, 184, 210, CM215					
A-CM120	4	4.134" / 105mm	1.850" / 47mm	.118" / 3mm	.827" / 21mm
For Models: 212, 220, 211, 264, CM135, CM166, CM167, CM168, CM170, CM210					
A-DM303	9 LH	3.858" / 98mm	1.575" / 40mm	.157" / 4mm	.640" / 16.25mm
For Models: 230, 265, 275, 320					
A-DM304	9 RH	3.858" / 98mm	1.575" / 40mm	.157" / 4mm	.640" / 16.25mm
For Models: 230, 265, 275, 320					
A-MT52S	1	3.543" / 90mm	1.575" / 40mm	.118" / 3mm	.748" / 19mm
For Models: 230, 265, 275, 320					
A-TF71	10 LH	3.7" / 94mm	1.89" / 48mm	.12" / 3mm	.75" / 19mm
For Models: CM184, CM185, CM186, CM187, CM189, CM190, CM230, CM265, CM270					
A-TF70	10 RH	3.7" / 94mm	1.89" / 48mm	.12" / 3mm	.75" / 19mm
For Models: CM184, CM185, CM186, CM187, CM189, CM190, CM230, CM265, CM270					
A-TT97	9	3.78" / 96mm	1.58" / 40mm	.12" / 19mm	.75" / 19mm
For Models: CM185H					
A-DM160	9 RH	3.661" / 93 MM	1.575" / 40 MM	.118" / 3 MM	.640" / 16.25 MM
For Models: SEVERAL Check Dimensions					
A-DM155	9 LH	3.661" / 93 MM	1.575" / 40 MM	.118" / 3 MM	.640" / 16.25 MM
For Models: SEVERAL Check Dimensions					
A-MT452S	1	3.779" / 96 MM	1.575" / 40 MM	.118" / 3 MM	.748" / 19 MM
For Models: SEVERAL Check Dimensions					
A-M452S	9	3.78" / 96mm	1.57" / 40mm	.12" / 3mm	.75" / 19mm
For Models: (DISC MOWER: SEVERAL)					

DISC MOWER PARTS

DISC MOWER BLADE BOLTS & NUTS



A-76N929 Blade Bolt & Nut

BUSH HOG SEVERAL

A-76N924 Blade Bolt & Nut

GEHL SEVERAL

A-76N927 Blade Bolt & Nut

NEW HOLLAND 442, 452, 462

A-76N927 Blade Bolt & Nut

JOHN DEERE CUTTER PARTS

A-76N928 Blade Bolt & Nut

JOHN DEERE CUTTER PARTS

A-76N927 Blade Bolt & Nut

KUHN SEVERAL

A-76N928 Blade Bolt & Nut

KUHN SEVERAL

A-76N929 Blade Bolt & Nut

NEW IDEA SEVERAL

A-56294000 Blade Bolt & Nut

TAARUP SEVERAL

A-76N924 Blade Bolt & Nut

VICON SEVERAL

A-475219 Blade Bolt & Nut

Used w/blade holder 121248

FELLA KM166A, KM191, KM192A

A-126287 Blade Bolt & Nut

Used w/blade holder 122181

FELLA SM215, SM216

A-477274 Blade Bolt & Nut

Used w/blade holder 477263

FELLA FKM180, FKM2, FKM2H

A-475219 Blade Bolt & Nut

Used w/blade holder 121248

FELLA KM166A, KM191, KM192A

A-124508 Bolt, Disc Mower

Used w/ 475219 nut, Fits 121248 Blade Holder

FELLA KM166A, KM191, KM192A

A-122181K Blade Bolt/Nut Kit

Consists of 122181 Bolt & 126287 Nut

FELLA SM215, SM216

A-90081160K Blade Bolt, Nut Kit

Consists of 90081160 Bolt & 30577100 Nut

FAHR SM2.17, SM2.21, SM2.24, SM3.24, SM3.28

A-06568555K Blade Bolt, Nut Kit

FAHR SEVERAL

A-478415K Blade Bolt, Nut Kit

Consists of Bolt & Nut

FELLA SEVERAL

A-01141150 Knife Bolt

FAHR SM45

A-06561225 Knife, Special Nut

Used w/ 01141150 Bolt

FAHR SM45

A-477263 Bolt, Disc Mower Blade

Uses 477274 Nut

FELLA FKM180, FKM2, FKM2H

A-477274 Nut, Blade Bolt

Used w/ 477263 Bolt

FELLA FKM180, FKM2, FKM2H

A-KBL760 Knifehead Bolts/Locknuts, 1-1/4" (25 pc./each)

1-1/4" Grade 8, Rib Neck Bolt,

Package of 25 pcs./Each of Bolts & Locknuts.

Misc. SEVERAL Knifeheads Requiring 1-1/4" Bolts

BLADE DISC



A-DC19535 Disc

JOHN DEERE 240, 260

A-56200700 Disc

KUHN GMD55, GMD66, GMD77, GMD44

A-56452100 Heavy Duty Disc

KUHN GMD55HD, GMD66HD, GMD77HD

A-56808200 Disc Mower Blade

KUHN GMD500, GMD600, GMD700

A-274117 Disc

NEW HOLLAND 442, 452, 462

A-1019894 Disc

VICON CM165 Series 14034 & 14037, CM240 Series 14039, CM247

BLADE HOLDERS



A-1101701055000 Blade Holder

DIXIE SEVERAL



A-9210651 Blade Holder

CLAAS WM20, WM24, WM26, WM31F



A-9474271 Blade Holder

CLAAS CORTO 290F, WM165, WM185

DISC MOWER PARTS



A-9484591 Blade Holder
CLAAS CORTO 165, CORTO 185, CORTO 210, CORTO 300, WM210



A-PZ0250 Blade Holder
ZWEEGER SEVERAL



A-121248 Blade Holder
FELLA KM166A, KM191, KM192A



A-06563514 Blade Holder
FAHR KM20, KM22, KM24, KM25

A-06580109 Blade Holder
FAHR KM20, KM22, KM24, KM25



A-EU056 Blade Holder
FAHR KM3.23S, KM3.23STC



A-PZ0243 Blade Holder
FAHR KM3.21FS, KM3.21S



A-PZ116 Blade Holder
ZWEEGER 185

SKID PLATE



A-ZA526875 Skid Plate
CASE-IH 3309

A-ZA526438 Skid Plate
CASE-IH 3204, 3205, 3206

A-56330200 Skid Plate Weld on Pad
KUHN GMD55, GMD55HD, GMD66, GMD66HD, GMD77, GMD77HD

GUARDS



A-56205800 Inner Shoe Guard
JOHN DEERE 240, 260

A-56205802 Inner Shoe Guard
KUHN (44, 55, 66 ALL w/o adjustable bolt)

A-56205800 Inner Shoe Guard
KUHN GMD44 SN 784792>, GMD55 SN 780101>, GMD66 SN 760501>, GMD66HD, GMD77HD

A-56990603 Stone Guard
KUHN GMD44, GMD55 SN 780101>, GMD55HD, GMD66, GMD66HD, GMD77, GMD77HD

A-56801420 Stone Guard
KUHN GMD500, (GMD600, GMD700 ALL SN 940001>)

A-781810 Inner Shoe Guard
NEW HOLLAND 442, 452, 462, 463, 465

A-781809 Stone Guard
NEW HOLLAND 442, 452, 462, 463, 465

A-781810NH Inner Shoe Guard
NEW HOLLAND 442, 462, 463

A-781809NH Stone Guard
NEW HOLLAND 442, 462, 463

DISC MOWER PARTS

STONE GUARDS



A-56190600 Stone Guard

JOHN DEERE (240, 260 ALL w/ adjustable bolt)

A-90015853 Center Stone Guard

VICON CM240 Series 14039 Except 1st & 2nd Outer Disc

A-90015923 End Stone Guard

VICON CM165 Series 14034 & 14037 On All Knife Discs, CM205 Series 14028 On All Knife Discs, CM240 Series 14039 On 1st & 2nd Outer Knife Disc

A-186-13456 Stone Gaurd

VICON (CM165, CM167, CM240, CM247 ALL new style)

A-186-13457 Stone Gaurd

VICON (CM216, CM217 ALL new style)

SKID PLATE



A-526875 Disc Mower Skid Plate

NEW IDEA 5406, 5407, 5408, 5409, 5209, 5212

A-526438 Disc Mower Skid Plate

NEW IDEA (526, 527, 528 ALL <-1989)

A-90062054 Skid Plate

VICON CM165 Series 14023, CM240 Series 14024

A-90066591 Skid Plate

VICON CM165 Series 14034 & 14037, CM205 Series 14028, CM240 Series 14039

LOCK NUT

A-99307816 Lock Nut

TAARUP ALL MODELS

DISC MOWER CURTAINS



BUSH HOG

PART	DESCRIPTION	LENGTH	WIDTH
A-84152	Disc Mower Curtain	93.120"	44.940"
<i>For Models: (DISC MOWER: DM7 7 Ft. Curtain)</i>			
A-84153	Disc Mower Curtain	105.210"	44.940"
<i>For Models: (DISC MOWER: DM8 8 Ft. Curtain)</i>			
A-84154	Disc Mower Curtain	123.120"	44.940"
<i>For Models: (DISC MOWER: DM9 9 Ft. Curtain)</i>			

KUHN

PART	DESCRIPTION	LENGTH	WIDTH
A-56165000	Disc Mower Curtain	56.500"	42.500"
<i>For Models: (DISC MOWER: GMD44)</i>			
A-56221000	Disc Mower Curtain	71.880"	42.500"
<i>For Models: (DISC MOWER: GMD55)</i>			
A-56206600	Disc Mower Curtain	86.810"	42.500"
<i>For Models: (DISC MOWER: GMD66)</i>			
A-56224300	Disc Mower Curtain	100.000"	42.500"
<i>For Models: (DISC MOWER: GMD77)</i>			

LELY

PART	DESCRIPTION	LENGTH	WIDTH
A-4120114990	Disc Mower Curtain	72.880"	44.500"
<i>For Models: (DISC MOWER: 165)</i>			
A-4120214970	Disc Mower Curtain	89.500"	44.500"
<i>For Models: (DISC MOWER: 205)</i>			
A-4120314960	Disc Mower Curtain	103.380"	44.500"
<i>For Models: (DISC MOWER: 240)</i>			
A-41201014990	Disc Mower Curtain	119.880"	44.500"
<i>For Models: (DISC MOWER: 280)</i>			
A-4121901950	Disc Mower Curtain	133.380"	44.500"
<i>For Models: (DISC MOWER: 320)</i>			

M & W

PART	DESCRIPTION	LENGTH	WIDTH
A-772637	Disc Mower Curtain	84.300"	36.610"
<i>For Models: (DISC MOWER: HC5)</i>			
A-772638	Disc Mower Curtain	97.240"	36.610"
<i>For Models: (DISC MOWER: HC6)</i>			
A-772639	Disc Mower Curtain	105.120"	36.610"
<i>For Models: (DISC MOWER: HC7)</i>			

NEW HOLLAND

PART	DESCRIPTION	LENGTH	WIDTH
A-86622313	Disc Mower Curtain	95.330"	51.630"
<i>For Models: (DISC MOWER: 615)</i>			
A-86622314	Disc Mower Curtain	109.500"	51.630"
<i>For Models: (DISC MOWER: 616)</i>			
A-86622315	Disc Mower Curtain	125.250"	51.630"
<i>For Models: (DISC MOWER: 617)</i>			

NEW IDEA

PART	DESCRIPTION	LENGTH	WIDTH
A-526791	Disc Mower Curtain	73.100"	43.300"
<i>For Models: (DISC MOWER: 5406)</i>			
A-526792	Disc Mower Curtain	88.810"	43.300"
<i>For Models: (DISC MOWER: 5407)</i>			
A-526793	Disc Mower Curtain	102.630"	43.300"
<i>For Models: (DISC MOWER: 5408)</i>			
A-526794	Disc Mower Curtain	119.000"	43.300"
<i>For Models: (DISC MOWER: 5409)</i>			

RHINO

PART	DESCRIPTION	LENGTH	WIDTH
A-772637	Disc Mower Curtain	84.300"	36.610"
<i>For Models: (DISC MOWER: DM82)</i>			
A-772638	Disc Mower Curtain	97.240"	36.610"
<i>For Models: (DISC MOWER: DM95)</i>			
A-772639	Disc Mower Curtain	105.120"	36.610"
<i>For Models: (DISC MOWER: DM112)</i>			

VICON

PART	DESCRIPTION	LENGTH	WIDTH
A-97884569	Disc Mower Curtain	69.500"	45.000"
<i>For Models: (DISC MOWER: CM165 Series 14013, 20, 23, 26, 34, 54, 26, 34 & 54)</i>			
A-97884570	Disc Mower Curtain	95.500"	44.500"
<i>For Models: (DISC MOWER: CM216 Series 14031, 14038, 14044, 14048 & 14055)</i>			
A-90083107	Disc Mower Curtain		
A-90081590	Disc Mower Curtain	101.000"	44.500"
<i>For Models: (DISC MOWER: CM240 Series 14027)</i>			
A-97884571	Disc Mower Curtain	106.000"	44.500"
<i>For Models: (DISC MOWER: CM240 Series 14035, 14039, 14052 & 14056)</i>			
A-B1310578	Disc Mower Curtain	60.380"	45.000"
<i>For Models: (DISC MOWER: CM144)</i>			
A-1108993	Disc Mower Curtain	74.750"	45.000"
<i>For Models: (DISC MOWER: CM166 Series 14030)</i>			

ROTARY CUTTER BLADES

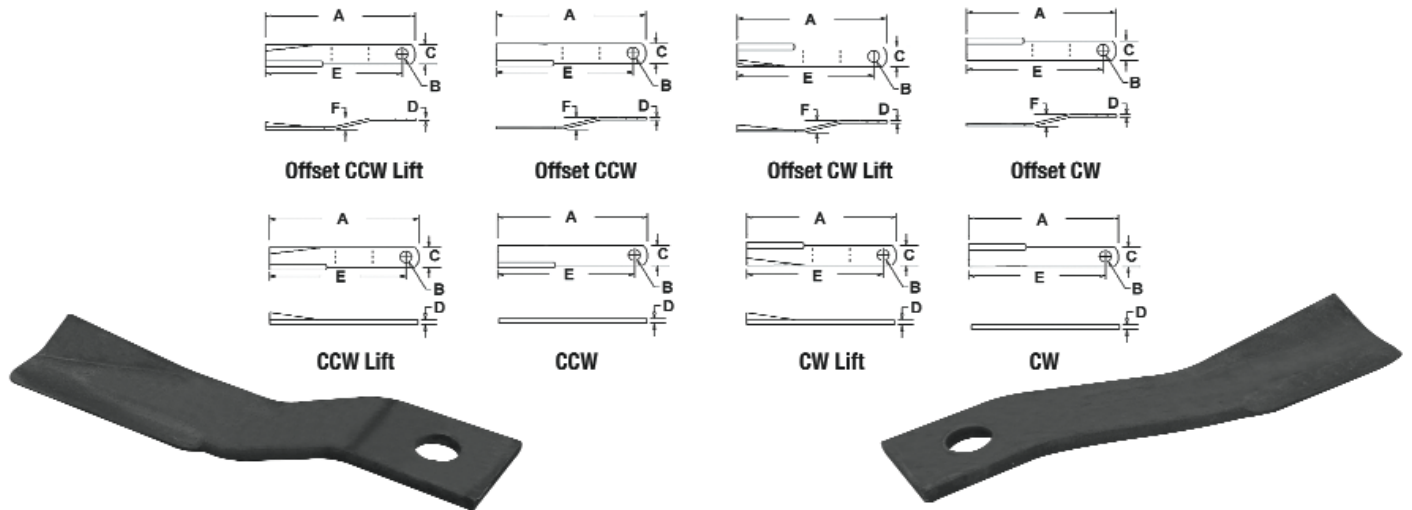

BUSH HOG

PART	DESCRIPTION	OVERALL LENGTH	HOLE DIAMETER	WIDTH	THICKNESS	CENTER HOLE/END	OFFSET HEIGHT
A-67743BH	CW lift	17.125"	1.500"	4.00"	.500"	14.625"	2.500"
For Models: (1268, 268 ALL 8 Ft. Mowers, LH)							
A-67744BH	CCW lift	17.125"	1.500"	4.00"	.500"	14.625"	2.500"
For Models: (1268, 268 ALL 8 Ft. Mowers, RH), SQ84 Squealer 7 Ft. Mower							
A-7828BH	CW lift	19.250"	1.500"	4.00"	.500"	16.750"	2.500"
For Models: 109, 109 OFFSET, 1109, 1109 OFFSET, 1166, 1209, 12512, 13108, 13108 OFFSET, 160, 1600, 166, 2512, 3108, 3108 OFFSET, 3209, 3209 OFFSET							
A-7829BH	CW lift	19.250"	1.500"	4.00"	.500"	16.750"	2.500"
For Models: 109, 1109, 1166, 1209, 12512, 13108, 160, 1600, 166, 2512, 3108, 3209							
A-8664BH	CCW lift	20.750"	1.500"	4.000"	.500"	18.250"	2.500"
For Models: 13368, 3214, 3368							
A-8665BH	CW lift	20.750"	1.500"	4.000"	.500"	18.250"	2.500"
For Models: 13368, 3214, 3368							
A-78494BH	CW lift	24.000"	1.500"	4.000"	.500"	21.500"	2.500"
For Models: 13126R, 13126S, 3126R, 3126S							
A-78495BH	CCW lift	24.000"	1.500"	4.000"	.500"	21.500"	2.500"
For Models: 13126R, 13126S, 3126R, 3126R Offset, 3126S, 3126S Offset							
A-90015BH	CCW lift	24.000"	1.500"	4.000"	.500"	21.500"	2.500"
For Models: 3126, 3210							
A-90014BH	CW lift	24.000"	1.500"	4.000"	.500"	21.500"	2.500"
For Models: 3126, 3210							
A-81395BH	CCW	24.625"	1.265"	3.000"	.375"	22.125"	2.375"
For Models: RAZORBACK RZ60							
A-262BH	CCW	24.750"	1.500"	3.500"	.500"	22.125"	2.000"
For Models: SEVERAL							
A-63968BH	CW/CCW	24.750"	1.500"	3.000"	.500"	22.250"	2.000"
For Models: SM160, SM60							
A-462BH	CCW	24.750"	1.500"	3.000"	.500"	22.250"	2.000"
For Models: 105, 12, 205, 255, 266, 305, 502, 600, RB60, SQ60, SQ600-3, SQ60-5							
A-11150BH	CW lift	24.750"	1.500"	4.000"	.500"	22.250"	2.500"
For Models: 1126, 1226, 126, (12610, 12615 ALL LH), 1315, 2315, 2415, 2510, (2610, 2615 ALL LH), 315, (3610, 3615 ALL LH)							
A-36ULBH	CCW	24.750"	1.500"	3.000"	.500"	22.250"	2.000"
For Models: 105, 12, 205, 255, 266, 305, 502, 6, 600, RB60							
A-36BH		24.750"	1.500"	3.000"	.500"	22.250"	2.000"
For Models: 105, 12, 205, 255, 266, 305, 502, 6, 600, RB60							
A-7555BH	CCW lift	24.750"	1.500"	4.000"	.500"	22.250"	2.500"
For Models: 105, 1126, 1126 OFFSET, 12, 1226, 126, 126 OFFSET, 12610 RH, 12615, 1310, 1315, 205, 206, 2315, 2415, 2510, 255, 2610 RH, 2615, 266, 275, 285, 305, 310, 315, 3610 RH, 3615, 502, 600, RB60, SQ60, SQ600-3, SQ60-5							
A-7278BH	CCW	27.750"	2.000"	5.000"	.625"	25.250"	2.625"
For Models: (1406, 406 ALL Extra Heavy Duty Blade)							
A-304BH	CCW	27.750"	1.500"	3.000"	.500"	25.250"	2.000"
For Models: 1206, 206, 306, SQ72-4							
A-463BH	CCW lift	27.750"	1.500"	3.500"	.500"	25.250"	2.000"
For Models: 1206, 1256, 206, 256, 306, SQ720, SQ720-3, SQ72-4							

ROTARY CUTTER BLADES

A-7556BH	CCW lift	27.750"	1.500"	4.000"	.500"	25.250"	2.500"
For Models: 1206, 1256, (12610, 12615, 1310, 1315 ALL Center), 206, (2315, 2415 ALL Center), 256, (2610, 2615 ALL Center), 276, 286, 306, (310, 315, 3610, 3615 ALL Center), SQ720, SQ720-3, SQ72-4							
A-7557BH	CCW lift	30.750"	1.500"	4.000"	.500"	28.250"	2.500"
For Models: 1207, 1220 Center & RH, 1257, 1287, 1307, 207, 220 Center & RH, 257, 2620 Center & RH, 277, 287, 307, SQ7, SQ840							
A-67327BH	CCW	30.750"	1.500"	3.000"	.500"	28.250"	2.500"
For Models: SQ72, SQ72-2, SQ72-3							
A-464BH	CCW	30.750"	1.500"	3.500"	.500"	28.250"	2.000"
For Models: 1207, 1257, 1307, 207, 257, 307							

FORD

PART	DESCRIPTION	OVERALL LENGTH	HOLE DIAMETER	WIDTH	THICKNESS	CENTER HOLE/END	OFFSET HEIGHT
A-220633	CCW	22.000"	1.500"	3.000"	.375"	20.500"	2.000"
For Models: 22-100, 22-111, 22-112, 22-113, 22-117, 22-118, 22-119, 22-127, 22-127A, 22-140, 22-141, 22-171, 22-172, 22-176, 22-177, 22-178, 22-179, 22-194, 22-195, 22-196, 22-197, 22-198, 22-199, 22-220, 22-221, 22-222, 22-223, 22-47, 22-60, 22-70, 22-99, 505, 901, 908, 909, 910							
A-221854	CCW twist	22.250"	1.500"	3.000"	.375"	20.500"	2.000"
For Models: 22-111, 22-113, 22-127, 22-127A, 22-140, 22-141, 22-171, 22-172, 22-176, 22-177, 22-178, 22-179, 22-196, 22-197, 22-198, 22-199, 22-47, 22-60, 22-70, 505, 901, 908, 909, 910							

FRED CAIN

PART	DESCRIPTION	OVERALL LENGTH	HOLE DIAMETER	WIDTH	THICKNESS	CENTER HOLE/END	OFFSET HEIGHT
A-72280	CCW lift	19.750"	1.500"	4.000"	.500"	16.750"	2.500"
For Models: ROTARY MOWER - CHECK DIM.							
A-360	CCW	24.750"	1.500"	3.000"	.500"	22.250"	2.000"
For Models: ROTARY MOWER - CHECK DIM.							
A-360UL	CCW lift	24.750"	1.500"	3.000"	.500"	22.250"	2.000"
For Models: ROTARY MOWER - CHECK DIM.							
A-4620	CCW	24.750"	1.500"	3.500"	.500"	22.250"	2.000"
For Models: ROTARY MOWER - CHECK DIM.							
A-3040	CCW	27.750"	1.500"	3.000"	.500"	25.250"	2.000"
For Models: ROTARY MOWER - CHECK DIM.							
A-4630	CCW	27.750"	1.500"	3.500"	.500"	25.250"	2.000"
For Models: ROTARY MOWER - CHECK DIM.							
A-4640	CCW	30.750"	1.500"	3.500"	.500"	28.250"	2.000"
For Models: ROTARY MOWER - CHECK DIM.							

HICO

PART	DESCRIPTION	OVERALL LENGTH	HOLE DIAMETER	WIDTH	THICKNESS	CENTER HOLE/END	OFFSET HEIGHT
A-420HC	CCW	24.750"	1.500"	3.500"	.500"	22.125"	2.000"
For Models: 5 FT. ROTARY MOWERS							
A-420UL	CCW lift	24.750"	1.500"	3.500"	.500"	22.125"	2.000"
For Models: 5 FT. ROTARY MOWERS							
A-422HC	CCW	27.750"	1.500"	3.500"	.500"	25.250"	2.000"
For Models: 6 FT. ROTARY MOWER							

HARDEE

PART	DESCRIPTION	OVERALL LENGTH	HOLE DIAMETER	WIDTH	THICKNESS	CENTER HOLE/END	OFFSET HEIGHT
A-C1256	CCW lift	18.750"	1.500"	3.500"	.500"	16.500"	2.000"
For Models: T8398							
A-C1257	CW lift	18.750"	1.500"	3.500"	.500"	16.500"	2.000"
For Models: T8398							
A-C49HDC	CCW	22.750"	1.500"	3.500"	.500"	20.250"	2.750"
For Models: (H-CO, T160, T160LT, T160LTO, T166, T166LT, T166LTO, T172, T172LT, T172LTO ALL Heavy Duty, Except 66" & 72" W/ Round Blade Holder)							
A-C49A	CCW	23.000"	1.500"	3.000"	.500"	20.500"	3.000"
For Models: 52LT, 60LT, 60LTO, 66LT, 66LTO, 72LT, H360CO, HS260CO, T160LT, T160LTO, T166LT, T166LTO, T172LT, T172LTO							
A-C49RC	CCW	23.000"	1.500"	3.000"	.500"	20.500"	2.500"
For Models: (H-CO, T160, T160LT, T160LTO, T166, T166LT, T166LTO, T172, T172LT, T172LTO ALL Except 66" & 72" W/ Round Blade Holder)							
A-C49ND	CW/CCW	23.000"	1.500"	3.000"	.500"	20.500"	2.500"
For Models: (H-CO, T160, T160LT, T160LTO, T166, T166LT, T166LTO, T172, T172LT, T172LTO ALL Except 66" & 72" W/ Round Blade Holder)							
A-C469ND	CW/CCW	26.000"	1.500"	3.500"	.500"	23.500"	3.000"
For Models: (C66, H8, PW, T8215 ALL W/ Round Blade Holder)							
A-C1169L	CCW	26.000"	1.500"	3.500"	.500"	23.500"	3.000"
For Models: (H8115AIS, T8215PTW ALL For 66" Mower W/ Round Blade Holder)							

ROTARY CUTTER BLADES

A-C1169R	CW	26.000"	1.500"	3.500"	.500"	23.500"	3.000"
For Models: (H8115AIS, T8215PTW ALL For 66" Mower W/ Round Blade Holder)							

A-C470	CCW	28.750"	1.500"	3.500"	.500"	26.250"	2.500"
For Models: (772, T484LT, T484PT, T884LT, T884PT ALL W/ Round Blade Holder)							

IMCO

PART	DESCRIPTION	OVERALL LENGTH	HOLE DIAMETER	WIDTH	THICKNESS	CENTER HOLE/END	OFFSET HEIGHT
A-10751	CCW	24.750"	1.500"	3.000"	.500"	22.250"	2.000"
For Models: ROTARY MOWER - CHECK DIM.							
A-10751UL	CCW lift	24.750"	1.500"	3.000"	.500"	22.250"	2.000"
For Models: ROTARY MOWER - CHECK DIM.							

JOHN DEERE

PART	DESCRIPTION	OVERALL LENGTH	HOLE DIAMETER	WIDTH	THICKNESS	CENTER HOLE/END	OFFSET HEIGHT
A-W45327	CCW	21.500"	1.500"	4.000"	.500"	19.500"	3.000"
For Models: (CX15, CX20 ALL Center & RH Wing), HX10, (HX15, HX20 ALL Center & RH Wing), MX10, MX5, MX6							
A-W45326	CW	21.500"	1.500"	4.000"	.500"	19.500"	3.000"
For Models: (CX15, CX20 ALL LH Wing), HX10, (HX15, HX20 ALL LH Wing), MX10							
A-W34286	CW/ CCW	11.00"	1.250"	3.000"	9.500"	0.250"	0.250"
For Models: 205, 227, 307							
A-W43048		21.750"	1.500"	4.000"	19.750"	2.750"	Flat Offset
For Models: 1008, 1508, 509, 609, 709							
A-80A39201	CCW	21.875"	1.500"	4.000"	.500"	19.750"	2.500"
For Models: 1008, 1508, 727, 737							
A-W43040	CCW	21.875"	1.500"	4.000"	.500"	19.750"	2.500"
For Models: 1008, 1508, 509, 609, 709, 727, 737							
A-80A39204		18.25"	1.500"	4.000"	16.25"	2.750"	Flat Offset
For Models: 1408, 1418							

LAND PRIDE

PART	DESCRIPTION	OVERALL LENGTH	HOLE DIAMETER	WIDTH	THICKNESS	CENTER HOLE/END	OFFSET HEIGHT
A-820-075C		27"	1.500"	3.000"	.500"		
For Models: 35120							
A-820-075C		27"	1.500"	3.000"	.500"		
For Models: 35120							
A-820-067C	CW	24"	1.500"	3.000"	.500"		2.000"
For Models: 1560, 2560							
A-820-066C	CW	30.5"	1.500"	3.000"	.500"		2.000"
For Models: 1572, 2572, 2584							

MONO

PART	DESCRIPTION	OVERALL LENGTH	HOLE DIAMETER	WIDTH	THICKNESS	CENTER HOLE/END	OFFSET HEIGHT
A-850500	CCW	25.000"	1.500"	3.000"	.500"	22.500"	2.000"
For Models: 5 FT. ROTARY MOWERS							
A-850500UL	CCW lift	25.000"	1.500"	3.000"	.500"	22.500"	2.000"
For Models: 5 FT. ROTARY MOWERS							

RHINO

PART	DESCRIPTION	OVERALL LENGTH	HOLE DIAMETER	WIDTH	THICKNESS	CENTER HOLE/END	OFFSET HEIGHT
A-37118	CCW lift	18.750"	1.375"	3.625"	.500"	17.000"	flat
For Models: SEVERAL							
A-681063	CW/CCW	19.125"	1.375"	4.000"	.500"	17.125"	1.750"
For Models: 1310							
A-0731340000	CW lift	19.750"	1.000"	3.000"	.375"	18.000"	4.500"
For Models: SATURN 8							
A-0731350000	CCW lift	19.750"	1.000"	3.000"	.375"	18.000"	4.500"
For Models: SATURN 8							
A-00753841	CW lift	19.875"	1.500"	3.500"	.500"	17.375"	2.500"
For Models: TW96 RH							
A-00753842	CCW lift	19.875"	1.500"	3.500"	.500"	17.375"	2.500"
For Models: TW96 LH							

ROTARY CUTTER BLADES

A-8589	CCW lift	20.125"	1.500"	4.000"	.500"	18.125"	2.500"
For Models: A960, TW60							
A-8590	CW lift	20.125"	1.500"	4.000"	.500"	18.250"	2.250"
For Models: SR15, TW120							
A-00759338	CW lift	21.500"	1.375"	4.000"	.500"	19.500"	3.000"
For Models: SR15 LH Wing Blade							
A-00759339	CCW lift	21.500"	1.375"	4.000"	.500"	19.500"	3.000"
For Models: SR15 RH Wing Blade							
A-652011R	CW	24.500"	1.375"	4.000"	.500"	22.500"	3.562"
For Models: 1008 FLEX 15							
A-622013	CCW	24.500"	1.375"	4.000"	.500"	22.500"	3.562"
For Models: 1008 FLEX 15, CYCLONE 60							
A-0652010030	CW/CCW	24.500"	1.391"	4.000"	.500"	22.500"	3.562"
For Models: CYCLONE 60, FLEX 15, GR60, S128							
A-622013F	CCW lift	24.750"	1.375"	4.000"	.500"	22.500"	3.562"
For Models: (1008, CY60, FLEX 15, SA15 ALL LH)							
A-652011RF	CW lift	24.750"	1.375"	4.000"	.500"	22.500"	3.562"
For Models: (1008, FLEX 15, SA15 ALL RH)							
A-8588	CCW lift	26.250"	1.500"	4.000"	.500"	24.250"	2.500"
For Models: A972, TW144, TW72							
A-71103	CCW lift	24.500"	1.0625"	3.000"	.375"	22.750"	3.000"
For Models: SEVERAL							
A-582013	CCW	27.000"	1.375"	4.000"	.500"	25.500"	3.250"
For Models: CYCLONE 72 Main Blade, FLEX 15 Center Blade							
A-582013F	CCW	27.750"	1.375"	4.000"	.500"	25.500"	3.250"
For Models: 1008 Center, CY72, (FLEX 15, SA15 ALL Center)							

SCHULTE

PART	DESCRIPTION	OVERALL LENGTH	HOLE DIAMETER	WIDTH	THICKNESS	CENTER HOLE/END	OFFSET HEIGHT
A-401-014	CCW Lift	24.750"	1.500"	4.000"	.500"	22.250"	2.500"
For Models: SEVERAL Check Dimensions							
A-401-015	CCW Lift	27.750"	1.500"	4.000"	.500"	25.250"	2.500"
For Models: SEVERAL Check Dimensions							
A-401-013	CW Lift	27.750"	1.500"	4.000"	.500"	22.250"	2.500"
For Models: SEVERAL Check Dimensions							
A-401-028	CW	27.750"	1.500"	4.000"	.500"		2.750"
For Models: 5026 Center, Suction, 5026 RH Inner, Suction, V1280 RH							
A-401-027	CW	24.750"	1.500"	4.000"	.500"		2.750"
For Models: 5026 RH Outer, Suction, (S100, XH1000 All RH)							
A-401-026	CCW	24.750"	1.500"	4.000"	.500"		2.750"
For Models: 5026 LH Outer, Suction, (S100, XH1000 All RH)							
A-401-032	CCW	27.750"	1.500"	4.500"	.500"		2.750"
For Models: 5026 LH Inner, Suction, S100 Center, V1280 LH, XH1000 Center, XH600							
A-401-033		24.750"	1.500"	4.000"	.375"		
For Models: 5026 RH Outer, Upper & LH Outer, Upper							
A-401-034		27.750"	1.500"	4.000"	.375"		
For Models: 5026 RH/LH Inner, Upper & Center, Upper							
A-401-036		8.812"	1.000"	3.000"	.500"		
For Models: V1280 Center							

SIDEWINDER

PART	DESCRIPTION	OVERALL LENGTH	HOLE DIAMETER	WIDTH	THICKNESS	CENTER HOLE/END	OFFSET HEIGHT
A-21301SW	CW/CCW	17.375"	1.500"	3.000"	.375"	15.375"	2.000"
For Models: GB-50, SX-50							
A-15074SW	CCW	20.250"	1.500"	3.500"	.500"	17.750"	4.500"
For Models: GB144, GB48, RS160, RS213, SW66							
A-17065SW	CCW	22.375"	1.500"	3.000"	.375"	20.375"	2.000"
For Models: 5X5, K-60, SX-60							
A-15096SW	CCW	22.750"	1.500"	3.500"	.500"	20.250"	2.750"
For Models: 605, 660, GB60, GB602, SW72							
A-22334SW	CW/CCW	24.875"	1.500"	3.500"	.500"	22.375"	3.000"
For Models: PG210							
A-20013SW	CW/CCW	25.437"	1.500"	3.500"	.500"	22.937"	3.125"
For Models: FW215							
A-15120SW	CCW	28.750"	1.500"	3.500"	.500"	26.250"	3.000"
For Models: 6X6, GB722, GB842, SW842							

ROTARY CUTTER BLADES

TIGER

PART	DESCRIPTION	OVERALL LENGTH	HOLE DIAMETER	WIDTH	THICKNESS	CENTER HOLE/END	OFFSET HEIGHT
A-UTB2031A	CW	17.375"	1.500"	5.000"	.500"	14.687"	1.500"
For Models: BOOM MOWER							
A-TB2031	CW	17.375"	1.500"	5.000"	.500"	14.687"	2.500"
For Models: BOOM MOWER							
A-6T1021R	CW lift	20.000"	1.500"	4.000"	.500"	17.500"	2.500"
For Models: BOOM MOWER							
A-6T1021RS	CW twist	20.000"	1.500"	4.000"	.500"	17.500"	2.500"
For Models: ROTARY HIGHWAY MOWERS							

TERRAIN KING

PART	DESCRIPTION	OVERALL LENGTH	HOLE DIAMETER	WIDTH	THICKNESS	CENTER HOLE/END	OFFSET HEIGHT
A-02761500	CW/CCW	14.500"	1.500"	5.000"	.625"	12.000"	flat
For Models: A1300M, A-BOOM							
A-2886200	CW lift	20.125"	1.500"	4.000"	.500"	17.875"	2.500"
For Models: 60" VERSA MOWER, 72" VERSA MOWER							
A-750787	CW	24.750"	1.500"	3.500"	.500"	22.250"	3.000"
For Models: HYDRO 15, TK15, X5							
A-750788	CCW lift	24.750"	1.500"	3.500"	.500"	22.250"	3.000"
For Models: HYDRO 15, TK15, X5							
A-750121	CW/CCW	24.875"	1.500"	3.500"	.500"	22.375"	3.000"
For Models: TK15							

WOODS-COPELAND

PART	DESCRIPTION	OVERALL LENGTH	HOLE DIAMETER	WIDTH	THICKNESS	CENTER HOLE/END	OFFSET HEIGHT
A-15789	CCW	18.500"	1.500"	3.000"	.375"	17.125"	twist
For Models: DO80-2, MDO80-2							
A-3900WD	CCW twist	18.375"	.875"	3.000"	.375"	17.125"	.750"
For Models: 80, B080, B80, B80U, C080, C80, C80U, D08, D80, K4, M80, MB80							
A-3975WD	CW	19.562"	.875"	2.500"	N/A	N/A	N/A
For Models: 42							
A-6330WD	CCW	22.000"	1.500"	3.000"	.375"	20.500"	2.000"
For Models: 60-2, 60-3, 60-4, E60, M5-4, RM5-3							
A-6866WD	CCW twist	22.000"	1.500"	3.000"	.375"	20.500"	2.375"
For Models: 60-4, E60, M5, M60							
A-12892WD	CCW lift	24.000"	1.500"	4.000"	.375"	21.375"	2.625"
For Models: 2090, 312, D210R, D315, HD210R-2, HD210R-3, (HD210R-4, HD315-4 ALL Early), MR105, R105, S105 Early, S105-1, S105-2							
A-24771WD	CW lift	24.000"	1.500"	4.000"	.375"	21.500"	2.625"
For Models: 2090, D210R, D315, D315-2, D315-3, (HD210R-4, HD315-4 ALL Early), HS105, HS105-1, HS105-2, HS105-3, S105 Late, S105-3							
A-8825WD	CW lift	30.000"	1.500"	4.000"	.500"	27.375"	3.750"
For Models: 211, 213Q, 214, 214Q, 214R, 215, 315, 320, 84-1, B106, B214, B214QR, B320, CADET 72, CADET 8, M214, M84, MB106, MR107, R107, S106 Early, S214, SM214							
A-8820WD	CCW lift	30.000"	1.500"	4.000"	.500"	27.375"	3.750"
For Models: 211, 213Q, 214, 214Q, 214R, 215, 315, 320, B214, B214QR, B320, HS106, M214, S106 Late, S106-3, S214, SM214							
A-6323WD	CCW lift	30.250"	1.500"	4.000"	.401"	27.375"	N/A
For Models: 213, 320, 72, 84, B315-4, M72, M84, MD172, MD184, XT184							
A-11768WD	CW lift	20.125"	1.500"	4.000"	.375"		2.500"
For Models: 2080							
A-11769WD	CCW lift	20.125"	1.500"	4.000"	.375"		2.500"
For Models: 2080							
A-17130WD	CW lift	24.000"	1.500"	4.000"	.375"		2.625"
For Models: 121, O121							
A-19160WD	CCW lift	25.250"	1.500"	4.000"	.500"		3.000"
For Models: 3180, HD315-5							
A-19161WD	CW lift	25.250"	1.500"	4.000"	.500"		3.000"
For Models: 3180, HD315-5							
A-4742WD	CCW lift	24.000"	1.500"	4.000"	.375"		2.188"
For Models: 121, MD160, O121							

ROTARY CUTTER PARTS

ROTARY CUTTER BLADE BOLTS & NUTS



A-7A5000 Blade Bolt & Nut
Kit Contains 7A4997 Bolt, Nut & Lock Washer
Used with 420HC, 422HC Blades

BUSH HOG 105, 109, 1109, 1126, 12, 1209, 1226, 126, 1310, 1315, 160, 1600, 205, 206, 226, 305, 306, 307, 307R, 310, 315, 502, 6, 600

A-63607BH Bolt Kit
Contains 2 Each 7919BH Bolts, Nuts & Lock Washers

BUSH HOG 105, 109, 1109, 1126, 12, 1209, 1226, 126, 1310, 1315, 160, 1600, 205, 206, 226, 305, 306, 307, 307R, 310, 315, 502, 6, 600

A-7A5495 Blade Bolt & Nut
Kit Contains 7A5494 Bolt, Nut & Lock Washer

DIXIE SEVERAL

A-7A5495 Blade Bolt & Nut
Kit Contains 7A5494 Bolt, Nut & Lock Washer
2-7/8" LENGTH, 1-3/8" THREAD LENGTH, .562" SHOULDER LENGTH

DIXIE SEVERAL

A-7A5000 Bolt Kit
Kit Contains 7A4997 Bolt, Nut & Lock Washer
Used with 420HC, 422HC Blades

FRED CAIN SEVERAL

A-309719 Blade Bolt Kit
Includes Bolt, Nut, Spacer, & Cotter Pin

FORD 22-47, 22-60, 22-70

A-7A5495 Blade Bolt & Nut
Kit Contains 7A5494 Bolt, Nut & Lock Washer
2-7/8" LENGTH, 1-3/8" THREAD LENGTH, .562" SHOULDER LENGTH

COVINGTON SEVERAL

A-7A5575 Bolt Kit

HICO SEVERAL

A-HL418N Bolt & Nut

HICO SEVERAL w/ new square shoulder

A-7A5495 Blade Bolt & Nut
Kit Contains 7A5494 Bolt, Nut & Lock Washer
2-7/8" LENGTH, 1-3/8" THREAD LENGTH, .562" SHOULDER LENGTH

HICO SEVERAL

A-7A5000 Blade Bolt & Nut
Kit Contains 7A4997 Bolt, Nut & Lock Washer
Used with 420HC, 422HC Blades

HICO

A-7A5500 Bolt Kit
Includes 3.625" Bolt, Nut & Lock washer
1-C48 BOLT, 1-C46 NUT, 1-C47 LOCKWASHER

HARDEE SEVERAL

A-7A5495 Blade Bolt & Nut
Kit Contains 7A5494 Bolt, Nut & Lock Washer
2-7/8" LENGTH, 1-3/8" THREAD LENGTH, .562" SHOULDER LENGTH

IMCO SEVERAL

A-7A5495 Blade Bolt & Nut
Kit Contains 7A5494 Bolt, Nut & Lock Washer
2-7/8" LENGTH, 1-3/8" THREAD LENGTH, .562" SHOULDER LENGTH

MONO SEVERAL

A-7A6000 Blade Bolt Kit
For 1/2" Blades; Kit Contains Bolt, Nut, Spacer & Cotter Pin

MONO SEVERAL

A-7A6010 Blade Bolt Kit
Kit Contains Bolt, Nut, Spacer & Cotter Pin

MONO SEVERAL W/ 3/8" Blades

A-63607BH Bolt Kit
Contains 2 Each 7919BH Bolts, Nuts & Lock Washers

MARVEL SEVERAL

A-B36107A2ALH Bolt Kit
Kit Contains Bolt & Lock Nut

RHINO SEVERAL

A-B571044 Blade Bolt Kit
Kit Contains 571044 1" LH bolt, 5GL16140 LH nut

RHINO SEVERAL

A-27723SW Bolt Kit
Kit Contains Bolt, Nut & Spacer

SIDEWINDER SEVERAL W/ 1/2" Blade, 6X6

A-27722SW Bolt Kit
Kit Contains Bolt, Nut & Spacer

SIDEWINDER SEVERAL W/ 3/8" Blade, 6X6

A-7A5492 Bolt Kit
Includes Bolt & Nut

SIDEWINDER SEVERAL

A-27724SW Blade Bolt w/ Nut
Kit Contains 15060SW Bolt & Nut

SIDEWINDER FW16, FW216, GB605, GB725, GB842, RS160, RS213, SW66, SW72, SW84, SW842

A-7A6015 Bolt Kit
Includes Bolt & Lock Nut

TIGER SEVERAL

A-7A6042 Blade Bolt Kit
For 02761500 blade (Kit Contains Bolt, Lockwasher, Nut & Roll Pin)

TERRAIN KING A1300M, A-BOOM

SLIP CLUTCH ASSEMBLY



A-80A80 Hvy Spring, 3 required (B)

BMB 2162 w/ 3 spring 60" and 72" cutters

A-7142 Front Plate (C)

BMB 2162 w/ 3 spring 60" and 72" cutters

A-8053 Facing, 2 required (D)

BMB 2162 w/ 3 spring 60" and 72" cutters

A-7143 Back Plate (F)

BMB 2162 w/ 3 spring 60" and 72" cutters

CLUTCH FACING



A-374BH Clutch Facing, Inner
6.5" O.D. 1.187" I.D.

BUSH HOG SEVERAL

ROTARY CUTTER PARTS

CLUTCH FACING



A-372-1BH Clutch Facing, Outer
For 368-1BH Slip Clutch

BUSH HOG SEVERAL

SPRING & LINING KIT



A-67303BH Spring & Lining Kit
Kit Contains 2-Linings & 8-64657BH 6MM Springs

BUSH HOG SQ60, SQ60-4 w/ spline input shaft on gearbox, SQ72-3 pull type

A-67304BH Spring & Lining Kit

Kit Contains: 2-64644BH Linings, 8-64657BH 6MM Linings

BUSH HOG 12610, 12615, 255R, 255R-2, 256R, 256R-2, 2610, 2615, (1220R, 1220RW, 1220S, 1220SW, 1310R, 1310RW, 1310S, 1310SW, 1315R, 1315RW, 1315S, 1315SW, 220, 220R, 220RW, 220S, 220SW, 310R, 310RW, 310S, 310SW, 315R, 315RW, 315S, 315SW ALL for wing drive shaft), (SQ72-2, SQ72-3 ALL lift models w/ input shaft on gearbox)

A-67305BH Spring & Lining Kit

Kit Contains: 4-Linings & 8-64657BH 6MM Springs

BUSH HOG 12680R, 1268R, 2680R, 268R, 277, (12620, 13615, 2620, 3615 ALL for wing and center driveline), (1256R-2, 1257R, 1257R-2 ALL pull models), (257R, 257R-2 ALL lift models), (2512-11, 2512-13, 2512-14, 2512-18 ALL w/o jackshaft)

A-67306BH Spring & Lining Kit

Kit Contains: 4-64644BH Linings & 8-64657BH 6MM Springs

BUSH HOG 13108, 13108 OFFSET, 13126, 13126 OFFSET, 13368, 13618, 3108, 3108 OFFSET, 3126, 3126 OFFSET, 3168, 3368, (2512, 12512 ALL w/ lift & semi-lift mounts), 2512 pull type, (1220R, 1220RW, 1220S, 1220SW, 1310R, 1310RW, 1310S, 1310SW, 1315R, 1315RW, 1315S, 1315SW, 220, 220R, 220RW, 220S, 220SW, 2512-01, 2512-03, 2512-04, 2512-08, 310R, 310RW, 310S, 310SW, 315R, 315RW, 315S, 315SW ALL w/ jackshaft)

LINING



A-970-4140 Lining, (140mm) 5-1/2" OD
For 800 Series Cutters

BUSH HOG (1257R, 257R ALL lift & pull type), 40, 52, 60, RT32

A-64644BH Lining, (160mm) 6-5/16" OD

BUSH HOG 1220R, 1310R, 1315R, 220R, 310R, 315R, (255R, 256R ALL LIFT & PULL TYPE)

BUSHING



A-64828BH Bushing

BUSH HOG 1220R, 1310R, 1315R, 220R, 310R, 315R, 40, 52, 60, RT32, (1257R, 257R ALL lift & pull type)

SPRING COIL



A-351016370 Spring Coil, (5mm) 3/16", 8 required

BUSH HOG SEVERAL

A-64657BH Spring Coil, (6mm) 1/4", 8 required

BUSH HOG SEVERAL

A-64648BH Spring Coil, (7mm) 9/32", 8 required

BUSH HOG SEVERAL

WHEEL ASSEMBLY

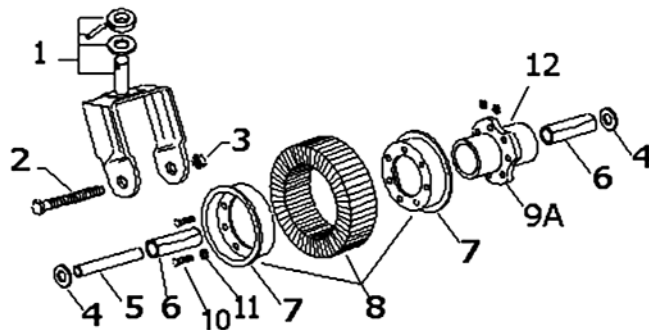

A-12269BH Caster Wheel Assy.

A-12528BH Fork Assy. (1)

A-20123BH Bolt 3/4"-10x8" (2)

A-15591BH Lock Nut 3/4" - 10 (3)

A-80A122 Wear Washer (4)

A-VLH1722 Spacer (5)

A-12250BH Roller Brg w/Sleeve (6)

A-233BH Wheel Half (7) *not included

A-500BH 400x8 Tail Wheel Assy. (8)

A-12268BH Hub w/ Bolts (9A) *not included

A-12105BH Hub less Bolts (9B)

A-HD12X1NCBLT Bolt 1/2" - 13x1" (10)

A-HD12LW 1/2" Lock Washer (11)

A-GF1428TT Grease Fitting (12)

BUSH HOG 104, 105, 1050, 1051, 109, 1109, 1126, 12, 1209, 1226, 126, 1307, 1405, 1405HR, 1406, 1406HR, 266, 305, 306, 307, 405, 405HR, 406, 406HR, 502, 600

ROTARY CUTTER PARTS

BEARING SET



A-8A911 1 Required Per Hub

BUSH HOG 104, 105, 1050, 1051, 109, 1109, 1126, 12, 1209, 1226, 126, 1307, 1405, 1405HR, 1406, 1406HR, 266, 305, 306, 307, 405, 405HR, 406, 406HR, 502, 600

ROLLER BEARING KIT



A-12250BH Roller Bearing Kit

For New Style Tail Wheel

BUSH HOG 104, 105, 1050, 1051, 109, 1109, 1126, 12, 1209, 1226, 126, 1307, 1405, 1405HR, 1406, 1406HR, 266, 305, 306, 307, 405, 405HR, 406, 406HR, 502, 600

WHEEL ASSEMBLY

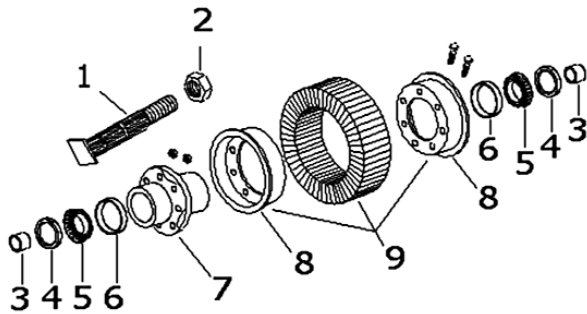

A-215BH Caster Wheel Assy.

A-1317BH Axle Bolt, 1"x7", 3/4" thread (1)

A-15591BH Lock Nut 3/4" - 10 (2)

A-610335BH Bushing (3)

A-30BH Seal (4)

A-22BH Cone (5)

A-170BH Cup (6)

A-1311BH Hub w/ brg cups (7)

A-233BH Wheel Half (8)

A-500BH 400x8 Tail Wheel Assy. (9)

BUSH HOG SEVERAL

HUB KIT



A-80A311 Hub Kit

Includes Hub, 4 Lug Bolts, Bearings, Seals, Spacers, Axle Bolt & Lock Nut

BUSH HOG SEVERAL

WHEEL HALVES



A-80A502 2 Wheel Halves w/ Bolts

BUSH HOG SEVERAL

BEARING SETS



A-8A901 Bearing Set

BUSH HOG SEVERAL

A-8A902 Bearing Set

Contains two of the following: Seal, Cone, Cup, Bushing

BUSH HOG SEVERAL

A-610335BH Bushing

BUSH HOG SEVERAL

WHEEL ASSEMBLIES



A-VPN1035 4x8 Tail Wheel Assembly

BUSH HOG SEVERAL w/1-1/2" Shaft

A-8A1035 Bearing Kit W/ Spindle Assy

BUSH HOG SEVERAL

A-VPN1038 Bearing Kit

For VPN1035 Contains 2 Each Bearing Cones, Cups & Seals

BUSH HOG SEVERAL

A-4A1035 Spindle Assembly

BUSH HOG SEVERAL

ROTARY CUTTER PARTS

HUBS



A-60990BH Hub, 4 bolt on 5" circle, less bushings
W/Bolts, Less Bushing

BUSH HOG SEVERAL

A-63813BH Hub, 4 bolt on 5" circle, w/ .750" bushings

BUSH HOG SEVERAL

A-44090BH 3/4" x 7" Tail Wheel Hub Bolt

BUSH HOG SEVERAL

A-15591BH Lock Nut 3/4" - 10

BUSH HOG 104, 105, 1050, 1051, 109, 1109, 1126, 12, 1209, 1226, 126, 1307, 1405, 1405HR, 1406, 1406HR, 266, 305, 306, 307, 405, 405HR, 406, 406HR, 502, 600, SEVERAL

A-63811BH 3/4" ID Bushing
3/4" I.D., 2 Req'd Per Hub

BUSH HOG

A-80A616 1" ID Bushing
1" I.D., 2 Req'd Per Hub

BUSH HOG

TAIL TIRE



A-294BH 6x9 Tail Tire w/ Rims

BUSH HOG SEVERAL

SLIP CLUTCH ASSEMBLY

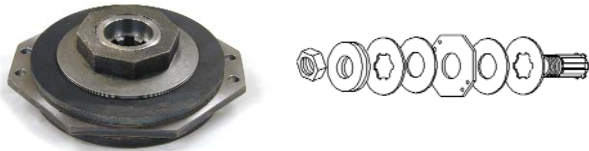

A-3054 Clutch Assembly, w/ 3 springs

CALDWELL SEVERAL

A-4406 Clutch Assembly, w/ 2 springs

CALDWELL SEVERAL

A-8320 Adjustable Nut, 1 Req'd (A)

CALDWELL SEVERAL

A-8319 Spring, as req'd (B)

CALDWELL SEVERAL

A-8322 Drive Plate, 1 Req'd (C)

CALDWELL SEVERAL

A-8323 Facing, 6.5" OD, 2.625" ID, 2 Req'd (D)

CALDWELL SEVERAL

A-8318 Plate, 1 Req'd (E)

CALDWELL SEVERAL

A-8324 Back Plate, 1 Req'd (F)

CALDWELL SEVERAL

A-3061 Hub, 1 Req'd (G)

CALDWELL SEVERAL

A-3059 Facing, 6.5" OD, 2" ID

CALDWELL SEVERAL

ROLLER BEARING KIT



A-8A91 Roller Bearing Kit
(Kit Contains 2 Cups, 2 Brgs, 1 Seal)

FOREST CITY SEVERAL

TAIL WHEEL



A-AC27 4x8 Tail Wheel

FRED CAIN SEVERAL

A-80A502 2 Wheel Halves w/ Bolts

FRED CAIN SEVERAL

A-80A501 1 Wheel Half

FRED CAIN SEVERAL

SLIP CLUTCH



A-7502531 Slip Clutch

FORD

A-7500438 Slip Clutch

FORD

A-7500438-H Slip Clutch Assy.
Has 2 Heavy Springs.

FORD

ROTARY CUTTER PARTS

HUB KIT



A-80A350 Hub Kit

FRED CAIN SEVERAL

A-80A1311 Wheel Hub w/ Bolts & Cups

FRED CAIN SEVERAL

A-BC18 Hub Axle Bolt

FRED CAIN SEVERAL

A-HD1NCNUT Hub Axle Nut, 1"-8 HEX

FRED CAIN SEVERAL

A-452554 SEAL

FRED CAIN SEVERAL

A-AC21 Bushing

FRED CAIN SEVERAL

BEARING SET



A-8A901 Bearing Set *order seperately

FRED CAIN SEVERAL

A-8A902 Bearing Set (set of 2) *order seperately

FRED CAIN SEVERAL

HUBS



A-80A600 4 Bolt Hub (5" center), less Bushing

FRED CAIN SEVERAL

A-80A616 1" ID Bushing

FRED CAIN SEVERAL

TAIL TIRE



A-80A500 4x8 Tail Tire w/ Rims

HARDEE SEVERAL

A-80A502 2 Wheel Halves w/ Bolts

HARDEE SEVERAL

A-80A501 1 Wheel Half

HARDEE SEVERAL

TAIL WHEEL HUB



A-C37 Tail Wheel Hub

HARDEE SEVERAL

TAIL WHEEL PARTS



A-8A993 Wheel Bearing Kit

For Tail Wheel Hub C37

HARDEE SEVERAL

A-VPN1035 4x8 Tail Wheel Assembly

HARDEE SEVERAL w/1-1/2" Shaft

A-8A1035 Bearing Kit W/ Spindle Assy

HARDEE SEVERAL

A-VPN1038 Bearing Kit

For VPN1035 Contains 2 Each Bearing Cones, Cups & Seals

HARDEE SEVERAL

A-4A1035 Spindle Assembly

HARDEE SEVERAL

ROTARY CUTTER PARTS

SLIP CLUTCH ASSEMBLY

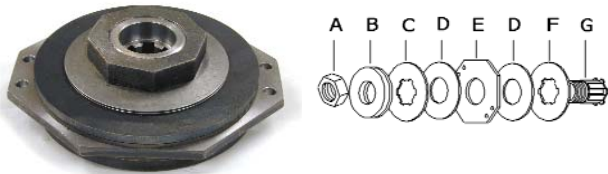

A-80A75 Slip Clutch Assy. w/ 2 Springs
HARDEE T160LT, T160LTO, T166LT, T166LTO, T172LT, T172LTO, T52LT

A-C61A Adjustable Nut, 1 reqd
HARDEE T160LT, T160LTO, T166LT, T166LTO, T172LT, T172LTO, T52LT

A-C60A Spring, 2 reqd
HARDEE T160LT, T160LTO, T166LT, T166LTO, T172LT, T172LTO, T52LT

A-C56A Front Plate
HARDEE T160LT, T160LTO, T166LT, T166LTO, T172LT, T172LTO, T52LT

A-36F42 Facing, 2.625" hole, 6.25" OD, 2 reqd
HARDEE T160LT, T160LTO, T166LT, T166LTO, T172LT, T172LTO, T52LT

A-80A81 Drive Plate, 1 reqd
HARDEE T160LT, T160LTO, T166LT, T166LTO, T172LT, T172LTO, T52LT

A-C433 Back Plate
HARDEE T160LT, T160LTO, T166LT, T166LTO, T172LT, T172LTO, T52LT

A-80A79 Hub
HARDEE T160LT, T160LTO, T166LT, T166LTO, T172LT, T172LTO, T52LT

SLIP CLUTCH LINING



A-970-4140 Slip Clutch Lining, 5.5" OD, 3.375" ID
HARDEE 800 SERIES

FRICTION DISC



A-970-2110 Friction Disc, 6" OD
HARDEE SEVERAL

WHEEL HUB



A-80A1311 Wheel Hub w/ Bolts & Cups
IMCO SEVERAL

SLIP CLUTCH DISC



A-W39301 SLIP CL DISC
JOHN DEERE

A-DC38275 SLIP CLUTCH DISC
JOHN DEERE

WHEEL ASSEMBLY



A-VPN1035 4x8 Tail Wheel Assembly
LAND PRIDE SEVERAL w/1-1/2" Shaft

A-8A1035 Bearing Kit W/ Spindle Assy
LAND PRIDE SEVERAL

A-VPN1038 Bearing Kit

For VPN1035 Contains 2 Each Bearing Cones, Cups & Seals
LAND PRIDE SEVERAL

A-4A1035 Spindle Assembly
LAND PRIDE SEVERAL

WHEEL ASSEMBLY



A-4010048 4x8 Tail Tire w/ Rims
MODERN SEVERAL

A-80A502 2 Wheel Halves w/ Bolts
MODERN SEVERAL

A-80A501 1 Wheel Half
MODERN SEVERAL

ROTARY CUTTER PARTS

SLIP CLUTCH ASSEMBLY

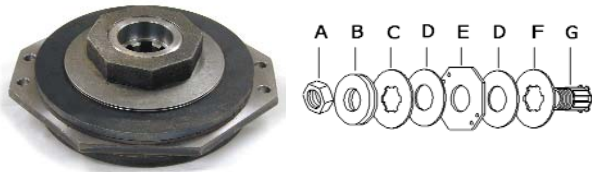

A-80A75 Slip Clutch Assy. w/ 2 Springs

MONO SEVERAL

A-80A78 Adjusting Nut

MONO SEVERAL

A-80A82 Drive Plate

MONO SEVERAL

A-36F42 Facing, 2.625" hole, 6.25" OD, 2 reqd

MONO SEVERAL

A-80A81 Drive Plate, 1 reqd

MONO SEVERAL

A-80A83 Back Plate

MONO SEVERAL

A-80A79 Hub

MONO SEVERAL

TAIL TIRE



A-80A500 4x8 Tail Tire w/ Rims

MARVEL SEVERAL, MODERN SEVERAL, MONO, HARDEE SEVERAL

A-80A502 2 Wheel Halves w/ Bolts

MARVEL SEVERAL, MODERN SEVERAL, MONO HARDEE SEVERAL

A-80A501 1 Wheel Half

MARVEL SEVERAL, MODERN SEVERAL, MONO HARDEE SEVERAL

A-373024H 4x8 Tail Tire w/ Rims

NEW IDEA SEVERAL

A-00025200 6X9 Tail Tire w/ Rims

NEW IDEA SEVERAL

A-373024B 2 Wheel Halves w/ Bolts

NEW IDEA SEVERAL

A-80A501 1 Wheel Half

NEW IDEA SEVERAL

A-373024C Tail Wheel Hub

NEW IDEA SEVERAL

A-8A993 Bearing Set

NEW IDEA SEVERAL

A-37302C2C Bushing

NEW IDEA SEVERAL

A-373024H 4x8 Tail Tire w/ Rims

RHINO SEVERAL

A-00025200 6X9 Tail Tire w/ Rims

RHINO SEVERAL

A-373024B 2 Wheel Halves w/ Bolts

RHINO SEVERAL

A-80A501 1 Wheel Half

RHINO SEVERAL

A-373024C Tail Wheel Hub

RHINO SEVERAL

A-8A993 Bearing Set

RHINO SEVERAL

A-37302C2C Bushing

RHINO SEVERAL

TAIL WHEEL BEARING SET



A-VLH1717 Tail Wheel Bearing Set

RHINO FL15M, SEVERAL, SR15M, TW168

4 BOLT HUB



A-VPN1004 4 Bolt Hub (5" center) w/ Brgs & Seals

RHINO SEVERAL

SLIP CLUTCH ASSEMBLY



A-0731070000 Slip Clutch Assy. w/ 3 Springs

RHINO SEVERAL

A-073-1070-007 Adjusting Nut (A)

RHINO SEVERAL

A-073-1070-006 Spring (B)

RHINO SEVERAL

A-073-1070-005 Front Plate (C)

RHINO SEVERAL

A-073-1070-003 Facing, 2.625" hole, 6.5" OD (D)

RHINO SEVERAL

A-073-1070-004 Drive Plate (E)

RHINO SEVERAL

A-073-1070-002 Back Plate (F)

RHINO SEVERAL

A-80A79 Hub (G)

RHINO SEVERAL

ROTARY CUTTER PARTS

SLIP CLUTCH DISC



A-007-54-202 Slip Clutch Disc, 3-19/32" hole, 6" OD

RHINO TW60, TW72, TW84

A-073-1070-003 Facing, 2.625" hole, 6.5" OD

RHINO TW60, TW72, TW84

A-058-1060-003 Slip Clutch Disc, 3.75" hole, 7" OD

RHINO TW60, TW72, TW84

FRICTION DISC



A-970-2110 Friction Disc, 6" OD

For Flexible Couplers

RHINO SEVERAL

TAIL WHEEL HUB



A-37-302-4C Tail Wheel Hub w/ Brg Cups

RHINO SAT5, SAT6, SAT7, SAT8, CY60, CY72, G72, RHINO 128

TAIL WHEEL HUB BUSHING



A-37-302C-2C Bushing for Tail Wheel Hub

RHINO SEVERAL

WHEEL BEARING KIT



A-8A996 Wheel Bearing Kit (6 Bolt Hub)

For Pull Type Cutters

RHINO FLEX 1310, FLEX 15

A-8A997 Wheel Bearing Kit (6 Bolt Hub)

For Pull Type Cutters

RHINO GR84

A-8A994 Wheel Bearing Kit

For Pull Type Cutters

RHINO CY60, CY72, FLEX 15 w/ 5 bolt hub, FS15 outside axle only, G60, G72, SAT6, SAT7, SAT8

A-8A993 Wheel Bearing Kit

For Tail Wheel Hub

RHINO CY60, CY72, G72, RHINO 128, SAT5, SAT6, SAT7, SAT8

HUB



A-80A196 Hub w/ Bolts, Cups, Cones, Seals, Bushings

SIDEWINDER

A-16952SW Hub w/ Bolts & Cups

SIDEWINDER SEVERAL

A-80A15196 Bushing

SIDEWINDER SEVERAL

A-8A993 Wheel Bearing Kit *sold separately

SIDEWINDER SEVERAL

HEAVY SPRING



A-80A80 Hvy Spring

MONO SEVERAL

ROTARY CUTTER PARTS

4 BOLT HUB



A-80A600 4 Bolt Hub (5" center), less Bushing

SIDEWINDER SEVERAL

A-80A612 .725" ID Bushing

SIDEWINDER SEVERAL

A-80A616 1" ID Bushing

SIDEWINDER SEVERAL

TAIL TIRE



A-15205SW Tail Tire w/ Rims

SIDEWINDER SEVERAL

A-17122SW Tail Tire w/ Rims

SIDEWINDER SEVERAL

A-80A502 2 Wheel Halves w/ Bolts

SIDEWINDER SEVERAL

A-80A501 1 Wheel Half

SIDEWINDER SEVERAL

A-80A600 4 Bolt Hub (5" center), less Bushing

SIDEWINDER SEVERAL

A-80A612 .725" ID Bushing

SIDEWINDER SEVERAL

A-80A616 1" ID Bushing

SIDEWINDER SEVERAL

A-16952SW Hub w/ Bolts & Cups

SIDEWINDER SEVERAL

A-80A196 Hub w/ Bolts, Cups, Cones, Seals, Bushings

SIDEWINDER SEVERAL

A-15196SW Bushing

SIDEWINDER SEVERAL

A-8A993 Wheel Bearing Kit

For Tail Wheel Hub

SIDEWINDER SEVERAL

SLIP CLUTCH ASSEMBLY



A-15432-03SW Slip Clutch Assy. w/ 1-3/8" 6 splines

SIDEWINDER SEVERAL

A-15440SW Adjusting Nut (A)

SIDEWINDER SEVERAL

A-18311-018SW Spring (B)

SIDEWINDER SEVERAL

A-15435SW Front Plate (C)

SIDEWINDER SEVERAL

A-15436SW Facing (D)

SIDEWINDER SEVERAL

A-15437-03SW Drive Plate (E)

SIDEWINDER SEVERAL

A-15435-02SW Back Plate (F)

SIDEWINDER SEVERAL

A-20770SW Hub (G)

SIDEWINDER SEVERAL

FRICION DISC



A-970-2110 Friction Disc, 6" OD

For Flexible Couplers

SIDEWINDER SEVERAL

SLIP CLUTCH ASSEMBLY

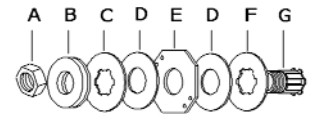

A-80A75 Slip Clutch Assy. w/ 2 Springs

Used on 6' Cutters

TERRAIN KING SEVERAL

A-748830 Adjusting Nut (A)

TERRAIN KING SEVERAL

A-748831 Spring (B)

TERRAIN KING SEVERAL

A-748832 Front Plate (C)

TERRAIN KING SEVERAL

A-748833 Facing (D)

TERRAIN KING SEVERAL

A-748826 Drive Plate (E)

TERRAIN KING SEVERAL

A-748834 Back Plate (F)

TERRAIN KING SEVERAL

A-80A79 Hub (G)

TERRAIN KING SEVERAL

ROTARY CUTTER PARTS

SLIP CLUTCH DISC



A-00754202 Slip Clutch Disc, 6" OD, 3.625" ID
TERRAIN KING SEVERAL

WHEEL HUB



A-80A1311 Wheel Hub w/ Bolts & Cups
TERRAIN KING SEVERAL

BEARING SET



A-8A993 Bearing Set (for Wheel Hub 80A1311)
TERRAIN KING SEVERAL

FRICTION DISC



A-970-2110 Friction Disc, 6" OD
For Flexible Couplers
TAYLORWAY SEVERAL

SLIP CLUTCH ASSEMBLY



A-80A75 Slip Clutch Assy. w/ 2 Springs
Used on 6' Cutters

VERMEER SEVERAL

A-80A78 Adjusting Nut (A)

VERMEER SEVERAL

A-4976-005-01 Spring (B)

VERMEER SEVERAL

A-1417-013-01 Front Plate (C)

VERMEER SEVERAL

A-4976-003-1 Facing (D)

VERMEER SEVERAL

A-80A81 Drive Plate (E)

VERMEER SEVERAL

A-4976-015-1 Back Plate (F)

VERMEER SEVERAL

A-80A79 Hub (G)

VERMEER SEVERAL

SLIP CLUTCH DISC



A-106416-017 Slip Clutch Disc
VERMEER SEVERAL

BLADE PIN KIT



A-32606WD Blade Pin Kit

WOODS-COPELAND SEVERAL

A-32602WD Blade Pin (C)

WOODS-COPELAND SEVERAL

A-7A6005 Clamp Kit (A, B)

WOODS-COPELAND SEVERAL

ROTARY CUTTER PARTS

SLIP CLUTCH DISC



A-7280WD Slip Clutch Disc
For Rotary Cutters

WOODS-COPELAND 0120, 0121, 120, 121, 208, 2090, 214, 60, 72, 84, B106, B214, B315, B320, D15, D210R, HD210, HD315, M121, M208, M4, M5, M60, M72, M84, MB106, MC72, MK105, R105, S105, S106, SM2090, SM214

FRICTION DISC



A-970-2110 Friction Disc
BUSH HOG SEVERAL

SLIP CLUTCH



A-7502531 Slip Clutch
FORD

A-7500438 Slip Clutch
FORD

A-7500438-H Slip Clutch Assy.
Has 2 Heavy Springs.
FORD

MISCELLANEOUS

A-567300 Friction Disk (6.024" O.D. X 3.583" I.D.)
For W2100, W2200, W1, W2300, W220, W230, W2400, W11, W240, W2500, W2600 German Type PTO

MISCELLANEOUS

A-159335 Mower Deck Height Stabilizer
Kit Contains 2 Chains With Brackets

MISCELLANEOUS

A-VTE7920 FRICTION DISC (6.024" OD X 3.583" ID)
4/PACK

MISCELLANEOUS

MOWER DECK HEIGHT STABILIZER

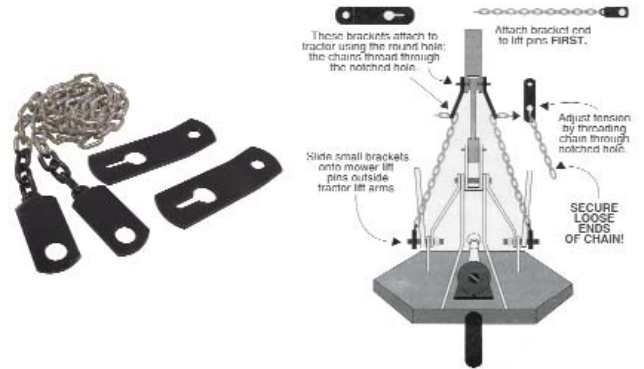

A-159335 Mower Deck Height Stabilizer
Kit Contains 2 Chains With Brackets
MISCELLANEOUS applications

BANANA BLADES

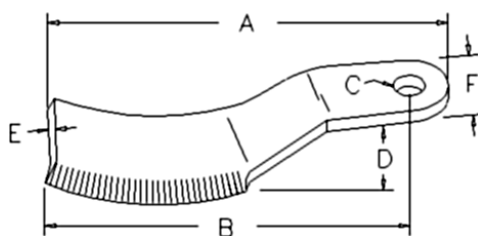

Agriquip

PART	OVERALL LENGTH	HOLE CTR-END	BOLT HOLE	OFFSET	THICKNESS
A-BB1850	17.500"	15.750"	1.500"	2.000"	.500"
For Models: AGRI FOUR					
A-BB1870	31.750"	30.000"	1.500"	2.000"	.500"
For Models: AGRI SIX					
A-BB1878	15.500"	13.750"	1.500"	1.500"	.500"
For Models: AGRI 42"					
A-BB1885	26.750"	25.000"	1.500"	2.000"	.500"
For Models: AGRI 6.6					
A-BB1887	27.750"	26.000"	1.500"	2.000"	.500"
For Models: AGRI SIX					
A-BB1891	23.750"	22.000"	1.500"	2.000"	.500"
For Models: AGRI FIVE					

ALAMO

PART	OVERALL LENGTH	HOLE CTR-END	BOLT HOLE	OFFSET	THICKNESS
A-BB1845	30.500"	28.750"	1.500"	2.000"	.500"
For Models: SEVERAL					
A-BB1854	19.750"	18.000"	1.500"	2.000"	.500"
For Models: SEVERAL					
A-BB1865	24.750"	23.000"	1.375"	3.000"	.500"
For Models: SEVERAL					
A-BB1867	25.500"	23.750"	1.500"	3.000"	.500"
For Models: AG72 BOOM MOWER					
A-BB1871	28.000"	26.250"	1.375"	3.000"	.500"
For Models: SEVERAL					
A-BB1872	24.750"	23.000"	1.375"	3.000"	.500"
For Models: SEVERAL					
A-BB1892	23.750"	22.000"	1.500"	2.000"	.500"
For Models: SEVERAL					
A-BB1893	21.750"	20.000"	1.375"	3.500"	.500"
For Models: SEVERAL					
A-BB1922	30.500"	28.750"	1.500"	2.000"	.500"
For Models: SEVERAL					

BIG BEE

PART	OVERALL LENGTH	HOLE CTR-END	BOLT HOLE	OFFSET	THICKNESS
A-BB1889	29.750"	28.000"	1.500"	2.000"	.500"
For Models: SEVERAL					
A-BB1895	24.250"	22.500"	1.500"	2.250"	.500"
For Models: SEVERAL					

BUSH HOG

PART	OVERALL LENGTH	HOLE CTR-END	BOLT HOLE	OFFSET	THICKNESS
A-BB1843	24.375"	22.625"	1.500"	1.500"	.500"
For Models: 1126, 1226, 126, (12610, 12615 ALL LH), 1315, 2315, 2415, 2510, (2610, 2615 ALL LH), 315, (3610, 3615 ALL LH)					
A-BB1845	30.500"	28.750"	1.500"	2.000"	.500"
For Models: 1207, 1257, 1307, 207, 257, 307, 800					
A-BB1850	17.500"	15.750"	1.500"	2.000"	.500"
For Models: 104, 204					
A-BB1854	19.750"	18.000"	1.500"	2.000"	.500"
For Models: 13168 RH & Center, 3368 LH					

BANANA BLADES

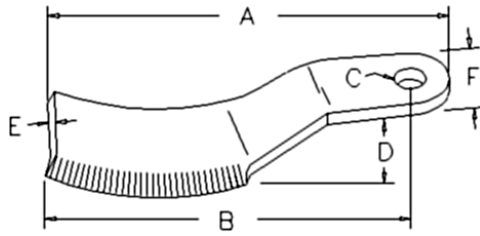

A-BB1863	24.500"	22.750"	1.500"	2.000"	.500"
For Models: 1050, (SM16, SM60 ALL LH)					
A-BB1864	24.500"	22.750"	1.500"	2.000"	.500"
For Models: (SM16, SM60 ALL RH)					
A-BB1874	18.750"	17.000"	1.500"	2.000"	.500"
For Models: 109, 1109, 1209, 160, 1600					
A-BB1875	18.750"	17.000"	1.500"	2.000"	.500"
For Models: 109, 1109, 1209, 160, 1600					
A-BB1881	20.250"	18.500"	1.500"	2.000"	.500"
For Models: 13168 LH, 3368 RH & Center					
A-BB1883	22.750"	21.000"	1.250"	2.000"	.375"
For Models: RAZORBACK RZ60					
A-BB1885	26.750"	25.000"	1.500"	2.000"	.500"
For Models: 1206, 1310C, 206, 306, 310C, 315C					
A-BB1887	27.750"	26.000"	1.500"	2.000"	.500"
For Models: 603					
A-BB1889	29.750"	28.000"	1.500"	2.000"	.500"
For Models: 307, 307R, SQ72					
A-BB1890	16.250"	14.500"	1.500"	2.000"	.500"
For Models: 1268, 268					
A-BB1891	23.750"	22.000"	1.500"	2.000"	.500"
For Models: 3126 RH & Center, 3126 OFFSET, 3126R, 3126S					
A-BB1892	23.750"	22.000"	1.500"	2.000"	.500"
For Models: 13126R, 13126S, 3126 LH, 3126R, 3126S					
A-BB1895	24.250"	22.500"	1.500"	2.250"	.500"
For Models: 105, 1126LS & O, 12, 1226LS, 126LS & O, 1310RS, 1315RS, 205, 266, 305, 310, 310RS, 315RS, 502, 6, 600					
A-BB1922	30.500"	28.750"	1.500"	2.000"	.500"
For Models: 220, 2620					
A-BB1923	16.250"	14.500"	1.500"	2.000"	.500"
For Models: 1268, 268, SQ84					

BMB

PART	OVERALL LENGTH	HOLE CTR-END	BOLT HOLE	OFFSET	THICKNESS
A-BB1834	26.500"	24.750"	1.250"	4.000"	.500"
For Models: FR7.3					
A-BB1846	20.000"	18.250"	1.250"	4.000"	.500"
For Models: SEVERAL					
A-BB1847	20.000"	18.250"	1.250"	4.000"	.500"
For Models: SEVERAL					
A-BB1848	20.000"	18.250"	1.250"	4.000"	.375"
For Models: SEVERAL					
A-BB1849	19.500"	17.750"	1.250"	2.000"	.500"
For Models: SEVERAL					
A-BB1853	19.500"	17.750"	1.500"	2.000"	.500"
For Models: BR5, SUPERFLEX 15, SUPERFLEX HD, XL100					
A-BB1885	26.750"	25.000"	1.500"	2.000"	.500"
For Models: BR6, SUPERFLEX HD					

Brown

PART	OVERALL LENGTH	HOLE CTR-END	BOLT HOLE	OFFSET	THICKNESS
A-BB1860	22.500"	20.750"	1.500"	2.000"	.500"
For Models: 560, 572, 584					
A-BB1838	29.250"	27.500"	1.625"	1.750"	.375"
For Models: SEVERAL					
A-BB1883	22.750"	21.000"	1.250"	2.000"	.375"
For Models: 60, 66, 72					

BANANA BLADES

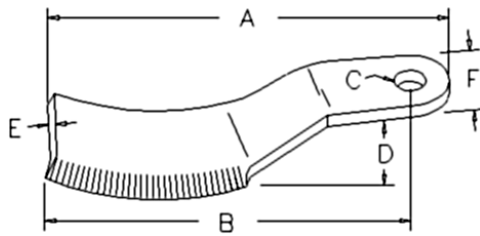

Corsicana

PART	OVERALL LENGTH	HOLE CTR-END	BOLT HOLE	OFFSET	THICKNESS
A-BB1860	22.500"	20.750"	1.500"	2.000"	.500"
For Models: F, G					

FORD

PART	OVERALL LENGTH	HOLE CTR-END	BOLT HOLE	OFFSET	THICKNESS
A-BB1882	22.750"	21.000"	1.500"	2.000"	.375"
For Models: 22-100, 22-111, 22-112, 22-113, 22-117, 22-118, 22-119, 22-127, 22-127A, 22-140, 22-141, 22-171, 22-172, 22-176, 22-177, 22-178, 22-179, 22-194, 22-195, 22-196, 22-197, 22-198, 22-199, 22-220, 22-221, 22-222, 22-223, 22-47, 22-60, 22-70, 22-99, 505, 901, 908, 909, 910					
A-BB1885	26.750"	25.000"	1.500"	2.000"	.500"
For Models: 6' MODEL					

FRED CAIN

PART	OVERALL LENGTH	HOLE CTR-END	BOLT HOLE	OFFSET	THICKNESS
A-BB1850	17.500"	15.750"	1.500"	2.000"	.500"
For Models: SEVERAL					
A-BB1860	22.500"	20.750"	1.500"	2.000"	.500"
For Models: SEVERAL					
A-BB1885	26.750"	25.000"	1.500"	2.000"	.500"
For Models: SEVERAL					
A-BB1863	24.500"	22.750"	1.500"	2.000"	.500"
For Models: SEVERAL					
A-BB1864	24.500"	22.750"	1.500"	2.000"	.500"
For Models: SEVERAL					
A-BB1874	18.750"	17.000"	1.500"	2.000"	.500"
For Models: 8' ROTARY CUTTER					
A-BB1875	18.750"	17.000"	1.500"	2.000"	.500"
For Models: 8' ROTARY CUTTER					
A-BB1889	29.750"	28.000"	1.500"	2.000"	.500"
For Models: SEVERAL					
A-BB1895	24.250"	22.500"	1.500"	2.250"	.500"
For Models: SEVERAL					

HICO

PART	OVERALL LENGTH	HOLE CTR-END	BOLT HOLE	OFFSET	THICKNESS
A-BB1844	24.375"	22.625"	1.500"	1.500"	.500"
For Models: 500S 5 Ft. Cutter					
A-BB1850	17.500"	15.750"	1.500"	2.000"	.500"
For Models: 400 4 Ft. Cutters					
A-BB1860	22.500"	20.750"	1.500"	2.000"	.500"
For Models: M SERIES 4.5					
A-BB1885	26.750"	25.000"	1.500"	2.000"	.500"
For Models: 6 FT. ROTARY MOWER					
A-BB1863	24.500"	22.750"	1.500"	2.000"	.500"
For Models: BOSS 10					
A-BB1864	24.500"	22.750"	1.500"	2.000"	.500"
For Models: BOSS 10					

HARDEE

PART	OVERALL LENGTH	HOLE CTR-END	BOLT HOLE	OFFSET	THICKNESS
A-BB1882	22.750"	21.000"	1.500"	2.000"	.375"
For Models: C160LT, C60LT					

BANANA BLADES

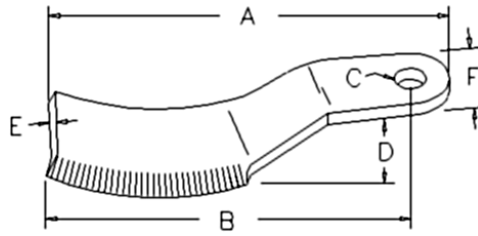

A-BB1860	22.500"	20.750"	1.500"	2.000"	.500"
For Models: T160, T160LT, T160LTO, T166, T166LT, T166LTO, T172, T172LT, T172LTO, T660, T8009LT, T8009PT, T8414, TH360					
A-BB1867	25.500"	23.750"	1.500"	3.000"	.500"
For Models: T666, T8215PTW					
A-BB1868	25.500"	23.750"	1.500"	3.000"	.500"
For Models: T666, T8215PTW					
A-BB1869	28.500"	26.750"	1.500"	2.000"	.500"
For Models: T672LT, T872LT, T872TP, T884LTW					
A-BB1873	22.500"	20.750"	1.500"	2.000"	.500"
For Models: T8009LT, T8009PT, T8414					
A-BB1874	18.750"	17.000"	1.500"	2.000"	.500"
For Models: T8398LT, T8398PT					
A-BB1875	18.750"	17.000"	1.500"	2.000"	.500"
For Models: H-CO, T52LT, T52PT, T8398LT, T8398PT					
A-BB1879	15.750"	14.000"	1.500"	1.500"	.375"
For Models: E36LT, E48LT					
A-BB1880	18.500"	16.750"	1.500"	2.000"	.375"
For Models: C148LT, E52PT					
A-BB1888	29.000"	27.250"	1.500"	2.000"	.500"
For Models: C172LT					

IMCO

PART	OVERALL LENGTH	HOLE CTR-END	BOLT HOLE	OFFSET	THICKNESS
A-BB1868	25.500"	23.750"	1.500"	3.000"	.500"
For Models: 5 & 6 FOOT ROTARY CUTTERS					
A-BB1889	29.750"	28.000"	1.500"	2.000"	.500"
For Models: 7' MODELS					

JOHN DEERE

PART	OVERALL LENGTH	HOLE CTR-END	BOLT HOLE	OFFSET	THICKNESS
A-BB1850	17.500"	15.750"	1.500"	2.000"	.500"
For Models: (1008, 1408, 1418 ALL 4 Ft. Cutters)					
A-BB1851	17.500"	15.750"	1.500"	2.000"	.500"
For Models: 1008, 1408, 1418					
A-BB1874	18.750"	17.000"	1.500"	2.000"	.500"
For Models: 1008, 1408, 1414, 1418					
A-BB1875	18.750"	17.000"	1.500"	2.000"	.500"
For Models: 1008, 1408, 1418, 403					
A-BB1876	18.750"	17.000"	1.500"	1.000"	.500"
For Models: 1008, 1408, 1418					
A-BB1877	18.750"	17.000"	1.500"	1.000"	.500"
For Models: 1008, 1408, 1418					
A-BB1889	29.750"	28.000"	1.500"	2.000"	.500"
For Models: 603					
A-BB1891	23.750"	22.000"	1.500"	2.000"	.500"
For Models: 503					
A-BB1896	21.750"	20.000"	1.500"	2.500"	.500"
For Models: 1008, 1508, 1517, 1518, 509, 516, 616, 717, 727, 737					
A-BB1897	21.750"	20.000"	1.500"	2.500"	.500"
For Models: 1008, 1018, 1508, 1517, 1518					

King Kutter

PART	OVERALL LENGTH	HOLE CTR-END	BOLT HOLE	OFFSET	THICKNESS
A-BB1835	23.750"	22.000"	1.500"	2.375"	.500"
For Models: L60-HD, P60-HD					

BANANA BLADES

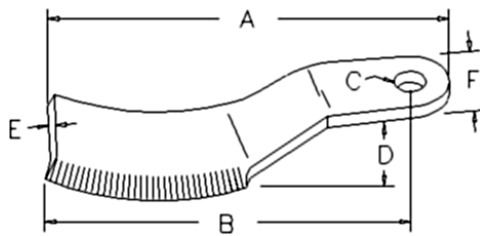

A-BB1836	29.500"	27.750"	1.500"	2.375"	.500"
For Models: L72 HD, L72 RD, L84 HD, P72 RD, P84 HD					
A-BB1889	29.750"	28.000"	1.500"	2.000"	.500"
For Models: SEVERAL					
A-BB1891	23.750"	22.000"	1.500"	2.000"	.500"
For Models: SEVERAL					

LAND PRIDE

PART	OVERALL LENGTH	HOLE CTR-END	BOLT HOLE	OFFSET	THICKNESS
A-BB1885	26.750"	25.000"	1.500"	2.000"	.500"
For Models: 35120, 45180					
A-BB1875	18.750"	17.000"	1.500"	2.000"	.500"
For Models: RC1548					
A-BB1886	26.750"	25.000"	1.500"	2.000"	.500"
For Models: 35120, 45180					
A-BB1889	29.750"	28.000"	1.500"	2.000"	.500"
For Models: 1572, 3584					
A-BB1891	23.750"	22.000"	1.500"	2.000"	.500"
For Models: 1560, 2560, 3560					

LONG

PART	OVERALL LENGTH	HOLE CTR-END	BOLT HOLE	OFFSET	THICKNESS
A-BB1878	15.500"	13.750"	1.500"	1.500"	.500"
For Models: SEVERAL					
A-BB1867	25.500"	23.750"	1.500"	3.000"	.500"
For Models: SEVERAL					
A-BB1881	20.250"	18.500"	1.500"	2.000"	.500"
For Models: SEVERAL					
A-BB1880	18.500"	16.750"	1.500"	2.000"	.375"
For Models: SEVERAL					
A-BB1882	22.750"	21.000"	1.500"	2.000"	.375"
For Models: SEVERAL					
A-BB1896	21.750"	20.000"	1.500"	2.500"	.500"
For Models: SEVERAL					
A-BB1895	24.250"	22.500"	1.500"	2.250"	.500"
For Models: SEVERAL					

M & W

PART	OVERALL LENGTH	HOLE CTR-END	BOLT HOLE	OFFSET	THICKNESS
A-BB1842	23.750"	22.000"	1.625"	1.000"	.500"
For Models: SEVERAL					

MOHAWK

PART	OVERALL LENGTH	HOLE CTR-END	BOLT HOLE	OFFSET	THICKNESS
A-BB1850	17.500"	15.750"	1.500"	2.000"	.500"
For Models: (1360, 840 ALL 4 Ft. Cutters)					
A-BB1863	24.500"	22.750"	1.500"	2.000"	.500"
For Models: 15' FLEXWING					
A-BB1867	25.500"	23.750"	1.500"	3.000"	.500"
For Models: 720					

BANANA BLADES

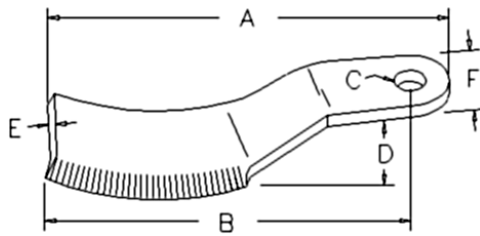

MODERN

PART	OVERALL LENGTH	HOLE CTR-END	BOLT HOLE	OFFSET	THICKNESS
A-BB1859	22.500"	20.750"	1.500"	3.000"	.375"
For Models: SEVERAL					
A-BB1887	27.750"	26.000"	1.500"	2.000"	.500"
For Models: 6' MODELS					

MONO

PART	OVERALL LENGTH	HOLE CTR-END	BOLT HOLE	OFFSET	THICKNESS
A-BB1866	25.500"	23.750"	1.500"	2.000"	.500"
For Models: 5 FT. ROTARY MOWERS					

MISCELLANEOUS

PART	OVERALL LENGTH	HOLE CTR-END	BOLT HOLE	OFFSET	THICKNESS
A-BB1830	19.00"	17.25"	.875"	.375"	.375"
For Models: SEVERAL Rotary Cutters / Check Dimensions					
A-BB1839	24.500"	22.750"	1.500"	1.000"	.500"
For Models: SEVERAL Rotary Cutters / Check Dimensions					
A-BB1840	24.500"	22.750"	1.500"	1.000"	.500"
For Models: SEVERAL Rotary Cutters / Check Dimensions					
A-BB1841	23.750"	22.000"	1.625"	1.000"	.500"
For Models: SEVERAL Rotary Cutters / Check Dimensions					
A-BB1857	20.000"	18.250"	1.500"	3.000"	.500"
For Models: SEVERAL Rotary Cutters / Check Dimensions					
A-BB1858	20.000"	18.750"	1.500"	3.000"	.500"
For Models: SEVERAL Rotary Cutters / Check Dimensions					
A-BB1894	21.750"	20.000"	1.375"	3.500"	.500"
For Models: SEVERAL Rotary Cutters / Check Dimensions					
A-BB1925	15.750"	14.000"	1.625"	.375"	
For Models: SEVERAL Rotary Cutters / Check Dimensions					

RHINO

PART	OVERALL LENGTH	HOLE CTR-END	BOLT HOLE	OFFSET	THICKNESS
A-BB1831	24.375"	22.625"	1.000"	1.750"	.375"
For Models: SE6					
A-BB1832	16.000"	14.250"	1.000"	.375"	
For Models: SEVERAL					
A-BB1845	30.500"	28.750"	1.500"	2.000"	.500"
For Models: SR20					
A-BB1855	20.000"	18.250"	1.000"	2.000"	.500"
For Models: SATURN 8					
A-BB1856	20.000"	18.250"	1.000"	2.000"	.500"
For Models: SATURN 8					
A-BB1865	24.750"	23.000"	1.375"	3.000"	.500"
For Models: 1008 FLEX 15, FLEX 15 RH					
A-BB1871	28.000"	26.250"	1.375"	3.000"	.500"
For Models: CYCLONE 72, FLEX 15 Center					
A-BB1872	24.750"	23.000"	1.375"	3.000"	.500"
For Models: 1008 FLEX 15, CYCLONE 60, FLEX 15 LH					
A-BB1922	30.500"	28.750"	1.500"	2.000"	.500"
For Models: SR20					
A-BB1924	24.250"	22.500"	1.000"	3.000"	.375"
For Models: SATURN 5', SATURN 6'					

BANANA BLADES

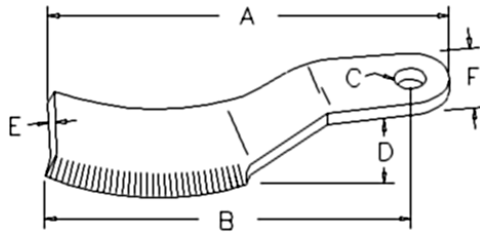

Rollins

PART	OVERALL LENGTH	HOLE CTR-END	BOLT HOLE	OFFSET	THICKNESS
A-BB1863	24.500"	22.750"	1.500"	2.000"	.500"
For Models: ECONO 6'					
A-BB1891	23.750"	22.000"	1.500"	2.000"	.500"
For Models: ECONO 5'					

SIDEWINDER

PART	OVERALL LENGTH	HOLE CTR-END	BOLT HOLE	OFFSET	THICKNESS
A-BB1853	19.500"	17.750"	1.500"	2.000"	.500"
For Models: GB144, GB48, RS160, RS213, SW66					
A-BB1860	22.500"	20.750"	1.500"	2.000"	.500"
For Models: 605, 660, GB60, GB602, SW72					
A-BB1864	24.500"	22.750"	1.500"	2.000"	.500"
For Models: FW215 CW, FW215 Flex Wing (RH)					
A-BB1866	25.500"	23.750"	1.500"	2.000"	.500"
For Models: FW215, FW215 Flex Wing (LH)					
A-BB1869	28.500"	26.750"	1.500"	2.000"	.500"
For Models: 6X6, GB722, GB842, SW642					
A-BB1880	18.500"	16.750"	1.500"	2.000"	.375"
For Models: GB-50, SX-50					
A-BB1882	22.750"	21.000"	1.500"	2.000"	.375"
For Models: 5X5, K-60, SX-60					

Taylor (Midland)

PART	OVERALL LENGTH	HOLE CTR-END	BOLT HOLE	OFFSET	THICKNESS
A-BB1850	17.500"	15.750"	1.500"	2.000"	.500"
For Models: SEVERAL					
A-BB1885	26.750"	25.000"	1.500"	2.000"	.500"
For Models: 240 - 66"					
A-BB1889	29.750"	28.000"	1.500"	2.000"	.500"
For Models: 240 - 72"					
A-BB1891	23.750"	22.000"	1.500"	2.000"	.500"
For Models: 240 - 60"					

TIGER

PART	OVERALL LENGTH	HOLE CTR-END	BOLT HOLE	OFFSET	THICKNESS
A-BB1854	19.750"	18.000"	1.500"	2.000"	.500"
For Models: ROTARY HIGHWAY MOWERS					
A-BB1890	16.250"	14.500"	1.500"	2.000"	.500"
For Models: BOOM MOWER					

TERRAIN KING

PART	OVERALL LENGTH	HOLE CTR-END	BOLT HOLE	OFFSET	THICKNESS
A-BB1843	24.375"	22.625"	1.500"	1.500"	.500"
For Models: HYDRO 15, TK15, X5					
A-BB1854	19.750"	18.000"	1.500"	2.000"	.500"
For Models: 60" VERSA MOWER, 72" VERSA MOWER					
A-BB1895	24.250"	22.500"	1.500"	2.250"	.500"
For Models: (HYDRO 15, TK15, X5 ALL LH)					

BANANA BLADES

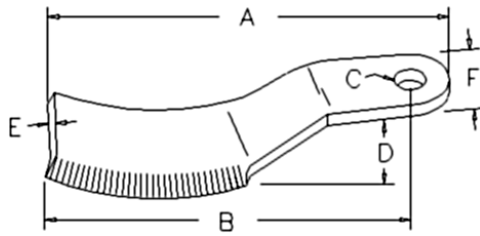

WOODS-COPELAND

PART	OVERALL LENGTH	HOLE CTR-END	BOLT HOLE	OFFSET	THICKNESS
A-BB1852	18.625"	16.750"	.875"	1.000"	.375"
For Models: 80, B080, B80, B80U, C080, C80, C80U, D08, D80, K4, M80, MB80					
A-BB1859	22.500"	20.750"	1.500"	3.000"	.375"
For Models: 60-2, 60-3, 60-4, E60, M5-3, M5-4					
A-BB1861	24.000"	22.250"	1.500"	2.000"	.375"
For Models: D210R-2, D210-R3, D315-2, D315-3, MR105, R105, S105-1, S105-2, SM2090					
A-BB1862	24.000"	22.250"	1.500"	2.000"	.375"
For Models: 121					
A-BB1863	24.500"	22.750"	1.500"	2.000"	.500"
For Models: D210-3, D210R-2, D315-2, D315-3, DM2090, HD315-5, S105-3					
A-BB1864	24.500"	22.750"	1.500"	2.000"	.500"
For Models: 3180, HD315-5					
A-BB1881	20.250"	18.500"	1.500"	2.000"	.500"
For Models: 208, B315					
A-BB1889	29.750"	28.000"	1.500"	2.000"	.500"
For Models: 211, 213, 213Q, 214Q, 214R, 315, 320, 84-1, B106, M84, MB106, MR107, R107, SM214, SM215					
A-BB1895	24.250"	22.500"	1.500"	2.250"	.500"
For Models: 3180 LH					
A-BB1920	29.750"	28.000"	1.500"	2.000"	.375"
For Models: 211, 213, 213Q, 214Q, 214R, 215, 315, 320, HS106-1, HS106-2, HS106-3, S106-3, SM214					
A-BB1921	29.750"	28.000"	1.500"	1.250"	.500"
For Models: 72-1, 72-3, 84-2					
A-BB1926	14.250"	12.500"	.875"	.250"	.375"
For Models: SEVERAL					
A-BB1927	18.625"	16.750"	.875"	1.000"	.375"
For Models: 80, B80, B80U, C080, C80, C80U, D080, D80, MB80					

LAWN MOWER BLADES

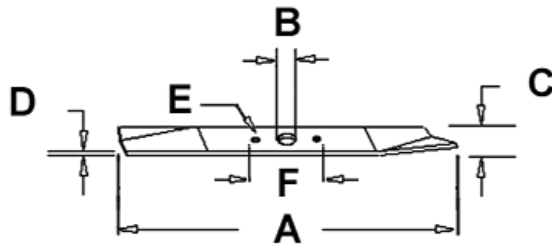

ALLIS-CHALMERS

PART	OVERALL LENGTH	HOLE DIAMETER	WIDTH	THICKNESS	OUTER HOLE DIA.	HOLE CTR-CTR
A-71656144	14.562" / 370mm	2.50" / 63.5mm	.170" / 4mm	1.375" / 35mm		
For Models: (608, 610, 710, 7106SP, 712H, 712S, 716H ALL W/ 42" LH CUT)						
A-71656143	16.687" / 424mm	2.50" / 63.5mm	.170" / 4mm	1.375" / 35mm		
For Models: (710, 712H, 712S, 7166SP, 716H, 718 ALL LH W/ 48" CUT)						

BIG BEE

PART	OVERALL LENGTH	HOLE DIAMETER	WIDTH	THICKNESS	OUTER HOLE DIA.	HOLE CTR-CTR
A-19B19	19"	0.531"	Formed	2.50"	0.250"	
For Models: SEVERAL 4 FT. FINISHING MOWERS						
A-19B20	20"	0.531"	Formed	2.50"	0.250"	
For Models: SEVERAL 5 Ft. Finishing Mower						
A-19B25	25"	0.531"	Formed	2.50"	0.250"	
For Models: SEVERAL 6 Ft. Finishing Mower						

BUSH HOG

PART	OVERALL LENGTH	HOLE DIAMETER	WIDTH	THICKNESS	OUTER HOLE DIA.	HOLE CTR-CTR
A-82324BH	21.000"	.500"	2.250"	.234"	N/A	N/A
For Models: 60 (Turf Hog)						

CAIN

PART	OVERALL LENGTH	HOLE DIAMETER	WIDTH	THICKNESS	OUTER HOLE DIA.	HOLE CTR-CTR
A-19FC22	16.687"	N/A	2.250"	N/A	N/A	N/A
For Models: SEVERAL						
A-19FC25	25.000"	N/A	2.250"	N/A	N/A	N/A

CASE-IH

PART	OVERALL LENGTH	HOLE DIAMETER	WIDTH	THICKNESS	OUTER HOLE DIA.	HOLE CTR-CTR
A-C24442	LH Cut	15 9/16"	1 1/4"	13/32"	2 5/8"	2 1/2"
For Models: SEVERAL						

GREAT PLAINS

PART	OVERALL LENGTH	HOLE DIAMETER	WIDTH	THICKNESS	OUTER HOLE DIA.	HOLE CTR-CTR
A-19LP457	20.937"	1.000"	2.500"	.203"	N/A	N/A
For Models: SEVERAL						
A-19LP456	24.906"	1.000"	2.500"	.250"	N/A	N/A
For Models: SEVERAL						

King Kutter

PART	OVERALL LENGTH	HOLE DIAMETER	WIDTH	THICKNESS	OUTER HOLE DIA.	HOLE CTR-CTR
A-190124KK	24.750"	1.500"	3.000"	.500"	22.250"	2.000"
For Models: SEVERAL Check Dimensions						
A-190224KK	24.750"	1.500"	3.000"	.500"	22.250"	2.000"
For Models: SEVERAL Check Dimensions						
A-190230KK	27.750"	1.500"	3.500"	.500"	25.250"	2.000"
For Models: SEVERAL Check Dimensions						

LAWN MOWER BLADES

KUBOTA

PART	OVERALL LENGTH	HOLE DIAMETER	WIDTH	THICKNESS	OUTER HOLE DIA.	HOLE CTR-CTR
A-7650099010	16.687"	.718"	2.000"	.187"	.343"	1.500"
For Models: RC48-62A, RC48-62F, RC48-62H						
A-7071299010	15.343"	.718"	2.000"	.187"	.343"	1.500"
For Models: RC44G						
A-7071234330	15.343"	.718"	2.000"	.187"	.343"	1.500"
For Models: RC44G						
A-7008000777	20.187"	.625"	2.000"	.187"	N/A	N/A
For Models: L3559, L3560, L590						
A-7072234330	20.437"	.718"	2.000"	.203"	N/A	N/A
For Models: MR6000, RC60-1, RC60-27, RC60-71H, RC60-72, RC60-72H, RC60-82H						
A-7650034330	16.687"	.718"	2.000"	.187"	.343"	N/A
For Models: RC48-62A, RC48-62F, RC48-62H						
A-7072134330	16.687"	.718"	2.000"	.187"	.343"	1.500"
For Models: MR4800						
A-7008000234	12.000"	.750"	2.500"	.187"	N/A	N/A
For Models: B44, K44						

MASSEY FERGUSON

PART	OVERALL LENGTH	HOLE DIAMETER	WIDTH	THICKNESS	OUTER HOLE DIA.	HOLE CTR-CTR
A-517915M1	17.437"	.625"	2"	.155"	.187"	2.134"
For Models: SEVERAL Lawn & Garden Tractors w/ 34" Cut						
A-1041224M1	17.063"	.855"	2"	.170"	.398"	2.563"
For Models: SEVERAL Lawn & Garden Tractors w/ 42" Cut High Lift						
A-517308M1	14.937"	.75" x 1"	2"	.155"	.262"	2.140"
For Models: SEVERAL Lawn & Garden Tractors w/ 42" Cut & Double D Center Hole						
A-3020019M1	14.50"	.524"	2"	.187"	.262"	2.140"
For Models: SEVERAL Lawn & Garden Tractors w/ 42" Cut						

MURRAY

PART	OVERALL LENGTH	HOLE DIAMETER	WIDTH	THICKNESS	OUTER HOLE DIA.	HOLE CTR-CTR
A-19MU107	19.437"	.850"	2.25"	.140"	91745HT, 91742E701	
For Models: SEVERAL 36" & 38" Cut (for bagger)						

SITREX

PART	OVERALL LENGTH	HOLE DIAMETER	WIDTH	THICKNESS	OUTER HOLE DIA.	HOLE CTR-CTR
A-48007700	16.875"	.750"	2.000"	.250"	N/A	N/A
For Models: SM120						
A-SM512150	20.250"	.750"	N/A	N/A	N/A	N/A
For Models: SM150						
A-SM612180	24.125"	.750"	N/A	N/A	N/A	N/A
For Models: SM180						

SIMPLICITY

PART	OVERALL LENGTH	HOLE DIAMETER	WIDTH	THICKNESS	OUTER HOLE DIA.	HOLE CTR-CTR
A-19SIM3	14.562"	1.375"	2.50"	.170"	.390"	3.0625"
For Models: SEVERAL w/ 42" LH Cut						
A-19SIM4	16.687"	1.375"	2.50"	.170"	.39"	3.0625"
For Models: (7000, 7100 ALL S/N <1987 w/ 48" LH Cut)						

SNAPPER

PART	OVERALL LENGTH	HOLE DIAMETER	WIDTH	THICKNESS	OUTER HOLE DIA.	HOLE CTR-CTR
A-19879	14.50"	.524"	2.00"	.187"	.262"	2.140"
For Models: SEVERAL w/ 42" Cut						
A-19645	20.687"	.375"	2.750"	.170"	.375"	2.750"
For Models: SEVERAL W/ 21" Steel Deck						

LAWN MOWER BLADES

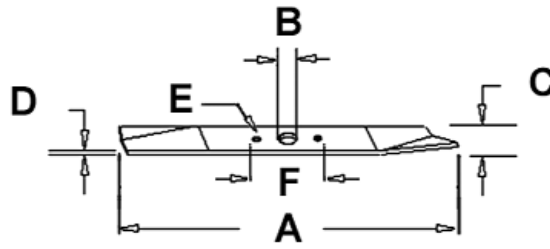

A-19795	20.8125"	.385"	2.750"	.164"	.385"	2.750" (center to center)
For Models: SEVERAL w/ 41" STD. & BBC Walk-Behind Tractor						
A-18069	30.00"	1.0625"	2.750"	.187"	.562"	7.50"
For Models: SEVERAL 30" Riders						
A-19523	33.00"	1.0625"	2.750"	.187"	.545"	7.50"
For Models: SEVERAL 33" Riders						

SEARS

PART	OVERALL LENGTH	HOLE DIAMETER	WIDTH	THICKNESS	OUTER HOLE DIA.	HOLE CTR-CTR
A-19SE14	15.34	.375"	2.250"	.187"	Straight	25034R, 25034
For Models: SEVERAL 44" Cut						
A-19SE15	19.375"	.375"	2.250"	.187"	Straight	25036R, 25036
For Models: SEVERAL 38" Cut w/o bagger						

WOODS-COPELAND

PART	OVERALL LENGTH	HOLE DIAMETER	WIDTH	THICKNESS	OUTER HOLE DIA.	HOLE CTR-CTR
A-5081WD	16.750"	.625"	1.750"	.203"	N/A	N/A
For Models: SEVERAL						
A-6950WD	20.187"	.625"	2.000"	.187"	N/A	N/A
For Models: SEVERAL						
A-23825WD	20.187"	.625"	2.000"	.187"	N/A	N/A
For Models: SEVERAL						
A-13404WD	24.437"	1.000"	2.500"	.203"	N/A	N/A
For Models: SEVERAL						

TEETH: BALER, COMBINE REEL, HARROW, RAKE, TEDDER, ETC.

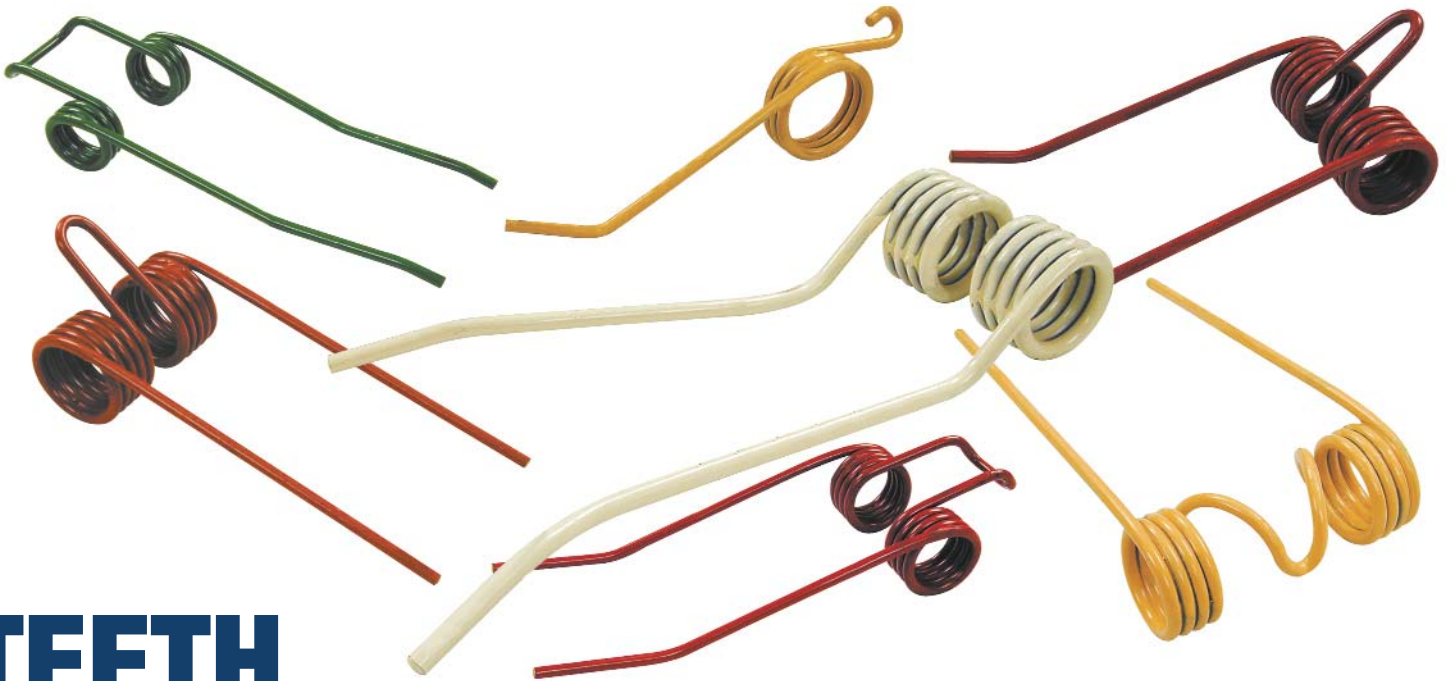

TEETH

BALER, COMBINE REEL, HARROW, RAKE, TEDDER, ETC.

ALLIS CHALMERS

A-70511506 Rake tooth



(A) 7.750" (B) 1.875" (C) 4.000"

ALLIS-CHALMERS:

ATLAS

A-203055 Rake tooth

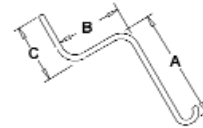

DIM A (1) 15" DIM B (2) 11.5" DIM C (3) 6.5"

ATLAS: SEVERAL

CASE-IH

A-531727 Rake tooth

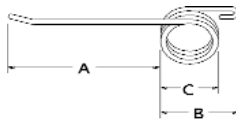

DIM A (1) 7" DIM B (2) 3.750" DIM C (3) 2.250"

ALLIS-CHALMERS: SEVERAL

A-96HE2 Rake tooth

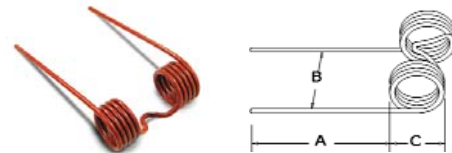

DIM A (1) A- 6.000" DIM B (2) B- 3.500" DIM C (3) C- 1.875"

CASE-IH: SEVERAL Mfg By Hesston Same

A-539754 Rake tooth

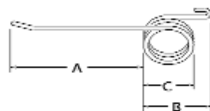

DIM A (1) 7" DIM B (2) 3.375" DIM C (3) 2.250"

ALLIS-CHALMERS: SEVERAL

A-ZA103012 Baler Tooth



DIM A (1) 5.750" DIM B (2) 2.625" DIM C (3) 1.5"

CASE-IH: 3650

TEETH: BALER, COMBINE REEL, HARROW, RAKE, TEDDER, ETC.

A-626742R1 Baler Tooth

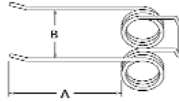

DIM A (1) 4.125" DIM B (2) 4.375"

CASE-IH: (BALER: 2400)

A-10670P Rake Tooth

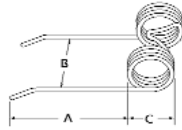

DIM A (1) 6.10" DIM B (2) 4.20" DIM C (3) 1.59"

CASE-IH: SEVERAL

A-MA74528 Baler tooth

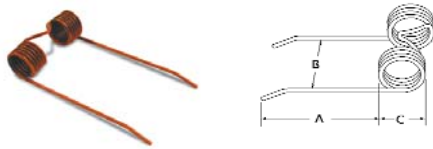

DIM A (1) 6.125" DIM B (2) 4" DIM C (3) 1.625"

CASE-IH: 27, 37, 45, 46, 47, 55, 56, 57, 60, 70, 71, 420, 430, 440, (FORAGE HARVESTER: 15, 16, 55, 350, 550, 650)

A-210614C1 Baler tooth

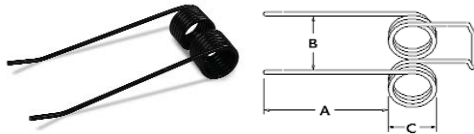

DIM A (1) 6.25" DIM B (2) 2.75" DIM C (3) 1.375"

CASE-IH: 428, 435, 445, 5420

A-T17350 Rake tooth



DIM A (1) 7.125" DIM B (2) 3.75" DIM C (3) 2.187"

CASE-IH: 281 1960->

A-R-740S Rake tooth



DIM A (1) 7.75" DIM B (2) 3.437" DIM C (3) 1.5"

CASE-IH: 169, 170, F170

A-R740S Rake tooth



DIM A (1) 7.50" DIM B (2) 4.125" DIM C (3) 2.50"

CASE-IH: (170, F170 ALL 1939 & Up)

A-455165R1 Rake tooth



DIM A (1) 7.75" DIM B (2) 3.625" DIM C (3) 1.812"

CASE-IH: 5 1952>

A-462978R1 Rake tooth

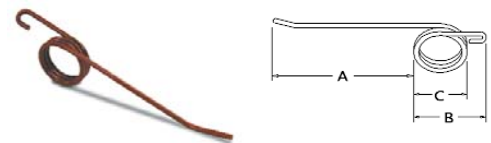

DIM A (1) 6.750" DIM B (2) 2.25" DIM C (3) 1.75"

Replaces: 457374R1

CASE-IH: (11, 15 ALL 1956>), 14, 16, 3, 30, 35, 4, 5, 8, 86, 9, 96, 97

A-R15080 Rake tooth



DIM A (1) 8.5" DIM B (2) 3.5"

CASE-IH: SEVERAL

A-540565R1 Rake/Tedder tooth



DIM A (1) 7.125" DIM B (2) 3.750" DIM C (3) 1.875"

CASE-IH: 1190, 1490, 1590, 990

A-R1044S Rake tooth



DIM A (1) 7.250" DIM B (2) 1.562" DIM C (3) 2.500"

CASE-IH: (RAKE: 200 1953>)

TEETH: BALER, COMBINE REEL, HARROW, RAKE, TEDDER, ETC.

CLAAS

A-9029160 Tedder Tooth

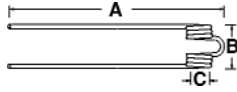

DIM A (1) 21.000" DIM B (2) 3.540" DIM C (3) 1.575"

CLAAS: ANDEX 280, ANDEX 310, WSDS310, WSDS370

A-9020830 Tedder Tooth

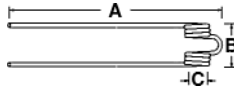

DIM A (1) 18.750" DIM B (2) 3.312" DIM C (3) 1.535"

CLAAS: WS280, WS310, WSDS280, WSDS310

A-9023442 Tedder Tooth (LH)

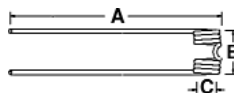

DIM A (1) 14.960" DIM B (2) 3.858" DIM C (3) 1.650"

CLAAS: VOLTO 450, VOLTO 540, VOLTO 640, VOLTO 740, W360, W400, W540, W600, W730, WA360, WA400, WA540, WA600, WA730

A-9024820 Tedder Tooth (RH)



DIM A (1) 15.280" DIM B (2) 15.870" DIM C (3) 3.780" DIM D (4) 1.575"

CLAAS: W360, W450, W540, WA360, WA450, WA540

A-9024830 Tedder Tooth (LH)



DIM A (1) 15.870" DIM B (2) 15.275" DIM C (3) 3.780" DIM D (4) 1.575"

CLAAS: W360, W450, W540, W600S, W730S, WA360, WA450, WA540

DAVID BRADLEY

A-DB1 Tooth



DIM A (1) 6.75" DIM B (2) 3.687" DIM C (3) 2.437"

DAVID BRADLEY:

DARF

A-L10503 Rake tooth



DIM A (1) 7.250" DIM B (2) 1.687"

DARF:

FAHR

A-6580456 Tedder Tooth



DIM A (1) 14.875" DIM B (2) 3.750" DIM C (3) 1.625"

FAHR: KH2.76DN, KH20, KH300DN, KH40, KH400DN, KH45DN, KH500DN, KH60, KH600DN, KH700DN, KH2.36DN, KH2.44DN, KH2.52DN

A-06580647 Tedder Tooth



DIM A (1) 15.156" DIM B (2) 16.140" DIM C (3) 3.625" DIM D (4) 1.614"

FAHR: APOLLO, KU250DN, KV3500

A-06580648 Tedder Tooth

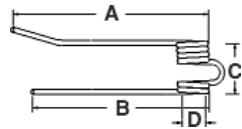

DIM A (1) 16.140" DIM B (2) 15.156" DIM C (3) 3.625" DIM D (4) 1.180"

FAHR: APOLLO, KU250DN, KV3500

A-16504333 Tedder Tooth

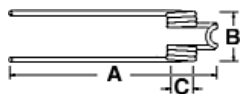

DIM A (1) 24.800" DIM B (2) 3.88" DIM C (3) 1.575"

FAHR: KS1.30, KS2.29, KS2.33, KS1.30DN, KS1.50DN, KS1.70DN

A-16504331 Tedder Tooth

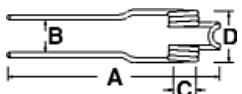

DIM A (1) 24.800" DIM B (2) 2.952" DIM C (3) 1.575" DIM D (4) 3.88"

FAHR: KS1.50, KS1.70, KS2.37, KS2.42, KS2.60, KS1.30DN, KS1.50DN, KS1.70DN

TEETH: BALER, COMBINE REEL, HARROW, RAKE, TEDDER, ETC.

A-1104000150010

Tedder Tooth

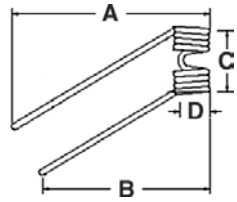

DIM A (1) 14.567" **DIM B (2)** 13.150" **DIM C (3)** 4.134" **DIM D (4)** 1.375"
FAHR: KH2N, KH4N, KH6N

A-1104000150110

Tedder Tooth

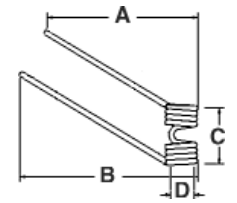

DIM A (1) 13.150" **DIM B (2)** 14.567" **DIM C (3)** 4.134" **DIM D (4)** 1.375"
FAHR: KH2N, KH4N, KH6N

A-06565574

Tedder Tooth

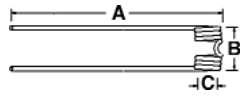

DIM A (1) 14.760" **DIM B (2)** 3.780" **DIM C (3)** 1.650"
FAHR: SEVERAL

A-1103663011300

Tedder Tooth

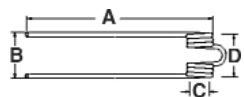

DIM A (1) 17.520" **DIM B (2)** 3.425" **DIM C (3)** 1.575" **DIM D (4)** 3.190"
FAHR: KS80DN

A-04303010700 Rake/Tedder tooth



DIM A (1) 12.750" **DIM B (2)** 2.250"
FAHR: (TEDDER: SEVERAL), (RAKE: SEVERAL)

A-11043030107 Tedder tooth

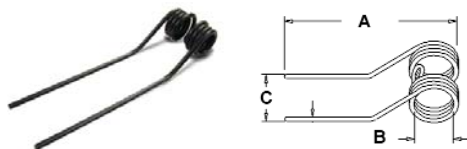

DIM A (1) 14.875" **DIM B (2)** 1.625" **DIM C (3)** 2.625"
FAHR: KH4S, KH20, KH40, KH60, KH300DN, KH400, KH500DN, KH600N

FARMHAND

A-L2117R

Rake tooth, RH



DIM A (1) 5" **DIM B (2)** 5"
FARMHAND: 76

A-96FH2L

Rake tooth, LH

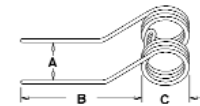

DIM A (1) 5.250" **DIM B (2)** 4.5" **DIM C (3)** 1.875"
FARMHAND: LR5, LR6, M5, M6, 3P black RH

FELLA

A-461110

Rake Tooth

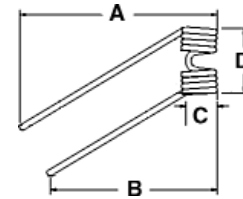

DIM A (1) 15.350" **DIM B (2)** 13.780" **DIM C (3)** 4.840" **DIM D (4)** 1.535"
FELLA: TH2, TH20, TH40

A-461111

Rake Tooth

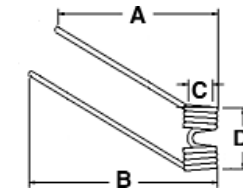

DIM A (1) 13.780" **DIM B (2)** 15.350" **DIM C (3)** 1.535" **DIM D (4)** 4.84"
FELLA: TH2, TH20, TH40

A-460181

Rake Tooth (RH)

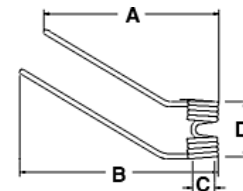

DIM A (1) 13.390" **DIM B (2)** 14.490" **DIM C (3)** 1.535" **DIM D (4)** 4.000"
FELLA: TH330, TH380, TH4, TH460, TH6

TEETH: BALER, COMBINE REEL, HARROW, RAKE, TEDDER, ETC.

A-460182 Rake Tooth (LH)

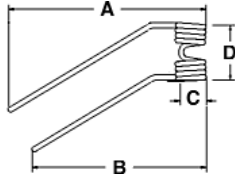

DIM A (1) 14.570" **DIM B (2)** 13.975" **DIM C (3)** 1.570" **DIM D (4)** 4.050"
FELLA: TH330, TH380, TH4, TH460, TH6

A-488072 Tedder Tooth

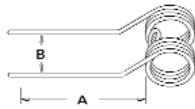

DIM A (1) 13.15" **DIM B (2)** 3.75"
FELLA: TH360, TH370, TH410, TH430, TH440

A-487922 Tedder Tooth

DIM A (1) 13.25" **DIM B (2)** 3.75"
FELLA: TH410, TH430, TH450H, TH520, TH540, TH680, TH700, TH800

A-491774 Tedder Tooth

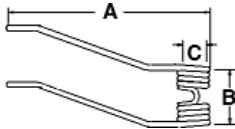

DIM A (1) 22.440" **DIM B (2)** 3.580" **DIM C (3)** 1.535"
FELLA: TS250, TS280, TS290, TS310, TS320, TS330, TS335, TS385, TS415, TS630, TS631, TS780

A-490046 Tedder Tooth

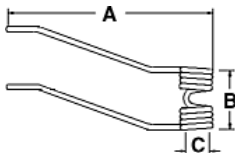

DIM A (1) 17.370" **DIM B (2)** 3.625" **DIM C (3)** 1.520"
FELLA: TS7, TS8, UH320

A-491000 Tedder Tooth

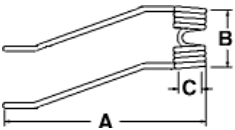

DIM A (1) 17.375" **DIM B (2)** 3.625" **DIM C (3)** 1.620"
FELLA: UH320

FARENDLOSE

A-66230000 Tedder Tooth

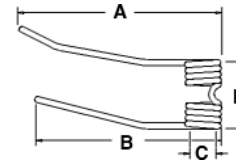

DIM A (1) 14.570" **DIM B (2)** 13.976" **DIM C (3)** 1.968" **DIM D (4)** 4.291"
FARENDLOSE: RW330C

A-66231000 Tedder Tooth

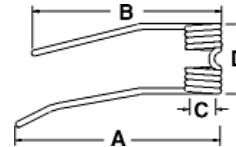

DIM A (1) 14.570" **DIM B (2)** 13.976" **DIM C (3)** 1.968" **DIM D (4)** 4.291"
FARENDLOSE: RW330C

FORD

A-149956 Baler Tooth



(A) 6.0" **(B)** 1.5" **(C)** 4.0"
FORD: 150, 250, 350, 504, 506, 509, 520, 530, 532, 540, 542

A-142856 Rake tooth

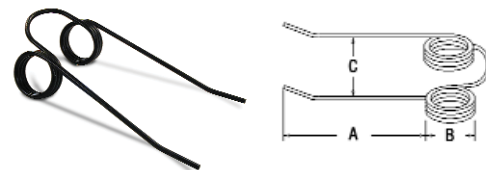

(A) 7.375" **(B)** 2.250" **(C)** 3.500"
FORD: 14-20 < S/N W2000 1948 & up

A-146545 Rake tooth

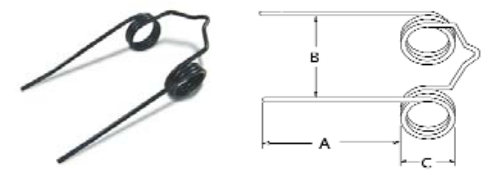

DIM A (1) 6.25" **DIM B (2)** 5" **DIM C (3)** 2.25"
FORD: 503

TEETH: BALER, COMBINE REEL, HARROW, RAKE, TEDDER, ETC.

A-107058 Rake tooth



DIM A (1) 6.75" DIM B (2) 3.687" DIM C (3) 2.437"
FORD: 508

A-143049 Rake tooth

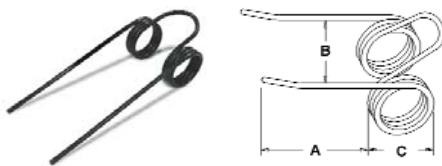

DIM A (1) 7.25" DIM B (2) 3.5" DIM C (3) 2.25"
FORD: 14-20 S/N Z1000 >, (14-40, 14-41 ALL 1949 & UP), SEVERAL

FREEMAN

A-F1226 Baler tooth



DIM A (1) 7" DIM B (2) 2.75" DIM C (3) 1.562"
FREEMAN: (BALER: SEVERAL)

FREUDENDAHL (JF)

A-14330200 Rake Tooth

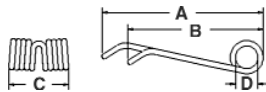

DIM A (1) 14.170" DIM B (2) 10.430" DIM C (3) 4.134" DIM D (4) 2.000"
Freudendahl (JF): (RAKE: SEVERAL)

A-14330201 Rake Tooth

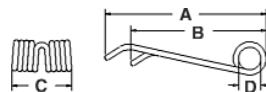

DIM A (1) 14.170" DIM B (2) 10.430" DIM C (3) 4.134" DIM D (4) 2.000"
Freudendahl (JF): (RAKE: SEVERAL)

GALFRE

A-GT107SV Tedder Tooth

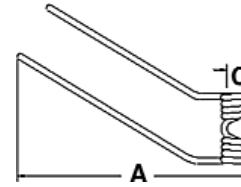

DIM A (1) 14.960" DIM B (2) 3.940" DIM C (3) 1.535"
GALFRE: (RAKE: SEVERAL)

A-GT108SV Tedder Tooth

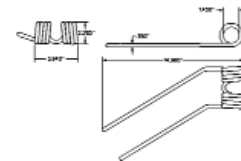

DIM A (1) 14.960" DIM B (2) 3.940" DIM C (3) 1.456"
GALFRE: (RAKE: SEVERAL)

A-10370000 Rake & Tedder tooth

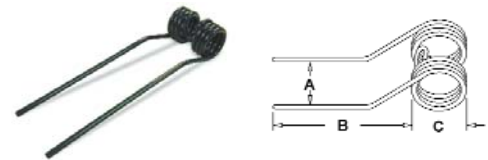

DIM A (1) 3.5" DIM B (2) 15.250" DIM C (3) 2.787"
GALFRE: (280, GT280, GTS280 ALL <-1995)

A-GS-3 LH Rake / Tedder tooth

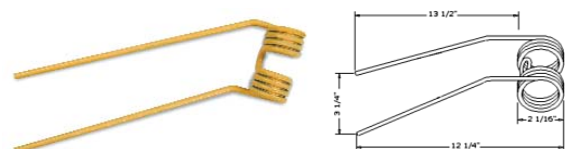

DIM A (1) 13.500" DIM B (2) 3.250"
GALFRE: 250 Blue Tooth

A-GS-2 RH Rake/Tedder tooth

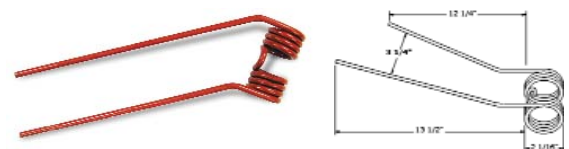

DIM A (1) 13.500" DIM B (2) 3.250"
GALFRE: 250 White Tooth

TEETH: BALER, COMBINE REEL, HARROW, RAKE, TEDDER, ETC.

GEHL

A-664491 Baler Tooth

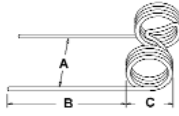

DIM A (1) 5.125" Tine Length DIM B (2) 3.500" Width
DIM C (3) 1.625" Coil Dia.

GEHL: (BALER: 1600)

A-96HE2 Rake tooth

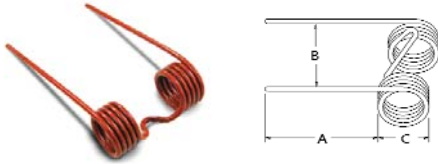

DIM A (1) A- 6.000" DIM B (2) B- 3.500" DIM C (3) C- 1.875"

GEHL: 2130, 2160

A-56350 Baler tooth

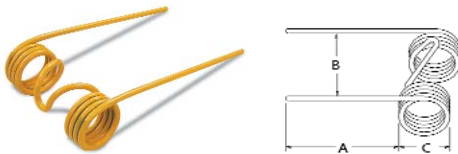

DIM A (1) 4.625" DIM B (2) 4" DIM C (3) 1.625"

GEHL: (BALER: SEVERAL)

A-71607 Baler tooth

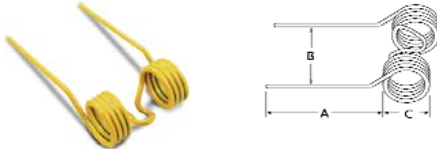

DIM A (1) 5.5" DIM B (2) 3.625" DIM C (3) 1.5"

GEHL: (BALER: SEVERAL)

A-611181 Rake tooth

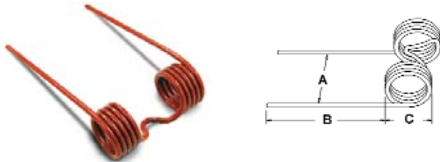

DIM A (1) 6" DIM B (2) 3.750" DIM C (3) 1.875"

GEHL: 2130, 2160

GRIMM

A-GT51 Tedder tooth



DIM A (1) 9.125" DIM B (2) 3.687"

GRIMM: (TEDDER: SEVERAL)

GUAPPO

A-608754 Rake tooth



DIM A (1) 12.750" DIM B (2) 7.5" DIM C (3) 5"

Guappo: SEVERAL

H & S

A-203055 Rake tooth

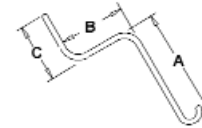

DIM A (1) 15" DIM B (2) 11.5" DIM C (3) 6.5"

H&S: SEVERAL tooth .262" diameter

HAY BUSTER

A-268SE Baler tooth

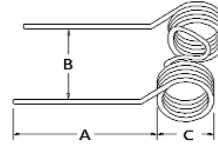

DIM A (1) 4.75" DIM B (2) 3.187" DIM C (3) 1.5"

HAY BUSTER: (BALER: SEVERAL)

HAWK BILT

A-186SE Rake tooth

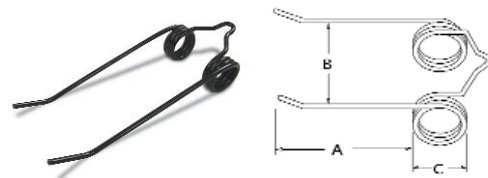

DIM A (1) 7.5" DIM B (2) 3.687" DIM C (3) 1.75"

HAWK BILT: (RAKE: SEVERAL)

HESSTON

A-01710102 Baler tooth

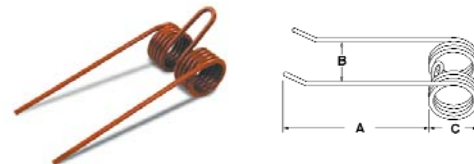

DIM A (1) 5.250" DIM B (2) 2.5" DIM C (3) 1.5"

HESSTON: 530, 540, 5510, 5530, 5540, 5545, 5585

TEETH: BALER, COMBINE REEL, HARROW, RAKE, TEDDER, ETC.

A-96HE2 Rake tooth

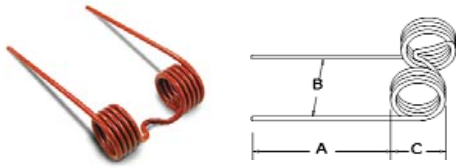

DIM A (1) A- 6.000" **DIM B (2)** B- 3.500" **DIM C (3)** C- 1.875"
HESSTON: (MOWER: PT7, PT10, PT12), (MOWER CONDITIONER: 1012, 1014, 1070, 1090), (WINDROWER: 420, 620, 1014, 6600)

A-7893746 Baler tooth

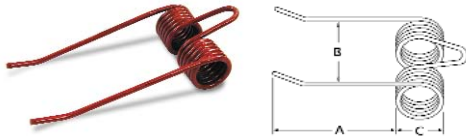

DIM A (1) 6.250" **DIM B (2)** 3.312" **DIM C (3)** 1.5"
HESSTON: 4800

A-1711951 Baler tooth

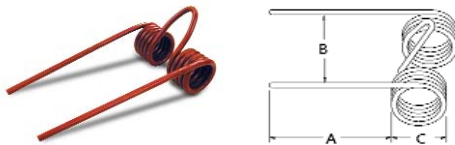

DIM A (1) 5.5" **DIM B (2)** 3.125" **DIM C (3)** 1.5"
HESSTON: 5510

A-7894306 Baler tooth

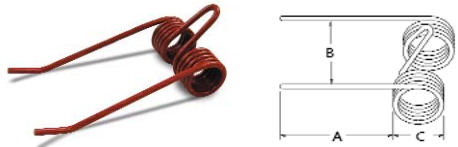

DIM A (1) 5.5" **DIM B (2)** 3.625" **DIM C (3)** 1.5"
HESSTON: 5500

A-7751621 Tedder tooth

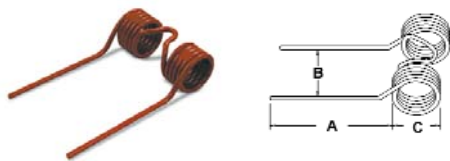

DIM A (1) 4.625" **DIM B (2)** 3.125" **DIM C (3)** 1.5"
HESSTON: 5600, 5800

A-PZ107 Tedder tooth



DIM A (1) 9" **DIM B (2)** 5.125" **DIM C (3)** 4" **DIM D (4)** 6.750"
DIM E (5) 2.5"
HESSTON: SEVERAL LH narrow

A-PZ224 Tedder tooth

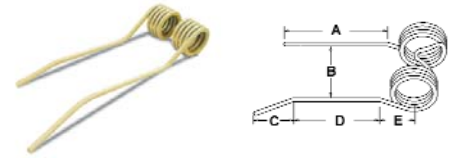

DIM A (1) 9.5" **DIM B (2)** 5" **DIM C (3)** 4" **DIM D (4)** 7" **DIM E (5)** 2.5"
HESSTON: SEVERAL RH narrow

A-PZ225 Tedder tooth

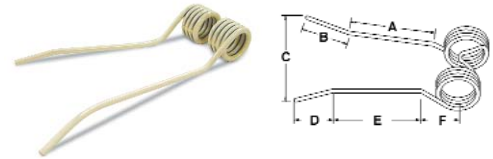

DIM A (1) 8" **DIM B (2)** 3" **DIM C (3)** 8" **DIM D (4)** 2.5" **DIM E (5)** 6.5"
DIM F (6) 2.5"
HESSTON: SEVERAL RH wide

A-PZ110 Tedder tooth

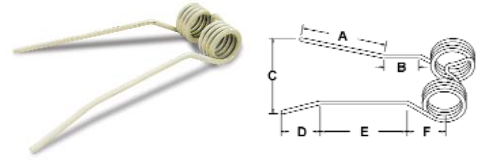

DIM A (1) 8.5" **DIM B (2)** .750" **DIM C (3)** 7.125" **DIM D (4)** 4.5"
DIM E (5) 6.5" **DIM F (6)** 2.5"
HESSTON: SEVERAL LH wide

HUME

A-481088 LH Reel tooth

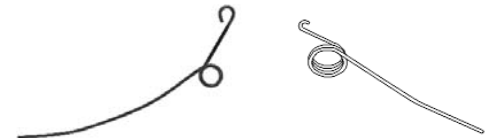

Replaces: (JD: H33333) (AC: 1171800), (IH: 167652C1), (WH: W2722907)
HUME: (REEL: SEVERAL)

A-48107 RH Reel tooth



DIM A (1) 3.00" **DIM B (2)** 1.50" **DIM C (3)** 11.50"
Replaces: (JD: H33333) (AC: 1129508), (IH: 167652C1), (WH: W2722937)
HUME: (REEL: SEVERAL)

TEETH: BALER, COMBINE REEL, HARROW, RAKE, TEDDER, ETC.

A-H1611 Reel tooth, large dia.



DIM A (1) .218"

HUME: (REEL: SEVERAL)

A-H31 Reel tooth, small dia.



DIM A (1) .187"

HUME: (REEL: SEVERAL)

H & S

A-HS1RT Rake Tooth (6.5 MM / .256" Wire)

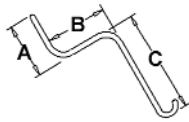

DIM A (1) 6.00" DIM B (2) 11.00" DIM C (3) 15.00"

H&S: SEVERAL

A-HS1ERT Rake Tooth (7MM / .276" Wire)

DIM A (1) 6.00" DIM B (2) 11.00" DIM C (3) 15.00"

H&S: SEVERAL

JOHN DEERE

A-241SE Rake Tooth

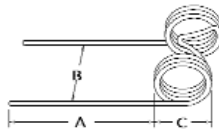

DIM A (1) 5.50" DIM B (2) 4.00" DIM C (3) 1.75"

JOHN DEERE: SEVERAL

A-P45961 Pickup Tooth

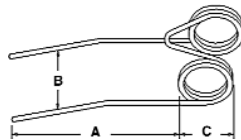

DIM A (1) 4.750" DIM B (2) 1.500" DIM C (3) .875"

JOHN DEERE: SEVERAL Used On Pickup Belt Attachment

A-E39915 Pickup Tooth

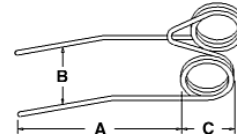

DIM A (1) 4.750" DIM B (2) 1.625" DIM C (3) .875"

JOHN DEERE: SEVERAL Used On Pickup Belt Attachment

A-278830 Tedder Tooth

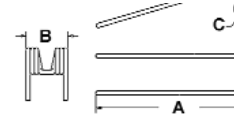

DIM A (1) 15.750" DIM B (2) 4.218" DIM C (3) 2.000"

NEW HOLLAND: SEVERAL

A-EF2888001 Rake Tooth (Single Tine)



JOHN DEERE: (RAKE: 700)

A-AE57831 Rake tooth

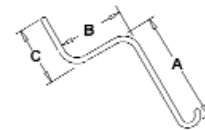

DIM A (1) 17.50" DIM B (2) 10.00" DIM C (3) 6.00"

JOHN DEERE: 702, 704

A-E41833 Baler tooth



DIM A (1) 6.5" DIM B (2) 2.25" DIM C (3) 1.625"

JOHN DEERE: 327, 336, 337, 346, 347, 467

A-E67036 Baler tooth



DIM A (1) 4.625" DIM B (2) 2.375" DIM C (3) 1.5"

JOHN DEERE: 410, 430, 500, 510, 530

TEETH: BALER, COMBINE REEL, HARROW, RAKE, TEDDER, ETC.

A-276SE Baler tooth

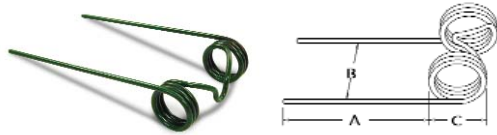

DIM A (1) 6.75" **DIM B (2)** 3.812" **DIM C (3)** 2.25"
JOHN DEERE: 14T, 24T, 214T

A-257SE Rake tooth

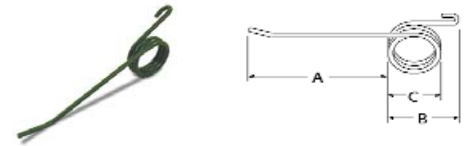

DIM A (1) 7" **DIM B (2)** 3.625" **DIM C (3)** 2.187"
JOHN DEERE: 350, 851, 858, 894, 896

A-268SE Baler tooth

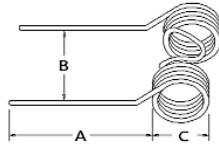

DIM A (1) 4.75" **DIM B (2)** 3.187" **DIM C (3)** 1.5"
JOHN DEERE: 8F w/ pick-up attachment

A-237SE Rake tooth

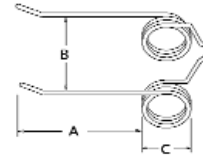

DIM A (1) 7.375" **DIM B (2)** 3.625" **DIM C (3)** 1.75"
JOHN DEERE: 14, 596, 597, 714

A-E74678 Baler tooth

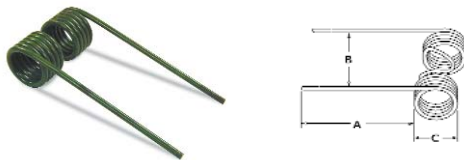

DIM A (1) 4.625" **DIM B (2)** 2.437" **DIM C (3)** 4.625"
JOHN DEERE: 330, 340, 530, (435, 535 ALL Early Models)

A-AE47389 Rubber mtd rake tooth



DIM A (1) 1-5/8" YOKE OPENING
JOHN DEERE: 700

A-E79475 Baler tooth



DIM A (1) 5.75" **DIM B (2)** 2.437" **DIM C (3)** 1.5"
JOHN DEERE: (335, 375 ALL SN 915001->), 435 SN 921151->, 535 SN 921940->

A-E68906 Windrower teeth



DIM A (1) 7" **DIM B (2)** 3.5" **DIM C (3)** 2"
JOHN DEERE: (WINDROWER-SWATHER: 1207, 1209, 1210, 1217, 1380, 230 new models)

A-AE47389 Rake Tooth (Single Tine)



DIM A (1) 1-5/8" YOKE OPENING
JOHN DEERE: (RAKE: 54, 64, 650, 660, 670, 672, 74, 652, 662)

A-E37596 Windrower teeth

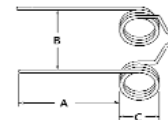

DIM A (1) 5.5" **DIM B (2)** 3.5" **DIM C (3)** 1.75"
JOHN DEERE: 1207, 1209, 1214, 385 old models, 480, 483

A-186SE Rake tooth

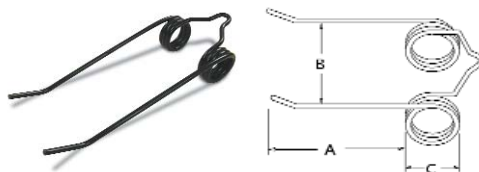

DIM A (1) 7.5" **DIM B (2)** 3.687" **DIM C (3)** 1.75"
JOHN DEERE: 553, 594

KRAUSE

A-76-156 Harrow Tooth

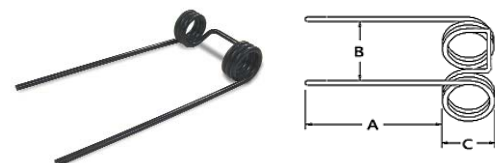

DIM A (1) A- 13 1/2" **DIM B (2)** B- 7" **DIM C (3)** C- 3"
KRAUSE: (HARROW: SEVERAL) Double tooth

TEETH: BALER, COMBINE REEL, HARROW, RAKE, TEDDER, ETC.

KRONE

A-600039 LH Reel tooth (yellow)

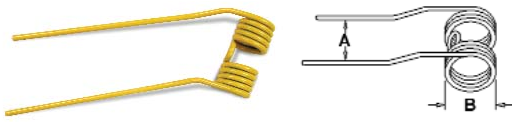

DIM A (1) 4.125" DIM B (2) 2.250"

KRONE: (REEL: SEVERAL)

A-600038 RH tedder tooth (red)



DIM A (1) 4.125" DIM B (2) 2.250"

KRONE: (REEL: SEVERAL)

A-9379190 Baler Tooth

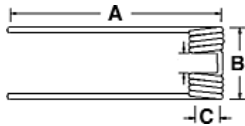

DIM A (1) 6.250" DIM B (2) 3.000" DIM C (3) 1.062"

KRONE: KR120, KR150, KR180

A-9380403 Baler Tooth

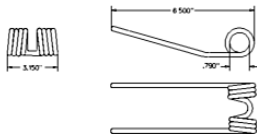

DIM A (1) 6.500" DIM B (2) 3.150" DIM C (3) .790"

KRONE: (ROUND BALER: KR120, KR150, KR155)

A-0280650 Rake Tooth

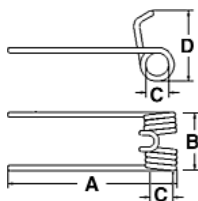

DIM A (1) 7.280" DIM B (2) 2.640" DIM C (3) 1.062" DIM D (4) 2.950"

KRONE: (RAKE: LM65)

KOEHN

A-203055 Rake tooth

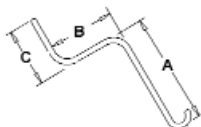

DIM A (1) 15" DIM B (2) 11.5" DIM C (3) 6.5"

KOEHN: SEVERAL tooth .262" diameter

KUHN



A-57601673 Rake tooth

DIM A (1) 12.5" DIM B (2) 3.625" DIM C (3) 2.750"

KUHN: GF22N, GF5000, GF6001

A-57502000 Tedder Tooth

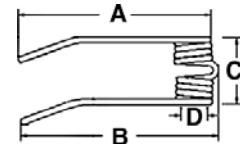

DIM A (1) 18.500" DIM B (2) 19.020" DIM C (3) 3.900" DIM D (4) 1.730"

KUHN: GA20, GA230, GA250, GA280, GA300

A-57601100 Tedder Tooth

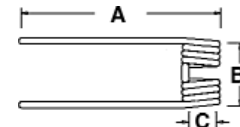

DIM A (1) 15.200" DIM B (2) 4.370" DIM C (3) 1.812"

KUHN: GF5000H, GRS20, GRS21

A-57644010 Tedder Tooth

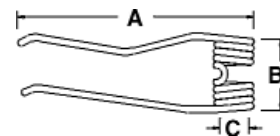

DIM A (1) 20.275" DIM B (2) 4.135" DIM C (3) 2.000"

KUHN: GRS25N SN 800001>

A-57701701 Tedder Tooth

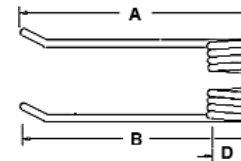

DIM A (1) 17.050" DIM B (2) 16.930" DIM C (3) 3.860" DIM D (4) 1.690"

KUHN: GA280, GA300, GA301, GA402

TEETH: BALER, COMBINE REEL, HARROW, RAKE, TEDDER, ETC.

A-57720200 Tedder Tooth

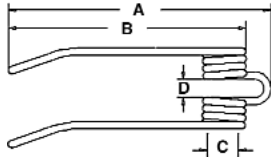

DIM A (1) 23.030" **DIM B (2)** 22.250" **DIM C (3)** 20.050" **DIM D (4)** .630"
KUHN: GA300, GA381, GA4101, GA682, GA7301, GA732, GA782, GM10

A-58505210 Hay tedder tooth

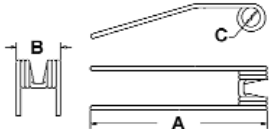

DIM A (1) 15.750" **DIM B (2)** 4.218" **DIM C (3)** 2"
KUHN: GF440, GF452

A-58561900 Tedder Tooth



DIM A (1) 12.750" **DIM B (2)** 3.625" **DIM C (3)** 2.750"
KUHN: GF440S, GF671, SRP, (23N, 440 ALL 1981->), GF22F, GF4000, GF440, GF5000

A-57609000 Tedder tooth

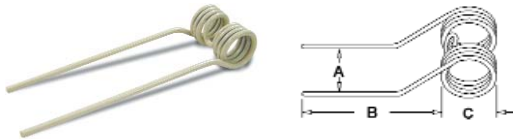

DIM A (1) 12.5" **DIM B (2)** 3.625" **DIM C (3)** 2.75"
KUHN: GF4201, GF5000, GF5001, GF6000, GF6001, GF6301, GF7001, GRS24

LELY

A-4100302080 Tedder Tooth (LH)

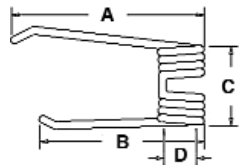

DIM A (1) 14.570" **DIM B (2)** 11.220" **DIM C (3)** 4.020" **DIM D (4)** 1.420"
LELY: GEMINI 300 Early Model

A-4101101390 Tedder Tooth (RH)

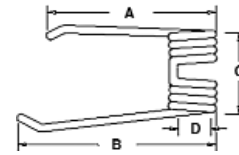

DIM A (1) 11.220" **DIM B (2)** 14.570" **DIM C (3)** 4.016"
LELY: GEMINI 300 Early Model

A-4101500580 Tedder Tooth

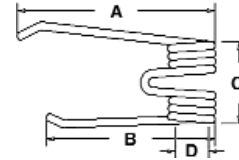

DIM A (1) 14.960" **DIM B (2)** 11.220" **DIM C (3)** 3.780" **DIM D (4)** 1.460"
LELY: LOTUS 230

A-4101500680 Tedder Tooth

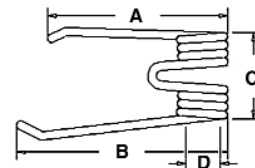

DIM A (1) 11.220" **DIM B (2)** 14.960" **DIM C (3)** 3.780" **DIM D (4)** 1.460"
LELY: LOTUS 230

A-4101601490 Tedder Tooth (RH)

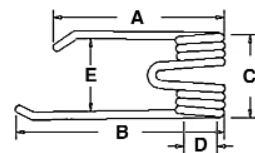

DIM A (1) 11.140" **DIM B (2)** 14.960" **DIM C (3)** 3.860"
DIM D (4) 1.460" **DIM E (5)** 4.450"
LELY: (LOTUS 300, LOTUS 600 ALL Early Model)

A-4101601590 Tedder Tooth (LH)

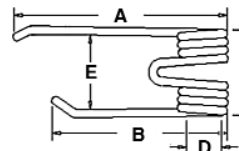

DIM A (1) 14.960" **DIM B (2)** 11.140" **DIM C (3)** 3.860"
DIM D (4) 1.460" **DIM E (5)** 4.450"
LELY: (LOTUS 300, LOTUS 600 ALL Early Model)

TEETH: BALER, COMBINE REEL, HARROW, RAKE, TEDDER, ETC.

A-4101701260 Tedder Tooth (LH)

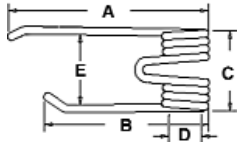

DIM A (1) 14.570" **DIM B (2)** 10.830" **DIM C (3)** 3.540"
DIM D (4) 1.460" **DIM E (5)** 3.940"

LELY: LOTUS 300, LOTUS 460, LOTUS 520, LOTUS 600 SNB, LOTUS STABILO 520, LOTUS STABILO 600, LOTUS STABILO 640, LOTUS STABILO 675, LOTUS STABILO 725, LOTUS STABILO 770

A-4101701380 Tedder Tooth (RH)

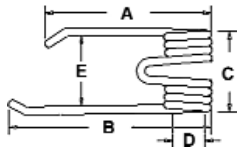

DIM A (1) 10.830" **DIM B (2)** 14.570" **DIM C (3)** 3.540"
DIM D (4) 1.460" **DIM E (5)** 3.940"

LELY: LOTUS 300, LOTUS 460, LOTUS 520, LOTUS 600 SNB, LOTUS STABILO 520, LOTUS STABILO 600, LOTUS STABILO 640, LOTUS STABILO 675, LOTUS STABILO 725, LOTUS STABILO 770

A-4108003910 Tedder Tooth (LH)

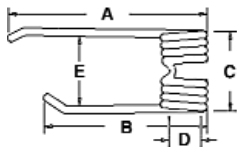

DIM A (1) 14.570" **DIM B (2)** 11.140" **DIM C (3)** 4.020"
DIM D (4) 1.378" **DIM E (5)** 3.900"

LELY: GEMINI 300, GEMINI 600

A-4108003920 Tedder Tooth (RH)

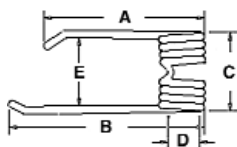

DIM A (1) 11.140" **DIM B (2)** 14.570" **DIM C (3)** 4.020"
DIM D (4) 1.378" **DIM E (5)** 3.900"

LELY: GEMINI 300, GEMINI 600

LONG

A-96L01 Peanut Combine Tooth

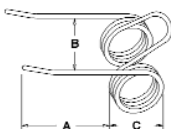

DIM A (1) 4" **DIM B (2)** 2.625" **DIM C (3)** 1.406"

LONG: curved cyl tooth .281" diameter

A-96L01A Peanut Combine Tooth

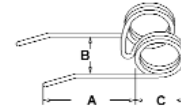

DIM A (1) 4.750" **DIM B (2)** 2.250" **DIM C (3)** 2.312"

LONG: stripper bar tooth .250" diameter

A-145351 Peanut Combine tooth

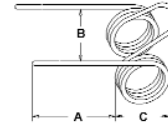

DIM A (1) 4" **DIM B (2)** 2.687" **DIM C (3)** 1.750"

LONG: straight 2nd cylinder .281" diameter

LILLISTON

A-96LL3 Peanut Combine tooth

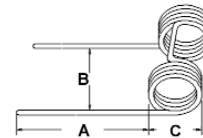

DIM A (1) 4.750" **DIM B (2)** 3.250" **DIM C (3)** 1.687"

LILLISTON: 1500

A-96LL2 Peanut Combine tooth

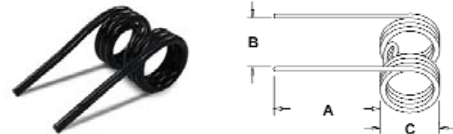

DIM A (1) 3.250" **DIM B (2)** 2.5" **DIM C (3)** 2.250"

LILLISTON:

MASSEY FERGUSON

A-TEO01236 Rake tooth

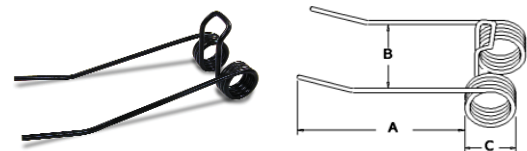

DIM A (1) A- 9.00" **DIM B (2)** B- 3.50" **DIM C (3)** C- 1.75"

MASSEY FERGUSON:

A-665930M1 Baler tooth

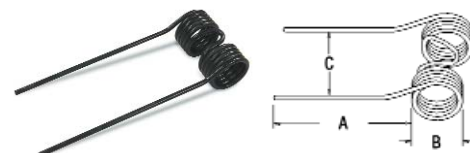

(A) 6.500" **(B)** 1.625" **(C)** 2.625"

MASSEY FERGUSON: 10, 12, 3, 9

TEETH: BALER, COMBINE REEL, HARROW, RAKE, TEDDER, ETC.

A-580848M1 Rake tooth - LH



MASSEY FERGUSON: 25 SN 419009907>, 36 SN 012159>, 37

A-1023216M1 Rake teeth

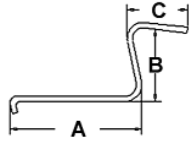

DIM A (1) 17.5" **DIM B (2)** 12.5" **DIM C (3)** 6"

MASSEY FERGUSON: 29 12 1/2" Offset

A-1053394M1 Baler tooth

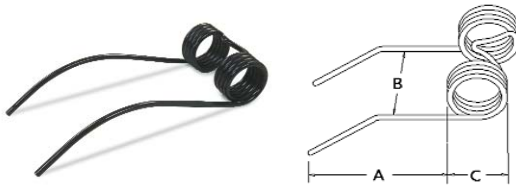

DIM A (1) 7" **DIM B (2)** 2.875" **DIM C (3)** 1.687"

MASSEY FERGUSON: 1560, 1655

A-665929M1 Baler tooth

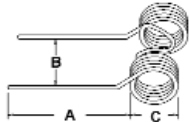

DIM A (1) 6.375" **DIM B (2)** 4" **DIM C (3)** 1.625"

MASSEY FERGUSON: (3, 9, 10, 12 ALL <-1958)

A-151075M2 Baler tooth



DIM A (1) 6" **DIM B (2)** 2.75" **DIM C (3)** 1.625"

MASSEY FERGUSON: SEVERAL <-1958

A-92611 Rake tooth

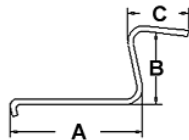

DIM A (1) 17.5" **DIM B (2)** 10" **DIM C (3)** 6"

MASSEY FERGUSON: 29, 39 5 bar

A-1031118M1 Rake tooth

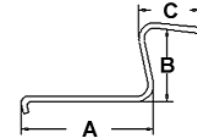

DIM A (1) 17.5" **DIM B (2)** 10" **DIM C (3)** 6"

MASSEY FERGUSON: 29 SN 1233000011> W/ 10" Offset, 39 SN 1411000001> W/ 10" Offset

A-667656M1 Rake tooth



DIM A (1) 7.375" **DIM B (2)** 2" **DIM C (3)** 1.875"

MASSEY FERGUSON: SEVERAL <-1958

A-668364M1 Rake tooth



DIM A (1) 7.25" **DIM B (2)** 1.937" **DIM C (3)** 3.875"

MASSEY FERGUSON: 25, 36, 37

A-585136M1 Baler tooth

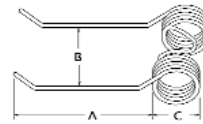

DIM A (1) 6.5" **DIM B (2)** 2.75" **DIM C (3)** 1.625"

MASSEY FERGUSON: 120, 124, 126, 128, 130, 220, 224, 228

A-542397M1 Pickup Tooth

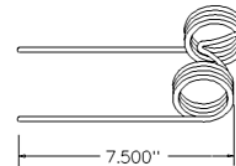

DIM A (1) 7.500"

MASSEY FERGUSON: (COMBINE: 50)

A-1052668M1 Tedder Tooth



DIM A (1) 7.750"

MASSEY FERGUSON: (SWATHER: 775, 785, 885), (COMBINE: SEVERAL Pickup Reels)

TEETH: BALER, COMBINE REEL, HARROW, RAKE, TEDDER, ETC.

A-27997001 2 Prong rubber mtd tooth



MASSEY FERGUSON: 1440, 1455, 1550, 1565

A-581318M91 Tine Bar Bearing



DIM A (1) 1 7/8" Bearing O.D. **DIM B (2)** 2 1/8" Overall Length
DIM C (3) 1 1/2" Thread Length **DIM D (4)** 3/4" Thread

MASSEY FERGUSON: (RAKE: 25 SN 419012167>, 37 SN 1283005190>, 585, 588)

A-667530M1 Rake tooth



DIM A (1) 7.25" **DIM B (2)** 1.875"

MASSEY FERGUSON: (RAKE: 21 MH, 25 SN 14550>)

MIDWEST

A-CH113A Harrow tooth



DIM A (1) 12.750" **DIM B (2)** 6.5" **DIM C (3)** 3.250"

MIDWEST: (HARROW: SEVERAL) 1.5" ID coil

M & W

A-1437430 Baler Tooth

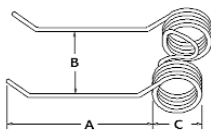

DIM A (1) 5.20" **DIM B (2)** 3.00" **DIM C (3)** 1.05"

M & W: SEVERAL

A-3637507 Rake Tooth

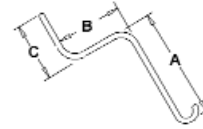

DIM A (1) 15" **DIM B (2)** 11.5" **DIM C (3)** 6.5"

M & W: SEVERAL

A-1437434 Baler Tooth

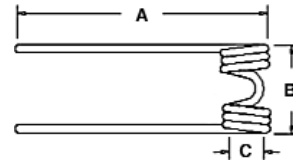

DIM A (1) 6.300" **DIM B (2)** 2.834" **DIM C (3)** 1.100"

M & W: 1500, 1800

NIEMEYER

A-600032 Tedder Tooth (LH)

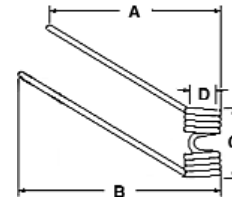

DIM A (1) 13.385" **DIM B (2)** 14.375" **DIM C (3)** 4.725" **DIM D (4)** 1.500"

NIEMEYER: HR301, HR361, HR362, HR401, HR460.11, HR462, HR501, HR562, HR621, HR702, HR751

A-600033 Tedder Tooth (RH)

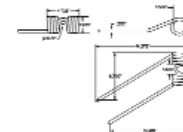

DIM A (1) 14.375" **DIM B (2)** 13.385" **DIM C (3)** 4.725" **DIM D (4)** 1.500"

NIEMEYER: HR301, HR361, HR362, HR401, HR460.11, HR462, HR501, HR562, HR621, HR702, HR751

A-600013 Tedder Tooth

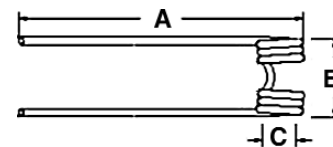

DIM A (1) 21.614" **DIM B (2)** 3.425" **DIM C (3)** 1.500"

NIEMEYER: RS280, RS281, RS28D SN 1601>, RS30, RS300, RS310, RS330, RS420D

TEETH: BALER, COMBINE REEL, HARROW, RAKE, TEDDER, ETC.

A-600014 Tedder Tooth

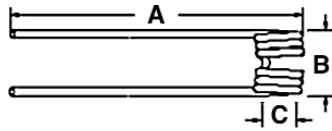

DIM A (1) 22.640" **DIM B (2)** 3.385" **DIM C (3)** 1.575"
NIEMEYER: RS28DL SN <1600

A-600034 Tedder Tooth

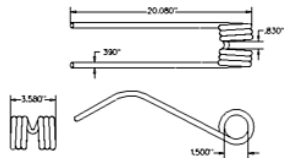

DIM A (1) 20.080" **DIM B (2)** 3.580" **DIM C (3)** 1.500"
NIEMEYER: RS311D, RS330D SN 2450>, RS330VRF, RS430D, RS550D

A-600030 Tedder Tooth

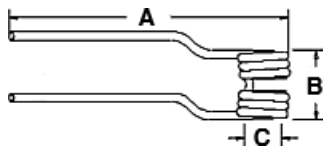

DIM A (1) 21.250" **DIM B (2)** 3.465" **DIM C (3)** 1.500"
NIEMEYER: RS420D

A-600029 Tedder Tooth



DIM A (1) 21.250" **DIM B (2)** 3.390" **DIM C (3)** 1.535"
NIEMEYER: SEVERAL

NEW HOLLAND

A-64562 Baler tooth



DIM A (1) 7" **DIM B (2)** 3.875" **DIM C (3)** 2.375"
NEW HOLLAND: 55, 56, 57, 256, 258, 259, 260

A-40917 Baler tooth

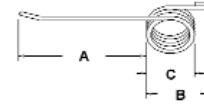

DIM A (1) 7" **DIM B (2)** 3.375" **DIM C (3)** 2.25"
NEW HOLLAND: 55 prior to 1951

A-37762 Baler Tooth

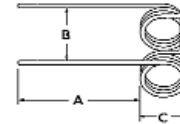

DIM A (1) 6.00" **DIM B (2)** 4.00" **DIM C (3)** 1.50"
NEW HOLLAND: 67

A-12027 Baler Tooth

DIM A (1) 7.25" **DIM B (2)** 4.00" **DIM C (3)** 1.50"
NEW HOLLAND: 77, 80, 87, 98, SUPER 77

A-278687 Tedder Tooth



DIM A (1) 12.750" **DIM B (2)** 3.625" **DIM C (3)** 2.750"
NEW HOLLAND: 156, 158, 162 Early Models

A-279542 Tedder Tooth

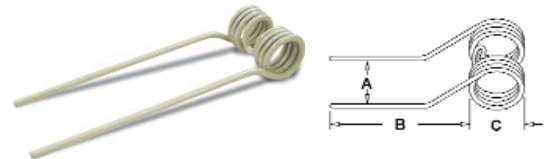

DIM A (1) 12.5" **DIM B (2)** 3.625" **DIM C (3)** 2.75"
NEW HOLLAND: 162 Late Models, 163, 165

A-28286 Baler Tooth



DIM A (1) A- 6.375" **DIM B (2)** B- 4.250" **DIM C (3)** C- 1.500"
NEW HOLLAND: 166, 66, SUPER 66

A-127566 Baler tooth

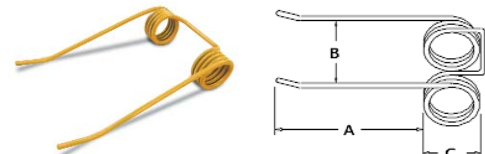

DIM A (1) 5.75" **DIM B (2)** 4" **DIM C (3)** 1.5"
NEW HOLLAND: 67, SUPER 68, 69, 78, 268, 269, 270

TEETH: BALER, COMBINE REEL, HARROW, RAKE, TEDDER, ETC.

A-241380L LH Baler tooth

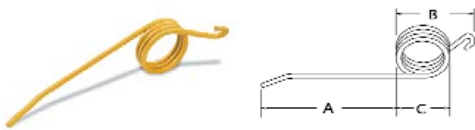

DIM A (1) 6" DIM B (2) 2.5" DIM C (3) 4.437"

NEW HOLLAND: 488, 495, 499, 1495, 1499

A-241379R RH Baler tooth

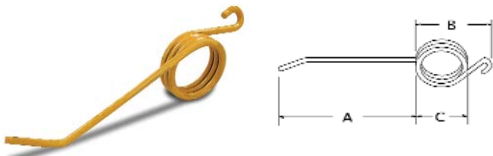

DIM A (1) 6" DIM B (2) 2.5" DIM C (3) 4.437"

NEW HOLLAND: 488, 495, 499, 1495, 1499

A-29971 Pickup Tooth

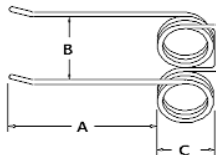

DIM A (1) 4.20" DIM B (2) 5.90" DIM C (3) 1.50"

NEW HOLLAND: 626, 727, 728, 820, 821

A-210614C1 Baler tooth

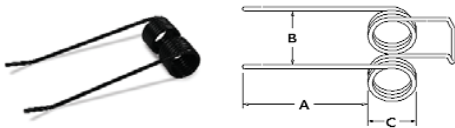

DIM A (1) 6.25" DIM B (2) 2.75" DIM C (3) 1.375"

NEW HOLLAND: 555, 565, 571, 571W

A-788853 Baler tooth

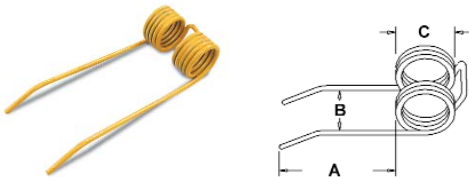

DIM A (1) 5.75" DIM B (2) 2.5" DIM C (3) 1.625"

NEW HOLLAND: 565 SN 808917>, 570 SN 804880>, 575 SN 808665>, 848 SN 714629>, 853 SN 724165>, 855 SN 733140>

A-131673 Baler tooth

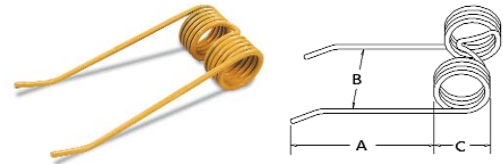

DIM A (1) 5.75" DIM B (2) 2.5" DIM C (3) 1.625"

NEW HOLLAND: 845, 846, 847, 850, 851, 852

A-683310 Baler tooth

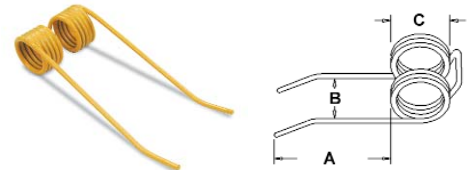

DIM A (1) 5.75" DIM B (2) 2.5" DIM C (3) 1.625"

NEW HOLLAND: 2000, 848 SN <714628, 849, 853 SN <724164, 855 SN <733139

A-850613 LH Rubber Mounted Tooth



NEW HOLLAND: 258, 259, 260

A-850614 RH Rubber Mounted Tooth



NEW HOLLAND: 258, 259, 260

A-850612 Rake Tooth (Single Tine)



DIM A (1) Yoke Opening 1-5/8" DIM B (2) Punched Hole

DIM C (3) For 3/8" Bolt

NEW HOLLAND: 256, 56, 57

A-76517 Windrower teeth

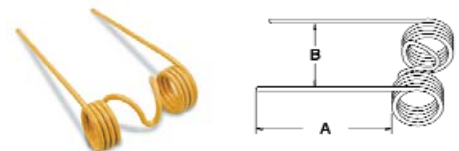

DIM A (1) 6.5" DIM B (2) 4.25" DIM C (3) 1.875"

NEW HOLLAND: 460, 461, 467, 468, 472, 474, 488, 492, 903, 907, 909, 912, 1100, 1112, 1114, 1118 self-propelled

TEETH: BALER, COMBINE REEL, HARROW, RAKE, TEDDER, ETC.

A-128102 Baler tooth

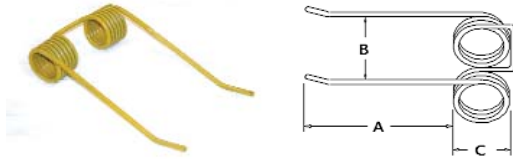

DIM A (1) 7.25" DIM B (2) 4"

NEW HOLLAND: 1280, 1281, 1290, 280, 281, 290

NEW IDEA

A-M873 Rake Tooth

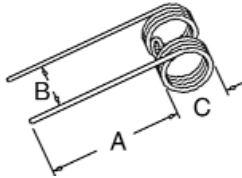

DIM A (1) 9.00" DIM B (2) 3.30" DIM C (3) 1.98"

NEW IDEA: 4, 44, 45G

A-400033 Rake Tooth

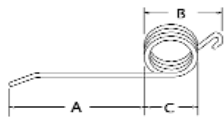

DIM A (1) 6.625" DIM B (2) 2.437" DIM C (3) 4.00"

NEW IDEA: (400, 402, 403, 49 ALL 1955>)

A-290141 Rake Tooth

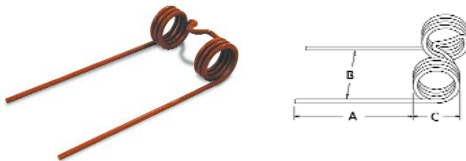

DIM A (1) 7.125" DIM B (2) 3.750" DIM C (3) 1.875"

NEW IDEA: 270, 271, 299, 750, 751, 752

A-103012 Baler tooth



DIM A (1) 5.750" DIM B (2) 2.625" DIM C (3) 1.5"

NEW IDEA: 55, 465, 483, 484, 485, 486

A-048ME Rake tooth

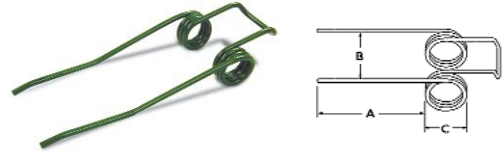

DIM A (1) 7.5" DIM B (2) 3.375" DIM C (3) 1.750"

NEW IDEA: 4, 44, 45G

A-NE400033 Rake Tooth

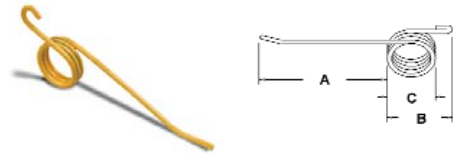

DIM A (1) 6.625" DIM B (2) 3.875" DIM C (3) 2.5"

NEW IDEA: 49, 400, 402, 403 1955->

A-96R1 Rake Tooth



DIM A (1) YOKE OPENING 1-5/8" DIM B (2) PUNCHED HOLE
DIM C (3) FOR 3/8" BOLT

NEW IDEA: (RAKE: SEVERAL) single tooth for all parallel bar rakes

A-96R2 Rake Tooth



NEW IDEA: (RAKE: SEVERAL)
double tooth for all wheel rakes

A-VLH7001 Rake & Tedder tooth

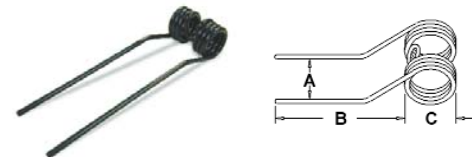

DIM A (1) 3.5" DIM B (2) 15.250" DIM C (3) 2.787"

NEW IDEA: (RAKE: SEVERAL)

A-0782ME1 Rake teeth

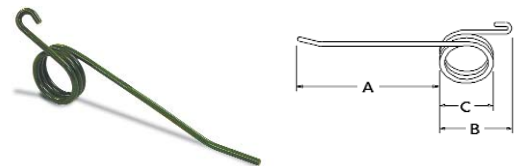

DIM A (1) 7" DIM B (2) 3.625" DIM C (3) 2.5"

NEW IDEA: SEVERAL 1957->

TEETH: BALER, COMBINE REEL, HARROW, RAKE, TEDDER, ETC.

A-149781 Harrow tooth

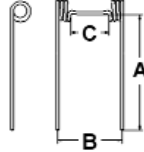

DIM A (1) 11.250" DIM B (2) 7.5" DIM C (3) 3.5"

NEW IDEA: (HARROW: SEVERAL) tooth coil 1.8125" ID

A-41410 Harrow tooth

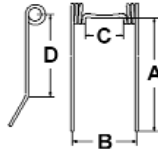

DIM A (1) 16.5" DIM B (2) 7.5" DIM C (3) 3.5" DIM D (4) 12.5"

NEW IDEA: (HARROW: SEVERAL) tooth coil 1.8125" ID

NIEMEYER

A-600038 RH tedder tooth (red)

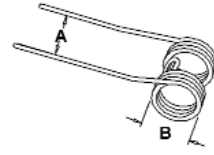

DIM A (1) 4.125" DIM B (2) 2.250"

NIEMEYER: HR301, HR361, HR362, HR401, HR460.11, HR462, HR501, HR562, HR621, HR702, HR751

A-600039 LH Reel tooth (yellow)

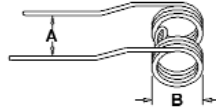

DIM A (1) 4.125" DIM B (2) 2.250"

NIEMEYER: HR301, HR361, HR362, HR401, HR460.11, HR462, HR501, HR562, HR621, HR702, HR751

OMC

A-11032347 Baler tooth

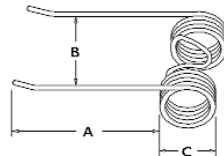

DIM A (1) 6.125" DIM B (2) 2.5" DIM C (3) 1.562"

OMC: 590, 595, 596

OTMA

A-OT2TT Tedder Tooth

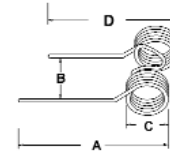

DIM A (1) 13.40" DIM B (2) 3.75" DIM C (3) 1.95"

OTMA: SEVERAL

A-OT3RT Rake Tooth

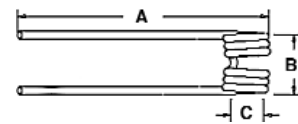

DIM A (1) 26.380" DIM B (2) 3.780" DIM C (3) 1.770"

OTMA: SEVERAL

A-203055 Rake tooth

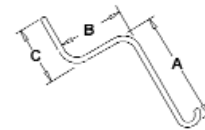

DIM A (1) 15" DIM B (2) 11.5" DIM C (3) 6.5"

OTMA: SEVERAL tooth .262" diameter

OWATTONA

A-11032354 Windrower teeth

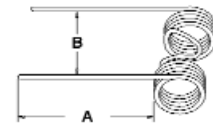

DIM A (1) 6.5" DIM B (2) 4.25" DIM C (3) 1.875"

OWATTONA: 157, 207, 235, 257

PANORAMA

A-P2567920 Tedder Tooth

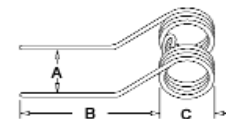

DIM A (1) 14.00" DIM B (2) 3.60" DIM C (3) 2.80"

Panorama: SEVERAL

TEETH: BALER, COMBINE REEL, HARROW, RAKE, TEDDER, ETC.

POLLARD

A-7D265 Rake tooth



DIM A (1) 5.375" DIM B (2) 1.812"

POLLARD: (RAKE: SEVERAL)

A-2010R Rake tooth

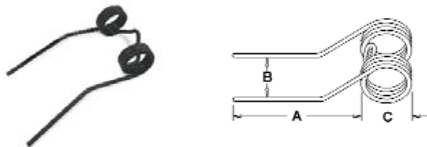

DIM A (1) 8" DIM B (2) 3.875" DIM C (3) 1.875"

POLLARD: (RAKE: SEVERAL)

ROANOKE HUSTLER

A-19439 Peanut Combine tooth

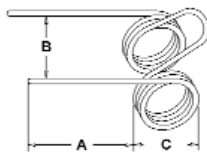

DIM A (1) 4" DIM B (2) 2.687" DIM C (3) 1.406"

ROANOKE HUSTLER: (COMBINE: SEVERAL)

A-96L01 Peanut Combine Tooth

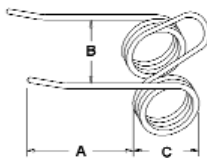

DIM A (1) 4" DIM B (2) 2.625" DIM C (3) 1.406"

ROANOKE HUSTLER: (COMBINE: SEVERAL)

curved cyl tooth .281" diameter

ROSSI

A-608754 Rake tooth



DIM A (1) 12.750" DIM B (2) 7.5" DIM C (3) 5"

ROSSI: SEVERAL

A-54 Rake tooth

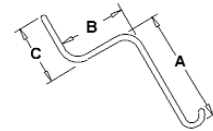

DIM A (1) 12.750" DIM B (2) 8.5" DIM C (3) 5"

ROSSI: 2222

SITREX

A-SS1RT Rake Tooth

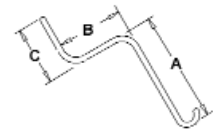

DIM A (1) 15.00" DIM B (2) 11.00" DIM C (3) 6.00"

SITREX: (RAKE: SEVERAL)

A-SS2TT Tedder Tooth

DIM A (1) 12.50" DIM B (2) 3.45" DIM C (3) 2.60"

SITREX: (TEDDER: SEVERAL)

A-203055 Rake tooth

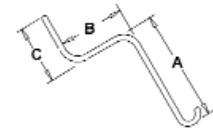

DIM A (1) 15" DIM B (2) 11.5" DIM C (3) 6.5"

SITREX: (RAKE: SEVERAL) tooth .262" diameter

A-VLH7002 Rake & Tedder tooth

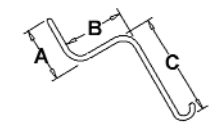

DIM A (1) 7.250" DIM B (2) 11" DIM C (3) 15"

SITREX: (RAKE: SEVERAL)

TONUTTI

A-0330049 Rake Tooth

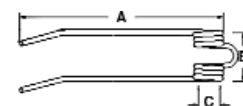

DIM A (1) 18.500" DIM B (2) 3.385" DIM C (3) 1.850"

TONUTTI: SEVERAL

TEETH: BALER, COMBINE REEL, HARROW, RAKE, TEDDER, ETC.

A-010940 Tedder Tooth

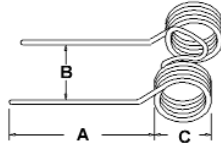

DIM A (1) 11.57" **DIM B (2)** 3.75" **DIM C (3)** 3.75"
TONUTTI: SEVERAL

A-PLO15 Rake Tooth - LH

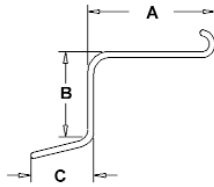

DIM A (1) 17.250" **DIM B (2)** 13" **DIM C (3)** 5.250"
TONUTTI: P4-74, P5-79, RK90, RTP-8, RTP-10

A-PRO15 Rake Tooth - RH

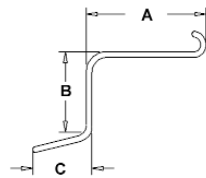

DIM A (1) 17.250" **DIM B (2)** 13" **DIM C (3)** 5.250"
TONUTTI: P4-74, P5-79, RK90, RTP-8, RTP-10

UNIVERSAL

A-96UH1 Combine Reel Tooth



UNIVERSAL: (REEL: SEVERAL) snap lock finger

A-C5H Combine Reel Tooth



UNIVERSAL: (REEL: SEVERAL) hvy duty snap lock finger

VERMEER

A-96R5 Rubber mtd Baler Tooth



VERMEER:

A-48893001 Baler tooth

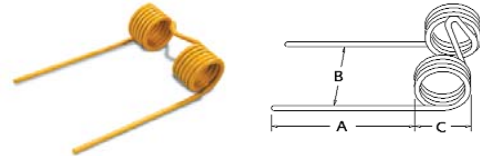

DIM A (1) 4.875" **DIM B (2)** 3.75" **DIM C (3)** 1.625"
VERMEER: B, C

A-29001 Baler Tooth

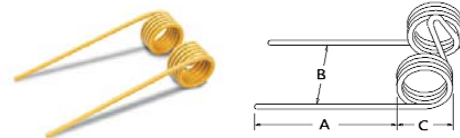

DIM A (1) 4.75" **DIM B (2)** 3" **DIM C (3)** 1.625"
VERMEER: D

A-4059001 Baler Tooth



DIM A (1) 7" **DIM B (2)** 2.875" **DIM C (3)** 1.687"
VERMEER: E, F, G

A-27997001 2 Prong rubber mtd tooth



VERMEER: (RAKE: SEVERAL)

A-115663001 Rake Tooth

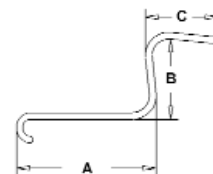

DIM A (1) 17.5" **DIM B (2)** 10" **DIM C (3)** 6"
VERMEER: (RAKE: SEVERAL wheel)

TEETH: BALER, COMBINE REEL, HARROW, RAKE, TEDDER, ETC.

VICON

A-51000856 Tedder Tooth (LH)

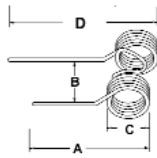

DIM A (1) 15.43" **DIM B (2)** 4.37" **DIM C (3)** 1.65" **DIM D (4)** 16.50"

VICON: (RS410, RS510, RS610, RS740 ALL Newer Model)

A-51000855 Tedder Tooth (RH)

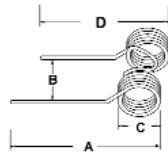

DIM A (1) 16.50" **DIM B (2)** 4.37" **DIM C (3)** 1.65" **DIM D (4)** 15.43"

VICON: (RS410, RS510, RS610, RS740 ALL Newer Model)

A-96VI1 Rake Tooth

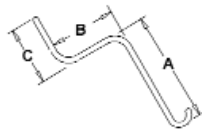

DIM A (1) 17.50" **DIM B (2)** 10.00" **DIM C (3)** 6.00"

VICON: ACROBAT Newer Model, H1020, H1050

A-51001286 Tedder Tooth

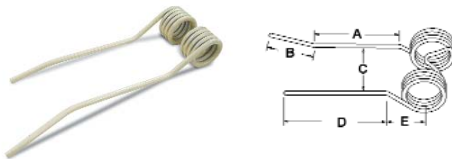

DIM A (1) 7.000" **DIM B (2)** 4.125" **DIM C (3)** 5.125"

DIM D (4) 9.250" **DIM E (5)** 2.500"

VICON: HAYBOB 300

A-51001289 Tedder Tooth

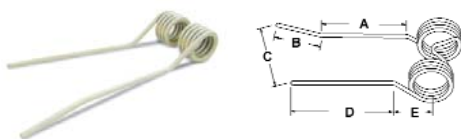

DIM A (1) 6.875" **DIM B (2)** 4.125" **DIM C (3)** 7.5"

DIM D (4) 9.125" **DIM E (5)** 2.625"

VICON: HAYBOB 300

A-51001287 Tedder Tooth



DIM A (1) 9.000" **DIM B (2)** 5.125" **DIM C (3)** 4.000"

DIM D (4) 6.750" **DIM E (5)** 2.500"

VICON: HAYBOB 300, HS360

A-51001288 Tedder Tooth

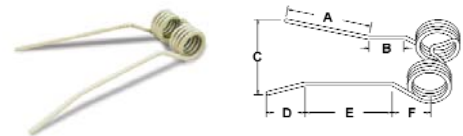

DIM A (1) 8.50" **DIM B (2)** 0.75" **DIM C (3)** 7.125"

DIM D (4) 4.50" **DIM E (5)** 6.50" **DIM F (6)** 2.50"

VICON: HAYBOB 300, HS360

A-51001367 Tedder Tooth

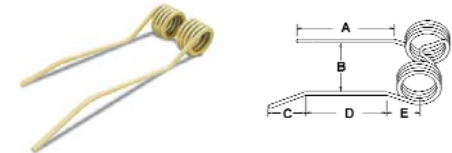

DIM A (1) 9.5" **DIM B (2)** 5.0" **DIM C (3)** 4.0"

DIM D (4) 7.0" **DIM E (5)** 2.5"

VICON: HS360

A-92611 Rake Tooth

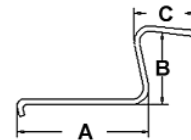

DIM A (1) 17.5" **DIM B (2)** 10" **DIM C (3)** 6"

VICON: 5, ACROBAT Older Models, H1020, H820, HKM SPRINTER, HKX500 Old Style, HKX620

A-36133 Rake Tooth

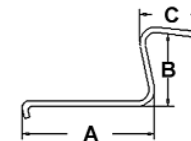

DIM A (1) 17.5" **DIM B (2)** 10.00" **DIM C (3)** 6.00"

VICON: 6

TEETH: BALER, COMBINE REEL, HARROW, RAKE, TEDDER, ETC.

A-PZ225 Tedder Tooth

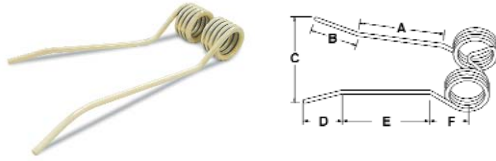

DIM A (1) 8" DIM B (2) 3" DIM C (3) 8" DIM D (4) 2.5"
DIM E (5) 6.5" DIM F (6) 2.5"

VICON: HS360

WALTON

A-1407 Tedder Tooth

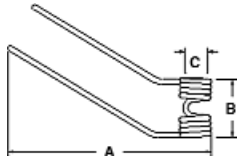

DIM A (1) 14.960" DIM B (2) 3.940" DIM C (3) 1.456"

Walton: WT9

A-5515L RAKE TOOTH-LH

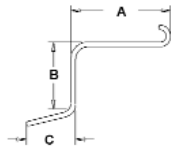

DIM A (1) 17.250" DIM B (2) 13" DIM C (3) 5.250"

Walton: FINGER REEL RAKES

A-0946 TEDDER TOOTH

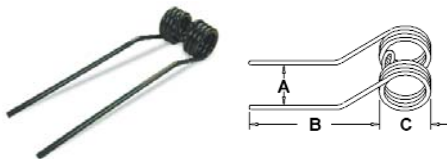

DIM A (1) 3.5" DIM B (2) 15.25" DIM C (3) 2.787"

Walton: 21046, WT16, WT19, WT21

A-1408 Tedder Tooth

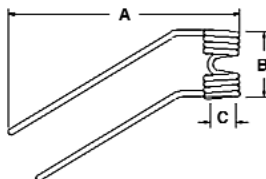

DIM A (1) 14.960" DIM B (2) 3.940" DIM C (3) 1.456"

Walton: WT9

A-5515R RAKE TOOTH-RH

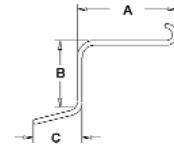

DIM A (1) 17.250" DIM B (2) 13.000" DIM C (3) 5.250"

Walton: FINGER REEL RAKES

WELGER

A-0940522500 Rake Tooth

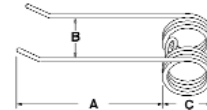

DIM A (1) 6.29" DIM B (2) 2.75" DIM C (3) 2.75"

WELGER: SEVERAL

A-034312 Rake Tooth

DIM A (1) 7.08" DIM B (2) 2.90" DIM C (3) 1.18"

WELGER: SEVERAL

A-034317 Rake Tooth

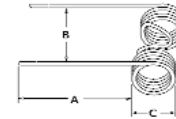

DIM A (1) 7.00" DIM B (2) 2.95" DIM C (3) 1.25"

WELGER: SEVERAL

A-034338 Rake Tooth

DIM A (1) 6.61" DIM B (2) 2.95" DIM C (3) 1.25"

WELGER: SEVERAL

WHITE/OLIVER

A-500629E Rake tooth



DIM A (1) 6.625" DIM B (2) 3.25" DIM C (3) 1.812"

WHITE/OLIVER: 107 rotor bar

WILRICH

A-16429 Harrow Tooth



DIM A (1) 16" DIM B (2) 9.375" DIM C (3) 5"

WILRICH: (HARROW: SEVERAL) tooth coil 1.625" ID

TEETH: BALER, COMBINE REEL, HARROW, RAKE, TEDDER, ETC.

ZWEEGER

A-PZ107 Tedder Tooth



DIM A (1) 9" **DIM B (2)** 5.125" **DIM C (3)** 4" **DIM D (4)** 6.750"
DIM E (5) 2.5"

ZWEEGER: (HAY BOB, HS360 ALL LH narrow)

A-PZ110 Tedder Tooth

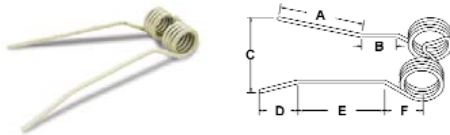

DIM A (1) 8.5" **DIM B (2)** .750" **DIM C (3)** 7.125"
DIM D (4) 4.5" **DIM E (5)** 6.5" **DIM F (6)** 2.5"

ZWEEGER: (HAY BOB, HS360 ALL LH wide)

A-PZ106 Tedder Tooth

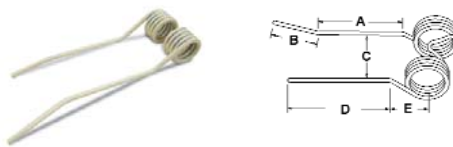

DIM A (1) 7" **DIM B (2)** 4.125" **DIM C (3)** 5.125"
DIM D (4) 9.250" **DIM E (5)** 2.5"

ZWEEGER: HAY BOB RH narrow

A-PZ111 Tedder Tooth

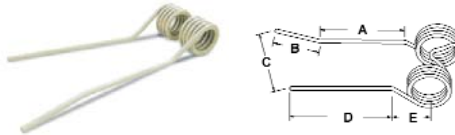

DIM A (1) 6.875" **DIM B (2)** 4.125" **DIM C (3)** 7.5"
DIM D (4) 9.125" **DIM E (5)** 2.625"

ZWEEGER: HAY BOB RH wide

A-PZ224 Tedder Tooth

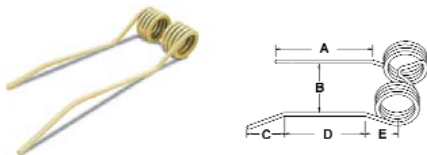

DIM A (1) 9.5" **DIM B (2)** 5" **DIM C (3)** 4" **DIM D (4)** 7" **DIM E (5)** 2.5"

ZWEEGER: HS360 RH narrow

A-PZ225 Tedder Tooth

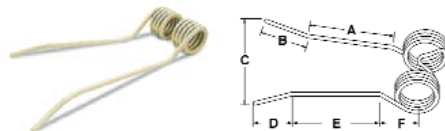

DIM A (1) 8" **DIM B (2)** 3" **DIM C (3)** 8" **DIM D (4)** 2.5"
DIM E (5) 6.5" **DIM F (6)** 2.5"

ZWEEGER: HS360 RH wide

A-PZ190 Tedder Tooth

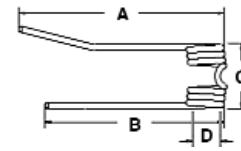

DIM A (1) 13.312" **DIM B (2)** 11.650" **DIM C (3)** 4.370" **DIM D (4)** 1.650"

ZWEEGER: DS5000

A-PZ191 Tedder Tooth

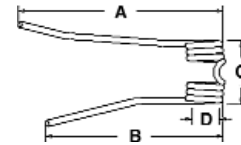

DIM A (1) 13.312" **DIM B (2)** 11.650" **DIM C (3)** 4.375" **DIM D (4)** 1.653"

ZWEEGER: DS5000

A-PZ192 Tedder Tooth

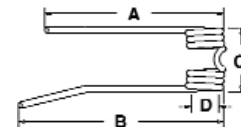

DIM A (1) 11.650" **DIM B (2)** 13.312" **DIM C (3)** 4.370" **DIM D (4)** 1.650"

ZWEEGER: DS5000

A-PZ193 Tedder Tooth

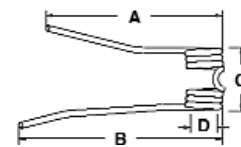

DIM A (1) 11.650" **DIM B (2)** 13.312" **DIM C (3)** 4.375" **DIM D (4)** 1.653"

ZWEEGER: DS5000

A-PZ339 Tedder Tooth (LH)

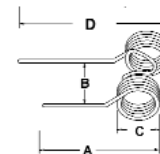

DIM A (1) 15.43" **DIM B (2)** 4.37" **DIM C (3)** 1.65" **DIM D (4)** 16.50"

ZWEEGER: (FANEX 400, FANEX 500, FANEX 600, FANEX 641, FANEX 730 ALL 1987>, 400, 500)

TEETH: BALER, COMBINE REEL, HARROW, RAKE, TEDDER, ETC.

A-PZ340 Tedder Tooth (RH)

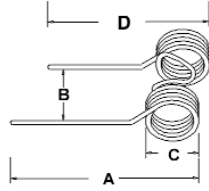

DIM A (1) 16.50" **DIM B (2)** 4.37" **DIM C (3)** 1.65" **DIM D (4)** 15.43"
ZWEEGER: (FANEX 400, FANEX 500, FANEX 600, FANEX 641, FANEX 730 ALL 1987>), 400, 500

A-11010401 Tedder Tooth

DIM A (1) 3.50" **DIM B (2)** 15.250" **DIM C (3)** 2.787"
ROSSI: G4L, G4LPE

MISCELLANEOUS



A-91C246 Combine reel flex tine
Misc.: for wood bats, includes mtg hardware



A-91C366 Combine reel flex tine
Misc.: for tear drop style bats, includes mtg hardware

COMPLETE FINGERWHEELS

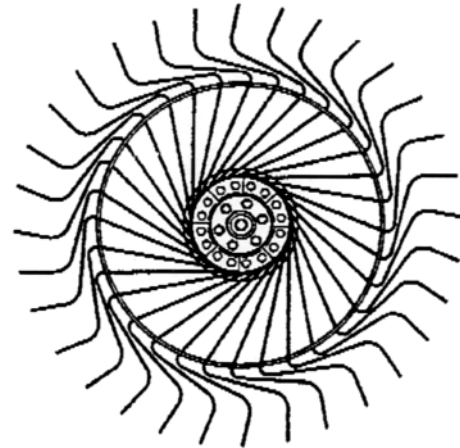

A-V90095347Z RIGHT HAND WHEEL RAKE
VICON, OLDER GEHL & MASSEY RAKES: ALL WHEEL RAKES

A-V90095862Z LEFT HAND WHEEL RAKE
VICON, OLDER GEHL & MASSEY RAKES: V-RAKES ONLY

A-P20BG003 RIGHT HAND ITALIAN WHEEL RAKE (7 mm Tines)
OTMA, ROSSI, SITREX, TONUTTI, GEHL, H&S, JD, VERMEER, WALTON: ALL WHEEL RAKES

A-P20BG004 LEFT HAND ITALIAN WHEEL RAKE (7 mm Tines)
OTMA, ROSSI, SITREX, TONUTTI, GEHL, H&S, JD, VERMEER, WALTON: V-RAKES ONLY

CAM FOLLOWER BEARINGS / PLUNGER ROLLER BEARINGS

CAM FOLLOWER BEARINGS

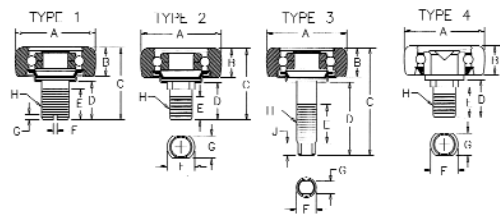

PART	DESCRIPTION	BRG TYPE							
			(A)	(B)	(C)	(D)	(E)	(F)	
A-CF108S4F6	Cam Follower Bearing	3	1 1/2	5/8	1 13/32	25/32	3/8 24 UNF2A	1/2 HEX	
A-CF108S7F	Cam Follower Bearing	5	1 1/2	5/8	2 1/16	15/16	7/16 20 UNF2A	11/16 RND	
A-CF108S10F	Cam Follower Bearing	4	1 1/2	5/8	1 3/4	13/16	1/2 20 UNF2A	-	
A-CF110S8F10	Cam Follower Bearing	6	1 5/8	7/8	Z 3/16	3/4	5/6 18 UNF2A	-	
A-CF6032	Cam Follower Bearing	2	1 1/4	5/8	1 5/16	3/4	3/16 24 UNF2A	3/16	
A-CF6416	Cam Follower Bearing	3	1 1/4	5/8	1 5/16	3/4	3/8 24 UNF2A	1/2 HEX	
A-CF6522	Cam Follower Bearing	2	1 1/4	5/8	2	1 1/6	3/16 24 UNF2A	3/16	
A-CF6888	Cam Follower Bearing	4	1 3/4	3/4	1 23/32	3/4	.375-.378-		
A-CF7811E	Cam Follower Bearing	3	1 1/2	5/8	2 1/32	1 1/16	1/2 20 UNF2A	5/16 HEX	
A-CF7811	Cam Follower Bearing	3	1 1/2	5/8	2 1/32	1 1/16	1/2 20 UNF2A	5/16 HEX	
A-CF9727	Cam Follower Bearing	7	1 3/4	3/4	2 1/8	1	1/2 20 UNF2A	5/16 HEX	

PLUNGER ROLLER BEARINGS

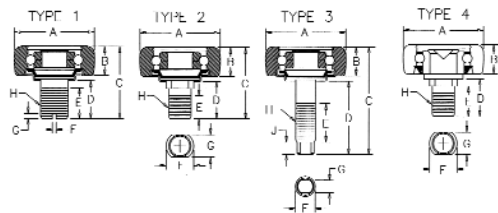

PART	DESCRIPTION	BRG TYPE							
			(A)	(B)	(C)	(D)	(E)	(F)	(G)
A-6922LH	Plunger Roller Bearing	1	2.0472	0.7	2 17/32	1.375	3/4	0.09	1/8
A-B74K	Plunger Roller Bearing	1	5/8" X 77"		5/8"	13/32"	1955.8		
A-6901P	Plunger Roller Bearing	4	2.5	0.888	2.25	1.15625	13/16	1	0.75
A-6901PA	Plunger Roller Bearing	4	2.5	0.888	2.25	1.15625	13/16	1	0.75
A-6901PW	Plunger Roller Bearing	4	2.5	1.125	2.484375	1.15625	13/16	1	0.75
A-6901M	Plunger Roller Bearing	2	2.5	0.888	2.25	1.15625	13/16	1	0.795
A-6901S	Plunger Roller Bearing	2	2.5	0.888	2 1/4	1.1875	13/16	1	0.75
A-PR6956	Plunger Roller Bearing	1	2.5	0.888	2 7/32	1 1/6	15/16	0.157	0.16

ROLLER CHAINS & ATTACHMENT LINKS



Connector Link

Offset Link

Roller Link

Roller Chain

Double Roller Chain

Heavy Roller Chain

Stainless Steel Roller Chain

CHAINS & CHAIN LINKS

CHAIN LUBE & BELT DRESSING

PART	DESCRIPTION	SIZE	PKG QTY
A-1T1475	Chain Lube	16 oz	12

ROLLER CHAIN BREAKER TOOLS



PART	DESCRIPTION
A-5A1	Roller Chain Breaker
<i>notes for above: For use on chain 25 thru 60</i>	
A-5A1S	Screw w/ tip & handle

ROLLER CHAIN BREAKER TOOLS



PART	DESCRIPTION
A-5A2	Roller Chain Breaker
<i>notes for above: For use on chain 60 thru 100</i>	
A-5A2S	Screw w/ tip

25 ROLLER CHAINS AND ATTACHMENT LINKS

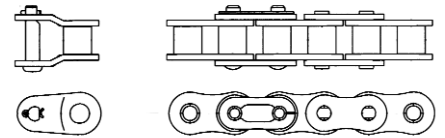

PART	DESCRIPTION	PITCH LENGTH	WIDTH	LINKS PER 10 FT
A-CL25IMP	25 connector link			
A-OL25	25 offset link			
A-OL25IMP	25 offset link (Import)			

35 ROLLER CHAINS AND ATTACHMENT LINKS

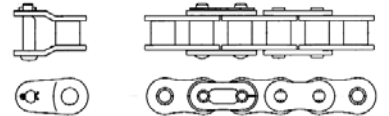

PART	DESCRIPTION	PITCH LENGTH	WIDTH
A-RC35	35 roller chain, 10ft	3/8"	3/16"
A-RC35IMP	35 roller chain, 10ft (Import)	3/8"	3/16"
A-RC35X50	35 Roller Chain X 50ft		
A-RC35X50IMP	35 roller chain, 50ft (Import)	3/8"	3/16"
A-CL35	35 connector link		
A-CL35IMP	35 connector link (Import)		
A-OL35	35 offset link		
A-OL35IMP	35 offset link (Import)		
A-RL35	35 roller link	3/8"	

ROLLER CHAINS & ATTACHMENT LINKS

40 ROLLER CHAINS AND ATTACHMENT LINKS

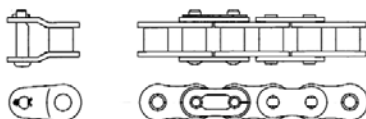

PART	DESCRIPTION	PITCH LENGTH	WIDTH	LINKS PER 10 FT
A-RC40	40 roller chain, 10ft	1/2"	5/16"	240
A-RC40IMP	40 roller chain, 10ft (Import)	1/2"	5/16"	240
A-RC40X50	40 roller chain, 50ft	1/2"	5/16"	240
A-RC40X50IMP	40 roller chain, 50ft (Import)	1/2"	5/16"	240
A-RC40X100IMP	40 roller chain, 100ft (Import)	1/2"	5/16"	240
A-CL40	40 connector link			
A-CL40IMP	40 connector link (Import)			
A-CL40SSIMP	40 stainless steel connector link (Import)			
A-OL40	40 offset link			
A-OL40IMP	40 offset link (Import)			
A-OL40SSIMP	40 stainless steel offset link			
A-OL40SSIMP	40 stainless steel offset link (Import)			
A-RL40	40 roller link			

40 DOUBLE ROLLER CHAINS AND ATTACHMENT LINKS

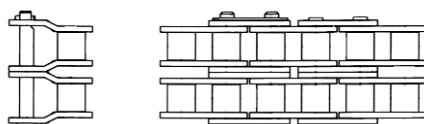

PART	DESCRIPTION	PITCH LENGTH	WIDTH	LINKS PER 10 FT
A-RC40DIMP	40 Double Roller Chain X 10Ft, (Import)	1/2"	5/16"	240
A-CL40D	40 Double Connector Link, USA			
A-CL40DIMP	40 Double Connector Link, (Import)			
A-OL40D	40 Double Offset Link, USA			
A-OL40DIMP	40 Double Offset Link, (Import)			

41 ROLLER CHAINS AND ATTACHMENT LINKS

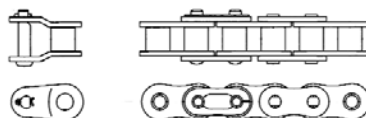

PART	DESCRIPTION	PITCH LENGTH	WIDTH	LINKS PER 10 FT
A-RC41	41 roller chain, 10ft	1/2"	1/4"	240
A-RC41IMP	41 roller chain, 10ft (Import)	1/2"	1/4"	240
A-RC41X50	41 roller chain, 50ft	1/2"	1/4"	240
A-RC41X50IMP	41 roller chain, 50ft (Import)	1/2"	1/4"	240
A-CL41	41 connector link			
A-CL41IMP	41 connector link (Import)			
A-OL41	41 offset link			
A-OL41IMP	41 offset link (Import)			
A-RL41	41 roller link			

50 ROLLER CHAINS AND ATTACHMENT LINKS

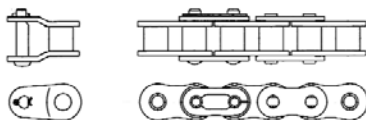

PART	DESCRIPTION	PITCH LENGTH	WIDTH	LINKS PER 10 FT
A-RC50	50 roller chain, 10ft	5/8"	3/8"	192
A-RC50IMP	50 roller chain, 10ft (Import)	5/8"	3/8"	192
A-RC50SSIMP	50 stainless steel roller chain, 10ft (Import)			
A-RC50X50	50 roller chain, 50ft	5/8"	3/8"	192
A-RC50X50IMP	50 roller chain, 50ft (Import)	5/8"	3/8"	192
A-CL50	50 connector link			

A-CL50IMP	50 connector link (Import)			
A-CL50SSIMP	50 stainless steel connector link (Import)			
A-OL50	50 offset link			
A-OL50IMP	50 offset link (Import)			
A-OL50SSIMP	50 stainless steel offset link (Import)			
A-RL50	50 roller link			
A-RC50HIMP	50 Hvy roller chain, 10ft (Import)	5/8"	3/8"	192
A-CL50HIMP	50 Hvy connector link (Import)			
A-OL50HIMP	50 Hvy offset link (Import)			

50 DOUBLE ROLLER CHAINS AND ATTACHMENT LINKS

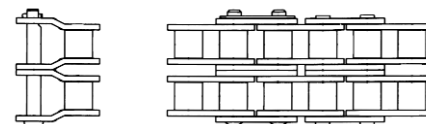

PART	DESCRIPTION	PITCH LENGTH	WIDTH	LINKS PER 10 FT
A-RC50D	50 Double Roller Chain X 10Ft.	5/8"	3/8"	192
A-RC50DIMP	50 Double Roller Chain X 10Ft. (Import)	5/8"	3/8"	192
A-RC50DX50	ROLLER CHAIN, USA			
A-CL50D	50 Double Connector Link			
A-CL50DIMP	50 Double Connector Link, (Import)			
A-OL50D	50 Double Offset Link			
A-OL50DIMP	50 Double Offset Link, (Import)			

60 ROLLER CHAINS AND ATTACHMENT LINKS

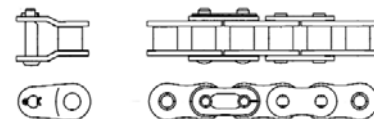

PART	DESCRIPTION	PITCH LENGTH	WIDTH	LINKS PER 10 FT
A-RC60	60 roller chain, 10ft	3/4"	1/2"	160
A-RC60IMP	60 roller chain, 10ft (Import)	3/4"	1/2"	160
A-RC60X50	60 roller chain, 50ft	3/4"	1/2"	160
A-RC60X50IMP	60 roller chain, 50ft (Import)	3/4"	1/2"	160
A-RC60X100	60 Roller Chain X 100 Ft., USA			
A-RC60X100IMP	60 roller chain, 100ft (Import)	3/4"	1/2" (width)	160 (links per 10 ft)
A-CL60	60 connector link			
A-CL60IMP	60 connector link (Import)			
A-CL60SSIMP	60 stainless steel connector link (Import)			
A-OL60	60 offset link			
A-OL60IMP	60 offset link (Import)			
A-OL60SSIMP	60 stainless steel offset link (Import)			
A-RL60	60 roller link			
A-RC60H	60 Hvy roller chain, 10ft	3/4"	1/2"	160
A-RC60HIMP	60 Hvy roller chain, 10ft (Import)	3/4"	1/2"	160
A-RC60HX50	60 Hvy roller chain, 50ft	3/4"	1/2"	160
A-RC60HX50IMP	60 Hvy roller chain, 50ft (Import)	3/4"	1/2"	160
A-CL60H	60 Hvy connector link			
A-CL60HIMP	60 Hvy connector link (Import)			
A-OL60H	60 Hvy offset link			
A-OL60HIMP	60 Hvy offset link (Import)			
A-RL60H	60 Hvy roller link			

ROLLER CHAINS & ATTACHMENT LINKS

60 DOUBLE ROLLER CHAINS AND ATTACHMENT LINKS

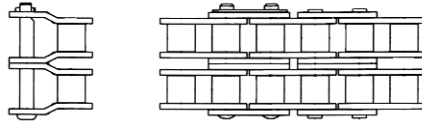

PART	DESCRIPTION	PITCH LENGTH	WIDTH	LINKS PER 10 FT
A-RC60D	60 Double Roller Chain X 10 Ft.	3/4"	3/4"	160
A-RC60DIMP	60 Double Roller Chain X 10Ft. (Import)	3/4"	3/4"	160
A-RC60DX50	60 Double Roller Chain X 50 Ft.	3/4"	3/4"	160
A-CL60D	60 Double Connector Link			
A-CL60DIMP	60 Double Connector Link, (Import)			
A-OL60D	60 Double Offset Link			
A-OL60DIMP	60 Double Offset Link, (Import)			

80 ROLLER CHAINS AND ATTACHMENT LINKS

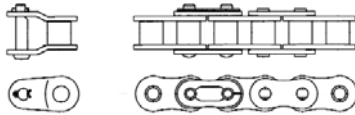

PART	DESCRIPTION	PITCH LENGTH	WIDTH	LINKS PER 10 FT
A-RC80	80 roller chain, 10ft	1"	5/8"	120
A-RC80IMP	80 roller chain, 10ft (Import)	1"	5/8"	120
A-RC80X50	80 roller chain, 50ft	1"	5/8"	120
A-RC80X50IMP	80 roller chain, 50ft (Import)	1"	5/8"	120
A-CL80	80 connector link			
A-CL80IMP	80 connector link (Import)			
A-OL80	80 offset link			
A-OL80IMP	80 offset link (Import)			
A-RL80	80 roller link			

A-RC80H	80 Hvy roller chain, 10ft	1"	5/8"	120
A-RC80IMP	80 Hvy roller chain, 10ft (Import)	1"	5/8"	120
A-RC80HX50	80 Hvy roller chain, 50ft	1"	5/8"	120
A-CL80H	80 Hvy connector link			
A-CL80HIMP	80 Hvy connector link (Import)			
A-OL80H	80 Hvy offset link			
A-OL80HIMP	80 Hvy offset link (Import)			
A-RL80H	80 Hvy roller link			

80 DOUBLE ROLLER CHAINS AND ATTACHMENT LINKS

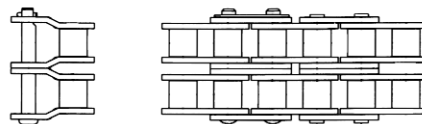

PART	DESCRIPTION	PITCH LENGTH	WIDTH	LINKS PER 10 FT
A-RC80D	80 Double Roller Chain X 10Ft. 1"	5/8"	1"	120
A-RC80DIMP	80 Double Roller Chain X 10Ft. (Import)	5/8"	1"	120
A-CL80D	80 Double Connector Link			
A-CL80DIMP	80 Double Connector Link, (Import)			
A-OL80D	80 Double Offset Link			
A-OL80DIMP	80 Double Offset Link, (Import)			

100 ROLLER CHAINS AND ATTACHMENT LINKS

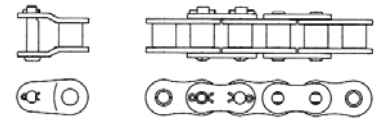

PART	DESCRIPTION	PITCH LENGTH	WIDTH	LINKS PER 10 FT
A-RC100	100 roller chain, 10ft	1-1/4"	3/4"	96
A-RC100IMP	100 roller chain, 10ft (Import)			
A-CL100	100 connector link			
A-CL100IMP	100 connector link (Import)			
A-OL100	100 offset link			
A-OL100IMP	100 offset link (Import)			
A-RL100	100 roller link			

120 ROLLER CHAINS AND ATTACHMENT LINKS

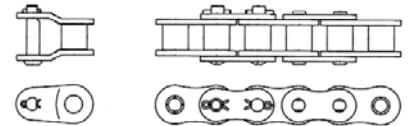

PART	DESCRIPTION	PITCH LENGTH	WIDTH	LINKS PER 10 FT
A-RC120	120 roller chain, 10ft			
A-RC120IMP	120 roller chain, 10ft (Import)	1-1/2"	1"	
A-CL120	120 connector link			
A-CL120IMP	120 connector link (Import)			
A-OL120	120 offset link			
A-OL120IMP	120 offset link (Import)			

2040 ROLLER CHAINS AND ATTACHMENT LINKS

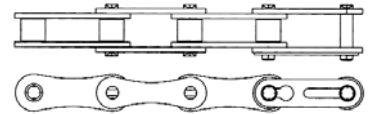

PART	DESCRIPTION	PITCH LENGTH	WIDTH	LINKS PER 10 FT
A-RC2040	2040 Extended pitch roller chain, 10ft	1"	5/16"	120
A-RC2040IMP	2040 Ext. pitch roller chain, 10ft (Import)	1"	5/16"	120
A-RC2040X50	2040 Ext. pitch roller chain, 50ft	1"	5/16"	120
A-RC2040X50IMP	2040 Ext. pitch roller chain, 50ft (Import)	1"	5/16"	120
A-CL2040	2040 Extended pitch connector link			
A-CL2040IMP	2040 Extended pitch connector link (Import)			
A-OL2040	2040 Extended pitch offset link			
A-OL2040IMP	2040 Extended pitch offset link (Import)			
A-RL2040	2040 Extended pitch roller link			

2050 ROLLER CHAINS AND ATTACHMENT LINKS

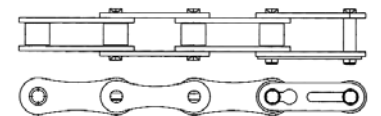

PART	DESCRIPTION	PITCH LENGTH	WIDTH	LINKS PER 10'
A-RC2050	2050 Extended pitch roller chain, 10ft	1-1/4"	3/8"	96
A-RC2050IMP	2050 Extended pitch roller chain, 10ft (Import)	1-1/4"	3/8"	96
A-RC2050X50	2050 Extended pitch roller chain, 50ft	1-1/4"	3/8"	96
A-RC50X50IMP	2050 Extended pitch roller chain, 50ft (Import)	5/8"	3/8"	192
A-RC2050X100IMP	2050 Extended pitch roller chain, 100ft (Import)	1-1/4"	3/8"	96
A-CL2050	2050 Extended pitch connector link			
A-CL2050IMP	2050 Extended pitch connector link (Import)			
A-OL2050	2050 Extended pitch offset link			
A-OL2050IMP	2050 Extended pitch offset link (Import)			
A-RL2050	2050 Extended pitch roller link			

ROLLER CHAINS & ATTACHMENT LINKS

2060 ROLLER CHAINS AND ATTACHMENT LINKS

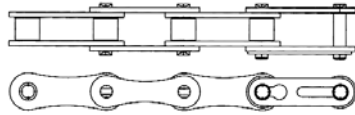

PART	DESCRIPTION	PITCH LENGTH	WIDTH	LINKS PER 10'
A-RC2060	2060 Extended pitch roller chain, 10ft	1-1/2"	1/2"	80
A-RC2060IMP	2060 Ext. pitch roller chain, 10ft (Import)	1-1/2"	1/2"	80
A-RC2060X50IMP	2060 Extended pitch roller chain, 50ft	1-1/2"	1/2"	80
A-CL2060	2060 Extended pitch connector link			
A-CL2060IMP	2060 Extended pitch connector link (Import)			
A-OL2060	2060 Extended pitch offset link			
A-OL2060IMP	2060 Extended pitch offset link (Import)			
A-RL2060	2060 Extended pitch roller link			

A550 ROLLER CHAINS AND ATTACHMENT LINKS

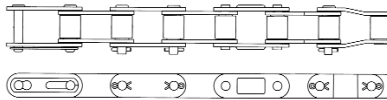

PART	DESCRIPTION
A-A550	A550 Roller Chain, 10 ft
A-A550C	A550-C Connector Link
A-A550R	A550-R Roller Link
A-A550O	A550-O Offset Link

ROLLER CHAINS AND ATTACHMENT LINKS

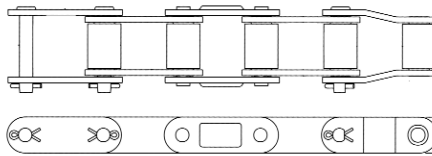

PART	DESCRIPTION
A-A620	A620 Roller Chain, 10 ft
A-A620C	A620-C Connector Link
A-A620R	A620-R Roller Link
A-A620O	A620-O Offset Link

CA550 ROLLER CHAINS AND ATTACHMENT LINKS

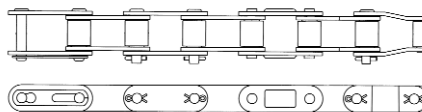

PART	DESCRIPTION
A-CA550	CA550 Conveyor Series Chain, 10 ft
A-CA550C	CA550-C Connector Link
A-CA550R	CA550-R Roller Link
A-CA550O	CA550-O Offset Link

CA550 ROLLER CHAINS AND ATTACHMENT LINKS

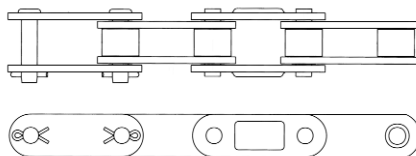

PART	DESCRIPTION
A-CA555	CA555 Conveyor Series Chain, 10 ft
A-CA555C	CA555-C Connector Link
A-CA555R	CA555-R Roller Link
A-CA555O	CA555-O Offset Link

CA557 ROLLER CHAINS AND ATTACHMENT LINKS

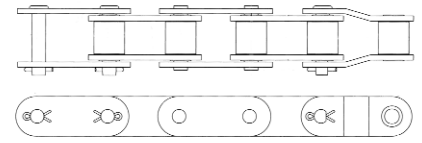

PART	DESCRIPTION
A-CA557	CA557 Conveyor Series Chain, 10 ft
A-CA557C	CA557-C Connector Link
A-CA557R	CA557-R Roller Link
A-CA557O	CA557-O Offset Link

CA620 ROLLER CHAINS AND ATTACHMENT LINKS

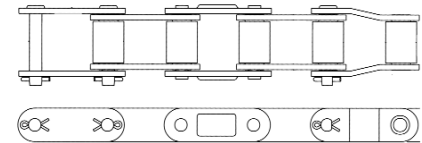

PART	DESCRIPTION
A-CA620	CA620 Conveyor Series Chain, 10 ft
A-CA620C	CA620-C Connector Link
A-CA620R	CA620-R Roller Link
A-CA620O	CA620-O Offset Link

PINTLE CHAINS

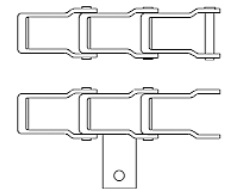

PART	DESCRIPTION
A-AL662	AL662 Pintle Chain, 10 ft
A-AL662CO	AL662-CO Connector Link
A-AL667H	AL667H Pintle Chain, 10 ft
A-AL667HCO	AL667H-CO Connector Link
A-AL667HASCO	AL667H-AS-CO Attaching Link
A-AL667X	AL667X Pintle Chain, 10 ft
A-AL667XCO	AL667X-CO Connector Link
A-AL667XASCO	AL667X-AS-CO Attaching Link

ROUND BALER CHAINS

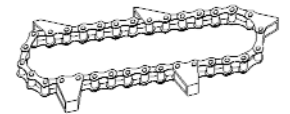

for New Holland models

PART	DESCRIPTION	(TOTAL LINKS)	(ATT. LINKS)
A-268766	Round Baler Lower Floor Chain	71	17
A-714619	Round Baler Lower Floor Chain	61	15
A-710395	Round Baler Lower Floor Chain	78	19
A-718096	Round Baler Lower Floor Chain	65	16

ROUND BALER CHAINS

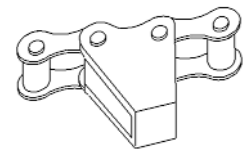

for New Holland models

PART	DESCRIPTION
A-262268	Repair Section
<i>notes for above: for chains: 268766, 714619</i>	
A-702378	Repair Section
<i>notes for above: for chains: 710395, 718096</i>	

ROLLER CHAINS & ATTACHMENT LINKS

ROUND BALER CHAINS

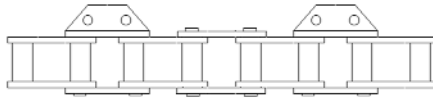

for New Holland models

PART	DESCRIPTION	(TOTAL LINKS)	(ATT. LINKS)
A-704545	Upper Slat Chain, CA550	180	60
A-634335	Upper Slat Chain, CA550	192	64
A-795027	Upper Slat Chain, CA557	228	76
A-855594	Upper Slat Chain, CA557	228	57
A-679303	Upper Slat Chain, CA557	240	80
A-273260	Upper Slat Chain, CA550	216	72
A-679768	Upper Slat Chain, CA557	234	78
A-850096	Upper Slat Chain, CA557	248	62



STEEL DETACHABLE CHAINS

PART	DESCRIPTION
A-55CO	55CO Attachment Link
A-62CO	62CO Attachment Link

ROUND BALER CHAINS



for New Holland models

PART	DESCRIPTION
A-639219	Repair Section, CA550
<i>notes for above: for chains: 704545, 634335, 273260, 679768, 795027</i>	
A-770522	Repair Section, CA557
<i>notes for above: for chain 855594</i>	

STEEL DETACHABLE CHAINS

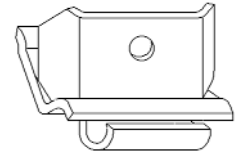

PART	DESCRIPTION
A-55C1	55C1 Attachment Link
A-62C1	62C1 Attachment Link

T-ROD CHAIN LINK

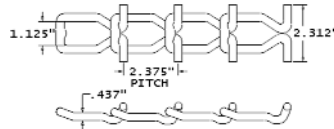

The unique design of T-Rod Chain Links allows removing or adding links without tools. Just turn the link 45 degrees and with a slight twist a link can be disengaged.

PART	DESCRIPTION
A-AL67R	67 T-Rod Chain Link, 10 ft (50 links)

STEEL DETACHABLE CHAINS

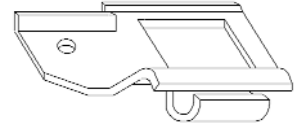

PART	DESCRIPTION
A-55A2L	55A2L Attachment Link
A-55A2R	55A2R Attachment Link

STEEL DETACHABLE CHAINS

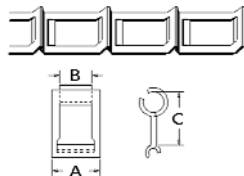

STEEL DETACHABLE CHAINS

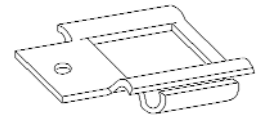

PART	DESCRIPTION
A-55A1L	55A1L Attachment Link
A-55A1R	55A1R Attachment Link

STEEL DETACHABLE CHAINS

PART	DESCRIPTION	DIM A (1)	DIM B (2)	DIM C (3)
A-25	25 Steel Detachable Chain (10 ft)	45/64	27/64	29/32
A-32	32 Steel Detachable Chain (10 ft)	15/16	19/32	1-5/32
A-32W	32W Steel Detachable Chain (10 ft)	1-1/16	19/32	1-5/32
A-33	33 Steel Detachable Chain (10 ft)	1-1/16	11/16	1-13/32
A-42	42 Steel Detachable Chain (10 ft)	1-7/32	25/32	1-3/8
A-50H	50H Steel Detachable Chain (10 ft)	1-9/32	25/32	1-3/8
A-51	51 Steel Detachable Chain (10 ft)	1-3/32	45/64	1-5/32
A-52	52 Steel Detachable Chain (10 ft)	1-13/32	27/32	1-1/2
A-55	55 Steel Detachable Chain (10 ft)	1-9/32	51/64	1-5/8
A-62	62 Steel Detachable Chain (10 ft)	1-9/16	63/64	1-21/32
A-62A	62A Steel Detachable Chain (10 ft)	1-15/16	63/64	1-43/64
A-62H	62H Steel Detachable Chain (10 ft)	1-7/8	63/64	1-21/32
A-67H	67H Steel Detachable Chain (10 ft)	1-7/8	1-3/32	2-5/16
A-67XH	67XH Steel Detachable Chain (10 ft)	1-7/8	1-3/32	2-5/16
A-70	70 Steel Detachable Chain (10 ft)	1-15/16	1-3/32	2-1/64
A-7212A	71-1/2 Steel Detachable Chain (10 ft)	2	1-5/32	1-41/64

PART	DESCRIPTION
A-62A1L	62A1L Attachment Link
A-62A1R	62A1R Attachment Link

STEEL DETACHABLE CHAINS

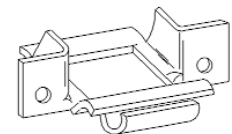

PART	DESCRIPTION
A-55SH	55SH Attachment Link

STEEL DETACHABLE CHAINS

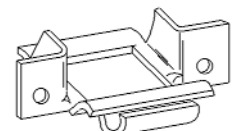

PART	DESCRIPTION
A-55SD	55SD Attachment Link
A-62SD	62SD Attachment Link

ROLLER CHAINS & ATTACHMENT LINKS

STEEL DETACHABLE CHAINS

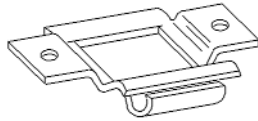

PART	DESCRIPTION
A-55K1	55K1 Attachment Link
A-62K1	62K1 Attachment Link

STEEL DETACHABLE CHAINS

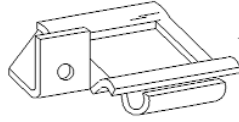

PART	DESCRIPTION
A-55G27L	55G27L Attachment Link
A-55G27R	55G27R Attachment Link
A-62G27L	62G27L Attachment Link
A-62G27R	62G27R Attachment Link

STEEL DETACHABLE CHAINS

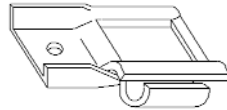

PART	DESCRIPTION
A-67HASL	67HASL Attachment Link
A-67HASR	67HASR Attachment Link
A-67XHASL	67XHASL Attachment Link
A-67XHASR	67XHASR Attachment Link

ROUND BALER BELTING

ROUND BALER BELTING

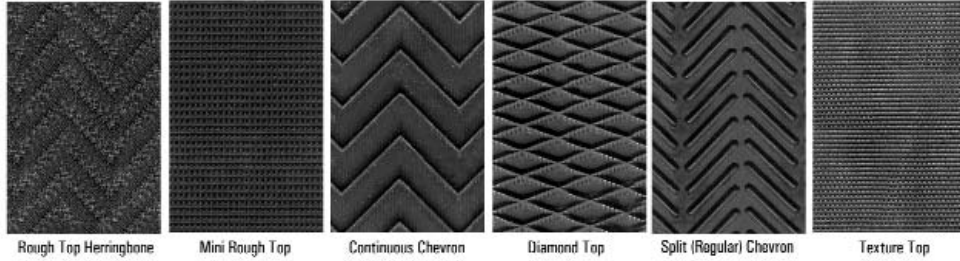

AC

MODELS	PART	DESCRIPTION	SIZE (INCH)	PLY/TEXTURE	#BELTS REPL	WT
Roto-Baler	A-1000573	Upper belting	5.5 X 72	2Ply Texture Top w/ Clipper fastener	6	3
Roto-Baler	A-1000574	Lower belting	5.5 X 102	2Ply Texture Top w/ Clipper fastener	6	5

Case IH

MODELS	PART	DESCRIPTION	SIZE (INCH)	PLY/TEXTURE	#BELTS REPL	WT
241, 2400	A-1000557	Upper belting	4 X 431	2Ply Texture Top w/ Clipper fastener	9	208510C92 12
241, 2400	A-1000669	Upper belting	4 X 431	3Ply Texture Top w/ Clipper fastener	9	208510C92 14
241, 2400	A-1000588	Upper belting	10 X 431	2Ply Texture Top w/ Clipper fastener		35
241, 2400	A-1000612	Upper belting	10 X 431	3Ply Texture Top w/ Clipper fastener		39
241, 2400	A-1000660	Lower belting	60 X 120	2Ply Texture Top w/ Clipper fastener	1	210480C92 65
2400	A-1001776	Upper belting	4 X 424	2Ply Texture Top w/ Clipper fastener	9	12
2400	A-1001777	Upper belting	4 X 424	3Ply Texture Top w/ Clipper fastener	9	14
2400	A-1001778	Upper belting	10 X 424	2Ply Texture Top w/ Clipper fastener		35
2400	A-1001779	Upper belting	10 X 424	3Ply Texture Top w/ Clipper fastener		39
3440	A-1000397	Upper belting	11 X 73.25	2Ply Texture Top w/ Clipper fastener	12	6
3440	A-1000398	Upper belting	11 X 73.25	3Ply Texture Top w/ Clipper fastener	12	8
3440	A-1000399	Lower belting	11 X 103.5	2Ply Texture Top w/ Clipper fastener	4	19
3440	A-1000400	Lower belting	11 X 103.5	3Ply Texture Top w/ Clipper fastener	4	22
3450	A-1000569	Upper belting	4.75 X 73.25	2Ply Texture Top w/ Clipper fastener	30	3
3450	A-1000685	Upper belting	4.75 X 73.25	3Ply Texture Top w/ Clipper fastener	30	5
3450	A-1000397	Upper belting	11 X 73.25	2Ply Texture Top w/ Clipper fastener	15	6
3450	A-1000398	Upper belting	11 X 73.25	3Ply Texture Top w/ Clipper fastener	15	8
3450	A-1000399	Lower belting	11 X 103.5	2Ply Texture Top w/ Clipper fastener	5	19
3450	A-1000400	Lower belting	11 X 103.5	3Ply Texture Top w/ Clipper fastener	5	22
3640	A-1000397	Upper belting	11 X 73.25	2Ply Texture Top w/ Clipper fastener	20	6
3640	A-1000398	Upper belting	11 X 73.25	3Ply Texture Top w/ Clipper fastener	20	8
3640	A-1000599	Lower belting	11 X 121.25	2Ply Texture Top w/ Clipper fastener	4	10
3640	A-1000623	Lower belting	11 X 121.25	3Ply Texture Top w/ Clipper fastener	4	13
3650	A-1000569	Upper belting	4.75 X 73.25	2Ply Texture Top w/ Clipper fastener	55	3
3650	A-1000685	Upper belting	4.75 X 73.25	3Ply Texture Top w/ Clipper fastener	55	5
3650	A-1000397	Upper belting	11 X 73.25	2Ply Texture Top w/ Clipper fastener	25	6
3650	A-1000398	Upper belting	11 X 73.25	3Ply Texture Top w/ Clipper fastener	25	8
3650	A-1000599	Lower belting	11 X 121.25	2Ply Texture Top w/ Clipper fastener	5	10
3650	A-1000623	Lower belting	11 X 121.25	3Ply Texture Top w/ Clipper fastener	5	13
8420	A-1001772	Upper belting	4.8 X 364	2Ply Texture Top w/ Clipper fastener	5	700-700-802 15
8420	A-1000357	Upper belting	4.8 X 364	3Ply Mini Rough w/ Clipper fastener	5	700-700-802 19
8430	A-1002467	Upper belting	7 X 366	2Ply Texture Top w/ Clipper fastener	6	700-709-185 19
8430	A-1002860	Upper belting	7 X 366	3Ply Chevron w/ Clipper fastener	6	700-709-185 23
8430	A-1003209	Upper belting	7 X 366	3Ply Chevron w/ Titan fastener	6	23
8430	A-1002727	Upper belting	7 X 366	3Ply Mini Rough w/ Clipper fastener	6	23
8435	A-1003213	Upper belting	7 X 471.5	2Ply Texture Top w/ Clipper fastener	6	26
8435	A-1003214	Upper belting	7 X 471.5	3Ply Chevron w/ Clipper fastener	6	30
8435	A-1003210	Upper belting	7 X 471.5	3Ply Chevron w/ Titan fastener	6	30
8440	A-1000561	Upper belting	4 X 452	2Ply Texture Top w/ Clipper fastener	9	828178 13
8440	A-1002854	Upper belting	4 X 452	3Ply Chevron w/ Clipper fastener	9	828178 17
8440	A-1000355	Upper belting	4 X 452	3Ply Herringbone w/ Clipper fastener	9	17
8450	A-1002455	Upper belting	6.5 X 572.5	2Ply Texture Top w/ Clipper fastener	2	700-708-740 28
8450	A-1002859	Upper belting	6.5 X 572.5	3Ply Chevron w/ Clipper fastener	2	700-708-740 33
8450	A-1002457	Upper belting	7 X 570	2Ply Texture Top w/ Clipper fastener	4	700-707-162 30
8450	A-1002862	Upper belting	7 X 570	3Ply Chevron w/ Clipper fastener	4	700-707-162 36

BELTING

A&I parts are not original parts, and are not sponsored affiliated or otherwise connected with any major brand.

ROUND BALER BELTING



A&I parts are not original parts, and are not sponsored affiliated or otherwise connected with any major brand.

BELTING

Case IH continued

MODELS	PART	DESCRIPTION	SIZE (INCH)	PLY/TEXTURE	#BELTS	REPL	WT
8450	A-1003208	Upper belting	6.5 X 572.5	3Ply Chevron w/ Titan fastener	2		33
8450	A-1003212	Upper belting	7 X 570	3Ply Chevron w/ Titan fastener	4		36
8450	A-1002456	Upper belting	6.5 X 572.5	3Ply Herringbone w/ Clipper fastener	2		33
8450	A-1002458	Upper belting	7 X 570	3Ply Herringbone w/ Clipper fastener	4		36
8455	A-1002865	Upper belting	7 X 562.5	2Ply Texture Top w/ Clipper fastener	6		29
8455	A-1002861	Upper belting	7 X 562.5	3Ply Chevron w/ Clipper fastener	6		36
8455	A-1003211	Upper belting	7 X 562.5	3Ply Chevron w/ Titan fastener	6		36
8455	A-1002867	Upper belting	7 X 562.5	3Ply Herringbone w/ Clipper fastener	6		36
8460	A-1002455	Early / upper belting	6.5 X 572.5	2Ply Texture Top w/ Clipper fastener	2	700-708-740	28
8460	A-1002859	Early / upper belting	6.5 X 572.5	3Ply Chevron w/ Clipper fastener	2	700-708-740	33
8460	A-1002457	Early / upper belting	7 X 570	2Ply Texture Top w/ Clipper fastener	6	700-707-162	30
8460	A-1002862	Early / upper belting	7 X 570	3Ply Chevron w/ Clipper fastener	6	700-707-162	36
8460	A-1003208	Upper belting	6.5 X 572.5	3Ply Chevron w/ Titan fastener	2		33
8460	A-1003212	Upper belting	7 X 570	3Ply Chevron w/ Titan fastener	6		36
8460	A-1002456	Early / upper belting	6.5 X 572.5	3Ply Herringbone w/ Clipper fastener	2		33
8460	A-1002458	Early / upper belting	7 X 570	3Ply Herringbone w/ Clipper fastener	6		36
8460	A-1002861	Upper belting	7 X 562.5	3Ply Chevron w/ Clipper fastener	8		36
8460	A-1003211	Upper belting	7 X 562.5	3Ply Chevron w/ Titan fastener	8		36
8460	A-1002867	Newer / Upper belting	7 X 562.5	3Ply Herringbone w/ Clipper fastener	8		36
8465	A-1002865	Upper belting	7 X 562.5	2Ply Texture Top w/ Clipper fastener	8		29
8465	A-1002861	Upper belting	7 X 562.5	3Ply Chevron w/ Clipper fastener	8		36
8465	A-1003211	Upper belting	7 X 562.5	3Ply Chevron w/ Titan fastener	8		36
8465	A-1002867	Upper belting	7 X 562.5	3Ply Herringbone w/ Clipper fastener	8		36
8480	A-1000397	Upper belting	11 X 73.25	2Ply Texture Top w/ Clipper fastener	25		6
8480	A-1000398	Upper belting	11 X 73.25	3Ply Texture Top w/ Clipper fastener	25		8
8480	A-1000599	Lower belting	11 X 121.25	2Ply Texture Top w/ Clipper fastener	5		10
8480	A-1000623	Lower belting	11 X 121.25	3Ply Texture Top w/ Clipper fastener	5		13
RBX441	A-1003784	Upper belting	7 X 272.5	3Ply Chevron w/ Titan fastener	6		18
RBX441	A-1003785	Upper belting	7 X 272.5	3Ply Chevron w/ Clipper fastener	6		18
RBX451	A-1003786	Upper belting	7 X 343	3Ply Chevron w/ Titan fastener	6		22
RBX451	A-1003787	Upper belting	7 X 343	3Ply Chevron w/ Clipper fastener	6		22
RBX451	A-1003786	Upper belting	7 X 343	3Ply Chevron w/ Titan fastener	6		22
RBX451	A-1003787	Upper belting	7 X 343	3Ply Chevron w/ Clipper fastener	6		22
RBX461	A-1003788	Upper belting	7 X 420.5	3Ply Chevron w/ Titan fastener	6		26
RBX461	A-1003789	Upper belting	7 X 420.5	3Ply Chevron w/ Clipper fastener	6		26
RBX561	A-1003788	Upper belting	7 X 420.5	3Ply Chevron w/ Titan fastener	8		26
RBX561	A-1003789	Upper belting	7 X 420.5	3Ply Chevron w/ Clipper fastener	8		26
RS451	A-1003638	Upper belting	7 X 475	3Ply Chevron w/ Titan fastener	6		36
RS451	A-1003335	Upper belting	7 X 475	3Ply Chevron w/ Clipper fastener	6		36
RS451	A-1003670	Upper belting	7 X 475	3Ply Chevron w/ Titan fastener	6		40
RS551	A-1003638	Upper belting	7 X 475	3Ply Chevron w/ Titan fastener	8		36
RS551	A-1003335	Upper belting	7 X 475	3Ply Chevron w/ Clipper fastener	8		36
RS551	A-1003670	Upper belting	7 X 475	.315 Mini w/ Titan fastener	8		40
RS561	A-1003621	Upper belting	7 X 547	3Ply Chevron w/ Titan fastener	8		46
RS561	A-1003620	Upper belting	7 X 547	3Ply Chevron w/ Clipper fastener	8		46

Claas

MODELS	PART	DESCRIPTION	SIZE (INCH)	PLY/TEXTURE	#BELTS	REPL	WT
Rollaut 180	A-1003668	Upper belting	8.66 X 500	3Ply Mini Rough Top w/ Titan fastener	5		37

FORD / NH

MODELS	PART	DESCRIPTION	SIZE (INCH)	PLY/TEXTURE	#BELTS	REPL	WT
551	A-1000575	Upper belting	6 X 450	2Ply Texture Top w/ Clipper fastener	2	GH-059802	19
551	A-1000688	Upper belting	6 X 450	3Ply Texture Top w/ Clipper fastener	2	GH-059802	24
551	A-1000571	Upper belting	5 X 450	2Ply Texture Top w/ Clipper fastener	3	GH-066548	16
551	A-1000686	Upper belting	5 X 450	3Ply Texture Top w/ Clipper fastener	3	GH-066548	22
551	A-1000652	Lower/V-Guide belting	44.25 X 69.5	2Ply Texture Top w/ Clipper fastener	1	GH-066556	26
551	A-1000651	Lower/V-Guide belting	44.25 X 56.5	2Ply Texture Top w/ Clipper fastener	1	GH-066548	26
552	A-1000577	Upper belting	6 X 466	2Ply Texture Top w/ Clipper fastener	6	GH-059800	20
552	A-1000690	Upper belting	6 X 466	3Ply Texture Top w/ Clipper fastener	6	GH-059800	25

ROUND BALER BELTING

FORD / NH continued

MODELS	PART	DESCRIPTION	SIZE (INCH)	PLY/TEXTURE	#BELTS	REPL	WT
552	A-1000657	Lower/V-Guide belting	60 X 96	2Ply Texture Top w/ Clipper fastener	1	GH-056580	47
630, 634	A-1002459	Upper belting	7 X 272.5	2Ply Texture Top w/ Clipper fastener	6		14
630, 634	A-1002460	Upper belting	7 X 272.5	3Ply Mini Rough Top w/ Clipper fastener	6		18
638	A-1002459	Upper belting	7 X 272.5	2Ply Texture Top w/ Clipper fastener	6		14
638	A-1002460	Upper belting	7 X 272.5	3Ply Mini Rough Top w/ Clipper fastener	6		18
640, 644	A-1002864	Upper belting	7 X 343	2Ply Texture Top w/ Clipper fastener	6	9843314	18
640, 644	A-1002866	Upper belting	7 X 343	3Ply Mini Rough Top w/ Clipper fastener	6	9843314	22
640, 644	A-1002980	Upper belting	7 X 343	.315" Thick Mini Rough w/ Clipper fastener	6		28
648	A-1002864	Upper belting	7 X 343	2Ply Texture Top w/ Clipper fastener	6		18
648	A-1002866	Upper belting	7 X 343	3Ply Mini Rough Top w/ Clipper fastener	6		22
648	A-1002980	Upper belting	7 X 343	.315" Thick Mini Rough w/ Clipper fastener	6		28
650, 654	A-1002461	Upper belting	7 X 420.5	2Ply Texture Top w/ Clipper fastener	6		21
650, 654	A-1002462	Upper belting	7 X 420.5	3Ply Mini Rough Top w/ Clipper fastener	6		27
658	A-1002461	Upper belting	7 X 420.5	2Ply Texture Top w/ Clipper fastener	6		21
658	A-1002462	Upper belting	7 X 420.5	3Ply Mini Rough Top w/ Clipper fastener	6		27
658	A-1002981	Upper belting	7 X 420.5	.315" Thick Mini Rough w/ Clipper fastener	6		34
660, 664	A-1002461	Upper belting	7 X 420.5	2Ply Texture Top w/ Clipper fastener	8		21
660, 664	A-1002462	Upper belting	7 X 420.5	3Ply Mini Rough Top w/ Clipper fastener	8		27
650, 654	A-1002981	Upper belting	7 X 420.5	.315" Thick Mini Rough w/ Clipper fastener	6		34
668	A-1002461	Upper belting	7 X 420.5	2Ply Texture Top w/ Clipper fastener	8		21
668	A-1002462	Upper belting	7 X 420.5	3Ply Mini Rough Top w/ Clipper fastener	8		27
668	A-1002981	Upper belting	7 X 420.5	.315" Thick Mini Rough w/ Clipper fastener	8		34
678	A-1002864	Upper belting	7 X 343	2Ply Texture Top w/ Clipper fastener	8		18
678	A-1002866	Upper belting	7 X 343	3Ply Mini Rough Top w/ Clipper fastener	8		22
678	A-1002980	Upper belting	7 X 343	.315" Thick Mini Rough w/ Clipper fastener	8		28
688	A-1002461	Upper belting	7 X 420.5	2Ply Texture Top w/ Clipper fastener	8		21
688	A-1002462	Upper belting	7 X 420.5	3Ply Mini Rough Top w/ Clipper fastener	8		27
688	A-1002981	Upper belting	7 X 420.5	.315" Thick Mini Rough w/ Clipper fastener	8		34

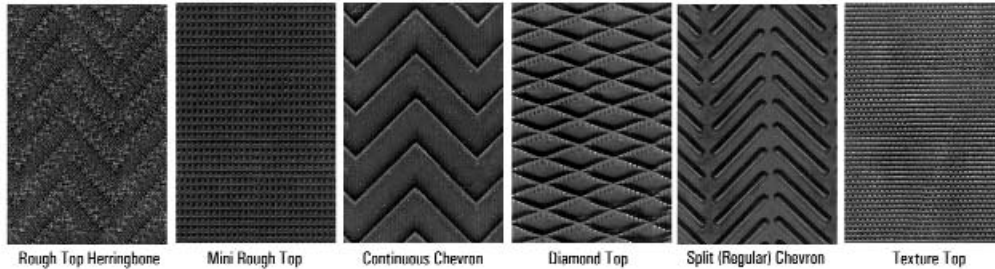

Rough Top Herringbone

Mini Rough Top

Continuous Chevron

Diamond Top

Split (Regular) Chevron

Texture Top

Gehl

MODELS	PART	DESCRIPTION	SIZE (INCH)	PLY/TEXTURE	#BELTS	REPL	WT
1400	A-1000575	Upper belting	6 X 450	2Ply Texture Top w/ Clipper fastener	2	68254	19
1400	A-1000688	Upper belting	6 X 450	3Ply Texture Top w/ Clipper fastener	2	68254	24
1400	A-1000571	Upper belting	5 X 450	2Ply Texture Top w/ Clipper fastener	3	66548	16
1400	A-1000686	Upper belting	5 X 450	3Ply Texture Top w/ Clipper fastener	3	66548	22
1400	A-1000651	Lower belting w/ "V-Guide"	44.25 X 56.5	2Ply Texture Top w/ Clipper fastener	1	69784	26
1400, 1440	A-1000652	Lower belting w/ "V-Guide"	44.25 X 69.5	2Ply Texture Top w/ Clipper fastener	1	66556	26
1450, 1460, 1465	A-1000576	Upper belting belting	6 X 468.5	2Ply Texture Top w/ Clipper fastener	5	75567	20
1450, 1460, 1465	A-1000689	Upper belting	6 X 468.5	3Ply Texture Top w/ Clipper fastener	5	75567	25
1450, 1460, 1465	A-1000651	Lower belting w/ "V-Guide"	44.25 X 56.5	2Ply Texture Top w/ Clipper fastener	1		24
1465, 1470, 1475, 1500	A-1000576	Upper belting	6 X 468.5	2Ply Texture Top w/ Clipper fastener	6		20
1465, 1470, 1475, 1500	A-1000689	Upper belting	6 X 468.5	3Ply Texture Top w/ Clipper fastener	6		25
1465, 1470, 1475, 1500	A-1002856	Optional Upper belting	6 X 468.5	3Ply Chevron w/ Clipper fastener	6		26
1465, 1470, 1475, 1500	A-1002463	Optional Upper belting	6 X 468.5	3Ply Mini Rough Top w/ Clipper fastener	6		27
1500	A-1000563	Upper belting	4 X 466	2Ply Texture Top w/ Clipper fastener	9	56479	13
1500	A-1000675	Upper belting	4 X 466	3Ply Texture Top w/ Clipper fastener	9	56479	18

ROUND BALER BELTING



Gehl continued

MODELS	PART	DESCRIPTION	SIZE (INCH)	PLY/TEXTURE	#BELTS	REPL	WT
1500	A-1000593	Upper belting	10 X 466	2Ply Texture Top w/ Clipper fastener			35
1500	A-1000617	Upper belting	10 X 466	3Ply Texture Top w/ Clipper fastener			44
1500A, 1600	A-1000577	Upper belting	6 X 466	2Ply Texture Top w/ Clipper fastener	6	59800	20
1500A, 1600	A-1000690	Upper belting	6 X 466	3Ply Texture Top w/ Clipper fastener	6	59800	25
1500, 1500A, 1600	A-1000657	Lower belting w/ "V-Guide"	60 X 96	2Ply Texture Top w/ Clipper fastener	1	56480	47
1850, 1860	A-1000578	Upper belting	6 X 546	2Ply Texture Top w/ Clipper fastener	7	75742	23
1850, 1860	A-1000691	Upper belting	6 X 546	3Ply Texture Top w/ Clipper fastener	7	75742	29
1850, 1860	A-1000656	Lower w/ "V-Guide"	60 X 56.5	2Ply Texture Top w/ Clipper fastener	1	74727	27
1865, 1870	A-1002464	Upper belting	6 X 545.5	2Ply Texture Top w/ Clipper fastener	8		23
1865, 1870	A-1002465	Upper belting	6 X 545.5	3Ply Texture Top w/ Clipper fastener	8		29
1865, 1870	A-1002857	Optional Upper belting	6 X 545.5	3Ply Chevron w/ Clipper fastener	8		30
1865, 1870	A-1002466	Optional Upper belting	6 X 545.5	3Ply Mini Rough Top w/ Clipper fastener	8		32
1875	A-1002863	Upper belting	6 X 552	2Ply Texture Top w/ Clipper fastener	8	119477	24
1875	A-1002858	Upper belting	6 X 552	3Ply Chevron w/ Clipper fastener	8	119477	30
2480	A-1003783	Upper belting	6 X 468.5	3Ply Mini Rough Top w/ Clipper fastener	6		28
2580	A-1003780	Upper belting	6.5 X 474.5	3Ply Reg. Chevron w/ Alligator Rivet	2		29
2580	A-1003779		6.5 X 502	3Ply Reg. Chevron w/ Alligator Rivet	4		31
2680	A-1003781	Upper belting	6.5 X 556	3Ply Reg. Chevron w/ Alligator Rivet	2		34
2680	A-1003782		6.5 X 577.5	3Ply Reg. Chevron w/ Alligator Rivet	4		36
2780	A-1003783	Upper belting	6 X 468.5	3Ply Mini Rough Top w/ Clipper fastener	8		28
2880	A-1003781	Upper belting	6.5 X 556	3Ply Reg. Chevron w/ Alligator Rivet	4		34
2880	A-1003782		6.5 X 577.5	3Ply Reg. Chevron w/ Alligator Rivet	4		36

Hesston

MODELS	PART	DESCRIPTION	SIZE (INCH)	PLY/TEXTURE	#BELTS	REPL	WT
514	A-1000397	Upper belting	11 X 73.25	2Ply Texture Top w/ Clipper fastener	25		6
514	A-1000398	Upper belting belting	11 X 73.25	3Ply Texture Top w/ Clipper fastener	25		8
514	A-1000599	Lowerr belting	11 X 121.25	2Ply Texture Top w/ Clipper fastener	5		10
514	A-1000623	Lowerr belting	11 X 121.25	3Ply Texture Top w/ Clipper fastener	5		13
530	A-1001772	Upper belting	4.8 X 364	2Ply Texture Top w/ Clipper fastener	5	700-700-802	15
530	A-1003557	Upper belting	4.8 X 364	3Ply Mini Rough Top w/ Clipper fastener	5	700-700-802	19
540	A-1002467	Upper belting	7 X 366	2Ply Texture Top w/ Clipper fastener	6	700-709-185	19
540	A-1002860	Upper belting	7 X 366	3Ply Chevron w/ Clipper fastener	6	700-709-185	23
540	A-1003209	Optional Upper belting	7 X 366	3Ply Chevron w/ Titan fastener	6		23
540	A-1002468	Optional Upper belting	7 X 366	3Ply Rough Herring Bone w/ Clipper fastener	6		23
545	A-1003213	Upper belting	7 X 471.5	2Ply Texture Top w/ Clipper fastener	6	700-714-815	23
545	A-1003214	Upper belting	7 X 471.5	3Ply Chevron w/ Clipper fastener	6	700-714-815	23
545	A-1003334	Upper belting/Endless	7 X 471.5	3Ply Chevron w/ Clipper fastener	6		30
545	A-1003210	Upper belting	7 X 471.5	3Ply Chevron w/ Titan fastener	6		30
550	A-1002455	Upper belting	6.5 X 572.5	2Ply Texture Top w/ Clipper fastener	2	700-708-740	29
550	A-1002859	Upper belting	6.5 X 572.5	3Ply Chevron w/ Clipper fastener	2	700-708-740	36
550	A-1003208	Optional Upper belting	6.5 X 572.5	3Ply Chevron w/ Titan fastener	2		36
550	A-1002456	Optional Upper belting	6.5 X 572.5	3Ply Rough Herring Bone w/ Clipper fastener	2		36
550	A-1002457	Upper belting	7 X 570	2Ply Texture Top w/ Clipper fastener	4	700-707-162	29
550	A-1002862	Upper belting	7 X 570	3Ply Chevron w/ Clipper fastener	4	700-707-162	36
550	A-1003212	Optional Upper belting	7 X 570	3Ply Chevron w/ Titan fastener	4	700-713-630	36
550	A-1002458	Optional Upper belting	7 X 570	3Ply Rough Herring Bone w/ Clipper fastener	4		36
555	A-1002865	Upper belting	7 X 562.5	2Ply Texture Top w/ Clipper fastener	6	700-709-999	29
555	A-1002861	Upper belting	7 X 562.5	3Ply Chevron w/ Clipper fastener	6	700-709-999	36
555	A-1003211	Upper belting	7 X 562.5	3Ply Chevron w/ Titan fastener	6	700-713-617	36
560, 565	A-1002457	Upper belting	7 X 570	2Ply Texture Top w/ Clipper fastener	8		29
560, 565	A-1002862	Upper belting	7 X 570	3Ply Chevron w/ Clipper fastener	8		36
560, 565	A-1003212	Upper belting	7 X 570	3Ply Chevron w/ Titan fastener	8		36
560, 565	A-1002458	Optional Upper belting	7 X 570	3Ply Rough Herring Bone w/ Clipper fastener	8		36
565	A-1003887	Upper belting	7 X 562.5	Mini-Rough Top w/ Clipper fastener	8	700728090	
840	A-1003209	Upper belting	7 X 366	3Ply Chevron w/ Titan fastener	6		23
840	A-1002467	Optional Upper belting	7 X 366	2Ply Texture Top w/ Clipper fastener	6		19
840	A-1002860	Optional Upper belting	7 X 366	3Ply Chevron w/ Clipper fastener	6		23
846A	A-1003680	Upper belting	7 X 547	3Ply .315 Mini Rough w/ Titan fastener	6		44
845	A-1003335	Upper belting	7 X 475	3Ply Chevron w/ Clipper fastener	8	700-716-049	36
845	A-1003336	Upper belting/Endless	7 X 475	3Ply Chevron w/ Clipper fastener	8	700-717-965	36

A&I parts are not original parts, and are not sponsored affiliated or otherwise connected with any major brand.

BELTING

ROUND BALER BELTING

Hesston continued

MODELS	PART	DESCRIPTION	SIZE (INCH)	PLY/TEXTURE	#BELTS	REPL	WT
855	A-1003335	Upper belting	7 X 475	3Ply Chevron w/ Clipper fastener	8	700-716-049	36
855	A-1003336	Upper belting/Endless	7 X 475	3Ply Chevron w/ Clipper fastener	8	700-717-965	36
856	A-1003335	Upper belting	7 X 547	3Ply Chevron w/ Clipper fastener	8	700-717-717	36
856	A-1003336	Upper belting/Endless	7 X 547	3Ply Chevron w/ Clipper fastener	8	700-717-966	36
856A	A-1003886	Mini-Rough	7 X 547	Mini-Rough w/ Clipper fastener	8	700728088	
5400	A-1000550	Upper belting	4 X 127	2Ply Texture Top w/ Clipper fastener	9	728733	3
5400	A-1000662	Upper belting	4 X 127	3Ply Texture Top w/ Clipper fastener	9	728733	5
5500, 5510	A-1000561	Upper belting	4 X 452	2Ply Texture Top w/ Clipper fastener	9	828178	13
5500, 5510	A-1002854	Upper belting	4 X 452	3Ply Chevron w/ Clipper fastener	9	828178	17
5500, 5510	A-1000355	Optional Upper belting	4 X 452	3Ply Rough Herring Bone w/ Clipper fastener	9		17
5530	A-1001772	Upper belting	4.8 X 365	2Ply Texture Top w/ Clipper fastener	5		15
5530	A-1000357	Upper belting	4.8 X 365	3Ply Mini Rough Top w/ Clipper fastener	5		19
5540	A-1000572	Upper belting	5.3 X 470	2Ply Texture Top w/ Clipper fastener	6	828335	18
5540	A-1002855	Upper belting	5.3 X 470	3Ply Chevron w/ Clipper fastener	6	828335	30
5540	A-1000358	Optional Upper belting	5.3 X 470	3Ply Rough Herring Bone w/ Clipper fastener	6		30
5545	A-1001773	Upper belting	5.3 X 465	2Ply Texture Top w/ Clipper fastener	6		15
5545	A-1003332	Upper belting	5.3 X 465	3Ply Chevron w/ Clipper fastener	6		20
5545	A-1000354	Optional Upper belting	5.3 X 465	3Ply Mini Rough Top w/ Clipper fastener	8		19
5580	A-1000572	Upper belting	5.3 X 470	2Ply Texture Top w/ Clipper fastener	8	828335	18
5580	A-1002855	Upper belting	5.3 X 470	3Ply Chevron w/ Clipper fastener	8	828335	30
5580	A-1000358	Optional Upper belting	5.3 X 470	3Ply Rough Herring Bone w/ Clipper fastener	8		30
5585	A-1001773	Upper belting	5.3 X 465	2Ply Texture Top w/ Clipper fastener	8		15
5585	A-1003332	Upper belting	5.3 X 465	3Ply Chevron w/ Clipper fastener	8		20
5585	A-1000354	Optional Upper belting	5.3 X 465	3Ply Mini Rough Top w/ Clipper fastener	8		19
5600	A-1000554	Upper belting	4 X 400	2Ply Texture Top w/ Clipper fastener	9	728832	11
5600	A-1000666	Upper belting	4 X 400	3Ply Texture Top w/ Clipper fastener	9	728832	13
5600	A-1000585	Optional Upper belting	10 X 400	2Ply Texture Top w/ Clipper fastener			30
5600	A-1000697	Optional Upper belting	10 X 400	3Ply Texture Top w/ Clipper fastener			34
5600	A-1000658	Lower belting w/ V-Guide	60 X 120	2Ply Texture Top w/ Clipper fastener	1	728931	58
5800	A-1000564	Upper belting	4 X 480	2Ply Texture Top w/ Clipper fastener	9	7827991	14
5800	A-1000363	Upper belting	4 X 480	3Ply Texture Top w/ Clipper fastener	9	7827991	18
5800	A-1000350	Optional Upper belting*	10 X 480	2Ply Texture Top w/ Clipper fastener			30
5800	A-1000618	Optional Upper belting*	10 X 480	3Ply Texture Top w/ Clipper fastener			35

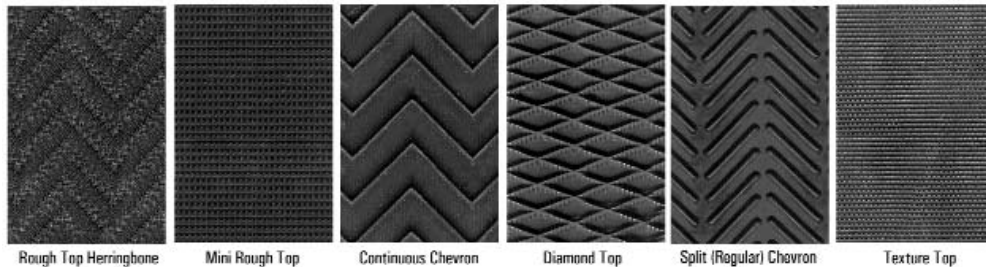

Rough Top Herringbone

Mini Rough Top

Continuous Chevron

Diamond Top

Split (Regular) Chevron

Texture Top

JD

MODELS	PART	DESCRIPTION	SIZE (INCH)	PLY/TEXTURE	#BELTS	REPL	WT
330, 335, 446, 447	A-1002599	Upper belting	7 X 402.75	3Ply Diamond Top w/ Clipper fastener	2	DC22173	38
330, 335, 446, 447	A-1003290	Upper belting	7 X 402.75	3Ply Diamond w/ Alligator fastener	2	DC22173	38
330, 335, 446, 447	A-1002600	Upper belting	7 X 410.25	3Ply Diamond Top w/ Clipper fastener	4	DC22174	38
330, 335, 446, 447	A-1003289	Upper belting	7 X 410.25	3Ply Diamond w/ Alligator fastener	4	DC22174	38
330, 335, 446, 447	A-1002942	Upper belting	7 X 402.75	3Ply Diamond w/ Titan fastener	2		38
330, 335, 446, 447	A-1003290	Upper belting	7 X 402.75	3Ply Diamond w/ Alligator fastener	2		38
330, 335, 446, 447	A-1002943	Upper belting	7 X 410.25	3Ply Diamond w/ Titan fastener	4		38
330, 335, 446,							

A&I parts are not original parts, and are not sponsored affiliated or otherwise connected with any major brand.

ROUND BALER BELTING



JD continued

MODELS	PART	DESCRIPTION	SIZE (INCH)	PLY/TEXTURE	#BELTS	REPL	WT
447	A-1003289	Upper belting	7 X 410.25	3Ply Diamond w/ Alligator fastener	4		38
375, 546, 547	A-1002599	Upper belting	7 X 402.75	3Ply Diamond Top w/ Clipper fastener	4	DC22173	38
375, 546, 547	A-1003290	Upper belting	7 X 402.75	3Ply Diamond w/ Alligator fastener	4	DC22173	38
375, 546, 547	A-1002600	Upper belting	7 X 410.25	3Ply Diamond Top w/ Clipper fastener	4	DC22174	38
375, 546, 547	A-1003289	Upper belting	7 X 410.25	3Ply Diamond w/ Alligator fastener	4	DC22174	38
375, 546, 547	A-1002942	Upper belting	7 X 402.75	3Ply Diamond w/ Titan fastener	4		38
375, 546, 547	A-1003290	Upper belting	7 X 402.75	3Ply Diamond w/ Alligator fastener	4		38
375, 546, 547	A-1002943	Upper belting	7 X 410.25	3Ply Diamond w/ Titan fastener	4		38
375, 546, 547	A-1003289	Upper belting	7 X 410.25	3Ply Diamond w/ Alligator fastener	4		38
385, 456, 457	A-1003002	Upper belting	7 X 461	3Ply Diamond Top w/ Clipper fastener	2		43
385, 456, 457	A-1003004	Upper belting	7 X 466.5	3Ply Diamond Top w/ Clipper fastener	4		44
385, 456, 457	A-1003003	Upper belting	7 X 461	3Ply Diamond w/ Titan fastener	2		43
385, 456, 457	A-1003005	Upper belting	7 X 466.5	3Ply Diamond w/ Titan fastener	4		44
556, 557	A-1003002	Upper belting	7 X 461	3Ply Diamond Top w/ Clipper fastener	4		43
556, 557	A-1003004	Upper belting	7 X 466.5	3Ply Diamond Top w/ Clipper fastener	4		44
556, 557	A-1003003	Upper belting	7 X 461	3Ply Diamond w/ Titan fastener	4		43
556, 557	A-1003005	Upper belting	7 X 466.5	3Ply Diamond w/ Titan fastener	4		44
410	A-1000555	Upper belting	4 X 415	2Ply Texture Top w/ Clipper fastener	6	AE35930	12
410	A-1000667	Upper belting	4 X 415	3Ply Texture Top w/ Clipper fastener	6	AE35930	15
410	A-1000586	Upper belting	10 X 415	2Ply Texture Top w/ Clipper fastener			28
410	A-1000698	Upper belting	10 X 415	3Ply Texture Top w/ Clipper fastener			32
410	A-1001742	Upper belting	12 X 417.5	2Ply Texture Top w/ Clipper fastener		AE41723	32
410	A-1001743	Upper belting	12 X 417.5	3Ply Texture Top w/ Clipper fastener		AE41723	37
410	A-1003566	Lower belting	8 X 74.5	2Ply Texture Top w/ Clipper fastener	5	AE37525	5
410	A-1003281	Lower belting	8 X 74.5	3Ply Texture Top w/ Clipper fastener	5	AE37525	37
430, 435	A-1000388	Upper belting	7 X 525	3Ply Diamond Top w/ Clipper fastener	2	AE40797	49
430, 435	A-1003288	Upper belting	7 X 525	3Ply Diamond w/ Alligator fastener	2	AE40797	49
430, 435	A-1000389	Upper belting	7 X 531	3Ply Diamond Top w/ Clipper fastener	4	AE40798	49
430, 435	A-1003287	Upper belting	7 X 531	3Ply Diamond w/ Alligator fastener	4	AE40798	49
530, 535, 566, 567	A-1000388	Upper belting	7 X 525	3Ply Diamond Top w/ Clipper fastener	4	AE40797	49
530, 535, 566, 567	A-1003288	Upper belting	7 X 525	3Ply Diamond w/ Alligator fastener	4	AE40797	49
530, 535, 566, 567	A-1000389	Upper belting	7 X 531	3Ply Diamond Top w/ Clipper fastener	4	AE40798	49
530, 535, 566, 567	A-1003287	Upper belting	7 X 531	3Ply Diamond w/ Alligator fastener	4	AE40798	49
430, 435	A-1002940	Upper belting	7 X 525	3Ply Diamond w/ Titan fastener	2	AE53295	49
430, 435	A-1003288	Upper belting	7 X 525	3Ply Diamond w/ Alligator fastener	2	AE53295	49
430, 435	A-1002941	Upper belting	7 X 531	3Ply Diamond w/ Titan fastener	4	AE53296	49
430, 435	A-1003287	Upper belting	7 X 531	3Ply Diamond w/ Alligator fastener	4	AE53296	49
530, 535, 566, 567	A-1002940	Upper belting	7 X 525	3Ply Diamond w/ Titan fastener	4	AE53295	49
530, 535, 566, 567	A-1003288	Upper belting	7 X 525	3Ply Diamond w/ Alligator fastener	4	AE53295	49
530, 535, 566, 567	A-1002941	Upper belting	7 X 531	3Ply Diamond w/ Titan fastener	4	AE53296	49
530, 535, 566, 567	A-1003287	Upper belting	7 X 531	3Ply Diamond w/ Alligator fastener	4	AE53296	49
466, 467	A-1000388	Upper belting	7 X 525	3Ply Diamond Top w/ Clipper fastener	2	AE40797	49
466, 467	A-1003288	Upper belting	7 X 525	3Ply Diamond w/ Alligator fastener	2	AE40797	49
466, 467	A-1000389	Upper belting	7 X 531	3Ply Diamond Top w/ Clipper fastener	4	AE40798	49
466, 467	A-1003287	Upper belting	7 X 531	3Ply Diamond w/ Alligator fastener	4	AE40798	49
466, 467	A-1002940	Upper belting	7 X 525	3Ply Diamond w/ Titan fastener	2	AE53295	49
466, 467	A-1003288	Upper belting	7 X 525	3Ply Diamond w/ Alligator fastener	2	AE53295	49
466, 467	A-1002941	Upper belting	7 X 531	3Ply Diamond w/ Titan fastener	4	AE53296	49
466, 467	A-1003287	Upper belting	7 X 531	3Ply Diamond w/ Alligator fastener	4	AE53296	49
500	A-1000556	Upper belting	4 X 422	2Ply Texture Top w/ Clipper fastener	9	AE3390	12
500	A-1000668	Upper belting	4 X 422	3Ply Texture Top w/ Clipper fastener	9	AE3390	16
500	A-1000587	Upper belting	10 X 422	2Ply Texture Top w/ Clipper fastener			28
500	A-1000699	Upper belting	10 X 422	3Ply Texture Top w/ Clipper fastener			16
500	A-1000661	Lower belting/V-Guide	60 X 138	2Ply Texture Top w/ Clipper fastener	1	AE58828	65

A&I parts are not original parts, and are not sponsored affiliated or otherwise connected with any major brand.

BELTING

ROUND BALER BELTING

JD continued

MODELS	PART	DESCRIPTION	SIZE (INCH)	PLY/TEXTURE	#BELTS	REPL	WT
510	A-1000565	Upper belting	4 X 484	2Ply Texture Top w/ Clipper fastener	9	AE35484	14
510	A-1000677	Upper belting	4 X 484	3Ply Texture Top w/ Clipper fastener	9	AE35484	18
510	A-1000595	Upper belting	10 X 484	2Ply Texture Top w/ Clipper fastener			31
510	A-1000619	Upper belting	10 X 484	3Ply Texture Top w/ Clipper fastener			35
510	A-1000650	Upper belting	12 X 486.5	2Ply Texture Top w/ Clipper fastener		AE41724	41
510	A-1000624	Upper belting	12 X 486.5	3Ply Texture Top w/ Clipper fastener		AE41724	46
510	A-1003566	Lower belting	8 X 74.5	2Ply Texture Top w/ Clipper fastener	7	AE37525	5
510	A-1003281	Lower belting	8 X 74.5	3Ply Texture Top w/ Clipper fastener	7	AE37525	13

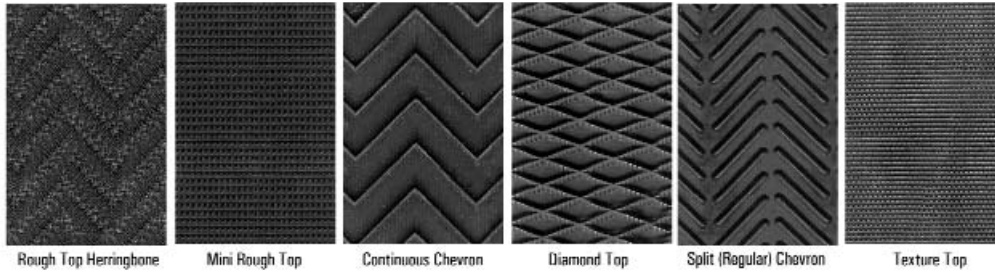

Rough Top Herringbone

Mini Rough Top

Continuous Chevron

Diamond Top

Split (Regular) Chevron

Texture Top

MF

MODELS	PART	DESCRIPTION	SIZE (INCH)	PLY/TEXTURE	#BELTS	REPL	WT
450	A-1000553	Upper belting	4 X 388	2Ply Texture Top w/ Clipper fastener	8	1047868M93	11
450	A-1000665	Upper belting	4 X 388	3Ply Texture Top w/ Clipper fastener	8	1047868M93	15
450	A-1000582	Upper belting	9 X 388	2Ply Texture Top w/ Clipper fastener			28
450	A-1000694	Upper belting	9 X 388	3Ply Texture Top w/ Clipper fastener			30
450	A-1000658	Lower belting	60 X 120	2Ply Texture Top w/ Clipper fastener			58
560	A-1000559	Upper belting	4 X 440	2Ply Texture Top w/ Clipper fastener	9	1045352M92	13
560	A-1000671	Upper belting	4 X 440	3Ply Texture Top w/ Clipper fastener	9	1045352M92	17
560	A-1000590	Upper belting	10 X 440	2Ply Texture Top w/ Clipper fastener		1096895M91	33
560	A-1000614	Upper belting	10 X 440	3Ply Texture Top w/ Clipper fastener		1096895M91	38
634	A-1002469	Upper belting	6 X 428	2Ply Texture Top w/ Clipper fastener	4		20
634	A-1002470	Upper belting	6 X 428	3Ply Texture Top w/ Clipper fastener	4		23
645	A-1000394	Upper belting	6.5 X 528	2Ply Texture Top w/ Clipper fastener	6		26
645	A-1000395	Upper belting	6.5 X 528	3Ply Texture Top w/ Clipper fastener	6		31
656	A-1000394	Upper belting	6.5 X 528	2Ply Texture Top w/ Clipper fastener	8		26
656	A-1000395	Upper belting	6.5 X 528	3Ply Texture Top w/ Clipper fastener	8		31
822	A-1002717	Front Upper belting	6.375 X 187.8	2Ply Texture Top w/ Clipper fastener	6		9
822	A-1002869	Front Upper belting	6.375 X 187.8	3Ply Mini Rough Top w/ Clipper fastener	6		10
822	A-1002721	Rear Upper belting	6.375 X 226.8	2Ply Texture Top w/ Clipper fastener	6		11
822	A-1002871	Rear Upper belting	6.375 X 226.8	3Ply Mini Rough Top w/ Clipper fastener	6		12
825	A-1000576	Upper belting	6 X 462.5	2Ply Texture Top w/ Clipper fastener	6		20
825	A-1002856	Upper belting	6 X 462.5	3Ply Chevron w/ Clipper fastener	6		25
828	A-1002719	Front Upper belting	6.375 X 211.42	2Ply Texture Top w/ Clipper fastener	6		10
828	A-1002870	Front Upper belting	6.375 X 211.42	3Ply Mini Rough Top w/ Clipper fastener	6		12
828	A-1002723	Rear Upper belting	6.375 X 306.3	2Ply Texture Top w/ Clipper fastener	6		15
828	A-1002872	Rear Upper belting	6.375 X 306.3	3Ply Mini Rough Top w/ Clipper fastener	6		16
834	A-1002719	Front Upper belting	6.375 X 211.42	2Ply Texture Top w/ Clipper fastener	8		10
834	A-1002870	Front Upper belting	6.375 X 211.42	3Ply Mini Rough Top w/ Clipper fastener	8		12
834	A-1002723	Rear Upper belting	6.375 X 306.3	2Ply Texture Top w/ Clipper fastener	8		15
834	A-1002872	Rear Upper belting	6.375 X 306.3	3Ply Mini Rough Top w/ Clipper fastener	8		18
835	A-1002464	Upper belting	6 X 545.5	2Ply Texture Top w/ Clipper fastener	8		24
835	A-1002857	Upper belting	6 X 545.5	3Ply Chevron w/ Clipper fastener	8		30
1440, 1450, 1455	A-1000558	Upper belting	4 X 436	2Ply Texture Top w/ Clipper fastener	8	1045352M92	13
1440, 1450, 1455	A-1000670	Upper belting	4 X 436	3Ply Texture Top w/ Clipper fastener	8	1045352M92	17
1440, 1450, 1455	A-1000390	Upper belting	9 X 436	2Ply Texture Top w/ Clipper fastener			32
1440, 1450, 1455	A-1000391	Upper belting	9 X 436	3Ply Texture Top w/ Clipper fastener			37
1440, 1450, 1455	A-1000589	Upper belting	10 X 436	2Ply Texture Top w/ Clipper fastener		1095895M91	33
1440, 1450, 1455	A-1000613	Upper belting	10 X 436	3Ply Texture Top w/ Clipper fastener		1095895M91	38
1550, 1560, 1565	A-1000567	Upper belting	4 X 512	2Ply Texture Top w/ Clipper fastener	6	1053386M91	14
1550, 1560, 1565	A-1000679	Upper belting	4 X 512	3Ply Texture Top w/ Clipper fastener	6	1053386M91	19

ROUND BALER BELTING



MF continued

MODELS	PART	DESCRIPTION	SIZE (INCH)	PLY/TEXTURE	#BELTS	REPL	WT
1550, 1560, 1565	A-1000583	Upper/Options belting	9 X 512	2Ply Texture Top w/ Clipper fastener	3		33
1550, 1560, 1565	A-1000695	Upper/Options belting	9 X 512	3Ply Texture Top w/ Clipper fastener	3		38
1550, 1560, 1565	A-1000597	Upper/Optional belting	10 X 512	2Ply Texture Top w/ Clipper fastener	2	1053387M91	34
1550, 1560, 1565	A-1000621	Upper/Optional belting	10 X 512	3Ply Texture Top w/ Clipper fastener	2	1053387M91	39

McKee

MODELS	PART	DESCRIPTION	SIZE (INCH)	PLY/TEXTURE	#BELTS	REPL	WT
875	A-1001610	Upper belting	4.75 X 64.5	2Ply Texture Top w/ Clipper fastener	45		3
875	A-1001611	Upper belting	4.75 X 64.5	3Ply Texture Top w/ Clipper fastener	45		5
875	A-1001612	Lower belting	7 X 104.5	2Ply Texture Top w/ Clipper fastener	6		5
875	A-1001613	Lower belting	7 X 104.5	3Ply Texture Top w/ Clipper fastener	6		7
1500, 1578	A-1000569	Upper belting	4.75 X 73.25	2Ply Texture Top w/ Clipper fastener	55		3
1500, 1578	A-1000685	Upper belting	4.75 X 73.25	3Ply Texture Top w/ Clipper fastener	55		5
1500, 1578	A-1000599	Lower belting	11 X 121.25	2Ply Texture Top w/ Clipper fastener	5		10
1500, 1578	A-1000623	Lower belting	11 X 121.25	3Ply Texture Top w/ Clipper fastener	5		13
1500, 1578	A-1000570	Bk-cleat belting	4.75 X 73.25	2Ply Texture Top w/ Clipper fastener	N/A		3
1500, 1578	A-1001744	Bk-cleat belting	4.75 X 73.25	3Ply Texture Top w/ Clipper fastener	N/A		5

New Idea

MODELS	PART	DESCRIPTION	SIZE (INCH)	PLY/TEXTURE	#BELTS	REPL	WT
483	A-1000397	Lower Belting	11 X 73.25	2Ply Texture Top w/ Clipper fastener	12		6
483	A-1000398	Lower Belting	11 X 73.25	3Ply Texture Top w/ Clipper fastener	12		8
484	A-1000399	Lower Belting	11 X 103.5	2Ply Texture Top w/ Clipper fastener	4		9
484	A-1000400	Lower Belting	11 X 103.5	3Ply Texture Top w/ Clipper fastener	4		22
484	A-1000569	Upper Belting	4.75 X 73.25	2Ply Texture Top w/ Clipper fastener	30	104412	3
484	A-1000685	Upper Belting	4.75 X 73.25	3Ply Texture Top w/ Clipper fastener	30	104412	5
484	A-1000399	Lower Belting	11 X 103.5	2Ply Texture Top w/ Clipper fastener	5		9
484	A-1000400	Lower Belting	11 X 103.5	3Ply Texture Top w/ Clipper fastener	5		22
485	A-1000397	Upper Belting	11 X 73.25	2Ply Texture Top w/ Clipper fastener	20	105003	6
485	A-1000398	Upper Belting	11 X 73.25	3Ply Texture Top w/ Clipper fastener	20	105003	8
4855	A-1000599	Upper Belting	11 X 121.25	2Ply Texture Top w/ Clipper fastener	4	104108	10
4855	A-1000623	Upper Belting	11 X 121.25	3Ply Texture Top w/ Clipper fastener	4	104108	13
456, 486, 4865	A-1000569	Upper Belting	4.75 X 73.25	2Ply Texture Top w/ Clipper fastener	55	104412	3
456, 486, 4865	A-1000685	Upper Belting	4.75 X 73.25	3Ply Texture Top w/ Clipper fastener	55	104412	5
456, 486, 4865	A-1000397	Upper Belting	11 X 73.25	2Ply Texture Top w/ Clipper fastener	25		6
456, 486, 4865	A-1000398	Upper Belting	11 X 73.25	3Ply Texture Top w/ Clipper fastener	25		8
456, 486, 4865	A-1000599	Lower Belting	11 X 121.25	2Ply Texture Top w/ Clipper fastener	5	104411	10
456, 486, 4865	A-1000623	Lower Belting	11 X 121.25	3Ply Texture Top w/ Clipper fastener	5	104411	13
456, 486, 4865	A-1000570	Bk-cleat Belting	4.75 X 73.25	2Ply Texture Top w/ Clipper fastener		104104	3
456, 486, 4865	A-1001744	Bk-cleat Belting	4.75 X 73.25	3Ply Texture Top w/ Clipper fastener		104104	5
4643	A-1001772	Upper Belting	4.8 X 364	2Ply Texture Top w/ Clipper fastener	5		14
4643	A-1000357	Upper Belting	4.8 X 364	3Ply Mini Rough Top w/ Clipper fastener	5		16
4644	A-1002467	Upper Belting	7 X 366	2Ply Texture Top w/ Clipper fastener	6		20
4644	A-1002860	Upper Belting	7 X 366	3Ply Chevron w/ Clipper fastener	6		23
4644	A-1003209	Upper Belting	7 X 366	3Ply Chevron w/ Titan fastener	6		23
4664	A-1002865	Upper Belting	7 X 562.5	2Ply Texture Top w/ Clipper fastener	6		29
4664	A-1002861	Upper Belting	7 X 562.5	3Ply Chevron w/ Clipper fastener	6		36
4664	A-1003211	Upper Belting	7 X 562.5	3Ply Chevron w/ Titan fastener	6		36
4665	A-1002865	Upper Belting	7 X 562.5	2Ply Texture Top w/ Clipper fastener	8		31
4665	A-1002861	Upper Belting	7 X 562.5	3Ply Chevron w/ Clipper fastener	8		36
4665	A-1003211	Upper Belting	7 X 562.5	3Ply Chevron w/ Titan fastener	8		36
6343	A-1001772	Upper Belting	4.8 X 364	2Ply Texture Top w/ Clipper fastener	5		15
6343	A-1000357	Upper Belting	4.8 X 364	3Ply Mini Rough Top w/ Clipper fastener	5		19
6344	A-1002467	Upper Belting	7 X 366	2Ply Texture Top w/ Clipper fastener	6		19
6344	A-1002860	Upper Belting	7 X 366	3Ply Chevron w/ Clipper fastener	6		23
6364	A-1002865	Upper Belting	7 X 562.5	2Ply Texture Top w/ Clipper fastener	6		29
6364	A-1002861	Upper Belting	7 X 562.5	3Ply Chevron w/ Clipper fastener	6		36
6364	A-1003211	Upper Belting	7 X 562.5	3Ply Chevron w/ Titan fastener	6		36
6365	A-1002865	Upper Belting	7 X 562.5	2Ply Texture Top w/ Clipper fastener	6		29
6365	A-1002861	Upper Belting	7 X 562.5	3Ply Chevron w/ Clipper fastener	6		36
6365	A-1003211	Upper Belting	7 X 562.5	3Ply Chevron w/ Titan fastener	6		36

A&I parts are not original parts, and are not sponsored affiliated or otherwise connected with any major brand.

BELTING

ROUND BALER BELTING



Rough Top Herringbone

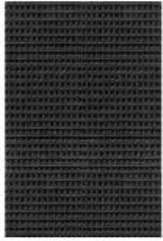

Mini Rough Top



Continuous Chevron



Diamond Top



Split (Regular) Chevron



Texture Top

Renn

MODELS	PART	DESCRIPTION	SIZE (INCH)	PLY/TEXTURE	#BELTS REPL	WT
121	A-1001614	Upper Belting	4 X 465	2Ply Texture Top w/ Clipper fastener	4	13
121	A-1001615	Upper Belting	4 X 465	3Ply Texture Top w/ Clipper fastener	4	18
121	A-1001616	Upper Belting	9 X 465	2Ply Texture Top w/ Clipper fastener	2	35
121	A-1001617	Upper Belting	9 X 465	3Ply Texture Top w/ Clipper fastener	2	39
151	A-1001614	Upper Belting	4 X 465	2Ply Texture Top w/ Clipper fastener	6	13
151	A-1001615	Upper Belting	4 X 465	3Ply Texture Top w/ Clipper fastener	6	18
151	A-1001616	Upper Belting	9 X 465	2Ply Texture Top w/ Clipper fastener	2	35
151	A-1001617	Upper Belting	9 X 465	3Ply Texture Top w/ Clipper fastener	2	39

Vermeer

MODELS	PART	DESCRIPTION	SIZE (INCH)	PLY/TEXTURE	#BELTS REPL	WT
403F, 403G	A-1000551	Upper Belting	4 X 358	2Ply Texture Top w/ Clipper fastener	6	10
403F, 403G	A-1000663	Upper Belting	4 X 358	3Ply Texture Top w/ Clipper fastener	6	13
403F, 403G	A-1000581	Upper Belting	9 X 358	2Ply Texture Top w/ Clipper fastener		23
403F, 403G	A-1000693	Upper Belting	9 X 358	3Ply Texture Top w/ Clipper fastener		26
503I	A-1000392	Upper Belting	6.5 X 431	2Ply Texture Top w/ Clipper fastener	4	17
503I	A-1000393	Upper Belting	6.5 X 431	3Ply Texture Top w/ Clipper fastener	4	20
504C	A-1000553	Upper Belting	4 X 388	2Ply Texture Top w/ Clipper fastener	8	F-685 11
504C	A-1000665	Upper Belting	4 X 388	3Ply Texture Top w/ Clipper fastener	8	F-685 15
504C	A-1000582	Upper Belting	9 X 388	2Ply Texture Top w/ Clipper fastener		28
504C	A-1000694	Upper Belting	9 X 388	3Ply Texture Top w/ Clipper fastener		30
504F, 504G, 504H	A-1000558	Upper Belting	4 X 436	2Ply Texture Top w/ Clipper fastener	8	826-003 12
504F, 504G, 504H	A-1000670	Upper Belting	4 X 436	3Ply Texture Top w/ Clipper fastener	8	826-003 16
504F, 504G, 504H	A-1000589	Upper Belting	10 X 436	2Ply Texture Top w/ Clipper fastener		4075-001 33
504F, 504G, 504H	A-1000613	Upper Belting	10 X 436	3Ply Texture Top w/ Clipper fastener		4075-001 37
504F, 504G, 504H	A-1000390	Upper Belting	9 X 436	2Ply Texture Top w/ Clipper fastener		31
504F, 504G, 504H	A-1000391	Upper Belting	9 X 436	3Ply Texture Top w/ Clipper fastener		35
504I	A-1002469	Upper Belting	6 X 428	2Ply Texture Top w/ Clipper fastener	6	20
504I	A-1002470	Upper Belting	6 X 428	3Ply Texture Top w/ Clipper fastener	6	23
505I	A-1002569	Upper Belting	6 X 424	2Ply Texture Top w/ Clipper fastener	8	20
505I	A-1002570	Upper Belting	6 X 424	3Ply Texture Top w/ Clipper fastener	8	23
505I	A-1002569	Upper Belting	6 X 424	2Ply Texture Top w/ Clipper fastener	2	Optional 20
505I	A-1002570	Upper Belting	6 X 424	3Ply Texture Top w/ Clipper fastener	2	Optional 23
505I	A-1002563	Upper Belting	14 X 424	2Ply Texture Top w/ Clipper fastener	3	Optional 47
505I	A-1002564	Upper Belting	14 X 424	3Ply Texture Top w/ Clipper fastener	3	Optional 54
5400	A-1002563	Upper Belting	14 X 424	2Ply Texture Top w/ Clipper fastener	2	47
5400	A-1002564	Upper Belting	14 X 424	3Ply Texture Top w/ Clipper fastener	2	54
5400	A-1002569	Upper Belting	6 X 424	2Ply Texture Top w/ Clipper fastener	2	20
5400	A-1002570	Upper Belting	6 X 424	3Ply Texture Top w/ Clipper fastener	2	23
5500	A-1002563	Upper Belting	14 X 424	2Ply Texture Top w/ Clipper fastener	3	47
5500	A-1002564	Upper Belting	14 X 424	3Ply Texture Top w/ Clipper fastener	3	54
5500	A-1002569	Upper Belting	6 X 424	2Ply Texture Top w/ Clipper fastener	2	20
5500	A-1002570	Upper Belting	6 X 424	3Ply Texture Top w/ Clipper fastener	2	23
554XL	A-1003791	Upper Belting	14 X 450	2Ply Texture Top w/ Clipper fastener	2	48
554XL	A-1003794	Upper Belting	14 X 450	3Ply Texture Top w/ Clipper fastener	2	60
554XL	A-1003792	Upper Belting	16 X 450	2Ply Texture Top w/ Clipper fastener	2	55
554XL	A-1003795	Upper Belting	16 X 450	3Ply Texture Top w/ Clipper fastener	2	68
555XL	A-1003791	Upper Belting	14 X 450	2Ply Texture Top w/ Clipper fastener	3	48
555XL	A-1003794	Upper Belting	14 X 450	3Ply Texture Top w/ Clipper fastener	3	60
555XL	A-1003793	Upper Belting	6 X 450	2Ply Texture Top w/ Clipper fastener	2	21
555XL	A-1003796	Upper Belting	6 X 450	3Ply Texture Top w/ Clipper fastener	2	24

ROUND BALER BELTING



Vermeer continued

MODELS	PART	DESCRIPTION	SIZE (INCH)	PLY/TEXTURE	#BELTS	REPL	WT
604XL	A-1002565	Upper Belting	14 X 528	2Ply Texture Top w/ Clipper fastener	2		56
604XL	A-1002566	Upper Belting	14 X 528	3Ply Texture Top w/ Clipper fastener	2		70
604XL	A-1000394	Upper Belting	6.5 X 528	2Ply Texture Top w/ Clipper fastener	2		26
604XL	A-1000395	Upper Belting	6.5 X 528	3Ply Texture Top w/ Clipper fastener	2		31
605A	A-1000554	Upper Belting	4 X 400	2Ply Texture Top w/ Clipper fastener	9	F-158	11
605A	A-1000666	Upper Belting	4 X 400	3Ply Texture Top w/ Clipper fastener	9	F-158	13
605A	A-1000585	Upper Belting	10 X 400	2Ply Texture Top w/ Clipper fastener			30
605A	A-1000697	Upper Belting	10 X 400	3Ply Texture Top w/ Clipper fastener			34
605B	A-1000552	Upper Belting	4 X 387	2Ply Texture Top w/ Clipper fastener	9	F-1670	11
605B	A-1000664	Upper Belting	4 X 387	3Ply Texture Top w/ Clipper fastener	9	F-1670	15
605B	A-1000625	Upper Belting	10 X 387	2Ply Texture Top w/ Clipper fastener			24
605B	A-1000626	Upper Belting	10 X 387	3Ply Texture Top w/ Clipper fastener			29
605A, 605B	A-1000658	Lower Belting	60 X 120	2Ply Texture Top w/ Clipper fastener	1		58
605C	A-1000559	Upper Belting	4 X 440	2Ply Texture Top w/ Clipper fastener	9	F-894	13
605C	A-1000671	Upper Belting	4 X 440	3Ply Texture Top w/ Clipper fastener	9	F-894	17
605C	A-1000590	Upper Belting	10 X 440	2Ply Texture Top w/ Clipper fastener			33
605C	A-1000614	Upper Belting	10 X 440	3Ply Texture Top w/ Clipper fastener			38
605D	A-1000560	Upper Belting	4 X 450	2Ply Texture Top w/ Clipper fastener	9	F-1447	13
605D	A-1000672	Upper Belting	4 X 450	3Ply Texture Top w/ Clipper fastener	9	F-1447	17
605D	A-1000591	Upper Belting	10 X 450	2Ply Texture Top w/ Clipper fastener			34
605D	A-1000615	Upper Belting	10 X 450	3Ply Texture Top w/ Clipper fastener			39
605E	A-1000562	Upper Belting	4 X 457	2Ply Texture Top w/ Clipper fastener	5		13
605E	A-1000674	Upper Belting	4 X 457	3Ply Texture Top w/ Clipper fastener	5		17
605E	A-1000592	Upper Belting	10 X 457	2Ply Texture Top w/ Clipper fastener	2		35
605E	A-1000616	Upper Belting	10 X 457	3Ply Texture Top w/ Clipper fastener	2		39
605E	A-1000559	Upper Belting	4 X 440	2Ply Texture Top w/ Clipper fastener	5		13
605E	A-1000671	Upper Belting	4 X 440	3Ply Texture Top w/ Clipper fastener	5		17
605E	A-1000590	Upper Belting	10 X 440	2Ply Texture Top w/ Clipper fastener	2		33
605E	A-1000614	Upper Belting	10 X 440	3Ply Texture Top w/ Clipper fastener	2		38
605F, 605G, 605H	A-1000567	Upper Belting	4 X 512	2Ply Texture Top w/ Clipper fastener	6	1826-001	14
605F, 605G, 605H	A-1000679	Upper Belting	4 X 512	3Ply Texture Top w/ Clipper fastener	6	1826-001	19
605F, 605G, 605H	A-1000583	Upper Belting	9 X 512	2Ply Texture Top w/ Clipper fastener	3		32
605F, 605G, 605H	A-1000695	Upper Belting	9 X 512	3Ply Texture Top w/ Clipper fastener	3		37
605F, 605G, 605H	A-1000597	Upper Belting	10 X 512	2Ply Texture Top w/ Clipper fastener	2		34
605F, 605G, 605H	A-1000621	Upper Belting	10 X 512	3Ply Texture Top w/ Clipper fastener	2		39
605F, 605G, 605H	A-1000394	Upper Belting	6.5 X 528	2Ply Texture Top w/ Clipper fastener	6		23
605F, 605G, 605H	A-1000395	Upper Belting	6.5 X 528	3Ply Texture Top w/ Clipper fastener	6		28
604K	A-1000394	Upper Belting	6.5 X 528	2Ply Texture Top w/ Clipper fastener	2		26
604K	A-1000395	Upper Belting	6.5 X 528	3Ply Texture Top w/ Clipper fastener	2		31
604K	A-1002565	Upper Belting	14 X 528	2Ply Texture Top w/ Clipper fastener	2		56
604K	A-1002566	Upper Belting	14 X 528	3Ply Texture Top w/ Clipper fastener	2		70
605J	A-1000394	Upper Belting	6.5 X 528	2Ply Texture Top w/ Clipper fastener	8		26
605J	A-1000395	Upper Belting	6.5 X 528	3Ply Texture Top w/ Clipper fastener	8		31
605J	A-1003338	Upper Belting	6.5 X 542	2Ply Texture Top w/ Clipper fastener	8		28
605J	A-1003339	Upper Belting	6.5 X 542	3Ply Texture Top w/ Clipper fastener	8		32
605K	A-1000394	Upper Belting	6.5 X 528	2Ply Texture Top w/ Clipper fastener	2		26
605K	A-1000395	Upper Belting	6.5 X 528	3Ply Texture Top w/ Clipper fastener	2		31
605K	A-1002565	Upper Belting	14 X 528	2Ply Texture Top w/ Clipper fastener	3		56
605K	A-1002566	Upper Belting	14 X 528	3Ply Texture Top w/ Clipper fastener	3		70
605XL	A-1002565	Upper Belting	14 X 528	2Ply Texture Top w/ Clipper fastener	3		56
605XL	A-1002566	Upper Belting	14 X 528	3Ply Texture Top w/ Clipper fastener	3		70
605XL	A-1000394	Upper Belting	6.5 X 528	2Ply Texture Top w/ Clipper fastener	2		26
605XL	A-1000395	Upper Belting	6.5 X 528	3Ply Texture Top w/ Clipper fastener	2		31
706A	A-1000566	Upper Belting	4 X 493	2Ply Texture Top w/ Clipper fastener	11	F-329	14
706A	A-1000678	Upper Belting	4 X 493	3Ply Texture Top w/ Clipper fastener	11	F-329	17
706A	A-1000596	Upper Belting	10 X 493	2Ply Texture Top w/ Clipper fastener			37
706A	A-1000620	Upper Belting	10 X 493	3Ply Texture Top w/ Clipper fastener			43
706C	A-1000568	Upper Belting	4 X 541	2Ply Texture Top w/ Clipper fastener	12	F-1037	15
706C	A-1000680	Upper Belting	4 X 541	3Ply Texture Top w/ Clipper fastener	12	F-1037	20
706C	A-1000598	Upper Belting	10 X 541	2Ply Texture Top w/ Clipper fastener			41
706C	A-1000622	Upper Belting	10 X 541	3Ply Texture Top w/ Clipper fastener			45

A&I parts are not original parts, and are not sponsored affiliated or otherwise connected with any major brand.

BELTING

ROUND BALER BELTING

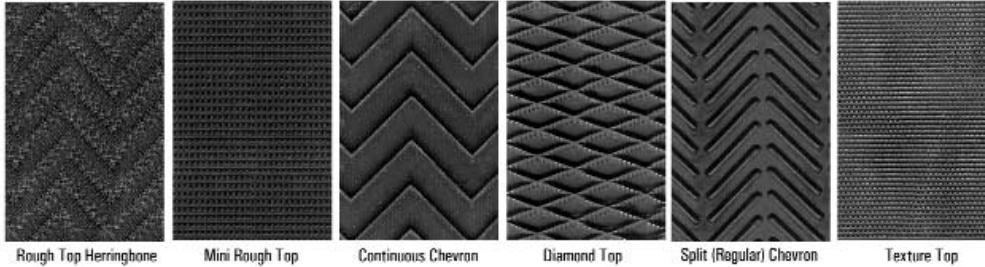

Rough Top Herringbone

Mini Rough Top

Continuous Chevron

Diamond Top

Split (Regular) Chevron

Texture Top

Vicon

MODELS	PART	DESCRIPTION	SIZE (INCH)	PLY/TEXTURE	#BELTS REPL	WT
260	A-1001618	Upper Belting	7 X 64.5	2Ply Texture Top w/ Clipper fastener	30	6
260	A-1001619	Upper Belting	7 X 64.5	3Ply, clupper lacing w/ Clipper fastener	30	8
260	A-1001612	Lower Belting	7 X 104.5	2Ply Texture Top w/ Clipper fastener	6	9
260	A-1001613	Lower Belting	7 X 104.5	3Ply, clupper lacing w/ Clipper fastener	6	12
560	A-1000397	Upper Belting	11 X 73.25	2Ply Texture Top w/ Clipper fastener	25	6
560	A-1000398	Upper Belting	11 X 73.25	3Ply, clupper lacing w/ Clipper fastener	25	8
560	A-1000599	Lower Belting	11 X 121.25	2Ply Texture Top w/ Clipper fastener	5	10
560	A-1000623	Lower Belting	11 X 121.25	3Ply, clupper lacing w/ Clipper fastener	5	13
1200	A-1001614	Upper Belting	4 X 465	2Ply Texture Top w/ Clipper fastener	4	13
1200	A-1001615	Upper Belting	4 X 465	3Ply, clupper lacing w/ Clipper fastener	4	18
1200	A-1001616	Upper Belting	9 X 465	2Ply Texture Top w/ Clipper fastener	2	35
1200	A-1001617	Upper Belting	9 X 465	3Ply, clupper lacing w/ Clipper fastener	2	39
RP1210	A-1001610	Upper Belting	4.75 X 64.75	2Ply Texture Top w/ Clipper fastener	45	3
RP1210	A-1001611	Upper Belting	4.75 X 64.75	3Ply, clupper lacing w/ Clipper fastener	45	5
RP1210	A-1001618	Upper Belting	7 X 64.75	2Ply Texture Top w/ Clipper fastener	30	6
RP1210	A-1001619	Upper Belting	7 X 64.75	3Ply, clupper lacing w/ Clipper fastener	30	8
RP1210	A-1001612	Lower Belting	7 X 104.5	2Ply Texture Top w/ Clipper fastener	6	9
RP1210	A-1001613	Lower Belting	7 X 104.5	3Ply, clupper lacing w/ Clipper fastener	6	12
RP1211	A-1000627	Upper Belting	7.28 X 64.8	2Ply Texture Top w/ Clipper fastener	25	6
RP1211	A-1002479	Upper Belting	7.28 X 64.8	3Ply, clupper lacing w/ Clipper fastener	25	8
RP1211	A-1000631	Lower Belting	7.28 X 96.85	2Ply Texture Top w/ Clipper fastener	5	6
RP1211	A-1002480	Lower Belting	7.28 X 96.85	3Ply, clupper lacing w/ Clipper fastener	5	8
RP1510	A-1000569	Upper Belting	4.75 X 73.25	2Ply Texture Top w/ Clipper fastener	55	3
RP1510	A-1000685	Upper Belting	4.75 X 73.25	3Ply, clupper lacing w/ Clipper fastener	55	5
RP1510	A-1000599	Lower Belting	11 X 121.25	2Ply Texture Top w/ Clipper fastener	5	10
RP1510	A-1000623	Lower Belting	11 X 121.25	3Ply, clupper lacing w/ Clipper fastener	5	13
RP1510	A-1000397	Upper Belting	11 X 73.25	2Ply Texture Top w/ Clipper fastener	25	6
RP1510	A-1000398	Upper Belting	11 X 73.25	3Ply, clupper lacing w/ Clipper fastener	25	8
RP1510	A-1000599	Lower Belting	11 X 121.25	2Ply Texture Top w/ Clipper fastener	5	10
RP1510	A-1000623	Lower Belting	11 X 121.25	3Ply, clupper lacing w/ Clipper fastener	5	13
RP1511	A-1002481	Upper Belting	11 X 75.75	2Ply Texture Top w/ Clipper fastener	25	11
RP1511	A-1002482	Upper Belting	11 X 75.75	3Ply, clupper lacing w/ Clipper fastener	25	14
RP1511	A-1002483	Upper Belting	11 X 112	2Ply Texture Top w/ Clipper fastener	5	14
RP1511	A-1002484	Upper Belting	11 X 112	3Ply, clupper lacing w/ Clipper fastener	5	17
RV1501	A-1003797	Upper Belting	8.46 X 403.54	2Ply Texture Top w/ Clipper fastener	5	28
RV1501	A-1003803	Upper Belting	8.46 X 403.54	3Ply, clupper lacing w/ Clipper fastener	5	32
RV1501	A-1003800	Upper Belting	8.46 X 403.54	3Ply, clupper lacing w/ Clipper fastener	5	32
RV1601	A-1003798	Upper Belting	8.46 X 421.26	2Ply Texture Top w/ Clipper fastener	5	29
RV1601	A-1003804	Upper Belting	8.46 X 421.26	3Ply, clupper lacing w/ Clipper fastener	5	33
RV1601	A-1003801	Upper Belting	8.46 X 421.26	3Ply, clupper lacing w/ Clipper fastener	5	33
RV1901	A-1003799	Upper Belting	8.46 X 472.44	2Ply Texture Top w/ Clipper fastener	5	32
RV1901	A-1003805	Upper Belting	8.46 X 472.44	3Ply, clupper lacing w/ Clipper fastener	5	37
RV1901	A-1003802	Upper Belting	8.46 X 472.44	3Ply, clupper lacing w/ Clipper fastener	5	37

SICKLE ASSEMBLIES & PARTS

SICKLE SECTIONS - CASE-IH

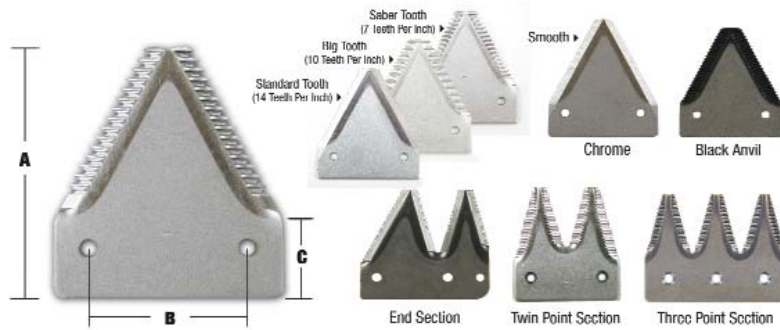

PART NO.	DESCRIPTION	DIM A (1)	DIM B (2)	DIM C (3)	FASTENER	REPL. NO.
A-211-003	black 14ga under serrated	3.250"	2.062"	1"	7/32 x 5/8	1145
A-212-063	chrome 14ga under serrated	3.250"	2.062"	1"	7/32 x 5/8	604800
A-211-011	black 11ga smooth	3.250"	2.062"	1"	7/32 x 5/8	26622
A-212-131	chrome 11ga smooth	3.250"	2.062"	1"	7/32 x 5/8	457605R3
A-211-001	black 11ga under serrated	3.250"	2.062"	1"	7/32 x 5/8	29875
A-212-061	chrome 11ga under serrated	3.250"	2.062"	1"	7/32 x 5/8	060635
A-211-211	black 11ga top serrated, 2 hole	3.250"	2.062"	1"	7/32 x 5/8	9622744
A-231-211	black 11ga big tooth, 2 hole	3.250"	2.062"	1"	7/32 x 5/8	124737BT
A-231-461	black 11ga saber tooth	3.250"	2.062"	1"	7/32 x 5/8	9622744ST
A-212-001	chrome 11ga top serrated	3.250"	2.062"	1"	7/32 x 5/8	700705300
A-232-001	chrome 11ga big tooth	3.250"	2.062"	1"	7/32 x 5/8	700705300BT
A-232-461	chrome 11ga saber tooth	3.250"	2.062"	1"	7/32 x 5/8	9826090ST
A-612-140	(10) RH end sections, chrm top ser	end section			7/32 x 5/8	148200C1
A-612-150	(10) RH end sections, chrm top ser	3 hole			7/32 x 5/8	700705463
A-612-090	(10) LH end sections, chrm top ser	end section			7/32 x 5/8	700705462

SICKLE PARTS - CASE-IH

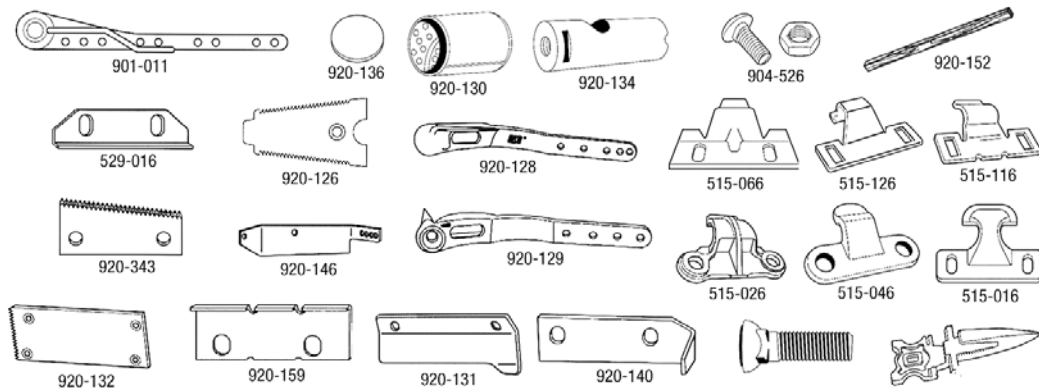

PART NO.	DESCRIPTION	REPLACES	APPLICATION
A-901-012	Sickle Head	MA999	
A-901-011	Sickle Head	56692C91	(MOWER: CUTTER PARTS balanced head)
A-901-075	Sickle Head	ZA502562	(MOWER CONDITIONER: 1490, 1590)
A-901-042	Sickle Head	824594C91	(WINDROWER: 4000, 5000)
A-901-018	Sickle Head, LH	6821078	(WINDROWER: 8820, 8320, 8330, 8350)
A-901-019	Sickle Head, RH	6821136	(WINDROWER: 8820)
A-901-013	Sickle Head	540607R11	(MOWER CONDITIONER: 990)
A-901-120	Sickle Head, LH	700111003	(WINDROWER: 8820, 8830, 8840, 8360, 8370, 8330, 8340)
A-901-137	Sickle Head, RH	700116709	(WINDROWER: 8820, 8830, 8840)
A-901-158	Sickle Head	823710C1	(WINDROWER: 375, 275)
A-901-130	Sickle Head, RH/LH	700114594	(WINDROWER: 8840, 8380)
A-920-223	Bearing	176699C91	(WINDROWER: 810, 820)
A-920-130	Bronze Bushing	458971R1	(MOWER: SERIES 100)
A-920-136	Head Plug	458972R1	(MOWER: CUTTER PARTS balanced head)
A-920-314	Knifehead Pin	458973R4	(WINDROWER: 1100, 1300)
A-725-001	Knifehead Pin Kit	176699C91	
A-529-016	Wear Plate	71116532, 71176537	
A-920-159	Head Wear Plate	MB22863	(MOWER: CUTTER PARTS)

SICKLE ASSEMBLIES & PARTS

A-920-101	Center Guard	50HS4A, 143HSA	
A-920-102	Outer Guard		
A-920-126	Ledger Plate	455634R1	(MOWER: CUTTER PARTS)
A-904-520	(50) 7/16x1-1/2" bolts		
A-904-521	(50) 7/16x1-3/4" bolts		
A-920-127	Outer Shoe Plate	MA330	(MOWER: CUTTER PARTS)
A-920-343	Inner Shoe Plate	458965R1	(MOWER: CUTTER PARTS)
A-920-146	Inner Sole	MC465	(MOWER: CUTTER PARTS)
A-920-140	Rear Guide, Upper	M22161	(MOWER: CUTTER PARTS)
A-M22184	Pitman Wood 35.687"	M22184	(MOWER: 16, 24, 32)
A-M32119	Pitman Wood 35.687"	M32119	(MOWER: 25V, 27V, 27VA)
A-920-128	Pitman Strap, front	MA1577	(MOWER: CUTTER PARTS)
A-920-129	Pitman Strap, rear	M1578	(MOWER: CUTTER PARTS)
A-920-182	(10) Shims	6821052	
A-515-046	Malleable Knife Clip	MA812, XL1000	(MOWER: CUTTER PARTS for riveted sickle only)
A-515-026	Malleable Knife Clip	MB812, XA1000, 611759R1	(MOWER: CUTTER PARTS for riveted sickle only)
A-515-126	Knifehead Clip	611759R1, 595648R1	(MOWER: CUTTER PARTS for bolted sickle only)
A-515-016	Knife Clip	71176540	(MOWER: CUTTER PARTS floating headers, Gen II & III HC)
A-515-066	Knife Clip	61384282	(MOWER: CUTTER PARTS)
A-904-022	(1lb) 7/32 x 5/8" OH rivet	700000883	(MOWER: CUTTER PARTS for extra heavy sections)
A-904-500	(50) 7/32 x 5/8" Bolt & Nut	700705296	(MOWER: CUTTER PARTS for standard straight hole sections)
A-904-525	(50) 7/32 x 5/8" 60° CTSK Bolt & Nut	700002978	(MOWER: CUTTER PARTS for J.E.Love & Hart Carter)

SICKLE ASSEMBLIES - CASE-IH

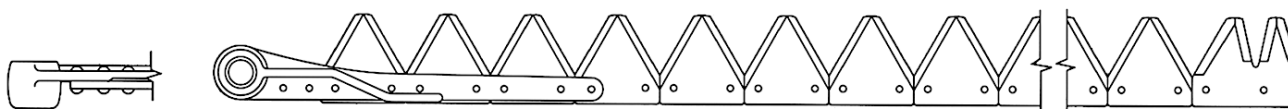

BOLT ON	RIVETED	DESCRIPTION	LENGTH	HEAD NO.	OEM SICKLE NO.	SECT. PART NO.
A-800-071	black 11ga under serrated		5 ft.	MA999	1958205C1	826722C2
A-801-073	A-800-073	black 11ga under serrated	6 ft.	501015E	501012ESXH	501017EXH
A-801-074	A-800-074	black 11ga smooth	7 ft.	501015E	501013ESXH	501016EXH
A-801-076	A-800-076	black 11ga under serrated	7 ft.	MA999	1958207C1	826722C2
A-801-078	A-800-078	black 11ga smooth	9 ft.	MA999	463293R91	826724C2
A-801-079	A-800-079	black 11ga under serrated	9 ft.	MA999	463294R91	826722C2
For Models: (MOWER: CUTTER PARTS except series 100 balanced heads)						
A-801-064	A-800-064	black 11ga under serrated	5 ft.	56692C91	463408R93	826722C2
A-801-065	A-800-065	black 11ga under serrated	6 ft.	56692C91	465112R93	826722C2
A-801-060	A-800-060	black 11ga smooth	7 ft.	56692C91	462381R93	826724C2
A-801-066	A-800-066	black 11ga under serrated	7 ft.	56692C91	462380R93	826722C2
A-801-691	A-800-691	black 11top serrated	7 ft.	56692C91	1281292C92	826720C3
A-861-010	N/A	black 11ga big tooth	7 ft.	56692C91	1281292C92BT	826720C3BT
A-801-061	A-800-061	black 11ga smooth	9 ft.	56692C91	463182R93	826724C2
A-801-692	A-800-692	black 11top serrated	9 ft.	56692C91	1281291C92	826720C3
A-861-527	N/A	black 11ga big tooth	9 ft.	56692C91	1281291C92BT	826720C3BT
For Models: (MOWER: SERIES 100 balanced heads, 1100, 1130)						

SICKLE ASSEMBLIES - CASE-IH

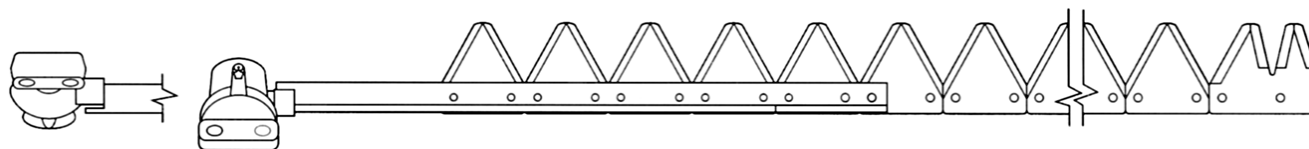

BOLT ON	RIVETED	DESCRIPTION	LENGTH	HEAD NO.	OEM SICKLE NO.	SECT. PART NO.
A-801-245	A-800-245	chrome 14ga top serrated	7 ft.	451948	6193510	049213
A-801-246	A-800-246	chrome 14ga top serrated	9 ft.	451948	451955	049213
A-801-247	A-800-247	chrome 12ga top serrated	9 ft.	451948	6566178	049254
For Models: (MOWER CONDITIONER: 555)						

SICKLE ASSEMBLIES & PARTS

SICKLE ASSEMBLIES - CASE-IH

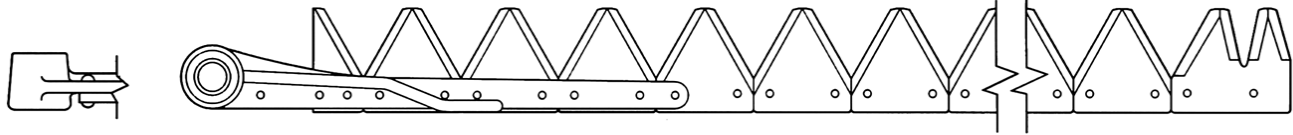

BOLT ON	RIVETED	DESCRIPTION	LENGTH	HEAD NO.	OEM SICKLE NO.	SECT. PART NO.
A-801-399	A-800-399	black 11ga under serrated	7 ft.	540607R11	542816R92	826722C2
A-801-080	A-800-080	black 11ga under serrated	9 ft.	540607R11	540605R92	826722C2
A-831-865	A-830-865	black 11ga top serrated	9 ft.	540607R11	540605R92BL	826720C3

For Models: (MOWER CONDITIONER: 990)

SICKLE ASSEMBLIES - CASE-IH

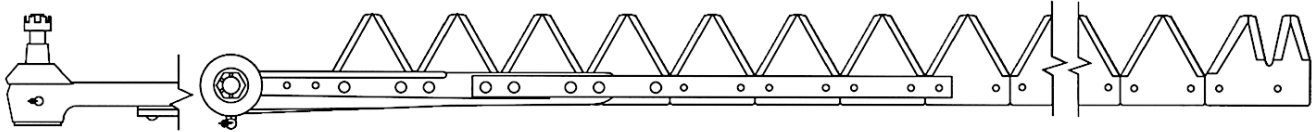

BOLT ON	RIVETED	DESCRIPTION	LENGTH	HEAD NO.	OEM SICKLE NO.	SECT. PART NO.
A-801-400	A-800-400	black 11ga under serrated	7 ft.	824594C91	101987C95	W501017E
A-801-306	A-800-306	black 11ga under serrated	9 ft.	824594C91	101988C95	W501017E
A-831-869	A-830-869	black 11ga under serrated	9 ft.	824594C91	1960310C1	W501017ETS

For Models: (MOWER CONDITIONER: 1190)

SICKLE ASSEMBLIES - CASE-IH

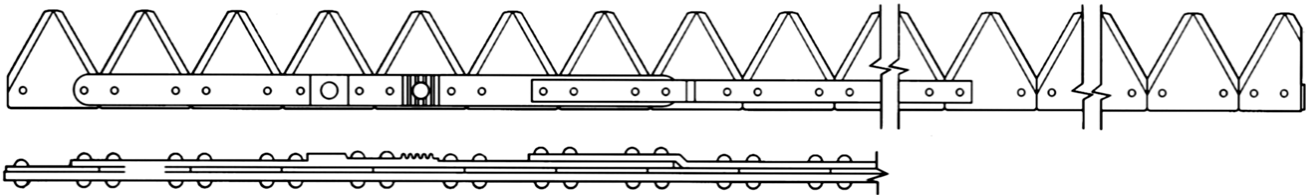

BOLT ON	RIVETED	DESCRIPTION	LENGTH	HEAD NO.	OEM SICKLE NO.	SECT. PART NO.
A-801-084	A-800-084	chrome 11ga under serrated	12 ft.	823710C1	595650R93, 824427C92	457607R3

For Models: (MOWER CONDITIONER: 1290)

SICKLE ASSEMBLIES - CASE-IH

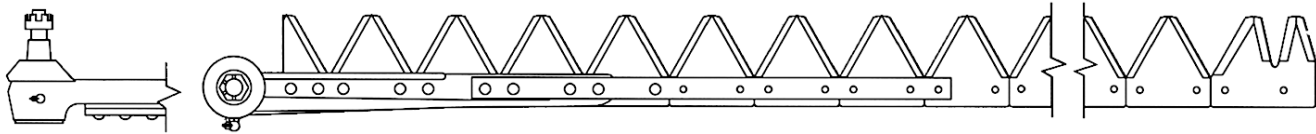

BOLT ON	RIVETED	DESCRIPTION	LENGTH	HEAD NO.	OEM SICKLE NO.	SECT. PART NO.
A-801-764	A-800-764	chrome 11ga under serrated	12 ft.	ZA502562	ZA502930, ZA502889	502933
A-801-765	A-800-765	chrome 11ga under serrated	14 ft.	ZA502562	ZA502931, ZA502890	502933

For Models: (MOWER CONDITIONER: 1490 (12'), 1590 (14'))

SICKLE ASSEMBLIES - CASE-IH

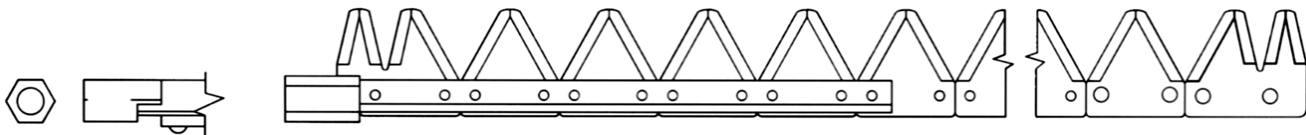

BOLT ON	RIVETED	DESCRIPTION	LENGTH	HEAD NO.	OEM SICKLE NO.	SECT. PART NO.
A-801-778	A-800-778	chrome 11ga under serrated	7 ft.	6821078	700111432	700705300
A-801-779	A-800-779	chrome 11ga under serrated	9 ft.	6821078	700111430	700705300
A-831-904	N/A	black 11ga under serrated	9 ft.	6821078	700111430BL	700705299
A-801-540	A-800-540	chrome 11ga under serrated	12 ft.	6821078	700109341	700705300
A-831-906	N/A	black 11ga under serrated	12 ft.	6821078	700109341BL	700705299

For Models: (MOWER CONDITIONER: 8320 (7'), 8330 (9'), 8350 (12'))

SICKLE ASSEMBLIES & PARTS

SICKLE ASSEMBLIES - CASE-IH

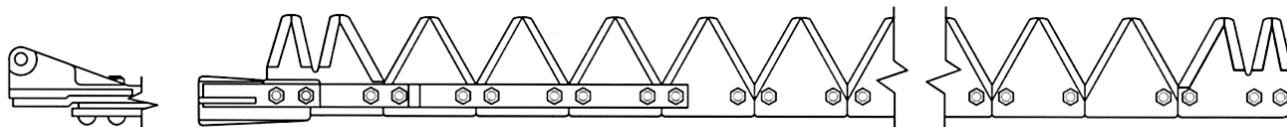

BOLT ON	RIVETED	DESCRIPTION	LENGTH	HEAD NO.	OEM SICKLE NO.	SECT. PART NO.
A-801-984	N/A	chrome 11ga top serrated	9 ft.	700111003	700118673	700705300
For Models: (MOWER CONDITIONER: 8340)						
A-801-742	N/A	chrome 11ga top serrated	9 ft.	Headless	700118671	700705300
A-831-905	N/A	black 11ga top serrated	9 ft.	700111003	700118673BL	700705299
For Models: (MOWER CONDITIONER: 8340)						

SICKLE ASSEMBLIES - CASE-IH

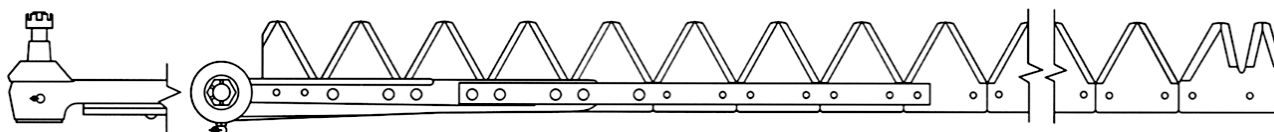

BOLT ON	RIVETED	DESCRIPTION	LENGTH	HEAD NO.	OEM SICKLE NO.	SECT. PART NO.
A-801-308	A-800-308	chrome 11ga under serrated	12-1/2 ft.	824594C91	827813C92	457607R3
A-801-309	A-800-309	chrome 11ga under serrated	14-1/2 ft.	824594C91	827814C92	457607R3
A-801-771	A-800-771	chrome 11ga top serrated	14-1/2 ft.	824594C91	831607C94	700705300
A-861-534	A-860-534	black 11ga top serrated	14-1/2 ft.	824594C91	831607C94BL	826720C3
A-801-310	A-800-310	chrome 11ga under serrated	16-1/2 ft.	824594C91	827815C92	457607R3
A-831-870	A-830-870	black 11ga top serrated	16-1/2 ft.	824594C91	827815C92BL	826720C3
A-861-102	A-860-102	chrome 11ga top serrated	16-1/2 ft.	824594C91	827815C92TS	700705300
A-801-535	A-800-535	chrome 11ga under serrated	19-1/2 ft.	824594C91	827816C92	457607R3
A-831-871	A-830-871	black 11ga top serrated	19-1/2 ft.	824594C91	827816C92BL	826720C3
A-801-372	A-800-372	chrome 11ga under serrated	24-1/2 ft. 1 pc.	824594C91	827830C92	457607R3
A-831-872	A-830-872	black 11ga top serrated	24-1/2 ft. 1 pc.	824594C91	827830C92BL	826720C3
A-861-105	A-860-105	chrome 11ga top serrated	24-1/2 ft. 1 pc.	824594C91	827830C92TS	700705300
For Models: (WINDROWER: (230, 4000, 500 ALL w/ single auger or 12' - 24' draper header), 210 SN 3700>)						

SICKLE ASSEMBLIES - CASE-IH

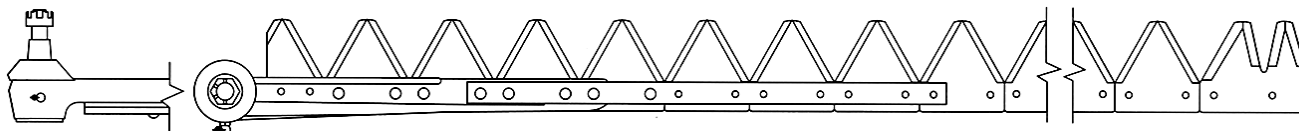

BOLT ON	RIVETED	DESCRIPTION	LENGTH	HEAD NO.	OEM SICKLE NO.	SECT. PART NO.
A-801-516	A-800-516	chrome 11ga under serrated	13 ft	STUDS	271981PLBT	457607R3
A-831-866	A-830-866	black 11ga top serrated	12 ft.	824594C91	827724C92BL	826720C3
A-801-517	A-800-517	chrome 11ga under serrated	15 ft	STUDS	271981PLBT	457607R3
A-801-848	A-800-848	chrome 11ga top serrated	14 ft.	824594C91	827701C92	700705300
A-831-458	A-830-458	chrome 11ga big tooth	14 ft.	824594C91	827701C92BT	700705300BT
A-831-867	A-830-867	black 11ga top serrated	14 ft.	824594C91	827701C92BL	826720C3
N/A	A-800-518	chrome 11ga under serrated	16 ft.	824594C91	827726C92	457607R3
A-831-868	A-830-868	black 11ga top serrated	16 ft.	824594C91	827726C92BL	826720C3
For Models: (WINDROWER: (4000, 5000, 5500 ALL w/ dual auger headers))						

SICKLE ASSEMBLIES & PARTS

SICKLE ASSEMBLIES - CASE-IH

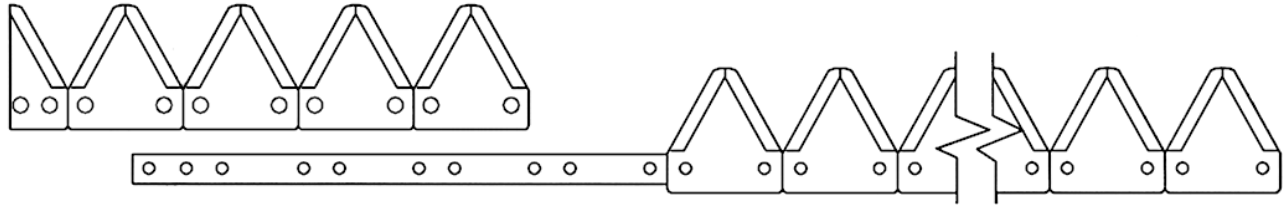

BOLT ON	RIVETED	DESCRIPTION	LENGTH	HEAD NO.	OEM SICKLE NO.	SECT. PART NO.
A-801-657	A-800-657	chrome 14ga under serrated	15 ft.	Headless	16641PL	7253
A-801-490	A-800-490	chrome 14ga under serrated	18 ft.	Headless	824874C91	457606R3
A-801-491	A-800-491	chrome 14ga under serrated	21 ft.	Headless	824875C91	457606R3
A-801-658	A-800-658	chrome 14ga under serrated	25 ft.	Headless	824699C91	457606R3

For Models: (WINDROWER: 75 pull)

SICKLE ASSEMBLIES - CASE-IH

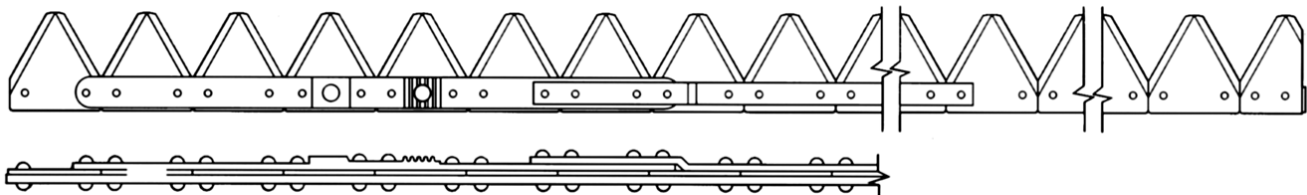

BOLT ON	RIVETED	DESCRIPTION	LENGTH	HEAD NO.	OEM SICKLE NO.	SECT. PART NO.
A-801-084	A-800-084	chrome 11ga under serrated	12 ft.	823710C1	595650R93, 824427C92	457607R3
A-801-085	A-800-085	chrome 11ga under serrated	14 ft.	823710C1	595651R93	457607R3

For Models: (WINDROWER: 275, 375)

SICKLE ASSEMBLIES - CASE-IH

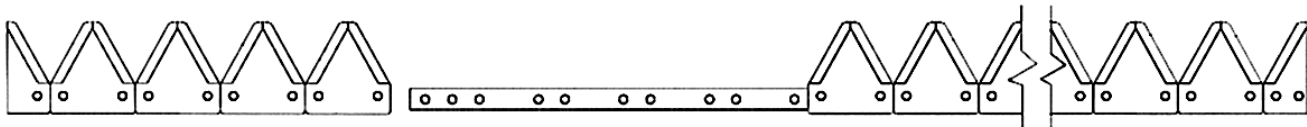

BOLT ON	RIVETED	DESCRIPTION	LENGTH	HEAD NO.	OEM SICKLE NO.	SECT. PART NO.
A-801-772	A-800-772	chrome 11ga top serrated	21 ft.	Headless	90966C91	700705300
A-801-773	A-800-773	chrome 11ga top serrated	26 ft. 1 pc.	Headless	80648C91	700705300
A-801-774	A-800-774	chrome 11ga top serrated	31 ft. 1 pc.	Headless	80650C91	700705300

For Models: (WINDROWER: 721, 725, 730, 736, 742, 750, 6000, 6500)

SICKLE ASSEMBLIES - CASE-IH

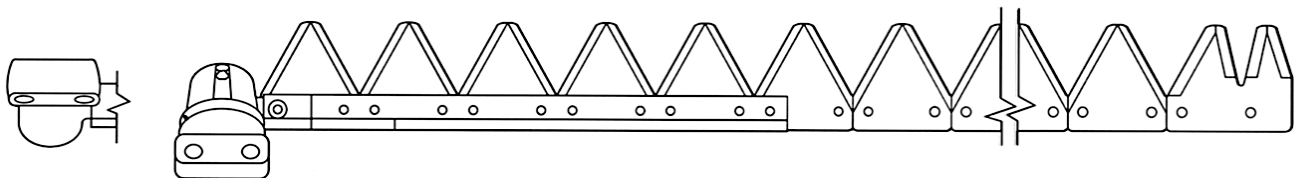

BOLT ON	RIVETED	DESCRIPTION	LENGTH	HEAD NO.	OEM SICKLE NO.	SECT. PART NO.
A-801-237	A-800-237	chrome 14ga top serrated	12 ft.	379370	373522	049213
A-801-239	A-800-239	chrome 14ga top serrated	14 ft.	379370	373530	049213
A-801-241	A-800-241	chrome 12ga top serrated	14 ft.	379370	373530H	049254
A-801-243	A-800-243	chrome 14ga top serrated	16 ft.	379370	373548	049213

For Models: (WINDROWER: 950, 955, 1050, 1055, 1150, 1155)

SICKLE ASSEMBLIES & PARTS

SICKLE ASSEMBLIES - CASE-IH

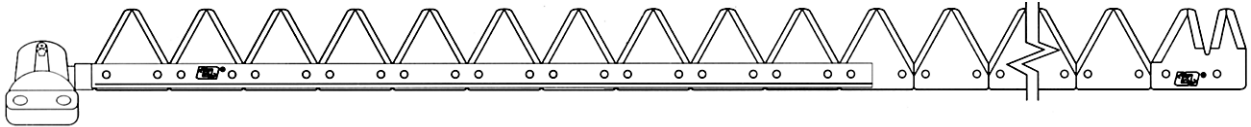

BOLT ON	RIVETED	DESCRIPTION	LENGTH	HEAD NO.	OEM SICKLE NO.	SECT. PART NO.
A-801-248	A-800-248	chrome 14ga top serrated	10 ft.	6193577, 6497416	6193619	049213
A-801-249	A-800-249	chrome 14ga top serrated	12 ft.	6193577, 6497416	6193627	049213
A-801-250	A-800-250	chrome 14ga top serrated	12 ft.	Headless	6206023	049213
A-801-251	A-800-251	chrome 12ga top serrated	12 ft.	6193577, 6497416	6272959	049254
A-801-252	A-800-252	chrome 12ga top serrated	12 ft.	Headless	6497457	049254
A-861-054	N/A	chrome 11ga big tooth	12 ft.	6497416	6196327BT	700705300BT
A-801-253	A-800-253	chrome 14ga top serrated	14 ft.	6193577, 6497416	6193635	049213
A-801-254	A-800-254	chrome 14ga top serrated	14 ft.	Headless	6206031	049213
A-801-255	A-800-255	chrome 12ga top serrated	14 ft.	6193577, 6497416	6272967	049254
A-801-256	A-800-256	chrome 12ga top serrated	14 ft.	Headless	6497465	049254
A-801-706	N/A	black 11ga top serrated	14 ft.	Headless	6497465BL	700705299
A-861-060	N/A	chrome 11ga big tooth	14 ft.	Headless	6497465BT	700705300BT
A-801-728	N/A	black 11ga top serrated	14 ft.	6497416	6272967BL	700705299
A-801-397	A-800-397	chrome 12ga top serrated	14 ft.	6497416	6497119	049254
A-831-508	N/A	chrome 11ga big tooth	14 ft.	6497416	6497119BT	700705300BT
A-801-388	A-800-388	chrome 12ga top serrated	16 ft.	6497416	6497374	049254
A-801-257	A-800-257	chrome 12ga top serrated	16 ft.	Headless	6497473	049254
A-801-707	N/A	black 11ga top serrated	16 ft.	Headless	6497473BL	700705299
A-831-509	N/A	chrome 11ga big tooth	16 ft.	6497416	6497374BT	700705300BT

For Models: (WINDROWER: 1075, 1085, 1275)

SICKLE ASSEMBLIES - CASE-IH

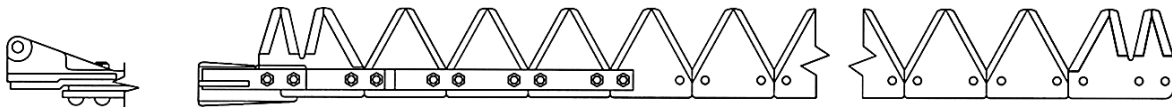

BOLT ON	RIVETED	DESCRIPTION	LENGTH	HEAD NO.	OEM SICKLE NO.	SECT. PART NO.
A-801-826	A-800-826	chrome 11ga top serrated	12 ft.	700111003	700110730	700705300
A-801-928	A-800-928	chrome 11ga top serrated	12 ft.	Headless	700115887	700705300
A-831-514	A-830-514	chrome 11ga big tooth	12 ft.	700111003	700110730BT	700705300BT
A-831-907	N/A	black 11ga top serrated	12 ft.	700111003	700110730BL	700705299
A-801-780	A-800-780	chrome 11ga top serrated	14 ft.	700111003	700110731	700705300
A-801-781	A-800-781	chrome 11ga top serrated	14 ft.	Headless	700115804	700705300
A-831-515	A-830-515	chrome 11ga big tooth	14 ft.	700111003	700110731BT	700705300BT
A-831-908	N/A	black 11ga top serrated	14 ft.	700111003	700110731BL	700705299

For Models: (WINDROWER: 8360 w/ 12' enter pivot, 8370 w/ 14' enter pivot, 8830 w/ 12' & 14' enter pivot)

SICKLE ASSEMBLIES - CASE-IH

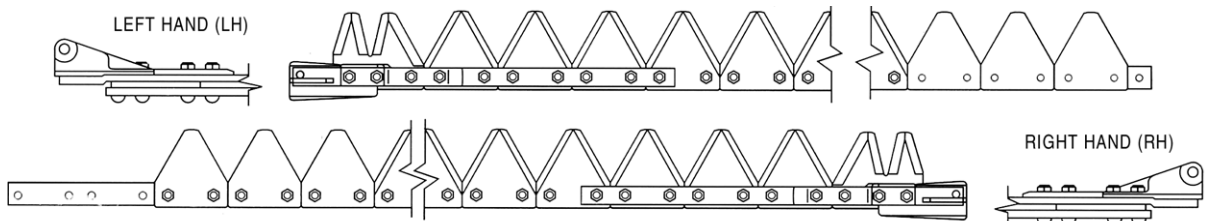

BOLT ON	RIVETED	DESCRIPTION	LENGTH	HEAD NO.	OEM SICKLE NO.	SECT. PART NO.
A-861-511	N/A	black 11ga top serrated	8 ft. LH	700111003	700709646BL	700705299
A-861-512	N/A	black 11ga top serrated	7 ft. RH	700116709	700709647BL	700705299
A-861-513	N/A	black 11ga top serrated	9 ft. LH	700111003	700709648BL	700705299
A-861-514	N/A	black 11ga top serrated	9 ft. RH	700116709	700709649BL	700705299
A-801-973	A-800-973	chrome 12ga top serrated	11 ft. LH	700116003	700709650	049254
A-801-974	A-800-974	chrome 12ga top serrated	10 ft. RH	700116709	700709651	049254
A-861-515	N/A	black 11ga top serrated	11 ft. LH	700116003	700709650BL	700705299
A-861-516	N/A	black 11ga top serrated	10 ft. RH	700116709	700709651BL	700705299

For Models: (WINDROWER: (8820, 8830, 8840 ALL w/ 15', 18', 21' draper headers))

SICKLE ASSEMBLIES & PARTS

SICKLE ASSEMBLIES - CASE-IH

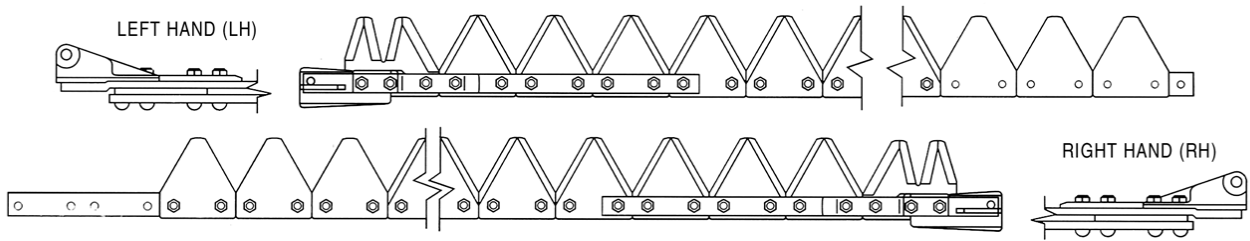

BOLT ON	RIVETED	DESCRIPTION	LENGTH	HEAD NO.	OEM SICKLE NO.	SECT. PART NO.
A-801-973	A-800-973	chrome 12ga top serrated	11 ft. LH	700116003	700709650	049254
A-801-974	A-800-974	chrome 12ga top serrated	10 ft. RH	700116709	700709651	049254
A-861-515	N/A	black 11ga top serrated	11 ft. LH	700116003	700709650BL	700705299
A-861-516	N/A	black 11ga top serrated	10 ft. RH	700116709	700709651BL	700705299
A-861-517	N/A	black 11ga top serrated	13 ft. LH	700116003	700709652BL	700705299
A-861-518	N/A	black 11ga top serrated	12 ft. RH	700116709	700709653BL	700705299
A-861-519	N/A	black 11ga top serrated	15 ft. LH	700116003	700709654BL	700705299
A-861-520	N/A	black 11ga top serrated	15 ft. RH	700116709	700709655BL	700705299

For Models: (WINDROWER: 8820 shiftable draper header (21', 25', 30'))

SICKLE ASSEMBLIES - CASE-IH

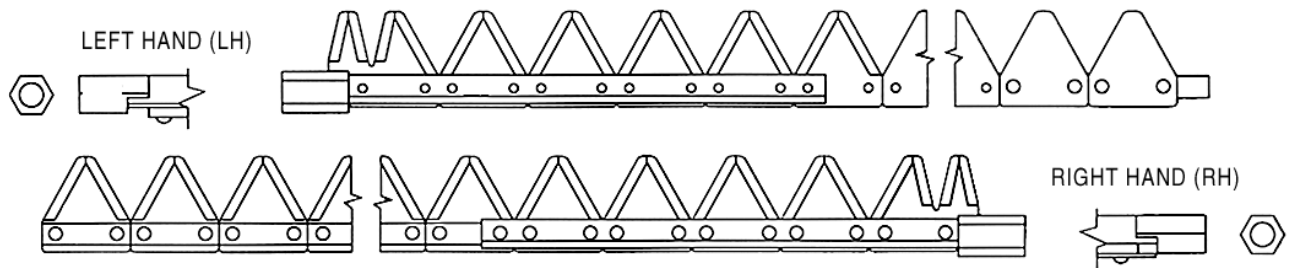

BOLT ON	RIVETED	DESCRIPTION	LENGTH	HEAD NO.	OEM SICKLE NO.	SECT. PART NO.
A-801-175	A-800-175	Xchrome 12ga top serrated	7 ft. LH	6821078	6832174	700705300
A-801-181	A-800-181	Xchrome 12ga top serrated	7 ft. RH	6821136	6832224	700705300
A-831-510	A-830-510	chrome 11ga big tooth	7 ft. LH	6821078	6832174BT	700705300BT
A-831-511	A-830-511	chrome 11ga big tooth	7 ft. RH	6821136	6832224BT	700705300BT
A-801-173	A-800-173	Xchrome 12ga top serrated	8 ft. LH	6821078	6832182	700705300
A-801-179	A-800-179	Xchrome 12ga top serrated	8 ft. RH	6821136	6832232	700705300
A-861-630	N/A	Xchrome 12ga top serrated	8 ft. LH	Headless	6832182	700705300
A-861-631	N/A	Xchrome 12ga top serrated	8 ft. RH	Headless	6832232	700705300
A-831-512	A-830-512	chrome 11ga big tooth	8 ft. LH	6821078	6832182BT	700705300BT
A-831-513	A-830-513	chrome 11ga big tooth	8 ft. RH	6821136	6832232BT	700705300BT

For Models: (WINDROWER: 8820 single auger header (14', 16'))

SICKLE ASSEMBLIES - CASE-IH

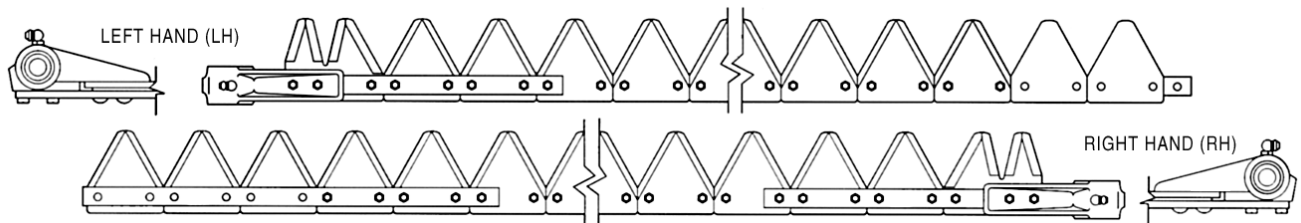

BOLT ON	RIVETED	DESCRIPTION	LENGTH	HEAD NO.	OEM SICKLE NO.	SECT. PART NO.
A-801-985	A-800-985	chrome 11ga top serrated	7 ft. LH	700114594	700114590	700705300
A-801-986	A-800-986	chrome 11ga top serrated	7 ft. RH	700114594	700114591	700705300
A-801-797	A-800-797	chrome 11ga top serrated	7 ft. LH	Headless	700709581	700705300
A-801-796	A-800-796	chrome 11ga top serrated	7 ft. RH	Headless	700709582	700705300
A-831-459	A-830-459	chrome 11ga big tooth	7 ft. LH	700114594	700114590BT	700705300BT
A-831-460	A-830-460	chrome 11ga big tooth	7 ft. RH	700114594	700114591BT	700705300BT

SICKLE ASSEMBLIES & PARTS

A-861-956	N/A	chrome 11ga sabertooth	7 ft. LH	700114594	700114590ST	700705300ST
A-861-957	N/A	chrome 11ga sabertooth	7 ft. RH	700114594	700114591ST	700705300ST
A-861-958	N/A	chrome 11ga sabertooth	7 ft. LH	Headless	700709581NHST	700705300ST
A-861-959	N/A	chrome 11ga sabertooth	7 ft. RH	Headless	700709582NHST	700705300ST
A-801-979	A-800-979	chrome 11ga top serrated	8 ft. LH	700114594	700114592	700705300
A-801-980	A-800-980	chrome 11ga top serrated	8 ft. RH	700114594	700114593	700705300
A-801-799	A-800-799	chrome 11ga top serrated	8 ft. LH	Headless	700709585	700705300
A-801-798	A-800-798	chrome 11ga top serrated	8 ft. RH	Headless	700709586	700705300
A-831-461	A-830-461	chrome 11ga big tooth	8 ft. LH	700114594	700114592BT	700705300BT
A-831-462	A-830-462	chrome 11ga big tooth	8 ft. RH	700114594	700114593BT	700705300BT
A-861-960	N/A	chrome 11ga sabertooth	8 ft. LH	700114594	700114592ST	700705300ST
A-861-961	N/A	chrome 11ga sabertooth	8 ft. RH	700114594	700114593ST	700705300ST
A-861-962	N/A	chrome 11ga sabertooth	8 ft. LH	Headless	700709585NHST	700705300ST
A-861-963	N/A	chrome 11ga sabertooth	8 ft. RH	Headless	700709586NHST	700705300ST
A-881-001	N/A	chrome 11ga top serrated	9 ft. LH	700114594	700715778	700705300
A-881-002	N/A	chrome 11ga top serrated	9 ft. RH	700114594	700715779	700705300
A-881-003	N/A	chrome 11ga top serrated	9 ft. LH	Headless	700715778NH	700705300
A-881-004	N/A	chrome 11ga top serrated	9 ft. RH	Headless	700715779NH	700705300
A-881-005	N/A	chrome 11ga big tooth	9 ft. LH	700114594	700715778BT	700705300BT
A-881-006	N/A	chrome 11ga big tooth	9 ft. RH	700114594	700715779BT	700705300BT
A-881-007	N/A	chrome 11ga sabertooth	9 ft. LH	700114594	700715778ST	700705300ST
A-881-008	N/A	chrome 11ga sabertooth	9 ft. RH	700114594	700715779ST	700705300ST
A-881-009	N/A	chrome 11ga sabertooth	9 ft. LH	Headless	700715778NHST	700705300ST
A-881-010	N/A	chrome 11ga sabertooth	9 ft. RH	Headless	700715779NHST	700705300ST

For Models: (WINDROWER: (8840, 8870, 8380 ALL w/ 625 auger headers))

SICKLE SECTIONS - FORD

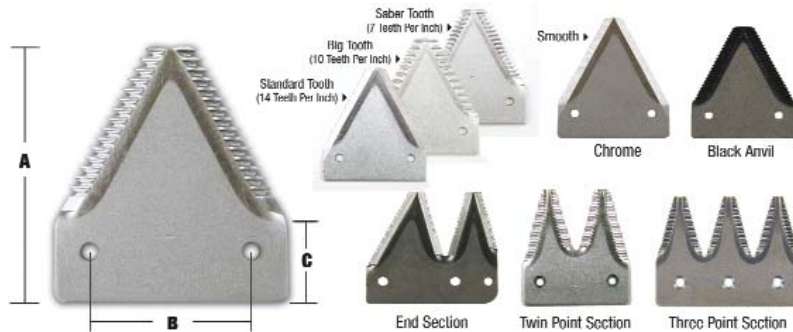

PART NO.	DESCRIPTION	DIM A (1)	DIM B (2)	DIM C (3)	FASTENER	REPL. NO.
A-211-203	chrome 14ga under serrated	3.250"	2"	1"	7/32 x 5/8	Z7029H
A-211-102	black 12ga smooth	3.250"	2"	1"	7/32 x 5/8	Z6451H
A-211-022	black 12ga under serrated	3.250"	2"	1"	7/32 x 5/8	Z7030H
A-211-611	black 11ga top serrated	3.250"	2"	1"	7/32 x 5/8	E76370BL
A-211-001	black 11ga top serrated	3.250"	2.062"	1"	7/32 x 5/8	29875
A-211-232	black 12ga top serrated	3.250"	2.062"	1"	7/32 x 5/8	340-32015
A-211-011	black 11ga smooth	3.250"	2.062"	1"	7/32 x 5/8	26622
A-211-211	black 11ga top serrated	3.250"	2.062"	1"	7/32 x 5/8	9622744
A-231-211	black 11ga big tooth	3.250"	2.062"	1"	7/32 x 5/8	124737BT
A-211-002	black 12ga under serrated	3.250"	2.062"	1"	7/32 x 5/8	OU557HS

SICKLE PARTS - FORD

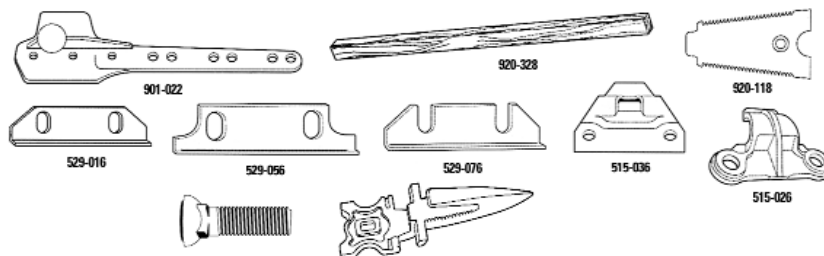

PART NO.	DESCRIPTION	REPLACES	APPLICATION
A-901-011	Sickle Head	56692C91	(MOWER: 505 riveted)
A-901-022	Sickle Head	147874	(MOWER: 501)

SICKLE ASSEMBLIES & PARTS

A-901-047	Sickle Head	140019	(MOWER: 502)
A-901-059	Sickle Head	290271	(MOWER CONDITIONER: 535)
A-901-071	Sickle Head	142670	(MOWER: 14, 15)
A-901-128	Sickle Head	242063	(MOWER: 14, 15)
A-920-130	Bronze Bushing	458971R1	(MOWER: 505)
A-920-136	Head Plug	458972R1	(MOWER: 505)
A-920-314	Knifehead Pin	458973R4	(MOWER: 505)
A-725-001	Knifehead Pin Kit	176699C91	
A-515-126	Knifehead clip		
A-515-066	Low knifehead clip		
A-515-036	Knife Clip	142726	
A-515-026	Knifehead Clip	MB812, XA1000, 611759R1	
A-920-101	Center Guard	50HS4A, 143HSA	
A-920-102	Outer Guard	15011105M1	
A-920-118	Ledger Plate	142570	
A-904-520	(50) 7/16x1-1/2" bolts		
A-904-521	(50) 7/16x1-3/4" bolts		
A-529-076	Wear Plate, 6" slotted		
A-149197	Pitman Wood 37.687"	149197	(MOWER: 501)
A-149198	Pitman Wood 46.437"	149198	
A-920-128	Pitman Strap, front	MA1577	
A-920-129	Pitman Strap, rear	M1578	
A-904-022	(1lb) 7/32 x 5/8" OH rivet	700000883	
A-904-500	(50) 7/32 x 5/8" Bolt & Nut	700705296	
A-904-525	(50) 7/32 x 5/8" 60° CTSK Bolt & Nut	700002978	

SICKLE ASSEMBLIES - FORD

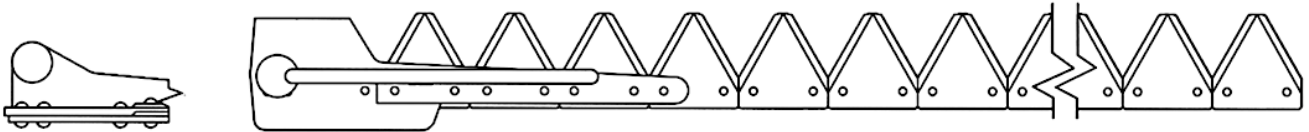

BOLT ON	RIVETED	DESCRIPTION	LENGTH	HEAD NO.	OEM SICKLE NO.	SECT. PART NO.
A-801-465	A-800-465	black 12ga under serrated	7 ft	142670	142669H	141198

For Models: (MOWER: 14, 15, 16, 62, 63, 65, 66)

SICKLE ASSEMBLIES - FORD

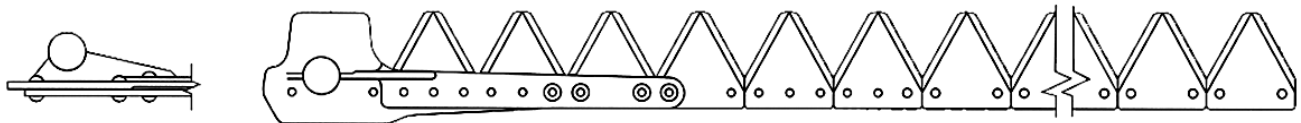

BOLT ON	RIVETED	DESCRIPTION	LENGTH	HEAD NO.	OEM SICKLE NO.	SECT. PART NO.
A-801-200	A-800-200	black 14ga under serrated	6 ft	147874	148122	141113
A-801-201	A-800-201	black 12ga under serrated	6 ft	147874	240906	141198
A-801-203	A-800-203	black 14ga under serrated	7 ft	147874	148119	141113
A-801-205	A-800-205	black 12ga under serrated	7 ft	147874	240891	141198

For Models: (MOWER: 501 SERIES, 14-94, 95, 96, 97, 175, 176, 257, 258, 259, 260)

SICKLE ASSEMBLIES - FORD

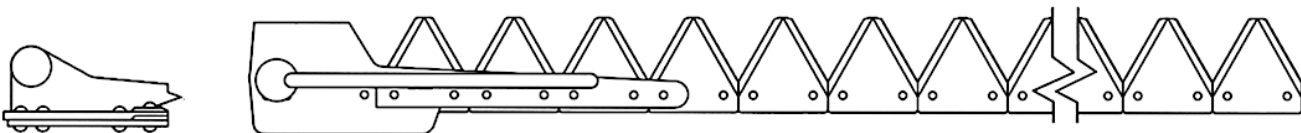

BOLT ON	RIVETED	DESCRIPTION	LENGTH	HEAD NO.	OEM SICKLE NO.	SECT. PART NO.
A-801-463	N/A	black 12ga under serrated	6 ft	140019	148723	141198

For Models: (MOWER: 502)

N/A	A-860-455	black 14ga under serrated	6 ft	140019	140017F	141113
A-831-275	N/A	black 12ga under serrated	7 ft	140019	241150	141198

For Models: (MOWER: 502)

SICKLE ASSEMBLIES & PARTS

SICKLE ASSEMBLIES - FORD

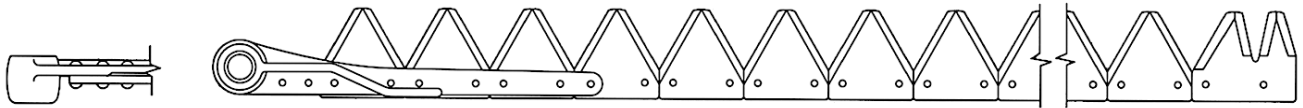

BOLT ON	RIVETED	DESCRIPTION	LENGTH	HEAD NO.	OEM SICKLE NO.	SECT. PART NO.
A-801-064	A-800-064	black 12ga under serrated	5 ft.	56692C91	463408R93	29875
A-801-065	A-800-065	black 12ga under serrated	6 ft.	56692C91	465112R93	29875
A-801-060	A-800-060	black 11ga smooth	7 ft.	56692C91	462381R93	26622
A-801-066	A-800-066	black 12ga under serrated	7 ft.	56692C91	462380R93	29875
A-801-691	A-800-691	black 11ga top serrated	7 ft.	56692C91	1281292C92	9622744
A-861-010	N/A	black 11ga big tooth	7 ft.	56692C91	1281292C92BT	9622744BT
A-801-061	A-800-061	black 11ga smooth	9 ft.	56692C91	463182R93	26622
A-801-067	A-800-067	black 12ga under serrated	9 ft.	56692C91	463159R93	29875
A-801-692	A-800-692	black 11ga top serrated	9 ft.	56692C91	1281291C92	9622744
A-861-527	N/A	black 11ga big tooth	9 ft.	56692C91	1281291C92BT	9622744BT

For Models: (MOWER: 505 balanced head)

SICKLE ASSEMBLIES - FORD

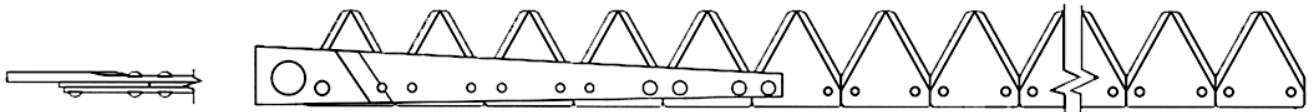

BOLT ON	RIVETED	DESCRIPTION	LENGTH	HEAD NO.	OEM SICKLE NO.	SECT. PART NO.
A-801-697	A-800-697	black 12ga under serrated	7 ft	242063	241905	141198
A-801-698	A-800-698	black 12ga under serrated	8 ft	242063	241906	141198

For Models: (MOWER: 515 SERIES)

SICKLE ASSEMBLIES - FORD

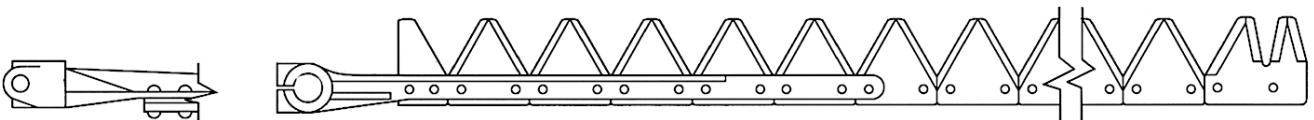

BOLT ON	RIVETED	DESCRIPTION	LENGTH	HEAD NO.	OEM SICKLE NO.	SECT. PART NO.
A-801-348	A-800-348	black 12ga under serrated	9 ft.	Headless	290744S, 290627S	OU577HS
A-801-419	A-800-419	black 12ga under serrated	9 ft.	290271	290744, 290627	OU577HS

For Models: (MOWER CONDITIONER: 535)

SICKLE ASSEMBLIES - FORD

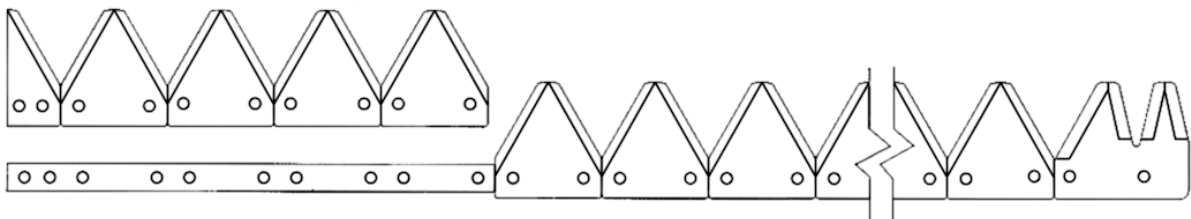

BOLT ON	RIVETED	DESCRIPTION	LENGTH	HEAD NO.	OEM SICKLE NO.	SECT. PART NO.
A-801-349	A-800-349	black 12ga top serrated	9 ft.	Headless	340-32016	340-32015

For Models: (MOWER CONDITIONER: 536)

SICKLE ASSEMBLIES & PARTS

SICKLE ASSEMBLIES - FORD

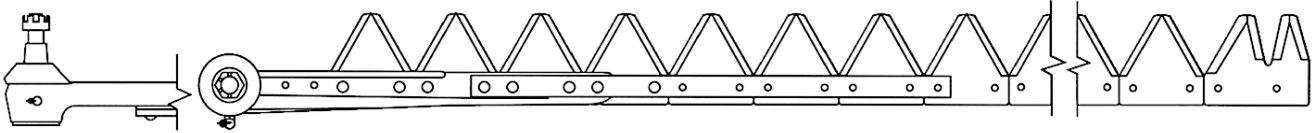

BOLT ON	RIVETED	DESCRIPTION	LENGTH	HEAD NO.	OEM SICKLE NO.	SECT. PART NO.
A-801-400	A-800-400	black 11ga under serrated	7 ft.	824594C91	101987C95	29875
A-801-306	A-800-306	black 11ga under serrated	9 ft.	824594C91	101988C95	29875
A-831-869	A-830-869	black 11ga top serrated	9 ft.	824594C91	1960310C1	9622744

For Models: (MOWER CONDITIONER: 538)

SICKLE SECTIONS - GEHL

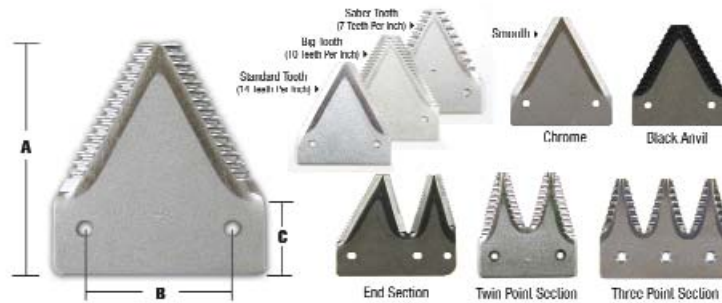

PART NO.	DESCRIPTION	DIM A (1)	DIM B (2)	DIM C (3)	FASTENER	REPL. NO.
A-211-232	black 12ga top serrated	3.250"	2.062"	1"	7/32 x 5/8	340-32015
A-211-002	black 12ga under serrated	3.250"	2.062"	1"	7/32 x 5/8	OU557HS
A-211-003	chrome 14ga top serrated	3.250"	2.062"	1"	7/32 x 5/8	1145
A-211-211	black 11ga top serrated	3.250"	2.062"	1"	7/32 x 5/8	9622744
A-231-211	black 11ga big tooth	3.250"	2.062"	1"	7/32 x 5/8	124737BT
A-231-211	black 12ga top serrated	3.250"	2.062"	1"	7/32 x 5/8	124737BT
A-211-011	black 11ga smooth	3.250"	2.062"	1"	7/32 x 5/8	26622
A-211-211	black 11ga top serrated	3.250"	2.062"	1"	7/32 x 5/8	9622744
A-231-211	black 11ga big tooth	3.250"	2.062"	1"	7/32 x 5/8	124737BT
A-211-002	black 12ga under serrated	3.250"	2.062"	1"	7/32 x 5/8	OU557HS
A-212-061	chrome 11ga under serrated	3.250"	2.062"	1"	7/32 x 5/8	060635
A-212-001	chrome 11ga top serrated	3.250"	2.062"	1"	7/32 x 5/8	700705300
A-232-001	chrome 11ga big tooth	3.250"	2.062"	1"	7/32 x 5/8	700705300BT
A-411-132	black 12ga top serrated	3.250"	2.062"	1.5"	7/32 x 5/8	340-32041
A-212-133	chrome 14ga smooth	3.250"	2.062"	1.5"	7/32 x 5/8	340-16456

SICKLE PARTS - GEHL

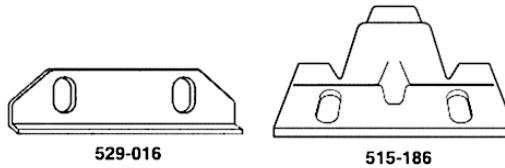

PART NO.	DESCRIPTION	REPLACES	APPLICATION
A-901-018	Sickle Head, LH	6821078	(WINDROWER: 2262)
A-901-019	Sickle Head, RH	6821136	(WINDROWER: 2262)
A-901-028	Sickle Head	611344	(WINDROWER: 2230)
A-901-029	Sickle Head	611440	(MOWER CONDITIONER: 2130, 2160)
A-901-049	Sickle Head	060320	(MOWER CONDITIONER: 770, 1070, 880, 1090)
A-529-016	Wear Plate	71116532, 71176537	
A-515-126	Knifehead clip		
A-515-066	Knife Clip	61384282	(MOWER: CUTTER PARTS uses 7/16" guard)
A-515-186	Knife Clip	110-10157, 110-10734	(MOWER: CUTTER PARTS uses 1/2" guard)
A-904-022	(1lb) 7/32 x 5/8" OH rivet	700000883	(MOWER: CUTTER PARTS for extra heavy sections)
A-904-500	(50) 7/32 x 5/8" Bolt & Nut	700705296	(MOWER: CUTTER PARTS for standard straight hole sections)
A-904-525	(50) 7/32 x 5/8" 60° CTSK Bolt & Nut	700002978	(MOWER: CUTTER PARTS for J.E.Love & Hart Carter)

SICKLE ASSEMBLIES & PARTS

SICKLE ASSEMBLIES - GEHL

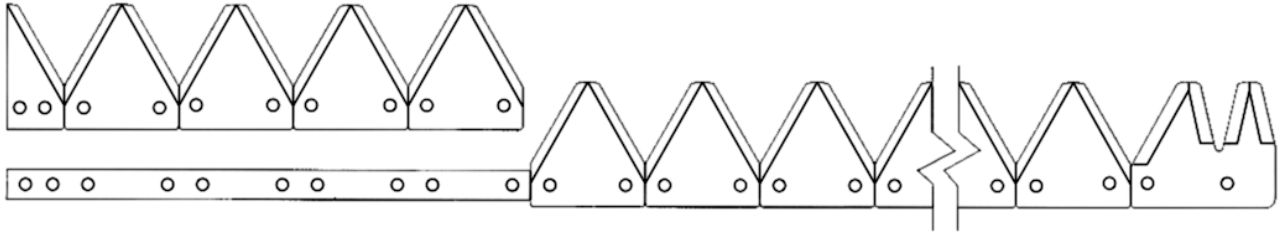

BOLT ON	RIVETED	DESCRIPTION	LENGTH	HEAD NO.	OEM SICKLE NO.	SECT. PART NO.
A-801-349	A-800-349	black 12ga top serrated	9 ft.	Headless	340-32016	340-32015
A-801-766	A-800-766	black 12ga top serrated	9-1/2 ft.	Headless	340-32063TS	340-32015
N/A	A-860-494	black 12ga top serrated	9-1/2 ft.	Headless	340-32063	340-32049
A-801-351	A-800-351	black 12ga top serrated	12 ft.	Headless	340-32019	340-32015
A-801-352	A-800-352	black 12ga top serrated	14 ft.	Headless	340-32020TS	340-32015
A-861-495	A-860-495	black 12ga under serrated	14 ft.	Headless	340-32020	340-32049

For Models: (MOWER CONDITIONER: 208, 216, 217 (9'), 235 w/ swing-tongue (12' & 14'), 229)

SICKLE ASSEMBLIES - GEHL

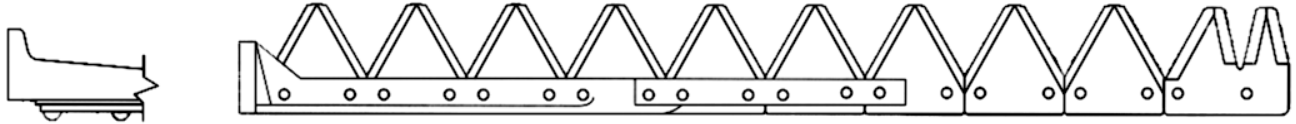

BOLT ON	RIVETED	DESCRIPTION	LENGTH	HEAD NO.	OEM SICKLE NO.	SECT. PART NO.
A-801-355	A-800-355	chrome 12ga under serrated	7 ft.	60320	60337	60635
A-801-356	A-800-356	chrome 12ga under serrated	9 ft.	60320	60322	60635
A-801-354	A-800-354	chrome 12ga under serrated	9 ft.	Headless	60969	60635
N/A	A-860-493	chrome 12ga under serrated	9 ft.	Headless	060969TS	124737

For Models: (MOWER CONDITIONER: 770, 1070 (7'), (880, 1090 ALL (9')))

SICKLE ASSEMBLIES - GEHL

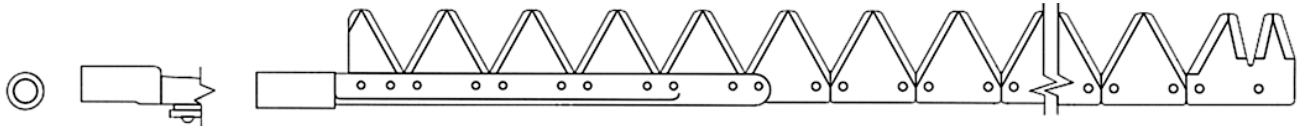

BOLT ON	RIVETED	DESCRIPTION	LENGTH	HEAD NO.	OEM SICKLE NO.	SECT. PART NO.
A-801-389	A-800-389	chrome 12ga top serrated	7 ft.	6584031	700711999	049254
A-801-258	A-800-258	chrome 12ga top serrated	9 ft.	6582522	700711999	049254
A-861-063	N/A	chrome 11ga big tooth	9 ft.	611440	611439BT	700705300BT

For Models: (MOWER CONDITIONER: 2130 (7'), 2160 (9'))

SICKLE ASSEMBLIES - GEHL

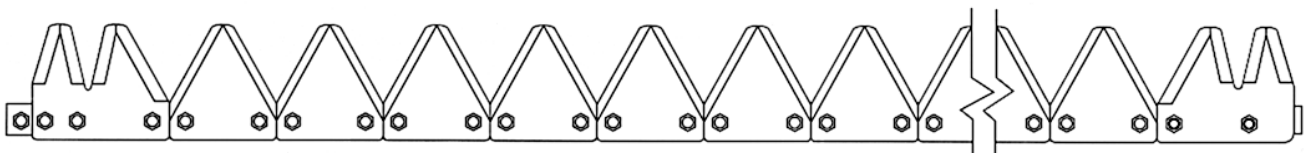

BOLT ON	RIVETED	DESCRIPTION	LENGTH	HEAD NO.	OEM SICKLE NO.	SECT. PART NO.
A-831-752	N/A	black 12ga top serrated	7 ft.	Headless	90655	124737

For Models: (MOWER CONDITIONER: 2140 (7'), 2170 (9'), 2240 swing frame (12'), 2270 (14'))

A-831-753	N/A	black 12ga top serrated	9 ft.	Headless	90692	124737
A-831-754	N/A	black 11ga top serrated	12 ft.	Headless	91804	124737
A-861-059	N/A	black 11ga big tooth	12 ft.	Headless	091804BT	124737BT
A-831-755	N/A	black 11ga top serrated	14 ft.	Headless	91805	124737

For Models: (MOWER CONDITIONER: 2140 (7'), 2170 (9'), 2240 swing frame (12'), 2270 (14'))

SICKLE ASSEMBLIES & PARTS

SICKLE ASSEMBLIES - GEHL

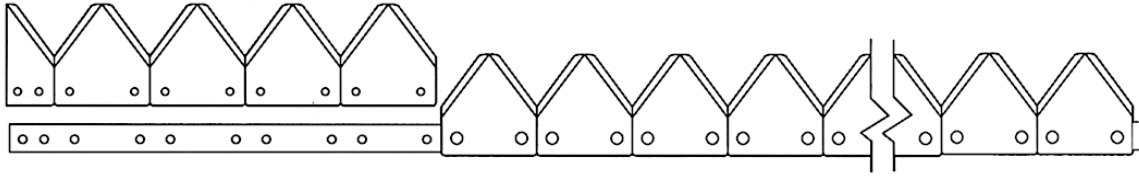

BOLT ON	RIVETED	DESCRIPTION	LENGTH	HEAD NO.	OEM SICKLE NO.	SECT. PART NO.
A-801-832	A-800-832	black 12ga top serrated	12 ft.	Headless	340-32045	340-32041
A-801-840	A-800-840	black 12ga top serrated	14 ft.	Headless	340-32046	340-32041
A-801-997	A-800-997	black 12ga top serrated	16 ft.	Headless	340-32047	340-32041
A-801-904	A-800-904	black 12ga top serrated	20 ft.	Headless	340-32048	340-32041
A-801-843	A-800-843	black 12ga top serrated	21 ft.	Headless	340-32062	340-32041

For Models: (WINDROWER: 260D, 262, 265, 270D, 275, 280, 281 w/ high sholder sections)

SICKLE ASSEMBLIES - GEHL

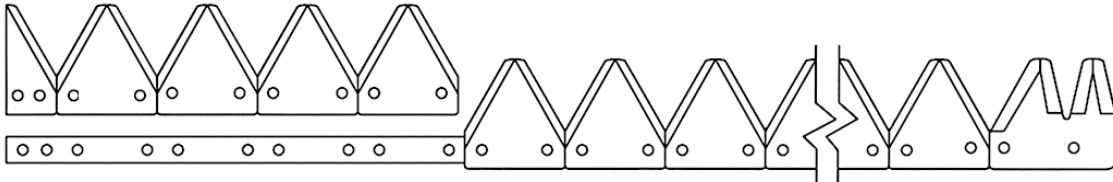

BOLT ON	RIVETED	DESCRIPTION	LENGTH	HEAD NO.	OEM SICKLE NO.	SECT. PART NO.
A-801-350	A-800-350	black 12ga top serrated	10 ft.	Headless	340-32018	340-32015
A-801-351	A-800-351	black 12ga top serrated	12 ft.	Headless	340-32019	340-32015
A-801-352	A-800-352	black 12ga top serrated	14 ft.	Headless	340-32020TS	340-32015
A-861-495	A-860-495	black 12ga under serrated	14 ft.	Headless	340-32020	340-32049
A-801-501	A-801-501	black 12ga top serrated	16 ft.	Headless	340-32021TS	340-32015
A-861-496	A-861-496	black 12ga under serrated	16 ft.	Headless	340-32021	340-32049
A-801-665	A-800-665	black 12ga top serrated	20 ft.	Headless	340-32028	340-32015

For Models: (WINDROWER: 260, 265, 270, 275, 280, 281, 282, 285, 800, 900 (10' - 20'), 2650SP (14' & 16'))

SICKLE ASSEMBLIES - GEHL

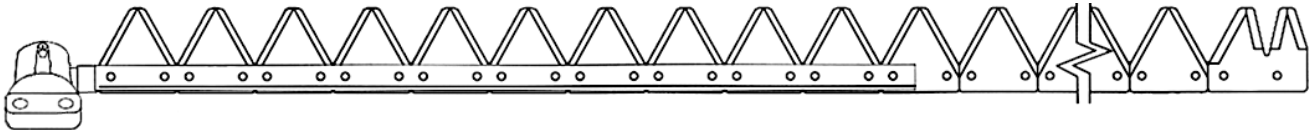

BOLT ON	RIVETED	DESCRIPTION	LENGTH	HEAD NO.	OEM SICKLE NO.	SECT. PART NO.
A-801-249	A-800-249	chrome 14ga top serrated	12 ft.	6193577, 6497416	6193627	049213
A-801-250	A-800-250	chrome 14ga top serrated	12 ft.	Headless	6206023	049213
A-801-251	A-800-251	chrome 12ga top serrated	12 ft.	6193577, 6497416	6272959	049254
A-801-252	A-800-252	chrome 12ga top serrated	12 ft.	Headless	6497457	049254

For Models: (WINDROWER: 2230)

SICKLE ASSEMBLIES - GEHL

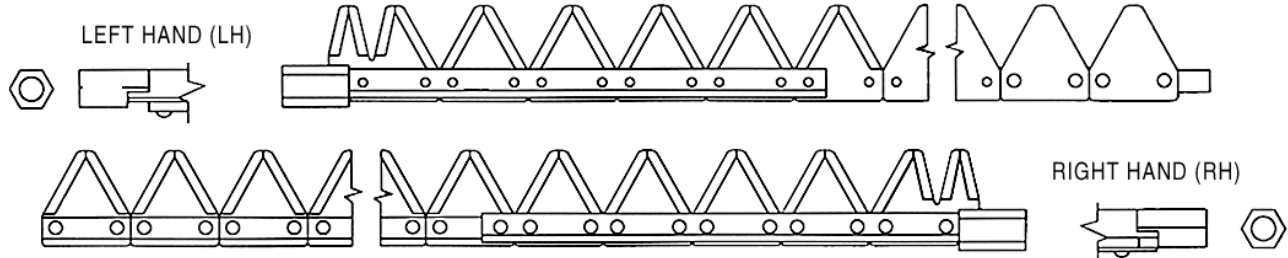

BOLT ON	RIVETED	DESCRIPTION	LENGTH	HEAD NO.	OEM SICKLE NO.	SECT. PART NO.
A-801-175	A-800-175	chrome 12ga top serrated	7 ft. LH	6821078	6832174	700705300
A-801-181	A-800-181	chrome 12ga top serrated	7 ft. RH	6821136	6832224	700705300
A-831-510	A-830-510	chrome 11ga big tooth	7 ft. LH	6821078	6832174BT	700705300BT
A-831-511	A-830-511	chrome 11ga big tooth	7 ft. RH	6821136	6832224BT	700705300BT

For Models: (WINDROWER: 2262)

SICKLE ASSEMBLIES & PARTS

SICKLE SECTIONS - HART CARTER

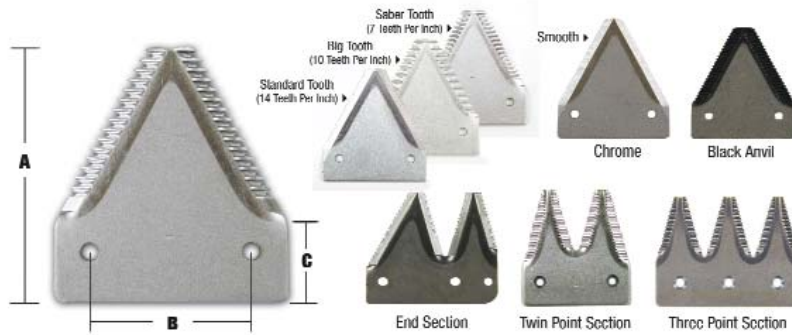

PART NO.	DESCRIPTION	DIM A (1)	DIM B (2)	DIM C (3)	FASTENER	REPL. NO.
A-111-001	black 11ga top serrated	2.500"	2.000"	.875"	7/32 X 5/8" ctsk	71176531 BL
A-112-001	chrome 11ga top serrated	2.5"	2"	.875"	7/32 x 5/8	179736C3
A-132-001	chrome 11ga big tooth	2.5"	2"	.875"	7/32 x 5/8	179736C3BT
A-131-001	black 11ga big tooth	3"	2"	.875"	7/32 x 5/8 CTSK	277444BLBT

SICKLE PARTS - HART CARTER

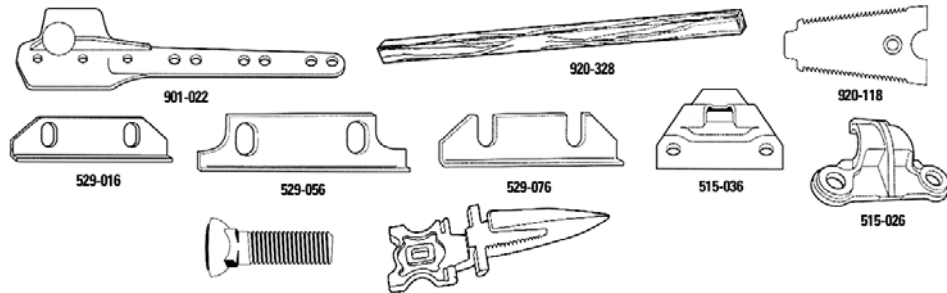

PART NO.	DESCRIPTION	REPLACES	APPLICATION
A-901-046	Sickle Head	179765C1	(MOWER: CUTTER PARTS Hart Carter Gen. I)
A-901-016	Sickle Head	180859C91	(MOWER: CUTTER PARTS Hart Carter Gen. III)
A-901-015	Head Plate	180497C1	(MOWER: CUTTER PARTS Hart Carter Gen. II)
A-529-016	Wear Plate	71116532, 71176537	(MOWER: CUTTER PARTS all Hart Carter headers)
A-529-056	Wear Plate, 6"		(MOWER: CUTTER PARTS alternative to 529-016)
A-529-076	Wear Plate, 6" slotted		(MOWER: CUTTER PARTS alternative to 529-016)
A-515-016	Low Knife Clip	71176540	(MOWER: CUTTER PARTS all Hart Carter headers)
A-904-525	(50) 7/32 x 5/8" 60° CTSK Bolt & Nut	700002978	(MOWER: CUTTER PARTS For J.E.Love & Hart Carter)
A-904-528	(25) 7/32 X 1" 60° CTSK Bolt & Nut		(MOWER: CUTTER PARTS for Hart Carter headers)
A-904-003	7/32 X 5/8" CTSK rivet		(MOWER: CUTTER PARTS for HC extra hvy CTSK sections)
A-904-022	(11lb) 7/32 x 5/8" OH rivet	700000883	(MOWER: CUTTER PARTS For extra heavy sections)
A-904-500	(50) 7/32 x 5/8" Bolt & Nut	700705296	(MOWER: CUTTER PARTS for standard straight hole sections)
A-904-525	(50) 7/32 x 5/8" 60° CTSK Bolt & Nut		(MOWER: CUTTER PARTS For J.E.Love & Hart Carter)

SICKLE SECTIONS - HESSTON

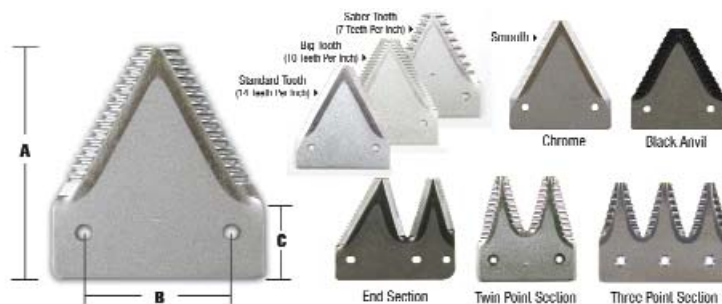

PART NO.	DESCRIPTION	DIM A (1)	DIM B (2)	DIM C (3)	FASTENER	REPL. NO.
A-212-063	chrome 14ga under serrated	3.250"	2.062"	1"	7/32 x 5/8	604800
A-212-133	chrome 14ga smooth	3.250"	2.062"	1.5"	7/32 x 5/8	340-16456
A-212-003	chrome 14ga top serrated	3.250"	2.062"	1"	7/32 x 5/8	604921

SICKLE ASSEMBLIES & PARTS

A-212-132	chrome 12ga smooth	3.250"	2.062"	1"	7/32 x 5/8	049262
A-211-232	black 12ga top serrated	3.250"	2.062"	1"	7/32 x 5/8	340-32015
A-212-012	chrome 12ga top serrated	3.250"	2.062"	1"	7/32 x 5/8	94579
A-212-001	chrome 11ga top serrated	3.250"	2.062"	1"	7/32 x 5/8	700705300
A-212-001	chrome 11ga top serrated	3.250"	2.062"	1"	7/32 x 5/8	700705300
A-211-211	black 11ga top serrated, 2 hole	3.250"	2.062"	1"	7/32 x 5/8	9622744
A-232-001	chrome 11ga big tooth	3.250"	2.062"	1"	7/32 x 5/8	700705300BT
A-231-461	black 11ga saber tooth	3.250"	2.062"	1"	7/32 x 5/8	9622744ST
A-231-211	black 11ga big tooth, 2 hole	3.250"	2.062"	1"	7/32 x 5/8	124737BT
A-232-461	chrome 11ga saber tooth	3.250"	2.062"	1"	7/32 x 5/8	9826090ST
A-212-262	chrome 12ga top serrated	rivet type			7/32 x 5/8 CTSK	706424H
A-519-002	chrome 11ga saw tooth	overlap			7/32 x 5/8 CTSK	748152
A-612-150	(10) RH end sections, chrn top ser	3 hole			7/32 x 5/8	700705463
A-612-090	(10) LH end sections, chrn top ser	end section			7/32 x 5/8	700705462
A-711-001	(kit) sections w/ rivets, chrn top ser	overlap section kit			7/32 x 5/8 CTSK	

SICKLE PARTS - HESSTON

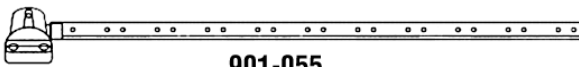

901-055



904-022



904-003



904-500

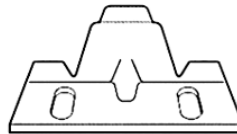

515-066

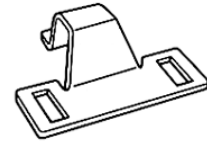

515-126

PART NO.	DESCRIPTION	REPLACES	APPLICATION
A-901-027	Sickle Head	451948	(MOWER: PT10, PT7), (MOWER CONDITIONER: 1010)
A-901-030	Sickle Head	433102	(MOWER: PT12), 600
A-901-029	Sickle Head	611440	(MOWER CONDITIONER: 1070, 1090, 1071, 1091)
A-901-026	Sickle Head	379370	200 - 500
A-901-055	Sickle Head, long	6497416	CUTTER PARTS
A-901-028	Sickle Head, short	611344	CUTTER PARTS
A-901-018	Sickle Head, LH (MOWER CONDITIONER: 1150), LH	6821078	(WINDROWER: 6450, 6550, 6650), (MOWER CONDITIONER: 1110), 1120,
A-901-019	Sickle Head, RH	6821136	(WINDROWER: 6450, 6550, 6650), RH
A-901-120	Sickle Head, RH/LH 1160)	700111003	(WINDROWER: 8200), (MOWER CONDITIONER: 1130), (WINDROWER:
A-901-130	Sickle Head, RH/LH	700114594	(MOWER CONDITIONER: 1170), (WINDROWER: 8400)
A-920-182	(10) Shims	6821052	CUTTER PARTS
A-515-126	Knifehead Clip	611759R1, 595648R1	CUTTER PARTS
A-515-066	Knife Clip, low	61384282	CUTTER PARTS
A-904-022	(1lb) 7/32 x 5/8" OH rivet	700000883	CUTTER PARTS
A-904-003	7/32 x 5/8" CTSK rivet	700000583	CUTTER PARTS
A-904-500	(50) 7/32 x 5/8" bolt/nut	700705296	CUTTER PARTS

SICKLE ASSEMBLIES - HESSTON

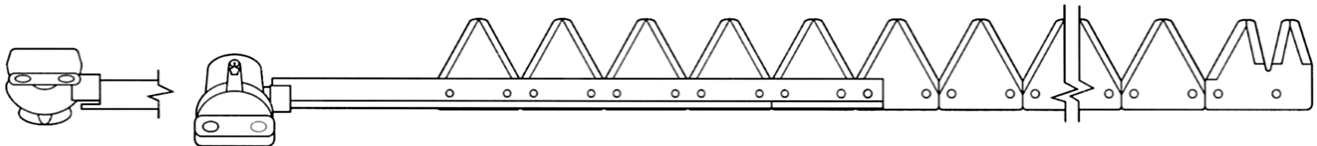

BOLT ON	RIVETED	DESCRIPTION	LENGTH	HEAD NO.	OEM SICKLE NO.	SECT. PART NO.
A-801-245	A-800-245	chrome 14ga top serrated	7 ft.	451948	6193510	049213
A-801-246	A-800-246	chrome 14ga top serrated	9 ft.	451948	451955	049213
A-801-247	A-800-247	chrome 12ga top serrated	9 ft.	451948	6566178	049254

For Models: (MOWER: PT10 9', PT7 7'), (MOWER CONDITIONER: 1010 9')

SICKLE ASSEMBLIES & PARTS

SICKLE ASSEMBLIES - HESSTON

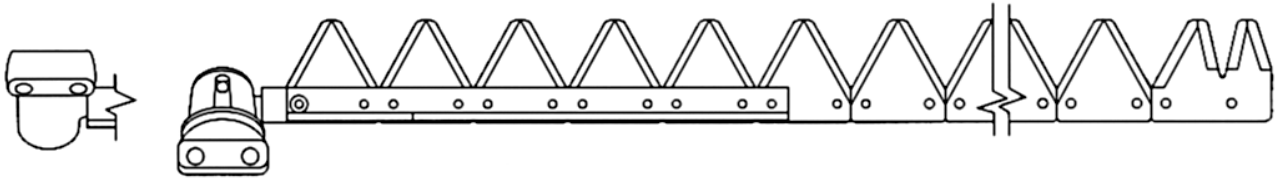

BOLT ON	RIVETED	DESCRIPTION	LENGTH	HEAD NO.	OEM SICKLE NO.	SECT. PART NO.
A-801-264	A-800-264	chrome 14ga top serrated	12 ft.	433102	429498	049213

For Models: (MOWER: PT12)

SICKLE ASSEMBLIES - HESSTON

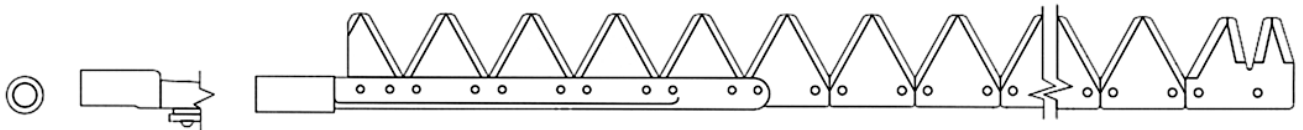

BOLT ON	RIVETED	DESCRIPTION	LENGTH	HEAD NO.	OEM SICKLE NO.	SECT. PART NO.
A-801-389	A-800-389	chrome 12ga top serrated	7 ft.	700711999	6584031	049254
A-801-258	A-800-258	chrome 12ga top serrated	9 ft.	700711999	6582522	049254
A-831-063	N/A	chrome 11ga big tooth	9 ft.	700711999	658252BT	700705300BT

For Models: (MOWER CONDITIONER: 1070 7', 1090, 1071 7', 1095 9', 1085, 1091)

SICKLE ASSEMBLIES - HESSTON

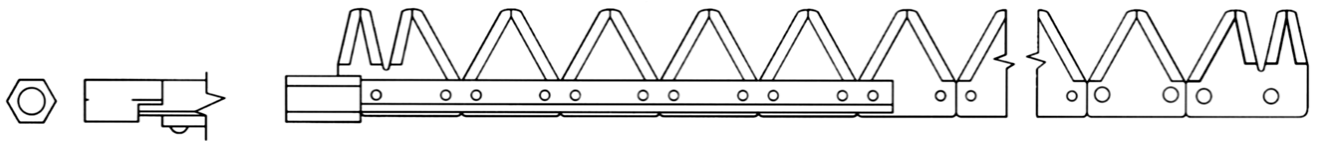

BOLT ON	RIVETED	DESCRIPTION	LENGTH	HEAD NO.	OEM SICKLE NO.	SECT. PART NO.
A-801-778	A-800-778	chrome 12ga top serrated	7 ft.	6821078	700111432	700705300
A-801-779	A-800-779	chrome 12ga top serrated	9 ft.	6821078	700111430	700705300
A-831-904	N/A	black 11ga top serrated	9 ft.	6821078	700111430BL	700705299
A-801-540	A-800-540	chrome 12ga top serrated	12 ft.	6821078	700109341	700705300
A-831-906	N/A	black 112ga top serrated	12 ft.	6821078	700109341BL	700705299

For Models: (MOWER CONDITIONER: 1110 7', 1150 12', 1290 9')

SICKLE ASSEMBLIES - HESSTON

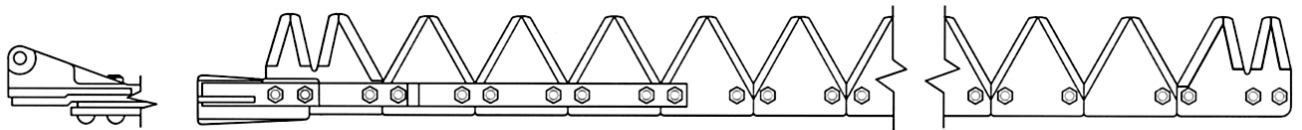

BOLT ON	RIVETED	DESCRIPTION	LENGTH	HEAD NO.	OEM SICKLE NO.	SECT. PART NO.
A-801-984	N/A	chrome 11ga top serrated	9 ft.	700111003	700118673	700705300

For Models: (MOWER CONDITIONER: 1130)

A-801-742	N/A	chrome 11ga top serrated	9 ft.	Headless	700118671	700705300
A-831-905	N/A	black 11ga top serrated	9 ft.	700111003	700118673BL	700705299

For Models: (MOWER CONDITIONER: 1130)

SICKLE ASSEMBLIES & PARTS

SICKLE ASSEMBLIES - HESSTON

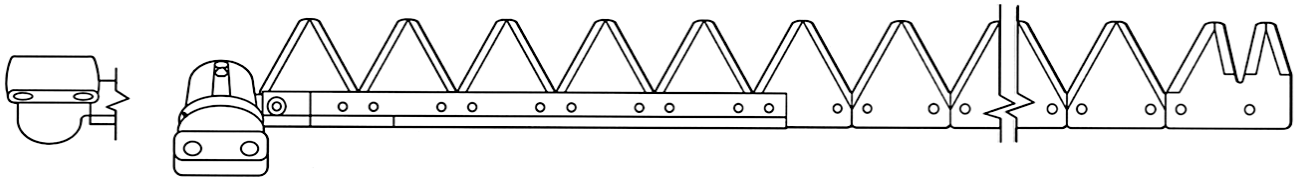

BOLT ON	RIVETED	DESCRIPTION	LENGTH	HEAD NO.	OEM SICKLE NO.	SECT. PART NO.
A-801-237	A-800-237	chrome 14ga top serrated	12 ft.	379370	373522	049213
A-801-239	A-800-239	chrome 14ga top serrated	14 ft.	379370	373530	049213
A-801-241	A-800-241	chrome 12ga top serrated	14 ft.	379370	373530H	049254
A-801-243	A-800-243	chrome 14ga top serrated	16 ft.	379370	373548	049213

For Models: (WINDROWER: 300, 200, 220, 240, 260, 280, 500)

SICKLE ASSEMBLIES - HESSTON

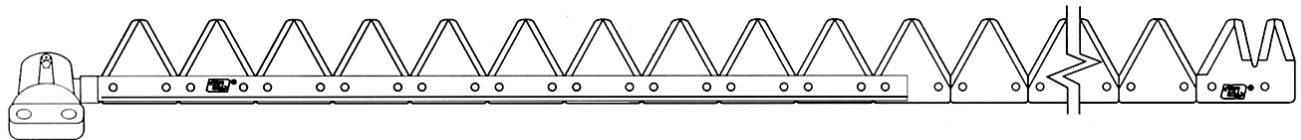

BOLT ON	RIVETED	DESCRIPTION	LENGTH	HEAD NO.	OEM SICKLE NO.	SECT. PART NO.
A-801-248	A-800-248	chrome 14ga top serrated	10 ft.	6193577, 6497416	6193619	049213
A-801-249	A-800-249	chrome 14ga top serrated	12 ft.	6193577, 6497416	6193627	049213
A-801-250	A-800-250	chrome 14ga top serrated	12 ft.	Headless	6206023	049213
A-801-251	A-800-251	chrome 12ga top serrated	12 ft.	6193577, 6497416	6272959	049254
A-801-252	A-800-252	chrome 12ga top serrated	12 ft.	Headless	6497457	049254
A-861-054	N/A	chrome 11ga big tooth	12 ft.	6497416	6196327BT	700705300BT
A-801-253	A-800-253	chrome 14ga top serrated	14 ft.	6193577, 6497416	6193635	049213
A-801-254	A-800-254	chrome 14ga top serrated	14 ft.	Headless	6206031	049213
A-801-255	A-800-255	chrome 12ga top serrated	14 ft.	6193577, 6497416	6272967	049254
A-801-256	A-800-256	chrome 12ga top serrated	14 ft.	Headless	6497465	049254
A-801-706	N/A	black 11ga top serrated	14 ft.	Headless	6497465BL	700705299
A-861-060	N/A	chrome 11ga big tooth	14 ft.	Headless	6497465BT	700705300BT
A-801-728	N/A	black 11ga top serrated	14 ft.	6497416	6272967BL	700705299
A-801-397	A-800-397	chrome 12ga top serrated	14 ft.	6497416	6497119	049254
A-831-508	A-830-508	chrome 11ga big tooth	14 ft.	6497416	6497119BT	700705300BT
A-801-388	A-800-388	chrome 12ga top serrated	16 ft.	6497416	6497374	049254
A-801-257	A-800-257	chrome 12ga top serrated	16 ft.	Headless	6497473	049254
A-801-707	N/A	black 11ga top serrated	16 ft.	Headless	6497473BL	700705299
A-831-509	A-830-509	chrome 11ga big tooth	16 ft.	6497416	6497374BT	700705300BT

For Models: (WINDROWER: 520, 620, 6200, 6400, 6450, 6610, 1014 hydro-swing, 6600, 6465)

SICKLE ASSEMBLIES - HESSTON

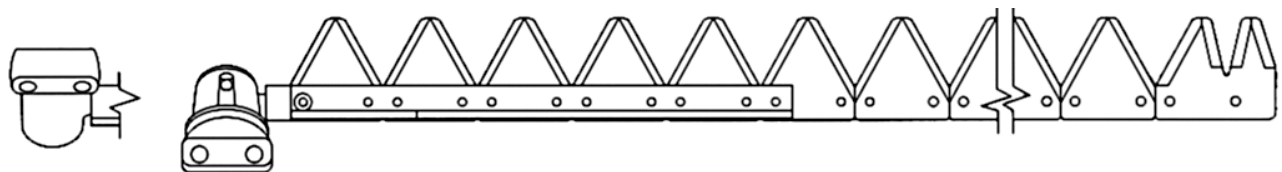

BOLT ON	RIVETED	DESCRIPTION	LENGTH	HEAD NO.	OEM SICKLE NO.	SECT. PART NO.
A-801-264	A-800-264	chrome 14ga top serrated	12 ft.	433102	429498	049213
A-801-395	A-800-395	chrome 14ga top serrated	14 ft.	433102	441527	049213

For Models: (WINDROWER: 600)

SICKLE ASSEMBLIES & PARTS

SICKLE ASSEMBLIES - HESSTON

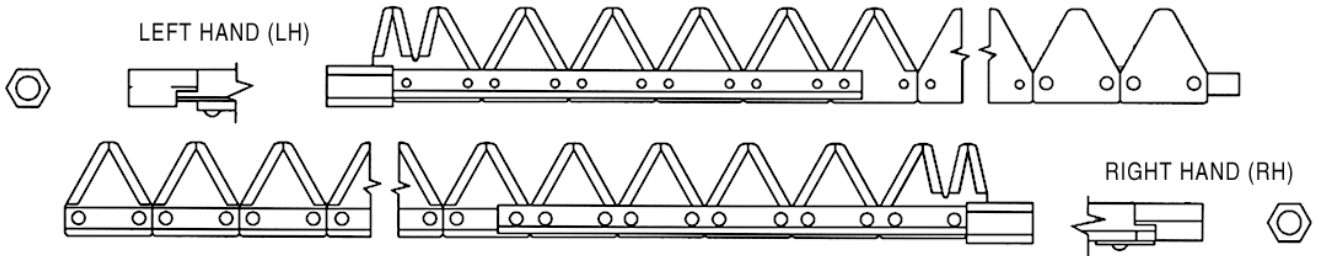

BOLT ON	RIVETED	DESCRIPTION	LENGTH	HEAD NO.	OEM SICKLE NO.	SECT. PART NO.
A-801-596	A-800-596	chrome 12ga top serrated	7-1/2 ft. LH	6821078	6821045	049254
A-801-599	A-800-599	chrome 12ga top serrated	7-1/2 ft. RH	6821136	6821110	049254
A-861-055	N/A	chrome 11ga big tooth	9 ft. LH	6821078	6839146BT	700705300BT
A-861-056	N/A	chrome 11ga big tooth	9 ft. RH	6821136	6839153BT	700705300BT
A-801-597	A-800-597	chrome 12ga top serrated	9 ft. LH	6821078	6839146	049254
A-801-600	A-800-600	chrome 12ga top serrated	9 ft. RH	6821136	6839153	049254
A-801-598	A-800-598	chrome 12ga top serrated	10-1/2 ft. LH	6821078	6839161	049254
A-801-601	A-800-601	chrome 12ga top serrated	10-1/2 ft. RH	6821136	6839179	049254
A-861-057	N/A	chrome 11ga big tooth	10-1/2 ft. LH	6821078	6839161BT	700705300BT
A-861-058	N/A	chrome 11ga big tooth	10-1/2 ft. RH	6821136	6839179BT	700705300BT

For Models: (WINDROWER: (6450, 8200, 65 ALL draper), SPECIALTY)

SICKLE ASSEMBLIES - HESSTON

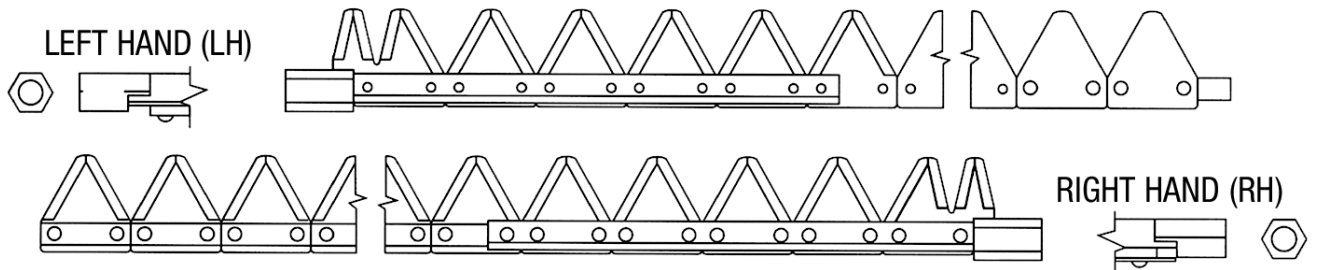

BOLT ON	RIVETED	DESCRIPTION	LENGTH	HEAD NO.	OEM SICKLE NO.	SECT. PART NO.
A-801-177	A-800-177	chrome 11ga top serrated	6 ft. LH	6821078	6823272	700705300
A-801-183	A-800-183	chrome 11ga top serrated	6 ft. RH	6821136	6823280	700705300
A-801-175	A-800-175	chrome 11ga top serrated	7 ft. LH	6821078	6832174	700705300
A-801-181	A-800-181	chrome 11ga top serrated	7 ft. RH	6821136	6832224	700705300
A-831-510	A-830-510	chrome 11ga big tooth	7 ft. LH	6821078	6832174BT	700705300BT
A-831-511	A-830-511	chrome 11ga big tooth	7 ft. RH	6821136	6832224BT	700705300BT
A-801-173	A-800-173	chrome 11ga top serrated	8 ft. LH	6821078	6832182	700705300
A-801-179	A-800-179	chrome 11ga top serrated	8 ft. RH	6821136	6832232	700705300
A-861-630	N/A	chrome 11ga top serrated	8 ft. LH	Headless	6832182	700705300
A-861-631	N/A	chrome 11ga top serrated	8 ft. RH	Headless	6832232	700705300
A-831-512	A-830-512	chrome 11ga big tooth	8 ft. LH	6821078	6832182BT	700705300BT
A-831-513	A-830-513	chrome 11ga big tooth	8 ft. RH	6821136	6832232BT	700705300BT

For Models: (WINDROWER: 6550, 6650, 6666, 8100 auger header, 6566, 1014+2, 6665)

SICKLE ASSEMBLIES & PARTS

SICKLE ASSEMBLIES - HESSTON

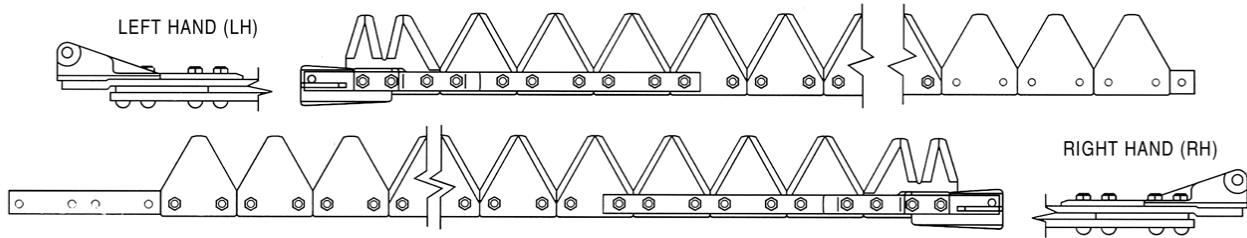

BOLT ON	RIVETED	DESCRIPTION	LENGTH	HEAD NO.	OEM SICKLE NO.	SECT. PART NO.
A-861-511	N/A	black 11ga top serrated	8 ft. LH	700111003	700709646BL	700705299
For Models: (WINDROWER: (8200, 8400, 8100 ALL draper header))						
A-861-512	N/A	black 11ga top serrated	7 ft. RH	700116709	700709647BL	700705299
A-861-513	N/A	black 11ga top serrated	9 ft. LH	700111003	700709648BL	700705299
A-861-514	N/A	black 11ga top serrated	9 ft. RH	700116709	700709649BL	700705299
A-801-973	A-800-973	chrome 12ga top serrated	11 ft. LH	700116003	700709650	049254
A-801-974	A-800-974	chrome 12ga top serrated	10 ft. RH	700116709	700709651	049254
A-861-515	N/A	black 11ga top serrated	11 ft. LH	700116003	700709650BL	700705299
A-861-516	N/A	black 11ga top serrated	10 ft. RH	700116709	700709651BL	700705299
For Models: (WINDROWER: (8200, 8400, 8100 ALL draper header))						

SICKLE ASSEMBLIES - HESSTON

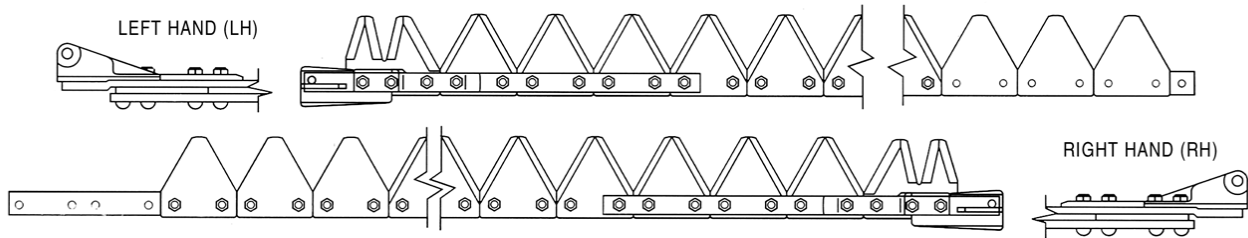

BOLT ON	RIVETED	DESCRIPTION	LENGTH	HEAD NO.	OEM SICKLE NO.	SECT. PART NO.
A-801-973	A-800-973	chrome 12ga top serrated	11 ft. LH	700116003	700709650	049254
A-801-974	A-800-974	chrome 12ga top serrated	10 ft. RH	700116709	700709651	049254
A-861-515	N/A	black 11ga top serrated	11 ft. LH	700116003	700709650BL	700705299
A-861-516	N/A	black 11ga top serrated	10 ft. RH	700116709	700709651BL	700705299
A-861-517	N/A	black 11ga top serrated	13 ft. LH	700116003	700709652BL	700705299
A-861-518	N/A	black 11ga top serrated	12 ft. RH	700116709	700709653BL	700705299
A-861-519	N/A	black 11ga top serrated	15 ft. LH	700116003	700709654BL	700705299
A-861-520	N/A	black 11ga top serrated	15 ft. RH	700116709	700709655BL	700705299
For Models: (WINDROWER: 8100 shiftable draper header (21', 25', 30'))						

SICKLE ASSEMBLIES - HESSTON

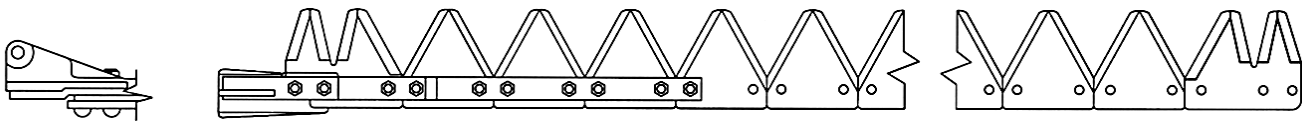

BOLT ON	RIVETED	DESCRIPTION	LENGTH	HEAD NO.	OEM SICKLE NO.	SECT. PART NO.
A-801-826	A-800-826	chrome 11ga top serrated	12 ft.	700111003	700110730	700705300
A-801-928	A-800-928	chrome 11ga top serrated	12 ft.	Headless	700115887	700705300
A-831-514	A-830-514	chrome 11ga big tooth	12 ft.	700111003	700110730BT	700705300BT
A-831-907	N/A	black 11ga top serrated	12 ft.	700111003	700110730BL	700705299
A-801-780	A-800-780	chrome 11ga top serrated	14 ft.	700111003	700110731	700705300
A-801-781	A-800-781	chrome 11ga top serrated	14 ft.	Headless	700115804	700705300
A-831-515	A-830-515	chrome 11ga big tooth	14 ft.	700111003	700110731BT	700705300BT
A-831-908	N/A	black 11ga top serrated	14 ft.	700111003	700110731BL	700705299
For Models: (WINDROWER: 8200, 1160 center pivot (14'))						

SICKLE ASSEMBLIES & PARTS

SICKLE ASSEMBLIES - HESSTON

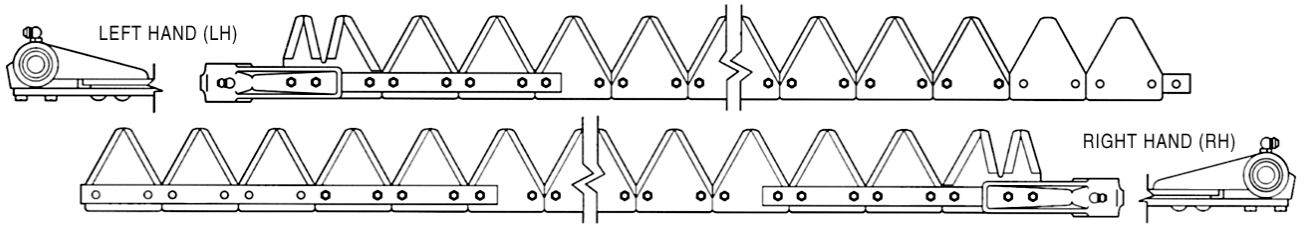

BOLT ON	RIVETED	DESCRIPTION	LENGTH	HEAD NO.	OEM SICKLE NO.	SECT. PART NO.
A-801-985	A-800-985	chrome 11ga top serrated	7 ft. LH	700114594	700114590	700705300
A-801-986	A-800-986	chrome 11ga top serrated	7 ft. RH	700114594	700114591	700705300
A-801-797	A-800-797	chrome 11ga top serrated	7 ft. LH	Headless	700709581	700705300
A-801-796	A-800-796	chrome 11ga top serrated	7 ft. RH	Headless	700709582	700705300
A-831-459	A-830-459	chrome 11ga big tooth	7 ft. LH	700114594	700114590BT	700705300BT
A-831-460	A-830-460	chrome 11ga big tooth	7 ft. RH	700114594	700114591BT	700705300BT
A-861-956	N/A	chrome 11ga sabertooth	7 ft. LH	700114594	700114590ST	700705300ST
A-861-957	N/A	chrome 11ga sabertooth	7 ft. RH	700114594	700114591ST	700705300ST
A-861-958	N/A	chrome 11ga sabertooth	7 ft. LH	Headless	700709581NHST	700705300ST
A-861-959	N/A	chrome 11ga sabertooth	7 ft. RH	Headless	700709582NHST	700705300ST
A-801-979	A-800-979	chrome 11ga top serrated	8 ft. LH	700114594	700114592	700705300
A-801-980	A-800-980	chrome 11ga top serrated	8 ft. RH	700114594	700114593	700705300
A-801-799	A-800-799	chrome 11ga top serrated	8 ft. LH	Headless	700709585	700705300
A-801-798	A-800-798	chrome 11ga top serrated	8 ft. RH	Headless	700709586	700705300
A-831-461	A-830-461	chrome 11ga big tooth	8 ft. LH	700114594	700114592BT	700705300BT
A-831-462	A-830-462	chrome 11ga big tooth	8 ft. RH	700114594	700114593BT	700705300BT
A-861-960	N/A	chrome 11ga sabertooth	8 ft. LH	700114594	700114592ST	700705300ST
A-861-961	N/A	chrome 11ga sabertooth	8 ft. RH	700114594	700114593ST	700705300ST
A-861-962	N/A	chrome 11ga sabertooth	8 ft. LH	Headless	700709585NHST	700705300ST
A-861-963	N/A	chrome 11ga sabertooth	8 ft. RH	Headless	700709586NHST	700705300ST
A-881-001	N/A	chrome 11ga top serrated	9 ft. LH	700114594	700715778	700705300
A-881-002	N/A	chrome 11ga top serrated	9 ft. RH	700114594	700715779	700705300
A-881-003	N/A	chrome 11ga top serrated	9 ft. LH	Headless	700715778NH	700705300
A-881-004	N/A	chrome 11ga top serrated	9 ft. RH	Headless	700715779NH	700705300
A-881-005	N/A	chrome 11ga big tooth	9 ft. LH	700114594	700715778BT	700705300BT
A-881-006	N/A	chrome 11ga big tooth	9 ft. RH	700114594	700715779BT	700705300BT
A-881-007	N/A	chrome 11ga sabertooth	9 ft. LH	700114594	700715778ST	700705300ST
A-881-008	N/A	chrome 11ga sabertooth	9 ft. RH	700114594	700715779ST	700705300ST
A-881-009	N/A	chrome 11ga sabertooth	9 ft. LH	Headless	700715778NHST	700705300ST
A-881-010	N/A	chrome 11ga sabertooth	9 ft. RH	Headless	700715779NHST	700705300ST

For Models: (WINDROWER: 8400, 8600), (MOWER CONDITIONER: 1170 w/ 625 auger header)

SICKLE SECTIONS - JOHN DEERE

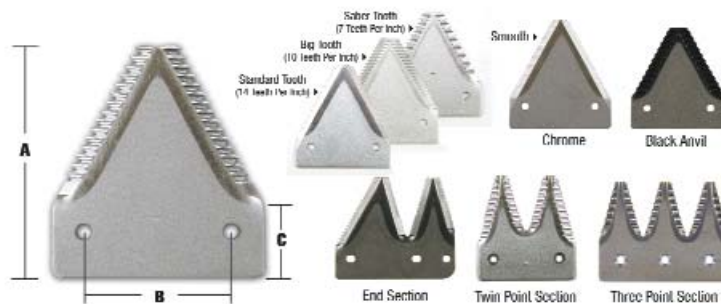

PART NO.	DESCRIPTION	DIM A (1)	DIM B (2)	DIM C (3)	FASTENER	REPL. NO.
A-211-203	chrome 14ga under serrated	3.250"	2"	1"	7/32 x 5/8	Z7029H
A-212-073	chrome 14ga under serrated	3.250"	2"	1"	7/32 x 5/8	H21529
A-211-102	black 12ga smooth	3.250"	2"	1"	7/32 x 5/8	Z6451H
A-212-152	chrome 12ga smooth	3.250"	2"	1"	7/32 x 5/8	H21525
A-211-022	black 12ga under serrated	3.250"	2"	1"	7/32 x 5/8	Z7030H
A-212-082	chrome 12ga under serrated	3.250"	2"	1"	7/32 x 5/8	H21530

SICKLE ASSEMBLIES & PARTS

A-212-242	chrome 12ga top serrated	3.250"	2"	1"	7/32 x 5/8	E45996
A-211-292	black 12ga top serrated	3.250"	2"	1"	7/32 x 5/8	E45996BL
A-232-242	chrome 12ga big tooth	3.250"	2"	1"	7/32 x 5/8	E45996BT
A-231-292	black 12ga big tooth	3.250"	2"	1"	7/32 x 5/8	E45996BLBT
A-211-631	black 11ga smooth	3.250"	2"	1"	7/32 x 5/8	E76372
A-211-021	black 11ga under serrated	3.250"	2"	1"	7/32 x 5/8	E76373
A-212-081	chrome 11ga under serrated	3.250"	2"	1"	7/32 x 5/8	E76371
A-211-611	black 11ga top serrated	3.250"	2"	1"	7/32 x 5/8	E76370BL
A-231-451	black 11ga sabertooth	3.250"	2"	1"	7/32 x 5/8	E76370BLST
A-232-451	chrome 11ga sabertooth	3.250"	2"	1"	7/32 x 5/8	E76370ST
A-212-241	chrome 12ga top serrated	3.250"	2"	1"	7/32 x 5/8	E76370
A-232-241	chrome 11ga big tooth	3.250"	2"	1"	7/32 x 5/8	E76370BT
A-231-611	black 11ga big tooth	3.250"	2"	1"	7/32 x 5/8	E76370BLBT
A-211-223	black 14ga under serrated	3.250"	2.125"	1"	7/32 x 5/8	875785L
A-412-102	chrome 12ga top serrated	3" wide	3.218"long	1"	7/32 x 5/8	1055090M1
A-711-003	chrome 12ga top serrated	twin sect			overlap kit	

SICKLE PARTS - JOHN DEERE

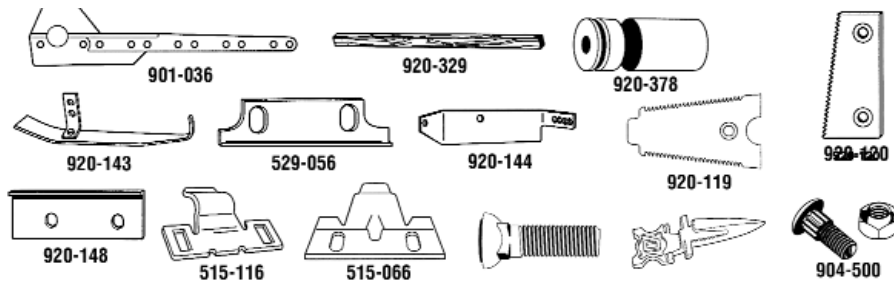

PART NO.	DESCRIPTION	REPLACES	APPLICATION
A-901-036	Sickle Head	H28076H	
A-901-039	Sickle Head	AE24247	
A-901-235	Sickle Head	AE48583	
A-901-233	Sickle Head, LH	AE48125	
A-901-234	Sickle Head, RH	AE48126	
A-920-378	Knifehead Pin	E77840	
A-920-379	Needle Bearing	AE48137	
A-920-334	Seal	E56795	
A-725-003	Knifehead Pin Kit		
A-920-101	Center Guard	50HS4A, 143HSA	
A-920-102	Outer Guard		
A-920-119	Ledger Plate	Z5110H	
A-904-520	(50) 7/16x1-1/2" bolts		
A-904-521	(50) 7/16x1-3/4" bolts		
A-920-143	Outer Sole	AH11948H	
A-920-144	Inner Sole	H24076H	
A-920-148	Head Wear Plate	Z5870H	
A-H28286	Pitman Wood 36.812"	H28286	(MOWER: 8W, 9W)
A-Z9298H	Pitman Wood 33.875"	Z9298H	(MOWER: 5)
A-Z9913H	Pitman Wood 26.750"	Z9913H	(MOWER: 8, 9)
A-529-056	Wear Plate 6"	206196M1, 231303M1	
A-515-066	Knife Clip	61384282	
A-515-126	Knifehead clip		
A-904-524	(25) Strap Bolt & Nut	H125889	(MOWER: CUTTER PARTS 7/8" bolt)
A-904-549	(25) Head Bolt & Nut	H125890	(MOWER: CUTTER PARTS 3/4" bolt)

SICKLE ASSEMBLIES - JOHN DEERE

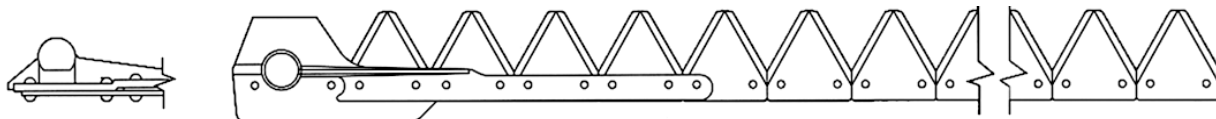

BOLT ON	RIVETED	DESCRIPTION	LENGTH	HEAD NO.	OEM SICKLE NO.	SECT. PART NO.
A-801-292	A-800-292	black 12ga smooth	7 ft.	H28076H	AZ958H	Z6451H
A-801-294	A-800-294	black 12ga under serrated	7 ft.	H28076H	AZ1299H	Z7030H
A-801-296	A-800-296	black 12ga smooth	9 ft.	H28076H	AZ3987H	Z6451H
A-801-298	A-800-298	black 12ga under serrated	9 ft.	H28076H	AZ3988H	Z7030H

For Models: (MOWER: 5, 8, 9, 11, 37, 38, 39, 39N)

SICKLE ASSEMBLIES & PARTS

SICKLE ASSEMBLIES - JOHN DEERE

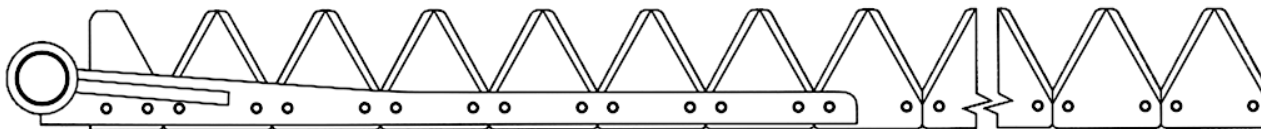

BOLT ON	RIVETED	DESCRIPTION	LENGTH	HEAD NO.	OEM SICKLE NO.	SECT. PART NO.
A-831-687	A-830-687	black 12ga smooth	7 ft.	AE48583	AE48593BL, AE36101	Z6451H
A-831-686	A-830-686	black 12ga under serrated	7 ft.	AE48583	AE48592, AE36097	Z7030H
A-831-689	A-830-689	black 12ga smooth	9 ft.	AE48583	AE48595, AE69106	Z6451H
A-831-688	A-830-688	black 12ga under serrated	9 ft.	AE48583	AE48594, AE36102	Z7030H
A-831-685	A-830-685	chrome 12ga top serrated	9 ft.	AE48583	AE48594TSPL, AE36102TSPL	E45996
A-831-813	A-830-813	Xblack 12ga top serrated	9 ft.	AE48583	AE48594TS, AE36102TS	E76370BL

For Models: (MOWER: 47, 50, 250, 350, 450, 3700 w/ needle brg style head)

SICKLE ASSEMBLIES - JOHN DEERE

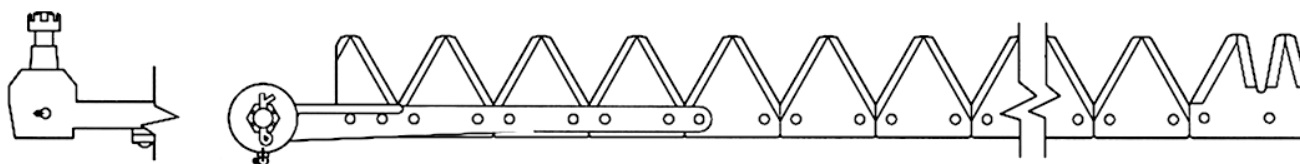

BOLT ON	RIVETED	DESCRIPTION	LENGTH	HEAD NO.	OEM SICKLE NO.	SECT. PART NO.
A-801-374	A-800-374	chrome 12ga under serrated	9 ft.	AE24247	AE27623	H21530
A-801-280	A-800-280	chrome 12ga top serrated	9 ft.	AE24247	AE27602	E45996
A-801-377	A-800-377	chrome 12ga under serrated	12 ft.	AE24247	AE28069	H21530
A-801-281	A-800-281	chrome 12ga top serrated	12 ft.	AE24247	AE28067	E45996
A-801-378	A-800-378	chrome 12ga under serrated	14 ft.	AE24247	AE28075	H21530
A-801-282	A-800-282	chrome 12ga top serrated	14 ft.	AE24247	AE28073	E45996

For Models: (MOWER CONDITIONER: 1209 SN <-285000 (9'), 480, 483, 485 (9'), 1214 (12' & 14'))

SICKLE ASSEMBLIES - JOHN DEERE

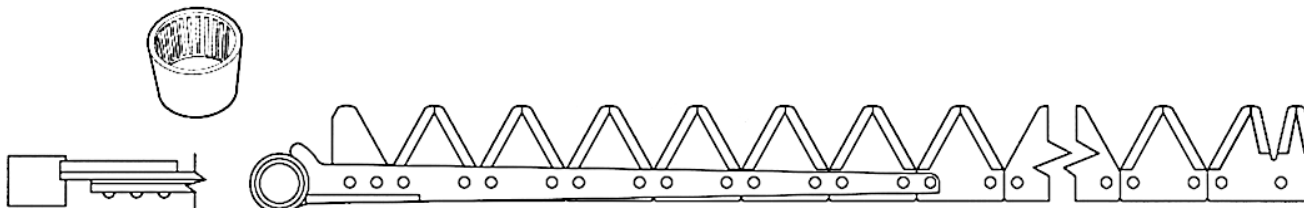

BOLT ON	RIVETED	DESCRIPTION	LENGTH	HEAD NO.	OEM SICKLE NO.	SECT. PART NO.
A-831-815	A-830-815	Xchrome 12ga top serrated	7 ft.	AE48125	AE48663	E76370
A-831-691	A-830-691	Xchrome 12ga under serrated	7 ft.	AE48125	AE48661	E76371
A-831-579	A-830-579	Xchrome 12ga top serrated	9 ft.	AE48125	AE48664	E76370
A-831-692	A-830-692	Xchrome 12ga under serrated	9 ft.	AE48125	AE48662	E76371
A-831-821	A-830-821	Xblack 12ga top serrated	9 ft.	AE48125	AE48664BL	E76370BL
A-861-544	N/A	black 11ga big tooth	9 ft.	AE48125	AE48664BLBT	E76370BLBT
A-831-580	A-830-580	Xchrome 12ga top serrated	12 ft.	AE48125	AE48652	E76370
A-831-818	A-830-818	Xchrome 12ga under serrated	12 ft.	AE48125	AE48651	E76371
A-831-875	A-830-875	Xblack 12ga top serrated	12 ft.	AE48125	AE48651BL	E76370BL
A-861-545	N/A	black 11ga big tooth	12 ft.	AE48125	AE48652BLBT	E76370BLBT
A-831-581	A-830-581	Xchrome 12ga top serrated	14 ft.	AE48125	AE48654	E76370
A-831-819	A-830-819	Xchrome 12ga under serrated	14 ft.	AE48125	AE48655	E76371
A-831-876	A-830-876	Xblack 12ga top serrated	14 ft.	AE48125	AE48654BL	E76370BL
A-861-546	N/A	black 11ga big tooth	14 ft.	AE48125	AE48654BLBT	E76370BLBT

For Models: (MOWER CONDITIONER: 1209 SN 285001->, 1217 (7'), 1219 SN 710001-> (9'), 1380 mid pivot, 1424 (12' & 24'))

SICKLE ASSEMBLIES & PARTS

SICKLE ASSEMBLIES - JOHN DEERE

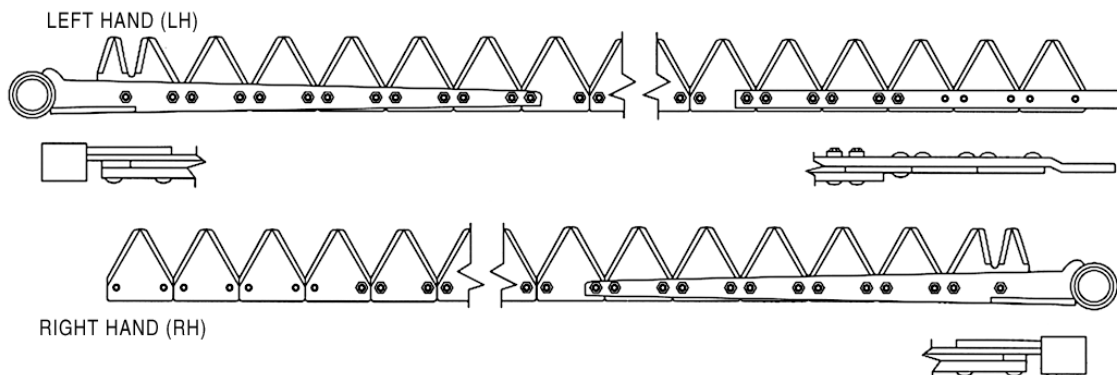

BOLT ON	RIVETED	DESCRIPTION	LENGTH	HEAD NO.	OEM SICKLE NO.	SECT. PART NO.
A-801-484	A-800-484	Xchrome 12ga top serrated	6 ft. RH	AE48126	AE48597	E76370
A-801-485	A-800-485	Xchrome 12ga top serrated	6 ft. LH	AE48125	AE48665	E76370
A-831-888	A-830-888	Xblack 12ga top serrated	6 ft. RH	AE48126	AE48597BL	E76370BL
A-831-887	A-830-887	Xblack 12ga top serrated	6 ft. LH	AE48125	AE48665BL	E76370BL
A-831-476	N/A	chrome 11ga big tooth	6 ft. RH	AE48126	AE48126	E76370BT
A-831-477	N/A	chrome 11ga big tooth	6 ft. LH	AE48125	AE48665BT	E76370BT
A-801-486	A-800-486	Xchrome 12ga top serrated	7 ft. RH	AE48126	AE48135	E76370
A-801-487	A-800-487	Xchrome 12ga top serrated	7 ft. LH	AE48125	AE48131	E76370
A-831-890	A-830-890	Xblack 12ga top serrated	7 ft. RH	AE48126	AE48135BL	E76370BL
A-831-889	A-830-889	Xblack 12ga top serrated	7 ft. LH	AE48125	AE48131BL	E76370BL
A-881-056	N/A	chrome 11ga sabertooth	7 ft. RH	AE48125	AE48135ST	E76370ST
A-881-057	N/A	chrome 11ga sabertooth	7 ft. LH	AE48125	AE48131ST	E76370ST

For Models: (MOWER CONDITIONER: 1525 w/ 300 twin knife drive, 1600 SN <-880001, platform (12' & 14'))

SICKLE ASSEMBLIES - JOHN DEERE

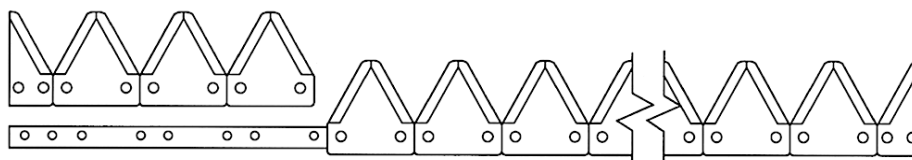

BOLT ON	RIVETED	DESCRIPTION	LENGTH	HEAD NO.	OEM SICKLE NO.	SECT. PART NO.
A-801-659	A-800-659	black 14ga under serrated	18 ft.	Headless	899416L	875785L
A-801-660	A-800-660	black 14ga under serrated	21 ft.	Headless	885194L	875785L
A-801-661	A-800-661	black 14ga under serrated	25 ft.	Headless	885477	875785L
A-801-391	A-800-391	black 14ga under serrated	31 ft. 1 pc.	Headless	AW24760	W30344

For Models: (WINDROWER: 580, 590 (30'))

SICKLE ASSEMBLIES - JOHN DEERE

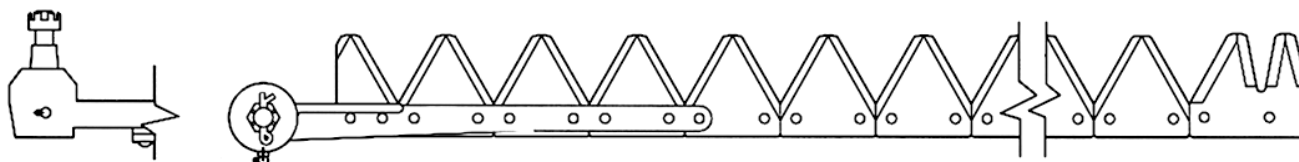

BOLT ON	RIVETED	DESCRIPTION	LENGTH	HEAD NO.	OEM SICKLE NO.	SECT. PART NO.
A-801-377	A-800-377	chrome 12ga under serrated	12 ft.	AE24247	AE28069	H21530
A-801-281	A-800-281	chrome 12ga top serrated	12 ft.	AE24247	AE28067	E45996
A-801-378	A-800-378	chrome 12ga under serrated	14 ft.	AE24247	AE28075	H21530
A-801-282	A-800-282	chrome 12ga top serrated	14 ft.	AE24247	AE28073	E45996
A-801-454	A-800-454	chrome 12ga top serrated	15 ft.	AE24247	AE23898	E45996
A-801-283	A-800-283	chrome 12ga top serrated	16 ft.	AE24247	AE32359	E45996
A-801-492	A-800-492	chrome 12ga top serrated	18 ft.	AE24247	AE23782	E45996
A-801-493	A-800-493	chrome 12ga top serrated	21 ft.	AE24247	AE25476	E45996

For Models: (WINDROWER: 2270 platforms: 88, 120, 188, 220 (12' - 21'), 830, 780, 800, 880, 2250)

SICKLE ASSEMBLIES & PARTS

SICKLE ASSEMBLIES - JOHN DEERE

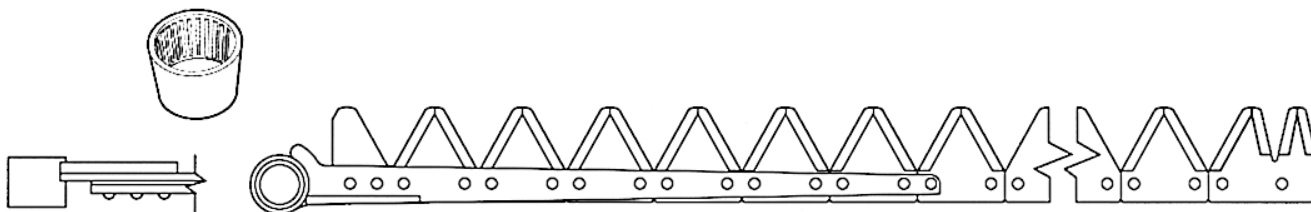

BOLT ON	RIVETED	DESCRIPTION	LENGTH	HEAD NO.	OEM SICKLE NO.	SECT. PART NO.
A-831-580	A-830-580	Xchome 12ga top serrated	12 ft.	AE48125	AE48652	E76370
A-831-818	A-830-818	Xchome 12ga under serrated	12 ft.	AE48125	AE48651	E76371
A-831-875	A-830-875	Xblack 12ga top serrated	12 ft.	AE48125	AE48651BL	E76370BL
A-861-545	N/A	black 11ga big tooth	12 ft.	AE48125	AE48652BLBT	E76370BLBT
A-831-581	A-830-581	Xchome 12ga top serrated	14 ft.	AE48125	AE48654	E76370
A-831-819	A-830-819	Xchome 12ga under serrated	14 ft.	AE48125	AE48655	E76371
A-831-876	A-830-876	Xblack 12ga top serrated	14 ft.	AE48125	AE48654BL	E76370BL
A-861-546	N/A	black 11ga big tooth	14 ft.	AE48125	AE48654BLBT	E76370BLBT
A-831-582	A-830-582	chome 12ga top serrated	15 ft.	AE48125	AE38816	E45996
A-831-583	A-830-583	Xchome 12ga top serrated	16 ft.	AE48125	AE48657	E76370
A-831-820	A-830-820	Xchome 12ga under serrated	16 ft.	AE48125	AE48656	E76371
A-831-877	A-830-877	Xblack 12ga top serrated	16 ft.	AE48125	AE48657BL	E76370BL
A-861-547	N/A	black 11ga big tooth	16 ft.	AE48125	AE48657BLBT	E76370BLBT
A-831-584	A-830-584	Xchome 12ga top serrated	18 ft.	AE48125	AE48599	E76370
A-831-878	A-830-878	Xblack 12ga top serrated	18 ft.	AE48125	AE48599BL	E76370BL
A-861-548	N/A	black 11ga big tooth	18 ft.	AE48125	AE48599BLBT	E76370BLBT
A-831-585	A-830-585	Xchome 12ga top serrated	21 ft.	AE48125	AE48598	E76370
A-831-879	A-830-879	Xblack 12ga top serrated	21 ft.	AE48125	AE48598BL	E76370BL
A-861-549	N/A	black 11ga big tooth	21 ft.	AE48125	AE48598BLBT	E76370BLBT
A-831-586	A-830-586	Xchome 12ga top serrated	25 ft.	AE48125	AE39178	E76370
A-831-880	A-830-880	Xblack 12ga top serrated	25 ft.	AE48125	AE39178BL	E76370BL
A-861-550	N/A	black 11ga big tooth	25 ft.	AE48125	AE39178BLBT	E76370BLBT

For Models: (2280, 2320, 2420 ALL auger:230,240(12',14',16'); draper:130,135(15',18',21',25'))

SICKLE ASSEMBLIES - JOHN DEERE

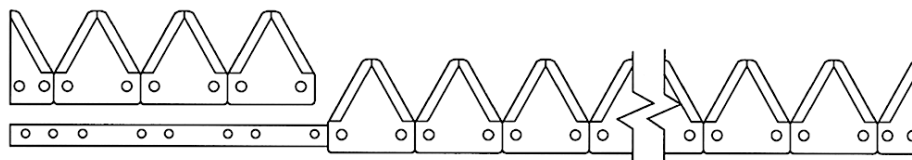

BOLT ON	RIVETED	DESCRIPTION	LENGTH	HEAD NO.	OEM SICKLE NO.	SECT. PART NO.
A-801-648	A-800-648	chome 12ga top serrated	15 ft.	Headless	1057966M91, 1057964M91	31-7970650
A-831-833	A-830-833	Xblack 12ga top serrated	15 ft.	Headless	33703	34390
A-801-649	A-800-649	chome 12ga top serrated	18 ft.	Headless	1057967M91, 1057965M91	1055090M1
A-831-834	A-830-834	Xblack 12ga top serrated	18 ft.	Headless	33704	34390
A-801-650	A-800-650	chome 12ga top serrated	21 ft.	Headless	1057508M91	1055090M1
A-831-835	A-830-835	Xblack 12ga top serrated	21 ft.	Headless	33705	34390
A-801-651	A-800-651	chome 12ga top serrated	26 ft 1 pc.	Headless	1056739M91, 1056738M91	1055090M1
A-831-836	A-830-836	Xblack 12ga top serrated	28 ft 1 pc.	Headless	33746	34390
A-801-652	A-800-652	chome 12ga top serrated	31 ft 1 pc.	Headless	1057912M91	1055090M1
A-831-837	A-830-837	Xblack 12ga top serrated	33 ft 1 pc.	Headless	33747	34390

For Models: (WINDROWER: 2360 w/ draper header)

SICKLE ASSEMBLIES & PARTS

SICKLE ASSEMBLIES - JOHN DEERE

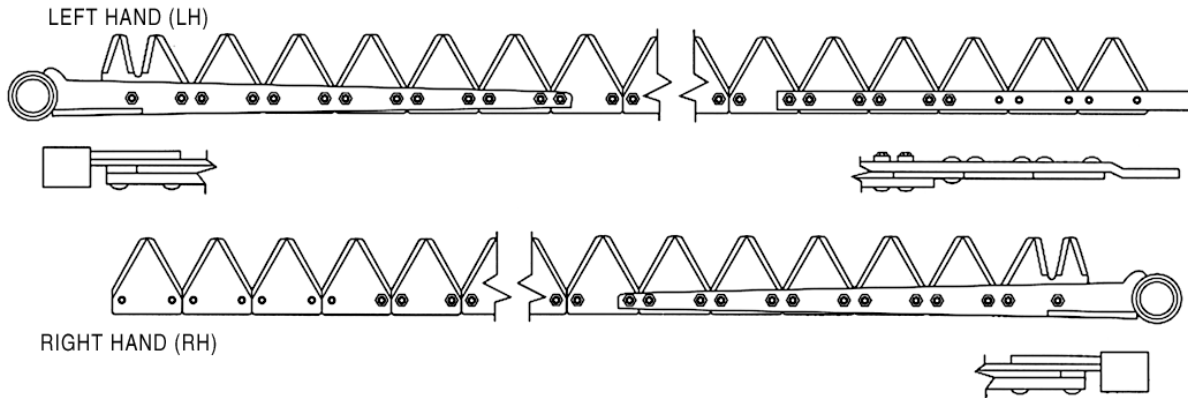

BOLT ON	RIVETED	DESCRIPTION	LENGTH	HEAD NO.	OEM SICKLE NO.	SECT. PART NO.
A-801-484	A-800-484	Xchrome 12ga top serrated	6 ft. RH	AE48126	AE48597	E76370

SICKLE ASSEMBLIES - JOHN DEERE

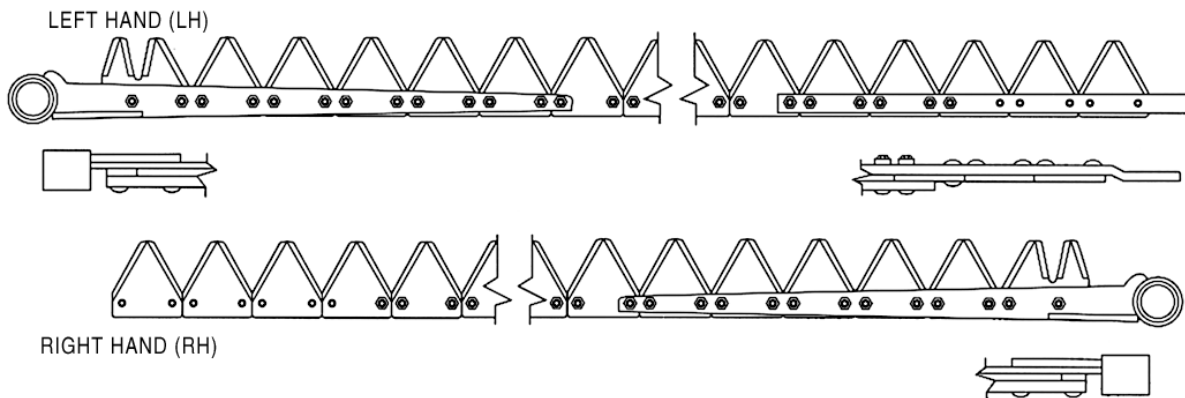

BOLT ON	RIVETED	DESCRIPTION	LENGTH	HEAD NO.	OEM SICKLE NO.	SECT. PART NO.
A-801-485	A-800-485	Xchrome 12ga top serrated	6 ft. LH	AE48125	AE48665	E76370
A-831-888	A-830-888	Xblack 12ga top serrated	6 ft. RH	AE48126	AE48597BL	E76370BL
A-831-887	A-830-887	Xblack 12ga top serrated	6 ft. LH	AE48125	AE48665BL	E76370BL
A-831-476	N/A	chrome 11ga big tooth	6 ft. RH	AE48126	AE48126	E76370BT
A-831-477	N/A	chrome 11ga big tooth	6 ft. LH	AE48125	AE48665BT	E76370BT
A-801-486	A-800-486	Xchrome 12ga top serrated	7 ft. RH	AE48126	AE48135	E76370
A-801-487	A-800-487	Xchrome 12ga top serrated	7 ft. LH	AE48125	AE48131	E76370
A-831-890	A-830-890	Xblack 12ga top serrated	7 ft. RH	AE48126	AE48135BL	E76370BL
A-831-889	A-830-889	Xblack 12ga top serrated	7 ft. LH	AE48125	AE48131BL	E76370BL
A-881-056	N/A	chrome 11ga sabertooth	7 ft. RH	AE48125	AE48135ST	E76370ST
A-881-057	N/A	chrome 11ga sabertooth	7 ft. LH	AE48125	AE48131ST	E76370ST
A-801-590	A-800-590	Xchrome 12ga top serrated	8 ft. RH	AE48126	AE48134	E76370
A-801-591	A-800-591	Xchrome 12ga top serrated	8 ft. LH	AE48125	AE48130	E76370
A-831-892	A-830-892	Xblack 12ga top serrated	8 ft. RH	AE48126	AE48134BL	E76370BL
A-831-891	A-830-891	Xblack 12ga top serrated	8 ft. LH	AE48125	AE48130BL	E76370BL
A-881-058	N/A	chrome 11ga sabertooth	8 ft. RH	AE48126	AE48134ST	E76370ST
A-881-059	N/A	chrome 11ga sabertooth	8 ft. LH	AE48125	AE48130ST	E76370ST

For Models: (WINDROWER: (3430, 3830 ALL w/ 300 & 300A twin knife drive (12'-16') SN <-880000))

SICKLE ASSEMBLIES & PARTS

SICKLE ASSEMBLIES - JOHN DEERE

LEFT HAND (LH)

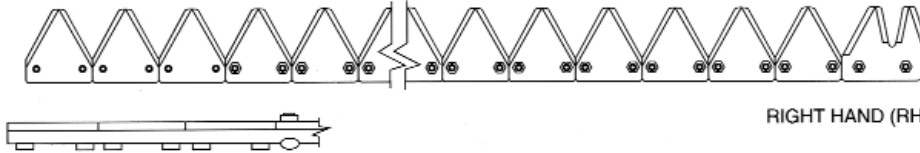
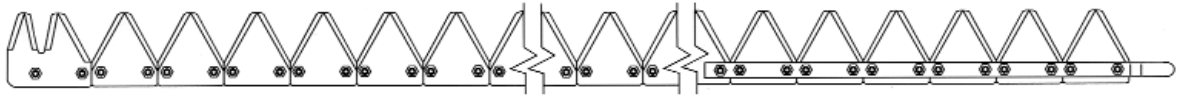

RIGHT HAND (RH)

BOLT ON	RIVETED	DESCRIPTION	LENGTH	HEAD NO.	OEM SICKLE NO.	SECT. PART NO.
A-861-970	N/A	Xchome 12ga top serrated	7 ft. LH	Headless	AE55769	E76370
For Models: (WINDROWER: 4890 w/ 890 platform)						
A-861-971	N/A	Xchome 12ga top serrated	7 ft. RH	Headless	AE55770	E76370
A-861-972	N/A	Xchome 12ga top serrated	8 ft. LH	Headless	AE55771	E76370
A-861-973	N/A	Xchome 12ga top serrated	8 ft. RH	Headless	AE55772	E76370
A-861-974	N/A	Xchome 12ga top serrated	9 ft. LH	Headless	AE56459	E76370
A-861-975	N/A	Xchome 12ga top serrated	9 ft. RH	Headless	AE56460	E76370
For Models: (WINDROWER: 4890 w/ 890 platform)						

SICKLE PARTS - MAC DON

PART NO.	DESCRIPTION	APPLICATION
A-515-126	Knifehead clip	
A-515-066	Low knifehead clip	

SICKLE ASSEMBLIES - MAC DON

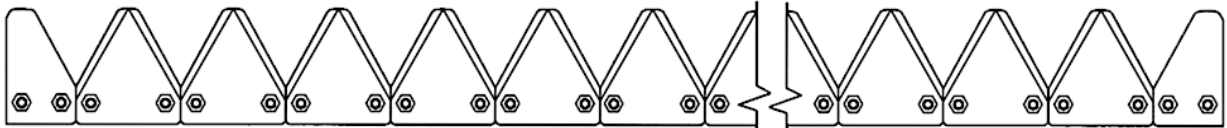

BOLT ON	RIVETED	DESCRIPTION	LENGTH	HEAD NO.	OEM SICKLE NO.	SECT. PART NO.
A-861-999	N/A	black 11ga top serrated	9 ft.	Headless	36931	34390
For Models: (MOWER CONDITIONER: 4000)						
A-861-980	N/A	black 11ga sabertooth	9 ft.	Headless	36931ST	102053
For Models: (MOWER CONDITIONER: 4000)						

SICKLE ASSEMBLIES - MAC DON

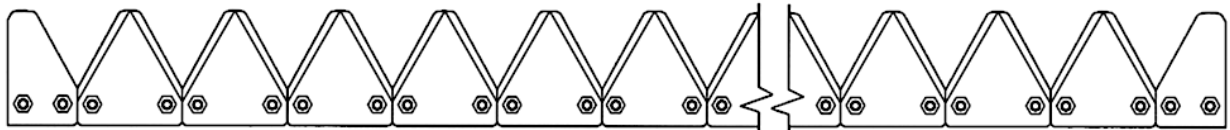

BOLT ON	RIVETED	DESCRIPTION	LENGTH	HEAD NO.	OEM SICKLE NO.	SECT. PART NO.
A-881-078	N/A	black 11ga top serrated	12 ft.	Headless	38632	34390
For Models: (WINDROWER: 942 multi-crop header & 741, 941 hay conditioner w/ single drive)						
A-881-079	N/A	black 11ga sabertooth	12 ft.	Headless	38632ST	102053
For Models: (WINDROWER: 942 multi-crop header & 741, 941 hay conditioner w/ single drive)						

SICKLE ASSEMBLIES & PARTS

SICKLE ASSEMBLIES - MAC DON

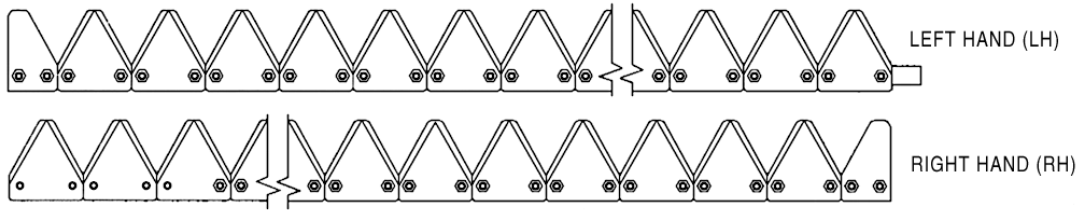

BOLT ON	RIVETED	DESCRIPTION	LENGTH	HEAD NO.	OEM SICKLE NO.	SECT. PART NO.
A-881-019	N/A	black 11ga top serrated	8 ft. RH	Headless	47783	34390
For Models: (WINDROWER: 942 multi-crop header & 741, 941 hay conditioner w/ double drive)						
A-881-022	N/A	black 11ga sabertooth	8 ft. RH	Headless	47783ST	102053
A-881-020	N/A	black 11ga top serrated	9 ft. LH	Headless	47788	34390
A-881-023	N/A	black 11ga sabertooth	9 ft. LH	Headless	47788ST	102053
A-881-021	N/A	black 11ga top serrated	9 ft. RH	Headless	47793	34390
A-881-024	N/A	black 11ga sabertooth	9 ft. RH	Headless	47793ST	102053
For Models: (WINDROWER: 942 multi-crop header & 741, 941 hay conditioner w/ double drive)						

SICKLE ASSEMBLIES - MAC DON

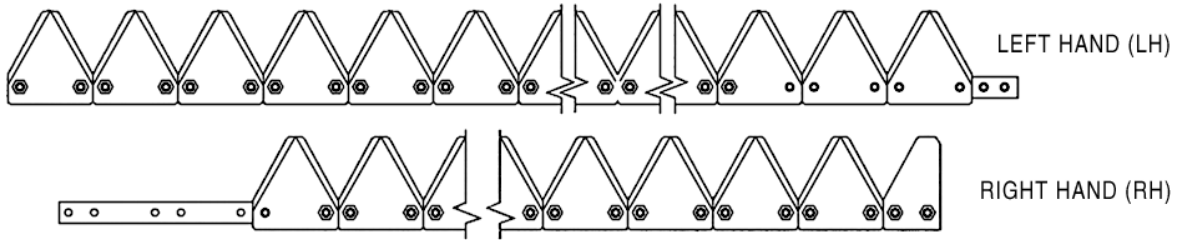

BOLT ON	RIVETED	DESCRIPTION	LENGTH	HEAD NO.	OEM SICKLE NO.	SECT. PART NO.
A-881-025	N/A	black 11ga top serrated	21 ft. LH	Headless	49667	34390
For Models: (WINDROWER: 960 double & triple delivery harvest headers, 962 (30' & 36'), double & triple delivery harvest headers)						
A-881-029	N/A	black 11ga sabertooth	21 ft. LH	Headless	49667ST	102053
A-881-026	N/A	black 11ga top serrated	4 ft. RH	Headless	43076	34390
A-881-030	N/A	black 11ga sabertooth	4 ft. RH	Headless	43076ST	102053
A-881-027	N/A	black 11ga top serrated	9 ft. RH	Headless	43077	34390
A-881-031	N/A	black 11ga sabertooth	9 ft. RH	Headless	43077ST	102053
A-881-028	N/A	black 11ga top serrated	15 ft. RH	Headless	43078	34390
A-881-032	N/A	black 11ga sabertooth	15 ft. RH	Headless	43078ST	102053
For Models: (WINDROWER: 960 double & triple delivery harvest headers, 962 (30' & 36'), double & triple delivery harvest headers)						

SICKLE ASSEMBLIES - MAC DON

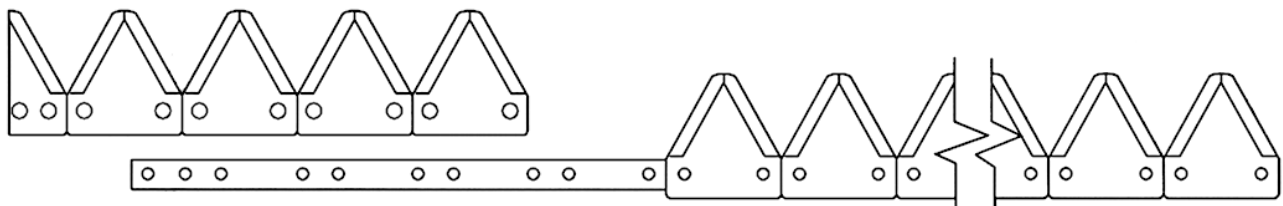

BOLT ON	RIVETED	DESCRIPTION	LENGTH	HEAD NO.	OEM SICKLE NO.	SECT. PART NO.
A-801-657	A-800-657	chrome 14ga under serrated	15 ft.	Headless	16641PL	7253
A-801-659	A-800-659	black 14ga under serrated	18 ft.	Headless	899416L	875785L
A-801-641	A-800-641	chrome 14ga top serrated	18 ft.	Headless	1042904M91	1046779M1
A-801-660	A-800-660	black 14ga under serrated	21 ft.	Headless	885194L	875785L
A-801-642	A-800-642	chrome 14ga top serrated	21 ft.	Headless	1041471M91	1046779M1
A-801-661	A-800-661	black 14ga under serrated	25 ft.	Headless	885477	875785L
A-801-643	A-800-643	chrome 14ga top serrated	25 ft.	Headless	1050779M91	1046779M1
For Models: (WINDROWER: RENN 1000 Prairie-Mac pull type)						

SICKLE ASSEMBLIES & PARTS

SICKLE ASSEMBLIES - MAC DON

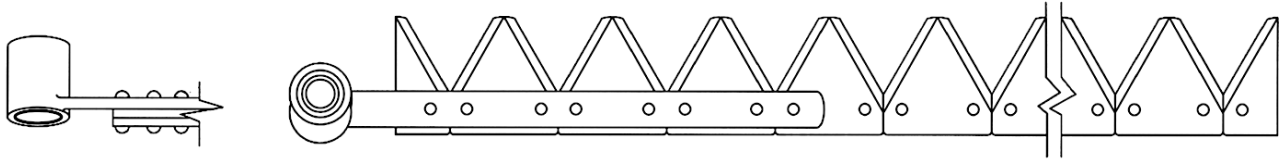

BOLT ON	RIVETED	DESCRIPTION	LENGTH	HEAD NO.	OEM SICKLE NO.	SECT. PART NO.
A-801-409	A-800-409	chrome 12ga top serrated	12 ft.	31-7970683	1046768M1	31-7970650
A-801-411	A-800-411	chrome 12ga top serrated	15 ft.	31-7970683	31-7970623	31-7970650
A-801-413	A-800-413	chrome 12ga top serrated	18 ft.	31-7970683	31-7970633	31-7970650
A-801-415	A-800-415	chrome 12ga top serrated	21 ft.	31-7970683	31-7970643	31-7970650

For Models: (WINDROWER: RENN 2000 Hydro-Mac)

SICKLE ASSEMBLIES - MAC DON

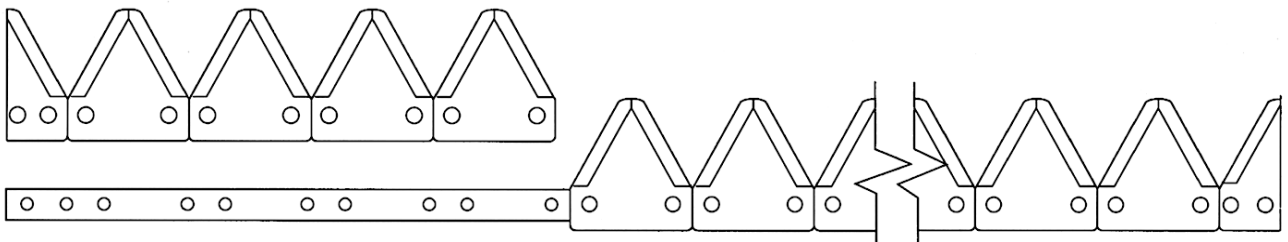

BOLT ON	RIVETED	DESCRIPTION	LENGTH	HEAD NO.	OEM SICKLE NO.	SECT. PART NO.
A-801-670	A-800-670	black 14ga under serrated	21 ft.	Headless	1043842M91	1041472M1
A-801-671	A-800-671	black 14ga under serrated	25 ft.	Headless	1065051M91	1041472M1
A-801-672	A-800-672	black 14ga under serrated	30 ft.	Headless	1065052M91	1041472M1
A-801-673	A-800-673	black 14ga under serrated	21 ft. LH	Headless	1069664M91	1041472M1
A-801-674	A-800-674	black 14ga under serrated	15 ft. RH	Headless	1069665M91	1041472M1

For Models: (WINDROWER: 3000 pull type swather, single & duplex)

SICKLE ASSEMBLIES - MAC DON

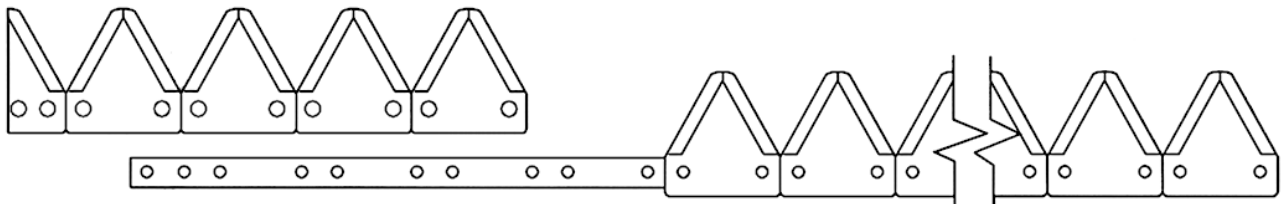

BOLT ON	RIVETED	DESCRIPTION	LENGTH	HEAD NO.	OEM SICKLE NO.	SECT. PART NO.
A-881-033	N/A	black 11ga top serrated	12 ft.	Headless	34181	34390

For Models: (WINDROWER: 5000 power tongue, 910, 920, 930 auger header w/ single drive)

A-861-977	N/A	black 11ga sabertooth	12 ft.	Headless	34181ST	102053
A-881-034	N/A	black 11ga top serrated	14 ft.	Headless	34182	34390
A-861-978	N/A	black 11ga sabertooth	14 ft.	Headless	34182ST	102053
A-881-035	N/A	black 11ga top serrated	16 ft.	Headless	34183	34390
A-861-979	N/A	black 11ga sabertooth	16 ft.	Headless	34183ST	102053

For Models: (WINDROWER: 5000 power tongue, 910, 920, 930 auger header w/ single drive)

SICKLE ASSEMBLIES & PARTS

SICKLE ASSEMBLIES - MAC DON

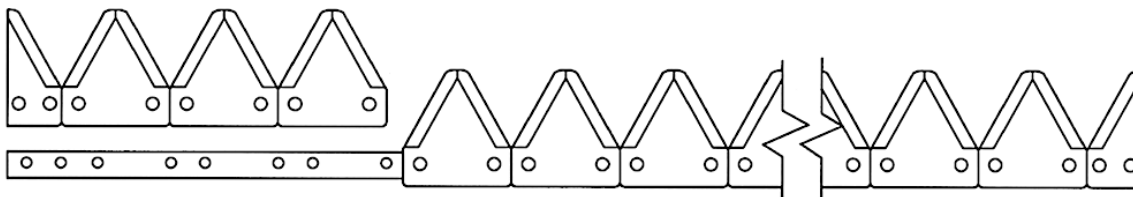

BOLT ON	RIVETED	DESCRIPTION	LENGTH	HEAD NO.	OEM SICKLE NO.	SECT. PART NO.
A-801-644	A-800-644	black 11ga top serrated	12 ft.	Headless	1057934M91	1071707M1
A-801-645	A-800-645	black 11ga top serrated	14 ft.	1056738M91	-	1056865M91
A-801-646	A-800-646	black 11ga top serrated	14 ft.	Headless	1056866M91	1071707M1
A-831-530	N/A	black 11ga big tooth	14 ft.	Headless	34393BT	34390BT
A-801-647	A-800-647	black 11ga top serrated	14 ft.	Headless	1057538M91	1071707M1

For Models: (WINDROWER: 7000 auger header)

SICKLE ASSEMBLIES - MAC DON

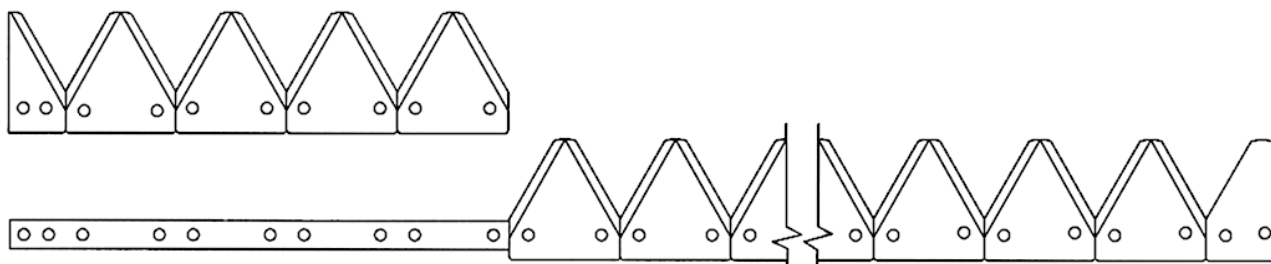

BOLT ON	RIVETED	DESCRIPTION	LENGTH	HEAD NO.	OEM SICKLE NO.	SECT. PART NO.
A-831-833	A-830-833	black 11ga top serrated	15 ft.	Headless	33703	34390
A-831-834	A-830-834	black 11ga top serrated	18 ft.	Headless	33704	34390
A-831-835	A-830-835	black 11ga top serrated	21 ft.	Headless	33705	34390
A-831-836	A-830-836	black 11ga top serrated	26 ft. 1 pc.	Headless	33746	34390
A-831-837	A-830-837	black 11ga top serrated	31 ft. 1 pc.	Headless	33747	34390

For Models: (WINDROWER: 7000 draper headers, multi-crop header, harvest header)

SICKLE ASSEMBLIES - MAC DON

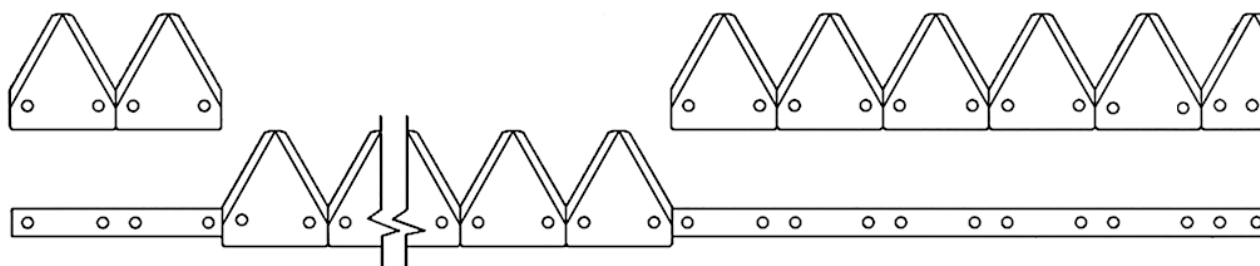

BOLT ON	RIVETED	DESCRIPTION	LENGTH	HEAD NO.	OEM SICKLE NO.	SECT. PART NO.
A-831-839	N/A	black 11ga top serrated	7 ft. LH	Headless	33715, 34211	34390
A-861-996	N/A	black 11ga sabertooth	7 ft. LH	Headless	34211ST	102053
A-831-838	A-830-838	black 11ga top serrated	7 ft. RH	Headless	33718, 34212	34390
A-861-995	N/A	black 11ga sabertooth	7 ft. RH	Headless	34212ST	102053
A-831-841	A-830-841	black 11ga top serrated	8 ft. LH	Headless	33716, 34212	34390
A-861-998	N/A	black 11ga sabertooth	8 ft. LH	Headless	34212ST	102053
A-831-840	A-830-840	black 11ga top serrated	8 ft. RH	Headless	33719, 34313	34390
A-861-997	N/A	black 11ga sabertooth	8 ft. RH	Headless	34213ST	102053

For Models: (WINDROWER: 7000 w/ 910, 920, 930 auger header, double knife drive & standard)

SICKLE ASSEMBLIES & PARTS

SICKLE ASSEMBLIES - MAC DON

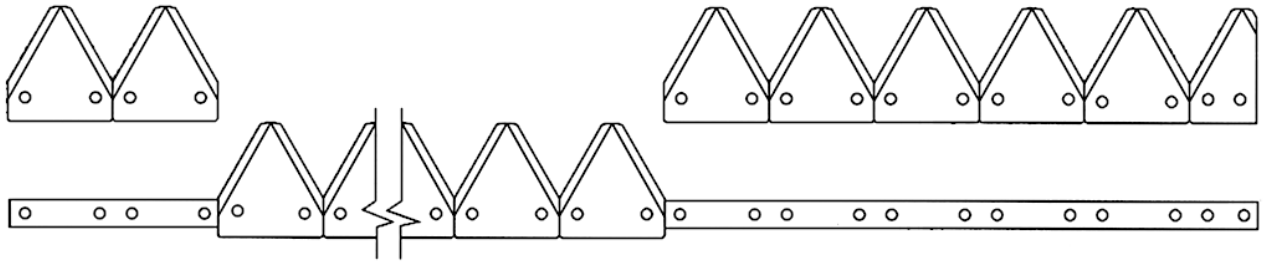

BOLT ON	RIVETED	DESCRIPTION	LENGTH	HEAD NO.	OEM SICKLE NO.	SECT. PART NO.
A-881-036	N/A	black 11ga top serrated	6 ft. LH	Headless	34328	34390
For Models: (WINDROWER: 7000 w/ 910, 920, 930 auger header, double knife drive & stub gau)						
A-861-981	N/A	black 11ga sabertooth	6 ft. LH	Headless	34328ST	102053
A-881-039	N/A	black 11ga top serrated	6 ft. RH	Headless	34674	34390
A-861-983	N/A	black 11ga sabertooth	6 ft. RH	Headless	34674ST	102053
A-881-037	N/A	black 11ga top serrated	7 ft. LH	Headless	34329	34390
A-861-982	N/A	black 11ga sabertooth	7 ft. LH	Headless	34329ST	102053
A-881-038	N/A	black 11ga top serrated	7 ft. RH	Headless	34678	34390
A-861-984	N/A	black 11ga sabertooth	7 ft. RH	Headless	34678ST	102053
A-881-040	N/A	black 11ga top serrated	8 ft. LH	Headless	34330	34390
A-861-985	N/A	black 11ga sabertooth	8 ft. LH	Headless	34330ST	102053
A-881-041	N/A	black 11ga top serrated	8 ft. RH	Headless	34679	34390
A-861-986	N/A	black 11ga sabertooth	8 ft. RH	Headless	34679ST	102053
For Models: (WINDROWER: 7000 w/ 910, 920, 930 auger header, double knife drive & stub gau)						

SICKLE SECTIONS - MASSEY FERGUSON

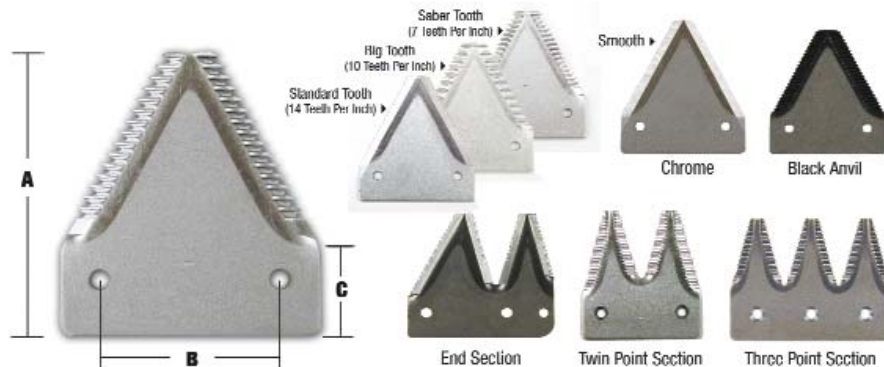

PART NO.	DESCRIPTION	DIM A (1)	DIM B (2)	DIM C (3)	FASTENER	REPL. NO.
A-211-002	black 12ga under serrated	3.250"	2.062"	1"	7/32 x 5/8	OU557HS
A-211-201	black 11ga under serrated	3.250"	2.125"	1"	7/32 x 5/8	130356M1
A-212-091	chrome 11ga under serrated	3.250"	2.125"	1"	7/32 x 5/8	669807M1
A-212-181	chrome 11ga smooth	3.250"	2.125"	1"	7/32 x 5/8	669806M1
A-212-403	chrome 14ga top serrated	3.250"	2.125"	1"	7/32 x 5/8	1046779M1
A-211-223	black 14ga under serrated	3.250"	2.125"	1"	7/32 x 5/8	875785L
A-211-162	black 12ga smooth	3.250"	2.125"	1"	7/32 x 5/8	130357M1
A-212-103	chrome 14ga under serrated	3.250"	2.125"	1"	7/32 x 5/8	160262M1
A-212-412	chrome 12ga top serrated	3.250"	2.125"	1"	7/32 x 5/8	31-7970650
A-232-412	chrome 12ga big tooth	3.250"	2.125"	1"	7/32 x 5/8	1046776M1BT
A-211-411	black 11ga top serrated	3.250"	2.125"	1"	7/32 x 5/8	1071707M1
A-231-411	black 11ga big tooth	3.250"	2.125"	1"	7/32 x 5/8	1071707M1BT
A-412-102	chrome 12ga top serrated	3" wide	3.218" long		7/32 x 5/8	1055090M1
A-412-032	chrome 12ga top serrated	3.250"	2"	1.250"	7/32 x 5/8	146503M2, 26143M1H
A-211-273	black 14ga under serrated	3.250"	width 3"		1/4 x 5/8	1146
A-211-362	black 14ga top serrated	3.250"	width 3"		1/4 x 5/8	A10081

SICKLE ASSEMBLIES & PARTS

SICKLE PARTS - MASSEY FERGUSON

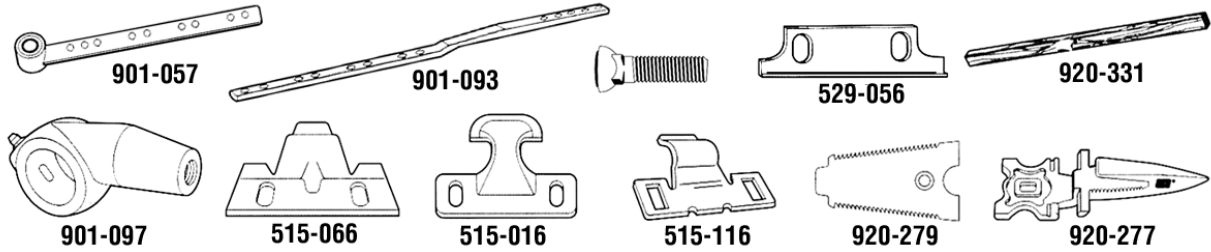

PART NO.	DESCRIPTION	REPLACES	APPLICATION
A-901-010	Sickle Head	683879M91	
A-920-229	Bushing	683458M1	
A-901-056	Sickle Head	144306M91	
A-920-222	Bushing	143015M1	
A-901-057	Sickle Head	31-7970683	
A-901-054	Bushing	SW1740	
A-901-123	Sickle Head	1049406M91	
A-901-109	Sickle Head	1056738M91	
A-901-090	Head	669505M3	
A-901-070	Head & Strap	667200M95	
A-901-087	Head only	581387M1	
A-901-114	Spring, Head, Connector	581169M91	
A-901-097	Connector	667015M1	
A-529-056	Wear Plate	206196M1, 231303M1	
A-669434M1	Pitman Wood, 34"	669434M1	
A-515-126	Knifehead clip		
A-515-066	Low Knife Clip	61384282	
A-920-277	Guard, Center Malleable	679837M91	
A-920-278	Guard, Outer Malleable	668457M92	
A-920-101	Center Guard	50HS4A, 143HSA	
A-920-102	Outer Guard	15011105M1	
A-920-118	Ledger Plate		
A-904-520	(50) 7/16x1-1/2" bolts		
A-904-521	(50) 7/16x1-3/4" bolts		
A-920-302	Outer Shoe Plate	669099M1	
A-920-275	Ledger Plate	668611M1	

SICKLE ASSEMBLIES - MASSEY FERGUSON

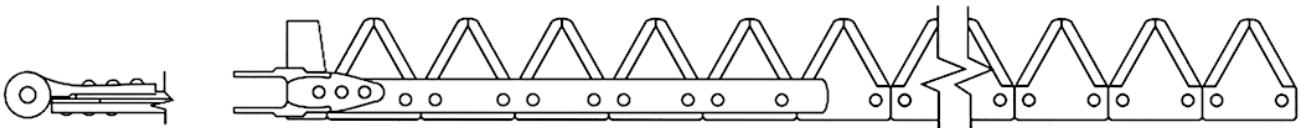

BOLT ON	RIVETED	DESCRIPTION	LENGTH	HEAD NO.	OEM SICKLE NO.	SECT. PART NO.
A-801-474	A-800-474	chrome 11ga under serrated	6 ft.	667200M95	669787M93	669807M1
A-801-475	A-800-475	chrome 11ga under serrated	7 ft.	667200M95	669791M93	669807M1
A-801-476	A-800-476	chrome 11ga under serrated	8 ft.	667200M95	669703M93	669807M1

For Models: (MOWER: DYNA-BALANCE 31, DYNA-BALANCE 51, DYNA-BALANCE 71, DYNA-BALANCE 135 series FEO (cast gear box))

SICKLE ASSEMBLIES - MASSEY FERGUSON

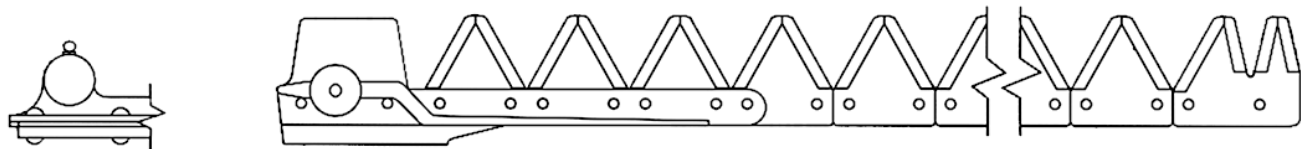

BOLT ON	RIVETED	DESCRIPTION	LENGTH	HEAD NO.	OEM SICKLE NO.	SECT. PART NO.
A-801-633	A-800-633	chrome 11ga under serrated	6 ft.	669505M3	669818M92	669807M1
A-801-608	A-800-608	chrome 11ga under serrated	7 ft.	669505M3	669822M92	669807M1

For Models: (MOWER: PITMAN 32, PITMAN 42, PITMAN 52, PITMAN 238)

SICKLE ASSEMBLIES & PARTS

SICKLE ASSEMBLIES - MASSEY FERGUSON

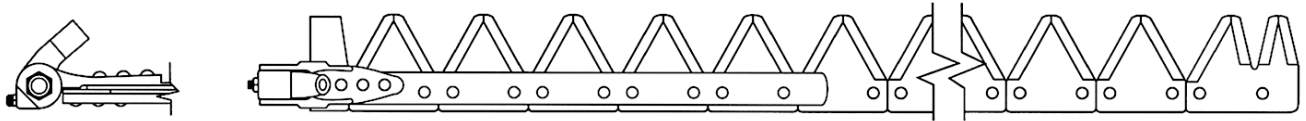

BOLT ON	RIVETED	DESCRIPTION	LENGTH	HEAD NO.	OEM SICKLE NO.	SECT. PART NO.
A-801-477	A-800-477	chrome 11ga smooth	6 ft.	581387M1	581172M92	669806M1
A-801-478	A-800-478	chrome 11ga under serrated	6 ft.	581387M1	581173M92	669807M1
A-801-479	A-800-479	chrome 11ga smooth	7 ft.	581387M1	581176M92	669806M1
A-801-480	A-800-480	chrome 11ga under serrated	7 ft.	581387M1	581177M92	669807M1
A-801-481	A-800-481	chrome 11ga under serrated	8 ft.	581387M1	581181M92	669807M1

For Models: (MOWER: DYNA-BALANCE 135 SN 18100810-> (welded gear box), DYNA-BALANCE 41)

SICKLE ASSEMBLIES - MASSEY FERGUSON

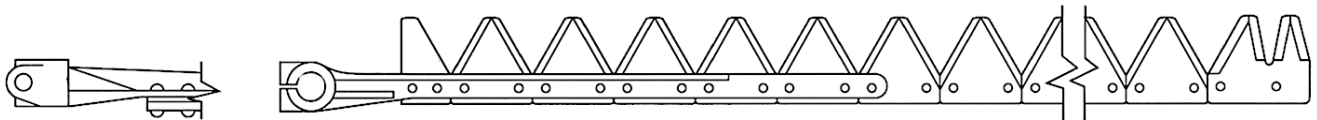

BOLT ON	RIVETED	DESCRIPTION	LENGTH	HEAD NO.	OEM SICKLE NO.	SECT. PART NO.
A-801-348	A-800-348	black 12ga under serrated	9 ft.	Headless	290744S, 290627S	OU577HS

For Models: (MOWER CONDITIONER: 81 haytender)

SICKLE ASSEMBLIES - MASSEY FERGUSON

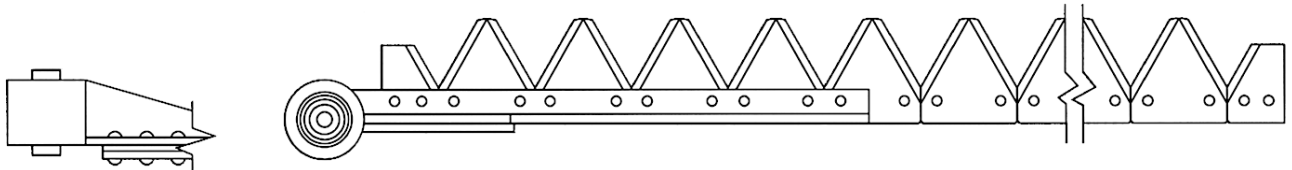

BOLT ON	RIVETED	DESCRIPTION	LENGTH	HEAD NO.	OEM SICKLE NO.	SECT. PART NO.
A-801-056	A-800-056	black 12ga under serrated	7 ft.	683879M91	683590M91	683937M1
A-801-053	A-800-053	black 12ga under serrated	9 ft.	683879M91	683583M91	683937M1
A-801-694	A-800-694	black 12ga under serrated	9 ft.	Headless	683583M91-S	683937M1

For Models: (MOWER CONDITIONER: 725 (7'), 925 (9'), BN1000 (7'), BN1005 (9'))

SICKLE ASSEMBLIES - MASSEY FERGUSON

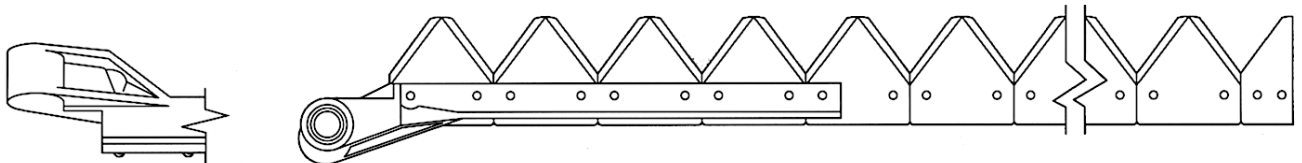

BOLT ON	RIVETED	DESCRIPTION	LENGTH	HEAD NO.	OEM SICKLE NO.	SECT. PART NO.
A-801-402	A-800-402	chrome 12ga top serrated	12 ft.	144306M91	146469M91	146503M2
A-801-403	A-800-403	chrome 14ga top serrated	14 ft.	144306M91	146459M91	261431M1
A-801-405	A-800-405	chrome 14ga top serrated	16 ft.	144306M91	146462M91	261431M1
A-801-407	A-800-407	chrome 14ga top serrated	18 ft.	144306M91	146465M91	261431M1

For Models: (WINDROWER: 36, 34, 44)

SICKLE ASSEMBLIES & PARTS

SICKLE ASSEMBLIES - MASSEY FERGUSON

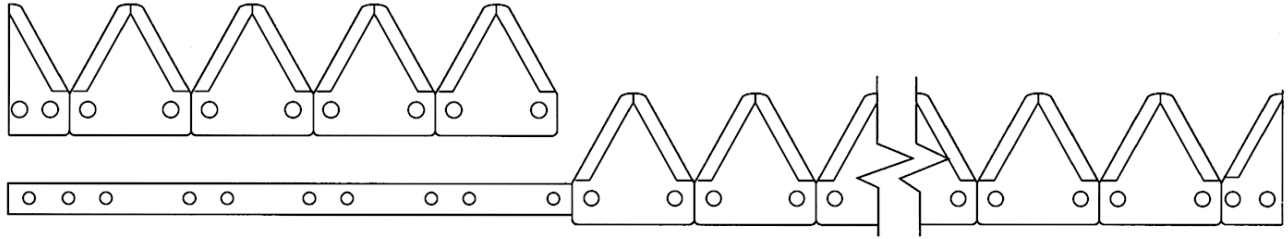

BOLT ON	RIVETED	DESCRIPTION	LENGTH	HEAD NO.	OEM SICKLE NO.	SECT. PART NO.
A-801-641	A-800-641	chome 14ga top serrated	18 ft.	Headless	1042904M91	1046779M1
A-801-642	A-800-642	chome 14ga top serrated	21 ft.	Headless	1041471M91	1046779M1
N/A	A-830-564	chome 14ga top serrated	21 ft.	Headless	1041471M91BT	1046779M1BT
A-801-643	A-800-643	chome 14ga top serrated	25 ft.	Headless	1050779M91	1046779M1

For Models: (WINDROWER: 35)

SICKLE ASSEMBLIES - MASSEY FERGUSON

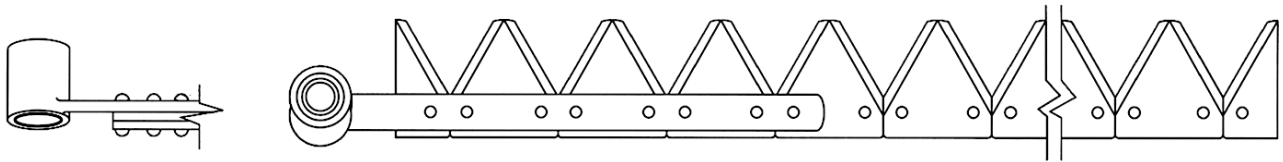

BOLT ON	RIVETED	DESCRIPTION	LENGTH	HEAD NO.	OEM SICKLE NO.	SECT. PART NO.
A-801-409	A-800-409	chome 12ga top serrated	12 ft.	31-7970683	1046768M1	31-7970650
A-801-411	A-800-411	chome 12ga top serrated	15 ft.	31-7970683	31-7970623	31-7970650
A-801-413	A-800-413	chome 12ga top serrated	18 ft.	31-7970683	31-7970633	31-7970650
A-801-415	A-800-415	chome 12ga top serrated	21 ft.	31-7970683	31-7970643	31-7970650

For Models: (WINDROWER: 655, 675, 775, 785 w/ draper header)

SICKLE ASSEMBLIES - MASSEY FERGUSON

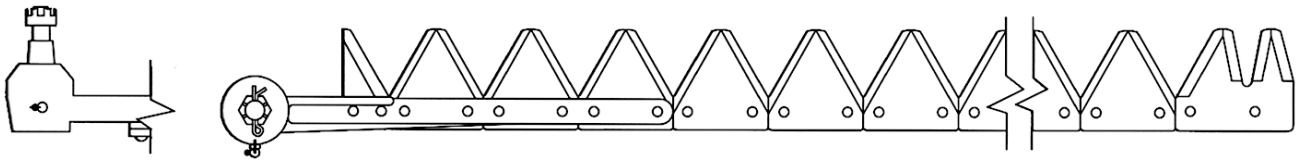

BOLT ON	RIVETED	DESCRIPTION	LENGTH	HEAD NO.	OEM SICKLE NO.	SECT. PART NO.
A-801-786	A-800-786	chome 12ga top serrated	12 ft.	1049406M91	1049402M91	1046776M1
A-801-787	A-800-787	chome 12ga top serrated	14 ft.	1049406M91	1049403M91	1046776M1

For Models: (WINDROWER: 775 w/ auger header)

SICKLE ASSEMBLIES & PARTS

SICKLE ASSEMBLIES - MASSEY FERGUSON

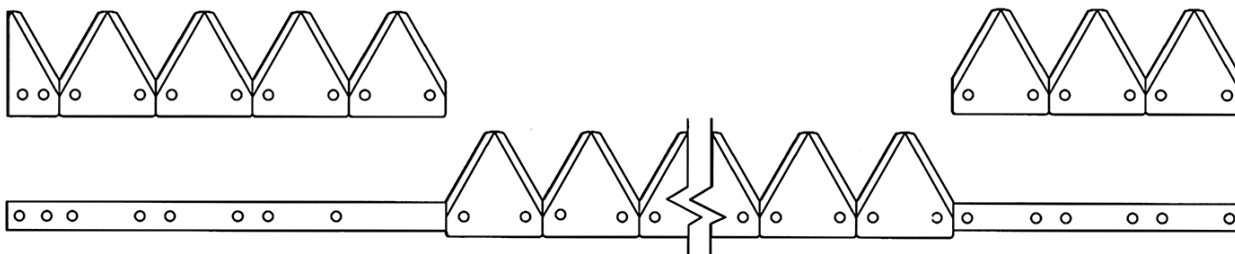

BOLT ON	RIVETED	DESCRIPTION	LENGTH	HEAD NO.	OEM SICKLE NO.	SECT. PART NO.
A-831-859	A-830-859	black 14ga under serrated	14 ft. LH	Headless	32849 Rivet, A10127 Bolt	1146
A-831-847	N/A	black 12ga top serrated	14 ft. LH	Headless	48892	A10081
A-831-854	A-830-854	black 14ga under serrated	4 ft. RH	Headless	39871 Rivet, A10122 Bolt	1146
A-831-842	N/A	black 12ga top serrated	4 ft. RH	Headless	48896	A10081
A-831-855	A-830-855	black 14ga under serrated	8 ft. RH	Headless	39868 Rivet, A101123 Bolt	1146
A-831-843	N/A	black 12ga top serrated	8 ft. RH	Headless	48894	A10081
A-831-856	A-830-856	black 14ga under serrated	12 ft. RH	Headless	32850 Rivet, A10124 Bolt	1146
A-831-844	N/A	black 12ga top serrated	12 ft. RH	Headless	48893	A10081
A-831-857	A-830-857	black 14ga under serrated	16 ft. RH	Headless	39870 Rivet, A10125 Bolt	1146
A-831-845	N/A	black 12ga top serrated	16 ft. RH	Headless	48895	A10081
A-831-858	A-830-858	black 14ga under serrated	20 ft. RH	Headless	39869 Rivet, A10126 Bolt	1146
A-831-846	N/A	black 12ga top serrated	20 ft. RH	Headless	3729276M1TS	A10081

For Models: (SWATHER: 200 self propelled, 210 pull type)

SICKLE ASSEMBLIES - MASSEY FERGUSON

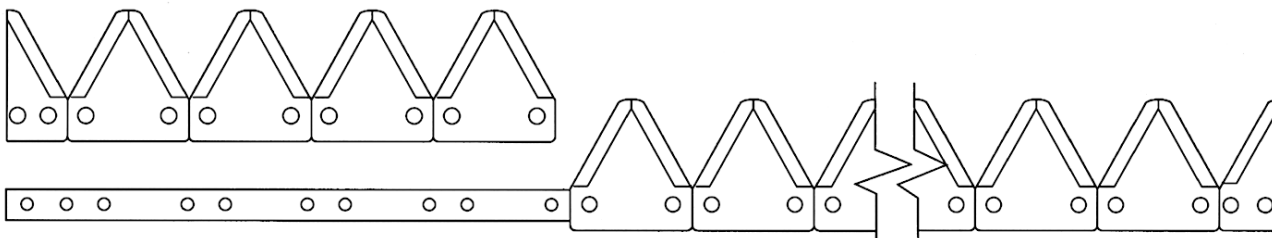

BOLT ON	RIVETED	DESCRIPTION	LENGTH	HEAD NO.	OEM SICKLE NO.	SECT. PART NO.
A-801-670	A-800-670	black 14ga under serrated	21 ft.	Headless	1043842M91	1041472M1
A-801-671	A-800-671	black 14ga under serrated	25 ft.	Headless	1065051M91	1041472M1
A-801-672	A-800-672	black 14ga under serrated	30 ft.	Headless	1065052M91	1041472M1
A-801-673	A-800-673	black 14ga under serrated	21 ft. LH	Headless	1069664M91	1041472M1
A-801-674	A-800-674	black 14ga under serrated	15 ft. RH	Headless	1069665M91	1041472M1

For Models: (SWATHER: 613 pull type, 625)

SICKLE ASSEMBLIES - MASSEY FERGUSON

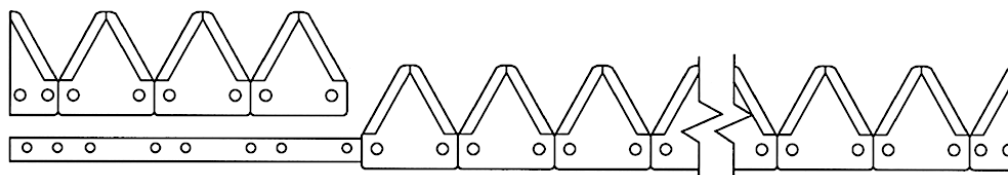

BOLT ON	RIVETED	DESCRIPTION	LENGTH	HEAD NO.	OEM SICKLE NO.	SECT. PART NO.
A-801-644	A-800-644	Xblack 12ga top serrated	12 ft.	Headless	1057934M91	1071707M1
A-801-645	A-800-645	Xblack 12ga top serrated	14 ft.	1056738M91	1056865M91	1071707M1
A-801-646	A-800-646	Xblack 12ga top serrated	14 ft.	Headless	1056866M91	1071707M1
A-801-647	A-800-647	Xblack 12ga top serrated	14 ft.	Headless	1057538M91	1071707M1

For Models: (SWATHER: 885 w/ auger header)

SICKLE ASSEMBLIES & PARTS

SICKLE ASSEMBLIES - MASSEY FERGUSON

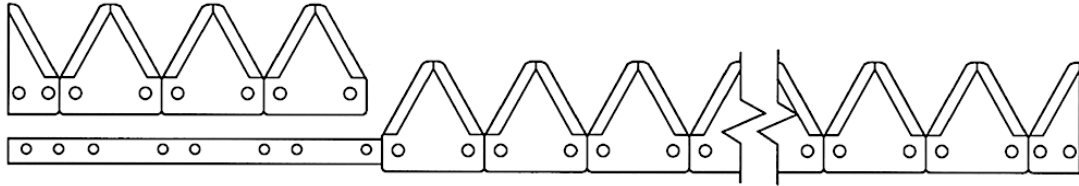

BOLT ON	RIVETED	DESCRIPTION	LENGTH	HEAD NO.	OEM SICKLE NO.	SECT. PART NO.
A-801-648	A-800-648	chrome 12ga top serrated	15 ft.	Headless	1057966M91, 1057964M91	31-7970650
A-801-649	A-800-649	chrome 12ga top serrated	18 ft.	Headless	1057967M91, 1057965M91	1055090M1
A-801-650	A-800-650	chrome 12ga top serrated	21 ft.	Headless	1057508M91	1055090M1
A-801-651	A-800-651	chrome 12ga top serrated	26 ft 1 pc.	Headless	1056739M91, 1056738M91	1055090M1
A-801-652	A-800-652	chrome 12ga top serrated	31 ft 1 pc.	Headless	1057912M91	1055090M1

For Models: (SWATHER: 885 w/ draper header)

SICKLE SECTIONS - NEW HOLLAND

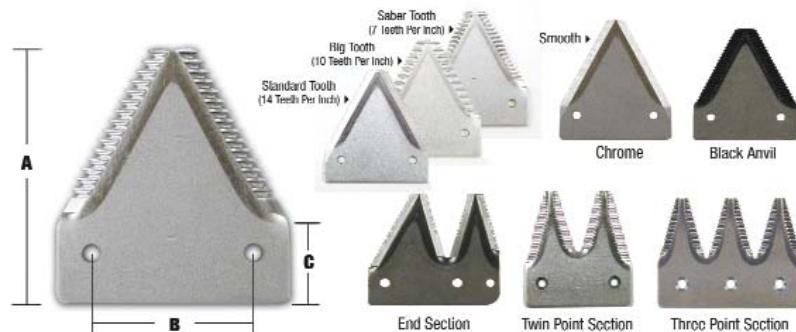

PART NO.	DESCRIPTION	DIM A (1)	DIM B (2)	DIM C (3)	FASTENER	REPL. NO.
A-211-003	black 14ga under serrated	3.250"	2.062"	1"	7/32 x 5/8	1145
A-212-063	chrome 14ga under serrated	3.250"	2.062"	1"	7/32 x 5/8	604800
A-211-233	black 14ga top serrated	3.250"	2.062"	1"	7/32 x 5/8	67631
A-212-003	chrome 14ga top serrated	3.250"	2.062"	1"	7/32 x 5/8	604921
A-212-012	chrome 12ga top serrated	3.250"	2.062"	1"	7/32 x 5/8	94579
A-211-211	black 11ga top serrated, 2 hole	3.250"	2.062"	1"	7/32 x 5/8	9622744
A-231-211	black 11ga big tooth, 2 hole	3.250"	2.062"	1"	7/32 x 5/8	124737BT
A-231-461	black 11ga saber tooth	3.250"	2.062"	1"	7/32 x 5/8	9622744ST
A-212-001	chrome 11ga top serrated	3.250"	2.062"	1"	7/32 x 5/8	700705300
A-232-001	chrome 11ga big tooth	3.250"	2.062"	1"	7/32 x 5/8	700705300BT
A-232-461	chrome 11ga saber tooth	3.250"	2.062"	1"	7/32 x 5/8	9826090ST
A-211-011	black 11ga smooth	3.250"	2.062"	1"	7/32 x 5/8	26622
A-212-001	chrome 11ga top serrated	3.250"	2.062"	1"	7/32 x 5/8	700705300
A-212-061	chrome 12ga top serrated	3.250"	2.062"	1"	7/32 x 5/8	060635
A-212-403	chrome 14ga top serrated	3.250"	2.125"	1"	7/32 x 5/8	1046779M1
A-212-412	chrome 12ga top serrated	3.250"	2.125"	1"	7/32 x 5/8	31-7970650
A-611-070	black 11ga under serrated	end sect.	3 holes	RH	7/32 x 5/8	630555
A-611-090	black 11ga under serrated	end sect.	3 holes	LH	7/32 x 5/8	634789
A-611-130	black 11ga top serrated	end sect.	3 slotted	RH	7/32 x 5/8	9622715
A-611-140	black 11ga top serrated	end sect.	3 slotted	LH	7/32 x 5/8	9622714
A-212-262	chrome 12ga top serrated	rivet type	btmCTSK	rivet type	7/32 x 5/8 CTSK	706424H
A-212-232	chrome 12ga top serrated	rivet type	top CTSK	rivet type	7/32 x 5/8 CTSK	706423H
A-622-271	chrome 11ga top serrated	overlap	btmCTSK	rivet type	7/32 x 5/8 CTSK	766758
A-622-281	chrome 11ga top serrated	overlap	top CTSK	rivet type	7/32 x 5/8 CTSK	766757
A-412-161	chrome 11ga top serrated	overlap	btmCTSK	rivet type	7/32 x 5/8 CTSK	694722
A-212-513	chrome 14ga top serrated	bolt type	btmCTSK	bolt type	7/32 x 5/8 CTSK	9826047
A-212-523	chrome 14ga top serrated	bolt type	top CTSK	bolt type	7/32 x 5/8 CTSK	9826046
A-212-302	chrome 12ga top serrated	bolt type	btmCTSK	bolt type	7/32 x 5/8 CTSK	9826047H
A-212-312	chrome 12ga top serrated	bolt type	top CTSK	bolt type	7/32 x 5/8 CTSK	9826046H
A-211-191	chrome 11ga top serrated	bolt type	btmCTSK	bolt type	7/32 x 5/8 CTSK	861353
A-211-181	chrome 11ga top serrated	bolt type	top CTSK	bolt type	7/32 x 5/8 CTSK	861354
A-711-002	kit: chrm 12ga top ser	rivet type	top/btm	rivet type	7/32 x 5/8 CTSK	
A-711-004	kit: chrm 11ga top ser	bolt type	top/btm	bolt type	7/32 x 5/8 CTSK	
A-711-005	kit: blk 11ga top ser	bolt type	top/btm	bolt type	7/32 x 5/8 CTSK	
A-711-006	kit: chrm 14ga top ser	bolt type	top/btm	bolt type	7/32 x 5/8 CTSK	

SICKLE ASSEMBLIES & PARTS

SICKLE PARTS - NEW HOLLAND

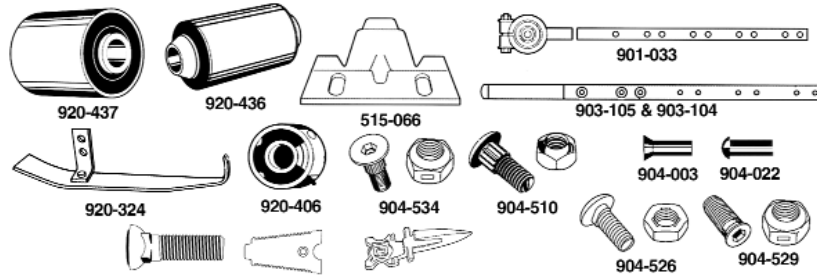

PART NO.	DESCRIPTION	REPLACES	APPLICATION
A-901-008	Sickle Head	858740	
A-920-433	Bushing	127610	(MOWER: 450, 456, 499, 1496), (WINDROWER: 499, 1496, 1499)
A-901-005	Sickle Head	86507377	(MOWER CONDITIONER: 460, 461, 467, 469)
A-920-434	Bushing	134182	(MOWER CONDITIONER: 460, 467, 469)
A-901-007	Sickle Head	577868	(MOWER CONDITIONER: 472, 477, 478)
A-901-006	Sickle Head	577867	(MOWER CONDITIONER: 479, 488, 490, 1496)
A-920-437	Bushing	254132	(MOWER CONDITIONER: 472, 479)
A-901-033	Sickle Head	289488	(MOWER CONDITIONER: 474, 489)
A-920-406	Hub & Bushing	701401	(MOWER CONDITIONER: 474, 489)
A-901-034	Sickle Head	86508155	(MOWER CONDITIONER: 495, 1495)
A-901-001	Sickle Head, RH	137635	(WINDROWER: 907, 912)
A-920-436	Bushing	76417	(WINDROWER: 907, 912, 114, 1112, 1116, 1118)
A-901-002	Sickle Head, LH	135822	(WINDROWER: 907, 912)
A-901-003	Sickle Head, RH	858714	(WINDROWER: 1112, 1116)
A-901-004	Sickle Head, LH	858713	(WINDROWER: 1112, 1116)
A-901-009	Sickle Head	76173	(WINDROWER: 905)
A-901-060	Sickle Head, RH	704316, 858756	(WINDROWER: 114)
A-901-061	Sickle Head, LH	575163, 858755	(WINDROWER: 114)
A-901-107	Sickle Head, LH	86536346	(WINDROWER: 499, 1496, 1499)
A-920-433	Bushing	127610	(MOWER: 450, 456, 499, 1496), (WINDROWER: 499, 1496, 1499)
A-529-016	Wear Plate	71116532, 71176537	
A-515-066	Low Knife Clip	61384282	
A-515-126	Knifehead clip		
A-920-323	Inner Sole	36653	
A-920-324	Outer Sole	37025	

SICKLE ASSEMBLIES - NEW HOLLAND

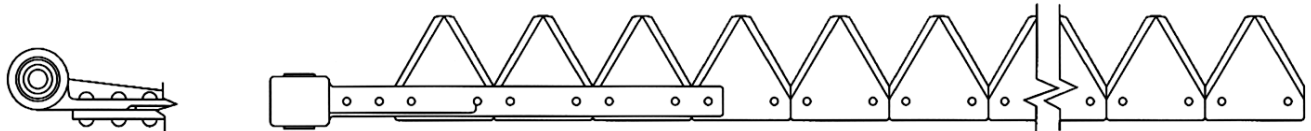

BOLT ON	RIVETED	DESCRIPTION	LENGTH	HEAD NO.	OEM SICKLE NO.	SECT. PART NO.
A-801-049	A-800-049	black 11ga under serrated	7 ft	858740	143607	29875
A-801-051	A-800-051	black 11ga under serrated	9 ft	858740	143609	29875
N/A	A-800-696	black 11ga top serrated	9 ft	858740	143609TS	9622744
For Models: 450 SN 87764->, 455 SN 88846->						
A-801-362	A-800-362	black 11ga under serrated	7 ft	858740	228435	29875
A-861-418	A-860-418	black, 11ga top serrated	7 ft	858740	228435TS, 86534626	9622744
A-861-013	N/A	black, 11ga big tooth	7 ft	858740	228435BT, 86534625BT	9622744BT
N/A	A-860-383	black, 11ga smooth	9 ft	858740	228432	26622
A-801-363	A-800-363	black, 11g under serrated	9 ft	858740	228434, 858746	29875
A-801-756	A-800-756	black, 11ga top serrated	9 ft	858740	86534626	9622744
For Models: 451, 456						

SICKLE ASSEMBLIES & PARTS

SICKLE ASSEMBLIES - NEW HOLLAND

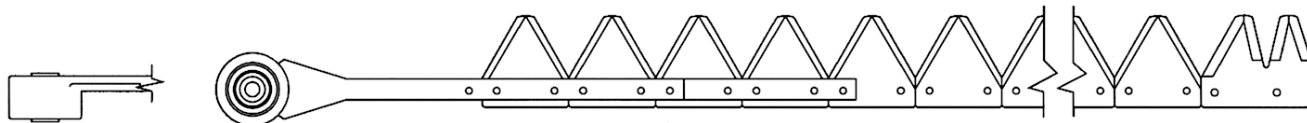

BOLT ON	RIVETED	DESCRIPTION	LENGTH	HEAD NO.	OEM SICKLE NO.	SECT. PART NO.
A-801-035	A-800-035	black, 11ga under serrated	7 ft	86507377	137214	29875
For Models: 467						
A-801-036	A-800-036	black, 11ga under serrated	9 ft	86507377	127609, 134186	29875
For Models: 460, 461						
A-801-037	A-800-037	black, 11ga under serrated	9 ft	86507377	86518677, 648844	29875
A-801-767	A-800-767	black, 11ga top serrated	9 ft	86507377	86518678	9622744
N/A	A-861-440	black, 11ga big tooth	9 ft	86507377	86518678BT	9622744BT
For Models: 469, 1469 SN <-220947						
A-801-274	A-800-274	black, 11ga under serrated	12 ft	86507377	174593	29875
For Models: 490 SN <-259714						

SICKLE ASSEMBLIES - NEW HOLLAND

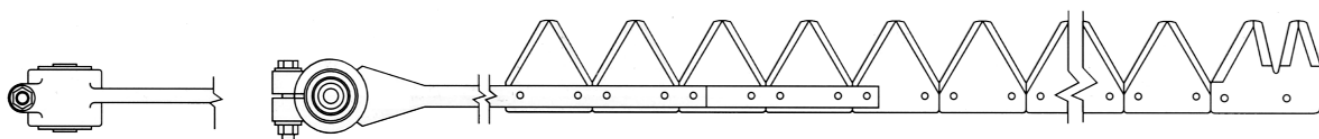

BOLT ON	RIVETED	DESCRIPTION	LENGTH	HEAD NO.	OEM SICKLE NO.	SECT. PART NO.
A-801-040	A-800-040	black, 11ga under serrated	7 ft	577868	648832, 858708	29875
A-831-079	N/A	black, 11ga top serrated	7 ft	577868	9623792, 9623571	9622744
N/A	A-830-079	black, 11ga top serrated	7 ft	577868	9623792, 9623571	9622744
A-801-042	A-800-042	black, 11ga under serrated	9 ft	577867	648840, 858700	29875
A-801-768	A-800-768	black, 11ga top serrated	9 ft	577867	9623793, 9623570	9622744
A-861-012	N/A	black, 11ga big tooth	9 ft	577867	9623570BT	9622744BT
A-801-520	A-800-520	black, 11ga under serrated	12 ft	86512652	579171	29875
For Models: 472, 477, 478 7', 479, 488 9', 490 12', SN 259714->, 1469 9', SN 220947->						

SICKLE ASSEMBLIES - NEW HOLLAND

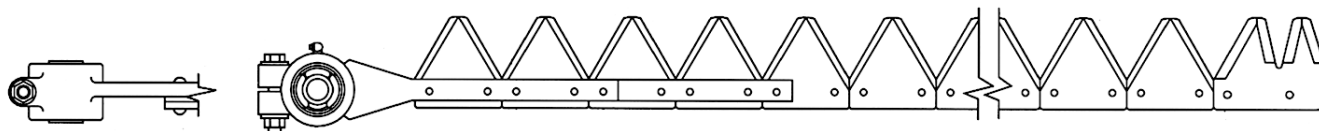

BOLT ON	RIVETED	DESCRIPTION	LENGTH	HEAD NO.	OEM SICKLE NO.	SECT. PART NO.
A-801-500	A-800-500	black, 11ga under serrated	7 ft	289488	648831, 858748	29875
A-831-822	N/A	black, 11ga top serrated	7 ft	289488	9623560	9622744
A-801-270	A-800-270	black, 11ga under serrated	9 ft	289488	648835, 858702	29875
A-801-769	A-800-769	black, 11ga top serrated	9 ft	289488	86529232	9622744
A-861-011	N/A	black, 11ga big tooth	9 ft	289488	86529232BT	9622744BT
For Models: 474 7', 489, 492 9', 1465						

SICKLE ASSEMBLIES - NEW HOLLAND

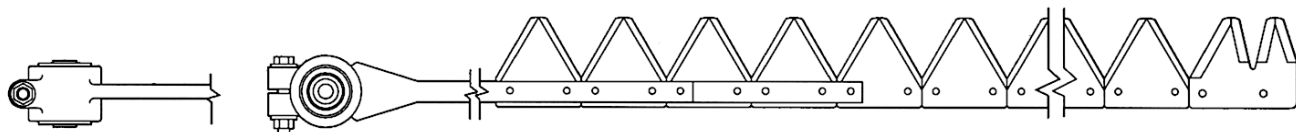

BOLT ON	RIVETED	DESCRIPTION	LENGTH	HEAD NO.	OEM SICKLE NO.	SECT. PART NO.
A-801-271	A-800-271	black, 11ga under serrated	12 ft	86508155	648003, 858706	29875
A-801-770	A-800-770	black, 11ga top serrated	12 ft	86508155	9623797, 9623572	9622744
A-831-572	A-830-572	black, 11ga big tooth	12 ft	86508155	9623797BT, 9623572BT	9622744BT
For Models: 495, 1495						

SICKLE ASSEMBLIES & PARTS

SICKLE ASSEMBLIES - NEW HOLLAND

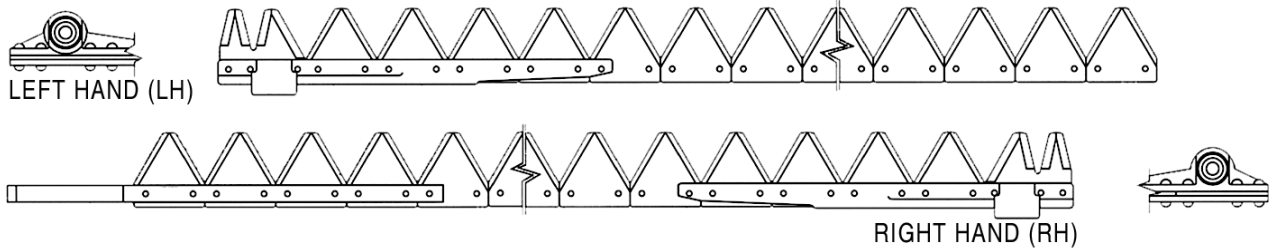

BOLT ON	RIVETED	DESCRIPTION	LENGTH	HEAD NO.	OEM SICKLE NO.	SECT. PART NO.
A-801-482	A-800-482	black, 11ga under serrated	6 ft LH	86536346	635163, 9619698	29875
A-801-483	A-800-483	black, 11ga under serrated	6 ft RH	86536345	635279, 9619669	29875
A-831-823	A-830-823	black, 11ga top serrated	6 ft LH	86536346	86536819, 9622712	9622744
A-831-824	A-830-824	black, 11ga top serrated	6 ft RH	86536345	86536820, 9622713	9622744
A-831-495	N/A	black, 11ga big tooth	6 ft LH	86536346	86536819BT, 9622712BT	9622744BT
A-831-496	N/A	black, 11ga big tooth	6 ft RH	86536345	86536820BT, 9622713BT	9622744BT
A-861-562	N/A	chrome 11ga top serrated	6 ft LH	86536346	86536819PL, 9622712PL	9826090
A-861-565	N/A	chrome 11ga top serrated	6 ft RH	86536345	86536820PL, 9622713PL	9826090

For Models: 499 pivot tongue, 1496, 1499

SICKLE ASSEMBLIES - NEW HOLLAND

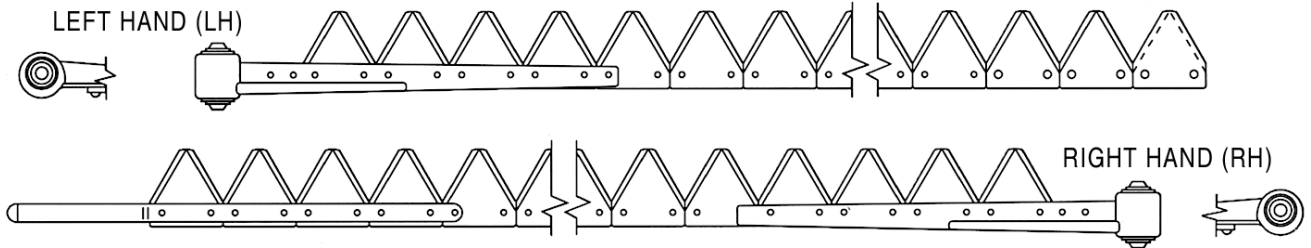

BOLT ON	RIVETED	DESCRIPTION	LENGTH	HEAD NO.	OEM SICKLE NO.	SECT. PART NO.
A-801-420	N/A	black, 14ga under serrated	6 ft RH	858756, 704316	858752, 708297	67630
For Models: 114 pivot tongue						
N/A	A-800-420	black, 14ga under serrated	6 ft RH	858756, 704317	858752, 708298	67630
A-801-422	N/A	black, 14ga under serrated	6 ft LH	858755, 575163	858751, 708296	67630
N/A	A-800-422	black, 14ga under serrated	6 ft LH	858755, 575164	858751, 708297	67630
A-801-421	N/A	black, 14ga under serrated	7 ft RH	858756, 704316	858750, 575114	67630
N/A	A-800-421	black, 14ga under serrated	7 ft RH	858756, 704317	858750, 575115	67630
A-801-423	N/A	black, 14ga under serrated	7 ft LH	858755, 575163	858749, 575106	67630
N/A	A-800-423	black, 14ga under serrated	7 ft LH	858755, 575164	858749, 575107	67630
A-861-754	N/A	black, 11ga top serrated	7 ft RH	858756	858750TS	9622744
A-861-755	N/A	black, 11ga top serrated	7 ft LH	858755	858749TS	9622744

For Models: 114 pivot tongue

SICKLE ASSEMBLIES - NEW HOLLAND

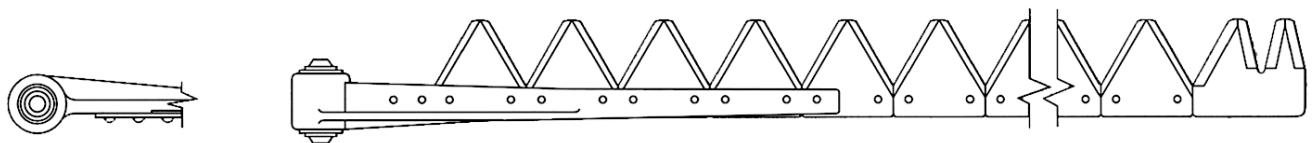

BOLT ON	RIVETED	DESCRIPTION	LENGTH	HEAD NO.	OEM SICKLE NO.	SECT. PART NO.
A-801-043	A-800-043	chrome 14ga top serrated	12 ft	76173	67156	604921
A-801-044	A-800-044	chrome 14ga top serrated	14 ft	76173	67145	604921

For Models: 905

SICKLE ASSEMBLIES & PARTS

SICKLE ASSEMBLIES - NEW HOLLAND

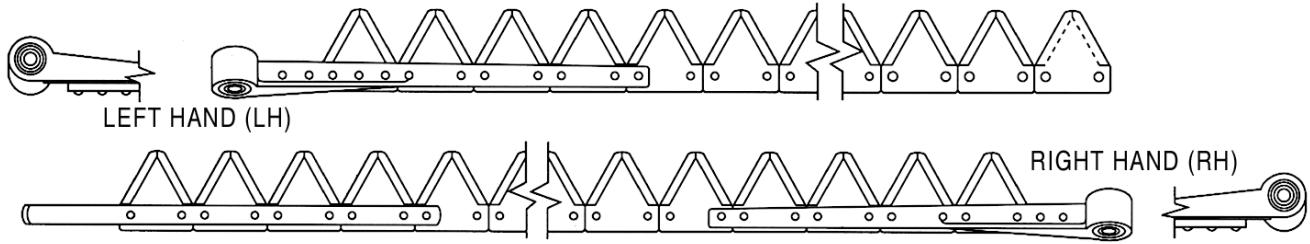

BOLT ON	RIVETED	DESCRIPTION	LENGTH	HEAD NO.	OEM SICKLE NO.	SECT. PART NO.
A-801-005	A-800-005	chome 14ga under serrated	6 ft RH	137635	139179	604800
A-801-006	A-800-006	chome 14ga under serrated	6 ft LH	135822	139182	604800
A-801-015	A-800-015	chome 14ga under serrated	7 ft RH	137635	139184	604800
A-801-016	A-800-016	chome 14ga under serrated	7 ft LH	135822	139185	604800
A-801-011	A-800-011	chome 12ga top serrated	7 ft RH	137635	9623845	604921H
A-801-012	A-800-012	chome 12ga top serrated	7 ft LH	135822	9623844	604921H
A-881-068	N/A	chome 11ga sabre tooth	7 ft RH	137635	9623845ST	9826090ST
A-881-069	N/A	chome 11ga sabre tooth	7 ft LH	135822	9623844ST	9826090ST
A-801-025	A-800-025	chome 14ga under serrated	8 ft RH	137635	139186	604800
A-801-026	A-800-026	chome 14ga under serrated	8 ft LH	135822	139187	604800
A-801-021	A-800-021	chome 12ga top serrated	8 ft RH	137635	9623843	604921H
A-801-022	A-800-022	chome 12ga top serrated	8 ft LH	135822	9623842	604921H

For Models: 907, 909, 910, 912

SICKLE ASSEMBLIES - NEW HOLLAND

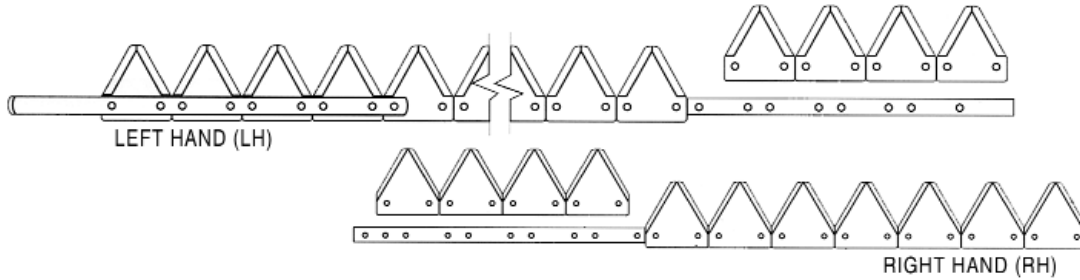

BOLT ON	RIVETED	DESCRIPTION	LENGTH	HEAD NO.	OEM SICKLE NO.	SECT. PART NO.
A-801-003	A-800-003	chome 12ga top serrated	6 ft RH	Headless	706420	604921H
A-801-004	N/A	chome 12ga top serrated	6 ft LH	Headless	706419	604921H
A-801-013	A-800-013	chome 12ga top serrated	7 ft RH	Headless	706418	604921H
A-801-014	A-800-014	chome 12ga top serrated	7 ft LH	Headless	706417	604921H
A-881-072	N/A	chome 11ga sabre tooth	7 ft RH	Headless	706418ST	9826090ST
A-881-073	N/A	chome 11ga sabre tooth	7 ft LH	Headless	706417ST	9826090ST
A-801-023	A-800-023	chome 12ga top serrated	8 ft RH	Headless	706416	604921H
A-801-024	A-800-024	chome 12ga top serrated	8 ft LH	Headless	706415	604921H

For Models: (907, 909, 912, 1112, 1114, 1116, 116 ALL w/ headless sickles)

SICKLE ASSEMBLIES - NEW HOLLAND

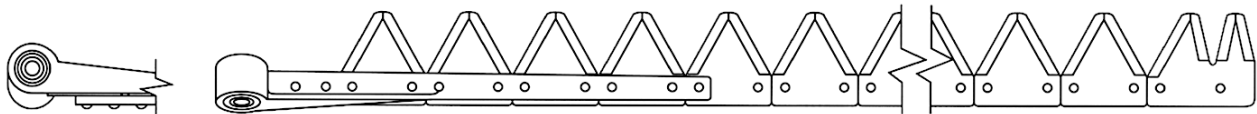

BOLT ON	RIVETED	DESCRIPTION	LENGTH	HEAD NO.	OEM SICKLE NO.	SECT. PART NO.
A-801-505	A-800-505	chome 12ga under serrated	10 ft	135822	143013PL	604800
N/A	A-800-510	chome 12ga under serrated	12 ft	135822	135853PL	604800
A-801-502	N/A	chome 12ga under serrated	14 ft	135822	137969PL	604800

For Models: 1100 w/ auger or draper head, 903 12'

SICKLE ASSEMBLIES & PARTS

SICKLE ASSEMBLIES - NEW HOLLAND

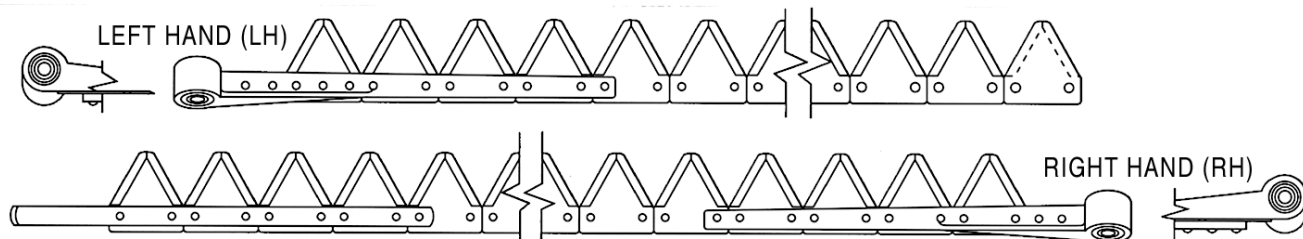

BOLT ON	RIVETED	DESCRIPTION	LENGTH	HEAD NO.	OEM SICKLE NO.	SECT. PART NO.
A-801-009	A-800-009	chome 14ga under serrated	6 ft RH	858714	264984PL	604800
A-801-010	A-800-010	chome 14ga under serrated	6 ft LH	858713	264986PL	604800
A-861-039	N/A	black 14ga under serrated	6 ft RH	858714	264984	276617
A-861-040	N/A	black 14ga under serrated	6 ft LH	858713	264986	276617
A-801-017	A-800-017	chome 12ga top serrated	7 ft RH	858714	86518780H, 9826051H	604921H
A-801-018	A-800-018	chome 12ga top serrated	7 ft LH	858713	86518780H, 9826050H	604921H
A-801-019	A-800-019	chome 14ga under serrated	7 ft RH	858714	247988PL, 9619697PL	604800
A-801-020	A-800-020	chome 14ga under serrated	7 ft LH	858713	247987PL, 9619696PL	604800
A-831-008	A-800-008	black 14ga under serrated	7 ft RH	858714	247988, 9619697	604921
A-831-009	A-830-009	black 14ga under serrated	7 ft LH	858713	247987, 9619696	604921
A-831-893	A-830-893	black 11ga top serrated	7 ft RH	858714	247988TS, 9619697TS	9622744
A-831-894	A-830-894	black 11ga top serrated	7 ft LH	858713	247987TS, 9619696TS	9622744
A-831-825	N/A	black 11ga big tooth	7 ft RH	858714	247988BT, 9619697BT	9622744BT
A-831-826	N/A	black 11ga big tooth	7 ft LH	858713	247987BT, 9619696BT	9622744BT
A-831-201	A-830-201	chome 11ga big tooth	7 ft RH	858714	247988PLBT, 9619697PLBT	9826090BT
A-831-202	A-830-202	chome 11ga big tooth	7 ft LH	858713	247987PLBT, 9619696PLBT	9826090BT
A-801-027	A-800-027	chome 12ga top serrated	8 ft RH	858714	86518782H, 9826049H	604921H
A-801-028	A-800-028	chome 12ga top serrated	8 ft LH	858713	86518783H, 9826048H	604921H
A-801-029	A-800-029	chome 14ga under serrated	8 ft RH	858714	264985PL, 9619695PL	604800
A-801-030	A-800-030	chome 14ga under serrated	8 ft LH	858713	264987PL, 9619694PL	604800
A-831-010	A-830-010	black 12ga under serrated	8 ft RH	858714	264985, 9619695	604921
A-831-011	A-830-011	black 12ga under serrated	8 ft LH	858713	264987, 9619694	604921
A-831-895	A-830-895	black 11ga top serrated	8 ft RH	858714	264985TS, 9619695TS	9622744
A-831-896	A-830-896	black 11ga top serrated	8 ft LH	858713	264987TS, 9619694TS	9622744
A-831-497	N/A	black 11ga big tooth	8 ft RH	858714	264985BT, 9619695BT	9622744BT
A-831-498	N/A	black 11ga big tooth	8 ft LH	858713	264987BT, 9619694BT	9622744BT
A-861-035	N/A	black 11ga big tooth	8 ft RH	858714	264985PLBT, 9619695PLBT	9826090BT
A-861-036	N/A	black 11ga big tooth	8 ft LH	858713	264987PLBT, 9619694PLBT	9826090BT

For Models: 1100 high perform header, 1112, 1114, 1116, 1118, 116 14' and 16' pivot tongue

SICKLE ASSEMBLIES - NEW HOLLAND

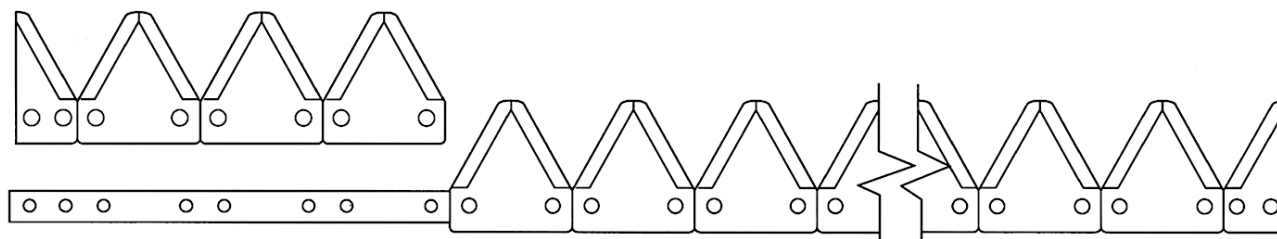

BOLT ON	RIVETED	DESCRIPTION	LENGTH	HEAD NO.	OEM SICKLE NO.	SECT. PART NO.
N/A	A-800-653	chome 12ga top serrated	12 ft	Headless	9605373	275521
N/A	A-800-654	chome 12ga top serrated	15 ft	Headless	275503	275521
N/A	A-800-655	chome 14ga top serrated	18 ft	Headless	275504R	275522
N/A	A-800-656	chome 14ga top serrated	21 ft	Headless	275505R	275522

For Models: 1090 self propelled headless

SICKLE ASSEMBLIES & PARTS

SICKLE ASSEMBLIES - NEW HOLLAND

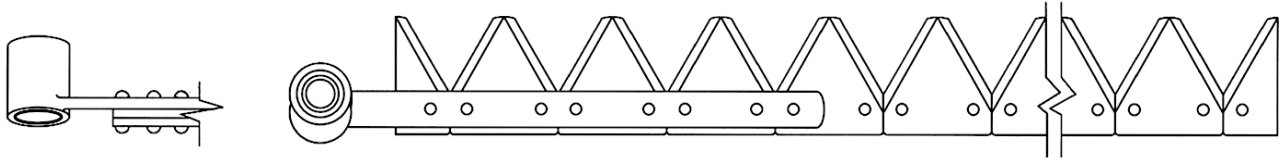

BOLT ON	RIVETED	DESCRIPTION	LENGTH	HEAD NO.	OEM SICKLE NO.	SECT. PART NO.
A-801-409	A-800-409	chrome 12ga top serrated	12 ft.	31-7970683	1046768M1	31-7970650
A-801-411	A-800-411	chrome 12ga top serrated	15 ft.	31-7970683	31-7970623	31-7970650
A-801-413	A-800-413	chrome 12ga top serrated	18 ft.	31-7970683	31-7970633	31-7970650
A-801-415	A-800-415	chrome 12ga top serrated	21 ft.	31-7970683	31-7970643	31-7970650

For Models: 1090 self propelled w/ head

SICKLE ASSEMBLIES - NEW HOLLAND

LEFT HAND (LH)

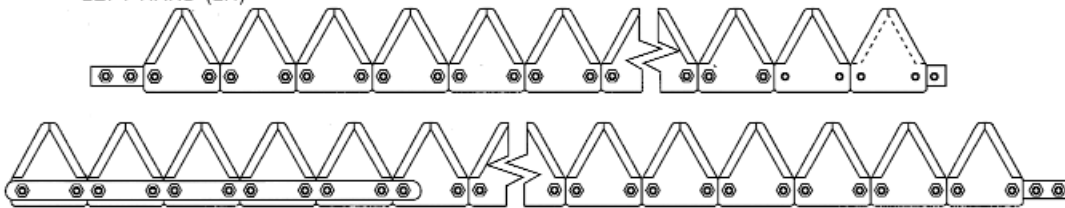

RIGHT HAND (RH)

BOLT ON	RIVETED	DESCRIPTION	LENGTH	HEAD NO.	OEM SICKLE NO.	SECT. PART NO.
A-861-388	N/A	black 11ga top serrated	6 ft LH	Headless	86528151	9622744

For Models: 1475 dbl overlap design, 2200, 2300, 2450, 2550

A-861-389	N/A	black 11ga top serrated	6 ft RH	Headless	86528152	9622744
A-861-390	N/A	black 11ga top serrated	7 ft LH	Headless	86528149	9622744
A-861-391	N/A	black 11ga top serrated	7 ft RH	Headless	86528150	9622744
A-861-398	N/A	black 11ga big tooth	7 ft LH	Headless	86544308	9622744BT
A-861-399	N/A	black 11ga big tooth	7 ft RH	Headless	86544309	9622744BT
A-881-062	N/A	black 11ga sabre tooth	7 ft LH	Headless	86544308ST	9622744ST
A-881-063	N/A	black 11ga sabre tooth	7 ft RH	Headless	86544309ST	9622744ST
A-861-392	N/A	black 11ga top serrated	8 ft LH	Headless	86528147	9622744
A-861-393	N/A	black 11ga top serrated	8 ft RH	Headless	86528148	9622744
A-861-400	N/A	black 11ga big tooth	8 ft LH	Headless	86544306	9622744BT
A-861-401	N/A	black 11ga big tooth	8 ft RH	Headless	86544307	9622744BT
A-881-064	N/A	black 11ga sabre tooth	8 ft LH	Headless	86544306ST	9622744ST
A-881-065	N/A	black 11ga sabre tooth	8 ft RH	Headless	86544307ST	9622744ST
A-861-394	N/A	black 11ga top serrated	9 ft LH	Headless	86528145	9622744
A-861-395	N/A	black 11ga top serrated	9 ft RH	Headless	86528146	9622744
A-861-402	N/A	black 11ga big tooth	9 ft LH	Headless	86544304	9622744BT
A-861-403	N/A	black 11ga big tooth	9 ft RH	Headless	86544305	9622744BT

For Models: 1475 dbl overlap design, 2200, 2300, 2450, 2550

SICKLE ASSEMBLIES - NEW HOLLAND

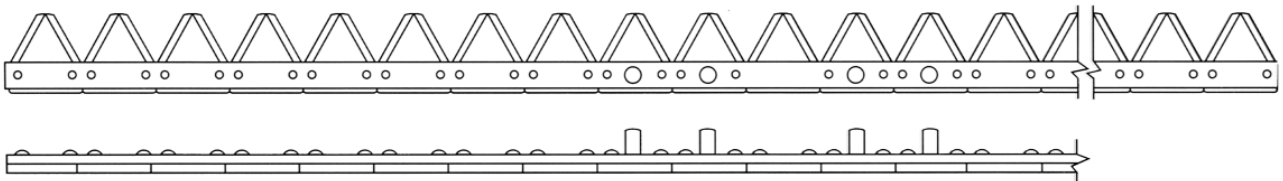

BOLT ON	RIVETED	DESCRIPTION	LENGTH	HEAD NO.	OEM SICKLE NO.	SECT. PART NO.
A-801-146	A-800-146	chrome 11ga top serrated	13 ft	STUDS	271979PL	271981PL
A-801-516	A-800-516	chrome 11ga big tooth	13 ft	STUDS	271979PLBT	271981PLBT
A-801-148	A-800-148	chrome 11ga top serrated	15 ft	STUDS	271980PL	271981PL
A-801-517	A-800-517	chrome 11ga big tooth	15 ft	STUDS	271980PLBT	271981PLBT
A-801-150	A-800-150	chrome 11ga top serrated	16 ft	STUDS	-	271981PL
A-831-518	N/A	chrome 11ga big tooth	16 ft	STUDS	-	271981PLBT

SICKLE ASSEMBLIES & PARTS

A-801-152	A-800-152	chrome 11ga top serrated	18 ft	STUDS	-	271981PL
A-801-154	A-800-154	chrome 11ga top serrated	20 ft	STUDS	273847PL	271981PL
A-831-520	N/A	chrome 11ga big tooth	20 ft	STUDS	273847PLBT	271981PLBT
N/A	A-800-156	chrome 11ga top serrated	22 ft.	STUDS	273847PLBT	271981PL

For Models: 960 flex header

SICKLE ASSEMBLIES - NEW HOLLAND

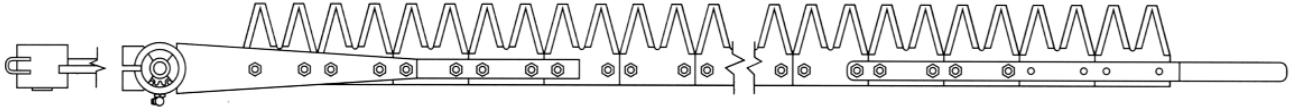

BOLT ON	RIVETED	DESCRIPTION	LENGTH	HEAD NO.	OEM SICKLE NO.	SECT. PART NO.
A-802-040	N/A	chrome 11ga top serrated	10 ft RH	848094	851662	848093
For Models: (TR75, TR85, TR86, TR95, TR96, TX36, TX66, TX88 ALL w/ header), (970, 971, 972, 973 ALL w/ twin points)						
A-802-041	N/A	chrome 11ga top serrated	10 ft LH	848094	851663	848093
A-802-043	N/A	chrome 11ga top serrated	12 ft LH	848094	9842537	848093
A-802-045	N/A	chrome 11ga top serrated	15 ft LH	848094	9820456	848093
For Models: (TR75, TR85, TR86, TR95, TR96, TX36, TX66, TX88 ALL w/ header), (970, 971, 972, 973 ALL w/ twin points)						

SICKLE ASSEMBLIES - NEW HOLLAND

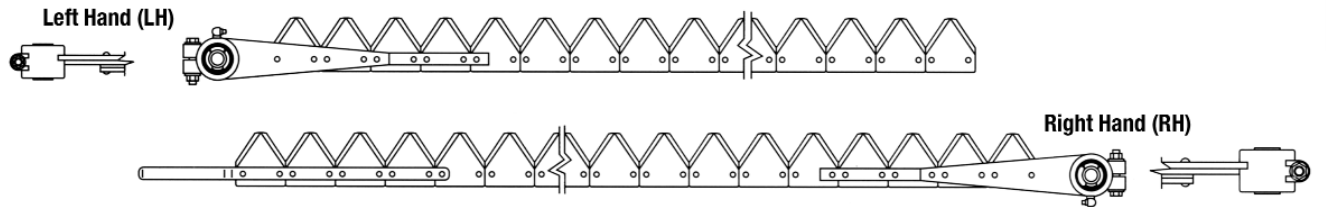

BOLT ON	RIVETED	DESCRIPTION	LENGTH	HEAD NO.	OEM SICKLE NO.	SECT. PART NO.
A-801-429	N/A	chrome 11ga top serrated	15 ft	848094	605039, 851667	694723
For Models: (TR75, TR85, TR86, TR95, TR96, TX36, TX66, TX88 ALL w/ header), 970, 971, 972, 973						
N/A	A-800-431	chrome 11ga top serrated	18 ft	848094	605663, 851654	694723
A-801-432	N/A	chrome 11ga top serrated	10 ft RH	848094	605665, 851668	694723
A-801-433	N/A	chrome 11ga top serrated	10 ft LH	848094	605668, 851669	694723
For Models: (TR75, TR85, TR86, TR95, TR96, TX36, TX66, TX88 ALL w/ header), 970, 971, 972, 973						

SICKLE SECTIONS - NEW IDEA

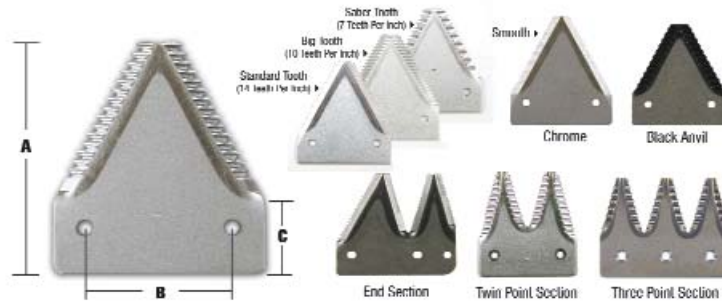

PART NO.	DESCRIPTION	DIM A (1)	DIM B (2)	DIM C (3)	FASTENER	REPL. NO.
A-211-003	black 14ga under serrated	3.250"	2.062"	1"	7/32 x 5/8	1145
A-211-002	black 12ga under serrated	3.250"	2.062"	1"	7/32 x 5/8	OU557HS
A-211-001	black 11ga under serrated	3.250"	2.062"	1"	7/32 x 5/8	29875
A-212-001	chrome 11ga top serrated	3.250"	2.062"	1"	7/32 x 5/8	700705300
A-212-063	chrome 14ga top serrated	3.250"	2.062"	1"	7/32 x 5/8	604800
A-211-233	black 14ga top serrated	3.250"	2.062"	1"	7/32 x 5/8	67631
A-212-003	chrome 14ga top serrated	3.250"	2.062"	1"	7/32 x 5/8	604921
A-212-012	chrome 12ga top serrated	3.250"	2.062"	1"	7/32 x 5/8	94579
A-211-211	black 11ga top serrated	3.250"	2.062"	1"	7/32 x 5/8	9622744
A-231-211	black 11ga big tooth	3.250"	2.062"	1"	7/32 x 5/8	124737BT
A-231-461	black 11ga saber tooth	3.250"	2.062"	1"	7/32 x 5/8	9622744ST
A-212-001	chrome 11ga top serrated	3.250"	2.062"	1"	7/32 x 5/8	700705300
A-232-001	chrome 11ga big tooth	3.250"	2.062"	1"	7/32 x 5/8	700705300BT

SICKLE ASSEMBLIES & PARTS

A-232-461	chrome 11ga sabertooth	3.250"	2.062"	1"	7/32 x 5/8	9826090ST
A-211-011	black 11ga smooth	3.250"	2.062"	1"	7/32 x 5/8	26622
A-211-001	black 11ga under serrated	3.250"	2.062"	1"	7/32 x 5/8	29875
A-212-061	chrome 11ga under serrated	3.250"	2.062"	1"	7/32 x 5/8	060635
A-212-262	overlap chrm 12ga top ser	rivet type			7/32 x 5/8 CTSK	706424H
A-212-232	overlap chrm 12ga top ser	rivet type			7/32 x 5/8 CTSK	706423H
A-212-513	overlap chrm 14ga top ser	bolt type			7/32 x 5/8 CTSK	9826047
A-212-523	overlap chrm 14ga top ser	bolt type			7/32 x 5/8 CTSK	9826046
A-212-302	overlap chrm 12ga top ser	bolt type			7/32 x 5/8 CTSK	9826047H
A-212-312	overlap chrm 12ga top ser	bolt type			7/32 x 5/8 CTSK	9826046H
A-211-191	overlap blk 11ga top ser	bolt type			7/32 x 5/8 CTSK	861353
A-211-181	overlap blk 11ga top ser	bolt type			7/32 x 5/8 CTSK	861354
A-711-002	ovrlap kit, chrm 12ga top ser	rivet type			7/32 x 5/8 CTSK	
A-711-004	ovrlap kit, chrm 12ga top ser	bolt type			7/32 x 5/8 CTSK	
A-711-005	ovrlap kit, blk 11ga top ser	bolt type			7/32 x 5/8 CTSK	
A-711-006	ovrlap kit, chrm 14ga top ser	bolt type			7/32 x 5/8 CTSK	

SICKLE PARTS - NEW IDEA

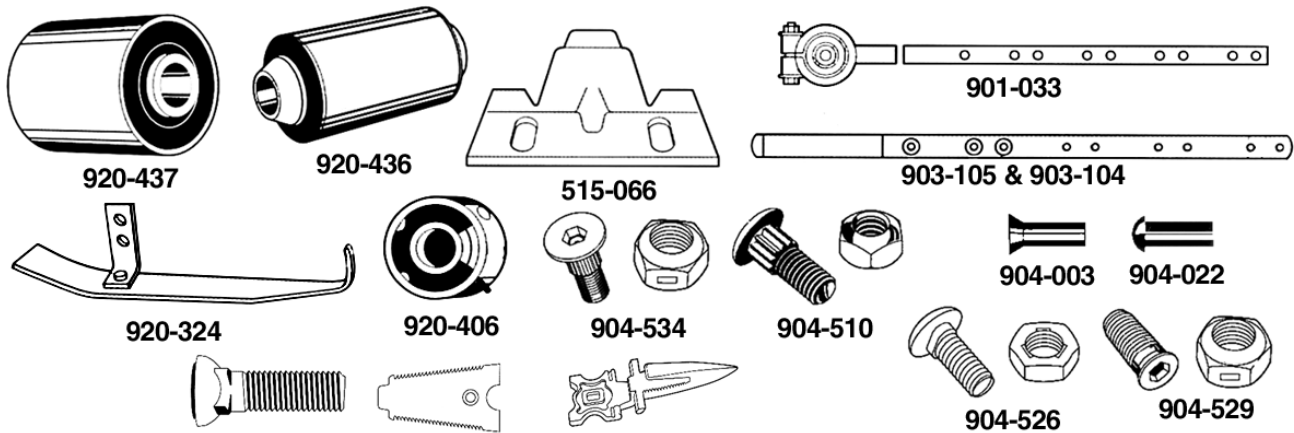

PART NO.	DESCRIPTION	REPLACES	APPLICATION
A-901-008	Sickle head	858740	
A-901-005	Sickle head	86507377	(MOWER CONDITIONER: 460, 461, 467, 469)
A-901-007	Sickle head	577868	(MOWER CONDITIONER: 472, 477, 478)
A-901-006	Sickle head	577867	(MOWER CONDITIONER: 479, 488, 490, 1496)
A-901-033	Sickle head	289488	(MOWER CONDITIONER: 474, 489)
A-901-034	Sickle head	86508155	(MOWER CONDITIONER: 495, 1495)
A-901-009	Sickle head	76173	(WINDROWER: 905)
A-901-002	Sickle head, LH	135822	(WINDROWER: 907, 912)
A-901-004	Sickle head, LH	858713	(WINDROWER: 1112, 1116)
A-901-061	Sickle head, LH	575163, 858755	(WINDROWER: 114)
A-901-107	Sickle head, LH	86536346	
A-901-001	Sickle head, RH	137635	(WINDROWER: 907, 912)
A-901-003	Sickle head, RH	858714	(WINDROWER: 1112, 1116)
A-901-060	Sickle head, RH	704316, 858756	(WINDROWER: 114)
A-901-108	Sickle head, RH	86536345	(MOWER CONDITIONER: 1496, 499, 1499)
A-910-059	Knifehead	290271	(MOWER: 290)
A-901-075	Knifehead	ZA502562	(MOWER CONDITIONER: 512, 514)
A-901-042	Knifehead	824594C91	(MOWER CONDITIONER: 507, 5107, 509, 5109)
A-901-063	Knifehead	045HSA	
A-920-433	Bushing	127610	(MOWER: 450, 456)
A-920-434	Bushing	134182	(MOWER CONDITIONER: 460, 469)
A-920-437	Bushing	254132	(MOWER CONDITIONER: 472, 479, 488, 495, 1495)
A-920-436	Bushing	76417	(WINDROWER: 907, 114, 1118)
A-920-323	Inner sole	36653	
A-515-066	Low knife clip	61384282	
A-515-126	Knifehead clip		
A-920-101	Center Guard	50HS4A, 143HSA	
A-920-102	Outer Guard		
A-920-118	Ledger Plate		
A-904-520	(50) 7/16x1-1/2" bolts		
A-904-521	(50) 7/16x1-3/4" bolts		
A-920-324	Outer sole	37025	

SICKLE ASSEMBLIES & PARTS

A-903-104	Overlap strap	858762, 86502971
A-903-105	Overlap strap	861711, 86502821
A-529-016	Wear plate	71116532, 71176537
A-W20HSA	Pitman wood 36"	W20HSA

SICKLE ASSEMBLIES - NEW IDEA

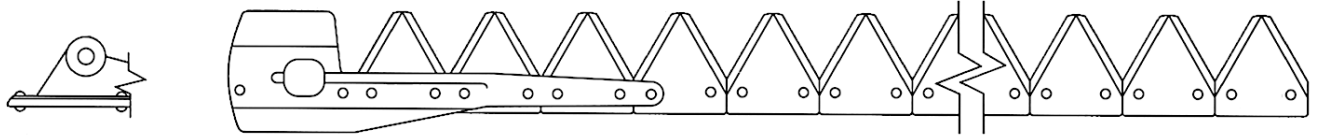

BOLT ON	RIVETED	DESCRIPTION	LENGTH	HEAD NO.	OEM SICKLE NO.	SECT. PART NO.
A-801-442	A-800-442	black 12ga under serrated	7 ft.	045HSA	0U286HSA	0U577HS
For Models: (MOWER: 10, 20, 30, 40, 41, 250, 251, 252, 253, 254, 255)						

SICKLE ASSEMBLIES - NEW IDEA

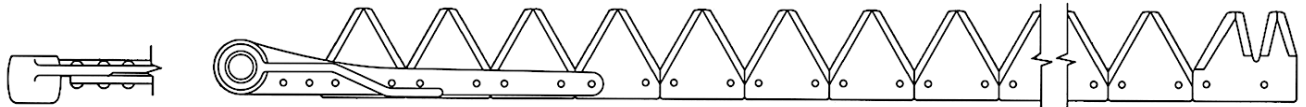

BOLT ON	RIVETED	DESCRIPTION	LENGTH	HEAD NO.	OEM SICKLE NO.	SECT. PART NO.
A-801-064	A-800-064	Xblack 12ga under serrated	5 ft.	56692C91	463408R93	826722C2
A-801-065	A-800-065	Xblack 12ga under serrated	6 ft.	56692C91	465112R93	826722C2
A-801-060	A-800-060	black 11ga smooth	7 ft.	56692C91	462381R93	826724C2
A-801-066	A-800-066	Xblack 12ga under serrated	7 ft.	56692C91	462380R93	826722C2
A-801-691	A-800-691	black 11ga top serrated	7 ft.	56692C91	1281292C92	826720C3
A-861-010	N/A	black 11ga big tooth	7 ft.	56692C91	1281292C92BT	826720C3BT
A-801-061	A-800-061	black 11ga smooth	9 ft.	56692C91	463182R93	826724C2
A-801-692	A-800-692	black 11ga top serrated	9 ft.	56692C91	1281291C92	826720C3
A-861-527	N/A	black 11ga big tooth	9 ft.	56692C91	1281291C92BT	826720C3BT
For Models: (WINDROWER: 521, 522)						

SICKLE ASSEMBLIES - NEW IDEA

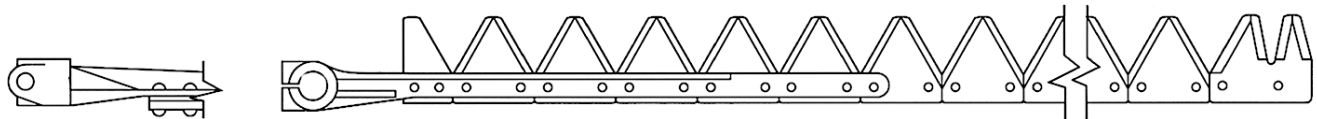

BOLT ON	RIVETED	DESCRIPTION	LENGTH	HEAD NO.	OEM SICKLE NO.	SECT. PART NO.
A-801-348	A-800-348	black 12ga under serrated	9 ft.	Headless	290744S, 290627S	0U577HS
A-801-419	A-800-419	black 12ga under serrated	9 ft.	290271	290744, 290627	0U577HS
For Models: (MOWER CONDITIONER: 290)						

SICKLE ASSEMBLIES - NEW IDEA

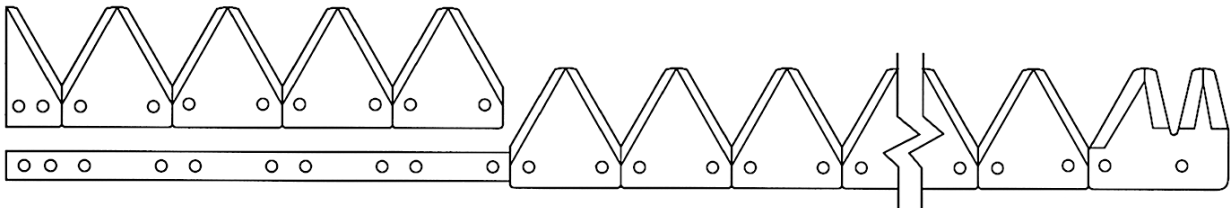

BOLT ON	RIVETED	DESCRIPTION	LENGTH	HEAD NO.	OEM SICKLE NO.	SECT. PART NO.
A-801-777	A-800-777	black 12ga under serrated	9 ft.	Headless	290927	0U577HS
For Models: (MOWER CONDITIONER: 299)						

SICKLE ASSEMBLIES & PARTS

SICKLE ASSEMBLIES - NEW IDEA

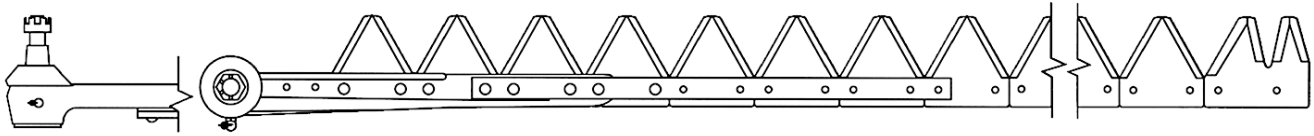

BOLT ON	RIVETED	DESCRIPTION	LENGTH	HEAD NO.	OEM SICKLE NO.	SECT. PART NO.
A-801-400	A-800-400	Xblack 12ga under serrated	7 ft.	824594C91	101987C95	W501017E
A-801-306	A-800-306	Xblack 12ga under serrated	9 ft.	824594C91	101988C95	W501017E
A-831-869	A-830-869	black 11ga top serrated	9 ft.	824594C91	1960310C1	W501017ETS

For Models: (MOWER CONDITIONER: 507, 5107 (7'), 509, 5109 (9'))

SICKLE ASSEMBLIES - NEW IDEA

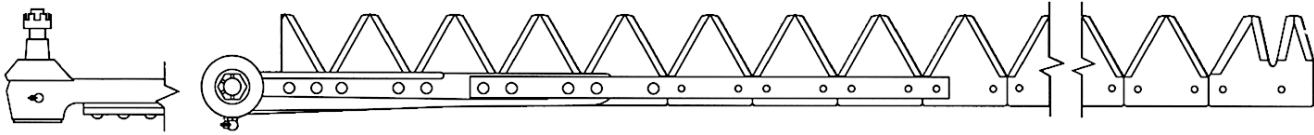

BOLT ON	RIVETED	DESCRIPTION	LENGTH	HEAD NO.	OEM SICKLE NO.	SECT. PART NO.
A-801-764	A-800-764	chrome 11ga under serrated	12 ft.	ZA502562	ZA502930, ZA502889	502933
A-801-765	A-800-765	chrome 11ga under serrated	14 ft.	ZA502562	ZA502931, ZA502890	502933

For Models: (MOWER CONDITIONER: 512 (12') pivot tongue, 514 (14') pivot tongue)

SICKLE SECTIONS - PMI

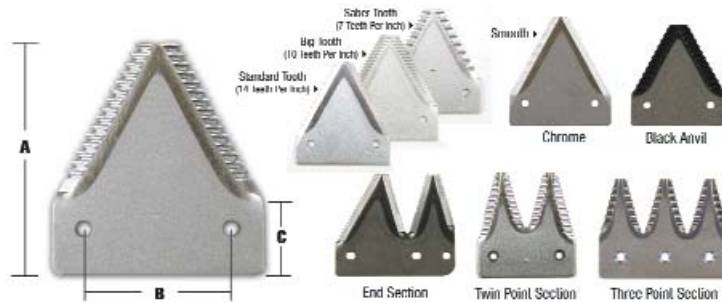

PART NO.	DESCRIPTION	DIM A (1)	DIM B (2)	DIM C (3)	FASTENER	REPL. NO.
A-211-003	black 14ga under serrated	3.250"	2.062"	1"	7/32 x 5/8	1145
A-211-273	black 14ga under serrated	3.250"	width 3"		1/4 x 5/8	1146
A-211-362	black 12ga top serrated	3.250"	width 3"		1/4 x 5/8	A10081

SICKLE ASSEMBLIES - PMI

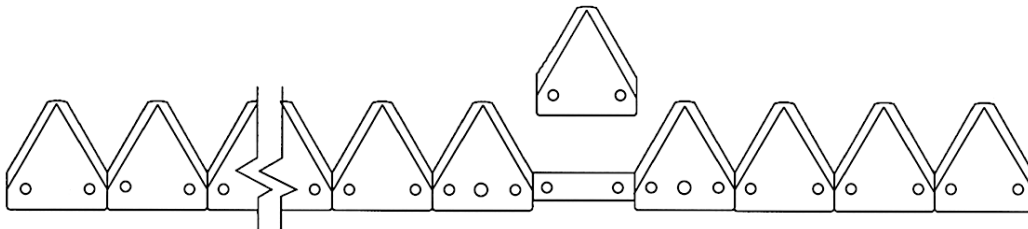

BOLT ON	RIVETED	DESCRIPTION	LENGTH	HEAD NO.	OEM SICKLE NO.	SECT. PART NO.
N/A	A-830-593	black 14ga under serrated	15 ft.	Headless	1301, 40035	1145
N/A	A-860-212	black 14ga under serrated	18 ft.	Headless	1302, 40036	1145

For Models: (SWATHER: 500 sp)

SICKLE ASSEMBLIES & PARTS

SICKLE ASSEMBLIES - PMI

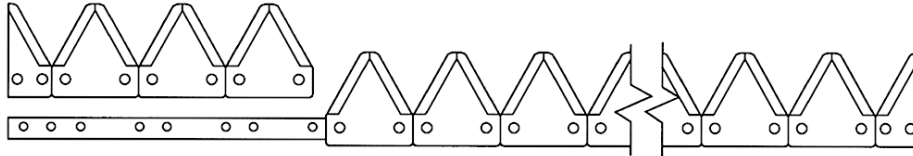

BOLT ON	RIVETED	DESCRIPTION	LENGTH	HEAD NO.	OEM SICKLE NO.	SECT. PART NO.
A-801-662	A-800-662	black 14ga under serrated	15 ft.	Headless	40059,10813, 14021	1145
A-801-663	A-800-663	black 14ga under serrated	18 ft.	Headless	40060, 10816, 14022	1145
A-801-664	A-800-664	black 14ga under serrated	21 ft.	Headless	40061, 10819, 14023	1145
For Models: (SWATHER: 550)						

SICKLE ASSEMBLIES - PMI

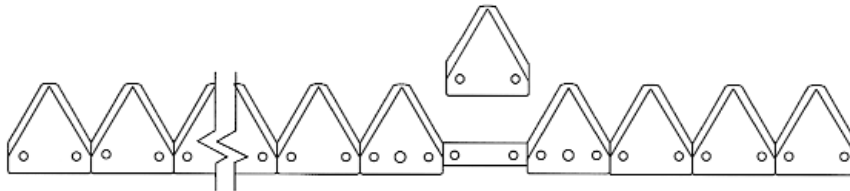

BOLT ON	RIVETED	DESCRIPTION	LENGTH	HEAD NO.	OEM SICKLE NO.	SECT. PART NO.
N/A	A-830-594	black 14ga under serrated	15 ft.	Headless	1304, 40038	1145
For Models: (SWATHER: 601 pull type)						
N/A	A-830-595	black 14ga under serrated	18 ft.	Headless	1305, 40039	1145
For Models: (SWATHER: 601 pull type)						

SICKLE ASSEMBLIES - PMI

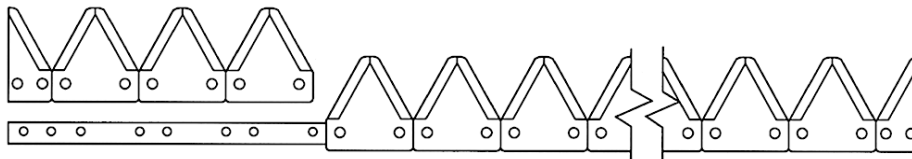

BOLT ON	RIVETED	DESCRIPTION	LENGTH	HEAD NO.	OEM SICKLE NO.	SECT. PART NO.
A-831-856	A-830-856	black 14ga under serrated	12 ft. RH	Headless	32850 Rivet, A10124 Bolt	1146
A-831-844	N/A	black 12ga top serrated	12 ft. RH	Headless	48893	A10081
A-831-859	A-830-859	black 14ga under serrated	14 ft. LH	Headless	32849 Rivet, A10127 Bolt	1146
A-831-857	N/A	black 12ga top serrated	16 ft. RH	Headless	39870 Rivet, A10125 Bolt	1146
For Models: (SWATHER: 626 pull type)						

SICKLE ASSEMBLIES - PMI

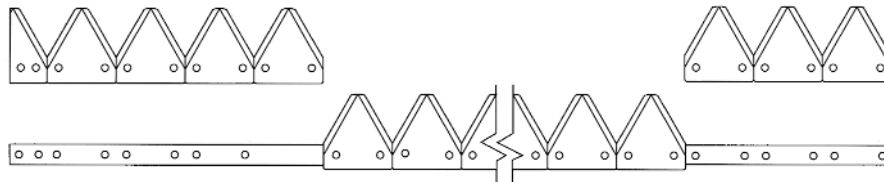

BOLT ON	RIVETED	DESCRIPTION	LENGTH	HEAD NO.	OEM SICKLE NO.	SECT. PART NO.
A-831-854	A-830-854	black 14ga under serrated	4 ft. RH	Headless	39871 Rivet, A10122 Bolt	1146
A-831-842	N/A	black 12ga top serrated	4 ft. RH	Headless	48896	A10081
A-831-855	A-830-855	black 14ga under serrated	8 ft. RH	Headless	39868 Rivet, A101123 Bolt	1146
A-831-843	N/A	black 12ga top serrated	8 ft. RH	Headless	48894	A10081
A-831-856	A-830-856	black 14ga under serrated	12 ft. RH	Headless	32850 Rivet, A10124 Bolt	1146
A-831-844	N/A	black 12ga top serrated	12 ft. RH	Headless	48893	A10081
A-831-859	A-830-859	black 14ga under serrated	14 ft. LH	Headless	32849 Rivet, A10127 Bolt	1146
A-831-847	N/A	black 12ga top serrated	14 ft. LH	Headless	48892	A10081
A-831-857	A-830-857	black 14ga under serrated	16 ft. RH	Headless	39870 Rivet, A10125 Bolt	1146
A-831-845	N/A	black 12ga top serrated	16 ft. RH	Headless	48895	A10081
A-831-858	A-830-858	black 14ga under serrated	20 ft. RH	Headless	39869 Rivet, A10126 Bolt	1146
A-831-846	N/A	black 12ga top serrated	20 ft. RH	Headless	3729276M1TS	A10081
For Models: (SWATHER: (702, 722 ALL w/ 2pc sickle assy))						

SICKLE ASSEMBLIES & PARTS

SICKLE ASSEMBLIES - PMI

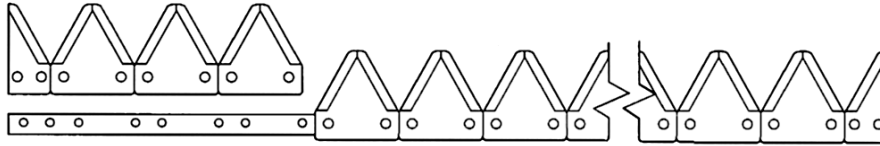

BOLT ON	RIVETED	DESCRIPTION	LENGTH	HEAD NO.	OEM SICKLE NO.	SECT. PART NO.
N/A	A-830-639	black 14ga under serrated	21 ft. LH	Headless	35483	1146
For Models: (SWATHER: 742 sp)						
N/A	A-830-638	black 14ga under serrated	21 ft. RH	Headless	35484	1146
For Models: (SWATHER: 742 sp)						

SICKLE SECTIONS - VERSATILE

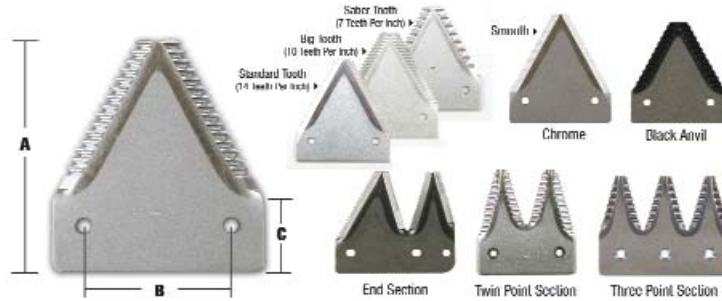

PART NO.	DESCRIPTION	DIM A (1)	DIM B (2)	DIM C (3)	FASTENER	REPL. NO.
A-211-123	black 14ga top serrated	3.250"	2.062"	1"	7/32 x 9/16	93545
A-212-362	chrome 12ga under serrated	3.250"	2.062"	1"	7/32 x 9/16	93544
A-211-053	black 14ga top serrated	3"	2.062"	.875"	7/32 x 5/8 CTSK	SW1616 CTSK
A-231-053	black 14ga big tooth	3"	2.062"	.875"	7/32 x 5/8 CTSK	SW1616BT CTSK
A-212-213	chrome 14ga top serrated	3"	2.062"	.875"	7/32 x 5/8 CTSK	SW1616PL CTSK
A-411-083	black 14ga top serrated	3"	2.062"	1.250"	7/32 x 5/8 CTSK	SW1776 CTSK
A-431-083	black 14ga big tooth	3"	2.062"	1.250"	7/32 x 5/8 CTSK	SW1776BT CTSK
A-412-063	chrome 14ga top serrated	3"	2.062"	1.250"	7/32 x 5/8 CTSK	SW1776PL CTSK
A-212-012	chrome 14ga top serrated	3.250"	2.062"	1"	7/32 x 5/8	94579
A-212-001	chrome 11ga top serrated	3.250"	2.062"	1"	7/32 x 5/8	700705300
A-232-001	chrome 11ga big tooth	3.250"	2.062"	1"	7/32 x 5/8	700705300BT

SICKLE PARTS - VERSATILE



PART NO.	DESCRIPTION	REPLACES	APPLICATION
A-901-020	Sickle Head	SWA28253	(WINDROWER: 10, 103, 400)
A-901-054	Sickle Bushing	SW1740	(WINDROWER: 10, 103, 400, 4400)
A-901-078	Sickle Head	SWA28509	(WINDROWER: 4400)
A-515-076	Low Knife Clip	SW202	
A-904-529	(50) 7/32 x 9/16" 60° CTSK Bolt & Nut		
A-904-528	(25) 7/32 x 1" 60° CTSK Bolt & Nut		
A-904-002	7/32 x 5/8 CTSK rivet		

SICKLE ASSEMBLIES & PARTS

SICKLE ASSEMBLIES - VERSATILE

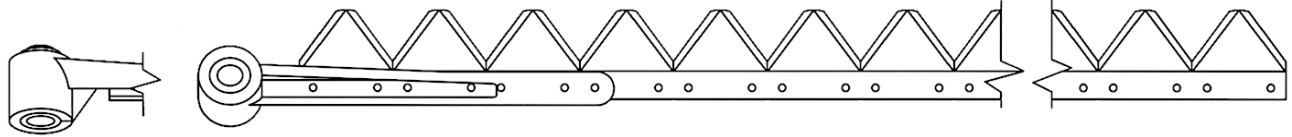

BOLT ON	RIVETED	DESCRIPTION	LENGTH	HEAD NO.	OEM SICKLE NO.	SECT. PART NO.
A-801-186	A-800-186	R TS PL	12 ft.	SWA28253	SWA1783PL, 74339	SW1776PL
A-801-189	A-800-189	R TS PL	15 ft.	SWA28253	SWA25571PL	SW1616PL
A-801-190	A-800-190	R TS BL	15 ft.	SWA28253	SWA1786, 74344	SW1776
A-831-552	A-830-552	R BT BL	15 ft.	SWA28253	SWA1786BT, 74344	SW1776BT
A-801-191	A-800-191	R TS PL	15 ft.	SWA28253	SWA1786PL, 74345	SW1776PL
A-801-193	A-800-193	R TS PL	18 ft.	SWA28253	SWA25572PL	SW1616PL
A-801-194	A-800-194	R TS BL	18 ft.	SWA28253	SWA1789, 74350	SW1776
A-831-553	A-830-553	R BT BL	18 ft.	SWA28253	SWA1789BT, 74350	SW1776BT
A-801-195	A-800-195	R TS PL	18 ft.	SWA28253	SWA1789PL, 74351	SW1776PL
A-801-197	A-800-197	R TS PL	20 ft.	SWA28253	SWA25573PL	SW1616PL
A-801-198	A-800-198	R TS BL	20 ft.	SWA28253	SWA3311, 74455	SW1776
A-831-554	A-830-554	R BT 1BL	20 ft.	SWA28253	SWA3311BT, 74455	SW1776BT
A-801-199	A-800-199	R TS PL	20 ft.	SWA28253	SWA3311PL, 74456	SW1776PL
A-801-521	A-800-521	R TS BL	24 ft.	SWA28253	SWA35743	SW1776
A-831-555	A-830-555	R BT BL	24 ft.	SWA28253	SWA35743BT	SW1776BT
A-801-683	A-800-683	R TS PL	24 ft.	SWA28253	SWA48346	SW1776PL

For Models: (WINDROWER: 10, 103, 400)

SICKLE ASSEMBLIES - VERSATILE

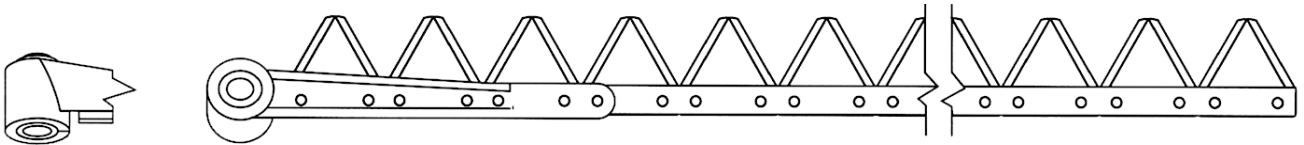

BOLT ON	RIVETED	DESCRIPTION	LENGTH	HEAD NO.	OEM SICKLE NO.	SECT. PART NO.
A-801-522	A-800-522	R TS PL	15 ft.	SWA28509	SWA54834	SW1616PL
A-831-556	A-830-556	R BT BL	15 ft.	SWA28509	SWA54834BT	SW1616BT
A-801-523	A-800-523	R TS PL	18 ft.	SWA28509	SWA54840	SW1616PL
A-831-557	A-830-557	R BT BL	18 ft.	SWA28509	SWA54840BT	SW1616BT
A-801-524	A-800-524	R TS PL	20 ft.	SWA28509	SWA54846	SW1616PL
A-831-558	A-830-558	R BT BL	20 ft.	SWA28509	SWA54846BT	SW1616BT
A-801-525	A-800-525	R TS PL	22 ft.	SWA28509	SWA54850	SW1616PL
A-831-559	A-830-559	R BT BL	22 ft.	SWA28509	SWA54850BT	SW1616BT

For Models: (WINDROWER: 4400)

SICKLE ASSEMBLIES - VERSATILE

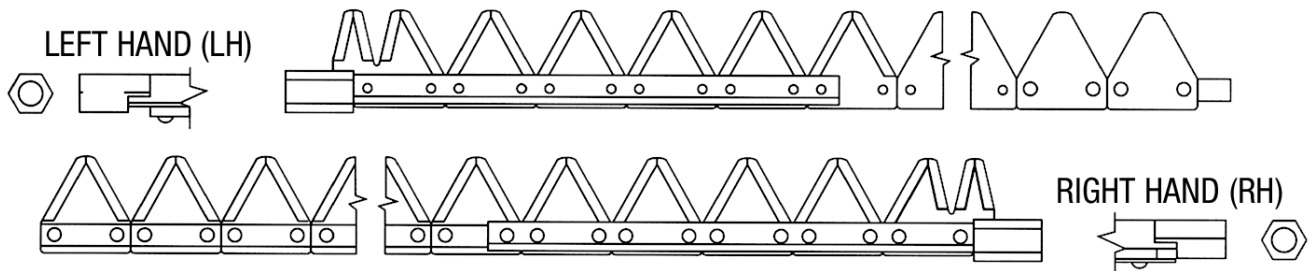

BOLT ON	RIVETED	DESCRIPTION	LENGTH	HEAD NO.	OEM SICKLE NO.	SECT. PART NO.
A-801-177	A-800-177	XH TS PL	6 ft. LH	6821078	6823272	700705300
A-801-183	A-800-183	XH TS PL	6 ft. RH	6821136	6823280	700705300
A-801-175	A-800-175	XH TS PL	7 ft. LH	6821078	6832174	700705300
A-801-181	A-800-181	XH TS PL	7 ft. RH	6821136	6832224	700705300
A-831-510	A-830-510	XH BT PL	7 ft. LH	6821078	6832174BT	700705300BT
A-831-511	A-830-511	XH BT PL	7 ft. RH	6821136	6832224BT	700705300BT

For Models: (WINDROWER: 4812 (12'), 4814 (14'))

SICKLE ASSEMBLIES & PARTS

SICKLE ASSEMBLIES - VERSATILE

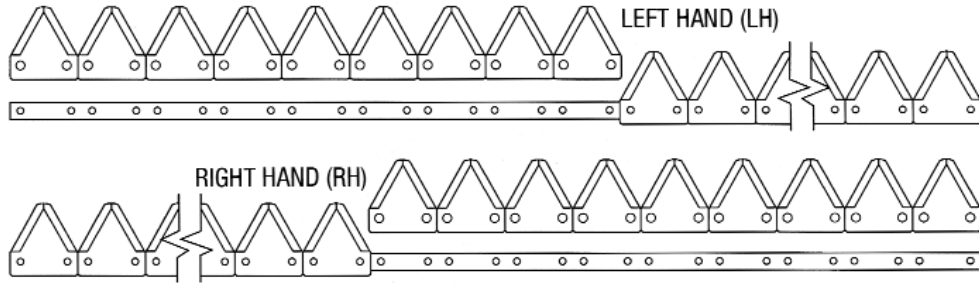

BOLT ON	RIVETED	DESCRIPTION	LENGTH	HEAD NO.	OEM SICKLE NO.	SECT. PART NO.
N/A	A-860-776	R TS BL	9 ft. LH	Headless	103830	93545
For Models: (SWATHER: 4700 double drive, 4750)						
N/A	A-860-777	R TS BL	9 ft. RH	Headless	103784	93545
N/A	A-860-778	R TS BL	11 ft. LH	Headless	103832	93545
N/A	A-860-779	R TS BL	11 ft. RH	Headless	103786	93545
N/A	A-860-108	R TS BL	12 ft. LH	Headless	103833	93545
N/A	A-860-107	R TS BL	13 ft. RH	Headless	103787	93545
N/A	A-860-523	R TS BL	15 ft. LH	Headless	103834	93545
N/A	A-860-524	R TS BL	15 ft. RH	Headless	103788	93545
For Models: (SWATHER: 4700 double drive, 4750)						

SICKLE SECTIONS - WHITE/OLIVER

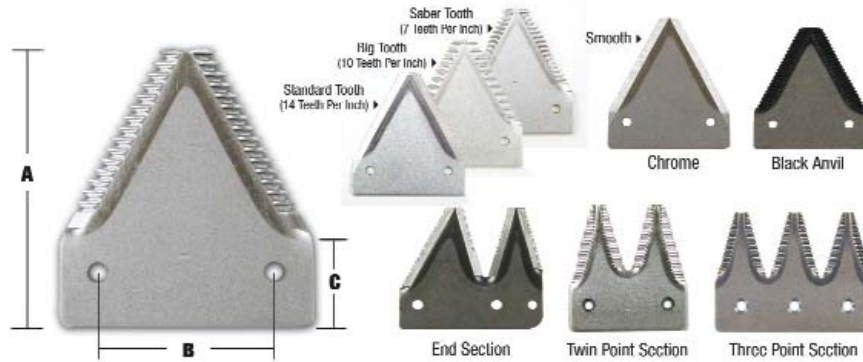

PART NO.	DESCRIPTION	DIM A (1)	DIM B (2)	DIM C (3)	FASTENER	REPL. NO.
A-211-223	black 14ga under serrated	3.250"	2.125"	1"	7/32 x 5/8	875785L
A-212-412	chrome 14ga top serrated	3.250"	2.125"	1"	7/32 x 5/8	31-7970650
A-621-022	3point blk 12ga under ser	4.5"	3.312"	3 point	1/4 x 5/8	31-1714750

SICKLE PARTS - WHITE/OLIVER

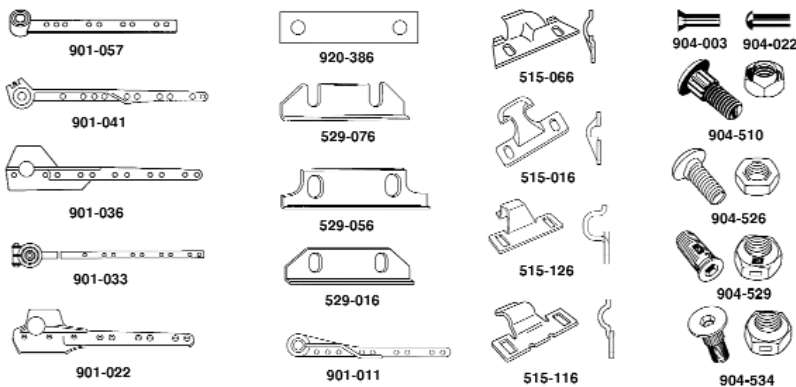

PART NO.	DESCRIPTION	REPLACES	APPLICATION
A-901-057	Sickle Head	31-7970683	(WINDROWER: 6200)
A-515-126	Knifehead clip		
A-515-066	Low knifehead clip		

SICKLE ASSEMBLIES & PARTS

SICKLE ASSEMBLIES - WHITE/OLIVER

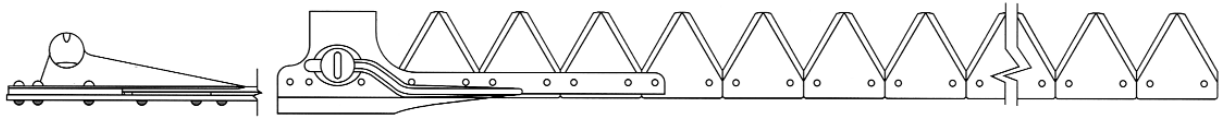

BOLT ON	RIVETED	DESCRIPTION	LENGTH	HEAD NO.	OEM SICKLE NO.	SECT. PART NO.
A-801-073	A-800-073	black 11ga under serrated	6 ft.	501015E	501012ESXH	501017EXH
A-801-074	A-800-074	black 11ga smooth	7 ft.	501015E	501013ESXH	501016EXH

For Models: (MOWER: 57, 82, 84, 344, 355, 356, 415)

SICKLE ASSEMBLIES - WHITE/OLIVER

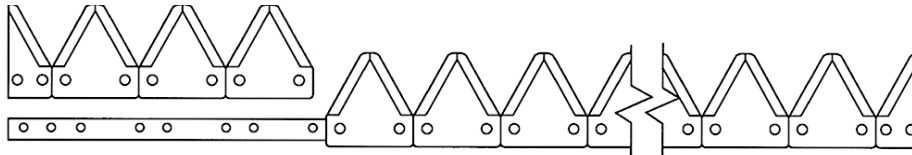

BOLT ON	RIVETED	DESCRIPTION	LENGTH	HEAD NO.	OEM SICKLE NO.	SECT. PART NO.
A-801-659	A-800-659	black 14ga under serrated	18 ft.	Headless	899416L	875785L
A-801-660	A-800-660	black 14ga under serrated	21 ft.	Headless	885194L	875785L
A-801-661	A-800-661	black 14ga under serrated	25 ft.	Headless	885477	875785L

For Models: (WINDROWER: 601 pull type)

SICKLE ASSEMBLIES - WHITE/OLIVER

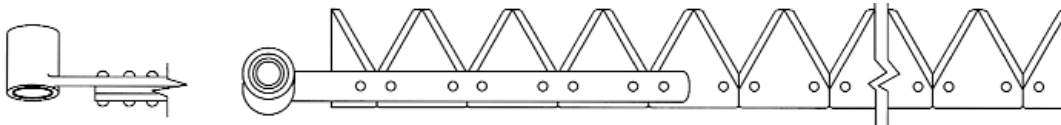

BOLT ON	RIVETED	DESCRIPTION	LENGTH	HEAD NO.	OEM SICKLE NO.	SECT. PART NO.
A-801-409	A-800-409	chrome 12ga top serrated	12 ft.	31-7970683	1046768M1	31-7970650
A-801-411	A-800-411	chrome 12ga top serrated	15 ft.	31-7970683	31-7970623	31-7970650
A-801-413	A-800-413	chrome 12ga top serrated	18 ft.	31-7970683	31-7970633	31-7970650
A-801-415	A-800-415	chrome 12ga top serrated	21 ft.	31-7970683	31-7970643	31-7970650

For Models: (WINDROWER: SP6200 w/ draper header)

SICKLE ASSEMBLIES - WHITE/OLIVER

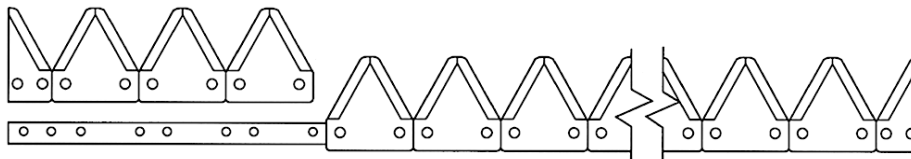

BOLT ON	RIVETED	DESCRIPTION	LENGTH	HEAD NO.	OEM SICKLE NO.	SECT. PART NO.
A-801-644	A-800-644	black 11ga top serrated	12 ft.	Headless	1057934M91	1071707M1
A-801-645	A-800-645	black 11ga top serrated	14 ft.	1056738M91	1056865M91	1071707M1
A-801-646	N/A	black 11ga top serrated	14 ft.	Headless	1056866M91	1071707M1
A-801-647	N/A	black 11ga top serrated	14 ft.	Headless	1057538M91	1071707M1
N/A	A-800-647	black 11ga top serrated	14 ft.	Headless	1057538M91	1071707M1

For Models: (WINDROWER: 6400 w/ auger header)

SICKLE ASSEMBLIES - WHITE/OLIVER

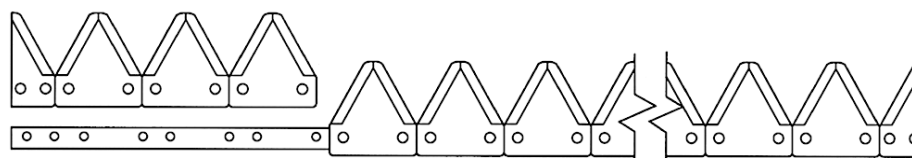

BOLT ON	RIVETED	DESCRIPTION	LENGTH	HEAD NO.	OEM SICKLE NO.	SECT. PART NO.
A-801-648	N/A	chrome 12ga top serrated	15 ft.	Headless	1057966M91, 1057964M91	31-7970650

SICKLE ASSEMBLIES & PARTS

SICKLE ASSEMBLIES - WHITE/OLIVER

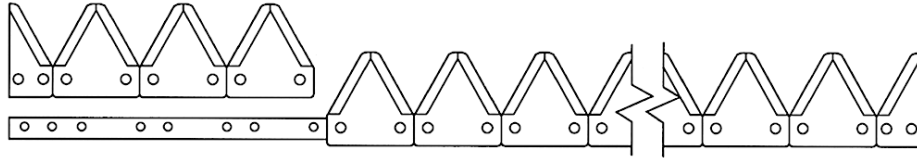

BOLT ON	RIVETED	DESCRIPTION	LENGTH	HEAD NO.	OEM SICKLE NO.	SECT. PART NO.
IN/A	A-800-648	black 11ga top serrated	15 ft.	Headless	1057966M91, 1057964M91	31-7970650

SICKLE ASSEMBLIES - WHITE/OLIVER

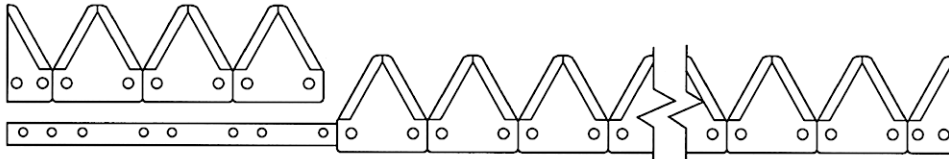

BOLT ON	RIVETED	DESCRIPTION	LENGTH	HEAD NO.	OEM SICKLE NO.	SECT. PART NO.
A-801-649	A-800-649	chrome 12ga top serrated	18 ft.	Headless	1057967M91, 1057965M91	31-7970650
A-801-650	A-800-650	chrome 12ga top serrated	21 ft.	Headless	1057508M91	31-7970650
A-801-651	A-800-651	chrome 12ga top serrated	25 ft 1 pc.	Headless	1056739M91, 1056738M91	31-7970650
A-801-652	A-800-652	chrome 12ga top serrated	30 ft 1 pc.	Headless	1057912M91	31-7970650

For Models: (WINDROWER: 6400 w/ draper header)

OVERLAP SICKLE SECTION KITS

A-OSK615 Overlap Sickle Section Kit

2 LH, 3 RH, 10 Rivets

One Complete Set: For Left & Right Hand Sickles

CASE-IH SEVERAL Twin Sickle Hay Equipment

A-OSK616 Overlap Sickle Section Kit

3 LH, 2 RH, 10 Rivets

One Complete Set: For Left & Right Hand Sickles

NEW HOLLAND SEVERAL Twin Sickle Hay Equipment

OVAL HEAD RIVETS

A-OHR761 Oval Head Rivets, 9/16" (150 pcs.)

9/16" Oval Head, Packages of 150 pcs.

MISC. SEVERAL

A-OHR765 Oval Head Rivets, 5/8" (125 pcs.)

5/8" Oval Head, Packages of 125 pcs.

MISC. SEVERAL

A-OHR763 Oval Head Rivets, 7/8" (100 pcs.)

7/8" Oval Head, Packages of 100 pcs.

MISC. SEVERAL

A-CR762 Countersunk Rivets, 5/8" (175 pcs.)

5/8" Countersunk, Packages of 175 pcs.

MISC. SEVERAL

A-OHRA764 Oval Head Rivet Asst.

Kit Contains 70 (5/8"), 7 (5/16"), 5 (1-1/4")

MISC. Designed for most 9' Sickle Assemblies

SECTION BOLTS/LOCKNUTS

A-SBL757 Section Bolts/Locknuts, 5/8" (50 pcs.)

5/8" Grade 8, Rib Neck Bolt, Packages of 50 pcs. each

MISC. SEVERAL

A-SBL757 Section Bolts/Locknuts, 5/8" (50 pcs. each)

5/8" Grade 8, Rib Neck Bolt, Packages of 50 pcs. each

MISC. SEVERAL

A-KBL758 Knifehead Bolts/Locknuts, 1" (25 pcs. each)

1" Grade 8, Rib Neck Bolt, Packages of 25 pcs. each

MISC. SEVERAL

A-LN759 Locknuts, Section/Knifehead (100 pcs.)

Package of 100 pcs.

MISC. SEVERAL/Knifeheads Requiring 12-24 Locknut

UNIVERSAL KNIFE CLIP SET (2)

A-UCS750 Universal Knife Clip Set (2)

Low Clip, For Bolted or Riveted Sections, Set of 515-116 Knife Clips Replaces: (JD) H127081, H84412, 143241M1, 206195M1; (IH) 176722C1; (AC) 71189684, 71346158

MISC. ALL MODELS Except w/Hart-Carter & J.E. Love Headers

FORGED GUARDS



Badger/Northland

PART	DESCRIPTION	DIM A (1)	DIM B (2)	REPLACES
A-699020M1	Forged Guard	Two Prong		BU250
<i>For Models: (MOWER: ALL MODELS)</i>				
A-683994M1	FORGED GUARD	Two Prong		683181M1, 683476M1 & BU215A
<i>For Models: ALL MODELS</i>				
A-683994M1H	FORGED GUARD	Two Prong	Double Heat Treated	683181M1H, 683476M1 & BU215H
<i>For Models: ALL MODELS</i>				

CASE-IH

PART	DESCRIPTION	DIM A (1)	DIM B (2)	REPLACES
A-483500R3	Forged Guard	Two Prong		H483500R3 & BU210
<i>For Models: 1000, 1100, 1110, 115, 1190, 1200, 1290, 1300, 1490, 1590, 200, 230, 230, 275, 3110, 375, 4000, 5000, 5500, 650, 655, 75, 816, 990, (100, 110, 120 ALL 1966>), 210 W/ Platform SN 3700></i>				
A-633098R1	FORGED GUARD	Two Prong		BU265
<i>For Models: 810 Header, 815, 915</i>				
A-613838R3	Forged Guard	Two Prong		613838R1 & BU270
<i>For Models: 100 1958-1965, 110 1960-1965, 115 <1965, 120 1961-1965, 1290, 175, 201, 210, 225, 230, 275, 375, 4000, 5000, 5500, 75, 820 Header, 1190, 1490, 1590</i>				
A-049239	Forged Guard	Two Prong	Plateless	748178 & BU245
<i>For Models: 1050, 1055, 1150, 1155, 1275, 950, 955</i>				
A-823025C1	FORGED GUARD	Two Prong	2 Pc. Tie Knife Guard	FH049270 & BU260
<i>For Models: 1050, 1055, 1085, 1150, 1155, 1275, 1290, 210, 225, 230, 275, 375, 820, 950, 955</i>				

CLAAS

PART	DESCRIPTION	DIM A (1)	DIM B (2)	REPLACES
A-6762352	Forged Guard	Two Prong		BU215A
<i>For Models: (MOWER: ALL MODELS)</i>				
A-6762352H	Forged Guard	Two Prong	Double Heat Treated	BU215H
<i>For Models: (MOWER: ALL MODELS)</i>				

FORD

PART	DESCRIPTION	DIM A (1)	DIM B (2)	REPLACES
A-483500R3	Forged Guard	Two Prong		H483500R3 & BU210
<i>For Models: 538</i>				
A-290385	Forged Guard	Two Prong		BU280
<i>For Models: 535</i>				
A-11032327	Forged Guard	Two Prong		MC11032327, 11032342 & BU206
<i>For Models: 536, 537</i>				

Field Queen

PART	DESCRIPTION	DIM A (1)	DIM B (2)	REPLACES
A-049270	Forged Guard	Two Prong	Forged Plateless	BU260
<i>For Models: 420, 620</i>				
A-049239	Forged Guard	Two Prong	Plateless	748178 & BU245
<i>For Models: 420, 620</i>				

GEHL

PART	DESCRIPTION	DIM A (1)	DIM B (2)	REPLACES
A-044779	Forged Guard	Two Prong		BU270
<i>For Models: HK108, KH440, MA206A</i>				
A-059827	Forged Guard	Two Prong		072057 & BU220
<i>For Models: 1070, 1090, 770, 880</i>				

HART CARTER

PART	DESCRIPTION	DIM A (1)	DIM B (2)	REPLACES
A-232155	Forged Guard	Two Prong		234006 & BU231
<i>For Models: (COMBINE: ALL COMBINES W/ Floating Cutter Bar)</i>				

FORGED GUARDS



HESSTON

PART	DESCRIPTION	DIM A (1)	DIM B (2)	REPLACES
A-049270	Forged Guard	Two Prong	Forged Plateless	BU260
<i>For Models:</i> 1010, 1014, 1070, 1085, 1090, 1095, 300, 420, 500, 520, 620, 6200, 6400, 6450, 6465, 6600, 6610, PT10, PT12, PT7				
A-049239	Forged Guard	Two Prong	Plateless	748178 & BU245
<i>For Models:</i> ALL MODELS Windrowers & Mower Conditioners				

JOHN DEERE

PART	DESCRIPTION	DIM A (1)	DIM B (2)	REPLACES
A-H145791	Forged Guard	Two Prong	One Piece Construction	H61954, H75386 & BU240A
<i>For Models:</i> 213, 215, 216, 218, 220, 222, 224, 230, 913, 915, 918, 920, 922, 924, 925, 930				
A-W30341	Forged Guard	Two Prong		BU235
<i>For Models:</i> 580 Pull Type				
A-E82559	Forged Guard	Two Prong	One Piece Construction	E48093, E52667 & BU220
<i>For Models:</i> 120, 1214, 130, 135, 183, 250, 350, 37, 38, 39, 450, 480, 483, 485, 78				

Killberry

PART	DESCRIPTION	DIM A (1)	DIM B (2)	REPLACES
A-K8420S	Forged Guard	Two Prong		BU235
<i>For Models:</i> (WINDROWER: ALL MODELS)				

Kosch

PART	DESCRIPTION	DIM A (1)	DIM B (2)	REPLACES
A-K101	Forged Guard	Two Prong		BU270
<i>For Models:</i> (MOWER: ALL MODELS)				

LOVE

PART	DESCRIPTION	DIM A (1)	DIM B (2)	REPLACES
A-LB208	Forged Guard	Two Prong		LB214 & BU275
<i>For Models:</i> ALL MODELS Grain Heads				

LOWE

PART	DESCRIPTION	DIM A (1)	DIM B (2)	REPLACES
A-044779	Forged Guard	Two Prong		BU270
<i>For Models:</i> (MOWER: ALL MODELS)				

MAC DON

PART	DESCRIPTION	DIM A (1)	DIM B (2)	REPLACES
A-K8420S	Forged Guard	Two Prong		BU235
<i>For Models:</i> 1000, 2000, 3000, 7000				

MASSEY FERGUSON

PART	DESCRIPTION	DIM A (1)	DIM B (2)	REPLACES
A-1036339M1	Forged Guard	Two Prong		BU280
<i>For Models:</i> MF81				
A-228392M2	Forged Guard	Two Prong		228392M1 & BU240A
<i>For Models:</i> 205, 300, 35, 405, 410, 510, 540, 550, 60, 70, 72, 750, 760, 80, 82, 850, 860, 92				
A-1041468M1	Forged Guard	Two Prong		BU235
<i>For Models:</i> 35, 655, 775, 785				
A-699020M1	Forged Guard	Two Prong		BU250
<i>For Models:</i> 725, 885, 925				
A-683994M1	FORGED GUARD	Two Prong		683181M1, 683476M1 & BU215A
<i>For Models:</i> 613, 625, 725, 775, 785, 885, 925				
A-683994M1H	FORGED GUARD	Two Prong	Double Heat Treated	683181M1H, 683476M1 & BU215H
<i>For Models:</i> 613, 625, 725, 925, 775, 785, 885				
A-1053174M1	FORGED GUARD	Two Prong		BU231
<i>For Models:</i> (540, 550, 750, 760, 850, 860 ALL W/ Floating Cutter Bar)				

FORGED GUARDS



NEW HOLLAND

PART	DESCRIPTION	DIM A (1)	DIM B (2)	REPLACES
A-134024	FORGED GUARD	Two Prong		BU240A
<i>For Models:</i> 960, 975, 985, 995				
A-273846	FORGED GUARD	Two Prong		271971 & BU275
<i>For Models:</i> 960 W/ Love Floating Cutterbar				
A-219190	FORGED GUARD	Two Prong		144176 & BU218
<i>For Models:</i> 451, 456, 505, 507				
A-65327	FORGED GUARD	Two Prong		BU245
<i>For Models:</i> 1469, 460, 461, 467, 469, 490, 827, 830, 880, 900, 903, 905, 907, 909, 910, 912				
A-86617061	Forged Guard	Two Prong	Stub Guard	257634, 132146, 86553348, 86521592, 858764 & BU250
<i>For Models:</i> 1100, 1112, 1114, 1116, 114, 1465, 1469, 1495, 1496, 1499, 460, 461, 467, 469, 472, 474, 477, 478, 479, 488, 489, 490, 492, 495, 499, 536, 537, 903, 905, 907, 909, 910, 912				
A-86615982	Forged Guard	Two Prong		219191, 695501, 858778, 86521587, 86553340 & BU215A
<i>For Models:</i> 1090, 1100, 1112, 1114, 1116, 1118, 114, 116, 1465, 1469, 1475, 1495, 1496, 1499, 2450, 2550, 472, 474, 477, 478, 479, 488, 489, 490, 492, 495, 499, 903, 910, 912				
A-86615982H	Forged Guard	Two Prong	Double Heat Treated	219191, 695501, 858778, 86521587, 86553340 & BU215H
<i>For Models:</i> 1090, 1100, 1112, 1114, 1116, 1118, 114, 116, 1465, 1469, 1475, 1495, 1496, 1499, 2450, 2550, 472, 474, 477, 478, 479, 488, 489, 490, 492, 495, 499, 903, 910, 912				
A-11010657	Forged Guard	Two Prong		MC11010657 & BU205
<i>For Models:</i> 536				

NEW IDEA

PART	DESCRIPTION	DIM A (1)	DIM B (2)	REPLACES
A-290385	Forged Guard	Two Prong		BU280
<i>For Models:</i> 290, 7135, 7165				
A-65327	FORGED GUARD	Two Prong		BU245
<i>For Models:</i> 815, 816, 817, 818, 819, 820				

OWATTONA

PART	DESCRIPTION	DIM A (1)	DIM B (2)	REPLACES
A-11032327	Forged Guard	Two Prong		MC11032327, 11032342 & BU206
<i>For Models:</i> ALL MODELS Windrowers & Mower Conditioners 1979>				
A-11010657	Forged Guard	Two Prong		MC11010657 & BU205
<i>For Models:</i> ALL MODELS Windrowers				

VERSATILE

PART	DESCRIPTION	DIM A (1)	DIM B (2)	REPLACES
A-86544410	Forged Guard	Two Prong		V1605, SW1605, 9705050 & BU290
<i>For Models:</i> 103, 10V, 1400V, 1950V, 2400V, 2800V, 400V, 420V, 42V, 4400V, 440V, 5000V				

WHITE/OLIVER

PART	DESCRIPTION	DIM A (1)	DIM B (2)	REPLACES
A-895744L	Forged Guard	Two Prong		BU235
<i>For Models:</i> 100, 101, 501, 502, 503				

BONDIOLI & PAVESI



WALTERSCHEID

COMER



Weasler

NEAPCO
Binnacchi

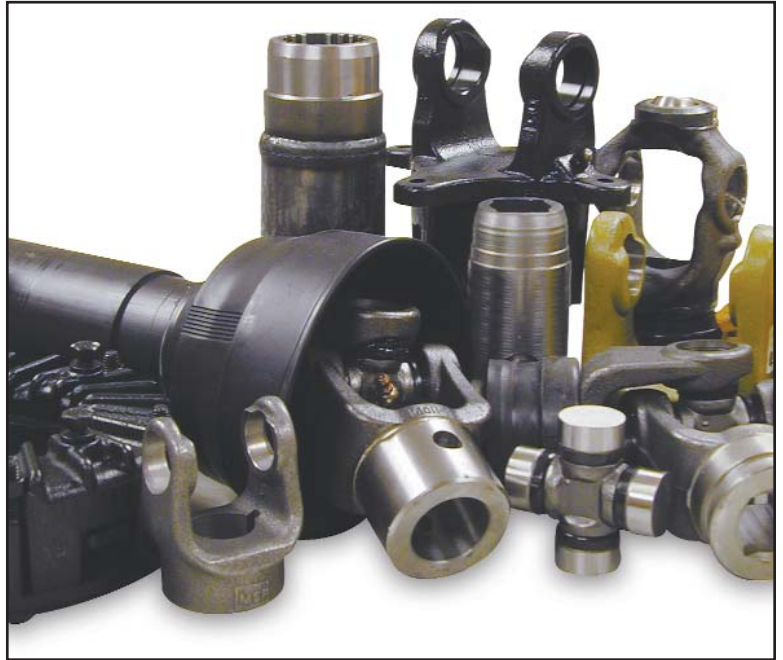

Please refer to A&I's Driveline Catalog, Ag Supply Catalog (CT224) or A&I's Driveline Flyer (CT243) for more information and for an extensive list of drivelines and driveline parts.

PTO CLUTCHES

FOR A FULL LISTING OF PTO CLUTCHES, PLEASE LOOK IN A&I'S DRIVELINE CATALOG OR AG SUPPLY CATALOG



Friction Clutch

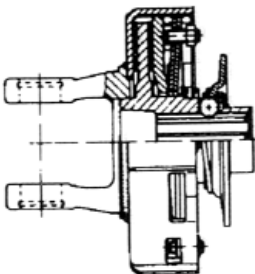

Adjustable Friction Clutch

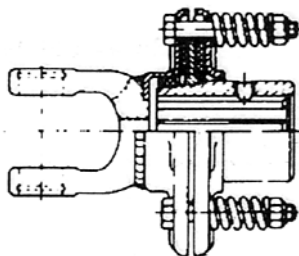

Radial Pin Clutch

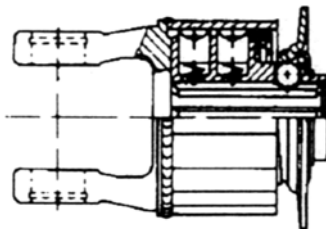

Key-Type Overrunning Clutch

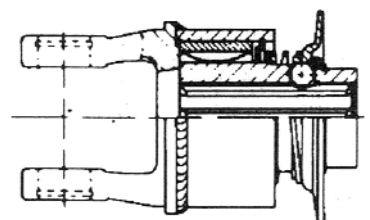

METRIC REPLACEMENT DRIVELINES

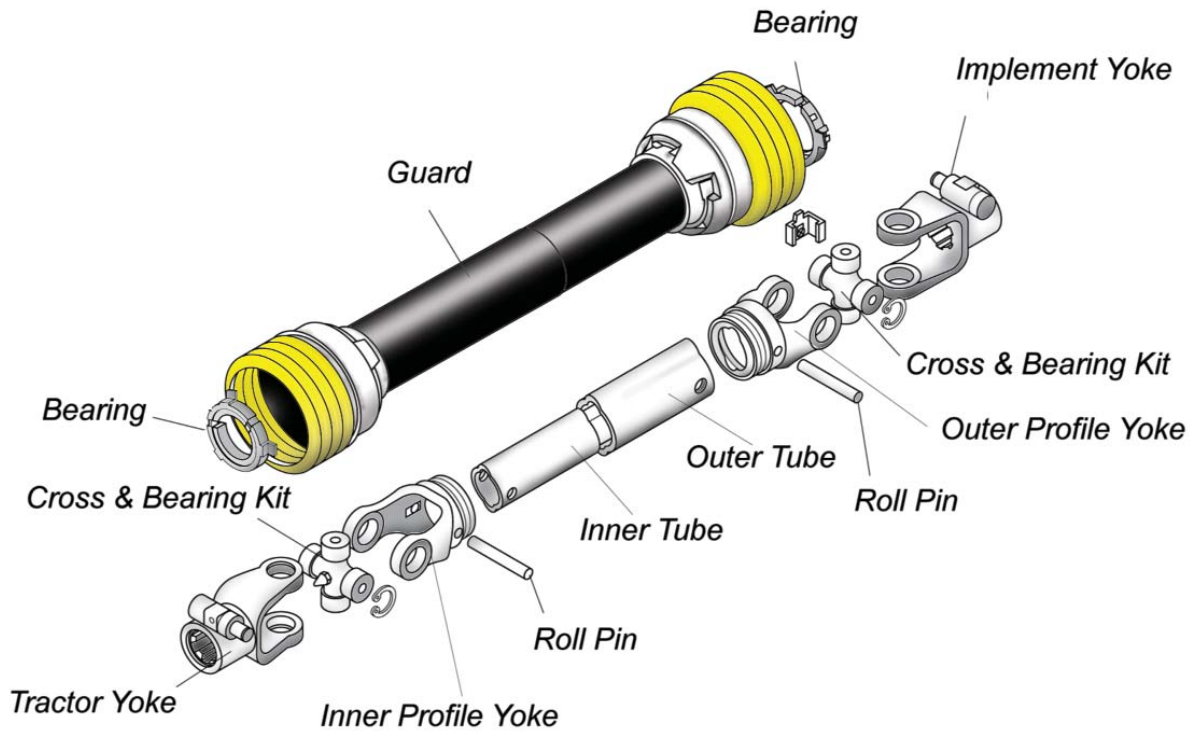

Finishing Mower



Stock Number	*Series	Overall Compressed Length - Dim. "A"	Tractor Yoke	Implement Yoke
A-14006446	BYPY 4	46"	1-3/8" x 6 SPL QD	1-3/8" x 6 SPL QD
A-14006637	BYPY 6	37"	1-3/8" x 6 SPL QD	1-3/8" x 6 SPL QD
A-14006340	BYPY 3	40"	1 3/8" x 6 Spl. QD	1 3/8" x 6 Spl. QD

Rotary Cutter



Stock Number	*Series	Type	Overall Compressed Length - Dim. "A"	Tractor Yoke	Implement Yoke
A-14006251	BYPY 2	Pull (Towed)	51"	1-3/8" x 6 SPL QD	1-3/8" RD with Pinhole
A-14006451	BYPY 4	Pull (Towed)	51"	1-3/8" x 6 SPL QD	1-3/8" RD with Pinhole
A-14006432	BYPY 4	4 ft. Lift (3-pt. Hitch)	32"	1-3/8" x 6 SPL QD	1-3/8" RD with Pinhole
A-14006436	BYPY 4	5 ft. Lift (3-pt. Hitch)	36"	1-3/8" x 6 SPL QD	1-3/8" RD with Pinhole
A-14006442	BYPY 4	6 ft. Lift / 3-pt. Hitch	42"	1 3/8" x 6 Spl. QD	1 3/8" Rd w/ Pinhole
A-14006542	BYPY 5	6 ft. Lift (3-pt. Hitch)	42"	1-3/8" x 6 SPL QD	1-3/8" RD with Pinhole
A-14006652	BYPY 6	7 ft. Lift (3-pt. Hitch)	52"	1-3/8" x 6 SPL QD	1-3/8" RD with Pinhole



Stock Number	*Series	Type	Overall Compressed Length - Dim. "A"	Tractor Yoke	Implement Yoke
A-14106438	BYPY 4	Pull (Towed)	38"	1-3/8" x 6 SPL QD	1-3/8" x 6 SPL Friction Clutch
A-14106546	BYPY 5	Pull (Towed)	46"	1-3/8" x 6 SPL QD	1-3/8" x 6 SPL Friction Clutch
A-14106654	BYPY 6	7 Ft. Lift (3-pt. Hitch)	54"	1-3/8" x 6 SPL QD	1-3/8" x 6 SPL Friction Clutch

METRIC REPLACEMENT DRIVELINES

Disc Mower

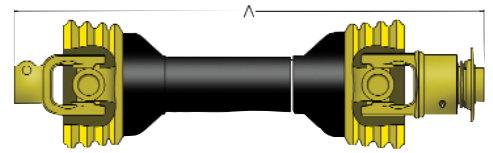

Stock Number	*Series	Overall Compressed Length - Dim. "A"	Tractor Yoke	Implement Yoke
A-14306639	BYPY 6	39"	1-3/8" x 6 SPL QD	1-3/8" x 6 SPL w/Overrunning Clutch
A-14307645	W/S 2400	45"	1-3/8" x 6 SPL QD	1-3/8" x 6 SPL w/Overrunning Clutch

Fertilizer Spreader



Stock Number	*Series	Overall Compressed Length - Dim. "A"	Tractor Yoke	Implement Yoke
A-14006127	BYPY 1	27"	1-3/8" x 6 SPL QD	1-3/8" x 6 SPL QD
A-14006135	BYPY 1	35"	1-3/8" x 6 SPL QD	1-3/8" x 6 SPL QD

Post Hole Digger

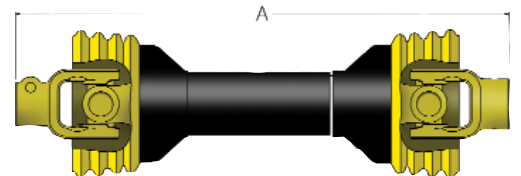

Stock Number	*Series	Type	Overall Compressed Length - Dim. "A"	Tractor Yoke	Implement Yoke
A-14006252	BYPY 2	Light Duty	52"	1-3/8" x 6 SPL QD	1-1/4" RD with Pinhole
A-14006453	BYPY 4	Heavy Duty	53"	1-3/8" x 6 SPL QD	1-1/4" RD with Pinhole

Hay Tedder

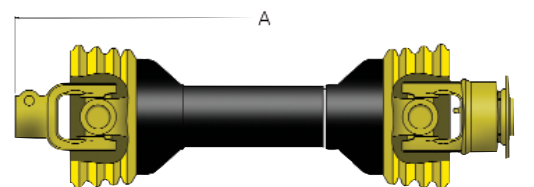

Stock Number	*Series	Type	Overall Compressed Length - Dim. "A"	Tractor Yoke	Implement Yoke
A-14206252	BYPY 2	2 Rotor	52"	1-3/8" x 6 SPL QD	1-3/8" x 6 SPL Radial Pin Clutch
A-14206454	BYPY 4	4 Rotor	54"	1-3/8" x 6 SPL QD	1-3/8" x 6 SPL Radial Pin Clutch

All Purpose Driveline

SIMPLE TO MODIFY CUT-TO-LENGTH

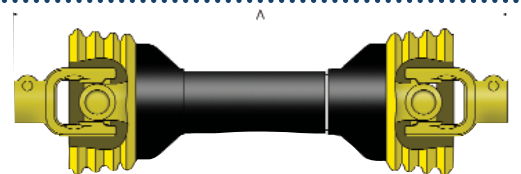

Stock Number	*Series	Overall Compressed Length - Dim. "A"	Tractor Yoke	Implement Yoke
A-14006247	BYPY 2	47"	1-3/8" x 6 SPL QD	1-3/8" x 6 SPL QD
A-14006448	BYPY 4	48"	1-3/8" x 6 SPL QD	1-3/8" x 6 SPL QD
A-14006424	BYPY 4 (CATFISH POND DRIVELINE)	48"	1-3/8" x 6 SPL QD	1-1/2" RD. with 3/8" Keyway
A-14006657	BYPY 6	57"	1-3/8" x 6 SPL QD	1-3/8" x 6 SPL QD
A-14006857	BYPY 8	57"	1-3/8" x 6 SPL QD	1-3/8" x 6 SPL QD

*INTERCHANGES WITH BONDIOLI & PAVESI AND WALTERSCHEID DRIVELINES

80° CV'S FOR FLEX WING CUTTERS - DOMESTIC & METRIC

BUSH HOG®

RHINO®

DEERE®



METRIC

- Star profile telescoping members to better handle thrust.
- Produced at Weasler's European facility...
WeaslerAgdrive
- Patented Easy Lock Guard System!
- Competitively priced



METRIC / DOMESTIC

- Direct replacement with standard lengths and series. Select tractor yoke and domestic or metric style driveline.
- Fully assembled...*ready-to-go*
- HUGE field population of flex-wings = HUGE opportunity
- Remember - DO NOT EXCEED 80° in both operating and non-operating modes.



DOMESTIC

- Highest capacity CV - 55 series/Cat.6... compared to competition's Cat.5.
- Patented features include greasing system and guarding.
- Competitively priced - check it out through the OEM.

Interchange with **BUSH HOG®**

Model #:2615, 3615

Also fits other competitive models



	CV Part #	Overall Tractor Yoke	Implement Compressed Length	Clamp Yoke	Series
Domestic	A-14505555	1-3/8" x 6 Spline	55"	1-3/8" x 6 Spline	55
Domestic	A-14605555	1-3/8" x 21 Spline	55"	1-3/8" x 6 Spline	55
Domestic	A-14705555	1-3/4" x 20 Spline	55"	1-3/8" x 6 Spline	55
Metric	A-14507955	1-3/8" x 6 Spline	55"	1-3/8" x 6 Spline	BP 8/WS 2580*
Metric	A-14607955	1-3/8" x 21 Spline	55"	1-3/8" x 6 Spline	BP 8/WS 2580*
Metric	A-14707955	1-3/4" x 20 Spline	55"	1-3/8" x 6 Spline	BP 8/WS 2580*

Interchange with **RHINO®**

Model #:SR-15, SE-15



	CV Part #	Overall Tractor Yoke	Implement Compressed Length	Clamp Yoke	Series
Domestic	A-14505551	1-3/8" x 6 Spline	51"	1-3/4" x 20 Spline	55
Domestic	A-14605551	1-3/8" x 21 Spline	51"	1-3/4" x 20 Spline	55
Domestic	A-14705551	1-3/4" x 20 Spline	51"	1-3/4" x 20 Spline	55
Metric	A-14507951	1-3/8" x 6 Spline	51"	1-3/4" x 20 Spline	BP 8/WS 2580*
Metric	A-14607951	1-3/8" x 21 Spline	51"	1-3/4" x 20 Spline	BP 8/WS 2580*
Metric	A-14707951	1-3/4" x 20 Spline	51"	1-3/4" x 20 Spline	BP 8/WS 2580*

Interchange with **DEERE®**

Model #:1517, 1518, 2018

Also fits other competitive models

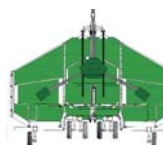

	CV Part #	Overall Tractor Yoke	Implement Compressed Length	Clamp Yoke	Series
Domestic	A-14515555	1-3/8" x 6 Spline	55"	1-3/4" x 20 Spline	55
Domestic	A-14615555	1-3/8" x 21 Spline	55"	1-3/4" x 20 Spline	55
Domestic	A-14715555	1-3/4" x 20 Spline	55"	1-3/4" x 20 Spline	55
Metric	A-14517955	1-3/8" x 6 Spline	55"	1-3/4" x 20 Spline	BP 8/WS 2580*
Metric	A-14617955	1-3/8" x 21 Spline	55"	1-3/4" x 20 Spline	BP 8/WS 2580*
Metric	A-14717955	1-3/4" x 20 Spline	55"	1-3/4" x 20 Spline	BP 8/WS 2580*

*Interchanges with either Bondioli & Pavesi or Walterscheid

80° CV ROUND BALER DRIVELINES



DEERE - MODEL #467 AND #466

540 RPM

*A-14503558	Driveline
A-59018000	Clutch Pak
A-817-3506	Clutch Yoke
A-200-3500	Cross Repair Kit

1000 RPM

*A-14603558	Driveline
A-59018000	Clutch Pak
A-817-3506	Clutch Yoke
A-200-3500	Cross Repair Kit

DEERE - MODEL #567 AND #566

540 RPM

*A-14503558	Driveline
A-59010000	Clutch Pak
A-817-3506	Clutch Yoke
A-200-3500	Cross Repair Kit

1000 RPM

*A-14603558	Driveline
A-59010000	Clutch Pak
A-817-3506	Clutch Yoke
A-200-3500	Cross Repair Kit



GEHL DELUXE - MODEL #2880

540 RPM

*A-14503567	Driveline
A-57015000	Clutch Pak
A-817-3521	Clutch Yoke
A-200-3500	Cross Repair

1000 RPM

*A-14603567	Driveline
A-57015000	Clutch Pak
A-817-3521	Clutch Yoke
A-200-3500	Cross Repair



CASE - MODEL #8455S AND 8455T

540 RPM

*A-14503558	Driveline
A-57015000	Clutch Pak
A-817-3506	Clutch Yoke
A-200-3500	Cross Repair Kit

1000 RPM

*A-14603558	Driveline
A-57015000	Clutch Pak
A-817-3506	Clutch Yoke
A-200-3500	Cross Repair Kit



VERMEER - MODEL #604K

540 RPM

*A-14503558	Driveline
A-57015000	Clutch Pak
A-817-3506	Clutch Yoke
A-200-3500	Cross Repair Kit

1000 RPM

*A-14603558	Driveline
A-57015000	Clutch Pak
A-817-3506	Clutch Yoke
A-200-3500	Cross Repair Kit



HESSTON - MODEL #555S AND 555T

540 RPM

*A-14503558	Driveline
A-57015000	Clutch Pak
A-817-3506	Clutch Yoke
A-200-3500	Cross Repair Kit

1000 RPM

*A-14603558	Driveline
A-57015000	Clutch Pak
A-817-3506	Clutch Yoke
A-200-3500	Cross Repair Kit

*Implement yoke and cross must be purchased separately

PARTS FOR TORQMASTER CLUTCH

Part #	Description	Part #	Description
7" Clutch			
A-987-9000	Disc Spring	A-98910000	Disc Spring
A-98712000	Disc Spring	A-98915000	Disc Spring
A-98715000	Disc Spring	A-98918000	Disc Spring
A-98718000	Disc Spring	Separator Plate 9" Clutch	
Separator Plate 7" Clutch		A-990-9000	Separator Plate
A-990-7000	Separator Plate	Disc 9" Clutch	
Disc 7" Clutch		A-970-9000	Friction Disc
A-970-7000	Friction Disc		